

GUIDELINES ON PHYTOSANITARY PROCEDURES FOR AREA-WIDE MANAGEMENT OF FRUIT FLY PESTS



GUIDELINES ON PHYTOSANITARY PROCEDURES FOR AREA-WIDE MANAGEMENT OF FRUIT FLY PESTS

Required citation:

FAO/IAEA. 2023. *Guideline on phytosanitary procedures for area-wide management of fruit fly pests*. Vienna, FAO. <https://doi.org/10.4060/cc9843en>

The designations employed and the presentation of material in this information product do not imply the expression of any opinion whatsoever on the part of the Food and Agriculture Organization of the United Nations (FAO) concerning the legal or development status of any country, territory, city or area or of its authorities, or concerning the delimitation of its frontiers or boundaries. The mention of specific companies or products of manufacturers, whether or not these have been patented, does not imply that these have been endorsed or recommended by FAO in preference to others of a similar nature that are not mentioned.

The views expressed in this information product are those of the author(s) and do not necessarily reflect the views or policies of FAO.

ISBN 978-92-5-138607-1

© FAO, 2024



Some rights reserved. This work is made available under the Creative Commons Attribution-NonCommercial-ShareAlike 3.0 IGO licence (CC BY-NC-SA 3.0 IGO; <https://creativecommons.org/licenses/by-nc-sa/3.0/igo/legalcode>).

Under the terms of this licence, this work may be copied, redistributed and adapted for non-commercial purposes, provided that the work is appropriately cited. In any use of this work, there should be no suggestion that FAO endorses any specific organization, products or services. The use of the FAO logo is not permitted. If the work is adapted, then it must be licensed under the same or equivalent Creative Commons licence. If a translation of this work is created, it must include the following disclaimer along with the required citation: “This translation was not created by the Food and Agriculture Organization of the United Nations (FAO). FAO is not responsible for the content or accuracy of this translation. The original [Language] edition shall be the authoritative edition.”

Disputes arising under the licence that cannot be settled amicably will be resolved by mediation and arbitration as described in Article 8 of the licence except as otherwise provided herein. The applicable mediation rules will be the mediation rules of the World Intellectual Property Organization <http://www.wipo.int/amc/en/mediation/rules> and any arbitration will be conducted in accordance with the Arbitration Rules of the United Nations Commission on International Trade Law (UNCITRAL).

Third-party materials. Users wishing to reuse material from this work that is attributed to a third party, such as tables, figures or images, are responsible for determining whether permission is needed for that reuse and for obtaining permission from the copyright holder. The risk of claims resulting from infringement of any third-party-owned component in the work rests solely with the user.

Sales, rights and licensing. FAO information products are available on the FAO website (www.fao.org/publications) and can be purchased through publications-sales@fao.org. Requests for commercial use should be submitted via: www.fao.org/contact-us/licence-request. Queries regarding rights and licensing should be submitted to: copyright@fao.org.

Cover design: ©FAO/Ewaryst Izewski

Preparation of this document

The FAO and the International Atomic Energy Agency (IAEA) are grateful to J. Reyes-Flores, W.R. Enkerlin, J. Hendrichs and R. Pereira for drafting and editing this publication. This publication is unique and represents a major contribution to the effective control of fruit fly pests worldwide.

The FAO/IAEA officer responsible for the publication is W. Enkerlin of the Joint FAO/IAEA Programme of Nuclear Techniques in Food and Agriculture.

Contents

| | |
|--|-------------|
| Preamble | xv |
| Abbreviations | xvii |
| 1. Introduction | 1 |
| 2. Factors influencing phytosanitary procedures for the management of fruit flies | 3 |
| 2.1 Definition of the target fruit fly | 3 |
| 2.1.1 Identification of the fruit fly pest | 3 |
| 2.1.2 Fruit fly pest status | 4 |
| 2.2 Factors related to the fruit fly pest | 4 |
| 2.2.1 Life cycle | 4 |
| 2.2.2 Behaviour | 5 |
| 2.2.3 Fruit fly population dynamics | 5 |
| 2.3 Factors related to the fruit fly hosts | 7 |
| 2.3.1 Type of host | 7 |
| 2.3.2 Host phenology | 8 |
| 2.3.3 Host distribution | 8 |
| 2.4 Factors related to the area under fruit fly management | 8 |
| 2.4.1 Size of the area | 8 |
| 2.4.2 Isolation | 9 |
| 2.4.3 Topography | 9 |
| 2.4.4 Climate | 9 |
| 2.4.5 Characteristics of landscapes | 10 |
| 2.4.6 Human infrastructure | 10 |
| 2.5 Fruit fly survey tools | 11 |
| 2.6 Stakeholder participation | 12 |
| 2.7 Public awareness | 12 |
| Bibliography | 12 |
| 3. Cultural and mechanical practices | 15 |
| 3.1 Background | 15 |
| 3.1.1 Cultural control | 15 |
| 3.1.2 Physical control | 15 |
| 3.1.3 Mechanical control | 15 |
| 3.2 Cultural and mechanical practices | 16 |
| 3.2.1 Sanitation | 16 |
| 3.2.2 Fruit stripping | 16 |
| 3.2.3 Removal of rejected fruit | 17 |
| 3.2.4 Combination of sanitation and fruit stripping | 17 |
| 3.2.5 Disposal of unwanted fruit | 17 |
| 3.2.6 Ploughing | 18 |
| 3.2.7 Water management | 18 |
| 3.2.8 Pruning | 18 |
| 3.2.9 Host tree removal | 19 |

| | | |
|-----------|---|-----------|
| 3.2.10 | Resistant varieties | 19 |
| 3.2.11 | Trap cropping | 20 |
| 3.2.12 | Planting sites with low pest prevalence or absence of the target fruit fly species | 21 |
| 3.2.13 | Harvest at a specific stage of fruit development | 21 |
| 3.2.14 | Growing host fruit when pest incidence is low or when the pest is temporally absent | 21 |
| 3.2.15 | Flowering and timing of fruit production | 21 |
| 3.3 | Fruit bagging | 22 |
| 3.4 | Pest exclusion structures | 22 |
| 3.5 | Other practices | 22 |
| 3.6 | Evaluation | 22 |
| 3.7 | Uses of cultural and mechanical practices | 23 |
| 3.8 | Comparative features of cultural and mechanical practices | 23 |
| | Bibliography | 24 |
| 4. | Bait application technique | 27 |
| 4.1 | Background | 27 |
| 4.2 | Types of bait sprays | 27 |
| 4.2.1 | Malathion and hydrolysed protein | 27 |
| 4.2.2 | GF-120 | 28 |
| 4.3 | Aerial application of bait sprays | 28 |
| 4.3.1 | Spraying using malathion and hydrolysed protein | 28 |
| 4.3.2 | Spraying using GF-120 | 30 |
| 4.3.3 | Aerial equipment | 30 |
| 4.3.4 | Calibration of aerial equipment | 34 |
| 4.3.5 | Application procedures | 38 |
| 4.3.6 | Public awareness before aerial applications | 38 |
| 4.3.7 | Evaluation | 39 |
| 4.3.8 | Uses of aerial bait sprays | 39 |
| 4.3.9 | Comparative features of aerial BAT | 40 |
| 4.4 | Ground application of bait sprays | 40 |
| 4.4.1 | Spot spray method | 40 |
| 4.4.2 | Ground spray using malathion and bait | 42 |
| 4.4.3 | Ground spray using GF-120 | 42 |
| 4.4.4 | Ground equipment | 43 |
| 4.4.5 | Calibration of equipment | 44 |
| 4.4.6 | Application procedures | 46 |
| 4.4.7 | Public awareness before ground applications | 47 |
| 4.4.8 | Evaluation | 47 |
| 4.4.9 | Uses of ground bait sprays | 47 |
| 4.4.10 | Comparative features of ground bait sprays | 48 |
| | Bibliography | 48 |
| 5. | Bait stations | 51 |
| 5.1 | Background | 51 |
| 5.2 | Components of a BS | 51 |

| | | |
|-----------|---|-----------|
| 5.2.1 | Body | 51 |
| 5.2.2 | Attractant | 51 |
| 5.2.3 | Killing agent | 52 |
| 5.3 | Handmade devices | 52 |
| 5.3.1 | Killing bags and corncobs | 52 |
| 5.4 | Commercial devices | 53 |
| 5.4.1 | Wax-BS | 53 |
| 5.4.2 | Magnet MED | 53 |
| 5.5 | Others | 53 |
| 5.5.1 | BS disseminating the entomopathogen <i>Beauveria bassiana</i> | 53 |
| 5.5.2 | Prototypes under research | 54 |
| 5.6 | Application procedures | 54 |
| 5.6.1 | Placement in the tree | 54 |
| 5.6.2 | Location within the area subject to control | 54 |
| 5.6.3 | Distribution and density | 55 |
| 5.6.4 | Number of treatments | 55 |
| 5.6.5 | Records and mapping | 56 |
| 5.7 | Evaluation | 56 |
| 5.7.1 | Uses of bait stations | 56 |
| 5.8 | Comparative features of BS | 57 |
| 5.8.1 | Operational factors | 57 |
| 5.8.2 | Environmental factors | 57 |
| | Bibliography | 58 |
| 6. | Mass trapping | 61 |
| 6.1 | Background | 61 |
| 6.2 | Components of a trap | 61 |
| 6.2.1 | Body | 61 |
| 6.2.2 | Attractant | 61 |
| 6.2.3 | Killing agent | 62 |
| 6.2.4 | Devices commonly used | 62 |
| 6.3 | Handmade devices | 62 |
| 6.3.1 | Plastic bottle | 63 |
| 6.4 | Commercial devices | 63 |
| 6.4.1 | MS2 | 63 |
| 6.4.2 | Ceratrapp | 63 |
| 6.4.3 | Maxitrap | 63 |
| 6.4.4 | Decis trap | 64 |
| 6.4.5 | Moskisan | 64 |
| 6.5 | Application procedures | 64 |
| 6.5.1 | Trap placement in the tree | 64 |
| 6.5.2 | Timing of deployment | 65 |
| 6.5.3 | Distribution | 65 |
| 6.5.4 | Density | 65 |
| 6.5.5 | Replacing/Rebating | 65 |

| | | |
|-----------|--|-----------|
| 6.6 | Evaluation | 65 |
| 6.6.1 | Uses of mass trapping | 66 |
| 6.7 | Comparative features of mass trapping | 66 |
| 6.7.1 | Control and monitoring | 66 |
| 6.7.2 | Cost | 66 |
| | Bibliography | 66 |
| 7. | Male annihilation technique | 69 |
| 7.1 | Background | 69 |
| 7.2 | Target fruit flies for MAT application | 69 |
| 7.3 | MAT application against <i>B. dorsalis</i> | 69 |
| 7.4 | Components of MAT devices | 70 |
| 7.5 | Application of MAT | 70 |
| 7.5.1 | Preparation of fibre blocks devices | 70 |
| 7.5.2 | Application density | 70 |
| 7.5.3 | Coverage | 70 |
| 7.6 | Application procedures | 70 |
| 7.6.1 | Deployment procedure | 71 |
| 7.6.2 | Application schedule | 71 |
| 7.7 | Alternative MAT applications | 71 |
| 7.7.1 | Gel | 71 |
| 7.8 | Evaluation | 72 |
| 7.9 | Uses of MAT | 72 |
| 7.10 | Comparative features of MAT | 72 |
| 7.10.1 | Environment | 72 |
| 7.10.2 | Efficacy | 72 |
| 7.11 | MAT and other control methods | 73 |
| | Bibliography | 73 |
| 8. | Augmentative biological control | 75 |
| 8.1 | Background | 75 |
| 8.2 | Biocontrol agents | 75 |
| 8.2.1 | Parasitoids | 75 |
| 8.2.2 | Entomopathogens | 76 |
| 8.3 | Biocontrol using <i>Diachasmimorpha longicaudata</i> | 76 |
| 8.3.1 | Mass-rearing | 76 |
| 8.3.2 | Post-production | 77 |
| 8.3.3 | Parasitoid emergence and release facility | 78 |
| 8.4 | Ground releases | 79 |
| 8.4.1 | Holding and emergence of parasitoids | 79 |
| 8.4.2 | Emergence in plastic buckets | 79 |
| 8.4.3 | Emergence in paper bags | 79 |
| 8.4.4 | Ground release procedures | 80 |
| 8.4.5 | Roving release in plastic buckets | 80 |
| 8.4.6 | Roving release in paper bags | 80 |
| 8.4.7 | Ground release in plastic containers | 81 |

| | | |
|------------|--|------------|
| 8.5 | Aerial releases | 81 |
| 8.5.1 | Holding and emergence of parasitoids | 81 |
| 8.6 | Application procedures | 82 |
| 8.6.1 | Area subject to treatment | 82 |
| 8.6.2 | Time of ABC application | 82 |
| 8.6.3 | Release and densities | 82 |
| 8.7 | Quality control | 83 |
| 8.8 | Evaluation of parasitism rate in the field | 84 |
| 8.9 | ABC using <i>D. longicaudata</i> | 84 |
| 8.10 | ABC using <i>Beauveria bassiana</i> | 85 |
| 8.10.1 | Bait station disseminating <i>Beauveria bassiana</i> | 85 |
| 8.11 | Evaluation | 85 |
| 8.12 | Comparative features of ABC | 86 |
| 8.12.1 | Operational factors | 86 |
| 8.12.2 | Environmental factors | 86 |
| | Bibliography | 87 |
| 9. | Sterile Insect Technique | 89 |
| 9.1 | Background | 89 |
| 9.2 | Target species | 89 |
| 9.3 | <i>SIT to control C. capitata</i> | 90 |
| 9.3.1 | Mass-rearing facility | 90 |
| 9.3.2 | Sterilization | 90 |
| 9.3.3 | Sterile fly packing, holding and release facility | 91 |
| 9.4 | Sterile fly releases | 91 |
| 9.4.1 | Sterile fly densities | 92 |
| 9.4.2 | Release schedule | 92 |
| 9.4.3 | Quality control tests | 92 |
| 9.5 | Identification and interpretation of captured flies | 93 |
| 9.6 | Evaluation | 93 |
| 9.7 | Uses of the SIT | 94 |
| 9.8 | Comparative advantages of the SIT | 95 |
| 9.8.1 | Pest control at low pest prevalence | 95 |
| 9.8.2 | SIT enhanced effectivity | 95 |
| 9.8.3 | Environmental factors | 95 |
| | Bibliography | 96 |
| 10. | Regulatory and quarantine procedures | 101 |
| 10.1 | Background | 101 |
| 10.2 | Regulatory procedures | 101 |
| 10.2.1 | Check points at the international ports of entry | 101 |
| 10.2.2 | Domestic check points | 101 |
| 10.3 | Evaluation | 102 |
| 10.4 | Uses of regulatory and quarantine procedures | 103 |
| | Bibliography | 103 |

| | | |
|--|---|------------|
| Appendix | | |
| Glossary of terms | | 105 |
| Annex 1. | | |
| Implementation of fruit fly eradication programmes | | 111 |
| A-1.1 | Introduction | 111 |
| A-1.2 | Type of fruit fly management programmes | 111 |
| A-1.2.1 | Suppression programmes | 111 |
| A-1.2.2 | Eradication programmes | 111 |
| A-1.2.3 | Containment programmes | 111 |
| A-1.2.4 | Exclusion programmes | 112 |
| A-1.3 | General characteristics of AW fruit fly management programmes | 112 |
| A-1.4 | Stages of eradication programmes | 113 |
| A-1.5 | Stage I. Pre-eradication (planning) | 114 |
| A-1.5.1 | Step 1. Collection of information | 114 |
| A-1.5.2 | Step 2. Economic and technical assessments | 115 |
| A-1.5.3 | Step 3. Eradication plan and official launching | 116 |
| A-1.5.4 | Step 4. Organization and management | 117 |
| A-1.6 | Stage II. Eradication (execution) | 130 |
| A-1.6.1 | Step 5. Public relations | 130 |
| A-1.6.2 | Step 6. Surveillance and R&Q actions | 131 |
| A-1.6.3 | Step 7. Mass-rearing facility and FE&RF | 131 |
| A-1.6.4 | Step 8. Eradication process | 132 |
| A-1.7 | Stage III. Post-eradication | 144 |
| A-1.7.1 | Step 9. Domestic declaration of pest freedom | 144 |
| A-1.7.2 | Step 10. PFA notification to international organizations and trading partners | 144 |
| A-1.7.3 | Step 11. Maintenance of the FF-PFA | 145 |
| A-1.7.4 | Step 12. Contingency plan | 145 |
| | Bibliography | 146 |
| | Bibliography specific to area-wide SIT operational programmes | 147 |
| Annex 2 | | |
| Contingency plan for detection, delimitation, and eradication of outbreaks of invasive quarantine fruit fly pests | | 149 |
| A-2.1 | Introduction | 149 |
| A-2.2 | Types of FF-PFA | 149 |
| A-2.3 | Contingency plan in permanent natural FF-PFA | 149 |
| A-2.4 | Contingency plan in permanent created FF-PFA | 149 |
| A-2.5 | Corrective action protocol in temporary FF-PFA | 150 |
| A-2.6 | Differences between contingency plans and corrective action protocols | 151 |
| A-2.7 | Eradication process and models applied in outbreaks occurring in FF-PFA | 151 |
| A-2.8 | Features of contingency plans | 152 |
| A-2.9 | Preliminary activities before implementing a contingency plan | 153 |
| A-2.10 | Main elements of a contingency plan | 153 |
| A-2.11 | PART A. General information | 153 |
| A-2.11.1 | Action statement | 153 |
| A-2.11.2 | Information of the target fruit fly | 154 |

| | | |
|----------|--|-----|
| A-2.11.3 | Official directory | 154 |
| A-2.11.4 | Organization of the contingency plan | 155 |
| A-2.12 | PART B. Surveillance procedures | 156 |
| A-2.12.1 | The outbreak area | 156 |
| A-2.12.2 | Fruit sampling | 156 |
| A-2.12.3 | Trapping | 157 |
| A-2.13 | Part C. Quarantine and regulatory procedures | 159 |
| A-2.13.1 | Quarantine area | 159 |
| A-2.13.2 | Quarantine checkpoints | 159 |
| A-2.13.3 | Regulatory procedures | 159 |
| A-2.14 | Part D. Eradication procedures | 160 |
| A-2.14.1 | The triggers, duration, and completion of treatments | 160 |
| A-2.14.2 | Cultural and mechanical practices | 160 |
| A-2.14.3 | Chemical control | 161 |
| A-2.14.4 | Biological control | 162 |
| A-2.15 | Part E. Verification | 162 |
| A-2.15.1 | Verification criteria | 162 |
| A-2.15.2 | Compilation of technical records | 163 |
| A-2.15.3 | Final actions | 163 |
| | Bibliography | 163 |

Annex 3

Guideline for the preparation of bilateral work plans for exports of fruits and vegetables that are fruit fly (*Tephritidae*) hosts **165**

| | | |
|----------|---|-----|
| A-3.1 | Introduction | 165 |
| A-3.2 | Market access and pest risk management measures | 165 |
| A-3.2.1 | Non-host | 165 |
| A-3.3 | FF-Pest Free Areas | 165 |
| A-3.3.1 | Post-Harvest Treatments | 166 |
| A-3.3.2 | Systems Approach | 166 |
| A-3.4 | Bilateral work plans | 167 |
| A-3.5 | Situations where BWP are not needed | 167 |
| A-3.5.1 | Non-host status | 167 |
| A-3.5.2 | Local or domestic markets | 167 |
| A-3.5.3 | Non-discriminating export markets | 167 |
| A-3.6 | Purpose of BWP | 167 |
| A-3.7 | Types of BWP | 168 |
| A-3.8 | Preliminary activities before developing a BWP | 168 |
| A-3.9 | Prototype of BWP | 168 |
| A-3.10 | Main elements of BWP | 168 |
| A-3.11 | Part A. Official data | 169 |
| A-3.11.1 | Title | 169 |
| A-3.11.2 | Duration and reviews | 169 |
| A-3.11.3 | Effective date and signatures | 170 |
| A-3.12 | Part B. Introduction | 170 |
| A-3.12.1 | Target fruit fly | 170 |

| | | |
|----------|---------------------------------------|-----|
| A-3.12.2 | Fruit commodities for export | 170 |
| A-3.12.3 | Area of production | 170 |
| A-3.12.4 | Points of entry | 170 |
| A-3.12.5 | Participants and responsibilities | 170 |
| A-3.13 | Part C. Phytosanitary measures | 171 |
| A-3.13.1 | Pre-harvest phytosanitary procedures | 171 |
| A-3.13.2 | Post-harvest phytosanitary procedures | 172 |
| A-3.14 | Part D. Verification procedures | 172 |
| A-3.14.1 | Auditing | 172 |
| A-3.14.2 | Corrective actions | 172 |
| A-3.15 | Part E. General information | 173 |
| A-3.15.1 | Compliance Agreement with industry | 173 |
| A-3.15.2 | Documentation | 173 |
| A-3.15.3 | Definitions | 173 |
| A-3.16 | Annual reviews | 173 |
| | Bibliography | 173 |

Preamble

This guideline describes the most widely used classic and modern phytosanitary procedures for the management of fruit flies that infest fruits and vegetables and that are of quarantine and economic importance, specifically species of the genera *Anastrepha*, *Bactrocera*, *Ceratitis*, *Dacus*, *Rhagoletis* and *Zeugodacus*. Pest management can be aimed at the native species of fruit flies or to prevent the introduction, establishment and spread of those non- native species.

Not all phytosanitary procedures have the same function and results may differ according to the agroecological conditions where they are applied. Given this situation, this guideline also presents the appropriate control tactics for each phytosanitary procedure, including timing and intensity, as well as the most suitable combination of the procedures to achieve an efficient integrated management of the target fruit fly populations.

This document is the first comprehensive guideline developed by FAO/IAEA for area-wide fruit fly pest management including area-wide suppression, containment, eradication, and exclusion strategies. It is a much-needed complement to the already published FAO/IAEA guidelines for fruit fly survey “Trapping Guidelines for Area-wide Fruit Fly Programmes” and “Fruit Sampling Guidelines for Area-Wide Fruit Fly Programmes”.

The main purpose is to present the range of tools available that the FAO and IAEA Member States can consider to effectively manage fruit fly pests. This with the aim of reducing fruit damage and complying with the quarantine risk level required by importing countries as a prerequisite for international trade of fruit and vegetables that are considered fruit fly hosts.

Consequently, information in this guideline can be used to apply the most suitable pest risk mitigation options such as the establishment and maintenance of fruit fly pest free areas (FF-PFA), areas of low pest prevalence for fruit flies (FF-ALPP), as the main components of a systems approach for fruit flies (FF-SA), or to reduce pest populations in places of production to the required level before the use of Probit-9 post-harvest treatments (Probit-9 PHT). Thus this guideline will also be a valuable source of technical information for the implementation of the FAO IPPC International Standards for Phytosanitary Measures such as the ISPM No. 10 “Requirements for the Establishment of Pest Free Places of Production and Pest Free Production Sites”, ISPM No. 26 “Establishment of Pest Free Areas for Fruit Flies (*Tephritidae*)”, and ISPM No. 35 “Systems Approach for Pest Risk Management of Fruit Flies”.

The guideline is designed to be a working document, subject to periodic reviews and updates based on new developments in area-wide fruit fly pest management. Future editions will endeavour to include more specific recommendations for additional species of fruit flies as relevant data become available.

Relevant information to this guideline was gathered from publications in international journals and congresses. It was also collected from manuals available in different plant protection organizations such as the Moscafrut Programme SENASICA Mexico; Regional Guatemala-Mexico-USA Moscamed Programme; USDA/APHIS/PPQ; USDA/ARS Hilo, Hawaii; California Department of Food and Agriculture (CDFA); Florida Department of Agriculture and Consumer Services (FDACS), and from procedures manuals of area-wide fruit fly management programmes in Australia, China, Croatia, Greece, Israel, Japan, La Reunion (France), Spain, South Africa, and Tunisia.

Abbreviations

| | |
|--------------------------|---|
| ABC | augmentative biological control |
| ALOP | Appropriate Level of Protection |
| ALPP | area of low pest prevalence |
| AW | area-wide |
| BAT | bait application technique |
| BS | bait station |
| CAP | corrective action protocol |
| C&M practices | cultural and mechanical practices |
| CL | cue-lure |
| FAO | Food and Agriculture Organization of the United Nations |
| FE&RF | fly emergence and release facility |
| FF-ALPP | areas of low pest prevalence for fruit flies |
| FF-PFA | fruit fly pest free areas |
| FF-SA | systems approach for fruit flies |
| FTD-f | fertile fly per trap per day |
| FTD-s | sterile fly per trap per day |
| GIS | geographical information systems |
| GPS | Global Positioning System |
| IAEA | International Atomic Energy Agency |
| IPM | integrated pest management |
| IPPC | International Plant Protection Convention |
| ISPM | International Standard for Phytosanitary Measures |
| MAT | male annihilation technique |
| ME | methyl-eugenol |
| NPPO | National Plant Protection Organization |
| PE&RF | parasitoid emergence and release facility |
| PFA | pest free areas |
| PHT | post-harvest treatment |
| PRA | pest risk analysis |
| PRP | preventive release programme |
| R&Q | regulatory and quarantine procedures |
| RK | raspberry ketone |
| RPPO | Regional Plant Protection Organization |
| SA | systems approach |
| SIT | Sterile Insect Technique |
| TML | Trimedlure |
| ULV | ultra-low volume |

1. Introduction

Fruit flies are responsible for inflicting major economic losses to the most valuable fruit and vegetable crops worldwide. They cause very severe damages to host commodities, producing major direct loss to fruit and vegetable growers and to the industry. Their presence can restrict national and international commercialization of host commodities through the imposition of strict quarantine measures, seriously affecting agricultural income.

Fortunately, phytosanitary procedures are available that when applied at the right life stage of the fruit fly, at the appropriate time and location within an agroecosystem, can result in effective fruit fly suppression and substantial reduction of fruit fly damage to commercial commodities.

A phytosanitary procedure is defined by the FAO-IPPC glossary as “any official method for implementing phytosanitary measures including the performance of inspections, tests, surveillance, or treatments in connection with regulated pests”. The phytosanitary procedures presented in this guideline, however, only include the technology and methods aimed at control of fruit flies of economic importance. Surveillance procedures have been already addressed in the FAO/IAEA guidelines “Trapping Guidelines for Area-wide Fruit Fly Programmes” and “Fruit Sampling Guidelines for Area-Wide Fruit Fly Programmes” available at:

<https://www.iaea.org/sites/default/files/trapping-guideline.pdf>

<https://www.iaea.org/sites/default/files/ca5716en.pdf>

In this guideline, the phytosanitary procedures are organized into eight groups as follows:

- Cultural and mechanical practices (**Chapter 3**);
- Bait application technique (**Chapter 4**);
- Bait stations (**Chapter 5**);
- Mass trapping (**Chapter 6**),
- Male annihilation technique (**Chapter 7**);
- Augmentative biological control (**Chapter 8**);
- Sterile insect technique (**Chapter 9**);
- Regulatory and quarantine procedures (**Chapter 10**).

Numerous countries that export fruit fly host commodities implement area-wide (AW) fruit fly management programmes to prevent quarantine non-native fruit fly pest introductions to fruit fly free areas and to suppress or eradicate established fruit fly populations. Currently, there are four management strategies that have been internationally defined for the management of fruit fly pests: suppression, eradication, containment, and exclusion. Each chapter discusses the use of specific phytosanitary procedures to manage fruit fly pests based on each of the fruit fly management strategies.

Although the scope of this guideline includes area-wide suppression, containment, eradication, and exclusion strategies, it gives a special attention to the AW fruit fly management programmes aimed at eradication. **Annex 1** presents the specific features of an AW fruit fly eradication programme. development and application.

2. Factors influencing phytosanitary procedures for the management of fruit flies

The most effective application of phytosanitary procedures to achieve the objective of the selected fruit fly management strategy will primarily depend on the characteristics of the phytosanitary conditions (pest/host/area) where such procedures will be applied. Therefore, there is a need for a correct identification of the target fruit fly species, determination of its status as a pest, good understanding of the biology and ecology of the pest and its hosts, and a comprehensive knowledge of the characteristics of the agroecosystem where the phytosanitary intervention will take place.

Other more indirect factors relevant to the effectiveness of the phytosanitary procedures and consequently of the success of the applied management strategy, are the level of stakeholder support as well as support from the general public to programme activities.

2.1 Definition of the target fruit fly

2.1.1 Identification of the fruit fly pest

Proper identification is crucial for the management of fruit fly pests. National Plant Protection Organizations (NPPOs) should have in place adequate infrastructure and trained personnel to identify either native or quarantine non-native fruit fly species.

Diagnostic protocols for identification of fruit fly immature stages and adults are usually available at the NPPO if the target pest is native or has become established. For a non-native fruit fly pest, however, the NPPO may need to develop proper diagnostic procedures for identification of fruit fly specimens detected in imported consignments or when an incursion has occurred. Sometimes cooperative agreements with national research or academic institutions or with other countries may be necessary to have immediate access to expertise in case of a need to identify non-native fruit flies, especially those from remote geographic regions.

Appropriate application of regulatory measures, specifically preventive actions such as quarantine and pre-clearance procedures, should be based on the accurate identification of the fruit fly species. Once a pest has been detected or an outbreak has occurred (see **Annex 2**), containment and eradication strategies should also be based on correct pest identification. The latter is also true in case of implementation of regulatory actions to protect FF-PFA from native fruit fly pests.

Currently, many countries and international organizations have available fruit fly identification manuals and protocols that provide harmonized guidelines to support NPPOs in the right identification of fruit flies of economic and quarantine importance, for instance, the International Plant Protection Convention (IPPC) has published two international standards for fruit flies of the genus *Anastrepha* and the *Bactrocera dorsalis* complex contained in **Annex 9 and 29**, respectively, of ISPM No. 27 “Diagnostic Protocols for Regulated Pests” and in the FAO/IAEA guideline entitled “Harmonized Identification Guideline of Tephritid Fruit Flies that might be considered of Economic and Quarantine Importance in Latin America and the Caribbean”, available at: <https://www.iaea.org/resources/manual/harmonized-identification-guideline-of-tephritids-that-might-be-considered-of-economic-and-quarantine-importance-in-latin-america-and-the-caribbean>.

Once a fruit fly has been identified, the next step is to define its pest status.

2.1.2 Fruit fly pest status

Pest status is defined in the FAO-IPPC glossary as “the presence or absence, at the present time, of a pest in an area, including where appropriate its distribution, based on current and historical official pest records, expert judgement, and other information”.

Determination of pest status is used by NPPOs to prepare pest risk analysis and to establish official AW fruit fly management programmes dedicated to the suppression or eradication of native fruit fly pests, or to enforce quarantine and exclusion measures and apply contingency action plans to eradicate or contain incursions of non-native quarantine pests.

Pest status is an important legal term in the national phytosanitary legislation enabling the implementation of regulatory measures against fruit fly pests. A comprehensive description of the concept and application of pest status is available in ISPM No. 8 “Determination of Pest Status in an Area”.

2.2 Factors related to the fruit fly pest

Understanding of the specific biology and ecology of fruit fly pests, as well as the role hosts play in their distribution and abundance, provides necessary information to develop helpful tools for fruit fly surveillance and control, in addition to helping design AW pest management strategies.

2.2.1 Life cycle

Even though there are thousands of fruit fly species, the basic life cycle of most of these are quite similar, consisting of four distinct stages: egg, larva, pupa, and adult. Females lay their eggs individually or in egg masses directly into the maturing fruits (or other parts in some species) of the host plant. The larvae inside the fruit pass through three instars, each one separated by a shedding before they pupate, usually

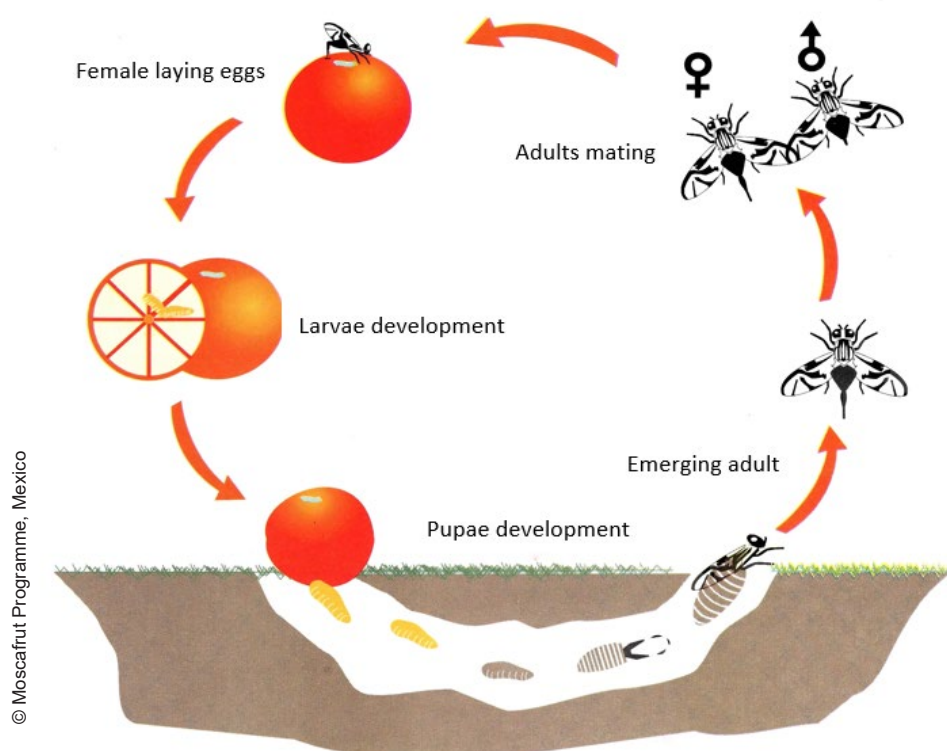

Figure 2.1. Typical fruit fly life cycle

in the ground beneath the host tree. After emergence, the adult looks for water and food supplies. Males usually only need carbohydrates to survive, but females also need proteinaceous sources to produce eggs. After sexual maturation, male and female courtship and mating, females start laying eggs in the ripening fruits of host plants (**Figure 2.1**).

The fruit fly life cycle is closely regulated by abiotic factors, mainly temperature and humidity. The rate of development of immature stages largely depends on temperature, being more rapid at higher temperatures. The egg is the stage requiring the least amount of time, normally from two days to one week. Larva, and pupa require from one to a couple of weeks to complete each stage; adults, however, can live for several weeks or months. At lower temperatures, the life stages can last for a much longer time.

Although larvae naturally pupate in the soil below the host tree or sometimes inside the fallen fruit, it is not uncommon that larvae, once outside of the fruit, can pupate in almost any substrate. For instance, if infested fruits are placed in commercial boxes and transported to markets for sale, after some days third instar larvae will emerge from the fruits and will pupate inside the packing box, from where adult will emerge.

2.2.2 Behaviour

Fruit fly species of economic and quarantine importance can mostly be divided into two main groups: monophagous univoltine species and polyphagous multivoltine species.

Monophagous and univoltine species, usually attack a single host (or a limited variety of plants related to the host), have one or two generations per year and occur in temperate regions. If they occur in tropical or subtropical regions, they are present at high altitudes where the climate is temperate. Most of the year is spent in pupal diapause and adult emergence is usually synchronized with the fruiting season of their host.

Polyphagous and multivoltine species attack a wide range of both commercial and non-commercial hosts. They have several generations per year, largely determined by host availability and climate, and usually occur in subtropical or tropical regions. Some of these species have broadened their climatic range and become established in the warmer parts of temperate areas, where the climate is more Mediterranean type, passing the coldest months of the year in the larval or pupal stage. Due to the climate change effects, it is likely that these species will increasingly invade temperate areas and expand their geographical distribution.

This frugivorous group includes the major pests of commercial fruit and vegetables in countries where they are native or have been introduced. When introduced, these species can infest the fruits of a high number of commercial, ornamental, and native varieties of fruit trees, including different plant species from those they attack in their places of origin.

2.2.3 Fruit fly population dynamics

An efficient AW fruit fly management strategy requires an in-depth knowledge of population changes in number and in geographical distribution in an area over time.

Adult populations in multivoltine fruit fly species present remarkable fluctuations throughout the year. This is correlated with the interaction of availability of suitable hosts and climatic factors, particularly temperature and rainfall.

Increases of fruit fly adult numbers are correlated with the time of the year when temperatures are warm and when the fruiting peak of the most favoured hosts has just passed. Often, the highest pest population levels do not coincide with the end of harvest of the commercial hosts, but with the ripening of the preferred non-commercial alternate hosts. Although abrupt decreases of a population are typically produced by extreme weather conditions, they can also be a result of very low or null availability of fruits of the alternate host at the end of the fruiting period of the main commercial host (**Figure 2.2**).

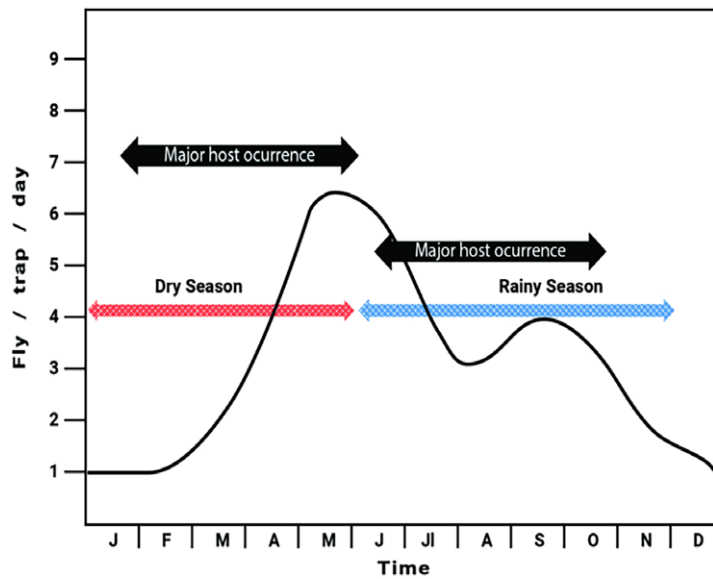

Figure 2.2. Typical *C. capitata* population curve showing the effect of climate and host fruit occurrence along the Pacific coast of Central America.

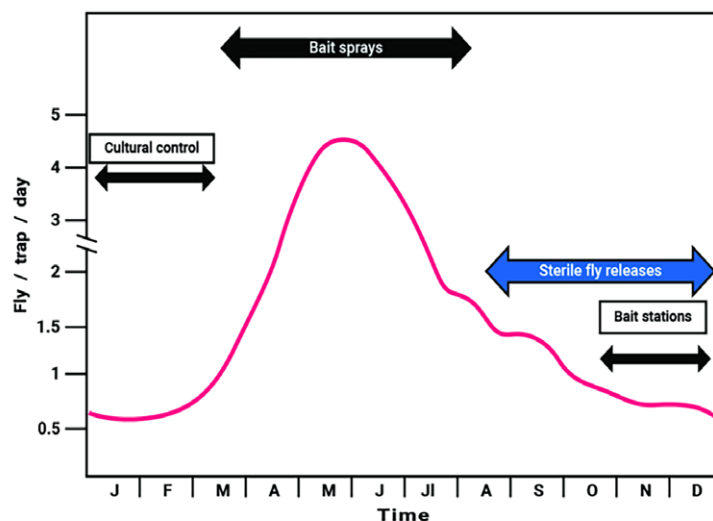

Figure 2.3. Integrated application of four phytosanitary procedures to suppress populations of the *C. capitata* in Central America. Cultural and mechanical practices followed by bait sprays before rapid population increase, the releases of sterile insects when population decreases to achieve a competitive sterile to fertile ratio, and bait stations placed in pest reservoirs.

For instance, in north-eastern Mexico, the populations of the *Anastrepha ludens* builds-up in its native host yellow chapote (*Sargentia greggii*) present in natural areas along the foothills of the Sierra Madre Mountain range. After the fruiting of *S. greggii* is over, *A. ludens* populations move to citrus commercial orchards where they infest citrus fruits throughout the fruiting season until harvest. In years where the availability of the *S. greggii* fruits is scarce because of dry conditions, *A. ludens* populations move in lower numbers to the citrus orchards resulting in low fruit infestation.

Knowing the seasonal fluctuation of the population is of great value to assess the type and possible combinations of phytosanitary procedures to be integrated at a given time in a given area to manage pest populations. Phytosanitary procedures can be single or multiple applied. If multiple procedures are required, they can be applied simultaneously, partially overlapping or in a sequential mode (**Figure 2.3**).

On the other hand, most polyphagous fruit fly species are highly mobile, capable of infesting several alternate non-commercial hosts throughout the year when the commercial host is not available. Movement of the target fruit fly pest into commercial fields frequently occurs from alternate hosts present in marginal areas (abandoned orchards, backyards, natural areas, etc.), which can be close or far away from the commercial places of production. Therefore, knowledge of the spatial distribution of the pest in the area where the fruit fly management programme is carried out is fundamental.

Fruit fly populations are not evenly distributed, even though the main commercial host can be uniformly planted as is the case of large-scale mango and orange production areas, or in continuous coffee plantations. Fruit flies will tend to have an aggregated (clumped) distribution pattern with continuous dispersal movements throughout an area, resulting in higher densities in some places than in others.

The clumped distribution pattern of insect pests is a major challenge for pest management. Hence, knowledge of the pest spatial distribution based on historical data is useful in both the places of commercial production as well as in the entire area under fruit fly management. At the places of production individual growers can apply more intensive suppression procedures to specific parts of their orchards where fruit flies first occur every year, and in marginal areas the management programme may apply intensive pest suppression procedures in those favourable fruit fly habitats where pest reservoirs are usually found.

2.3 Factors related to the fruit fly hosts

In general, where hosts are present there will be fruit fly presence as well. Fruit fly prevalence level, as well as temporal and spatial distribution will be correlated with the abundance, distribution, and phenology of the different types of hosts present in an area. Often, by observing the host patterns a general insight into the dynamics of the fruit fly populations and the reasons behind it can be inferred.

Due to the pest/host binomial condition, fruit fly management can be more effectively applied if the phenology and spatial distribution of the hosts are known. Sometimes, generating such knowledge can take several years due to the variability of the host phenology, where the same plant may produce fruit in some years and not in others or may produce fruits at different times in the year and not always in the same amounts. Common information related to the host phenology and host distribution which is most useful for AW fruit fly management programmes is discussed below.

2.3.1 Type of host

Fruits and vegetables can have different host status. Based on the degree of susceptibility to the target pest, they can be major hosts if these are highly susceptible, or poor hosts. Abundance of major hosts can produce high target pest populations that can increase several-fold in just one generation.

Based on the time of ripening, the hosts can be alternate if their ripening season occurs before or after the harvest of the commercial host. Alternate hosts can serve as a bridge between two harvesting seasons of the commercial hosts.

Wild hosts are those that have not been planted for commercial purposes or those that have been planted but are not commercially exploited. If these hosts ripe simultaneously to the commercial commodity they can serve as a reservoir of the target populations when the pest is being controlled in the places of production.

In recent years studies of host status are more frequently conducted as part of pest risk analysis to negotiate bilateral workplans for exports (see **Annex 3**). In these studies, specific fruit species are subject to natural or artificial infestations by the target pest so that their status as a host or their degree of susceptibility is determined. These studies also serve to assess the host range of the target fruit flies in specific areas.

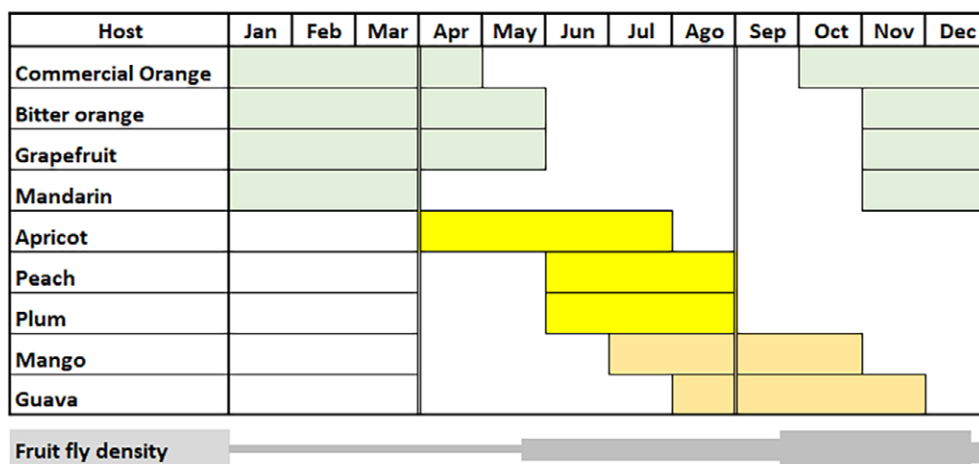

Figure 2.4. Sequential and overlapping *Ceratitis capitata* hosts in northern Africa and their effect on *C. capitata* population density

2.3.2 Host phenology

Fruit fly host phenology tables may be prepared based on the field observations of host availability and their relative attractiveness to the target fruit fly. These charts clearly show the simultaneous, partially overlapping, or sequential fruiting periods of the hosts (**Figure 2.4**).

2.3.3 Host distribution

Fruit fly host distribution maps are of topmost importance to apply efficient fruit fly phytosanitary procedures. They can be prepared using geographical information systems (GIS) and complemented with records of the preferred natural host trees. It is also important to indicate in the maps abandoned orchards, backyards, and commercial places of production, as well as to identify and categorize the sites where single or multiple natural hosts occur or sites where no hosts are present.

Particular attention must be given to pinpoint in the maps difficult to access sites with presence of natural hosts since they may function as pest reservoirs.

2.4 Factors related to the area under fruit fly management

To carry out an efficient AW fruit fly management programme, features of the landscape must be considered in the same way the pest and hosts are. Effectiveness of a programme will be influenced by the size of the area, geographical isolation (natural barriers), topography, climate, complexity of the agroecosystem, availability of communication infrastructure (roads, airports, telecommunications, electricity, etc.), and presence of rural settlements and urban landscapes.

2.4.1 Size of the area

The limits of the target area should be defined, and the surface calculated normally in square kilometres and hectares or square miles and acres. Delimitation of the area in detailed cartographic maps is necessary, including an accurate description of the boundaries using Global Positioning System GPS. The FAO/IAEA has prepared a helpful guideline in the use of GPS and geographical information systems (GIS) for AW fruit fly management programmes: www.iaea.org/sites/default/files/21/06/nafa-ipc-manual-ipc-gismanual-web.pdf.

2.4.2 Isolation

Geographical or natural barriers (seas, deserts, high mountains, etc.) help to keep the area free from natural pest incursions. However, in large-scale eradication programmes (see Annex 1) where working areas, intervention blocks or temporal FF-PFA are usually created along the eradication process, artificial barriers or buffer zones may be established if neighbouring areas harbour hosts or populations of the target pest.

2.4.3 Topography

Terrain relief significantly affects the application of phytosanitary procedures to manage fruit flies. In interior lowlands or coastal plains phytosanitary measure can be implemented with much less difficulties compared with uplands where some suppression procedures are difficult to implement due to difficult terrain, including steep slopes, cliffs, gulches, and others. In these situations, expensive equipment such as helicopters are used to transport people and materials or to directly apply aerial control treatments. Drones and ultra-light helicopters have shown to be useful under these conditions.

2.4.4 Climate

The main elements of climate that favour or inhibit development of fruit fly populations are temperature, rainfall, relative humidity and prevailing wind speed and direction.

In tropical or subtropical climates, heavy and prolonged periods of rainfall have a detrimental effect on fruit fly populations. However, the dry seasons with warmer temperatures allow fruit fly population to shorten their life cycles, resulting in an increase in the number of fruit fly generations.

Arid and semiarid regions, where there is enough water supply (rivers or groundwater), and where hosts can be grown all year round such as oasis, greatly favour fruit fly populations that can remain stable throughout the year.

Areas located in the warmer temperate ranges become suitable for fruit fly development all year round, except in the coldest months of the winter when freezing temperatures may considerably reduce fruit fly populations. Multivoltine fruit flies frequently overwinter through this unfavourable period in the larval or pupal stages. In these temperate climates, forecasting the emergence of adults from overwintering pupae and the number of generations can be assessed using degree-day mathematical models if the development temperature thresholds of the fruit fly are known. These adult population predictions cannot be done in subtropical and tropical latitudes because there are no clearly defined periods during the year when fruit flies are inactive.

By comparing multiannual climate graphs produced with historical data of climatic factors with charts of temporal and spatial pest distribution, it is possible to understand how these factors may affect the normal fluctuations of pest populations in large areas. As a result, it is possible to forecast potential changes in the typical fluctuations when unusual global climate patterns in the Pacific Ocean occur, such as El Niño (both the Southern Oscillation and North Atlantic Oscillation) and La Niña. For instance, in the Moscamed Programme in Guatemala (*C. capitata* containment programme), drastic population fluctuations of *C. capitata* may occur, influenced by such unusual climatic conditions, affecting the capacity of the programme to maintain adequate sterile to wild ratios required to suppress or eradicate populations.

Effects of climate change on fruit fly management strategies will be increasingly important. Temperate areas are already being threatened by tropical fruit fly species due to the changing environment, making previously inhospitable conditions suitable to such pests.

Wind is another factor influencing fruit fly populations. Although it may not significantly affect population fluctuations, it is extremely important because it can move the pest over long distances. Fruit fly populations tend to disperse when there are sudden changes in environmental conditions. This may happen after completion of fruit harvest or during a dry season spell. Fruit fly adults will use the

dominant wind currents such as the trade winds to disperse to more favourable habitats. In some places, storms with strong winds may cause reinfestation of the target pest into previously eradicated areas. Wind is an important factor to consider when developing suppression or eradication strategies.

2.4.5 Characteristics of landscapes

Many species of multivoltine and polyphagous fruit flies do not feed, seek shelter and mate in the same host plant where they lay eggs. Fruit fly individuals require sufficient amount of a variety of resources to be able to survive and reproduce, such as adequate temperature, humidity, food, and places for shelter, resting, mating and oviposition.

The full suite of required resources is not easily found in areas where vegetation is scarce or dominated by a single plant species, even when it is a host, for instance, extensive plantations of mangoes, oranges, guavas, papayas, etc.

On the other hand, areas where a single commercial fruit fly host is mixed with patches of, sometimes, undisturbed vegetation including alternate hosts and non-host trees, offer the most suitable conditions for fruit flies to establish and reproduce. Fruit fly populations tend to establish and remain in this type of vegetation not only due to the number, density, and variety of plant species, but also due to the structural complexity of the vegetation that provides protection, for instance, tropical or subtropical wild vegetation such as forests or jungles near commercial host plantations. Scarce vegetation with a single host and richly mixed vegetation with multiple hosts are contrasting characteristics that significantly affect the carrying capacity of fruit fly populations in an agroecosystem.

The simplicity or complexity of the landscape affects pest density and spatial distribution, but also affects the type, timing, and intensity of application of the phytosanitary procedures required to effectively manage fruit fly populations. In simple agroecosystems, control procedures are more effective, less costly, and easier to apply than in complex landscapes.

In complex, relatively stable agroecosystems natural enemies may be present, particularly parasitoids (either naturally occurring or previously introduced), which, although they may not drastically affect pest populations, can serve both as a potential control agent or as bioindicators of the possible detrimental effects in the environment resulting from the control procedures used in the management of the target fruit fly.

2.4.6 Human infrastructure

Most places inhabited by humans provide basic systems and services required to live and work, such as roads, airports, telecommunications, internet, power, and water supplies services. This infrastructure is very useful to operate AW fruit fly management programmes.

Implementation of AW fruit fly management programmes can be more easily conducted and is less costly if such infrastructure is available. Nevertheless, the presence of villages or cities within the intervention area may be less advantageous for an effective implementation of AW fruit fly management programmes due to the host diversity in suburban areas and the possibility of rejection of programme activities by the general public.

The infrastructure available in the programme intervention area should be assessed with the aid of official cartographic maps. These maps can be improved by adding layers of other relevant information such as pedestrian paths and dirt roads that give access to the intervention area. Human settlements should be listed and located in the maps no matter how small they are. The main and secondary roads, airports or airstrips that can be used to access the area under fruit fly control should be clearly indicated. In these locations quarantine check points can be established later. Finally, the movement and flow of vehicles, people and agricultural commodities should be analysed, specifically those commodities known to be fruit fly hosts.

2.5 Fruit fly survey tools

Survey tools are basic components of phytosanitary procedures for efficient application of control procedures. They are used to determine the characteristics of fruit fly populations and as an assessment tool to evaluate the effect of phytosanitary procedures that have been carried out.

Information about where, when, and how many fruit fly individuals are present in an area can be mostly obtained by application of appropriate surveillance systems such as trapping and fruit sampling. Historical surveillance records may be useful to develop pest population forecasting tools, so that management of fruit flies can be done in a preventive rather than in a reactive manner.

On the other hand, fruit fly monitoring also provides useful information about the efficacy of the phytosanitary procedures being applied to control the pest. Data on population levels before and after suppression actions can be compared. This will allow making the necessary modifications in the application of the phytosanitary procedures, including changing the phytosanitary procedures being used or adjusting the time and/or intensity of the procedures if the results are not within the established goals.

In summary, survey procedures are important to generate quantitative data on fruit fly populations and population dynamics. The lack of such information limits the ability of programme managers to predict the feasibility, effectiveness, and cost of any given method of management, or the combination of control tactics. These data become essential if phytosanitary procedures such as augmentative biological control or sterile insect releases are integrated to suppress or eliminate the target fruit fly pest.

Inaccurate data are produced when surveillance activities are inefficient due to the use of inappropriate materials or faulty procedures, misleading suppression actions. One of the most common mistakes is when surveys indicate that the pest is not present when in fact it is. The worst scenario occurs when traps are not serviced during a long period of time and the target pest has had enough time to reproduce and spread. These situations in turn result in failures of the management programme with loss of resources for the producers, NPPOs, and stakeholders.

Additional care should be taken to determine seasonal efficiency of traps because of prevailing climatic conditions, otherwise infestation based on trapping results can also mislead the assessment of fruit fly suppression activities. It has been demonstrated that during the rainy season in regions with heavy rain there is a reduction in trap efficiency. For example, for *C. capitata* using Jackson traps and Trimedlure (TML) (Figure 2.5).

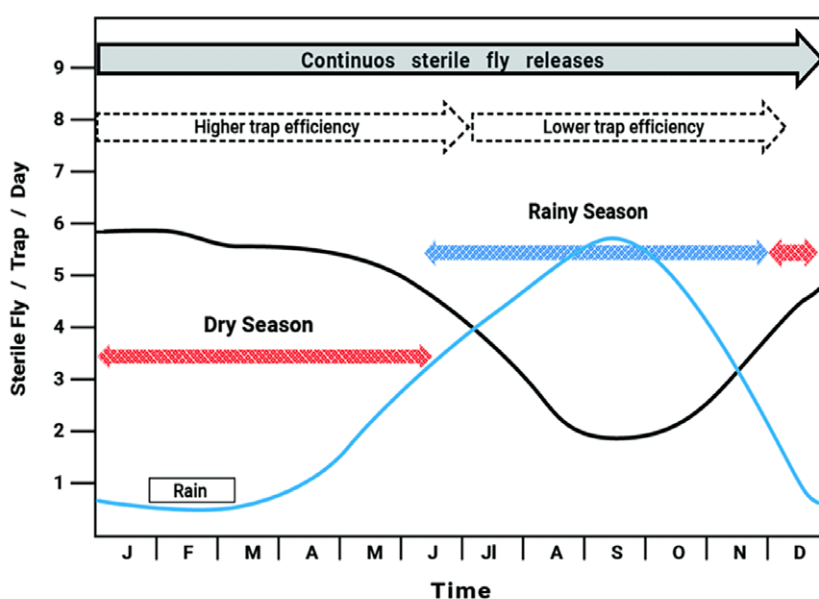

Figure 2.5. Typical effect of rain on the efficiency of Jackson traps baited with TML in the Pacific coastal area of Mexico and Central America. Graph based on sterile fly recapture from year-round uniform *C. capitata* sterile fly releases.

Information on how to select the optimal fruit fly survey tool and the way in which it can be used is available in the following FAO/IAEA guidelines on fruit sampling and trapping:

www.iaea.org/sites/default/files/ca5716en.pdf,

www.iaea.org/sites/default/files/trapping-guideline.pdf.

2.6 Stakeholder participation

Success of suppression, eradication, containment, and exclusion programmes against fruit flies infesting commercial commodities will very much depend on the support and active participation of all concerned, namely: national, regional, or local phytosanitary authorities, fruit and vegetable producers, packers, transporters, brokers, and the general public. Subscribing partnerships between the public and private sectors is essential for a smooth programme implementation.

A framework of the fruit fly management programme needs to be established with clear governance, including the roles and responsibilities of all entities involved. Usually, these AW fruit fly management programmes are planned under a multi-year basis, and their relevance and effectiveness will last as long as the entities involved maintain a strong and continued commitment to the particular fruit fly problem.

2.7 Public awareness

The general public should be fully aware of any AW fruit fly management programme. This should include those in the local communities that live in and around the area where the quarantine actions of the programme are being implemented. Awareness should also extend to those moving across the area where programme actions are applied (travellers, tourists, merchants, etc.), as well as to the consumers of the commercial commodities being protected.

Therefore, the public and in particular those being affected, such as owners of regulated articles, should be adequately informed about the activities that will be implemented. Managers of the fruit fly management programme need to be sensitive to the perceptions of the public towards the programme activities.

Public awareness campaigns are more important in areas where an active management programme is ongoing or in areas where the risk of introduction is higher. It is, therefore, essential to keep the public informed to prevent negative perceptions and outrage towards the programme. A public awareness campaign should be part of the preparedness stage of the programme. It should be launched well before any field intervention and be kept active throughout the life of the programme.

Bibliography

- Aluja, M.** 1994. Bionomics and management of *Anastrepha*. *Annr. Rev. Entomol.* 39: 155–78.
- Auclair, A, Chen, C., Macheel, W., Rendon, P., Lira, E., Midgarden, D., Magarey, R. et al.** 2008. *Using climate indices to predict medfly outbreaks in Guatemala and Mexico*. Memorias de la 7a Reunion del Grupo de Trabajo en Moscas de la Fruta del Hemisferio Occidental. Nov. 2–7, Mazatlan, Sinaloa, Mexico.
- Bateman, M.A.** 1972. The ecology of fruit flies. *Ann. Rev. Entomol.* 17: 493–518.
- Christenson, L.D. & Foote, R.H.** 1960. Biology of fruit flies. *Ann. Rev. of Entomol.* 5: 171–192. <https://doi.org/10.1146/annurev.en.05.010160.001131>
- Cirio, U.** 1982. *Ecology of the medfly in the Mediterranean area in relation to use of the sterile insect technique*. Contribution No. 16. ENEA, Department FARE, Division B10-AG Laboratory Technologies for the Protection of Agro-ecosystems, C. S. Casaccia, Rome, Italy.

- Dyck, V. A., Reyes Flores, J., Vreysen, M.J.B., Regidor Fernández, E.E., Barnes, B.N., Loosjes, M., Gómez Riera, P., Teruya, T. & Lindquist, D.** 2021. Management of area-wide pest management programmes that integrate the sterile insect technique, pp. 549–574. In: V. A. Dyck, J. Hendrichs & A.S. Robinson, eds. *Sterile Insect Technique. Principles and Practice in Area-wide Integrated Pest Management*. Second edition, CRC Press, Boca Raton, Florida, USA.
- Dyck, V.A., Regidor Fernández, E.E., Barnes, B.N., Gómez Riera, P., Teruya, T., Reyes Flores, J., Iriarte, G., Reuben, R. & Lindquist, D.** 2021. Communication and stakeholder engagement in area-wide pest management programmes that integrate the sterile insect technique, pp. 549–574. In: V. A. Dyck, J. Hendrichs & A.S. Robinson, eds. *Sterile Insect Technique. Principles and Practice in Area-wide Integrated Pest Management*. Second edition, CRC Press, Boca Raton, Florida, USA.
- Enkerlin, D., García R.L & López M.F.** 1989. Mexico, Central and South America, pp. 83–90. In: A.S. Robinson, and G. Hooper, eds, *World Crop Pests, Volume 3A. Fruit Flies. Their Biology, Natural Enemies and Control*. Elsevier, Amsterdam, The Netherlands.
- Enkerlin, W.** 1987. *Orientación y dispersión de poblaciones de la mosca mexicana de la fruta (Anastrepha ludens, Loew.) estériles y silvestres en el municipio de Allende, N. L. en el periodo de septiembre de 1985 a agosto de 1986*. Tesis Maestro en Ciencias. Instituto Tecnológico y de Estudios Superiores de Monterrey. pp. 76.
- Enkerlin, W., Villaseñor, A., Flores, S., Midgarden, D., Lira, E. et al.** 2016. Descriptive analysis of the factors affecting population fluctuation of the Mediterranean fruit fly (*Ceratitis capitata*, Wied.) in coffee areas located in Guatemala and its implications in IPM strategies pp. 46–63. In: B. Sabater-Muñoz, T. Vera, R. Pereira & W. Orankanok, eds. *Proceedings of the 9th International Symposium on Fruit Flies of Economic Importance*.
- FAO.** 2016. *Fruit fly pest free areas*. International Standard for Phytosanitary Measures (ISPM) No. 26. International Plant Protection Convention (IPPC). FAO, Rome, Italy. www.acfs.go.th/sps/downloads/133631_ISPM26_2006_E.pdf.
- FAO.** 2021. *Determination of pest status in an area*. ISPM No. 8, International Plant Protection Convention (IPPC). FAO, Rome, Italy. www.fao.org/3/x2968e/x2968e.pdf.
- FAO/IAEA.** 2006. *Designing and implementing a geographical information system: a guide for managers of area-wide pest management programmes*. IAEA, Vienna, April 2006. 29 pp. www.iaea.org/sites/default/files/21/06/nafa-ipc-manual-ipc-gismanual-web.pdf.
- FAO/IAEA.** 2018. *Trapping guidelines for area-wide fruit fly programmes*. 2nd edition. W.R. Enkerlin, & J.R. Flores, eds. Rome. 65 pp. www.iaea.org/sites/default/files/trapping-guideline.pdf.
- FAO/IAEA.** 2019. *Fruit sampling guidelines for area-wide fruit fly programmes*. W.R. Enkerlin, J. Reyes & G. Ortiz, eds. Rome, Italy. 38 pp. www.iaea.org/sites/default/files/ca5716en.pdf.
- Fletcher, B.S.** 1989. Life history strategies of tephritid fruit flies, pp. 195–208. In: A.S. Robinson, and G.H.S. Hooper, eds, *Fruit Flies: Their Biology, Natural Enemies and Control, Vol. 3B, World Crop Pests*. Elsevier, Amsterdam.
- Gutierrez, A.P., Ponti, L., Neteler, M., Suckling, D.M. & Cure, J.R.** 2021. Invasive potential of tropical fruit flies in temperate regions under climate change. *Commun. Biol.* 4: 1141. <https://doi.org/10.1038/s42003-021-02599-9> www.nature.com/commsbio
- Gutiérrez, S.J.** 1976. *La mosca del Mediterráneo, Ceratitis capitata (Wiedemann) y los factores ecológicos que favorecerían su establecimiento y propagación en México*. DGSV/SAG. México.
- Hendrichs, J., Vreysen, M.J.B., Enkerlin, W.R. & Cayol, J.P.** 2021. Strategic options in using sterile insects for area-wide integrated pest management. In: V.A. Dyck, J. Hendrichs & A.S. Robinson, eds. *Sterile insect technique: principles and practice in area-wide integrated pest management*, pp. 841–884. 2nd edn. CRC; Press, Boca Raton, USA. <https://doi.org/10.1201/9781003035572-26>.
- Harris, E.J.** 1993. Relationship between host plant fruiting phenology and *Ceratitis capitata* distribution and abundance in Hawaii, pp. 137–143. In: M. Aluja & P. Liedo, eds. *Fruit Flies: Biology and Management*. Springer Verlag, N. Y., USA.

- Izquierdo, J.** 1985. *Eco-biological considerations regarding the possible “rainfall” effect as criteria for identifying medfly eradication strategies in Central America and Panama*. RLAC/85/39. PROVEG-3. FAO/RLAC.
- Lindquist, A.W.** 1969. Biological information needed in the sterile-male method of insect control, pp. 33–37. In: *Proceedings of a Panel on Sterile-Male Technique for Eradication or Control of Harmful Insects*. Vienna, Austria, 27–31 May 1968. STI/PUB/224, IAEA, Vienna (1969). https://www.iaea.org/sites/default/files/el_harmful_insects.pdf.
- Lira, E. & D. Midgarden.** 2021. GIS-Based modelling of Mediterranean fruit fly populations in Guatemala as a support for decision-making on pest management: Effects of ENSO, climate change, and ecological factors, pp. 483–504. In: J. Hendrichs, R. Pereira & M.J.B. Vreysen, eds. *Area-wide Integrated Pest Management: Development and Field Application*. CRC Press, Boca Raton, Florida, USA.
- Meats, A.** 1989. Abiotic mortality factors- temperature, pp. 229–239. In: A.S. Robinson & G.H.S. Hooper, eds. *Fruit Flies: Their Biology, Natural Enemies and Control, Vol. 3B, World Crop Pests*. Elsevier, Amsterdam, The Netherlands.
- Meats, A.** 1989. Bioclimatic potential, pp 241–251. Chapter 8.5. In: A.S. Robinson & G.H.S. Hooper, eds. *Fruit Flies: Their Biology, Natural Enemies and Control, Vol. 3B, World Crop Pests*. Elsevier, Amsterdam, The Netherlands.
- Midgarden, D., Lira, E.** 2008. Ecological relationship of medfly and coffee in Guatemala and Mexico, pp. 241–247. In: R. Sugayama, R. Zucchi, S. Ovruski & J. Sivinski, eds. *Fruit Flies of Economic Importance: From Basic to Applied Knowledge*. Proceedings of the 7th International Symposium on Fruit Flies of Economic Importance. 10–15 September 2006, Salvador, Brazil.
- Mitchell, W.C., Andrew, C.O., Hagen, K.S., Hamilton, R.A., Harris, E.J., Maehler, K.L. & Rhode, R.H.** 1977. *The Mediterranean fruit fly and its economic impact on Central America countries and Panama*. UC/AID Pest Management and Related Environmental Protection Project. University of California, Berkeley, USA. 189 pp.
- National Research Council.** 1969. *Insect-Pest Management and Control*. The National Academies Press. Washington, D. C. USA. <https://doi.org/10.17226/18674>
- Ortiz, G., Liedo, P., Reyes, J., Schwarz, A. & Hendrichs, J.** 1984. Mediterranean fruit fly *Ceratitis capitata*: Present status of the eradication program in southern Mexico, pp. 101–111. In: R. Cavalloro, ed. *Proceedings International Symposium on Fruit Flies of Economic Importance. Commission of the European Communities and IOBC*. A. A. Balkeman, Rotterdam, The Netherlands.
- Poole, R.W.** 1974. *An introduction to quantitative ecology*. McGraw-Hill Series in Population Biology. McGraw-Hill Kogakusha, LTD. 532 pp.
- Price, P.W. & Waldbauer, G.P.** 1975. Ecological aspects of pest management, pp. 37–73. In: R.L. Metcalf & W.H. Luckmann, eds. *Introduction to Insect Pest Management*. Wiley, N.Y., USA.
- Rhode, R.H.** 1975. A medfly eradication programme for Central America. Controlling fruit flies by the sterile insect technique, pp. 159–166. In: *Proceedings of a Panel and Research Co-Ordination Meeting. 12–16 November 1973*. Joint FAO/IAEA Division of Atomic Energy in Food and Agriculture, Vienna, Austria. www.iaea.org/sites/default/files/ipc-fruit_flies-sterile-insect-technique-1975.pdf.
- Rohwer, G.G.** 1992. *Recommendations regarding fruit fly management/eradication in the Western Hemisphere*. Bull. No. 10. OIRSA, San Salvador, El Salvador.
- Reyes, F.J., Villaseñor, A., Schwarz, A. & Hendrichs, J.** 1988. Organization of medfly eradication campaigns, pp. 107–116. In: *Proceedings of a Symposium on Modern Insect Control. Nuclear Techniques and Biotechnology*. 16–20 November 1987. FAO/IAEA, Vienna, Austria. www.iaea.org/sites/default/files/ipc-modern-insect-control.pdf.
- Weidhass, D.E.** 1973. Principles of the sterile male technique with emphasis on ecology, pp. 17–22. In: *Proceedings of a Panel on Computer Models and Application of the Sterile Male Technique*. 13–17 December 1971. FAO/IAEA. Vienna, Austria. www.iaea.org/sites/default/files/el_computer_models.pdf.

3. Cultural and mechanical practices

3.1 Background

Cultural, physical, and mechanical methods are the oldest of insect pest control practices. These methods to suppress fruit fly pests have been refined through the years, so, their use is as important today as in the past.

These practices are more effectively applied in temperate and simple landscapes, such as arid areas or areas of low agroecological complexity, and against univoltine or monophagous species. In subtropical or tropical areas with more complex agroecosystem, their application becomes more complicated as well as for polyphagous and multivoltine species.

These methods are often low cost and easy to apply, although when applied alone their impact on population suppression is not great. Highest effectiveness is obtained when the biology and ecology of the pest is well known, and when applied in combination with other suppression methods.

The principles and practices required to reduce pest infestation in each of the cultural, physical, and mechanical control tactics are different. For a clearer understanding these methods are defined below.

3.1.1 Cultural control

This activity involves a deliberate alteration of the standard crop production practices and thoughtful manipulation of the environment to make it less favourable to the fruit fly pests.

3.1.2 Physical control

They are direct or indirect procedures taken to destroy the insect outright, disrupt normal physiological activity by means other than chemical insecticides, or modify the environment to a degree that makes it unacceptable or unbearable to the insect. Physical protection mechanisms are also a direct protection of the crop by establishing a barrier to prevent the access or to exclude female fruit flies from reaching the host, for this reason in some countries this control practice is also called 'exclusion' control.

3.1.3 Mechanical control

The suppression of fruit flies by mechanical methods is based on the principle of direct removal and destruction of pest individuals from the host commodity or place of production.

Physical and mechanical controls are different from cultural controls in that the action is directed specifically against any of the different life stages of the insect rather than being a modified orchard management practice.

Even though each of these three methods has its own and unique principles to reduce pest infestation, their combined application is frequently named cultural methods, cultural practices, mechanical control, and in some countries the combination of these practices are called physical control. Based on the most used terminology, for the purpose of this guideline, these group of phytosanitary procedures for fruit fly control are called cultural and mechanical practices (C&M practices).

The C&M practices can be applied to any species of fruit flies of economic and quarantine importance, particularly species of the genera *Anastrepha*, *Bactrocera*, *Ceratitis*, *Dacus*, *Rhagoletis* and *Zeugodacus*.

3.2 Cultural and mechanical practices

3.2.1 Sanitation

Sanitation is the practice of removing dropped and decaying fruits. For a long time, this has been the most common cultural practice to suppress fruit fly pests. Fruits fall due to different factors; among them, the existence of larvae inside the fruits that accelerates their maturation. Dropped and decaying fruit may harbour important number of eggs and larvae at any given time. Consequently, the collection, safe removal, and appropriate disposal (e.g. deep burial) of fallen fruits during maturation and harvest eliminate immature stages of the fruit fly pest in places of production. Such practice is necessary not only in the planted crop but also in fruit fly hosts present around packing sheds, warehouses, storage buildings, etc. located within the places of production.

For AW fruit fly management programmes which operate mostly in areas outside of the places of production, effectiveness of this methods increases when the collection and disposal of fallen fruit focuses on the preferred hosts. Also, field observations have demonstrated that in some fruit species such as guava, larvae are present in higher concentrations in mature fruits that are still in the tree than in fallen fruits. Therefore, collection of fruits in marginal areas can increase the effectivity of sanitation if this practice is done on preferred hosts and on mature fruits that remain on the trees. On the other hand, in some other fruits such as mango, last instar larvae can be found in fruits that are still in the tree as well as on those that have recently dropped.

For good results, collection and disposal of fruits should be done by the growers systematically before, during and after harvest of the commercial commodity in the places of production, or before and during ripening of wild hosts in marginal areas when the activity is part of an AW fruit fly management programme.

3.2.2 Fruit stripping

Early fruit stripping. Female fruit flies looking for ovipositing sites disperse early from outside alternate hosts into the orchards. If these few individuals lay eggs in those fruits that mature early a major infestation may develop by the time of harvest.

Fruits that mature early in the fruiting season are highly attractive to fruit flies, thus acting as a ‘fruit-trap’; these fruits normally harbour many larvae. Consequently, removing the few early ripening fruits from the trees, with or without signs of infestation, to reduce the amount of substrate for oviposition and larval breeding material, is a sound fruit fly suppression practice that can be used by individual producers as well as AW fruit fly management programmes.

Late fruit stripping. Fruit that remains on the host trees after harvest should also be collected and disposed of to help reduce the fruit fly population. Once the harvest is over, the late-ripening fruits remaining on the trees also act as a fruit-trap.

These fruits do not represent an important economic income to the producer due to their low amount and are therefore left in the field unharvested. Fruit fly adults that may be present in the orchard, despite their low population level, tend to oviposit on these unharvested fruits, creating a pest reservoir from where adults will move later to alternate hosts outside the orchards. This population will become the main source of infestation for the commercial crop in the following season.

Late fruit stripping is especially important for those fruit fly species that are monophagous, univoltine and thus hibernate in the orchard; therefore, the fruit left on the trees becomes the source of infestation in the following season.

3.2.3 Removal of rejected fruit

Fruit rejected because of poor quality during harvest and packing should also be collected and disposed of to help eliminate potential immature stages occurring in such fruits.

3.2.4 Combination of sanitation and fruit stripping

Fruit fly demographic studies have shown that adults only encompass a low part of the total pest population, whereas eggs and larvae represent a high proportion of the population. Therefore, the removal of unwanted fruits (early or late ripening, fallen, or rejected fruits), will have an important suppression effect on the subsequent adult population, and consequently a significantly reduce the damage to the commercial host.

Due to the lack of systemic insecticides aimed at killing immature stages of fruit flies inside the fruit and due to the low effectiveness of biocontrol agents when populations are low, collection and disposal of the fruits through sanitation and fruit stripping is a logic practice to eliminate immature stages.

3.2.5 Disposal of unwanted fruit

Collecting and disposing of unwanted fruits is not a popular practice among orchard managers and owners. Collecting and disposing any volume of fruits in the field throughout the maturation period, as well as a post-harvest activity in packing facilities, entails actions that distract manual labour from other activities that are believed to be more important. Also, for AW fruit fly management programmes the disposal of high volumes of unwanted fruits becomes a challenge, especially in those locations where the general public is objecting the removal of backyard fruit.

Burying. Small volumes of fruit to be disposed can be buried by digging a hole in the ground, pouring the fruit inside, covering the fruit with a thin layer of lime, and then covering the fruits with a layer of at least 50 cm of compacted soil (**Figure 3.1**).

When the collection of unwanted fruit is done on a large-scale, the destruction of large volumes of fruit requires digging larger and deeper holes in the ground, which involves using special machinery such as mechanical excavators. In these situations, it is also advisable to use industrial incinerators to burn the fruits collected instead of burying them.

In species that attack annual crops such as cucurbits (melon, watermelon, etc.), the remains of the crop may be crushed and buried. In some species of fruit flies, such as the *Zeugodacus cucurbitae*, placing culled fruit in augmentoria, burying the fruit 0.50 m deep or placing infested fruit under a screen and 0.75 m beyond the infested fruit pile can be effective in sequestering adult fruit fly emerging from infested fruit. In the last case, the edges of the screen should be buried to prevent the escape of emerging adult flies.

Plastic bags. Another practice is to place the unwanted fruits into plastic bags and leave them in the sun for three to five days to kill the larvae through heat, then burying these fruits in a hole in the ground,



Figure 3.1. Collection and burying of fallen and stripped fruit covered by a thin layer of lime

as described before. Plastic bags can be black or transparent. The advantage of using transparent bags is that the condition of the fruit can be seen as well as, occasionally, the larvae exposed to high temperatures when coming out of the fruit.

Unwanted fruit placed in plastic bags can accumulate and be kept throughout the harvest season. At the end, a couple of weeks after the last collection, the bags can be emptied in a dumping site previously prepared. Baited traps should be placed around the dumping site and be checked weekly to detect any fly that may have survived to the adult stage. This is a way to ensure that dumping sites do not become a source of infestation.

Animal feed. In some countries it is common to feed livestock or other animal with the rejected fruits. This practice needs to be carefully evaluated by the grower or the AW fruit fly management programme managers because there is a high risk of moving the pest in the rejected fruits, thereby increasing probabilities of pest survival, and spread. If this practice is carried out, it is important to place fruit fly traps around the pens where the animals are fed.

Compost. Collected fallen and unwanted fruit should not be left in a waste heap or added to compost due to the high risk of pupae reaching the adult stage.

3.2.6 *Ploughing*

This principle is applied based on field observations indicating that tephritid larvae often pupate and emerge under the trees from which the infested fruits have fallen. Therefore, removing or ploughing the soil around the trees can bring buried pupae into the surface, exposing them to predatory insects, or to desiccation by sunlight. This activity must be carried out with care because removing the soil can damage superficial roots which would facilitate the development of diseases caused by bacteria, fungi, or nematodes.

Elimination of weeds using hoes or weed cutters produce similar effects as ploughing. If vegetation in orchards is kept low, fallen fruit with larvae may be more exposed to direct sunlight and natural enemies which will contribute to mortality of fruit fly immature stages. Conversely, tall vegetation will allow newly emerged adult flies to find shelter or protection from predators and bad weather. In addition, eliminating weeds at the place of production will facilitate collection of fallen fruit.

3.2.7 *Water management*

Moisture is an important factor in the ability of larvae and pupae to survive in the ground and later to emerge as adults. Humid soils are easier than dry ones for larvae to bury into the soil. However excess or lack of humidity for prolonged periods of time can be detrimental for the survival of immature stages.

Ground swamping. Where sufficient water is available, flooding of the area below the canopy of host trees to drown larvae or pupae may also be used as a fruit fly suppression practice.

Minimize watering. In places with hot temperature and where water is scarce, the use of trickle irrigation and mulching to minimize the use of available water can cause pupal mortality.

3.2.8 *Pruning*

Pruning of commercial commodity. Pruning of the commercial commodity at the recommended time is important to eliminate excess of foliage that provides shelter to adult fruit flies. Also pruning allows keeping fruit trees at a manageable size to facilitate the fruit harvest and fruit fly control methods such as bait spray, bagging, and netting.

Pruning of hosts different to the commercial commodity. Pruning of both young and mature trees of non-commercial preferred hosts is a practice that will help prevent fruit fly damage to the commercial host.

This practice, applied to preferred alternate host trees different from the commercial crop, aims at eliminating branches that will bloom. This will reduce the amount of oviposition substrate in the alternate host for early fruit fly populations, prior to the blooming of the commercial crop.

These preferred alternate hosts are usually wild varieties which most of the time are more attractive to the pest than the commercial varieties. They can be found interspersed inside the place of production or outside, along roadsides, or in backyards or marginal areas surrounding the commercial plantation, such as in small villages. For instance, tropical plum (*Spondias spp.*) is a major host of the, *Anastrepha obliqua*, in tropical and subtropical areas of America and the Caribbean. It is a common practice in southern Mexico and Central America to use tropical plum as a live fence to divide mango orchards from other properties or roads. These tropical plum trees are the most important source of infestation to commercial plantations of mango if they are not pruned or replaced by other non-host trees.

An alternative practice to pruning of branches with early blooms is the total removal and destruction of the fruits in the green stage.

3.2.9 Host tree removal

Fruit flies infesting commercial fruit plantations usually originate in alternate hosts outside or within the plantations where they reproduce and build up their populations. It is therefore a recommended practice for fruit fly suppression to eliminate or replace the preferred alternate non-commercial hosts.

This principle of host destruction or replacement, besides eliminating potential fruit fly reservoirs, helps to break the continuity of pest generations and migrations from the alternate hosts to the commercial fields. This practice of host tree removal usually produces substantial reduction of fruit infestations at a later stage.

This practice should also be carried out in marginal areas around the place of production, including uncultivated land, abandoned orchards, public areas such as parks and those neglected fruit trees growing along public roads, on vacant lots or along streets in urban areas.

The non-commercial hosts can be native or introduced. In both cases, their substitution by non-host trees or non-fruit bearing trees such as ornamentals and shrubs can become a social problem when the fruit of these hosts is used for local consumption as fresh, dried, or canned fruits, or to prepare jelly and beverages. Therefore, it is necessary to have agreements with local authorities or to enforce special regulations related to this practice. If these non-commercial hosts are only used as shade trees, social problems can be minimized by replacing them with non-host trees that have similar features as the replaced tree (height, canopy, etc.).

For example, in mango producing areas in tropical and sub-tropical America, the packing facilities, warehouses, storage facilities, dining houses, etc. are usually close to the commercial fruit plantation. It is common to have wild mangos and other wild fruit fly hosts around (guava, star apple, tropical almond, tropical plum, etc.), that are used as shade trees to protect vehicles from sunlight and other uses like fresh consumption and refreshing beverages. These host trees become a major source of fruit fly infestations that later invade the commercial orchards. Replacement of these by non-host or non-fruit bearing trees is one of the most suitable options.

3.2.10 Resistant varieties

Resistance is used here as synonym of non-preference, low attraction, tolerance, or low susceptibility of the host to the target fruit fly species.

Host resistance to fruit fly damage depends on the local pest population/host interactions. It is the property that enables fruits to avoid or tolerate injury by fruit fly populations that may cause greater damage to other fruit of the same host species but of different variety under similar environmental conditions. This property arises from certain biochemical (presence of toxic compounds, etc.) or

morphological characteristics of fruit which affect the development of the eggs or larvae. Sometimes a variety of a fruit fly host has such a strong resistance that it is considered as a non-host, for example, 'Hass' avocado.

Plant breeding programmes are aimed at developing new varieties to improve their visual characteristics, quality of the fruit or yield increase. However, few research programmes are aimed at finding fruit varieties resistant to species of fruit flies.

Often, identification of resistant host trees to fruit fly species results from field observations of individual trees that under normal field conditions are less damaged than other varieties under the same conditions. Therefore, selecting these less susceptible fruit species or varieties of the commercial commodity to fruit fly pest is highly recommended.

Resistant varieties found by accident sometimes produce outstanding results. For instance, in the states of Veracruz and Chiapas, Mexico, mangoes of the varieties 'Ataulfo', 'Haden', 'Keitt' and 'Palmer' are less attacked by *A. obliqua* than 'Manila' and 'Kent', and in some places of Central America mango varieties 'Van Dyke' and 'Keitt' are much less infested than 'Tommy Atkins'. Varieties of coffee, *Coffea arabica*, such as 'Caturra', 'Bourbon' and 'Mundo novo' are more susceptible to *C. capitata* infestations than the varieties of *Coffea canephora* such as 'Robusta' and 'Comilon'.

Recently, there has been specific research to determine the host status of certain commercial host varieties to determine the best pest risk mitigation scheme to be used. For instance, in Brazil the mango variety 'Carlota' is heavily infested by *A. obliqua*, while the variety 'Espada' is not infested at all. In Australia, it was found that the major citrus crops commercially cultivated have a relatively low susceptibility to *Bactrocera tryoni*, with 'Eureka' lemons being a particular poor host.

It is conceivable that planting a combination of resistant, or partially resistant varieties of commercial hosts with susceptible varieties of fruit fly hosts as a trap crop (discussed in the next section), can result in low fruit fly populations and a greater yield of the commercial commodity.

3.2.11 Trap cropping

The host selected as a trap crop should not only be more attractive to the pest than the commercial commodity, but it is highly desirable that it blooms and matures before the commercial variety. The principle of trap cropping is that when the trap crop matures before the commercial commodity, it attracts adults of the adult populations migrating early in the season, thus diverting them away from the commercial variety.

Although trap cropping by itself can be a useful indicator of pest occurrence, baited traps may also be placed in the trap crop to detect the first incursions of adults. In this way fruit flies are detected almost immediately instead of having to wait to detect the pest later in larval stages in the fruits of the trap crop. To eliminate the pest individuals that arrive at the trap crops, insecticide-bait sprays are directed at the trap crop and/or ripening fruits are systematically collected and destroyed.

Trap crops are usually planted on the edge of the orchards. One or two rows of trees of the variety selected as a trap crop are used in such a way that these trees serve as an initial barrier against the fruit fly adults migrating into the orchards. This delays the spread of the pest to the commercial crop. Trap crops established on the edge of the commercial host can be planted together with the commercial crop or at any later stage.

Having a trap crop can be a serious problem if it is not well managed, because it would become a source of infestation for the commercial crop. If attending the trap crop becomes a problem, it is better to eliminate or replace the trees by non-host trees and use mass trapping or bait station arrays around the commercial area. These arrays should consist of the most powerful trap/bait combination, otherwise, pest invasion can easily pass the trap crop barrier and go directly into the commercial crop.

3.2.12 Planting sites with low pest prevalence or absence of the target fruit fly species

Many areas across the globe are natural low pest prevalence areas or are areas where the target fruit fly species is not present. This could be the case of areas which, despite being suitable for fruit production, have not been used for many years for this purpose, for example, areas covered with annual grasses or cattle ranches. Often, fruit fly wild hosts are not found in these areas.

Annual crops, such as cucurbits and solanaceous plants, that are hosts of fruit flies, may be planted, and harvested throughout the year in these geographical areas. FF-ALPP can be established in these areas to produce and export fruits and vegetables under an FF-SA or an FF-PFA strategy.

This practice can also be applied to perennial fruit crops in areas that have not been subjected to fruit production. The areas would have to be selected and protected with quarantine check points as a prerequisite for production and exports either under FF-PFA or FF-SA.

It can also be applied in areas where the fruit fly pests were eradicated but no commercial plantations are established. For example, some areas in northern Mexico that were used to produce wheat or livestock were planted with mango after eradication of *A. ludens* and *A. obliqua*. Mango is now being sold to the local and export markets with no quarantine risk.

3.2.13 Harvest at a specific stage of fruit development

Early harvesting. Fruit fly infestations may be prevented by picking fruit and vegetables early. Early harvests can be achieved by planting early varieties which produce fruits before the fruit fly population natural build-up.

Harvesting in green stage. This a practice commonly used as part of bilateral work plans for exports of fresh fruit and vegetables under an FF-SA (see **Annex 3**). Many countries export green, but physiologically ripe, papayas and tomatoes following this procedure.

3.2.14 Growing host fruit when pest incidence is low or when the pest is temporally absent

Geographical and climatic conditions adverse for fruit fly development are common in many areas. These conditions may limit fruit fly populations. For example, low temperatures and seasons of heavy rain may restrict development and movement of adults, reducing population size and movement.

Fruit producers can take advantage of this natural control to harvest the commercial commodity during or at the end of such seasons, when pest populations are still low, so the commodity is least likely to be infested. For example, in arid areas the lowest pest populations usually occur in winter, whereas, in tropical areas it occurs at the end of the rainy season.

3.2.15 Flowering and timing of fruit production

Flowering of the commercial commodity can be artificially induced to prompt an early or late harvest that coincides fully or partially with periods of low pest prevalence or when the availability of wild fruit host is limited.

Flowering induction in fruit trees is a cultural practice based on the application of phytohormones, fertilizers, management of water and girdling. These are standard agricultural practices aimed at having a preferential window for exports. This practice works well to escape fruit infestation, although it can only be applied for some varieties or species of fruit hosts. For example, inducing early flowering of mango in subtropical areas produces an early harvest in autumn when *A. obliqua* populations are still at low prevalence levels and tropical plum (*Spondias* spp.), its major wild host, has no fruits.

3.3 Fruit bagging

Cloth netting or paper bags to cover young fruits to protect them against fruit fly female oviposition have been used for centuries.

This practice is resource-intensive, therefore, is mostly applied in high value commercial fruits. The practice starts by eliminating part of the total fruits in a tree, leaving only those that present the best quality features, which are selected and bagged. The bags are periodically removed to maintain fruit quality and to check for sanitation until they are harvested.

3.4 Pest exclusion structures

This practice is aimed not at killing the pest but at excluding the pest from the environment where the host is grown.

In many countries with economically important native fruit fly species, fruit and vegetables are grown in places of production under complete protection using pest exclusion structures. Such structures can be glasshouses or greenhouses built with an appropriate mesh size (e.g. mesh size of 1.67 mm). Therefore, in some way, these fruit fly free growing structures work as a closed fruit fly free place of production. Sometimes the insect-proof netting is not covering the total crop but only individual separate trees.

Pest exclusion through physical protection practices is usually prohibitively expensive for most of the commercial commodities but can be economically acceptable for the highest value crops.

3.5 Other practices

Other cultural and mechanical practices related to orchard management are the number and array of trees per unit surface. Having an appropriate distance between trees and eliminating those that are misplaced can help to expose them to sufficient sunlight and to ground insecticide-bait treatments to suppress fruit fly populations.

3.6 Evaluation

The effect of using C&M practices on populations is not seen immediately. The result of their application can take at least one generation. When they are used against polyphagous, multivoltine species they should be applied throughout the fruiting and harvesting season. The results can be seen by growers throughout the harvest season.

In the case of monophagous univoltine species, since these methods are applied during maturation and all of the harvesting season, results are only seen by the growers until the beginning of the next production season.

The significant reduction of fruit fly populations by the application of C&M practices is beyond doubt, but assessment of their effectiveness is difficult. In AW fruit fly management programmes, where infestation data are gathered continuously and throughout the intervened area, effect of these practices for specific areas and seasons can be assessed by comparing historical data along several months. However, these data can be biased because results may also reflect the suppression effect resulting from other suppression procedures applied simultaneously or sequentially.

Evaluation of these control methods can be conducted through measuring the relative population level using the parameter fertile fly per trap per day (FTD-f) in a specific area and point in time, before and after the application of the C&M practices.

3.7 Uses of cultural and mechanical practices

Most of the above discussed fruit fly suppression methods can be practiced by individual or organized producers to:

- Keep the pest below the economic injury level, so that production can be traded in local markets;
- Achieve a reduced pest population level which combined with a Probit-9 Post Harvest Treatment (PHT), allows exports of major host fruit commodities;
- Reach a specific low pest prevalence level so that poor fruit fly hosts can be exported using an FF-SA without the need for a PHT.

Using any of the last two options producers may be able to export the commercial fruit fly host commodity to the international market or to move these products into a domestic fruit fly free area or areas under official control without further phytosanitary requirements.

These C&M practices are often more effective if practiced throughout a wide area, instead of a field-by-field approach. This is especially true for most of the fruit fly species, where adults can disperse long distances from wild hosts or abandoned orchards and reach well-managed commercial orchards. However, fruit growers regularly refuse to implement these practices outside of the orchards. This results in higher fruit fly infestations and therefore the dependence on chemical treatments as a permanent practice.

The most common methods that are critical components of bilateral work plans (See **Annex 3**) to export fruit under FF-SA are:

- Producing using resistant varieties (with poor host status);
- Producing within pest exclusion structures;
- Trapping around places of production;
- Planting sites with low or no-pest incidence of target fruit fly species;
- Managing flowering and time for fruit production and harvesting;
- Harvesting at a specific stage of fruit development.

The C&M practices (mostly sanitation and fruit stripping) are an important part of bilateral work plans (see **Annex 3**) to export fruit under a Probit-9 PHT. These practices are also commonly applied by AW fruit fly management programmes in at least two specific situations:

- In areas with high concentration of primary fruit fly hosts with scarce mature fruits available due to the end of the fruiting season (end of rainy season), when historically remanent fruit fly populations become sources of infestation or bridges to alternate hosts;
- When a fruit fly host has shown to be very attractive at the beginning of a dry season when pest populations start to increase. Sometimes, but less frequently, eradication programmes also use host tree removal and heavy pruning of non-commercial hosts.

Sanitation and fruit stripping are key suppression methods included in contingency action plans (see **Annex 2**) when fruit fly pests are detected in FF-PFA. These methods, when used to eliminate an outbreak, should immediately be applied, and aimed not only at the major hosts but to any tree that bears fruits, although giving more importance to those fruit species that have previously been shown to be good hosts in the area or similarly endangered areas.

3.8 Comparative features of cultural and mechanical practices

In most cases these phytosanitary procedures work very well to prevent pest infestations, although growers too often overlook the advantages of the preventive approach.

Cost

Some advantages of these methods are that they utilize low-cost manual labour, and they pose no insecticide residue problems. However, in some countries, manual labour is so expensive that practicing these controls may be less cost-effective.

Constraints

Producers are often reluctant to apply C&M practices because results are not immediately visible. Furthermore, the immediate population suppression resulting from the use of bait-sprays has limited a wider use of C&M practices.

Bibliography

- Allwood, A.** 2000. Regional approaches to the management of fruit flies in the Pacific, pp. 439–448. In: K.H. Tan, ed. *Area-wide Control of Fruit Flies and Other Insect Pests*. Penerbit Universiti Sains Malaysia, Penang, Malaysia.
- Aluja, M.** 1994. Bionomics and management of *Anastrepha*. *Ann. Rev. Entomol.* 39: 155–78.
- Cabrera, H. & Villanueva, J.** 1987. *Infestación natural de moscas de la fruta en 21 cultivares y ocho selecciones de mango en el campo agrícola experimental Cotaxtla. Primer informe anual sobre los trabajos de investigación en moscas de la fruta en mango*. INIFAP. 1987. INIFAP. SARH. pp. 71–87.
- Carey, J.R.** 1982. Demography and population dynamics of the Mediterranean fruit fly. *Ecol. Model.* 16: 125–150.
- Carvalho, R.S., Nascimento, A.S., Morgante, J.S. & Fonseca, N.** 1996. Susceptibility of different mango varieties (*Mangifera indica*) to the attack of the fruit fly *Anastrepha obliqua*, pp. 325–331. In: B.A. McPherson & G.J. Steck, eds. *Fruit Fly Pests, a World Assessment of their Biology and Management*. St. Lucie Press, Delray Beach, Florida, USA.
- Cohen, H. & Yuval, B.** 2000. Perimeter trapping strategy to reduce Mediterranean fruit fly (Diptera: Tephritidae) damage on different host species in Israel. *J. Econ. Entomol.* 93 (3): 721–725.
- Croft, B.A.** 1975. Tree fruit pest management, pp. 471–507. In: R.L. Metcalf & W.H. Luckmann, eds. *Introduction to Insect Pest Management*. Wiley, N.Y., USA.
- DGSV/CONASA/SAGAR.** 1999. *Apéndice técnico para las operaciones de campo*. Campaña Nacional Contra Moscas de la Fruta. México.
- Enkerlin, D., Liedo, P., Ortiz, G., Reyes, J. & Schwarz, A.** 1984. Review, procedures, and present status of the Medfly Program in Mexico. Regional Seminar on Nuclear Techniques in Crop Production. 18–23 November 1984. Comisión Interamericana de Energía Nuclear, OEA-CENA and Universidad de Sao Paulo, Brazil.
- Enkerlin, W.R. & Reyes, J.** 1984. Evaluación de un sistema de muestreo de frutos para la detección de *Ceratitidis capitata* (Wied.). 11 Congreso Nacional de Manejo Integrado de Plagas. Asociación Guatemalteca de Manejo Integrado de Plagas (AGMIP). Ciudad de Guatemala, Guatemala, Centro América.
- Enkerlin, W.R., Reyes, J., Bernabé A., Sánchez, J.L., Toledo, J. & Aluja, M.** 1993. El aguacate “Hass” como hospedante de tres especies de *Anastrepha* (Diptera: Tephritidae), en condiciones forzadas y naturales. *Agrociencia. Serie Protección Vegetal* 4 (3). Montecillo, México. ISSN 0188-3046.
- FAO.** 2012. *Systems approach for pest risk management of fruit flies (Tephritidae)*. *International Standard for Phytosanitary Measures*. (ISPM) No. 35. International Plant Protection Convention (IPPC). FAO, Rome, Italy. <https://www.ippc.int/en/publications/635>.
- FAO.** 2016. *Establishment of pest free areas for fruit flies (Tephritidae)*. *International Standard for Phytosanitary Measures*. (ISPM) No. 26. International Plant Protection Convention (IPPC). FAO, Rome, Italy. http://www.acfs.go.th/sps/downloads/133631_ISPM26_2006_E.pdf.

- FAO/IAEA**. 2011. Guidelines for implementing systems approaches for pest risk management of fruit flies. June 7–11, 2010. Report and recommendations of the consultants group meeting organized by the Joint FAO/IAEA Division of Nuclear Techniques in Food and agriculture, Vienna, Austria. www.iaea.org/sites/default/files/21/07/nafa-ipc-technical-report-systems-approach-2011.pdf.
- Harris, E.J., Ford-Livene, C. & Lee, C.Y.L.** 1988. Population monitoring of tephritid fruit flies by stratified sampling on the island of Oahu, Hawaii. 1st. Intl. Symp. on Fruit Flies in the Tropics. K. Lumpur, Malaysia.
- Jang, E.B., Klungness, L.M. & McQuate, G.T.** 2007. Extension of the use of augmentoria for sanitation in a cropping system susceptible to alien tephritid fruit flies (Diptera: Tephritidae) in Hawaii. *J. Appl. Sci. Environ. Management* 11 (2): 239–248.
- Klungness, L.M., Jang, E.B., Mau, R.F.L., Vargas, R.I., Sugano, J.S. & Fujitani, E.** 2005. New sanitation techniques for controlling Tephritid Fruit Flies (Diptera: Tephritidae) in Hawaii. *J. Applied Sci. & Environ. Management* 9 (2): 5–14.
- Knipling, E.F.** 1979. *The basic principles of insect population suppression and management*. USDA Agriculture Handbook No. 512. SEA, USDA, Washington, D.C., USA. 659 pp. <https://naldc.nal.usda.gov/download/CAT80732659/PDF>.
- Liedo, P., Carey, J.R., Celedonio, H. & Guillen, J.** 1993. Demography of Anastrepha fruit flies: A case study of three species of economic importance, pp. 119–124. In: M. Aluja, and P. Liedo, eds. *Fruit Flies: Biology and Management*. Springer-Verlag, N.Y., USA.
- Lloyd, A.C., Hamacek, E.L., Smith, D., Kopittke, R.A. & Gu, H.** 2013. Host susceptibility of Citrus cultivars to Queensland fruit fly (Diptera: Tephritidae). *J. Econ. Entomol.* 106 (2): 883–890.
- Mangan, R.L.** 2005. Population suppression in support of the sterile insect technique, pp. 407–425. In: V.A. Dyck, J. Hendrichs & A.S. Robinson, eds. *Sterile insect technique. Principles and Practice in Area-wide Integrated Pest Management*. Springer, Dordrecht, The Netherlands.
- National Research Council.** 1969. *Insect-Pest Management and Control*. The National Academies Press. Washington, D.C., USA. <https://doi.org/10.17226/18674>.
- Programa Moscamed Guatemala-México-USA.** 2015. *Manual de procedimientos para el control mecánico de la mosca del Mediterráneo, Ceratitis capitata (Wied.)*. Programa Moscamed. Guatemala-México-USA.
- Reyes, J., Villaseñor, A., Ortiz, G. & Liedo, P.** 1986. *Manual de las operaciones de campo en una campaña de erradicación de la mosca del Mediterráneo en regiones tropicales y subtropicales, utilizando la técnica del insecto estéril*. Programa Moscamed, México.
- Reyes, J. and Guillén, J.C.** 1982. Hospederas de la mosca del Mediterráneo *Ceratitis capitata* (Wied.) (Diptera: Tephritidae) en México. *Folia Entomológica Mexicana* 54: 19–20.
- Salas, L.A.** 1958. *Informe sobre el estudio de la mosca del Mediterráneo en Costa Rica*. Publicaciones de la Universidad de Costa Rica. Serie Agronomía No. 1. Editorial Universitaria. San José, Costa Rica.
- Secretaría de Agricultura, Ganadería, Desarrollo Rural, Pesca y Alimentación (SAGARPA).** 1999. *Norma Oficial Mexicana NOM-023-FITO-1995. Apéndice técnico para las operaciones de campo*. Campaña Nacional Contra Moscas de la Fruta. México.
- Seewooruthun, S.I., Permalloo, S., Gungah, B., Soonnoo, A.R. & Alleck, M.** 2000. Eradication of an exotic fruit fly from Mauritius, pp. 389–393. In: K.H. Tan, ed. *Area-wide Control of Fruit Flies and Other Insect Pests*. Penerbit Universiti Sains Malaysia, Penang, Malaysia.
- Van Sauers-Muller, A.** 1993. Pilot eradication project for the Carambola fruit fly in Coronie, Surinam, pp. 439–442. In: M. Aluja & P. Liedo, eds. *Fruit Flies, Biology and Management*. Springer Verlag, N.Y., USA.
- Vijaysegaran, S.** 1993. Control of fruit flies in the tropical regions of Asia, pp. 455–463. In: M. Aluja, & P. Liedo eds. *Fruit flies. Biology and Management*. Springer Verlag, N.Y., USA.

4. Bait application technique

4.1 Background

The bait application technique (BAT) is a chemical control method that includes an insecticide in a bait mixture. It is a unique type of chemical control that combines a toxicant with a bait to be more specific and attractive to the target pest. Common baits include food attractants such as hydrolysed protein and high-fructose syrups alone or in combination. The procedures used in their application minimize adverse effects on people, non-target organisms, and the environment.

Fruit fly females need a supply of proteins for sexual maturation and production of eggs, so protein-based foods are highly attractive to them. On the other hand, fruit fly adults are more susceptible to insecticides compared to other insects (e.g. Coleoptera, Lepidoptera, etc.), consequently a combination of a protein-based material plus a low toxicity insecticide creates a mixture that is more selective and effective to suppress fruit flies than conventional cover sprays based solely on insecticides.

Since the beginning of the 1950s, a mixture of organophosphate insecticides and hydrolysed proteins have been used to suppress or eradicate established populations or outbreaks of several species of tephritid flies. In the 1990s, there were major efforts to find an alternative to the above mixture due to concerns about the negative effects of malathion (the most commonly used organophosphate insecticide used in baits) on the environment. As a result, a product named GF-120, which is a mixture of the biological insecticide Spinosad (derived from the bacterial species *Saccharopolyspora spinosa*) and a food attractant called Solbait, was developed and is commercially available. Currently, both products applied as bait sprays or as bait stations are the chemical control methods most widely used against a range of fruit fly pests.

For the purpose of this guideline the BAT is defined as “the dispersion in the environment of a mixture of an insecticide and a female-biased food bait”. The BAT is also referred to as bait-sprays, bait applications, insecticide-bait application, toxic-bait application, poisoned-bait sprays, etc. The BAT shares the same attract-and-kill technical principle as bait stations and mass trapping in that its main goal is to suppress female populations.

This phytosanitary procedure is applied to all species of fruit flies of the genera *Anastrepha*, *Bactrocera*, *Ceratitis*, *Dacus*, *Rhagoletis* and *Zeugodacus* that respond to a female-biased food bait.

4.2 Types of bait sprays

Although there are several bait formulations to manage fruit fly pests, the most used worldwide are the two described below.

4.2.1 Malathion and hydrolysed protein

This bait is a mixture of an insecticide (malathion) and a hydrolysed protein (Buminal, Miller, Nulure, etc.). The insecticide in this mixture works either by contact or ingestion.

Malathion. It is an organophosphate insecticide selected over other insecticides due to its low residuality (7–10 days), allowing applications to be carried out close to harvest; also, it is preferred due to its low mammalian toxicity and relative lower price. As malathion has been used for many years in the public campaigns against mosquito vectors of diseases, it also became the most widely used insecticide applied as a bait spray in AW fruit fly management programmes. One constraint with this insecticide is its high toxicity for bees. It can also damage the paint in vehicles if it is not properly applied.

Protein. It is derived from brewer’s yeast, corn protein, cotton seed, wheat gluten and other products. It has three components: protein 10–25%; salts < 10%; and water. It has a density of 1.2–1.4 gr/mL, and a pH of 4–6. Products with a high protein content and less than 10% salts are recommended.

4.2.2 GF-120

This bait mixture is a premixed solution combining Spinosad, a biological insecticide, and Solbait, a powerful food bait attractant and feeding stimulant based on hydrolysed protein, fructose, soybean oil, ammonium acetate and surfactants. This mixture needs to be ingested by the adult to be effective.

Spinosad. It is a combination of spinosyn compounds that are purified from the fermentation produced by the soil actinomycete, *Saccharopolyspora spinosa*.

Solbait. It is based on Solulys, a spray-dried enzymatically hydrolysed protein that is produced from the industrial processing of corn for recovery of sugars and oil. Other additives including feeding stimulants, adjuvants, auxiliary attractants, and conditioners.

Since both insecticide-baits contain a specific attractant for fruit flies, large droplets of the mixture work as tiny bait stations. Consequently, it is of major importance to apply the optimum droplet size and the most uniform distribution of droplets over the treated area.

The mixtures can be applied either by air or using ground equipment. Both applications reduce fruit fly populations to a level where the rate of matings is also reduced. The reduction in wild fruit fly populations enhances the effectiveness of eradication efforts using the sterile insect technique (SIT), where a high sterile:fertile fly ratio is required.

4.3 Aerial application of bait sprays

Aerially applied BAT is generally the fastest way to suppress fruit fly populations. It is aimed at covering large areas in the shortest amount of time. In many instances, it is the only tool readily available to prevent a rapid increase of fruit fly populations.

Aerial applications are commonly used in AW fruit fly management programmes where the target pest and its hosts are scattered in large patches over large extensions of land. Also, it is used by fruit growers over extensive commercial production areas.

The aerial spray achieves a more uniform insecticide-bait coverage of the treated area, and in large-scale applications it is more cost-effective than ground sprays, bait stations or mass trapping. Although aerial BAT sprays are mostly used in combination with other control methods to eliminate fruit fly pest populations, there are recorded cases where they have been the only suppression method used to eliminate outbreaks of *C. capitata* in FF-PFAs.

Aerial insecticide-bait applications are quite different from conventional aerial spraying of insecticides because they involve spraying ultra-low-volume (ULV) insecticide formulations. This type of application allows a significant reduction in the amount of active ingredient used per unit area.

Consequently, the equipment, procedures and parameters more commonly used for conventional aerial or ground application had to be adapted for ULV bait spray application. These procedures are detailed below. For additional information, consult FAO's "Guidelines on Good Practice for Aerial Application of Pesticides" which include information and general recommendations on the conventional aerial application of insecticides, available at: www.fao.org/documents/card/es/c/aca691a8-54ae-548d-a531-08112b9b2b3b/.

4.3.1 Spraying using malathion and hydrolysed protein

4.3.1.1 Mixture

Mixture ratio. The bait is prepared by mixing Malathion 95% and a hydrolysed protein (Nulure, Miller, Buminal, etc.), in a 1:4 ratio (respectively, 20% of insecticide and 80% of protein) for ULV application. It has a density of 1.36 gr/mL.

Mixture preparation. As malathion ULV is a type of oily undiluted formulation (emulsifiers are not added), and hydrolysed protein is a water-based solution, phase separation of the mixture components easily occurs. To keep a homogeneous product, the mixture should be continuously agitated.

In addition to the agitation, the sequence in which the components are mixed is also important to help a faster combination of both products. Thus, once the protein is in the mixer tank, malathion ULV is gradually added while the agitator continuously mixes both materials for about 30 minutes. The bait spray mixture should be prepared in the early morning so that applications may start at the earliest time, this is particularly recommended in hot climates.

4.3.1.2 Application dose

Since application of this mixture is at ULV, the dose is very low. The recommended aerial dose rate is of 1.0 L/ha and applied regardless of the height or size of tree canopies or density of trees per hectare.

4.3.1.3 Droplet size and distribution

Droplets should be large; recommended size of droplets ranges from 0.7–3 mm (700–3000 μ) in diameter and a density of 300 to 400 droplets per square metre.

4.3.1.4 Coverage application method

Due to the attractiveness of the bait, the application of the malathion and hydrolysed protein mixture is carried out in alternate swaths instead of full coverage; this will not only attract females of the target pest to a droplet but will protect parasitoid populations (**Figure 4.1**). Based on this alternate swath approach, aerial bait application considers the parameters of *treated area* for the insecticide-bait and *protected area* for the pest. For example, if suppression of the target fruit fly is scheduled on 1000 hectares using alternate swaths, effective aerial application will be on 500 hectares only. Therefore, the *protected area* is 1000 hectares equivalent to the total area where fruit fly suppression was scheduled, and the *treated area* is 500 hectares.

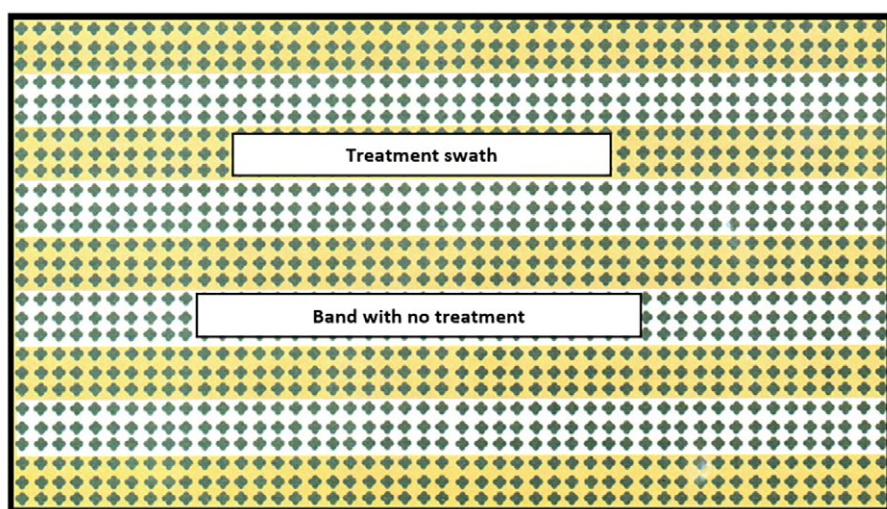

Figure 4.1. Aerial BAT treatment using a mixture of malathion and hydrolysed protein in alternating swaths (modified from the Moscafrut Programme, Mexico)

4.3.2 Spraying using GF-120

4.3.2.1 Mixture

Mixture ratio. The mixture is prepared by mixing GF-120 and water in a 1:1.5 ratio (respectively, 40% GF-120 and 60% of water).

Mixture preparation. To keep density or viscosity uniform, the mixture should be kept homogenous most of the time, therefore the mixture should be continuously agitated, otherwise the GF-120 and the water phases could separate at the time of the spraying.

Homogenization is achieved by placing initially 80% of the water and all the GF-120 in a tank. The mixture is homogenized through the tank agitators, subsequently the remaining 20% of the water is added and mixing is continued for 20 minutes. Homogenization must be maintained between and during refills of the aircrafts. If aerial applications are stopped, when they restart, the mixture should be agitated for 20 minutes, before refill. Refills must be done slowly to prevent formation of foam.

4.3.2.2 Application dose

Recommended dose rate for the GF-120 bait is of 4 L/ha.

4.3.2.3 Droplet size and distribution

Recommended size of droplets goes from 3 to 6 mm (3000–6000 μ) in diameter and a density of 60–80 droplets per square metre (**Figure 4.2**).

4.3.2.4 Coverage application method

Because GF-120 is not toxic to the beneficial fauna, aerial spraying of GF-120 is carried out at full coverage. This is a major difference with aerial applications of malathion-based baits, where the alternating swath approach is used to protect beneficial insects.

4.3.3 Aerial equipment

For aerial insecticide-bait applications, a variety of aircrafts can be used to transport and disperse insecticide-bait accurately over the target area. The proper type of aircraft to ensure effective treatment is mainly determined by the topography and size of the area to be treated and the availability of nearby airfields.

The aircraft must have a Differential GPS equipment, to allow for an accurate and rapid location of the areas and the treatment lanes, as well as the protected areas and the already treated areas.



Figure 4.2. Droplets of the GF-120 bait on foliage of coffee plants



Figure 4.3. Aerial spraying using a high-powered twin-engine airplane

4.3.3.1 Airplanes

Fixed-wing, single-engine aircrafts, such as the ones commonly used for conventional insecticide aerial spraying, are recommended for small- to medium-scale sprays (less than 80 000 ha), over flat terrain or terrain with a slight slope and with continuous host areas. Such standard airplanes may hold from 400 to 1500 L. On the other hand, for large-scale sprays (from 80 000 to 150 000 ha) over terrains with abrupt slopes, high powered fixed-wing aircrafts are recommended (**Figure 4.3**).

4.3.3.2 Helicopters

Helicopters are usually used over abrupt or difficult to access areas, or where hosts are scattered. They can also be used over flatlands if the area to be treated is small and isolated. Helicopters offer the advantage of extreme manoeuvrability, speed variation, and operability over almost any type of land since no airstrips are needed. However, helicopters are more expensive to operate than fixed-wing aircrafts. Standard helicopters can hold 240–400 L of mixture (**Figure 4.4**).

4.3.3.3 Bait delivery system

For the application of undiluted formulations, such as ULV bait sprays, all components of the sprayer delivery system should be made from materials which are compatible with such formulations. Moreover, due to the reduced liquid flow rates used in ULV spraying, a spray monitoring system and a flow metre are essential.

Tank. The tank should be made of fiberglass or another material highly resistant to corrosion. It should have a mechanism which allows emptying the contents rapidly in case of an emergency, a volumetric scale for measuring the contents, and an effective shaking system since the content requires constant stirring.

Pump and flow system. The liquid dispersal system must meet the minimum specific requirements for ULV bait spray applications, since the physical/chemical properties of bait sprays are very special and differ from those of conventional insecticides. The bait sprayed is highly corrosive and has an unusually high viscosity. As the mixture should be always kept uniform, the aircraft should have a type of agitation system to maintain a homogeneous formulation, in addition to the conventional mixture recirculation system.



Figure 4.4. Aerial spraying using a helicopter

Boom sprayer. The horizontal tubelike structure on which the nozzles are mounted, usually spans 12–16 m for small airplanes, with a diameter of 3–4 cm. Each of the ends should have a unidirectional shut-off valve. End caps on booms should be removable for easy cleaning.

The structure supports 40–44 nozzles, however, for bait sprays, most of the orifices are sealed and only 4 to 8 nozzles are used, equally spaced across the boom span. The distance between the left and right outboard nozzles should be at least $\frac{3}{4}$ of the wingspan. Trailing edge booms are desirable, and the nozzles should be placed on the boom where the pilot can easily see them to check for clogging during spray operations.

Nozzles. These are the most critical elements of bait spraying. Therefore, selection of the size, number, distribution in the boom, and angle deflection position is important.

For small, single-engine airplanes, such as Piper Pawnee and Stearman, the most common nozzles used to spray malathion and protein are the TeeJet nos. 4664 with orifices D3–D4, with 200 mesh screens.

For larger high-powered aircrafts operating at 250 km/h or faster, bigger nozzles are placed in the boom, such as the TeeJet 8001 or 8002 with wider orifices (D5–D6) and 100 mesh screens (**Table 4.1**). If using airplanes type DC-3, the nozzle can be handmade with copper tubes of 1–2 cm of diameter.

The nozzle used in this guideline to determine parameters for calibration and spraying is the solid stream #4664 TeeJet with disc type orifice D4 (less core plate), which has a built-in check valve to prevent dripping from nozzles when the pressure is shut off, and a 200-mesh screen, made of brass, manufactured by Spraying systems Co. (**Figure 4.5**).

4.3.3.4 *Ground support equipment*

Tank, pump, and agitator. Support mixer tanks should be transportable and of high capacity (from 1500 to 3000 L). The main difference between conventional mixtures and insecticide-baits is that the latter should be homogenized continuously. Therefore, the mixer tank should also have a specific pump for preparation and supply to the aircraft, with a specific agitation system to maintain the formulation mixed or a circulation system like those included in high pressure sprayers. To supply helicopters with the bait mixture, pumps from 9 to 16 HP are enough due to the low volume loads, but for fixed-wing aircraft that manage higher volumes more powerful pumps are needed, such as 16 to 21 HP pump for a faster recharge.

Table 4.1. Nozzle orifices and diameters (adapted from a catalogue of Spraying Systems Co.)

| Orifice no. | Orifice diameter | | | |
|-------------|------------------|-------|------|------|
| | Inches | cm | mm | |
| D3 | 3/64 | 0.047 | 0.12 | 1.2 |
| D4 | 4/64 | 0.063 | 0.16 | 1.6 |
| D5 | 5/64 | 0.078 | 0.20 | 2.0 |
| D6 | 6/64 | 0.094 | 0.24 | 2.4 |
| Etc. | Etc. | Etc. | Etc. | Etc. |

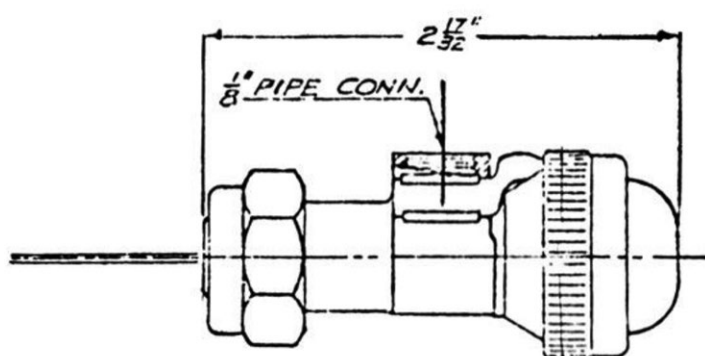

Figure 4.5. Solid stream #4664 TeeJet nozzle (Spraying Systems Co., Drawing. No. 5551)

The tanks should be large enough to avoid having to refill frequently, resistant to corrosion, and easy to fill and clean. They must be suitably shaped for handling and efficient shaking; suitable diameter openings for the pump and shaking system connections. They should have an external level gauge to show the liquid level. The main opening must have a reliable cap to avoid leakage and splashing when moving the tanks and must be wide enough to make cleaning easy. A large drainage valve must be provided at the bottom of the tanks so that they can be completely emptied.

Support tanks should have a 20-mesh screen along the circulation system to prevent alien material (leaves, trash, etc.) entering to aircraft tanks and boom. In addition, every two flights the tank and the boom need to be cleaned to prevent clogging.

Tanks made of fiberglass and polyethylene are the most suitable due to their lower cost and corrosion resistance. However, since polyethylene is affected by the ultraviolet light, tanks made of this material should be protected from sunlight when not in use.

The ground equipment and dispersal system in the aircraft should be always clean. At the end of each day, the mixing tanks, hoses, and peripheral equipment should be washed. They should not have residues of other products as fungicides, herbicides, etc. because these products can change the insecticide-bait properties.

There must be a way to handle the waste produced by the washing of the equipment. Options can be to expressly build septic tanks at the site of the reloads, or to refill the empty, used barrels. The objective is not to contaminate soil or water sources with the toxic materials contained in the dirty water or waste produced by cleaning the equipment.

Warehouses for storage and preservation of baits. Drums containing protein must not be left outside of warehouses. They should at least be placed under a covered area, and preferably over platforms, to avoid deterioration. Only those drums to be used for a day of spraying should be removed from storage.

Since protein hydrolysate is a suspension liquid, the drums containing it must be well shaken before use. It is usual for drums containing protein to present 10% of sediment after long time in storage. To avoid sedimentation, it is advisable that at least every two months the drums be lightly shaken, and their stacked position altered.

Protection equipment. Basic equipment comprises helmets, goggles, back protectors, gloves, and boots made of PVC resistant to chemicals and derivatives, masks with activated carbon filter and ear protectors.

Communication equipment. An efficient communication system should be in place to keep the pilot and ground personnel on the airstrip and in the field informed of any events occurring related to the spraying that is being carried out.

4.3.4 Calibration of aerial equipment

Accurate calibration of liquid dispersal systems on aircrafts is essential to assure proper application rate, best droplet size and an optimum droplet distribution pattern.

Flow rates and distribution patterns for highly viscous fluids like insecticide-baits should be determined experimentally because rates and patterns described by the dispersal system manufacturer are based on spraying water (roughly a density of 1 gr/mL). The initial setting can be calculated by multiplying the total flow rate determined by the manufacturer by 1.2–1.4, which is the average density of the malathion ULV-based bait mixture. If the dose calibration procedure is not available from the nozzle manufacturer, then the initial calibration should be done with water.

Calibration of each aircraft should be carefully determined at the beginning of the spraying programme and checked occasionally thereafter to assure that the discharge rate and droplet size and distribution pattern of the insecticide-bait remain constant.

Elements to consider when calibrating the liquid dispersal system of an aircraft are pump pressure, type/size, number, distribution, and deflection angle of nozzles on the boom sprayer.

Although several factors usually affect a single parameter, basically, the pressure of the pump has a direct effect on the flow rate; pump pressure and nozzle deflection angles affect droplet size; flight height and speed influence droplet distribution; flight height modifies the swath width, and drift depositions are mainly affected by flight height and wind speed.

4.3.4.1 Calibration to determine flow rate

With the aircraft on the ground, the flow rate in litres per minute (L/min) is determined. This test also helps to determine if the agitation system produces a homogeneous mixture. The following procedures must be applied:

- 1) Select and place the number and type of nozzles on the boom sprayer in the predetermined locations and deflection angle.
- 2) Load the aircraft with 75–100 L of insecticide-bait.
- 3) Select the initial pump pressure (psi or kg/cm²) from the manufacturer catalogue based on a one litre per hectare flow rate and selected nozzle.
- 4) Inform the pressure data to the pilot.
- 5) Increase the pressure a bit to correct the data from the manufacturer, that are based on water (1 gr/ml), to that of the bait density (1.3 gr/mL)

- 6) Place a plastic bag or small bucket under each nozzle to measure the delivered liquid for 10 seconds; measurement is done using a graduated cylinder.
- 7) Replicate this process 5 times to obtain an accurate average.
- 8) Finally, determine the exact aircraft speed necessary to reach a dose of one litre per hectare according to the selected pressure and flow rate obtained. Nozzle manufacturer catalogues are useful for these calculations.

The flow rate or delivery output (L/min) is calculated using the following formula:

$$FR = DRn \times Nn \times 6$$

where

FR is flow rate (L/min)

DRn is delivery rate of each nozzle (L/10 sec); it is an average of 5 replications

Nn is number of nozzles

4.3.4.2 Calibration to determine swath width, droplet size and distribution pattern

With the aircraft in the air, this test is carried out to define the swath width which in turn will serve to determine the dose (L/ha), droplet size (mm) and distribution pattern (number of droplets per square metre). The following procedures must be applied at different flight heights:

- 1) For fixed-wing aircraft a line of 50 numbered Kromekote cards (20 × 20 cm) or 30 cards for helicopters are placed at intervals of two meters, covering a perpendicular line of 100 meters at each extreme of the airstrip (**Figure 4.6**).
- 2) The flight speed and pump pressure used in this test must be the same as previously used in the flow rate calibration test on the ground.
- 3) The pilot should open the valve approximately 100 meters before reaching the first line of cards perpendicularly located at the beginning of the airstrip and close it 100 meters after passing the second line of cards near to the opposite end of the airstrip.
- 4) The Kromekote cards are checked to know the results in term of the variables being evaluated (**Figure 4.7**).

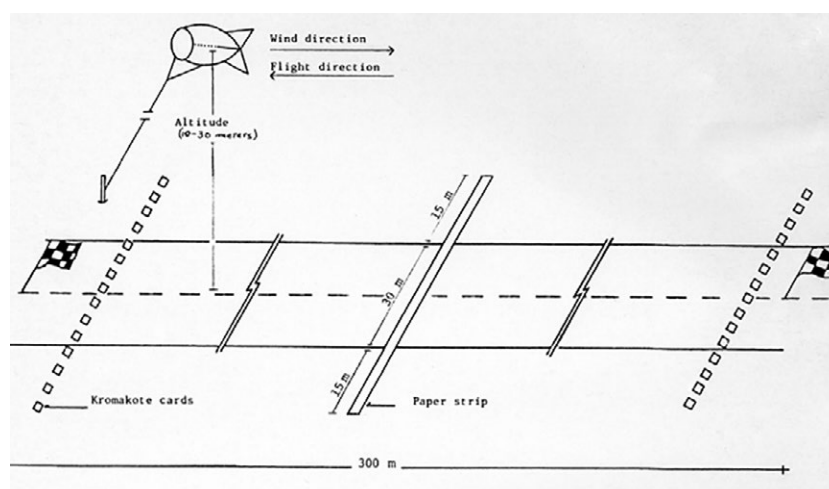

Figure 4.6. This figure illustrates the placing of the Kromekote cards at the beginning and end of the airstrip to determine the characteristics and distribution of the spray droplets as well as the coverage (swath width) of the spraying (modified from Moscamed Programme, Mexico).



© Moscaimed Programme, Guatemala

Figure 4.7. Kromekote cards (30 cm × 30 cm) showing the droplets of GF-120 after application of insecticide-bait by helicopter

- 5) Above 80% of the droplets should be within the recommended size range, either for the mixture of malathion and protein as well as for GF-120.
- 6) Measuring the swath width having acceptable size and droplet distribution serves to calculate the amount of bait applied per hectare.
- 7) If more than 5 cards, usually at both ends of the swath have many droplets of a size less than 0.5 mm, the major factors causing this should be identified to modify them and to repeat the test to verify the correction.
- 8) If many cards have no droplets (usually on one side of the card lines), it means that drift depositions are beyond the cards line, therefore a close check of the wind speed, the main factor producing drift, should be undertaken in order to stop spraying under such wind conditions. There is potential for a higher degree of drift with the smaller droplets used in ULV spraying than for GF-120 application.

After selecting the droplet size and knowing the effective swath width, the dose per hectare is recalculated following the formula below.

$$D = \frac{FR \times K}{SW \times V}$$

where

| | |
|-----------|---------------------------------|
| <i>D</i> | is dose (L/ha) |
| <i>FR</i> | is flow rate (L/min) |
| <i>SW</i> | is swath width (m) |
| <i>V</i> | is speed of the aircraft (km/h) |
| <i>K</i> | is constant (600) |

If the dosage obtained based on the swath width is not the required dose of 1L/ha, then new recalculations should be made in order to adjust the speed, using the following formula.

$$V = \frac{FR \times K}{SW \times D}$$

where

| | |
|-----------|---------------------------------|
| <i>D</i> | is dose (L/ha) |
| <i>FR</i> | is flow rate (L/min) |
| <i>SW</i> | is swath width (m) |
| <i>V</i> | is speed of the aircraft (km/h) |
| <i>K</i> | is constant (600) |

Another useful formula to calculate the flow rate per unit time based on the variables discussed above is:

$$FR = \frac{D \times SW \times V}{K}$$

where

| | |
|-----------|---------------------------------|
| <i>D</i> | is dose (L/ha) |
| <i>FR</i> | is flow rate (L/min) |
| <i>SW</i> | is swath width (m) |
| <i>V</i> | is speed of the aircraft (km/h) |
| <i>K</i> | is constant (600) |

4.3.4.2 Bait application general parameters

Application parameters are different for any combination of aircraft and bait; therefore, accurate parameters need to be obtained through calibration of the equipment to be used. Below, reference data are given that can be useful as a starting point for calibration to obtain the recommended dose of 1 L per hectare for malathion and bait and 4 L per hectare for GF-120. The data are based on the use of small, single-engine, fixed-wing aircraft over flat terrain to obtain an average swath width of 25–35 meters, which is a standard for bait aerial applications. Calibration should only be done if wind speed is below 35 km/h and temperature lower than 35 °C.

Malathion and bait

| | |
|--------------------|--|
| Flight height | 30–100 meters over the ground (usually 30–50 meters above the tree top canopy) |
| Flight speed | 100–170 km/h (usually 125 km/h) |
| Number of nozzles | 4–6 (usually 4) |
| Type of nozzles | Diaphragm TeeJet Solid Stream |
| Nozzle no | 4664 or 6135 (usually 4664) |
| Orifice of nozzles | D3–D6 (usually D4) |
| Deflection angle | 135°–180° |
| Pump pressure | 15–30 psi (1–2 kg/cm ²) |

GF-120

| | |
|---------------------|--|
| Flight height: | 30–100 meters over the ground (usually 30–50 meters above the tree top canopy) |
| Flight speed: | 100–170 km/h (usually 125 km/h) |
| Number of nozzles: | 6–8 |
| Type of nozzles: | TeeJet Solid Stream |
| Nozzle no.: | 8001 or 80015 |
| Orifice of nozzles: | D6 |
| Deflection angle: | From 135° to 180° |
| Pump pressure: | 15–30 psi (1–2 kg/cm ²) |

The GF-120 has a similar density of 1.2 gr/cc than the mixture of ULV malathion and hydrolysed protein, however, the major difference is in the application dose (4 L/ha vs 1 L/ha, respectively). Therefore, the only difference in the parameters is the bigger number or the wider diameter of the nozzles.

If aerial applications are conducted by helicopters, due to their slower working speed, getting appropriate droplet size will need that the nozzles are placed at a deflection angle of 90°.

If aerial application is conducted by high-powered fixed-wing aircrafts such as Thrush commander, Turbo Thrush, or even the PV2 or DC-3, which operates at over 250 km/h, two to four nozzles of 20 mm of diameter, placed at a deflection angle of 180° can be used. These nozzles can be handmade with copper tubes.

4.3.5 Application procedures

4.3.5.1 Area subject to treatment

Once the treatment area is planned in the office, it should be clearly identified in the field by GPS and recorded in digitalized maps using GIS software. Such information is used by the aerial applicator to aim the bait sprays at the target area; thus, treatment is more efficient and adverse effects to the environment and to humans are minimized.

4.3.5.2 Time of applications

High temperature and sunlight will cause the insecticide to break down and bait droplets to dry out after long exposure on top of the trees or on the ground. Therefore, it is highly recommended that aerial treatments be done early in the morning when temperatures and wind speed are lower. Avoiding high temperatures, particularly in arid and tropical/sub-tropical areas also helps workers and staff to be more comfortable and to properly use the protection equipment.

4.3.5.3 Application schedule

In arid, subtropical, and tropical regions, the standard interval between applications and number of applications to have a significantly reduction of fruit fly populations under normal conditions may be 7 days and 12 treatments (targeting three pest life cycles of 28 days/cycle) from the last fruit fly detection. However, as mentioned above, due to the detrimental effects of temperature, sunlight and humidity on the insecticide, the residual activity of the insecticide-bait over time and the duration of the target pest life cycle should be known under the environmental conditions in the specific area subject to treatments, so that intervals and number of applications are appropriate.

Rainfall can easily wash out the applied bait spray. Therefore, if after application there are over 12.5 mm of rainfall, the treatment must be repeated at the earliest opportunity. If rainfall is over 12.5 mm occurring one day after application, the next treatment should take place within the following 3 to 4 days. Rainfall below 12.5 mm does not reduce the effectiveness of the bait spray. It is not recommended to carry out bait sprays during the rainy season unless there is a dry period.

4.3.6 Public awareness before aerial applications

4.3.6.1 Public

Successful aerial applications carried out by AW fruit fly management programmes need the support of the local community, including the people that live in and around the area, as well as those entering the area where aerial spraying is being carried out.

The public in many countries is very sensitive to any kind of aerial activity. Therefore, the public and local authorities, who ultimately suffer the political cost of aerial sprays, should be fully informed of the pros and cons of aerial applications. AW fruit fly management programme managers need to be sensitive to the perceptions of the public towards these activities. A dedicated phone line service to respond the queries of the public may be useful.

4.3.6.2 *Beekeepers*

Since bees are highly sensitive to malathion, beehives must be covered during aerial spraying. A close collaboration and communication between the aerial sprays supervisor and beekeepers is needed so that they can protect the beehives in advance. Flags should be posted to indicate to the pilot the location of beehives, and sites identified in maps using GPS, so that the pilot can shut off the nozzles when flying over sensitive areas.

Although it has been proven that GF120 does not have an impact on bees, the above procedures may also be applied in those countries where beekeepers are concerned about GF-120 aerial applications.

4.3.7 *Evaluation*

To assess the effectiveness of BAT applications in fruit fly pest suppression, three key performance indicators are used:

- Fertile fly/trap/day (FTD-f). It is an index providing information on pest relative abundance.
- Percentage of traps with fertile captures. It provides information on pest distribution in the treated area.
- Larval infestation levels (larvae/kg and larvae/fruit sample) in preferred hosts. It is another measure of the pest relative abundance.

To determine BAT effectivity, the values of these three parameters are compared before and after BAT application. Weekly comparisons are most recommended. If aerial BAT application has been effective, the values of the above-mentioned parameters should decrease after treatments.

4.3.8 *Uses of aerial bait sprays*

Aerial sprays are usually implemented to cover large-scale production areas managed by producer associations or individual producers.

They can be preventive or reactive. They are preventive when they are applied when the pest is first detected in the marginal areas surrounding the places of production or inside the commercial production areas. They are reactive when they are applied afterwards, following an action threshold, to keep pest populations under control outside and inside the places of production before and throughout the harvesting period.

AW fruit fly management programmes apply aerial bait sprays at any stage of the eradication process. They are conducted to reduce the target fruit fly population prior to the release of sterile flies, or, conversely, as an emergency measure to quickly reduce the pest population if it is increasing and cannot be controlled by the application of other suppression methods.

Aerial BAT applications are considered the best option to eliminate fruit fly incursions into FF-PFA. When an incursion is detected, however, the first actions are quarantine, ground sprays, bait stations and fruit stripping, because the use of aerial BAT application requires special logistics that usually take several days to be implemented, including identifying airports facilities, obtaining air navigation permits, and supplying equipment such as navigation radio communication and application systems.

As outbreaks in FF-PFA trigger an emergency response aiming at eradication (see **Annex 2**), malathion-based aerial BAT treatments may be applied in full coverage instead of alternating swaths, and intervals between treatments may be reduced from the conventional 7 days to 3 days.

4.3.9 Comparative features of aerial BAT

In AW fruit fly management programmes, aerial BAT application has some advantages over other control methods.

4.3.9.1 Fast application over large extensions

The capacity of applying baits over large areas, in short periods of time, is one of the most distinctive characteristics of aerial spraying, representing a significant advantage over suppression procedures carried out on the ground. Vast areas of dense or dispersed host vegetation, either continuous or scattered, can be treated to suppress fruit fly populations in a very short time. This characteristic makes aerial BAT application the first option to eliminate extended outbreaks in FF-PFA.

4.3.9.2 Immediate control of exploding pest populations

Due to unusual abiotic factors that produce extraordinary ripening periods of fruit fly hosts or due to alternative suppression procedures that were not effectively applied, target fruit fly populations suddenly increase to levels that cannot be reduced using slow acting suppression procedures such as bait stations, mass trapping or biological control. In these situations, aerial-BAT is the most effective alternative to provide direct and immediate control of the fruit fly populations.

4.4 Ground application of bait sprays

Ground bait sprays are applied locally as a complement after aerial bait applications or sterile fly releases to eliminate remaining pest foci (hot spots), or to suppress the target pest in sensitive areas where aerial bait spray treatments have to be restricted, such as human settlements, protected natural areas or water reservoirs.

Ground sprays complemented with other fruit fly suppression procedures, such as sanitation and fruit stripping, can be applied as a replacement of aerial spraying to eliminate incipient localized outbreaks that have not yet spread.

Ground spray applications are used to control fruit flies in relatively small marginal areas or places of production. There is no fixed size area for applying ground sprays. The area that can be treated depends on the characteristics of the terrain and other factors such as the cost of manual labour and the equipment that is available to implement the activity (backpack sprayers vs high pressure motorized equipment). As a reference, areas smaller than five square kilometres (500 hectares) may be appropriate for ground spraying, especially if high pressure motorized equipment is available.

4.4.1 Spot spray method

As in aerial BAT applications, ground bait treatments differ from conventional ground insecticide applications in that full coverage of the area is not needed. The use of baits helps to suppress fruit flies by placing the insecticide only in localized spots on the canopy of host trees. Fruit fly females occurring in the area will be attracted to the spots where the bait has been deposited, thus, survival of parasitoid populations is assured.

The treated sites are called spot sprays. They are small patches of insecticide-bait applied to a limited foliage surface through a single shot of a conventional sprayer. The size and droplet distribution pattern of the spot application will vary according to the type of equipment and the spraying distance to the target surface.

Each spot spray is composed of many bait droplets; thus, each droplet works as individual bait stations. In fact, spot sprays are the predecessors of bait stations. For over fifty years, spot sprays have been the most common ground treatment to suppress fruit fly pests of the genera *Anastrepha*, *Bactrocera*, *Ceratitis* and *Dacus*.

4.4.1.1 *Spot spray features*

Defining spot spray features helps to standardize the treatment criteria and allows comparison with other combinations of insecticide-bait and equipment, regarding the amount of product used and cost.

Shot. It is the amount of insecticide-bait delivered by a sprayer on a surface with a normal single pressing (0.5 to 1.5 second). The amount is the flow rate or dose per spot.

This is the most important parameter of the spot sprays. The flow rate per shot will depend on the equipment's pump pressure and nozzle, therefore calibration of the equipment is of critical importance.

Droplet size and distribution. Ideal droplet size and density per spot should be the same as in aerial BAT applications (0.7–3 mm, and 300–400 droplets/square metre). In the spot spray method, it is not easy to produce a standard droplet size or uniform distribution of the mixture, therefore, it is especially important to avoid an excess of insecticide-bait per spot. This can cause the insecticide-bait to run off to the ground or high concentration of it can cause foliage burns.

Spot size. It is the foliage area covered by a shot. It is determined by the shot flow rate, nozzle type and distance of application. The area covered may be semi-round in shape, although most of the time it is irregular.

The size can be large enough to be equivalent to the canopy surface where the spot is being applied, but field observations have shown that several spots of smaller size are more effective than a single large spot.

4.4.1.2 *Dose based on spot sprays*

The dose applied per hectare is a standard parameter when using insecticide aerial treatments or conventional ground applications. However, when insecticide-bait is applied as spot sprays, the reference dose used is associated to the amount of bait applied per each spot spray or per tree, instead of hectares. Albeit dose per hectare, if needed, can be derived by the applied dose per spot or per tree.

Moreover, there is no standard dose per tree. The dose varies depending on the height, canopy size and leafiness of the tree. For instance, a mango tree has much more foliage volume than a coffee plant, therefore, dose per mango trees is higher (1–3 spots/tree) than in coffee plants (1 spot/plant).

The dose per hectare will depend on the amount of bait applied per spot or per tree, multiplied by the number of spots applied, or the number of trees treated per hectare. Therefore, dose per hectare is variable for ground bait sprays when compared with aerial treatments for which the dose used is a fixed amount despite spraying over similar or different density or type of vegetation.

Recommended fixed doses per hectare for ground bait sprays are based on the orchard layout. For instance, in some AW fruit fly management programmes a dose of 5 L per hectare (full coverage or alternate rows indistinctly) is recommended. For this amount, if applied in a mango orchard (80 trees/ha on average), under full coverage (all trees), each tree should receive 62.5 cc. (one spot of 62.5 cc/tree). If applied in alternate rows (40 trees/ha), the dose per tree should be of 125 cc. (two spots of 62.5 or one spot of 125 cc.).

If the recommended dose is of 10 L per hectare, the dose will be duplicated. Under full coverage each tree should receive 125 cc; and in alternate rows, the dose per tree should be of 250 cc/tree (one spot of 250 cc, two spots of 125 cc or three spots of 83 cc).

However, if the area to be treated is marginal, where trees are scattered and are not planted in a fixed array as in the commercial orchards, the density of trees per hectare will be highly variable. Therefore, it is difficult to apply here a planned fixed dose per hectare. In this situation, the plan can be based on the number of spots to be applied or trees per hectare that will be receiving a dose.

4.4.2 Ground spray using malathion and bait

4.4.2.1 Mixture

Mixture ratio. The insecticide-bait is prepared by mixing a formulation of malathion 40%–80% EC with hydrolysed protein (Buminal, Miller, Nulure, etc.) and water in a ratio of 1:4:95 (respectively 1% insecticide, 4% bait, and 95% water). The mixture has a density of 1.1 gr/mL.

Although there are several organophosphate insecticides available for ground sprays, the most used is malathion formulated as emulsified concentrate. If available, a deodorized product is highly recommended, since it does not produce pungent smells which cause annoyance to the applicators and people that are present around the spraying sites. This deodorized product must be carefully handled because its presence will be difficult to detect, and unnoticed contamination might occur.

Mixture preparation. Even though malathion is an emulsified concentrate, when combined with hydrolysed protein and water the mixture tends to separate. Care must be taken over the sequence in which the components are added. Protein hydrolysate and water must be mixed first, followed by malathion.

The bait spray mixture, as in aerial spraying, should be prepared in the early morning so that applications may start at the earliest hour; this is particularly recommended in hot climates. The bait spray should be prepared and applied on the same day.

4.4.2.2 Application dose

In general terms, the dose recommended for small trees (e.g. coffee plants, young citrus trees) is 25 to 50 cc of spray mixture (1 spot/plant); for medium height trees (e.g. commercial citrus or stone fruits) 50 to 90 cc (1–2 spots/tree), and for the tallest trees (e.g. mangos, avocados, sapote trees) 120 to 350 cc (1–3 spots/tree).

4.4.2.3 Droplet size and distribution

As in aerial BAT application, droplet size from 0.7 to 3 mm (700–3000 μ), with a density of 300 to 400 droplets per square metre, is the most recommended.

4.4.2.4 Coverage application method

In addition to the localized application of spots in a tree, ground applications are applied in spots to alternate trees or alternate rows of trees, in the same way aerial sprays are applied in alternate swaths.

4.4.3 Ground spray using GF-120

4.4.3.1 Mixture

Mixture ratio. The mixture is prepared by combining GF-120 and water in a 1:1.5 ratio (40% of GF-120 and 60% of water).

Mixture preparation. Once the 80% of water is in the tank agitation is activated, then GF-120 is gradually poured into the water. The remaining 20% of water is added at the end and the agitation is maintained for at least 30 additional minutes.

4.4.3.2 Application dose

The recommended dose is of 5 L per hectare. For calculating the dose per spot or per tree, follow the procedure detailed in section “Dose based on spot spray” in this chapter. The common rate flow used for GF-120 ground spraying is 18 to 25 cc per spot, and the range of spots per tree can be from 1 to 3.

4.4.3.3 Droplet size and distribution

As in aerial BAT application, droplet size from 3 to 6 mm (3000–6000 μ) with a density of 60 to 80 droplets per square metre is the most used.

4.4.3.4 Coverage application method

The spots are applied in full coverage (to all trees) as in conventional insecticide treatment.

4.4.4 Ground equipment

There are several types of equipment commercially available for ground sprays, however three types are the most used. Each of them has specific characteristics that complement each other to cover the different types and patterns of vegetation.

4.4.4.1 Manual backpack sprayers

Manual sprayers are best suited for small areas, not easily accessible sites, applications within isolated patches of trees, individual trees, and backyards in human settlements.

They can hold 10 to 16 L of mixture and achieve pressures of 60–90 psi (4–6 kg/cm²) which allow to have a distance coverage of up to 3 meters. Although using extension tubes longer distances can be covered (up to 5 meters), coverage is still shorter than with other types of sprayers that will be discussed later. The sprayer should hold an adjustable nozzle that allows to produce a wide range of droplet sizes and variable distribution (nozzle No. 4 is recommended).

Although the use of these sprayers is fatiguing, some advantages are their light weight (5–7 kg), low cost, and are easy to repair and maintain (**Figure 4.8**).

4.4.4.2 Motorized backpack sprayers

Motorized sprayers are better suited for larger areas than manual sprayers. Their main advantage is that they are more effective and practical in treating areas with dense and continuous host vegetation, such as coffee plantations or areas where hosts are scattered over large extensions of continuous vegetation.

They can hold from 15–25 L and reach pressures up to 150 psi (10 kg/cm²), therefore, these sprayers can cover a distance of up to 8 meters. They also have an adjustable nozzle that allows a wide range of droplet sizes and variable distribution.



Figure 4.8. Conventional manual backpack sprayer



Figure 4.9. Conventional motorized backpack sprayer

Although they spray at longer distances and the coverage of the treated area is done faster, motorized backpack sprayers have some practical disadvantages compared with the manual sprayer such as their weight (10–12 kg), their need of fuel and oil, and sometimes, they require reparation and maintenance by specialists.

If backpack sprayers are used far from a water source, a supporting tank for refilling needs to be close to the site where applications are being carried out. The tanks can be like the ones used for high pressure sprayers (**Figure 4.9**).

4.4.4.3 High pressure sprayers

High-pressure sprayers are the most suitable for easy to access, flat terrain and for places of production. Although they should be mounted on pick-ups or trucks, or pulled by tractors, they have the advantage of covering a wider area per unit time (**Figure 4.10**).

These sprayers can hold from 800 to 1000 L of mixture. Pressures from 150 up to 400 psi (10–27 kg/cm²) can be achieved, which allow delivering the bait spray to over 8 meters, reaching the medium or top canopy of tall trees.

The tank should be large enough to avoid the need for frequent refilling, resistant to corrosion, and easy to fill and clean. A large drainage valve must be located at the bottom of the tank so that it can be completely emptied. Tanks made of fiberglass are the most suitable due to their lower cost and resistance to corrosion.

The distribution system encompasses a single spray handgun with adjustable nozzle to deliver the insecticide-bait easily at different flow ratios and distribution patterns. Nozzle number 8 is recommended. Hoses from 10 to 25 m are recommended to be able to access places where the vehicle carrying the sprayer cannot enter (**Figure 4.11**).

4.4.5 Calibration of equipment

Proper calibration of ground application equipment is critical but often a neglected task. Accurate calibration of ground spraying equipment is as essential as in aerial equipment to assure a uniform dose distribution.

The pressure and type of nozzle is of major importance to obtain an accurate flow rate per shot and proper droplet size and distribution as well as an adequate spot size. Because the density/viscosity of



Figure 4.10. High pressure sprayers

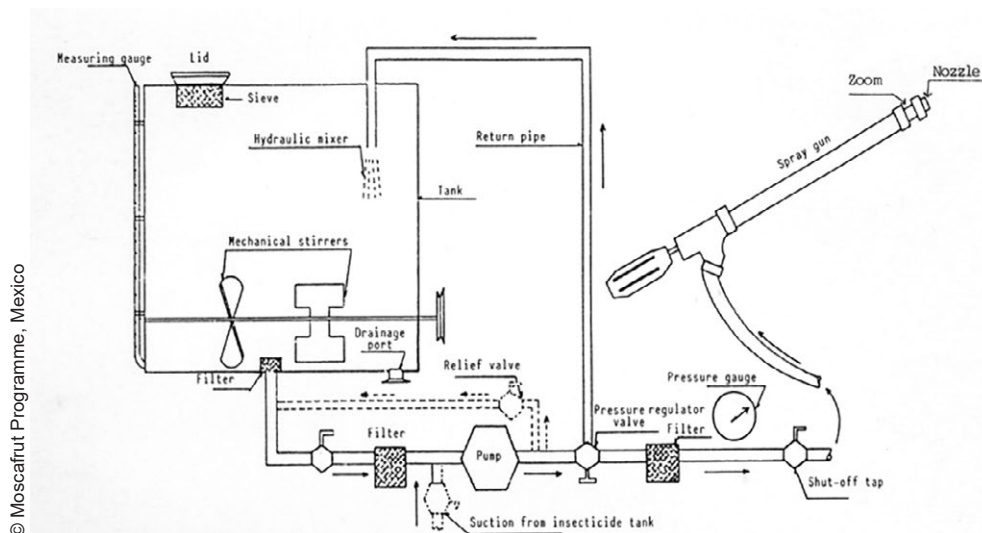

Figure 4.11. Diagram of a high-pressure sprayer showing the most important components

the bait is higher than that of water it is necessary to remove the filter (screen) and diffusor from the nozzle to allow the mixture to come out easily.

Pressure has a direct effect on the spraying distance and spot size, whereas the nozzle affects flow rate, droplet size and distribution pattern. Therefore, calibration requires adjustment of these two elements to deliver the appropriate dose at the required distance.

If the dose per tree is greater than the maximum flow rate of the sprayer, a smaller flow rate should be used, and more than one spot should be applied per tree. Therefore, it is important to know the range of flow rate and spraying distance for each type of the equipment.

4.4.5.1 Calibration procedure

The following procedures should be applied for manual and motorized sprayers:

- Use a nozzle without filter (screen) and diffusor.
- Fill the sprayer with the insecticide-bait mixture to half the tank capacity.
- Operate to reach maximum pressure.
- Play with different adjusts of the nozzle from closed to entirely open.
- Produce a shot, in each adjustment, into a plastic bag or plastic graduate beaker.
- Transfer the bait delivered in a graduated cylinder to determine the output volume.
- Select the adjustment that best fits the desired dose/shot.
- Replicate the last action 5–8 times until the desired rate flow is achieved.
- To know distance and droplet size, several shots should be fired using different pressures and nozzle adjustments close to the previously selected rate flow, until the desired distance and droplet size is achieved.
- Mark the nozzle and spray wand at the selected opening to avoid replicating the test.

Calibration is an easy task. Once the personnel doing ground spraying has carried out a few calibration exercises, they will be able to easily calibrate combinations of equipment and mixtures.

4.4.5.2 Spot spray general parameters

Application parameters are different for the various combinations of ground equipment and bait mixture. Accurate parameters need to be obtained through proper calibration of the equipment. Below

there are reference values that can be useful as a baseline to get a uniform dose for the insecticide-bait application.

4.4.5.3 Manual and motorized sprayers

The following procedures must be applied:

- Fill with bait spray mixture to half tank capacity;
- Operate to reach maximum pressure;
- Use nozzle number 4, without filter and diffuser;
- Produce a flow rate per shot between 40–60 cc;
- A distance up to 3 meters should produce a spot of ca. 30–50 cm²

4.4.5.4 High pressure sprayers

The following procedures must be applied:

- Fill with bait spray mixture to one third of capacity;
- Operate to reach pump pressure of 150–300 psi (10–20 kg/ cm²);
- Use nozzle number 8, without filter and diffuser;
- Produce a flow rate per shot between 150–300 cc.
- A distance of over 8 meters should produce a spot of ca. 0.5 to 1.5 m².

4.4.6 Application procedures

4.4.6.1 Location of the spot sprays

If backpack sprayers are used, the spots should be placed on the underside of the leaves, since this will provide to the spot a greater protection against rainfall, daily dew, and sunlight. This will enhance the persistence of spot sprays.

With high pressure sprayers it would be difficult and sometimes not possible to place the spot spray underneath the leaves. The spot should therefore be located outside, between the middle and top of the tree canopy. Spraying should always be carried out downwind to avoid drifting towards the applicator.

For applications of malathion-based bait in places of production, the spot sprays should be placed on alternate trees or alternate rows of trees (**Figure 4.12**). The second application should be done in a different row of trees or different side of the tree to avoid accumulation of bait on one side and to increase the treated surface over time. For GF-120 ground applications, the spot sprays should be carried out at full coverage (**Figure 4.13**).

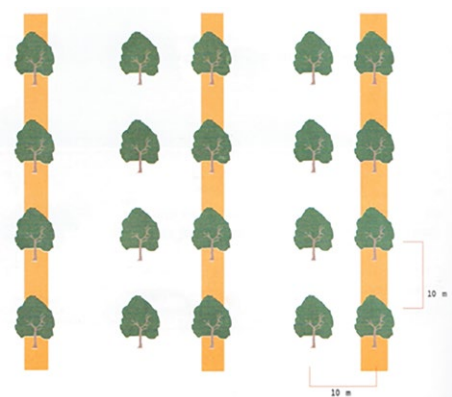

Figure 4.12. Malathion and hydrolysed protein spot spray application on alternate rows of trees (modified from the Moscafrut Programme, Mexico)

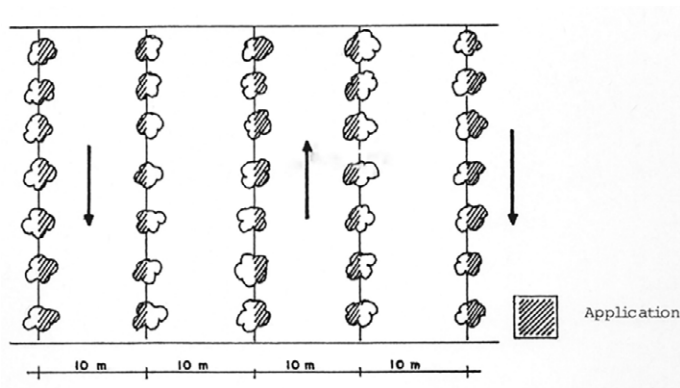

Figure 4.13. GF-120 spot spray application at full coverage (modified from the Moscafrut Programme, Mexico)

For ground applications of malathion-based bait in marginal areas of dense continuous vegetation bearing host and non-host trees, the whole target area should be delimited into small blocks of 1 km² (100 ha). The bait should be applied to all trees along imaginary lines every 50 meters of the block (2 lines/ha; 200 lines/km²).

If the vegetation is scattered, apply spot spray to alternate trees, giving preference to hosts. Quadrants can be delimited by creeks, fences, dirt roads, etc. In sites where hosts are heavily grouped in the middle of a large area with no hosts (grasslands, sugarcane plantations, etc.), apply bait spots to all trees.

Special consideration should be given to fruit flies that infest host plants that grow low (e.g. cucurbits, tomatoes, peppers, etc.). Insecticide-bait should be applied on taller plants or trees present in the surroundings of the agricultural fields that often serve as shelter and source of food to the species of fruit fly attacking these commodities. Such vegetation can occur naturally at the edge of the agricultural field or can be planted for that effect, such as corn.

4.4.6.2 Time and application schedule

For the same reasons explained in the Section “Time of applications” of the aerial bait sprays in this chapter, the ground spot sprays should be applied preferably in the early hours of the day, whereby the insecticide-bait should be applied on the eastern side of the tree canopy which receives the first sunlight of the day.

Time to initiate treatments in orchards and marginal areas, as well as number of treatments, are the same as for the aerial bait spray (see **Section ‘Application schedule’** in this chapter).

4.4.7 Public awareness before ground applications

Follow the same recommendations on public awareness as for aerial bait sprays.

4.4.8 Evaluation

Follow the same procedure as for aerial BAT applications, using the three basic parameters (a) fertile fly/trap/day (FTD-f); (b) percentage of traps with fertile captures, and/or (c) larval infestation levels (larvae/kg and larvae/fruit sample) in preferred hosts.

To determine ground BAT spray effectivity, the values of the three basic parameters are compared before and after ground application. Weekly comparisons are recommended. If ground BAT application has been effective, the values of the above-mentioned parameters should decrease after treatments.

4.4.9 Uses of ground bait sprays

In small places of production managed by individual growers, that are not part of large-scale production areas (where aerial sprays can be applied), the target fruit fly pest is usually suppressed using ground bait sprays.

In large-scale places of production, ground sprays may complement aerial BAT sprays in those hot spots where the target pest was not totally suppressed, or in sensitive areas where aerial application could not be applied. Ground bait sprays are also applied for pest suppression in abandoned or poorly managed orchards. They are also applied to specific sites in marginal areas surrounding the places of production where localized fruit fly reservoirs are present and may become sources of infestation for places of production.

Ground applications in marginal areas should be preventive rather than reactive. Applications may be initiated early in the season when the commercial commodity is blooming in the orchards and should last until the fruit in the orchards is ready for harvest.

In places of production, ground bait application is reactive. It is initiated when the target fruit fly is detected, and the fruit is still quite small, unripe, and not suitable for eggs laying. Ground bait spot sprays applications can also be preventive if applied on the trap crop that may be placed along the periphery of the orchards.

In AW fruit fly management programmes ground BAT application is implemented in those hot spots where the target pest has not totally been suppressed by other control methods, or in sensitive areas where aerial application could not be applied. Since AW fruit fly management programmes are implemented over large extended areas, it is likely that sensitive areas will be located in the intervention area, so ground bait spray application is a common and frequently used method.

When a non-native quarantine pest is detected, the first actions taken to eliminate it or contain its spread are usually quarantine and ground bait sprays. This is because, as commented above for the use of aerial BAT sprays, these require special logistics that usually last several days to be implemented. When aerial BAT sprays are implemented, ground bait sprays are restricted to sensitive areas or in hot spots inside the aerial bait spray blocks.

4.4.10 Comparative features of ground bait sprays

Ground bait sprays are suitable to suppress initial pest detections in places of production in which the size of the treatment area is not appropriate for aerial applications using fixed-wing aircraft. These areas could be treated using helicopters; however, the cost of applications could be prohibitive.

Ground BAT application is inappropriate for suppression over large extensions of either commercial hosts or continuous non-commercial hosts over large extensions of land.

In addition, ground BAT spraying yields faster pest suppression compared with other ground suppression methods such as bait stations or mass trapping.

Bibliography

- Baio F.H.R., Antuniassi, U.R., Castilho, B.R., Teodoro, P.E. & Silva, E.E.** 2019. Factors affecting aerial spray drift in the Brazilian Cerrado. *PLoS ONE* 14 (2): e0212289.
- Burns, R.E., Harris, D.L., Moreno, D.S. & Eger, J.E.** 2001. Efficacy of Spinosad bait sprays to control Mediterranean and Caribbean fruit flies (Diptera: Tephritidae) in commercial citrus in Florida. *Fla. Entomol.* 84 (4): 672–678.
- Conway, H.E. & Thomas Forrester, O.** 2011. Efficacy of ground spray application of bait sprays with Malathion or Spinosad on Mexican fruit fly (Diptera: Tephritidae) in Texas Citrus. *J. Econ. Entomol.* 104 (2): 452–458. <http://www.bioone.org/doi/full/10.1603/EC10354>.
- DGSV/CONASA/SAGAR.** 1999. *Apéndice técnico para las operaciones de campo.* Campaña Nacional Contra Moscas de la Fruta. México.
- DGSV/SENASICA/SAGARPA.** 2019. *Manual técnico para las operaciones de campo. Sección II. Control Químico.* Campaña Nacional Contra Moscas de la Fruta. México.
- FAO.** 2001. *Guidelines on Good Practice for Aerial Application of Pesticides.* Rome, Italy. 44 pp. <https://www.fao.org/documents/card/es/c/aca691a8-54ae-548d-a531-08112b9b2b3b/>
- Ekesi, S., Mohamed, S.A., Hanna, R., Lux, S.A., Gnanvossou, D. & Bokonon-Ganta, A.** 2007. Fruit fly suppression: purpose, tools and methodology, pp. D1–D15. In: S. Ekesi & M.K. Billah, eds. *A Field Guide to the Management of Economically Important Tephritid Fruit Flies in Africa.* International Centre of Insect Physiology and Ecology, Nairobi, Kenya.
- López, F., Chambers, D.L., Sánchez, M., and Kamasaki, H.** 1969. Control of the Mexican fruit fly by bait sprays concentrated at discrete locations. *J. Econ. Entomol.* 62 (6): 1255–1257. <https://doi.org/10.1093/jee/62.6.1255>.

- McPhail, M.** 1939. Protein lures for fruit flies. *J. Econ. Entomol.* 32 (6): 758–761. <https://doi.org/10.1093/jee/32.6.758>.
- Mangan, R.L., Moreno, D. & Thompson, G.** 2006. Bait dilution, spinosad concentration, and efficacy of GF-120 based fruit fly sprays. *Crop Protection* 25(2): 125–133.
- Mangan, R.L. & Moreno, D.S.** 2007. Development of bait stations for fruit fly population suppression. *J. Econ. Entomol.* 100 (2): 440-450.
- Manrakhan, A., Kotze, C., Daneel, J.H., Stephen, P.R. & Beck, R.R.** 2013. Investigating a replacement for malathion in bait sprays for fruit fly control in South African citrus orchards. *Crop Protection* 43: 45–53.
- Programa Moscamed Guatemala-Mexico-USA.** 2015. *Manual para aspersiones del cebo GF-120 y uso de estaciones cebo para el control de la mosca del Mediterráneo (Ceratitis capitata)*. Programa Moscamed. Guatemala-Mexico-USA.
- Rhode, R.H., Perdomo, A., Daxl, R. & Gutierrez, J.** 1972. Control of Mediterranean fruit flies in shade- grown coffee with ultra-low-volume aerial insecticide applications. *J. Econ. Entomol.* 65 (6): 1749–1952.
- Reyes, J., Villaseñor, A., Ortiz, G & Liedo, P.** 1986. *Manual de las operaciones de campo en una campaña de erradicación de la mosca del Mediterráneo en regiones tropicales y subtropicales, utilizando la técnica del insecto estéril*. Programa Moscamed. México.
- Roessler, Y.** 1989. Insecticidal bait and cover sprays, pp. 329–335. In: A.S. Robinson & G.H.S. Hooper, eds. *Fruit Flies: Their Biology, Natural Enemies and Control*. Vol. 3B, World Crop Pests. Elsevier, Amsterdam, The Netherlands.
- Steiner, L.F.** 1952. Fruit fly control in Hawaii with poison-bait sprays containing protein hydrolysates. *J. Econ. Entomol.* 45 (5): 838–843.
- Steiner, L.F.** 1955. *Fruit fly control with bait sprays in relation to passion fruit production*. Proceedings Hawaiian Entomological Society 15 (3): 601–608.
- Steiner, L.F., Mitchell, W.C. & Ohinata, K.** 1958. *Fruit fly control with poisoned-bait sprays in Hawaii*. U.S. Department of Agriculture, ARS-33-3.
- Steiner, L.F., Rower, G.G., Ayers, E. & Christenson, L.D.** 1961. The role of attractants in the recent Mediterranean fruit fly eradication program in Florida. *J. Econ. Entomol.* 54 (1): 30–35. <https://doi.org/10.1093/jee/54.1.30>.
- USDA/USEPA.** 1974. *Applying pesticides correctly. A guide for private and commercial applicators*.
- Utah Department of Agriculture.** *Aerial application pest control. Pesticide application and safety training study guide*. 38 pp. <https://ag.utah.gov/documents/AerialApplicationStudyGuide.pdf>.

5. Bait stations

5.1 Background

The bait stations (BS) technique is a variation derived from the spot spray method used in ground BAT sprays. As discussed earlier, to suppress fruit fly females using the BAT, many spot sprays are applied per hectare, each spot spray being a kind of bait station, consequently, ground BAT application and BS deployment share the same biological and technological principles.

In the mid 1980s, BS use became a natural replacement of ground bait sprays due to several limiting factors existing in the areas where AW fruit fly management programmes operate. For instance, insecticide-bait ground applications are severely conditioned during rainy seasons by continuous rainfall that washes out the product, reducing its effectivity and causing environmental and social concerns as it filters into the ground.

Thus, the first generation of protein-based BS was developed by eradication programmes against *C. capitata*. These BS contain a generic hydrolysate protein solution (Buminal, Nulure or Stanley PIB No. 7) as a bait mixed with malathion as a killing agent and water. Devices used to absorb such mixtures were small bags, called ‘killing bags’, made of natural fibre and filled with an absorbent material, or corn cobs, both aimed at the suppression of *C. capitata*, *A. ludens* and *A. obliqua*.

These simple killing bags and corn cobs, which are still in use, evolved into sophisticated BS which include more selective and long-lasting food lures and insecticides. They also include additional improvements such as devices to protect from the rain and in certain cases the use of biodegradable materials.

For the purpose of this guideline, BS are defined as “devices containing a combination of female-biased bait and a killing agent which does not retain the attracted insects”. This definition is important to differentiate BS from devices used in mass trapping, which retain the attracted insects so that they can be counted and recorded, if necessary.

BS are part of attract-and-kill techniques aimed at controlling female fruit flies, similar to bait sprays and mass trapping.

5.2 Components of a BS

BS have three main components: Body, attractant and killing agent. They have also a hook to hang them on the selected host tree or alternative site. There are BS that have additional components; however, a particular feature is that BS do not have a recipient or glue to retain attracted flies. The attractant and killing agent may be contained in a device or is directly applied to the surface of the body.

5.2.1 Body

The body of a BS is the recipient device containing or retaining the attractant and the killing agent. The body can be of different colours adding a visual cue, that, together with the attractant, enhances the response of fruit flies to the BS device. Dry BS are the most commonly used.

5.2.2 Attractant

The female-biased attractive bait that can be natural, synthetic, liquid, or dry.

5.2.3 Killing agent

The killing agent can be a broad-spectrum or selective insecticide, organic or synthetic. It may act by contact, ingestion, or pathogenicity, and it can be fast or slow acting.

Common killing synthetic contact agents are insecticides such as dichlorvos, malathion, fipronil and deltamethrin, among others. Spinosad is an organic biological insecticide and the entomopathogen *Bauveria bassiana* is a pathogenic insecticide.

5.3 Handmade devices

Common handmade devices include killing bags, corn cobs and sponges. These can be made by growers or by AW fruit fly management programmes, using local materials, and applied against *C. capitata* and several species of *Anastrepha*.

5.3.1 Killing bags and corncobs

Killing bags are textile devices of 8 cm × 12 cm or 10 cm × 15 cm, filled with an absorbent material such as sawdust, cotton waste, etc. (**Figure 5.1**).

Corn cobs used for BS are of a diameter of no more than 3 cm wide and 10 cm long (**Figure 5.2**). Similar biodegradable materials can be used according to local availability.

Both types of handcrafted BS are utilized during the dry and rainy seasons. When applied during the rainy season it is recommended to protect them from the rain. Killing bags are protected by a small ‘hat’ or ‘cap’ made of wax-coated cardboard or plastic placed on the top. Corn cobs can be similarly protected by a such a cap (**Figure 5.2**), or by an inverted 1-L plastic bottle open from the bottom and with four small holes opened from the middle to the upper part of the bottle.

Malathion-based BS. Killing bags or corn cobs are soaked until saturation (ca. 24 hours) in a mixture of hydrolysed protein (Buminal or Nulure), an organophosphate insecticide (Malathion 50–57% EC), and water at a ratio of 4:1:45. The lesser amount of water used compared to the ground spray mixture is to prevent leaking of the mixture when the bag is fully saturated. Rebaiting should be done once a week. After 4 weeks of deployment replace and dispose the BS in an appropriate manner considering the presence of hazardous materials, especially when synthetic insecticides are used.

GF-120-based BS. Both devices are soaked with GF-120, the organic Spinosad-based toxic bait also used in ground sprays. Corn cobs of 10 cm in length are soaked with a mixture of GF-120 and water in



Figure 5.1. Killing bag-based BS with protective cover. The bag is not yet immersed in the mixture of malathion and hydrolysed protein



Figure 5.2. Corncob-based BS baited with GF-120

a 9:1 ratio (90% GF-120 and 10% water). Usually, they absorb from 30 to 40 cc of mixture. Rebaiting should be done once a week. After 4 weeks of deployment replace the BS and dispose them in an appropriate manner.

5.4 Commercial devices

5.4.1 Wax-BS

These BS are applied against *C. capitata* and *A. ludens*. They are a rectangular box coated with paraffin (6 cm × 4 cm) with 24 holes on both sides. Inside they contain a matrix also coated with wax with a solid toxic food bait composed of Spinosad, corn syrup and granulated sugar (as feeding stimulants). In addition, the matrix contains a synthetic lure (Biolure-3C) composed of trimethylamine, ammonium acetate and putrescine. The yellow-green colour is added to the surface of the device to provide a visual cue (**Figure 5.3**).

Effective in rainy and dry seasons, these BS last for 6 - 8 weeks, after which they should be replaced. If a hat or other protective cover is used over these BS, the residual killing effect extends up to 12 weeks.

5.4.2 Magnet MED

These BS consist of a paper envelop impregnated with the contact insecticide deltamethrin. Inside the envelope, the attractants consist of two membrane dispensers of trimethylamine and ammonium acetate, lasting up to 26 weeks.

These BS have produced good results for the suppression of the *C. capitata* in the Mediterranean basin, although in humid, tropical, and subtropical climates it has not been effective (**Figure 5.4**).

5.5 Others

5.5.1 BS disseminating the entomopathogen *Beauveria bassiana*

These BS are applied against *C. capitata* during the dry and rainy seasons. The toxic effect is different from the use of insecticides. Rather than causing an immediate suppression of pest populations, these BS propagate the entomopathogen *Beauveria bassiana* by infecting adult flies that get into direct contact with the BS. Afterwards, the infected adults spread the control agent to other adults in the population through interactions during lek formation and mating.



Figure 5.3. Wax-BS



Figure 5.4. Magnet MED) (Source: T. Shelly *et al.* eds. *Trapping and the Detection, Control, and Regulation of Tephritid Fruit Flies*. Springer, Dordrechtv, The Netherlands.)



Figure 5.5. BS disseminating *Beauveria bassiana* (Source: T. Shelly *et al.* eds. *Trapping and the Detection, Control, and Regulation of Tephritid Fruit Flies*. Springer, Dordrecht, The Netherlands.)

These BS consist of a rectangular (23 cm × 14 cm) yellow galvanized panel. A basket holding a plug with 3 g of TML as attractant is inserted in a 2.5 cm hole in the centre of the panel. The panel is covered with yellow plush fabric (23 cm × 14 cm) impregnated with 2 g of *B. bassiana* conidia (**Figure 5.5**). The plush fabric of the BS is impregnated with fungal conidia every 2 weeks. Additional information on *B. bassiana* is covered in the chapter on biological control.

5.5.2 Prototypes under research

Recently, bait stations have been the subject of intense development and evaluation to improve their specificity, effectiveness, and cost-effectiveness. Consequently, there are a number of useful research articles related to the description and performance of BS prototypes that can be used in the future. Some of these prototypes and target fruit flies are listed below:

- DakoFaka for *B. olea*;
- L&K for *C. capitata*;
- Ladd trap for *R. pomonella*;
- M3 for *C. capitata*;
- MAGNET-OL for *B. olea*;
- Mitchell bait station for *A. suspensa*;
- Papaya Leaf Mimic for *C. capitata*, *B. dorsalis* and *Z. cucurbitae*.

5.6 Application procedures

5.6.1 Placement in the tree

Similarly, as for ground BAT sprays or for female-baited traps, it is recommended that BS be placed in the eastern side of the trees, which receive the sunlight in the early hours of the day. BS should be placed at middle height of the host plant canopy, depending on the size of the host plant, and inside the tree canopy to avoid exposure to direct sunlight.

5.6.2 Location within the area subject to control

Areas under treatment may involve places of production or marginal areas with scattered host trees (individual or in patches) such as rural communities, suburban and urban human settlements, and marginal areas with continuous vegetation covering large extension of land.

BS should be deployed in preferred hosts or in poor hosts if preferred hosts are absent. In areas with no hosts identified, BS should be placed in plants that can provide shelter and protection to adult fruit flies, such as trees with leafy and compact canopies.

For marginal areas with a continuous vegetation covering large extensions of land or large extensions with commercial commodities, BS are not recommended due to the high application costs. However, if localized infestations are found, small areas of 1 km² each can be delimited to deploy the BS. They are placed within these areas in proper sites and trees to maximize their suppressive effect on fruit fly populations.

5.6.3 Distribution and density

BS deployment and density follows the same technical basis as for ground BAT application; therefore, distribution and density will depend on the spatial distribution of fruit hosts.

In commercial places of production, uniform BS arrays should be used with BS placed equidistantly. Even though most of the BS tend to provide a greater protection to beneficial insects in view that the insecticide-bait is contained inside the device, BS are deployed in orchards in alternate trees or rows. For instance, in a mango orchard (80 trees/ha on average) the suggested density is 40 BS/ha. For marginal areas with scattered host trees (individual or in patches), BS follows the irregular distribution of the hosts deploying one BS in each host tree, but not exceeding a range of 15 to 25 BS/ha.

In marginal areas with continuous vegetation covering large extensions of land or large extensions with commercial commodities, BS are only deployed in sites where historical records show presence of the target fruit fly. In this case a uniform BS array should be used with BS placed equidistantly in predefined small areas of 1 km² size, as in the case of ground BAT sprays. Density will vary depending on the occurrence of major hosts, but not exceeding a range of 15 to 25 BS/ha.

BS density will also depend on the strategic aim of BS deployment. For instance, the number of BS per hectare would be different if a detection of the target fruit fly occurs in an FF-PFA or in an FF-ALPP. As a rule, BS should be placed at least 25 meters away from any trap used for population survey.

5.6.4 Number of treatments

This parameter refers to the number of rebaitings or replacements. The number of required treatments using BS depends basically on the BS longevity, which is based on the residuality of the attractants and insecticide components, as well as the duration of the fruit fly target species life cycle.

The field longevity of BS is more variable than for aerial and ground bait sprays. It is closely related to the type of BS being used, therefore the number of treatments recommended to suppress target fruit fly should be linked to the type of BS involved.

Based on longevity we can divide BS into three categories:

- short-lasting (1–2 weeks)
- medium-lasting (up to 8 weeks)
- long-lasting (up to 26 weeks)

Number of BS treatments in places of production and in marginal areas close to these places should take into consideration the phenology of the commercial commodity and of the wild hosts (blooming, small fruit, ripening fruit, etc.); therefore, treatments need to be adjusted to the time these host phenology stages last.

BS should be deployed during three biological cycles of the target fruit fly pest. Thus, for a pest that completes a life cycle in approximately 30 days, application for 12 weeks is recommended. In this case 6–12 treatments of a short-lasting BS would be necessary to cover three cycles, two treatments of a medium-lasting BS, or one treatment of a long-lasting BS.

The density of BS as well as the number of treatments required may be optimized with reliable information on fruit fly spatial and temporal distribution and host phenology in either places of production or marginal areas.

In the case of retrievable and biodegradable BS, rebaiting or replacement should be done every 2 to 4 months depending on the specific BS longevity. BS can be retrievable at the end of the harvesting season; this is a desirable practice for commercial fruit production. There are also biodegradable BS that can remain in the field, until they are degraded; these are suitable for AW fruit fly management programmes.

5.6.5 Records and mapping

In AW fruit fly management programmes, schedules of BS requiring re-baiting or replacement must be systematically managed and implemented. Records can be kept by orchards, blocks (in continuous vegetation), or by individual BS in the case of backyards in villages.

It is recommended that the location of orchards, blocks or individual BS is geo-referenced with the use of GPS equipment. A database or BS recording book needs to be maintained of all orchards, blocks, or individual BS with their corresponding coordinates. With this information a map or sketch of the BS layout and individual BS location can be prepared.

In the case of BS located in backyards within communities, references should include an address or specific allusions of the property where BS are placed. BS references should be clear enough to allow workers replacing BS to find them easily.

Another objective of maintaining detailed records is to monitor the placement of BS to prevent leaving any devices belonging to AW fruit fly management programmes in the field, even if the remaining BS are no longer useful. This policy prevents environmental contamination, but, above all, it gives the fruit fly management programme a good image.

For biodegradable BS it may also be useful to keep records of the sites where BS were deployed. Records may provide useful information about their efficacy if pest detections are recurrent (or no detection occurring at all) in the same places where BS were located.

5.7 Evaluation

Follow the same evaluation procedure as for BAT application, using the three basic parameters: a) fertile fly/trap/day (FTD-f); b) percentage of traps with fertile captures, and/or c) larval infestation levels (larvae/kg and larvae/fruit sample) in preferred hosts.

To determine BS efficacy, the values of the three basic parameters should be compared before and after BS placement; weekly comparisons are recommended. If BS application has been effective, the values of the above-mentioned parameters should decrease after treatments. A more reliable method to measure the effectiveness of BS in reducing infestations, is through fruit sampling. Detailed information on fruit sampling procedures is available in the “Fruit Sampling Guidelines for Area-Wide Fruit Fly Programmes”, available at: (<https://www.iaea.org/sites/default/files/ca5716en.pdf>).

5.7.1 Uses of bait stations

BS can complement aerial bait sprays or fully replace ground bait sprays either in places of production of commercial crops or in marginal areas under AW fruit fly management; therefore, the BS technique is used in the same way as the BAT in aerial and ground sprays. A major difference is that aerial bait treatments are used to suppress the target pest over large areas, whereas BS, as in the case of ground bait sprays, are applied in smaller areas.

In general, for places of production, BS can be used in a preventive fashion, meaning that BS should be deployed in nearby areas outside the crop or the periphery of the crop before fruit fly pests invade the crop. In AW fruit fly management programmes, however, BS are usually applied once the target fruit fly has been detected. The timing for BS deployment as well as their distribution and density will depend on the strategic use of this suppression method.

A particular case in AW fruit fly management programmes is when buffer zones or temporal pest free areas are subjected to recurrent pest invasion pressures so that an invasive seasonal pattern of the incursions is established. In these cases deployment of BS needs to follow such a pattern.

5.8 Comparative features of BS

The competitive advantages of BS compared with ground bait sprays are presented here.

5.8.1 Operational factors

5.8.1.1 Rainfall

BS are in general rain proof; thus, they remain effective in the field during continuous and heavy rains compared to ground bait sprays which are normally washed away, requiring additional treatments. In addition, when ground bait sprays are washed away, residues may go to the soil and eventually contaminate water reservoirs.

Although conventional designs of BS, such as killing bags or corn cobs may have a shortened life and reduced effectivity in the field during rainy seasons, they can be protected from the rain by providing them with protective covers and other measures.

The use of BS as a replacement of ground bait sprays is most convenient in AW fruit fly management programmes operating year-round, including the rainy seasons. For commercial orchards, however, a careful analysis needs to be done since production and harvest periods of many commercial commodities in tropical and subtropical areas occur normally during the dry season, so ground bait sprays may be effectively used.

5.8.1.2 Difficult access sites

Applying ground bait sprays in difficult to access sites (i.e. steep slopes), where applications must be done using manual or motorized backpacks weighing 5 – 10 kg, is a difficult task. In these situations, it is more convenient to carry and place BS in the target site.

5.8.1.3 Efficiency

Malathion-based ground bait sprays are relatively short-lived (usually 7–10 days) under normal climatic conditions, because the insecticide degrades through exposure to sunlight and the bait droplets desiccate. On the other hand, conventional designs of BS such as killing bags and corn cobs based on malathion or GF120 can last in the field for 1–2 weeks. Recently developed BS devices can last from 4 to over 24 weeks.

5.8.2 Environmental factors

5.8.2.1 Social factors

Ground insecticide-bait treatments can be annoying to the public if applied in communities in semi-urban or urban areas (trees in gardens, on the streets, or public parks) or even in rural communities (backyard orchards, abandoned orchards), due to the noise of the equipment used and the need for personnel in charge of ground spraying to enter into private properties. In contrast, BS are more accepted

by people living in rural and urban areas not only for being a less intrusive method, but also because the number of visits to the households is significantly reduced since BS remain active for longer time.

In certain rural and urban areas, where there are precedents of social or environmental problems, ground bait treatments cannot be applied. People living in these areas do not accept any type of bait sprays even if using GF-120, which is an organic insecticide. In these cases, the use of BS may be the only available option. Moreover, personnel deploying BS are less exposed to insecticides than when applying ground BAT sprays.

5.8.2.2 Agroecological factors

Ground applications release thousands of small insecticide-bait droplets into the environment. This does not happen in the case of BS as the insecticide-bait is contained within. Therefore, BS are a more accepted fruit fly control method in those situations where open field insecticide-bait applications are restricted or not possible, such as organic orchards or crops, protected parks, beekeeping industry, aquaculture farms, fruit packing premises, coffee processing facilities, and others.

Insecticide-baits also attract non-target organisms, therefore ground sprays in open field situations can have a greater detrimental effect on these organisms, compared with BS that are more selective and contain the insecticide within.

Bibliography

- Conway, H., Gracia, G., Rendón, P. & Vitek, C. 2020. Bait stations for control of Mexican fruit flies (*Anastrepha ludens*), first year. Chapter 8. In: D. Perez-Staples, F. Diaz-Fleischer, P. Montoya & M.T. Vera, eds. *Area-wide management of fruit fly pests*. CRC Press.
- DGSV/SENASICA/SAGARPA. 2019. *Manual técnico para las operaciones de campo*. Sección II. Control Químico. Campaña Nacional contra Moscas de la Fruta. México.
- Enkerlin, W., Rendón, P., Villaseñor, A., Valle, A., Castañeda, R. 2016. Integrating bait stations as an IPM component in area-wide fruit fly operational programmes, pp. 162–171. In: B. Sabater-Muñoz, M.T. Vera, R. Pereira & W. Orankanok, eds. *Proceedings of the 9th International Symposium on Fruit Flies of Economic Importance*.
- Epsky, N.D., Midgarden, D., Rendón, R., Villatoro, D. & Heath, R.R. 2012. Efficacy of wax matrix bait stations for Mediterranean fruit flies (Diptera: Tephritidae). *J. Econ. Entomol.* 105 (2): 471–479. doi: 10.1603/ec11147.
- FAO. 2018. *Establishment of fruit fly pest free areas*. International Standard for Phytosanitary Measures (ISPM) No. 26, International Plant Protection Convention (IPPC). FAO, Rome, Italy. <https://www.fao.org/3/k7557e/k7557e.pdf>.
- FAO/IAEA. 2007. *Development of improved attractants and their integration into fruit fly SIT management programmes*. Proceedings of a final research coordination meeting organized by the Joint FAO/IAEA Programme of Nuclear Techniques in Food and Agriculture and held in Vienna, 5-7 May 2005. IAEA-TECDOC-1574.
- FAO/IAEA. 2009. *Development of bait stations for fruit fly suppression in support of the SIT*. Report and recommendations of the consultants group meeting organized by the Joint FAO/IAEA Division of Nuclear Techniques in Food and Agriculture, Mazatlán, Mexico, 30 October – 1 November 2008. IAEA-314.D4 08CT11588.
- Flores, S., Gómez, E., Campos, S., Gálvez, F., Toledo, J., Liedo, P., Pereira, R. & Montoya, P. 2017. Evaluation of mass trapping and bait stations to control *Anastrepha* (Diptera: Tephritidae) fruit flies in mango orchards of Chiapas, Mexico. *Fla Entomol.* 100: 358–365.
- Heath, R.R., Lavallee, S.G., Schnell, E., Midgarden, D.G., and Epsky, N.D. 2009. Laboratory and field cage studies on female-targeted attract-and kill bait stations for *Anastrepha suspensa* (Diptera: Tephritidae). *Pest Manag. Sci.* 65: 672–677. <https://doi.org/10.1002>.
- Lanier, G.N. 1990. Principles of attraction-annihilation: mass trapping and other means, pp. 25–45. In: R.L. Ridgway, R.M. Silverstein, M.N. Inscoe, eds. *Behaviour-modifying Chemicals for Insect*

Management. Applications of Pheromones and other Attractants. Marcel Dekker, N. Y., USA and Basel, Switzerland.

Mangan, R. & Moreno, D. 2007. Development of bait stations for fruit fly population suppression. *J. Econ. Entomol.* 100 (2): 440–450.

Orozco, D., Enkerlin, W.R. & Reyes, J. 1994. The Moscamed Program: Practical achievements and contributions to science. Chapter 15. In: C. O. Calkins, W. Klassen & P. Liedo, eds. *Fruit flies and the sterile insect technique*. Papers from the International Congress of Entomology, held in Beijing, China, June 27 – July 4, 1992. CRC Press, Boca Raton, Florida, USA.

Piñero, J.C., Enkerlin, W. & Epsky, N. 2014. Recent developments and applications of bait stations for integrated pest management of Tephritid fruit flies, pp. 457–492. Chapter 13. In: T. Shelly, N. Epsky, E.B. Jang, J. Reyes-Flores & R. Vargas, eds. *Trapping and the Detection, Control, and Regulation of Tephritid Fruit Flies*. Springer, Dordrecht, The Netherlands. doi.org/10.1007/978-94-017-9193-9_13.

Piñero, J.C., Mau, R.F.L., McQuate, G.T. & Vargas, R.I. 2009. Novel bait stations for attract-and-kill of pestiferous fruit flies. *Entomol. Exp. Appl.* 133: 208–216. <https://doi.org/10.1111/j.1570-7458.2009.00912.x>.

Programa Moscamed/DGSV/SARH. 1980. *Informe anual de la Unidad de Apoyo Técnico*. México.

Programa Moscamed Guatemala-Mexico-USA. 2015. *Manual para aspersiones del cebo GF-120 y uso de estaciones cebo para el control de la mosca del Mediterráneo (Ceratitis capitata)*. Programa Moscamed. Guatemala-Mexico-USA.

Rahman, T. & Broughton, S. 2016. Suppressing Mediterranean fruit fly (Diptera: Tephritidae) with an attract-and-kill device in pome and stone fruit orchards in Western Australia. *Crop Protection* 80: 108–117.

6. Mass trapping

6.1 Background

At the start of the 20th century fruit fly baits were mostly male attractants used in traps not for monitoring but for control purposes. When kerosene was used in an attempt to control *C. capitata*, traps captured huge amounts of male flies, nevertheless, infestation was never reduced because females continued stinging and laying eggs in the fruit hosts.

Experiences such as the one above demonstrated that traps aimed at removing individuals from an insect pest population should mainly target females, which is the gender causing damage to the commercial commodity. Traps currently used in mass trapping are female-biased and share the same attract-and-kill technical principle to eliminate females from a fruit fly population as BAT sprays and BS deployment.

Although trapping is predominantly used for fruit fly survey purposes it may be used to suppress fruit fly populations if applied massively. Traps, like BS, are useless for controlling fruit fly populations if deployed at low densities, but if deployed in massive numbers they can suppress fruit fly populations under certain situations.

In this guideline, traps used in mass trapping (MT) are defined as “devices containing a combination of female-biased bait and a killing agent, which retain the attracted insects, so they can be counted, if necessary”.

Although MT is remarkably similar to the BS technique, it is important to differentiate between traps, which retain the attracted insects, and BS which do not retain the attracted insects. Traps used for mass trapping of adult flies are included in a group of fruit fly control methods called attract-and-kill.

6.2 Components of a trap

The effective use of traps relies on the combined ability of their three components to attract and retain target pest, these are: Body, attractant, and killing agent. Additionally, they have a hook to place them on the selected host tree or appropriate site.

6.2.1 Body

There are many trap designs aimed at capturing fruit flies, a particular feature, however, is that the trap body includes either a recipient or a sticker glue to retain attracted flies. This is a major difference with BS devices.

Body design changes depending on the target fruit fly and the products employed as attractant and killing agent. Yellow, red, or green colour is sometimes included in the trap design as an additional visual attractant. Because of the high trap densities required in mass trapping, the selected trap design should be of low cost and easy handling. The body design is as important as the lure and the killing agent in determining trap effectiveness.

6.2.2 Attractant

Baits are critical for trap effectivity and consequently for mass trapping efficiency. Unfortunately, the most powerful lures for fruit fly attract only males and their capacity to extract females from the field population is virtually null.

Female-biased protein attractants are available (natural, synthetic in liquid and dry formulations), and although they capture both genders, male captures are significantly lower. Moreover, synthetic attractants capture fewer non-target insects.

6.2.3 Killing agent

Killing agents work through physical action as sticky materials or liquids, or through toxic action as insecticides like dichlorvos, malathion, fipronil and deltamethrin. Depending on the killing agent, traps can be defined as wet if an aqueous solution is the means used to retain the flies or dry if sticky material or a dry insecticide is utilized.

Wet traps, including food-based liquid baits, are efficient when used for survey purposes. However, when placed in high numbers for mass trapping, handling becomes a critical handicap, particularly during rebaiting. Hence, the best traps for mass trapping are those that include dry materials as attractants because these require less handling.

The attractant and killing agent may be contained within the trap, or directly applied to an appropriate surface of the body of the trap. Traps that include a sticky material become less effective at high population levels because their retention capacity decreases as they become overloaded with captured flies; therefore, although wet traps are widely used the selection of dry non-sticky traps is recommended for purposes of mass trapping.

Moreover, to overcome the problem of the sticky materials, the addition of insecticides in traps is suggested. To avoid unintentional contamination of personnel handling traps, the most recommended insecticides are those that come in dry presentation.

6.2.4 Devices commonly used

Traps used for fruit fly surveys, although generally more efficient, cannot always be used in MT trapping because of their cost or more complex handling. The number of traps managed in trapping surveys are much lower than the numbers used in mass trapping; therefore, traps used for survey purposes can be more expensive.

In addition, specimens captured in survey traps should not deteriorate to allow easy counting and identification, whereas counting and identifying pest individuals captured in mass trapping is not necessary and in most of the times is not carried out.

Moreover, trap components for trapping surveys should be standardized, otherwise, results cannot be compared. Meanwhile, in mass trapping standardization of trap components is not necessary because results are measured in terms of population suppression rather than determining pest presence, abundance, or distribution.

Traps for surveys can be costly but there is a positive technical trade-off. Traps for mass trapping, however, should be low cost. If carrying out mass trapping using traps aimed at surveys, useful information can be found in the FAO/IAEA “Trapping guidelines for area-wide fruit fly programmes”, available at: <https://www.iaea.org/sites/default/files/trapping-guideline.pdf>.

Less expensive or easier to handle traps aimed at mass trapping and that are usually not employed in official surveys are described below.

6.3 Handmade devices

Even though dry non-sticky traps are recommended for purposes of mass trapping, most of the handmade devices used for mass trapping by commercial producers or by fruit fly management programmes are wet devices prepared with recycled plastic bottles of commercial beverages which are easily available in most of the human settlements.

6.3.1 Plastic bottle

Diverse sizes of plastic bottles filled with different insecticide-baits are used as handmade traps to capture *C. capitata* and several species of *Anastrepha* (Figure 6.1). Insecticide-baits included in these for mass trapping devices can be the mixture of Malathion and hydrolysed protein or GF-120.

Malathion and hydrolysate protein. Use a 600-cc plastic bottle, vertically hung, with 2 or 3 square (4.5 cm × 4.5 cm) or rectangular (5 cm × 4 cm) openings in the middle to the top part of the bottle. The bottle is stuffed with a natural fibre material such as cotton waste and then filled with 120 mL of a mixture composed of 60 cc of hydrolysed protein, 6 cc of malathion, 42 cc of water, and 12 cc of propylene glycol (to reduce evaporation). Rebaiting or replacement of the mixture is done every week.

GF-120. The same-sized bottle is first filled with 150 cc of pure GF-120. During each weekly rebaiting, 50 cc of GF-120 are added until completing a volume of 250 cc in the third rebait. Rebaiting is done every week and replacement of the whole mixture every 4 weeks.

6.4 Commercial devices

6.4.1 MS2

Plastic bottle-shaped trap with yellow bottom and holes in the upper part, filled with the attractant Ceratrap (liquid protein bait) used to control *A. ludens* and *A. obliqua* (Figure 6.2).

6.4.2 Ceratrap

Plastic cylinder trap with yellow bottom, filled with the attractant Ceratrap (liquid protein bait) used to control *C. capitata* (Figure 6.3).

6.4.3 Maxitrap

Bucket-shaped trap with invaginated yellow bottom and holes in the upper part, filled with the attractants: ammonium acetate, trimethylamine, and alkene diamine used to control *C. capitata* (Figure 6.4).



© Moscamed Programme, Guatemala



© Moscamed Programme, Guatemala



© Moscamed Programme, Guatemala

Figure 6.1. Plastic bottles with insecticide-bait used for fruit fly mass trapping

Figure 6.2. MS2 trap used in mass trapping of fruit flies (Source: T. Shelly *et al.* eds. *Trapping and the Detection, Control, and Regulation of Tephritid Fruit Flies*. Springer, Dordrecht, The Netherlands.)

Figure 6.3. Ceratrap, used in fruit fly mass trapping (Source: T. Shelly *et al.* eds. *Trapping and the Detection, Control, and Regulation of Tephritid Fruit Flies*. Springer, Dordrecht, The Netherlands.)



Figure 6.4. Maxitrap, used for fruit fly mass trapping

(Source: T. Shelly *et al.* eds. *Trapping and the Detection, Control, and Regulation of Tephritid Fruit Flies*. Springer, Dordrecht, The Netherlands)

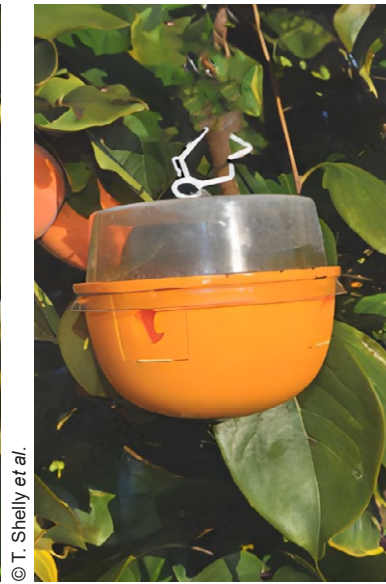

Figure 6.5. Decis trap used in fruit fly mass trapping



Figure 6.6. Moskisan trap used in fruit fly mass trapping

6.4.4 Decis trap

Rounded bucket-shape trap with yellow bottom and holes in the upper part filled with the attractants: ammonium acetate, trimethylamine, and alkene diamine used to control *C. capitata* (Figure 6.5).

6.4.5 Moskisan

Rounded bucket-shape trap with yellow bottom and lateral chimneys filled with the attractants: ammonium acetate, trimethylamine, and alkene diamine used to control *C. capitata* (Figure 6.6).

6.5 Application procedures

Mass trapping can be used in marginal areas to remove as many females as possible before they disperse into the places of production. In this case, mass trapping may be placed in the surroundings of the places of production, similar to the trap cropping practice. Mass trapping applied in the periphery of the orchards may be a replacement or a complement to trap crops.

Traps deployed for mass trapping by individual growers can serve as monitoring traps to determine the presence and provide rough estimates of the population fluctuations. If orchards are part of an AW fruit fly management programme which deploys specific survey traps in the orchards, care should be taken by growers to avoid having the mass trapping devices close to the survey traps.

6.5.1 Trap placement in the tree

As with the BS technique or the use of female-baited traps, it is recommended that traps be placed in the eastern side of the host trees, thus receiving the first sunlight of the day. Traps should be placed in the middle part of the host plant or tree canopy, depending on the height of the host, and inside the canopy to avoid exposure to direct sunlight. In cooler climates traps should be placed in the warmer part of the trees, while in tropical and subtropical areas traps should be placed in the shady part of the hosts.

6.5.2 Timing of deployment

In general, as in the case of bait sprays and BS, mass trapping can be used initially for pest prevention and afterwards for suppression in commercial orchards. This means that the massive deployment of traps should be early enough to prevent the invasion of the commercial orchards by fruit fly females.

6.5.3 Distribution

Massive trap deployment in the places of production, as with ground bait sprays and BS placement, should follow a uniform array, placing traps equidistantly in alternate rows. In addition to the traps deployed in the host trees, traps can also be placed in non-host trees inside the orchard premises, including warehouses, packing facility and others.

6.5.4 Density

There are many factors involved in assessing the appropriate trap density, such as type of trap, lure, killing agent, pest species, host susceptibility, market value of the host, climate, and time of blooming and harvesting. Therefore, the number of traps required to achieve a suppression level below a desired economic threshold needs to be defined for each specific area of production.

Mass trapping has been mainly used against *C. capitata* and *B. oleae* in the Mediterranean basin with questionable results in terms of cost-benefit. There are no standard criteria available to determine effective densities of traps used for mass trapping because this method has not yet been widely used.

Trap manufacturers sometimes recommend for mass trapping one trap per tree; however, suggested densities to effectively suppress fruit fly populations may vary from 50 to 400 traps/ha. This means that for an AW fruit fly management programme operating over an area of 10 000 ha, and using the lowest suggested density of traps, the total number of traps in the area would be of 500 000. Cost and handling of this amount of devices would be expensive, in addition, the logistics of managing such an operation would be very challenging.

If applied for multivoltine, polyphagous species in subtropical and tropical areas, where pest populations occur permanently due to the continuous availability of hosts, trap densities would reach unmanageable numbers per unit area.

6.5.5 Replacing/Rebating

Usually, every 1–8 weeks depending on the attractant and the insecticide lifespan.

6.6 Evaluation

Follow the same procedure as for BAT and BS evaluation, using the three basic parameters: (a) fertile fly/trap/day (FTD-f); (b) percentage of traps with fertile captures; and/or (c) larval infestation levels (larvae/kg and larvae/fruit sample) in preferred hosts. However, in mass trapping a specific monitoring trapping network should be needed, using standard traps.

To determine mass trapping effectivity, the values of the three basic parameters are compared before and after mass trapping application. Weekly comparisons are recommended. If mass trapping application has been effective, values of the above-mentioned parameters should decrease after mass trapping treatments.

Special care should be taken, however, when assessing the effectiveness of mass trapping using the performance indicators fertile fly/trap/day (FTD-f) or percentage of traps with fertile captures, because trapping devices used for mass trapping can mislead the capturing results if these traps are close to the standard traps placed to monitor the pest relative abundance and distribution.

Hence, a more reliable method to measure the effectiveness of mass trapping in reducing infestations is through fruit sampling. Detailed information on fruit sampling procedures is available in the “Fruit Sampling Guidelines for Area-Wide Fruit Fly Programmes” (<https://www.iaea.org/sites/default/files/ca5716en.pdf>).

6.6.1 Uses of mass trapping

AW fruit fly management programmes do not utilize mass trapping as a method of control because the cost of applying it to suppress pest populations in vast extensions of marginal areas, with or without continuous host presence, is prohibitively high.

As mass trapping is also very expensive for most of the commercial commodities, it may only be used under limited situations where there is an added value to the commodity. This may include production of fruits and vegetables for markets that request low insecticide residues, organic farming or high value crops sold in niche markets that pay a premium for pesticide free products.

6.7 Comparative features of mass trapping

6.7.1 Control and monitoring

Devices applied in mass trapping may be also used to determine the relative abundance and spatial distribution of fruit flies, so an additional tool for population monitoring may not be required. However, when these devices are not standardized, comparing the population suppression effect of the mass trapping traps with that of standard surveillance traps should be done very carefully, otherwise misleading results can be easily obtained. Ground BAT application and BS use require both a surveillance tool for population monitoring and one to determine their effectiveness in population suppression.

6.7.2 Cost

The main factors considered to select a trap over a BS for fruit fly control are low cost and ease of handling. Trap designs include an element to capture and retain adult flies that BS do not. This difference significantly increases the cost and handling of such device when multiplied by the number of devices deployed for mass trapping purposes. Manpower needed to deploy and service huge number of traps result in significant cost differences.

Mass trapping and in particular BS could become more cost-effective control methods with the development of less expensive devices, longer lasting specific lures and killing agent formulations.

Bibliography

- Avery, J.W., Chambers, D.L., Cunningham, R.T. & Leonhardt, B.A. 1994. Use of Ceralure and Trimedlure in Mediterranean fruit fly (Diptera: Tephritidae) mass-trapping tests. *J. Entomol. Sci.* 29 (4): 543–556.
- Balock, J.W. & Lopez, F.D. 1969. Trapping for control of the Mexican fruit fly in mango and citrus groves. *J. Econ. Entomol.* 62: 54–56.
- Broumas, T., Haniotakis, G., Liaropoulos, C., Tomazou, T. & Ragoussis, N. 2002. The efficacy of an improved form of the mass-trapping method, for the control of the olive fruit fly, *Bactrocera oleae* (Gmelin) (Dipt., Tephritidae): Pilot-scale feasibility studies. *J. Appl. Entomol.* 126 (5): 217–223.
- Cohen, H. & Yuval, B. 2000. Perimeter trapping strategy to reduce Mediterranean fruit fly (Diptera: Tephritidae) damage on different host species in Israel. *J. Econ. Entomol.* 93 (3): 721–725.

- FAO.** 2018. *Establishment of fruit fly pest free areas*. International Standard for Phytosanitary Measures (ISPM) No. 26, International Plant Protection Convention (IPPC). FAO, Rome, Italy. www.fao.org/3/k7557e/k7557e.pdf
- FAO/IAEA.** 2018. *Trapping guidelines for area-wide fruit fly programmes*, 2nd Edition. W.R. Enkerlin & J. Reyes Flores, eds. Rome, Italy. 65 pp. <https://www.iaea.org/sites/default/files/trapping-guideline.pdf>.
- Flores, S., Gómez, E., Campos, S., Gálvez, F., Toledo, J., Liedo, P., Pereira, R. & Montoya, P.** 2017. Evaluation of mass trapping and bait stations to control *Anastrepha* (Diptera: Tephritidae) fruit flies in mango orchards of Chiapas, Mexico. *Fla. Entomol.* 100 (2): 358–365.
- Heath, R.R., Epsky, N.D., Mangan, R.L., Enkerlin, W. & Hendrichs, J.** 2005. *Systems to advance and enhance exotic pest control – a case study of a global partnership in developing monitoring systems for use in SIT management of the Mediterranean fruit fly*. FAO/IAEA Area-Wide Insect Management Symposium Proceedings.
- FAO/IAEA.** 2007. *Development of improved attractants and their integration into fruit fly SIT management programmes*. Proceedings of a final Research Coordination Meeting organized by the Joint FAO/IAEA Programme of Nuclear Techniques in Food and Agriculture and held in Vienna, 5–7 May 2005. IAEA-TECDOC-1574.
- FAO/IAEA.** 2009. *Development of bait stations for fruit fly suppression in support of SIT*. Report and recommendations of the consultants group meeting organized by the Joint FAO/IAEA Division of Nuclear Techniques in Food and Agriculture, Mazatlán, Mexico, 30 October –1 November 2008. IAEA-314.D4 08CT11588, Vienna.
- Lanier, G.N.** 1990. Principles of attraction-annihilation: mass trapping and other means, pp. 25–45. In: R.L. Ridgway, R.M. Silverstein & M.N. Inscoe, eds. *Behaviour-modifying Chemicals for Insect Management. Applications of Pheromones and other Attractants*. Marcel Dekker, N.Y., USA and Basel, Switzerland.
- Leza, M.M., Juan, A., Capllonch, M. & Alemany, A.** 2008. Female-biased mass trapping vs. bait application techniques against the Mediterranean fruit fly, *Ceratitis capitata* (Diptera, Tephritidae). *J. Appl. Entomol.* 132: 753–761.
- Mediouni, B.H.J., Bachrouch, O., Allimi, E. & Dhouibi, M.H.** 2010. Field evaluation of Mediterranean fruit fly mass trapping with Tripack® as alternative to malathion bait-spraying in citrus orchards. *SJAR* 8 (2): 400–408.
- Navarro-Llopis, V. & Vacas, S.** 2014. Mass trapping for fruit fly control, pp. 513–555. Chapter 15. In: T. Shelly, N. Epsky, E.B. Jang, J. Reyes-Flores & R. Vargas, eds. *Trapping and the Detection, Control, and Regulation of Tephritid Fruit Flies*. Springer, Dordrecht, The Netherlands. doi.org/10.1007/978-94-017-9193-9_15.
- Piñero, J., Enkerlin, W. & Epsky, N.** 2014. Recent developments and applications of bait stations for integrated pest management of Tephritid fruit flies, pp. 457–492. Chapter 13. In: T. Shelly, N. Epsky, E.B. Jang, J. Reyes-Flores & R. Vargas, eds. *Trapping and the Detection, Control, and Regulation of Tephritid Fruit Flies*. Springer, Dordrecht, The Netherlands. doi.org/10.1007/978-94-017-9193-9_13
- Severin, H.H.P. & Severin, H.C.** 1913. A historical account on the use of kerosene to trap the Mediterranean fruit fly (*Ceratitis capitata* Wied.). *J. Econ. Entomol.* 6 (4): 347–351.
- Wolf, W.W., Kishaba, A.N. & Toba, H.H.** 1971. Proposed method for determining density of traps required to reduce an insect population. *J. Econ. Entomol.* 64 (4): 872–877. <https://doi.org/10.1093/jee/64.4.872>.

7. Male annihilation technique

7.1 Background

The possibility of controlling fruit fly populations using male lures, particularly methyl eugenol (ME), was recognized since the beginning of the 20th century. However, it was not until the mid-1950s that this powerful male lure was successfully applied over large areas to eradicate the *B. dorsalis*, by attracting and eliminating the males of the target population. The approach was named as “male-annihilation”, currently known as the male annihilation technique (MAT).

Since then, the MAT has been used with varying degrees of success to eradicate populations of some *Bactrocera* species in insular or continental countries. In all cases, eradication was attempted or achieved through repeated AW high-density deployment, aerially and/or ground, of devices impregnated with ME and an insecticide. Lately, the MAT has been more frequently applied for eradication of *B. dorsalis* outbreaks, in combination with other suppression methods such as foliar bait sprays, fruit removal, and quarantine actions.

The MAT is another suppression method classified as chemical control and identified as part of the group of attract-and-kill methods such as the BAT, the use of BS, and mass trapping.

7.2 Target fruit flies for MAT application

The MAT can be applied against all species of fruit flies of the genera *Bactrocera*, *Dacus*, and *Zeugodacus* that respond to male attractants such as ME or cue-lure (CL)/raspberry ketone (RK). These fruit flies may comprise about 18 species of the Dacine that respond to ME and 86 responding to CL/RK.

For those species of *Bactrocera* for which males have a strong response to ME, the MAT has been extensively proven as an effective stand-alone tool to eradicate outbreaks. This includes *B. caramboleae*, *B. dorsalis*, *B. philippinensis*, *B. tryoni*, and *B. xanthodes*.

The response of *Dacus* and *Zeugodacus* males to CL is weaker, so that more time and effort is required to achieve outbreak eradication. In this case, pest eradication definitively requires a combined application with other suppression methods. Currently *Z. cucurbitae* is the only species attracted to CL to which the MAT has been successfully applied for eradication.

7.3 MAT application against *B. dorsalis*

The MAT is a specific technique for AW fruit fly management of *Bactrocera*, *Dacus* and *Zeugodacus* fruit fly species. It involves the deployment in the target area of large numbers of small fibre blocks or circular plastic dispensers (discs) that work as bait stations impregnated with the male lure (ME or CL) together with a killing agent or applied as a gel in different surfaces of structures such as poles and fences.

The MAT is extremely effective because ME is such a strong attractant that works as a sex pheromone; therefore, most sexually mature males are attracted to it. This attractiveness can be effective over long distances. Once the mature males come into contact with the bait and ingest the mixture of attractant and insecticide, they die almost immediately.

There is a great variation in MAT applications in both the materials and procedures used in the different AW fruit fly management programmes. Variations are due to the objective of the management procedures, the materials used as bait dispensers, the processes of deployment, and most importantly the density at which MAT baits are distributed in the area under treatment.

The most common materials and procedures used for MAT application to eradicate *B. dorsalis* outbreaks are described below.

7.4 Components of MAT devices

Devices have three main components: Carrier, attractant and killing agent.

- **Carrier.** Absorbent fibre blocks made of fibre board, coconut husk, cotton string or wicks, moulded paper pulp, as well as plastic circular dispensers (discs). Blocks and discs may be procured from a supplier in a pre-manufactured form. There are also slow-release dispensers such as the plastic discs.
- **Attractant.** Methyl eugenol or cue-lure/raspberry ketone.
- **Killing agent.** Insecticides such as naled, malathion or fipronil.

7.5 Application of MAT

7.5.1 Preparation of fibre blocks devices

Soft fibre square blocks (5 cm × 5 cm) 1.3 cm thick, are soaked in a mixture of ME and malathion 50% EC at a ratio 3:1 for a minimum of 24 hours.

7.5.2 Application density

MAT devices are deployed at an average density of 100–200 per km². The density will very much depend on the abundance of the vegetation, level of pest population, weather, type of application, etc. Most important is the species, for instance, first uses against *B. dorsalis* were carried out at 12–40 per km², whereas for *B. carambolae* in Surinam the suppression programme applied 400–2000 per km². For outbreak elimination in California 230 gel-like stains per km² applied to utility poles and trunks of street trees is recommended for members of the *B. dorsalis* complex and other species, such as *B. correcta*.

7.5.3 Coverage

MAT devices must be distributed widely to cover as much area as possible to ensure that essentially all fruit fly males are exposed to the ME bait. A uniform coverage produces such a reduction of mature males that females have difficulties finding sexual mates and thus are unable to produce fertile eggs. Consequently, the aerial and/or ground deployment of MAT blocks must be over the entire area under treatment.

An AW large-scale application is essential to reduce possibilities of mature males immigrating from neighbouring areas into the target area, because a single male can fertilize several females and maintain a population.

7.6 Application procedures

The MAT may be implemented in large-scale fruit crop production areas managed by individual or groups of growers and homeowners. *B. dorsalis* and *Z. cucurbitae* can be suppressed by MAT combined with other fruit fly suppression techniques such as field sanitation and ground bait sprays until a level below an economic threshold is reached.

MAT use under an AW fruit fly management programme needs to be continuously applied until the target pest is declared eradicated. For *B. tryoni* a CL-attracted species, the MAT is applied to reduce the density of the target pest population prior to the release of sterile flies.

When an outbreak of a non-native quarantine pest is detected, the first action is to apply the MAT together with quarantine actions. The eradication process using the MAT may include other suppression procedures such as sanitation, fruit stripping, BAT sprays and quarantine actions.

7.6.1 Deployment procedure

One option is airdropping the impregnated devices using airplanes in urban areas and helicopters in mountainous regions. Releases of the MAT blocks by airplanes are carried out at 230 to 350 meters above the terrain in lines 150 to 330 meters apart, depending on the fruit fly species to be controlled. Application of MAT baits can also be conducted by ground in urban areas where MAT blocks are either hung on fruit trees and non-fruit plants, or nailed to telephone and light poles, fences, and other inanimate objects. Deployment should be on sites that are out of the reach of children.

7.6.2 Application schedule

Single application may cover a range of every 2–6 weeks, although the application interval, as for BAT and BS methods, will much depend on the weather. In arid areas, treatments should be more frequent, meanwhile in areas with lower temperatures MAT treatments are effective at longer periods of times.

7.7 Alternative MAT applications

7.7.1 Gel

The ground placement of a large number of MAT devices can be time consuming, particularly in non-urban areas and the field, and is not always ideal for AW eradication programmes as some MAT devices used, such as plastic disks, are not biodegradable.

Alternative options that make this technology more convenient and flexible include the application of SPLAT and Min-U-Gel treatments; both can be applied by backpack sprayers or high-pressure sprayers mounted on trucks (**Figure 7.1**).

Min-U-Gel uses gel as a carrier mixed with ME and the organophosphate insecticide naled as a sprayable formulation. It is applied to utility poles and tree trunks to eradicate outbreaks of *B. dorsalis* (**Figure 7.2**).

Min-U-Gel-naled-ME application can be replaced by SPLAT-MAT-Spinosad-ME, which is more convenient because Spinosad, an organic insecticide, is safer to handle than naled (**Figure 7.3**).



Figure 7.1. Application of MAT product using a high-pressure sprayer mounted on a truck

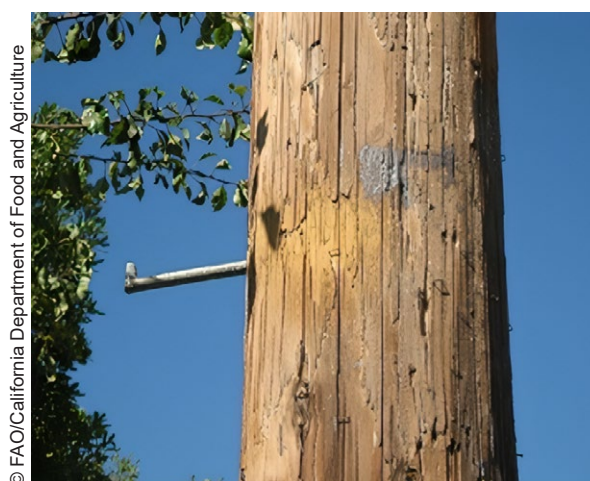

Figure 7.2. Gel application on pole



© R. Cardoso

Figure 7.3. SPLAT spot on a tree trunk with *B. dorsalis* adults feeding on it

7.8 Evaluation

Follow the same procedure as for BAT evaluation, using the three basic parameters: (a) fertile males/trap/day; (b) percentage of traps with fertile male captures; and/or (c) larval infestation levels (larvae/kg and larvae/fruit sample) in preferred hosts. Another indicator is the occurring percentage of inseminated females.

To determine MAT effectiveness, the values of these basic parameters are compared before and after MAT application. Weekly comparisons are recommended. If MAT application has been effective, values of the above-mentioned parameters should decrease after systematic AW treatment.

7.9 Uses of MAT

MAT has been the core technology for eradication of *B. dorsalis* outbreaks, sometimes in combination with other suppression methods such as foliar bait sprays, fruit removal, and quarantine actions.

7.10 Comparative features of MAT

7.10.1 Environment

ME is a very powerful and specific attractant, that when applied as MAT area-wide treatments, is highly effective in controlling fruit flies that respond to this attractant without affecting other insect species. Even though MAT baits include an insecticide, discrete application using fibre blocks, discs, or gels as spot applications, result in very small amounts of insecticide being released into the environment. The above-mentioned properties allow MAT to be applied in urban and rural landscapes.

7.10.2 Efficacy

A constraint of MAT application is the need to eliminate almost all males in large areas to prevent that a single mature male can fertilize several females in a short period of time. However, successful field experiences in elimination of recent introductions of non-native fruit flies attracted to ME endorse its use with minor risks in these situations.

For fruit fly species that respond to CL/RK it is not possible for MAT to achieve the same level of efficacy as with ME. Consequently, using MAT with CL/RK attractants will necessarily need the integration of other suppression techniques including the SIT.

7.11 MAT and other control methods

MAT has been successfully applied in combination with C&M practices and bait sprays to suppress native fruit flies or to eliminate recently introduced non-native quarantine species of *Bactrocera*, *Dacus*, and *Zeugodacus*.

Also, applications of MAT to reduce male populations prior to the release of sterile fruit flies has been used successfully in eradication programmes of *Z. cucurbitae*. This sequential approach is particularly effective in urban and other sensitive areas where bait sprays are difficult to apply in advance of SIT releases. In these cases, the combined sequential application of MAT and SIT reduce the use of insecticide and suppress the pest populations more effectively.

Although MAT has not been applied simultaneously with the SIT to improve *B. dorsalis* control because the released sterile males can also be attracted and killed by the toxic devices used in MAT; lately, there is ongoing research to explore the potential synergistic effect of simultaneous application of MAT and SIT.

This approach is based on the reduction of wild male population through MAT and the simultaneous release of previously lure-exposed sterile males that would be much less responsive to the MAT baits. This methodology has the potential of substantially increasing the sterile to wild overflooding male ratios, thereby significantly increasing SIT cost-effectiveness.

Bibliography

- Barclay, H.J. & Hendrichs, J.** 2014. Models for assessing the male annihilation of *Bactrocera* spp. with methyl eugenol baits. *Ann. Entomol. Soc. Am.* 107 (1): 81–96. <http://dx.doi.org/10.1603/AN13046>.
- Barclay, H.J., McInnis, D. & Hendrichs, J.** 2014. Modeling the area-wide integration of male annihilation and the simultaneous release of methyl eugenol-exposed *Bactrocera* spp. sterile males. *Ann. Entomol. Soc. Am.* 107: 97–112. <https://doi.org/10.1603/AN13010>.
- Chuang, Y.Y. & Hou, R.F.,** 2008. Effectiveness of attract-and-kill systems using methyl eugenol incorporated with neonicotinoid insecticides against the Oriental fruit fly (Diptera: Tephritidae). *J. Econ. Entomol.* 101 (2): 352–359.
- Cunningham, R.T.** 1989. Male annihilation, pp. 345–351. In: A.A. Robinson, G.H S. Hooper, eds. *Fruit Flies: Their Biology, Natural Enemies and Control*, Vol. 3B, World Crop Pests. Elsevier, Amsterdam, The Netherlands.
- Department of Agriculture, Forestry and Fisheries.** 2018. *Action Plan for the control of the Oriental fruit fly*. Pretoria, South Africa.
- FAO/IAEA.** 1999. *Thematic Plan for Fruit Fly Control Using the Sterile Insect Technique*, Thematic Planning Meeting, 15–19 November 1999, Vienna, Austria. https://www.iaea.org/sites/default/files/21/07/web_ff_thematic_plan.pdf
- Hancock, D.L., Osborn, R., Broughton, S. & Gleeson, P.** 2000. Eradication of *Bactrocera papaya* (Diptera: Tephritidae) by male annihilation and protein baiting in Queensland, Australia, pp. 381–388. In: K H. Tan, ed. *Area Wide Control of Fruit Flies and Other Insect Pests*. Penerbit Universiti Sains Malaysia, Penang, Malaysia.
- Jang E.B., Dowell, R.V. & Manoukis, N.C.** 2017. *Mark-release-recapture experiments on the effectiveness of Methyl Eugenol–Spinosad male annihilation technique against an invading population of Bactrocera dorsalis*. *Proceedings of the Hawaiian Entomological Society* 49: 37–45.
- Kakinohana, H.** 1994. The melon fly eradication program in Japan. Chapter 16. In: C.O. Calkins, W. Klassen & P. Liedo, eds. *Fruit Flies and the Sterile Insect Technique*. Papers from the International Congress of Entomology, held in Beijing, China, June 27–July 4, 1992. CRC Press. Boca Raton, Florida, USA.
- Malavasi, A., Van Sauers-Muller, A., Midgarden, D., Kellman, V., Didelot, D., Caplong, P., and Ribeiro, O.** 2000. Regional Programme for the eradication of the Carambola fruit fly in South

- America, pp. 395–399. In: K.H. Tan, ed. *Area Wide Control of Fruit Flies and Other Insect Pests*. Penerbit Universiti Sains Malaysia, Penang, Malaysia.
- Manoukis, N.C., Malavasi, A. & Pereira, R.** 2023. Técnica de aniquilação de machos, In: R.A. Zucchi, A. Malavasi, R. Adaime, D. Nava, eds. *Moscas-das-Frutas no Brasil: Conhecimento Básico e Aplicado*. 2nd ed., FEALQ, Piracicaba, SP, Brasil. pp. 429–435.
- Manoukis, N.C., Vargas, R.I., Carvalho, L., Fezza, T., Wilson, S., Collier, T. & Shelly, T.** 2019. A field test on the effectiveness of male annihilation technique against *Bactrocera dorsalis* (Diptera: Tephritidae) at varying application densities. *PLoS ONE* 14 (3): e0213337. <https://doi.org/10.1371/journal.pone.0213337>.
- Manoukis, N.C., Siderhurst, M. & Jang, E.B.** 2015. Field estimates of attraction of *Ceratitidis capitata* to trimedlure and *Bactrocera dorsalis* to methyl eugenol in varying environments. *Environ. Entomol.* 44: 695–703.
- Rahman, T. & Broughton, S.** 2016. Suppressing Mediterranean fruit fly (Diptera: Tephritidae) with an attract-and-kill device in pome and stone fruit orchards in Western Australia. *Crop Protection* 80: 108–117.
- Shelly, T., Nishimoto, J., Diaz, A., Leathers, J., War, M., Shoemaker, R., Al-Zubaidy, M. & Joseph, D.** 2010. Capture probability of released males of two *Bactrocera* species (Diptera: Tephritidae) in detection traps in California. *J. Econ. Entomol.* 103 (6): 2042–2051. <http://doi.org/10.1603/EC10153>.
- Shelly, T.** 2020. Evaluation of a Genetic Sexing Strain of the Oriental Fruit Fly as a Candidate for Simultaneous Application of Male Annihilation and Sterile Insect Techniques (Diptera:Tephritidae). *J. Econ. Entomol.* 13; 113 (4): 1913–1921. Published by Oxford University Press on behalf of Entomological Society of America. doi: 10.1093/jee/toaa099.
- Steiner, L.F. & Lee, R.K.** 1955. Large-area tests of a male annihilation method for oriental fruit fly control. *J. Econ. Entomol.* 48: 311–317.
- Steiner, L.F., Mitchell, W.C., Harris, E.J., Kozuma, T.T. & Fujimoto, M.S.** 1965. Oriental fruit fly eradication by male annihilation. *J. Econ. Entomol.* 58: 961–964.
- Steiner, L.F., Hart, W.G., Harris, E.J., Cunningham, R.T., Ohinata, K. & Kamakahi, D.C.** 1970. Eradication of the oriental fruit fly from the Mariana Islands by the methods of male annihilation and sterile insect release. *J. Econ. Entomol.* 63: 131–135.
- Vargas, R.I., Stark, J.D., Hertlein, M., Maafrá-Neto, A., Coler, R. & Piñero, J.C.** 2008. Evaluation of SPLAT with Spinosad and Methyl Eugenol or Cue-Lure for ‘Attract-and-Kill’ of oriental and melon fruit flies (Diptera: Tephritidae) in Hawaii. *J. Econ. Entomol.* 101 (3): 759–768.
- Vargas, R.I., Piñero, J.C., Mau, R.F.L., Stark, J.D., Hertlein, M., Mafra-Neto, A., Coler, R. & Getchell, A.** 2009. Attraction and mortality of oriental fruit flies to SPLAT-MAT-methyl eugenol with Spinosad. *Entomol. Exp. Appl.* 131: 286–293. <https://doi.org/10.1111/j.1570-7458.2009.00853.x>.
- Vargas R.I., Leblanc, L., Piñero, J.C. & Hoffman, K.M.** 2014. Male annihilation, past, present, and future, pp. 493–511. In: T. Shelly, N. Epsky, E.B. Jang, J. Reyes-Flores & R. Vargas, eds. *Trapping and the Detection, Control, and Regulation of Tephritid Fruit Flies*. Springer, Dordrecht, The Netherlands. doi.org/10.1007/978-94-017-9193-9_14.
- Vargas, R.I., Souder, S.K., Borges, R., Mafra-Neto, A., Mackey, B., Chou, M-Y. & Spafford, H.** 2014. Effectiveness of a sprayable male annihilation treatment with a biopesticide against fruit flies (Diptera: Tephritidae) attacking tropical fruits. *Biopestic. Int.* 10: 1–10.

8. Augmentative biological control

8.1 Background

Since the late 19th century there have been many successful cases of biological control against different insect pests. This followed the classical approach of importation and release of biocontrol agents that are specific to the pest in its region of origin. However, despite a high number of classical biological control attempts that have been implemented in the world against fruit fly species of economic importance, only incomplete control has been achieved. This is clearly insufficient in view of the high value of fruit and vegetable commodities that have a very low tolerance threshold to fruit fly damage.

Several decades ago, the biological control approach increasingly changed towards suppressing fruit flies of economic importance. The tactic involves complementing other suppression methods with the continuous release of high numbers of biological control agents over the fruit fly pest populations in an area. Thus, AW fruit fly management programmes started a gradual shift from the classic importation and release approach towards mass-rearing and programmed continued augmentative releases.

This new tactic, currently called augmentative biological control (ABC), has been applied since the 1990s by some AW fruit fly management programmes as an alternative to the BAT for suppressing pest populations prior to the use, or in conjunction with the use, of sterile insects.

The release of biological control agents by a country is regulated by its own domestic phytosanitary rules. However, importation and international movement requires complying with existing international standards such as the ISPM No. 3 “Guidelines for the Export, Shipment, Import and Release of Biological Control Agents and other Beneficial Organisms”. These standard addresses biological control agents capable of self-replication, including parasitoids and pathogens, such as fungi, bacteria, and viruses.

For the purposes of this guideline, augmentative biological control can be defined as “the technique of mass-production and release of biological agents into the environment, at regular intervals, to obtain an immediate and direct control of insect pest populations”.

Augmentative biological control can be referred also as ‘inundative biological control’.

8.2 Biocontrol agents

Although different groups of biocontrol agents have been identified and experimentally applied to suppress fruit flies, there are only two that are currently used in AW fruit fly management programmes:

- parasitoids
- entomopathogens

8.2.1 Parasitoids

Releases of parasitoids have been carried out since the 1980s in different countries to assess the effect of this method as a fruit fly control tool. Parasitoids such as *Opius concolor*, *Pachycrepoideus vindex*, *Diachasmimorpha tryoni*, and *D. longicaudata* have been tested against fruit flies of economic and quarantine importance, such as *C. capitata*, *B. olea*, *B. dorsalis*, *B. tryoni*, *A. ludens*, *A. obliqua* and *A. suspensa*.

Parasitoids that have been regularly used in augmentative releases for large-scale programmes are the opiine braconids *D. longicaudata* and *D. tryoni*. The mass-rearing has also been developed for *Fopius arisanus*, *D. kraussi*, and *Doryctobracon crawfordi*, however, the use of these parasitoids to suppress fruit flies has only been at an experimental level.

D. tryoni and *D. longicaudata* have been used in an ABC approach against *C. capitata*, *A. ludens*, *A. obliqua* and *A. suspensa*. *D. longicaudata*, is the only parasitoid that has been permanently used for over two decades in AW fruit fly management programmes to suppress *Anastrepha* spp. populations.

The long-term use of *D. longicaudata* has not been accidental. Its specific advantages, compared with other parasitoids, include greater survival and fertility, more specificity for tephritid larvae, greater adaptability to different agroecosystems, higher host search capacity, and a host density-dependent functional response. In addition, an efficient mass-rearing technology and effective emergence and release methodologies are currently available for *D. longicaudata*, making this parasitoid a reference for ABC.

8.2.2 Entomopathogens

The use of microorganisms to infect and thereby suppression fruit fly pest species has been less applied than parasitoids.

Some viruses have been recovered from naturally infested *B. olea* and *C. capitata*, but none are pathogenic enough to be considered as control agents.

Entomopathogenic nematodes are good prospects for ABC because they can be economically mass-produced and deployed in the soil to infect mature fallen larvae ready to pupate under fruit fly host plants. Nevertheless, there is no experience of the practical application of such nematodes.

Bacterial pathogens have been also found naturally associated with dead larvae and pupae of fruit flies, but their role in the cause of death is still not clear. *Bacillus thuringiensis* is a versatile entomopathogen that can be mass-produced, formulated, and applied as an ABC agent. However, as in the case of nematodes, most of the fruit fly control experiences have been in the laboratory. There are no practical applications of bacterial pathogens for fruit fly species in the field, except for a specific strain applied against *B. oleae*.

On the other hand, the fungi *Metarhizium anisopliae* and *Beauveria bassiana*, which are natural inhabitants of the soil and obligate parasites of several insect species, are two species of entomopathogens with great potential for the suppression of a number of fruit fly species. Recently, a practical application of microorganisms to control fruit flies has been developed using *B. bassiana* to suppress *C. capitata* populations in AW fruit fly management programmes. For more detailed information see the Section below entitled Biocontrol using *Beauveria bassiana*.

8.3 Biocontrol using *Diachasmimorpha longicaudata*

D. longicaudata is a solitary fruit fly endoparasitoid native to the Indo-Australian region. It attacks at least 14 fruit fly species of the genus *Bactrocera*. This parasitoid has been selected for augmentative releases because it has shown a high capacity to adapt to the different environments where it has been introduced. In many cases, after being introduced, it has reached the highest percent of natural parasitism in relation to other parasitoid species, including native ones, against which it favourably competes (**Figure 8.1**).

An ABC programme releasing this endoparasitoid is divided into two major areas of activity: (a) mass-rearing, and (b) post-production.

8.3.1 Mass-rearing

It includes all processes carried in the factory, such as the mass-rearing and sterilization of the host and the mass-rearing of the parasitoid. The mass-rearing of parasitoids is a specialized and delicate activity in which slight variations in rearing procedures can have a significant impact on the quality of the reared parasitoids. Rearing and irradiation of the host as well as parasitoid production are carried out in



© Ana Rodríguez

Figure 8.1. *D. longicaudata* ovipositing into a larva inside an orange fruit.



© Moscafruit Programme, Mexico

Figure 8.2. Different events of the mass-rearing process of *D. longicaudata* in irradiated host larvae of *A. ludens*. (a) Cages in the breeding colony, (b) Parasitoid female ovipositing; (c) Adult parasitoid rearing cage with larval cassette; and (d) Larvae that have been exposed to parasitoids, including pupating larvae.

strictly controlled environments prior to either immediate release in an area close to the mass-rearing facility or packing and shipping for release in areas far from the location of the mass-rearing facility.

D. longicaudata is mass-reared on third instar (7–8 day old) larvae of *A. ludens*. These larvae are irradiated at this stage at 45 Gy to avoid the emergence of fertile adult flies from non-parasitized pupae when releasing parasitoids in the field. The irradiated larvae together with the diet are placed in cassette-type containers (23.2 cm × 14.2 cm) covered with mesh (tricot fabric). The cassettes are then individually inserted in mesh-covered cages (30 cm × 42 cm × 47 cm) contained in an aluminium structure (**Figure 8.2a**). Within these cages, the larvae in the cassettes are exposed to female parasitoids at a rate of two larvae per female (**Figure 8.2b, c**). After 1–3 hours of exposure, the fruit fly host larvae are collected and placed inside containers with vermiculite to allow pupation (**Figure 8.2d**). Fourteen days later, the parasitized pupae are ready to be packed and transported to a parasitoid emergence and release facility (PE&RF) for field releases.

Quality control tests to evaluate the process of the mass-rearing is performed for each production lot. The main parameters are:

- Weight and volume of host larvae;
- Host mortality after exposure to the parasitoid;
- Weight and volume of parasitized pupae;
- Percentage of parasitoid emergence and viability.

In addition to an efficient mass-rearing process, what ultimately makes parasitoid ABC suitable for field application is the availability of an effective emergence and large-scale release method. Therefore, the next section is focused on the process after mass-rearing, which is the post-production processes.

8.3.2 Post-production

This activity includes various processes such as packing, shipping, handling, emergence, and release of parasitoids. It is also a specialized procedure that requires different skills. Generally, insects are handled in smaller batches with a focus on the adult stage. Adults have entirely different demands for space and

movement compared with factory-based stages and are generally held for several days compared with weeks in the production facility.

Prior to their release, parasitized pupae are packed at the mass-rearing facility, shipped to a local or foreign destination, where parasitoid adults emerge from the parasitized pupa and are left to mature in an *ad-hoc* PE&RF. Finally, the parasitoids are loaded into a delivery vehicle for ground or aerial release.

Packing. After irradiation, parasitized pupae should be properly and carefully packed in the production facility for transportation to a PE&RF. Packing procedures for short and long-distance transportations, including transboundary shipments, may vary.

Two days before parasitoid emergence, the parasitized pupae are mixed with vermiculite (size 3) in a ratio of 2:1, respectively, to prevent overheating and physical damage to the pupae, and packed in cylindrical plastic bags (70 cm × 18 cm) each with a capacity of approximately a hundred fifty thousand pupae. Once packaged inside the bags, they are placed in cardboard boxes (72.5 cm × 35 cm × 33 cm) specifically designed to preserve the packaging media and temperature. Transfer to the airport should be done in refrigerated trucks with a temperature of 15–20° C and a relative humidity of 50–60%.

Personnel should have knowledge of the factors that affect parasitoid quality, such as physical damage, temperature, humidity, and others, to manage parasitoids adequately and thus prevent mortality as much as possible. In addition, it is essential that these activities are carried out in the least possible time, to keep parasitoid emergence at the required levels.

Shipping. Air-conditioned or refrigerated vehicles are used for transport from the mass-rearing facility to the airport. To facilitate tracking of consignments, boxes should have shipment number and the complete information of the addressee.

During transportation, boxes containing parasitized pupae should not be handled roughly or be subjected to excessive stocking and compacting to prevent accumulation of metabolic heat. Parasitized pupae are sensitive to excessive vibration. An officer should complete a datasheet with the specifications and conditions of the parasitized pupae being shipped.

For long-distance shipment, pupae are typically transported by commercial airlines in a portion of the cargo where temperature and air pressure are held at ‘cabin’ levels. Airline routing should be carefully selected to minimize transit points and overall shipment time.

8.3.3 Parasitoid emergence and release facility

Upon arrival at the airport of destination, the receiver, usually personnel from the PE&RF, should carefully check the datasheets that accompanies the consignment and verify that: (a) the datasheet has been signed by the shipper, and (b) the content of the package matches the information reported on the datasheet. Air-conditioned or refrigerated vehicles are used for the transport from the airport to the PE&RF.

Once the parasitized pupae shipment has arrived at the PE&RF, they are examined for damage, and then each bag opened individually to break the hypoxia. Designated personnel also check the temperatures of the bags.

The PE&RF should include several holding and emergency rooms to provide appropriate environmental conditions to the parasitized pupae within a temperature range of 21–26°C and a relative humidity range of 65–75%. It is advisable to have an electrical generator to be able to supply electricity in case of a power failure.

Type of emergence container and release method. The specific holding media for parasitoid emergence will greatly depend on the release method, which can be by ground or air.

8.4 Ground releases

8.4.1 Holding and emergence of parasitoids

For ground releases of parasitoids, holding and emergence of parasitized pupae can be carried out in: (a) 20-L buckets (**Figure 8.3**), (b) paper bags, and (c) other plastic release containers.

8.4.2 Emergence in plastic buckets

Parasitized pupae are placed inside a standard 20-L plastic bucket (ca 40 cm deep, 32 cm diameter), with three circular openings (20 cm diameter) around the sides of the bucket, and one additional circular opening of 15 cm in the lid; all openings covered by a hard mesh (1.5 mm) to provide ventilation and access to the food (**Figure 8.4**).

Inside of the bucket, corrugated paper pieces or a grid of six alternating plastic strips measuring 24×8 cm are placed to provide additional resting surface to the emerged adults. In addition, pieces of paper impregnated with dry honey, as food, are placed in the circular windows covered by a mesh, and in the top circular opening a sponge with water is also placed (**Figure 8.4**). The supply of food and water should be maintained all along the parasitoid emergence process.

The number of parasitized pupae per bucket should be enough to yield at least 10 000 emerged adults, based on a pre-defined average parasitoid emergence. For instance, if average emergency is of 60%, plastic buckets should be filled with 17 000 pupae.

For the first four days, buckets are placed in a room at a temperature of $25 \pm 1^\circ\text{C}$ and $70 \pm 5\%$ relative humidity and the last two days they are moved to another room with a temperature of $21 \pm 1^\circ\text{C}$. In both rooms the photoperiod should be of 12 h light and 12 h dark until both males and females have emerged, which happens in approximately 6 days.

On average, the emergence is around 60% but this depends on the care taken and the environmental conditions during handling and packing. The female: male sex ratio is approximately 2:1. Parasitoids are ready to be released at day 7.

8.4.3 Emergence in paper bags

Parasitized fruit fly pupae are packed in Kraft paper bags (size no. 20) with sucrose as food, at a density of approximately 2500 pupae per bag. Bagged pupae are placed in dark rooms at about $25^\circ\text{C} \pm 2^\circ\text{C}$ and



Figure 8.3. Parasitoid emergence 20-L bucket

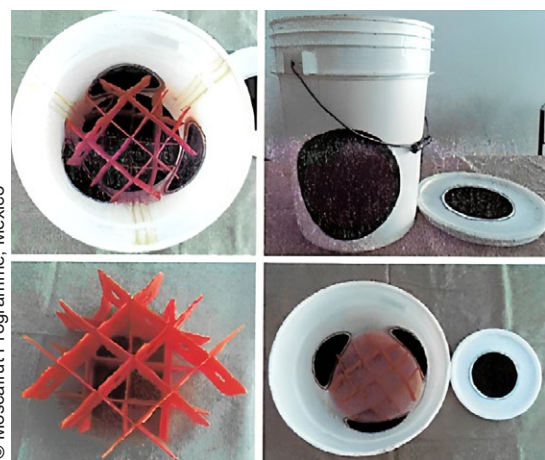

Figure 8.4. 20-L plastic bucket for parasitoid emergence with grid of plastic strips to provide additional resting surface

65 ± 5% relative humidity for 5–6 six days, until both male and female parasitoids have emerged. The average emergence is around 60% (equivalent to about 1500 parasitoids per bag), but this depends on the care taken and the environmental conditions during handling and packing. The female: male sex ratio is of approximately 2:1. Parasitoids are ready to be released at day 7.

Since the mid 1990s the paper bag method has been used in AW fruit fly management programmes to emerge and release parasitoids by air and ground in the same way as it is applied for emergence and release of sterile flies. However, the use of paper bags has been questioned because, unlike fruit flies, parasitoids have mandibles that can tear the bags and allow them to escape, causing a certain loss in the number of parasitoids to be released. To prevent such losses, a daily inspection should be carried out and rips found in paper bags should be sealed with masking tape.

Releases of parasitoids using paper bags by air or ground have demonstrated for many years that it is an effective method to suppress *A. ludens* and *A. obliqua* populations to a level low enough to allow subsequent releases of sterile flies to eliminate populations of these pests.

8.4.4 Ground release procedures

Vehicles used to transport emerged parasitoids for ground releases are usually pick-up trucks equipped with a camper with air conditioning. The temperature inside the camper should be maintained at 21° C at the moment of loading the vehicle, to prevent an increase of temperature due to the accumulation of metabolic heat that is generated inside each holding container.

Ground releases should be carried out in the early hours of the morning to provide the most suitable conditions of temperature and humidity to the parasitoid, and they should not be done after 11:00 a.m.

It is critical to define in advance the sites where the release of parasitoids will take place so that the parasitoids are not released in the same places and, thus, an adequate coverage of the area under treatment can be achieved.

8.4.5 Roving release in plastic buckets

The 20-L buckets containing the parasitoids are placed inside the release vehicle and moved to the previously selected release sites where these are opened to release the parasitoids.

An alternative practice is to take a release route using the transport vehicle around the target area and leaving the buckets uncovered along the route. If the characteristics of the area are not suited for the use of vehicles, the release should be done on foot. The goal is to cover most of the area selected for parasitoid release.

Pupae from which parasitoids have not emerge and have remained at the bottom of the bucket can be placed in an open paper bag (Kraft no. 20) that is left in the field in a protected site so that the parasitoids can emerge at a later stage.

8.4.6 Roving release in paper bags

The bags containing the parasitoids are placed inside the release vehicle and moved to the selected release sites where these should be completely ripped open to facilitate the rapid exit of the parasitoids. It is convenient that the bags are placed in the shade of a tree and out of the reach of predators, like hanging them in the lower branches. The personnel doing the releases should also be responsible for collecting the paper bags from previous releases, to avoid contamination and possible complaints from the public.

8.4.7 Ground release in plastic containers

Hanging plastic containers with parasitoids on trees has been used as a standard release method for research purposes. This approach to the release and distribution of parasitoids in the field has given effective results in suppressing *C. capitata* and *A. suspensa* populations in small areas.

To suppress *C. capitata* using *D. tryoni*, white plastic 3.8 L containers (14 cm deep, 20 cm diameter) with eight 1 cm diameter emergence holes, are hung on fruit trees. The release containers are protected from ants by coating the container wire holder with sticker glue.

Small paper bags holding ca. 4900 parasitized *C. capitata* pupae (ca. 20 gr, 245 pupae per gram, average weight of 4 mg/pupa) are placed inside the plastic containers at weekly intervals when fruits are in season. To estimate the number of parasitoids released, five 5 g samples of each batch of parasitized puparia are held to monitor parasitoid sex ratios and emergence rates.

To suppress *A. suspensa* populations using *D. longicaudata*, plastic 3.8 L containers, painted silver to reflect light are hung and maintained on trees. The containers have twenty 1.5-cm holes around its circumference. The holes are located 2 cm below the rim. Inside of the plastic containers, ca. 4500 parasitized *A. suspensa* pupae (ca. 100 mL, 45 pupae per mL, average weight of 10 mg/pupa), are placed in a variable number of plastic cups (1–6) each week. Also, to prevent ants from entering the containers, the wire holder is coated with sticky material.

8.5 Aerial releases

In AW fruit fly management programmes, the most important factor in maximizing the use of ABC is having an effective parasitoid aerial delivery system. In areas of continuous vegetation where the use of aerial bait sprays is sensitive, the large-scale dispersal of parasitoids to suppress target fly populations, prior to sterile insect aerial releases, is essential. It gives the ABC great logistic advantages over the deployment of BS, which can only be applied on a small scale.

To date, there is no method specifically developed for the aerial release of parasitoids thus, some sterile fly aerial release procedures have been tested for parasitoids aerial releases. Some of the methods are: (a) paper bags, (b) chilled adults in paper bags, and (c) chilled adults in plastic aerial release containers.

Below, it is only described the procedure of aerial releases using paper bags because there is not enough knowledge about the efficiency of the chilled adult methods and their effects on the performance of released parasitoids. In addition, several studies have shown that adults of *D. longicaudata* are highly sensitive to the chilling processes and release speeds used for sterile flies.

8.5.1 Holding and emergence of parasitoids

8.5.1.1 Emergence in paper bags

Emergence of parasitoids to be released aurally by paper bags follow the same procedures as described above for ground releases.

8.5.1.2 Aerial release in paper bags

Paper bags are placed inside the aircraft, either horizontally or vertically, trying to optimize the available space. Based on the type of aircraft, a range of 400–500 bags can be transported. Aerial releases should preferably be carried out by helicopter to have higher precision in the releases. If this is not possible, airplanes should fly at a height between 50–70 m over ground and at a speed of 100–125 km/h (lower flight speed than the used to the sterile fly releases), to reduce drift and damage to the parasitoids. At this speed the spacing of the bags will be of 70–90 m from each other.

It is convenient that paper bags are slightly ripped on the topside as they exit the aircraft. If the bag is completely ripped, there is a risk of parasitoid damage as they fall onto the ground.

8.6 Application procedures

When the distribution of fruit fly host trees is uniform and covers vast areas, parasitoid releases must be carried out by air using helicopters or airplanes. Otherwise, if the host trees have a discrete distribution as in isolated backyard orchards, abandoned groves, villages, or even bigger human settlements, parasitoids are released using ground release systems.

8.6.1 Area subject to treatment

Once the treatment area is selected in cartographic maps, a recognition in the field should be conducted using GPS and recorded in digitalized maps using GIS. This information is used by the pilot to make the release of the parasitoids over the target area more accurate.

8.6.2 Time of ABC application

ABC is implemented by AW fruit fly management programmes all year round in tropical or subtropical regions, targeting specific areas for population suppression. However, when ABC is used to suppress the target fruit fly populations in marginal areas, it is applied focusing intensively on the fruit maturation phenology of the wild hosts to prevent the introduction of the pest into the places of production.

8.6.3 Release and densities

Release densities are determined based on the agroecological complexity of the target area. They follow the principle that efficiency of the biological agent is ruled by the relationship between the number of parasitoids released and the complexity of the agroecosystem occupied by the fruit hosts where the parasitoids will be foraging for larvae or any other immature stage depending on the species of parasitoid.

The standard densities of parasitoids that have been applied for population suppression in AW fruit fly management programmes against *Anastrepha* spp., based on empirical knowledge from operational programmes, are shown in **Table 8.1**. Consequently, parasitoid release densities range between 500 to 2500 parasitoids/ha on a weekly basis. These densities have produced good results and have been used for the last 15 years. The higher densities given in each complexity category are applied at the time when populations are expected to increase and viceversa.

The ecosystem or landscape complexity includes not only the vegetation density, but the structural complexity of the plants. For a better understanding, low complexity environments are those that have medium-sized vegetation, with small trees or bushes and with a large separation between them. Meanwhile high complexity landscapes include a mixed vegetation of different heights in layers like shrubs, medium height trees such as citrus, and trees over 5 m tall such as mango, and other higher trees growing close to each other (**Figure 8.5**).

Table 8.1. *D. longicaudata* release densities based on the complexity of the target agroecosystem (Moscafruit Programme, Mexico)

| Agroecosystem complexity | Release density (number/h) |
|--------------------------|----------------------------|
| High | 2000–2500 |
| Medium | 1000–2000 |
| Low | 500–1000 |

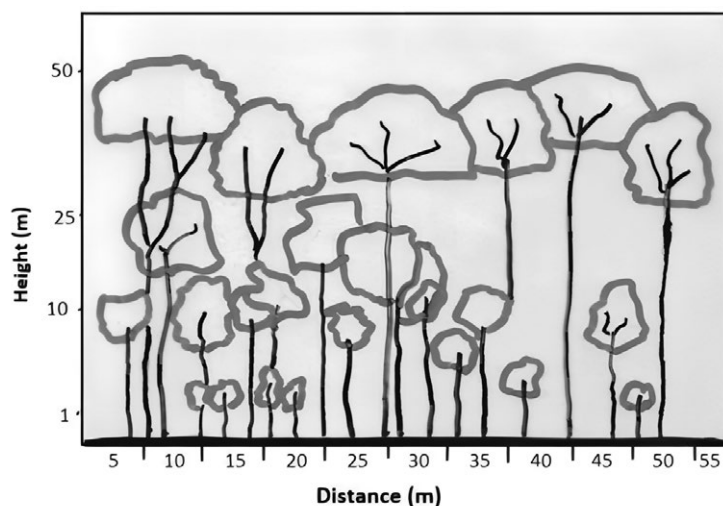

Figure 8.5. Diagrammatic profile of a complex agroecosystem

The number of release devices (plastic containers or paper bags) to be deployed in the field should be adjusted based on the percent parasitoid emergence obtained in the PE&RF to maintain the weekly recommended density of parasitoids per hectare in the field.

A more appropriate parasitoid release density may be applied if it is adjusted based on the relative fruit fly population density, using either fruit sampling or trapping (larvae/kg or fly/trap/day) data. However, as ABC is applied before the pest population increases, timely data on pest density are difficult to obtain because it must be assessed when the amount of susceptible or infested fruits in the field is at or near the lowest level.

To determine the most effective parasitoid density in relation to the pest density, mathematical approaches should be applied to determine the size of the pest population. Parameters that can be used are:

- The relative number of mature fruits;
- The number of infested fruits, obtained through field observations;
- The number of larvae/fruit obtained from a systematic fruit sampling survey;
- The number of adults obtained from a systematic trapping survey based on the index FTD (fly per trap per day).

Several adjustments based on theoretical assumptions and mathematical calculations should be done to convert values of these parameters into values of relative or absolute pest population numbers. The FAO/IAEA guideline on the use of mathematics for operational fruit fly management programmes may be of help. It can be found at: www-naweb.iaea.org/nafa/ipc/public/tephritid-fruit-flies-manual.pdf.

8.7 Quality control

Quality control tests to evaluate the effect of holding and emergence procedures on parasitoids is performed for each lot to be released. The key parameters are: (a) weight and volume of parasitized pupae, (b) percentage of parasitoid emergence, and (c) longevity with and without food. Parameters such as percentage of parasitoid emergence and longevity with and without food are also evaluated after release to determine the possible effects of the parasitoid management from the PE&RF to the field.

The parasitoids that are produced and released for pest suppression should have attributes similar to the wild individuals, including longevity, flight ability and host searching capacity, to have a good performance in the field.

8.8 Evaluation of parasitism rate in the field

The impact of parasitoids on fruit fly populations is assessed by comparing areas with and without releases or by comparing with historical data from the same place. It is determined through: (a) surveys by trapping (i.e. FTD-f index) and (b) surveys by fruit sampling (number of larvae per fruit and per kilogram), as well as by assessing the percentage of parasitism which is estimated as follows:

$$P = \frac{EP}{EP + EF \times 100}$$

where

P is percentage of parasitism
 EP is number of emerged parasitoids
 EF is number of emerged fruit flies

Each fruit sample collected must be around 0.5–3 kg in weight, depending on fruit size and availability.

The parasitism rate is variable and depends upon the type of host fruits, size of fruits, level of pest infestation and season. However, levels above 50% of parasitism are considered to indicate a significant effect of the parasitoids on fruit fly populations. Effective augmentative releases of *D. longicaudata* are known to suppress fruit fly populations by 70% in certain fruit crops like mango.

8.9 ABC using *D. longicaudata*

Currently, ABC is only carried out against fruit flies in AW fruit fly management programmes to suppress the target fruit fly population prior to the releases of sterile insects. This is because its use requires a large investment in the construction of a production plant for the mass-rearing of the parasitoid, which in turn depends on having a mass-production plant for the host, in this case, a specific species of fruit fly.

In addition to this cost, ABC must be carried out following an area-wide approach, otherwise the suppression of the target pest populations may not be effective. These factors limit the use of ABC by individual growers. However, if necessary, grower associations may buy parasitoids from a domestic or international commercial supplier.

ABC applied by AW fruit fly management programmes is usually implemented in highly sensitive areas where insecticide-bait treatments cannot be applied to suppress the target fruit fly populations. Since AW fruit fly management programmes are implemented over large areas, many sensitive places, such as human settlements, organic orchards, protected natural parks, beekeeping areas, open-field aquaculture, and water reservoirs, are frequently located within the intervention areas of such programmes.

There are models that have shown the potential and benefits of integrating ABC and SIT applications to produce complementary synergistic effects by simultaneously controlling two different stages of the fly population (i.e. immature, and adult stages).

The use of ABC as a suppression method to eradicate outbreaks in pest free areas is limited or discarded because the time needed to know its impact on the pest population is not short enough as required by the strategic measures used to eliminate an outbreak. An emergency response requires intense application of suppression procedures to obtain immediate results. Occasionally, AW fruit fly management programmes have applied ABC in combination with other phytosanitary procedures in a multitactical approach to eliminate recurrent introductions of fruit fly individuals coming from adjacent infested or buffer zones into temporally pest free areas.

8.10 ABC using *Beauveria bassiana*

Recently, a practical application of the fungus *B. bassiana* has been developed to suppress *C. capitata* populations. Most conventional insecticide applications result in an immediate mortality of the pest. In the case of the application of *B. bassiana*, however, the mortality effect is slow. The fungus infects *C. capitata* adults through the body wall or cuticle. It can also enter naturally into the respiratory system via the spiracles or via the oral route when ingested.

The fungal conidia germinate and form a special structure which penetrates the cuticle of the infected insect. The fungus then grows in the insect body until it is filled with mycelia. Meanwhile the adult gets into contact with other adults which are then also infected. In the process of mycelial growth, toxins excreted eventually kill the infected insect.

B. bassiana can be introduced into wild *C. capitata* populations through the deployment of conidia disseminator devices inoculated with the fungus that work as a bait station. Wild *C. capitata* male adults become infected with *B. bassiana* when they approach and land, attracted by the TML incorporated into the bait station. Alternatively, both females and males are attracted when a food attractant is used in the bait stations, on which they feed and become infected. Thus, adults become vectors or carriers of fungal conidia that can be transferred to non-infected wild flies when they interact and come into contact, generating a multiplicative conidia transmission effect.

B. bassiana is disseminated among individuals of the wild *C. capitata* population, causing an epizootic that results in significant pest suppression. Nevertheless, this method has been only used in tropical and subtropical areas where the humidity is high enough for germination of the fungus spores and transmission of the pathogen from one insect host to another.

8.10.1 Bait station disseminating *Beauveria bassiana*

The conidia disseminator device is a rectangular (23 cm × 14 cm) yellow galvanized panel. A basket holding a plug with 3 g of TML is inserted in a 2.5 cm hole in the centre of the panel. The panel is covered with yellow plush fabric (23 cm × 14 cm) impregnated with 2 g of *B. bassiana* conidia. The plush fabric of the BS is treated with a concentration of fungal conidia every 2 weeks.

For uniform dissemination of conidia, one *B. bassiana*-BS/ha is recommended. This *B. bassiana*-BS is effective in rainy and dry seasons. During the rainy season a hat can be placed on top of the BS to protect the inoculated panel from the rain.

Additional information on the use of *B. bassiana* to control fruit flies can be found at: www.iaea.org/sites/default/files/21/05/2019_ipc_use_of_entomopathogenic_fungi_eng.pdf

ABC using bait stations inoculated with *B. bassiana* against fruit fly pests has currently only been applied in AW fruit fly programmes to suppress *C. capitata*. Application procedures of bait stations using *B. bassiana* is also covered in the Chapter entitled “Bait stations”.

8.11 Evaluation

Evaluation of ABC can follow the same procedures as for the BAT, using the three basic parameters: (a) fertile fly/trap/day (FTD-f), (b) percentage of traps with fertile captures, and/or (c) larval infestation levels (larvae/kg and larvae/fruit sample) in preferred hosts.

To determine ABC effectivity the values of the three basic parameters are compared before and after ABC application. Weekly comparisons are recommended. If ABC application has been effective, values of the above-mentioned parameters should decrease after treatments.

8.12 Comparative features of ABC

In AW fruit fly management programmes, the use of ABC is strategically very similar to the application of ground BAT, BS, and mass trapping. This includes, small scale applications, treatments of pest reservoirs, and use in remote isolated places. Therefore, the comparative advantages of their use are also very similar.

In general, the application of ABC as a complement to the SIT has the advantage over any other suppression techniques in that it is the most environment-friendly available tool. If ABC treatments are carried out by air, ABC has a double advantage. It can be applied in large extensions as in the case of aerial bait sprays, which is not possible with BS or mass trapping, and it is environment-friendly.

Competitive advantages, as an environment-friendly alternative over other suppression procedures, are discussed below.

8.12.1 Operational factors

8.12.1.1 Rainfall

During the rainy season ABC remains effective in the field during continuous and heavy rains compared to the BAT applications, which are normally washed away requiring additional treatments. The use of ABC as a replacement of insecticide-bait application is worthwhile in AW fruit fly management programmes that operate year-round in tropical and subtropical regions, as the rainfall season will not interfere with ABC applications.

8.12.1.2 Small difficult to access sites

ABC application is recommended in small remote or difficult to access sites with high density of wild hosts (e.g. steep slopes, creeks, cliffs, canyons, etc.), that preclude intensive implementation of ground BAT application or BS deployment.

8.12.1.3 Application over large areas

In large areas with environmental constraints, such as high presence of urban zones, protected natural parks, water-based industries, etc. where aerial insecticide-bait application cannot be carried out, and the control tools applied at small-scale such as ground BAT, BS, or mass trapping are not practical, ABC becomes an essential fruit fly suppression approach prior to release of sterile flies.

8.12.2 Environmental factors

8.12.2.1 Social factors

Due to the use of backpack or motorized sprayers, ground BAT application is many times more annoying to the public if applied close to sites where humans are present. Also, in some areas bait applications are not allowed due to precedents of social or environmental problems; thus, the use of ABC may be preferable. An additional advantage is that personnel working with ABC are not exposed to toxic insecticides.

8.12.2.2 Ecological factors

Because the BAT is widely known to pollute the environment, ABC is more accepted for suppression of target fruit flies in those situations where open field BAT application is highly restricted, such as organic agriculture, protected natural parks, beekeeping industry, aquaculture farms and water reservoirs.

Because baits may also attract non-target organisms, including native biological control agents, the BAT applied in open field can cause a detrimental effect on natural enemies, whereas ABC does not.

Bibliography

- Burns, R.E., Diaz, J.O. & Holler, T.C.** 1996. Inundative releases of the parasitoid *Diachasmimorpha longicaudata* for the control of the Caribbean fruit fly, *Anastrepha suspensa*, pp. 377–381. In: B.A. McPherson & G.J. Steck, eds. *Fruit Fly Pests: A World Assessment of their Biology and Management*. St. Lucie Press, Florida, USA.
- Cancino, J.** 2000. Procedimientos y fundamentos de la cría masiva de *Diachasmimorpha longicaudata* (Ashmead), parasitoide de moscas de la fruta, pp. 427–435. In: *Memorias del XIII Curso Internacional sobre Moscas de la Fruta*. Programa Moscamed, DGSV-CONASAG-SAGAR, Metapa de Domínguez, Chiapas, México.
- Cancino, J., Bello-Rivera, A., Cardenas-Lozano, J., Galvez, F., García-Perez, V., Camacho-Bojórquez, E., Segura-Bailon, E., Leyva-Castro, M. & Ramírez y Ramirez, F.** 2020. Biological control of *Anastrepha* populations in wild areas to strengthen the commercial status of mango production along the Pacific coast of Mexico, 235–249. In: D. Perez-Staples, F. Diaz-Fleischer, P. Montoya & M.T. Vera, eds. *Area-wide Management of Fruit Fly Pests*. CRC Press. USA.
- Cancino, J., Leal-Mubarqui, R., Angulo, R., Perez, C. & Tirado, L.** 2020. Effect of density and lethargy duration in pre-release packing of the fruit fly (Diptera: Tephritidae) parasitoid, *Diachasmimorpha longicaudata* (Hymenoptera; Braconidae). *J. Insect Sci.* 20 (1): 11. <https://doi.org/10.1093/jisesa/ieaa004>.
- Cancino, J., Mazariegos, D., Pérez, C., Ayala, A., Diaz-Fleischer, F., Leal-Mubarqui, R. & Angulo, R.** 2020. Pre-release packing, and chilling reduce host-searching ability of the parasitoid *Diachasmimorpha longicaudata* used in the augmentative control of tephritid flies. *Entomol. Exp. Appl.* 168: 350–359.
- DGSV/SENASICA.** 1999. *Apéndice técnico para las operaciones de campo. Capítulo VII, Control Biológico*. Campaña Nacional Contra Moscas de la Fruta. México.
- DGSV/SENASICA.** 2019. *Manual técnico. Sección IV. Control Biológico*. Programa Nacional de Moscas de la Fruta. Mexico.
- Enkerlin, D., Cancino, J., Guillén, J. & Martinez, L.** 1990. *Evaluaciones del efecto de las liberaciones de parasitoides sobre poblaciones de moscas de la fruta del género Anastrepha (Diptera: Tephritidae) en Mazapa de Madero, Chiapas*. XIII Reunion Nacional de Control Biologico. México.
- FAO.** 2017. *Guidelines for the export, shipment, import and release of biological control agents and other beneficial organisms*. International Standard for Phytosanitary Measures (ISPM) 3, International Plant Protection Convention (IPPC). FAO. <http://www.fao.org/3/a0450e/a0450e00.htm>.
- FAO/IAEA.** 2017. *Guideline for packing, shipping, holding and release of sterile flies in area-wide fruit fly control programmes*. 2nd Edition. J. L. Zavala-López & W.R. Enkerlin, eds. FAO/IAEA, Vienna, Austria. 144 pp. www.iaea.org/resources/manual/guideline-for-packing-shipping-holding-and-release-of-sterile-flies-in-area-wide-fruit-fly-control-programmes.
- FAO/IAEA.** 2019. *Use of entomopathogenic fungi for fruit fly control in area-wide SIT programmes*. A. Villaseñor, S. Flores, S.E. Campos, J. Toledo, P. Montoya, P. Liedo and W. Enkerlin, eds. FAO/IAEA. Vienna, Austria. 43 pp. https://www.iaea.org/sites/default/files/21/05/2019_ipc_use_of_entomopathogenic_fungi_eng.pdf.
- Jang E.B., Klungness, L.M. & McQuate, G.T.** 2007. Extension of the use of augmentoria for sanitation in a cropping system susceptible to the alien terphritid fruit flies (Diptera: Tephritidae) in Hawaii. *J. Appl. Sci. Environ. Manage.* 11 (2): 239–248.
- Knipling, E.F.** 1979. *The basic principles of insect population suppression and management*. USDA Agriculture Handbook No. 512. SEA, USDA, Washington, D. C., USA. 659 pp. <https://naldc.nal.usda.gov/download/CAT80732659/pdf>.
- Knipling, E.F.** 1992. *Principles of insect parasitism analysed from new perspectives*. USDA Agricultural Handbook No. 693. ARS-USDA, Washington, D. C. USA. 335 pp.
- Montoya, P. J., Cancino, J.L., G. Santiago & Reyes, J.** 1997. *Control biológico aumentativo de moscas de la fruta. El caso de Diachasmimorpha longicaudata (Ashmead) (Hymenoptera: Braconidae)*. Campaña Nacional Contra Moscas de la Fruta. DGSV/CONASA. México.

- Montoya, P., Liedo, P., Benrey, B., Cancino, J., Barrera, J.F., Sivinski, J. & Aluja, M.** 2000. Biological control of *Anastrepha* spp. (Diptera: Tephritidae) in mango orchards through augmentative releases of *Diachasmimorpha longicaudata* (Ashmead) (Hymenoptera: Braconidae). *Biol. Control* 18: 216–224. <https://doi.org/10.1006/bcon.2000.0819>.
- Montoya, P. & Cancino, J.**, 2004. Control biológico por aumento en moscas de la fruta (Diptera:Tephritidae). *Folia Entomol. Mex.* 43 (3): 257–270.
- Montoya, P., Cancino, J., Zenil, M., Gomez, E. & Villaseñor, A.** 2005. Parasitoid releases in the control of *Ceratitidis capitata* (Diptera: Tephritidae) outbreaks, in coffee growing zones of Chiapas, Mexico. *Vedalia* 12 (1): 85–89.
- Montoya, P., Cancino, J., Zenil, M., Santiago, G. & Gutiérrez, J.** 2007. The augmentative biological control component in the Mexican national campaign against *Anastrepha* spp. fruit flies pp. 661–670. In: M.J.B. Vreysen, A.S. Robinson, and J. Hendrichs, eds. *Area-Wide Control of Insect Pests*. Springer, Dordrecht, The Netherlands.
- Montoya, P., Cancino, J. & Ruiz, L.** 2012. Packing of fruit fly parasitoids for augmentative releases. *Insects* 3: 889–899.
- Orozco, D., Domínguez, J., Reyes, J., Villaseñor, A. & Gutiérrez, J.** 2002. SIT and biological control of *Anastrepha* fruit flies in Mexico, pp. 245–249. In: *Proceedings of 6th International Fruit Fly Symposium. 6–10 May 2002*. Stellenbosch, South Africa.
- Sivinski, J.M.** 1996. The past and potential of biological control of fruit flies, pp. 369–375. In: B.A. McPherson & G.J. Steck, eds. *Fruit Fly Pests: A World Assessment of their Biology and Management*. St. Lucie Press, Florida, USA.
- Sivinski, J.M., Calkins, C.O., Baranowski, R., Harris, D., Brambila, J., Diaz, J., Burns, R.E., Holler, T. & Dodson, G.** 1996. Suppression of a Caribbean fruit fly (*Anastrepha suspensa* (Loew) (Diptera: Tephritidae) population through augmented releases of the parasitoid *Diachasmimorpha longicaudata* (Ashmead) (Hymenoptera: Braconidae). *Biol. Control* 6: 177–185.
- Sivinski, J., Jeronimo, F. & Holler, T.** 2000. Development of aerial releases of *Diachasmimorpha tryoni* (Cameron) (Hymenoptera: Braconidae), a parasitoid that attacks the Mediterranean fruit fly, *Ceratitidis capitata* (Wiedemann) (Diptera: Tephritidae), in the Guatemalan highlands. *Biocontrol Sci. Technol.* 10: 15–25.
- Wharton, R.A.** 1989. Classical biological control of fruit-infesting Tephritidae, pp. 303–313. In: A.S. Robinson & G.H.S. Hooper, eds. *Fruit Flies: Their Biology, Natural Enemies and Control*. Vol. 3B, World Crop Pests. Elsevier, Amsterdam, The Netherlands.
- Wong, T.T.Y., Ramadan, M.M., McInnis, D.O., Mochizuki, N., Nishimoto, J.I. & Herr, J.C.** 1991. Augmentative releases of *Diachasmimorpha tryoni* (Hymenoptera: Braconidae) to suppress a Mediterranean fruit fly (Diptera: Tephritidae) population in Kula, Maui, Hawaii. *Biol. Control* 1: 2–7.
- Wong, T. T. Y., Ramadan, M.M., Herr, J.C. & McInnis, D.O.** 1992. Suppression of a Mediterranean fruit fly (Diptera:Tephritidae) population with concurrent parasitoid and sterile fly releases in Kula, Maui, Hawaii. *J. Econ. Entomol.* 85: (5) 1671–1681.

9. Sterile Insect Technique

9.1 Background

Since the early 1950s it was found that when males of the livestock pest *Cochliomyia hominivorax* (screwworm) were sterilized using X-rays and confined with non-sterilized females for mating purposes, females were unable to produce viable offspring. Sterile males were able to pass on sperm to females, however, because of the lethal mutations induced by the radiation in the sperm, the result was no development of viable embryos.

In 1955, sexual sterilization of insects was established as a practical means of control when *C. hominivorax* was eradicated from the island of Curacao through the release of sterile male flies.

Soon after this achievement, exploratory studies based on this method were initiated against tropical tephritid fruit flies, which culminated in the eradication of *Z. cucurbitae* from the island of Rota and of *B. dorsalis* from the island of Guam. Releases of sterile *A. ludens*, were conducted in the 1960s along the Mexican–California border to contain the spread and establishment of this citrus pest in southern California.

Since then, this species-specific, biologically-based method, now called the ‘Sterile Insect Technique (SIT)’ has been successfully used worldwide to suppress or eradicate a number of fruit fly species of the genera *Anastrepha*, *Bactrocera*, *Ceratitis* and *Zeugodacus*.

The SIT is among the most environment-friendly insect pest control methods ever developed. Sterilization is induced through the effects of irradiation on the reproductive cells of the reared insects. Conventional SIT does not involve transgenic mechanisms for sterilization.

The SIT requires mass-production, sterilization, and field release of sterile insects. If sterile fly releases are carried out sequentially and in adequate sterile to wild male over-flooding ratios, this eventually results in the reduction of a pest population and, if the target population is isolated, can ultimately lead to its elimination.

The SIT is not a stand-alone technique; it needs to be combined with other population suppression methods to get the adequate sterile:fertile ratios. In addition, SIT application should be conducted on an AW basis to cover the total fruit fly population in an area, otherwise, immigration of already mated wild females to the sterile fly release area can jeopardize the effectivity of the technique.

The SIT is defined by FAO-IPPC glossary as a “method of pest control using AW inundative release of sterile insects to reduce reproduction in a field population of the same species”, and under ISPM No. 3 “Guidelines for the export, shipment, import and release of biological control agents and other beneficial organisms”, sterile insects are included among as beneficial organisms.

SIT can be referred also as ‘autocidal control’, ‘genetic control’, ‘sterile male technique’, ‘sterile insect release method’, and sometimes it is classified as a biological control method.

9.2 Target species

Although research and development activities for mass-rearing and sterilization have been carried out for a number of fruit fly species including *A. fraterculus*, *A. serpentina*, *B. oleae*, *B. zonata*, *C. rosa*, *R. pomonella* and *R. indifferens*, large-scale application of the technology has only been used against *A. ludens*, *A. obliqua*, *A. suspensa*, *Z. cucurbitae*, *B. dorsalis*, *B. philippinensis*, *B. tryoni* and *C. capitata*.

In general, the SIT is not applied for those fruit fly species of the genera *Bactrocera*, *Dacus*, and *Zeugodacus* that respond to ME, since the MAT has been effective in controlling and even eradicating these fruit flies.

Since *C. capitata* is the fruit fly specie of economic importance for which the SIT has been more widely used, a detailed description of the SIT application for this pest is presented below as a model to follow.

9.3 SIT to control *C. capitata*

An AW fruit fly management programme with an SIT component is organized in three major areas of activity: (a) mass-rearing, (b) sterilization, and (c) packing, holding and sterile fly field releases.

9.3.1 Mass-rearing facility

Mass-rearing involves factory-related operations (**Figure 9.1**). In general, these consists of an intricate series of activities that require a well-designed process to ensure that mass-production yields the expected quantity and quality of insects, and that the process is done in a cost-effective manner.

FAO/IAEA has produced a guideline and an Excel model for the design and operation of generic insect mass-rearing facilities available in www.iaea.org/sites/default/files/21/06/nafa-ipc-manual-spreadsheet-insect-mass-rearing.pdf.

In addition, managers and staff of mass-production facilities can monitor insect rearing operations by using an Excel-based dashboard developed by the FAO/IAEA for this purpose (www.iaea.org/sites/default/files/23_mar_2018_corrected_version_mmb_-_19_march_2018_-_b5.pdf).

9.3.2 Sterilization

The fruit fly sterilization process involves irradiation of the late pupal stage during a short period of time to inhibit reproduction without drastically affecting the behaviour and mating capacity of the sterilized insect. The right time for irradiation is determined by observing changes in pupal eye colour. Afterwards, pupae are marked with fluorescent dye before irradiation to be able to distinguish the emerged sterile flies from the wild flies once they have been released. The size and shape of the packaging container used for irradiation of the pupae is typically a function of the size and shape of the chamber in the irradiator (**Figure 9.2**).

Use of reduced-oxygen atmospheres during irradiation of tephritid pupae is mandatory to allow higher levels of sterility without unduly reducing the quality and competitiveness of the irradiated flies. For



Figure 9.1. Two fruit fly mass-rearing facilities. At the front, the *C. capitata* mass-rearing facility. At the back the *A. ludens* and *A. obliqua* facilities. In between these two facilities there is a module to produce *D. longicaudata*. Metapa de Domínguez, Chiapas, México.



Figure 9.2. Gammacell 220 irradiator

© Moscamed Programme México



Figure 9.3. *C. capitata* fly emergence and release facility

© Moscamed Programme México

Figure 9.4. Single-engine airplane releasing *C. capitata* sterile flies in paper bags

© Moscamed Programme México



each insect species and for each irradiator, a dose mapping helps establishing the process parameters needed to deliver the correct radiation dose. The irradiation facility and the procedure used to irradiate insects must be thoroughly characterized and tested to ensure with a high degree of confidence that the process will properly sterilize the insects. FAO/IAEA has developed a comprehensive guideline related to the sterilization process available at www.iaea.org/sites/default/files/qcv7.pdf.

9.3.3 Sterile fly packing, holding and release facility

Packing of the mass-reared sterile flies for release in the field is also a specialized procedure that requires different skills. At the fly emergence and release facility (FE&RF) pupa develop into adult flies. Maturing adults have entirely different demands for space and movement compared with immature mass-reared stages and are generally held for several days compared with weeks in the production facility. The very different environments that the mass-reared adult flies must go through before being released in the field, expose them to a number of physical stresses. It is critical therefore, to quickly identify and correct possible problems that might affect the chain of processes involved in optimal emergence, handling, and release and that can have a very negative impact on the sterile fly quality (Figure 9.3).

9.4 Sterile fly releases

There are different methods to release sterile flies. These will depend on the combination of the type of packing and release method (Figure 9.4).

An FAO/IAEA standard operation procedures guideline presents in detail all the post-production process involved in packing, shipping, handling, emergence, holding and different types of sterile fly release processes such as the aerial and ground roving methods. The guideline is available at www.iaea.org/resources/manual/guideline-for-packing-shipping-holding-and-release-of-sterile-flies-in-area-wide-fruit-fly-control-programmes.

9.4.1 Sterile fly densities

Calculating an effective sterile fly release density, enough to eventually eliminate target wild fruit fly populations, is a critical process. Many times, the success or failure of SIT application rests on the calculation of this parameter. AW fruit fly management programmes should determine their required release densities based on the suppression strategy, density of the wild population, structural complexity of the landscape, and the inherent quality of the sterile flies being released. For instance, low wild populations in a simple ecosystem such as ecological islands or isolated niches in coastal lowland areas will need approximately 500 sterile flies/ha, but highly complex ecosystems such as continuous coffee plantations immersed in tropical forests in mountainous areas (800–1500 meters above sea level), will require at least 5000 sterile flies/ha.

For the above-mentioned reason FAO/IAEA has produced a spreadsheet model that performs calculations to estimate optimal required sterile fly densities based on specific entry values. This useful tool is being used routinely in AW fruit fly management programmes for an efficient use of the sterile insects. This Excel spreadsheet is available at www.iaea.org/resources/manual/manual-and-spreadsheet-for-assessment-of-sterile-insect-release-densities.

9.4.2 Release schedule

The release schedule is important to maintain constantly a critical density of sterile flies in the field. As generations normally overlap in fruit fly multivoltine species, sterile fly releases to eliminate populations of such species must be continuous, with survival rates determining whether releases have to be done once or twice a week. Release interval should be adjusted according to the longevity of the insect. If sterile flies in the field present short longevity, releases may have to be conducted twice a week to maintain a uniform density in an area.

Determining realistic sterile fly release densities may require calculation of the size of wild populations. FAO/IAEA has prepared a guideline that shows in an easy manner how to carry out these calculations with the use of small portable computers or calculators. The guideline is entitled “Guidelines of the use of mathematics in operational AW fruit fly management programmes using the sterile insect technique with special focus on tephritid fruit flies”. The guideline can be found at www.iaea.org/sites/default/files/21/06/nafa-ipc-manual-tephritid-fruit-flies-manual.pdf.

9.4.3 Quality control tests

Routine and periodic quality control tests are required throughout the entire SIT application process to determine the effect and efficiency of mass-rearing, irradiation, handling, shipment, holding, emergence, and release processes. On the other hand, measurement of insect quality in the field is the only way to determine efficacy of the SIT application and provide feedback information to all steps of the process so that they can modify or improve protocols to maintain or improve insect quality.

A set of international quality control standard parameters adopted worldwide can be found in the FAO/IAEA/USDA “Product Quality Control for Sterile Mass-Reared and Released Tephritid Fruit Flies” manual available at www.iaea.org/sites/default/files/qcv7.pdf.

9.5 Identification and interpretation of captured flies

Identification of captured sterile and wild fruit flies is important in evaluating the effectiveness of the releases in terms of reducing or eliminating fertile fruit fly populations. Accurate identification of specimens is also very important as a trigger for implementing population suppression or eradication procedures. Moreover, as released sterile flies are re-captured in the same traps that are used for detection of wild populations, this provides feedback to know if the release procedures are attaining the desired sterile fly density and the appropriate sterile:wild ratios.

Accurate identification of sterile and wild fruit flies is important in evaluating the effectiveness of the releases. Conversely, misidentification of fertile and sterile flies may have serious consequences. Identifying sterile flies as wild flies, in areas where sterile flies are released to suppress or eliminate wild populations, may lead to the implementation of unnecessary mitigation measures that can be costly and time-consuming.

To support this crucial activity in AW fruit fly management programmes that use the SIT, FAO/IAEA has published two manuals that include standardized procedures to determine the fertility or sterility of captured adults of *C. capitata* and *A. ludens*, which are available at www.iaea.org/sites/default/files/cc-differentiation.pdf and www.fao.org/3/ca1211es/CA1211ES.pdf.

9.6 Evaluation

There are two types of assessments in AW fruit fly management programmes that managers should understand and practice to determine the competitiveness of the SIT in suppressing target fruit fly populations in an area.

- Efficiency at which release activities are carried out (managerial operational parameters);
- Effectiveness of the sterile releases in the suppression of the wild populations (technique performance indicators).

Two operational parameters to evaluate the efficiency of the release activities are used:

- Sterile fly/trap/day (FTD-s) (sterile fly relative abundance);
- Percentage of traps with sterile captures (sterile fly distribution in the field).

To determine the degree of operational efficiency the planned values of these parameters are compared against the achieved values.

To assess the effectiveness of sterile fly releases in achieving fruit fly pest suppression, the same procedures applied for BAT evaluation can be followed using the same three basic parameters:

- Fertile fly/trap/day (FTD-f) (pest relative abundance)
- Percentage of traps with fertile captures (pest distribution)
- Larval infestation levels in the preferred host (larvae/kg or larvae/fruit) (pest relative abundance).

To determine SIT effectiveness, the values of these three basic parameters, in a selected area and point in time, should be compared before and after SIT application. Weekly comparisons are recommended. If SIT application has been effective, values of the above-mentioned parameters should decrease after treatments.

SIT effectiveness in AW fruit fly management programmes can also be assessed by evaluating additional parameters such as:

- Sterile to wild ratio (S:W ratio) obtained from trapping;

- Egg sterility measurements in host fruits;
- Survival of sterile flies using FTD-s (in this case different marking colours should be used in the weekly releases of sterile fruit fly batches).

A more comprehensive information about evaluation of the effect of the sterile fly releases in the suppression of the wild fly populations can be found in the FAO/IAEA publication “Guidance for packing, shipping, holding and release of sterile flies in AW fruit fly management programmes”, available at www.iaea.org/resources/manual/guideline-for-packing-shipping-holding-and-release-of-sterile-flies-in-area-wide-fruit-fly-control-programmes.

9.7 Uses of the SIT

Currently, the SIT is mostly used in AW fruit fly management programmes either:

- To eradicate the target fruit fly pest from an infested area;
- To prevent the establishment in FF-PFA of non-native quarantine pests through preventive releases;
- To eliminate outbreaks in FF-PFA (see **Annex 2**);
- To contain a non-native pest in order to reduce the risk of its introduction from an adjacent infested area;
- To suppress the target population to keep it at low prevalence levels, thereby replacing the use of insecticides.

SIT applications require a large initial investment in the construction of a production and sterilization facility (unless the sterile flies are procured commercially), as well as a regular budget for the operational expenses of the mass-rearing, sterilization, release, and field monitoring processes. In addition to this cost, the SIT should be carried out using an AW approach, otherwise, the suppression of the target pest populations may not be effective. These factors limit the use of the SIT by individual growers.

Grower associations, however, that aim at production and exports of fruit fly host commodities, can produce their own sterile flies or can obtain them from domestic or foreign government or private commercial production facilities through contracts. This can be done through multiyear contracts or on a seasonal basis, depending on the objective of the management programme and the seasonality of the pest.

The SIT has been mostly used to eradicate fruit fly pests which may be native or non-native, established recently or long time ago, spread over a small or large area. The fruit fly management strategy is usually implemented by a governmental AW fruit fly management programme operated by its own professional staff and according to an eradication plan previously developed.

When an AW fruit fly management programme begins operating in an infested area, application of aerial sterile fly releases is initiated when the pest population has been lowered by climatic factors or through the previous application of other phytosanitary suppression procedures. Through the continuous sterile fly releases, the eradication of the remaining population is eventually achieved. Once a programme progresses, buffer zones are established and areas free of the pest are created, so that targeted ground sterile fly releases, together with ground BAT application and BS deployment, may be applied to eliminate any localized pest reservoirs.

When a non-native quarantine pest outbreak is detected in an endangered area, SIT application together with other suppression procedures, is considered the best option to achieve rapid eradication. However, even when the pest incursion was detected early and therefore the level of infestation was low enough

to allow SIT use, immediate application of the SIT is not always possible since frequently a source of sterile flies is not readily available.

In controlling outbreaks, the first activities are usually quarantine actions, ground sprays, and fruit stripping. Aerial bait sprays may support these initial activities if the recently introduced pest shows an unexpected dispersal pattern (multiple detections over a large area) with the threat of invading other areas. During the time of these preliminary activities to contain an outbreak, a temporal FE&RF should be built in the affected area, or a mobile FE&RF should be made available, in preparation for the reception of sterile flies once available.

The SIT is a method that can be used for eradication programmes or preventive release programmes (PRP). PRP programmes are aimed at avoiding the establishment of a non-native quarantine pest in an FF-PFA with a history of a high risk of incursions of the target pest, even though these may originate far from the endangered area to be protected.

The cost of maintaining a PRP is significantly lower when compared to the costs involved in emergency eradication actions that must be used to eliminate each outbreak. Preventing pest establishment and outbreaks by using the PRP strategy also significantly reduces the costs of quarantines imposed on growers and the horticultural industry. Moreover, the SIT infrastructure is operational in case of large outbreaks. Furthermore, no pesticides are utilized in the PRP, making the programme environment-friendly when compared with the use of aerial bait sprays applied over every pest incursion detected. Overall, the PRP strategy provides a better return on investment than a reactive approach in such situations.

9.8 Comparative advantages of the SIT

In AW fruit fly management programmes, the SIT has several comparative advantages over other suppression methods including aerial bait sprays.

9.8.1 Pest control at low pest prevalence

The SIT is effective at low pest population levels, a property that is not shared by any other suppression method. Therefore, the SIT is the ideal tool to apply in combination with other methods that have greater efficacy to suppress pests at high population densities, such as the BAT, BS, and ABC.

The application of the SIT is most recommended after the suppression of the target fruit fly populations using such other phytosanitary suppression procedures, or after a drastic population decrease resulting from the effect of abiotic factors, such as intense and prolonged rain fall or cold weather.

9.8.2 SIT enhanced effectivity

SIT has demonstrated its value in eradicating well-established pest population or in eliminating outbreaks following quarantine pest introductions. It is also effective in maintaining containment barriers to prevent incursions of target fruit fly pests into FF-PFA coming from adjacent infested areas. Moreover, the SIT is the only control method available in preventing the establishment of fruit fly pests in FF-PFA through the implementation of sterile fly preventive release programmes (PRP).

The SIT remains effective in the field during rainy seasons with continuous and heavy rains when compared to BAT applications, which are normally washed away requiring additional treatments.

9.8.3 Environmental factors

Considering that the SIT is an environment-friendly pest control method, it is more accepted and particularly suited for the management of fruit fly pests in those scenarios where open field insecticide-

based applications are highly restricted, such as areas with organic agriculture, beekeeping, and aquacultural farms, as well in protected natural parks and water reservoirs.

Unlike classic biological control, the SIT does not introduce non-native species into an ecosystem. In addition, the released sterile insects are not self-replicating, therefore, the sterile insects cannot become established in the environment as occurs with biological control agents.

Bibliography

- Bushland, R.C. & Hopkins, D.E.** 1951. Experiments with screw-worm flies sterilized by X-rays. *J. Econ. Entomol.* 44 (5): 725–31.
- Bushland R.C.** 1960. Male sterilization for the control of insects, pp. 1–25. In: R.L. Metcalf, ed. *Advances of Pest Control Research*. Volume III. Interscience Publishers, N.Y., USA.
- De Longo, O., Colombo, A., Gomez-Riera, P. & Bertolucci, A.** 2000. The use of massive SIT for the control of the medfly, *Ceratitis capitata* (Wied.), strain SEIB 6-96, in Mendoza, Argentina, pp. 351–359. In: K.H. Tan, ed. *Area-wide Control of Fruit Flies and Other Insect Pests*. Penerbit Universiti Sains Malaysia, Penang, Malaysia.
- De Murtas, I.D., Cirio, U., Enkerlin, D.** 1972. *Dispersal of Ceratitis capitata on Procida Island. I. Distribution of sterilized Mediterranean fruit fly on Procida and its relation to irradiation doses and feeding*. OEPBA/EPPO Bull. 6: 63–68.
- DGSV/CONASA/SAGAR.** 1999. *Apéndice técnico para las operaciones de campo*. Campaña Nacional Contra Moscas de la Fruta. México.
- Dowell, R., Siddiqui, I.A., Meyer, F. & Spaugy, L.** 2000. Mediterranean fruit fly preventative release programme in Southern California, pp. 369–375. In: K.H. Tan, ed. *Area-wide Control of Fruit Flies and Other Insect Pests*. Penerbit Universiti Sains Malaysia, Penang, Malaysia.
- Dyck V. A., Hendrichs, J. & Robinson, A.S., eds.** 2021. *Sterile Insect Technique. Principles and Practice in Area-Wide Integrated Pest Management*. Second edition, CRC Press, Boca Raton, Florida, USA, 1200 pp.
- Enkerlin S.D.** 1984. Success and problems in the use of the sterile insect technique for the eradication of the medfly and the screwworm in Mexico, pp. 505–513. In: W. Engels & W.H. Clark, eds. *Advances in Invertebrate Reproduction 3: Proceedings 3rd Internal Symposium International Society Invertebrate Reproduction*. Elsevier Science, Amsterdam, The Netherlands.
- Enkerlin, D., Liedo, P., Ortiz, G., Reyes, J. & Schwarz, A.** 1984. *Review, procedures, and present status of the Medfly Program in Mexico*. Regional Seminar on Nuclear Techniques in Crop Production. 18–23 November 1984. Comisión Interamericana de Energía Nuclear, OEA-CENA and Universidad de Sao Paulo, Brazil.
- Enkerlin, W.** 2003. Economics of area-wide SIT control programmes, pp. 1–10. In: *Recent trends on sterile insect technique and area-wide integrated pest management. Economic feasibility, control projects, farmer organization and Bactrocera dorsalis complex control study*. Research Institute for Subtropics, Naha, Okinawa, Japan.
- Enkerlin, W.R.** 2021. Impact of fruit fly control programmes using the sterile insect technique, pp. 979–1006. In: V.A. Dyck, J. Hendrichs & A.S. Robinson, eds. *Sterile Insect Technique. Principles and Practice in Area-wide Integrated Pest Management*. Second edition, CRC Press, Boca Raton, Florida, USA.
- Enkerlin, W.R., Gutierrez Ruelas, J.M., Pantaleon, R., Soto Litera, C., Villaseñor Cortes, A., Zavala Lopez, J.L., Orozco Davila, D., Montoya Gerardo, P., Silva Villarreal, L., Cotoc Roldan, E., Hernandez Lopez, F., Arenas Castillo, A., Castellanos Dominguez, D., Valle Mora, A., Rendon Arana, P., Caceres Barrios, C., Midgarden, D., Villatoro Villatoro, C., Lira Prera, E., Zelaya Estrada, O., Castaneda Aldana, R., Lopez Culajay, J., Ramirez y Ramirez, F., Liedo Fernández, P., Ortiz Moreno, G., Reyes Flores, J. & Hendrichs, J.** 2017. The Moscamed Regional Programme: A success story of area-wide Sterile Insect Technique application. *Entomol. Exp. Appl.* 164 (Special Issue): 188–203.

- FAO.** 2017. Guidelines for the export, shipment, import and release of biological control agents and other beneficial organisms. International Standard for Phytosanitary Measures (ISPM) 3. International Plant Protection Convention (IPPC). www.fao.org/3/a0450e/a0450e00.htm
- FAO/IAEA/USDA.** 2019. *Product quality control for sterile mass-reared and released tephritid fruit flies*. Version 7.0. Joint FAO/IAEA Programme of Nuclear Techniques in Food and Agriculture. International Atomic Energy Agency, Vienna, Austria. 148 pp. www.iaea.org/sites/default/files/qcv7.pdf
- FAO/IAEA.** *Insect Pest Control Section webpage*. Joint FAO/IAEA Programme of Nuclear Techniques in Food and Agriculture. www.iaea.org/topics/sterile-insect-technique
- FAO/IAEA.** 1999. Thematic plan for fruit fly control using the Sterile Insect Technique. Thematic Planning Meeting. Vienna, Austria, 15–19 November 1999. www.iaea.org/sites/default/files/21/07/web_ff_thematic_plan.pdf
- FAO/IAEA.** 2007. *Guidance for packing, shipping, holding and release of sterile flies in area-wide fruit fly control programmes*. W. Enkerlin, ed. Vienna, Austria. 134 pp. www.iaea.org/resources/manual/guideline-for-packing-shipping-holding-and-release-of-sterile-flies-in-area-wide-fruit-fly-control-programmes
- FAO/IAEA.** 2012. *Spreadsheet for designing and operation of insect mass-rearing facilities*. C. Cáceres, P. Rendón & A. Jessup, eds. Vienna, Austria. 49 pp. <https://www.iaea.org/sites/default/files/21/06/nafa-ipc-manual-spreadsheet-insect-mass-rearing.pdf>
- FAO/IAEA.** 2016. *The use of mathematics in area-wide Integrated Pest management programmes using the Sterile Insect Technique with a special focus on tephritid fruit flies*. H.J. Barclay, W. Enkerlin, N.C. Manoukis & J. Reyes Flores, eds. Vienna, Austria. 97 pp. www.iaea.org/sites/default/files/21/06/nafa-ipc-manual-tephritid-fruit-flies-manual.pdf
- FAO/IAEA.** 2016. *Manual to differentiate wild Mediterranean fruit flies *Ceratitis capitata* (Wied.) from non-irradiated (fertile) and irradiated (sterile) VIENNA temperature sensitive lethal strain flies*. J.C. Guillen, L. López, E. Pérez, E. Flores, V. López, V. Marroquín, J. Domínguez & E. Recinos, eds. Vienna, Austria. 52 pp. www.iaea.org/sites/default/files/cc-differentiation.pdf
- FAO/IAEA.** 2017. Guideline for packing, shipping, holding and release of sterile flies in area-wide fruit fly control programmes. 2nd Edition. J.L. Zavala-López & W. R. Enkerlin, eds. Vienna, Austria. 144 pp. www.iaea.org/resources/manual/guideline-for-packing-shipping-holding-and-release-of-sterile-flies-in-area-wide-fruit-fly-control-programmes
- FAO/IAEA.** 2018. *Manual para diferenciar moscas de *Anastrepha ludens* (Loew) silvestres y criadas de cepa normal (“bi-sexual”) y cepa sexada genéticamente (Tapachula-7), irradiadas y sin irradiar*. J.C. Guillen, J.C. López, E.F. López & D. N. Soto, eds. Vienna, Austria. 88 pp. www.fao.org/3/ca1211es/CA1211ES.pdf
- FAO/IAEA.** 2018. “The Dashboard” for managers of sterile insect technique production facilities. *A mass-rearing metrics and monitoring tool*. P. Rendón, A. Aldana & C. Cáceres, eds. Vienna, Austria. 18 pp. www.iaea.org/sites/default/files/23_mar_2018_corrected_version_mmb_-_19_march_2018_-_b5.pdf
- FAO/IAEA.** 2019. *Sterile insect release density calculations spreadsheet*. P. Rendón, W. Enkerlin & C. Cáceres, eds. Vienna, Austria. 30 pp. www.iaea.org/resources/manual/manual-and-spreadsheet-for-assessment-of-sterile-insect-release-densities
- Fisher K.T., Hill, A.R. & Sproul, A.N.** 1985. Eradication of *Ceratitis capitata* (Wiedemann) (Diptera: Tephritidae) in Carnarvon, Western Australia. *Aust. J. Entomol.* 24: 207–208.
- Hendrichs, J., Ortíz G., Liedo P., Schwarz A.** 1983. Six years of successful medfly program in Mexico and Guatemala, pp. 353–365. In: R. Cavalloro, ed. *Fruit Flies of Economic Importance*. A. A. Balkema, Rotterdam, The Netherlands.
- Hendrichs, J.** 2000. Use of the sterile insect technique against key insect pests. *Sust. Dev. Int.* 2: 75–79.
- Hendrichs, J., Kenmore, P., Robinson, A.S. & Vreysen, M.J.B.** 2007. Area-wide integrated pest management (AW-IPM): Principles, practice and prospects, pp. 3–33. In: M.J.B. Vreysen, A.S. Robinson & J. Hendrichs, eds. *Area-wide Control of Insect Pests. From Research to Field*

- Implementation*. Springer, Dordrecht, The Netherlands. www.iaea.org/sites/default/files/area-wide-control-insect-pests-book.pdf
- Hendrichs, J., Vreysen, M.J.B., Enkerlin, W.R. & Cayol, J.P.** 2021. Strategic options in using sterile insects for area-wide integrated pest management, pp. 841–884. In: V.A. Dyck, J. Hendrichs & A.S. Robinson, eds. *Sterile Insect Technique. Principles and Practice in Area-wide Integrated Pest Management*. Second edition, CRC Press, Boca Raton, Florida, USA.
- Jessup, A.J., Dominiak, B., Woods, B., De Lima, C.P.F., Tomkins, A. & Smallridge, C.J.** 2007. Area-wide management of fruit flies in Australia, pp. 685–697. In: M.J.B. Vreysen, A.S. Robinson & J. Hendrichs, eds. *Area-wide Control of Insect Pests. From Research to Field Implementation*. Springer, Dordrecht, The Netherlands. www.iaea.org/sites/default/files/area-wide-control-insect-pests-book.pdf
- Klassen, W.** 2000. Area-wide approaches to insect pest management: history and lessons, pp. 21–38. In: K.H. Tan, ed. *Area-wide Control of Fruit Flies and Other Insect Pests*. Penerbit Universiti Sains Malaysia, Penang, Malaysia.
- Knipling, E.F.** 1955. Possibilities of insect control or eradication through the use of sexually sterile males. *J. Econ. Entomol.* 48: 459–462. <https://doi.org/10.1093/jee/48.4.459>
- Knipling, E.F.** 1969. Concept and value of eradication or continuous suppression of insect populations, pp. 19–32. In: *Sterile-Male Technique for Eradication or Control of Harmful Insects*. Joint FAO/IAEA Division of Atomic Energy in Food and Agriculture, 27–31 May 1968, Vienna, Austria. STI/PUB/224. IAEA, Vienna, Austria. www.iaea.org/sites/default/files/el_harmful_insects.pdf
- Knipling, E.F.** 1979. *The basic principles of insect population suppression and management*. USDA Agriculture Handbook Number 512. SEA, USDA, Washington, D. C., USA. 659 pp. <https://naldc.nal.usda.gov/download/CAT80732659/PDF>
- Koyama, J., Kakinohana, H. & Miyatake, T.** 2004. Eradication of the melon fly, *Bactrocera cucurbitae*, in Japan: importance of behavior, ecology, genetics, and evolution. *Annu. Rev. Entomol.* 49: 331–349. <https://doi.org/10.1146/annurev.ento.49.061802.123224>
- LaChance, L.E.** 1967. The induction of dominant lethal mutations in insects by ionizing radiation and chemicals as related to the sterile male technique of insect control, pp. 617–650. In: J. W. Wright & R. Pal, eds. *Genetics of Insect Vectors of Disease*. Elsevier Amsterdam, The Netherlands.
- Lindquist, A.W.** 1955. The use of gamma radiation for control or eradication of the screwworm. *J. Econ. Entomol.* 48 (4): 467–469. <https://doi.org/10.1093/jee/48.4.467>
- Lindquist, D.A., Butt, B., Feldmann, U., Gingrich, R.E. & Economopoulos, A.P.** 1990. Current status and future prospects for genetic methods of insect control or eradication, pp. 69–88. In: J.E. Casida, ed. *Pesticides and Alternatives*. Elsevier, Amsterdam, The Netherlands.
- Lindquist, D.A.** 2000. Pest management strategies: Area-wide and conventional, pp. 13–19. In: K.H. Tan, ed. *Area-wide Control of Fruit Flies and Other Insect Pests*. Penerbit Universiti Sains Malaysia, Penang, Malaysia.
- Olalquiaga, G. & Lobos, C.** 1993. *La mosca del Mediterráneo en Chile: Introducción y erradicación*. Ministerio de Agricultura, Servicio Agrícola y Ganadero. Santiago, Chile.
- Patton, P.** 1980. Mediterranean fruit fly eradication trial in Mexico, pp. 81–83. In: *Proceedings of Symposium on Fruit Fly Problems, XIV International Congress of Entomology*. ICE, Kyoto, Japan.
- Pereira, R., Yuval, B., Liedo, P., Teal, P.E.A., Shelly, T.E., McInnis, D.O. & Hendrichs, J.** 2013. Improving sterile male performance in support of programmes integrating the sterile insect technique against fruit flies. *J. Applied Entomol.* 137 (Special Issue S1): 178–190. <https://doi.org/10.1111/j.1439-0418.2011.01664.x>
- Programa Moscamed Guatemala-México-Estados Unidos.** 2018. *Manual de procedimientos para el control autocida de la mosca del Mediterráneo Ceratitis capitata*. Programa Moscamed. Guatemala-México-Estados Unidos.
- Quiroga, D., Ramírez, W., Fedyszak, P., Garavelli, E., Vazquez, M.F. & Ruiz, C.** 2016. Programa nacional de control y erradicación de moscas de los frutos de Argentina (PROCEM): Lecciones

- aprendidas y desafíos a futuro, pp. 21. In: *Book of Abstracts, 9a Reunion del Grupo de Trabajo en Moscas de la Fruta del Hemisferio Occidental*, 16–22 October 2016, Buenos Aires, Argentina.
- Rendon, P., McInnis, D.O., Lance, D. & Stewart, J.** 2004. Medfly (Diptera: Tephritidae) genetic sexing: Large-scale field comparison of males-only and bisexual sterile fly releases in Guatemala. *J. Econ. Entomol.* 97: 1547–1553.
- Rhode, R.H., Simón, J., Perdomo, A., Gutiérrez, J., Dowling, C.F. Jr. & Lindquist, D.A.** 1971. Application of the sterile-insect release technique in Mediterranean fruit fly suppression. *J. Econ. Entomol.* 64 (3): 708–713.
- Reyes, J., Villaseñor, A., Ortiz, G. & Liedo, P.** 1986. *Manual de las operaciones de campo en una campaña de erradicación de la mosca del Mediterráneo en regiones tropicales y subtropicales, utilizando la técnica del insecto estéril*. Moscamed Programme SAGARPA/USDA. Mexico.
- Reyes, J., Villaseñor, A., Schwarz, A. & Hendrichs, J.** 1988. Organization of medfly eradication campaigns, pp. 107–116. In: *Proceedings of a Symposium on Modern Insect Control, Nuclear Techniques and Biotechnology. 16–20 November 1987*. FAO/IAEA. Vienna, Austria.
- Reyes, F.J., Santiago, M.G. & Hernández M.P.** 2000. The Mexican fruit fly eradication programme, pp. 377–380. In: K.H. Tan, ed. *Area-wide control of fruit flies and other insect pests*. Penerbit Universiti Sains Malaysia, Penang, Malaysia.
- Rull, J.A., Reyes F.J. & W. Enkerlin.** 1996. The Mexican fruit fly eradication campaign: Largest fruit fly industrial complex in the world, pp 561–563. In: B.A. McPheron & G.J. Steck, eds. *Fruit fly Pests. A World Assessment of their Biology and Management*. St. Lucie Press, Delray Beach, Florida, USA.
- SAG (Servicio Agrícola y Ganadero).** 1996. *Chile: País libre de mosca de la fruta*. Departamento de Protección Agrícola, Proyecto 335, Moscas de la Fruta. Segunda edición, Julio 1996. Ministerio de Agricultura, Servicio Agrícola y Ganadero, Santiago, Chile.
- Suckling, D.M.** 2003. Applying the sterile insect technique for biosecurity: Benefits and constraints. *N. Z. Plant Prot.* 56: 21–26. http://nzpps.org/journal/56/nzpp_560210.pdf
- Sutantawong, M., Orankanok, W., Enkerlin, W.R., Wornoyaporn, V. & Caceres, C.** 2004. The sterile insect technique for control of the oriental fruit fly, *Bactrocera dorsalis* (Hendel), in mango orchards of Ratchaburi Province, Thailand, pp. 223–232. In: B.N. Barnes, ed. *Proceedings Symposium: 6th International Symposium on Fruit Flies of Economic Importance, 6–10 May 2002, Stellenbosch, South Africa*. Isteg Scientific Publications, Irene, South Africa. https://nucleus.iaea.org/sites/naipc/twd/Documents/6thISFFEI_Proceedings/6th-ISFFEI-Proceedings-2004-Stellenbosch-South-Africa.pdf
- Tween, G.** 2004. MOSCAMED-Guatemala – An evolution of ideas, pp. 119–126. In: B.N. Barnes, ed. *Proceedings Symposium: 6th International Symposium on Fruit Flies of Economic Importance, 6–10 May 2002, Stellenbosch, South Africa*. Isteg Scientific Publications, Irene, South Africa. https://nucleus.iaea.org/sites/naipc/twd/Documents/6thISFFEI_Proceedings/6th-ISFFEI-Proceedings-2004-Stellenbosch-South-Africa.pdf
- Yamagishi, M., Kakinohana, H., Kuba, H., Kohama, T., Nakamoto, Y., Sokei, Y. & Kinjo, K.** 1993. Eradication of the melon fly from Okinawa, Japan, by means of the sterile insect technique, pp. 49–60. In: *Proceedings: Management of Insect Pests: Nuclear and Related Molecular and Genetic Techniques. IAEA and FAO symposium, 19–23 October 1992, Vienna, Austria*. STI/PUB/909. IAEA, Vienna, Austria. <https://www.iaea.org/publications/3782/management-of-insect-pests-nuclear-and-related-molecular-and-genetic-techniques>

10. Regulatory and quarantine procedures

10.1 Background

Since the late 19th century, countries worldwide have enforced national regulatory laws to protect their agricultural welfare from plant pests. Since then, quarantine procedures have been considered as a pest control technique in their own right, because their application have successfully prevented the spread of quarantine pests across international borders.

Fruit flies are capable of dispersing over short distances by natural means. Such natural movement can be halted by physical barriers such as oceans, high mountains, large deserts, and others. On the other hand, dispersal of fruit fly species by humans through the movement of infested fruits (in commercial and non-commercial transport), is one of the most important factors in their long distance spread across geographical regions in a relatively short time. For that reason, it is not surprising that among the ten most frequently cited insects in the quarantine regulations of 125 countries, five belong to Tephritidae species.

Incursions of regulated fruit flies into pest free areas or areas under official control within the same country, in most cases, these are the result of the transport of infested fruit by people. In summary, humans are the main factor in the spread of fruit fly species within a country or across international borders.

10.2 Regulatory procedures

Provisions for regulatory procedures in relation to fruit fly management may include a combination of rules such as: (a) establishing obligatory dates for planting and harvest, (b) obligatory cultural activities at harvesting time (in annual crops as cucurbits), (c) location of dumping sites for crop residues, (d) pruning of targeted host trees, (e) elimination or replacement of non-commercial host trees with non-hosts or non-bearing fruit plants, (f) controlling the movement of regulated articles or treatment of commodities other than hosts since target pest may be spread in association with them, and (g) location of quarantine check points to prevent the entry of target pests into areas under fruit fly official control.

10.2.1 Check points at the international ports of entry

To prevent the entrance of a quarantine non-native fruit fly pest, NPPOs officially control the movement of fruit fly hosts into the country by applying exclusion procedures such as: inspection of commercial shipments and passengers at the international ports of entry (seaports, airports, and land border crossings).

Port of entry activities against fruit flies include operations at international air, maritime and land border ports, domestic preclearance activities and foreign mail inspection. With the global increase in trade and tourism, preventing entrance of quarantine non-native pests is becoming a much more important issue of national agricultural policies. The use of quarantine regulations is expanding as globalization increases the risk of quarantine non-native pest introductions.

10.2.2 Domestic check points

Establishment of domestic quarantine check points is necessary to prevent the movement of regulated commercial products from infested to non-infested areas, or between areas with different phytosanitary status within the same country. Regional or local quarantine check points may include a combination of two or more procedures such as the use of detector dogs, soft X-ray imagery, incinerators to destroy seized fruits, fumigation chambers to treat regulated commodities and specific parking spaces to carry out more detailed vehicle inspections.



© Moscamed Programme, Guatemala

Figure 10.1. Domestic quarantine check point



© Moscamed Programme, Guatemala

Figure 10.2. Fumigation chambers in support of domestic quarantine check points

There are also supporting procedures such as road signs alerting travellers just before the quarantine check points of the imminent inspection of vehicles in search for regulated fruits and the liabilities for non-declaration of the fruits (**Figures 10.1** and **10.2**).

These check points are usually officially managed by local or national plant protection authorities. However, they may also be managed by associations of growers interested in the effective regulation of the movement of commercial fruit fly hosts. This latter case can be applied by means of an “approval or certification scheme” through which the government delegates the management of such quarantine points to the growers under precise protocols that may include verifications and audits for compliance.

10.3 Evaluation

The effect of the R&Q procedures is not seen immediately. Tangible outcome of their application can take long time, at least one year. Drastic reduction of fruit fly movement by the application of R&Q procedures is beyond doubt, but assessment of their effectiveness is difficult. In AW fruit fly management programmes, where infestation data are gathered continuously and across all the intervention area, the effect of quarantine practices for specific temporal or permanent FF-PFA areas can be assessed by comparing with historical data of target fruit fly interceptions and introductions to the FF-PFA.

There are two types of assessments to determine the effectivity of R&Q procedures:

- Efficiency at which R&Q procedures are carried out (managerial operational parameters);
- Effectiveness of the R&Q procedures in the prevention of target fruit fly introductions (performance indicators).

Three operational parameters to evaluate the efficiency may be used:

- Number of vehicles and people inspected;
- Number and amount (kg) of confiscated target fruit fly hosts;
- Amount of fruit fumigated.

Two performance indicators to evaluate the effectiveness may be used:

- Number of fruits detected with immatures of the target fruit fly, separated by variety or species of the infested commodity;
- Number of larvae intercepted of the target fruit fly in the confiscated fruits.

10.4 Uses of regulatory and quarantine procedures

In areas under official pest suppression or eradication measures, establishment of temporal or permanent quarantine check points is necessary at the entrance to the areas.

In an on-going fruit fly eradication programme, quarantine actions are not permanently applied in the same area. Actions are applied on a temporary basis to protect from reinfestations the areas or blocks from which the pest has already been eradicated (buffer zones and temporal fruit fly free areas), as the eradication programme makes progress towards targeting new infested areas. Therefore, it is important that quarantine procedures are continuously assessed to make the necessary adjustments to fulfil the objectives of the programme. Once the FF-PFA has been officially recognized, quarantine procedures should be applied on a permanent basis to protect the FF-PFA as long it exists.

In such eradication programmes, check points are established at the limits between the infested area and the buffer zone that protects the FF-PFA. These check points can be mobile, so that they are relocated according with the progress of the eradication programme, however, always located at the limits between the infested area and the buffer zone or the buffer zone and the temporal FF-PFA.

If a fruit fly outbreak is detected in an FF-PFA, special R&Q procedures need to be immediately enacted and applied as established by the contingency action plan set-up to eliminate such outbreaks (see **Annex 2**).

Bibliography

- Berg, G.** 1989. *La cuarentena vegetal: Teoría y práctica*. Organismo Internacional Regional de Sanidad Agropecuaria (OIRSA). San Salvador, El Salvador.
- Crooks, E., Haavel, K., Shannon, M., Snyder, G. & Wallenmaier, T.** 1983. Stopping pest introductions. Chapter 9. In: C.L. Wilson & C.L. Graham, eds. *Exotic Plant Pests and North American Agriculture*. Academic Press.
- Diario Oficial de la Federación.** 1999. *Norma Oficial Mexicana NOM-023-FITO-1995 por la que se establece la Campaña Nacional Contra Moscas de la Fruta*. 11 de febrero 1999, Mexico, D.F.
- Dent, D.** 1991. Quarantine, legislation and politics, pp. 421–437. Chapter 9. In: *Insect Pest Management*, CAB International, UK.
- Ke Chung, K.** 1983. How to detect and combat exotic pests. Chapter 10. In: C.L. Wilson & C.L. Graham, eds. *Exotic plant pests and North American agriculture*. Academic Press.
- Klassen, W. & Vreysen, M.J.B.** 2021. Area-wide integrated pest management and the sterile insect technique, pp. 75–112. In: V.A. Dyck, J. Hendrichs & A. Robinson, eds. *Sterile Insect Technique. Principles and Practice in Area-wide Integrated Pest Management*. Second edition, CRC Press, Boca Raton, Florida, USA.
- National Research Council.** 1969. Regulatory control. Chapter 4. In: *Insect Pest Management and Control*. The National Academies Press. Washington, D.C., USA. <https://doi.org/10.17226/18674>
- Reyes, F.J., Santiago M.G. & Hernandez, M.P.** 2000. The Mexican fruit fly eradication programme, pp. 377–380. In: K.H. Tan, ed. *Area Wide Control of Fruit Flies and Other Insect Pests*. Penerbit Universiti Sains Malaysia, Penang, Malaysia.
- Rohwer, G.G.** 1992. *Recommendations regarding fruit fly management/eradication in the Western Hemisphere*. Bull. No. 10. OIRSA, San Salvador, El Salvador.

Appendix

Glossary of terms

Some definitions of the terms included in this glossary have been adapted from classical or conventional definitions, with the aim of ensuring that they are relevant considering the context in which they are being used.

Agroecosystem

A dynamic complex of cultivated and wild plant, animal and micro-organism communities and their abiotic environment interacting as a functional unit (adapted from ISPM No. 3).

Syn. Ecosystem, environment, landscape.

Alternate host

Plant with a ripening period that is before or after the ripening period of the commercial.

Syn. Secondary host.

Appropriate Level of Protection

It is the level of phytosanitary protection to be achieved through the use of fruit fly management measures to comply with the estimated level of quarantine risk deemed appropriate by the importing country. [Adapted from the World Trade Organization (WTO), Agreement on the Application of Sanitary and Phytosanitary Measures (SPS Agreement)]. For practical purposes, it is equivalent to the quarantine security level requested by importing countries and is based on the risk of introduction and potential economic impact of a pest.

This concept is the key factor in selecting pest management options. For practical purposes, it is equivalent to the quarantine security level requested by the importing countries, and it is based on the risk of introduction and potential economic impact of a pest.

Syn. Quarantine security level

Area of low pest prevalence

An area in which the target pest is present at low levels, and which is subject to effective surveillance or control procedures (adapted from ISPM No. 5).

Area-wide

It refers to the total population of an insect pest in a delimited area, large enough to prevent insect immigration. The limits of the area can be either natural or artificially established, (modified from Hendrichs *et al.*, 2007).

Area-wide (insect) pest management

It is the systematic reduction of a target key pest to predetermined population levels through the use of uniformly applied control measures over large geographical area clearly defined by biologically based criteria (Knipling, 1999).

Area-wide pest management is a concept of preventive suppression of a mobile insect pest species throughout its geographic range, rather than reactive field-by-field control (USDA, 2006).

Area-wide (insect) control programme

It is a long-term planned campaign against an insect pest population over a relatively large, predefined area, with the objective of reducing the insect population to a non-economic level or of eliminating the pest from such an area (modified from Lindquist, 2000).

Syn. Action programme, area-wide IPM programme, area-wide fruit fly management programme, area-wide pest management programme, intervention programme, large-scale insect control programme, large-scale operational field programme, regulatory programme.

Area-wide IPM programme

It is the integrated pest management against an entire pest population within a delimited geographic area with a minimum size large enough or protected by a buffer zone so that natural dispersal of the population occurs only within this area (Klassen, 2005).

Buffer zone

An area surrounding or adjacent to an area officially delimited for phytosanitary purposes in order to minimize the probability of spread of the target pest into or out of the delimited area, and subject to phytosanitary or other control measures, if appropriate (ISPM No. 10). Buffer zones can be natural or artificially created. It is a conceptual term, there is not a conventional fixed width for such zones.

Commercial host

Plant that is the value entity of a fruit fly control process.

Syn. Host commodity, target host.

Compliance Agreement

A written agreement between the NPPO and the fruit industry of the exporting country engaged in the production, treatment, packing and transport of host commodities to the importing country.

Containment

Application of phytosanitary measures in and around an infested area to prevent spread of a pest (FAO-IPPC glossary).

Control (of a pest)

Suppression, containment, or eradication of a pest population (FAO-IPPC glossary)

Core area

Central area of 500 m radius, surrounding the point of a confirmed target fruit fly detection.

Corrective action protocol

It is a written document used by AW fruit fly eradication programmes to eliminate fruit fly incursions into recently created or temporal FF-PFA.

Day degrees

A prediction model based on an accumulation of heat units above a specified developmental temperature threshold during a life stage.

Delimiting survey

Survey conducted to establish the boundaries of an area considered to be infested by or free from a pest (FAO-IPPC glossary).

Delimiting trapping

A survey conducted to determine the extent of the infestation in an area where the target fruit fly has been detected.

Detection trapping

A survey conducted in a susceptible area not known to be infested with the target fruit fly.

Ecological island

An area isolated by natural or artificial means from the surrounding land, where a natural micro-habitat conducive for the target pest exists amidst a larger differing ecosystem. These places are frequently found in the coastal areas of tropical and subtropical regions, in valleys of temperate climate and semi-arid lands.

Syn. Ecological niches, population islands, vegetation islands.

Epicentre

The initial site of an infestation, usually the centre of the core area with the size of 1 km².

Eradication

Application of phytosanitary measures to eliminate a pest from an area (FAO-IPPC glossary)

Fruit fly pest free area

It is an area in which a specific fruit fly pest is absent as demonstrated by scientific evidence and in which, where appropriate, this condition is being officially maintained.

Generation (life cycle)

The period of time for the pest to complete all stages of development.

Gradient (trapping)

The trapping pattern beginning with the core area and continuing outward through each of the buffer rings.

Host

A plant species or cultivar that has been scientifically found to be infested by the target fruit fly species under natural conditions and able to sustain its development to viable adults (modified from ISPM No. 37).

Infestation

The accumulation of larvae, pupa, a mated female, or two or more adults within a short period of time, or within a delimited area, indicating that there is an established pest population.

Infested area

An area that has been determined to have an established pest population (term eliminated from FAO-IPPC glossary).

Intervention area

It is the total delimited area where a pest management programme is applied, including surveillance and suppression activities.

Syn. Area under control, working area.

Indigenous pest

Insect or plant originating or occurring naturally in a particular area.

Syn. Native pest.

International Plant Protection Convention

This Convention is an intergovernmental treaty signed by over 180 countries, aiming to protecting the world's plant resources from the spread and introduction of pests, and promoting safe trade. The Convention is the sole global standard setting organization for plant health. The IPPC is deposited with the Director-General of the FAO and is administered through the IPPC Secretariat located in FAO's Plant Protection Service.

International Standards for Phytosanitary Measures

These standards were introduced by the IPPC as its main tool to achieve its goals, being the international standards in plant protection most used. Therefore, where an ISPM is indicated it refers to an FAO-IPPC standard.

Intervention block

Part of a working area, and the smaller piece of land where an eradication process is applied to eradicate fruit fly populations.

Large-scale area of production

Many places of production distributed within an extensive area where the target pest is managed as a single production unit by an association of growers. It is a conceptual term, there is no conventional fixed size to determine the extent of such areas.

Marginal area

An area adjacent or surrounding a place of production where a commercial host is grown. It may include wild vegetation (with or without pest hosts trees), abandoned orchards, protected parks, rural (villages) or urban (cities) human settlements, etc. It is a conceptual term, there is no conventional fixed size to determine the extent of such area.

Major host

Plant with high degree of susceptibility to the target fruit fly species.

Syn. Good host, main host, primary host.

Monitoring

An official ongoing process to verify phytosanitary situations (FAO-IPPC glossary).

Non-host

A plant species or cultivar that has not been found to be infested by the target fruit fly species or is not able to sustain its development to viable adults under natural conditions (modified from ISPM No. 37).

Non-Native

Pest or plant not originating or occurring naturally in a particular area.

Syn. Exotic.

Official control

The active enforcement of mandatory phytosanitary regulations and the application of mandatory phytosanitary procedures with the objective of suppression, eradication, containment, or exclusion of quarantine pests (adapted from FAO-IPPC glossary).

Outbreak

A recently detected pest population, including an incursion, or a sudden significant increase of an established pest population in an area (FAO-IPPC glossary). It is a conceptual term, there is not a conventional area fixed to determine the extent of the outbreak, however, for logistic purposes, AW fruit fly management programmes and CP delimit outbreaks in a range of fixed size areas, for instance 1 km², 5 km² or 1 sq. mile, 5 sq. miles, etc. Sometimes these areas are called core-area, quarantined area, etc.

Syn. Hot spot.

Outbreak area (quarantine area)

The core area of 1 km², which includes the site where the first specimen was detected (epicentre), and four buffer rings of 1 km width around the core area, equalling to a total area of 81 km².

Pest free area

An area in which a specific pest is absent as demonstrated by scientific evidence and in which, where appropriate, this condition is being officially maintained (ISPM No. 2).

Pest reservoir

It is a place with optimal conditions to maintain a reproductive fruit fly population nested inside an area subject to control procedures. In this reservoir, undetectable pests present at very low population levels may occur for short periods of time, however, once the population grows the pest is detected by the surveillance methods, becoming a source of infestation.

Syn. Favoured habitat, foci, foci of infestation.

Pest Risk Analysis

The process of evaluating biological or other scientific and economic evidence to determine whether an organism is a pest, whether it should be regulated, and the strength of any phytosanitary measures to be taken against it (ISPM No. 2).

Pest risk management

Evaluation and selection of options to reduce the risk of introduction and spread of a pest (ISPM No. 11). It is a system used to mitigate the pest risk to fulfil the ALOP determined by an importing country.

Phytosanitary certificate

An official paper document or its official electronic equivalent, consistent with the model certificates of the IPPC, attesting that a consignment meets phytosanitary import requirements (FAO-IPPC glossary).

Phytosanitary condition

Specific phytosanitary combination or relationship between a target fruit fly species, a target host commodity, and a particular production area. These relationships determine the fruit fly management strategy to be used. For instance, in areas where a quarantine species of fruit fly coexists with a commercial commodity that is qualified as poor host, a system approach strategy can be applied, but if the same species of fruit fly coexists in the same area with a commercial commodity that is known to be a major host, the most appropriate strategy will be a Probit-9 PHT or the establishment of permanent FF-PFA.

Place of production

Any premise, cultivated with the commercial host commodity, operated as a single production unit by an individual, independent grower or producer (adapted from FAO-IPPC glossary).
Syn. Commercial field, farm, orchard.

Plant phenology

The periodic plant events such as leave bud, fruit bud, bloom, fruiting, fruit maturation, leaf falling and dormancy.

Poor host

Plant that, having a low degree of susceptibility to the target fruit fly species, can become infested in the absence of major hosts.
Syn. Occasional host, secondary hos.

Probit-9

A statistical mortality level reaching 99.9968%, used as the efficacy level for a post-harvest treatment designed to achieve quarantine security.

Protocol area

An area where a BWP is applied under agreement between the NPPO of the exporting and importing countries.
Syn: Working area

Quadrant

A square area of 1 km per side (1 km²).

Regulated pest

A quarantine pest or a regulated non-quarantine pest (FAO-IPPC glossary).

Safeguard measures

Actions sometimes required by the importing country to protect a consignment from being infested, keeping thus its phytosanitary integrity. In BWP that apply to a systems approach, safeguard measures are additional dependent measures or elements. Safeguard measures may also be required in a consignment transiting third countries.

Suppression

The application of phytosanitary measures in an infested area to reduce pest populations (FAO-IPPC glossary).

Surveillance

An official process which collects and records data on pest occurrence or absence by survey, monitoring or other procedures (FAO-IPPC glossary).

Survey

An official procedure conducted over a defined period of time to determine the characteristics of a pest population or to determine which species occur in an area (FAO-IPPC glossary).

Systems approach

A pest risk management option that integrates different measures, at least two of which act independently, with cumulative effect (ISPM No. 14).

Wild host trees

Not domesticated or cultivated, they could be planted hosts trees but not attended such as abandoned orchards. They could also be planted and attended but not commercially exploited such as host trees in house backyards, host trees growing in public parks, along the streets, etc. (adapted from the Oxford English Dictionary 1990).

Wild fruit fly individual or populations

Naturally reproducing fruit flies. Antonym of sterile insects which are artificially reared.

Working area.

It is the total area determined and delimited to apply an AW fruit fly management programme, including surveillance activities and phytosanitary procedures to control the target fruit fly.

Annex 1

Implementation of fruit fly eradication programmes

A-1.1 Introduction

Countries implement AW fruit fly management programmes over extensive areas with the objective of suppressing and/or eradicating native populations or preventing the introduction and spread of populations of non-native quarantine species. To reach their objective these programmes may apply one or more of the four strategic objectives internationally used to manage fruit fly populations: suppression, eradication, containment, or exclusion, as describe in the ISPM No. 26.

A-1.2 Type of fruit fly management programmes

The type of programme to be conducted depends on the specific objectives and the corresponding fruit fly management strategy used to achieve the objectives. Thus, there are four main types of such AW programmes.

A-1.2.1 *Suppression programmes*

Suppression programmes are designed with active participation of grower organizations and other stakeholders for a coordinated management of target fruit fly populations over large areas where effective control cannot be accomplished through uncoordinated individual efforts.

In these cases, the government cooperates to manage the fruit fly populations in marginal areas, while the growers coordinate to suppress the pest in the production areas to keep the target populations below an economic threshold. This allows trading of the horticultural commodities in domestic markets. Alternatively, with the application of a complementary pest mitigation measure such as a Probit-9 PHT, or a SA based on an FF-ALPP, it allows trading in international markets.

A-1.2.2 *Eradication programmes*

Eradication programmes are conducted to eliminate the target fruit fly populations from a geographical area. Such programmes are usually applied against non-native invasive fruit flies that have recently been introduced and are not well established yet, or against non-native or endemic fruit flies that, even though established over a portion of a country, are targets of eradication in view of favourable economics and available technology that increase the feasibility of sustainably eliminating such populations.

A-1.2.3 *Containment programmes*

Containment programmes are conducted to contain or slow the natural or artificial spread of fruit fly pests from an infested area towards an FF-PFA where favourable ecological conditions exist for establishment. Containment programmes are usually implemented by establishing fixed barriers rather than attempting to eliminate populations throughout the infested areas. The containment efforts are applied within the barriers established in the periphery of the infested area.

This strategic objective has been used to contain the movement of fruit fly pests along the border between an infested and a pest free country, or in adjacent areas within the same country, where one of them is infested and the other is not. These programmes frequently become long-term containment

efforts; therefore, they should be subjected to frequent reviews to assure that their objectives are being attained.

In active AW eradication programmes, mobile containment barriers or temporary buffer zones are often used to progressively protect recently created FF-PFA from reinfestation.

A-1.2.4 Exclusion programmes

The exclusion strategic objective is used by programmes to prevent the entry or establishment of a pest into an PFA. The conventional exclusion strategy is applied by NPPOs to prevent the movement of fruit fly hosts through the official inspection of commercial cargo and passengers.

More recently, the scope of application of exclusion strategies has been further broaden by applying phytosanitary procedures in the places of production of fruit commodities through preclearance exclusion programmes.

Specific cases of exclusion programmes using sterile insects are the fruit fly preventive release programmes which release sterile flies over FF-PFAs at high risk of introductions and that are continuously threatened by highly invasive non-native fruit fly species. In other specific cases, sterile flies are released as exclusion barriers, which are established along the inner borders of FF-PFAs to protect them against introductions of the fruit fly target pest coming from adjacent infested areas.

A-1.3 General characteristics of AW fruit fly management programmes

AW fruit fly programmes aimed at eradication, containment, and exclusion also involve R&Q activities to prevent reinfestation or spread of the pest to new areas. These activities are often supported by the horticultural industry.

These programmes can be simple and short-term such as those established to eradicate recent introductions of non-native quarantine fruit fly pests from an FF-PFA. Other programmes are more complex and planned for intervention over larger areas and long periods of time, such as those established to eradicate fruit fly populations present across wide areas.

There are also permanent AW fruit fly management programmes that use containment and exclusion barriers to prevent the establishment of the target pest in an FF-PFA that is subject to continuous incursions of the pest. These common programmes operate at the limits between an infested and a PFA or between an infested and a pest free country. Sometimes, exclusion programmes are established to protect territories that are not located in the limits of an infested area, but it is subject to continuous incursions of fruit fly pests because they bear important aerial or maritime ports.

The AW fruit fly management programmes as part of their intrinsic process, may apply suppression, containment, and exclusion strategies altogether. Characteristics of the various AW fruit fly management programmes are presented in **Figure A-1.1**.

All the above-mentioned types of programmes, despite their differences in strategic objective, coverage, and time frame, share many common elements, from their establishment to their execution and closure.

An AW fruit fly eradication programme that integrates the SIT over large areas against established fruit fly pests that respond to TML, or proteinaceous baits serve as a good model to describe other programmes with different strategic objectives which might be smaller in size and less complex. For this reason, a programme like that is used in this guideline as a model to discuss how the different types of AW fruit fly management programmes may be implemented. It is important to note that the AW fruit fly eradication programme with a SIT component, used as a model in this guideline, implies targeting a single fruit fly species. AW programmes aimed at the eradication of more than one fruit fly species require more complex considerations.



Figure A-1.1. Usual attributes of AW fruit fly management programmes related to pest management strategy, coverage, and time frame.

| STAGES | | STEPS | | Time |
|--------|----------------------------|-------|--|------|
| I | Pre-eradication (Planning) | 1 | Collection of information | |
| | | 2 | Economic and technical assesments | |
| | | 3 | Eradication plan and official launching | |
| | | 4 | Organization and management | |
| II | Eradication (Execution) | 5 | Public relations | |
| | | 6 | Surveillance and R&Q actions | |
| | | 7 | Mass rearing facility and FE&RF | |
| | | 8 | Eradication process | |
| III | Post-eradication (outcome) | 9 | Domestic declaration of pest freedom | |
| | | 10 | PFA notification to International organizations and trading partners | |
| | | 11 | Maintenance of FF-PFA | |
| | | 12 | Contingency plan | |

Figure A-1.2. Simplified sequence of an AW fruit fly eradication programme, divided into logical operational stages and steps across a timeline

A-1.4 Stages of eradication programmes

Implementing an eradication programme against an established native or non-native fruit fly pest, to create an FF-PFA is not an easy task, particularly if it is large-scale, multi-year based and include the release of biological agents such as sterile flies or parasitoids to achieve its goal.

This type of programmes tends to utilize sophisticated technologies such as computer-based models, satellite imaginary, software for geographic information systems, global positioning system and data management. Despite the professional management of these programmes, from the initial planning to handling of the day-to-day issues, there are a number of things that can go wrong. However, if the fruit fly management programme is divided into operational stages and steps following a timeline, with clear objectives and outcomes established for each stage and step, it is much easier to manage the eradication programme and to achieve the final goal (Figure A-1.2).

As in any conventional project, an AW fruit fly eradication programme, regardless of its strategic objectives, has three basic operational stages which in project management terminology are called: (a) planning, (b) execution/evaluation, and (c) outcome/closure. In this guideline, however, the nomenclature used is associated to an eradication process, so that the name of each stage is linked to the operational phase corresponding to this process.

The three major operational stages into which an eradication programme is therefore divided are:

- Pre-eradication or Preparatory stage (planning);
- Eradication (execution and evaluation);
- Post-eradication (outcomes and closure).

In each stage, a number of actions are conducted that are grouped into different steps. Achievement of the specific objectives of each stage and each step should ultimately lead to eradication and the establishment of an FF-PFA.

The number of steps vary depending on the scope, size, and complexity of the eradication programme. However, the 12 steps presented in **Figure A-1.2**, are the ones that might be used in a large-scale eradication programme using the SIT. The specific activities that encompass each step are discussed below.

A-1.5 Stage I. Pre-eradication (planning)

A-1.5.1 Step 1. Collection of information

The starting point of an eradication programme is the collection of baseline data, including technical, scientific, economic, social, and environmental data related to the target pest, hosts, and area where the programme will be conducted. The main data needed are listed below.

- Pest biology and ecology. Seasonal and spatial distribution and levels of pest incidence.
- Commercial and wild hosts, their phenology and preference to the target fruit fly species.
- Characteristics of the intervention area depicted in cartographic maps showing topographic, hydrographic, and road maps and the distribution of agroecological zones. Aerial photography and satellite imagery are tools that can help in developing the maps. Historical records of climate information, mainly rainfall, relative humidity, and temperature are needed to prepare climate charts and regional maps of the bioclimatic zones that help provide the potential distribution of the pest.
- The characteristics of the area in relation to the presence and distribution of urban settlements, roads, railroads, and other similar means of communication.
- Commercial host commodities with or without the potential to be exported.
- Insecticide products used in the current control of the target pest.
- Current fruit fly pest control practices used by individual and organized growers.
- Records of social and environmental problems that have emerged as a result of the use of insecticide applications.

The above information will help to prepare the basic documents, such as the technical feasibility study and the economic feasibility assessment, to support the eradication programme.

In addition, if this information is kept in a database, it may also be an additional valuable source of information for programme managers.

A-1.5.2 Step 2. Economic and technical assessments

A-1.5.2.1 Cost-benefit analysis

A cost-benefit analysis should be conducted to assess the potential costs of an eradication programme and the benefits that fruit fly eradication may generate for different scenarios of pest damage levels, size of areas and time horizons. The damage assessment should focus on the losses to commercial hosts from the target fruit fly species and the size of the production area. The time horizons are the expected time in which the eradication goal may be achieved by the programme. The result of the analysis will determine whether the programme is financially feasible or not.

The cost-benefit analysis can also include relevant indirect social, and environment benefits difficult to quantify in monetary terms, such as the reduction of environmental damage from insecticide used by growers to control the target pest. The main data used to prepare this analysis are listed below.

- Definition of the target pest(s);
- Size of the working area from where the pest will be eradicated;
- Size of the intervention blocks into which the working area will be divided;
- Damage caused in each of the commercial hosts attacked by the target fruit fly pest;
- Size of the area where specific commercial host are grown;
- Cost of the current control practices;
- Impact of the eradication on fruit production, associated industries, and market access;
- Impact of the eradication on the environment.

The Joint FAO/IAEA Centre has developed a cost-benefit analysis model to be used as a tool for AW fruit fly management. This model, contained in a CD, can be requested directly from the contact points available at the IPCS TWD database: <https://nucleus.iaea.org/sites/naipc/twd/Pages/Contact-Point.aspx>

A-1.5.2.2 Technical feasibility study

A technical feasibility study assesses in depth if, in the selected intervention area, the key elements and technology for eradication are available and can be successfully applied. The study may also include possible alternative ways of solving current constraints. In summary, it presents the logistics and tactical plan on how eradication can be carried out in the target area. These are some of the main elements that should be considered in preparing this study:

- Description of the technology that can be used to eradicate the target fruit fly pest. As the technology components used in eradication programmes, such as the SIT, are a major issue, evaluation of eventual social, or logistic constraints is relevant.
- Availability of local qualified staff needed, classified in categories such as senior-level, professional, technicians and employees. In some cases, the availability of such work force can be a limitation, therefore, it is important to indicate if expertise from elsewhere or abroad may be needed.
- Availability in the local market of specific materials needed to conduct the field operations or the mass-rearing. It should be indicated if the materials are available in the local market or if they need to be purchased elsewhere or abroad.
- Availability of services mainly for aerial spraying and sterile fly aerial releases. Often, availability of commercial aerial services for domestic flights or for agricultural services are difficult to obtain. These key factors should be analysed in depth and alternatives should be provided in case of lack of such services.

- Availability of sites near the airports or airstrips to build permanent or establish mobile fly emergence and release facilities (FE&RF) or the field operations headquarters close to them. The location of the FE&RF is critical due to the increase of costs from ground transport and aerial ferry time incurred in the case of permanent flight schedules.
- Availability of easy communication systems, including telephones and internet connections.
- Availability of functioning national quarantine services, without which FF-PFAs resulting from successful eradication cannot be sustained.
- Identification of areas with agroecological features that can complicate the eradication activities (e.g. wide-spread continuous or scattered host areas with high infestations or large fruit production places immersed in such sensitive areas). Evaluation of the difficulties to implement pest suppression in such areas and ways of overcoming such difficulties need to be addressed.
- Evaluate options and determine the most applicable deadlines for each operational stage and step
- Add supporting financial information. It is critical that the technical and financial data utilized in the study be reconciled. These data would be used to prepare the cost-benefit analysis.
- Include alternative plans in case externalities such as socio-political or economic issues interfere with programme implementation as originally planned. Alternatives that can take advantage of the partial progress attained by the programme at certain point in time would be useful.

As a result of this study, interested groups of stakeholders will know if it is technically feasible or not to eradicate the target pest, as well as the major advantages, risks and constraints given the prevailing conditions.

A-1.5.3 Step 3. Eradication plan and official launching

A-1.5.3.1 Comprehensive eradication plan

If the cost-benefit analysis results in a positive return on investment and the technical feasibility study demonstrate that it is possible to implement an AW fruit fly eradication programme with negligible risk of failure, a comprehensive eradication plan needs to be prepared.

In general terms, the plan includes the global technical and financial strategies, the specific timelines, goals, and milestones to be achieved in each operational stage and step, the temporal and spatial phases of the eradication process (see **Step 8, Eradication process**), as well as the defined working area and intervention blocks. The eradication plan, in addition to presenting the technicalities will guide the eradication programme throughout its implementation.

The comprehensive eradication plan is shared among potential stakeholders and other interest groups involved in the horticultural sector, such as fruit growers, traders, and exporters associations, regional and local authorities, and politicians to lobby for political and financial support. Fundraising options for programmes of this type usually come from the national and regional governments, as well as international financial institutions that can provide loans and grants to governments.

The comprehensive plan should include the following elements:

- Definition of target fruit fly species;
- Definition of commercial commodities hosts of target fruit fly pest;
- Delimitation of the infested area under eradication;
- Description of the temporal and spatial eradication model to apply (**Step 8, Eradication process**);

- Planned duration of the eradication programme, in years, with stages and steps following a timeline, including milestones and goals for each of the stages and steps;
- Size of the total area to be eradicated and division of the area into intervention blocks;
- Description of the phytosanitary procedures to be used for pest eradication;
- Calculations of the annual and total costs;
- Identification of potential financing sources;
- Definition of the organizational structure.

A-1.5.3.2 Official declaration to launch an eradication programme

Fruit fly eradication programmes are efforts aimed at protecting the agricultural welfare of a country. They involve large-scale interventions, in most of the cases also on top of populated areas, with eradication actions that include aerial and ground phytosanitary activities. Setting up a legal framework that supports eradication actions on public and private property is therefore essential for smooth programme operations.

In addition, preserving the established FF-PFA status, or preventing introductions of non-native quarantine pests that infest the same commercial commodities that the programme aims to protect, is essential in order not to jeopardize the outcome of the eradication efforts. Therefore, it is also crucial to have in place a clear and strong legislation and regulation so that exclusion activities such as quarantine inspection at international points of entry and domestic checkpoints can be implemented.

The operation of eradication programmes, including legislation to support actions in populated areas and points of entry, requires that the programme is declared of public interest. The official declaration to set-up an eradication programme may include the following major elements:

- Objective and justification. Why the programme is needed, incorporating the potential economic, social and environment benefits, based on estimations of the target fruit fly impact on agricultural welfare and the benefits of the eradication;
- Territorial extent. Define the area of the eradication programme, including geographical and political/administrative boundaries;
- List of participants/stakeholders that will be part of the programme. The groups of people may include the national and local phytosanitary authorities, individual or association of producers, owners of post-harvest treatment facilities, fruit dealers and exporters, academic and research observers;
- Quarantine enforcement to establish quarantine stations at all the international points of entry, including seaports and airports in the country;
- Additional regulations that may be required to implement a programme include:
 - Prohibition of any artificial reproduction of the target pest in laboratories inside the eradication area, including those related to research;
 - Determination of the dates for harvesting;
 - Application of official procedures in the marginal areas;
 - Quarantine enforcement for establishing local checkpoints.

A-1.5.4 Step 4. Organization and management

This step starts with the allocation of resources needed to launch and sustain all programme operations. Financial sources may originate from the government (both national and local) and also

from stakeholders (producer association, exporters association, international organizations, financial institutions, etc.). The main activities relevant to this step are discussed below.

A-1.5.4.1 Personnel and organization

Selection of staff and personnel

Selected personnel should preferably be selected for the following profile:

- No direct family ties among members of the management or staff group;
- Technical staff having a philosophy of work and commitment to the objective of the programme, and not only interested in earning money;
- Not bearing ideas contrary to the principles of the programme;
- Have specialization in some of the following areas: integrated pest management insect ecology, insect physiology, the SIT or radiation biology, fruit fly rearing, quarantine, public relations, etc.

Organizational structure

AW eradication programmes with a SIT component aimed at eliminating established fruit fly populations, include four major groups of staff with specific but interrelated activities (**Figure A-1.3**).

- Consultative committees
- Support units
- Field operations group
- Mass-rearing group.

If the programme will purchase sterile flies or parasitoids from an outside source, then it will only need FE&PFs, which in turn will be part of the field operations unit.

The chain of command between these four groups of staff is depicted in **Figure A-1.3**, and the description of each element of the organizational structure is presented below.

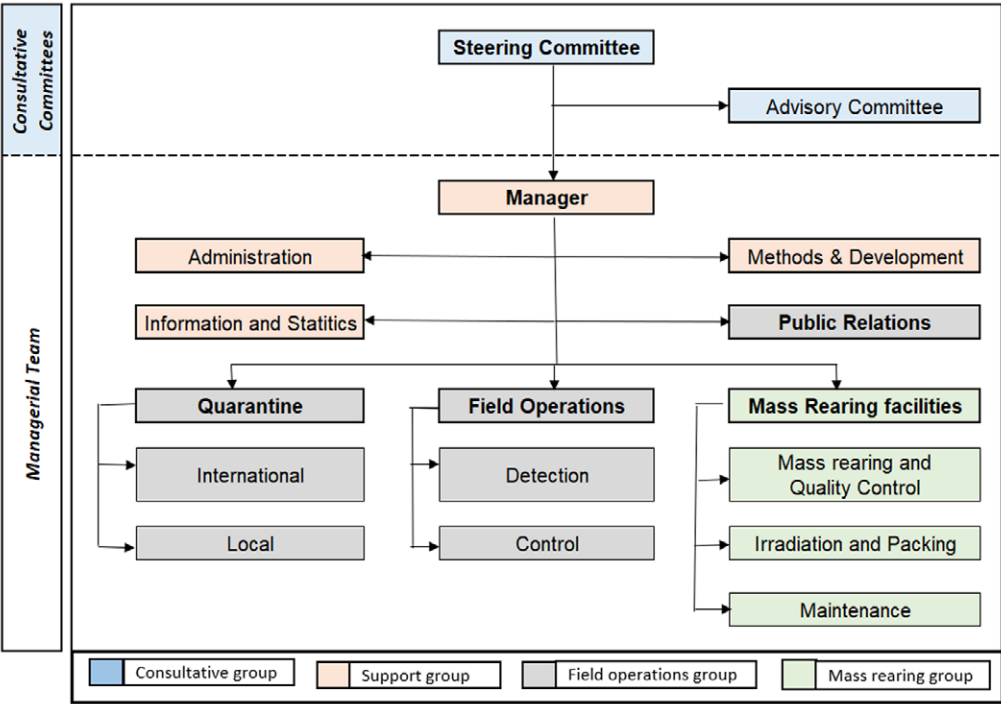

Figure A-1.3. Simplified organizational chart of an AW eradication programme with a SIT component

Consultative committees

Large-scale AW eradication programmes usually require two consultative committees.

Steering committee

This is integrated by the group of stakeholders. The leadership of this committee falls to high officials of the national agricultural authority and the NPPO. Usually, decision making members of this committee are those that contribute to the funding of programme operations.

Often this group also includes representatives of various other interested groups of stakeholders such as local authorities, local and national producers and exporters associations, and representatives of international organizations.

Advisory committee

This committee is composed by a team of independent external national and international experts specialized in different areas of AW fruit fly eradication programmes. This team is usually called 'Technical Advisory Committee (TAC)' and can be integrated by professionals such as managers with experience in large-scale application of fruit fly eradication schemes, in phytosanitary procedures used for pest eradication, in AW programme operational activities, or with expertise in relevant basic and applied research.

The TAC conducts periodic visits, which may initiate even before launching the eradication programme. It is set up to evaluate the general eradication plan including spatial and temporal tactics, to evaluate progress made during the eradication process, and to provide overall technical advice. The TAC may also provide guidance on the applied research required to solve technical problems found during the day-to-day eradication actions.

A-1.5.4.2 Managerial team

The managerial team is composed of a general programme manager, support units including administration, informatics and statistics, methods & development, and public relations, as well as operational technical units including quarantine, field operations and mass-rearing facilities (**Figure A-1.3**). The general manager is responsible for providing direction, and the unit heads for coordinating activities and providing oversight to the programme.

Programme manager

The programme manager is overall responsible for programme and administrative functions. Each unit head should report directly to him. Due to the complexity of large-scale eradication programmes, including finances, environmental and social issues intrinsic to the large areas under eradication which may lead to political conflicts, the manager of such programmes should bear specific attributes. The main abilities that a programme manager should fulfil are discussed in detail in Chapter 5.3 of the book "Sterile Insect Technique. Principles and Practice in Area-Wide Integrated Pest Management" of the FAO/IAEA, Insect Pest Control Section at: www.taylorfrancis.com/books/oa-edit/10.1201/9781003035572/sterile-insect-technique-dyck-hendrichs-robinson)

A-1.5.4.3 Support group

Administrative unit

This unit supports the programme manager with the administration of programme resources. Some of the major activities include (a) leasing of adequate facilities, (b) acquisition and maintenance of a pool of vehicles, (c) providing communication services (telephones and radio, if appropriate), (d) supplying furniture, administrative and technical materials and equipment, (e) arrange for staff salaries, services and travels, (f) contracting for aerial services (aerial spraying or sterile fly/parasitoid releases), and (g) preparing compliance agreements with growers, packers, and other stakeholders.

Research & development unit

Activities of this unit are usually an important component of AW eradication programmes planned to last for several years. It is mainly focused on applied research to solve problems affecting programme operations and on optimization of processes and technology. It may address issues such as: (a) adaptation of eradication technology to specific local conditions, (b) optimization of technology and improving of operational processes to reduce cost and increase efficiency such as replacement of imported diet ingredients for mass-rearing by equivalent local supplies, (c) development of decision support tools such as models to forecast population trends and optimization of sterile fly release, (d) development of improved techniques for eradication, which can become novel advanced technologies.

In eradication programmes, it is common to think about research as a luxury since the mind frame is that the programmes must be fully dedicated to managing the target fruit fly. Nevertheless, applied research can solve many technical problems which could otherwise become bottlenecks that reduce or slow down progress. Outsourcing basic research can be a good option to improve current technology, however, day-to-day constraints in the technical operations can be solved more effectively through a programme's applied R&D unit.

Information and Statistical Unit

Basic functions of this unit are to obtain, classify, process and record information received from the operational technical units of the programme. The duties also involve handling of maps, aerial photographs, meteorological and climatological information, which are critical support tools for the field work.

Once this unit has gathered the technical information, it is responsible for setting up a technical report system containing information of the overall activities of the technical units and pest incidence. With this information daily and periodic (weekly, monthly, and yearly) reports are produced.

Reports should include not only progress made in operational activities and constraints, but also information on conflicts affecting the programme including public unrest. All information should be recorded in databases specifically design for this purpose and kept during the programme's life and beyond.

These reports should be internally circulated among the units that comprise the programme, particularly to the public relations, quarantine, field operations and mass-rearing units. This unit also facilitates the reports to the manager and notifications of the status of the target fruit fly, which may be sent to interested groups of stakeholders and the general public.

Information is a basic element for planning and execution of programme activities; therefore, it is essential that an eradication programme has an efficient information management system. Information should be accurate, clear, and timely. Otherwise, programme efficiency may be compromised affecting the eradication processes and programme results.

This unit may also manage the physical or digital library of the programme. The library should include the baseline data and feasibility assessments conducted during the pre-eradication stage of the programme. It may also contain books and scientific articles related to the target pest and manuals on phytosanitary procedures for pest survey and suppression.

Here, it is essential to describe comprehensively the management of technical information before discussing the next groups of staff, because it will help to understand how data can be originated, processed, and managed systematically to produce standardized information reports, as well as the parameters used to assess the efficiency of the activities performed and progress in the pest control achieved.

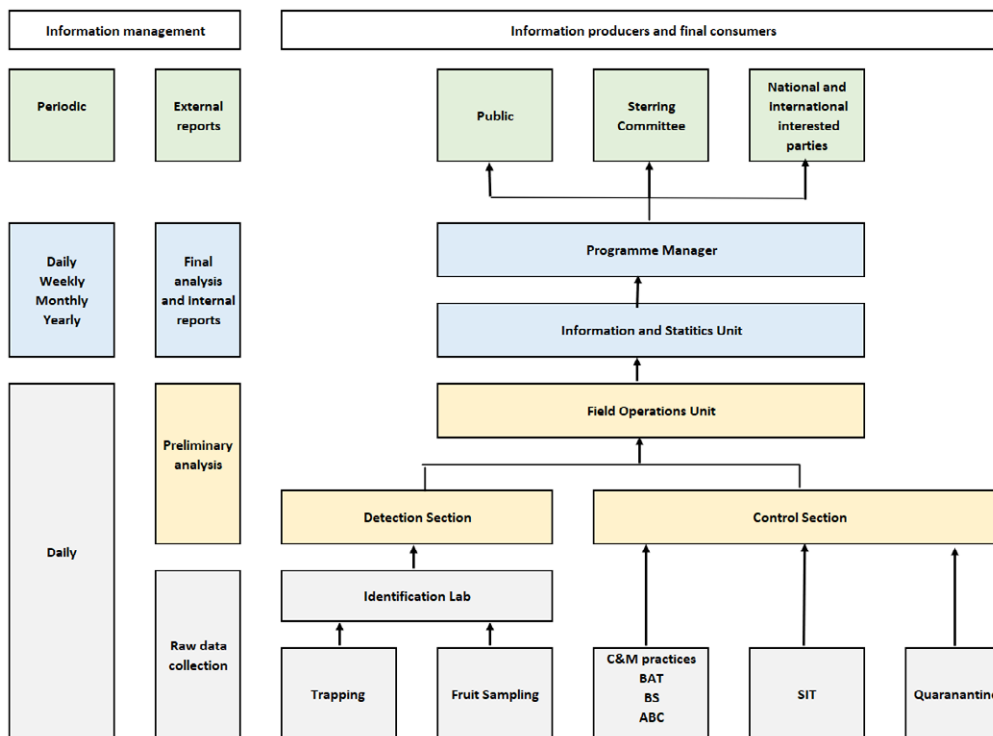

Figure A-1.4. Illustration of how data are streamlined from the original source through different managerial levels of the programme, analysed, and information reported to the decision-making level and external stakeholders

A-1.5.4.4 Information management

Information streamline

From raw data to the final information user, there should be a clear path so that information can be transmitted smoothly through the different organizational levels (**Figure A-1.4**).

Specific reports should be internally circulated among the technical and administrative units that comprise the eradication programme, particularly to the public relations, quarantine, field operations and mass-rearing units. The programme manager should notify relevant information to concerned external groups of stakeholders, local, national, and international organizations, specific interest groups and the general public.

Uniform management of information

Data are managed to produce standardized information in terms of space and time so that users can carry out easy calculations and fast comparisons without any additional data analysis. To produce uniform information that can be easily compared, the intervention area and the time are divided into units of equal size. Specific parameters are defined, and the results are presented for each area and time unit based on these parameters.

The same parameters are used for programme evaluation and for decision making throughout the programme's duration. The data are finally used to support obtaining the FF-PFA status and to prepare bilateral work plans (see **Annex 3**) for exports of fruit commodities.

Division of the working area

The working area is the extent of land where the eradication phases are carried out. Division of the working area into units of the same size (km², sq. mile, etc.), has the following advantages:

- Results of detection and control activities are standardized by using equal-sized units that allow for fast comparisons without any additional data analysis;
- Rapid location and easy determination of distances to interesting sites from a point of reference. For example, rapid location of hot spots, outbreaks, pest reservoirs, isolated detections, towns with social problems, accidents, etc. and to assess how close or far from the point of reference they are;
- Facilitates keeping close monitoring over the operation of the detection and control systems.

To divide the working area into equal-sized unit areas, it is split into quadrants based on the conventional coordinates used in cartographic maps. Recommended maps are those at a scale of 1:100 000 on which 1 cm on the map equals 1 km on the ground. The size of the quadrants will depend basically on the size of the total working area, although quadrants of 100 km² (10 km × 10 km) are the most commonly used.

For prompt location of points of interest, a code is given to each quadrant. The use of Cartesian coordinates is recommended for this purpose, but it should be noticed that, instead of determining the position of a point on a plane, we determine an area (quadrant). In this way, a pair of numerical coordinates is assigned to each quadrant. Thus, each quadrant is uniquely identified by such pair of numerical coordinates, for instance (2, 4).

The most important issue related to each quadrant's code is to assign the quadrant of origin from the outset of the eradication programme. The quadrant of origin is usually selected where an important landmark is located, such as the headquarters of the eradication programme, the field operations office, the mass-rearing facility, the FE&RF, etc. Defining this point of origin becomes important because it will be the point of reference from which distances will be calculated (**Figure A-1.5**).

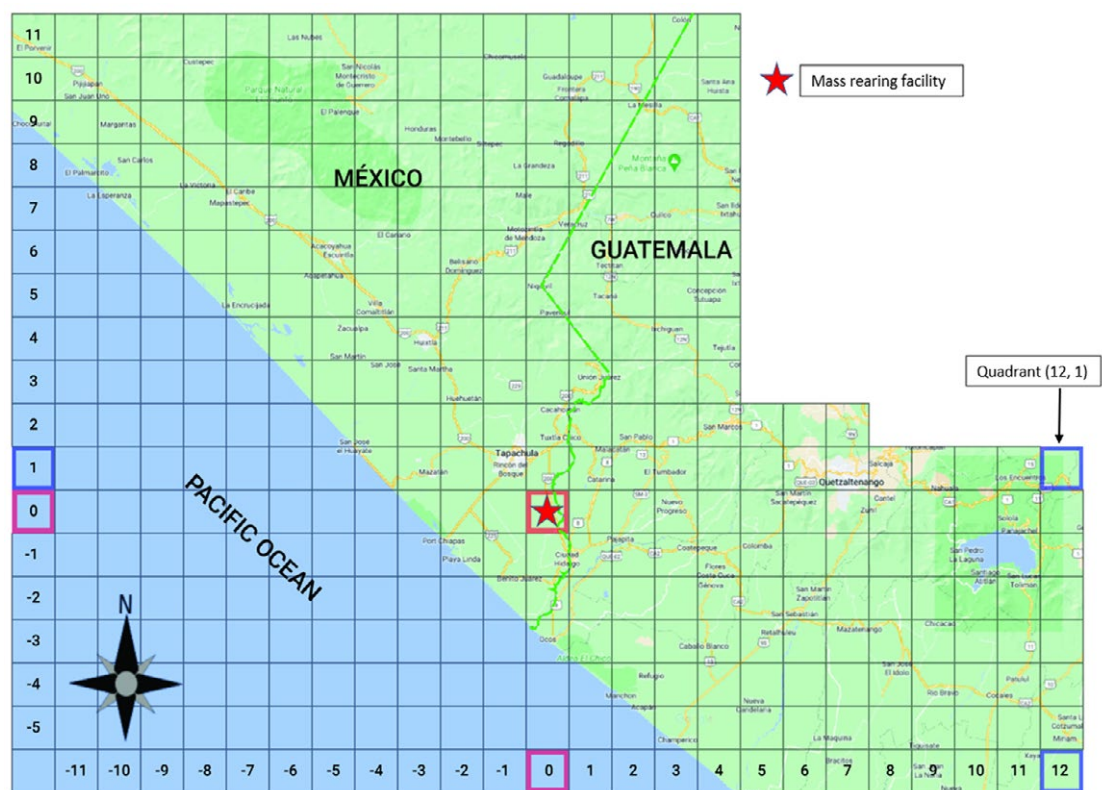

Figure A-1.5. Example of a working area divided into 100 km² quadrants. The point of origin (red square) at (0,0) is where the *C. capitata* mass production and sterilization facility is located in Mexico. The blue squares show the code (12, 1), meaning 120 km to the east and 10 km to the north from the mass-rearing facility.

By using unit areas of the same size, all the field data, including infestation and pest control, can be easily compared. On the contrary, if unit areas of different size would be employed and the data show different levels of infestation, this would result in uncertainties in interpreting infestation rates.

Ground surveillance and control activities can be planned and carried out based on the division of the working area into equal-sized quadrants. However, for planning of aerial control activities, the same division cannot be used because aerial BAT or sterile fly releases are conducted by asymmetrical blocks following the irregular spatial distribution of the pest. Data of these activities, however, can easily be transferred into the quadrant information method by using global positioning systems (GPS), so that records of surveillance and ground and aerial suppression activities can be presented in the same quadrant approach.

Since field activities in eradication programmes deal with information that depends on location, the use of GPS by the field operations personnel along with the application of geographical information systems (GIS) can easily produce field information of any activity by quadrants in a map.

Use of GIS allows accurate spatial and temporal analysis and quadrants allow a rapid location and easy determination of distances to relevant sites from a point of reference. The two methods complement each other.

In this way, each quadrant becomes a phytosanitary radiography where the results of surveillance, control activities, infestation levels and spatial distribution of the pest are shown. As each quadrant is coded, they will work as a data-cell containing the recorded information related to surveillance, control and pest infestation that can be compared at any point in time.

At the start of a programme, the field operations personnel may have problems working in the field with quadrants outlined by imaginary lines. However, with some training in the use of maps and their interpretation in the field, they become able to find any site in the field and capable to handle the quadrants as an integral part of their job. Information placed in quadrants can also be useful for non-programme staff such as stakeholders and the general public, because once the scale of the quadrants is explained, people can easily understand the data values presented in the quadrants.

Division of the conventional calendar

To produce standardized information, which allows to carry out rapid calculations and comparisons through a timeline, data should also be managed in standard units of time. In this way, results of the activities obtained in a number of consecutive years will show figures obtained over equal periods of time. Therefore, the conventional calendar is divided into equal lengths of time in a defined order.

The year is divided into 13 periods of four weeks each. This will add up to 364 days. The remaining day can then be added either to the last period of the current year or to the first period of the following year. Using this system, despite having a week with an additional day, will facilitate data comparisons.

Since reports addressed to the stakeholders (government, international organizations, growers, and general public), should be submitted using the conventional monthly division of the calendar, to prevent preparing two different reports, it is recommended that the 12 months of the year be distributed among the 13 equal periods.

Figure A-1.6 shows how the calendar year is divided into periods of equal time-length (4 weeks) and how the months of the year are distributed to the standardized periods.

Classifying information

In complex organizations such as large-scale eradication programmes, information is the cornerstone for strategic planning and decision making, including the technical parameters of surveillance and control activities. Therefore, it is essential to have an efficient information management system.

Information should be accurate, understandable, timely and managed through parameters that allow conducting evaluations in space and time. Lack or unreliable information will not only reduce

| Period Number | Week Number | Time Elapse | | | | Month |
|---------------|-------------|-------------|-----|-----|-----|-----------|
| | | From | JAN | To | JAN | |
| I | 1 | | 1 | | 7 | JANUARY |
| | 2 | | 8 | | 14 | |
| | 3 | | 15 | | 21 | |
| | 4 | | 22 | | 28 | |
| II | 5 | JAN | 29 | FEB | 4 | FEBRUARY |
| | 6 | | 5 | | 11 | |
| | 7 | | 12 | | 18 | |
| | 8 | | 19 | | 25 | |
| III | 9 | FEB | 26 | MAR | 4 | MARCH |
| | 10 | | 5 | | 11 | |
| | 11 | | 12 | | 18 | |
| | 12 | | 19 | | 25 | |
| IV | 13 | MAR | 26 | APR | 1 | APRIL |
| | 14 | | 2 | | 8 | |
| | 15 | | 9 | | 15 | |
| | 16 | | 16 | | 22 | |
| V | 17 | | 23 | | 29 | MAY |
| | 18 | APR | 30 | MAY | 6 | |
| | 19 | | 7 | | 13 | |
| | 20 | | 14 | | 20 | |
| VI | 21 | | 21 | | 27 | JUNE |
| | 22 | MAY | 28 | JUN | 3 | |
| | 23 | | 4 | | 10 | |
| | 24 | | 11 | | 17 | |
| VII | 25 | | 18 | | 24 | JULY |
| | 26 | JUN | 25 | JUL | 1 | |
| | 27 | | 2 | | 8 | |
| | 28 | | 9 | | 15 | |
| VIII | 29 | | 16 | | 22 | AUGUST |
| | 30 | | 23 | | 29 | |
| | 31 | JUL | 30 | AUG | 5 | |
| | 32 | | 6 | | 12 | |
| IX | 33 | | 13 | | 19 | SEPTEMBER |
| | 34 | | 20 | | 26 | |
| | 35 | AGO | 27 | SEP | 2 | |
| | 36 | | 3 | | 9 | |
| X | 37 | | 10 | | 16 | OCTOBER |
| | 38 | | 17 | | 23 | |
| | 39 | | 24 | | 30 | |
| | 40 | OCT | 1 | OCT | 7 | |
| XI | 41 | | 8 | | 14 | NOVEMBER |
| | 42 | | 15 | | 21 | |
| | 43 | | 22 | | 28 | |
| | 44 | OCT | 29 | NOV | 4 | |
| XII | 45 | | 5 | | 11 | DECEMBER |
| | 46 | | 12 | | 18 | |
| | 47 | | 19 | | 25 | |
| | 48 | NOV | 26 | | 2 | |
| XIII | 49 | | 3 | | 9 | DECEMBER |
| | 50 | | 10 | | 16 | |
| | 51 | | 17 | | 23 | |
| | 52 | DIC | 24 | DIC | 30 | |

Figure A-1.6. Hypothetical calendar year divided into thirteen periods with equal number of weeks, with the months of the year distributed to the standardized periods

programme efficiency, but may hide events such as remaining population pockets, size of hot spots, high risk pathways etc. that may jeopardize the eradication processes, affecting programme results.

Technical parameters

There is a set of technical parameters that provide estimates of pest infestation levels. Data for these parameters are produced by pest surveillance activities including trapping and fruit sampling. To know how effective the phytosanitary procedures are to suppress the pest, the technical parameters should be compared along a timeline. The baseline is the previous value of the same parameter.

| Detection method | Technical parameters | Population Assessment |
|------------------|---|-----------------------|
| Trapping | Fertil Fly per trap-day (FPTD-f) | Pest infestation |
| | Number/percentage of traps with fertile flies | Pest distribution |
| | Number of traps with more than xx fertile flies | Pest concentration |
| Fruit sampling | Fruit fly larvae/kg of fruit collected | Pest infestation |
| | Percentage of infested samples (Number of infested samples / number of collected samples) | Pest distribution |
| | Number of fruits or samples with more than xx larvae | Pest concentration |

Figure A-1.7. Technical parameters used to assess the infestation of the pest population through trapping and fruit sampling. Note that in fruit sampling the term ‘fruits’ refers to natural hosts only.

Intensity of treatments may vary and their effect on the pest populations is evaluated by comparing the value of the infestation levels. **Figure A-1.7** lists the basic technical parameters to assess pest infestation through trapping and fruit sampling.

Operational parameters

Operational parameters estimate the performance of surveillance and control activities. These performance parameters are continuously analysed by managerial staff to conduct necessary adjustments and to plan and implement changes aimed at increasing the efficiency of surveillance and control procedures. **Figure A-1.8** lists the basic operational parameters used to assess performance of field activities in an eradication programme.

There are several more technical and operational parameters which are discussed in the IAEA trapping and fruit sampling guidelines available in: www.iaea.org/sites/default/files/trapping-guideline.pdf and / www.iaea.org/sites/default/files/ca5716en.pdf

Use of the technical parameters

Through technical parameters the degree of effectivity of the control treatments can be assessed by comparing the infestation levels from one point in time to another. Moreover, by using the same parameter comparisons between different areas, temporal and spatial changes of pest populations can be plotted in charts and maps. In addition, if values of these parameters are plotted by quadrants, it is possible to observe where the pest is under control and where it is not.

To carry out conventional and statistical analysis of the field data gathered by eradication programmes, the FAO/IAEA guideline entitled “Guidelines for the Use of Mathematics in Operational Area-Wide Integrated Pest Management Programmes Using the Sterile Insect Technique with a Special Focus on Tephritid Fruit Flies” can be useful. This guideline is available at www-naweb.iaea.org/nafa/ipc/public/tephritid-fruit-flies-manual.pdf

A-1.5.4.5 Field operations group

This group of units carries out the activities directly in the field; they represent the core activities of any AW fruit fly eradication programme.

| Phytosanitary Procedure | Operational Parameters |
|-------------------------|--|
| Trapping | Installed traps |
| | Percentage of inspected traps |
| | Average exposure (days) |
| Fruit sampling | Fruit collected (kg) |
| | Number of samples collected |
| C&M practices | Fruit destroyed (stripped, removed or buried) (Kg) |
| BAT | Aerial bait application (km ²) |
| | Ground bait application (lt) |
| ABC | Aerial parasitoids released (Millions) |
| | Ground parasitoids released (Milliones) |
| | Density of parasitodis per ha |
| SIT | Aerial fly released (millions) |
| | Ground fly releases (millions) |
| | Density of sterile flies per ha |
| | Sterile fly per trap per day (FTD-s) |
| | Percentage of traps with sterile flies |
| Quarantine actions | Fruit sized (kg) |
| | Fumigated fruit (kg) |
| | Number of inspected vehicles |
| | Number of inspected people |

Figure A-1.8. Major operational parameters used to assess the performance of field activities in an eradication programme. Note that in fruit sampling, ‘fruit collected’ refers to natural hosts only.

Public relations unit

The public relations unit is responsible for raising public awareness regarding the eradication activities. Most of the social and political problems that affect programme implementation arise from the activities carried out by the field operations and quarantine units, since these have direct contact and immediate effect on the people and the areas where they work, live, or pass by.

It is therefore necessary that the public relations unit works in close coordination with field operations and quarantines staff as a single unit to address and process claims and complaints. In this way, detection, control, and quarantine as the main surveillance and suppression methods used in the programme, are integrated in the public awareness plans in a holistic manner. The aforementioned actions give this unit an essence of field activity rather than as a support activity as it is usually understood.

Additionally, this unit is also responsible of managing programme information delivered to the stakeholders and other groups of interest, and to the programme employees through a systematic internal information scheme. Therefore, this unit produces and oversees the distribution of outreach materials, including leaflets, brochures, posters, placards, and signs at the points of entry and transit corridors. It also produces radio spots and podcasts as well as video and photo essays which can be

used in meetings, uploaded in digital social media, as well as in the mass media, including newspapers, TV, and radio stations.

Quarantine unit

Regardless of whether the target fruit fly is present or absent, countries need to apply offshore quarantine procedures to prevent the entrance and spread of non-native quarantine fruit flies, or domestic quarantines to prevent the movement of target fruit fly hosts from infested areas to FF-PFAs within the same country. For this reason, an organized and functioning quarantine service should exist before an eradication programme is launched.

The national or domestic R&Q services are not under the direction and policies of the eradication programme; they are under the responsibility and management of the NPPO. However, since regulatory procedures against the target pest are necessary to achieve programme goals, a close collaboration between the quarantine services already in place and the eradication programme is needed.

Therefore, one of the most important duties of the quarantine unit is to work together with the national R&Q service. Another important duty is to establish domestic permanent or random quarantine checkpoints to protect and isolate the area under eradication, based on the quarantine rules issued by the national authority.

Field operations unit

This unit, with its two sections, is directly responsible for applying the phytosanitary procedures throughout the eradication process. The main objectives of the field operations unit are to ensure timely detection of the target wild fruit fly in any biological stage, and to suppress and eradicate the wild populations and detected outbreaks. The field operations unit is mainly responsible for the eradication of the pest.

Detection section. These activities are carried out by personnel dedicated to conduct the trapping and fruit sampling activities. The section is responsible for the planning, establishment, operation and evaluation of a highly effective systematic fruit fly surveillance system and identification of captured specimens to determine the geographical distribution and the temporal and spatial pest infestation levels.

Control section. This section is responsible for planning, implementing, operating, and evaluating the phytosanitary procedures aimed at reducing and eliminating wild pest populations. If some phytosanitary procedures need to be applied at specific times, the personnel of this section can be split into various specialized crews, each one conducting different activities in different times of the year. For instance, the group responsible for chemical control, which applies aerial and ground BAT sprays when required, is divided into crews dedicated to C&M practices. The SIT group, which applies aerial and ground releases of sterile flies, when needed can also carry out the activities related to parasitoid releases.

Phytosanitary procedures to detect and suppress fruit flies used in AW fruit fly eradication programmes are discussed in the main body of this Guideline.

A-1.5.4.6 Rearing group

Fruit fly mass rearing unit

The sterile fly production process includes mass-rearing, sterilization, packing of sterile insects and maintenance of the mass-rearing facility. The mass-rearing of insects is a specialized activity where minimum variations in diet ingredients, temperature, and other environmental conditions of the rearing rooms, or in the process itself, can have a significant impact on the yields and quality of the mass-reared fruit flies.

Rearing operations require strict management of the whole production process, including specific tests to assess the quality of the diet ingredients, the conditions, and procedures under which all live stages of the insects are reared, and the appropriate irradiation dose for sterilization to assure producing sterile

insect of good quality, prior to the packing and shipping of the sterile flies for release. These activities are performed by specialized personnel working in the different sections of the mass-rearing facility, such as mass-rearing, quality control and maintenance. The fruit fly mass-rearing is widely discussed in the main body of this Guideline.

Parasitoid mass-rearing unit

The parasitoid production process is a little more complex, since in addition to the mass-rearing and sterilization of the host using radiation (fruit fly eggs, larvae, or pupae), it also requires the mass-rearing of the parasitoid itself. As in the case of fruit flies, the mass-rearing of parasitoids is a specialized process that may include insect mass-rearing and packing, quality control and factory maintenance. The parasitoid production is widely discussed in the main body of this Guideline.

A-1.5.4.7 Management procedures

The management procedures, which play a critical role in eradication programmes, are presented, and described below.

Personnel management

It is crucial to develop a job description template to serve as a model for the different programme positions. The job descriptions should include primary duties and responsibilities, as well as the skills and qualifications necessary to fulfil any position. In addition, a salary table is an important component for proper compensation according to performance and skills.

Policies

Regulations on the use and maintenance of key equipment and materials such as vehicles, laboratory devices, sensitive tools, etc. should be in place.

Establish an internal policy to encourage publication of innovations and improvements made to any of the technologies used in fruit fly surveillance, suppression, mass-rearing, packing and release. These publications can be done individually in national or international journals or as part of special issues on specific topics.

Standard Operational Procedures

Standard operation procedures should be developed for the major administration processes and for each of the phytosanitary procedures used during the eradication process, including C&M practices, BAT, BS, MT, ABC and SIT activities and for the mass-rearing of sterile flies and parasitoids. To have a programme with high operational standards and credibility from stakeholders, it is recommended for administrative and mass-rearing processes to be certified as ISO-9000 by a reliable certification body.

Reports

Weekly, monthly, and annual technical and administrative reports should be prepared based on standard technical parameters and operational indices used to assess technical performance and progress of eradication.

Meetings

Weekly meetings among the managerial, administrative, and technical staff should be held to inform on the activities carried out during the previous week, results achieved, the constraints that prevent the appropriate progress of the programme, as well as the corrective actions that will be conducted in the following week. In these meetings, administrative and technical reports are presented by the unit heads.

In addition, periodic meetings (e.g. every 6 months) should be held among the stakeholders, phytosanitary authorities, and programme decision makers, to present and discuss the status of the programme, progress made, resources used and needed, and foreseen future actions.

Moreover, at least one annual meeting should be held with financial stakeholders. It should include a visit to those places where crucial activities are conducted such as bait sprays, sterile fly releases, mass-rearing facilities, and FE&RFs, so that stakeholders can see *in situ* the progress of the eradication programme.

A-1.5.4.8 Programme evaluation

Regular programme evaluations should be carried out. These evaluations should be technical, administrative, socio-economic, and political. It is highly recommended to perform at least once a year technical and administrative reviews, but not less than once every two years.

Technical evaluations should assess the progress achieved in the field, by looking at the specific parameters set-up for that purpose. Administrative evaluations should particularly review the correct use of funds and resources. External technical and administrative audits are recommended.

Socio-economic and political assessments of the eradication programme impact is a difficult task. Although there is recognition among funding organizations and governments for the need to evaluate public interventions, in some instances there is also reluctance to undertake formal evaluations particularly due to the logistics involved and the cost incurred in implementing the evaluations.

A-1.5.4.9 The eradication programme managed as a system

The management of complex programmes such as AW fruit fly eradication programmes integrating the SIT, should follow a holistic approach and should be seen as a system. Efficient management determines and organizes the elements that encompass a functional system and uses the system to maintain the programme running on its own. Such an organization, more than a group of interrelated components, works and reacts as a single unit. **Figure A-1.9** shows a simplified functional flowchart for the management of an eradication system integrating the SIT. It depicts the main elements that are involved in it, so that their cause-effect interrelation is easily understood.

The process starts with the programme manager who, based on the plans and recommendations previously prepared by the Steering and Advisory Committees and the managerial and technical staff of the programme, develops a work plan detailing the activities that the four technical unit heads should implement daily to reach the goals determined in the global eradication plan. These activities have an immediate impact on the target pest in the field and on the public.

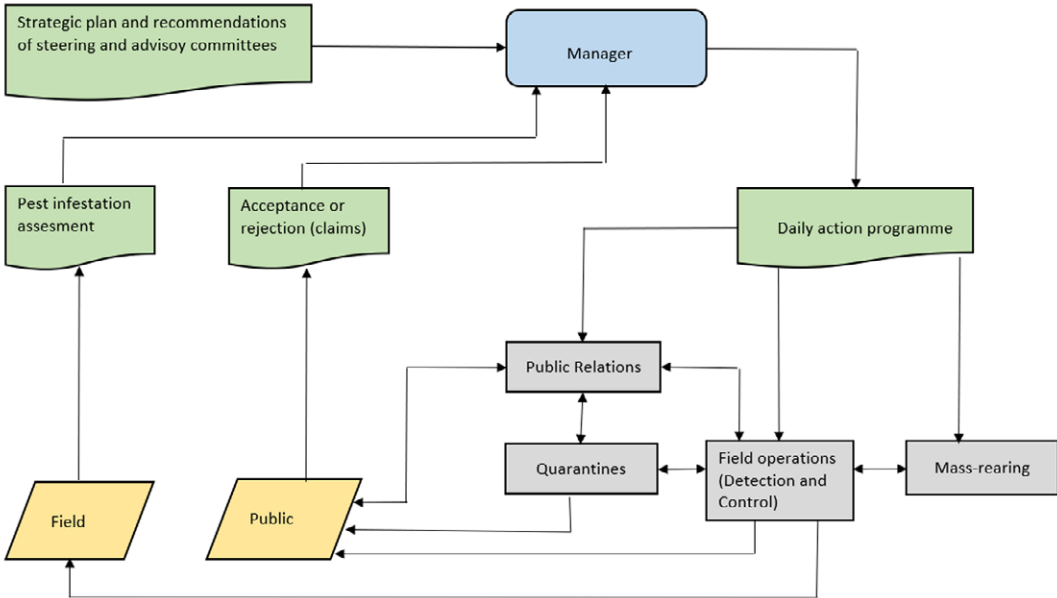

Figure A-1.9. Simplified flow chart showing the management of an eradication programme as a system

The impacts are assessed through the infestation indices (decrease or increase of the pest after suppression activities are applied) and the acceptance or rejection of the project (measured in terms of complaints or acknowledgments received). Once the manager gets information of the impacts of field activities and the public response, the daily strategy is adjusted, if necessary, taking new decisions that determine the next actions. This process is repeated until the programme objectives are achieved.

Complementary information on the management of eradication programmes can be found in Chapter 5.3 of the book “Sterile Insect Technique. Principles and Practice in Area-Wide Integrated Pest Management” of the FAO/IAEA, Insect Pest Control Section find at: www.taylorfrancis.com/books/oa-edit/10.1201/9781003035572/sterile-insect-technique-dyck-hendrichs-robinson

A-1.6 Stage II. Eradication (execution)

Field actions aimed at suppressing and eradicating the target pest, including the production of sterile insects and their subsequent release, as well as the activities of creating public awareness devoted to preventing social problems, are carried out during the eradication stage.

A-1.6.1 Step 5. Public relations

Public relation activities play an important role in the achievement of programme objectives. Many people involved in planning and implementing eradication programmes have referred to the critical importance of this activity. Nevertheless, often once the programme has been launched, the public information unit does not receive the necessary support.

It has been observed that even when measures taken to eradicate the pest may eventually be successful, the lack of an efficient public information campaign may negatively affect programme execution, and the multimillion investments involved in the programme are insufficient in the best case, or the programme may become a failure in the worst case.

Public awareness is the first step of the eradication process. An intensive public information campaign should be launched before any field operation actions start, even surveillance activities. The campaign should inform the general public living in the target area and those first exposed to the eradication actions, about the existence of the programme and its potential benefits and prepare them for the actions that will be implemented in the area.

Once the surveillance and R&Q procedures have been initiated, public awareness should become more intense and have greater coverage in preparation for aerial or ground insecticide-bait spraying. Although public relations are activities conducted throughout the life of the programme, they should also become more intense before initiating the sterile fly releases. The general public should be kept constantly informed about programme activities and progress.

To reach specific target groups with the most appropriate information, the overall general public should be stratified into specific groups using different criteria such as: (a) place of living (urban, suburban, rural, etc.), (b) source of living (agriculture, industry, etc.), and (c) income, (low, medium high income, etc.). With this information a matrix correlating the surveillance and control activities performed against the number and type of claims received by the affected public is developed to determine the public conflict sites or ‘hot spots’ in the area of intervention. Worldwide experiences have shown that the combination of phytosanitary procedures (surveillance and control activities) with the type of claim and sector of the general public affected, varies among countries and locations, therefore the exercise to detect those potential or real conflict sites and issues is important.

A more complete discussion on public relations issues can be found in Chapter 5.4 of the book “Sterile Insect Technique. Principles and Practice in Area-Wide Integrated Pest Management” of the FAO/IAEA, Insect Pest Control Section at: www.taylorfrancis.com/books/oa-edit/10.1201/9781003035572/sterile-insect-technique-dyck-hendrichs-robinson

A-1.6.2 Step 6. Surveillance and R&Q actions

A-1.6.2.1 Surveillance

Trap surveys have to be carried out before an eradication programme is launched, to obtain baseline data, to determine seasonal and spatial distribution of the pest, and to prepare the technical and economic feasibility studies. Nevertheless, once the eradication programme starts, one of the first activities is to establish a preliminary surveillance network in the initial working area to determine the current level of pest infestation as well as the pest geographical distribution. This is important to determine the intensity and extension of the suppression procedures in that area.

General information about the occurrence of the target pest in the infested area subject to intervention should already be available and can be retrieved from the global sources described in Step 1; however, updated information for the specific working area is crucial to determine the baseline data which will be used later to compare the effect of the suppression procedures.

Comprehensive information about the type of surveillance (trapping and fruit sampling) to be implemented and the intensity and coverage required in accordance with the different eradication phases and working areas can be found in two guidelines that FAO and IAEA have produced which are available at www.iaea.org/sites/default/files/trapping-guideline.pdf and www.iaea.org/sites/default/files/ca5716en.pdf

A-1.6.2.2 Quarantine actions

Simultaneously with the initiation of surveillance activities, local or domestic quarantine check points should be established. This network of quarantine check points should be established based on maps and information, compiled during Step 1, about the pathways along which people and fruit commodities move. This will prevent the movement through human transport of the target fruit fly in hosts from still infested areas to the adjacent working area that are already being subjected to eradication actions.

A list of regulated hosts (major or poor) should be notified through mass media, to inform the general public which fruits are not allowed to move from the infested areas to the area under eradication.

The affected industry (fruit producers, packers, and carriers) outside of the intervention area should be notified about the regulated host commodities that will not be allowed into the eradication area. The information should also include the approved PHT that enable the movement of host commodities from infested areas to areas under eradication. If necessary, PHT facilities should be implemented near the limits of the infested area and the area under eradication. Complementary information on quarantines is available in the main body of this Guideline.

A-1.6.3 Step 7. Mass-rearing facility and FE&RF

Use of sterile insects is the most effective phytosanitary procedure to achieve fruit fly eradication. Although there are several examples of fruit fly eradication using bait sprays as a single measure, these are limited to small areas (less than 500 km²). Pest eradication in larger areas, can effectively only be achieved through the integration of sterile fly releases.

Availability of sufficient numbers of sterile flies to execute a short-term eradication programme can be possible through donations or purchase from external sources. However, when eradication is planned over large areas and long periods of time, it is more convenient for an eradication programme to have its own mass-rearing and sterilization facility.

Planning and building a sterile fly production facility and implementing the mass-rearing and sterilization process until the start of sterile fly releases in the field, entails a multifaceted process that involves many qualified professionals and skilled labour force.

Detailed information about the design and equipment of a fruit fly mass-rearing facility, the mass-rearing and sterilization process, and process management for facility managers can be found in the following FAO/IAEA manuals:

- The FAO/IAEA spreadsheet for designing and operation of insect mass-rearing facilities: www.iaea.org/sites/default/files/21/06/nafa-ipc-manual-spreadsheet-insect-mass-rearing.pdf
- “The Dashboard” for Managers of Sterile Insect Technique Production Facilities: www.iaea.org/sites/default/files/23_mar_2018_corrected_version_mmb_-_19_march_2018_-_b5.pdf

A-1.6.4 Step 8. Eradication process

The eradication process using sterile insects consist of several temporal eradication phases which are conducted over the infested target area. Therefore, the eradication strategy will very much depend on the selected spatial model. This will define the timing of the eradication phases in the specific intervention areas.

A-1.6.4.1 Temporal phases of an eradication process

As described in the diagram below (**Figure A-1.10**), the eradication process implemented over an area follows a logical sequence of phases along a timeline. By applying these phases in a sequential manner, the original infested area becomes at the end of the process an established FF-PFA. The operational phases listed below, are applied in a sequential manner during the eradication process (**Figure A-1.10**):

- Suppression
- Eradication
- Verification

Each phase includes several different combinations of phytosanitary procedures (surveillance and control) which are conducted at different intensities to achieve the particular goals of each specific phase (specific phytosanitary status). The result at the end of the process is an FF-PFA.

Phase 1. Suppression

Quarantine checkpoints should be in place to isolate the infested areas from the target area that will be under official suppression procedures, prior to the initiation of the suppression actions.

Suppression procedures must be applied to reduce the population from its original level of infestation to an appropriate low prevalence level prior to the release of sterile insects. This requires the intense application of phytosanitary procedures that can be one or more of the following suppression methods: C&M practices, aerial and ground BAT, BS, MT, aerial and ground ABC. Reducing the target populations to a level where the programme can achieve the sterile to wild fly ratios required for eradication in a cost-effective manner, is a critical precondition for population eradication using the SIT.

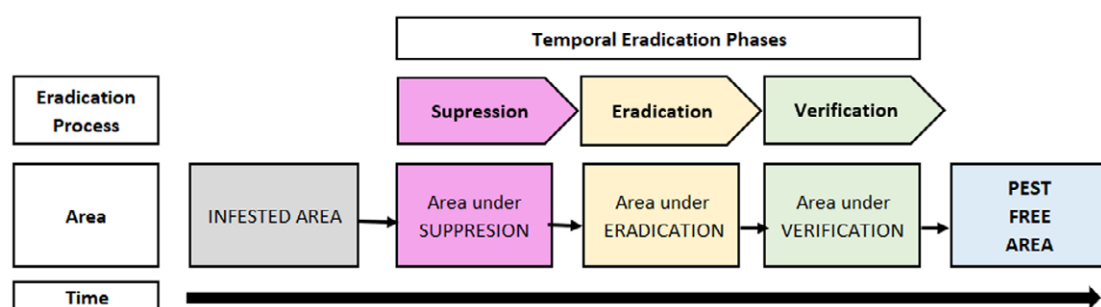

Figure A-1.10. Diagram showing the phases of an eradication process following a timeline, with corresponding change in the phytosanitary status of the area

A delimiting survey should be completed to confirm earlier surveys. Monitoring surveys should then continue during suppression, with a significant increase of sensitivity to perform a fine check of the distribution of the pest and to effectively assess the reduction of the pest population to the preestablished low prevalence level.

During this phase, the intervened area goes from being an infested area to an area of low pest prevalence.

Phase 2. Eradication

During this phase, pest eradication requires the intense application of the appropriate phytosanitary procedures to further reduce a pest population from the low prevalence level, reached in the previous phase, to zero. Apart from a strong application of the SIT, eradication actions can include complementary suppression procedures such as intensive ground BAT, BS, or ground ABC applied mainly to eliminate pest reservoirs.

In areas where sterile insects are being released, trapping is adjusted to lower trap densities to avoid the recapture of large numbers of sterile flies. In this situation, fruit sampling becomes the most effective surveillance tool.

During this phase, the phytosanitary status of the intervened area goes from being an FF-ALPP to a temporary FF-PFA, established for at least one generation to assure that the pest has been eliminated. This is a preliminary criterium of pest elimination before embarking on a more intensive evaluation which is applied during the verification phase.

To protect the recently created FF-PFA, additional actions are implemented such as the establishment of buffer zones that function as a containment barrier and improvement of the quarantine procedures.

Phase 3. Verification

During this phase the eradication programme carries out a thorough evaluation of the newly created FF-PFA, using three criteria:

- No detection of the pest in any of its biological stages during three generations after the last detection;
- Verification based on increased sensitivity of the detection method;
- Verification during the time of the year when climatic conditions are the most suitable for the pest to occur.

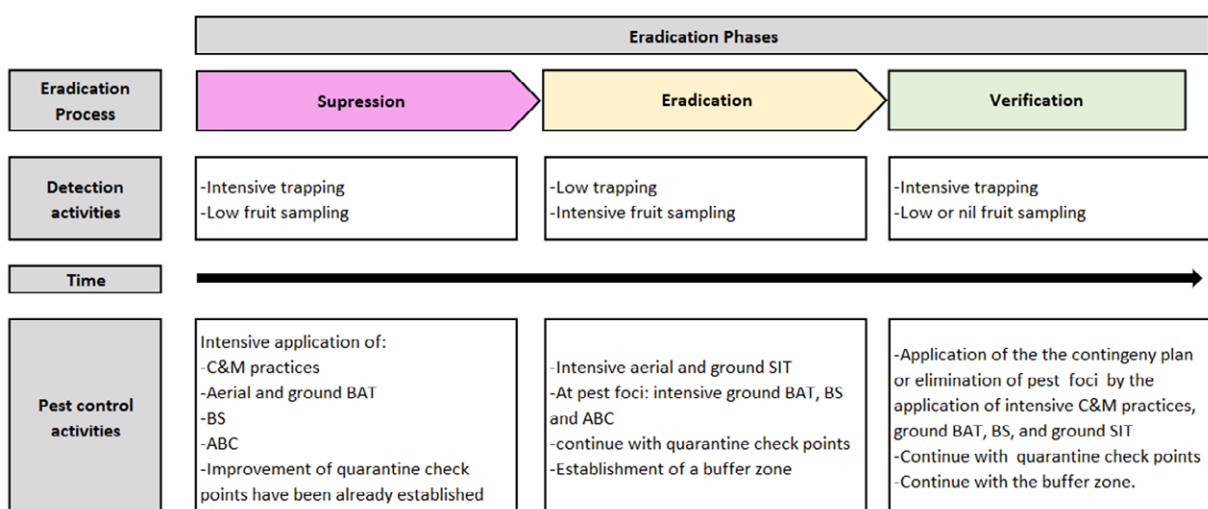

Figure A-1.11. Major phytosanitary procedures carried out in each of the eradication phases

Programmes may take a whole year to meet these criteria. If absence of the pest is confirmed, the area changes its phytosanitary status from being a temporary FF-PFA to a verified FF-PFA (**Figure A1-11**).

In the verification phase, the sensitivity of the surveillance method using traps is intensified by increased trap densities aimed at proving pest absence from the area. Fruit sampling is not applied, except in the case of transient detections.

During this verification phase, application of a contingency plan is essential in case a pest residue is detected, or an incursion occurs that could result in an outbreak. These could have either originated by adult flies that have overcome the buffer zone, infested fruit trespassing the quarantine check points or fruit fly foci that may have been left in areas difficult to access and that may have prevented the effectiveness of the eradication actions (**Figure A1-6**).

A1-1.6.4.2 *Spatial eradication models*

There are different spatial fruit fly eradication models that have been used for given infested areas. However, there are three models that have been mostly used:

- Single fixed-area
- Multiple fixed-area
- Rolling carpet

Selection of one of the spatial eradication models will mainly depend on the size of the area from which eradication of the target pest is planned, and the resources available to apply the eradication actions in the selected area. Eradication can cover the total infested area at once or only portions of it, addressed in sequence.

Buffer zones

It is essential to discuss buffer zones before describing the spatial eradication process because they help to understand and apply the spatial models in eradication programmes.

A buffer zones is defined by FAO-IPPC glossary “as an area surrounding or adjacent to an area officially delimited for phytosanitary purposes to minimize the probability of spread of the target pest into or out of the delimited area, and subject to phytosanitary or other control measures, if appropriate”.

In an eradicating process, buffer zones are used to protect an area that has a lower population level, or an area with no infestation at all, from an adjacent area that is infested.

Thus, buffer zones in those areas under eradication serve as a barrier or filter in such a way that if there is a potential pest incursion or movement from an infested area towards a PFA, this movement is detected (by surveillance) in the buffer zone and the pest is eliminated (using control procedures) before it reaches the PFA. Thus, the buffer zone protects the free area and prevents the loss of its phytosanitary status.

Even though the definition in the FAO-IPPC glossary indicates an official process, buffer zones can be a practical approach, used as barriers by organized growers in many situations involving AW fruit fly management.

In addition, it has been conventionally accepted that oceans, mountains, deserts, and large non-host areas can function as natural buffer zones. Buffer zones (in certain cases created with sterile insects) can be located adjacent to infested areas or PFAs, depending on where they are placed, and they can also be named as a containment or exclusion barrier (**Figure A-1.12**).

As buffer zones act as a barrier or filter, its width becomes its main feature. Effective width is a function of the natural dispersal rate of the target pest. Thus, for highly mobile pests the buffer zone width should be larger than that used against a poor flier. Therefore, pest biology and ecology play an important role in determining the size of buffer zones.

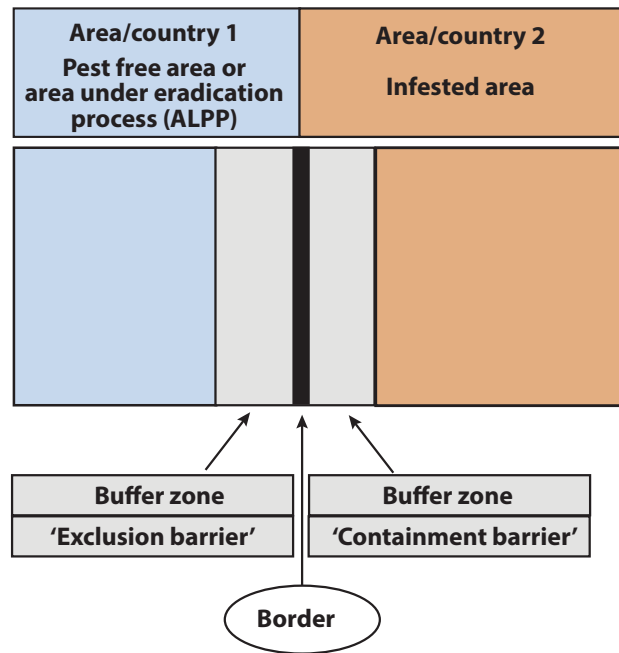

Figure A-1.12. Chart showing the location of a buffer zone in relation to an infested area or a PFA

A special case of buffer zone is given when applying an FF-SA as a pest risk mitigation option to export or move fruit commodities from infested areas to PFA. The protected area (orchard) is an ALPP and the infested area with no control (marginal area) is also an ALPP. If between both areas the grower establishes an intensive trapping wide barrier, this trapping creates a buffer zone where pest incursions coming from the marginal areas are detected early and may be eliminated (with control procedures) before they reach the protected ALPP. This is a typical case of buffer zones where ground BAT and BS are used rather than SIT.

Single fixed-area model

If the area from which to eradicate is small, adequately isolated in relation to the biology of the pest and can be technically and economically treated as a single unit, then the single fixed-area approach is the most suitable option. The best practical example of this approach is the eradication of target fruit fly from islands, oasis (ecological islands), or outbreaks.

This approach has been tested in different islands with different pest species and various eradication procedures. In fact, this approach was the first one used to demonstrate that the SIT can be a successful technique for pest eradication, when it was applied against the screwworm (*Cochliomyia hominivorax*) to eradicate it from the island of Curacao. The first successful use of the SIT against an insect pest, other than the screwworm fly, was the eradication in 1963 of the *Z. cucurbitae* from Rota in the Mariana Islands. Other efforts to eradicate fruit flies from islands were research pilot projects conducted against *C. capitata* in the Canary Islands in Spain and Procida island in Italy.

Small islands, or small oasis (ecological islands) scattered in larger desert or wide non-host areas offer the best scenario to eradicate a fruit fly pest, since they have the ocean or the desert around as a buffer zone. However, oceans and deserts are not impenetrable barriers since there are fly species with the ability to fly or move with weather fronts long distances and which can therefore invade islands and oases by air from neighbouring infested areas. In such cases effective surveillance networks and quarantine check points in the seaports of the islands or at the roads entering to the oasis are good exclusion practices supporting the natural buffer areas.

If the area under eradication is a result of an outbreak, the endangered area should immediately be protected through an artificially created buffer zone acting as a containment barrier. **Figure A-1.13**

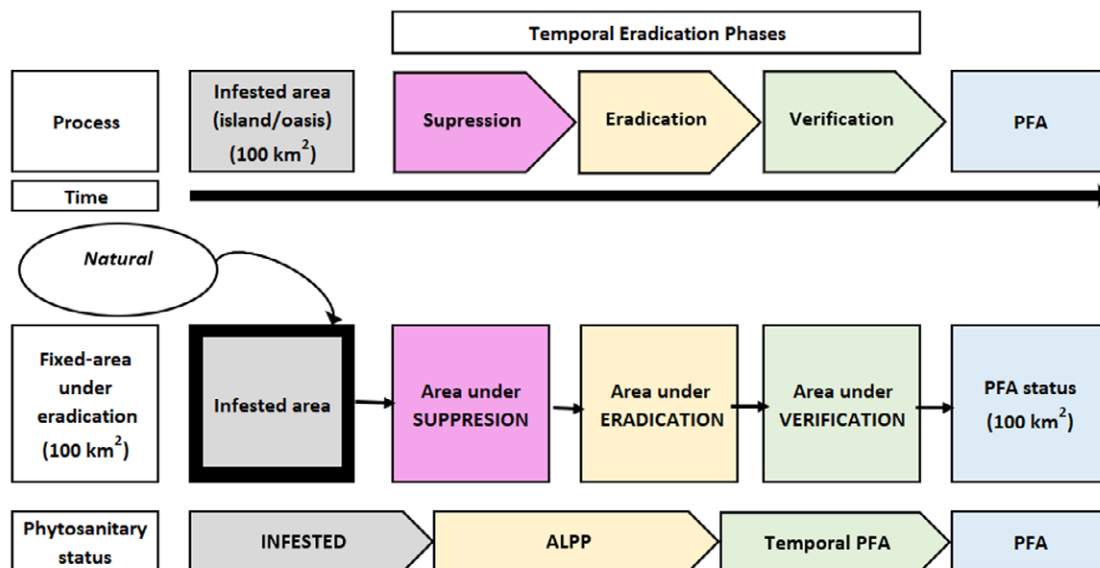

Figure A-1.13. Temporal eradication process following a single fixed-area model (island model). Note that the buffer zone is natural.

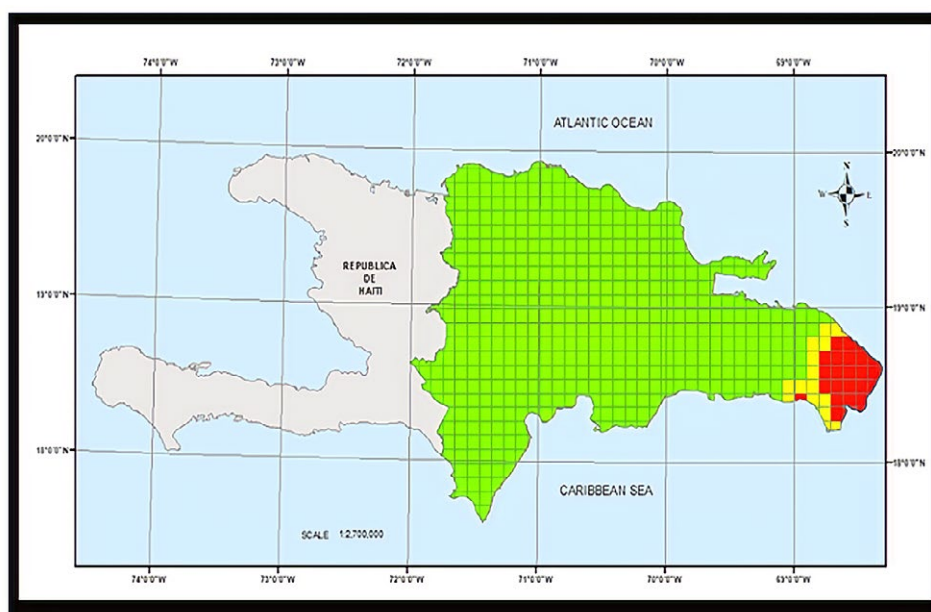

Figure A-1.14. Map of the island of Hispaniola showing the Mediterranean fruit fly-infested area (in red) in the eastern part of Dominican Republic in 2015 (Source: Zavala, J.L., Marte-Diaz, G. & Martinez-Pujols, F. 2021. Successful area-wide eradication of the invading Mediterranean fruit fly in the Dominican Republic, pp. 519–537. In: J. Hendrichs, R. Pereira & M.J.B. Vreysen, eds. *Area-wide Integrated Pest Management: Development and Field Application*. CRC Press, Boca Raton, USA.)

presents the single fixed-area model, showing the temporal eradication phases applied independently over the same fixed area.

An example of the single fixed-area model is the eradication of an extensive *C. capitata* outbreak in the Dominican Republic.

The presence of the Mediterranean fruit fly, *C. capitata*, in the Dominican Republic was officially reported in March 2015. The pest had already spread to 2053 km² in the eastern part of the country, constituting a mayor outbreak. The outbreak was located in Punta Cana, one of the most important

tourist destinations of the Caribbean, where agricultural production for exports is non-existent. The production sites of horticultural commodities affected by the ban were more than 200 km away from the outbreak (Figure A-1.14).

As an emergency response, the Government through its Ministry of Agriculture established the Moscamed Programme in the Dominican Republic (Moscamed-RD), providing the required financial and operational support to carry out all required surveillance and eradication activities. The FAO, the IAEA, and the United States Department of Agriculture (USDA) joined hands to assist the country in establishing a national monitoring network to delimit the geographical extent of the outbreak and to initiate an eradication campaign with support from regional organizations such as the Organismo Internacional Regional de Sanidad Agropecuaria (OIRSA) and the Instituto Interamericano de Cooperacion para la Agricultura (IICA). The regional Guatemala-Mexico-USA Moscamed Programme played a major role in assisting through technology transfer, which included the application of the SIT and other components of an AW fruit fly eradication programme.

The detection system was gradually enhanced from the original limited preventive trapping to an effective national surveillance system. The trapping network during the pre-eradication phase rapidly expanded from 1,006 traps, mainly at points of entry (inspected every two weeks with inspection levels of only about 25% of traps) to 14 589 traps country wide (and weekly inspection with inspection levels over 90%).

Eradication actions started with population suppression actions by applying ground and aerial BAT using GF-120 at a dose of 4 litres per hectare (Spinosad 40%:water 60%). The use of BS was included in support of the ground sprays within the one square kilometre core area of the delimitation trapping area and to cover some areas outside of the core area. BS were installed in areas neighbouring the outbreaks. They were also used as a preventative measure in areas where previously wild flies had been found.

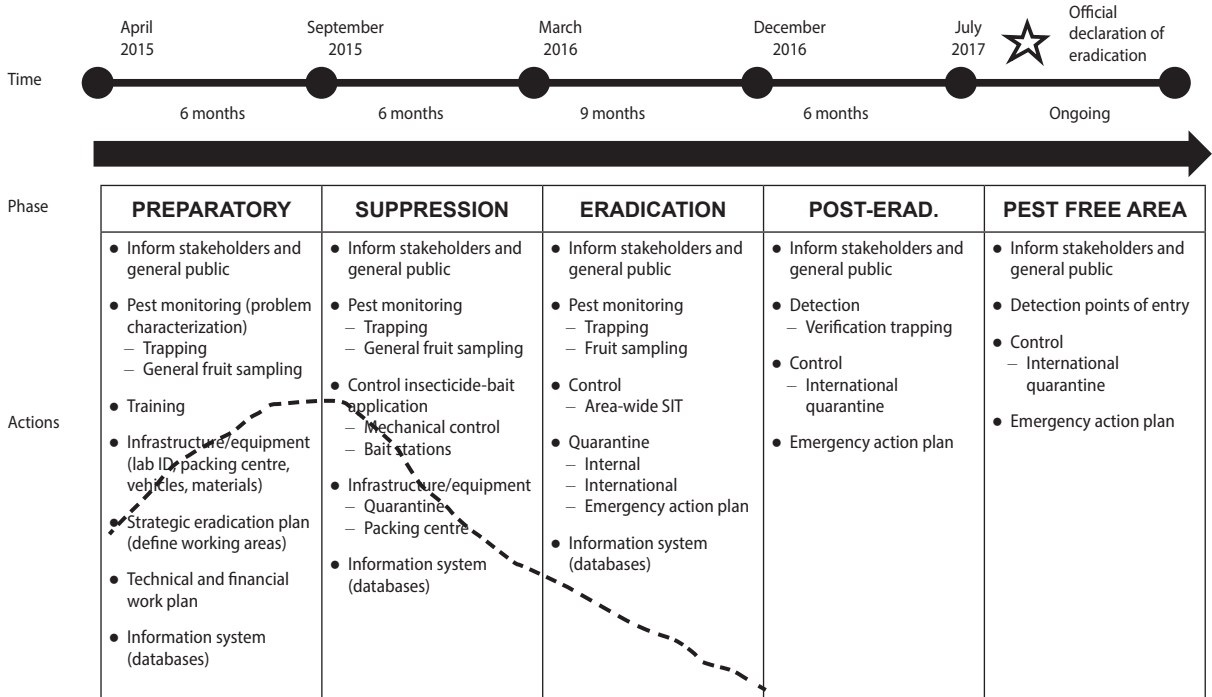

Figure A-1.15. Eradication process followed during the *C. capitata* eradication programme 2015–2017 (dotted line is a theoretical representation of the pest population density) (Source: W. Enkerlin, FAO/IAEA Insect Pest Control Section). In this figure the column named as ‘Preparatory’ is equivalent to the ‘Pre-eradication’ stage, ‘Suppression’ and ‘Eradication’ are equal to the ‘Eradication’ stage, and column ‘Post-Erad.’ and ‘Pest Free Area’ to the ‘Post-eradication’ stage discussed earlier in this annex.

To prevent the movement of the *C. capitata* in infested fruits from the infested area to the PFA, a network of five quarantine road stations was placed on the main highways and exits points. When the extent of the Mediterranean fruit fly infestation was very well defined and the high population spots suppressed, the release of sterile male flies was started, initially using ground releases with paper bags and later, aerial releases using the chilled adult release system following an area-wide approach. The total number of sterile flies released throughout the eradication programme was 4,062 million. Release areas were located mostly along the coastal line. Areas showing low sterile fly distribution were reinforced through ground releases specifically around detection and outbreak sites.

Eradication of the Mediterranean fruit fly from the Dominican Republic using an IPM approach integrating area-wide SIT was confirmed in April 2017, after a period of at least three full life cycles with zero captures. Nevertheless, the official declaration of eradication took place in July 2017 after six generations of zero catches and an additional verification trapping network established in high-risk areas including previous detection sites. These confirmed the absence of the pest. A Technical Advisory Committee (TAC), chaired by FAO/IAEA, provided technical oversight throughout the eradication campaign. A schematic representation of the eradication process followed is shown in **Figure A-1.15**.

Multiple fixed-area model

If the area from which to eradicate (infested area or intervention area) is large and it is not possible to treat the whole area as a single unit due to logistical or economical limitations, then the multiple fixed-area approach is an option. The eradication process is initiated and finalized in each of the fixed areas, one at the time. This option is more appropriate when the distribution of the pest and hosts is fragmented or patchy in the form of ecological islands in the total area from which eradication is planned. It is common in this type of areas to have low host diversity, which includes the major commercial host(s) and two or three additional major or poor hosts growing in the marginal areas among or between the commercial orchards. These areas are typical of temperate, Mediterranean, or semi-arid climates.

As there are logistical and economical limitations to treat the whole infested area, this is then divided into independent working areas of a size appropriate to be treated as a single unit. The size of the independent fixed-areas will not only depend on the availability of resources, but on the pest and host distribution patterns and on the characteristics of the agroecosystem that allow the use of either natural or artificial barriers to isolate the independent fixed areas within the whole intervention area.

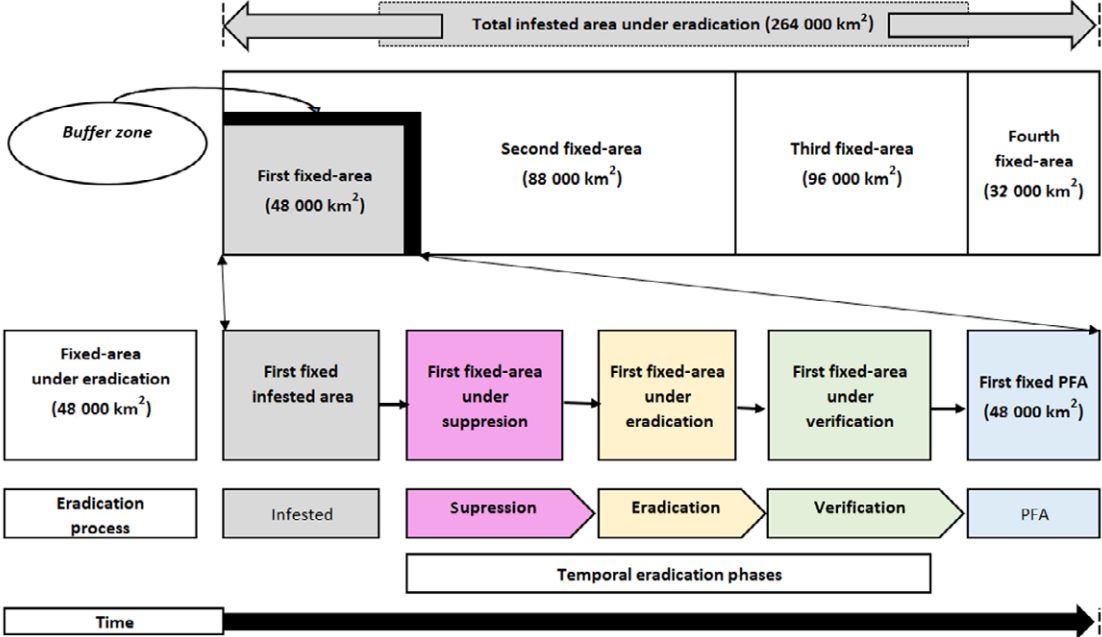

Figure A-1.16. Schematic sequence of a spatial eradication process followed for multiple fixed-areas, pointing out the changes in the phytosanitary status of the area treated. Buffer zones can be either natural or artificially created.



Figure A-1.17. *C. capitata* PFAs established in the various oases of the Mendoza Province (left) and in the region of Patagonia, Argentina (right) using a multiple fixed-area eradication model (Source PROCEM-SENASA)

Thus, each delimited working area is treated as a whole single fixed-area. The number of fixed areas that conform the total area from which eradication is planned do not necessarily have to be equal in size, but each one is treated as a fixed single unit. **Figure A-1.16** shows how a large, infested area from which to eradicate is divided into smaller areas to be treated as a single unit.

Once the infestation from the first fixed-area is eliminated and becomes a PFA, eradication activities start in the second fixed-area. If necessary, buffer zones are kept as protection border barriers until the infestation in the second fixed area is fully eliminated. The same approach is followed for the subsequent fixed areas.

An example of a multiple fixed-area model is the successful eradication of the *A. ludens* and *A. obliqua* in 2000 from the northern and north-western regions of Mexico through the Fruit Fly Eradication Campaign -Programa Moscafrut- (SAGAR-CONASA), launched by the NPPO of Mexico in 1992. In this eradication programme against two fruit fly species intense use of aerial and ground BAT, BS, releases of sterile flies of both species and aerial and ground releases of the parasitoid *D. longicaudata*, was conducted. The R&Q activities at domestic airports and main road entering the areas under eradication, equipped with soft X-ray imagery and incinerators, played an important role. This AW eradication programme built two mass-rearing facilities to produce *A. ludens* and *A. obliqua* sterile flies as well as a facility to mass rear *D. longicaudata*. This effort was also supported by the California Department of Food and Agriculture (CDFA) and the IICA.

Another example of a multiple fixed-area model is the eradication of the *C. capitata* from some areas in Argentina. In 1994, the National Fruit Fly Control and Eradication Programme (PROCEM-SENASA) was established by the NPPO of Argentina.

Using this eradication model and integrating main phytosanitary procedures as the BAT and C&M practices for population suppression, and the SIT for population eradication. The pest was eradicated in 1999 from isolated valleys of the Patagonia region and from fruit production oasis in the Province of Mendoza in 2006 (**Figure A-1.17**). The eradication was verified, and the areas were declared PFAs.

Rigorous quarantine checkpoints were established to protect the PFAs, and a contingency plan is enforced to eliminate any pest outbreaks. This allowed, not only to boost the production and commercialization in domestic and export markets, but the opening of new markets for the pome and stone fruits grown in these areas. Current exports of pome fruits from the fruit fly free area in the Patagonia region is valued at USD 400 million per year. Currently, apple and pear farmers in Patagonia save USD 3 million per fruit growing season by not having to apply a Probit-9 PHT as a prerequisite for exports.

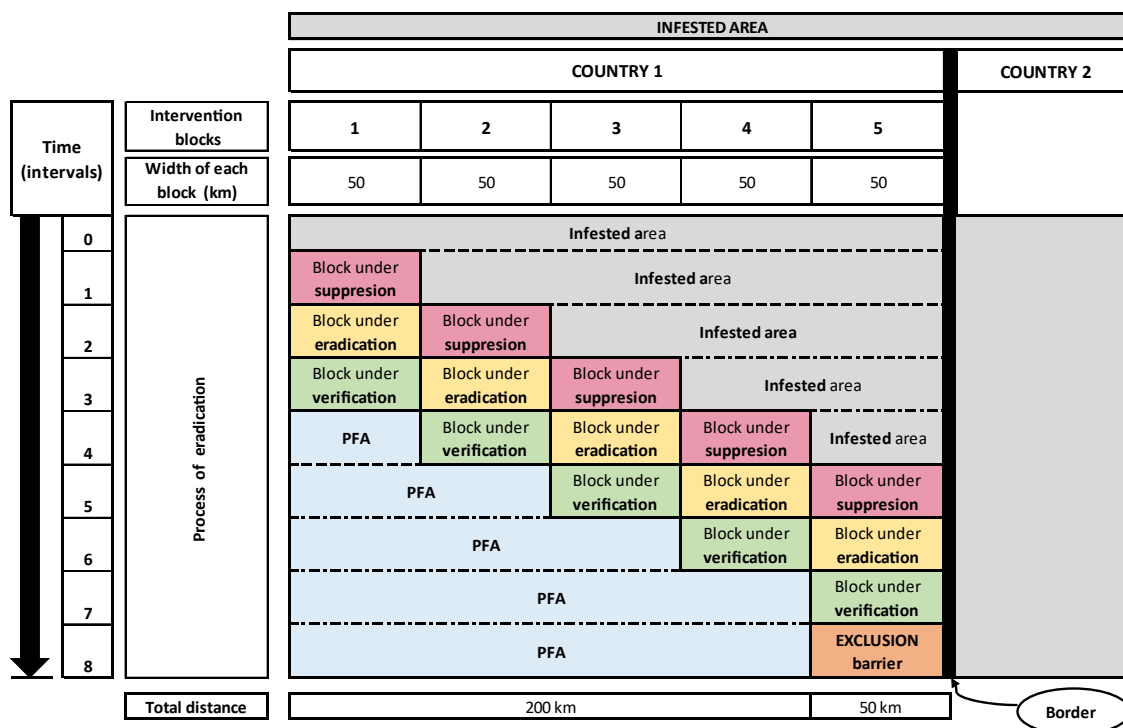

Figure A-1.18. Diagram depicting the spatial (intervention blocks) and the temporal (intervals of time) eradication phases to create a PFA from a hypothetical medium-sized infested area, which is treated as a single working area divided into five intervention blocks

Rolling carpet model

If the infested area under eradication is large and it is not possible to treat the whole area as a single unit due to logistical or economical limitations, and, if in addition, the pest and host distribution follow a continuous pattern throughout the infested or intervention area, the most appropriate option to apply is the rolling carpet model. The whole target area is divided into continuous intervention blocks. Blocks are subjected to different eradication phases as the eradication process moves forward.

The eradication process starts with the suppression phase in the initial block and continues with eradication, verification and PFA status phases in that same block. In the meantime, as the process moves forward in the initial block, the adjacent block (second block) is subjected to suppression and to the rest of the phases until the PFA status is achieved. The same happens in the third block and next adjacent blocks in a continuous manner until the PFA status is achieved in all the blocks in the whole intervention area (**Figure A-1.18**).

As mentioned above, this model is applied when the distribution of the pest and host follows a continuous pattern, which is a distinctive difference with the multiple fixed-area model that is applied when the distribution of the pest and host is fragmented or patchy. In this continuous application of the rolling carpet model, it is common to find a great number of hosts either wild and/or commercial, and a continuous distribution of the non-host vegetation, providing the fruit flies shelter and food all year round. These areas are typical of tropical and subtropical climates.

In addition to the economic and logistic factors, the size and shape of the intervention blocks will depend on the features of the agroecosystem that may allow the use of natural barriers to isolate the intervention blocks or to facilitate the application of the phytosanitary procedures. However, many times intervention blocks have to be artificially isolated by buffer zones. Thus, in this model, the creation of buffer zones as artificial barriers is essential to isolate the blocks under eradication from the infested area. Figure 18 shows both the spatial and temporal approaches of an eradication process using the rolling carpet model.

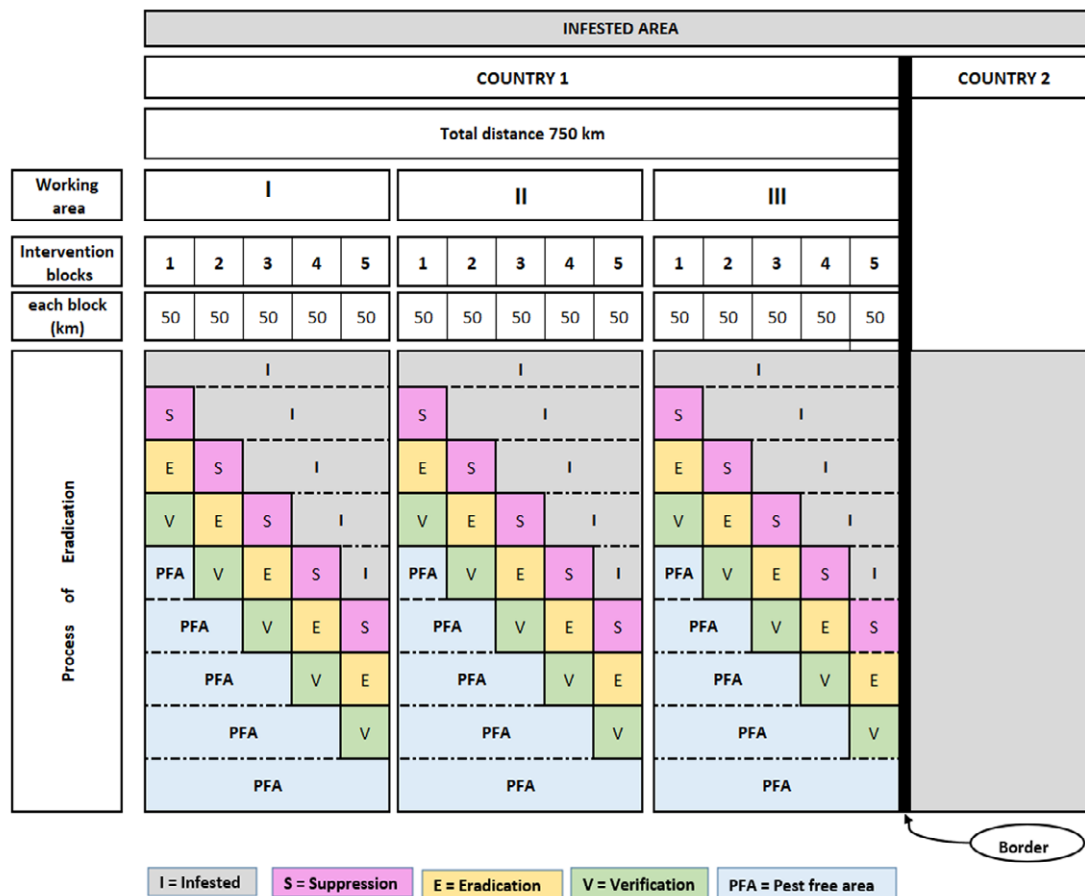

Figure A-1.19. Diagram depicting the rolling carpet approach to develop a PFA from a hypothetical very large, infested area which will be entirely treated through three working areas, subdivided each one into five intervention blocks

If the area planned for eradication of the target fruit fly is very large (e.g. over 70 000 km²), then the area may be divided into several working areas based on the availability of resources, which in turn are also subdivided into continuous intervention blocks, each one of those under a specific eradication phase. This approach presents the most challenging eradication scenarios. This challenge is reflected in the eradication model, which is also one of the most complicated (**Figure A-1.19**).

A complementary discussion on the eradication process (temporal phases and spatial models) can be found in Chapter 6.1 of the book “Sterile Insect Technique. Principles and Practice in Area-Wide Integrated Pest Management” of the FAO/IAEA, Insect Pest Control Section at (<https://www.taylorfrancis.com/books/oa-edit/10.1201/9781003035572/sterile-insect-technique-dyck-hendrichs-robinson>)

An example of a rolling carpet approach model is the eradication of *C. capitata* infestation in the State of Chiapas, in southern Mexico. In 1975, with the invasion of practically the whole Central American territory (except for Belize and Guatemala), and the imminent northward spread of the pest into Guatemala and Mexico, the agricultural authorities of Mexico and Guatemala responded by subscribing a Cooperative Agreement aimed at containing its spread northwards, through the creation of the Moscamed Mexico-Guatemala Commission. By early 1977, when the pest had been detected in the state of Chiapas, a Mexican eradication programme against *C. capitata* -Moscamed Programme- (SAGAR-DGSV), was established by the NPPO of Mexico, which immediately implemented, together with the Moscamed Mexico-Guatemala Commission, intensive eradication actions in the areas the *C. capitata* had invaded along the Pacific Coast of Chiapas, Mexico. At this time the USDA incorporated in these efforts. The eradication programme received the support from FAO and the IAEA

The rolling-carpet approach was applied from west to east covering the total infested area in Chiapas and Oaxaca (Mexico) and the infested areas in Guatemala bordering Chiapas (**Figure A-1.20**).

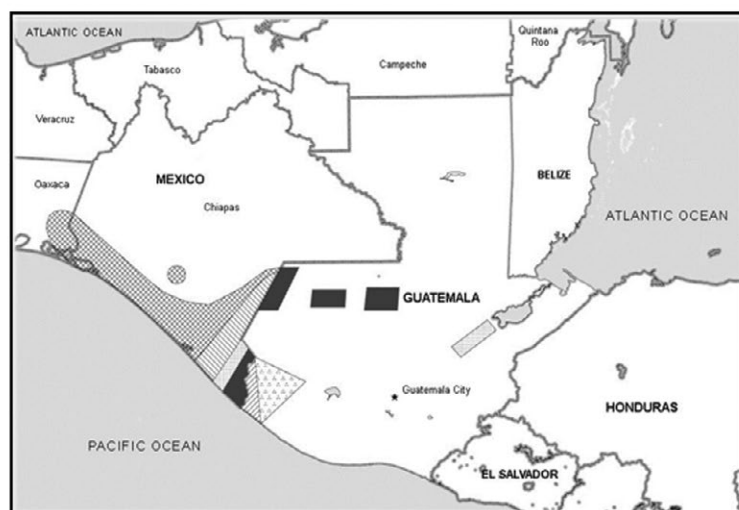

| Year | Block | Code | MEX (x000 ha) | GUA (x000 ha) | Total (x000 ha) |
|---------|-------|----------------------------|------------------|------------------|--------------------|
| 1979 | 1 | [Cross-hatch pattern] | 360 | 0 | 360 |
| 1980 | 2 | [Diagonal lines pattern] | 200 | 0 | 200 |
| 1981 | 3 | [Horizontal lines pattern] | 100 | 80 | 180 |
| 1982/83 | 4 | [Solid black pattern] | 120 | 260 | 380 |
| 1984 | 5 | [Diagonal lines pattern] | 0 | 100 | 100 |
| 1985 | 6 | [Dotted pattern] | 0 | 207 | 207 |
| Total | - | | 780 | 674 | 1427 |

Figure A-1.20. *C. capitata* fruit fly eradication areas in Mexico and Guatemala between 1979 and 1985 using a rolling carpet approach (Source: Enkerlin et. al. 2017. The Moscamed Regional Programme: A success story of area-wide Sterile Insect Technique application. *Entomol. Exp. App.* 164 (Special Issue): 188–203.)

The First Stage (or Preparatory/Pre-eradication Stage) was implemented in the total area divided into six intervention blocks. It consisted mainly in expanding the trapping network already established to characterize the infested areas through baseline data collection and analysis of the spatial and temporal distribution and abundance of the pest. This phase also consisted of staff training and preparing the necessary infrastructure, including establishing field operations centres, the mass-rearing and sterilization facility to produce *C. capitata* sterile, and the FE&RF.

The Second Stage (or Eradication Stage), subsequently applied to these six intervention blocks, consisted mainly of aerial large-scale applications of BAT and C&M practices which included fruit removal and disposal that maintained the populations suppressed. The ground BAT focused on the infested areas with the highest population density.

With the *C. capitata* mass-rearing facility and FE&RF initiating operations in southern Mexico, and well-trained technical staff available in sufficient numbers, the aerial weekly sterile fly releases at the front of the infestation (first block), integrated with ground BAT in remaining hot spots.

Overall, 2.8 billion sterile flies were released over the same area where the pest had previously been suppressed by aerial BAT. With these integrated actions the pest was eradicated from the first intervened block consisting of 360 000 ha. In 1980, with the release of 11.7 billion sterile flies, eradication was also achieved in second block consisting of 200 000 ha. In 1981, as the eradication programme advanced towards the east, reaching the border with Guatemala, 26.5 billion sterile flies were released over the third block, which resulted in the eradication of the pest from this block, consisting of 100 000 ha

in Chiapas and 80 000 in Guatemala. In 1982, 30.1 billion sterile flies were released over the fourth block, resulting in the eradication of the pest from this area consisting of 120 000 ha at the border area of Chiapas and Guatemala, and 260 000 ha in southwestern Guatemala. These efforts led to the Third Stage (Post-Eradication) on which the *C. capitata* eradication was officially declared by the Mexican NPPO in September 1982 from the areas that had been previously infested in Oaxaca and Chiapas, Mexico, amounting to 780 000 ha (Figure A-1.20).

As part of the post-eradication actions, in all blocks a thorough surveillance for early detection and rapid application of the contingency plan designed in case of detection was implemented. These actions have been combined with R&Q actions and a containment barrier in Guatemala, along the border with the State of Chiapas, to maintain the FF-PFA status. The programme has shown to be effective since eradication of the pest from Chiapas, Mexico, in 1982.

A-1.6.4.3 Effects of the agroecosystem features in the eradication process

Agroecosystem features affect both the global pest management strategy as well as the temporal and spatial eradication strategies, i.e. they affect the selection of the eradication model and the degree of progress and cost of the programme. Figure A-1.21 describes the relationship between the agroecosystem features and the eradication model to apply.

The length of each phase is determined by the time required to reduce the pest to the levels planned for each specific phase.

The level of pest reduction is influenced by the intensity and extension of the detection and suppression activities, which are determined not only by the level of pest infestation but also by the pest distribution, which in turn depends on the density, distribution, and phenology of the fruit fly commercial and wild hosts. Topography and meteorological conditions are also components of the agroecosystem that have a direct effect on the efficiency of detection and control activities. Moreover, the distance to permanently infested areas may negatively impact the efforts carried out to maintain the FF-PFA which has recently been verified as such.

The landscape characteristics of an area such as host distribution and host category (commercial, wild, major, or poor host, etc.), jungle, forests, extension of major natural hosts (e.g. coffee plantations), presence of high mountains, plains, canyons, rivers, lakes, roads and small or big human settlements have a direct effect on the determination of the size and shape (boundaries) of the working areas and intervention blocks. Although sometimes, to prevent re-infestations, boundaries and size of intervention blocks are additionally influenced by the need to create artificial isolation barriers between the infested and the newly created FF-PFAs.

| Agroecosystem features | Size area | Eradication model |
|--|---|----------------------|
| Islands, oasis | Small ($< 2000 \text{ km}^2$) | Single fixed-area |
| Isolated ecological islands nested in large desertic or semidesertic areas | Medium sized and above ($> 2000 \text{ km}^2$) | Multiple fixed-areas |
| Continuos vegetation | Medium sized and above ($> 2000 \text{ km}^2$) | Rolling carpet |

Figure A-1.21. Relationship between the agroecosystem features and the eradication model to apply

Even though agroecosystem features have an effect on the spatial strategy selected (size and shape of the working areas and intervention blocks), as described above, their most important effect is on the length of time required to complete each of the phases of the eradication process. A long eradication process, due to a complex landscape, increases the cost and more importantly, it can be the cause of reduced efficiencies and failures, as well as tiredness and diminishing support from the general public.

As a general principle, the eradication process can be fast and at low cost in plain and midland areas, where annual crops are grown, or in islands, oasis, isolated canyons, and ecological niches. The same applies to areas where commercial hosts are distributed in patchy patterns among desert or semidesert areas with no more than 3 hosts occurring among the commercial plantations, and where the climate is temperate, Mediterranean or semi-arid.

On the other hand, eradication actions may be slow and at a high cost in mountainous areas, or areas with continuous vegetation, where a great number of hosts are extensively distributed among commercial plantations. Equally, eradication efforts are difficult in areas with the presence of the main host in vast areas (e.g. coffee plantations), or scattered main hosts growing in vast non-host vegetation areas such as jungles or forests, and where the climate is tropical or subtropical with long rainy periods and where hot or warmer temperatures prevail throughout the year.

A-1.7 Stage III. Post-eradication

Complementary detailed information in connection with the next four topics discussed in this section (steps 9, 10, 11 and 12), is available in ISPM No. 4 “Requirements for the

establishment of pest free areas, ISPM No. 8 “Determination of pest status in an area”, ISPM No. 17 “Pest reporting”, and ISPM, and ISPM No. 26 “Establishment of Pest Free Areas for Fruit Flies (Tephritidae)”, and in the FAO-IPPC “Guide for Establishing and Maintaining Pest Free Areas”, available at www.fao.org/3/ca5844en/CA5844EN.pdf)

A-1.7.1 Step 9. Domestic declaration of pest freedom

Once the pest eradication has been verified in a specific area by the eradication programme according to the established criteria (Stage II, Step 8, Phase 3 ‘Verification’), the NPPO compiles and keeps the documentation and records supporting all eradication stages. These include procedures set up to establish and verify the phytosanitary status of the area, as well as historical records of detection and results of the phytosanitary procedures applied. Procedures to establishing, maintaining, and verifying the FF-PFA status should comply with or be more stringent than the ISPMs No. 4 and No. 26 mentioned above.

The NPPO publishes an official declaration of the achievement of eradication in the government’s relevant official media. In addition, communications related to this event are circulated among the main stakeholders and other interested parties, such as fruit growers and exporters associations, as well as national environmental agencies and local authorities where the PFA is located.

A-1.7.2 Step 10. PFA notification to international organizations and trading partners

The NPPO also informs about the establishment of the PFA and the domestic declaration of such a status to the IPPC and Regional Plant Protection Organizations (RPPOs), as well as the NPPO of trading partners and high-level regional authorities, including agricultural committees, and other stakeholders. Communications may include a technical dossier with the relevant evidence supporting the domestic declaration of eradication.

The technical dossier may include records of all eradication processes, as well as the precise limits of the FF-PFA and a list of commercial fruit hosts grown in the area. This is a preliminary step to the

negotiation of formal bilateral work plans (see **Annex 3**) for export of fruit commodities using the FF-PFA as the pest risk management option.

A-1.7.3 Step 11. Maintenance of the FF-PFA

The FF-PFA status should be monitored and always verified by the NPPO to assure sustainability of the PFA status. There are several phytosanitary procedures that can be used for monitoring and verification of the PFA. These actions include an intensive surveillance effort, mainly trapping. Trap density, trap deployment and periodic revisions for the appropriate trapping surveys can be found in the manual developed for such purpose by FAO/IAEA, available at www.iaea.org/sites/default/files/trapping-guideline.pdf)

Standard operation procedures should be available for handling suspicious target pest specimens. Procedures should cover all aspects, from trap retrieval to packing of the specimens in appropriate vials and to shipping them to the authorized reference identification laboratory. The standard operation procedures should also include the handling of pest specimens that are intercepted at the quarantine checkpoints in host material moving into the FF-PFA.

Periodic reports on the survey activities (at least monthly) should be produced, which should include tables and maps, showing the trapping network, trap density, interval of trap inspection and results, such as number of traps inspected, traps or trapping routes that were not inspected and reason, etc. Complete reports or a summary of them should be circulated among the trading partners and groups of interested stakeholders. Records of these activities should be kept for at least one year.

A-1.7.4 Step 12. Contingency plan

Once an area has been declared as fruit fly free, it is important to rely on a contingency plan (see **Annex 2**) to eliminate eventual outbreaks occurring in the FF-PFA. The plan should indicate very clearly the phytosanitary procedures to be applied in case of outbreaks, including additional delimiting surveys and the specific control actions such as R&Q procedures and public awareness to be carried out to prevent the spread of the pest introduction.

The plan should include a directory (including phone number and office addresses) of the persons or authorities responsible for implementing the plan so that it can be initiated as soon as possible but no later than 72 hours after the pest detection. It should also indicate the information flow to assure that the information reaches managers and the decision making level and immediate appropriate notification to interested stakeholder groups and relevant trading partners.

This contingency plan must be reviewed and if necessary, updated at least once a year, so that it reflects the state of the art in surveillance and control technologies, as well as changes that may occur in the staff directory. Simulations of implementing contingency plans should be carried out at least once every two years.

A-1.8 Final considerations

Whether the FF-PFA in question was the only area from which the pest was eradicated (single fixed-area model) or if it was the final area subject to eradication within a set of areas or intervention blocks (multiple fixed-area model), the eradication programme is successfully completed and closed. In both cases, the ongoing management to maintain the area as an FF-PFA does not require maintaining an eradication programme with a specific organizational structure. The full and direct responsibility of maintaining the FF-PFA falls within the structure of the NPPO. In this structure, the core of the successful eradication programme staff and personnel may continue as the responsible for maintaining the pest free area status of the recently created FF-PFA.

On the other hand, in the case of a rolling carpet approach, the eradication programme continues to be responsible for maintaining the PFA, as the next area or intervention block are subjected to the

eradication process. Only after all the areas and intervention blocks have been freed from the pest, does the NPPO take over the maintenance of the FF-PFA as described above.

Bibliography

- Anonymous.** 1984. *Technical feasibility for eradication of the Medfly from Central America and Panama*. Document from a technical meeting among personnel of USDA, Mexico, Guatemala, OIRSA and IAEA, held in Guatemala, Central America. Dec. 1984.
- Barclay, H.J., Matlock, R., Gilchrist, S., Suckling, D.M., Reyes, J., Enkerlin, W.R. & Vreysen, M.J.B.** 2011. A conceptual model for assessing the minimum size area for an area-wide integrated pest management program. *Int. J. Agron.* 2011:409328. doi:10.1155/2011/409328.
- California Department of Food and Agriculture.** 2002. *Mediterranean Fruit Fly Preventive Release Program*. March 2002. CDFA, Sacramento, California, USA.
- Dyck, V.A., Reyes, F.J., Vreysen, M.J.B., et al** 2021. Management of area-wide pest management programmes that integrate the sterile insect technique, pp. 549–574. In: V.A. Dyck, J. Hendrichs & A.S. Robinson, eds. *Sterile Insect Technique. Principles and Practice in Area-wide Integrated Pest Management*. CRC Press, Boca Raton, Florida, USA. <https://doi.org/10.1201/9781003035572>
- Dyck, V.A., Regidor Fernandez, E.E., Barnes, B.N., et al.** 2021. Communication and stakeholder engagement in area-wide pest management programmes that integrate the sterile insect technique, pp. 549–574. In: V.A. Dyck, J. Hendrichs & A.S. Robinson, eds. *Sterile Insect Technique. Principles and Practice in Area-wide Integrated Pest Management*. CRC Press, Boca Raton, Florida, USA. <https://doi.org/10.1201/9781003035572>
- Enkerlin, W.R. & Mumford, J.** 1997. Economic evaluation of three alternative methods for control of the Mediterranean fruit fly (Diptera; Tephritidae) in Israel, Palestinian Territories, and Jordan. *J. Econ. Entomol.* 90: 1066–1072. <https://doi:10.1093/jee/90.5.1066>
- Enkerlin, W. R., Gutierrez Ruelas, J.M., Pantaleon, R., Soto Litera, C., Villaseñor Cortes, A., Zavala Lopez, J.L., Orozco Davila, D., Montoya Gerardo, P., Silva Villarreal, L., Cotoc Roldan, Hernandez Lopez, F., Arenas Castillo, A., Castellanos Dominguez, D., Valle Mora, A., Rendon Arana, P., Caceres Barrios, C., Midgarden, D., Villatoro, C., Lira Prera, E., Zelaya Estrada, O., Castaneda Aldana, R., Lopez Culajay, J., Ramirez y Ramirez, F., Liedo Fernandez, P., Ortiz Moreno, G., Reyes Flores, J. & Hendrichs, J.** 2017. The Moscamed Regional Programme: A success story of area-wide Sterile Insect Technique application. *Entomol. Exp. App.* 164 (Special Issue): 188–203. <https://doi.org/10.1111/eea.12611>
- FAO/IAEA.** 2006. *Designing and implementing a geographical information system. A guide for managers of area-wide pest management programmes*. M.J.B. Vreysen & W. Enkerlin, eds. Vienna, Austria.
- Gutierrez, S.J.** 1976. *La mosca del Mediterráneo, Ceratitis capitata (Wiedemann) y los factores ecológicos que favorecerían su establecimiento y propagación en México*. DGSV/SAG, México.
- Hendrichs, J., Vreysen, M.J.B., Enkerlin, W.R. & Cayol, J.P.** 2021. Strategic option in using sterile insects for area-wide integrated pest management, pp 841–884. In: V.A. Dyck, J.Hendrichs & A.S. Robinson, eds. *Sterile Insect Technique. Principles and Practice in Area-wide Integrated Pest Management*. Second edition. CRC Press, Boca Raton, Florida, USA. <https://doi.org/10.1201/9781003035572>
- International Plant Protection Convention (IPPC).** 2015. *Establishment of pest free areas for fruit flies (Tephritidae)*. International Standard for Phytosanitary Measures (ISPM 26). FAO, Rome, Italy. <http://www.fao.org/3/k7557e/k7557e.pdf>
- IPPC.** 2017. *Guidelines for pest eradication programs. International Standard for Phytosanitary Measures (ISPM 9)*. FAO, Rome, Italy. <http://www.fao.org/3/x2981e/x2981e.pdf>
- IPPC.** 1995. *Requirements for the establishment of pest free areas*. (ISPM 4). FAO, Rome, Italy. <http://www.fao.org/3/w1127e/w1127e.pdf>
- Klassen, W. & Vreysen, M.J.B.** 2021. Area-wide integrated pest management and the sterile insect technique, pp. 75–112. In: V.A. Dyck, J. Hendrichs and A.S. Robinson, eds. *Sterile insect technique*.

- Principles and practice in area-wide integrated pest management*. Second edition. CRC Press, Boca Raton, Florida, USA.
- National Research Council**. 1969. *Insect-Pest Management and Control*. The National Academies Press. Washington, D. C. USA. <https://doi.org/10.17226/18674>
- Koyama, J., Kakinohana, H. & Miyatake, T.** 2004. Eradication of the melon fly, *Bactrocera cucurbitae*, in Japan: importance of behavior, ecology, genetics, and evolution. *Ann. Rev. Entomol.* 49: 331–349. <https://doi.org/10.1146/annurev.ento.49.061802.123224>
- Leppla, N.C.** 1984. Systems management of insect-population-suppression programs based on mass-production of biological-control organisms. In: E.G. King & N. C. Leppla. *Advances and challenges in insect rearing*. USDA-ARS, (Southern Region), New Orleans, Louisiana, USA.
- Tween, G.** 1993. Fruit fly control and eradication program management: Factors influencing action criteria and program design, pp. 307–310. In: M. Aluja & P. Liedo, eds. *Fruit Flies. Biology and Management*. Springer-Verlag, New York, USA.
- Reyes, J., Villaseñor, A., Ortiz, G. and Liedo, P.** 1986. *Manual de Operaciones de Campo para la erradicación de la Mosca de Mediterráneo en regiones tropicales y subtropicales, utilizando la técnica del insecto estéril*. Programa Moscamed. DGSV-SARH. México.
- Reyes, J. & Ortiz, G.** 1982. *An ecological and logistic study on the eradication of the Mediterranean fruit fly in Egypt*. IAEA, Viena, Austria. (L83-21432).
- Reyes, P., Reyes, J., Enkerlin, W., Galvez, J., Jimeno, M. & Ortiz, G.** 1991. *Estudio beneficio-costo de la Campaña Nacional Contra Moscas de la Fruta*. Secretaria de Agricultura y Recursos Hidraulicos (SARH), México.
- Secretaria de Agricultura y Recursos Hidráulicos/Dirección General de Sanidad Vegetal.** 1991. *Campaña nacional contra las moscas de la fruta*. Mexico.
- Steiner, L.F., Harris, E.J., Mitchell, W.C., Fujimoto, M.S. & Christenson, L.D.** 1965. Melon fly eradication by overflowing with sterile flies. *J. Econ. Entomol.* 58: 519–522. <https://doi.org/10.1093/jee/58.3.519>
- Steiner, L.F., Hart, W.G., Harris, E.J., Cunningham, R.T., Ohinata, K. & Kamakahi, D.C.** 1970. Eradication of the oriental fruit fly from the Mariana Islands by the methods of male annihilation and sterile insect release. *J. Econ. Entomol.* 63: 131–135.
- Suckling, D.M., Kean, J.M., Stringer, L.D., Cáceres, C., Hendrichs, J., Reyes-Flores, J. & Dominiak, B.C.** 2014. Eradication of tephritid fruit fly pest populations: outcomes and prospects. *Pest Manag. Sci.* 72 (3): 456–465. <https://doi.org/10.1002/ps.3905>
- Zavala, J.L., Marte-Diaz, G. & Martinez-Pujols, F.** 2021. Successful area-wide eradication of the invading Mediterranean fruit fly in the Dominican Republic, pp. 519–537. In: J. Hendrichs, R. Pereira & M.J.B. Vreysen, eds. *Area-wide Integrated Pest Management: Development and Field Application*. CRC Press, Boca Raton, USA.

Bibliography specific to area-wide SIT operational programmes

- Barnes, B.N. & Eyles, D.K.** 2000. Feasibility of eradicating *Ceratitis* spp. fruit flies from the Western Cape of South Africa by the sterile insect technique, pp. 449–455. In: K.H. Tan, ed. *Area-Wide Control of Fruit Flies and Other Insect Pests*. Penerbit Universiti Sains Malaysia, Penang, Malaysia.
- De Longo, O., Colombo, A., Gomez-Riera, P. & Bertolucci, A.** 2000. The use of massive SIT for the control of the medfly, *Ceratitis capitata* (Wied.), strain SEIB 6-96, in Mendoza, Argentina, pp. 351–359. In: K.H. Tan, ed. *Area-Wide Control of Fruit Flies and Other Insect Pests*. Penerbit Universiti Sains Malaysia, Penang, Malaysia.
- Dowell, R., Siddiqui, I.A., Meyer, F. & Spaugy, L.** 2000. Mediterranean fruit fly preventative release programme in Southern California, pp. 369–375. In: K.H. Tan, ed. *Area Wide Control of Fruit Flies and Other Insect Pests*. Penerbit Universiti Sains Malaysia, Penang, Malaysia.

- Dyck V.A., Hendrichs, J. & Robinson, A.S., eds.** 2021. *Sterile Insect Technique. Principles and Practice in Area-wide Integrated Pest Management*. Second edition, CRC Press, Boca Raton, Florida, USA, 1200 pp. <https://doi.org/10.1201/9781003035572>
- Enkerlin, D., Liedo, P., Ortiz, G., Reyes, J & Schwarz, A.** 1984. *Review, procedures, and present status of the Medfly Program in Mexico*. Regional Seminar on Nuclear Techniques in Crop Production. 18–23 November 1984. Comision Interamericana de Energía Nuclear, OEA-CENA and Universidad de Sao Paulo, Brazil.
- Hendrichs, J., Ortiz, G., Liedo, P. & Schwarz, A.** 1983. Six years of successful medfly program in Mexico and Guatemala, pp. 353–365. In: R. Cavalloro, ed. *Fruit Flies of Economic Importance*. A.A. Balkema, Rotterdam, The Netherlands.
- Klassen, W.** 2000. Area-wide approaches to insect pest management: history and lessons, pp. 21–38. In: K.H. Tan, ed. *Area-Wide Control of Fruit Flies and Other Insect Pests*. Penerbit Universiti Sains Malaysia, Penang, Malaysia.
- Knipling, E.F.** 1969. Concept and value of eradication or continuous suppression of insect populations, pp. 19–32. In: *Proceedings of a Panel: Sterile-Male Technique for Eradication or Control of Harmful Insects*. Joint FAO/IAEA Division of Atomic Energy in Food and Agriculture, 27–31 May 1968, Vienna, Austria. STI/PUB/224. IAEA, Vienna, Austria. www.iaea.org/sites/default/files/el_harmful_insects.pdf
- Koyama, J., Kakinohana, H. & Miyatake, T.** 2004. Eradication of the melon fly, *Bactrocera cucurbitae*, in Japan: importance of behavior, ecology, genetics, and evolution. *Ann. Rev. Entomol.* 49: 331–349. <https://doi.org/10.1146/annurev.ento.49.061802.123224>
- Lindquist, A.W.** 1955. The use of gamma radiation for control or eradication of the screw-worm. *J. Econ. Entomol.* 48(4): 467–469. <https://doi.org/10.1093/jee/48.4.467>
- Lindquist, D.A.** 2000. Pest management strategies: area-wide and conventional, pp. 13–19. In K.H. Tan, ed. *Area-Wide Control of Fruit Flies and Other Insect Pests*. Penerbit Universiti Sains Malaysia, Penang, Malaysia.
- Olalquiaga, G. & Lobos, C.** 1993. *La mosca del Mediterráneo en Chile: Introducción y erradicación*. Ministerio de Agricultura. Servicio Agrícola y Ganadero. Santiago, Chile.
- Patton, P.** 1980. Mediterranean fruit fly eradication trial in Mexico, pp. 81–83. In: *Proceedings of a Symposium on Fruit Fly Problems*. XIV International Congress of Entomology. ICE, Kyoto, Japan.
- Rhode, R.H., Simón, J., Perdomo, A., Gutiérrez, J., Dowling, C.F.Jr. & Lindquist, D.A.** 1971. Application of the sterile-insect release technique in Mediterranean fruit fly suppression. *J. Econ. Entomol.* 64 (3): 708–713.
- Reyes, J., A. Villaseñor, A. Schwarz & J. Hendrichs.** 1988. Organization of medfly eradication campaigns, pp. 107–116. In: *Proceedings of a Symposium: Modern Insect Control: Nuclear Techniques and Biotechnology*. International Atomic Energy Agency, and Food and Agriculture Organization of the United Nations, 16–20 November 1987, Vienna, Austria. STI/PUB/763. IAEA, Vienna, Austria. <https://www.iaea.org/sites/default/files/ipc-modern-insect-control.pdf>
- Reyes, J., Santiago M.G., & Hernández M.P.** 2000. The Mexican fruit fly eradication programme, pp. 377–380. In: K.H. Tan, ed. *Area-wide control of fruit flies and other insect pests*. Penerbit Universiti Sains Malaysia, Penang, Malaysia.
- Tween, G.** 2004. MOSCAMED-Guatemala – An evolution of ideas, pp.119–126. In: B.N. Barnes, ed. *Proceedings of a Symposium: 6th International Symposium on Fruit Flies of Economic Importance*. 6–10 May 2002, Stellenbosch, South Africa. Isteg Scientific Publications, Irene, South Africa.

Annex 2

Contingency plan for detection, delimitation, and eradication of outbreaks of invasive quarantine fruit fly pests

A-2.1 Introduction

A contingency plan (CP) is a documented plan of eradication actions to be implemented against fruit fly pests as a matter of urgency in an endangered fruit fly pest free area (FF-PFA). The plan is activated as a response to the detection of an unforeseen quarantine fruit fly entry, that is categorized as an outbreak. The objective of activating the CP is to prevent the spread of the pest to other areas which may result in fruit damage and economic losses. The CP is aimed at protecting recently created or long-time established FF-PFA. A pest entry which does not result in an outbreak, is not subjected to the enforcement of the CP.

For the purpose of this guideline, pest free areas are equivalent to FF-PFA. Also, the features and elements of a CP discussed below are only related to the phytosanitary procedures applied to eradicate outbreaks in permanent FF-PFA.

A-2.2 Types of FF-PFA

Adapted from the FAO-IPPC glossary definition of a ‘pest free area’, an “FF-PFA is an area in which a specific fruit fly pest is absent as demonstrated by scientific evidence and in which, where appropriate, this condition is being officially maintained”.

The term FF-PFA encompasses a wide range of such areas based on different conditions. Therefore, it is convenient to discuss the CP by dividing FF-PFAs in three types, based on their origin:

- Permanent natural FF-PFA
- Permanent created FF-PFA
- Temporary FF-PFA

A-2.3 Contingency plan in permanent natural FF-PFA

Developing of a CP in countries where FF-PFA have been established, because of the absence of the target pest, is facilitated by the experiences gained in other countries with similar areas where eradication procedures have been successful. This also has the advantage of being able to perform periodic field exercises in response to simulated detections, so that when needed, the eradication actions can be executed rapidly. Lack of such a CP, in the event of an unforeseen quarantine fruit fly incursion, may lead to pest spread over larger areas, turning eradication difficult and costly.

A-2.4 Contingency plan in permanent created FF-PFA

Countries with permanent FF-PFA resulting from previous successful eradication programmes, most likely have already developed a CP based on the experience obtained during the eradication efforts.

A-2.5 Corrective action protocol in temporary FF-PFA

In the AW fruit fly eradication programmes, during the process of pest suppression and eradication, create temporal FF-ALPP, buffer zones and FF-PFA as well. FF-PFA particularly have a temporal status until they undergo a process of verification to assure that the pest has been eradicated. Only after pest eradication has been verified is the area officially declared as pest free.

Enforcement of a Corrective Actions Protocol (CAP) to eliminate the pest in the temporal FF-PFA is a common procedure in AW fruit fly eradication programmes due to the recurrent entries of the target pest. These are a consequence of the territorial limits of the temporal FF-PFA being adjacent to the low prevalence or infested areas.

| Differences | Corrective Action Protocol (CAP) Temporal FF-PFA (As part of an eradication programme) | Contingency Plan (CP) Permanent FF-PFA |
|------------------------|---|---|
| outbreak features | Outbreaks are expected Trigger to launch eradication: One adult or immature | Outbreaks are an unexpected event Trigger to launch eradication: One gravid female, larvae occurrence or two adults. Capture of an adult does not necessarily launch an eradication programme |
| Response and resources | Immediate surveillance and suppression treatments Immediate availability of resources (equipment, materials, personnel, bait, parasitoids, sterile flies, etc.) Ongoing quarantine check points Ongoing public awareness campaigning | Immediate surveillance but suppression treatments are delayed Availability of resources is not immediate, except trapping materials. Quarantine check points should be established Public awareness campaigning should be launched |
| Impact | Low economic impact because it happens in an FF-PFA which is still not officially recognized, therefore, there is no export of fruit commodities. Eradication can be reached in a short time | Substantial economic impact because it happens in a recognized FF-PFA, therefore export of fruit commodities are immediately restricted Eradication may takes long time or at least longer than in a temporal FF-PFA. |

Figure A-2.1. Major differences in eliminating pest outbreaks between a temporal and a permanent FF-PFA

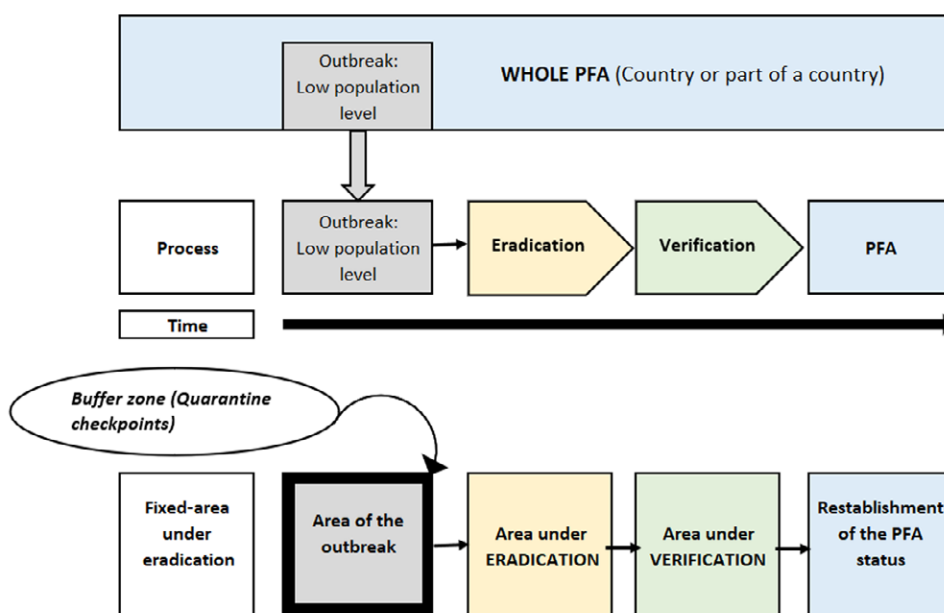

Figure A-2.2. Direct eradication process. No suppression phase is required to eliminate an outbreak with a low population level.

The highest likelihood of pest entries into the temporal FF-PFA requires that a CAP be continuously applied until the area has a more permanent pest-free status. In comparison, in permanent areas that have been pest free for a longer time, pest entries are less likely. In these cases, when a pest entry occurs, a CP is applied as an emergency measure.

A-2.6 Differences between contingency plans and corrective action protocols

Although technically the contingency plan and corrective action protocol share the same technical basis, there are major operative and economic differences (Figure A-2.1).

Although phytosanitary procedures to eliminate an outbreak in a temporal FF-PFA of an ongoing eradication programme are the same as for an outbreak in a permanent FF-PFA, they are applied differently in terms of combination of procedures, sequence in their application, intensity, and time length. Also, although the area delimiting an outbreak might be of the same size in a temporal and permanent FF-PFAs, its economic and political impact in the permanent FF-PFA is much higher.

A-2.7 Eradication process and models applied in outbreaks occurring in FF-PFA

A CP is, in general terms, a written eradication strategy that will be applied through a relatively small-scale eradication programme to eliminate an outbreak in an FF-PFA.

Since fruit fly population levels in outbreaks are generally low because the pest has not yet become established in the area (low level infestation), there is no need for a phase of pest suppression; thus, suppression actions are applied directly to achieve eradication of the fruit fly pest (Figure A-2.2).

If, on the contrary, the population levels in the outbreak are already high when detected, the eradication process is the same as for large-scale programmes, encompassing three temporal phases. The phases are conducted in a logical sequence over the area where the outbreak has been detected: (a) suppression, (b) eradication, and (c) verification (Figure A-2.3).

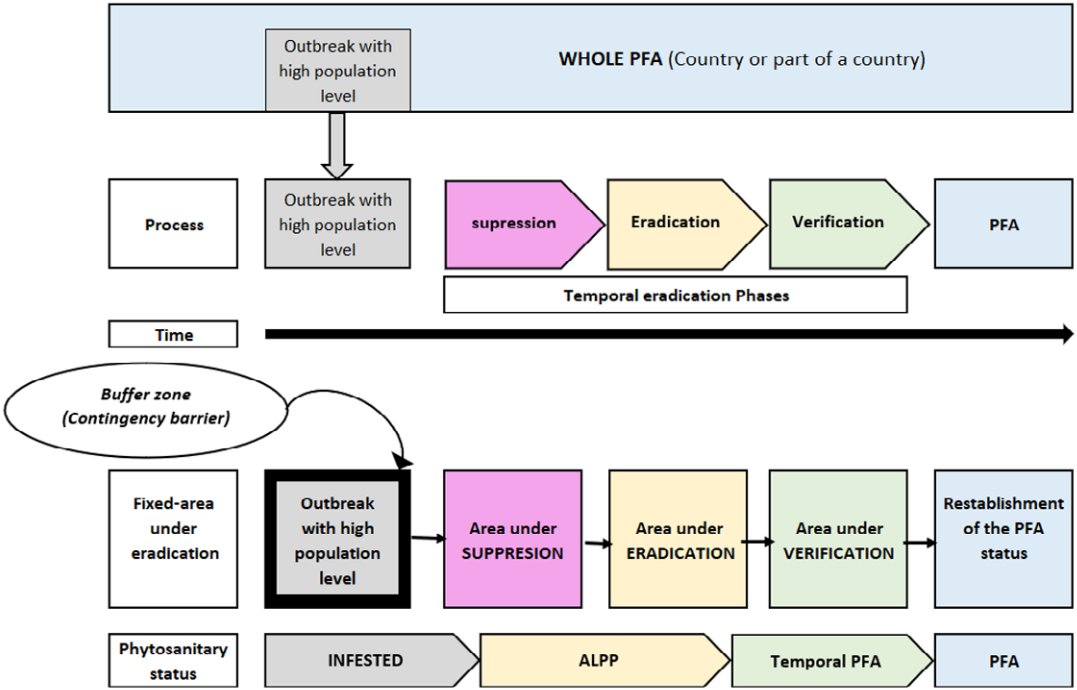

Figure A-2.3. Eradication process using a single fixed-area eradication model applied to eliminate an outbreak with a high population level

Moreover, because outbreaks usually do not spread over very large areas, especially when they are detected early, the working area of the largest outbreak is relatively small (<500 km²) when compared with the total area of large-scale eradication programmes. In this case the whole outbreak area delimited for intervention can be treated as a single unit, therefore the single fixed-area eradication model is the most suitable. More detailed information on the process used to eliminate a target pest from an area using the single fixed-area eradication model is discussed in **Annex 1** of this Guideline.

A-2.8 Features of contingency plans

Contingency plans usually address one target fruit fly pest at a time; however, if a single phytosanitary procedure is able to eliminate several species of fruit flies, a CP can be designed for the eradication of one or more fruit fly species. For instance, MAT can be used as a stand-alone measure to eliminate several species of *Bactrocera*, mainly those that respond strongly to ME.

There are several species of fruit fly pests that are grouped based on their response to proteinaceous food baits such as *Anastrepha* spp. However, if the main phytosanitary procedure to eradicate species of these genera is SIT which is a species-specific technique, then a CP for each species of fruit fly pest should be developed.

The eradication of an outbreak in a permanent FF-PFA follows a similar process as any large-scale, long-term AW fruit fly management programme. It includes a planning stage (preparation of the CP document), eradication stage (execution of the CP) and closure stage (reinstatement of the phytosanitary status of the area).

CP should be immediately implemented. Once an outbreak of a quarantine fruit fly pest is detected, the field eradication activities are immediately implemented including specific regulations such as quarantine restrictions to move regulated articles out of the infested area, fruit disinfestation treatments,

| Parts | | List of topics |
|--------|--------------------------------------|---|
| Part A | General information | A.1 Action statement A.2 Information of the target fruit fly A.3 Official directory A.4 Organization of the contingency plan |
| PART B | Surveillance procedures | B.1 Outbreak area B.2 Fruit sampling B.3 Trapping |
| PART C | Quarantine and Regulatory Procedures | C.1 Quarantine area C.2 Quarantine checkpoints C.3 Regulatory measures |
| PART D | Eradication Procedures | D.1 Cultural and Mechanical control D.2 Chemical control (BAT, BS and MAT) D.3 Biological control (ABC and SIT) |
| PART E | Verification | E.1 Verification criteria E.2 Compilation of technical records E.3 Final actions |

Figure A-2.4. Main parts and topics of a generic CP

and operation of quarantine checkpoints to prevent the movement of infested fruit from the affected area to the rest of the FF-PFA.

Supplementary intensive surveillance, fruit stripping and disposal, and ground bait applications are key activities before the main eradication activities such as aerial BAT sprays, MAT or SIT are applied.

When surveillance validates that no further detections of the target fruit fly species have occurred during a predetermined period of time, according to a set of criteria, eradication of the outbreak can be considered successful. After the pest absence has been validated, the NPPO reinstates the FF-PFA status and informs trading partners, RPPO and the IPPC.

A-2.9 Preliminary activities before implementing a contingency plan

In a permanent FF-PFA, the detection of a single target fruit fly together with an immature specimen, or an inseminated female, or two or more fertile adults, is defined as an outbreak and immediately triggers three actions that can be conducted either simultaneously or in sequence:

- Domestic declaration by the NPPO of the suspension of the pest free status for the whole FF-PFA or the affected part within the FF-PFA;
- Notification to the trading partners and interest groups;
- Implementation of the CP including pest eradication actions.

A-2.10 Main elements of a contingency plan

The CP model, discussed below, which addresses the phytosanitary procedures applied **to eradicate** one target fruit fly; is based on several contingency plans and experiences in fruit fly eradication programmes worldwide. The parts of the plan presented, and the topics of each of the parts, include the activities of a generic CP, therefore it does not contain numbers, values, and parameters for specific species of fruit flies (**Figure A-2.4**).

A-2.11 PART A. General information

This initial part contains the basic elements on which to develop the rest of the CP parts, which are technical.

A-2.11.1 Action statement

Topics included in this part are:

Purpose and scope

Objectives of the contingency plan (CP) should be clear and concise. It should include the target fruit fly pest or group of pests (including common and scientific name) for which the CP has been prepared.

Explain that the CP is a guideline to be used by NPPO officers, staff, and employees, containing the strategy and emergency actions to be taken to eradicate an outbreak of the target pest.

Legal basis

The relevant official legislation, regulations, directives, standards, and policies that are the legal umbrella to launch eradication actions under the CP, should be specifically identified. Sometimes this topic is included in the purpose and scope.

A-2.11.2 Information of the target fruit fly

A-2.11.2.1 Origin and distribution

List the name of countries where the target pest has been reported, grouped by continents. Even though this information seems to be not so important for the application of the eradication activities, it gives an idea of the potential the pest has for transboundary spread across different continents and climates.

A-2.11.2.2 Biology

In this section there should be a general description of the life cycle. It should also explain, given that fruit fly development is temperature dependent, the time to complete each developmental stage and to complete the life cycle, which depend on the average environmental daily temperatures. It can be emphasized that the duration of eradication activities, including regulatory and quarantine actions (R&Q actions) and the declaration of pest eradication, are mostly based on the duration of the life cycle. Therefore, in a temperate area, a continuous monitoring of the daily temperature is important. It can be useful to include tables showing the degree days for different climate areas and fruit fly species. In subtropical and tropical climates, average time for fruit fly development is quite similar. For instance, in warm tropical areas, 26 to 30 days is the average time that *C. capitata* requires to complete one generation.

A-2.11.2.3 Host range and damages

Indicate the global number of known hosts and include a list of the known natural hosts, categorized by commercial and non-commercial, natural major and poor hosts. It is important to clarify that many times major hosts in one country may be poor hosts or non-hosts in others. Moreover, there may be fruit species in the endangered area that have not been reported as hosts worldwide, but when the pest is introduced, these may be infested.

The accuracy of this information is crucial since the host list contains those host commodities that will be quarantined in the outbreak area and the host trees that will be subjected to fruit stripping activities. If the target fruit fly species has never been established in the area, the initial host list can be taken from pest risk assessment studies, scientific publications indicating the hosts of the pest in its geographical distribution range, databases of international organizations dedicated to agriculture, and from reports available in the RPPOs.

A-2.11.3 Official directory

A-2.11.3.1 Preliminary events to activate the contingency plan

When a suspicious fruit fly specimen is found by the surveillance network established for detection of quarantine fruit flies, the NPPO officer in-charge of the surveillance sends the specimen to the authorized identification laboratory according to the protocol available for such events. If the specified identification laboratory determines that the specimen(s) is of quarantine importance, it reports back to the NPPO officer who, in turn, informs about the finding to the NPPO authority.

A-2.11.3.2 Roles and responsibilities of the lead government agencies

Once the NPPO authority is informed about the presence of a quarantine fruit fly, it informs the agriculture national authority, prepares, and sends the official domestic and international notifications, and starts the process of implementation of the CP.

Usually, at the outset of the eradication actions, high officials of the Ministry of Agriculture and the NPPO authority establish an advisory group that will take the lead and act as an oversight committee. The manager of the national fruit fly project (if it exists) is usually selected as the manager of the CP. Otherwise, the CP should indicate which office within the NPPO organizational structure will be responsible for implementing the CP. The CP document should identify the responsible persons and

include, if appropriate, their phone numbers. Since governmental officers are frequently rotated, the CP document should be reviewed every year and the names and phone numbers of the officers updated.

A-2.11.4 Organization of the contingency plan

A-2.11.4.1 Organizational structure of the contingency plan

Since the goal of the CP is to allow reacting immediately to eradicate as soon as possible the outbreak of the quarantine fruit fly species recently detected, which become the target pest, there should be a defined organizational structure to implement the CP, as in the case of large-scale eradication programmes. Given that the outbreak of a quarantine pest is classified as an emergency, the structure should be that of an incidence command system. The structure provides a standardized approach to the command, control, and coordination of an emergency response. The CP manager will appoint in advance selected key personnel from national or local government agencies, if appropriate, to the management structure.

Initial staffing comprises three basic units: (a) Field Operations, (b) Public Relations, and two support units, (c) Administration, and (d) Information and statistics. These units will support the CP manager to address the immediate CP staffing needs. The Field Operations Unit has three technical units: (a) Surveillance, (b) Control, and (c) Quarantine.

If the outbreak is of low magnitude (low population level) there is no need to establish a sophisticated structure, but any CP should include the major conceptual operational activities which are: (a) Public Relations, (b) Quarantine, (c) Detection, and (d) Control (**Figure A-2.5**).

A-2.11.4.2 Responsibilities of manager and staff

In general, the CP manager will be responsible for the overall CP (operational and administrative functions). Each unit head reports directly to the CP manager. Major roles and responsibilities of each unit are presented below.

Manager. Identifies financial needs, deploys emergency equipment, assures suitable inventory of technical supplies, establishes a daily, weekly, monthly, or periodic reporting system and record keeping, maintains track of eradication actions, acts as a liaison, and coordinates notifications to stakeholders and interest groups.

Detection Unit Head. Intensifies surveillance systems in the outbreak area, strengthens facilities and assembles equipment for identification, implements identification procedures, administers the protocol for handling of suspicious specimens found in the field by the trapping and fruit sampling detection network, and ships these specimens in case additional confirmation is necessary.

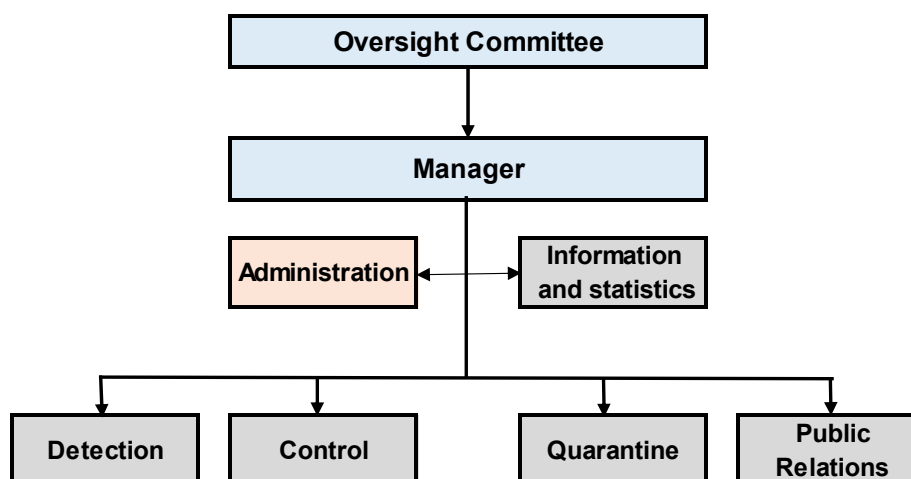

Figure A-2.5. Organizational structure showing the main units involved in planning and executing a CP

Control Unit Head. Immediately implements C&M practices and ground BAT sprays, including appropriate collection and disposal of infested fruit. As the plan progresses, implements aerial BAT and SIT application or MAT, if appropriate, provides equipment for radio communication, identifies airport facilities and aerial services, supervises the adequate use of pesticides and baits in field application and storage.

Quarantine Unit Head. Establishes quarantine check points, issues quarantine notifications on regulated articles to the public and affected fruit industry and establishes outbreak boundaries and informs on the approved regulatory treatments.

Public Relations Unit Head. Publishes spots in radio, TV and newspapers, contacts interested groups, particularly fruit industry and stakeholders, coordinates visitor activities, prints, delivers pamphlets and posters.

Information Unit Head. Obtains, classifies, process and records information on the eradication actions applied in the field. Duties also involve handling of maps, aerial photography, meteorological and climatological information which are essential tools for the field work.

A-2.12 PART B. Surveillance procedures

The purpose of the surveillance system is to detect, delimit and determine over time the spread and extension of the fruit fly target pest outbreak.

A-2.12.1 The outbreak area

The area where the outbreak occurs, also called ‘quarantine area’, is divided into quadrants to allow carrying out a more precise management of the surveillance and eradication activities. The reference point is the site where the first specimen was detected. This site, even though it is of several square meters (i.e. the site where the trap with the initial pest catch was hung, or the tree where the larvae were found), is conventionally called the ‘epicentre’ of the ‘core area’, which in turn is the central quadrant with a size of 1 km². The adjacent quadrants around the core area define the extension of the buffer zone, which ends at the border of the infested area, this is determined by the surveillance (**Figure A-2.6**).

If several detection points occur within the outbreak area because of pest spread or multiple incursions, each point will have a unique core area and buffer zones, to keep a close oversight of the surveillance and eradication actions. The total area on which several detection points occur, however, is managed as an entire infested surface and it can be divided by bigger quadrants (5 km × 5 km or 10 km × 10 km), similar to those used in large-scale eradication programmes.

A-2.12.2 Fruit sampling

There are two types of surveys to detect incipient populations, fruit sampling and trapping. Trapping with powerful attractants such as ME and TML is normally more effective than fruit sampling, however, fruit sampling has demonstrated its value in situations where host availability is limited, or traps use weak attractants such as hydrolysed proteins.

If in the area under eradication there are key hosts of the target fruit fly, fruit sampling can be more effective than trapping based on generic food baits. For example, at low pest population levels, coffee, and guava for *C. capitata*, and grapefruit for *A. ludens* are powerful trap crops (if fruiting), that may give better detection results through fruit sampling than using traps baited with TML or food baits. In these situations, detection of *C. capitata* and *A. ludens* can be carried out in the preferred hosts, directly sampling and dissecting fruit on-site in the core area and buffer zones of the outbreak.

Based on the host list suggested in **Section A-2.11.2**, a host attractiveness graduated table may be included in this section as a guide to plan and implement fruit sampling activities.

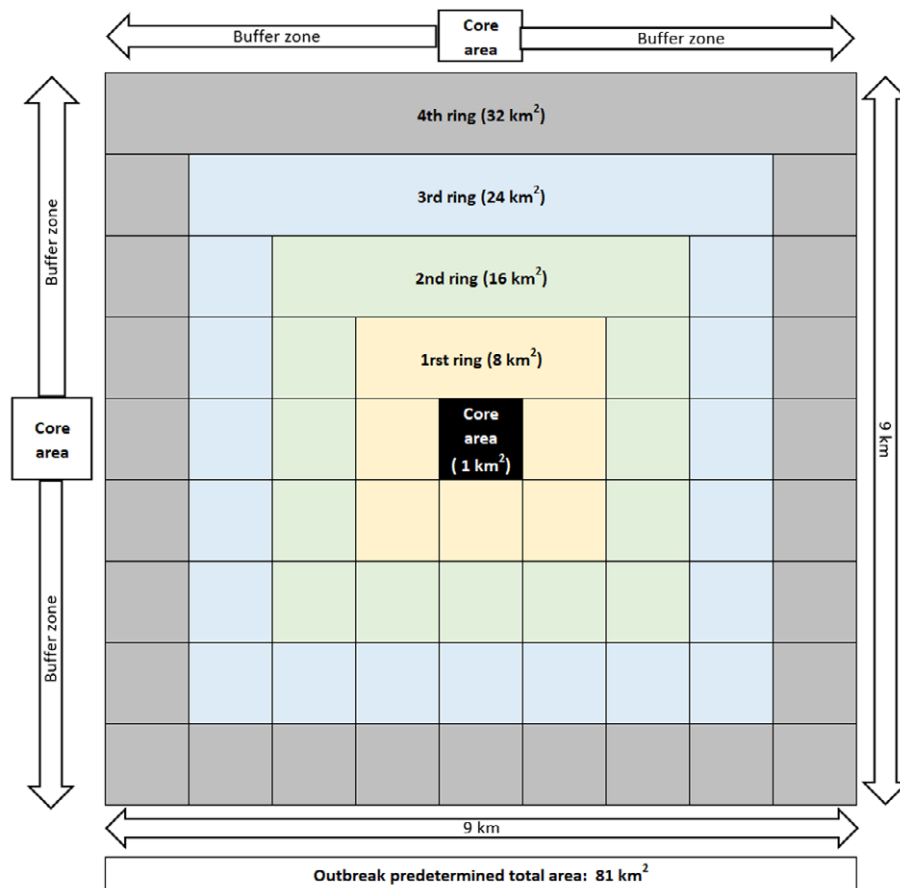

Figure A-2.6. Predetermined working area of an outbreak (quarantine area) with the core area (in black), as the epicentre and buffer zone set up by the quadrants of the four coloured rings around the core area. The total area is 81 km².

Sometimes, where single adult flies have been detected, fruit sampling and holding of fruit in the laboratory for one life cycle can confirm pest infestation. Supplementary and more comprehensive information on the use of fruit sampling to detect fruit flies can be found in the FAO/IAEA “Fruit sampling guideline for area-wide fruit fly programmes” available at www.iaea.org/sites/default/files/ca5716en.pdf

A-2.12.3 Trapping

A regular surveillance system targeting quarantine fruit flies, operated by the NPPO and called detection survey, is placed in sensitive areas based on pest risk assessments (usually points of entry, tourist sites, fruit markets, places of target commercial fruit host production, etc.). The surveillance system should be in place throughout the year. This survey is designed to detect several species of quarantine fruit flies, not just the one target of the CP. eradication.

The CP is triggered when the finding of target pest specimens through the regular surveillance network (detection and sampling surveys) is categorized as an outbreak (see in **A-2.14 Part D** the definition of an outbreak). The first action after detection is to expand and strengthen the current trapping network to transform such a detection survey into a delimiting survey, which will help to determine the extent of the outbreak (delimit its boundaries) and to keep track of any changes in the non-native fruit fly population.

Delimiting trapping. Often, incursions of a quarantine fruit fly are not single but multiple, or, only apparently single as fruit fly adults may spread before they are detected. Therefore, the outbreak area may comprise a relatively large surface with several scattered fruit fly finds. Delimiting trapping

should be deployed every time a new fly is detected in the outbreak area to establish its specific spatial distribution and to adjust (expand) the outbreak area.

The delimiting trapping is kept in place in the outbreak area during the period when the fly find is being delimited, which is normally one generation of the target pest from the date of the last fly find. In the delimiting survey, trap densities are the highest and service intervals the shortest compared with the detection and monitoring surveys. or in the regular surveillance system.

Once the outbreak has been delimited and the quarantine area established, the delimiting trapping is replaced by a monitoring trapping aimed at evaluating the impact of the suppression and eradication actions. The monitoring survey is kept in the quarantine area until the eradication of the outbreak has been confirmed and the FF-PFA status reinstated. The area then returns to the normal survey strategy where the only remaining trapping is the regular surveillance system placed in high-risk areas such as points of entry, tourist sites and fruit markets.

Regulatory trapping. Regulatory trapping is deployed in the infested area around all establishments and facilities where regulated articles are sold, handled, processed, or moved, such as local markets, packing facilities, dumping sites, airports, bus, and railroad stations, etc. The number of traps placed will depend on the nature of the facility, but service intervals should be as in the monitoring trapping.

Traps and attractants. The type of trap and attractant that should be used throughout the eradication of the outbreak has to be determined. Based on the target fruit fly species, type of trapping, and stage of the eradication process, it is likely that different combinations of trap and attractant will be used for surveillance. One combination may be applied as the primary survey method and others as a secondary method.

One recommendation is that the primary combination of traps and attractants be used from the start of the eradication process and maintained until eradication is achieved, so that the data generated by this survey can be compared in time and space.

Trap densities. The density of traps and trap layout pattern may vary according to the type of trapping, target fruit fly species, combination of trap and attractant, area under survey (core and buffer), area under eradication (infested and buffer), stage of the eradication and application of other surveillance methods such as fruit sampling.

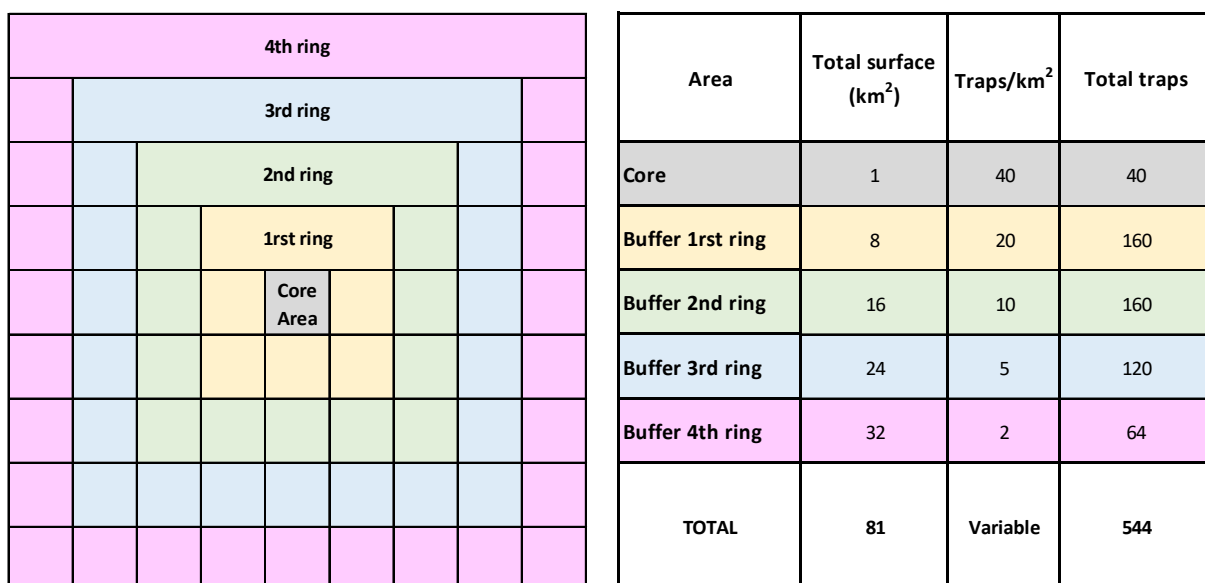

Figure A-2.7. Trap density in the core and adjacent buffer rings of a delimiting trapping. Number of traps within the outbreak area is hypothetical, presented as an example of the gradient from the epicentre (core area) to the border.

Trap density and layout pattern based on the former variables should be very specific to allow a systematic follow up of the pest infestation, distribution, and effect of the suppression and eradication actions. **Figure A-2.7** presents an example of the layout and the trap density gradient of a delimiting trapping in the outbreak area (quarantine area).

A description of the traps and lures used as primary and secondary survey methods should be included in the CP document. These data can be retrieved from the FAO/IAEA “Trapping guideline for area-wide fruit fly programmes” which contain supplementary and exhaustive information on the type of trappings, suitable combinations of trap and attractant based on the target species of fruit fly, densities based on sensitive and risk areas, and intervals of servicing. This guideline is available at www.iaea.org/sites/default/files/trapping-guideline.pdf

A-2.13 Part C. Quarantine and regulatory procedures

The Q&R procedures are always a source of people discontent due to the feeling of invasion of their privacy and therefore need to be managed tactfully and with strong public relations support; nevertheless, these measures are of critical importance to prevent the spread of the infestation of the target pest.

In view of the above, there needs to be a balance between the extent and scale of the R&Q procedures and the characteristics of the outbreak, such as risk posed by the fruit fly species, agroecological characteristics of the area, degree of infestation and likelihood of spread.

For instance, regulation of local fruit retail activities may be not necessary if the infestation is limited and there are poor climatic conditions for pest spread. On the other hand, mandatory checks of passenger baggage at airports, bus and railroad stations may be essential when the pest has a high potential for establishment, the area produces major hosts, or the infestation presents high population levels and is widely spread.

A-2.13.1 Quarantine area

It is a convention that the predetermined quarantine area around the detection site (core area), is a circular area of 5 km radius, that equals to approximately 81 km². If subsequent fruit flies of the target pest are detected within this initial area, the area is extended according to each new fruit fly find. The actual infested surface to be subjected to eradication and quarantine actions will be determined once the results of the delimiting trapping for each of the fruit fly finds are known.

A-2.13.2 Quarantine checkpoints

Once the CP is launched, the first field action is the establishment of quarantine checkpoints along roads leaving the predetermined first quarantined area. Also, if airport and railroad stations are near the detection site, luggage of passengers leaving the quarantined area should be checked to regulate the movement of fruit hosts from the area.

These actions have to be carried out simultaneously with an intensive public awareness campaign on radio and TV through which the public is informed about the regulated fruit species whose movement outside of the quarantine area is restricted. The CP manager and/or the NPPO should involve the local phytosanitary and political authorities in the implementation and execution of above-described actions.

A-2.13.3 Regulatory procedures

List of regulated fruit species. The list of regulated fruit species should be widely distributed among the CP personnel as well as the public. Such a list should include the common names given to the fruits in the region where the outbreak occurs.

Regulated establishments. As mentioned above, all establishments and facilities where the regulated articles (host fruits) are sold, handled, processed, or moved, such as local established fruit markets, flea markets, nurseries, places and sites of host commodity production, packing facilities, canning facilities, transportation companies, and any other establishments that handle, manage or process the regulated fruit products, should be regulated and presented with options to allow them to continue with their activities as much as possible, but mitigating the risk of pest spread.

Consequently, compliance agreements should be subscribed with the groups of interest and stakeholders, and quarantine post-harvest treatments and certification of host commercial commodity shipments should be offered.

A-2.14 Part D. Eradication procedures

The phytosanitary fruit fly management procedures that are followed to achieve eradication of a fruit fly outbreak are the same as those applied in large-scale, long-term fruit fly eradication programmes.

These procedures include C&M practices, BAT, BS, MAT the application, and if appropriate, ABC and the SIT. Local conditions will determine the most acceptable procedure or combination of procedures to achieve eradication. Comprehensive and exhaustive information about the available phytosanitary procedures and their application is found in this Guideline.

Although phytosanitary procedures are the same, the combination, sequence, intensity, timing, and duration of their integration may be different from those applied in ongoing eradication programmes. This is because when an unexpected outbreak occurs in FF-PFA, the required materials and equipment for surveillance and control may not be readily available, so the procedures need to be adjusted based on what is at hand considering the pressure for immediate eradication of the pest incursion. These factors are not present in a temporal FF-PFA of an ongoing eradication programme.

A-2.14.1 The triggers, duration, and completion of treatments

A target pest entry does not necessarily represent an outbreak, and therefore does not always result in the enforcement of the CP. The biological criteria used to determine whether a fruit fly outbreak occurred, which then triggers the implementation of the CP, are the following:

- The detection of two or more adults in an area;
- The identification of an inseminated female;
- The finding of an immature specimen in fruit.

Duration and completion of the eradication procedures depends on each of the methods applied. It is conventionally accepted that phytosanitary procedures to eradicate outbreaks should cover three full biological cycles of the pest after the last pest detection.

To determine duration of the life cycle under prevailing climatic conditions, a temperature dependent model can be used, or research data consulted, as mentioned in **Section A-2.11.2** “Information of the target fruit fly”. Temperature dependent models are available at http://ipm.ucanr.edu/PHENOLOGY/ma-med_fruit_fly.html

A-2.14.2 Cultural and mechanical practices

The first suppression activities to be implemented are sanitation, involving the collection, stripping, and disposal of all fruit from all host trees that bear fruits with potential to be infested. This is done in all private and public properties in the core area, giving particular importance to those fruit species that have shown to be good hosts on previous outbreaks in the area or in similar external endangered areas.

It is recommended, if possible, that some of the collected and stripped fruit that shows infestation symptoms is dissected right away on-site, or to hold some of it for few days in the laboratory, to check

if any fruit fly larvae are present. However, if a secure fruit holding facility is not available during the time of fruit sanitation activities, safe disposal would be more appropriate.

This activity is stopped once there are no more available fruits in the host trees in the area. The major difference with sanitation activities in ongoing large scale and long-term AW fruit fly eradication programmes is that sanitation in these programmes is aimed only at major host fruits. Options for fruit disposal are the same as in both programmes (fumigation, burial or placing in plastic bags).

A-2.14.3 Chemical control

A-2.14.3.1 Ground BAT

This method is one of the first actions to be applied to eliminate the outbreak as soon as possible, or at least to initially contain the spread of the pest incursion. This is because the use of aerial bait application technique (BAT) requires extraordinary logistics that usually take several days to be organized and implemented. Ground bait sprays can be applied simultaneously, if possible, to the C&M practices.

BAT treatments within the core area should be directed at all hosts, bearing and not-bearing fruit and to those non-host trees serving as a potential shelter for adults.

When aerial BAT is implemented, ground sprays can be discontinued or used in fruit fly reservoirs, if present, inside the aerial bait spray blocks. Ground BAT is applied at a weekly or shorter interval and discontinued after two generations of negative fruit fly finds.

A-2.14.3.2 Bait stations

Hand-made bait stations (BS) locally produced can be placed on host trees in the buffer zone. They can also be used as a complement to ground and aerial BAT in the core area in host and non-host trees located in sensitive areas such as public parks, trees along streets and avenues, and in hospital and school gardens.

The BS densities in the core area will depend on the sensitivity of the area. For the buffer zones, they follow a gradient, being the density higher in the first ring adjacent to the core area and lower towards the outer rings. The effective time of a BS in the field is the same as for the ground BAT.

A-2.14.3.3 Aerial BAT

As discussed before, aerial BAT sprays are not usually part of the first activities that are implemented due to their complex logistics. However strong efforts should be made to put aerial BAT application into practice as soon as possible, mostly if the outbreak is comprised of multiple detections scattered over a large area.

For outbreaks, the aerial BAT treatments are conducted giving full coverage instead of treating only alternating swaths (as in conventional AW fruit fly eradication programmes). Intervals between treatments may be reduced from the conventional 7 days to 4 days, especially during the rainy season and should last at least over a period of two life cycles of the pest. These chemical treatments should be discontinued after a period of two life cycles of negative captures. The area covered by aerial BAT treatments includes the core area for each fly find, the buffer zone and 2 to 3 additional km beyond the last ring of the buffer zone, to assure the whole outbreak area is covered.

A-2.14.3.4 MAT

The MAT can be applied against all species of fruit flies of the genera *Bactrocera* and *Dacus* that respond to male baits such as ME or CL. Since *Bactrocera* males have a strong response to ME, the MAT can be used as a stand-alone eradication method for *B. dorsalis* outbreaks. For CL attracted species, such as *B. tryoni* or *Z. cucurbitae*, the MAT is normally integrated with other suppression methods to reduce the density of the target pest population prior to the use of SIT.

The MAT is applied over the whole outbreak area, with higher density of MAT blocks and shorter intervals in the core area than in the buffer zones. The MAT application interval between treatments is every two weeks. It should be shortened during the rainy season and treatments should last over a period of two life cycles. If aerial MAT is applied, the area covered may include the core area, the buffer zone and 2 to 3 additional km beyond the last ring of the buffer zone.

A-2.14.4 Biological control

A-2.14.4.1 Augmentative biological control

An outbreak in a permanent FF-PFA is an emergency on which suppression procedures to eradicate the target pest are more intensely used because fast results are expected. In these situations, the use of ABC is limited or discarded. Although it can achieve control of the pest in a relatively short period of time, its suppression effect is not as short as required by the strategic objectives of fighting an outbreak. In AW fruit fly management programmes that integrate ABC as a standard procedure, it may be used as a complement to eliminate outbreaks in temporal FF-PFA.

A-2.14.4.2 Sterile insect technique

The SIT is considered the best option for eradication of outbreaks for species that do not respond to ME and CL. Even when the outbreaks present low population levels, adequate for the effective implementation of the SIT, normally this method is not used immediately because the source of sterile flies is not readily available or close enough to the intervention area.

During the time quarantine actions, C&M practices, ground BAT, and aerial BAT are ongoing, a temporal FE&RF should be built in or near the endangered area to receive the sterile flies once available.

Application of the SIT can include different release methods such as: ground static or roving and aerial releases. Static and roving releases are used in the core area once the sterile flies become available and before aircraft services are accessible and operational to start with aerial releases.

The ground releases are discontinued once aerial sterile fly releases start. Roving releases can be used in the core and buffer zone to complement or supplement aerial releases in those pest reservoirs showing the most favourable environment for fruit fly development or where larvae are detected.

Sterile fly densities are equally distributed over the entire outbreak area, including the core area and the four surrounding rings (81 km²) or beyond, depending on the severity and distance range of the detections.

Sterile fly treatments are done once or twice a week to keep constant the predetermined density of sterile flies per hectare. The densities used in an outbreak area are generally higher than those used in conventional AW fruit fly management programmes and should continue during three generations after the last pest finding.

A-2.15 Part E. Verification

A-2.15.1 Verification criteria

It is conventionally accepted that the criteria to determine that eradication has been successful are, a) to complete three biological life cycles with no detection from the last fly find, and b) no detections should be confirmed by monitoring surveys conducted during suitable environmental conditions for pest development. During this verification period of three life cycles, control treatments should not be applied.

A-2.15.2 Compilation of technical records

Once the verification criteria of eradication have been met, the manager of the CP gathers the necessary documentation and historical records supporting the surveillance and phytosanitary procedures that were applied to achieve the eradication. These should include the criteria and procedures followed to verify the phytosanitary status of the area, which should comply with the ISPMs No. 4 and No. 26 of the FAO-IPPC. Once this administrative task has been finished, the manager informs the programme's oversight committee about completion of the outbreak eradication.

A-2.15.3 Final actions

Domestic declaration of reinstatement of pest freedom. The NPPO produces an official declaration of eradication which is published in the official media used for this purpose and communicates the outcome to the main stakeholders and affected and interested parties.

FF-PFA notification to international organizations and trade partners. The NPPO also informs the international and regional phytosanitary bodies such as IPPC and RPPO, as well as the NPPO of trading partners, about the reinstatement of the FF-PFA and the domestic declaration of pest free status. Communications may include the relevant evidence supporting the domestic declaration.

Review and evaluation of the contingency plan. Before closing the CP, an evaluation meeting is held where discussions are carried out on general and specific experiences, bottlenecks, and lessons learned, etc., aimed at improving the current CP.

Bibliography

- Croatian Ministry of Agriculture.** 2018. *Action plan on measures to prevent the spread and to control the Mediterranean fruit fly – Ceratitis capitata (Wiedemann) in the Neretva River valley from 2018 to 2021.* Doc. P/7576903. Zagreb, Croatia.
- FAO/IAEA.** 2018. *Trapping guidelines for area-wide fruit fly programmes.* W.R. Enkerlin & J. Reyes-Flores, eds. Second edition, Rome, Italy. 65 pp. License: CC BY-NC-SA 3.0 IGO. www.iaea.org/sites/default/files/trapping-guideline.pdf
- FAO/IAEA.** 2019. *Fruit sampling guidelines for area-wide fruit fly programmes.* W.R. Enkerlin, J. Reyes-Flores & G. Ortiz, eds. Vienna, Austria. 46 pp. www.iaea.org/sites/default/files/ca5716en.pdf
- FAO/IAEA.** 2000. *Action plan peach fruit fly Bactrocera zonata (Saunders).* P. Gomes, ed. Vienna, Austria. 55 pp. www.iaea.org/resources/manual/action-plan-peach-fruit-fly-bactrocera-zonata-saunders
- FAO.** 1998. *Guidelines for pest eradication programmes.* International Standard for Phytosanitary Measures (ISPM) No. 26, International Plant Protection Convention (IPPC). FAO, Rome, Italy.
- FAO.** 2016. *Establishment of Pest Free Areas for Fruit Flies (Tephritidae).* International Standard for Phytosanitary Measures (ISPM) No. 26, International Plant Protection Convention (IPPC). FAO, Rome, Italy.
- FAO.** 2017. *Requirements for the establishment of pest free areas.* International Standard for Phytosanitary Measures (ISPM) No. 24, International Plant Protection Convention (IPPC). FAO, Rome, Italy.
- Manoukis, N.C., Collier, T.C.** 2021. Agent-based simulations to determine Mediterranean fruit fly declaration of eradication following outbreaks: Concepts and practical examples, pp. 869–888. In: J. Hendrichs, R. Pereira & M.J.B. Vreysen, eds. *Area-Wide Integrated Pest Management: Development and Field Application.* CRC Press, Boca Raton, Florida, USA. <https://doi.org/10.1201/9781003169239>
- USDA.** 2003. *Mediterranean fruit fly action plan.* APHIS-PPQ. www.aphis.usda.gov/import_export/plants/manuals/emergency/downloads/medfly_action_plan.pdf

SAGADER/DGSV. 2000. *NOM-076-FITO-1999, Norma oficial mexicana, sistema preventivo y dispositivo nacional de emergencia contra las moscas exóticas de la fruta.* Ciudad de México, Mexico. <http://legismex.mty.itesm.mx/normas/fito/fito076.pdf>

South Africa Department of Agriculture, Forestry and Fisheries. 2018. *Action plan for the control of the Oriental fruit fly Bactrocera dorsalis (Hendel).* A. Manrakhan, J.H. Venter & V. Hattingh, eds. Pretoria, South Africa.

Annex 3

Guideline for the preparation of bilateral work plans for exports of fruits and vegetables that are fruit fly (Tephritidae) hosts

A-3.1 Introduction

The ultimate goal that governments and horticultural industry pursue when controlling fruit fly pests is to provide growers with options to move and trade fruit fly host commodities in national and international markets. Markets may be either kept and expanded, or new markets may be opened.

Economically important fruit and vegetable species or varieties are frequently attacked by fruit fly species (Diptera: Tephritidae) that are categorized as quarantine or regulated pests. This is due to their high fecundity and wide host range. The threat of introduction of invasive fruit fly species of the genera *Anastrepha*, *Bactrocera*, *Ceratitis*, *Dacus*, *Rhagoletis*, and others often results in the establishment of phytosanitary barriers to trade.

A-3.2 Market access and pest risk management measures

Currently, under the Sanitary and Phytosanitary (SPS) Agreement of the World Trade Organization (WTO), most countries worldwide have agreed to allow free trade to continue while maintaining individual country sovereignty in preventing the entry and spread of regulated pests that are new to an area, such as fruit flies. Therefore, to have access to these markets, the National Plant Protection Organisation (NPPO) of the importing or exporting country, or the NPPOs of both trading partners, may evaluate the pest risk of the proposed exports/imports using a Pest Risk Analysis (PRA) methodology.

In the PRA, the potential pest(s) of concern are categorized in terms of the likelihood of entry and establishment and the magnitude of the consequences if introduction does occur. This provides the basis for exporting countries to determine the pest risk management measures to be implemented to reduce the risk and fulfil the Appropriate Level of Protection (ALOP) set by the importing country NPPO.

The ALOP is the level of protection to be achieved using pest management measures to reach the estimated risk deemed appropriate by the country regarding the quarantine pest. This concept is the key factor in selecting the most appropriate pest risk management option.

There are a range of options for fruit fly risk management as shown in the chart on the following page (**Figure A-3.1**). These options are briefly outlined below.

A-3.2.1 Non-host

If the fruit commodity is a non-host for a specific target pest, this should be enough as a stand-alone measure to allow the commodity to be traded, without additional risk mitigation measures.

A-3.3 FF-Pest Free Areas

If the production area is an FF-PFA of the target fruit fly pest, this implies that no other phytosanitary measures specific to the target fruit fly species are required for host commodities produced within the

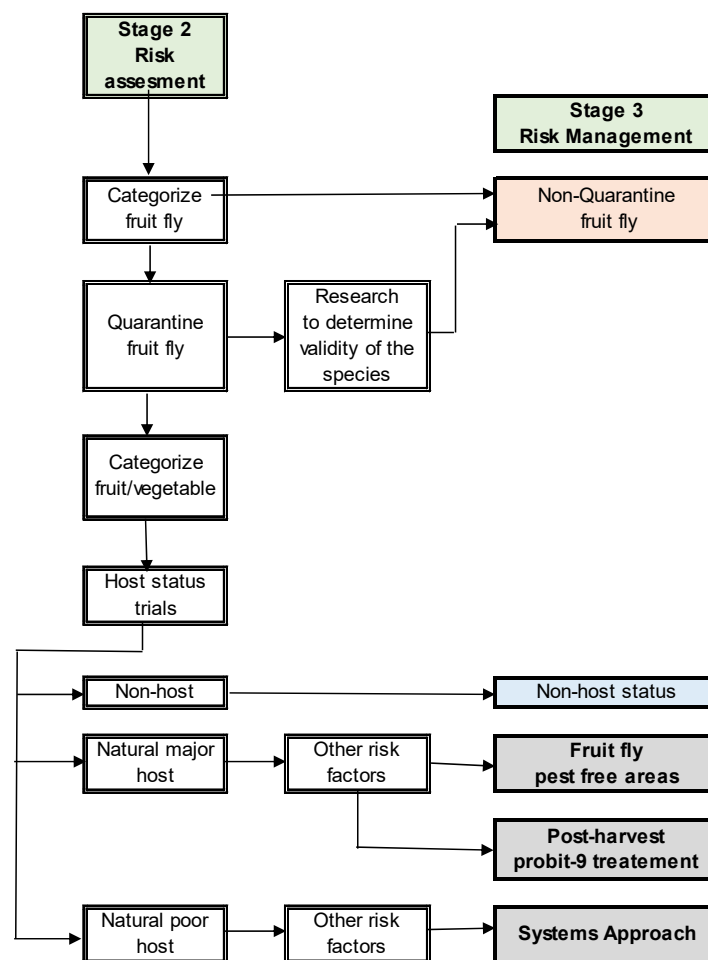

Figure A-3.1. Chart illustrating the relationship between the risk posed by fruit flies and the available risk management options. The chart shows only the last two stages of a pest risk analysis (modified from FAO/IAEA, 2011. Guidelines for Implementing Systems Approaches for Pest Risk Management of Fruit Flies).

PFA (besides surveillance) to allow the commodity to be traded. Although safeguarding may be in place during conveyance of the commodity.

A-3.3.1 Post-Harvest Treatments

If the fruit commodity is a natural major host for a specific target fruit fly, Probit-9 PHT can be used as stand-alone measure to allow the fruit commodity to be traded, therefore there is no need for additional measures to mitigate risk.

A-3.3.2 Systems Approach

If the target fruit fly is present at a low pest population level in the production area, the establishment of an FF-SA may allow the commodity to be traded. An FF-SA includes the use of at least two independent and several dependent measures for reducing risk, applied at the stage of pre-harvest and post-harvest. This enables proper functioning of other measures that are available for integration into the SA to reduce risk to an acceptable level. Also, many times, less than Probit-9 PHT may be used as components of an FF-SA.

A-3.4 Bilateral work plans

Successful implementation of FF-PFA, Probiot-9 PHT or FF-SA as risk mitigation strategies depends on the clear description of activities that should be conducted and on the effective coordination of actions among participants, thus, a bilateral work plan (BWP) endorsed by the trading partners becomes a technical and administrative guide as well as an official document for export.

A-3.5 Situations where BWP are not needed

A-3.5.1 Non-host status

For non-host status, there is no need for developing a BWP, however, exporting countries using this mitigation option to export fruit commodities should make available to the importing countries research records and results that demonstrate the non-host status of the commodity to be exported. The research should, as far as possible, be peer-reviewed and published in a scientific journal.

A-3.5.2 Local or domestic markets

Access to local markets is the simplest case since trade does not need the intervention of any phytosanitary authority. This is usually the case when orchards and markets are both located in an area with the same phytosanitary condition.

If located within infested areas, individual or associated producers suppress the pest infestation to keep it below the economic injury level, or even lower, to increase fruit quality or prevent the occurrence of larvae in the fruit in the market.

A-3.5.3 Non-discriminating export markets

In general, these markets do not demand special phytosanitary requirements to import fruit and vegetables, although may demand that the produce traded comes from a production using good agricultural practices and has some degree of quality (size, maturity degree, colour, etc.) and contains no pesticide residues.

For instance, in fruit fly hosts exported to Europe, BWP are not widely used but some good agricultural practices may have to be implemented to fulfil the requirements of the importing country.

A-3.6 Purpose of BWP

The BWP is a document intended to clearly identify the phytosanitary procedures agreed between trading partners to move fruit fly host commodities from a country to another with a high level of phytosanitary security.

BWPs are a framework which ensures that specific fruit fly commodities that are hosts of regulated pest, produced in a specific area, and exported by one of the countries, comply with the ALOP set by the importing country.

BWPs are simply called work plans; this guideline, however, applies the term bilateral to reinforce its property of being an agreement between two countries. It is also known as protocol of export as it also serves to facilitate exports.

BWPs are usually written in the official language of the two countries participating. The format may follow a 2-columns layout with each paragraph numbered to facilitate its use.

A-3.7 Types of BWP

There are three types of BWPs that countries may use to export or move expeditiously and without phytosanitary setbacks their commodities that are host material of fruit flies of quarantine importance. The BWPs are based on the pest risk management options discussed above:

- BWP for FF-PFA. Applied to export hosts of a specific fruit fly (or flies) from an established FF-PFA.
- BWP for Probit-9 PHT. Applied to export fruit fly major hosts from a place of production and production site (orchard), maintained under low pest prevalence, located in an infested area. The low prevalence levels may or may not be equal to those applied for official FF-ALPP. The low pest level in the field should meet the requirement of the importing country, before sending the fruits for post-harvest treatment application.
- BWP for FF-SA. Applied to export fruit fly poor hosts from an FF-ALPP (place of production, production site (orchards)) located in an infested area. This SA may or may not include a requirement for the application of a less than Probit-9.

The BWPs for an FF-PFA, or for an FF-ALPP as a component of an FF-SA, should include the provisions detailed in ISPM No. 26 “Establishment of pest free areas for fruit flies (Tephritidae)” and ISPM No. 35 “Systems approach for pest risk management of fruit flies (Tephritidae)” respectively.

A-3.8 Preliminary activities before developing a BWP

When a country requires exporting or moving domestically a fruit fly host with quarantine restrictions, either because of demands of the fruit industry or because the government plan is to access export markets in support of its fruit industry, the following fourth steps are normally used:

- Select the type of BWP to be proposed to the importing country, based on the targeted host commodity/pest/area of production and the pest risk management options available.
- Collect the necessary information relevant to the BWP previously selected to technically support the proposal for the export of the targeted host commodity.
- Contact the potential importing country to determine if the proposal meets the ALOP set by the trading partner for the targeted host commodity/pest/area of production.
- Develop the official BWP once the proposal has been discussed with the trade partner and the definitive export procedures that fulfil the ALOP have been agreed.

A-3.9 Prototype of BWP

Although conventional BWP share major elements, they may exhibit several differences and scopes depending on the target pest, the host commodity, and the selected risk management option.

A-3.10 Main elements of BWP

The BWP model, discussed below, is based on case studies between exporting and importing countries worldwide. The topics and scope of each topic cover most of the different activities of a conventional BWP. They address the individual phytosanitary condition which includes fruit fly species, target host and area of production, and the specific ALOP requested by the importing country. Therefore, it does not include defined figures, values, and parameters (**Figure A-3.2**).

| Parts | | List of topics |
|----------------------------|--------|-------------------------|
| Administrative Information | Part A | Official Data |
| | Part B | Introduction |
| Operational Procedures | Part C | Phytosanitary Measures |
| | Part D | Verification Procedures |
| Administrative Information | PART E | General Data |

| |
|---------------------------------------|
| Title |
| Duration and Reviews |
| Effective Date and Signature |
| Target fruit fly |
| Fruit commodities for export |
| Area of Production |
| Points of entry |
| Participants and Responsibilities |
| Pre-harvest phytosanitary procedures |
| Post-harvest phytosanitary procedures |
| Auditing |
| Corrective Actions |
| Compliance agreement |
| Documentation |
| Definitions |

Figure A-3.2. Main parts and topics covered under each part by a conventional BWP

A BWP contains two types of information:

- **Administrative.** This includes the information regarding the date of official launching, duration and closing of the agreed BWP; as well as those actions related to the handling of official documentation.
- **Operational.** This includes the core technical actions related to the application of the phytosanitary procedures for surveillance, control and verification of the target pest levels.

A-3.11 Part A. Official data

This part is mostly the initial page of the BWP. It contains the official authorization of the trading partners to implement it and its period of enforcement and duration as described below.

A-3.11.1 Title

The title of the BWP should describe the subject of the workplan, i.e. the export of a particular host under specific pest risk management measures and includes the names of the exporting and importing countries.

A-3.11.2 Duration and reviews

The BWP may have unlimited or fixed duration; this should be specified. It should also be specified in this part if periodic reviews of the BWP are needed, how to proceed in case of the need for amendments, and how to act in case of situations that are not envisaged in the BWP.

A-3.11.3 Effective date and signatures

This section defines the date the BWP becomes effective and identifies a space for the signatures usually from the director or representative of the NPPO of each country.

A-3.12 Part B. Introduction

This part details the phytosanitary scenario of host/pest/area in which the BWP will be implemented, and the phytosanitary measures that must be carried out before any shipment leaves the exporting country. Sometimes it specifically identifies the relevant official legislation, regulations, directives, standards, and policies of both countries that allow the subscription and putting into force the BWP.

A-3.12.1 Target fruit fly

The target fruit fly population of concern should be identified by species, and if necessary, by subspecies or biotype. It may also include additional information of other species of fruit flies occurring in the area that are not addressed by the BWP.

A-3.12.2 Fruit commodities for export

The specific commodity or group of related commodities for export should be described by species, variety, and cultivar, if relevant.

A-3.12.3 Area of production

This is the area from where the commodities will be exported, sometimes called ‘protocol area’ or ‘working area’. This exporting area may comprise single or several places of production (single orchards or extensive areas cultivated with fruit fly commercial host), a part of a country or an entire country. Limits of these areas should be specified. Administrative borders within the exporting country are often used.

A-3.12.4 Points of entry

If entry into the importing country is limited to specific points of entry or to specific areas (non-endangered), whether for phytosanitary or operational reasons, these specific points in the importing country should be listed in this section.

A-3.12.5 Participants and responsibilities

There are two major entities involved in implementing BWP, which should be clearly identified: (a) the NPPOs of the trading partners, and (b) the horticultural industry of each country.

The horticultural industry, in this instance, includes the people involved in producing, packing, treating, and exporting the fruit fly host commodities, including packinghouses, storage facilities and transportation companies, authorized non-government personnel who will participate in applying phytosanitary procedures or in related activities. These people may be an individual, partnership, corporation, company, legal society, association, or other organized group.

The main responsibilities of the NPPO of the importing country are related to supervision, and verification of activities outlined and described in the BWP, which are carried out by the NPPO and industry of the exporting country.

Sometimes, the movement of the imported commodity is restricted to certain areas of the importing country. In this situation, it falls within the responsibilities of the NPPO of the importing country to control the distribution of the imported host commodity in these specified areas.

The main responsibilities of the NPPO of the exporting country are related to the administration of the BWP in the production area, these activities may include:

- Supervision of the pest populations surveillance and suppression in the places and sites of production (orchards);
- Approval and certification of the packing houses;
- Approval and certification of the PHT facilities;
- Information to their NPPO counterpart of any major problem that might jeopardize BWP implementation;
- Supervision of the activities carried out by the exporting industry;
- Issuance of export phytosanitary certificates.

Responsibilities of the exporting industry, in addition to the application of the procedures indicated in the BWP to suppress pest levels, may include financial obligations such as payment of supervision, inspection, certification processes and general administration expenses related to the implementation of the BWP. A detailed list of responsibilities is available in **Section A-3.15** on the “Compliance agreement with industry”.

A-3.13 Part C. Phytosanitary measures

Phytosanitary measures may be applied in either the exporting or importing country to mitigate the risk of quarantine pest introduction to the importing country. All phytosanitary measures to be implemented under the BWP should be described in detail.

A-3.13.1 Pre-harvest phytosanitary procedures

These BWP procedures are applied at the places of production and in marginal areas before a crop is harvested. These procedures include a variety of surveys and pest suppression procedures. The intensity, timing, and duration of the measures will depend on:

- Nature of the target pest species (monophagous, polyphagous, univoltine, multivoltine, attracted to food-bait, to synthetic attractants, etc.);
- Nature of the target host species and variety (natural major or poor host);
- Phytosanitary and agroecological features of the area where the place of production is located (highly infested, natural FF-ALPP, area under official suppression or eradication, including temporary FF-ALPP, buffer zones, temporary FF-PFA, permanent FF-PFA, etc.).

Because fruit fly pest management activities (suppression, eradication, containment, or exclusion) may be carried out by an official AW fruit fly management programme over places of production as well as in marginal areas, normally these activities are left out of the scope of specific BWP. It is important to note that the phytosanitary procedures described in the BWP are only those applied by the NPPO or the producer within the export area determined by the BWP.

Orchards located in areas that are under official pest control, even though the actual control may be conducted only in marginal areas surrounding the orchards, pose great advantages for fruit producers because the sources of infestation coming from outside the orchards are already suppressed, so achieving the pest level requested by the BWP in the orchard may become a relatively easy task.

Pre-harvest procedures applied to detect and control target pest infestations in orchards are listed and comprehensively described in the main body of this guideline and in the “Trapping Guideline for Area-Wide Fruit Fly Programmes” and “Fruit Sampling Guidelines for Area-Wide Fruit Fly Programmes”, developed by FAO/IAEA which are available at www.iaea.org/sites/default/files/trapping-guideline.pdf and www.iaea.org/sites/default/files/ca5716en.pdf

A-3.13.2 Post-harvest phytosanitary procedures

These BWP actions are conducted after the crop is harvested and prior to shipment; they are sometimes called safeguards. Post-harvest procedures may include conveyance from the orchards to the packing facility, packing and treatment facilities inspections, post-harvest treatments, trapping around treatment and packing facilities, etc. If measures to maintain phytosanitary integrity of consignments are required, the BWP should specify the type of measures required and when they should be applied. These procedures may include special packaging, storage temperature requirements, segregation, sealing, etc.

Many times, phytosanitary measures are applied in the importing country at the designated official point of entry, such as random sampling, inspection, or phytosanitary treatments. This is done prior to the release of the shipment, and these measures should be indicated in this section.

A-3.14 Part D. Verification procedures

A-3.14.1 Auditing

The NPPO of the exporting country has the responsibility to monitor the implementation and the effectiveness of all procedures specified by the BWP. In cases where the operational procedures of an BWP are not appropriately followed, a joint review should be conducted to ensure that phytosanitary import requirements are met. This review may not necessarily involve the suspension of trade but will assure the confidence of the importing trading partner.

The NPPO of the importing country may audit the procedures specified in the BWP in agreement with the NPPO of the exporting country. The frequency of such verification audits may be influenced by the design of the BWP and experiences from previous years. The methodology, sample size and practice to be followed should consider criteria such as the target pest, nature of the commodity, and available facilities. The information above should be specified in the BWP. The BWP should also indicate the frequency of the audits.

NPPO of the importing country should keep the relevant documentation and verification (audit) procedures.

A-3.14.2 Corrective actions

The BWP should specify corrective actions to be taken for non-compliance of the requirements specified in the BWP. The workplan should define who is responsible for applying the corrective actions.

Certain non-compliances may present phytosanitary risks of such a nature for the importing country that suspension of some of the growers’ participating in the export programme or of the entire trade may be necessary. However, suspension should be seen as the last option. The BWP also should include requirements to be met for reinstatement of a participant who has been suspended for reasons of non-compliance, and for reinstating the BWP if suspension was necessary.

The BWP should also indicate procedures for notification of non-compliance and resulting actions based on ISPM No. 13 “Guidelines for the notification of non-compliance and emergency action”. Timelines for notifications may also be specified.

A-3.15 Part E. General information

A-3.15.1 Compliance Agreement with industry

To make sure that the industry of the exporting country understands the provisions of the BWP and is willing to implement it, a “Compliance Agreement” between the NPPO of the exporting country and its industry is useful. Major provisions included in the Compliance Agreement may be, but are not limited to:

- Register with the NPPO those entities involved in the production, treatment and/or packing of the products for export;
- Define cooperation with the NPPO in carrying out fruit fly surveillance and control procedures;
- Comply with the requirements relative to the origin of the product, its transportation to the treatment or packing facility, selection, packing, inspection, certification, security, and transportation to the point of entry (e. g. use of stamps and specific labelled boxes, avoidance of the reuse of packing material, etc.);
- Keep records of fruit fly surveillance and control procedures;
- Make records available to the NPPO of the exporting and importing country;
- Inform to the NPPO of any major problem that might jeopardize the implementation of the BWP.

A-3.15.2 Documentation

If any specific documentation such as phytosanitary certificates, labelling, or marking is required, these requirements should be specified in this section. Templates or examples of additional documents such as treatment certificates, inspection reports or verification reports should be attached to the workplan as appendices if they are necessary.

If an additional declaration is necessary in any of the above documents, the exact wording should be specified in the BWP and should, where applicable, conform to the recommended wording for additional declarations specified in Appendix 2 of ISPM 12.

A-3.15.3 Definitions

Important terms used in the BWP should be clearly defined. This helps to set up a common language that prevents confusion and disagreements when the plan is under implementation, particularly with those people significantly participating in some of the process of the plan that are not familiar with phytosanitary terms and regulations.

A-3.16 Annual reviews

It is highly recommended that the BWP be reviewed and updated every year by the participants to keep it operating efficiently. These reviews can take place before the beginning of the production season, after the last shipment has been released within the importing country, or when serious failures are detected in the processes. Any modifications agreed by the trading parties based on the reviews may be incorporated at any time in revised BWP.

Bibliography

FAO/IAEA. 2011. *Guidelines for Implementing Systems Approaches for Pest Risk Management of Fruit Flies*. Report and recommendations of the consultants group meeting organized by the Joint FAO/IAEA Division of Nuclear Techniques in Food and Agriculture, Vienna, Austria.

- FAO.** 2016. *Establishment of Pest Free Areas for Fruit Flies (Tephritidae). International Standard for Phytosanitary Measures.* (ISPM) No. 26, International Plant Protection Convention. FAO, Rome, Italy.
- FAO.** 2016. *Determination of host status of fruit to fruit flies (Tephritidae). International Standard for Phytosanitary Measures.* (ISPM) No. 37, International Plant Protection Convention. FAO, Rome, Italy.
- FAO.** 2013. *Market Access. A guide to phytosanitary issues for national plant protection organizations.* Capacity Development series, No. 3, International Plant Protection Convention. FAO, Rome, Italy.
- FAO.** 2012. *System approach for pest risk management of fruit flies (Tephritidae).* International Standard for Phytosanitary Measures, No. 35, International Plant Protection Convention (IPPC). FAO, Rome, Italy.
- FAO.** 2007. *Framework for pest risk analysis.* International Standard for Phytosanitary Measures, No. 2, International Plant Protection Convention. FAO, Rome, Italy.
- FAO.** 1999. *Requirements for the establishment of pest free places of production and pest free production sites.* International Standard for Phytosanitary Measures, No. 10, International Plant Protection Convention. FAO, Rome, Italy.
- Hendrichs, J., Vreysen, M.J.B., Enkerlin, W.R. & Cayol, J.P.** 2021. Strategic options in using sterile insects for area-wide integrated pest management pp. 841–884. In: V.A. Dyck, J.Hendrichs, & A.S. Robinson, eds. *Sterile Insect Technique. Principles and Practice in Area-wide Integrated Pest Management.* Second edition, CRC Press, Boca Raton, Florida, USA.
- North American Plant Protection Organization.** 2003. *Directrices para la elaboración de Planes de Trabajo Bilaterales.* NRMF 19. NAPPO, Ottawa, Ontario, Canada.
- World Trade Organization.** 1995. *Agreement on the Application of Sanitary and Phytosanitary Measures.*

GUIDELINES ON PHYTOSANITARY PROCEDURES FOR AREA-WIDE MANAGEMENT OF FRUIT FLY PESTS

This guideline describes the most widely used classic and modern phytosanitary procedures for the management of fruit flies that infest fruits and vegetables and that are of quarantine and economic importance, specifically species of the genera *Anastrepha*, *Bactrocera*, *Ceratitis*, *Dacus*, *Rhagoletis* and *Zeugodacus*. Pest management can be aimed at the native species of fruit flies or to prevent the introduction, establishment and spread of those non-native species.

Not all phytosanitary procedures have the same function and results may differ according to the agroecological conditions where they are applied. Given this situation, this guideline also presents the appropriate control tactics for each phytosanitary procedure, including timing and intensity, as well as the most suitable combination of the procedures to achieve an efficient integrated management of the target fruit fly populations.

This document is the first comprehensive guideline developed by FAO/IAEA for area-wide fruit fly pest management including area-wide suppression, containment, eradication, and exclusion strategies.

ISBN 978-92-5-138607-1



9 789251 386071

CC9843EN/1/03.24