



THE Welding Table

weldingnews 2017/1

FAST AND EASY CLAMPING

With DEMMELER you get the tools to master even the biggest challenges.



DEMMELEER SUCCESSFUL AT THE EUROBLECH 2016 IN HANOVER

Page 2



IDEAL CLAMPING POSSIBILITIES THROUGH FUNCTIONAL BORE GRID

Page 5



OUR "HEAVYWEIGHTS" ENABLE WORKING WITH AN ERGONOMIC POSTURE

Page 20

Dear Ladies and gentlemen,
Dear business partners and customers,

A new year lies ahead us. Do you try to get a hold on something in 2017? Doing more sports, eat healthier, more time for the family ... Or you generally do not take good resolutions at the turn of the year? From a famous industrialist and politician there is an even more famous quote: "Who stops getting better has stopped being good." Therefore we have to constantly question our established processes and invest in new technologies to secure the competitiveness. The topics "increasing productivity", "raising quality" as well as "improving ergonomics and occupational safety" belong to our daily tasks.

In turn, DEMMELER will place the guiding principle 'We are successful if you are successful' in the centre of its activities. This is our firm conviction! With our products we would like to support you with the above described topics.

So we are proud that during the leading trade fair 2016, the EuroBLECH in Hanover, we convinced visitors, expert jury and others with our reversible clamping device Rotatorix®. Thereby, we were honored as shortlist-candidate with the EuroBLECH Award.

In the new edition of the **weldingnews** we provide you with the broadest product portfolio in the field of 3D clamping systems and manipulators. Thus you have ready a perfect solution for every challenge in clamping, reversing and positioning your work pieces. For questions or tricky tasks please feel free to contact our sales team, which can always offer you a good solution due to its experience in the topics clamping and manipulating.

When manufacturing products DEMMELER places great value on highest quality at a price in line. In order to achieve this, DEMMELER relies on the manufacturing facility Heimertingen and therefore on "Made in Germany".

At the beginning of the new year we offer you savings campaigns of selected angles and bolts for a fast fixation and high stability. Also benefit from the price advantages of our extensive accessories-sets for the series PROFIEcoLINE, PROFIPlusLINE as well as PROFIPremiumLINE in all system sizes – D16, D22 and D28.

We look forward to a mutually successful year 2017.

Kind regards,
Stefan Bernhard
Head of Sales & Marketing

FAIR DATES 2017

See our applications live on the most important trade fairs!

DEMMELER will be represented on the most important trade fairs directly or by our trading partners. We are pleased to inform you onsite about our current products and present you our innovations. We are looking forward to your visit.

LEIPZIG

07.03. – 10.03.2017

HALL 2 STAND B24/C23



HANNOVER

18.09. – 23.09.2017



DÜSSELDORF

25.09. – 29.09.2017



STUTT GART

09.10. – 12.10.2017



STUTT GART

07.11. – 10.11.2017



DEMMELER is one of the greatest innovators of the EuroBLECH

The international Sheet Metal Working Technology Exhibition in Hanover was a big success: On the EuroBLECH's first days DEMMELER registered a large number of visitors which still increased during the week. A very positive resonance achieved the clamping device Rotatorix®: The new generation of the clamping device could persuade on the EuroBLECH Award, which honours the most innovative exhibits of the trade fair, and was elected as finalist.



D28 System

**DEMONT 760 M
BLACK EDITION**
THE NEW HARDNESS



Clamping and locating angle 300 Bore / Bore / Oblong hole

- 300 x 175 x 50 mm
- DEMONT 760 M Black Edition, hardened
- Extended face plate with two bores in the face plate
- Mounting plate with oblong hole 100
- Precision scaling on both sides

Clamping and locating angle 300
Special offer on request.

Article no. PL28-03001-016



D16 System

**DEMONT 760 M
BLACK EDITION**
THE NEW HARDNESS



Clamping and locating angle large Bore / Oblong hole

- 140 x 90 x 25 mm
- DEMONT 760 M Black Edition, hardened
- Precision scaling on both sides
- Compatible with all clamping and locating angles
- Dimension adjustment using grid lines on 3D worktable possible

Clamping and locating angle large
Special offer on request.

Article no. D16-03008-000



D28 System

PPC Bolt Set D28, short Consisting of 8 bolts

- Very fast clamping and inserting
- Force-locked through surface contact
- Easy on materials
- Low susceptibility to dirt
- Extrem robust
- Long service life guaranteed



European patent
No. 2569548

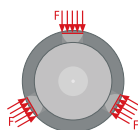

8x PPC Bolt, short
Special offer on request.

Article no. D28-06025-020

D16 System

PC Bolt Set D16, short Consisting of 10 bolts

- Connecting element for all system components on tables, perforated plates etc. or for special fixtures
- Very fast connection with simultaneous large stroke
- Very high clamping force due to planetary gear effect and by avoiding a double thread
- Force-fit and form-fitting, O-ring for self-centring connection
- With clamping range



10x PC Bolt, short
Special offer on request.

Article no. D16-06001-010

* All promotional prices are valid from
15.01.2017 until 31.03.2017.
While stocks last. Errors and changes
are reserved. Offer is subject to change.



Comparison of table lines

DEMONT – The Hardness

DEMMELER 3D welding tables with extreme hardness up to 860 Vickers

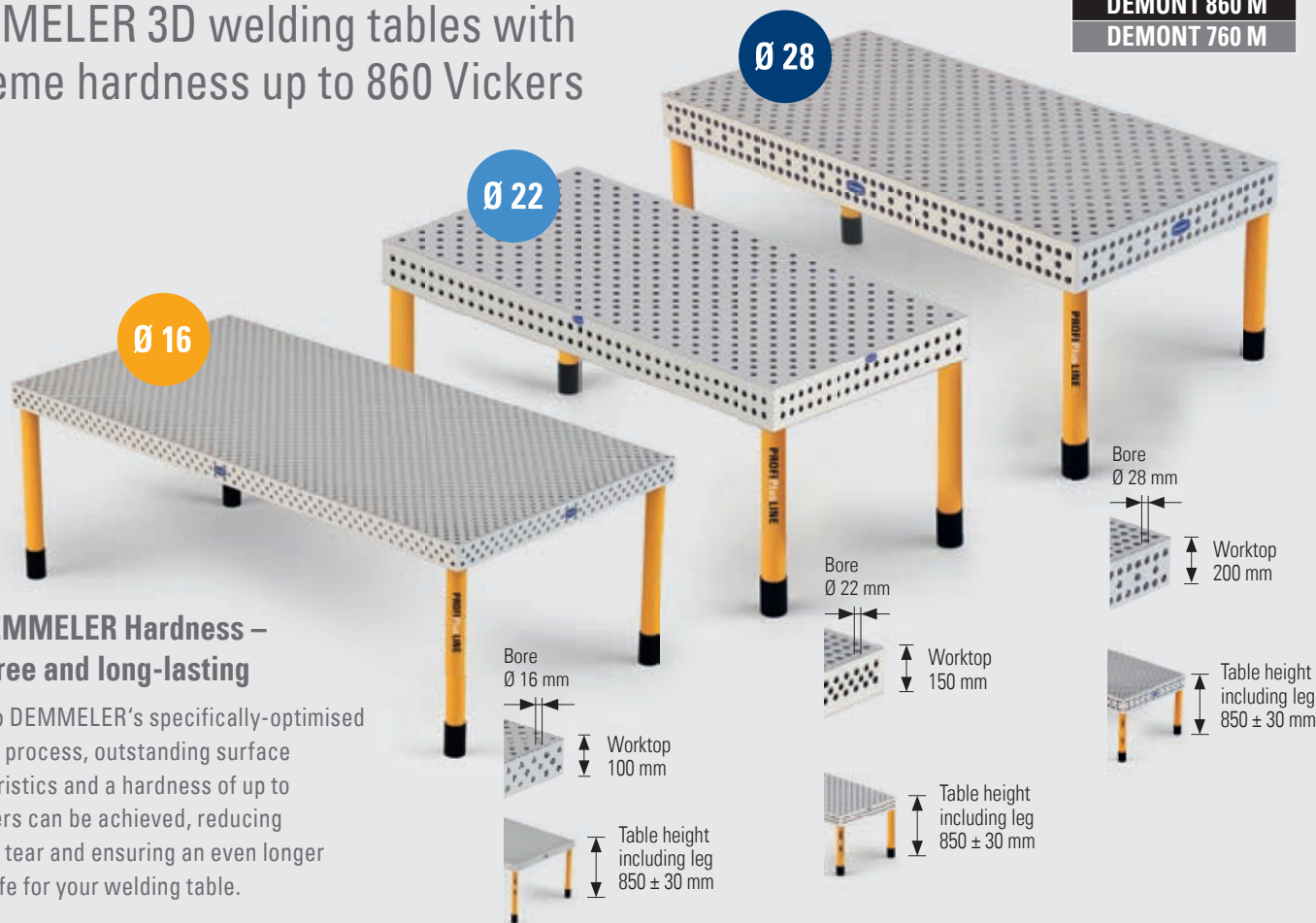
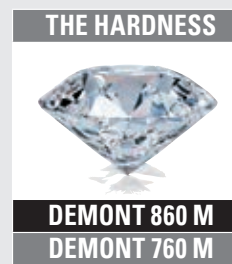

THE DEMMELER Hardness – wear-free and long-lasting

Thanks to DEMMELER's specifically-optimised hardness process, outstanding surface characteristics and a hardness of up to 860 Vickers can be achieved, reducing wear and tear and ensuring an even longer service life for your welding table.

DEMONT 760 M

Hardness up to 760 Vickers



DEMONT 860 M

Hardness up to 860 Vickers



The further advantages of THE 3D clamping system from DEMMELER!



Axis designation in x and y-direction. Standard version includes precision scaling.

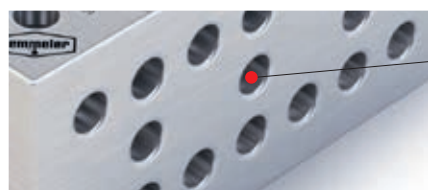

Additional bores in the side stanchion for even more clamping options.

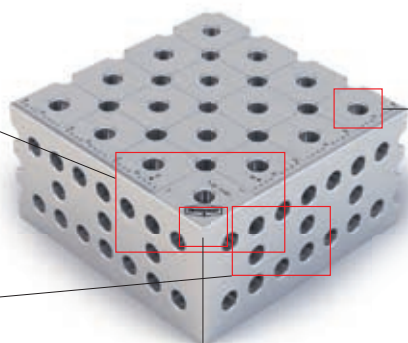

Radius for improved ergonomics and better design

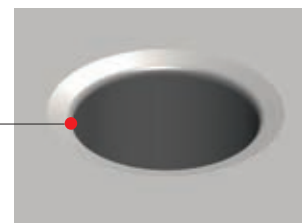

Innovative protective countersinks: Optimum bolt and clamp insertion with simultaneous protection of the tabletop against damage from materials, even in case of extreme strain on the system bore or when used with aluminium.

For every application the ideal 3D welding table – the intelligent system grids improve productivity

Those who can position their work piece optimally, work not only more precise, but also much more effectively. In addition to the hardness, DEMMELER's system tables offer clear advantages in comparison to conventional tables. These include intelligent system grids, axis designation with precision scaling, additional bores as well as protective countersinks for optimal protection of tools and table surface.

D16 PROFIplusLINE (PL)

- Diagonal grid 50 mm x 50 mm
- 3-row bore pattern on the table side plates, 50 mm grid in the top, middle and bottom row

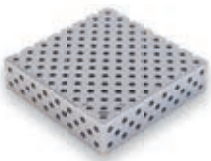

D16 PROFIEcoLINE (PE)

- Grid 50 mm x 50 mm
- 3-row bore pattern on the table side plates, 50 mm grid in the top, middle and bottom row

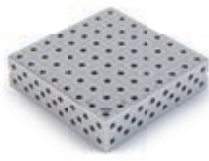

D22 PROFIPremiumLINE (PP)

- Grid 50 x 50 mm
- 3-row bore pattern on the table side plates, diagonal grid 50 x 50 mm

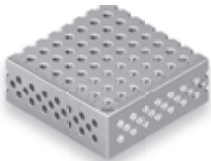

D22 PROFIplusLINE (PL)

- Diagonal grid 100 mm x 100 mm
- 2-row bore pattern on the table side plates, grid 50 mm



D28 PROFIPremiumLINE (PP)

- Grid 50 x 50 mm
- 3-row bore pattern on the table side plates, 50 mm grid in the top and bottom rows, with additional 100 mm grid in the middle



D28 PROFIplusLINE (PL)

- Diagonal grid 100 x 100 mm
- 3-row bore pattern on the table side plates, 50 mm grid in the top and bottom rows, with additional 100 mm grid in the middle



D28 PROFIEcoLINE (PE)

- Grid 100 x 100 mm
- 3-row bore pattern on the table side plates, 50 mm grid in the top row with additional 100 mm grid in the middle



D28 HobbyLINE (H)

- Grid 100 x 100 mm
- Worktop approx. 25 mm high with D28 system bores in a 100 mm x 100 mm grid



These feet stand securely!

Efficient work is guaranteed! From the fine-adjustable standard foot to the mobile heavy-duty foot, a variety of table feet is available for the different table systems to meet the needs of every application. This ensures you have the greatest possible freedom in production. Thanks to their intelligent design, the sturdy attachment of the feet is straightforward. The robust version ensures a long life.

Foot sleeve prevents pinching the welding hose and protects the threaded spindle against dirt.



Pivoting foot with sturdy M30x2 (System D28), M28x2 (System 22) or M24x2 (System D16) threaded spindle, adjustment travel 30 mm fine adjustable.

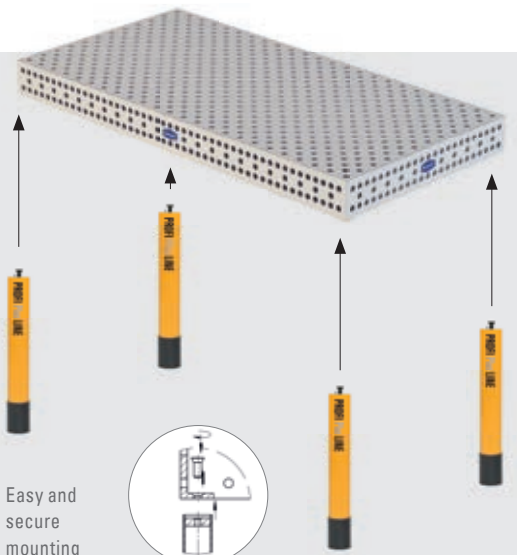
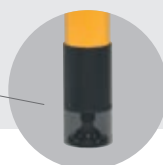

Easy and secure mounting

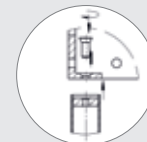

D28 System 3D welding table PROFIEcoLINE (PE) 28



D28 System
 3D welding table
 PROFIEcoLINE (PE) 28

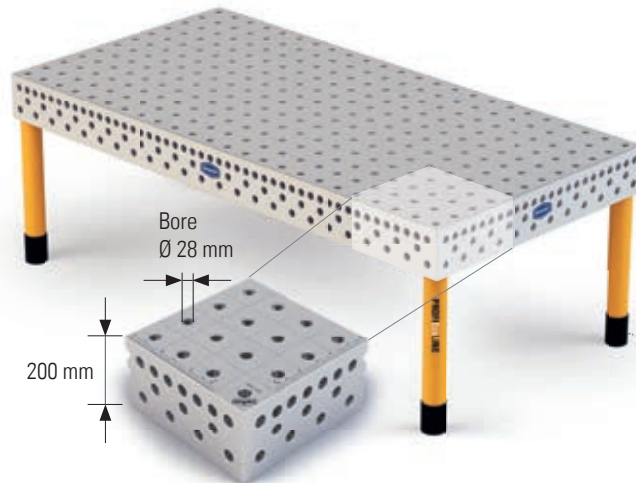
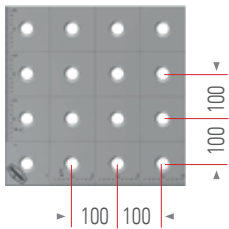

Pivoting foot with sturdy M 30 x 2 threaded spindle, finely adjustable ± 30 mm

Foot sleeve prevents pinching the welding hose and protects the threaded spindle against dirt.



Table size W x H	TABLE WITH STANDARD LEGS	HARDNESS DEMONT 760 M	HARDNESS DEMONT 860 M
1000 x 1000 mm	PE28-01001-001	PE28-01001-011	PE28-01001-021
1200 x 800 mm	PE28-11019-001	PE28-11019-011	PE28-11019-021
1500 x 1000 mm	PE28-01011-001	PE28-01011-011	PE28-01011-021
1200 x 1200 mm	PE28-01056-001	PE28-01056-011	PE28-01056-021
1500 x 1500 mm	PE28-01031-001	PE28-01031-011	PE28-01031-021
2000 x 1000 mm	PE28-01002-001	PE28-01002-011	PE28-01002-021
2000 x 2000 mm	PE28-01006-001	PE28-01006-011	PE28-01006-021
2400 x 1200 mm	PE28-01003-001	PE28-01003-011	PE28-01003-021
3000 x 1500 mm	PE28-01004-001	PE28-01004-011	PE28-01004-021
4000 x 2000 mm	PE28-01005-001	PE28-01005-011	PE28-01005-021
4800 x 2400 mm	PE28-11085-001	PE28-11085-011	PE28-11085-021



Custom dimensions available on request! On request, the table can also be supplied in casting and stainless steel!

Different leg versions are available on request.



Errors and changes are reserved. Offer is subject to change.



SET E 710 Article no.: E28-52000-710 (32 pieces)



SET E 720 Article no.: E28-52000-720 (52 pieces)

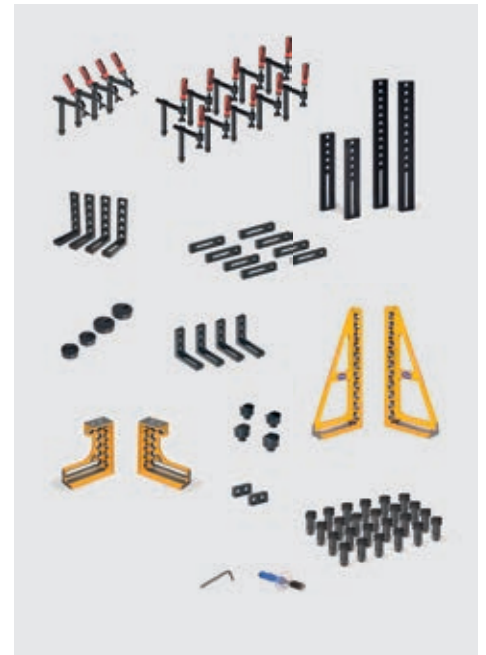

SET E 730 Article no.: E28-52000-730 (74 pieces)

	E 710	E 720	E 730		
	4	4	4	PE28-03001-000	Clamping and locating angle 175 × 175 × 50 mm
		1	1	E28-03002-000	ECO clamping and locating angle right 300 × 275 mm
		1	1	E28-03002-001	ECO clamping and locating angle left 300 × 275 mm
			1	E28-03003-002	ECO clamping and locating angle right 600 × 275 × 80 mm
			1	E28-03003-003	ECO clamping and locating angle left 600 × 275 × 80 mm
		2	4	PE28-03008-000	Clamping and locating angle 275 × 175 × 50 mm
	4	4	8	E28-05001-000	ECO universal stop / large 225 × 50 × 25 mm
	2	2	2	E28-05002-000	ECO universal stop / small 100 × 50 × 25 mm
		2	2	D28-05003-000	Stop-strip L 500–500 × 100 × 25 mm
			2	D28-05003-001	Stop-strip L 800–800 × 100 × 25 mm
		2	2	D28-05013-000	Locating disk 25–50 mm
	2	2	2	D28-05013-001	Locating disk 25–75 mm
	12	18	24	E28-06001-000	ECO clamping pin – short EcoLINE
	6	8	10	D28-07005-000	Screw clamp 180° with spindle
		4	4	D28-07009-000	Swing clamp 45° with spindle
			4	D28-09003-000	V-block holding fixture Ø 58 mm
	1	1	1	D28-10002-000	Round brush Ø 30 mm
	1	1	1	E28-10008-000	ECO ball-head Allen key AF8



Accessory cart D28

(without accessories)

Article no.: D28-11001-000

On request, Eco clamping pins can be replaced by PC clamping pins.

PC bolt surcharge

Set E 710 E28-52000-711

Set E 720 E28-52000-721

Set E 730 E28-52000-731



On request, Eco clamping pins can be replaced by PPC clamping pins.

PPC bolt surcharge

Set E 710 E28-52000-712

Set E 720 E28-52000-722

Set E 730 E28-52000-732



You can individually assemble or supplement your sets with the large selection of Demmeler accessories. Visit www.demmeler.com for the Demmeler main catalogue.

D28 System 3D welding table PROFIPlusLINE (PL) 28

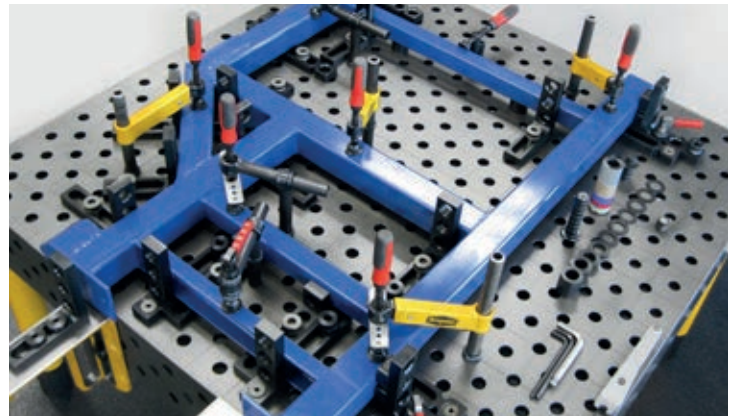
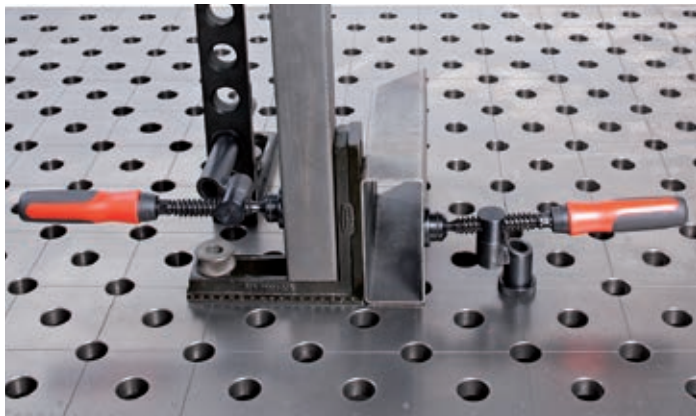

D28 System
3D welding table
PROFIPlusLINE (PL) 28

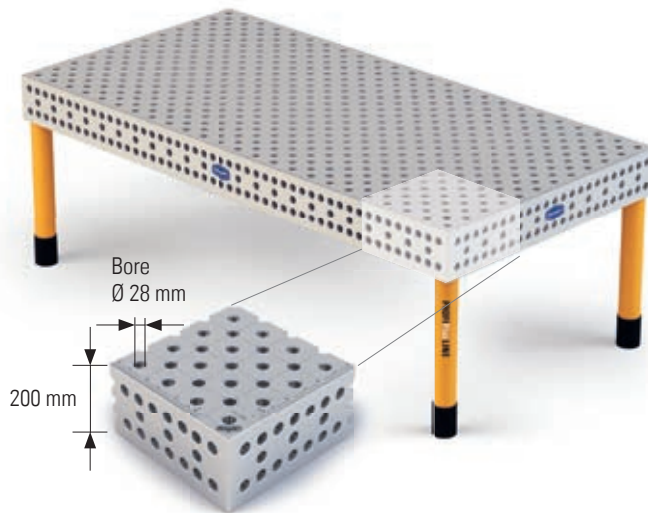
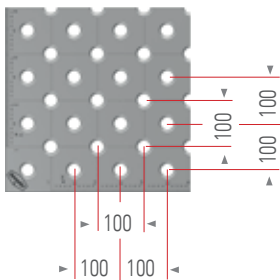

Pivoting foot with sturdy M 30 x 2 threaded spindle, finely adjustable ± 30 mm

Foot sleeve prevents pinching the welding hose and protects the threaded spindle against dirt.



Table size W x H	TABLE WITH STANDARD LEGS	HARDNESS DEMONT 760 M	HARDNESS DEMONT 860 M
1000 x 1000 mm	PL28-01001-001	PL28-01001-011	PL28-01001-021
1200 x 800 mm	PL28-11019-001	PL28-11019-011	PL28-11019-021
1500 x 1000 mm	PL28-01011-001	PL28-01011-011	PL28-01011-021
1200 x 1200 mm	PL28-01056-001	PL28-01056-011	PL28-01056-021
1500 x 1500 mm	PL28-01031-001	PL28-01031-011	PL28-01031-021
2000 x 1000 mm	PL28-01002-001	PL28-01002-011	PL28-01002-021
2000 x 2000 mm	PL28-01006-001	PL28-01006-011	PL28-01006-021
2400 x 1200 mm	PL28-01003-001	PL28-01003-011	PL28-01003-021
3000 x 1500 mm	PL28-01004-001	PL28-01004-011	PL28-01004-021
4000 x 2000 mm	PL28-01005-001	PL28-01005-011	PL28-01005-021
4800 x 2400 mm	PL28-11085-001	PL28-11085-011	PL28-11085-021



Custom dimensions available on request! On request, the table can also be supplied in casting and stainless steel!

Different leg versions are available on request.



Telescoping leg



Heavy-duty wheel



Anchoring leg



Holding frame

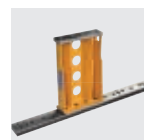

Leg for spacer block



Shifting foot



Scissor lift

Errors and changes are reserved. Offer is subject to change.

Sets PROFIPlusLINE (PL) 28

	D 710	D 720	D 730		
	4	4	4	PE28-03001-000	Clamping and locating angle 175 x 175 x 50 mm
	2	4		D28-03001-005	Clamping and locating angle 175 x 75 x 50 mm
	2	1		D28-03002-000	Clamping and locating angle right 300 x 275 mm
	2	1		D28-03002-001	Clamping and locating angle left 300 x 275 mm
			1	D28-03003-000	Clamping and locating angle right 600 x 375 mm
			1	D28-03003-001	Clamping and locating angle left 600 x 375 mm
	2	2	4	PE28-03008-000	Clamping and locating angle 275 x 175 x 50 mm
	4	2	4	D28-05001-000	Universal stop / large 225 x 50 x 25 mm
	4	2		D28-05003-000	Stop-strip L 500-500 x 100 x 25 mm
		2		D28-05003-001	Stop-strip L 800-800 x 100 x 25 mm
	2	4	4	D28-05009-000	Universal stop L 300-300 x 50 x 25 mm
		2		D28-05013-000	Locating disk 25-50 mm
		2		D28-05013-001	Locating disk 25-75 mm
			2	D28-05013-010	Angle-setting template
	4	4	4	D28-05015-000	Displacement stop 150 x 50 x 25 mm
	12	20	24	D28-06001-000	PC-clamping pin / short
			2	D28-06002-000	PC-clamping pin / long
	6	10	12	D28-06009-000	Stop and positioning bolt Ø 28
	2	2		D28-07001-000	Compensating swing clamp 150 mm with spindle
	4	2	2	D28-07002-000	Compensating swing clamp 200 mm with spindle
	4	4		D28-07005-000	Screw clamp 180° with spindle
	4	4		D28-07005-014	Screw clamp 180° with spindle, clamping tube 350 mm long
		4		D28-07005-015	Screw clamp 180° with quick-action clamping cylinder
	2	4		D28-07008-000	Swing clamp 90° with adjusting screw
	4	4	4	D28-07009-000	Swing clamp 45° with adjusting screw
		4		D28-07009-011	Swing clamp 45° with adjusting screw, clamping tube 350 mm
		2	2	D28-09001-000	Spacer set 11 pieces Ø 50
			2	D28-09001-005	Spacer set with thread Ø 50
			8	D28-09003-000	V-block locations blackened steel Ø 58 mm
	1	1	1	D28-10002-000	Round brush Ø 28
		1	1	D00-10007-000	Bench stone
			1	D00-10009-000	Ground connector D 16 / D 28
	1	1	1	D00-10016-001	Lifter fork - 250 x 40 mm, AF 14



SET D 710 Article no.: D28-52000-710 (44 pieces)

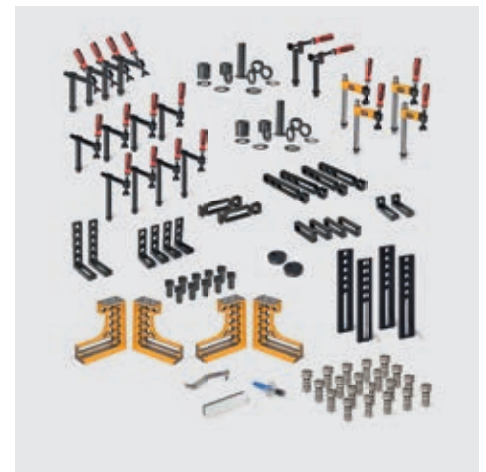

SET D 720 Article no.: D28-52000-720 (81 pieces)



SET D 730 Article no.: D28-52000-730 (120 pieces)

PPC bolt surcharge

- Set D710 D28-52000-711
- Set D720 D28-52000-721
- Set D730 D28-52000-731



You can individually assemble or supplement your sets with the large selection of Demmeler accessories. Visit www.demmeler.com for the Demmeler main catalogue.

D28 System 3D welding table PROFIPremiumLINE (PP) 28

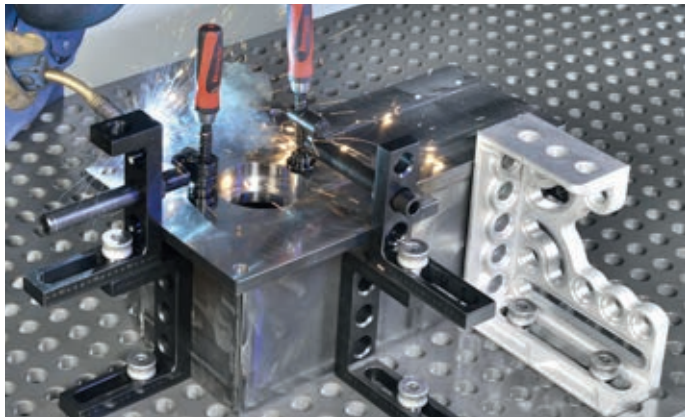

D28 System
3D welding table
PROFIPremiumLINE (PP) 28

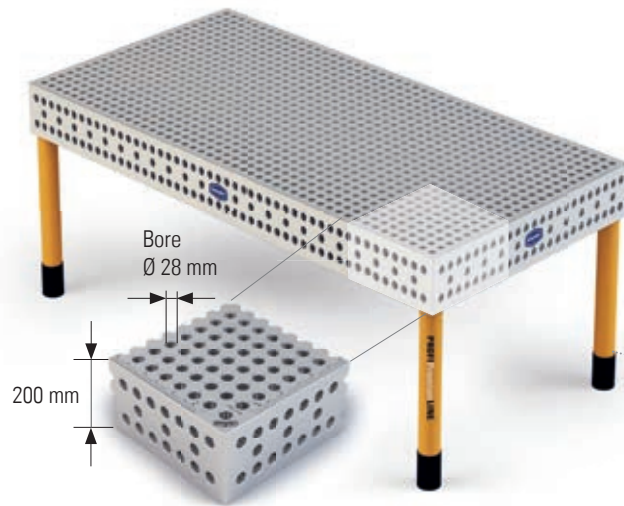
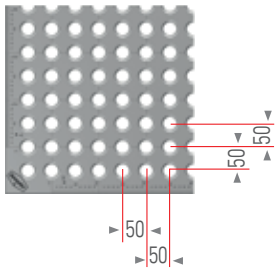

Pivoting foot with sturdy M 30 x 2 threaded spindle, finely adjustable ± 30 mm

Foot sleeve prevents pinching the welding hose and protects the threaded spindle against dirt.



Table size W x H	TABLE WITH STANDARD LEGS	HARDNESS DEMONT 760 M	HARDNESS DEMONT 860 M
1000 x 1000 mm	PP28-01001-001	PP28-01001-011	PP28-01001-021
1200 x 800 mm	PP28-11019-001	PP28-11019-011	PP28-11019-021
1200 x 1200 mm	PP28-01056-001	PP28-01056-011	PP28-01056-021
1500 x 1000 mm	PP28-01011-001	PP28-01011-011	PP28-01011-021
1500 x 1500 mm	PP28-01031-001	PP28-01031-011	PP28-01031-021
2000 x 1000 mm	PP28-01002-001	PP28-01002-011	PP28-01002-021
2000 x 2000 mm	PP28-01006-001	PP28-01006-011	PP28-01006-021
2400 x 1200 mm	PP28-01003-001	PP28-01003-011	PP28-01003-021
3000 x 1500 mm	PP28-01004-001	PP28-01004-011	PP28-01004-021
4000 x 2000 mm	PP28-01005-001	PP28-01005-011	PP28-01005-021
4800 x 2400 mm	PP28-11085-001	PP28-11085-011	PP28-11085-021



Custom dimensions available on request! On request, the table can also be supplied in casting and stainless steel!

Different leg versions are available on request.



Errors and changes are reserved. Offer is subject to change.

Sets PROFIPremiumLINE (PP) 28

	P 710	P 720	P 730		
	1	1	1	P28-03002-000	PP clamping and locating angle, right 300 x 275 mm, hardened
	1	1	1	P28-03002-001	PP clamping and locating angle, left 300 x 275 mm, hardened
		1	1	P28-03003-002	PP clamping and locating angle, aluminium-titanium, right 600 x 375 mm
		1	1	P28-03003-003	PP clamping and locating angle, aluminium-titanium, left 600 x 375 mm
	4	4	4	PE28-03001-000	Clamping and locating angle 175 x 175 x 50 mm (bore / oblong hole)
			1	P28-03004-000	PP clamping and locating angle, aluminium-titanium, right 800 x 375 mm
			1	P28-03004-001	PP clamping and locating angle, aluminium-titanium, left 800 x 375 mm
		2	4	D28-03001-005	Clamping and locating angle / small 175 x 75 x 50 mm, scale on both sides
		2	2	PP28-03001-017	Clamping and locating angle 225 x 300 x 50 x 125 mm, hardened
			2	PL28-03001-015	Clamping and locating angle 225 x 200 x 50 x 125 mm, hardened
			1	P28-05013-011	PP angle bracket, right 200 x 200 x 75 mm, hardened
			1	P28-05013-012	PP angle bracket, left 200 x 200 x 75 mm, hardened
			4	D28-05001-001	Universal stop / large with plunger 225 x 50 x 25 mm
	4	4	4	D28-05001-010	Universal stop with scale 225 x 50 x 25 mm
	2	2	2	D28-05003-000	Stop-strip L 500 - 500 x 100 x 25 mm
		2	2	D28-05003-001	Stop-strip L 800 - 800 x 100 x 25 mm
			2	D28-05003-008	Stop-strip L 1000 - 1000 x 100 x 25 mm
			2	D28-05013-000	Locating disk Ø 75 - stop dimension 25-50 mm, continuous
		2	2	D28-05013-001	Locating disk Ø 100 - stop dimension 25-75 mm, continuous
	4	4	8	D28-05015-000	Displacement stop - 150 x 50 x 25 mm, scale on both sides
	12	20	24	D28-06025-000	PPC bolt / short - Ø 28-0.02, AF 14
	6	10	12	D28-06009-000	Stop and positioning bolt Ø 28 / 40 x 74 mm
			2	D28-07001-001	Compensating swing clamp 150 mm with quick-action clamping cylinder
	2	2	2	D28-07002-000	Compensating swing clamp 200 mm with spindle
		4	4	D28-07005-014	Screw clamp 180° with spindle - vertical tube 350 mm
	4			D28-07005-000	Screw clamp 180° with spindle - vertical tube 220 mm
			4	D28-07005-015	Screw clamp 180° with quick-action clamping cylinder - vertical tube 350 mm
		4	4	D28-07005-033	Screw clamp 180° with spindle - vertical tube 500 mm
		2	2	D28-07009-011	Swing clamp 45° with adjusting screw - vertical tube 350 mm
			2	D28-07009-012	Screw clamp 45° with quick-action clamping cylinder - vertical tube 350 mm
	4	4	4	D28-07009-033	Performance-clamp incl. spindle, angle-adjustable +50°
		2	4	D28-09001-005	Spacer set with thread - Ø 50x125 mm
			8	D28-09003-000	V-block locations blackened steel, Ø 58 mm - 130°
	1	1	1	D28-10002-000	Round brush Ø 28 x 260 mm, with protective cap
		1	1	D00-10007-000	Bench stone 200 x 50 x 25 mm, 2-sided
			1	D00-10009-000	Ground connector D16/D28 - for cable 50-70 mm², load up to 500 A
	1	1	1	D00-10016-001	Extraction tool - 250 x 40 mm, AF 14

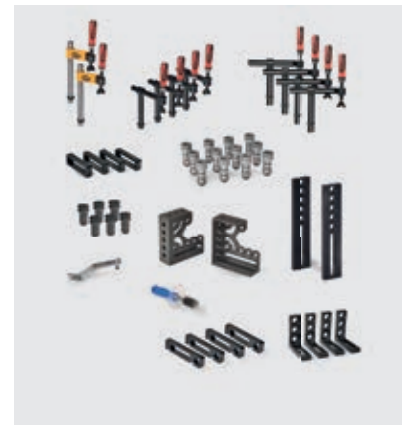

SET P 710 Article no.: P28-52000-710
(46 pieces)

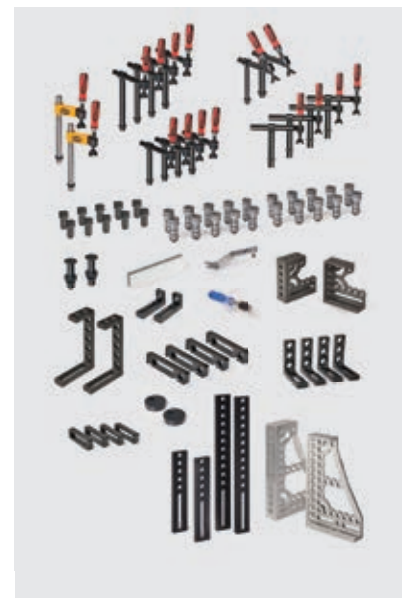

SET P 720 Article no.: P28-52000-720
(77 pieces)



SET P 730 Article no.: P28-52000-730
(122 pieces)

You can individually assemble or supplement your sets with the large selection of Demmeler accessories.
Visit www.demmeler.com for the Demmeler main catalogue.

D22 System 3D welding table PROFIPlusLINE (PL) 22

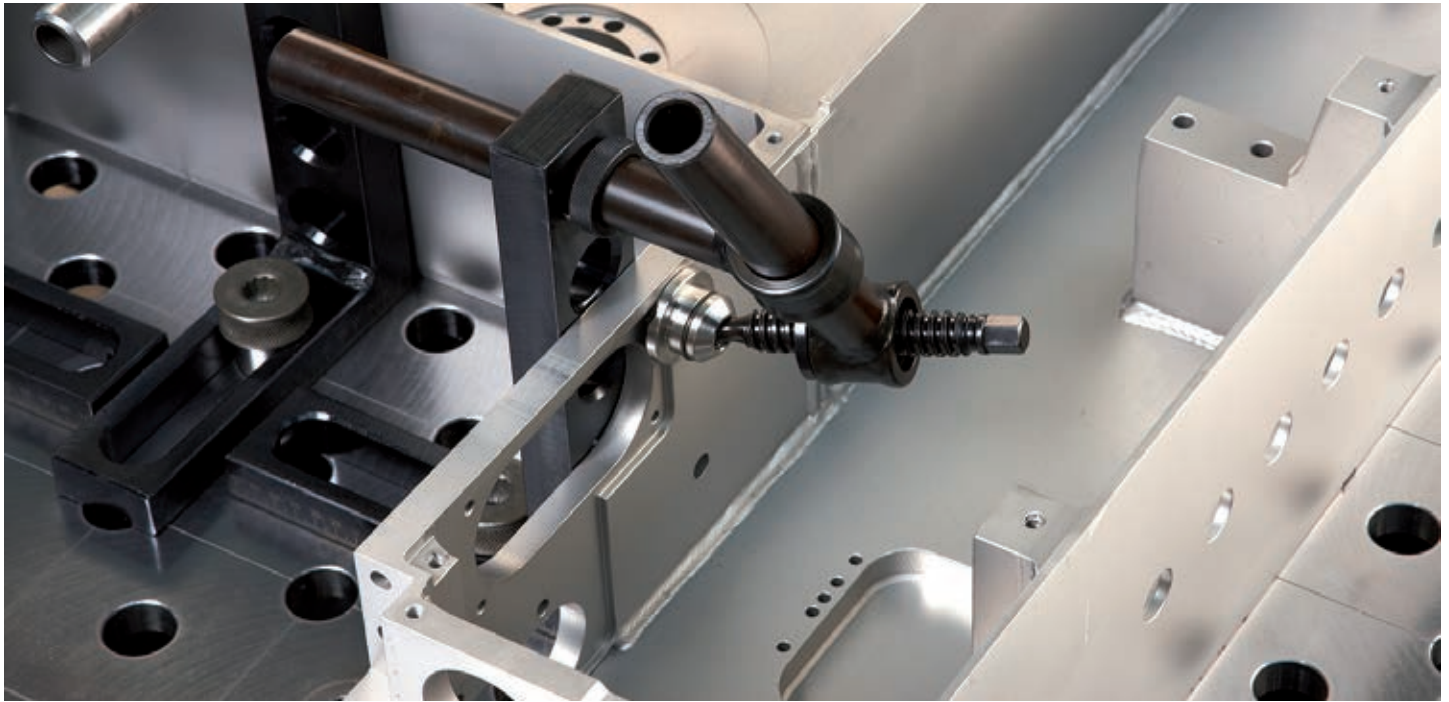

D22 System
3D welding table
PROFIPlusLINE (PL) 22

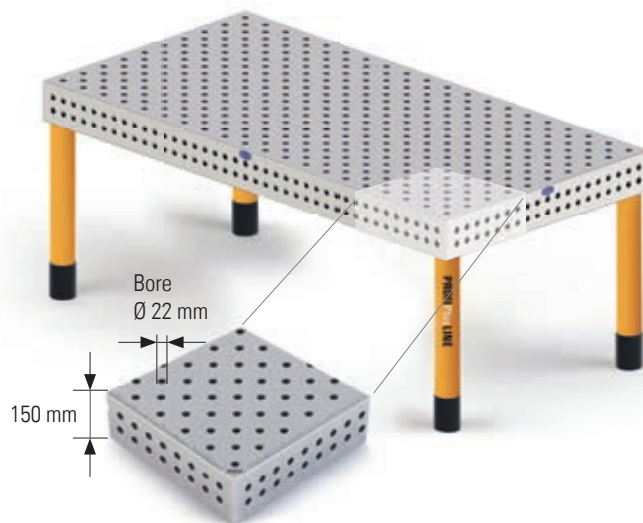
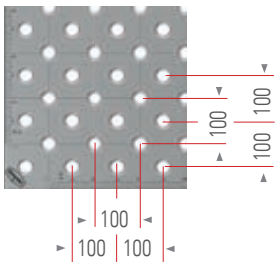

Pivoting foot with sturdy M 28 x 2 threaded spindle, finely adjustable ± 30 mm

Foot sleeve prevents pinching the welding hose and protects the threaded spindle against dirt.

Table size W x H	TABLE WITH STANDARD LEGS	HARDNESS DEMONT 760 M
1000 x 1000 mm	PL22-01001-001	PL22-01001-011
2000 x 1000 mm	PL22-01002-001	PL22-01002-011
2400 x 1200 mm	PL22-01003-001	PL22-01003-011
3000 x 1500 mm	PL22-01004-001	PL22-01004-011

Different leg versions are available on request.

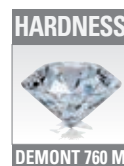

Telescoping leg



Heavy-duty wheel



Anchoring leg

Custom dimensions available on request! On request the table is also available in a stainless steel version!



SET D 710 Article no.: D22-52000-710 (26 pieces)



SET D 720 Article no.: D22-52000-720 (57 pieces)



SET D 730 Article no.: D22-52000-730 (77 pieces)

	D 710	D 720	D 730		
		4		D22-06026-000	PPC bolt/long – Ø 22, AF 6
	10	16	20	E22-06025-000	EcoLINE bolt/short – Ø 22, AF 6
		6	8	D22-06009-000	Stop and positioning bolts Ø 22/31 x 52 mm
		2	2	D22-09001-005	Spacer set with thread – Ø 50 x 125 mm, height compensation 22-105 mm, continuous
		2	2	D22-05013-000	Locating disk Ø 75 – stop dimension 25-50 mm, continuous
		2	2	D22-09001-000	Spacer set 11 pieces – Ø 50 x 125 mm, height compensation 5-100 mm increment 1 mm
	4	4	4	D22-05015-000	Displacement stop – 100 x 50 x 18 mm, scale on both sides
	4		4	D22-05001-000	Universal stop /size 225 x 50 x 18 mm
		4	4	PE22-03001-000	Clamping and locating angle 175 x 175 mm (bore/oblong hole)
	2	4	4	D22-05009-000	Universal stop L 300 – 300 x 50 x 18 mm
		2	2	D22-05003-000	Stop strip L 500 – 500 x 100 x 25 mm
		4	4	D22-07009-000	Swing clamp 45° with spindle – vertical pipe 250 mm
	4	4	4	D22-07005-000	Swing clamp 180° with spindle – vertical pipe 250 mm
		4	6	D22-07001-000	Compensating swing clamp 180° with spindle – vertical pipe 300 mm
	1	1	1	D22-10002-000	Round brush Ø 22, with protective cap, for cleaning the system bore
	1	1	1	D22-10016-001	Extraction tool – 250 x 40 mm, AF 10
		1	1	D00-10007-000	Bench stone 200 x 50 x 25 mm
			1	PE22-03003-001	Clamping and locating angle H 500, DEMONT 760 M Black Edition, hardened casting, left
			1	PE22-03003-000	Clamping and locating angle H 500, DEMONT 760 M Black Edition, hardened casting, right
			1	PE22-03004-001	Clamping and locating angle H 750, DEMONT 760 M Black Edition, hardened casting, left
			1	PE22-03004-000	Clamping and locating angle H 750, DEMONT 760 M Black Edition, hardened casting, right



**Clamping and locating angle
175 x 175 mm**

- Combination system bores / oblong hole; Numerous clamping possibilities
- Precision scaling on both sides
- Steel, hardened

Article no.:
PE22-03001-000



You can individually assemble or supplement your sets with the large selection of Demmeler accessories.
Visit www.demmeler.com for the Demmeler main catalogue.

D22 System 3D welding table PROFIPremiumLINE (PP) 22

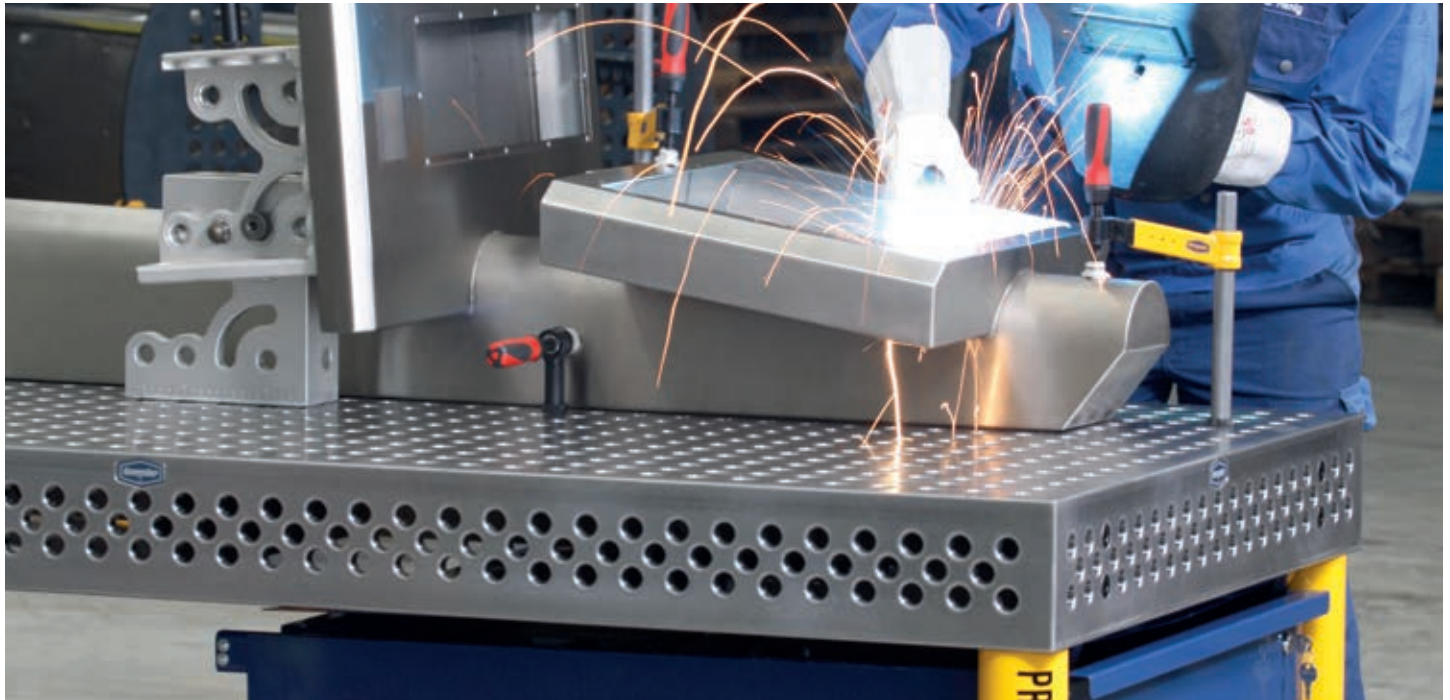

D22 System
3D welding table
PROFIPremiumLINE (PP) 22

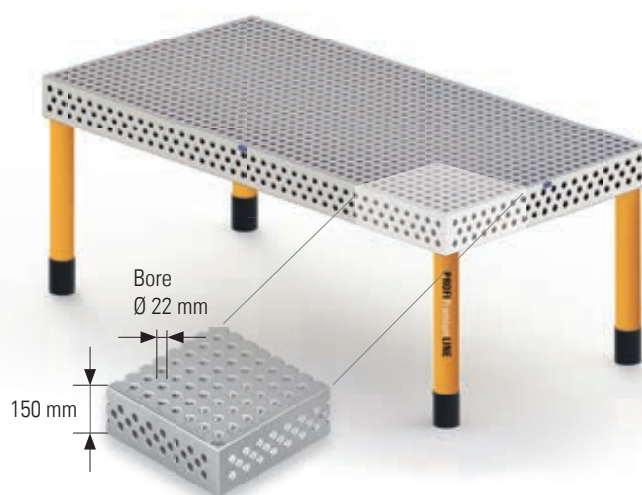
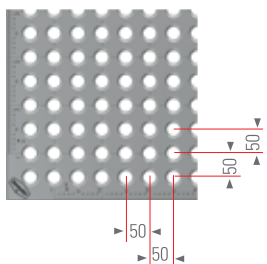

Pivoting foot with sturdy M 28 x 2 threaded spindle, finely adjustable ± 30 mm

Foot sleeve prevents pinching the welding hose and protects the threaded spindle against dirt.

Table size
W x H

TABLE WITH STANDARD LEGS



HARDNESS DEMONT 760 M



1000 x 1000 mm	PP22-01001-001	PP22-01001-011
2000 x 1000 mm	PP22-01002-001	PP22-01002-011
2400 x 1200 mm	PP22-01003-001	PP22-01003-011
3000 x 1500 mm	PP22-01004-001	PP22-01004-011

Different leg versions are available on request.

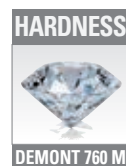

Telescoping leg



Heavy-duty wheel



Anchoring leg

Custom dimensions available on request! On request the table is also available in a stainless steel version!



SET D 710 Article no.: D22-52000-710 (26 pieces)

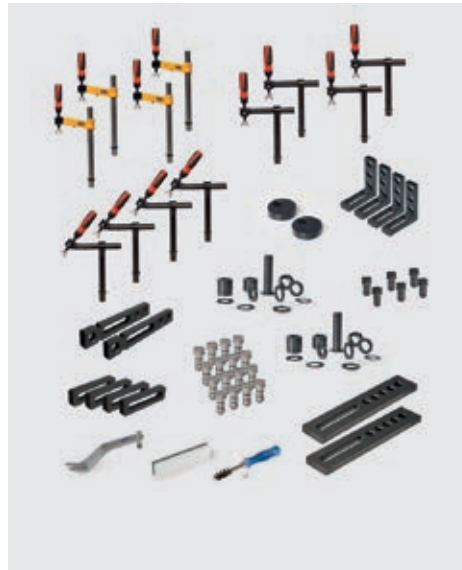

SET D 720 Article no.: D22-52000-720 (57 pieces)



SET D 730 Article no.: D22-52000-730 (77 pieces)

	D 710	D 720	D 730		
		4		D22-06026-000	PPC bolt/long – Ø 22, AF 10, clamping range 49.5–52.5 mm
	10	16	20	E22-06025-000	EcoLINE bolt/short – Ø 22, AF 10, clamping range 32-33.5 mm
		6	8	D22-06009-000	Stop and positioning bolts Ø 22/31 × 52 mm
		2	2	D22-09001-005	Spacer set with thread – Ø 50 × 125 mm, height compensation 22-105 mm, continuous
		2	2	D22-05013-000	Locating disk Ø 75 – stop dimension 25-50 mm, continuous
		2	2	D22-09001-000	Spacer set 11 pieces – Ø 50 × 125 mm, height compensation 5-100 mm increment 1 mm
	4	4	4	D22-05015-000	Displacement stop – 100 × 50 × 18 mm, scale on both sides
	4		4	D22-05001-000	Universal stop /size 225 × 50 × 18 mm
		4	4	PE22-03001-000	Clamping and locating angle 175 × 175 mm (bore/oblong hole)
	2	4	4	D22-05009-000	Universal stop L 300 - 300 × 50 × 18 mm
		2	2	D22-05003-000	Stop strip L 500 – 500 × 100 × 25 mm
		4	4	D22-07009-000	Swing clamp 45° with spindle – vertical pipe 175 mm
	4	4	4	D22-07005-000	Swing clamp 180° with spindle – vertical pipe 175 mm
		4	6	D22-07001-000	Compensating swing clamp 180° with spindle – vertical pipe 300 mm
	1	1	1	D22-10002-000	Round brush Ø 22 × 260 mm, with protective cap, for cleaning the system bore
	1	1	1	D22-10016-001	Extraction tool – 250 × 40 mm, AF 10
		1	1	D00-10007-000	Bench stone 200 × 50 × 25 mm
		1		PE22-03003-001	Clamping and locating angle H 500, DEMONT 760 M Black Edition, hardened casting, left
		1		PE22-03003-000	Clamping and locating angle H 500, DEMONT 760 M Black Edition, hardened casting, right
		1		PE22-03004-001	Clamping and locating angle H 750, DEMONT 760 M Black Edition, hardened casting, left
		1		PE22-03004-000	Clamping and locating angle H 750, DEMONT 760 M Black Edition, hardened casting, right



The Clever Toolbox

(without accessories) can be mounted on all four sides and has a load capacity of up to 170 kg. L × W × H: 980 mm × 780 mm × 520 mm. Saves space, saves time, protects tools, lockable. From a table size of 1000 × 1000 mm.

Article no.: D22-11001-015

You can individually assemble or supplement your sets with the large selection of Demmeler accessories. Visit www.demmeler.com for the Demmeler main catalogue.

D16 System 3D welding table PROFIEcoLINE (PE) 16



D16 System
3D welding table
PROFIEcoLINE (PE) 16

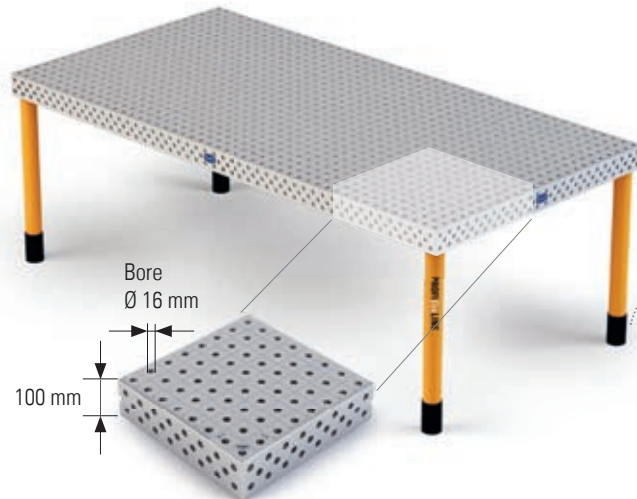
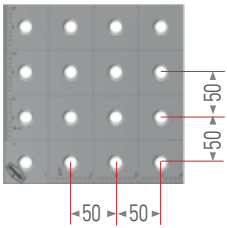

Pivoting foot with sturdy M 24 x 2 threaded spindle, finely adjustable ± 30 mm

Foot sleeve prevents pinching the welding hose and protects the threaded spindle against dirt.

Table size W x H	TABLE WITH STANDARD LEGS	HARDNESS DEMONT 760 M
1000 x 500 mm	PE16-01000-001	PE16-01000-011
1000 x 1000 mm	PE16-01001-001	PE16-01001-011
1200 x 800 mm	PE16-11019-001	PE16-11019-011
1500 x 1000 mm	PE16-01017-001	PE16-01017-011
1200 x 1200 mm	PE16-01056-001	PE16-01056-011
1500 x 1500 mm	PE16-01011-001	PE16-01011-011
2000 x 1000 mm	PE16-01002-001	PE16-01002-011
2400 x 1200 mm	PE16-01003-001	PE16-01003-011
3000 x 1500 mm*	PE16-01004-001	PE16-01004-011

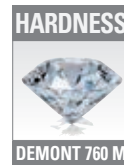

Different leg versions are available on request.



Telescoping leg



Heavy-duty wheel



Anchoring leg

*Consisting of 2x 1500 x 1500 x 100 mm.

Custom dimensions available on request! On request the table is also available in a stainless steel version!

Errors and changes are reserved. Offer is subject to change.

Sets PROFIEcoLINE (PE) 16



SET E 710 Article no.: E16-52000-710 (29 pieces)



SET E 720 Article no.: E16-52000-720 (79 pieces)



SET E 730 Article no.: E16-52000-730 (114 pieces)

	E 710	E 720	E 730		
		4	4	E16-03008-000	ECO clamping and locating angle 140 x 90 x 25 mm
	4	4	10	E16-03001-000	ECO clamping and locating angle 90 x 90 x 25 mm
	2	4	4	E16-03001-002	ECO clamping and locating angle 90 x 37,5 x 25 mm
		2	1	E16-03002-000	ECO clamping and locating angle R 200 x 137,5 x 50 mm
		2	1	E16-03002-001	ECO clamping and locating angle L 200 x 137,5 x 50 mm
	2		4	E16-05002-000	ECO universal stop / small
	4	4	12	E16-05001-000	ECO universal stop / large
		4	2	D16-09001-000	Spacer set 9 pieces
		4	2	E16-05015-000	ECO displacement-stop
			4	D16-05003-000	Stop-strip L 250 - 250 x 50 x 12 mm
		2	2	D16-05003-001	Stop-strip 400 mm
	4	8	8	D16-07005-000	Screw clamp 180° with spindle
	2	8	8	D16-07009-000	Swing clamp 45° with adjusting screw
		4	8	D16-09003-000	V-block locations blackened steel up to 140 mm tubes
	1	1	1	D16-10002-000	Round brush Ø 16 mm
	1	1	1	D00-10007-000	Bench stone
	1	1	1	E16-10008-000	Ball end hex wrench AF5
			4	D16-06003-000	Extension sleeve / short
		2	4	E16-06002-000	ECOLine bolt / short
	8	24	32	E16-06001-000	ECOLine bolt / short
			1	D16-11001-002	Accessory cart D16



Accessory cart D16
(without accessories)
Article no. D16-11001-002

On request, Eco clamping pins can be replaced by PC clamping pins.

PC bolt surcharge

Set E 710 E16-52000-711
Set E 720 E16-52000-721
Set E 730 E16-52000-731



You can individually assemble or supplement your sets with the large selection of Demmeler accessories. Visit www.demmeler.com for the Demmeler main catalogue.

D16 System 3D welding table PROFIPlusLINE (PL) 16



D16 System
3D welding table
PROFIPlusLINE (PL) 16

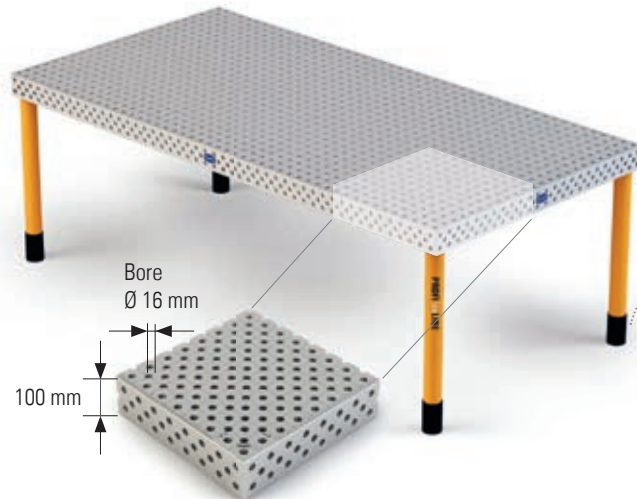
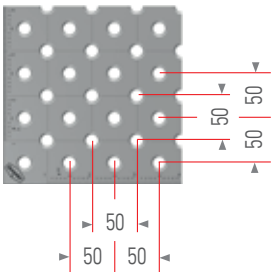

Pivoting foot with sturdy M 24 x 2 threaded spindle, finely adjustable ± 30 mm

Foot sleeve prevents pinching the welding hose and protects the threaded spindle against dirt.

Table size W x H	TABLE WITH STANDARD LEGS	HARDNESS DEMONT 760 M
1000 x 500 mm	PL16-01000-001	PL16-01000-011
1000 x 1000 mm	PL16-01001-001	PL16-01001-011
1200 x 800 mm	PL16-11019-001	PL16-11019-011
1200 x 1200 mm	PL16-01056-001	PL16-01056-011
1500 x 1000 mm	PL16-01017-001	PL16-01017-011
1500 x 1500 mm	PL16-01011-001	PL16-01011-011
2000 x 1000 mm	PL16-01002-001	PL16-01002-011
2400 x 1200 mm	PL16-01003-001	PL16-01003-011
3000 x 1500 mm*	PL16-01004-001	PL16-01004-011

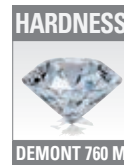

Different leg versions are available on request.



Telescoping leg



Heavy-duty wheel



Anchoring leg

*Consisting of 2x 1500 x 1500 x 100 mm.

Custom dimensions available on request! On request the table is also available in a stainless steel version!

Errors and changes are reserved. Offer is subject to change.



SET D 155 Article no.: D16-52000-155 (39 pieces)



SET D 255 Article no.: D16-52000-255 (87 pieces)



SET D 720 Article no.: D16-52000-720 (125 pieces)

	D 155	D 255	D 720		
	4	4	8	D16-03001-000	Clamping and locating angle 90 x 90 x 25 mm
	2	2	4	D16-03001-002	Clamping and locating angle 90 x 37.5 x 25 mm
	2	4		D16-05002-000	Universal stop / small / L55
		1	1	D16-03002-000	Clamping and locating angle, right, casting 200 x 137.5 x 50 mm
		1	1	D16-03002-001	Clamping and locating angle, left, casting 200 x 137.5 x 50 mm
			1	D16-03003-000	Clamping and locating angle, right 400 x 187.5 x 50 mm
			1	D16-03003-001	Clamping and locating angle, left 400 x 187.5 x 50 mm
	4	4		D16-03008-000	Clamping and locating angle 140 x 90 x 25 mm
	6	8	8	D16-05001-004	Universal stop with scale - 115 x 25 x 12 mm
			2	D16-05003-000	Stop-strip L 250 - 250 x 50 x 12 mm
			4	D16-05003-001	Stop-strip L 400 - 400 x 50 x 12 mm
	2	2		D16-05009-000	Universal stop / 165
			2	D16-05013-010	Angle-setting template, scale on both sides
		2	8	D16-05015-000	Displacement stop - 150 x 25 x 12 mm
	10	20	24	D16-06001-000	PC-bolts / short - Ø 16-0.01
		2	2	D16-06002-000	PC-bolts / long - Ø 16-0.01
		4	12	D16-06009-000	Stop and positioning bolt Ø 16
			4	D16-07001-001	Compensating swing clamp with quick-action clamping cylinder
	4	6		D16-07001-000	Compensating swing clamp 100 mm with spindle
	2	4	8	D16-07005-000	Screw clamp 180° with spindle
	2	2	4	D16-07008-000	Swing clamp 90°
		4	8	D16-07009-000	Swing clamp 45° with adjusting screw
	2	4	4	D16-09001-000	Spacer set 9 pieces
		2	8	D16-09003-000	V-block locations blackened steel up to 140 mm tubes
		8	4	D16-09004-000	V-block locations blackened steel up to 70 mm tubes
	1	1	1	D16-10002-000	Round brush 16 mm
	1	1	1	D00-10007-000	Bench stone
	1	1	1	D16-10008-000	Ball end hex wrench AF8



Accessory cart D16
(without accessories)
Article no. D16-11001-000

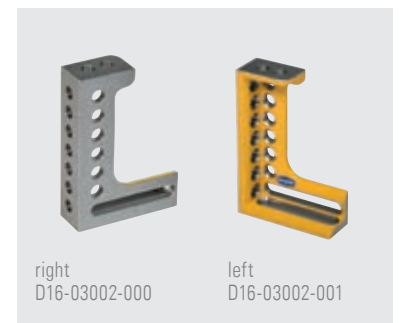

Clamping and locating angle, casting 200
Article no. D16-03002-000 right
Article no. D16-03002-001 left

You can individually assemble or supplement your sets with the large selection of Demmeler accessories.
Visit www.demmeler.com for the Demmeler main catalogue.



ERGONOMIX® M 2000 / V 1250

Article no.: M02-02000-006

Price on request

Description		M 2000 / V1250	M 2000 / V2500	M4000	M8000
Bearing load (without worktop)	[kg]	2000	2000	4000	8000
D=max. Interference area at 180°	[mm]	1000	1000	1500	2000
Max. rotation speed	[U/min]	2	2	2	1,5
Torque	[Nm]	1250	2500	5000	10000
Tilt angle	[°]	180	180	180	180
Moment of tilt	[Nm]	8000	8000	32000	64000
A=min. Height	[mm]	490	490	747	853
B=max. Height at 180° pivoting	[mm]	970	970	983	1142
C=max. Height at 90° pivoting	[mm]	1480	1480	1685	1940
Pendant control panel		✓	✓	✓	✓
10-speed control		✓	✓	✓	✓
Foot switch		✓	✓	✓	✓
Motors / rotary axis		1	2	2	2
Article no.		M02-02000-006	M02-02000-007	M04-04000-000	M08-08000-000



OUR PERFORMANCE
makes THE DIFFERENCE

Straightforward positioning with large working space

Unique
swivel range
up to 180°!



The specified dimensions
refer to the manipulator
without worktop

Demmeler Ergonomix M 2|4|8 tons

Our “heavyweights”
make your job easier!

They relieve workers of heavy handling tasks and enable working with an ergonomic posture. Welding processes can be carried out with less fatigue and consistently high precision. Excessive strain and missed time due to illness are prevented as well.

Your benefits:

- Reduced production costs
- Increased productivity
- Less personnel shortages due to illness
- Improved occupational safety

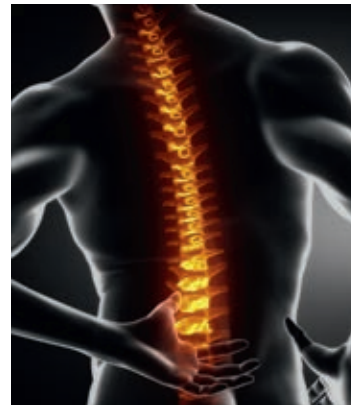

Working ergonomically!

Proper ergonomic design of the workplace allows efficient and error-free performance of work and protects staff against health hazards, even during long assignments. The „Demmeler Ergonomix M” manipulators offer preventative occupational safety, more safety at the workplace, higher efficiency and thereby improved quality in production.

360° work piece machining



TECHNICAL SPECIFICATIONS

- Bearing load 2,000 kg per reversible clamping device unit, 4,000 kg when using 2 units
- Swing diameter 1,250 mm
- Centre of rotation at a height of 785 mm
- with 950 mm hole
- Device dimensions approx. 1,500 x 1,300 mm
- Flexibly adjustable length
- Torque 1770 Nm

Continuous rotation of growing or asymmetrical work pieces of up to 4,000 kg around their own axes

With the Rotatorix® R 2000 / 950, when using two reversible clamping devices, work pieces of up to 4,000 kg can be continuously rotated round their own axis to enable a worker to easily access them from all sides. Each work piece can be manually or electrically rotated – mainly for growing or asymmetrical work pieces – which means less strain on the worker’s back. Not only does this prevent overloading and symptoms of fatigue, but it also enables access to the work area,

eliminating the need for dangerous and time-consuming turning of the work piece by crane. In addition, the best possible quality can also be obtained as, thanks to optimised welding sequences, less welding distortion is produced on the work pieces. The Rotatorix® also increases deposition efficiency. The system is based on the D28 clamping system.

Flexible right down to the last detail – configuration examples



Rotatorix® with manual drive in a fixed position



Rotatorix® with frequency-controlled drive on a Demmeler foundation track system for work pieces of varying lengths



Rotatorix® with motorised drive in variable positions



**Rotatorix®
R 2000 / 950 basic device**
comprising 1 Rotatorix® R 2000 / 950 reversible
clamping device assembly: turning unit for 360°
continuous rotation of growing, symmetrical
and asymmetrical work pieces
Article no. R02-01000-001

The reversible clamping device is available in several versions to ensure the best conditions for each application. So, for example, both assemblies can be equipped with rollers for perfect flexibility, or one assembly can be fitted with rollers while the other is fixed to the floor with plugs. The Demmeler rail system is also available in a version with guide rollers. Individual work pieces are clamped either by means of a standard brace with an attachment chain or using individual braces which are specially designed for the respective requirements. Where drive options are concerned, the possibilities range from manual drives and highly accurate frequency-controlled drives to the connection of an additional robot axis.

Equipment options

No.	Drive options	Article No.
A1	Manual drive , comprises a rotation unit for manual operation and clamp	RA2-01000-002
A2	Motorised drive for electrically-driven rotation of work pieces with set rotation speeds including control panel and confirm key	RA2-01000-003
A3	Frequency-controlled drive for electrically-driven rotation of work pieces with infinitely variable rotation speeds controlled by potentiometer, for example, for circular welding. includes a control panel and confirm key.	RA2-01000-001
A4	Drive with arrangement for integrating the Rotatorix® as an external robot axis , mainly for circular welding (e.g. for ABB-, Cloos-, Kuka-, Fanuc-, etc.-type robots)	RA2-01000-004
A5	Foot pedal for rotating the work pieces with pre-set speed – in combination with the motorised drive	RA2-01000-005
A6	Confirm key for rotating the work pieces with pre-set speed for use in the customer's own protective enclosure – in combination with the motorised drive	RA2-01000-006



No.	Positioning options	Article No.
P1	For perfectly flexible positioning (manual adjustment) of an assembly on a level factory floor, comprising 4 rollers	RP2-01000-001
P2	For using an assembly on a Demmeler foundation track system, comprising 4 rollers and 4 x D28 PPS bolts	RP2-01000-002
P3	For attaching an assembly in position, comprising 4 floor anchors	RP2-01000-003
P4	For partially attaching an assembly in position, comprising 4 adjustable feet	RP2-01000-004



No.	Accessory	Article No.
M1	Ground connection, D28 system for welding device (load up to 500 A)	RM2-01000-001

No.	Device option	Article No.
V1	1 x brace including 2 x D28 PPS bolts for attaching the brace	RV2-01000-001
V2	1 x chain tensioner including chain and plastic protection caps	RV2-01000-002

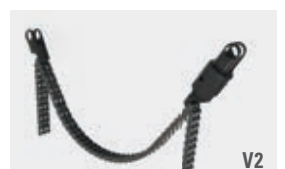

Visit us!



Order form

Fax: + 49 (0) 83 35 98 59-27

Quantity	Article no.	Item designation	Unit price EUR	Total price EUR

Your address / company stamp / signature



Please send me the main catalogue

“Original 3D Clamping Systems and Worktables”

Our main catalogue offers a complete overview of our comprehensive product range with numerous interesting application examples.



OUR PERFORMANCE
makes THE DIFFERENCE



Company brochure
Contract manufacturing
up to 100 tons
unit weight



NC rotary tables



Tool change systems
Tool arena



Manipulators

Demmeler Maschinenbau GmbH & Co. KG
Alpenstraße 10, 87751 Heimertingen / Germany

Telephone: +49 (0) 83 35 98 59-0
Telefax: +49 (0) 83 35 98 59-27
E-mail: vertrieb@demmeler.com
Internet: www.demmeler.com

Your authorised distribution partner: