

# Knürr DCM®

*Modular rack platform – for future-proof data centers*

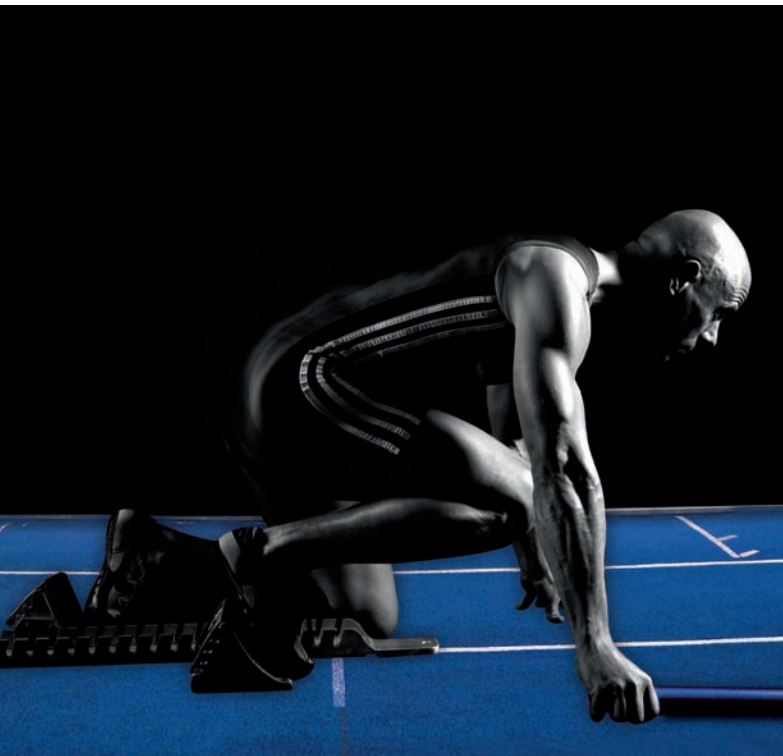

# Knürr DCM<sup>®</sup>, the new platform of innovative racks for IT applications in data centers

## Emerson Network Power

*Business-Critical Continuity™ to keep you going strong*

### Centers of Expertise

- AC Power
- Connectivity
- DC Power
- Embedded Computing
- Embedded Power
- Infrastructure Management & Monitoring
- Outside Plant
- Power Switching & Controls
- Precision Cooling
- Racks & Integrated Cabinets
- Services
- Surge Protection

Regardless of your size, you can't afford for your critical business systems to go down.

At Emerson Network Power, we've built our capabilities – and stake our reputation – on delivering reliable power, precision cooling, connectivity and embedded solutions so your technology investment can keep delivering at its peak.

Emerson Network Power's broad technology offering and deep expertise support a full spectrum of enterprise-wide solutions for today's vital business needs.

Around the world, customers like you count on us to get the most out of their critical investments, knowing that we deliver purpose-driven innovation and optimized solutions from a single global

source, one that is backed by local service and support.

Our ability to keep your network infrastructure up and running, regardless of whether the content is voice, data or multi-media, comes from a time-tested grid-to-chip portfolio of products, services and systems that can maintain a wide range of computing, telecom, healthcare and industrial applications. The result is a level of confidence achieved only by partnering with Emerson Network Power.

We're here to prepare you for the unknown, whatever comes your way, navigating with you through changing business environments and the uncharted demands they place on your technology investment. That's what we mean by **Business-Critical Continuity™**



*Speed, power and precision – straight out of the blocks. Everything starts with the Knürr DCM®.*

# The Knürr DCM® is the foundation stone of Emerson Network Power's IT infrastructure solutions

## Everything in the data center begins with the Knürr DCM®!

A rack's mission is supposedly easy: every kind of IT component must be accepted. That is then, servers, storage elements, switches, cable management – and provide the most suitable physical environment at the same time. An environment that consists of the space, power supply, cooling and integration into the infrastructure management.

We know that no two data centers are the same. A customized solution adjusted to different requirements is a constant requirement.

A modular building box is the proven solution to be fast, cost-effective and future-proof. Emerson Network Power provides optimized and harmonized standard components that can be selected, set up and changed as required, and therefore make the data center expandable.

Knürr DCM® is the foundation stone for all this. Standard modules for space, power, cooling and infrastructure management that are harmonized with one another in such a way that they remain freely combinable with one another

and can therefore be adjusted to every requirement.

This applies to both the rack interior (DCM® features + accessories in the rack) and exterior racks with the most diverse applications, combination with suite cooling equipment, modular suite UPSs, power distribution racks and cold aisle containments.

All these elements provide “one common look and feel”. We are now talking about the energy-efficient SmartAisle™ from Emerson Network Power.

## COLD-AISLE CONTAINMENT

SmartAisle™

### MODULAR USP

Liebert APM

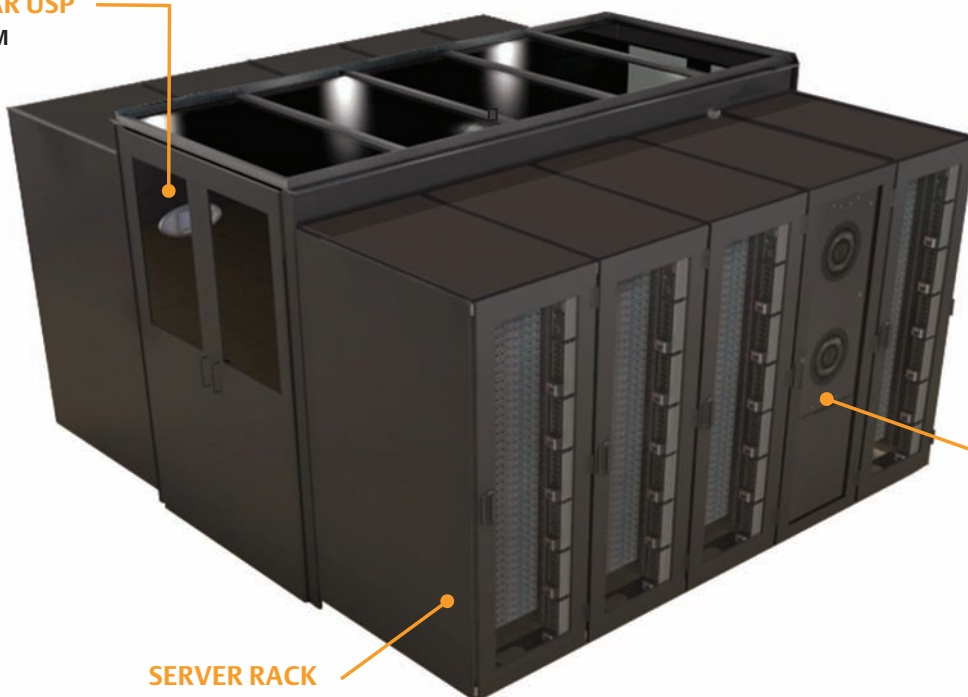

### SERVER RACK

Knürr DCM®

### SUITE COOLING EQUIPMENT

Liebert CRV



**The right rack size for every application – worldwide**

■ **Knürr Data Center Module**

The Knürr DCM<sup>®</sup> is the globally available rack platform from Emerson Network Power. Ready for you all over the world for standardized data center planning. Cooling racks, power racks and server racks on the basis of the Knürr DCM<sup>®</sup> platform guarantee integration into the rack suite.

■ **Metric dimensions**

For global application

■ **Safe and stable**

Earthquake-tested Knürr DCM<sup>®</sup> version available on request

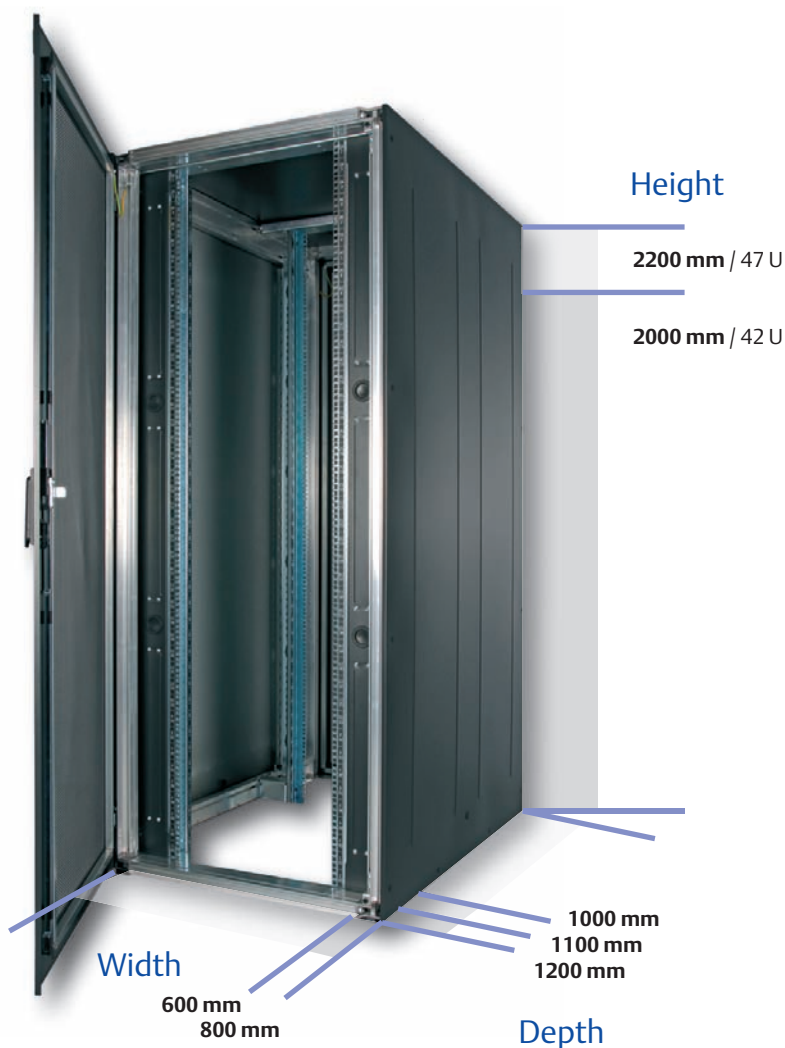

# Beneficial technology features

## 2,000 millimeters for 42 height units, 1,500 kg load rating, Lightweight aluminum design



**Lighter aluminum frame; can be taken apart**  
Easier transport because lighter and take-apart



**Tilt restraint integration**  
Quick and easy assembly and disassembly

- More space and safety with integrated tilt restraint
- Ideally integrated into the rack
- Maximum safety against tilt over



**Simple internal cabling**

- Tool-less accessories
- Easy assembly
- Flexibility by Velcro
- Cable entry via the top cover and bottom cover

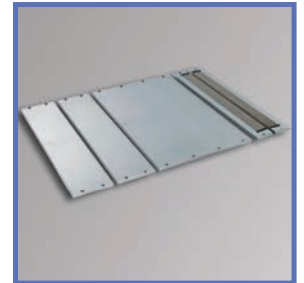

**Modular bottom covers**  
Later installation (or conversion) possible, as the bottom covers are completely positioned below the 19" level



**Convenience and safety**  
Low heavy duty castors mean the rack can also be safely and conveniently pushed when fully equipped



**Installation-friendly PDU bracket**  
Vertical cable routing or PDU upgrade prepared



**42 + 6 usable HU; width 800 mm / height 2000 mm**  
More space due to six additional vertical HU (48 usable in the rack; width 800mm/height 2000 mm)

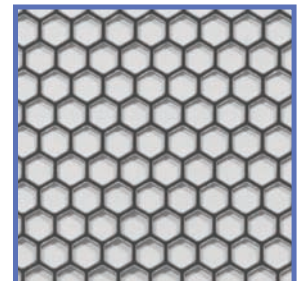

**More air with the biggest possible perforation**  
83 % perforation in flow cross-section



**Maximum space for cable and power supply installations**

**Structural stability without stiffeners**

**Increased flexibility with stepless depth-adjustable air separation**

Optimum side-panel insulation due to high-performance cold-hot separation.

Up  
**1,500kg**  
loading possible



**INFO**

You will find more details and order numbers in our product catalog:

[www.emersonnetworkpower-emea.com](http://www.emersonnetworkpower-emea.com)

# Knürr DCM®

## Strong points

### 1 Heavy Duty Rack

Static load of 1,500 kg. Use of re-designed more stable extrusions and new heavier duty corner joints.

### 2 Threaded construction

Dismantling the rack guarantees easy accessibility, even to the most restricted areas.

### 3 Lighter aluminum frame

Easier transport because lighter

### 4 Convenient

Door mounting without tools

### 5 Low heavy duty castors

Rack can also be safely equipped and conveniently pushed as required

### 6 Cable management

Guaranteed orderly and space-saving cable management. Adjustment at installation site, cable routing can be selected with extensive range of accessory components.

### 7 Biggest possible perforation

For improved airflow

### No more depth braces

PDUs and cable management can also be housed in the space between the 19" level and the side panel

### 8 Depth-adjustable air separation

Cold/warm separation seals on the side panels and can therefore easily be shifted in depth.

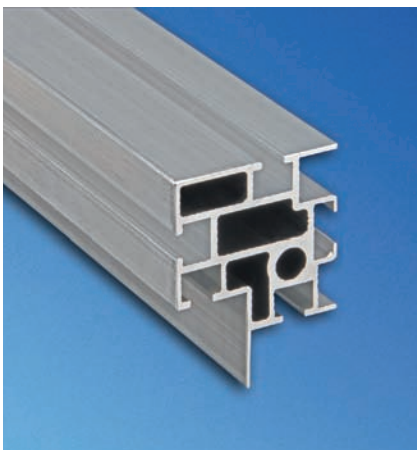

1

DCM20059



3

DCM20030



2

DCM20008



4

DCM20006



5

DCM20028



6

DCM20027

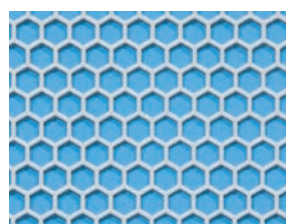

7

MIR20265



8

DCM20000



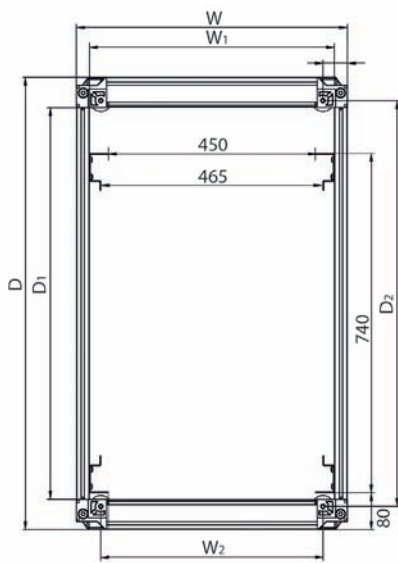

DCM20066

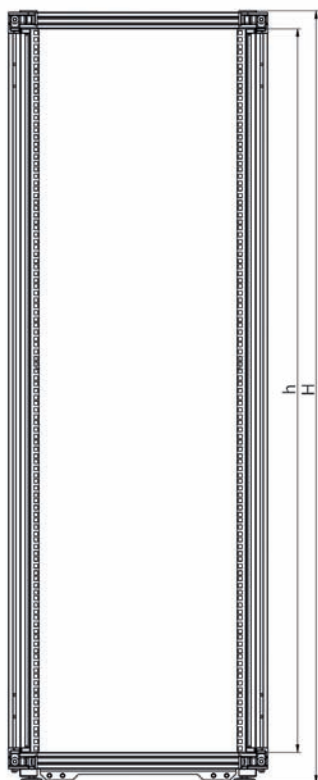

**Material**

- Extruded aluminum
- Corner piece, die-cast aluminum
- Covers, zinc-passivated sheet steel
- Sheet steel doors

**Installation dimensions in acc. with IEC 60297**

- Height: 1866.9 mm (42 U)
- 2089.15 mm (47 U)
- (1U = 44.45 mm)
- Width: 482.6 mm
- (19" construction)

**Space solution**

- Front jumpering space 80 mm
- Door opening angle > 130°

**Configurations**

- Stationary, on leveling feet
- Mobile with castor mounting on leveling feet

**Finish/color**

- Basic rack, aluminum, polished
- Visible surfaces of the covers, powder-coated, RAL 7021 dark grey

**Static load rating**

- 15,000 N (stationary model)
- 10,000 N (mobile model)

**Tests according to version**

- IP test in acc. with DIN EN 60529
- Equipotential bonding and grounding in acc. with:
  - DIN EN 60950-1/A11
  - IEC 60950-1
  - UL 60950-1
  - CAN/CSA C22.2 No. 60950-1

Further standards and tests on request.

**Rack suites**

To create a rack suite with "n" number of racks, you require:

- n-1 racks without side panels and 1 rack with side panels
- One set of connectors (per connection) in a rack suite

Nom. dimension (mm)	W	W <sub>1</sub>	W <sub>2</sub>	D	D <sub>1</sub>	D <sub>2</sub>
W 600 / D 1000	591	535	485	986	856	885
W 600 / D 1100	591	535	485	1086	956	985
W 600 / D 1200	591	535	485	1186	1056	1085
W 800 / D 1000	791	735	685	986	856	885
W 800 / D 1100	791	735	685	1086	956	985
W 800 / D 1200	791	735	685	1186	1056	1085

Nom. height (mm)	H	h
H 2000	1996	1872.60
H 2200	2218	2094.85

# Knürr DCM<sup>®</sup> stationary ...



DCM20003

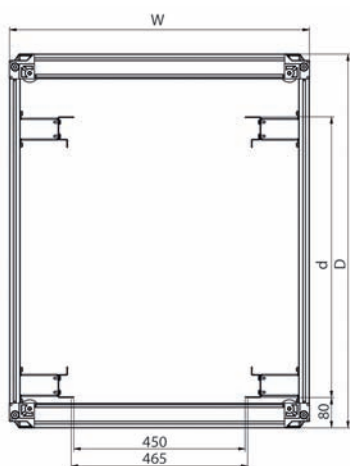

Cross-section width 800 mm DCM20063

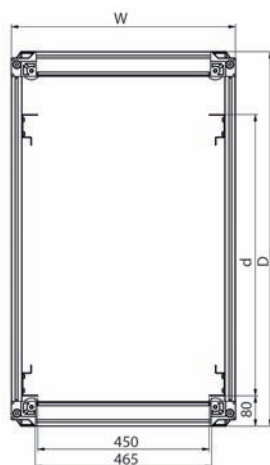

Cross-section width 600 mm DCM20062

Dimensions in mm: W = width  
H = Height  
D = depth  
h = installation height  
d = useful depth  
L = length  
U = standard height unit  
1 U = 44.45 mm  
UP = unit of packaging  
kg = weight

Conversion: 1 mm = 0.03937 inch 1 kg = 2.2046 pound

- Perforated front door
- Rear side perforated double door
- Special 19" server extrusions for mounting all trade standard 19" servers
- Components in acc. with IEC 60297
- Cable entry via top cover and bottom cover
- Cable entry on the top cover, can be completely removed at the rear, allowing top cover removal and replacement after cabling

**■ Jumping space**

Front, 80 mm

**■ Load rating**

15.000 N static

**■ Protection rating**

IP 20

**■ Tests**

- Equipotential bonding and grounding in acc. with DIN EN 60950
- IP test in acc. with DIN EN 60529

**■ Airflow circulation**

- Perforation: 83 %

**■ Material / Finish**

- Basic rack, extruded aluminum, polished
- Corner piece, die-cast aluminum, polished

- Doors, sheet steel, powder-coat textured
- Covers, zinc-passivated sheet steel, powder-coated texture

**■ Color**

Visible surface of covers  
RAL 7021 dark gray

**■ Supply schedule**

- 1 basic frame
- 4 19" server extrusions, sheet steel incl. U numbering
- 2 side panels with quick connectors
- 1 top cover with cable entry (three-piece sliding plates, can also be opened completely)
- 1 front door, single, perforated with handle and mounting for cylinder lock
- 1 rear door, double, perforated, sheet steel, with handle and mounting for cylinder lock
- 4 leveling feet
- 1 complete earthing set

**■ How supplied**

Assembled

**■ Note**

Also order mounting adapter for 19" server extrusion for mounting Knürr accessories

W	H	D	U	d	Model	Order no.	UP
600	2000	1000	42	740	Stationary, with side panels	DB6ECGSSCFBXXX8	1
600	2000	1100	42	740	Stationary, with side panels	DB6FCGSSCFBXXX8	1
600	2000	1200	42	740	Stationary, with side panels	DB6GCGSSCFBXXX8	1
600	2200	1000	47	740	Stationary, with side panels	DD6ECGSSCFBXXX8	1
600	2200	1100	47	740	Stationary, with side panels	DD6FCGSSCFBXXX8	1
600	2200	1200	47	740	Stationary, with side panels	DD6GCGSSCFBXXX8	1
600	2000	1000	42	740	Stationary, no side panels	DB6ECGSSCFXXX8	1
600	2000	1100	42	740	Stationary, no side panels	DB6FCGSSCFXXX8	1
600	2000	1200	42	740	Stationary, no side panels	DB6GCGSSCFXXX8	1
600	2200	1000	47	740	Stationary, no side panels	DD6ECGSSCFXXX8	1
600	2200	1100	47	740	Stationary, no side panels	DD6FCGSSCFXXX8	1
600	2200	1200	47	740	Stationary, no side panels	DD6GCGSSCFXXX8	1
800	2000	1000	42	740	Stationary, with side panels	DB8ECGSSCFBXXX8	1
800	2000	1100	42	740	Stationary, with side panels	DB8FCGSSCFBXXX8	1
800	2000	1200	42	740	Stationary, with side panels	DB8GCGSSCFBXXX8	1
800	2200	1000	47	740	Stationary, with side panels	DD8ECGSSCFBXXX8	1
800	2200	1100	47	740	Stationary, with side panels	DD8FCGSSCFBXXX8	1
800	2200	1200	47	740	Stationary, with side panels	DD8GCGSSCFBXXX8	1
800	2000	1000	42	740	Stationary, no side panels	DB8ECGSSCFXXX8	1
800	2000	1100	42	740	Stationary, no side panels	DB8FCGSSCFXXX8	1
800	2000	1200	42	740	Stationary, no side panels	DB8GCGSSCFXXX8	1
800	2200	1000	47	740	Stationary, no side panels	DD8ECGSSCFXXX8	1
800	2200	1100	47	740	Stationary, no side panels	DD8FCGSSCFXXX8	1
800	2200	1200	47	740	Stationary, no side panels	DD8GCGSSCFXXX8	1

# mobile...



DCM20022

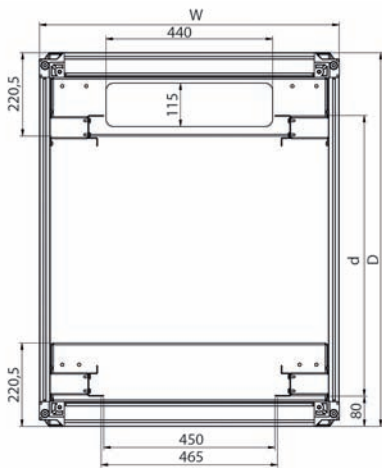

Cross-section width 800 mm CM20065

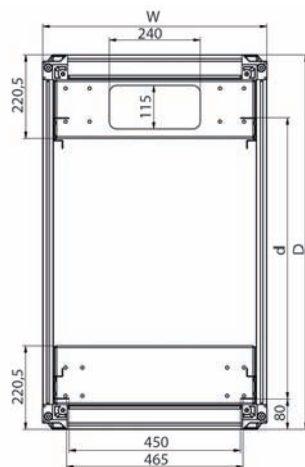

Cross-section width 600 mm CM20064

- Perforated front door
- Rear side perforated double door
- Special 19" server extrusions for mounting all trade standard 19" servers
- Components in acc. with IEC 60297
- **Mobile, heavy duty castors** with high floor clearance
- Cable entry via top cover and bottom cover
- Cable entry on the top cover, can be completely removed at the rear, allowing top cover removal and replacement after cabling

■ **Jumpering space**

Front, 80 mm

■ **Load rating**

15,000 N static  
10,000 N mobile in data center with load

■ **Protection rating**

IP 20

■ **Tests**

- Equipotential bonding and grounding in acc. with DIN EN 60950
- IP test in acc. with DIN EN 60529

■ **Airflow circulation**

- Perforation: 83 %

■ **Material / Finish**

- Basic rack, extruded aluminum, polished
- Corner piece, die-cast aluminum, polished

- Doors, sheet steel, powder-coat textured
- Covers, zinc-passivated sheet steel, powder-coated texture

■ **Color**

Visible surface of covers  
RAL 7021 dark gray

■ **Supply schedule**

- 1 basic frame
- 4 19" server extrusions, sheet steel incl. U numbering
- 2 side panels with quick connectors
- 1 top cover with cable entry (three-piece sliding plates, can also be opened completely)
- 1 front door, single, perforated with handle and mounting for cylinder lock
- 1 rear door, double, perforated, sheet steel, with handle and mounting for cylinder lock
- 2 castor mountings with heavy duty castors with integrated cable entry
- 4 leveling feet
- 1 complete earthing set

■ **How supplied**

Assembled

■ **Note**

Also order mounting adapter for 19" server extrusion for mounting Knürr accessories

W	H	D	U	d	Model	Order no.	UP
600	2000	1000	42	740	Mobile, with side panels	DB6ECGSSCRBXXX8	1
600	2000	1100	42	740	Mobile, with side panels	DB6FCGSSCRBXXX8	1
600	2000	1200	42	740	Mobile, with side panels	DB6GCGSSCRBXXX8	1
600	2200	1000	47	740	Mobile, with side panels	DD6ECGSSCRBXXX8	1
600	2200	1100	47	740	Mobile, with side panels	DD6FCGSSCRBXXX8	1
600	2200	1200	47	740	Mobile, with side panels	DD6GCGSSCRBXXX8	1
600	2000	1000	42	740	Mobile, no side panels	DB6ECGSSCRXXX8	1
600	2000	1100	42	740	Mobile, no side panels	DB6FCGSSCRXXX8	1
600	2000	1200	42	740	Mobile, no side panels	DB6GCGSSCRXXX8	1
600	2200	1000	47	740	Mobile, no side panels	DD6ECGSSCRXXX8	1
600	2200	1100	47	740	Mobile, no side panels	DD6FCGSSCRXXX8	1
600	2200	1200	47	740	Mobile, no side panels	DD6GCGSSCRXXX8	1
800	2000	1000	42	740	Mobile, with side panels	DB8ECGSSCRBXXX8	1
800	2000	1100	42	740	Mobile, with side panels	DB8FCGSSCRBXXX8	1
800	2000	1200	42	740	Mobile, with side panels	DB8GCGSSCRBXXX8	1
800	2200	1000	47	740	Mobile, with side panels	DD8ECGSSCRBXXX8	1
800	2200	1100	47	740	Mobile, with side panels	DD8FCGSSCRBXXX8	1
800	2200	1200	47	740	Mobile, with side panels	DD8GCGSSCRBXXX8	1
800	2000	1000	42	740	Mobile, no side panels	DB8ECGSSCRXXX8	1
800	2000	1100	42	740	Mobile, no side panels	DB8FCGSSCRXXX8	1
800	2000	1200	42	740	Mobile, no side panels	DB8GCGSSCRXXX8	1
800	2200	1000	47	740	Mobile, no side panels	DD8ECGSSCRXXX8	1
800	2200	1100	47	740	Mobile, no side panels	DD8FCGSSCRXXX8	1
800	2200	1200	47	740	Mobile, no side panels	DD8GCGSSCRXXX8	1

# Accessory diversity, as you need it ...

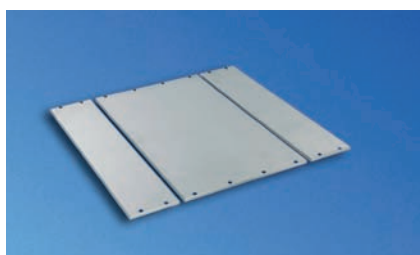

DCM20032

## DCM® Bottom Cover, in 3 parts

- To cover the rack underside
- For flexible cable entry on the front and rear
- For racks **with** castor mounting

■ **Material / Finish**  
Sheet steel, zinc-passivated

■ **Supply schedule**  
3 bottom covers  
2 mounting brackets  
Mounting material

■ **How supplied**  
Flat-packed kit

**Optionally available:**  
DCM® Bottom Cover, for cable entry with sponge rubber seal, IP 40

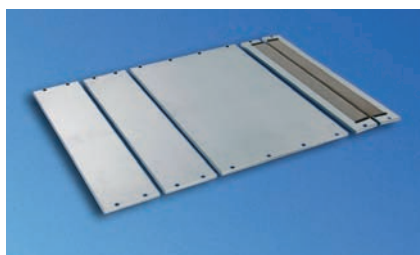

DCM20035



DCM20026

## Tilt restraint for DCM®

- Easy and quick mounting and removal
- DCM rack integration possible
- Use only as required

■ **Supply schedule**  
2 anti-tilt restrainers

■ **How supplied**  
In sets



DCM20037b

## DCM® Heavy Duty Plinth, stationary, height 100 mm / 200 mm

- Stationary incl. leveling option
- Cable entry possible from all sides
- Panel front and rear with airing vents and installation options for filter mat

■ **Load rating**  
10,000 N static

■ **Material**  
Sheet steel

■ **Finish**  
Powder-coated texture, RAL 7021

■ **Supply schedule**  
4 plinth corners with leveling feet  
8 panels (4 panels)  
Mounting material

■ **How supplied**  
Flat-packed kit

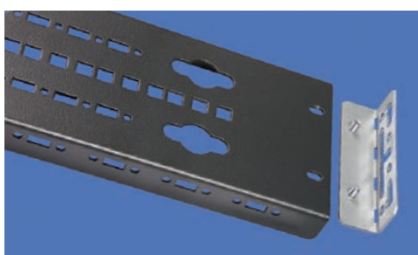

DCM20076

### DCM® PDU-Bracket

- For orderly cable management in the rack
- For hanging on trade standard PDUs without tools

■ **Material / Finish**  
Sheet steel, zinc-passivated, powder-coated

■ **Color**  
RAL 7021 dark gray

■ **Supply schedule**  
1 PDU Bracket  
Mounting material

■ **How supplied**  
Flat-packed kit



DCM20009

DCM20010



LUF20033a

### DCM® Air Partitioning, closed

- Quick and easy upgrade of the cold/warm area separation in the rack
- Side panels closed
- Screwed on the side on the 19" extrusions
- Seal to the side panels or to the same level in the linked rack with foam elements, making it stepless depth-adjustable

■ **Material**  
Sheet steel

■ **Finish**  
Powder-coated, RAL 7021 dark gray

■ **Supply schedule**  
2 side panels  
2 panels, top/bottom  
Mounting material

■ **How supplied**  
Flat-packed kit

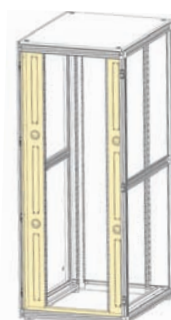

LUF20033b

### DCM® Air Partitioning with 3x 1 U panels, vertical

- Quick and easy upgrade of the cold/warm area separation in the rack
- Side panels with 2 cut-outs each for cable routing
- 3 x 1 U cut-outs, covered with panels
- Screwed on the side on the 19" extrusions
- Seal to the side panels or to the same level in the linked rack with foam elements, making it stepless depth-adjustable

■ **Material**  
Sheet steel

■ **Finish**  
Powder-coated, RAL 7021 dark gray

■ **Supply schedule**  
2 side panels  
2 panels, top/bottom  
Mounting material

■ **How supplied**  
Flat-packed kit

INFO

You will find more details and order numbers in our product catalog:

[www.emersonnetworkpower-emea.com](http://www.emersonnetworkpower-emea.com)

# Knürr Cable Management quick – easy – transparent

**Cable routing without obstacles enjoys a long tradition in the Knürr Rack! The high cable volume, their variety and the structural connections quickly demonstrate that a lot more than just access is at stake here. We are talking about "cable management"!**

The rack platform used in data centers or network technology is especially well-thought-out by Knürr; and not just how to accommodate the active and passive components, but rather how to also design their cabling as easy as possible.

## ■ Bending loads

The bending radii must never be less than the values provided by the cable manufacturer in the respective data sheets. At points that bend too much, the electrical properties of the cable change and reduce the transmission bandwidths and ranges. If manufacturer specifications are not available, then the following rule of thumb applies: With loose cabling, at least 15 times the external cable diameter and with fixed cabling, at least 10 times the external cable diameter.

## ■ Kink stress

Extreme bending loads can cause the cable to break.

## ■ Tensile stress

This is only determined by the copper cross-section of the conductor, as all other materials are too soft. The

cable must not be stressed more than 50N/mm<sup>2</sup> (Cu cross-section) as otherwise the conductors are stretched and the cross-section is reduced. If higher "pulling" forces are required, then cables with additional strain relief elements must be used.

## ■ Compressive stress

Compressive stress is caused by loads bearing down from above, fixed clamping or sharp cable kinking and must always be avoided, as otherwise the "loose" cable structure changes and the electrical transmission properties are impaired.

## ■ Torque strains (twisting)

These must never have an effect on the cable, as they drive the cable elements into one another and therefore impair the transmission properties.





- Different components for fiber glass and copper cables, especially the fixing options using Velcro strips and cable bundling with different colored Velcro strip cable ties, guarantee a transparent cable management, which is the optimum starting situation for an intelligent expansion of the network and for the highest standard of servicing convenience.
- With all cable management components, special attention has been paid to ensuring that fixing is possible with Velcro strip cable ties. Velcro cable ties not only guarantee a stress-free fixing of the cables, they can also be released at any time and re-used again and again. Velcro cable ties are also extremely helpful for the installation engineer in providing pinch-free cable bundling – and also because they are so quick to apply.
- Excess cable lengths are stored separate from the patch fields, but in a position that is always easy to access. Copper cable excess can be stored separate from fiber glass excess lengths within the Knürr rack systems: the copper cables are stored hanging on a side and the more sensitive fiber glass cables are stored flat in a front-accessible excess length drawer.
- A closer look at the individual products reveals that some possess an inherent "multi-talent". The cable routing brace, for example, not only has the option of routing cables horizontally and vertically using Velcro ties or cable ties, but rather also allows numerous components to be mounted using screws and caged nuts. These caged nuts can also be shifted with room for play in a slot, so that every mounting dimension can be accommodated.
- The prescribed radii are preset with the radial limiter. These components ensure that neither a reduction of the transmission bandwidths and ranges nor a cable break occur.



# Safe, efficient and economical: Rack PDUs from Emerson Network Power

Reliable power distribution is especially important in a server rack! Emerson Network Power's Power Distribution Units (PDU) provide high **safety and availability** due to a robust setup of their electro-mechanics.

The rack PDUs offer **economic advantages**. Modularity also enables expansion as required and always compatible.

Rack PDUs provide economical solutions for specific requirements and great performance with many technical features.



*In its interaction with Rack PDUs, Rack Monitoring Systems and "Cool" systems, Liebert NFORM guarantees the monitoring and controlling of all relevant infrastructure parameters in server rooms and data centers, alarms as required, and even intervenes with controls to prevent damage.*



## BASIC

### Features:

- High stability and torsional strength provided with closed sheet steel casing
- Optimum conductivity: full-length brass busbar available with many models
- Double spring contacts for shock hazard safety and low contact resistance



## MANAGED

### Features:

- Highest possible safety and availability with max. 55°C operating temperature
- Extensive measuring functions (current, voltage, power and energy) with a measuring precision of  $\pm 1\%$
- Remotely switchable outputs available with many models
- Same communication card as with Liebert MPX™, which means same software interface with administration.
- Up to 4 Liebert MPX™/MPH™ can be controlled via one IP address
- External sensors and a display can also be connected



## ADAPTIVE

### Features:

- The Liebert MPX™ is a modular PDU, input modules and output modules can be flexibly configured as required.
- A fixed data bus is integrated on a full-length busbar; additional wiring between the modules is not necessary.
- Max. performance density of 3 x 63 A per rail
- Additional monitoring (N-conductor, apparent power, crest factor and power factor) means possible failures are already identified early on
- Measuring up to output level and remote switching is possible depending on the output module, which means each server can be individually monitored.
- The output modules can be changed during running operation; there are no downtimes



# Flexible power supply

Rack PDUs are easily integrated into new or existing management platforms

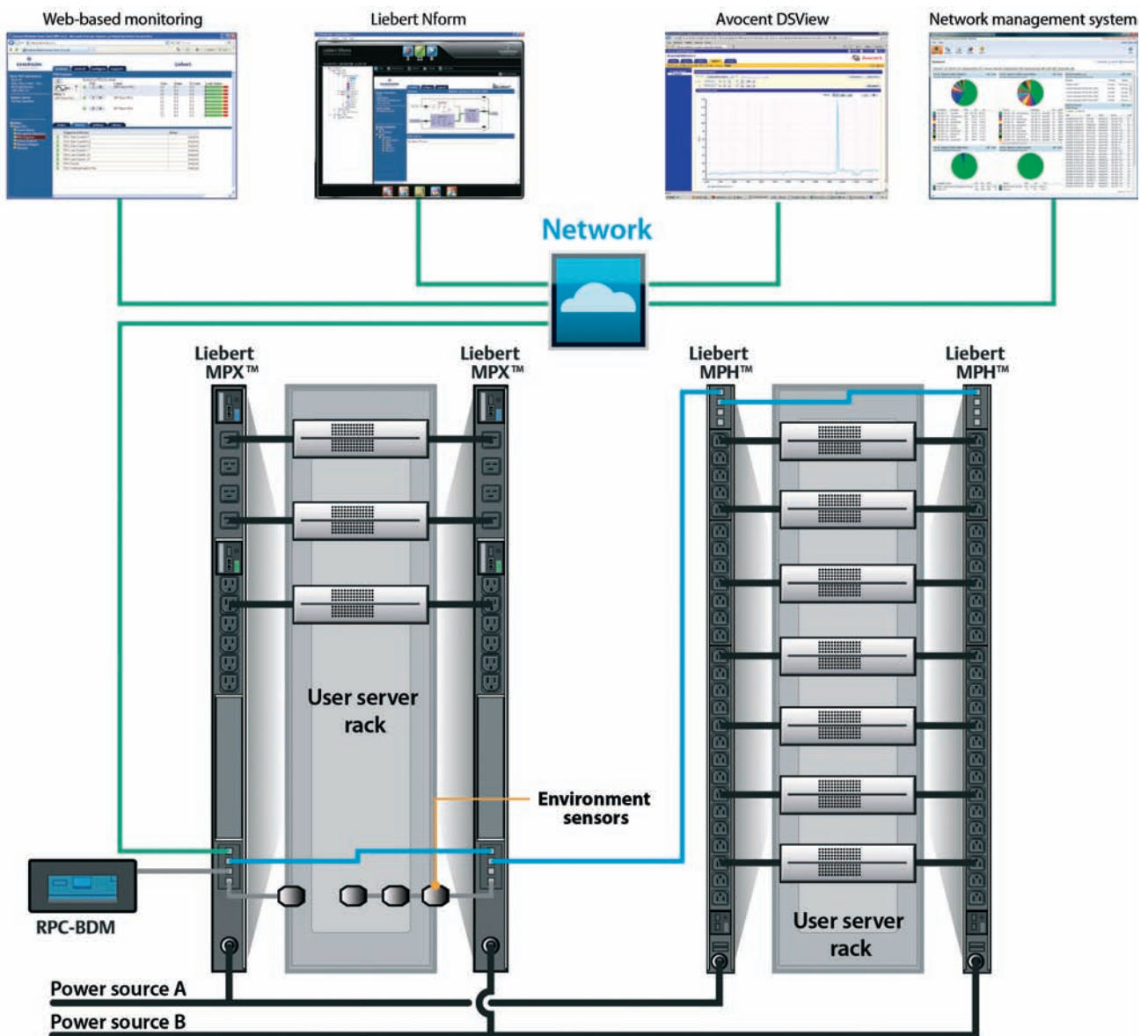

Rack PDU Array (up to four systems)

# Emerson Network Power Overview

## Rack PDUs Europe

Merkmale	Knürr DI-STRIP BASIC Rack PDU®			Liebert MPH™ MANAGED Rack PDU		Liebert MPX™ ADAPTIVE Rack PDU			
	Knürr DI-STRIP®	Knürr DI-STRIP M®	Knürr DI-STRIP RM®	Liebert MPH™ Branch Monitored	Liebert MPH™ controlled	Liebert MPX™ Elementary	Liebert MPX™ Elementary Phase monitored	Liebert MPX™ Branch monitored	Liebert MPX™ Receptacle managed
Power distribution	x	x	x	x	x	x	x	x	x
Modular						x	x	x	x
Display		Fixed	Fixed	Modular	Modular		Modular	Modular	Modular
Remote interface			x	x	x		x	x	x
Measuring on input level		x	x	x	x		x	x	x
Measuring per group				x	x			x	x
Measuring per output									x
Switching per output					x				x
Measuring parameters		A	A	A,V,W,KWh, Hz	A,V,W,KWh, Hz		A,V,W,KWh, Hz	A,V,W,KWh, VA, Hz, power factor	A,V,W,KWh, VA, Hz, power factor, crest factor
Input power	1ph + 3ph max 32A	1ph + 3ph max 32A	1ph + 3ph max 32A	1ph + 3ph max 32A	1ph + 3ph max 32A	1ph + 3ph max 63A	1ph + 3ph max 63A	1ph + 3ph max 63A	1ph + 3ph max 63A
Outputs	IECC13&C19 Schuko Switzerland France	IEC C13&C19 Schuko Switzerland France	IEC C13&C19 Schuko Switzerland France	IECC13&C19	IEC C13&C19	IECC13&C19 Schuko	IEC C13&C19 Schuko	IEC C13&C19 Schuko	IECC13&C19 Schuko
Different sensors can be connected				x	x		x	x	x



You will find details and order numbers in our product catalog:  
[www.emersonnetworkpower-emea.com](http://www.emersonnetworkpower-emea.com)



reddot design award  
winner 2011

# Liebert MPX™ Europa

		Order number	MPX Elementary	MPX Elementary Phase monitored	MPX Branch monitored	MPX Receptacle managed
<b>Busbars</b>	Length 1035	MPXPRC-V1035XXX	x	x	x	x
	Length 1880	MPXPRC-V1880XXX	x	x	x	x
<b>Input modules</b>	1ph 32A fixed	MPXPPEM-EHAEXQ30	x			
		MPXPPEM-EHAXXQ30		x	x	x
	3ph 16A fixed	MPXPPEM-EHAEXT30	x			
		MPXPPEM-EHAXXT30		x	x	x
	3ph 32A fixed	MPXPPEM-EHAEXR30	x			
		MPXPPEM-EHAXXR30		x	x	x
3ph 63A fixed	MPXPPEM-EHBEXZ30	x				
	MPXPPEM-EHBXXZ30		x	x	x	
<b>Output modules: Elementary</b>	IEC-C13 L1	MPXB RM-EEBC7N1N	x	x		
	IEC-C13 L2	MPXB RM-EEBC7N2N	x	x		
	IEC-C13 L3	MPXB RM-EEBC7N3N	x	x		
	IEC-C19 L1	MPXB RM-EEBC4O1N	x	x		
	IEC-C19 L2	MPXB RM-EEBC4O2N	x	x		
	IEC-C19 L3	MPXB RM-EEBC4O3N	x	x		
	Schuko L1	MPXB RM-EEBC3P1N	x	x		
	Schuko L2	MPXB RM-EEBC3P2N	x	x		
<b>Output modules: Branch monitored</b>	IEC-C13 L1	MPXB RM-EBBC6N1N			x	
	IEC-C13 L2	MPXB RM-EBBC6N2N			x	
	IEC-C13 L3	MPXB RM-EBBC6N3N			x	
	IEC-C19 L1	MPXB RM-EBBC4O1N			x	
	IEC-C19 L2	MPXB RM-EBBC4O2N			x	
	IEC-C19 L3	MPXB RM-EBBC4O3N			x	
	Schuko L1	MPXB RM-EBBC3P1N			x	
	Schuko L2	MPXB RM-EBBC3P2N			x	
<b>Output modules: Receptacle managed</b>	IEC-C13 L1	MPXB RM-ERBC6N1N				x
	IEC-C13 L2	MPXB RM-ERBC6N2N				x
	IEC-C13 L3	MPXB RM-ERBC6N3N				x
	IEC-C19 L1	MPXB RM-ERBC4O1N				x
	IEC-C19 L2	MPXB RM-ERBC4O2N				x
	IEC-C19 L3	MPXB RM-ERBC4O3N				x
	Schuko L1	MPXB RM-ERBC3P1N				x
	Schuko L2	MPXB RM-ERBC3P2N				x
<b>Interface card</b>		RPC-1000		x	x	x
	1xTemp.	SN-Z01		x	x	x
	3xTemp.	SN-Z02		x	x	x
<b>Sensors</b>	3xT. + 1xHum	SN-Z03		x	x	x
	1xTemp. Mod.	SN-T		x	x	x
	Temp/Hum Mod.	SN-TH		x	x	x
	2xDoor Mod.	SN-2D		x	x	x
	3xInput Mod.	SN-3C		x	x	x
	<b>Display ext.</b>		RPCBDM-1000		x	x

Upgrade possible!

Different combinations possible!

# Centers of Expertise



When you partner with **Emerson Network Power** for your *Business-Critical Continuity™* needs across your enterprise, you benefit from more than products to **support and protect your technology infrastructure**.

Developing such a wide range of technologies gives us in-depth industry knowledge and a “big-picture” understanding of how all systems must work together within any critical environment.

We deliver this knowledge through Emerson Network Power’s Centers of Expertise, distinct areas of **world-class products and services** that help you determine what you need and where, depending on your application.

All so that you can keep your business moving forward for your customers.

## ■ AC Power

Sustaining critical operations that simply can’t go down. We deliver a full range of uninterruptible Liebert® and Chloride AC power systems and associated power distribution and racks, from individual products to integrated systems that keep network closets, computer rooms and data centers up and running.

## ■ Infrastructure Management & Monitoring

Managing and monitoring critical environments at multiple sites around the clock. We make it easy in today’s ROI-driven business environment, with comprehensive infrastructure management and 24/7 monitoring systems and services that provide continuous oversight of data centers, computer rooms and network closets, as well as wireless, wireline and enterprise telecom applications.

## ■ Power Switching & Controls

Safeguarding facilities from operational disruption due to electrical power interruption. We provide ASCO® power-transfer switches, generator paralleling switchgear/power control systems, and touch screen SCADA for monitoring and control of the utility service and on-site backup power generators, helping ensure continuity of supply to essential and mission-critical communications, data-processing, life-safety, and other critical loads. Backed by the largest manufacturers, direct field based project management and service technicians in the industry.

## ■ Precision Cooling

Maintaining precise temperature for reliable equipment performance. We deliver “chip-to-room cooling”- the most comprehensive range of Liebert precision-cooling solutions, which protect mission-critical applications from even the slightest increase in temperature.



### ■ Racks & Integrated Cabinets

Optimizing technology and performance needs for indoor IT applications. We deliver standard and customized integrated cabinet solutions that meet unique and specific needs, from Knürr and Liebert rack solutions for computer rooms of all sizes to integrated racks that include self-contained air conditioning, UPS and cable management in a sturdy, lockable cabinet.

### ■ Surge Protection

Defending power, voice and data moving through the network against grid irregularities and dangerous electrical disturbances. Depending on the application, we offer Liebert and PowerSure™ AC Power Protection, Islatrol™ Active Tracking Filters and Edco™ data/signal surge protective devices, all of which provide power protection to reduce downtime, saving crucial man-hours and extending equipment life.

### ■ Services

Delivering assessment, testing and reliability programs backed by the largest global services organization in the industry. We encompass engineering, installation, startup services, project management, training, and total on-site operations management, preventive and predictive maintenance and energy consumption monitoring.

## Infrastructure Services and Support

Emerson Network Power supports its Centers of Expertise with the largest global services organization in the industry, delivering:

- Design, installation and startup
- Warranty service
- Preventive maintenance
- 24/7 remote monitoring
- Emergency service
- Site audits

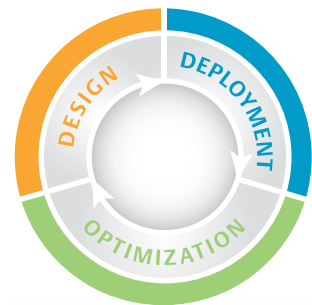

### Design

Upfront planning is critical to the success of any facility. So is flexibility. That's why we offer an array of design services to help get your installation up and running and to assure it operates efficiently and effectively throughout its lifetime.

### Deployment

We can build in the necessary flexibility today to assure you have the scalability you need to grow tomorrow.

### Optimization

Optimization is making the most of your infrastructure. Emerson Network Power can provide optimized support for your day-to-day demands and your longer-term plans, particularly for energy savings.

### Chloride LIFE.net

- Maximized system availability - real-time diagnosis and resolution of all possible operating anomalies
- Minimized downtime - expert engineer available 24/7
- Reduced operating costs - through preventative maintenance

# Emerson Network Power

## Data Center Infrastructure

### Precision Cooling

#### SmartAisle™

- Aisle containment
- Provides highest energy efficiency
- Works with any Liebert Cooling Unit



#### Liebert HPM

- From 4 kW to 230 kW, DX-Digital Scroll-CW
- Premium energy efficiency
  - Eurovent certified performance
  - Unique control capabilities with iCOM



#### Liebert HPC

- Wide range of high-efficiency freecooling chillers from 40 kW to 1600 kW
- Designed specifically for data center applications and to work with SmartAisle™
  - Premium energy efficiency version
  - iCOM control featured



#### Liebert CRV

- Row-based high efficiency precision cooling units available in DX or CW versions
- Decoupled control for airflow and cooling capacity
- Modulating cooling capacity with digital scroll
- iCOM control with remote rack sensors



#### Liebert XD

- Refrigerant based high density cooling installed close to the server
- Hot spot management for up to 30 kW per rack
- On-demand upgrade with plug and play
- High efficiency and 100% sensible cooling

### AC Power

#### Chloride Trinergy

- Dynamic functioning modes (VFI, VI, VFD) with average working efficiency of 97.9%
- Three dimensions of modularity for optimum scalability (up to 9.6 MW)
- Maximum availability thanks to internal redundancy and concurrent maintainability



#### Liebert NXL

- UPS for critical high power applications
- Provides greater power capacity along with superior reliability
- Meets power requirements and energy efficiency in high availability data centers



#### Liebert STS

- Solid-state digital bus transfer switch for uninterrupted power supply
- Dual-bus power systems connecting critical loads with two independent UPS systems
- Best reliability with Triple Logic Redundancy in power control



#### Power Distribution Rack

- Central connection unit for power supplies in individual server racks
- Interface between the low voltage feed and PDU
  - Individual plug-in units
  - Up to 329 kVA/Rack



#### Rack PDU

- Rack-based power distribution units
- Supports strip-level metering, outlet-level switching and outlet-level metering/switching for remote power management and control
  - Horizontal and vertical models for a variety of rack configurations in branch and remote offices

### Racks & Integrated Cabinets



#### Knürr CoolTherm® 4–35 KW

- Energy efficient server cabinet technology
- Significant Total Cost of Ownership (TCO) reduction
  - Autonomous server rack; independent from environmental conditions
  - Up to 30% improved cooling system energy efficiency



#### Knürr DCD®

- Passive chilled water heat exchanger
- Cools up to 30 kW
  - Neutralizes room heat
  - Fits to Knürr and third party products



#### Knürr DCM®

- 19" rack platform for server, telecommunication and network technology
- Aluminum construction
  - Screw construction
  - T-slot system

### Surge Protection

#### Liebert TVSS

- Easily connected to UPS, to distribution panels or at the service entrance of facilities
- Surge Protective Devices (SPD) designed to protect sensitive equipment from damaging transient voltage surges

### Infrastructure Management & Monitoring



#### Avocent MergePoint® Unity Appliance

- Secure remote KVM over IP access to servers
- Secure remote access to servers in data centers and branch offices
  - Using both in-band and out-of-band tools together allows for a more fault-tolerant and complete, remote management solution



#### Avocent MergePoint® Service Processor Manager

- Secure remote management of embedded service processors
- Single-console for multiple service processor types and IPMI
  - Support for SoL, power control and hardware monitoring



#### Avocent ACS Console Server

- Secure remote serial over IP access to console devices
- Remote access to servers, routers and other console based equipment
  - Physical appliance or encapsulated in a virtual machine



#### Alber Battery Monitoring

- Monitors batteries and prevents premature battery failures
- Internal DC resistance test method to eliminate uncertainty
- Much like a battery ultrasound, it enables the user to assess the battery's true condition



#### Knürr Synergy®

- Supports monitoring in any control room with consoles, monitoring walls and mobile charts
- Standards compliance and ergonomics
  - Manual height selection, even in the basic version
  - Modular construction



#### Avocent DSView® 3 Management Software

- Centralized data center management
- Remotely accesses, monitors and controls target devices on multiple platforms at numerous locations—anywhere, anytime
  - Secure, out-of-band, centralized management of all connected IT and network devices in dispersed data centers

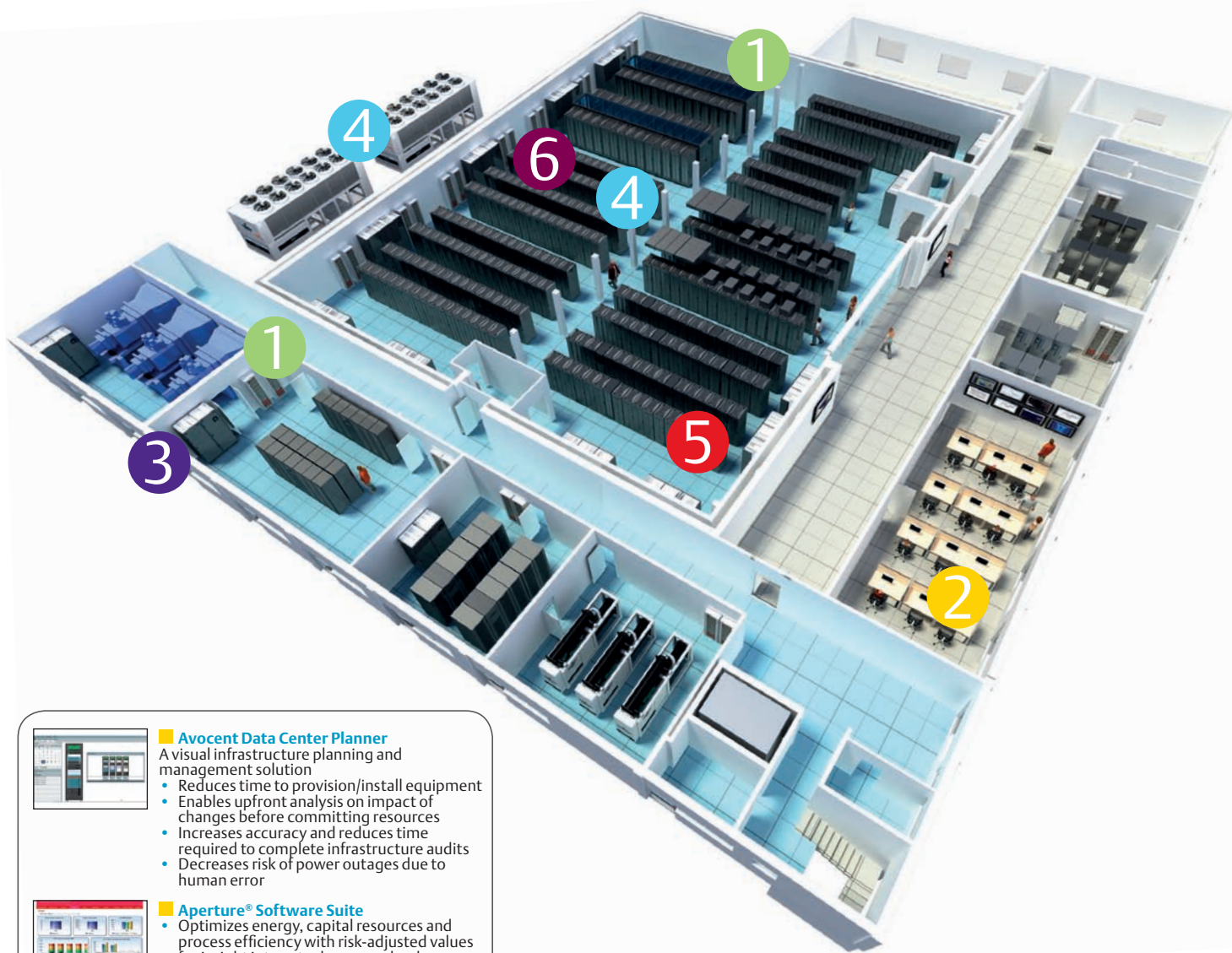

**Avocent Data Center Planner**

A visual infrastructure planning and management solution

- Reduces time to provision/install equipment
- Enables upfront analysis on impact of changes before committing resources
- Increases accuracy and reduces time required to complete infrastructure audits
- Decreases risk of power outages due to human error



**Aperture® Software Suite**

- Optimizes energy, capital resources and process efficiency with risk-adjusted values for insight into actual resource load
- Right-size physical infrastructure and extended data center lifespan with a holistic view of the infrastructure
- Maintains a single, trusted source of information for the entire data center and its contents within a business service view



**Avocent DSView® 3 Power Manager**

Detailed power and environmental information and control at your fingertips

- Adds power monitoring capability to the access and control functions of DSView 3 software
- Monitors/measures IT energy consumption, and determines costs/trends of the data center within and remote locations

1

AC Power

2

Infrastructure Management & Monitoring

3

Power Switching & Controls

4

Precision Cooling

5

Racks & Integrated Cabinets

6

Surge Protection



# SmartAisle™

## Data center and server room infrastructure requirements

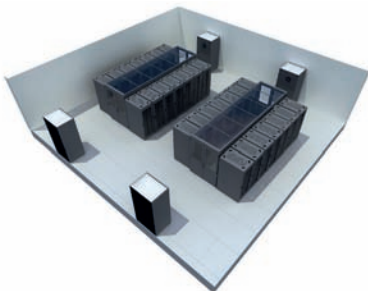

*Raised floor data center with perimeter precision cooling (Liebert HPM)*

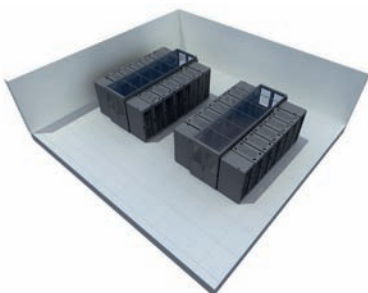

*Slab floor data center with Liebert CRV row-based precision cooling*

**An unstoppable IT further development has left three basic requirements practically untouched:**

### **Availability:**

"Priority 1" for operating data centers – regardless of the size – has the system availability. But high availability costs a lot of money and has to be properly adjusted according to the priority of the planning, implementation and operation of the respective application.

### **Total costs (TCO):**

Running operating costs have overtaken investment costs when the total costs are considered. The enormous energy consumption requirements are the primary cost driver. Studies show that the total power costs in a year for operating a server are about as high as its purchase price. The requirements for optimized energy efficiency are understandably

priority number 1. The requirements for "green IT" in this respect becoming accordingly "loud". The fact that other variables, such as the usage level of building surfaces and components, the staff costs for operating a data center and the costs for planning and construction, significantly influence the total costs, is, however often overlooked. A strong leverage for reducing total costs is provided by only investing in what is really required (pay as you go).

### **Future-proof:**

In addition to the requirement of being able to invest step-by-step in expanding the infrastructure, it must also be ensured that an investment made will remain useable for the long-term. We are talking about investment security! It must be possible to adjust, change and expand installed systems at all times so that a scarcely foreseeable dynamic IT development can be taken into account.





*SmartAisle™ is the perfect solution for IT rooms for optimizing operating costs*

# SmartAisle™ – Full solution concept for the data center

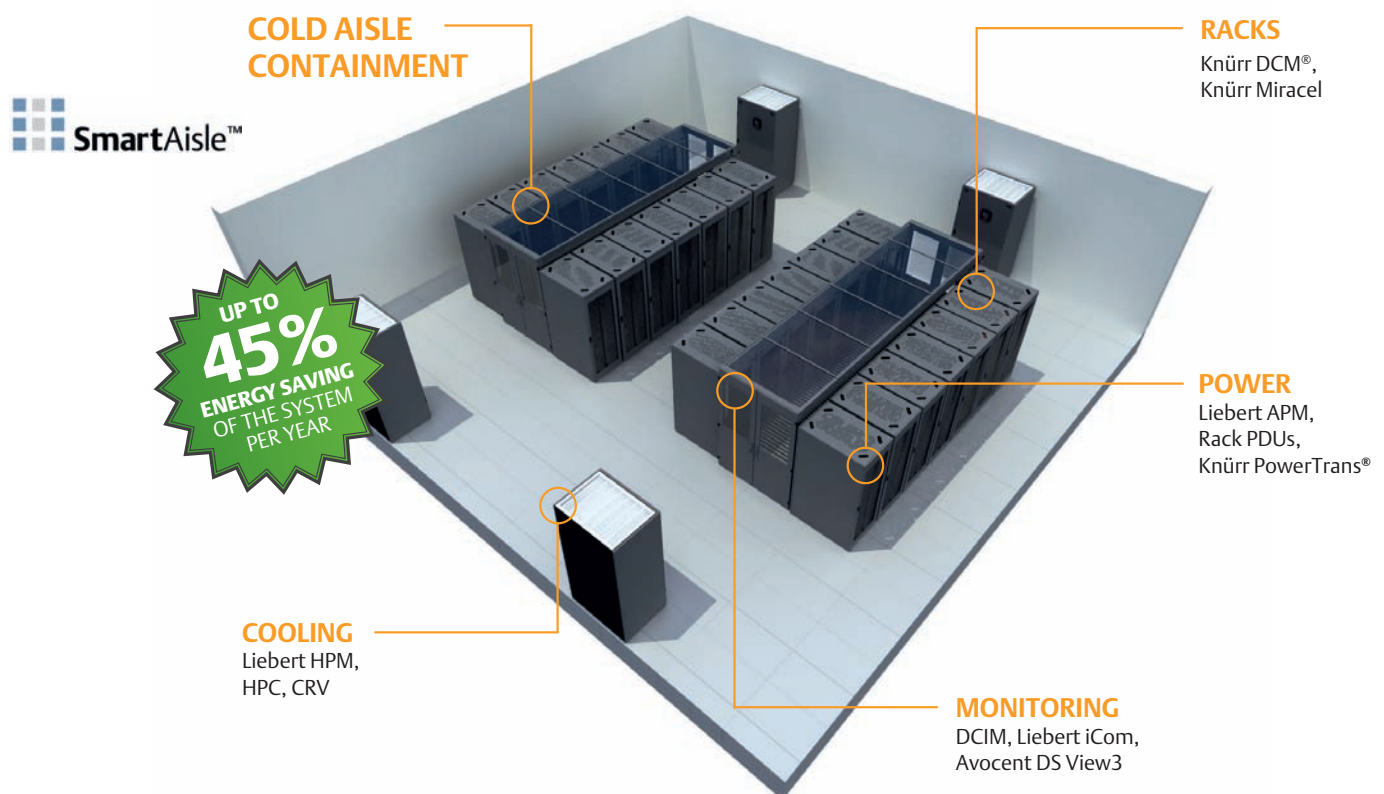

**IT's most important response is the increasing independence of applications from the IT infrastructure; virtualization and cloud computing are the current concepts. Energy-efficient IT components and their dynamic control in accordance with current application requirements form the hardware basis for this.**

Emerson Network Power's SmartAisle is the answer for the physical infrastructure. SmartAisle™ provides the space,

power supply and cooling for servers, storage elements and the network in the data center. The selection of a comprehensive portfolio of components harmonized with one another in every respect enables the adjustment of the physical infrastructure to every conceivable requirement; no two data centers are the same and none remains unchanged for very long. The most important components are:

### Complete Solution

- Racks
- Rack PDUs

- Power Distribution
- UPS
- Cooling with iCOM control
- Containment
- Cable management
- Monitoring: Rack & Row
- DCIM: Avocent
- Startup and Maintenance
- Other services

All have interfaces to a comprehensive infrastructure management system (Trellis), which enables the holistic monitoring, management and automation of the physical infrastructure.

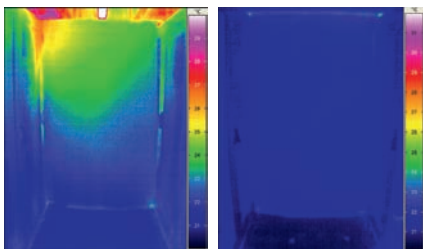

Thermal image:  
Conventional  
data center

Thermal image:  
SmartAisle™

Taking cooling as an example it can clearly be seen how SmartAisle™ contributes toward satisfying the overreaching demands placed on a data center infrastructure that is efficient in its energy consumption.

### Best Practice

Racks in a modern data center should be installed in compliance with the cold aisle/ warm aisle principle. Perforated raised floor panels should only be placed where cold air is needed – i.e., in the cold aisle. In addition, the raised floor should be sealed as airtight as possible (e.g., cable ducts) so that no cold air is lost. To prevent recirculation in the racks, all open areas must be closed with 19" blanking plates.

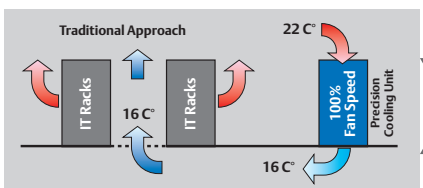

Conventional data center

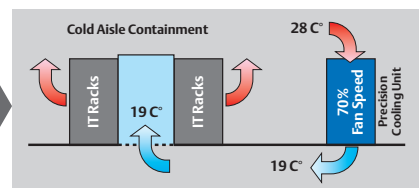

Data center with cold aisle containment

### Innovative patented regulation concept

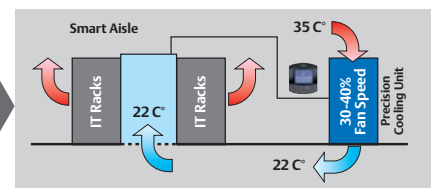

Data center with SmartAisle™

### Problems in conventional data centers

Clear separation between warm and cold air is often not the case in data centers. Warm and cold air mix as a result. This is due, on the one hand, to recirculation of the warm air over the racks or the ends of the aisles. On the other hand, aisles are over exposed to cold air. To ensure that all racks and aisles up to the top-most height unit (HU) receive cold air, the chillers must supply large volumes of cold air under high pressure and at high speed. The fans in the chillers run under full load (100 %).

#### Characteristics

- Low level of fail-safety
- High levels of energy consumption
- Hot spots are unavoidable

### Data center with cold aisle containment

Hot spots (recirculation) are prevented using cold aisle containment. The cold air cannot mix with the warm air. As a consequence, less cold air is needed – i.e., less energy is required to cool the IT components. The chillers work more efficiently since the difference between supply and return air temperatures is increased. The fans in the chillers run at about 70 % capacity. The complete temperature level of the air and water is increased, meaning that the chillers can work longer each year with free cooling.

#### Characteristics

- Improved fail-safety levels
- Low levels of energy consumption
- No hot spots

### Data center with SmartAisle™

Until now the speed of the fans in the air-conditioning units was regulated by means of the return air temperature (i.e., the temperature in the warm zone). However, the critical factor is the temperature of the air supplied to the servers. By applying this regulation principle the data center becomes efficient in its energy consumption. The chillers work at a low speed of about 30–40 % of their capability to supply the appropriate volume of cold air. **The SmartAisle™ data center offers the best levels of redundancy and fail-safety.**

#### Characteristics

- Best fail-safety levels
- Lowest levels of energy consumption
- No hot spots
- Easy to plan and operate

# SmartAisle™

## True Customer Solutions Generates True Customer Benefits

**Emerson Network Power system technology with solutions that meet IT operation requirements.**

**SmartAisle™ ensures...**

### Availability

- Balanced temperature level for all IT components, no hot spots, no temperature-related performance reduction, no temperature-related failures.
- Insensitivity to the distribution IT components; the cold air supply is ensured at every position in the rack/suite.
- Reliable identification of capacity limits is possible via the fan speed of the cooling devices.
- Uncritical behavior with failures of individual cooling devices, because the sufficient and balanced distribution of the cooling air is maintained in every situation.
- Significantly longer bridging time with failures of the cooling system compared with solutions without containment.
- Increased redundancy with upgrading containments; the capacity of the individual cooling devices increases with the higher return air temperature; fewer cooling devices provide the total required cooling power.

### Total costs

#### Operation

- Enormous saving in power costs
  - with dynamic fan speed control
  - higher cooling air and higher cooling water temperature (free cooling)
- Saving on penalty taxes for CO2 (e.g. UK Carbon Tax)
- Lower staff costs; the system behaves uncritically; prognostic, easy monitoring

#### Usage level of buildings and components

- Better space usage with higher power densities
- Higher cooling power per cooling device with higher return air temperature
- Over-capacity as “safety reserve” no longer required
- Not much data has to be recorded with few sensors for monitoring the operation/capacity limits

#### Planning and building, Upgrading

- With fully foreseeable system behavior/power parameters; simple and safe planning
- Straightforward system configuration; no expensive simulations or similar required

- No expensive coordination work with construction and start-up
- Quick and easy upgrade of existing data centers

### Pay as you go

- A modular expansion in line with increasing power requirements is possible, as the system does not require any significant over-capacities and the distance from the capacity limits is known

### Agility

- Continuous adjustment to current power requirements with dynamic system control
- Reliable early identification of capacity limits
- Modular expansion concept, successive equipping of racks/suites with IT equipment, rooms with further rack suites, additional cooling devices – with constant optimum efficiency
- Zone-by-zone DC expansion
- Additional cooling power with suite cooling devices
- Can be combined with rack cooling for the highest possible power densities

Achieved with patented cold aisle containment in numerous projects (banks, insurance companies, industrial applications, etc.):

UP TO  
**45%**  
ENERGY SAVING  
OF THE SYSTEM  
PER YEAR



the green grid™

### Green IT

- Reduced CO2 emissions with optimum energy efficiency
- Very good PUE values achieved, frequently better than 1.35
- Compliance with EU Code of Conduct

*Containment is proven to produce considerable savings in energy costs*

# The SmartAisle™ Standard Series

## SmartAisle™ from Emerson Network Power



**The SmartAisle™ standard series comprises flexible, adaptable, user-friendly components.**

The individual components compensate for the tolerances of the installed racks, which are generally not mounted with millimeter precision. The system not only fits to the Knürr racks, but also to most racks available in the market.



The racks do not have to be installed in pairs. The ceiling panels are transparent so that the available room lighting can be used. The ceiling panels are 150 mm higher than the racks. On the one hand, this improves the regulation of the chillers. On the other hand, this area enables sensors, etc. to be positioned and entry is more comfortable for tall persons.



Different door systems are available: folding doors and sliding doors. Automatic locks are available to both kinds of

door system so that the data center can always be operated energy-efficiently – there is no recirculation (no waste of cool air). Folding and swing doors have advantages in regard to safety. In contrast, sliding doors take up less space. The automatic locks on the doors are selected and set in such a way that personal protection is assured. All door systems can be easily opened under little pressure in emergency cases.

### Standard series

- Aisle widths: 1200 / 1500 and 1800 mm
- Rack heights: 2000 and 2200 mm

### Characteristics

- Ideally suited for new data centers and for refitting homogeneous rack rows
- Industrial prefabrication makes the series the most economic solution
- Fast, easy installation on site

# Freestanding and Customized



*Free-standing solution*



*Customized solution*

## Freestanding

Along with the server racks, so-called freestanding systems are also installed in many data centers. These racks often have customized dimensions and are replaced on a regular basis (usually every 1 to 3 years).

Freestanding systems can be storage cabinets, cluster applications (for example: IBM, SUN) or server racks (for example: IBM, HP, SUN, etc.). There are different reasons for delivery of the system as a complete package including racks. For storage applications, one main reason relates to product liability, while cluster applications are generally leased and there are often marketing reasons in the case of server applications.

The challenge faced by "SmartAisle™ for Freestanding" is to construct a flexible cold aisle containment that permits fast, modular replacement of the freestanding systems.

The freestanding cold aisle containment solution is based on the SmartAisle™ standard series and is used in combination with those products. Panel sizes for

the freestanding system can be adapted in both dimensions (height and width) according to the rack dimensions.

## Characteristics

- Flexible adaptation to racks with custom dimensions
- For racks and applications that are regularly replaced
- Used in combination with the SmartAisle™ standard series

## Customized

Data centers are often the result of a structure that has evolved over years. The racks differ and are not always aligned in a single line. Knürr offers this solution on the basis of a profile section construction design that can be manufactured to fit each individual data center.

## Characteristics

- Customized fitting for racks and rack positioning
- Suitable for refitting inhomogeneous data centers
- Used in combination with the SmartAisle™ standard series

# Highlight Features



On the safe side.

## Early fire detection and extinguishing

**SmartAisle™ containment systems have been awarded the Dekra seal of quality with certification for compliance with the requirements for fire protection.**

Early fire detection is absolutely indispensable in today's modern data centers. Together with leading manufacturers of fire-protection articles, DEKRA has determined that no modifications are generally required in a VdS-conformant data center with SmartAisle™ cold aisle containment. In fact, the detection time can even be reduced thanks to a cold aisle containment.

Fire-extinguishing systems typically use an inert gas (argon, N<sub>2</sub>) or a halogenated hydrocarbon, such as FM200 or NOVEC1230. For technical reasons, no major modifications are generally needed in this regard with a cold aisle containment.

From a technical point of view, it is not necessary to have sprinklers installed in the aisle. Sprinklers are used only for building protection, but not for protecting IT components.

## Advantages of cold aisle containment over conventional designs

- No so-called hot spots (recirculation of the warm air from the warm aisle to the cold aisle)
- Lowest possible energy costs for the chillers (particularly with SmartAisle™ regulation)
- Multiple servers can be installed
- Pressure equalization in raised floors not required
- Free placement of servers in the rack (in conventional data centers, servers are generally not positioned at the top of racks and facing outward in the aisle)
- High fail-safe levels due to increased redundancy of chillers working in energy-efficient mode
- Greater security in the event of total failure of the cooling (2–3 times longer bridging time with a cold aisle containment)



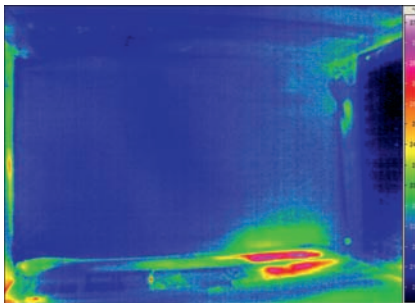

**Thermal image:** Cold aisle containment with no air separation

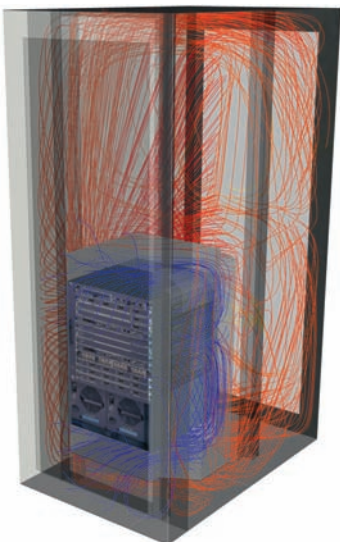

**Thermal image:** Switch-Tube

### Sealing in racks and raised floors

It is just as important to consistently separate warm air from cold air in racks and raised floors in order to prevent recirculation of the warm air. We offer products for separation of air in racks (e.g., air isolation, blanking panels, etc.) as well as in raised floors (e.g., air blocks in raised floors for cable ducts, etc.).

### Cooling of switches

Servers draw in cold air for cooling from the front and blow out the warmed air behind. In contrast, switches generally suck in cold air from the side and blow out the air on the side or behind. This means that cooling problems occur in racks with consistent separation of warm and cold air. Special air-conduction systems are needed for switch applications in order to have a safe, energy-efficient solution.

The SmartAisle™ SwitchTube is a safe, flexible supplement to the full SmartAisle™ range. Depending on the switch type, different standard products are available.

### SmartAisle™ regulation

Until now the speed of the fans in the air-conditioning units was regulated by means of the return air temperature (i.e., the temperature in the warm zone). However, the critical factor is the temperature of the air supplied to the servers. However, the appropriate server temperature cannot be ensured using the return air temperature. For reasons of energy efficiency, the supply air temperature should be selected to be as high as possible (according to ASHRAE).

With the patented SmartAisle™ regulation, the chillers are regulated by means of the cold aisle temperature – i.e., the supply air temperature of the servers. This regulation provides the lowest possible energy consumption for cooling with maximum safety.



# Emerson Network Power Containerized Data Center Infrastructure

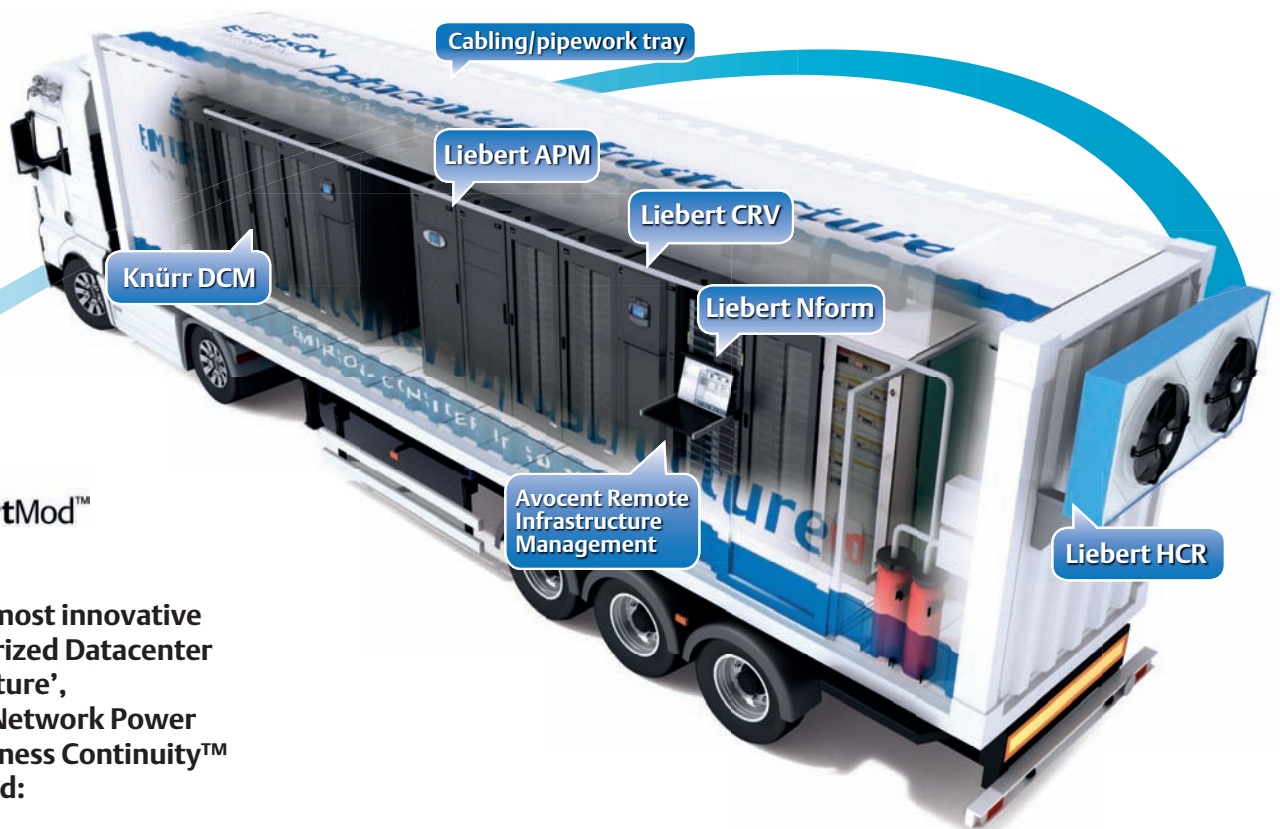

## With the most innovative 'Containerized Datacenter Infrastructure', Emerson Network Power takes Business Continuity™ on the road:

Disaster recovery, natural disasters and humanitarian actions, sports events, movie productions or, more simply, the quick expansion of a data center with no need for construction works: the infrastructure offered by Emerson Network Power contains all it takes to deliver Business-Critical Continuity™.

Emerson Network Power once again guarantees maximum efficiency with an effective all-in-one solution for any ordinary and extraordinary situation. The containerized data center infrastructure is the one that can move rapidly to provide full and efficient protection for IT infrastructures that support operations in ordinary and extraordinary circumstances.

Configurable to specific customer needs, the container can reach any area to support the efficiency of stationary or temporary operating rooms.

There are several benefits offered by a data center developed for quick repositioning: protection of the IT environment with no impact on computing performance, power management continuity during an emergency, provision of a ready-to-use integrated platform that can be activated quickly.

The internal infrastructure incorporates the most innovative of solutions: from Knürr racks to the UPS units from Liebert, from rack power distribution units

to precision cooling units from Emerson Network Power. The layout is completed by Avocent solutions for infrastructure management and monitoring software.

Find a virtual tour of the containerized solution:

[www.datacenterinfrastructure.eu](http://www.datacenterinfrastructure.eu)



## Emerson Network Power

*Innovative Technologies that provide our customers with a distinct competitive advantage.*

IT Managers of Data Centers and Enterprises are today facing many increasing challenges: higher density IT infrastructures, multiple suppliers for multiple critical equipment (power, cooling, cabling, racks), energy efficiency issues.

**Emerson Network Power offers integrated and pre-engineered IT Solutions for Small-Medium-Business.**

Our racks, UPS, cooling equipment, power distribution and cable management solutions, supported by reliable monitoring systems, represent the right choice to rely on to build data centers of today and of the future.

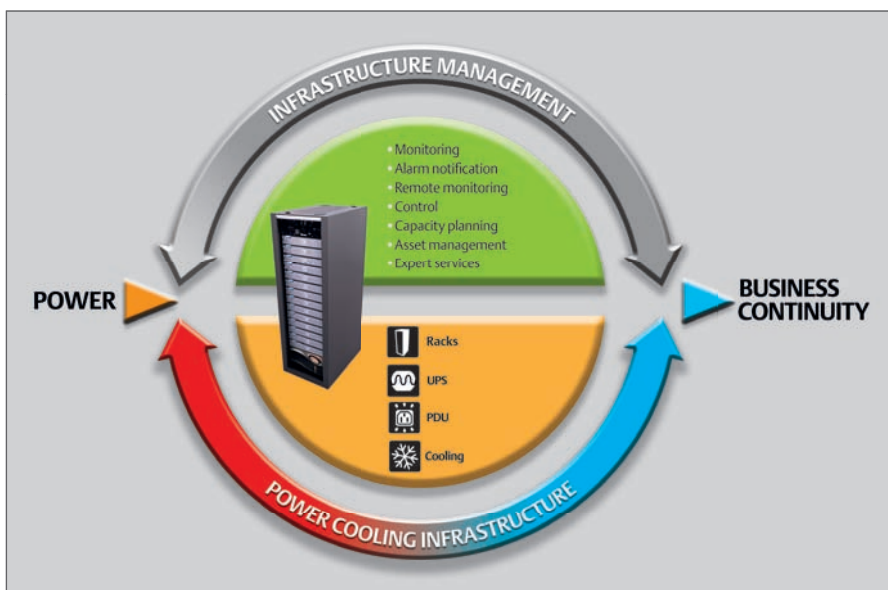

Today's successful businesses depend on adaptable technologies to help them respond quickly to market demands. Your data center must be built on a support infrastructure designed to match the power and cooling needs of rapidly changing IT initiatives such as virtualization and consolidation. Each IT change, move or addition will affect the entire support infrastructure so you need products and support that ensure your IT systems will operate reliably in these environments.

Get More on line:  
[www.emersonnetworkpower-emea.com](http://www.emersonnetworkpower-emea.com)

Emerson Network Power, a division of Emerson (NySE:EMR), is the world's leading provider of Business-Critical Continuity™ "Grid-to-Chip" solutions for telecommunication networks, data centers, medical facilities and industrial systems.

Emerson Network Power provides innovative solutions and expertise in areas such as AC and DC power supply, precision cooling systems, embedded computer and power supply systems, integrated racks and enclosures, network circuits and controls, monitoring and connectivity. All solutions are supported locally all over the world by Emerson Network Power customer service technicians. You will find more information on Emerson Network Power's products and support services at

[www.emersonnetworkpower.com](http://www.emersonnetworkpower.com)  
[www.eu.emersonnetworkpower.com](http://www.eu.emersonnetworkpower.com)  
[www.emerson.com](http://www.emerson.com)  
[www.knuerr.com](http://www.knuerr.com)

While every precaution has been taken to ensure accuracy and completeness in this literature, Emerson Network Power assumes no responsibility and disclaims all liability for damages resulting from use of this information or for any errors or omissions.

©2011 Emerson Network Power.  
All rights reserved throughout the world. Specifications subject to change without notice.

## Emerson Network Power™

*The Global leader in Business-Critical Continuity™ solutions.*

- |                |  |                              |                               |
|----------------|--|------------------------------|-------------------------------|
| ■ AC Power     | ■ Embedded Computing                     | ■ Outside Plant              | ■ Racks & Integrated Cabinets |
| ■ Connectivity | ■ Embedded Power                         | ■ Power Switching & Controls | ■ Services                    |
| ■ DC Power     | ■ Infrastructure Management & Monitoring | ■ Precision Cooling          | ■ Surge Protection            |

Business-Critical Continuity, Emerson Network Power and the Emerson Network Power logo are trademarks and service marks of Emerson Electric Co. ©2011 Emerson Electric Co.

### Locations

**Emerson Network Power - EMEA**  
Via Leonardo Da Vinci 16/18  
Zona Industriale Tognana  
35028 Piove di Sacco (PD) • Italy  
T +39 049 9719 111  
F +39 049 5841 257  
[marketing.emea@emersonnetworkpower.com](mailto:marketing.emea@emersonnetworkpower.com)

### Emerson Network Power - Racks and Solutions

Mariakirchener Straße 38  
94424 Arnstorf • Germany  
T +49 8723 27 0  
F +49 8723 27 154  
[info@knuerr.com](mailto:info@knuerr.com)

### Emerson Network Power - USA

1050 Dearborn Drive  
P.O. Box 29186  
Columbus, OH 43229  
T +1 614 8880246

### Emerson Network Power - Asia

7/F, Dah Sing Financial Centre  
108 Gloucester Road, Wanchai  
Hong Kong  
T +852 2572220  
F +852 28029250