

Issued/Distribuée/Publicado: 2013
Catalog/Catalogue/Catalogo: CQ-2030
Supersedes/Remplace/Reemplaza: 2011
MFG Code/Code de Fabricant/Codigo de Fabricante: RBR



Fleet + Heavy Duty Applications

Véhicules a usage intensif et flottes de véhicules Aplicaciones para Flotillas y Servicio Pesado

Includes 1996 + Newer Applications for Med/HD Trucks
Convientt aux camionnettes de gamme moyenne et aux camionnettes
a usage intensif construites en 1996 après.
Incluyen Aplicaciones de 1996 en adelante para Servicio Pesado.



For 1995 + Older Medium/HD Trucks see catalog #CQ-2030CD
Pour les modeles construits en 1995 ou avant, voir CQ-2030CD
Para aplicaciones 1995 y anteriores de Servicio Pesado ver CQ-2030CD

2013



PIC Gauge. The first digital tool that determines belt wear.



Think outside the toolbox.

Sharpen your Accessory Belt Drive System diagnostic skills with PIC Gauge – the world's most advanced, next gen, belt wear diagnostic tool – developed by Gates. PIC Gauge is the first-ever smartphone App that can deliver accurate measurement and evaluation of automotive and heavy-duty K-section serpentine belts.

Using state-of-the-art digital imaging technology in concert with industry-standard specifications for serpentine belts, PIC Gauge utilizes a photograph taken with the smartphone's built-in camera, by analyzing it with patent-pending software to determine the degree of rib wear detected.

Download PIC Gauge today!

PIC GAUGE ALLOWS YOU TO:

- Quickly perform important maintenance inspections for your customers.
- Show customers the degree of belt wear detected, educating them as to why a belt replacement is being recommended.
- Be confident in your belt replacement recommendations.



For more information contact your
CARQUEST/Gates Sales Representative
or visit gatesbeltwear.com

Get the app!
It's FREE!



When it comes to demanding heavy-duty applications, four out of five fleets demand CARQUEST products. We put state-of-the-art technology into our Green Stripe® products so they can withstand the punishment heavy-duty fleets and off-road equipment dish out.

Over the long haul, heavy-duty Green Stripe® products help lower your cost-per-mile by reducing your down time repairs – critical needs of any fleet operator. When you install CARQUEST belts and hoses, you ride with a name you can depend on, mile after mile.

Heavy-duty truck, bus and road + construction equipment dealers know CARQUEST as a leading supplier of products to the aftermarket. In fact, we're the No. 1 choice for long-lasting, dependable performance.

Table of Contents

Belts + Drive Systems	A2 - A5
Industrial Belts	A6
Hose + Systems	
Coolant	A7 - A13
Heater	A14 - A16
Hose Clamps	A17
Fuel Systems Hose	A18 - A21
Oil Systems + Power Steering Systems	A22
Braking Systems	A23 - A27
Hydraulics	
Hose Products	A28 - A31
Couplings + Adapters	A32 - A33
Accessories	A34
Air + Defroster Systems	A35 - A37
Service Hose	A38 - A40
Exhaust System Hose	A41
Fleet Accessories	A42
Merchandisers + Sales Aids	A43 - A45
Professional-Grade Tools	A46 - A49
How to Use	A50
Index by Equipment Type and Make	B1 - B2
Model and Manufacturer Index	C1 - C23
Abbreviations	C24
Alphabetical Listings	
Medium + Heavy-Duty Trucks [1996 + Newer] ...	1 - 224
Refrigeration Units	225 - 233
School Buses	234 - 386
Transit Buses	387 - 404
Road + Construction Equipment	405 - 510
Power Units	511 - 533
Lift + Industrial Equipment	534 - 581
Straight Hose Size List	583 - 584
Green Stripe® Truck and Bus V-Belts	
Listed by Number and Size	585 - 588
Green Stripe® Truck and Bus Powerband® Belts	
Listed by Number and Size	589 - 590
FleetRunner® Heavy-Duty V-Belts	
Listed by Number and Size	591 - 592
XL® Belts	
Listed by Number and Size	593 - 596
FleetRunner® Micro-V® Belts	
Listed by Number and Size	597 - 601
Micro-V AT® Belts	
Listed by Number and Size	602 - 610
Special Belts	
Listed by Number and Size	611 - 612
Hi-Power® II V-Belts	
Listed by Number	613 - 614
Hi-Power® II PowerBand® Belts	615
Super HC® V-Belts	616
Super HC® PowerBand® Belts	617
Tri-Power® V-Belts	618
Truflex® and PoweRated®	619 - 620
Green Stripe® Vulco-Flex® Coolant Hose	
Listed by Number and Size	621 - 622
Vulco-Flex® II Coolant Hose	
Listed by Number and Size	623 - 624
Air Vent Hose	
Manufacturers Part Numbers	625
Changeover Listing	626
Air Vent Hose Dimensions	627 - 629
Changeover Listing - FleetRunner®	630 - 631

Issued/Distribuée/Publicado: 2013
 Catalog/Catalogue/Catalogo: CQ-2030
 Supersedes/Remplace/Reemplaza: 2011
 MFG Code/Code de Fabricant/Código de Fabricante: RBR

Warning

Be safe! Do not use CARQUEST belts, pulleys or sprockets on any aircraft propeller or rotor drive systems or in-flight accessory drives. Those CARQUEST products are not designed or intended for aircraft use.

Caution

Use CARQUEST products only on applications specified in CARQUEST literature. Install and maintain products according to the vehicle manufacturers' recommended procedures and with recommended tools. Failure to follow these instructions could result in injury or property damage. CARQUEST disclaims all liability due to failure to follow these instructions.

Limited Warranty for the Life of the Merchandise

Goods are warranted to be free from defects in material or workmanship for the life of the Goods (or the published recommended replacement interval specified by CARQUEST). CARQUEST will replace or repair, at its option, any Goods proved defective in material or workmanship during the warranty period. This is the sole remedy for breach of warranty. Color fade and color difference is not warranted. This warranty is void if the defect is caused by improper installation, use or maintenance of the Goods, or used for racing or competition. Goods are not warranted to comply with laws that may apply to uses of the Goods not stated in related materials, e.g., use in manned or unmanned aviation or life support applications.

ALL OTHER WARRANTIES, EXPRESS OR IMPLIED, INCLUDING, BUT NOT LIMITED TO WARRANTIES OF MERCHANTABILITY AND FITNESS FOR A PARTICULAR PURPOSE, ARE EXPRESSLY DISCLAIMED. FAILURE TO REPLACE TIMING BELTS OR OTHER CARQUEST PRODUCTS AS SPECIFIED MAY RESULT IN CATASTROPHIC ENGINE OR EQUIPMENT DAMAGE FOR WHICH CARQUEST DISCLAIMS ALL RESPONSIBILITY, TO THE EXTENT PERMITTED BY APPLICABLE LAW.

This publication contains the latest information available to our engineers. If you require additional application or part number information, contact the Automotive Product Application Tech Line at 303-744-5651.



Copyright 2013
 Printed in U.S. of America

CARQUEST Corporation
 Raleigh, NC 27604



Belts + Drive Systems

Micro-V® Dual-sided Belts

For replacing original equipment belts on serpentine drives that require a higher degree of efficiency when transmitting power. Designed for small diameter pulleys and for use with or without automatic tensioners.

- V-ribbed on both sides of the belt.
- Specially designed to resist wear and cracking.
- Broad coverage on unique applications.

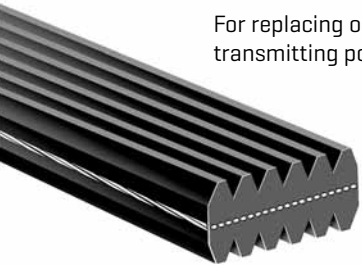

XL® V-Belts

Replacement belt for the most demanding engine drives. Due to thermal forces, this variable notched belt tightens on the drive as it gets hot. This results in improved belt performance by reducing tension decay and noise.

- Fiber-loaded rubber stock puts more flexibility along the length of the belt, yet gives the belt greater lateral stability in the pulley.
- Thermally active tensile cords for maintenance-free performance when properly installed and tensioned.
- Form ground to ensure precise top width and sidewall dimensional control for proper fit in pulley as well as a smoother, quieter running belt.
- Meets or exceeds SAE J636c specifications.

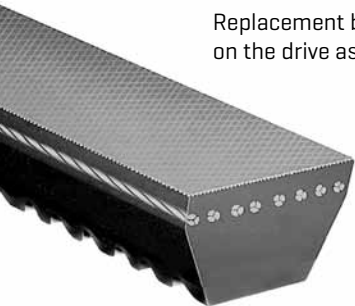

FleetRunner® Heavy-Duty V-Belts

Patented EPDM construction with distinct green overcord built specifically for more durability and longer life on heavy duty drives.

- Outperforms the competition on the most troublesome drives.
- Special compound provides un-matched flexibility, stability, load carrying capacity and belt life.
- Patented material provides peak performance at extreme prolonged operating temperatures.
- Heavy-duty construction resists cracking and wear.
- Oil and heat resistant.
- Unique undercord notch pattern offers increased flexibility for smaller diameter pulleys.
- Available in over 70 sizes.

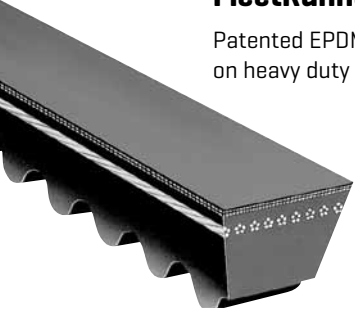

FleetRunner® Micro-V® Belts

Designed for the toughest applications, FleetRunner® construction provides superior flexibility, stability, load capacity and unsurpassed belt life. Patented materials deliver peak performance at extreme prolonged operating temperatures making this belt the ultimate problem solver. An advanced blend of EPDM rubber technology withstands the modern threats of deterioration from increased exposure to ozone and water-based coolants. FleetRunner® does this all while providing the lowest cost per mile for fleets, including $\frac{3}{4}$ + 1 ton pickups.

- Belt of choice by fleets, including $\frac{3}{4}$ + 1 ton pickups.
- Lowest cost per mile.
- Consistently outperforms all competitors.
- Outstanding crack resistance at extreme temperatures.
- Problem-solver designed for the toughest applications.

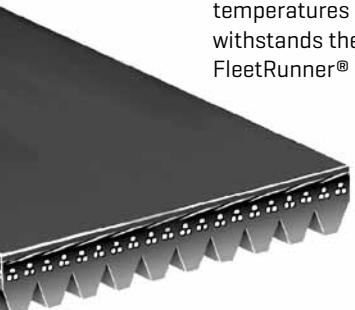

Belts + Drive Systems

Green Stripe® Micro-V AT® Belts

Long wearing fiber-loaded stocks with greater load-carrying capacity designed for demanding, heavy-service drives. Designed for replacing original belts on serpentine drives and other heavy-duty V-ribbed belt applications.

- Special belt constructions eliminate belt noise, reduce tension loss and solve problem drive applications.
- Extra heavy-duty construction resists cracking and wear.
- Precision ground to assure optimum belt-to-pulley fit.
- Special formation process for precise dimensional control.
- Reinforced with stretch-resistant, thermally active polyester tensile members.
- Meets or exceeds SAE J1459 specifications.

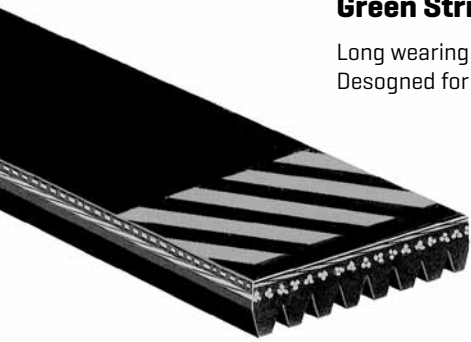

Green Stripe® PowerBand® Belts

Designed for problem, heavy-duty, heavily vibrating applications requiring belt sets. Tie-band feature joining belts together ensures stability lacking in ordinary belt sets.

- Even load distribution between strands provides better shock load absorption.
- Belt cannot turn over or slip off drive.
- Unique tensile cord design gives belt extra strength, added flexibility and shock-load resistance.
- Molded notches reduce bending stress, especially on small diameter pulleys, while dissipating heat.
- Meets or exceeds SAE J1459 specifications.

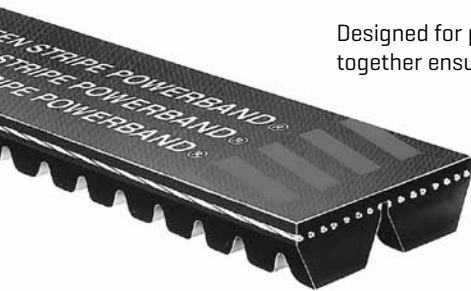

Green Stripe® Truck and Bus Series V-Belts

Specifically designed for heavy-duty truck, bus and off-road equipment applications. Absorbs normal shock loads without damage to belt.

- Special tensile cords give high stretch resistance.
- Special notch design resists cracking while providing tensile member support during operation.
- Oil and heat-resistant construction throughout.
- Meets SAE J636b and SAE J637 specifications.

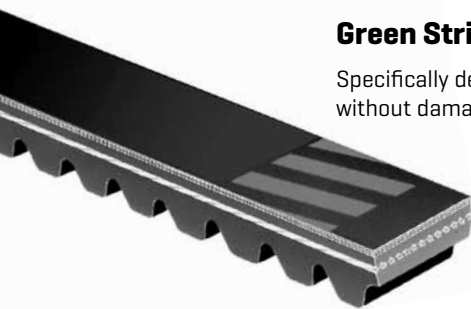

Green Stripe® XL® V-Belts

Premium quality replacement belts for heavy-duty engines.

- Fiber loaded rubber stock puts added flexibility along belt's length, yet affords greater lateral stability.
- Variable notch pattern causes belt to run cooler, quieter and with less bending stress.
- Precision V-forming process assures exact size and angle control.
- High tenacity tensile cords and special layer of reinforcement for long, maintenance-free performance when belt is properly installed and tensioned.
- Meets or exceeds SAE 636 specifications.
- Meets or exceeds RMA standards for static conductivity.

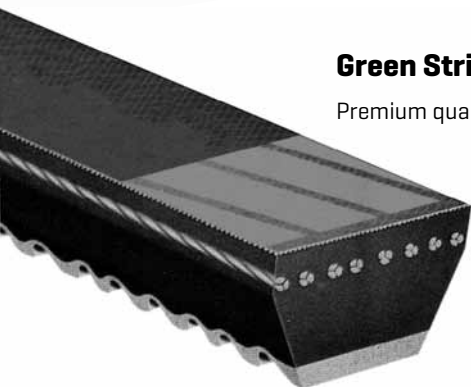

Belts + Drive Systems

Hi-Power® II Belts

Featuring a composite, multi-purpose construction, these belts resist oil and heat, ozone, sunlight, weather and aging. Suitable for all industrial applications, including v-flat drives.



- Curves provide proper cord support and full contact with the sheave-groove for uniform loading, uniform wear and increased belt life.
- Flex-bonded cords are strongly bonded to the body of the belt resulting in equal load distribution and the absorption of bending stress without cord deterioration.
- The Flex-Weave® Cover is a patented fabric construction for longer cover life, providing extended protection to the belt core from oil, dirt and heat.
- Meet or exceed RMA standards for static conductivity and oil and heat resistance.

Tri-Power® Belts

Constructed with proprietary construction, this belt has a superior combination of flex and load carrying capacity, as well as less stretch resulting in less maintenance. This provides superior performance on the toughest heavy-duty A, B and C Section industrial drives. Suitable for all industrial applications, particularly where small or sub-minimal sheave diameters are required.



- Notches molded into the belt during manufacturing make this belt well suited for drives with smaller diameter sheaves.
- Belt edge is machined for even sheave groove contact resulting in less slip and wear.
- Flex-bonded cords are strongly bonded to the body of the belt resulting in equal load distribution and the absorption of bending stress without cord deterioration.
- Meets RMA oil and heat resistant standards.
- Meets RMA static conductivity requirements.

Note: Tri-Power® belts are available in AX, BX, and CX sizes.

Tri-Power® belts longer than 210 inches are a banded, cut notch construction.

DriveAlign® Heavy-Duty Automatic Belt Tensioners

The longest lasting belt tensioners in the industry. Engineered to exceed demanding OEM requirements. In laboratory tests, under extreme peak-to-peak vibration and contamination tests, DriveAlign® heavy-duty tensioners lasted up to three times longer than competitive aftermarket tensioners.



- Labyrinth Seal – prevents contamination of internal parts for maximum durability and service life.
- Machined Steel Pulley – reduces surface wear while shielding internal bearing from outside contaminants.
- Double Row Bearings – twin rows of bearings carry more load and last up to three times longer than two individual bearings.
- Optimized Components – engineered for maximum strength and durability.
- Patented Design – provides superior belt alignment and tension for improved drive efficiency and life.
- Round Spring Wire – includes chrome-silicone torsion spring for less flex-fatigue than flat-wire designs.
- Patented Damping Mechanism – provides maximum stability, reducing vibration and increasing the life of belt, tensioner and other accessory drive components.

Belts + Drive Systems

DriveAlign® Heavy-Duty Idler Pulleys

Long-lasting pulleys built to endure the rigors of today's heavy-duty, fleet and off-road equipment.



- Superior bearings out perform OE Idler Pulleys.
- Robust and high quality pulley materials to withstand contaminants.
- New hardware included on some popular applications.
- Built with precise dimensional tolerance to ensure proper fit and long lasting performance.
- Built with corrosive-resistant coating to prevent rust and increase durability.

Belt Wear and the Accessory Belt Drive System (ABDS)

An important message on Belt Wear and its role in the ABDS!!

New belt vs. Worn belt illustration

Over time, belt ribs lose material, similar to a tire. With material loss, the space between the ribs increases which can cause the belt to “bottom out” on the pulley, resulting in:

- accelerated belt wear
- slip
- noise
- hydroplaning

Neoprene belts exhibit cracks as they age. Ethylene Propylene Diene Monomer (EPDM), belts do **NOT** show cracks as quickly and have a life expectancy of 50-60K miles. Until all belt manufacturers supply EPDM belts, you will continue to see cracks as a sign of wear on belts!

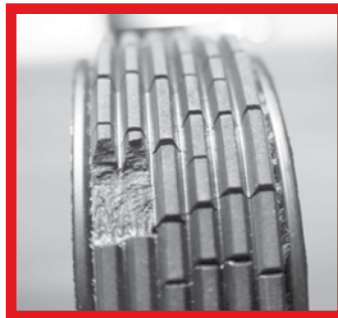

Neoprene belt with 100,000 miles

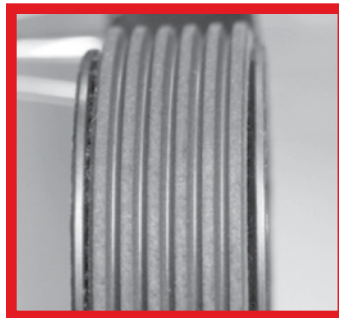

EPDM belt with 100,000 miles

Industrial Belts

Super HC® and Super HC® Molded Notch V-Belts

Recommended for use on special drives where space and weight limitations are critical. These “narrow” cross-sections can transmit up to three times the horsepower of the classical cross-sections (A, B, C and D) in the same amount of drive space. Suitable for all industrial applications, particularly where space, weight and horsepower capacity are critical.

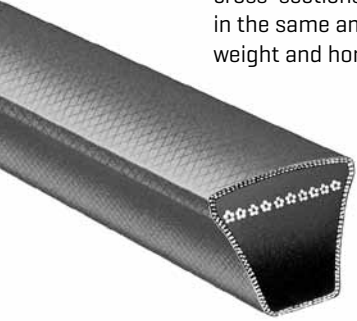

- Curves provide proper cord support and full contact with the sheave-groove for uniform loading, uniform wear and increased belt life.
- Flex-bonded cords are strongly bonded to the body of the belt resulting in equal load distribution and the absorption of bending stress without cord deterioration.
- The Flex-Weave® cover is a patented construction for longer cover life, providing extended protection to the core of the belt from oil, dirt, and heat.
- Meets or exceeds RMA standards for static conductivity and heat and oil resistance.

Industrial Micro-V® Belts (J, L and M Series)

Exclusive truncated [shortened] profile gives Micro-V® belts increased flexibility, reduced heat buildup and allows performance at higher speeds on smaller diameter sheaves. Well suited for applications such as appliances, outdoor power equipment, roller conveyors, machine tools, medical equipment and exercise equipment.

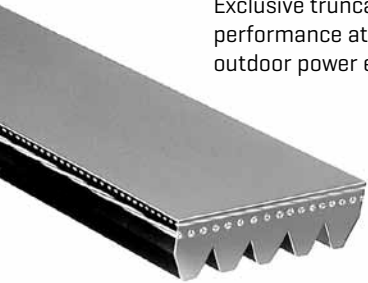

- Fiber reinforced ribs for excellent wear resistance.
- High modulus, low stretch tensile member for added strength and dependability.
- Smooth running for minimal vibration at high speeds.
- Meets or exceeds RMA standards for static conductivity and heat and oil resistance.

Super HC® and Super HC® Molded Notch PowerBand® V-Belts

The PowerBand® construction allows multiple belts to function as a single unit, with even load distribution and each strand fitting securely in the sheave groove. Recommended for multiple V-belt drives exposed to pulsating or heavy shock loads which can make belts whip, turn over or jump off the drive.

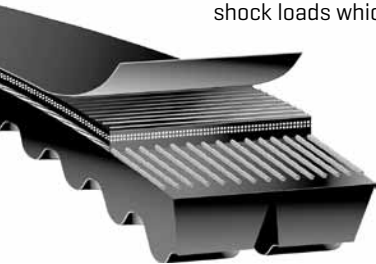

- The tie band assures high lateral rigidity, guiding the belt in a straight line and preventing it from coming off the drive.
- Concave sidewalls provide proper cord support and full contact with the sheave-groove for equal loading and uniform wear.
- Flex-bonded cords are strongly bonded to the body of the belt resulting in equal load distribution and the absorption of bending stress without cord deterioration.
- Meets or exceeds RMA standards for static conductivity and heat and oil resistance.

Hose + Systems

Coolant

Hose Shelf Life

Storage environment, along with rubber materials, can vary the shelf life limit. Shelf life is difficult to quantify as many variables affect the hose. Proper storage precautions can result in three to five years of shelf life. Beyond this time, there can be a significant service life decrease, depending on storage environment variables.

Some variables include:

Hose should be stored in a cool, dry area never exceeding +100°F [+38°C]. If stored below freezing, pre-warming may be required prior to handling, testing and placing into service. Store hose in original container. Never stack hose too high, as its weight can crush hose at the bottom of the stack. CARQUEST recommends hose in extended storage be visually inspected and tested prior to use. Hose judged marginal should be replaced to avoid potential failure, property damage or bodily injury. Store hose on a first-in/first-out basis. Unusually long storage, or poor storage environment can deteriorate hose, reduce performance and may lead to premature failure.

Molded Coolant Hose

CARQUEST molded coolant hose is manufactured to fit specific applications. Similar to OEM specifications. Approved for marine applications.



- Recommend for upper, lower, by-pass, heater and other coolant hose applications.
 - Heat and ozone resistant cover.
 - Engineered to resist electrochemical degradation - the leading cause of hose failure.
 - Re-engineered materials resist vacuum collapse, this reduces the need for internal springs in many applications.
 - Meets SAE 20R4 and 20R3 Type EC Class D-1 and D-2 specifications.
 - Temperature rating: -40° F to 275° F [-40° C to 135° C] in coolant hose applications.
- Note:** CARQUEST recommends replacing standard worm drive and spring loaded clamps with PowerGrip® SB Clamps each time a new coolant hose is installed.
- Caution:** Do not use for fuel or oil transfer applications.

Branched Radiator Hose

Molded to fit specific applications. Factory quality connections are durable and eliminate coolant leaks.



- Engineered to resist electrochemical degradation - the leading cause of hose failure.
 - Heat and ozone resistant cover.
 - Meets SAE 20R4 and 20R3 Type EC Class D-1 and D-2 specifications.
 - Temperature rating: -40°F to +275°F [-40°C to +135°C] in coolant hose applications.
- Note:** CARQUEST recommends replacing standard worm drive and spring loaded clamps with PowerGrip® SB Clamps each time a new coolant hose is installed.
- Caution:** Do not use for fuel or oil transfer applications.

Hose + Systems

Coolant

Vulco-Flex® II Coolant Hose

Vulco-Flex® II hose will bend in almost any direction. It easily replicates the angles and planes of a wide variety of expensive original equipment coolant hose, for quick, easy replacement.



- Improved sealing surface for greater leak resistance and increased flexibility for easier installation.
- Heat and ozone resistant cover.
- Rated for SAE 20R5 Class D-2 performance.
- High temperature rating up to +257°F[+125°C].

Note: CARQUEST recommends replacing clamps each time a new coolant hose is installed.

Caution: Do not use for fuel or oil transfer applications.

Part No.	I.D. Inches[mm]	Length Inches[mm]	Part No.	I.D. Inches[mm]	Length Inches[mm]
25150	1 ¹ / ₈ [29]	12[305]	25384	1 ³ / ₈ [35]	25[635]
25152	1 ¹ / ₈ [29]	15[381]	25409	1 ³ / ₈ [35], 1 ¹ / ₂ [38]	26[660]
25154	1 ¹ / ₈ [29]	18[457]	25428	1 ³ / ₈ [35], 1 ⁵ / ₈ [41]	17[432]
25157	1 ¹ / ₈ [29]	23[584]	25472	1 ¹ / ₂ [38]	8[205]
25180	1 ¹ / ₈ [29], 1 ¹ / ₄ [32]	19[483]	25473	1 ¹ / ₂ [38]	10 ¹ / ₂ [265]
25249	1 ¹ / ₄ [32]	7 ¹ / ₂ [190]	25474	1 ¹ / ₂ [38]	12[305]
25250	1 ¹ / ₄ [32]	9 ¹ / ₂ [240]	25476	1 ¹ / ₂ [38]	14[356]
25251	1 ¹ / ₄ [32]	13[330]	25477	1 ¹ / ₂ [38]	15 ¹ / ₂ [394]
25252	1 ¹ / ₄ [32]	15[381]	25478	1 ¹ / ₂ [38]	17[394]
25253	1 ¹ / ₄ [32]	17[432]	25480	1 ¹ / ₂ [38]	20[508]
25254	1 ¹ / ₄ [32]	18 ¹ / ₂ [470]	25482	1 ¹ / ₂ [38]	22[559]
25255	1 ¹ / ₄ [32]	20[508]	25484	1 ¹ / ₂ [38]	25[635]
25257	1 ¹ / ₄ [32]	23[584]	25487	1 ¹ / ₂ [38]	30[762]
25260	1 ¹ / ₄ [32]	26 ¹ / ₂ [673]	25490	1 ¹ / ₂ [38]	35[889]
25262	1 ¹ / ₄ [32]	30[762]	25499	1 ¹ / ₂ [38]	48[1219]
25265	1 ¹ / ₄ [32]	35[889]	25526	1 ¹ / ₂ [38], 1 ³ / ₄ [44]	13 ¹ / ₅ [335]
25269	1 ¹ / ₄ [32]	41[1041]	25527	1 ¹ / ₂ [38], 1 ³ / ₄ [44]	15[381]
25284	1 ¹ / ₄ [32], 1 ³ / ₈ [35]	26[660]	25528	1 ¹ / ₂ [38], 1 ³ / ₄ [44]	16 ¹ / ₂ [419]
25300	1 ¹ / ₄ [32], 1 ¹ / ₂ [38]	12[305]	25530	1 ¹ / ₂ [38], 1 ³ / ₄ [44]	20[508]
25302	1 ¹ / ₄ [32], 1 ¹ / ₂ [38]	15 ¹ / ₂ [394]	25532	1 ¹ / ₂ [38], 1 ³ / ₄ [44]	22[559]
25305	1 ¹ / ₄ [32], 1 ¹ / ₂ [38]	19 ¹ / ₂ [495]	25535	1 ¹ / ₂ [38], 1 ³ / ₄ [44]	27[686]
25307	1 ¹ / ₄ [32], 1 ¹ / ₂ [38]	23[584]	25582	1 ¹ / ₂ [38], 2[51]	22[559]
25309	1 ¹ / ₄ [32], 1 ¹ / ₂ [38]	26[660]	25804*	1 ¹ / ₂ [38]	19 ³ / ₄ [505]
25311	1 ¹ / ₄ [32], 1 ¹ / ₂ [38]	29[737]	25806*	1 ¹ / ₂ [38]	23 ¹ / ₈ [589]
25321	1 ¹ / ₄ [32], 1 ¹ / ₂ [38]	44[1118]	25808*	1 ¹ / ₂ [38]	25 ⁵ / ₈ [650]

* 90° end

Hose + Systems

Coolant

Vulco Straight Coolant Hose

Specially engineered stick hose is ideal for straight coolant/air connections in automotive, stationary engine, industrial and home applications.

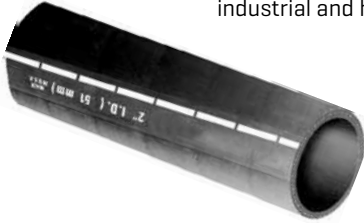

- Heat-resistant cover.
- Meets SAE 20R1 Standard Wall Class D-2 requirements.
- Cover marked in one-inch increments for easy measuring and cutting allows "custom fit" light-duty coolant installations.
- Temperature rating: -40°F to 257°F [-40°C to 125°C].
- Packaging: 3 ft. lengths.

Caution: Do not use for fuel or oil transfer applications.

Part No.	I.D. (In.)	O.D. (In.)	Work. Press. (psi)	Part No.	I.D. (In.)	O.D. (In.)	Work. Press. (psi)	Part No.	I.D. (In.)	O.D. (In.)	Work. Press. (psi)
24008	1/2	.89	105	24026	1 5/8	2.02	55	24042	2 5/8	3.02	30
24012	3/4	1.14	80	24028	1 3/4	2.14	50	24044	2 3/4	3.14	30
24014	7/8	1.27	80	24030	1 7/8	2.27	50	24046	2 7/8	3.27	25
24016	1	1.39	75	24032	2	2.39	50	24048	3	3.39	25
24018	1 1/8	1.52	75	24034	2 1/8	2.52	45	24052	3 1/4	3.64	20
24020	1 1/4	1.64	65	24036	2 1/4	2.64	40	24056	3 1/2	3.89	18
24022	1 3/8	1.77	65	24038	2 3/8	2.77	40	24064	4	4.39	12
24024	1 1/2	1.89	60	24040	2 1/2	2.89	35				

Green Stripe® 4-Ply Coolant Hose

For severe operating conditions found on stationary engines, construction equipment and off-road vehicle applications. Nitrile tube specially compounded to handle common coolants and additives.

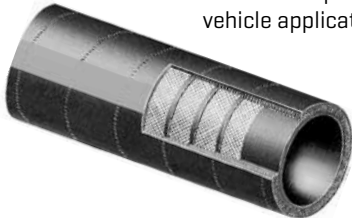

- Four-ply woven, heavy-duty fabric reinforcement
- Neoprene cover resists heat, abrasion and oil.
- Handles higher temperatures and resists petroleum additives.
- Exceeds SAE 20R1 [Class B Tube, Class C Cover, Heavy Wall].
- Reduces water loss from water permeating the hose wall and cover, a distinct advantage over silicone.
- Engineered to resist electrochemical degradation – the leading cause of hose failure.
- Temperature rating: -40°F to +212°F [-40°C to +100°C], intermittent to 257°F [125°C].
- Packaging: 3 ft. lengths, 1 each.



Caution: Do not use for gasoline or diesel transfer applications.

Part No.	I.D. (In.)	O.D. (In.)	Work. Press. (psi)	Part No.	I.D. (In.)	O.D. (In.)	Work. Press. (psi)	Part No.	I.D. (In.)	O.D. (In.)	Work. Press. (psi)
24428	1 3/4	2.31	100	24440	2 1/2	3.06	75	24452	3 1/4	3.81	50
24430	1 7/8	2.43	100	24442	2 5/8	3.18	75	24456	3 1/2	4.06	50
24432	2	2.56	90	24444	2 3/4	3.31	60	24458	3 5/8	4.18	50
24434	2 1/8	2.68	90	24446	2 7/8	3.43	60	24460	3 3/4	4.31	50
24436	2 1/4	2.81	90	24448	3	3.56	60	24464	4	4.56	40
24438	2 3/8	2.94	90	24450	3 1/8	3.68	60	24480	5	5.56	40

Hose + Systems

Coolant

Green Stripe® Vibraflex® Coolant Hose

For heavy-duty applications requiring short length hose that must absorb vibration and/or fitting misalignment. High flexibility reduces installation time and provides lower cost-per-mile operation.



- Oil and heat resistant nitrile tube.
- Oil, abrasion and heat resistant neoprene cover.
- Exceeds SAE J20 [Class B Tube and Class C Cover].
- Two-ply fabric reinforced.
- Temperature rating: -40°F to 212°F [-40° to 100°C].
- Packaging: One each, not cartoned.

Caution: Do not use for gasoline or diesel transfer applications.



Part No.	I.D. [In.]	Work. Press. [psi]	Part No.	I.D. [In.]	Work. Press. [psi]	Part No.	I.D. [In.]	Work. Press. [psi]
23505	1¼ x 4	70	23547	2¼ x 4½	40	23567	2¾ x 4½	30
23511	1¾ x 5	60	23557	2¾ x 5	35	23568	2¾ x 5¾	30
23515	1½ x 5	60	23559	2¾ x 6¼	35	23572	3 x 4	25
23520	1¾ x 5	55	23562	2½ x 4½	35	23575	3 x 7	25
23531	2 x 3½	50	23550	2½ x 6	35	23585	3½ x 5½	25
23533	2 x 5	50	23566	2¾ x 3¼	30			

Wire-Inserted Green Stripe® Coolant Hose

Provides the ability to replace many sizes of tailor-made curved hoses. Results in maximum coverage with minimum inventory. Approved for marine applications.



- Heavy-duty fabric reinforcement with helical carbon steel wire.
- Bends easily to make curved connections.
- Cuts easily with knife and wire cutters to reduce installation time.
- Exceeds SAE 20R2 Type EC [Class D2 Tube and cover] except in vacuum applications.
- Engineered to resist electrochemical degradation - the leading cause of hose failure.
- Temperature rating: -40°F to +257°F [-40°C to +125°C].
- Packaging: Available in 5 ft. and 10 ft. lengths, individually cartoned.

Caution: Do not use for fuel or oil transfer applications.



Part No. 5 Foot	Part No. 10 Foot	I.D. [In.]	O.D. [In.]	Work. Press. [psi]	Vacuum [In. Hg.]	Min. Bend Radius [In.]	Part No. 5 Foot	Part No. 10 Foot	I.D. [In.]	O.D. [In.]	Work. Press. [psi]	Vacuum [In. Hg.]	Min. Bend Radius [In.]
24916	28316	1	1.46	100	25	2	24938	—	2¾	2.83	50	20	6½
24918	—	1½	1.58	100	25	2½	24940	28340	2½	2.96	50	20	6½
24920	28320	1¾	1.71	100	25	2½	24942	—	2¾	3.08	40	15	7½
24922	—	1¾	1.83	85	25	3	24944	28344	2¾	3.21	40	15	7½
24924	28324	1½	1.96	85	20	3½	24946	—	2¾	3.33	40	15	9
24926	28326	1¾	2.08	75	20	3½	24948	28348	3	3.43	40	15	9
24928	28328	1¾	2.21	75	20	4	24956	28356	3½	3.93	35	15	12
24930	28330	1¾	2.33	60	20	4½	24964	—	4	4.43	30	10	20
24932	28332	2	2.46	60	20	4½	24980	—	5	5.43	15	5	24
24934	—	2¾	2.58	55	20	5½	24996	—	6	6.43	15	5	30
24936	28336	2¼	2.71	55	20	5½							

NOTE: Long spans must be supported every 3 feet.

Hose + Systems Coolant

Green Stripe® Vulco-Flex® Coolant Hose

Heavy-duty flexible hose designed to replace straight or curved coolant hoses. The benefit is maximum coverage with minimum inventory. Hose inside diameter remains constant from end to end. No convolutions inside hose so tube is smooth, allowing free coolant flow. Approved for marine applications.



- Excellent flexibility, yet collapse and kink resistant.
- Extra strength fabric reinforcement with helical steel wire spiral molded between tube and cover.
- Heat resistant construction throughout.
- EPDM tube and neoprene cover for extended service life.
- Performs to SAE 20R5 Type EC Class D-2 specifications.
- Engineered to resist electrochemical degradation – the leading cause of hose failure.
- Temperature rating: -40°F to +257°F [-40°C to +125°C].
- Working pressure 40 psi maximum.
- Packaging: 5 per carton.

Caution: Do not use for fuel or oil transfer applications.

Part No.	I.D. Inches[mm]	Length Inches[mm]	Part No.	I.D. Inches[mm]	Length Inches[mm]
26501	1¾ [44]	13½ [343]	26516	2 [51], 2¼ [57]	17½ [445]
26502	1¾ [44]	16½ [419]	26517	2 [51], 2¼ [57]	25 [635]
26503	1¾ [44], 2 [51]	10 [254]	26518	2 [51], 2½ [64]	20 [508]
26504	1¾ [44], 2 [51]	16½ [419]	26519	2¼ [57]	9 [229]
26505	1¾ [44], 2 [51]	19 [483]	26520	2¼ [57]	11 [279]
26506	1¾ [44], 2 [51]	23½ [597]	26521	2¼ [57]	14 [356]
26507	2 [51]	9½ [241]	26522	2¼ [57]	17 [432]
26508	2 [51]	12¼ [311]	26530	2½ [64]	14 [356]
26509	2 [51]	14½ [368]	26531	2½ [64]	16 [406]
26510	2 [51]	17 [432]	26532	2½ [64]	24 [610]
26511	2 [51]	20 [508]	26533	2½ [64]	28 [711]
26512	2 [51]	24 [610]	26534	2¾ [70]	7 [178]
26513	2 [51]	33 [838]	26535	2¾ [70]	14 [356]
26514	2 [51], 2¼ [57]	8½ [216]	26536	2¾ [70]	18 [457]
26515	2 [51], 2¼ [57]	15 [381]	26537	2¾ [70]	32 [813]
26523	2¼ [57]	19 [483]	26538	3 [76]	37 [940]
26524	2¼ [57]	24 [610]	26601	1¾ [44]	6 [152]
26525	2¼ [57]	27 [686]	26602	1¾ [44]	8½ [216]
26526	2¼ [57], 2½ [64]	18 [457]	26603	1¾ [44]	11 [279]
26527	2¼ [57], 2½ [64]	21 [533]	26611	1¾ [44]	19 [483]
26528	2¼ [57], 2½ [64]	25 [635]	26612	1¾ [44]	23½ [597]
26529	2½ [64]	11 [279]			

Hose + Systems Coolant

Green Stripe® Straight Coolant Hose

Stick hose designed for demanding heavy-duty coolant/air applications. Approved for marine applications.



- Two-ply bias fabric construction to maximize flexibility and strength.
- Resists "cold water leaks" due to advanced EPDM tube and cover that stay soft and pliable, even under adverse operating conditions.
- Exceeds SAE 20R1 Type EC [Class D-1 Tube, and cover, Standard Wall].
- Cover marked in one-inch increments to facilitate approximate cut lengths, allows "custom-fit" installations.
- Engineered to resist electrochemical degradation – the leading cause of hose failure.
- Temperature rating: -40°F to +257°F [-40°C to +125°C].
- Packaging: 3 ft. lengths.



Note: For a maintenance free connection, use PowerGrip® SB Clamps.

Caution: Do not use for fuel or oil transfer applications.

Part No.	I.D. [In.]	O.D. [In.]	Work. Press. [psi]	Part No.	I.D. [In.]	O.D. [In.]	Work. Press. [psi]	Part No.	I.D. [In.]	O.D. [In.]	Work. Press. [psi]
24212	3/4	1.14	100	24230	1 7/8	2.27	75	24248	3	3.39	25
24214	7/8	1.27	100	24232	2	2.39	60	24250	3 1/8	3.52	25
24216	1	1.39	100	24234	2 1/8	2.52	60	24252	3 1/4	3.64	20
24218	1 1/8	1.52	100	24236	2 1/4	2.64	60	24256	3 1/2	3.89	18
24220	1 1/4	1.64	100	24238	2 3/8	2.77	60	24260	3 3/4	4.14	18
24222	1 3/8	1.77	100	24240	2 1/2	2.89	60	24264	4	4.39	12
24224	1 1/2	1.89	100	24242	2 5/8	3.02	60	24272	4 1/2	4.92	12
24226	1 5/8	2.02	85	24244	2 3/4	3.14	60				
24228	1 3/4	2.14	75	24246	2 7/8	3.27	55				

Silicone Coolant Hose

Extra long-lasting hose constructed with silicone rubber. Ideal for extremely high temperature service in radiator, heater and other coolant transfer hose applications.



- Excellent for extreme ambient and radiant temperature conditions.
- Resists weathering, ozone, heat and coolant deterioration.
- Silicone tube and cover resist prolonged exposure to under-hood and coolant heat.
- Use PowerGrip® SB clamps or silicone hose clamps.
- Exceeds SAE 20R1 [Class A Standard Wall].
- Temperature rating: -70°F to +350°F [-56°C to +177°C].
- Packaging: 3 ft. lengths. Individually polybagged.

Caution: Do not use for fuel or oil transfer applications.

Part No.	I.D. [In.]	Work. Press. [psi]	Part No.	I.D. [In.]	Work. Press. [psi]	Part No.	I.D. [In.]	Work. Press. [psi]	Part No.	I.D. [In.]	Work. Press. [psi]
24808	1/2	110	24820	1 1/4	85	24836	2 1/4	75	24852*	3 1/4	40
24810	5/8	110	24822	1 3/8	85	24838	2 3/8	65	24856*	3 1/2	35
24812	3/4	110	24824	1 1/2	85	24840	2 1/2	65	24860*	3 3/4	35
24814	7/8	110	24826	1 5/8	80	24844	2 3/4	50	24864*	4	35
24816	1	90	24828	1 3/4	80	24848	3	50	24872*	4 1/2	25
24818	1 1/8	90	24832	2	75	24850	3 1/8	40			

* SB clamps not available, use silicone hose clamps

Hose + Systems

Coolant

Molded Silicone Elbow Coolant Hose

Newer heavy-duty engines with advanced emissions systems [from 2007 to current model year] produce higher under-hood temperatures, requiring the use of silicone coolant hose. In these new low engine-air-flow and high-heat conditions, Silicone Coolant Hose is the perfect product.

CARQUEST now offers high-quality 4-ply silicone coolant hose for high-heat (up to 500°F) performance in these demanding conditions.

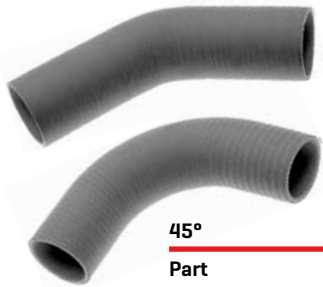

- Premium 4-ply construction.
- High-heat resistance material meets or exceeds OE specifications.
- Industry standard blue cover for easy identification.
- Used when hose routing passes near turbo or hot side of the charged air system.

45°		90°	
Part No.	I.D. (In.)	Part No.	I.D. (In.)
28205	1 ³ / ₄	28217	1 ³ / ₄
28206	2	28210	2
28200	2 ¹ / ₂	28211	2 ¹ / ₄
28207	2 ¹ / ₄	28212	2 ¹ / ₂
28201	2 ³ / ₄	28213	2 ³ / ₄
28202	3	28214	3
28203	3 ¹ / ₂	28215	3 ¹ / ₂
28204	4	28216	4

500°F Severe Service Silicone Coolant Hose

Newer heavy-duty engines with advanced emissions systems [from 2007 to current model year] produce higher under-hood temperatures, requiring the use of silicone coolant hose. In these new low engine-air-flow and high-heat conditions, Silicone Coolant Hose is the perfect product.

CARQUEST now offers high-quality 4-ply silicone coolant hose for high-heat (up to 500° F) performance in these demanding conditions.



- Available in 36" straight sections.
- Premium 4-ply construction.
- High heat resistance material meets or exceeds OE specifications.
- Industry standard blue cover for easy identification.
- Used when hose routing passes near turbo or hot side of the charged air system.

Part No.	I.D. (In.)	Part No.	I.D. (In.)
28225	1	28230	2 ¹ / ₄
28226	1 ¹ / ₄	28231	2 ¹ / ₂
28227	1 ¹ / ₂	28232	2 ³ / ₄
28228	1 ³ / ₄	28233	3
28229	2		

Hose + Systems

Heater

90° Molded Heater Hose

Especially designed for difficult heater hose applications requiring sharp 90° bends in the hose. Eliminates the need for extensive inventory of OE type curved heater hose. Just 22 sizes handle thousands of applications.



- Engineered to resist electrochemical degradation – the leading cause of hose failure.
- Resists water permeation.
- Similar to heater SAE 20R3 Type EC Class D-2.
- Use with heater hose connectors and bulk heater hose for virtually complete molded heater hose coverage.
- Temperature rating: -40°F to 275°F [-40°C to 135°C].

Caution: Do not use for fuel or oil transfer applications.

Arm Lengths [In.]	Arm Lengths [mm]	1/4" [6.35mm]	5/16" [7.9mm]	3/8" [9.5mm]	1/2" [12.7mm]	5/8" [15.9mm]	5/8" x 3/4" [15.0 x 19.1mm]	3/4" x 5/8" [19.1 x 15.9mm]	3/4" [19.0mm]
4 x 6	101.6 x 152.4	18010	18020	18030	28460	28466	18079	18070	28474
4 x 12	101.6 x 304.8	18011	18021	18031	28461	28467	—	18071	28475
4 x 18	101.6 x 457.2	—	—	—	28462	28468	18076	—	28476
8 x 18	203.2 x 457.2	—	—	—	28463	28469	—	18072	—
4 x 24	101.6 x 609.6	—	—	—	28464	28470	—	18073	28477
8 x 24	203.2 x 609.6	—	—	—	—	—	—	—	28478
4 x 33	101.6 x 825.0	—	—	—	—	—	18077	—	—
8 x 34	203.2 x 863.6	—	—	—	—	—	—	18078	—
4 x 36	101.6 x 914.4	—	—	—	28465	28471	—	18074	28479
4 x 48	101.6 x 1219.2	—	—	—	—	28472	—	—	28480
4 x 60	101.6 x 1524.0	—	—	—	—	28473	—	18075	28481

Silicone Heater Hose

Constructed with silicone rubber. Ideal for extremely high temperature service in radiator, heater and other coolant transfer hose applications. Approved for marine applications.



- Reinforced with tough, high temperature resistant polyester textile cords.
- Exceptionally flexible.
- Highly resistant to weathering, coolant deterioration, ozone and temperature extremes.
- Exceeds SAE 20R3 Class A Tube and Cover.
- Can be used for emission hose applications.
- For proper installation, use PowerGrip® SB clamps or silicone hose clamps.
- Temperature rating: -70°F to +400°F [-57°C to +204°C].
- Packaging: Individually cartoned.

Caution: Do not use for fuel or oil transfer applications.

Part No.	I.D. [In.]	I.D. [mm]	O.D. [In.]	O.D. [mm]	Length [Ft.]	Work. Press. [psi]
26239	3/8	9.5	.74	17.5	25	60
26240	1/2	12.7	.87	20.7	25	60
26241	5/8	15.9	.99	23.9	25	60
26242	3/4	19.0	1.12	27.0	25	50
26244	1	25.4	1.37	33.4	25	45

Hose + Systems

Heater

Green Stripe® Heater Hose

Heavy-duty construction assures dependable operation in truck, bus and off-road equipment heater systems. For a maintenance free connection, install with Power-Grip® SB clamps. Approved for marine applications.



- Green Stripe® construction provides best cost-per-mile economics.
- Cover is abrasion resistant.
- Advanced EPDM tube, cover and reinforcement withstand high under-hood and coolant temperatures. Designed for extended use without cracking or hardening.
- Engineered to resist electrochemical degradation – the leading cause of hose failure.
- Exceeds SAE 20R1 Type EC, Standard Wall Class D-1.
- Reduces water loss from water permeating the hose wall and cover, a distinct advantage over silicone.
- Temperature rating: -40°F to +275°F [-40°C to +135°C].
- Packaging: Individually cartoned.

Caution: Do not use for fuel or oil transfer applications.

Part No.	I.D. [In.]	I.D. [mm]	Length [Ft.]	Working Pressure [psi]
28439	1/2	12.7	50	105
28441	5/8	15.9	50	95
28442	3/4	19	50	80
28443	7/8	22.2	50	80
28444	1	25.4	50	75
28445	1 1/4	31.7	50	70
28447	5/8	15.9	300	95
28448	3/4	19	300	80
28449	1	25.4	300	75

Firewall® Heater Hose

Extra heavy-duty hose designed for maximum durability. Easily recognized by its red cover.

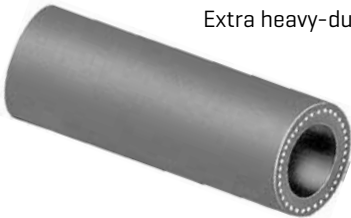

- Unaffected by most coolants and non-oil based coolant additives.
- Unaffected by high cooling system pressures.
- Similar to SAE 20R3 Class D-2.
- Temperature rating: -40°F to +257°F [-40°C to +125°C].
- Packaging: Individually cartoned.

Caution: Do not use for fuel or oil transfer applications.

Part No.	I.D. [In.]	I.D. [mm]	O.D. [In.]	Length [Ft.]	Working Pressure [psi]
28430	1/2	12.7	.77	50	60
28431	5/8	15.9	.89	50	60
28432	3/4	19.0	1.02	50	50
28433	5/8	15.9	.89	250	60
28434	3/4	19.0	1.02	250	50

Hose + Systems

Heater

Polybagged Safety Stripe® Heater Hose

Ideal self-service package for retail-oriented merchandising. Fits standard pegboard displays.



- Package measures 12" wide x 13" high.
- Hose comes in 6 ft. lengths of Safety Stripe® heater hose in 3/8", 1/2", 5/8" and 3/4" I.D.
- Packaging: 25 units per carton.

Part No.	I.D. [In.]	I.D. [mm]	O.D. [In.]
28489	3/8	9.5	.69
28490	1/2	12.7	.77
28491	5/8	15.9	.89
28492	3/4	19.0	1.02

Hose I.D. Reducers

Slip inside current hose to reduce inside diameters, providing maximum coverage with minimum hose inventory. Make it possible to adjust inside diameters of larger hoses for emergency replacements.



- Quality rubber construction assures maximum dependability, no leakage.
- Fits Green Stripe® straight or Green Stripe® Vulco-Flex® hoses.

Caution: Recommended for coolant and air applications only.

Part No.	Size [In.]	Part No.	Size [In.]
26390	1 1/2 to 1 1/4	26393	2 1/4 to 2
26391	1 3/4 to 1 1/2	26394	2 1/2 to 2 1/4
26392	2 to 1 3/4	26395	3 to 2 1/2

Dual I.D. Heater Hose

Specially designed for heater hose applications requiring changes in diameter. Use with hose connectors and bulk heater hose for virtually complete molded heater hose coverage.



- Engineered to resist electrochemical degradation – the leading cause of hose failure.
- Meets SAE 20R4 Type EC Class D-2.
- Temperature rating: -40°F to 275°F [-40C to 135°C].

Caution: Do not use for fuel or oil transfer applications.

Length [In.]	Part No. 1/2" x 5/8" I.D.	Part No. 5/8" x 3/4" I.D.
6	18050	18080
12	18051	18081
18	—	18082
36	—	18083
60	—	18084

Hose Clamps

PowerGrip® SB Clamps

Maintenance-free clamps that retain dynamic tension and never need retightening. These clamps stop leaks, even on out-of-round applications. Clamp down better in all conditions and temperature extremes. Environmentally friendly by eliminating antifreeze leaks and ground water contamination.



- Easy to install with ordinary heat gun.
- Wider sealing area entraps connector bead.
- Conform to any shape of hose and housing, even out-of-round fittings.
- Made from a heat-sensitive thermoplastic with a memory to prevent over- or under-tightening.
- Can be used with all brands of silicone hose.
- Temperature rating: -40°F - 302°F [-40°C - 150°C].
- Packaging: Ten to carton.

Part No.	Size	Nominal Hose I.D. [In.]	Fits Hose O.D. [In.]*	Part No.	Size	Nominal Hose I.D. [In.]	Fits Hose O.D. [In.]*	Part No.	Size	Nominal Hose I.D. [In.]	Fits Hose O.D. [In.]*
32915	SB15	1/4	1/2 to 11/16	32934	SB34	1	15/16 to 1 1/2	32967	SB67	2 1/4	2 1/2 to 2 3/4
32919	SB19	3/8	11/16 to 13/16	32941	SB41	1 1/4	1 1/2 to 1 3/4	32973	SB73	2 1/2	2 3/4 to 3
32922	SB22	1/2	13/16 to 15/16	32948	SB48	1 1/2	1 3/4 to 2	32979	SB79	2 3/4	3 to 3 1/4
32925	SB25	5/8	15/16 to 1 1/16	32954	SB54	1 3/4	2 to 2 1/4	32986	SB86	3	3 1/4 to 3 1/2
32929	SB29	3/4	1 1/16 to 1 3/16	32960	SB60	2	2 1/4 to 2 1/2	32990	SB90	3 1/8	3 1/2 to 3 5/8
32932	SB32	7/8	1 3/16 to 1 5/16								

Gates offers The Best Fleet + Heavy-Duty Solutions Available In The Industry

For over 100 years Gates has been the industry leader in innovation, durability and reliability for heavy-duty belts, hose and hydraulics.



Heavy Duty VIN Decoder

The Gates Heavy Duty VIN Decoder is easy and simple to use.

Visit www.vindecipher.com/gates and simply enter your heavy-duty vehicle's Vehicle Identification Number (VIN) and review the Gates Belts, Hose and Tensioners that are available.

www.vindecipher.com/gates

Fuel Systems

Hose

Barricade® Fuel Injection Hose (MPI)

Low-permeation, premium hose for use on all fuel systems, including fuel injection (MPI). Approved for use with gasoline, diesel, bio-diesel including soybean methyl ester (SME), rapeseed methyl ester (RME), palm methyl ester (PME) per ASTM D6751, E-85, methanol, ethanol, ethanol extended gasoline, and gasohol fuels. Patented five-layer Greenshield® barrier technology keeps fuel out of the environment while delivering peak fuel efficiency.



- Exceeds SAE J30R14T2 (except for kink resistance) as well as low-permeation requirements for CARB.
- Aramid reinforcement spiral braid and thermoplastic barrier layer.
- Oil, heat, ozone and abrasion resistant cover.
- 225 psi working pressure rating.
- Recommended for any fuel injection applications for superior service life.
- Temperature rating : -40° F to 275° F [-40° C to 135° C] continuous, up to 302°F [150°C] intermittent.

Note: Do not submerge in gasoline.

Packaging:				Working	2' retail	15' length	25' length	250' reel
I.D. [in.]	I.D. [mm]	O.D. [in.]	O.D. [mm]	[psi]	PartNo.	PartNo.	PartNo.	PartNo.
1/4	6.3	1/2	12.7	225	27334	27347	27339	27344
5/16	8.0	9/16	14.3	225	27335	27348	27340	27345
3/8	9.5	5/8	15.9	225	27336	27349	27341	27346

Barricade® Carburetion Fuel Line Hose

Low-permeation, premium hose for use on carbureted engines, PCV and EEC systems, and for fuel return hose on fuel injection systems. Not for use on the pressure-side of fuel injection systems. Approved for use with leaded and unleaded gasoline, diesel, bio-diesel, E-85, methanol, ethanol, and gasohol fuels. Patented five-layer Greenshield® barrier technology keeps fuel out of the environment while delivering peak fuel efficiency.



- Meets SAE J30R14T1, EPA 40 CFR 1051.110, and CARB small engine off-road requirements for low permeation (except for kink resistance).
- Textile spiral layer (two spiral) and thermoplastic barrier layer.
- Oil, heat, ozone and abrasion resistant cover.
- Recommended for carbureted engines in cars, light trucks, off-road vehicles and small engines.
- Temperature rating: -40° F to 257° F [-40° C to 125° C].

Note: Do not submerge in gasoline.

Caution: Do not use on pressure lines on fuel injection systems or cooling system applications. Use MPI (4219D) or Barricade Fuel Injection (4219BF) hose for Multi-Port Injection systems.

Packaging:				Working	2' retail	25' length	250' reel
I.D. [in.]	I.D. [mm]	O.D. [in.]	O.D. [mm]	[psi]	PartNo.	PartNo.	PartNo.
3/16	4.8	13/32	10.3	50	27302	27312	27321
1/4	6.3	1/2	12.7	50	27303	27313	27323
5/16	8.0	9/16	14.3	50	27304	27314	27324
3/8	9.5	5/8	15.9	50	27305	27315	27325
1/2	12.7	25/32	19.8	35	27306	27316	27326

Fuel Systems

Hose

Fuel Fill Hose

Designed for transferring fuel from vehicle's filler neck to fuel tank. Works on passenger cars and light trucks, as well as on auxiliary fuel tanks on recreational vehicles. For use with most types of fuels – especially resistant to gasoline and diesel.



- Suitable for use with gasoline, gasohol blends of ethanol, methanol, ethers, diesel and biodiesel to B20 (up to maximum concentrations allowed by the EPA).
- Corrugated cover with helical wire reinforcement.
- Features a high quality nitrile tube.
- Meets requirements of SAE 30R5.
- Cuts easily with knife and wire cutters.
- Temperature rating: -40°F to 212°F [-40°C to +100°C] with gasoline blends, -40°F to 125°F [-40°C to +51°C] with biodiesel (B20).
- Packaging: 3 ft. lengths.

Note: Use Super Hex Clamps for reliable installation.

I.D. [In.]	Work. Press. [psi]	Part No.	Std. Pkg.
1¼	20	23963	10
1½	20	23924	10
1⅞	20	23930	10
2	20	23932	10
2¼	20	23936	8
2½	20	23940	8

Fuel Filler Neck Hose

Designed specifically for auxiliary gas tanks on recreational vehicles. Excellent replacement for passenger cars and trucks where a straight hose with a minimal bend is required.



- Suitable for use with gasoline, gasohol blends of ethanol, methanol, ethers, diesel and biodiesel to B20 (up to maximum concentrations allowed by the EPA).
- Smooth oil resistant cover, tough textile cord reinforcement and petroleum-resistant nitrile tube.
- Non-wire reinforced.
- Meets SAE 30R6 specifications.
- Temperature rating: -40°F to +212°F [-40°C to +100°C].
- Biodiesel (B20) temperature rating: -40°F to +212°F [-40°C to +51°C].

Caution: Not recommended for marine gasoline applications.

Part No.	I.D. [In.]	O.D. [In.]	Ctr. Length [ft.]	Work. Press. [psi]	45° Bend:			90° Bend:				
					Part No.	I.D. [In.]	Ctr. Length [in.]	Work. Press. [psi]	Part No.	I.D. [In.]	Ctr. Length [in.]	Work. Press. [psi]
24702	1⅞	1.71	3	20								
24703	1½	1.84	1.5	20								
24704	1¾	2.09	1.5	20								
24705	2	2.14	1.5	20								
23964	1½	1.84	3	20	24710	1½	15.9	20	24715	1½	15.1	20
23968	1¾	2.09	3	20	24711	1¾	15.9	20	24716	1¾	15.0	20
23972	2	2.14	3	20	24712	2	15.9	20	24717	2	14.9	20
23976	2¼	2.59	3	20	24713	2¼	15.9	20	24718	2¼	14.7	20
23980	2½	2.84	3	20	24714	2½	15.8	20	24719	2½	14.6	20

Fuel Systems

Hose

Diesel Emission Fluid (DEF) Hose Assemblies

Diesel Emission Fluid (DEF) Hose Assemblies are specially designed and manufactured to convey Diesel Emission Fluid (DEF). Because DEF freezes at +11°F (-12°C), the hose and couplings are electronically heated using the revolutionary carbon fiber heating system. This patent pending technology allows for more uniform fluid heating compared to heated-wire designs. Customizable hose lengths offer greater flexibility in design while thermoplastic over-molds protect electrical connections against moisture and corrosion.



Part Number	OEM Part Number	Make/Model	Engine
DEF7000	M50602071230800	Peterbilt / Cummins	Pete 386 w/ ISX
DEF7001	M50602274110500	Peterbilt / Cummins	Pete 386 w/ ISX
DEF7002	M50602274320500	Peterbilt / Cummins	Pete 386 w/ ISX
DEF7004	04-28650-000	Freightliner	2012 Cascadia DD15
DEF7006	04-28841-200	Freightliner	2012 Cascadia DD15
DEF7007	52122427AC	Chrysler	Dodge Ram PU 6.7L

Diesel Emission Fluid (DEF) Tank Fill Hose

DEF Tank Transfer Hose are manufactured for the specific filling functions of DEF tanks. They feature the highest quality construction to meet the demands of DEF handling and transfer.



- 3/4" and 1" standard I.D. sizes.
- Temperature rating: -40°F to +212°F [-40°C to +100°C].
- Non-zinc, peroxide-cured EPDM.

Part No.	Description
DEF750025	3/4" DEF Hose 25'
DEF750300	3/4" DEF Hose 300'
DEF100025	1" DEF Hose 25'
DEF100300	1" Hose 300'

Submersible Fuel Line Hose

Ordinary fuel line hose is designed to handle fuel on the inside only. The Submersible Fuel Line Hose exceeds the SAE 30R10 rating and is capable of handling gasoline, alcohol-extended gasoline or diesel fuel in fully immersed, mobile, stationary and marine applications.



- Engineered for constant contact with gasoline (and other liquid petroleum distillates) on the inside and the outside.
- Excellent for use on fuel pumps in the gas tank.
- Meets the SAE 30R10 specification for submersible fuel line hose applications.
- Fluoroelastomer (FKM) tubed cover resists gas permeation and retards aging.
- Aramid Fiber reinforcement—the same fiber used in bulletproof vests and is pound-for-pound stronger than steel.
- Maximum temperature rating: +302°F [+150°C].

I.D. (In.)	Work. Press. (psi)	1-Ft. Part No.	10-Ft. Part No.	32.8-Ft. Part No.
1/4	100	27086	27087	27083
5/16	100	27093	27080	27084
3/8	100	27097	27081	27089

Fuel Systems

Hose

Packaged Safety Stripe® II Return Fuel Line/PCV/Evaporative Emission Control Hose (1986 + older)

Convenient, popular two foot lengths of return fuel line, PCV and EEC hose in self-service, reusable, recyclable package. Can be stacked on shelf or hung on a pegboard display.



- Easy to follow instructions in each package.
- Handy hose diameter indicator helps customer select the correct size.

I.D. (In.)	I.D. (mm)	O.D. (In.)	O.D. (mm)	Work. Press. (psi)	Part No.
1/4	6.3	1/2	12.7	50	27027
5/16	8.0	9/16	14.3	50	27028
3/8	9.5	5/8	15.9	50	27029

Safety Stripe® II Return Fuel Line/PCV/Evaporative Emission Control Hose (1986 + older)

Control Hose [1986 + older]

Multi-purpose hose for use on return fuel lines, PCV and EEC systems, and for fuel return hose connections on diesel fuel injection systems. Approved for use with leaded and unleaded gasoline, diesel and gasoline blends of ethanol [E85], methanol and ethers (up to the legal limits allowed by the EPA).

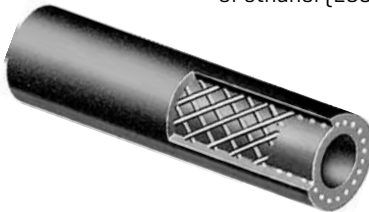

- Spiral reinforced construction.
 - Nitrile tube.
 - NBR-PVC cover.
 - Oil resistant cover resists the effects of high heat and ozone found in engine compartments.
 - Meets SAE 30R6 and 30R7.
 - Vacuum rating of 24 In./Hg for sizes less than 1/2" I.D., and 10 In./Hg for sizes 1/2" to 3/4" I.D. at ambient temperatures.
 - Temperature rating: -40°F to 257°F [-40°C to 125°C] with gasoline blends
- Caution:** Do not use for pressure lines on fuel injected engines or for cooling system applications. Use Barricade Fuel Injection hose for fuel injection applications. Intended for use with fuels where MTBE concentrations are no greater than 15% by volume.

I.D. (In.)	I.D. (mm)	O.D. (In.)	O.D. (mm)	Work. Press. (psi)	25 Foot Reel Part No.	25 Foot Box Part No.	250 Foot Reel Part No.
1/8	3.2	5/16	7.9	50	27000	—	27099
3/16	4.8	13/32	10.3	50	27001	—	27098
1/4	6.3	1/2	12.7	50	27002	—	27068
3/16	8.0	9/16	14.3	50	27003	—	27069
3/8	9.5	5/8	15.9	50	27004	—	27070
7/16	11.1	47/64	18.3	35	—	27005	27071
1/2	12.7	25/32	19.8	35	—	27006	27019
5/8	15.9	15/16	23.8	35	—	27008	27020
3/4	19.0	1 1/8	28.6	35	—	27010	27021

Oil Systems + Power Steering Systems

Transmission Oil Cooler Hose

Provides a safe, heat and oil resistant connecting line between oil cooler and transmission.



- One fiber braid reinforcement over an oil resistant nitrile rubber tube.
- Oil and abrasion resistant black hypalon cover.
- Meets or exceeds SAE J1019 requirements.
- Can be stacked on shelf or hung on pegboard.
- Easy-to-follow instructions in each package.
- Handy hose diameter indicator on package.
- Package is recyclable.
- Maximum temperature rating: +300°F [+150°C]
- Packaging: 3 ft. lengths in retail package; 25 ft. and 50 ft. lengths individually cartoned.

I.D. [In.]	O.D. [In.]	Work. [psi]	Press. Burst	3 Foot	25 Foot	50 Foot
				Length	Length	Length
				Part No.	Part No.	Part No.
5/16	.56	400	1600	27056	27058	27060
3/8	.625	400	1600	27057	27059	27061
1/2	.780	400	1600	27065	27066	27067

PS188 Power Steering Hose

Recommended for power steering pressure lines.



- Synthetic rubber hose cover developed specifically to resist rugged under-hood environments Type CSM.
- Use with one-piece CARQUEST PowerCrimp® power steering couplings [Refer to catalog 431-2080 for details].
- Meets SAE J2050 Type 1 performance requirements.
- Packaging: 25 ft. or 50 ft. lengths.
- 25 Foot Part No. 86049.
- 50 Foot Part No. 86050.

Power Steering Return Line End Fitting

Furnished separately – for use with Return Line Power Steering Hose.



- Zinc-dichromate plated to resist corrosion.
- Coverage includes popular inverted flare threads.
- Packaging: Individually boxed.

Power Steering products are supplied through Edelmann at 1-800-770-4639.

Braking Systems

Air Brake Hose Assemblies*

Factory crimped assemblies meet the rigorous demands of the fleet and heavy-duty market.



- Extremely flexible and kink resistant.
- Two spiral construction meets SAE J1402 specifications.
- Complies with DOT FMVSS 106 requirements.
- Couplings meet SAE and DOT minimum pull-off requirements.
- High quality brass male pipe fitting on one end, female air brake swivel with male pipe adapter on other end.
- Temperature rating: -40°F to +212°F [-40°C to +100°C].
- Packaging: Individually cartoned.

3/8" I.D. Hose With 1/4" MPT Fixed + Swivel		3/8" I.D. Hose With 3/8" MPT Fixed + Swivel		1/2" I.D. Hose With 3/8" MPT Fixed + Swivel		1/2" I.D. Hose With 1/2" MPT Fixed + Swivel	
Length (In.)	Part No.	Length (In.)	Part No.	Length (In.)	Part No.	Length (In.)	Part No.
14	27242	14	27261	18	27252	18	27286
16	27243	16	27262	20	27253	20	27287
18	27244	18	27263	24	27254	24	27289
20	27245	20	27264	28	27255	28	27291
24	27246	24	27266	48	27360	30	27292
26	27247	26	27267	60	27361	32	27293
30	27248	28	27268	72	27362	34	27294
32	27249	30	27269	30	27256	36	27295
36	27250	32	27270	32	27257	42	27297
42	27251	34	27271	36	27258		
48	27350	36	27272	42	27259		
		42	27275				
		45	27277				
		48	27279				
		60	27281				

Brake Line Abrasion Shields

The Federal Motor Carrier Safety Administration's recently launched Compliance Safety Accountability (CSA) program requires abrasion shields on brake lines that fall below the chassis and in circumstances where chafing, kinking or other mechanical damage can occur. CARQUEST provides high-quality products that meet the rules and specifications for brake line protection.



PolySleeve High Density Polyethylene Hose Wrap

Protects lines and hoses from chafing, rubbing, crushing, ultraviolet rays and other hazards that cause hose failures. Easy to install before or after assemblies are in place. Effective temperature range from -40°F to +280°F.

Nylon Sleeves

Nylon filament mesh forms a self-renewing shield that protects against abrasion for brake lines, hose and hose bundles. Extremely flexible, flame resistant and easy to install.

Plastic Coil Sleeve

Economical, lightweight plastic sleeving protects lines and hoses from water, air, gasoline, hydraulic fluids and impacts. Easy to install before or after assemblies are in place. Effective temperature range from -40°F to +250°F.

* **Note:** Federal law requires registration with the Department of Transportation for anyone producing air brake hose assemblies with swaged or crimped fittings.

Braking Systems

SureLok™ Fittings

Recommended for compressed air connector on all nylon air brake tubing air brake systems at locations other than between chassis frame and axle or between towed and towing vehicle. Also recommended as a connector on all air operated systems as applicable to suspension, steering, engine, transmission and auxiliary mechanisms. Fittings and tubing comply to Department of Transportation Federal Motor Vehicle Safety Standard, [DOT FMVSS 106] [mandatory requirements for inch tube fittings in U.S.A.] Society for Automotive Engineers [SAE] J1131 [inch tube and fittings] and meet DIN 74324 and German TUV requirements [metric tube and fittings].



- Simple tube connection and disconnection.
- Fewer component parts – Internally machined form in body to secure collet.
- All collets marked with tube size.
- Ease of tube insertion in areas of restricted access.
- Total fittings system solution.

Maximum Working Pressure: 0 to 150 psi

Working Temperature: -40°F to +220°F [-40°C to +100°C]

Materials: Body, tube support, Collet - Brass; O-Ring - Buna N [Low Nitrile]; Thread Sealant - Precoat 5

Tubing: Tube should be to SAE J844 or DIN 74324

Small Air Brake Assortment

This small SureLok™ assortment is a basic starter package for the jobber or fleet. The SureLok™ coupling allows for repairs or replacement of J844 nylon air brake lines without the need of tools. Part Number: A33001. Assortment contains:



- Four hose sizes.
- 16 coupling configurations.
- 158 individual couplings.

Large Air Brake Assortment

The large SureLok™ assortment is perfect for the jobber or fleet. SureLok™ couplings allow for repairs or replacement of J844 nylon air brake lines without tools. Along with the SureLok couplings, this assortment features brass field attachable couplings for SAE J1402 DOT All hose. Part Number: A33002.

Assortment contains:



- Seven sizes of hoses
- 51 coupling configurations
- 318 individual couplings

Note: Federal law requires registration with the Department of Transportation for anyone producing air brake hose assemblies with swaged or crimped fittings.

Braking Systems

Compression Fittings

Recommended for compressed air connector on all nylon air brake tubing air brake systems at locations other than between chassis frame and axle or between towed and towing vehicle. Also recommended as a connector on all air operated systems as applicable to suspension, steering, engine, transmission and auxiliary mechanisms. Fittings and tubing comply to Department of Transportation Federal Motor Vehicle Safety Standard, [DOT FMVSS571.106] [Mandatory requirements for inch tube fittings in U.S.A.] Society for Automotive Engineers [SAE J246] and [SAE J1131] [inch tube and fittings].

- Maximum Working Pressure: 150 psi
- Working Temperature: -40°F to +200°F [-40°C to +100°C]
- Materials: Brass
- Tubing: SAE J844 or DIN 74324

Component Functions: The compression coupling has four parts:

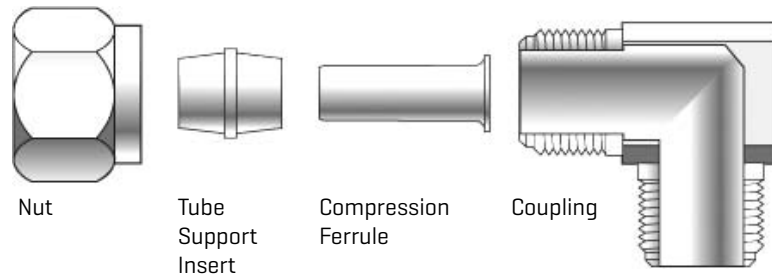

Small Compression Assortment

Handy, small compression assortment is a basic starter package for the jobber or fleet. This assortment features brass compression couplings for J844 nylon air brake hose. Part Number: A33003.

Assortment contains:



- Four sizes of hoses.
- 31 coupling configurations.
- 211 individual couplings.

Large Compression Assortment

The large compression assortment is perfect for the jobber or fleet. This assortment features both brass compression couplings for J844 nylon air brake hose and brass field attachable couplings for SAE J1402 DOT.

Part Number: A33004.

Assortment Contains:



- Seven sizes of hoses.
- 59 coupling configurations.
- 330 individual couplings.

Note: Federal law requires registration with the Department of Transportation for anyone producing air brake hose assemblies with swaged or crimped fittings.

Braking Systems

AB Series Air Brake Hose

Computer-controlled manufacturing process virtually insures product uniformity.



- Superior EPDM rubber resists damaging effects of ozone and heat, plus harmful grease and oil common to air brake systems.
- Four-spiral polyester construction, meets SAE J1402 specifications. Complies with DOT FMVSS 106 requirements.
- Flexible and kink-resistant.
- Designed to accept all styles of air brake couplings, including conventional brass and plastic couplings.
- Temperature rating: -40°F to +212°F [-40°C to +100°C].
- Packaging: 50 ft. per carton or 250 ft. reels (max. 3 pieces, shortest length 50 ft. or greater).

I.D. [In.]	O.D. [In.]	Length [Ft.]	Work. Press. [psi]	Part No.
3/8	3/4	50	225	27240
3/8	3/4	250	225	28760
1/2	7/8	50	225	27241
1/2	7/8	250	225	28761

Green Stripe® Vacuum Brake Hose 69W

Extra heavy-duty hose designed to fit most air brake systems on trucks, trailers and other heavy equipment.



- Wrapped hose construction with multiple plies of rubber-impregnated fabric.
- Resists collapsing or deforming even under high vacuum at elevated temperatures.
- Rated at 30 In./Hg.
- Exceeds SAE J1403, Type H. Complies with DOT FMVSS 106VH.
- Temperature rating: -40°F to +257°F [-40°C to +125°C].
- Packaging: 50 ft. lengths, individually cartoned.

I.D. [In.]	Work. Press. [psi]	O.D. [In.]	Part No.
3/8	85	13/16	27210
1/2	85	15/16	27211
5/8	85	11/16	27212
3/4	85	13/16	27213

Note: Federal law requires registration with the Department of Transportation for anyone producing air brake hose assemblies with swaged or crimped fittings.

Braking Systems

Power Brake Vacuum Hose

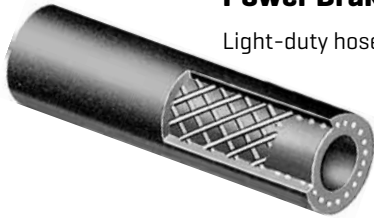

Light-duty hose specially engineered for power brake applications on passenger cars and light trucks.

- Complies with DOT FMVSS 106VL. Meets SAE 1403 Type L.
- Ozone-resistant EPDM cover.
- Textile reinforcement.
- Vacuum rating 30 In. Hg.
- Temperature rating: -40°F to +257°F [-40°C to +125°C].

I.D. [In.]	O.D. [In.]	Work. Press. [psi]	Part No. 3 Foot	Part No. 50 Foot
11/32	.70	85	27232	27230
15/32	.82	85	27233	27231

Heavy-Duty Green Stripe® Air Brake Hose



Can be used as flexible connector between frame and axle.

- Compatible with standard air brake couplings.
- Neoprene construction is oil resistant.
- Two-braid rayon reinforced construction with smooth cover.
- Exceeds SAE J1402 and Bendix specifications.
- Complies with DOT FMVSS 106 requirements.
- Packaging: Individually cartoned.

I.D. [In.]	O.D. [In.]	Length [Ft.]	Work. Press. [psi]	Part No.
3/8	3/4	50	225	27220
3/8	3/4	250	225	28304
1/2	7/8	50	225	27221

Nylon Air Brake Tubing

Recommended for truck, bus and mobile air brake, and service lines where heat and battery acids are not present. Conforms to SAE J844 specifications. Meets D.O.T. FMVSS 106.



- Tube: Heat and light stabilized seamless extruded nylon.
 - Cover: Nylon. Available in black [NABTA], blue [NABTB], green [NABTG], red [NABTR], yellow [NABTY] and orange [NABTO] colors. Other colors available upon request.
 - Temperature rating: -40°F to +200°F
 - Couplings: Use CARQUEST D.O.T. SureLok™ [G31] or CARQUEST D.O.T. compression. [G32]
- Type A: Non-reinforced in sizes 1/8", 5/32", 3/16", and 1/4".
- Note:** Sizes 1/8" and 5/32" are NOT recognized by D.O.T. for air brake systems. These are for service lines only.
- Type B: Reinforced with one open ply of fibrous nylon in sizes 5/16", 3/8", 1/2", 5/8" and 3/4".

Hydraulics Hose Products

Ultra High Pressure



G8K Spiral Wire Hose

Recommended for: ultra high-pressure, high-impulse applications such as hydrostatic transmissions, for use in the construction, agriculture, forestry, underground or open pit mining, or other industries on applications where extremely high pressure capability is required. G8K hose and couplings offer industry-leading bend radius capability, which leads to ease of routing and installation, longer hose life in flexing applications and fewer bent tube fitting requirements.

Extremely High Pressure



EFG6K Spiral Wire Hose—SAE 100R15

EFG6K is designed to meet or exceed all requirements of SAE 100R15 specifications and performance requirements of EN 856 4SP [-6, -8, -10 and -12], EN 856 4SH [-12, -16, and -20], and ISO 3862 Type R15 [-6, -8, -10, -12, -16, -24].

Available with unique abrasion-resistant MegaTuff® cover.



EFG5K Spiral Wire Hose—SAE 100R13

EFG5K is designed to meet or exceed all requirements of SAE 100R13 specifications and performance requirements of EN 856 4SH [-16 and -20], EN 856 4SP [-8, -10, and -12] and EN 856 R13.

Available with unique abrasion-resistant MegaTuff® cover.



EFG4K Spiral Wire Hose—SAE 100R12

EFG4K is designed to meet or exceed all requirements of SAE 100R12 specifications and performance requirements of EN 856 R12 and EN 856 4SP [-16].

Available with unique abrasion-resistant MegaTuff® cover.



EFG3K Spiral Wire Hose—SAE 100R12

EFG3K is designed to meet or exceed all requirements of SAE 100R12 specifications and performance requirements of EN 856 R12 and performance requirements of EN 856 4SP.

Available with unique abrasion-resistant MegaTuff® cover.

Fleet Application



C5C Hydraulic Hose—SAE 100R5

Recommended for: medium pressure hydraulic petroleum-base oil lines in impulse applications, lube oil, air and water in applications such as air brakes, power steering [CAUTION: Intended for heavy-duty commercial vehicle use only], turbocharger oil supplies, tilt cab cylinders, transmission coolant and filtration lines. Meets or exceeds requirements of SAE 100R5 for traditional hydraulic applications, DOT FMVSS 106-74 Type All and SAE J1402 Type All for air brake applications [-4 to -12]. Not recommended for gasoline or diesel fuel.



C5D High-Temp Multi-Fluid Hose

Recommended for: petroleum-base or phosphate ester fluids, diesel fuels and filtration lines, transmission coolant lines, hot lube oil lines, power steering [CAUTION: Intended for heavy-duty commercial vehicle use only], gasoline and turbocharger oil supplies. Tilt cab cylinder and air brakes. C5D [-4 to -12] meets or exceeds DOT FMVSS 106-74 Type All, SAE J1402 Type All and SAE J1405 and fuel resistance of SAE J30R2. Not approved for bio diesel.

Hydraulics Hose Products

Fleet Application continued



C5M Marine Fuel Line Hose

Recommended for: on-shore/off-shore and marine diesel fuel and gasoline applications and hot oil lines up to +212°F. Meets USCG marine fuel line specifications, SAE J1527 B100 to +125°F Type A Class 1 and SAE J1942 requirements. Exceeds performance requirements of SAE J30R2 for non-marine applications.



C5E High-Temp Flexline Hose

Recommended for: air brake hose, power steering [CAUTION: Intended for heavy-duty commercial vehicle use only], fuel filter, engine and transmission coolant lines, and hot [+300°F] lube oil lines.



MegaTech® 1000 High-Temp Oil/Air Return

Recommended for: air brake, pressurized hot oil return lines and rotary oil/air compressor lines. Meets the requirements of DOT FMVSS 106- 74, SAE J1402, for Air Brake Hose [-4, 6, 8, 10], and SAE J1405 performance specifications for high-temperature transmission and lubricating oil systems using petroleum base oils. Not recommended for gasoline or diesel fuel applications.



MegaTech® 500 High-Temp Oil/Air Return

Recommended for: air brake hose, pressurized hot oil return lines and rotary oil/air compressor lines. Meets the requirements of SAE J1405 performance specifications for high-temperature transmission and lubricating oil systems using petroleum-base oils. Not recommended for gasoline or diesel fuel applications.



MegaTech® 250 High-Temp Transmission Oil Cooler (TOC) Hose

Recommended for: high-temperature [300°F] transmission oil cooler lines, pressurized hot oil return lines and turbocharger oil supplies. Meets or exceeds SAE J1405 performance specifications for high-temperature transmission and lubricating oil systems using petroleum base oils. Not recommended for gasoline or diesel fuel applications.



MegaTech® G5TB Extreme Heat Oil/Air Return

Recommended For: pressurized hot oil return lines and rotary oil lines. Meets the requirements of SAE J1405 performance specifications for high-temperature transmission and lubricating oil systems using petroleum base oils.

Specialty/Thermoplastic



TH8 Hydraulic Hose—SAE 100R8

Recommended for: use with petroleum, water base and synthetic hydraulic fluids. Applications include: power and telephone mobile equipment [cherry pickers], lubrication lines, blowout preventer control lines, hydraulic lifts and farm and construction machinery. TH8 hose meets or exceeds performance requirements of SAE 100R8 with a significantly tighter bend radius.



TH8NC Non Conductive Hydraulic Hose—SAE 100R8

Recommended for: use with petroleum, water base and synthetic hydraulic fluids. Applications include: power and telephone mobile equipment [cherry pickers], lubrication lines, blowout preventer control lines, hydraulic lifts and farm and construction machinery. TH8NC hose [orange cover] meets SAE 100R8 non-conductivity requirements. TH8NC hose meets or exceeds performance requirements of SAE 100R8 with a significantly tighter bend radius.

Hydraulics

Hose Products



TH7 Hydraulic Hose—SAE 100R7

Recommended for: petroleum, water base and synthetic hydraulic fluids. Applications include: power and telephone mobile equipment (cherry pickers), lubrication lines, blowout preventer control lines, hydraulic lifts and farm and construction machinery. TH7 hose meets or exceeds performance requirements of SAE 100R7 with a significantly tighter bend radius.



TH7NC Non Conductive Hydraulic Hose—SAE 100R7

Recommended for: power and telephone mobile equipment (cherry pickers), lubrication lines, blowout preventer control lines, hydraulic lifts and farm and construction machinery. Orange color TH7NC meets SAE 100R7 non-conductivity requirements and meets or exceeds performance requirements of SAE 100R7 with a significantly tighter bend radius. Meets ANSI A92.2 for vehicle mounted aerial devices [-4 to -8].



TH7DL Dual Line Hydraulic Hose—SAE 100R7

Recommended for: petroleum, water base and synthetic hydraulic fluids. Applications include: power and telephone mobile equipment (cherry pickers), lubrication lines, blowout preventer control lines, hydraulic lifts and farm and construction machinery. TH7DL hose meets or exceeds performance requirements of SAE 100R7 with significantly tighter bend radius.



TH7NCDL Non Conductive Dual Line Hydraulic Hose—SAE 100R7

Recommended for: petroleum, water base and synthetic hydraulic fluids. Applications include: power and telephone mobile equipment (cherry pickers), lubrication lines, blowout preventer control lines, hydraulic lifts and farm and construction machinery. Orange color TH7NCDL meets SAE 100R7 non-conductivity requirements and meets or exceeds performance requirements of SAE 100R7 with significantly tighter bend radius. Meets ANSI A92.2 for vehicle mounted aerial devices [-3 and -8].



TH18 Constant Pressure Hydraulic Hose—SAE 100R18

Recommended for: petroleum or synthetic-based hydraulic fluids. TH18 hose meets or exceeds performance requirements of SAE 100R18 with a significantly tighter bend radius. TH18 is ideal for industrial and agricultural applications exposed to low temperatures or cyclic and quick temperature changes. Remains highly flexible in cold weather conditions and is resistant to hydraulic fluids, high temperatures, aging and weathering.



TH18NC Constant Pressure Non Conductive Hydraulic Hose—SAE 100R18

Recommended for: petroleum or synthetic-based hydraulic fluids. TH18NC hose meets or exceeds performance requirements of SAE 100R18 with a significantly tighter bend radius. TH18NC non-conductive hoses are suitable for use in high-voltage applications. Remains highly flexible in cold weather conditions and is resistant to hydraulic fluids, high temperatures, aging and weathering.



C14 PTFE Hose—SAE 100R14 Type A—Nonconductive

Recommended for: air compressor discharge, hot oil and fluids, hot and greasy environments.

C14CT PTFE Hose—SAE 100R14 Type B—Conductive

Recommended for: air compressor discharge, hot oil and fluids, hot and greasy environments.

Hydraulics Hose Products



Power Clean™ Hose

When you have to keep it clean, nothing does the job better than Industrial high pressure cleaning hose for water cleanup applications at food handling and processing operations, meat and poultry plants, creameries, paper mills, and other facilities. Depending on your need, our durable, reliable hose line handles pressures up to 5000 psi, temperatures up to 250°F, and can be used with hot or cold water, steam injected water, and mild detergents.



LP350 Liquid Hose

Recommended for: liquid or gaseous propane, butane, or a combination of the two. Consumer applications include gas grills, heaters, torches, and other outdoor equipment. It can also be used as an industrial transfer hose and for natural gas under certain conditions such as open/outside areas and well ventilated factory buildings [if local building codes permit].

Note: Not recommended for residential or office buildings. Contact CARQUEST Product Application for inspection and assembly testing information.

Small Nylon Tubing Cutter + Replacement Blades

Tubing cutter gives straight, clean, square cuts on J844 tubing.



- Lightweight and compact size – 3/4" by 3".
- Designed to ensure user safety.
- Blade guard offers more protection against accidental blade contact.
- Handle has ribs for improved grip.

MegaClean™ System

Used to remove dirt with the help of pressurized launchers and compatible nozzles. CARQUEST MegaClean™ foam projectiles sweep through the inside surface of the hose, taking fine particles of loose dirt and other contaminants with them. At 20–30 percent larger than the hose ID, these projectiles leave nothing behind but a hose that is clean from the inside out.



Air Brake Fittings

CARQUEST is proud to offer a large assortment of air brake fittings. The assortment includes SureLok™ fittings, compression fittings, air brake copper tubing and air brake fittings for rubber hose.



Hydraulics

Couplings + Adapters

CARQUEST hydraulic hoses and couplings beat the competition, and meet or exceed the toughest SAE requirements. These products offer maximum flexibility and leak prevention on heavy-duty applications, regardless of pressure. By offering a full line of couplings and adapters, CARQUEST can meet your every need. The listing below is not an exhaustive list of all CARQUEST has to offer, for all of CARQUEST couplers and adapters please see the 2012 Hydraulic Catalog.

G8K Couplings

CARQUEST offers a full line of G8K Couplings for most every need.



- Caterpillar Style O-Ring Flange
- Caterpillar Style O-Ring Flange - 45° Bent Tube and 90° Bent Tube
- G8K Ferrule for G8K Spiral Hose

Globalspiral™ Couplings

A new, no-skive permanent coupling design with superior performance features is now available for extreme high-pressure and high-impulse hydraulic applications. The GlobalSpiral™ coupling can be used with C13 and G6K six- and four-spiral wire hydraulic hoses and the C12 four-spiral wire hose.



- Can be used on hoses with up to 6,000 psi working pressure in all sizes.
- Available in + 30 thread/flange configurations.
- Bite the wire crimp.
- Non-lead steel.
- + 250°F temperature capability.

Power Crimp® Couplings

Wide variety of couplings available for easy installation.



- Designed to perform with high and medium pressure hose.
- Sizes $\frac{3}{16}$ " through 2" I.D.
- Zinc plated carbon steel.

MegaCrimp® Couplings

MegaCrimp couplings give you a leak-proof seal that's so innovative, it's patented. In fact, it surpassed one million impulse cycles during design testing. MegaCrimp® couplings set a new standard for hydraulic couplings. The unique "C" insert ensures "weep-free" concentric crimping to keep equipment and the environment clean.



- Robust "bite-the-wire" crimp .
- Low profile.
- Full stem insertion.
- Full-length crimp.
- TuffCoat™ plating for 500% better corrosion resistance.
- Fully qualified EN-performance coupling.

LOC, GI And GLP Couplings

Wide variety of couplings available for easy installation.



- Brass Field Attachable Couplings For Lock-On
- GLP Couplings
- GI Couplings

Hydraulics

Couplings + Adapters

C14 Couplings

Special tools available to make swage type installations easy.



- Designed to perform with C14 Hose.
- Sizes $\frac{3}{16}$ " through $\frac{7}{8}$ " O.D.
- Stainless steel, brass or carbon steel.
- 13 thread configurations.

PCTS Thermoplastic Couplings

Swage style couplings make factory quality assemblies.



- Designed to perform with C7 and C8 thermoplastic hose.
- Sizes $\frac{3}{16}$ " through 1" O.D.
- 21 thread configurations.

Field Attachable C5 Couplings

Makes assemblies without a crimper.



- Designed to perform with C5 hose.
- Sizes $\frac{3}{16}$ " through $1\frac{13}{16}$ " I.D.
- 22 thread configurations.
- Zinc plated carbon steel.
- Meets DOT FMVSS 106-74 Type All

Field Attachable C5E Couplings

Makes assemblies without a crimper.



- Designed to perform with C5E Hose.
- Sizes $\frac{1}{4}$ " through $1\frac{1}{4}$ " O.D.
- 16 thread configurations.
- Zinc plated carbon steel.
- Meets DOT FMVSS 106-74 Type All

Adapters

For easy assembly on extremely high, very high, high and medium pressure hose



- [Rated to SAE 100R2 pressure maximum.]
- 8 flange to MJ adapters for extremely and very high pressure hose.
- 69 thread configurations.

Quick Disconnect Couplers

Features a meaningful part number that makes coupling identification fast and easy.



- Full line of hydraulic quick disconnects.
- Agriculture and Industrial interchange.
- Flush face and wing nut styles.
- Dust caps and plugs.

Hydraulics Accessories

Nylon Protective Sleeve

CARQUEST Nylon Sleeves perform a dual role. They provide excellent abrasion resistance to protect individual hoses and they can be used to bundle several hose assemblies together for maximum protection. Downtime and maintenance costs are reduced. These Nylon Sleeves are unique because they form an extra protective layer against abrasive forces. Specifically, thousands of tiny Nylon filaments, woven into the texturized yarn, “friz” into a self-renewing shield that is extremely resistant to severe abrasion.

This nylon sleeving has MSHA flame-resistance approval. Add $\frac{1}{8}$ " for installation.

Note: Do not use the Nylon Sleeve where ambient temperatures exceed 250°F.



Life Guard™ Line-of-Sight Sleeving

The LifeGuard™ Line-of-Sight Sleeving System is the first true protection in line-of-sight hydraulic applications. It contains bursts up to 10,000 psi and pinhole leaks up to 5,000 psi at 250°F for up to five minutes. After redirecting the explosive force down the length of the hose, the LifeGuard sleeve disperses the energy and fluids at the hose ends via carefully designed “channel” clamps. The leaked fluid then allows for fast hose failure detection. The double-layer sleeve effectively shields against hazards.



Hose Guards

CARQUEST offers a full line of hose guards for most every need.



- Plated Wire Spring Guards
- Plated Flat Armor Spring Guards
- Plastic Protective Coil Sleeves
- PolySleeve™ High Density Polyethylene Hose Wrap - Black
- HeatGuard® Protective Sheathing
- HeatGuard® High-Temp Protective Sheathing

Vinyl Bend Restrictor

Tapered PVC sleeve reduces bending stress in the hose near the coupling to prevent damage, such as in power wash applications. Installed during hose assembly, this smoothly-finished product withstands temperatures from -40°F to +200°F [-40°C to +93°C].



- Friction Fit.
- Smooth finish will not scratch finish on equipment being washed.
- Tapered design reduces bending stress.
- Wide temperature helps give extra long service life for both hot and cold power wash assemblies.

Air + Defroster Systems

Green Stripe® Ring Retained Turbocharger Hose

Made for turbocharged Class 8 and heavy-duty diesel engines. Multi-hump design isolates vibration and absorbs rotational shock. Depending on application, hose is engineered with three or four rings to maintain design integrity.



- Four layer silicone construction with aramid fiber reinforcement for maximum durability.
- Meets or exceeds OEM specifications.
- Temperature rating: -60°F to +500°F [-51°C to +260°C]

Part No.	I.D. (In.)	Length (In.)	Work. Press. (psi)
26200	3	6	25
26201	3½	6	25
26203	4	6	25
26204	4	8	25

Defroster/Air Intake Hose

For defrosters, air ducts, air intakes, under-hood applications and other low pressure, low suction applications. Approved for marine applications.



- Flexible, heat-resistant materials and helical steel wire reinforced.
- Easily cut and formed to desired shape and length.
- Tear, abrasion and ozone resistant.
- Complies with DOT FMVSS 302.
- Temperature rating: -40°F to +200°F [-40°C to +93°C].
- Packaging: Individually boxed in six ft. lengths [compressed to 21"].

I.D. (In.)	Part No.	I.D. (In.)	Part No.	I.D. (In.)	Part No.
1¼	23820	2½	23840	4	23864
1½	23824	2¾	23844	4½	23872
1¾	23828	3	23848	5	23880
2	23832	3¼	23850	6	23896
2¼	23836	3½	23856		

Green Stripe® Heavy-Duty Air Vent Hose

Specifically designed for air cleaner-to-engine connections and other ducting applications.



- Heat and oil-resistant tube.
- Flexible, helical wire reinforced.
- Cover is heat, oil and abrasion resistant.
- Smooth interior offers minimum air resistance for maximum efficiency.
- Easily cut with knife and wire cutters.
- Temperature rating: -40°F to +257°F [-40°C to +125°C]
- Packaging: 10 ft. lengths, individually cartoned.

Caution: Not recommended for conveying liquids.

Part No.	I.D. (In.)	O.D. (In.)	Work Press. (psi)	Vacuum Rating (In. /Hg)
23764	4	4.38	10	7
23772	4½	4.88	10	7
23780	5	5.38	10	6
23788	5½	5.88	10	6

Air + Defroster Systems

Turbocharger Hose

Specially compounded for use as a short, flexible connector between the air intake and the turbocharger. Can also be used for turbocharger air discharge. Approved for Marine Applications.

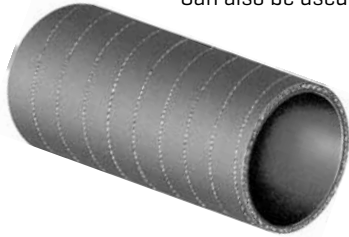

- Silicone elastomer inner liner reinforced with woven fiberglass fabric and coated with orange silicone rubber.
- Resists high temperatures and pressures.
- Resists coolants, weathering and ozone.
- Highly visible orange color helps distinguish this hose from engine coolant hose.
- Temperature rating: -60°F to +500°F [-51°C to +260°C]
- Packaging: 1 each.

I.D. [In.]	Part No.	Length [In.]	Work Press. [psi]	I.D. [In.]	Part No.	Length [In.]	Work Press. [psi]	I.D. [In.]	Part No.	Length [In.]	Work Press. [psi]
1	26116	36	45	2 ³ / ₄	26144	36	25	3 ¹ / ₂	26156	36	20
1 ¹ / ₂	26124	36	40	3	26001	3	25	3 ³ / ₄	26160	36	15
1 ³ / ₄	26128	36	35	3	26148	36	25	3 ⁷ / ₈	26162	36	15
2	26132	36	35	3 ³ / ₈	26002	3 ¹ / ₂	15	4	26164	36	15
2 ¹ / ₄	26136	36	30	3 ³ / ₈	26003	6	15	4 ¹ / ₂	26166	36	15
2 ³ / ₈	26138	36	30	3 ³ / ₈	26154	36	15	5	26007	3 ¹ / ₂	15
2 ¹ / ₂	26140	36	30	3 ¹ / ₂	26004	3	30	5 ¹ / ₂	26008	3 ¹ / ₂	15
2 ⁵ / ₈	26142	36	15								

AV Series Air Vent Hose

Specifically designed for air cleaner-to-engine connections and other ducting applications.



- Available in pre-formed hump (similar to Vibraflex®), straight and curved configurations.
- Heat and oil resistant.
- Temperature rating: -40°F to +225°F

Style	Part No.	(I.D. xLength) [In.]	Style	Part No.	(I.D. xLength) [In.]
Hump	23002	4 x 5	Molded	23201	3 x 5 ¹ / ₄ x 90°*
	23004	5 x	Elbow	23202	3 ¹ / ₂ x 5 ¹ / ₄ x 45°
	23005	5 ¹ / ₂ x 6		23203	3 ¹ / ₂ x 5 ¹ / ₂ x 90°*
	23006	6 x 5		23208	5 x 5 ¹ / ₄ x 45°
Straight	23400	4 x 22	23209	5 x 6 x 90°	
Flexible	23401	6 x 19	23215	6 x 6 ¹ / ₂ x 45°*	
	23402	6 ¹ / ₈ x 19	23216	6 x 7 ¹ / ₂ x 45°*	
Reducer	23100	3 ¹ / ₂ x 3 x 5 ¹ / ₄	23218	6 x 7 x 90°*	
Hump	23101	4 x 3 x 5 ¹ / ₄	23221	7 x 7 ¹ / ₂ x 90°	
	23106	6 x 5 ¹ / ₂ x 6	Reducer	23300	6 x 5 ¹ / ₂ x 90°
	23107	7 x 6 x 5	Elbow		

*Ribbed

Air + Defroster Systems

Emission Control Duct Hose

Connects hot air from exhaust manifold shroud to air cleaner for efficient control of emissions. Helps eliminate carburetor icing and improves engine warmup.



- Aluminum polyester construction for economy.
- Fiberglass aluminum (black) for greater strength and durability.
- Completely flexible and easily bent, yet retains shape after forming.
- Resists heat, cold, oil and water.
- Cuts with knife for easy installation.
- Install with or without clamps.
- Temperature rating: -40°F to 400°F [-40°C to +204°C].
- Packaging: Individually packed.

I.D. [In.]	Length [In.]	Part No.	I.D. [mm]	Length [mm]	Part No.
3/4	36	28092	40	1000	28091
7/8	36	28085	50	1000	28082
1 1/2	18	28093	60	1000	28081
1 1/2	36	28088			
1 3/4	18	28094			
1 3/4	36	28089			
2	18	28095			
2	36	28090			

Air Vent Hose

Light-duty hose for air cleaner-to-engine connections, defroster ducts and air or heater ducting.



- Extremely flexible.
- Helical wire construction.
- Heat and oil resistant tube.
- Temperature rating: -40°F to +212°F [-40°C to +100°C]
- Packaging: 10 ft. lengths, individually cartoned.

Note: For abrasive environments use Green Stripe® Heavy-Duty Air Vent Hose.
Caution: Not recommended for conveying liquids.

Part No.	I.D. [In.]	O.D. [In.]	Work. Press. [psi]	Vacuum Rating [In/Hg]	Part No.	I.D. [In.]	O.D. [In.]	Work. Press. [psi]	Vacuum Rating [In/Hg]
23610	5/8	.85	10	5	23636	2 1/4	2.35	5	3
23612	3/4	.97	10	5	23638	2 3/8	2.47	5	3
23614	7/8	1.10	10	5	23640	2 1/2	2.60	5	3
23616	1	1.22	10	5	23642	2 5/8	2.72	5	3
23620	1 1/4	1.47	10	5	23644	2 3/4	2.97	5	3
23622	1 3/8	1.60	10	5	23648	3	3.22	5	3
23624	1 1/2	1.72	10	5	23656	3 1/2	3.35	5	3
23626	1 5/8	1.85	10	5	23658	3 5/8	3.47	5	3
23628	1 3/4	1.97	10	5	23664	4	3.72	5	3
23630	1 7/8	2.10	10	5	23672	4 1/2	3.85	5	3
23632	2	2.22	5	3	23680	5	4.24	5	3
23634	2 1/8	2.28	5	3	23688	5 1/2	4.74	5	3

Service Hose

Multi-Use Hose

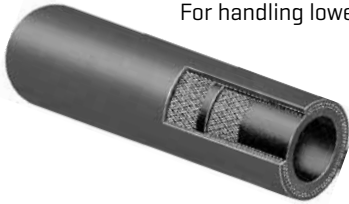

For handling lower pressure air, water, agricultural spraying, oil or grease. Can also be used for air spray painting.

- Nitrile tube and cover provide high oil resistance.
- One braid polyester cord reinforcement.
- Temperature rating: 0°F to +212°F [-18°C to +100°C]
- Packaging: 50 ft. to carton; 300 ft. reels (maximum three pieces, shortest piece 50 ft.).

Caution: Not recommended for use as small I.D. by-pass, coolant and heater hose. Do not use for fuel transfer applications.

Part No. 50 Ft.	Part No. 300 Ft.	I.D. [In.]	O.D. [In.]	Work Press. [psi]	Braid
27402	28652	1/4	1/2	315	1
27404	28657	5/16	5/8	315	1
27406	28661	3/8	11/16	315	1
27410	28665	1/2	27/32	315	1
27414	28667	5/8	15/16	315	1
27418	28671	3/4	13/32	315	1
—	28765	1	13/32	250	1

Thermo GP®X Air Hose

Light-weight thermoplastic hose suitable for air impact tools and general service applications.



- White virgin PVC tube with polyester cord reinforcement.
- Red w/black PVC cover resists abrasion and combats the effects of sunlight, weathering and ozone.
- Bend restrictors for extended life.
- 0.5" ferrule wall thickness to resist crushing and deforming.
- Allows dirt and grease to be cleaned off easily.
- Suitable for air impact tools.
- Factory crimped, heavy-duty male couplings assure maximum dependability pressure.
- Temperature rating: -15°F to +150°F [-26°C to +66°C] continuous service.
- Packaging: 25 ft. and 50 ft. assemblies, individually cartoned.

Caution: Do not use near welding equipment.

Part No.	I.D. [In.]	O.D. [In.]	Length [Ft.]	Working Pressure [psi]*	Coupling Thread Size
27480	1/4	35/64	25	300	1/4-18NPT
27481	1/4	35/64	50	300	1/4-18NPT
27482	3/8	5/8	25	300	1/4-18NPT
27483	3/8	5/8	50	300	1/4-18NPT
27499	1/2	49/64	25	300	1/2-14NPT
27500	1/2	49/64	50	300	1/2-14NPT

Service Hose

Safety Stripe® Air Hose



Durable, premium hose for garage and service station air impact tools.

- High strength reinforcement.
- High flexibility is easy on wrists.
- Perforated EPDM red cover that resists ozone and abrasion.
- Bend restrictors for extended life.
- Factory assembled male couplings with 300 lb. minimum coupling pull.
- Temperature rating: -40°F to +200°F [-40°C to +93°C]
- Packaging: 25 ft. and 50 ft. individually cartoned.

Part No.	I.D. [In.]	O.D. [In.]	Length [Ft.]	Working Pressure [psi]	Coupling Thread Size
27485	1/4	35/64	25	300	1/4-18NPT
27486	1/4	35/64	50	300	1/4-18NPT
27488	3/8	23/32	25	300	1/4-18NPT
27489	3/8	23/32	50	300	1/4-18NPT
27491	1/2	27/32	25	300	1/2-14NPT
27492	1/2	27/32	50	300	1/2-14NPT

Charter® Air Hose



Designed for multi-purpose air hose applications. Capable of impact tool use.

- Textile reinforcement.
- Perforated EPDM red cover is ozone and abrasion resistant.
- Factory applied male couplings have 250 lb. minimum coupling pull.
- Temperature rating: -40°F to +200°F [-40°C to +93°C]
- Packaging: 25 ft. and 50 ft. coupled lengths individually cartoned; 300 ft. reels (maximum two pieces, shortest length 50 ft.).

Part No.	I.D. [In.]	O.D. [In.]	Length [Ft.]	Working Pressure [psi]	Coupling Thread Size
27475	1/4	35/64	25	200	1/4-18NPT
27476	1/4	35/64	50	200	1/4-18NPT
28673	1/4	35/64	300*	200	—
27478	3/8	47/64	25	200	1/4-18NPT
27479	3/8	47/64	50	200	1/4-14NPT
28674	3/8	47/64	300*	200	—

*300' lengths are not coupled.

Service Hose

Charter® Multi-Use Air/Water Hose

Ideal for air and water applications. Engineered for heat, abrasion and ozone resistance.

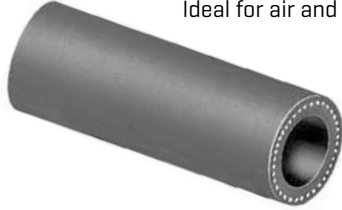

- EPDM rubber tube and cover.
 - Two layers of spiral synthetic reinforcement.
 - Power Crimp® specifications available*
 - Temperature rating: -40°F to +200°F.
 - Packaging: 50-ft. cartons, bulk reels.
- *Contact your local CARQUEST sales associate for specification information.
Caution: Do not use for oil, grease or fuel transfer.

I.D. (in.)	Work. Press. (psi.)	Part No. 50Ft.	Part No. Reels	Reel Length Ft.	I.D. (in.)	Work. Press. (psi.)	Part No. 50Ft.	Part No. Reels	Reel Length Ft.
1/4	200	28823	28800	500	5/8	200	28830	28812	500
5/16	200	28825	28803	500	3/4	200	28832	28815	500
3/8	200	28826	28806	500	1	200	28836	28818	300
1/2	200	28828	28809	500					

Signal Call Tubing

Designed for driveway signal devices in service stations and garages.

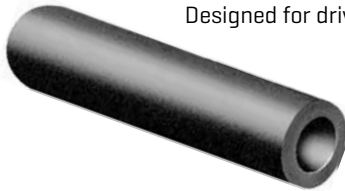

- Long-lasting EPDM rubber tubing specially built to register under the slightest pressure.
- Withstands vehicle weight at temperatures up to +150°F [+66°C]
- Meets SAE J1037, J942b specifications.
- Packaging: 50 ft. and 100 ft. [without couplings] individually cartoned; 300 ft. reels [maximum two pieces, shortest length 100 ft.].

Part No.	I.D. (In.)	O.D. (In.)	Length (Ft.)
27539	3/8	5/8	50
28681	3/8	5/8	100
28686	3/8	5/8	300

Diesel Emission Fluid [DEF] Hose Assemblies are specially designed and manufactured to convey Diesel Emission Fluid [DEF]. Because DEF freezes at +11°F [-12°C], the hose and couplings are electronically heated using the revolutionary carbon fiber heating system. This patent pending technology allows for more uniform fluid heating compared to heated-wire designs. Customizable hose lengths offer greater flexibility in design while thermoplastic over-molds protect electrical connections against moisture and corrosion.

CARQUEST also provides DEF Tank Transfer Hose are manufactured for the specific filling functions of DEF tanks. They feature the highest quality construction to meet the demands of DEF handling and transfer.

DEF Hose + Hose Assemblies

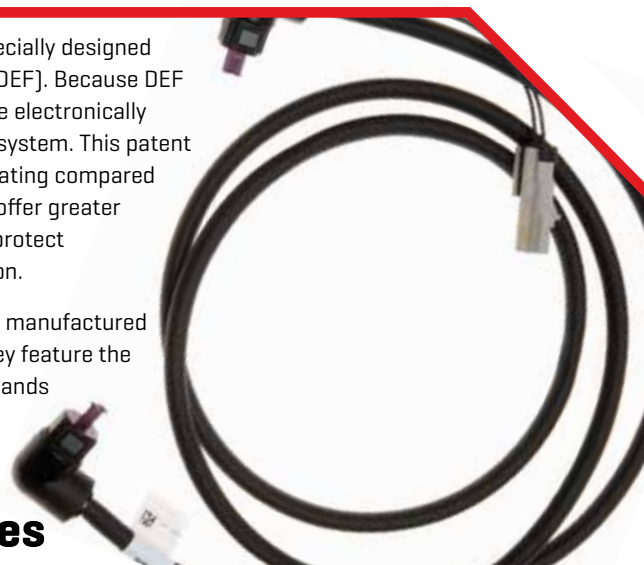

Exhaust System Hose

Exhaust Hose (Hardwall) Wire Reinforced

Heavy-duty fabric-reinforced hose with a helical steel wire reinforcement to meet marine water and wet exhaust hose requirements.

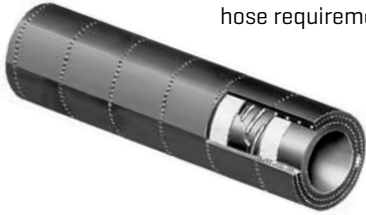

- Features blue layline for easy identification.
- Resists heat and oil.
- Meets SAE J2006 requirements.
- Working pressure 100 psi for water application, 10 psi for exhaust application.
- May be used for engine water circulation, discharge lines, heat exchangers and wet exhaust connections.
- Packaging: 12.5 foot lengths.

I.D. (In.)	O.D. (In.)	12.5 Foot Length Part No.	I.D. (In.)	O.D. (In.)	12.5 Foot Length Part No.	I.D. (In.)	O.D. (In.)	12.5 Foot Length Part No.
1 ¹ / ₈	1.50	250-1184	2 ¹ / ₈	2.49	250-2184	3 ¹ / ₂	4.04	250-3124
1 ³ / ₄	1.63	250-1144	2 ³ / ₄	2.63	250-2144	4	4.54	250-4004
1 ³ / ₈	1.75	250-1384	2 ³ / ₈	2.75	250-2384	4 ¹ / ₂	5.04	250-4124
1 ¹ / ₂	1.88	250-1124	2 ¹ / ₂	2.90	250-2124	5	5.54	250-5004
1 ⁵ / ₈	2.00	250-1584	2 ⁵ / ₈	3.02	250-2584	5 ¹ / ₂	6.04	250-5124
1 ³ / ₄	2.12	250-1344	2 ³ / ₄	3.22	250-2344	6	6.68	250-6004
1 ⁷ / ₈	2.24	250-1784	2 ⁷ / ₈	3.42	250-2784			
2	2.36	250-2004	3	3.54	250-3004			

Since their introduction into heavy-duty applications, automatic tensioners have largely replaced locked-center tensioners on serpentine belt drives - for good reason. They increase the life of the drive belt and accessory bearings, and reduce maintenance and downtime. Automatic tensioners apply a constant force to the accessory drive belt, compensating for belt wear and changes in operating loads. When optimum tension is maintained, belts last longer and noise problems decrease.

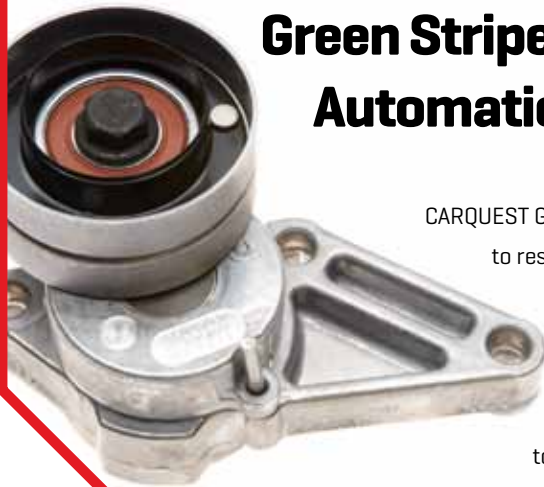

Green Stripe® DriveAlign® Heavy-Duty Automatic Belt Tensioners

CARQUEST Green Stripe® DriveAlign® automatic belt tensioner is designed to resist extreme vibrations while providing stable damping for the life of the engine. During peak-to-peak vibration tests equivalent to 400,000 road miles, CARQUEST tensioner lasted three times longer than OEM or competitive aftermarket products. The DriveAlign tensioner's ability to absorb extreme vibration means that it has high damping levels so that tensioner motion and fatigue of the inner torsion spring are reduced. In addition, the universal design can be set up at the factory to provide tension in either direction, depending on the application.

Fleet Accessories

Splash Guards

Minimizes splashing of rain and settled water from wheels on medium and heavy-duty trucks.



- Tough rubber and fabric-filled construction for maximum service life.
- Special half-round reinforced ridge resists tearing and cracking.
- Body is $\frac{3}{4}$ " thick and edge is $\frac{3}{8}$ " thick for extra strength.
- Packaging: Order in pairs [unpacked].

Length [In.]	Width [In.]	Part No.
26	24	90335
30	24	90333
36	24	90334
40	24	90332

Static Straps

Discharges potentially dangerous static electricity from equipment when properly grounded.



- Specially compounded rubber conducts static electricity.
- Resists weathering, abrasion and tearing.
- Meets, military specifications MILR3065C
- Packaging: 25 per carton.

Length [In.]	Width [In.]	Depth [In.]	Part No.
25	1 $\frac{1}{16}$	$\frac{3}{16}$	90330
30	1 $\frac{1}{16}$	$\frac{3}{16}$	90331

Although vehicle manufacturers are upgrading both cooling system capacities and air handling on new models, fleets don't know what life cycles they can expect from seals, gaskets, bearings, hoses and even exterior paint surfaces. When it comes to the drive system belts, however, you can expect that CARQUEST Green Stripe® FleetRunner® Micro-V belt and FleetRunner® V-belt will give you nearly twice the service life of an ordinary belt.

FleetRunner® belts



Extend your belt change intervals, prevent downtime and cut maintenance expenses with FleetRunner® belts and Green Stripe® DriveAlign® tensioners.

Merchandisers + Sales Aids

Heater Hose Merchandiser



Attractive, yet rugged metal cabinet organizes and keeps stock neat. Designed to hold dispensing cartons, making it easy to pull hose out for measuring. Create a "Hose Center" by adding the popular Fuel Line/PCV/EEC and Vacuum Tubing Merchandiser to the top of this unit. Part No. 91160.

- Holds one each 50 ft. cartons of $\frac{1}{2}$ ", $\frac{5}{16}$ " and $\frac{3}{4}$ " heater hose.
- Handy 36" measuring scale printed on side makes it easy to measure the exact length of hose needed.
- Assembled unit measures 20 $\frac{1}{8}$ " x 17 $\frac{1}{2}$ " x 43". [Shipped K.D.]

Note: Merchandiser does not include hose.

Barricade® Fuel Line and Vacuum Tubing Merchandiser/Assortment

Attractive, metal cabinet comes assembled. Holds and dispenses 12 reels of fast-selling CARQUEST Barricade® Fuel Line, EEC and PCV hoses, or tubing for windshield washers and vacuum-operated accessories. Part No. 91184 and Part No. 91183 - Display only. Charge Item. Replaces the 91158/91159 rack.



- Contains 12 fast-selling hose sizes on individually mounted and replaceable reels.
- Handy measuring scale printed on lid makes it easy to measure exact size of hose needed.
- Can be displayed on counter or mounted on wall.
- Attached chain designed to hold hand-held hose cutter.
- Base dimensions are 16"D x 19 $\frac{1}{2}$ "W x 18"H.

Note: Combine this merchandiser with the Heater Hose Merchandiser to create the modular "Hose Center" shown below.

Fuel Line /PCV / EEC Hose			Vacuum Tubing			Barricade® Carburetion Hose			Barricade® Injection Hose		
I.D. [In.]	Length [Ft.]	Part No.	I.D. [In.]	Length [Ft.]	Part No.	I.D. [In.]	Length [Ft.]	Part No.	I.D. [In.]	Length [Ft.]	Part No.
$\frac{1}{8}$	25	27000	$\frac{1}{8}$	50	27041	$\frac{1}{4}$	25	27313	$\frac{1}{4}$	25	27339
$\frac{3}{16}$	25	27001	$\frac{5}{32}$	50	27042	$\frac{5}{16}$	25	27314	$\frac{5}{16}$	25	27340
			$\frac{7}{32}$	50	27043	$\frac{3}{8}$	25	27315	$\frac{3}{8}$	25	27341
			$\frac{1}{4}$	50	27044						

Create a "Hose Center"



Add the popular Fuel Line/PCV/EEC and Vacuum Tubing Merchandiser to the Heater Hose Merchandiser, and all the popular small I.D. hoses will be located in one neat and convenient location. Part No. 91183 + 91160.

- Base dimensions are 20 $\frac{1}{8}$ " D x 19 $\frac{1}{2}$ "W x 61"H.

Merchandisers + Sales Aids

Heater Hose Connector Assortment

Sturdy impact-resistant plastic case holds an assortment of 36 hose connectors for 1/4" through 3/4" I.D. hose. Part No. 91136. Charge Item.



- Case opens from either side.
- Handy plan-o-gram inside both lids identifies location of each type and size connector.
- Assortment contains two each elbow, straight, reducer and "T" connectors.
- Provides convenient storage for complete line of connectors.

Part No.	Description	I.D. (in.)	Part No.	Description	O.D. (in.)
28621	Plastic Elbow	1/4	28601	Hose Connector	1/4
28622	Plastic Elbow	3/8	28602	Hose Connector	3/8
28623	Plastic Elbow	1/2	28603	Hose Connector	1/2
28624	Plastic Elbow	5/8	28604	Hose Connector	5/8
28625	Plastic Elbow	3/4	28605	Hose Connector	3/4
28631	Plastic Tee	1/4	28609	Hose Reducer	3/8 to 1/2
28632	Plastic Tee	3/8	28610	Hose Reducer	1/2 to 5/8
28633	Plastic Tee	1/2	28611	Hose Reducer	5/8 to 3/4
28634	Plastic Tee	5/8			
28635	Plastic Tee	3/4			

Fuel Line and Vacuum Tubing Connector Kit

Handy impact resistant plastic case holds an assortment of 36 fuel line and vacuum tubing connectors. Assortment includes two of each connector shapes - "Y", elbow, tee, reducer and straight. Part No. 91156.



- Plan-o-gram inside lid identifies location of each type and size connector.
- Provides convenient storage for complete line of fuel line and vacuum tubing connectors.
- Assortment contains two of each size from 3/32" to 3/16" O.D.

Part No.	Description	I.D. (In.)	Part No.	Description	I.D. (In.)
28561	Straight Connector	3/32	28574	Elbow	3/16
28562	Straight Connector	1/8	28592	Reducer	1/8 - 5/32
28563	Straight Connector	5/32	28552	"Y" Connector	1/8
28564	Straight Connector	3/16	28581	Tee	3/32
28591	Reducer	3/32 - 1/8	28582	Tee	1/8
28551	"Y" Connector	3/32	28583	Tee	5/32
28571	Elbow	3/32	28584	Tee	3/16
28572	Elbow	1/8	28593	Reducer	3/16 - 1/4
28573	Elbow	5/32	28554	"Y" Connector	3/16

Professional-Grade Tools

POWERCLEAN™ Flush Tool

Cooling systems can be difficult to flush completely due to accumulated debris. Inadequate flushing can ruin a newly installed water pump and result in warranty problems and frustrated customers. Make sure you perform a complete cooling system flush by using clean water and compressed air. The Power Clean™ Flush Tool “water hammers” accumulated sludge and scale deposits without the use of harsh chemicals or solvents. It cleans radiators, heat exchangers, hoses and engine blocks more effectively than conventional flushes, maintains system integrity and ensures warranty coverage on replacement parts, including water pumps. The Power Clean™ Flush Tool patented process uses fixed dimensional control of the air and liquid flow paths. The process allows air to pressurize the cleaning fluid to scrub deep into corners and crevices, eliminating trapped debris. Part No. 91002.



- Pulsating gun assembly with pre-set regulator.
- Water line backflow preventer.
- Large rubber tip for radiator necks and direct flushing of the engine block.
- Small rubber tip on whip hose for direct access to heater core tube stubs.
- $\frac{5}{8}$ " And $\frac{3}{4}$ " heater hose barbs for flushing heater cores or engine blocks.
- Durable protective storage case with room for additional items.

Belt Installation Tool

Time-saving tool affords control and reach when installing serpentine belts. Also helps install V-belts and timing belts located in difficult-to-reach areas. Part No. 91209. Charge Item.



- Two pin design affords convenient belt push/pull capability.
- Tool's handle lends easy twisting control of belt in hard-to-reach places.

Bend-N-Fit Tube Bender

Simply and easily duplicates bent tubes. Part No. 91025.



- Power steering
- Air conditioning
- Transmission oil cooler
- Fuel lines
- Plus many more applications
- Bends sae tubing as well as metric tubing – without changing any tooling – in the following sizes: $\frac{1}{4}$ " $\frac{5}{16}$ " $\frac{3}{8}$ " $\frac{1}{2}$ " 6mm –13mm.

Serpentine Belt Tension Relief Tool

Ideal tool for removing and installing serpentine belts. Provides necessary leverage and clearance to release spring pressure and move tensioner pulley arm. Part No. 91015.



- Three-bar design includes seven sockets [13mm, 14mm, 15mm, 16mm, 18mm, $\frac{3}{8}$ " and $\frac{1}{2}$ "].

Professional-Grade Tools

Heavy-Duty PowerGrip® SB Clamp Removal Tool

Offers easiest method for removing PowerGrip® SB clamps. Part No. 91215 Tool. Charge Item.



- Quickly removes clamps without damaging hose.

DriveAlign® Laser Alignment Device

Exclusive, patented tool is compatible with all automotive serpentine belt drives. Quickly identifies two most common types of pulley misalignment – parallel offset and angular – that reduce belt and pulley service life and produce unwanted noise. Simply position tool within grooves of pulley and aim laser beam at opposite pulley. Part No. 91006.



- Lightweight, easy-to-use tool includes special laser enhancement glasses for easy viewing in all light conditions.
- Comes with high-impact resistant carrying case.

SureLok™ Quick-Release Pliers

SureLok™ couplings [Push-to-Connect] are the easiest and quickest coupling to install, but can be difficult to disconnect. Placement near obstructions, as well as age and road debris, affect the ability to disconnect the SureLok™ coupling. Tight spaces can also make removing a coupling almost impossible. SureLok™ pliers allow for the removal of a Push-to-Connect coupling from the tubing in seconds with just one hand. To help get into tight spaces, SureLok pliers offer two different heads; one straight and one with a 90° offset. They come in two sizes: Small, for tubing from 1/8" to 3/8"; and Large, for tubing 3/8" to 3/4". An instructional CD is included with each part number.

Sold as single units, packs of two [Large or Small], as well as all four in a handy carrying case.



Single Units

Small

Part No. 91023, Vertical
Part No. 91021, Angle

Large

Part No. 91022, Vertical
Part No. 91020, Angle

Four Pack

Part No. 91017

Belt Wear Gauge

Like tires, EPDM belts wear out gradually, steadily losing rubber material. This unique tool designed to help inspect serpentine belts for wear. EPDM belts, installed by original equipment manufacturers on new equipment, typically do not show obvious signs of wear such as cracking. Contact your local CARQUEST representative to receive your tool. Part No. 91190.



Professional-Grade Tools

PolarSeal® II Pliers

PolarSeal® II Pliers are used to crimp clamps on PolarSeal® II couplings. Any one of three pliers will get the job done. Each tool is designed with slightly different features.

Ratcheting Plier – Part No. 77953



- The ratcheting plier features a no-release function. Once a crimp is started the plier does not release until the crimp is complete. This guarantees a proper seal, with no guess work in the crimp.

Straight Jaw Plier – Part No. 77952



- The straight jaw plier is a low cost, no-frills plier. This plier works best when there are no obstructions to hinder gripping the clamp or completing the crimp.

Notched Jaw Plier – Part No. 77951

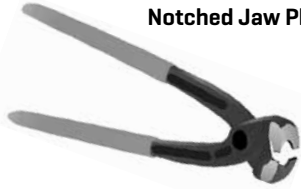

- The notched jaw plier is designed for the hard-to-reach places. If obstructions prohibit the use of straight jaw pliers this is the tool to use. Use either side or the front of this plier to make the crimp.

Kriket™ V-Belt Tension Gauge

This easy-to-use gauge is designed for tensioning all automotive V-belts up to, and including, $\frac{7}{8}$ " top widths. Part No. 91107. Charge Item.



- Scale reads in pounds and kilograms. Measures tension from 30 to 160 lbs., and 15 to 75 kg.
- Die-cast aluminum body, nylon indicator arm and pressure pad.
- Fits in pocket with stainless steel pocket clip.
- Packaging: Individually boxed.

Note: Not for use on timing belts.

Kriket™ II Micro-V AT® (V-Ribbed) Belt Tension Gauge

Designed for tensioning V-ribbed belts on passenger cars, light trucks, heavy trucks and buses. Part No. 91132. Charge Item.



- Bright green pressure pad and indicator arm.
- Calibrated to measure tension from 100 to 320 lbs., and 50 to 150 kg.
- Measure belts up to eight ribs in width.
- Packaging: Individually boxed.

Note: Not for use on timing belts.

Professional-Grade Tools

Coolant + Battery Refractometer

Measures concentration of coolant mixture in engine. Place small sample of coolant on lens, then hold lens up to light source. Light bends through liquid, providing an accurate reading on scale. Part No. 91001.



- Measuring coolant concentrations is essential to cooling system maintenance.
- Most technicians use hydrometers to test coolant concentration via gravity or floating ball scales.
- Hydrometers must be temperature corrected, and may give false readings when testing new, propylene-based coolants.
- The refractometer automatically corrects for temperature on both types of coolant (ethylene and propylene glycol) while measuring battery charge levels.

Hose Cutters (Hand-Held) and Replacement Blades

Makes clean cuts with no ragged edges. Cuts most non-metal reinforced rubber hoses up to 3" I.D. Excellent for cutting thin walled flexible pipe, PE and PVC pipe (up to 1½") used in sprinkler systems.



- Lightweight with nylon handles.
- Blade closes into handle for safety.
- Use small cutter for hoses up to 1½" I.D.
- Packaging: Cutter and blades individually packaged on shrink-wrapped cards ready for pegboard display.

Hose Cutter	Description	Replacement Blade	Cuts to Hose I.D.
91143	Large I.D. Hose Cutter	91144	3"
91153	Small I.D. Hose Cutter	91154	1½"

Serpentine Ratcheting Wrench Set

Provides fast way of releasing tension on serpentine belt drives. Reversible, 21-tooth ratcheting heads on each end allow for better tool positioning and more swing than standard serpentine belt wrenches. Part No. 91011.



- Wrenches are 21½" long, 6" longer than competitive designs for increased leverage.
- Includes eight sizes for maximum application coverage: 13mm, 14mm, 15mm, 16mm, 17mm, ⅜", ½" and ¾".

How to Use

This catalog contains seven distinct Equipment Type specific Application sections. Each Application section is sorted alphabetically by Equipment Manufacturer, then further sorted based on a hierarchy pertinent to the Equipment Type. The 'Index by Equipment Type and Make' serves as a quick reference to aid in easily navigating the catalog. Also included in this catalog are Product Pages, a Model and Manufacturer Index, Size Lists (Including Straight Hose), and an Interchange that Relates FleetRunner® Belt Part Numbers to standard Micro-V AT® Belt and XL® V-Belt Part Numbers.

The Application Sections could contain the following:

1. Equipment Type Specific Hierarchy (Make, will also include a subset of Year, Model and Engine)
2. Our Part Number
3. Manufacturer Part Number (for Belts, Tensioners, and Pulleys)
4. Application Description and Comments
5. Footnotes
6. Footnote definitions for footnotes used on the page
7. Inside Diameter (and Length required if available) for Straight Hose*

Belts and Coolant Hose for Medium/Heavy-Duty Trucks (1996 and Newer)					
Application	Mfr. Part No.	Our No.	Application	Mfr. Part No.	Our No.
FORD - Continued			FREIGHTLINER		
1996 - Continued			2012		
Ford V-8 7.0 L - Continued			Cummins ISX15 Diesel		
F700, F800 - Continued			Coronado		
Belt - Fan & Alt., W/40A, 50A, Alt., W/Fixed Fan, W/O Cowl Cab	E6P28520G	◆9451HD	Belt - Fan	0132161200	K120896HD
Belt - Fan & Alt., W/75A, Alt., W/Fan Clutch	D9P28620M	◆9447HD	Belt - A.C.	0132162574	◆K06058HD
Belt - Fan & Alt., W/75A, Alt., W/Fixed Fan	E2H28620C	◆9463HD	Tensioner Assy - A.C.	3104149	38610
Belt - Fan & Alt., W/90A, 130A, Alt., W/Fan Clutch	E6P28520G	◆9451HD	Tensioner Assy - Fan	2671292	38587
Belt - Fan & Alt., W/90A, 130A, Alt., W/Fixed Fan	E2H28620C	◆9463HD	Idler Pulley - A.C.	3682229	36223
Belt - Fan & P.S.; W/Single A.P.	◆9538HD	◆9558HD	Hose - Lower - Rad. To Pipe		≧21891
Belt - P.S. W/Dual Belts	E8H28620P	◆9588HD	Hose - Lower - Pipe To Pipe		≧21135
Belt - P.S. W/Single Belt	C9P28620CR	◆9548HD	Hose - Lower - Pipe To Eng		≧21891
Belt - P.S. & A.C.	D4HE8520CA	◆9488HD	Detroit Diesel DD13 Diesel		
Belt - A.C.	E5H28620C	◆9368HD	Cascadia, Coronado		
Belt - Air Compr.; W/Air Brakes	E8H28620A	◆9658HD	Belt - Alt. & A.C.	0132732680	K081055HD
Belt - Air Compr.; W/Hyd. Brakes	E0P28520G	◆9618HD	Belt - Fan	0132731835	K100643HD
Belt - Idler; W/High Mount Fan	D4HE8520CA	◆9488HD	Detroit Diesel DD15 Diesel		
Hose - Upper; W/P.T.O.		≧21936	Cascadia		
Hose - Upper; W/Auto. Trans.; W/O P.T.O.		21938	Belt - Fan	0131893835	K100643HD
Hose - Lower; W/P.T.O.		21536	Belt - A.C. & Alt.	0132732700	K081085HD
Hose - By Pass		≧21942	Hose - Upper - Rad. To Pipe		≧21115
Hose - Heater (5/8" I.D.)		28441	Hose - Lower - Pipe To Rad		≧21891
F7900			DEF Hose Assy - Pressure - Tank To Pump		
Belt - Alt. W/40A, 60A, Alt., W/Fan Clutch; W/Cowl Cab	C9P28620FN	◆9448HD	DEF Hose Assy - Pressure - Pump To Injector	0428941200	DEF7008
Belt - Alt. W/40A, 60A, Alt., W/Fan Clutch; W/O Cowl Cab	E8P28620F	◆9435HD	Coronado		
Belt - Alt. W/40A, 60A, Alt., W/Fixed Fan; W/Cowl Cab	◆9447HD	◆9447HD	Belt - Fan	0131893835	K100643HD
Belt - Alt. W/40A, 60A, Alt., W/Fixed Fan; W/O Cowl Cab	E6P28520G	◆9451HD	Belt - Alt. & A.C.	0132732700	K081085HD
			Hose - Upper - Rad. To Pipe; (2 1/2" I.D.)		≧24240
			Hose - Upper - Pipe To Eng.; (2 1/2" I.D.)		≧24240
			2011		
			Cummins Diesel		

1

3

5

2

4

7

6

◆ Standard Belt Available. See Pages 630-631.
◆ Green Strip® PowerBand® Belt May Work, Use Template to Check.

② Two Required.
≧ Cut to Fit.

* Straight Hose part numbers listed in the catalog are bulk hose part numbers, sold in lengths ranging from 3' stick hose to 300' reels. Be sure to indicate the length of hose you'd like when ordering these part numbers. When available the length required for the application has been provided along with the Inside Diameter as a comment in the Application section. To see alternative hose construction options refer to the Straight Hose Size List.

A red trapezoidal graphic element is positioned at the top left of the page. It consists of a solid red triangle on the left side, which is connected to a white trapezoidal shape on the right. The white trapezoid has a thin red border and contains the word "Notes" in red text.

Notes



Notes

Index by Equipment Type and Make

Make	Page Number	Make	Page Number	Make	Page Number
Medium & Heavy-Duty Trucks (1996 & Newer)		Transit Buses - Continued		Road & Construction Equipment - Continued	
Autocar	1	MCR	399	Herc	470
Bering Truck Corp.	1	Nabi	399	Hitachi	470
Chevrolet	1 - 10	National Coach	399	Huber-Warco	471 - 472
Crane Carrier Company	10	Neoplan	399 - 400	Hughes-Kennan	472
Dodge	10	New Flyer	400 - 401	Hydra-Mac	472
Ford	10 - 31	Nova Bus	401	Hyhoe	472
Freightliner	31 - 71	Optare	401	Hyster	472 - 473
GMC	71 - 80	Optima Bus Corporation	401	ICC	473
Hino	80 - 83	Orion	401 - 403	Ingersoll	473 - 474
International/Navistar	83 - 121	Prevost	403	Ingram	474
Isuzu	121 - 125	Setra	403	Insley	474
Kenworth	125 - 152	Thomas Built	403	International	474 - 478
Mack	152 - 161	TMC	403	Jaeger	478 - 479
Mitsubishi Fuso	161 - 162	Turtle Top	403 - 404	JCB	479
Peterbilt	162 - 188	U.S. Bus	404	John Deere	479 - 487
Sterling	188 - 200	Van Hool	404	Joy	487 - 488
UD (Nissan)	200 - 201			Kawasaki	488
Volvo	201 - 212	Road & Construction Equipment		Kobelco	488
Western Star	212 - 220	Advance Sweeper	405	Koehring	488 - 489
Workhorse	220 - 224	Allis-Chalmers	405 - 408	Komatsu	489 - 492
		American Crane Corp.	408	Kubota	492 - 493
Refrigeration Units		Arrow-Master, Inc.	408	Le Roi	493
Arctic Traveler	225	Austin-Western	408 - 411	Le Tourneau	493
Carrier	225	Badger	411	Liebherr	494
Thermo King	225 - 232	Bantam	411 - 412	Link-Belt	494
Transcold	232 - 233	Barber-Greene	412	Little Giant	495
		Bay City	412 - 414	Long	495
School Buses		Blaw-Knox	414	Lorain	495
Amtran	234 - 235	Bobcat-Melroe	414 - 415	M-R-S	495
Bluebird	235 - 240	Bomag	415 - 416	Massey Ferguson	495 - 496
Carpenter	240	Broderson	416	MDI/Yutani	496
Chevrolet	240 - 256	BROS	416 - 417	Multihoe	496
Collins	256	Brown	417	MultiQuip	496
Corbeil	256	Bucyrus-Erie	417 - 418	Mustang	496
Crown Coach	256 - 258	Buffalo Springfield	418 - 419	New Holland	496 - 497
Dodge	258 - 263	Case	419 - 425	Owatonna	497
Ford	263 - 286	Caterpillar	425 - 437	P & H	497 - 498
Freightliner	286 - 287	Cedar Rapids	437 - 438	Parsons	498
GMC	287 - 305	Champion	438	Pettibone	498
International/Navistar	305 - 380	Chicago-Pneumatic	438	Poclair	498 - 500
Mid Bus	380	Clark-Lima	438 - 439	Pumpmaster	500
Thomas Built	380 - 385	Clark-Michigan-VME	439 - 446	Raygo	500 - 501
Ward	385 - 386	Cleveland	446	Rex	501
		CMI	446	Samsung	501
Transit Buses		Dart	446	Smith Co.	501
ABC Bus Company, Inc.	387	Ditch Witch	447	Sullair	501
Aerocoach	387	Dresser-Dressta	447 - 450	Takeuchi	501
AM General	387	Dresser-Galion	450 - 454	Tampo	501 - 502
Beaver Coach	387	Dresser-Hough	454 - 460	Tamrock	502
Bluebird	387 - 388	Drott	460 - 463	TCI	502
Champion Bus	388	Dynahoe	463	Terex	502 - 504
Chance Mfg. Co.	388	Dynapac	463	Thew Shovel	504 - 505
Chevrolet	388	Easi-Doer	463	Thomas	505
Eagle	388 - 389	Elgin	463	Toyota	505
El Dorado	389	Elite	463	Trojan-Yale	505 - 506
Flxible	389 - 391	Euclid	463 - 464	Unimog	506
Gillig	391 - 393	Ferguson Shovel Supply	465	Unit Crane & Shovel	506
GMC	394 - 397	Fiat-Allis	465 - 466	Vermeer	506
Goshen Coach	397	FMC	466	Versa	506
Graf & Stift	397	Ford	466 - 467	Vibro-Plus	506
Ikarus	397	Fresia	467	Vibromax	506
International/Navistar	397	Gardner-Denver	467 - 469	VME	506
LAG	397	Gehl	469	Volvo	506 - 508
M.A.N.	397	Gomaco	469	Wabco	508 - 509
Marcopolo	397	Grimmer-Schmidt	469	Waldon	509 - 510
MCI	397 - 399	Grove	469 - 470	Warner & Swasey	510
		Hamm	470	Weldon	510
				Zettlemeyer	510

Indexes
& Abbrev.



Index by Equipment Type and Make

Indexes
& Abbrev.

Make	Page Number	Make	Page Number	Make	Page Number
Power Units		Lift & Industrial Equipment - Continued		Lift & Industrial Equipment - Continued	
Aggreko	511	Case	546	Lift All	568 - 569
Allis-Chalmers	511 - 513	Caterpillar	546 - 552	Lull	569
Amita	513	Champ	552	Massey Ferguson	569
Bedford	513	Clark	553 - 554	Mercury	569
Caterpillar	513 - 518	Condor	554	Mitsubishi	569
Cummins	518 - 528	Dresser-Dressta	554	Mobilift	569 - 571
Deutz-Allis	528 - 530	Economobile	555	Namco	571
International	530 - 531	Fabtek	555	Nissan	571
Isuzu	531	Genie	555	Ottawa	571 - 572
John Deere	531	Gerlinger	555 - 557	Pettibone	572 - 574
Lister	531	Gradall	557	Skytrak	574
Mkt Mfg. Inc.	531	Gradall-Loed	558	Snorkel Lift	574
Northern Lights	532	Grove	558	Taylor	574 - 575
Onan	532	Herculift	558	TCL	575
P & H	532 - 533	Hyster	558 - 562	TCM-Toyo	575
Perkins	533	Ingersoll-Rand	562	Teco-Crab	575
Sheppard	533	International	562	Towmotor	575 - 577
Universal	533	JLG	562	Toyota	577 - 578
Wisconsin	533	John Deere	562 - 563	United Tractor	578
Lift & Industrial Equipment		K-D Manitou	563	Walden	578
Allis-Chalmers	534 - 540	Kalamazoo	563	White	578 - 579
Automatic Transportation	540	Kalmar	563 - 568	Yale	579 - 581
Baker	540 - 546	Komatsu	568	Zetor	581

Model and Manufacturer Index

Model	Manufacturer	Model	Manufacturer	Model	Manufacturer
1		1 - Continued		1 - Continued	
1-Step-30.....	Ottawa	110.....	Austin-Western	165.....	Dresser-Dressta
10.....	Bay City	110-9.....	Clark-Michigan-VME	165.....	Hino
10-14 Ton.....	Dresser-Galion	110-11.....	Clark-Michigan-VME	166.....	Koehring
10-14 Ton.....	Huber-Warco	110-11B.....	Clark-Michigan-VME	166-15.....	Parsons
10 Ton.....	Huber-Warco	110-15.....	Clark-Michigan-VME	170.....	John Deere
10 Ton.....	Ingram	110 III-H14.....	Clark-Michigan-VME	170B.....	Case
10B.....	Bucyrus-Erie	110HT.....	Clark-Michigan-VME	170RD2.....	Le Roi
10D.....	Huber-Warco	112E (91G).....	Caterpillar	170RD2.....	Wabco
10R.....	Bucyrus-Erie	112F (89J).....	Caterpillar	175.....	Grimmer-Schmidt
11-5400.....	Ingram	115ZIII.....	Kawasaki	175.....	International
11B.....	Fiat-Allis	118.....	Dresser-Galion	175A.....	Clark-Michigan-VME
11D.....	Huber-Warco	118C.....	Dresser-Galion	175A.....	Jaeger
12+2.....	Case	120 (10R).....	Caterpillar	175A III.....	Clark-Michigan-VME
12B.....	Clark-Michigan-VME	120 (13U).....	Caterpillar	175B.....	Clark-Michigan-VME
12BR Control.....	Clark-Michigan-VME	120 (14K).....	Caterpillar	175B.....	Dresser-Dressta
12E (99E).....	Caterpillar	120 (89G).....	Caterpillar	175B.....	International
12F (13K).....	Caterpillar	120G (87V).....	Caterpillar	175C.....	Clark-Michigan-VME
12F (73G).....	Caterpillar	122.....	Austin-Western	175C.....	Dresser-Dressta
12F (89H).....	Caterpillar	125.....	Dresser-Galion	175C.....	International
12G (61M).....	Caterpillar	125.....	Jaeger	175CTA62.....	Cummins
12RH.....	Gerlinger	125.....	John Deere	175DFBD.....	Onan
12RT.....	Euclid	125.....	Smith Co.	175DGFA.....	Onan
13C.....	Sheppard	125A.....	Dresser-Galion	175RG1.....	Chicago Pneumatic
13D.....	Sheppard	125A I.....	Clark-Michigan-VME	180.....	Bay City
13E.....	Sheppard	125A II.....	Clark-Michigan-VME	180.....	Clark-Michigan-VME
13F.....	Sheppard	125A III.....	Clark-Michigan-VME	180.....	International
14.....	Sheppard	125B.....	Case	180.....	Jaeger
14-20 Ton.....	Dresser-Galion	125B.....	Clark-Michigan-VME	180 I.....	Clark-Michigan-VME
14B (64C).....	Caterpillar	125C.....	Clark-Michigan-VME	180 I.....	Volvo
14C.....	Sheppard	125C.....	Dresser-Dressta	180 II.....	Volvo
14C-VD.....	Hydra-Mac	125C.....	International	180 III.....	Clark-Michigan-VME
14D (96F).....	Caterpillar	125E.....	Dresser-Dressta	185.....	Bay City
14E (12K).....	Caterpillar	125G.....	Dresser-Dressta	185.....	Hino
14E (72G).....	Caterpillar	125RG2.....	Chicago Pneumatic	185.....	Ingersoll
14E (99G).....	Caterpillar	125RO2.....	Chicago Pneumatic	185.....	Sullair
14G (96U).....	Caterpillar	130G (74V).....	Caterpillar	187C.....	P & H
14YD.....	Herc	135HLD.....	Champ	190 4.....	Dynahoe
15.....	Bay City	140.....	Dynahoe	190-T52.....	Bay City
15.....	John Deere	140.....	International	190-T6430.....	Bay City
15-15.....	Namco	140 (11R).....	Caterpillar	195 Road Widener.....	Blaw-Knox
15 (4W).....	Caterpillar	140 (14U).....	Caterpillar	198.....	Hino
15A.....	Bay City	140 (24R).....	Caterpillar	1000A Travelift.....	Drott
15B.....	Bucyrus-Erie	140G (13W).....	Caterpillar	1000AI Travelift.....	Drott
15RH.....	Gerlinger	140G (72V).....	Caterpillar	1001.....	Transcold
15T-MC.....	Thew Shovel	145.....	Allis-Chalmers	1003.....	Transcold
16.....	Sheppard	145.....	Hino	1010C.....	John Deere
16 (49G).....	Caterpillar	145T.....	Allis-Chalmers	1025SK.....	Ditch Witch
16B.....	Fiat-Allis	150.....	Dresser-Dressta	1055.....	P & H
16TDT.....	Euclid	150.....	Dresser-Galion	1085C.....	Badger
17.....	Sheppard	150.....	P & H	1088.....	Case
17A.....	Sheppard	150.....	Sullair	1103.....	Vibromax
19.....	Sheppard	150 Crawler.....	International	1150B Crawler.....	Case
19B.....	Bucyrus-Erie	150A.....	Dresser-Galion	1150E.....	Case
100.....	Champ	150C.....	Fiat-Allis	1150G Crawler.....	Case
100.....	Pettibone	150CTA61.....	Cummins	1155E.....	Case
100 Hauler.....	International	150DGFA.....	Onan	1170.....	Caterpillar
100B.....	International	150F.....	Dresser-Galion	1200.....	Owatonna
100BT62.....	Cummins	150FA.....	Dresser-Galion	1200 Series.....	Brown
100C.....	Dresser-Dressta	150RG1.....	Wabco	1280.....	Case
100C.....	Fiat-Allis	150TC.....	P & H	1280B.....	Case
100E.....	Dresser-Dressta	151-T41.....	Bay City	1500.....	Drott
100E.....	International	160.....	Dresser-Galion	1550.....	Case
100FLW.....	Pettibone	160.....	Dynahoe	1550B.....	JCB
100G.....	Dresser-Dressta	160.....	Jaeger	1652 SC.....	International/Navistar
100H.....	Waldon	160.....	Poclair	1670.....	Caterpillar
101F.....	Wabco	160H.....	Caterpillar	1673 (1L).....	Caterpillar
102.....	Austin-Western	160RF2.....	Dresser-Galion	1673 (69D).....	Caterpillar
104.....	Dresser-Galion	161.....	Fiat-Allis	1673 (70B).....	Caterpillar
105.....	Jaeger	161.....	Transcold	1673B (1L).....	Caterpillar

Indexes & Abbrev.

Model and Manufacturer Index

Indexes
& Abbrev.

Model	Manufacturer	Model	Manufacturer	Model	Manufacturer
1 - Continued		2 - Continued		2 - Continued	
1673B (69D)	Caterpillar	25B	Bucyrus-Erie	250	Transcold
1673B (70B)	Caterpillar	25GS4	Pettibone	250 Skid Steer	John Deere
1673C (1L)	Caterpillar	28TDT	Euclid	250 Travelift	Drott
1673C (69D)	Caterpillar	29	Pettibone	250AI Travelift	Drott
1673C (70B)	Caterpillar	200	Champ	250B	Dresser-Dressta
1676	Caterpillar	200	Dresser-Dressta	250B	International
1680	White	200	Peterbilt	250C	Dresser-Dressta
1693	Caterpillar	200	Pettibone	250C	Ford
1700	Owatonna	200	Poclair	250C	International
1700	Trojan-Yale	200	Transcold	250C	Transcold
1700B	JCB	200B	Transcold	250CM	Transcold
1737	Case	200C	Fiat-Allis	250D	John Deere
1740	Case	200DFBD	Onan	250DFB6	Onan
1740 Wheel Loader	Case	200FLW	Pettibone	250E	Dresser-Dressta
1800	Drott	200HL	Champ	250FLW	Pettibone
1800	Ford	200HLD	Champ	250NT5	Cummins
1816	Case	200RF2	Dresser-Galion	250RF2	Dresser-Galion
1816C	Case	200W	Pettibone	250RG2	Chicago Pneumatic
1818	Case	201	Transcold	250RO2	Chicago Pneumatic
1825	Case	202	Transcold	250W	Pettibone
1825B	Case	203	Transcold	251	Transcold
1835C	Case	204	Transcold	253	Vibromax
1840	Case	210	Austin-Western	254	Transcold
1845	Case	210	Grimmer-Schmidt	255A	Bay City
1845C	Case	210	Jaeger	255A	Koehring
1900	Trojan-Yale	210C Backhoe	John Deere	255A	P & H
10000	Allis-Chalmers	210C Wheel Loader	John Deere	255ATC	P & H
10042	Skytrak	210H	Clark-Michigan-VME	255L	Parsons
11000	Allis-Chalmers	210LE	John Deere	258ALP	Hino
16000	Allis-Chalmers	210M	Dresser-Dressta	258LP	Hino
16000H	Allis-Chalmers	210RG2	Chicago Pneumatic	260	Allis-Chalmers
2		210S	JCB	260	Transcold
2	Barber-Greene	215	P & H	260 Skid Steer	John Deere
2-36 Romper	Raygo	215D (9TF)	Caterpillar	260A	Allis-Chalmers
2-66 Ranger	Raygo	220	Case	260AE	Allis-Chalmers
2-78 Forklift	White	220	Poclair	260C	Ford
2AB	Isuzu	220	Transcold	260E	Allis-Chalmers
2FD	Euclid	220B	Case	260EA	Allis-Chalmers
2FG15	Toyota	220B	Transcold	261B	Fiat-Allis
2FG20	Toyota	220DFBE	Onan	268	Hino
2FG25	Toyota	220FF	Bedford	270	International
2LDT	Euclid	220NT5	Cummins	270	Peterbilt
2SDK7	Toyota	220S	Dresser-Galion	270	Transcold
2SDK8	Toyota	221	Transcold	270 Skid Steer	John Deere
2T551	International	222	Transcold	275 Articulated	Clark-Michigan-VME
20	Bay City	222G	Wabco	275 III	Clark-Michigan-VME
20-15	Namco	223	Transcold	275A I	Clark-Michigan-VME
20-20	P & H	224	Transcold	275A III	Clark-Michigan-VME
20B	Bucyrus-Erie	225	Bobcat-Melroe	275B	Clark-Michigan-VME
20GS4	Pettibone	225 (51U)	Caterpillar	275C	Clark-Michigan-VME
20H	Bucyrus-Erie	229G	Wabco	275DFCB	Onan
20H III	Bucyrus-Erie	230	Transcold	275NTA2	Cummins
20R	Bucyrus-Erie	230B	Transcold	280	Clark-Michigan-VME
21H	Bucyrus-Erie	230C	Transcold	280	Volvo
21H IV	Bucyrus-Erie	230CM	Transcold	280 Articulated	Volvo
21LDT	Euclid	230CP	Transcold	280 I	Clark-Michigan-VME
21TD	Euclid	230DFBD	Onan	280 I	Volvo
21TDT	Euclid	231	Transcold	280 II	Volvo
22B	Bucyrus-Erie	234	Transcold	280 III	Clark-Michigan-VME
22BM-2	Bucyrus-Erie	235	Clark	280 III	Volvo
22TD	Euclid	235 (64R)	Caterpillar	280 Skid Steer	John Deere
22TDT	Euclid	238	Hino	280A III	Clark-Michigan-VME
24	John Deere	240 Skid Steer	John Deere	280B	Volvo
24TDT	Euclid	244J	John Deere	280C	Volvo
25	American Crane Corp.	245 (95V)	Caterpillar	280CSP	Bucyrus-Erie
25	Bay City	247	Cleveland	287C	P & H
25	John Deere	250	International	295	International
25+4XP	Case	250	Jaeger	295B	International
		250	Pettibone	2000	Bobcat-Melroe



Model and Manufacturer Index

Model	Manufacturer	Model	Manufacturer	Model	Manufacturer
2 - Continued		3 - Continued		3 - Continued	
2000.....	Trojan-Yale	300.....	Smith Co.	340.....	Peterbilt
2005.....	Transcold	300.....	Wabco	344E.....	John Deere
2010 Crawler.....	John Deere	300 Backhoe.....	John Deere	345C.....	Ford
2020.....	Ditch Witch	300 Hydro-Cruiser.....	Warner & Swasey	348.....	Peterbilt
2210.....	Hamm	300 Hydro-Scopic.....	Warner & Swasey	348 (36J).....	Caterpillar
2300.....	Ditch Witch	300 Wheel Loader.....	John Deere	348 (38J).....	Caterpillar
2310.....	Ditch Witch	300A.....	Raygo	350.....	Champ
2500.....	Drott	300B Backhoe.....	John Deere	350.....	International
2500.....	Trojan-Yale	300B Wheel Loader.....	John Deere	350.....	Towmotor
2500 Constructall.....	International	300D.....	John Deere	350 Crawler.....	Case
2500A.....	Kalamazoo	300DFCB.....	Onan	350 Crawler Loader.....	John Deere
2500B.....	Kalamazoo	300FLW.....	Pettibone	350 Crawler Tractor.....	John Deere
2510.....	Drott	300G.....	Pettibone	350C Crawler Loader.....	John Deere
2554.....	International/Navistar	300GT.....	Pettibone	350C Crawler Tractor.....	John Deere
2574.....	International/Navistar	300NTA2.....	Cummins	350DFCC.....	Onan
2654.....	International/Navistar	300P.....	Pettibone	350NTA3.....	Cummins
2674.....	International/Navistar	300TM-C.....	Warner & Swasey	351S.....	Towmotor
2700.....	Nissan	300W.....	Pettibone	352.....	K-D Manitou
21000.....	Allis-Chalmers	301 Backhoe.....	John Deere	355.....	Clark
21000H.....	Allis-Chalmers	301 Wheel Loader.....	John Deere	355.....	K-D Manitou
25000.....	Allis-Chalmers	301A Backhoe.....	John Deere	355PD.....	Clark
25000 Mark II.....	Allis-Chalmers	301A Wheel Loader.....	John Deere	356.....	Clark
3		301S.....	Clark-Michigan-VME	357.....	Peterbilt
3-5 Ton.....	Dresser-Galion	302 Backhoe.....	John Deere	358.....	Hino
3-5 Ton.....	Huber-Warco	302 Wheel Loader.....	John Deere	360.....	Sterling
3FG35.....	Toyota	302A Backhoe.....	John Deere	362.....	Peterbilt
3FGC20.....	Toyota	302A Wheel Loader.....	John Deere	365.....	Jaeger
3FGC25.....	Toyota	303.....	Dresser-Galion	365.....	Peterbilt
3LDT.....	Euclid	304.....	Bantam	365RO2.....	Chicago Pneumatic
3SDK5.....	Toyota	304.....	Koehring	367.....	Peterbilt
3.152.....	Perkins	305.....	Koehring	375.....	John Deere
3.25.....	Nissan	308.....	Hino	375.....	Peterbilt
3.5.....	Nissan	310.....	Clark-Michigan-VME	375A.....	Clark-Michigan-VME
30.....	Bay City	310.....	John Deere	377.....	Peterbilt
30+4.....	Case	310 III.....	Clark-Michigan-VME	378.....	Peterbilt
30DH.....	Drott	310D.....	John Deere	379.....	Peterbilt
30F.....	JLG	310DFCC.....	Onan	380.....	Case
30GA.....	Pettibone	310G.....	John Deere	380.....	John Deere
30GS.....	Pettibone	310NTA3.....	Cummins	380 I.....	Clark-Michigan-VME
30GS4.....	Pettibone	313.....	John Deere	380 I.....	Volvo
30H II.....	Bucyrus-Erie	315.....	Jaeger	380 II.....	Clark-Michigan-VME
30R.....	Gerlinger	315.....	John Deere	380 II.....	Volvo
30RH.....	Gerlinger	315SG.....	John Deere	380 III.....	Clark-Michigan-VME
30S.....	Gerlinger	317 Skid Steer.....	John Deere	380 III.....	Volvo
30SH.....	Gerlinger	319D.....	John Deere	384.....	Peterbilt
30YC.....	Drott	320.....	Peterbilt	385.....	Peterbilt
31TD.....	Euclid	320 Loader Backhoe.....	Case	386.....	Peterbilt
32.....	Bay City	320 Skid Steer.....	John Deere	387.....	Peterbilt
33.....	Bay City	320 Wheel Loader.....	Case	387A.....	P & H
35.....	American Crane Corp.	320A.....	Raygo	387B.....	P & H
35.....	Drott	320B Loader Backhoe.....	Case	387C.....	P & H
35.....	Terex	320B Wheel Loader.....	Case	387H.....	P & H
35.....	Wabco	323D.....	John Deere	388.....	Peterbilt
35A.....	Clark-Michigan-VME	325 Skid Steer.....	John Deere	389.....	Peterbilt
35AWS.....	Clark-Michigan-VME	328 Skid Steer.....	John Deere	390.....	Towmotor
35B.....	Clark-Michigan-VME	329D.....	John Deere	391.....	Towmotor
35C.....	Wabco	330.....	International	391S.....	Towmotor
35D.....	Drott	330.....	Peterbilt	392S.....	Towmotor
35E.....	Terex	330FF.....	Bedford	3000.....	Nissan
35EC.....	Drott	330H.....	Wabco	3000.....	Trojan-Yale
36.....	Pettibone	331.....	Bobcat-Melroe	3023.....	Bobcat-Melroe
37.....	Bay City	332 Skid Steer.....	John Deere	3145 (65P).....	Caterpillar
37B.....	Bucyrus-Erie	333D.....	John Deere	3150 (97M).....	Caterpillar
38B.....	Bucyrus-Erie	335.....	Bobcat-Melroe	3208 (79V).....	Caterpillar
38D.....	Barber-Greene	335.....	Peterbilt	3304 (2B).....	Caterpillar
38TC.....	Bucyrus-Erie	337.....	Peterbilt	3304 (66D).....	Caterpillar
300.....	Champ	338.....	Hino	3305.....	Terex
300.....	Pettibone	340.....	Ford	3306 (2B).....	Caterpillar
		340.....	International	3306 (66D).....	Caterpillar

Indexes & Abbrev.

Model and Manufacturer Index

 Indexes
& Abbrev.

Model	Manufacturer	Model	Manufacturer	Model	Manufacturer
3 - Continued		4 - Continued		4 - Continued	
3307.....	Terex	45.....	Bay City	440C Skidder.....	John Deere
3309.....	Terex	45.....	Clark-Michigan-VME	441.....	Towmotor
3315.....	Terex	45A.....	Clark-Michigan-VME	442.....	International
3375.....	John Deere	45B.....	Clark-Michigan-VME	442B.....	International
3400A.....	International	45BP.....	Clark-Michigan-VME	444.....	International
3406 (90V).....	Caterpillar	45C.....	Clark-Michigan-VME	444B.....	International
3408 (67U).....	Caterpillar	45CIIIB100.....	Bucyrus-Erie	444C.....	John Deere
3412 (38S).....	Caterpillar	45R.....	Bucyrus-Erie	444E.....	John Deere
3412 Generator.....	Caterpillar	46.....	Ferguson Shovel Supply	445.....	Owatonna
3444.....	International	400.....	Pettibone	445 Skid Steer.....	Case
3500.....	Ditch Witch	400.....	Wabco	445C Backhoe.....	Ford
3500.....	Nissan	400 Backhoe.....	John Deere	445C Wheel.....	Ford
3514.....	International	400 Wheel Loader.....	John Deere	450.....	Bay City
3600.....	International	400G.....	Pettibone	450.....	Gardner-Denver
3600A.....	International	400GT.....	Pettibone	450 Crawler.....	Case
3600A.....	Kalamazoo	400P.....	Pettibone	450 Crawler Loader.....	John Deere
3616.....	International	400P.....	Towmotor	450 Crawler Tractor.....	John Deere
3700 Series.....	Western Star	401 Backhoe.....	John Deere	450 Skid Steer.....	Case
3800.....	International	401 Wheel Loader.....	John Deere	450B Crawler.....	Case
3800 Series.....	Western Star	401B.....	John Deere	450B Crawler Tractor.....	John Deere
3820.....	International	401B Backhoe.....	John Deere	450C.....	Case
3820A.....	International	401C Backhoe.....	John Deere	450C Crawler Loader.....	John Deere
3850.....	International	401C Wheel Loader.....	John Deere	450C Crawler Tractor.....	John Deere
3964.....	International	402.....	Pettibone	452.....	K-D Manitou
3984.....	International	402C.....	Pettibone	455A.....	P & H
4		403.....	Pettibone	455C.....	Case
4-6 TON.....	Dresser-Galion	404.....	Pettibone	455G.....	John Deere
4-6 TON.....	Huber-Warco	405-2A.....	Koehring	460.....	Allis-Chalmers
4-78 Forklift.....	White	406.....	JCB	460.....	Towmotor
4.0.....	Nissan	406.....	Unimog	460B.....	Allis-Chalmers
4B153.....	Allis-Chalmers	410.....	Austin-Western	460C.....	Allis-Chalmers
4B182.....	Allis-Chalmers	410.....	John Deere	461.....	Towmotor
4BD153.....	Allis-Chalmers	410.....	Towmotor	462S.....	Towmotor
4BD182.....	Allis-Chalmers	410 Skid Steer.....	Case	465 Skid Steer.....	Case
4DA153.....	Allis-Chalmers	410B.....	John Deere	475 Articulated.....	Clark-Michigan-VME
4DA182.....	Allis-Chalmers	410C.....	John Deere	475A III.....	Clark-Michigan-VME
4DC645.....	Allis-Chalmers	410D.....	John Deere	475B.....	Clark-Michigan-VME
4FD.....	Euclid	410G.....	John Deere	480.....	Case
4FGC20.....	Toyota	411.....	Towmotor	480.....	Clark-Michigan-VME
4L.....	Gerlinger	412.....	International	480.....	John Deere
4MH.....	Gerlinger	412B.....	Dresser-Dressta	480 I.....	Volvo
4MO645.....	Allis-Chalmers	414E.....	Caterpillar	480A.....	John Deere
4N.....	Gerlinger	414MC.....	Thew Shovel	480B.....	Case
4.192.....	Perkins	416 (5PC).....	Caterpillar	480B.....	John Deere
4.203.....	Perkins	420.....	Ford	480CK.....	Case
4.270D.....	Perkins	420.....	Towmotor	480D.....	Case
4.99.....	Perkins	420 Skid Steer.....	Case	480E.....	Case
40.....	Austin-Western	421.....	Towmotor	480ELL.....	Case
40.....	Pettibone	422S.....	Towmotor	480F.....	Case
40-0.....	JLG	424.....	Bantam	480FLL.....	Case
40-45.....	JLG	425.....	Bay City	480G.....	John Deere
40 Crawler.....	Drott	425.....	Bobcat-Melroe	480P.....	Towmotor
40 Cruz-Air.....	Drott	428.....	Koehring	482C.....	John Deere
40C.....	Drott	430.....	Bobcat-Melroe	487C.....	P & H
40F.....	JLG	430 Scatback.....	Case	487H.....	P & H
40GA.....	Pettibone	430 Skid Steer.....	Case	490D.....	John Deere
40GS.....	Pettibone	430CK Loader Backhoe.....	Case	495.....	International
40R.....	Drott	430H.....	Bobcat-Melroe	4000.....	Dresser-Dressta
40R.....	Gerlinger	431.....	International	4000.....	Nissan
40RH.....	Gerlinger	431B.....	International	4000.....	Pumpmaster
40S.....	Gerlinger	433.....	International	4000.....	Trojan-Yale
40SH.....	Gerlinger	433B.....	International	4010.....	Ditch Witch
40XT.....	Case	435 Skid Steer.....	Case	4030.....	Skytrak
40YR.....	Drott	440.....	Bay City	4039D.....	John Deere
41B.....	Fiat-Allis	440.....	Towmotor	4040.....	Ford
44.....	Barber-Greene	440.....	Wabco	4066.....	Terex
44HL.....	Champ	440 Skid Steer.....	Case	4100.....	International/Navistar
45.....	Allis-Chalmers	440 Skidder.....	John Deere	4100.....	Walden
		440B Skidder.....	John Deere	4100.....	Waldon

Model and Manufacturer Index

Model	Manufacturer	Model	Manufacturer	Model	Manufacturer
4 - Continued		5 - Continued		5 - Continued	
4200.....	International/Navistar	502C.....	Pettibone	561C (85H) Pipelayer.....	Caterpillar
4300.....	International/Navistar	502P.....	Towmotor	570.....	Dresser-Dressta
4400.....	International/Navistar	502S.....	Towmotor	570.....	Dresser-Hough
4420G.....	Grove	503A.....	Dresser-Galion	570.....	John Deere
4475.....	John Deere	503L.....	Dresser-Galion	570A.....	John Deere
4500A.....	Dresser-Dressta	510.....	Allis-Chalmers	571E PS (64A) Pipelayer...	Caterpillar
4500B.....	Dresser-Dressta	510.....	Dresser-Hough	571F (95N) Pipelayer.....	Caterpillar
4700.....	International/Navistar	510.....	John Deere	571G (16W) Pipelayer.....	Caterpillar
4800.....	International/Navistar	510B.....	Dresser-Dressta	572C (21A) Pipelayer.....	Caterpillar
4800 Series.....	Western Star	510B.....	Dresser-Hough	572D (21A) Pipelayer.....	Caterpillar
4900.....	International/Navistar	510B.....	John Deere	572E (65A) Pipelayer.....	Caterpillar
4900 Series.....	Western Star	510C.....	Dresser-Dressta	572F PS (96N) Pipelayer...	Caterpillar
4900EX.....	Western Star	510C.....	Dresser-Hough	572G Pipelayer.....	Caterpillar
4900FA.....	Western Star	510P.....	Towmotor	579.....	Peterbilt
4900SA.....	Western Star	512.....	Allis-Chalmers	580.....	Case
5		515.....	Dresser-Hough	580.....	Dresser-Hough
5-6 Ton.....	Huber-Warco	515B.....	Dresser-Dressta	580B.....	Case
5-8 Ton.....	Dresser-Galion	515B.....	Dresser-Hough	580BCK.....	Case
5-8 Ton.....	Huber-Warco	520B.....	Dresser-Dressta	580C.....	Case
5-8A.....	Ferguson Shovel Supply	520B.....	Dresser-Hough	580CK.....	Case
5 KW.....	Universal	524K.....	John Deere	580CK Forklift.....	Case
5 Ton.....	Dresser-Galion	530.....	Dresser-Dressta	580D.....	Case
5 Ton.....	Huber-Warco	530.....	Dresser-Hough	580E.....	Case
5FD.....	Euclid	530CK.....	Case	580K.....	Case
5GO.....	Onan	534.....	Gradall-Loed	583H (61A) Pipelayer.....	Caterpillar
5LDT.....	Euclid	534B.....	Gradall	584.....	Case
5N1.....	Long	535.....	Bay City	584C.....	Case
50.....	Drott	540.....	Dresser-Dressta	584D.....	Case
50.....	Hyster	540.....	Dresser-Hough	584E.....	Case
50BEC.....	Drott	540.....	John Deere	585.....	Case
50GA.....	Pettibone	540.....	Towmotor	585C.....	Case
50GS.....	Pettibone	540A.....	John Deere	585D.....	Case
50J.....	Thew Shovel	540B.....	John Deere	585E.....	Case
50K.....	Thew Shovel	540D.....	John Deere	586.....	Case
51B.....	Bucyrus-Erie	542.....	Gradall-Loed	586C.....	Case
54B.....	Bucyrus-Erie	544 Skidder.....	John Deere	586D.....	Case
55.....	Austin-Western	544 Wheel Loader.....	John Deere	586E.....	Case
55.....	Clark-Michigan-VME	544B Skidder.....	John Deere	587.....	Peterbilt
55.....	International	544B Wheel Loader.....	John Deere	590.....	Towmotor
55 III.....	Clark-Michigan-VME	544C.....	John Deere	590S.....	Towmotor
55A I.....	Clark-Michigan-VME	544E.....	John Deere	594 (62H) Pipelayer.....	Caterpillar
55A II.....	Clark-Michigan-VME	544G.....	John Deere	597C.....	American Crane Corp.
55A III.....	Clark-Michigan-VME	545.....	Allis-Chalmers	5000.....	International/Navistar
55B.....	Clark-Michigan-VME	545.....	Mustang	5000.....	Nissan
55C.....	Clark-Michigan-VME	545.....	Owatonna	5000.....	Walden
500.....	Pettibone	545C.....	Ford	5000.....	Waldon
500.....	Towmotor	545C Backhoe.....	Ford	5010.....	Ditch Witch
500.....	Wabco	545D Backhoe.....	Ford	5010 Scraper.....	John Deere
500 Backhoe.....	John Deere	545D Wheel.....	Ford	5028.....	Skytrak
500 Travelift.....	Case	545H.....	Allis-Chalmers	5028HT.....	Skytrak
500 Wheel Loader.....	John Deere	550.....	Case	5100.....	Walden
500 Wheel Tractor.....	John Deere	550.....	Dresser-Dressta	5100.....	Waldon
500A Travelift.....	Drott	550.....	Dresser-Hough	5500i.....	International/Navistar
500AI Travelift.....	Drott	550.....	Ford	5530.....	American Crane Corp.
500B Travelift.....	Case	552.....	Barber-Greene	5575.....	John Deere
500C.....	Dresser-Dressta	552.....	Gradall-Loed	5600G.....	Advance Sweeper
500C Backhoe.....	John Deere	554.....	Gradall-Loed	5600i.....	International/Navistar
500E.....	Dresser-Dressta	555.....	Dresser-Dressta	5800 Series.....	Western Star
500G.....	Pettibone	555.....	Dresser-Hough	5900 Series.....	Western Star
500GT.....	Pettibone	555.....	John Deere	5900i.....	International/Navistar
500H.....	Bucyrus-Erie	555.....	Wabco	6	
500P.....	Pettibone	555C.....	Ford	6-33.....	Pettibone
500P.....	Towmotor	560.....	Allis-Chalmers	6B230.....	Allis-Chalmers
500TC.....	Clark-Lima	560.....	Champion	6B273.....	Allis-Chalmers
501.....	Towmotor	560.....	Dresser-Dressta	6BD230.....	Allis-Chalmers
501P.....	Towmotor	560.....	Dresser-Hough	6BD273.....	Allis-Chalmers
501S.....	Clark-Michigan-VME	560B.....	Dresser-Dressta	6C.....	Sheppard
502.....	Pettibone	560B.....	Dresser-Hough	6CTA 8.3 L GST.....	Cummins
		561B (62A) Pipelayer.....	Caterpillar		

Indexes & Abbrev.

Model and Manufacturer Index

Indexes
& Abbrev.

Model	Manufacturer	Model	Manufacturer	Model	Manufacturer
6 - Continued		6 - Continued		6 - Continued	
6D.....	Sheppard	610-T8445.....	Bay City	645.....	Allis-Chalmers
6D2.....	Huber-Warco	613.....	Caterpillar	645.....	Dresser-Dressta
6DA230.....	Allis-Chalmers	613A (71M).....	Caterpillar	645.....	Transcold
6DA273.....	Allis-Chalmers	613B (38W).....	Caterpillar	645B.....	Allis-Chalmers
6DA779.....	Allis-Chalmers	613C.....	Caterpillar	645B.....	Fiat-Allis
6DA844.....	Allis-Chalmers	613C (92X).....	Caterpillar	645C.....	John Deere
6DA970.....	Allis-Chalmers	614.....	Allis-Chalmers	650.....	Case
6DAS510.....	Allis-Chalmers	615 (46Z).....	Caterpillar	650.....	Transcold
6DAS516.....	Allis-Chalmers	615 Backhoe.....	Allis-Chalmers	650A Travelift.....	Drott
6DAS844.....	Allis-Chalmers	615 Wheel Loader.....	Allis-Chalmers	650G Crawler.....	Case
6DC844.....	Allis-Chalmers	619C (61F).....	Caterpillar	651 (33G).....	Caterpillar
6DC970.....	Allis-Chalmers	620.....	Economobile	651 (44M).....	Caterpillar
6DCB879.....	Allis-Chalmers	620B.....	Economobile	651B (67K).....	Caterpillar
6DCS844.....	Allis-Chalmers	620KTA31.....	Cummins	655.....	Transcold
6DCS1879.....	Allis-Chalmers	620.750DFJA.....	Onan	655A.....	P & H
6DH691.....	Allis-Chalmers	621.....	Allis-Chalmers	655B.....	P & H
6DH909.....	Allis-Chalmers	621.....	Case	655D.....	Ford
6DT389.....	Allis-Chalmers	621 (23H).....	Caterpillar	657 (19G).....	Caterpillar
6DT488.....	Allis-Chalmers	621B.....	Case	657 (31G).....	Caterpillar
6DTS468.....	Allis-Chalmers	621B (45P).....	Caterpillar	657 (46M).....	Caterpillar
6E.....	Sheppard	623 (52U).....	Caterpillar	657B (47M).....	Caterpillar
6F.....	Sheppard	623B (46P).....	Caterpillar	657B (68K).....	Caterpillar
6GO.....	Onan	623E (5SG).....	Caterpillar	657E (86Z).....	Caterpillar
6MO672.....	Allis-Chalmers	623E (6CB).....	Caterpillar	660.....	Transcold
6MO779.....	Allis-Chalmers	623E (6DB).....	Caterpillar	660B (58K).....	Caterpillar
6MO893.....	Allis-Chalmers	623E (6YF).....	Caterpillar	660DFJB.....	Onan
6MO970.....	Allis-Chalmers	624E.....	John Deere	660KTA32.....	Cummins
6.305.....	Perkins	624G.....	John Deere	662.....	Clark-Michigan-VME
6.354.....	Perkins	624GH.....	John Deere	664.....	Clark-Michigan-VME
60.....	Austin-Western	624H.....	John Deere	664B.....	Clark-Michigan-VME
60.....	Bay City	627 (54K).....	Caterpillar	664C.....	Clark-Michigan-VME
60.....	Hyster	627 (68M).....	Caterpillar	666.....	Clark-Michigan-VME
60.....	Jaeger	627B (14S).....	Caterpillar	666.....	Le Tourneau
60AS.....	Gerlinger	627B (15S).....	Caterpillar	666.....	Wabco
60AV.....	Gerlinger	627B (38V).....	Caterpillar	666 (77F).....	Caterpillar
60BR.....	JLG	630.....	Dresser-Dressta	666 Power Flow.....	Wabco
60L.....	Bucyrus-Erie	630B (14G).....	Caterpillar	666B.....	Clark-Michigan-VME
60XT.....	Case	630W.....	Dresser-Dressta	666B.....	Wabco
62.....	Bay City	631B (13G).....	Caterpillar	666B (66K).....	Caterpillar
63.....	Bay City	632 (14G).....	Caterpillar	666C.....	Clark-Michigan-VME
64-18.....	Grove	633.....	Caterpillar	666C.....	Wabco
65.....	Fiat-Allis	633 (44J).....	Caterpillar	666D.....	Koehring
65.....	International	633C (66M).....	Caterpillar	670.....	Towmotor
65B.....	Fiat-Allis	635.....	Dresser-Dressta	670.....	Transcold
65BT61.....	Cummins	635B.....	Dresser-Dressta	670 Grader.....	John Deere
65C.....	International	635E.....	Dresser-Dressta	670A.....	John Deere
66.....	Austin-Western	635W.....	Dresser-Dressta	672B.....	John Deere
66 (4D).....	Caterpillar	637 (79P).....	Caterpillar	675.....	Clark-Michigan-VME
68.....	Grove	637D (23W).....	Caterpillar	675.....	John Deere
600.....	Allis-Chalmers	637D (27W).....	Caterpillar	675B.....	John Deere
600.....	Bay City	640.....	Dresser-Dressta	680C.....	Case
600.....	Champ	640.....	Economobile	680E.....	Case
600.....	Champion	640.....	John Deere	680G.....	Case
600.....	Jaeger	640.....	Transcold	680H.....	Case
600.....	Towmotor	641.....	Bobcat-Melroe	680L.....	Case
600 Backhoe.....	John Deere	641 (41M).....	Caterpillar	680P.....	Towmotor
600 Skid Steer.....	Case	641 (50G).....	Caterpillar	685.....	Clark
600 Wheel Loader.....	John Deere	641 (64F).....	Caterpillar	687B.....	P & H
600A Travelift.....	Drott	641 (70G).....	Caterpillar	687C.....	P & H
600GTC.....	Pettibone	641 (80F).....	Caterpillar	687H.....	P & H
600GTF.....	Pettibone	641B (65K).....	Caterpillar	688.....	Case
600RO2.....	Chicago Pneumatic	642.....	Bobcat-Melroe	690.....	John Deere
600WD.....	Koehring	642B.....	Bobcat-Melroe	690A.....	John Deere
601P.....	Towmotor	643.....	Bobcat-Melroe	690B.....	John Deere
602.....	Vibromax	644 Wheel Loader.....	John Deere	690DLC.....	John Deere
605B.....	Fiat-Allis	644B Wheel Loader.....	John Deere	695.....	Hyhoe
610 Super Skytrak.....	Skytrak	644C Wheel Loader.....	John Deere	6000.....	Nissan
610B.....	John Deere	644EH.....	John Deere	6000.....	Trojan-Yale
610-T6435.....	Bay City	644J.....	John Deere	6000.....	Walden

Model and Manufacturer Index

Model	Manufacturer	Model	Manufacturer	Model	Manufacturer
6 - Continued		7 - Continued		8	
6000.....	Waldon	712.....	Dresser-Galion	8.....	Sheppard
6000A.....	Transcold	714.....	Austin-Western	8-10 Ton.....	Dresser-Galion
6000W.....	ICC	714.....	Dresser-Galion	8-10 Ton.....	Huber-Warco
6004A.....	Transcold	715 Backhoe.....	Allis-Chalmers	8-12 Ton.....	Dresser-Galion
6007.....	Transcold	715 Wheel Loader.....	Allis-Chalmers	8-12 Ton.....	Ferguson Shovel Supply
6007A.....	Transcold	715D.....	Allis-Chalmers	8-12 Ton.....	Huber-Warco
6008.....	Transcold	720.....	Austin-Western	8-33.....	Pettibone
6008A.....	Transcold	720.....	Bay City	8DA1125.....	Allis-Chalmers
6036.....	Skytrak	720.....	Clark-Lima	8DA1290.....	Allis-Chalmers
6200LC.....	Dresser-Dressta	720A.....	Champion	8DAS1125.....	Allis-Chalmers
6220LC.....	Dresser-Dressta	721D.....	Case	8DAS1290.....	Allis-Chalmers
6300.....	Versa	724J.....	John Deere	8DC1125.....	Allis-Chalmers
6500.....	Ford	730A.....	Champion	8DC1290.....	Allis-Chalmers
6619A.....	John Deere	740.....	John Deere	8DCS1125.....	Allis-Chalmers
6620.....	Koehring	742.....	Bobcat-Melroe	8DCS1290.....	Allis-Chalmers
6675.....	John Deere	743.....	Bobcat-Melroe	8DCS2505.....	Allis-Chalmers
6900XD.....	Western Star	743B.....	Bobcat-Melroe	8MO1290.....	Allis-Chalmers
7		744E.....	John Deere	8MOS1290.....	Allis-Chalmers
7D.....	Sheppard	745.....	Allis-Chalmers	8N.....	Ford
7D2.....	Huber-Warco	745B.....	Fiat-Allis	8PC2505.....	Allis-Chalmers
7E.....	Sheppard	745HB.....	Fiat-Allis	80.....	Dresser-Galion
70 (8C).....	Caterpillar	747.....	TCI	80.....	Hyster
70XT.....	Case	750.....	Ford	80 (5W).....	Caterpillar
71B.....	Bucyrus-Erie	750KTA31.....	Cummins	80 Cruz-Air.....	Drott
72.....	Bay City	750S.....	Towmotor	80BT61.....	Cummins
72-20.....	Terex	753.....	Bobcat-Melroe	80D.....	Lift All
72-21.....	Terex	755.....	Ford	82-30.....	Terex
72-31.....	Terex	755D.....	John Deere	82-40.....	Terex
72-31B.....	Terex	760.....	Case	82-40 Crawler.....	Euclid
72-40.....	Terex	760.....	John Deere	82A.....	Barber-Greene
72-41.....	Terex	760A.....	John Deere	82AG.....	Barber-Greene
72-51.....	Terex	762 Scaper.....	John Deere	83.....	Austin-Western
72-51B.....	Terex	762A.....	John Deere	84.....	John Deere
72-61.....	Terex	763H.....	Bobcat-Melroe	85.....	Sullair
72-71.....	Terex	764HSD Dozer.....	John Deere	85A.....	Jaeger
72-81.....	Terex	768C (02X).....	Caterpillar	85A I.....	Clark-Michigan-VME
75.....	Clark-Michigan-VME	769 (99F).....	Caterpillar	85A II.....	Clark-Michigan-VME
75.....	International	770 Grader.....	John Deere	85A III.....	Clark-Michigan-VME
75.....	Jaeger	770B.....	John Deere	85B.....	Jaeger
75.....	Parsons	770BH.....	John Deere	85BT61.....	Cummins
75 III.....	Clark-Michigan-VME	772A.....	John Deere	85C.....	Clark-Michigan-VME
75A.....	Jaeger	772AH.....	John Deere	85RGH1.....	Chicago Pneumatic
75A II.....	Clark-Michigan-VME	773 (63G).....	Caterpillar	85RM2.....	Dresser-Galion
75A III.....	Clark-Michigan-VME	774.....	Barber-Greene	85XT.....	Case
75B.....	Clark-Michigan-VME	777.....	Barber-Greene	88B.....	Bucyrus-Erie
75B.....	Jaeger	777.....	Massey Ferguson	800 Skid Steer.....	Case
75C.....	Clark-Michigan-VME	777.....	Wabco	800AC Travelift.....	Drott
75XT.....	Case	777 Power Flow.....	Wabco	800DFJB.....	Onan
77.....	Austin-Western	777B.....	Wabco	800DFJC.....	Onan
77 (4D).....	Caterpillar	780.....	Case	800KTA32.....	Cummins
700.....	Champ	780B.....	Case	800KTA33.....	Cummins
700GTC.....	Pettibone	780C.....	Case	814 (90P).....	Caterpillar
700TC.....	Clark-Lima	780D.....	Case	815 (91P).....	Caterpillar
703SC.....	Clark-Lima	790D.....	John Deere	815T.....	Toyota
705.....	Barber-Greene	7000.....	Dresser-Dressta	816 (57U).....	Caterpillar
705C.....	Allis-Chalmers	7300.....	International/Navistar	816 Backhoe.....	Allis-Chalmers
705D.....	Allis-Chalmers	7400.....	International/Navistar	816 Wheel Loader.....	Allis-Chalmers
706.....	Allis-Chalmers	7500.....	Ford	820KS.....	Thew Shovel
706B.....	Allis-Chalmers	7500.....	International/Navistar	820MC.....	Thew Shovel
706C.....	Allis-Chalmers	7500.....	Trojan-Yale	824.....	Caterpillar
706D.....	Allis-Chalmers	7600.....	International/Navistar	824 (29G).....	Caterpillar
708.....	Dresser-Galion	7700.....	International/Navistar	824B.....	Caterpillar
708C.....	Allis-Chalmers	7753.....	Bobcat-Melroe	824B (36H).....	Caterpillar
708D.....	Allis-Chalmers	7760.....	Case	825.....	Case
710.....	Dresser-Galion	7760.....	Drott	825B (43N).....	Caterpillar
710B.....	John Deere	7775.....	John Deere	830.....	Dresser-Galion
710C.....	John Deere			834.....	Caterpillar
710D.....	John Deere			834 (43E).....	Caterpillar
				835.....	Barber-Greene

Indexes & Abbrev.



Model and Manufacturer Index

Indexes
& Abbrev.

Model	Manufacturer	Model	Manufacturer	Model	Manufacturer
8 - Continued		9 - Continued		9 - Continued	
835 (44N).....	Caterpillar	922B (88J).....	Caterpillar	980.....	Case
837.....	Barber-Greene	922B (94A).....	Caterpillar	980 (42H).....	Caterpillar
838.....	Barber-Greene	926 (4NB).....	Caterpillar	980B.....	Case
840 Articulated.....	Allis-Chalmers	926 (4TC).....	Caterpillar	980B (89P).....	Caterpillar
840B Articulated.....	Allis-Chalmers	926 (7TC).....	Caterpillar	980C.....	Caterpillar
843.....	Bobcat-Melroe	926 (8NB).....	Caterpillar	980C (63X).....	Caterpillar
843B.....	Bobcat-Melroe	926 (94Z).....	Caterpillar	983 (38K).....	Caterpillar
844.....	John Deere	926E (94Z).....	Caterpillar	988 (87A).....	Caterpillar
844 Highlander.....	Lull	930 (8CB).....	Caterpillar	988B (50W).....	Caterpillar
845.....	Barber-Greene	930 (17B).....	Caterpillar	990 Excavator.....	John Deere
847.....	Barber-Greene	930 (41K).....	Caterpillar	990TC.....	Drott
848A.....	Barber-Greene	930 (57Z).....	Caterpillar	992 (25K).....	Caterpillar
850.....	Barber-Greene	930 (60G).....	Caterpillar	9000.....	International
850.....	Dresser-Galion	930 (71H).....	Caterpillar	9010.....	Case
850B Crawler.....	Case	930 (73U).....	Caterpillar	9010B.....	Case
850B Crawler Tractor.....	John Deere	930 (79J).....	Caterpillar	9020.....	Case
850D Crawler.....	Case	930G.....	Caterpillar	9020B.....	Case
850G Crawler.....	Case	933C (11A).....	Caterpillar	9030.....	Case
850K Crawler Dozer.....	John Deere	933E (11A).....	Caterpillar	9030B.....	Case
852.....	Barber-Greene	933G (42A).....	Caterpillar	9040.....	Case
853.....	Bobcat-Melroe	936 (2ZB).....	Caterpillar	9040B.....	Case
855.....	P & H	936 (4SB).....	Caterpillar	9050.....	Case
855D.....	Case	936 (5GC).....	Caterpillar	9050B.....	Case
857.....	Barber-Greene	936 (33Z).....	Caterpillar	9060.....	Case
860.....	John Deere	936 (45Z).....	Caterpillar	9060B.....	Case
860A.....	John Deere	936E (33Z).....	Caterpillar	9100.....	International/Navistar
862.....	John Deere	938G.....	Caterpillar	9100i.....	International/Navistar
870.....	Dresser-Galion	940 Articulated.....	Allis-Chalmers	9125TC.....	P & H
880.....	Case	941 (80H).....	Caterpillar	9200.....	International/Navistar
880.....	Owatonna	941B (80H).....	Caterpillar	9200i.....	International/Navistar
880B.....	Case	943 (19Z).....	Caterpillar	9254.....	P & H
880C.....	Case	944 (87J).....	Caterpillar	9300.....	International/Navistar
880D.....	Case	945B.....	Fiat-Allis	9400.....	International/Navistar
888.....	Case	950 (58H).....	Caterpillar	9400i.....	International/Navistar
895.....	Hyhoe	950 (81J).....	Caterpillar	9600.....	International/Navistar
8000-42.....	Teco-Crab	950 (90A).....	Caterpillar	9700.....	International/Navistar
8020.....	Ditch Witch	950B (22Z).....	Caterpillar	9800.....	International/Navistar
8031.05.....	Aggreko	951B (69H).....	Caterpillar	9900.....	International/Navistar
8061.25R.....	Aggreko	951B (79H).....	Caterpillar	9900i.....	International/Navistar
8100.....	International/Navistar	951C (69H).....	Caterpillar	9900ix.....	International/Navistar
8200.....	International/Navistar	951C (86J).....	Caterpillar		
8435G.....	Grove	953 (76Y).....	Caterpillar	A	
8500.....	International/Navistar	955A.....	P & H	A4D.....	Gerlinger
8500.....	Waldon	955C (12A).....	Caterpillar	A10.....	Gerlinger
8600.....	International/Navistar	955E (12A).....	Caterpillar	A10.....	Towmotor
8875.....	John Deere	955H (60A).....	Caterpillar	A12.....	Gerlinger
9		955K (61H).....	Caterpillar	A12.....	Towmotor
9.....	Sheppard	955L (85J).....	Caterpillar	A15.....	Gerlinger
9-2800.....	Ingram	966A (33A).....	Caterpillar	A15.....	Towmotor
9D.....	Huber-Warco	966B (75A).....	Caterpillar	A16.....	Gerlinger
90XT.....	Case	966C (9KC).....	Caterpillar	A16.....	Towmotor
95.....	International	966C (18B).....	Caterpillar	A18.....	Gerlinger
95XT.....	Case	966C (25U).....	Caterpillar	A18.....	Towmotor
99SW.....	Austin-Western	966C (30K).....	Caterpillar	A20.....	Gerlinger
900.....	Jaeger	966C (42J).....	Caterpillar	A20.....	Towmotor
900.....	Sullair	966C (76J).....	Caterpillar	A22.....	Gerlinger
900.....	Towmotor	966C (78G).....	Caterpillar	A22.....	Towmotor
900DFJC.....	Onan	966D (99Y).....	Caterpillar	A24.....	Gerlinger
900KA33.....	Cummins	970.....	Dresser-Dressta	A24.....	Towmotor
900RO2.....	Chicago Pneumatic	970 Turbo Articulated.....	Dresser-Dressta	A25C.....	Volvo
910 (80U).....	Caterpillar	970C.....	Dresser-Dressta	A42.....	Snorkel Lift
915.....	Clark	973 (66G).....	Caterpillar	A60.....	Snorkel Lift
918.....	Allis-Chalmers	973 (86G).....	Caterpillar	A61.....	Onan
920 (41J).....	Caterpillar	975.....	Bobcat-Melroe	A62.....	Ford
920 (62K).....	Caterpillar	977D (20A).....	Caterpillar	A64.....	Ford
920 (75J).....	Caterpillar	977E (20A).....	Caterpillar	A66.....	Ford
922A (59A).....	Caterpillar	977H (53A).....	Caterpillar	A66A.....	Hyster
922A (63A).....	Caterpillar	977K (11K).....	Caterpillar	A150E Thru A225E.....	Hyster
		977L (11K).....	Caterpillar	A219-89.....	Le Roi

Model and Manufacturer Index

Model	Manufacturer	Model	Manufacturer	Model	Manufacturer
A - Continued		A - Continued		C	
A300	Bobcat-Melroe	AJ	Onan	C	Thermo King
A400E	Dresser-Galion	A-Line	Sterling	C	Wabco
A440	Mercury	AM	Gerlinger	C9A	International
A450E	Dresser-Galion	AMP	Gerlinger	C40	Champ
A452	Mercury	AMZ40	Grove	C40E	Allis-Chalmers
A460	Mercury	AMZ50	Grove	C40X	Allis-Chalmers
A500	Dresser-Galion	AMZ56	Grove	C48	Little Giant
A550	Dresser-Galion	AMZ66	Grove	C50	Kalmar
A560E	Dresser-Galion	AMZ66XT	Grove	C61	Euclid
A600	Dresser-Galion	AP206	Grove	C62	Euclid
A606	Dresser-Galion	Argosy	Freightliner	C63	Euclid
A930	Mercury	AT	Allis-Chalmers	C64	Euclid
A940	Mercury	AT20	Yale	C65	Euclid
A950	Mercury	AT30X	Yale	C80A	Champion
A960	Mercury	ATB46N	Snorkel Lift	C166	Bantam
AAG	Gardner-Denver	ATD	Allis-Chalmers	C175	New Holland
ACC20	Kalmar	ATM	Allis-Chalmers	C200	Pettibone
ACC20L	Kalmar	ATMD	Allis-Chalmers	C201	Isuzu
ACC25	Kalmar	Autocar	Volvo	C221	Isuzu
ACC25L	Kalmar	Aut hauler	Volvo	C240	Isuzu
ACC30	Kalmar	B		C266	Bantam
ACC30L	Kalmar	B	Arctic Traveler	C330A	Hyster
ACC35	Kalmar	B	Mobilift	C330B	Hyster
ACC40	Kalmar	B1	Thermo King	C340A	Hyster
ACC45	Kalmar	B10	Towmotor	C350	Hyster
ACC50	Kalmar	B12	Towmotor	C350A	Hyster
ACC55	Kalmar	B15	Gerlinger	C350AD	Hyster
ACC60	Kalmar	B15	Towmotor	C350D	Hyster
ACC60C	Kalmar	B16	Gerlinger	C366	Bantam
ACC70	Kalmar	B16	Towmotor	C450A	Hyster
ACC80	Kalmar	B17	Gerlinger	C451	Bantam
ACC100	Kalmar	B18	Gerlinger	C475	Bantam
ACP20	Kalmar	B18	Towmotor	C500	Hyster
ACP20L	Kalmar	B19	Gerlinger	C500	Kenworth
ACP25	Kalmar	B20	Gerlinger	C500A	Hyster
ACP25L	Kalmar	B20	Towmotor	C530	Hyster
ACP30	Kalmar	B21	Gerlinger	C530A	Hyster
ACP30L	Kalmar	B22	Gerlinger	C610B	Hyster
ACP30PS	Kalmar	B22	Towmotor	C612B	Hyster
ACP35	Kalmar	B23	Gerlinger	C615A	Hyster
ACP40	Kalmar	B24	Gerlinger	C615B	Hyster
ACP45	Kalmar	B24	Towmotor	C617B	Hyster
ACP50	Kalmar	B25	Towmotor	C624B	Hyster
ACP55	Kalmar	B70	Le Tourneau	C625B	Hyster
ACP60	Kalmar	B80PD	Baker	C627B	Hyster
ACP60D	Kalmar	B125	Allis-Chalmers	C727A	Hyster
ACP60DX	Kalmar	B140PC	Baker	C748A	Hyster
ACP60L	Kalmar	B224	Mobilift	C832A	Hyster
ACP70	Kalmar	Badger Shovel	Austin-Western	C852A	Hyster
ACP70D	Kalmar	BD	Allis-Chalmers	C852B	Hyster
ACP70L	Kalmar	BD2	Allis-Chalmers	C4500	Chevrolet
ACP80	Kalmar	BD3	Allis-Chalmers	C4500	GMC
ACP80D	Kalmar	BF12L 714	Deutz-Allis	C5500	Chevrolet
ACP80DX	Kalmar	BF43	Wabco	C5500	GMC
ACP100	Allis-Chalmers	BFA6	Wabco	C6500	Chevrolet
ACP100	Kalmar	BFA9	Wabco	C6500	GMC
ACP100C	Kalmar	BH700	Vermeer	C7500	Chevrolet
ACP110	Kalmar	BSF2	Cedar Rapids	C7500	GMC
Acterra	Sterling	BSF2H	Cedar Rapids	C8500	Chevrolet
ACX Xpeditor	Autocar	BSF3R	Cedar Rapids	C8500	GMC
AD	Allis-Chalmers	BSF4	Cedar Rapids	C-90-B	Cummins
AD3	Allis-Chalmers	BT	Gerlinger	C-90-BI	Cummins
AD4	Allis-Chalmers	Bullet	Sterling	C-90-I	Cummins
AD30	Allis-Chalmers	Business Class M2	Freightliner	C-90-IP	Cummins
AD40	Allis-Chalmers	BW142PD	Bomag	C-105-B	Cummins
AFE1	Wabco	BW161AD	Bomag	C-105-BI	Cummins
AFE5	Wabco	BW210AVA	Bomag	C-105-I	Cummins
AFE6	Wabco	BW213D	Bomag	C-105-IP	Cummins
AG65	CMI			C-140-B	Cummins

Indexes & Abbrev.

Model and Manufacturer Index

Indexes
& Abbrev.

Model	Manufacturer	Model	Manufacturer	Model	Manufacturer
C - Continued		C - Continued		D - Continued	
C-145.....	Cummins	CGS1250.....	Thermo King	D3C.....	Caterpillar
C-160.....	Cummins	CH Series.....	Mack	D3 (79U).....	Caterpillar
C-160-B.....	Cummins	Challenger.....	Arctic Traveler	D3B (27Y).....	Caterpillar
C-160-BI.....	Cummins	Challenger.....	Champ	D4D.....	Caterpillar
C-160-CI.....	Cummins	CHIEF.....	Dresser-Galion	D4E.....	Caterpillar
C-160-IP.....	Cummins	CHN Series.....	Mack	D4 (6U).....	Caterpillar
C-175-B.....	Cummins	CHU Series.....	Mack	D4 (7J).....	Caterpillar
C-175-BI.....	Cummins	CK35-1.....	Komatsu	D4 (7U).....	Caterpillar
C-175-CI.....	Cummins	CL40.....	Ford	D4C (39A).....	Caterpillar
C-175-IP.....	Cummins	CL65.....	Ford	D4C (40A).....	Caterpillar
C-180.....	Cummins	CL Series.....	Mack	D4D (22C).....	Caterpillar
C-180-B.....	Cummins	Clarklift C20B.....	Clark	D4D (78A).....	Caterpillar
C-180-BI.....	Cummins	Clarklift C25B.....	Clark	D4D (82J).....	Caterpillar
C-180-CI.....	Cummins	Clarklift CFY20B.....	Clark	D4D (83J).....	Caterpillar
C-180-IP.....	Cummins	Clarklift CFY25B.....	Clark	D4D LGP (7R).....	Caterpillar
C-190.....	Cummins	Classic.....	Freightliner	D4D LGP (61J).....	Caterpillar
C-464-B160.....	Cummins	Classic XL.....	Freightliner	D4D SA (20J).....	Caterpillar
C-464-C160.....	Cummins	CM.....	Thermo King	D4D SA (84J).....	Caterpillar
C-464-P160.....	Cummins	CM695D.....	Ingersoll	D4E (28X).....	Caterpillar
CA.....	Thermo King	Columbia.....	Freightliner	D4E (29X).....	Caterpillar
CA12PD.....	Dynapac	Commando 30.....	Ottawa	D4E (70X).....	Caterpillar
CA12PDB.....	Dynapac	Commando 30A.....	Ottawa	D4H (8PB).....	Caterpillar
CA15PD.....	Dynapac	Commando 50.....	Ottawa	D4M1.....	Thermo King
CA20.....	Vibro-Plus	Commando 60T.....	Ottawa	D4P60.....	TCI
CA25.....	Vibro-Plus	Condor.....	Freightliner	D4P80.....	TCI
CA25PD.....	Dynapac	Condor.....	Sterling	D4P100.....	TCI
CADET.....	Austin-Western	Coronado.....	Freightliner	D5B.....	Caterpillar
Cary-All Super 8.....	Pettibone	CPS130.....	Chicago Pneumatic	D5 (21J).....	Caterpillar
Cary-Lift 6.....	Pettibone	CPS270.....	Chicago Pneumatic	D5 (81H).....	Caterpillar
Cary-Lift 8.....	Pettibone	CR.....	Le Tourneau	D5 (82H).....	Caterpillar
Cary-Lift 54H.....	Pettibone	CR331.....	Cedar Rapids	D5 (83H).....	Caterpillar
Cary-Lift 150.....	Pettibone	CR461.....	Cedar Rapids	D5 (84H).....	Caterpillar
Cary-Lift 204D.....	Pettibone	CR-160-CI.....	Cummins	D5B LGP (46X).....	Caterpillar
Cary-Lift Super 4.....	Pettibone	CR-D.....	Dresser-Galion	D6.....	Caterpillar
Cary-Lift Super 5.....	Pettibone	Crown 500.....	Thermo King	D6 (8U).....	Caterpillar
Cary-Lift Super 6.....	Pettibone	CS70.....	Clark-Michigan-VME	D6 (9U).....	Caterpillar
Cary-Lift Super 7.....	Pettibone	CS-195.....	Cummins	D6B (37A).....	Caterpillar
Cary-Lift Super 8.....	Pettibone	CS-195-B.....	Cummins	D6B (44A).....	Caterpillar
Cary-Lift Super 10.....	Pettibone	CS-195-CI.....	Cummins	D6C (10K).....	Caterpillar
Cary-Lift Super 15.....	Pettibone	CS-464-B180.....	Cummins	D6C (71A).....	Caterpillar
Cary-Lift Super 20.....	Pettibone	CS-464-C160.....	Cummins	D6C (73A).....	Caterpillar
Cary-Lift Super 25.....	Pettibone	CS-464-C180.....	Cummins	D6C (74A).....	Caterpillar
Cary-Lift Super 30.....	Pettibone	CS-464-C195.....	Cummins	D6C (76A).....	Caterpillar
Cary-Lift Super 40.....	Pettibone	CS-464-P180.....	Cummins	D6C (99J).....	Caterpillar
Cary-Lift Super 60.....	Pettibone	CS Series.....	Mack	D6C LGP (69U).....	Caterpillar
Cary-Lift Super 70.....	Pettibone	CT25.....	Dynapac	D6D (3X).....	Caterpillar
Cascadia.....	Freightliner	CT315.....	John Deere	D6D (4X).....	Caterpillar
CB3 Chore Boy.....	United Tractor	CT-464-B175.....	Cummins	D6D SA (5X).....	Caterpillar
CB40.....	Champ	CT-464-C175.....	Cummins	D6H (3ZF).....	Caterpillar
CB50.....	Champ	CT-464-P175.....	Cummins	D6H (4RC).....	Caterpillar
CB50 Chore Boy.....	United Tractor	CT Series.....	Mack	D7.....	Caterpillar
CB514 (6YD).....	Caterpillar	CTA61.....	Cummins	D7F.....	Caterpillar
CBCI.....	Thermo King	CTA62.....	Cummins	D7G.....	Caterpillar
CB-I.....	Thermo King	CTP Series.....	Mack	D7C (17A).....	Caterpillar
CB-II.....	Thermo King	CV Series.....	Mack	D7D (17A).....	Caterpillar
CB-III.....	Thermo King	CX Series.....	Mack	D7E (47A).....	Caterpillar
CCK.....	Onan	CXN Series.....	Mack	D7E (48A).....	Caterpillar
Centurion.....	Crane Carrier Company	CXP Series.....	Mack	D7E (93N).....	Caterpillar
Century Class.....	Freightliner	CXT.....	International/Navistar	D7F (93N).....	Caterpillar
CF500.....	International/Navistar	CXU Series.....	Mack	D7F (94N).....	Caterpillar
CF600.....	International/Navistar	D		D7G (92V).....	Caterpillar
CF7000.....	Ford	D.....	Barber-Greene	D7H (79Z).....	Caterpillar
CF8000.....	Ford	D.....	Mobilift	D8.....	Caterpillar
CF-160.....	Cummins	D1 Series.....	Thermo King	D8L.....	Caterpillar
CF-160-B.....	Cummins	D2 (4U).....	Caterpillar	D8 (14A).....	Caterpillar
CFA19.....	Wabco	D2 (5U).....	Caterpillar	D8E (14A).....	Caterpillar
CFA20B.....	Wabco	D2M2.....	Thermo King	D8G (15A).....	Caterpillar
CFT8000.....	Ford	D3 Series.....	Thermo King	D8H (22A).....	Caterpillar
CG.....	Thermo King			D8H (35A).....	Caterpillar



Model and Manufacturer Index

Model	Manufacturer	Model	Manufacturer	Model	Manufacturer
D - Continued		D - Continued		D - Continued	
D8H (36A).....	Caterpillar	D230.....	Allis-Chalmers	D342 (31B).....	Caterpillar
D8H (46A).....	Caterpillar	D250.....	Gardner-Denver	D342 (49B).....	Caterpillar
D8H (52A).....	Caterpillar	D262.....	Allis-Chalmers	D342 (71B).....	Caterpillar
D8H (68A).....	Caterpillar	D300.....	Gardner-Denver	D342C (5A).....	Caterpillar
D8K (77V).....	Caterpillar	D311.....	Caterpillar	D342C (31B).....	Caterpillar
D8L (53Y).....	Caterpillar	D311 (4V).....	Caterpillar	D342C (49B).....	Caterpillar
D8N (9TC).....	Caterpillar	D311 (7S).....	Caterpillar	D342C (71B).....	Caterpillar
D9.....	Caterpillar	D311 (51B).....	Caterpillar	D343 (33B).....	Caterpillar
D9G (66A).....	Caterpillar	D315 (4V).....	Caterpillar	D343 (62B).....	Caterpillar
D9G (90J).....	Caterpillar	D315 (9S).....	Caterpillar	D344.....	Allis-Chalmers
D9H (90V).....	Caterpillar	D315 (48B).....	Caterpillar	D346 (39J).....	Caterpillar
D9L (14Y).....	Caterpillar	D315 (52B).....	Caterpillar	D346 (40J).....	Caterpillar
D10A.....	Komatsu	D315C (4V).....	Caterpillar	D346 (77F).....	Caterpillar
D20A3.....	Komatsu	D315C (9S).....	Caterpillar	D353 (46B).....	Caterpillar
D20P3.....	Komatsu	D315C (48B).....	Caterpillar	D353 (77B).....	Caterpillar
D20PL3.....	Komatsu	D315C (52B).....	Caterpillar	D353C (46B).....	Caterpillar
D20Q3.....	Komatsu	D318.....	Caterpillar	D353C (77B).....	Caterpillar
D20S3.....	Komatsu	D318 (3V).....	Caterpillar	D355A.....	Komatsu
D21A3.....	Komatsu	D318 (5V).....	Caterpillar	D355A1.....	Komatsu
D21P3.....	Komatsu	D318 (6V).....	Caterpillar	D355A3.....	Komatsu
D21Q3.....	Komatsu	D318 (45B).....	Caterpillar	D364 (19B).....	Caterpillar
D21S3.....	Komatsu	D318 (53B).....	Caterpillar	D364 (21B).....	Caterpillar
D30.....	Allis-Chalmers	D318G (3V).....	Caterpillar	D375.....	Caterpillar
D30A15.....	Komatsu	D318G (5V).....	Caterpillar	D375A.....	Komatsu
D30P15.....	Komatsu	D318G (6V).....	Caterpillar	D375 (16B).....	Caterpillar
D30Q15.....	Komatsu	D319G (45B).....	Caterpillar	D375 (18B).....	Caterpillar
D30S15.....	Komatsu	D319G (53B).....	Caterpillar	D375 (43B).....	Caterpillar
D31A.....	Komatsu	D320 (63B).....	Caterpillar	D375D (16B).....	Caterpillar
D37E2.....	Komatsu	D326 (25B).....	Caterpillar	D375D (18B).....	Caterpillar
D40.....	Allis-Chalmers	D326 (39B).....	Caterpillar	D375D (43B).....	Caterpillar
D40P1.....	Komatsu	D326F (25B).....	Caterpillar	D379 (68B).....	Caterpillar
D45P1.....	Komatsu	D326F (39B).....	Caterpillar	D379 (76B).....	Caterpillar
D50A15.....	Komatsu	D330 (2B).....	Caterpillar	D386 (10B).....	Caterpillar
D50P15.....	Komatsu	D330 (4B).....	Caterpillar	D386 (12B).....	Caterpillar
D50S15.....	Komatsu	D330 (5B).....	Caterpillar	D386 (15B).....	Caterpillar
D53A1.....	Komatsu	D330 (56B).....	Caterpillar	D397.....	Caterpillar
D53S1.....	Komatsu	D330 (81B).....	Caterpillar	D397 (10B).....	Caterpillar
D55S.....	Komatsu	D330 (82B).....	Caterpillar	D397 (12B).....	Caterpillar
D55S3.....	Komatsu	D330 (85B).....	Caterpillar	D397 (15B).....	Caterpillar
D60P.....	Komatsu	D330A (2B).....	Caterpillar	D397D (10B).....	Caterpillar
D60A6.....	Komatsu	D330A (4B).....	Caterpillar	D397D (12B).....	Caterpillar
D60P6.....	Komatsu	D330A (5B).....	Caterpillar	D397D (15B).....	Caterpillar
D60PL6.....	Komatsu	D330A (56B).....	Caterpillar	D398 (66B).....	Caterpillar
D65E.....	Komatsu	D330A (81B).....	Caterpillar	D398 (75B).....	Caterpillar
D65EX.....	Komatsu	D330A (82B).....	Caterpillar	D399 (91B).....	Caterpillar
D65P.....	Komatsu	D330A (85B).....	Caterpillar	D400.....	Dresser-Dressta
D65S.....	Komatsu	D333 (23C).....	Caterpillar	D400.....	Dresser-Hough
D65A6.....	Komatsu	D333 (58B).....	Caterpillar	D424.....	Mobilift
D65E6.....	Komatsu	D333 (59B).....	Caterpillar	D500.....	Dresser-Dressta
D65S6.....	Komatsu	D333 (66D).....	Caterpillar	D500.....	Dresser-Hough
D66S1.....	Komatsu	D333 (67D).....	Caterpillar	D516.....	Allis-Chalmers
D75S.....	Komatsu	D333 (79B).....	Caterpillar	D600B.....	Dart
D80A.....	Komatsu	D333 (79C).....	Caterpillar	D779.....	Allis-Chalmers
D85E.....	Komatsu	D333 (80B).....	Caterpillar	D825.....	Gardner-Denver
D85A12.....	Komatsu	D333 (87B).....	Caterpillar	D844.....	Allis-Chalmers
D90C.....	Dresser-Dressta	D333A (23C).....	Caterpillar	D1402.....	Caterpillar
D90C.....	Dresser-Hough	D333A (58B).....	Caterpillar	D1700.....	Huber-Warco
D95S1.....	Komatsu	D333A (59B).....	Caterpillar	D2551.....	Dart
D100B.....	Dresser-Dressta	D333A (66D).....	Caterpillar	D2552.....	Dart
D100B.....	Dresser-Hough	D333A (67D).....	Caterpillar	D2561.....	Dart
D120C.....	Dresser-Dressta	D333A (79B).....	Caterpillar	D2562.....	Dart
D120C.....	Dresser-Hough	D333A (79C).....	Caterpillar	D2661.....	Dart
D125.....	Gardner-Denver	D333A (80B).....	Caterpillar	D2662.....	Dart
D135A.....	Komatsu	D333A (87B).....	Caterpillar	D3400 (1T).....	Caterpillar
D135A2.....	Komatsu	D334 (92B).....	Caterpillar	D3400 (3R).....	Caterpillar
D153.....	Allis-Chalmers	D334 (93B).....	Caterpillar	D3400 (3S).....	Caterpillar
D155A.....	Komatsu	D337F (37B).....	Caterpillar	D3400 (9J).....	Caterpillar
D155A1.....	Komatsu	D339 (34B).....	Caterpillar	D4400 (1S).....	Caterpillar
D175.....	Allis-Chalmers	D342 (5A).....	Caterpillar	D4400 (3R).....	Caterpillar

Indexes
& Abbrev.

Model and Manufacturer Index

Indexes
& Abbrev.

Model	Manufacturer	Model	Manufacturer	Model	Manufacturer
D - Continued		F		F - Continued	
D4400 (5S)	Caterpillar	F	Allis-Chalmers	FD	Allis-Chalmers
D4400 (6S)	Caterpillar	F	Mobilift	FD10	Arctic Traveler
D4600 (1S)	Caterpillar	F	Wabco	FD30	Baker
D4600 (3R)	Caterpillar	F1L 310	Deutz-Allis	FD35	TCM-Toyo
D4600 (5S)	Caterpillar	F1L 410	Deutz-Allis	FD40	Baker
D4600 (6S)	Caterpillar	F1L 712	Deutz-Allis	FD60	Baker
D5000	Ingersoll	F1L 714	Deutz-Allis	FD2218	Hino
D6000	ICC	F1L 812	Deutz-Allis	FD2220	Hino
D6000	Ingersoll	F2L 310	Deutz-Allis	FD2320	Hino
D7505	Ingersoll	F2L 410	Deutz-Allis	FDS	Allis-Chalmers
D8800 (3V)	Caterpillar	F2L 514	Deutz-Allis	FDX	Allis-Chalmers
D13000	Caterpillar	F2L 712	Deutz-Allis	FE	Mitsubishi Fuso
D13000 (1N)	Caterpillar	F2L 812	Deutz-Allis	FE2618	Hino
D13000 (2V)	Caterpillar	F2L 812S	Deutz-Allis	FE2620	Hino
D13000 (3R)	Caterpillar	F2L 912	Deutz-Allis	FE Series	Volvo
D13000 (3S)	Caterpillar	F03	Nissan	FF3018	Hino
D13000 (4S)	Caterpillar	F3L 514	Deutz-Allis	FF3020	Hino
D17000	Caterpillar	F3L 712	Deutz-Allis	FG	Mitsubishi Fuso
D17000 (2V)	Caterpillar	F3L 812	Deutz-Allis	FG005	Nissan
D17000 (3S)	Caterpillar	F3L 911	Deutz-Allis	FG10 II	TCM-Toyo
D17000 (8S)	Caterpillar	F3L 912	Deutz-Allis	FG14 II	TCM-Toyo
DA40	Ingersoll	F4L 514	Deutz-Allis	FG15	Komatsu
DA120	Isuzu	F4L 712	Deutz-Allis	FG15	TCM-Toyo
DA220	Isuzu	F4L 812	Deutz-Allis	FG15	Toyota
DA640	Isuzu	F4L 912	Deutz-Allis	FG20	Komatsu
DD6	Elite	F4M 716	Deutz-Allis	FG20	TCM-Toyo
DD8	Elite	F6L 413	Deutz-Allis	FG20	Toyota
DD10	Elite	F6L 514	Deutz-Allis	FG20 III	TCM-Toyo
DE2772	Dart	F6L 712	Deutz-Allis	FG25	Komatsu
DFEB	Onan	F6L 714	Deutz-Allis	FG25	Toyota
DFFA	Onan	F6L 812	Deutz-Allis	FG25N3	TCM-Toyo
DFFB	Onan	F6L 911	Deutz-Allis	FG28	Toyota
DFLB	Onan	F6L 912	Deutz-Allis	FG30	Baker
DFLC	Onan	F6M 716	Deutz-Allis	FG30	Toyota
DFLD	Onan	F8L 413	Deutz-Allis	FG30M	TCM-Toyo
DH4B	Case	F8L 714	Deutz-Allis	FG30ZU	TCM-Toyo
DH5	Case	F8M 716	Deutz-Allis	FG35	Toyota
DH100	Isuzu	F10L 714	Deutz-Allis	FG40	Komatsu
DL6000	ICC	F12M 716	Deutz-Allis	FG40	Toyota
DL7000	ICC	F40	Allis-Chalmers	FG60	Baker
DM Series	Mack	F48	Barber-Greene	FG101	Nissan
DMM Series	Mack	F50	Allis-Chalmers	FG102	Nissan
DPS-90SS	Multiquip	F60	Allis-Chalmers	FG103	Nissan
DPS-180SST	Multiquip	F90	Fresia	FG104	Nissan
DRP	Onan	F235	Clark	FG105	Nissan
DS844	Allis-Chalmers	F450 Super Duty	Ford	FG106	Nissan
DuraStar 4300	International/Navistar	F550 Super Duty	Ford	FG107	Nissan
DuraStar 4400	International/Navistar	F602B	Le Tourneau	FGA030	Baker
DuraStar Hybrid	International/Navistar	F650 Super Duty	Ford	FGA050	Baker
DZB	Onan	F700	Ford	FGA070	Baker
DZC	Onan	F750 Super Duty	Ford	FGC10	Toyota
DZD	Onan	F800	Ford	FGC15	Toyota
E		F802A	Le Tourneau	FGC20	Mitsubishi
E	Mobilift	F804A	Le Tourneau	FGC20	Toyota
E200	International	F1204	Le Tourneau	FGC25	Mitsubishi
E211	International	F1500	Huber-Warco	FGC25	Toyota
E270	International	F Super Duty	Ford	FGD020	Baker
E450 Super Duty	Ford	FA1415	Hino	FGD025	Baker
E550 Super Duty	Ford	FA1517	Hino	FGD030	Baker
EC	Onan	FB2	Thermo King	FGD040	Baker
ED	Onan	FB2-M5	Thermo King	FGD050	Baker
EF	Onan	FB1715	Hino	FGD060	Baker
EL240B (5WG)	Caterpillar	FB1817	Hino	FGD070	Baker
ER	Mobilift	FC	Allis-Chalmers	FGD080	Baker
EUBH	International	FC	Poclair	FGF020	Baker
EW	Mobilift	FC70	Freightliner	FGF025	Baker
		FC80	Freightliner	FGF030	Baker
		FC100	Fresia	FGF040	Baker
		FCG25	TCM-Toyo	FGF050	Baker

Model and Manufacturer Index

Model	Manufacturer	Model	Manufacturer	Model	Manufacturer
F - Continued		F - Continued		F - Continued	
FGU40	Baker	FMF050	Baker	FTL60 Thru 100	Allis-Chalmers
FGU60	Baker	Forward W4	GMC	FTL70	Allis-Chalmers
FH	Mitsubishi Fuso	Forward W5	GMC	FTL75	Allis-Chalmers
FIA030	Baker	Forward W6	GMC	FTL80	Allis-Chalmers
FIA050	Baker	Forward W7	GMC	FTL100	Allis-Chalmers
FIA070	Baker	FP	Allis-Chalmers	FTLB50	Allis-Chalmers
FID020	Baker	FPD	Allis-Chalmers	FTOH	Allis-Chalmers
FID025	Baker	FPD60	Allis-Chalmers	FTOHL	Allis-Chalmers
FID030	Baker	FPD70	Allis-Chalmers	FTP	Allis-Chalmers
FID040	Baker	FPD80	Allis-Chalmers	FTP20	Allis-Chalmers
FID050	Baker	FPDX	Allis-Chalmers	FTP30	Allis-Chalmers
FID060	Baker	FPDX60	Allis-Chalmers	FTP40	Allis-Chalmers
FID070	Baker	FPDX70	Allis-Chalmers	FTPD	Allis-Chalmers
FID080	Baker	FPDX80	Allis-Chalmers	FTPD30	Allis-Chalmers
FIF020	Baker	FPL	Allis-Chalmers	FTPD40	Allis-Chalmers
FIF025	Baker	FPL20	Allis-Chalmers	FTPDX	Allis-Chalmers
FIF030	Baker	FPL25	Allis-Chalmers	FTPL	Allis-Chalmers
FIF040	Baker	FPL50	Allis-Chalmers	FTPL20	Allis-Chalmers
FIF050	Baker	FR12B	Fiat-Allis	FTPL30	Allis-Chalmers
FJA020	Baker	FR15B	Fiat-Allis	FTPL40	Allis-Chalmers
FJA025	Baker	FRH20	Baker	FTPL60	Allis-Chalmers
FJA030	Baker	FRR	Isuzu	FTR	Isuzu
FJA050	Baker	FRT80	Baker	FTS	Allis-Chalmers
FJA070	Baker	FS	Allis-Chalmers	FTSD	Allis-Chalmers
FJC030	Baker	FSD	Allis-Chalmers	FTSL60	Allis-Chalmers
FJD020	Baker	FSL	Allis-Chalmers	FTXB50	Allis-Chalmers
FJD025	Baker	FSL20 Thru 120 Series	Allis-Chalmers	FU40	Allis-Chalmers
FJD030	Baker	FSR	Isuzu	FVR	Isuzu
FJD040	Baker	FT	Allis-Chalmers	FXR	Isuzu
FJD050	Baker	FT20	Allis-Chalmers	FY	Poclain
FJD060	Baker	FT25	Allis-Chalmers	FY235	Clark
FJD070	Baker	FT30-15	Allis-Chalmers		
FJD080	Baker	FT30-24	Allis-Chalmers	G	
FJF020	Baker	FT40	Allis-Chalmers	G3 Series	Yale
FJF025	Baker	FT50	Allis-Chalmers	G5 Series	Yale
FJF030	Baker	FT100	Allis-Chalmers	G10P	Yale
FJF040	Baker	FT900	Ford	G12	Austin-Western
FJF050	Baker	FT PL40	Allis-Chalmers	G12	Gerlinger
FK	Mitsubishi Fuso	FTB	Allis-Chalmers	G15	Gerlinger
FL	Allis-Chalmers	FTB30	Allis-Chalmers	G15	Pettibone
FL50	Freightliner	FTB50	Allis-Chalmers	G15B	Pettibone
FL60	Freightliner	FTBL	Allis-Chalmers	G16	Gerlinger
FL70	Freightliner	FTBL30	Allis-Chalmers	G18	Gerlinger
FL80	Freightliner	FTBL50	Allis-Chalmers	G20	Gerlinger
FL106	Freightliner	FTD	Allis-Chalmers	G20	Pettibone
FL112	Freightliner	FTD020	Baker	G20B	Pettibone
FL120	Allis-Chalmers	FTD025	Baker	G22	Gerlinger
FLB	Freightliner	FTD30-15	Allis-Chalmers	G25	Amita
FLC	Freightliner	FTD30-24	Allis-Chalmers	G25	Pettibone
FLD	Freightliner	FTD40	Allis-Chalmers	G25B	Pettibone
FLS	Allis-Chalmers	FTD50	Allis-Chalmers	G30	Pettibone
FLS112	Freightliner	FTD70	Allis-Chalmers	G30A	Pettibone
FM	Mitsubishi Fuso	FTDB	Allis-Chalmers	G30H	Pettibone
FMA030	Baker	FTDB50	Allis-Chalmers	G40	Pettibone
FMA050	Baker	FTDOA	Allis-Chalmers	G40H	Pettibone
FMA070	Baker	FTDOH	Allis-Chalmers	G50	Pettibone
FMC030	Baker	FTDX	Allis-Chalmers	G51C	Yale
FMD020	Baker	FTDX30-15	Allis-Chalmers	G51C Series	Yale
FMD025	Baker	FTDX30-24	Allis-Chalmers	G51CN Series	Yale
FMD030	Baker	FTDX40	Allis-Chalmers	G51NC	Yale
FMD040	Baker	FTDXB	Allis-Chalmers	G51P Series	Yale
FMD050	Baker	FTDXB50	Allis-Chalmers	G52 Series	Yale
FMD060	Baker	FTL	Allis-Chalmers	G54C Series	Yale
FMD070	Baker	FTL20	Allis-Chalmers	G54P Series	Yale
FMD080	Baker	FTL25	Allis-Chalmers	G60	Pettibone
FMF020	Baker	FTL30-15	Allis-Chalmers	G81	Yale
FMF025	Baker	FTL30-24	Allis-Chalmers	G83C	Yale
FMF030	Baker	FTL40	Allis-Chalmers	G83P	Yale
FMF040	Baker	FTL50	Allis-Chalmers	G86	Yale

Indexes & Abbrev.

Model and Manufacturer Index

Indexes
& Abbrev.

Model	Manufacturer	Model	Manufacturer	Model	Manufacturer
G - Continued		G - Continued		H - Continued	
G138.....	Allis-Chalmers	GS30A.....	Pettibone	H65G.....	Dresser-Hough
G149.....	Allis-Chalmers	GS30H.....	Pettibone	H70.....	Dresser-Hough
G226.....	Allis-Chalmers	GS40.....	Pettibone	H70B.....	Dresser-Hough
G262.....	Allis-Chalmers	GS50.....	Pettibone	H70B.....	Hyster
G357A.....	Yale	GS60.....	Pettibone	H70C.....	Dresser-Hough
G660.....	Warner & Swasey	GSS15.....	Pettibone	H70C.....	Hyster
GA.....	Thermo King	GSS15B.....	Pettibone	H70D.....	Dresser-Hough
GA30H.....	Pettibone	GSS20A.....	Pettibone	H80.....	Lift All
GA40.....	Pettibone	GSS20B.....	Pettibone	H80A.....	Dresser-Hough
GA40H.....	Pettibone	GSS25.....	Pettibone	H80B.....	Dresser-Hough
GA50.....	Pettibone	GSS25B.....	Pettibone	H80B.....	Hyster
GA60.....	Pettibone	GSS30.....	Pettibone	H80C.....	Hyster
GA70.....	Pettibone	GSS30A.....	Pettibone	H80XL.....	Hyster
GA80.....	Pettibone	GT6000-66.....	Gomaco	H90B.....	Dresser-Hough
GATOR.....	Raygo	GT6000-78.....	Gomaco	H90C.....	Dresser-Hough
GC.....	Poclair	GTC Series.....	Yale	H90D.....	Dresser-Hough
GC100.....	Yale	GTP50R.....	Yale	H90E.....	Dresser-Hough
GC120.....	Poclair	GU Series.....	Mack	H100.....	Dresser-Hough
GC150.....	Yale	GY.....	Poclair	H100.....	Lift All
GC Series.....	Yale	H		H100A.....	Dresser-Hough
GCS20.....	Clark	H.....	Jaeger	H100B.....	Dresser-Hough
GD22H-1.....	Komatsu	H.....	Mobilift	H100B.....	Hyster
GD30-5M.....	Komatsu	H4M32G.....	Herculift	H100C.....	Dresser-Hough
GD31-5H.....	Komatsu	H4M50.....	TCI	H100C.....	Hyster
GD37-5H.....	Komatsu	H4M60.....	TCI	H100XL.....	Hyster
GD615A.....	Komatsu	H4M80.....	TCI	H110F.....	Hyster
GD655-3.....	Komatsu	H12.....	Dresser-Hough	H120.....	Dresser-Hough
GD705A.....	Komatsu	H20E.....	Hyster	H120.....	Lift All
Genesis TM1000.....	Transcold	H25.....	Dresser-Hough	H120A.....	Dresser-Hough
GL.....	Thermo King	H25B.....	Dresser-Hough	H120B.....	Dresser-Hough
GLC050.....	Yale	H25E.....	Hyster	H120B.....	Hyster
GLC Series.....	Yale	H30.....	Clark	H120C.....	Dresser-Hough
GLF30.....	Automatic Transportation	H30.....	Dresser-Hough	H120C.....	Hyster
GLF40.....	Automatic Transportation	H30A.....	Dresser-Hough	H130F.....	Hyster
GLF50.....	Automatic Transportation	H30B.....	Dresser-Hough	H140C.....	Hyster
GLF60.....	Automatic Transportation	H30E.....	Hyster	H150.....	Lift All
GLF70.....	Automatic Transportation	H30F.....	Dresser-Hough	H150C.....	Hyster
GLF80.....	Automatic Transportation	H30F.....	Hyster	H150E.....	Hyster
GLF100.....	Automatic Transportation	H30FB.....	Dresser-Hough	H150F.....	Hyster
GLFP30.....	Automatic Transportation	H30H.....	Hyster	H165E.....	Hyster
GLFP40.....	Automatic Transportation	H30R.....	Dresser-Hough	H173.....	Allis-Chalmers
GLFP50.....	Automatic Transportation	H30RB.....	Dresser-Hough	H180E.....	Hyster
GLFP60.....	Automatic Transportation	H32.....	Gerlinger	H199.....	Allis-Chalmers
GLFP70.....	Automatic Transportation	H35XL.....	Hyster	H200E.....	Hyster
GLFP80.....	Automatic Transportation	H36.....	Gerlinger	H200ES.....	Hyster
GMF150.....	Automatic Transportation	H40F.....	Hyster	H202C.....	Unit Crane & Shovel
GMF160.....	Automatic Transportation	H40H.....	Hyster	H205.....	Allis-Chalmers
GMF180.....	Automatic Transportation	H40XL.....	Hyster	H217.....	Allis-Chalmers
GMF200.....	Automatic Transportation	H40.....	Dresser-Hough	H225E.....	Hyster
GP040.....	Yale	H40.....	Gerlinger	H225ES.....	Hyster
GP050R.....	Yale	H48.....	Ford	H250A.....	Hyster
GP52 Series.....	Yale	H50.....	Clark	H250E.....	Hyster
GP060L.....	Yale	H50.....	Dresser-Hough	H260.....	Allis-Chalmers
GP080L.....	Yale	H50B.....	Dresser-Hough	H275H.....	Hyster
GP100.....	Yale	H50C.....	Dresser-Hough	H298.....	Allis-Chalmers
GP150.....	Yale	H50F.....	Hyster	H300.....	Hyster
GPR52 Series.....	Yale	H50H.....	Hyster	H300A.....	Hyster
GPS15.....	Clark	H50XL.....	Hyster	H312.....	P & H
GPS30.....	Clark	H60.....	Dresser-Hough	H326.....	Allis-Chalmers
GR52 Series.....	Yale	H60B.....	Dresser-Hough	H330.....	Hyster
GS4-20.....	Pettibone	H60B.....	Hyster	H350B.....	Hyster
GS4-25.....	Pettibone	H60C.....	Hyster	H355.....	Clark
GS15.....	Pettibone	H60E.....	Dresser-Hough	H355PD.....	Clark
GS15B.....	Pettibone	H60F.....	Hyster	H360A.....	Hyster
GS20.....	Pettibone	H60H.....	Hyster	H400.....	Dresser-Hough
GS20B.....	Pettibone	H65.....	Dresser-Hough	H400A.....	Hyster
GS25.....	Pettibone	H65B.....	Dresser-Hough	H400B.....	Dresser-Hough
GS25B.....	Pettibone	H65C.....	Dresser-Hough	H400C.....	Dresser-Hough
GS30.....	Pettibone			H418.....	P & H



Model and Manufacturer Index

Model	Manufacturer	Model	Manufacturer	Model	Manufacturer
H - Continued		H - Continued		J	
H460A.....	Hyster	HR-6-B.....	Cummins	J.....	Thermo King
H550.....	Warner & Swasey	HR-6-BI.....	Cummins	J36HD.....	Cleveland
H560.....	Dresser-Hough	HR-6-CI.....	Cummins	J-4.....	Cummins
H560B.....	Insley	HR-6-G.....	Cummins	J-6.....	Cummins
H685.....	Clark	HR-6-I.....	Cummins	J-6-BI.....	Cummins
H875.....	Insley	HR-6-IP.....	Cummins	J-6-CI.....	Cummins
H900A.....	Warner & Swasey	HR-6-P.....	Cummins	J-6-I.....	Cummins
H915.....	Clark	HRC-4-B.....	Cummins	J-6-IP.....	Cummins
H1500.....	Insley	HRC-4-G.....	Cummins	J-6-P.....	Cummins
H-6-B.....	Cummins	HRC-4-I.....	Cummins	J-70-B.....	Cummins
H-6-BI.....	Cummins	HRC-4-IP.....	Cummins	J-70-BI.....	Cummins
H-6-CI.....	Cummins	HRC-4-P.....	Cummins	J-70-I.....	Cummins
H-6-G.....	Cummins	HRF-6-B.....	Cummins	J-70-IP.....	Cummins
H-6-I.....	Cummins	HRF-6-BI.....	Cummins	J-80-B.....	Cummins
H-6-IF.....	Cummins	HRF-6-CI.....	Cummins	J-80-BI.....	Cummins
H-6-IP.....	Cummins	HRF-6-G.....	Cummins	J-80-I.....	Cummins
H-6-P.....	Cummins	HRF-6-I.....	Cummins	J-80-IP.....	Cummins
H-135-CI.....	Cummins	HRF-6-IP.....	Cummins	J-120-B.....	Cummins
H-743-C.....	Cummins	HRF-6-P.....	Cummins	JC.....	Onan
H-743-L.....	Cummins	HRS-6-B.....	Cummins	JD646.....	John Deere
HA.....	Thermo King	HRS-6-BI.....	Cummins	JD646B.....	John Deere
HC.....	Poclain	HRS-6-CI.....	Cummins	JD-I 30.....	Thermo King
HC18.....	Link-Belt	HRS-6-G.....	Cummins	JD-I 50.....	Thermo King
HC78B.....	Link-Belt	HRS-6-I.....	Cummins	JF-6-B.....	Cummins
HC100.....	Hamm	HRS-6-IP.....	Cummins	JF-6-BI.....	Cummins
HC108C.....	Link-Belt	HRS-6-P.....	Cummins	JF-6-CI.....	Cummins
HC120.....	Hamm	HS-6-B.....	Cummins	JF-6-I.....	Cummins
HC218.....	Link-Belt	HS-6-BI.....	Cummins	JF-6-IP.....	Cummins
HC300.....	Poclain	HS-6-CI.....	Cummins	JF-6-P.....	Cummins
HD16DP.....	Fiat-Allis	HS-6-G.....	Cummins	JN-6-B.....	Cummins
HD180-4.....	Komatsu	HS-6-I.....	Cummins	JN-6-BI.....	Cummins
HD320-2.....	Komatsu	HS-6-IP.....	Cummins	JN-6-CI.....	Cummins
HD344.....	Allis-Chalmers	HS-6-P.....	Cummins	JN-6-I.....	Cummins
HD516.....	Allis-Chalmers	HSP8018.....	Link-Belt	JN-6-IP.....	Cummins
HD680.....	Komatsu	HSP8028S.....	Link-Belt	JN-6-P.....	Cummins
HDR12EH.....	Le Roi	HSP8040.....	Link-Belt	JN-130.....	Cummins
HE50.....	Hyster	HT4.....	Caterpillar	JNF-130.....	Cummins
Herculift 40.....	TCI	HT80.....	Lift All	JNR-6-BI.....	Cummins
HF.....	Dresser-Hough	HT100.....	Lift All	JNR-100.....	Cummins
HF.....	Gerlinger	HT120.....	Lift All	JNS-6-B.....	Cummins
HG1250.....	Arrow-Master, Inc.	HT150.....	Lift All	JNS-6-BI.....	Cummins
HH.....	Dresser-Hough	HT450.....	Link-Belt	JNS-6-CI.....	Cummins
HJ1250R.....	Arrow-Master, Inc.	HT3100.....	Gardner-Denver	JNS-6-IP.....	Cummins
HK.....	Onan	HT4418.....	Warner & Swasey	JNS-6-P.....	Cummins
HK 30.....	Thermo King	HTR.....	Isuzu	JS-6-B.....	Cummins
HK 60.....	Thermo King	HVR.....	Isuzu	JS-6-BI.....	Cummins
HK 100.....	Thermo King	HW.....	Mobilift	JS-6-CI.....	Cummins
HL644-22.....	Pettibone	HXR.....	Isuzu	JS-6-IP.....	Cummins
HM.....	Dresser-Hough	HY40.....	Clark	JS-6-P.....	Cummins
HM.....	Thermo King	HY50.....	Clark	JT-6-B.....	Cummins
HM250.....	Rex	HY355PD.....	Clark	JT-6-BI.....	Cummins
HN.....	Onan	HY685.....	Clark	JT-6-CI.....	Cummins
HO.....	Dresser-Hough	HY1425.....	Clark	JT-6-I.....	Cummins
HP175.....	Mkt Mfg. Inc.	HY1625.....	Clark	JT-6-IP.....	Cummins
HP205.....	Allis-Chalmers	HY1830.....	Clark	JT-6-P.....	Cummins
HP217.....	Allis-Chalmers	HY2030.....	Clark		
HP234.....	Allis-Chalmers			K	
HP260.....	Allis-Chalmers			K.....	Buffalo Springfield
HP298.....	Allis-Chalmers			K.....	Mobilift
HP326.....	Allis-Chalmers	I105S.....	M-R-S	K1D.....	Dresser-Galion
HP351.....	Allis-Chalmers	I110S.....	M-R-S	K5-30.....	Towmotor
HR.....	Mobilift	IC701A.....	Broderson	K5-33.....	Towmotor
HR3.....	Lister	IT12B (1KF).....	Caterpillar	K5-36.....	Towmotor
HR-4-B.....	Cummins	IT14B (3NJ).....	Caterpillar	K5-40.....	Towmotor
HR-4-BI.....	Cummins	IT28B (1HF).....	Caterpillar	K45.....	Bomag
HR-4-G.....	Cummins	IT355.....	Clark	K45A.....	Kalamazoo
HR-4-I.....	Cummins	IT581.....	Clark	K100.....	Kenworth
HR-4-IP.....	Cummins			K300.....	Bomag
HR-4-P.....	Cummins			K300.....	Kenworth

Indexes & Abbrev.



Model and Manufacturer Index

Indexes
& Abbrev.

Model	Manufacturer	Model	Manufacturer	Model	Manufacturer
K - Continued		K - Continued		L - Continued	
K360.....	Kenworth	KTTA19.....	Cummins	L555.....	New Holland
K360B.....	Hyster	KTTA19G.....	Cummins	L565.....	New Holland
K400.....	Kubota	KTTA38.....	Cummins	L634.....	Onan
K428.....	Allis-Chalmers	KTTA50.....	Cummins	L775.....	New Holland
K907LC Mark II.....	Kobelco	KTTT12.....	Cummins	L781.....	New Holland
K909LC Mark II.....	Kobelco	KW.....	Mobilift	L785.....	New Holland
K935.....	P & H	KX41.....	Kubota	L8000.....	Ford
K-6.....	Cummins	KX71.....	Kubota	L8500.....	Ford
KB.....	Onan	KX101.....	Kubota	L9000.....	Ford
KD-I.....	Thermo King	KX151.....	Kubota	L9500.....	Ford
KD-II.....	Thermo King	L		LA8000.....	Ford
KE.....	Hyster	L.....	Cummins	LA9000.....	Ford
KF30.....	Buffalo Springfield	L.....	Elgin	LB90.....	New Holland
KG51 Series 10.....	Yale	L.....	Mobilift	LC.....	Poclain
KG51 Series 15.....	Yale	L4.....	Perkins	LC.....	Thermo King
KG51 Series 20H.....	Yale	L12.....	Gerlinger	LC790.....	Lorain
KG51 Series 30.....	Yale	L15.....	Gerlinger	LCF.....	Ford
KG51 Series 30X.....	Yale	L16.....	Gerlinger	LE Series.....	Mack
KG51 Series 40.....	Yale	L18.....	Gerlinger	LEU Series.....	Mack
KG51 Series 50.....	Yale	L20.....	Gerlinger	LK.....	Onan
KG51 Series 60.....	Yale	L20.....	VME	LK350 Mark II.....	Kobelco
KG51 Series 70.....	Yale	L22.....	Gerlinger	LK700A.....	Kobelco
KG51 Series 80.....	Yale	L27.....	Thew Shovel	LL9000.....	Ford
KG51 Series 100.....	Yale	L30.....	Thew Shovel	LLA9000.....	Ford
KGA51 Series.....	Yale	L30.....	VME	L-Line.....	Sterling
KGP51 Series.....	Yale	L30.....	Volvo	LLS9000.....	Ford
KGP Series.....	Yale	L35.....	New Holland	LM.....	Cummins
KGPA51 Series.....	Yale	L35 Backhoe.....	Kubota	LM200.....	Fresia
KH007.....	Kubota	L37.....	Thew Shovel	LN7000.....	Ford
KH10D.....	Kubota	L40.....	Lift All	LN8000.....	Ford
KH18L.....	Kubota	L40.....	Thew Shovel	LN9000.....	Ford
KH28L.....	Kubota	L41.....	Thew Shovel	LND 30.....	Thermo King
KH35.....	Kubota	L41MC.....	Thew Shovel	LND 30 PEG.....	Thermo King
KH41.....	Kubota	L45.....	Thew Shovel	LND 50.....	Thermo King
KH60.....	Kubota	L50.....	Lift All	LND 50 PEG.....	Thermo King
KH90.....	Kubota	L50.....	Thew Shovel	LNT8000.....	Ford
KH91.....	Kubota	L50.....	Volvo	LNT9000.....	Ford
KH170L.....	Kubota	L50B.....	Volvo	LO525.....	Allis-Chalmers
KH191.....	Kubota	L51 Series 30.....	Yale	LoneStar.....	International/Navistar
KH191L.....	Kubota	L51 Series 40.....	Yale	LR.....	Cummins
KL 10.....	Thermo King	L51 Series 50.....	Yale	LR.....	Thermo King
KL 20.....	Thermo King	L51 Series 60.....	Yale	LR-I.....	Thermo King
KL 30.....	Thermo King	L51 Series 70.....	Yale	LRM.....	Cummins
KL 40.....	Thermo King	L51 Series 80.....	Yale	LRT.....	Cummins
KL 40S.....	Thermo King	L51 Series 100.....	Yale	LRT18U.....	Koehring
KL 50.....	Thermo King	L52 Series.....	Yale	LRT180.....	Koehring
KL 62.....	Thermo King	L56.....	Thew Shovel	LRT275.....	Koehring
KL A.....	Thermo King	L60.....	Lift All	LRT1600.....	Koehring
Kodiak C5500.....	Chevrolet	L64MH.....	Ingersoll	LRTM.....	Cummins
Kodiak C6500.....	Chevrolet	L66.....	Thew Shovel	LS78.....	Link-Belt
Kodiak C7500.....	Chevrolet	L70.....	Volvo	LS98.....	Link-Belt
Kodiak C8500.....	Chevrolet	L70B.....	Volvo	LS98H.....	Link-Belt
KR.....	Onan	L83C.....	Yale	LS108B.....	Link-Belt
KR.....	Thermo King	L83P.....	Yale	LS128DLC.....	Link-Belt
KT7B.....	Bomag	L85A.....	Thew Shovel	LS190.....	New Holland
KT8.....	Bomag	L87.....	Thew Shovel	LS2700.....	Link-Belt
KT15.....	Bomag	L90.....	Volvo	LS2800CII.....	Link-Belt
KT19G.....	Cummins	L90B.....	Volvo	LS4000.....	Link-Belt
KT38.....	Cummins	L95.....	Thew Shovel	LS4300CII.....	Link-Belt
KTA12.....	Cummins	L120.....	Volvo	LS5800.....	Link-Belt
KTA19.....	Cummins	L150.....	Volvo	LS5800CII.....	Link-Belt
KTA19G.....	Cummins	L175.....	New Holland	LS7400.....	Link-Belt
KTA38.....	Cummins	L185.....	New Holland	LS8000.....	Ford
KTA38G1.....	Cummins	L225.....	New Holland	LS9000.....	Ford
KTA50.....	Cummins	L423.....	Onan	LSPRM8A.....	Bros
KTA52.....	Cummins	L501.....	Thew Shovel	LSPRM84A.....	Bros
KTA53.....	Cummins	L524.....	Mobilift	LT8000.....	Ford
KTT11.....	Cummins	L553.....	New Holland	LT9000.....	Ford
KTT12.....	Cummins			LTA9000.....	Ford



Model and Manufacturer Index

Model	Manufacturer	Model	Manufacturer	Model	Manufacturer
L - Continued		M - Continued		M - Continued	
LTL9000.....	Ford	MC530W.....	Thew Shovel	MWC 30.....	Thermo King
LTLA9000.....	Ford	MC540A.....	Lorain	MWC 40.....	Thermo King
LTLS9000.....	Ford	MC660.....	Thew Shovel	MWC 50.....	Thermo King
LTS8000.....	Ford	MC794.....	Thew Shovel	MWCL 25.....	Thermo King
LTS9000.....	Ford	MC875.....	Thew Shovel	MWCT.....	Thermo King
LX665.....	New Holland	MD140.....	MDI/Yutani	MXT.....	International/Navistar
LX985.....	New Holland	MD200.....	MDI/Yutani	MY40.....	Mobilift
LY.....	Poclain	MD240.....	MDI/Yutani	MY40B.....	Mobilift
		MD320.....	MDI/Yutani	MY50.....	Mobilift
		MD Series.....	Bering Truck Corp.	MY50B.....	Mobilift
		MDA.....	Multiho	MY60.....	Mobilift
M.....	Elgin	MD-I.....	Thermo King	MY60B.....	Mobilift
M.....	Mobilift	MD-II.....	Thermo King	MY70.....	Mobilift
M.....	Poclain	MF11.....	Massey Ferguson	MY70B.....	Mobilift
M4K.....	Case	MF20C.....	Massey Ferguson	MY80B.....	Mobilift
M13.....	Thermo King	MF30B.....	Massey Ferguson	MZ48B.....	Grove
M15.....	Thermo King	MF44B.....	Massey Ferguson	MZ66.....	Grove
M22.....	Thermo King	MF50A.....	Massey Ferguson	MZ116D.....	Grove
M24.....	Gerlinger	MF66.....	Massey Ferguson		
M26.....	Gerlinger	MF70.....	Massey Ferguson	N	
M28.....	Gerlinger	MF77C.....	Massey Ferguson	N.....	Elgin
M30.....	Gerlinger	MF80.....	Massey Ferguson	N-495-B130.....	Cummins
M40.....	Mobilift	MF202.....	Massey Ferguson	N-495-C130.....	Cummins
M50.....	Mobilift	MF202 Forklift.....	Massey Ferguson	N-495-P130.....	Cummins
M60.....	Lift All	MF203.....	Massey Ferguson	N-927.....	Cummins
M70.....	Allis-Chalmers	MF204.....	Massey Ferguson	ND9031.....	Zetor
M70.....	Lift All	MF204 Forklift.....	Massey Ferguson	NDB40.....	Transcold
M80.....	Lift All	MF205.....	Massey Ferguson	NDE40.....	Transcold
M100.....	Allis-Chalmers	MF220.....	Massey Ferguson	NDJ40.....	Transcold
M100.....	Lift All	MF300 Backhoe.....	Massey Ferguson	NDS40.....	Transcold
M100B.....	Allis-Chalmers	MF320.....	Massey Ferguson	NDT40.....	Transcold
M120.....	Huber-Warco	MF450.....	Massey Ferguson	NFD.....	Thermo King
M150.....	Huber-Warco	MF450S.....	Massey Ferguson	NH250-B.....	Cummins
M180.....	Huber-Warco	MF470.....	Massey Ferguson	NH250-BI.....	Cummins
M324.....	Mobilift	MF811.....	Massey Ferguson	NH250-C.....	Cummins
M600D.....	Bobcat-Melroe	MF2500.....	Massey Ferguson	NH250-CI.....	Cummins
M620.....	Bobcat-Melroe	MF4500.....	Massey Ferguson	NH-6-IF.....	Cummins
M643.....	Northern Lights	MF6500.....	Massey Ferguson	NH-180-B.....	Cummins
M700.....	Bobcat-Melroe	MH42A.....	Broderson	NH-195-B.....	Cummins
M753.....	Northern Lights	MH42B.....	Broderson	NH-220.....	Cummins
M843N.....	Northern Lights	ML153.....	Thew Shovel	NH-220-B.....	Cummins
M964.....	Northern Lights	MPH100S.....	Bomag	NH-220-BI.....	Cummins
M970.....	Bobcat-Melroe	MPH-1.....	Koehring	NH-220-CI.....	Cummins
M4276T.....	Northern Lights	MR Series.....	Mack	NH-220-G.....	Cummins
MA20.....	Mobilift	MRU Series.....	Mack	NH-220-I.....	Cummins
MA25.....	Mobilift	MS20.....	Mobilift	NH-220-IP.....	Cummins
MA30.....	Mobilift	MS25.....	Mobilift	NH-220-P.....	Cummins
MA30 II.....	Mobilift	MS30.....	Mobilift	NH-230.....	Cummins
MA30S.....	Mobilift	MS35.....	Mobilift	NH-230-B.....	Cummins
MA35.....	Mobilift	MS Series.....	Mack	NH-250.....	Cummins
MA40.....	Mobilift	MSB20.....	Mobilift	NH-250-IP.....	Cummins
MA40 II.....	Mobilift	MSB25.....	Mobilift	NH-250-P.....	Cummins
MA45.....	Mobilift	MSB30.....	Mobilift	NHC-4-B.....	Cummins
MA50.....	Mobilift	MSB35.....	Mobilift	NHC-4-BI.....	Cummins
MA50 II.....	Mobilift	MT35.....	Freightliner	NHC-4-G.....	Cummins
MA55.....	Mobilift	MT45.....	Freightliner	NHC-4-I.....	Cummins
MA60.....	Mobilift	MT52.....	Bobcat-Melroe	NHC-4-IP.....	Cummins
MA60 II.....	Mobilift	MT55.....	Freightliner	NHC-4-P.....	Cummins
Maintainer.....	Huber-Warco	MT60.....	Lift All	NHC-250.....	Cummins
MC2.....	Thew Shovel	MT70.....	Lift All	NHCT-270-B.....	Cummins
MC3.....	Thew Shovel	MT80.....	Lift All	NHD-180-B.....	Cummins
MC4.....	Thew Shovel	MT100.....	Lift All	NHE-180-B.....	Cummins
MC30H.....	Lorain	MTS20.....	Mobilift	NHE-180-CI.....	Cummins
MC107.....	Thew Shovel	MTS25.....	Mobilift	NHE-180-I.....	Cummins
MC320.....	Lorain	MTS30.....	Mobilift	NHE-195-B.....	Cummins
MC430.....	Thew Shovel	MTS35.....	Mobilift	NHE-220-B.....	Cummins
MC504.....	Thew Shovel	MW.....	Thermo King	NHE-225.....	Cummins
MC504W.....	Thew Shovel	MWC 10.....	Thermo King	NHE-225-B.....	Cummins
MC520.....	Thew Shovel	MWC 20.....	Thermo King	NHR-195-CI.....	Cummins
MC524.....	Thew Shovel				

Indexes & Abbrev.

Model and Manufacturer Index

Indexes
& Abbrev.

Model	Manufacturer	Model	Manufacturer	Model	Manufacturer
N - Continued		N - Continued		P	
NHRS-6-B.....	Cummins	NTA-370-B.....	Cummins	P3.....	Nissan
NHRS-6-BI.....	Cummins	NTA-380.....	Cummins	P3.....	Perkins
NHRS-6-CI.....	Cummins	NTA-400.....	Cummins	P4.....	Perkins
NHRS-6-G.....	Cummins	NTA-420.....	Cummins	P5.....	Nissan
NHRS-6-I.....	Cummins	NTA-420-C.....	Cummins	P6.....	Perkins
NHRS-6-IP.....	Cummins	NTC-290.....	Cummins	P6S042.....	Chevrolet
NHRS-6-P.....	Cummins	NTC-335.....	Cummins	P6S042.....	GMC
NHS-6-B.....	Cummins	NTC-335-B.....	Cummins	P8.....	Nissan
NHS-6-BI.....	Cummins	NTC-350.....	Cummins	P30.....	Chevrolet
NHS-6-CI.....	Cummins	NTE-235-B.....	Cummins	P40A.....	Hyster
NHS-6-I.....	Cummins	NTE-235-BI.....	Cummins	P50.....	Allis-Chalmers
NHS-6-IP.....	Cummins	NTO-6-B.....	Cummins	P50A.....	Hyster
NHS-6-P.....	Cummins	NTO-6-BI.....	Cummins	P60A.....	Hyster
NPR.....	Isuzu	NTO-6-CI.....	Cummins	P80A.....	Hyster
NQR.....	Isuzu	NTO-6-I.....	Cummins	P125A.....	Hyster
NRR.....	Isuzu	NTO-6-IP.....	Cummins	P150A.....	Hyster
NRT-6-B.....	Cummins	NTO-6-P.....	Cummins	P150B.....	Hyster
NRT-6-BI.....	Cummins	NTO-262.....	Cummins	P165A.....	Hyster
NRT-6-CI.....	Cummins	NTO-262-B.....	Cummins	P180A.....	Hyster
NRT-6-I.....	Cummins	NTO-262-BI.....	Cummins	P200B.....	Hyster
NRT-6-IP.....	Cummins	NTO-262-CI.....	Cummins	P3500.....	GMC
NRT-6-P.....	Cummins	NTO-262-I.....	Cummins	P Series.....	Workhorse
NRTO-6-B.....	Cummins	NTO-262-IP.....	Cummins	Pacer 100.....	Austin-Western
NRTO-6-BI.....	Cummins	NTO-262-P.....	Cummins	Pacer 200.....	Austin-Western
NRTO-6-CI.....	Cummins	NTO-280-B.....	Cummins	Pacer 300.....	Austin-Western
NRTO-6-I.....	Cummins	NTO-280-CI.....	Cummins	Pacer 301.....	Austin-Western
NRTO-6-IP.....	Cummins	NTRO-6-P.....	Cummins	Pacer 400.....	Austin-Western
NSD1-1012.....	Thermo King	NVH12-450.....	Cummins	Pacer 500.....	Austin-Western
NT-6-B.....	Cummins	NVH-12.....	Cummins	Pactor.....	Rex
NT-6-BI.....	Cummins	NWD.....	Thermo King	PayStar 5500i.....	International/Navistar
NT-6-CI.....	Cummins	NWD 30 3000.....	Thermo King	PayStar 5600i.....	International/Navistar
NT-6-I.....	Cummins	NWD 30 3005.....	Thermo King	PayStar 5900i.....	International/Navistar
NT-6-IP.....	Cummins	NWD 30 3006.....	Thermo King	PC.....	Gerlinger
NT-6-P.....	Cummins	NWD 30 3100 Series.....	Thermo King	PC05-5.....	Komatsu
NT-165-BI.....	Cummins	NWD 30 AM4.....	Thermo King	PC120.....	Komatsu
NT-180-B.....	Cummins	NWD 30 AM6.....	Thermo King	PC180LC.....	Komatsu
NT-180-BI.....	Cummins	NWD 30 AM7.....	Thermo King	PC200LC.....	Komatsu
NT-200-B.....	Cummins	NWD 30 M4.....	Thermo King	PC220LC.....	Komatsu
NT-200-BI.....	Cummins	NWD 30 M10A.....	Thermo King	PC300LC.....	Komatsu
NT-270-CT.....	Cummins	NWD 30 M20.....	Thermo King	PC360LC.....	Komatsu
NT-280.....	Cummins	NWD 30 M22.....	Thermo King	PC400LC3.....	Komatsu
NT-280-B.....	Cummins	NWD 30 M30.....	Thermo King	PC650.....	Komatsu
NT-280-BI.....	Cummins	NWD 30 M35.....	Thermo King	PF25.....	Blaw-Knox
NT-280-CI.....	Cummins	NWD 30 M46.....	Thermo King	PF30.....	Gerlinger
NT-300-B.....	Cummins	NWD 30 M50.....	Thermo King	PF65.....	Blaw-Knox
NT-300-BI.....	Cummins	NWD 30 M100.....	Thermo King	PF120.....	Blaw-Knox
NT-300-CI.....	Cummins	NWD 30 M1212.....	Thermo King	PF500.....	Blaw-Knox
NT-310.....	Cummins	NWD 35 AM6.....	Thermo King	PFH30.....	Gerlinger
NT-310-CI.....	Cummins	NWD 35 AM7.....	Thermo King	PH462.....	Gerlinger
NT-335.....	Cummins	NWD 35 AM8.....	Thermo King	PH562.....	Gerlinger
NT-335-B.....	Cummins	NWD 35 M4.....	Thermo King	PH662.....	Gerlinger
NT-335-BI.....	Cummins	NWD 35 M5.....	Thermo King	PH862.....	Gerlinger
NT-335-CI.....	Cummins	NWD 35 M21.....	Thermo King	PH962.....	Gerlinger
NT-335-G.....	Cummins	NWD 50.....	Thermo King	Pneumatic Tire Roller.....	Dresser-Galion
NT-380-B.....	Cummins	NWD 50 3000.....	Thermo King	PR11.....	Austin-Western
NT-380-BI.....	Cummins	NWD 50 3011.....	Thermo King	PRO126.....	Snorkel Lift
NT-380-G.....	Cummins	NWD 50 3100 Series.....	Thermo King	ProStar Series.....	International/Navistar
NT-380-I.....	Cummins	NWD 50 M207.....	Thermo King	PSR9.....	Bomag
NT-380-IP.....	Cummins	NWD 62.....	Thermo King	PSR30.....	Bomag
NT-855-B335.....	Cummins	NWD 62 30M5.....	Thermo King	PSRC10.....	Bomag
NT-855-B380.....	Cummins	NWD 62 50.....	Thermo King	PW.....	Gerlinger
NT-855-C310.....	Cummins	NWD 622 30M10A.....	Thermo King		
NT-855-C335.....	Cummins	NWD (Super & Crown).....	Thermo King	Q	
NT-855-C380.....	Cummins	NWD-AM1.....	Thermo King	Q125DJE.....	Le Roi
NT-855-G5.....	Cummins	NWD-AM3.....	Thermo King	Quicksilver QS-5.0G.....	Lister
NT-855-P280.....	Cummins	NWD-AM4.....	Thermo King	Quicksilver QS-7.5G 0.9 L.....	Lister
NT-855-P335.....	Cummins	NWD-AM8.....	Thermo King	Quicksilver QS-8.0D 1.0 L.....	Lister
NT-855-P380.....	Cummins	NWE MAX.....	Thermo King	Quicksilver QS-8.0G 0.9 L.....	Lister
NTA-370.....	Cummins	NWG.....	Thermo King	Quicksilver QS-10.G 1.2 L.....	Lister

Model and Manufacturer Index

Model	Manufacturer	Model	Manufacturer	Model	Manufacturer
R		R - Continued		S - Continued	
R6.....	Perkins	RP250G31.....	Joy	S40.....	Genie
R15 (91FD).....	Euclid	RP365.....	Gardner-Denver	S46.....	Bomag
R18 (91FD).....	Euclid	RP600.....	Gardner-Denver	S60.....	Genie
R22 (59TD).....	Euclid	RP600D.....	Gardner-Denver	S60E.....	Hyster
R22 (63TD).....	Euclid	RP600DB.....	Gardner-Denver	S65.....	Genie
R30.....	Ditch Witch	RP900.....	Gardner-Denver	S70E.....	Hyster
R30 (71TD).....	Euclid	RPS185.....	Joy	S80.....	Genie
R35 (74TD).....	Euclid	RPS750.....	Joy	S80E.....	Hyster
R35 (201TD).....	Euclid	RPS900DB30.....	Joy	S85.....	Genie
R40.....	Caterpillar	RPS1050.....	Joy	S100E.....	Hyster
R40 (9FFD).....	Euclid	RPS1200.....	Joy	S125A.....	Hyster
R45 (9FFD).....	Euclid	RPS1300.....	Joy	S130.....	Bobcat-Melroe
R50 (201LD).....	Euclid	RPV100GA20.....	Joy	S135 (4V).....	Caterpillar
R65.....	Ditch Witch	RPV160DA23.....	Joy	S150A.....	Hyster
R80.....	Caterpillar	RPV160GA20.....	Joy	S220.....	International
R100D.....	Ditch Witch	RS16A.....	Tampo	S240.....	International
R310.....	Kubota	RS28.....	Tampo	S300.....	Bobcat-Melroe
R372.....	International	RS425.....	CMI	S318 (3V).....	Caterpillar
R406.....	International	RSP750.....	Joy	S588 Telekruiser.....	Bantam
R410.....	Kubota	RT.....	Allis-Chalmers	S626 Telekruiser.....	Bantam
R450.....	International	RT.....	Thermo King	S628 Telekruiser.....	Bantam
R510.....	Kubota	RT48.....	Grove	SA41.....	Barber-Greene
R911LC.....	Liebherr	RT48A.....	Condor	SB68.....	Pettibone
R925.....	Liebherr	RT59S.....	Grove	SB-I 30.....	Thermo King
R961LC.....	Liebherr	RT400.....	Grove	SB-I 50.....	Thermo King
Ram 30.....	Raygo	RT500C.....	Grove	SB-I 1000.....	Thermo King
Ram 4500HD.....	Dodge	RT500DXL.....	Grove	SB-I 1200.....	Thermo King
Ram 5500HD.....	Dodge	RT522.....	Grove	SB-I 2000.....	Thermo King
Ranger 500.....	Tamrock	RT625.....	Grove	SB-I 5300.....	Thermo King
Rascal 220B.....	Raygo	RT630.....	Grove	SB-II 30.....	Thermo King
Rascal 300A.....	Raygo	RT745.....	Grove	SB-II 30 DELTA.....	Thermo King
Rascal 320A.....	Raygo	RTD.....	Allis-Chalmers	SB-II 30 PEG.....	Thermo King
Rascal 400A.....	Raygo	RTL40.....	Allis-Chalmers	SB-II 30 1500 AC.....	Thermo King
Rascal 420B.....	Raygo	Rubber Tire Compactor.....	Dresser-Galion	SB-II 30 1500 PEG.....	Thermo King
Rascal 600A.....	Raygo	Rustler 304A.....	Raygo	SB-II 50.....	Thermo King
Razor 350.....	Raygo	Rustler 404B.....	Raygo	SB-II 50 TC.....	Thermo King
RB Series.....	Mack	RW181.....	Clark-Michigan-VME	SB-II C201.....	Thermo King
RC.....	Poclain	RXT.....	International/Navistar	SB-II Convertible.....	Thermo King
RC8.....	Sullair	S		SB-II HP.....	Thermo King
RC60.....	Caterpillar	S.....	Elgin	SB-II Max.....	Thermo King
RC60.....	Gerlinger	S4AG9A.....	Massey Ferguson	SB-II Max 30.....	Thermo King
RC200.....	Poclain	S5-8A.....	Dresser-Galion	SB-II Max 50 EEC.....	Thermo King
RCD.....	Thermo King	S5H9A.....	Massey Ferguson	SB-II Max Plus.....	Thermo King
RD Series.....	Mack	S7.....	Dresser-Dressta	SB-II PE.....	Thermo King
RD-I 30.....	Thermo King	S7.....	Terex	SB-II Reverse Air.....	Thermo King
RD-I 50.....	Thermo King	S8.....	Dresser-Dressta	SB-II TC.....	Thermo King
RD-I SSIV.....	Thermo King	S8.....	Gerlinger	SB-II Tracker.....	Thermo King
RD-II.....	Thermo King	S8.....	International	SB-III 30 TC.....	Thermo King
RDJC.....	Onan	S8N.....	Gerlinger	SB-III Max 30.....	Thermo King
RJC.....	Onan	S8-10.5A.....	Dresser-Galion	SB-III Max 50.....	Thermo King
RL.....	Thermo King	S8-12A.....	Dresser-Galion	SB-III SR.....	Thermo King
RL 20.....	Thermo King	S10N.....	Gerlinger	SB-III SRMP Plus.....	Thermo King
RL 50.....	Thermo King	S10.....	Gerlinger	SB-III TC Max.....	Thermo King
RLA.....	Thermo King	S10-14A.....	Dresser-Galion	SC.....	Poclain
RLD.....	Thermo King	S11E.....	Terex	SC60.....	Gerlinger
Roadster 120.....	Raygo	S12.....	Gerlinger	SC7000.....	Sterling
Roadster C.....	Le Tourneau	S12.....	Terex	SC8000.....	Sterling
Roadster D.....	Le Tourneau	S12 (77FDT).....	Euclid	SD70.....	Ingersoll
ROL 30.....	Thermo King	S12 (78FDT).....	Euclid	SD-I 1012.....	Thermo King
ROL 40.....	Thermo King	S15.....	Gerlinger	SD-I 1013.....	Thermo King
ROL 50.....	Thermo King	S16.....	Gerlinger	Sentry 30.....	Thermo King
RP16D.....	Tampo	S18.....	Gerlinger	Sentry 30 PEG.....	Thermo King
RP60.....	Dresser-Galion	S18.....	Terex	Sentry 30 1000.....	Thermo King
RP125DA.....	Gardner-Denver	S23E.....	Terex	Sentry 30 1200.....	Thermo King
RP125G.....	Gardner-Denver	S24.....	Terex	Sentry 30 2000.....	Thermo King
RP125G51.....	Joy	S28.....	Terex	Sentry 50 Convertible.....	Thermo King
RP210DA.....	Gardner-Denver	S32.....	Terex	Sentry 50 1000.....	Thermo King
RP210GA.....	Gardner-Denver	S35E.....	Terex	Sentry 50 1200.....	Thermo King
RP250D31.....	Joy			Sentry 50 2000.....	Thermo King

Indexes & Abbrev.

Model and Manufacturer Index

Indexes
& Abbrev.

Model	Manufacturer	Model	Manufacturer	Model	Manufacturer
S - Continued		S - Continued		S - Continued	
Sentry DI 30.....	Thermo King	SPQDC.....	Gardner-Denver	Super XMT.....	Thermo King
Sentry DI 30 PE.....	Thermo King	SPQDD.....	Gardner-Denver	Supra 550.....	Carrier
Sentry DI 30 PEG.....	Thermo King	SPTDA.....	Gardner-Denver	Supra 622.....	Carrier
Sentry DI 50.....	Thermo King	SPTDB.....	Gardner-Denver	Supra 644.....	Carrier
Sentry DI Convertible.....	Thermo King	SPTDC.....	Gardner-Denver	Supra 922.....	Carrier
Sentry DI Convertible PE.....	Thermo King	SPTDD.....	Gardner-Denver	Supra 944.....	Carrier
Sentry DI TC.....	Thermo King	SPV627.....	Bros	SW77.....	Easi-Doer
Sentry TC Convertible.....	Thermo King	SPV627VA.....	Bros	Sweepmaster.....	Weldon
SG3320.....	Hino	SPV735.....	Bros	T	
SG3323.....	Hino	SPV735VA.....	Bros	T.....	Elgin
SG3325.....	Hino	SPV850.....	Bros	T3M43.....	Thermo King
SG5523.....	Hino	SPWDA.....	Gardner-Denver	T4.....	Ingersoll
Silver Star.....	Sterling	SPWDB.....	Gardner-Denver	T25.....	Caterpillar
SK60.....	Champ	SPWDC.....	Gardner-Denver	T25D.....	Caterpillar
SK70.....	Champ	SR4.....	Lister	T30.....	Caterpillar
SK80.....	Champ	SRH (4H Series).....	Gerlinger	T30B.....	Caterpillar
SK100.....	Champ	SRL.....	Thermo King	T30B.....	Towmotor
SK815-5.....	Komatsu	SRL-50.....	Thermo King	T30C.....	Caterpillar
SK820-5.....	Komatsu	SROL.....	Thermo King	T30D.....	Caterpillar
SK1020-5.....	Komatsu	SS12 (77FDT).....	Euclid	T35B.....	Caterpillar
SK1026-5.....	Komatsu	SS12 (78FDT).....	Euclid	T35B.....	Towmotor
SKF.....	Thermo King	SS18 (23TDT).....	Euclid	T35D.....	Caterpillar
SL150-2.....	Samsung	SS24 (33LOT).....	Euclid	T40.....	Caterpillar
SL180-2.....	Samsung	SS24 (33LOT).....	Terex	T40.....	Fabtek
SL6625.....	Gehl	SS40 (49LDT).....	Terex	T40B.....	Caterpillar
SLH3280HG.....	Snorkel Lift	SSPRIN1-7.....	Bros	T40B.....	Towmotor
SLH3284HD.....	Snorkel Lift	SSPRN7.....	Bros	T40C.....	Caterpillar
SM20.....	Gerlinger	STB-I.....	Thermo King	T40D.....	Caterpillar
SM26 Shop Mule.....	United Tractor	STB-II.....	Thermo King	T40DSA.....	Caterpillar
SM30.....	Gerlinger	STB-III.....	Thermo King	T45B.....	Caterpillar
SM30 Shop Mule.....	United Tractor	Super 100.....	Austin-Western	T45B.....	Towmotor
SM40 Shop Mule.....	United Tractor	Super 200.....	Austin-Western	T50.....	Caterpillar
SM50 Shop Mule.....	United Tractor	Super 250/270.....	Cummins	T50B.....	Caterpillar
SM80 Shop Mule.....	United Tractor	Super 300.....	Austin-Western	T50B.....	Towmotor
SM160 Shop Mule.....	United Tractor	Super 400.....	Austin-Western	T50C.....	Caterpillar
SM710.....	Pettibone	Super 500.....	Austin-Western	T50D.....	Caterpillar
SM4688XT.....	Grove	Super C.....	Le Tourneau	T50DSA.....	Caterpillar
SMH.....	Gerlinger	Super C Tornadozer.....	Le Tourneau	T53.....	Austin-Western
SP42.....	Ingersoll	Super GS.....	Thermo King	T55B.....	Caterpillar
SP54.....	Ingersoll	Super II 30.....	Thermo King	T60.....	Caterpillar
SP54C.....	Bros	Super II 30 Dehumidifier.....	Thermo King	T60B.....	Caterpillar
SP75D.....	Ferguson Shovel Supply	Super II 30 Max.....	Thermo King	T60B.....	Towmotor
SP107.....	Thew Shovel	Super II 30 TC.....	Thermo King	T60C.....	Caterpillar
SP120B.....	Ferguson Shovel Supply	Super II 50.....	Thermo King	T60C.....	Towmotor
SP255.....	Bros	Super MAX.....	Thermo King	T70C.....	Towmotor
SP524.....	Thew Shovel	Super NWD.....	Thermo King	T80C.....	Caterpillar
SP530.....	Thew Shovel	Super NWD 30.....	Thermo King	T80C.....	Towmotor
SP600.....	Rex	Super NWD 30 5154 BP.....	Thermo King	T84.....	Austin-Western
SP600DK.....	Gardner-Denver	Super NWD 30 5200 AMG.....	Thermo King	T90C.....	Towmotor
SP700.....	Rex	Super NWD 30 5237 ESP.....	Thermo King	T100C.....	Caterpillar
SP730B.....	Bros	Super NWD 30 5300.....	Thermo King	T100C.....	Towmotor
SP735.....	Bros	Super NWD 30 5300 AMG.....	Thermo King	T104.....	Austin-Western
SP1200DE.....	Gardner-Denver	Super NWD 30 PE 1000.....	Thermo King	T110C.....	Caterpillar
SP1200DF.....	Gardner-Denver	Super NWD 30 PE 1200.....	Thermo King	T120C.....	Caterpillar
SP4000.....	Bros	Super NWD 30 PE 5000.....	Thermo King	T120C.....	Towmotor
SP6000.....	Bros	Super NWD 30 PE 5100.....	Thermo King	T165.....	Caterpillar
SP6000B.....	Bros	Super NWD 30 PE 5200.....	Thermo King	T170.....	Kenworth
SPCGA.....	Gardner-Denver	Super NWD 50.....	Thermo King	T180.....	Caterpillar
SPFGA.....	Gardner-Denver	Super NWD 50 SS TV.....	Thermo King	T180F.....	International
SPFGB.....	Gardner-Denver	Super NWD 50 5000.....	Thermo King	T180FB.....	International
SPFGC.....	Gardner-Denver	Super NWD 50 5100.....	Thermo King	T183HD.....	Thomas
SPHDA.....	Gardner-Denver	Super NWD 50 5200.....	Thermo King	T200.....	Caterpillar
SPHGA.....	Gardner-Denver	Super NWD 50 5200 AMG.....	Thermo King	T225.....	International
SPHGC.....	Gardner-Denver	Super NWD 50 5237 ESP.....	Thermo King	T225SL.....	International
SPKDB.....	Gardner-Denver	Super NWD 50 5300.....	Thermo King	T270.....	Kenworth
SPNDA.....	Gardner-Denver	Super NWD 50 5300 AMG.....	Thermo King	T300.....	Caterpillar
SPNDB.....	Gardner-Denver	Super NWD 5137.....	Thermo King	T300.....	International
SPQDA.....	Gardner-Denver	Super NWD 5137 AMG.....	Thermo King	T300.....	Kenworth
SPQDB.....	Gardner-Denver	Super NWD LR.....	Thermo King		



Model and Manufacturer Index

Model	Manufacturer	Model	Manufacturer	Model	Manufacturer
T - Continued		T - Continued		T - Continued	
T300SL.....	International	TD7E.....	International	TL545.....	Allis-Chalmers
T330.....	New Holland	TD7E Crawler.....	Dresser-Dressta	TM2500.....	Grove
T370.....	Kenworth	TD7G Crawler.....	Dresser-Dressta	Topkick C5500.....	GMC
T400.....	Caterpillar	TD8C.....	Dresser-Dressta	Topkick C6500.....	GMC
T400.....	Kenworth	TD8C.....	International	Topkick C7500.....	GMC
T400A.....	Dresser-Galion	TD8E.....	International	Topkick C8500.....	GMC
T440.....	Kenworth	TD8E Crawler.....	Dresser-Dressta	Tornadozer.....	Le Tourneau
T450.....	Kenworth	TD8G Crawler.....	Dresser-Dressta	Tournapull.....	Le Tourneau
T470.....	Kenworth	TD12.....	International	Tournapull B.....	Le Tourneau
T470H.....	Kenworth	TD12 Crawler.....	Dresser-Dressta	Tournapull C.....	Le Tourneau
T500.....	Dresser-Galion	TD12B.....	Dresser-Dressta	Tournapull D.....	Le Tourneau
T500A.....	Dresser-Galion	TD15B.....	Dresser-Dressta	Tournatractor B.....	Le Tourneau
T500C.....	Dresser-Galion	TD15B.....	International	Tournatractor C.....	Le Tourneau
T500L.....	Dresser-Galion	TD15C.....	International	TR225.....	CMI
T500S.....	International	TD15C Articulated Crawler.....	Dresser-Dressta	TR260.....	Allis-Chalmers
T550.....	New Holland	TD15C Crawler.....	Dresser-Dressta	TranStar 8500.....	International/Navistar
T600.....	Dresser-Galion	TD15E Crawler.....	Dresser-Dressta	TranStar 8600.....	International/Navistar
T600.....	Kenworth	TD20B.....	Dresser-Dressta	TS14.....	Terex
T644 Teleskoop.....	Bantam	TD20B.....	International	TS14B.....	Terex
T660.....	Kenworth	TD20C.....	Dresser-Dressta	TS18.....	Terex
T680.....	Kenworth	TD20C.....	International	TS18 (29LOT).....	Terex
T700.....	Dresser-Galion	TD20E.....	International	TS24.....	Terex
T700.....	Kenworth	TD20E Crawler.....	Dresser-Dressta	TS32.....	Terex
T725A Teleskoop.....	Bantam	TD20G Crawler.....	Dresser-Dressta	TS160.....	Allis-Chalmers
T750.....	Parsons	TD25B.....	Dresser-Dressta	TS200.....	Allis-Chalmers
T800.....	Kenworth	TD25B.....	International	TS260.....	Allis-Chalmers
T800S.....	International	TD25C.....	Dresser-Dressta	TS360.....	Allis-Chalmers
T1386.....	Austin-Western	TD25C.....	International	TWD.....	Thermo King
T2000.....	Kenworth	TD25E.....	International	TX.....	Poclain
T5500.....	Chevrolet	TD25E Crawler.....	Dresser-Dressta	TY.....	Poclain
T5500.....	GMC	TD25G Crawler.....	Dresser-Dressta	TY45.....	Poclain
T6500.....	Chevrolet	TD40 Crawler.....	Dresser-Dressta	TYS.....	Poclain
T6500.....	GMC	TD40B Crawler.....	Dresser-Dressta		
T7500.....	Chevrolet	TD180FB.....	International	U	
T7500.....	GMC	TD225SL.....	International	U1.....	International
T8500.....	Chevrolet	TD300SL.....	International	U2.....	International
T8500.....	GMC	TD588 Telekrane.....	Bantam	U2A.....	International
TA77.....	Barber-Greene	TD Series.....	Mack	U4.....	International
TA341.....	Tamrock	TDB.....	Transcold	U6.....	International
TB025.....	Takeuchi	TD-II.....	Thermo King	U6.....	Towmotor
TB37.....	Snorkel Lift	TDS.....	Transcold	U8.....	Gerlinger
TB68S.....	Takeuchi	TE4.....	Bros	U8.....	Towmotor
TB650S.....	Takeuchi	TE750.....	Arctic Traveler	U9.....	International
TB800.....	Takeuchi	TerraStar.....	International/Navistar	U14.....	International
TC.....	Poclain	TGS.....	Transcold	U21.....	International
TC12.....	Euclid	TH8-12D.....	Dresser-Galion	U123.....	International
TC30.....	Barber-Greene	TH8-12G.....	Dresser-Galion	U164.....	International
TC30.....	Caterpillar	The Articulator.....	Brown	U169.....	International
TC30C.....	Caterpillar	Three Wheel.....	Huber-Warco	U175.....	International
TC40C.....	Caterpillar	Tiltmaster W4.....	Chevrolet	U220.....	International
TC44H.....	John Deere	Tiltmaster W5.....	Chevrolet	U240.....	International
TC50C.....	Caterpillar	Tiltmaster W6.....	Chevrolet	U264.....	International
TC54H.....	John Deere	Tiltmaster W7.....	Chevrolet	U281.....	International
TC60.....	Dresser-Hough	TL10.....	Allis-Chalmers	U350.....	International
TC60C.....	Caterpillar	TL11.....	Allis-Chalmers	U372.....	International
TC60D.....	Caterpillar	TL12.....	Allis-Chalmers	U406.....	International
TC60DSA.....	Caterpillar	TL14.....	Allis-Chalmers	U450.....	International
TC62H.....	John Deere	TL14A.....	Allis-Chalmers	U501.....	International
TC80C.....	Caterpillar	TL16.....	Allis-Chalmers	U1091.....	International
TC100C.....	Caterpillar	TL16A.....	Allis-Chalmers	U1200.....	Unimog
TC110C.....	Caterpillar	TL20.....	Allis-Chalmers	UB220.....	International
TC120C.....	Caterpillar	TL25K.....	Thew Shovel	UB240.....	International
TCB.....	Poclain	TL26.....	Takeuchi	UB264.....	International
TCS.....	Poclain	TL30.....	Allis-Chalmers	UC60.....	International
TCS-M1.....	Poclain	TL40.....	Allis-Chalmers	UC135.....	International
TCS-M2.....	Poclain	TL40.....	Champ	UC221.....	International
TD.....	Thermo King	TL40C.....	Champ	UC263.....	International
TD7C.....	Dresser-Dressta	TL50.....	Champ	UD6.....	International
TD7C.....	International	TL254W.....	Thew Shovel	UD6A.....	International

Indexes & Abbrev.



Model and Manufacturer Index

Indexes
& Abbrev.

Model	Manufacturer	Model	Manufacturer	Model	Manufacturer
U - Continued		V - Continued		V - Continued	
UD9	International	V12-525	Cummins	V200	Caterpillar
UD9A	International	V25D	Caterpillar	V200	Towmotor
UD14	International	V30	Caterpillar	V200B	Caterpillar
UD14A	International	V30	Ditch Witch	V200ES	Caterpillar
UD16	International	V30B	Caterpillar	V200HF	Caterpillar
UD18	International	V30B	Towmotor	V225	Caterpillar
UD18A	International	V30C	Caterpillar	V225	Towmotor
UD24	International	V30D	Caterpillar	V225B	Caterpillar
UD236	International	V35B	Caterpillar	V225HF	Caterpillar
UD264	International	V35B	Towmotor	V250B	Caterpillar
UD281	International	V35C	Caterpillar	V300	Caterpillar
UD282	International	V35D	Caterpillar	V300B	Caterpillar
UD350	International	V40	Caterpillar	V330B	Caterpillar
UD370	International	V40B	Caterpillar	V785-B235	Cummins
UD525	International	V40B	Towmotor	V785-B265	Cummins
UD554	International	V40C	Caterpillar	V785-C220	Cummins
UD691	International	V40D	Caterpillar	V785-C265	Cummins
UD817	International	V40DSA	Caterpillar	V785-P265	Cummins
UD1091	International	V41	Caterpillar	V-155	Cummins
UDE	Transcold	V41B	Caterpillar	V-352-C140	Cummins
UDG	Transcold	V45B	Caterpillar	V-378	Cummins
UDT817	International	V45B	Towmotor	V-470	Cummins
UDT1091	International	V45C	Caterpillar	V-504	Cummins
UH20	Hitachi	V50	Caterpillar	V-555C	Cummins
UH30	Hitachi	V50B	Caterpillar	V-588-B195	Cummins
UH062	Hitachi	V50B	Towmotor	V-588-B200	Cummins
UH119	Parsons	V50C	Caterpillar	V-588-C180	Cummins
UH122	Hitachi	V50D	Caterpillar	V-588-C200	Cummins
UH172	Hitachi	V50DSA	Caterpillar	V-903	Cummins
UK	Thermo King	V51	Caterpillar	V-903-C	Cummins
US	Thermo King	V51B	Caterpillar	V-1710-B500	Cummins
US-50	Thermo King	V55B	Caterpillar	V-1710-C500	Cummins
UT40	Baker	V55B	Towmotor	V-1710-P500	Cummins
UV345	International	V60	Caterpillar	Vanguard 4000SP	FMC
UV401	International	V60B	Caterpillar	Vanguard V3000SP	FMC
UV461	International	V60B	Towmotor	VC40D	Caterpillar
UV549	International	V60C	Caterpillar	VC60D	Caterpillar
UWD	Thermo King	V60C	Towmotor	VC60DSA	Caterpillar
UWTD	Thermo King	V60D	Caterpillar	VH10 Roustabout	Hughes-Keenan
V		V60DSA	Caterpillar	VH20 Roustabout	Hughes-Keenan
V6 Roustabout	Hughes-Keenan	V60E	Caterpillar	VHD	Volvo
V6-B	Cummins	V70C	Caterpillar	VM33	Bomag
V6-CI	Cummins	V70C	Towmotor	VN Series	Volvo
V6-SVC-B	Cummins	V70D	Caterpillar	VOS2-42A	Dresser-Galion
V6-SVC-CI	Cummins	V70E	Caterpillar	VOS2-66B	Dresser-Galion
V6-140	Cummins	V80C	Caterpillar	VOS66A	Dresser-Galion
V6-155	Cummins	V80C	Towmotor	VOS84A	Dresser-Galion
V6-200-B	Cummins	V80D	Caterpillar	VOSA66A	Dresser-Galion
V6-200-CI	Cummins	V80E	Caterpillar	VOSA84A	Dresser-Galion
V6-378	Cummins	V100	Caterpillar	VOSD66A	Dresser-Galion
V6E-195-B	Cummins	V100	Towmotor	VOSD84A	Dresser-Galion
V6E-195-BI	Cummins	V110	Caterpillar	VOSPD66A	Dresser-Galion
V6R-180-CI	Cummins	V120	Caterpillar	VOSPD84A	Dresser-Galion
V8-185	Cummins	V120	Towmotor	VOST2-42A	Dresser-Galion
V8-210	Cummins	V130	Caterpillar	VR84H	Dresser-Galion
V8-265	Cummins	V140	Caterpillar	VR642	Ingersoll-Rand
V8-265-B	Cummins	V140	Towmotor	VT8-430-B	Cummins
V8-265-C	Cummins	V150	Caterpillar	VT8-430-BI	Cummins
V8-265-P	Cummins	V160	Caterpillar	VT8-430-CI	Cummins
V8-350-B	Cummins	V160	Towmotor	VT8-460-BI	Cummins
V8-350-BI	Cummins	V160B	Caterpillar	VT12-600	Cummins
V8-350-CI	Cummins	V160D	Caterpillar	VT12-700	Cummins
V8-350-IP	Cummins	V160E	Caterpillar	VT28	Cummins
V8E-170	Cummins	V160HF	Caterpillar	VT48	Bomag
V8E-235	Cummins	V180	Caterpillar	VT1710-C635	Cummins
V8E-235-B	Cummins	V180	Towmotor	VT-12	Cummins
V8R-220-C	Cummins	V180B	Caterpillar	VT-903	Cummins
V10 Roustabout	Hughes-Keenan	V180E	Caterpillar	VT-1710-P635	Cummins
		V180HF	Caterpillar	VT Series	Volvo



Model and Manufacturer Index

Model	Manufacturer	Model	Manufacturer	Model	Manufacturer
V - Continued		W - Continued		X	
VTA28.....	Cummins	WA150.....	Komatsu	XKL 10.....	Thermo King
VTA-1710-B700.....	Cummins	WA180.....	Komatsu	XKL 10LT.....	Thermo King
VTA-1710-C700.....	Cummins	WA250.....	Komatsu	XKL 20.....	Thermo King
VTA-1710-C800.....	Cummins	WA250-5.....	Komatsu	XKL 20LT.....	Thermo King
VTA-1710-P700.....	Cummins	WA320.....	Komatsu	XKL 30.....	Thermo King
VTA-1710-P800.....	Cummins	WA320-5.....	Komatsu	XKL 30LT.....	Thermo King
W		WA350.....	Komatsu	XKL 50.....	Thermo King
W5.....	Case	WA380.....	Komatsu	XKL 50LT.....	Thermo King
W5A.....	Case	WA380-6.....	Komatsu	XKW.....	Thermo King
W7.....	Case	WA600.....	Komatsu	XMD.....	Thermo King
W7E.....	Case	Warrior.....	Dresser-Gallon	XMD 30.....	Thermo King
W8B.....	Case	WB140-2N.....	Komatsu	XMD 50.....	Thermo King
W8C.....	Case	WB146PS.....	Komatsu	XMD 50D.....	Thermo King
W8E.....	Case	WB156PS.....	Komatsu	XMD-I.....	Thermo King
W9.....	Case	WBD.....	Gardner-Denver	XMT.....	Thermo King
W9A.....	Case	WBG.....	Gardner-Denver	XNWD.....	Thermo King
W9B.....	Case	WBH.....	Gardner-Denver	XNWD 30.....	Thermo King
W9E.....	Case	WBK.....	Gardner-Denver	XNWE 100.....	Thermo King
W10.....	Case	WC20.....	Mobilift	XP750.....	Ingersoll
W10B.....	Case	WC25.....	Mobilift	XP750WJD.....	Ingersoll
W10E.....	Case	WC30.....	Mobilift	Xpeditor.....	Volvo
W11B.....	Case	WC35.....	Mobilift	XROL 10.....	Thermo King
W12.....	Case	WC40.....	Mobilift	XROL 10HT.....	Thermo King
W12.....	Gerlinger	WC45.....	Mobilift	XROL 20.....	Thermo King
W14.....	Case	WC50.....	Mobilift	XROL 20HT.....	Thermo King
W14B.....	Case	WC55.....	Mobilift	XROL 30.....	Thermo King
W15.....	Gerlinger	WC60.....	Mobilift	XROL 30HT.....	Thermo King
W16.....	Gerlinger	WCA Series.....	Volvo	XROL 30 M5.....	Thermo King
W18.....	Case	WG Series.....	Volvo	XROL 50.....	Thermo King
W18.....	Gerlinger	WGH.....	Gardner-Denver	XROL 50HT.....	Thermo King
W18B.....	Case	WH105GB.....	Gardner-Denver	XROL 50 M5.....	Thermo King
W20.....	Case	WH105GC.....	Gardner-Denver	XRW.....	Thermo King
W20.....	Gerlinger	WH105GJ.....	Gardner-Denver	XRW 20D.....	Thermo King
W20B.....	Case	WH105GK.....	Gardner-Denver	XRWL.....	Thermo King
W20C.....	Case	WH105GP.....	Gardner-Denver	XUK 50 M4.....	Thermo King
W22.....	Gerlinger	WH105GQ.....	Gardner-Denver		
W22.....	Workhorse	WH315G.....	Gardner-Denver	Y	
W24B.....	Case	WH600.....	Gardner-Denver	Y20WO.....	Taylor
W24C.....	Case	WHD.....	Gardner-Denver	Y30.....	Clark
W26B.....	Case	WHF.....	Gardner-Denver	Y40.....	Clark
W30.....	Case	WHHDA.....	Gardner-Denver	Y50.....	Clark
W36.....	Case	WHHDB.....	Gardner-Denver	Y235.....	Clark
W42.....	Workhorse	WHHDC.....	Gardner-Denver	Y355.....	Clark
W62.....	Workhorse	WHHDD.....	Gardner-Denver	Y355PD.....	Clark
W201.....	Allis-Chalmers	WHK.....	Gardner-Denver	Y685.....	Clark
W226.....	Allis-Chalmers	WHL.....	Gardner-Denver	Y1425.....	Clark
W900.....	Kenworth	WHX.....	Gardner-Denver	Y1625.....	Clark
W3500.....	Chevrolet	WIA Series.....	Volvo	Y1830.....	Clark
W3500.....	GMC	Windjammer 500.....	Thermo King	Y2030.....	Clark
W4500.....	Chevrolet	WN300.....	P & H	YC38.....	Link-Belt
W4500.....	GMC	WorkStar 7300.....	International/Navistar	YT30.....	Ottawa
W5500.....	Chevrolet	WorkStar 7400.....	International/Navistar	YT50.....	Ottawa
W5500.....	GMC	WorkStar 7500.....	International/Navistar		
W5500HD.....	Chevrolet	WorkStar 7600.....	International/Navistar	Z	
W5500HD.....	GMC	WorkStar 7700.....	International/Navistar	Z90A.....	Hyster
WA30.....	Komatsu	WPI430.....	Wisconsin	ZL602.....	Zettlemeyer
WA40.....	Komatsu	WT5500.....	Chevrolet		
WA70.....	Komatsu	WT5500.....	GMC		
WA100.....	Komatsu	WX.....	Autocar		
WA120.....	Komatsu	WXLL.....	Autocar		

Indexes & Abbrev.



Abbreviations

Indices
& Abbrev.

A.	Amperes	Exc.	Except	Nom.	Nominal
A.C.	Air Conditioning	Exch.	Exchanger	O.C.	Outside Circumference
A.P.	Air Pump	Ext.	External	O.D.	Outside Diameter
A.T.F.	Automatic Transmission Fluid	F.	Fahrenheit	O.H.C.	Overhead Cam
ABDS	Accessory Belt Drive System	Fed.	Federal	O.H.V.	Overhead Valve
Accy.	Accessory	FHP	Fractional Horse Power	OE	Original Equipment
Adj.	Adjustable	FWD	Front Wheel Drive	OEM	Original Equipment Manufacturer
Adjmt.	Adjustment	Ft.	Foot (Feet)	P.S.	Power Steering
ADP	Alternator Decoupler Pulley	G.V.W.	Gross Vehicle Weight	P.T.O.	Power Take-Off
Air-Hyd.	Air Over Hydraulic	Gal.	Gallon	Pass.	Passenger
Almnm.	Aluminum	Gas	Gasoline	PCV	Positive Crankcase Ventilation
Alt.	Alternator	Gen.	Generator	Perf.	Performance
Assy.	Assembly	GM	General Motors	Pkg.	Package
Auto.	Automatic	GMC	General Motors Corporation	Prod.	Production
Aux.	Auxiliary	Gov.	Governor	Pt. No.	Part Number
AWD	All Wheel Drive	H.D.	Heavy Duty	R.P.M.	Revolutions per Minute
B.B.C.	Bumper To Back Of Cab	H.O.	High Output	Rad. (Rads.)	Radiator(s)
Bbl.	Barrel	H.P.	Horsepower	Rec.	Recreational
Brkt	Bracket	Hemi.	Hemispherical	Repl.	Replacement
C.	Celsius	Hi Perf.	High Performance	RWD	Rear Wheel Drive
C.I.D.	Cubic Inch Displacement	Horiz.	Horizontal	S.P.	Steering Pump
C.O.E.	Cab Over Engine	Hyd.	Hydraulic	SBDS	Synchronous Belt Drive System
C.S.	Crankshaft	Hydra.	Hydramatic	Ser.	Serial
Calif.	California	Hydro.	Hydrostatic	SHO	Super High Output
Cam.	Camshaft	Hz	Hertz	SOHC	Single Overhead Cam
Carb.	Carburetor	I.C.	Inside Circumference	Spec.	Special
Cat.	Caterpillar	I.D.	Inside Diameter	Sq.	Square
CC (cc)	Cubic Centimeter(s)	ID	Identification	Std.	Standard
CDC	Consolidated Diesel Corporation	In.	Inch (Inches)	Stg.	Steering
Chry.	Chrysler	Inc.	Increased	Strt.	Straight
Circ.	Circumference	Incl.	Includes	Susp.	Suspension
CNG	Compressed Natural Gas	Ind.	Industrial	SVT	Special Vehicle Teams
Co.	Company	Inj.	Injection	T.W.	Top Width
Comm.	Commercial	Inst.	Installed	Temp.	Temperature
Compr.	Compressor	Install.	Installation	Trans.	Transmission
Cond.	Conditioning(er)	J.S.	Jack Shaft	Trlr.	Trailer
Conv.	Conventional	L	Litre	Trk.	Truck
Cool.	Cooling	L.C.F.	Low Cab Forward	TSB	Technical Service Bulletin
Corp.	Corporation	L.C.I.	Low Cut-In	Turbo	Turbocharged
Cu.	Cubic	L.D.	Light Duty	V.	Volts
Cust.	Custom	Lb. (Lbs.)	Pound(s)	V.P.	Vacuum Pump
CVT	Continuously Variable Transmission	Limo	Limousine	V.S.	Variable Speed
Cyl.	Cylinder	LPG	Liquid Petroleum Gas	Vac.	Vacuum
DEF	Diesel Emissions Fluid	m	Meters	Vert.	Vertical
Deg.	Degree	M.D.	Medium Duty	VIN	Vehicle Identification Number
Dia.	Diameter	Mach.	Machine	VIO	Vehicles in Operation
Dlr.	Dealer	Man.	Manual	VTEC	Variable Valve Timing & Lift Electronic Control
DOHC	Dual Overhead Cam	Max.	Maximum	W/	With
DOT	Department of Transportation	Mech.	Mechanical	W/O	Without
DPFE	Differential Pressure Feedback EGR	Mfg.	Manufacturing	W.	Watts
E.E.C.	Evaporative Emission Control	Mfr.	Manufacturer	W.B.	Wheelbase
E.G.R.	Exhaust Gas Recirculation	MHz	Megahertz	W.P.	Water Pump
EBS	Electronic Braking System	Min.	Minimum	X.C. (XC)	Extra Cooling
Elec.	Electric	mm	Millimeter	2WD	2 Wheel Drive
Eng.	Engine	MPI	Multi-Port Injection	4WD	4 Wheel Drive
EPDM	Ethylene Propylene Diene Monomer	Mtd.	Mounted	4WS	4 Wheel Steering
Equip.	Equipped, Equipment	Mtr.	Motor		
Evap.	Evaporative	No.	Number		



Notes

Indexes
& Abbrev.





Notes



Indexes
& Abbrev.



Belts and Coolant Hose for Medium/Heavy-Duty Trucks (1996 and Newer)

Includes Truck Models Over 1 Ton Capacity.
Order Belts and Hose by Our Number. Manufacturers' Part Number is shown for reference only.

Medium & Heavy-Duty Trucks
(1996 & Newer)

Application	Mfr. Part No.	Our No.	Application	Mfr. Part No.	Our No.
AUTOCAR			BERING TRUCK CORP.		
2009			2000-1999		
Cummins ISM Diesel			Cummins ISB Diesel		
ACX Xpeditor; WX; WXL			MD Series		
Belt - A.C.	4004824	♣K060539HD	Tensioner Assy. - Fan, W.P. & Alt.	3945627	38516
Belt - Fan & Alt.	5080780	♣K080780HD	CHEVROLET		
Tensioner Assy. - A.C.	3102888	38505	2010		
Tensioner Assy. - Fan & Alt.	4920105	38622	Isuzu 4HK1-TC Diesel		
Idler Pulley - A.C.	3104139	36225	W3500		
Idler Pulley - Fan & Alt.	3400883	36308	Serpentine Belt	8980031870	K070404HD
Hose - Upper - Eng. To Pipe; (2 1/2" I.D.)		♣<24440	Belt - A.C.	8980108410	♣9650HD
Hose - Upper - Pipe To Rad.; (2 1/4" I.D.)		♣<24436	W5500; W5500HD		
Hose - Lower - Eng. To Pipe; (2 1/2" I.D.)		♣<24440	Belt - Fan & Alt.	8980031870	K070404HD
Hose - Lower - Pipe To Heat Exch.		♣<21194	Belt - A.C.	8980108410	♣9650HD
Hose - Lower - Heat Exch. To Rad.		♣<21194	2009		
2008			Caterpillar C7 Diesel		
Cummins ISL Diesel			C6500; C7500; C8500		
WX			Belt - Fan, A.C., Alt. & W.P.		
Serpentine Belt - Accessory Drive	A2080106001	♣K080926HD	Tensioner Assy. - Fan, A.C., Alt. & W.P.	15170283	♣K080810HD
Tensioner Assy.	3973819	38627	GM V-8 6.0 L		
Idler Pulley	3970945	36283	W3500; W4500		
Hose - Upper - Eng. To Pipe		23547	Belt - A.C.; Installation Tool Required ...	12603509	K040355SF
Hose - Lower - Eng. To Pipe		23547	Belt - Fan, Alt. & P.S.	8980361660	♣K061010HD
Cummins ISM Diesel			Stretch Fit Belt Installation Tool		
WX; WXL			Tensioner Assy. - Fan, Alt. & P.S.		
Belt - Fan, Alt. & W.P.		♣K080780HD	GM V-8 6.6 L Diesel		
Tensioner Assy. - Fan, W.P. & Alt.	4920105	38622	C4500; C5500		
Tensioner Assy. - A.C.	3102888	38505	Belt - Fan, Alt., P.S. & A.C.		
Idler Pulley - A.C.	3104139	36225	Tensioner Assy. - Fan, Alt., P.S. & A.C.		
Idler Pulley - Fan & Alt.	3400883	36308	Idler Pulley - Lower (Smooth)		
Hose - Upper - Eng. To Pipe; (2 1/2" I.D.)		♣<24440	Idler Pulley - Upper (Smooth)		
Hose - Upper - Pipe To Rad.; (2 1/4" I.D.)		♣<24436	GM V-8 8.1 L		
Hose - Lower - Eng. To Pipe; (2 1/2" I.D.)		♣<24440	C4500; C5500; C6500; C7500; C8500		
Hose - Lower - Pipe To Heat Exch.		♣<21194	Belt - Fan, Alt., P.S. & A.C.		
Hose - Lower - Heat Exch. To Rad.		♣<21194	Tensioner Assy. - Fan, Alt., P.S. & A.C.		
2006			Idler Pulley - Fan, Alt. & A.C.		
Cummins ISC Diesel			12617797		
WX			♣K061000HD		
Belt - Fan To Alt. & A.C.	A2080036001	♣K080726HD	38258		
Tensioner Assy. - Alt. & A.C.	3976831	38516	36299		
Cummins ISL Diesel			Isuzu 4HK1-TC Diesel		
WX			W3500; W5500; W5500HD		
Belt - Fan, Alt. & A.C.	A2080036001	♣K080726HD	Belt - Fan & Alt.		
Tensioner Assy. - Fan, Alt. & A.C.	3976831	38516	Belt - A.C.		
Hose - Upper - Eng. To Pipe		23547	8980031870		
Hose - Lower - Eng. To Pipe		23547	8980108410		
Hose - Lower - Rad. To Pipe; 90 Deg. Bend Hose		21194	♣9650HD		
Cummins ISM Diesel			Isuzu 6HK1-TC Diesel		
WX			C6500; C7500; C8500		
Belt - Fan, Alt. & W.P.	3401283	♣K060516HD	Belt - Fan, Alt. & A.C.		
Belt - A.C.	4004824	♣K060539HD	Belt - W.P.		
Tensioner Assy. - Fan, W.P. & Alt.	4920105	38622	1136714641		
Tensioner Assy. - A.C.	3102888	38505	Tensioner Assy. - Fan, Alt. & A.C.		
2003			Idler Pulley - Fan, Alt. & A.C.		
Cummins ISM Diesel			89022559		
WX			Hose - Upper - Eng. To Rad.		
Belt - Fan	3081862	♣K080585HD	22767		
Belt - Hub & Alt.	3020251	♣K050345HD	22768		
Belt - Hub & A.C.	800347	♣9560HD	2008		
Hose - Upper - Eng. To Rad.; (2 1/2" I.D.)		24240	Caterpillar C7 Diesel		
Hose - Upper - Rad. To Pipe; (2 1/2" I.D.)		24240	C6500; C7500; C8500		
Hose - Lower - Eng. To Pipe; (2 1/2" I.D.)		24240	Belt - Fan, A.C., Alt. & W.P.		
Hose - Lower - Rad. To Pipe; (3" I.D.)		24248	Tensioner Assy. - Fan, A.C., Alt. & W.P.		
2009			GM V-8 6.6 L Diesel		
Cummins ISM Diesel			C4500		
WX			Belt - Fan, Alt., P.S. & A.C.; W/Single		
Belt - Fan	3081862	♣K080585HD	Alt.		
Belt - Hub & Alt.	3020251	♣K050345HD	89035629		
Belt - Hub & A.C.	800347	♣9560HD	K061203		
Hose - Upper - Eng. To Rad.; (2 1/2" I.D.)		24240	Belt - Fan, Alt., P.S. & A.C.; W/Dual Alts.		
Hose - Upper - Rad. To Pipe; (2 1/2" I.D.)		24240	89034045		
Hose - Lower - Eng. To Pipe; (2 1/2" I.D.)		24240	Tensioner Assy.; W/Dual 105A. Alts.		
Hose - Lower - Rad. To Pipe; (3" I.D.)		24248	8973290620		
2009			Idler Pulley; W/Flat Idler Pulley		
Cummins ISM Diesel			97209546		
WX			36310		
Belt - Fan	3081862	♣K080585HD	Idler Pulley; W/O A.C.		
Belt - Hub & Alt.	3020251	♣K050345HD	14102597		
Belt - Hub & A.C.	800347	♣9560HD	36177		
Hose - Upper - Eng. To Rad.; (2 1/2" I.D.)		24240	Tensioner Pulley		
Hose - Upper - Rad. To Pipe; (2 1/2" I.D.)		24240	8973290620		
Hose - Lower - Eng. To Pipe; (2 1/2" I.D.)		24240	36239		
Hose - Lower - Rad. To Pipe; (3" I.D.)		24248			

♣ Standard Belt Available. See Pages 630-631.

♣< Cut to Fit.

Belts and Coolant Hose for Medium/Heavy-Duty Trucks (1996 and Newer)

Medium & Heavy-Duty Trucks
(1996 & Newer)

Application	Mfr. Part No.	Our No.
CHEVROLET - Continued		
2008 - Continued		
GM V-8 6.6 L Diesel - Continued		
C4500 - Continued		
Idler Pulley; W/Dual 105A. Alts.	98072072	36310
C5500		
Belt - Fan, Alt., P.S. & A.C.	98035629	K061203
Tensioner Assy.	8973290620	38172
Idler Pulley; W/Flat Idler Pulley	97209546	36310
Idler Pulley; W/O A.C.	14102597	36177
Tensioner Pulley	8973290620	36239
GM V-8 8.1 L		
C4500; C5500		
Belt - Fan, Alt., P.S. & A.C.	12576754	▲K060994HD
Tensioner Assy. - Fan, Alt., P.S. & A.C.	12581203	38258
Idler Pulley	12580771	36299
Tensioner Pulley	12581203	38006
Hose - Upper		22769
Hose - Lower		22770
C6500; C7500; C8500		
Belt - Fan, Alt., P.S. & A.C.	15768485	▲K071247HD
Belt - Fan, Alt. & P.S.; W/O A.C.	15021740	▲K071056HD
Belt - Air Compr.	15074400	▲K040745HD
Tensioner Assy. - Fan, Alt., P.S. & A.C.	15021742	38256
Tensioner Pulley - Fan, Alt., P.S. & A.C.	15021742	38033
Tensioner Pulley - Fan & Air Compr.	15001551	38006
Hose - Upper		22769
Hose - Lower		22770
Isuzu 4HK1-TC Diesel		
W3500; W4500; W5500; W5500HD		
Belt - Fan & Alt.	98003187	K070404HD
Belt - A.C.	8980108410	▲9650HD
Isuzu 6HK1-TC Diesel		
C6500; C7500; C8500		
Belt - Fan, Alt. & A.C.	15020893	▲K070786HD
Belt - W.P.	1136714641	TR22461
Tensioner Assy. - Fan, Alt. & A.C.	12597859	38548
Idler Pulley - Fan, Alt. & A.C.	89022559	36096
Hose - Upper - Eng. To Rad.		22767
Hose - Lower - Eng. To Rad.		22768
T6500; T7500; T8500		
Belt - Fan, Alt. & A.C.	15065874	▲K080726HD
Tensioner Assy. - Fan, Alt. & A.C.	15098394	38579
Hose - Upper - Eng. To Rad.		22855
2007		
Caterpillar C7 Diesel		
C6500; C7500; C8500		
Belt - Fan, Alt. & A.C.	15170173	▲K080806HD
Tensioner Assy. - Fan, Alt. & A.C.	15170283	38586
Idler Pulley	89022559	36096
GM V-8 6.0 L		
W3500; W4500		
Belt - Fan, Alt. & P.S.	12576754	▲K060994HD
Belt - A.C.	12576447	▲K040378HD
Tensioner Assy. - Alt. & P.S.	12580162	38158
Tensioner Assy. - A.C.	12580196	38159
Tensioner Pulley - Alt. & P.S.	12580162	38009
Tensioner Pulley - A.C.	12580196	36169
Hose - Upper - Eng. To Rad.		23098
Hose - Lower - Eng. To Rad.		23097
GM V-8 6.6 L Diesel		
C4500; C5500		
Belt - Fan, Alt., P.S. & A.C.; W/105A. Alt.	97300654	▲K061187HD
Belt - Fan, Alt., P.S. & A.C.; W/150A. Alt.	97300656	▲K061195HD
Belt - Fan, Alt., P.S. & A.C.; W/Dual 105A. Alts.	97300655	▲K061360HD
Tensioner Assy.	8973290620	38172
Idler Pulley; W/Flat Idler Pulley	97209546	36310
Idler Pulley; W/O A.C.	14102597	36177
Tensioner Pulley	8973290620	36239

Application	Mfr. Part No.	Our No.
CHEVROLET - Continued		
2007 - Continued		
GM V-8 6.6 L Diesel - Continued		
C4500; C5500 - Continued		
Hose - Upper - Eng. To Rad.		22763
GM V-8 8.1 L		
C4500; C5500		
Belt - Fan, Alt., P.S. & A.C.; W/150A. Alt.	12576754	▲K060994HD
Belt - Fan, Alt., P.S. & A.C.; W/105A. Alt.	12576755	▲K061140HD
Belt - Fan, Alt. & P.S.; W/150A. Alt.; W/O A.C.	12576751	▲K060910HD
Belt - Fan, Alt. & P.S.; W/105A. Alt.; W/O A.C.	12576752	▲K061058HD
Tensioner Assy.	12581203	38258
Idler Pulley - Smooth	12580771	36299
Idler Pulley - Grooved; W/O A.C.	12580774	38008
Tensioner Pulley	12581203	38006
Hose - Upper - Eng. To Rad.		22769
Hose - Lower - Eng. To Rad.		22770
C6500		
Belt - Fan, Alt., P.S. & A.C.	15021740	▲K071056HD
Belt - Fan, Alt. & P.S.; W/O A.C.	15021740	▲K071056HD
Belt - Air Compr.	15074400	▲K040745HD
Tensioner Assy. - Fan, Alt., P.S. & A.C.	15021742	38256
Tensioner Pulley - Fan, Alt., P.S. & A.C.	15021742	38033
Tensioner Pulley - Fan & Air Compr.	15001551	38006
Hose - Upper - Eng. To Rad.		22854
Hose - Lower - Eng. To Rad.		22771
C7500; C8500		
Belt - Fan, Alt., P.S. & A.C.	15768485	▲K071247HD
Belt - Fan, Alt. & P.S.; W/O A.C.	15021740	▲K071056HD
Belt - Air Compr.	15074400	▲K040745HD
Tensioner Assy. - Fan, Alt., P.S. & A.C.	15021742	38256
Tensioner Pulley - Fan, Alt., P.S. & A.C.	15021742	38033
Tensioner Pulley - Fan & Air Compr.	15001551	38006
Hose - Upper - Eng. To Rad.		22854
Hose - Lower - Eng. To Rad.		22771
Isuzu 4HK1-TC Diesel		
W3500; W4500; W5500; W5500HD		
Belt - Fan & Alt.	8971801811	②▲9420HD
Belt - Alt. & A.C.	8971801832	▲9620HD
Hose - Upper - Eng. To Rad.		23096
Hose - Lower - Eng. To Rad.		23095
Isuzu 6HK1-TC Diesel		
C6500; C7500; C8500		
Belt - Fan, Alt. & A.C.	15020893	▲K070786HD
Belt - W.P. & P.S.	97730199	TR22461
Hose - Upper - Eng. To Rad.		22767
Hose - Lower - Eng. To Rad.		22768
T6500; T7500; T8500		
Belt - Fan, Alt. & A.C.	15065874	▲K080726HD
Belt - Fan & Alt.	15065875	▲K080556HD
Tensioner Assy. - Fan, Alt. & A.C.	15098394	38579
Hose - Upper - Eng. To Rad.		22855
Hose - Lower - Eng. To Rad.		22856
2006		
Caterpillar C7 Diesel		
C6500; C7500; C8500		
Belt - Fan, Alt. & A.C.	15170173	▲K080806HD
Tensioner Assy. - Fan, Alt. & A.C.	15170283	38586
Idler Pulley	89022559	36096
Hose - Upper - Eng. To Rad.		23087
Hose - Lower - Eng. To Rad.		23088
GM V-8 6.0 L		
W3500; W4500		
Belt - Fan, Alt. & P.S.	12576754	▲K060994HD
Belt - A.C.	12576447	▲K040378HD
Tensioner Assy. - Alt. & P.S.	12580162	38158
Tensioner Assy. - A.C.	12580196	38159
Idler Pulley	12580771	36299

▲ Standard Belt Available. See Pages 630-631.

② Two Required.

Belts and Coolant Hose for Medium/Heavy-Duty Trucks (1996 and Newer)

 Medium & Heavy-Duty Trucks
(1996 & Newer)

Application	Mfr. Part No.	Our No.
CHEVROLET - Continued		
2006 - Continued		
GM V-8 6.0 L - Continued		
W3500; W4500 - Continued		
Tensioner Pulley - Alt. & P.S.	12580162	38009
Tensioner Pulley - A.C.	12580196	36169
Hose - Upper - Eng. To Rad.		23098
Hose - Lower - Eng. To Rad.		23097
GM V-8 6.6 L Diesel		
C4500; C5500		
Belt - Fan, Alt., P.S. & A.C.; W/105A. Alt.	97300654	♣K061187HD
Belt - Fan, Alt., P.S. & A.C.; W/150A. Alt.	97300656	♣K061195HD
Belt - Fan, Alt., P.S. & A.C.; W/Dual 105A. Alts.	97300655	♣K061360HD
Tensioner Assy.	97288625	38172
Idler Pulley; W/Flat Idler Pulley	97209546	36310
Idler Pulley; W/O A.C.	14102597	36177
Tensioner Pulley	97288625	36239
Hose - Upper - Eng. To Rad.		22763
Hose - Lower - Eng. To Rad.		22771
GM V-8 8.1 L		
C4500; C5500		
Belt - Fan, Alt. & P.S.; W/O A.C.; W/Dual 105A. Alts.	12563074	♣K061058HD
Belt - Fan, Alt., P.S. & A.C.; W/Single 150A. Alt.	12563076	♣K060994HD
Tensioner Assy.	12581203	38258
Idler Pulley; W/A.C.	12580771	36299
Idler Pulley - Smooth; W/O A.C.	12580771	36299
Idler Pulley - Grooved; W/O A.C.	12580774	38008
Tensioner Pulley	12581203	38006
Hose - Upper - Eng. To Rad.		22769
Hose - Lower - Eng. To Rad.		22770
C6500; C7500; C8500		
Belt - Fan, Alt., P.S. & A.C.	15768485	♣K071247HD
Belt - Fan, Alt. & P.S.; W/O A.C.	15021740	♣K071056HD
Belt - Air Compr.	15074400	♣K040745HD
Tensioner Assy. - Fan, Alt., P.S. & A.C.	15021742	38256
Tensioner Pulley - Fan, Alt., P.S. & A.C.	15021742	38033
Tensioner Pulley - Fan & Air Compr.	15001551	38006
Hose - Upper - Eng. To Rad.		22854
Hose - Lower - Eng. To Rad.		22771
Isuzu 4HK1-TC Diesel		
W3500; W4500; W5500; W5500HD		
Belt - Fan & Alt.	8971801811	②♣9420HD
Belt - Alt. & A.C.	8971801832	♣9620HD
Hose - Upper - Eng. To Rad.		23096
Hose - Lower - Eng. To Rad.		23095
Isuzu 6HK1-TC Diesel		
C6500; C7500; C8500		
Belt - Fan, Alt. & A.C.	15020893	♣K070786HD
Belt - W.P. & P.S.	97730199	TR22461
Tensioner Assy.	15008841	38548
Hose - Upper - Eng. To Rad.		22767
Hose - Lower - Eng. To Rad.		22768
T6500; T7500; T8500		
Belt - Fan, Alt. & A.C.	15065874	♣K080726HD
Belt - Fan & Alt.	15065875	♣K080550HD
Tensioner Assy. - Fan, Alt. & A.C.	15098394	38579
Hose - Upper - Eng. To Rad.		22855
Hose - Lower - Eng. To Rad.		22856
2005		
Caterpillar C7 Diesel		
C6500; C7500; C8500		
Belt - Fan, Alt. & A.C.	15170173	♣K080806HD
Tensioner Assy. - Fan, Alt. & A.C.	15170283	38586
Idler Pulley	89022559	36096
Hose - Upper - Eng. To Rad.; W/O H.D. Cool.		23087
Hose - Upper - Eng. To Rad.; W/H.D. Cool.		23099
Hose - Lower - Eng. To Rad.		23088

♣ Standard Belt Available. See Pages 630-631.

Application	Mfr. Part No.	Our No.
CHEVROLET - Continued		
2005 - Continued		
GM V-8 6.0 L		
W3500; W4500		
Belt - Fan, Alt. & P.S.	12576754	♣K060994HD
Belt - A.C.	12576447	♣K040378HD
Tensioner Assy. - Alt. & P.S.	12580162	38158
Tensioner Assy. - A.C.	12580196	38159
Idler Pulley	12580771	36299
Tensioner Pulley - Alt. & P.S.	12580162	38009
Tensioner Pulley - A.C.	12580196	36169
Hose - Upper - Eng. To Rad.		23098
Hose - Lower - Eng. To Rad.		23097
GM V-8 6.6 L Diesel		
C4500; C5500		
Belt - Fan, Alt., P.S. & A.C.; W/105A. Alt.	97300654	♣K061187HD
Belt - Fan, Alt., P.S. & A.C.; W/150A. Alt.	97300656	♣K061195HD
Belt - Fan, Alt., P.S. & A.C.; W/Dual 105A. Alts.	97300655	♣K061360HD
Tensioner Assy.	97288625	38172
Idler Pulley; W/Flat Idler Pulley	97209546	36310
Idler Pulley; W/O A.C.	14102597	36177
Tensioner Pulley	97288625	36239
Hose - Upper - Eng. To Rad.		22763
Hose - Lower - Eng. To Rad.		22771
GM V-8 8.1 L		
C4500; C5500		
Belt - Fan, Alt., P.S. & A.C.; W/Single 105A. Alt.	12563075	♣K060988HD
Belt - Fan, Alt. & P.S.; W/O A.C.; W/Single 105A. Alt.	12563072	♣K060905HD
Belt - Fan, Alt., P.S. & A.C.; W/Dual 105A. Alts.	12563077	♣K061140HD
Belt - Fan, Alt. & P.S.; W/O A.C.; W/Dual 105A. Alts.	12563074	♣K061058HD
Belt - Fan, Alt., P.S. & A.C.; W/Single 150A. Alt.	12563076	♣K060994HD
Tensioner Assy.	12581203	38258
Idler Pulley; W/A.C.	12580771	36299
Idler Pulley - Smooth; W/O A.C.	12580771	36299
Idler Pulley - Grooved; W/O A.C.	12580774	38008
Tensioner Pulley	12581203	38006
Hose - Upper - Eng. To Rad.		22769
Hose - Lower - Eng. To Rad.		22770
C6500; C7500; C8500		
Belt - Fan, Alt., P.S. & A.C.	15768485	♣K071247HD
Belt - Fan, Alt. & P.S.; W/O A.C.	15021740	♣K071056HD
Belt - Air Compr.	15074400	♣K040745HD
Tensioner Assy. - Fan, Alt., P.S. & A.C.	15021742	38256
Tensioner Pulley - Fan, Alt., P.S. & A.C.	15021742	38033
Tensioner Pulley - Fan & Air Compr.	15001551	38006
Hose - Upper - Eng. To Rad.		22854
Hose - Lower - Eng. To Rad.		22771
Isuzu 4HK1-TC Diesel		
W3500; W4500; W5500; W5500HD		
Belt - Fan & Alt.	8971801811	②♣9420HD
Belt - Alt. & A.C.	8971801832	♣9620HD
Hose - Upper - Eng. To Rad.		23096
Hose - Lower - Eng. To Rad.		23095
Isuzu 6HK1-TC Diesel		
C6500; C7500; C8500		
Belt - Fan, Alt. & A.C.	15020893	♣K070786HD
Belt - W.P. & P.S.	97730199	TR22461
Tensioner Assy.	15008841	38548
Hose - Upper - Eng. To Rad.		22767
Hose - Lower - Eng. To Rad.		22768
T6500; T7500; T8500		
Belt - Fan, Alt. & A.C.	15065874	♣K080726HD
Belt - Fan & Alt.	15065875	♣K080550HD
Tensioner Assy. - Fan, Alt. & A.C.	15098394	38579
Hose - Upper - Eng. To Rad.		22855
Hose - Lower - Eng. To Rad.		22856

② Two Required.

Belts and Coolant Hose for Medium/Heavy-Duty Trucks (1996 and Newer)

Medium & Heavy-Duty Trucks
(1996 & Newer)

Application	Mfr. Part No.	Our No.
CHEVROLET - Continued		
2004		
Caterpillar C7 Diesel		
C6500; C7500; C8500		
Belt - Fan, Alt. & A.C.	15170173	♣K080806HD
Tensioner Assy. - Fan, Alt. & A.C.	15170283	38586
Idler Pulley	89022559	36096
Hose - Upper - Eng. To Rad.; W/O H.D. Cool.		23087
Hose - Upper - Eng. To Rad.; W/H.D. Cool.		23099
Hose - Lower - Eng. To Rad.		23088
GM V-8 6.0 L		
W3500; W4500		
Belt - Fan, Alt. & P.S.		♣K060994HD
Belt - A.C.	12576447	♣K040378HD
Tensioner Assy. - Alt. & P.S.	12580162	38158
Tensioner Assy. - A.C.	12580196	38159
Idler Pulley	12580771	36299
Tensioner Pulley - Alt. & P.S.	12580162	38009
Tensioner Pulley - A.C.	12580196	36169
Hose - Upper - Eng. To Rad.		23098
Hose - Lower - Eng. To Rad.		23097
GM V-8 6.6 L Diesel		
C4500; C5500		
Belt - Fan, Alt., P.S. & A.C.; W/105A. Alt. 97300654		♣K061187HD
Belt - Fan, Alt., P.S. & A.C.; W/150A. Alt. 97300656		♣K061195HD
Belt - Fan, Alt., P.S. & A.C.; W/Dual		
105A. Alts.	97300655	♣K061360HD
Tensioner Assy.	97288625	38172
Idler Pulley; W/Flat Idler Pulley	97209546	36310
Idler Pulley; W/O A.C.	14102597	36177
Tensioner Pulley	97288625	36239
Hose - Upper - Eng. To Rad.		22763
Hose - Lower - Eng. To Rad.		22771
GM V-8 8.1 L		
C4500; C5500		
Belt - Fan, Alt., P.S. & A.C.; W/Single		
105A. Alt.	12563075	♣K060988HD
Belt - Fan, Alt. & P.S.; W/O A.C.;		
W/Single 105A. Alt.	12563072	♣K060905HD
Belt - Fan, Alt., P.S. & A.C.; W/Dual		
105A. Alts.	12563077	♣K061140HD
Belt - Fan, Alt. & P.S.; W/O A.C.; W/Dual		
105A. Alts.	12563074	♣K061058HD
Belt - Fan, Alt., P.S. & A.C.; W/Single		
150A. Alt.	12563076	♣K060994HD
Tensioner Assy.	12581203	38258
Idler Pulley; W/A.C.	12580771	36299
Idler Pulley - Smooth; W/O A.C.	12580771	36299
Idler Pulley - Grooved; W/O A.C.	12580774	38008
Tensioner Pulley	12581203	38006
Hose - Upper - Eng. To Rad.		22769
Hose - Lower - Eng. To Rad.		22770
C6500; C7500; C8500		
Belt - Fan, Alt., P.S. & A.C.	15768485	♣K071247HD
Belt - Fan, Alt. & P.S.; W/O A.C.	15021740	♣K071056HD
Belt - Air Compr.	15074400	♣K040745HD
Tensioner Assy. - Fan, Alt., P.S. & A.C.	15021742	38256
Tensioner Pulley - Fan, Alt., P.S. & A.C.	15021742	38033
Tensioner Pulley - Fan & Air Compr.	15001551	38006
Hose - Upper - Eng. To Rad.		22854
Hose - Lower - Eng. To Rad.		22771
Isuzu 4HE1-TC Diesel		
W3500; W4500; W5500		
Belt - Fan & Alt.	8971801811	♣9420HD
Belt - Alt. & A.C.	8971801832	♣9620HD
Hose - Upper - Eng. To Rad.		23096
Hose - Lower - Eng. To Rad.		23095
Isuzu 6HK1-TC Diesel		
C6500; C7500; C8500		
Belt - Fan, Alt. & A.C.	15020893	♣K070786HD
Belt - W.P. & P.S.	97730199	TR22461

Application	Mfr. Part No.	Our No.
CHEVROLET - Continued		
2004 - Continued		
Isuzu 6HK1-TC Diesel - Continued		
C6500; C7500; C8500 - Continued		
Tensioner Assy.	15008841	38548
Hose - Upper - Eng. To Rad.		22767
Hose - Lower - Eng. To Rad.		22768
T6500; T7500; T8500		
Belt - Fan, Alt. & A.C.	15065874	♣K080726HD
Belt - Fan & Alt.	15065875	♣K080550HD
Tensioner Assy. - Fan, Alt. & A.C.	15098394	38579
Hose - Upper - Eng. To Rad.		22855
Hose - Lower - Eng. To Rad.		22856
W4500; W5500; WT5500		
Belt - Fan & Alt.	1136714641	ⓉTR22461
Belt - A.C.	8943951720	TR22434
Hose - Upper - Eng. To Rad.		22733
Hose - Lower - Eng. To Rad.		22734
2003		
Caterpillar 3126 Diesel		
C6500		
Belt - W.P.	0618384	♣9335HD
Tensioner Assy.	15083306	38557
Idler Pulley	89022559	36096
Tensioner Pulley	15083306	36091
Hose - Upper - Eng. To Rad.; W/H.D. Cool.		22764
Hose - Upper - Eng. To Rad.; W/O H.D. Cool.		22765
Hose - Lower - Eng. To Rad.		22766
C7500; C8500		
Belt - Fan, Alt. & A.C.	15008836	♣K070835HD
Belt - Fan & Alt.; W/O A.C.	15043146	♣K070709HD
Belt - W.P.	0618384	♣9335HD
Tensioner Assy.	15083306	38557
Idler Pulley	89022559	36096
Tensioner Pulley	15083306	36091
Hose - Upper - Eng. To Rad.; W/H.D. Cool.		22764
Hose - Upper - Eng. To Rad.; W/O H.D. Cool.		22765
Hose - Lower - Eng. To Rad.		22766
T5500; T6500; T7500; T8500		
Belt - Hub & W.P.	0366775	♣9341HD
Belt - Fan & Alt.	15149560	♣K070553HD
Belt - Fan, Alt. & A.C.	15985715	♣K070677HD
Tensioner Assy.	15999618	38578
Tensioner Pulley	15999618	36091
Hose - Upper - Eng. To Rad.		22706
Hose - Lower - Eng. To Rad.		22705
GM V-8 5.7 L		
W3500; W4500		
Belt - Fan, Alt., P.S. & A.C.	8971106400	♣K061010HD
Tensioner Assy. - Fan, Alt., P.S. & A.C.	8971619590	38528
Hose - Upper - Eng. To Rad.		22731
Hose - Lower - Eng. To Rad.		22732
GM V-8 6.0 L		
W4500		
Belt - Fan, Alt. & P.S.		♣K060994HD
Belt - A.C.	12576447	♣K040378HD
Tensioner Assy. - Alt. & P.S.	12580162	38158
Tensioner Assy. - A.C.	12580196	38159
Idler Pulley	12580771	36299
Tensioner Pulley - Alt. & P.S.	12580162	38009
Tensioner Pulley - A.C.	12580196	36169
Hose - Upper - Eng. To Rad.		23098
Hose - Lower - Eng. To Rad.		23097
GM V-8 6.6 L Diesel		
C4500; C5500		
Belt - Fan, Alt., P.S. & A.C.; W/105A. Alt. 97300654		♣K061187HD
Belt - Fan, Alt., P.S. & A.C.; W/150A. Alt. 97300656		♣K061195HD
Belt - Fan, Alt., P.S. & A.C.; W/Dual		
105A. Alts.	97300655	♣K061360HD
Tensioner Assy.	97288625	38172

♣ Standard Belt Available. See Pages 630-631.

Ⓣ Two Required.

Belts and Coolant Hose for Medium/Heavy-Duty Trucks (1996 and Newer)

 Medium & Heavy-Duty Trucks
(1996 & Newer)

Application	Mfr. Part No.	Our No.
CHEVROLET - Continued		
2003 - Continued		
GM V-8 6.6 L Diesel - Continued		
C4500; C5500 - Continued		
Idler Pulley; W/Flat Idler Pulley	97209546	36310
Idler Pulley; W/O A.C.	14102597	36177
Tensioner Pulley	97288625	36239
Hose - Upper - Eng. To Rad.		22763
Hose - Lower - Eng. To Rad.		22771
GM V-8 8.1 L		
C4500; C5500		
Belt - Fan, Alt., P.S. & A.C.; W/Single 105A. Alt.	12563075	♣K060988HD
Belt - Fan, Alt. & P.S.; W/O A.C.; W/Single 105A. Alt.	12563072	♣K060905HD
Belt - Fan, Alt., P.S. & A.C.; W/Dual 105A. Alts.	12563077	♣K061140HD
Belt - Fan, Alt. & P.S.; W/O A.C.; W/Dual 105A. Alts.	12563074	♣K061058HD
Belt - Fan, Alt., P.S. & A.C.; W/Single 150A. Alt.	12563076	♣K060994HD
Belt - Fan, Alt. & P.S.; W/O A.C.; W/Single 150A. Alt.	12563073	♣K060910HD
Tensioner Assy.	12581203	38258
Idler Pulley; W/A.C.	12580771	36299
Idler Pulley - Smooth; W/O A.C.	12580771	36299
Idler Pulley - Grooved; W/O A.C.	12580774	38008
Tensioner Pulley	12581203	38006
Hose - Upper - Eng. To Rad.		22769
Hose - Lower - Eng. To Rad.		22770
C6500; C7500; C8500		
Belt - Fan, Alt., P.S. & A.C.	15768485	♣K071247HD
Belt - Fan, Alt. & P.S.; W/O A.C.	15021740	♣K071056HD
Belt - Air Compr.	15074400	♣K040745HD
Tensioner Assy. - Fan, Alt., P.S. & A.C.	15021742	38256
Tensioner Pulley - Fan, Alt., P.S. & A.C.	15021742	38033
Tensioner Pulley - Fan & Air Compr.	15001551	38006
Hose - Upper - Eng. To Rad.		22854
Isuzu 4HE1-TC Diesel		
W3500; W4500; W5500		
Belt - Fan & Alt.	8971801811	②♣9420HD
Belt - Alt. & A.C.	8971801832	♣9620HD
Hose - Upper - Eng. To Rad.		23096
Hose - Lower - Eng. To Rad.		23095
Isuzu 6HK1-TC Diesel		
C6500; C7500; C8500		
Belt - Fan, Alt. & A.C.	15020893	♣K070786HD
Belt - W.P. & P.S.	97730199	TR22461
Tensioner Assy.	15008841	38548
Hose - Upper - Eng. To Rad.		22767
Hose - Lower - Eng. To Rad.		22768
T5500; T6500; T7500; T8500; W5500; WT5500		
Belt - Fan & Alt.	94395171	②TR22461
Belt - A.C.	94395172	TR22434
Hose - Upper - Eng. To Rad.		22733
Hose - Lower - Eng. To Rad.		22734

♣ Standard Belt Available. See Pages 630-631.

Application	Mfr. Part No.	Our No.
CHEVROLET - Continued		
2002 - Continued		
Caterpillar 3126 Diesel - Continued		
T5500; T6500; T7500; T8500		
Belt - Hub & W.P.	0366775	♣9341HD
Belt - Fan & Alt.	15149560	♣K070553HD
Belt - Fan, Alt. & A.C.	15985715	♣K070677HD
Tensioner Assy.	15999618	38578
Tensioner Pulley	15999618	36091
Hose - Upper - Eng. To Rad.		22706
Hose - Lower - Eng. To Rad.		22705
GM V-8 5.7 L		
W3500; W4500		
Belt - Fan, Alt., P.S. & A.C.	8971106400	♣K061010HD
Tensioner Assy. - Fan, Alt., P.S. & A.C.	8971619590	38528
Hose - Upper - Eng. To Rad.		22731
Hose - Lower - Eng. To Rad.		22732
GM V-8 8.1 L		
C5500; C6500; C7500; C8500		
Belt - Fan, Alt., P.S. & A.C.	15768485	♣K071247HD
Belt - Fan, Alt. & P.S.; W/O A.C.	15021740	♣K071056HD
Belt - Fan & Air Compr.	15060753	♣K040762HD
Tensioner Assy. - Fan, Alt., P.S. & A.C.	15021742	38256
Tensioner Assy. - Fan & Air Compr.	15001551	38261
Tensioner Pulley - Fan, Alt., P.S. & A.C.	15021742	38033
Tensioner Pulley - Fan & Air Compr.	15001551	38006
Hose - Upper - Eng. To Rad.		22678
Hose - Lower - Eng. To Rad.		22679
Isuzu 4HE1-TC Diesel		
W3500; W4500; W5500		
Belt - Fan & Alt.	8971801810	②♣9415HD
Belt - Alt. & A.C.	8971801830	♣9610HD
Hose - Upper - Eng. To Rad.		23096
Hose - Lower - Eng. To Rad.		23095
Isuzu 6HK1-TC Diesel		
T5500; T6500; T7500; T8500; W5500; WT5500		
Belt - Fan & Alt.	94395171	②TR22461
Belt - A.C.	94395172	TR22434
Hose - Upper - Eng. To Rad.		22733
Hose - Lower - Eng. To Rad.		22734
2001		
Caterpillar 3126 Diesel		
C5500; C6500; C7500; C8500		
Belt - W.P.	0366775	♣9341HD
Belt - Fan & Alt.; W/O A.C.	15670937	♣K070705HD
Belt - Fan, Alt. & A.C.	15690236	♣K070733HD
Tensioner Assy.	7E3999	38509
Idler Pulley	89022559	36096
Tensioner Pulley	7E3999	36091
Hose - Upper - Eng. To Rad.; W/Conventional Hood		22032
Hose - Upper - Eng. To Rad.; W/High Visibility Hood		22664
Hose - Lower - Eng. To Rad.		21985
Hose - Heater Inlet; (3/4" I.D.)		28442
Hose - Heater Outlet; (5/8" I.D.)		28441
T5500; T6500; T7500; T8500		
Belt - Hub & W.P.	0366775	♣9341HD
Belt - Fan & Alt.; W/O A.C.	15149560	♣K070553HD
Belt - Fan, Alt. & A.C.	15985715	♣K070677HD
Tensioner Assy.	15999618	38578
Tensioner Pulley	15999618	36091
Hose - Upper - Eng. To Rad.		22706
Hose - Lower - Eng. To Rad.		22705
GM V-8 5.7 L		
W3500; W4500		
Belt - Fan, Alt., P.S. & A.C.	8971106400	♣K061010HD
Tensioner Assy. - Fan, Alt., P.S. & A.C.	8971619590	38528
Hose - Upper - Eng. To Rad.		22731
Hose - Lower - Eng. To Rad.		22732

② Two Required.

Belts and Coolant Hose for Medium/Heavy-Duty Trucks (1996 and Newer)

Medium & Heavy-Duty Trucks
(1996 & Newer)

Application	Mfr. Part No.	Our No.
CHEVROLET - Continued		
2001 - Continued		
GM V-8 8.1 L		
C5500; C6500; C7500; C8500		
Belt - Fan, Alt., P.S. & A.C.	15768485	♣K071247HD
Belt - Fan, Alt. & P.S.; W/O A.C.	15021740	♣K071056HD
Belt - Fan & Air Compr.	15060753	♣K040762HD
Tensioner Assy. - Fan, Alt., P.S. & A.C.	15021742	38256
Tensioner Assy. - Fan & Air Compr.	15001551	38261
Tensioner Pulley - Fan, Alt., P.S. & A.C.	15021742	38033
Tensioner Pulley - Fan & Air Compr.	15001551	38006
Hose - Upper - Eng. To Rad.	22678	
Hose - Lower - Eng. To Rad.	22679	
Isuzu 4HE1-TC Diesel		
W3500; W4500; W5500		
Belt - Fan & Alt.	8971801810	②♣9415HD
Belt - Alt. & A.C.	8971801830	♣9610HD
Hose - Upper - Eng. To Rad.		23096
Hose - Lower - Eng. To Rad.		23095
Isuzu 6HK1-TC Diesel		
T5500; T6500; T7500; T8500; W5500; WT5500		
Belt - Fan & Alt.	94395171	②TR22461
Belt - A.C.	94395172	TR22434
Hose - Upper - Eng. To Rad.		22733
Hose - Lower - Eng. To Rad.		22734
2000		
Caterpillar 3116 Diesel		
C6500; C7500; C8500		
Belt - W.P.	0366775	♣9341HD
Belt - Fan & Alt.; W/O A.C.	15670937	♣K070705HD
Belt - Fan, Alt. & A.C.	15690236	♣K070733HD
Tensioner Assy.	7E3999	38509
Tensioner Pulley	7E3999	36091
Hose - Upper - Eng. To Rad.; W/Rad. Shutters		22032
Hose - Upper - Eng. To Rad.; W/O Rad. Shutters		21989
Hose - Lower - Eng. To Rad.		21985
P30		
Belt - Fan & Alt.	15670937	♣K070705HD
Tensioner Assy. - Fan & Alt.	7E0339	38624
Hose - Upper - Eng. To Rad.		22134
Hose - Lower - Eng. To Rad.		21985
Caterpillar 3126 Diesel		
C5500; C6500; C7500; C8500		
Belt - W.P.	0366775	♣9341HD
Belt - Fan & Alt.; W/O A.C.	15670937	♣K070705HD
Belt - Fan, Alt. & A.C.	15690236	♣K070733HD
Tensioner Assy.	7E3999	38509
Idler Pulley	89022559	36096
Tensioner Pulley	7E3999	36091
Hose - Upper - Eng. To Rad.; W/Conventional Hood		22032
Hose - Upper - Eng. To Rad.; W/High Visibility Hood		22664
Hose - Lower - Eng. To Rad.		21985
Hose - Heater Inlet; (3/4" I.D.)		28442
Hose - Heater Outlet; (5/8" I.D.)		28441
P30		
Belt - Fan & Alt.	15670937	♣K070705HD
Tensioner Assy. - Fan & Alt.	7E0339	38624
Hose - Upper - Eng. To Rad.		22664
Hose - Lower - Eng. To Rad.		21985
T5500; T6500; T7500; T8500		
Belt - Hub & W.P.	0366775	♣9341HD
Belt - Fan & Alt.; W/O A.C.	15149560	♣K070553HD
Belt - Fan, Alt. & A.C.	15985715	♣K070677HD
Tensioner Assy.	15999618	38578
Tensioner Pulley	15999618	36091
Hose - Upper - Eng. To Rad.		22706
Hose - Lower - Eng. To Rad.		22705
GM V-8 5.7 L		
W3500; W4500		
Belt - Fan, Alt., P.S. & A.C.	8971106400	♣K061010HD

Application	Mfr. Part No.	Our No.
CHEVROLET - Continued		
2000 - Continued		
GM V-8 5.7 L - Continued		
W3500; W4500 - Continued		
Tensioner Assy. - Fan, Alt., P.S. & A.C.	8971619590	38528
Hose - Upper - Eng. To Rad.		22731
Hose - Lower - Eng. To Rad.		22732
GM V-8 7.4 L		
C5500; C6500; C7500; C8500		
Belt - Fan & Alt.	15722647	♣K060660HD
Belt - Fan To A.C.	15987600	♣9476HD
Belt - Fan & P.S.; W/Hyd. Brakes	11502405	♣9640HD
Belt - P.S.; W/Air Brakes	9433884	♣9395HD
Belt - P.S.; Mexico	9433883	♣9390HD
Belt - Fan & Air Compr.	11502412	♣9680HD
Hose - Upper - Eng. To Rad.		22663
Hose - Lower - Eng. To Rad.		22135
P30		
Belt - Fan & Alt.	15722647	♣K060660HD
Belt - P.S.; W/Hyd. Brakes	11502405	♣9640HD
Belt - P.S.; W/Ross P.S. Pump	9433884	♣9395HD
Belt - Air Compr.	11502412	♣9680HD
Hose - Upper - Eng. To Rad.		22663
Hose - Lower - Eng. To Rad.		22135
Isuzu 4HE1-TC Diesel		
W3500; W4500; W5500		
Belt - Fan & Alt.	8971801810	②♣9415HD
Belt - Alt. & A.C.	8971801830	♣9610HD
Hose - Upper - Eng. To Rad.		23096
Hose - Lower - Eng. To Rad.		23095
Isuzu 6HK1-TC Diesel		
T5500; T6500; T7500; T8500; W5500; WT5500		
Belt - Fan & Alt.	94395171	②TR22461
Belt - A.C.	94395172	TR22434
Hose - Upper - Eng. To Rad.		22733
Hose - Lower - Eng. To Rad.		22734
1999		
Caterpillar 3116 Diesel		
C5500; C6500; C7500; C8500		
Belt - W.P.	0366775	♣9341HD
Belt - Fan & Alt.; W/O A.C.	15670937	♣K070705HD
Belt - Fan, Alt. & A.C.	15690236	♣K070733HD
Tensioner Assy.	7E3999	38509
Tensioner Pulley	7E3999	36091
Hose - Upper - Eng. To Rad.; W/Rad. Shutters		22032
Hose - Upper - Eng. To Rad.; W/O Rad. Shutters		21989
Hose - Lower - Eng. To Rad.		21985
P30		
Belt - Fan & Alt.	15670937	♣K070705HD
Tensioner Assy. - Fan & Alt.	7E0339	38624
Hose - Upper - Eng. To Rad.		22134
Hose - Lower - Eng. To Rad.		21985
Tiltmaster W6; Tiltmaster W7		
Belt - Hub & W.P.	0366775	♣9341HD
Belt - Fan & Alt.; W/O A.C.	15149560	♣K070553HD
Belt - Fan, Alt. & A.C.	15985715	♣K070677HD
Tensioner Assy.	15999618	38578
Tensioner Pulley	15999618	36091
Hose - Upper - Eng. To Rad.		22706
Hose - Lower - Eng. To Rad.		22705
Caterpillar 3126 Diesel		
C5500; C6500; C7500; C8500		
Belt - W.P.	0366775	♣9341HD
Belt - Fan & Alt.; W/O A.C.	15670937	♣K070705HD
Belt - Fan, Alt. & A.C.	15690236	♣K070733HD
Tensioner Assy.	7E3999	38509
Idler Pulley	89022559	36096
Tensioner Pulley	7E3999	36091
Hose - Upper - Eng. To Rad.; W/Conventional Hood		22032
Hose - Upper - Eng. To Rad.; W/High Visibility Hood		22664

♣ Standard Belt Available. See Pages 630-631.

② Two Required.

Belts and Coolant Hose for Medium/Heavy-Duty Trucks (1996 and Newer)

 Medium & Heavy-Duty Trucks
(1996 & Newer)

Application	Mfr. Part No.	Our No.
CHEVROLET - Continued		
1999 - Continued		
Caterpillar 3126 Diesel - Continued		
C5500; C6500; C7500; C8500 - Continued		
Hose - Lower - Eng. To Rad.		21985
Hose - Heater Inlet; (3/4" I.D.)		28442
Hose - Heater Outlet; (5/8" I.D.)		28441
P30		
Belt - Fan & Alt.	15670937	♣K070705HD
Tensioner Assy. - Fan & Alt.	7E0339	38624
Hose - Upper - Eng. To Rad.		22664
Hose - Lower - Eng. To Rad.		21985
T5500; T6500; T7500; T8500; Tiltmaster W6; Tiltmaster W7		
Belt - Hub & W.P.	0366775	♣9341HD
Belt - Fan & Alt.; W/O A.C.	15149560	♣K070553HD
Belt - Fan, Alt. & A.C.	15985715	♣K070677HD
Tensioner Assy.	15999618	38578
Tensioner Pulley	15999618	36091
Hose - Upper - Eng. To Rad.		22706
Hose - Lower - Eng. To Rad.		22705
GM V-8 5.7 L		
Tiltmaster W4		
Belt - Fan, Alt., P.S. & A.C.	8971106400	♣K061010HD
Tensioner Assy.	97161959	38528
GM V-8 7.4 L		
C5500; C6500; C7500; C8500		
Belt - Fan & Alt.	15722647	♣K060660HD
Belt - Fan To A.C.	15987600	♣9476HD
Belt - Fan & P.S.; W/Hyd. Brakes	11502405	♣9640HD
Belt - P.S.; W/Air Brakes	9433884	♣9395HD
Belt - P.S.; Mexico	9433883	♣9390HD
Belt - Fan & Air Compr.	11502412	♣9680HD
Hose - Upper - Eng. To Rad.		22663
Hose - Lower - Eng. To Rad.		22135
P30		
Belt - Fan & Alt.	15722647	♣K060660HD
Belt - P.S.; W/Hyd. Brakes	11502405	♣9640HD
Belt - P.S.; W/Ross P.S. Pump	9433884	♣9395HD
Belt - Air Compr.	11502412	♣9680HD
Hose - Upper - Eng. To Rad.		22663
Hose - Lower - Eng. To Rad.		22135
Isuzu 4HE1-TC Diesel		
Tiltmaster W4; Tiltmaster W5		
Belt - Fan & Alt.	8971801810	②♣9415HD
Belt - Alt. & A.C.	8971801830	♣9610HD
Hose - Upper - Eng. To Rad.		23096
Hose - Lower - Eng. To Rad.		23095
Isuzu 6HE1-TC Diesel		
Tiltmaster W5		
Belt - Fan & Alt.	94395171	②TR22461
Belt - A.C.	94395172	TR22434
Hose - Upper - Eng. To Rad.		22733
Hose - Lower - Eng. To Rad.		22734
Isuzu 6HK1-TC Diesel		
T5500; T6500; T7500; T8500		
Belt - Fan & Alt.	94395171	②TR22461
Belt - A.C.	94395172	TR22434
Hose - Upper - Eng. To Rad.		22733
Hose - Lower - Eng. To Rad.		22734

♣ Standard Belt Available. See Pages 630-631.

Application	Mfr. Part No.	Our No.
CHEVROLET - Continued		
1998 - Continued		
Caterpillar 3116 Diesel - Continued		
C6500; C7500; C8500 - Continued		
Tensioner Assy.	7E3999	38509
Tensioner Pulley	7E3999	36091
Hose - Upper - Eng. To Rad.; W/High Visibility Hood		22134
Hose - Upper - Eng. To Rad.; W/O Rad. Shutters		21989
Hose - Upper - Eng. To Rad.; W/Rad. Shutters		22032
Hose - Lower - Eng. To Rad.		21985
P30		
Belt - Fan & Alt.	15670937	♣K070705HD
Tensioner Assy. - Fan & Alt.	7E0339	38624
Hose - Upper - Eng. To Rad.		22134
Hose - Lower - Eng. To Rad.		21985
T5500; T6500; T7500; T8500; Tiltmaster W6; Tiltmaster W7		
Belt - Hub & W.P.	0366775	♣9341HD
Belt - Fan & Alt.; W/O A.C.	15149560	♣K070553HD
Belt - Fan, Alt. & A.C.	15985715	♣K070677HD
Tensioner Assy.	15999618	38578
Tensioner Pulley	15999618	36091
Hose - Upper - Eng. To Rad.		22706
Hose - Lower - Eng. To Rad.		22705
Caterpillar 3126 Diesel		
C5500; C6500; C7500; C8500		
Belt - W.P.	0366775	♣9341HD
Belt - Fan & Alt.; W/O A.C.	15670937	♣K070705HD
Belt - Fan, Alt. & A.C.	15690236	♣K070733HD
Tensioner Assy.	7E3999	38509
Idler Pulley	89022559	36096
Tensioner Pulley	7E3999	36091
Hose - Upper - Eng. To Rad.; W/Conventional Hood		22032
Hose - Upper - Eng. To Rad.; W/High Visibility Hood		22664
Hose - Lower - Eng. To Rad.		21985
Hose - Heater Inlet; (3/4" I.D.)		28442
Hose - Heater Outlet; (5/8" I.D.)		28441
P30		
Belt - Fan & Alt.	15670937	♣K070705HD
Tensioner Assy. - Fan & Alt.	7E0339	38624
Hose - Upper - Eng. To Rad.		22664
Hose - Lower - Eng. To Rad.		21985
T5500; T6500; T7500; T8500; Tiltmaster W4; Tiltmaster W5; Tiltmaster W6; Tiltmaster W7		
Belt - Hub & W.P.	0366775	♣9341HD
Belt - Fan & Alt.; W/O A.C.	15149560	♣K070553HD
Belt - Fan, Alt. & A.C.	15985715	♣K070677HD
Tensioner Assy.	15999618	38578
Tensioner Pulley	15999618	36091
Hose - Upper - Eng. To Rad.		22706
Hose - Lower - Eng. To Rad.		22705
GM V-8 5.7 L		
Tiltmaster W4		
Belt - Fan, Alt., P.S. & A.C.	8971106400	♣K061010HD
Tensioner Assy. - Fan, Alt., P.S. & A.C.	97161959	38528
GM V-8 6.0 L		
C5500; C6500; C7500; C8500		
Belt - Fan & Alt.	15608928	♣K060672HD
Belt - P.S.; W/Air Brakes	9433884	♣9395HD
Belt - Fan & P.S.; W/Hyd. Brakes	11502406	♣9650HD
Belt - Fan To A.C.	15987600	♣9476HD
Belt - Fan & Air Brake Compr.	11502413	♣9690HD
Hose - Upper - Eng. To Rad.; W/Conventional Hood		22031
Hose - Upper - Eng. To Rad.; W/High Visibility Hood		22136
Hose - Lower - Eng. To Rad.; W/Auto. Trans.		21987
Hose - Lower - Eng. To Rad.; W/Man. Trans.		22030
P30		
Belt - Fan & Alt.	15608928	♣K060672HD
Belt - Fan & P.S.	11502406	♣9650HD
Belt - P.S.; W/Air Brakes	9433884	♣9395HD
Belt - Fan, A.C. & P.S.	14033869	7603
Belt - Air Brake Compr.	11502413	♣9690HD
Hose - Upper - Eng. To Rad.		22136

② Two Required.

Belts and Coolant Hose for Medium/Heavy-Duty Trucks (1996 and Newer)

Medium & Heavy-Duty Trucks
(1996 & Newer)

Application	Mfr. Part No.	Our No.
CHEVROLET - Continued		
1998 - Continued		
GM V-8 6.0 L - Continued		
P30 - Continued		
Hose - Lower - Eng. To Rad.		22135
T5500; T6500; T7500; Tiltmaster W5; Tiltmaster W6; Tiltmaster W7		
Belt - Fan & Alt.	15608928	♣K060672HD
Belt - P.S.	9433884	♣9395HD
Belt - A.C.	15987600	♣9476HD
GM V-8 6.5 L Diesel		
P30		
Belt - Alt., W.P. & P.S.	12555011	♣K061015HD
Belt - Fan	15994965	♣K060547HD
Tensioner Assy.		38118
Tensioner Pulley		38006
Hose - Upper		22268
Hose - Lower		22237
Hose - By Pass		22210
Hose - By Pass - Tank To Rad.		28465
Hose - Heater To Rad.; W/Grumman Body	≠18083	
Hose - Heater To Valve; W/Grumman Body(3/4" x 16")		28412
Hose - Intake Manifold To Rad.; W/Grumman Body	≠18084	
Hose - Valve To Eng.; W/Grumman Body(3/4" x 18")		28412
GM V-8 7.0 L		
C5500; C6500; C7500; C8500		
Belt - Fan & Alt.	15608928	♣K060672HD
Belt - P.S.; W/Air Brakes	9433884	♣9395HD
Belt - Fan & P.S.; W/Hyd. Brakes	11502406	♣9650HD
Belt - Fan To A.C.	15987600	♣9476HD
Belt - Fan & Air Brake Compr.	11502413	♣9690HD
Hose - Upper - Eng. To Rad.; W/Conventional Hood		22031
Hose - Upper - Eng. To Rad.; W/High Visibility Hood		22136
Hose - Lower - Eng. To Rad.; W/Auto. Trans.		21987
Hose - Lower - Eng. To Rad.; W/Man. Trans.		22030
P30		
Belt - Fan & Alt.	15608928	♣K060672HD
Belt - Fan & P.S.	11502406	♣9650HD
Belt - P.S.; W/Air Brakes	9433884	♣9395HD
Belt - Fan, A.C. & P.S.	14033869	7603
Belt - Air Brake Compr.	11502413	♣9690HD
Hose - Upper - Eng. To Rad.		22136
Hose - Lower - Eng. To Rad.		22135
Isuzu 4BD2 Diesel		
Tiltmaster W4; Tiltmaster W5; Tiltmaster W6; Tiltmaster W7		
Belt - Fan	5138700041	7420
Belt - Fan & Alt.	5138711270	♣9510HD
Belt - A.C.	8944529040	♣9400HD
Isuzu 6HE1-TC Diesel		
T5500; T6500; T7500; T8500		
Belt - Fan & Alt.	94395171	ⓉTR22461
Belt - A.C.	94395172	TR22434
Hose - Upper - Eng. To Rad.		22733
Hose - Lower - Eng. To Rad.		22734
Tiltmaster W5; Tiltmaster W6; Tiltmaster W7		
Belt - Fan & Alt.	94395171	TR22461
Belt - A.C.	94395172	TR22434
Hose - Upper - Eng. To Rad.		22733
Hose - Lower - Eng. To Rad.		22734
1997		
Caterpillar 3116 Diesel		
C6500; C7500; C8500		
Belt - W.P.	0366775	♣9341HD
Belt - Fan & Alt.; W/O A.C.; W/6-Ribbed Belt	15608928	♣K060672HD
Belt - Fan & Alt.; W/O A.C.; W/7-Ribbed Belt	15670937	♣K070705HD
Belt - Fan, Alt. & A.C.; W/Dealer Inst. A.C.		♣K070825HD
Belt - Fan, Alt. & A.C.; W/Factory Inst. A.C.	15958695	♣K070735HD
Tensioner Assy.	7E3999	38509

Application	Mfr. Part No.	Our No.
CHEVROLET - Continued		
1997 - Continued		
Caterpillar 3116 Diesel - Continued		
C6500; C7500; C8500 - Continued		
Tensioner Pulley	7E3999	36091
Hose - Upper - Eng. To Rad.; W/High Visibility Hood		22134
Hose - Upper - Eng. To Rad.; W/O Rad. Shutters		21989
Hose - Upper - Eng. To Rad.; W/Rad. Shutters		22032
Hose - Lower - Eng. To Rad.		21985
P30		
Belt - Fan & Alt.	15670937	♣K070705HD
Tensioner Assy. - Fan & Alt.	7E0339	38624
Hose - Upper - Eng. To Rad.		22134
Hose - Lower - Eng. To Rad.		21985
T5500; T6500; T7500; T8500; Tiltmaster W4; Tiltmaster W5; Tiltmaster W6; Tiltmaster W7		
Belt - Hub & W.P.	0366775	♣9341HD
Belt - Fan & Alt.; W/O A.C.	15149560	♣K070553HD
Belt - Fan, Alt. & A.C.	15985715	♣K070677HD
Tensioner Assy.	15999618	38578
Tensioner Pulley	15999618	36091
Hose - Lower - Eng. To Rad.		22705
Caterpillar 3126 Diesel		
P30		
Belt - Fan & Alt.	15670937	♣K070705HD
Tensioner Assy. - Fan & Alt.	7E0339	38624
Hose - Upper - Eng. To Rad.		22664
Hose - Lower - Eng. To Rad.		21985
GM V-8 5.7 L		
Tiltmaster W4		
Belt - Fan, Alt., P.S. & A.C.	8971106400	♣K061010HD
Tensioner Assy. - Fan, Alt., P.S. & A.C.	97161959	38528
GM V-8 6.0 L		
C5500; C6500; C7500; C8500		
Belt - Fan & Alt.	15608928	♣K060672HD
Belt - P.S.; W/Air Brakes	9433884	♣9395HD
Belt - Fan & P.S.; W/Hyd. Brakes	11502406	♣9650HD
Belt - Fan To A.C.	15987600	♣9476HD
Belt - Fan & Air Brake Compr.	11502413	♣9690HD
Hose - Upper - Eng. To Rad.; W/Conventional Hood		22031
Hose - Upper - Eng. To Rad.; W/High Visibility Hood		22136
Hose - Lower - Eng. To Rad.; W/Auto. Trans.		21987
Hose - Lower - Eng. To Rad.; W/Man. Trans.; W/Conventional Hood		22030
Hose - Lower - Eng. To Rad.; W/Man. Trans.; W/High Visibility Hood		22135
P30		
Belt - Fan & Alt.	15608928	♣K060672HD
Belt - Fan & P.S.	11502406	♣9650HD
Belt - P.S.; W/Air Brakes	9433884	♣9395HD
Belt - Fan, A.C. & P.S.	14033869	7603
Belt - Air Brake Compr.	11502413	♣9690HD
Hose - Upper - Eng. To Rad.		22136
Hose - Lower - Eng. To Rad.		22135
T5500; T6500; T7500; Tiltmaster W5; Tiltmaster W6		
Belt - Fan & Alt.	15608928	♣K060672HD
Belt - P.S.	9433884	♣9395HD
Belt - A.C.	15987600	♣9476HD
GM V-8 6.5 L Diesel		
P30		
Belt - Alt., W.P. & P.S.	12555011	♣K061015HD
Belt - Fan	15994965	♣K060547HD
Tensioner Assy.		38118
Tensioner Pulley		38006
Hose - Upper		22268
Hose - Lower		22237
Hose - By Pass		22210
Hose - By Pass - Tank To Rad.		28465
Hose - Heater To Rad.; W/Grumman Body	≠18083	
Hose - Heater To Valve; W/Grumman Body(3/4" x 16")		28412
Hose - Intake Manifold To Rad.; W/Grumman Body	≠18084	

♣ Standard Belt Available. See Pages 630-631.

Ⓣ Two Required.

≠ Cut to Fit.

Belts and Coolant Hose for Medium/Heavy-Duty Trucks (1996 and Newer)

 Medium & Heavy-Duty Trucks
(1996 & Newer)

Application	Mfr. Part No.	Our No.
CHEVROLET - Continued		
1997 - Continued		
GM V-8 6.5 L Diesel - Continued		
P30 - Continued		
Hose - Valve To Eng.; W/Grumman Body(3/4" x 18")		28412
GM V-8 7.0 L		
C5500; C6500; C7500; C8500		
Belt - Fan & Alt.	15608928	♣K060672HD
Belt - P.S.; W/Air Brakes	9433884	♣9395HD
Belt - Fan & P.S.; W/Hyd. Brakes	11502406	♣9650HD
Belt - Fan To A.C.	15987600	♣9476HD
Belt - Fan & Air Brake Compr.	11502413	♣9690HD
Hose - Upper - Eng. To Rad.; W/Conventional Hood		22031
Hose - Upper - Eng. To Rad.; W/High Visibility Hood		22136
Hose - Lower - Eng. To Rad.; W/Auto. Trans.		21987
Hose - Lower - Eng. To Rad.; W/Man. Trans.; W/Conventional Hood		22030
Hose - Lower - Eng. To Rad.; W/Man. Trans.; W/High Visibility Hood		22135
P30		
Belt - Fan & Alt.	15608928	♣K060672HD
Belt - Fan & P.S.	11502406	♣9650HD
Belt - P.S.; W/Air Brakes	9433884	♣9395HD
Belt - Fan, A.C. & P.S.	14033869	7603
Belt - Air Brake Compr.	11502413	♣9690HD
Hose - Upper - Eng. To Rad.		22136
Hose - Lower - Eng. To Rad.		22135
Isuzu 4BD2 Diesel		
Tiltmaster W4; Tiltmaster W5; Tiltmaster W6; Tiltmaster W7		
Belt - Fan	5138700041	7420
Belt - Fan & Alt.	5138711270	♣9510HD
Belt - A.C.	8944529040	♣9400HD
Isuzu 6HE1-TC Diesel		
T5500; T6500; T7500; T8500		
Belt - Fan & Alt.	94395171	ⓉTR22461
Belt - A.C.	94395172	TR22434
Hose - Upper - Eng. To Rad.		22733
Hose - Lower - Eng. To Rad.		22734
Tiltmaster W5; Tiltmaster W6		
Belt - Fan & Alt.	94395171	TR22461
Belt - A.C.	94395172	TR22434
Hose - Upper - Eng. To Rad.		22733
Hose - Lower - Eng. To Rad.		22734
Tiltmaster W7		
Belt - Fan & Alt.	94395171	ⓉTR22461
Belt - A.C.	94395172	TR22434
Hose - Upper - Eng. To Rad.		22733
Hose - Lower - Eng. To Rad.		22734
1996		
Caterpillar 3116 Diesel		
Kodiak C6500; Kodiak C7500; Kodiak C8500		
Belt - W.P.	7E0744	♣9345HD
Belt - Fan & Alt.; W/O A.C.	15625166	♣K070673HD
Belt - Fan, Alt. & A.C.; W/Dealer Inst. A.C.		♣K070825HD
Belt - Fan, Alt. & A.C.; W/Factory Inst. A.C.	15958695	♣K070735HD
Tensioner Assy.	7E3999	38509
Tensioner Pulley	7E3999	36091
Hose - Upper - Eng. To Rad.; W/O Rad. Shutters		21989
Hose - Upper - Eng. To Rad.; W/Rad. Shutters		22032
Hose - Lower - Eng. To Rad.		21985
P6S042		
Belt - W.P.	7E0744	♣9345HD
Belt - Fan & Alt.; W/64 5/8" Belt O.C.	15681040	♣K070640HD
Belt - Fan & Alt.; W/71 1/8" Belt O.C.	15670937	♣K070705HD
Tensioner Assy. - Fan & Alt.	7E0339	38624
Hose - Upper - Eng. To Rad.		22161
Hose - Lower - Eng. To Rad.		22160

♣ Standard Belt Available. See Pages 630-631.
Ⓣ Cut to Fit.

Application	Mfr. Part No.	Our No.
CHEVROLET - Continued		
1996 - Continued		
GM V-8 5.7 L		
Tiltmaster W4		
Belt - Fan, Alt., P.S. & A.C.	8971106400	♣K061010HD
Belt - Fan, Alt. & P.S.		♣K061000HD
Tensioner Assy.	8971619590	38528
Hose - Upper - Eng. To Rad.		22731
Hose - Lower - Eng. To Rad.		22732
GM V-8 6.0 L		
Kodiak C5500; Kodiak C6500; Kodiak C7500; Kodiak C8500		
Belt - Fan & Alt.	15608928	♣K060672HD
Belt - P.S.; W/Air Brakes	9433884	♣9395HD
Belt - Fan & P.S.; W/Hyd. Brakes	11502406	♣9650HD
Belt - Fan To A.C.	11502379	♣9540HD
Belt - Fan & Air Brake Compr.	11502413	♣9690HD
Hose - Upper - Eng. To Rad.		22031
Hose - Lower - Eng. To Rad.; W/Auto. Trans.		21987
Hose - Lower - Eng. To Rad.; W/Man. Trans.		22030
P30		
Belt - Fan & Alt.	15608928	♣K060672HD
Belt - Fan & P.S.	11502406	♣9650HD
Belt - P.S.; W/Air Brakes	9433884	♣9395HD
Belt - Fan, A.C. & P.S.	14033869	7603
Belt - Air Brake Compr.	11502413	♣9690HD
Hose - Upper - Eng. To Rad.		22136
Hose - Lower - Eng. To Rad.		22135
GM V-8 6.5 L Diesel		
P30		
Serpentine Belt; W/A.C.; W/V.P.; W/124A. Alt.; Exc. Motor Home		♣K061020HD
Serpentine Belt; W/O A.C.; W/105A. Alt.; Exc. Motor Home		♣K061010HD
Tensioner Assy.		38118
Tensioner Pulley; Exc. Motor Home		38006
Hose - Upper; W/Turbo; Motor Home		22267
Hose - Upper; Exc. Motor Home		22268
Hose - Lower; Exc. Motor Home		22237
Hose - By Pass; W/Turbo; Motor Home		22210
Hose - By Pass; Exc. Motor Home		22210
Hose - By Pass - Tank To Rad.; Exc. Motor Home		28465
Hose - Heater To Rad.; W/Grumman Body		Ⓢ18083
Hose - Heater To Valve; W/Grumman Body(3/4" x 16")		28412
Hose - Intake Manifold To Rad.; W/Grumman Body		Ⓢ18084
Hose - Valve To Eng.; W/Grumman Body(3/4" x 18")		28412
GM V-8 7.0 L		
Kodiak C5500; Kodiak C6500; Kodiak C7500; Kodiak C8500		
Belt - Fan & Alt.	15608928	♣K060672HD
Belt - P.S.; W/Air Brakes	9433884	♣9395HD
Belt - Fan & P.S.; W/Hyd. Brakes	11502406	♣9650HD
Belt - Fan To A.C.	11502379	♣9540HD
Belt - Fan & Air Brake Compr.	11502413	♣9690HD
Hose - Upper - Eng. To Rad.		22031
Hose - Lower - Eng. To Rad.; W/Auto. Trans.		21987
Hose - Lower - Eng. To Rad.; W/Man. Trans.		22030
P30		
Belt - Fan & Alt.	15608928	♣K060672HD
Belt - Fan & P.S.	11502406	♣9650HD
Belt - P.S.; W/Air Brakes	9433884	♣9395HD
Belt - Fan, A.C. & P.S.	14033869	7603
Belt - Air Brake Compr.	11502413	♣9690HD
Hose - Upper - Eng. To Rad.		22136
Hose - Lower - Eng. To Rad.		22135
GM V-8 7.4 L		
P30		
Belt - Fan & Alt.	15608928	♣K060672HD
Belt - Fan & P.S.; W/Hyd. Brakes	11502406	♣9650HD
Belt - P.S.; W/Air Brakes	9433884	♣9395HD
Belt - Air Brake Compr.	11502413	♣9690HD
Hose - Upper		22136
Hose - Lower		22135

Ⓣ Two Required.

Belts and Coolant Hose for Medium/Heavy-Duty Trucks (1996 and Newer)

Medium & Heavy-Duty Trucks
(1996 & Newer)

Application	Mfr. Part No.	Our No.
CHEVROLET - Continued		
1996 - Continued		
Isuzu 4BD2-TC Diesel		
Tiltmaster W4		
Belt - Fan	5138700041	7420
Belt - Fan & Alt.	5138711270	▲9510HD
Belt - A.C.	8944529040	▲9400HD
Isuzu 6HE1-TC Diesel		
Tiltmaster W5; Tiltmaster W6; Tiltmaster W7		
Belt - Fan & Alt.	94395171	②TR22461
Belt - A.C.	94395172	TR22434
Hose - Upper - Eng. To Rad.		22733
Hose - Lower - Eng. To Rad.		22734
CRANE CARRIER COMPANY		
2007		
Caterpillar C11 Diesel		
Centurion		
Belt - Fan, Alt. & A.C.		▲K081035HD
Idler Pulley - Grooved	1979642	36341
Idler Pulley - Smooth	2078118	36269
DODGE		
2012-2011		
Cummins 6-Cyl. 6.7 L Diesel		
Ram 4500HD; Ram 5500HD		
Serpentine Belt; W/A.C.	53041138AC	▲K081264HD
Serpentine Belt; W/O A.C.	53041139AC	▲K081102HD
Tensioner Assy.	5086958AA	38285
Idler Pulley	68000833AD	36315
2010-2008		
Cummins 6-Cyl. 6.7 L Diesel		
Ram 4500HD; Ram 5500HD		
Serpentine Belt; W/A.C.	53041138AA	▲K081264HD
Serpentine Belt; W/O A.C.	53041139AA	▲K081102HD
Tensioner Assy.	5086958AA	38285
Idler Pulley	68000833AD	36315
Hose - Upper		22892
Hose - Lower		22893
Hose - Heater Inlet		18774
Hose - Heater Outlet		≈18710
FORD		
2011		
Cummins ISB-07 Diesel		
F650 Super Duty; F750 Super Duty		
Belt - Accessory Drive	BC4Z8620BA	▲K080830HD
Ford V-8 5.4 L		
E450 Super Duty		
Serpentine Belt; W/A.C.	BC2Z8620A	▲K060997HD
Serpentine Belt; W/O A.C.	BC3Z8620D	K060810
Tensioner Assy.	1L2Z6B209AA	38274
Idler Pulley	1L2Z8678AB	38001
Hose - Upper		22315
Hose - Lower		23667
Ford V-8 6.7 L Diesel		
F450 Super Duty; F550 Super Duty		
Serpentine Belt; W/Single Alt.	BC3Z8620C	DK081254
Serpentine Belt; W/Dual Alts.	BC3Z8620B	DK081403
Tensioner Assy.	BC3Z6B209A	39153
Ford V-10 6.8 L		
E450 Super Duty		
Serpentine Belt; W/A.C.	BC2Z8620A	▲K060997HD
Serpentine Belt; W/O A.C.	BC3Z8620D	K060810
Tensioner Assy.	1L2Z6B209AA	38274
Idler Pulley	1L2Z8678AB	38001
Hose - Upper		22315

Application	Mfr. Part No.	Our No.
FORD - Continued		
2011 - Continued		
Ford V-10 6.8 L - Continued		
E450 Super Duty - Continued		
Hose - Lower		23667
2010		
Cummins ISB-07 Diesel		
F650 Super Duty; F750 Super Duty		
Belt - Accessory Drive	BC4Z8620BA	▲K080830HD
Ford V-8 5.4 L		
E450 Super Duty		
Serpentine Belt; Jan. 28, 2010 & Newer;		
W/A.C.	9C2Z8620C	K060995
Serpentine Belt; Jan. 27, 2010 & Older;		
W/A.C.	9C2Z8620A	▲K060994HD
Serpentine Belt; Jan. 28, 2010 & Newer;		
W/O A.C.	9C2Z8620D	K060804
Serpentine Belt; Jan. 27, 2010 & Older;		
W/O A.C.	9C2Z8620B	▲K060806HD
Tensioner Assy.; W/A.C.	1L2Z6B209AA	38274
Tensioner Assy.; W/O A.C.	2L3Z6B209CA	38329
Idler Pulley	1L2Z8678AB	38001
Tensioner Pulley; W/A.C.		38006
Hose - Upper		22316
Hose - Lower; W/O Trlr. Tow. Pkg.		22372
Ford V-8 6.0 L Diesel		
E450 Super Duty		
Serpentine Belt; W/Dual Alts.	8C2Z8620B	K081369HD
Tensioner Assy. - Alt.; W/Dual Alts.	3C3Z6B209BA	38321
Tensioner Assy. - Accessory Drive	3C2Z6B209CA	38257
Idler Pulley - Accessory Drive (Smooth)	3C3Z8678BB	36234
Idler Pulley - Accessory Drive (Grooved)	3C3Z8678EB	36324
Idler Pulley - Alt. Drive	3C2Z8678CB	②36329
Hose - Upper		23077
Hose - Lower		23076
Hose - By Pass		23569
Ford V-8 6.4 L Diesel		
F450 Super Duty; F550 Super Duty		
Serpentine Belt - Accessory Drive;		
W/Single Alt.	7C3Z8620E	▲K080865HD
Serpentine Belt - Accessory Drive;		
W/Dual Alts.	7C3Z8620F	▲K080956HD
Serpentine Belt - A.C.	7C3Z8620C	▲K060393HD
Tensioner Assy. - Accessory Drive	7C3Z6B209A	39051
Tensioner Assy. - A.C.	7C3Z6B209B	39052
Idler Pulley - Alt. Brkt.	3C2Z8678AA	36354
Idler Pulley - P.S. Brkt.	3C3Z8678BB	36234
Hose - Upper		23815
Hose - Lower - Rad. To Pipe		23817
Hose - Lower - Pipe To Eng.		23816
Hose - Reservoir To Rad.		23818
Ford V-10 6.8 L		
E450 Super Duty		
Serpentine Belt; Jan. 28, 2010 & Newer;		
W/A.C.	9C2Z8620C	K060995
Serpentine Belt; Jan. 27, 2010 & Older;		
W/A.C.	9C2Z8620A	▲K060994HD
Serpentine Belt; Jan. 28, 2010 & Newer;		
W/O A.C.	9C2Z8620D	K060804
Serpentine Belt; Jan. 27, 2010 & Older;		
W/O A.C.	9C2Z8620B	▲K060806HD
Tensioner Assy.; W/A.C.	1L2Z6B209AA	38274
Tensioner Assy.; W/O A.C.	2L3Z6B209CA	38329
Idler Pulley	1L2Z8678AB	38001
Tensioner Pulley; W/A.C.		38006
Hose - Upper		22315
F450 Super Duty; F550 Super Duty		
Serpentine Belt; W/A.C.; W/Ambient Air		
Pkg.	2L3Z8620DB	▲K060990HD
Serpentine Belt; W/A.C.; W/O Ambient		
Air Pkg.	7C3Z8620D	▲K061005HD

▲ Standard Belt Available. See Pages 630-631.
≈ Cut to Fit.

② Two Required.

Belts and Coolant Hose for Medium/Heavy-Duty Trucks (1996 and Newer)

 Medium & Heavy-Duty Trucks
(1996 & Newer)

Application	Mfr. Part No.	Our No.
FORD - Continued		
2010 - Continued		
Ford V-10 6.8 L - Continued		
F450 Super Duty; F550 Super Duty		
Serpentine Belt; W/O A.C.	5C3Z8620BA	♣K060806HD
Tensioner Assy.; W/A.C.	1L2Z6B209AA	38274
Tensioner Assy.; W/O A.C.	2L3Z6B209CA	38329
Idler Pulley	1L2Z8678AB	38001
Tensioner Pulley; W/A.C.		38006
2009		
Caterpillar C7 Diesel		
F650 Super Duty; F750 Super Duty		
Belt - Accessory Drive	4C4Z8620GA	♣K080774HD
Cummins ISB-07 Diesel		
F650 Super Duty; F750 Super Duty		
Belt - Fan, Alt. & A.C.	3289963	K080834HD
Tensioner Assy. - Fan, Alt. & A.C.	4937433	38631
Ford V-6 4.5 L Diesel		
LCF		
Belt - W.P., Fan, Alt. & A.C.	1846055C1	♣K081331HD
Tensioner Assy.	1844538C1	38257
Ford V-8 5.4 L		
E450 Super Duty		
Serpentine Belt; W/A.C.	5C3Z8620AA	♣K060997HD
Serpentine Belt; W/O A.C.	2C3Z8620DA	♣K060806HD
Tensioner Assy.; W/A.C.	1L2Z6B209AA	38274
Tensioner Assy.; W/O A.C.	2L3Z6B209CA	38329
Idler Pulley - Smooth	1L3Z8678AB	38001
Idler Pulley - Grooved	1L2Z6C348AA	36157
Tensioner Pulley; W/A.C.		38006
Ford V-8 6.0 L Diesel		
E450 Super Duty		
Serpentine Belt; W/Single Alt.	3C2Z8620AA	♣K081298HD
Serpentine Belt; W/Dual Alts.	8C2Z8620B	K081369HD
Tensioner Assy. - Alt.; W/Dual Alts.	3C3Z6B209BA	38321
Tensioner Assy. - Accessory Drive	3C2Z6B209CA	38257
Idler Pulley - Accessory Drive (Smooth)	3C3Z8678BB	36234
Idler Pulley - Accessory Drive (Grooved)	3C3Z8678EB	36324
Idler Pulley - Alt. Drive	3C2Z8678CB	Ⓣ36329
Hose - Upper		23077
Hose - Lower		23076
Hose - By Pass		23569
Ford V-8 6.4 L Diesel		
F450 Super Duty; F550 Super Duty		
Serpentine Belt - Accessory Drive;		
W/Single Alt.	7C3Z8620E	♣K080865HD
Serpentine Belt - Accessory Drive;		
W/Dual Alts.	7C3Z8620F	♣K080956HD
Serpentine Belt - A.C.	7C3Z8620C	♣K060393HD
Tensioner Assy. - Accessory Drive	7C3Z6B209A	39051
Tensioner Assy. - A.C.	7C3Z6B209B	39052
Idler Pulley - Alt. Brkt.	3C2Z8678AA	36354
Idler Pulley - P.S. Brkt.	3C3Z8678BB	36234
Hose - Upper		23815
Hose - Lower - Rad. To Pipe		23817
Hose - Lower - Pipe To Eng.		23816
Hose - Reservoir To Rad.		23818
Ford V-10 6.8 L		
E450 Super Duty		
Serpentine Belt; W/A.C.	5C3Z8620AA	♣K060997HD
Serpentine Belt; W/O A.C.	2C3Z8620DA	♣K060806HD
Tensioner Assy.; W/A.C.	1L2Z6B209AA	38274
Tensioner Assy.; W/O A.C.	2L3Z6B209CA	38329
Idler Pulley - Smooth	1L3Z8678AB	38001
Idler Pulley - Grooved	1L2Z6C348AA	36157
Tensioner Pulley; W/A.C.		38006
Hose - Upper		22315
F450 Super Duty; F550 Super Duty		
Serpentine Belt; W/A.C.; W/Ambient Air		
Pkg.	2L3Z8620DB	♣K060990HD

♣ Standard Belt Available. See Pages 630-631.

Application	Mfr. Part No.	Our No.
FORD - Continued		
2009 - Continued		
Ford V-10 6.8 L - Continued		
F450 Super Duty; F550 Super Duty - Continued		
Serpentine Belt; W/A.C.; W/O Ambient		
Air Pkg.	7C3Z8620D	♣K061005HD
Serpentine Belt; W/O A.C.	5C3Z8620BA	♣K060806HD
Tensioner Assy.; W/A.C.	1L2Z6B209AA	38274
Tensioner Assy.; W/O A.C.	2L3Z6B209CA	38329
Idler Pulley	1L2Z8678AB	38001
Tensioner Pulley; W/A.C.		38006
2008		
Caterpillar C7 Diesel		
F650 Super Duty; F750 Super Duty		
Belt - Accessory Drive	4C4Z8620GA	♣K080774HD
Cummins ISB-07 Diesel		
F650 Super Duty; F750 Super Duty		
Belt - Fan, Alt. & A.C.	3289963	K080834HD
Tensioner Assy. - Fan, Alt. & A.C.	4937433	38631
Ford V-6 4.5 L Diesel		
LCF		
Belt - W.P., Fan, Alt. & A.C.	1846055C1	♣K081331HD
Tensioner Assy.	1844538C1	38257
Ford V-8 5.4 L		
E450 Super Duty		
Serpentine Belt; W/A.C.	5C3Z8620AA	♣K060997HD
Serpentine Belt; W/O A.C.	5C3Z8620BA	♣K060806HD
Tensioner Assy.; W/A.C.	1L2Z6B209AA	38274
Tensioner Assy.; W/O A.C.	2L3Z6B209CA	38329
Idler Pulley - Smooth	1L2Z8678AB	38001
Idler Pulley - Grooved	1L2Z6C348AA	36157
Tensioner Pulley; W/A.C.		38006
Idler Pulley	1L2E19A216AC	38001
Hose - Upper		23273
Ford V-8 6.0 L Diesel		
E450 Super Duty		
Serpentine Belt; W/Single Alt.	3C2Z8620AA	♣K081298HD
Serpentine Belt - Accessory Drive;		
W/Dual Alts.	8C2Z8620B	K081369HD
Tensioner Assy. - Alt.; W/Dual Alts.	3C3Z6B209BA	38321
Tensioner Assy. - Accessory Drive	3C2Z6B209CA	38257
Idler Pulley - Accessory Drive (Smooth)	3C3Z8678BB	36234
Idler Pulley - Accessory Drive (Grooved)	3C3Z8678EB	36324
Idler Pulley - Alt. Drive	3C2Z8678CB	Ⓣ36329
Hose - Upper		23077
Hose - Lower		23076
Hose - By Pass		23569
Ford V-8 6.4 L Diesel		
F450 Super Duty; F550 Super Duty		
Serpentine Belt - Accessory Drive;		
W/Single Alt.	7C3Z8620E	♣K080865HD
Serpentine Belt - Accessory Drive;		
W/Dual Alts.	7C3Z8620F	♣K080956HD
Serpentine Belt - A.C.	7C3Z8620C	♣K060393HD
Tensioner Assy. - Accessory Drive	7C3Z6B209A	39051
Tensioner Assy. - A.C.	7C3Z6B209B	39052
Idler Pulley - Alt. Brkt.	3C2Z8678AA	36354
Idler Pulley - P.S. Brkt.	3C3Z8678BB	36234
Hose - Upper		23815
Hose - Lower - Rad. To Pipe		23817
Hose - Lower - Pipe To W.P.		23816
Hose - Reservoir To Rad.		23818
Ford V-10 6.8 L		
E450 Super Duty		
Serpentine Belt; W/A.C.	5C3Z8620AA	♣K060997HD
Serpentine Belt; W/O A.C.	2C3Z8620DA	♣K060806HD
Tensioner Assy.; W/A.C.	1L2Z6B209AA	38274
Tensioner Assy.; W/O A.C.	2L3Z6B209CA	38329
Idler Pulley - Smooth	1L3Z8678AB	38001
Idler Pulley - Grooved	1L2Z6C348AA	36157
Tensioner Pulley; W/A.C.		38006
Hose - Upper		22315

Ⓣ Two Required.

Belts and Coolant Hose for Medium/Heavy-Duty Trucks (1996 and Newer)

Medium & Heavy-Duty Trucks
(1996 & Newer)

Application	Mfr. Part No.	Our No.
FORD - Continued		
2008 - Continued		
Ford V-10 6.8 L - Continued		
E450 Super Duty - Continued		
Tensioner Pulley; W/A.C.		38006
Hose - Upper		22315
F450 Super Duty		
Serpentine Belt; W/A.C.; W/Ambient Air		
Pkg.	2L3Z8620DB	▲K060990HD
Serpentine Belt; W/A.C.; W/O Ambient		
Air Pkg.	7C3Z8620D	▲K061005HD
Serpentine Belt; W/O A.C.	5C3Z8620BA	▲K060806HD
Tensioner Assy.; W/A.C.	1L2Z6B209AA	38274
Tensioner Assy.; W/O A.C.	2L3Z6B209CA	38329
Idler Pulley; W/A.C.	1L2Z8678AB	38001
Tensioner Pulley		38006
F550 Super Duty		
Serpentine Belt; W/A.C.; W/Ambient Air		
Pkg.	2L3Z8620DB	▲K060990HD
Serpentine Belt; W/A.C.; W/O Ambient		
Air Pkg.	7C3Z8620D	▲K061005HD
Serpentine Belt; W/O A.C.	5C3Z8620BA	▲K060806HD
Tensioner Assy.; W/A.C.	1L2Z6B209AA	38274
Tensioner Assy.; W/O A.C.	2L3Z6B209CA	38329
Idler Pulley; W/A.C.	1L2Z8678AB	38001
Tensioner Pulley; W/A.C.		38006
2007		
Caterpillar C7 Diesel		
F650 Super Duty; F750 Super Duty		
Belt - Fan, Alt. & A.C.	3586467C1	▲K080774HD
Tensioner Assy. - Fan, Alt. & A.C.	2201209	38550
Hose - Upper - Pipe To Eng.		21571
Hose - Upper - Pipe To Rad.; (2" I.D.)		24232
Cummins ISB Diesel		
F650 Super Duty; F750 Super Duty		
Belt - W.P., Fan, Alt. & A.C.	3289809	▲K080797HD
Tensioner Assy. - W.P., Alt. & A.C.	3976833	38517
Hose - Upper - Eng. To Pipe		20206
Hose - Upper - Rad. To Pipe; (2 1/4" I.D.)		24236
Ford V-6 4.5 L Diesel		
LCF		
Belt - W.P., Fan, Alt. & A.C.	1846055C1	▲K081331HD
Tensioner Assy.	1844538C1	38257
Ford V-8 5.4 L		
E450 Super Duty		
Serpentine Belt; W/A.C.	5C3Z8620AA	▲K060997HD
Serpentine Belt; W/O A.C.	5C3Z8620BA	▲K060806HD
Tensioner Assy.; W/A.C.	1L2Z6B209AA	38274
Tensioner Assy.; W/O A.C.	2L3Z6B209CA	38329
Idler Pulley - Smooth	1L2Z8678AB	38001
Idler Pulley - Grooved	1L2Z6C348AA	36157
Tensioner Pulley; W/A.C.		38006
Hose - Upper		23273
Ford V-8 6.0 L Diesel		
E450 Super Duty		
Serpentine Belt - Alt.; W/Dual Alts.	3C2Z8620HB	▲K060658HD
Serpentine Belt - Accessory Drive;		
W/Single Alt.	3C2Z8620AA	▲K081298HD
Serpentine Belt - Accessory Drive;		
W/Dual Alts.	3C2Z8620BB	▲K081362HD
Tensioner Assy. - Alt.; W/Dual Alts.	3C3Z6B209BA	38321
Tensioner Assy. - Accessory Drive	3C2Z6B209CA	38257
Idler Pulley - Accessory Drive (Smooth)	3C3Z8678BB	36234
Idler Pulley - Accessory Drive (Grooved)	3C3Z8678EB	36324
Idler Pulley - Alt. Drive	3C2Z8678CB	②36329
Hose - Upper		23077
Hose - Lower		23076
Hose - By Pass		23569
F450 Super Duty; F550 Super Duty		
Belt - Fan, Alt., P.S. & A.C.; W/Single		
Alt.	3C3E8620DA	▲K081265HD

Application	Mfr. Part No.	Our No.
FORD - Continued		
2007 - Continued		
Ford V-8 6.0 L Diesel - Continued		
F450 Super Duty; F550 Super Duty - Continued		
Belt - Fan, Alt., P.S. & A.C.; W/Dual Alts.	3C3Z8620BC	▲K081325HD
Belt - Alt.; W/Dual Alts.	3C2Z8620HA	▲K060658HD
Tensioner Assy. - Alt.; W/Dual Alts.	3C3Z6B209BA	38321
Tensioner Assy. - Accessory Drive	3C2Z6B209CA	38257
Idler Pulley - Accessory Drive (Smooth)	3C3Z8678BB	36234
Idler Pulley - Accessory Drive (Grooved)	3C3Z8678EB	36324
Idler Pulley - Alt. Drive	3C2Z8678CB	②36329
Hose - Upper		22779
Hose - Lower; W/Twin I-Beam Suspension		22780
Hose - Lower; W/Monobeam Suspension		23513
Hose - Reservoir To Eng.		22953
F650 Super Duty; F750 Super Duty		
Belt - Fan, Alt. & A.C.	1839963C1	▲K080830HD
Belt - Fan & Air Compr.	1843218C1	▲K060509HD
Tensioner Assy. - Fan, Alt. & A.C.	1833688C2	38556
Hose - Upper - Eng. To Rad.		22774
Hose - Lower - Eng. To Rad.		22775
Ford V-10 6.8 L		
E450 Super Duty		
Serpentine Belt; W/A.C.	5C3Z8620AA	▲K060997HD
Serpentine Belt; W/O A.C.	2C3Z8620DA	▲K060806HD
Tensioner Assy.; W/A.C.	1L2Z6B209AA	38274
Tensioner Assy.; W/O A.C.	2L3Z6B209CA	38329
Idler Pulley - Smooth	1L3Z8678AB	38001
Idler Pulley - Grooved	1L2Z6C348AA	36157
Tensioner Pulley; W/A.C.		38006
Hose - Upper		22315
F450 Super Duty; F550 Super Duty		
Serpentine Belt; W/A.C.	5C3Z8620AA	▲K060997HD
Serpentine Belt; W/O A.C.	5C3Z8620BA	▲K060806HD
Tensioner Assy.; W/O A.C.	2L3Z6B209CA	38329
Idler Pulley - Smooth	1L3Z8678AB	38001
Idler Pulley - Grooved	1L2Z6C348AA	36157
Tensioner Pulley; W/A.C.		38006
Hose - Upper		23275
Hose - Lower		23266
2006		
Caterpillar C7 Diesel		
F650 Super Duty; F750 Super Duty		
Belt - Fan, Alt. & A.C.	3586467C1	▲K080774HD
Tensioner Assy. - Fan, Alt. & A.C.	2201209	38550
Hose - Upper - Pipe To Eng.		21571
Hose - Upper - Pipe To Rad.; (2" I.D.)		24232
Cummins ISB Diesel		
F650 Super Duty; F750 Super Duty		
Belt - W.P., Fan, Alt. & A.C.	3289809	▲K080797HD
Tensioner Assy. - W.P., Alt. & A.C.	3957433	38517
Hose - Upper - Eng. To Pipe		20206
Hose - Upper - Rad. To Pipe; (2 1/4" I.D.)		24236
Hose - Lower - Rad. To Pipe		≧20611
Ford V-6 4.5 L Diesel		
LCF		
Belt - W.P., Fan, Alt. & A.C.	1846055C1	▲K081331HD
Tensioner Assy.	1844538C1	38257
Ford V-8 5.4 L		
E450 Super Duty		
Serpentine Belt; W/A.C.	5C3Z8620AA	▲K060997HD
Serpentine Belt; W/O A.C.	5C3Z8620BA	▲K060806HD
Tensioner Assy.; W/A.C.	1L2Z6B209AA	38274
Tensioner Assy.; W/O A.C.	2L3Z6B209CA	38329
Idler Pulley - Smooth	1L2Z8678AB	38001
Idler Pulley - Grooved	1L2Z6C348AA	36157
Tensioner Pulley; W/A.C.		38006
Hose - Upper		23273

▲ Standard Belt Available. See Pages 630-631.
≧ Cut to Fit.

② Two Required.

Belts and Coolant Hose for Medium/Heavy-Duty Trucks (1996 and Newer)

 Medium & Heavy-Duty Trucks
(1996 & Newer)

Application	Mfr. Part No.	Our No.
FORD - Continued		
2006 - Continued		
Ford V-8 6.0 L Diesel		
E450 Super Duty		
Belt - Fan, Alt., P.S. & A.C.: W/Single Alt.	3C2E8620AC	▲K081298HD
Belt - Fan, Alt., P.S. & A.C.: W/Dual Alts.	3C2Z8620BB	▲K081362HD
Belt - Alt.: W/Dual Alts.	3C2Z8620HB	▲K060658HD
Tensioner Assy. - Alt.: W/Dual Alts.	3C3Z6B209BA	38321
Tensioner Assy. - Accessory Drive	3C2Z6B209CA	38257
Idler Pulley - Accessory Drive (Smooth)	3C3Z8678BB	36234
Idler Pulley - Accessory Drive (Grooved)	3C3Z8678EB	36324
Idler Pulley - Alt. Drive	3C2Z8678CB	②36329
Hose - Upper - Eng. To Rad.		23077
Hose - Lower - Eng. To Rad.		23076
Hose - By Pass		23569
F450 Super Duty		
Belt - Fan, Alt., P.S. & A.C.: W/Single Alt.	3C3E8620DA	▲K081265HD
Belt - Fan, Alt., P.S. & A.C.: W/Dual Alts.	3C3Z8620BC	▲K081325HD
Belt - Alt.: W/Dual Alts.	3C2Z8620HA	▲K060658HD
Tensioner Assy. - Alt.: W/Dual Alts.	3C3Z6B209BA	38321
Tensioner Assy. - Accessory Drive	3C2Z6B209CA	38257
Idler Pulley - Accessory Drive (Smooth)	3C3Z8678BB	36234
Idler Pulley - Accessory Drive (Grooved)	3C3Z8678EB	36324
Idler Pulley - Alt. Drive	3C2Z8678CB	②36329
Hose - Upper - Eng. To Rad.		22779
Hose - Lower - Eng. To Rad.: W/Twin I-Beam Suspension		22780
Hose - Lower: W/Monobeam Suspension		23513
Hose - Heater To Pipe-1		19832
Hose - Heater To Pipe-2		19834
Hose - Pipe-2 To Tee		19833
Hose - Reservoir To Eng.		22953
F550 Super Duty		
Belt - Fan, Alt., P.S. & A.C.: W/Single Alt.	3C3E8620DA	▲K081265HD
Belt - Fan, Alt., P.S. & A.C.: W/Dual Alts.	3C3Z8620BC	▲K081325HD
Belt - Alt.: W/Dual Alts.	3C2Z8620HA	▲K060658HD
Tensioner Assy. - Alt.: W/Dual Alts.	3C3Z6B209BA	38321
Tensioner Assy. - Accessory Drive	3C2Z6B209CA	38257
Idler Pulley - Accessory Drive (Smooth)	3C3Z8678BB	36234
Idler Pulley - Accessory Drive (Grooved)	3C3Z8678EB	36324
Idler Pulley - Alt. Drive	3C2Z8678CB	②36329
Hose - Upper - Eng. To Rad.		22779
Hose - Lower - Eng. To Rad.: W/Twin I-Beam Suspension		22780
Hose - Lower: W/Monobeam Suspension		23513
F650 Super Duty; F750 Super Duty		
Belt - Fan, Alt. & A.C.	1839963C1	▲K080830HD
Belt - Fan & Air Compr.	1843218C1	▲K060509HD
Tensioner Assy. - Fan, Alt. & A.C.	1833688C2	38556
Hose - Upper - Eng. To Rad.		22774
Hose - Lower - Eng. To Rad.		22775
Ford V-10 6.8 L		
E450 Super Duty		
Serpentine Belt; W/A.C.	2C2Z8620DB	K060984
Serpentine Belt; W/O A.C.	2C3Z8620DA	▲K060806HD
Belt - Fan, Alt., P.S. & A.C.	5C2E8620AA	K060984
Tensioner Assy.; W/O A.C.	2L3Z6B209CA	38329
Tensioner Assy.; W/A.C.	1L2Z6B209AA	38274
Idler Pulley - Smooth	1L3Z8678AB	38001
Idler Pulley - Grooved	1L2Z6C348AA	36157
Tensioner Pulley; W/A.C.		38006
Hose - Upper		22315
F450 Super Duty; F550 Super Duty		
Serpentine Belt; W/A.C.	5C3Z8620AA	▲K060997HD
Serpentine Belt; W/O A.C.	2C3Z8620DA	▲K060806HD
Tensioner Assy.; W/A.C.	1L2Z6B209AA	38274
Tensioner Assy.; W/O A.C.	2L3Z6B209CA	38329
Idler Pulley - Smooth	1L3Z8678AB	38001
Idler Pulley - Grooved	1L2Z6C348AA	36157
Tensioner Pulley; W/A.C.		38006
Hose - Upper		23275
Hose - Lower		23266

 ▲ Standard Belt Available. See Pages 630-631.
 ≡ Cut to Fit.

Application	Mfr. Part No.	Our No.
FORD - Continued		
2005		
Caterpillar C7 Diesel		
F650 Super Duty		
Belt - Fan, Alt. & A.C.	1514968C1	▲K080774HD
Tensioner Assy. - Fan, Alt. & A.C.	2201209	38550
Hose - Upper - Pipe To Eng.		21571
Hose - Upper - Pipe To Rad.; (2" I.D.)		24232
F750 Super Duty		
Belt - Fan, Alt. & A.C.; W/O P.T.O.	1514968C1	▲K080774HD
Belt - Fan, Alt. & A.C.; W/P.T.O.	4C4Z8620EA	▲K080839HD
Tensioner Assy. - Fan, Alt. & A.C.	2201209	38550
Hose - Upper - Pipe To Eng.		21571
Hose - Upper - Pipe To Rad.; (2" I.D.)		24232
Cummins ISB Diesel		
F650 Super Duty; F750 Super Duty		
Belt - W.P., Fan, Alt. & A.C.	3289809	▲K080797HD
Tensioner Assy. - W.P., Alt. & A.C.	3957433	38517
Hose - Upper - Eng. To Pipe		20206
Hose - Upper - Rad. To Pipe; (2 1/4" I.D.)		24236
Hose - Lower - Rad. To Pipe		≡20611
Ford V-8 5.4 L		
E450 Super Duty		
Serpentine Belt; W/A.C.	2C2Z8620DB	K060984
Serpentine Belt; W/O A.C.	2C3Z8620DA	▲K060806HD
Tensioner Assy.; W/O A.C.	2L3Z6B209CA	38329
Tensioner Pulley; W/A.C.		38006
Ford V-8 6.0 L Diesel		
E450 Super Duty		
Belt - Fan, Alt., P.S. & A.C.: W/Single Alt.	3C2E8620AC	▲K081298HD
Belt - Fan, Alt., P.S. & A.C.: W/Dual Alts.	3C2Z8620BB	▲K081362HD
Belt - Alt.: W/Dual Alts.	3C2Z8620HB	▲K060658HD
Tensioner Assy. - Alt.: W/Dual Alts.	3C3Z6B209BA	38321
Tensioner Assy. - Accessory Drive	3C2Z6B209CA	38257
Idler Pulley - Accessory Drive (Smooth)	3C3Z8678BB	36234
Idler Pulley - Accessory Drive (Grooved)	3C3Z8678EB	36324
Idler Pulley - Alt. Drive	3C2Z8678CB	②36329
Hose - Upper - Eng. To Rad.		23077
Hose - Lower - Eng. To Rad.		23076
Hose - By Pass		23569
F450 Super Duty; F550 Super Duty		
Belt - Fan, Alt., P.S. & A.C.: W/Single Alt.	3C3E8620DA	▲K081265HD
Belt - Fan, Alt., P.S. & A.C.: W/Dual Alts.	3C3Z8620BC	▲K081325HD
Belt - Alt.: W/Dual Alts.	3C2Z8620HA	▲K060658HD
Tensioner Assy. - Alt.: W/Dual Alts.	3C3Z6B209BA	38321
Tensioner Assy. - Accessory Drive	3C2Z6B209CA	38257
Idler Pulley - Accessory Drive (Smooth)	3C3Z8678BB	36234
Idler Pulley - Accessory Drive (Grooved)	3C3Z8678EB	36324
Idler Pulley - Alt. Drive	3C2Z8678CB	②36329
Hose - Upper - Eng. To Rad.		22779
Hose - Lower - Eng. To Rad.: W/Twin I-Beam Suspension		22780
Hose - Lower: W/Monobeam Suspension		23513
Hose - Heater To Pipe-1		19832
Hose - Heater To Pipe-2		19834
Hose - Pipe-2 To Tee		19833
Hose - Reservoir To Eng.		22953
F650 Super Duty; F750 Super Duty		
Belt - Fan, Alt. & A.C.	1839963C1	▲K080830HD
Tensioner Assy. - Fan, Alt. & A.C.	1833688C1	38556
Hose - Upper - Eng. To Rad.		22774
Hose - Lower - Eng. To Rad.		22775
Ford V-10 6.8 L		
E450 Super Duty		
Belt - Fan, Alt., P.S. & A.C.	2C2E8620DC	K060984
Tensioner Assy.; W/A.C.	1L3Z6B209AA	38133
Tensioner Assy.; W/O A.C.	F75Z6B209EA	38330
Idler Pulley	1L2Z8678AB	38001
Tensioner Pulley; W/A.C.		38006

② Two Required.

Belts and Coolant Hose for Medium/Heavy-Duty Trucks (1996 and Newer)

Medium & Heavy-Duty Trucks
(1996 & Newer)

Application	Mfr. Part No.	Our No.
FORD - Continued		
2005 - Continued		
Ford V-10 6.8 L - Continued		
F450 Super Duty; F550 Super Duty		
Serpentine Belt; W/A.C.	2C3Z8620EB	♣K061000HD
Serpentine Belt; W/O A.C.	2C3Z8620DA	♣K060806HD
Tensioner Assy.; W/A.C.	1L2Z6B209AA	38274
Tensioner Assy.; W/O A.C.	2L3Z6B209CA	38329
Idler Pulley - Smooth	1L3Z8678AB	38001
Idler Pulley - Grooved	1L2Z6C348AA	36157
Tensioner Pulley; W/A.C.		38006
Hose - Upper		22431
Hose - Lower		22432
2004		
Caterpillar 3126 Diesel		
F650 Super Duty; F750 Super Duty		
Belt - Fan, Alt. & A.C.	YC358620BA	♣K080816HD
Tensioner Assy. - Fan, Alt. & A.C.	1352142	38506
Tensioner Pulley - Fan, Alt. & A.C.	1352142	36091
Hose - Upper - Eng. To Pipe		20611
Hose - Upper - Pipe To Rad.; (2" I.D.)		24232
Hose - Lower - Eng. To Pipe		20611
Hose - Lower - Pipe To Rad.; (2" I.D.)		24232
Caterpillar C7 Diesel		
F650 Super Duty; F750 Super Duty		
Belt - Fan, Alt. & A.C.	1514968C1	♣K080774HD
Tensioner Assy. - Fan, Alt. & A.C.	2201209	38550
Hose - Upper - Pipe To Eng.		21571
Hose - Upper - Pipe To Rad.; (2" I.D.)		24232
Cummins ISB Diesel		
F650 Super Duty; F750 Super Duty		
Belt - Fan, W.P. & Alt.	3943214	♣K080726HD
Belt - Fan & A.C.	YC3Z8620AB	♣9375HD
Tensioner Assy. - Fan, W.P. & Alt.	3936213	38516
Tensioner Pulley - Fan, W.P. & Alt.	3936213	36093
Hose - Upper - Eng. To Pipe; (2" I.D.)		24232
Hose - Upper - Pipe To Rad.; (2" I.D.)		24232
Hose - Lower - Eng. To Pipe; (2" I.D.)		24232
Hose - Lower - Pipe To Rad.; (2" I.D.)		24232
Ford V-8 5.4 L		
E450 Super Duty		
Serpentine Belt; W/A.C.	2C2Z8620DB	K060984
Serpentine Belt; W/O A.C.	2C3Z8620DA	♣K060806HD
Tensioner Assy.	1L2Z6B209AA	38274
Tensioner Pulley; W/A.C.		38006
Hose Kit - DPFE		27079
Ford V-8 6.0 L Diesel		
E450 Super Duty		
Belt - Fan, Alt., P.S. & A.C.; W/Single		
Alt.	3C2E8620AC	♣K081298HD
Belt - Fan, Alt., P.S. & A.C.; W/Dual Alts.	3C2Z8620BB	♣K081362HD
Belt - Alt.; W/Dual Alts.	3C2Z8620HB	♣K060658HD
Tensioner Assy. - Alt.; W/Dual Alts.	3C3Z6B209BA	38321
Tensioner Assy. - Accessory Drive	3C2Z6B209CA	38257
Idler Pulley - Accessory Drive (Smooth)	3C3Z8678BB	36234
Idler Pulley - Accessory Drive (Grooved)	3C3Z8678EB	36324
Idler Pulley - Alt. Drive	3C2Z8678CB	②36329
F450 Super Duty; F550 Super Duty		
Belt - Fan, Alt., P.S. & A.C.; W/Single		
Alt.	3C3E8620DA	♣K081265HD
Belt - Fan, Alt., P.S. & A.C.; W/Dual Alts.	3C3Z8620BC	♣K081325HD
Belt - Alt.; W/Dual Alts.	3C2Z8620HA	♣K060658HD
Tensioner Assy. - Alt.; W/Dual Alts.	3C3Z6B209BA	38321
Tensioner Assy. - Accessory Drive	3C2Z6B209CA	38257
Idler Pulley - Accessory Drive (Smooth)	3C3Z8678BB	36234
Idler Pulley - Accessory Drive (Grooved)	3C3Z8678EB	36324
Idler Pulley - Alt. Drive	3C2Z8678CB	②36329
Hose - Upper - Eng. To Rad.		22779
Hose - Lower - Eng. To Rad.		22780
Hose - Heater To Pipe-1		19832
Hose - Heater To Pipe-2		19834

Application	Mfr. Part No.	Our No.
FORD - Continued		
2004 - Continued		
Ford V-8 6.0 L Diesel - Continued		
F450 Super Duty; F550 Super Duty - Continued		
Hose - Pipe-2 To Tee		19833
Hose - Reservoir To Eng.		22953
F650 Super Duty; F750 Super Duty		
Belt - Fan, Alt. & A.C.	1839963C1	♣K080830HD
Tensioner Assy. - Fan, Alt. & A.C.	1833688C1	38556
Hose - Upper - Eng. To Rad.		22774
Hose - Lower - Eng. To Rad.		22775
Ford V-8 7.3 L Diesel		
F550 Super Duty		
Serpentine Belt; W/O Ambulance Prep.		
Pkg.; W/Single Alt.; W/122.2" Belt		
O.C.	1C2Z8620LA	♣K081223HD
Serpentine Belt; W/121.3" Belt O.C.	1C2Z8620NA	♣K081213HD
Serpentine Belt; W/Ambulance Prep.		
Pkg.; W/Dual Alts.	F8TZ8620GC	♣K081377HD
Tensioner Assy.	F8TZ6B209BA	38191
Tensioner Pulley - Smooth		38028
Tensioner Pulley - Grooved		38053
Idler Pulley - Smooth	F8TZ8678FA	36234
Hose - Upper; Preferred Hose; Upper hose routes around serpentine belt		22433
Hose - Upper; Optional Hose; Routes through serpentine belt		22542
Hose - Lower		22690
Hose - Heater To Eng.		19200
Hose - Heater To W.P.		19201
Hose - Rad. To Reservoir; W/3/8" I.D. Hose(3/8" x 16")		28409
Hose - Reservoir To Rad.; W/1" I.D. Hose		19812
Hose Connector - Heater Hose		②28500
F650 Super Duty; F750 Super Duty		
Belt - W.P., Fan & Alt.; W/Air Brakes	YC3Z8620FA	♣K081153HD
Belt - W.P., Fan & Alt.; W/Hyd. Brakes .	YC3Z8620HA	♣K080820HD
Belt - W.P., Fan, Alt. & A.C.; W/Air		
Brakes	YC3Z8620EA	♣K081223HD
Belt - W.P., Fan, Alt. & A.C.; W/Hyd.		
Brakes	YC3Z8620GA	♣K080893HD
Tensioner Assy.	F8TZ6B209BA	38191
Tensioner Pulley - Smooth		38028
Tensioner Pulley - Grooved		38053
Hose - Upper - Eng. To Pipe		≈20611
Hose - Upper - Pipe To Rad.; (2" I.D.)		24232
Hose - Lower - Eng. To Pipe		≈20611
Hose - Lower - Pipe To Rad.; (2" I.D.)		24232
Ford V-10 6.8 L		
E450 Super Duty		
Belt - Fan, Alt., P.S. & A.C.	2C2E8620DC	K060984
Tensioner Assy.; W/A.C.	1L3Z6B209AA	38133
Tensioner Assy.; W/O A.C.	F75Z6B209EA	38330
Idler Pulley	1L2Z8678AB	38001
Tensioner Pulley; W/A.C.		38006
Hose Kit - DPFE		27079
F450 Super Duty; F550 Super Duty		
Serpentine Belt; W/A.C.	2C3Z8620EB	♣K061000HD
Serpentine Belt; W/O A.C.	2C3Z8620DA	♣K060806HD
Tensioner Assy.; W/A.C.	1L2Z6B209AA	38274
Tensioner Assy.; W/O A.C.	2L3Z6B209CA	38329
Idler Pulley - Smooth	1L3Z8678AB	38001
Idler Pulley - Grooved	1L2Z6C348AA	36157
Tensioner Pulley; W/A.C.		38006
Hose Kit - DPFE		27079
Hose - Upper		22431
Hose - Lower		22432
Hose - Heater To Intake Manifold; Re-use existing flow restrictor.		19218
Hose - Heater To Pipe-1		19306
Hose - Reservoir To Rad.; W/1" I.D. Hose		19812

♣ Standard Belt Available. See Pages 630-631.

② Two Required.

≈ Cut to Fit.

Belts and Coolant Hose for Medium/Heavy-Duty Trucks (1996 and Newer)

 Medium & Heavy-Duty Trucks
(1996 & Newer)

Application	Mfr. Part No.	Our No.	Application	Mfr. Part No.	Our No.
FORD - Continued			FORD - Continued		
2003			2003 - Continued		
Caterpillar 3126 Diesel			Ford V-8 7.3 L Diesel - Continued		
F650 Super Duty; F750 Super Duty			E450 Super Duty - Continued		
Belt - Fan, Alt. & A.C.	YC358620BA	▲K080816HD	Hose - Upper		23308
Tensioner Assy. - Fan, Alt. & A.C.	1352142	38506	Hose - Lower		23073
Tensioner Pulley - Fan, Alt. & A.C.	1352142	36091	E550 Super Duty		
Hose - Upper - Eng. To Pipe		20611	Belt - W.P., Fan, Alt., A.C. & Air Compr. F8UE8620DB		▲K081213HD
Hose - Upper - Pipe To Rad.; (2" I.D.)		24232	Belt - W.P., Fan, Alt. & A.C.	2C2Z8620GA	▲K081223HD
Hose - Lower - Eng. To Pipe		20611	Tensioner Pulley - Smooth		38028
Hose - Lower - Pipe To Rad.; (2" I.D.)		24232	Tensioner Pulley - Grooved		38053
Cummins ISB Diesel			Hose - Upper		23308
F650 Super Duty; F750 Super Duty			Hose - Lower		23073
Belt - Fan, W.P. & Alt.	3943214	▲K080726HD	F450 Super Duty; F550 Super Duty		
Belt - Fan & A.C.	YC3Z8620AB	▲9375HD	Serpentine Belt; W/O Ambulance Prep.		
Tensioner Assy. - Fan, W.P. & Alt.	3936213	38516	Pkg.; W/Single Alt.; W/122.2" Belt		
Tensioner Pulley - Fan, W.P. & Alt.	3936213	36093	O.C.	1C2Z8620LA	▲K081223HD
Hose - Upper - Eng. To Pipe; (2" I.D.)		24232	Serpentine Belt; W/121.3" Belt O.C.	1C2Z8620NA	▲K081213HD
Hose - Upper - Pipe To Rad.; (2" I.D.)		24232	Serpentine Belt; W/Ambulance Prep.		
Hose - Lower - Eng. To Pipe; (2" I.D.)		24232	Pkg.; W/Dual Alts.	F8TZ8620GC	▲K081377HD
Hose - Lower - Pipe To Rad.; (2" I.D.)		24232	Tensioner Assy.	F8TZ6B209BA	38191
Ford V-8 5.4 L			Tensioner Pulley - Smooth		38028
E450 Super Duty			Tensioner Pulley - Grooved		38053
Serpentine Belt; W/A.C.	2C2Z8620DB	K060984	Idle Pulley - Smooth	F8TZ8678FA	36234
Serpentine Belt; W/O A.C.	2C3Z8620DA	▲K060806HD	Hose - Upper; Preferred Hose; Upper hose routes around		
Tensioner Assy.	1L2Z6B209AA	38274	serpentine belt		22433
Tensioner Pulley; W/A.C.		38006	Hose - Upper; Optional Hose; Routes through serpentine		
Hose Kit - DPFE		27079	belt		22542
Hose - Upper		22315	Hose - Lower		22690
Hose - Lower		22297	Hose - Heater To Eng.		19200
Ford V-8 6.0 L Diesel			Hose - Heater To W.P.		19201
E450 Super Duty			Hose - Rad. To Reservoir; W/3/8" I.D. Hose(3/8" x 16")		28409
Belt - Fan, Alt., P.S. & A.C.; W/Single			Hose - Reservoir To Rad.; W/1" I.D. Hose		19812
Alt.	3C2E8620AC	▲K081298HD	Hose Connector - Heater Hose		Ⓣ28500
Belt - Fan, Alt., P.S. & A.C.; W/Dual Alts.	3C2Z8620BB	▲K081362HD	F650 Super Duty; F750 Super Duty		
Belt - Alt.; W/Dual Alts.	3C2Z8620HB	▲K060658HD	Belt - W.P., Fan & Alt.; W/Air Brakes	YC3Z8620FA	▲K081153HD
Tensioner Assy. - Alt.; W/Dual Alts.	3C3Z6B209BA	38321	Belt - W.P., Fan & Alt.; W/Hyd. Brakes .	YC3Z8620HA	▲K080820HD
Tensioner Assy. - Accessory Drive	3C2Z6B209CA	38257	Belt - W.P., Fan, Alt. & A.C.; W/Air		
Idle Pulley - Accessory Drive (Smooth)	3C3Z8678BB	36234	Brakes	YC3Z8620EA	▲K081223HD
Idle Pulley - Accessory Drive (Grooved)	3C3Z8678EB	36324	Belt - W.P., Fan, Alt. & A.C.; W/Hyd.		
Idle Pulley - Alt. Drive	3C2Z8678CB	Ⓣ36329	Brakes	YC3Z8620GA	▲K080893HD
F450 Super Duty; F550 Super Duty			Tensioner Assy.	F8TZ6B209BA	38191
Belt - Fan, Alt., P.S. & A.C.; W/Single			Tensioner Pulley - Smooth		38028
Alt.	3C3E8620DA	▲K081265HD	Tensioner Pulley - Grooved		38053
Belt - Fan, Alt., P.S. & A.C.; W/Dual Alts.	3C3Z8620BC	▲K081325HD	Hose - Upper - Eng. To Pipe		Ⓢ20611
Belt - Alt.; W/Dual Alts.	3C2Z8620HA	▲K060658HD	Hose - Upper - Pipe To Rad.; (2" I.D.)		24232
Tensioner Assy. - Alt.; W/Dual Alts.	3C3Z6B209BA	38321	Hose - Lower - Eng. To Pipe		Ⓢ20611
Tensioner Assy. - Accessory Drive	3C2Z6B209CA	38257	Hose - Lower - Pipe To Rad.; (2" I.D.)		24232
Idle Pulley - Accessory Drive (Smooth)	3C3Z8678BB	36234	Ford V-10 6.8 L		
Idle Pulley - Accessory Drive (Grooved)	3C3Z8678EB	36324	E450 Super Duty; E550 Super Duty		
Idle Pulley - Alt. Drive	3C2Z8678CB	Ⓣ36329	Serpentine Belt; W/A.C.	2C2Z8620DB	K060984
Hose - Upper - Eng. To Rad.		22779	Serpentine Belt; W/O A.C.	2C3Z8620DA	▲K060806HD
Hose - Lower - Eng. To Rad.		22780	Tensioner Assy.; W/A.C.	1L3Z6B209AA	38133
Hose - Heater To Pipe-1		19832	Tensioner Assy.; W/O A.C.	F75Z6B209EA	38330
Hose - Heater To Pipe-2		19834	Idle Pulley	1L2Z8678AB	38001
Hose - Pipe-2 To Tee		19833	Tensioner Pulley; W/A.C.		38006
Hose - Reservoir To Eng.		22953	Hose Kit - DPFE		27079
F650 Super Duty; F750 Super Duty			Hose - Upper		22315
Belt - Fan, Alt. & A.C.	1839963C1	▲K080830HD	Hose - Heater To Intake Manifold; W/O Aux. Heater; Re-use		
Tensioner Assy. - Fan, Alt. & A.C.	1833688C1	38556	existing flow restrictor		19277
Hose - Upper - Eng. To Rad.		22774	Hose - Heater To Pipe-1; W/O Aux. Heater		19191
Hose - Lower - Eng. To Rad.		22775	F450 Super Duty; F550 Super Duty		
Ford V-8 7.3 L Diesel			Serpentine Belt; W/A.C.	2C3Z8620EB	▲K061000HD
E450 Super Duty			Serpentine Belt; W/O A.C.	2C3Z8620DA	▲K060806HD
Belt - W.P., Fan, Alt., A.C. & Air Compr. F8UE8620DB		▲K081213HD	Tensioner Assy.; W/A.C.	1L2Z6B209AA	38274
Belt - W.P., Fan, Alt. & A.C.; W/Dual			Tensioner Assy.; W/O A.C.	2L3Z6B209CA	38329
Alts.	F8UZ8620EB	▲K081359HD	Idle Pulley - Smooth	1L3Z8678AB	38001
Belt - W.P., Fan, Alt. & A.C.; W/Single			Idle Pulley - Grooved	1L2Z6C348AA	36157
Alt.	1C2Z8620JA	▲K081207HD	Tensioner Pulley; W/A.C.		38006
Tensioner Assy.	F8UZ6B209CA	39100	Hose Kit - DPFE		27079
Tensioner Pulley - Smooth		38028	Hose - Upper		22431
Tensioner Pulley - Grooved		38053	Hose - Lower		22432

 ▲ Standard Belt Available. See Pages 630-631.
 Ⓢ Cut to Fit.

Ⓣ Two Required.

Belts and Coolant Hose for Medium/Heavy-Duty Trucks (1996 and Newer)

Medium & Heavy-Duty Trucks
(1996 & Newer)

Application	Mfr. Part No.	Our No.
FORD - Continued		
2003 - Continued		
Ford V-10 6.8 L - Continued		
F450 Super Duty; F550 Super Duty - Continued		
Hose - Heater To Intake Manifold; Re-use existing flow restrictor		19218
Hose - Heater To Pipe-1		19306
Hose - Reservoir To Rad.; W/1" I.D. Hose		19812
2002		
Caterpillar 3126 Diesel		
F650 Super Duty; F750 Super Duty		
Belt - Fan, Alt. & A.C.	YC358620BA	▲K080816HD
Tensioner Assy. - Fan, Alt. & A.C.	1352142	38506
Tensioner Pulley - Fan, Alt. & A.C.	1352142	36091
Hose - Upper - Eng. To Pipe		20611
Hose - Upper - Pipe To Rad.; (2" I.D.)		24232
Hose - Lower - Eng. To Pipe		20611
Hose - Lower - Pipe To Rad.; (2" I.D.)		24232
Cummins ISB Diesel		
F650 Super Duty; F750 Super Duty		
Belt - W.P., Fan & Alt.	3943214	▲K080726HD
Belt - Fan & A.C.	YC3Z8620AB	▲9375HD
Tensioner Assy. - Fan, W.P. & Alt.	3936213	38516
Tensioner Pulley - Fan, W.P. & Alt.	3936213	36093
Hose - Upper - Eng. To Pipe; (2" I.D.)		24232
Hose - Upper - Pipe To Rad.; (2" I.D.)		24232
Hose - Lower - Eng. To Pipe; (2" I.D.)		24232
Hose - Lower - Pipe To Rad.; (2" I.D.)		24232
Ford V-8 5.4 L		
E450 Super Duty		
Serpentine Belt; W/A.C.	2C2Z8620DA	▲K060990HD
Serpentine Belt; W/O A.C.	2C3Z8620DA	▲K060806HD
Tensioner Assy.; W/A.C.	1L2Z6B209AA	38274
Tensioner Pulley; W/A.C.		38006
Hose - Upper		22315
Hose - Heater To Intake Manifold; W/O Aux. Heater; Re-use existing flow restrictor		19277
Hose - Heater To Pipe-1; W/O Aux. Heater		19191
Hose Connector - Heater To Intake Manifold		28501
Hose Connector - Heater To Pipe-1		28500
Hose - Reservoir To Rad.; (3/8" x 16")		28409
Ford V-8 7.3 L Diesel		
E450 Super Duty		
Belt - W.P., Fan, Alt., A.C. & Air Compr.	F8UE8620DB	▲K081213HD
Belt - W.P., Fan, Alt. & A.C.; W/Dual Alts.	F8UZ8620EB	▲K081359HD
Belt - W.P., Fan, Alt. & A.C.; W/Single Alt.	1C2Z8620JA	▲K081207HD
Tensioner Assy.	F8UZ6B209CA	39100
Tensioner Pulley - Smooth		38028
Tensioner Pulley - Grooved		38053
Hose - Upper		23308
Hose - Lower		23073
E550 Super Duty		
Belt - W.P., Fan, Alt., A.C. & Air Compr.	F8UE8620DB	▲K081213HD
Belt - W.P., Fan, Alt. & A.C.	2C2Z8620GA	▲K081223HD
Tensioner Pulley - Smooth		38028
Tensioner Pulley - Grooved		38053
Hose - Upper		23308
Hose - Lower		23073
F450 Super Duty; F550 Super Duty		
Serpentine Belt; W/O Ambulance Prep. Pkg.; W/Single Alt.; W/122.2" Belt		
O.C.	1C2Z8620LA	▲K081223HD
Serpentine Belt; W/121.3" Belt O.C.	1C2Z8620NA	▲K081213HD
Serpentine Belt; W/Ambulance Prep. Pkg.; W/Dual Alts.	F8TZ8620GC	▲K081377HD
Tensioner Assy.	F8TZ6B209BA	38191
Tensioner Pulley - Smooth		38028
Tensioner Pulley - Grooved		38053
Idler Pulley - Smooth	F8TZ8678FA	36234

Application	Mfr. Part No.	Our No.
FORD - Continued		
2002 - Continued		
Ford V-8 7.3 L Diesel - Continued		
F450 Super Duty; F550 Super Duty - Continued		
Hose - Upper; Preferred Hose; Upper hose routes around serpentine belt		22433
Hose - Upper; Optional Hose; Routes through serpentine belt		22542
Hose - Lower		22690
Hose - Heater To Eng.		19200
Hose - Heater To W.P.		19201
Hose - Rad. To Reservoir; W/3/8" I.D. Hose(3/8" x 16")		28409
Hose - Reservoir To Rad.; W/1" I.D. Hose		19812
Hose Connector - Heater Hose		②28500
F650 Super Duty; F750 Super Duty		
Belt - W.P., Fan & Alt.; W/Air Brakes	YC3Z8620FA	▲K081153HD
Belt - W.P., Fan & Alt.; W/Hyd. Brakes .	YC3Z8620HA	▲K080820HD
Belt - W.P., Fan, Alt. & A.C.; W/Air Brakes	YC3Z8620EA	▲K081223HD
Belt - W.P., Fan, Alt. & A.C.; W/Hyd. Brakes	YC3Z8620GA	▲K080893HD
Tensioner Assy.	F8TZ6B209BA	38191
Tensioner Pulley - Smooth		38028
Tensioner Pulley - Grooved		38053
Hose - Upper - Eng. To Pipe		≈20611
Hose - Upper - Pipe To Rad.; (2" I.D.)		24232
Hose - Lower - Eng. To Pipe		≈20611
Hose - Lower - Pipe To Rad.; (2" I.D.)		24232
Ford V-10 6.8 L		
E450 Super Duty; E550 Super Duty		
Serpentine Belt; W/A.C.	2C2Z8620DB	K060984
Serpentine Belt; W/O A.C.	2C3Z8620DA	▲K060806HD
Tensioner Assy.; W/A.C.	1L3Z6B209AA	38133
Tensioner Assy.; W/O A.C.	F75Z6B209EA	38330
Idler Pulley	1L2Z8678AB	38001
Tensioner Pulley; W/A.C.		38006
Hose Kit - DPFE		27079
Hose - Upper		22315
Hose - Heater To Intake Manifold; W/O Aux. Heater; Re-use existing flow restrictor		19277
Hose - Heater To Pipe-1; W/O Aux. Heater		19191
F450 Super Duty; F550 Super Duty		
Serpentine Belt; W/A.C.	2C3Z8620EB	▲K061000HD
Serpentine Belt; W/O A.C.	2C3Z8620DA	▲K060806HD
Tensioner Assy.; W/A.C.	1L2Z6B209AA	38274
Tensioner Assy.; W/O A.C.	2L3Z6B209CA	38329
Idler Pulley - Smooth	1L3Z8678AB	38001
Idler Pulley - Grooved	1L2Z6C348AA	36157
Idler Pulley; W/A.C.		38006
Hose Kit - DPFE		27079
Hose - Upper		22431
Hose - Lower		22432
Hose - Heater To Intake Manifold; Re-use existing flow restrictor		19218
Hose - Heater To Pipe-1		19306
Hose - Reservoir To Rad.; W/1" I.D. Hose		19812
2001		
Caterpillar 3126 Diesel		
F650 Super Duty; F750 Super Duty		
Belt - Fan, Alt. & A.C.	YC358620BA	▲K080816HD
Tensioner Assy. - Fan, Alt. & A.C.	1352142	38506
Tensioner Pulley - Fan, Alt. & A.C.	1352142	36091
Hose - Upper - Eng. To Pipe		20611
Hose - Upper - Pipe To Rad.; (2" I.D.)		24232
Hose - Lower - Eng. To Pipe; (2" I.D.)		24232
Hose - Lower - Pipe To Rad.; (2" I.D.)		24232
Cummins ISB Diesel		
F650 Super Duty; F750 Super Duty		
Belt - W.P., Fan & Alt.	3943214	▲K080726HD
Belt - Fan & A.C.	YC3Z8620AB	▲9375HD
Tensioner Assy. - Fan & A.C.	3936213	38516
Tensioner Pulley - Fan & A.C.	3936213	36093

▲ Standard Belt Available. See Pages 630-631.
≈ Cut to Fit.

② Two Required.

Belts and Coolant Hose for Medium/Heavy-Duty Trucks (1996 and Newer)

 Medium & Heavy-Duty Trucks
(1996 & Newer)

Application	Mfr. Part No.	Our No.
FORD - Continued		
2001 - Continued		
Cummins ISB Diesel - Continued		
F650 Super Duty; F750 Super Duty - Continued		
Hose - Upper - Eng. To Pipe; (2" I.D.)		24232
Hose - Upper - Pipe To Rad.; (2" I.D.)		24232
Hose - Lower - Eng. To Pipe; (2" I.D.)		24232
Hose - Lower - Pipe To Rad.; (2" I.D.)		24232
Ford V-8 5.4 L		
E450 Super Duty		
Serpentine Belt; W/A.C.		♣K080991HD
Serpentine Belt; W/O A.C.		♣K080806HD
Tensioner Assy.; W/A.C.		38133
Idler Pulley		38022
Tensioner Pulley - Smooth		38023
Hose - Upper		22315
Hose - Lower		22318
Hose - Heater To Intake Manifold; W/O Aux. Heater; Re-use existing flow restrictor.		19277
Hose - Heater To Pipe-1; W/O Aux. Heater		19191
Ford V-8 7.3 L Diesel		
E450 Super Duty		
Belt - W.P., Fan, Alt., A.C. & Air Compr. F8UE8620DB		♣K081213HD
Tensioner Assy. F8UZ6B209CA		39100
Tensioner Pulley - Smooth		38028
Tensioner Pulley - Grooved		38053
Hose - Upper		23308
Hose - Lower		22319
F450 Super Duty; F550 Super Duty		
Serpentine Belt; W/O Ambulance Prep. Pkg.; W/Single Alt. .		♣K081223HD
Serpentine Belt; W/Ambulance Prep. Pkg.; W/Dual Alts. F8TZ8620GC		♣K081377HD
Tensioner Assy. F8TZ6B209BA		38191
Tensioner Pulley - Smooth		38028
Tensioner Pulley - Grooved		38053
Idler Pulley - Smooth F8TZ8678FA		36234
Hose - Upper; Preferred Hose; Upper hose routes around serpentine belt		22433
Hose - Upper; Optional Hose; Routes through serpentine belt.		22542
Hose - Lower		22690
Hose - Heater To Eng.		19200
Hose - Heater To W.P.		19201
Hose - Rad. To Reservoir; W/3/8" I.D. Hose(3/8" x 16")		28409
Hose - Reservoir To Rad.; W/1" I.D. Hose		19812
Hose Connector - Heater Hose		Ⓜ28500
F650 Super Duty; F750 Super Duty		
Belt - W.P., Fan & Alt.; W/Air Brakes YC3Z8620FA		♣K081153HD
Belt - W.P., Fan & Alt.; W/Hyd. Brakes YC3Z8620HA		♣K080820HD
Belt - W.P., Fan, Alt. & A.C.; W/Air Brakes YC3Z8620EA		♣K081223HD
Belt - W.P., Fan, Alt. & A.C.; W/Hyd. Brakes YC3Z8620GA		♣K080893HD
Tensioner Assy. F8TZ6B209BA		38191
Tensioner Pulley - Smooth		38028
Tensioner Pulley - Grooved		38053
Hose - Upper - Eng. To Pipe		Ⓜ20611
Hose - Upper - Pipe To Rad.; (2" I.D.)		24232
Hose - Lower - Eng. To Pipe		Ⓜ20611
Hose - Lower - Pipe To Rad.; (2" I.D.)		24232
Ford V-10 6.8 L		
E450 Super Duty		
Belt - Fan, Alt., P.S. & A.C. F7UE8620EB		♣K080991HD
Belt - Fan, Alt. & P.S.		♣K080806HD
Tensioner Assy.; W/A.C.		38133
Tensioner Assy.; W/O A.C. F75Z6B209EA		38330
Idler Pulley		38022
Tensioner Pulley; W/A.C.		38023
Hose Kit - DPFE		27079
Hose - Upper		22316
Hose - Lower		22371
Hose - Heater To Intake Manifold; W/O Aux. Heater; Re-use existing flow restrictor.		19277

Application	Mfr. Part No.	Our No.
FORD - Continued		
2001 - Continued		
Ford V-10 6.8 L - Continued		
E450 Super Duty - Continued		
Hose - Heater To Pipe-1; W/O Aux. Heater		19191
Hose Connector - Heater To Intake Manifold		28501
Hose Connector - Heater To Pipe-1		28500
Hose Connector - Aux. Heater		28500
F450 Super Duty; F550 Super Duty		
Belt - Fan, Alt., P.S. & A.C. F81Z8620JA		♣K081000HD
Belt - Fan, Alt. & P.S. F7UZ8620FA		♣K080806HD
Tensioner Assy.; W/A.C. F75Z6B209DA		38133
Tensioner Assy.; W/O A.C. F75Z6B209EA		38330
Idler Pulley		38022
Tensioner Pulley; W/A.C.		38023
Tensioner Pulley - Smooth F75Z6B209DA		38023
Hose Kit - DPFE		27079
Hose - Upper		22431
Hose - Lower		22432
Hose - Heater To Intake Manifold; Re-use existing flow restrictor.		19218
Hose - Heater To Pipe-1		19306
Hose - Reservoir To Rad.; W/1" I.D. Hose		19812
2000		
Caterpillar 3126 Diesel		
F650 Super Duty; F750 Super Duty		
Belt - Fan, Alt. & A.C. YC358620BA		♣K080816HD
Tensioner Assy. - Fan, Alt. & A.C. 1352142		38506
Tensioner Pulley - Fan, Alt. & A.C. 1352142		36091
Hose - Upper - Eng. To Pipe		20611
Hose - Upper - Pipe To Rad.; (2" I.D.)		24232
Hose - Lower - Eng. To Pipe; (2" I.D.)		24232
Hose - Lower - Pipe To Rad.; (2" I.D.)		24232
Cummins ISB Diesel		
F650 Super Duty; F750 Super Duty		
Belt - Fan, Alt. & Hub 3943214		♣K080726HD
Belt - Fan & A.C.		Ⓜ♣9375HD
Tensioner Assy. - Fan, Alt. & Hub 3945527		38516
Tensioner Pulley - Fan, Alt. & Hub 3945527		36093
Hose - Upper - Eng. To Pipe; (2" I.D.)		24232
Hose - Upper - Pipe To Rad.; (2" I.D.)		24232
Hose - Lower - Eng. To Pipe; (2" I.D.)		24232
Hose - Lower - Pipe To Rad.; (2" I.D.)		24232
Ford V-8 5.4 L		
E450 Super Duty		
Serpentine Belt; W/A.C.		♣K080991HD
Serpentine Belt; W/O A.C.		♣K080806HD
Tensioner Assy.; W/A.C.		38133
Idler Pulley		38022
Tensioner Pulley - Smooth		38023
Hose - Upper		22315
Hose - Lower		22318
Hose - Heater To Pipe-1; W/Aux. Heater		22624
Hose - Heater To Intake Manifold; W/O Aux. Heater; Re-use existing flow restrictor.		19277
Hose - Heater To Pipe-1; W/O Aux. Heater		19191
Hose - Heater To Intake Manifold; W/Aux. Heater		22614
Ford V-8 7.3 L Diesel		
E450 Super Duty		
Belt - W.P., Fan, Alt., A.C. & Air Compr. F8UE8620DB		♣K081213HD
Tensioner Assy. F8UZ6B209CA		39100
Tensioner Pulley - Smooth		38028
Tensioner Pulley - Grooved		38053
Hose - Upper		23308
Hose - Lower		22319
F450 Super Duty; F550 Super Duty		
Serpentine Belt; W/O Ambulance Prep. Pkg.; W/Single Alt. .		♣K081223HD
Serpentine Belt; W/Ambulance Prep. Pkg.; W/Dual Alts. F8TZ8620GC		♣K081377HD
Belt - Fan, Alt., P.S. & A.C. F8TE8620FC		♣K081223HD
Tensioner Assy. F8TZ6B209BA		38191

♣ Standard Belt Available. See Pages 630-631.
Ⓜ Cut to Fit.

Ⓜ Two Required.

Belts and Coolant Hose for Medium/Heavy-Duty Trucks (1996 and Newer)

Medium & Heavy-Duty Trucks
(1996 & Newer)

Application	Mfr. Part No.	Our No.
FORD - Continued		
2000 - Continued		
Ford V-8 7.3 L Diesel - Continued		
F450 Super Duty; F550 Super Duty - Continued		
Tensioner Pulley - Smooth		38028
Tensioner Pulley - Grooved		38053
Idler Pulley - Smooth	F8TZ8678FA	36234
Hose - Upper; Preferred Hose; Upper hose routes around serpentine belt		22433
Hose - Upper; Optional Hose; Routes through serpentine belt		22542
Hose - Lower		22434
Hose - Heater To Eng.		19200
Hose - Heater To W.P.		19201
Hose - Rad. To Reservoir; W/3/8" I.D. Hose(3/8" x 16")		28409
Hose - Reservoir To Rad.; W/1" I.D. Hose		19812
Hose Connector - Heater Hose		②28500
F650 Super Duty; F750 Super Duty		
Belt - W.P., Fan & Alt.; W/Air Brakes	YC3Z8620FA	♣K081153HD
Belt - W.P., Fan & Alt.; W/Hyd. Brakes .	YC3Z8620HA	♣K080820HD
Belt - W.P., Fan, Alt. & A.C.; W/Air Brakes	YC3Z8620EA	♣K081223HD
Belt - W.P., Fan, Alt. & A.C.; W/Hyd. Brakes	YC3Z8620GA	♣K080893HD
Tensioner Assy.	F8TZ6B209BA	38191
Tensioner Pulley - Smooth		38028
Tensioner Pulley - Grooved		38053
Hose - Upper - Eng. To Pipe		∞20611
Hose - Upper - Pipe To Rad.; (2" I.D.)		24232
Hose - Lower - Eng. To Pipe		∞20611
Hose - Lower - Pipe To Rad.; (2" I.D.)		24232
Ford V-10 6.8 L		
E450 Super Duty		
Belt - Fan, Alt., P.S. & A.C.	F7UE8620EB	♣K080991HD
Belt - Fan, Alt. & P.S.		♣K080806HD
Tensioner Assy.; W/A.C.		38133
Tensioner Assy.; W/O A.C.	F75Z6B209EA	38330
Idler Pulley		38022
Tensioner Pulley; W/A.C.		38023
Hose Kit - DPFE		27079
Hose - Upper		22316
Hose - Lower		22371
Hose Connector - Heater To Intake Manifold		28501
Hose Connector - Heater To Pipe-1		28500
Hose Connector - Aux. Heater		28500
F450 Super Duty; F550 Super Duty		
Belt - Fan, Alt., P.S. & A.C.	F81Z8620JA	♣K081000HD
Belt - Fan, Alt. & P.S.	F7UZ8620FA	♣K080806HD
Tensioner Assy.; W/A.C.	F75Z6B209DA	38133
Tensioner Assy.; W/O A.C.	F75Z6B209EA	38330
Idler Pulley		38022
Tensioner Pulley; W/A.C.		38023
Tensioner Pulley - Smooth	F75Z6B209DA	38023
Hose Kit - DPFE		27079
Hose - Upper		22431
Hose - Lower		22432
Hose - Heater To Intake Manifold; Re-use existing flow restrictor.		19218
Hose - Heater To Pipe-1		19306
Hose - Reservoir To Rad.; W/1" I.D. Hose		19812
1999		
Cummins ISB Diesel		
F800		
Belt - W.P., Fan & Alt.	F3HZ8620F	♣K080830HD
Belt - A.C.	F4HZ8620GA	♣9412HD
Hose - Upper - Eng. To Pipe; (2" I.D.)		24232
Hose - Upper - Pipe To Rad.; (2" I.D.)		24232
Hose - Lower - Eng. To Pipe; (2" I.D.)		24232
Hose - Lower - Pipe To Rad.; (2" I.D.)		24232
Cummins ISC Diesel		
F800		
Belt - W.P., Fan & Alt.	F3HZ8620C	♣K080720HD

Application	Mfr. Part No.	Our No.
FORD - Continued		
1999 - Continued		
Cummins ISC Diesel - Continued		
F800 - Continued		
Belt - A.C.	F3HZ8620D	♣9640HD
Hose - Upper - Eng. To Pipe; (2" I.D.)		24232
Hose - Upper - Pipe To Rad.; (2" I.D.)		24232
Hose - Lower - Eng. To Pipe; (2" I.D.)		24232
Hose - Lower - Pipe To Rad.; (2" I.D.)		24232
Ford V-8 7.0 L		
F800		
Belt - Alt.; W/40A., 60A. Alt.; W/Fan Clutch; W/Cowl Cab	C9PZ8620FN	♣9440HD
Belt - Alt.; W/40A., 60A. Alt.; W/Fan Clutch; W/O Cowl Cab	E6PZ8620F	♣9435HD
Belt - Alt.; W/40A., 60A. Alt.; W/Fixed Fan; W/Cowl Cab		②♣9447HD
Belt - Alt.; W/40A., 60A. Alt.; W/Fixed Fan; W/O Cowl Cab	E6PZ8620G	♣9451HD
Belt - Alt.; W/75A. Alt.; W/Fan Clutch		②♣9447HD
Belt - Alt.; W/90A., 130A. Alt.; W/Fan Clutch	E6PZ8620G	♣9451HD
Belt - Alt.; W/75A., 90A., 130A. Alt.; W/Fixed Fan	E2HZ8620C	♣9463HD
Belt - Alt.; W/High Mount Fan; W/Idler Pulley	C9PZ8620CD	♣9480HD
Belt - P.S.; W/Dual Belts		②♣9630HD
Belt - P.S.; W/Single Belt	D9PZ8620CR	♣9540HD
Belt - A.C.	F1HZ8620E	7660
Belt - A.C. & A.P.	E8HT8620A	♣9650HD
Hose - Upper; W/Auto. Trans.; W/O P.T.O.		21938
Hose - Upper; W/P.T.O.		∞21936
Hose - Lower; W/O P.T.O.		21249
Hose - By Pass		∞21942
Hose - Heater; (5/8" I.D.)		28441
Ford V-8 7.3 L Diesel		
E450 Super Duty		
Belt - W.P., Fan, Alt., A.C. & Air Compr.	F8UE8620DB	♣K081213HD
Tensioner Assy.	F8UZ6B209CA	39100
Tensioner Pulley - Smooth		38028
Tensioner Pulley - Grooved		38053
Hose - Lower		22319
F450 Super Duty		
Belt - Fan, Alt., P.S. & A.C.	F8TE8620FC	♣K081223HD
Tensioner Assy.	F8TZ6B209BA	38191
Tensioner Pulley - Smooth		38028
Tensioner Pulley - Grooved		38053
Idler Pulley - Smooth	F8TZ8678FA	36234
Hose - Upper; W/Dual Alts.		22433
Hose - Upper; W/Single Alt.		22542
Hose - Upper; Optional Hose; Routes through serpentine belt		22542
Hose - Lower		22434
Hose - Reservoir To Rad.; W/1" I.D. Hose		19812
F550 Super Duty		
Belt - Fan, Alt., P.S. & A.C.	F8TE8620FC	♣K081223HD
Tensioner Assy.	F8TZ6B209BA	38191
Tensioner Pulley - Smooth		38028
Tensioner Pulley - Grooved		38053
Idler Pulley - Smooth	F8TZ8678FA	36234
Hose - Upper; W/Dual Alts.		22433
Hose - Upper; W/Single Alt.		22542
Hose - Upper; Optional Hose; Routes through serpentine belt		22542
Hose - Lower		22434
Ford V-10 6.8 L		
E450 Super Duty		
Belt - Fan, Alt., P.S. & A.C.		♣K080991HD
Belt - Fan, Alt. & P.S.		♣K080806HD
Tensioner Assy.; W/A.C.		38133
Tensioner Assy.; W/O A.C.	F75Z6B209EA	38330
Idler Pulley		38022
Tensioner Pulley; W/A.C.		38023
Hose Kit - DPFE		27079

② Two Required.
∞ Cut to Fit.

♣ Standard Belt Available. See Pages 630-631.

Belts and Coolant Hose for Medium/Heavy-Duty Trucks (1996 and Newer)

 Medium & Heavy-Duty Trucks
(1996 & Newer)

Application	Mfr. Part No.	Our No.
FORD - Continued		
1999 - Continued		
Ford V-10 6.8 L - Continued		
E450 Super Duty - Continued		
Hose - Upper		22316
Hose - Lower		22371
F450 Super Duty; F550 Super Duty		
Belt - Fan, Alt., P.S. & A.C.	F81Z8620JA	♣K081000HD
Belt - Fan, Alt. & P.S.	F7UZ8620FA	♣K080806HD
Tensioner Assy.; W/A.C.	F75Z6B209DA	38133
Tensioner Assy.; W/O A.C.	F75Z6B209EA	38330
Idler Pulley		38022
Tensioner Pulley; W/A.C.		38023
Tensioner Pulley - Smooth	F75Z6B209DA	38023
Hose Kit - DPFE		27079
Hose - Upper		22431
Hose - Lower		22432
Hose - Heater To Intake Manifold; Re-use existing flow restrictor.		19218
Hose - Heater To Pipe-1		19306
Hose - Reservoir To Rad.; W/1" I.D. Hose		19812
1998		
Caterpillar 3126 Diesel		
L8000; LA8000; LN8000; LNT8000; LS8000		
Belt - W.P.		♣9341HD
Belt - Fan	F2HT8620FA	♣K080780HD
Tensioner Assy. - Fan	1352151	38511
Tensioner Pulley - Fan	1352151	36091
Caterpillar 3176 Diesel		
L8000; LA8000; LA9000; LLA9000; LS8000; LTA9000; LTLA9000; LTLS9000		
Belt - Fan; W/1050 High Cool.	F7HZ8620JA	♣K140682HD
Belt - Fan; W/1050 Low Cool., 1300 Cool.	F6HZ8620C	♣K140603HD
Belt - Fan; W/900 Cool.	F6HZ8620AD	♣K140618HD
Belt - Alt.; W/1050 High Cool.	F7HZ8620AA	♣9465HD
Belt - Alt.; W/1050 Low Cool., 1300 Cool.	E6PZ8620F	♣9435HD
Belt - Alt.; W/900 Cool.	F6HZ8620EB	♣9412HD
Belt - A.C.; W/1050 High Cool.	C5TZ8620TA	♣9435HD
Belt - A.C.; W/1050 Low Cool., 1300 Cool.		♣9465HD
Belt - A.C.; W/900 Cool.	E2HZ8620C	♣9463HD
Caterpillar 3306 Diesel		
L8000; LA8000; LLA9000; LS8000; LTLA9000; LTLS9000		
Belt - Fan	F6HZ8620ALA	♣K080545HD
Belt - Alt.	F6HZ8620AA	♣9490HD
Belt - A.C.	E8HZ8620LA	♣9585HD
Caterpillar 3406 Diesel		
LA9000; LLA9000; LTA9000; LTLA9000; LTLS9000		
Belt - Fan; W/1050 High Cool.	F7HZ8620KA	♣K140662HD
Belt - Fan; W/1050 Low Cool.	F6HZ8620E	♣K140597HD
Belt - Fan; W/900 Cool.	F6HZ8620F	♣K140594HD
Belt - Alt.; W/47" Belt O.C.	F6HZ8620GB	♣9465HD
Belt - Alt.; W/48 1/2" Belt O.C.	F6HT8620ANA	♣9480HD
Belt - Alt.; W/50" Belt O.C.	F6HT8620AVA	♣9495HD
Belt - A.C.; W/1050 High Cool.	C5TZ8620TA	♣9435HD
Belt - A.C.; W/900 Cool.	F6HZ8620U	♣9465HD
Caterpillar C10 Diesel		
LA9000; LLA9000; LS9000; LT8000; LT9000; LTA9000; LTL9000; LTLA9000; LTLS9000; LTS8000; LTS9000		
Belt - Fan	F6HT8620AZA	♣K140618HD
Belt - Alt.	C5TS8620T	♣9440HD
Belt - A.C.	F6HT8620AJA	♣9463HD
Hose - Upper; (2 1/2" I.D.)		24240
Hose - Lower; (2 1/2" I.D.)		24240
Caterpillar C12 Diesel		
L8000; LA8000; LA9000; LL9000; LLA9000; LLS9000; LS8000; LT9000; LTA9000; LTL9000; LTLA9000; LTLS9000; LTS9000		
Belt - Fan	F6HT8620AZA	♣K140618HD
Belt - Alt.	C5TS8620T	♣9440HD

♣ Standard Belt Available. See Pages 630-631.

Application	Mfr. Part No.	Our No.
FORD - Continued		
1998 - Continued		
Caterpillar C12 Diesel - Continued		
L8000; LA8000; LA9000; LL9000; LLA9000; LLS9000; LS8000; LT9000; LTA9000; LTL9000; LTLA9000; LTLS9000; LTS9000 - Continued		
Belt - A.C.	F6HT8620AKA	♣9465HD
Hose - Upper; (2 1/2" I.D.)		24240
Hose - Lower; (2 1/2" I.D.)		24240
Cummins ISB Diesel		
F700; F800		
Belt - Hub, Fan, Alt. & A.C.	F3HT8620SA	♣K080830HD
Belt - Fan To Hyd. Pump	F3HZ8620A	♣9420HD
Tensioner Assy. - Hub, Fan, Alt. & A.C.	3936197	38517
Tensioner Pulley - Hub, Fan, Alt. & A.C.	3936197	36095
Hose - Upper - Eng. To Pipe; (2" I.D.)		24232
Hose - Upper - Pipe To Rad.; (2" I.D.)		24232
Hose - Lower - Eng. To Pipe; (2" I.D.)		24232
Hose - Lower - Pipe To Rad.; (2" I.D.)		24232
FT900		
Belt - Fan & Alt.	F3HZ8620F	♣K080830HD
Tensioner Assy. - Fan & Alt.	3936197	38517
Tensioner Pulley - Fan & Alt.	3936197	36095
Hose - Upper - Eng. To Pipe; (2" I.D.)		24232
Hose - Upper - Pipe To Rad.; (2" I.D.)		24232
Hose - Lower - Eng. To Pipe; (2" I.D.)		24232
Hose - Lower - Pipe To Rad.; (2" I.D.)		24232
L8000		
Belt - Fan & Alt.; W/210, 230 H.P. Eng.	F3HZ8620M	♣K080839HD
Belt - Fan	F1HZ8620C	♣K080710HD
Belt - A.C.	D5TZ8620C	♣9395HD
Tensioner Assy. - Fan & Alt.	3936197	38517
Tensioner Pulley - Fan & Alt.	3936197	36095
Hose - Upper - Eng. To Pipe; (2 5/8" I.D.)		24242
Hose - Upper - Pipe To Rad.; (2" I.D.)		24232
Hose - Lower - Eng. To Pipe; (2" I.D.)		24232
Hose - Lower - Rad. To Pipe; (2 3/8" I.D.)		24238
LA8000; LLA9000; LS8000; LTLA9000; LTLS9000		
Belt - Fan	F1HZ8620C	♣K080710HD
Belt - A.C.	D5TZ8620C	♣9395HD
Cummins ISC Diesel		
F800		
Belt - Fan & Alt.	F3HZ8620C	♣K080720HD
Belt - A.C.	F3HZ8620D	♣9640HD
Tensioner Assy. - Fan, W.P. & Alt.	3936206	38513
Tensioner Pulley - Fan, W.P. & Alt.	3936206	36091
Hose - Upper - Eng. To Pipe; (2" I.D.)		24232
Hose - Upper - Pipe To Rad.; (2" I.D.)		24232
Hose - Lower - Eng. To Pipe; (2" I.D.)		24232
Hose - Lower - Pipe To Rad.; (2" I.D.)		24232
FT900		
Belt - W.P., Fan & Alt.	F3HZ8620C	♣K080720HD
Belt - A.C.	F3HZ8620D	♣9640HD
Tensioner Assy. - Fan, W.P. & Alt.	3936206	38513
Tensioner Pulley - Fan, W.P. & Alt.	3936206	36091
Hose - Upper - Eng. To Pipe; (2" I.D.)		24232
Hose - Upper - Pipe To Rad.; (2" I.D.)		24232
Hose - Lower - Eng. To Pipe; (2" I.D.)		24232
Hose - Lower - Pipe To Rad.; (2" I.D.)		24232
L8000		
Belt - Fan	F6HZ8620N	♣K080733HD
Belt - Fan & Alt.	F6HT8620AYA	♣K080726HD
Belt - P.S.	F6HT8620ASA	♣9465HD
Belt - A.C.; W/47" Belt O.C.		♣9465HD
Belt - A.C.; W/64" Belt O.C.	E8HT8620KA	♣9640HD
Tensioner Assy. - Fan & Alt.	3936206	38513
Tensioner Pulley - Fan & Alt.	3936206	36091
Hose - Upper - Eng. To Pipe; (2 1/4" I.D.)		24236
Hose - Upper - Pipe To Rad.; (2" I.D.)		24232
Hose - Lower - Eng. To Pipe; (2 1/2" I.D.)		24240
Hose - Lower - Rad. To Pipe; (2 3/8" I.D.)		24238
Hose - Lower - Pipe To Cooler; (2" I.D.)		24232

Belts and Coolant Hose for Medium/Heavy-Duty Trucks (1996 and Newer)

Medium & Heavy-Duty Trucks
(1996 & Newer)

Application	Mfr. Part No.	Our No.
FORD - Continued		
1998 - Continued		
Cummins ISC Diesel - Continued		
L8500		
Belt - Fan	F6HZ8620N	▲K080733HD
Belt - Fan & Alt.	F6HT8620AYA	▲K080726HD
Belt - P.S.	F6HT8620ASA	▲9465HD
Belt - A.C.; W/47" Belt O.C.		▲9465HD
Belt - A.C.; W/64" Belt O.C.	E8HT8620KA	▲9640HD
Tensioner Assy. - Fan & Alt.	3936206	38513
Tensioner Pulley - Fan & Alt.	3936206	36091
Hose - Upper - Eng. To Pipe; (2 1/4" I.D.)		24236
Hose - Upper - Pipe To Rad.; (2" I.D.)		24232
L9000		
Belt - Fan	F6HZ8620N	▲K080733HD
Belt - Fan & Alt.	F6HT8620AYA	▲K080726HD
Belt - P.S.	F6HT8620ASA	▲9465HD
Belt - A.C.; W/47" Belt O.C.		▲9465HD
Belt - A.C.; W/64" Belt O.C.	E8HT8620KA	▲9640HD
Tensioner Assy. - Fan & Alt.	3936206	38513
Tensioner Pulley - Fan & Alt.	3936206	36091
Hose - Upper - Eng. To Pipe; (2 1/4" I.D.)		24236
Hose - Upper - Pipe To Rad.; (2" I.D.)		24232
Hose - Lower - Eng. To Pipe; (2 1/2" I.D.)		24240
Hose - Lower - Rad. To Pipe; (2 3/8" I.D.)		24238
Hose - Lower - Pipe To Pipe; (2" I.D.)		24232
L9500; LA8000; LA9000; LLA9000; LS8000; LS9000; LT8000; LTA9000; LTLA9000; LTLS9000; LTS8000		
Belt - Fan	F6HZ8620N	▲K080733HD
Belt - Fan & Alt.	F6HT8620AYA	▲K080726HD
Belt - P.S.	F6HT8620ASA	▲9465HD
Belt - A.C.; W/47" Belt O.C.		▲9465HD
Belt - A.C.; W/64" Belt O.C.	E8HT8620KA	▲9640HD
Tensioner Assy. - Fan & Alt.	3936206	38513
Tensioner Pulley - Fan & Alt.	3936206	36091
Hose - Upper - Eng. To Pipe; (2 1/4" I.D.)		24236
Hose - Upper - Pipe To Rad.; (2" I.D.)		24232
Cummins ISM Diesel		
L8000; L9000; LA8000; LA9000; LLA9000; LS8000; LS9000; LTA9000; LTLA9000; LTLS9000		
Belt - Fan; W/52" Belt O.C.	F6HT8620BA	▲K140516HD
Belt - Fan; W/60" Belt O.C.	F6HZ8620F	▲K140594HD
Belt - Alt.	E7HT8620GA	▲K050360HD
Belt - A.C.; W/29" Belt O.C.	DGHZ8620AA	▲9290HD
Belt - A.C.; W/48" Belt O.C.	C9PZ8620CD	▲9640HD
Hose - Upper - Eng. To Pipe; (2 1/4" I.D.)		24236
Hose - Upper - Pipe To Rad.; (2 1/2" I.D.)		24240
Hose - Lower - Eng. To Pipe; (2" I.D.)		24232
Hose - Lower - Pipe To Rad.; (2 1/2" I.D.)		24240
Cummins N14 Diesel		
L8000; LA8000; LA9000; LLA9000; LS8000; LTA9000; LTLA9000; LTLS9000		
Belt - Hub & Fan; W/1050 High Cool., 1300 Cool.	F6HZ8620M	▲K140429HD
Belt - Hub & Fan; W/900 Cool.	F6HZ8620L	▲K140433HD
Belt - Alt.	E5HZ8620EA	▲9435HD
Belt - Hub & A.C.	C6TZ8620JA	▲9420HD
Hose - Upper - Eng. To Pipe; (2 1/2" I.D.)		24240
Hose - Upper - Pipe To Rad.; (2 1/2" I.D.)		24240
Hose - Lower - Eng. To Pipe; (2 1/2" I.D.)		24240
Hose - Lower - Pipe To Rad.; (2 1/2" I.D.)		24240
Hose - Lower - Pipe To Pipe; (2 1/2" I.D.)		24240
Detroit Diesel Series 60 Diesel		
L8000; LA8000; LLA9000; LS8000; LTLA9000; LTLS9000		
Belt - Fan; W/50" Belt O.C.	F6HT8620LA	▲K140496HD
Belt - Fan; W/59" Belt O.C.	F7HZ8620CA	▲K140580HD
Belt - Alt.; Optional Belt		②▲9485HD
Belt - Alt.; Preferred Belt	F7HT8620VA	29485FPB
Belt - A.C.	C8TA8620D	▲9370HD
Hose - Upper - Pipe To Rad.; (2 1/2" I.D.)		24240
Hose - Upper - Pipe To Pipe; (2 1/2" I.D.)		24240
Hose - Lower; (2 1/2" I.D.)		24240

Application	Mfr. Part No.	Our No.
FORD - Continued		
1998 - Continued		
Ford V-8 7.0 L		
F700		
Belt - Fan	C9PZ8620CD	▲9480HD
Belt - Fan & Alt.; W/40A., 60A. Alt.; W/Fan Clutch; W/Cowl Cab	C9PZ8620FN	▲9440HD
Belt - Fan & Alt.; W/40A., 60A. Alt.; W/Fan Clutch; W/O Cowl Cab	E6PZ8620F	▲9435HD
Belt - Fan & Alt.; W/40A., 60A. Alt.; W/Fixed Fan; W/Cowl Cab	D9PZ8620M	▲9447HD
Belt - Fan & Alt.; W/40A., 60A. Alt.; W/Fixed Fan; W/O Cowl Cab	E6PZ8620G	▲9451HD
Belt - Fan & Alt.; W/75A. Alt.; W/Fan Clutch	D9PZ8620M	▲9447HD
Belt - Fan & Alt.; W/75A. Alt.; W/Fixed Fan	E2HZ8620C	▲9463HD
Belt - Fan & Alt.; W/90A., 130A. Alt.; W/Fan Clutch	E6PZ8620G	▲9451HD
Belt - Fan & Alt.; W/90A., 130A. Alt.; W/Fixed Fan	E2HZ8620C	▲9463HD
Belt - Fan & P.S.; W/Single A.P.		②▲9530HD
Belt - P.S.; W/Dual Belts	E8HZ8620P	②▲9580HD
Belt - P.S.; W/Single Belt	C9PZ8620CR	▲9540HD
Belt - P.S. & A.C.	D4HE8620CA	▲9480HD
Belt - A.C.	E5HZ8620C	▲9360HD
Belt - Air Compr.; W/Air Brakes	E8HZ8620A	▲9650HD
Belt - Air Compr.; W/Hyd. Brakes	E0PZ8620G	▲9610HD
Belt - Idler; W/High Mount Fan	D4HE8620CA	▲9480HD
F800		
Belt - Fan	C9PZ8620CD	▲9480HD
Belt - Fan & Alt.; W/40A., 60A. Alt.; W/Fan Clutch; W/Cowl Cab	C9PZ8620FN	▲9440HD
Belt - Fan & Alt.; W/40A., 60A. Alt.; W/Fan Clutch; W/O Cowl Cab	E6PZ8620F	▲9435HD
Belt - Fan & Alt.; W/40A., 60A. Alt.; W/Fixed Fan; W/Cowl Cab	D9PZ8620M	▲9447HD
Belt - Fan & Alt.; W/40A., 60A. Alt.; W/Fixed Fan; W/O Cowl Cab	E6PZ8620G	▲9451HD
Belt - Fan & Alt.; W/75A. Alt.; W/Fan Clutch	D9PZ8620M	▲9447HD
Belt - Fan & Alt.; W/75A. Alt.; W/Fixed Fan	E2HZ8620C	▲9463HD
Belt - Fan & Alt.; W/90A., 130A. Alt.; W/Fan Clutch	E6PZ8620G	▲9451HD
Belt - Fan & Alt.; W/90A., 130A. Alt.; W/Fixed Fan	E2HZ8620C	▲9463HD
Belt - Fan & P.S.; W/Single A.P.		②▲9530HD
Belt - P.S.; W/Dual Belts	E8HZ8620P	②▲9580HD
Belt - P.S.; W/Single Belt	C9PZ8620CR	▲9540HD
Belt - P.S. & A.C.	D4HE8620CA	▲9480HD
Belt - A.C.	E5HZ8620C	▲9360HD
Belt - Air Compr.; W/Air Brakes	E8HZ8620A	▲9650HD
Belt - Air Compr.; W/Hyd. Brakes	E0PZ8620G	▲9610HD
Belt - Idler; W/High Mount Fan	D4HE8620CA	▲9480HD
Hose - Upper; W/P.T.O.		≈21936
Hose - Upper; W/Auto. Trans.; W/O P.T.O.		21938
Hose - Upper; W/Man. Trans.		21938
Hose - Lower; W/O P.T.O.		21249
Hose - Lower; W/P.T.O.		21536
Hose - By Pass		≈21942
Hose - Heater; (5/8" I.D.)		28441
FT900		
Belt - Alt.; W/40A., 60A. Alt.; W/Fan Clutch; W/Cowl Cab	C9PZ8620FN	▲9440HD
Belt - Alt.; W/40A., 60A. Alt.; W/Fan Clutch; W/O Cowl Cab	E6PZ8620F	▲9435HD
Belt - Alt.; W/40A., 60A. Alt.; W/Fixed Fan; W/Cowl Cab		②▲9447HD
Belt - Alt.; W/40A., 60A. Alt.; W/Fixed Fan; W/O Cowl Cab	E6PZ8620G	▲9451HD
Belt - Alt.; W/75A. Alt.; W/Fan Clutch		②▲9447HD
Belt - Alt.; W/75A. Alt.; W/Fixed Fan	E2HZ8620C	▲9463HD
Belt - Alt.; W/90A., 130A. Alt.; W/Fixed Fan	E2HZ8620C	▲9463HD

▲ Standard Belt Available. See Pages 630-631.

◆ Green Stripe® PowerBand® Belt May Work, Use Template to Check.

② Two Required.

≈ Cut to Fit.

Belts and Coolant Hose for Medium/Heavy-Duty Trucks (1996 and Newer)

 Medium & Heavy-Duty Trucks
(1996 & Newer)

Application	Mfr. Part No.	Our No.
FORD - Continued		
1998 - Continued		
Ford V-8 7.0 L - Continued		
FT900 - Continued		
Belt - Alt.; W/High Mount Fan; W/Idler Pulley	C9PZ8620CD	♣9480HD
Belt - P.S.; W/Dual Belts		②♣9580HD
Belt - P.S.; W/Single Belt	C9PZ8620CR	♣9540HD
Belt - A.C.	F1HZ8620E	7660
Belt - A.P.; W/Air Brakes	E8HZ8620A	♣9650HD
Belt - A.P.; W/Hyd. Brakes	E0PZ8620G	♣9610HD
Ford V-8 7.3 L Diesel		
E450 Super Duty		
Serpentine Belt; W/H.D. Alt.	1C2Z8620CA	♣K081213HD
Serpentine Belt; W/Dual Alts.	F8UZ8620EB	♣K081359HD
Serpentine Belt; W/Ambulance Prep. Pkg.		♣K081196HD
Serpentine Belt; W/O Ambulance Prep. Pkg.		♣K081177HD
Tensioner Assy.	F8UZ6B209CA	39100
Tensioner Pulley - Smooth		38028
Tensioner Pulley - Grooved		38053
Hose - Lower		22319
Hose - Heater To Eng.; W/O Aux. Heater		19180
Hose - Heater To Tee; W/O Aux. Heater(5/8" x 24")		28411
Hose - Heater To W.P.; W/O Aux. Heater(5/8" x 33")		28411
Hose - Tee To Eng.; W/O Aux. Heater(5/8" x 24")		28411
Hose - Tee To Pipe-1; W/O Aux. Heater(5/8" x 12")		28411
Hose - Pipe-1 To Rad.; W/O Aux. Heater		≈<28467
Hose - Tee-2 To W.P.; W/4-Speed Auto. Trans.; W/Aux. Heater		≈<18703
Hose - Tee-1 To Tee-3		18785
Hose - Tee-3 To Eng.; (5/8" x 12")		28411
Hose - Pipe-3 To Rad.		≈<28467
Hose - Heater To Tee-1; W/Aux. Heater		≈<28467
Hose - Heater To Tee-2; W/Aux. Heater		≈<28467
Hose - Pipe To Aux. Heater Pipe; (5/8" x 33")		②28411
Hose - Tee To Aux. Heater; (5/8" x 33")		②28411
F Super Duty		
Belt - Alt., P.S., A.C. & Air Compr.; W/O Ambulance Prep. Pkg.	F5TZ8620B	♣K081189HD
Belt - Alt., P.S., A.C. & Air Compr.; W/Ambulance Prep. Pkg.	F5TZ8620E	♣K081196HD
Idler Pulley - Smooth	F5TZ8678E	38022
Hose - Upper; W/O H.D. Cool.		21403
Hose - Upper; W/H.D. Cool.		22158
Hose - Lower; W/O H.D. Cool.		21395
Hose - Lower; W/H.D. Cool.		22216
Ford V-8 7.5 L		
F Super Duty		
Belt - Fan, Alt. & A.P.; W/75A., 90A. Alt.	F6UE8620FA	♣K060495HD
Belt - Fan, Alt. & A.P.; W/130A. Alt.	E8UZ8620G	K060505
Belt - Fan, A.C. & P.S.	E8DZ8620H	♣K060675HD
Belt - Fan, P.S. & Idler; W/O A.C.	E8DZ8620H	♣K060675HD
Hose - Upper - Eng. To Rad.		21668
Hose - Lower - Eng. To Rad.		21875
Hose - Lower - Rad. To Cooler		21875
Hose - Lower - Eng. To Cooler		21909
1997		
Caterpillar 3176 Diesel		
L8000		
Belt - Fan; W/1050 High Cool.	F7HZ8620JA	♣K140682HD
Belt - Fan; W/1050 Low Cool., 1300 Cool.		♣K140603HD
Belt - Fan; W/900 Cool.	F6HZ8620AD	♣K140618HD
Belt - Alt.; W/1050 High Cool.	F7HZ8620AA	♣9465HD
Belt - Alt.; W/1050 Low Cool., 1300 Cool.		♣9435HD
Belt - Alt.; W/900 Cool.	F6HZ8620EB	♣9412HD
Belt - A.C.; W/1050 High Cool.	C5TZ8620TA	♣9435HD
Belt - A.C.; W/1050 Low Cool., 1300 Cool.		♣9465HD
Belt - A.C.; W/900 Cool.	E2HZ8620C	♣9463HD
Belt - Fan & Alt.	F0HZ8620A	♣K080780HD

Application	Mfr. Part No.	Our No.
FORD - Continued		
1997 - Continued		
Caterpillar 3176 Diesel - Continued		
L9000 - Continued		
Belt - A.C.; W/Eaton Fan Clutch	E2HZ8620C	♣9463HD
Belt - A.C.; W/Bendix Fan Clutch	D9PZ8620M	♣9447HD
Tensioner Assy. - Fan & Alt.		38506
Hose - Upper - Rad. To Pipe		22440
Hose - Upper - Eng. To Rad.		22440
Hose - Lower - Eng. To Rad.		22440
Hose - Lower - Pipe To Rad.		22440
L9500		
Belt - Fan	F6HZ8620B	♣K140627HD
Belt - Alt.	F6HZ8620NA	♣9455HD
Belt - A.C.	F6HZ8620R	♣9485HD
LA8000; LLA9000		
Belt - Fan; W/1050 High Cool.	F7HZ8620JA	♣K140682HD
Belt - Fan; W/1050 Low Cool., 1300 Cool.		♣K140603HD
Belt - Fan; W/900 Cool.	F6HZ8620AD	♣K140618HD
Belt - Alt.; W/1050 High Cool.	F7HZ8620AA	♣9465HD
Belt - Alt.; W/1050 Low Cool., 1300 Cool.		♣9435HD
Belt - Alt.; W/900 Cool.	F6HZ8620EB	♣9412HD
Belt - A.C.; W/1050 High Cool.	C5TZ8620TA	♣9435HD
Belt - A.C.; W/1050 Low Cool., 1300 Cool.		♣9465HD
Belt - A.C.; W/900 Cool.	E2HZ8620C	♣9463HD
LN9000; LNT9000		
Belt - Fan & Alt.	F0HZ8620A	♣K080780HD
Belt - A.C.; W/Eaton Fan Clutch	E2HZ8620C	♣9463HD
Belt - A.C.; W/Bendix Fan Clutch	D9PZ8620M	♣9447HD
Tensioner Assy. - Fan & Alt.		38506
Hose - Upper - Eng. To Pipe; (2 1/2" I.D.)		24240
Hose - Upper - Pipe To Eng.; (2 1/2" I.D.)		24240
Hose - Lower - Eng. To Rad.		22188
LS8000		
Belt - Fan; W/1050 High Cool.	F7HZ8620JA	♣K140682HD
Belt - Fan; W/1050 Low Cool., 1300 Cool.		♣K140603HD
Belt - Fan; W/900 Cool.	F6HZ8620AD	♣K140618HD
Belt - Alt.; W/1050 High Cool.	F7HZ8620AA	♣9465HD
Belt - Alt.; W/1050 Low Cool., 1300 Cool.		♣9435HD
Belt - Alt.; W/900 Cool.	F6HZ8620EB	♣9412HD
Belt - A.C.; W/1050 High Cool.	C5TZ8620TA	♣9435HD
Belt - A.C.; W/1050 Low Cool., 1300 Cool.		♣9465HD
Belt - A.C.; W/900 Cool.	E2HZ8620C	♣9463HD
LS9000		
Belt - Fan & Alt.	F0HZ8620A	♣K080780HD
Belt - A.C.; W/Eaton Fan Clutch	E2HZ8620C	♣9463HD
Belt - A.C.; W/Bendix Fan Clutch	D9PZ8620M	♣9447HD
Tensioner Assy. - Fan & Alt.		38506
Hose - Upper - Rad. To Pipe		22440
Hose - Upper - Eng. To Rad.		22440
Hose - Lower - Eng. To Rad.		22440
Hose - Lower - Pipe To Rad.		22440
LT9000		
Belt - Fan	F6HZ8620B	♣K140627HD
Belt - Alt.	F6HZ8620NA	♣9455HD
Belt - A.C.	F6HZ8620R	♣9485HD
LTA9000		
Belt - Fan; W/1050 High Cool.	F7HZ8620JA	♣K140682HD
Belt - Fan; W/1050 Low Cool., 1300 Cool.		♣K140603HD
Belt - Fan; W/900 Cool.	F6HZ8620AD	♣K140618HD
Belt - Alt.; W/1050 High Cool.	F7HZ8620AA	♣9465HD
Belt - Alt.; W/1050 Low Cool., 1300 Cool.		♣9435HD
Belt - Alt.; W/900 Cool.	F6HZ8620EB	♣9412HD
Belt - A.C.; W/1050 High Cool.	C5TZ8620TA	♣9435HD
Belt - A.C.; W/1050 Low Cool., 1300 Cool.		♣9465HD
Belt - A.C.; W/900 Cool.	E2HZ8620C	♣9463HD

 ♣ Standard Belt Available. See Pages 630-631.
 ≈< Cut to Fit.

② Two Required.

Belts and Coolant Hose for Medium/Heavy-Duty Trucks (1996 and Newer)

Medium & Heavy-Duty Trucks
(1996 & Newer)

Application	Mfr. Part No.	Our No.
FORD - Continued		
1997 - Continued		
Caterpillar 3176 Diesel - Continued		
LTL9000		
Belt - Fan	F6HZ8620B	▲K140627HD
Belt - Alt.	F6HZ8620NA	▲9455HD
Belt - A.C.	F6HZ8620R	▲9485HD
LTLA9000; LTLS9000		
Belt - Fan; W/1050 High Cool.	F7HZ8620JA	▲K140682HD
Belt - Fan; W/1050 Low Cool., 1300 Cool.	F6HZ8620C	▲K140603HD
Belt - Fan; W/900 Cool.	F6HZ8620AD	▲K140618HD
Belt - Alt.; W/1050 High Cool.	F7HZ8620AA	▲9465HD
Belt - Alt.; W/1050 Low Cool., 1300 Cool.	E6PZ8620F	▲9435HD
Belt - Alt.; W/900 Cool.	F6HZ8620EB	▲9412HD
Belt - A.C.; W/1050 High Cool.	C5TZ8620TA	▲9435HD
Belt - A.C.; W/1050 Low Cool., 1300 Cool.	E2HZ8620C	▲9465HD
Belt - A.C.; W/900 Cool.		▲9463HD
LTS9000		
Belt - Fan	F6HZ8620B	▲K140627HD
Belt - Alt.	F6HZ8620NA	▲9455HD
Belt - A.C.	F6HZ8620R	▲9485HD
Caterpillar 3306 Diesel		
L8000		
Belt - Fan	F6HZ8620ALA	▲K080545HD
Belt - Alt.	F6HZ8620AA	▲9490HD
Belt - A.C.	E8HZ8620LA	▲9585HD
L9000		
Belt - Fan; Preferred Belt		②▲9590HD
Belt - Fan; Preferred Belt	E4HT8620YA	2/9590PB
Belt - Alt.; Preferred Belt		②▲9530HD
Belt - Alt.; Preferred Belt	E4HT8620AAA	2/9530PB
Belt - A.C.	C9PZ8620CD	▲9480HD
Hose - Upper - Eng. To Rad.		21845
Hose - Lower - Eng. To Pipe		22192
Hose - By Pass; (3/8" I.D.)		28409
Hose - Coolant Reservoir; (1" I.D.)		24216
Hose - Oil Cooler; (2 1/4" I.D.)		24236
Hose - Heater; (5/8" I.D.)		28441
LA8000; LLA9000		
Belt - Fan	F6HZ8620ALA	▲K080545HD
Belt - Alt.	F6HZ8620AA	▲9490HD
Belt - A.C.	E8HZ8620LA	▲9585HD
LS9000		
Belt - Fan; Preferred Belt	E4HT8620YA	2/9590PB
Belt - Fan; Preferred Belt		②▲9590HD
Belt - Alt.; Preferred Belt	E4HT8620AAA	2/9530PB
Belt - Alt.; Preferred Belt		②▲9530HD
Belt - A.C.	C9PZ8620CD	▲9480HD
Hose - Upper - Eng. To Rad.		21845
Hose - Lower - Eng. To Pipe		22192
Hose - By Pass; (3/8" I.D.)		28409
Hose - Coolant Reservoir; (1" I.D.)		24216
Hose - Oil Cooler; (2 1/4" I.D.)		24236
Hose - Heater; (5/8" I.D.)		28441
LTLA9000; LTLS9000		
Belt - Fan	F6HZ8620ALA	▲K080545HD
Belt - Alt.	F6HZ8620AA	▲9490HD
Belt - A.C.	E8HZ8620LA	▲9585HD
Caterpillar 3406 Diesel		
L8000		
Belt - Fan	F1HZ8620G	▲K100618HD
Belt - Alt.; Preferred Belt	E4HT8620AAA	2/9530PB
Belt - Alt.; Preferred Belt	E8HZ8620K	②▲9530HD
Belt - A.C.	C9PZ8620FP	▲9490HD
Hose - Upper - Eng. To Rad.		22194
L9000		
Belt - Fan	F1HZ8620G	▲K100618HD
Belt - Alt.	E8HZ8620K	▲9530HD
Belt - A.C.	C9PZ8620FP	▲9490HD
Hose - Upper - Eng. To Rad.		22194

Application	Mfr. Part No.	Our No.
FORD - Continued		
1997 - Continued		
Caterpillar 3406 Diesel - Continued		
LA8000; LA9000		
Belt - Fan	F1HZ8620G	▲K100618HD
Belt - Alt.; Preferred Belt	E4HT8620AAA	2/9530PB
Belt - Alt.; Preferred Belt	E8HZ8620K	②▲9530HD
Belt - A.C.	C9PZ8620FP	▲9490HD
Hose - Upper - Eng. To Rad.		22194
LL9000		
Serpentine Belt; W/55" Belt O.C.	F4HZ8620C	▲K140555HD
Belt - Fan; W/51" Belt O.C.	F1HZ8620H	▲K100510HD
Belt - Fan; W/66" Belt O.C.	F4HZ8620D	▲K140662HD
Belt - Fan & A.C.; W/375 H.P. Eng. & Under	C9PZ8620FP	▲9490HD
Belt - Fan, Alt. & A.C.; W/410 H.P. Eng. & Over	F4HZ8620B	▲9550HD
Belt - Alt.		②▲9545HD
Hose - Upper - Eng. To Rad.; W/O P.S.		22194
LLA9000		
Belt - Fan	F4HZ8620D	▲K140662HD
LLS9000		
Belt - Fan	F1HZ8620G	▲K100618HD
Belt - Alt.; Preferred Belt	E4HT8620AAA	2/9530PB
Belt - Alt.; Preferred Belt	E8HZ8620K	②▲9530HD
Belt - A.C.	C9PZ8620FP	▲9490HD
Hose - Upper - Eng. To Rad.		22194
LN9000; LNT9000		
Belt - Fan	F1HZ8620H	▲K100510HD
Belt - Alt.	E8HZ8620K	▲9530HD
Belt - A.C.	C9PZ8620FP	▲9490HD
Hose - Upper - Eng. To Rad.; W/O P.S.		22194
LS8000; LS9000		
Belt - Fan	F1HZ8620G	▲K100618HD
Belt - Alt.; Preferred Belt	E4HT8620AAA	2/9530PB
Belt - Alt.; Preferred Belt	E8HZ8620K	②▲9530HD
Belt - A.C.	C9PZ8620FP	▲9490HD
Hose - Upper - Eng. To Rad.		22194
LT9000		
Belt - Fan; W/10-Ribbed Belt	F1HZ8620G	▲K100618HD
Belt - Fan; W/14-Ribbed Belt	F4HZ8620D	▲K140662HD
Belt - Alt.; Preferred Belt	E4HT8620AAA	2/9530PB
Belt - Alt.; Preferred Belt		②▲9530HD
Belt - A.C.	C9PZ8620FP	▲9490HD
Hose - Upper - Eng. To Rad.; W/O P.S.		≈22194
LTA9000		
Belt - Fan	F4HZ8620D	▲K140662HD
LTL9000		
Belt - Fan	F4HZ8620D	▲K140662HD
Belt - Alt.; Preferred Belt		2/9545PB
Belt - Alt.; Preferred Belt		②▲9545HD
Belt - A.C.		▲9525HD
Hose - Upper - Eng. To Rad.; W/O P.S.		≈22194
Hose - By Pass; (1 1/2" I.D.)		24224
LTLA9000		
Belt - Fan	F4HZ8620D	▲K140662HD
LTLS9000		
Belt - Fan	F4HZ8620D	▲K140662HD
Hose - Upper - Eng. To Rad.; (2 3/8" I.D.)		24238
Hose - Upper - Rad. To Rad.; (2 3/8" I.D.)		24238
LTS8000		
Belt - Fan	F4HZ8620D	▲K140662HD
LTS9000		
Belt - Fan; W/10-Ribbed Belt	F1HZ8620G	▲K100618HD
Belt - Fan; W/14-Ribbed Belt	F4HZ8620D	▲K140662HD
Belt - Alt.; Preferred Belt	E4HT8620AAA	2/9530PB
Belt - Alt.; Preferred Belt		②▲9530HD
Belt - A.C.	C9PZ8620FP	▲9490HD
Hose - Upper - Eng. To Rad.; W/O P.S.		≈22194

▲ Standard Belt Available. See Pages 630-631.
≈ Cut to Fit.

② Two Required.

Belts and Coolant Hose for Medium/Heavy-Duty Trucks (1996 and Newer)

 Medium & Heavy-Duty Trucks
(1996 & Newer)

Application	Mfr. Part No.	Our No.
FORD - Continued		
1997 - Continued		
Caterpillar C10 Diesel		
LA9000; LLA9000; LS9000; LT8000; LT9000; LTA9000; LTL9000; LTLA9000; LTLS9000; LTS8000; LTS9000		
Belt - Fan		♣K140618HD
Belt - Alt.		♣9440HD
Belt - A.C.		♣9463HD
Hose - Upper; (2 1/2" I.D.)		24240
Hose - Lower; (2 1/2" I.D.)		24240
Caterpillar C12 Diesel		
L8000; LA8000; LA9000; LL9000; LLA9000; LLS9000; LS8000; LT9000; LTA9000; LTL9000; LTLA9000; LTLS9000; LTS9000		
Belt - Fan		♣K140618HD
Belt - Alt.	C5T8620T	♣9440HD
Belt - A.C.	F6HT8620AKA	♣9465HD
Hose - Upper; (2 1/2" I.D.)		24240
Hose - Lower; (2 1/2" I.D.)		24240
Cummins B Series 5.9 L Diesel		
CF7000; CF8000; CFT8000		
Belt - Fan & Alt.	F3HZ8620K	♣K080585HD
F700; F800		
Belt - Hub, Fan, Alt. & A.C.	F3HT8620SA	♣K080830HD
Tensioner Assy. - Hub, Fan, Alt. & A.C.	3936197	38517
Tensioner Pulley - Hub, Fan, Alt. & A.C.	3936197	36095
Hose - Upper - Eng. To Pipe; (2" I.D.)		24232
Hose - Upper - Pipe To Rad.; (2" I.D.)		24232
Hose - Lower - Eng. To Pipe; (2" I.D.)		24232
Hose - Lower - Pipe To Rad.; (2" I.D.)		24232
FT900		
Belt - Fan & Alt.	F3HZ8620F	♣K080830HD
Tensioner Assy.	3936197	38517
Tensioner Pulley	3936197	36095
Hose - Upper - Eng. To Pipe; (2" I.D.)		24232
Hose - Upper - Pipe To Rad.; (2" I.D.)		24232
Hose - Lower - Eng. To Pipe; (2" I.D.)		24232
Hose - Lower - Pipe To Rad.; (2" I.D.)		24232
L8000; L9000		
Belt - Alt.; W/210, 230 H.P. Eng.	F3HZ8620M	♣K080839HD
Belt - A.C.	D5TZ8620C	♣9395HD
Hose - Upper - Eng. To Pipe; (2 5/8" I.D.)		24242
Hose - Upper - Pipe To Rad.; (2" I.D.)		24232
Hose - Lower - Eng. To Pipe; (2" I.D.)		24232
Hose - Lower - Rad. To Pipe; (2 3/8" I.D.)		24238
LA8000; LA9000; LL9000; LLA9000; LLS9000		
Belt - Fan	F1HZ8620C	♣K080710HD
Belt - Alt.	F3HZ8620M	♣K080839HD
Belt - A.C.	D5TZ8620C	♣9395HD
LN7000		
Belt - Fan & Alt.	F3HZ8620M	♣K080839HD
Tensioner Assy. - Fan & Alt.		38517
Hose - Upper - Eng. To Pipe; (1 5/8" I.D.)		24226
Hose - Upper - Pipe To Rad.; (2" I.D.)		24232
Hose - Heater; (3/4" I.D.)		28442
LN8000; LN9000; LNT8000; LNT9000		
Belt - Fan & Alt.	F3HZ8620M	♣K080839HD
Hose - Upper - Eng. To Pipe; (1 5/8" I.D.)		24226
Hose - Upper - Pipe To Rad.; (2" I.D.)		24232
Hose - Lower - Eng. To Pipe; (2" I.D.)		24232
Hose - Lower - Rad. To Pipe; (2 3/8" I.D.)		24238
Hose - Heater; (3/4" I.D.)		28442
LS8000		
Belt - Fan	F1HZ8620C	♣K080710HD
Belt - Alt.	F3HZ8620M	♣K080839HD
Belt - A.C.	D5TZ8620C	♣9395HD
LS9000; LT8000; LT9000		
Belt - Alt.	F3HZ8620M	♣K080839HD
LTA9000		
Belt - Fan		♣K080710HD
Belt - Alt.		♣K080839HD
Belt - A.C.		♣9395HD

Application	Mfr. Part No.	Our No.
FORD - Continued		
1997 - Continued		
Cummins B Series 5.9 L Diesel - Continued		
LTL9000		
Belt - Alt.	F3HZ8620M	♣K080839HD
LTLA9000; LTLS9000		
Belt - Fan		♣K080710HD
Belt - Alt.	F3HZ8620M	♣K080839HD
Belt - A.C.		♣9395HD
LTS8000; LTS9000		
Belt - Alt.	F3HZ8620M	♣K080839HD
Cummins C Series 8.3 L Diesel		
F800		
Belt - Fan & Alt.	F3HZ8620C	♣K080720HD
Belt - A.C.	F3HZ8620D	♣9640HD
Hose - Upper - Eng. To Pipe; (2" I.D.)		24232
Hose - Upper - Pipe To Rad.; (2" I.D.)		24232
Hose - Lower - Eng. To Pipe; (2" I.D.)		24232
Hose - Lower - Pipe To Rad.; (2" I.D.)		24232
FT900		
Belt - W.P., Fan & Alt.	F3HZ8620C	♣K080720HD
Belt - A.C.	F3HZ8620D	♣9640HD
Tensioner Assy. - Fan, W.P. & Alt.	3936206	38513
Tensioner Pulley - Fan, W.P. & Alt.	3936206	36091
Hose - Upper - Eng. To Pipe; (2" I.D.)		24232
Hose - Upper - Pipe To Rad.; (2" I.D.)		24232
Hose - Lower - Eng. To Pipe; (2" I.D.)		24232
Hose - Lower - Pipe To Rad.; (2" I.D.)		24232
L8000; L9000		
Belt - Fan & Alt.	F3HT8620C	♣K080720HD
Belt - A.C.	F3HT8620D	♣9640HD
Hose - Upper - Eng. To Pipe; (2 1/8" I.D.)		24234
Hose - Upper - Pipe To Rad.; (2" I.D.)		24232
Hose - Lower - Eng. To Pipe; (2 1/2" I.D.)		24240
Hose - Lower - Pipe To Rad.; (2 3/8" I.D.)		24238
Hose - Lower - Pipe To Cooler; (2" I.D.)		24232
LA8000; LA9000; LL9000; LLA9000; LLS9000		
Belt - Alt.	F3HZ8620C	♣K080720HD
Belt - A.C.	F3HZ8620D	♣9640HD
Hose - Upper - Eng. To Pipe; (2 1/4" I.D.)		24236
Hose - Upper - Pipe To Rad.; (2" I.D.)		24232
LN7000; LN8000; LN9000; LNT8000; LNT9000		
Belt - Alt.	F3HZ8620C	♣K080720HD
Belt - A.C.	F3HZ8620D	♣9640HD
Hose - Upper - Eng. To Pipe; (2 1/8" I.D.)		24234
Hose - Upper - Rad. To Pipe; (2" I.D.)		24232
Hose - Lower - Eng. To Rad.; W/Auto. Trans.		22191
Hose - Lower - Pipe To Cooler; (2" I.D.)		24232
Hose - Lower - Rad. To Pipe; (2 3/8" I.D.)		24238
LS8000; LS9000		
Belt - Alt.	F3HZ8620C	♣K080720HD
Belt - A.C.	F3HZ8620D	♣9640HD
Hose - Upper - Eng. To Pipe; (2 1/4" I.D.)		24236
Hose - Upper - Pipe To Rad.; (2" I.D.)		24232
LT8000		
Belt - Fan & Alt.	F6HT8620AYA	♣K080726HD
Belt - Alt.	F3HZ8620C	♣K080720HD
Belt - P.S.	F6HT8620ASA	♣9465HD
Belt - A.C.	F3HZ8620D	♣9640HD
Hose - Upper - Eng. To Pipe; (2 1/4" I.D.)		24236
Hose - Upper - Pipe To Rad.; (2" I.D.)		24232
LT9000		
Belt - Fan & Alt.		♣K080726HD
Belt - Alt.	F3HZ8620C	♣K080720HD
Belt - P.S.		♣9465HD
Belt - A.C.		♣9640HD
Hose - Upper - Eng. To Pipe; (2 1/4" I.D.)		24236
Hose - Upper - Pipe To Rad.; (2" I.D.)		24232
LTA9000		
Belt - Alt.	F3HZ8620C	♣K080720HD
Belt - A.C.	F3HZ8620D	♣9640HD
Hose - Upper - Eng. To Pipe; (2 1/4" I.D.)		24236

♣ Standard Belt Available. See Pages 630-631.

Belts and Coolant Hose for Medium/Heavy-Duty Trucks (1996 and Newer)

Medium & Heavy-Duty Trucks
(1996 & Newer)

Application	Mfr. Part No.	Our No.
FORD - Continued		
1997 - Continued		
Cummins C Series 8.3 L Diesel - Continued		
LTA9000 - Continued		
Hose - Upper - Pipe To Rad.; (2" I.D.)		24232
LTL9000		
Belt - Fan & Alt.		▲K080726HD
Belt - Alt.	F3HZ8620C	▲K080720HD
Belt - P.S.		▲9465HD
Belt - A.C.		▲9640HD
Hose - Upper - Eng. To Pipe; (2 1/4" I.D.)		24236
Hose - Upper - Pipe To Rad.; (2" I.D.)		24232
LTLA9000; LTLS9000		
Belt - Alt.	F3HZ8620C	▲K080720HD
Belt - A.C.	F3HZ8620D	▲9640HD
Hose - Upper - Eng. To Pipe; (2 1/4" I.D.)		24236
Hose - Upper - Pipe To Rad.; (2" I.D.)		24232
LTS8000		
Belt - Fan & Alt.	F6HT8620AYA	▲K080726HD
Belt - Alt.	F3HZ8620C	▲K080720HD
Belt - P.S.	F6HT8620ASA	▲9465HD
Belt - A.C.	F3HZ8620D	▲9640HD
Hose - Upper - Eng. To Pipe; (2 1/4" I.D.)		24236
Hose - Upper - Pipe To Rad.; (2" I.D.)		24232
LTS9000		
Belt - Fan & Alt.		▲K080726HD
Belt - Alt.	F3HZ8620C	▲K080720HD
Belt - P.S.		▲9465HD
Belt - A.C.		▲9640HD
Hose - Upper - Eng. To Pipe; (2 1/4" I.D.)		24236
Hose - Upper - Pipe To Rad.; (2" I.D.)		24232
Cummins ISC Diesel		
CF7000; CF8000; CFT8000		
Belt - Alt.	F3HZ8620F	▲K080830HD
Belt - A.C.	F3HZ8620D	▲9640HD
Cummins L10 Diesel		
L9000; LA9000		
Belt - Fan	F1HT8620AAA	▲K080575HD
Belt - Alt.; W/Delco Alt.	E4FZ8620C	▲K050360HD
Belt - Alt.; W/Motorcraft Alt.	F1HT8620BA	▲K050345HD
Belt - A.C.	C9PZ8620CD	▲9480HD
Hose - Upper - Eng. To Pipe; (2 1/4" I.D.)		24236
Hose - Upper - Pipe To Rad.; (2 1/2" I.D.)		24240
Hose - Lower - Eng. To Pipe; (2" I.D.)		24232
Hose - Lower - Pipe To Rad.; (2 1/2" I.D.)		24240
LN9000; LNT9000		
Belt - Fan	F1HT8620AAA	▲K080575HD
Belt - Alt.; W/Delco Alt.	E4FZ8620C	▲K050360HD
Belt - Alt.; W/Motorcraft Alt.	F1HT8620BA	▲K050345HD
Belt - A.C.	C9PZ8620CD	▲9480HD
Hose - Upper - Eng. To Pipe; (2 1/4" I.D.)		24236
Hose - Upper - Rad. To Pipe; W/Auto. Trans.		21302
Hose - Heater; (5/8" I.D.)		28441
LS9000		
Belt - Fan	F1HT8620AAA	▲K080575HD
Belt - Alt.; W/Delco Alt.	E4FZ8620C	▲K050360HD
Belt - Alt.; W/Motorcraft Alt.	F1HT8620BA	▲K050345HD
Belt - A.C.	C9PZ8620CD	▲9480HD
Hose - Upper - Eng. To Pipe; (2 1/4" I.D.)		24236
Hose - Upper - Pipe To Rad.; (2 1/2" I.D.)		24240
Hose - Lower - Eng. To Pipe; (2" I.D.)		24232
Hose - Lower - Pipe To Rad.; (2 1/2" I.D.)		24240
LT9000; LTA9000; LTL9000		
Belt - Fan; W/14-Ribbed Belt	F6HT8620BA	▲K140516HD
Belt - Fan; W/8-Ribbed Belt	F2HT8620HA	▲K080570HD
Belt - Alt.	E7HT8620GA	▲K050360HD
Belt - A.C.	D0HA8620AJ	▲9480HD
Hose - Upper - Eng. To Pipe; (2 1/4" I.D.)		24236
Hose - Upper - Pipe To Rad.; (2 1/2" I.D.)		24240
Hose - Lower - Eng. To Pipe; (2" I.D.)		24232
Hose - Lower - Pipe To Rad.; (2 1/2" I.D.)		24240

Application	Mfr. Part No.	Our No.
FORD - Continued		
1997 - Continued		
Cummins L10 Diesel - Continued		
LTS9000		
Belt - Fan; W/14-Ribbed Belt	F6HT8620BA	▲K140516HD
Belt - Fan; W/8-Ribbed Belt	F2HT8620HA	▲K080570HD
Belt - Alt.	E7HT8620GA	▲K050360HD
Belt - A.C.	D0HA8620AJ	▲9480HD
Hose - Upper - Eng. To Pipe; (2 1/4" I.D.)		24236
Hose - Upper - Pipe To Rad.		21302
Hose - Heater; (5/8" I.D.)		28441
Cummins M11 Diesel		
L8000		
Belt - Fan; W/52" Belt O.C.		▲K140516HD
Belt - Fan; W/60" Belt O.C.		▲K140594HD
Belt - Alt.		▲K050360HD
Belt - A.C.; W/29" Belt O.C.		▲9290HD
Belt - A.C.; W/48" Belt O.C.		▲9480HD
Hose - Upper - Eng. To Pipe; (2 1/4" I.D.)		24236
Hose - Upper - Pipe To Rad.; (2 1/2" I.D.)		24240
Hose - Lower - Eng. To Pipe; (2" I.D.)		24232
Hose - Lower - Pipe To Rad.; (2 1/2" I.D.)		24240
L9000		
Belt - Fan		▲K140516HD
Belt - Alt.		▲K050360HD
Belt - A.C.		▲9480HD
Hose - Upper - Eng. To Pipe; (2 1/4" I.D.)		24236
Hose - Upper - Pipe To Rad.; (2 1/2" I.D.)		24240
Hose - Lower - Eng. To Pipe; (2" I.D.)		24232
Hose - Lower - Pipe To Rad.; (2 1/2" I.D.)		24240
LA8000; LA9000; LLA9000; LS8000		
Belt - Fan; W/52" Belt O.C.		▲K140516HD
Belt - Fan; W/60" Belt O.C.		▲K140594HD
Belt - Alt.		▲K050360HD
Belt - A.C.; W/29" Belt O.C.		▲9290HD
Belt - A.C.; W/48" Belt O.C.		▲9480HD
Hose - Upper - Eng. To Pipe; (2 1/4" I.D.)		24236
Hose - Upper - Pipe To Rad.; (2 1/2" I.D.)		24240
Hose - Lower - Eng. To Pipe; (2" I.D.)		24232
Hose - Lower - Pipe To Rad.; (2 1/2" I.D.)		24240
LS9000		
Belt - Fan		▲K140516HD
Belt - Alt.		▲K050360HD
Belt - A.C.		▲9480HD
Hose - Upper - Eng. To Pipe; (2 1/4" I.D.)		24236
Hose - Upper - Pipe To Rad.; (2 1/2" I.D.)		24240
Hose - Lower - Eng. To Pipe; (2" I.D.)		24232
Hose - Lower - Pipe To Rad.; (2 1/2" I.D.)		24240
LTA9000; LTLA9000; LTLS9000		
Belt - Fan; W/52" Belt O.C.		▲K140516HD
Belt - Fan; W/60" Belt O.C.		▲K140594HD
Belt - Alt.		▲K050360HD
Belt - A.C.; W/29" Belt O.C.		▲9290HD
Belt - A.C.; W/48" Belt O.C.		▲9480HD
Hose - Upper - Eng. To Pipe; (2 1/4" I.D.)		24236
Hose - Upper - Pipe To Rad.; (2 1/2" I.D.)		24240
Hose - Lower - Eng. To Pipe; (2" I.D.)		24232
Hose - Lower - Pipe To Rad.; (2 1/2" I.D.)		24240
Cummins N14 Diesel		
L8000		
Belt - Fan; W/1050 High Cool., 1300 Cool.		▲K140429HD
Belt - Fan; W/900 Cool.		▲K140433HD
Belt - Fan; W/V-Belt Drive		③TR22443
Belt - Alt.		②▲9435HD
Belt - P.S.		②▲9447HD
Belt - A.C.		▲9420HD
L9000		
Belt - W.P.	3076492	▲K060425HD
Belt - Fan	E8HZ8620T	③TR22443
Belt - Alt.; Preferred Belt	E6PZ8620F	2/9435PB
Belt - Alt.; Optional Belt		②▲9435HD
Belt - P.S.	C9PZ8620BY	②▲9447HD

▲ Standard Belt Available. See Pages 630-631.
② Two Required.

③ Three Required.

Belts and Coolant Hose for Medium/Heavy-Duty Trucks (1996 and Newer)

 Medium & Heavy-Duty Trucks
(1996 & Newer)

Application	Mfr. Part No.	Our No.
FORD - Continued		
1997 - Continued		
Cummins N14 Diesel - Continued		
L9000 - Continued		
Belt - A.C.	C9PZ8620BS	♣9420HD
Hose - Upper - Eng. To Pipe; (2 1/4" I.D.)		24236
LA8000		
Belt - Fan; W/1050 High Cool., 1300 Cool.		♣K140429HD
Belt - Fan; W/900 Cool.		♣K140433HD
Belt - Fan; W/V-Belt Drive		③TR22443
Belt - Alt.		②♣9435HD
Belt - P.S.		②♣9447HD
Belt - A.C.		♣9420HD
LA9000		
Belt - Fan; W/1050 High Cool., 1300 Cool.	F6HZ8620M	♣K140429HD
Belt - Fan; W/900 Cool.	F6HZ8620L	♣K140433HD
Belt - Fan; W/V-Belt Drive		③TR22443
Belt - Alt.	E5HZ8620EA	♣9435HD
Belt - P.S.		②♣9447HD
Belt - A.C.	C9PZ8620BS	♣9420HD
LL9000		
Belt - W.P.	3076492	♣K060425HD
Belt - Fan & Hub; W/V-Ribbed Belt; W/35" Belt O.C.	F1HZ8620J	♣K140345HD
Belt - Fan & Hub; W/V-Ribbed Belt Drive; W/37 1/2" Belt O.C.	F4HZ8620A	♣K140370HD
Belt - Alt.; Preferred Belt	E6PZ8620F	2/9435PB
Belt - Alt.; Optional Belt		②♣9435HD
Belt - P.S.	CPPZ8620BY	②♣9447HD
Belt - A.C.	C9PZ8620BS	♣9420HD
Hose - Upper - Eng. To Rad.		21302
LLA9000		
Belt - Fan; W/1050 High Cool., 1300 Cool.		♣K140429HD
Belt - Fan; W/900 Cool.		♣K140433HD
Belt - Fan; W/V-Belt Drive		③TR22443
Belt - Alt.		②♣9435HD
Belt - P.S.		②♣9447HD
Belt - A.C.		♣9420HD
LLS9000		
Belt - W.P.	3076492	♣K060425HD
Belt - Fan & Hub; W/V-Ribbed Belt	F1HZ8620J	♣K140345HD
Belt - Fan; W/V-Belt Drive	E8HZ8620T	TR22443
Belt - Alt.; Preferred Belt	E6PZ8620F	2/9435PB
Belt - Alt.; Optional Belt		②♣9435HD
Belt - P.S.	C9PZ8620BY	②♣9447HD
Belt - A.C.	C9PZ8620BS	♣9420HD
LN9000; LNT9000		
Belt - W.P.	3076492	♣K060425HD
Belt - Fan	E8HT8620T	②TR22443
Belt - Alt.; Preferred Belt	E6PZ8620F	2/9435PB
Belt - Alt.; Optional Belt		②♣9435HD
Belt - P.S.	9PZ8620BY	②♣9447HD
Belt - A.C.	C9PZ8620BS	♣9420HD
Hose - Upper - Eng. To Pipe; (2 1/4" I.D.)		24236
LS8000		
Belt - Fan; W/1050 High Cool., 1300 Cool.		♣K140429HD
Belt - Fan; W/900 Cool.		♣K140433HD
Belt - Fan; W/V-Belt Drive		③TR22443
Belt - Alt.		②♣9435HD
Belt - P.S.		②♣9447HD
Belt - A.C.		♣9420HD
LS9000		
Belt - W.P.	3076492	♣K060425HD
Belt - Fan	E8HZ8620T	③TR22443
Belt - Alt.; Preferred Belt	E6PZ8620F	2/9435PB
Belt - Alt.; Optional Belt		②♣9435HD
Belt - P.S.	C9PZ8620BY	②♣9447HD
Belt - A.C.	C9PZ8620BS	♣9420HD
Hose - Upper - Eng. To Pipe; (2 1/4" I.D.)		24236
LT8000; LT9000		
Belt - Fan		③TR22443

Application	Mfr. Part No.	Our No.
FORD - Continued		
1997 - Continued		
Cummins N14 Diesel - Continued		
LT8000; LT9000 - Continued		
Belt - Alt.		②♣9435HD
Belt - P.S.		②♣9447HD
Belt - A.C.	C9PZ8620BS	♣9420HD
LTA9000		
Belt - Fan; W/1050 High Cool., 1300 Cool.	F6HZ8620M	♣K140429HD
Belt - Fan; W/900 Cool.	F6HZ8620L	♣K140433HD
Belt - Fan; W/V-Belt Drive		③TR22443
Belt - Alt.	E5HZ8620EA	♣9435HD
Belt - P.S.		②♣9447HD
Belt - A.C.	C9PZ8620BS	♣9420HD
LTL9000		
Belt - Fan		③TR22443
Belt - Alt.		②♣9435HD
Belt - P.S.		②♣9447HD
Belt - A.C.	C9PZ8620BS	♣9420HD
Hose - Upper - Eng. To Pipe; (2 1/4" I.D.)		24236
Hose - Upper - Rad. To Pipe		21302
Hose - By Pass; (3/4" I.D.)		28442
Hose - Aftercooler		21488
Hose - Heater; (5/8" I.D.)		28441
LTLA9000; LTLS9000		
Belt - Fan; W/1050 High Cool., 1300 Cool.		♣K140429HD
Belt - Fan; W/900 Cool.		♣K140433HD
Belt - Fan; W/V-Belt Drive		③TR22443
Belt - Alt.		②♣9435HD
Belt - P.S.		②♣9447HD
Belt - A.C.	C9PZ8620BS	♣9420HD
LTS8000; LTS9000		
Belt - Fan		③TR22443
Belt - Alt.		②♣9435HD
Belt - P.S.		②♣9447HD
Belt - A.C.	C9PZ8620BS	♣9420HD
Detroit Diesel Series 60 Diesel		
L8000; LA8000; LLA9000; LS8000		
Belt - Fan	F7HZ8620CA	♣K140580HD
Belt - Alt.; Preferred Belt	F7HT8620VA	2/9485FPB
Belt - Alt.; Optional Belt		②♣9485HD
Belt - A.C.	C8TA8620D	♣9370HD
Hose - Upper - Pipe To Rad.; (2 1/2" I.D.)		24240
Hose - Upper - Pipe To Pipe; (2 1/2" I.D.)		24240
Hose - Lower; (2 1/2" I.D.)		24240
LTA9000; LTLA9000; LTLS9000		
Belt - Fan		♣K140580HD
Belt - Alt.; Preferred Belt		2/9485FPB
Belt - Alt.; Optional Belt		②♣9485HD
Belt - A.C.		♣9370HD
Hose - Upper - Pipe To Rad.; (2 1/2" I.D.)		24240
Hose - Upper - Pipe To Pipe; (2 1/2" I.D.)		24240
Hose - Lower; (2 1/2" I.D.)		24240
Detroit Diesel 6-Cyl. 11.1 L Diesel		
LA9000		
Belt - Fan		♣K140580HD
Belt - Alt.; Preferred Belt		2/9485FPB
Belt - Alt.; Optional Belt		②♣9485HD
Belt - A.C.		♣9370HD
Hose - Upper - Pipe To Rad.; (2 1/2" I.D.)		24240
Hose - Upper - Pipe To Pipe; (2 1/2" I.D.)		24240
Hose - Lower; (2 1/2" I.D.)		24240
Ford V-8 7.0 L		
F700; F800		
Belt - Fan	C9PZ8620CD	♣9480HD
Belt - Fan & Alt.; W/40A., 60A. Alt.; W/Fan Clutch; W/Cowl Cab	C9PZ8620FN	♣9440HD
Belt - Fan & Alt.; W/40A., 60A. Alt.; W/Fan Clutch; W/O Cowl Cab	E6PZ8620F	♣9435HD
Belt - Fan & Alt.; W/40A., 60A. Alt.; W/Fixed Fan; W/Cowl Cab	D9PZ8620M	♣9447HD

♣ Standard Belt Available. See Pages 630-631.
② Two Required.

③ Three Required.

Belts and Coolant Hose for Medium/Heavy-Duty Trucks (1996 and Newer)

Medium & Heavy-Duty Trucks
(1996 & Newer)

Application	Mfr. Part No.	Our No.
FORD - Continued		
1997 - Continued		
Ford V-8 7.0 L - Continued		
F700; F800 - Continued		
Belt - Fan & Alt.; W/40A., 60A. Alt.; W/Fixed Fan; W/O Cowl Cab	E6PZ8620G	♣9451HD
Belt - Fan & Alt.; W/75A. Alt.; W/Fan Clutch	D9PZ8620M	♣9447HD
Belt - Fan & Alt.; W/75A. Alt.; W/Fixed Fan	E2HZ8620C	♣9463HD
Belt - Fan & Alt.; W/90A., 130A. Alt.; W/Fan Clutch	E6PZ8620G	♣9451HD
Belt - Fan & Alt.; W/90A., 130A. Alt.; W/Fixed Fan	E2HZ8620C	♣9463HD
Belt - Fan & P.S.; W/Single A.P.	②♣9530HD	♣9530HD
Belt - P.S.; W/Dual Belts	E8HZ8620P	②♣9580HD
Belt - P.S.; W/Single Belt	C9PZ8620CR	♣9540HD
Belt - P.S. & A.C.	D4HE8620CA	♣9480HD
Belt - A.C.	E5HZ8620C	♣9360HD
Belt - Air Compr.; W/Air Brakes	E8HZ8620A	♣9650HD
Belt - Air Compr.; W/Hyd. Brakes	E0PZ8620G	♣9610HD
Belt - Idler; W/High Mount Fan	D4HE8620CA	♣9480HD
Hose - Upper; W/P.T.O.	♣21936	♣21936
Hose - Upper; W/Auto. Trans.; W/O P.T.O.	21938	21938
Hose - Upper; W/Man. Trans.	21938	21938
Hose - Lower; W/P.T.O.	21536	21536
Hose - By Pass	♣21942	♣21942
Hose - Heater; (5/8" I.D.)	28441	28441
FT900		
Belt - Alt.; W/40A., 60A. Alt.; W/Fan Clutch; W/Cowl Cab	C9PZ8620FN	♣9440HD
Belt - Alt.; W/40A., 60A. Alt.; W/Fan Clutch; W/O Cowl Cab	E6PZ8620F	♣9435HD
Belt - Alt.; W/40A., 60A. Alt.; W/Fixed Fan; W/Cowl Cab	②♣9447HD	♣9447HD
Belt - Alt.; W/40A., 60A. Alt.; W/Fixed Fan; W/O Cowl Cab	E6PZ8620G	♣9451HD
Belt - Alt.; W/75A. Alt.; W/Fan Clutch	②♣9447HD	♣9447HD
Belt - Alt.; W/75A. Alt.; W/Fixed Fan	E2HZ8620C	♣9463HD
Belt - Alt.; W/90A., 130A. Alt.; W/Fixed Fan	E2HZ8620C	♣9463HD
Belt - Alt.; W/High Mount Fan; W/Idler Pulley	C9PZ8620CD	♣9480HD
Belt - P.S.; W/Dual Belts	②♣9580HD	♣9580HD
Belt - P.S.; W/Single Belt	C9PZ8620CR	♣9540HD
Belt - A.C.	F1HZ8620E	7660
Belt - A.P.; W/Air Brakes	E8HZ8620A	♣9650HD
Belt - A.P.; W/Hyd. Brakes	E0PZ8620G	♣9610HD
Ford V-8 7.3 L Diesel		
F Super Duty		
Belt - Alt., P.S., A.C. & Air Compr.; W/O Ambulance Prep. Pkg.	F5TZ8620B	♣K081189HD
Belt - Alt., P.S., A.C. & Air Compr.; W/Ambulance Prep. Pkg.	F5TZ8620E	♣K081196HD
Idler Pulley - Smooth	F5TZ8678E	38022
Hose - Upper; W/O H.D. Cool.	21403	21403
Hose - Upper; W/H.D. Cool.	22158	22158
Hose - Lower; W/O H.D. Cool.	21395	21395
Hose - Lower; W/H.D. Cool.	22216	22216
Ford V-8 7.5 L		
F Super Duty		
Belt - Fan, Alt. & A.P.; W/75A., 90A. Alt.	F6UE8620FA	♣K060495HD
Belt - Fan, Alt. & A.P.; W/130A. Alt.	E8UZ8620G	K060505
Belt - Fan, A.C. & P.S.	E8DZ8620H	♣K060675HD
Belt - Fan, P.S. & Idler; W/O A.C.	E8DZ8620H	♣K060675HD
Hose - Upper - Eng. To Rad.	21668	21668
Hose - Lower - Eng. To Rad.	21875	21875
Hose - Lower - Rad. To Cooler	21875	21875
Hose - Lower - Eng. To Cooler	21909	21909
1996		
Caterpillar 3176 Diesel		
L9000		
Belt - Fan & Alt.	F0HZ8620A	♣K080780HD

Application	Mfr. Part No.	Our No.
FORD - Continued		
1996 - Continued		
Caterpillar 3176 Diesel - Continued		
L9000 - Continued		
Belt - A.C.; W/Eaton Fan Clutch	E2HZ8620C	♣9463HD
Belt - A.C.; W/Bendix Fan Clutch	D9PZ8620M	♣9447HD
Tensioner Assy. - Fan & Alt.		38506
Hose - Upper - Rad. To Pipe		22440
Hose - Upper - Eng. To Rad.		22440
Hose - Lower - Eng. To Rad.		22440
Hose - Lower - Pipe To Rad.		22440
Hose - Lower; W/Man. Trans.		22188
L9500		
Belt - Fan	F6HZ8620B	♣K140627HD
Belt - Alt.	F6HZ8620NA	♣9463HD
Belt - A.C.	F6HZ8620R	♣9485HD
LL9000		
Belt - Fan & Alt.	F0HZ8620A	♣K080780HD
Belt - A.C.; W/Eaton Fan Clutch	E2HZ8620C	♣9463HD
Belt - A.C.; W/Bendix Fan Clutch	D9PZ8620M	♣9447HD
Tensioner Assy. - Fan & Alt.		38506
Hose - Upper - Eng. To Pipe		20532
Hose - Upper - Pipe To Rad.		22177
Hose - Lower - Eng. To Pipe; (2" I.D.)		24232
Hose - Lower - Pipe To Rad.; (2 1/2" I.D.)		24240
Hose - Lower; W/Man. Trans.		22188
LLA9000		
Belt - Fan; W/1050 Low Cool., 1300 Cool.	F6HZ8620B	♣K140627HD
Belt - Fan; W/900 Cool.	F6HZ8620AD	♣K140618HD
Belt - Fan; W/70 1/2" Belt O.C.	F3HT8620L	♣K140700HD
Belt - Fan & Alt.; W/78 1/2" Belt O.C. ...	F0HT8620CA	♣K080780HD
Belt - Alt.	F6HZ8620NA	♣9455HD
Belt - A.C.; W/1050 Low Cool., 1300 Cool.	F6HZ8620R	♣9485HD
Belt - A.C.; W/45" Belt O.C.	D2TE8620ADA	♣9447HD
Belt - A.C.; W/900 Cool.	E2HZ8620C	♣9463HD
Tensioner Assy. - Fan & Alt.		38506
LLS9000		
Belt - Fan & Alt.	F0HZ8620A	♣K080780HD
Belt - A.C.; W/Eaton Fan Clutch	E2HZ8620C	♣9463HD
Belt - A.C.; W/Bendix Fan Clutch	D9PZ8620M	♣9447HD
Tensioner Assy. - Fan & Alt.		38506
Hose - Upper - Eng. To Pipe		20532
Hose - Upper - Pipe To Rad.		22177
Hose - Lower - Eng. To Pipe; (2" I.D.)		24232
Hose - Lower - Pipe To Rad.; (2 1/2" I.D.)		24240
LN9000; LNT9000		
Belt - Fan & Alt.	F0HZ8620A	♣K080780HD
Belt - A.C.; W/Eaton Fan Clutch	E2HZ8620C	♣9463HD
Belt - A.C.; W/Bendix Fan Clutch	D9PZ8620M	♣9447HD
Tensioner Assy. - Fan & Alt.		38506
Hose - Upper - Eng. To Pipe; (2 1/2" I.D.)		24240
Hose - Upper - Pipe To Eng.; (2 1/2" I.D.)		24240
Hose - Lower - Eng. To Rad.		22188
LS9000		
Belt - Fan & Alt.	F0HZ8620A	♣K080780HD
Belt - A.C.; W/Eaton Fan Clutch	E2HZ8620C	♣9463HD
Belt - A.C.; W/Bendix Fan Clutch	D9PZ8620M	♣9447HD
Tensioner Assy. - Fan & Alt.		38506
Hose - Upper - Rad. To Pipe		22440
Hose - Upper - Eng. To Rad.		22440
Hose - Lower - Eng. To Rad.		22440
Hose - Lower - Pipe To Rad.		22440
Hose - Lower; W/Man. Trans.		22188
LT9000; LTL9000		
Belt - Fan & Alt.; W/70 1/2" Belt O.C. ...	F3HT8620L	♣K140700HD
Belt - Fan & Alt.; W/78 1/2" Belt O.C. ...	F0HT8620CA	♣K080780HD
Belt - A.C.	D2TE8620ADA	♣9447HD
Tensioner Assy. - Fan & Alt.		38506
Hose - Lower; W/Man. Trans.		22188

♣ Standard Belt Available. See Pages 630-631.
◆ Green Stripe® PowerBand® Belt May Work, Use Template to Check.

② Two Required.
♣ Cut to Fit.

Belts and Coolant Hose for Medium/Heavy-Duty Trucks (1996 and Newer)

 Medium & Heavy-Duty Trucks
(1996 & Newer)

Application	Mfr. Part No.	Our No.
FORD - Continued		
1996 - Continued		
Caterpillar 3176 Diesel - Continued		
LTLA9000		
Belt - Fan; W/1050 Low Cool., 1300 Cool.	F6HZ8620B	♣K140627HD
Belt - Fan; W/900 Cool.	F6HZ8620AD	♣K140618HD
Belt - Fan; W/70 1/2" Belt O.C.	F3HT8620L	♣K140700HD
Belt - Fan & Alt.	FOHT8620CA	♣K080780HD
Belt - Alt.	F6HZ8620NA	♣9455HD
Belt - A.C.; W/1050 Low Cool., 1300 Cool.	F6HZ8620R	♣9485HD
Belt - A.C.; W/45" Belt O.C.	D2TE8620ADA	♣9447HD
Belt - A.C.; W/900 Cool.	E2HZ8620C	♣9463HD
Tensioner Assy. - Fan & Alt.		38506
LTL9000		
Belt - Fan; W/1050 High Cool.	F7HZ8620JA	♣K140682HD
Belt - Fan; W/1050 Low Cool., 1300 Cool.	F6HZ8620C	♣K140603HD
Belt - Fan; W/900 Cool.	F6HZ8620AD	♣K140618HD
Belt - Alt.; W/1050 High Cool.	F7HZ8620AA	♣9465HD
Belt - Alt.; W/1050 Low Cool., 1300 Cool.	E6PZ8620F	♣9435HD
Belt - Alt.; W/900 Cool.	F6HZ8620EB	♣9412HD
Belt - A.C.; W/1050 High Cool.	C5TZ8620TA	♣9435HD
Belt - A.C.; W/1050 Low Cool., 1300 Cool.		♣9465HD
Belt - A.C.; W/900 Cool.	E2HZ8620C	♣9463HD
Tensioner Assy. - Fan & Alt.		38506
LTS9000		
Belt - Fan & Alt.; W/70 1/2" Belt O.C.	F3HT8620L	♣K140700HD
Belt - Fan & Alt.; W/78 1/2" Belt O.C.	FOHT8620CA	♣K080780HD
Belt - A.C.	D2TE8620ADA	♣9447HD
Tensioner Assy. - Fan & Alt.		38506
Hose - Lower; W/Man. Trans.		22188
Caterpillar 3306 Diesel		
L9000; LS9000; LT9000; LTS9000		
Belt - Fan; Optional Belt		②♣9590HD
Belt - Fan; Preferred Belt	E4HT8620YA	2/9590PB
Belt - Alt.; Optional Belt		②♣9530HD
Belt - Alt.; Preferred Belt	E4HT8620AAA	2/9530PB
Belt - A.C.	C9PZ8620CD	♣9480HD
Hose - Upper - Eng. To Rad.		21845
Hose - Lower - Eng. To Pipe		22192
Hose - By Pass; (3/8" I.D.)		28409
Hose - Coolant Reservoir; (1" I.D.)		24216
Hose - Oil Cooler; (2 1/4" I.D.)		24236
Hose - Heater; (5/8" I.D.)		28441
Caterpillar 3406 Diesel		
L8000		
Belt - Fan	F1HZ8620G	♣K100618HD
Belt - Alt.; Preferred Belt	E4HT8620AAA	2/9530PB
Belt - Alt.; Optional Belt	E8HZ8620K	②♣9530HD
Belt - A.C.	C9PZ8620FP	♣9490HD
Hose - Upper - Eng. To Rad.		22194
L9000		
Belt - Fan	F1HZ8620G	♣K100618HD
Belt - Alt.	E8HZ8620K	♣9530HD
Belt - A.C.	C9PZ8620FP	♣9490HD
Hose - Upper - Eng. To Rad.		22194
LA8000; LA9000		
Belt - Fan	F1HZ8620G	♣K100618HD
Belt - Alt.; Preferred Belt	E4HT8620AAA	2/9530PB
Belt - Alt.; Optional Belt	E8HZ8620K	②♣9530HD
Belt - A.C.	C9PZ8620FP	♣9490HD
Hose - Upper - Eng. To Rad.		22194
LL9000		
Serpentine Belt; W/55" Belt O.C.	F4HZ8620C	♣K140555HD
Belt - Fan; W/51 1/2" Belt O.C.	F1HZ8620H	♣K100510HD
Belt - Fan; W/66" Belt O.C.	F4HZ8620D	♣K140662HD
Belt - Fan & A.C.; W/375 H.P. Eng. & Under	C9PZ8620FP	♣9490HD

Application	Mfr. Part No.	Our No.
FORD - Continued		
1996 - Continued		
Caterpillar 3406 Diesel - Continued		
LL9000 - Continued		
Belt - Fan, Alt. & A.C.; W/410 H.P. Eng. & Over	F4HZ8620B	♣9550HD
Belt - Alt.		②♣9545HD
Hose - Upper - Eng. To Rad.; W/O P.S.		22194
LLA9000		
Belt - Fan; W/56" Belt O.C.	F4HT8620AA	♣K140555HD
Belt - Fan; W/67" Belt O.C.	F4HZ8620D	♣K140662HD
Belt - Alt.; Preferred Belt	E6HT8620AA	2/9545PB
Belt - Alt.; Optional Belt		②♣9545HD
Belt - A.C.	DOHA8620AG	♣9525HD
LLS9000		
Belt - Fan	F1HZ8620G	♣K100618HD
Belt - Alt.; Preferred Belt	E4HT8620AAA	2/9530PB
Belt - Alt.; Optional Belt	E8HZ8620K	②♣9530HD
Belt - A.C.	C9PZ8620FP	♣9490HD
Hose - Upper - Eng. To Rad.		22194
LN9000; LNT9000		
Belt - Fan	F1HZ8620H	♣K100510HD
Belt - Alt.	E8HZ8620K	♣9530HD
Belt - A.C.	C9PZ8620FP	♣9490HD
Hose - Upper - Eng. To Rad.; W/O P.S.		22194
LS8000; LS9000		
Belt - Fan	F1HZ8620G	♣K100618HD
Belt - Alt.; Preferred Belt	E4HT8620AAA	2/9530PB
Belt - Alt.; Optional Belt	E8HZ8620K	②♣9530HD
Belt - A.C.	C9PZ8620FP	♣9490HD
Hose - Upper - Eng. To Rad.		22194
LT9000		
Belt - Fan; W/10-Ribbed Belt	F1HZ8620G	♣K100618HD
Belt - Fan; W/14-Ribbed Belt	F4HZ8620D	♣K140662HD
Belt - Alt.; Optional Belt		②♣9530HD
Belt - Alt.; Preferred Belt	E4HT8620AAA	2/9530PB
Belt - A.C.	C9HZ8620FP	♣9490HD
Hose - Upper - Eng. To Rad.; W/O P.S.		≈22194
LTA9000		
Belt - Fan; W/56" Belt O.C.	F4HT8620AA	♣K140555HD
Belt - Fan; W/60" Belt O.C.	F6HT8620ATA	♣K140594HD
Belt - Fan; W/67" Belt O.C.	F4HZ8620D	♣K140662HD
Belt - Fan & A.C.	F2HZ8620F	♣9505HD
Belt - Alt.; W/50 1/2" Belt O.C.	F6HZ8620RA	♣9500HD
Belt - Alt.; W/55 1/4" Belt O.C.; Optional Belt		②♣9545HD
Belt - Alt.; W/55 1/4" Belt O.C.; Preferred Belt	E6HT8620AA	2/9545PB
Belt - A.C.; W/51 1/2" Belt O.C.	E4HT8620DA	♣9505HD
Belt - A.C.; W/53" Belt O.C.	DOHA8620AG	♣9525HD
Hose - Upper - Eng. To Pipe; (2 1/2" I.D.)		24240
Hose - Lower - Eng. To Pipe; (3" I.D.)		24248
Hose - Lower - Pipe To Rad.; (2 1/2" I.D.)		24240
LTL9000		
Belt - Fan; W/14-Ribbed Belt		♣K140662HD
Belt - Alt.; Preferred Belt		2/9545PB
Belt - Alt.; Optional Belt		②♣9545HD
Belt - A.C.		♣9525HD
Hose - Upper - Eng. To Rad.; W/O P.S.		≈22194
Hose - By Pass; (1 1/2" I.D.)		24224
LTLA9000		
Belt - Fan; W/56" Belt O.C.	F4HT8620AA	♣K140555HD
Belt - Fan; W/67" Belt O.C.	F4HZ8620D	♣K140662HD
Belt - Alt.; Preferred Belt	E6HT8620AA	2/9545PB
Belt - Alt.; Optional Belt		②♣9545HD
Belt - A.C.	DOHA8620AG	♣9525HD
LTL9000		
Belt - Fan; W/56" Belt O.C.	F4HT8620AA	♣K140555HD
Belt - Fan; W/67" Belt O.C.	F4HZ8620D	♣K140662HD
Belt - Alt.; Preferred Belt	E6HT8620AA	2/9545PB
Belt - Alt.; Optional Belt		②♣9545HD
Belt - A.C.	DOHA8620AG	♣9525HD
Hose - Upper - Eng. To Rad.; (2 3/8" I.D.)		24238

♣ Standard Belt Available. See Pages 630-631.
≈ Cut to Fit.

② Two Required.

Belts and Coolant Hose for Medium/Heavy-Duty Trucks (1996 and Newer)

Medium & Heavy-Duty Trucks
(1996 & Newer)

Application	Mfr. Part No.	Our No.
FORD - Continued		
1996 - Continued		
Caterpillar 3406 Diesel - Continued		
LTL59000 - Continued		
Hose - Upper - Rad. To Rad.; (2 3/8" I.D.)		24238
LTS8000		
Belt - Fan	F4HZ8620D	▲K140662HD
LTS9000		
Belt - Fan; W/10-Ribbed Belt	F1HZ8620G	▲K100618HD
Belt - Fan; W/14-Ribbed Belt	F4HZ8620D	▲K140662HD
Belt - Alt.; Preferred Belt	E4HT8620AAA	29530PB
Belt - Alt.; Optional Belt		②▲9530HD
Belt - A.C.	C9HZ8620FP	▲9490HD
Hose - Upper - Eng. To Rad.; W/O P.S.		≡<22194
Cummins B Series 5.9 L Diesel		
CF7000; CF8000; CFT8000		
Belt - Fan & Alt.	F3HZ8620K	▲K080585HD
F700; F800		
Belt - Fan & Alt.	F3HZ8620F	▲K080830HD
Belt - P.S.	C6TA8620J	▲9420HD
Belt - A.C.	F4HZ8620GA	▲9412HD
Belt - Hyd. Brake Boost Pump	F4HT8620GA	▲9412HD
Tensioner Assy. - Fan & Alt.	3936197	38517
Tensioner Pulley - Fan & Alt.	3936197	36095
Hose - Upper - Eng. To Pipe; (2" I.D.)		24232
Hose - Upper - Pipe To Rad.; (2" I.D.)		24232
Hose - Lower - Eng. To Pipe; (2" I.D.)		24232
Hose - Lower - Pipe To Rad.; (2" I.D.)		24232
FT900		
Belt - Fan & Alt.	F3HZ8620F	▲K080830HD
Tensioner Assy. - Fan & Alt.	3936197	38517
Tensioner Pulley - Fan & Alt.	3936197	36095
Hose - Upper - Eng. To Pipe; (2" I.D.)		24232
Hose - Upper - Pipe To Rad.; (2" I.D.)		24232
Hose - Lower - Eng. To Pipe; (2" I.D.)		24232
Hose - Lower - Pipe To Rad.; (2" I.D.)		24232
L8000		
Belt - Alt.; W/210, 230 H.P. Eng.	F3HZ8620M	▲K080839HD
Hose - Upper - Eng. To Pipe; (2 5/8" I.D.)		24242
Hose - Upper - Pipe To Rad.; (2" I.D.)		24232
Hose - Lower - Eng. To Pipe; (2" I.D.)		24232
Hose - Lower - Rad. To Pipe; (2 3/8" I.D.)		24238
L9000		
Belt - Alt.	F3HZ8620M	▲K080839HD
Hose - Upper - Eng. To Pipe; (2 5/8" I.D.)		24242
Hose - Upper - Pipe To Rad.; (2" I.D.)		24232
Hose - Lower - Eng. To Pipe; (2" I.D.)		24232
Hose - Lower - Rad. To Pipe; (2 3/8" I.D.)		24238
LA8000; LA9000; LL9000; LLA9000; LLS9000		
Belt - Alt.	F3HZ8620M	▲K080839HD
LN7000		
Belt - Fan & Alt.	F3HZ8620M	▲K080839HD
Tensioner Assy. - Fan & Alt.		38517
Hose - Upper - Eng. To Pipe; (1 5/8" I.D.)		24226
Hose - Upper - Pipe To Rad.; (2" I.D.)		24232
Hose - Heater; (3/4" I.D.)		28442
LN8000; LN9000; LNT8000; LNT9000		
Belt - Fan & Alt.	F3HZ8620M	▲K080839HD
Hose - Upper - Eng. To Pipe; (1 5/8" I.D.)		24226
Hose - Upper - Pipe To Rad.; (2" I.D.)		24232
Hose - Lower - Eng. To Pipe; (2" I.D.)		24232
Hose - Lower - Rad. To Pipe; (2 3/8" I.D.)		24238
Hose - Heater; (3/4" I.D.)		28442
LS8000; LS9000; LT8000; LT9000; LTA9000; LTL9000; LTLA9000;		
LTL59000; LTS8000; LTS9000		
Belt - Alt.	F3HZ8620M	▲K080839HD
Cummins C Series 8.3 L Diesel		
CF7000; CF8000; CFT8000		
Belt - Alt.	F3HZ8620F	▲K080830HD
Belt - A.C.	F3HZ8620D	▲9640HD

Application	Mfr. Part No.	Our No.
FORD - Continued		
1996 - Continued		
Cummins C Series 8.3 L Diesel - Continued		
F800		
Belt - Fan & Alt.	F3HZ8620C	▲K080720HD
Belt - A.C.	F3HZ8620D	▲9640HD
Tensioner Assy. - Fan & Alt.	3936206	38513
Tensioner Pulley - Fan & Alt.	3936206	36091
Hose - Upper - Eng. To Pipe; (2" I.D.)		24232
Hose - Upper - Pipe To Rad.; (2" I.D.)		24232
Hose - Lower - Eng. To Pipe; (2" I.D.)		24232
Hose - Lower - Pipe To Rad.; (2" I.D.)		24232
FT900		
Belt - Fan & Alt.	F3HZ8620C	▲K080720HD
Belt - A.C.	F3HZ8620D	▲9640HD
Tensioner Assy. - Fan, W.P. & Alt.	3936206	38513
Tensioner Pulley - Fan, W.P. & Alt.	3936206	36091
Hose - Upper - Eng. To Pipe; (2" I.D.)		24232
Hose - Upper - Pipe To Rad.; (2" I.D.)		24232
Hose - Lower - Eng. To Pipe; (2" I.D.)		24232
Hose - Lower - Pipe To Rad.; (2" I.D.)		24232
L8000; L9000		
Belt - Fan & Alt.	F3HT8620C	▲K080720HD
Belt - A.C.	F3HT8620D	▲9640HD
Tensioner Assy. - Fan & Alt.	3936206	38513
Tensioner Pulley - Fan & Alt.	3936206	36091
Hose - Upper - Eng. To Pipe; (2 1/8" I.D.)		24234
Hose - Upper - Pipe To Rad.; (2" I.D.)		24232
Hose - Lower - Eng. To Pipe; (2 1/2" I.D.)		24240
Hose - Lower - Pipe To Rad.; (2 3/8" I.D.)		24238
Hose - Lower - Pipe To Cooler; (2" I.D.)		24232
LA8000		
Belt - Fan & Alt.	F3HT8620GA	▲K080720HD
Belt - A.C.	F3HZ8620D	▲9640HD
Tensioner Assy. - Fan & Alt.	3936206	38513
Tensioner Pulley - Fan & Alt.	3936206	36091
LA9000		
Belt - Fan	F6HZ8620N	▲K080733HD
Belt - Alt.	F3HZ8620C	▲K080720HD
Belt - A.C.	F3HZ8620D	▲9640HD
LL9000		
Belt - Fan & Alt.	F3HZ8620C	▲K080720HD
Belt - A.C.	F3HZ8620D	▲9640HD
Tensioner Assy. - Fan & Alt.	3936206	38513
Tensioner Pulley - Fan & Alt.	3936206	36091
LLA9000		
Belt - Fan & Alt.	F6HT8620AYA	▲K080726HD
Belt - A.C.; W/47" Belt O.C.	F6HT8620ASA	▲9465HD
Belt - A.C.; W/64 1/2" Belt O.C.	F3HZ8620D	▲9640HD
Hose - Upper - Eng. To Pipe; (2 1/4" I.D.)		24236
Hose - Upper - Pipe To Rad.; (2" I.D.)		24232
LLS9000		
Belt - Fan & Alt.	F3HZ8620C	▲K080720HD
Belt - A.C.	F3HZ8620D	▲9640HD
Tensioner Assy. - Fan & Alt.	3936206	38513
Tensioner Pulley - Fan & Alt.	3936206	36091
LN7000; LN8000; LN9000; LNT8000; LNT9000		
Belt - Fan & Alt.	F3HZ8620C	▲K080720HD
Belt - A.C.	F3HZ8620D	▲9640HD
Tensioner Assy. - Fan & Alt.	3936206	38513
Tensioner Pulley - Fan & Alt.	3936206	36091
Hose - Upper - Eng. To Pipe; (2 1/8" I.D.)		24234
Hose - Upper - Rad. To Pipe; (2" I.D.)		24232
Hose - Lower - Eng. To Rad.; W/Auto. Trans.		22191
Hose - Lower - Pipe To Cooler; (2" I.D.)		24232
Hose - Lower - Rad. To Pipe; (2 3/8" I.D.)		24238
LS8000		
Belt - Fan & Alt.	F3HT8620GA	▲K080720HD
Belt - A.C.	F3HZ8620D	▲9640HD
Tensioner Assy. - Fan & Alt.	3936206	38513
Tensioner Pulley - Fan & Alt.	3936206	36091

▲ Standard Belt Available. See Pages 630-631.
≡< Cut to Fit.

② Two Required.

Belts and Coolant Hose for Medium/Heavy-Duty Trucks (1996 and Newer)

 Medium & Heavy-Duty Trucks
(1996 & Newer)

Application	Mfr. Part No.	Our No.
FORD - Continued		
1996 - Continued		
Cummins C Series 8.3 L Diesel - Continued		
LS9000		
Belt - Fan & Alt.	F3HZ8620C	▲K080720HD
Belt - A.C.	F3HZ8620D	▲9640HD
Tensioner Assy. - Fan & Alt.	3936206	38513
Tensioner Pulley - Fan & Alt.	3936206	36091
LT8000		
Belt - Fan & Alt.	F3HT8620GA	▲K080720HD
Belt - A.C.; W/63 1/2" Belt O.C.	E7HT8620CA	▲9630HD
Belt - A.C.; W/64 1/2" Belt O.C.	F3HT8620D	▲9640HD
Tensioner Assy. - Fan & Alt.	3936206	38513
Tensioner Pulley - Fan & Alt.	3936206	36091
LT9000		
Belt - Fan & Alt.	F3HZ8620C	▲K080720HD
Belt - A.C.	F3HZ8620D	▲9640HD
Tensioner Assy. - Fan & Alt.	3936206	38513
Tensioner Pulley - Fan & Alt.	3936206	36091
LTA9000		
Belt - Fan	F6HZ8620N	▲K080733HD
Belt - Alt.	F3HZ8620C	▲K080720HD
Belt - A.C.	F3HZ8620D	▲9640HD
LTL9000		
Belt - Fan & Alt.	F3HZ8620C	▲K080720HD
Belt - A.C.	F3HZ8620D	▲9640HD
Tensioner Assy. - Fan & Alt.	3936206	38513
Tensioner Pulley - Fan & Alt.	3936206	36091
LTLA9000; LTLS9000		
Belt - Fan & Alt.	F6HT8620AYA	▲K080726HD
Belt - A.C.; W/47" Belt O.C.	F6HT8620ASA	▲9465HD
Belt - A.C.; W/64 1/2" Belt O.C.	F3HZ8620D	▲9640HD
Hose - Upper - Eng. To Pipe; (2 1/4" I.D.)		24236
Hose - Upper - Pipe To Rad.; (2" I.D.)		24232
LTS8000		
Belt - Fan & Alt.	F3HT8620GA	▲K080720HD
Belt - A.C.; W/63 1/2" Belt O.C.	E7HT8620CA	▲9630HD
Belt - A.C.; W/64 1/2" Belt O.C.	F3HT8620D	▲9640HD
Tensioner Assy. - Fan & Alt.	3936206	38513
Tensioner Pulley - Fan & Alt.	3936206	36091
LTS9000		
Belt - Fan & Alt.	F3HZ8620C	▲K080720HD
Belt - A.C.	F3HZ8620D	▲9640HD
Tensioner Assy. - Fan & Alt.	3936206	38513
Tensioner Pulley - Fan & Alt.	3936206	36091
Cummins L10 Diesel		
L9000; LA9000		
Belt - Fan	F1HT8620AAA	▲K080575HD
Belt - Alt.; W/Delco Alt.	E4FZ8620C	▲K050360HD
Belt - Alt.; W/Motorcraft Alt.	F1HT8620BA	▲K050345HD
Belt - A.C.		▲9480HD
Hose - Upper - Eng. To Pipe; (2 1/4" I.D.)		24236
Hose - Upper - Pipe To Rad.; (2 1/2" I.D.)		24240
Hose - Lower - Eng. To Pipe; (2" I.D.)		24232
Hose - Lower - Pipe To Rad.; (2 1/2" I.D.)		24240
LN9000; LNT9000		
Belt - Fan	F1HT8620AAA	▲K080575HD
Belt - Alt.; W/Delco Alt.	E4FZ8620C	▲K050360HD
Belt - Alt.; W/Motorcraft Alt.	F1HZ8620K	▲K050350HD
Belt - A.C.	C9PZ8620CD	▲9480HD
Hose - Upper - Eng. To Pipe; (2 1/4" I.D.)		24236
Hose - Upper - Rad. To Pipe; W/Auto. Trans.		21302
Hose - Heater; (5/8" I.D.)		28441
LS9000		
Belt - Fan	F1HT8620AAA	▲K080575HD
Belt - Alt.; W/Delco Alt.	E4FZ8620C	▲K050360HD
Belt - Alt.; W/Motorcraft Alt.	F1HT8620BA	▲K050345HD
Belt - A.C.		▲9480HD
Hose - Upper - Eng. To Pipe; (2 1/4" I.D.)		24236
Hose - Upper - Pipe To Rad.; (2 1/2" I.D.)		24240
Hose - Lower - Eng. To Pipe; (2" I.D.)		24232
Hose - Lower - Pipe To Rad.; (2 1/2" I.D.)		24240

▲ Standard Belt Available. See Pages 630-631.

Application	Mfr. Part No.	Our No.
FORD - Continued		
1996 - Continued		
Cummins L10 Diesel - Continued		
LT9000		
Hose - Upper - Eng. To Pipe; (2 1/4" I.D.)		24236
Hose - Upper - Pipe To Rad.; (2 1/2" I.D.)		24240
Hose - Lower - Eng. To Pipe; (2" I.D.)		24232
Hose - Lower - Pipe To Rad.; (2 1/2" I.D.)		24240
LTA9000		
Belt - Fan		▲K140516HD
Belt - Alt.		▲K050360HD
Belt - A.C.		▲9480HD
Hose - Upper - Eng. To Pipe; (2 1/4" I.D.)		24236
Hose - Upper - Pipe To Rad.; (2 1/2" I.D.)		24240
Hose - Lower - Eng. To Pipe; (2" I.D.)		24232
Hose - Lower - Pipe To Rad.; (2 1/2" I.D.)		24240
LTL9000		
Hose - Upper - Eng. To Pipe; (2 1/4" I.D.)		24236
Hose - Upper - Pipe To Rad.; (2 1/2" I.D.)		24240
Hose - Lower - Eng. To Pipe; (2" I.D.)		24232
Hose - Lower - Pipe To Rad.; (2 1/2" I.D.)		24240
LTS9000		
Belt - Fan; W/8-Ribbed Belt	F2HT8620HA	▲K080570HD
Belt - Alt.	E7HT8620GA	▲K050360HD
Belt - A.C.	DOHA8620AJ	▲9480HD
Hose - Upper - Eng. To Pipe; (2 1/4" I.D.)		24236
Hose - Upper - Pipe To Rad.		21302
Hose - Heater; (5/8" I.D.)		28441
Cummins M11 Diesel		
L8000		
Belt - Fan; W/52" Belt O.C.		▲K140516HD
Belt - Fan; W/60" Belt O.C.		▲K140594HD
Belt - Alt.		▲K050360HD
Belt - A.C.; W/29" Belt O.C.		▲9290HD
Belt - A.C.; W/48" Belt O.C.		▲9480HD
Hose - Upper - Eng. To Pipe; (2 1/4" I.D.)		24236
Hose - Upper - Pipe To Rad.; (2 1/2" I.D.)		24240
Hose - Lower - Eng. To Pipe; (2" I.D.)		24232
Hose - Lower - Pipe To Rad.; (2 1/2" I.D.)		24240
L9000		
Belt - Fan		▲K140516HD
Belt - Alt.		▲K050360HD
Belt - A.C.		▲9480HD
Hose - Upper - Eng. To Pipe; (2 1/4" I.D.)		24236
Hose - Upper - Pipe To Rad.; (2 1/2" I.D.)		24240
Hose - Lower - Eng. To Pipe; (2" I.D.)		24232
Hose - Lower - Pipe To Rad.; (2 1/2" I.D.)		24240
LA8000; LA9000; LLA9000; LS8000		
Belt - Fan; W/52" Belt O.C.		▲K140516HD
Belt - Fan; W/60" Belt O.C.		▲K140594HD
Belt - Alt.		▲K050360HD
Belt - A.C.; W/29" Belt O.C.		▲9290HD
Belt - A.C.; W/48" Belt O.C.		▲9480HD
Hose - Upper - Eng. To Pipe; (2 1/4" I.D.)		24236
Hose - Upper - Pipe To Rad.; (2 1/2" I.D.)		24240
Hose - Lower - Eng. To Pipe; (2" I.D.)		24232
Hose - Lower - Pipe To Rad.; (2 1/2" I.D.)		24240
LS9000		
Belt - Fan		▲K140516HD
Belt - Alt.		▲K050360HD
Belt - A.C.		▲9480HD
Hose - Upper - Eng. To Pipe; (2 1/4" I.D.)		24236
Hose - Upper - Pipe To Rad.; (2 1/2" I.D.)		24240
Hose - Lower - Eng. To Pipe; (2" I.D.)		24232
Hose - Lower - Pipe To Rad.; (2 1/2" I.D.)		24240
LTA9000; LTLA9000; LTLTS9000		
Belt - Fan; W/52" Belt O.C.		▲K140516HD
Belt - Fan; W/60" Belt O.C.		▲K140594HD
Belt - Alt.		▲K050360HD
Belt - A.C.; W/29" Belt O.C.		▲9290HD
Belt - A.C.; W/48" Belt O.C.		▲9480HD
Hose - Upper - Eng. To Pipe; (2 1/4" I.D.)		24236

Belts and Coolant Hose for Medium/Heavy-Duty Trucks (1996 and Newer)

Medium & Heavy-Duty Trucks
(1996 & Newer)

Application	Mfr. Part No.	Our No.
FORD - Continued		
1996 - Continued		
Cummins M11 Diesel - Continued		
LTA9000; LTLA9000; LTLS9000 - Continued		
Hose - Upper - Pipe To Rad.; (2 1/2" I.D.)		24240
Hose - Lower - Eng. To Pipe; (2" I.D.)		24232
Hose - Lower - Pipe To Rad.; (2 1/2" I.D.)		24240
Cummins N14 Diesel		
L8000		
Belt - Fan; W/1050 High Cool., 1300 Cool.		▲K140429HD
Belt - Fan; W/900 Cool.	F6HZ8620L	▲K140433HD
Belt - Fan; W/V-Belt Drive		③TR22443
Belt - Alt.		②▲9435HD
Belt - P.S.		②▲9447HD
Belt - A.C.	C9PZ8620BS	▲9420HD
L9000		
Belt - W.P.	3076492	▲K060425HD
Belt - Fan	E8HZ8620T	③TR22443
Belt - Alt.; Preferred Belt	E6PZ8620F	2/9435PB
Belt - Alt.; Optional Belt		②▲9435HD
Belt - P.S.	C9PZ8620BY	②▲9447HD
Belt - A.C.	C9PZ8620BS	▲9420HD
Hose - Upper - Eng. To Pipe; (2 1/4" I.D.)		24236
LA8000		
Belt - Fan; W/1050 High Cool., 1300 Cool.		▲K140429HD
Belt - Fan; W/900 Cool.	F6HZ8620L	▲K140433HD
Belt - Fan; W/V-Belt Drive		③TR22443
Belt - Alt.		②▲9435HD
Belt - P.S.		②▲9447HD
Belt - A.C.	C9PZ8620BS	▲9420HD
LA9000		
Belt - Fan		③TR22443
Belt - Alt.		②▲9435HD
Belt - P.S.		②▲9447HD
Belt - A.C.	C9PZ8620BS	▲9420HD
LL9000		
Belt - W.P.	3076492	▲K060425HD
Belt - Fan & Hub; W/V-Ribbed Belt; W/35" Belt O.C.	F1HZ8620J	▲K140345HD
Belt - Fan & Hub; W/V-Ribbed Belt Drive; W/37 1/2" Belt O.C.	F4HZ8620A	▲K140370HD
Belt - Alt.; Preferred Belt	E6PZ8620F	2/9435PB
Belt - Alt.; Optional Belt		②▲9435HD
Belt - P.S.	CPPZ8620BY	②▲9447HD
Belt - A.C.	C9PZ8620BS	▲9420HD
Hose - Upper - Eng. To Rad.		21302
LLA9000		
Belt - Fan; W/1050 High Cool., 1300 Cool.		▲K140429HD
Belt - Fan; W/900 Cool.		▲K140433HD
Belt - Fan; W/V-Belt Drive		③TR22443
Belt - Alt.		②▲9435HD
Belt - P.S.		②▲9447HD
Belt - A.C.	C9PZ8620BS	▲9420HD
LLS9000		
Belt - W.P.	3076492	▲K060425HD
Belt - Fan & Hub; W/V-Ribbed Belt	F1HZ8620J	▲K140345HD
Belt - Fan; W/V-Belt Drive	E8HZ8620T	TR22443
Belt - Alt.; Preferred Belt	E6PZ8620F	2/9435PB
Belt - Alt.; Optional Belt		②▲9435HD
Belt - P.S.	C9PZ8620BY	②▲9447HD
Belt - A.C.	C9PZ8620BS	▲9420HD
LN9000; LNT9000		
Belt - W.P.	3076492	▲K060425HD
Belt - Fan	E8HT8620T	②TR22443
Belt - Alt.; Preferred Belt	E6PZ8620F	2/9435PB
Belt - Alt.; Optional Belt		②▲9435HD
Belt - P.S.	9PZ8620BY	②▲9447HD
Belt - A.C.	C9PZ8620BS	▲9420HD
Hose - Upper - Eng. To Pipe; (2 1/4" I.D.)		24236
LS8000		
Belt - Fan; W/1050 High Cool., 1300 Cool.		▲K140429HD
Belt - Fan; W/900 Cool.	F6HZ8620L	▲K140433HD

Application	Mfr. Part No.	Our No.
FORD - Continued		
1996 - Continued		
Cummins N14 Diesel - Continued		
LS8000 - Continued		
Belt - Fan; W/V-Belt Drive		③TR22443
Belt - Alt.		②▲9435HD
Belt - P.S.		②▲9447HD
Belt - A.C.	C9PZ8620BS	▲9420HD
LS9000		
Belt - W.P.	3076492	▲K060425HD
Belt - Fan	E8HZ8620T	③TR22443
Belt - Alt.; Preferred Belt	E6PZ8620F	2/9435PB
Belt - Alt.; Optional Belt		②▲9435HD
Belt - P.S.	C9PZ8620BY	②▲9447HD
Belt - A.C.	C9PZ8620BS	▲9420HD
Hose - Upper - Eng. To Pipe; (2 1/4" I.D.)		24236
LT8000; LT9000; LTA9000		
Belt - Fan		③TR22443
Belt - Alt.		②▲9435HD
Belt - P.S.		②▲9447HD
Belt - A.C.	C9PZ8620BS	▲9420HD
LTL9000		
Belt - Fan		③TR22443
Belt - Alt.		②▲9435HD
Hose - Upper - Eng. To Pipe; (2 1/4" I.D.)		24236
Hose - Upper - Rad. To Pipe		21302
Hose - By Pass; (3/4" I.D.)		28442
Hose - Aftercooler		21488
Hose - Heater; (5/8" I.D.)		28441
LTLA9000; LTLS9000		
Belt - Fan; W/1050 High Cool., 1300 Cool.		▲K140429HD
Belt - Fan; W/900 Cool.		▲K140433HD
Belt - Fan; W/V-Belt Drive		③TR22443
Belt - Alt.		②▲9435HD
Belt - P.S.		②▲9447HD
Belt - A.C.	C9PZ8620BS	▲9420HD
LTS8000; LTS9000		
Belt - Fan		③TR22443
Belt - Alt.		②▲9435HD
Belt - P.S.		②▲9447HD
Belt - A.C.	C9PZ8620BS	▲9420HD
Detroit Diesel Series 60 Diesel		
L8000; LA8000; LS8000		
Belt - Fan; W/50" Belt O.C.		▲K140496HD
Belt - Fan; W/52" Belt O.C.		▲K140516HD
Belt - Alt.; Preferred Belt		2/9485FPB
Belt - Alt.; Optional Belt		②▲9485HD
Belt - A.C.		▲9370HD
Detroit Diesel 6-Cyl. 11.1 L Diesel		
LA9000; LLA9000; LTA9000; LTLA9000; LTLS9000		
Belt - Fan; W/50" Belt O.C.	F6HT8620LA	▲K140496HD
Belt - Fan; W/52" Belt O.C.	F6HZ8620K	▲K140516HD
Belt - Alt.; Preferred Belt	F7HT8620VA	2/9485FPB
Belt - Alt.; Optional Belt		②▲9485HD
Belt - A.C.	C8TA8620D	▲9370HD
Detroit Diesel 6-Cyl. 12.7 L Diesel		
LA9000; LLA9000; LTA9000; LTLA9000; LTLS9000		
Belt - Fan; W/50" Belt O.C.	F6HT8620LA	▲K140496HD
Belt - Fan; W/52" Belt O.C.	F6HZ8620K	▲K140516HD
Belt - Alt.; Preferred Belt	F7HT8620VA	2/9485FPB
Belt - Alt.; Optional Belt		②▲9485HD
Belt - A.C.	C8TA8620D	▲9370HD
Ford V-8 7.0 L		
F700; F800		
Belt - Fan	C9PZ8620CD	▲9480HD
Belt - Fan & Alt.; W/40A., 60A. Alt.		
W/Fan Clutch; W/Cowl Cab	C9PZ8620FN	▲9440HD
Belt - Fan & Alt.; W/40A., 60A. Alt.		
W/Fan Clutch; W/O Cowl Cab	E6PZ8620F	▲9435HD
Belt - Fan & Alt.; W/40A., 60A. Alt.		
W/Fixed Fan; W/Cowl Cab	D9PZ8620M	▲9447HD

▲ Standard Belt Available. See Pages 630-631.
② Two Required.

③ Three Required.

Belts and Coolant Hose for Medium/Heavy-Duty Trucks (1996 and Newer)

 Medium & Heavy-Duty Trucks
(1996 & Newer)

Application	Mfr. Part No.	Our No.	Application	Mfr. Part No.	Our No.
FORD - Continued			FREIGHTLINER		
1996 - Continued			2012		
Ford V-8 7.0 L - Continued			Cummins ISX15 Diesel		
F700; F800 - Continued			Coronado		
Belt - Fan & Alt.; W/40A., 60A. Alt.;			Belt - Fan	0132161200	K120866HD
W/Fixed Fan; W/O Cowl Cab	E6PZ8620G	♣9451HD	Belt - A.C.	0132162674	♣K060658HD
Belt - Fan & Alt.; W/75A. Alt.; W/Fan			Tensioner Assy. - A.C.	3104149	38610
Clutch	D9PZ8620M	♣9447HD	Tensioner Assy. - Fan	2871292	38587
Belt - Fan & Alt.; W/75A. Alt.; W/Fixed			Idler Pulley - A.C.	3682229	36223
Fan	E2HZ8620C	♣9463HD	Hose - Lower - Rad. To Pipe		≡21891
Belt - Fan & Alt.; W/90A., 130A. Alt.;			Hose - Lower - Pipe To Pipe		≡21135
W/Fan Clutch	E6PZ8620G	♣9451HD	Hose - Lower - Pipe To Eng.		≡21891
Belt - Fan & Alt.; W/90A., 130A. Alt.;			Detroit Diesel DD13 Diesel		
W/Fixed Fan	E2HZ8620C	♣9463HD	Cascadia; Coronado		
Belt - Fan & P.S.; W/Single A.P.		②♣9530HD	Belt - Alt. & A.C.	0132732680	K081055HD
Belt - P.S.; W/Dual Belts	E8HZ8620P	②♣9580HD	Belt - Fan	0132731635	K100643HD
Belt - P.S.; W/Single Belt	C9PZ8620CR	♣9540HD	Detroit Diesel DD15 Diesel		
Belt - P.S. & A.C.	D4HE8620CA	♣9480HD	Cascadia		
Belt - A.C.	E5HZ8620C	♣9360HD	Belt - Fan	0131893635	K100643HD
Belt - Air Compr.; W/Air Brakes	E8HZ8620A	♣9650HD	Belt - A.C. & Alt.	0132732700	K081065HD
Belt - Air Compr.; W/Hyd. Brakes	E0PZ8620G	♣9610HD	Hose - Lower - Eng. To Pipe		≡21115
Belt - Idler; W/High Mount Fan	D4HE8620CA	♣9480HD	Hose - Lower - Pipe To Rad.		≡21891
Hose - Upper; W/P.T.O.		≡21936	DEF Hose Assy. - Pressure - Tank To		
Hose - Upper; W/Auto. Trans.; W/O P.T.O.		21938	Pump	0428650000	DEF7004
Hose - Upper; W/Man. Trans.		21938	DEF Hose Assy. - Pressure - Pump To		
Hose - Lower; W/P.T.O.		21536	Injector	0428841200	DEF7006
Hose - By Pass		≡21942	Coronado		
Hose - Heater; (5/8" I.D.)		28441	Belt - Fan	0131893635	K100643HD
FT900			Belt - Alt. & A.C.	0132732700	K081065HD
Belt - Alt.; W/40A., 60A. Alt.; W/Fan			Hose - Upper - Rad. To Pipe; (2 1/2" I.D.)		≡24240
Clutch; W/Cowl Cab	C9PZ8620FN	♣9440HD	Hose - Upper - Pipe To Eng.; (2 1/2" I.D.)		≡24240
Belt - Alt.; W/40A., 60A. Alt.; W/Fan			2011		
Clutch; W/O Cowl Cab	E6PZ8620F	♣9435HD	Cummins ISC Diesel		
Belt - Alt.; W/40A., 60A. Alt.; W/Fixed Fan; W/Cowl Cab		②♣9447HD	Business Class M2		
Belt - Alt.; W/40A., 60A. Alt.; W/Fixed			Belt - Fan	0132241146	K080845HD
Fan; W/O Cowl Cab	E6PZ8620G	♣9451HD	Tensioner Assy. - Fan	3973819	38627
Belt - Alt.; W/75A. Alt.; W/Fan Clutch; W/Cowl Cab		②♣9447HD	Idler Pulley - Fan	3970945	36283
Belt - Alt.; W/75A. Alt.; W/Fan Clutch;			Cummins ISX15 Diesel		
W/O Cowl Cab	D9PZ8620M	♣9447HD	Cascadia		
Belt - Alt.; W/75A. Alt.; W/Fixed Fan	E2HZ8620C	♣9463HD	Belt - A.C. - From W.P.	0132162674	♣K060658HD
Belt - Alt.; W/90A., 130A. Alt.; W/Fixed			Belt - Fan, Alt. & W.P.	0132161200	K120866HD
Fan	E2HZ8620C	♣9463HD	Tensioner Assy. - A.C.	3104149	38610
Belt - Alt.; W/High Mount Fan; W/Idler			Tensioner Assy. - Fan, W.P. & Alt.	2871292	38587
Pulley	C9PZ8620CD	♣9480HD	Idler Pulley - A.C.	3682229	36223
Belt - P.S.; W/Dual Belts		②♣9580HD	Coronado		
Belt - P.S.; W/Single Belt	C9PZ8620CR	♣9540HD	Belt - Fan	0132161200	K120866HD
Belt - A.P.; W/Hyd. Brakes	E0PZ8620G	♣9610HD	Belt - A.C.	0132162674	♣K060658HD
Belt - Air Compr.; W/Air Brakes	E8HZ8620A	♣9650HD	Tensioner Assy. - A.C.	3104149	38610
Ford V-8 7.3 L Diesel			Tensioner Assy. - Fan	2871292	38587
F Super Duty			Idler Pulley - A.C.	3682229	36223
Belt - Alt., P.S., A.C. & Air Compr.; W/O			Hose - Lower - Rad. To Pipe		≡21891
Ambulance Prep. Pkg.	F5TZ8620B	♣K081189HD	Hose - Lower - Pipe To Pipe		≡21135
Belt - Alt., P.S., A.C. & Air Compr.;			Hose - Lower - Pipe To Eng.		≡21891
W/Ambulance Prep. Pkg.	F5TZ8620E	♣K081196HD	Detroit Diesel 6-Cyl. 14.0 L Diesel		
Idler Pulley - Smooth	F5TZ8678E	38022	Argosy		
Hose - Upper; W/O H.D. Cool.		21403	Belt - Fan	0131893416	K100557HD
Hose - Upper; W/Man. Trans.; W/H.D. Cool.		20584	Belt - Alt. & A.C.	0129859445	♣K080570HD
Hose - Upper; W/Auto. Trans.; W/H.D. Cool.		22158	Tensioner Assy. - Fan	0127846000	38503
Hose - Lower; W/O H.D. Cool.		21395	Tensioner Assy. - Alt. & A.C.	0127425000	38501
Hose - Lower; W/Man. Trans.; W/H.D. Cool.		21048	Columbia		
Hose - Lower; W/Auto. Trans.; W/H.D. Cool.		22216	Belt - Fan	0124894004	♣K100502HD
Ford V-8 7.5 L			Belt - Hub, Alt. & A.C.	0129859445	K100557HD
F Super Duty			Tensioner Assy. - Fan	0127846000	38503
Belt - Fan, Alt. & A.P.; W/75A., 90A. Alt.	F6UE8620FA	♣K060495HD	Tensioner Assy. - Hub, Alt. & A.C.	0127425000	38501
Belt - Fan, Alt. & A.P.; W/130A. Alt.	E8UZ8620G	K060505	Tensioner Pulley - Fan	0127846000	38076
Belt - Fan, A.C. & P.S.	E8DZ8620H	♣K060675HD	Tensioner Pulley - Hub, Alt. & A.C.	0127425000	38075
Belt - Fan, P.S. & Idler; W/O A.C.	E8DZ8620H	♣K060675HD	Hose - Upper - Rad. To Pipe; (2 1/2" I.D.)		≡24240
Hose - Upper - Eng. To Rad.		21668	Hose - Upper - Pipe To Eng.; (2 1/2" I.D.)		≡24240
Hose - Lower - Eng. To Rad.		21875	Hose - Lower - Rad. To Pipe		≡20987
Hose - Lower - Rad. To Cooler		21875	Hose - Lower - Pipe To Eng.		≡20987
Hose - Lower - Eng. To Cooler		21909			

♣ Standard Belt Available. See Pages 630-631.
 ◆ Green Stripe® PowerBand® Belt May Work, Use Template to Check.

② Two Required.
 ≡ Cut to Fit.

Belts and Coolant Hose for Medium/Heavy-Duty Trucks (1996 and Newer)

Medium & Heavy-Duty Trucks
(1996 & Newer)

Application	Mfr. Part No.	Our No.
FREIGHTLINER - Continued		
2011 - Continued		
Detroit Diesel DD13 Diesel		
Business Class M2		
Belt - Alt.	0132732680	K081055HD
Belt - Fan	0131893635	K100643HD
Cascadia		
Belt - Fan	0131893635	K100643HD
Hose - Lower		≈20987
Coronado		
Belt - Alt. & A.C.	0132732680	K081055HD
Belt - Fan	0132731635	K100643HD
Detroit Diesel DD15 Diesel		
Cascadia		
Belt - Fan	0131893635	K100643HD
Belt - A.C. & Alt.	0132732700	K081065HD
Hose - Lower - Eng. To Pipe		≈21115
Hose - Lower - Pipe To Rad.		≈21891
Coronado		
Belt - Fan	0131893635	K100643HD
Belt - Alt. & A.C.	0132732700	K081065HD
Hose - Upper - Rad. To Pipe; (2 1/2" I.D.)		≈24240
Hose - Upper - Pipe To Eng.; (2 1/2" I.D.)		≈24240
Mercedes-Benz MBE 4000 Diesel		
Cascadia		
Belt - A.C.	0124587002	♣K080855HD
Belt - Fan	0127116013	♣K080505HD
Tensioner Assy. - Fan		38597
Tensioner Assy. - A.C.		38501
Tensioner Pulley - A.C.		38075
Hose - Upper - Eng. To Pipe; (2 1/2" I.D.)		≈24440
Hose - Upper - Pipe To Rad.		21891
2010		
Cummins ISB CNG		
MT55		
Belt - Alt.	3288812	♣K080575HD
Tensioner Assy. - Alt.	3938022	38504
Cummins ISB Diesel		
Business Class M2		
Belt - Accessory Drive	0132241065	K080813HD
Tensioner Assy.	5264111	38631
Hose - Upper		22743
Hose - Lower; (2" I.D.)		≈24832
MT45		
Belt - Fan, A.C., Alt. & W.P.	3289952	♣K080751HD
Tensioner Assy. - Fan, A.C., Alt. & W.P.	3976834	38516
Tensioner Pulley - Fan, A.C., Alt. & W.P.		36093
Hose - Upper - Rad. To Pipe; (2" I.D.)		≈24232
Hose - Upper - Pipe To Eng.; (1 3/4" I.D.)		≈24228
Hose - Lower - Rad. To Pipe; (2" I.D.)		≈24232
Hose - Lower - Pipe To Rad.; (2" I.D.)		≈24232
Cummins ISX15 Diesel		
Cascadia		
Belt - A.C. - From W.P.	0132162619	♣K060637HD
Belt - Fan, Alt. & W.P.	0132161200	K120866HD
Tensioner Assy. - A.C.	3104149	38610
Tensioner Assy. - Fan, W.P. & Alt.	2871292	38587
Idler Pulley - A.C.	3682229	36223
Detroit Diesel 6-Cyl. 14.0 L Diesel		
Columbia		
Belt - Fan	0124894004	♣K100502HD
Belt - Hub, Alt. & A.C.	0124587006	♣K080570HD
Tensioner Assy. - Fan	0127846000	38503
Tensioner Assy. - Hub, Alt. & A.C.	0127425000	38501
Tensioner Pulley - Fan	0127846000	38076
Tensioner Pulley - Hub, Alt. & A.C.	0127425000	38075
Hose - Upper - Rad. To Pipe; (2 1/2" I.D.)		≈24240
Hose - Upper - Pipe To Eng.; (2 1/2" I.D.)		≈24240
Hose - Lower - Rad. To Pipe		≈20987

Application	Mfr. Part No.	Our No.
FREIGHTLINER - Continued		
2010 - Continued		
Detroit Diesel 6-Cyl. 14.0 L Diesel - Continued		
Columbia - Continued		
Hose - Lower - Pipe To Eng.		≈20987
Detroit Diesel DD13 Diesel		
Cascadia		
Belt - Fan	0132731635	K100643HD
Hose - Lower - Rad. To Pipe		≈20987
Detroit Diesel DD15 Diesel		
Cascadia		
Belt - Alt., P.S., A.C. & Air Compr.	0131894642	♣K081035HD
Belt - Fan	0131893635	K100643HD
Hose - Lower - Eng. To Pipe		≈21115
Hose - Lower - Pipe To Rad.		≈21891
Century Class		
Belt - Fan	0124894004	♣K100502HD
Belt - Hub, Alt. & A.C.	0129859445	K100557HD
Tensioner Assy. - Fan	0127846000	38503
Tensioner Assy. - Hub, Alt. & A.C.	0127425000	38501
Mercedes-Benz MBE 4000 Diesel		
Business Class M2; Cascadia		
Belt - W.P., Alt. & A.C.	0124587002	♣K080855HD
Belt - Fan	0127116013	♣K080505HD
Tensioner Assy. - W.P., Alt. & A.C.	0127425000	38501
Tensioner Assy. - Fan	0127427001	38597
Tensioner Pulley - W.P., Alt. & A.C.		38075
Hose - Upper - Eng. To Pipe; (2 1/2" I.D.)		≈24440
Hose - Upper - Pipe To Rad.		21891
Columbia		
Belt - W.P., Alt. & A.C.	0124587002	♣K080855HD
Belt - Fan	0127116013	♣K080505HD
Tensioner Assy. - Fan	0127427001	38597
Tensioner Assy. - Alt.	0127425000	38501
2009		
Caterpillar C13 Diesel		
Business Class M2		
Belt - Alt.	0130884175	♣K060858HD
Belt - Fan & A.C.	0130883420	K100953HD
Tensioner Assy. - Alt.	2756558	38635
Tensioner Assy. - Fan & A.C.	2873203	38646
Idler Pulley - Alt. (Upper)	2790251	36227
Idler Pulley - Alt. (Lower)	2790251	36227
Hose - Lower - Eng. To Pipe; (2 1/2" I.D.)		≈24440
Hose - Lower - Pipe To Rad.		≈21891
Caterpillar C15 Diesel		
Argosy		
Tensioner Assy. - Fan & Alt.	2002279	38569
Tensioner Assy. - Fan To A.C.	2178938	38511
Idler Pulley - Smooth	1979641	36091
Idler Pulley - Grooved	1979642	36341
Tensioner Pulley - Fan To A.C.	2178938	36091
Hose - Upper - Eng. To Rad.		23229
Hose - Lower - Eng. To Rad.		23015
FLD		
Belt - Fan	0130882000	K120985HD
Belt - A.C.	0131165840	K060723HD
Tensioner Assy. - Fan	2790253	38636
Tensioner Assy. - A.C.	3368955	38609
Idler Pulley - A.C. (Lower)	2850277	36282
Cummins ISB Diesel		
Business Class M2		
Belt - Fan, A.C., Alt. & W.P.	0123415077	K080813HD
Tensioner Assy. - Fan, A.C., Alt. & W.P.	4937433	38631
Hose - Upper - Eng. To Rad.		≈22743
Hose - Lower - Eng. To Pipe; (2" I.D.)		≈24432
Hose - Lower - Pipe To Rad.; (2" I.D.)		≈24432
MT45		
Belt - Fan, A.C., Alt. & W.P.	3289952	♣K080751HD

≈ Cut to Fit.

* Durion® Silicone Hose Recommended.

♣ Standard Belt Available. See Pages 630-631.

Belts and Coolant Hose for Medium/Heavy-Duty Trucks (1996 and Newer)

Medium & Heavy-Duty Trucks
(1996 & Newer)

Application	Mfr. Part No.	Our No.
FREIGHTLINER - Continued		
2009 - Continued		
Cummins ISB Diesel - Continued		
MT45 - Continued		
Tensioner Assy. - Fan, A.C., Alt. & W.P.	3976834	38516
Tensioner Pulley - Fan, A.C., Alt. & W.P.		36093
Hose - Upper - Rad. To Pipe; (2" I.D.)		☞24232
Hose - Upper - Pipe To Eng.; (1 3/4" I.D.)		☞24228
Hose - Lower - Eng. To Pipe; (2" I.D.)		☞24232
Hose - Lower - Pipe To Eng.; (2" I.D.)		☞24232
Cummins ISC Diesel		
Business Class M2		
Belt - Fan, A.C., Alt. & W.P.	0123415100	♣K080820HD
Tensioner Assy. - Fan, A.C., Alt. & W.P.	3973819	38627
Idler Pulley - Fan, A.C., Alt. & W.P.	3970945	36283
Hose - Upper - Rad. To Pipe; (2 1/2" I.D.)		☞24240
Hose - Lower - Eng. To Pipe		☞21135
Cummins ISX Diesel		
Cascadia		
Belt - A.C. - From W.P.	0132162619	♣K060637HD
Belt - Fan, Alt. & W.P.	0132161200	K120866HD
Tensioner Assy. - A.C.	3104149	38610
Tensioner Assy. - Fan, W.P. & Alt.	2871292	38587
Idler Pulley - A.C.	3682229	36223
Hose - Upper - Eng. To Rad.; (2 1/2" I.D.)		24440
Hose - Lower - Eng. To Pipe		☞21891
Hose - Lower - Pipe To Pipe; (2 1/2" I.D.)		☞24440
Hose - Lower - Pipe To Rad.		21891
Detroit Diesel 6-Cyl. 12.7 L Diesel		
Coronado		
Belt - Fan	0124894004	♣K100502HD
Belt - Hub, Alt. & A.C.	0124587004	♣K080565HD
Tensioner Assy. - Fan	0127846000	38503
Tensioner Assy. - Hub, Alt. & A.C.	0127425000	38501
Tensioner Pulley - Fan	0127846000	38076
Tensioner Pulley - Hub, Alt. & A.C.	0127425000	38075
Hose - Upper - Eng. To Pipe		21135
Hose - Upper - Pipe To Rad.; (2 1/2" I.D.)		24240
Hose - Lower - Eng. To Pipe; (2 1/2" I.D.)		24240
Detroit Diesel 6-Cyl. 14.0 L Diesel		
Cascadia		
Belt - W.P., Alt. & A.C.; W/58 3/8" Belt		♣K080580HD
O.C.	0124587000	
Belt - W.P., Alt. & A.C.; W/56 7/8" Belt		♣K080570HD
O.C.	0124587006	
Belt - Fan - From C.S.	0124894004	♣K100502HD
Tensioner Assy. - W.P., Alt. & A.C.	0127425000	38501
Tensioner Assy. - Fan	0127846000	38503
Columbia		
Belt - Fan	0124894004	♣K100502HD
Belt - Hub, Alt. & A.C.	0124587006	♣K080570HD
Tensioner Assy. - Fan	0127846000	38503
Tensioner Assy. - Hub, Alt. & A.C.	0127425000	38501
Tensioner Pulley - Fan	0127846000	38076
Tensioner Pulley - Hub, Alt. & A.C.	0127425000	38075
Hose - Upper - Rad. To Pipe; (2 1/2" I.D.)		☞24240
Hose - Upper - Pipe To Eng.; (2 1/2" I.D.)		☞24240
Hose - Lower - Rad. To Pipe		☞20987
Hose - Lower - Pipe To Eng.		☞20987
Coronado		
Belt - Fan	0124894004	♣K100502HD
Belt - Hub, Alt. & A.C.	0124587004	♣K080565HD
Tensioner Assy. - Fan	0127846000	38503
Tensioner Assy. - Hub, Alt. & A.C.	0127425000	38501
Tensioner Pulley - Fan	0127846000	38076
Tensioner Pulley - Hub, Alt. & A.C.	0127425000	38075
Hose - Upper - Eng. To Pipe		21135
Hose - Upper - Pipe To Rad.; (2 1/2" I.D.)		24240
Hose - Lower - Eng. To Pipe; (2 1/2" I.D.)		24240
FLD		
Belt - Fan	0124587006	♣K080570HD
Belt - A.C.	0124587000	♣K080580HD

☞ Cut to Fit.

Application	Mfr. Part No.	Our No.
FREIGHTLINER - Continued		
2009 - Continued		
Detroit Diesel 6-Cyl. 14.0 L Diesel - Continued		
FLD - Continued		
Tensioner Assy. - Fan	0127846000	38503
Tensioner Assy. - A.C.	0127425000	38501
Detroit Diesel DD13 Diesel		
Cascadia		
Belt - Alt.	0131894642	♣K081035HD
Belt - Fan	0132731635	K100643HD
Hose - Lower - Rad. To Pipe		☞20987
Detroit Diesel DD15 Diesel		
Cascadia		
Belt - Alt., P.S., A.C. & Air Compr.	0131894642	♣K081035HD
Belt - Fan - From C.S.	0131893635	K100643HD
Hose - Lower - Eng. To Pipe		☞21115
Hose - Lower - Pipe To Rad.		☞21891
Columbia		
Belt - Alt., P.S., A.C. & Air Compr.	A4729930496	♣K081035HD
Mercedes-Benz MBE 900 Diesel		
Business Class M2		
Belt - Fan - From C.S.	0127116013	♣K080505HD
Belt - W.P., Fan, Alt. & A.C.	0124587002	♣K080855HD
Tensioner Assy. - Alt. & A.C.	0127425000	38501
Tensioner Assy. - Fan	0127427001	38597
Hose - Upper - Pipe To Rad.		21891
MT55		
Hose - Turbo - Intercooler To Engine (Cold Side)	0129982000	29001
Mercedes-Benz MBE 4000 Diesel		
Business Class M2		
Belt - W.P., Alt. & A.C.	0124587002	♣K080855HD
Belt - Fan	0127116013	♣K080505HD
Tensioner Assy. - W.P., Alt. & A.C.	0127425000	38501
Tensioner Assy. - Fan	0127427001	38597
Hose - Upper - Eng. To Pipe; (2 1/2" I.D.)		☞24440
Hose - Upper - Pipe To Rad.		21891
Cascadia; Century Class; Classic; Classic XL		
Belt - A.C.	0124587002	♣K080855HD
Belt - Fan	0127116013	♣K080505HD
Tensioner Assy. - Fan		38597
Tensioner Assy. - A.C.		38501
Tensioner Pulley - A.C.		38075
Hose - Upper - Eng. To Pipe; (2 1/2" I.D.)		☞24440
Hose - Upper - Pipe To Rad.		21891
Columbia		
Belt - W.P., Alt. & A.C.	0127116004	♣K080855HD
Belt - Fan	0127116013	♣K080505HD
Tensioner Assy. - Fan	0127427001	38597
Tensioner Assy. - Hub, Alt. & A.C.	0127425000	38501
Tensioner Pulley - Hub, Alt. & A.C.	0127425000	38075
FLD		
Belt - A.C.	0124587002	♣K080855HD
Belt - Fan	0127116013	♣K080505HD
Tensioner Assy. - Fan		38597
Tensioner Assy. - A.C.		38501
Tensioner Pulley - A.C.		38075
Hose - Upper - Eng. To Pipe; (2 1/2" I.D.)		☞24440
Hose - Upper - Pipe To Rad.		21891
2008		
Caterpillar C13 Diesel		
Columbia		
Belt - Fan, Alt. & A.C.	0123415055	♣K080952HD
Tensioner Assy. - Fan, Alt. & A.C.	2117895	38590
Tensioner Pulley - Fan, Alt. & A.C.	2117895	36164
Idler Pulley - Smooth	2078118	36269
Idler Pulley - Grooved	1979642	36341
Hose - Upper - Eng. To Rad.		22950
Hose - Lower - Eng. To Pipe; (2 1/2" I.D.)		24240
Hose - Lower - Rad. To Pipe; (2 1/2" I.D.)		24240

♣ Standard Belt Available. See Pages 630-631.

Belts and Coolant Hose for Medium/Heavy-Duty Trucks (1996 and Newer)

Medium & Heavy-Duty Trucks
(1996 & Newer)

Application	Mfr. Part No.	Our No.
FREIGHTLINER - Continued		
2008 - Continued		
Caterpillar C15 Diesel		
Columbia		
Belt - Fan	0130882000	K120985HD
Belt - A.C.	0131165840	K060723HD
Tensioner Assy. - Alt.	2790253	38636
Tensioner Assy. - A.C.	2362301	38609
Idler Pulley - A.C. (Lower)	2850277	36282
Coronado		
Belt - Fan To Alt.	0131165048	K060723HD
Idler Pulley - A.C.; WV-Groove Idler Pulley	2850277	36282
Hose - Lower - Rad. To Pipe		21891
FLD		
Belt - Fan & Alt.	0123415079	♣K080991HD
Belt - Fan To A.C.	0127177010	♣K060586HD
Tensioner Assy. - Fan & Alt.	2002279	38569
Tensioner Assy. - Fan To A.C.	2178938	38511
Idler Pulley - Smooth	1979641	36091
Idler Pulley - Grooved	1979642	36341
Tensioner Pulley - Fan To A.C.	2178938	36091
Hose - Upper - Eng. To Rad.		23229
Hose - Lower - Eng. To Rad.		23015
Cummins ISB Diesel		
Business Class M2		
Belt - Fan, Alt. & A.C.	0123415077	K080813HD
Tensioner Assy. - Fan, Alt. & A.C.	4937433	38631
Idler Pulley - Fan, Alt. & A.C.	4991240	36093
Hose - Upper - Eng. To Rad.		22743
Hose - Lower - Eng. To Pipe; (2" I.D.)		♣24432
Hose - Lower - Rad. To Pipe; (2" I.D.)		♣24432
Cummins ISC Diesel		
Business Class M2		
Belt - Fan, Alt. & A.C.	0123415100	♣K080820HD
Tensioner Assy.	3973819	38627
Idler Pulley	3970945	36283
Hose - Upper - Eng. To Pipe; (2 1/4" I.D.)		24236
Hose - Upper - Rad. To Pipe; (2" I.D.)		24232
Hose - Lower - Eng. To Pipe; (2 1/4" I.D.)		24236
Hose - Lower - Rad. To Pipe; (2" I.D.)		24232
Detroit Diesel 6-Cyl. 12.7 L Diesel		
Columbia		
Belt - Fan	0124894004	♣K100502HD
Belt - Hub To Alt. & A.C.	0124587004	♣K080565HD
Tensioner Assy. - Fan	0127846000	38503
Tensioner Assy. - Hub, Alt. & A.C.	0127425000	38501
Tensioner Pulley - Fan	0127846000	38076
Tensioner Pulley - Hub, Alt. & A.C.	0127425000	38075
Hose - Upper - Eng. To Rad.; (2 1/2" I.D.)		24240
Hose - Upper - Rad. To Pipe; (2 1/2" I.D.)		24240
Hose - Lower - Eng. To Rad.		22877
Coronado		
Belt - Fan	0124894004	♣K100502HD
Belt - Hub, Alt. & A.C.	0124587004	♣K080565HD
Tensioner Assy. - Fan	0127846000	38503
Tensioner Assy. - Hub, Alt. & A.C.	0127425000	38501
Tensioner Pulley - Fan	0127846000	38076
Tensioner Pulley - Hub, Alt. & A.C.	0127425000	38075
Hose - Upper - Eng. To Pipe		21135
Hose - Upper - Pipe To Rad.; (2 1/2" I.D.)		24240
Hose - Lower - Eng. To Pipe; (2 1/2" I.D.)		24240
FLD		
Belt - Fan	0124894000	♣K100579HD
Belt - Hub To Alt. & A.C.	0124587004	♣K080565HD
Tensioner Assy. - Fan	0127846000	38503
Tensioner Assy. - Hub, Alt. & A.C.	0127425000	38501
Tensioner Pulley - Fan	0127846000	38076
Tensioner Pulley - Hub, Alt. & A.C.	0127425000	38075
Hose - Upper - Eng. To Pipe; (2 1/2" I.D.)		24240
Hose - Upper - Rad. To Pipe		♣21115
Hose - Lower - Eng. To Pipe; (2 1/2" I.D.)		24240

Application	Mfr. Part No.	Our No.
FREIGHTLINER - Continued		
2008 - Continued		
Detroit Diesel 6-Cyl. 12.7 L Diesel - Continued		
FLD - Continued		
Hose - Lower - Rad. To Pipe		21135
Detroit Diesel 6-Cyl. 14.0 L Diesel		
Cascadia		
Belt - Fan	0124894004	♣K100502HD
Belt - Alt. & A.C.	0124587000	♣K080580HD
Tensioner Assy. - Fan	0127846000	38503
Tensioner Assy. - Alt. & A.C.	0127425000	38501
Tensioner Pulley - Fan	0127846000	38076
Tensioner Pulley - Alt. & A.C.	0127425000	38075
Hose - Upper - Eng. To Pipe; (2 1/2" I.D.)		24240
Hose - Upper - Rad. To Pipe; (2 1/2" I.D.)		24240
Hose - Lower - Eng. To Pipe; (2 1/2" I.D.)		24240
Hose - Lower - Rad. To Pipe		21891
Century Class		
Belt - Alt.	0124587006	♣K080570HD
Belt - Fan	GT4100502DF	♣K100502HD
Tensioner Assy.	0127425000	38501
Classic; Classic XL		
Belt - Fan	0124894004	♣K100502HD
Belt - Hub, Alt. & A.C.	0124587006	♣K080570HD
Tensioner Assy. - Fan	0127846000	38503
Tensioner Assy. - Hub, Alt. & A.C.	0127425000	38501
Tensioner Pulley - Fan	0127846000	38076
Tensioner Pulley - Hub, Alt. & A.C.	0127425000	38075
Hose - Upper - Eng. To Pipe; (2 1/2" I.D.)		24240
Hose - Upper - Rad. To Pipe; (2 1/2" I.D.)		24240
Hose - Lower - Eng. To Pipe; (2 1/2" I.D.)		24240
Hose - Lower - Rad. To Pipe		21891
Columbia		
Belt - Fan	0124894004	♣K100502HD
Belt - Hub, Alt. & A.C.	0124587006	♣K080570HD
Tensioner Assy. - Fan	0127846000	38503
Tensioner Assy. - Hub, Alt. & A.C.	0127425000	38501
Tensioner Pulley - Fan	0127846000	38076
Tensioner Pulley - Hub, Alt. & A.C.	0127425000	38075
Hose - Upper - Eng. To Pipe; (2 1/2" I.D.)		24240
Hose - Upper - Rad. To Pipe; (2 1/2" I.D.)		24240
Hose - Lower - Eng. To Pipe; (2 1/2" I.D.)		24240
Hose - Lower - Rad. To Pipe		♣21115
Coronado		
Belt - Fan	0124894004	♣K100502HD
Belt - Hub, Alt. & A.C.	0124587004	♣K080565HD
Tensioner Assy. - Fan	0127846000	38503
Tensioner Assy. - Hub, Alt. & A.C.	0127425000	38501
Tensioner Pulley - Fan	0127846000	38076
Tensioner Pulley - Hub, Alt. & A.C.	0127425000	38075
Hose - Upper - Eng. To Pipe		21135
Hose - Upper - Pipe To Rad.; (2 1/2" I.D.)		24240
Hose - Lower - Eng. To Pipe; (2 1/2" I.D.)		24240
FLD		
Belt - Fan	0124894004	♣K100502HD
Belt - Hub, Alt. & A.C.	0124587006	♣K080570HD
Tensioner Assy. - Fan	0127846000	38503
Tensioner Assy. - Hub, Alt. & A.C.	0127425000	38501
Tensioner Pulley - Fan	0127846000	38076
Tensioner Pulley - Hub, Alt. & A.C.	0127425000	38075
Hose - Upper - Eng. To Pipe; (2 1/2" I.D.)		24240
Hose - Upper - Rad. To Pipe; (2 1/2" I.D.)		24240
Hose - Lower - Eng. To Pipe; (2 1/2" I.D.)		♣24240
Detroit Diesel DD15 Diesel		
Cascadia		
Belt - Fan	0131893635	K100643HD
Belt - Alt., P.S., A.C. & Air Compr.	0131894642	♣K081035HD
Hose - Lower - Eng. To Pipe		♣21115
Hose - Lower - Pipe To Rad.		♣21891
Mercedes-Benz MBE 900 Diesel		
Business Class M2		
Belt - Fan, Alt. & A.C.	0129866094	♣K080825HD

♣ Standard Belt Available. See Pages 630-631.

♣ Cut to Fit.

Belts and Coolant Hose for Medium/Heavy-Duty Trucks (1996 and Newer)

 Medium & Heavy-Duty Trucks
(1996 & Newer)

Application	Mfr. Part No.	Our No.
FREIGHTLINER - Continued		
2008 - Continued		
Mercedes-Benz MBE 900 Diesel - Continued		
Business Class M2 - Continued		
Tensioner Assy. - Alt. & A.C.	9062003170	38567
Hose - Upper - Eng. To Pipe; (2" I.D.)		24232
Hose - Upper - Rad. To Pipe; (2" I.D.)		24232
Hose - Lower - Eng. To Pipe		20206
Hose - Lower - Rad. To Pipe		20206
Mercedes-Benz MBE 4000 Diesel		
Cascadia		
Belt - A.C.	0124587002	♣K080855HD
Belt - Fan	0127116013	♣K080505HD
Tensioner Assy. - Fan		38597
Tensioner Assy. - A.C.		38501
Tensioner Pulley - A.C.		38075
Hose - Upper - Eng. To Pipe; (2 1/2" I.D.)		♣24440
Hose - Upper - Pipe To Rad.		21891
Columbia		
Belt - Fan	0127116013	♣K080505HD
Belt - Hub, Alt. & A.C.	0127116004	♣K080855HD
Tensioner Assy. - Fan	0127427001	38597
Tensioner Assy. - Hub, Alt. & A.C.	0127425000	38501
Tensioner Pulley - Hub, Alt. & A.C.	0127425000	38075
2007		
Caterpillar 3126 Diesel		
Business Class M2		
Belt - Fan, Alt. & A.C.; W/145A. Alt.	0123415040	♣K080774HD
Belt - Fan, Alt. & A.C.; W/130A. Alt.	0123415058	♣K080780HD
Tensioner Assy. - Fan, Alt. & A.C.	2201209	38550
Idler Pulley - Smooth	1979641	36091
Idler Pulley	2534525	36096
Hose - Upper - Eng. To Rad.		22745
Hose - Lower - Eng. To Pipe; (2" I.D.)		24232
Hose - Lower - Rad. To Pipe; (2 1/2" I.D.)		24240
Hose - Lower - Pipe To Cooler		21128
Hose - Lower - Cooler To Pipe		21128
Caterpillar C7 Diesel		
Business Class M2		
Belt - Fan, Alt. & A.C.; W/145A. Alt.	0123415040	♣K080774HD
Belt - Fan, Alt. & A.C.; W/130A. Alt.	0123415058	♣K080780HD
Tensioner Assy. - Fan, Alt. & A.C.	2201209	38550
Idler Pulley - Upper	1979641	36091
Idler Pulley - Lower	2534525	36096
Hose - Upper - Eng. To Rad.		22745
Hose - Lower - Eng. To Pipe; (2" I.D.)		24232
Hose - Lower - Rad. To Pipe; (2 1/2" I.D.)		24240
Hose - Lower - Pipe To Cooler		21128
Hose - Lower - Cooler To Pipe		21128
Caterpillar C9 Diesel		
Business Class M2		
Belt - Fan, Alt. & A.C.	0123415069	♣K080785HD
Tensioner Assy. - Fan, Alt. & A.C.	2201209	38550
Idler Pulley - Smooth	2078118	36269
Hose - Upper - Eng. To Rad.		23085
Hose - Lower - Eng. To Rad.		23173
Caterpillar C11 Diesel		
Business Class M2; Columbia		
Belt - Fan, Alt. & A.C.	0123415080	♣K081005HD
Tensioner Assy. - Fan, Alt. & A.C.	2117895	38590
Tensioner Pulley - Fan, Alt. & A.C.	2117895	36164
Idler Pulley - Smooth	2078118	36269
Idler Pulley - Grooved	1979642	36341
Hose - Upper - Eng. To Rad.		23086
Hose - Lower - Eng. To Rad.		22952
FLD		
Belt - Fan, Alt. & A.C.	0123415080	♣K081005HD
Tensioner Assy. - Fan, Alt. & A.C.	2117895	38590
Tensioner Pulley - Fan, Alt. & A.C.	2117895	36164
Idler Pulley - Smooth	2078118	36269

Application	Mfr. Part No.	Our No.
FREIGHTLINER - Continued		
2007 - Continued		
Caterpillar C11 Diesel - Continued		
FLD - Continued		
Idler Pulley - Grooved	1979642	36341
Hose - Upper - Eng. To Pipe; (2 1/2" I.D.)		24240
Hose - Upper - Rad. To Pipe; (2 1/2" I.D.)		24240
Hose - Lower - Eng. To Pipe; (2 1/2" I.D.)		24240
Hose - Lower - Rad. To Pipe		21135
Caterpillar C13 Diesel		
Business Class M2		
Belt - Hub, Fan, Alt. & A.C.	0123415055	♣K080952HD
Tensioner Assy. - Hub, Fan, Alt. & A.C.	2117895	38590
Tensioner Pulley - Hub, Fan, Alt. & A.C.	2117895	36164
Idler Pulley - Smooth	2078118	36269
Idler Pulley - Grooved	1979642	36341
Hose - Upper - Eng. To Rad.		23086
Hose - Lower - Eng. To Rad.		22952
Century Class; Classic; Classic XL		
Belt - Accessory Drive	0123415080	♣K081005HD
Tensioner Assy.	2117895	38590
Idler Pulley - Smooth	2078118	36269
Idler Pulley - Grooved	1979642	36341
Columbia		
Belt - Fan, Alt. & A.C.	0123415055	♣K080952HD
Tensioner Assy. - Fan, Alt. & A.C.	2117895	38590
Tensioner Pulley - Fan, Alt. & A.C.	2117895	36164
Idler Pulley - Smooth	2078118	36269
Idler Pulley - Grooved	1979642	36341
Hose - Upper - Eng. To Rad.		22950
Hose - Lower - Eng. To Pipe; (2 1/2" I.D.)		24240
Hose - Lower - Rad. To Pipe; (2 1/2" I.D.)		24240
FLD		
Belt - Fan, Alt. & A.C.	0123415080	♣K081005HD
Tensioner Assy. - Fan, Alt. & A.C.	2117895	38590
Tensioner Pulley - Fan, Alt. & A.C.	2117895	36164
Idler Pulley - Smooth	2078118	36269
Idler Pulley - Grooved	1979642	36341
Hose - Upper - Eng. To Pipe; (2 1/2" I.D.)		24240
Hose - Upper - Rad. To Pipe; (2 1/2" I.D.)		24240
Hose - Lower - Eng. To Pipe; (2 1/2" I.D.)		24240
Hose - Lower - Rad. To Pipe		21135
Caterpillar C15 Diesel		
Century Class; Classic; Classic XL		
Idler Pulley - Smooth	1979641	36091
Idler Pulley - Grooved	1979642	36341
Columbia		
Belt - Fan; W/93" Belt O.C.	0123415078	♣K080926HD
Belt - Fan; W/69 5/8" Belt O.C.	0123415098	♣K080694HD
Belt - A.C. & Alt.	0129729610	♣K060635HD
Tensioner Assy. - Fan	2002279	38569
Idler Pulley - Smooth	1979641	36091
Idler Pulley - Grooved	1979642	36341
Hose - Upper - Eng. To Pipe; (2 1/2" I.D.)		♣24440
Hose - Upper - Pipe To Rad.		♣21891
Hose - Lower - Pipe To Rad.; (2 1/2" I.D.)		♣24440
Coronado		
Belt - Fan & Alt.	5080990	♣K080991HD
Belt - A.C.	0129730485	♣K060586HD
Tensioner Assy. - Fan & Alt.	2002279	38569
Tensioner Assy. - A.C.	2178938	38511
Idler Pulley - Smooth	1979641	36091
Idler Pulley - Grooved	1979642	36341
Hose - Lower		23084
FLD		
Belt - Fan & Alt.	0123415079	♣K080991HD
Belt - Fan To A.C.	0127177010	♣K060586HD
Tensioner Assy. - Fan & Alt.	2002279	38569
Tensioner Assy. - Fan To A.C.	2178938	38511
Idler Pulley - Smooth	1979641	36091
Idler Pulley - Grooved	1979642	36341
Tensioner Pulley - Fan To A.C.	2178938	36091

♣ Standard Belt Available. See Pages 630-631.

♣ Cut to Fit.

Belts and Coolant Hose for Medium/Heavy-Duty Trucks (1996 and Newer)

Medium & Heavy-Duty Trucks
(1996 & Newer)

Application	Mfr. Part No.	Our No.
FREIGHTLINER - Continued		
2007 - Continued		
Caterpillar C15 Diesel - Continued		
FLD - Continued		
Hose - Upper - Eng. To Rad.		23229
Hose - Lower - Eng. To Rad.		23015
Cummins ISB Diesel		
Business Class M2		
Belt - Fan, Alt. & A.C.	0123415077	K080813HD
Tensioner Assy. - Fan, Alt. & A.C.	4937433	38631
Hose - Upper - Eng. To Pipe; (2" I.D.)		24232
Hose - Upper - Rad. To Pipe; (2" I.D.)		24232
Hose - Lower - Eng. To Pipe; (2" I.D.)		24232
Hose - Lower - Rad. To Pipe; (2" I.D.)		24232
MT45; MT55		
Belt - Fan, Alt. & A.C.	3289864	▲K080825HD
Tensioner Assy. - Fan, Alt. & A.C.	3976831	38516
Hose - Upper - Eng. To Rad.		23114
Hose - Lower - Eng. To Pipe; (2 1/4" I.D.)		24236
Hose - Lower - Rad. To Pipe; (2 1/4" I.D.)		24236
Cummins ISC Diesel		
Business Class M2		
Belt - Fan, Alt. & A.C.	0123415100	▲K080820HD
Tensioner Assy.	3973819	38627
Idler Pulley	3970945	36283
Hose - Upper - Eng. To Pipe; (2 1/4" I.D.)		24236
Hose - Upper - Rad. To Pipe; (2" I.D.)		24232
Hose - Lower - Eng. To Pipe; (2 1/4" I.D.)		24236
Hose - Lower - Rad. To Pipe; (2" I.D.)		24232
Cummins ISM Diesel		
Columbia		
Belt - Alt.	0127110006	▲K080730HD
Belt - A.C.	0126709009	▲K060575HD
Detroit Diesel 6-Cyl. 12.7 L Diesel		
Argosy		
Belt - Fan	0124894000	▲K100579HD
Belt - Alt. & A.C.	0124587000	▲K080580HD
Tensioner Assy. - Fan		38503
Tensioner Assy. - Alt. & A.C.	23520317	38501
Tensioner Pulley - Fan		38076
Tensioner Pulley - Alt. & A.C.		38075
Hose - Upper - Eng. To Pipe; (2 1/2" I.D.)		24240
Hose - Upper - Rad. To Pipe; (2 1/2" I.D.)		24240
Hose - Lower - Eng. To Cooler; (2 3/4" I.D.)		24244
Hose - Lower - Cooler To Pipe; (2 3/4" I.D.)		24244
Hose - Lower - Rad. To Pipe		≈<21891
Century Class		
Belt - Fan	0124894004	▲K100502HD
Belt - Hub To Alt. & A.C.	0124587004	▲K080565HD
Tensioner Assy. - Fan	0127846000	38503
Tensioner Assy. - Hub, Alt. & A.C.	0127425000	38501
Tensioner Pulley - Fan	0127846000	38076
Tensioner Pulley - Hub, Alt. & A.C.	0127425000	38075
Hose - Upper - Eng. To Pipe; (2 1/2" I.D.)		24240
Hose - Upper - Rad. To Pipe; (2 1/2" I.D.)		24240
Hose - Lower - Eng. To Pipe; (2 1/2" I.D.)		≈<21115
Hose - Lower - Rad. To Pipe		21135
Classic; Classic XL		
Belt - Fan	0124894000	▲K100579HD
Belt - Hub, Alt. & A.C.	0124587004	▲K080565HD
Tensioner Assy. - Fan	0127846000	38503
Tensioner Assy. - Hub, Alt. & A.C.	0127425000	38501
Tensioner Pulley - Fan	0127846000	38076
Tensioner Pulley - Hub, Alt. & A.C.	0127425000	38075
Hose - Upper - Eng. To Pipe; (2 1/2" I.D.)		24240
Hose - Upper - Rad. To Pipe; (2 1/2" I.D.)		≈<21115
Hose - Lower - Eng. To Pipe; (2 1/2" I.D.)		24240
Hose - Lower - Rad. To Pipe		21135
Columbia		
Belt - Fan	0124894004	▲K100502HD
Belt - Hub To Alt. & A.C.	0124587004	▲K080565HD
Tensioner Assy. - Fan	0127846000	38503
Tensioner Assy. - Hub, Alt. & A.C.	0127425000	38501
Tensioner Pulley - Fan	0127846000	38076
Tensioner Pulley - Hub, Alt. & A.C.	0127425000	38075
Hose - Upper - Eng. To Rad.; (2 1/2" I.D.)		24240
Hose - Upper - Rad. To Pipe; (2 1/2" I.D.)		24240
Hose - Lower - Eng. To Rad.		22877

Application	Mfr. Part No.	Our No.
FREIGHTLINER - Continued		
2007 - Continued		
Detroit Diesel 6-Cyl. 12.7 L Diesel - Continued		
Columbia - Continued		
Tensioner Pulley - Fan	0127846000	38076
Tensioner Pulley - Hub, Alt. & A.C.	0127425000	38075
Hose - Upper - Eng. To Rad.; (2 1/2" I.D.)		24240
Hose - Upper - Rad. To Pipe; (2 1/2" I.D.)		24240
Hose - Lower - Eng. To Rad.		22877
Coronado		
Belt - Fan	0124894004	▲K100502HD
Belt - Hub, Alt. & A.C.	0124587004	▲K080565HD
Tensioner Assy. - Fan	0127846000	38503
Tensioner Assy. - Hub, Alt. & A.C.	0127425000	38501
Tensioner Pulley - Fan	0127846000	38076
Tensioner Pulley - Hub, Alt. & A.C.	0127425000	38075
Hose - Upper - Eng. To Pipe		21135
Hose - Upper - Pipe To Rad.; (2 1/2" I.D.)		24240
Hose - Lower - Eng. To Pipe; (2 1/2" I.D.)		24240
FLD		
Belt - Fan	0124894000	▲K100579HD
Belt - Hub To Alt. & A.C.	0124587004	▲K080565HD
Tensioner Assy. - Fan	0127846000	38503
Tensioner Assy. - Hub, Alt. & A.C.	0127425000	38501
Tensioner Pulley - Fan	0127846000	38076
Tensioner Pulley - Hub, Alt. & A.C.	0127425000	38075
Hose - Upper - Eng. To Pipe; (2 1/2" I.D.)		24240
Hose - Upper - Rad. To Pipe		≈<21115
Hose - Lower - Eng. To Pipe; (2 1/2" I.D.)		24240
Hose - Lower - Rad. To Pipe		21135
Detroit Diesel 6-Cyl. 14.0 L Diesel		
Argosy		
Belt - Fan	0124894000	▲K100579HD
Belt - Alt. & A.C.	0124587000	▲K080580HD
Tensioner Assy. - Fan		38503
Tensioner Assy. - Alt. & A.C.	23520317	38501
Tensioner Pulley - Fan		38076
Tensioner Pulley - Alt. & A.C.		38075
Hose - Upper - Eng. To Pipe; (2 1/2" I.D.)		24240
Hose - Upper - Rad. To Pipe; (2 1/2" I.D.)		24240
Hose - Lower - Eng. To Cooler; (2 3/4" I.D.)		24244
Hose - Lower - Cooler To Pipe; (2 3/4" I.D.)		24244
Hose - Lower - Rad. To Pipe		≈<21891
Century Class		
Belt - Fan	0124894004	▲K100502HD
Belt - Hub To Alt. & A.C.	0124587004	▲K080565HD
Tensioner Assy. - Fan	0127846000	38503
Tensioner Assy. - Hub, Alt. & A.C.	0127425000	38501
Tensioner Pulley - Fan	0127846000	38076
Tensioner Pulley - Hub, Alt. & A.C.	0127425000	38075
Hose - Upper - Eng. To Pipe; (2 1/2" I.D.)		24240
Hose - Upper - Rad. To Pipe; (2 1/2" I.D.)		24240
Hose - Lower - Eng. To Pipe; (2 1/2" I.D.)		≈<21115
Hose - Lower - Rad. To Pipe		21135
Classic; Classic XL		
Belt - Fan	0124894000	▲K100579HD
Belt - Hub, Alt. & A.C.	0124587004	▲K080565HD
Tensioner Assy. - Fan	0127846000	38503
Tensioner Assy. - Hub, Alt. & A.C.	0127425000	38501
Tensioner Pulley - Fan	0127846000	38076
Tensioner Pulley - Hub, Alt. & A.C.	0127425000	38075
Hose - Upper - Eng. To Pipe; (2 1/2" I.D.)		24240
Hose - Upper - Rad. To Pipe		≈<21115
Hose - Lower - Eng. To Pipe; (2 1/2" I.D.)		24240
Hose - Lower - Rad. To Pipe		21135
Columbia		
Belt - Fan	0124894004	▲K100502HD
Belt - Hub To Alt. & A.C.	0124587004	▲K080565HD
Tensioner Assy. - Fan	0127846000	38503
Tensioner Assy. - Hub, Alt. & A.C.	0127425000	38501
Tensioner Pulley - Fan	0127846000	38076
Tensioner Pulley - Hub, Alt. & A.C.	0127425000	38075
Hose - Upper - Eng. To Rad.; (2 1/2" I.D.)		24240
Hose - Upper - Rad. To Pipe; (2 1/2" I.D.)		24240
Hose - Lower - Eng. To Rad.		22877

▲ Standard Belt Available. See Pages 630-631.

≈< Cut to Fit.

Belts and Coolant Hose for Medium/Heavy-Duty Trucks (1996 and Newer)

 Medium & Heavy-Duty Trucks
(1996 & Newer)

Application	Mfr. Part No.	Our No.
FREIGHTLINER - Continued		
2007 - Continued		
Detroit Diesel 6-Cyl. 14.0 L Diesel - Continued		
Coronado		
Belt - Fan	0124894004	▲K100502HD
Belt - Hub, Alt. & A.C.	0124587004	▲K080565HD
Tensioner Assy. - Fan	0127846000	38503
Tensioner Assy. - Hub, Alt. & A.C.	0127425000	38501
Tensioner Pulley - Fan	0127846000	38076
Tensioner Pulley - Hub, Alt. & A.C.	0127425000	38075
Hose - Upper - Eng. To Pipe		21135
Hose - Upper - Pipe To Rad.; (2 1/2" I.D.)		24240
Hose - Lower - Eng. To Pipe; (2 1/2" I.D.)		24240
FLD		
Belt - Fan	0124894000	▲K100579HD
Belt - Hub To Alt. & A.C.	0124587004	▲K080565HD
Tensioner Assy. - Fan	0127846000	38503
Tensioner Assy. - Hub, Alt. & A.C.	0127425000	38501
Tensioner Pulley - Fan	0127846000	38076
Tensioner Pulley - Hub, Alt. & A.C.	0127425000	38075
Hose - Upper - Eng. To Pipe; (2 1/2" I.D.)		24240
Hose - Upper - Rad. To Pipe		≈21115
Hose - Lower - Eng. To Pipe; (2 1/2" I.D.)		24240
Hose - Lower - Rad. To Pipe		21135
Mercedes-Benz MBE 900 Diesel		
Business Class M2		
Belt - Fan, Alt. & A.C.; W/O P.T.O.	0129866094	▲K080825HD
Belt - Fan; W/P.T.O.	0127116011	▲K080615HD
Belt - W.P., Alt. & A.C.; W/P.T.O.	0129866094	▲K080825HD
Belt - Fan, Alt. & A.C.; W/84" Belt O.C. .	0129866118	▲K080830HD
Tensioner Assy. - Fan; W/P.T.O.	0129079000	38598
Tensioner Assy. - Alt. & A.C.	9062003170	38567
Hose - Upper - Eng. To Rad.; W/O P.T.O.		21378
Hose - Upper - Eng. To Pipe; W/P.T.O.(2" I.D.)		24232
Hose - Upper - Rad. To Pipe; W/P.T.O.(2 1/2" I.D.)		24240
Hose - Lower - Eng. To Pipe		20206
Hose - Lower - Pipe To Cooler; W/P.T.O.		20206
Hose - Lower - Rad. To Pipe; W/O P.T.O.(2" I.D.)		24032
Hose - Lower - Rad. To Pipe; W/P.T.O.(2 1/2" I.D.)		24240
Hose - Lower - Cooler To Pipe; W/P.T.O.(2" I.D.)		24232
MT55		
Belt - Fan & Alt.	0129859699	▲K080670HD
Tensioner Assy. - Fan & Alt.	9062003170	38567
Hose - Turbo - Intercooler To Engine (Cold Side)	0129982000	29001
Mercedes-Benz MBE 4000 Diesel		
Business Class M2		
Belt - Fan	0127116013	▲K080505HD
Belt - Hub, Alt. & A.C.	0127116004	▲K080855HD
Tensioner Assy. - Fan	0127427001	38597
Tensioner Assy. - Hub, Alt. & A.C.	0127425000	38501
Tensioner Pulley - Hub, Alt. & A.C.	0127425000	38075
Hose - Upper - Eng. To Rad.		22959
Hose - Lower - Eng. To Rad.		23171
Century Class		
Belt - Fan	0127116013	▲K080505HD
Belt - Hub, Alt. & A.C.	0127116004	▲K080855HD
Tensioner Assy. - A.C.	0127425000	38501
Tensioner Assy. - Fan	0127427001	38597
Columbia		
Belt - Fan	0127116013	▲K080505HD
Belt - Hub, Alt. & A.C.	0127116004	▲K080855HD
Tensioner Assy. - Fan	0127427001	38597
Tensioner Assy. - Hub, Alt. & A.C.	0127425000	38501
Tensioner Pulley - Hub, Alt. & A.C.	0127425000	38075
Hose - Upper - Eng. To Rad.		22959
Hose - Lower - Eng. To Rad.		23171
FLD		
Belt - Fan	0127116013	▲K080505HD
Belt - Hub, Alt. & A.C.	0127116004	▲K080855HD
Tensioner Assy. - Hub, Alt. & A.C.	0127425000	38501
Tensioner Assy. - Fan	0127427001	38597

▲ Standard Belt Available. See Pages 630-631.

Application	Mfr. Part No.	Our No.
FREIGHTLINER - Continued		
2006		
Caterpillar C7 Diesel		
Business Class M2		
Belt - Fan, Alt. & A.C.; W/145A. Alt.	0123415040	▲K080774HD
Belt - Fan, Alt. & A.C.; W/130A. Alt.	0123415058	▲K080780HD
Tensioner Assy. - Fan, Alt. & A.C.	2201209	38550
Idler Pulley - Upper	1979641	36091
Hose - Upper - Eng. To Rad.		22745
Hose - Lower - Eng. To Pipe; (2" I.D.)		24232
Hose - Lower - Rad. To Pipe; (2 1/2" I.D.)		24240
Hose - Lower - Pipe To Cooler		21128
Hose - Lower - Cooler To Pipe		21128
Caterpillar C9 Diesel		
Business Class M2		
Belt - Fan, Alt. & A.C.	0123415069	▲K080785HD
Tensioner Assy. - Fan, Alt. & A.C.	2201209	38550
Idler Pulley - Smooth	2078118	36269
Hose - Upper - Eng. To Rad.		23085
Hose - Lower - Eng. To Rad.		23173
Caterpillar C11 Diesel		
Century Class		
Belt - Fan, Alt. & A.C.	0123415080	▲K081005HD
Tensioner Assy. - Fan, Alt. & A.C.	2117895	38590
Tensioner Pulley - Fan, Alt. & A.C.	2117895	36164
Idler Pulley - Smooth	2078118	36269
Idler Pulley - Grooved	1979642	36341
Hose - Upper - Eng. To Pipe; (2 1/2" I.D.)		24240
Hose - Upper - Rad. To Pipe; (2 1/2" I.D.)		24240
Hose - Lower - Eng. To Pipe; (2 1/2" I.D.)		24240
Hose - Lower - Rad. To Pipe		21135
Classic; Classic XL		
Idler Pulley - Smooth	2078118	36269
Idler Pulley - Grooved	1979642	36341
Columbia		
Belt - Fan, Alt. & A.C.	0123415080	▲K081005HD
Tensioner Assy. - Fan, Alt. & A.C.	2117895	38590
Tensioner Pulley - Fan, Alt. & A.C.	2117895	36164
Idler Pulley - Smooth	2078118	36269
Idler Pulley - Grooved	1979642	36341
Hose - Upper - Eng. To Rad.		23086
Hose - Lower - Eng. To Rad.		22952
FLD		
Belt - Fan, Alt. & A.C.	0123415080	▲K081005HD
Tensioner Assy. - Fan, Alt. & A.C.	2117895	38590
Tensioner Pulley - Fan, Alt. & A.C.	2117895	36164
Idler Pulley - Smooth	2078118	36269
Idler Pulley - Grooved	1979642	36341
Hose - Upper - Eng. To Pipe; (2 1/2" I.D.)		24240
Hose - Upper - Rad. To Pipe; (2 1/2" I.D.)		24240
Hose - Lower - Eng. To Pipe; (2 1/2" I.D.)		24240
Hose - Lower - Rad. To Pipe		21135
Caterpillar C13 Diesel		
Business Class M2		
Belt - Hub, Fan, Alt. & A.C.	0123415055	▲K080952HD
Tensioner Assy. - Hub, Fan, Alt. & A.C.	2117895	38590
Tensioner Pulley - Hub, Fan, Alt. & A.C.	2117895	36164
Idler Pulley - Smooth	2078118	36269
Idler Pulley - Grooved	1979642	36341
Hose - Upper - Eng. To Rad.		23086
Hose - Lower - Eng. To Rad.		22952
Century Class		
Belt - Fan, Alt. & A.C.	0123415080	▲K081005HD
Tensioner Assy. - Fan, Alt. & A.C.	2117895	38590
Tensioner Pulley - Fan, Alt. & A.C.	2117895	36164
Idler Pulley - Smooth	2078118	36269
Idler Pulley - Grooved	1979642	36341
Hose - Upper - Eng. To Pipe; (2 1/2" I.D.)		24240
Hose - Upper - Rad. To Pipe; (2 1/2" I.D.)		24240
Hose - Lower - Eng. To Pipe; (2 1/2" I.D.)		24240
Hose - Lower - Rad. To Pipe		21135

≈ Cut to Fit.

Belts and Coolant Hose for Medium/Heavy-Duty Trucks (1996 and Newer)

Medium & Heavy-Duty Trucks
(1996 & Newer)

Application	Mfr. Part No.	Our No.
FREIGHTLINER - Continued		
2006 - Continued		
Caterpillar C13 Diesel - Continued		
Classic; Classic XL		
Idler Pulley - Smooth	2078118	36269
Idler Pulley - Grooved	1979642	36341
Columbia		
Belt - Fan, Alt. & A.C.	0123415080	♣K081005HD
Tensioner Assy. - Fan, Alt. & A.C.	2117895	38590
Tensioner Pulley - Fan, Alt. & A.C.	2117895	36164
Idler Pulley - Smooth	2078118	36269
Idler Pulley - Grooved	1979642	36341
Hose - Upper - Eng. To Rad.		23086
Hose - Lower - Eng. To Rad.		22952
FLD		
Belt - Fan, Alt. & A.C.	0123415080	♣K081005HD
Tensioner Assy. - Fan, Alt. & A.C.	2117895	38590
Tensioner Pulley - Fan, Alt. & A.C.	2117895	36164
Idler Pulley - Smooth	2078118	36269
Idler Pulley - Grooved	1979642	36341
Hose - Upper - Eng. To Pipe; (2 1/2" I.D.)		24240
Hose - Upper - Rad. To Pipe; (2 1/2" I.D.)		24240
Hose - Lower - Eng. To Pipe; (2 1/2" I.D.)		24240
Hose - Lower - Rad. To Pipe		21135
Caterpillar C15 Diesel		
Century Class		
Belt - Fan & Alt.	0123415078	♣K080926HD
Belt - Fan To A.C.	0126709018	♣K060635HD
Tensioner Assy. - Fan & Alt.	2002279	38569
Tensioner Assy. - Fan To A.C.	2178938	38511
Idler Pulley - Smooth	1979641	36091
Idler Pulley - Grooved	1979642	36341
Tensioner Pulley - Fan To A.C.	2178938	36091
Hose - Upper - Eng. To Rad.; (2 1/2" I.D.)		24240
Hose - Upper - Rad. To Pipe		21891
Hose - Lower - Eng. To Pipe; (2 1/2" I.D.)		24240
Hose - Lower - Rad. To Pipe; (2 1/2" I.D.)		24240
Classic; Classic XL		
Belt - Fan & Alt.	0123415079	♣K080991HD
Belt - Fan To A.C.	0127177010	♣K060586HD
Tensioner Assy. - Fan & Alt.	1900649	38506
Tensioner Assy. - Fan To A.C.	1382514	38508
Idler Pulley - Smooth	1979641	36091
Idler Pulley - Grooved	1979642	36341
Tensioner Pulley - Fan & Alt.	1900649	36091
Tensioner Pulley - Fan To A.C.	1382514	36091
Hose - Upper - Eng. To Rad.		23229
Hose - Lower - Eng. To Rad.		23015
Columbia		
Belt - Fan, Alt. & A.C.	0123415078	♣K080926HD
Tensioner Assy.	2002279	38569
Idler Pulley - Smooth	1979641	36091
Idler Pulley - Grooved	1979642	36341
Hose - Upper - Eng. To Pipe; (2 1/2" I.D.)		≈24240
Hose - Upper - Pipe To Rad.		21891
Hose - Lower - Rad. To Pipe; (2 1/2" I.D.)		≈24240
Coronado		
Belt - Fan & Alt.	0128415078	♣K080926HD
Belt - Fan To A.C.	0129730485	♣K060586HD
Tensioner Assy. - Fan & Alt.	2002279	38569
Tensioner Assy. - Fan To A.C.	2178938	38511
Idler Pulley - Smooth	1979641	36091
Idler Pulley - Grooved	1979642	36341
Tensioner Pulley - Fan To A.C.	2178938	36091
Hose - Upper - Eng. To Pipe		21891
Hose - Upper - Rad. To Pipe; (2 1/2" I.D.)		24240
Hose - Lower - Eng. To Rad.		23084
FLD		
Belt - Fan & Alt.	0123415078	♣K080926HD
Belt - Fan To A.C.	0126709018	♣K060635HD
Tensioner Assy. - Fan & Alt.	2002279	38569
Tensioner Assy. - Fan To A.C.	2178938	38511

Application	Mfr. Part No.	Our No.
FREIGHTLINER - Continued		
2006 - Continued		
Caterpillar C15 Diesel - Continued		
FLD - Continued		
Idler Pulley - Smooth	1979641	36091
Idler Pulley - Grooved	1979642	36341
Tensioner Pulley - Fan To A.C.	2178938	36091
Hose - Upper - Eng. To Rad.; (2 1/2" I.D.)		24240
Hose - Upper - Rad. To Pipe		21891
Hose - Lower - Eng. To Pipe; (2 1/2" I.D.)		24240
Hose - Lower - Rad. To Pipe; (2 1/2" I.D.)		24240
Cummins ISB Diesel		
MT35; MT45; MT55		
Belt - Fan & Alt.	3926856	♣K080694HD
Belt - Fan To A.C.		♣9430HD
Tensioner Assy. - Fan & Alt.	3936213	38516
Tensioner Pulley - Fan & Alt.	3936213	36093
Hose - Upper		22795
Hose - Lower - Eng. To Pipe; (2 1/4" I.D.)		24236
Hose - Lower - Pipe To Rad.; (2" I.D.)		24232
Cummins ISC Diesel		
Business Class M2		
Belt - Hub, Fan, Alt. & A.C.	0123415100	♣K080820HD
Tensioner Assy. - Hub, Fan, Alt. & A.C.	3976831	38516
Idler Pulley	3970945	36283
Hose - Upper - Eng. To Rad.		23170
Hose - Lower - Eng. To Pipe; (2 1/2" I.D.)		24240
Hose - Lower - Rad. To Pipe		21135
Detroit Diesel 6-Cyl. 12.7 L Diesel		
Argosy		
Belt - Fan	0124894000	♣K100579HD
Belt - Alt. & A.C.	0124587000	♣K080580HD
Tensioner Assy. - Fan		38503
Tensioner Assy. - Alt. & A.C.	23520317	38501
Tensioner Pulley - Fan		38076
Tensioner Pulley - Alt. & A.C.		38075
Hose - Upper - Eng. To Pipe; (2 1/2" I.D.)		24240
Hose - Upper - Rad. To Pipe; (2 1/2" I.D.)		24240
Hose - Lower - Eng. To Cooler; (2 3/4" I.D.)		24244
Hose - Lower - Cooler To Pipe; (2 3/4" I.D.)		24244
Hose - Lower - Rad. To Pipe		≈21891
Century Class		
Belt - Fan	0124894004	♣K100502HD
Belt - Hub To Alt. & A.C.	0124587004	♣K080565HD
Tensioner Assy. - Fan	0127846000	38503
Tensioner Assy. - Hub, Alt. & A.C.	0127425000	38501
Tensioner Pulley - Fan	0127846000	38076
Tensioner Pulley - Hub, Alt. & A.C.	0127425000	38075
Hose - Upper - Eng. To Pipe; (2 1/2" I.D.)		24240
Hose - Upper - Rad. To Pipe; (2 1/2" I.D.)		24240
Classic; Classic XL		
Belt - Fan	0124894000	♣K100579HD
Belt - Hub, Alt. & A.C.	0124587004	♣K080565HD
Tensioner Assy. - Fan	0127846000	38503
Tensioner Assy. - Hub, Alt. & A.C.	0127425000	38501
Tensioner Pulley - Fan	0127846000	38076
Tensioner Pulley - Hub, Alt. & A.C.	0127425000	38075
Hose - Upper - Eng. To Pipe; (2 1/2" I.D.)		24240
Hose - Upper - Rad. To Pipe		≈21115
Hose - Lower - Eng. To Pipe; (2 1/2" I.D.)		24240
Hose - Lower - Rad. To Pipe		21135
Columbia		
Belt - Fan	0124894004	♣K100502HD
Belt - Hub To Alt. & A.C.	0124587004	♣K080565HD
Tensioner Assy. - Fan	0127846000	38503
Tensioner Assy. - Hub, Alt. & A.C.	0127425000	38501
Tensioner Pulley - Fan	0127846000	38076
Tensioner Pulley - Hub, Alt. & A.C.	0127425000	38075
Hose - Upper - Eng. To Rad.		21135
Hose - Upper - Rad. To Pipe; (2 1/2" I.D.)		24240
Hose - Lower - Eng. To Rad.		22877

♣ Standard Belt Available. See Pages 630-631.

≈ Cut to Fit.

Belts and Coolant Hose for Medium/Heavy-Duty Trucks (1996 and Newer)

 Medium & Heavy-Duty Trucks
(1996 & Newer)

Application	Mfr. Part No.	Our No.
FREIGHTLINER - Continued		
2006 - Continued		
Detroit Diesel 6-Cyl. 12.7 L Diesel - Continued		
Coronado		
Belt - Fan	0124894004	▲K100502HD
Belt - Hub, Alt. & A.C.	0124587004	▲K080565HD
Tensioner Assy. - Fan	0127846000	38503
Tensioner Assy. - Hub, Alt. & A.C.	0127425000	38501
Tensioner Pulley - Fan	0127846000	38076
Tensioner Pulley - Hub, Alt. & A.C.	0127425000	38075
Hose - Upper - Eng. To Pipe		21135
Hose - Upper - Pipe To Rad.; (2 1/2" I.D.)		24240
Hose - Lower - Eng. To Pipe; (2 1/2" I.D.)		24240
FLD		
Belt - Fan	0124894000	▲K100579HD
Belt - Hub To Alt. & A.C.	0124587004	▲K080565HD
Tensioner Assy. - Fan	0127846000	38503
Tensioner Assy. - Hub, Alt. & A.C.	0127425000	38501
Tensioner Pulley - Fan	0127846000	38076
Tensioner Pulley - Hub, Alt. & A.C.	0127425000	38075
Hose - Upper - Eng. To Pipe; (2 1/2" I.D.)		24240
Hose - Upper - Rad. To Pipe		≧21115
Hose - Lower - Eng. To Pipe; (2 1/2" I.D.)		24240
Hose - Lower - Rad. To Pipe		21135
Detroit Diesel 6-Cyl. 14.0 L Diesel		
Argosy		
Belt - Fan	0124894000	▲K100579HD
Belt - Alt. & A.C.	0124587000	▲K080580HD
Tensioner Assy. - Fan		38503
Tensioner Assy. - Alt. & A.C.	23520317	38501
Tensioner Pulley - Fan		38076
Tensioner Pulley - Alt. & A.C.		38075
Hose - Upper - Eng. To Pipe; (2 1/2" I.D.)		24240
Hose - Upper - Rad. To Pipe; (2 1/2" I.D.)		24240
Hose - Lower - Eng. To Cooler; (2 3/4" I.D.)		24244
Hose - Lower - Cooler To Pipe; (2 3/4" I.D.)		24244
Hose - Lower - Rad. To Pipe		≧21891
Century Class		
Belt - Fan	0124894004	▲K100502HD
Belt - Hub To Alt. & A.C.	0124587004	▲K080565HD
Tensioner Assy. - Fan	0127846000	38503
Tensioner Assy. - Hub, Alt. & A.C.	0127425000	38501
Tensioner Pulley - Fan	0127846000	38076
Tensioner Pulley - Hub, Alt. & A.C.	0127425000	38075
Hose - Upper - Eng. To Pipe; (2 1/2" I.D.)		24240
Hose - Upper - Rad. To Pipe; (2 1/2" I.D.)		24240
Hose - Lower - Eng. To Rad.		22877
Classic; Classic XL		
Belt - Fan	0124894000	▲K100579HD
Belt - Hub, Alt. & A.C.	0124587004	▲K080565HD
Tensioner Assy. - Fan	0127846000	38503
Tensioner Assy. - Hub, Alt. & A.C.	0127425000	38501
Tensioner Pulley - Fan	0127846000	38076
Tensioner Pulley - Hub, Alt. & A.C.	0127425000	38075
Hose - Upper - Eng. To Pipe; (2 1/2" I.D.)		24240
Hose - Upper - Rad. To Pipe		≧21115
Hose - Lower - Eng. To Pipe; (2 1/2" I.D.)		24240
Hose - Lower - Rad. To Pipe		21135
Columbia		
Belt - Fan	0124894004	▲K100502HD
Belt - Hub To Alt. & A.C.	0124587004	▲K080565HD
Tensioner Assy. - Fan	0127846000	38503
Tensioner Assy. - Hub, Alt. & A.C.	0127425000	38501
Tensioner Pulley - Fan	0127846000	38076
Tensioner Pulley - Hub, Alt. & A.C.	0127425000	38075
Hose - Upper - Eng. To Rad.		21135
Hose - Upper - Rad. To Pipe; (2 1/2" I.D.)		24240
Hose - Lower - Eng. To Rad.		22877
Coronado		
Belt - Fan	0124894004	▲K100502HD
Belt - Hub, Alt. & A.C.	0124587004	▲K080565HD
Tensioner Assy. - Fan	0127846000	38503
Tensioner Assy. - Hub, Alt. & A.C.	0127425000	38501

Application	Mfr. Part No.	Our No.
FREIGHTLINER - Continued		
2006 - Continued		
Detroit Diesel 6-Cyl. 14.0 L Diesel - Continued		
Coronado - Continued		
Tensioner Pulley - Fan	0127846000	38076
Tensioner Pulley - Hub, Alt. & A.C.	0127425000	38075
Hose - Upper - Eng. To Pipe		21135
Hose - Upper - Pipe To Rad.; (2 1/2" I.D.)		24240
Hose - Lower - Eng. To Pipe; (2 1/2" I.D.)		24240
FLD		
Belt - Fan	0124894000	▲K100579HD
Belt - Hub To Alt. & A.C.	0124587004	▲K080565HD
Tensioner Assy. - Fan	0127846000	38503
Tensioner Assy. - Hub, Alt. & A.C.	0127425000	38501
Tensioner Pulley - Fan	0127846000	38076
Tensioner Pulley - Hub, Alt. & A.C.	0127425000	38075
Hose - Upper - Eng. To Pipe; (2 1/2" I.D.)		24240
Hose - Upper - Rad. To Pipe		≧21115
Hose - Lower - Eng. To Pipe; (2 1/2" I.D.)		24240
Hose - Lower - Rad. To Pipe		21135
Mercedes-Benz MBE 900 Diesel		
Business Class M2		
Belt - Fan, Alt. & A.C.; W/O P.T.O.	0129866094	▲K080825HD
Belt - Fan; W/P.T.O.	0127116011	▲K080615HD
Belt - W.P., Alt. & A.C.; W/P.T.O.	0129866094	▲K080825HD
Tensioner Assy. - Fan; W/P.T.O.	0129079000	38598
Tensioner Assy. - Alt. & A.C.	9062003170	38567
Hose - Upper - Eng. To Rad.; W/O P.T.O.		21378
Hose - Upper - Eng. To Pipe; W/P.T.O.(2" I.D.)		24232
Hose - Upper - Rad. To Pipe; W/P.T.O.(2 1/2" I.D.)		24240
Hose - Lower - Eng. To Pipe		20206
Hose - Lower - Pipe To Cooler; W/P.T.O.		20206
Hose - Lower - Rad. To Pipe; W/O P.T.O.(2" I.D.)		24032
Hose - Lower - Rad. To Pipe; W/P.T.O.(2 1/2" I.D.)		24240
Hose - Lower - Cooler To Pipe; W/P.T.O.(2" I.D.)		24232
MT45		
Belt - Fan, Alt. & A.C.	0127110048	▲K080839HD
Hose - Upper - Eng. To Rad.		20611
Hose - Lower - Eng. To Rad.		21571
MT55		
Hose - Turbo - Intercooler To Engine (Cold Side)	0129982000	29001
Mercedes-Benz MBE 4000 Diesel		
Business Class M2; Columbia		
Belt - Fan	0127116013	▲K080505HD
Belt - Hub, Alt. & A.C.	0127116004	▲K080855HD
Tensioner Assy. - Fan	0127427001	38597
Tensioner Assy. - Hub, Alt. & A.C.	0127425000	38501
Tensioner Pulley - Hub, Alt. & A.C.	0127425000	38075
Hose - Upper - Eng. To Rad.		22959
Hose - Lower - Eng. To Rad.		23171
FLD		
Belt - Alt.	0127116004	▲K080855HD
Tensioner Assy. - Alt.	0127425000	38501
2005		
Caterpillar 3126 Diesel		
FL80		
Belt - Fan, Alt. & A.C.; W/Delco Alt.	0123415000	▲K080702HD
Belt - Fan, Alt. & A.C.; W/Leece Neville Alt.	0127110003	▲K080708HD
Belt - W.P.		▲9341HD
Tensioner Assy. - Fan, Alt. & A.C.	1352151	38511
Idler Pulley	1445612	36096
Tensioner Pulley - Fan, Alt. & A.C.	1352151	36091
Hose - Upper - Eng. To Rad.		22668
Hose - Lower - Eng. To Pipe; W/2 1/4" I.D. Hose		20748
Hose - Lower - Eng. To Pipe; W/2" I.D. Hose		21571
Hose - Lower - Rad. To Pipe; W/2 1/4" I.D. Hose		21194
Hose - Lower - Rad. To Pipe; W/2" I.D. Hose		≧20611

▲ Standard Belt Available. See Pages 630-631.

≧ Cut to Fit.

Belts and Coolant Hose for Medium/Heavy-Duty Trucks (1996 and Newer)

Medium & Heavy-Duty Trucks
(1996 & Newer)

Application	Mfr. Part No.	Our No.
FREIGHTLINER - Continued		
2005 - Continued		
Caterpillar C7 Diesel		
Business Class M2		
Belt - Fan, Alt. & A.C.; W/145A. Alt.	0123415040	♣K080774HD
Belt - Fan, Alt. & A.C.; W/130A. Alt.	0123415058	♣K080780HD
Tensioner Assy. - Fan, Alt. & A.C.	2201209	38550
Idler Pulley - Upper	1979641	36091
Hose - Upper - Eng. To Rad.		22745
Hose - Lower - Eng. To Pipe; (2 1/2" I.D.)		24240
Hose - Lower - Rad. To Pipe; (2 1/2" I.D.)		24240
Condor		
Idler Pulley - Upper	1979641	36091
FL60; FL70		
Belt - Fan & Alt.	0123415045	♣K080745HD
Belt - W.P.	0366775	♣9341HD
Tensioner Assy. - Fan & Alt.	1382514	38508
Tensioner Assy. - Fan, Alt. & A.C.	1352151	38511
Idler Pulley - Upper	1979641	36091
Tensioner Pulley - Fan, Alt. & A.C.	1352151	36091
Hose - Upper - Eng. To Rad.		22668
Hose - Lower - Rad. To Cooler		21891
Hose - Lower - Pipe To Cooler		22951
FL80		
Belt - W.P.	0366775	♣9341HD
Belt - Fan & Alt.	0123415045	♣K080745HD
Tensioner Assy. - Fan & Alt.	1382514	38508
Tensioner Assy. - Fan, Alt. & A.C.	1352151	38511
Idler Pulley - Upper	1979641	36091
Tensioner Pulley - Fan, Alt. & A.C.	1352151	36091
Hose - Upper - Eng. To Rad.		22668
Hose - Lower - Rad. To Cooler		21891
Hose - Lower - Pipe To Cooler		22951
Caterpillar C9 Diesel		
Business Class M2		
Belt - Fan, Alt. & A.C.	0123415069	♣K080785HD
Tensioner Assy. - Fan, Alt. & A.C.	2201209	38550
Idler Pulley - Smooth	2078118	36269
Hose - Upper - Eng. To Rad.		23085
Hose - Lower - Eng. To Rad.		23173
Caterpillar C11 Diesel		
Century Class; Classic; Classic XL; Columbia		
Idler Pulley - Smooth	2078118	36269
Idler Pulley - Grooved	1979642	36341
Condor		
Belt - Hub, Fan, Alt. & A.C.	0127110055	♣K081020HD
Tensioner Assy. - Hub, Fan, Alt. & A.C.	2117895	38590
Tensioner Pulley - Hub, Fan, Alt. & A.C.	2117895	36164
Idler Pulley - Smooth	2078118	36269
Idler Pulley - Grooved	1979642	36341
FLD		
Belt - Fan, Alt. & A.C.	0123415080	♣K081005HD
Tensioner Assy. - Fan, Alt. & A.C.	2117895	38590
Tensioner Pulley - Fan, Alt. & A.C.	2117895	36164
Idler Pulley - Smooth	2078118	36269
Idler Pulley - Grooved	1979642	36341
Hose - Upper - Eng. To Pipe; (2 1/2" I.D.)		24240
Hose - Upper - Rad. To Pipe; (2 1/2" I.D.)		24240
Hose - Lower - Eng. To Pipe; (2 1/2" I.D.)		24240
Hose - Lower - Rad. To Pipe		21135
Caterpillar C13 Diesel		
Business Class M2		
Belt - Hub, Fan, Alt. & A.C.	0123415080	♣K081005HD
Tensioner Assy. - Hub, Fan, Alt. & A.C.	2117895	38590
Tensioner Pulley - Hub, Fan, Alt. & A.C.	2117895	36164
Idler Pulley - Smooth	2078118	36269
Idler Pulley - Grooved	1979642	36341
Hose - Upper - Eng. To Rad.		23086
Hose - Lower - Eng. To Rad.		22952
Century Class		
Idler Pulley - Smooth	2078118	36269

Application	Mfr. Part No.	Our No.
FREIGHTLINER - Continued		
2005 - Continued		
Caterpillar C13 Diesel - Continued		
Century Class - Continued		
Idler Pulley - Grooved	1979642	36341
Classic; Classic XL		
Belt - Accessory Drive	0123415080	♣K081005HD
Tensioner Assy.	2117895	38590
Idler Pulley - Smooth	2078118	36269
Idler Pulley - Grooved	1979642	36341
Columbia		
Belt - Fan, Alt. & A.C.	0123415055	♣K080952HD
Tensioner Assy. - Fan, Alt. & A.C.	2117895	38590
Tensioner Pulley - Fan, Alt. & A.C.	2117895	36164
Idler Pulley - Smooth	2078118	36269
Idler Pulley - Grooved	1979642	36341
Hose - Upper - Eng. To Pipe		22950
Hose - Lower - Eng. To Pipe; (2 1/2" I.D.)		24240
Hose - Lower - Rad. To Pipe; (2 1/2" I.D.)		24240
Condor		
Belt - Hub, Fan, Alt. & A.C.	0127110055	♣K081020HD
Tensioner Assy. - Hub, Fan, Alt. & A.C.	2117895	38590
Tensioner Pulley - Hub, Fan, Alt. & A.C.	2117895	36164
Idler Pulley - Smooth	2078118	36269
Idler Pulley - Grooved	1979642	36341
FLD		
Belt - Fan, Alt. & A.C.	0123415080	♣K081005HD
Tensioner Assy. - Fan, Alt. & A.C.	2117895	38590
Tensioner Pulley - Fan, Alt. & A.C.	2117895	36164
Idler Pulley - Smooth	2078118	36269
Idler Pulley - Grooved	1979642	36341
Hose - Upper - Eng. To Pipe; (2 1/2" I.D.)		24240
Hose - Upper - Rad. To Pipe; (2 1/2" I.D.)		24240
Hose - Lower - Eng. To Pipe; (2 1/2" I.D.)		24240
Hose - Lower - Rad. To Pipe		21135
Caterpillar C15 Diesel		
Century Class		
Belt - Fan & Alt.	0123415078	♣K080926HD
Belt - Fan To A.C.	0126709018	♣K060635HD
Tensioner Assy. - Fan & Alt.	2002279	38569
Tensioner Assy. - Fan To A.C.	2178938	38511
Idler Pulley - Smooth	1979641	36091
Idler Pulley - Grooved	1979642	36341
Tensioner Pulley - Fan To A.C.	2178938	36091
Hose - Upper - Eng. To Rad.; (2 1/2" I.D.)		24240
Hose - Upper - Rad. To Pipe		21891
Hose - Lower - Eng. To Pipe; (2 1/2" I.D.)		24240
Hose - Lower - Rad. To Pipe; (2 1/2" I.D.)		24240
Classic		
Belt - Fan & Alt.	0123415079	♣K080991HD
Belt - Fan To A.C.	0127177010	♣K060586HD
Tensioner Assy. - Fan & Alt.	1900649	38506
Tensioner Assy. - Fan To A.C.	1382514	38508
Idler Pulley - Smooth	1979641	36091
Idler Pulley - Grooved	1979642	36341
Tensioner Pulley - Fan & Alt.	1900649	36091
Tensioner Pulley - Fan To A.C.	1382514	36091
Hose - Upper - Eng. To Pipe		21194
Hose - Upper - Pipe To Rad.; (2 1/2" I.D.)		24240
Hose - Lower - Eng. To Rad.		23015
Classic XL; Columbia		
Belt - Fan & Alt.	0123415078	♣K080926HD
Belt - Fan To A.C.	0126709018	♣K060635HD
Tensioner Assy. - Fan & Alt.	2002279	38569
Tensioner Assy. - Fan To A.C.	2178938	38511
Idler Pulley - Smooth	1979641	36091
Idler Pulley - Grooved	1979642	36341
Tensioner Pulley - Fan To A.C.	2178938	36091
Hose - Upper - Eng. To Rad.; (2 1/2" I.D.)		24240
Hose - Upper - Rad. To Pipe		21891
Hose - Lower - Eng. To Pipe; (2 1/2" I.D.)		24240
Hose - Lower - Rad. To Pipe; (2 1/2" I.D.)		24240

♣ Standard Belt Available. See Pages 630-631.

Belts and Coolant Hose for Medium/Heavy-Duty Trucks (1996 and Newer)

Medium & Heavy-Duty Trucks (1996 & Newer)

Application	Mfr. Part No.	Our No.
FREIGHTLINER - Continued		
2005 - Continued		
Caterpillar C15 Diesel - Continued		
Coronado		
Belt - Fan & Alt.	0128415078	♣K080926HD
Belt - Fan To A.C.	0129730485	♣K060586HD
Tensioner Assy. - Fan & Alt.	2002279	38569
Tensioner Assy. - Fan To A.C.	2178938	38511
Idler Pulley - Smooth	1979641	36091
Idler Pulley - Grooved	1979642	36341
Tensioner Pulley - Fan To A.C.	2178938	36091
Hose - Upper - Eng. To Pipe		21891
Hose - Upper - Rad. To Pipe; (2 1/2" I.D.)		24240
Hose - Lower - Eng. To Rad.		23084
FLD		
Belt - Fan & Alt.	0123415078	♣K080926HD
Belt - Fan To A.C.	0126709018	♣K060635HD
Tensioner Assy. - Fan & Alt.	2002279	38569
Tensioner Assy. - Fan To A.C.	2178938	38511
Idler Pulley - Smooth	1979641	36091
Idler Pulley - Grooved	1979642	36341
Tensioner Pulley - Fan To A.C.	2178938	36091
Hose - Upper - Eng. To Rad.; (2 1/2" I.D.)		24240
Hose - Upper - Rad. To Pipe		21891
Hose - Lower - Eng. To Pipe; (2 1/2" I.D.)		24240
Hose - Lower - Rad. To Pipe; (2 1/2" I.D.)		24240
Cummins ISB Diesel		
FC80		
Belt - Fan & Alt.	3290073	♣K080605HD
MT35; MT45; MT55		
Belt - Fan, Alt. & A.C.	3289864	♣K080825HD
Tensioner Assy. - Fan, Alt. & A.C.	3976831	38516
Hose - Upper - Eng. To Rad.		23114
Hose - Lower - Eng. To Pipe; (2 1/4" I.D.)		24236
Hose - Lower - Rad. To Pipe; (2 1/4" I.D.)		24236
Cummins ISC Diesel		
FL50; FL70; FL80		
Belt - Fan, Alt. & Hub	3289404	♣K080716HD
Belt - Fan To A.C.	2310001067	♣9480HD
Tensioner Assy. - Fan, Alt. & Hub	3936213	38516
Tensioner Pulley - Fan, Alt. & Hub	3936213	36093
Hose - Upper - Eng. To Pipe; (2 1/4" I.D.)		24236
Hose - Upper - Pipe To Rad.; (2" I.D.)		24232
Hose - Lower - Eng. To Pipe		20206
Hose - Lower - Pipe To Cooler		21194
Cummins ISL Diesel		
Condor		
Belt - Fan		♣K080765HD
Belt - A.C.		♣9412HD
Tensioner Assy.		38516
Detroit Diesel 6-Cyl. 12.7 L Diesel		
Argosy		
Belt - Fan	0124894000	♣K100579HD
Belt - Alt. & A.C.	0124587000	♣K080580HD
Tensioner Assy. - Fan		38503
Tensioner Assy. - Alt. & A.C.	23520317	38501
Tensioner Pulley - Fan		38076
Tensioner Pulley - Alt. & A.C.		38075
Hose - Upper - Eng. To Pipe; (2 1/2" I.D.)		24240
Hose - Upper - Rad. To Pipe; (2 1/2" I.D.)		24240
Hose - Lower - Eng. To Cooler; (2 3/4" I.D.)		24244
Hose - Lower - Cooler To Pipe; (2 3/4" I.D.)		24244
Hose - Lower - Rad. To Pipe		≈<21891
Century Class		
Belt - Fan	0124894004	♣K100502HD
Belt - Hub To Alt. & A.C.	0124587004	♣K080565HD
Tensioner Assy. - Fan	0127846000	38503
Tensioner Assy. - Hub, Alt. & A.C.	0127425000	38501
Tensioner Pulley - Fan	0127846000	38076
Tensioner Pulley - Hub, Alt. & A.C.	0127425000	38075
Hose - Upper - Eng. To Pipe; (2 1/2" I.D.)		24240

Application	Mfr. Part No.	Our No.
FREIGHTLINER - Continued		
2005 - Continued		
Detroit Diesel 6-Cyl. 12.7 L Diesel - Continued		
Century Class - Continued		
Hose - Upper - Rad. To Pipe; (2 1/2" I.D.)		24240
Hose - Lower - Eng. To Rad.		22877
Classic		
Belt - Fan	0124894000	♣K100579HD
Belt - Hub, Alt. & A.C.	0124587004	♣K080565HD
Tensioner Assy. - Fan	0127846000	38503
Tensioner Assy. - Hub, Alt. & A.C.	0127425000	38501
Tensioner Pulley - Fan	0127846000	38076
Tensioner Pulley - Hub, Alt. & A.C.	0127425000	38075
Hose - Upper - Eng. To Pipe; (2 1/2" I.D.)		24240
Hose - Upper - Rad. To Pipe		≈<21115
Hose - Lower - Eng. To Pipe; (2 1/2" I.D.)		24240
Hose - Lower - Rad. To Pipe		21135
Classic XL		
Belt - Fan	0124894000	♣K100579HD
Belt - Hub, Alt. & A.C.	0124587004	♣K080565HD
Tensioner Assy. - Fan	0127846000	38503
Tensioner Assy. - Hub, Alt. & A.C.	0127425000	38501
Tensioner Pulley - Fan	0127846000	38076
Tensioner Pulley - Hub, Alt. & A.C.	0127425000	38075
Hose - Upper - Eng. To Pipe; (2 1/2" I.D.)		24240
Hose - Upper - Rad. To Pipe		≈<21150
Hose - Lower - Eng. To Pipe; (2 1/2" I.D.)		24240
Hose - Lower - Rad. To Pipe		21135
Columbia		
Belt - Fan	0124894004	♣K100502HD
Belt - Hub To Alt. & A.C.	0124587004	♣K080565HD
Tensioner Assy. - Fan	0127846000	38503
Tensioner Assy. - Hub, Alt. & A.C.	0127425000	38501
Tensioner Pulley - Fan	0127846000	38076
Tensioner Pulley - Hub, Alt. & A.C.	0127425000	38075
Hose - Upper - Eng. To Rad.		21135
Hose - Upper - Rad. To Pipe; (2 1/2" I.D.)		24240
Hose - Lower - Eng. To Rad.		22877
Coronado		
Belt - Fan	0124894004	♣K100502HD
Belt - Hub, Alt. & A.C.	0124587004	♣K080565HD
Tensioner Assy. - Fan	0127846000	38503
Tensioner Assy. - Hub, Alt. & A.C.	0127425000	38501
Tensioner Pulley - Fan	0127846000	38076
Tensioner Pulley - Hub, Alt. & A.C.	0127425000	38075
Hose - Upper - Eng. To Pipe		21135
Hose - Upper - Pipe To Rad.; (2 1/2" I.D.)		24240
Hose - Lower - Eng. To Pipe; (2 1/2" I.D.)		24240
Hose - Lower - Pipe To Rad.; (2 1/2" I.D.)		24240
FLD		
Belt - Fan	0124894000	♣K100579HD
Belt - Hub To Alt. & A.C.	0124587004	♣K080565HD
Tensioner Assy. - Fan	0127846000	38503
Tensioner Assy. - Hub, Alt. & A.C.	0127425000	38501
Tensioner Pulley - Fan	0127846000	38076
Tensioner Pulley - Hub, Alt. & A.C.	0127425000	38075
Hose - Upper - Eng. To Pipe; (2 1/2" I.D.)		24240
Hose - Upper - Rad. To Pipe		≈<21115
Hose - Lower - Eng. To Pipe; (2 1/2" I.D.)		24240
Hose - Lower - Rad. To Pipe		21135
Detroit Diesel 6-Cyl. 14.0 L Diesel		
Argosy		
Belt - Fan	0124894000	♣K100579HD
Belt - Alt. & A.C.	0124587000	♣K080580HD
Tensioner Assy. - Fan		38503
Tensioner Assy. - Alt. & A.C.	23520317	38501
Tensioner Pulley - Fan		38076
Tensioner Pulley - Alt. & A.C.		38075
Hose - Upper - Eng. To Pipe; (2 1/2" I.D.)		24240
Hose - Upper - Rad. To Pipe; (2 1/2" I.D.)		24240
Hose - Lower - Eng. To Cooler; (2 3/4" I.D.)		24244
Hose - Lower - Cooler To Pipe; (2 3/4" I.D.)		24244
Hose - Lower - Rad. To Pipe		≈<21891

♣ Standard Belt Available. See Pages 630-631.

≈< Cut to Fit.

Belts and Coolant Hose for Medium/Heavy-Duty Trucks (1996 and Newer)

Medium & Heavy-Duty Trucks
(1996 & Newer)

Application	Mfr. Part No.	Our No.
FREIGHTLINER - Continued		
2005 - Continued		
Detroit Diesel 6-Cyl. 14.0 L Diesel - Continued		
Century Class		
Belt - Fan	0124894004	♣K100502HD
Belt - Hub To Alt. & A.C.	0124587004	♣K080565HD
Tensioner Assy. - Fan	0127846000	38503
Tensioner Assy. - Hub, Alt. & A.C.	0127425000	38501
Tensioner Pulley - Fan	0127846000	38076
Tensioner Pulley - Hub, Alt. & A.C.	0127425000	38075
Hose - Upper - Eng. To Pipe; (2 1/2" I.D.)	24240	24240
Hose - Upper - Rad. To Pipe; (2 1/2" I.D.)	24240	24240
Hose - Lower - Eng. To Rad.	22877	22877
Classic; Classic XL		
Belt - Fan	0124894000	♣K100579HD
Belt - Hub, Alt. & A.C.	0124587004	♣K080565HD
Tensioner Assy. - Fan	0127846000	38503
Tensioner Assy. - Hub, Alt. & A.C.	0127425000	38501
Tensioner Pulley - Fan	0127846000	38076
Tensioner Pulley - Hub, Alt. & A.C.	0127425000	38075
Hose - Upper - Eng. To Pipe; (2 1/2" I.D.)	24240	24240
Hose - Upper - Rad. To Pipe	21115	21115
Hose - Lower - Eng. To Pipe; (2 1/2" I.D.)	24240	24240
Hose - Lower - Rad. To Pipe	21135	21135
Columbia		
Belt - Fan	0124894004	♣K100502HD
Belt - Hub To Alt. & A.C.	0124587004	♣K080565HD
Tensioner Assy. - Fan	0127846000	38503
Tensioner Assy. - Hub, Alt. & A.C.	0127425000	38501
Tensioner Pulley - Fan	0127846000	38076
Tensioner Pulley - Hub, Alt. & A.C.	0127425000	38075
Hose - Upper - Eng. To Rad.	21135	21135
Hose - Upper - Rad. To Pipe; (2 1/2" I.D.)	24240	24240
Hose - Lower - Eng. To Rad.	22877	22877
Coronado		
Belt - Fan	0124894004	♣K100502HD
Belt - Hub, Alt. & A.C.	0124587004	♣K080565HD
Tensioner Assy. - Fan	0127846000	38503
Tensioner Assy. - Hub, Alt. & A.C.	0127425000	38501
Tensioner Pulley - Fan	0127846000	38076
Tensioner Pulley - Hub, Alt. & A.C.	0127425000	38075
Hose - Upper - Eng. To Pipe	21135	21135
Hose - Upper - Pipe To Rad.; (2 1/2" I.D.)	24240	24240
Hose - Lower - Eng. To Pipe; (2 1/2" I.D.)	24240	24240
Hose - Lower - Pipe To Rad.; (2 1/2" I.D.)	24240	24240
FLD		
Belt - Fan	0124894000	♣K100579HD
Belt - Hub To Alt. & A.C.	0124587004	♣K080565HD
Tensioner Assy. - Fan	0127846000	38503
Tensioner Assy. - Hub, Alt. & A.C.	0127425000	38501
Tensioner Pulley - Fan	0127846000	38076
Tensioner Pulley - Hub, Alt. & A.C.	0127425000	38075
Hose - Upper - Eng. To Pipe; (2 1/2" I.D.)	24240	24240
Hose - Upper - Rad. To Pipe	21115	21115
Hose - Lower - Eng. To Pipe; (2 1/2" I.D.)	24240	24240
Hose - Lower - Rad. To Pipe	21135	21135
Mercedes-Benz MBE 900 Diesel		
Business Class M2		
Belt - Fan, Alt. & A.C.	0127110016	♣K080830HD
Tensioner Assy.	9062002470	38567
Hose - Upper - Eng. To Rad.	21378	21378
Hose - Lower - Eng. To Pipe	20206	20206
Hose - Lower - Rad. To Pipe; (2" I.D.)	24232	24232
FL70; FL80		
Belt - Fan, Alt. & A.C.	0127110016	♣K080830HD
Hose - Upper - Eng. To Rad.	22701	22701
Hose - Lower - Eng. To Pipe	20611	20611
Hose - Lower - Pipe To Rad.	22702	22702
MT35; MT45		
Belt - Fan, Alt. & A.C.	0127110048	♣K080839HD
Hose - Upper - Eng. To Rad.	20611	20611
Hose - Lower - Eng. To Rad.	21571	21571

Application	Mfr. Part No.	Our No.
FREIGHTLINER - Continued		
2005 - Continued		
Mercedes-Benz MBE 900 Diesel - Continued		
MT55		
Belt - Fan, Alt. & A.C.	0127110048	♣K080839HD
Hose - Turbo - Intercooler To Engine (Cold Side)	0129982000	29001
Hose - Upper - Eng. To Rad.	20611	20611
Hose - Lower - Eng. To Rad.	21571	21571
Mercedes-Benz MBE 4000 Diesel		
Business Class M2		
Belt - Fan	0127116013	♣K080505HD
Belt - Hub, Alt. & A.C.	0127116004	♣K080855HD
Tensioner Assy. - Fan	0127427001	38597
Tensioner Assy. - Hub, Alt. & A.C.	0127425000	38501
Tensioner Pulley - Hub, Alt. & A.C.	0127425000	38075
Hose - Upper - Eng. To Rad.	22959	22959
Hose - Lower - Eng. To Rad.	23171	23171
Century Class		
Belt - Fan	0127116007	♣K080575HD
Belt - W.P., Alt. & A.C.	0127116004	♣K080855HD
Tensioner Assy. - Fan	0127427001	38597
Tensioner Assy. - Hub, Alt. & A.C.	0127425000	38501
Tensioner Pulley - Fan	0127425000	38075
Hose - Upper - Eng. To Rad.; (2 1/2" I.D.)	24240	24240
Hose - Upper - Rad. To Pipe; (2 1/2" I.D.)	24240	24240
Hose - Lower - Eng. To Rad.	21891	21891
Hose - Lower - Rad. To Pipe; (2 1/2" I.D.)	24240	24240
Columbia		
Belt - Fan	0127116007	♣K080575HD
Belt - Hub, Alt. & A.C.	0127116004	♣K080855HD
Tensioner Assy. - Fan	0127427001	38597
Tensioner Assy. - Hub, Alt. & A.C.	0127425000	38501
Tensioner Pulley - Hub, Alt. & A.C.	0127425000	38075
Hose - Upper - Eng. To Rad.	22959	22959
Hose - Lower - Eng. To Rad.	23013	23013
2004		
Caterpillar 3126 Diesel		
Business Class M2		
Belt - Fan, Alt. & A.C.; W/145A. Alt.	0123415040	♣K080774HD
Belt - Fan, Alt. & A.C.; W/130A. Alt.	0123415058	♣K080780HD
Tensioner Assy. - Fan, Alt. & A.C.	2201209	38550
Hose - Upper - Eng. To Rad.	22745	22745
Hose - Lower - Eng. To Rad.	22744	22744
FL50		
Belt - Fan, Alt. & A.C.; W/Delco Alt.	0123415000	♣K080702HD
Belt - Fan, Alt. & A.C.; W/Leece Neville Alt.	0127110003	♣K080708HD
Belt - W.P.	9341HD	9341HD
Tensioner Assy. - Fan, Alt. & A.C.	1352151	38511
Idler Pulley - Alt. & A.C.	1445612	36096
Tensioner Pulley - Fan, Alt. & A.C.	1352151	36091
Hose - Upper - Eng. To Rad.	22668	22668
Hose - Lower - Eng. To Pipe; W/2 1/4" I.D. Hose	20748	20748
Hose - Lower - Eng. To Pipe; W/2" I.D. Hose	21571	21571
Hose - Lower - Rad. To Pipe; W/2 1/4" I.D. Hose	21194	21194
Hose - Lower - Rad. To Pipe; W/2" I.D. Hose	20611	20611
FL60; FL70; FL80		
Belt - Fan, Alt. & A.C.; W/Delco Alt.	0123415000	♣K080702HD
Belt - Fan, Alt. & A.C.; W/Leece Neville Alt.	0127110003	♣K080708HD
Belt - W.P.	9341HD	9341HD
Tensioner Assy. - Fan, Alt. & A.C.	1352151	38511
Idler Pulley	1445612	36096
Tensioner Pulley - Fan, Alt. & A.C.	1352151	36091
Hose - Upper - Eng. To Rad.	22668	22668
Hose - Lower - Eng. To Pipe; W/2 1/4" I.D. Hose	20748	20748
Hose - Lower - Eng. To Pipe; W/2" I.D. Hose	21571	21571
Hose - Lower - Rad. To Pipe; W/2 1/4" I.D. Hose	21194	21194
Hose - Lower - Rad. To Pipe; W/2" I.D. Hose	20611	20611

♣ Standard Belt Available. See Pages 630-631.

≡ Cut to Fit.

Belts and Coolant Hose for Medium/Heavy-Duty Trucks (1996 and Newer)

 Medium & Heavy-Duty Trucks
(1996 & Newer)

Application	Mfr. Part No.	Our No.	Application	Mfr. Part No.	Our No.
FREIGHTLINER - Continued			FREIGHTLINER - Continued		
2004 - Continued			2004 - Continued		
Caterpillar C7 Diesel			Caterpillar C10 Diesel - Continued		
Business Class M2			FLD - Continued		
Belt - Fan, Alt. & A.C.; W/145A. Alt.	0123415040	♣K080774HD	Hose - Upper - Rad. To Pipe		21891
Belt - Fan, Alt. & A.C.; W/130A. Alt.	0123415058	♣K080780HD	Hose - Lower - Eng. To Pipe; (2 1/2" I.D.)		24240
Tensioner Assy. - Fan, Alt. & A.C.	2201209	38550	Hose - Lower - Rad. To Pipe		21891
Idler Pulley - Upper	1979641	36091	Caterpillar C11 Diesel		
Hose - Upper - Eng. To Rad.		22745	Century Class; Classic; Classic XL		
Hose - Lower - Eng. To Rad.		22744	Idler Pulley - Smooth		
FL50			Idler Pulley - Grooved		
Belt - Fan & Alt.	0123415045	♣K080745HD		2078118	36269
Belt - W.P.	0366775	♣9341HD		1979642	36341
Tensioner Assy. - Fan & Alt.	1382514	38508	Columbia		
Idler Pulley - Upper	1979641	36091	Belt - Fan, Alt. & A.C.		
Hose - Upper - Eng. To Rad.		22668	Tensioner Assy. - Fan, Alt. & A.C.		
Hose - Lower - Rad. To Cooler		21891	Tensioner Pulley - Fan, Alt. & A.C.		
Hose - Lower - Pipe To Cooler		22951	Idler Pulley - Smooth		
FL60; FL70; FL80			Idler Pulley - Grooved		
Belt - Fan & Alt.	0123415045	♣K080745HD	Hose - Upper - Eng. To Pipe		
Belt - W.P.	0366775	♣9341HD	Hose - Lower - Eng. To Pipe; (2 1/2" I.D.)		
Tensioner Assy. - Fan & Alt.	1382514	38508	Hose - Lower - Rad. To Pipe; (2 1/2" I.D.)		
Tensioner Assy. - Fan, Alt. & A.C.	1352151	38511	Condor; FLD		
Idler Pulley - Upper	1979641	36091	Idler Pulley - Smooth		
Tensioner Pulley - Fan, Alt. & A.C.	1352151	36091	Idler Pulley - Grooved		
Hose - Upper - Eng. To Rad.		22668	Caterpillar C12 Diesel		
Hose - Lower - Rad. To Cooler		21891	Argosy		
Hose - Lower - Pipe To Cooler		22951	Belt - Fan & Alt.		
Caterpillar C9 Diesel			Belt - Fan To A.C.		
Business Class M2			Tensioner Assy. - Fan, Alt. & Hub		
Belt - Fan, Alt. & A.C.	0123415069	♣K080785HD	Tensioner Assy. - Fan To A.C.		
Tensioner Assy. - Fan, Alt. & A.C.	2201209	38550	Idler Pulley - Fan & Alt.; W/Flat Idler		
Idler Pulley - Smooth	2078118	36269	Pulley		
Hose - Upper - Eng. To Rad.		23085	Idler Pulley - Fan & Alt.;		
Hose - Lower - Eng. To Rad.		23173	W/Multi-Grooved Idler Pulley		
Caterpillar C10 Diesel			Tensioner Pulley - Fan, Alt. & Hub		
Condor			Tensioner Pulley - Fan To A.C.		
Belt - Fan & Alt.	0124587007	♣K080878HD	Century Class		
Belt - A.C.		♣K060495HD	Belt - Fan & Alt.; W/O Idler		
Tensioner Assy. - Fan, Alt. & Hub	1600649	38506	Belt - Fan To A.C.		
Tensioner Assy. - Fan To A.C.	DCO568	38524	Tensioner Assy. - Fan & Alt.		
Idler Pulley - Fan & Alt.; W/Flat Idler			Tensioner Assy. - Fan To A.C.		
Pulley	1337023	36091	Idler Pulley - Fan & Alt.; W/Flat Idler		
Idler Pulley - Fan & Alt.;			Pulley		
W/Multi-Grooved Idler Pulley	1731498	36231	Idler Pulley - Fan & Alt.;		
Tensioner Pulley - Fan, Alt. & Hub	1600649	36091	W/Multi-Grooved Idler Pulley		
Tensioner Pulley - Fan To A.C.	DCO568	36091	Tensioner Pulley - Fan To A.C.		
FL112			Classic		
Belt - Fan, Alt. & Hub	0123415034	♣K080872HD	Idler Pulley - Fan & Alt.; W/Flat Idler		
Belt - Fan To A.C.	0126709000	♣K060529HD	Pulley		
Tensioner Assy. - Fan, Alt. & Hub	1600649	38506	Idler Pulley - Fan & Alt.;		
Tensioner Assy. - Fan To A.C.	DCO568	38524	W/Multi-Grooved Idler Pulley		
Idler Pulley - Fan & Alt.; W/Flat Idler			Columbia		
Pulley	1337023	36091	Belt - Fan, Alt. & Hub		
Idler Pulley - Fan & Alt.;			Belt - Fan To A.C.		
W/Multi-Grooved Idler Pulley	1731498	36231	Tensioner Assy. - Fan, Alt. & Hub		
Tensioner Pulley - Fan, Alt. & Hub	1600649	36091	Tensioner Assy. - Fan To A.C.		
Tensioner Pulley - Fan To A.C.	DCO568	36091	Idler Pulley - Fan & Alt.; W/Flat Idler		
Hose - Upper - Eng. To Pipe		21891	Pulley		
Hose - Upper - Pipe To Rad.; (2 1/2" I.D.)		24240	Idler Pulley - Fan & Alt.;		
Hose - Lower - Eng. To Pipe		21891	W/Multi-Grooved Idler Pulley		
Hose - Lower - Pipe To Rad.; (2 1/2" I.D.)		24240	Tensioner Pulley - Fan, Alt. & Hub		
FLD			Tensioner Pulley - Fan To A.C.		
Belt - Fan & Alt.	0128330002	K080850HD	Condor		
Belt - Fan To A.C.	0129729330	♣K060523HD	Belt - Fan & Alt.		
Tensioner Assy. - Fan & Alt.	1900649	38506	Belt - A.C.		
Tensioner Assy. - Fan To A.C.	DCO568	38524	Tensioner Assy. - Fan, Alt. & Hub		
Idler Pulley - Fan & Alt.; W/Flat Idler			Tensioner Assy. - Fan To A.C.		
Pulley	1337023	36091	Idler Pulley - Fan & Alt.; W/Flat Idler		
Idler Pulley - Fan & Alt.;			Pulley		
W/Multi-Grooved Idler Pulley	1731498	36231	Idler Pulley - Fan & Alt.;		
Tensioner Pulley - Fan, Alt. & Hub	1600649	36091	W/Multi-Grooved Idler Pulley		
Tensioner Pulley - Fan To A.C.	DCO568	36091	Tensioner Pulley - Fan, Alt. & Hub		
Hose - Upper - Eng. To Pipe		21891	Tensioner Pulley - Fan To A.C.		
Hose - Upper - Pipe To Rad.; (2 1/2" I.D.)		24240	K080850HD		
Hose - Lower - Eng. To Pipe		21891	♣K060525HD		
Hose - Lower - Pipe To Rad.; (2 1/2" I.D.)		24240	Tensioner Assy. - Fan, Alt. & Hub		
FLD			Tensioner Assy. - Fan To A.C.		
Belt - Fan & Alt.	0128330002	K080850HD	Idler Pulley - Fan & Alt.; W/Flat Idler		
Belt - Fan To A.C.	0129729330	♣K060523HD	Pulley		
Tensioner Assy. - Fan & Alt.	1900649	38506	Idler Pulley - Fan & Alt.;		
Tensioner Assy. - Fan To A.C.	DCO568	38524	W/Multi-Grooved Idler Pulley		
Idler Pulley - Fan & Alt.; W/Flat Idler			Tensioner Pulley - Fan, Alt. & Hub		
Pulley	1337023	36091	Tensioner Pulley - Fan To A.C.		
Idler Pulley - Fan & Alt.;			K080878HD		
W/Multi-Grooved Idler Pulley	1731498	36231	♣K060495HD		
Tensioner Pulley - Fan, Alt. & Hub	1600649	36091	Tensioner Assy. - Fan, Alt. & Hub		
Tensioner Pulley - Fan To A.C.	DCO568	36091	Tensioner Assy. - Fan To A.C.		
Hose - Upper - Eng. To Pipe		21891	Idler Pulley - Fan & Alt.; W/Flat Idler		
Hose - Upper - Pipe To Rad.; (2 1/2" I.D.)		24240	Pulley		
Hose - Lower - Eng. To Pipe		21891	Idler Pulley - Fan & Alt.;		
Hose - Lower - Pipe To Rad.; (2 1/2" I.D.)		24240	W/Multi-Grooved Idler Pulley		
FLD			Tensioner Pulley - Fan, Alt. & Hub		
Belt - Fan & Alt.	0128330002	K080850HD	Tensioner Pulley - Fan To A.C.		
Belt - Fan To A.C.	0129729330	♣K060523HD	K080850HD		
Tensioner Assy. - Fan & Alt.	1900649	38506	♣K060495HD		
Tensioner Assy. - Fan To A.C.	DCO568	38524	Tensioner Assy. - Fan, Alt. & Hub		
Idler Pulley - Fan & Alt.; W/Flat Idler			Tensioner Assy. - Fan To A.C.		
Pulley	1337023	36091	Idler Pulley - Fan & Alt.; W/Flat Idler		
Idler Pulley - Fan & Alt.;			Pulley		
W/Multi-Grooved Idler Pulley	1731498	36231	Idler Pulley - Fan & Alt.;		
Tensioner Pulley - Fan, Alt. & Hub	1600649	36091	W/Multi-Grooved Idler Pulley		
Tensioner Pulley - Fan To A.C.	DCO568	36091	Tensioner Pulley - Fan, Alt. & Hub		
Hose - Upper - Eng. To Pipe		21891	Tensioner Pulley - Fan To A.C.		
Hose - Upper - Pipe To Rad.; (2 1/2" I.D.)		24240	K080878HD		
Hose - Lower - Eng. To Pipe		21891	♣K060495HD		
Hose - Lower - Pipe To Rad.; (2 1/2" I.D.)		24240	Tensioner Assy. - Fan, Alt. & Hub		
FLD			Tensioner Assy. - Fan To A.C.		
Belt - Fan & Alt.	0128330002	K080850HD	Idler Pulley - Fan & Alt.; W/Flat Idler		
Belt - Fan To A.C.	0129729330	♣K060523HD	Pulley		
Tensioner Assy. - Fan & Alt.	1900649	38506	Idler Pulley - Fan & Alt.;		
Tensioner Assy. - Fan To A.C.	DCO568	38524	W/Multi-Grooved Idler Pulley		
Idler Pulley - Fan & Alt.; W/Flat Idler			Tensioner Pulley - Fan, Alt. & Hub		
Pulley	1337023	36091	Tensioner Pulley - Fan To A.C.		
Idler Pulley - Fan & Alt.;			K080878HD		
W/Multi-Grooved Idler Pulley	1731498	36231	♣K060495HD		
Tensioner Pulley - Fan, Alt. & Hub	1600649	36091	Tensioner Assy. - Fan, Alt. & Hub		
Tensioner Pulley - Fan To A.C.	DCO568	36091	Tensioner Assy. - Fan To A.C.		
Hose - Upper - Eng. To Pipe		21891	Idler Pulley - Fan & Alt.; W/Flat Idler		
Hose - Upper - Pipe To Rad.; (2 1/2" I.D.)		24240	Pulley		
Hose - Lower - Eng. To Pipe		21891	Idler Pulley - Fan & Alt.;		
Hose - Lower - Pipe To Rad.; (2 1/2" I.D.)		24240	W/Multi-Grooved Idler Pulley		

♣ Standard Belt Available. See Pages 630-631.

Belts and Coolant Hose for Medium/Heavy-Duty Trucks (1996 and Newer)

Medium & Heavy-Duty Trucks
(1996 & Newer)

Application	Mfr. Part No.	Our No.
FREIGHTLINER - Continued		
2004 - Continued		
Caterpillar C12 Diesel - Continued		
FL112		
Belt - Fan & Alt.	0128330002	K080850HD
Belt - Fan To A.C.	0124196013	▲K060523HD
Tensioner Assy. - Fan, Alt. & Hub	1600649	38506
Tensioner Assy. - Fan To A.C.	DCO568	38524
Idler Pulley - Fan & Alt.; W/Flat Idler Pulley	1337023	36091
Idler Pulley - Fan & Alt.; W/V-Groove Idler Pulley	1731498	36231
Tensioner Pulley - Fan, Alt. & Hub	1600649	36091
Tensioner Pulley - Fan To A.C.	DCO568	36091
FLD		
Belt - Fan & Alt.	0128330002	K080850HD
Belt - Fan To A.C.	0129729330	▲K060523HD
Tensioner Assy. - Fan & Alt.	1900649	38506
Tensioner Assy. - Fan To A.C.	DCO568	38524
Idler Pulley - Fan & Alt.; W/Flat Idler Pulley	1337023	36091
Idler Pulley - Fan & Alt.; W/Multi-Grooved Idler Pulley	1731498	36231
Tensioner Pulley - Fan To A.C.	DCO568	36091
Hose - Upper - Eng. To Pipe; (2 1/2" I.D.)		24240
Hose - Upper - Rad. To Pipe		21891
Hose - Lower - Eng. To Pipe; (2 1/2" I.D.)		24240
Hose - Lower - Rad. To Pipe		21891
Caterpillar C13 Diesel		
Business Class M2		
Belt - Hub, Fan, Alt. & A.C.	0123415080	▲K081005HD
Tensioner Assy. - Hub, Fan, Alt. & A.C.	2117895	38590
Tensioner Pulley - Hub, Fan, Alt. & A.C.	2117895	36164
Idler Pulley - Smooth	2078118	36269
Idler Pulley - Grooved	1979642	36341
Hose - Upper - Eng. To Rad.		23086
Hose - Lower - Eng. To Rad.		22952
Century Class; Classic; Classic XL		
Idler Pulley - Smooth	2078118	36269
Idler Pulley - Grooved	1979642	36341
Columbia		
Belt - Fan, Alt. & A.C.	0123415055	▲K080952HD
Tensioner Assy. - Fan, Alt. & A.C.	2117895	38590
Tensioner Pulley - Fan, Alt. & A.C.	2117895	36164
Idler Pulley - Smooth	2078118	36269
Idler Pulley - Grooved	1979642	36341
Hose - Upper - Eng. To Pipe		22950
Hose - Lower - Eng. To Pipe; (2 1/2" I.D.)		24240
Hose - Lower - Rad. To Pipe; (2 1/2" I.D.)		24240
Condor; FLD		
Idler Pulley - Smooth	2078118	36269
Idler Pulley - Grooved	1979642	36341
Caterpillar C15 Diesel		
Argosy		
Belt - Fan & Alt.		▲K080952HD
Belt - Fan To A.C.		▲K060547HD
Tensioner Assy. - Fan & Alt.	1900649	38506
Tensioner Assy. - Fan To A.C.	1382514	38508
Tensioner Pulley - Fan & Alt.	1900649	36091
Tensioner Pulley - Fan To A.C.	1382514	36091
Hose - Upper - Eng. To Pipe; (2 1/2" I.D.)		24240
Hose - Upper - Rad. To Pipe; (2 1/2" I.D.)		24240
Hose - Lower - Eng. To Pipe		21400
Hose - Lower - Rad. To Pipe		≈21891
Century Class		
Belt - Fan & Alt.	0123415029	▲K080952HD
Belt - Fan To A.C.	0126709006	▲K060598HD
Tensioner Assy. - Fan & Alt.	1352142	38506
Tensioner Assy. - Fan To A.C.	1382514	38508
Idler Pulley - Upper	1979641	36091
Idler Pulley - Grooved	1979642	36341
Tensioner Pulley - Fan & Alt.	1352142	36091

Application	Mfr. Part No.	Our No.
FREIGHTLINER - Continued		
2004 - Continued		
Caterpillar C15 Diesel - Continued		
Century Class - Continued		
Tensioner Pulley - Fan To A.C.	1382514	36091
Hose - Upper - Eng. To Pipe; (2 1/2" I.D.)		24240
Hose - Upper - Pipe To Rad.; (2 1/2" I.D.)		24240
Hose - Lower - Eng. To Pipe; (3" I.D.)		24248
Hose - Lower - Pipe To Rad.; (3" I.D.)		24248
Classic		
Belt - Fan & Alt.	0123415079	▲K080991HD
Belt - Fan To A.C.	0127177010	▲K060586HD
Tensioner Assy. - Fan & Alt.	1900649	38506
Tensioner Assy. - Fan To A.C.	1382514	38508
Idler Pulley - Smooth	1979641	36091
Idler Pulley - Grooved	1979642	36341
Tensioner Pulley - Fan & Alt.	1900649	36091
Tensioner Pulley - Fan To A.C.	1382514	36091
Hose - Upper - Eng. To Pipe		21194
Hose - Upper - Pipe To Rad.; (2 1/2" I.D.)		24240
Hose - Lower - Eng. To Rad.		23015
Classic XL		
Belt - Fan & Alt.	0123415050	▲K080944HD
Belt - Fan To A.C.	0126709007	▲K060547HD
Tensioner Assy. - Fan & Alt.	1900649	38506
Tensioner Assy. - Fan To A.C.	1382514	38508
Idler Pulley - Smooth	1979641	36091
Idler Pulley - Grooved	1979642	36341
Tensioner Pulley - Fan & Alt.	1900649	36091
Tensioner Pulley - Fan To A.C.	1382514	36091
Hose - Upper - Eng. To Pipe; (2 1/2" I.D.)		24240
Hose - Upper - Pipe To Rad.; (2 1/2" I.D.)		24240
Hose - Lower - Eng. To Pipe; (3" I.D.)		24248
Hose - Lower - Pipe To Rad.; (2 1/2" I.D.)		24240
Columbia		
Belt - Fan, Alt. & A.C.	0123415078	▲K080926HD
Tensioner Assy.	2002279	38569
Idler Pulley - Smooth	1979641	36091
Idler Pulley - Grooved	1979642	36341
Hose - Upper - Eng. To Pipe; (2 1/2" I.D.)		≈24240
Hose - Upper - Rad. To Pipe		21891
Hose - Lower - Pipe To Rad.; (2 1/2" I.D.)		≈24240
Coronado		
Belt - Fan & Alt.; W/130A. Alt.	0127110011	▲K080952HD
Belt - Fan & Alt.; W/135A. Alt.	0123415053	▲K080939HD
Belt - Fan To A.C.	0126709007	▲K060547HD
Tensioner Assy. - Fan & Alt.	1900649	38506
Tensioner Assy. - Fan To A.C.	1382514	38508
Idler Pulley - Smooth	1979641	36091
Idler Pulley - Grooved	1979642	36341
Tensioner Pulley - Fan & Alt.	1900649	36091
Tensioner Pulley - Fan To A.C.	1382514	36091
Hose - Upper - Eng. To Pipe		21891
Hose - Upper - Pipe To Rad.; (2 1/2" I.D.)		24240
Hose - Lower - Eng. To Pipe		21891
Hose - Lower - Pipe To Rad.; (2 1/2" I.D.)		24240
FLD		
Belt - Fan & Alt.	0123415050	▲K080944HD
Belt - Fan To A.C.	0126709007	▲K060547HD
Tensioner Assy. - Fan & Alt.	1900649	38506
Tensioner Assy. - Fan To A.C.	1382514	38508
Idler Pulley - Smooth	1979641	36091
Idler Pulley - Grooved	1979642	36341
Tensioner Pulley - Fan & Alt.	1900649	36091
Tensioner Pulley - Fan To A.C.	1382514	36091
Hose - Upper - Eng. To Pipe; (2 1/2" I.D.)		24240
Hose - Upper - Pipe To Rad.; (2 1/2" I.D.)		24240
Hose - Lower - Eng. To Pipe; (3" I.D.)		24248
Hose - Lower - Pipe To Rad.; (2 1/2" I.D.)		24240
Caterpillar C16 Diesel		
Columbia		
Belt - Fan & Alt.; W/130A. Alt.	0123415050	▲K080944HD
Belt - Fan & Alt.; W/135A. Alt.	0123415053	▲K080939HD

▲ Standard Belt Available. See Pages 630-631.

≈ Cut to Fit.

Belts and Coolant Hose for Medium/Heavy-Duty Trucks (1996 and Newer)

 Medium & Heavy-Duty Trucks
(1996 & Newer)

Application	Mfr. Part No.	Our No.
FREIGHTLINER - Continued		
2004 - Continued		
Caterpillar C16 Diesel - Continued		
Columbia - Continued		
Belt - Fan To A.C.	0126709007	♣K060547HD
Tensioner Assy. - Fan & Alt.	1352142	38506
Tensioner Assy. - Fan To A.C.	1382514	38508
Tensioner Pulley - Fan & Alt.	1352142	36091
Tensioner Pulley - Fan To A.C.	1382514	36091
Hose - Upper - Eng. To Pipe; (2 1/2" I.D.)	24240	24240
Hose - Upper - Pipe To Rad.; (2 1/2" I.D.)	24240	24240
Hose - Lower - Eng. To Pipe; (3 1/4" I.D.)	24052	24052
Hose - Lower - Pipe To Rad.; (2 1/2" I.D.)	24240	24240
FLD		
Belt - Fan & Alt.	0123415050	♣K080944HD
Belt - Fan To A.C.	0126709007	♣K060547HD
Tensioner Assy. - Fan & Alt.	1900649	38506
Tensioner Assy. - Fan To A.C.	1382514	38508
Tensioner Pulley - Fan & Alt.	1900649	36091
Tensioner Pulley - Fan To A.C.	1382514	36091
Hose - Upper - Eng. To Pipe; (2 1/2" I.D.)	24240	24240
Hose - Upper - Pipe To Rad.; (2 1/2" I.D.)	24240	24240
Hose - Lower - Eng. To Pipe; (3" I.D.)	24248	24248
Hose - Lower - Pipe To Rad.; (2 1/2" I.D.)	24240	24240
Cummins ISB Diesel		
MT35; MT45; MT55		
Belt - Fan, Alt. & A.C.	3959840	♣K080825HD
Tensioner Assy. - Fan, Alt. & A.C.	3957433	38517
Hose - Upper - Eng. To Rad.	23114	23114
Hose - Lower - Eng. To Pipe; (2" I.D.)	24232	24232
Hose - Lower - Rad. To Pipe; (2" I.D.)	24232	24232
Cummins ISC Diesel		
Business Class M2		
Belt - Fan & Alt.	3289404	♣K080716HD
Tensioner Assy. - Fan & Alt.	3936213	38516
Idler Pulley	3970945	36283
Tensioner Pulley - Fan & Alt.	3936213	36093
Hose - Upper - Eng. To Pipe; (2 1/4" I.D.)	24236	24236
Hose - Upper - Rad. To Pipe; (2" I.D.)	24232	24232
Hose - Lower - Rad. To Pipe	21891	21891
FL50; FL60; FL70; FL80		
Belt - Fan, Alt. & Hub	3289404	♣K080716HD
Belt - Fan To A.C.	2310001067	♣9480HD
Tensioner Assy. - Fan, Alt. & Hub	3936213	38516
Tensioner Pulley - Fan, Alt. & Hub	3936213	36093
Hose - Upper - Eng. To Pipe; (2 1/4" I.D.)	24236	24236
Hose - Upper - Pipe To Rad.; (2" I.D.)	24232	24232
Hose - Lower - Eng. To Pipe	20206	20206
Hose - Lower - Pipe To Cooler	21194	21194
Cummins ISL Diesel		
Condor		
Belt - Fan	♣K080765HD	38516
Belt - A.C.	♣9412HD	38516
Tensioner Assy.	38516	38516
Cummins 4-Cyl. 3.9 L Diesel		
MT35		
Belt - Fan & Alt.	3289179	♣K080680HD
Tensioner Assy. - Fan & Alt.	3976831	38516
Hose - Upper - Eng. To Rad.	20206	20206
Detroit Diesel 6-Cyl. 12.7 L Diesel		
Argosy		
Belt - Fan	0124894000	♣K100579HD
Belt - Alt. & A.C.	0124587000	♣K080580HD
Tensioner Assy. - Fan	38503	38503
Tensioner Assy. - Alt. & A.C.	23520317	38501
Tensioner Pulley - Fan	38076	38076
Tensioner Pulley - Alt. & A.C.	38075	38075
Hose - Upper - Eng. To Pipe; (2 1/2" I.D.)	24240	24240
Hose - Upper - Rad. To Pipe; (2 1/2" I.D.)	24240	24240
Hose - Lower - Eng. To Cooler; (2 3/4" I.D.)	24244	24244
Hose - Lower - Cooler To Pipe; (2 3/4" I.D.)	24244	24244

Application	Mfr. Part No.	Our No.
FREIGHTLINER - Continued		
2004 - Continued		
Detroit Diesel 6-Cyl. 12.7 L Diesel - Continued		
Argosy - Continued		
Hose - Lower - Rad. To Pipe		♣21891
Century Class		
Belt - Fan	0124894004	♣K100502HD
Belt - Hub To Alt. & A.C.	0124587004	♣K080565HD
Tensioner Assy. - Fan	0127846000	38503
Tensioner Assy. - Hub, Alt. & A.C.	0127425000	38501
Tensioner Pulley - Fan	0127846000	38076
Tensioner Pulley - Hub, Alt. & A.C.	0127425000	38075
Hose - Upper - Eng. To Pipe; (2 1/2" I.D.)	24240	24240
Hose - Upper - Rad. To Pipe; (2 1/2" I.D.)	24240	24240
Hose - Lower - Eng. To Rad.	22877	22877
Classic; Classic XL		
Belt - Fan; V-Belt; Preferred Belt		3/9525PB
Belt - Fan; V-Belt; Optional Belt	2310001051	♣9525HD
Belt - Fan; W/V-Ribbed Belt	0124894000	♣K100579HD
Belt - Hub, Alt. & A.C.	0124587006	♣K080570HD
Tensioner Assy. - Hub, Alt. & A.C.	0127425000	38501
Tensioner Pulley - Hub, Alt. & A.C.	0127425000	38075
Hose - Upper - Eng. To Pipe; (2 1/2" I.D.)	24240	24240
Hose - Upper - Pipe To Rad.; (2 1/2" I.D.)	24240	24240
Hose - Lower - Eng. To Pipe; (2 1/2" I.D.)	24240	24240
Hose - Lower - Pipe To Rad.; (2 1/2" I.D.)	24240	24240
Columbia		
Belt - Fan	0124894004	♣K100502HD
Belt - Hub To Alt. & A.C.	0124587004	♣K080565HD
Tensioner Assy. - Fan	0127846000	38503
Tensioner Assy. - Hub, Alt. & A.C.	0127425000	38501
Tensioner Pulley - Fan	0127846000	38076
Tensioner Pulley - Hub, Alt. & A.C.	0127425000	38075
Hose - Upper - Eng. To Rad.	21135	21135
Hose - Upper - Rad. To Pipe; (2 1/2" I.D.)	24240	24240
Hose - Lower - Eng. To Rad.	22877	22877
Coronado		
Belt - Fan	0124894004	♣K100502HD
Belt - Hub, Alt. & A.C.	0124587004	♣K080565HD
Tensioner Assy. - Fan	0127846000	38503
Tensioner Assy. - Hub, Alt. & A.C.	0127425000	38501
Tensioner Pulley - Fan	0127846000	38076
Tensioner Pulley - Hub, Alt. & A.C.	0127425000	38075
Hose - Upper - Eng. To Pipe	21135	21135
Hose - Upper - Pipe To Rad.; (2 1/2" I.D.)	24240	24240
Hose - Lower - Eng. To Pipe; (2 1/2" I.D.)	24240	24240
Hose - Lower - Pipe To Rad.; (2 1/2" I.D.)	24240	24240
FLD		
Belt - Fan; V-Belt; Preferred Belt		3/9525PB
Belt - Fan; V-Belt; Optional Belt	2310001051	♣9525HD
Belt - Fan; W/V-Ribbed Belt	0124894000	♣K100579HD
Belt - Hub, Alt. & A.C.	0124587006	♣K080570HD
Tensioner Assy. - Hub, Alt. & A.C.	0127425000	38501
Tensioner Pulley - Hub, Alt. & A.C.	0127425000	38075
Hose - Upper - Eng. To Pipe	21135	21135
Hose - Upper - Pipe To Rad.; (2 1/2" I.D.)	24240	24240
Hose - Lower - Eng. To Pipe; (2 1/2" I.D.)	24240	24240
Hose - Lower - Pipe To Rad.; (2 1/2" I.D.)	24240	24240
Detroit Diesel 6-Cyl. 14.0 L Diesel		
Argosy		
Belt - Fan	0124894000	♣K100579HD
Belt - Alt. & A.C.	0124587000	♣K080580HD
Tensioner Assy. - Fan	38503	38503
Tensioner Assy. - Alt. & A.C.	23520317	38501
Tensioner Pulley - Fan	38076	38076
Tensioner Pulley - Alt. & A.C.	38075	38075
Hose - Upper - Eng. To Pipe; (2 1/2" I.D.)	24240	24240
Hose - Upper - Rad. To Pipe; (2 1/2" I.D.)	24240	24240
Hose - Lower - Eng. To Cooler; (2 3/4" I.D.)	24244	24244
Hose - Lower - Cooler To Pipe; (2 3/4" I.D.)	24244	24244
Hose - Lower - Rad. To Pipe	♣21891	♣21891

♣ Standard Belt Available. See Pages 630-631.
 ③ Three Required.

≅ Cut to Fit.

Belts and Coolant Hose for Medium/Heavy-Duty Trucks (1996 and Newer)

Medium & Heavy-Duty Trucks
(1996 & Newer)

Application	Mfr. Part No.	Our No.
FREIGHTLINER - Continued		
2004 - Continued		
Detroit Diesel 6-Cyl. 14.0 L Diesel - Continued		
Century Class		
Belt - Fan	0124894004	♣K100502HD
Belt - Hub To Alt. & A.C.	0124587004	♣K080565HD
Tensioner Assy. - Fan	0127846000	38503
Tensioner Assy. - Hub, Alt. & A.C.	0127425000	38501
Tensioner Pulley - Fan	0127846000	38076
Tensioner Pulley - Hub, Alt. & A.C.	0127425000	38075
Hose - Upper - Eng. To Pipe; (2 1/2" I.D.)		24240
Hose - Upper - Rad. To Pipe; (2 1/2" I.D.)		24240
Hose - Lower - Eng. To Rad.		22877
Classic; Classic XL		
Belt - Fan; V-Belt; Preferred Belt		3/9525PB
Belt - Fan; V-Belt; Optional Belt	2310001051	♣9525HD
Belt - Fan; W/V-Ribbed Belt	0124894000	♣K100579HD
Belt - Hub, Alt. & A.C.	0124587006	♣K080570HD
Tensioner Assy. - Hub, Alt. & A.C.	0127425000	38501
Tensioner Pulley - Hub, Alt. & A.C.	0127425000	38075
Hose - Upper - Eng. To Pipe; (2 1/2" I.D.)		24240
Hose - Upper - Pipe To Rad.; (2 1/2" I.D.)		24240
Hose - Lower - Eng. To Pipe; (2 1/2" I.D.)		24240
Hose - Lower - Pipe To Rad.; (2 1/2" I.D.)		24240
Columbia		
Belt - Fan	0124894004	♣K100502HD
Belt - Hub To Alt. & A.C.	0124587004	♣K080565HD
Tensioner Assy. - Fan	0127846000	38503
Tensioner Assy. - Hub, Alt. & A.C.	0127425000	38501
Tensioner Pulley - Fan	0127846000	38076
Tensioner Pulley - Hub, Alt. & A.C.	0127425000	38075
Hose - Upper - Eng. To Rad.		21135
Hose - Upper - Rad. To Pipe; (2 1/2" I.D.)		24240
Hose - Lower - Eng. To Rad.		22877
Coronado		
Belt - Fan	0124894004	♣K100502HD
Belt - Hub, Alt. & A.C.	0124587004	♣K080565HD
Tensioner Assy. - Fan	0127846000	38503
Tensioner Assy. - Hub, Alt. & A.C.	0127425000	38501
Tensioner Pulley - Fan	0127846000	38076
Tensioner Pulley - Hub, Alt. & A.C.	0127425000	38075
Hose - Upper - Eng. To Pipe		21135
Hose - Upper - Pipe To Rad.; (2 1/2" I.D.)		24240
Hose - Lower - Eng. To Pipe; (2 1/2" I.D.)		24240
Hose - Lower - Pipe To Rad.; (2 1/2" I.D.)		24240
FLD		
Belt - Fan; V-Belt; Preferred Belt		3/9525PB
Belt - Fan; V-Belt; Optional Belt	2310001051	♣9525HD
Belt - Fan; W/V-Ribbed Belt	0124894000	♣K100579HD
Belt - Hub, Alt. & A.C.	0124587006	♣K080570HD
Tensioner Assy. - Hub, Alt. & A.C.	0127425000	38501
Tensioner Pulley - Hub, Alt. & A.C.	0127425000	38075
Hose - Upper - Eng. To Pipe; (2 1/2" I.D.)		24240
Hose - Upper - Pipe To Rad.; (2 1/2" I.D.)		24240
Hose - Lower - Eng. To Pipe; (2 1/2" I.D.)		24240
Hose - Lower - Pipe To Rad.; (2 1/2" I.D.)		24240
Mercedes-Benz MBE 900 Diesel		
Business Class M2		
Belt - Fan, Alt. & A.C.	0127110016	♣K080830HD
Belt - Fan & Alt.	0127110046	♣K080677HD
Tensioner Assy.	9062002470	38567
Hose - Upper - Eng. To Rad.		≠21378
Hose - Lower - Eng. To Pipe		20206
Hose - Lower - Rad. To Pipe; (2" I.D.)		24232
FL50; FL60; FL70; FL80		
Belt - Fan, Alt. & A.C.	0127110016	♣K080830HD
Hose - Upper - Eng. To Rad.		22701
Hose - Lower - Eng. To Pipe		20611
Hose - Lower - Pipe To Rad.		22702
MT35; MT45		
Belt - Fan, Alt. & A.C.	0127110045	♣K080830HD
Hose - Upper - Eng. To Rad.		20611

Application	Mfr. Part No.	Our No.
FREIGHTLINER - Continued		
2004 - Continued		
Mercedes-Benz MBE 900 Diesel - Continued		
MT35; MT45 - Continued		
Hose - Lower - Eng. To Rad.		21571
MT55		
Belt - Fan, Alt. & A.C.	0127110045	♣K080830HD
Hose - Turbo - Intercooler To Engine (Cold Side)	0129982000	29001
Hose - Upper - Eng. To Rad.		20611
Hose - Lower - Eng. To Rad.		21571
Mercedes-Benz MBE 4000 Diesel		
Business Class M2		
Belt - Fan	0127116007	♣K080575HD
Belt - Hub, Alt. & A.C.	0127116004	♣K080855HD
Tensioner Assy. - Fan	0127427001	38597
Tensioner Assy. - Hub, Alt. & A.C.	0127425000	38501
Tensioner Pulley - Hub, Alt. & A.C.	0127425000	38075
Hose - Upper - Eng. To Rad.		23013
Hose - Lower - Eng. To Rad.		23014
Century Class		
Belt - Fan	0127086004	♣K080672HD
Belt - Hub & Alt.	0127198001	♣K090609HD
Belt - A.C.	0127177001	♣K060439HD
Tensioner Assy. - Fan	A4572001970	38542
Tensioner Assy. - Hub & Alt.	A4602000770	38541
Tensioner Assy. - A.C.	A4602000870	38540
Hose - Upper - Eng. To Rad.; (2 1/2" I.D.)		24240
Hose - Upper - Rad. To Pipe; (2 1/2" I.D.)		24240
Hose - Lower - Eng. To Rad.		21891
Hose - Lower - Rad. To Pipe; (2 1/2" I.D.)		24240
Classic; Columbia		
Belt - Fan	0127086004	♣K080672HD
Belt - Hub & Alt.	0127198001	♣K090609HD
Belt - A.C.	0127177004	♣K060439HD
Tensioner Assy. - Fan	A4602000970	38542
Tensioner Assy. - Hub & Alt.	A4602000770	38541
Tensioner Assy. - A.C.	A4602000870	38540
Hose - Upper - Eng. To Pipe; (2 1/2" I.D.)		24240
Hose - Upper - Pipe To Rad.; (2 1/2" I.D.)		24240
Hose - Lower - Eng. To Pipe		21891
Hose - Lower - Pipe To Rad.; (2 1/2" I.D.)		24240
FL112		
Belt - Fan	0127086004	♣K080672HD
Belt - Hub & Alt.	0127198001	♣K090609HD
Belt - A.C.	0127177004	♣K060439HD
Tensioner Assy. - Fan	A4602000970	38542
Tensioner Assy. - Hub & Alt.	A4602000770	38541
Tensioner Assy. - A.C.	A4602000870	38540
Hose - Upper - Eng. To Pipe; (2 1/2" I.D.)		24240
Hose - Upper - Pipe To Rad.; (2 1/2" I.D.)		24240
Hose - Lower - Eng. To Pipe		21891
Hose - Lower - Pipe To Rad.; (2 1/2" I.D.)		24240
2003		
Caterpillar 3126 Diesel		
Business Class M2		
Belt - Fan, Alt. & A.C.; W/145A. Alt.	0123415040	♣K080774HD
Belt - Fan, Alt. & A.C.; W/130A. Alt.	0123415058	♣K080780HD
Tensioner Assy. - Fan, Alt. & A.C.	2201209	38550
Hose - Upper - Eng. To Rad.		22745
Hose - Lower - Eng. To Rad.		22744
FL50; FL60; FL70; FL80		
Belt - Fan, Alt. & A.C.; W/Delco Alt.	0123415000	♣K080702HD
Belt - Fan, Alt. & A.C.; W/Leece Neville Alt.	0127110003	♣K080708HD
Belt - W.P.		♣9341HD
Tensioner Assy. - Fan, Alt. & A.C.	1352151	38511
Idler Pulley - Alt. & A.C.	1445612	36096
Tensioner Pulley - Fan, Alt. & A.C.	1352151	36091
Hose - Upper - Eng. To Rad.		22668
Hose - Lower - Eng. To Pipe; W/2 1/4" I.D. Hose		20748

♣ Standard Belt Available. See Pages 630-631.
≠ Cut to Fit.

③ Three Required.

Belts and Coolant Hose for Medium/Heavy-Duty Trucks (1996 and Newer)

 Medium & Heavy-Duty Trucks
(1996 & Newer)

Application	Mfr. Part No.	Our No.
FREIGHTLINER - Continued		
2003 - Continued		
Caterpillar 3126 Diesel - Continued		
FL50; FL60; FL70; FL80 - Continued		
Hose - Lower - Eng. To Pipe; W/2" I.D. Hose		21571
Hose - Lower - Rad. To Pipe; W/2 1/4" I.D. Hose		21194
Hose - Lower - Rad. To Pipe; W/2" I.D. Hose		≧20611
Caterpillar C10 Diesel		
Argosy		
Belt - Fan & Alt.	0128330003	♣K080855HD
Belt - Fan To A.C.	0129729330	♣K060523HD
Tensioner Assy. - Fan, Alt. & Hub	1600649	38506
Tensioner Assy. - Fan To A.C.	DCO568	38524
Idler Pulley - Fan & Alt.; W/Flat Idler Pulley	1337023	36091
Idler Pulley - Fan & Alt.; W/Multi-Grooved Idler Pulley	1731498	36231
Tensioner Pulley - Fan, Alt. & Hub	1600649	36091
Tensioner Pulley - Fan To A.C.	DCO568	36091
Century Class		
Belt - Fan & Alt.; W/O Idler	0128330001	♣K080922HD
Belt - Fan To A.C.	0129729220	♣K060480HD
Tensioner Assy. - Fan & Alt.	1900649	38506
Tensioner Assy. - Fan To A.C.	DCO568	38524
Idler Pulley - Fan & Alt.; W/Flat Idler Pulley	1337023	36091
Idler Pulley - Fan & Alt.; W/Multi-Grooved Idler Pulley	1731498	36231
Tensioner Pulley - Fan To A.C.	DCO568	36091
Classic; Classic XL		
Idler Pulley - Fan & Alt.; W/Flat Idler Pulley	1337023	36091
Idler Pulley - Fan & Alt.; W/Multi-Grooved Idler Pulley	1731498	36231
Columbia		
Belt - Fan, Alt. & Hub	0123415056	K080850HD
Belt - Fan To A.C.	0124196013	♣K060523HD
Tensioner Assy. - Fan, Alt. & Hub	1600649	38506
Tensioner Assy. - Fan To A.C.	DCO568	38524
Idler Pulley - Fan & Alt.; W/Flat Idler Pulley	1337023	36091
Idler Pulley - Fan & Alt.; W/Multi-Grooved Idler Pulley	1731498	36231
Tensioner Pulley - Fan, Alt. & Hub	1600649	36091
Tensioner Pulley - Fan To A.C.	DCO568	36091
Hose - Upper - Eng. To Pipe		21891
Hose - Upper - Pipe To Rad.		21891
Hose - Lower - Eng. To Pipe		21891
Hose - Lower - Pipe To Rad.; (2 1/2" I.D.)		24240
Condor		
Belt - Fan & Alt.	0124587007	♣K080878HD
Belt - A.C.		♣K060495HD
Tensioner Assy. - Fan, Alt. & Hub	1600649	38506
Tensioner Assy. - Fan To A.C.	DCO568	38524
Idler Pulley - Fan & Alt.; W/Flat Idler Pulley	1337023	36091
Idler Pulley - Fan & Alt.; W/Multi-Grooved Idler Pulley	1731498	36231
Tensioner Pulley - Fan, Alt. & Hub	1600649	36091
Tensioner Pulley - Fan To A.C.	DCO568	36091
FL112		
Belt - Fan, Alt. & Hub	0123415034	♣K080872HD
Belt - Fan To A.C.	0126709000	♣K060529HD
Tensioner Assy. - Fan, Alt. & Hub	1600649	38506
Tensioner Assy. - Fan To A.C.	DCO568	38524
Idler Pulley - Fan & Alt.; W/Flat Idler Pulley	1337023	36091
Idler Pulley - Fan & Alt.; W/Multi-Grooved Idler Pulley	1731498	36231
Tensioner Pulley - Fan, Alt. & Hub	1600649	36091
Tensioner Pulley - Fan To A.C.	DCO568	36091
Hose - Upper - Eng. To Pipe		21891
Hose - Upper - Pipe To Rad.; (2 1/2" I.D.)		24240

≧ Cut to Fit.

Application	Mfr. Part No.	Our No.
FREIGHTLINER - Continued		
2003 - Continued		
Caterpillar C10 Diesel - Continued		
FL112 - Continued		
Hose - Lower - Eng. To Pipe		21891
Hose - Lower - Pipe To Rad.; (2 1/2" I.D.)		24240
FLD		
Belt - Fan & Alt.; W/O Idler	0128330001	♣K080922HD
Belt - Fan To A.C.	0129729220	♣K060480HD
Tensioner Assy. - Fan & Alt.	1900649	38506
Tensioner Assy. - Fan To A.C.	DCO568	38524
Idler Pulley - Fan & Alt.; W/Flat Idler Pulley	1337023	36091
Idler Pulley - Fan & Alt.; W/Multi-Grooved Idler Pulley	1731498	36231
Tensioner Pulley - Fan To A.C.	DCO568	36091
Hose - Upper - Eng. To Pipe		21891
Hose - Upper - Pipe To Rad.; (2 1/2" I.D.)		24240
Hose - Lower - Eng. To Cooler		21891
Hose - Lower - Pipe To Cooler; (2 1/2" I.D.)		24240
Hose - Lower - Pipe To Rad.; (2 1/2" I.D.)		24240
Caterpillar C12 Diesel		
Argosy		
Belt - Fan & Alt.	0128330003	♣K080855HD
Belt - Fan To A.C.	0129729330	♣K060523HD
Tensioner Assy. - Fan, Alt. & Hub	1600649	38506
Tensioner Assy. - Fan To A.C.	DCO568	38524
Idler Pulley - Fan & Alt.; W/Flat Idler Pulley	1337023	36091
Idler Pulley - Fan & Alt.; W/Multi-Grooved Idler Pulley	1731498	36231
Tensioner Pulley - Fan, Alt. & Hub	1600649	36091
Tensioner Pulley - Fan To A.C.	DCO568	36091
Century Class		
Belt - Fan & Alt.; W/O Idler	0128330001	♣K080922HD
Belt - Fan To A.C.	0129729220	♣K060480HD
Tensioner Assy. - Fan & Alt.	1900649	38506
Tensioner Assy. - Fan To A.C.	DCO568	38524
Idler Pulley - Fan & Alt.; W/Flat Idler Pulley	1337023	36091
Idler Pulley - Fan & Alt.; W/Multi-Grooved Idler Pulley	1731498	36231
Tensioner Pulley - Fan To A.C.	DCO568	36091
Classic; Classic XL		
Idler Pulley - Fan & Alt.; W/Flat Idler Pulley	1337023	36091
Idler Pulley - Fan & Alt.; W/Multi-Grooved Idler Pulley	1731498	36231
Columbia		
Belt - Fan, Alt. & Hub	0123415056	K080850HD
Belt - Fan To A.C.	0124196013	♣K060523HD
Tensioner Assy. - Fan, Alt. & Hub	1600649	38506
Tensioner Assy. - Fan To A.C.	DCO568	38524
Idler Pulley - Fan & Alt.; W/Flat Idler Pulley	1337023	36091
Idler Pulley - Fan & Alt.; W/Multi-Grooved Idler Pulley	1731498	36231
Tensioner Pulley - Fan To A.C.	DCO568	36091
Classic; Classic XL		
Idler Pulley - Fan & Alt.; W/Flat Idler Pulley	1337023	36091
Idler Pulley - Fan & Alt.; W/Multi-Grooved Idler Pulley	1731498	36231
Columbia		
Belt - Fan, Alt. & Hub	0123415056	K080850HD
Belt - Fan To A.C.	0124196013	♣K060523HD
Tensioner Assy. - Fan, Alt. & Hub	1600649	38506
Tensioner Assy. - Fan To A.C.	DCO568	38524
Idler Pulley - Fan & Alt.; W/Flat Idler Pulley	1337023	36091
Idler Pulley - Fan & Alt.; W/Multi-Grooved Idler Pulley	1731498	36231
Idler Pulley	1731498	36231
Tensioner Pulley - Fan, Alt. & Hub	1600649	36091
Tensioner Pulley - Fan To A.C.	DCO568	36091
Hose - Upper - Eng. To Pipe		21891
Hose - Upper - Pipe To Rad.		21891
Hose - Lower - Eng. To Pipe		21891
Hose - Lower - Pipe To Rad.; (2 1/2" I.D.)		24240
Condor		
Belt - Fan & Alt.	0124587007	♣K080878HD
Belt - A.C.		♣K060495HD
Tensioner Assy. - Fan, Alt. & Hub	1600649	38506
Tensioner Assy. - Fan To A.C.	DCO568	38524
Idler Pulley - Fan & Alt.; W/Flat Idler Pulley	1337023	36091
Idler Pulley - Fan & Alt.; W/Multi-Grooved Idler Pulley	1731498	36231
Tensioner Pulley - Fan, Alt. & Hub	1600649	36091
Tensioner Pulley - Fan To A.C.	DCO568	38524
Idler Pulley - Fan & Alt.; W/Flat Idler Pulley	1337023	36091
Idler Pulley - Fan & Alt.; W/Multi-Grooved Idler Pulley	1731498	36231

♣ Standard Belt Available. See Pages 630-631.

Belts and Coolant Hose for Medium/Heavy-Duty Trucks (1996 and Newer)

Medium & Heavy-Duty Trucks
(1996 & Newer)

Application	Mfr. Part No.	Our No.
FREIGHTLINER - Continued		
2003 - Continued		
Caterpillar C12 Diesel - Continued		
Condor - Continued		
Tensioner Pulley - Fan, Alt. & Hub	1600649	36091
Tensioner Pulley - Fan To A.C.	DCO568	36091
FL112		
Belt - Fan, Alt. & Hub	0123415034	♣K080872HD
Belt - Fan To A.C.	0126709000	♣K060529HD
Tensioner Assy. - Fan, Alt. & Hub	1600649	38506
Tensioner Assy. - Fan To A.C.	DCO568	38524
Idler Pulley - Fan & Alt.; W/Flat Idler Pulley	1337023	36091
Idler Pulley - Fan & Alt.; W/Multi-Grooved Idler Pulley	1731498	36231
Tensioner Pulley - Fan, Alt. & Hub	1600649	36091
Tensioner Pulley - Fan To A.C.	DCO568	36091
Hose - Upper - Eng. To Pipe	21891	24240
Hose - Upper - Pipe To Rad.; (2 1/2" I.D.)	21891	24240
Hose - Lower - Eng. To Pipe	21891	24240
Hose - Lower - Pipe To Rad.; (2 1/2" I.D.)	21891	24240
FLD		
Belt - Fan & Alt.; W/O Idler	0128330001	♣K080922HD
Belt - Fan To A.C.	0129729220	♣K060480HD
Tensioner Assy. - Fan & Alt.	1900649	38506
Tensioner Assy. - Fan To A.C.	DCO568	38524
Idler Pulley - Fan & Alt.; W/Flat Idler Pulley	1337023	36091
Idler Pulley - Fan & Alt.; W/Multi-Grooved Idler Pulley	1731498	36231
Tensioner Pulley - Fan To A.C.	DCO568	36091
Hose - Upper - Eng. To Pipe	21891	24240
Hose - Upper - Pipe To Rad.; (2 1/2" I.D.)	21891	24240
Hose - Lower - Eng. To Cooler	21891	24240
Hose - Lower - Pipe To Cooler; (2 1/2" I.D.)	21891	24240
Hose - Lower - Pipe To Rad.; (2 1/2" I.D.)	21891	24240
Caterpillar C15 Diesel		
Argosy		
Belt - Fan & Alt.		♣K080952HD
Belt - Fan To A.C.		♣K060547HD
Tensioner Assy. - Fan & Alt.	1900649	38506
Tensioner Assy. - Fan To A.C.	1382514	38508
Tensioner Pulley - Fan & Alt.	1900649	36091
Tensioner Pulley - Fan To A.C.	1382514	36091
Hose - Upper - Eng. To Pipe; (2 1/2" I.D.)	24240	24240
Hose - Upper - Pipe To Rad.; (2 1/2" I.D.)	24240	24240
Hose - Lower - Eng. To Pipe	21400	24240
Hose - Lower - Rad. To Pipe	21891	24240
Century Class		
Belt - Fan & Alt.	0123415029	♣K080952HD
Belt - Fan To A.C.	0126709006	♣K060598HD
Tensioner Assy. - Fan & Alt.	1352142	38506
Tensioner Assy. - Fan To A.C.	1382514	38508
Tensioner Pulley - Fan & Alt.	1352142	36091
Tensioner Pulley - Fan To A.C.	1382514	36091
Hose - Upper - Eng. To Pipe; (2 1/2" I.D.)	24240	24240
Hose - Upper - Pipe To Rad.; (2 1/2" I.D.)	24240	24240
Hose - Lower - Eng. To Pipe; (3" I.D.)	24248	24248
Hose - Lower - Pipe To Rad.; (3" I.D.)	24248	24248
Classic		
Belt - Fan & Alt.	0123415050	♣K080944HD
Belt - Fan To A.C.	0126709007	♣K060547HD
Tensioner Assy. - Fan & Alt.	1900649	38506
Tensioner Assy. - Fan To A.C.	1382514	38508
Tensioner Pulley - Fan & Alt.	1900649	36091
Tensioner Pulley - Fan To A.C.	1382514	36091
Hose - Upper - Eng. To Pipe; (2 1/2" I.D.)	24240	24240
Hose - Upper - Pipe To Rad.; (2 1/2" I.D.)	24240	24240
Hose - Lower - Eng. To Pipe; (3" I.D.)	24248	24248
Hose - Lower - Pipe To Rad.; (2 1/2" I.D.)	24240	24240
Classic XL		
Belt - Fan & Alt.	0123415050	♣K080944HD
Belt - Fan To A.C.	0126709007	♣K060547HD

Application	Mfr. Part No.	Our No.
FREIGHTLINER - Continued		
2003 - Continued		
Caterpillar C15 Diesel - Continued		
Classic XL - Continued		
Tensioner Assy. - Fan & Alt.	1900649	38506
Tensioner Assy. - Fan To A.C.	1900642	38508
Idler Pulley - Lower (Grooved)	1731498	36231
Idler Pulley - Upper (Smooth)	1337023	36091
Hose - Upper - Eng. To Pipe; (2 1/2" I.D.)		24240
Hose - Upper - Pipe To Rad.; (2 1/2" I.D.)		24240
Hose - Lower - Eng. To Pipe; (3" I.D.)		24248
Hose - Lower - Pipe To Rad.; (2 1/2" I.D.)		24240
Columbia		
Belt - Fan & Alt.; W/130A. Alt.	0123415050	♣K080944HD
Belt - Fan & Alt.; W/135A. Alt.	0123415053	♣K080939HD
Belt - Fan To A.C.	0126709007	♣K060547HD
Tensioner Assy. - Fan & Alt.	1352142	38506
Tensioner Assy. - Fan To A.C.	1382514	38508
Tensioner Pulley - Fan & Alt.	1352142	36091
Tensioner Pulley - Fan To A.C.	1382514	36091
Hose - Upper - Eng. To Pipe; (2 1/2" I.D.)		24240
Hose - Upper - Pipe To Rad.; (2 1/2" I.D.)		24240
Hose - Lower - Eng. To Pipe; (3 1/4" I.D.)		24052
Hose - Lower - Pipe To Rad.; (2 1/2" I.D.)		24240
Coronado		
Belt - Fan & Alt.; W/130A. Alt.	0127110011	♣K080952HD
Belt - Fan & Alt.; W/135A. Alt.	0123415053	♣K080939HD
Belt - Fan To A.C.	0126709007	♣K060547HD
Tensioner Assy. - Fan & Alt.	1900649	38506
Tensioner Assy. - Fan To A.C.	1382514	38508
Tensioner Pulley - Fan & Alt.	1900649	36091
Tensioner Pulley - Fan To A.C.	1382514	36091
Hose - Upper - Eng. To Pipe		21891
Hose - Upper - Pipe To Rad.; (2 1/2" I.D.)		24240
Hose - Lower - Eng. To Pipe		21891
Hose - Lower - Pipe To Rad.; (2 1/2" I.D.)		24240
FLD		
Belt - Fan & Alt.	0123415050	♣K080944HD
Belt - Fan To A.C.	0126709007	♣K060547HD
Tensioner Assy. - Fan & Alt.	1900649	38506
Tensioner Assy. - Fan To A.C.	1382514	38508
Tensioner Pulley - Fan & Alt.	1900649	36091
Tensioner Pulley - Fan To A.C.	1382514	36091
Hose - Upper - Eng. To Pipe; (2 1/2" I.D.)		24240
Hose - Upper - Pipe To Rad.; (2 1/2" I.D.)		24240
Hose - Lower - Eng. To Pipe; (3" I.D.)		24248
Hose - Lower - Pipe To Rad.; (2 1/2" I.D.)		24240
Caterpillar C16 Diesel		
Classic; Classic XL		
Belt - Fan & Alt.	0123415050	♣K080944HD
Belt - Fan To A.C.	0126709007	♣K060547HD
Tensioner Assy. - Fan & Alt.	1900649	38506
Tensioner Assy. - Fan To A.C.	1382514	38508
Tensioner Pulley - Fan & Alt.	1900649	36091
Tensioner Pulley - Fan To A.C.	1382514	36091
Hose - Upper - Eng. To Pipe; (2 1/2" I.D.)		24240
Hose - Upper - Pipe To Rad.; (2 1/2" I.D.)		24240
Hose - Lower - Eng. To Pipe; (3" I.D.)		24248
Hose - Lower - Pipe To Rad.; (2 1/2" I.D.)		24240
Columbia		
Belt - Fan & Alt.; W/130A. Alt.	0123415050	♣K080944HD
Belt - Fan & Alt.; W/135A. Alt.	0123415053	♣K080939HD
Belt - Fan To A.C.	0126709007	♣K060547HD
Tensioner Assy. - Fan & Alt.	1352142	38506
Tensioner Assy. - Fan To A.C.	1382514	38508
Tensioner Pulley - Fan & Alt.	1900649	36091
Tensioner Pulley - Fan To A.C.	1382514	36091
Hose - Upper - Eng. To Pipe; (2 1/2" I.D.)		24240
Hose - Upper - Pipe To Rad.; (2 1/2" I.D.)		24240
Hose - Lower - Eng. To Pipe; (3 1/4" I.D.)		24052
Hose - Lower - Pipe To Rad.; (2 1/2" I.D.)		24240
Coronado		
Belt - Fan & Alt.; W/130A. Alt.	0127110011	♣K080952HD

♣ Standard Belt Available. See Pages 630-631.

≡< Cut to Fit.

Belts and Coolant Hose for Medium/Heavy-Duty Trucks (1996 and Newer)

 Medium & Heavy-Duty Trucks
(1996 & Newer)

Application	Mfr. Part No.	Our No.
FREIGHTLINER - Continued		
2003 - Continued		
Caterpillar C16 Diesel - Continued		
Coronado - Continued		
Belt - Fan & Alt.; W/135A. Alt.	0123415053	♣K080939HD
Belt - Fan To A.C.	0126709007	♣K060547HD
Tensioner Assy. - Fan & Alt.	1900649	38506
Tensioner Assy. - Fan To A.C.	1382514	38508
Tensioner Pulley - Fan & Alt.	1900649	36091
Tensioner Pulley - Fan To A.C.	1382514	36091
Hose - Upper - Eng. To Pipe Hose - Upper - Pipe To Rad.; (2 1/2" I.D.) 24240	21891 24240
Hose - Lower - Eng. To Pipe Hose - Lower - Pipe To Rad.; (2 1/2" I.D.) 24240	21891 24240
FLD		
Belt - Fan & Alt.	0123415050	♣K080944HD
Belt - Fan To A.C.	0126709007	♣K060547HD
Tensioner Assy. - Fan & Alt.	1900649	38506
Tensioner Assy. - Fan To A.C.	1382514	38508
Tensioner Pulley - Fan & Alt.	1900649	36091
Tensioner Pulley - Fan To A.C.	1382514	36091
Hose - Upper - Eng. To Pipe; (2 1/2" I.D.) Hose - Upper - Pipe To Rad.; (2 1/2" I.D.) 24240	24240 24240
Hose - Lower - Eng. To Pipe; (3" I.D.) Hose - Lower - Pipe To Rad.; (2 1/2" I.D.) 24240	24248 24240
Cummins ISB Diesel		
FC70; FC80		
Belt - Alt. & A.C.	0127086001	♣K080594HD
Tensioner Assy.	3936197	38517
Tensioner Pulley	3936197	36095
Hose - Upper - Eng. To Pipe Hose - Upper - Pipe To Rad.; (2" I.D.) 24232	20206 24232
Hose - Lower - Eng. To Pipe; (2" I.D.) Hose - Lower - Cooler To Pipe Hose - Lower - Pipe To Rad.; (2" I.D.) 24232	24232 Ⓞ21891 24232
FL50; FL60; FL70; FL80		
Belt - Fan, Alt. & Hub Belt - Fan & A.C.	3926856 2310001043	♣K080694HD ♣9447HD
Tensioner Assy. - Fan, Alt. & Hub Tensioner Pulley - Fan, Alt. & Hub	3936213 3936213	38516 36093
Hose - Upper - Eng. To Rad. Hose - Lower - Eng. To Rad.	22700 22704
MT45		
Belt - Fan, Alt. & Hub Belt - Fan To A.C.	3943214 17430	♣K080726HD ♣9430HD
Tensioner Assy. - Fan, Alt. & Hub Tensioner Pulley - Fan, Alt. & Hub	3936213 3936213	38516 36093
Hose - Upper - Eng. To Rad. Hose - Lower - Eng. To Pipe; (2 1/4" I.D.) Hose - Lower - Pipe To Rad.; (2" I.D.)	22795 24236 24232
MT55		
Belt - Fan To Alt. Belt - Fan To A.C.	3943214 17430	♣K080726HD ♣9430HD
Tensioner Assy. - Fan, Alt. & Hub Tensioner Pulley - Fan, Alt. & Hub	3936213 3936213	38516 36093
Hose - Upper - Eng. To Rad. Hose - Lower - Eng. To Pipe; (2 1/4" I.D.) Hose - Lower - Pipe To Rad.; (2" I.D.)	22795 24236 24232
Cummins ISC Diesel		
FL50; FL60; FL70; FL80		
Belt - Fan, Alt. & Hub Belt - Fan To A.C.	3911583 2310001067	♣K080708HD ♣9480HD
Tensioner Assy. - Fan, Alt. & Hub Tensioner Pulley - Fan, Alt. & Hub	3936213 3936213	38516 36093
Hose - Upper - Eng. To Pipe; (2 1/4" I.D.) Hose - Upper - Pipe To Rad. Hose - Lower - Eng. To Pipe Hose - Lower - Pipe To Rad.	24236 21571 20206 20206
Cummins ISM Diesel		
Classic; Classic XL		
Belt - Fan, Alt. & Hub Belt - Hub & A.C.	0127110014 0124196015	♣K080817HD ♣K060559HD

♣ Standard Belt Available. See Pages 630-631.

Application	Mfr. Part No.	Our No.
FREIGHTLINER - Continued		
2003 - Continued		
Cummins ISM Diesel - Continued		
Classic; Classic XL - Continued		
Tensioner Assy. - Fan, Alt. & Hub	3400885	38521
Tensioner Assy. - Hub & A.C.	4004933	38505
Idler Pulley - Fan & Alt.	3400884	36308
Tensioner Pulley - A.C.	4004933	36091
Hose - Upper - Eng. To Pipe; (2 1/4" I.D.) Hose - Upper - Pipe To Rad.; (2 1/2" I.D.)	24236 24240
Hose - Lower - Eng. To Cooler; (2 1/2" I.D.) Hose - Lower - Pipe To Cooler	24240 21042
Hose - Lower - Cooler To Pipe; (3" I.D.) Hose - Lower - Pipe To Rad.; (2 1/2" I.D.)	24248 24240
Columbia		
Belt - Fan & Alt.	0127110006	♣K080730HD
Belt - Hub & A.C.	0126709009	♣K060575HD
Tensioner Assy. - Fan & Alt.	3400885	38521
Tensioner Assy. - Hub & A.C.	4004933	38505
Idler Pulley - Fan & Alt.	3400884	36308
Tensioner Pulley - A.C.	4004933	36091
FL112		
Belt - Fan & Alt.	0127110006	♣K080730HD
Belt - Hub & A.C.	0126709008	♣K060559HD
Tensioner Assy. - Fan & Alt.	3400885	38521
Tensioner Assy. - Hub & A.C.	4004933	38505
Idler Pulley - Fan & Alt.	3400884	36308
Tensioner Pulley - A.C.	4004933	36091
Hose - Upper - Eng. To Pipe; (2 1/2" I.D.) Hose - Upper - Pipe To Rad.; (2 1/2" I.D.)	24240 24240
Hose - Lower - Eng. To Pipe; (2 1/2" I.D.) Hose - Lower - Pipe To Rad.; (2 1/2" I.D.)	24240 24240
FLD		
Belt - Fan, Alt. & Hub Belt - Hub & A.C.	0127110014 0124196015	♣K080817HD ♣K060559HD
Tensioner Assy. - Fan, Alt. & Hub Tensioner Assy. - Hub & A.C.	3400885 4004933	38521 38505
Idler Pulley - Fan & Alt.	3400884	36308
Tensioner Pulley - A.C.	4004933	36091
Hose - Upper - Eng. To Pipe; (2 1/4" I.D.) Hose - Upper - Pipe To Rad.; (2 1/2" I.D.)	24240 24240
Hose - Lower - Eng. To Cooler; (2 1/2" I.D.) Hose - Lower - Pipe To Cooler	24240 21042
Hose - Lower - Cooler To Pipe; (3" I.D.) Hose - Lower - Pipe To Rad.; (2 1/2" I.D.)	24248 24240
Cummins ISX Diesel		
Argosy; FLD		
Belt - Fan & W.P.		♣K060685HD
Belt - W.P., Alt. & A.C.		♣K100710HD
Tensioner Assy. - Fan Tensioner Assy. - Hub, Alt. & A.C.	3681240 3680194	38535 38532
Idler Pulley - Alt. & A.C.	4026886	36226
Tensioner Pulley - Fan Tensioner Pulley - Hub, Alt. & A.C.	3681240 3680194	36092 36095
Cummins N14 Diesel		
Classic XL		
Belt - Fan Belt - Hub & W.P.	0127191000	2/TR28466PB ♣K060425HD
Belt - Alt. Belt - Hub & A.C.	2310001028 2310001087	♣9451HD ♣9435HD
Hose - Upper - Eng. To Pipe; (2 1/2" I.D.) Hose - Upper - Pipe To Rad.; (2 1/2" I.D.)	24240 24240
Hose - Lower - Eng. To Pipe; (2 1/2" I.D.) Hose - Lower - Pipe To Rad.; (3" I.D.)	24240 24248
Columbia		
Belt - Fan & Hub Belt - Hub & W.P.	0127191002	TR28445 ♣K060425HD
Belt - Alt. Belt - Hub & A.C.	2310001028 GT17446	♣9451HD ♣9447HD
Hose - Upper - Eng. To Rad.; (2 1/2" I.D.) Hose - Upper - Pipe To Rad.; (2 1/2" I.D.)	24240 24240
Hose - Lower - Eng. To Rad.; (2 1/2" I.D.)	24240

Ⓞ Two Required.

Belts and Coolant Hose for Medium/Heavy-Duty Trucks [1996 and Newer]

Medium & Heavy-Duty Trucks
(1996 & Newer)

Application	Mfr. Part No.	Our No.
FREIGHTLINER - Continued		
2003 - Continued		
Cummins N14 Diesel - Continued		
Columbia - Continued		
Hose - Lower - Pipe To Rad.; (2 1/2" I.D.)		24240
FLD		
Belt - Fan	0127191000	2/TR28466PB
Belt - Hub & W.P.		▲K060425HD
Belt - Alt.	2310001028	▲9451HD
Belt - Hub & A.C.	2310001087	▲9435HD
Hose - Upper - Eng. To Pipe; (2 1/2" I.D.)		24240
Hose - Upper - Pipe To Rad.; (2 1/2" I.D.)		24240
Hose - Lower - Eng. To Pipe; (2 1/2" I.D.)		24240
Hose - Lower - Pipe To Rad.; (3" I.D.)		24248
Cummins 4-Cyl. 3.9 L Diesel		
MT35		
Belt - Fan To Alt.	3943214	▲K080726HD
Belt - Fan To A.C.	17430	▲9430HD
Tensioner Assy. - Fan, Alt. & Hub	3936213	38516
Tensioner Pulley - Fan, Alt. & Hub	3936213	36093
Hose - Upper - Eng. To Rad.		22795
Hose - Lower - Eng. To Pipe; (2 1/4" I.D.)		24236
Hose - Lower - Pipe To Rad.; (2" I.D.)		24232
Detroit Diesel 6-Cyl. 11.1 L Diesel		
Argosy		
Belt - Fan	0124894000	▲K100579HD
Belt - Alt. & A.C.	0124587000	▲K080580HD
Tensioner Assy. - Fan		38503
Tensioner Assy. - Alt. & A.C.	23520317	38501
Tensioner Pulley - Fan		38076
Tensioner Pulley - Alt. & A.C.		38075
Hose - Upper - Eng. To Pipe; (2 1/2" I.D.)		24240
Hose - Upper - Rad. To Pipe; (2 1/2" I.D.)		24240
Hose - Lower - Eng. To Cooler; (2 3/4" I.D.)		24244
Hose - Lower - Cooler To Pipe; (2 3/4" I.D.)		24244
Hose - Lower - Rad. To Pipe		≠21891
Century Class		
Belt - Fan; Preferred Belt; W/50 3/8" Belt O.C.		3/9500PB
Belt - Fan; Optional Belt; W/50 3/8" Belt O.C.	2310001022	③▲9500HD
Belt - Hub, Alt. & A.C.	0124587006	▲K080570HD
Tensioner Assy. - Hub, Alt. & A.C.	23520317	38501
Tensioner Pulley - Hub, Alt. & A.C.	23520317	38075
Hose - Upper - Eng. To Pipe		21891
Hose - Upper - Pipe To Rad.; (2 1/2" I.D.)		24240
Hose - Lower - Eng. To Pipe; (2 1/2" I.D.)		24240
Hose - Lower - Pipe To Rad.; (2 1/2" I.D.)		24240
Detroit Diesel 6-Cyl. 12.7 L Diesel		
Argosy		
Belt - Fan	0124894000	▲K100579HD
Belt - Alt. & A.C.	0124587000	▲K080580HD
Tensioner Assy. - Fan		38503
Tensioner Assy. - Alt. & A.C.	23520317	38501
Tensioner Pulley - Fan		38076
Tensioner Pulley - Alt. & A.C.		38075
Hose - Upper - Eng. To Pipe; (2 1/2" I.D.)		24240
Hose - Upper - Rad. To Pipe; (2 1/2" I.D.)		24240
Hose - Lower - Eng. To Cooler; (2 3/4" I.D.)		24244
Hose - Lower - Cooler To Pipe; (2 3/4" I.D.)		24244
Hose - Lower - Rad. To Pipe		≠21891
Century Class		
Belt - Fan; Preferred Belt; W/50 3/8" Belt O.C.		3/9500PB
Belt - Fan; Optional Belt; W/50 3/8" Belt O.C.	2310001022	③▲9500HD
Belt - Hub, Alt. & A.C.	0124587006	▲K080570HD
Tensioner Assy. - Hub, Alt. & A.C.	23520317	38501
Tensioner Pulley - Hub, Alt. & A.C.	23520317	38075
Hose - Upper - Eng. To Pipe		21891
Hose - Upper - Pipe To Rad.; (2 1/2" I.D.)		24240
Hose - Lower - Eng. To Pipe; (2 1/2" I.D.)		24240
Hose - Lower - Pipe To Rad.; (2 1/2" I.D.)		24240

Application	Mfr. Part No.	Our No.
FREIGHTLINER - Continued		
2003 - Continued		
Detroit Diesel 6-Cyl. 12.7 L Diesel - Continued		
Classic; Classic XL		
Belt - Fan; Preferred Belt		3/9525PB
Belt - Fan; Optional Belt		③▲9525HD
Belt - Hub, Alt. & A.C.; W/130A. Alt.	0124587000	▲K080580HD
Belt - Hub, Alt. & A.C.; W/135A. Alt.	0124587006	▲K080570HD
Tensioner Assy. - Hub, Alt. & A.C.	0127425000	38501
Tensioner Pulley - Hub, Alt. & A.C.	0127425000	38075
Hose - Upper - Eng. To Pipe; (2 1/2" I.D.)		24240
Hose - Upper - Pipe To Rad.; (2 1/2" I.D.)		24240
Hose - Lower - Eng. To Pipe; (2 1/2" I.D.)		24240
Hose - Lower - Pipe To Rad.; (2 1/2" I.D.)		24240
Columbia		
Belt - Fan; Preferred Belt; W/50 3/8" Belt O.C.		3/9500PB
Belt - Fan; Optional Belt; W/50 3/8" Belt O.C.	2310001022	③▲9500HD
Belt - Hub, Alt. & A.C.; W/135A. Alt.	0124587006	▲K080570HD
Belt - Hub, Alt. & A.C.; W/130A. Alt.	0124587000	▲K080580HD
Tensioner Assy. - Hub, Alt. & A.C.	0127425000	38501
Tensioner Pulley - Hub, Alt. & A.C.	0127425000	38075
Hose - Upper - Eng. To Pipe		21891
Hose - Upper - Pipe To Rad.; (2 1/2" I.D.)		24240
Hose - Lower - Eng. To Pipe; (2 1/2" I.D.)		24240
Hose - Lower - Pipe To Rad.; (2 1/2" I.D.)		24240
Coronado		
Belt - Fan	0124894000	▲K100579HD
Belt - Hub, Alt. & A.C.	0124587004	▲K080565HD
Tensioner Assy. - Fan	0517808000	38503
Tensioner Assy. - Hub, Alt. & A.C.	23520317	38501
Tensioner Pulley - Fan	0517808000	38076
Tensioner Pulley - Hub, Alt. & A.C.	23520317	38075
Hose - Upper - Eng. To Pipe; (2 1/2" I.D.)		24240
Hose - Upper - Pipe To Rad.; (2 1/2" I.D.)		24240
Hose - Lower - Pipe To Rad.; (2 1/2" I.D.)		24240
FLD		
Belt - Fan; Preferred Belt		3/9525PB
Belt - Fan; Optional Belt		③▲9525HD
Belt - Hub, Alt. & A.C.; W/130A. Alt.	0124587000	▲K080580HD
Belt - Hub, Alt. & A.C.; W/135A. Alt.	0124587006	▲K080570HD
Tensioner Assy. - Hub, Alt. & A.C.	0127425000	38501
Tensioner Pulley - Hub, Alt. & A.C.	0127425000	38075
Hose - Upper - Eng. To Pipe; (2 1/2" I.D.)		24240
Hose - Upper - Pipe To Rad.; (2 1/2" I.D.)		24240
Hose - Lower - Eng. To Pipe; (2 1/2" I.D.)		24240
Hose - Lower - Pipe To Rad.; (2 1/2" I.D.)		24240
Detroit Diesel 6-Cyl. 14.0 L Diesel		
Argosy		
Belt - Fan	0124894000	▲K100579HD
Belt - Alt. & A.C.	0124587000	▲K080580HD
Tensioner Assy. - Fan		38503
Tensioner Assy. - Alt. & A.C.	23520317	38501
Tensioner Pulley - Fan		38076
Tensioner Pulley - Alt. & A.C.		38075
Hose - Upper - Eng. To Pipe; (2 1/2" I.D.)		24240
Hose - Upper - Rad. To Pipe; (2 1/2" I.D.)		24240
Hose - Lower - Eng. To Cooler; (2 3/4" I.D.)		24244
Hose - Lower - Cooler To Pipe; (2 3/4" I.D.)		24244
Hose - Lower - Rad. To Pipe		≠21891
Century Class		
Belt - Fan; Preferred Belt; W/50 3/8" Belt O.C.		3/9500PB
Belt - Fan; Optional Belt; W/50 3/8" Belt O.C.	2310001022	③▲9500HD
Belt - Hub, Alt. & A.C.	0124587006	▲K080570HD
Tensioner Assy. - Hub, Alt. & A.C.	23520317	38501
Tensioner Pulley - Hub, Alt. & A.C.	23520317	38075
Hose - Upper - Eng. To Pipe		21891
Hose - Upper - Pipe To Rad.; (2 1/2" I.D.)		24240
Hose - Lower - Eng. To Pipe; (2 1/2" I.D.)		24240
Hose - Lower - Pipe To Rad.; (2 1/2" I.D.)		24240
Classic; Classic XL		
Belt - Fan; Preferred Belt		3/9525PB

▲ Standard Belt Available. See Pages 630-631.
③ Three Required.

≠ Cut to Fit.

Belts and Coolant Hose for Medium/Heavy-Duty Trucks (1996 and Newer)

 Medium & Heavy-Duty Trucks
(1996 & Newer)

Application	Mfr. Part No.	Our No.
FREIGHTLINER - Continued		
2003 - Continued		
Detroit Diesel 6-Cyl. 14.0 L Diesel - Continued		
Classic; Classic XL - Continued		
Belt - Fan: Optional Belt		③▲9525HD
Belt - Hub, Alt. & A.C.; W/130A. Alt.	0124587000	▲K080580HD
Belt - Hub, Alt. & A.C.; W/135A. Alt.	0124587006	▲K080570HD
Tensioner Assy. - Hub, Alt. & A.C.	0127425000	38501
Tensioner Pulley - Hub, Alt. & A.C.	0127425000	38075
Hose - Upper - Eng. To Pipe: (2 1/2" I.D.)		24240
Hose - Upper - Pipe To Rad.: (2 1/2" I.D.)		24240
Hose - Lower - Eng. To Pipe: (2 1/2" I.D.)		24240
Hose - Lower - Pipe To Rad.: (2 1/2" I.D.)		24240
Columbia		
Belt - Fan: Preferred Belt; W/50 3/8" Belt O.C.		3/9500PB
Belt - Fan: Optional Belt; W/50 3/8" Belt O.C.	2310001022	③▲9500HD
Belt - Hub, Alt. & A.C.; W/135A. Alt.	0124587006	▲K080570HD
Belt - Hub, Alt. & A.C.; W/130A. Alt.	0124587000	▲K080580HD
Tensioner Assy. - Hub, Alt. & A.C.	0127425000	38501
Tensioner Pulley - Hub, Alt. & A.C.	0127425000	38075
Hose - Upper - Eng. To Pipe		21891
Hose - Upper - Pipe To Rad.: (2 1/2" I.D.)		24240
Hose - Lower - Eng. To Pipe: (2 1/2" I.D.)		24240
Hose - Lower - Pipe To Rad.: (2 1/2" I.D.)		24240
Coronado		
Belt - Fan	0124894000	▲K100579HD
Belt - Hub, Alt. & A.C.	0124587004	▲K080565HD
Tensioner Assy. - Fan	0517808000	38503
Tensioner Assy. - Hub, Alt. & A.C.	23520317	38501
Tensioner Pulley - Fan	0517808000	38076
Tensioner Pulley - Hub, Alt. & A.C.	23520317	38075
Hose - Upper - Eng. To Pipe: (2 1/2" I.D.)		24240
Hose - Upper - Pipe To Rad.: (2 1/2" I.D.)		24240
Hose - Lower - Pipe To Rad.: (2 1/2" I.D.)		24240
FLD		
Belt - Fan: Preferred Belt		3/9525PB
Belt - Fan: Optional Belt		③▲9525HD
Belt - Hub, Alt. & A.C.; W/130A. Alt.	0124587000	▲K080580HD
Belt - Hub, Alt. & A.C.; W/135A. Alt.	0124587006	▲K080570HD
Tensioner Assy. - Hub, Alt. & A.C.	0127425000	38501
Tensioner Pulley - Hub, Alt. & A.C.	0127425000	38075
Hose - Upper - Eng. To Pipe: (2 1/2" I.D.)		24240
Hose - Upper - Pipe To Rad.: (2 1/2" I.D.)		24240
Hose - Lower - Eng. To Pipe: (2 1/2" I.D.)		24240
Hose - Lower - Pipe To Rad.: (2 1/2" I.D.)		24240
Mercedes-Benz MBE 900 Diesel		
Business Class M2		
Belt - Fan, Alt. & A.C.	0127110016	▲K080830HD
Belt - Fan & Alt.	0127110046	▲K080677HD
Hose - Upper - Eng. To Rad.		≈21378
Hose - Lower - Pipe To Rad.: (2" I.D.)		24232
FL50; FL60; FL70; FL80		
Belt - Fan, Alt. & A.C.	0127110016	▲K080830HD
Hose - Upper - Eng. To Rad.		22701
Hose - Lower - Eng. To Pipe		20611
Hose - Lower - Pipe To Rad.		22702
MT45		
Belt - Fan, Alt. & A.C.	0127110045	▲K080830HD
Hose - Upper - Eng. To Rad.		20611
Hose - Lower - Eng. To Rad.		21571
Mercedes-Benz MBE 4000 Diesel		
Columbia; FL112		
Belt - Fan	A0149975992	▲K080672HD
Belt - Hub & Alt.	0127198001	▲K090609HD
Belt - A.C.	0127117004	▲K060439HD
Tensioner Assy. - Fan	A4602000970	38542
Tensioner Assy. - Hub & Alt.	A4602000770	38541
Tensioner Assy. - A.C.	A4602000870	38540
Hose - Upper - Eng. To Pipe: (2 1/2" I.D.)		24240
Hose - Upper - Pipe To Rad.: (2 1/2" I.D.)		24240
Hose - Lower - Eng. To Pipe		21891

 ③ Three Required.
 ≈ Cut to Fit.

Application	Mfr. Part No.	Our No.
FREIGHTLINER - Continued		
2003 - Continued		
Mercedes-Benz MBE 4000 Diesel - Continued		
Columbia; FL112 - Continued		
Hose - Lower - Pipe To Rad.: (2 1/2" I.D.)		24240
2002		
Caterpillar 3126 Diesel		
Business Class M2		
Belt - Fan, Alt. & A.C.; W/145A. Alt.	0123415040	▲K080774HD
Belt - Fan, Alt. & A.C.; W/130A. Alt.	0123415058	▲K080780HD
Tensioner Assy. - Fan, Alt. & A.C.	2201209	38550
Hose - Upper - Eng. To Rad.		22745
Hose - Lower - Eng. To Rad.		22744
FL50; FL60; FL70; FL80		
Belt - Fan, Alt. & A.C.; W/Delco Alt.	0123415000	▲K080702HD
Belt - Fan, Alt. & A.C.; W/Leece Neville Alt.	0127110003	▲K080708HD
Belt - W.P.		▲9341HD
Tensioner Assy. - Fan, Alt. & A.C.	1352151	38511
Idler Pulley	1445612	36096
Tensioner Pulley - Fan, Alt. & A.C.	1352151	36091
Hose - Upper - Eng. To Rad.		22668
Hose - Lower - Eng. To Pipe; W/2 1/4" I.D. Hose		20748
Hose - Lower - Eng. To Pipe; W/2" I.D. Hose		21571
Hose - Lower - Rad. To Pipe; W/2 1/4" I.D. Hose		21194
Hose - Lower - Rad. To Pipe; W/2" I.D. Hose		≈20611
Caterpillar C10 Diesel		
Argosy		
Belt - Fan & Alt.	0128330003	▲K080855HD
Belt - Fan To A.C.	0129729330	▲K060523HD
Tensioner Assy. - Fan, Alt. & Hub	1600649	38506
Tensioner Assy. - Fan To A.C.	DC0568	38524
Idler Pulley - Fan & Alt.; W/Flat Idler Pulley	1337023	36091
Idler Pulley - Fan & Alt.; W/Multi-Grooved Idler Pulley	1731498	36231
Tensioner Pulley - Fan, Alt. & Hub	1600649	36091
Tensioner Pulley - Fan To A.C.	DC0568	36091
Century Class		
Belt - Fan & Alt.	0127110018	▲K080780HD
Belt - Fan To A.C.		▲K060529HD
Tensioner Assy. - Fan & Alt.	1333529	38506
Tensioner Assy. - Fan To A.C.	DC0568	38524
Idler Pulley - Fan & Alt.; W/Flat Idler Pulley	1337023	36091
Idler Pulley - Fan & Alt.; W/Multi-Grooved Idler Pulley	1731498	36231
Tensioner Pulley - Fan & Alt.	1333529	36091
Tensioner Pulley - Fan To A.C.	DC0568	36091
Classic; Classic XL		
Idler Pulley - Fan & Alt.; W/Flat Idler Pulley	1337023	36091
Idler Pulley - Fan & Alt.; W/Multi-Grooved Idler Pulley	1731498	36231
Columbia		
Belt - Fan, Alt. & Hub	0123415056	K080850HD
Belt - Fan To A.C.	0124196013	▲K060523HD
Tensioner Assy. - Fan, Alt. & Hub	1600649	38506
Tensioner Assy. - Fan To A.C.	DC0568	38524
Idler Pulley - Fan & Alt.; W/Flat Idler Pulley	1337023	36091
Idler Pulley - Fan & Alt.; W/Multi-Grooved Idler Pulley	1731498	36231
Idler Pulley	1731498	36231
Tensioner Pulley - Fan, Alt. & Hub	1600649	36091
Tensioner Pulley - Fan To A.C.	DC0568	36091
Hose - Upper - Eng. To Pipe		21891
Hose - Upper - Pipe To Rad.		21891
Hose - Lower - Eng. To Pipe		21891
Hose - Lower - Pipe To Rad.: (2 1/2" I.D.)		24240
Condor		
Belt - Fan & Alt.	0124587007	▲K080878HD

▲ Standard Belt Available. See Pages 630-631.

Belts and Coolant Hose for Medium/Heavy-Duty Trucks (1996 and Newer)

Medium & Heavy-Duty Trucks
(1996 & Newer)

Application	Mfr. Part No.	Our No.
FREIGHTLINER - Continued		
2002 - Continued		
Caterpillar C10 Diesel - Continued		
Condor - Continued		
Belt - A.C.		▲K060495HD
Tensioner Assy. - Fan, Alt. & Hub	1600649	38506
Tensioner Assy. - Fan To A.C.	DCO568	38524
Idler Pulley - Fan & Alt.; W/Flat Idler Pulley	1337023	36091
Idler Pulley - Fan & Alt.; W/Multi-Grooved Idler Pulley	1731498	36231
Tensioner Pulley - Fan, Alt. & Hub	1600649	36091
Tensioner Pulley - Fan To A.C.	DCO568	36091
FL112		
Belt - Fan, Alt. & Hub	0127110008	▲K080855HD
Belt - Fan To A.C.	0126709340	▲K060529HD
Tensioner Assy. - Fan, Alt. & Hub	1481974	38506
Tensioner Assy. - Fan To A.C.	DCO568	38524
Idler Pulley - Fan & Alt.; W/Flat Idler Pulley	1337023	36091
Idler Pulley - Fan & Alt.; W/Multi-Grooved Idler Pulley	1731498	36231
Tensioner Pulley - Fan, Alt. & Hub	1481974	36091
Tensioner Pulley - Fan To A.C.	DCO568	36091
Hose - Upper - Eng. To Pipe	21891	
Hose - Upper - Pipe To Rad.; (2 1/2" I.D.)	24240	
Hose - Lower - Eng. To Pipe	21891	
Hose - Lower - Pipe To Rad.	21891	
Hose - Lower - Pipe To Cooler	21891	
FLD		
Belt - Fan & Alt.	0127110018	▲K080780HD
Belt - Fan To A.C.; W/V-Belt Drive	2310001022	▲9500HD
Belt - Fan To A.C.; W/V-Ribbed Belt		▲K060529HD
Tensioner Assy. - Fan & Alt.	1333529	38506
Tensioner Assy. - Fan To A.C.	DCO568	38524
Idler Pulley - Fan & Alt.; W/Flat Idler Pulley	1337023	36091
Idler Pulley - Fan & Alt.; W/Multi-Grooved Idler Pulley	1731498	36231
Tensioner Pulley - Fan & Alt.	1333529	36091
Tensioner Pulley - Fan To A.C.	DCO568	36091
Hose - Upper - Eng. To Pipe	21891	
Hose - Upper - Pipe To Rad.; (2 1/2" I.D.)	24240	
Hose - Lower - Eng. To Cooler	21891	
Hose - Lower - Pipe To Cooler; (2 1/2" I.D.)	24240	
Hose - Lower - Pipe To Rad.; (2 1/2" I.D.)	24240	
Caterpillar C12 Diesel		
Argosy		
Belt - Fan & Alt.	0128330003	▲K080855HD
Belt - Fan To A.C.	0129729330	▲K060523HD
Tensioner Assy. - Fan, Alt. & Hub	1600649	38506
Tensioner Assy. - Fan To A.C.	DCO568	38524
Idler Pulley - Fan & Alt.; W/Flat Idler Pulley	1337023	36091
Idler Pulley - Fan & Alt.; W/Multi-Grooved Idler Pulley	1731498	36231
Tensioner Pulley - Fan, Alt. & Hub	1600649	36091
Tensioner Pulley - Fan To A.C.	DCO568	36091
Century Class		
Belt - Fan & Alt.	0127110018	▲K080780HD
Belt - Fan To A.C.		▲K060529HD
Tensioner Assy. - Fan & Alt.	1333529	38506
Tensioner Assy. - Fan To A.C.	DCO568	38524
Idler Pulley - Fan & Alt.; W/Flat Idler Pulley	1337023	36091
Idler Pulley - Fan & Alt.; W/Multi-Grooved Idler Pulley	1731498	36231
Tensioner Pulley - Fan & Alt.	1333529	36091
Tensioner Pulley - Fan To A.C.	DCO568	36091
Classic; Classic XL; Columbia		
Idler Pulley - Fan & Alt.; W/Flat Idler Pulley	1337023	36091

Application	Mfr. Part No.	Our No.
FREIGHTLINER - Continued		
2002 - Continued		
Caterpillar C12 Diesel - Continued		
Classic; Classic XL; Columbia - Continued		
Idler Pulley - Fan & Alt.; W/Multi-Grooved Idler Pulley	1731498	36231
Condor		
Belt - Fan & Alt.	0124587007	▲K080878HD
Belt - A.C.		▲K060495HD
Tensioner Assy. - Fan, Alt. & Hub	1600649	38506
Tensioner Assy. - Fan To A.C.	DCO568	38524
Idler Pulley - Fan & Alt.; W/Flat Idler Pulley	1337023	36091
Idler Pulley - Fan & Alt.; W/Multi-Grooved Idler Pulley	1731498	36231
Tensioner Pulley - Fan, Alt. & Hub	1600649	36091
Tensioner Pulley - Fan To A.C.	DCO568	36091
FL112		
Belt - Fan, Alt. & Hub	0127110008	▲K080855HD
Belt - Fan To A.C.	0126709340	▲K060529HD
Tensioner Assy. - Fan, Alt. & Hub	1481974	38506
Tensioner Assy. - Fan To A.C.	DCO568	38524
Idler Pulley - Fan & Alt.; W/Flat Idler Pulley	1337023	36091
Idler Pulley - Fan & Alt.; W/Multi-Grooved Idler Pulley	1731498	36231
Tensioner Pulley - Fan, Alt. & Hub	1481974	36091
Tensioner Pulley - Fan To A.C.	DCO568	36091
Hose - Upper - Eng. To Pipe	21891	
Hose - Upper - Pipe To Rad.; (2 1/2" I.D.)	24240	
Hose - Lower - Eng. To Pipe	21891	
Hose - Lower - Pipe To Rad.	21891	
Hose - Lower - Pipe To Cooler	21891	
FLD		
Belt - Fan & Alt.	0127110018	▲K080780HD
Belt - Fan To A.C.; W/V-Belt Drive	2310001022	▲9500HD
Belt - Fan To A.C.; W/V-Ribbed Belt		▲K060529HD
Tensioner Assy. - Fan & Alt.	1333529	38506
Tensioner Assy. - Fan To A.C.	DCO568	38524
Idler Pulley - Fan & Alt.; W/Flat Idler Pulley	1337023	36091
Idler Pulley - Fan & Alt.; W/Multi-Grooved Idler Pulley	1731498	36231
Tensioner Pulley - Fan & Alt.	1333529	36091
Tensioner Pulley - Fan To A.C.	DCO568	36091
Hose - Upper - Eng. To Pipe	21891	
Hose - Upper - Pipe To Rad.; (2 1/2" I.D.)	24240	
Hose - Lower - Eng. To Cooler	21891	
Hose - Lower - Pipe To Cooler; (2 1/2" I.D.)	24240	
Hose - Lower - Pipe To Rad.; (2 1/2" I.D.)	24240	
Caterpillar C15 Diesel		
Argosy		
Belt - Fan & Alt.		▲K080952HD
Belt - Fan To A.C.		▲K060547HD
Tensioner Assy. - Fan & Alt.	1900649	38506
Tensioner Assy. - Fan To A.C.	1382514	38508
Tensioner Pulley - Fan & Alt.	1900649	36091
Tensioner Pulley - Fan To A.C.	1382514	36091
Hose - Upper - Eng. To Pipe; (2 1/2" I.D.)	24240	
Hose - Upper - Rad. To Pipe; (2 1/2" I.D.)	24240	
Hose - Lower - Eng. To Pipe	21400	
Hose - Lower - Rad. To Pipe	≠21891	
Century Class		
Belt - Fan & Alt.	0123415029	▲K080952HD
Belt - Fan To A.C.	0126709006	▲K060598HD
Tensioner Assy. - Fan & Alt.	1352142	38506
Tensioner Assy. - Fan To A.C.	1382514	38508
Tensioner Pulley - Fan & Alt.	1352142	36091
Tensioner Pulley - Fan To A.C.	1382514	36091
Hose - Upper - Eng. To Pipe; (2 1/2" I.D.)	24240	
Hose - Upper - Pipe To Rad.; (2 1/2" I.D.)	24240	
Hose - Lower - Eng. To Pipe; (3" I.D.)	24248	
Hose - Lower - Pipe To Rad.; (3" I.D.)	24248	

▲ Standard Belt Available. See Pages 630-631.

≠ Cut to Fit.

Belts and Coolant Hose for Medium/Heavy-Duty Trucks (1996 and Newer)

 Medium & Heavy-Duty Trucks
(1996 & Newer)

Application	Mfr. Part No.	Our No.
FREIGHTLINER - Continued		
2002 - Continued		
Caterpillar C15 Diesel - Continued		
Classic; Classic XL		
Belt - Fan & Alt.	0127110011	♣K080952HD
Belt - Fan To A.C.	0124196005	♣K060598HD
Tensioner Assy. - Fan & Alt.	1352142	38506
Tensioner Assy. - Fan To A.C.	1382514	38508
Tensioner Pulley - Fan & Alt.	1352142	36091
Tensioner Pulley - Fan To A.C.	1382514	36091
Hose - Upper - Eng. To Pipe; (2 1/2" I.D.)		24240
Hose - Upper - Pipe To Rad.; (2 1/2" I.D.)		24240
Hose - Lower - Eng. To Pipe; (3" I.D.)		24248
Hose - Lower - Pipe To Rad.; (3" I.D.)		24248
Columbia		
Belt - Fan & Alt.; W/130A. Alt.	0127110011	♣K080952HD
Belt - Fan & Alt.; W/135A. Alt.	0123415053	♣K080939HD
Belt - Fan To A.C.	0126709007	♣K060547HD
Tensioner Assy. - Fan & Alt.	1352142	38506
Tensioner Assy. - Fan To A.C.	1382514	38508
Tensioner Pulley - Fan & Alt.	1352142	36091
Tensioner Pulley - Fan To A.C.	1382514	36091
Hose - Upper - Eng. To Pipe; (2 1/2" I.D.)		24240
Hose - Upper - Pipe To Rad.; (2 1/2" I.D.)		24240
Hose - Lower - Eng. To Pipe; (3 1/4" I.D.)		24052
Hose - Lower - Pipe To Rad.; (2 1/2" I.D.)		24240
Coronado		
Belt - Fan & Alt.; W/130A. Alt.	0127110011	♣K080952HD
Belt - Fan & Alt.; W/135A. Alt.	0123415053	♣K080939HD
Belt - Fan To A.C.	0126709007	♣K060547HD
Tensioner Assy. - Fan & Alt.	1352142	38506
Tensioner Assy. - Fan To A.C.	1382514	38508
Tensioner Pulley - Fan & Alt.	1352142	36091
Tensioner Pulley - Fan To A.C.	1382514	36091
Hose - Upper - Eng. To Pipe		21891
Hose - Upper - Pipe To Rad.; (2 1/2" I.D.)		24240
Hose - Lower - Eng. To Pipe		21891
Hose - Lower - Pipe To Rad.; (2 1/2" I.D.)		24240
FLD		
Belt - Fan & Alt.	0127110011	♣K080952HD
Belt - Fan To A.C.	0124196005	♣K060598HD
Tensioner Assy. - Fan & Alt.	1352142	38506
Tensioner Assy. - Fan To A.C.	1382514	38508
Tensioner Pulley - Fan & Alt.	1352142	36091
Tensioner Pulley - Fan To A.C.	1382514	36091
Hose - Upper - Eng. To Pipe; (2 1/2" I.D.)		24240
Hose - Upper - Pipe To Rad.; (2 1/2" I.D.)		24240
Hose - Lower - Eng. To Pipe; (3" I.D.)		24248
Hose - Lower - Pipe To Rad.; (3" I.D.)		24248
Caterpillar C16 Diesel		
Classic; Classic XL		
Belt - Fan & Alt.	0127110011	♣K080952HD
Belt - Fan To A.C.	0124196005	♣K060598HD
Tensioner Assy. - Fan & Alt.	1352142	38506
Tensioner Assy. - Fan To A.C.	1382514	38508
Tensioner Pulley - Fan & Alt.	1352142	36091
Tensioner Pulley - Fan To A.C.	1382514	36091
Hose - Upper - Eng. To Pipe; (2 1/2" I.D.)		24240
Hose - Upper - Pipe To Rad.; (2 1/2" I.D.)		24240
Hose - Lower - Eng. To Pipe; (3" I.D.)		24248
Hose - Lower - Pipe To Rad.; (3" I.D.)		24248
Columbia		
Belt - Fan & Alt.; W/130A. Alt.	0127110011	♣K080952HD
Belt - Fan & Alt.; W/135A. Alt.	0123415053	♣K080939HD
Belt - Fan To A.C.	0126709007	♣K060547HD
Tensioner Assy. - Fan & Alt.	1352142	38506
Tensioner Assy. - Fan To A.C.	1382514	38508
Tensioner Pulley - Fan & Alt.	1352142	36091
Tensioner Pulley - Fan To A.C.	1382514	36091
Hose - Upper - Eng. To Pipe; (2 1/2" I.D.)		24240
Hose - Upper - Pipe To Rad.; (2 1/2" I.D.)		24240
Hose - Lower - Eng. To Pipe; (3 1/4" I.D.)		24052
Hose - Lower - Pipe To Rad.; (2 1/2" I.D.)		24240

Application	Mfr. Part No.	Our No.
FREIGHTLINER - Continued		
2002 - Continued		
Caterpillar C16 Diesel - Continued		
Coronado		
Belt - Fan & Alt.; W/130A. Alt.	0127110011	♣K080952HD
Belt - Fan & Alt.; W/135A. Alt.	0123415053	♣K080939HD
Belt - Fan To A.C.	0126709007	♣K060547HD
Tensioner Assy. - Fan & Alt.	1352142	38506
Tensioner Assy. - Fan To A.C.	1382514	38508
Tensioner Pulley - Fan & Alt.	1352142	36091
Tensioner Pulley - Fan To A.C.	1382514	36091
Hose - Upper - Eng. To Pipe		21891
Hose - Upper - Pipe To Rad.; (2 1/2" I.D.)		24240
Hose - Lower - Eng. To Pipe		21891
Hose - Lower - Pipe To Rad.; (2 1/2" I.D.)		24240
FLD		
Belt - Fan & Alt.	0127110011	♣K080952HD
Belt - Fan To A.C.	0124196005	♣K060598HD
Tensioner Assy. - Fan & Alt.	1352142	38506
Tensioner Assy. - Fan To A.C.	1382514	38508
Tensioner Pulley - Fan & Alt.	1352142	36091
Tensioner Pulley - Fan To A.C.	1382514	36091
Hose - Upper - Eng. To Pipe; (2 1/2" I.D.)		24240
Hose - Upper - Pipe To Rad.; (2 1/2" I.D.)		24240
Hose - Lower - Eng. To Pipe; (3" I.D.)		24248
Hose - Lower - Pipe To Rad.; (3" I.D.)		24248
Cummins ISB Diesel		
FL50; FL60; FL70; FL80		
Belt - Fan, Alt. & Hub	3926856	♣K080694HD
Belt - Fan & A.C.	2310001081	♣9463HD
Tensioner Assy. - Fan, Alt. & Hub	3936213	38516
Tensioner Pulley - Fan, Alt. & Hub	3936213	36093
Hose - Upper - Eng. To Rad.		22700
Hose - Lower - Eng. To Rad.		22704
MT45; MT55		
Belt - Fan, Alt. & Hub	3943214	♣K080726HD
Belt - Fan To A.C.		♣9430HD
Tensioner Assy. - Fan, Alt. & Hub	3936213	38516
Tensioner Pulley - Fan, Alt. & Hub	3936213	36093
Hose - Upper - Eng. To Rad.		22795
Hose - Lower - Eng. To Pipe; (2 1/4" I.D.)		24236
Hose - Lower - Pipe To Rad.; (2" I.D.)		24232
Cummins ISC Diesel		
FL50; FL60; FL70; FL80		
Belt - Fan, Alt. & Hub	3281981	♣K080680HD
Belt - Fan & A.C.	2310001037	♣9510HD
Tensioner Assy. - Fan, Alt. & Hub	3936213	38516
Tensioner Pulley - Fan, Alt. & Hub	3936213	36093
Hose - Upper - Eng. To Pipe; (2 1/4" I.D.)		24236
Hose - Upper - Pipe To Rad.		21571
Hose - Lower - Eng. To Pipe		21194
Hose - Lower - Pipe To Rad.		21194
Cummins ISM Diesel		
Classic; Classic XL		
Belt - Fan, Alt. & Hub	0127110014	♣K080817HD
Belt - Hub & A.C.	0124196015	♣K060559HD
Tensioner Assy. - Fan, Alt. & Hub	3400885	38521
Tensioner Assy. - Hub & A.C.	4004933	38505
Idler Pulley - Fan & Alt.	3400884	36308
Tensioner Pulley - A.C.	4004933	36091
Hose - Upper - Eng. To Pipe; (2 1/2" I.D.)		24240
Hose - Upper - Pipe To Rad.; (2 1/2" I.D.)		24240
Hose - Lower - Eng. To Cooler; (2 1/2" I.D.)		24240
Hose - Lower - Pipe To Cooler		21042
Hose - Lower - Cooler To Pipe; (3" I.D.)		24248
Hose - Lower - Pipe To Rad.; (2 1/2" I.D.)		24240
Columbia		
Belt - Fan & Alt.	0127110006	♣K080730HD
Belt - Hub & A.C.	0126709009	♣K060575HD
Tensioner Assy. - Fan & Alt.	3400885	38521
Tensioner Assy. - Hub & A.C.	4004933	38505
Idler Pulley - Fan & Alt.	3400884	36308

♣ Standard Belt Available. See Pages 630-631.

Belts and Coolant Hose for Medium/Heavy-Duty Trucks [1996 and Newer]

Medium & Heavy-Duty Trucks
(1996 & Newer)

Application	Mfr. Part No.	Our No.
FREIGHTLINER - Continued		
2002 - Continued		
Cummins ISM Diesel - Continued		
Columbia - Continued		
Tensioner Pulley - A.C.	4004933	36091
Condor		
Belt - Fan & Alt.		▲K080760HD
Belt - A.C.	0126709009	▲K060575HD
Tensioner Assy. - Fan & Alt.	3400885	38521
Tensioner Assy. - Hub & A.C.	4004933	38505
Tensioner Pulley - A.C.	4004933	36091
FL112		
Belt - Fan & Alt.	0127110006	▲K080730HD
Belt - Hub & A.C.	0126709008	▲K060559HD
Tensioner Assy. - Fan & Alt.	3400885	38521
Tensioner Assy. - Hub & A.C.	4004933	38505
Idler Pulley - Fan & Alt.	3400884	36308
Tensioner Pulley - A.C.	4004933	36091
Hose - Upper - Eng. To Pipe; (2 1/2" I.D.)		24240
Hose - Upper - Pipe To Rad.; (2 1/2" I.D.)		24240
Hose - Lower - Eng. To Pipe; (2 1/2" I.D.)		24240
Hose - Lower - Pipe To Rad.; (2 1/2" I.D.)		24240
FLD		
Belt - Fan, Alt. & Hub	0127110014	▲K080817HD
Belt - Hub & A.C.	0124196015	▲K060559HD
Tensioner Assy. - Fan, Alt. & Hub	3400885	38521
Tensioner Assy. - Hub & A.C.	4004933	38505
Idler Pulley - Fan & Alt.	3400884	36308
Tensioner Pulley - A.C.	4004933	36091
Hose - Upper - Eng. To Pipe; (2 1/2" I.D.)		24240
Hose - Upper - Pipe To Rad.; (2 1/2" I.D.)		24240
Hose - Lower - Eng. To Cooler; (2 1/2" I.D.)		24240
Hose - Lower - Pipe To Cooler		21042
Hose - Lower - Cooler To Pipe; (3" I.D.)		24248
Hose - Lower - Pipe To Rad.; (2 1/2" I.D.)		24240
Cummins ISX Diesel		
Argosy; FLD		
Belt - Fan & W.P.		▲K060685HD
Belt - W.P., Alt. & A.C.		▲K100710HD
Tensioner Assy. - Fan	3681240	38535
Tensioner Assy. - Hub, Alt. & A.C.	3680194	38532
Idler Pulley - Alt. & A.C.	4026886	36226
Tensioner Pulley - Fan	3681240	36092
Tensioner Pulley - Hub, Alt. & A.C.	3680194	36095
Cummins N14 Diesel		
Classic		
Belt - Hub & W.P.		▲K060425HD
Belt - Alt.	2310001028	▲9451HD
Belt - Hub & A.C.	2310001087	▲9435HD
Belt - Fan	0127191000	2/TR28466PB
Hose - Upper - Eng. To Pipe; (2 1/2" I.D.)		24240
Hose - Upper - Pipe To Rad.; (2 1/2" I.D.)		24240
Hose - Lower - Eng. To Pipe; (2 1/2" I.D.)		24240
Hose - Lower - Pipe To Rad.; (3" I.D.)		24248
Classic XL		
Belt - Fan	0127191000	2/TR28466PB
Belt - Hub & W.P.		▲K060425HD
Belt - Alt.	2310001028	▲9451HD
Belt - Hub & A.C.	2310001087	▲9435HD
Hose - Upper - Eng. To Pipe; (2 1/2" I.D.)		24240
Hose - Upper - Pipe To Rad.; (2 1/2" I.D.)		24240
Hose - Lower - Eng. To Pipe; (2 1/2" I.D.)		24240
Hose - Lower - Pipe To Rad.; (3" I.D.)		24248
FLD		
Belt - Hub & W.P.		▲K060425HD
Belt - Alt.	2310001028	▲9451HD
Belt - Hub & A.C.	2310001087	▲9435HD
Belt - Fan	0127191000	2/TR28466PB
Hose - Upper - Eng. To Pipe; (2 1/2" I.D.)		24240
Hose - Upper - Pipe To Rad.; (2 1/2" I.D.)		24240
Hose - Lower - Eng. To Pipe; (2 1/2" I.D.)		24240
Hose - Lower - Pipe To Rad.; (3" I.D.)		24248

Application	Mfr. Part No.	Our No.
FREIGHTLINER - Continued		
2002 - Continued		
Cummins 4-Cyl. 3.9 L Diesel		
MT35		
Belt - Fan, Alt. & Hub	3943214	▲K080726HD
Belt - Fan To A.C.		▲9430HD
Tensioner Assy. - Fan, Alt. & Hub	3936213	38516
Tensioner Pulley - Fan, Alt. & Hub	3936213	36093
Hose - Upper - Eng. To Rad.		22795
Hose - Lower - Eng. To Pipe; (2 1/4" I.D.)		24236
Hose - Lower - Pipe To Rad.; (2" I.D.)		24232
Detroit Diesel 6-Cyl. 11.1 L Diesel		
Argosy		
Belt - Fan	0124894000	▲K100579HD
Belt - Alt. & A.C.	0124587000	▲K080580HD
Tensioner Assy. - Fan		38503
Tensioner Assy. - Alt. & A.C.	23520317	38501
Tensioner Pulley - Fan		38076
Tensioner Pulley - Alt. & A.C.		38075
Hose - Upper - Eng. To Pipe; (2 1/2" I.D.)		24240
Hose - Upper - Rad. To Pipe; (2 1/2" I.D.)		24240
Hose - Lower - Eng. To Cooler; (2 3/4" I.D.)		24244
Hose - Lower - Cooler To Pipe; (2 3/4" I.D.)		24244
Hose - Lower - Rad. To Pipe		≧21891
Century Class		
Belt - Fan; Preferred Belt; W/50 3/8" Belt O.C.		3/9500PB
Belt - Fan; Optional Belt; W/50 3/8" Belt O.C.	2310001022	③▲9500HD
Belt - Hub, Alt. & A.C.	0124587006	▲K080570HD
Tensioner Assy. - Hub, Alt. & A.C.	23520317	38501
Tensioner Pulley - Hub, Alt. & A.C.	23520317	38075
Hose - Upper - Eng. To Pipe		21891
Hose - Upper - Pipe To Rad.; (2 1/2" I.D.)		24240
Hose - Lower - Eng. To Pipe; (2 1/2" I.D.)		24240
Hose - Lower - Pipe To Rad.; (2 1/2" I.D.)		24240
Classic; Classic XL; FLD		
Belt - Fan; Preferred Belt		3/9525PB
Belt - Fan; Optional Belt		③▲9525HD
Belt - Hub, Alt. & A.C.; W/130A. Alt.	0124587000	▲K080580HD
Belt - Hub, Alt. & A.C.; W/135A. Alt.	0124587005	▲K080575HD
Tensioner Assy. - Hub, Alt. & A.C.	23520317	38501
Tensioner Pulley - Hub, Alt. & A.C.	23520317	38075
Hose - Upper - Eng. To Pipe; (2 1/2" I.D.)		24240
Hose - Upper - Pipe To Rad.; (2 1/2" I.D.)		24240
Hose - Lower - Eng. To Pipe; (2 1/2" I.D.)		24240
Hose - Lower - Pipe To Rad.; (2 1/2" I.D.)		24240
Detroit Diesel 6-Cyl. 12.7 L Diesel		
Argosy		
Belt - Fan	0124894000	▲K100579HD
Belt - Alt. & A.C.	0124587000	▲K080580HD
Tensioner Assy. - Fan		38503
Tensioner Assy. - Alt. & A.C.	23520317	38501
Tensioner Pulley - Fan		38076
Tensioner Pulley - Alt. & A.C.		38075
Hose - Upper - Eng. To Pipe; (2 1/2" I.D.)		24240
Hose - Upper - Rad. To Pipe; (2 1/2" I.D.)		24240
Hose - Lower - Eng. To Cooler; (2 3/4" I.D.)		24244
Hose - Lower - Cooler To Pipe; (2 3/4" I.D.)		24244
Hose - Lower - Rad. To Pipe		≧21891
Century Class		
Belt - Fan; Preferred Belt; W/50 3/8" Belt O.C.		3/9500PB
Belt - Fan; Optional Belt; W/50 3/8" Belt O.C.	2310001022	③▲9500HD
Belt - Hub, Alt. & A.C.	0124587006	▲K080570HD
Tensioner Assy. - Hub, Alt. & A.C.	23520317	38501
Tensioner Pulley - Hub, Alt. & A.C.	23520317	38075
Hose - Upper - Eng. To Pipe		21891
Hose - Upper - Pipe To Rad.; (2 1/2" I.D.)		24240
Hose - Lower - Eng. To Pipe; (2 1/2" I.D.)		24240
Hose - Lower - Pipe To Rad.; (2 1/2" I.D.)		24240
Classic; Classic XL		
Belt - Fan; Preferred Belt		3/9525PB

▲ Standard Belt Available. See Pages 630-631.
③ Three Required.

≧ Cut to Fit.

Belts and Coolant Hose for Medium/Heavy-Duty Trucks (1996 and Newer)

 Medium & Heavy-Duty Trucks
(1996 & Newer)

Application	Mfr. Part No.	Our No.
FREIGHTLINER - Continued		
2002 - Continued		
Detroit Diesel 6-Cyl. 12.7 L Diesel - Continued		
Classic; Classic XL - Continued		
Belt - Fan: Optional Belt		③▲9525HD
Belt - Hub, Alt. & A.C.; W/130A. Alt.	0124587000	▲K080580HD
Belt - Hub, Alt. & A.C.; W/135A. Alt.	0124587005	▲K080575HD
Tensioner Assy. - Hub, Alt. & A.C.	23520317	38501
Tensioner Pulley - Hub, Alt. & A.C.	23520317	38075
Hose - Upper - Eng. To Pipe; (2 1/2" I.D.)		24240
Hose - Upper - Pipe To Rad.; (2 1/2" I.D.)		24240
Hose - Lower - Eng. To Pipe; (2 1/2" I.D.)		24240
Hose - Lower - Pipe To Rad.; (2 1/2" I.D.)		24240
Columbia		
Belt - Fan: Preferred Belt; W/50 3/8" Belt O.C.		3/9500PB
Belt - Fan: Optional Belt; W/50 3/8" Belt O.C.	2310001022	③▲9500HD
Belt - Hub, Alt. & A.C.; W/135A. Alt.	0124587006	▲K080570HD
Belt - Hub, Alt. & A.C.; W/130A. Alt.	0124587000	▲K080580HD
Tensioner Assy. - Hub, Alt. & A.C.	23520317	38501
Tensioner Pulley - Hub, Alt. & A.C.	23520317	38075
Hose - Upper - Eng. To Pipe		21891
Hose - Upper - Pipe To Rad.; (2 1/2" I.D.)		24240
Hose - Lower - Eng. To Pipe; (2 1/2" I.D.)		24240
Hose - Lower - Pipe To Rad.; (2 1/2" I.D.)		24240
Coronado		
Belt - Fan	0124894000	▲K100579HD
Belt - Hub, Alt. & A.C.	0124587004	▲K080565HD
Tensioner Assy. - Fan	0517808000	38503
Tensioner Assy. - Hub, Alt. & A.C.	23520317	38501
Tensioner Pulley - Fan	0517808000	38076
Tensioner Pulley - Hub, Alt. & A.C.	23520317	38075
Hose - Upper - Eng. To Pipe; (2 1/2" I.D.)		24240
Hose - Upper - Pipe To Rad.; (2 1/2" I.D.)		24240
Hose - Lower - Pipe To Rad.; (2 1/2" I.D.)		24240
FLD		
Belt - Fan: Preferred Belt		3/9525PB
Belt - Fan: Optional Belt		③▲9525HD
Belt - Hub, Alt. & A.C.; W/130A. Alt.	0124587000	▲K080580HD
Belt - Hub, Alt. & A.C.; W/135A. Alt.	0124587005	▲K080575HD
Tensioner Assy. - Hub, Alt. & A.C.	23520317	38501
Tensioner Pulley - Hub, Alt. & A.C.	23520317	38075
Hose - Upper - Eng. To Pipe; (2 1/2" I.D.)		24240
Hose - Upper - Pipe To Rad.; (2 1/2" I.D.)		24240
Hose - Lower - Eng. To Pipe; (2 1/2" I.D.)		24240
Hose - Lower - Pipe To Rad.; (2 1/2" I.D.)		24240
Detroit Diesel 6-Cyl. 14.0 L Diesel		
Columbia		
Belt - Fan: Preferred Belt; W/50 3/8" Belt O.C.		3/9500PB
Belt - Fan: Optional Belt; W/50 3/8" Belt O.C.	2310001022	③▲9500HD
Belt - Hub, Alt. & A.C.; W/135A. Alt.	0124587006	▲K080570HD
Belt - Hub, Alt. & A.C.; W/130A. Alt.	0124587000	▲K080580HD
Tensioner Assy. - Hub, Alt. & A.C.	23520317	38501
Tensioner Pulley - Hub, Alt. & A.C.	23520317	38075
Hose - Upper - Eng. To Pipe		21891
Hose - Upper - Pipe To Rad.; (2 1/2" I.D.)		24240
Hose - Lower - Eng. To Pipe; (2 1/2" I.D.)		24240
Hose - Lower - Pipe To Rad.; (2 1/2" I.D.)		24240
FLD		
Belt - Fan: Preferred Belt		3/9525PB
Belt - Fan: Optional Belt		③▲9525HD
Belt - Hub, Alt. & A.C.; W/130A. Alt.	0124587000	▲K080580HD
Belt - Hub, Alt. & A.C.; W/135A. Alt.	0124587005	▲K080575HD
Tensioner Assy. - Hub, Alt. & A.C.	23520317	38501
Tensioner Pulley - Hub, Alt. & A.C.	23520317	38075
Hose - Upper - Eng. To Pipe; (2 1/2" I.D.)		24240
Hose - Upper - Pipe To Rad.; (2 1/2" I.D.)		24240
Hose - Lower - Eng. To Pipe; (2 1/2" I.D.)		24240
Hose - Lower - Pipe To Rad.; (2 1/2" I.D.)		24240

 ③ Three Required.
 ≧ Cut to Fit.

Application	Mfr. Part No.	Our No.
FREIGHTLINER - Continued		
2002 - Continued		
Mercedes-Benz MBE 900 Diesel		
Business Class M2		
Belt - Fan, Alt. & A.C.	0127110016	▲K080830HD
Belt - Fan & Alt.	0127110046	▲K080677HD
Hose - Upper - Eng. To Rad.		≧21378
Hose - Lower - Pipe To Rad.; (2" I.D.)		24232
FL50; FL60; FL70; FL80		
Belt - Fan, Alt. & A.C.	0127110016	▲K080830HD
Hose - Upper - Eng. To Rad.		22743
Hose - Lower - Eng. To Pipe		20611
Hose - Lower - Pipe To Rad.		22702
MT45		
Belt - Fan, Alt. & A.C.	0127110045	▲K080830HD
Hose - Upper - Eng. To Rad.		20611
Hose - Lower - Eng. To Rad.		21571
Mercedes-Benz MBE 4000 Diesel		
FL112		
Belt - Alt.	0127198001	▲K090609HD
Belt - A.C.	0127177004	▲K060439HD
Belt - Fan		▲K080672HD
2001		
Caterpillar 3126 Diesel		
FL50; FL60; FL70		
Belt - Fan, Alt. & A.C.; W/Delco Alt.	0123415000	▲K080702HD
Belt - Fan, Alt. & A.C.; W/Leece Neville Alt.	0127110003	▲K080708HD
Belt - W.P.		▲9341HD
Tensioner Assy. - Fan, Alt. & A.C.	1352151	38511
Idler Pulley	1445612	36096
Tensioner Pulley - Fan, Alt. & A.C.	1352151	36091
Hose - Upper - Eng. To Rad.		22668
Hose - Lower - Eng. To Pipe; W/2 1/4" I.D. Hose		20748
Hose - Lower - Eng. To Pipe; W/2" I.D. Hose		21571
Hose - Lower - Rad. To Pipe; W/2 1/4" I.D. Hose		21194
Hose - Lower - Rad. To Pipe; W/2" I.D. Hose		≧20611
FL80		
Belt - Fan, Alt. & A.C.; W/Delco Alt.	0123415000	▲K080702HD
Belt - Fan, Alt. & A.C.; W/Leece Neville Alt.	0127110003	▲K080708HD
Belt - W.P.	0366775	▲9341HD
Tensioner Assy. - Fan, Alt. & A.C.	1352151	38511
Idler Pulley	1445612	36096
Tensioner Pulley - Fan, Alt. & A.C.	1352151	36091
Hose - Upper - Eng. To Rad.		22668
Hose - Lower - Eng. To Pipe; W/2 1/4" I.D. Hose		20748
Hose - Lower - Eng. To Pipe; W/2" I.D. Hose		21571
Hose - Lower - Rad. To Pipe; W/2 1/4" I.D. Hose		21194
Hose - Lower - Rad. To Pipe; W/2" I.D. Hose		≧20611
Caterpillar C10 Diesel		
Argosy		
Belt - Fan & Alt.	0128330003	▲K080855HD
Belt - Fan To A.C.	0129729330	▲K060523HD
Tensioner Assy. - Fan, Alt. & Hub	1600649	38506
Tensioner Assy. - Fan To A.C.	DCO568	38524
Idler Pulley - Fan & Alt.; W/Flat Idler Pulley	1337023	36091
Idler Pulley - Fan & Alt.; W/Multi-Grooved Idler Pulley	1731498	36231
Tensioner Pulley - Fan, Alt. & Hub	1600649	36091
Tensioner Pulley - Fan To A.C.	DCO568	36091
Century Class		
Belt - Fan & Alt.	0123415014	▲K080855HD
Belt - Fan To A.C.		▲K060523HD
Tensioner Assy. - Fan & Alt.	1333529	38506
Tensioner Assy. - Fan To A.C.	DCO568	38524
Idler Pulley - Fan & Alt.; W/Flat Idler Pulley	1337023	36091
Idler Pulley - Fan & Alt.; W/Multi-Grooved Idler Pulley	1731498	36231

▲ Standard Belt Available. See Pages 630-631.

Belts and Coolant Hose for Medium/Heavy-Duty Trucks [1996 and Newer]

Medium & Heavy-Duty Trucks
(1996 & Newer)

Application	Mfr. Part No.	Our No.
FREIGHTLINER - Continued		
2001 - Continued		
Caterpillar C10 Diesel - Continued		
Century Class - Continued		
Tensioner Pulley - Fan & Alt.	1333529	36091
Tensioner Pulley - Fan To A.C.	DCO568	36091
Classic; Classic XL		
Idler Pulley - Fan & Alt.; W/Flat Idler Pulley	1337023	36091
Idler Pulley - Fan & Alt.; W/Multi-Grooved Idler Pulley	1731498	36231
Columbia		
Belt - Fan, Alt. & Hub	0123415056	K080850HD
Belt - Fan To A.C.	0124196013	▲K060523HD
Tensioner Assy. - Fan, Alt. & Hub	1600649	38506
Tensioner Assy. - Fan To A.C.	DCO568	38524
Idler Pulley - Fan & Alt.; W/Flat Idler Pulley	1337023	36091
Idler Pulley - Fan & Alt.; W/Multi-Grooved Idler Pulley	1731498	36231
Idler Pulley	1731498	36231
Tensioner Pulley - Fan, Alt. & Hub	1600649	36091
Tensioner Pulley - Fan To A.C.	DCO568	36091
Hose - Upper - Eng. To Pipe	21891	21891
Hose - Upper - Pipe To Rad.	21891	21891
Hose - Lower - Eng. To Pipe	21891	21891
Hose - Lower - Pipe To Rad.; (2 1/2" I.D.)	24240	24240
Condor		
Belt - Fan & Alt.	0124587007	▲K080878HD
Belt - A.C.		▲K060495HD
Tensioner Assy. - Fan, Alt. & Hub	1600649	38506
Tensioner Assy. - Fan To A.C.	DCO568	38524
Idler Pulley - Fan & Alt.; W/Flat Idler Pulley	1337023	36091
Idler Pulley - Fan & Alt.; W/Multi-Grooved Idler Pulley	1731498	36231
Tensioner Pulley - Fan, Alt. & Hub	1600649	36091
Tensioner Pulley - Fan To A.C.	DCO568	36091
FL112		
Belt - Fan, Alt. & Hub	0123415014	▲K080855HD
Belt - Fan & A.C.	0126709000	▲K060529HD
Tensioner Assy. - Fan, Alt. & Hub	1481974	38506
Tensioner Assy. - Fan To A.C.	DCO568	38524
Idler Pulley - Fan & Alt.; W/Flat Idler Pulley	1337023	36091
Idler Pulley - Fan & Alt.; W/Multi-Grooved Idler Pulley	1731498	36231
Tensioner Pulley - Fan, Alt. & Hub	1481974	36091
Tensioner Pulley - Fan To A.C.	DCO568	36091
Hose - Upper - Eng. To Pipe	≅21891	21891
Hose - Upper - Pipe To Rad.; (2 1/2" I.D.)	24240	24240
Hose - Lower - Eng. To Pipe	≅21891	21891
Hose - Lower - Pipe To Rad.	≅21891	21891
FLD		
Belt - Fan & Alt.; W/78 1/2" Belt O.C. ...	0123415009	▲K080780HD
Belt - Fan & Alt.; W/90" Belt O.C.	0123415014	▲K080855HD
Belt - Fan To A.C.; W/V-Belt Drive	2310001022	▲9500HD
Belt - Fan To A.C.; W/V-Ribbed Belt		▲K060523HD
Tensioner Assy. - Fan & Alt.	1333529	38506
Tensioner Assy. - Fan To A.C.	DCO568	38524
Idler Pulley - Fan & Alt.; W/Flat Idler Pulley	1337023	36091
Idler Pulley - Fan & Alt.; W/Multi-Grooved Idler Pulley	1731498	36231
Tensioner Pulley - Fan & Alt.	1333529	36091
Tensioner Pulley - Fan To A.C.	DCO568	36091
Hose - Upper - Eng. To Pipe	21891	21891
Hose - Upper - Pipe To Rad.; (2 1/2" I.D.)	24240	24240
Hose - Lower - Pipe To Rad.; (2 1/2" I.D.)	24240	24240
Hose - Lower - Eng. To Cooler	21891	21891
Hose - Lower - Pipe To Cooler; (2 1/2" I.D.)	24240	24240

Application	Mfr. Part No.	Our No.
FREIGHTLINER - Continued		
2001 - Continued		
Caterpillar C12 Diesel		
Argosy		
Belt - Fan & Alt.	0128330003	▲K080855HD
Belt - Fan To A.C.	0129729330	▲K060523HD
Tensioner Assy. - Fan, Alt. & Hub	1600649	38506
Tensioner Assy. - Fan To A.C.	DCO568	38524
Idler Pulley - Fan & Alt.; W/Flat Idler Pulley	1337023	36091
Idler Pulley - Fan & Alt.; W/Multi-Grooved Idler Pulley	1731498	36231
Tensioner Pulley - Fan, Alt. & Hub	1600649	36091
Tensioner Pulley - Fan To A.C.	DCO568	36091
Century Class		
Belt - Fan & Alt.	0123415014	▲K080855HD
Belt - Fan To A.C.		▲K060523HD
Tensioner Assy. - Fan & Alt.	1333529	38506
Tensioner Assy. - Fan To A.C.	DCO568	38524
Idler Pulley - Fan & Alt.; W/Flat Idler Pulley	1337023	36091
Idler Pulley - Fan & Alt.; W/Multi-Grooved Idler Pulley	1731498	36231
Tensioner Pulley - Fan & Alt.	1333529	36091
Tensioner Pulley - Fan To A.C.	DCO568	36091
Classic; Classic XL; Columbia		
Idler Pulley - Fan & Alt.; W/Flat Idler Pulley	1337023	36091
Idler Pulley - Fan & Alt.; W/Multi-Grooved Idler Pulley	1731498	36231
Condor		
Belt - Fan & Alt.	0124587007	▲K080878HD
Belt - A.C.		▲K060495HD
Tensioner Assy. - Fan, Alt. & Hub	1600649	38506
Tensioner Assy. - Fan To A.C.	DCO568	38524
Idler Pulley - Fan & Alt.; W/Flat Idler Pulley	1337023	36091
Idler Pulley - Fan & Alt.; W/Multi-Grooved Idler Pulley	1731498	36231
Tensioner Pulley - Fan, Alt. & Hub	1600649	36091
Tensioner Pulley - Fan To A.C.	DCO568	36091
FL112		
Belt - Fan, Alt. & Hub	0123415014	▲K080855HD
Belt - Fan & A.C.	0126709000	▲K060529HD
Tensioner Assy. - Fan, Alt. & Hub	1481974	38506
Tensioner Assy. - Fan To A.C.	DCO568	38524
Idler Pulley - Fan & Alt.; W/Flat Idler Pulley	1337023	36091
Idler Pulley - Fan & Alt.; W/Multi-Grooved Idler Pulley	1731498	36231
Tensioner Pulley - Fan, Alt. & Hub	1481974	36091
Tensioner Pulley - Fan To A.C.	DCO568	36091
Hose - Upper - Eng. To Pipe	≅21891	21891
Hose - Upper - Pipe To Rad.; (2 1/2" I.D.)	24240	24240
Hose - Lower - Eng. To Pipe	≅21891	21891
Hose - Lower - Pipe To Rad.; (2 1/2" I.D.)	24240	24240
Hose - Lower - Eng. To Pipe	21891	21891
Hose - Lower - Pipe To Rad.	21891	21891
FLD		
Belt - Fan & Alt.; W/78 1/2" Belt O.C. ...	0123415009	▲K080780HD
Belt - Fan & Alt.; W/90" Belt O.C.	0123415014	▲K080855HD
Belt - Fan To A.C.; W/V-Belt Drive	2310001022	▲9500HD
Belt - Fan To A.C.; W/V-Ribbed Belt		▲K060523HD
Tensioner Assy. - Fan & Alt.	1333529	38506
Tensioner Assy. - Fan To A.C.	DCO568	38524
Idler Pulley - Fan & Alt.; W/Flat Idler Pulley	1337023	36091
Idler Pulley - Fan & Alt.; W/Multi-Grooved Idler Pulley	1731498	36231
Tensioner Pulley - Fan & Alt.	1333529	36091
Tensioner Pulley - Fan To A.C.	DCO568	36091
Hose - Upper - Eng. To Pipe	21891	21891
Hose - Upper - Pipe To Rad.; (2 1/2" I.D.)	24240	24240
Hose - Lower - Pipe To Rad.; (2 1/2" I.D.)	24240	24240
Hose - Lower - Eng. To Cooler	21891	21891
Hose - Lower - Pipe To Cooler; (2 1/2" I.D.)	24240	24240

▲ Standard Belt Available. See Pages 630-631.

≅ Cut to Fit.

Belts and Coolant Hose for Medium/Heavy-Duty Trucks (1996 and Newer)

 Medium & Heavy-Duty Trucks
(1996 & Newer)

Application	Mfr. Part No.	Our No.
FREIGHTLINER - Continued		
2001 - Continued		
Caterpillar C15 Diesel		
Argosy		
Belt - Fan & Alt.		♣K080952HD
Belt - Fan To A.C.		♣K060547HD
Tensioner Assy. - Fan & Alt.	1900649	38506
Tensioner Assy. - Fan To A.C.	1382514	38508
Tensioner Pulley - Fan & Alt.	1900649	36091
Tensioner Pulley - Fan To A.C.	1382514	36091
Hose - Upper - Eng. To Pipe; (2 1/2" I.D.)		24240
Hose - Upper - Rad. To Pipe; (2 1/2" I.D.)		24240
Hose - Lower - Eng. To Pipe		21400
Hose - Lower - Rad. To Pipe		≈21891
Century Class		
Belt - Fan & Alt.	0123415029	♣K080952HD
Belt - Fan To A.C.	0126709006	♣K060598HD
Tensioner Assy. - Fan & Alt.	1352142	38506
Tensioner Assy. - Fan To A.C.	1382514	38508
Tensioner Pulley - Fan & Alt.	1352142	36091
Tensioner Pulley - Fan To A.C.	1382514	36091
Hose - Upper - Eng. To Pipe; (2 1/2" I.D.)		24240
Hose - Upper - Pipe To Rad.; (2 1/2" I.D.)		24240
Hose - Lower - Eng. To Pipe; (3" I.D.)		24248
Hose - Lower - Pipe To Rad.; (3" I.D.)		24248
Classic; Classic XL		
Belt - Fan & Alt.	0123415029	♣K080952HD
Belt - Fan To A.C.	0124196005	♣K060598HD
Tensioner Assy. - Fan & Alt.	1352142	38506
Tensioner Assy. - Fan To A.C.	1382514	38508
Tensioner Pulley - Fan & Alt.	1352142	36091
Tensioner Pulley - Fan To A.C.	1382514	36091
Hose - Upper - Eng. To Pipe; (2 1/2" I.D.)		24240
Hose - Upper - Pipe To Rad.; (2 1/2" I.D.)		24240
Hose - Lower - Eng. To Pipe; (3" I.D.)		24248
Hose - Lower - Pipe To Rad.; (3" I.D.)		24248
Columbia		
Belt - Fan & Alt.	0123415029	♣K080952HD
Belt - Fan To A.C.	0124196014	♣K060547HD
Tensioner Assy. - Fan & Alt.	1352142	38506
Tensioner Assy. - Fan To A.C.	1382514	38508
Tensioner Pulley - Fan & Alt.	1352142	36091
Tensioner Pulley - Fan To A.C.	1382514	36091
Hose - Upper - Eng. To Pipe; (2 1/2" I.D.)		24240
Hose - Upper - Pipe To Rad.; (2 1/2" I.D.)		24240
Hose - Lower - Eng. To Pipe; (3 1/4" I.D.)		24052
Hose - Lower - Pipe To Rad.; (2 1/2" I.D.)		24240
FLD		
Belt - Fan & Alt.	0123415029	♣K080952HD
Belt - Fan To A.C.	0124196005	♣K060598HD
Tensioner Assy. - Fan & Alt.	1352142	38506
Tensioner Assy. - Fan To A.C.	1382514	38508
Tensioner Pulley - Fan & Alt.	1352142	36091
Tensioner Pulley - Fan To A.C.	1382514	36091
Hose - Upper - Eng. To Pipe; (2 1/2" I.D.)		24240
Hose - Upper - Pipe To Rad.; (2 1/2" I.D.)		24240
Hose - Lower - Eng. To Pipe; (3" I.D.)		24248
Hose - Lower - Pipe To Rad.; (3" I.D.)		24248
Caterpillar C16 Diesel		
Classic; Classic XL		
Belt - Fan & Alt.	0123415029	♣K080952HD
Belt - Fan To A.C.	0124196005	♣K060598HD
Tensioner Assy. - Fan & Alt.	1352142	38506
Tensioner Assy. - Fan To A.C.	1382514	38508
Tensioner Pulley - Fan & Alt.	1352142	36091
Tensioner Pulley - Fan To A.C.	1382514	36091
Hose - Upper - Eng. To Pipe; (2 1/2" I.D.)		24240
Hose - Upper - Pipe To Rad.; (2 1/2" I.D.)		24240
Hose - Lower - Eng. To Pipe; (3" I.D.)		24248
Hose - Lower - Pipe To Rad.; (3" I.D.)		24248
Columbia		
Belt - Fan & Alt.	0123415029	♣K080952HD
Belt - Fan To A.C.	0124196014	♣K060547HD

Application	Mfr. Part No.	Our No.
FREIGHTLINER - Continued		
2001 - Continued		
Caterpillar C16 Diesel - Continued		
Columbia - Continued		
Tensioner Assy. - Fan & Alt.	1352142	38506
Tensioner Assy. - Fan To A.C.	1382514	38508
Tensioner Pulley - Fan & Alt.	1352142	36091
Tensioner Pulley - Fan To A.C.	1382514	36091
Hose - Upper - Eng. To Pipe; (2 1/2" I.D.)		24240
Hose - Upper - Pipe To Rad.; (2 1/2" I.D.)		24240
Hose - Lower - Eng. To Pipe; (3 1/4" I.D.)		24052
Hose - Lower - Pipe To Rad.; (2 1/2" I.D.)		24240
FLD		
Belt - Fan & Alt.	0123415029	♣K080952HD
Belt - Fan To A.C.	0124196005	♣K060598HD
Tensioner Assy. - Fan & Alt.	1352142	38506
Tensioner Assy. - Fan To A.C.	1382514	38508
Tensioner Pulley - Fan & Alt.	1352142	36091
Tensioner Pulley - Fan To A.C.	1382514	36091
Hose - Upper - Eng. To Pipe; (2 1/2" I.D.)		24240
Hose - Upper - Pipe To Rad.; (2 1/2" I.D.)		24240
Hose - Lower - Eng. To Pipe; (3" I.D.)		24248
Hose - Lower - Pipe To Rad.; (3" I.D.)		24248
Cummins ISB CNG		
MT45; MT55		
Belt - Fan, Alt. & Hub	3911562	♣K080575HD
Tensioner Assy. - Fan, Alt. & Hub	3937553	38504
Tensioner Pulley - Fan, Alt. & Hub	3937553	36091
Hose - Upper - Eng. To Pipe; (2" I.D.)		24232
Hose - Upper - Pipe To Rad.		20206
Hose - Lower - Eng. To Pipe; (2 1/2" I.D.)		24240
Hose - Lower - Pipe To Rad.; (2 1/2" I.D.)		24240
Cummins ISB Diesel		
FL50; FL60; FL70; FL80		
Belt - Fan & Alt.	3926856	♣K080694HD
Belt - Fan & A.C.		②♣9463HD
Tensioner Assy. - Fan & Alt.	3936213	38516
Tensioner Pulley - Fan & Alt.	3936213	36093
Hose - Upper - Eng. To Rad.		22669
Hose - Lower - Eng. To Rad.		22670
MT45; MT55		
Belt - Fan & Alt.	3926856	♣K080694HD
Belt - Fan To A.C.		♣9430HD
Tensioner Assy. - Fan & Alt.	3936213	38516
Tensioner Pulley - Fan & Alt.	3936213	36093
Hose - Upper		22795
Hose - Lower - Eng. To Pipe; (2 1/4" I.D.)		24236
Hose - Lower - Pipe To Rad.; (2" I.D.)		24232
Cummins ISC Diesel		
FL50; FL60; FL70; FL80		
Belt - Fan, Alt. & Hub	3911581	♣K080690HD
Belt - Fan & A.C.	2310001037	♣9510HD
Tensioner Assy. - Fan, Alt. & Hub	3936205	38525
Hose - Upper - Eng. To Pipe; (2 1/4" I.D.)		24236
Hose - Upper - Pipe To Rad.		21571
Hose - Lower - Eng. To Pipe; (2" I.D.)		24232
Hose - Lower - Pipe To Rad.		20206
Cummins ISM Diesel		
Century Class		
Belt - Fan & Alt.		♣K080730HD
Belt - Hub & A.C.		♣K060559HD
Tensioner Assy. - Fan & Alt.	3400885	38521
Tensioner Assy. - Hub & A.C.	4004933	38505
Idler Pulley - Fan & Alt.	3400884	36308
Tensioner Pulley - A.C.	4004933	36091
Hose - Upper - Eng. To Pipe; (2 1/4" I.D.)		24236
Hose - Upper - Pipe To Rad.; (2 1/2" I.D.)		24240
Hose - Lower - Eng. To Pipe; (2 1/2" I.D.)		24240
Hose - Lower - Pipe To Rad.		21891
Classic		
Belt - Fan, Alt. & Hub	0127110014	♣K080817HD

♣ Standard Belt Available. See Pages 630-631.
② Two Required.

≈ Cut to Fit.

Belts and Coolant Hose for Medium/Heavy-Duty Trucks (1996 and Newer)

Medium & Heavy-Duty Trucks
(1996 & Newer)

Application	Mfr. Part No.	Our No.
FREIGHTLINER - Continued		
2001 - Continued		
Cummins ISM Diesel - Continued		
Classic - Continued		
Belt - Fan & Alt.	0123415028	▲K080816HD
Belt - Hub & A.C.	0124196015	▲K060559HD
Tensioner Assy. - Fan, Alt. & Hub	3400885	38521
Tensioner Assy. - Hub & A.C.	4004933	38505
Idler Pulley - Fan & Alt.	3400884	36308
Tensioner Pulley - A.C.	4004933	36091
Hose - Upper - Eng. To Pipe; (2 1/2" I.D.)	24240	24240
Hose - Upper - Pipe To Rad.; (2 1/2" I.D.)	24240	24240
Hose - Lower - Pipe To Rad.; (2 1/2" I.D.)	24240	24240
Hose - Lower - Eng. To Cooler; (2 1/2" I.D.)	24240	24240
Hose - Lower - Cooler To Pipe; (3" I.D.)	24248	24248
Classic XL		
Belt - Fan & Alt.	0123415028	▲K080816HD
Belt - Hub & A.C.	0124196015	▲K060559HD
Tensioner Assy. - Fan & Alt.	3400885	38521
Tensioner Assy. - Hub & A.C.	4004933	38505
Idler Pulley - Fan & Alt.	3400884	36308
Tensioner Pulley - A.C.	4004933	36091
Hose - Upper - Eng. To Pipe; (2 1/2" I.D.)	24240	24240
Hose - Upper - Pipe To Rad.; (2 1/2" I.D.)	24240	24240
Hose - Lower - Pipe To Rad.; (2 1/2" I.D.)	24240	24240
Hose - Lower - Eng. To Cooler; (2 1/2" I.D.)	24240	24240
Hose - Lower - Pipe To Cooler; (2 1/2" I.D.)	24240	24240
Columbia		
Belt - Fan & Alt.	0123415045	▲K080745HD
Belt - Hub & A.C.		▲K060559HD
Tensioner Assy. - Fan & Alt.	3400885	38521
Tensioner Assy. - Hub & A.C.	4004933	38505
Idler Pulley - Fan & Alt.	3400884	36308
Tensioner Pulley - A.C.	4004933	36091
Hose - Upper - Eng. To Pipe; (2 1/4" I.D.)	24236	24240
Hose - Upper - Pipe To Rad.; (2 1/2" I.D.)	24240	24240
Hose - Lower - Eng. To Pipe; (2 1/2" I.D.)	24240	24240
Hose - Lower - Pipe To Rad.; (2 1/2" I.D.)	24240	24240
Condor		
Belt - Fan & Alt.		▲K080760HD
Belt - A.C.	0126709009	▲K060575HD
Tensioner Assy. - Fan & Alt.	3400885	38521
Tensioner Assy. - Hub & A.C.	4004933	38505
Tensioner Pulley - A.C.	4004933	36091
FL112		
Belt - Fan & Alt.	0123415026	▲K080730HD
Belt - Hub & A.C.	0124196015	▲K060559HD
Tensioner Assy. - Fan & Alt.	3400885	38521
Tensioner Assy. - Hub & A.C.	4004933	38505
Idler Pulley - Fan & Alt.	3400884	36308
Tensioner Pulley - A.C.	4004933	36091
Hose - Upper - Eng. To Pipe; (2 1/4" I.D.)	24236	24240
Hose - Upper - Pipe To Rad.; (2 1/2" I.D.)	24240	24240
Hose - Lower - Eng. To Pipe; (2 1/2" I.D.)	24240	24240
Hose - Lower - Pipe To Rad.	21891	21891
FLD		
Belt - Fan & Alt.	0123415028	▲K080816HD
Belt - Hub & A.C.	0124196015	▲K060559HD
Tensioner Assy. - Fan & Alt.	3400885	38521
Tensioner Assy. - Hub & A.C.	4004933	38505
Idler Pulley - Fan & Alt.	3400884	36308
Hose - Upper - Eng. To Pipe; (2 1/2" I.D.)	24240	24240
Hose - Upper - Pipe To Rad.; (2 1/2" I.D.)	24240	24240
Hose - Lower - Pipe To Rad.; (2 1/2" I.D.)	24240	24240
Hose - Lower - Eng. To Cooler; (2 1/2" I.D.)	24240	24240
Hose - Lower - Pipe To Cooler; (2 1/2" I.D.)	24240	24240
Cummins ISX Diesel		
Argosy		
Belt - Fan & W.P.		▲K060685HD
Belt - W.P., Alt. & A.C.		▲K100710HD
Tensioner Assy. - Fan	3681240	38535
Tensioner Assy. - Hub, Alt. & A.C.	3680194	38532
Idler Pulley - Alt. & A.C.	4026886	36226

Application	Mfr. Part No.	Our No.
FREIGHTLINER - Continued		
2001 - Continued		
Cummins ISX Diesel - Continued		
Argosy - Continued		
Tensioner Pulley - Fan	3681240	36092
Tensioner Pulley - Hub, Alt. & A.C.	3680194	36095
Century Class		
Belt - Fan & Hub	3681811	▲K100710HD
Belt - Hub, Alt. & A.C.	0124196010	▲K060685HD
Tensioner Assy. - Fan & Hub	3681240	38535
Tensioner Assy. - Hub, Alt. & A.C.	3680194	38532
Idler Pulley - Alt. & A.C.	4026886	36226
Tensioner Pulley - Fan & Hub	3681240	36092
Tensioner Pulley - Hub, Alt. & A.C.	3680194	36095
Hose - Upper - Eng. To Pipe; (2 1/2" I.D.)	24240	24240
Hose - Upper - Pipe To Rad.; (2 1/2" I.D.)	24240	24240
Hose - Lower - Eng. To Pipe; (2 1/2" I.D.)	24240	24240
Hose - Lower - Pipe To Rad.	21891	21891
Classic XL		
Belt - Fan	3681811	▲K100710HD
Belt - Hub, Alt. & A.C.	0124196010	▲K060685HD
Tensioner Assy. - Fan	3681240	38532
Tensioner Assy. - Hub, Alt. & A.C.	3680194	38535
Idler Pulley - Alt. & A.C.	4026886	36226
Tensioner Pulley - A.C.	4004933	36091
Tensioner Pulley - Fan	3681240	36092
Tensioner Pulley - Hub, Alt. & A.C.	3680194	36095
Hose - Upper - Eng. To Pipe; (2 1/2" I.D.)	24240	24240
Hose - Upper - Pipe To Rad.; (2 1/2" I.D.)	24240	24240
Hose - Lower - Eng. To Pipe; (2 1/2" I.D.)	24240	21891
Hose - Lower - Pipe To Rad.; (2 1/2" I.D.)	24240	≈24240
Columbia		
Belt - Fan & Hub	3681811	▲K100710HD
Belt - Hub, Alt. & A.C.	0124196010	▲K060685HD
Tensioner Assy. - Fan & Hub	3681240	38535
Tensioner Assy. - Hub, Alt. & A.C.	3680194	38532
Idler Pulley - Alt. & A.C.	4026886	36226
Tensioner Pulley - Fan & Hub	3681240	36092
Tensioner Pulley - Hub, Alt. & A.C.	3680194	36095
Hose - Upper - Eng. To Pipe; (2 1/2" I.D.)	24240	24240
Hose - Upper - Pipe To Rad.; (2 1/2" I.D.)	24240	24240
Hose - Lower - Eng. To Pipe; (2 1/2" I.D.)	24240	24240
Hose - Lower - Pipe To Rad.	21891	21891
FLD		
Belt - Fan	3681811	▲K100710HD
Belt - Hub, Alt. & A.C.	0124196010	▲K060685HD
Tensioner Assy. - Fan	3681240	38535
Tensioner Assy. - Hub, Alt. & A.C.	3680194	38532
Idler Pulley - Alt. & A.C.	4026886	36226
Tensioner Pulley - A.C.	4004933	36091
Tensioner Pulley - Fan	3681240	36092
Tensioner Pulley - Hub, Alt. & A.C.	3680194	36095
Hose - Upper - Eng. To Pipe; (2 1/2" I.D.)	24240	24240
Hose - Upper - Pipe To Rad.; (2 1/2" I.D.)	24240	24240
Hose - Lower - Eng. To Pipe; (2 1/2" I.D.)	24240	21891
Hose - Lower - Pipe To Rad.	21891	21891
Cummins N14 Diesel		
Century Class		
Belt - Hub & Fan; Preferred Belt		2/TR28411PB
Belt - Hub & Fan; Optional Belt		②TR28412
Belt - Alt.		②▲9451HD
Belt - Hub & A.C.	2310001087	▲9435HD
Belt - Hub & W.P.		▲K060425HD
Hose - Upper - Eng. To Pipe; (2 1/2" I.D.)	24240	24240
Hose - Upper - Pipe To Rad.; (2 1/2" I.D.)	24240	24240
Hose - Lower - Eng. To Pipe; (2 1/2" I.D.)	24240	24240
Hose - Lower - Pipe To Rad.; (2 1/2" I.D.)	24240	24240
Classic; Classic XL; FLD		
Belt - Hub & Fan		②TR28429
Belt - Alt.		②▲9451HD
Belt - Hub & A.C.	2310001087	▲9435HD
Belt - Hub & W.P.		▲K060425HD
Hose - Upper - Eng. To Pipe; (2 1/2" I.D.)	24240	24240

▲ Standard Belt Available. See Pages 630-631.

② Two Required.

≈ Cut to Fit.

Belts and Coolant Hose for Medium/Heavy-Duty Trucks (1996 and Newer)

 Medium & Heavy-Duty Trucks
(1996 & Newer)

Application	Mfr. Part No.	Our No.
FREIGHTLINER - Continued		
2001 - Continued		
Cummins N14 Diesel - Continued		
Classic; Classic XL; FLD - Continued		
Hose - Upper - Pipe To Rad.; (2 1/2" I.D.)		24240
Hose - Lower - Eng. To Pipe; (2 1/2" I.D.)		24240
Hose - Lower - Pipe To Rad.; (3" I.D.)		24248
Cummins 4-Cyl. 3.9 L Diesel		
MT35		
Belt - Fan & Alt.	3926856	♣K080694HD
Belt - Fan To A.C.		♣9430HD
Tensioner Assy. - Fan & Alt.	3936213	38516
Tensioner Pulley - Fan & Alt.	3936213	36093
Hose - Upper		22795
Hose - Lower - Eng. To Pipe; (2 1/4" I.D.)		24236
Hose - Lower - Pipe To Rad.; (2" I.D.)		24232
Detroit Diesel Series 50 Diesel		
FL106		
Belt - Fan		♣9465HD
Belt - Fan & Alt.	2310001039	♣9530HD
Belt - Alt. & Hyd. Pump		♣9610HD
Belt - Hub & A.C.	0120984004	2/9435PB
Hose - Upper - Eng. To Pipe; (2 1/2" I.D.)		24240
Hose - Upper - Pipe To Rad.; (2 1/2" I.D.)		24240
Hose - Lower - Pipe To Rad.		♣21194
Detroit Diesel 6-Cyl. 11.1 L Diesel		
Argosy		
Belt - Fan	0124894000	♣K100579HD
Belt - Alt. & A.C.	0124587000	♣K080580HD
Tensioner Assy. - Fan		38503
Tensioner Assy. - Alt. & A.C.	23520317	38501
Tensioner Pulley - Fan		38076
Tensioner Pulley - Alt. & A.C.		38075
Hose - Upper - Eng. To Pipe; (2 1/2" I.D.)		24240
Hose - Upper - Rad. To Pipe; (2 1/2" I.D.)		24240
Hose - Lower - Eng. To Cooler; (2 3/4" I.D.)		24244
Hose - Lower - Cooler To Pipe; (2 3/4" I.D.)		24244
Hose - Lower - Rad. To Pipe		♣21891
Century Class		
Belt - Fan; Preferred Belt; W/50 3/8" Belt O.C.		3/9500PB
Belt - Fan; Optional Belt; W/50 3/8" Belt O.C.		♣9500HD
Belt - Hub, Alt. & A.C.; W/130A. Alt.	0124587006	♣K080570HD
Belt - Hub, Alt. & A.C.; W/135A. Alt.	0124587004	♣K080565HD
Tensioner Assy. - Hub, Alt. & A.C.	23520317	38501
Tensioner Pulley - Hub, Alt. & A.C.	23520317	38075
Hose - Upper - Eng. To Pipe		21891
Hose - Upper - Pipe To Rad.; (2 1/2" I.D.)		24240
Hose - Lower - Eng. To Pipe; (2 1/2" I.D.)		24240
Hose - Lower - Pipe To Rad.; (2 1/2" I.D.)		24240
Classic; Classic XL		
Belt - Fan; Preferred Belt		3/9525PB
Belt - Fan; Optional Belt		♣9525HD
Belt - Hub, Alt. & A.C.; W/130A. Alt.	0124587000	♣K080580HD
Belt - Hub, Alt. & A.C.; W/135A. Alt.	0124587005	♣K080575HD
Tensioner Assy. - Hub, Alt. & A.C.	23520317	38501
Tensioner Pulley - Hub, Alt. & A.C.	23520317	38075
Hose - Upper - Eng. To Pipe; (2 1/2" I.D.)		24240
Hose - Upper - Pipe To Rad.; (2 1/2" I.D.)		24240
Hose - Lower - Eng. To Pipe; (3" I.D.)		24248
Hose - Lower - Pipe To Rad.; (3" I.D.)		24248
Columbia		
Belt - Fan; Preferred Belt; W/50 3/8" Belt O.C.		3/9500PB
Belt - Fan; Optional Belt; W/50 3/8" Belt O.C.		♣9500HD
Belt - Hub, Alt. & A.C.; W/135A. Alt.	0124587006	♣K080570HD
Belt - Hub, Alt. & A.C.; W/130A. Alt.	0124587000	♣K080580HD
Tensioner Assy. - Hub, Alt. & A.C.	23520317	38501
Tensioner Pulley - Hub, Alt. & A.C.	23520317	38075
Hose - Upper - Eng. To Pipe		21891
Hose - Upper - Pipe To Rad.; (2 1/2" I.D.)		24240
Hose - Lower - Eng. To Pipe; (2 1/2" I.D.)		24240
Hose - Lower - Pipe To Rad.; (2 1/2" I.D.)		24240
FLD		
Belt - Fan; Preferred Belt		3/9525PB
Belt - Fan; Optional Belt		♣9525HD
Belt - Hub, Alt. & A.C.; W/130A. Alt.	0124587000	♣K080580HD
Belt - Hub, Alt. & A.C.; W/135A. Alt.	0124587005	♣K080575HD
Tensioner Assy. - Hub, Alt. & A.C.	23520317	38501
Tensioner Pulley - Hub, Alt. & A.C.	23520317	38075
Hose - Upper - Eng. To Pipe; (2 1/2" I.D.)		24240
Hose - Upper - Pipe To Rad.; (2 1/2" I.D.)		24240

Application	Mfr. Part No.	Our No.
FREIGHTLINER - Continued		
2001 - Continued		
Detroit Diesel 6-Cyl. 11.1 L Diesel - Continued		
Columbia - Continued		
Hose - Lower - Pipe To Rad.; (2 1/2" I.D.)		24240
FLD		
Belt - Fan; Preferred Belt		3/9525PB
Belt - Fan; Optional Belt		♣9525HD
Belt - Hub, Alt. & A.C.; W/130A. Alt.	0124587000	♣K080580HD
Belt - Hub, Alt. & A.C.; W/135A. Alt.	0124587005	♣K080575HD
Tensioner Assy. - Hub, Alt. & A.C.	23520317	38501
Tensioner Pulley - Hub, Alt. & A.C.	23520317	38075
Hose - Upper - Eng. To Pipe; (2 1/2" I.D.)		24240
Hose - Upper - Pipe To Rad.; (2 1/2" I.D.)		24240
Hose - Lower - Eng. To Pipe; (3" I.D.)		24248
Hose - Lower - Pipe To Rad.; (3" I.D.)		24248
Detroit Diesel 6-Cyl. 12.7 L Diesel		
Argosy		
Belt - Fan	0124894000	♣K100579HD
Belt - Alt. & A.C.	0124587000	♣K080580HD
Tensioner Assy. - Fan		38503
Tensioner Assy. - Alt. & A.C.	23520317	38501
Tensioner Pulley - Fan		38076
Tensioner Pulley - Alt. & A.C.		38075
Hose - Upper - Eng. To Pipe; (2 1/2" I.D.)		24240
Hose - Upper - Rad. To Pipe; (2 1/2" I.D.)		24240
Hose - Lower - Eng. To Cooler; (2 3/4" I.D.)		24244
Hose - Lower - Cooler To Pipe; (2 3/4" I.D.)		24244
Hose - Lower - Rad. To Pipe		♣21891
Century Class		
Belt - Fan; Preferred Belt; W/50 3/8" Belt O.C.		3/9500PB
Belt - Fan; Optional Belt; W/50 3/8" Belt O.C.		♣9500HD
Belt - Hub, Alt. & A.C.; W/130A. Alt.	0124587006	♣K080570HD
Belt - Hub, Alt. & A.C.; W/135A. Alt.	0124587004	♣K080565HD
Tensioner Assy. - Hub, Alt. & A.C.	23520317	38501
Tensioner Pulley - Hub, Alt. & A.C.	23520317	38075
Hose - Upper - Eng. To Pipe		21891
Hose - Upper - Pipe To Rad.; (2 1/2" I.D.)		24240
Hose - Lower - Eng. To Pipe; (2 1/2" I.D.)		24240
Hose - Lower - Pipe To Rad.; (2 1/2" I.D.)		24240
Classic; Classic XL		
Belt - Fan; Preferred Belt		3/9525PB
Belt - Fan; Optional Belt		♣9525HD
Belt - Hub, Alt. & A.C.; W/130A. Alt.	0124587000	♣K080580HD
Belt - Hub, Alt. & A.C.; W/135A. Alt.	0124587005	♣K080575HD
Tensioner Assy. - Hub, Alt. & A.C.	23520317	38501
Tensioner Pulley - Hub, Alt. & A.C.	23520317	38075
Hose - Upper - Eng. To Pipe; (2 1/2" I.D.)		24240
Hose - Upper - Pipe To Rad.; (2 1/2" I.D.)		24240
Hose - Lower - Eng. To Pipe; (3" I.D.)		24248
Hose - Lower - Pipe To Rad.; (3" I.D.)		24248
Columbia		
Belt - Fan; Preferred Belt; W/50 3/8" Belt O.C.		3/9500PB
Belt - Fan; Optional Belt; W/50 3/8" Belt O.C.		♣9500HD
Belt - Hub, Alt. & A.C.; W/135A. Alt.	0124587006	♣K080570HD
Belt - Hub, Alt. & A.C.; W/130A. Alt.	0124587000	♣K080580HD
Tensioner Assy. - Hub, Alt. & A.C.	23520317	38501
Tensioner Pulley - Hub, Alt. & A.C.	23520317	38075
Hose - Upper - Eng. To Pipe		21891
Hose - Upper - Pipe To Rad.; (2 1/2" I.D.)		24240
Hose - Lower - Eng. To Pipe; (2 1/2" I.D.)		24240
Hose - Lower - Pipe To Rad.; (2 1/2" I.D.)		24240
FLD		
Belt - Fan; Preferred Belt		3/9525PB
Belt - Fan; Optional Belt		♣9525HD
Belt - Hub, Alt. & A.C.; W/130A. Alt.	0124587000	♣K080580HD
Belt - Hub, Alt. & A.C.; W/135A. Alt.	0124587005	♣K080575HD
Tensioner Assy. - Hub, Alt. & A.C.	23520317	38501
Tensioner Pulley - Hub, Alt. & A.C.	23520317	38075
Hose - Upper - Eng. To Pipe; (2 1/2" I.D.)		24240
Hose - Upper - Pipe To Rad.; (2 1/2" I.D.)		24240

 ♣ Standard Belt Available. See Pages 630-631.
 ♣< Cut to Fit.

Ⓜ Three Required.

Belts and Coolant Hose for Medium/Heavy-Duty Trucks [1996 and Newer]

Medium & Heavy-Duty Trucks
(1996 & Newer)

Application	Mfr. Part No.	Our No.
FREIGHTLINER - Continued		
2001 - Continued		
Detroit Diesel 6-Cyl. 12.7 L Diesel - Continued		
FLD - Continued		
Hose - Lower - Eng. To Pipe; (3" I.D.)		24248
Hose - Lower - Pipe To Rad.; (3" I.D.)		24248
Detroit Diesel 6-Cyl. 14.0 L Diesel		
Classic XL; FLD		
Belt - Fan; Preferred Belt		3/9525PB
Belt - Fan; Optional Belt		③▲9525HD
Belt - Hub, Alt. & A.C.; W/130A. Alt.	0124587000	▲K080580HD
Belt - Hub, Alt. & A.C.; W/135A. Alt.	0124587005	▲K080575HD
Tensioner Assy. - Hub, Alt. & A.C.	23520317	38501
Tensioner Pulley - Hub, Alt. & A.C.	23520317	38075
Hose - Upper - Eng. To Pipe; (2 1/2" I.D.)		24240
Hose - Upper - Pipe To Rad.; (2 1/2" I.D.)		24240
Hose - Lower - Eng. To Pipe; (3" I.D.)		24248
Hose - Lower - Pipe To Rad.; (3" I.D.)		24248
Mercedes-Benz MBE 900 Diesel		
FL50; FL60; FL70; FL80		
Belt - Fan, Alt. & A.C.	0126246000	▲K080830HD
Hose - Upper - Eng. To Rad.		22743
Hose - Lower - Eng. To Pipe		20206
Hose - Lower - Pipe To Rad.		20206
Mercedes-Benz MBE 4000 Diesel		
Century Class		
Belt - Fan	9355103	③▲9510HD
Belt - Hub & Alt.	0124587004	▲K080565HD
Belt - A.C.	9363156	▲K080560HD
Tensioner Assy. - A.C.	23520317	38501
Tensioner Pulley - A.C.		38075
Hose - Upper - Eng. To Pipe; (2 1/2" I.D.)		24240
Hose - Upper - Pipe To Rad.; (2 1/2" I.D.)		24240
Hose - Lower - Eng. To Pipe; (2 1/2" I.D.)		24240
Hose - Lower - Pipe To Rad.; (2 1/2" I.D.)		24240
2000		
Caterpillar 3126 Diesel		
FL50; FL60; FL70; FL80		
Belt - W.P.	0366775	▲9341HD
Belt - Fan, Alt. & A.C.; W/Delco Alt.	0123415000	▲K080702HD
Belt - Fan, Alt. & A.C.; W/Leece Neville Alt.	0127110003	▲K080708HD
Tensioner Assy. - Fan, Alt. & A.C.	1352151	38511
Idler Pulley	1445612	36096
Tensioner Pulley - Fan, Alt. & A.C.	1352151	36091
Hose - Upper - Eng. To Rad.		22668
Hose - Lower - Eng. To Pipe; W/2 1/4" I.D. Hose		20748
Hose - Lower - Eng. To Pipe; W/2" I.D. Hose		21571
Hose - Lower - Rad. To Pipe; W/2 1/4" I.D. Hose		21194
Hose - Lower - Rad. To Pipe; W/2" I.D. Hose		≈20611
Caterpillar 3406 Diesel		
Argosy		
Belt - Fan & Alt.		▲K080952HD
Belt - Fan To A.C.		▲K060547HD
Hose - Upper - Eng. To Pipe; (2 1/2" I.D.)		24240
Hose - Upper - Rad. To Pipe; (2 1/2" I.D.)		24240
Hose - Lower - Eng. To Pipe		21400
Hose - Lower - Rad. To Pipe		≈21891
Century Class		
Belt - A.C. - From Fan	0124196014	▲K060547HD
Belt - Fan & Alt.	0123415029	▲K080952HD
Tensioner Assy. - A.C.	1900642	38508
Idler Pulley - Upper (Smooth)	1337023	36091
Idler Pulley - Lower (Grooved)	1731498	36231
Tensioner Pulley - A.C.	36091	36091
FLD		
Belt - Fan & Alt.	0123415029	▲K080952HD
Belt - Fan To A.C.	0124196005	▲K060598HD
Tensioner Assy. - Fan & Alt.	1352142	38506
Tensioner Assy. - Fan To A.C.	1382514	38508

Application	Mfr. Part No.	Our No.
FREIGHTLINER - Continued		
2000 - Continued		
Caterpillar 3406 Diesel - Continued		
FLD - Continued		
Tensioner Pulley - Fan & Alt.	1352142	36091
Tensioner Pulley - Fan To A.C.	1382514	36091
Hose - Upper - Eng. To Pipe; (2 1/2" I.D.)		24240
Hose - Upper - Pipe To Rad.; (2 1/2" I.D.)		24240
Hose - Lower - Eng. To Pipe; (3" I.D.)		24248
Hose - Lower - Pipe To Rad.; (3" I.D.)		24248
Caterpillar C10 Diesel		
Argosy		
Belt - Fan & Alt.	0128330003	▲K080855HD
Belt - Fan To A.C.	0129729330	▲K060523HD
Tensioner Assy. - Fan, Alt. & Hub	1600649	38506
Tensioner Assy. - Fan To A.C.	DC0568	38524
Idler Pulley - Fan & Alt.; W/Flat Idler Pulley		
	1337023	36091
Idler Pulley - Fan & Alt.; W/V-Groove		
Idler Pulley	1731498	36231
Tensioner Pulley - Fan, Alt. & Hub	1600649	36091
Tensioner Pulley - Fan To A.C.	DC0568	36091
Century Class		
Belt - Fan, Alt. & Hub	0123415014	▲K080855HD
Belt - Fan & A.C.	0124196013	▲K060523HD
Tensioner Assy. - Fan, Alt. & Hub	1481974	38506
Tensioner Assy. - Fan & A.C.	1421987	38534
Idler Pulley - Fan & Alt.; W/Flat Idler Pulley		
	1337023	36091
Idler Pulley - Fan & Alt.; W/V-Groove		
Idler Pulley	1731498	36231
Tensioner Pulley - Fan, Alt. & Hub	1481974	36091
Tensioner Pulley - Alt. & A.C.	1421987	38092
FL112		
Belt - Fan, Alt. & Hub	0123415014	▲K080855HD
Belt - Fan & A.C.; W/V-Belt Drive	2310001022	▲9500HD
Belt - Fan & A.C.; W/V-Ribbed Belt Drive; W/Sanden A.C. Compr.		
	0124196013	▲K060523HD
Tensioner Assy. - Fan, Alt. & Hub	1481974	38506
Tensioner Assy. - Fan & A.C.	1421987	38534
Idler Pulley - Fan & Alt.; W/Flat Idler Pulley		
	1337023	36091
Idler Pulley - Fan & Alt.; W/V-Groove		
Idler Pulley	1731498	36231
Tensioner Pulley - Fan, Alt. & Hub	1481974	36091
Tensioner Pulley - Alt. & A.C.	1421987	38092
Hose - Upper - Eng. To Pipe		≈21891
Hose - Upper - Pipe To Rad.; (2 1/2" I.D.)		24240
Hose - Lower - Eng. To Pipe		21891
Hose - Lower - Pipe To Rad.; (2 1/2" I.D.)		24240
FLD		
Belt - Fan, Alt. & Hub	0123415014	▲K080855HD
Belt - Fan & A.C.	0124196013	▲K060523HD
Tensioner Assy. - Fan, Alt. & Hub	1481974	38506
Tensioner Assy. - Fan & A.C.	1421987	38534
Idler Pulley - Fan & Alt.; W/Flat Idler Pulley		
	1337023	36091
Idler Pulley - Fan & Alt.; W/V-Groove		
Idler Pulley	1731498	36231
Tensioner Pulley - Fan, Alt. & Hub	1481974	36091
Tensioner Pulley - Alt. & A.C.	1421987	38092
Caterpillar C12 Diesel		
Argosy		
Belt - Fan & Alt.	0128330003	▲K080855HD
Belt - Fan To A.C.	0129729330	▲K060523HD
Tensioner Assy. - Fan, Alt. & Hub	1600649	38506
Tensioner Assy. - Fan To A.C.	DC0568	38524
Idler Pulley - Fan & Alt.; W/Flat Idler Pulley		
	1337023	36091
Idler Pulley - Fan & Alt.; W/V-Groove		
Idler Pulley	1731498	36231
Tensioner Pulley - Fan, Alt. & Hub	1600649	36091
Tensioner Pulley - Fan To A.C.	DC0568	36091

③ Three Required.
≈ Cut to Fit.

▲ Standard Belt Available. See Pages 630-631.

Belts and Coolant Hose for Medium/Heavy-Duty Trucks (1996 and Newer)

 Medium & Heavy-Duty Trucks
(1996 & Newer)

Application	Mfr. Part No.	Our No.
FREIGHTLINER - Continued		
2000 - Continued		
Caterpillar C12 Diesel - Continued		
Century Class		
Belt - Fan, Alt. & Hub	0123415014	♣K080855HD
Belt - Fan & A.C.	0124196013	♣K060523HD
Tensioner Assy. - Fan, Alt. & Hub	1481974	38506
Tensioner Assy. - Fan & A.C.	1421987	38534
Idler Pulley - Fan & Alt.; W/Flat Idler Pulley	1337023	36091
Idler Pulley - Fan & Alt.; W/V-Groove Idler Pulley	1731498	36231
Tensioner Pulley - Fan, Alt. & Hub	1481974	36091
Tensioner Pulley - Alt. & A.C.	1421987	38092
FL112		
Belt - Fan, Alt. & Hub	0123415014	♣K080855HD
Belt - Fan & A.C.; W/V-Belt Drive	2310001022	♣9500HD
Belt - Fan & A.C.; W/V-Ribbed Belt Drive; W/Sanden A.C. Compr.	0124196013	♣K060523HD
Tensioner Assy. - Fan, Alt. & Hub	1481974	38506
Tensioner Assy. - Fan & A.C.	1421987	38534
Idler Pulley - Fan & Alt.; W/Flat Idler Pulley	1337023	36091
Idler Pulley - Fan & Alt.; W/V-Groove Idler Pulley	1731498	36231
Tensioner Pulley - Fan, Alt. & Hub	1481974	36091
Tensioner Pulley - Alt. & A.C.	1421987	38092
Hose - Upper - Eng. To Pipe		21891
Hose - Upper - Pipe To Rad.; (2 1/2" I.D.)		24240
Hose - Lower - Eng. To Pipe		♣21891
Hose - Lower - Pipe To Rad.; (2 1/2" I.D.)		24240
FLD		
Belt - Fan, Alt. & Hub	0123415014	♣K080855HD
Belt - Fan & A.C.	0124196013	♣K060523HD
Tensioner Assy. - Fan, Alt. & Hub	1481974	38506
Tensioner Assy. - Fan & A.C.	1421987	38534
Idler Pulley - Fan & Alt.; W/Flat Idler Pulley	1337023	36091
Idler Pulley - Fan & Alt.; W/V-Groove Idler Pulley	1731498	36231
Tensioner Pulley - Fan, Alt. & Hub	1481974	36091
Tensioner Pulley - Alt. & A.C.	1421987	38092
Caterpillar C15 Diesel		
FLD		
Belt - Fan & Alt.	0123415029	♣K080952HD
Belt - Fan To A.C.	0124196005	♣K060598HD
Tensioner Assy. - Fan & Alt.	1352142	38506
Tensioner Assy. - Fan To A.C.	1382514	38508
Tensioner Pulley - Fan & Alt.	1352142	36091
Tensioner Pulley - Fan To A.C.	1382514	36091
Hose - Upper - Eng. To Pipe; (2 1/2" I.D.)		24240
Hose - Upper - Pipe To Rad.; (2 1/2" I.D.)		24240
Hose - Lower - Eng. To Pipe; (3" I.D.)		24248
Hose - Lower - Pipe To Rad.; (3" I.D.)		24248
Caterpillar C16 Diesel		
FLD		
Belt - Fan & Alt.	0123415029	♣K080952HD
Belt - Fan To A.C.	0124196005	♣K060598HD
Tensioner Assy. - Fan & Alt.	1352142	38506
Tensioner Assy. - Fan To A.C.	1382514	38508
Tensioner Pulley - Fan & Alt.	1352142	36091
Tensioner Pulley - Fan To A.C.	1382514	36091
Hose - Upper - Eng. To Pipe; (2 1/2" I.D.)		24240
Hose - Upper - Pipe To Rad.; (2 1/2" I.D.)		24240
Hose - Lower - Eng. To Pipe; (3" I.D.)		24248
Hose - Lower - Pipe To Rad.; (3" I.D.)		24248
Cummins ISB Diesel		
FL50; FL60; FL70; FL80		
Belt - Fan & Alt.	3926856	♣K080694HD
Belt - Fan & A.C.	2310001067	♣9480HD
Tensioner Assy. - Fan & Alt.	3936213	38516
Tensioner Pulley - Fan & Alt.	3936213	36093
Hose - Upper - Eng. To Rad.		22669

♣ Standard Belt Available. See Pages 630-631.

Application	Mfr. Part No.	Our No.
FREIGHTLINER - Continued		
2000 - Continued		
Cummins ISB Diesel - Continued		
FL50; FL60; FL70; FL80 - Continued		
Hose - Lower - Eng. To Rad.		22670
MT45; MT55		
Belt - Fan & Alt.	3926856	♣K080694HD
Belt - Fan To A.C.		♣9430HD
Tensioner Assy. - Fan & Alt.	3936213	38516
Tensioner Pulley - Fan & Alt.	3936213	36093
Hose - Upper		22795
Hose - Lower - Eng. To Pipe; (2 1/4" I.D.)		24236
Hose - Lower - Pipe To Rad.; (2" I.D.)		24232
Cummins ISC Diesel		
FL50; FL60; FL70; FL80		
Belt - Fan, Alt. & Hub	3911581	♣K080690HD
Belt - Fan & A.C.	2310001037	♣9510HD
Tensioner Assy. - Fan, Alt. & Hub	3936205	38525
Hose - Upper - Eng. To Pipe; (2 1/4" I.D.)		24236
Hose - Upper - Pipe To Rad.		21571
Hose - Lower - Eng. To Pipe; (2" I.D.)		24232
Hose - Lower - Pipe To Rad.		20206
Cummins ISM Diesel		
Argosy		
Belt - Fan & Alt.	3289314	♣K080708HD
Belt - A.C.		♣9412HD
Tensioner Assy. - Fan & Alt.	3400885	38521
Idler Pulley - Fan & Alt.	3400884	36308
Hose - Upper - Eng. To Pipe; (2 1/4" I.D.)		24236
Hose - Upper - Pipe To Rad.; (2 1/2" I.D.)		24240
Hose - Lower - Eng. To Pipe; (2 1/2" I.D.)		24240
Hose - Lower - Pipe To Rad.; (2 1/2" I.D.)		24240
Century Class		
Belt - Fan & Alt.	0123415026	♣K080730HD
Belt - Hub & A.C.	0124196004	♣K060560HD
Tensioner Assy. - Fan & Alt.	3400885	38521
Tensioner Assy. - Hub & A.C.	4004933	38505
Idler Pulley - Fan & Alt.	3400884	36308
Tensioner Pulley - A.C.	4004933	36091
Hose - Upper - Eng. To Pipe; (2 1/4" I.D.)		24236
Hose - Upper - Pipe To Rad.; (2 1/2" I.D.)		24240
Hose - Lower - Eng. To Pipe; (2 1/2" I.D.)		24240
Hose - Lower - Pipe To Rad.; (2 1/2" I.D.)		24240
FL112		
Belt - Fan & Alt.; W/130A. Delco Alt.	0123415026	♣K080730HD
Belt - Fan & Alt.; W/130A. Lece Neville Alt.	0123415027	♣K080785HD
Belt - Hub & A.C.	0124196004	♣K060559HD
Tensioner Assy. - Fan & Alt.	3400885	38521
Tensioner Assy. - Hub & A.C.	4004933	38505
Idler Pulley - Fan & Alt.	3400884	36308
Tensioner Pulley - A.C.	4004933	36091
Hose - Upper - Eng. To Pipe; (2 1/4" I.D.)		24236
Hose - Upper - Pipe To Rad.; (2 1/2" I.D.)		24240
Hose - Lower - Eng. To Pipe; (2 1/2" I.D.)		24240
Hose - Lower - Pipe To Rad.; (2 1/2" I.D.)		24240
FLD		
Belt - W.P., Fan & Alt.	0123415027	♣K080785HD
Belt - Hub & A.C.	0224196015	♣K060559HD
Tensioner Assy. - Fan, W.P. & Alt.	3400885	38521
Tensioner Assy. - Hub & A.C.	4004933	38505
Idler Pulley - Fan & Alt.	3400884	36308
Tensioner Pulley - A.C.	4004933	36091
Hose - Upper - Eng. To Pipe; (2 1/2" I.D.)		24240
Hose - Upper - Pipe To Rad.; (2 1/2" I.D.)		24240
Hose - Lower - Eng. To Pipe; (2 1/2" I.D.)		24240
Hose - Lower - Pipe To Rad.; (2 1/2" I.D.)		24240
Cummins ISX Diesel		
Argosy		
Belt - Fan & W.P.		♣K060685HD
Belt - W.P., Alt. & A.C.		♣K100710HD
Tensioner Assy. - Fan	3681240	38535

≡ Cut to Fit.

Belts and Coolant Hose for Medium/Heavy-Duty Trucks (1996 and Newer)

Medium & Heavy-Duty Trucks
(1996 & Newer)

Application	Mfr. Part No.	Our No.
FREIGHTLINER - Continued		
2000 - Continued		
Cummins ISX Diesel - Continued		
Argosy - Continued		
Tensioner Assy. - Hub, Alt. & A.C.	3680194	38532
Idler Pulley - Alt. & A.C.	4026886	36226
Tensioner Pulley - Fan	3681240	36092
Tensioner Pulley - Hub, Alt. & A.C.	3680194	36095
Century Class		
Belt - Fan	3681811	▲K100710HD
Belt - Hub, Alt. & A.C.	0124196010	▲K060685HD
Tensioner Assy. - Fan	3681240	38535
Tensioner Assy. - Hub, Alt. & A.C.	3680194	38532
Idler Pulley - Alt. & A.C.	4026886	36226
Tensioner Pulley - Fan	3681240	36092
Tensioner Pulley - Hub, Alt. & A.C.	3680194	36095
Hose - Upper - Eng. To Pipe; (2 1/2" I.D.)		24240
Hose - Upper - Pipe To Rad.; (2 1/2" I.D.)		24240
Hose - Lower - Eng. To Pipe		21135
Hose - Lower - Pipe To Rad.; (2 1/2" I.D.)		24240
FLD		
Belt - Fan	3681811	▲K100710HD
Belt - Hub, Alt. & A.C.	0124196010	▲K060685HD
Tensioner Assy. - Fan	3681240	38535
Tensioner Assy. - Hub, Alt. & A.C.	3680194	38532
Idler Pulley - Alt. & A.C.	4026886	36226
Tensioner Pulley - Fan	3681240	36092
Tensioner Pulley - Hub, Alt. & A.C.	3680194	36095
Hose - Upper - Eng. To Pipe; (2 1/2" I.D.)		24240
Hose - Upper - Pipe To Rad.; (2 1/2" I.D.)		24240
Hose - Lower - Eng. To Pipe		21891
Hose - Lower - Pipe To Rad.; (2 1/2" I.D.)		≧24240
Cummins N14 Diesel		
Century Class		
Belt - Hub & W.P.		▲K060425HD
Belt - Hub & Fan; Preferred Belt		2/TR28411PB
Belt - Hub & Fan; Optional Belt		②TR28412
Belt - Alt.		②▲9451HD
Belt - Hub & A.C.	2310001087	▲9435HD
Hose - Upper - Eng. To Pipe; (2 1/2" I.D.)		24240
Hose - Upper - Pipe To Rad.; (2 1/2" I.D.)		24240
Hose - Lower - Eng. To Pipe; (2 1/2" I.D.)		24240
Hose - Lower - Pipe To Rad.; (2 1/2" I.D.)		24240
FLD		
Belt - Hub & W.P.		▲K060425HD
Belt - Hub & Fan		②TR28429
Belt - Alt.		②▲9463HD
Belt - Hub & A.C.	2310001087	▲9435HD
Hose - Upper - Eng. To Pipe; (2 1/2" I.D.)		24240
Hose - Upper - Pipe To Rad.; (2 1/2" I.D.)		24240
Hose - Lower - Eng. To Pipe; (2 1/2" I.D.)		24240
Hose - Lower - Pipe To Rad.; (3" I.D.)		24248
Cummins 4-Cyl. 3.9 L Diesel		
MT35		
Belt - Fan & Alt.	3926856	▲K080694HD
Belt - Fan To A.C.		▲9430HD
Tensioner Assy. - Fan & Alt.	3936213	38516
Tensioner Pulley - Fan & Alt.	3936213	36093
Hose - Upper		22795
Hose - Lower - Eng. To Pipe; (2 1/4" I.D.)		24236
Hose - Lower - Pipe To Rad.; (2" I.D.)		24232
Detroit Diesel Series 50 Diesel		
FL106		
Belt - Fan		③▲9465HD
Belt - Fan & Alt.	2310001039	▲9530HD
Belt - Alt. & Hyd. Pump		▲9610HD
Belt - Hub & A.C.	0120984004	2/9435PB
Hose - Upper - Eng. To Pipe; (2 1/2" I.D.)		24240
Hose - Upper - Pipe To Rad.; (2 1/2" I.D.)		24240
Hose - Lower - Pipe To Rad.		≧21194

Application	Mfr. Part No.	Our No.
FREIGHTLINER - Continued		
2000 - Continued		
Detroit Diesel 6-Cyl. 11.1 L Diesel		
Argosy		
Belt - Fan	0124894000	▲K100579HD
Belt - Alt. & A.C.	0124587000	▲K080580HD
Tensioner Assy. - Fan		38503
Tensioner Assy. - Alt. & A.C.	23520317	38501
Tensioner Pulley - Fan		38076
Tensioner Pulley - Alt. & A.C.		38075
Hose - Upper - Eng. To Pipe; (2 1/2" I.D.)		24240
Hose - Upper - Rad. To Pipe; (2 1/2" I.D.)		24240
Hose - Lower - Eng. To Cooler; (2 3/4" I.D.)		24244
Hose - Lower - Cooler To Pipe; (2 3/4" I.D.)		24244
Hose - Lower - Rad. To Pipe		≧21891
Century Class		
Belt - Fan; Preferred Belt; W/50 3/8" Belt O.C.		3/9500PB
Belt - Fan; Optional Belt; W/50 3/8" Belt O.C.		③▲9500HD
Belt - Hub, Alt. & A.C.	0124587000	▲K080580HD
Tensioner Assy. - Hub, Alt. & A.C.	23520317	38501
Tensioner Pulley - Hub, Alt. & A.C.		38075
Hose - Upper - Eng. To Pipe		21891
Hose - Upper - Pipe To Rad.; (2 1/2" I.D.)		24240
Hose - Lower - Eng. To Pipe; (2 1/2" I.D.)		24240
Hose - Lower - Pipe To Rad.; (2 1/2" I.D.)		24240
Columbia		
Belt - Fan; Preferred Belt; W/50 3/8" Belt O.C.		3/9500PB
Belt - Fan; Optional Belt; W/50 3/8" Belt O.C.		③▲9500HD
Belt - Hub, Alt. & A.C.; W/135A. Alt.	0124587006	▲K080570HD
Belt - Hub, Alt. & A.C.; W/130A. Alt.	0124587000	▲K080580HD
Tensioner Assy. - Hub, Alt. & A.C.	23520317	38501
Tensioner Pulley - Hub, Alt. & A.C.	23520317	38075
Hose - Upper - Eng. To Pipe		21891
Hose - Upper - Pipe To Rad.; (2 1/2" I.D.)		24240
Hose - Lower - Eng. To Pipe; (2 1/2" I.D.)		24240
Hose - Lower - Pipe To Rad.; (2 1/2" I.D.)		24240
FLD		
Belt - Fan; Preferred Belt		3/9525PB
Belt - Fan; Optional Belt		③▲9525HD
Belt - W.P., Alt. & A.C.; W/Dual Belts		②▲9510HD
Belt - W.P., Alt. & A.C.; W/V-Ribbed Belt Drive	0124587000	▲K080580HD
Tensioner Assy. - Hub, Alt. & A.C.	23520317	38501
Tensioner Pulley - Hub, Alt. & A.C.		38075
Hose - Upper - Eng. To Pipe; (2 1/2" I.D.)		24240
Hose - Upper - Pipe To Rad.; (2 1/2" I.D.)		24240
Hose - Lower - Eng. To Pipe; (2 1/2" I.D.)		24240
Hose - Lower - Pipe To Rad.; (3" I.D.)		24248
FLS112		
Belt - Fan		②▲9590HD
Belt - Hub, Alt. & A.C.	0120984003	2/9550PB
Hose - Upper - Eng. To Pipe; (2 1/2" I.D.)		24240
Hose - Upper - Pipe To Rad.; (2 1/2" I.D.)		24240
Hose - Lower - Eng. To Pipe; (2 1/2" I.D.)		24240
Hose - Lower - Pipe To Rad.; (3" I.D.)		24248
Detroit Diesel 6-Cyl. 12.7 L Diesel		
Argosy		
Belt - Fan	0124894000	▲K100579HD
Belt - Alt. & A.C.	0124587000	▲K080580HD
Tensioner Assy. - Fan		38503
Tensioner Assy. - Alt. & A.C.	23520317	38501
Tensioner Pulley - Fan		38076
Tensioner Pulley - Alt. & A.C.		38075
Hose - Upper - Eng. To Pipe; (2 1/2" I.D.)		24240
Hose - Upper - Rad. To Pipe; (2 1/2" I.D.)		24240
Hose - Lower - Eng. To Cooler; (2 3/4" I.D.)		24244
Hose - Lower - Cooler To Pipe; (2 3/4" I.D.)		24244
Hose - Lower - Rad. To Pipe		≧21891
Century Class		
Belt - Fan; Preferred Belt; W/50 3/8" Belt O.C.		3/9500PB

▲ Standard Belt Available. See Pages 630-631.
② Two Required.

≧ Cut to Fit.
③ Three Required.

Belts and Coolant Hose for Medium/Heavy-Duty Trucks (1996 and Newer)

 Medium & Heavy-Duty Trucks
(1996 & Newer)

Application	Mfr. Part No.	Our No.
FREIGHTLINER - Continued		
2000 - Continued		
Detroit Diesel 6-Cyl. 12.7 L Diesel - Continued		
Century Class - Continued		
Belt - Fan; Optional Belt; W/50 3/8" Belt		
O.C.	2310001022	③▲9500HD
Belt - Hub, Alt. & A.C.	0124587000	▲K080580HD
Tensioner Assy. - Hub, Alt. & A.C.	23520317	38501
Tensioner Pulley - Hub, Alt. & A.C.		38075
Hose - Upper - Eng. To Pipe		21891
Hose - Upper - Pipe To Rad.; (2 1/2" I.D.)		24240
Hose - Lower - Eng. To Pipe; (2 1/2" I.D.)		24240
Hose - Lower - Pipe To Rad.; (2 1/2" I.D.)		24240
Columbia		
Belt - Fan; Preferred Belt; W/50 3/8" Belt O.C.		3/9500PB
Belt - Fan; Optional Belt; W/50 3/8" Belt		
O.C.	2310001022	③▲9500HD
Belt - Hub, Alt. & A.C.; W/135A. Alt.	0124587006	▲K080570HD
Belt - Hub, Alt. & A.C.; W/130A. Alt.	0124587000	▲K080580HD
Tensioner Assy. - Hub, Alt. & A.C.	23520317	38501
Tensioner Pulley - Hub, Alt. & A.C.	23520317	38075
Hose - Upper - Eng. To Pipe		21891
Hose - Upper - Pipe To Rad.; (2 1/2" I.D.)		24240
Hose - Lower - Eng. To Pipe; (2 1/2" I.D.)		24240
Hose - Lower - Pipe To Rad.; (2 1/2" I.D.)		24240
FLD		
Belt - Fan; Preferred Belt		3/9525PB
Belt - Fan; Optional Belt		③▲9525HD
Belt - W.P., Alt. & A.C.; W/Dual Belts		②▲9510HD
Belt - W.P., Alt. & A.C.; W/V-Ribbed Belt		
Drive	0124587000	▲K080580HD
Tensioner Assy. - Hub, Alt. & A.C.	23520317	38501
Tensioner Pulley - Hub, Alt. & A.C.		38075
Hose - Upper - Eng. To Pipe; (2 1/2" I.D.)		24240
Hose - Upper - Pipe To Rad.; (2 1/2" I.D.)		24240
Hose - Lower - Eng. To Pipe; (2 1/2" I.D.)		24240
Hose - Lower - Pipe To Rad.; (3" I.D.)		24248
FLS112		
Belt - Fan		②▲9590HD
Belt - Hub, Alt. & A.C.	0120984003	2/9550PB
Hose - Upper - Eng. To Pipe; (2 1/2" I.D.)		24240
Hose - Upper - Pipe To Rad.; (2 1/2" I.D.)		24240
Hose - Lower - Eng. To Pipe; (2 1/2" I.D.)		24240
Hose - Lower - Pipe To Rad.; (3" I.D.)		24248
Mercedes-Benz MBE 900 Diesel		
FL50; FL60; FL70; FL80		
Belt - Hub, Fan, Alt. & A.C.	0126246000	▲K080830HD
Hose - Upper - Eng. To Rad.		20611
Hose - Lower - Eng. To Pipe		20206
Hose - Lower - Pipe To Rad.		20206
1999		
Caterpillar 3126 Diesel		
FL50; FL60; FL70; FL80		
Belt - Fan, Alt. & A.C.	0123415000	▲K080702HD
Belt - W.P.	0366775	▲9341HD
Tensioner Assy. - Fan, Alt. & A.C.	1352151	38511
Idler Pulley	1445612	36096
Tensioner Pulley - Fan, Alt. & A.C.	1352151	36091
Hose - Lower - Eng. To Pipe; W/2 1/4" I.D. Hose		20748
Hose - Lower - Eng. To Pipe; W/2" I.D. Hose		21571
Hose - Lower - Rad. To Pipe; W/2 1/4" I.D. Hose		21194
Hose - Lower - Rad. To Pipe; W/2" I.D. Hose		②<20611
Caterpillar 3406 Diesel		
Argosy		
Belt - Fan & Alt.		▲K080952HD
Belt - Fan To A.C.		▲K060547HD
Hose - Upper - Eng. To Pipe; (2 1/2" I.D.)		24240
Hose - Upper - Rad. To Pipe; (2 1/2" I.D.)		24240
Hose - Lower - Eng. To Pipe		21400
Hose - Lower - Rad. To Pipe		②<21891

 ③ Three Required.
 ② Two Required.

Application	Mfr. Part No.	Our No.
FREIGHTLINER - Continued		
1999 - Continued		
Caterpillar 3406 Diesel - Continued		
Century Class; FLD		
Belt - Fan & Alt.	0123415022	▲K080952HD
Belt - Fan To A.C.		▲K060594HD
Tensioner Assy. - Fan & Alt.	1352142	38506
Tensioner Assy. - Fan To A.C.	1382514	38508
Tensioner Pulley - Fan & Alt.	1352142	36091
Tensioner Pulley - Fan To A.C.	1382514	36091
Hose - Upper - Eng. To Pipe; (2 1/2" I.D.)		24240
Hose - Upper - Pipe To Rad.; (2 1/2" I.D.)		24240
Hose - Lower - Eng. To Pipe; (3" I.D.)		24248
Hose - Lower - Pipe To Rad.; (3" I.D.)		24248
Caterpillar C10 Diesel		
Argosy		
Idler Pulley - Fan & Alt.; W/Flat Idler		
Pulley	1337023	36091
Idler Pulley - Fan & Alt.; W/V-Groove		
Idler Pulley	1731498	36231
Century Class		
Belt - Fan & Alt.	0123415016	▲K080922HD
Belt - A.C.; W/48 1/2" Belt O.C.	0124196002	▲K060480HD
Belt - A.C.; W/52 3/4" Belt O.C.	0124196003	▲K060523HD
Tensioner Assy. - Fan & A.C.	1421987	38534
Tensioner Assy. - Fan & Alt.	1481974	38506
Idler Pulley - Fan & Alt.; W/Flat Idler		
Pulley	1337023	36091
Idler Pulley - Fan & Alt.;		
W/Multi-Grooved Idler Pulley	1731498	36231
Tensioner Pulley - Alt. & A.C.	1421987	38092
Tensioner Pulley - Fan & Alt.	1481974	36091
FL112		
Belt - Fan & Alt.	0123415014	▲K080855HD
Belt - Fan & A.C.		▲K060523HD
Tensioner Assy. - Fan & Alt.	1481974	38506
Tensioner Assy. - Fan & A.C.	1421987	38534
Idler Pulley - Fan & Alt.; W/Flat Idler		
Pulley	1337023	36091
Idler Pulley - Fan & Alt.;		
W/Multi-Grooved Idler Pulley	1731498	36231
Tensioner Pulley - Fan & Alt.	1481974	36091
Tensioner Pulley - Alt. & A.C.	1421987	38092
Hose - Upper - Eng. To Pipe		②<21194
Hose - Upper - Pipe To Rad.; (2 1/2" I.D.)		24240
FLD		
Belt - Fan & Alt.	0123415016	▲K080922HD
Belt - A.C.; W/48 1/2" Belt O.C.	0124196002	▲K060480HD
Belt - A.C.; W/52 3/4" Belt O.C.	0124196003	▲K060523HD
Tensioner Assy. - Fan & Alt.	1481974	38506
Tensioner Assy. - Fan & A.C.	1421987	38534
Idler Pulley - Fan & Alt.; W/Flat Idler		
Pulley	1337023	36091
Idler Pulley - Fan & Alt.;		
W/Multi-Grooved Idler Pulley	1731498	36231
Tensioner Pulley - Fan & Alt.	1481974	36091
Tensioner Pulley - Alt. & A.C.	1421987	38092
Caterpillar C12 Diesel		
Argosy		
Idler Pulley - Fan & Alt.; W/Flat Idler		
Pulley	1337023	36091
Idler Pulley - Fan & Alt.; W/V-Groove		
Idler Pulley	1731498	36231
Century Class		
Belt - Fan & Alt.	0123415016	▲K080922HD
Belt - A.C.; W/48 1/2" Belt O.C.	0124196002	▲K060480HD
Belt - A.C.; W/52 3/4" Belt O.C.	0124196003	▲K060523HD
Tensioner Assy. - Fan & Alt.	1481974	38506
Tensioner Assy. - Fan & A.C.	1421987	38534
Idler Pulley - Fan & Alt.; W/Flat Idler		
Pulley	1337023	36091
Idler Pulley - Fan & Alt.;		
W/Multi-Grooved Idler Pulley	1731498	36231

 ▲ Standard Belt Available. See Pages 630-631.
 ②< Cut to Fit.

Belts and Coolant Hose for Medium/Heavy-Duty Trucks [1996 and Newer]

Medium & Heavy-Duty Trucks
(1996 & Newer)

Application	Mfr. Part No.	Our No.
FREIGHTLINER - Continued		
1999 - Continued		
Caterpillar C12 Diesel - Continued		
Century Class - Continued		
Tensioner Pulley - Alt. & A.C.	1421987	38092
Tensioner Pulley - Fan & Alt.	1481974	36091
FL112		
Belt - Fan & Alt.	0123415014	♣K080855HD
Belt - Fan & A.C.		♣K060523HD
Tensioner Assy. - Fan & Alt.	1481974	38506
Tensioner Assy. - Fan & A.C.	1421987	38534
Idler Pulley - Fan & Alt.; W/Flat Idler Pulley	1337023	36091
Idler Pulley - Fan & Alt.; W/Multi-Grooved Idler Pulley	1731498	36231
Tensioner Pulley - Fan & Alt.	1481974	36091
Tensioner Pulley - Alt. & A.C.	1421987	38092
Hose - Lower - Eng. To Pipe		≈21194
Hose - Lower - Pipe To Rad.; (2 1/2" I.D.)		24240
FLD		
Belt - Fan & Alt.	0123415016	♣K080922HD
Belt - A.C.; W/48 1/2" Belt O.C.	0124196002	♣K060480HD
Belt - A.C.; W/52 3/4" Belt O.C.	0124196003	♣K060523HD
Tensioner Assy. - Fan & Alt.	1481974	38506
Tensioner Assy. - Fan & A.C.	1421987	38534
Idler Pulley - Fan & Alt.; W/Flat Idler Pulley	1337023	36091
Idler Pulley - Fan & Alt.; W/Multi-Grooved Idler Pulley	1731498	36231
Tensioner Pulley - Fan & Alt.	1481974	36091
Tensioner Pulley - Alt. & A.C.	1421987	38092
Cummins ISB Diesel		
FC70; FC80		
Serpentine Belt	3922828	♣K080580HD
FL50; FL60; FL70; FL80		
Belt - Fan, W.P. & Alt.	3926856	♣K080694HD
Belt - Fan & A.C.	2310001067	♣9480HD
Tensioner Assy. - Fan, W.P. & Alt.	3936213	38516
Tensioner Pulley - Fan, W.P. & Alt.	3936213	36093
Hose - Upper - Eng. To Rad.		22669
Hose - Lower - Eng. To Rad.		22670
MT45; MT55		
Belt - Fan & Alt.	3926856	♣K080694HD
Belt - Fan To A.C.		♣9430HD
Tensioner Assy. - Fan & Alt.	3936213	38516
Tensioner Pulley - Fan & Alt.	3936213	36093
Hose - Upper		22795
Hose - Lower - Eng. To Pipe; (2 1/4" I.D.)		24236
Hose - Lower - Pipe To Rad.; (2" I.D.)		24232
Cummins ISC Diesel		
FL50; FL60; FL70		
Belt - Fan, Alt. & Hub; W/69 1/2" Belt O.C.		♣K080690HD
Belt - Fan, Alt. & Hub; W/64" Belt O.C.	3926866	♣K080638HD
Belt - Hub, Fan & A.C.	2310001038	♣9510HD
Tensioner Assy. - Fan, Alt. & Hub	3936213	38516
Tensioner Pulley - Fan, Alt. & Hub	3936213	36093
FL80		
Belt - Fan, Alt. & Hub; W/69 1/2" Belt O.C.		♣K080690HD
Belt - Fan, Alt. & Hub; W/64" Belt O.C.	3926866	♣K080638HD
Belt - Fan & A.C.	2310001037	♣9510HD
Tensioner Assy. - Fan, Alt. & Hub	3934823	38513
Tensioner Pulley - Fan, Alt. & Hub	3934823	36091
Cummins ISM Diesel		
Argosy		
Belt - Fan & Alt.		♣K080730HD
Hose - Upper - Eng. To Pipe; (2 1/4" I.D.)		24236
Hose - Upper - Rad. To Pipe		21891
Hose - Lower - Eng. To Pipe; (2 1/2" I.D.)		24240
Hose - Lower - Rad. To Pipe; (2 1/2" I.D.)		24240
Century Class		
Belt - Fan & Alt.	0123415026	♣K080730HD
Belt - Fan	6819971493	♣K080530HD

Application	Mfr. Part No.	Our No.
FREIGHTLINER - Continued		
1999 - Continued		
Cummins ISM Diesel - Continued		
Century Class - Continued		
Belt - Hub & Alt.	3028521	♣K050345HD
Belt - Hub & A.C.; W/53" Belt O.C.	0123415004	♣K080537HD
Belt - Hub & A.C.; W/56" Belt O.C.	0124196004	♣K060560HD
Tensioner Assy. - Fan & Alt.	3400885	38521
Tensioner Assy. - Hub & A.C.	4004933	38505
Idler Pulley - Fan & Alt.	3400884	36308
Tensioner Pulley - A.C.	4004933	36091
Hose - Upper - Eng. To Pipe; (2 1/2" I.D.)		24240
Hose - Upper - Pipe To Rad.; (2 1/2" I.D.)		24240
Hose - Lower - Eng. To Pipe; (2 1/2" I.D.)		24240
Hose - Lower - Pipe To Rad.; (2 1/2" I.D.)		24240
Hose - By Pass; (1 3/4" I.D.)		24228
FL112		
Belt - Fan	6819971493	♣K080530HD
Belt - Hub & Alt.	3028521	♣K050345HD
Belt - Hub & A.C.	6124196003	♣K060523HD
Tensioner Assy. - Hub & A.C.	4004933	38505
Tensioner Pulley - A.C.	4004933	36091
Hose - Upper - Eng. To Pipe; (2 1/4" I.D.)		24236
Hose - Upper - Pipe To Rad.; (2 1/2" I.D.)		24240
Hose - Lower - Eng. To Pipe; (2 1/2" I.D.)		24240
Hose - Lower - Pipe To Rad.; (2 1/2" I.D.)		24240
Hose - By Pass; (1 3/4" I.D.)		24228
FLD		
Belt - Fan; W/53 1/2" Belt O.C.	6819971493	♣K080530HD
Belt - Fan; W/61 1/2" Belt O.C.	6819971593	♣K080610HD
Belt - Hub & Alt.	3028521	♣K050345HD
Belt - A.C.	0124196003	♣K060523HD
Belt - Hub & A.C.		♣K060559HD
Tensioner Assy. - Hub & A.C.	3161562	38505
Tensioner Pulley - A.C.	3161562	36091
Hose - Upper - Eng. To Pipe; (2 1/4" I.D.)		24236
Hose - Upper - Pipe To Rad.; (2 1/4" I.D.)		24236
Hose - Lower - Eng. To Pipe; (2 1/4" I.D.)		24236
Hose - Lower - Pipe To Rad.; (2 1/4" I.D.)		24236
Hose - By Pass; (1 3/4" I.D.)		24228
Cummins ISX Diesel		
Argosy		
Belt - Fan & W.P.		♣K060685HD
Belt - W.P., Alt. & A.C.		♣K100710HD
Tensioner Assy. - Fan	3681240	38535
Tensioner Assy. - Hub, Alt. & A.C.	3680194	38532
Idler Pulley - Alt. & A.C.	4026886	36226
Tensioner Pulley - Fan	3681240	36092
Tensioner Pulley - Hub, Alt. & A.C.	3680194	36095
FLD		
Belt - Fan	3681811	♣K100710HD
Belt - Hub, Alt. & A.C.	0124196010	♣K060685HD
Tensioner Assy. - Fan	3681240	38535
Tensioner Assy. - Hub, Alt. & A.C.	3680194	38532
Idler Pulley - Alt. & A.C.	4026886	36226
Tensioner Pulley - Fan	3681240	36092
Tensioner Pulley - Hub, Alt. & A.C.	3680194	36095
Hose - Upper - Eng. To Pipe; (2 1/2" I.D.)		24240
Hose - Upper - Pipe To Rad.; (2 1/2" I.D.)		24240
Hose - Lower - Eng. To Pipe		21891
Hose - Lower - Pipe To Rad.; (2 1/2" I.D.)		≈24240
Cummins N14 Diesel		
Century Class		
Belt - Hub & Fan; Preferred Belt		2/TR28411PB
Belt - Hub & Fan; Optional Belt		②TR28412
Belt - Hub & W.P.		♣K060425HD
Belt - Alt.		②♣9451HD
Belt - Hub & A.C.	2310001087	♣9435HD
Hose - Upper - Eng. To Pipe; (2 1/2" I.D.)		24240
Hose - Upper - Pipe To Rad.; (2 1/2" I.D.)		24240
Hose - Lower - Eng. To Pipe; (2 1/2" I.D.)		24240
Hose - Lower - Pipe To Rad.; (2 1/2" I.D.)		24240

♣ Standard Belt Available. See Pages 630-631.
② Two Required.

≈ Cut to Fit.

Belts and Coolant Hose for Medium/Heavy-Duty Trucks (1996 and Newer)

Medium & Heavy-Duty Trucks
(1996 & Newer)

Application	Mfr. Part No.	Our No.
FREIGHTLINER - Continued		
1999 - Continued		
Cummins N14 Diesel - Continued		
FLB		
Belt - Fan		②TR28473
Belt - Alt.		②▲9451HD
Belt - W.P.	3095880	▲K060415HD
Belt - A.C.		▲9451HD
FLD		
Belt - Hub & Fan		②TR28429
Belt - Hub & W.P.		▲K060425HD
Belt - Alt.		②▲9463HD
Belt - Hub & A.C.	2310001087	▲9435HD
Hose - Upper - Eng. To Pipe; (2 1/2" I.D.)		24240
Hose - Upper - Pipe To Rad.; (2 1/2" I.D.)		24240
Hose - Lower - Eng. To Pipe; (2 1/2" I.D.)		24240
Hose - Lower - Pipe To Rad.; (3" I.D.)		24248
Cummins 4-Cyl. 3.9 L Diesel		
MT35		
Belt - Fan & Alt.	3926856	▲K080694HD
Belt - Fan To A.C.		▲9430HD
Tensioner Assy. - Fan & Alt.	3936213	38516
Tensioner Pulley - Fan & Alt.	3936213	36093
Hose - Upper		22795
Hose - Lower - Eng. To Pipe; (2 1/4" I.D.)		24236
Hose - Lower - Pipe To Rad.; (2" I.D.)		24232
Detroit Diesel Series 50 Diesel		
FL106		
Belt - Fan		③▲9465HD
Belt - Fan & Alt.	2310001039	▲9530HD
Belt - Hub & A.C.	0120984004	2/9435PB
Detroit Diesel 6-Cyl. 11.1 L Diesel		
Argosy		
Belt - Fan		②▲9590HD
Belt - Alt. & A.C.; W/V-Belt Drive		②▲9600HD
Belt - Hub, Alt. & A.C.; W/V-Ribbed Belt		▲K080585HD
Tensioner Assy. - Hub, Alt. & A.C.	23520317	38501
Tensioner Pulley - Hub, Alt. & A.C.		38075
Hose - Upper - Eng. To Pipe; (2 1/2" I.D.)		24240
Hose - Upper - Rad. To Pipe; (2 1/2" I.D.)		24240
Hose - Lower - Eng. To Cooler; (2 3/4" I.D.)		24244
Hose - Lower - Cooler To Pipe; (2 3/4" I.D.)		24244
Hose - Lower - Rad. To Pipe		≅21891
Century Class		
Belt - Fan; W/V-Belt Drive; Preferred Belt; W/50 3/8" Belt O.C.		3/9500PB
Belt - Fan; W/V-Belt Drive; Optional Belt; W/50 3/8" Belt O.C.	2310001022	③▲9500HD
Belt - Fan; W/V-Belt Drive; W/51 3/8" Belt O.C.		③▲9510HD
Belt - Fan; W/V-Ribbed Belt	0124894004	▲K100502HD
Belt - Hub, Alt. & A.C.; W/Dual Belts; Optional Belt		②▲9510HD
Belt - Hub, Alt. & A.C.; W/Dual Belts; Preferred Belt	0120984001	2/9510PB
Belt - Hub, Alt. & A.C.; W/V-Ribbed Belt Drive	0124587000	▲K080580HD
Tensioner Assy. - Hub, Alt. & A.C.	23520317	38501
Tensioner Pulley - Hub, Alt. & A.C.		38075
Hose - Upper - Eng. To Pipe		21891
Hose - Upper - Pipe To Rad.; (2 1/2" I.D.)		24240
Hose - Lower - Eng. To Pipe; (2 1/2" I.D.)		24240
Hose - Lower - Pipe To Rad.; (2 1/2" I.D.)		24240
FLB		
Hose - Upper; (2 1/2" I.D.)		24240
Hose - Lower; Strt. Hose(2 1/2" I.D.)		24240
Hose - Lower - Pipe To Rad.; Molded Hose		21472
Hose - By Pass; (1 3/4" I.D.)		24228
Hose - Inlet To W.P.; (3" I.D.)		24248
Hose - Heater Inlet; (3/4" I.D.)		28442
Hose - Heater Outlet; (5/8" I.D.)		28441
FLD		
Belt - Fan; W/V-Belt Drive		③▲9610HD
Belt - Fan; W/V-Ribbed Belt	0124894004	▲K100502HD
Belt - Hub, Alt. & A.C.	0120984001	2/9510PB
Hose - Upper - Eng. To Pipe; (2 1/2" I.D.)		24240
Hose - Upper - Pipe To Rad.; (2 1/2" I.D.)		24240
Hose - Lower - Eng. To Pipe; (2 1/2" I.D.)		24240
Hose - Lower - Pipe To Rad.; (3" I.D.)		24248

Application	Mfr. Part No.	Our No.
FREIGHTLINER - Continued		
1999 - Continued		
Detroit Diesel 6-Cyl. 11.1 L Diesel - Continued		
FLD - Continued		
Belt - Hub, Alt. & A.C.	0120984001	2/9510PB
Hose - Upper - Eng. To Pipe; (2 1/2" I.D.)		24240
Hose - Upper - Pipe To Rad.; (2 1/2" I.D.)		24240
Hose - Lower - Eng. To Pipe; (2 1/2" I.D.)		24240
Hose - Lower - Pipe To Rad.; (3" I.D.)		24248
Detroit Diesel 6-Cyl. 12.7 L Diesel		
Argosy		
Belt - Fan		②▲9590HD
Belt - Alt. & A.C.; W/V-Belt Drive		②▲9600HD
Belt - Hub, Alt. & A.C.; W/V-Ribbed Belt		▲K080585HD
Tensioner Assy. - Hub, Alt. & A.C.	23520317	38501
Tensioner Pulley - Hub, Alt. & A.C.		38075
Hose - Upper - Eng. To Pipe; (2 1/2" I.D.)		24240
Hose - Upper - Rad. To Pipe; (2 1/2" I.D.)		24240
Hose - Lower - Eng. To Cooler; (2 3/4" I.D.)		24244
Hose - Lower - Cooler To Pipe; (2 3/4" I.D.)		24244
Hose - Lower - Rad. To Pipe		≅21891
Century Class		
Belt - Fan; W/V-Belt Drive; Preferred Belt; W/50 3/8" Belt O.C.		3/9500PB
Belt - Fan; W/V-Belt Drive; Optional Belt; W/50 3/8" Belt O.C.	2310001022	③▲9500HD
Belt - Fan; W/V-Belt Drive; W/51 3/8" Belt O.C.		③▲9510HD
Belt - Fan; W/V-Ribbed Belt	0124894004	▲K100502HD
Belt - Hub, Alt. & A.C.; W/Dual Belts; Optional Belt		②▲9510HD
Belt - Hub, Alt. & A.C.; W/Dual Belts; Preferred Belt	0120984001	2/9510PB
Belt - Hub, Alt. & A.C.; W/V-Ribbed Belt Drive	0124587000	▲K080580HD
Tensioner Assy. - Hub, Alt. & A.C.	23520317	38501
Tensioner Pulley - Hub, Alt. & A.C.		38075
Hose - Upper - Eng. To Pipe		21891
Hose - Upper - Pipe To Rad.; (2 1/2" I.D.)		24240
Hose - Lower - Eng. To Pipe; (2 1/2" I.D.)		24240
Hose - Lower - Pipe To Rad.; (2 1/2" I.D.)		24240
FLB		
Hose - Upper; (2 1/2" I.D.)		24240
Hose - Lower; Strt. Hose(2 1/2" I.D.)		24240
Hose - Lower - Pipe To Rad.; Molded Hose		21472
Hose - By Pass; (1 3/4" I.D.)		24228
Hose - Inlet To W.P.; (3" I.D.)		24248
Hose - Heater Inlet; (3/4" I.D.)		28442
Hose - Heater Outlet; (5/8" I.D.)		28441
FLD		
Belt - Fan; W/V-Belt Drive		③▲9610HD
Belt - Fan; W/V-Ribbed Belt	0124894004	▲K100502HD
Belt - Hub, Alt. & A.C.	0120984001	2/9510PB
Hose - Upper - Eng. To Pipe; (2 1/2" I.D.)		24240
Hose - Upper - Pipe To Rad.; (2 1/2" I.D.)		24240
Hose - Lower - Eng. To Pipe; (2 1/2" I.D.)		24240
Hose - Lower - Pipe To Rad.; (3" I.D.)		24248
1998		
Caterpillar 3126 Diesel		
FL50; FL60; FL70; FL80		
Belt - Fan, Alt. & A.C.	0123415000	▲K080702HD
Belt - W.P.	0366775	▲9341HD
Tensioner Assy. - Fan, Alt. & A.C.	1352151	38511
Idler Pulley	1445612	36096
Tensioner Pulley - Fan, Alt. & A.C.	1352151	36091
Hose - Lower - Eng. To Pipe; W/2 1/4" I.D. Hose		20748
Hose - Lower - Eng. To Pipe; W/2" I.D. Hose		21571
Hose - Lower - Pipe To Rad.		21194
Hose - Lower - Rad. To Pipe; W/2" I.D. Hose		≅20611
Caterpillar 3406 Diesel		
Century Class; FLD		
Belt - Fan & Alt.	0123415022	▲K080952HD
Belt - Fan To A.C.		▲K060594HD

② Two Required.
③ Three Required.

▲ Standard Belt Available. See Pages 630-631.
≅ Cut to Fit.

Belts and Coolant Hose for Medium/Heavy-Duty Trucks (1996 and Newer)

Medium & Heavy-Duty Trucks
(1996 & Newer)

Application	Mfr. Part No.	Our No.
FREIGHTLINER - Continued		
1998 - Continued		
Caterpillar 3406 Diesel - Continued		
Century Class; FLD - Continued		
Tensioner Assy. - Fan & Alt.	1352142	38506
Tensioner Assy. - Fan To A.C.	1382514	38508
Tensioner Pulley - Fan & Alt.	1352142	36091
Tensioner Pulley - Fan To A.C.	1382514	36091
Hose - Upper - Eng. To Pipe; (2 1/2" I.D.)		24240
Hose - Upper - Pipe To Rad.; (2 1/2" I.D.)		24240
Hose - Lower - Eng. To Pipe; (3" I.D.)		24248
Hose - Lower - Pipe To Rad.; (3" I.D.)		24248
Caterpillar C10 Diesel		
Century Class; FLD		
Belt - Fan & Alt.	0123415016	▲K080922HD
Belt - A.C.; W/48 1/2" Belt O.C.	0124196002	▲K060480HD
Belt - A.C.; W/52 3/4" Belt O.C.	0124196003	▲K060523HD
Tensioner Assy. - Fan & Alt.	1481974	38506
Tensioner Assy. - Fan & A.C.	1421987	38534
Tensioner Pulley - Fan & Alt.	1481974	36091
Tensioner Pulley - Fan & A.C.	1421987	38092
Caterpillar C12 Diesel		
Century Class; FLD		
Belt - Fan & Alt.	0123415016	▲K080922HD
Belt - A.C.; W/48 1/2" Belt O.C.	0124196002	▲K060480HD
Belt - A.C.; W/52 3/4" Belt O.C.	0124196003	▲K060523HD
Tensioner Assy. - Fan & Alt.	1481974	38506
Tensioner Assy. - Fan & A.C.	1421987	38534
Tensioner Pulley - Fan & Alt.	1481974	36091
Tensioner Pulley - Fan & A.C.	1421987	38092
Cummins ISB Diesel		
FL50; FL60; FL70; FL80		
Belt - Fan, W.P. & Alt.	3926856	▲K080694HD
Belt - A.C.	2310001067	▲9480HD
Tensioner Assy. - Fan, W.P. & Alt.	3936213	38516
Tensioner Pulley - Fan, W.P. & Alt.	3936213	36093
Hose - Upper - Eng. To Rad.		22669
Hose - Lower - Eng. To Rad.		22670
MT45		
Belt - Fan & Alt.	3967026	▲K080575HD
Belt - Fan To A.C.		▲9430HD
Hose - Upper		22795
Hose - Lower - Eng. To Pipe; (2 1/4" I.D.)		24236
Hose - Lower - Pipe To Rad.; (2" I.D.)		24232
Cummins ISC Diesel		
FL50; FL60; FL70; FL80		
Belt - Fan & Alt.	3289012	▲K080638HD
Tensioner Assy.	3976832	38513
Tensioner Pulley	3976832	36091
Cummins ISM Diesel		
Century Class		
Belt - Fan & Alt.	0123415026	▲K080730HD
Belt - Fan	6819970593	K080491
Belt - Alt.	3028521	▲K050345HD
Belt - A.C.; W/V-Belt Drive	2310001062	▲9545HD
Belt - A.C.; W/V-Ribbed Belt	0124196004	▲K060560HD
Tensioner Assy. - Fan & Alt.	3400885	38521
Tensioner Assy. - A.C.; W/V-Ribbed Belt		38507
Tensioner Pulley - A.C.; W/V-Ribbed Belt		36091
Hose - Upper - Eng. To Pipe; (2 1/4" I.D.)		24236
Hose - Upper - Pipe To Rad.; (2 1/2" I.D.)		24240
Hose - Lower; (2 1/2" I.D.)		24240
Hose - By Pass; (1 3/4" I.D.)		24228
FL112		
Belt - Fan	6819970593	K080491
Belt - W.P. & Alt.	3028521	▲K050345HD
Belt - Hub & A.C.	2310001062	▲9545HD
Hose - Upper - Eng. To Pipe; (2 1/4" I.D.)		24236
Hose - Upper - Pipe To Rad.; (2 1/4" I.D.)		24236
Hose - Lower - Eng. To Pipe; (2 1/2" I.D.)		24240
Hose - Lower - Pipe To Rad.; (2 1/4" I.D.)		24236

Application	Mfr. Part No.	Our No.
FREIGHTLINER - Continued		
1998 - Continued		
Cummins ISM Diesel - Continued		
FL112 - Continued		
Hose - By Pass; (1 3/4" I.D.)		24228
FLD		
Belt - Fan	6819970693	▲K080570HD
Belt - Alt.	3028521	▲K050345HD
Belt - A.C.	2310001062	▲9545HD
Hose - Upper - Eng. To Pipe; (2 1/4" I.D.)		24236
Hose - Upper - Pipe To Rad.; (2 1/2" I.D.)		24240
Hose - Lower; (2 1/2" I.D.)		24240
Hose - By Pass; (1 3/4" I.D.)		24228
Cummins M11 Diesel		
FLB		
Belt - Fan	6819970693	▲K080570HD
Belt - W.P.	3028521	▲K050345HD
Belt - A.C.		▲9540HD
Cummins N14 Diesel		
Century Class		
Belt - Hub & Fan; Preferred Belt	2310001089	2/TR28411PB
Belt - Hub & Fan; Optional Belt		②TR28412
Belt - W.P.	3076492	▲K060425HD
Belt - Alt.; Preferred Belt	2310001028	2/9451PB
Belt - Alt.; Optional Belt		②▲9451HD
Belt - A.C.; Preferred Belt	2310001087	2/9435PB
Belt - A.C.; Optional Belt		②▲9435HD
Hose - Upper - Eng. To Pipe; (2 1/2" I.D.)		24240
Hose - Upper - Pipe To Rad.; (2 1/2" I.D.)		24240
Hose - Lower - Eng. To Pipe; (2 1/2" I.D.)		24240
Hose - Lower - Pipe To Rad.; (2 1/2" I.D.)		24240
FLB		
Belt - Fan; Preferred Belt		2/TR28411PB
Belt - Fan; Optional Belt	2310001089	②TR28412
Belt - W.P.	3076492	▲K060425HD
Belt - Alt.; Optional Belt		②▲9451HD
Belt - Alt.; Preferred Belt	2310001028	2/9451PB
Belt - A.C.; Optional Belt		②▲9435HD
Belt - A.C.; Preferred Belt	2310001087	2/9435PB
FLC		
Belt - Fan; Preferred Belt		2/TR28411PB
Belt - Fan; Optional Belt	2310001089	②TR28412
Belt - W.P.	3076492	▲K060425HD
Belt - Alt.; Optional Belt		②▲9451HD
Belt - Alt.; Preferred Belt	2310001028	2/9451PB
Belt - A.C.; Optional Belt		②▲9435HD
Belt - A.C.; Preferred Belt	2310001087	2/9435PB
Hose - Upper; W/O Aftercooler(2" I.D.)		24232
Hose - Upper; W/Aftercooler(2 1/2" I.D.)		24240
Hose - Upper; W/Single Hose		●26510
Hose - Lower; W/Aftercooler(3" I.D.)		24248
Hose - Lower; W/O Aftercooler(2 1/2" I.D.)		24240
Hose - By Pass; (1 1/2" I.D.)		24224
Hose - Aftercooler		21488
Hose - Heater; (3/4" I.D.)		28442
FLD		
Belt - Hub & Fan		②TR28429
Belt - Hub & W.P.		▲K060425HD
Belt - Alt.		②▲9463HD
Belt - Hub & A.C.; Optional Belt		②▲9435HD
Belt - Hub & A.C.; Preferred Belt	2310001087	2/9435PB
Hose - Upper - Eng. To Pipe; (2 1/2" I.D.)		24240
Hose - Upper - Pipe To Rad.; (2 1/2" I.D.)		24240
Hose - Lower - Eng. To Pipe; (2 1/2" I.D.)		24240
Hose - Lower - Pipe To Rad.; (2 1/2" I.D.)		24240
Cummins 4-Cyl. 3.9 L Diesel		
MT35		
Belt - Fan & Alt.	3911587	▲K080537HD
Detroit Diesel Series 50 Diesel		
FL106		
Belt - Fan		③▲9465HD

▲ Standard Belt Available. See Pages 630-631.
● Vulco-Flex® Coolant Hose.

② Two Required.
③ Three Required.

Belts and Coolant Hose for Medium/Heavy-Duty Trucks (1996 and Newer)

 Medium & Heavy-Duty Trucks
(1996 & Newer)

Application	Mfr. Part No.	Our No.
FREIGHTLINER - Continued		
1998 - Continued		
Detroit Diesel Series 50 Diesel - Continued		
FL106 - Continued		
Belt - Fan & Alt.	2310001039	▲9530HD
Belt - Hub & A.C.	0120984004	2/9435PB
Detroit Diesel Series 55 Diesel		
Century Class; FL112		
Belt - Fan	0123683001	▲K060470HD
Detroit Diesel 6-Cyl. 11.1 L Diesel		
Century Class		
Belt - Fan; Preferred Belt; W/50 3/8" Belt O.C.		3/9500PB
Belt - Fan; Optional Belt; W/50 3/8" Belt O.C.	2310001022	③▲9500HD
Belt - Fan; W/51 3/8" Belt O.C.	2310001037	③▲9510HD
Belt - Alt. & A.C.	0120984001	2/9510PB
Belt - Hub, Alt. & A.C.		②▲9510HD
Hose - Upper - Eng. To Pipe		21891
Hose - Upper - Pipe To Rad.; (2 1/2" I.D.)		24240
Hose - Lower - Eng. To Pipe; (2 1/2" I.D.)		24240
Hose - Lower - Pipe To Rad.; Molded Hose		21472
Hose - Lower - Pipe To Rad.; Strt. Hose(2 1/2" I.D.)		24240
Hose - By Pass; (1 3/4" I.D.)		24228
Hose - Inlet To W.P.; (3" I.D.)		24248
Hose - Heater Inlet; (3/4" I.D.)		28442
Hose - Heater Outlet; (5/8" I.D.)		28441
FLB		
Hose - Upper; (2 1/2" I.D.)		24240
Hose - Lower; Strt. Hose(2 1/2" I.D.)		24240
Hose - Lower - Pipe To Rad.; Molded Hose		21472
Hose - By Pass; (1 3/4" I.D.)		24228
Hose - Inlet To W.P.; (3" I.D.)		24248
Hose - Heater Inlet; (3/4" I.D.)		28442
Hose - Heater Outlet; (5/8" I.D.)		28441
FLC		
Belt - Fan; W/50 3/8" Belt O.C.; Preferred Belt		3/9500PB
Belt - Fan; W/50 3/8" Belt O.C.; Optional Belt	2310001022	③▲9500HD
Belt - Fan; W/51 3/8" Belt O.C.	2310001037	③▲9510HD
Belt - Alt.	0120984001	2/9510PB
Hose - Upper; (2 1/2" I.D.)		24240
Hose - Lower; Strt. Hose(2 1/2" I.D.)		24240
Hose - Lower - Pipe To Rad.; Molded Hose		21472
Hose - By Pass; (1 3/4" I.D.)		24228
Hose - Inlet To W.P.; (3" I.D.)		24248
Hose - Heater Inlet; (3/4" I.D.)		28442
Hose - Heater Outlet; (5/8" I.D.)		28441
FLD		
Belt - Fan		③▲9510HD
Belt - Hub, Alt. & A.C.	0120984001	2/9510PB
Hose - Upper - Eng. To Pipe; (2 1/2" I.D.)		24240
Hose - Upper - Pipe To Rad.; (2 1/2" I.D.)		24240
Hose - Lower - Eng. To Pipe; (2 1/2" I.D.)		24240
Hose - Lower - Pipe To Rad.; Strt. Hose(2 1/2" I.D.)		24240
Hose - Lower - Pipe To Rad.; Molded Hose		21472
Hose - By Pass; (1 3/4" I.D.)		24228
Hose - Inlet To W.P.; (3" I.D.)		24248
Hose - Heater Inlet; (3/4" I.D.)		28442
Hose - Heater Outlet; (5/8" I.D.)		28441
FLF		
Belt - Fan		③▲9510HD
Belt - Hub, Alt. & A.C.	0120984001	2/9510PB
Hose - Upper - Eng. To Pipe; (2 1/2" I.D.)		24240
Hose - Upper - Pipe To Rad.; (2 1/2" I.D.)		24240
Hose - Lower - Eng. To Pipe; (2 1/2" I.D.)		24240
Hose - Lower - Pipe To Rad.; Strt. Hose(2 1/2" I.D.)		24240
Hose - Lower - Pipe To Rad.; Molded Hose		21472
Hose - By Pass; (1 3/4" I.D.)		24228
Hose - Inlet To W.P.; (3" I.D.)		24248
Hose - Heater Inlet; (3/4" I.D.)		28442
Hose - Heater Outlet; (5/8" I.D.)		28441
Detroit Diesel 6-Cyl. 12.7 L Diesel		
Century Class		
Belt - Fan; Preferred Belt; W/50 3/8" Belt O.C.		3/9500PB
Belt - Fan; Optional Belt; W/50 3/8" Belt O.C.	2310001022	③▲9500HD
Belt - Fan; W/51 3/8" Belt O.C.	2310001037	③▲9510HD
Belt - Alt. & A.C.	0120984001	2/9510PB
Belt - Hub, Alt. & A.C.		②▲9510HD
Hose - Upper - Eng. To Pipe		21891
Hose - Upper - Pipe To Rad.; (2 1/2" I.D.)		24240
Hose - Lower - Eng. To Pipe; (2 1/2" I.D.)		24240
Hose - Lower - Pipe To Rad.; Molded Hose		21472
Hose - Lower - Pipe To Rad.; Strt. Hose(2 1/2" I.D.)		24240

Application	Mfr. Part No.	Our No.
FREIGHTLINER - Continued		
1998 - Continued		
Detroit Diesel 6-Cyl. 12.7 L Diesel - Continued		
Century Class - Continued		
Hose - By Pass; (1 3/4" I.D.)		24228
Hose - Inlet To W.P.; (3" I.D.)		24248
Hose - Heater Inlet; (3/4" I.D.)		28442
Hose - Heater Outlet; (5/8" I.D.)		28441
FLB		
Hose - Upper; (2 1/2" I.D.)		24240
Hose - Lower; Strt. Hose(2 1/2" I.D.)		24240
Hose - Lower - Pipe To Rad.; Molded Hose		21472
Hose - By Pass; (1 3/4" I.D.)		24228
Hose - Inlet To W.P.; (3" I.D.)		24248
Hose - Heater Inlet; (3/4" I.D.)		28442
Hose - Heater Outlet; (5/8" I.D.)		28441
FLC		
Belt - Fan; W/50 3/8" Belt O.C.; Preferred Belt		3/9500PB
Belt - Fan; W/50 3/8" Belt O.C.; Optional Belt	2310001022	③▲9500HD
Belt - Fan; W/51 3/8" Belt O.C.	2310001037	③▲9510HD
Belt - Alt.	0120984001	2/9510PB
Hose - Upper; (2 1/2" I.D.)		24240
Hose - Lower; Strt. Hose(2 1/2" I.D.)		24240
Hose - Lower - Pipe To Rad.; Molded Hose		21472
Hose - By Pass; (1 3/4" I.D.)		24228
Hose - Inlet To W.P.; (3" I.D.)		24248
Hose - Heater Inlet; (3/4" I.D.)		28442
Hose - Heater Outlet; (5/8" I.D.)		28441
FLD		
Belt - Fan		③▲9510HD
Belt - Hub, Alt. & A.C.	0120984001	2/9510PB
Hose - Upper - Eng. To Pipe; (2 1/2" I.D.)		24240
Hose - Upper - Pipe To Rad.; (2 1/2" I.D.)		24240
Hose - Lower - Eng. To Pipe; (2 1/2" I.D.)		24240
Hose - Lower - Pipe To Rad.; Strt. Hose(2 1/2" I.D.)		24240
Hose - Lower - Pipe To Rad.; Molded Hose		21472
Hose - By Pass; (1 3/4" I.D.)		24228
Hose - Inlet To W.P.; (3" I.D.)		24248
Hose - Heater Inlet; (3/4" I.D.)		28442
Hose - Heater Outlet; (5/8" I.D.)		28441
1997		
Caterpillar 3126 Diesel		
FL50; FL60; FL70; FL80		
Belt - Fan, Alt. & A.C.	0123415000	▲K080702HD
Belt - W.P.	0366775	▲9341HD
Tensioner Assy. - Fan, Alt. & A.C.	1352151	38511
Idler Pulley	1445612	36096
Tensioner Pulley - Fan, Alt. & A.C.	1352151	36091
Hose - Lower - Eng. To Pipe; W/2 1/4" I.D. Hose		20748
Hose - Lower - Eng. To Pipe; W/2" I.D. Hose		21571
Hose - Lower - Rad. To Pipe; W/2 1/4" I.D. Hose		21194
Hose - Lower - Rad. To Pipe; W/2" I.D. Hose		≅20611
Caterpillar 3406 Diesel		
Century Class		
Belt - Fan	GT17506	②▲9505HD
Belt - Alt. & A.C.	2310001052	②▲9600HD
Hose - Upper - Eng. To Pipe; (2 1/2" I.D.)		24240
Hose - Lower - Eng. To Pipe; (3" I.D.)		24248
Hose - Lower - Pipe To Rad.; (2 1/2" I.D.)		24240
FLB		
Hose - Upper; (2 1/2" I.D.)		24240
Hose - Lower; (3" I.D.)		24248
FLD		
Belt - Fan; W/51 3/8" Belt O.C.	2310001049	②TR22508
Belt - Fan; Preferred Belt; W/52 1/4" Belt O.C.		2/TR22517PB
Belt - Fan; Optional Belt; W/52 1/4" Belt O.C.	2310001020	②◆TR22517
Belt - Fan; W/54" Belt O.C.	2310001050	②TR22534
Belt - Alt.; Preferred Belt	2310001032	2/9550PB
Belt - Alt.; Optional Belt		②◆▲9550HD

▲ Standard Belt Available. See Pages 630-631.
 ② Two Required.
 ◆ Green Stripe® PowerBand® Belt May Work, Use Template to Check.

③ Three Required.
 ≅ Cut to Fit.

Belts and Coolant Hose for Medium/Heavy-Duty Trucks (1996 and Newer)

Medium & Heavy-Duty Trucks
(1996 & Newer)

Application	Mfr. Part No.	Our No.
FREIGHTLINER - Continued		
1997 - Continued		
Caterpillar 3406 Diesel - Continued		
FLD - Continued		
Belt - Alt. & A.C.; W/60 3/8" Belt O.C.	2310001052	▲9600HD
Belt - Alt. & A.C.; W/62 3/8" Belt O.C.	2310001060	▲9620HD
Hose - Upper - Eng. To Pipe; (2 1/2" I.D.)	24240	24240
Hose - Upper - Pipe To Rad.; (2 1/2" I.D.)	24240	24240
Hose - Lower - Eng. To Pipe; (3" I.D.)	24248	24248
Hose - Lower - Pipe To Rad.; (3" I.D.)	24248	24248
Caterpillar C10 Diesel		
Century Class		
Belt - Fan & Alt.	0123415006	▲K080680HD
Belt - A.C.	2310001039	▲9530HD
Hose - Upper - Pipe To Rad.		21891
FLD		
Belt - Fan & Alt.	0123415006	▲K080680HD
Belt - Fan To A.C.		▲9530HD
Tensioner Assy. - Fan & Alt.	1333544	38514
Tensioner Pulley - Fan & Alt.	1333544	36091
Hose - Upper - Eng. To Pipe		21940
Hose - Upper - Pipe To Rad.		21194
Hose - Lower - Eng. To Pipe		21194
Hose - Lower - Pipe To Rad.; (3" I.D.)		24248
Caterpillar C12 Diesel		
Century Class		
Belt - Fan & Alt.	0123415006	▲K080680HD
Belt - A.C.	2310001039	▲9530HD
Hose - Upper - Pipe To Rad.		21891
FLD		
Belt - Fan & Alt.	0123415006	▲K080680HD
Belt - Fan To A.C.		▲9530HD
Tensioner Assy. - Fan & Alt.	1333544	38514
Tensioner Pulley - Fan & Alt.	1333544	36091
Hose - Upper - Eng. To Pipe		21940
Hose - Upper - Pipe To Rad.		21194
Hose - Lower - Eng. To Pipe		21194
Hose - Lower - Pipe To Rad.; (3" I.D.)		24248
Cummins B Series 5.9 L Diesel		
FL50; FL60; FL70		
Belt - Fan, W.P. & Alt.	3926856	▲K080694HD
Belt - A.C.	2310001067	▲9480HD
Tensioner Assy. - Fan, W.P. & Alt.	3936213	38516
Tensioner Pulley - Fan, W.P. & Alt.	3936213	36093
Hose - Upper - Eng. To Rad.		22669
Hose - Lower - Eng. To Rad.		22670
FL80		
Belt - Fan, W.P. & Alt.	3926856	▲K080694HD
Belt - A.C.	2310001067	▲9480HD
Tensioner Assy. - Fan, Alt. & Hub	3936213	38516
Tensioner Pulley - Fan, Alt. & Hub	3936213	36093
Hose - Upper - Eng. To Rad.		22669
Hose - Lower - Eng. To Rad.		22670
Cummins C Series 8.3 L Diesel		
FL50; FL60; FL70; FL80		
Belt - Fan, W.P. & Alt.	3922605	▲K080594HD
Belt - Fan & Alt.	3911572	▲K080610HD
Belt - A.C.	2310001081	▲9463HD
Tensioner Assy.	3937553	38504
Tensioner Pulley	3937553	36091
Cummins M11 Diesel		
Century Class		
Belt - Fan	6819970593	K080491
Belt - Alt.	3028521	▲K050345HD
Belt - A.C.	2310001062	▲9545HD
Hose - Upper - Eng. To Pipe; (2 1/4" I.D.)		24236
Hose - Upper - Pipe To Rad.; (2 1/2" I.D.)		24240
Hose - Lower; (2 1/2" I.D.)		24240
Hose - By Pass; (1 3/4" I.D.)		24228
FL112		
Belt - Fan	6819970593	▲K080496HD

Application	Mfr. Part No.	Our No.
FREIGHTLINER - Continued		
1997 - Continued		
Cummins M11 Diesel - Continued		
FL112 - Continued		
Belt - Alt.	3028521	▲K050345HD
Belt - A.C.	2310001062	▲9545HD
Hose - Upper - Eng. To Pipe; (2 1/4" I.D.)		24236
Hose - Upper - Pipe To Rad.; (2 1/2" I.D.)		24240
Hose - Lower; (2 1/2" I.D.)		24240
Hose - By Pass; (1 3/4" I.D.)		24228
FLB		
Belt - Fan	6819970693	▲K080570HD
Belt - W.P.	3028521	▲K050345HD
Belt - A.C.		▲9540HD
FLC; FLD		
Belt - Fan	6819970593	▲K080496HD
Belt - Alt.	3028521	▲K050345HD
Belt - A.C.	2310001062	▲9545HD
Hose - Upper - Eng. To Pipe; (2 1/4" I.D.)		24236
Hose - Upper - Pipe To Rad.; (2 1/2" I.D.)		24240
Hose - Lower; (2 1/2" I.D.)		24240
Hose - By Pass; (1 3/4" I.D.)		24228
Cummins N14 Diesel		
Century Class		
Belt - Hub & Fan		②TR28429
Belt - W.P.	3076492	▲K060425HD
Belt - Alt.; Optional Belt		②▲9451HD
Belt - Alt.; Preferred Belt	2310001028	2/9451PB
Belt - A.C.; Optional Belt		②▲9435HD
Belt - A.C.; Preferred Belt	2310001087	2/9435PB
FLB; FLC		
Belt - Fan; Preferred Belt		2/TR28411PB
Belt - Fan; Optional Belt	2310001089	②TR28412
Belt - W.P.	3076492	▲K060425HD
Belt - Alt.; Preferred Belt	2310001028	2/9451PB
Belt - Alt.; Optional Belt		②▲9451HD
Belt - A.C.; Preferred Belt	2310001087	2/9435PB
Belt - A.C.; Optional Belt		②▲9435HD
Hose - Upper; W/O Aftercooler(2" I.D.)		24232
Hose - Upper; W/Aftercooler(2 1/2" I.D.)		24240
Hose - Upper; W/Single Hose		●26510
Hose - Lower; W/Aftercooler(3" I.D.)		24248
Hose - Lower; W/O Aftercooler(2 1/2" I.D.)		24240
Hose - By Pass; (1 1/2" I.D.)		24224
Hose - Aftercooler		21488
Hose - Heater; (3/4" I.D.)		28442
FLD		
Belt - Hub & Fan		②TR28429
Belt - Hub & W.P.		▲K060425HD
Belt - Alt.		②▲9463HD
Belt - Hub & A.C.; Preferred Belt	2310001087	2/9435PB
Belt - Hub & A.C.; Optional Belt		②▲9435HD
Hose - Upper; W/Single Hose		●26510
Hose - Upper - Eng. To Pipe; (2 1/2" I.D.)		24240
Hose - Upper - Pipe To Rad.; (2 1/2" I.D.)		24240
Hose - Lower; W/Aftercooler(3" I.D.)		24248
Hose - Lower; W/O Aftercooler(2 1/2" I.D.)		24240
Hose - By Pass; (1 1/2" I.D.)		24224
Hose - Aftercooler		21488
Hose - Heater; (3/4" I.D.)		28442
Cummins 4-Cyl. 3.9 L Diesel		
MT35		
Belt - Fan & Alt.	3911587	▲K080537HD
Detroit Diesel Series 50 Diesel		
FL106		
Belt - Fan		③▲9465HD
Belt - Fan & Alt.	2310001039	▲9530HD
Belt - Hub & A.C.	0120984004	2/9435PB
Detroit Diesel Series 55 Diesel		
Century Class; FL112		
Belt - Fan	0123683001	▲K060470HD

▲ Standard Belt Available. See Pages 630-631.
● Vulco-Flex® Coolant Hose.

② Two Required.
③ Three Required.

Belts and Coolant Hose for Medium/Heavy-Duty Trucks (1996 and Newer)

 Medium & Heavy-Duty Trucks
(1996 & Newer)

Application	Mfr. Part No.	Our No.
FREIGHTLINER - Continued		
1997 - Continued		
Detroit Diesel Series 55 Diesel - Continued		
Century Class; FL112 - Continued		
Hose - Upper; (2 1/2" I.D.)		24240
Hose - Lower; (2 1/2" I.D.)		24240
Detroit Diesel 6-Cyl. 11.1 L Diesel		
Century Class		
Belt - Fan; Preferred Belt; W/50 3/8" Belt O.C.		3/9500PB
Belt - Fan; Optional Belt; W/50 3/8" Belt O.C.	2310001022	③▲9500HD
Belt - Fan; W/51 3/8" Belt O.C.	2310001037	③▲9510HD
Belt - Alt. & A.C.	0120984001	2/9510PB
FLB		
Hose - Upper; (2 1/2" I.D.)		24240
Hose - Lower; Strt. Hose(2 1/2" I.D.)		24240
Hose - Lower - Pipe To Rad.; Molded Hose		21472
Hose - By Pass; (1 3/4" I.D.)		24228
Hose - Inlet To W.P.; (3" I.D.)		24248
Hose - Heater Inlet; (3/4" I.D.)		28442
Hose - Heater Outlet; (5/8" I.D.)		28441
FLC		
Belt - Fan; W/50 3/8" Belt O.C.; Preferred Belt		3/9500PB
Belt - Fan; W/50 3/8" Belt O.C.; Optional Belt	2310001022	③▲9500HD
Belt - Fan; W/51 3/8" Belt O.C.	2310001037	③▲9510HD
Belt - Alt.	0120984001	2/9510PB
Hose - Upper; (2 1/2" I.D.)		24240
Hose - Lower; Strt. Hose(2 1/2" I.D.)		24240
Hose - Lower - Pipe To Rad.; Molded Hose		21472
Hose - By Pass; (1 3/4" I.D.)		24228
Hose - Inlet To W.P.; (3" I.D.)		24248
Hose - Heater Inlet; (3/4" I.D.)		28442
Hose - Heater Outlet; (5/8" I.D.)		28441
FLD		
Belt - Fan; W/53 1/2" Belt O.C.; Preferred Belt		3/9530PB
Belt - Fan; W/53 1/2" Belt O.C.; Optional Belt		③▲9530HD
Belt - Fan; W/51 1/2" Belt O.C.		③▲9510HD
Belt - Hub, Alt. & A.C.	0120984001	2/9510PB
Hose - Upper - Eng. To Pipe; (2 1/2" I.D.)		24240
Hose - Upper - Pipe To Rad.; (2 1/2" I.D.)		24240
Hose - Lower - Eng. To Pipe; (2 1/2" I.D.)		24240
Hose - Lower - Pipe To Rad.; Strt. Hose(3 1/2" I.D.)		24256
Hose - Lower - Pipe To Rad.; Molded Hose		21472
Hose - By Pass; (1 3/4" I.D.)		24228
Hose - Inlet To W.P.; (3" I.D.)		24248
Hose - Heater Inlet; (3/4" I.D.)		28442
Hose - Heater Outlet; (5/8" I.D.)		28441
Detroit Diesel 6-Cyl. 12.7 L Diesel		
Century Class		
Belt - Fan; Preferred Belt; W/50 3/8" Belt O.C.		3/9500PB
Belt - Fan; Optional Belt; W/50 3/8" Belt O.C.	2310001022	③▲9500HD
Belt - Fan; W/51 3/8" Belt O.C.	2310001037	③▲9510HD
Belt - Alt. & A.C.	0120984001	2/9510PB
FLB		
Hose - Upper; (2 1/2" I.D.)		24240
Hose - Lower; Strt. Hose(2 1/2" I.D.)		24240
Hose - Lower - Pipe To Rad.; Molded Hose		21472
Hose - By Pass; (1 3/4" I.D.)		24228
Hose - Inlet To W.P.; (3" I.D.)		24248
Hose - Heater Inlet; (3/4" I.D.)		28442
Hose - Heater Outlet; (5/8" I.D.)		28441
FLC		
Belt - Fan; W/50 3/8" Belt O.C.; Preferred Belt		3/9500PB
Belt - Fan; W/50 3/8" Belt O.C.; Optional Belt	2310001022	③▲9500HD
Belt - Fan; W/51 3/8" Belt O.C.	2310001037	③▲9510HD
Belt - Alt.	0120984001	2/9510PB
Hose - Upper; (2 1/2" I.D.)		24240
Hose - Lower; Strt. Hose(2 1/2" I.D.)		24240
Hose - Lower - Pipe To Rad.; Molded Hose		21472

③ Three Required.
② Two Required.

Application	Mfr. Part No.	Our No.
FREIGHTLINER - Continued		
1997 - Continued		
Detroit Diesel 6-Cyl. 12.7 L Diesel - Continued		
FLC - Continued		
Hose - By Pass; (1 3/4" I.D.)		24228
Hose - Inlet To W.P.; (3" I.D.)		24248
Hose - Heater Inlet; (3/4" I.D.)		28442
Hose - Heater Outlet; (5/8" I.D.)		28441
FLD		
Belt - Fan; W/53 1/2" Belt O.C.; Preferred Belt		3/9530PB
Belt - Fan; W/53 1/2" Belt O.C.; Optional Belt		③▲9530HD
Belt - Fan; W/51 1/2" Belt O.C.		③▲9510HD
Belt - Hub, Alt. & A.C.	0120984001	2/9510PB
Hose - Upper - Eng. To Pipe; (2 1/2" I.D.)		24240
Hose - Upper - Pipe To Rad.; (2 1/2" I.D.)		24240
Hose - Lower - Eng. To Pipe; (2 1/2" I.D.)		24240
Hose - Lower - Pipe To Rad.; Strt. Hose(3 1/2" I.D.)		24256
Hose - Lower - Pipe To Rad.; Molded Hose		21472
Hose - By Pass; (1 3/4" I.D.)		24228
Hose - Inlet To W.P.; (3" I.D.)		24248
Hose - Heater Inlet; (3/4" I.D.)		28442
Hose - Heater Outlet; (5/8" I.D.)		28441
1996		
Caterpillar 3126 Diesel		
FL50; FL60; FL70; FL80		
Belt - Fan, Alt. & A.C.	0123415000	▲K080702HD
Belt - W.P.	0366775	▲9341HD
Tensioner Assy. - Fan, Alt. & A.C.	1352151	38511
Idler Pulley	1445612	36096
Tensioner Pulley - Fan, Alt. & A.C.	1352151	36091
Hose - Lower - Eng. To Pipe		20748
Hose - Lower - Pipe To Rad.		21194
Caterpillar 3176 Diesel		
FLC		
Belt - Fan & Alt.; W/112" B.B.C.; W/74 1/2" Belt O.C.	6819970493	▲K080740HD
Belt - Fan & Alt.; W/112" B.B.C.; W/74" Belt O.C.	6819970393	▲K080733HD
Belt - Fan & Alt.; W/112" B.B.C.; W/75" Belt O.C.	6819970993	▲K080751HD
Belt - Fan & Alt.; W/120" B.B.C.	6819970293	▲K080680HD
Belt - A.C.; W/45 1/2" Belt O.C.	2310001028	▲9451HD
Belt - A.C.; W/47 1/2" Belt O.C.		▲9470HD
Belt - A.C.; W/48 1/2" Belt O.C.	2310001067	▲9480HD
Belt - A.C.; W/50 1/2" Belt O.C.	2310001022	▲9500HD
Belt - A.C.; W/51 1/2" Belt O.C.	2310001036	▲9510HD
FLD		
Belt - Fan & Alt.; W/112" B.B.C.; W/74 1/2" Belt O.C.	6819970493	▲K080740HD
Belt - Fan & Alt.; W/112" B.B.C.; W/74" Belt O.C.	6819970393	▲K080733HD
Belt - Fan & Alt.; W/112" B.B.C.; W/75" Belt O.C.	6819970993	▲K080751HD
Belt - Fan & Alt.; W/120" B.B.C.	6819970293	▲K080680HD
Belt - A.C.; W/45 1/2" Belt O.C.	2310001028	▲9451HD
Belt - A.C.; W/47 1/2" Belt O.C.		▲9470HD
Belt - A.C.; W/48 1/2" Belt O.C.	2310001067	▲9480HD
Belt - A.C.; W/50 1/2" Belt O.C.	2310001022	▲9500HD
Belt - A.C.; W/51 1/2" Belt O.C.	2310001036	▲9510HD
Hose - Upper - Eng. To Pipe; (2" I.D.)		24232
Hose - Upper - Pipe To Rad.; (2 1/2" I.D.)		24240
Hose - Lower - Eng. To Pipe; (2 1/4" I.D.)		24236
Hose - Lower - Pipe To Rad.; (2 1/2" I.D.)		24240
Hose - Heater Inlet; (3/4" I.D.)		28442
Hose - Heater Outlet; (5/8" I.D.)		28441
Caterpillar 3406 Diesel		
Century Class		
Belt - Fan	GT17506	②▲9505HD
Belt - Alt. & A.C.	2310001052	②▲9600HD
Hose - Upper - Eng. To Pipe; (2 1/2" I.D.)		24240
Hose - Lower - Eng. To Pipe; (3" I.D.)		24248
Hose - Lower - Pipe To Rad.; (2 1/2" I.D.)		24240

▲ Standard Belt Available. See Pages 630-631.

Belts and Coolant Hose for Medium/Heavy-Duty Trucks (1996 and Newer)

Medium & Heavy-Duty Trucks
(1996 & Newer)

Application	Mfr. Part No.	Our No.
FREIGHTLINER - Continued		
1996 - Continued		
Caterpillar 3406 Diesel - Continued		
FLD		
Belt - Fan; Preferred Belt; W/52 1/4" Belt O.C.		2/TR22517PB
Belt - Fan; Optional Belt; W/52 1/4" Belt O.C.		
Belt - Fan; W/54" Belt O.C.	2310001020	②◆TR22517
Belt - Fan, Alt. & A.C.		②TR22534
Belt - Alt.; Preferred Belt	2310001032	②◆9620HD
Belt - Alt.; Optional Belt		2/9550PB
Belt - Alt. & A.C.; W/60 3/8" Belt O.C. ...	2310001052	②◆9550HD
Hose - Upper - Eng. To Pipe; (2 1/2" I.D.)		◆9600HD
Hose - Upper - Pipe To Rad.; (2 1/2" I.D.)		24240
Hose - Lower - Eng. To Pipe; (3" I.D.)		24240
Hose - Lower - Pipe To Rad.; (3" I.D.)		24248
Hose - Lower - Pipe To Rad.; (3" I.D.)		24248
Caterpillar C10 Diesel		
Century Class		
Belt - A.C.	2310001039	◆9530HD
Hose - Upper - Pipe To Rad.		21891
Caterpillar C12 Diesel		
FLD		
Belt - Fan & Alt.	0123415006	◆K080680HD
Belt - Fan To A.C.		◆9530HD
Tensioner Assy. - Fan & Alt.	1333544	38514
Tensioner Pulley - Fan & Alt.	1333544	36091
Hose - Upper - Eng. To Pipe		21940
Hose - Upper - Pipe To Rad.		21194
Hose - Lower - Eng. To Pipe		21194
Hose - Lower - Pipe To Rad.; (3" I.D.)		24248
Cummins B Series 5.9 L Diesel		
FL50; FL60; FL70; FL80		
Belt - Fan & Alt.; W/56 3/8" Belt O.C. ...	3911557	◆K080560HD
Belt - Fan & Alt.; W/57 7/8" Belt O.C. ...	3911562	◆K080575HD
Belt - Fan & Alt.; W/58 3/8" Belt O.C. ...	3911565	◆K080580HD
Belt - A.C.; W/45 1/4" Belt O.C.	2310001043	◆9447HD
Belt - A.C.; W/47" Belt O.C.	2310001081	◆9463HD
Cummins C Series 8.3 L Diesel		
FL50; FL60; FL70		
Belt - Fan, W.P. & Alt.	3922605	◆K080594HD
Belt - Fan & Alt.	3911572	◆K080610HD
Belt - A.C.	2310001081	◆9463HD
Hose - Upper - Eng. To Rad.		21993
FL80		
Belt - Fan, W.P. & Alt.	3922605	◆K080594HD
Belt - Fan & Alt.	3911572	◆K080610HD
Belt - A.C.	2310001081	◆9463HD
Hose - Upper - Eng. To Rad.		21993
Hose - Upper; W/Single Hose		21993
Hose - Lower - Pipe To Rad.		21901
Cummins M11 Diesel		
Century Class; FL112		
Belt - Fan	6819970593	◆K080496HD
Belt - Alt.	3028521	◆K050345HD
Belt - A.C.	2310001062	◆9545HD
Hose - Upper - Eng. To Pipe; (2 1/4" I.D.)		24236
Hose - Upper - Pipe To Rad.; (2 1/2" I.D.)		24240
Hose - Lower; (2 1/2" I.D.)		24240
Hose - By Pass; (1 3/4" I.D.)		24228
FLB		
Belt - Fan	6819970693	◆K080570HD
Belt - W.P.	3028521	◆K050345HD
Belt - A.C.		◆9540HD
FLC		
Belt - Fan	6819970593	◆K080496HD
Belt - Alt.	3028521	◆K050345HD
Belt - A.C.	2310001062	◆9545HD
Hose - Upper - Eng. To Pipe; (2 1/4" I.D.)		24236
Hose - Upper - Pipe To Rad.; (2 1/2" I.D.)		24240
Hose - Lower; (2 1/2" I.D.)		24240
Hose - By Pass; (1 3/4" I.D.)		24228

Application	Mfr. Part No.	Our No.
FREIGHTLINER - Continued		
1996 - Continued		
Cummins M11 Diesel - Continued		
FLD		
Belt - Fan	6819970693	◆K080570HD
Belt - Alt.	3028521	◆K050345HD
Hose - Upper - Eng. To Pipe; (2 1/4" I.D.)		24236
Hose - Upper - Pipe To Rad.; (2 1/2" I.D.)		24240
Hose - Lower; (2 1/2" I.D.)		24240
Hose - By Pass; (1 3/4" I.D.)		24228
Cummins N14 Diesel		
Century Class		
Belt - W.P.	3076492	◆K060425HD
Belt - Hub & Fan; Preferred Belt		2/TR28411PB
Belt - Hub & Fan; Optional Belt		②TR28412
Belt - Alt.; Optional Belt		②◆9451HD
Belt - Alt.; Preferred Belt	2310001028	2/9451PB
Belt - A.C.; Optional Belt		②◆9435HD
Belt - A.C.; Preferred Belt	2310001087	2/9435PB
FLB; FLC		
Belt - W.P.; W/43 1/2" Belt O.C.	3063817	◆K040430HD
Belt - W.P.; W/45" Belt O.C.	3062620	◆K040445HD
Belt - Fan; W/43 1/2" Belt O.C.; Preferred Belt	2310001054	2/TR28429PB
Belt - Fan; W/43 1/2" Belt O.C.; Optional Belt		②TR28429
Belt - Fan; W/44 1/4" Belt O.C.; Preferred Belt	2310001056	2/TR28437PB
Belt - Fan; W/44 1/4" Belt O.C.; Optional Belt		②TR28437
Belt - Fan; W/45 1/8" Belt O.C.	2310001048	TR28445
Belt - Fan; W/47 7/8" Belt O.C.; Preferred Belt	2310001031	2/TR28473PB
Belt - Fan; W/47 7/8" Belt O.C.; Optional Belt		②TR28473
Belt - Fan; W/48 5/8" Belt O.C.; Preferred Belt	2310001044	2/TR28480PB
Belt - Fan; W/48 5/8" Belt O.C.; Optional Belt		②TR28480
Belt - Fan; W/49 7/8" Belt O.C.; Preferred Belt	2310001030	2/TR28492PB
Belt - Fan; W/49 7/8" Belt O.C.; Optional Belt		②TR28492
Belt - Alt.; W/46 1/2" Belt O.C.; Preferred Belt	2310001016	2/9463PB
Belt - Alt.; W/46 1/2" Belt O.C.; Optional Belt		②◆9463HD
Belt - Alt.; W/50 3/4" Belt O.C.; Preferred Belt	2310001029	2/TR28501PB
Belt - Alt.; W/50 3/4" Belt O.C.; Optional Belt		②TR28501
Belt - Alt.; W/90A. Alt.; W/45 1/2" Belt O.C.; Preferred Belt	2310001028	2/9451PB
Belt - Alt.; W/90A. Alt.; W/45 1/2" Belt O.C.; Optional Belt ...		②◆9451HD
Belt - A.C.; W/40 7/8" Belt O.C.		◆9405HD
Belt - A.C.; W/41 3/8" Belt O.C.	2310001035	◆9412HD
Belt - A.C.; W/42 1/2" Belt O.C.		◆9420HD
Belt - A.C.; W/42 7/8" Belt O.C.	2310001015	◆9425HD
Belt - A.C.; W/43 1/2" Belt O.C.	2310001065	◆9430HD
Belt - A.C.; W/44 7/8" Belt O.C.	2310001043	◆9447HD
Belt - A.C.; W/44" Belt O.C.	2310001087	◆9435HD
Belt - A.C.; W/45 3/8" Belt O.C.	2310001025	◆9451HD
Belt - A.C.; W/54 3/8" Belt O.C.		◆9540HD
Hose - Upper; W/O Aftercooler(2" I.D.)		24232
Hose - Upper; W/Aftercooler(2 1/2" I.D.)		24240
Hose - Upper; W/Single Hose		●26510
Hose - Lower; W/Aftercooler(3" I.D.)		24248
Hose - Lower; W/O Aftercooler(2 1/2" I.D.)		24240
Hose - By Pass; (1 1/2" I.D.)		24224
Hose - Aftercooler		21488
Hose - Heater; (3/4" I.D.)		28442
FLD		
Belt - W.P.; W/43 1/2" Belt O.C.	3063817	◆K040430HD
Belt - W.P.; W/45" Belt O.C.	3062620	◆K040445HD
Belt - Fan; W/43 1/2" Belt O.C.; Preferred Belt	2310001054	2/TR28429PB
Belt - Fan; W/43 1/2" Belt O.C.; Optional Belt		②TR28429
Belt - Fan; W/44 1/4" Belt O.C.; Preferred Belt	2310001056	2/TR28437PB
Belt - Fan; W/44 1/4" Belt O.C.; Optional Belt		②TR28437
Belt - Fan; W/45 1/8" Belt O.C.	2310001048	TR28445

② Two Required.

◆ Standard Belt Available. See Pages 630-631.

◆ Green Stripe® PowerBand® Belt May Work, Use Template to Check.

● Vulco-Flex® Coolant Hose.

Belts and Coolant Hose for Medium/Heavy-Duty Trucks (1996 and Newer)

 Medium & Heavy-Duty Trucks
(1996 & Newer)

Application	Mfr. Part No.	Our No.
FREIGHTLINER - Continued		
1996 - Continued		
Cummins N14 Diesel - Continued		
FLD - Continued		
Belt - Fan; W/47 7/8" Belt O.C.;		
Preferred Belt	2310001031	2/TR28473PB
Belt - Fan; W/47 7/8" Belt O.C.; Optional Belt		②TR28473
Belt - Fan; W/48 5/8" Belt O.C.;		
Preferred Belt	2310001044	2/TR28480PB
Belt - Fan; W/48 5/8" Belt O.C.; Optional Belt		②TR28480
Belt - Fan; W/49 7/8" Belt O.C.;		
Preferred Belt	2310001030	2/TR28492PB
Belt - Fan; W/49 7/8" Belt O.C.; Optional Belt		②TR28492
Belt - Alt.; W/46 1/2" Belt O.C.; Preferred		
Belt	2310001016	2/9463PB
Belt - Alt.; W/46 1/2" Belt O.C.; Optional Belt		②▲9463HD
Belt - Alt.; W/50 3/4" Belt O.C.; Preferred		
Belt	2310001029	2/TR28501PB
Belt - Alt.; W/50 3/4" Belt O.C.; Optional Belt		②TR28501
Belt - Alt.; W/90A. Alt.; W/45 1/2" Belt		
O.C.; Preferred Belt	2310001028	2/9451PB
Belt - Alt.; W/90A. Alt.; W/45 1/2" Belt O.C.; Optional Belt ...		②▲9451HD
Belt - A.C.; W/40 7/8" Belt O.C.		▲9405HD
Belt - A.C.; W/41 3/8" Belt O.C.	2310001035	▲9412HD
Belt - A.C.; W/42 1/2" Belt O.C.		▲9420HD
Belt - A.C.; W/42 7/8" Belt O.C.	2310001015	▲9425HD
Belt - A.C.; W/43 1/2" Belt O.C.	2310001065	▲9430HD
Belt - A.C.; W/44 7/8" Belt O.C.	2310001043	▲9447HD
Belt - A.C.; W/44" Belt O.C.	2310001087	▲9435HD
Belt - A.C.; W/45 3/8" Belt O.C.	2310001025	▲9451HD
Belt - A.C.; W/54 3/8" Belt O.C.	2310001062	▲9545HD
Hose - Upper; W/O Aftercooler(2" I.D.)		24232
Hose - Upper; W/Aftercooler(2 1/2" I.D.)		24240
Hose - Upper; W/Single Hose		●26510
Hose - Lower; W/Aftercooler(3" I.D.)		24248
Hose - Lower; W/O Aftercooler(2 1/2" I.D.)		24240
Hose - By Pass; (1 1/2" I.D.)		24224
Hose - Aftercooler		21488
Hose - Heater; (3/4" I.D.)		28442
Detroit Diesel Series 50 Diesel		
FL106		
Belt - Fan		③▲9465HD
Belt - Fan & Alt.	2310001039	▲9530HD
Belt - Hub & A.C.	0120984004	2/9435PB
Detroit Diesel 6-Cyl. 11.1 L Diesel		
FLB		
Belt - Fan		③▲9590HD
Belt - Alt. & A.C.	GT2PB51	2/9510PB
Hose - Upper - Eng. To Pipe; (2 1/2" I.D.)		24240
Hose - Upper - Rad. To Pipe; (2 1/2" I.D.)		24240
Hose - Lower - Eng. To Pipe; (2 1/2" I.D.)		24240
Hose - Lower - Rad. To Pipe; (2 1/2" I.D.)		24240
FLD		
Belt - Fan; W/53 1/2" Belt O.C.; Preferred Belt		3/9530PB
Belt - Fan; W/53 1/2" Belt O.C.; Optional Belt		③▲9530HD
Belt - Fan; W/52 1/2" Belt O.C.	GT17522	▲9520HD
Belt - Alt. & A.C.		2/9545PB
Hose - Upper; (2 1/2" I.D.)		24240
Hose - Lower - Pipe To Rad.; Strt. Hose(2 1/2" I.D.)		24240
Hose - Lower - Pipe To Rad.; Molded Hose		21472
Hose - By Pass; (1 3/4" I.D.)		24228
Hose - Inlet To W.P.; (3" I.D.)		24248
Hose - Heater Inlet; (3/4" I.D.)		28442
Hose - Heater Outlet; (5/8" I.D.)		28441
Detroit Diesel 6-Cyl. 12.7 L Diesel		
FLB		
Belt - Fan		③▲9590HD
Belt - Alt. & A.C.	GT2PB51	2/9510PB
Hose - Upper - Eng. To Pipe; (2 1/2" I.D.)		24240
Hose - Upper - Rad. To Pipe; (2 1/2" I.D.)		24240
Hose - Lower - Eng. To Pipe; (2 1/2" I.D.)		24240
Hose - Lower - Rad. To Pipe; (2 1/2" I.D.)		24240

② Two Required.
● Vulco-Flex® Coolant Hose.

Application	Mfr. Part No.	Our No.
FREIGHTLINER - Continued		
1996 - Continued		
Detroit Diesel 6-Cyl. 12.7 L Diesel - Continued		
FLC		
Belt - Fan; W/50 3/8" Belt O.C.; Preferred Belt		3/9500PB
Belt - Fan; W/50 3/8" Belt O.C.; Optional		
Belt	2310001022	③▲9500HD
Belt - Fan; W/51 3/8" Belt O.C.	2310001037	③▲9510HD
Belt - Alt.	0120984001	2/9510PB
Hose - Upper; (2 1/2" I.D.)		24240
Hose - Lower; Strt. Hose(2 1/2" I.D.)		24240
Hose - Lower - Pipe To Rad.; Molded Hose		21472
Hose - By Pass; (1 3/4" I.D.)		24228
Hose - Inlet To W.P.; (3" I.D.)		24248
Hose - Heater Inlet; (3/4" I.D.)		28442
Hose - Heater Outlet; (5/8" I.D.)		28441
FLD		
Belt - Fan; W/53 1/2" Belt O.C.; Preferred Belt		3/9530PB
Belt - Fan; W/53 1/2" Belt O.C.; Optional Belt		③▲9530HD
Belt - Fan; W/52 1/2" Belt O.C.	GT17522	▲9520HD
Belt - Alt. & A.C.		2/9545PB
Hose - Upper; (2 1/2" I.D.)		24240
Hose - Lower - Pipe To Rad.; Strt. Hose(2 1/2" I.D.)		24240
Hose - Lower - Pipe To Rad.; Molded Hose		21472
Hose - By Pass; (1 3/4" I.D.)		24228
Hose - Inlet To W.P.; (3" I.D.)		24248
Hose - Heater Inlet; (3/4" I.D.)		28442
Hose - Heater Outlet; (5/8" I.D.)		28441
Dodge V-8 5.9 L		
FL50; FL60; FL70		
Serpentine Belt; W/A.C.; W/Hyd. Brakes 2312178002		K071157
Dodge V-10 8.0 L		
FL50; FL60; FL70		
Serpentine Belt; W/A.C.	53041067	K071134
Hose - Upper - Eng. To Pipe		●26517
Hose - Lower - Eng. To Pipe		20206
GMC		
2010		
Isuzu 4HK1-TC Diesel		
W3500; W5500; W5500HD		
Belt - Fan & Alt.	8980031870	K070404HD
Belt - A.C.	8980108410	▲9650HD
2009		
Caterpillar C7 Diesel		
C6500; C7500; C8500		
Belt - Fan, A.C., Alt. & W.P.	12605194	▲K080810HD
Tensioner Assy. - Fan, A.C., Alt. & W.P.	15170283	38586
GM V-8 6.0 L		
W3500; W4500		
Belt - A.C.; Installation Tool Required ...	12603509	K040355SF
Belt - Fan, Alt. & P.S.	8980361660	▲K061010HD
Stretch Fit Belt Installation Tool		91030
Tensioner Assy. - Fan, Alt. & P.S.	12609719	39083
GM V-8 6.6 L Diesel		
C4500; C5500		
Belt - Fan, Alt., P.S. & A.C.	98035629	K061203
Tensioner Assy. - Fan, Alt., P.S. & A.C.	97329062	38172
Idler Pulley - Upper (Smooth)	98072072	36310
Idler Pulley - Lower (Smooth)	98072072	36310
GM V-8 8.1 L		
C4500; C5500; C6500; C7500; C8500		
Belt - Fan, Alt., P.S. & A.C.	12617797	▲K061000HD
Tensioner Assy. - Fan, Alt., P.S. & A.C.	12581203	38258
Idler Pulley - Fan, Alt. & A.C.	12580771	36299
Hose - Upper - Eng. To Rad.		22769

▲ Standard Belt Available. See Pages 630-631.
③ Three Required.

Belts and Coolant Hose for Medium/Heavy-Duty Trucks (1996 and Newer)

Medium & Heavy-Duty Trucks
(1996 & Newer)

Application	Mfr. Part No.	Our No.
GMC - Continued		
2009 - Continued		
Isuzu 4HK1-TC Diesel		
W3500; W5500; W5500HD		
Belt - Fan & Alt.	8980031870	K070404HD
Belt - A.C.	8980108410	▲9650HD
Isuzu 6HK1-TC Diesel		
C6500; C7500; C8500		
Belt - Fan, Alt. & A.C.	15020893	▲K070786HD
Belt - W.P.; V-Belt	1136714641	TR22461
Tensioner Assy. - Fan, Alt. & A.C.	12597859	38548
Idler Pulley - Fan, Alt. & A.C.	89022559	36096
Hose - Upper - Eng. To Rad.		22767
Hose - Lower - Eng. To Rad.		22768
2008		
Caterpillar C7 Diesel		
C6500; C7500; C8500		
Belt - Fan, A.C., Alt. & W.P.	12605194	▲K080810HD
Tensioner Assy. - Fan, A.C., Alt. & W.P.	15170283	38586
GM V-8 6.0 L		
W3500; W4500		
Belt - A.C.; Installation Tool Required ...	12603509	K040355SF
Belt - Fan, Alt. & P.S.	8980361660	▲K0101010HD
Stretch Fit Belt Installation Tool		91030
Tensioner Assy. - Fan, Alt. & P.S.	12609719	39083
Idler Pulley	97252188	38006
GM V-8 6.6 L Diesel		
C4500; C5500		
Belt - Fan, Alt., P.S. & A.C.	98035629	K061203
Tensioner Assy. - Fan, Alt., P.S. & A.C.	97329062	38172
Tensioner Assy.	8973290620	38172
Idler Pulley; W/Flat Idler Pulley	97209546	36310
Idler Pulley; W/O A.C.	14102597	36177
Tensioner Pulley	8973290620	36239
GM V-8 8.1 L		
C4500; C5500		
Belt - Fan, Alt., P.S. & A.C.	12576754	▲K060994HD
Tensioner Assy. - Fan, Alt., P.S. & A.C.	12581203	38258
Idler Pulley	12580771	36299
Tensioner Pulley	12581203	38006
Hose - Upper		22769
Hose - Lower		22770
C6500; C7500; C8500		
Belt - Fan, Alt., P.S. & A.C.	15768485	▲K071247HD
Belt - Fan, Alt. & P.S.; W/O A.C.	15021740	▲K071056HD
Belt - Air Compr.	15074400	▲K040745HD
Tensioner Assy. - Fan, Alt., P.S. & A.C.	15021742	38256
Tensioner Pulley - Fan, Alt., P.S. & A.C.	15021742	38033
Tensioner Pulley - Fan & Air Compr.	15001551	38006
Hose - Upper		22769
Hose - Lower		22770
Isuzu 4HK1-TC Diesel		
W3500; W4500; W5500; W5500HD		
Belt - W.P., Fan & Alt.	8980031870	K070404HD
Belt - A.C.	8980108410	▲9650HD
Isuzu 6HK1-TC Diesel		
C6500; C7500; C8500		
Belt - Fan, Alt. & A.C.	15020893	▲K070786HD
Belt - W.P.	1136714641	TR22461
Tensioner Assy. - Fan, Alt. & A.C.	12597859	38548
Idler Pulley - Fan, Alt. & A.C.	89022559	36096
Hose - Upper - Eng. To Rad.		22767
Hose - Lower - Eng. To Rad.		22768
T6500; T7500; T8500		
Belt - Fan, Alt. & A.C.	15065874	▲K080726HD
Tensioner Assy. - Fan, Alt. & A.C.	15098394	38579
Hose - Upper - Eng. To Rad.		22855

Application	Mfr. Part No.	Our No.
GMC - Continued		
2007		
Caterpillar C7 Diesel		
C6500; C7500; C8500		
Belt - Fan, Alt. & A.C.	15170173	▲K080806HD
Tensioner Assy. - Fan, Alt. & A.C.	15170283	38586
Idler Pulley	89022559	36096
GM V-8 6.0 L		
W3500; W4500		
Belt - Fan, Alt. & P.S.	12576754	▲K060994HD
Belt - A.C.	12576447	▲K040378HD
Tensioner Assy. - Alt. & P.S.	12580162	38158
Tensioner Assy. - A.C.	12580196	38159
Tensioner Pulley - Alt. & P.S.	12580162	38009
Tensioner Pulley - A.C.	12580196	36169
Hose - Upper - Eng. To Rad.		23098
Hose - Lower - Eng. To Rad.		23097
GM V-8 6.6 L Diesel		
C4500; C5500		
Belt - Fan, Alt., P.S. & A.C.; W/105A. Alt.	97300654	▲K061187HD
Belt - Fan, Alt., P.S. & A.C.; W/150A. Alt.	97300656	▲K061195HD
Belt - Fan, Alt., P.S. & A.C.; W/Dual 105A. Alts.	97300655	▲K061360HD
Tensioner Assy.	8973290620	38172
Idler Pulley; W/Flat Idler Pulley	97209546	36310
Idler Pulley; W/O A.C.	14102597	36177
Tensioner Pulley	8973290620	36239
Hose - Upper - Eng. To Rad.		22763
GM V-8 8.1 L		
C4500; C5500		
Belt - Fan, Alt., P.S. & A.C.; W/150A. Alt.	12576754	▲K060994HD
Belt - Fan, Alt., P.S. & A.C.; W/105A. Alt.	12576755	▲K061140HD
Belt - Fan, Alt. & P.S.; W/150A. Alt.; W/O A.C.	12576751	▲K060910HD
Belt - Fan, Alt. & P.S.; W/105A. Alt.; W/O A.C.	12576752	▲K061058HD
Tensioner Assy.	12581203	38258
Idler Pulley - Smooth	12580771	36299
Idler Pulley - Grooved; W/O A.C.	12580774	38008
Tensioner Pulley	12581203	38006
Hose - Upper - Eng. To Rad.		22769
Hose - Lower - Eng. To Rad.		22770
C6500; C7500; C8500		
Belt - Fan, Alt., P.S. & A.C.	15768485	▲K071247HD
Belt - Fan, Alt. & P.S.; W/O A.C.	15021740	▲K071056HD
Belt - Air Compr.	15074400	▲K040745HD
Tensioner Assy. - Fan, Alt., P.S. & A.C.	15021742	38256
Tensioner Pulley - Fan, Alt., P.S. & A.C.	15021742	38033
Tensioner Pulley - Fan & Air Compr.	15001551	38006
Hose - Upper - Eng. To Rad.		22854
Hose - Lower - Eng. To Rad.		22771
Isuzu 4HK1-TC Diesel		
W3500; W4500; W5500; W5500HD		
Belt - Fan & Alt.	8971801811	②▲9420HD
Belt - Alt. & A.C.	8971801832	▲9620HD
Hose - Upper - Eng. To Rad.		23096
Hose - Lower - Eng. To Rad.		23095
Isuzu 6HK1-TC Diesel		
C6500; C7500; C8500		
Belt - Fan, Alt. & A.C.	15020893	▲K070786HD
Belt - W.P. & P.S.	97730199	TR22461
Hose - Upper - Eng. To Rad.		22767
Hose - Lower - Eng. To Rad.		22768
T6500; T7500; T8500		
Belt - Fan, Alt. & A.C.	15065874	▲K080726HD
Belt - Fan & Alt.	15065875	▲K080550HD
Tensioner Assy. - Fan, Alt. & A.C.	15098394	38579
Hose - Upper - Eng. To Rad.		22855
Hose - Lower - Eng. To Rad.		22856

▲ Standard Belt Available. See Pages 630-631.

② Two Required.

Belts and Coolant Hose for Medium/Heavy-Duty Trucks (1996 and Newer)

 Medium & Heavy-Duty Trucks
(1996 & Newer)

Application	Mfr. Part No.	Our No.
GMC - Continued		
2006		
Caterpillar C7 Diesel		
C6500; C7500; C8500		
Belt - Fan, Alt. & A.C.	15170173	♣K080806HD
Tensioner Assy. - Fan, Alt. & A.C.	15170283	38586
Idler Pulley	89022559	36096
Hose - Upper - Eng. To Rad.		23087
Hose - Lower - Eng. To Rad.		23088
GM V-8 6.0 L		
W3500; W4500		
Belt - Fan, Alt. & P.S.	12576754	♣K060994HD
Belt - A.C.	12576447	♣K040378HD
Tensioner Assy. - Alt. & P.S.	12580162	38158
Tensioner Assy. - A.C.	12580196	38159
Tensioner Pulley - Alt. & P.S.	12580162	38009
Tensioner Pulley - A.C.	12580196	36169
Hose - Upper - Eng. To Rad.		23098
Hose - Lower - Eng. To Rad.		23097
GM V-8 6.6 L Diesel		
C4500; C5500		
Belt - Fan, Alt., P.S. & A.C.; W/105A. Alt. 97300654		♣K061187HD
Belt - Fan, Alt., P.S. & A.C.; W/150A. Alt. 97300656		♣K061195HD
Belt - Fan, Alt., P.S. & A.C.; W/Dual 105A. Alts.	97300655	♣K061360HD
Tensioner Assy.	97288625	38172
Idler Pulley; W/Flat Idler Pulley	97209546	36310
Idler Pulley; W/O A.C.	14102597	36177
Tensioner Pulley	97288625	36239
Hose - Upper - Eng. To Rad.		22763
Hose - Lower - Eng. To Rad.		22771
GM V-8 8.1 L		
C4500; C5500		
Belt - Fan, Alt. & P.S.; W/O A.C.; W/Dual 105A. Alts.	12563074	♣K061058HD
Belt - Fan, Alt., P.S. & A.C.; W/Single 150A. Alt.	12563076	♣K060994HD
Tensioner Assy.	12581203	38258
Idler Pulley; W/A.C.	12580771	36299
Idler Pulley - Smooth; W/O A.C.	12580771	36299
Idler Pulley - Grooved; W/O A.C.	12580774	38008
Tensioner Pulley	12581203	38006
Hose - Upper - Eng. To Rad.		22769
Hose - Lower - Eng. To Rad.		22770
C6500; C7500; C8500		
Belt - Fan, Alt., P.S. & A.C.	15768485	♣K071247HD
Belt - Fan, Alt. & P.S.; W/O A.C.	15021740	♣K071056HD
Belt - Air Compr.	15074400	♣K040745HD
Tensioner Assy. - Fan, Alt., P.S. & A.C.	15021742	38256
Tensioner Pulley - Fan, Alt., P.S. & A.C.	15021742	38033
Tensioner Pulley - Fan & Air Compr.	15001551	38006
Hose - Upper - Eng. To Rad.		22854
Hose - Lower - Eng. To Rad.		22771
Isuzu 4HK1-TC Diesel		
W3500; W4500; W5500; W5500HD		
Belt - Fan & Alt.	8971801811	②♣9420HD
Belt - Alt. & A.C.	8971801832	♣9620HD
Hose - Upper - Eng. To Rad.		23096
Hose - Lower - Eng. To Rad.		23095
Isuzu 6HK1-TC Diesel		
C6500; C7500; C8500		
Belt - Fan, Alt. & A.C.	15020893	♣K070786HD
Belt - W.P. & P.S.	97730199	TR22461
Tensioner Assy.	15008841	38548
Hose - Upper - Eng. To Rad.		22767
Hose - Lower - Eng. To Rad.		22768
T6500; T7500; T8500		
Belt - Fan, Alt. & A.C.	15065874	♣K080726HD
Belt - Fan & Alt.	15065875	♣K080550HD
Tensioner Assy. - Fan, Alt. & A.C.	15098394	38579
Hose - Upper - Eng. To Rad.		22855

♣ Standard Belt Available. See Pages 630-631.

Application	Mfr. Part No.	Our No.
GMC - Continued		
2006 - Continued		
Isuzu 6HK1-TC Diesel - Continued		
T6500; T7500; T8500 - Continued		
Hose - Lower - Eng. To Rad.		22856
2005		
Caterpillar C7 Diesel		
C6500; C7500; C8500		
Belt - Fan, Alt. & A.C.	15170173	♣K080806HD
Tensioner Assy. - Fan, Alt. & A.C.	15170283	38586
Idler Pulley	89022559	36096
Hose - Upper - Eng. To Rad.; W/O H.D. Cool.		23087
Hose - Upper - Eng. To Rad.; W/H.D. Cool.		23099
Hose - Lower - Eng. To Rad.		23088
GM V-8 6.0 L		
W3500; W4500		
Belt - Fan, Alt. & P.S.	12576754	♣K060994HD
Belt - A.C.	12576447	♣K040378HD
Tensioner Assy. - Alt. & P.S.	12580162	38158
Tensioner Assy. - A.C.	12580196	38159
Idler Pulley	12580771	36299
Tensioner Pulley - Alt. & P.S.	12580162	38009
Tensioner Pulley - A.C.	12580196	36169
Hose - Upper - Eng. To Rad.		23098
Hose - Lower - Eng. To Rad.		23097
GM V-8 6.6 L Diesel		
C4500; C5500		
Belt - Fan, Alt., P.S. & A.C.; W/105A. Alt. 97300654		♣K061187HD
Belt - Fan, Alt., P.S. & A.C.; W/150A. Alt. 97300656		♣K061195HD
Belt - Fan, Alt., P.S. & A.C.; W/Dual 105A. Alts.	97300655	♣K061360HD
Tensioner Assy.	97288625	38172
Idler Pulley; W/Flat Idler Pulley	97209546	36310
Idler Pulley; W/O A.C.	14102597	36177
Tensioner Pulley	97288625	36239
Hose - Upper - Eng. To Rad.		22763
Hose - Lower - Eng. To Rad.		22771
GM V-8 8.1 L		
C4500; C5500		
Belt - Fan, Alt., P.S. & A.C.; W/Single 105A. Alt.	12563075	♣K060988HD
Belt - Fan, Alt. & P.S.; W/O A.C.; W/Single 105A. Alt.	12563072	♣K060905HD
Belt - Fan, Alt., P.S. & A.C.; W/Dual 105A. Alts.	12563077	♣K061140HD
Belt - Fan, Alt. & P.S.; W/O A.C.; W/Dual 105A. Alts.	12563074	♣K061058HD
Belt - Fan, Alt., P.S. & A.C.; W/Single 150A. Alt.	12563076	♣K060994HD
Tensioner Assy.	12581203	38258
Idler Pulley; W/A.C.	12580771	36299
Idler Pulley - Smooth; W/O A.C.	12580771	36299
Idler Pulley - Grooved; W/O A.C.	12580774	38008
Tensioner Pulley	12581203	38006
Hose - Upper - Eng. To Rad.		22769
Hose - Lower - Eng. To Rad.		22770
C6500; C7500; C8500		
Belt - Fan, Alt., P.S. & A.C.	15768485	♣K071247HD
Belt - Fan, Alt. & P.S.; W/O A.C.	15021740	♣K071056HD
Belt - Air Compr.	15074400	♣K040745HD
Tensioner Assy. - Fan, Alt., P.S. & A.C.	15021742	38256
Tensioner Pulley - Fan, Alt., P.S. & A.C.	15021742	38033
Tensioner Pulley - Fan & Air Compr.	15001551	38006
Hose - Upper - Eng. To Rad.		22854
Hose - Lower - Eng. To Rad.		22771
Isuzu 4HK1-TC Diesel		
W3500; W4500		
Belt - Fan & Alt.	8971801811	②♣9420HD
Belt - Alt. & A.C.	8971801832	♣9620HD
Hose - Upper - Eng. To Rad.		23096
Hose - Lower - Eng. To Rad.		23095

② Two Required.

Belts and Coolant Hose for Medium/Heavy-Duty Trucks [1996 and Newer]

Medium & Heavy-Duty Trucks
(1996 & Newer)

Application	Mfr. Part No.	Our No.
GMC - Continued		
2005 - Continued		
Isuzu 4HK1-TC Diesel - Continued		
W5500; W5500HD		
Belt - Fan & Alt.	8971801811	♣9420HD
Belt - Alt. & A.C.	8971801832	♣9620HD
Hose - Upper - Eng. To Rad.		23096
Hose - Lower - Eng. To Rad.		23095
Isuzu 6HK1-TC Diesel		
C6500; C7500; C8500		
Belt - Fan, Alt. & A.C.	15020893	♣K070786HD
Belt - W.P. & P.S.	97730199	TR22461
Tensioner Assy. - Fan, Alt. & A.C.	15008841	38548
Hose - Upper - Eng. To Rad.		22767
Hose - Lower - Eng. To Rad.		22768
T6500; T7500; T8500		
Belt - Fan, Alt. & A.C.	15065874	♣K080726HD
Belt - Fan & Alt.	15065875	♣K080550HD
Tensioner Assy. - Fan, Alt. & A.C.	15098394	38579
Hose - Upper - Eng. To Rad.		22855
Hose - Lower - Eng. To Rad.		22856
2004		
Caterpillar C7 Diesel		
C6500; C7500; C8500		
Belt - Fan, Alt. & A.C.	15170173	♣K080806HD
Tensioner Assy. - Fan, Alt. & A.C.	15170283	38586
Idler Pulley	89022559	36096
Hose - Upper - Eng. To Rad.; W/O H.D. Cool.		23087
Hose - Upper - Eng. To Rad.; W/H.D. Cool.		23099
Hose - Lower - Eng. To Rad.		23088
GM V-8 6.0 L		
W3500; W4500		
Belt - Fan, Alt. & P.S.		♣K060994HD
Belt - A.C.	12576447	♣K040378HD
Tensioner Assy. - Alt. & P.S.	12580162	38158
Tensioner Assy. - A.C.	12580196	38159
Idler Pulley	12580771	36299
Tensioner Pulley - Alt. & P.S.	12580162	38009
Tensioner Pulley - A.C.	12580196	36169
Hose - Upper - Eng. To Rad.		23098
Hose - Lower - Eng. To Rad.		23097
GM V-8 6.6 L Diesel		
C4500; C5500		
Belt - Fan, Alt., P.S. & A.C.; W/105A. Alt.	97300654	♣K061187HD
Belt - Fan, Alt., P.S. & A.C.; W/150A. Alt.	97300656	♣K061195HD
Belt - Fan, Alt., P.S. & A.C.; W/Dual		
105A. Alts.	97300655	♣K061360HD
Tensioner Assy.	97288625	38172
Idler Pulley; W/Flat Idler Pulley	97209546	36310
Idler Pulley; W/O A.C.	14102597	36177
Tensioner Pulley	97288625	36239
Hose - Upper - Eng. To Rad.		22763
Hose - Lower - Eng. To Rad.		22771
GM V-8 8.1 L		
C4500; C5500		
Belt - Fan, Alt., P.S. & A.C.; W/Single		
105A. Alt.	12563075	♣K060988HD
Belt - Fan, Alt. & P.S.; W/O A.C.;		
W/Single 105A. Alt.	12563072	♣K060905HD
Belt - Fan, Alt., P.S. & A.C.; W/Dual		
105A. Alts.	12563077	♣K061140HD
Belt - Fan, Alt. & P.S.; W/O A.C.; W/Dual		
105A. Alts.	12563074	♣K061058HD
Belt - Fan, Alt., P.S. & A.C.; W/Single		
150A. Alt.	12563076	♣K060994HD
Tensioner Assy.	12581203	38258
Idler Pulley; W/A.C.	12580771	36299
Idler Pulley - Smooth; W/O A.C.	12580771	36299
Idler Pulley - Grooved; W/O A.C.	12580774	38008
Tensioner Pulley	12581203	38006
Hose - Upper - Eng. To Rad.		22769

Application	Mfr. Part No.	Our No.
GMC - Continued		
2004 - Continued		
GM V-8 8.1 L - Continued		
C4500; C5500 - Continued		
Hose - Lower - Eng. To Rad.		22770
C6500; C7500; C8500		
Belt - Fan, Alt., P.S. & A.C.	15768485	♣K071247HD
Belt - Fan, Alt. & P.S.; W/O A.C.	15021740	♣K071056HD
Belt - Air Compr.	15074400	♣K040745HD
Tensioner Assy. - Fan, Alt., P.S. & A.C.	15021742	38256
Tensioner Pulley - Fan, Alt., P.S. & A.C.	15021742	38033
Tensioner Pulley - Fan & Air Compr.	15001551	38006
Hose - Upper - Eng. To Rad.		22854
Hose - Lower - Eng. To Rad.		22771
Isuzu 4HE1-TC Diesel		
W3500; W4500; W5500		
Belt - Fan & Alt.	8971801811	②♣9420HD
Belt - Alt. & A.C.	8971801832	♣9620HD
Hose - Upper - Eng. To Rad.		23096
Hose - Lower - Eng. To Rad.		23095
Isuzu 6HK1-TC Diesel		
C6500; C7500; C8500		
Belt - Fan, Alt. & A.C.	15020893	♣K070786HD
Belt - W.P. & P.S.	97730199	TR22461
Tensioner Assy. - Fan, Alt. & A.C.	15008841	38548
Hose - Upper - Eng. To Rad.		22767
Hose - Lower - Eng. To Rad.		22768
T6500; T7500; T8500		
Belt - Fan, Alt. & A.C.	15065874	♣K080726HD
Belt - Fan & Alt.	15065875	♣K080550HD
Tensioner Assy. - Fan, Alt. & A.C.	15098394	38579
Hose - Upper - Eng. To Rad.		22855
Hose - Lower - Eng. To Rad.		22856
W4500; W5500; WT5500		
Belt - Fan & Alt.	1136714641	②TR22461
Belt - A.C.	8943951720	TR22434
Hose - Upper - Eng. To Rad.		22733
Hose - Lower - Eng. To Rad.		22734
2003		
Caterpillar 3126 Diesel		
C6500; C7500; C8500		
Belt - Fan, Alt. & A.C.	15008836	♣K070835HD
Belt - Fan & Alt.; W/O A.C.	15043146	♣K070709HD
Belt - W.P.	0618384	♣9335HD
Tensioner Assy.	15083306	38557
Idler Pulley	89022559	36096
Tensioner Pulley	15083306	36091
Hose - Upper - Eng. To Rad.; W/H.D. Cool.		22764
Hose - Upper - Eng. To Rad.; W/O H.D. Cool.		22765
Hose - Lower - Eng. To Rad.		22766
T5500; T6500; T7500; T8500		
Belt - Fan & Alt.	15149560	♣K070553HD
Belt - Fan, Alt. & A.C.	15985715	♣K070677HD
Belt - Hub & W.P.	0366775	♣9341HD
Tensioner Assy.	15999618	38578
Tensioner Pulley	15999618	36091
Hose - Upper - Eng. To Rad.		22706
Hose - Lower - Eng. To Rad.		22705
GM V-8 5.7 L		
W3500; W4500		
Belt - Fan, Alt., P.S. & A.C.	8971106400	♣K061010HD
Tensioner Assy. - Fan, Alt., P.S. & A.C.	8971619590	38528
Hose - Upper - Eng. To Rad.		22731
Hose - Lower - Eng. To Rad.		22732
GM V-8 6.0 L		
W4500		
Belt - Fan, Alt. & P.S.		♣K060994HD
Belt - A.C.	12576447	♣K040378HD
Tensioner Assy. - Alt. & P.S.	12580162	38158
Tensioner Assy. - A.C.	12580196	38159

♣ Standard Belt Available. See Pages 630-631.

② Two Required.

Belts and Coolant Hose for Medium/Heavy-Duty Trucks (1996 and Newer)

 Medium & Heavy-Duty Trucks
(1996 & Newer)

Application	Mfr. Part No.	Our No.
GMC - Continued		
2003 - Continued		
GM V-8 6.0 L - Continued		
W4500 - Continued		
Idler Pulley	12580771	36299
Tensioner Pulley - Alt. & P.S.	12580162	38009
Tensioner Pulley - A.C.	12580196	36169
Hose - Upper - Eng. To Rad.		23098
Hose - Lower - Eng. To Rad.		23097
GM V-8 6.6 L Diesel		
C4500; C5500		
Belt - Fan, Alt., P.S. & A.C.; W/105A. Alt. 97300654		♣K061187HD
Belt - Fan, Alt., P.S. & A.C.; W/150A. Alt. 97300656		♣K061195HD
Belt - Fan, Alt., P.S. & A.C.; W/Dual 105A. Alts.	97300655	♣K061360HD
Tensioner Assy.	97288625	38172
Idler Pulley; W/Flat Idler Pulley	97209546	36310
Idler Pulley; W/O A.C.	14102597	36177
Tensioner Pulley	97288625	36239
Hose - Upper - Eng. To Rad.		22763
Hose - Lower - Eng. To Rad.		22771
GM V-8 8.1 L		
C4500; C5500		
Belt - Fan, Alt., P.S. & A.C.; W/Single 105A. Alt.	12563075	♣K060988HD
Belt - Fan, Alt. & P.S.; W/O A.C.; W/Single 105A. Alt.	12563072	♣K060905HD
Belt - Fan, Alt., P.S. & A.C.; W/Dual 105A. Alts.	12563077	♣K061140HD
Belt - Fan, Alt. & P.S.; W/O A.C.; W/Dual 105A. Alts.	12563074	♣K061058HD
Belt - Fan, Alt., P.S. & A.C.; W/Single 150A. Alt.	12563076	♣K060994HD
Belt - Fan, Alt. & P.S.; W/O A.C.; W/Single 150A. Alt.	12563073	♣K060910HD
Tensioner Assy.	12581203	38258
Idler Pulley; W/A.C.	12580771	36299
Idler Pulley - Smooth; W/O A.C.	12580771	36299
Idler Pulley - Grooved; W/O A.C.	12580774	38008
Tensioner Pulley	12581203	38006
Hose - Upper - Eng. To Rad.		22769
Hose - Lower - Eng. To Rad.		22770
C6500; C7500; C8500		
Belt - Fan, Alt., P.S. & A.C.	15768485	♣K071247HD
Belt - Fan, Alt. & P.S.; W/O A.C.	15021740	♣K071056HD
Belt - Air Compr.	15074400	♣K040745HD
Tensioner Assy. - Fan, Alt., P.S. & A.C.	15021742	38256
Tensioner Pulley - Fan, Alt., P.S. & A.C.	15021742	38033
Tensioner Pulley - Fan & Air Compr.	15001551	38006
Hose - Upper - Eng. To Rad.		22854
Isuzu 4HE1-TC Diesel		
W3500; W4500; W5500		
Belt - Fan & Alt.	8971801811	②♣9420HD
Belt - Alt. & A.C.	8971801832	♣9620HD
Hose - Upper - Eng. To Rad.		23096
Hose - Lower - Eng. To Rad.		23095
Isuzu 6HK1-TC Diesel		
C6500; C7500; C8500		
Belt - Fan, Alt. & A.C.	15020893	♣K070786HD
Belt - W.P. & P.S.	97730199	TR22461
Tensioner Assy. - Fan, Alt. & A.C.	15008841	38548
Hose - Upper - Eng. To Rad.		22767
Hose - Lower - Eng. To Rad.		22768
T5500; T6500; T7500; T8500; W5500; WT5500		
Belt - Fan & Alt.	94395171	②TR22461
Belt - A.C.	94395172	TR22434
Hose - Upper - Eng. To Rad.		22733
Hose - Lower - Eng. To Rad.		22734

♣ Standard Belt Available. See Pages 630-631.

Application	Mfr. Part No.	Our No.
GMC - Continued		
2002		
Caterpillar 3126 Diesel		
C5500; C6500; C7500; C8500		
Belt - Fan & Alt.; W/O A.C.	15670937	♣K070705HD
Belt - Fan, Alt. & A.C.	15690236	♣K070733HD
Belt - W.P.	0366775	♣9341HD
Tensioner Assy.	7E3999	38509
Idler Pulley	89022559	36096
Tensioner Pulley	7E3999	36091
Hose - Upper - Eng. To Rad.; W/Conventional Hood		22032
Hose - Upper - Eng. To Rad.; W/High Visibility Hood		22664
Hose - Lower - Eng. To Rad.		21985
Hose - Heater Inlet; (3/4" I.D.)		28442
Hose - Heater Outlet; (5/8" I.D.)		28441
T5500; T6500; T7500; T8500		
Belt - Fan & Alt.; W/O A.C.	15149560	♣K070553HD
Belt - Fan, Alt. & A.C.	15985715	♣K070677HD
Belt - Hub & W.P.	0366775	♣9341HD
Tensioner Assy.	15999618	38578
Tensioner Pulley	15999618	36091
Hose - Upper - Eng. To Rad.		22706
Hose - Lower - Eng. To Rad.		22705
GM V-8 5.7 L		
W3500; W4500		
Belt - Fan, Alt., P.S. & A.C.	8971106400	♣K061010HD
Tensioner Assy. - Fan, Alt., P.S. & A.C.	8971619590	38528
Hose - Upper - Eng. To Rad.		22731
Hose - Lower - Eng. To Rad.		22732
GM V-8 8.1 L		
C5500; C6500; C7500; C8500		
Belt - Fan, Alt., P.S. & A.C.	15768485	♣K071247HD
Belt - Fan, Alt. & P.S.; W/O A.C.	15021740	♣K071056HD
Belt - Fan & Air Compr.	15060753	♣K040762HD
Tensioner Assy. - Fan, Alt., P.S. & A.C.	15021742	38256
Tensioner Assy. - Fan & Air Compr.	15001551	38261
Tensioner Pulley - Fan, Alt., P.S. & A.C.	15021742	38033
Tensioner Pulley - Fan & Air Compr.	15001551	38006
Hose - Upper - Eng. To Rad.		22678
Hose - Lower - Eng. To Rad.		22679
Isuzu 4HE1-TC Diesel		
W3500; W4500; W5500		
Belt - Fan & Alt.	8971801810	②♣9415HD
Belt - Alt. & A.C.	8971801830	♣9610HD
Hose - Upper - Eng. To Rad.		23096
Hose - Lower - Eng. To Rad.		23095
Isuzu 6HK1-TC Diesel		
T5500; T6500; T7500; T8500		
Belt - Fan & Alt.	94395171	②TR22461
Belt - A.C.	94395172	TR22434
Hose - Upper - Eng. To Rad.		22733
Hose - Lower - Eng. To Rad.		22734
W5500; WT5500		
Belt - Fan & Alt.	94395171	TR22461
Belt - A.C.	94395172	TR22434
Hose - Upper - Eng. To Rad.		22733
Hose - Lower - Eng. To Rad.		22734
2001		
Caterpillar 3126 Diesel		
C5500; C6500; C7500; C8500		
Belt - Fan & Alt.; W/O A.C.	15670937	♣K070705HD
Belt - Fan, Alt. & A.C.	15690236	♣K070733HD
Belt - W.P.	0366775	♣9341HD
Tensioner Assy.	7E3999	38509
Idler Pulley	89022559	36096
Tensioner Pulley	7E3999	36091
Hose - Upper - Eng. To Rad.; W/Conventional Hood		22032
Hose - Upper - Eng. To Rad.; W/High Visibility Hood		22664
Hose - Lower - Eng. To Rad.		21985
Hose - Heater Inlet; (3/4" I.D.)		28442

② Two Required.

Belts and Coolant Hose for Medium/Heavy-Duty Trucks [1996 and Newer]

Medium & Heavy-Duty Trucks
(1996 & Newer)

Application	Mfr. Part No.	Our No.
GMC - Continued		
2001 - Continued		
Caterpillar 3126 Diesel - Continued		
C5500; C6500; C7500; C8500 - Continued		
Hose - Heater Outlet; (5/8" I.D.)		28441
T5500; T6500; T7500; T8500		
Belt - Fan & Alt.; W/O A.C.	15149560	▲K070553HD
Belt - Fan, Alt. & A.C.	15985715	▲K070677HD
Belt - Hub & W.P.	0366775	▲9341HD
Tensioner Assy.	15999618	38578
Tensioner Pulley	15999618	36091
Hose - Upper - Eng. To Rad.		22706
Hose - Lower - Eng. To Rad.		22705
GM V-8 5.7 L		
W3500; W4500		
Belt - Fan, Alt., P.S. & A.C.	8971106400	▲K061010HD
Tensioner Assy. - Fan, Alt., P.S. & A.C.	8971619590	38528
Hose - Upper - Eng. To Rad.		22731
Hose - Lower - Eng. To Rad.		22732
GM V-8 8.1 L		
C5500; C6500; C7500; C8500		
Belt - Fan, Alt., P.S. & A.C.	15768485	▲K071247HD
Belt - Fan, Alt. & P.S.; W/O A.C.	15021740	▲K071056HD
Belt - Fan & Air Compr.	15060753	▲K040762HD
Tensioner Assy. - Fan, Alt., P.S. & A.C.	15021742	38256
Tensioner Assy. - Fan & Air Compr.	15001551	38261
Tensioner Pulley - Fan, Alt., P.S. & A.C.	15021742	38033
Tensioner Pulley - Fan & Air Compr.	15001551	38006
Hose - Upper - Eng. To Rad.		22678
Hose - Lower - Eng. To Rad.		22679
Isuzu 4HE1-TC Diesel		
W3500; W4500; W5500		
Belt - Fan & Alt.	8971801810	②▲9415HD
Belt - Alt. & A.C.	8971801830	▲9610HD
Hose - Upper - Eng. To Rad.		23096
Hose - Lower - Eng. To Rad.		23095
Isuzu 6HK1-TC Diesel		
T5500; T6500; T7500; T8500		
Belt - Fan & Alt.	94395171	②TR22461
Belt - A.C.	94395172	TR22434
Hose - Upper - Eng. To Rad.		22733
Hose - Lower - Eng. To Rad.		22734
W5500		
Belt - Fan & Alt.	94395171	TR22461
Belt - A.C.	94395172	TR22434
Hose - Upper - Eng. To Rad.		22733
Hose - Lower - Eng. To Rad.		22734
WT5500		
Belt - Fan & Alt.	94395171	②TR22461
Belt - A.C.	94395172	TR22434
Hose - Upper - Eng. To Rad.		22733
Hose - Lower - Eng. To Rad.		22734
2000		
Caterpillar 3116 Diesel		
C6500; C7500; C8500		
Belt - W.P.	0366775	▲9341HD
Belt - Fan & Alt.; W/O A.C.	15670937	▲K070705HD
Belt - Fan, Alt. & A.C.	15690236	▲K070733HD
Tensioner Assy.	7E3999	38509
Tensioner Pulley	7E3999	36091
Hose - Upper - Eng. To Rad.; W/Rad. Shutters		22032
Hose - Upper - Eng. To Rad.; W/O Rad. Shutters		21989
Hose - Lower - Eng. To Rad.		21985
P3500		
Belt - Fan & Alt.	15670937	▲K070705HD
Tensioner Assy. - Fan & Alt.	7E0339	38624
Hose - Upper - Eng. To Rad.		22134
Hose - Lower - Eng. To Rad.		21985

Application	Mfr. Part No.	Our No.
GMC - Continued		
2000 - Continued		
Caterpillar 3126 Diesel		
C5500; C6500; C7500; C8500		
Belt - W.P.	0366775	▲9341HD
Belt - Fan & Alt.; W/O A.C.	15670937	▲K070705HD
Belt - Fan, Alt. & A.C.	15690236	▲K070733HD
Tensioner Assy.	7E3999	38509
Idler Pulley	89022559	36096
Tensioner Pulley	7E3999	36091
Hose - Upper - Eng. To Rad.; W/Conventional Hood		22032
Hose - Upper - Eng. To Rad.; W/High Visibility Hood		22664
Hose - Lower - Eng. To Rad.		21985
Hose - Heater Inlet; (3/4" I.D.)		28442
Hose - Heater Outlet; (5/8" I.D.)		28441
P3500		
Belt - Fan & Alt.	15670937	▲K070705HD
Tensioner Assy. - Fan & Alt.	7E0339	38624
Hose - Upper - Eng. To Rad.		22664
Hose - Lower - Eng. To Rad.		21985
T5500; T6500; T7500; T8500		
Belt - Hub & W.P.	0366775	▲9341HD
Belt - Fan & Alt.; W/O A.C.	15149560	▲K070553HD
Belt - Fan, Alt. & A.C.	15985715	▲K070677HD
Tensioner Assy.	15999618	38578
Tensioner Pulley	15999618	36091
Hose - Upper - Eng. To Rad.		22706
Hose - Lower - Eng. To Rad.		22705
GM V-8 5.7 L		
W3500; W4500		
Belt - Fan, Alt., P.S. & A.C.	8971106400	▲K061010HD
Tensioner Assy. - Fan, Alt., P.S. & A.C.	8971619590	38528
Hose - Upper - Eng. To Rad.		22731
Hose - Lower - Eng. To Rad.		22732
GM V-8 7.4 L		
C5500; C6500; C7500; C8500		
Belt - Fan & Alt.	15722647	▲K060660HD
Belt - Fan To A.C.	15987600	▲9476HD
Belt - Fan & P.S.; W/Hyd. Brakes	11502405	▲9640HD
Belt - P.S.; W/Air Brakes	9433884	▲9395HD
Belt - P.S.; Mexico	9433883	▲9390HD
Belt - Fan & Air Compr.	11502412	▲9680HD
Hose - Upper - Eng. To Rad.		22663
Hose - Lower - Eng. To Rad.		22135
P3500		
Belt - Fan & Alt.	15722647	▲K060660HD
Belt - P.S.; W/Hyd. Brakes	11502405	▲9640HD
Belt - P.S.; W/Ross P.S. Pump	9433884	▲9395HD
Belt - Air Compr.	11502412	▲9680HD
Hose - Upper - Eng. To Rad.		22663
Hose - Lower - Eng. To Rad.		22135
Isuzu 4HE1-TC Diesel		
W3500; W4500; W5500		
Belt - Fan & Alt.	8971801810	②▲9415HD
Belt - Alt. & A.C.	8971801830	▲9610HD
Hose - Upper - Eng. To Rad.		23096
Hose - Lower - Eng. To Rad.		23095
Isuzu 6HK1-TC Diesel		
T5500; T6500; T7500; T8500		
Belt - Fan & Alt.	94395171	②TR22461
Belt - A.C.	94395172	TR22434
Hose - Upper - Eng. To Rad.		22733
Hose - Lower - Eng. To Rad.		22734
W5500		
Belt - Fan & Alt.	94395171	TR22461
Belt - A.C.	94395172	TR22434
Hose - Upper - Eng. To Rad.		22733
Hose - Lower - Eng. To Rad.		22734
WT5500		
Belt - Fan & Alt.	94395171	②TR22461
Belt - A.C.	94395172	TR22434

▲ Standard Belt Available. See Pages 630-631.

② Two Required.

Belts and Coolant Hose for Medium/Heavy-Duty Trucks (1996 and Newer)

 Medium & Heavy-Duty Trucks
(1996 & Newer)

Application	Mfr. Part No.	Our No.
GMC - Continued		
2000 - Continued		
Isuzu 6HK1-TC Diesel - Continued		
WT5500 - Continued		
Hose - Upper - Eng. To Rad.		22733
Hose - Lower - Eng. To Rad.		22734
1999		
Caterpillar 3116 Diesel		
C5500; C6500; C7500; C8500		
Belt - Fan & Alt.; W/O A.C.	15670937	♣K070705HD
Belt - Fan, Alt. & A.C.	15690236	♣K070733HD
Belt - W.P.	0366775	♣9341HD
Tensioner Assy.	7E3999	38509
Tensioner Pulley	7E3999	36091
Hose - Upper - Eng. To Rad.; W/Rad. Shutters		22032
Hose - Upper - Eng. To Rad.; W/O Rad. Shutters		21989
Hose - Lower - Eng. To Rad.		21985
Forward W6; Forward W7		
Belt - Fan & Alt.; W/O A.C.	15149560	♣K070553HD
Belt - Fan, Alt. & A.C.	15985715	♣K070677HD
Belt - Hub & W.P.	0366775	♣9341HD
Tensioner Assy.	15999618	38578
Tensioner Pulley	15999618	36091
Hose - Upper - Eng. To Rad.		22706
Hose - Lower - Eng. To Rad.		22705
P3500		
Belt - Fan & Alt.	15670937	♣K070705HD
Tensioner Assy. - Fan & Alt.	7E0339	38624
Hose - Upper - Eng. To Rad.		22134
Hose - Lower - Eng. To Rad.		21985
Caterpillar 3126 Diesel		
C5500; C6500; C7500; C8500		
Belt - Fan & Alt.; W/O A.C.	15670937	♣K070705HD
Belt - Fan, Alt. & A.C.	15690236	♣K070733HD
Belt - W.P.	0366775	♣9341HD
Tensioner Assy.	7E3999	38509
Idler Pulley	89022559	36096
Tensioner Pulley	7E3999	36091
Hose - Upper - Eng. To Rad.; W/Conventional Hood		22032
Hose - Upper - Eng. To Rad.; W/High Visibility Hood		22664
Hose - Lower - Eng. To Rad.		21985
Hose - Heater Inlet; (3/4" I.D.)		28442
Hose - Heater Outlet; (5/8" I.D.)		28441
Forward W6; Forward W7		
Belt - Fan & Alt.; W/O A.C.	15149560	♣K070553HD
Belt - Fan, Alt. & A.C.	15985715	♣K070677HD
Belt - Hub & W.P.	0366775	♣9341HD
Tensioner Assy.	15999618	38578
Idler Pulley	89022559	36096
Tensioner Pulley	15999618	36091
Hose - Upper - Eng. To Rad.		22706
Hose - Lower - Eng. To Rad.		22705
P3500		
Belt - Fan & Alt.; W/O A.C.	15670937	♣K070705HD
Tensioner Assy. - Fan & Alt.	7E0339	38624
Hose - Upper - Eng. To Rad.		22664
Hose - Lower - Eng. To Rad.		21985
T5500; T6500; T7500; T8500		
Belt - Fan & Alt.; W/O A.C.	15149560	♣K070553HD
Belt - Fan, Alt. & A.C.	15985715	♣K070677HD
Belt - Hub & W.P.	0366775	♣9341HD
Tensioner Assy.	15999618	38578
Tensioner Pulley	15999618	36091
Hose - Upper - Eng. To Rad.		22706
Hose - Lower - Eng. To Rad.		22705
GM V-8 5.7 L		
Forward W4		
Belt - Fan, Alt., P.S. & A.C.	8971106400	♣K061010HD
Tensioner Assy. - Fan, Alt., P.S. & A.C.	8971619590	38528

Application	Mfr. Part No.	Our No.
GMC - Continued		
1999 - Continued		
GM V-8 7.4 L		
C5500; C6500; C7500; C8500		
Belt - Fan & Alt.	15722647	♣K060660HD
Belt - Fan To A.C.	15987600	♣9476HD
Belt - Fan & P.S.; W/Hyd. Brakes	11502405	♣9640HD
Belt - P.S.; W/Air Brakes	9433884	♣9395HD
Belt - P.S.; Mexico	9433883	♣9390HD
Belt - Fan & Air Compr.	11502412	♣9680HD
Hose - Upper - Eng. To Rad.		22663
Hose - Lower - Eng. To Rad.		22135
P3500		
Belt - Fan & Alt.	15722647	♣K060660HD
Belt - P.S.; W/Hyd. Brakes	11502405	♣9640HD
Belt - P.S.; W/Ross P.S. Pump	9433884	♣9395HD
Belt - Air Compr.	11502412	♣9680HD
Hose - Upper - Eng. To Rad.		22663
Hose - Lower - Eng. To Rad.		22135
T5500; T6500; T7500; T8500		
Belt - A.C.	15987600	♣9476HD
Isuzu 4HE1-TC Diesel		
Forward W4; Forward W5		
Belt - Fan & Alt.	8971801810	Ⓜ♣9415HD
Belt - Alt. & A.C.	8971801830	♣9610HD
Hose - Upper - Eng. To Rad.		23096
Hose - Lower - Eng. To Rad.		23095
Isuzu 6HE1-TC Diesel		
Forward W5		
Belt - Fan & Alt.	94395171	ⓂTR22461
Belt - A.C.	94395172	TR22434
Hose - Upper - Eng. To Rad.		22733
Hose - Lower - Eng. To Rad.		22734
Isuzu 6HK1-TC Diesel		
T5500; T6500; T7500; T8500		
Belt - Fan & Alt.	94395171	ⓂTR22461
Belt - A.C.	94395172	TR22434
Hose - Upper - Eng. To Rad.		22733
Hose - Lower - Eng. To Rad.		22734
1998		
Caterpillar 3116 Diesel		
C6500; C7500; C8500		
Belt - Fan & Alt.; W/6-Ribbed Belt	15608928	♣K060672HD
Belt - Fan & Alt.; W/O A.C.; W/7-Ribbed Belt	15670937	♣K070705HD
Belt - Fan, Alt. & A.C.; W/Dealer Inst. A.C.		♣K070825HD
Belt - Fan, Alt. & A.C.; W/Factory Inst. A.C.	15958695	♣K070735HD
Belt - Hub & W.P.	0366775	♣9341HD
Tensioner Assy.	7E3999	38509
Tensioner Pulley	7E3999	36091
Hose - Upper - Eng. To Rad.; W/High Visibility Hood		22134
Hose - Upper - Eng. To Rad.; W/O Rad. Shutters		21989
Hose - Upper - Eng. To Rad.; W/Rad. Shutters		22032
Hose - Lower - Eng. To Rad.		21985
Forward W6; Forward W7		
Belt - Fan & Alt.; W/O A.C.	15149560	♣K070553HD
Belt - Fan, Alt. & A.C.	15985715	♣K070677HD
Belt - Hub & W.P.	0366775	♣9341HD
Tensioner Assy.	15999618	38578
Tensioner Pulley	15999618	36091
Hose - Upper - Eng. To Rad.		22706
Hose - Lower - Eng. To Rad.		22705
P3500		
Belt - Fan & Alt.		♣K070705HD
Tensioner Assy. - Fan & Alt.	7E0339	38624
Hose - Upper - Eng. To Rad.		22134
Hose - Lower - Eng. To Rad.		21985
T5500		
Belt - Fan & Alt.; W/O A.C.	15149560	♣K070553HD

♣ Standard Belt Available. See Pages 630-631.

Ⓜ Two Required.

Belts and Coolant Hoses for Medium/Heavy-Duty Trucks (1996 and Newer)

Medium & Heavy-Duty Trucks
(1996 & Newer)

Application	Mfr. Part No.	Our No.
GMC - Continued		
1998 - Continued		
Caterpillar 3116 Diesel - Continued		
T5500 - Continued		
Belt - Fan & Alt. & A.C.	15985715	▲K070677HD
Belt - Hub & W.P.	0366775	▲9341HD
Tensioner Assy.	15999618	38578
Tensioner Pulley	15999618	36091
Hose - Upper - Eng. To Rad.		22706
Hose - Lower - Eng. To Rad.		22705
T6500; T7500		
Belt - Fan & Alt.; W/O A.C.	15149560	▲K070553HD
Belt - Fan, Alt. & A.C.	15985715	▲K070677HD
Belt - Hub & W.P.	0366775	▲9341HD
Tensioner Assy.	15999618	38578
Tensioner Pulley	15999618	36091
Hose - Lower - Eng. To Rad.		22705
T8500		
Belt - Fan & Alt.; W/O A.C.	15149560	▲K070553HD
Belt - Fan, Alt. & A.C.	15985715	▲K070677HD
Tensioner Assy.	15999618	38578
Tensioner Pulley	15999618	36091
Hose - Lower - Eng. To Rad.		22705
Caterpillar 3126 Diesel		
C5500		
Belt - W.P.	0366775	▲9341HD
Belt - Fan & Alt.; W/O A.C.	15670937	▲K070705HD
Belt - Fan, Alt. & A.C.	15690236	▲K070733HD
Belt - Hub & W.P.	0366775	▲9341HD
Tensioner Assy.	7E3999	38509
Tensioner Pulley	7E3999	36091
Hose - Upper - Eng. To Rad.; W/Conventional Hood		22032
Hose - Upper - Eng. To Rad.; W/High Visibility Hood		22664
Hose - Lower - Eng. To Rad.		21985
Hose - Heater Inlet; (3/4" I.D.)		28442
Hose - Heater Outlet; (5/8" I.D.)		28441
C6500; C7500; C8500		
Belt - Fan & Alt.; W/O A.C.	15670937	▲K070705HD
Belt - Fan, Alt. & A.C.	15690236	▲K070733HD
Belt - Hub & W.P.	0366775	▲9341HD
Tensioner Assy.	7E3999	38509
Tensioner Pulley	7E3999	36091
Hose - Upper - Eng. To Rad.; W/Conventional Hood		22032
Hose - Upper - Eng. To Rad.; W/High Visibility Hood		22664
Hose - Lower - Eng. To Rad.		21985
Hose - Heater Inlet; (3/4" I.D.)		28442
Hose - Heater Outlet; (5/8" I.D.)		28441
Forward W4; Forward W5; Forward W6; Forward W7		
Belt - Fan & Alt.; W/O A.C.	15149560	▲K070553HD
Belt - Fan, Alt. & A.C.	15985715	▲K070677HD
Belt - Hub & W.P.	0366775	▲9341HD
Tensioner Assy.	15999618	38578
Tensioner Pulley	15999618	36091
Hose - Upper - Eng. To Rad.		22706
Hose - Lower - Eng. To Rad.		22705
P3500		
Belt - Fan & Alt.	15670937	▲K070705HD
Tensioner Assy. - Fan & Alt.	7E0339	38624
Hose - Upper - Eng. To Rad.		22664
Hose - Lower - Eng. To Rad.		21985
T5500; T6500; T7500; T8500		
Belt - Fan & Alt.; W/O A.C.	15149560	▲K070553HD
Belt - Fan, Alt. & A.C.	15985715	▲K070677HD
Belt - Hub & W.P.	0366775	▲9341HD
Tensioner Assy.	15999618	38578
Tensioner Pulley	15999618	36091
Hose - Upper - Eng. To Rad.		22706
Hose - Lower - Eng. To Rad.		22705
GM V-8 5.7 L		
Forward W4		
Belt - Fan, Alt., P.S. & A.C.	8971106400	▲K061010HD
Tensioner Assy. - Fan, Alt., P.S. & A.C.	97161959	38528

Application	Mfr. Part No.	Our No.
GMC - Continued		
1998 - Continued		
GM V-8 6.0 L		
C5500; C6500; C7500; C8500		
Belt - Fan & Alt.	15608928	▲K060672HD
Belt - P.S.; W/Air Brakes	9433884	▲9395HD
Belt - Fan & P.S.; W/Hyd. Brakes	11502406	▲9650HD
Belt - Fan To A.C.	15987600	▲9476HD
Belt - Fan & Air Brake Compr.	11502413	▲9690HD
Hose - Upper - Eng. To Rad.; W/Conventional Hood		22031
Hose - Upper - Eng. To Rad.; W/High Visibility Hood		22136
Hose - Lower - Eng. To Rad.; W/Auto. Trans.		21987
Hose - Lower - Eng. To Rad.; W/Man. Trans.		22030
Forward W5; Forward W6; Forward W7		
Belt - Fan & Alt.	15608928	▲K060672HD
Belt - P.S.	9433884	▲9395HD
Belt - A.C.	15987600	▲9476HD
P3500		
Belt - Fan & Alt.	15608928	▲K060672HD
Belt - Fan & P.S.	11502406	▲9650HD
Belt - P.S.; W/Air Brakes	9433884	▲9395HD
Belt - Fan, A.C. & P.S.	14033869	7603
Belt - Air Brake Compr.	11502413	▲9690HD
Hose - Upper - Eng. To Rad.		22136
Hose - Lower - Eng. To Rad.		22135
T5500; T6500; T7500		
Belt - Fan & Alt.	15608928	▲K060672HD
Belt - P.S.	9433884	▲9395HD
Belt - A.C.	15987600	▲9476HD
GM V-8 6.5 L Diesel		
P3500		
Belt - Fan	15994965	▲K060547HD
Belt - Alt., W.P. & P.S.	12555011	▲K061015HD
Tensioner Assy.		38118
Tensioner Pulley; Exc. Motor Home		38006
Hose - Upper; Exc. Motor Home		22268
Hose - Lower; Exc. Motor Home		22237
Hose - By Pass; Exc. Motor Home		22210
Hose - By Pass - Tank To Rad.; Exc. Motor Home		28465
Hose - Heater To Rad.; W/Grumman Body		≈18083
Hose - Heater To Valve; W/Grumman Body(3/4" x 16")		28412
Hose - Intake Manifold To Rad.; W/Grumman Body		≈18084
Hose - Valve To Eng.; W/Grumman Body(3/4" x 18")		28412
GM V-8 7.0 L		
C5500; C6500; C7500; C8500		
Belt - Fan & Alt.	15608928	▲K060672HD
Belt - P.S.; W/Air Brakes	9433884	▲9395HD
Belt - Fan & P.S.; W/Hyd. Brakes	11502406	▲9650HD
Belt - Fan To A.C.	15987600	▲9476HD
Belt - Fan & Air Brake Compr.	11502413	▲9690HD
Hose - Upper - Eng. To Rad.; W/Conventional Hood		22031
Hose - Upper - Eng. To Rad.; W/High Visibility Hood		22136
Hose - Lower - Eng. To Rad.; W/Auto. Trans.		21987
Hose - Lower - Eng. To Rad.; W/Man. Trans.		22030
P3500		
Belt - Fan & Alt.	15608928	▲K060672HD
Belt - Fan & P.S.	11502406	▲9650HD
Belt - P.S.; W/Air Brakes	9433884	▲9395HD
Belt - Fan, A.C. & P.S.	14033869	7603
Belt - Air Brake Compr.	11502413	▲9690HD
Hose - Upper - Eng. To Rad.		22136
Hose - Lower - Eng. To Rad.		22135
Isuzu 4BD2 Diesel		
Forward W4; Forward W5		
Belt - Fan	5138700041	7420
Belt - Fan & Alt.	5138711270	▲9510HD
Belt - A.C.	8944529040	▲9400HD
Isuzu 6HE1-TC Diesel		
Forward W5; Forward W6; Forward W7		
Belt - Fan & Alt.	94395171	TR22461
Belt - A.C.	94395172	TR22434

▲ Standard Belt Available. See Pages 630-631.

≈ Cut to Fit.

Belts and Coolant Hose for Medium/Heavy-Duty Trucks (1996 and Newer)

 Medium & Heavy-Duty Trucks
(1996 & Newer)

Application	Mfr. Part No.	Our No.
GMC - Continued		
1998 - Continued		
Isuzu 6HE1-TC Diesel - Continued		
Forward W5; Forward W6; Forward W7 - Continued		
Hose - Upper - Eng. To Rad.		22733
Hose - Lower - Eng. To Rad.		22734
T5500; T6500; T7500; T8500		
Belt - Fan & Alt.	94395171	②TR22461
Belt - A.C.	94395172	TR22434
Hose - Upper - Eng. To Rad.		22733
Hose - Lower - Eng. To Rad.		22734
Isuzu 6HK1-TC Diesel		
T5500; T6500; T7500; T8500		
Belt - Fan & Alt.	94395171	②TR22461
Belt - A.C.	94395172	TR22434
Hose - Upper - Eng. To Rad.		22733
Hose - Lower - Eng. To Rad.		22734
1997		
Caterpillar 3116 Diesel		
C6500; C7500; C8500		
Belt - Fan & Alt.; W/O A.C.; W/6-Ribbed		
Belt	15608928	♣K060672HD
Belt - Fan & Alt.; W/O A.C.; W/7-Ribbed		
Belt	15670937	♣K070705HD
Belt - Fan, Alt. & A.C.; W/Dealer Inst. A.C.		♣K070825HD
Belt - Fan, Alt. & A.C.; W/Factory Inst. A.C.	15958695	♣K070735HD
Belt - W.P.	0366775	♣9341HD
Tensioner Assy.	7E3999	38509
Tensioner Pulley	7E3999	36091
Hose - Upper - Eng. To Rad.; W/High Visibility Hood		22134
Hose - Upper - Eng. To Rad.; W/O Rad. Shutters		21989
Hose - Upper - Eng. To Rad.; W/Rad. Shutters		22032
Hose - Lower - Eng. To Rad.		21985
Forward W4; Forward W5; Forward W6; Forward W7		
Belt - Fan & Alt.; W/O A.C.	15149560	♣K070553HD
Belt - Fan, Alt. & A.C.	15985715	♣K070677HD
Belt - Hub & W.P.	0366775	♣9341HD
Tensioner Assy.	15999618	38578
Tensioner Pulley	15999618	36091
Hose - Lower - Eng. To Rad.		22705
P3500		
Belt - Fan & Alt.		♣K070705HD
Tensioner Assy. - Fan & Alt.	7E0339	38624
Hose - Upper - Eng. To Rad.		22134
Hose - Lower - Eng. To Rad.		21985
T5500; T6500; T7500; T8500		
Belt - Fan & Alt.; W/O A.C.	15149560	♣K070553HD
Belt - Fan, Alt. & A.C.	15985715	♣K070677HD
Belt - Hub & W.P.	0366775	♣9341HD
Tensioner Assy.	15999618	38578
Tensioner Pulley	15999618	36091
Hose - Lower - Eng. To Rad.		22705
Caterpillar 3126 Diesel		
P3500		
Belt - Fan & Alt.	15670937	♣K070705HD
Tensioner Assy. - Fan & Alt.	7E0339	38624
Hose - Upper - Eng. To Rad.		22664
Hose - Lower - Eng. To Rad.		21985
GM V-8 5.7 L		
Forward W4		
Belt - Fan, Alt., P.S. & A.C.	8971106400	♣K061010HD
Tensioner Assy. - Fan, Alt., P.S. & A.C.	97161959	38528
GM V-8 6.0 L		
C5500; C6500; C7500; C8500		
Belt - Fan & Alt.	15608928	♣K060672HD
Belt - P.S.; W/Air Brakes	9433884	♣9395HD
Belt - Fan & P.S.; W/Hyd. Brakes	11502406	♣9650HD
Belt - Fan To A.C.	15987600	♣9476HD
Belt - Fan & Air Brake Compr.	11502413	♣9690HD

Application	Mfr. Part No.	Our No.
GMC - Continued		
1997 - Continued		
GM V-8 6.0 L - Continued		
C5500; C6500; C7500; C8500 - Continued		
Hose - Upper - Eng. To Rad.; W/Conventional Hood		22031
Hose - Upper - Eng. To Rad.; W/High Visibility Hood		22136
Hose - Lower - Eng. To Rad.; W/Auto. Trans.		21987
Hose - Lower - Eng. To Rad.; W/Man. Trans.; W/Conventional Hood		22030
Hose - Lower - Eng. To Rad.; W/Man. Trans.; W/High Visibility Hood		22135
Forward W5; Forward W6		
Belt - Fan & Alt.	15608928	♣K060672HD
Belt - P.S.	9433884	♣9395HD
Belt - A.C.	15987600	♣9476HD
P3500		
Belt - Fan & Alt.	15608928	♣K060672HD
Belt - Fan & P.S.	11502406	♣9650HD
Belt - P.S.; W/Air Brakes	9433884	♣9395HD
Belt - Fan, A.C. & P.S.	14033869	7603
Belt - Air Brake Compr.	11502413	♣9690HD
Hose - Upper - Eng. To Rad.		22136
Hose - Lower - Eng. To Rad.		22135
T5500; T6500; T7500		
Belt - Fan & Alt.	15608928	♣K060672HD
Belt - P.S.	9433884	♣9395HD
Belt - A.C.	15987600	♣9476HD
GM V-8 6.5 L Diesel		
P3500		
Belt - Alt., W.P. & P.S.	12555011	♣K061015HD
Belt - Fan	15994965	♣K060547HD
Tensioner Assy.		38118
Tensioner Pulley; Exc. Motor Home		38006
Hose - Upper; Exc. Motor Home		22268
Hose - Lower; Exc. Motor Home		22237
Hose - By Pass; Exc. Motor Home		22210
Hose - By Pass - Tank To Rad.; Exc. Motor Home		28465
Hose - Heater To Rad.; W/Grumman Body		♣18083
Hose - Heater To Valve; W/Grumman Body(3/4" x 16")		28412
Hose - Intake Manifold To Rad.; W/Grumman Body		♣18084
Hose - Valve To Eng.; W/Grumman Body(3/4" x 18")		28412
GM V-8 7.0 L		
C5500; C6500; C7500; C8500		
Belt - Fan & Alt.	15608928	♣K060672HD
Belt - P.S.; W/Air Brakes	9433884	♣9395HD
Belt - Fan & P.S.; W/Hyd. Brakes	11502406	♣9650HD
Belt - Fan To A.C.	15987600	♣9476HD
Belt - Fan & Air Brake Compr.	11502413	♣9690HD
Hose - Upper - Eng. To Rad.; W/Conventional Hood		22031
Hose - Upper - Eng. To Rad.; W/High Visibility Hood		22136
Hose - Lower - Eng. To Rad.; W/Auto. Trans.		21987
Hose - Lower - Eng. To Rad.; W/Man. Trans.; W/Conventional Hood		22030
Hose - Lower - Eng. To Rad.; W/Man. Trans.; W/High Visibility Hood		22135
P3500		
Belt - Fan & Alt.	15608928	♣K060672HD
Belt - Fan & P.S.	11502406	♣9650HD
Belt - P.S.; W/Air Brakes	9433884	♣9395HD
Belt - Fan, A.C. & P.S.	14033869	7603
Belt - Air Brake Compr.	11502413	♣9690HD
Hose - Upper - Eng. To Rad.		22136
Hose - Lower - Eng. To Rad.		22135
Isuzu 4BD2 Diesel		
Forward W4; Forward W5; Forward W6; Forward W7		
Belt - Fan	5138700041	7420
Belt - Fan & Alt.	5138711270	♣9510HD
Belt - A.C.	8944529040	♣9400HD
Isuzu 6HE1-TC Diesel		
Forward W5; Forward W6; Forward W7		
Belt - Fan & Alt.	94395171	TR22461
Belt - A.C.	94395172	TR22434

② Two Required.
♣ Cut to Fit.

♣ Standard Belt Available. See Pages 630-631.

Belts and Coolant Hose for Medium/Heavy-Duty Trucks (1996 and Newer)

Medium & Heavy-Duty Trucks
(1996 & Newer)

Application	Mfr. Part No.	Our No.
GMC - Continued		
1997 - Continued		
Isuzu 6HE1-TC Diesel - Continued		
Forward W5; Forward W6; Forward W7 - Continued		
Hose - Upper - Eng. To Rad.		22733
Hose - Lower - Eng. To Rad.		22734
T5500; T6500; T7500; T8500		
Belt - Fan & Alt.	94395171	ⓉTR22461
Belt - A.C.	94395172	TR22434
Hose - Upper - Eng. To Rad.		22733
Hose - Lower - Eng. To Rad.		22734
1996		
Caterpillar 3116 Diesel		
P6S042		
Belt - Fan & Alt.; W/64 5/8" Belt O.C. ...	15681040	♣K070640HD
Belt - Fan & Alt.; W/71 1/8" Belt O.C. ...	15670937	♣K070705HD
Belt - W.P.	7E0744	♣9345HD
Tensioner Assy. - Fan & Alt.	7E0339	38624
Hose - Upper - Eng. To Rad.		22161
Hose - Lower - Eng. To Rad.		22160
Topkick C6500; Topkick C7500; Topkick C8500		
Belt - Fan & Alt.; W/O A.C.	15625166	♣K070673HD
Belt - Fan, Alt. & A.C.; W/Dealer Inst. A.C.		♣K070825HD
Belt - Fan, Alt. & A.C.; W/Factory Inst. A.C.	15958695	♣K070735HD
Belt - W.P.	7E0744	♣9345HD
Tensioner Assy.	7E3999	38509
Tensioner Pulley	7E3999	36091
Hose - Upper - Eng. To Rad.; W/O Rad. Shutters		21989
Hose - Upper - Eng. To Rad.; W/Rad. Shutters		22032
Hose - Lower - Eng. To Rad.		21985
GM V-8 5.7 L		
Forward W4		
Belt - Fan, Alt., P.S. & A.C.	8971106400	♣K061010HD
Belt - Fan, Alt. & P.S.		♣K061000HD
Tensioner Assy.	8971619590	38528
Hose - Upper - Eng. To Rad.		22731
Hose - Lower - Eng. To Rad.		22732
GM V-8 6.0 L		
P3500		
Belt - Fan & Alt.	15608928	♣K060672HD
Belt - Fan & P.S.	11502406	♣9650HD
Belt - P.S.; W/Air Brakes	9433884	♣9395HD
Belt - Fan, A.C. & P.S.	14033869	7603
Belt - Air Brake Compr.	11502413	♣9690HD
Hose - Upper - Eng. To Rad.		22136
Hose - Lower - Eng. To Rad.		22135
Topkick C5500; Topkick C6500; Topkick C7500; Topkick C8500		
Belt - Fan & Alt.	15608928	♣K060672HD
Belt - P.S.; W/Air Brakes	9433884	♣9395HD
Belt - Fan & P.S.; W/Hyd. Brakes	11502406	♣9650HD
Belt - Fan To A.C.	11502379	♣9540HD
Belt - Fan & Air Brake Compr.	11502413	♣9690HD
Hose - Upper - Eng. To Rad.		22031
Hose - Lower - Eng. To Rad.; W/Auto. Trans.		21987
Hose - Lower - Eng. To Rad.; W/Man. Trans.		22030
GM V-8 6.5 L Diesel		
P3500		
Serpentine Belt; W/A.C.; W/V.P.; W/124A. Alt.; Exc. Motor Home		♣K061020HD
Serpentine Belt; W/O A.C.; W/105A. Alt.; Exc. Motor Home		♣K061010HD
Tensioner Assy.		38118
Tensioner Pulley; Exc. Motor Home		38006
Hose - Upper; Motor Home		22267
Hose - Upper; Exc. Motor Home		22268
Hose - Lower; Exc. Motor Home		22237
Hose - By Pass; W/Turbo; Motor Home		22210
Hose - By Pass; Exc. Motor Home		22210
Hose - By Pass - Tank To Rad.; Exc. Motor Home		28465
Hose - Heater To Rad.; W/Grumman Body		≈18083
Hose - Heater To Valve; W/Grumman Body(3/4" x 16")		28412

Application	Mfr. Part No.	Our No.
GMC - Continued		
1996 - Continued		
GM V-8 6.5 L Diesel - Continued		
P3500 - Continued		
Hose - Intake Manifold To Rad.; W/Grumman Body		≈18084
Hose - Valve To Eng.; W/Grumman Body(3/4" x 18")		28412
GM V-8 7.0 L		
P3500		
Belt - Fan & Alt.	15608928	♣K060672HD
Belt - Fan & P.S.	11502406	♣9650HD
Belt - P.S.; W/Air Brakes	9433884	♣9395HD
Belt - Fan, A.C. & P.S.	14033869	7603
Belt - Air Brake Compr.	11502413	♣9690HD
Hose - Upper - Eng. To Rad.		22136
Hose - Lower - Eng. To Rad.		22135
Topkick C5500; Topkick C6500; Topkick C7500; Topkick C8500		
Belt - Fan & Alt.	15608928	♣K060672HD
Belt - P.S.; W/Air Brakes	9433884	♣9395HD
Belt - Fan & P.S.; W/Hyd. Brakes	11502406	♣9650HD
Belt - Fan To A.C.	11502379	♣9540HD
Belt - Fan & Air Brake Compr.	11502413	♣9690HD
Hose - Upper - Eng. To Rad.		22031
Hose - Lower - Eng. To Rad.; W/Auto. Trans.		21987
Hose - Lower - Eng. To Rad.; W/Man. Trans.		22030
GM V-8 7.4 L		
P3500		
Belt - Fan & Alt.	15608928	♣K060672HD
Belt - Fan & P.S.; W/Hyd. Brakes	11502406	♣9650HD
Belt - P.S.; W/Air Brakes	9433884	♣9395HD
Belt - Air Brake Compr.	11502413	♣9690HD
Hose - Upper		22136
Hose - Lower		22135
Isuzu 4BD2-TC Diesel		
Forward W4		
Belt - Fan	5138700041	7420
Belt - Fan & Alt.	5138711270	♣9510HD
Belt - A.C.	8944529040	♣9400HD
Hose - Upper		20121
Hose - Lower; W/Auto. Trans.		22041
Hose - Lower; W/Man. Trans.		≈22041
Isuzu 6HE1-TC Diesel		
Forward W5; Forward W6; Forward W7		
Belt - Fan & Alt.	94395171	ⓉTR22461
Belt - A.C.	94395172	TR22434
Hose - Upper - Eng. To Rad.		22733
Hose - Lower - Eng. To Rad.		22734
HINO		
2012		
Hino J08E-VB Diesel		
338		
Belt - Fan & Alt.	SZ91045377	♣K100563HD
Belt - A.C.	SZ91045354	♣9395HD
Hino J08E-VB Diesel (Canada)		
358		
Belt - Fan & Alt.	SZ91045377	♣K100563HD
Belt - A.C.	SZ91045354	♣9395HD
Hino J08E-VC Diesel		
258LP; 268		
Belt - Fan & Alt.	SZ91045377	♣K100563HD
Belt - A.C.	SZ91045354	♣9395HD
Hino J08E-VC Diesel (Canada)		
198		
Belt - Fan & Alt.	SZ91045377	♣K100563HD
Belt - A.C.	SZ91045354	♣9395HD

Ⓣ Two Required.
≈ Cut to Fit.

♣ Standard Belt Available. See Pages 630-631.

Belts and Coolant Hose for Medium/Heavy-Duty Trucks (1996 and Newer)

 Medium & Heavy-Duty Trucks
(1996 & Newer)

Application	Mfr. Part No.	Our No.
HINO - Continued		
2011		
Hino J08E-VB Diesel		
338		
Belt - Fan & Alt.	SZ91045377	♣K100563HD
Belt - A.C.	SZ91045354	♣9395HD
Hino J08E-VB Diesel (Canada)		
358		
Belt - Fan & Alt.	SZ91045377	♣K100563HD
Belt - A.C.	SZ91045354	♣9395HD
Hino J08E-VC Diesel		
238; 258ALP; 258LP; 268		
Belt - Fan & Alt.	SZ91045377	♣K100563HD
Belt - A.C.	SZ91045354	♣9395HD
Hino J08E-VC Diesel (Canada)		
198		
Belt - Fan & Alt.	SZ91045377	♣K100563HD
Belt - A.C.	SZ91045354	♣9395HD
2010		
Hino J05D-TF Diesel		
145		
Belt - Fan & Alt.	SZ91045307	②♣9463HD
Belt - A.C.	SZ91045266	A38
165; 185		
Belt - Fan & Alt.	SZ91049219	②♣9463HD
Belt - A.C.	SZ91045266	A38
Hino J08E-TV Diesel		
238		
Belt - Fan & Alt.	SZ91045306	K080539HD
Belt - A.C.	SZ91045354	♣9395HD
258ALP		
Belt - Fan & Alt.	SZ91045306	K080539HD
258LP		
Belt - Fan & Alt.	SZ91045306	K080539HD
Belt - A.C.	SZ91045354	♣9395HD
268		
Belt - Fan & Alt.	SZ91045306	K080539HD
Hino J08E-TV Diesel (Canada)		
338		
Belt - Fan	SZ91045306	K080539HD
Hino J08E-TW Diesel		
338		
Belt - Fan	SZ91045306	K080539HD
Hino J08E-TW Diesel (Canada)		
358		
Belt - Fan	SZ91045306	K080539HD
2009		
Hino J05D-TF Diesel		
145; 165		
Belt - Fan & Alt.	SZ91045307	②♣9463HD
Belt - A.C.	900145569A	A38
185		
Belt - Fan & Alt.	SZ91049219	②♣9463HD
Belt - A.C.	SZ91045266	A38
Hino J08E-TV Diesel		
238		
Belt - Fan & Alt.	SZ91045306	K080539HD
Belt - A.C.	SZ91045354	♣9395HD
258ALP		
Belt - Fan & Alt.	SZ91045306	K080539HD
258LP		
Belt - Fan & Alt.	SZ91045306	K080539HD
Belt - A.C.	SZ91045354	♣9395HD
268		
Belt - Fan & Alt.	SZ91045306	K080539HD

♣ Standard Belt Available. See Pages 630-631.

Application	Mfr. Part No.	Our No.
HINO - Continued		
2009 - Continued		
Hino J08E-TV Diesel (Canada)		
338		
Belt - Fan	SZ91045306	K080539HD
Belt - A.C.	SZ91045354	♣9395HD
Hino J08E-TW Diesel		
338		
Belt - Fan	SZ91045306	K080539HD
Belt - A.C.	SZ91045354	♣9395HD
Hino J08E-TW Diesel (Canada)		
358		
Belt - Fan	SZ91045306	K080539HD
2008		
Hino J05D-TF Diesel		
145		
Belt - Fan & Alt.	SZ91049219	②♣9463HD
Belt - A.C.	900145569A	A38
165		
Belt - Fan & Alt.	SZ91045307	②♣9463HD
Belt - A.C.	900145569A	♣9380HD
185		
Belt - Fan & Alt.	SZ91045307	♣9463HD
Belt - A.C.	900145569A	A38
Hino J08E-TV Diesel		
238; 258LP		
Belt - Fan & Alt.	SZ91045306	K080539HD
Belt - A.C.	SZ91045354	♣9395HD
268		
Belt - Fan & Alt.	SZ91045306	K080539HD
Hino J08E-TW Diesel		
338		
Belt - Fan	SZ91045306	K080539HD
Hino J08E-TW Diesel (Canada)		
358		
Belt - Fan	SZ91045306	K080539HD
2007		
Hino J05D-TA Diesel		
145; 165; 185		
Belt - Fan & Alt.	900145550A	②A43
Belt - A.C.	900145569A	A38
Hino J08E-TA Diesel		
238; 258LP; 268; 308		
Belt - Fan & Alt.	900145548A	♣K080514HD
Belt - A.C.	908611000	♣9400HD
Tensioner Assy. - Fan & Alt.	16630E0250	38659
Hino J08E-TB Diesel		
338		
Belt - Fan & Alt.	900145548A	♣K080514HD
Belt - A.C.	908611000	♣9400HD
Tensioner Assy. - Fan & Alt.	16630E0250	38659
2006		
Hino J05D-TA Diesel		
145; 165; 185		
Belt - Fan & Alt.	900145550A	②A43
Belt - A.C.	900145569A	A38
Hino J08E-TA Diesel		
238; 258LP; 268		
Belt - Fan & Alt.	900145548A	♣K080514HD
Belt - A.C.	908611000	♣9400HD
Tensioner Assy. - Fan & Alt.	16630E0250	38659
Hino J08E-TA Diesel (Canada)		
308		
Belt - Fan & Alt.	900145548A	♣K080514HD
Belt - A.C.	908611000	♣9400HD

② Two Required.

Belts and Coolant Hose for Medium/Heavy-Duty Trucks (1996 and Newer)

Medium & Heavy-Duty Trucks
(1996 & Newer)

Application	Mfr. Part No.	Our No.	Application	Mfr. Part No.	Our No.
HINO - Continued			HINO - Continued		
2006 - Continued			2001 - Continued		
Hino J08E-TA Diesel (Canada) - Continued			Hino J08C-TR Diesel - Continued		
308 - Continued			SG3325 - Continued		
Tensioner Assy. - Fan & Alt.	16630E0250	38659	Belt - A.C.	908611000	▲9400HD
Hino J08E-TB Diesel			Hino J08C-TP Diesel		
338			FD2220; FD2320; FE2620; FF3020; SG3320		
Belt - Fan & Alt.	900145548A	▲K080514HD	Belt - Fan & Alt.	900145421A	②TR20451
Belt - A.C.	908611000	▲9400HD	Belt - A.C.	908611000	▲9400HD
Tensioner Assy. - Fan & Alt.	16630E0250	38659	2000		
2005			Hino J05C-TD Diesel		
Hino J05D-TA Diesel			FA1517; FB1817		
145; 165; 185			Belt - Fan & Alt.	900145421A	②TR20451
Belt - Fan & Alt.	900145550A	②A43	Belt - A.C.	908611000	▲9400HD
Belt - A.C.	900145569A	A38	Hose - Upper - Eng. To Rad.		22727
Hino J08E-TA Diesel			Hose - Lower - Eng. To Rad.		
238; 268					22728
Belt - Fan & Alt.	900145548A	▲K080514HD	Hino J08C-TR Diesel		
Belt - A.C.	908611000	▲9400HD	SG3325		
Tensioner Assy. - Fan & Alt.	16630E0250	38659	Belt - Fan & Alt.		
Hino J08E-TA Diesel (Canada)			②TR20451		
308			Belt - W.P. & Alt.		
Belt - Fan & Alt.	900145548A	▲K080514HD	②TR22455		
Belt - A.C.	908611000	▲9400HD	▲9400HD		
Tensioner Assy. - Fan & Alt.	16630E0250	38659	Hino J08C-TP Diesel		
Hino J08E-TB Diesel			FD2220; FE2620; FF3020		
338			Belt - Fan & Alt.	900145421A	②TR20451
Belt - Fan & Alt.	900145548A	▲K080514HD	Belt - A.C.	908611000	▲9400HD
Belt - A.C.	908611000	▲9400HD	SG3320		
Tensioner Assy. - Fan & Alt.	16630E0250	38659	Belt - Fan & Alt.		
2004			②TR20451		
Hino J05C-TD Diesel			②TR22455		
FA1517; FB1817			▲9400HD		
Belt - Fan & Alt.	900145286A	②TR22455	22727		
Belt - A.C.	908611000	▲9400HD	22728		
Hose - Upper - Eng. To Rad.			Hino J08C-TP Diesel		
Hose - Lower - Eng. To Rad.			FD2220; FD2320; FE2620		
Hino J08C-TP Diesel			Belt - Fan & Alt.		
FD2220; FD2320; FE2620			900145286A		
Belt - Fan & Alt.	900145286A	②TR22474	②TR22474		
Belt - A.C.	908611000	▲9400HD	▲9400HD		
2003-2002			1999		
Hino J05C-TD Diesel			Hino J05C-TD Diesel		
FA1517; FB1817			FA1517; FB1817		
Belt - Fan & Alt.	900145286A	②TR22455	Belt - Fan & Alt.		
Belt - A.C.	908611000	▲9400HD	Belt - A.C.		
Hose - Upper - Eng. To Rad.			908611000		
Hose - Lower - Eng. To Rad.			Hose - Upper - Eng. To Rad.		
Hino J08C-TP Diesel			22727		
FD2220; FD2320; FE2620			Hose - Lower - Eng. To Rad.		
Belt - Fan & Alt.	900145286A	②TR22474	22728		
Belt - A.C.	908611000	▲9400HD	Hino J08C-TR Diesel		
FF3020; SG3320			SG3325		
Belt - Fan & Alt.			Belt - Fan & Alt.		
Belt - A.C.			②TR20451		
2001			▲9400HD		
Hino J05C-TD Diesel			Hino J08C-TP Diesel		
FA1517; FB1817			FD2220; FE2620; FF3020; SG3320		
Belt - Fan & Alt.	900145421A	②TR20451	Belt - Fan & Alt.		
Belt - A.C.	908611000	▲9400HD	Belt - A.C.		
Hose - Upper - Eng. To Rad.			②TR20451		
Hose - Lower - Eng. To Rad.			▲9400HD		
Hino J08C-TR Diesel			Hino J08C-TE Diesel		
SG3325			SG3323; SG3325		
Belt - Fan & Alt.	900145421A	②TR20451	Belt - Fan & Alt.		
2000			Belt - A.C.		
Hino J05C-TD Diesel			②TR20451		
FA1517; FB1817			▲9400HD		
Belt - Fan & Alt.	900145286A	②TR22455	Hino H06C-TM Diesel		
Belt - A.C.	908611000	▲9400HD	SG3323		
Hose - Upper - Eng. To Rad.			Belt - Alt. & W.P.		
Hose - Lower - Eng. To Rad.			900149223A		
Hino J08C-TP Diesel			883811110A		
FD2220; FE2620; FF3020; SG3320			②TR22534		
Belt - Fan & Alt.			▲9415HD		
Belt - A.C.			21944		
2001			1997		
Hino J05C-TD Diesel			Hino H06C-TM Diesel		
FA1517; FB1817			SG3323		
Belt - Fan & Alt.	900145421A	②TR20451	Belt - Alt. & W.P.		
Belt - A.C.	908611000	▲9400HD	900149223A		
Hose - Upper - Eng. To Rad.			883811110A		
Hose - Lower - Eng. To Rad.			②TR22534		
Hino J08C-TR Diesel			▲9415HD		
SG3325			21944		
Belt - Fan & Alt.	900145421A	②TR20451			

▲ Standard Belt Available. See Pages 630-631.

② Two Required.

Belts and Coolant Hose for Medium/Heavy-Duty Trucks (1996 and Newer)

 Medium & Heavy-Duty Trucks
(1996 & Newer)

Application	Mfr. Part No.	Our No.	Application	Mfr. Part No.	Our No.
HINO - Continued			HINO - Continued		
1997 - Continued			1996 - Continued		
Hino H06C-TM Diesel - Continued			Hino H06C-TN Diesel - Continued		
SG3323 - Continued			FF3020; SG3320 - Continued		
Hose - Upper		●26504	Hose - Upper		21944
Hose - Lower		21378	Hose - Lower	or	●26504
		or ●26513			21378
Hose - By Pass; (1 1/4" I.D.)		24220	Hose - By Pass; (1 1/4" I.D.)	or	●26513
					24220
Hino H06C-TN Diesel			Hino H06C-TP Diesel		
FD2218			FE2618		
Belt - Alt. & W.P.	900149223A	②TR22534	Belt - Alt. & W.P.	900149223A	②TR22534
Belt - Fan & Alt.		②TR20451	Belt - Fan & Alt.		②TR20451
Belt - A.C.		▲9400HD	Belt - A.C.		▲9400HD
Hose - Upper		21944	Hose - Upper		21944
		or ●26504			or ●26504
Hose - Lower		21378	Hose - Lower	or	21378
		or ●26513			or ●26513
Hose - By Pass; (1 1/4" I.D.)		24220	Hose - By Pass; (1 1/4" I.D.)	or	24220
FF3020; SG3320			FF3018		
Belt - Alt. & W.P.	900149223A	②TR22534	Belt - Alt. & W.P.	900149223A	②TR22534
Belt - A.C.	883811110A	▲9415HD	Belt - A.C.	883811110A	▲9415HD
Hose - Upper		21944	Hose - Upper		21944
		or ●26504			or ●26504
Hose - Lower		21378	Hose - Lower	or	21378
		or ●26513			or ●26513
Hose - By Pass; (1 1/4" I.D.)		24220	Hose - By Pass; (1 1/4" I.D.)	or	24220
Hino H06C-TP Diesel			Hino W04C-TH Diesel		
FE2618			FA1415; FB1715		
Belt - Alt. & W.P.	900149223A	②TR22534	Belt - Fan & Alt.		②TR20451
Belt - Fan & Alt.		②TR20451	Belt - A.C.		▲9400HD
Belt - A.C.		▲9400HD			
FF3018					
Belt - Alt. & W.P.	900149223A	②TR22534			
Belt - A.C.	883811110A	▲9415HD			
Hose - Upper		21944			
		or ●26504			
Hose - Lower		21378			
		or ●26513			
Hose - By Pass; (1 1/4" I.D.)		24220			
Hino W04C-TH Diesel			INTERNATIONAL/NAVISTAR		
FB1715			2012		
Belt - Fan & Alt.		②TR20451	International/Navistar MaxxForce 7 Diesel		
Belt - A.C.		▲9400HD	TerraStar		
			Tensioner Assy. - Fan		
				1833688C2	38567
			Idler Pulley - Fan		
				1832710C1	36351
Hino W04C-TM Diesel			International/Navistar MaxxForce 9 Diesel		
FA1415			WorkStar 7500		
Belt - Fan & Alt.		②TR20451	Belt - Fan	1888570C1	▲K080855HD
Belt - A.C.		▲9400HD	Belt - Alt. & A.C.	1847710C1	K100814HD
			Tensioner Assy. - Alt. & A.C.	1873217C1	38634
			Idler Pulley - Fan	1841930C1	36164
			Idler Pulley - Alt. & A.C.	1841930C1	36164
			Hose - Upper		≈21135
1996			International/Navistar MaxxForce 13 Diesel		
Hino H06C-TM Diesel			ProStar Series		
SG3323; SG5523			Belt - Alt. & A.C.		
Belt - Alt. & W.P.	900149223A	②TR22534		3664150C1	K080794HD
Belt - A.C.	883811110A	▲9415HD	TranStar 8600		
Hose - Upper		21944	Hose - Lower - Rad. To Pipe		
		or ●26504			21891
Hose - Lower		21378	Hose - Lower - Pipe To Eng.		
		or ●26513			21135
Hose - By Pass; (1 1/4" I.D.)		24220	WorkStar 7600		
			Belt - Alt. & A.C.	3664150C1	K080794HD
			Belt - Fan	3815648C1	▲K080776HD
Hino H06C-TN Diesel			International/Navistar MaxxForce DT Diesel		
FD2218			DuraStar 4400		
Belt - Alt. & W.P.	900149223A	②TR22534	Belt - Fan	1879845C1	K100877HD
Belt - Fan & Alt.		②TR20451	Tensioner Assy. - Fan	1873217C2	38634
Belt - A.C.		▲9400HD	Idler Pulley	1841930C1	36164
Hose - Upper		21944	Hose - Upper		23794
		or ●26504			
Hose - Lower		21378			
		or ●26513			
Hose - By Pass; (1 1/4" I.D.)		24220			
FF3020; SG3320			2011		
Belt - Alt. & W.P.	900149223A	②TR22534	Caterpillar C13 Diesel		
Belt - A.C.	883811110A	▲9415HD	9200i		
			Belt - Alt.		
				3808254C1	▲K060860HD
			Tensioner Assy. - Alt.		
				2756558	38635
			Tensioner Assy. - Fan & A.C.		
				2873203	38646
			Idler Pulley - Alt. (Upper)		
				2790251	36227

● Vulco-Flex® Coolant Hose.
▲ Standard Belt Available. See Pages 630-631.

② Two Required.
≈ Cut to Fit.

Belts and Coolant Hose for Medium/Heavy-Duty Trucks (1996 and Newer)

Medium & Heavy-Duty Trucks
(1996 & Newer)

Application	Mfr. Part No.	Our No.
INTERNATIONAL/NAVISTAR - Continued		
2011 - Continued		
Caterpillar C13 Diesel - Continued		
9200i - Continued		
Idler Pulley - Alt. (Lower)	2790251	36227
Hose - Upper - Rad. To Pipe		☞21135
Hose - Upper - Pipe To Eng.		☞21891
Hose - Lower - Rad. To Pipe		☞21135
Hose - Lower - Pipe To Eng.; (2 1/2" I.D.)		☞24440
Cummins ISX Diesel		
9200i		
Belt - A.C.	3565412C1	♣K060637HD
Belt - Fan	3817452C1	K120870HD
Tensioner Assy. - A.C.	3104149	38610
Idler Pulley - A.C.	3682229	36223
Hose - Upper - Rad. To Pipe		☞21135
Hose - Upper - Pipe To Pipe; (2 1/2" I.D.)		☞24440
Hose - Upper - Pipe To Eng.		☞21891
Hose - Lower - Rad. To Pipe; (2 1/2" I.D.)		☞24440
LoneStar		
Belt - A.C.	3565412C1	♣K060637HD
Belt - Fan	3833748C1	K120895HD
Tensioner Assy. - A.C.	3104149	38610
Idler Pulley - A.C.	3682229	36223
Hose - Upper - Rad. To Pipe		☞21135
Hose - Upper - Pipe To Eng.		☞21135
Hose - Lower - Rad. To Pipe		☞21891
ProStar Series		
Belt - Fan, Alt. & W.P.	3817452C1	K120870HD
Belt - A.C. - From W.P.	3565412C1	♣K060637HD
Tensioner Assy. - A.C.	3104149	38610
Idler Pulley - A.C.	3682229	36223
Hose - Upper - Rad. To Pipe; (2 1/2" I.D.)		☞24440
Hose - Upper - Pipe To Pipe; (2 1/2" I.D.)		☞24440
Hose - Upper - Pipe To Eng.		☞21891
Hose - Lower - Rad. To Pipe; (2 1/2" I.D.)		☞24440
Hose - Lower - Pipe To Eng.; (2 1/2" I.D.)		☞24440
International/Navistar MaxxForce 7 Diesel		
DuraStar 4300		
Tensioner Assy. - Fan	1833688C2	38556
Idler Pulley - Fan	1832710C1	36351
Hose - Upper		23795
Hose - Lower		23793
TerraStar		
Tensioner Assy. - Fan	1833688C2	38556
Idler Pulley - Fan	1832710C1	36351
International/Navistar MaxxForce 9 Diesel		
WorkStar 7400		
Belt - Fan	1888570C1	♣K080855HD
Belt - A.C. & Alt.	1847716C1	K100822HD
Tensioner Assy. - Alt. & A.C.	1873217C2	38634
Idler Pulley - Alt. & A.C. (Upper)	1841930C1	36164
Idler Pulley - Fan	1841930C1	36164
Hose - Upper		☞21135
Hose - Lower		☞21135
WorkStar 7500		
Tensioner Assy.	1873217C1	38634
Hose - Upper - Rad. To Pipe		21135
Hose - Lower		21135
International/Navistar MaxxForce 10 Diesel		
WorkStar 7400		
Belt - Fan	1888570C1	♣K080855HD
Belt - A.C. & Alt.	1847716C1	K100822HD
Tensioner Assy. - Alt. & A.C.	1873217C2	38634
Idler Pulley - Alt. & A.C. (Upper)	1841930C1	36164
Idler Pulley - Fan	1841930C1	36164
Hose - Upper		☞21135
Hose - Lower		☞21135
WorkStar 7500		
Tensioner Assy.	1873217C1	38634
Hose - Upper - Rad. To Pipe		21135

Application	Mfr. Part No.	Our No.
INTERNATIONAL/NAVISTAR - Continued		
2011 - Continued		
International/Navistar MaxxForce 10 Diesel - Continued		
WorkStar 7500 - Continued		
Hose - Lower		21135
International/Navistar MaxxForce 11 Diesel		
TranStar 8600		
Belt - Fan	3815648C1	♣K080776HD
Hose - Lower - Rad. To Pipe		☞21891
Hose - Lower - Pipe To Eng.		☞21135
International/Navistar MaxxForce 13 Diesel		
ProStar Series		
Belt - Alt. & A.C.	3664150C1	K080794HD
TranStar 8600		
Belt - Fan	3815648C1	♣K080776HD
Hose - Lower - Rad. To Pipe		☞21891
Hose - Lower - Pipe To Eng.		☞21135
WorkStar 7600		
Belt - Alt.	3815648C1	♣K080776HD
Belt - Fan	3625293C2	♣K080780HD
International/Navistar MaxxForce 15 Diesel		
PayStar 5900i		
Belt - A.C.		K060703
International/Navistar MaxxForce DT Diesel		
DuraStar 4300		
Belt - Fan	1847708C1	K100870HD
Tensioner Assy. - Fan	1873217C2	38634
Idler Pulley - Fan	1841930C1	36164
Hose - Upper		23794
Hose - Lower		☞21302
DuraStar 4400		
Belt - Fan	1847727C1	K100894HD
Tensioner Assy.	1873217C1	38634
Idler Pulley	1841930C1	36164
Hose - Upper		23794
Hose - Lower - Rad. To Pipe		☞21302
WorkStar 7500		
Belt - Fan	1847748C1	K100983HD
Tensioner Assy.	1873217C1	38634
Idler Pulley	1841930C1	36164
Hose - Upper		21135
Hose - Lower		21135
2010		
Cummins ISX Diesel		
LoneStar		
Belt - A.C. - From W.P.	3565412C1	♣K060637HD
Belt - Fan, Alt. & W.P.	3833748C1	K120895HD
Tensioner Assy. - A.C.	3104149	38610
Idler Pulley - A.C.	3682229	36223
Hose - Upper - Eng. To Pipe		21135
Hose - Upper - Pipe To Rad.		21135
Hose - Lower - Eng. To Pipe		☞20987
Hose - Lower - Pipe To Rad.		☞21891
ProStar Series		
Belt - Fan, Alt. & W.P.	3817452C1	K120870HD
Belt - A.C. - From W.P.	3565412C1	♣K060637HD
Tensioner Assy. - A.C.	3104149	38610
Idler Pulley - A.C.	3682229	36223
Hose - Upper - Rad. To Pipe; (2 1/2" I.D.)		☞24440
Hose - Upper - Pipe To Pipe; (2 1/2" I.D.)		☞24440
Hose - Upper - Pipe To Eng.		☞21891
Hose - Lower - Rad. To Pipe; (2 1/2" I.D.)		☞24440
Hose - Lower - Pipe To Eng.; (2 1/2" I.D.)		☞24440
International/Navistar MaxxForce 7 Diesel		
DuraStar 4300		
Belt - Fan & Alt.	1832193C2	K081065HD
Belt - Air Compr.	1847509C1	♣K060696HD
Tensioner Assy. - Fan & Alt.	1833688C2	38556
Tensioner Assy. - Air Brake Compr.	1832711C2	38629

☞ Cut to Fit.

♣ Standard Belt Available. See Pages 630-631.

Belts and Coolant Hose for Medium/Heavy-Duty Trucks (1996 and Newer)

Medium & Heavy-Duty Trucks
(1996 & Newer)

Application	Mfr. Part No.	Our No.
INTERNATIONAL/NAVISTAR - Continued		
2010 - Continued		
International/Navistar MaxxForce 7 Diesel - Continued		
DuraStar 4300 - Continued		
Idler Pulley - Upper; W/Air Brake Compr.	1832712C1	38006
Idler Pulley - Lower; W/Air Brake Compr.	1832712C1	38006
Hose - Upper		23795
Hose - Lower		23793
TerraStar		
Tensioner Assy. - Fan	1833688C2	38556
Idler Pulley - Fan	1832710C1	36351
International/Navistar MaxxForce 10 Diesel		
WorkStar 7500		
Belt - Fan, A.C., Alt. & W.P.	1847748C1	K100983HD
Tensioner Assy. - Fan, A.C., Alt. & W.P.	1873217C2	38634
Idler Pulley - Fan, A.C., Alt. & W.P.	1841930C1	36164
Hose - Upper - Eng. To Pipe; (2 1/4" I.D.)		≈24436
Hose - Upper - Pipe To Rad.		≈21135
Hose - Lower - Eng. To Pipe		≈20987
Hose - Lower - Pipe To Heat Exch.; (2 1/2" I.D.)		≈24440
Hose - Lower - Heat Exch. To Pipe		≈21891
Hose - Lower - Pipe To Rad.		≈21891
International/Navistar MaxxForce 13 Diesel		
WorkStar 7600		
Belt - Fan, A.C., Alt. & W.P.	1847748C1	K100983HD
Tensioner Assy. - Fan, A.C., Alt. & W.P.	1873217C2	38634
Idler Pulley - Fan, A.C., Alt. & W.P.	1841930C1	36164
Hose - Upper - Eng. To Pipe; (2 1/4" I.D.)		≈24436
Hose - Upper - Pipe To Rad.		21135
Hose - Lower - Eng. To Pipe		≈21891
Hose - Lower - Pipe To Heat Exch.; (2 1/2" I.D.)		≈24440
Hose - Lower - Heat Exch. To Pipe		≈21891
Hose - Lower - Pipe To Rad.		21891
International/Navistar MaxxForce DT Diesel		
DuraStar 4300		
Tensioner Assy. - Fan	1833688C2	38556
Idler Pulley - Fan	1841930C1	36164
Hose - Upper		23794
Hose - Lower		≈21302
DuraStar 4400		
Belt - Fan & Alt.	1847727C1	K100894HD
Tensioner Assy. - Fan & Alt.	1873217C2	38634
Idler Pulley - Fan & Alt.	1841930C1	36164
Hose - Upper		23794
Hose - Lower - Rad. To Pipe		≈21302
2009		
Caterpillar C13 Diesel		
WorkStar 7600		
Belt - Fan & A.C.	3817958C1	K101115HD
Belt - Alt.	3808254C1	♣K060860HD
Tensioner Assy. - Fan & A.C.	2873203	38646
Tensioner Assy. - Alt.	2756558	38635
Idler Pulley - Alt. (Left)	2790251	36227
Idler Pulley - Alt. (Right)	2790251	36227
Hose - Upper - Eng. To Pipe; (2 1/2" I.D.)		≈24440
Hose - Upper - Pipe To Rad.		21135
Caterpillar C15 Diesel		
PayStar 5600i		
Belt - Fan & Alt.	3577919C1	♣K081088HD
Belt - Fan To A.C.	3577620C1	♣K060555HD
Tensioner Assy. - Fan & Alt.	2002279	38569
Tensioner Assy. - Fan To A.C.	2178938	38511
Idler Pulley - Smooth	1979641	36091
Idler Pulley - Grooved	1979642	36341
Tensioner Pulley - Fan To A.C.	2178938	36091
Hose - Upper - Eng. To Pipe		21135
Hose - Upper - Rad. To Pipe		21891
Hose - Lower - Eng. To Pipe; (3" I.D.)		24248
Hose - Lower - Rad. To Pipe		21135

≈ Cut to Fit.

Application	Mfr. Part No.	Our No.
INTERNATIONAL/NAVISTAR - Continued		
2009 - Continued		
Caterpillar C15 Diesel - Continued		
PayStar 5900i		
Belt - Fan & Alt.	3676724C1	♣K060716HD
Belt - Fan & A.C.	3676401C1	K120992HD
Tensioner Assy. - Alt.	2790253	38636
Tensioner Assy. - Fan & A.C.	2362301	38609
Idler Pulley - A.C. (Lower)	2850277	36282
Hose - Upper - Eng. To Pipe		≈21891
Cummins ISM Diesel		
PayStar 5600i		
Belt - Fan & Alt.	3664150C1	K080794HD
Belt - A.C.	3579001C1	♣K060516HD
Tensioner Assy. - Fan & Alt.	4920105	38622
Tensioner Assy. - A.C.	3102888	38505
Idler Pulley - Fan & Alt.	3400884	36308
Idler Pulley - A.C.	3104139	36225
TranStar 8600		
Belt - Fan & Alt.	3578997C1	♣K080694HD
Belt - A.C.	3579001C1	♣K060516HD
Tensioner Assy. - Fan & Alt.	3102888	38505
Tensioner Assy. - A.C.	4920105	38622
Idler Pulley - Fan & Alt.	3400883	36308
Idler Pulley - A.C.	3104139	36225
Hose - Upper - Rad. To Pipe		≈21135
Hose - Lower - Rad. To Pipe		≈21135
WorkStar 7600		
Belt - A.C.	3579001C1	♣K060516HD
Belt - Alt.	3605646C1	♣K080816HD
Tensioner Assy. - Alt.	2871294	38622
Tensioner Assy. - A.C.	3102888	38505
Idler Pulley - Alt.	3400884	36308
Idler Pulley - A.C.	3104139	36225
Cummins ISX Diesel		
LoneStar		
Belt - A.C. - From W.P.	3565412C1	♣K060637HD
Belt - Fan, Alt. & W.P.	3833748C1	K120895HD
Tensioner Assy. - A.C.	3104149	38610
Idler Pulley - A.C.	3682229	36223
Hose - Upper - Eng. To Pipe		21135
Hose - Upper - Pipe To Rad.		21135
Hose - Lower - Eng. To Pipe		≈20987
Hose - Lower - Pipe To Rad.		≈21891
PayStar 5900i		
Belt - Fan & Alt.	3574308C1	♣K120964HD
Belt - Hub & A.C.	3565412C1	♣K060637HD
Tensioner Assy. - Fan & Alt.	3682946	38587
Tensioner Assy. - A.C.	3682683	38610
Idler Pulley - A.C.	3682229	36223
Tensioner Pulley - Fan & Alt.	3682946	36165
Hose - Upper - Eng. To Pipe		21135
Hose - Upper - Rad. To Pipe		21891
Hose - Lower - Eng. To Pipe; (2 1/2" I.D.)		24240
Hose - Lower - Rad. To Pipe		21135
ProStar Series		
Belt - W.P. To A.C.	3565412C1	♣K060637HD
Belt - W.P., Fan & Alt.	3817452C1	K120870HD
Tensioner Assy. - A.C.	3104149	38610
Idler Pulley - A.C.	3682229	36223
Hose - Upper - Pipe To Pipe; (2 1/2" I.D.)		≈24440
Hose - Upper - Pipe To Rad.; (2 1/2" I.D.)		≈24440
Hose - Lower - Eng. To Pipe; (2 1/2" I.D.)		≈24440
Hose - Lower - Pipe To Rad.; (2 1/2" I.D.)		≈24440
International/Navistar MaxxForce 7 Diesel		
DuraStar 4300		
Serpentine Belt	1832193C2	K081065HD
International/Navistar MaxxForce 9 Diesel		
WorkStar 7400		
Belt - Fan & Alt.; W/A.C.	1847748C1	K100983HD
Tensioner Assy. - Fan, Alt. & A.C.	1873217C2	38634

♣ Standard Belt Available. See Pages 630-631.

Belts and Coolant Hose for Medium/Heavy-Duty Trucks [1996 and Newer]

Medium & Heavy-Duty Trucks
(1996 & Newer)

Application	Mfr. Part No.	Our No.
INTERNATIONAL/NAVISTAR - Continued		
2009 - Continued		
International/Navistar MaxxForce 10 Diesel		
WorkStar 7500		
Belt - W.P., Fan, Alt. & A.C.	1847748C1	K100983HD
International/Navistar MaxxForce DT Diesel		
DuraStar 4300		
Belt - Fan, W.P. & Alt.	1847707C1	K100860HD
Tensioner Assy.	1873217C1	38634
Hose - Upper		23794
Hose - Lower		☞21302
DuraStar 4400		
Belt - Fan & Alt.	1847727C1	K100894HD
Tensioner Assy. - Fan & Alt.	1873217C2	38634
Idler Pulley - Fan & Alt.	1841930C1	36164
WorkStar 7300		
Belt - Accessory Drive	1847725C1	K101015HD
Tensioner Assy.	1873217C2	38634
Idler Pulley	1841930C1	36164
WorkStar 7400		
Belt - Fan, Alt. & W.P.; W/A.C.	1847720C1	K100994HD
Belt - Fan, Alt. & W.P.; W/O A.C.	1847750C1	K100830HD
Tensioner Assy.	1873217C2	38634
Idler Pulley	1841930C1	36164
Hose - Upper - Eng. To Pipe; (2 1/4" I.D.)		☞24436
Hose - Upper - Pipe To Rad.		☞21135
Hose - Lower - Eng. To Pipe		☞20987
Hose - Lower - Pipe To Heat Exch.; (2 1/2" I.D.)		☞24440
Hose - Lower - Heat Exch. To Pipe		☞21891
Hose - Lower - Pipe To Rad.		☞21891
2008		
Caterpillar C13 Diesel		
7600		
Belt - Fan, Alt. & A.C.	3565415C1	♣K081092HD
Tensioner Assy. - Fan, Alt. & A.C.	2117895	38590
Tensioner Pulley - Fan, Alt. & A.C.	2117895	36164
Idler Pulley - Smooth	2078118	36269
Idler Pulley - Grooved	1979642	36341
Hose - Upper - Eng. To Pipe; (2 1/2" I.D.)		24240
Hose - Upper - Rad. To Pipe		☞21115
Hose - Lower - Eng. To Pipe; (2 1/2" I.D.)		24240
Hose - Lower - Rad. To Pipe		21894
TranStar 8500; TranStar 8600; WorkStar 7700		
Idler Pulley - Smooth	2078118	36269
Idler Pulley - Grooved	1979642	36341
Caterpillar C15 Diesel		
PayStar 5600i		
Belt - Fan & Alt.	3577919C1	♣K081088HD
Belt - Fan To A.C.	3577620C1	♣K060555HD
Tensioner Assy. - Fan & Alt.	2002279	38569
Tensioner Assy. - Fan To A.C.	2178938	38511
Idler Pulley - Smooth	1979641	36091
Idler Pulley - Grooved	1979642	36341
Tensioner Pulley - Fan To A.C.	2178938	36091
Hose - Upper - Eng. To Pipe		21135
Hose - Upper - Rad. To Pipe		21891
Hose - Lower - Eng. To Pipe; (3" I.D.)		24248
Hose - Lower - Rad. To Pipe		21135
Cummins ISM Diesel		
PayStar 5500i		
Belt - Fan & Alt.	3579000C1	♣K080806HD
Belt - Hub & A.C.	3579001C1	♣K060516HD
Tensioner Assy. - Fan & Alt.	4920105	38622
Tensioner Assy. - Hub & A.C.	3102888	38505
Idler Pulley - Fan & Alt.	3400884	36308
Idler Pulley - A.C.	3104139	36225
Tensioner Pulley - A.C.	3102888	36091
PayStar 5600i		
Belt - Fan	3579000C1	♣K080806HD
Belt - A.C.	3579001C1	♣K060516HD

☞ Cut to Fit.

Application	Mfr. Part No.	Our No.
INTERNATIONAL/NAVISTAR - Continued		
2008 - Continued		
Cummins ISM Diesel - Continued		
TranStar 8500		
Idler Pulley - Fan & Alt.	3400884	36308
Idler Pulley - A.C.	3104139	36225
TranStar 8600		
Belt - Fan & Alt.	3578997C1	♣K080694HD
Belt - Hub & A.C.	3579001C1	♣K060516HD
Tensioner Assy. - Fan & Alt.	4920105	38622
Tensioner Assy. - Hub & A.C.	3102888	38505
Idler Pulley - Fan & Alt.	3400884	36308
Idler Pulley - A.C.	3104139	36225
Tensioner Pulley - A.C.	3102888	36091
Hose - Upper - Eng. To Pipe		21135
Hose - Upper - Rad. To Pipe		☞21135
Hose - Lower - Eng. To Pipe		21891
Hose - Lower - Rad. To Pipe		21135
WorkStar 7600		
Belt - Fan & Alt.	3579000C1	♣K080806HD
Belt - Hub & A.C.	3579001C1	♣K060516HD
Tensioner Assy. - Fan & Alt.	4920105	38622
Tensioner Assy. - Hub & A.C.	3102888	38505
Idler Pulley - Fan & Alt.	3400884	36308
Idler Pulley - A.C.	3104139	36225
Tensioner Pulley - A.C.	3102888	36091
Hose - Upper - Eng. To Pipe; (2 1/2" I.D.)		24240
Hose - Upper - Rad. To Pipe		21135
Hose - Lower - Cooler To Pipe; (2 1/2" I.D.)		24240
Hose - Lower - Rad. To Pipe		21891
Cummins ISX Diesel		
9200i		
Belt - Fan & Alt.	3565410C3	♣K120911HD
Belt - A.C.	3565412C1	♣K060637HD
Idler Pulley - A.C.	3682229	36223
Hose - Upper; (2 1/2" I.D.)		☞24440
Hose - Lower - Rad. To Pipe		☞21135
Hose - Lower - Pipe To Eng.; (2 1/2" I.D.)		☞24440
9900i		
Belt - Fan & Alt.	3565411C1	K120979
Belt - A.C.	3565412C1	♣K060637HD
PayStar 5500i		
Belt - Fan & Alt.	3574308C1	♣K120964HD
Belt - Hub & A.C.	3565412C1	♣K060637HD
Tensioner Assy. - Fan & Alt.	3682946	38587
Tensioner Assy. - A.C.	3682683	38610
Idler Pulley - A.C.	3682229	36223
Tensioner Pulley - Fan & Alt.	3682946	36165
Hose - Upper - Eng. To Pipe		21135
Hose - Upper - Rad. To Pipe		☞21115
Hose - Lower - Eng. To Pipe; (2 1/2" I.D.)		24240
Hose - Lower - Rad. To Pipe		21135
PayStar 5900i		
Belt - Fan & Alt.	3574308C1	♣K120964HD
Belt - Hub & A.C.	3565412C1	♣K060637HD
Tensioner Assy. - Fan & Alt.	3682946	38587
Tensioner Assy. - A.C.	3682683	38610
Idler Pulley - A.C.	3682229	36223
Tensioner Pulley - Fan & Alt.	3682946	36165
Hose - Upper - Eng. To Pipe		21135
Hose - Upper - Rad. To Pipe		21891
Hose - Lower - Eng. To Pipe; (2 1/2" I.D.)		24240
Hose - Lower - Rad. To Pipe		21135
ProStar Series		
Belt - Fan & Alt.	3289314	♣K080708HD
Belt - Hub & A.C.	3565412C1	♣K060637HD
Tensioner Assy. - A.C.	3682683	38610
Tensioner Assy. - Fan & Alt.	3400885	38521
Idler Pulley - A.C.	3682229	36223
Idler Pulley - Fan & Alt.	3400883	36308
Hose - Upper - Eng. To Pipe; (2 1/2" I.D.)		24240
Hose - Upper - Rad. To Pipe; (2 1/2" I.D.)		24240

♣ Standard Belt Available. See Pages 630-631.

Belts and Coolant Hose for Medium/Heavy-Duty Trucks (1996 and Newer)

 Medium & Heavy-Duty Trucks
(1996 & Newer)

Application	Mfr. Part No.	Our No.
INTERNATIONAL/NAVISTAR - Continued		
2008 - Continued		
Cummins ISX Diesel - Continued		
ProStar Series - Continued		
Hose - Lower - Eng. To Pipe; (2 1/2" I.D.)		24240
Hose - Lower - Rad. To Pipe; (2 1/2" I.D.)		24240
International/Navistar DT466 Diesel		
4300		
Belt - Fan, Alt. & A.C.	1842457C1	♣K080825HD
Tensioner Assy. - Fan, Alt. & A.C.	1841760C1	38620
Hose - Upper - Eng. To Rad.		20731
Hose - Lower - Eng. To Rad.		22742
4400		
Belt - Fan, Alt. & A.C.	1842457C1	♣K080825HD
Tensioner Assy. - Fan, Alt. & A.C.	1841760C1	38620
Hose - Upper - Eng. To Rad.		20731
Hose - Lower - Cooler To Rad.		21891
International/Navistar DT570 Diesel		
4400		
Belt - Hub, Fan, Alt. & A.C.	1842466C1	K080845HD
Tensioner Assy. - Hub, Fan, Alt. & A.C.	1841760C1	38620
Hose - Upper - Eng. To Rad.		20731
International/Navistar MaxxForce 7 Diesel		
DuraStar 4300		
Belt - Fan, Alt. & A.C.	1832193C2	K081065HD
Belt - Air Compr.	1847509C1	♣K060696HD
Tensioner Assy. - Fan, Alt. & A.C.	1833688C2	38556
Tensioner Assy. - Air Brake Compr.	1832711C2	38629
Hose - Upper - Eng. To Pipe		21135
Hose - Upper - Rad. To Pipe		21042
International/Navistar MaxxForce 9 Diesel		
WorkStar 7400		
Belt - Fan, Alt. & A.C.	1847748C1	K100983HD
Tensioner Assy. - Fan, Alt. & A.C.	1873217C1	38634
Hose - Upper - Eng. To Pipe; (2 1/2" I.D.)		24240
Hose - Upper - Rad. To Pipe		21135
Hose - Lower - Eng. To Cooler; (2 1/2" I.D.)		24240
Hose - Lower - Rad. To Pipe		21891
Hose - Lower - Cooler To Pipe; (2 1/2" I.D.)		24240
International/Navistar MaxxForce 10 Diesel		
TranStar 8500		
Belt - Accessory Drive	1879845C1	K100877HD
Tensioner Assy.	1873217C1	38634
WorkStar 7400		
Belt - Fan, Alt. & A.C.	1847748C1	K100983HD
Tensioner Assy. - Fan, Alt. & A.C.	1873217C1	38634
Hose - Upper		21135
Hose - Lower - Eng. To Cooler		21891
Hose - Lower - Rad. To Pipe		21891
Hose - Lower - Cooler To Pipe		21891
WorkStar 7500		
Tensioner Assy. - Fan, Alt. & A.C.	1873217C1	38634
Hose - Upper - Eng. To Pipe; (2 1/4" I.D.)		24236
Hose - Upper - Rad. To Pipe		21135
Hose - Lower - Eng. To Pipe		21891
Hose - Lower - Rad. To Pipe		21135
International/Navistar MaxxForce 13 Diesel		
ProStar Series		
Hose - Upper - Eng. To Pipe		21891
Hose - Upper - Rad. To Pipe		21135
Hose - Lower - Eng. To Pipe; (2 1/2" I.D.)		24240
Hose - Lower - Rad. To Pipe		21891
International/Navistar MaxxForce DT Diesel		
4400		
Belt - Fan & Alt.	1847727C1	K100894HD
Tensioner Assy. - Fan & Alt.	1873217C2	38634
Idler Pulley - Fan & Alt.	1841930C1	36164
DuraStar 4300		
Belt - Fan, Alt. & A.C.; W/Air Brake Compr.	1832193C2	K081065HD

♣ Standard Belt Available. See Pages 630-631.

Application	Mfr. Part No.	Our No.
INTERNATIONAL/NAVISTAR - Continued		
2008 - Continued		
International/Navistar MaxxForce DT Diesel - Continued		
DuraStar 4300 - Continued		
Belt - Fan, Alt. & A.C.; W/O Air Brake Compr.	1847707C1	K100860HD
Belt - Air Brake Compr.	1847509C1	♣K060696HD
Tensioner Assy. - Fan, Alt. & A.C.; W/Air Brake Compr.	1833688C2	38556
Tensioner Assy. - Fan, Alt. & A.C.; W/O Air Brake Compr.	1873217C1	38634
Tensioner Assy. - Air Brake Compr.	1832711C2	38629
Hose - Upper - Eng. To Rad.		20731
Hose - Lower - Eng. To Rad.		22742
DuraStar 4400		
Belt - Fan & Alt.	1847727C1	K100894HD
Tensioner Assy. - Fan & Alt.	1873217C2	38634
Hose - Upper		23794
Hose - Lower		♣21302
WorkStar 7300		
Belt - Fan, Alt. & A.C.	1847725C1	K101015HD
Tensioner Assy. - Fan, Alt. & A.C.	1873217C2	38634
Hose - Upper - Eng. To Pipe		21135
Hose - Lower - Pipe To Rad.		21135
WorkStar 7400		
Belt - Fan, Alt. & W.P.; W/A.C.	1847720C1	K100994HD
Belt - Fan, Alt. & W.P.; W/O A.C.	1847750C1	K100830HD
Tensioner Assy. - Fan & Alt.	1873217C2	38634
Idler Pulley - Fan & Alt.	1841930C1	36164
Hose - Upper - Eng. To Pipe; (2 1/4" I.D.)		♣24436
Hose - Upper - Pipe To Rad.		♣21135
Hose - Lower - Eng. To Pipe		♣20987
Hose - Lower - Pipe To Heat Exch.; (2 1/2" I.D.)		♣24440
Hose - Lower - Heat Exch. To Pipe		♣21891
Hose - Lower - Pipe To Rad.		♣21891
International/Navistar MaxxForce DT Diesel Electric Assist		
DuraStar Hybrid		
Belt - Fan	1847708C1	K100870HD
Tensioner Assy.	1873217C2	38634
Hose - Upper		23794
International/Navistar VT365 Diesel		
4200		
Belt - A.C.	1843218C1	♣K060509HD
Belt - Fan	1839963C1	♣K080830HD
Tensioner Assy. - A.C.	1833688C2	38556
Hose - Upper		22775
Hose - Lower		22774
MXT		
Belt - Fan, Alt. & A.C.	1842458C1	♣K080816HD
Hose - Lower - Rad. To Pipe		21891
2007		
Caterpillar C11 Diesel		
7600		
Belt - Fan, Alt. & A.C.	3565415C1	♣K081092HD
Tensioner Assy. - Fan, Alt. & A.C.	2117895	38590
Tensioner Pulley - Fan, Alt. & A.C.	2117895	36164
Hose - Upper - Eng. To Pipe; (2 1/2" I.D.)		24240
Hose - Lower - Eng. To Pipe; (2 1/2" I.D.)		24240
Hose - Lower - Rad. To Pipe		21894
8600		
Belt - Fan, Alt. & A.C.	3578774C1	♣K080944HD
Tensioner Assy. - Fan, Alt. & A.C.	2117895	38590
Tensioner Pulley - Fan, Alt. & A.C.	2117895	36164
Hose - Upper - Eng. To Pipe; (2 1/2" I.D.)		24240
Hose - Upper - Rad. To Pipe		21135
Hose - Lower - Eng. To Pipe		21135
Hose - Lower - Rad. To Pipe		21135
Caterpillar C13 Diesel		
5500i		
Belt - Fan, Alt. & A.C.	3565415C1	♣K081092HD

≡ Cut to Fit.

Belts and Coolant Hose for Medium/Heavy-Duty Trucks (1996 and Newer)

Medium & Heavy-Duty Trucks
(1996 & Newer)

Application	Mfr. Part No.	Our No.
INTERNATIONAL/NAVISTAR - Continued		
2007 - Continued		
Caterpillar C13 Diesel - Continued		
5500i - Continued		
Tensioner Assy. - Fan, Alt. & A.C.	2117895	38590
Tensioner Pulley - Fan, Alt. & A.C.	2117895	36164
Idler Pulley - Smooth	2078118	36269
Idler Pulley - Grooved	1979642	36341
Hose - Upper - Eng. To Rad.		21135
Hose - Upper - Rad. To Pipe		≧21115
Hose - Lower - Eng. To Pipe; (2 1/2" I.D.)		24240
Hose - Lower - Rad. To Cooler		21135
Hose - Lower - Cooler To Pipe; (2 1/2" I.D.)		24240
5600i; 5900i		
Idler Pulley - Smooth	2078118	36269
Idler Pulley - Grooved	1979642	36341
7600		
Belt - Fan, Alt. & A.C.	3565415C1	♣K081092HD
Tensioner Assy. - Fan, Alt. & A.C.	2117895	38590
Tensioner Pulley - Fan, Alt. & A.C.	2117895	36164
Idler Pulley - Smooth	2078118	36269
Idler Pulley - Grooved	1979642	36341
Hose - Upper - Eng. To Pipe; (2 1/2" I.D.)		24240
Hose - Upper - Rad. To Pipe		≧21115
Hose - Lower - Eng. To Pipe; (2 1/2" I.D.)		24240
Hose - Lower - Rad. To Pipe		21894
7700		
Idler Pulley - Smooth	2078118	36269
Idler Pulley - Grooved	1979642	36341
8600		
Belt - Fan, Alt. & A.C.	3578774C1	♣K080944HD
Tensioner Assy. - Fan, Alt. & A.C.	2117895	38590
Tensioner Pulley - Fan, Alt. & A.C.	2117895	36164
Idler Pulley - Smooth	2078118	36269
Idler Pulley - Grooved	1979642	36341
Hose - Upper - Eng. To Pipe; (2 1/2" I.D.)		24240
Hose - Upper - Rad. To Pipe		21135
Hose - Lower - Eng. To Pipe		21135
Hose - Lower - Rad. To Pipe		21135
9200i		
Belt - Fan, Alt. & A.C.	3578775C2	♣K081000HD
Tensioner Assy. - Fan, Alt. & A.C.	2117895	38590
Tensioner Pulley - Fan, Alt. & A.C.	2117895	36164
Idler Pulley - Smooth	2078118	36269
Idler Pulley - Grooved	1979642	36341
Hose - Upper - Eng. To Pipe; (2 1/2" I.D.)		24240
Hose - Upper - Rad. To Pipe		21135
Hose - Lower - Eng. To Pipe; (2 1/2" I.D.)		24240
Hose - Lower - Rad. To Pipe		21891
9400i		
Belt - Fan, Alt. & A.C.	3578775C2	♣K081000HD
Tensioner Assy. - Fan, Alt. & A.C.	2117895	38590
Tensioner Pulley - Fan, Alt. & A.C.	2117895	36164
Idler Pulley - Smooth	2078118	36269
Idler Pulley - Grooved	1979642	36341
9900i		
Belt - Fan, Alt. & A.C.	3578777C2	K081099HD
Tensioner Assy. - Fan, Alt. & A.C.	2117895	38590
Idler Pulley - Smooth	2078118	36269
Idler Pulley - Grooved	1979642	36341
Caterpillar C15 Diesel		
9400i		
Belt - Fan & Alt.	35664736C2	♣K080991HD
Belt - Fan To A.C.	3565414C1	♣K060605HD
Tensioner Assy. - Fan & Alt.	2002279	38569
Tensioner Assy. - Fan To A.C.	2178938	38511
Idler Pulley - Smooth	1979641	36091
Idler Pulley - Grooved	1979642	36341
Tensioner Pulley - Fan To A.C.	2178938	36091
Hose - Upper - Eng. To Pipe		21891
Hose - Upper - Rad. To Pipe		21135
Hose - Lower - Eng. To Pipe; (3" I.D.)		24248

Application	Mfr. Part No.	Our No.
INTERNATIONAL/NAVISTAR - Continued		
2007 - Continued		
Caterpillar C15 Diesel - Continued		
9400i - Continued		
Hose - Lower - Rad. To Pipe; (2 1/2" I.D.)		24240
9900i; 9900ix		
Belt - Fan & Alt.	3565415C1	♣K081092HD
Belt - Fan To A.C.	3565416C1	♣K060557HD
Tensioner Assy. - Fan & Alt.	2002279	38569
Tensioner Assy. - Fan To A.C.	2178938	38511
Idler Pulley - Smooth	1979641	36091
Idler Pulley - Grooved	1979642	36341
Tensioner Pulley - Fan To A.C.	2178938	36091
Hose - Upper - Eng. To Rad.		21891
Hose - Upper - Rad. To Pipe		21135
Hose - Lower - Eng. To Rad.; (3" I.D.)		24248
Hose - Lower - Rad. To Pipe; (2 1/2" I.D.)		24240
Cummins ISM Diesel		
5500i		
Belt - Fan & Alt.	3579000C1	♣K080806HD
Belt - Hub & A.C.	3579001C1	♣K060516HD
Tensioner Assy. - Fan & Alt.	4920105	38622
Tensioner Assy. - Hub & A.C.	3102888	38505
Idler Pulley - Fan & Alt.	3400884	36308
Idler Pulley - A.C.	3104139	36225
Tensioner Pulley - A.C.	3102888	36091
Hose - Upper - Eng. To Pipe; (2 1/2" I.D.)		24240
Hose - Upper - Rad. To Pipe		21135
Hose - Lower - Eng. To Pipe		21135
Hose - Lower - Rad. To Pipe		21891
Hose - Lower - Pipe To Cooler		21135
Hose - Lower - Cooler To Pipe; (2 1/2" I.D.)		24240
5600i		
Belt - Fan & Alt.	3579000C1	♣K080806HD
Belt - Hub & A.C.	3579001C1	♣K060516HD
Tensioner Assy. - Fan & Alt.	4920105	38622
Tensioner Assy. - Hub & A.C.	3102888	38505
Idler Pulley - Fan & Alt.	3400884	36308
Idler Pulley - A.C.	3104139	36225
Tensioner Pulley - A.C.	3102888	36091
Hose - Upper - Eng. To Pipe		≧21115
Hose - Upper - Rad. To Pipe; (2 1/2" I.D.)		24240
Hose - Lower - Eng. To Pipe; (2 1/2" I.D.)		24240
Hose - Lower - Rad. To Pipe		21135
5900i		
Idler Pulley - Fan & Alt.	3400884	36308
7600		
Belt - Fan & Alt.	3579000C1	♣K080806HD
Belt - Hub & A.C.	3579001C1	♣K060516HD
Tensioner Assy. - Fan & Alt.	4920105	38622
Tensioner Assy. - Hub & A.C.	3102888	38505
Idler Pulley - Fan & Alt.	3400884	36308
Idler Pulley - A.C.	3104139	36225
Tensioner Pulley - A.C.	3102888	36091
Hose - Upper - Eng. To Pipe		21891
Hose - Upper - Rad. To Pipe; (2 1/2" I.D.)		24240
Hose - Lower - Eng. To Pipe		21135
Hose - Lower - Rad. To Pipe		21891
7700		
Idler Pulley - Fan & Alt.	3400884	36308
8600		
Belt - Fan & Alt.	3578997C1	♣K080694HD
Belt - Hub & A.C.	3579001C1	♣K060516HD
Tensioner Assy. - Fan & Alt.	4920105	38622
Tensioner Assy. - Hub & A.C.	3102888	38505
Idler Pulley - Fan & Alt.	3400884	36308
Idler Pulley - A.C.	3104139	36225
Tensioner Pulley - A.C.	3102888	36091
Hose - Upper - Eng. To Pipe; (2 1/2" I.D.)		24240
Hose - Upper - Pipe To Rad.; (2 1/2" I.D.)		24240
Hose - Lower - Eng. To Pipe; (2 1/2" I.D.)		24240
Hose - Lower - Pipe To Rad.		21891

≧ Cut to Fit.

♣ Standard Belt Available. See Pages 630-631.

Belts and Coolant Hose for Medium/Heavy-Duty Trucks (1996 and Newer)

 Medium & Heavy-Duty Trucks
(1996 & Newer)

Application	Mfr. Part No.	Our No.
INTERNATIONAL/NAVISTAR - Continued		
2007 - Continued		
Cummins ISM Diesel - Continued		
9200i; 9400i		
Belt - Fan & Alt.	3578998C1	▲K080740HD
Belt - Hub & A.C.	3579001C1	▲K060516HD
Tensioner Assy. - Fan & Alt.	4920105	38622
Tensioner Assy. - Hub & A.C.	3102888	38505
Idler Pulley - Fan & Alt.	3400884	36308
Idler Pulley - A.C.	3104139	36225
Tensioner Pulley - A.C.	3102888	36091
Hose - Upper - Eng. To Pipe; (2 1/2" I.D.)		24240
Hose - Upper - Rad. To Pipe		21135
Hose - Lower - Eng. To Pipe; (2 1/2" I.D.)		24240
Hose - Lower - Rad. To Pipe		21891
Cummins ISX Diesel		
5500i		
Belt - Fan & Alt.	3574308C1	▲K120964HD
Belt - Hub & A.C.	3565412C1	▲K060637HD
Tensioner Assy. - Fan & Alt.	3682946	38587
Tensioner Assy. - A.C.	3682683	38610
Idler Pulley - A.C.	3682229	36223
Tensioner Pulley - Fan & Alt.	3682946	36165
Hose - Upper - Eng. To Pipe		21135
Hose - Upper - Rad. To Pipe		②21115
Hose - Lower - Eng. To Pipe; (2 1/2" I.D.)		24240
Hose - Lower - Rad. To Pipe		21135
5600i		
Belt - Fan & Alt.	3574308C1	▲K120964HD
Belt - Hub & A.C.	3565412C1	▲K060637HD
Tensioner Assy. - Fan & Alt.	3682946	38587
Tensioner Assy. - A.C.	3682683	38610
Idler Pulley - A.C.	3682229	36223
Tensioner Pulley - Fan & Alt.	3682946	36165
Hose - Upper - Rad. To Pipe		21891
Hose - Lower - Eng. To Pipe; (2 1/2" I.D.)		24240
Hose - Lower - Rad. To Pipe		21135
Hose - Lower - Pipe To Cooler; (2 1/2" I.D.)		24240
Hose - Lower - Cooler To Pipe; (2 1/2" I.D.)		②24240
5900i		
Belt - Fan & Alt.	3574308C1	▲K120964HD
Belt - Hub & A.C.	3565412C1	▲K060637HD
Tensioner Assy. - Fan & Alt.	3682946	38587
Tensioner Assy. - A.C.	3682683	38610
Idler Pulley - A.C.	3682229	36223
Tensioner Pulley - Fan & Alt.	3682946	36165
Hose - Upper - Eng. To Pipe		21135
Hose - Upper - Rad. To Pipe		21891
Hose - Lower - Eng. To Pipe; (2 1/2" I.D.)		24240
Hose - Lower - Rad. To Pipe		21135
9200i		
Belt - Fan & Alt.	3565410C3	▲K120911HD
Belt - Hub & A.C.	3565412C1	▲K060637HD
Tensioner Assy. - Fan & Alt.	3682946	38587
Tensioner Assy. - A.C.	3682683	38610
Idler Pulley - A.C.	3682229	36223
Tensioner Pulley - Fan & Alt.	3682946	36165
Hose - Upper - Eng. To Pipe		21135
Hose - Upper - Rad. To Pipe		21135
Hose - Lower - Eng. To Pipe		21891
Hose - Lower - Rad. To Pipe		21891
9400i		
Belt - Fan & Alt.	3565410C3	▲K120911HD
Belt - Hub & A.C.	3565412C1	▲K060637HD
Tensioner Assy. - Fan & Alt.	3682946	38587
Tensioner Assy. - A.C.	3682683	38610
Idler Pulley - A.C.	3682229	36223
Tensioner Pulley - Fan & Alt.	3682946	36165
Hose - Upper - Eng. To Pipe		21135
Hose - Upper - Rad. To Pipe		21135
Hose - Lower - Eng. To Pipe; (2 1/2" I.D.)		24240
Hose - Lower - Rad. To Pipe		21891

Application	Mfr. Part No.	Our No.
INTERNATIONAL/NAVISTAR - Continued		
2007 - Continued		
Cummins ISX Diesel - Continued		
9900i; 9900ix		
Belt - A.C.	3565412C1	▲K060637HD
Belt - Fan & Alt.	3565411C3	▲K120975HD
Tensioner Assy. - Fan & Alt.	3682946	38587
Tensioner Assy. - A.C.	3682683	38610
Idler Pulley - A.C.	3682229	36223
Tensioner Pulley - Fan & Alt.	3682946	36165
Hose - Upper - Eng. To Pipe		21135
Hose - Upper - Rad. To Pipe		21135
Hose - Lower - Eng. To Pipe; (2 1/2" I.D.)		24240
Hose - Lower - Pipe To Rad.; (2 1/2" I.D.)		24240
International/Navistar DT466 Diesel		
4300		
Belt - Fan, Alt. & A.C.	1842457C1	▲K080825HD
Tensioner Assy. - Fan, Alt. & A.C.	1841760C1	38620
Idler Pulley - Fan, Alt. & A.C.	1841930C1	36164
Hose - Upper - Eng. To Rad.		20731
Hose - Lower - Eng. To Rad.		22742
4400		
Belt - Fan, Alt. & A.C.	1842457C1	▲K080825HD
Tensioner Assy. - Fan, Alt. & A.C.	1841760C1	38620
Hose - Upper - Eng. To Rad.		20731
Hose - Lower - Cooler To Rad.		21891
7400		
Belt - Hub, Fan, Alt. & A.C.	1842461C1	▲K080926HD
Belt - Fan, Alt. & Hub	1842459C1	K080801HD
Tensioner Assy. - Hub, Fan, Alt. & A.C.	1841760C1	38620
Hose - Upper - Eng. To Rad.		21194
Hose - Upper - Rad. To Pipe; (2 1/2" I.D.)		24240
Hose - Lower - Eng. To Pipe		21135
Hose - Lower - Rad. To Pipe		21135
Hose - Lower - Pipe To Cooler; (2 1/2" I.D.)		24240
International/Navistar DT570 Diesel		
4400		
Belt - Hub, Fan, Alt. & A.C.	1842466C1	K080845HD
Tensioner Assy. - Hub, Fan, Alt. & A.C.	1841760C1	38620
Hose - Upper - Eng. To Rad.		20731
7400		
Belt - Hub, Fan, Alt. & A.C.	1842468C1	▲K080952HD
Tensioner Assy. - Hub, Fan, Alt. & A.C.	1841760C1	38620
Hose - Upper - Eng. To Pipe		21891
Hose - Upper - Rad. To Pipe; (2 1/2" I.D.)		24240
Hose - Lower - Eng. To Pipe		21135
Hose - Lower - Pipe To Cooler		21891
Hose - Lower - Cooler To Rad.		21891
Hose - Lower - Cooler To Pipe		21891
International/Navistar HT570 Diesel		
7500		
Belt - Fan, Alt. & A.C.	1842600C1	▲K080944HD
Tensioner Assy. - Fan, Alt. & A.C.	1841760C1	38620
Hose - Upper - Eng. To Pipe		21891
Hose - Upper - Rad. To Pipe; (2 1/2" I.D.)		24240
8500		
Belt - Fan, Alt. & A.C.	1842466C1	K080845HD
Tensioner Assy. - Fan, Alt. & A.C.	1841760C1	38620
Hose - Upper - Eng. To Rad.		21115
International/Navistar VT275 Diesel		
CF500; CF600		
Belt - Fan, Alt. & P.S.	1848715C1	▲K081331HD
Tensioner Assy.	1844538C1	38257
International/Navistar VT365 Diesel		
4100		
Belt - Fan, Alt. & A.C.	1839963C1	▲K080830HD
Tensioner Assy. - Fan, Alt. & A.C.	1833688C2	38556
Hose - Upper - Eng. To Rad.		22774
Hose - Lower - Eng. To Rad.		22775
4200		
Belt - Fan, Alt. & A.C.	1839963C1	▲K080830HD

▲ Standard Belt Available. See Pages 630-631.
② Two Required.

≅ Cut to Fit.

Belts and Coolant Hose for Medium/Heavy-Duty Trucks (1996 and Newer)

Medium & Heavy-Duty Trucks
(1996 & Newer)

Application	Mfr. Part No.	Our No.
INTERNATIONAL/NAVISTAR - Continued		
2007 - Continued		
International/Navistar VT365 Diesel - Continued		
4200 - Continued		
Belt - Fan & Air Compr.	1843218C1	♣K060509HD
Tensioner Assy. - Fan, Alt. & A.C.	1833688C2	38556
Tensioner Assy. - Air Brake Compr.	1832711C2	38629
Hose - Upper - Eng. To Rad.		22774
Hose - Lower - Eng. To Rad.		22775
MXT		
Belt - Fan, Alt. & A.C.	1842458C1	♣K080816HD
Hose - Lower - Rad. To Pipe		21891
2006		
Caterpillar C11 Diesel		
7600; 7700		
Belt - Fan, Alt. & A.C.	3565415C1	♣K081092HD
Tensioner Assy. - Fan, Alt. & A.C.	2117895	38590
Tensioner Pulley - Fan, Alt. & A.C.	2117895	36164
Hose - Upper - Eng. To Pipe; (2 1/2" I.D.)		24240
Hose - Upper - Rad. To Pipe; (2 1/2" I.D.)		24240
Hose - Lower - Eng. To Pipe; (2 1/2" I.D.)		24240
Hose - Lower - Rad. To Pipe		21894
8600		
Belt - Fan, Alt. & A.C.	3578774C1	♣K080944HD
Tensioner Assy. - Fan, Alt. & A.C.	2117895	38590
Tensioner Pulley - Fan, Alt. & A.C.	2117895	36164
Hose - Upper - Eng. To Pipe		21135
Hose - Upper - Rad. To Pipe; (2 1/2" I.D.)		24240
Hose - Lower - Eng. To Pipe; (2 1/2" I.D.)		24240
Hose - Lower - Rad. To Pipe		21891
Caterpillar C13 Diesel		
5500i		
Belt - Fan, Alt. & A.C.	3565415C1	♣K081092HD
Tensioner Assy. - Fan, Alt. & A.C.	2117895	38590
Tensioner Pulley - Fan, Alt. & A.C.	2117895	36164
Idler Pulley - Smooth	2078118	36269
Idler Pulley - Grooved	1979642	36341
Hose - Upper - Eng. To Rad.		21135
Hose - Upper - Rad. To Pipe		21115
Hose - Lower - Eng. To Pipe; (2 1/2" I.D.)		24240
Hose - Lower - Rad. To Cooler		21135
Hose - Lower - Cooler To Pipe; (2 1/2" I.D.)		24240
5600i; 5900i		
Idler Pulley - Smooth	2078118	36269
Idler Pulley - Grooved	1979642	36341
7600; 7700		
Belt - Fan, Alt. & A.C.	3565415C1	♣K081092HD
Tensioner Assy. - Fan, Alt. & A.C.	2117895	38590
Tensioner Pulley - Fan, Alt. & A.C.	2117895	36164
Idler Pulley - Smooth	2078118	36269
Idler Pulley - Grooved	1979642	36341
Hose - Upper - Eng. To Pipe; (2 1/2" I.D.)		24240
Hose - Upper - Rad. To Pipe; (2 1/2" I.D.)		24240
Hose - Lower - Eng. To Pipe; (2 1/2" I.D.)		24240
Hose - Lower - Rad. To Pipe		21894
8600		
Belt - Fan, Alt. & A.C.	3578774C1	♣K080944HD
Tensioner Assy. - Fan, Alt. & A.C.	2117895	38590
Tensioner Pulley - Fan, Alt. & A.C.	2117895	36164
Idler Pulley - Smooth	2078118	36269
Idler Pulley - Grooved	1979642	36341
Hose - Upper - Eng. To Pipe		21135
Hose - Upper - Rad. To Pipe; (2 1/2" I.D.)		24240
Hose - Lower - Eng. To Pipe; (2 1/2" I.D.)		24240
Hose - Lower - Rad. To Pipe		21891
9200i; 9400i		
Belt - Fan, Alt. & A.C.	3578775C2	♣K081000HD
Tensioner Assy. - Fan, Alt. & A.C.	2117895	38590
Tensioner Pulley - Fan, Alt. & A.C.	2117895	36164
Idler Pulley - Smooth	2078118	36269
Idler Pulley - Grooved	1979642	36341

Application	Mfr. Part No.	Our No.
INTERNATIONAL/NAVISTAR - Continued		
2006 - Continued		
Caterpillar C13 Diesel - Continued		
9200i; 9400i - Continued		
Hose - Upper - Eng. To Pipe; (2 1/2" I.D.)		24240
Hose - Upper - Rad. To Pipe		21135
Hose - Lower - Eng. To Pipe; (2 1/2" I.D.)		24240
Hose - Lower - Rad. To Pipe		21891
9900i		
Idler Pulley - Smooth	2078118	36269
Idler Pulley - Grooved	1979642	36341
Caterpillar C15 Diesel		
5900i		
Belt - Fan & Alt.	2577919C1	♣K081088HD
Belt - Fan To A.C.	3577920C1	♣K060555HD
Tensioner Assy. - Fan & Alt.	2002279	38569
Tensioner Assy. - Fan To A.C.	2178938	38511
Tensioner Pulley - Fan To A.C.	2178938	36091
Hose - Upper - Eng. To Pipe		21891
Hose - Upper - Rad. To Pipe		21135
Hose - Lower - Eng. To Pipe; (3" I.D.)		24248
Hose - Lower - Rad. To Pipe		21135
9400i		
Belt - Fan & Alt.	35664736C2	♣K080991HD
Belt - Fan To A.C.	3565414C1	♣K060605HD
Tensioner Assy. - Fan & Alt.	2002279	38569
Tensioner Assy. - Fan To A.C.	2178938	38511
Idler Pulley - Smooth	1979641	36091
Idler Pulley - Grooved	1979642	36341
Tensioner Pulley - Fan To A.C.	2178938	36091
Hose - Upper - Eng. To Pipe		21891
Hose - Upper - Rad. To Pipe		21135
Hose - Lower - Eng. To Pipe; (3" I.D.)		24248
Hose - Lower - Rad. To Pipe; (2 1/2" I.D.)		24240
9900i; 9900ix		
Belt - Fan & Alt.	3565415C1	♣K081092HD
Belt - Fan To A.C.	3565416C1	♣K060557HD
Tensioner Assy. - Fan & Alt.	2002279	38569
Tensioner Assy. - Fan To A.C.	2178938	38511
Idler Pulley - Smooth	1979641	36091
Idler Pulley - Grooved	1979642	36341
Tensioner Pulley - Fan To A.C.	2178938	36091
Hose - Upper - Eng. To Rad.		21891
Hose - Upper - Rad. To Pipe		21135
Hose - Lower - Eng. To Rad.; (3" I.D.)		24248
Hose - Lower - Rad. To Pipe; (2 1/2" I.D.)		24240
Cummins ISM Diesel		
5500i		
Belt - Fan & Alt.	3579000C1	♣K080806HD
Belt - Hub & A.C.	3579001C1	♣K060516HD
Tensioner Assy. - Fan & Alt.	4920105	38622
Tensioner Assy. - Hub & A.C.	3102888	38505
Idler Pulley - Fan & Alt.	3400884	36308
Idler Pulley - A.C.	3104139	36225
Tensioner Pulley - A.C.	3102888	36091
Hose - Upper - Eng. To Pipe; (2 1/2" I.D.)		24240
Hose - Upper - Rad. To Pipe		21135
Hose - Lower - Eng. To Pipe		21135
Hose - Lower - Rad. To Pipe		21891
Hose - Lower - Pipe To Cooler		21135
Hose - Lower - Cooler To Pipe; (2 1/2" I.D.)		24240
5600i; 5900i		
Belt - Fan & Alt.	3579000C1	♣K080806HD
Belt - Hub & A.C.	3579001C1	♣K060516HD
Tensioner Assy. - Fan & Alt.	4920105	38622
Tensioner Assy. - Hub & A.C.	3102888	38505
Idler Pulley - Fan & Alt.	3400884	36308
Idler Pulley - A.C.	3104139	36225
Tensioner Pulley - A.C.	3102888	36091
Hose - Upper - Eng. To Pipe; (2 1/2" I.D.)		24240
Hose - Upper - Rad. To Pipe		21135
Hose - Lower - Eng. To Pipe; (2 1/2" I.D.)		24240

♣ Standard Belt Available. See Pages 630-631.

≡ Cut to Fit.

Belts and Coolant Hose for Medium/Heavy-Duty Trucks (1996 and Newer)

Medium & Heavy-Duty Trucks
(1996 & Newer)

Application	Mfr. Part No.	Our No.
INTERNATIONAL/NAVISTAR - Continued		
2006 - Continued		
Cummins ISM Diesel - Continued		
5600i; 5900i - Continued		
Hose - Lower - Rad. To Pipe		21891
7600; 7700		
Belt - Fan & Alt.	3579000C1	♣K080806HD
Belt - Hub & A.C.	3579001C1	♣K060516HD
Tensioner Assy. - Fan & Alt.	4920105	38622
Tensioner Assy. - Hub & A.C.	3102888	38505
Idler Pulley - Fan & Alt.	3400884	36308
Idler Pulley - A.C.	3104139	36225
Tensioner Pulley - A.C.	3102888	36091
Hose - Upper - Eng. To Pipe; (2 1/2" I.D.)		24240
Hose - Upper - Rad. To Pipe; (2 1/2" I.D.)		24240
Hose - Lower - Eng. To Pipe		21135
Hose - Lower - Rad. To Pipe		21891
8600		
Belt - Fan & Alt.	3578997C1	♣K080694HD
Belt - Hub & A.C.	3579001C1	♣K060516HD
Tensioner Assy. - Fan & Alt.	4920105	38622
Tensioner Assy. - Hub & A.C.	3102888	38505
Idler Pulley - Fan & Alt.	3400884	36308
Idler Pulley - A.C.	3104139	36225
Tensioner Pulley - A.C.	3102888	36091
Hose - Upper - Eng. To Pipe; (2 1/2" I.D.)		24240
Hose - Upper - Pipe To Rad.; (2 1/2" I.D.)		24240
Hose - Lower - Eng. To Pipe; (2 1/2" I.D.)		24240
Hose - Lower - Pipe To Rad.		21891
9200i; 9400i		
Belt - Fan & Alt.	3578998C1	♣K080740HD
Belt - Hub & A.C.	3579001C1	♣K060516HD
Tensioner Assy. - Fan & Alt.	4920105	38622
Tensioner Assy. - Hub & A.C.	3102888	38505
Idler Pulley - Fan & Alt.	3400884	36308
Idler Pulley - A.C.	3104139	36225
Tensioner Pulley - A.C.	3102888	36091
Hose - Upper - Eng. To Pipe; (2 1/2" I.D.)		24240
Hose - Upper - Rad. To Pipe		21135
Hose - Lower - Eng. To Pipe; (2 1/2" I.D.)		24240
Hose - Lower - Rad. To Pipe		21891
Cummins ISX Diesel		
5500i		
Belt - Fan & Alt.	3574308C1	♣K120964HD
Belt - Hub & A.C.	3565412C1	♣K060637HD
Tensioner Assy. - Fan & Alt.	3682946	38587
Tensioner Assy. - A.C.	3682683	38610
Idler Pulley - A.C.	3682229	36223
Tensioner Pulley - Fan & Alt.	3682946	36165
Hose - Upper - Eng. To Pipe		21135
Hose - Upper - Rad. To Pipe		21135
Hose - Lower - Eng. To Pipe; (2 1/2" I.D.)		24240
Hose - Lower - Rad. To Pipe; (2 1/2" I.D.)		24240
Hose - Lower - Pipe To Cooler; (2 1/2" I.D.)		24240
Hose - Lower - Cooler To Pipe		21135
5600i		
Belt - Fan & Alt.	3574308C1	♣K120964HD
Belt - Hub & A.C.	3565412C1	♣K060637HD
Tensioner Assy. - Fan & Alt.	3682946	38587
Tensioner Assy. - A.C.	3682683	38610
Idler Pulley - A.C.	3682229	36223
Tensioner Pulley - Fan & Alt.	3682946	36165
Hose - Upper - Eng. To Pipe		21135
Hose - Upper - Rad. To Pipe		21135
Hose - Lower - Eng. To Pipe; (2 1/2" I.D.)		24240
Hose - Lower - Rad. To Pipe		21135
Hose - Lower - Pipe To Cooler; (2 1/2" I.D.)		24240
Hose - Lower - Cooler To Pipe; (2 1/2" I.D.)		Ⓣ24240
5900i		
Belt - Fan & Alt.	3574308C1	♣K120964HD
Belt - Hub & A.C.	3565412C1	♣K060637HD
Tensioner Assy. - A.C.	3682683	38610
Tensioner Assy. - Fan & Alt.	3682946	38587

Application	Mfr. Part No.	Our No.
INTERNATIONAL/NAVISTAR - Continued		
2006 - Continued		
Cummins ISX Diesel - Continued		
5900i - Continued		
Idler Pulley - A.C.	3682229	36223
Tensioner Pulley - Fan & Alt.	3682946	36165
Hose - Upper - Eng. To Pipe		21135
Hose - Upper - Rad. To Pipe		21135
Hose - Lower - Eng. To Pipe; (2 1/2" I.D.)		24240
Hose - Lower - Rad. To Pipe		21135
9200i; 9400i		
Belt - Fan & Alt.	3565410C3	♣K120911HD
Belt - Hub & A.C.	3565412C1	♣K060637HD
Tensioner Assy. - A.C.	3682683	38610
Tensioner Assy. - Fan & Alt.	3682946	38587
Idler Pulley - A.C.	3682229	36223
Tensioner Pulley - Fan & Alt.	3682946	36165
Hose - Upper - Eng. To Pipe		21135
Hose - Upper - Rad. To Pipe		21135
Hose - Lower - Eng. To Pipe; (2 1/2" I.D.)		24240
Hose - Lower - Rad. To Pipe		21891
9900i; 9900ix		
Belt - A.C.	3565412C1	♣K060637HD
Belt - Fan & Alt.	3565411C3	♣K120975HD
Tensioner Assy. - A.C.	3682683	38610
Tensioner Assy. - Fan & Alt.	3682946	38587
Idler Pulley - A.C.	3682229	36223
Tensioner Pulley - Fan & Alt.	3682946	36165
Hose - Upper - Eng. To Pipe		21135
Hose - Upper - Rad. To Pipe		21135
Hose - Lower - Eng. To Pipe		Ⓢ21115
Hose - Lower - Pipe To Rad.		21891
International/Navistar 570 Diesel		
7400		
Belt - Hub, Fan, Alt. & A.C.	1842468C1	♣K080952HD
Tensioner Assy. - Hub, Fan, Alt. & A.C.	1841760C1	38620
Hose - Upper - Eng. To Pipe		21891
Hose - Upper - Rad. To Pipe; (2 1/2" I.D.)		24240
Hose - Lower - Eng. To Pipe		21135
Hose - Lower - Pipe To Cooler		21891
Hose - Lower - Cooler To Rad.		21891
Hose - Lower - Cooler To Pipe		21891
International/Navistar DT466 Diesel		
4300		
Belt - Fan, Alt. & A.C.	1842457C1	♣K080825HD
Tensioner Assy. - Fan, Alt. & A.C.	1841760C1	38620
Hose - Upper - Eng. To Rad.		20731
Hose - Lower - Eng. To Rad.		22742
4400		
Belt - Fan, Alt. & A.C.	1842457C1	♣K080825HD
Tensioner Assy. - Fan, Alt. & A.C.	1841760C1	38620
Hose - Upper - Eng. To Rad.		20731
Hose - Lower - Cooler To Rad.		21891
7300		
Belt - Hub, Fan, Alt. & A.C.	1842461C1	♣K080926HD
Tensioner Assy. - Hub, Fan, Alt. & A.C.	1841760C1	38620
Hose - Upper - Eng. To Rad.		21194
Hose - Upper - Rad. To Pipe; (2 1/2" I.D.)		24240
7400		
Belt - Hub, Fan, Alt. & A.C.	1842461C1	♣K080926HD
Tensioner Assy. - Hub, Fan, Alt. & A.C.	1841760C1	38620
Hose - Upper - Eng. To Rad.		21194
Hose - Upper - Rad. To Pipe; (2 1/2" I.D.)		24240
Hose - Lower - Eng. To Pipe		21135
Hose - Lower - Rad. To Pipe		21135
Hose - Lower - Pipe To Cooler; (2 1/2" I.D.)		24240
CXT		
Belt - W.P., Fan, Alt. & A.C.	1842461C1	♣K080926HD
Tensioner Assy. - Hub, Fan, Alt. & A.C.	1841760C1	38620
Hose - Upper - Eng. To Pipe		21891
Hose - Upper - Rad. To Pipe; (2 1/2" I.D.)		24240
Hose - Lower - Eng. To Pipe		21135

♣ Standard Belt Available. See Pages 630-631.
Ⓢ Cut to Fit.

Ⓣ Two Required.

Belts and Coolant Hose for Medium/Heavy-Duty Trucks (1996 and Newer)

Medium & Heavy-Duty Trucks
(1996 & Newer)

Application	Mfr. Part No.	Our No.
INTERNATIONAL/NAVISTAR - Continued		
2006 - Continued		
International/Navistar DT466 Diesel - Continued		
CXT - Continued		
Hose - Lower - Rad. To Pipe		21135
Hose - Lower - Pipe To Cooler		21891
Hose - Lower - Cooler To Pipe		21891
International/Navistar DT570 Diesel		
4400		
Belt - Hub, Fan, Alt. & A.C.	1842466C1	K080845HD
Tensioner Assy. - Hub, Fan, Alt. & A.C.	1841760C1	38620
Hose - Upper - Eng. To Rad.		20731
8500		
Belt - Fan, Alt. & A.C.	1842466C1	K080845HD
Tensioner Assy. - Fan, Alt. & A.C.	1841760C1	38620
Hose - Upper - Eng. To Rad.		21115
RXT		
Belt - Hub, Fan, Alt. & A.C.	1842466C1	K080845HD
Tensioner Assy. - Hub, Fan, Alt. & A.C.	1841760C1	38620
Hose - Upper - Eng. To Rad.		20731
International/Navistar HT570 Diesel		
7500		
Belt - Fan, Alt. & A.C.	1842599C1	▲K080820HD
Tensioner Assy. - Fan, Alt. & A.C.	1841760C1	38620
Hose - Upper - Eng. To Pipe		21891
Hose - Upper - Rad. To Pipe; (2 1/2" I.D.)		24240
Hose - Lower - Eng. To Pipe; (2 1/2" I.D.)		24240
Hose - Lower - Rad. To Pipe; (2 3/4" I.D.)		24244
Hose - Lower - Pipe To Cooler; (2 1/2" I.D.)		24240
Hose - Lower - Cooler To Pipe; (2 3/4" I.D.)		24244
International/Navistar VT275 Diesel		
CF500; CF600		
Belt - W.P., Fan, Alt. & A.C.	1846055C1	▲K081331HD
Tensioner Assy.	1844538C1	38257
International/Navistar VT365 Diesel		
4100		
Belt - Fan, Alt. & A.C.	1839963C1	▲K080830HD
Tensioner Assy. - Fan, Alt. & A.C.	1833688C2	38556
Hose - Upper - Eng. To Rad.		22774
Hose - Lower - Eng. To Rad.		22775
4200		
Belt - Fan, Alt. & A.C.	1839963C1	▲K080830HD
Belt - Fan & Air Compr.	1843218C1	▲K060509HD
Tensioner Assy. - Fan, Alt. & A.C.	1833688C2	38556
Hose - Upper - Eng. To Rad.		22774
Hose - Lower - Eng. To Rad.		22775
2005		
Caterpillar C11 Diesel		
7600; 7700		
Belt - Fan, Alt. & A.C.	3565415C1	▲K081092HD
Tensioner Assy. - Fan, Alt. & A.C.	2117895	38590
Tensioner Pulley - Fan, Alt. & A.C.	2117895	36164
Hose - Upper - Eng. To Pipe; (2 1/2" I.D.)		24240
Hose - Upper - Rad. To Pipe; (2 1/2" I.D.)		24240
Hose - Lower - Eng. To Pipe; (2 1/2" I.D.)		24240
Hose - Lower - Rad. To Pipe		21891
8600		
Belt - Fan, Alt. & A.C.	3578774C1	▲K080944HD
Tensioner Assy. - Fan, Alt. & A.C.	2117895	38590
Tensioner Pulley - Fan, Alt. & A.C.	2117895	36164
Hose - Upper - Eng. To Pipe		21135
Hose - Upper - Rad. To Pipe		21135
Hose - Lower - Eng. To Pipe; (2 1/2" I.D.)		24240
Hose - Lower - Rad. To Pipe		21891
Caterpillar C13 Diesel		
5500i		
Belt - Fan, Alt. & A.C.	3565415C1	▲K081092HD
Tensioner Assy. - Fan, Alt. & A.C.	2117895	38590
Tensioner Pulley - Fan, Alt. & A.C.	2117895	36164

Application	Mfr. Part No.	Our No.
INTERNATIONAL/NAVISTAR - Continued		
2005 - Continued		
Caterpillar C13 Diesel - Continued		
5500i - Continued		
Idle Pulley - Smooth	2078118	36269
Idle Pulley - Grooved	1979642	36341
Hose - Upper - Eng. To Rad.		21135
Hose - Upper - Rad. To Pipe		▲21115
Hose - Lower - Eng. To Pipe; (2 1/2" I.D.)		24240
Hose - Lower - Rad. To Cooler		21135
Hose - Lower - Cooler To Pipe; (2 1/2" I.D.)		24240
5600i		
Belt - Fan, Alt. & A.C.	3595415C1	▲K081092HD
Tensioner Assy. - Fan, Alt. & A.C.	2117895	38590
Tensioner Pulley - Fan, Alt. & A.C.	2117895	36164
Idle Pulley - Smooth	2078118	36269
Idle Pulley - Grooved	1979642	36341
Hose - Upper - Eng. To Pipe		21135
Hose - Upper - Rad. To Pipe		21135
Hose - Lower - Eng. To Pipe; (2 1/2" I.D.)		24240
Hose - Lower - Rad. To Pipe		21135
5900i		
Idle Pulley - Smooth	2078118	36269
Idle Pulley - Grooved	1979642	36341
7600		
Belt - Fan, Alt. & A.C.	3565415C1	▲K081092HD
Tensioner Assy. - Fan, Alt. & A.C.	2117895	38590
Tensioner Pulley - Fan, Alt. & A.C.	2117895	36164
Idle Pulley - Smooth	2078118	36269
Idle Pulley - Grooved	1979642	36341
Hose - Upper - Eng. To Pipe; (2 1/2" I.D.)		24240
Hose - Upper - Rad. To Pipe; (2 1/2" I.D.)		24240
Hose - Lower - Eng. To Pipe; (2 1/2" I.D.)		24240
Hose - Lower - Rad. To Pipe		20206
7700		
Belt - Fan, Alt. & A.C.		▲K081092HD
Tensioner Assy. - Fan, Alt. & A.C.	2117895	38590
Tensioner Pulley - Fan, Alt. & A.C.	2117895	36164
Idle Pulley - Smooth	2078118	36269
Idle Pulley - Grooved	1979642	36341
Hose - Upper - Eng. To Pipe; (2 1/2" I.D.)		24240
Hose - Upper - Rad. To Pipe; (2 1/2" I.D.)		24240
Hose - Lower - Eng. To Pipe; (2 1/2" I.D.)		24240
Hose - Lower - Rad. To Pipe		21891
Hose - Lower - Pipe To Cooler; (2 1/2" I.D.)		24240
Hose - Lower - Cooler To Pipe		21891
8600		
Belt - Fan, Alt. & A.C.	3578774C1	▲K080944HD
Tensioner Assy. - Fan, Alt. & A.C.	2117895	38590
Tensioner Pulley - Fan, Alt. & A.C.	2117895	36164
Idle Pulley - Smooth	2078118	36269
Idle Pulley - Grooved	1979642	36341
Hose - Upper - Eng. To Pipe		21135
Hose - Upper - Rad. To Pipe		21135
Hose - Lower - Eng. To Pipe; (2 1/2" I.D.)		24240
Hose - Lower - Rad. To Pipe		21891
9200i		
Belt - Fan, Alt. & A.C.	3578775C2	▲K081000HD
Tensioner Assy. - Fan, Alt. & A.C.	2117895	38590
Tensioner Pulley - Fan, Alt. & A.C.	2117895	36164
Idle Pulley - Smooth	2078118	36269
Idle Pulley - Grooved	1979642	36341
Hose - Upper - Eng. To Pipe		21135
Hose - Upper - Rad. To Pipe; (2 1/2" I.D.)		24240
Hose - Lower - Eng. To Pipe; (2 1/2" I.D.)		24240
Hose - Lower - Rad. To Pipe		21891
9400i		
Belt - Fan, Alt. & A.C.	3578775C2	▲K081000HD
Tensioner Assy. - Fan, Alt. & A.C.	2117895	38590
Tensioner Pulley - Fan, Alt. & A.C.	2117895	36164
Idle Pulley - Smooth	2078118	36269
Idle Pulley - Grooved	1979642	36341
Hose - Upper - Eng. To Pipe		21135
Hose - Upper - Rad. To Pipe; (2 1/2" I.D.)		24240
Hose - Lower - Eng. To Pipe; (2 1/2" I.D.)		24240
Hose - Lower - Rad. To Pipe		24240

▲ Standard Belt Available. See Pages 630-631.

≧ Cut to Fit.

Belts and Coolant Hose for Medium/Heavy-Duty Trucks (1996 and Newer)

 Medium & Heavy-Duty Trucks
(1996 & Newer)

Application	Mfr. Part No.	Our No.
INTERNATIONAL/NAVISTAR - Continued		
2005 - Continued		
Caterpillar C13 Diesel - Continued		
9400i - Continued		
Hose - Upper - Rad. To Pipe		21135
Hose - Lower - Eng. To Pipe; (2 1/2" I.D.)		24240
Hose - Lower - Rad. To Pipe		21891
9900i		
Idler Pulley - Smooth	2078118	36269
Idler Pulley - Grooved	1979642	36341
Caterpillar C15 Diesel		
5900i		
Belt - Fan & Alt.	2577919C1	♣K081088HD
Belt - Fan To A.C.	3577920C1	♣K060555HD
Tensioner Assy. - Fan & Alt.	2002279	38569
Tensioner Assy. - Fan To A.C.	2178938	38511
Tensioner Pulley - Fan To A.C.	2178938	36091
Hose - Upper - Eng. To Pipe		21891
Hose - Upper - Rad. To Pipe		21135
Hose - Lower - Eng. To Pipe; (3" I.D.)		24248
Hose - Lower - Rad. To Pipe		21135
9400i		
Belt - Fan & Alt.	35664736C2	♣K080991HD
Belt - Fan To A.C.	3565414C1	♣K060605HD
Tensioner Assy. - Fan & Alt.	2002279	38569
Tensioner Assy. - Fan To A.C.	2178938	38511
Idler Pulley - Smooth	1979641	36091
Idler Pulley - Grooved	1979642	36341
Tensioner Pulley - Fan To A.C.	2178938	36091
Hose - Upper - Eng. To Pipe		21891
Hose - Upper - Rad. To Pipe		21135
Hose - Lower - Eng. To Pipe; (3" I.D.)		24248
Hose - Lower - Rad. To Pipe; (2 1/2" I.D.)		24240
9900i; 9900ix		
Belt - Fan & Alt.	3565415C1	♣K081092HD
Belt - Fan To A.C.	3565416C1	♣K060557HD
Tensioner Assy. - Fan & Alt.	2002279	38569
Tensioner Assy. - Fan To A.C.	2178938	38511
Idler Pulley - Smooth	1979641	36091
Idler Pulley - Grooved	1979642	36341
Tensioner Pulley - Fan To A.C.	2178938	36091
Hose - Upper - Eng. To Pipe		21891
Hose - Upper - Rad. To Pipe		21135
Hose - Lower - Eng. To Pipe; (3" I.D.)		24248
Hose - Lower - Rad. To Pipe; (2 1/2" I.D.)		24240
Cummins ISM Diesel		
5500i; 5600i		
Belt - Fan & Alt.	3579000C1	♣K080806HD
Belt - Hub & A.C.	3579001C1	♣K060516HD
Tensioner Assy. - Fan & Alt.	4920105	38622
Tensioner Assy. - Hub & A.C.	3102888	38505
Idler Pulley - Fan & Alt.	3400884	36308
Idler Pulley - A.C.	3104139	36225
Tensioner Pulley - A.C.	3102888	36091
Hose - Upper - Eng. To Pipe; (2 1/2" I.D.)		24240
Hose - Upper - Rad. To Pipe		21135
Hose - Lower - Eng. To Pipe; (2 1/2" I.D.)		24240
Hose - Lower - Rad. To Pipe		21891
5900i		
Belt - Fan & Alt.	3579000C1	♣K080806HD
Belt - Hub & A.C.	3579001C1	♣K060516HD
Tensioner Assy. - Fan & Alt.	4920105	38622
Tensioner Assy. - Hub & A.C.	3102888	38505
Idler Pulley - Fan & Alt.	3400884	36308
Idler Pulley - A.C.	3104139	36225
Tensioner Pulley - A.C.	3102888	36091
7400; 7600; 7700		
Belt - Fan & Alt.	3579000C1	♣K080806HD
Belt - Hub & A.C.	3579001C1	♣K060516HD
Tensioner Assy. - Fan & Alt.	4920105	38622
Tensioner Assy. - Hub & A.C.	3102888	38505
Idler Pulley - Fan & Alt.	3400884	36308

Application	Mfr. Part No.	Our No.
INTERNATIONAL/NAVISTAR - Continued		
2005 - Continued		
Cummins ISM Diesel - Continued		
7400; 7600; 7700 - Continued		
Idler Pulley - A.C.	3104139	36225
Tensioner Pulley - A.C.	3102888	36091
Hose - Upper - Eng. To Pipe; (2 1/2" I.D.)		24240
Hose - Upper - Rad. To Pipe; (2 1/2" I.D.)		24240
Hose - Lower - Eng. To Pipe		21135
Hose - Lower - Rad. To Pipe		21891
8600		
Belt - Fan & Alt.	3578997C1	♣K080694HD
Belt - Hub & A.C.	3579001C1	♣K060516HD
Tensioner Assy. - Fan & Alt.	4920105	38622
Tensioner Assy. - Hub & A.C.	3102888	38505
Idler Pulley - Fan & Alt.	3400884	36308
Idler Pulley - A.C.	3104139	36225
Tensioner Pulley - A.C.	3102888	36091
Hose - Upper - Eng. To Pipe; (2 1/2" I.D.)		24240
Hose - Upper - Rad. To Pipe		24240
Hose - Lower - Eng. To Pipe; (2 1/2" I.D.)		24240
Hose - Lower - Rad. To Pipe		21891
9200i		
Belt - Fan & Alt.	3578998C1	♣K080740HD
Belt - Hub & A.C.	3579001C1	♣K060516HD
Tensioner Assy. - Fan & Alt.	4920105	38622
Tensioner Assy. - Hub & A.C.	3102888	38505
Idler Pulley - Fan & Alt.	3400884	36308
Idler Pulley - A.C.	3104139	36225
Tensioner Pulley - A.C.	3102888	36091
Hose - Upper - Eng. To Pipe; (2 1/2" I.D.)		24240
Hose - Upper - Rad. To Pipe		21135
Hose - Lower - Eng. To Pipe; (2 1/2" I.D.)		24240
Hose - Lower - Rad. To Pipe		21891
9400i		
Belt - Fan & Alt.	3578998C1	♣K080740HD
Belt - Hub & A.C.	3579001C1	♣K060516HD
Tensioner Assy. - Fan & Alt.	3400885	38521
Tensioner Assy. - Hub & A.C.	4004933	38505
Idler Pulley - A.C.	3104139	36225
Tensioner Pulley - A.C.	4004933	36091
Idler Pulley - Fan & Alt.	3400884	36308
Hose - Upper - Eng. To Pipe; (2 1/2" I.D.)		24240
Hose - Upper - Rad. To Pipe		21135
Hose - Lower - Eng. To Pipe; (2 1/2" I.D.)		24240
Hose - Lower - Rad. To Pipe		21891
Cummins ISX Diesel		
5500i; 5600i; 5900i		
Belt - Fan & Alt.	3574308C1	♣K120964HD
Belt - Hub & A.C.	3565412C1	♣K060637HD
Tensioner Assy. - A.C.	3682683	38610
Tensioner Assy. - Fan & Alt.	3682946	38587
Idler Pulley - A.C.	3682229	36223
Tensioner Pulley - Fan & Alt.	3682946	36165
Hose - Upper - Eng. To Pipe		21135
Hose - Upper - Rad. To Pipe		21135
Hose - Lower - Eng. To Pipe; (2 1/2" I.D.)		24240
Hose - Lower - Rad. To Pipe; (2 1/2" I.D.)		24240
9200i; 9400i		
Belt - Fan & Alt.	3565410C3	♣K120911HD
Belt - Hub & A.C.	3565412C1	♣K060637HD
Tensioner Assy. - A.C.	3682683	38610
Tensioner Assy. - Fan & Alt.	3682946	38587
Idler Pulley - A.C.	3682229	36223
Tensioner Pulley - Fan & Alt.	3682946	36165
Hose - Upper - Eng. To Pipe		21135
Hose - Upper - Rad. To Pipe		21135
Hose - Lower - Eng. To Pipe; (2 1/2" I.D.)		24240
Hose - Lower - Rad. To Pipe		21891
9900i; 9900ix		
Belt - A.C.	3565412C1	♣K060637HD
Belt - Fan & Alt.	3565411C3	♣K120975HD
Tensioner Assy. - A.C.	3682683	38610

♣ Standard Belt Available. See Pages 630-631.

Belts and Coolant Hose for Medium/Heavy-Duty Trucks (1996 and Newer)

Medium & Heavy-Duty Trucks
(1996 & Newer)

Application	Mfr. Part No.	Our No.
INTERNATIONAL/NAVISTAR - Continued		
2005 - Continued		
Cummins ISX Diesel - Continued		
9900i; 9900ix - Continued		
Tensioner Assy. - Fan & Alt.	3682946	38587
Idler Pulley - A.C.	3682229	36223
Tensioner Pulley - Fan & Alt.	3682946	36165
Hose - Upper - Eng. To Pipe		21135
Hose - Upper - Rad. To Pipe		21135
Hose - Lower - Eng. To Pipe; (2 1/2" I.D.)		24240
Hose - Lower - Pipe To Rad.; (2 1/2" I.D.)		24240
International/Navistar 530 Diesel		
4400		
Belt - Fan, Alt. & Hub		♣K080685HD
Belt - Fan To A.C.	2017725C1	♣K060490HD
Tensioner Assy. - Fan, Alt. & Hub	1830033C1	38514
Tensioner Assy. - Fan To A.C.	3543883C1	38511
Tensioner Pulley - Fan, Alt. & Hub	1830033C1	36091
Tensioner Pulley - Fan To A.C.	3543883C1	36091
Hose - Upper - Eng. To Rad.		20731
Hose - Lower - Eng. To Rad.		22742
8500		
Belt - Fan & Alt.		♣K080685HD
Belt - Fan To A.C.	2017725C1	♣K060490HD
Tensioner Assy. - Fan & Alt.	1830033C1	38514
Tensioner Assy. - Fan To A.C.	3543883C1	38511
Tensioner Pulley - Fan & Alt.	1830033C1	36091
Tensioner Pulley - Fan To A.C.	3543883C1	36091
International/Navistar DT466 Diesel		
4300; 4400		
Belt - Fan, Alt. & A.C.	1842457C1	♣K080825HD
Tensioner Assy. - Fan, Alt. & A.C.	1841760C1	38620
Hose - Upper - Eng. To Rad.		20731
Hose - Lower - Eng. To Rad.		22742
7300		
Belt - Hub, Fan, Alt. & A.C.	1842597C1	♣K080934HD
Tensioner Assy. - Hub, Fan, Alt. & A.C.	1841760C1	38620
7400		
Belt - Hub, Fan, Alt. & A.C.; W/93" Belt		
O.C.	1842461C1	♣K080926HD
Belt - Hub, Fan, Alt. & A.C.; W/94" Belt		
O.C.	1842597C1	♣K080934HD
Tensioner Assy. - Hub, Fan, Alt. & A.C.	1841760C1	38620
Hose - Upper - Eng. To Rad.		21194
Hose - Upper - Rad. To Pipe; (2 1/2" I.D.)		24240
Hose - Lower - Eng. To Pipe		21135
Hose - Lower - Rad. To Pipe		21135
Hose - Lower - Pipe To Cooler; (2 1/2" I.D.)		24240
CXT		
Belt - W.P., Fan, Alt. & A.C.	1842461C1	♣K080926HD
Tensioner Assy. - Hub, Fan, Alt. & A.C.	1841760C1	38620
Hose - Upper - Eng. To Pipe		21891
Hose - Upper - Rad. To Pipe; (2 1/2" I.D.)		24240
Hose - Lower - Eng. To Pipe		21135
Hose - Lower - Rad. To Pipe		21135
Hose - Lower - Pipe To Cooler		21891
Hose - Lower - Cooler To Pipe		21891
International/Navistar DT530 Diesel		
7400		
Belt - Fan, Alt. & Hub	3543930C1	♣K080760HD
Belt - Fan To A.C.	1841563C1	♣K060458HD
Tensioner Assy. - Fan, Alt. & Hub	1830033C1	38514
Tensioner Assy. - A.C.	3543883C1	38511
Tensioner Pulley - Fan, Alt. & Hub	1830033C1	36091
Tensioner Pulley - A.C.	3543883C1	36091
Hose - Upper - Eng. To Pipe; (2 1/4" I.D.)		24236
Hose - Upper - Pipe To Rad.; (2 1/2" I.D.)		24240
Hose - Lower - Eng. To Rad.		22762
7500		
Belt - Fan & Alt.	1820547C3	♣K080774HD
Belt - Fan To A.C.	1841563C1	♣K060458HD
Tensioner Assy. - Fan & Alt.	1830033C1	38514

Application	Mfr. Part No.	Our No.
INTERNATIONAL/NAVISTAR - Continued		
2005 - Continued		
International/Navistar DT530 Diesel - Continued		
7500 - Continued		
Tensioner Assy. - Fan To A.C.	3543883C1	38511
Tensioner Pulley - Fan To A.C.	3543883C1	36091
Tensioner Pulley - Fan & Alt.	1830033C1	36091
Hose - Upper - Eng. To Pipe; (2 1/4" I.D.)		24236
Hose - Upper - Pipe To Rad.; (2 1/2" I.D.)		24240
Hose - Lower - Eng. To Rad.		22762
International/Navistar DT570 Diesel		
4400		
Belt - Hub, Fan, Alt. & A.C.	1842466C1	K080845HD
Tensioner Assy. - Hub, Fan, Alt. & A.C.	1841760C1	38620
Hose - Upper - Eng. To Rad.		20731
7400		
Belt - Hub, Fan, Alt. & A.C.	1842468C1	♣K080952HD
Tensioner Assy. - Hub, Fan, Alt. & A.C.	1841760C1	38620
Hose - Upper - Eng. To Pipe		21891
Hose - Upper - Rad. To Pipe; (2 1/2" I.D.)		24240
Hose - Lower - Eng. To Pipe		21135
Hose - Lower - Pipe To Cooler		21891
Hose - Lower - Cooler To Rad.		21891
Hose - Lower - Cooler To Pipe		21891
International/Navistar HT570 Diesel		
7500		
Belt - Fan, Alt. & A.C.	1842600C1	♣K080944HD
Tensioner Assy. - Fan, Alt. & A.C.	1841760C1	38620
Hose - Upper - Eng. To Pipe		21891
Hose - Upper - Rad. To Pipe; (2 1/2" I.D.)		24240
Hose - Lower - Eng. To Pipe; (2 1/2" I.D.)		24240
Hose - Lower - Rad. To Pipe; (2 3/4" I.D.)		24244
Hose - Lower - Pipe To Cooler; (2 1/2" I.D.)		24240
Hose - Lower - Cooler To Pipe; (2 3/4" I.D.)		24244
8500; 8600		
Belt - Fan, Alt. & A.C.	1842466C1	K080845HD
Tensioner Assy. - Fan, Alt. & A.C.	1841760C1	38620
International/Navistar VT275 Diesel		
CF500; CF600		
Belt - W.P., Fan, Alt. & A.C.	1846055C1	♣K081331HD
Tensioner Assy.	1844538C1	38257
International/Navistar VT365 Diesel		
4200		
Belt - Fan, Alt. & A.C.	1839963C1	♣K080830HD
Belt - Fan & Air Compr.	1843218C1	♣K060509HD
Tensioner Assy. - Fan, Alt. & A.C.	1833688C2	38556
Tensioner Assy. - Fan & Air Compr.	1832711C2	38629
Hose - Upper - Eng. To Rad.		22774
Hose - Lower - Eng. To Rad.		22775
2004		
Caterpillar C10 Diesel		
5500i; 5600i		
Belt - Fan & Alt.	3565420C1	♣K081005HD
Belt - Fan To A.C.	3565421C1	♣K060478HD
Tensioner Assy. - Fan & Alt.	1900649	38506
Tensioner Assy. - Fan To A.C.	1421987	38534
Idler Pulley - Fan & Alt.; W/Flat Idler		
Pulley	1337023	36091
Idler Pulley - Fan & Alt.;		
W/Multi-Grooved Idler Pulley	1731498	36231
Tensioner Pulley - Fan & Alt.	1900649	36091
Hose - Upper - Eng. To Pipe		21891
Hose - Upper - Rad. To Pipe		21891
Hose - Lower - Eng. To Pipe; (2 1/2" I.D.)		24240
Hose - Lower - Rad. To Pipe		21891
7600		
Belt - Fan & Alt.	3565420C2	♣K081005HD
Belt - Fan To A.C.	3565421C1	♣K060478HD
Tensioner Assy. - Fan & Alt.	1900649	38506
Tensioner Assy. - Fan To A.C.	1421987	38534

♣ Standard Belt Available. See Pages 630-631.

Belts and Coolant Hose for Medium/Heavy-Duty Trucks (1996 and Newer)

 Medium & Heavy-Duty Trucks
(1996 & Newer)

Application	Mfr. Part No.	Our No.
INTERNATIONAL/NAVISTAR - Continued		
2004 - Continued		
Caterpillar C10 Diesel - Continued		
7600 - Continued		
Idler Pulley - Fan & Alt.; W/Flat Idler Pulley	1337023	36091
Idler Pulley - Fan & Alt.; W/Multi-Grooved Idler Pulley	1731498	36231
Tensioner Pulley - Fan & Alt.	1900649	36091
Hose - Upper - Eng. To Pipe		21135
Hose - Upper - Rad. To Pipe; (2 1/2" I.D.)		24240
Hose - Lower - Eng. To Pipe; (2 1/2" I.D.)		24240
Hose - Lower - Rad. To Pipe		21891
8600		
Belt - Fan & Alt.	3559834C1	♣K080859HD
Belt - Fan To A.C.	3559835C1	♣K060586HD
Tensioner Assy. - Fan & Alt.	1900649	38506
Tensioner Assy. - Fan To A.C.	1900634	38507
Idler Pulley - Fan & Alt.; W/Flat Idler Pulley	1337023	36091
Idler Pulley - Fan & Alt.; W/Multi-Grooved Idler Pulley	1731498	36231
Tensioner Pulley - Fan & Alt.	1900649	36091
Tensioner Pulley - Fan To A.C.	1900634	36091
Hose - Upper - Eng. To Pipe; (2 1/2" I.D.)		24240
Hose - Upper - Pipe To Rad.		21135
Hose - Lower - Eng. To Pipe; (2 1/2" I.D.)		24240
Hose - Lower - Pipe To Rad.		21891
9200i		
Belt - Fan & Alt.	3571272C2	♣K080915HD
Belt - Fan To A.C.	3571274C1	♣K060523HD
Tensioner Assy. - Fan & Alt.	1900649	38506
Tensioner Assy. - Fan To A.C.	1900634	38507
Idler Pulley - Fan & Alt.; W/Flat Idler Pulley	1337023	36091
Idler Pulley - Fan & Alt.; W/Multi-Grooved Idler Pulley	1731498	36231
Tensioner Pulley - Fan & Alt.	1900649	36091
Tensioner Pulley - Fan To A.C.	1900634	36091
Hose - Upper - Eng. To Rad.		21135
Hose - Upper - Rad. To Pipe		21135
Hose - Lower - Eng. To Rad.; (2 1/2" I.D.)		24240
Hose - Lower - Rad. To Pipe		21891
Caterpillar C11 Diesel		
7600		
Belt - Fan, Alt. & A.C.	3565415C1	♣K081092HD
Tensioner Assy. - Fan, Alt. & A.C.	2117895	38590
Tensioner Pulley - Fan, Alt. & A.C.	2117895	36164
Hose - Upper - Eng. To Pipe; (2 1/2" I.D.)		24240
Hose - Upper - Rad. To Pipe; (2 1/2" I.D.)		24240
Hose - Lower - Eng. To Pipe; (2 1/2" I.D.)		24240
Hose - Lower - Rad. To Pipe		21891
8600		
Belt - Fan, Alt. & A.C.	3578774C1	♣K080944HD
Tensioner Assy. - Fan, Alt. & A.C.	2117895	38590
Tensioner Pulley - Fan, Alt. & A.C.	2117895	36164
Hose - Upper - Eng. To Pipe		21135
Hose - Upper - Rad. To Pipe		21135
Hose - Lower; (2 1/2" I.D.)		24240
Caterpillar C12 Diesel		
5500i; 5600i		
Belt - Fan & Alt.	3565420C1	♣K081005HD
Belt - Fan To A.C.	3565421C1	♣K060478HD
Tensioner Assy. - Fan & Alt.	1900649	38506
Tensioner Assy. - Fan To A.C.	1421987	38534
Idler Pulley - Fan & Alt.; W/Flat Idler Pulley	1337023	36091
Idler Pulley - Fan & Alt.; W/Multi-Grooved Idler Pulley	1731498	36231
Tensioner Pulley - Fan & Alt.	1900649	36091
Hose - Upper - Eng. To Pipe		21891
Hose - Upper - Rad. To Pipe		21891
Hose - Lower - Eng. To Pipe; (2 1/2" I.D.)		24240

Application	Mfr. Part No.	Our No.
INTERNATIONAL/NAVISTAR - Continued		
2004 - Continued		
Caterpillar C12 Diesel - Continued		
5500i; 5600i - Continued		
Hose - Lower - Rad. To Pipe		21891
5900i		
Belt - Fan & Alt.	3565420C1	♣K081005HD
Belt - Fan To A.C.	3565421C1	♣K060478HD
Tensioner Assy. - Fan & Alt.	1900649	38506
Tensioner Assy. - Fan To A.C.	1421987	38534
Idler Pulley - Fan & Alt.; W/Flat Idler Pulley	1337023	36091
Idler Pulley - Fan & Alt.; W/Multi-Grooved Idler Pulley	1731498	36231
Tensioner Pulley - Fan & Alt.	1900649	36091
Hose - Upper - Eng. To Pipe		21135
Hose - Upper - Rad. To Pipe		21135
Hose - Lower - Eng. To Pipe; (2 1/2" I.D.)		24240
Hose - Lower - Rad. To Pipe		21135
7600		
Belt - Fan & Alt.	3565420C2	♣K081005HD
Belt - Fan To A.C.	3565421C1	♣K060478HD
Tensioner Assy. - Fan & Alt.	1900649	38506
Tensioner Assy. - Fan To A.C.	1421987	38534
Idler Pulley - Fan & Alt.; W/Flat Idler Pulley	1337023	36091
Idler Pulley - Fan & Alt.; W/Multi-Grooved Idler Pulley	1731498	36231
Tensioner Pulley - Fan & Alt.	1900649	36091
Hose - Upper - Eng. To Pipe		21135
Hose - Upper - Rad. To Pipe; (2 1/2" I.D.)		24240
Hose - Lower - Eng. To Pipe; (2 1/2" I.D.)		24240
Hose - Lower - Rad. To Pipe		21891
8600		
Belt - Fan & Alt.	3559834C1	♣K080859HD
Belt - Fan To A.C.	3559835C1	♣K060586HD
Tensioner Assy. - Fan & Alt.	1900649	38506
Tensioner Assy. - Fan To A.C.	1900634	38507
Idler Pulley - Fan & Alt.; W/Flat Idler Pulley	1337023	36091
Idler Pulley - Fan & Alt.; W/Multi-Grooved Idler Pulley	1731498	36231
Tensioner Pulley - Fan & Alt.	1900649	36091
Tensioner Pulley - Fan To A.C.	1900634	36091
Hose - Upper - Eng. To Pipe; (2 1/2" I.D.)		24240
Hose - Upper - Pipe To Rad.		21135
Hose - Lower - Eng. To Pipe; (2 1/2" I.D.)		24240
Hose - Lower - Rad. To Pipe		21891
9200i		
Belt - Fan & Alt.	3571272C2	♣K080915HD
Belt - Fan To A.C.	3571274C1	♣K060523HD
Tensioner Assy. - Fan & Alt.	1900649	38506
Tensioner Assy. - Fan To A.C.	1900634	38507
Idler Pulley - Fan & Alt.; W/Flat Idler Pulley	1337023	36091
Idler Pulley - Fan & Alt.; W/Multi-Grooved Idler Pulley	1731498	36231
Tensioner Pulley - Fan & Alt.	1900649	36091
Tensioner Pulley - Fan To A.C.	1900634	36091
Hose - Upper - Eng. To Pipe; (2 1/2" I.D.)		24240
Hose - Upper - Pipe To Rad.		21135
Hose - Lower - Eng. To Pipe; (2 1/2" I.D.)		24240
Hose - Lower - Pipe To Rad.		21891
9900i		
Belt - A.C.		♣K060470HD
Idler Pulley - Fan & Alt.; W/Flat Idler Pulley	1337023	36091
Idler Pulley - Fan & Alt.; W/Multi-Grooved Idler Pulley	1731498	36231
Caterpillar C13 Diesel		
7600		
Belt - Fan, Alt. & A.C.	3565415C1	♣K081092HD
Tensioner Assy. - Fan, Alt. & A.C.	2117895	38590

♣ Standard Belt Available. See Pages 630-631.

Belts and Coolant Hose for Medium/Heavy-Duty Trucks (1996 and Newer)

Medium & Heavy-Duty Trucks
(1996 & Newer)

Application	Mfr. Part No.	Our No.
INTERNATIONAL/NAVISTAR - Continued		
2004 - Continued		
Caterpillar C13 Diesel - Continued		
7600 - Continued		
Tensioner Pulley - Fan, Alt. & A.C.	2117895	36164
Idler Pulley - Smooth	2078118	36269
Idler Pulley - Grooved	1979642	36341
Hose - Upper - Eng. To Pipe; (2 1/2" I.D.)	24240	24240
Hose - Upper - Rad. To Pipe; (2 1/2" I.D.)	24240	24240
Hose - Lower - Eng. To Pipe; (2 1/2" I.D.)	24240	24240
Hose - Lower - Rad. To Pipe	20206	20206
8600		
Belt - Fan, Alt. & A.C.	3578774C1	▲K080944HD
Tensioner Assy. - Fan, Alt. & A.C.	2117895	38590
Tensioner Pulley - Fan, Alt. & A.C.	2117895	36164
Idler Pulley - Smooth	2078118	36269
Idler Pulley - Grooved	1979642	36341
Hose - Upper - Eng. To Pipe	21135	21135
Hose - Upper - Rad. To Pipe	21135	21135
Hose - Lower; (2 1/2" I.D.)	24240	24240
9200i		
Belt - Fan, Alt. & A.C.	3578775C2	▲K081000HD
Tensioner Assy. - Fan, Alt. & A.C.	2117895	38590
Tensioner Pulley - Fan, Alt. & A.C.	2117895	36164
Idler Pulley - Smooth	2078118	36269
Idler Pulley - Grooved	1979642	36341
Hose - Upper - Eng. To Pipe	21135	21135
Hose - Upper - Rad. To Pipe; (2 1/2" I.D.)	24240	24240
Hose - Lower - Eng. To Pipe; (2 1/2" I.D.)	24240	24240
Hose - Lower - Rad. To Pipe	21891	21891
9400i		
Belt - Fan, Alt. & A.C.	3578775C2	▲K081000HD
Tensioner Assy. - Fan, Alt. & A.C.	2117895	38590
Tensioner Pulley - Fan, Alt. & A.C.	2117895	36164
Idler Pulley - Smooth	2078118	36269
Idler Pulley - Grooved	1979642	36341
Hose - Upper - Eng. To Pipe; (2 1/2" I.D.)	24240	24240
Hose - Upper - Rad. To Pipe	21135	21135
Hose - Lower - Eng. To Pipe; (2 1/2" I.D.)	24240	24240
Hose - Lower - Rad. To Pipe	21891	21891
9900i		
Idler Pulley - Smooth	2078118	36269
Idler Pulley - Grooved	1979642	36341
Caterpillar C15 Diesel		
5600i		
Belt - A.C.	3577920C1	▲K060555HD
Tensioner Assy. - Fan & Alt.	2002279	38569
Tensioner Assy. - Fan To A.C.	2178938	38511
Tensioner Pulley - Fan To A.C.	2178938	36091
5900i		
Belt - Fan & Alt.	2577919C1	▲K081088HD
Belt - Fan To A.C.	3577920C1	▲K060555HD
Tensioner Assy. - Fan & Alt.	2002279	38569
Tensioner Assy. - Fan To A.C.	2178938	38511
Tensioner Pulley - Fan To A.C.	2178938	36091
Hose - Upper - Eng. To Pipe	21891	21891
Hose - Upper - Rad. To Pipe	21135	21135
Hose - Lower - Eng. To Pipe; (3" I.D.)	24248	24248
Hose - Lower - Rad. To Pipe	21135	21135
9200i		
Belt - Fan & Alt.	2018284C1	▲K100771HD
Belt - Fan & A.C.	2005148C1	▲K060500HD
Hose - Upper - Eng. To Pipe; (2 1/2" I.D.)	24240	24240
Hose - Upper - Pipe To Rad.	21135	21135
Hose - Lower - Eng. To Pipe; (2 1/2" I.D.)	24240	24240
Hose - Lower - Pipe To Rad.	21135	21135
9400i		
Belt - Fan & Alt.	3565413C2	▲K080991HD
Belt - Fan To A.C.	3565414C1	▲K060605HD
Tensioner Assy. - Fan & Alt.	2002279	38569
Tensioner Assy. - Fan To A.C.	2178938	38511
Idler Pulley - Smooth	1979641	36091

Application	Mfr. Part No.	Our No.
INTERNATIONAL/NAVISTAR - Continued		
2004 - Continued		
Caterpillar C15 Diesel - Continued		
9400i - Continued		
Idler Pulley - Grooved	1979642	36341
Tensioner Pulley - Fan To A.C.	2178938	36091
9900i; 9900ix		
Belt - Fan & Alt.	3565415C1	▲K081092HD
Belt - Fan To A.C.	3565416C1	▲K060557HD
Tensioner Assy. - Fan & Alt.	2002279	38569
Tensioner Assy. - Fan To A.C.	2178938	38511
Idler Pulley - Smooth	1979641	36091
Idler Pulley - Grooved	1979642	36341
Tensioner Pulley - Fan To A.C.	2178938	36091
Hose - Upper - Eng. To Rad.	21891	21891
Hose - Upper - Rad. To Pipe	21135	21135
Hose - Lower - Eng. To Rad.; (3" I.D.)	24248	24248
Hose - Lower - Rad. To Pipe; (2 1/2" I.D.)	24240	24240
Cummins ISM Diesel		
5500i; 5600i; 5900i		
Belt - Fan & Alt.	3579000C1	▲K080806HD
Belt - Hub & A.C.	3579001C1	▲K060516HD
Tensioner Assy. - Fan & Alt.	3400885	38521
Tensioner Assy. - Hub & A.C.	3102888	38505
Idler Pulley - A.C.	3104139	36225
Idler Pulley - Fan & Alt.	3400884	36308
Tensioner Pulley - A.C.	3102888	36091
Hose - Upper - Eng. To Pipe; (2 1/2" I.D.)	24240	24240
Hose - Upper - Rad. To Pipe	21135	21135
Hose - Lower - Eng. To Pipe; (2 1/2" I.D.)	24240	24240
Hose - Lower - Rad. To Pipe; (2 1/2" I.D.)	24240	24240
7600		
Belt - Fan & Alt.	3579000C1	▲K080806HD
Belt - Hub & A.C.	3579001C1	▲K060516HD
Tensioner Assy. - Fan & Alt.	3400885	38521
Tensioner Assy. - Hub & A.C.	3102888	38505
Idler Pulley - A.C.	3104139	36225
Idler Pulley - Fan & Alt.	3400884	36308
Tensioner Pulley - A.C.	3102888	36091
Hose - Upper - Eng. To Pipe; (2 1/2" I.D.)	24240	24240
Hose - Upper - Rad. To Pipe; (2 1/2" I.D.)	24240	24240
Hose - Lower - Eng. To Cooler	21135	21135
Hose - Lower - Rad. To Cooler	21891	21891
8600		
Belt - Fan & Alt.	3578997C1	▲K080694HD
Belt - Hub & A.C.	3579001C1	▲K060516HD
Tensioner Assy. - Fan & Alt.	3400885	38521
Tensioner Assy. - Hub & A.C.	3102888	38505
Idler Pulley - A.C.	3104139	36225
Tensioner Pulley - A.C.	4004933	36091
Idler Pulley - Fan & Alt.	3400884	36308
Hose - Upper - Eng. To Pipe; (2 1/2" I.D.)	24240	24240
Hose - Upper - Pipe To Rad.; (2 1/2" I.D.)	24240	24240
Hose - Lower - Eng. To Pipe; (2 1/2" I.D.)	24240	24240
Hose - Lower - Pipe To Rad.	21891	21891
9200i; 9400i		
Belt - Fan & Alt.	3578998C1	▲K080740HD
Belt - Hub & A.C.	3579001C1	▲K060516HD
Tensioner Assy. - Fan & Alt.	3400885	38521
Tensioner Assy. - Hub & A.C.	4004933	38505
Idler Pulley - A.C.	3104139	36225
Tensioner Pulley - A.C.	4004933	36091
Idler Pulley - Fan & Alt.	3400884	36308
Hose - Upper - Eng. To Pipe; (2 1/2" I.D.)	24240	24240
Hose - Upper - Rad. To Pipe	21135	21135
Hose - Lower - Eng. To Pipe; (2 1/2" I.D.)	24240	24240
Hose - Lower - Rad. To Pipe	21891	21891
Cummins ISX Diesel		
5500i		
Belt - Fan & Alt.	3574308C1	▲K120964HD
Belt - Hub & A.C.	3565412C1	▲K060637HD
Tensioner Assy. - A.C.	3682683	38610

▲ Standard Belt Available. See Pages 630-631.

Belts and Coolant Hose for Medium/Heavy-Duty Trucks (1996 and Newer)

 Medium & Heavy-Duty Trucks
(1996 & Newer)

Application	Mfr. Part No.	Our No.
INTERNATIONAL/NAVISTAR - Continued		
2004 - Continued		
Cummins ISX Diesel - Continued		
5500i - Continued		
Tensioner Assy. - Fan & Alt.	3682946	38587
Idler Pulley - A.C.	3682229	36223
Tensioner Pulley - Fan & Alt.	3682946	36165
Hose - Upper - Eng. To Pipe		21135
Hose - Upper - Rad. To Pipe		21135
Hose - Lower - Eng. To Pipe; (2 1/2" I.D.)		24240
Hose - Lower - Rad. To Pipe; (2 1/2" I.D.)		24240
5900i		
Belt - Fan & Alt.	3574308C1	♣K120964HD
Belt - Hub & A.C.	3565412C1	♣K060637HD
Tensioner Assy. - A.C.	3682683	38610
Tensioner Assy. - Fan & Alt.	3682946	38587
Idler Pulley - A.C.	3682229	36223
Tensioner Pulley - Fan & Alt.	3682946	36165
Hose - Upper - Eng. To Pipe		21135
Hose - Upper - Rad. To Pipe		21135
Hose - Lower - Eng. To Pipe; (2 1/2" I.D.)		24240
Hose - Lower - Rad. To Pipe		21135
9200i		
Belt - Fan & Alt.		♣K120901HD
Belt - A.C.	3565412C1	♣K060637HD
Tensioner Assy. - A.C.	3682683	38610
Tensioner Assy. - Fan & Alt.	3682946	38587
Idler Pulley - A.C.	3682229	36223
Tensioner Pulley - Fan & Alt.	3682946	36165
Hose - Upper - Eng. To Pipe		21135
Hose - Upper - Rad. To Pipe		21135
Hose - Lower - Eng. To Pipe; (2 1/2" I.D.)		24240
Hose - Lower - Pipe To Rad.		21891
9400i		
Belt - Fan & Alt.	3565410C3	♣K120911HD
Belt - A.C.	3565412C1	♣K060637HD
Tensioner Assy. - A.C.	3682683	38610
Tensioner Assy. - Fan & Alt.	3682946	38587
Idler Pulley - A.C.	3682229	36223
Tensioner Pulley - Fan & Alt.	3682946	36165
Hose - Upper - Eng. To Pipe		21135
Hose - Upper - Rad. To Pipe		21135
Hose - Lower - Eng. To Pipe; (2 1/2" I.D.)		24240
Hose - Lower - Pipe To Rad.		21891
9900i; 9900ix		
Belt - Fan & Alt.	3565411C3	♣K120975HD
Belt - A.C.	3565412C1	♣K060637HD
Tensioner Assy. - A.C.	3682683	38610
Tensioner Assy. - Fan & Alt.	3682946	38587
Idler Pulley - A.C.	3682229	36223
Tensioner Pulley - Fan & Alt.	3682946	36165
Hose - Upper - Eng. To Pipe		21135
Hose - Upper - Rad. To Pipe		21135
Hose - Lower - Eng. To Pipe; (2 1/2" I.D.)		24240
Hose - Lower - Pipe To Rad.; (2 1/2" I.D.)		24240
International/Navistar 530 Diesel		
4400		
Belt - Fan, Alt. & Hub		♣K080685HD
Belt - Fan To A.C.	2017725C1	♣K060490HD
Tensioner Assy. - Fan, Alt. & Hub	1830033C1	38514
Tensioner Assy. - Fan To A.C.	3543883C1	38511
Tensioner Pulley - Fan, Alt. & Hub	1830033C1	36091
Tensioner Pulley - Fan To A.C.	3543883C1	36091
Hose - Upper - Eng. To Rad.		20731
Hose - Lower - Eng. To Rad.		22742
8500		
Belt - Fan & Alt.		♣K080685HD
Belt - Fan To A.C.	2017725C1	♣K060490HD
Tensioner Assy. - Fan & Alt.	1830033C1	38514
Tensioner Assy. - Fan To A.C.	3543883C1	38511
Tensioner Pulley - Fan & Alt.	1830033C1	36091
Tensioner Pulley - Fan To A.C.	3543883C1	36091

Application	Mfr. Part No.	Our No.
INTERNATIONAL/NAVISTAR - Continued		
2004 - Continued		
International/Navistar DT466 Diesel		
4300; 4400		
Belt - Fan, Alt. & Hub	1833009C1	♣K080702HD
Belt - Fan To A.C.	1830641C2	♣K060490HD
Tensioner Assy. - Fan, Alt. & Hub	1830033C1	38514
Tensioner Assy. - Fan To A.C.	3543883C1	38511
Tensioner Pulley - Fan, Alt. & Hub	1830033C1	36091
Tensioner Pulley - Fan To A.C.	3543883C1	36091
Hose - Upper - Eng. To Rad.		20731
Hose - Lower - Eng. To Rad.		22742
International/Navistar DT530 Diesel		
7400		
Belt - Fan, Alt. & Hub	3543930C1	♣K080760HD
Belt - Fan To A.C.	1841563C1	♣K060458HD
Tensioner Assy. - Fan, Alt. & Hub	1830033C1	38514
Tensioner Assy. - A.C.	3543883C1	38511
Tensioner Pulley - Fan, Alt. & Hub	1830033C1	36091
Tensioner Pulley - A.C.	3543883C1	36091
Hose - Upper - Eng. To Pipe; (2 1/4" I.D.)		24236
Hose - Upper - Pipe To Rad.; (2 1/2" I.D.)		24240
Hose - Lower - Eng. To Rad.		22762
7500		
Belt - Fan & Alt.	1820547C3	♣K080774HD
Belt - Fan To A.C.	1841563C1	♣K060458HD
Tensioner Assy. - Fan & Alt.	1830033C1	38514
Tensioner Assy. - Fan To A.C.	3543883C1	38511
Tensioner Pulley - Fan To A.C.	3543883C1	36091
Tensioner Pulley - Fan & Alt.	1830033C1	36091
Hose - Upper - Eng. To Pipe; (2 1/4" I.D.)		24236
Hose - Upper - Pipe To Rad.; (2 1/2" I.D.)		24240
Hose - Lower - Eng. To Rad.		22762
International/Navistar DT570 Diesel		
4400		
Belt - Hub, Fan, Alt. & A.C.	1842466C1	K080845HD
Tensioner Assy. - Hub, Fan, Alt. & A.C.	1841760C1	38620
Hose - Upper - Eng. To Rad.		20731
International/Navistar HT570 Diesel		
7500		
Belt - Fan, Alt. & A.C.	1842600C1	♣K080944HD
Tensioner Assy. - Fan, Alt. & A.C.	1841760C1	38620
Hose - Upper - Eng. To Pipe		21891
Hose - Upper - Rad. To Pipe; (2 1/2" I.D.)		24240
Hose - Lower - Eng. To Pipe; (2 1/2" I.D.)		24240
Hose - Lower - Rad. To Pipe; (2 3/4" I.D.)		24244
Hose - Lower - Pipe To Cooler; (2 1/2" I.D.)		24240
Hose - Lower - Cooler To Pipe; (2 3/4" I.D.)		24244
International/Navistar VT365 Diesel		
4200		
Belt - Fan, Alt. & A.C.	1839963C1	♣K080830HD
Belt - Fan To Compr.	1843218C1	♣K060509HD
Tensioner Assy. - Fan, Alt. & A.C.	1833688C1	38556
Tensioner Assy. - Air Brake Compr.	1832711C2	38629
Hose - Upper - Eng. To Rad.		22774
Hose - Lower - Eng. To Rad.		22775
2003		
Caterpillar 3406 Diesel		
5900i		
Belt - A.C.	3577920C1	♣K060555HD
Belt - Fan & Alt.	3577919C1	♣K081088HD
Tensioner Assy. - A.C.	1900642	38508
Tensioner Assy. - Fan & Alt.	1900649	38506
Hose - Upper - Rad. To Pipe		21135
Hose - Lower - Rad. To Pipe		21135
7600		
Belt - Fan & Alt.	3561002C1	♣K080986HD
Belt - Fan & A.C.	3561003C1	♣K060483HD

♣ Standard Belt Available. See Pages 630-631.

Belts and Coolant Hose for Medium/Heavy-Duty Trucks (1996 and Newer)

Medium & Heavy-Duty Trucks
(1996 & Newer)

Application	Mfr. Part No.	Our No.
INTERNATIONAL/NAVISTAR - Continued		
2003 - Continued		
Caterpillar C10 Diesel		
2554; 2574; 2654; 2674		
Belt - Fan	3561002C1	▲K080986HD
Belt - Fan To Alt. & A.C.	3561003C1	▲K060483HD
Idler Pulley - Fan & Alt.; W/Flat Idler		
Pulley	1337023	36091
Idler Pulley - Fan & Alt.;		
W/Multi-Grooved Idler Pulley	1731498	36231
Hose - Upper - Eng. To Pipe		21891
Hose - Upper - Pipe To Rad.; (2 1/2" I.D.)		24240
Hose - Lower - Eng. To Rad.; (2 1/2" I.D.)		24240
Hose - Lower - Pipe To Rad.		21891
5500i; 5600i		
Belt - Fan & Alt.	3565420C1	▲K081005HD
Belt - Fan To A.C.	3565421C1	▲K060478HD
Tensioner Assy. - Fan & Alt.	1900649	38506
Tensioner Assy. - Fan To A.C.	1421987	38534
Idler Pulley - Fan & Alt.; W/Flat Idler		
Pulley	1337023	36091
Idler Pulley - Fan & Alt.;		
W/Multi-Grooved Idler Pulley	1731498	36231
Tensioner Pulley - Fan & Alt.	1900649	36091
Hose - Upper - Eng. To Pipe		21891
Hose - Upper - Rad. To Pipe		21891
Hose - Lower - Eng. To Pipe; (2 1/2" I.D.)		24240
Hose - Lower - Rad. To Pipe		21891
5900i		
Belt - Fan & Alt.	3565420C1	▲K081005HD
Belt - Fan To A.C.	3565421C1	▲K060478HD
Tensioner Assy. - Fan & Alt.	1900649	38506
Tensioner Assy. - Fan To A.C.	1421987	38534
Idler Pulley - Fan & Alt.; W/Flat Idler		
Pulley	1337023	36091
Idler Pulley - Fan & Alt.;		
W/Multi-Grooved Idler Pulley	1731498	36231
Tensioner Pulley - Fan & Alt.	1900649	36091
Hose - Upper - Eng. To Pipe		21135
Hose - Upper - Rad. To Pipe		21135
Hose - Lower - Eng. To Pipe; (2 1/2" I.D.)		24240
Hose - Lower - Rad. To Pipe		21135
7600		
Belt - Fan & Alt.	3561002C1	▲K080986HD
Belt - Fan To A.C.	3561003C1	▲K060483HD
Tensioner Assy. - Fan & Alt.	1900649	38506
Tensioner Assy. - Fan To A.C.	1900634	38507
Idler Pulley - Fan & Alt.; W/Flat Idler		
Pulley	1337023	36091
Idler Pulley - Fan & Alt.;		
W/Multi-Grooved Idler Pulley	1731498	36231
Tensioner Pulley - Fan & Alt.	1900649	36091
Tensioner Pulley - Fan To A.C.	1900634	36091
Hose - Upper - Eng. To Pipe		21135
Hose - Upper - Pipe To Rad.; (2 1/2" I.D.)		24240
Hose - Lower - Eng. To Pipe; (2 1/2" I.D.)		24240
Hose - Lower - Pipe To Rad.		21891
8100; 8600		
Belt - Fan & Alt.	3559834C1	▲K080859HD
Belt - Fan To A.C.	3559835C1	▲K060586HD
Tensioner Assy. - Fan & Alt.	1900649	38506
Tensioner Assy. - Fan To A.C.	1900634	38507
Idler Pulley - Fan & Alt.; W/Flat Idler		
Pulley	1337023	36091
Idler Pulley - Fan & Alt.;		
W/Multi-Grooved Idler Pulley	1731498	36231
Tensioner Pulley - Fan & Alt.	1900649	36091
Tensioner Pulley - Fan To A.C.	1900634	36091
Hose - Upper - Eng. To Pipe		21135
Hose - Upper - Pipe To Rad.		21135
Hose - Lower - Eng. To Pipe; (2 1/2" I.D.)		24240
Hose - Lower - Pipe To Rad.		21891
9100i; 9200i		
Belt - Fan & Alt.	1618533C1	▲K080733HD

▲ Standard Belt Available. See Pages 630-631.

Application	Mfr. Part No.	Our No.
INTERNATIONAL/NAVISTAR - Continued		
2003 - Continued		
Caterpillar C10 Diesel - Continued		
9100i; 9200i - Continued		
Belt - Fan & A.C.; Preferred Belt	149635R2	2/9463PB
Belt - Fan & A.C.; Optional Belt		②▲9463HD
Hose - Upper - Eng. To Pipe		21135
Hose - Upper - Pipe To Rad.; (2 1/2" I.D.)		24240
Hose - Lower - Eng. To Pipe		21891
Hose - Lower - Rad. To Pipe		21135
Caterpillar C12 Diesel		
2554; 2574; 2654; 2674		
Belt - Fan	3561002C1	▲K080986HD
Belt - Fan To Alt. & A.C.	3561003C1	▲K060483HD
Idler Pulley - Fan & Alt.; W/Flat Idler		
Pulley	1337023	36091
Idler Pulley - Fan & Alt.;		
W/Multi-Grooved Idler Pulley	1731498	36231
Hose - Upper - Eng. To Pipe		21891
Hose - Upper - Pipe To Rad.; (2 1/2" I.D.)		24240
Hose - Lower - Eng. To Rad.; (2 1/2" I.D.)		24240
Hose - Lower - Pipe To Rad.		21891
5500i; 5600i		
Belt - Fan & Alt.	3565420C1	▲K081005HD
Belt - Fan To A.C.	3565421C1	▲K060478HD
Tensioner Assy. - Fan & Alt.	1900649	38506
Tensioner Assy. - Fan To A.C.	1421987	38534
Idler Pulley - Fan & Alt.; W/Flat Idler		
Pulley	1337023	36091
Idler Pulley - Fan & Alt.;		
W/Multi-Grooved Idler Pulley	1731498	36231
Tensioner Pulley - Fan & Alt.	1900649	36091
Hose - Upper - Eng. To Pipe		21891
Hose - Upper - Rad. To Pipe		21891
Hose - Lower - Eng. To Pipe; (2 1/2" I.D.)		24240
Hose - Lower - Rad. To Pipe		21891
5900i		
Belt - Fan & Alt.	3565420C1	▲K081005HD
Belt - Fan To A.C.	3565421C1	▲K060478HD
Tensioner Assy. - Fan & Alt.	1900649	38506
Tensioner Assy. - Fan To A.C.	1421987	38534
Idler Pulley - Fan & Alt.; W/Flat Idler		
Pulley	1337023	36091
Idler Pulley - Fan & Alt.;		
W/Multi-Grooved Idler Pulley	1731498	36231
Tensioner Pulley - Fan & Alt.	1900649	36091
Hose - Upper - Eng. To Pipe		21891
Hose - Upper - Rad. To Pipe		21891
Hose - Lower - Eng. To Pipe; (2 1/2" I.D.)		24240
Hose - Lower - Rad. To Pipe		21891
7600		
Belt - Fan & Alt.	3561002C1	▲K080986HD
Belt - Fan To A.C.	3561003C1	▲K060483HD
Tensioner Assy. - Fan & Alt.	1900649	38506
Tensioner Assy. - Fan To A.C.	1900634	38507
Idler Pulley - Fan & Alt.; W/Flat Idler		
Pulley	1337023	36091
Idler Pulley - Fan & Alt.;		
W/Multi-Grooved Idler Pulley	1731498	36231
Tensioner Pulley - Fan & Alt.	1900649	36091
Tensioner Pulley - Fan To A.C.	1900634	36091
Hose - Upper - Eng. To Pipe		21135
Hose - Upper - Pipe To Rad.; (2 1/2" I.D.)		24240
Hose - Lower - Eng. To Pipe; (2 1/2" I.D.)		24240
Hose - Lower - Rad. To Pipe		21135
8600		
Belt - Fan & Alt.	3559834C1	▲K080859HD
Belt - Fan To A.C.	3559835C1	▲K060586HD
Tensioner Assy. - Fan & Alt.	1900649	38506
Tensioner Assy. - Fan To A.C.	1900634	38507
Idler Pulley - Fan & Alt.; W/Flat Idler		
Pulley	1337023	36091

② Two Required.

Belts and Coolant Hose for Medium/Heavy-Duty Trucks (1996 and Newer)

 Medium & Heavy-Duty Trucks
(1996 & Newer)

Application	Mfr. Part No.	Our No.
INTERNATIONAL/NAVISTAR - Continued		
2003 - Continued		
Caterpillar C12 Diesel - Continued		
8600 - Continued		
Idler Pulley - Fan & Alt.:		
W/Multi-Grooved Idler Pulley	1731498	36231
Tensioner Pulley - Fan & Alt.	1900649	36091
Tensioner Pulley - Fan To A.C.	1900634	36091
Hose - Upper - Eng. To Pipe		21135
Hose - Upper - Pipe To Rad.		21135
Hose - Lower - Eng. To Pipe; (2 1/2" I.D.)		24240
Hose - Lower - Pipe To Rad.		21891
9100i		
Belt - Fan & Alt.	1618533C1	▲K080733HD
Belt - Fan & A.C.; Preferred Belt	149635R2	2/9463PB
Belt - Fan & A.C.; Optional Belt		②▲9463HD
Hose - Upper - Eng. To Pipe		21135
Hose - Upper - Pipe To Rad.; (2 1/2" I.D.)		24240
Hose - Lower - Eng. To Pipe		21891
Hose - Lower - Rad. To Pipe		21135
9200i		
Belt - Fan & Alt.	1618533C1	▲K080733HD
Belt - Fan & A.C.; Preferred Belt	149635R2	2/9463PB
Belt - Fan & A.C.; Optional Belt		②▲9463HD
Idler Pulley - Fan & Alt.; W/Flat Idler Pulley		
Pulley	1337023	36091
Idler Pulley - Fan & Alt.:		
W/Multi-Grooved Idler Pulley	1731498	36231
Hose - Upper - Eng. To Pipe		21135
Hose - Upper - Pipe To Rad.; (2 1/2" I.D.)		24240
Hose - Lower - Eng. To Pipe		21891
Hose - Lower - Rad. To Pipe		21135
9400i		
Belt - Fan & Alt.	1618533C1	▲K080733HD
Belt - Fan & A.C.; Preferred Belt	149635R2	2/9463PB
Belt - Fan & A.C.; Optional Belt		②▲9463HD
Hose - Upper - Eng. To Pipe		21135
Hose - Upper - Pipe To Rad.; (2 1/2" I.D.)		24240
Hose - Lower - Eng. To Pipe		21891
Hose - Lower - Rad. To Pipe		21135
9900i; 9900ix		
Belt - Fan & Alt.	1618533C1	▲K080733HD
Belt - Fan & A.C.; Preferred Belt	149635R2	2/9463PB
Belt - Fan & A.C.; Optional Belt		②▲9463HD
Idler Pulley - Fan & Alt.; W/Flat Idler Pulley		
Pulley	1337023	36091
Idler Pulley - Fan & Alt.:		
W/Multi-Grooved Idler Pulley	1731498	36231
Hose - Upper - Eng. To Pipe		21135
Hose - Upper - Pipe To Rad.; (2 1/2" I.D.)		24240
Hose - Lower - Eng. To Pipe		21891
Hose - Lower - Rad. To Pipe		21135
Caterpillar C15 Diesel		
5900i		
Belt - Alt.	3577919C1	▲K081088HD
Belt - A.C.	3577920C1	▲K060555HD
9200i; 9400i; 9900i; 9900ix		
Belt - Fan & Alt.	2018284C1	▲K100771HD
Belt - Fan & A.C.	2005148C1	▲K060500HD
Hose - Upper - Eng. To Pipe; (2 1/2" I.D.)		24240
Hose - Upper - Pipe To Rad.		21135
Hose - Lower - Eng. To Pipe; (2 1/2" I.D.)		24240
Hose - Lower - Pipe To Rad.		21135
Caterpillar C16 Diesel		
9200i; 9400i; 9900i		
Belt - Fan & Alt.	2018284C1	▲K100771HD
Belt - Fan & A.C.	2005148C1	▲K060500HD
Hose - Upper - Eng. To Pipe; (2 1/2" I.D.)		24240
Hose - Upper - Pipe To Rad.		21135
Hose - Lower - Eng. To Pipe; (2 1/2" I.D.)		24240
Hose - Lower - Pipe To Rad.		21135

▲ Standard Belt Available. See Pages 630-631.

Application	Mfr. Part No.	Our No.
INTERNATIONAL/NAVISTAR - Continued		
2003 - Continued		
Cummins ISM Diesel		
5500i; 5600i; 5900i		
Belt - Fan & Alt.	3579000C1	▲K080806HD
Belt - Hub & A.C.	3579001C1	▲K060516HD
Tensioner Assy. - Fan & Alt.	3400885	38521
Tensioner Assy. - Hub & A.C.	3102888	38505
Idler Pulley - A.C.	3104139	36225
Idler Pulley - Fan & Alt.	3400884	36308
Tensioner Pulley - A.C.	3102888	36091
Hose - Upper - Eng. To Pipe; (2 1/2" I.D.)		24240
Hose - Upper - Rad. To Pipe		21135
Hose - Lower - Eng. To Pipe; (2 1/2" I.D.)		24240
Hose - Lower - Rad. To Pipe; (2 1/2" I.D.)		24240
7600		
Belt - Fan & Alt.	3579000C1	▲K080806HD
Belt - Hub & A.C.	3579001C1	▲K060516HD
Tensioner Assy. - Fan & Alt.	3400885	38521
Tensioner Assy. - Hub & A.C.	3102888	38505
Idler Pulley - A.C.	3104139	36225
Idler Pulley - Fan & Alt.	3400884	36308
Tensioner Pulley - A.C.	3102888	36091
Hose - Upper - Eng. To Pipe; (2 1/2" I.D.)		24240
Hose - Upper - Rad. To Pipe; (2 1/2" I.D.)		24240
Hose - Lower - Eng. To Cooler		21135
Hose - Lower - Rad. To Cooler		21891
8100		
Belt - Fan	1648750C1	▲K080605HD
Belt - Hub & Alt.	586452C1	▲K050336HD
Belt - Hub & A.C.	2016338C1	TR22485
Hose - Upper - Eng. To Pipe; (2 1/2" I.D.)		24240
Hose - Upper - Pipe To Rad.		21135
Hose - Lower - Eng. To Pipe; (2 1/2" I.D.)		24240
Hose - Lower - Pipe To Rad.		21194
8600		
Belt - Fan & Alt.	3578097C1	▲K080694HD
Belt - Hub & A.C.	3579001C1	▲K060516HD
Tensioner Assy. - Fan & Alt.	3400885	38521
Tensioner Assy. - Hub & A.C.	4004933	38505
Idler Pulley - Fan & Alt.	3400884	36308
Tensioner Pulley - A.C.	4004933	36091
Hose - Upper - Eng. To Pipe; (2 1/4" I.D.)		24236
Hose - Upper - Pipe To Rad.; (2 1/2" I.D.)		24240
Hose - Lower - Eng. To Pipe; (2 1/2" I.D.)		24240
Hose - Lower - Pipe To Rad.		21891
9100i		
Belt - Fan	1651399C1	▲K080565HD
Belt - Hub & Alt.	586452C1	▲K050336HD
Belt - Hub & A.C.	2016338C1	TR22485
Hose - Upper - Eng. To Pipe; (2 1/2" I.D.)		24240
Hose - Upper - Pipe To Rad.		21135
Hose - Lower - Eng. To Pipe		21135
Hose - Lower - Pipe To Rad.; (2 1/2" I.D.)		24240
9200i		
Belt - Fan & Alt.	3578998C1	▲K080740HD
Belt - Hub & A.C.	3579001C1	▲K060516HD
Tensioner Assy. - Fan & Alt.	3400885	38521
Tensioner Assy. - Hub & A.C.	4004933	38505
Idler Pulley - Fan & Alt.	3400884	36308
Tensioner Pulley - A.C.	4004933	36091
Hose - Upper - Eng. To Pipe; (2 1/2" I.D.)		24240
Hose - Upper - Rad. To Pipe		21135
Hose - Lower - Eng. To Pipe; (2 1/2" I.D.)		24240
Hose - Lower - Rad. To Pipe		21891
9400i; 9900i		
Belt - Fan	1651399C1	▲K080565HD
Belt - Hub & Alt.	586452C1	▲K050336HD
Belt - Hub & A.C.	2016338C1	TR22485
Hose - Upper - Eng. To Pipe; (2 1/2" I.D.)		24240
Hose - Upper - Pipe To Rad.		21135
Hose - Lower - Eng. To Pipe		21135
Hose - Lower - Pipe To Rad.; (2 1/2" I.D.)		24240

② Two Required.

Belts and Coolant Hose for Medium/Heavy-Duty Trucks (1996 and Newer)

Medium & Heavy-Duty Trucks
(1996 & Newer)

Application	Mfr. Part No.	Our No.
INTERNATIONAL/NAVISTAR - Continued		
2003 - Continued		
Cummins ISX Diesel		
5500i		
Belt - Fan & Alt.	3574308C1	♣K120964HD
Belt - Hub & A.C.	3565412C1	♣K060637HD
Tensioner Assy. - A.C.	3682683	38610
Tensioner Assy. - Fan & Alt.	3682946	38587
Idler Pulley - A.C.	3682229	36223
Tensioner Pulley - Fan & Alt.	3682946	36165
Hose - Upper - Eng. To Pipe		21135
Hose - Upper - Rad. To Pipe		21135
Hose - Lower - Eng. To Pipe; (2 1/2" I.D.)		24240
Hose - Lower - Rad. To Pipe; (2 1/2" I.D.)		24240
5900i		
Belt - Fan & Alt.	3574308C1	♣K120964HD
Belt - Hub & A.C.	3565412C1	♣K060637HD
Tensioner Assy. - A.C.	3682683	38610
Tensioner Assy. - Fan & Alt.	3682946	38587
Idler Pulley - A.C.	3682229	36223
Tensioner Pulley - Fan & Alt.	3682946	36165
Hose - Upper - Eng. To Pipe		21135
Hose - Upper - Rad. To Pipe		21135
Hose - Lower - Eng. To Pipe; (2 1/2" I.D.)		24240
Hose - Lower - Rad. To Pipe		21135
9100i		
Belt - Fan	3681819	♣K100719HD
Belt - W.P. & A.C.	3681812	♣K060685HD
Tensioner Assy. - Fan	3681240	38535
Tensioner Assy. - W.P. & A.C.	3680194	38532
Idler Pulley - Alt. & A.C.	4026886	36226
Tensioner Pulley - Fan	3681240	36092
Tensioner Pulley - W.P. & A.C.	3680194	36095
Hose - Upper - Eng. To Pipe; (2 1/2" I.D.)		24240
Hose - Upper - Pipe To Rad.		21135
Hose - Lower - Eng. To Pipe		21891
Hose - Lower - Pipe To Rad.		21135
9200i		
Belt - Fan & Alt.		♣K120901HD
Belt - A.C.	3565412C1	♣K060637HD
Tensioner Assy. - A.C.	3682683	38610
Tensioner Assy. - Fan & Alt.	3682946	38587
Idler Pulley - A.C.	3682229	36223
Tensioner Pulley - Fan & Alt.	3682946	36165
Hose - Upper - Eng. To Pipe		21135
Hose - Upper - Rad. To Pipe		21135
Hose - Lower - Eng. To Pipe; (2 1/2" I.D.)		24240
Hose - Lower - Pipe To Rad.		21891
9400i		
Belt - Fan & Alt.	3565411C3	♣K120975HD
Belt - A.C.	3565412C1	♣K060637HD
Tensioner Assy. - A.C.	3682683	38610
Tensioner Assy. - Fan & Alt.	3682946	38587
Idler Pulley - A.C.	3682229	36223
Tensioner Pulley - Fan & Alt.	3682946	36165
Hose - Upper - Eng. To Pipe		21135
Hose - Upper - Rad. To Pipe		21135
Hose - Lower - Eng. To Pipe; (2 1/2" I.D.)		24240
Hose - Lower - Pipe To Rad.		21891
9900i		
Belt - Fan; W/O Clean Air Pkg.	3681819	♣K100719HD
Belt - Fan & Alt.; W/Clean Air Pkg.	3565411C3	♣K120975HD
Belt - W.P. & A.C.; W/O Clean Air Pkg.	3681812	♣K060685HD
Belt - W.P. & A.C.; W/Clean Air Pkg.	3565412C1	♣K060637HD
Tensioner Assy. - Fan; W/O Clean Air Pkg.	3681240	38535
Tensioner Assy. - Fan & Alt.; W/Clean Air Pkg.	3682946	38587
Tensioner Assy. - W.P. & A.C.; W/O Clean Air Pkg.	3680194	38532
Tensioner Assy. - W.P. & A.C.; W/Clean Air Pkg.	3682683	38610

Application	Mfr. Part No.	Our No.
INTERNATIONAL/NAVISTAR - Continued		
2003 - Continued		
Cummins ISX Diesel - Continued		
9900i - Continued		
Idler Pulley - Alt. & A.C.; W/O Clean Air Pkg.	4026886	36226
Idler Pulley - A.C.; W/Clean Air Pkg.	3682229	36223
Tensioner Pulley - Fan & Alt.; W/Clean Air Pkg.	3682946	36165
Tensioner Pulley - Fan; W/O Clean Air Pkg.	3681240	36092
Tensioner Pulley - W.P. & A.C.; W/O Clean Air Pkg.	3680194	36095
Hose - Upper - Eng. To Pipe		21135
Hose - Upper - Pipe To Rad.		21891
Hose - Upper - Rad. To Pipe		21135
Hose - Lower - Eng. To Pipe; (2 1/2" I.D.)		24240
Hose - Lower - Pipe To Rad.; (2 1/2" I.D.)		24240
9900ix		
Belt - Fan; W/O Clean Air Pkg.	3681819	♣K100719HD
Belt - Fan & Alt.; W/Clean Air Pkg.	3565411C3	♣K120975HD
Belt - W.P. & A.C.; W/O Clean Air Pkg.	3681812	♣K060685HD
Belt - W.P. & A.C.; W/Clean Air Pkg.	3565412C1	♣K060637HD
Tensioner Assy. - Fan; W/O Clean Air Pkg.	3681240	38535
Tensioner Assy. - Fan & Alt.; W/Clean Air Pkg.	3682946	38587
Tensioner Assy. - W.P. & A.C.; W/O Clean Air Pkg.	3680194	38532
Tensioner Assy. - W.P. & A.C.; W/Clean Air Pkg.	3682683	38610
Idler Pulley - Alt. & A.C.; W/O Clean Air Pkg.	4026886	36226
Idler Pulley - W.P. & A.C.; W/Clean Air Pkg.	3682229	36223
Tensioner Pulley - Fan & Alt.; W/Clean Air Pkg.	3682946	36165
Tensioner Pulley - Fan; W/O Clean Air Pkg.	3681240	36092
Tensioner Pulley - W.P. & A.C.; W/O Clean Air Pkg.	3680194	36095
Hose - Upper - Eng. To Pipe		21135
Hose - Upper - Pipe To Rad.		21891
Hose - Upper - Rad. To Pipe		21135
Hose - Lower - Eng. To Pipe; (2 1/2" I.D.)		24240
Hose - Lower - Pipe To Rad.; (2 1/2" I.D.)		24240
Cummins N14 Diesel		
2574		
Belt - Fan		②TR28522
Belt - Alt.		♣9447HD
Belt - W.P.	3076492	♣K060425HD
Belt - A.C.		♣9405HD
5500i; 5600i; 5900i		
Belt - Hub & W.P.	3865157	♣K060408HD
Belt - Hub & Fan	479577C1	②TR28522
Belt - Alt.	598183C1	②♣9447HD
Belt - Hub & A.C.	196666R1	♣9405HD
Hose - Upper - Eng. To Pipe; (2 1/2" I.D.)		24240
Hose - Upper - Pipe To Rad.		21891
Hose - Lower - Eng. To Pipe; (2 1/2" I.D.)		24240
Hose - Lower - Pipe To Rad.		21891
9100i		
Belt - W.P.	3095880	♣K060415HD
Belt - Fan	3501266C1	♣K100465HD
Belt - Alt.; Preferred Belt	598183C1	2/9447PB
Belt - Alt.; Optional Belt		②♣9447HD
Belt - Hub & A.C.	196666R1	♣9405HD
Hose - Upper - Eng. To Pipe; (2 1/2" I.D.)		24240
Hose - Upper - Pipe To Rad.		21135
Hose - Lower - Eng. To Pipe; (2 1/2" I.D.)		24240
Hose - Lower - Pipe To Rad.		21135
9200i; 9400i; 9900i; 9900ix		
Belt - Hub & W.P.	3076492	♣K060425HD

♣ Standard Belt Available. See Pages 630-631.

② Two Required.

Belts and Coolant Hose for Medium/Heavy-Duty Trucks (1996 and Newer)

 Medium & Heavy-Duty Trucks
(1996 & Newer)

Application	Mfr. Part No.	Our No.
INTERNATIONAL/NAVISTAR - Continued		
2003 - Continued		
Cummins N14 Diesel - Continued		
9200i; 9400i; 9900i; 9900ix - Continued		
Belt - Hub & Fan	3501266C1	♣K100465HD
Belt - Alt.	598183C1	♣9447HD
Belt - Hub & A.C.		♣9405HD
Hose - Upper - Eng. To Pipe; (2 1/2" I.D.)	24240	24240
Hose - Upper - Pipe To Rad.		21135
Hose - Lower - Eng. To Pipe; (2 1/2" I.D.)	24240	24240
Hose - Lower - Pipe To Rad.		21135
Detroit Diesel 6-Cyl. 12.7 L Diesel		
9100i		
Belt - Fan	3503813C1	♣K100570HD
Belt - Alt.	3560719C1	♣K080605HD
Belt - A.C.	3514954C1	♣K060340HD
Tensioner Assy. - Fan	3508604C91	38529
Tensioner Pulley - Fan	3508604C91	36092
9200i; 9400i; 9900i		
Belt - Fan	1687800C1	♣K100540HD
Hose - Upper - Eng. To Pipe; (2 1/2" I.D.)		24240
Hose - Upper - Rad. To Pipe		21135
Hose - Lower - Eng. To Pipe; (2 1/2" I.D.)		24240
Hose - Lower - Rad. To Pipe		21135
International/Navistar 530 Diesel		
4400		
Belt - Fan, Alt. & Hub		♣K080685HD
Belt - Fan To A.C.	2017725C1	♣K060490HD
Tensioner Assy. - Fan, Alt. & Hub	1830033C1	38514
Tensioner Assy. - Fan To A.C.	3543883C1	38511
Tensioner Pulley - Fan, Alt. & Hub	1830033C1	36091
Tensioner Pulley - Fan To A.C.	3543883C1	36091
Hose - Upper - Eng. To Rad.		20731
Hose - Lower - Eng. To Rad.		22742
7400; 7500		
Belt - Fan, Alt. & Hub	3543930C1	♣K080760HD
Belt - Fan To A.C.		♣K060458HD
Tensioner Assy. - Fan, Alt. & Hub	1830033C1	38514
Tensioner Assy. - Fan To A.C.	3543883C1	38511
Tensioner Pulley - Fan, Alt. & Hub	1830033C1	36091
Tensioner Pulley - Fan To A.C.	3543883C1	36091
Hose - Upper - Eng. To Pipe; (2 1/4" I.D.)		24236
Hose - Upper - Pipe To Rad.; (2 3/4" I.D.)		24244
Hose - Lower - Eng. To Rad.		22762
8100		
Belt - Fan, Alt. & Hub	168297C1	♣K080760HD
Belt - Fan & A.C.	3517822C1	♣K060478HD
Tensioner Assy. - Fan, Alt. & Hub	1830033C1	38514
Tensioner Assy. - Fan & A.C.	1687819C92	38512
Tensioner Pulley - Fan, Alt. & Hub	1830033C1	36091
Tensioner Pulley - Fan & A.C.	1687819C92	36091
Hose - Upper - Eng. To Pipe; (2 1/2" I.D.)		24240
Hose - Upper - Pipe To Rad.		21135
Hose - Lower - Eng. To Pipe		♣<21891
Hose - Lower - Pipe To Rad.		♣<21891
8500		
Belt - Fan & Alt.		♣K080685HD
Belt - Fan To A.C.	2017725C1	♣K060490HD
Tensioner Assy. - Fan & Alt.	1830033C1	38514
Tensioner Assy. - Fan To A.C.	3543883C1	38511
Tensioner Pulley - Fan & Alt.	1830033C1	36091
Tensioner Pulley - Fan To A.C.	3543883C1	36091
International/Navistar DT466 Diesel		
4300; 4400		
Belt - Fan, Alt. & Hub	1833009C1	♣K080702HD
Belt - Fan To A.C.	1830641C2	♣K060490HD
Tensioner Assy. - Fan, Alt. & Hub	1830033C1	38514
Tensioner Assy. - Fan To A.C.	3543883C1	38511
Tensioner Pulley - Fan, Alt. & Hub	1830033C1	36091
Tensioner Pulley - Fan To A.C.	3543883C1	36091
Hose - Upper - Eng. To Rad.		20731
Hose - Lower - Eng. To Rad.		22742

♣ Standard Belt Available. See Pages 630-631.

Application	Mfr. Part No.	Our No.
INTERNATIONAL/NAVISTAR - Continued		
2003 - Continued		
International/Navistar DT466 Diesel - Continued		
4800		
Belt - Fan & Alt.; W/P.T.O.; W/1.2 To 1 Fan Ratio	1819391C1	♣K080730HD
Belt - Fan & Alt.; W/P.T.O.; W/Mechanical Eng.; W/1.08 To 1 Fan Ratio	1682696C1	♣K080738HD
Belt - Fan & Alt.; W/P.T.O.; W/Electronic Eng.; W/1.08 To 1 Fan Ratio	1820547C2	♣K080774HD
Belt - Fan & Alt.; W/O P.T.O.	1822503C1	♣K080726HD
Belt - A.C.	1687797C1	♣K060470HD
Tensioner Assy. - Fan & Alt.	1814719C1	38514
Tensioner Assy. - Fan To A.C.	1687819C91	38511
Tensioner Pulley - Fan & Alt.	1814719C1	36091
Tensioner Pulley - Fan To A.C.	1687819C91	36091
Hose - Upper - Eng. To Rad.		21765
Hose - Lower - Eng. To Pipe		21842
Hose - Lower - Pipe To Rad.		21115
Hose - Lower - Eng. To Rad.		21842
7300		
Belt - Fan & Alt.	1820547C3	♣K080774HD
Belt - Fan To A.C.	1841563C1	♣K060458HD
Tensioner Assy. - Fan & Alt.	1830033C1	38514
Tensioner Assy. - Fan To A.C.	3543883C1	38511
Tensioner Pulley - Fan To A.C.	3543883C1	36091
Tensioner Pulley - Fan & Alt.	1830033C1	36091
7400		
Belt - Fan & Alt.; W/A.C.	1820547C3	♣K080774HD
Belt - Fan To A.C.	1841563C1	♣K060458HD
Belt - Fan & Alt.; W/O A.C.	1842459C1	K080801HD
Tensioner Assy. - Fan & Alt.	1830033C1	38514
Tensioner Assy. - Fan To A.C.	3543883C1	38511
Tensioner Pulley - Fan To A.C.	3543883C1	36091
Tensioner Pulley - Fan & Alt.	1830033C1	36091
Hose - Upper - Eng. To Pipe; (2 1/4" I.D.)		24236
Hose - Upper - Pipe To Rad.; (2 1/2" I.D.)		24240
Hose - Lower - Eng. To Rad.		22762
International/Navistar T444 Diesel		
1652 SC		
Belt - W.P., Fan & Alt.; W/O Air Brake Compr.; W/O Schwitzer Fan Clutch ..	1822830C1	♣K080893HD
Idler Pulley; W/Flat Idler Pulley	1822652C91	36287
Idler Pulley; W/V-Groove Idler Pulley ...	1822653C91	36288
International/Navistar VT365 Diesel		
4200; 4300; 4400		
Belt - Fan, Alt. & A.C.	1839963C1	♣K080830HD
Belt - Fan & Air Compr.	1833620C1	♣K060525HD
Tensioner Assy. - Fan, Alt. & A.C.	1833688C1	38556
Tensioner Assy. - Fan & Air Compr.	1832711C2	38629
Hose - Upper - Eng. To Rad.		22774
Hose - Lower - Eng. To Rad.		22775
2002		
Caterpillar C10 Diesel		
2574; 2674		
Belt - Fan & Alt.	1841558C1	♣K080755HD
Belt - A.C.	L17446	♣9447HD
5500i		
Belt - Fan & Alt.	3507969C1	♣K080780HD
Belt - Fan & A.C.	311175C2	♣9447HD
Hose - Upper - Eng. To Pipe		21335
Hose - Upper - Pipe To Rad.; (2 1/2" I.D.)		24240
Hose - Lower - Eng. To Pipe; (2 1/2" I.D.)		24240
Hose - Lower - Pipe To Rad.; (2 1/2" I.D.)		24240
5600i; 5900i		
Belt - Fan & Alt.	3507969C1	♣K080780HD
Belt - Fan & A.C.	311175C2	♣9447HD
Tensioner Assy. - Fan & Alt.	1333529	38506
Idler Pulley - Fan & Alt.; W/Flat Idler Pulley	1337023	36091

♣ Cut to Fit.

Belts and Coolant Hose for Medium/Heavy-Duty Trucks (1996 and Newer)

Medium & Heavy-Duty Trucks
(1996 & Newer)

Application	Mfr. Part No.	Our No.
INTERNATIONAL/NAVISTAR - Continued		
2002 - Continued		
Caterpillar C10 Diesel - Continued		
5600i; 5900i - Continued		
Idler Pulley - Fan & Alt.:		
W/Multi-Grooved Idler Pulley	1731498	36231
Tensioner Pulley - Fan & Alt.	1333529	36091
Hose - Upper - Eng. To Pipe		21335
Hose - Upper - Pipe To Rad.; (2 1/2" I.D.)		24240
Hose - Lower - Eng. To Pipe; (2 1/2" I.D.)		24240
Hose - Lower - Pipe To Rad.; (2 1/2" I.D.)		24240
7600		
Belt - Fan & Alt.	3561002C1	▲K080986HD
Belt - Fan To A.C.	3561003C1	▲K060483HD
Tensioner Assy. - Fan & Alt.	1900649	38506
Tensioner Assy. - Fan To A.C.	1900634	38507
Idler Pulley - Fan & Alt.; W/Flat Idler Pulley	1337023	36091
Idler Pulley - Fan & Alt.:		
W/Multi-Grooved Idler Pulley	1731498	36231
Tensioner Pulley - Fan & Alt.	1900649	36091
Tensioner Pulley - Fan To A.C.	1900634	36091
Hose - Upper - Eng. To Pipe		21135
Hose - Upper - Pipe To Rad.; (2 1/2" I.D.)		24240
Hose - Lower - Eng. To Pipe; (2 1/2" I.D.)		24240
Hose - Lower - Pipe To Rad.		21891
8100		
Belt - Fan & Alt.	3559834C1	▲K080859HD
Belt - Fan To A.C.	3559835C1	▲K060586HD
Tensioner Assy. - Fan & Alt.	1900649	38506
Tensioner Assy. - Fan To A.C.	1900634	38507
Idler Pulley - Fan & Alt.; W/Flat Idler Pulley	1337023	36091
Idler Pulley - Fan & Alt.:		
W/Multi-Grooved Idler Pulley	1731498	36231
Tensioner Pulley - Fan & Alt.	1900649	36091
Tensioner Pulley - Fan To A.C.	1900634	36091
Hose - Upper - Eng. To Pipe		21135
Hose - Upper - Pipe To Rad.		21135
Hose - Lower - Eng. To Pipe; (2 1/2" I.D.)		24240
Hose - Lower - Pipe To Rad.		21891
9100i; 9200i; 9400i; 9900i; 9900ix		
Belt - Fan & Alt.	1618533C1	▲K080733HD
Belt - Fan & A.C.; Preferred Belt	149635R2	2/9463PB
Belt - Fan & A.C.; Optional Belt		②▲9463HD
Hose - Upper - Eng. To Pipe		21135
Hose - Upper - Pipe To Rad.; (2 1/2" I.D.)		24240
Hose - Lower - Eng. To Pipe		21891
Hose - Lower - Rad. To Pipe		21135
Caterpillar C12 Diesel		
2574; 2674		
Belt - Fan & Alt.	1841558C1	▲K080755HD
Belt - A.C.	L17446	▲9447HD
5500i; 5600i; 5900i		
Belt - Fan & Alt.	3507969C1	▲K080780HD
Belt - Fan & A.C.	311175C2	▲9447HD
Tensioner Assy. - Fan & Alt.	1333529	38506
Idler Pulley - Fan & Alt.; W/Flat Idler Pulley	1337023	36091
Idler Pulley - Fan & Alt.:		
W/Multi-Grooved Idler Pulley	1731498	36231
Tensioner Pulley - Fan & Alt.	1333529	36091
Hose - Upper - Eng. To Pipe		21335
Hose - Upper - Pipe To Rad.; (2 1/2" I.D.)		24240
Hose - Lower - Eng. To Pipe; (2 1/2" I.D.)		24240
Hose - Lower - Pipe To Rad.; (2 1/2" I.D.)		24240
7600		
Belt - Fan & Alt.	3561002C1	▲K080986HD
Belt - Fan To A.C.	3561003C1	▲K060483HD
Tensioner Assy. - Fan & Alt.	1900649	38506
Tensioner Assy. - Fan To A.C.	1900634	38507
Idler Pulley - Fan & Alt.; W/Flat Idler Pulley	1337023	36091

Application	Mfr. Part No.	Our No.
INTERNATIONAL/NAVISTAR - Continued		
2002 - Continued		
Caterpillar C12 Diesel - Continued		
7600 - Continued		
Idler Pulley - Fan & Alt.:		
W/Multi-Grooved Idler Pulley	1731498	36231
Tensioner Pulley - Fan & Alt.	1900649	36091
Tensioner Pulley - Fan To A.C.	1900634	36091
Hose - Upper - Eng. To Pipe		21135
Hose - Upper - Pipe To Rad.; (2 1/2" I.D.)		24240
Hose - Lower - Eng. To Pipe; (2 1/2" I.D.)		24240
Hose - Lower - Pipe To Rad.		21891
9100i; 9200i; 9400i; 9900i; 9900ix		
Belt - Fan & Alt.	1618533C1	▲K080733HD
Belt - Fan & A.C.; Preferred Belt	149635R2	2/9463PB
Belt - Fan & A.C.; Optional Belt		②▲9463HD
Hose - Upper - Eng. To Pipe		21135
Hose - Upper - Pipe To Rad.; (2 1/2" I.D.)		24240
Hose - Lower - Eng. To Pipe		21891
Hose - Lower - Rad. To Pipe		21135
Caterpillar C15 Diesel		
9400i; 9900i; 9900ix		
Belt - Fan & Alt.	2018284C1	▲K100771HD
Belt - Fan & A.C.	2005148C1	▲K060500HD
Hose - Upper - Eng. To Pipe; (2 1/2" I.D.)		24240
Hose - Upper - Pipe To Rad.		21135
Hose - Lower - Eng. To Pipe; (2 1/2" I.D.)		24240
Hose - Lower - Pipe To Rad.		21135
Caterpillar C16 Diesel		
9400i; 9900i; 9900ix		
Belt - Fan & Alt.	2018284C1	▲K100771HD
Belt - Fan & A.C.	2005148C1	▲K060500HD
Hose - Upper - Eng. To Pipe; (2 1/2" I.D.)		24240
Hose - Upper - Pipe To Rad.		21135
Hose - Lower - Eng. To Pipe; (2 1/2" I.D.)		24240
Hose - Lower - Pipe To Rad.		21135
Cummins ISM Diesel		
5500i; 5600i; 5900i		
Belt - Fan & Alt.	3579000C1	▲K080806HD
Belt - Hub & A.C.	3579001C1	▲K060516HD
Tensioner Assy. - Fan & Alt.	3400885	38521
Tensioner Assy. - Hub & A.C.	3102888	38505
Idler Pulley - A.C.	3104139	36225
Idler Pulley - Fan & Alt.	3400884	36308
Tensioner Pulley - A.C.	3102888	36091
Hose - Upper - Eng. To Pipe; (2 1/2" I.D.)		24240
Hose - Upper - Rad. To Pipe		21135
Hose - Lower - Eng. To Pipe; (2 1/2" I.D.)		24240
Hose - Lower - Rad. To Pipe; (2 1/2" I.D.)		24240
8100		
Belt - Fan	1648750C1	▲K080605HD
Belt - Hub & Alt.	586452C1	▲K050336HD
Belt - Hub & A.C.	2016338C1	TR22485
Hose - Upper - Eng. To Pipe; (2 1/2" I.D.)		24240
Hose - Upper - Pipe To Rad.		21135
Hose - Lower - Eng. To Pipe; (2 1/2" I.D.)		24240
Hose - Lower - Pipe To Rad.		21194
9100i; 9200i; 9400i; 9900i; 9900ix		
Belt - Fan	1651399C1	▲K080565HD
Belt - Hub & Alt.	586452C1	▲K050336HD
Belt - Hub & A.C.	2016338C1	TR22485
Hose - Upper - Eng. To Pipe; (2 1/2" I.D.)		24240
Hose - Upper - Pipe To Rad.		21135
Hose - Lower - Eng. To Pipe		21135
Hose - Lower - Pipe To Rad.; (2 1/2" I.D.)		24240
Cummins ISX Diesel		
9100i		
Belt - Fan	3681819	▲K100719HD
Belt - W.P., Alt. & A.C.	3681812	▲K060685HD
Tensioner Assy. - Fan	3681240	38535
Tensioner Assy. - Hub, Alt. & A.C.	3680194	38532
Idler Pulley - Alt. & A.C.	4026886	36226

▲ Standard Belt Available. See Pages 630-631.

② Two Required.

Belts and Coolant Hose for Medium/Heavy-Duty Trucks (1996 and Newer)

 Medium & Heavy-Duty Trucks
(1996 & Newer)

Application	Mfr. Part No.	Our No.
INTERNATIONAL/NAVISTAR - Continued		
2002 - Continued		
Cummins ISX Diesel - Continued		
9100i - Continued		
Tensioner Pulley - Fan	3681240	36092
Tensioner Pulley - Hub, Alt. & A.C.	3680194	36095
Hose - Upper - Eng. To Pipe; (2 1/2" I.D.)		24240
Hose - Upper - Pipe To Rad.		21135
Hose - Lower - Eng. To Pipe		21891
Hose - Lower - Pipe To Rad.		21135
9400i; 9900i; 9900ix		
Belt - Fan	3681819	♣K100719HD
Belt - W.P., Alt. & A.C.	3681812	♣K060685HD
Tensioner Assy. - Fan	3681240	38535
Tensioner Assy. - W.P., Alt. & A.C.	3680194	38532
Idler Pulley - Alt. & A.C.	4026886	36226
Tensioner Pulley - Fan	3681240	36092
Tensioner Pulley - W.P., Alt. & A.C.	3680194	36095
Hose - Upper - Eng. To Pipe		21135
Hose - Upper - Pipe To Rad.		21891
Hose - Lower - Eng. To Pipe		21891
Hose - Lower - Pipe To Rad.		21135
Cummins N14 Diesel		
2674		
Belt - Fan	28523	TR28522
Belt - Alt.	17445	♣9447HD
Belt - A.C.	17405	♣9405HD
Belt - W.P.	3076492	♣K060425HD
5500i; 5600i; 5900i		
Belt - Hub & W.P.	3865157	♣K060408HD
Belt - Hub & Fan	479577C1	ⓉTR28522
Belt - Alt.	598183C1	Ⓣ♣9447HD
Belt - Hub & A.C.	196666R1	♣9405HD
Hose - Upper - Eng. To Pipe; (2 1/2" I.D.)		24240
Hose - Upper - Pipe To Rad.		21891
Hose - Lower - Eng. To Pipe; (2 1/2" I.D.)		24240
Hose - Lower - Pipe To Rad.		21891
9100i; 9200i; 9400i; 9900i; 9900ix		
Belt - W.P.	3095880	♣K060415HD
Belt - Fan	3501266C1	♣K100465HD
Belt - Alt.; Preferred Belt	598183C1	2/9447PB
Belt - Alt.; Optional Belt		Ⓣ♣9447HD
Belt - Hub & A.C.	196666R1	♣9405HD
Hose - Upper - Eng. To Pipe; (2 1/2" I.D.)		24240
Hose - Upper - Pipe To Rad.		21135
Hose - Lower - Eng. To Pipe; (2 1/2" I.D.)		24240
Hose - Lower - Pipe To Rad.		21135
Cummins Signature 600 Diesel		
9200i		
Belt - Fan	3529218C1	♣K100719HD
Belt - Hub, Alt. & A.C.	3527406C2	♣K060680HD
Tensioner Assy. - Fan	3681240	38535
Tensioner Assy. - Hub, Alt. & A.C.	3680194	38532
Idler Pulley - Alt. & A.C.	4026886	36226
Tensioner Pulley - Fan	3681240	36092
Tensioner Pulley - Hub, Alt. & A.C.	3680194	36095
Detroit Diesel 6-Cyl. 12.7 L Diesel		
9100i; 9200i; 9400i; 9900i; 9900ix		
Belt - Fan	1687800C1	♣K100540HD
Hose - Upper - Eng. To Pipe; (2 1/2" I.D.)		24240
Hose - Upper - Rad. To Pipe		21135
Hose - Lower - Eng. To Pipe; (2 1/2" I.D.)		24240
Hose - Lower - Rad. To Pipe		21135
International/Navistar 530 Diesel		
2554; 2654		
Belt - Fan, Alt. & Hub	168297C1	♣K080760HD
Belt - Fan & A.C.	3515596C1	♣K060470HD
Tensioner Assy. - Fan, Alt. & Hub	1830033C1	38514
Tensioner Assy. - Fan & A.C.	1687819C92	38512
Tensioner Pulley - Fan, Alt. & Hub	1830033C1	36091
Tensioner Pulley - Fan & A.C.	1687819C92	36091

Application	Mfr. Part No.	Our No.
INTERNATIONAL/NAVISTAR - Continued		
2002 - Continued		
International/Navistar 530 Diesel - Continued		
2554; 2654 - Continued		
Hose - Upper - Eng. To Rad.		22140
Hose - Lower - Eng. To Rad.		♣<21115
4400		
Belt - Fan, Alt. & Hub		♣K080685HD
Belt - Fan To A.C.	2017725C1	♣K060490HD
Tensioner Assy. - Fan, Alt. & Hub	1830033C1	38514
Tensioner Assy. - Fan To A.C.	3543883C1	38511
Tensioner Pulley - Fan, Alt. & Hub	1830033C1	36091
Tensioner Pulley - Fan To A.C.	3543883C1	36091
Hose - Upper - Eng. To Rad.		20731
Hose - Lower - Eng. To Rad.		22742
4700; 4800; 4900		
Belt - Fan, Alt. & Hub	1819392C1	♣K080716HD
Belt - Fan & A.C.	3515596C1	♣K060470HD
Tensioner Assy. - Fan, Alt. & Hub	1830033C1	38514
Tensioner Assy. - Fan & A.C.	1687819C92	38512
Tensioner Pulley - Fan, Alt. & Hub	1830033C1	36091
Tensioner Pulley - Fan & A.C.	1687819C92	36091
Hose - Upper - Eng. To Rad.		22140
Hose - Lower - Eng. To Rad.		♣<21115
7400; 7500		
Belt - Fan, Alt. & Hub	3543930C1	♣K080760HD
Belt - Fan To A.C.	3503871C1	♣K060458HD
Tensioner Assy. - Fan, Alt. & Hub	1830033C1	38514
Tensioner Assy. - Fan To A.C.	3543883C1	38511
Tensioner Pulley - Fan, Alt. & Hub	1830033C1	36091
Tensioner Pulley - Fan To A.C.	3543883C1	36091
Hose - Upper - Eng. To Pipe; (2 1/4" I.D.)		24236
Hose - Upper - Pipe To Rad.; (2 3/4" I.D.)		24244
Hose - Lower - Eng. To Rad.		22762
8100		
Belt - Fan, Alt. & Hub	168297C1	♣K080760HD
Belt - Fan & A.C.	3517822C1	♣K060478HD
Tensioner Assy. - Fan, Alt. & Hub	1830033C1	38514
Tensioner Assy. - Fan & A.C.	1687819C92	38512
Tensioner Pulley - Fan, Alt. & Hub	1830033C1	36091
Tensioner Pulley - Fan & A.C.	1687819C92	36091
Hose - Upper - Eng. To Pipe; (2 1/2" I.D.)		24240
Hose - Upper - Pipe To Rad.		21135
Hose - Lower - Eng. To Pipe		♣<21891
Hose - Lower - Pipe To Rad.		♣<21891
8500		
Belt - Fan & Alt.	3541491C1	♣K080685HD
Belt - Fan To A.C.	2017725C1	♣K060490HD
Tensioner Assy. - Fan & Alt.	1830033C1	38514
Tensioner Assy. - Fan To A.C.	3543883C1	38511
Tensioner Pulley - Fan & Alt.	1830033C1	36091
Tensioner Pulley - Fan To A.C.	3543883C1	36091
International/Navistar DT466 Diesel		
2554; 2574; 2654		
Belt - Fan, Alt. & Hub	1820547C2	♣K080774HD
Tensioner Assy. - Fan, Alt. & Hub	1830033C1	38514
Tensioner Pulley - Fan, Alt. & Hub	1830033C1	36091
Hose - Upper - Eng. To Pipe; (2 1/2" I.D.)		24240
Hose - Upper - Pipe To Rad.; (2 1/2" I.D.)		24240
Hose - Lower - Eng. To Pipe; (2 1/2" I.D.)		24240
Hose - Lower - Pipe To Rad.; (2 1/2" I.D.)		24240
4300; 4400		
Belt - Fan, Alt. & Hub		♣K080700HD
Belt - Fan To A.C.	2017725C1	♣K060490HD
Tensioner Assy. - Fan, Alt. & Hub	1830033C1	38514
Tensioner Assy. - Fan To A.C.	3543883C1	38511
Tensioner Pulley - Fan, Alt. & Hub	1830033C1	36091
Tensioner Pulley - Fan To A.C.	3543883C1	36091
Hose - Upper - Eng. To Rad.		20731
Hose - Lower - Eng. To Rad.		22742

♣ Standard Belt Available. See Pages 630-631.
♣< Cut to Fit.

Ⓣ Two Required.

Belts and Coolant Hose for Medium/Heavy-Duty Trucks (1996 and Newer)

Medium & Heavy-Duty Trucks
(1996 & Newer)

Application	Mfr. Part No.	Our No.
INTERNATIONAL/NAVISTAR - Continued		
2002 - Continued		
International/Navistar DT466 Diesel - Continued		
4700		
Belt - Fan & Alt.; W/P.T.O.; W/1.2 To 1		
Fan Ratio	1819391C1	♣K080730HD
Belt - Fan & Alt.; W/P.T.O.;		
W/Mechanical Eng.; W/1.08 To 1		
Fan Ratio	1682696C1	♣K080738HD
Belt - Fan & Alt.; W/P.T.O.; W/Electronic		
Eng.; W/1.08 To 1 Fan Ratio	1820547C2	♣K080774HD
Belt - Fan & Alt.; W/O P.T.O.	1822503C1	♣K080726HD
Belt - Fan & A.C.	3516596C1	♣K060470HD
Tensioner Assy. - Fan & Alt.	1830033C1	38514
Tensioner Assy. - Fan & A.C.	1687819C92	38512
Tensioner Pulley - Fan & Alt.	1830033C1	36091
Tensioner Pulley - Fan & A.C.	1687819C92	36091
Hose - Upper - Eng. To Rad.		22140
Hose - Lower - Eng. To Rad.		21115
4800		
Belt - Fan & Alt.; W/P.T.O.; W/1.2 To 1		
Fan Ratio	1819391C1	♣K080730HD
Belt - Fan & Alt.; W/P.T.O.;		
W/Mechanical Eng.; W/1.08 To 1		
Fan Ratio	1682696C1	♣K080738HD
Belt - Fan & Alt.; W/P.T.O.; W/Electronic		
Eng.; W/1.08 To 1 Fan Ratio	1820547C2	♣K080774HD
Belt - Fan & Alt.; W/O P.T.O.	1822503C1	♣K080726HD
Belt - Fan To A.C.	1687797C1	♣K060470HD
Tensioner Assy. - Fan & Alt.	1814719C1	38514
Tensioner Assy. - Fan To A.C.	1687819C91	38511
Tensioner Pulley - Fan & Alt.	1814719C1	36091
Tensioner Pulley - Fan To A.C.	1687819C91	36091
Hose - Upper - Eng. To Rad.		21765
Hose - Lower - Eng. To Pipe		21842
Hose - Lower - Pipe To Rad.		21115
Hose - Lower - Eng. To Rad.		21842
4900		
Belt - Fan & Alt.; W/P.T.O.; W/1.2 To 1		
Fan Ratio	1819391C1	♣K080730HD
Belt - Fan & Alt.; W/P.T.O.;		
W/Mechanical Eng.; W/1.08 To 1		
Fan Ratio	1682696C1	♣K080738HD
Belt - Fan & Alt.; W/P.T.O.; W/Electronic		
Eng.; W/1.08 To 1 Fan Ratio	1820547C2	♣K080774HD
Belt - Fan & Alt.; W/O P.T.O.	1822503C1	♣K080726HD
Belt - Fan To A.C.	3515596C1	♣K060470HD
Tensioner Assy. - Fan & Alt.	1830033C1	38514
Tensioner Assy. - Fan To A.C.	1687819C92	38512
Tensioner Pulley - Fan & Alt.	1830033C1	36091
Tensioner Pulley - Fan To A.C.	1687819C92	36091
Hose - Lower - Eng. To Rad.		21891
5500i; 5600i		
Belt - Fan & Alt.	1841558C1	♣K080755HD
Belt - A.C.	3515596C1	♣K060470HD
Tensioner Assy. - Fan & Alt.	1830033C1	38514
Tensioner Assy. - Fan & A.C.	1687819C92	38512
Tensioner Pulley - Fan & Alt.	1830033C1	36091
Tensioner Pulley - Fan & A.C.	1687819C92	36091
7300		
Belt - Fan & Alt.	1820547C3	♣K080774HD
Belt - Fan To A.C.	1841563C1	♣K060458HD
Tensioner Assy. - Fan & Alt.	1830033C1	38514
Tensioner Assy. - Fan To A.C.	3543883C1	38511
Tensioner Pulley - Fan & Alt.	1830033C1	36091
Tensioner Pulley - Fan To A.C.	3543883C1	36091
7400; 7500		
Belt - Fan & Alt.	1820547C3	♣K080774HD
Belt - Fan To A.C.	1841563C1	♣K060458HD
Tensioner Assy. - Fan & Alt.	1830033C1	38514
Tensioner Assy. - Fan To A.C.	3543883C1	38511
Tensioner Pulley - Fan & Alt.	1830033C1	36091
Tensioner Pulley - Fan To A.C.	3543883C1	36091
Hose - Upper - Eng. To Pipe; (2 1/4" I.D.)		24236

Application	Mfr. Part No.	Our No.
INTERNATIONAL/NAVISTAR - Continued		
2002 - Continued		
International/Navistar DT466 Diesel - Continued		
7400; 7500 - Continued		
Hose - Upper - Pipe To Rad.; (2 1/2" I.D.)		24240
Hose - Lower - Eng. To Rad.		22762
International/Navistar T444 Diesel		
1652 SC		
Belt - W.P., Fan & Alt.; W/O Air Brake		
Compr.; W/O Schwitzer Fan Clutch ..	1822830C1	♣K080893HD
Idler Pulley; W/Flat Idler Pulley	1822652C91	36287
Idler Pulley; W/V-Groove Idler Pulley ...	1822653C91	36288
4700		
Belt - W.P., Fan & Alt.; W/O Air Brake		
Compr.; W/Schwitzer Fan Clutch	1821840C1	♣K080922HD
Belt - W.P., Fan & Alt.; W/Air Brake		
Compr.; W/Schwitzer Fan Clutch	1821850C1	♣K081102HD
Belt - W.P., Fan, Alt. & A.C.; W/O Air		
Brake Compr.; W/Schwitzer Fan		
Clutch	1821839C1	♣K081035HD
Belt - W.P., Fan, Alt. & A.C.; W/Air		
Brake Compr.; W/Schwitzer Fan		
Clutch	1821843C1	♣K081223HD
Belt - W.P., Fan & Alt.; W/O Air Brake		
Compr.; W/O Schwitzer Fan Clutch ..	1822830C1	♣K080893HD
Belt - W.P., Fan & Alt.; W/Air Brake		
Compr.; W/O Schwitzer Fan Clutch ..	1822832C1	♣K081124HD
Belt - W.P., Fan, Alt. & A.C.; W/O Air		
Brake Compr.; W/O Schwitzer Fan		
Clutch	1822831C2	♣K081000HD
Belt - W.P., Fan, Alt. & A.C.; W/Air		
Brake Compr.; W/O Schwitzer Fan		
Clutch	1822833C1	♣K081265HD
Tensioner Assy.	1822679C3	38510
Idler Pulley; W/Flat Idler Pulley	1822652C91	36287
Idler Pulley; W/V-Groove Idler Pulley ...	1822653C91	36288
Hose - Upper - Eng. To Rad.		22159
Hose - Lower - Eng. To Rad.		22671
International/Navistar VT365 Diesel		
4200		
Belt - Fan, Alt. & A.C.	1839963C1	♣K080830HD
Belt - Fan & Air Compr.	1833620C1	♣K060525HD
Tensioner Assy. - Fan, Alt. & A.C.	1832688C1	38556
Tensioner Assy. - Fan & Air Compr.	1832711C2	38629
Hose - Upper - Eng. To Rad.		22774
Hose - Lower - Eng. To Rad.		22775
2001		
Caterpillar C10 Diesel		
2574		
Belt - Fan & Alt.	1841558C1	♣K080755HD
Belt - A.C.	L17446	♣9447HD
2674		
Belt - Fan & Alt.	1682697C1	♣K080760HD
Belt - Fan To A.C.		♣9447HD
Hose - Upper - Eng. To Pipe; (2 1/2" I.D.)		24240
Hose - Upper - Pipe To Rad.		21135
Hose - Lower - Eng. To Pipe; (2 1/2" I.D.)		24240
Hose - Lower - Pipe To Rad.		21891
5500i; 5600i; 5900i		
Belt - Fan & Alt.	3507969C1	♣K080780HD
Belt - Fan & A.C.	311175C2	♣9447HD
Hose - Upper - Eng. To Pipe		21335
Hose - Upper - Pipe To Rad.; (2 1/2" I.D.)		24240
Hose - Lower - Eng. To Pipe; (2 1/2" I.D.)		24240
Hose - Lower - Pipe To Rad.; (2 1/2" I.D.)		24240
8100		
Belt - Fan & Alt.	1682697C1	♣K080760HD
Belt - A.C.	311175C2	♣9447HD
Hose - Upper - Eng. To Pipe		21135
Hose - Upper - Pipe To Rad.; (2 1/2" I.D.)		24240
Hose - Lower - Eng. To Pipe		21891
Hose - Lower - Pipe To Rad.; (2 1/2" I.D.)		24240

♣ Standard Belt Available. See Pages 630-631.

≡ Cut to Fit.

Belts and Coolant Hose for Medium/Heavy-Duty Trucks (1996 and Newer)

 Medium & Heavy-Duty Trucks
(1996 & Newer)

Application	Mfr. Part No.	Our No.
INTERNATIONAL/NAVISTAR - Continued		
2001 - Continued		
Caterpillar C10 Diesel - Continued		
9100i; 9200i; 9400i; 9900i; 9900ix		
Belt - Fan & Alt.	1618533C1	♣K080733HD
Belt - Fan & A.C.; Preferred Belt	149635R2	2/9463PB
Belt - Fan & A.C.; Optional Belt		②♣9463HD
Hose - Upper - Eng. To Pipe		21135
Hose - Upper - Pipe To Rad.; (2 1/2" I.D.)		24240
Hose - Lower - Eng. To Pipe		21891
Hose - Lower - Rad. To Pipe		21135
Caterpillar C12 Diesel		
2574; 2674		
Belt - Fan & Alt.	1841558C1	♣K080755HD
Belt - A.C.	L17446	♣9447HD
5500i; 5600i; 5900i		
Belt - Fan & Alt.	3507969C1	♣K080780HD
Belt - Fan & A.C.	311175C2	♣9447HD
Hose - Upper - Eng. To Pipe		21335
Hose - Upper - Pipe To Rad.; (2 1/2" I.D.)		24240
Hose - Lower - Eng. To Pipe; (2 1/2" I.D.)		24240
Hose - Lower - Pipe To Rad.; (2 1/2" I.D.)		24240
9100i; 9200i; 9400i; 9900i; 9900ix		
Belt - Fan & Alt.	1618533C1	♣K080733HD
Belt - Fan & A.C.; Preferred Belt	149635R2	2/9463PB
Belt - Fan & A.C.; Optional Belt		②♣9463HD
Hose - Upper - Eng. To Pipe		21135
Hose - Upper - Pipe To Rad.; (2 1/2" I.D.)		24240
Hose - Lower - Eng. To Pipe		21891
Hose - Lower - Rad. To Pipe		21135
Caterpillar C15 Diesel		
9400i; 9900i; 9900ix		
Belt - Fan & Alt.	2018284C1	♣K100771HD
Belt - Fan & A.C.	2005148C1	♣K060500HD
Hose - Upper - Eng. To Pipe		21135
Hose - Upper - Pipe To Rad.; (2 1/2" I.D.)		24240
Hose - Lower - Eng. To Pipe		21135
Hose - Lower - Pipe To Rad.; (2 1/2" I.D.)		24240
Caterpillar C16 Diesel		
9400i; 9900i; 9900ix		
Belt - Fan & Alt.	2018284C1	♣K100771HD
Belt - Fan & A.C.	2005148C1	♣K060500HD
Hose - Upper - Eng. To Pipe		21135
Hose - Upper - Pipe To Rad.; (2 1/2" I.D.)		24240
Hose - Lower - Eng. To Pipe		21135
Hose - Lower - Pipe To Rad.; (2 1/2" I.D.)		24240
Cummins ISM Diesel		
5500i		
Belt - Alt.	L4050335	♣K050336HD
Belt - Fan	1675429C1	K080655
Belt - A.C.	2016339C1	TR22525
5900i		
Belt - Fan & Alt.	3579000C1	♣K080806HD
Belt - Hub & A.C.	3579001C1	♣K060516HD
Tensioner Assy. - Fan & Alt.	3400885	38521
Tensioner Assy. - Hub & A.C.	3102888	38505
Idler Pulley - A.C.	3104139	36225
Idler Pulley - Fan & Alt.	3400884	36308
Tensioner Pulley - A.C.	3102888	36091
Hose - Upper - Eng. To Pipe; (2 1/2" I.D.)		24240
Hose - Upper - Rad. To Pipe		21135
Hose - Lower - Eng. To Pipe; (2 1/2" I.D.)		24240
Hose - Lower - Rad. To Pipe; (2 1/2" I.D.)		24240
8100		
Belt - Fan	1648750C1	♣K080605HD
Belt - Hub & Alt.	586452C1	♣K050336HD
Belt - Hub & A.C.	2016338C1	TR22485
Hose - Upper - Eng. To Pipe; (2 1/2" I.D.)		24240
Hose - Upper - Pipe To Rad.		21135
Hose - Lower - Eng. To Pipe; (2 1/2" I.D.)		24240
Hose - Lower - Pipe To Rad.		21135

 ♣ Standard Belt Available. See Pages 630-631.
 ⚡ Cut to Fit.

Application	Mfr. Part No.	Our No.
INTERNATIONAL/NAVISTAR - Continued		
2001 - Continued		
Cummins ISM Diesel - Continued		
9100i; 9200i; 9400i; 9900i; 9900ix		
Belt - Fan	1651399C1	♣K080565HD
Belt - Hub & Alt.	586452C1	♣K050336HD
Belt - Hub & A.C.	2016338C1	TR22485
Hose - Upper - Eng. To Pipe; (2 1/2" I.D.)		24240
Hose - Upper - Pipe To Rad.		21135
Hose - Lower - Eng. To Pipe		21135
Hose - Lower - Pipe To Rad.; (2 1/2" I.D.)		24240
Cummins ISX Diesel		
9100i		
Belt - Fan	3681819	♣K100719HD
Belt - Hub, Alt. & A.C.	3681812	♣K060685HD
Tensioner Assy. - Fan	3681240	38535
Tensioner Assy. - Hub, Alt. & A.C.	3680194	38532
Idler Pulley - Alt. & A.C.	4026886	36226
Tensioner Pulley - Fan	3681240	36092
Tensioner Pulley - Hub, Alt. & A.C.	3680194	36095
Hose - Upper - Eng. To Pipe; (2 1/2" I.D.)		24240
Hose - Upper - Pipe To Rad.		21135
Hose - Lower - Eng. To Pipe		21891
Hose - Lower - Pipe To Rad.		21135
9400i; 9900i; 9900ix		
Belt - Fan	3681819	♣K100719HD
Belt - Hub, Alt. & A.C.	3681812	♣K060685HD
Tensioner Assy. - Fan	3681240	38535
Tensioner Assy. - Hub, Alt. & A.C.	3680194	38532
Idler Pulley - Alt. & A.C.	4026886	36226
Tensioner Pulley - Fan	3681240	36092
Tensioner Pulley - Hub, Alt. & A.C.	3680194	36095
Hose - Upper - Eng. To Pipe		21135
Hose - Upper - Pipe To Rad.		21891
Hose - Lower - Eng. To Pipe		21891
Hose - Lower - Pipe To Rad.		21135
Cummins N14 Diesel		
5500i; 5600i; 5900i		
Belt - Hub & W.P.	3865157	♣K060408HD
Belt - Hub & Fan	479577C1	②TR28522
Belt - Alt.	598183C1	②♣9447HD
Belt - Hub & A.C.	196666R1	♣9405HD
9100i; 9200i; 9400i; 9900i; 9900ix		
Belt - W.P.	3095880	♣K060415HD
Belt - Fan	3501266C1	♣K100465HD
Belt - Alt.; Preferred Belt	598183C1	2/9447PB
Belt - Alt.; Optional Belt		②♣9447HD
Belt - Hub & A.C.	196666R1	♣9405HD
Hose - Upper - Eng. To Pipe; (2 1/2" I.D.)		24240
Hose - Upper - Pipe To Rad.		21135
Hose - Lower - Eng. To Pipe; (2 1/2" I.D.)		24240
Hose - Lower - Pipe To Rad.		21135
Cummins Signature 600 Diesel		
9200i		
Belt - Fan	3529218C1	♣K100719HD
Belt - Hub, Alt. & A.C.	3527406C2	♣K060680HD
Tensioner Assy. - Fan	3681240	38535
Tensioner Assy. - Hub, Alt. & A.C.	3680194	38532
Idler Pulley - Alt. & A.C.	4026886	36226
Tensioner Pulley - Fan	3681240	36092
Tensioner Pulley - Hub, Alt. & A.C.	3680194	36095
Detroit Diesel 6-Cyl. 12.7 L Diesel		
9100i; 9200i		
Belt - Fan	3503813C1	♣K100570HD
Belt - Fan To Alt.	3505387C1	♣K060455HD
Belt - Hub & A.C.	3514954C1	♣K060340HD
Tensioner Assy. - Fan	3508604C91	38529
Tensioner Pulley - Fan	3508604C91	36092
Hose - Upper - Eng. To Pipe		⚡21891
Hose - Upper - Pipe To Rad.		⚡21135
Hose - Lower - Eng. To Pipe; (2 1/2" I.D.)		24240
Hose - Lower - Pipe To Rad.		⚡21135

② Two Required.

Belts and Coolant Hose for Medium/Heavy-Duty Trucks (1996 and Newer)

Medium & Heavy-Duty Trucks
(1996 & Newer)

Application	Mfr. Part No.	Our No.
INTERNATIONAL/NAVISTAR - Continued		
2001 - Continued		
Detroit Diesel 6-Cyl. 12.7 L Diesel - Continued		
9400i; 9900i; 9900ix		
Belt - Fan	1687800C1	♣K100540HD
Belt - Alt	3505387C1	♣K060455HD
Belt - A.C.	3514954C1	♣K060340HD
Tensioner Assy. - Fan	1687801C91	38519
Tensioner Pulley - Fan	1687801C91	36092
Hose - Upper - Eng. To Pipe		≡21891
Hose - Upper - Pipe To Rad.		≡21135
Hose - Lower - Eng. To Pipe; (2 1/2" I.D.)		24240
Hose - Lower - Pipe To Rad.		21135
International/Navistar 530 Diesel		
2554; 2654		
Belt - Fan, Alt. & Hub	168297C1	♣K080760HD
Belt - Fan & A.C.	3515596C1	♣K060470HD
Tensioner Assy. - Fan, Alt. & Hub	1830033C1	38514
Tensioner Assy. - Fan & A.C.	1687819C92	38512
Tensioner Pulley - Fan, Alt. & Hub	1830033C1	36091
Tensioner Pulley - Fan & A.C.	1687819C92	36091
Hose - Upper - Eng. To Rad.		22140
Hose - Lower - Eng. To Rad.		≡21115
4900		
Belt - Fan, Alt. & Hub	1819392C1	♣K080716HD
Belt - Fan & A.C.	3515596C1	♣K060470HD
Tensioner Assy. - Fan, Alt. & Hub	1830033C1	38514
Tensioner Assy. - Fan & A.C.	1687819C92	38512
Tensioner Pulley - Fan, Alt. & Hub	1830033C1	36091
Tensioner Pulley - Fan & A.C.	1687819C92	36091
Hose - Upper - Eng. To Rad.		22140
Hose - Lower - Eng. To Rad.		≡21115
8100		
Belt - Fan, Alt. & Hub	168297C1	♣K080760HD
Belt - Fan & A.C.	3517822C1	♣K060478HD
Tensioner Assy. - Fan, Alt. & Hub	1830033C1	38514
Tensioner Assy. - Fan & A.C.	1687819C92	38512
Tensioner Pulley - Fan, Alt. & Hub	1830033C1	36091
Tensioner Pulley - Fan & A.C.	1687819C92	36091
Hose - Upper - Eng. To Pipe; (2 1/2" I.D.)		24240
Hose - Upper - Pipe To Rad.		21135
Hose - Lower - Eng. To Pipe		≡21891
Hose - Lower - Pipe To Rad.		≡21891
International/Navistar DT466 Diesel		
2554		
Belt - Fan, Alt. & Hub; W/Delco Alt.	168297C1	♣K080760HD
Belt - Fan & A.C.	3517822C1	♣K060478HD
Tensioner Assy. - Fan, Alt. & Hub	1830033C1	38514
Tensioner Assy. - Fan & A.C.	1687819C92	38512
Tensioner Pulley - Fan, Alt. & Hub	1830033C1	36091
Tensioner Pulley - Fan & A.C.	1687819C92	36091
Hose - Upper - Eng. To Pipe; (2 1/2" I.D.)		24240
Hose - Upper - Pipe To Rad.; (2 1/2" I.D.)		24240
Hose - Lower - Eng. To Pipe; (2 1/2" I.D.)		24240
Hose - Lower - Pipe To Rad.; (2 1/2" I.D.)		24240
Hose - Lower - Cooler To Rad.		21571
2574		
Belt - Fan, Alt. & Hub	1820547C2	♣K080774HD
Tensioner Assy. - Fan, Alt. & Hub	1830033C1	38514
Tensioner Pulley - Fan, Alt. & Hub	1830033C1	36091
Hose - Upper - Eng. To Pipe; (2 1/2" I.D.)		24240
Hose - Upper - Pipe To Rad.; (2 1/2" I.D.)		24240
Hose - Lower - Eng. To Pipe; (2 1/2" I.D.)		24240
Hose - Lower - Pipe To Rad.; (2 1/2" I.D.)		24240
2654		
Belt - Fan, Alt. & Hub; W/Delco Alt.	168297C1	♣K080760HD
Belt - Fan & A.C.	3517822C1	♣K060478HD
Tensioner Assy. - Fan, Alt. & Hub	1830033C1	38514
Tensioner Assy. - Fan & A.C.	1687819C92	38512
Tensioner Pulley - Fan, Alt. & Hub	1830033C1	36091
Tensioner Pulley - Fan & A.C.	1687819C92	36091
Hose - Upper - Eng. To Pipe; (2 1/2" I.D.)		24240

Application	Mfr. Part No.	Our No.
INTERNATIONAL/NAVISTAR - Continued		
2001 - Continued		
International/Navistar DT466 Diesel - Continued		
2654 - Continued		
Hose - Upper - Pipe To Rad.; (2 1/2" I.D.)		24240
Hose - Lower - Eng. To Pipe; (2 1/2" I.D.)		24240
Hose - Lower - Pipe To Rad.; (2 1/2" I.D.)		24240
Hose - Lower - Cooler To Rad.		21571
4700		
Belt - Fan & Alt.; W/P.T.O.; W/1.2 To 1		
Fan Ratio	1819391C1	♣K080730HD
Belt - Fan & Alt.; W/P.T.O.;		
W/Mechanical Eng.; W/1.08 To 1		
Fan Ratio	1682696C1	♣K080738HD
Belt - Fan & Alt.; W/P.T.O.; W/Electronic		
Eng.; W/1.08 To 1 Fan Ratio	1820547C2	♣K080774HD
Belt - Fan & Alt.; W/O P.T.O.	1822503C1	♣K080726HD
Belt - Fan & A.C.	3516596C1	♣K060470HD
Tensioner Assy. - Fan & Alt.	1830033C1	38514
Tensioner Assy. - Fan & A.C.	1687819C92	38512
Tensioner Pulley - Fan & Alt.	1830033C1	36091
Tensioner Pulley - Fan & A.C.	1687819C92	36091
Hose - Upper - Eng. To Rad.		22140
Hose - Lower - Eng. To Rad.		≡21115
4800		
Belt - Fan & Alt.; W/P.T.O.; W/1.2 To 1		
Fan Ratio	1819391C1	♣K080730HD
Belt - Fan & Alt.; W/P.T.O.;		
W/Mechanical Eng.; W/1.08 To 1		
Fan Ratio	1682696C1	♣K080738HD
Belt - Fan & Alt.; W/P.T.O.; W/Electronic		
Eng.; W/1.08 To 1 Fan Ratio	1820547C2	♣K080774HD
Belt - Fan & Alt.; W/O P.T.O.	1822503C1	♣K080726HD
Belt - Fan To A.C.	1687797C1	♣K060470HD
Tensioner Assy. - Fan & Alt.	1814719C1	38514
Tensioner Assy. - Fan To A.C.	1687819C91	38511
Tensioner Pulley - Fan & Alt.	1814719C1	36091
Tensioner Pulley - Fan To A.C.	1687819C91	36091
Hose - Upper - Eng. To Rad.		21765
Hose - Lower - Eng. To Pipe		21842
Hose - Lower - Pipe To Rad.		21115
Hose - Lower - Eng. To Rad.		21842
4900		
Belt - Fan & Alt.; W/P.T.O.; W/1.2 To 1		
Fan Ratio	1819391C1	♣K080730HD
Belt - Fan & Alt.; W/P.T.O.;		
W/Mechanical Eng.; W/1.08 To 1		
Fan Ratio	1682696C1	♣K080738HD
Belt - Fan & Alt.; W/P.T.O.; W/Electronic		
Eng.; W/1.08 To 1 Fan Ratio	1820547C2	♣K080774HD
Belt - Fan & Alt.; W/O P.T.O.	1822503C1	♣K080726HD
Belt - Fan & A.C.	3516596C1	♣K060470HD
Tensioner Assy. - Fan & Alt.	1830033C1	38514
Tensioner Assy. - Fan & A.C.	1687819C92	38512
Tensioner Pulley - Fan & Alt.	1830033C1	36091
Tensioner Pulley - Fan & A.C.	1687819C92	36091
Hose - Upper - Eng. To Rad.		22140
Hose - Lower - Eng. To Rad.		≡21115
5500i; 5600i		
Belt - Fan & Alt.	1841558C1	♣K080755HD
Belt - A.C.	3515596C1	♣K060470HD
Tensioner Assy. - Fan & Alt.	1830033C1	38514
Tensioner Assy. - Fan & A.C.	1687819C92	38512
Tensioner Pulley - Fan & Alt.	1830033C1	36091
Tensioner Pulley - Fan & A.C.	1687819C92	36091
International/Navistar T444 Diesel		
1652 SC		
Belt - W.P., Fan & Alt.; W/O Air Brake		
Compr.; W/O Schwitzer Fan Clutch ..	1822830C1	♣K080893HD
Idler Pulley; W/Flat Idler Pulley	1822652C91	36287
Idler Pulley; W/V-Groove Idler Pulley ...	1822653C91	36288

♣ Standard Belt Available. See Pages 630-631.

≡ Cut to Fit.

Belts and Coolant Hose for Medium/Heavy-Duty Trucks (1996 and Newer)

 Medium & Heavy-Duty Trucks
(1996 & Newer)

Application	Mfr. Part No.	Our No.
INTERNATIONAL/NAVISTAR - Continued		
2001 - Continued		
International/Navistar T444 Diesel - Continued		
4700		
Belt - W.P., Fan & Alt.; W/O Air Brake Compr.; W/Schwitzer Fan Clutch	1821840C1	♣K080922HD
Belt - W.P., Fan & Alt.; W/Air Brake Compr.; W/Schwitzer Fan Clutch	1821850C1	♣K081102HD
Belt - W.P., Fan, Alt. & A.C.; W/O Air Brake Compr.; W/Schwitzer Fan Clutch	1821839C1	♣K081035HD
Belt - W.P., Fan, Alt. & A.C.; W/Air Brake Compr.; W/Schwitzer Fan Clutch	1821843C1	♣K081223HD
Belt - W.P., Fan & Alt.; W/O Air Brake Compr.; W/O Schwitzer Fan Clutch .	1822830C1	♣K080893HD
Belt - W.P., Fan & Alt.; W/Air Brake Compr.; W/O Schwitzer Fan Clutch .	1822832C1	♣K081124HD
Belt - W.P., Fan, Alt. & A.C.; W/O Air Brake Compr.; W/O Schwitzer Fan Clutch	1822831C2	♣K081000HD
Belt - W.P., Fan, Alt. & A.C.; W/Air Brake Compr.; W/O Schwitzer Fan Clutch	1822833C1	♣K081265HD
Tensioner Assy.	1822679C3	38510
Idler Pulley; W/Flat Idler Pulley	1822652C91	36287
Idler Pulley; W/V-Groove Idler Pulley ...	1822653C91	36288
Hose - Upper - Eng. To Rad.		22159
Hose - Lower - Eng. To Rad.		22671
2000		
Caterpillar 3406 Diesel		
9400i; 9900i; 9900ix		
Belt - Fan & Alt.	2018284C1	♣K100771HD
Belt - Fan To A.C.	2005148C1	♣K060500HD
Hose - Upper - Eng. To Pipe; (2 1/2" I.D.)		24240
Hose - Upper - Pipe To Rad.		21135
Hose - Lower - Eng. To Pipe; (3" I.D.)		24248
Hose - Lower - Pipe To Rad.; (2 1/2" I.D.)		24240
Caterpillar C10 Diesel		
2574; 2654; 2674		
Belt - Fan & Alt.	1682697C1	♣K080760HD
Belt - Fan To A.C.		♣9447HD
Hose - Upper - Eng. To Pipe; (2 1/2" I.D.)		24240
Hose - Upper - Pipe To Rad.		21135
Hose - Lower - Eng. To Pipe; (2 1/2" I.D.)		24240
Hose - Lower - Pipe To Rad.		21891
5000; 5500i; 5600i		
Belt - Fan & Alt.	3507969C1	♣K080780HD
Belt - Fan & A.C.	311175C2	♣9447HD
Hose - Upper - Eng. To Pipe; (2 1/2" I.D.)		24240
Hose - Upper - Pipe To Rad.		21135
Hose - Lower - Eng. To Pipe; (2 1/2" I.D.)		24240
Hose - Lower - Pipe To Rad.; (2 1/2" I.D.)		24240
5900i		
Belt - Fan & Alt.	3507969C1	♣K080780HD
Belt - Fan & A.C.	311175C2	♣9447HD
Tensioner Assy. - Fan & Alt.	1333529	38506
Tensioner Pulley - Fan & Alt.	1333529	36091
Hose - Upper - Eng. To Pipe; (2 1/2" I.D.)		24240
Hose - Upper - Pipe To Rad.		21135
Hose - Lower - Eng. To Pipe; (2 1/2" I.D.)		24240
Hose - Lower - Pipe To Rad.; (2 1/2" I.D.)		24240
8100		
Belt - Fan & Alt.	1682697C1	♣K080760HD
Belt - A.C.	311175C2	♣9447HD
Hose - Upper - Eng. To Pipe		21135
Hose - Upper - Pipe To Rad.		21135
Hose - Lower - Eng. To Pipe		21891
Hose - Lower - Pipe To Rad.; (2 1/2" I.D.)		24240
9100i; 9200i; 9400i		
Belt - Fan & Alt.	1618533C1	♣K080733HD
Belt - Fan & A.C.; Preferred Belt	149635R2	2/9463PB

Application	Mfr. Part No.	Our No.
INTERNATIONAL/NAVISTAR - Continued		
2000 - Continued		
Caterpillar C10 Diesel - Continued		
9100i; 9200i; 9400i - Continued		
Belt - Fan & A.C.; Optional Belt		♣9463HD
Hose - Upper - Eng. To Pipe		21135
Hose - Upper - Pipe To Rad.; (2 1/2" I.D.)		24240
Hose - Lower - Eng. To Pipe		21891
Hose - Lower - Rad. To Pipe		21135
9900i; 9900ix		
Belt - Fan & Alt.	1618533C1	♣K080733HD
Belt - Fan & A.C.; Optional Belt		♣9463HD
Belt - Fan & A.C.; Preferred Belt	149635R2	2/9463PB
Hose - Upper - Eng. To Pipe		21135
Hose - Upper - Pipe To Rad.; (2 1/2" I.D.)		24240
Hose - Lower - Eng. To Pipe		21891
Hose - Lower - Rad. To Pipe		21135
Caterpillar C12 Diesel		
2574; 2674		
Belt - Fan & Alt.	1841558C1	♣K080755HD
Belt - A.C.	L17446	♣9447HD
5500i; 5600i; 5900i		
Belt - Fan & Alt.	3507969C1	♣K080780HD
Belt - Fan & A.C.	311175C2	♣9447HD
Hose - Upper - Eng. To Pipe		21335
Hose - Upper - Pipe To Rad.; (2 1/2" I.D.)		24240
Hose - Lower - Eng. To Pipe; (2 1/2" I.D.)		24240
Hose - Lower - Pipe To Rad.; (2 1/2" I.D.)		24240
9100i; 9200i; 9400i		
Belt - Fan & Alt.	1618533C1	♣K080733HD
Belt - Fan & A.C.; Preferred Belt	149635R2	2/9463PB
Belt - Fan & A.C.; Optional Belt		♣9463HD
Hose - Upper - Eng. To Pipe		21135
Hose - Upper - Pipe To Rad.; (2 1/2" I.D.)		24240
Hose - Lower - Eng. To Pipe		21891
Hose - Lower - Rad. To Pipe		21135
9900i; 9900ix		
Belt - Fan & Alt.	1618533C1	♣K080733HD
Belt - Fan & A.C.; Optional Belt		♣9463HD
Belt - Fan & A.C.; Preferred Belt	149635R2	2/9463PB
Hose - Upper - Eng. To Pipe		21135
Hose - Upper - Pipe To Rad.; (2 1/2" I.D.)		24240
Hose - Lower - Eng. To Pipe		21891
Hose - Lower - Rad. To Pipe		21135
Caterpillar C15 Diesel		
9400i; 9900i; 9900ix		
Belt - Fan & Alt.	2018284C1	♣K100771HD
Belt - Fan & A.C.	2005148C1	♣K060500HD
Hose - Upper - Eng. To Pipe		21135
Hose - Upper - Pipe To Rad.; (2 1/2" I.D.)		24240
Hose - Lower - Eng. To Pipe		21135
Hose - Lower - Pipe To Rad.; (2 1/2" I.D.)		24240
Caterpillar C16 Diesel		
9400i; 9900i; 9900ix		
Belt - Fan & Alt.	2018284C1	♣K100771HD
Belt - Fan & A.C.	2005148C1	♣K060500HD
Hose - Upper - Eng. To Pipe		21135
Hose - Upper - Pipe To Rad.; (2 1/2" I.D.)		24240
Hose - Lower - Eng. To Pipe		21135
Hose - Lower - Pipe To Rad.; (2 1/2" I.D.)		24240
Cummins ISM Diesel		
2554; 2574; 2654; 2674		
Belt - Fan	1648750C1	♣K080605HD
Belt - Hub & Alt.; W/130A. Delco Alt.	586452C1	♣K050336HD
Belt - Hub & A.C.	2016338C1	TR22485
Hose - Upper - Eng. To Pipe; (2 1/2" I.D.)		24240
Hose - Upper - Pipe To Rad.		21135
Hose - Lower - Eng. To Pipe; (2 1/2" I.D.)		24240
Hose - Lower - Pipe To Rad.		21135
5000		
Belt - Fan	1648750C1	♣K080605HD

♣ Standard Belt Available. See Pages 630-631.

Ⓞ Two Required.

Belts and Coolant Hose for Medium/Heavy-Duty Trucks (1996 and Newer)

Medium & Heavy-Duty Trucks
(1996 & Newer)

Application	Mfr. Part No.	Our No.
INTERNATIONAL/NAVISTAR - Continued		
2000 - Continued		
Cummins ISM Diesel - Continued		
5000 - Continued		
Belt - Hub & Alt.	586452C1	▲K050336HD
Hose - Upper - Eng. To Pipe; (2 1/2" I.D.)		24240
Hose - Upper - Pipe To Rad.		21135
Hose - Lower - Eng. To Pipe; (2 1/2" I.D.)		24240
Hose - Lower - Pipe To Rad.; (2 1/2" I.D.)		24240
5500i; 5600i; 5900i		
Belt - Fan	1616076C1	▲K080645HD
Belt - Hub & Alt.	586452C1	▲K050336HD
Belt - Hub & A.C.	2016339C1	TR22525
Hose - Upper - Eng. To Pipe; (2 1/4" I.D.)		24236
Hose - Upper - Pipe To Rad.		20748
Hose - Lower - Eng. To Pipe; (2 1/4" I.D.)		24236
Hose - Lower - Pipe To Rad.; (2 1/4" I.D.)		24236
8100		
Belt - Fan	1648750C1	▲K080605HD
Belt - Hub & Alt.	586452C1	▲K050336HD
Belt - Hub & A.C.	2016338C1	TR22485
Hose - Upper - Eng. To Pipe; (2 1/2" I.D.)		24240
Hose - Upper - Pipe To Rad.		21135
Hose - Lower - Eng. To Pipe; (2 1/2" I.D.)		24240
Hose - Lower - Pipe To Rad.		21135
9100i; 9200i; 9400i; 9900i; 9900ix		
Belt - Fan	1651399C1	▲K080565HD
Belt - Hub & Alt.	586452C1	▲K050336HD
Belt - Hub & A.C.	2016338C1	TR22485
Hose - Upper - Eng. To Pipe; (2 1/2" I.D.)		24240
Hose - Upper - Pipe To Rad.		21135
Hose - Lower - Eng. To Pipe		21135
Hose - Lower - Pipe To Rad.; (2 1/2" I.D.)		24240
Cummins ISX Diesel		
9400i		
Belt - Fan	3681819	▲K100719HD
Belt - Hub, Alt. & A.C.	3681812	▲K060685HD
Tensioner Assy. - Fan	3681240	38535
Tensioner Assy. - Hub, Alt. & A.C.	3680194	38532
Idler Pulley - Alt. & A.C.	4026886	36226
Tensioner Pulley - Fan	3681240	36092
Tensioner Pulley - Hub, Alt. & A.C.	3680194	36095
Hose - Upper - Eng. To Pipe		21135
Hose - Upper - Pipe To Rad.		21891
Hose - Lower - Eng. To Pipe		21891
Hose - Lower - Pipe To Rad.		21135
9900i; 9900ix		
Belt - Fan	3681819	▲K100719HD
Belt - Hub, Alt. & A.C.	3681812	▲K060685HD
Tensioner Assy. - Fan	3681240	38535
Tensioner Assy. - Hub, Alt. & A.C.	3680194	38532
Idler Pulley - Alt. & A.C.	4026886	36226
Tensioner Pulley - Fan	3681240	36092
Tensioner Pulley - Hub, Alt. & A.C.	3680194	36095
Hose - Upper - Eng. To Pipe; (2 1/2" I.D.)		24240
Hose - Upper - Pipe To Rad.		21891
Hose - Lower - Eng. To Pipe		21891
Hose - Lower - Pipe To Rad.		21135
Cummins N14 Diesel		
2554; 2574; 2654; 2674		
Belt - Fan	479577C1	◎TR28522
Belt - W.P.		▲K060425HD
Belt - Alt.	598183C1	◎◆▲9447HD
Belt - A.C.	196666R1	▲9405HD
Hose - Upper - Eng. To Pipe; (2 1/2" I.D.)		24240
Hose - Upper - Pipe To Rad.; (2 1/2" I.D.)		24240
Hose - Lower - Eng. To Pipe; (2 1/2" I.D.)		24240
Hose - Lower - Pipe To Rad.; (2 1/2" I.D.)		24240
Hose - Coolant Reservoir; (1" I.D.)		24216
5500i; 5600i; 5900i		
Belt - Hub & W.P.	3865157	▲K060408HD
Belt - Hub & Fan		◎TR28522

Application	Mfr. Part No.	Our No.
INTERNATIONAL/NAVISTAR - Continued		
2000 - Continued		
Cummins N14 Diesel - Continued		
5500i; 5600i; 5900i - Continued		
Belt - Alt.		◎▲9447HD
Belt - Hub & A.C.	196666R1	▲9405HD
Hose - Upper - Eng. To Pipe; (2 1/4" I.D.)		24236
Hose - Upper - Pipe To Rad.		20748
Hose - Lower - Eng. To Pipe; (2 1/4" I.D.)		24236
Hose - Lower - Pipe To Rad.; (2 1/4" I.D.)		24236
9100i; 9200i; 9400i; 9900i; 9900ix		
Belt - W.P.	3095880	▲K060415HD
Belt - Fan	3501266C1	▲K100465HD
Belt - Alt.; Preferred Belt	598183C1	2/9447PB
Belt - Alt.; Optional Belt		◎▲9447HD
Belt - Hub & A.C.	196666R1	▲9405HD
Hose - Upper - Eng. To Pipe; (2 1/2" I.D.)		24240
Hose - Upper - Pipe To Rad.		21135
Hose - Lower - Eng. To Pipe; (2 1/2" I.D.)		24240
Hose - Lower - Pipe To Rad.		21135
Cummins Signature 600 Diesel		
9200i		
Belt - Fan	3529218C1	▲K100719HD
Belt - Hub, Alt. & A.C.	3527406C2	▲K060680HD
Tensioner Assy. - Fan	3681240	38535
Tensioner Assy. - Hub, Alt. & A.C.	3680194	38532
Idler Pulley - Alt. & A.C.	4026886	36226
Tensioner Pulley - Fan	3681240	36092
Tensioner Pulley - Hub, Alt. & A.C.	3680194	36095
Detroit Diesel Series 60 Diesel		
9100i; 9200i		
Belt - Fan	3503813C1	▲K100570HD
Belt - Fan To Alt.	3505387C1	▲K060455HD
Belt - Hub & A.C.	3514954C1	▲K060340HD
Tensioner Assy. - Fan	3508604C91	38529
Tensioner Pulley - Fan	3508604C91	36092
Hose - Upper - Eng. To Pipe		≧21891
Hose - Upper - Pipe To Rad.		≧21135
Hose - Lower - Eng. To Pipe; (2 1/2" I.D.)		24240
Hose - Lower - Pipe To Rad.; (2 1/2" I.D.)		24240
9400i; 9900i; 9900ix		
Belt - Fan	1687800C1	▲K100540HD
Belt - Alt.	3505387C1	▲K060455HD
Belt - A.C.	3514954C1	▲K060340HD
Tensioner Assy. - Fan	1687801C91	38519
Tensioner Pulley - Fan	1687801C91	36092
Hose - Upper - Eng. To Pipe		≧21891
Hose - Upper - Pipe To Rad.		≧21135
Hose - Lower - Eng. To Pipe; (2 1/2" I.D.)		24240
Hose - Lower - Pipe To Rad.		21135
International/Navistar 530 Diesel		
2554; 2574; 2654; 2674		
Belt - Fan, Alt. & Hub	168297C1	▲K080760HD
Belt - Fan & A.C.	3515596C1	▲K060470HD
Tensioner Assy. - Fan, Alt. & Hub	1830033C1	38514
Tensioner Assy. - Fan & A.C.	1687819C92	38512
Tensioner Pulley - Fan, Alt. & Hub	1830033C1	36091
Tensioner Pulley - Fan & A.C.	1687819C92	36091
Hose - Upper - Eng. To Rad.		22140
Hose - Lower - Eng. To Rad.		≧21115
4900		
Belt - Fan, Alt. & Hub	1819392C1	▲K080716HD
Belt - Fan & A.C.	3515596C1	▲K060470HD
Tensioner Assy. - Fan, Alt. & Hub	1830033C1	38514
Tensioner Assy. - Fan & A.C.	1687819C92	38512
Tensioner Pulley - Fan, Alt. & Hub	1830033C1	36091
Tensioner Pulley - Fan & A.C.	1687819C92	36091
Hose - Upper - Eng. To Rad.		22140
Hose - Lower - Eng. To Rad.		≧21115
5600i		
Belt - Alt.	1841558C1	▲K080755HD
Tensioner Assy. - Alt.	1830033C2	38514

▲ Standard Belt Available. See Pages 630-631.
◆ Green Stripe® PowerBand® Belt May Work, Use Template to Check.

◎ Two Required.
≧ Cut to Fit.

Belts and Coolant Hose for Medium/Heavy-Duty Trucks (1996 and Newer)

 Medium & Heavy-Duty Trucks
(1996 & Newer)

Application	Mfr. Part No.	Our No.
INTERNATIONAL/NAVISTAR - Continued		
2000 - Continued		
International/Navistar 530 Diesel - Continued		
8100		
Belt - Fan, Alt. & Hub	168297C1	♣K080760HD
Belt - Fan & A.C.	3517822C1	♣K060478HD
Tensioner Assy. - Fan, Alt. & Hub	1830033C1	38514
Tensioner Assy. - Fan & A.C.	1687819C92	38512
Tensioner Pulley - Fan, Alt. & Hub	1830033C1	36091
Tensioner Pulley - Fan & A.C.	1687819C92	36091
Hose - Upper - Eng. To Pipe; (2 1/2" I.D.)		24240
Hose - Upper - Pipe To Rad.		21135
Hose - Lower - Eng. To Pipe		♣<21891
Hose - Lower - Pipe To Rad.		♣<21891
International/Navistar DT466 Diesel		
2554; 2654		
Belt - Fan, Alt. & Hub		♣K080760HD
Belt - Fan & A.C.	3515596C1	♣K060470HD
Tensioner Assy. - Fan, Alt. & Hub	1830033C1	38514
Tensioner Assy. - Fan & A.C.	1687819C92	38512
Tensioner Pulley - Fan, Alt. & Hub	1830033C1	36091
Tensioner Pulley - Fan & A.C.	1687819C92	36091
Hose - Lower - Eng. To Rad.		♣<21891
4700		
Belt - Fan & Alt.; W/P.T.O.; W/1.2 To 1 Fan Ratio	1819391C1	♣K080730HD
Belt - Fan & Alt.; W/P.T.O.; W/Mechanical Eng.; W/1.08 To 1 Fan Ratio	1682696C1	♣K080738HD
Belt - Fan & Alt.; W/P.T.O.; W/Electronic Eng.; W/1.08 To 1 Fan Ratio	1820547C2	♣K080774HD
Belt - Fan & Alt.; W/O P.T.O.	1822503C1	♣K080726HD
Belt - A.C.	1687797C1	♣K060470HD
Tensioner Assy. - Fan & Alt.	1830033C1	38514
Tensioner Assy. - Fan & A.C.	1687819C92	38512
Tensioner Pulley - Fan & Alt.	1830033C1	36091
Tensioner Pulley - Fan & A.C.	1687819C92	36091
Hose - Upper - Eng. To Rad.		22140
Hose - Lower - Eng. To Rad.		♣<21115
4800		
Belt - Fan & Alt.; W/P.T.O.; W/1.2 To 1 Fan Ratio	1819391C1	♣K080730HD
Belt - Fan & Alt.; W/P.T.O.; W/Mechanical Eng.; W/1.08 To 1 Fan Ratio	1682696C1	♣K080738HD
Belt - Fan & Alt.; W/P.T.O.; W/Electronic Eng.; W/1.08 To 1 Fan Ratio	1820547C2	♣K080774HD
Belt - Fan & Alt.; W/O P.T.O.	1822503C1	♣K080726HD
Belt - Fan To A.C.	1687797C1	♣K060470HD
Tensioner Assy. - Fan & Alt.	1814719C1	38514
Tensioner Assy. - Fan To A.C.	1687819C91	38511
Tensioner Pulley - Fan & Alt.	1814719C1	36091
Tensioner Pulley - Fan To A.C.	1687819C91	36091
Hose - Upper - Eng. To Rad.		21765
Hose - Lower - Eng. To Pipe		21842
Hose - Lower - Pipe To Rad.		21115
Hose - Lower - Eng. To Rad.		21842
4900		
Belt - Fan & Alt.; W/P.T.O.; W/1.2 To 1 Fan Ratio	1819391C1	♣K080730HD
Belt - Fan & Alt.; W/P.T.O.; W/Mechanical Eng.; W/1.08 To 1 Fan Ratio	1682696C1	♣K080738HD
Belt - Fan & Alt.; W/P.T.O.; W/Electronic Eng.; W/1.08 To 1 Fan Ratio	1820547C2	♣K080774HD
Belt - Fan & Alt.; W/O P.T.O.	1822503C1	♣K080726HD
Belt - Fan & A.C.	1687797C1	♣K060470HD
Tensioner Assy. - Fan & Alt.	1830033C1	38514
Tensioner Assy. - Fan & A.C.	1687819C92	38512
Tensioner Pulley - Fan & Alt.	1830033C1	36091
Tensioner Pulley - Fan & A.C.	1687819C92	36091
Hose - Upper - Eng. To Rad.		22140
Hose - Lower - Eng. To Rad.		♣<21115

Application	Mfr. Part No.	Our No.
INTERNATIONAL/NAVISTAR - Continued		
2000 - Continued		
International/Navistar DT466 Diesel - Continued		
8100		
Belt - Fan & Alt.	1820547C3	♣K080774HD
Belt - A.C.	3515596C1	♣K060470HD
Tensioner Assy. - Fan & Alt.	1814719C1	38514
Tensioner Assy. - A.C.	1687819C91	38511
Tensioner Pulley - Fan & Alt.	1814719C1	36091
Tensioner Pulley - A.C.	1687819C91	36091
International/Navistar T444 Diesel		
1652 SC		
Idler Pulley; W/Flat Idler Pulley	1822652C91	36287
Idler Pulley; W/V-Groove Idler Pulley ...	1822653C91	36288
4700		
Belt - W.P., Fan & Alt.; W/O Air Brake Compr.; W/Schwitzer Fan Clutch	1821840C1	♣K080922HD
Belt - W.P., Fan & Alt.; W/Air Brake Compr.; W/Schwitzer Fan Clutch	1821850C1	♣K081102HD
Belt - W.P., Fan, Alt. & A.C.; W/O Air Brake Compr.; W/Schwitzer Fan Clutch	1821839C1	♣K081035HD
Belt - W.P., Fan, Alt. & A.C.; W/Air Brake Compr.; W/Schwitzer Fan Clutch	1821843C1	♣K081223HD
Belt - W.P., Fan & Alt.; W/O Air Brake Compr.; W/O Schwitzer Fan Clutch ..	1822830C1	♣K080893HD
Belt - W.P., Fan & Alt.; W/Air Brake Compr.; W/O Schwitzer Fan Clutch ..	1822832C1	♣K081124HD
Belt - W.P., Fan, Alt. & A.C.; W/O Air Brake Compr.; W/O Schwitzer Fan Clutch	1822831C2	♣K081000HD
Belt - W.P., Fan, Alt. & A.C.; W/Air Brake Compr.; W/O Schwitzer Fan Clutch	1822833C1	♣K081265HD
Tensioner Assy.	1822679C3	38510
Idler Pulley; W/Flat Idler Pulley	1822652C91	36287
Idler Pulley; W/V-Groove Idler Pulley ...	1822653C91	36288
Hose - Upper - Eng. To Rad.		22159
Hose - Lower - Eng. To Pipe		22671
Hose - Lower - Pipe To Rad.		20172
1999		
Caterpillar 3406 Diesel		
9300		
Belt - Fan & Alt.	2020036C1	♣K100852HD
Belt - A.C.	2009861C1	♣K060425HD
9400; 9900		
Belt - Fan & Alt.	2018284C1	♣K100771HD
Belt - Fan To A.C.	2005148C1	♣K060500HD
Hose - Upper - Eng. To Pipe; (2 1/2" I.D.)		24240
Hose - Upper - Pipe To Rad.		21135
Hose - Lower - Eng. To Pipe; (3" I.D.)		24248
Hose - Lower - Pipe To Rad.; (2 1/2" I.D.)		24240
Caterpillar C10 Diesel		
2554; 2574; 2654; 2674		
Belt - Fan & Alt.	1682692C1	♣K080720HD
Belt - Fan To A.C.		♣9447HD
Hose - Upper - Eng. To Pipe; (2 1/2" I.D.)		24240
Hose - Upper - Pipe To Rad.		21135
Hose - Lower - Eng. To Pipe; (2 1/2" I.D.)		24240
Hose - Lower - Pipe To Rad.		21891
5000		
Belt - Fan & Alt.	3507969C1	♣K080780HD
Belt - Fan & A.C.	311175C2	♣9447HD
Hose - Upper - Eng. To Pipe; (2 1/2" I.D.)		24240
Hose - Upper - Pipe To Rad.		21135
Hose - Lower - Eng. To Pipe; (2 1/2" I.D.)		24240
Hose - Lower - Pipe To Rad.; (2 1/2" I.D.)		24240
9100; 9200; 9400; 9900		
Belt - Fan & Alt.	1618533C1	♣K080733HD
Belt - Fan & A.C.; Optional Belt		♣9463HD
Belt - Fan & A.C.; Preferred Belt	149635R2	2/9463PB

♣ Standard Belt Available. See Pages 630-631.
 ② Two Required.

♣< Cut to Fit.

Belts and Coolant Hose for Medium/Heavy-Duty Trucks (1996 and Newer)

Medium & Heavy-Duty Trucks
(1996 & Newer)

Application	Mfr. Part No.	Our No.
INTERNATIONAL/NAVISTAR - Continued		
1999 - Continued		
Caterpillar C10 Diesel - Continued		
9100; 9200; 9400; 9900 - Continued		
Hose - Upper - Eng. To Pipe		21135
Hose - Upper - Pipe To Rad.; (2 1/2" I.D.)		24240
Hose - Lower - Eng. To Pipe		21891
Hose - Lower - Rad. To Pipe		21135
Caterpillar C12 Diesel		
2574; 2674		
Belt - Fan & Alt.	1841558C1	♣K080755HD
Belt - A.C.	L17446	♣9447HD
5000		
Belt - Fan & Alt.	3507969C1	♣K080780HD
Belt - Fan & A.C.	311175C2	♣9447HD
Tensioner Assy. - Fan & Alt.	1333529	38506
Tensioner Pulley - Fan & Alt.	1333529	36091
Hose - Upper - Eng. To Pipe; (2 1/2" I.D.)		24240
Hose - Upper - Pipe To Rad.		21135
Hose - Lower - Eng. To Pipe; (2 1/2" I.D.)		24240
Hose - Lower - Pipe To Rad.; (2 1/2" I.D.)		24240
9100; 9200; 9400; 9900		
Belt - Fan & Alt.	1618533C1	♣K080733HD
Belt - Fan & A.C.; Optional Belt		②♣9463HD
Belt - Fan & A.C.; Preferred Belt	149635R2	2/9463PB
Hose - Upper - Eng. To Pipe		21135
Hose - Upper - Pipe To Rad.; (2 1/2" I.D.)		24240
Hose - Lower - Eng. To Pipe		21891
Hose - Lower - Rad. To Pipe		21135
Cummins ISM Diesel		
2554; 2574; 2654; 2674		
Belt - Fan	1648750C1	♣K080605HD
Belt - Alt.	586452C1	♣K050336HD
Belt - A.C.	2016338C1	TR22485
5000		
Belt - Fan	1648750C1	♣K080605HD
Belt - Hub & Alt.	586452C1	♣K050336HD
Hose - Upper - Eng. To Pipe; (2 1/2" I.D.)		24240
Hose - Upper - Pipe To Rad.		21135
Hose - Lower - Eng. To Pipe; (2 1/2" I.D.)		24240
Hose - Lower - Pipe To Rad.; (2 1/2" I.D.)		24240
8100		
Belt - Fan; W/56 5/8" Belt O.C.		♣K080560HD
Belt - Fan; W/57 1/2" Belt O.C.	1609665C1	♣K080570HD
Belt - Fan; W/61 1/8" Belt O.C.	1648750C1	♣K080605HD
Belt - Alt.; W/33" Belt O.C.	2036266C1	♣K050323HD
Belt - Alt.; W/34 1/4" Belt O.C.	586452C1	♣K050336HD
Belt - Hub & Alt.	586452C1	♣K050336HD
Belt - Hub & A.C.	2016338C1	TR22485
Hose - Upper - Eng. To Pipe		20748
Hose - Upper - Pipe To Rad.; (2 1/4" I.D.)		24236
Hose - Lower - Eng. To Pipe; (2 1/2" I.D.)		24240
Hose - Lower - Pipe To Rad.		21135
9100; 9200; 9400; 9900		
Belt - Fan		♣K080465HD
Belt - Alt.		♣K050336HD
Cummins N14 Diesel		
2554; 2574; 2654; 2674		
Belt - Fan	479577C1	②TR28522
Belt - W.P.		♣K060425HD
Belt - Alt.	598183C1	②♣9447HD
Belt - A.C.	196666R1	♣9405HD
Hose - Upper - Eng. To Pipe; (2 1/2" I.D.)		24240
Hose - Upper - Pipe To Rad.; (2 1/2" I.D.)		24240
Hose - Lower - Eng. To Pipe; (2 1/2" I.D.)		24240
Hose - Lower - Pipe To Rad.; (2 1/2" I.D.)		24240
Hose - Coolant Reservoir; (1" I.D.)		24216
5000		
Belt - Hub & W.P.	386515WRZ	♣K060408HD
Belt - Hub & Fan		②TR28522
Belt - Alt.		②♣9447HD

Application	Mfr. Part No.	Our No.
INTERNATIONAL/NAVISTAR - Continued		
1999 - Continued		
Cummins N14 Diesel - Continued		
5000 - Continued		
Hose - Upper - Eng. To Pipe; (2 1/4" I.D.)		24236
Hose - Upper - Pipe To Rad.		20748
Hose - Lower - Eng. To Pipe; (2 1/4" I.D.)		24236
Hose - Lower - Pipe To Rad.; (2 1/4" I.D.)		24236
8100		
Belt - W.P.; W/43 1/8" Belt O.C.	3076492	♣K060425HD
Belt - W.P.; W/44 1/8" Belt O.C.	217638	♣K060435HD
Belt - Fan; W/47 7/8" Belt O.C.; Optional Belt		②TR28473
Belt - Fan; W/47 7/8" Belt O.C.;		
Preferred Belt	1686803	2/TR28473PB
Belt - Fan; W/53" Belt O.C.	479577C1	TR28522
Belt - Alt.; W/44 3/8" Belt O.C.	133758R2	♣9440HD
Belt - Alt.; W/46 3/8" Belt O.C.; Optional Belt		②♣9463HD
Belt - Alt.; W/46 3/8" Belt O.C.; Preferred		
Belt	447497C1	2/9463PB
Belt - A.C.	196666R1	♣9405HD
9100; 9200		
Belt - W.P.	3095880	♣K060415HD
Belt - Fan	3501266C1	♣K100465HD
Belt - Alt.; Preferred Belt	598183C1	2/9447PB
Belt - Alt.; Optional Belt		②♣9447HD
Belt - Hub & A.C.	196666R1	♣9405HD
Hose - Upper - Eng. To Pipe; (2 1/2" I.D.)		24240
Hose - Upper - Pipe To Rad.		21135
Hose - Lower - Eng. To Pipe; (2 1/2" I.D.)		24240
Hose - Lower - Pipe To Rad.		21135
9300		
Belt - W.P.	3095880	♣K060415HD
Belt - Fan	3513716C1	♣K100510HD
Belt - Alt.; Preferred Belt	598183C1	2/9447PB
Belt - Alt.; Optional Belt		②♣9447HD
Belt - A.C.	196666R1	♣9405HD
Hose - Upper - Eng. To Pipe		21135
Hose - Upper - Pipe To Rad.; (2 1/2" I.D.)		24240
Hose - Lower - Eng. To Pipe; (2 1/2" I.D.)		24240
Hose - Lower - Pipe To Rad.; (2 1/2" I.D.)		24240
9400		
Belt - W.P.	3095880	♣K060415HD
Belt - Fan	3501266C1	♣K100465HD
Belt - Alt.; Preferred Belt	598183C1	2/9447PB
Belt - Alt.; Optional Belt		②♣9447HD
Belt - Hub & A.C.	196666R1	♣9405HD
Hose - Upper - Eng. To Pipe; (2 1/2" I.D.)		24240
Hose - Upper - Pipe To Rad.		21135
Hose - Lower - Eng. To Pipe; (2 1/2" I.D.)		24240
Hose - Lower - Pipe To Rad.		21135
9800		
Belt - W.P.; W/43 1/8" Belt O.C.	3076492	♣K060425HD
Belt - W.P.; W/44 1/8" Belt O.C.	217638	♣K060435HD
Belt - Fan; W/43 1/2" Belt O.C.;		
Preferred Belt	488674C1	2/TR28492PB
Belt - Fan; W/43 1/2" Belt O.C.; Optional Belt		②TR28492
Belt - Fan; W/52" Belt O.C.	575817C1	TR28514
Belt - Fan; W/55 5/8" Belt O.C.	128805HA	TR28550
Belt - Fan; W/57 1/8" Belt O.C.	1688196C1	TR28565
Belt - A.C.	196666R1	♣9405HD
Hose - Upper - Eng. To Pipe; (2 1/2" I.D.)		24240
Hose - Upper - Pipe To Rad.; (2 1/2" I.D.)		24240
Hose - Lower - Eng. To Pipe; (2 1/2" I.D.)		24240
Hose - Lower - Pipe To Rad.; (2 1/2" I.D.)		24240
9900		
Belt - W.P.	3095880	♣K060415HD
Belt - Fan	3501266C1	♣K100465HD
Belt - Alt.; Preferred Belt	598183C1	2/9447PB
Belt - Alt.; Optional Belt		②♣9447HD
Belt - Hub & A.C.	196666R1	♣9405HD
Hose - Upper - Eng. To Pipe; (2 1/2" I.D.)		24240
Hose - Upper - Pipe To Rad.		21135
Hose - Lower - Eng. To Pipe; (2 1/2" I.D.)		24240

♣ Standard Belt Available. See Pages 630-631.

◆ Green Stripe® PowerBand® Belt May Work, Use Template to Check.

② Two Required.

Belts and Coolant Hose for Medium/Heavy-Duty Trucks (1996 and Newer)

 Medium & Heavy-Duty Trucks
(1996 & Newer)

Application	Mfr. Part No.	Our No.
INTERNATIONAL/NAVISTAR - Continued		
1999 - Continued		
Cummins N14 Diesel - Continued		
9900 - Continued		
Hose - Lower - Pipe To Rad.		21135
Detroit Diesel Series 60 Diesel		
9100; 9200		
Belt - Fan	3503813C1	♣K100570HD
Belt - Alt.	3505387C1	♣K060455HD
Belt - A.C.	2017725C1	♣K060490HD
Tensioner Assy. - Fan	3508604C91	38529
Tensioner Pulley - Fan	3508604C91	36092
Hose - Upper - Eng. To Pipe		21891
Hose - Upper - Pipe To Rad.		21135
Hose - Lower - Eng. To Pipe; (2 1/2" I.D.)		24240
Hose - Lower - Pipe To Rad.; (2 1/2" I.D.)		24240
9400; 9900		
Belt - Fan	1687800C1	♣K100540HD
Belt - Alt.	3505387C1	♣K060455HD
Belt - A.C.	3514954C1	♣K060340HD
Tensioner Assy. - Fan	1687801C91	38519
Tensioner Pulley - Fan	1687801C91	36092
Hose - Upper - Eng. To Pipe		21891
Hose - Upper - Pipe To Rad.		21135
Hose - Lower - Eng. To Pipe; (2 1/2" I.D.)		24240
Hose - Lower - Pipe To Rad.		21135
International/Navistar 530 Diesel		
2554; 2574; 2654; 2674		
Belt - Fan	1616076C1	♣K080645HD
Belt - Alt.	586452C1	♣K050336HD
Belt - A.C.	2016339C1	TR22525
Hose - Upper - Eng. To Pipe; (2 1/4" I.D.)		24236
Hose - Upper - Pipe To Rad.; (2 1/2" I.D.)		24240
Hose - Lower - Eng. To Pipe; (2 1/2" I.D.)		24240
Hose - Lower - Pipe To Rad.; (2 1/2" I.D.)		24240
4700; 4900		
Belt - Fan, Alt. & Hub	1819392C1	♣K080716HD
Belt - Fan & A.C.	3515596C1	♣K060470HD
Tensioner Assy. - Fan, Alt. & Hub	1830033C1	38514
Tensioner Assy. - Fan & A.C.	1687819C92	38512
Tensioner Pulley - Fan, Alt. & Hub	1830033C1	36091
Tensioner Pulley - Fan & A.C.	1687819C92	36091
Hose - Upper - Eng. To Rad.		22140
Hose - Lower - Eng. To Rad.		♣<21115
8100		
Belt - Fan, Alt. & Hub	1682697C1	♣K080760HD
Belt - Fan & A.C.	3517822C1	♣K060478HD
Tensioner Assy. - Fan, Alt. & Hub	1830033C1	38514
Tensioner Assy. - Fan & A.C.	1687819C92	38512
Tensioner Pulley - Fan, Alt. & Hub	1830033C1	36091
Tensioner Pulley - Fan & A.C.	1687819C92	36091
Hose - Upper - Eng. To Pipe; (2 1/4" I.D.)		24236
Hose - Upper - Pipe To Rad.		21135
Hose - Lower - Eng. To Pipe		♣<21891
Hose - Lower - Pipe To Rad.		♣<21891
International/Navistar DT466 Diesel		
2554; 2654		
Belt - Fan, Alt. & Hub; W/76 1/2" Belt O.C.	1682697C1	♣K080760HD
Belt - A.C.	3515596C1	♣K060470HD
Tensioner Assy. - Fan, Alt. & Hub	1830033C1	38514
Tensioner Assy. - A.C.	1687819C92	38512
Tensioner Pulley - Fan, Alt. & Hub	1830033C1	36091
Tensioner Pulley - A.C.	1687819C92	36091
Hose - Upper - Eng. To Pipe; (2 1/4" I.D.)		24236
Hose - Upper - Pipe To Rad.; (2 1/2" I.D.)		24240
Hose - Lower - Eng. To Pipe; (2 1/2" I.D.)		24240
Hose - Lower - Pipe To Rad.; (2 1/2" I.D.)		24240
4700; 4800; 4900		
Belt - Fan & Alt.; W/P.T.O.; W/1.2 To 1 Fan Ratio	1819391C1	♣K080730HD

Application	Mfr. Part No.	Our No.
INTERNATIONAL/NAVISTAR - Continued		
1999 - Continued		
International/Navistar DT466 Diesel - Continued		
4700; 4800; 4900 - Continued		
Belt - Fan & Alt.; W/P.T.O.;		
W/Mechanical Eng.; W/1.08 To 1		
Fan Ratio	1682696C1	♣K080738HD
Belt - Fan & Alt.; W/P.T.O.; W/Electronic		
Eng.; W/1.08 To 1 Fan Ratio	1820547C2	♣K080774HD
Belt - Fan & Alt.; W/O P.T.O.	1822503C1	♣K080726HD
Belt - Fan To A.C.	1687797C1	♣K060470HD
Tensioner Assy. - Fan & Alt.	1814719C1	38514
Tensioner Assy. - Fan To A.C.	1687819C91	38511
Tensioner Pulley - Fan & Alt.	1814719C1	36091
Tensioner Pulley - Fan To A.C.	1687819C91	36091
Hose - Upper - Eng. To Rad.		21765
Hose - Lower - Eng. To Pipe		21842
Hose - Lower - Pipe To Rad.		21115
Hose - Lower - Eng. To Rad.		♣<21115
8100		
Belt - Fan & Alt.	1820547C3	♣K080774HD
Belt - A.C.	3515596C1	♣K060470HD
Tensioner Assy. - Fan & Alt.	1814719C1	38514
Tensioner Assy. - A.C.	1687819C91	38511
Tensioner Pulley - Fan & Alt.	1814719C1	36091
Tensioner Pulley - A.C.	1687819C91	36091
International/Navistar T444 Diesel		
1652 SC		
Idler Pulley; W/Flat Idler Pulley	1822652C91	36287
Idler Pulley; W/V-Groove Idler Pulley ...	1822653C91	36288
4700		
Belt - W.P., Fan & Alt.; W/O Air Brake		
Compr.; W/Schwitzer Fan Clutch	1821840C1	♣K080922HD
Belt - W.P., Fan & Alt.; W/Air Brake		
Compr.; W/Schwitzer Fan Clutch	1821850C1	♣K081102HD
Belt - W.P., Fan, Alt. & A.C.; W/O Air		
Brake Compr.; W/Schwitzer Fan		
Clutch	1821839C1	♣K081035HD
Belt - W.P., Fan, Alt. & A.C.; W/Air		
Brake Compr.; W/Schwitzer Fan		
Clutch	1821843C1	♣K081223HD
Belt - W.P., Fan & Alt.; W/O Air Brake		
Compr.; W/O Schwitzer Fan Clutch .	1822830C1	♣K080893HD
Belt - W.P., Fan & Alt.; W/Air Brake		
Compr.; W/O Schwitzer Fan Clutch .	1822832C1	♣K081124HD
Belt - W.P., Fan, Alt. & A.C.; W/O Air		
Brake Compr.; W/O Schwitzer Fan		
Clutch	1822831C2	♣K081000HD
Belt - W.P., Fan, Alt. & A.C.; W/Air		
Brake Compr.; W/O Schwitzer Fan		
Clutch	1822833C1	♣K081265HD
Tensioner Assy.	1822679C3	38510
Idler Pulley; W/Flat Idler Pulley	1822652C91	36287
Idler Pulley; W/V-Groove Idler Pulley ...	1822653C91	36288
Hose - Upper - Eng. To Rad.		22159
Hose - Lower - Eng. To Pipe		22671
Hose - Lower - Pipe To Rad.		20172
1998		
Caterpillar 3406 Diesel		
8100		
Belt - Fan & Alt.	1682697C1	♣K080760HD
Hose - Upper - Eng. To Pipe; (2 1/2" I.D.)		24240
Hose - Upper - Pipe To Eng.		21135
Hose - Lower - Eng. To Pipe		21897
Hose - Lower - Pipe To Rad.; (2 1/2" I.D.)		24240
9100; 9200		
Belt - Fan & Alt.	2018284C1	♣K100771HD
Belt - Fan To A.C.	2005148C1	♣K060500HD
Hose - Upper - Eng. To Pipe; (2 1/2" I.D.)		24240
Hose - Upper - Pipe To Rad.; (2 1/2" I.D.)		24240
Hose - Lower - Eng. To Pipe; (3" I.D.)		24248
Hose - Lower - Pipe To Rad.; (2 1/2" I.D.)		24240

♣ Standard Belt Available. See Pages 630-631.

♣< Cut to Fit.

Belts and Coolant Hose for Medium/Heavy-Duty Trucks (1996 and Newer)

Medium & Heavy-Duty Trucks
(1996 & Newer)

Application	Mfr. Part No.	Our No.
INTERNATIONAL/NAVISTAR - Continued		
1998 - Continued		
Caterpillar 3406 Diesel - Continued		
9300		
Belt - Fan & Alt.	2020036C1	▲K100852HD
Belt - Fan To A.C.	2005148C1	▲K060500HD
Hose - Upper - Eng. To Pipe; (2 1/2" I.D.)	24240	24240
Hose - Upper - Pipe To Rad.; (2 1/2" I.D.)	24240	24240
Hose - Lower - Eng. To Pipe; (3" I.D.)	24248	24248
Hose - Lower - Pipe To Rad.; (2 1/2" I.D.)	24240	24240
9400		
Belt - Fan & Alt.	2018284C1	▲K100771HD
Belt - Fan To A.C.	2005148C1	▲K060500HD
Hose - Upper - Eng. To Pipe; (2 1/2" I.D.)	24240	24240
Hose - Upper - Pipe To Rad.; (2 1/2" I.D.)	24240	24240
Hose - Lower - Eng. To Pipe; (3" I.D.)	24248	24248
Hose - Lower - Pipe To Rad.; (2 1/2" I.D.)	24240	24240
Caterpillar C10 Diesel		
2574; 2674		
Belt - Fan & Alt.	1682697C1	▲K080760HD
Belt - Fan To A.C.		▲9447HD
Hose - Upper - Eng. To Pipe; (2 1/2" I.D.)	24240	24240
Hose - Upper - Pipe To Rad.	21135	21135
Hose - Lower - Eng. To Pipe; (2 1/2" I.D.)	24240	24240
Hose - Lower - Pipe To Rad.	21891	21891
5000		
Belt - Fan & Alt.	3507969C1	▲K080780HD
Belt - Fan & A.C.	311175C2	▲9447HD
Hose - Upper - Eng. To Pipe; (2 1/2" I.D.)	24240	24240
Hose - Upper - Pipe To Rad.	21135	21135
Hose - Lower - Eng. To Pipe; (2 1/2" I.D.)	24240	24240
Hose - Lower - Pipe To Rad.; (2 1/2" I.D.)	24240	24240
8100		
Belt - Fan & Alt.	1682697C1	▲K080760HD
Belt - A.C.	149635R2	▲9463HD
Hose - Upper - Eng. To Pipe	21135	21135
Hose - Upper - Pipe To Rad.	21135	21135
Hose - Lower - Eng. To Pipe; (2 1/2" I.D.)	24240	24240
Hose - Lower - Pipe To Rad.	21891	21891
9100		
Belt - Fan & Alt.	1618533C1	▲K080733HD
Belt - Fan & A.C.; Preferred Belt	149635R2	2/9463PB
Belt - Fan & A.C.; Optional Belt		②▲9463HD
Hose - Upper - Eng. To Pipe; (2 1/2" I.D.)	24240	24240
Hose - Upper - Pipe To Rad.	≧21135	21135
Hose - Lower - Eng. To Pipe	21891	21891
Hose - Lower - Rad. To Pipe	21135	21135
9200; 9300; 9400		
Belt - Fan & Alt.	1618533C1	▲K080733HD
Belt - Fan & A.C.; Preferred Belt	149635R2	2/9463PB
Belt - Fan & A.C.; Optional Belt		②▲9463HD
Hose - Upper - Eng. To Pipe	21135	21135
Hose - Upper - Pipe To Rad.; (2 1/2" I.D.)	24240	24240
Hose - Lower - Eng. To Pipe	21891	21891
Hose - Lower - Rad. To Pipe	21135	21135
Caterpillar C12 Diesel		
2574; 2674		
Belt - Fan & Alt.	1682697C1	▲K080760HD
Belt - Fan To A.C.		▲9447HD
Hose - Upper - Eng. To Pipe; (2 1/2" I.D.)	24240	24240
Hose - Upper - Pipe To Rad.	21135	21135
Hose - Lower - Eng. To Pipe; (2 1/2" I.D.)	24240	24240
Hose - Lower - Pipe To Rad.	21891	21891
5000		
Belt - Fan & Alt.	3507969C1	▲K080780HD
Belt - Fan & A.C.	311175C2	▲9447HD
Tensioner Assy. - Fan & Alt.	1333529	38506
Tensioner Pulley - Fan & Alt.	1333529	36091
Hose - Upper - Eng. To Pipe; (2 1/2" I.D.)	24240	24240
Hose - Upper - Pipe To Rad.	21135	21135
Hose - Lower - Eng. To Pipe; (2 1/2" I.D.)	24240	24240
Hose - Lower - Pipe To Rad.; (2 1/2" I.D.)	24240	24240

Application	Mfr. Part No.	Our No.
INTERNATIONAL/NAVISTAR - Continued		
1998 - Continued		
Caterpillar C12 Diesel - Continued		
9100; 9200; 9300; 9400		
Belt - Fan & Alt.	1618533C1	▲K080733HD
Belt - Fan & A.C.; Optional Belt		②▲9463HD
Belt - Fan & A.C.; Preferred Belt	149635R2	2/9463PB
Hose - Upper - Eng. To Pipe	21135	21135
Hose - Upper - Pipe To Rad.; (2 1/2" I.D.)	24240	24240
Hose - Lower - Eng. To Pipe	21891	21891
Hose - Lower - Rad. To Pipe	21135	21135
Cummins ISM Diesel		
2574; 2674		
Belt - Fan; W/57 1/2" Belt O.C.	1609665C1	▲K080570HD
Belt - Fan; W/61 1/8" Belt O.C.	1648750C1	▲K080605HD
Belt - Alt.; W/32 7/8" Belt O.C.	2036266C1	▲K050323HD
Belt - Alt.; W/34 1/4" Belt O.C.	586452C1	▲K050336HD
Belt - A.C.; W/11/16" Belt T.W.	2016338C1	TR22485
Belt - A.C.; W/31/64" Belt T.W.	865196R2	▲9485HD
5000		
Belt - Fan	1648750C1	▲K080605HD
Belt - Alt.	586452C1	▲K050336HD
Belt - A.C.	2016339C1	TR22525
Hose - Upper - Eng. To Pipe; (2 1/2" I.D.)	24240	24240
Hose - Upper - Pipe To Rad.; (2 1/2" I.D.)	24240	24240
Hose - Lower - Eng. To Pipe; (2 1/2" I.D.)	24240	24240
Hose - Lower - Pipe To Rad.; (2 1/2" I.D.)	24240	24240
8100		
Belt - Fan; W/61 1/8" Belt O.C.	1648750C1	▲K080605HD
Belt - Alt.; W/34 1/4" Belt O.C.	586452C1	▲K050336HD
Belt - A.C.	2016338C1	TR22485
Hose - Upper		≧21135
Hose - Upper - Eng. To Pipe; (2 1/4" I.D.)		24236
Hose - Upper - Pipe To Rad.; (2 1/2" I.D.)		24240
Hose - Lower - Eng. To Pipe; (2 3/8" I.D.)		24238
Hose - Lower - Pipe To Rad.		≧21135
Hose - Lower - Pipe To Pipe; (2 1/2" I.D.)		24240
Hose - Heater Inlet; (3/4" I.D.)		28442
Hose - Heater Outlet; (5/8" I.D.)		28441
8200		
Belt - Fan	1648750C1	▲K080605HD
Belt - Alt.	586452C1	▲K050336HD
Belt - A.C.	2016338C1	TR22485
Hose - Upper - Eng. To Pipe; (2 1/4" I.D.)		24236
Hose - Upper - Pipe To Rad.		21135
Hose - Lower - Eng. To Pipe; (2 1/2" I.D.)		24240
Hose - Lower - Pipe To Rad.		21135
Cummins L10 Diesel		
2574; 2674		
Belt - Fan	1648750C1	▲K080605HD
Belt - Alt.; W/32 7/8" Belt O.C.	2036266C1	▲K050323HD
Belt - Alt.; W/34 1/2" Belt O.C.	586452C1	▲K050336HD
Belt - A.C.	2016338C1	TR22485
Hose - Upper - Eng. To Pipe; (2 1/4" I.D.)		24236
Hose - Upper - Pipe To Rad.; (2 1/2" I.D.)		24240
Hose - Lower - Eng. To Pipe; (2 1/2" I.D.)		24240
Hose - Lower - Pipe To Rad.; (2 1/2" I.D.)		24240
5000		
Belt - Fan	1648750C1	▲K080605HD
Belt - Alt.	586452C1	▲K050336HD
Hose - Upper - Eng. To Pipe; (2 1/4" I.D.)		24236
Hose - Upper - Pipe To Rad.; (2 1/4" I.D.)		24236
Hose - Lower - Eng. To Pipe; (2 1/2" I.D.)		24240
Hose - Lower - Pipe To Rad.; (2 1/2" I.D.)		24240
Cummins M11 Diesel		
9100		
Belt - Fan	1651399C1	▲K080565HD
Belt - Alt.	586452C1	▲K050336HD
Belt - A.C.	2016338C1	TR22485
Hose - Upper - Eng. To Pipe; (2 1/2" I.D.)		24240
Hose - Upper - Pipe To Rad.; (2 1/2" I.D.)		24240
Hose - Lower - Eng. To Pipe; (2 1/2" I.D.)		24240

▲ Standard Belt Available. See Pages 630-631.
≧ Cut to Fit.

② Two Required.

Belts and Coolant Hose for Medium/Heavy-Duty Trucks (1996 and Newer)

 Medium & Heavy-Duty Trucks
(1996 & Newer)

Application	Mfr. Part No.	Our No.
INTERNATIONAL/NAVISTAR - Continued		
1998 - Continued		
Cummins M11 Diesel - Continued		
9100 - Continued		
Hose - Lower - Pipe To Rad.; (2 1/2" I.D.)		24240
9200		
Belt - Fan	1648750C1	▲K080605HD
Belt - Alt.	586452C1	▲K050336HD
Belt - A.C.	2016338C1	TR22485
Hose - Upper - Eng. To Pipe; (2 1/2" I.D.)		24240
Hose - Upper - Pipe To Rad.; (2 1/2" I.D.)		24240
Hose - Lower - Eng. To Pipe; (2 1/2" I.D.)		24240
Hose - Lower - Pipe To Rad.; (2 1/2" I.D.)		24240
Cummins N14 Diesel		
2574; 2674		
Belt - Fan	479577C1	②TR28522
Belt - W.P.		▲K060425HD
Belt - Alt.	598183C1	②▲9447HD
Belt - A.C.	196666R1	▲9405HD
Hose - Upper - Eng. To Pipe; (2 1/2" I.D.)		24240
Hose - Upper - Pipe To Rad.; (2 1/2" I.D.)		24240
Hose - Lower - Eng. To Pipe; (2 1/2" I.D.)		24240
Hose - Lower - Pipe To Rad.; (2 1/2" I.D.)		24240
Hose - Coolant Reservoir; (1" I.D.)		24216
5000		
Belt - W.P.; W/43 1/8" Belt O.C.	3076492	▲K060425HD
Belt - W.P.; W/44 1/8" Belt O.C.	217638	▲K060435HD
Belt - Fan	479577C1	TR28522
Belt - Alt.	598183C1	2/9447PB
Belt - A.C.	441695C1	▲9430HD
Hose - Upper - Eng. To Pipe; (2 1/2" I.D.)		24240
Hose - Lower - Eng. To Pipe; (2 1/2" I.D.)		24240
Hose - Lower - Pipe To Rad.; (2 1/2" I.D.)		24240
8100		
Belt - W.P.; W/43 1/8" Belt O.C.	3076492	▲K060425HD
Belt - W.P.; W/44 1/8" Belt O.C.	217638	▲K060435HD
Belt - Fan; W/47 7/8" Belt O.C.; Optional Belt		②TR28473
Belt - Fan; W/47 7/8" Belt O.C.;		
Preferred Belt	1686803	2/TR28473PB
Belt - Fan; W/53" Belt O.C.	479577C1	TR28522
Belt - Alt.; W/44 3/8" Belt O.C.	133758R2	▲9440HD
Belt - Alt.; W/46 3/8" Belt O.C.; Optional Belt		②▲9463HD
Belt - Alt.; W/46 3/8" Belt O.C.; Preferred		
Belt	447497C1	2/9463PB
Belt - A.C.	196666R1	▲9405HD
Hose - Upper - Eng. To Pipe; (2 1/2" I.D.)		24240
Hose - Upper - Pipe To Rad.; (2 1/2" I.D.)		24240
Hose - Lower - Eng. To Pipe; (2 1/2" I.D.)		24240
Hose - Lower - Pipe To Rad.; (2 1/2" I.D.)		24240
8200		
Belt - W.P.; W/4-Ribbed Belt		▲K040425HD
Belt - W.P.; W/6-Ribbed Belt		▲K060435HD
Belt - Fan; W/47 7/8" Belt O.C.; Optional Belt		TR28473
Belt - Fan; W/47 7/8" Belt O.C.; Preferred Belt		2/TR28473PB
Belt - Alt.		▲9447HD
Belt - A.C.		▲9405HD
Hose - Lower - Eng. To Pipe; (2 1/2" I.D.)		24240
Hose - Lower - Pipe To Rad.; (2 1/2" I.D.)		24240
9100; 9200		
Belt - W.P.	3095880	▲K060415HD
Belt - Fan	3513716C1	▲K100510HD
Belt - Alt.; Preferred Belt	598183C1	2/9447PB
Belt - Alt.; Optional Belt		②▲9447HD
Belt - A.C.	196666R1	▲9405HD
Hose - Upper - Eng. To Pipe; (2 1/2" I.D.)		24240
Hose - Upper - Pipe To Rad.; (2 1/2" I.D.)		24240
Hose - Lower - Eng. To Pipe; (2 1/2" I.D.)		24240
Hose - Lower - Pipe To Rad.; (2 1/2" I.D.)		24240
9300		
Belt - W.P.	3095880	▲K060415HD
Belt - Fan	3513716C1	▲K100510HD
Belt - Alt.; Preferred Belt	598183C1	2/9447PB

Application	Mfr. Part No.	Our No.
INTERNATIONAL/NAVISTAR - Continued		
1998 - Continued		
Cummins N14 Diesel - Continued		
9300 - Continued		
Belt - Alt.; Optional Belt		②▲9447HD
Belt - A.C.	196666R1	▲9405HD
Hose - Upper - Eng. To Pipe		21135
Hose - Upper - Pipe To Rad.; (2 1/2" I.D.)		24240
Hose - Lower - Eng. To Pipe; (2 1/2" I.D.)		24240
Hose - Lower - Pipe To Rad.; (2 1/2" I.D.)		24240
9400		
Belt - W.P.	3095880	▲K060415HD
Belt - Fan	3513716C1	▲K100510HD
Belt - Alt.; Preferred Belt	598183C1	2/9447PB
Belt - Alt.; Optional Belt		②▲9447HD
Belt - A.C.	196666R1	▲9405HD
Hose - Upper - Eng. To Pipe; (2 1/2" I.D.)		24240
Hose - Upper - Pipe To Rad.; (2 1/2" I.D.)		24240
Hose - Lower - Eng. To Pipe; (2 1/2" I.D.)		24240
Hose - Lower - Pipe To Rad.; (2 1/2" I.D.)		24240
9800		
Belt - W.P.; W/43 1/8" Belt O.C.	3076492	▲K060425HD
Belt - W.P.; W/44 1/8" Belt O.C.	217638	▲K060435HD
Belt - Fan; W/43 1/2" Belt O.C.;		
Preferred Belt	488674C1	2/TR28492PB
Belt - Fan; W/43 1/2" Belt O.C.; Optional Belt		②TR28492
Belt - Fan; W/52" Belt O.C.	575817C1	TR28514
Belt - Fan; W/55 5/8" Belt O.C.	128805HA	TR28550
Belt - Fan; W/57 1/8" Belt O.C.	1688196C1	TR28565
Belt - A.C.	196666R1	▲9405HD
Hose - Upper - Eng. To Pipe; (2 1/2" I.D.)		24240
Hose - Upper - Pipe To Rad.; (2 1/2" I.D.)		24240
Hose - Lower - Eng. To Pipe; (2 1/2" I.D.)		24240
Hose - Lower - Pipe To Rad.; (2 1/2" I.D.)		24240
Detroit Diesel Series 60 Diesel		
9100; 9200		
Belt - Fan	3503813C1	▲K100570HD
Belt - Alt.; Preferred Belt	284583C2	2/9313PB
Belt - Alt.; Optional Belt		②▲9313HD
Belt - Alt.; W/V-Ribbed Belt Drive	3505387C1	▲K060455HD
Belt - A.C.	2017725C1	▲K060490HD
Tensioner Assy. - Fan	1687801C91	38519
Tensioner Pulley - Fan	1687801C91	36092
Hose - Upper - Eng. To Pipe; (2 1/2" I.D.)		24240
Hose - Upper - Pipe To Rad.; (2 1/2" I.D.)		24240
Hose - Lower - Eng. To Pipe; (2 1/2" I.D.)		24240
Hose - Lower - Pipe To Rad.; (2 1/2" I.D.)		24240
9300		
Belt - Fan; W/56 7/8" Belt O.C.	3503813C1	▲K100570HD
Belt - Fan; W/64 5/8" Belt O.C.	2038371C1	▲K100640HD
Belt - Alt.; W/V-Ribbed Belt	3505387C1	K060450
Belt - Alt.; W/V-Belt Drive	284583C2	2/9313PB
Belt - A.C.	2017725C1	▲K060490HD
Hose - Upper - Eng. To Pipe; (2 1/2" I.D.)		24240
Hose - Upper - Pipe To Rad.; (2 1/2" I.D.)		24240
Hose - Lower - Eng. To Pipe; (2 1/2" I.D.)		24240
Hose - Lower - Pipe To Rad.; (2 1/2" I.D.)		24240
9400		
Belt - Fan	1687800C1	▲K100540HD
Belt - Alt.; Preferred Belt	284583C2	2/9313PB
Belt - Alt.; Optional Belt		②▲9313HD
Belt - Alt.; W/V-Ribbed Belt Drive	3505387C1	▲K060455HD
Belt - A.C.	2017725C1	▲K060490HD
Tensioner Assy. - Fan	1687801C91	38519
Tensioner Pulley - Fan	1687801C91	36092
Hose - Upper - Eng. To Pipe; (2 1/2" I.D.)		24240
Hose - Upper - Pipe To Rad.; (2 1/2" I.D.)		24240
Hose - Lower - Eng. To Pipe; (2 1/2" I.D.)		24240
Hose - Lower - Pipe To Rad.; (2 1/2" I.D.)		24240

▲ Standard Belt Available. See Pages 630-631.

◆ Green Stripe® PowerBand® Belt May Work, Use Template to Check.

② Two Required.

Belts and Coolant Hose for Medium/Heavy-Duty Trucks (1996 and Newer)

Medium & Heavy-Duty Trucks
(1996 & Newer)

Application	Mfr. Part No.	Our No.
INTERNATIONAL/NAVISTAR - Continued		
1998 - Continued		
International/Navistar 530 Diesel		
2554; 2574; 2654; 2674		
Belt - Fan, W.P. & Alt.; W/76 1/2" Belt		
O.C.	1682697C1	♣K080760HD
Belt - Fan, W.P. & Alt.; W/77 7/8" Belt		
O.C.	1820547C2	♣K080774HD
Belt - A.C.	3515596C1	♣K060470HD
Tensioner Assy. - Fan, W.P. & Alt.	1814719C1	38514
Tensioner Assy. - A.C.	1687819C91	38511
Tensioner Pulley - Fan, W.P. & Alt.	1814719C1	36091
Tensioner Pulley - A.C.	1687819C91	36091
Hose - Upper - Eng. To Pipe; (2 1/4" I.D.)		24236
Hose - Upper - Pipe To Rad.; (2 1/2" I.D.)		24240
Hose - Lower - Eng. To Pipe; (2 1/2" I.D.)		24240
Hose - Lower - Pipe To Rad.; W/Man. Trans.(2 1/2" I.D.) ...		24240
4900		
Belt - Fan, Alt. & Hub	1819392C1	♣K080716HD
Belt - Fan & A.C.	3515596C1	♣K060470HD
Tensioner Assy. - Fan, Alt. & Hub	1830033C1	38514
Tensioner Assy. - Fan & A.C.	1687819C92	38512
Tensioner Pulley - Fan, Alt. & Hub	1830033C1	36091
Tensioner Pulley - Fan & A.C.	1687819C92	36091
Hose - Upper - Eng. To Rad.		22140
Hose - Lower - Eng. To Rad.		♣21115
8100		
Belt - Fan, Alt. & Hub	168297C1	♣K080760HD
Belt - A.C.	1687797C1	♣K060470HD
Tensioner Assy. - Fan, Alt. & Hub	1830033C1	38514
Tensioner Assy. - A.C.	1687819C91	38511
Tensioner Pulley - Fan, Alt. & Hub	1830033C1	36091
International/Navistar DT466 Diesel		
2554; 2654		
Belt - Fan, Alt. & Hub; W/76 1/2" Belt		
O.C.	1682697C1	♣K080760HD
Belt - Fan, Alt. & Hub; W/77 7/8" Belt		
O.C.	1820547C1	♣K080774HD
Belt - Fan & A.C.	3517822C1	♣K060478HD
Tensioner Assy. - Fan, Alt. & Hub	1830033C1	38514
Tensioner Assy. - Fan & A.C.	1687819C92	38512
Tensioner Pulley - Fan, Alt. & Hub	1830033C1	36091
Tensioner Pulley - Fan & A.C.	1687819C92	36091
Hose - Upper - Eng. To Pipe; (2 1/4" I.D.)		24236
Hose - Upper - Pipe To Rad.; (2 1/2" I.D.)		24240
Hose - Lower - Eng. To Pipe; (2 1/2" I.D.)		24240
Hose - Lower - Pipe To Rad.; (2 1/2" I.D.)		24240
4700; 4800; 4900		
Belt - Fan & Alt.; W/P.T.O.; W/1.2 To 1		
Fan Ratio	1819391C1	♣K080730HD
Belt - Fan & Alt.; W/P.T.O.;		
W/Mechanical Eng.; W/1.08 To 1		
Fan Ratio	1682696C1	♣K080738HD
Belt - Fan & Alt.; W/P.T.O.; W/Electronic		
Eng.; W/1.08 To 1 Fan Ratio	1820547C2	♣K080774HD
Belt - Fan & Alt.; W/O P.T.O.	1822503C1	♣K080726HD
Belt - Fan To A.C.	1687797C1	♣K060470HD
Tensioner Assy. - Fan & Alt.	1814719C1	38514
Tensioner Assy. - Fan To A.C.	1687819C91	38511
Tensioner Pulley - Fan & Alt.	1814719C1	36091
Tensioner Pulley - Fan To A.C.	1687819C91	36091
Hose - Upper - Eng. To Rad.		21765
Hose - Lower - Eng. To Pipe		21842
Hose - Lower - Pipe To Rad.		21115
Hose - Lower - Eng. To Rad.		♣21115
8100		
Belt - Fan & Alt.	1820547C3	♣K080774HD
Belt - A.C.	3515596C1	♣K060470HD
Tensioner Assy. - Fan & Alt.	1814719C1	38514
Tensioner Assy. - A.C.	1687819C91	38511
Tensioner Pulley - Fan & Alt.	1814719C1	36091
Tensioner Pulley - A.C.	1687819C91	36091

Application	Mfr. Part No.	Our No.
INTERNATIONAL/NAVISTAR - Continued		
1998 - Continued		
International/Navistar T444 Diesel		
1652 SC		
Idler Pulley; W/Flat Idler Pulley	1822652C91	36287
Idler Pulley; W/V-Groove Idler Pulley ...	1822653C91	36288
4700		
Belt - W.P., Fan & Alt.; W/O Air Brake		
Compr.; W/Schwitzer Fan Clutch	1821840C1	♣K080922HD
Belt - W.P., Fan & Alt.; W/Air Brake		
Compr.; W/Schwitzer Fan Clutch	1821850C1	♣K081102HD
Belt - W.P., Fan, Alt. & A.C.; W/O Air		
Brake Compr.; W/Schwitzer Fan		
Clutch	1821839C1	♣K081035HD
Belt - W.P., Fan, Alt. & A.C.; W/Air		
Brake Compr.; W/Schwitzer Fan		
Clutch	1821843C1	♣K081223HD
Belt - W.P., Fan & Alt.; W/O Air Brake		
Compr.; W/O Schwitzer Fan Clutch .	1822830C1	♣K080893HD
Belt - W.P., Fan & Alt.; W/Air Brake		
Compr.; W/O Schwitzer Fan Clutch .	1822832C1	♣K081124HD
Belt - W.P., Fan, Alt. & A.C.; W/O Air		
Brake Compr.; W/O Schwitzer Fan		
Clutch	1822831C2	♣K081000HD
Belt - W.P., Fan, Alt. & A.C.; W/Air		
Brake Compr.; W/O Schwitzer Fan		
Clutch	1822833C1	♣K081265HD
Tensioner Assy.	1822679C3	38510
Idler Pulley; W/Flat Idler Pulley	1822652C91	36287
Idler Pulley; W/V-Groove Idler Pulley ...	1822653C91	36288
Hose - Upper - Eng. To Rad.		22159
Hose - Lower - Eng. To Pipe		22671
Hose - Lower - Pipe To Rad.		20172
1997		
Caterpillar 3176 Diesel		
8100		
Belt - Fan & Alt.; W/Bendix		
Westinghouse Fan Clutch	1682693C1	♣K080708HD
Belt - Fan & Alt.; W/Horton, Kysor Fan		
Clutch	1514968C1	♣K080774HD
Belt - Fan & Alt.; W/Schwitzer Fan		
Clutch	1682692C1	♣K080720HD
Belt - Fan & A.C.	1514968C1	♣K080774HD
Belt - A.C.	149635R2	♣9463HD
Tensioner Assy. - Fan & Alt.	1333542	38514
Tensioner Pulley	1333542	36091
Hose - Upper - Eng. To Pipe; (2 1/2" I.D.)		24240
Hose - Upper - Rad. To Pipe		21135
Hose - Lower - Eng. To Rad.		21135
Hose - Lower - Rad. To Pipe		21115
Caterpillar 3406 Diesel		
9200		
Belt - Fan & Alt.	2018284C1	♣K100771HD
Belt - Fan & A.C.	2005148C1	♣K060500HD
Hose - Upper - Eng. To Pipe; (2 1/2" I.D.)		24240
Hose - Upper - Pipe To Rad.; (2 1/2" I.D.)		24240
Hose - Lower - Eng. To Pipe; (3" I.D.)		24248
Hose - Lower - Pipe To Rad.; (2 1/2" I.D.)		24240
9300		
Belt - Fan & Alt.	2020036C1	♣K100852HD
Belt - Fan & A.C.	2009861C1	♣K060425HD
Hose - Upper - Eng. To Pipe; (2 1/2" I.D.)		24240
Hose - Upper - Pipe To Rad.; (2 1/2" I.D.)		24240
Hose - Lower - Eng. To Pipe; (3" I.D.)		24248
Hose - Lower - Pipe To Rad.; (2 1/2" I.D.)		24240
9400		
Belt - Fan & Alt.	2018284C1	♣K100771HD
Belt - Fan & A.C.	2005148C1	♣K060500HD
Hose - Upper - Eng. To Pipe; (2 1/2" I.D.)		24240
Hose - Upper - Pipe To Rad.; (2 1/2" I.D.)		24240
Hose - Lower - Eng. To Pipe; (3" I.D.)		24248
Hose - Lower - Pipe To Rad.; (2 1/2" I.D.)		24240

♣ Standard Belt Available. See Pages 630-631.

♣ Cut to Fit.

Belts and Coolant Hose for Medium/Heavy-Duty Trucks (1996 and Newer)

 Medium & Heavy-Duty Trucks
(1996 & Newer)

Application	Mfr. Part No.	Our No.
INTERNATIONAL/NAVISTAR - Continued		
1997 - Continued		
Caterpillar C10 Diesel		
2574; 2674		
Belt - Fan & Alt.	1682697C1	▲K080760HD
Hose - Upper - Eng. To Pipe; (2 1/2" I.D.)		24240
Hose - Upper - Pipe To Rad.		21135
Hose - Lower - Eng. To Pipe; (2 1/2" I.D.)		24240
Hose - Lower - Pipe To Rad.		21891
9200; 9300; 9400		
Belt - Fan & Alt.	1618533C1	▲K080733HD
Belt - Fan & A.C.; Preferred Belt	149635R2	2/9463PB
Belt - Fan & A.C.; Optional Belt		②▲9463HD
Hose - Upper - Eng. To Pipe		21135
Hose - Upper - Pipe To Rad.; (2 1/2" I.D.)		24240
Hose - Lower - Eng. To Pipe		21891
Hose - Lower - Rad. To Pipe		21135
Caterpillar C12 Diesel		
2574; 2674		
Belt - Fan & Alt.	1682697C1	▲K080760HD
Hose - Upper - Eng. To Pipe; (2 1/2" I.D.)		24240
Hose - Upper - Pipe To Rad.		21135
Hose - Lower - Eng. To Pipe; (2 1/2" I.D.)		24240
Hose - Lower - Pipe To Rad.		21891
9200; 9300; 9400		
Belt - Fan & Alt.	1618533C1	▲K080733HD
Belt - Fan & A.C.; Optional Belt		②▲9463HD
Belt - Fan & A.C.; Preferred Belt	149635R2	2/9463PB
Hose - Upper - Eng. To Pipe		21135
Hose - Upper - Pipe To Rad.; (2 1/2" I.D.)		24240
Hose - Lower - Eng. To Pipe		21891
Hose - Lower - Rad. To Pipe		21135
Cummins L10 Diesel		
2574; 2674		
Belt - Fan	1648750C1	▲K080605HD
Belt - Alt.; W/32 7/8" Belt O.C.	2036266C1	▲K050323HD
Belt - Alt.; W/34 1/2" Belt O.C.	586452C1	▲K050336HD
Belt - A.C.	2016338C1	TR22485
Hose - Upper - Eng. To Pipe; (2 1/4" I.D.)		24236
Hose - Upper - Pipe To Rad.; (2 1/2" I.D.)		24240
Hose - Lower - Eng. To Pipe; (2 1/2" I.D.)		24240
Hose - Lower - Pipe To Rad.; (2 1/2" I.D.)		24240
5000		
Belt - Fan	1648750C1	▲K080605HD
Belt - Alt.	586452C1	▲K050336HD
Hose - Upper - Eng. To Pipe; (2 1/4" I.D.)		24236
Hose - Upper - Pipe To Rad.; (2 1/4" I.D.)		24236
Hose - Lower - Eng. To Pipe; (2 1/2" I.D.)		24240
Hose - Lower - Pipe To Rad.; (2 1/2" I.D.)		24240
8100		
Belt - Fan	1648750C1	▲K080605HD
Belt - Alt.	2036266C1	▲K050323HD
Belt - A.C.	2016338C1	TR22485
Hose - Upper - Eng. To Pipe; (2 1/4" I.D.)		24236
Hose - Upper - Pipe To Rad.; (2 1/2" I.D.)		24240
Hose - Lower - Eng. To Pipe; (2 1/2" I.D.)		24240
Hose - Lower - Pipe To Rad.; (2 1/2" I.D.)		24240
8200		
Belt - Fan	609665C1	▲K080570HD
Belt - Alt.	586452C1	▲K050336HD
Belt - A.C.	2016338C1	TR22485
Hose - Upper - Eng. To Pipe; (2 1/4" I.D.)		24236
Hose - Upper - Pipe To Rad.; (2 1/2" I.D.)		24240
Hose - Lower - Eng. To Pipe; (2 1/2" I.D.)		24240
Hose - Lower - Pipe To Rad.; (2 1/2" I.D.)		24240
Cummins M11 Diesel		
2574; 2674		
Belt - Fan; W/57 1/2" Belt O.C.	1609665C1	▲K080570HD
Belt - Fan; W/61 1/8" Belt O.C.	1648750C1	▲K080605HD
Belt - Alt.; W/32 7/8" Belt O.C.	2036266C1	▲K050323HD
Belt - Alt.; W/34 1/4" Belt O.C.	586452C1	▲K050336HD
Belt - A.C.; W/11/16" Belt T.W.	2016338C1	TR22485

 ▲ Standard Belt Available. See Pages 630-631.
 ≡ Cut to Fit.

Application	Mfr. Part No.	Our No.
INTERNATIONAL/NAVISTAR - Continued		
1997 - Continued		
Cummins M11 Diesel - Continued		
2574; 2674 - Continued		
Belt - A.C.; W/31/64" Belt T.W.	865196R2	▲9485HD
Hose - Upper - Eng. To Pipe; (2 1/2" I.D.)		24240
Hose - Upper - Rad. To Pipe		21372
Hose - Lower - Eng. To Rad.; (2 1/2" I.D.)		24240
Hose - Lower - Rad. To Pipe; (2 1/2" I.D.)		24240
5000		
Belt - Fan		▲K080605HD
Belt - Alt.		▲K050336HD
Belt - A.C.		TR22525
Hose - Upper - Eng. To Pipe; (2 1/2" I.D.)		24240
Hose - Upper - Pipe To Rad.; (2 1/2" I.D.)		24240
Hose - Lower - Eng. To Pipe; (2 1/2" I.D.)		24240
Hose - Lower - Pipe To Rad.; (2 1/2" I.D.)		24240
8100		
Belt - Fan	1648750C1	▲K080605HD
Belt - Alt.	586452C1	▲K050336HD
Belt - A.C.	2016338C1	TR22485
Hose - Upper - Eng. To Pipe; (2 1/4" I.D.)		24236
Hose - Upper - Pipe To Rad.		≡21135
Hose - Lower - Eng. To Pipe; (2 3/8" I.D.)		24238
Hose - Lower - Pipe To Rad.		≡21135
Hose - Lower - Pipe To Pipe; (2 1/2" I.D.)		24240
Hose - Heater Inlet; (3/4" I.D.)		28442
Hose - Heater Outlet; (5/8" I.D.)		28441
8200		
Belt - Fan	1648750C1	▲K080605HD
Belt - Alt.	586452C1	▲K050336HD
Belt - A.C.	2016338C1	TR22485
Hose - Upper - Eng. To Pipe; (2 1/4" I.D.)		24236
Hose - Upper - Pipe To Rad.		21135
Hose - Lower - Eng. To Pipe; (2 1/2" I.D.)		24240
Hose - Lower - Pipe To Rad.		21135
9200; 9300; 9400		
Belt - Fan	1648750C1	▲K080605HD
Belt - Alt.	586452C1	▲K050336HD
Belt - A.C.	2016338C1	TR22485
Hose - Upper - Eng. To Pipe; (2 1/2" I.D.)		24240
Hose - Upper - Pipe To Rad.; (2 1/2" I.D.)		24240
Hose - Lower - Eng. To Pipe; (2 1/2" I.D.)		24240
Hose - Lower - Pipe To Rad.; (2 1/2" I.D.)		24240
9800		
Belt - W.P. & Alt.	2040924C1	K050415
Belt - Fan	1651399C1	▲K080565HD
Belt - A.C.	586328C1	TR22570
Hose - Upper - Eng. To Pipe; (2 1/2" I.D.)		24240
Hose - Upper - Pipe To Rad.; (2 1/2" I.D.)		24240
Hose - Lower - Eng. To Pipe; (2 1/2" I.D.)		24240
Hose - Lower - Pipe To Rad.; (2 1/2" I.D.)		24240
Cummins N14 Diesel		
2574; 2674		
Belt - Fan	479577C1	②TR28522
Belt - W.P.		▲K060425HD
Belt - Alt.	598183C1	②◆▲9447HD
Belt - A.C.	196666R1	▲9405HD
Hose - Upper - Eng. To Pipe; (2 1/2" I.D.)		24240
Hose - Upper - Pipe To Rad.; (2 1/2" I.D.)		24240
Hose - Lower - Eng. To Pipe; (2 1/2" I.D.)		24240
Hose - Lower - Pipe To Rad.; (2 1/2" I.D.)		24240
Hose - Coolant Reservoir; (1" I.D.)		24216
5000		
Belt - W.P.; W/43 1/8" Belt O.C.	3076492	▲K060425HD
Belt - W.P.; W/44 1/8" Belt O.C.	217638	▲K060435HD
Belt - Fan	479577C1	TR28522
Belt - Alt.	598183C1	2/9447PB
Belt - A.C.	441695C1	▲9430HD
Hose - Upper - Eng. To Pipe; (2 1/2" I.D.)		24240
Hose - Lower - Eng. To Pipe; (2 1/2" I.D.)		24240
Hose - Lower - Pipe To Rad.; (2 1/2" I.D.)		24240

 ② Two Required.
 ◆ Green Stripe® PowerBand® Belt May Work, Use Template to Check.

Belts and Coolant Hose for Medium/Heavy-Duty Trucks (1996 and Newer)

Medium & Heavy-Duty Trucks
(1996 & Newer)

Application	Mfr. Part No.	Our No.
INTERNATIONAL/NAVISTAR - Continued		
1997 - Continued		
Cummins N14 Diesel - Continued		
8100; 8200		
Belt - W.P.; W/4-Ribbed Belt		▲K040425HD
Belt - W.P.; W/6-Ribbed Belt		▲K060435HD
Belt - Fan; W/47 7/8" Belt O.C.; Preferred Belt		2/TR28473PB
Belt - Fan; W/47 7/8" Belt O.C.; Optional Belt		TR28473
Belt - Alt.		▲9447HD
Belt - A.C.		▲9405HD
Hose - Lower - Eng. To Pipe; (2 1/2" I.D.)		24240
Hose - Lower - Pipe To Rad.; (2 1/2" I.D.)		24240
9200; 9300; 9400		
Belt - W.P.; W/42" Belt O.C.	3095880	▲K060415HD
Belt - Fan; W/46 1/4" Belt O.C.	3501266C1	▲K100456HD
Belt - Fan; W/51 5/8" Belt O.C.	3513716C1	▲K100510HD
Belt - Alt.; W/44 7/8" Belt O.C.; Preferred Belt		2/9447PB
Belt - Alt.; W/44 7/8" Belt O.C.; Optional Belt		②▲9447HD
Belt - Alt.; W/46 3/8" Belt O.C.; Preferred Belt		2/9463PB
Belt - Alt.; W/46 3/8" Belt O.C.; Optional Belt		②▲9463HD
Hose - Upper - Eng. To Pipe; (2 1/2" I.D.)		24240
Hose - Upper - Pipe To Rad.; (2 1/2" I.D.)		24240
Hose - Lower - Eng. To Pipe; (2 1/2" I.D.)		24240
Hose - Lower - Pipe To Rad.; (2 1/2" I.D.)		24240
9800		
Belt - W.P.; W/43 1/8" Belt O.C.	3076492	▲K060425HD
Belt - W.P.; W/44 1/8" Belt O.C.	217638	▲K060435HD
Belt - Fan; W/43 1/2" Belt O.C.; Preferred Belt		2/TR28492PB
Belt - Fan; W/43 1/2" Belt O.C.; Optional Belt		②TR28492
Belt - Fan; W/52" Belt O.C.	575817C1	TR28514
Belt - Fan; W/55 5/8" Belt O.C.	128805HA	TR28550
Belt - Fan; W/57 1/8" Belt O.C.	1688196C1	TR28565
Belt - A.C.	196666R1	▲9405HD
Hose - Upper - Eng. To Pipe; (2 1/2" I.D.)		24240
Hose - Upper - Pipe To Rad.; (2 1/2" I.D.)		24240
Hose - Lower - Eng. To Pipe; (2 1/2" I.D.)		24240
Hose - Lower - Pipe To Rad.; (2 1/2" I.D.)		24240
Detroit Diesel Series 60 Diesel		
9400		
Belt - Fan; W/57 1/2" Belt O.C.	3503813C1	▲K100570HD
Belt - Fan; W/64 5/8" Belt O.C.	2012260C1	▲K100640HD
Belt - Alt.; Preferred Belt	284583C2	2/9313PB
Belt - Alt.; Optional Belt		②▲9313HD
Belt - Alt.; W/V-Ribbed Belt Drive	3505387C1	▲K060455HD
Belt - A.C.; W/49 1/2" Belt O.C.	2017725C1	▲K060490HD
Belt - A.C.; W/55 1/4" Belt O.C.	1687799C1	▲K060547HD
Tensioner Assy. - Fan	1687801C91	38519
Tensioner Pulley - Fan	1687801C91	36092
Hose - Upper - Eng. To Pipe; (2 1/2" I.D.)		24240
Hose - Upper - Pipe To Rad.; (2 1/2" I.D.)		24240
Hose - Lower - Eng. To Pipe; (2 1/2" I.D.)		24240
Hose - Lower - Pipe To Rad.; (2 1/2" I.D.)		24240
9800		
Belt - Fan; W/54 1/2" Belt O.C.	1687800C1	▲K100540HD
Belt - Fan; W/61 1/4" Belt O.C.	1687798C1	▲K100607HD
Belt - Alt.; W/V-Belt Drive; Preferred Belt	284583C2	2/9313PB
Belt - Alt.; W/V-Belt Drive; Optional Belt		②▲9313HD
Belt - Alt.; W/V-Ribbed Belt Drive	3505387C1	▲K060455HD
Belt - A.C.; W/47 1/2" Belt O.C.	1687797C1	▲K060470HD
Tensioner Assy. - Fan	1687801C91	38519
Tensioner Pulley - Fan	1687801C91	36092
Hose - Upper - Eng. To Pipe; (2 1/2" I.D.)		24240
Hose - Upper - Pipe To Rad.; (2 1/2" I.D.)		24240
Hose - Lower - Eng. To Pipe; (2 1/2" I.D.)		24240
Hose - Lower - Pipe To Rad.; (2 1/2" I.D.)		24240
Detroit Diesel 6-Cyl. 11.1 L Diesel		
9200		
Belt - Fan	2038371C1	▲K100637HD
Belt - Alt.		②▲9313HD
Belt - A.C.	1830641C2	▲K060490HD

Application	Mfr. Part No.	Our No.
INTERNATIONAL/NAVISTAR - Continued		
1997 - Continued		
Detroit Diesel 6-Cyl. 11.1 L Diesel - Continued		
9200 - Continued		
Tensioner Assy. - Fan	1687801C91	38519
Tensioner Pulley - Fan	1687801C91	36092
9300		
Belt - Fan; W/56 7/8" Belt O.C.	3503813C1	▲K100570HD
Belt - Fan; W/64 5/8" Belt O.C.	2038371C1	▲K100640HD
Belt - Alt.; W/V-Ribbed Belt	3505387C1	K060450
Belt - Alt.; W/V-Belt Drive	284583C2	2/9313PB
Belt - A.C.	2017725C1	▲K060490HD
Hose - Upper - Eng. To Pipe; (2 1/2" I.D.)		24240
Hose - Upper - Pipe To Rad.; (2 1/2" I.D.)		24240
Hose - Lower - Eng. To Pipe; (2 1/2" I.D.)		24240
Hose - Lower - Pipe To Rad.; (2 1/2" I.D.)		24240
Detroit Diesel 6-Cyl. 12.7 L Diesel		
9200		
Belt - Fan	2038371C1	▲K100637HD
Belt - Alt.		②▲9313HD
Belt - A.C.	1830641C2	▲K060490HD
Tensioner Assy. - Fan	1687801C91	38519
Tensioner Pulley - Fan	1687801C91	36092
9300		
Belt - Fan; W/56 7/8" Belt O.C.	3503813C1	▲K100570HD
Belt - Fan; W/64 5/8" Belt O.C.	2038371C1	▲K100640HD
Belt - Alt.; W/V-Ribbed Belt	3505387C1	K060450
Belt - Alt.; W/V-Belt Drive	284583C2	2/9313PB
Belt - A.C.	2017725C1	▲K060490HD
Hose - Upper - Eng. To Pipe; (2 1/2" I.D.)		24240
Hose - Upper - Pipe To Rad.; (2 1/2" I.D.)		24240
Hose - Lower - Eng. To Pipe; (2 1/2" I.D.)		24240
Hose - Lower - Pipe To Rad.; (2 1/2" I.D.)		24240
International/Navistar 530 Diesel		
2554		
Belt - Fan, W.P. & Alt.; W/76 1/2" Belt O.C.	1682697C1	▲K080760HD
Belt - Fan, W.P. & Alt.; W/77 7/8" Belt O.C.		▲K080774HD
Belt - A.C.	1820547C2	▲K060470HD
Tensioner Assy. - Fan, W.P. & Alt.	3515596C1	38514
Tensioner Assy. - A.C.	1814719C1	38511
Tensioner Pulley - Fan, W.P. & Alt.	1687819C91	36091
Tensioner Pulley - A.C.	1814719C1	36091
Hose - Upper - Eng. To Pipe; (2 1/4" I.D.)	1687819C91	24236
Hose - Upper - Pipe To Rad.; (2 1/2" I.D.)		24240
Hose - Lower - Eng. To Pipe; (2 1/2" I.D.)		24240
Hose - Lower - Pipe To Rad.; W/Man. Trans.(2 1/2" I.D.)		24240
2574		
Belt - Fan, Alt. & Hub	1819392C1	▲K080716HD
Belt - Fan, W.P. & Alt.; W/76 1/2" Belt O.C.	1682697C1	▲K080760HD
Belt - Fan, W.P. & Alt.; W/77 7/8" Belt O.C.		▲K080774HD
Belt - Fan & A.C.	1820547C2	▲K060470HD
Tensioner Assy. - Fan, W.P. & Alt.	3515596C1	38514
Tensioner Assy. - A.C.	1814719C1	38511
Tensioner Pulley - Fan, W.P. & Alt.	1687819C91	36091
Tensioner Pulley - A.C.	1814719C1	36091
Hose - Upper - Eng. To Pipe; (2 1/4" I.D.)	1687819C91	24236
Hose - Upper - Pipe To Rad.; (2 1/2" I.D.)		24240
Hose - Lower - Eng. To Pipe; (2 1/2" I.D.)		24240
Hose - Lower - Pipe To Rad.; W/Man. Trans.(2 1/2" I.D.)		24240
2654		
Belt - Fan, W.P. & Alt.; W/76 1/2" Belt O.C.	1682697C1	▲K080760HD
Belt - Fan, W.P. & Alt.; W/77 7/8" Belt O.C.		▲K080774HD
Belt - A.C.	1820547C2	▲K060470HD
Tensioner Assy. - Fan, W.P. & Alt.	3515596C1	38514
Tensioner Assy. - A.C.	1814719C1	38511
Tensioner Pulley - Fan, W.P. & Alt.	1687819C91	36091
Tensioner Pulley - A.C.	1814719C1	36091

▲ Standard Belt Available. See Pages 630-631.

② Two Required.

Belts and Coolant Hose for Medium/Heavy-Duty Trucks (1996 and Newer)

 Medium & Heavy-Duty Trucks
(1996 & Newer)

Application	Mfr. Part No.	Our No.
INTERNATIONAL/NAVISTAR - Continued		
1997 - Continued		
International/Navistar 530 Diesel - Continued		
2654 - Continued		
Hose - Upper - Eng. To Pipe; (2 1/4" I.D.)		24236
Hose - Upper - Pipe To Rad.; (2 1/2" I.D.)		24240
Hose - Lower - Eng. To Pipe; (2 1/2" I.D.)		24240
Hose - Lower - Pipe To Rad.; W/Man. Trans.(2 1/2" I.D.)		24240
2674		
Belt - Fan, Alt. & Hub	1819392C1	♣K080716HD
Belt - Fan, W.P. & Alt.; W/76 1/2" Belt O.C.	1682697C1	♣K080760HD
Belt - Fan, W.P. & Alt.; W/77 7/8" Belt O.C.	1820547C2	♣K080774HD
Belt - Fan & A.C.	3515596C1	♣K060470HD
Tensioner Assy. - Fan, W.P. & Alt.	1814719C1	38514
Tensioner Assy. - A.C.	1687819C91	38511
Tensioner Pulley - Fan, W.P. & Alt.	1814719C1	36091
Tensioner Pulley - A.C.	1687819C91	36091
Hose - Upper - Eng. To Pipe; (2 1/4" I.D.)		24236
Hose - Upper - Pipe To Rad.; (2 1/2" I.D.)		24240
Hose - Lower - Eng. To Pipe; (2 1/2" I.D.)		24240
Hose - Lower - Pipe To Rad.; W/Man. Trans.(2 1/2" I.D.)		24240
4900		
Belt - Fan, Alt. & Hub	1819392C1	♣K080716HD
Belt - Fan & A.C.	3515596C1	♣K060470HD
Tensioner Assy. - Fan, Alt. & Hub	1830033C1	38514
Tensioner Assy. - Fan & A.C.	1687819C92	38512
Tensioner Pulley - Fan, Alt. & Hub	1830033C1	36091
Tensioner Pulley - Fan & A.C.	1687819C92	36091
Hose - Upper - Eng. To Rad.		22140
Hose - Lower - Eng. To Rad.		♣<21115
8100; 8200		
Belt - Fan, Alt. & Hub; W/72 1/4" Belt O.C.	1682692C1	♣K080720HD
Belt - Fan, Alt. & Hub; W/73 1/4" Belt O.C.	1819391C1	♣K080730HD
Belt - Fan, Alt. & Hub; W/76 1/4" Belt O.C.	1692697C1	♣K080760HD
Belt - A.C.	1687797C1	♣K060470HD
Tensioner Assy. - Fan, Alt. & Hub	1830033C1	38514
Tensioner Assy. - A.C.	1687819C91	38511
Tensioner Pulley - Fan, Alt. & Hub	1830033C1	36091
Tensioner Pulley - A.C.	1687819C91	36091
Hose - Upper - Eng. To Pipe; (2 1/4" I.D.)		24236
Hose - Upper - Pipe To Rad.; (2 1/2" I.D.)		24240
Hose - Lower - Eng. To Pipe; (2 1/2" I.D.)		24240
Hose - Lower - Pipe To Rad.; (2 1/2" I.D.)		24240
International/Navistar DT408 Diesel		
4700; 4800; 4900		
Belt - Fan & Alt.; W/O P.T.O.	1822500C1	♣K080740HD
Belt - Fan & Alt.; W/P.T.O.	1819988C2	♣K080745HD
Belt - A.C.	1667797C1	♣K060470HD
Tensioner Assy. - Fan & Alt.	1830033C1	38514
Tensioner Assy. - A.C.	1687819C91	38511
Tensioner Pulley - Fan & Alt.	1830033C1	36091
Tensioner Pulley - A.C.	1687819C91	36091
Hose - Upper		22140
Hose - Lower		♣<21891
Hose - Coolant Reservoir; (1" I.D.)		24216
Hose - Heater Inlet; (3/4" I.D.)		28442
Hose - Heater Outlet; (3/8" I.D.)		28409
International/Navistar DT466 Diesel		
2554; 2654		
Belt - Fan, Alt. & Hub; W/76 1/2" Belt O.C.	1682697C1	♣K080760HD
Belt - Fan, Alt. & Hub; W/77 7/8" Belt O.C.	1820547C1	♣K080774HD
Belt - Fan & A.C.	3517822C1	♣K060478HD
Belt - A.C.	3515596C1	♣K060470HD
Tensioner Assy. - Fan, Alt. & Hub	1830033C1	38514
Tensioner Assy. - A.C.	1687819C91	38511
Tensioner Pulley - Fan, Alt. & Hub	1830033C1	36091

Application	Mfr. Part No.	Our No.
INTERNATIONAL/NAVISTAR - Continued		
1997 - Continued		
International/Navistar DT466 Diesel - Continued		
2554; 2654 - Continued		
Tensioner Pulley - A.C.	1687819C91	36091
Hose - Upper - Eng. To Pipe; (2 1/4" I.D.)		24236
Hose - Upper - Pipe To Rad.; (2 1/2" I.D.)		24240
Hose - Lower - Eng. To Pipe; (2 1/2" I.D.)		24240
Hose - Lower - Pipe To Rad.; (2 1/2" I.D.)		24240
4700; 4800		
Belt - Fan & Alt.; W/P.T.O.; W/1.2 To 1 Fan Ratio	1819391C1	♣K080730HD
Belt - Fan & Alt.; W/P.T.O.; W/Mechanical Eng.; W/1.08 To 1 Fan Ratio	1682696C1	♣K080738HD
Belt - Fan & Alt.; W/P.T.O.; W/Electronic Eng.; W/1.08 To 1 Fan Ratio	1820547C2	♣K080774HD
Belt - Fan & Alt.; W/O P.T.O.	1822503C1	♣K080726HD
Belt - A.C.	1687797C1	♣K060470HD
Tensioner Assy. - Fan & Alt.	1814719C1	38514
Tensioner Assy. - Fan To A.C.	1687819C91	38511
Tensioner Pulley - Fan & Alt.	1814719C1	36091
Tensioner Pulley - Fan To A.C.	1687819C91	36091
Hose - Upper - Eng. To Rad.		21765
Hose - Lower - Eng. To Pipe		21842
Hose - Lower - Pipe To Rad.		21115
Hose - Lower - Eng. To Rad.		♣<21115
4900		
Belt - Fan & Alt.; W/P.T.O.; W/1.2 To 1 Fan Ratio	1819391C1	♣K080730HD
Belt - Fan & Alt.; W/P.T.O.; W/Mechanical Eng.; W/1.08 To 1 Fan Ratio	1682696C1	♣K080738HD
Belt - Fan & Alt.; W/P.T.O.; W/Electronic Eng.; W/1.08 To 1 Fan Ratio	1820547C2	♣K080774HD
Belt - Fan & Alt.; W/O P.T.O.	1822503C1	♣K080726HD
Belt - A.C.	1687797C1	♣K060470HD
Tensioner Assy. - Fan & Alt.	1814719C1	38514
Tensioner Assy. - Fan To A.C.	1687819C91	38511
Tensioner Pulley - Fan & Alt.	1814719C1	36091
Tensioner Pulley - Fan To A.C.	1687819C91	36091
Hose - Upper - Eng. To Rad.		21765
Hose - Lower - Eng. To Pipe		21842
Hose - Lower - Pipe To Rad.		21115
Hose - Lower - Eng. To Rad.		21115
8100		
Belt - Fan & Alt.; W/250 H.P. Eng.	1820547C2	♣K080774HD
Belt - Alt.; W/73" Belt O.C.	1819391C1	♣K080730HD
Belt - Alt.; W/74 1/2" Belt O.C.	1819988C2	♣K080745HD
Belt - A.C.	1687797C1	♣K060470HD
Tensioner Assy. - Fan & Alt.	1814719C1	38514
Tensioner Assy. - A.C.	1687819C91	38511
Tensioner Pulley - Fan & Alt.	1814719C1	36091
Tensioner Pulley - A.C.	1687819C91	36091
Hose - Upper - Eng. To Pipe; (2 1/4" I.D.)		24236
8200		
Serpentine Belt; W/72 1/4" Belt O.C.	1682692C1	♣K080720HD
Serpentine Belt; W/73 1/4" Belt O.C.	1819391C1	♣K080730HD
Serpentine Belt; W/76 1/4" Belt O.C.	1692697C1	♣K080760HD
Belt - A.C.	1687797C1	♣K060470HD
Tensioner Assy. - Fan, Alt. & Hub	1830033C1	38514
Tensioner Assy. - A.C.	1687819C91	38511
Tensioner Pulley - Fan, Alt. & Hub	1830033C1	36091
Tensioner Pulley - A.C.	1687819C91	36091
Hose - Upper - Eng. To Pipe; (2 1/4" I.D.)		24236
Hose - Upper - Pipe To Rad.; (2 1/2" I.D.)		24240
Hose - Lower - Eng. To Pipe; (2 1/2" I.D.)		24240
Hose - Lower - Pipe To Rad.; (2 1/2" I.D.)		24240
International/Navistar T444 Diesel		
1652 SC		
Belt - Fan & Alt.	1803209C1	♣7575
Belt - Fan & Air Brake Compr.	446951C91	♣♣9585HD
Idler Pulley; W/Flat Idler Pulley	1822652C91	36287

♣ Standard Belt Available. See Pages 630-631.
♣♣ Two Required.

♣< Cut to Fit.

Belts and Coolant Hose for Medium/Heavy-Duty Trucks (1996 and Newer)

Medium & Heavy-Duty Trucks
(1996 & Newer)

Application	Mfr. Part No.	Our No.
INTERNATIONAL/NAVISTAR - Continued		
1997 - Continued		
International/Navistar T444 Diesel - Continued		
1652 SC - Continued		
Idler Pulley: W/V-Groove Idler Pulley ...	1822653C91	36288
Hose - Upper		21896
Hose - Lower		21893
4700; 4800; 4900		
Belt - W.P., Fan & Alt.; W/O Air Brake		
Compr.: W/Schwitzer Fan Clutch	1821840C1	▲K080922HD
Belt - W.P., Fan & Alt.; W/Air Brake		
Compr.: W/Schwitzer Fan Clutch	1821850C1	▲K081102HD
Belt - W.P., Fan, Alt. & A.C.; W/O Air		
Brake Compr.: W/Schwitzer Fan		
Clutch	1821839C1	▲K081035HD
Belt - W.P., Fan, Alt. & A.C.; W/Air		
Brake Compr.: W/Schwitzer Fan		
Clutch	1821843C1	▲K081223HD
Belt - W.P., Fan & Alt.; W/O Air Brake		
Compr.: W/O Schwitzer Fan Clutch ..	1822830C1	▲K080893HD
Belt - W.P., Fan & Alt.; W/Air Brake		
Compr.: W/O Schwitzer Fan Clutch ..	1822832C1	▲K081124HD
Belt - W.P., Fan, Alt. & A.C.; W/O Air		
Brake Compr.: W/O Schwitzer Fan		
Clutch	1822831C2	▲K081000HD
Belt - W.P., Fan, Alt. & A.C.; W/Air		
Brake Compr.: W/O Schwitzer Fan		
Clutch	1822833C1	▲K081265HD
Tensioner Assy.	1822679C3	38510
Idler Pulley: W/Flat Idler Pulley	1822652C91	36287
Idler Pulley: W/V-Groove Idler Pulley ...	1822653C91	36288
Hose - Upper - Eng. To Rad.		22159
Hose - Lower - Eng. To Pipe		22671
Hose - Lower - Pipe To Rad.		20172
1996		
Caterpillar 3176 Diesel		
8100		
Belt - Fan & Alt.; W/Bendix		
Westinghouse Fan Clutch	1682693C1	▲K080708HD
Belt - Fan & Alt.; W/Horton, Kysor Fan		
Clutch	1514968C1	▲K080774HD
Belt - Fan & Alt.; W/Schwitzer Fan		
Clutch	1682692C1	▲K080720HD
Belt - Fan & A.C.	1514968C1	▲K080774HD
Belt - A.C.	149635R2	▲9463HD
Tensioner Assy. - Fan & Alt.	1333542	38514
Tensioner Pulley	1333542	36091
Hose - Upper - Eng. To Pipe; (2 1/2" I.D.)		24240
Hose - Upper - Rad. To Pipe		21135
Hose - Lower - Eng. To Rad.		21135
Hose - Lower - Rad. To Pipe		21115
Caterpillar 3406 Diesel		
9200		
Belt - Fan & Alt.	2018284C1	▲K100771HD
Belt - A.C.	2005148C1	▲K060500HD
Hose - Upper - Eng. To Pipe; (2 1/2" I.D.)		24240
Hose - Upper - Pipe To Rad.; (2 1/2" I.D.)		24240
Hose - Lower - Eng. To Pipe; (3" I.D.)		24248
Hose - Lower - Pipe To Rad.; (2 1/2" I.D.)		24240
9300		
Belt - Fan & Alt.	2020036C1	▲K100852HD
Belt - A.C.	2009861C1	▲K060425HD
Hose - Upper - Eng. To Pipe; (2 1/2" I.D.)		24240
Hose - Upper - Pipe To Rad.; (2 1/2" I.D.)		24240
Hose - Lower - Eng. To Pipe; (3" I.D.)		24248
Hose - Lower - Pipe To Rad.; (2 1/2" I.D.)		24240
9400		
Belt - Fan & Alt.	2018284C1	▲K100771HD
Belt - A.C.	2005148C1	▲K060500HD
Hose - Upper - Eng. To Pipe; (2 1/2" I.D.)		24240
Hose - Upper - Pipe To Rad.; (2 1/2" I.D.)		24240
Hose - Lower - Eng. To Pipe; (3" I.D.)		24248

Application	Mfr. Part No.	Our No.
INTERNATIONAL/NAVISTAR - Continued		
1996 - Continued		
Caterpillar 3406 Diesel - Continued		
9400 - Continued		
Hose - Lower - Pipe To Rad.; (2 1/2" I.D.)		24240
Caterpillar C10 Diesel		
9200; 9300; 9400		
Belt - Fan & Alt.	1682692C1	▲K080720HD
Belt - Fan & A.C.; Optional Belt		②▲9463HD
Belt - Fan & A.C.; Preferred Belt	149635R2	2/9463PB
Hose - Upper - Eng. To Pipe		21135
Hose - Upper - Pipe To Rad.; (2 1/2" I.D.)		24240
Hose - Lower - Eng. To Pipe		21891
Hose - Lower - Rad. To Pipe		21135
Caterpillar C12 Diesel		
9200; 9300; 9400		
Belt - Fan & Alt.	1682692C1	▲K080720HD
Belt - Fan & A.C.; Optional Belt		②▲9463HD
Belt - Fan & A.C.; Preferred Belt	149635R2	2/9463PB
Hose - Upper - Eng. To Pipe		21135
Hose - Upper - Pipe To Rad.; (2 1/2" I.D.)		24240
Hose - Lower - Eng. To Pipe		21891
Hose - Lower - Rad. To Pipe		21135
Cummins L10 Diesel		
2574; 2674		
Belt - Fan; W/57 3/4" Belt O.C.	1609665C1	▲K080570HD
Belt - Fan; W/61 1/8" Belt O.C.	1648750C1	▲K080605HD
Belt - Alt.; W/32 7/8" Belt O.C.	2036266C1	▲K050323HD
Belt - Alt.; W/34 1/2" Belt O.C.	586452C1	▲K050336HD
Belt - A.C.; W/11/16" Belt T.W.	2016338C1	TR22485
Belt - A.C.; W/31/64" Belt T.W.	865196R2	▲9485HD
Hose - Upper - Eng. To Pipe; (2 1/4" I.D.)		24236
Hose - Upper - Pipe To Rad.; (2 1/2" I.D.)		24240
Hose - Lower - Eng. To Pipe; (2 1/2" I.D.)		24240
Hose - Lower - Pipe To Rad.; (2 1/2" I.D.)		24240
5000		
Belt - Fan	1648750C1	▲K080605HD
Belt - Alt.	586452C1	▲K050336HD
Hose - Upper - Eng. To Pipe; (2 1/4" I.D.)		24236
Hose - Upper - Pipe To Rad.; (2 1/4" I.D.)		24236
Hose - Lower - Eng. To Pipe; (2 1/2" I.D.)		24240
Hose - Lower - Pipe To Rad.; (2 1/2" I.D.)		24240
8100		
Belt - Fan	1671408C1	▲K080496HD
Belt - Alt.	586452C1	▲K050336HD
Belt - A.C.	2016338C1	TR22485
Hose - Upper - Eng. To Pipe		21372
Hose - Upper - Rad. To Pipe; (2 1/4" I.D.)		24236
Hose - Lower - Eng. To Pipe; (2 1/2" I.D.)		24240
Hose - Lower - Rad. To Pipe; (2 1/2" I.D.)		24240
8200		
Belt - Fan	1609665C1	▲K080570HD
Belt - Alt.	586452C1	▲K050336HD
Belt - A.C.	2016338C1	TR22485
Hose - Upper - Eng. To Pipe; (2 1/4" I.D.)		24236
Hose - Upper - Pipe To Rad.; (2 1/2" I.D.)		24240
Hose - Lower - Eng. To Pipe; (2 1/2" I.D.)		24240
Hose - Lower - Pipe To Rad.; (2 1/2" I.D.)		24240
Cummins M11 Diesel		
2574; 2674		
Belt - Fan; W/57 1/2" Belt O.C.	1609665C1	▲K080570HD
Belt - Fan; W/61 1/8" Belt O.C.	1648750C1	▲K080605HD
Belt - Alt.; W/32 7/8" Belt O.C.	2036266C1	▲K050323HD
Belt - Alt.; W/34 1/4" Belt O.C.	586452C1	▲K050336HD
Belt - A.C.; W/11/16" Belt T.W.	2016338C1	TR22485
Belt - A.C.; W/31/64" Belt T.W.	865196R2	▲9485HD
Hose - Upper - Eng. To Pipe; (2 1/2" I.D.)		24240
Hose - Upper - Rad. To Pipe		21372
Hose - Lower - Eng. To Rad.; (2 1/2" I.D.)		24240
Hose - Lower - Rad. To Pipe; (2 1/2" I.D.)		24240

▲ Standard Belt Available. See Pages 630-631.

② Two Required.

Belts and Coolant Hose for Medium/Heavy-Duty Trucks (1996 and Newer)

 Medium & Heavy-Duty Trucks
(1996 & Newer)

Application	Mfr. Part No.	Our No.
INTERNATIONAL/NAVISTAR - Continued		
1996 - Continued		
Cummins M11 Diesel - Continued		
5000		
Belt - Fan	1648750C1	♣K080605HD
Belt - Alt.	586452C1	♣K050336HD
Belt - A.C.	2016339C1	TR22525
Hose - Upper - Eng. To Pipe; (2 1/2" I.D.)		24240
Hose - Upper - Pipe To Rad.; (2 1/2" I.D.)		24240
Hose - Lower - Eng. To Pipe; (2 1/2" I.D.)		24240
Hose - Lower - Pipe To Rad.; (2 1/2" I.D.)		24240
8100		
Belt - Fan	1648750C1	♣K080605HD
Belt - Alt.	586452C1	♣K050336HD
Belt - A.C.	2016338C1	TR22485
Hose - Upper - Eng. To Pipe; (2 1/4" I.D.)		24236
Hose - Upper - Pipe To Rad.		♣<21135
Hose - Lower - Eng. To Pipe; (2 3/8" I.D.)		24238
Hose - Lower - Pipe To Rad.		♣<21135
Hose - Lower - Pipe To Pipe; (2 1/2" I.D.)		24240
Hose - Heater Inlet; (3/4" I.D.)		28442
Hose - Heater Outlet; (5/8" I.D.)		28441
8200		
Belt - Fan	1648750C1	♣K080605HD
Belt - Alt.	586452C1	♣K050336HD
Belt - A.C.	2016338C1	TR22485
Hose - Upper - Eng. To Pipe; (2 1/2" I.D.)		24240
Hose - Upper - Pipe To Rad.		♣<21135
Hose - Lower - Eng. To Pipe; (2 1/2" I.D.)		24240
Hose - Lower - Pipe To Rad.		♣<21135
Hose - Lower - Pipe To Pipe; (2 1/2" I.D.)		24240
Hose - Heater Inlet; (3/4" I.D.)		28442
Hose - Heater Outlet; (5/8" I.D.)		28441
9200; 9300; 9400		
Belt - Fan	1648750C1	♣K080605HD
Belt - Alt.	586452C1	♣K050336HD
Belt - A.C.	2016338C1	TR22485
Hose - Upper - Eng. To Pipe; (2 1/2" I.D.)		24240
Hose - Upper - Pipe To Rad.; (2 1/2" I.D.)		24240
Hose - Lower - Eng. To Pipe; (2 1/2" I.D.)		24240
Hose - Lower - Pipe To Rad.; (2 1/2" I.D.)		24240
9600; 9700		
Belt - W.P. & Alt.	2040924C1	K050415
Belt - Fan	1651399C1	♣K080565HD
Belt - A.C.	586328C1	TR22570
Hose - Upper - Eng. To Pipe; (2 1/2" I.D.)		24240
Hose - Upper - Pipe To Rad.; (2 1/2" I.D.)		24240
Hose - Lower - Eng. To Pipe; (2 1/2" I.D.)		24240
Hose - Lower - Pipe To Rad.; (2 1/2" I.D.)		24240
Cummins N14 Diesel		
2574; 2674		
Belt - Fan	479577C1	②TR28522
Belt - W.P.		♣K060425HD
Belt - Alt.	598183C1	②♣♣9447HD
Belt - A.C.	196666R1	♣9405HD
Hose - Upper - Eng. To Pipe; (2 1/2" I.D.)		24240
Hose - Upper - Pipe To Rad.; (2 1/2" I.D.)		24240
Hose - Lower - Eng. To Pipe; (2 1/2" I.D.)		24240
Hose - Lower - Pipe To Rad.; (2 1/2" I.D.)		24240
Hose - Coolant Reservoir; (1" I.D.)		24216
5000		
Belt - W.P.; W/43 1/8" Belt O.C.	3076492	♣K060425HD
Belt - W.P.; W/44 1/8" Belt O.C.	217638	♣K060435HD
Belt - Fan	479577C1	TR28522
Belt - Alt.	598183C1	2/9447PB
Belt - A.C.	441695C1	♣9430HD
Hose - Upper - Eng. To Pipe; (2 1/2" I.D.)		24240
Hose - Lower - Eng. To Pipe; (2 1/2" I.D.)		24240
Hose - Lower - Pipe To Rad.; (2 1/2" I.D.)		24240
8100; 8200		
Belt - W.P.; W/4-Ribbed Belt	3063024	♣K040425HD
Belt - W.P.; W/6-Ribbed Belt	217638	♣K060435HD

♣ Standard Belt Available. See Pages 630-631.
② Two Required.

Application	Mfr. Part No.	Our No.
INTERNATIONAL/NAVISTAR - Continued		
1996 - Continued		
Cummins N14 Diesel - Continued		
8100; 8200 - Continued		
Belt - Fan; W/Bendix Fan Clutch		②TR28522
Belt - Fan; W/Celect Eng.; W/Horton Fan Clutch		②TR28522
Belt - Fan; W/Slep Timing Control Eng.; W/Horton Fan Clutch		②TR28522
Belt - Fan; W/Horton Fan Clutch; W/B-W Air Brake Compr.		②TR28501
Belt - Fan; W/Horton Fan Clutch; W/O Compr.		②TR28510
Belt - Fan; W/Kysor Fan Clutch; W/30" Fan Dia.		②TR28514
Belt - Fan; W/Kysor Fan Clutch; W/28" Fan Dia.		②TR28522
Belt - Alt.	598183C1	②♣♣9447HD
Belt - A.C. To Alt.	178436	TR22358
Belt - A.C.; W/Eaton A.C. Compr.; W/R134 Coolant	441695C1	♣9430HD
Hose - Upper - Eng. To Pipe; (2 1/4" I.D.)		24236
Hose - Upper - Pipe To Rad.; (2 1/2" I.D.)		24240
Hose - Lower - Eng. To Pipe; (2 1/2" I.D.)		24240
Hose - Lower - Pipe To Rad.		21891
9200		
Belt - W.P.; W/43 3/8" Belt O.C.; Conv.		♣K040430HD
Belt - Fan; W/47 7/8" Belt O.C.; Preferred Belt	1686803C1	2/TR28473PB
Belt - Fan; W/47 7/8" Belt O.C.; Optional Belt	1686803C1	②TR28473
Belt - Fan; W/48 5/8" Belt O.C.; Preferred Belt	543042C1	2/TR28480PB
Belt - Fan; W/48 5/8" Belt O.C.; Optional Belt	543042C1	②TR28480
Belt - Fan; W/49 5/8" Belt O.C.; Preferred Belt; Conv.	488674C91	2/TR28492PB
Belt - Fan; W/49 5/8" Belt O.C.; Optional Belt; Conv.		②TR28492
Belt - Fan; W/55 5/8" Belt O.C.	128805HA	TR28550
Belt - Fan; W/57 1/8" Belt O.C.	1688196C1	TR28565
Belt - Fan; W/Bendix, Facet, Kysor Fan Clutch; Conv.	479331C91	TR28510
Belt - Fan; W/Rockford Fan Clutch; Conv.	479579C91	TR28522
Belt - Alt.; W/44 3/8" Belt O.C.; Conv.	398601C91	♣9440HD
Belt - Alt.; W/44 7/8" Belt O.C.; Preferred Belt	598183C1	2/9447PB
Belt - Alt.; W/44 7/8" Belt O.C.; Optional Belt		②♣9447HD
Belt - Alt.; W/46 3/8" Belt O.C.; Preferred Belt	447499C91	2/9463PB
Belt - Alt.; W/46 3/8" Belt O.C.; Optional Belt		②♣9463HD
Belt - A.C.; W/40 7/8" Belt O.C.	196666R1	♣9405HD
Belt - A.C.; W/42" Belt O.C.; Conv.	288202C2	♣9412HD
Belt - A.C.; W/Tecumseh, York A.C. Compr.; Preferred Belt	441697C91	2/9430PB
Belt - A.C.; W/Tecumseh, York A.C. Compr.; Optional Belt		②♣9430HD
Belt - A.C. - Compr. To Compr.; W/Dual Comprs.	597225C91	♣9330HD
Hose - Upper - Eng. To Pipe; (2 1/2" I.D.)		24240
Hose - Upper - Pipe To Rad.; (2 1/2" I.D.)		24240
Hose - Lower - Eng. To Pipe; (2 1/2" I.D.)		24240
Hose - Lower - Pipe To Rad.; (2 1/2" I.D.)		24240
9400		
Belt - Fan; W/Bendix, Facet, Kysor, Westinghouse Fan Clutch	479331C91	②TR28510
Belt - Fan; W/Evans, Horton, Rockford Fan Clutch	575819C91	②TR28514
Belt - Alt.		②♣9447HD
Belt - W.P.	3076492	♣K060425HD
Belt - A.C.		②♣9405HD
9600; 9700		
Belt - W.P.; W/42 7/8" Belt O.C.; W/4-Ribbed Belt		♣K040425HD
Belt - W.P.; W/43 1/8" Belt O.C.; W/6-Ribbed Belt	3076492	♣K060425HD
Belt - W.P.; W/44 1/8" Belt O.C.; W/6-Ribbed Belt	217638	♣K060435HD
Belt - Fan; W/43 1/2" Belt O.C.; Preferred Belt	488674C1	2/TR28492PB

♣ Cut to Fit.
◆ Green Stripe® PowerBand® Belt May Work, Use Template to Check.

Belts and Coolant Hose for Medium/Heavy-Duty Trucks [1996 and Newer]

Medium & Heavy-Duty Trucks
(1996 & Newer)

Application	Mfr. Part No.	Our No.
INTERNATIONAL/NAVISTAR - Continued		
1996 - Continued		
Cummins N14 Diesel - Continued		
9600; 9700 - Continued		
Belt - Fan; W/51 1/8" Belt O.C.	482145C1	TR28498
Belt - Fan; W/Evans, Horton, Rockford Fan Clutch	575819C91	TR28514
Belt - Alt.	1609082C91	▲9420HD
Belt - A.C.; W/43 3/8" Belt O.C.	441695C1	▲9430HD
Belt - A.C.; W/Dual Compr.; Preferred Belt	355719C91	2/9470PB
Belt - A.C.; W/Dual Compr.; Optional Belt		②▲9470HD
Belt - A.C.; W/Ogura A.C. Compr.	143441R2	▲9420HD
Hose - Upper - Eng. To Pipe; (2 1/2" I.D.)		24240
Hose - Upper - Pipe To Rad.; (2 1/2" I.D.)		24240
Hose - Lower - Eng. To Pipe; (2 1/2" I.D.)		24240
Hose - Lower - Pipe To Rad.; (2 1/2" I.D.)		24240
Detroit Diesel 6-Cyl. 11.1 L Diesel		
9200		
Belt - Fan	2038371C1	▲K100637HD
Belt - Alt.		②▲9313HD
Belt - A.C.	1830641C2	▲K060490HD
Tensioner Assy. - Fan	1687801C91	38519
Tensioner Pulley - Fan	1687801C91	36092
9300		
Belt - Fan; W/56 7/8" Belt O.C.	3503813C1	▲K100570HD
Belt - Fan; W/64 5/8" Belt O.C.	2038371C1	▲K100640HD
Belt - Alt.; W/V-Ribbed Belt	3505387C1	K060450
Belt - Alt.; W/V-Belt Drive	284583C2	2/9313PB
Belt - A.C.	2017725C1	▲K060490HD
Hose - Upper - Eng. To Pipe; (2 1/2" I.D.)		24240
Hose - Upper - Pipe To Rad.; (2 1/2" I.D.)		24240
Hose - Lower - Eng. To Pipe; (2 1/2" I.D.)		24240
Hose - Lower - Pipe To Rad.; (2 1/2" I.D.)		24240
9400		
Belt - Fan; W/57 1/2" Belt O.C.	3503813C1	▲K100570HD
Belt - Fan; W/64 1/4" Belt O.C.	2038371C1	▲K100637HD
Belt - Fan; W/64 5/8" Belt O.C.	2012260C1	▲K100640HD
Belt - Alt.; W/V-Belt Drive; Preferred Belt	284583C2	2/9313PB
Belt - Alt.; W/V-Belt Drive; Optional Belt		②▲9313HD
Belt - Alt.; W/V-Ribbed Belt Drive	3505387C1	▲K060455HD
Belt - A.C.	2017725C1	▲K060490HD
Tensioner Assy. - Fan	1687801C91	38519
Tensioner Pulley - Fan	1687801C91	36092
Hose - Upper - Eng. To Pipe; (2 1/2" I.D.)		24240
Hose - Upper - Pipe To Rad.; (2 1/2" I.D.)		24240
Hose - Lower - Eng. To Pipe; (2 1/2" I.D.)		24240
Hose - Lower - Pipe To Rad.; (2 1/2" I.D.)		24240
9600; 9700		
Belt - Fan; W/54 1/2" Belt O.C.	1687800C1	▲K100540HD
Belt - Fan; W/61 1/4" Belt O.C.	1687798C1	▲K100607HD
Belt - Alt.; W/V-Belt Drive; Preferred Belt	284583C2	2/9313PB
Belt - Alt.; W/V-Belt Drive; Optional Belt		②▲9313HD
Belt - Alt.; W/V-Ribbed Belt Drive	3505387C1	▲K060455HD
Belt - A.C.; W/47 1/2" Belt O.C.	1687797C1	▲K060470HD
Tensioner Assy. - Fan	1687801C91	38519
Tensioner Pulley - Fan	1687801C91	36092
Hose - Upper - Eng. To Pipe; (2 1/2" I.D.)		24240
Hose - Upper - Pipe To Rad.; (2 1/2" I.D.)		24240
Hose - Lower - Eng. To Pipe; (2 1/2" I.D.)		24240
Hose - Lower - Pipe To Rad.; (2 1/2" I.D.)		24240
Detroit Diesel 6-Cyl. 12.7 L Diesel		
9200		
Belt - Fan	2038371C1	▲K100637HD
Belt - Alt.		②▲9313HD
Belt - A.C.	1830641C2	▲K060490HD
Tensioner Assy. - Fan	1687801C91	38519
Tensioner Pulley - Fan	1687801C91	36092
9300		
Belt - Fan; W/56 7/8" Belt O.C.	3503813C1	▲K100570HD
Belt - Fan; W/64 5/8" Belt O.C.	2038371C1	▲K100640HD
Belt - Alt.; W/V-Ribbed Belt	3505387C1	K060450

Application	Mfr. Part No.	Our No.
INTERNATIONAL/NAVISTAR - Continued		
1996 - Continued		
Detroit Diesel 6-Cyl. 12.7 L Diesel - Continued		
9300 - Continued		
Belt - Alt.; W/V-Belt Drive	284583C2	2/9313PB
Belt - A.C.	2017725C1	▲K060490HD
Hose - Upper - Eng. To Pipe; (2 1/2" I.D.)		24240
Hose - Upper - Pipe To Rad.; (2 1/2" I.D.)		24240
Hose - Lower - Eng. To Pipe; (2 1/2" I.D.)		24240
Hose - Lower - Pipe To Rad.; (2 1/2" I.D.)		24240
9400		
Belt - Fan; W/57 1/2" Belt O.C.	3503813C1	▲K100570HD
Belt - Fan; W/64 1/4" Belt O.C.	2038371C1	▲K100637HD
Belt - Fan; W/64 5/8" Belt O.C.	2012260C1	▲K100640HD
Belt - Alt.; W/V-Belt Drive; Preferred Belt	284583C2	2/9313PB
Belt - Alt.; W/V-Belt Drive; Optional Belt		②▲9313HD
Belt - Alt.; W/V-Ribbed Belt Drive	3505387C1	▲K060455HD
Belt - A.C.	2017725C1	▲K060490HD
Tensioner Assy. - Fan	1687801C91	38519
Tensioner Pulley - Fan	1687801C91	36092
Hose - Upper - Eng. To Pipe; (2 1/2" I.D.)		24240
Hose - Upper - Pipe To Rad.; (2 1/2" I.D.)		24240
Hose - Lower - Eng. To Pipe; (2 1/2" I.D.)		24240
Hose - Lower - Pipe To Rad.; (2 1/2" I.D.)		24240
9700		
Belt - Fan; W/54 1/2" Belt O.C.	1687800C1	▲K100540HD
Belt - Fan; W/61 1/4" Belt O.C.	1687798C1	▲K100607HD
Belt - Alt.; W/V-Belt Drive; Preferred Belt	284583C2	2/9313PB
Belt - Alt.; W/V-Belt Drive; Optional Belt		②▲9313HD
Belt - Alt.; W/V-Ribbed Belt Drive	3505387C1	▲K060455HD
Belt - A.C.; W/47 1/2" Belt O.C.	1687797C1	▲K060470HD
Tensioner Assy. - Fan	1687801C91	38519
Tensioner Pulley - Fan	1687801C91	36092
Hose - Upper - Eng. To Pipe; (2 1/2" I.D.)		24240
Hose - Upper - Pipe To Rad.; (2 1/2" I.D.)		24240
Hose - Lower - Eng. To Pipe; (2 1/2" I.D.)		24240
Hose - Lower - Pipe To Rad.; (2 1/2" I.D.)		24240
International/Navistar 530 Diesel		
2554; 2574; 2654; 2674		
Belt - Fan, W.P. & Alt.; W/76 1/2" Belt O.C.	1682697C1	▲K080760HD
Belt - Fan, W.P. & Alt.; W/77 7/8" Belt O.C.	1820547C2	▲K080774HD
Belt - A.C.	3515596C1	▲K060470HD
Tensioner Assy. - Fan, W.P. & Alt.	1814719C1	38514
Tensioner Assy. - A.C.	1687819C91	38511
Tensioner Pulley - Fan, W.P. & Alt.	1814719C1	36091
Tensioner Pulley - A.C.	1687819C91	36091
Hose - Upper - Eng. To Pipe; (2 1/4" I.D.)		24236
Hose - Upper - Pipe To Rad.; (2 1/2" I.D.)		24240
Hose - Lower - Eng. To Pipe; (2 1/2" I.D.)		24240
Hose - Lower - Pipe To Rad.; W/Man. Trans. (2 1/2" I.D.)		24240
4900		
Belt - Fan, Alt. & Hub	1819392C1	▲K080716HD
Belt - Fan & A.C.	3515596C1	▲K060470HD
Tensioner Assy. - Fan, Alt. & Hub	1830033C1	38514
Tensioner Assy. - Fan & A.C.	1687819C92	38512
Tensioner Pulley - Fan, Alt. & Hub	1830033C1	36091
Tensioner Pulley - Fan & A.C.	1687819C92	36091
Hose - Upper - Eng. To Rad.		22140
Hose - Lower - Eng. To Rad.		≈21115
8100; 8200		
Belt - Fan, Alt. & Hub; W/72 1/4" Belt O.C.	1682692C1	▲K080720HD
Belt - Fan, Alt. & Hub; W/73 1/4" Belt O.C.	1819391C1	▲K080730HD
Belt - Fan, Alt. & Hub; W/76 1/4" Belt O.C.	1692697C1	▲K080760HD
Belt - A.C.	1687797C1	▲K060470HD
Tensioner Assy. - Fan, Alt. & Hub	1830033C1	38514
Tensioner Assy. - A.C.	1687819C91	38511
Tensioner Pulley - Fan, Alt. & Hub	1830033C1	36091
Tensioner Pulley - A.C.	1687819C91	36091

▲ Standard Belt Available. See Pages 630-631.
≈ Cut to Fit.

② Two Required.

Belts and Coolant Hose for Medium/Heavy-Duty Trucks (1996 and Newer)

 Medium & Heavy-Duty Trucks
(1996 & Newer)

Application	Mfr. Part No.	Our No.
INTERNATIONAL/NAVISTAR - Continued		
1996 - Continued		
International/Navistar 530 Diesel - Continued		
8100; 8200 - Continued		
Hose - Upper - Eng. To Pipe; (2 1/4" I.D.)		24236
Hose - Upper - Pipe To Rad.; (2 1/2" I.D.)		24240
Hose - Lower - Eng. To Pipe; (2 1/2" I.D.)		24240
Hose - Lower - Pipe To Rad.; (2 1/2" I.D.)		24240
International/Navistar DT466 Diesel		
2554; 2654		
Belt - Fan, Alt. & Hub; W/76 1/2" Belt		
O.C.	1682697C1	♣K080760HD
Belt - Fan, Alt. & Hub; W/77 7/8" Belt		
O.C.	1820547C1	♣K080774HD
Belt - Fan & A.C.	3517822C1	♣K060478HD
Tensioner Assy. - Fan, Alt. & Hub	1830033C1	38514
Tensioner Assy. - Fan & A.C.	1687819C92	38512
Tensioner Pulley - Fan, Alt. & Hub	1830033C1	36091
Tensioner Pulley - Fan & A.C.	1687819C92	36091
Hose - Upper - Eng. To Pipe; (2 1/4" I.D.)		24236
Hose - Upper - Pipe To Rad.; (2 1/2" I.D.)		24240
Hose - Lower - Eng. To Pipe; (2 1/2" I.D.)		24240
Hose - Lower - Pipe To Rad.; (2 1/2" I.D.)		24240
4700		
Belt - Fan & Alt.; W/P.T.O.; W/1.2 To 1		
Fan Ratio	1819391C1	♣K080730HD
Belt - Fan & Alt.; W/P.T.O.;		
W/Mechanical Eng.; W/1.08 To 1		
Fan Ratio	1682696C1	♣K080738HD
Belt - Fan & Alt.; W/P.T.O.; W/Electronic		
Eng.; W/1.08 To 1 Fan Ratio	1820547C2	♣K080774HD
Belt - Fan & Alt.; W/O P.T.O.	1822503C1	♣K080726HD
Belt - Fan To A.C.	1687797C1	♣K060470HD
Tensioner Assy. - Fan & Alt.	1814719C1	38514
Tensioner Assy. - Fan To A.C.	1687819C91	38511
Tensioner Pulley - Fan & Alt.	1814719C1	36091
Tensioner Pulley - Fan To A.C.	1687819C91	36091
Hose - Upper - Eng. To Rad.		21765
Hose - Lower - Eng. To Pipe		21842
Hose - Lower - Pipe To Rad.		21115
4800; 4900		
Belt - Fan & Alt.; W/P.T.O.; W/1.2 To 1		
Fan Ratio	1819391C1	♣K080730HD
Belt - Fan & Alt.; W/P.T.O.;		
W/Mechanical Eng.; W/1.08 To 1		
Fan Ratio	1682696C1	♣K080738HD
Belt - Fan & Alt.; W/P.T.O.; W/Electronic		
Eng.; W/1.08 To 1 Fan Ratio	1820547C2	♣K080774HD
Belt - Fan & Alt.; W/O P.T.O.	1822503C1	♣K080726HD
Belt - Fan To A.C.	1687797C1	♣K060470HD
Tensioner Assy. - Fan & Alt.	1814719C1	38514
Tensioner Assy. - Fan To A.C.	1687819C91	38511
Tensioner Pulley - Fan & Alt.	1814719C1	36091
Tensioner Pulley - Fan To A.C.	1687819C91	36091
Hose - Upper - Eng. To Rad.		21765
Hose - Lower - Eng. To Pipe		21842
Hose - Lower - Pipe To Rad.		21115
Hose - Lower - Eng. To Rad.		21842
8100		
Belt - Fan & Alt.; W/250 H.P. Eng.	1820547C2	♣K080774HD
Belt - Alt.; W/73" Belt O.C.	1819391C1	♣K080730HD
Belt - Alt.; W/74 1/2" Belt O.C.	1819988C2	♣K080745HD
Belt - A.C.	1687797C1	♣K060470HD
Tensioner Assy. - Fan & Alt.	1814719C1	38514
Tensioner Assy. - A.C.	1687819C91	38511
Tensioner Pulley - Fan & Alt.	1814719C1	36091
Tensioner Pulley - A.C.	1687819C91	36091
Hose - Upper - Eng. To Pipe; (2 1/4" I.D.)		24236
International/Navistar T444 Diesel		
1652 SC		
Belt - Fan & Alt.	1803209C1	②7575
Belt - Fan & Air Brake Compr.	446951C91	②♣9585HD
Idler Pulley; W/Flat Idler Pulley	1822652C91	36287

♣ Standard Belt Available. See Pages 630-631.

Application	Mfr. Part No.	Our No.
INTERNATIONAL/NAVISTAR - Continued		
1996 - Continued		
International/Navistar T444 Diesel - Continued		
1652 SC - Continued		
Idler Pulley; W/V-Groove Idler Pulley ...	1822653C91	36288
Hose - Upper		21896
Hose - Lower		21893
4700; 4800; 4900		
Belt - W.P., Fan & Alt.; W/O Air Brake		
Compr.; W/Schwitzer Fan Clutch	1821840C1	♣K080922HD
Belt - W.P., Fan & Alt.; W/Air Brake		
Compr.; W/Schwitzer Fan Clutch	1821850C1	♣K081102HD
Belt - W.P., Fan, Alt. & A.C.; W/O Air		
Brake Compr.; W/Schwitzer Fan		
Clutch	1821839C1	♣K081035HD
Belt - W.P., Fan, Alt. & A.C.; W/Air		
Brake Compr.; W/Schwitzer Fan		
Clutch	1821843C1	♣K081223HD
Belt - W.P., Fan & Alt.; W/O Air Brake		
Compr.; W/O Schwitzer Fan Clutch .	1822830C1	♣K080893HD
Belt - W.P., Fan & Alt.; W/Air Brake		
Compr.; W/O Schwitzer Fan Clutch .	1822832C1	♣K081124HD
Belt - W.P., Fan, Alt. & A.C.; W/O Air		
Brake Compr.; W/O Schwitzer Fan		
Clutch	1822831C2	♣K081000HD
Belt - W.P., Fan, Alt. & A.C.; W/Air		
Brake Compr.; W/O Schwitzer Fan		
Clutch	1822833C1	♣K081265HD
Tensioner Assy.	1822679C3	38510
Idler Pulley; W/Flat Idler Pulley	1822652C91	36287
Idler Pulley; W/V-Groove Idler Pulley ...	1822653C91	36288
Hose - Upper - Eng. To Rad.		22159
Hose - Lower - Eng. To Pipe		22671
Hose - Lower - Pipe To Rad.		20172
ISUZU		
2010		
Isuzu 4HK1-TC Diesel		
NPR		
Belt - Fan & Alt.	8980031870	K070404HD
Belt - A.C.	8980108410	♣9650HD
NQR		
Belt - Fan & Alt.	8980031870	K070404HD
Belt - A.C.	8980108410	②♣9650HD
NRR		
Belt - Fan & Alt.	8980031870	K070404HD
Belt - A.C.	8980108410	♣9650HD
2009		
GM V-8 6.0 L		
NPR		
Belt - A.C.; Installation Tool Required ...	12603509	K040355SF
Belt - Fan, Alt. & P.S.	8980361660	♣K061010HD
Stretch Fit Belt Installation Tool		91030
Tensioner Assy. - Fan, Alt. & P.S.	12609719	39083
Isuzu 4HK1-TC Diesel		
NPR		
Belt - Fan & Alt.	8980031870	K070404HD
Belt - A.C.	8980108410	♣9650HD
NQR		
Belt - Fan & Alt.	98003187	K070404HD
Belt - A.C.	8980108410	②♣9650HD
NRR		
Belt - Fan & Alt.	8980031870	K070404HD
Belt - A.C.	8980108410	♣9650HD
2008		
Isuzu 4HK1-TC Diesel		
NPR		
Belt - Fan & Alt.	8980031870	K070404HD
Belt - A.C.	8980108410	♣9650HD

② Two Required.

Belts and Coolant Hose for Medium/Heavy-Duty Trucks (1996 and Newer)

Medium & Heavy-Duty Trucks
(1996 & Newer)

Application	Mfr. Part No.	Our No.
ISUZU - Continued		
2008 - Continued		
Isuzu 4HK1-TC Diesel - Continued		
NQR		
Belt - Fan & Alt.	98003187	K070404HD
Belt - A.C.	8980108410	②▲9650HD
NRR		
Belt - Fan & Alt.	8980031870	K070404HD
Belt - A.C.	8980108410	▲9650HD
Isuzu 6HK1-TC Diesel		
FTR; FVR		
Belt - Fan, Alt. & A.C.	15065874	▲K080726HD
Tensioner Assy. - Fan, Alt. & A.C.	15098394	38579
Hose - Upper - Eng. To Rad.		22855
2007		
GM V-8 6.0 L		
NPR		
Belt - Fan, Alt. & P.S.	12576754	▲K060994HD
Belt - A.C.	12576447	▲K040378HD
Tensioner Assy. - Alt. & P.S.	12580162	38158
Tensioner Assy. - A.C.	12580196	38159
Tensioner Pulley - Alt. & P.S.	12580162	38009
Hose - Upper - Eng. To Rad.		23098
Hose - Lower - Eng. To Rad.		23097
Isuzu 4HK1-TC Diesel		
NPR		
Belt - Fan & Alt.	8980031870	K070404HD
Belt - A.C.	8980108410	▲9650HD
NQR		
Belt - Fan & Alt.	8971801811	②▲9420HD
Belt - A.C.	8971801832	▲9620HD
Isuzu 6HK1-TC Diesel		
FTR; FVR; FXR		
Belt - Fan, Alt. & A.C.	15065874	▲K080726HD
Tensioner Assy. - Fan, Alt. & A.C.	15098394	38579
Hose - Upper - Eng. To Rad.		22855
Hose - Lower - Eng. To Rad.		22856
HTR; HVR; HXR		
Belt - Fan, Alt. & A.C.	15020893	▲K070786HD
Belt - W.P. & P.S.	97730199	TR22461
Hose - Upper - Eng. To Rad.		22767
Hose - Lower - Eng. To Rad.		22768
2006		
GM V-8 6.0 L		
NPR		
Belt - Fan, Alt. & P.S.	12576754	▲K060994HD
Belt - A.C.	12576447	▲K040378HD
Tensioner Assy. - Alt. & P.S.	12580162	38158
Tensioner Assy. - A.C.	12580196	38159
Tensioner Pulley - Alt. & P.S.	12580162	38009
Hose - Upper - Eng. To Rad.		23098
Hose - Lower - Eng. To Rad.		23097
Isuzu 4HK1-TC Diesel		
NPR; NQR; NRR		
Belt - Fan & Alt.	8971801811	②▲9420HD
Belt - Alt. & A.C.	8971801832	▲9620HD
Hose - Upper - Eng. To Rad.		23096
Hose - Lower - Eng. To Rad.		23095
Isuzu 6HK1-TC Diesel		
FTR; FVR; FXR		
Belt - Fan, Alt. & A.C.	15065874	▲K080726HD
Tensioner Assy. - Fan, Alt. & A.C.	15098394	38579
Hose - Upper - Eng. To Rad.		22855
Hose - Lower - Eng. To Rad.		22856
HTR; HVR; HXR		
Belt - Fan, Alt. & A.C.	15020893	▲K070786HD
Belt - W.P. & P.S.	97730199	TR22461
Hose - Upper - Eng. To Rad.		22767

Application	Mfr. Part No.	Our No.
ISUZU - Continued		
2006 - Continued		
Isuzu 6HK1-TC Diesel - Continued		
HTR; HVR; HXR - Continued		
Hose - Lower - Eng. To Rad.		22768
2005		
GM V-8 6.0 L		
NPR		
Belt - Fan, Alt. & P.S.		▲K060994HD
Belt - A.C.	12576447	▲K040378HD
Tensioner Assy. - Alt. & P.S.	12580162	38158
Tensioner Assy. - A.C.	12580196	38159
Idler Pulley	12580771	36299
Tensioner Pulley - Alt. & P.S.	12580162	38009
Tensioner Pulley - A.C.	12580196	36169
Hose - Upper - Eng. To Rad.		23098
Hose - Lower - Eng. To Rad.		23097
Isuzu 4HK1-TC Diesel		
NPR; NQR; NRR		
Belt - Fan & Alt.	8971801811	②▲9420HD
Belt - Alt. & A.C.	8971801832	▲9620HD
Hose - Upper - Eng. To Rad.		23096
Hose - Lower - Eng. To Rad.		23095
Isuzu 6HK1-TC Diesel		
FTR; FVR; FXR		
Belt - Fan, Alt. & A.C.	15065874	▲K080726HD
Tensioner Assy. - Fan, Alt. & A.C.	15098394	38579
Hose - Upper - Eng. To Rad.		22855
Hose - Lower - Eng. To Rad.		22856
HTR; HVR; HXR		
Belt - Fan, Alt. & A.C.	15020893	▲K070786HD
Belt - W.P. & P.S.	97730199	TR22461
Hose - Upper - Eng. To Rad.		22767
Hose - Lower - Eng. To Rad.		22768
2004		
GM V-8 5.7 L		
NPR		
Belt - Fan, Alt., P.S. & A.C.	8971106400	▲K061010HD
Belt - Fan, Alt. & P.S.	8970427480	▲K061000HD
Tensioner Assy.	8971619590	38528
Hose - Upper - Eng. To Rad.		22731
Hose - Lower - Eng. To Rad.		22732
GM V-8 6.0 L		
NPR		
Belt - Fan, Alt. & P.S.		▲K060994HD
Belt - A.C.	12576447	▲K040378HD
Tensioner Assy. - Alt. & P.S.	12580162	38158
Tensioner Assy. - A.C.	12580196	38159
Idler Pulley	12580771	36299
Tensioner Pulley - Alt. & P.S.	12580162	38009
Tensioner Pulley - A.C.	12580196	36169
Hose - Upper - Eng. To Rad.		23098
Hose - Lower - Eng. To Rad.		23097
Isuzu 4HE1-TC Diesel		
NPR		
Belt - Fan & Alt.	8971801811	②▲9420HD
Belt - Alt. & A.C.	8971801832	▲9620HD
Hose - Upper - Eng. To Rad.		23096
Hose - Lower - Eng. To Rad.		23095
NQR		
Belt - Fan & Alt.	8971801810	②▲9415HD
Belt - Alt. & A.C.	8971801830	▲9610HD
Hose - Upper - Eng. To Rad.		23096
Hose - Lower - Eng. To Rad.		23095
Isuzu 6HK1-TC Diesel		
FRR		
Belt - Fan & Alt.	1136714641	TR22461
Belt - A.C.	8943951720	TR22434

② Two Required.

▲ Standard Belt Available. See Pages 630-631.

Belts and Coolant Hose for Medium/Heavy-Duty Trucks (1996 and Newer)

 Medium & Heavy-Duty Trucks
(1996 & Newer)

Application	Mfr. Part No.	Our No.
ISUZU - Continued		
2004 - Continued		
Isuzu 6HK1-TC Diesel - Continued		
FRR - Continued		
Hose - Upper - Eng. To Rad.		22733
Hose - Lower - Eng. To Rad.		22734
FTR; FVR		
Belt - Fan, Alt. & A.C.	15065874	♣K080726HD
Tensioner Assy. - Fan, Alt. & A.C.	15098394	38579
Hose - Upper - Eng. To Rad.		22855
Hose - Lower - Eng. To Rad.		22856
2003		
GM V-8 5.7 L		
NPR		
Belt - Fan, Alt., P.S. & A.C.	8971106400	♣K061010HD
Belt - Fan, Alt. & P.S.	8970427480	♣K061000HD
Tensioner Assy.	8971619590	38528
Hose - Upper - Eng. To Rad.		22731
Hose - Lower - Eng. To Rad.		22732
GM V-8 6.0 L		
NPR		
Belt - Fan, Alt. & P.S.	973233969	♣K061005HD
Tensioner Assy. - Alt. & P.S.	12580162	38158
Tensioner Assy. - A.C.	12580196	38159
Idler Pulley	12580771	36299
Tensioner Pulley - Alt. & P.S.	12580162	38009
Tensioner Pulley - A.C.	12580196	36169
Hose - Upper - Eng. To Rad.		23098
Hose - Lower - Eng. To Rad.		23097
Isuzu 4HE1-TC Diesel		
NPR		
Belt - Fan & Alt.	8971801811	②♣9420HD
Belt - Alt. & A.C.	8971801832	♣9620HD
Hose - Upper - Eng. To Rad.		23096
Hose - Lower - Eng. To Rad.		23095
NQR		
Belt - Fan & Alt.	8971801810	②♣9415HD
Belt - Alt. & A.C.	8971801830	♣9610HD
Hose - Upper - Eng. To Rad.		23096
Hose - Lower - Eng. To Rad.		23095
Isuzu 6HK1-TC Diesel		
FRR		
Belt - Fan & Alt.	1136714641	TR22461
Belt - A.C.	8943951720	TR22434
Hose - Upper - Eng. To Rad.		22733
Hose - Lower - Eng. To Rad.		22734
FTR; FVR		
Belt - Fan & Alt.	8943951710	TR22461
Belt - A.C.	8943951720	TR22434
Hose - Upper - Eng. To Rad.		22733
Hose - Lower - Eng. To Rad.		22734
2002		
GM V-8 5.7 L		
NPR		
Belt - Fan, Alt., P.S. & A.C.	8971106400	♣K061010HD
Belt - Fan, Alt. & P.S.	8970427480	♣K061000HD
Tensioner Assy.	8971619590	38528
Hose - Upper - Eng. To Rad.		22731
Hose - Lower - Eng. To Rad.		22732
Isuzu 4HE1-TC Diesel		
NPR; NQR		
Belt - Fan & Alt.	8971801810	②♣9415HD
Belt - Alt. & A.C.	8971801830	♣9610HD
Hose - Upper - Eng. To Rad.		23096
Hose - Lower - Eng. To Rad.		23095
Isuzu 6HK1-TC Diesel		
FRR; FSR		
Belt - Fan & Alt.	1136714050	②TR22474

Application	Mfr. Part No.	Our No.
ISUZU - Continued		
2002 - Continued		
Isuzu 6HK1-TC Diesel - Continued		
FRR; FSR - Continued		
Belt - A.C.	8943951720	TR22434
Hose - Upper - Eng. To Rad.		22733
Hose - Lower - Eng. To Rad.		22734
FTR		
Belt - Fan & Alt.	8943951710	TR22461
Belt - A.C.	8943951720	TR22434
Hose - Upper - Eng. To Rad.		22733
Hose - Lower - Eng. To Rad.		22734
FVR		
Belt - Fan & Alt.	1136714050	②TR22474
Belt - A.C.	8943951720	TR22434
Hose - Upper - Eng. To Rad.		22733
Hose - Lower - Eng. To Rad.		22734
2001		
GM V-8 5.7 L		
NPR		
Belt - Fan, Alt., P.S. & A.C.	8971106400	♣K061010HD
Belt - Fan, Alt. & P.S.	8970427480	♣K061000HD
Tensioner Assy.	8971619590	38528
Hose - Upper - Eng. To Rad.		22731
Hose - Lower - Eng. To Rad.		22732
Isuzu 4HE1-TC Diesel		
NPR; NQR		
Belt - Fan & Alt.	8971801810	②♣9415HD
Belt - Alt. & A.C.	8971801830	♣9610HD
Hose - Upper - Eng. To Rad.		23096
Hose - Lower - Eng. To Rad.		23095
Isuzu 6HK1-TC Diesel		
FRR		
Belt - Fan & Alt.	1136714050	②TR22474
Belt - A.C.	8943951720	TR22434
Hose - Upper - Eng. To Rad.		22733
Hose - Lower - Eng. To Rad.		22734
FSR; FTR; FVR		
Belt - Fan	8943951710	TR22461
Belt - A.C.	8943951720	TR22434
Hose - Upper - Eng. To Rad.		22733
Hose - Lower - Eng. To Rad.		22734
2000		
GM V-8 5.7 L		
NPR		
Belt - Fan, Alt., P.S. & A.C.	8971106400	♣K061010HD
Belt - Fan, Alt. & P.S.	8970427480	♣K061000HD
Tensioner Assy.	8971619590	38528
Hose - Upper - Eng. To Rad.		22731
Hose - Lower - Eng. To Rad.		22732
Isuzu 4BD2 Diesel		
NPR		
Belt - Fan	5136700041	7425
Belt - Fan & Alt.	5136711280	②7460
Belt - A.C.	8944595650	♣9395HD
Hose - Upper		●25474
Hose - Lower - Eng. To Pipe		≡20351
Hose - Lower - Pipe To Rad.		22041
Hose - By Pass		21746
Isuzu 4HE1-TC Diesel		
NPR; NQR		
Belt - Fan & Alt.	8971801810	②♣9415HD
Belt - Alt. & A.C.	8971801830	♣9610HD
Hose - Upper - Eng. To Rad.		23096
Hose - Lower - Eng. To Rad.		23095
Isuzu 6HE1-TC Diesel		
FRR		
Belt - Fan & Alt.	94395171	②TR22461

♣ Standard Belt Available. See Pages 630-631.
● Vulco-Flex® Coolant Hose.

② Two Required.
≡ Cut to Fit.

Belts and Coolant Hose for Medium/Heavy-Duty Trucks (1996 and Newer)

Medium & Heavy-Duty Trucks
(1996 & Newer)

Application	Mfr. Part No.	Our No.
ISUZU - Continued		
2000 - Continued		
Isuzu 6HE1-TC Diesel - Continued		
FRR - Continued		
Belt - A.C.	94395172	TR22434
Hose - Upper - Eng. To Rad.		22733
Hose - Lower - Eng. To Rad.		22734
Isuzu 6HK1-TC Diesel		
FRR; FSR; FTR; FVR		
Belt - Fan & Alt.	94395171	②TR22461
Belt - A.C.	94395172	TR22434
Hose - Upper - Eng. To Rad.		22733
Hose - Lower - Eng. To Rad.		22734
1999		
GM V-8 5.7 L		
NPR		
Belt - Fan, Alt., P.S. & A.C.	8971106400	♣K061005HD
Belt - Fan, Alt. & P.S.	8970427480	♣K061000HD
Tensioner Assy.	8971619590	38528
Hose - Upper - Eng. To Rad.		22731
Hose - Lower - Eng. To Rad.		22732
Isuzu 4BD2-TC Diesel		
NPR		
Belt - Fan	5136700041	7425
Belt - Fan & Alt.	5136711280	②7460
Belt - A.C.	8944595650	♣9395HD
Hose - Upper		●25474
Hose - Lower - Eng. To Pipe		⊘20351
Hose - Lower - Pipe To Rad.		22041
Hose - By Pass		21746
Isuzu 4HE1-TC Diesel		
NPR; NQR		
Belt - Fan & Alt.	8971801810	②♣9415HD
Belt - Alt. & A.C.	8971801830	♣9610HD
Hose - Upper - Eng. To Rad.		23096
Hose - Lower - Eng. To Rad.		23095
Isuzu 6HE1-TC Diesel		
FRR		
Belt - Fan & Alt.	94395171	②TR22461
Belt - A.C.	94395172	TR22434
Hose - Upper - Eng. To Rad.		22733
Hose - Lower - Eng. To Rad.		22734
FSR; FTR; FVR		
Belt - Fan	8943951710	TR22461
Belt - A.C.	8943951720	TR22434
Hose - Upper - Eng. To Rad.		22733
Hose - Lower - Eng. To Rad.		22734
Isuzu 6HK1-TC Diesel		
FSR		
Belt - Fan & Alt.	94395171	②TR22461
Belt - A.C.	94395172	TR22434
Hose - Upper - Eng. To Rad.		22733
Hose - Lower - Eng. To Rad.		22734
1998		
GM V-8 5.7 L		
NPR		
Belt - Fan, Alt., P.S. & A.C.	8971106400	♣K061010HD
Belt - Fan, Alt. & P.S.	8970427480	♣K061000HD
Tensioner Assy.	8971619590	38528
Hose - Upper - Eng. To Rad.		22731
Hose - Lower - Eng. To Rad.		22732
Isuzu 4BD2-TC Diesel		
NPR		
Belt - Fan	5136700041	7425
Belt - Fan & Alt.	5136711280	②7460
Belt - A.C.	8944595650	♣9395HD
Hose - Upper		●25474
Hose - Lower - Eng. To Pipe		⊘20351

Application	Mfr. Part No.	Our No.
ISUZU - Continued		
1998 - Continued		
Isuzu 4BD2-TC Diesel - Continued		
NPR - Continued		
Hose - Lower - Pipe To Rad.		22041
Hose - By Pass		21746
Isuzu 4HE1-TC Diesel		
NPR		
Belt - Fan & Alt.	8971801810	②♣9415HD
Belt - Alt. & A.C.	8971801830	♣9610HD
Hose - Upper - Eng. To Rad.		23096
Hose - Lower - Eng. To Rad.		23095
Isuzu 6HE1-TC Diesel		
FRR		
Belt - Fan & Alt.	94395171	TR22461
Belt - A.C.	94395172	TR22434
Hose - Upper - Eng. To Rad.		22733
Hose - Lower - Eng. To Rad.		22734
FSR; FTR; FVR		
Belt - Fan	8943951710	TR22461
Belt - A.C.	8943951720	TR22434
Hose - Upper - Eng. To Rad.		22733
Hose - Lower - Eng. To Rad.		22734
1997		
GM V-8 5.7 L		
NPR		
Belt - Fan, Alt., P.S. & A.C.	8971106400	♣K061010HD
Belt - Fan, Alt. & P.S.	8970427480	♣K061000HD
Tensioner Assy.	8971619590	38528
Hose - Upper - Eng. To Rad.		22731
Hose - Lower - Eng. To Rad.		22732
Isuzu 4BD2-TC Diesel		
NPR		
Belt - Fan	5136700041	7425
Belt - Fan & Alt.	5136711280	②7460
Belt - A.C.	8944595650	♣9395HD
Hose - Upper		●25474
Hose - Lower - Eng. To Pipe		⊘20351
Hose - Lower - Pipe To Rad.		22041
Hose - By Pass		21746
Isuzu 6HE1-TC Diesel		
FRR		
Belt - Fan & Alt.	94395171	②TR22461
Belt - A.C.	94395172	TR22434
Hose - Upper - Eng. To Rad.		22733
Hose - Lower - Eng. To Rad.		22734
FSR		
Belt - Fan	8943951710	TR22461
Belt - A.C.	8943951720	TR22434
Hose - Upper - Eng. To Rad.		22733
Hose - Lower - Eng. To Rad.		22734
FTR; FVR		
Belt - Fan	94395171	②TR22461
Belt - A.C.	94395172	TR22434
Hose - Upper - Eng. To Rad.		22733
Hose - Lower - Eng. To Rad.		22734
1996		
GM V-8 5.7 L		
NPR		
Belt - Fan, Alt., P.S. & A.C.	8971106400	♣K061010HD
Belt - Fan, Alt. & P.S.	8970427480	♣K061000HD
Tensioner Assy.	8971619590	38528
Hose - Upper - Eng. To Rad.		22731
Hose - Lower - Eng. To Rad.		22732
Isuzu 4BD2-TC Diesel		
NPR		
Belt - Fan	5136700041	7425
Belt - Fan & Alt.	5136711280	②7460

② Two Required.
● Vulco-Flex® Coolant Hose.

♣ Standard Belt Available. See Pages 630-631.
⊘ Cut to Fit.

Belts and Coolant Hose for Medium/Heavy-Duty Trucks (1996 and Newer)

 Medium & Heavy-Duty Trucks
(1996 & Newer)

Application	Mfr. Part No.	Our No.
ISUZU - Continued		
1996 - Continued		
Isuzu 4BD2-TC Diesel - Continued		
NPR - Continued		
Belt - A.C.	8944595650	▲9395HD
Hose - Upper		●25474
Hose - Lower - Eng. To Pipe		⊗20351
Hose - Lower - Pipe To Rad.		22041
Hose - By Pass		21746
Isuzu 6HE1-TC Diesel		
FRR; FSR; FTR; FVR		
Belt - Fan & Alt.	94395171	⊗TR22461
Belt - A.C.	94395172	TR22434
Hose - Upper - Eng. To Rad.		22733
Hose - Lower - Eng. To Rad.		22734
KENWORTH		
2013		
Cummins ISX15 Diesel		
T660		
Belt - Fan	D8410006122180	K120858HD
Belt - A.C.	D8410006061620	▲K060637HD
Tensioner Assy. - Fan	3682946	38587
Tensioner Assy. - A.C.	2891940	38610
Idler Pulley	3682229	36223
2012		
Cummins ISX15 Diesel		
T660		
Belt - Fan	D8410006122180	K120858HD
Belt - A.C.	D8410006061620	▲K060637HD
Tensioner Assy. - Fan	3682946	38587
Tensioner Assy. - A.C.	2891940	38610
Idler Pulley	3682229	36223
T800		
Belt - Fan	D8410006122180	K120858HD
Belt - A.C.	D8410006061620	▲K060637HD
Tensioner Assy. - Fan	3682946	38587
Tensioner Assy. - A.C.	3104149	38610
Tensioner Pulley - Fan	3682946	36165
Idler Pulley - A.C.	3682229	36223
Hose - Upper		⊗21891
Hose - Lower		⊗21891
Paccar MX Diesel		
T660		
Belt - Fan	D841002121640	K120645HD
Belt - A.C.	D841002071939	K070762HD
T800		
Belt - Alt. & A.C.	D841000071939	K070762HD
Paccar PX-8 Diesel		
T370		
Belt - Fan	4933083	▲K080842HD
Tensioner Assy.	3973819	38627
Idler Pulley	3970945	36283
2011		
Caterpillar C15 Diesel		
T660		
Belt - Fan & A.C.	D8410006122490	K120980HD
Belt - Alt.	D8410006061878	▲K060739HD
Tensioner Assy.	2790253	38636
Cummins ISL Diesel		
T470		
Belt - Fan & Alt.	3289930	▲K080690HD
Belt - A.C.	D8410006061290	▲K060509HD
Tensioner Assy. - Fan & Alt.	3973819	38627
Cummins ISM Diesel		
T800		
Belt - Fan & Alt.	D8410006081735	K080683HD

Application	Mfr. Part No.	Our No.
KENWORTH - Continued		
2011 - Continued		
Cummins ISM Diesel - Continued		
T800 - Continued		
Belt - A.C.	4004824	▲K060539HD
Tensioner Assy. - Fan & Alt.	4920105	38622
Tensioner Assy. - A.C.	3102888	38505
Cummins ISX15 Diesel		
T660		
Belt - Fan & Alt.	D8410006122180	K120858HD
Belt - A.C.	D8410006061620	▲K060637HD
Tensioner Assy. - Fan & Alt.	2871292	38587
Tensioner Assy. - A.C.	3104149	38610
Tensioner Pulley - Fan & Alt.	2871292	36165
Idler Pulley - A.C.	3682229	36223
T700; T800		
Belt - Fan	D8410006122180	K120858HD
Belt - Alt. & A.C.	D8410006061620	▲K060637HD
Tensioner Assy. - Fan	2871292	38587
Tensioner Assy. - Alt. & A.C.	3104149	38610
Tensioner Pulley - Fan	2871292	36165
W900		
Belt - A.C.	D8410006061535	▲K060605HD
Tensioner Assy. - Fan & Alt.	2871292	38587
Tensioner Assy. - A.C.	3104149	38610
Tensioner Pulley - Fan & Alt.	2871292	36165
Idler Pulley - A.C.	3682229	36223
Paccar MX Diesel		
T700; T800		
Belt - Fan	D841002121640	K120645HD
Belt - Alt. & A.C.	D841002071939	K070762HD
Paccar PX-6 Diesel		
T270		
Belt - Fan	3289864	▲K080825HD
T370		
Belt - Fan	4080825	▲K080825HD
Hose - Upper - Rad. To Pipe; (2 1/2" I.D.)		⊗24840
Hose - Upper - Pipe To Eng.; (1 3/4" I.D.)		⊗24828
Hose - Lower - Rad. To Pipe; (2 1/4" I.D.)		⊗24836
Hose - Lower - Pipe To Eng.; (2" I.D.)		⊗24832
2010		
Cummins ISL Diesel		
T440; T450; T470H		
Belt - Fan & Alt.	3974246	K080860HD
Belt - A.C.	D8410006060856	K060337HD
Tensioner Assy. - Fan, W.P. & Alt.	3973819	38627
Cummins ISM Diesel		
T800		
Belt - Fan & Alt.	D8410006081735	K080683HD
Belt - A.C.	4004824	▲K060539HD
Tensioner Assy. - Fan & Alt.	4920105	38622
Tensioner Assy. - A.C.	3102888	38505
Cummins ISX15 Diesel		
T660		
Belt - A.C. - From W.P.	D8410006061620	▲K060637HD
Belt - Fan, W.P. & Alt.	D8410006122215	▲K120872HD
Tensioner Assy. - A.C.	3104149	38610
Tensioner Assy. - Fan, W.P. & Alt.	3682946	38587
Idler Pulley - A.C.	3682229	36223
Tensioner Pulley - Fan, W.P. & Alt.	3682946	36165
Hose - Upper - Eng. To Pipe		⊗21891
Hose - Lower - Eng. To Pipe; (2 1/2" I.D.)		⊗24440
Hose - Lower - Pipe To Rad.; (2 1/2" I.D.)		⊗24440
T700		
Belt - Fan	D8410006122180	K120858HD
Belt - Alt. & A.C.	D8410006061620	▲K060637HD
Tensioner Assy. - Fan	2871292	38587
Tensioner Assy. - Alt. & A.C.	3104149	38610
Tensioner Pulley - Fan	2871292	36165

▲ Standard Belt Available. See Pages 630-631.
 ⊗ Cut to Fit.
 * Durion® Silicone Hose Recommended.

● Vulco-Flex® Coolant Hose.
 ⊗ Two Required.

Belts and Coolant Hose for Medium/Heavy-Duty Trucks (1996 and Newer)

Medium & Heavy-Duty Trucks
(1996 & Newer)

Application	Mfr. Part No.	Our No.
KENWORTH - Continued		
2010 - Continued		
Cummins ISX15 Diesel - Continued		
T800		
Belt - A.C. - From W.P.	D8410006061620	▲K060637HD
Belt - Fan, W.P. & Alt.	D8410006122215	▲K120872HD
Tensioner Assy. - A.C.	3104149	38610
Tensioner Assy. - Fan, W.P. & Alt.	2871292	38587
Idler Pulley - A.C.	3682229	36223
Hose - Upper - Eng. To Pipe		≡21891
Hose - Lower - Eng. To Pipe; (2 1/2" I.D.)		≡24440
Hose - Lower - Pipe To Rad.		≡21891
T2000		
Belt - Fan	D8410006122180	K120858HD
Belt - Alt. & A.C.	D8410006061620	▲K060637HD
Tensioner Assy. - Fan	2871292	38587
Tensioner Assy. - Alt. & A.C.	3104149	38610
Tensioner Pulley - Fan	2871292	36165
W900		
Belt - A.C. - From W.P.	D8410006061620	▲K060637HD
Belt - Fan, W.P. & Alt.	D8410006122310	▲K120911HD
Tensioner Assy. - A.C.	3104149	38610
Tensioner Assy. - Fan, W.P. & Alt.	2871292	38587
Idler Pulley - A.C.	3682229	36223
Hose - Upper - Eng. To Pipe		≡21891
Hose - Lower - Eng. To Pipe; (2 1/2" I.D.)		*24840
Hose - Lower - Pipe To Rad.		21135
Paccar MX Diesel		
T700		
Belt - Fan	D841002121640	K120645HD
Belt - Alt. & A.C.	D841002071939	K070762HD
2009		
Caterpillar C13 Diesel		
T660		
Belt - Fan & A.C.	D8410006102405	K100946HD
Belt - Alt.	D8410006062175	▲K060858HD
Tensioner Assy. - Fan & A.C.	2873203	38646
Tensioner Assy. - Alt.	2756558	38635
Idler Pulley - Alt.	2790251	36227
Hose - Upper		≡21891
T800		
Belt - Fan & Alt.	D8410006102405	K100946HD
Belt - A.C.	D8410006062175	▲K060858HD
Tensioner Assy. - Fan & Alt.	2756558	38635
Tensioner Assy. - A.C.	2873203	38646
Hose - Upper - Eng. To Pipe; (2 1/2" I.D.)		≡24240
Hose - Upper - Pipe To Rad.; (2 1/2" I.D.)		24240
Hose - Lower - Eng. To Pipe		21891
Hose - Lower - Pipe To Rad.		21891
Caterpillar C15 Diesel		
C500		
Belt - Fan & A.C.	D8410006061695	K060667
Tensioner Assy. - Fan & A.C.	3368955	38609
Tensioner Assy. - Alt.	2790253	38636
T660		
Belt - Fan & A.C.		K120980HD
Belt - Alt.		▲K060739HD
Tensioner Assy. - Alt.		38609
Tensioner Assy. - Fan & A.C.		38587
Tensioner Pulley - Fan & A.C.		36165
Hose - Upper - Eng. To Pipe		≡21891
Hose - Upper - Pipe To Rad.; (2 1/2" I.D.)		≡24240
Hose - Lower - Eng. To Pipe; (2 1/2" I.D.)		≡24240
Hose - Lower - Pipe To Rad.		≡21135
T800		
Belt - Fan & A.C.	D8410006122490	K120980HD
Belt - Fan To Alt.	D8410006061870	K060736HD
Tensioner Assy. - Fan & A.C.	2362301	38609
Tensioner Assy. - Alt.	2790253	38636
Idler Pulley - A.C. (Lower)	2850277	36282
Hose - Upper - Eng. To Pipe		≡21891

Application	Mfr. Part No.	Our No.
KENWORTH - Continued		
2009 - Continued		
Caterpillar C15 Diesel - Continued		
T800 - Continued		
Hose - Lower - Eng. To Pipe; (2 1/2" I.D.)		≡24240
Hose - Lower - Pipe To Rad.		≡21891
W900		
Belt - Alt. - From Fan	D8410006061750	▲K060690HD
Belt - Fan & A.C.	D8410006122665	K121049HD
Tensioner Assy. - Fan & Alt.	2790253	38636
Tensioner Assy. - Fan & A.C.	2362301	38609
Idler Pulley - A.C. (Lower)	2850277	36282
Hose - Upper - Eng. To Pipe; (2 1/2" I.D.)		24440
Hose - Upper - Pipe To Rad.; (2 1/2" I.D.)		*24840
Hose - Lower - Eng. To Pipe; (2 1/2" I.D.)		24440
Hose - Lower - Pipe To Rad.; (2 1/2" I.D.)		24440
Cummins ISL Diesel		
W900		
Belt - Fan & Alt.	3289930	▲K080690HD
Belt - A.C.	D8410006061290	▲K060509HD
Tensioner Assy. - A.C.	3973819	38627
Cummins ISM Diesel		
T800		
Belt - Fan & Alt.	D8410006081735	K080683HD
Belt - A.C.	4004824	▲K060539HD
Tensioner Assy. - Fan & Alt.	4920105	38622
Tensioner Assy. - A.C.	3102888	38505
W900		
Belt - Fan & Alt.	D8410006081735	K080683HD
Belt - A.C.	D8410003061370	▲K060539HD
Tensioner Assy. - Fan & Alt.	2871294	38622
Cummins ISX Diesel		
T660		
Belt - Fan, Alt. & W.P.	D8410006122215	▲K120872HD
Belt - A.C. - From W.P.	D8410006061620	▲K060637HD
Tensioner Assy. - Fan, W.P. & Alt.	3682946	38587
Tensioner Assy. - A.C.	3104149	38610
Idler Pulley - A.C.	3682229	36223
Hose - Upper - Eng. To Pipe		21891
Hose - Lower - Eng. To Pipe; (2 1/2" I.D.)		24440
Hose - Lower - Pipe To Rad.; (2 1/2" I.D.)		24440
T800		
Belt - A.C. - From W.P.	D8410006061620	▲K060637HD
Belt - Fan, Alt. & W.P.; W/88" Belt O.C. .	D8410006122215	▲K120872HD
Belt - Fan, Alt. & W.P.; W/91 5/8" Belt O.C.	D8410006122310	▲K120911HD
Tensioner Assy. - A.C.	3104149	38610
Tensioner Assy. - Fan, W.P. & Alt.	2871292	38587
Idler Pulley - A.C.	3682229	36223
Hose - Upper - Eng. To Pipe; W/Conventional Hood		≡21891
Hose - Upper - Eng. To Pipe; W/Wide Hood(3" I.D.)		≡24448
Hose - Lower - Eng. To Pipe; W/Conventional Hood(2 1/2" I.D.)		24440
Hose - Lower - Pipe To Rad.; W/Conventional Hood		≡21891
Hose - Lower - Eng. To Pipe; W/Wide Hood(3" I.D.)		≡24448
Hose - Lower - Pipe To Pipe; W/Wide Hood(3" I.D.)		≡24448
W900		
Belt - Fan, Alt. & W.P.	D8410006122310	▲K120911HD
Belt - A.C. - From W.P.	D8410006061620	▲K060637HD
Tensioner Assy. - A.C.	3104149	38610
Tensioner Assy. - Fan, W.P. & Alt.	2871292	38587
Idler Pulley - A.C.	3682229	36223
Hose - Upper - Eng. To Pipe		≡21891
Hose - Lower - Eng. To Pipe; (2 1/2" I.D.)		≡24440
Hose - Lower - Pipe To Rad.		≡21135
Paccar PX-6 Diesel		
T170		
Belt - Fan, A.C., Alt. & W.P.	3972377	K080868HD
Tensioner Assy. - Fan, A.C., Alt. & W.P.	4937433	38631
T270		
Belt - Fan, A.C., Alt. & W.P.	3972377	K080868HD

▲ Standard Belt Available. See Pages 630-631.
* Durion® Silicone Hose Recommended.

≡ Cut to Fit.

Belts and Coolant Hose for Medium/Heavy-Duty Trucks (1996 and Newer)

 Medium & Heavy-Duty Trucks
(1996 & Newer)

Application	Mfr. Part No.	Our No.
KENWORTH - Continued		
2009 - Continued		
Paccar PX-6 Diesel - Continued		
T270 - Continued		
Tensioner Assy. - Fan, A.C., Alt. & W.P.	4937433	38631
Hose - Upper - Eng. To Pipe; (1 3/4" I.D.)		☞24428
Hose - Lower - Eng. To Pipe; (1 3/4" I.D.)		☞24428
T300; T370		
Belt - Fan, Alt. & A.C.; W/86" Belt O.C.	3289974	▲K080855HD
Belt - Fan, Alt. & A.C.; W/87 1/4" Belt O.C.	3972377	K080868HD
Tensioner Assy. - Fan, Alt. & A.C.	4937433	38631
Hose - Upper - Eng. To Pipe; (1 3/4" I.D.)		24228
Hose - Upper - Pipe To Rad.; (2 1/2" I.D.)		24240
Hose - Lower - Eng. To Pipe; (1 3/4" I.D.)		24228
Hose - Lower - Pipe To Rad.; (2 1/2" I.D.)		24240
Paccar PX-8 Diesel		
T270; T370		
Belt - Fan, A.C., Alt. & W.P.	3289974	▲K080855HD
Tensioner Assy. - Fan, A.C., Alt. & W.P.	3973819	38627
2008		
Caterpillar C11 Diesel		
T800		
Belt - Fan, Alt. & A.C.	D11084930	▲K080952HD
Tensioner Assy. - Fan, Alt. & A.C.	2117895	38590
Tensioner Pulley - Fan, Alt. & A.C.	2117895	36164
Idler Pulley - Smooth	2078118	36269
Idler Pulley - Grooved	1979642	36341
Hose - Upper - Eng. To Pipe; (2 1/2" I.D.)		24240
Hose - Upper - Pipe To Rad.; (2 1/2" I.D.)		24240
Hose - Lower - Eng. To Rad.; (2 1/2" I.D.)		24240
Hose - Lower - Rad. To Pipe; (3" I.D.)		24248
Caterpillar C13 Diesel		
T800		
Belt - Fan & A.C.	D8410006102405	K100946HD
Belt - Alt.	D8410006062175	▲K060858HD
Tensioner Assy. - Alt.	2756558	38635
Tensioner Assy. - Fan & A.C.	2873203	38646
Hose - Upper - Eng. To Pipe		21891
Hose - Upper - Pipe To Rad.; (2 1/2" I.D.)		24240
Hose - Lower - Eng. To Pipe		21891
Hose - Lower - Pipe To Rad.		21891
W900		
Belt - Fan & A.C.	D8410006102405	K100946HD
Belt - Alt.	D8410006062175	▲K060858HD
Tensioner Assy. - Alt.	2756558	38635
Caterpillar C15 Diesel		
T600		
Tensioner Assy. - Fan & A.C.	2362301	38609
T660		
Belt - Fan & A.C.	D8410006122490	K120980HD
Belt - Fan To Alt.	D8410006061870	K060736HD
Hose - Upper - Eng. To Pipe		21891
Hose - Upper - Pipe To Rad.; (2 1/2" I.D.)		☞24240
Hose - Lower - Eng. To Pipe; (2 1/2" I.D.)		☞24240
Hose - Lower - Pipe To Rad.		21135
T800		
Belt - Fan & Alt.; W/Conventional Hood;		
W/94" Belt O.C.	D8410001082370	▲K080934HD
Belt - Fan & Alt.; W/Conventional Hood;		
W/103" Belt O.C.	D11089803	▲K081023HD
Belt - Fan To A.C.; W/Conventional Hood;		
W/50 1/2" Belt O.C.	D8410003061280	K060505
Belt - Fan To A.C.; W/Conventional Hood;		
W/58" Belt O.C.	D11085689	▲K060575HD
Belt - Fan & Alt.; W/Short Hood	D8410006061870	K060736HD
Belt - Fan & A.C.; W/Short Hood	D8410006122490	K120980HD
Tensioner Assy. - Fan & A.C.	2362301	38609
Tensioner Assy. - Fan & Alt.	2790253	38636
Idler Pulley - A.C.; W/V-Groove Idler Pulley	2850277	36282

☞ Cut to Fit.

Application	Mfr. Part No.	Our No.
KENWORTH - Continued		
2008 - Continued		
Caterpillar C15 Diesel - Continued		
T800 - Continued		
Hose - Upper - Eng. To Pipe; (2 1/2" I.D.)		24240
Hose - Upper - Pipe To Rad.; (2 1/2" I.D.)		24240
Hose - Lower - Eng. To Pipe; (3" I.D.)		24248
Hose - Lower - Pipe To Rad.; (3" I.D.)		24248
W900		
Belt - Fan & A.C.	D8410006122665	K121049HD
Belt - Fan To Alt.	D8410006061750	▲K060690HD
Tensioner Assy. - Fan & Alt.	2362301	38609
Tensioner Assy. - Fan To A.C.	2790253	38636
Idler Pulley - Smooth	1979641	36091
Idler Pulley - Grooved	1979642	36341
Hose - Upper - Eng. To Pipe; (2 1/2" I.D.)		24240
Hose - Upper - Pipe To Rad.; (2 1/2" I.D.)		24240
Hose - Lower - Eng. To Pipe; (2 1/2" I.D.)		24240
Hose - Lower - Pipe To Rad.		21135
Cummins ISC Diesel		
T300		
Belt - Fan, Alt. & A.C.	D8410001082430	▲K080956HD
Idler Pulley	3970945	36283
Hose - Upper - Eng. To Pipe; (2 1/2" I.D.)		24240
Hose - Upper - Pipe To Rad.; (2 1/2" I.D.)		24240
Hose - Lower - Eng. To Rad.; (2 1/4" I.D.)		24236
Hose - Lower - Rad. To Pipe; (2 1/2" I.D.)		24240
Cummins ISL Diesel		
T800		
Belt - Fan, W.P. & Alt.	3972383	▲K080806HD
Belt - Fan To A.C.		▲9380HD
Tensioner Assy. - Fan, W.P. & Alt.	3936213	38516
Tensioner Pulley - Fan, W.P. & Alt.	3936213	36093
Hose - Upper - Eng. To Pipe; (2 1/4" I.D.)		24236
Hose - Upper - Pipe To Rad.; (2 1/4" I.D.)		24236
Hose - Lower - Eng. To Pipe; (2" I.D.)		24232
Hose - Lower - Pipe To Cooler; (2 1/4" I.D.)		24236
Hose - Lower - Cooler To Pipe; (2 1/2" I.D.)		24240
Hose - Lower - Pipe To Rad.; (3 1/4" I.D.)		24052
W900		
Belt - Fan & Alt.	3289930	▲K080690HD
Belt - A.C.	D8410006061290	▲K060509HD
Tensioner Assy. - A.C.	3973819	38627
Cummins ISM Diesel		
T600		
Belt - Alt.	D8410006081735	K080683HD
Belt - A.C.	4004824	▲K060539HD
Tensioner Assy. - Alt.	2871294	38622
Idler Pulley - Fan & Alt.	3400884	36308
Tensioner Pulley - A.C.	4004933	36091
T800		
Belt - Fan & Alt.	D8410006081735	K080683HD
Belt - A.C.	4004824	▲K060539HD
Tensioner Assy. - Fan & Alt.	4920105	38622
Tensioner Assy. - A.C.	3102888	38505
W900		
Belt - Fan & Alt.	D8410006081735	K080683HD
Belt - A.C.	D8410003061370	▲K060539HD
Tensioner Assy. - Fan & Alt.	2871294	38622
Cummins ISX Diesel		
T600		
Idler Pulley - A.C.	3682229	36223
T660		
Belt - Fan & Alt.	D8410006122215	▲K120872HD
Belt - Hub & A.C.	D8410006061620	▲K060637HD
Tensioner Assy. - Hub & A.C.	3682683	38610
Tensioner Assy. - Fan & Alt.	3682946	38587
Idler Pulley - A.C.	3682229	36223
Tensioner Pulley - Fan & Alt.	3682946	36165
Hose - Upper - Eng. To Pipe		21891
Hose - Upper - Rad. To Pipe; (2 1/2" I.D.)		24240

▲ Standard Belt Available. See Pages 630-631.

Belts and Coolant Hose for Medium/Heavy-Duty Trucks (1996 and Newer)

Medium & Heavy-Duty Trucks
(1996 & Newer)

Application	Mfr. Part No.	Our No.
KENWORTH - Continued		
2008 - Continued		
Cummins ISX Diesel - Continued		
T660 - Continued		
Hose - Lower - Eng. To Pipe; (2 1/2" I.D.)		24240
Hose - Lower - Rad. To Pipe; (2 1/2" I.D.)		24240
T800		
Belt - Fan & Alt.	D8410006122215	♣K120872HD
Belt - Hub & A.C.	D11085527	♣K060637HD
Tensioner Assy. - Hub & A.C.	3682683	38610
Tensioner Assy. - Fan & Alt.	3682946	38587
Idler Pulley - A.C.	3682229	36223
Tensioner Pulley - Fan & Alt.	3682946	36165
Hose - Upper - Eng. To Pipe		21891
Hose - Upper - Pipe To Rad.; (2 1/2" I.D.)		24240
Hose - Lower - Eng. To Pipe; (2 1/2" I.D.)		24240
Hose - Lower - Pipe To Rad.		21891
T2000		
Idler Pulley - A.C.	3682229	36223
W900		
Belt - Fan & Alt.	D8410006122310	♣K120911HD
Belt - A.C.	D8410006061620	♣K060637HD
Tensioner Assy. - Fan & Alt.	3682946	38587
Tensioner Assy. - A.C.	3682683	38610
Paccar 6-Cyl. 5.9 L Diesel		
K360		
Tensioner Assy.	4891116	38584
Paccar PX-6 Diesel		
T170		
Belt - W.P., Fan, Alt. & A.C.	3972377	K080868HD
Tensioner Assy. - W.P., Alt. & A.C.	4937433	38631
T300		
Belt - Fan, Alt. & A.C.; W/86" Belt O.C. .	3289974	♣K080855HD
Belt - Fan, Alt. & A.C.; W/87 1/4" Belt O.C.		
Tensioner Assy. - Fan, Alt. & A.C.	4937433	K080868HD
Hose - Upper - Eng. To Pipe; (1 3/4" I.D.)		24228
Hose - Upper - Pipe To Rad.; (2 1/2" I.D.)		24240
Hose - Lower - Eng. To Pipe; (1 3/4" I.D.)		24228
Hose - Lower - Pipe To Rad.; (2 1/2" I.D.)		24240
Paccar PX-8 Diesel		
T300; T370		
Idler Pulley	3970945	36283
2007		
Caterpillar C7 Diesel		
T300		
Belt - Fan, Alt. & A.C.	D11084843	♣K080810HD
Tensioner Assy. - Fan, Alt. & A.C.	2222880	38586
Idler Pulley - Lower	2534525	36096
Hose - Upper - Eng. To Pipe		20206
Hose - Upper - Pipe To Rad.		21194
Caterpillar C11 Diesel		
T800		
Belt - Fan, Alt. & A.C.	D11084930	♣K080952HD
Tensioner Assy. - Fan, Alt. & A.C.	2117895	38590
Tensioner Pulley - Fan, Alt. & A.C.	2117895	36164
Idler Pulley - Smooth	2078118	36269
Idler Pulley - Grooved	1979642	36341
Hose - Upper - Eng. To Pipe; (2 1/2" I.D.)		24240
Hose - Upper - Pipe To Rad.; (2 1/2" I.D.)		24240
Hose - Lower - Eng. To Rad.; (2 1/2" I.D.)		24240
Hose - Lower - Rad. To Pipe; (3" I.D.)		24248
W900		
Belt - Fan, Alt. & A.C.	D8410003082450	K080964HD
Tensioner Assy. - Fan, Alt. & A.C.	2117895	38590
Tensioner Pulley - Fan, Alt. & A.C.	2117895	36164
Idler Pulley - Smooth	2078118	36269
Idler Pulley - Grooved	1979642	36341
Hose - Upper - Eng. To Pipe; (2 1/2" I.D.)		24240
Hose - Upper - Pipe To Rad.; (2 1/2" I.D.)		24240
Hose - Lower - Eng. To Rad.; (2 1/2" I.D.)		24240
Hose - Lower - Rad. To Pipe; (3" I.D.)		24248

Application	Mfr. Part No.	Our No.
KENWORTH - Continued		
2007 - Continued		
Caterpillar C11 Diesel - Continued		
W900 - Continued		
Hose - Lower - Eng. To Rad.; (2 1/2" I.D.)		24240
Hose - Lower - Rad. To Pipe; (3" I.D.)		24248
Caterpillar C13 Diesel		
T800		
Belt - Fan, Alt. & A.C.	D11084930	♣K080952HD
Tensioner Assy. - Fan, Alt. & A.C.	2117895	38590
Tensioner Pulley - Fan, Alt. & A.C.	2117895	36164
Idler Pulley - Smooth	2078118	36269
Idler Pulley - Grooved	1979642	36341
Hose - Upper - Eng. To Pipe; (2 1/2" I.D.)		24240
Hose - Upper - Pipe To Rad.; (2 1/2" I.D.)		24240
Hose - Lower - Eng. To Rad.; (3" I.D.)		24248
Hose - Lower - Rad. To Pipe; (3" I.D.)		24248
W900		
Belt - Fan, Alt. & A.C.		♣K080968HD
Tensioner Assy. - Fan, Alt. & A.C.	2117895	38590
Tensioner Pulley - Fan, Alt. & A.C.	2117895	36164
Idler Pulley - Smooth	2078118	36269
Idler Pulley - Grooved	1979642	36341
Hose - Upper - Eng. To Pipe; (2 1/2" I.D.)		24240
Hose - Upper - Pipe To Rad.; (2 1/2" I.D.)		24240
Hose - Lower - Eng. To Rad.; (2 1/2" I.D.)		24240
Hose - Lower - Rad. To Pipe; (3" I.D.)		24248
Caterpillar C15 Diesel		
C500		
Belt - Fan & Alt.	D8410003082875	♣K081124HD
Belt - Fan To A.C.	D840003061315	♣K060516HD
Tensioner Assy. - Fan & Alt.	2002279	38569
Tensioner Assy. - Fan To A.C.	2178938	38511
Idler Pulley - Smooth	1979641	36091
Idler Pulley - Grooved	1979642	36341
Tensioner Pulley - Fan To A.C.	2178938	36091
T600		
Belt - Fan & Alt.	D8410001082370	♣K080934HD
Belt - Fan To A.C.	D8410003061460	♣K060575HD
Tensioner Assy. - Fan & Alt.	2002279	38569
Tensioner Assy. - Fan To A.C.	2178938	38511
Idler Pulley - Smooth	1979641	36091
Idler Pulley - Grooved	1979642	36341
Hose - Upper - Eng. To Pipe; (2 1/2" I.D.)		24240
Hose - Upper - Pipe To Rad.; (2 1/2" I.D.)		24240
Hose - Lower - Eng. To Pipe; (3" I.D.)		24248
Hose - Lower - Pipe To Rad.; (3" I.D.)		24248
T660		
Idler Pulley - Smooth	1979641	36091
Idler Pulley - Grooved	1979642	36341
T800		
Belt - Fan & Alt.; W/Conventional Hood; W/94" Belt O.C.	D8410001082370	♣K080934HD
Belt - Fan & Alt.; W/Conventional Hood; W/103" Belt O.C.	D11089803	♣K081023HD
Belt - Fan & Alt.; W/Short Hood	D8410003122480	♣K120975HD
Belt - Fan To A.C.; W/Conventional Hood; W/50 1/2" Belt O.C.	D8410003061280	K060505
Belt - Fan To A.C.; W/Conventional Hood; W/58" Belt O.C.	D11085689	♣K060575HD
Belt - Fan To A.C.; W/Short Hood	D8410003061470	♣K060578HD
Tensioner Assy. - Fan & Alt.; W/Conventional Hood	2002279	38569
Tensioner Assy. - Fan To A.C.	2178938	38511
Idler Pulley - Smooth	1979641	36091
Idler Pulley - Grooved	1979642	36341
Hose - Upper - Eng. To Pipe; (2 1/2" I.D.)		24240
Hose - Upper - Pipe To Rad.; (2 1/2" I.D.)		24240
Hose - Lower - Eng. To Pipe; (3" I.D.)		24248
Hose - Lower - Pipe To Rad.; (3" I.D.)		24248
T2000		
Belt - Fan & Alt.	D11084936	♣K080939HD

♣ Standard Belt Available. See Pages 630-631.

Belts and Coolant Hose for Medium/Heavy-Duty Trucks (1996 and Newer)

 Medium & Heavy-Duty Trucks
(1996 & Newer)

Application	Mfr. Part No.	Our No.	Application	Mfr. Part No.	Our No.
KENWORTH - Continued			KENWORTH - Continued		
2007 - Continued			2007 - Continued		
Caterpillar C15 Diesel - Continued			Cummins ISM Diesel - Continued		
T2000 - Continued			T2000		
Belt - Fan To A.C.	D11085527	▲K060637HD	Idler Pulley - Fan & Alt.	3400884	36308
Tensioner Assy. - Fan & Alt.	2002279	38569	W900		
Tensioner Assy. - Fan To A.C.	2178938	38511	Belt - Fan & Alt.; W/Short Hood	D8410001081780	▲K080702HD
Idler Pulley - Smooth	1979641	36091	Belt - Hub & A.C.; W/Short Hood	4004824	▲K060539HD
Idler Pulley - Grooved	1979642	36341	Tensioner Assy. - Fan & Alt.	4920105	38622
Tensioner Pulley - Fan To A.C.	2178938	36091	Tensioner Assy. - Hub & A.C.	4004933	38505
Hose - Upper - Eng. To Pipe; (2 1/2" I.D.)		24240	Idler Pulley - Fan & Alt.	3400884	36308
Hose - Lower - Eng. To Pipe; (3" I.D.)		24248	Tensioner Pulley - A.C.	4004933	36091
Hose - Lower - Pipe To Rad.; (2 1/2" I.D.)		24240	Hose - Upper - Eng. To Pipe; (2 1/2" I.D.)		24240
W900			Hose - Upper - Pipe To Rad.; (2 1/2" I.D.)		24240
Belt - Fan & Alt.; W/8-Ribbed Belt	D11084884	▲K080952HD	Hose - Lower - Eng. To Pipe; (2 1/2" I.D.)		24240
Belt - Fan & Alt.; W/12-Ribbed Belt	D8410001122540	K121000HD	Hose - Lower - Pipe To Rad.; (3" I.D.)		24248
Belt - Fan & A.C.; W/55 7/8" Belt O.C. ...	D11085700	▲K060555HD	Cummins ISX Diesel		
Belt - Fan To A.C.; W/62" Belt O.C.	D11085352	▲K060615HD	T600		
Tensioner Assy. - Fan & Alt.;			Belt - Fan & Alt.	D8410001122195	▲K120864HD
W/8-Ribbed Belt	2002279	38569	Belt - Hub, Alt. & A.C.	D8410003061620	▲K060637HD
Tensioner Assy. - Fan & Alt.;			Tensioner Assy. - Hub & A.C.	3682683	38610
W/12-Ribbed Belt	2362301	38609	Tensioner Assy. - Fan & Alt.	3682946	38587
Tensioner Assy. - Fan To A.C.	2178938	38511	Idler Pulley - A.C.	3682229	36223
Idler Pulley - Smooth	1979641	36091	Tensioner Pulley - Fan & Alt.	3682946	36165
Idler Pulley - Grooved	1979642	36341	Hose - Upper - Eng. To Pipe; (2 1/2" I.D.)		24240
Tensioner Pulley - Fan To A.C.	2178938	36091	Hose - Upper - Pipe To Rad.; (2 1/2" I.D.)		24240
Hose - Upper - Eng. To Pipe; (2 1/2" I.D.)		24240	Hose - Lower - Eng. To Pipe; (2 1/2" I.D.)		24240
Hose - Upper - Pipe To Rad.; (2 1/2" I.D.)		24240	Hose - Lower - Pipe To Rad.; (3" I.D.)		24248
Hose - Lower - Eng. To Pipe; (3" I.D.)		24248	T660		
Hose - Lower - Pipe To Rad.; (3" I.D.)		24248	Tensioner Assy. - Hub & A.C.	3682683	38610
Cummins ISB Diesel			Tensioner Assy. - Fan & Alt.	3682946	38587
T300			Idler Pulley - A.C.	3682229	36223
Belt - Fan, Alt. & A.C.	3289974	▲K080855HD	Tensioner Pulley - Fan & Alt.	3682946	36165
Tensioner Assy. - Fan, Alt. & A.C.	3976833	38517	T800		
Hose - Upper - Eng. To Pipe; (1 3/4" I.D.)		24228	Belt - Fan, Alt. & W.P.; W/Conventional		
Hose - Upper - Pipe To Rad.		≈21115	Hood	D8410001122195	▲K120864HD
Hose - Lower - Eng. To Cooler; (2 1/2" I.D.)		24240	Belt - Fan, Alt. & W.P.; W/Wide Hood ...	D8410003122400	K120945HD
Cummins ISC Diesel			Belt - A.C. - From W.P.	D8410003061620	▲K060637HD
T300			Tensioner Assy. - Hub & A.C.	3682683	38610
Belt - Fan, Alt. & A.C.	D8410001082430	▲K080956HD	Tensioner Assy. - Fan & Alt.	3682946	38587
Belt - Fan & Alt.; W/O A.C.	3972265	▲K080878HD	Idler Pulley - A.C.	3682229	36223
Tensioner Assy. - Fan, Alt. & A.C.	3976831	38516	Tensioner Pulley - Fan & Alt.	3682946	36165
Idler Pulley	3970945	36283	Hose - Upper - Eng. To Pipe; (2 1/2" I.D.)		24240
Hose - Upper - Eng. To Pipe; (2 1/2" I.D.)		24240	Hose - Upper - Pipe To Rad.; (2 1/2" I.D.)		24240
Hose - Upper - Pipe To Rad.; (2 1/2" I.D.)		24240	Hose - Lower - Eng. To Pipe; (2 1/2" I.D.)		24240
Hose - Lower - Eng. To Rad.; (2 1/4" I.D.)		24236	Hose - Lower - Pipe To Rad.; (3" I.D.)		24248
Hose - Lower - Rad. To Pipe; (2 1/2" I.D.)		24240	T2000		
Cummins ISL Diesel			Belt - Fan, Alt. & Hub	D8410001122195	▲K120864HD
T800			Belt - Hub & A.C.	D8410003061620	▲K060637HD
Belt - Fan, W.P. & Alt.	3972383	▲K080806HD	Tensioner Assy. - Hub & A.C.	3682683	38610
Belt - Fan To A.C.		▲9380HD	Tensioner Assy. - Fan & Alt.	3682946	38587
Tensioner Assy. - Fan, W.P. & Alt.	3936213	38516	Idler Pulley - A.C.	3682229	36223
Tensioner Pulley - Fan, W.P. & Alt.	3936213	36093	Tensioner Pulley - Fan & Alt.	3682946	36165
Hose - Upper - Eng. To Pipe; (2 1/4" I.D.)		24236	Hose - Upper - Eng. To Pipe; (2 1/2" I.D.)		24240
Hose - Upper - Pipe To Rad.; (2 1/4" I.D.)		24236	Hose - Upper - Pipe To Rad.		●26531
Hose - Lower - Eng. To Pipe; (2" I.D.)		24232	Hose - Lower - Eng. To Pipe		21591
Hose - Lower - Pipe To Cooler; (2 1/4" I.D.)		24236	Hose - Lower - Pipe To Rad.; (2 1/2" I.D.)		24240
Hose - Lower - Cooler To Pipe; (2 1/2" I.D.)		24240	W900		
Hose - Lower - Pipe To Rad.; (3 1/4" I.D.)		24052	Belt - Fan & Alt.	D11084210	▲K120878HD
Cummins ISM Diesel			Belt - Hub, Alt. & A.C.	D11085527	▲K060637HD
T600			Tensioner Assy. - Hub & A.C.	3682683	38610
Idler Pulley - Fan & Alt.	3400884	36308	Tensioner Assy. - Fan & Alt.	3682946	38587
Tensioner Pulley - A.C.	4004933	36091	Idler Pulley - A.C.	3682229	36223
T660			Tensioner Pulley - Fan & Alt.	3682946	36165
Idler Pulley - Fan & Alt.	3400884	36308	Hose - Upper - Eng. To Pipe; (2 1/2" I.D.)		24240
T800			Hose - Upper - Pipe To Rad.; W/O E.G.R. (2 1/2" I.D.)		24240
Belt - Fan & Alt.	D11084891	▲K080702HD	Hose - Lower - Eng. To Pipe; (2 1/2" I.D.)		24240
Belt - A.C.	4004824	▲K060539HD	Hose - Lower - Pipe To Rad.; (2 1/2" I.D.)		24240
Tensioner Assy. - Fan & Alt.	4920105	38622	Paccar 6-Cyl. 5.9 L Diesel		
Tensioner Assy. - A.C.	3102888	38505	K360		
Idler Pulley - Fan & Alt.	3400884	36308	Tensioner Assy. - Fan & Alt.	4891116	38584
Tensioner Pulley - A.C.		36091			

▲ Standard Belt Available. See Pages 630-631.
● Vulco-Flex® Coolant Hose.

≈ Cut to Fit.

Belts and Coolant Hose for Medium/Heavy-Duty Trucks (1996 and Newer)

Medium & Heavy-Duty Trucks
(1996 & Newer)

Application	Mfr. Part No.	Our No.
KENWORTH - Continued		
2007 - Continued		
Paccar PX-6 Diesel		
T300		
Belt - Fan, Alt. & A.C.	3972377	K080868HD
Tensioner Assy. - Fan, Alt. & A.C.	4937433	38631
Hose - Upper - Eng. To Pipe; (1 3/4" I.D.)		24228
Hose - Upper - Pipe To Rad.; (2 1/2" I.D.)		24240
Hose - Lower - Eng. To Pipe; (1 3/4" I.D.)		24228
Hose - Lower - Pipe To Rad.; (2 1/2" I.D.)		24240
2006		
Caterpillar C7 Diesel		
T300		
Belt - Fan, Alt. & A.C.	D11084843	▲K080810HD
Tensioner Assy. - Fan, Alt. & A.C.	2222880	38586
Idler Pulley - Upper	1979641	36091
Idler Pulley - Lower	2534525	36096
Hose - Upper - Eng. To Pipe		20206
Hose - Upper - Pipe To Rad.		21194
Caterpillar C11 Diesel		
T800		
Belt - Fan, Alt. & A.C.	D11084930	▲K080952HD
Tensioner Assy. - Fan, Alt. & A.C.	2117895	38590
Tensioner Pulley - Fan, Alt. & A.C.	2117895	36164
Idler Pulley - Smooth	2078118	36269
Idler Pulley - Grooved	1979642	36341
Hose - Upper - Eng. To Pipe; (2 1/2" I.D.)		24240
Hose - Upper - Pipe To Rad.; (2 1/2" I.D.)		24240
Hose - Lower - Eng. To Rad.; (2 1/2" I.D.)		24240
Hose - Lower - Rad. To Pipe; (3" I.D.)		24248
W900		
Belt - Fan, Alt. & A.C.	D8410003082450	K080964HD
Tensioner Assy. - Fan, Alt. & A.C.	2117895	38590
Tensioner Pulley - Fan, Alt. & A.C.	2117895	36164
Idler Pulley - Smooth	2078118	36269
Idler Pulley - Grooved	1979642	36341
Hose - Upper - Eng. To Pipe; (2 1/2" I.D.)		24240
Hose - Upper - Pipe To Rad.; (2 1/2" I.D.)		24240
Hose - Lower - Eng. To Rad.; (2 1/2" I.D.)		24240
Hose - Lower - Rad. To Pipe; (3" I.D.)		24248
Caterpillar C13 Diesel		
T800		
Belt - Fan, Alt. & A.C.; W/Short Hood		▲K080952HD
Tensioner Assy. - Fan, Alt. & A.C.	2117895	38590
Tensioner Pulley - Fan, Alt. & A.C.	2117895	36164
Idler Pulley - Smooth	2078118	36269
Idler Pulley - Grooved	1979642	36341
Hose - Upper - Eng. To Pipe; (2 1/2" I.D.)		24240
Hose - Upper - Pipe To Rad.; (2 1/2" I.D.)		24240
Hose - Lower - Eng. To Rad.; (2 1/2" I.D.)		24240
Hose - Lower - Rad. To Pipe; (3" I.D.)		24248
T2000		
Belt - Accessory Drive		▲K080956HD
Tensioner Assy.	2117895	38590
Hose - Upper - Eng. To Pipe		≈21891
Hose - Upper - Pipe To Rad.		≈20996
Hose - Lower - Eng. To Pipe; (2 1/2" I.D.)		≈24240
W900		
Belt - Fan, Alt. & A.C.		▲K080968HD
Tensioner Assy. - Fan, Alt. & A.C.	2117895	38590
Tensioner Pulley - Fan, Alt. & A.C.	2117895	36164
Idler Pulley - Smooth	2078118	36269
Idler Pulley - Grooved	1979642	36341
Hose - Upper - Eng. To Pipe; (2 1/2" I.D.)		24240
Hose - Upper - Pipe To Rad.; (2 1/2" I.D.)		24240
Hose - Lower - Eng. To Rad.; (2 1/2" I.D.)		24240
Hose - Lower - Rad. To Pipe; (3" I.D.)		24248
Caterpillar C15 Diesel		
C500		
Belt - Fan & Alt.	D8410003082875	▲K081124HD
Belt - Fan To A.C.	D840003061315	▲K060516HD

Application	Mfr. Part No.	Our No.
KENWORTH - Continued		
2006 - Continued		
Caterpillar C15 Diesel - Continued		
C500 - Continued		
Tensioner Assy. - Fan & Alt.	2002279	38569
Tensioner Assy. - Fan To A.C.	2178938	38511
Idler Pulley - Smooth	1979641	36091
Idler Pulley - Grooved	1979642	36341
Tensioner Pulley - Fan To A.C.	2178938	36091
T600		
Belt - Fan & Alt.	D8410001082370	▲K080934HD
Belt - Fan To A.C.	D8410003061460	▲K060575HD
Tensioner Assy. - Fan & Alt.	1900649	38506
Tensioner Assy. - Fan To A.C.	1900642	38508
Idler Pulley - Smooth	1979641	36091
Idler Pulley - Grooved	1979642	36341
Tensioner Pulley - Fan & Alt.	1900649	36091
Tensioner Pulley - Fan To A.C.	1900642	36091
Hose - Upper - Eng. To Pipe; (2 1/2" I.D.)		24240
Hose - Upper - Pipe To Rad.; (2 1/2" I.D.)		24240
Hose - Lower - Eng. To Pipe; (3" I.D.)		24248
Hose - Lower - Pipe To Rad.; (3" I.D.)		24248
T800		
Belt - Fan & Alt.; W/Conventional Hood	D8410001082370	▲K080934HD
Belt - Fan & Alt.; W/Short Hood	D8410003122480	▲K120975HD
Belt - Fan & Alt.; W/Wide Hood	D8410003082600	▲K081023HD
Belt - Fan To A.C.; W/Conventional Hood	D11085689	▲K060575HD
Belt - Fan To A.C.; W/Short Hood	D8410003061470	▲K060578HD
Belt - Fan & A.C.; W/Wide Hood	D8410003061280	K060505
Tensioner Assy. - Fan & Alt.; W/Conventional Hood	2002279	38569
Tensioner Assy. - Fan & A.C.	2178938	38511
Idler Pulley - Smooth	1979641	36091
Idler Pulley - Grooved	1979642	36341
Hose - Upper - Eng. To Pipe; (2 1/2" I.D.)		24240
Hose - Upper - Pipe To Rad.; W/Conventional Hood(2 1/2" I.D.)		24240
Hose - Lower - Eng. To Pipe; (3" I.D.)		24248
Hose - Lower - Pipe To Rad.; (3" I.D.)		24248
T2000		
Belt - Fan & Alt.	D11084936	▲K080939HD
Belt - Fan To A.C.	D11085527	▲K060637HD
Tensioner Assy. - Fan & Alt.	2002279	38569
Tensioner Assy. - Fan To A.C.	2178938	38511
Idler Pulley - Smooth	1979641	36091
Idler Pulley - Grooved	1979642	36341
Tensioner Pulley - Fan To A.C.	2178938	36091
Hose - Upper - Eng. To Pipe; (2 1/2" I.D.)		24240
Hose - Upper - Pipe To Rad.; W/O Clean Air Pkg.(2 1/2" I.D.)		24240
Hose - Lower - Eng. To Pipe; (3" I.D.)		24248
Hose - Lower - Pipe To Rad.; W/Clean Air Pkg.(2 1/2" I.D.) ..		24240
Hose - Lower - Pipe To Rad.; W/O Clean Air Pkg.(3" I.D.) ..		24248
W900		
Belt - Fan & Alt.; W/8-Ribbed Belt; W/96" Belt O.C.	D11084884	▲K080952HD
Belt - Fan & Alt.; W/8-Ribbed Belt; W/106" Belt O.C.	D11085882	K081055HD
Belt - Fan & Alt.; W/12-Ribbed Belt	D8410001122540	K121000HD
Belt - Fan To A.C.; W/62" Belt O.C.	D11085352	▲K060615HD
Belt - Fan & A.C.; W/55 7/8" Belt O.C. ...	D11085700	▲K060555HD
Tensioner Assy. - Fan & Alt.; W/8-Ribbed Belt	2002279	38569
Tensioner Assy. - Fan & Alt.; W/12-Ribbed Belt	2362301	38609
Tensioner Assy. - Fan To A.C.	2178938	38511
Idler Pulley - Smooth	1979641	36091
Idler Pulley - Grooved	1979642	36341
Tensioner Pulley - Fan To A.C.	2178938	36091
Hose - Upper - Eng. To Pipe; (2 1/2" I.D.)		24240
Hose - Upper - Pipe To Rad.; (2 1/2" I.D.)		24240
Hose - Lower - Eng. To Pipe; (3" I.D.)		24248
Hose - Lower - Pipe To Rad.; (3" I.D.)		24248

▲ Standard Belt Available. See Pages 630-631.

≈ Cut to Fit.

Belts and Coolant Hose for Medium/Heavy-Duty Trucks (1996 and Newer)

 Medium & Heavy-Duty Trucks
(1996 & Newer)

Application	Mfr. Part No.	Our No.
KENWORTH - Continued		
2006 - Continued		
Cummins ISB Diesel		
T300		
Belt - Fan, Alt. & A.C.	3289974	▲K080855HD
Tensioner Assy. - Fan, Alt. & A.C.	3976833	38517
Hose - Upper - Eng. To Pipe; (1 3/4" I.D.)		24228
Hose - Lower - Pipe To Rad.		≅21115
Hose - Lower - Eng. To Cooler; (2 1/2" I.D.)		24240
Cummins ISC Diesel		
T300		
Belt - Fan, Alt. & A.C.	3972265	▲K080878HD
Tensioner Assy. - Fan, Alt. & A.C.	3976831	38516
Idler Pulley	3970945	36283
Hose - Upper - Eng. To Pipe; (2 1/4" I.D.)		24236
Hose - Upper - Pipe To Rad.; (2 1/4" I.D.)		24236
Cummins ISL Diesel		
T800		
Belt - Fan, W.P. & Alt.	3972383	▲K080806HD
Belt - Fan To A.C.		▲9380HD
Tensioner Assy. - Fan, W.P. & Alt.	3936213	38516
Tensioner Pulley - Fan, W.P. & Alt.	3936213	36093
Hose - Upper - Eng. To Pipe; (2 1/4" I.D.)		24236
Hose - Upper - Rad. To Pipe; (2 1/4" I.D.)		24236
Hose - Lower - Eng. To Pipe; (2" I.D.)		24232
Hose - Lower - Pipe To Cooler; (2 1/4" I.D.)		24236
Hose - Lower - Cooler To Pipe; (2 1/2" I.D.)		24240
Hose - Lower - Rad. To Pipe; (3 1/4" I.D.)		24052
Cummins ISM Diesel		
T600		
Idler Pulley - Fan & Alt.	3400884	36308
Tensioner Pulley - A.C.	4004933	36091
T800		
Belt - Fan & Alt.	D8410001081780	▲K080702HD
Belt - Hub & A.C.	4004824	▲K060539HD
Tensioner Assy. - Fan & Alt.	4920105	38622
Tensioner Assy. - Hub & A.C.	4004933	38505
Idler Pulley - Fan & Alt.	3400884	36308
Tensioner Pulley - A.C.	4004933	36091
Hose - Upper - Eng. To Pipe; (2 1/2" I.D.)		24240
Hose - Upper - Pipe To Rad.; (2 1/2" I.D.)		24240
Hose - Lower - Eng. To Pipe; (2 1/2" I.D.)		24240
Hose - Lower - Pipe To Rad.; (3" I.D.)		24248
T2000		
Idler Pulley - Fan & Alt.	3400884	36308
W900		
Belt - Fan & Alt.; W/Short Hood	D8410001081780	▲K080702HD
Belt - Hub & A.C.; W/Short Hood	4004824	▲K060539HD
Tensioner Assy. - Fan & Alt.	4920105	38622
Tensioner Assy. - Hub & A.C.	4004933	38505
Idler Pulley - Fan & Alt.	3400884	36308
Tensioner Pulley - A.C.	4004933	36091
Hose - Upper - Eng. To Pipe; (2 1/2" I.D.)		24240
Hose - Upper - Pipe To Rad.; (2 1/2" I.D.)		24240
Hose - Lower - Eng. To Pipe; (2 1/2" I.D.)		24240
Hose - Lower - Pipe To Rad.; (3" I.D.)		24248
Cummins ISX Diesel		
T600		
Belt - Fan, Alt. & W.P.	D11084213	▲K120864HD
Belt - W.P. To A.C.	D8410003061620	▲K060637HD
Tensioner Assy. - Hub & A.C.	3682683	38610
Tensioner Assy. - Fan & Alt.	3682946	38587
Idler Pulley - A.C.	3682229	36223
Tensioner Pulley - Fan & Alt.	3682946	36165
Hose - Upper - Eng. To Pipe; (2 1/2" I.D.)		24240
Hose - Upper - Pipe To Rad.; (2 1/2" I.D.)		24240
Hose - Lower - Eng. To Pipe; (2 1/2" I.D.)		24240
Hose - Lower - Pipe To Rad.; (3" I.D.)		24248
T800		
Belt - Fan, Alt. & W.P.; W/Conventional Hood	D8410001122195	▲K120864HD

Application	Mfr. Part No.	Our No.
KENWORTH - Continued		
2006 - Continued		
Cummins ISX Diesel - Continued		
T800 - Continued		
Belt - Fan, Alt. & W.P.; W/Wide Hood ...	D8410003122400	K120945HD
Belt - A.C. - From W.P.	D8410003061620	▲K060637HD
Tensioner Assy. - Hub & A.C.	3682683	38610
Tensioner Assy. - Fan & Alt.	3682946	38587
Idler Pulley - A.C.	3682229	36223
Tensioner Pulley - Fan & Alt.	3682946	36165
Hose - Upper - Eng. To Pipe; (2 1/2" I.D.)		24240
Hose - Upper - Pipe To Rad.; (2 1/2" I.D.)		24240
Hose - Lower - Eng. To Pipe; (2 1/2" I.D.)		24240
Hose - Lower - Pipe To Rad.; (3" I.D.)		24248
T2000		
Belt - Fan, Alt. & Hub	D8410001122195	▲K120864HD
Belt - Hub & A.C.	D8410003061620	▲K060637HD
Tensioner Assy. - Hub & A.C.	3682683	38610
Tensioner Assy. - Fan & Alt.	3682946	38587
Idler Pulley - A.C.	3682229	36223
Tensioner Pulley - Fan & Alt.	3682946	36165
Hose - Upper - Eng. To Pipe; (2 1/2" I.D.)		24240
Hose - Upper - Pipe To Rad.		●26531
Hose - Lower - Eng. To Pipe		21591
Hose - Lower - Pipe To Rad.; (2 1/2" I.D.)		24240
W900		
Belt - Fan & Alt.	D8410001122230	▲K120878HD
Belt - Hub, Alt. & A.C.	D8410003061620	▲K060637HD
Tensioner Assy. - Hub & A.C.	3682683	38610
Tensioner Assy. - Fan & Alt.	3682946	38587
Idler Pulley - A.C.	3682229	36223
Tensioner Pulley - Fan & Alt.	3682946	36165
Hose - Upper - Eng. To Pipe; (2 1/2" I.D.)		24240
Hose - Upper - Pipe To Rad.; W/O E.G.R. (2 1/2" I.D.)		24240
Hose - Lower - Eng. To Pipe; (2 1/2" I.D.)		24240
Hose - Lower - Pipe To Rad.; (2 1/2" I.D.)		24240
2005		
Caterpillar C7 Diesel		
T300		
Belt - Fan, Alt. & A.C.	D8410001082175	▲K080859HD
Tensioner Assy. - Fan, Alt. & A.C.	2222880	38586
Idler Pulley - Upper	1979641	36091
Idler Pulley - Lower	2534525	36096
Hose - Upper - Eng. To Pipe		20206
Hose - Upper - Pipe To Rad.		21194
Caterpillar C11 Diesel		
T800		
Belt - Fan, Alt. & A.C.; W/Conventional Hood	D8410001082420	▲K080952HD
Belt - Fan, Alt. & A.C.; W/Short Hood ...	D8410003082730	▲K081074HD
Tensioner Assy. - Fan, Alt. & A.C.	2117895	38590
Tensioner Pulley - Fan, Alt. & A.C.	2117895	36164
Idler Pulley - Smooth	2078118	36269
Idler Pulley - Grooved	1979642	36341
Hose - Upper - Eng. To Pipe; (2 1/2" I.D.)		24240
Hose - Upper - Pipe To Rad.; W/Conventional Hood(2 1/2" I.D.)		24240
Hose - Lower - Eng. To Pipe; W/Conventional Hood(2 1/2" I.D.)		24240
Hose - Lower - Eng. To Pipe; W/Short Hood		21891
Hose - Lower - Pipe To Pipe; W/Short Hood(2 1/2" I.D.)		24240
Hose - Lower - Pipe To Rad.; (3" I.D.)		24248
W900		
Belt - Fan, Alt. & A.C.	D8410003082450	K080964HD
Tensioner Assy. - Fan, Alt. & A.C.	2117895	38590
Tensioner Pulley - Fan, Alt. & A.C.	2117895	36164
Idler Pulley - Smooth	2078118	36269
Idler Pulley - Grooved	1979642	36341
Hose - Upper - Eng. To Pipe; (2 1/2" I.D.)		24240
Hose - Upper - Pipe To Rad.; (2 1/2" I.D.)		24240
Hose - Lower - Eng. To Rad.; (2 1/2" I.D.)		24240
Hose - Lower - Rad. To Pipe; (3" I.D.)		24248

▲ Standard Belt Available. See Pages 630-631.
● Vulco-Flex® Coolant Hose.

≅ Cut to Fit.

Belts and Coolant Hose for Medium/Heavy-Duty Trucks [1996 and Newer]

Medium & Heavy-Duty Trucks
(1996 & Newer)

Application	Mfr. Part No.	Our No.
KENWORTH - Continued		
2005 - Continued		
Caterpillar C13 Diesel		
T800		
Belt - Fan, Alt. & A.C.; W/Conventional Hood	D8410001082420	▲K080952HD
Belt - Fan, Alt. & A.C.; W/Short Hood ...	D8410003082730	▲K081074HD
Tensioner Assy. - Fan, Alt. & A.C.	2117895	38590
Tensioner Pulley - Fan, Alt. & A.C.	2117895	36164
Idler Pulley - Smooth	2078118	36269
Idler Pulley - Grooved	1979642	36341
Hose - Upper - Eng. To Pipe; (2 1/2" I.D.)		24240
Hose - Upper - Pipe To Rad.; W/Conventional Hood(2 1/2" I.D.)		24240
Hose - Lower - Eng. To Pipe; W/Conventional Hood(2 1/2" I.D.)		24240
Hose - Lower - Eng. To Pipe; W/Short Hood		21891
Hose - Lower - Pipe To Pipe; W/Short Hood(2 1/2" I.D.)		24240
Hose - Lower - Pipe To Rad.; (3" I.D.)		24248
W900		
Belt - Fan, Alt. & A.C.		▲K080968HD
Tensioner Assy. - Fan, Alt. & A.C.	2117895	38590
Tensioner Pulley - Fan, Alt. & A.C.	2117895	36164
Idler Pulley - Smooth	2078118	36269
Idler Pulley - Grooved	1979642	36341
Hose - Upper - Eng. To Pipe; (2 1/2" I.D.)		24240
Hose - Upper - Pipe To Rad.; (2 1/2" I.D.)		24240
Hose - Lower - Eng. To Rad.; (2 1/2" I.D.)		24240
Hose - Lower - Rad. To Pipe; (3" I.D.)		24248
Caterpillar C15 Diesel		
T600		
Belt - Fan & Alt.; W/Clean Air Pkg.; W/84 7/8" Belt O.C.	D8410001082135	▲K080842HD
Belt - Fan & Alt.; W/Clean Air Pkg.; W/89 7/8" Belt O.C.	D11084906	▲K080893HD
Belt - Fan To A.C.	D8410003061450	▲K060569HD
Tensioner Assy. - Fan & Alt.; W/Clean Air Pkg.; W/84" Belt O.C.	1900643	38620
Tensioner Assy. - Fan & Alt.; W/Clean Air Pkg.; W/89" Belt O.C.	1900649	38506
Tensioner Assy. - Fan To A.C.	1900642	38508
Idler Pulley - Smooth	1979641	36091
Idler Pulley - Grooved	1979642	36341
Tensioner Pulley - Fan To A.C.	1900642	36091
Hose - Upper - Eng. To Pipe; (2 1/2" I.D.)		24240
Hose - Upper - Pipe To Rad.; (2 1/2" I.D.)		24240
Hose - Lower - Eng. To Pipe; (3" I.D.)		24248
Hose - Lower - Pipe To Rad.; (3" I.D.)		24248
T800		
Belt - Fan & Alt.	D11084948	▲K080934HD
Belt - Fan To A.C.	D11085688	▲K060575HD
Tensioner Assy. - Fan & Alt.	2002279	38569
Tensioner Assy. - Fan To A.C.	2178938	38511
Idler Pulley - Smooth	1979641	36091
Idler Pulley - Grooved	1979642	36341
Hose - Upper - Eng. To Pipe; (2 1/2" I.D.)		24240
Hose - Upper - Pipe To Rad.; (2 1/2" I.D.)		24240
Hose - Lower - Eng. To Pipe; (3" I.D.)		24248
Hose - Lower - Pipe To Rad.; (3" I.D.)		24248
T2000		
Belt - Fan & Alt.	D11084936	▲K080939HD
Belt - Fan To A.C.	D11085527	▲K060637HD
Tensioner Assy. - Fan & Alt.	2002279	38569
Tensioner Assy. - Fan To A.C.	2178938	38511
Idler Pulley - Smooth	1979641	36091
Idler Pulley - Grooved	1979642	36341
Tensioner Pulley - Fan To A.C.	2178938	36091
Hose - Upper - Eng. To Pipe; (2 1/2" I.D.)		24240
Hose - Upper - Pipe To Rad.; W/O Clean Air Pkg.(2 1/2" I.D.)		24240
Hose - Lower - Eng. To Pipe; (3" I.D.)		24248
Hose - Lower - Pipe To Rad.; W/Clean Air Pkg.(2 1/2" I.D.) ..		24240
Hose - Lower - Pipe To Rad.; W/O Clean Air Pkg.(3" I.D.) ..		24248

Application	Mfr. Part No.	Our No.
KENWORTH - Continued		
2005 - Continued		
Caterpillar C15 Diesel - Continued		
W900		
Belt - Fan & Alt.; W/8-Ribbed Belt; W/96" Belt O.C.	D11084884	▲K080952HD
Belt - Fan & Alt.; W/8-Ribbed Belt; W/106" Belt O.C.	D11085882	K081055HD
Belt - Fan To A.C.	D11085352	▲K060615HD
Tensioner Assy. - Fan & Alt.	2002279	38569
Tensioner Assy. - Fan To A.C.	2178938	38511
Idler Pulley - Smooth	1979641	36091
Idler Pulley - Grooved	1979642	36341
Tensioner Pulley - Fan To A.C.	2178938	36091
Hose - Upper - Eng. To Pipe; (2 1/2" I.D.)		24240
Hose - Upper - Pipe To Rad.; (2 1/2" I.D.)		24240
Hose - Lower - Eng. To Pipe; (3" I.D.)		24248
Hose - Lower - Pipe To Rad.; (3" I.D.)		24248
Cummins ISB Diesel		
T300		
Belt - Fan, Alt. & A.C.	3289974	▲K080855HD
Tensioner Assy. - Fan, Alt. & A.C.	3957433	38517
Hose - Upper - Eng. To Pipe; (1 3/4" I.D.)		24228
Hose - Upper - Pipe To Rad.		≈21115
Hose - Lower - Eng. To Cooler; (2 1/2" I.D.)		24240
Cummins ISC Diesel		
T300		
Belt - Fan & Alt.	3959841	▲K080720HD
Belt - Fan To A.C.	D11022461	7417
Tensioner Assy. - Fan & Alt.	3976831	38516
Hose - Upper - Eng. To Pipe; (2 1/4" I.D.)		24236
Hose - Lower - Eng. To Pipe; (2 1/4" I.D.)		24236
Hose - Lower - Pipe To Cooler; (2 1/2" I.D.)		24240
Cummins ISL Diesel		
T800		
Belt - Fan, W.P. & Alt.	3289369	▲K080716HD
Belt - Fan To A.C.	D11023525	▲9463HD
Tensioner Assy. - Fan, W.P. & Alt.	3936213	38516
Tensioner Pulley - Fan, W.P. & Alt.	3936213	36093
Hose - Upper - Eng. To Pipe; (2 1/4" I.D.)		24236
Hose - Upper - Pipe To Rad.; (2 1/4" I.D.)		24236
Hose - Lower - Eng. To Pipe; (2" I.D.)		24232
Hose - Lower - Pipe To Cooler; (2 1/4" I.D.)		24236
Hose - Lower - Cooler To Pipe; (2 1/2" I.D.)		24240
Hose - Lower - Pipe To Rad.; (3 1/4" I.D.)		24052
Cummins ISM Diesel		
T600		
Idler Pulley - Fan & Alt.	3400884	36308
T800		
Belt - Fan & Alt.	D8410001081780	▲K080702HD
Belt - Hub & A.C.	4004824	▲K060539HD
Tensioner Assy. - Fan & Alt.	4920105	38622
Tensioner Assy. - Hub & A.C.	4004933	38505
Idler Pulley - Fan & Alt.	3400884	36308
Tensioner Pulley - A.C.	4004933	36091
Hose - Upper - Eng. To Pipe; (2 1/2" I.D.)		24240
Hose - Upper - Pipe To Rad.; (2 1/2" I.D.)		24240
Hose - Lower - Eng. To Pipe; (2 1/2" I.D.)		24240
Hose - Lower - Pipe To Rad.; (3" I.D.)		24248
T2000		
Idler Pulley - Fan & Alt.	3400884	36308
W900		
Belt - Fan & Alt.	D11084891	▲K080702HD
Belt - Hub & A.C.	4004824	▲K060539HD
Tensioner Assy. - Fan & Alt.	4920105	38622
Tensioner Assy. - Hub & A.C.	3102888	38505
Idler Pulley - Fan & Alt.	3400884	36308
Idler Pulley - A.C.	3104139	36225
Tensioner Pulley - A.C.	3102888	36091
Hose - Upper - Eng. To Pipe; (2 1/2" I.D.)		24240
Hose - Upper - Pipe To Rad.; (2 1/2" I.D.)		24240
Hose - Lower - Eng. To Pipe; (2 1/2" I.D.)		24240

▲ Standard Belt Available. See Pages 630-631.

≈ Cut to Fit.

Belts and Coolant Hose for Medium/Heavy-Duty Trucks (1996 and Newer)

 Medium & Heavy-Duty Trucks
(1996 & Newer)

Application	Mfr. Part No.	Our No.
KENWORTH - Continued		
2005 - Continued		
Cummins ISM Diesel - Continued		
W900 - Continued		
Hose - Lower - Pipe To Rad.; (3" I.D.)		24248
Cummins ISX Diesel		
T600		
Belt - Fan & Alt.	D8410001122195	▲K120864HD
Belt - Hub, Alt. & A.C.	D8410003061620	▲K060637HD
Tensioner Assy. - Hub & A.C.	3682683	38610
Tensioner Assy. - Fan & Alt.	3682946	38587
Idler Pulley - A.C.	3682229	36223
Tensioner Pulley - Fan & Alt.	3682946	36165
Hose - Upper - Eng. To Pipe; (2 1/2" I.D.)		24240
Hose - Upper - Pipe To Rad.; (2 1/2" I.D.)		24240
Hose - Lower - Eng. To Pipe; (2 1/2" I.D.)		24240
Hose - Lower - Pipe To Rad.; (3" I.D.)		24248
T800		
Belt - Fan, Alt. & W.P.; W/Conventional Hood		
	D8410001122195	▲K120864HD
Belt - Fan, Alt. & W.P.; W/Wide Hood ...	D8410003122400	K120945HD
Belt - A.C. - From W.P.	D8410003061620	▲K060637HD
Tensioner Assy. - Hub & A.C.	3682683	38610
Tensioner Assy. - Fan & Alt.	3682946	38587
Idler Pulley - A.C.	3682229	36223
Tensioner Pulley - Fan & Alt.	3682946	36165
Hose - Upper - Eng. To Pipe; (2 1/2" I.D.)		24240
Hose - Upper - Pipe To Rad.; (2 1/2" I.D.)		24240
Hose - Lower - Eng. To Pipe; (2 1/2" I.D.)		24240
Hose - Lower - Pipe To Rad.; (3" I.D.)		24248
T2000		
Belt - Fan, Alt. & Hub	D8410001122195	▲K120864HD
Belt - Hub & A.C.	D8410003061620	▲K060637HD
Tensioner Assy. - Hub & A.C.	3682683	38610
Tensioner Assy. - Fan & Alt.	3682946	38587
Idler Pulley - A.C.	3682229	36223
Tensioner Pulley - Fan & Alt.	3682946	36165
Hose - Upper - Eng. To Pipe; (2 1/2" I.D.)		24240
Hose - Upper - Pipe To Rad.		●26531
Hose - Lower - Eng. To Pipe		21591
Hose - Lower - Pipe To Rad.; (2 1/2" I.D.)		24240
W900		
Belt - Hub, Alt. & A.C.	D8410003061620	▲K060637HD
Tensioner Assy. - Fan & Alt.	3682946	38587
Tensioner Assy. - Hub & A.C.	3682683	38610
Idler Pulley - A.C.	3682229	36223
Tensioner Pulley - Fan & Alt.	3682946	36165
Hose - Upper - Eng. To Pipe; (2 1/2" I.D.)		24240
Hose - Upper - Pipe To Rad.; W/O E.G.R.(2 1/2" I.D.)		24240
Hose - Lower - Eng. To Pipe; (2 1/2" I.D.)		24240
Hose - Lower - Pipe To Rad.; (2 1/2" I.D.)		24240

2004

Caterpillar C7 Diesel		
T300		
Belt - Fan, Alt. & A.C.	D8410001082060	▲K080810HD
Tensioner Assy. - Fan, Alt. & A.C.	2222880	38586
Idler Pulley - Upper	1979641	36091
Idler Pulley - Lower	2534525	36096
Hose - Upper - Eng. To Rad.		20206
Hose - Upper - Rad. To Rad.		≧20611
Caterpillar C10 Diesel		
T600		
Belt - Fan, Alt. & Hub	D11080001	▲K080825HD
Belt - Fan To A.C.		▲9510HD
Tensioner Assy. - Fan, Alt. & Hub	1481974	38506
Idler Pulley - Fan & Alt.; W/Flat Idler Pulley	1337023	36091
Idler Pulley - Fan & Alt.; W/Multi-Grooved Idler Pulley	1731498	36231
Tensioner Pulley - Fan, Alt. & Hub	1481974	36091
Hose - Upper - Eng. To Pipe; (2 1/2" I.D.)		24240

Application	Mfr. Part No.	Our No.
KENWORTH - Continued		
2004 - Continued		
Caterpillar C10 Diesel - Continued		
T600 - Continued		
Hose - Upper - Pipe To Rad.; (2 1/2" I.D.)		24240
Hose - Lower - Eng. To Pipe; (2 1/2" I.D.)		24240
Hose - Lower - Pipe To Rad.; (3" I.D.)		24248
T800		
Belt - Fan, Alt. & Hub	D8410001082060	▲K080810HD
Belt - Fan & A.C.	D11023637	▲9500HD
Tensioner Assy. - Fan, Alt. & Hub	1900649	38506
Idler Pulley - Fan & Alt.; W/Flat Idler Pulley	1337023	36091
Idler Pulley - Fan & Alt.; W/Multi-Grooved Idler Pulley	1731498	36231
Tensioner Pulley - Fan, Alt. & Hub	1900649	36091
Hose - Upper - Eng. To Pipe; (2 1/2" I.D.)		24240
Hose - Upper - Pipe To Rad.; (2 1/2" I.D.)		24240
Hose - Lower - Eng. To Pipe; (2 1/2" I.D.)		24240
Hose - Lower - Pipe To Rad.; (3" I.D.)		24248
W900		
Belt - Fan & Alt.		▲K080810HD
Belt - Fan To A.C.		▲9540HD
Idler Pulley - Fan & Alt.; W/Flat Idler Pulley	1337023	36091
Idler Pulley - Fan & Alt.; W/Multi-Grooved Idler Pulley	1731498	36231
Hose - Upper - Eng. To Pipe; (2 1/2" I.D.)		24240
Hose - Upper - Pipe To Rad.; (2 1/2" I.D.)		24240
Hose - Lower - Eng. To Pipe; (2 1/2" I.D.)		24240
Hose - Lower - Pipe To Rad.; (2 1/2" I.D.)		24240
Caterpillar C11 Diesel		
T800		
Belt - Fan, Alt. & A.C.; W/Conventional Hood		
	D8410001082420	▲K080952HD
Belt - Fan, Alt. & A.C.; W/Short Hood ...	D8410003082730	▲K081074HD
Tensioner Assy. - Fan, Alt. & A.C.	2117895	38590
Tensioner Pulley - Fan, Alt. & A.C.	2117895	36164
Idler Pulley - Smooth	2078118	36269
Idler Pulley - Grooved	1979642	36341
Hose - Upper - Eng. To Pipe; (2 1/2" I.D.)		24240
Hose - Upper - Pipe To Rad.; W/Conventional Hood(2 1/2" I.D.)		24240
Hose - Lower - Eng. To Pipe; W/Conventional Hood(2 1/2" I.D.)		24240
Hose - Lower - Eng. To Pipe; W/Short Hood		21891
Hose - Lower - Pipe To Pipe; W/Short Hood(2 1/2" I.D.)		24240
Hose - Lower - Pipe To Rad.; (3" I.D.)		24248
Caterpillar C12 Diesel		
T600		
Belt - Fan, Alt. & Hub	D11080001	▲K080825HD
Belt - Fan To A.C.		▲9510HD
Tensioner Assy. - Fan, Alt. & Hub	1481974	38506
Idler Pulley - Fan & Alt.; W/Flat Idler Pulley	1337023	36091
Idler Pulley - Fan & Alt.; W/Multi-Grooved Idler Pulley	1731498	36231
Tensioner Pulley - Fan, Alt. & Hub	1481974	36091
Hose - Upper - Eng. To Pipe; (2 1/2" I.D.)		24240
Hose - Upper - Pipe To Rad.; (2 1/2" I.D.)		24240
Hose - Lower - Eng. To Pipe; (2 1/2" I.D.)		24240
Hose - Lower - Pipe To Rad.; (3" I.D.)		24248
T800		
Belt - Fan, Alt. & Hub	D8410001082060	▲K080810HD
Belt - Fan & A.C.	D11023637	▲9500HD
Tensioner Assy. - Fan, Alt. & Hub	1900649	38506
Idler Pulley - Fan & Alt.; W/Flat Idler Pulley	1337023	36091
Idler Pulley - Fan & Alt.; W/Multi-Grooved Idler Pulley	1731498	36231
Tensioner Pulley - Fan, Alt. & Hub	1900649	36091
Hose - Upper - Eng. To Pipe; (2 1/2" I.D.)		24240
Hose - Upper - Pipe To Rad.; (2 1/2" I.D.)		24240

▲ Standard Belt Available. See Pages 630-631.
≧ Cut to Fit.

● Vulco-Flex® Coolant Hose.

Belts and Coolant Hose for Medium/Heavy-Duty Trucks (1996 and Newer)

Medium & Heavy-Duty Trucks
(1996 & Newer)

Application	Mfr. Part No.	Our No.
KENWORTH - Continued		
2004 - Continued		
Caterpillar C12 Diesel - Continued		
T800 - Continued		
Hose - Lower - Eng. To Pipe; (2 1/2" I.D.)		24240
Hose - Lower - Pipe To Rad.; (3" I.D.)		24248
W900		
Idler Pulley - Fan & Alt.; W/Flat Idler		
Pulley	1337023	36091
Idler Pulley - Fan & Alt.;		
W/Multi-Grooved Idler Pulley	1731498	36231
Caterpillar C13 Diesel		
T800		
Belt - Fan, Alt. & A.C.; W/Conventional		
Hood	D8410001082420	♣K080952HD
Belt - Fan, Alt. & A.C.; W/Short Hood ...	D8410003082730	♣K081074HD
Tensioner Assy. - Fan, Alt. & A.C.	2117895	38590
Tensioner Pulley - Fan, Alt. & A.C.	2117895	36164
Idler Pulley - Smooth	2078118	36269
Idler Pulley - Grooved	1979642	36341
Hose - Upper - Eng. To Pipe; (2 1/2" I.D.)		24240
Hose - Upper - Pipe To Rad.; W/Conventional Hood(2 1/2" I.D.)		24240
Hose - Lower - Eng. To Pipe; W/Conventional Hood(2 1/2" I.D.)		24240
Hose - Lower - Eng. To Pipe; W/Short Hood		21891
Hose - Lower - Pipe To Pipe; W/Short Hood(2 1/2" I.D.)		24240
Hose - Lower - Pipe To Rad.; (3" I.D.)		24248
W900		
Belt - Fan, Alt. & A.C.		♣K080968HD
Tensioner Assy. - Fan, Alt. & A.C.	2117895	38590
Tensioner Pulley - Fan, Alt. & A.C.	2117895	36164
Idler Pulley - Smooth	2078118	36269
Idler Pulley - Grooved	1979642	36341
Hose - Upper - Eng. To Pipe; (2 1/2" I.D.)		24240
Hose - Upper - Pipe To Rad.; (2 1/2" I.D.)		24240
Hose - Lower - Eng. To Rad.; (2 1/2" I.D.)		24240
Hose - Lower - Rad. To Pipe; (3" I.D.)		24248
Caterpillar C15 Diesel		
T600		
Belt - Fan & Alt.; W/Clean Air Pkg.; W/84		
7/8" Belt O.C.	D8410001082135	♣K080842HD
Belt - Fan & Alt.; W/Clean Air Pkg.; W/89		
7/8" Belt O.C.	D11084906	♣K080893HD
Belt - Fan To A.C.; W/Clean Air Pkg.	D8410003061450	♣K060569HD
Belt - Fan & W.P.; W/O Clean Air Pkg.; Preferred Belt		2/TR22553PB
Belt - Fan & W.P.; W/O Clean Air Pkg.; Optional Belt		②TR22553
Belt - Fan, Alt. & A.C.; W/O Clean Air Pkg.		②♣9620HD
Tensioner Assy. - Fan & Alt.; W/Clean		
Air Pkg.; W/84" Belt O.C.	1900643	38620
Tensioner Assy. - Fan & Alt.; W/Clean		
Air Pkg.; W/89" Belt O.C.	1900649	38506
Tensioner Assy. - Fan To A.C.; W/Clean		
Air Pkg.	1900642	38508
Idler Pulley - Smooth	1979641	36091
Idler Pulley - Grooved	1979642	36341
Tensioner Pulley - Fan To A.C.;		
W/Clean Air Pkg.	1900642	36091
Hose - Upper - Eng. To Pipe; (2 1/2" I.D.)		24240
Hose - Upper - Pipe To Rad.; (2 1/2" I.D.)		24240
Hose - Lower - Eng. To Pipe; (3" I.D.)		24248
Hose - Lower - Pipe To Rad.; (3" I.D.)		24248
T800		
Belt - Fan & Alt.; W/Clean Air Pkg.; W/84		
7/8" Belt O.C.	D8410001082135	♣K080842HD
Belt - Fan & Alt.; W/Clean Air Pkg.; W/89		
7/8" Belt O.C.	D11084906	♣K080893HD
Belt - Fan & W.P.; W/O Clean Air Pkg.		②TR22545
Belt - Fan To A.C.; W/Clean Air Pkg.	D11085634	♣K060569HD
Belt - Fan, Alt. & A.C.; W/O Clean Air Pkg.		②♣9620HD
Tensioner Assy. - Fan & Alt.; W/Clean		
Air Pkg.; W/84" Belt O.C.	1900643	38620

Application	Mfr. Part No.	Our No.
KENWORTH - Continued		
2004 - Continued		
Caterpillar C15 Diesel - Continued		
T800 - Continued		
Tensioner Assy. - Fan & Alt.; W/Clean		
Air Pkg.; W/89" Belt O.C.	1900649	38506
Tensioner Assy. - Fan To A.C.; W/Clean		
Air Pkg.	1900642	38508
Idler Pulley - Smooth	1979641	36091
Idler Pulley - Grooved	1979642	36341
Tensioner Pulley - Fan & Alt.; W/Clean		
Air Pkg.	1900649	36091
Tensioner Pulley - Fan To A.C.;		
W/Clean Air Pkg.	1900642	36091
Hose - Upper - Eng. To Pipe; (2 1/2" I.D.)		24240
Hose - Upper - Pipe To Rad.; (2 1/2" I.D.)		24240
Hose - Lower - Eng. To Pipe; (3" I.D.)		24248
Hose - Lower - Pipe To Rad.; W/Clean Air Pkg.(2 1/2" I.D.) .		24240
Hose - Lower - Pipe To Rad.; W/O Clean Air Pkg.(3" I.D.) ..		24248
T2000		
Belt - Fan & Alt.; W/Clean Air Pkg.	D11084936	♣K080939HD
Belt - Fan; W/O Clean Air Pkg.; Preferred Belt		2/TR22570PB
Belt - Fan; W/O Clean Air Pkg.; Optional Belt		②TR22570
Belt - Fan To A.C.; W/Clean Air Pkg.	D11085527	♣K060637HD
Belt - Fan To Alt. & A.C.; W/O Clean Air Pkg.		②♣9650HD
Tensioner Assy. - Fan & Alt.	2002279	38569
Tensioner Assy. - Fan To A.C.	2178938	38511
Idler Pulley - Smooth	1979641	36091
Idler Pulley - Grooved	1979642	36341
Tensioner Pulley - Fan To A.C.	2178938	36091
Hose - Upper - Eng. To Pipe; (2 1/2" I.D.)		24240
Hose - Upper - Pipe To Rad.; W/O Clean Air Pkg.(2 1/2" I.D.)		24240
Hose - Lower - Eng. To Pipe; (3" I.D.)		24248
Hose - Lower - Pipe To Rad.; W/Clean Air Pkg.(2 1/2" I.D.) .		24240
Hose - Lower - Pipe To Rad.; W/O Clean Air Pkg.(3" I.D.) ..		24248
W900		
Belt - Fan & Alt.; W/Clean Air Pkg.	D11084884	♣K080952HD
Belt - Fan & Alt.; W/O Clean Air Pkg.		②TR22648
Belt - Fan To A.C.; W/Clean Air Pkg.	D11085352	♣K060615HD
Belt - Fan To A.C.; W/O Clean Air Pkg.		②♣9520HD
Tensioner Assy. - Fan & Alt.	2002279	38569
Tensioner Assy. - Fan To A.C.	2178938	38511
Idler Pulley - Smooth	1979641	36091
Idler Pulley - Grooved	1979642	36341
Tensioner Pulley - Fan To A.C.	2178938	36091
Hose - Upper - Eng. To Pipe; (2 1/2" I.D.)		24240
Hose - Upper - Pipe To Rad.; (2 1/2" I.D.)		24240
Hose - Lower - Eng. To Pipe; (3" I.D.)		24248
Hose - Lower - Pipe To Rad.; (3" I.D.)		24248
Cummins ISC Diesel		
T300		
Belt - Fan, Alt. & Hub	3944837	♣K080745HD
Belt - Fan To A.C.		7420
Tensioner Assy. - Fan, Alt. & Hub	3936213	38516
Tensioner Pulley - Fan, Alt. & Hub	3936213	36093
Hose - Upper - Eng. To Pipe; (2 1/4" I.D.)		24236
Hose - Upper - Pipe To Rad.		≧21115
W900		
Belt - Fan & Alt.	3289404	♣K080716HD
Belt - A.C.		♣9463HD
Tensioner Assy. - Fan & Alt.	3936213	38516
Tensioner Pulley - Fan & Alt.	3936213	36093
Cummins ISL Diesel		
T800		
Belt - Fan, W.P. & Alt.	3289369	♣K080716HD
Belt - Fan To A.C.	D11023525	♣9463HD
Tensioner Assy. - Fan, W.P. & Alt.	3936213	38516
Tensioner Pulley - Fan, W.P. & Alt.	3936213	36093
Hose - Upper - Eng. To Pipe; (2 1/4" I.D.)		24236
Hose - Upper - Pipe To Rad.; (2 1/4" I.D.)		24236
Hose - Lower - Eng. To Pipe; (2" I.D.)		24232
Hose - Lower - Pipe To Cooler; (2 1/4" I.D.)		24236

♣ Standard Belt Available. See Pages 630-631.
≧ Cut to Fit.

② Two Required.

Belts and Coolant Hose for Medium/Heavy-Duty Trucks (1996 and Newer)

 Medium & Heavy-Duty Trucks
(1996 & Newer)

Application	Mfr. Part No.	Our No.
KENWORTH - Continued		
2004 - Continued		
Cummins ISL Diesel - Continued		
T800 - Continued		
Hose - Lower - Cooler To Pipe; (2 1/2" I.D.)		24240
Hose - Lower - Pipe To Rad.; (3 1/4" I.D.)		24052
Cummins ISM Diesel		
T600		
Belt - Alt.	D8410001081780	▲K080702HD
Belt - A.C.	4004824	▲K060539HD
Tensioner Assy. - Alt.	3400885	38521
Tensioner Assy. - A.C.	3102888	38505
Idler Pulley - Alt.	3400883	36308
T800		
Belt - Fan & Alt.	D8410001081780	▲K080702HD
Belt - Hub & A.C.	4004824	▲K060539HD
Tensioner Assy. - Fan & Alt.	3400885	38521
Tensioner Assy. - Hub & A.C.	4004933	38505
Idler Pulley - Fan & Alt.	3400884	36308
Tensioner Pulley - A.C.	4004933	36091
Hose - Upper - Eng. To Pipe; (2 1/2" I.D.)		24240
Hose - Upper - Pipe To Rad.; (2 1/2" I.D.)		24240
Hose - Lower - Eng. To Pipe; (2 1/2" I.D.)		24240
Hose - Lower - Pipe To Rad.; (3" I.D.)		24248
W900		
Belt - Fan & Alt.	D11084891	▲K080702HD
Belt - Hub & A.C.	4004824	▲K060539HD
Tensioner Assy. - Fan & Alt.	3400885	38521
Tensioner Assy. - Hub & A.C.	3102888	38505
Idler Pulley - A.C.	3104139	36225
Idler Pulley - Fan & Alt.	3400884	36308
Tensioner Pulley - A.C.	3102888	36091
Hose - Upper - Eng. To Pipe; (2 1/2" I.D.)		24240
Hose - Upper - Rad. To Pipe; (2 1/2" I.D.)		24240
Hose - Lower - Eng. To Pipe; (2 1/2" I.D.)		24240
Hose - Lower - Rad. To Pipe; (3" I.D.)		24248
Cummins ISX Diesel		
T600		
Belt - Fan & Alt.	D8410001122195	▲K120864HD
Belt - Hub, Alt. & A.C.	D8410003061620	▲K060637HD
Tensioner Assy. - Hub & A.C.	3682683	38610
Tensioner Assy. - Fan & Alt.	3682946	38587
Idler Pulley - A.C.	3682229	36223
Tensioner Pulley - Fan & Alt.	3682946	36165
Hose - Upper - Eng. To Pipe; (2 1/2" I.D.)		24240
Hose - Upper - Pipe To Rad.; (2 1/2" I.D.)		24240
Hose - Lower - Eng. To Pipe; (2 1/2" I.D.)		24240
Hose - Lower - Pipe To Rad.; (3" I.D.)		24248
T800		
Belt - Fan, Alt. & W.P.; W/Conventional Hood	D8410001122195	▲K120864HD
Belt - Fan, Alt. & W.P.; W/Wide Hood ...	D8410003122400	K120945HD
Belt - A.C. - From W.P.	D8410003061620	▲K060637HD
Tensioner Assy. - Hub & A.C.	3682683	38610
Tensioner Assy. - Fan & Alt.	3682946	38587
Idler Pulley - A.C.	3682229	36223
Tensioner Pulley - Fan & Alt.	3682946	36165
Hose - Upper - Eng. To Pipe; (2 1/2" I.D.)		24240
Hose - Upper - Pipe To Rad.; (2 1/2" I.D.)		24240
Hose - Lower - Eng. To Pipe; (2 1/2" I.D.)		24240
Hose - Lower - Pipe To Rad.; (3" I.D.)		24248
T2000		
Belt - Fan, Alt. & Hub	D8410001122195	▲K120864HD
Belt - Hub & A.C.	D8410003061620	▲K060637HD
Tensioner Assy. - Hub & A.C.	3682683	38610
Tensioner Assy. - Fan & Alt.	3682946	38587
Idler Pulley - A.C.	3682229	36223
Tensioner Pulley - Fan & Alt.	3682946	36165
Hose - Upper - Eng. To Pipe; (2 1/2" I.D.)		24240
Hose - Upper - Pipe To Rad.		●26531
Hose - Lower - Eng. To Pipe		21591
Hose - Lower - Pipe To Rad.; (2 1/2" I.D.)		24240

▲ Standard Belt Available. See Pages 630-631.

Application	Mfr. Part No.	Our No.
KENWORTH - Continued		
2004 - Continued		
Cummins ISX Diesel - Continued		
W900		
Belt - Fan & Alt.	D8410001122230	▲K120878HD
Belt - Hub, Alt. & A.C.	D8410003061620	▲K060637HD
Tensioner Assy. - Hub & A.C.	3682683	38610
Tensioner Assy. - Fan & Alt.	3682946	38587
Idler Pulley - A.C.	3682229	36223
Tensioner Pulley - Fan & Alt.	3682946	36165
Hose - Upper - Eng. To Pipe; (2 1/2" I.D.)		24240
Hose - Upper - Pipe To Rad.; W/O E.G.R.(2 1/2" I.D.)		24240
Hose - Lower - Eng. To Pipe; (2 1/2" I.D.)		24240
Hose - Lower - Pipe To Rad.; (2 1/2" I.D.)		24240
2003		
Caterpillar 3126 Diesel		
T300		
Belt - Fan, Alt. & A.C.	4080767	▲K080774HD
Belt - W.P.	0366775	▲9341HD
Tensioner Assy. - Fan, Alt. & A.C.	1352151	38511
Tensioner Pulley - Fan, Alt. & A.C.	1352151	36091
Hose - Upper - Eng. To Pipe		21891
Hose - Upper - Pipe To Rad.		21115
Hose - Lower - Eng. To Pipe; (2" I.D.)		24232
Hose - Lower - Pipe To Pipe; (2 1/2" I.D.)		24240
Hose - Lower - Pipe To Rad.		22707
Caterpillar C10 Diesel		
T600		
Belt - Fan, Alt. & Hub	D11080001	▲K080825HD
Belt - Fan To A.C.		▲9510HD
Tensioner Assy. - Fan, Alt. & Hub	1481974	38506
Idler Pulley - Fan & Alt.; W/Flat Idler Pulley	1337023	36091
Idler Pulley - Fan & Alt.; W/Multi-Grooved Idler Pulley	1731498	36231
Tensioner Pulley - Fan, Alt. & Hub	1481974	36091
Hose - Upper - Eng. To Pipe; (2 1/2" I.D.)		24240
Hose - Upper - Pipe To Rad.; (2 1/2" I.D.)		24240
Hose - Lower - Eng. To Pipe; (2 1/2" I.D.)		24240
Hose - Lower - Pipe To Rad.; (3" I.D.)		24248
T800		
Belt - Fan, Alt. & Hub; W/Clean Air Pkg.	D8410001082060	▲K080810HD
Belt - Fan, Alt. & Hub; W/O Clean Air Pkg.	D11080005	▲K080797HD
Belt - Fan & A.C.; W/Clean Air Pkg.	D11023637	▲9500HD
Belt - Fan & A.C.; W/O Clean Air Pkg.		▲9555HD
Tensioner Assy. - Fan, Alt. & Hub	1900649	38506
Idler Pulley - Fan & Alt.; W/Flat Idler Pulley	1337023	36091
Idler Pulley - Fan & Alt.; W/Multi-Grooved Idler Pulley	1731498	36231
Tensioner Pulley - Fan & Alt.	1900649	36091
Hose - Upper - Eng. To Pipe; (2 1/2" I.D.)		24240
Hose - Upper - Pipe To Rad.; (2 1/2" I.D.)		24240
Hose - Lower - Eng. To Pipe; (2 1/2" I.D.)		24240
Hose - Lower - Pipe To Rad.; (3" I.D.)		24248
W900		
Belt - Fan & Alt.		▲K080810HD
Belt - Fan To A.C.		▲9540HD
Idler Pulley - Fan & Alt.; W/Flat Idler Pulley	1337023	36091
Idler Pulley - Fan & Alt.; W/Multi-Grooved Idler Pulley	1731498	36231
Hose - Upper - Eng. To Pipe; (2 1/2" I.D.)		24240
Hose - Upper - Pipe To Rad.; (2 1/2" I.D.)		24240
Hose - Lower - Eng. To Pipe; (2 1/2" I.D.)		24240
Hose - Lower - Pipe To Rad.; (2 1/2" I.D.)		24240
Caterpillar C11 Diesel		
T800		
Belt - Fan, Alt. & A.C.; W/Conventional Hood	D8410001082420	▲K080952HD
Belt - Fan, Alt. & A.C.; W/Short Hood ...	D8410003082730	▲K081074HD

● Vulco-Flex® Coolant Hose.

Belts and Coolant Hose for Medium/Heavy-Duty Trucks (1996 and Newer)

Medium & Heavy-Duty Trucks
(1996 & Newer)

Application	Mfr. Part No.	Our No.
KENWORTH - Continued		
2003 - Continued		
Caterpillar C11 Diesel - Continued		
T800 - Continued		
Belt - Fan, Alt. & A.C.	2117895	38590
Tensioner Pulley - Fan, Alt. & A.C.	2117895	36164
Idler Pulley - Smooth	2078118	36269
Idler Pulley - Grooved	1979642	36341
Hose - Upper - Eng. To Pipe; (2 1/2" I.D.)		24240
Hose - Upper - Pipe To Rad.; W/Conventional Hood(2 1/2" I.D.)		24240
Hose - Lower - Eng. To Pipe; W/Conventional Hood(2 1/2" I.D.)		24240
Hose - Lower - Eng. To Pipe; W/Short Hood		21891
Hose - Lower - Pipe To Pipe; W/Short Hood(2 1/2" I.D.)		24240
Hose - Lower - Pipe To Rad.; (3" I.D.)		24248
Caterpillar C12 Diesel		
T600		
Belt - Fan, Alt. & Hub	D11080001	♣K080825HD
Belt - Fan To A.C.		♣9510HD
Tensioner Assy. - Fan, Alt. & Hub	1481974	38506
Idler Pulley - Fan & Alt.; W/Flat Idler Pulley	1337023	36091
Idler Pulley - Fan & Alt.; W/Multi-Grooved Idler Pulley	1731498	36231
Tensioner Pulley - Fan, Alt. & Hub	1481974	36091
Hose - Upper - Eng. To Pipe; (2 1/2" I.D.)		24240
Hose - Upper - Pipe To Rad.; (2 1/2" I.D.)		24240
Hose - Lower - Eng. To Pipe; (2 1/2" I.D.)		24240
Hose - Lower - Pipe To Rad.; (3" I.D.)		24248
T800		
Belt - Fan, Alt. & Hub; W/Clean Air Pkg. D8410001082060		♣K080810HD
Belt - Fan, Alt. & Hub; W/O Clean Air Pkg.	D11080005	♣K080797HD
Belt - Fan & A.C.; W/Clean Air Pkg.	D11023637	♣9500HD
Belt - Fan & A.C.; W/O Clean Air Pkg.		♣9555HD
Tensioner Assy. - Fan, Alt. & Hub	1900649	38506
Idler Pulley - Fan & Alt.; W/Flat Idler Pulley	1337023	36091
Idler Pulley - Fan & Alt.; W/Multi-Grooved Idler Pulley	1731498	36231
Tensioner Pulley - Fan & Alt.	1900649	36091
Hose - Upper - Eng. To Pipe; (2 1/2" I.D.)		24240
Hose - Upper - Pipe To Rad.; (2 1/2" I.D.)		24240
Hose - Lower - Eng. To Pipe; (2 1/2" I.D.)		24240
Hose - Lower - Pipe To Rad.; (3" I.D.)		24248
W900		
Idler Pulley - Fan & Alt.; W/Flat Idler Pulley	1337023	36091
Idler Pulley - Fan & Alt.; W/Multi-Grooved Idler Pulley	1731498	36231
Caterpillar C15 Diesel		
C500		
Belt - Fan		②TR22635
Belt - Fan, Alt. & A.C.		②♣9520HD
Hose - Upper - Eng. To Pipe; (2" I.D.)		24232
Hose - Upper - Pipe To Rad.; (2 1/2" I.D.)		24240
Hose - Lower - Eng. To Pipe; (3" I.D.)		24248
Hose - Lower - Pipe To Rad.; (2 1/2" I.D.)		24240
T600		
Belt - Fan & Alt.; W/Clean Air Pkg.; W/84 7/8" Belt O.C.	D8410001082135	♣K080842HD
Belt - Fan & Alt.; W/Clean Air Pkg.; W/89 7/8" Belt O.C.	D11084906	♣K080893HD
Belt - Fan To A.C.; W/Clean Air Pkg.	D8410003061450	♣K060569HD
Belt - Fan & W.P.; W/O Clean Air Pkg.; Preferred Belt		2/TR22553PB
Belt - Fan & W.P.; W/O Clean Air Pkg.; Optional Belt		②TR22553
Belt - Fan, Alt. & A.C.; W/O Clean Air Pkg.	17621	②♣9620HD
Tensioner Assy. - Fan & Alt.; W/Clean Air Pkg.; W/84" Belt O.C.	1900643	38620
Tensioner Assy. - Fan & Alt.; W/Clean Air Pkg.; W/89" Belt O.C.	1900649	38506

Application	Mfr. Part No.	Our No.
KENWORTH - Continued		
2003 - Continued		
Caterpillar C15 Diesel - Continued		
T600 - Continued		
Tensioner Assy. - Fan To A.C.; W/Clean Air Pkg.	1900642	38508
Idler Pulley - Smooth	1979641	36091
Idler Pulley - Grooved	1979642	36341
Tensioner Pulley - Fan To A.C.; W/Clean Air Pkg.	1900642	36091
Hose - Upper - Eng. To Pipe; (2 1/2" I.D.)		24240
Hose - Upper - Pipe To Rad.; (2 1/2" I.D.)		24240
Hose - Lower - Eng. To Pipe; (3" I.D.)		24248
Hose - Lower - Pipe To Rad.; (3" I.D.)		24248
T800		
Belt - Fan & W.P.		②TR22545
Belt - Fan, Alt. & A.C.		②♣9620HD
Hose - Upper - Eng. To Pipe; (2 1/2" I.D.)		24240
Hose - Upper - Pipe To Rad.; (2 1/2" I.D.)		24240
Hose - Lower - Eng. To Pipe; (3" I.D.)		24248
Hose - Lower - Pipe To Rad.; (3" I.D.)		24248
T2000		
Belt - Fan; Preferred Belt		2/TR22570PB
Belt - Fan; Optional Belt		②TR22570
Belt - Fan To Alt. & A.C.		②♣9650HD
Hose - Upper - Eng. To Pipe; (2 1/2" I.D.)		24240
Hose - Upper - Pipe To Rad.; (2 1/2" I.D.)		24240
Hose - Lower - Eng. To Pipe; (3" I.D.)		24248
Hose - Lower - Pipe To Rad.; (3" I.D.)		24248
W900		
Belt - Fan; Preferred Belt		2/TR22570PB
Belt - Fan; Optional Belt		②TR22570
Belt - Fan, Alt. & A.C.	17611	②♣9610HD
Hose - Upper - Eng. To Pipe; (2 1/2" I.D.)		24240
Hose - Upper - Pipe To Rad.; (2 1/2" I.D.)		24240
Hose - Lower - Eng. To Pipe; (3" I.D.)		24248
Hose - Lower - Pipe To Rad.; (3" I.D.)		24248
Caterpillar C16 Diesel		
T800		
Belt - Fan & W.P.		②TR22545
Belt - Fan, Alt. & A.C.		②♣9620HD
Hose - Upper - Eng. To Pipe; (2 1/2" I.D.)		24240
Hose - Upper - Pipe To Rad.; (2 1/2" I.D.)		24240
Hose - Lower - Eng. To Pipe; (3" I.D.)		24248
Hose - Lower - Pipe To Rad.; (3" I.D.)		24248
T2000		
Belt - Fan; Preferred Belt		2/TR22570PB
Belt - Fan; Optional Belt		②TR22570
Belt - Fan To Alt. & A.C.		②♣9650HD
Hose - Upper - Eng. To Pipe; (2 1/2" I.D.)		24240
Hose - Upper - Pipe To Rad.; (2 1/2" I.D.)		24240
Hose - Lower - Eng. To Pipe; (3" I.D.)		24248
Hose - Lower - Pipe To Rad.; (3" I.D.)		24248
W900		
Belt - Fan; Preferred Belt		2/TR22570PB
Belt - Fan; Optional Belt		②TR22570
Belt - Fan, Alt. & A.C.	17611	②♣9610HD
Hose - Upper - Eng. To Pipe; (2 1/2" I.D.)		24240
Hose - Upper - Pipe To Rad.; (2 1/2" I.D.)		24240
Hose - Lower - Eng. To Pipe; (3" I.D.)		24248
Hose - Lower - Pipe To Rad.; (3" I.D.)		24248
Cummins ISC Diesel		
T300		
Belt - Fan, Alt. & Hub	3944837	♣K080745HD
Belt - Fan To A.C.		7420
Tensioner Assy. - Fan, Alt. & Hub	3936213	38516
Tensioner Pulley - Fan, Alt. & Hub	3936213	36093
Hose - Upper - Eng. To Pipe; (2 1/4" I.D.)		24236
Hose - Upper - Pipe To Rad.		≈21115
W900		
Belt - Fan & Alt.	3289404	♣K080716HD
Belt - A.C.		♣9463HD

♣ Standard Belt Available. See Pages 630-631.
≈ Cut to Fit.

② Two Required.

Belts and Coolant Hose for Medium/Heavy-Duty Trucks (1996 and Newer)

 Medium & Heavy-Duty Trucks
(1996 & Newer)

Application	Mfr. Part No.	Our No.
KENWORTH - Continued		
2003 - Continued		
Cummins ISC Diesel - Continued		
W900 - Continued		
Tensioner Assy. - Fan & Alt.	3936213	38516
Tensioner Pulley - Fan & Alt.	3936213	36093
Cummins ISL Diesel		
T800		
Belt - Fan, W.P. & Alt.	3289369	♣K080716HD
Belt - Fan To A.C.	D11023525	♣9463HD
Tensioner Assy. - Fan, W.P. & Alt.	3936213	38516
Tensioner Pulley - Fan, W.P. & Alt.	3936213	36093
Hose - Upper - Eng. To Pipe; (2 1/4" I.D.)		24236
Hose - Upper - Pipe To Rad.; (2 1/4" I.D.)		24236
Hose - Lower - Eng. To Pipe; (2" I.D.)		24232
Hose - Lower - Pipe To Cooler; (2 1/4" I.D.)		24236
Hose - Lower - Cooler To Pipe; (2 1/2" I.D.)		24240
Hose - Lower - Pipe To Rad.; (3 1/4" I.D.)		24052
Cummins ISM Diesel		
T800		
Belt - Fan & Alt.	D8410001081810	♣K080716HD
Belt - Hub & A.C.	4004824	♣K060539HD
Tensioner Assy. - Fan & Alt.	3400885	38521
Tensioner Assy. - Hub & A.C.	4004933	38505
Idler Pulley - Fan & Alt.	3400884	36308
Tensioner Pulley - A.C.	4004933	36091
Hose - Upper - Eng. To Pipe; (2 1/4" I.D.)		24236
Hose - Lower - Eng. To Pipe; (2 1/2" I.D.)		24240
Hose - Lower - Pipe To Pipe; (2 1/2" I.D.)		24240
Hose - Lower - Pipe To Rad.; (2 1/2" I.D.)		24240
W900		
Belt - Fan & Alt.	D11084891	♣K080702HD
Belt - Hub & A.C.	4004824	♣K060539HD
Tensioner Assy. - Fan & Alt.	3400885	38521
Tensioner Assy. - Hub & A.C.	3102888	38505
Idler Pulley - A.C.	3104139	36225
Idler Pulley - Fan & Alt.	3400884	36308
Tensioner Pulley - A.C.	3102888	36091
Hose - Upper - Eng. To Pipe; (2 1/2" I.D.)		24240
Hose - Upper - Rad. To Pipe; (2 1/2" I.D.)		24240
Hose - Lower - Eng. To Pipe; (2 1/2" I.D.)		24240
Hose - Lower - Rad. To Pipe; (3" I.D.)		24248
Cummins ISX Diesel		
T600		
Belt - Fan	3681817	♣K100658HD
Belt - Hub, Alt. & A.C.	3681812	♣K060685HD
Tensioner Assy. - Fan	3681240	38535
Tensioner Assy. - Hub, Alt. & A.C.	3680194	38532
Idler Pulley - Alt. & A.C.	4026886	36226
Tensioner Pulley - Fan	3681240	36092
Tensioner Pulley - Hub, Alt. & A.C.	3680194	36095
Hose - Upper - Eng. To Pipe; (2 1/2" I.D.)		24240
Hose - Upper - Pipe To Rad.; (2 1/2" I.D.)		24240
Hose - Lower - Eng. To Pipe; (2 1/2" I.D.)		24240
Hose - Lower - Pipe To Rad.; (3" I.D.)		24248
T800		
Belt - Fan	3681816	♣K100739HD
Belt - Hub, Alt. & A.C.	3681812	♣K060685HD
Tensioner Assy. - Fan	3681240	38535
Tensioner Assy. - Hub, Alt. & A.C.	3680194	38532
Idler Pulley - Alt. & A.C.	4026886	36226
Tensioner Pulley - Fan	3681240	36092
Tensioner Pulley - Hub, Alt. & A.C.	3680194	36095
Hose - Upper - Eng. To Pipe; (2 1/2" I.D.)		24240
Hose - Upper - Rad. To Pipe		●26531
Hose - Lower - Eng. To Pipe; (2 1/2" I.D.)		24240
Hose - Lower - Pipe To Rad.; (2 1/2" I.D.)		24240
T2000		
Belt - Fan	3681821	♣K100675HD
Belt - W.P., Alt. & A.C.	3681812	♣K060685HD
Tensioner Assy. - Fan	3681240	38535
Tensioner Assy. - Hub, Alt. & A.C.	3680194	38532

Application	Mfr. Part No.	Our No.
KENWORTH - Continued		
2003 - Continued		
Cummins ISX Diesel - Continued		
T2000 - Continued		
Idler Pulley - Alt. & A.C.	4026886	36226
Tensioner Pulley - Fan	3681240	36092
Tensioner Pulley - Hub, Alt. & A.C.	3680194	36095
Hose - Upper - Eng. To Pipe; (2 1/2" I.D.)		24240
Hose - Upper - Pipe To Rad.		●26532
Hose - Lower - Eng. To Pipe; (2 1/2" I.D.)		24240
Hose - Lower - Pipe To Rad.; (2 1/2" I.D.)		24240
W900		
Belt - Fan; W/O Clean Air Pkg.	3681823	♣K100670HD
Belt - Fan & Alt.; W/81 1/4" Belt O.C.	3681822	♣K100810HD
Belt - Fan & Alt.; W/Clean Air Pkg.	D8410001122365	♣K120931HD
Belt - Hub, Alt. & A.C.; W/Clean Air Pkg.		♣K060637HD
Belt - Hub, Alt. & A.C.; W/O Clean Air Pkg.	3681812	♣K060685HD
Tensioner Assy. - Fan; W/O Clean Air Pkg.	3681240	38535
Tensioner Assy. - Fan & Alt.; W/Clean Air Pkg.	3682946	38587
Tensioner Assy. - Hub, Alt. & A.C.; W/Clean Air Pkg.	3682683	38610
Tensioner Assy. - Hub, Alt. & A.C.; W/O Clean Air Pkg.	3680194	38532
Idler Pulley - Alt. & A.C.	4026886	36226
Idler Pulley - A.C.; W/Clean Air Pkg.	3682229	36223
Tensioner Pulley - Fan; W/O Clean Air Pkg.	3681240	36092
Tensioner Pulley - Fan & Alt.; W/Clean Air Pkg.	3682946	36165
Tensioner Pulley - Hub, Alt. & A.C.; W/O Clean Air Pkg.	3680194	36095
Hose - Upper - Eng. To Pipe; (2 1/2" I.D.)		24240
Hose - Upper - Pipe To Rad.; W/O E.G.R. (2 1/2" I.D.)		24240
Hose - Lower - Eng. To Pipe; (2 1/2" I.D.)		24240
Hose - Lower - Pipe To Rad.; (2 1/2" I.D.)		24240
Cummins N14 Diesel		
T800		
Belt - Hub & W.P.		♣K060425HD
Belt - Hub To Fan	D11025738	TR28463
Belt - Alt.	D11023497	♣9451HD
Belt - Hub & A.C.	17425	♣9425HD
Hose - Upper - Eng. To Pipe; (2 1/2" I.D.)		24240
Hose - Upper - Pipe To Rad.; (2 1/2" I.D.)		24240
Hose - Lower - Eng. To Pipe; (2 1/2" I.D.)		24240
Hose - Lower - Pipe To Rad.; (2 1/2" I.D.)		24240
Hose - Lower - Pipe To Pipe; (2 1/2" I.D.)		24240
W900		
Belt - Hub & W.P.	3076492	♣K060425HD
Belt - Hub & Fan	D11025780	TR28473
Belt - Alt.		②♣9451HD
Belt - Hub & A.C.	17425	♣9425HD
Hose - Upper - Eng. To Pipe; (2 1/2" I.D.)		24240
Hose - Upper - Pipe To Rad.; (2 1/2" I.D.)		24240
Hose - Lower - Eng. To Pipe; (2 1/2" I.D.)		24240
Hose - Lower - Pipe To Rad.; (2 1/2" I.D.)		24240
Cummins Signature 600 Diesel		
T600		
Belt - Fan	3681817	♣K100658HD
Belt - Hub, Alt. & A.C.	3681812	♣K060685HD
Tensioner Assy. - Fan	3681240	38535
Tensioner Assy. - Hub, Alt. & A.C.	3680194	38532
Idler Pulley - Alt. & A.C.	4026886	36226
Tensioner Pulley - Fan	3681240	36092
Tensioner Pulley - Hub, Alt. & A.C.	3680194	36095
Hose - Upper - Eng. To Pipe; (2 1/2" I.D.)		24240
Hose - Upper - Pipe To Rad.; (2 1/2" I.D.)		24240
Hose - Lower - Eng. To Pipe; (2 1/2" I.D.)		24240
Hose - Lower - Pipe To Rad.; (3" I.D.)		24248
W900		
Idler Pulley - Alt. & A.C.	4026886	36226

♣ Standard Belt Available. See Pages 630-631.
② Two Required.

● Vulco-Flex® Coolant Hose.

Belts and Coolant Hose for Medium/Heavy-Duty Trucks (1996 and Newer)

Medium & Heavy-Duty Trucks
(1996 & Newer)

Application	Mfr. Part No.	Our No.
KENWORTH - Continued		
2002		
Caterpillar 3126 Diesel		
T300		
Belt - Fan, Alt. & A.C.	4080767	♣K080774HD
Belt - W.P.	0366775	♣9341HD
Tensioner Assy. - Fan, Alt. & A.C.	1352151	38511
Tensioner Pulley - Fan, Alt. & A.C.	1352151	36091
Hose - Upper - Eng. To Pipe; W/2 1/2" I.D. Hose	21891	21891
Hose - Upper - Pipe To Rad.	21115	21115
Hose - Lower - Eng. To Pipe; (2" I.D.)	24232	24232
Hose - Lower - Pipe To Pipe; (2 1/2" I.D.)	24240	24240
Hose - Lower - Pipe To Rad.	22707	22707
Caterpillar C10 Diesel		
T600		
Belt - Fan, Alt. & Hub	D11080001	♣K080825HD
Belt - Fan To A.C.		♣9510HD
Tensioner Assy. - Fan, Alt. & Hub	1481974	38506
Idler Pulley - Fan & Alt.; W/Flat Idler		
Pulley	1337023	36091
Idler Pulley - Fan & Alt.;		
W/Multi-Grooved Idler Pulley	1731498	36231
Tensioner Pulley - Fan, Alt. & Hub	1481974	36091
Hose - Upper - Eng. To Pipe; (2 1/2" I.D.)	24240	24240
Hose - Upper - Pipe To Rad.; (2 1/2" I.D.)	24240	24240
Hose - Lower - Eng. To Pipe; (2 1/2" I.D.)	24240	24240
Hose - Lower - Pipe To Rad.; (3" I.D.)	24248	24248
T800		
Belt - Fan, Alt. & Hub; W/Conventional		
Hood	D11080033	♣K080825HD
Belt - Fan, Alt. & Hub; W/Short Hood		♣K080806HD
Belt - Fan & A.C.		♣9555HD
Tensioner Assy. - Fan, Alt. & Hub	1481974	38506
Idler Pulley - Fan & Alt.; W/Flat Idler		
Pulley	1337023	36091
Idler Pulley - Fan & Alt.;		
W/Multi-Grooved Idler Pulley	1731498	36231
Tensioner Pulley - Fan, Alt. & Hub	1481974	36091
Hose - Upper - Eng. To Pipe; (3" I.D.)	24248	24248
Hose - Upper - Pipe To Rad.; (2 1/2" I.D.)	24240	24240
Hose - Lower - Eng. To Pipe; (2 1/2" I.D.)	24240	24240
Hose - Lower - Pipe To Rad.; (2 1/2" I.D.)	24240	24240
W900		
Belt - Fan & Alt.		♣K080810HD
Belt - Fan To A.C.		♣9540HD
Idler Pulley - Fan & Alt.; W/Flat Idler		
Pulley	1337023	36091
Idler Pulley - Fan & Alt.;		
W/Multi-Grooved Idler Pulley	1731498	36231
Hose - Upper - Eng. To Pipe; (2 1/2" I.D.)	24240	24240
Hose - Upper - Pipe To Rad.; (2 1/2" I.D.)	24240	24240
Hose - Lower - Eng. To Pipe; (2 1/2" I.D.)	24240	24240
Hose - Lower - Pipe To Rad.; (2 1/2" I.D.)	24240	24240
Caterpillar C12 Diesel		
T600		
Belt - Fan, Alt. & Hub	D11080001	♣K080825HD
Belt - Fan To A.C.		♣9510HD
Tensioner Assy. - Fan, Alt. & Hub	1481974	38506
Idler Pulley - Fan & Alt.; W/Flat Idler		
Pulley	1337023	36091
Idler Pulley - Fan & Alt.;		
W/Multi-Grooved Idler Pulley	1731498	36231
Tensioner Pulley - Fan, Alt. & Hub	1481974	36091
Hose - Upper - Eng. To Pipe; (2 1/2" I.D.)	24240	24240
Hose - Upper - Pipe To Rad.; (2 1/2" I.D.)	24240	24240
Hose - Lower - Eng. To Pipe; (2 1/2" I.D.)	24240	24240
Hose - Lower - Pipe To Rad.; (3" I.D.)	24248	24248
T800		
Belt - Fan, Alt. & Hub; W/Conventional		
Hood	D11080033	♣K080825HD
Belt - Fan, Alt. & Hub; W/Short Hood		♣K080806HD
Belt - Fan & A.C.		♣9555HD
Tensioner Assy. - Fan, Alt. & Hub	1481974	38506

Application	Mfr. Part No.	Our No.
KENWORTH - Continued		
2002 - Continued		
Caterpillar C12 Diesel - Continued		
T800 - Continued		
Idler Pulley - Fan & Alt.; W/Flat Idler		
Pulley	1337023	36091
Idler Pulley - Fan & Alt.; W/W-Groove		
Idler Pulley	1731498	36231
Tensioner Pulley - Fan, Alt. & Hub	1481974	36091
Hose - Upper - Eng. To Pipe; (3" I.D.)		24248
Hose - Upper - Pipe To Rad.; (2 1/2" I.D.)		24240
Hose - Lower - Eng. To Pipe; (2 1/2" I.D.)		24240
Hose - Lower - Pipe To Rad.; (2 1/2" I.D.)		24240
W900		
Idler Pulley - Fan & Alt.; W/Flat Idler		
Pulley	1337023	36091
Idler Pulley - Fan & Alt.;		
W/Multi-Grooved Idler Pulley	1731498	36231
Caterpillar C15 Diesel		
C500		
Belt - Fan		②TR22635
Belt - Fan, Alt. & A.C.		②♣9520HD
Hose - Upper - Eng. To Pipe; (2" I.D.)		24232
Hose - Upper - Pipe To Rad.; (2 1/2" I.D.)		24240
Hose - Lower - Eng. To Pipe; (3" I.D.)		24248
Hose - Lower - Pipe To Rad.; (2 1/2" I.D.)		24240
T600		
Belt - Fan & Alt.; W/Clean Air Pkg.; W/84		
7/8" Belt O.C.	D8410001082135	♣K080842HD
Belt - Fan & Alt.; W/Clean Air Pkg.; W/89		
7/8" Belt O.C.	D11084906	♣K080893HD
Belt - Fan To A.C.; W/Clean Air Pkg.	D8410003061450	♣K060569HD
Belt - Fan & W.P.; W/O Clean Air Pkg.; Preferred Belt		2/TR22553PB
Belt - Fan & W.P.; W/O Clean Air Pkg.; Optional Belt		②TR22553
Belt - Fan, Alt. & A.C.; W/O Clean Air Pkg.		②♣9620HD
Tensioner Assy. - Fan & Alt.; W/Clean		
Air Pkg.; W/84" Belt O.C.	1900643	38620
Tensioner Assy. - Fan & Alt.; W/Clean		
Air Pkg.; W/89" Belt O.C.	1900649	38506
Tensioner Assy. - Fan To A.C.; W/Clean		
Air Pkg.	1900642	38508
Idler Pulley - Smooth	1979641	36091
Idler Pulley - Grooved	1979642	36093
Tensioner Pulley - Fan To A.C.;		
W/Clean Air Pkg.	1900642	36091
Hose - Upper - Eng. To Pipe; (2 1/2" I.D.)		24240
Hose - Upper - Pipe To Rad.; (2 1/2" I.D.)		24240
Hose - Lower - Eng. To Pipe; (3" I.D.)		24248
Hose - Lower - Pipe To Rad.; (3" I.D.)		24248
T800		
Belt - Fan & W.P.		②TR22545
Belt - Fan, Alt. & A.C.		②♣9620HD
Hose - Upper - Eng. To Pipe; (2 1/2" I.D.)		24240
Hose - Upper - Pipe To Rad.; (2 1/2" I.D.)		24240
Hose - Lower - Eng. To Pipe; (3" I.D.)		24248
Hose - Lower - Pipe To Rad.; (3" I.D.)		24248
T2000		
Belt - Fan; Preferred Belt		2/TR22570PB
Belt - Fan; Optional Belt		②TR22570
Belt - Fan To Alt. & A.C.		②♣9650HD
Hose - Upper - Eng. To Pipe; (2 1/2" I.D.)		24240
Hose - Upper - Pipe To Rad.		≈21115
Hose - Lower - Eng. To Pipe; (3" I.D.)		24248
Hose - Lower - Pipe To Rad.; (2 1/2" I.D.)		24240
W900		
Belt - Fan; Preferred Belt		2/TR22570PB
Belt - Fan; Optional Belt		②TR22570
Belt - Fan, Alt. & A.C.	17611	②♣9610HD
Hose - Upper - Eng. To Pipe; (2 1/2" I.D.)		24240
Hose - Upper - Pipe To Rad.; (2 1/2" I.D.)		24240
Hose - Lower - Eng. To Pipe; (3" I.D.)		24248
Hose - Lower - Pipe To Rad.; (3" I.D.)		24248

♣ Standard Belt Available. See Pages 630-631.
≈ Cut to Fit.

② Two Required.

Belts and Coolant Hose for Medium/Heavy-Duty Trucks (1996 and Newer)

Medium & Heavy-Duty Trucks
(1996 & Newer)

Application	Mfr. Part No.	Our No.
KENWORTH - Continued		
2002 - Continued		
Caterpillar C16 Diesel		
T800		
Belt - Fan & W.P.		②TR22545
Belt - Fan, Alt. & A.C.		②▲9620HD
Hose - Upper - Eng. To Pipe; (2 1/2" I.D.)		24240
Hose - Upper - Pipe To Rad.; (2 1/2" I.D.)		24240
Hose - Lower - Eng. To Pipe; (3" I.D.)		24248
Hose - Lower - Pipe To Rad.; (3" I.D.)		24248
T2000		
Belt - Fan; Preferred Belt		2/TR22570PB
Belt - Fan; Optional Belt		②TR22570
Belt - Fan To Alt. & A.C.		②▲9650HD
Hose - Upper - Eng. To Pipe; (2 1/2" I.D.)		24240
Hose - Upper - Pipe To Rad.		≈<21115
Hose - Lower - Eng. To Pipe; (3" I.D.)		24248
Hose - Lower - Pipe To Rad.; (2 1/2" I.D.)		24240
W900		
Belt - Fan; Preferred Belt		2/TR22570PB
Belt - Fan; Optional Belt		②TR22570
Belt - Fan, Alt. & A.C.	17611	②▲9610HD
Hose - Upper - Eng. To Pipe; (2 1/2" I.D.)		24240
Hose - Upper - Pipe To Rad.; (2 1/2" I.D.)		24240
Hose - Lower - Eng. To Pipe; (3" I.D.)		24248
Hose - Lower - Pipe To Rad.; (3" I.D.)		24248
Cummins ISC Diesel		
T300		
Belt - Fan, Alt. & Hub	3944837	▲K080745HD
Belt - Fan To A.C.		7420
Tensioner Assy. - Fan, Alt. & Hub	3936213	38516
Tensioner Pulley - Fan, Alt. & Hub	3936213	36093
Hose - Upper - Eng. To Pipe; (2 1/4" I.D.)		24236
Hose - Upper - Pipe To Rad.		≈<21115
Cummins ISL Diesel		
T800		
Belt - Fan, W.P. & Alt.	3289369	▲K080716HD
Belt - Fan To A.C.	D11023525	▲9463HD
Tensioner Assy. - Fan, W.P. & Alt.	3936213	38516
Tensioner Pulley - Fan, W.P. & Alt.	3936213	36093
Hose - Upper - Eng. To Pipe; (2 1/4" I.D.)		24236
Hose - Upper - Pipe To Rad.; (2 1/4" I.D.)		24236
Hose - Lower - Eng. To Pipe; (2" I.D.)		24232
Hose - Lower - Pipe To Cooler; (2 1/4" I.D.)		24236
Hose - Lower - Cooler To Pipe; (2 1/2" I.D.)		24240
Hose - Lower - Pipe To Rad.; (3 1/4" I.D.)		24052
Cummins ISM Diesel		
T600; T800		
Belt - Fan & Alt.	3099256	▲K080708HD
Belt - Hub & A.C.		▲9530HD
Tensioner Assy. - Fan & Alt.	3400885	38521
Idler Pulley - Fan & Alt.	3400884	36308
Hose - Upper - Eng. To Pipe; (2 1/2" I.D.)		24240
Hose - Upper - Pipe To Rad.; (2 1/2" I.D.)		24240
Hose - Lower - Eng. To Pipe; (2 1/2" I.D.)		24240
Hose - Lower - Pipe To Rad.; (2 1/2" I.D.)		24240
W900		
Belt - Fan & Alt.	3099256	▲K080708HD
Belt - Hub & A.C.		▲9530HD
Tensioner Assy. - Fan & Alt.	3400885	38521
Idler Pulley - Fan & Alt.	3400884	36308
Cummins ISX Diesel		
T600		
Belt - Fan	3681817	▲K100658HD
Belt - W.P. & A.C.	3681812	▲K060685HD
Tensioner Assy. - Fan	3681240	38535
Tensioner Assy. - W.P. & A.C.	3680194	38532
Idler Pulley - Alt. & A.C.	4026886	36226
Tensioner Pulley - Fan	3681240	36092
Tensioner Pulley - W.P. & A.C.	3680194	36095
Hose - Upper - Eng. To Pipe; (2 1/2" I.D.)		24240

② Two Required.
≈< Cut to Fit.

Application	Mfr. Part No.	Our No.
KENWORTH - Continued		
2002 - Continued		
Cummins ISX Diesel - Continued		
T600 - Continued		
Hose - Upper - Pipe To Rad.; (2 1/2" I.D.)		24240
Hose - Lower - Eng. To Pipe; (2 1/2" I.D.)		24240
Hose - Lower - Pipe To Rad.; (3" I.D.)		24248
T800		
Belt - Fan	3681817	▲K100658HD
Belt - W.P., Alt. & A.C.	3681812	▲K060685HD
Tensioner Assy. - Fan	3681240	38535
Tensioner Assy. - W.P., Alt. & A.C.	3680194	38532
Idler Pulley - Alt. & A.C.	4026886	36226
Tensioner Pulley - Fan	3681240	36092
Tensioner Pulley - W.P., Alt. & A.C.	3680194	36095
Hose - Upper - Eng. To Pipe; (2 1/2" I.D.)		24240
Hose - Upper - Pipe To Rad.; (2 1/2" I.D.)		24240
Hose - Lower - Eng. To Pipe; (2 1/2" I.D.)		24240
Hose - Lower - Pipe To Rad.; (3" I.D.)		24248
T2000		
Belt - Fan	3681821	▲K100675HD
Belt - W.P., Alt. & A.C.	3681812	▲K060685HD
Tensioner Assy. - Fan	3681240	38535
Tensioner Assy. - W.P., Alt. & A.C.	3680194	38532
Idler Pulley - Alt. & A.C.	4026886	36226
Tensioner Pulley - Fan	3681240	36092
Tensioner Pulley - W.P., Alt. & A.C.	3680194	36095
Hose - Upper - Eng. To Pipe; (2 1/2" I.D.)		24240
Hose - Upper - Pipe To Rad.		●26532
Hose - Lower - Eng. To Pipe; (2 1/2" I.D.)		24240
Hose - Lower - Pipe To Rad.; (2 1/2" I.D.)		24240
W900		
Belt - Fan	3681823	▲K100670HD
Belt - W.P., Alt. & A.C.	3681812	▲K060685HD
Tensioner Assy. - Fan	3681240	38535
Tensioner Assy. - W.P., Alt. & A.C.	3680194	38532
Idler Pulley - Alt. & A.C.	4026886	36226
Tensioner Pulley - Fan	3681240	36092
Tensioner Pulley - W.P., Alt. & A.C.	3680194	36095
Hose - Upper - Eng. To Pipe; (2 1/2" I.D.)		24240
Hose - Upper - Pipe To Rad.; (2 1/2" I.D.)		24240
Hose - Lower - Eng. To Pipe; (2 1/2" I.D.)		24240
Hose - Lower - Pipe To Rad.; (2 1/2" I.D.)		24240
Cummins N14 Diesel		
T800		
Belt - Hub & W.P.		▲K060425HD
Belt - Hub To Fan; W/44" Belt O.C.		TR28437
Belt - Hub To Fan; W/46 1/2" Belt O.C. .	D11025738	TR28463
Belt - Alt.	D11023497	▲9451HD
Belt - Hub & A.C.	17425	▲9425HD
Hose - Upper - Eng. To Pipe; (2 1/2" I.D.)		24240
Hose - Upper - Pipe To Rad.; (2 1/2" I.D.)		24240
Hose - Lower - Eng. To Pipe; (2 1/2" I.D.)		24240
Hose - Lower - Pipe To Rad.; (2 1/2" I.D.)		24240
Hose - Lower - Pipe To Pipe; (2 1/2" I.D.)		24240
W900		
Belt - Hub & W.P.	3076492	▲K060425HD
Belt - Hub & Fan		②TR28483
Belt - Alt.		②▲9451HD
Belt - Hub & A.C.	17425	▲9425HD
Hose - Upper - Eng. To Pipe; (2 1/2" I.D.)		24240
Hose - Upper - Pipe To Rad.; (2 1/2" I.D.)		24240
Hose - Lower - Eng. To Pipe; (2 1/2" I.D.)		24240
Hose - Lower - Pipe To Rad.; (2 1/2" I.D.)		24240
Cummins Signature 600 Diesel		
W900		
Belt - Fan	3681823	▲K100670HD
Belt - W.P., Alt. & A.C.	3681812	▲K060685HD
Tensioner Assy. - Fan	3681240	38535
Tensioner Assy. - W.P., Alt. & A.C.	3680194	38532
Idler Pulley - Alt. & A.C.	4026886	36226
Tensioner Pulley - Fan	3681240	36092

▲ Standard Belt Available. See Pages 630-631.
● Vulco-Flex® Coolant Hose.

Belts and Coolant Hose for Medium/Heavy-Duty Trucks (1996 and Newer)

Medium & Heavy-Duty Trucks
(1996 & Newer)

Application	Mfr. Part No.	Our No.
KENWORTH - Continued		
2002 - Continued		
Cummins Signature 600 Diesel - Continued		
W900 - Continued		
Tensioner Pulley - W.P., Alt. & A.C.	3680194	36095
Hose - Upper - Eng. To Pipe; (2 1/2" I.D.)		24240
Hose - Upper - Pipe To Rad.; (2 1/2" I.D.)		24240
Hose - Lower - Eng. To Pipe; (2 1/2" I.D.)		24240
Hose - Lower - Pipe To Rad.; (2 1/2" I.D.)		24240
2001		
Caterpillar 3126 Diesel		
T300		
Belt - Fan, Alt. & A.C.	4080767	▲K080774HD
Belt - W.P.	0366775	▲9341HD
Tensioner Assy. - Fan, Alt. & A.C.	1352151	38511
Tensioner Pulley - Fan, Alt. & A.C.	1352151	36091
Hose - Upper - Eng. To Pipe		21891
Hose - Upper - Pipe To Rad.		21115
Hose - Lower - Eng. To Pipe; (2" I.D.)		24232
Hose - Lower - Pipe To Pipe; (2 1/2" I.D.)		24240
Hose - Lower - Pipe To Rad.		22707
Caterpillar C10 Diesel		
T600		
Belt - Fan, Alt. & Hub	D11080001	▲K080825HD
Belt - Fan & A.C.		▲9555HD
Tensioner Assy. - Fan, Alt. & Hub	1481974	38506
Idler Pulley - Fan & Alt.; W/Flat Idler Pulley	1337023	36091
Idler Pulley - Fan & Alt.; W/Multi-Grooved Idler Pulley	1731498	36231
Tensioner Pulley - Fan, Alt. & Hub	1481974	36091
Hose - Upper - Eng. To Rad.; (2 1/2" I.D.)		24240
Hose - Upper - Pipe To Rad.; (2 1/2" I.D.)		24240
Hose - Lower - Eng. To Pipe; (3" I.D.)		24248
Hose - Lower - Pipe To Rad.; (3" I.D.)		24248
T800		
Belt - Fan, Alt. & Hub; W/Conventional Hood	D11080033	▲K080825HD
Belt - Fan, Alt. & Hub; W/Short Hood		▲K080806HD
Belt - Fan & A.C.		▲9555HD
Tensioner Assy. - Fan, Alt. & Hub	1481974	38506
Idler Pulley - Fan & Alt.; W/Flat Idler Pulley	1337023	36091
Idler Pulley - Fan & Alt.; W/Multi-Grooved Idler Pulley	1731498	36231
Tensioner Pulley - Fan, Alt. & Hub	1481974	36091
Hose - Upper - Eng. To Pipe; (3" I.D.)		24248
Hose - Upper - Pipe To Rad.; (2 1/2" I.D.)		24240
Hose - Lower - Eng. To Pipe; (2 1/2" I.D.)		24240
Hose - Lower - Pipe To Rad.; (2 1/2" I.D.)		24240
W900		
Belt - Fan & Alt.		▲K080810HD
Belt - Fan To A.C.		▲9540HD
Idler Pulley - Fan & Alt.; W/Flat Idler Pulley	1337023	36091
Idler Pulley - Fan & Alt.; W/Multi-Grooved Idler Pulley	1731498	36231
Hose - Upper - Eng. To Pipe; (2 1/2" I.D.)		24240
Hose - Upper - Pipe To Rad.; (2 1/2" I.D.)		24240
Hose - Lower - Eng. To Pipe; (2 1/2" I.D.)		24240
Hose - Lower - Pipe To Rad.; (2 1/2" I.D.)		24240
Caterpillar C12 Diesel		
T600		
Belt - Fan, Alt. & Hub	D11080001	▲K080825HD
Belt - Fan & A.C.		▲9555HD
Tensioner Assy. - Fan, Alt. & Hub	1481974	38506
Idler Pulley - Fan & Alt.; W/Flat Idler Pulley	1337023	36091
Idler Pulley - Fan & Alt.; W/Multi-Grooved Idler Pulley	1731498	36231
Tensioner Pulley - Fan, Alt. & Hub	1481974	36091
Hose - Upper - Eng. To Pipe; (2 1/2" I.D.)		24240
Hose - Upper - Pipe To Rad.; (2 1/2" I.D.)		24240
Hose - Lower - Eng. To Pipe; (2 1/2" I.D.)		24240
Hose - Lower - Pipe To Rad.; (2 1/2" I.D.)		24240

Application	Mfr. Part No.	Our No.
KENWORTH - Continued		
2001 - Continued		
Caterpillar C12 Diesel - Continued		
T600 - Continued		
Hose - Upper - Pipe To Rad.; (2 1/2" I.D.)		24240
Hose - Lower - Eng. To Pipe; (3" I.D.)		24248
Hose - Lower - Pipe To Rad.; (3" I.D.)		24248
T800		
Belt - Fan, Alt. & Hub; W/Conventional Hood	D11080033	▲K080825HD
Belt - Fan, Alt. & Hub; W/Short Hood		▲K080806HD
Belt - Fan & A.C.		▲9555HD
Tensioner Assy. - Fan, Alt. & Hub	1481974	38506
Tensioner Pulley - Fan, Alt. & Hub	1481974	36091
Hose - Upper - Eng. To Pipe; (3" I.D.)		24248
Hose - Upper - Pipe To Rad.; (2 1/2" I.D.)		24240
Hose - Lower - Eng. To Pipe; (2 1/2" I.D.)		24240
Hose - Lower - Pipe To Rad.; (2 1/2" I.D.)		24240
W900		
Belt - Fan & Alt.		▲K080810HD
Belt - Fan To A.C.		▲9540HD
Idler Pulley - Fan & Alt.; W/Flat Idler Pulley	1337023	36091
Idler Pulley - Fan & Alt.; W/Multi-Grooved Idler Pulley	1731498	36231
Hose - Upper - Eng. To Pipe; (2 1/2" I.D.)		24240
Hose - Upper - Pipe To Rad.; (2 1/2" I.D.)		24240
Hose - Lower - Eng. To Pipe; (2 1/2" I.D.)		24240
Hose - Lower - Pipe To Rad.; (2 1/2" I.D.)		24240
Caterpillar C15 Diesel		
C500		
Belt - Fan		②TR22635
Belt - Fan, Alt. & A.C.		②▲9520HD
Hose - Upper - Eng. To Pipe; (2" I.D.)		24232
Hose - Upper - Pipe To Rad.; (2 1/2" I.D.)		24240
Hose - Lower - Eng. To Pipe; (2 1/2" I.D.)		24240
Hose - Lower - Pipe To Rad.; (2 1/2" I.D.)		24240
T600		
Belt - Fan & Alt.; W/Clean Air Pkg.; W/84 7/8" Belt O.C.	D8410001082135	▲K080842HD
Belt - Fan & Alt.; W/Clean Air Pkg.; W/89 7/8" Belt O.C.	D11084906	▲K080893HD
Belt - Fan To A.C.; W/Clean Air Pkg.	D8410003061450	▲K060569HD
Belt - Fan & W.P.; W/O Clean Air Pkg.; Preferred Belt		2/TR22553PB
Belt - Fan & W.P.; W/O Clean Air Pkg.; Optional Belt		②TR22553
Belt - Fan, Alt. & A.C.; W/O Clean Air Pkg.		②▲9620HD
Tensioner Assy. - Fan & Alt.; W/Clean Air Pkg.; W/84" Belt O.C.	1900643	38620
Tensioner Assy. - Fan & Alt.; W/Clean Air Pkg.; W/89" Belt O.C.	1900649	38506
Tensioner Assy. - Fan To A.C.; W/Clean Air Pkg.	1900642	38508
Idler Pulley - Smooth	1979641	36091
Idler Pulley - Grooved	1979642	36341
Tensioner Pulley - Fan To A.C.; W/Clean Air Pkg.	1900642	36091
Hose - Upper - Eng. To Pipe; (2 1/2" I.D.)		24240
Hose - Upper - Pipe To Rad.; (2 1/2" I.D.)		24240
Hose - Lower - Eng. To Pipe; (3" I.D.)		24248
Hose - Lower - Pipe To Rad.; (3" I.D.)		24248
T800		
Belt - Fan & W.P.		②TR22545
Belt - Fan, Alt. & A.C.		②▲9620HD
Hose - Upper - Eng. To Pipe; (2 1/2" I.D.)		24240
Hose - Upper - Pipe To Rad.; (2 1/2" I.D.)		24240
Hose - Lower - Eng. To Pipe; (3" I.D.)		24248
Hose - Lower - Pipe To Rad.; (3" I.D.)		24248
T2000		
Belt - Fan; Preferred Belt		2/TR22570PB
Belt - Fan; Optional Belt		②TR22570
Belt - Fan, Alt. & A.C.		②▲9560HD
Hose - Upper - Eng. To Rad.; (2 1/2" I.D.)		24240
Hose - Upper - Pipe To Rad.; (2 1/2" I.D.)		24240

▲ Standard Belt Available. See Pages 630-631.

② Two Required.

Belts and Coolant Hose for Medium/Heavy-Duty Trucks (1996 and Newer)

 Medium & Heavy-Duty Trucks
(1996 & Newer)

Application	Mfr. Part No.	Our No.
KENWORTH - Continued		
2001 - Continued		
Caterpillar C15 Diesel - Continued		
T2000 - Continued		
Hose - Lower - Eng. To Pipe; (2 1/2" I.D.)		24240
Hose - Lower - Pipe To Rad.; (2 1/2" I.D.)		24240
W900		
Belt - Fan; Preferred Belt		2/TR22570PB
Belt - Fan; Optional Belt		②TR22570
Belt - Fan, Alt. & A.C. 17611		②▲9610HD
Hose - Upper - Eng. To Pipe; (2 1/2" I.D.)		24240
Hose - Upper - Pipe To Rad.; (2 1/2" I.D.)		24240
Hose - Lower - Eng. To Pipe; (3" I.D.)		24248
Hose - Lower - Pipe To Rad.; (3" I.D.)		24248
Caterpillar C16 Diesel		
T800		
Belt - Fan & W.P.		②TR22545
Belt - Fan, Alt. & A.C.		②▲9620HD
Hose - Upper - Eng. To Pipe; (2 1/2" I.D.)		24240
Hose - Upper - Pipe To Rad.; (2 1/2" I.D.)		24240
Hose - Lower - Eng. To Pipe; (3" I.D.)		24248
Hose - Lower - Pipe To Rad.; (3" I.D.)		24248
T2000		
Belt - Fan; Preferred Belt		2/TR22570PB
Belt - Fan; Optional Belt		②TR22570
Belt - Fan, Alt. & A.C.		②▲9560HD
Hose - Upper - Eng. To Rad.; (2 1/2" I.D.)		24240
Hose - Upper - Pipe To Rad.; (2 1/2" I.D.)		24240
Hose - Lower - Eng. To Pipe; (2 1/2" I.D.)		24240
Hose - Lower - Pipe To Rad.; (2 1/2" I.D.)		24240
W900		
Belt - Fan; Preferred Belt		2/TR22570PB
Belt - Fan; Optional Belt		②TR22570
Belt - Fan, Alt. & A.C. 17611		②▲9610HD
Hose - Upper - Eng. To Pipe; (2 1/2" I.D.)		24240
Hose - Upper - Pipe To Rad.; (2 1/2" I.D.)		24240
Hose - Lower - Eng. To Pipe; (3" I.D.)		24248
Hose - Lower - Pipe To Rad.; (3" I.D.)		24248
Cummins ISB Diesel		
K300		
Belt - Fan, W.P. & Alt. 3911579		▲K080675HD
Belt - Fan & A.C. 17481		▲9480HD
Cummins ISC Diesel		
T300		
Belt - Fan, Alt. & Hub	3944837	▲K080745HD
Belt - Fan & A.C.		7420
Tensioner Assy. - Fan, Alt. & Hub	3936213	38516
Tensioner Pulley - Fan, Alt. & Hub	3936213	36093
Hose - Upper - Eng. To Pipe; (2 1/4" I.D.)		24236
Hose - Upper - Pipe To Rad.		≈21115
Hose - Lower - Eng. To Pipe		20206
Cummins ISL Diesel		
T800		
Belt - Fan, W.P. & Alt. 3289369		▲K080716HD
Belt - Fan To A.C. D11023525		▲9463HD
Tensioner Assy. - Fan, W.P. & Alt. 3936213		38516
Tensioner Pulley - Fan, W.P. & Alt. 3936213		36093
Hose - Upper - Eng. To Pipe; (2 1/4" I.D.)		24236
Hose - Upper - Rad. To Pipe; (2 1/4" I.D.)		24236
Hose - Lower - Eng. To Pipe; (2" I.D.)		24232
Hose - Lower - Pipe To Cooler; (2 1/4" I.D.)		24236
Hose - Lower - Cooler To Pipe; (2 1/2" I.D.)		24240
Hose - Lower - Rad. To Pipe; (3 1/4" I.D.)		24052
Cummins ISM Diesel		
T600; T800		
Belt - Fan & Alt. 3099256		▲K080708HD
Belt - Hub & A.C.		▲9530HD
Tensioner Assy. - Fan & Alt. 3400885		38521
Idler Pulley - Fan & Alt. 3400884		36308
Hose - Upper - Eng. To Pipe; (2 1/2" I.D.)		24240
Hose - Upper - Pipe To Rad.; (2 1/2" I.D.)		24240

 ② Two Required.
 ≈ Cut to Fit.

Application	Mfr. Part No.	Our No.
KENWORTH - Continued		
2001 - Continued		
Cummins ISM Diesel - Continued		
T600; T800 - Continued		
Hose - Lower - Eng. To Pipe; (2 1/2" I.D.)		24240
Hose - Lower - Pipe To Rad.; (2 1/2" I.D.)		24240
W900		
Belt - Fan & Alt. 3099256		▲K080708HD
Belt - Hub & A.C.		▲9530HD
Tensioner Assy. - Fan & Alt. 3400885		38521
Idler Pulley - Fan & Alt. 3400884		36308
Cummins ISX Diesel		
T800		
Belt - Fan	3681817	▲K100658HD
Belt - Hub, Alt. & A.C.	3681812	▲K060685HD
Tensioner Assy. - Fan	3681240	38535
Tensioner Assy. - Hub, Alt. & A.C.	3680194	38532
Idler Pulley - Alt. & A.C. 4026886		36226
Tensioner Pulley - Fan	3681240	36092
Tensioner Pulley - Hub, Alt. & A.C.	3680194	36095
Hose - Upper - Eng. To Pipe; (2 1/2" I.D.)		24240
Hose - Upper - Pipe To Rad.; (2 1/2" I.D.)		24240
Hose - Lower - Eng. To Pipe; (2 1/2" I.D.)		24240
Hose - Lower - Pipe To Rad.; (3" I.D.)		24248
T2000		
Belt - Fan	3681821	▲K100675HD
Belt - Hub, Alt. & A.C.	3681812	▲K060685HD
Belt - W.P., Alt. & A.C.	3681812	▲K060685HD
Tensioner Assy. - Fan	3681240	38535
Tensioner Assy. - Hub, Alt. & A.C.	3680194	38532
Idler Pulley - Alt. & A.C. 4026886		36226
Tensioner Pulley - Fan	3681240	36092
Tensioner Pulley - Hub, Alt. & A.C.	3680194	36095
Hose - Upper - Eng. To Pipe; (2 1/2" I.D.)		24240
Hose - Upper - Pipe To Rad.		●26532
Hose - Lower - Eng. To Pipe; (2 1/2" I.D.)		24240
Hose - Lower - Pipe To Rad.; (2 1/2" I.D.)		24240
W900		
Belt - Fan	3681823	▲K100670HD
Belt - Hub, Alt. & A.C.	3681812	▲K060685HD
Tensioner Assy. - Fan	3681240	38535
Tensioner Assy. - Hub, Alt. & A.C.	3680194	38532
Idler Pulley - Alt. & A.C. 4026886		36226
Tensioner Pulley - Fan	3681240	36092
Tensioner Pulley - Hub, Alt. & A.C.	3680194	36095
Hose - Upper - Eng. To Pipe; (2 1/2" I.D.)		24240
Hose - Upper - Pipe To Rad.; (2 1/2" I.D.)		24240
Hose - Lower - Eng. To Pipe; (2 1/2" I.D.)		24240
Hose - Lower - Pipe To Rad.; (2 1/2" I.D.)		24240
Cummins N14 Diesel		
T600; T800		
Belt - Hub & W.P.		▲K060425HD
Belt - Hub & Fan		②TR28437
Belt - Alt.		②▲9451HD
Belt - Hub & A.C. 17425		▲9425HD
Hose - Upper - Eng. To Pipe; (2 1/2" I.D.)		24240
Hose - Upper - Pipe To Rad.; (2 1/2" I.D.)		24240
Hose - Lower - Eng. To Pipe; (2 1/2" I.D.)		24240
Hose - Lower - Pipe To Rad.; (3" I.D.)		24248
T2000		
Belt - W.P. 3076492		▲K060425HD
Belt - A.C. 17421		▲9420HD
Belt - Fan	28413	TR28412
Belt - Alt. 17451		▲9451HD
W900		
Belt - Hub & W.P. 3076492		▲K060425HD
Belt - Hub & Fan		②TR28483
Belt - Alt.		②▲9451HD
Belt - Hub & A.C. 17425		▲9425HD
Hose - Upper - Eng. To Pipe; (2 1/2" I.D.)		24240
Hose - Upper - Pipe To Rad.; (2 1/2" I.D.)		24240
Hose - Lower - Eng. To Pipe; (2 1/2" I.D.)		24240

 ▲ Standard Belt Available. See Pages 630-631.
 ● Vulco-Flex® Coolant Hose.

Belts and Coolant Hose for Medium/Heavy-Duty Trucks (1996 and Newer)

Medium & Heavy-Duty Trucks
(1996 & Newer)

Application	Mfr. Part No.	Our No.
KENWORTH - Continued		
2001 - Continued		
Cummins N14 Diesel - Continued		
W900 - Continued		
Hose - Lower - Pipe To Rad.; (2 1/2" I.D.)		24240
Cummins Signature 600 Diesel		
W900		
Belt - Fan	3681823	▲K100670HD
Belt - W.P., Alt. & A.C.	3681812	▲K060685HD
Tensioner Assy. - Fan	3681240	38535
Tensioner Assy. - Hub, Alt. & A.C.	3680194	38532
Idler Pulley - Alt. & A.C.	4026886	36226
Tensioner Pulley - Fan	3681240	36092
Tensioner Pulley - Hub, Alt. & A.C.	3680194	36095
Hose - Upper - Eng. To Pipe; (2 1/2" I.D.)		24240
Hose - Upper - Pipe To Rad.; (2 1/2" I.D.)		24240
Hose - Lower - Eng. To Pipe; (2 1/2" I.D.)		24240
Hose - Lower - Pipe To Rad.; (2 1/2" I.D.)		24240
Detroit Diesel 6-Cyl. 11.1 L Diesel		
T800		
Belt - Fan		③▲9447HD
Belt - Hub, Alt. & A.C.		▲K080580HD
Tensioner Assy. - Hub, Alt. & A.C.	23520317	38501
Tensioner Pulley - Hub, Alt. & A.C.		38075
Hose - Upper - Eng. To Pipe; (2 1/2" I.D.)		24240
Hose - Upper - Pipe To Rad.; (2 1/2" I.D.)		24240
Hose - Lower - Eng. To Pipe; (2 1/2" I.D.)		24240
Hose - Lower - Pipe To Rad.; (3" I.D.)		24248
W900		
Belt - Fan; W/47 3/4" Belt O.C.; Preferred Belt		3/9470PB
Belt - Fan; W/47 3/4" Belt O.C.; Optional Belt		③▲9470HD
Belt - Hub, Alt. & A.C.	23520613	▲K080580HD
Tensioner Assy. - Hub, Alt. & A.C.	23520317	38501
Tensioner Pulley - Hub, Alt. & A.C.		38075
Hose - Upper - Eng. To Pipe; (2 1/2" I.D.)		24240
Hose - Upper - Pipe To Rad.; (2 1/2" I.D.)		24240
Hose - Lower - Eng. To Pipe; (2 1/2" I.D.)		24240
Hose - Lower - Pipe To Rad.; (2 1/2" I.D.)		24240
Detroit Diesel 6-Cyl. 12.7 L Diesel		
T800		
Belt - Fan		③▲9447HD
Belt - Hub, Alt. & A.C.		▲K080580HD
Tensioner Assy. - Hub, Alt. & A.C.	23520317	38501
Tensioner Pulley - Hub, Alt. & A.C.		38075
Hose - Upper - Eng. To Pipe; (2 1/2" I.D.)		24240
Hose - Upper - Pipe To Rad.; (2 1/2" I.D.)		24240
Hose - Lower - Eng. To Pipe; (2 1/2" I.D.)		24240
Hose - Lower - Pipe To Rad.; (3" I.D.)		24248
T2000		
Belt - A.C.	23520613	▲K080580HD
W900		
Belt - Fan; W/47 3/4" Belt O.C.; Preferred Belt		3/9470PB
Belt - Fan; W/47 3/4" Belt O.C.; Optional Belt		③▲9470HD
Belt - Hub, Alt. & A.C.	23520613	▲K080580HD
Tensioner Assy. - Hub, Alt. & A.C.	23520317	38501
Tensioner Pulley - Hub, Alt. & A.C.		38075
Hose - Upper - Eng. To Pipe; (2 1/2" I.D.)		24240
Hose - Upper - Pipe To Rad.; (2 1/2" I.D.)		24240
Hose - Lower - Eng. To Pipe; (2 1/2" I.D.)		24240
Hose - Lower - Pipe To Rad.; (2 1/2" I.D.)		24240

Application	Mfr. Part No.	Our No.
KENWORTH - Continued		
2000 - Continued		
Caterpillar 3126 Diesel - Continued		
T300 - Continued		
Hose - Lower - Pipe To Rad.		22707
	or	●26531
Caterpillar 3406 Diesel		
T800		
Belt - Fan & Hub		②TR22545
Belt - Fan, Alt. & A.C.		②▲9620HD
Hose - Upper - Eng. To Pipe; (2 1/2" I.D.)		24240
Hose - Upper - Pipe To Rad.; (2 1/2" I.D.)		24240
Hose - Lower - Eng. To Pipe; (3" I.D.)		24248
Hose - Lower - Pipe To Rad.; (3" I.D.)		24248
T2000		
Belt - Fan; Preferred Belt		2/TR22570PB
Belt - Fan; Optional Belt		②TR22570
Belt - Fan, Alt. & A.C.		②▲9650HD
Hose - Upper - Eng. To Pipe; (2 1/2" I.D.)		24240
Hose - Upper - Pipe To Rad.		21891
Hose - Lower - Eng. To Pipe; (3 1/4" I.D.)		24052
Hose - Lower - Pipe To Rad.; (2 1/2" I.D.)		24240
W900		
Belt - Fan; Preferred Belt		2/TR22570PB
Belt - Fan; Optional Belt		②TR22570
Belt - Fan, Alt. & A.C.		②▲9610HD
Hose - Upper - Eng. To Pipe; (2 1/2" I.D.)		24240
Hose - Upper - Pipe To Rad.; (2 1/2" I.D.)		24240
Hose - Lower - Eng. To Pipe; (3" I.D.)		24248
Hose - Lower - Pipe To Rad.; (3" I.D.)		24248
Caterpillar C10 Diesel		
T600		
Belt - Fan, Alt. & Hub	D11080001	▲K080825HD
Belt - Fan & A.C.		▲9555HD
Tensioner Assy. - Fan, Alt. & Hub	1900649	38506
Idler Pulley - Fan & Alt.; W/Flat Idler Pulley	1337023	36091
Idler Pulley - Fan & Alt.; W/Multi-Grooved Idler Pulley	1731498	36231
Tensioner Pulley - Fan, Alt. & Hub	1900649	36091
Hose - Upper - Eng. To Pipe; (2 1/2" I.D.)		24240
Hose - Upper - Pipe To Rad.; (2 1/2" I.D.)		24240
Hose - Lower - Eng. To Pipe; (3" I.D.)		24248
Hose - Lower - Pipe To Rad.; (3" I.D.)		24248
T800		
Belt - Fan, Alt. & Hub; W/Conventional Hood	D11080033	▲K080825HD
Belt - Fan, Alt. & Hub; W/Short Hood		▲K080806HD
Belt - Fan & A.C.		▲9555HD
Tensioner Assy. - Fan, Alt. & Hub	1481974	38506
Idler Pulley - Fan & Alt.; W/Flat Idler Pulley	1337023	36091
Idler Pulley - Fan & Alt.; W/Multi-Grooved Idler Pulley	1731498	36231
Tensioner Pulley - Fan, Alt. & Hub	1481974	36091
Hose - Upper - Eng. To Pipe; (3" I.D.)		24248
Hose - Upper - Pipe To Rad.; (2 1/2" I.D.)		24240
Hose - Lower - Eng. To Pipe; (2 1/2" I.D.)		24240
Hose - Lower - Pipe To Rad.; (2 1/2" I.D.)		24240
W900		
Belt - Fan; Preferred Belt		2/TR22570PB
Belt - Fan; Optional Belt		②TR22570
Belt - Fan, Alt. & A.C.		②▲9610HD
Idler Pulley - Fan & Alt.; W/Flat Idler Pulley	1337023	36091
Idler Pulley - Fan & Alt.; W/Multi-Grooved Idler Pulley	1731498	36231
Hose - Upper - Eng. To Pipe; (3" I.D.)		24248
Hose - Upper - Pipe To Rad.; (3" I.D.)		24248
Hose - Lower - Eng. To Pipe; (3" I.D.)		24248
Hose - Lower - Pipe To Rad.; (3" I.D.)		24248

▲ Standard Belt Available. See Pages 630-631.
● Vulco-Flex® Coolant Hose.

③ Three Required.
② Two Required.

Belts and Coolant Hose for Medium/Heavy-Duty Trucks (1996 and Newer)

 Medium & Heavy-Duty Trucks
(1996 & Newer)

Application	Mfr. Part No.	Our No.
KENWORTH - Continued		
2000 - Continued		
Caterpillar C12 Diesel		
T600		
Belt - Fan, Alt. & Hub	D11080001	♣K080825HD
Belt - Fan & A.C.		♣9555HD
Tensioner Assy. - Fan, Alt. & Hub	1900649	38506
Idler Pulley - Fan & Alt.; W/Flat Idler Pulley	1337023	36091
Idler Pulley - Fan & Alt.; W/Multi-Grooved Idler Pulley	1731498	36231
Tensioner Pulley - Fan, Alt. & Hub	1900649	36091
Hose - Upper - Eng. To Rad.; (2 1/2" I.D.)		24240
Hose - Upper - Pipe To Rad.; (2 1/2" I.D.)		24240
Hose - Lower - Eng. To Pipe; (3" I.D.)		24248
Hose - Lower - Pipe To Rad.; (3" I.D.)		24248
T800		
Belt - Fan, Alt. & Hub; W/Conventional Hood	D11080033	♣K080825HD
Belt - Fan, Alt. & Hub; W/Short Hood		♣K080806HD
Belt - Fan & A.C.		♣9555HD
Tensioner Assy. - Fan, Alt. & Hub	1481974	38506
Idler Pulley - Fan & Alt.; W/Flat Idler Pulley	1337023	36091
Idler Pulley - Fan & Alt.; W/Multi-Grooved Idler Pulley	1731498	36231
Tensioner Pulley - Fan, Alt. & Hub	1481974	36091
Hose - Upper - Eng. To Pipe; (2 1/2" I.D.)		24240
Hose - Upper - Pipe To Rad.; (3" I.D.)		24248
Hose - Lower - Eng. To Pipe; (2 1/2" I.D.)		24240
Hose - Lower - Pipe To Rad.; (2 1/2" I.D.)		24240
W900		
Belt - Fan; Preferred Belt		2/TR22570PB
Belt - Fan; Optional Belt		②TR22570
Belt - Fan, Alt. & A.C.		②♣9610HD
Idler Pulley - Fan & Alt.; W/Flat Idler Pulley	1337023	36091
Idler Pulley - Fan & Alt.; W/Multi-Grooved Idler Pulley	1731498	36231
Hose - Upper - Eng. To Pipe; (3" I.D.)		24248
Hose - Upper - Pipe To Rad.; (3" I.D.)		24248
Hose - Lower - Eng. To Pipe; (3" I.D.)		24248
Hose - Lower - Pipe To Rad.; (3" I.D.)		24248
Caterpillar C15 Diesel		
C500		
Belt - Fan		②TR22635
Belt - Fan, Alt. & A.C.		②♣9520HD
Hose - Upper - Eng. To Pipe; (2" I.D.)		24232
Hose - Upper - Pipe To Rad.; (2 1/2" I.D.)		24240
Hose - Lower - Eng. To Pipe; (3" I.D.)		24248
Hose - Lower - Pipe To Rad.; (2 1/2" I.D.)		24240
T600		
Belt - Fan & Alt.; W/Clean Air Pkg.; W/84 7/8" Belt O.C.	D8410001082135	♣K080842HD
Belt - Fan & Alt.; W/Clean Air Pkg.; W/89 7/8" Belt O.C.	D11084906	♣K080893HD
Belt - Fan To A.C.; W/Clean Air Pkg.	D8410003061450	♣K060569HD
Belt - Fan & W.P.; W/O Clean Air Pkg.; Preferred Belt		2/TR22553PB
Belt - Fan & W.P.; W/O Clean Air Pkg.; Optional Belt		②TR22553
Belt - Fan, Alt. & A.C.; W/O Clean Air Pkg.		②♣9620HD
Tensioner Assy. - Fan & Alt.; W/Clean Air Pkg.; W/84" Belt O.C.	1900643	38620
Tensioner Assy. - Fan & Alt.; W/Clean Air Pkg.; W/89" Belt O.C.	1900649	38506
Tensioner Assy. - Fan To A.C.; W/Clean Air Pkg.	1900642	38508
Idler Pulley - Smooth	1979641	36091
Idler Pulley - Grooved	1979642	36341
Tensioner Pulley - Fan To A.C.; W/Clean Air Pkg.	1900642	36091
Hose - Upper - Eng. To Pipe; (2 1/2" I.D.)		24240
Hose - Upper - Pipe To Rad.; (2 1/2" I.D.)		24240
Hose - Lower - Eng. To Pipe; (3" I.D.)		24248
Hose - Lower - Pipe To Rad.; (3" I.D.)		24248

 ♣ Standard Belt Available. See Pages 630-631.
 Ⓜ Cut to Fit.

Application	Mfr. Part No.	Our No.
KENWORTH - Continued		
2000 - Continued		
Caterpillar C15 Diesel - Continued		
T800		
Belt - Fan & W.P.		②TR22545
Belt - Fan, Alt. & A.C.		②♣9620HD
Hose - Upper - Eng. To Pipe; (2 1/2" I.D.)		24240
Hose - Upper - Pipe To Rad.; (2 1/2" I.D.)		24240
Hose - Lower - Eng. To Pipe; (3" I.D.)		24248
Hose - Lower - Pipe To Rad.; (3" I.D.)		24248
T2000		
Belt - Fan; Preferred Belt		2/TR22570PB
Belt - Fan; Optional Belt		②TR22570
Belt - Fan, Alt. & A.C.		②♣9560HD
Hose - Upper - Eng. To Rad.; (2 1/2" I.D.)		24240
Hose - Upper - Pipe To Rad.; (2 1/2" I.D.)		24240
Hose - Lower - Eng. To Pipe; (2 1/2" I.D.)		24240
Hose - Lower - Pipe To Rad.; (2 1/2" I.D.)		24240
W900		
Belt - Fan; Preferred Belt		2/TR22570PB
Belt - Fan; Optional Belt		②TR22570
Belt - Fan, Alt. & A.C.		②♣9610HD
Hose - Upper - Eng. To Pipe; (2 1/2" I.D.)		24240
Hose - Upper - Pipe To Rad.; (2 1/2" I.D.)		24240
Hose - Lower - Eng. To Pipe; (3" I.D.)		24248
Hose - Lower - Pipe To Rad.; (3" I.D.)		24248
Caterpillar C16 Diesel		
C500		
Belt - Fan		②TR22635
Belt - Fan, Alt. & A.C.		②♣9520HD
Hose - Upper - Eng. To Pipe; (2" I.D.)		24232
Hose - Upper - Pipe To Rad.; (2 1/2" I.D.)		24240
Hose - Lower - Eng. To Pipe; (3" I.D.)		24248
Hose - Lower - Pipe To Rad.; (2 1/2" I.D.)		24240
T800		
Belt - Fan & W.P.		②TR22545
Belt - Fan, Alt. & A.C.		②♣9620HD
Hose - Upper - Eng. To Pipe; (2 1/2" I.D.)		24240
Hose - Upper - Pipe To Rad.; (2 1/2" I.D.)		24240
Hose - Lower - Eng. To Pipe; (3" I.D.)		24248
Hose - Lower - Pipe To Rad.; (3" I.D.)		24248
T2000		
Belt - Fan; Preferred Belt		2/TR22570PB
Belt - Fan; Optional Belt		②TR22570
Belt - Fan, Alt. & A.C.		②♣9560HD
Hose - Upper - Eng. To Rad.; (2 1/2" I.D.)		24240
Hose - Upper - Pipe To Rad.; (2 1/2" I.D.)		24240
Hose - Lower - Eng. To Pipe; (2 1/2" I.D.)		24240
Hose - Lower - Pipe To Rad.; (2 1/2" I.D.)		24240
W900		
Belt - Fan; Preferred Belt		2/TR22570PB
Belt - Fan; Optional Belt		②TR22570
Belt - Fan, Alt. & A.C.		②♣9610HD
Hose - Upper - Eng. To Pipe; (2 1/2" I.D.)		24240
Hose - Upper - Pipe To Rad.; (2 1/2" I.D.)		24240
Hose - Lower - Eng. To Pipe; (3" I.D.)		24248
Hose - Lower - Pipe To Rad.; (3" I.D.)		24248
Cummins ISB Diesel		
K300		
Belt - Fan, W.P. & Alt.	3911579	♣K080675HD
Belt - Fan & A.C.	17481	♣9480HD
Cummins ISC Diesel		
T300		
Belt - Fan, Alt. & Hub	3944837	♣K080745HD
Belt - Fan & A.C.		7420
Belt - Fan To A.C.		7419
Tensioner Assy. - Fan, Alt. & Hub	3934819	38527
Hose - Upper - Eng. To Pipe; (2 1/4" I.D.)		24236
Hose - Upper - Pipe To Rad.		Ⓜ-21115
Hose - Lower - Eng. To Pipe		20206

② Two Required.

Belts and Coolant Hose for Medium/Heavy-Duty Trucks (1996 and Newer)

Medium & Heavy-Duty Trucks
(1996 & Newer)

Application	Mfr. Part No.	Our No.
KENWORTH - Continued		
2000 - Continued		
Cummins ISM Diesel		
T600		
Belt - A.C.	17535	▲9530HD
Belt - Fan & Alt.	3289314	▲K080708HD
Tensioner Assy. - Fan & Alt.	3400885	38521
Idler Pulley	3400883	36308
Tensioner Pulley	3400884	36308
T800		
Belt - Fan & Alt.	3099256	▲K080708HD
Belt - Hub & A.C.		▲9530HD
Tensioner Assy. - Fan & Alt.	3400885	38521
Idler Pulley - Fan & Alt.	3400884	36308
Hose - Upper - Eng. To Pipe; (2 1/2" I.D.)		24240
Hose - Upper - Pipe To Rad.; (2 1/2" I.D.)		24240
Hose - Lower - Eng. To Pipe; (2 1/2" I.D.)		24240
Hose - Lower - Pipe To Rad.; (2 1/2" I.D.)		24240
Cummins ISX Diesel		
T800		
Belt - Fan	3681817	▲K100658HD
Belt - Hub, Alt. & A.C.	3681812	▲K060685HD
Tensioner Assy. - Fan	3681240	38535
Tensioner Assy. - Hub, Alt. & A.C.	3680194	38532
Idler Pulley - Alt. & A.C.	4026886	36226
Tensioner Pulley - Fan	3681240	36092
Tensioner Pulley - Hub, Alt. & A.C.	3680194	36095
Hose - Upper - Eng. To Pipe; (2 1/2" I.D.)		24240
Hose - Upper - Pipe To Rad.; (2 1/2" I.D.)		24240
Hose - Lower - Eng. To Pipe; (2 1/2" I.D.)		24240
Hose - Lower - Pipe To Rad.; (3" I.D.)		24248
T2000		
Belt - Fan	3681821	▲K100675HD
Belt - W.P., Alt. & A.C.	3681812	▲K060685HD
Tensioner Assy. - Fan	3681240	38535
Tensioner Assy. - Hub, Alt. & A.C.	3680194	38532
Idler Pulley - Alt. & A.C.	4026886	36226
Tensioner Pulley - Fan	3681240	36092
Tensioner Pulley - Hub, Alt. & A.C.	3680194	36095
Hose - Upper - Eng. To Pipe; (2 1/2" I.D.)		24240
Hose - Upper - Pipe To Rad.		●26532
Hose - Lower - Eng. To Pipe; (2 1/2" I.D.)		24240
Hose - Lower - Pipe To Rad.; (2 1/2" I.D.)		24240
W900		
Belt - Fan	3681823	▲K100670HD
Belt - W.P., Alt. & A.C.	3681812	▲K060685HD
Tensioner Assy. - Fan	3681240	38535
Tensioner Assy. - Hub, Alt. & A.C.	3680194	38532
Idler Pulley - Alt. & A.C.	4026886	36226
Tensioner Pulley - Fan	3681240	36092
Tensioner Pulley - Hub, Alt. & A.C.	3680194	36095
Hose - Upper - Eng. To Pipe; (2 1/2" I.D.)		24240
Hose - Upper - Pipe To Rad.; (2 1/2" I.D.)		24240
Hose - Lower - Eng. To Pipe; (2 1/2" I.D.)		24240
Hose - Lower - Pipe To Rad.; (2 1/2" I.D.)		24240
Cummins N14 Diesel		
T600; T800		
Belt - Hub & W.P.	3076492	▲K060425HD
Belt - Hub & Fan		②TR28437
Belt - Alt.		②▲9451HD
Belt - Hub & A.C.	17425	▲9425HD
Hose - Upper - Eng. To Pipe; (2 1/2" I.D.)		24240
Hose - Upper - Pipe To Rad.; (2 1/2" I.D.)		24240
Hose - Lower - Eng. To Pipe; (2 1/2" I.D.)		24240
Hose - Lower - Pipe To Rad.; (3" I.D.)		24248
T2000		
Belt - Hub & W.P.	3076492	▲K060425HD
Belt - Hub & Fan; Preferred Belt		2/TR28411PB
Belt - Hub & Fan; Optional Belt		②TR28412
Belt - Hub & A.C.	17421	▲9420HD
Hose - Upper - Eng. To Pipe; (2 1/2" I.D.)		24240
Hose - Upper - Pipe To Rad.		●26529

Application	Mfr. Part No.	Our No.
KENWORTH - Continued		
2000 - Continued		
Cummins N14 Diesel - Continued		
T2000 - Continued		
Hose - Lower - Eng. To Pipe; (2 1/2" I.D.)		24240
Hose - Lower - Pipe To Rad.; (2 1/2" I.D.)		24240
W900		
Belt - Hub & W.P.	3076492	▲K060425HD
Belt - Hub & Fan		②TR28483
Belt - Alt.		②▲9451HD
Belt - Hub & A.C.	17425	▲9425HD
Hose - Upper - Eng. To Pipe; (2 1/2" I.D.)		24240
Hose - Upper - Pipe To Rad.; (2 1/2" I.D.)		24240
Hose - Lower - Eng. To Pipe; (2 1/2" I.D.)		24240
Hose - Lower - Pipe To Rad.; (2 1/2" I.D.)		24240
Cummins Signature 600 Diesel		
W900		
Belt - Fan	3681823	▲K100670HD
Belt - W.P., Alt. & A.C.	3681812	▲K060685HD
Tensioner Assy. - Fan	3681240	38535
Tensioner Assy. - Hub, Alt. & A.C.	3680194	38532
Idler Pulley - Alt. & A.C.	4026886	36226
Tensioner Pulley - Fan	3681240	36092
Tensioner Pulley - Hub, Alt. & A.C.	3680194	36095
Hose - Upper - Eng. To Pipe; (2 1/2" I.D.)		24240
Hose - Upper - Pipe To Rad.; (2 1/2" I.D.)		24240
Hose - Lower - Eng. To Pipe; (2 1/2" I.D.)		24240
Hose - Lower - Pipe To Rad.; (2 1/2" I.D.)		24240
Detroit Diesel 6-Cyl. 11.1 L Diesel		
T800		
Belt - Fan		③▲9447HD
Belt - Hub, Alt. & A.C.		▲K080580HD
Tensioner Assy. - Hub, Alt. & A.C.	23520317	38501
Tensioner Pulley - Hub, Alt. & A.C.		38075
Hose - Upper - Eng. To Pipe; (2 1/2" I.D.)		24240
Hose - Upper - Pipe To Rad.; (2 1/2" I.D.)		24240
Hose - Lower - Eng. To Pipe; (2 1/2" I.D.)		24240
Hose - Lower - Pipe To Rad.; (3" I.D.)		24248
T2000		
Belt - Fan; W/47 3/4" Belt O.C.; Preferred Belt		3/9470PB
Belt - Fan; W/47 3/4" Belt O.C.; Optional Belt		③▲9470HD
Belt - Hub, Alt. & A.C.; W/V-Belt Drive		②▲9495HD
Belt - Hub, Alt. & A.C.; W/V-Ribbed Belt Drive	23520613	▲K080580HD
Tensioner Assy. - Hub, Alt. & A.C.	23520317	38501
Tensioner Pulley - Hub, Alt. & A.C.		38075
Hose - Upper - Eng. To Pipe; (2 1/2" I.D.)		24240
Hose - Upper - Pipe To Rad.		●26529
Hose - Lower - Eng. To Pipe; (2 1/2" I.D.)		24240
Hose - Lower - Pipe To Rad.; (2 1/2" I.D.)		24240
W900		
Belt - Fan; W/47 3/4" Belt O.C.; Preferred Belt		3/9470PB
Belt - Fan; W/47 3/4" Belt O.C.; Optional Belt		③▲9470HD
Belt - Hub, Alt. & A.C.	23520613	▲K080580HD
Tensioner Assy. - Hub, Alt. & A.C.	23520317	38501
Tensioner Pulley - Hub, Alt. & A.C.		38075
Hose - Upper - Eng. To Pipe; (2 1/2" I.D.)		24240
Hose - Upper - Pipe To Rad.; (2 1/2" I.D.)		24240
Hose - Lower - Eng. To Pipe; (2 1/2" I.D.)		24240
Hose - Lower - Pipe To Rad.; (2 1/2" I.D.)		24240
Detroit Diesel 6-Cyl. 12.7 L Diesel		
T600		
Belt - Fan, Alt. & A.C.	17446	③▲9447HD
T800		
Belt - Fan		③▲9447HD
Belt - Hub, Alt. & A.C.		▲K080580HD
Tensioner Assy. - Hub, Alt. & A.C.	23520317	38501
Tensioner Pulley - Hub, Alt. & A.C.		38075
Hose - Upper - Eng. To Pipe; (2 1/2" I.D.)		24240
Hose - Upper - Pipe To Rad.; (2 1/2" I.D.)		24240
Hose - Lower - Eng. To Pipe; (2 1/2" I.D.)		24240
Hose - Lower - Pipe To Rad.; (3" I.D.)		24248

▲ Standard Belt Available. See Pages 630-631.
② Two Required.

● Vulco-Flex® Coolant Hose.
③ Three Required.

Belts and Coolant Hose for Medium/Heavy-Duty Trucks (1996 and Newer)

 Medium & Heavy-Duty Trucks
(1996 & Newer)

Application	Mfr. Part No.	Our No.
KENWORTH - Continued		
2000 - Continued		
Detroit Diesel 6-Cyl. 12.7 L Diesel - Continued		
T2000		
Belt - Fan; W/47 3/4" Belt O.C.; Preferred Belt		3/9470PB
Belt - Fan; W/47 3/4" Belt O.C.; Optional Belt		③▲9470HD
Belt - Hub, Alt. & A.C.; W/V-Belt Drive		②▲9495HD
Belt - Hub, Alt. & A.C.; W/V-Ribbed Belt Drive	23520613	▲K080580HD
Tensioner Assy. - Hub, Alt. & A.C.	23520317	38501
Tensioner Pulley - Hub, Alt. & A.C.		38075
Hose - Upper - Eng. To Pipe; (2 1/2" I.D.)		24240
Hose - Upper - Pipe To Rad.		●26529
Hose - Lower - Eng. To Pipe; (2 1/2" I.D.)		24240
Hose - Lower - Pipe To Rad.; (2 1/2" I.D.)		24240
W900		
Belt - Fan; W/47 3/4" Belt O.C.; Preferred Belt		3/9470PB
Belt - Fan; W/47 3/4" Belt O.C.; Optional Belt		③▲9470HD
Belt - Hub, Alt. & A.C.	23520613	▲K080580HD
Tensioner Assy. - Hub, Alt. & A.C.	23520317	38501
Tensioner Pulley - Hub, Alt. & A.C.		38075
Hose - Upper - Eng. To Pipe; (2 1/2" I.D.)		24240
Hose - Upper - Pipe To Rad.; (2 1/2" I.D.)		24240
Hose - Lower - Eng. To Pipe; (2 1/2" I.D.)		24240
Hose - Lower - Pipe To Rad.; (2 1/2" I.D.)		24240
1999		
Caterpillar 3126 Diesel		
T300		
Belt - Fan, Alt. & A.C.	4080767	▲K080774HD
Belt - W.P.	0366775	▲9341HD
Tensioner Assy. - Fan, Alt. & A.C.	1352151	38511
Tensioner Pulley - Fan, Alt. & A.C.	1352151	36091
Hose - Upper - Eng. To Pipe		21891
Hose - Upper - Pipe To Rad.		21115
Hose - Lower - Eng. To Pipe; (2" I.D.)		24232
Hose - Lower - Pipe To Pipe; (2 1/2" I.D.)		24240
Hose - Lower - Pipe To Rad.		22707
Caterpillar 3406 Diesel		
T600		
Belt - Fan		②TR22545
Belt - Alt. & A.C.; Preferred Belt	17611	2/9610PB
Belt - Alt. & A.C.; Optional Belt		②▲9610HD
Hose - Upper; (2 1/2" I.D.)		24240
Hose - Lower - Eng. To Pipe; (3" I.D.)		24248
Hose - Lower - Pipe To Rad.; (2 1/2" I.D.)		24240
Hose - Lower - Pipe To Pipe; (2 1/2" I.D.)		24240
Hose - Heater; (3/4" I.D.)		28442
T800		
Belt - Fan & Hub		②TR22545
Belt - Fan, Alt. & A.C.		②▲9620HD
Hose - Upper - Eng. To Pipe; (2 1/2" I.D.)		24240
Hose - Upper - Pipe To Rad.; (2 1/2" I.D.)		24240
Hose - Lower - Eng. To Pipe; (3" I.D.)		24248
Hose - Lower - Pipe To Rad.; (3" I.D.)		24248
Hose - Lower - Pipe To Pipe; (2 1/2" I.D.)		24240
Hose - Heater; (3/4" I.D.)		28442
T2000		
Belt - Fan; Preferred Belt		2/TR22570PB
Belt - Fan; Optional Belt		②TR22570
Belt - Alt. & A.C.; Preferred Belt		2/9640PB
Belt - Alt. & A.C.; Optional Belt		②▲9640HD
Hose - Upper - Eng. To Pipe; (2 1/2" I.D.)		24240
Hose - Upper - Pipe To Rad.		21115
Hose - Lower - Eng. To Pipe; (3" I.D.)		24248
Hose - Lower - Pipe To Rad.; (2 1/2" I.D.)		24240
W900		
Belt - Fan; W/56" Belt O.C.		②TR22553
Belt - Fan; Preferred Belt; W/57 1/2" Belt O.C.		2/TR22570PB
Belt - Fan; Optional Belt; W/57 1/2" Belt O.C.		②TR22570
Belt - Fan, Alt. & A.C.		②▲9610HD
Belt - Alt. & A.C.; Preferred Belt		2/9590PB

③ Three Required.
② Two Required.

Application	Mfr. Part No.	Our No.
KENWORTH - Continued		
1999 - Continued		
Caterpillar 3406 Diesel - Continued		
W900 - Continued		
Belt - Alt. & A.C.; Optional Belt		②▲9590HD
Hose - Upper - Eng. To Pipe; (2 1/2" I.D.)		24240
Hose - Upper - Pipe To Rad.; (2 1/2" I.D.)		24240
Hose - Lower - Eng. To Pipe; (3" I.D.)		24248
Hose - Lower - Pipe To Rad.; (3" I.D.)		24248
Hose - By Pass; (1" I.D.)		24216
Hose - Heater; (5/8" I.D.)		28441
Caterpillar C10 Diesel		
T600		
Belt - Fan, Alt. & Hub	D11080001	▲K080825HD
Belt - Fan & A.C.		▲9555HD
Tensioner Assy. - Fan, Alt. & Hub	1900649	38506
Idler Pulley - Fan & Alt.; W/Flat Idler Pulley	1337023	36091
Idler Pulley - Fan & Alt.; W/Multi-Grooved Idler Pulley	1731498	36231
Tensioner Pulley - Fan, Alt. & Hub	1900649	36091
Hose - Upper - Eng. To Rad.; (2 1/2" I.D.)		24240
Hose - Upper - Pipe To Rad.; (2 1/2" I.D.)		24240
Hose - Lower - Eng. To Pipe; (3" I.D.)		24248
Hose - Lower - Pipe To Rad.; (3" I.D.)		24248
T800		
Belt - Fan, Alt. & Hub	D11080033	▲K080825HD
Belt - Fan & A.C.		▲9555HD
Tensioner Assy. - Fan, Alt. & Hub	1481974	38506
Tensioner Pulley - Fan, Alt. & Hub	1481974	36091
Hose - Upper - Eng. To Pipe; (2 1/2" I.D.)		24240
Hose - Upper - Pipe To Rad.; (3" I.D.)		24248
Hose - Lower - Eng. To Pipe; (2 1/2" I.D.)		24240
Hose - Lower - Pipe To Rad.; (2 1/2" I.D.)		24240
T2000		
Belt - Fan & Alt.		▲K080645HD
Belt - A.C.		▲9520HD
Tensioner Assy. - Fan & Alt.	3161562	38505
Tensioner Pulley - A.C.	3161562	36091
W900		
Belt - Fan; Preferred Belt		2/TR22570PB
Belt - Fan; Optional Belt		②TR22570
Belt - Fan, Alt. & A.C.		②▲9610HD
Idler Pulley - Fan & Alt.; W/Flat Idler Pulley	1337023	36091
Idler Pulley - Fan & Alt.; W/Multi-Grooved Idler Pulley	1731498	36231
Hose - Upper - Eng. To Pipe; (3" I.D.)		24248
Hose - Upper - Pipe To Rad.; (3" I.D.)		24248
Hose - Lower - Eng. To Pipe; (3" I.D.)		24248
Hose - Lower - Pipe To Rad.; (3" I.D.)		24248
Caterpillar C12 Diesel		
T600		
Belt - Fan, Alt. & Hub	D11080001	▲K080825HD
Belt - Fan & A.C.		▲9555HD
Tensioner Assy. - Fan, Alt. & Hub	1900649	38506
Idler Pulley - Fan & Alt.; W/Flat Idler Pulley	1337023	36091
Idler Pulley - Fan & Alt.; W/Multi-Grooved Idler Pulley	1731498	36231
Tensioner Pulley - Fan, Alt. & Hub	1900649	36091
Hose - Upper - Eng. To Rad.; (2 1/2" I.D.)		24240
Hose - Upper - Pipe To Rad.; (2 1/2" I.D.)		24240
Hose - Lower - Eng. To Pipe; (3" I.D.)		24248
Hose - Lower - Pipe To Rad.; (3" I.D.)		24248
T800		
Belt - Fan, Alt. & Hub	D11080033	▲K080825HD
Belt - Fan & A.C.		▲9555HD
Tensioner Assy. - Fan, Alt. & Hub	1481974	38506
Tensioner Pulley - Fan, Alt. & Hub	1481974	36091
Hose - Upper - Eng. To Pipe; (2 1/2" I.D.)		24240
Hose - Upper - Pipe To Rad.; (3" I.D.)		24248
Hose - Lower - Eng. To Pipe; (2 1/2" I.D.)		24240

▲ Standard Belt Available. See Pages 630-631.
● Vulco-Flex® Coolant Hose.

Belts and Coolant Hose for Medium/Heavy-Duty Trucks (1996 and Newer)

Medium & Heavy-Duty Trucks
(1996 & Newer)

Application	Mfr. Part No.	Our No.
KENWORTH - Continued		
1999 - Continued		
Caterpillar C12 Diesel - Continued		
T800 - Continued		
Hose - Lower - Pipe To Rad.; (2 1/2" I.D.)		24240
T2000		
Belt - Fan & Alt.	▲K080645HD	
Belt - A.C.	▲9520HD	
Tensioner Assy. - Fan & Alt.	3161562	38505
Tensioner Pulley - A.C.	3161562	36091
Cummins ISC Diesel		
T300		
Belt - Fan, Alt. & Hub	3915768	▲K080733HD
Belt - Fan To A.C.		7419
Tensioner Assy. - Fan, Alt. & Hub		38513
Hose - Upper - Eng. To Pipe; (2 1/2" I.D.)		24240
Hose - Upper - Pipe To Rad.		☉21115
Hose - Lower - Eng. To Pipe		☉20611
Cummins ISM Diesel		
T800		
Belt - Fan & Alt.	3099256	▲K080708HD
Belt - Hub & A.C.		▲9530HD
Tensioner Assy. - Fan & Alt.	3400885	38521
Idler Pulley - Fan & Alt.	3400884	36308
Hose - Upper - Eng. To Pipe; (2 1/2" I.D.)		24240
Hose - Upper - Pipe To Rad.; (2 1/2" I.D.)		24240
Hose - Lower - Eng. To Pipe; (2 1/2" I.D.)		24240
Hose - Lower - Pipe To Rad.; (2 1/2" I.D.)		24240
W900		
Belt - Accessory Drive	4080485	▲K080485HD
Cummins ISX Diesel		
T800		
Belt - Fan	3681817	▲K100658HD
Belt - Hub, Alt. & A.C.	3681812	▲K060685HD
Tensioner Assy. - Fan	3681240	38535
Tensioner Assy. - Hub, Alt. & A.C.	3680194	38532
Idler Pulley - Alt. & A.C.	4026886	36226
Tensioner Pulley - Fan	3681240	36092
Tensioner Pulley - Hub, Alt. & A.C.	3680194	36095
Hose - Upper - Eng. To Pipe; (2 1/2" I.D.)		24240
Hose - Upper - Pipe To Rad.; (2 1/2" I.D.)		24240
Hose - Lower - Eng. To Pipe; (2 1/2" I.D.)		24240
Hose - Lower - Pipe To Rad.; (3" I.D.)		24248
T2000		
Belt - Fan	3681821	▲K100675HD
Belt - Hub, Alt. & A.C.	3681812	▲K060685HD
Tensioner Assy. - Fan	3681240	38535
Tensioner Assy. - Hub, Alt. & A.C.	3680194	38532
Idler Pulley - Alt. & A.C.	4026886	36226
Tensioner Pulley - Fan	3681240	36092
Tensioner Pulley - Hub, Alt. & A.C.	3680194	36095
Hose - Upper - Eng. To Pipe; (2 1/2" I.D.)		24240
Hose - Upper - Pipe To Rad.		●26532
Hose - Lower - Eng. To Pipe; (2 1/2" I.D.)		24240
Hose - Lower - Pipe To Rad.; (2 1/2" I.D.)		24240
W900		
Belt - Fan	3681823	▲K100670HD
Belt - Hub, Alt. & A.C.	3681812	▲K060685HD
Tensioner Assy. - Fan	3681240	38535
Tensioner Assy. - Hub, Alt. & A.C.	3680194	38532
Idler Pulley - Alt. & A.C.	4026886	36226
Tensioner Pulley - Fan	3681240	36092
Tensioner Pulley - Hub, Alt. & A.C.	3680194	36095
Hose - Upper - Eng. To Pipe; (2 1/2" I.D.)		24240
Hose - Upper - Pipe To Rad.; (2 1/2" I.D.)		24240
Hose - Lower - Eng. To Pipe; (2 1/2" I.D.)		24240
Hose - Lower - Pipe To Rad.; (2 1/2" I.D.)		24240
Cummins N14 Diesel		
T600; T800		
Belt - Hub & W.P.	3076492	▲K060425HD
Belt - Hub & Fan		②TR28437

Application	Mfr. Part No.	Our No.
KENWORTH - Continued		
1999 - Continued		
Cummins N14 Diesel - Continued		
T600; T800 - Continued		
Belt - Alt.		②▲9451HD
Belt - Hub & A.C.		▲9425HD
Hose - Upper - Eng. To Pipe; (2 1/2" I.D.)		24240
Hose - Upper - Pipe To Rad.; (2 1/2" I.D.)		24240
Hose - Lower - Eng. To Pipe; (2 1/2" I.D.)		24240
Hose - Lower - Pipe To Rad.; (3" I.D.)		24248
T2000		
Belt - Hub & W.P.	3076492	▲K060425HD
Belt - Hub & Fan; Preferred Belt		2/TR28411PB
Belt - Hub & Fan; Optional Belt		②TR28412
Belt - Hub & A.C.	17421	▲9420HD
Hose - Upper - Eng. To Pipe; (2 1/2" I.D.)		24240
Hose - Upper - Pipe To Rad.		●26529
Hose - Lower - Eng. To Pipe; (2 1/2" I.D.)		24240
Hose - Lower - Pipe To Rad.; (2 1/2" I.D.)		24240
W900		
Belt - Hub & W.P.	3076492	▲K060425HD
Belt - Hub & Fan		②TR28483
Belt - Alt.		②▲9451HD
Belt - Hub & A.C.	17425	▲9425HD
Hose - Upper - Eng. To Pipe; (2 1/2" I.D.)		24240
Hose - Upper - Pipe To Rad.; (2 1/2" I.D.)		24240
Hose - Lower - Eng. To Pipe; (2 1/2" I.D.)		24240
Hose - Lower - Pipe To Rad.; (2 1/2" I.D.)		24240
Detroit Diesel 6-Cyl. 11.1 L Diesel		
T600; T800		
Belt - Fan		③▲9447HD
Belt - Alt. & A.C.; Preferred Belt		2/9520PB
Belt - Alt. & A.C.; Optional Belt		②▲9520HD
Hose - Upper; (2 1/2" I.D.)		24240
Hose - Lower - Eng. To Pipe; (2 1/2" I.D.)		24240
Hose - Lower - Pipe To Rad.; (3" I.D.)		24248
Hose - Heater Inlet; (3/4" I.D.)		28442
Hose - Heater Outlet; (5/8" I.D.)		28441
T2000		
Belt - Fan; W/47 3/4" Belt O.C.; Preferred Belt		3/9470PB
Belt - Fan; W/47 3/4" Belt O.C.; Optional Belt		③▲9470HD
Belt - Alt. & A.C.		▲9525HD
Hose - Upper; (2 1/2" I.D.)		24240
Hose - Lower - Eng. To Pipe; (2 1/2" I.D.)		24240
Hose - Lower - Pipe To Rad.; (3" I.D.)		24248
Hose - Heater Inlet; (3/4" I.D.)		28442
Hose - Heater Outlet; (5/8" I.D.)		28441
W900		
Belt - Fan; W/47 3/4" Belt O.C.; Preferred Belt		3/9470PB
Belt - Fan; W/47 3/4" Belt O.C.; Optional Belt		③▲9470HD
Belt - Alt. & A.C.; Optional Belt		②▲9520HD
Belt - Alt. & A.C.; Preferred Belt		2/9520PB
Hose - Upper; (2 1/2" I.D.)		24240
Hose - Lower - Eng. To Pipe; (2 1/2" I.D.)		24240
Hose - Lower - Pipe To Rad.; (3" I.D.)		24248
Hose - Heater Inlet; (3/4" I.D.)		28442
Hose - Heater Outlet; (5/8" I.D.)		28441
Detroit Diesel 6-Cyl. 12.7 L Diesel		
T600; T800		
Belt - Fan		③▲9447HD
Belt - Alt. & A.C.; Preferred Belt		2/9520PB
Belt - Alt. & A.C.; Optional Belt		②▲9520HD
Hose - Upper; (2 1/2" I.D.)		24240
Hose - Lower - Eng. To Pipe; (2 1/2" I.D.)		24240
Hose - Lower - Pipe To Rad.; (3" I.D.)		24248
Hose - Heater Inlet; (3/4" I.D.)		28442
Hose - Heater Outlet; (5/8" I.D.)		28441
T2000		
Belt - Fan; W/47 3/4" Belt O.C.; Preferred Belt		3/9470PB
Belt - Fan; W/47 3/4" Belt O.C.; Optional Belt		③▲9470HD
Belt - Alt. & A.C.		▲9525HD
Hose - Upper; (2 1/2" I.D.)		24240
Hose - Lower; (2 1/2" I.D.)		24240
W900		
Belt - Fan; W/47 3/4" Belt O.C.; Preferred Belt		3/9470PB

▲ Standard Belt Available. See Pages 630-631.
● Vulco-Flex® Coolant Hose.
③ Three Required.

☉ Cut to Fit.
② Two Required.

Belts and Coolant Hose for Medium/Heavy-Duty Trucks (1996 and Newer)

 Medium & Heavy-Duty Trucks
(1996 & Newer)

Application	Mfr. Part No.	Our No.
KENWORTH - Continued		
1999 - Continued		
Detroit Diesel 6-Cyl. 12.7 L Diesel - Continued		
W900 - Continued		
Belt - Fan; W/47 3/4" Belt O.C.; Optional Belt		③▲9470HD
Belt - Alt. & A.C.; Preferred Belt		2/9520PB
Belt - Alt. & A.C.; Optional Belt		②▲9520HD
Hose - Upper; (2 1/2" I.D.)		24240
Hose - Lower - Eng. To Pipe; (2 1/2" I.D.)		24240
Hose - Lower - Pipe To Rad.; (3" I.D.)		24248
Hose - Heater Inlet; (3/4" I.D.)		28442
Hose - Heater Outlet; (5/8" I.D.)		28441
1998		
Caterpillar 3126 Diesel		
T300		
Belt - Fan, Alt. & A.C.	4080767	▲K080774HD
Belt - W.P.	0366775	▲9341HD
Tensioner Assy. - Fan, Alt. & A.C.	1352151	38511
Tensioner Pulley - Fan, Alt. & A.C.	1352151	36091
Hose - Upper - Eng. To Pipe		21891
Hose - Upper - Pipe To Rad.		21115
Hose - Lower - Eng. To Pipe; (2" I.D.)		24232
Hose - Lower - Pipe To Pipe; (2 1/2" I.D.)		24240
Hose - Lower - Pipe To Rad.		22707
Caterpillar 3406 Diesel		
T600; T800		
Belt - Fan		②TR22545
Belt - Alt. & A.C.; Preferred Belt	17611	2/9610PB
Belt - Alt. & A.C.; Optional Belt		②▲9610HD
Hose - Upper; (2 1/2" I.D.)		24240
Hose - Lower - Eng. To Pipe; (3" I.D.)		24248
Hose - Lower - Pipe To Rad.; (2 1/2" I.D.)		24240
Hose - Lower - Pipe To Pipe; (2 1/2" I.D.)		24240
Hose - Heater; (3/4" I.D.)		28442
T2000		
Belt - Fan; Preferred Belt		2/TR22570PB
Belt - Fan; Optional Belt		②TR22570
Belt - Alt. & A.C.; Preferred Belt		2/9640PB
Belt - Alt. & A.C.; Optional Belt		②▲9640HD
Hose - Upper - Eng. To Pipe; (2 1/2" I.D.)		24240
Hose - Upper - Pipe To Rad.		21115
Hose - Lower - Eng. To Pipe; (3" I.D.)		24248
Hose - Lower - Pipe To Rad.; (2 1/2" I.D.)		24240
W900		
Belt - Fan; Preferred Belt		2/TR22570PB
Belt - Fan; Optional Belt		②TR22570
Belt - Alt. & A.C.; Preferred Belt		2/9590PB
Belt - Alt. & A.C.; Optional Belt		②▲9590HD
Hose - Upper; (2 1/2" I.D.)		24240
Hose - Lower; (3" I.D.)		24248
Hose - By Pass; (1" I.D.)		24216
Hose - Heater; (5/8" I.D.)		28441
Caterpillar C10 Diesel		
T600		
Belt - Fan, Alt. & Hub	D11080001	▲K080825HD
Belt - Fan & A.C.		▲9555HD
Tensioner Assy. - Fan, Alt. & Hub	1900649	38506
Idler Pulley - Fan & Alt.; W/Flat Idler		
Pulley	1337023	36091
Idler Pulley - Fan & Alt.;		
W/Multi-Grooved Idler Pulley	1731498	36231
Tensioner Pulley - Fan, Alt. & Hub	1900649	36091
Hose - Upper - Eng. To Rad.; (2 1/2" I.D.)		24240
Hose - Upper - Pipe To Rad.; (2 1/2" I.D.)		24240
Hose - Lower - Eng. To Pipe; (3" I.D.)		24248
Hose - Lower - Pipe To Rad.; (3" I.D.)		24248
T800		
Belt - Fan, Alt. & Hub	D11080033	▲K080825HD
Belt - Fan, Alt. & A.C.		▲K080797HD
Belt - A.C.		▲9555HD
Tensioner Assy. - Fan, Alt. & Hub	1481974	38506
Idler Pulley - Fan & Alt.; W/Flat Idler		
Pulley	1337023	36091
Idler Pulley - Fan & Alt.;		
W/Multi-Grooved Idler Pulley	1731498	36231
Tensioner Pulley - Fan, Alt. & Hub	1481974	36091
Hose - Upper; (2 1/2" I.D.)		24240
Hose - Lower - Eng. To Pipe; (2 1/2" I.D.)		24240
Hose - Lower - Pipe To Rad.; (3" I.D.)		24248
T2000		
Belt - Fan & Alt.		▲K080645HD
Belt - A.C.		▲9520HD
Tensioner Assy. - Fan & Alt.	3161562	38505
Tensioner Pulley - A.C.	3161562	36091

Application	Mfr. Part No.	Our No.
KENWORTH - Continued		
1998 - Continued		
Caterpillar C10 Diesel - Continued		
T800 - Continued		
Idler Pulley - Fan & Alt.; W/Flat Idler		
Pulley	1337023	36091
Idler Pulley - Fan & Alt.;		
W/Multi-Grooved Idler Pulley	1731498	36231
Tensioner Pulley - Fan, Alt. & Hub	1481974	36091
Hose - Upper; (2 1/2" I.D.)		24240
Hose - Lower - Eng. To Pipe; (2 1/2" I.D.)		24240
Hose - Lower - Pipe To Rad.; (3" I.D.)		24248
T2000		
Belt - Fan & Alt.		▲K080645HD
Belt - A.C.		▲9520HD
Tensioner Assy. - Fan & Alt.	3161562	38505
Tensioner Pulley - A.C.	3161562	36091
W900		
Belt - Fan; Preferred Belt		2/TR22570PB
Belt - Fan; Optional Belt		②TR22570
Belt - Fan, Alt. & A.C.		②▲9610HD
Idler Pulley - Fan & Alt.; W/Flat Idler		
Pulley	1337023	36091
Idler Pulley - Fan & Alt.;		
W/Multi-Grooved Idler Pulley	1731498	36231
Hose - Upper - Eng. To Pipe; (3" I.D.)		24248
Hose - Upper - Pipe To Rad.; (3" I.D.)		24248
Hose - Lower - Eng. To Pipe; (3" I.D.)		24248
Hose - Lower - Pipe To Rad.; (3" I.D.)		24248
Caterpillar C12 Diesel		
T600		
Belt - Fan, Alt. & Hub	D11080001	▲K080825HD
Belt - Fan & A.C.		▲9555HD
Tensioner Assy. - Fan, Alt. & Hub	1900649	38506
Idler Pulley - Fan & Alt.; W/Flat Idler		
Pulley	1337023	36091
Idler Pulley - Fan & Alt.;		
W/Multi-Grooved Idler Pulley	1731498	36231
Tensioner Pulley - Fan, Alt. & Hub	1900649	36091
Hose - Upper - Eng. To Rad.; (2 1/2" I.D.)		24240
Hose - Upper - Pipe To Rad.; (2 1/2" I.D.)		24240
Hose - Lower - Eng. To Pipe; (3" I.D.)		24248
Hose - Lower - Pipe To Rad.; (3" I.D.)		24248
T800		
Belt - Fan, Alt. & Hub	D11080033	▲K080825HD
Belt - Fan, Alt. & A.C.		▲K080797HD
Belt - A.C.		▲9555HD
Tensioner Assy. - Fan, Alt. & Hub	1481974	38506
Idler Pulley - Fan & Alt.; W/Flat Idler		
Pulley	1337023	36091
Idler Pulley - Fan & Alt.;		
W/Multi-Grooved Idler Pulley	1731498	36231
Tensioner Pulley - Fan, Alt. & Hub	1481974	36091
Hose - Upper; (2 1/2" I.D.)		24240
Hose - Lower - Eng. To Pipe; (2 1/2" I.D.)		24240
Hose - Lower - Pipe To Rad.; (3" I.D.)		24248
T2000		
Belt - Fan & Alt.		▲K080645HD
Belt - A.C.		▲9520HD
Tensioner Assy. - Fan & Alt.	3161562	38505
Tensioner Pulley - A.C.	3161562	36091
Cummins ISC Diesel		
T300		
Serpentine Belt; W/O A.C.		▲K081020HD
Cummins M11 Diesel		
T600; T800		
Belt - Fan		▲K080485HD
Belt - Alt.	3028521	▲K050345HD
Belt - A.C.		▲9530HD
Cummins N14 Diesel		
T600		
Belt - Hub & W.P.	3076492	▲K060425HD

③ Three Required.
② Two Required.

▲ Standard Belt Available. See Pages 630-631.

Belts and Coolant Hose for Medium/Heavy-Duty Trucks (1996 and Newer)

Medium & Heavy-Duty Trucks
(1996 & Newer)

Application	Mfr. Part No.	Our No.
KENWORTH - Continued		
1998 - Continued		
Cummins N14 Diesel - Continued		
T600 - Continued		
Belt - Hub & Fan		②TR28437
Belt - Alt		②▲9451HD
Hose - Upper - Eng. To Pipe; (2 1/2" I.D.)		24240
Hose - Upper - Pipe To Rad.; (2 1/2" I.D.)		24240
Hose - Lower - Eng. To Pipe; (2 1/2" I.D.)		24240
Hose - Lower - Pipe To Rad.; (3" I.D.)		24248
T800		
Belt - Hub & W.P.		▲K060425HD
Belt - Hub & Fan		TR28437
Belt - Alt		▲9451HD
Belt - Hub & A.C.		▲9425HD
Hose - Upper - Eng. To Pipe; (2 1/2" I.D.)		24240
Hose - Upper - Pipe To Rad.; (2 1/2" I.D.)		24240
Hose - Lower - Eng. To Pipe; (2 1/2" I.D.)		24240
Hose - Lower - Pipe To Rad.; (3" I.D.)		24248
T2000		
Belt - Hub & W.P.	3076492	▲K060425HD
Belt - Hub & Fan; Preferred Belt		2/TR28411PB
Belt - Hub & Fan; Optional Belt		②TR28412
Belt - Hub & A.C.	17421	▲9420HD
Hose - Upper - Eng. To Pipe; (2 1/2" I.D.)		24240
Hose - Upper - Pipe To Rad.		●26529
Hose - Lower - Eng. To Pipe; (2 1/2" I.D.)		24240
Hose - Lower - Pipe To Rad.; (2 1/2" I.D.)		24240
W900		
Belt - Hub & W.P.		▲K060425HD
Belt - Hub & Fan		TR28483
Belt - Alt		▲9451HD
Belt - Hub & A.C.		▲9425HD
Hose - Upper - Eng. To Pipe; (2 1/2" I.D.)		24240
Hose - Upper - Pipe To Rad.; (2 1/2" I.D.)		24240
Hose - Lower - Eng. To Pipe; (2 1/2" I.D.)		24240
Hose - Lower - Pipe To Rad.; (2 1/2" I.D.)		24240
Detroit Diesel 6-Cyl. 11.1 L Diesel		
T600; T800		
Belt - Fan		▲9447HD
Belt - Alt. & A.C.; Preferred Belt		2/9520PB
Belt - Alt. & A.C.; Optional Belt		②▲9520HD
Hose - Upper; (2 1/2" I.D.)		24240
Hose - Lower - Eng. To Pipe; (2 1/2" I.D.)		24240
Hose - Lower - Pipe To Rad.; (3" I.D.)		24248
Hose - Heater Inlet; (3/4" I.D.)		28442
Hose - Heater Outlet; (5/8" I.D.)		28441
T2000		
Belt - Fan; W/47 3/4" Belt O.C.; Preferred Belt		3/9470PB
Belt - Fan; W/47 3/4" Belt O.C.; Optional Belt		③▲9470HD
Belt - Alt. & A.C.		②▲9525HD
Hose - Upper; (2 1/2" I.D.)		24240
Hose - Lower; (2 1/2" I.D.)		24240
W900		
Belt - Fan; W/47 3/4" Belt O.C.; Preferred Belt		3/9470PB
Belt - Fan; W/47 3/4" Belt O.C.; Optional Belt		③▲9470HD
Belt - Alt. & A.C.; Preferred Belt		2/9520PB
Belt - Alt. & A.C.; Optional Belt		②▲9520HD
Hose - Upper; (2 1/2" I.D.)		24240
Hose - Lower - Eng. To Pipe; (2 1/2" I.D.)		24240
Hose - Lower - Pipe To Rad.; (3" I.D.)		24248
Hose - Heater Inlet; (3/4" I.D.)		28442
Hose - Heater Outlet; (5/8" I.D.)		28441
Detroit Diesel 6-Cyl. 12.7 L Diesel		
T600		
Belt - Fan		▲9447HD
Belt - Alt. & A.C.; Preferred Belt		2/9520PB
Belt - Alt. & A.C.; Optional Belt		②▲9520HD
Hose - Upper; (2 1/2" I.D.)		24240
Hose - Lower - Eng. To Pipe; (2 1/2" I.D.)		24240
Hose - Lower - Pipe To Rad.; (3" I.D.)		24248
Hose - Heater Inlet; (3/4" I.D.)		28442

Application	Mfr. Part No.	Our No.
KENWORTH - Continued		
1998 - Continued		
Detroit Diesel 6-Cyl. 12.7 L Diesel - Continued		
T600 - Continued		
Hose - Heater Outlet; (5/8" I.D.)		28441
T2000		
Belt - Fan; W/47 3/4" Belt O.C.; Preferred Belt		3/9470PB
Belt - Fan; W/47 3/4" Belt O.C.; Optional Belt		③▲9470HD
Belt - Alt. & A.C.		②▲9525HD
Hose - Upper; (2 1/2" I.D.)		24240
Hose - Lower; (2 1/2" I.D.)		24240
W900		
Belt - Fan; W/47 3/4" Belt O.C.; Preferred Belt		3/9470PB
Belt - Fan; W/47 3/4" Belt O.C.; Optional Belt		③▲9470HD
Belt - Alt. & A.C.; Preferred Belt		2/9520PB
Belt - Alt. & A.C.; Optional Belt		②▲9520HD
Hose - Upper; (2 1/2" I.D.)		24240
Hose - Lower - Eng. To Pipe; (2 1/2" I.D.)		24240
Hose - Lower - Pipe To Rad.; (3" I.D.)		24248
Hose - Heater Inlet; (3/4" I.D.)		28442
Hose - Heater Outlet; (5/8" I.D.)		28441
1997		
Caterpillar 3126 Diesel		
T300		
Belt - Fan & Alt.	4080767	▲K080774HD
Belt - W.P.	0366775	▲9341HD
Tensioner Assy. - Fan & Alt.	1352151	38511
Tensioner Pulley - Fan, Alt. & A.C.	1352151	36091
Hose - Upper - Eng. To Pipe		21891
Hose - Upper - Pipe To Rad.		21115
Hose - Lower - Eng. To Pipe; (2" I.D.)		24232
Hose - Lower - Pipe To Pipe; (2 1/2" I.D.)		24240
Hose - Lower - Pipe To Rad.		22707
Caterpillar 3406 Diesel		
T600; T800		
Belt - Fan		②TR22545
Belt - Alt. & A.C.; Preferred Belt	17611	2/9610PB
Belt - Alt. & A.C.; Optional Belt		②▲9610HD
Hose - Upper; (2 1/2" I.D.)		24240
Hose - Lower - Eng. To Pipe; (3" I.D.)		24248
Hose - Lower - Pipe To Rad.; (2 1/2" I.D.)		24240
Hose - Lower - Pipe To Pipe; (2 1/2" I.D.)		24240
Hose - Heater; (3/4" I.D.)		28442
T2000		
Belt - Fan; Preferred Belt		2/TR22570PB
Belt - Fan; Optional Belt		②TR22570
Belt - Alt. & A.C.; Preferred Belt		2/9640PB
Belt - Alt. & A.C.; Optional Belt		②▲9640HD
Hose - Upper - Eng. To Pipe; (2 1/2" I.D.)		24240
Hose - Upper - Pipe To Rad.		21115
Hose - Lower - Eng. To Pipe; (3" I.D.)		24248
Hose - Lower - Pipe To Rad.; (2 1/2" I.D.)		24240
W900		
Belt - Fan; Preferred Belt		2/TR22570PB
Belt - Fan; Optional Belt		②TR22570
Belt - Alt. & A.C.; Preferred Belt		2/9590PB
Belt - Alt. & A.C.; Optional Belt		②▲9590HD
Hose - Upper; (2 1/2" I.D.)		24240
Hose - Lower; (3" I.D.)		24248
Hose - By Pass; (1" I.D.)		24216
Hose - Heater; (5/8" I.D.)		28441
Caterpillar C10 Diesel		
T600		
Belt - Fan, Alt. & Hub	D11080001	▲K080825HD
Belt - Fan & A.C.		▲9555HD
Tensioner Assy. - Fan, Alt. & Hub	1900649	38506
Idler Pulley - Fan & Alt.; W/Flat Idler Pulley	1337023	36091
Idler Pulley - Fan & Alt.; W/Multi-Grooved Idler Pulley	1731498	36231
Tensioner Pulley - Fan, Alt. & Hub	1900649	36091

② Two Required.
● Vulco-Flex® Coolant Hose.

▲ Standard Belt Available. See Pages 630-631.
③ Three Required.

Belts and Coolant Hose for Medium/Heavy-Duty Trucks (1996 and Newer)

 Medium & Heavy-Duty Trucks
(1996 & Newer)

Application	Mfr. Part No.	Our No.
KENWORTH - Continued		
1997 - Continued		
Caterpillar C10 Diesel - Continued		
T600 - Continued		
Hose - Upper - Eng. To Rad.: (2 1/2" I.D.)		24240
Hose - Upper - Pipe To Rad.: (2 1/2" I.D.)		24240
Hose - Lower - Eng. To Pipe: (2 1/2" I.D.)		24240
Hose - Lower - Pipe To Rad.: (3" I.D.)		24248
T800		
Belt - Fan, Alt. & Hub	D11080033	▲K080825HD
Belt - A.C.		▲9555HD
Tensioner Assy. - Fan, Alt. & Hub	1481974	38506
Idler Pulley - Fan & Alt.; W/Flat Idler Pulley	1337023	36091
Idler Pulley - Fan & Alt.; W/Multi-Grooved Idler Pulley	1731498	36231
Tensioner Pulley - Fan, Alt. & Hub	1481974	36091
Hose - Upper; (2 1/2" I.D.)		24240
Hose - Lower - Eng. To Pipe: (2 1/2" I.D.)		24240
Hose - Lower - Pipe To Rad.: (3" I.D.)		24248
T2000		
Belt - Fan & Alt.		▲K080645HD
Belt - A.C.		▲9525HD
Tensioner Assy. - Fan & Alt.	3161562	38505
Tensioner Pulley - A.C.	3161562	36091
Hose - Upper; (2 1/2" I.D.)		24240
Hose - Lower - Eng. To Pipe: (2 1/2" I.D.)		24240
Hose - Lower - Pipe To Rad.: (3" I.D.)		24248
W900		
Belt - Fan; Preferred Belt		2/TR22570PB
Belt - Fan; Optional Belt		②TR22570
Belt - Fan, Alt. & A.C.		②▲9610HD
Idler Pulley - Fan & Alt.; W/Flat Idler Pulley	1337023	36091
Idler Pulley - Fan & Alt.; W/Multi-Grooved Idler Pulley	1731498	36231
Hose - Upper - Eng. To Pipe: (3" I.D.)		24248
Hose - Upper - Pipe To Rad.: (3" I.D.)		24248
Hose - Lower - Eng. To Pipe: (3" I.D.)		24248
Hose - Lower - Pipe To Rad.: (3" I.D.)		24248
Caterpillar C12 Diesel		
T600		
Belt - Fan, Alt. & Hub	D11080001	▲K080825HD
Belt - Fan & A.C.		▲9555HD
Tensioner Assy. - Fan, Alt. & Hub	1900649	38506
Idler Pulley - Fan & Alt.; W/Flat Idler Pulley	1337023	36091
Idler Pulley - Fan & Alt.; W/Multi-Grooved Idler Pulley	1731498	36231
Tensioner Pulley - Fan, Alt. & Hub	1900649	36091
Hose - Upper - Eng. To Rad.: (2 1/2" I.D.)		24240
Hose - Upper - Pipe To Rad.: (2 1/2" I.D.)		24240
Hose - Lower - Eng. To Pipe: (3" I.D.)		24248
Hose - Lower - Pipe To Rad.: (3" I.D.)		24248
T800		
Belt - Fan, Alt. & Hub	D11080033	▲K080825HD
Belt - A.C.		▲9555HD
Tensioner Assy. - Fan, Alt. & Hub	1481974	38506
Idler Pulley - Fan & Alt.; W/Flat Idler Pulley	1337023	36091
Idler Pulley - Fan & Alt.; W/Multi-Grooved Idler Pulley	1731498	36231
Tensioner Pulley - Fan, Alt. & Hub	1481974	36091
Hose - Upper; (2 1/2" I.D.)		24240
Hose - Lower - Eng. To Pipe: (2 1/2" I.D.)		24240
Hose - Lower - Pipe To Rad.: (3" I.D.)		24248
T2000		
Belt - Fan & Alt.		▲K080645HD
Belt - A.C.		▲9525HD
Tensioner Pulley - A.C.	3161562	36091
Hose - Upper - Eng. To Pipe: (2 1/2" I.D.)		24240
Hose - Lower - Pipe To Rad.: (2 1/2" I.D.)		●26530
Hose - Lower - Eng. To Pipe: (2 1/2" I.D.)		24240

Application	Mfr. Part No.	Our No.
KENWORTH - Continued		
1997 - Continued		
Caterpillar C12 Diesel - Continued		
T2000 - Continued		
Hose - Lower - Pipe To Rad.: (3" I.D.)		24248
Cummins C Series 8.3 L Diesel		
K300		
Belt - W.P. & Alt.; W/58" Belt O.C.	3911562	▲K080575HD
Belt - W.P. & Alt.; W/59 1/2" Belt O.C. ..	3911558	▲K080590HD
Belt - A.C.		▲9390HD
T300		
Serpentine Belt; W/O A.C.		▲K081020HD
Cummins L10 Diesel		
T400; T600; T800		
Belt - Fan; W/46 7/8" Belt O.C.	3034942	▲K080465HD
Belt - Fan; W/48 7/8" Belt O.C.	3034348	▲K080485HD
Belt - Alt.; W/34 3/8" Belt O.C.	3037425	▲K050340HD
Belt - Alt.; W/35 3/8" Belt O.C.	3039376	▲K050350HD
Belt - A.C.; W/53 3/8" Belt O.C.		▲9530HD
Belt - A.C.; W/56 3/8" Belt O.C.		▲9560HD
Cummins M11 Diesel		
T400; T600; T800		
Belt - Fan		▲K080485HD
Belt - Alt.	3028521	▲K050345HD
Belt - A.C.		▲9530HD
Cummins N14 Diesel		
T600		
Belt - Hub & W.P.	3076492	▲K060425HD
Belt - Hub & Fan		②TR28437
Belt - Alt.		②▲9451HD
Hose - Upper - Eng. To Pipe: (2 1/2" I.D.)		24240
Hose - Upper - Pipe To Rad.: (2 1/2" I.D.)		24240
Hose - Lower - Eng. To Pipe: (2 1/2" I.D.)		24240
Hose - Lower - Pipe To Rad.: (3" I.D.)		24248
T800		
Belt - Hub & W.P.		▲K060425HD
Belt - Hub & Fan		②TR28483
Belt - Alt.		②▲9463HD
Belt - Hub & A.C.	17425	▲9425HD
T2000		
Belt - Hub & W.P.	3076492	▲K060425HD
Belt - Hub & Fan; Preferred Belt		2/TR28411PB
Belt - Hub & Fan; Optional Belt		②TR28412
Belt - Alt.		②▲9451HD
Belt - Hub & A.C.	17421	▲9420HD
Hose - Upper - Eng. To Pipe: (2 1/2" I.D.)		24240
Hose - Upper - Pipe To Rad.		●26529
Hose - Lower - Eng. To Pipe: (2 1/2" I.D.)		24240
Hose - Lower - Pipe To Rad.: (2 1/2" I.D.)		24240
W900		
Belt - Hub & W.P.		▲K060425HD
Belt - Hub & Fan		②TR28483
Belt - Alt.		②▲9463HD
Belt - Hub & A.C.	17425	▲9425HD
Hose - Upper - Eng. To Pipe: (2 1/2" I.D.)		24240
Hose - Upper - Pipe To Rad.: (2 1/2" I.D.)		24240
Hose - Lower - Eng. To Pipe: (2 1/2" I.D.)		24240
Hose - Lower - Pipe To Rad.: (2 1/2" I.D.)		24240
Detroit Diesel 6-Cyl. 11.1 L Diesel		
T600; T800		
Belt - Fan		▲9447HD
Belt - Alt. & A.C.; Preferred Belt		2/9520PB
Belt - Alt. & A.C.; Optional Belt		②▲9520HD
Hose - Upper; (2 1/2" I.D.)		24240
Hose - Lower - Eng. To Pipe: (2 1/2" I.D.)		24240
Hose - Lower - Pipe To Rad.: (3" I.D.)		24248
Hose - Heater Inlet; (3/4" I.D.)		28442
Hose - Heater Outlet; (5/8" I.D.)		28441
T2000		
Belt - Fan; W/47 3/4" Belt O.C.; Preferred Belt		3/9470PB
Belt - Fan; W/47 3/4" Belt O.C.; Optional Belt		③▲9470HD

▲ Standard Belt Available. See Pages 630-631.
● Vulco-Flex® Coolant Hose.

② Two Required.
③ Three Required.

Belts and Coolant Hose for Medium/Heavy-Duty Trucks (1996 and Newer)

Medium & Heavy-Duty Trucks
(1996 & Newer)

Application	Mfr. Part No.	Our No.
KENWORTH - Continued		
1997 - Continued		
Detroit Diesel 6-Cyl. 11.1 L Diesel - Continued		
T2000 - Continued		
Belt - Alt. & A.C.		▲9525HD
Hose - Upper; (2 1/2" I.D.)		24240
Hose - Lower; (2 1/2" I.D.)		24240
W900		
Belt - Fan; W/47 3/4" Belt O.C.; Preferred Belt		3/9470PB
Belt - Fan; W/47 3/4" Belt O.C.; Optional Belt	③▲9470HD	
Belt - Alt. & A.C.; Preferred Belt		2/9520PB
Belt - Alt. & A.C.; Optional Belt	②▲9520HD	
Hose - Upper; (2 1/2" I.D.)		24240
Hose - Lower - Eng. To Pipe; (2 1/2" I.D.)		24240
Hose - Lower - Pipe To Rad.; (3" I.D.)		24248
Hose - Heater Inlet; (3/4" I.D.)		28442
Hose - Heater Outlet; (5/8" I.D.)		28441
Detroit Diesel 6-Cyl. 12.7 L Diesel		
T600; T800		
Belt - Fan		▲9447HD
Belt - Alt. & A.C.; Preferred Belt		2/9520PB
Belt - Alt. & A.C.; Optional Belt	②▲9520HD	
Hose - Upper; (2 1/2" I.D.)		24240
Hose - Lower - Eng. To Pipe; (2 1/2" I.D.)		24240
Hose - Lower - Pipe To Rad.; (3" I.D.)		24248
Hose - Heater Inlet; (3/4" I.D.)		28442
Hose - Heater Outlet; (5/8" I.D.)		28441
T2000		
Belt - Fan; W/47 3/4" Belt O.C.; Preferred Belt		3/9470PB
Belt - Fan; W/47 3/4" Belt O.C.; Optional Belt	③▲9470HD	
Belt - Alt. & A.C.		▲9525HD
Hose - Upper; (2 1/2" I.D.)		24240
Hose - Lower; (2 1/2" I.D.)		24240
W900		
Belt - Fan; W/47 3/4" Belt O.C.; Preferred Belt		3/9470PB
Belt - Fan; W/47 3/4" Belt O.C.; Optional Belt	③▲9470HD	
Belt - Alt. & A.C.; Preferred Belt		2/9520PB
Belt - Alt. & A.C.; Optional Belt	②▲9520HD	
Hose - Upper; (2 1/2" I.D.)		24240
Hose - Lower - Eng. To Pipe; (2 1/2" I.D.)		24240
Hose - Lower - Pipe To Rad.; (3" I.D.)		24248
Hose - Heater Inlet; (3/4" I.D.)		28442
Hose - Heater Outlet; (5/8" I.D.)		28441
1996		
Caterpillar 3126 Diesel		
T300		
Belt - Fan & Alt.	4080767	▲K080774HD
Belt - W.P.	0366775	▲9341HD
Tensioner Assy. - Fan & Alt.	1352151	38511
Tensioner Pulley - Fan, Alt. & A.C.	1352151	36091
Hose - Upper - Eng. To Pipe		21891
Hose - Upper - Pipe To Rad.		21115
Hose - Lower - Eng. To Pipe; (2" I.D.)		24232
Hose - Lower - Pipe To Pipe; (2 1/2" I.D.)		24240
Hose - Lower - Pipe To Rad.		22707
Caterpillar 3176 Diesel		
T450		
Belt - Fan & Alt.; W/67 7/8" Belt O.C.		▲K080675HD
Belt - Fan & Alt.; W/68 3/8" Belt O.C. ...	D11026617	▲K080680HD
Belt - Fan & Alt.; W/70 3/8" Belt O.C. ...	D11026675	▲K080700HD
Belt - A.C.; W/50" Belt O.C.		▲9505HD
Belt - A.C.; W/54 1/2" Belt O.C.		▲9540HD
Belt - A.C.; W/56 1/2" Belt O.C.		▲9560HD
Tensioner Assy. - Fan & Alt.	1333543	38506
Caterpillar 3406 Diesel		
T600		
Belt - Fan; W/43 1/2" Belt O.C.; Preferred Belt		2/TR28437PB
Belt - Fan; W/43 1/2" Belt O.C.; Optional Belt	②TR28437	
Belt - Fan; W/55 1/8" Belt O.C.		②TR22545
Belt - Fan; Preferred Belt; W/57 5/8" Belt O.C.		2/TR22570PB
Belt - Fan; Optional Belt; W/57 5/8" Belt O.C.		②TR22570

▲ Standard Belt Available. See Pages 630-631.
② Two Required.

Application	Mfr. Part No.	Our No.
KENWORTH - Continued		
1996 - Continued		
Caterpillar 3406 Diesel - Continued		
T600 - Continued		
Belt - Fan; W/63 1/8" Belt O.C.		②TR22625
Belt - Alt.; Preferred Belt		2/9463PB
Belt - Alt.; Optional Belt		②▲9463HD
Belt - Alt. & A.C.; W/58 1/2" Belt O.C.		▲9580HD
Belt - Alt. & A.C.; W/61 3/8" Belt O.C.; Preferred Belt		2/9610PB
Belt - Alt. & A.C.; W/61 3/8" Belt O.C.; Optional Belt	②▲9610HD	
Belt - Alt. & A.C.; W/61" Belt O.C.		▲9605HD
Belt - Alt. & A.C.; W/62 3/8" Belt O.C.		▲9620HD
Belt - Alt. & A.C.; W/65 3/8" Belt O.C.		▲9650HD
Belt - A.C.	17425	▲9425HD
Hose - Upper; (2 1/2" I.D.)		24240
Hose - Lower - Eng. To Pipe; (3" I.D.)		24248
Hose - Lower - Pipe To Rad.; (2 1/2" I.D.)		24240
Hose - Lower - Pipe To Pipe; (2 1/2" I.D.)		24240
Hose - Heater; (3/4" I.D.)		28442
T800		
Belt - Fan; W/43 1/2" Belt O.C.; Preferred Belt		2/TR28437PB
Belt - Fan; W/43 1/2" Belt O.C.; Optional Belt	②TR28437	
Belt - Fan; W/55 1/8" Belt O.C.		②TR22545
Belt - Fan; Preferred Belt; W/57 5/8" Belt O.C.		2/TR22570PB
Belt - Fan; Optional Belt; W/57 5/8" Belt O.C.		②TR22570
Belt - Fan; W/63 1/8" Belt O.C.		②TR22625
Belt - Alt.; Preferred Belt		2/9463PB
Belt - Alt.; Optional Belt		②▲9463HD
Belt - Alt. & A.C.; W/58 1/2" Belt O.C.		▲9580HD
Belt - Alt. & A.C.; W/61 3/8" Belt O.C.; Preferred Belt		2/9610PB
Belt - Alt. & A.C.; W/61 3/8" Belt O.C.; Optional Belt	②▲9610HD	
Belt - Alt. & A.C.; W/62 3/8" Belt O.C.		▲9620HD
Belt - Alt. & A.C.; W/65 3/8" Belt O.C.		▲9650HD
Belt - A.C.	17425	▲9425HD
Hose - Upper; (2 1/2" I.D.)		24240
Hose - Lower - Eng. To Pipe; (3" I.D.)		24248
Hose - Lower - Pipe To Rad.; (2 1/2" I.D.)		24240
Hose - Lower - Pipe To Pipe; (2 1/2" I.D.)		24240
Hose - Heater; (3/4" I.D.)		28442
W900		
Belt - Fan; W/55 3/4" Belt O.C.		②TR22553
Belt - Fan; W/59 1/8" Belt O.C.		②TR22588
Belt - Fan; W/Horton Fan Clutch; W/65" Belt O.C.		②TR22648
Belt - Fan; Preferred Belt; W/57 5/8" Belt O.C.		2/TR22570PB
Belt - Fan; Optional Belt; W/57 5/8" Belt O.C.		②TR22570
Belt - Fan & Alt.; Preferred Belt		2/9555PB
Belt - Fan & Alt.; Optional Belt		②▲9560HD
Belt - Alt. & A.C.; W/58 1/2" Belt O.C. ...	17581	▲9580HD
Belt - Alt. & A.C.; W/59 1/2" Belt O.C.; Preferred Belt		2/9590PB
Belt - Alt. & A.C.; W/59 1/2" Belt O.C.; Optional Belt		②▲9590HD
Belt - Alt. & A.C.; W/60 7/8" Belt O.C.		▲9605HD
Belt - Alt. & A.C.; W/61 3/8" Belt O.C.; Preferred Belt		2/9610PB
Belt - Alt. & A.C.; W/61 3/8" Belt O.C.; Optional Belt	②▲9610HD	
Belt - Alt. & A.C.; W/62 3/8" Belt O.C.		▲9620HD
Belt - Alt. & A.C.; W/65 3/8" Belt O.C.; Preferred Belt		2/9650PB
Belt - Alt. & A.C.; W/65 3/8" Belt O.C.; Optional Belt	②▲9650HD	
Hose - Upper; (2 1/2" I.D.)		24240
Hose - Lower; (3" I.D.)		24248
Hose - By Pass; (1" I.D.)		24216
Hose - Heater; (5/8" I.D.)		28441
Caterpillar C10 Diesel		
T600		
Serpentine Belt		▲K080690HD
Belt - A.C.		▲9555HD
Hose - Upper; (2 1/2" I.D.)		24240
Hose - Lower - Eng. To Pipe; (2 1/2" I.D.)		24240
Hose - Lower - Pipe To Rad.; (3" I.D.)		24248
T800		
Hose - Upper; (2 1/2" I.D.)		24240
Hose - Lower - Eng. To Pipe; (2 1/2" I.D.)		24240
Hose - Lower - Pipe To Rad.; (3" I.D.)		24248

③ Three Required.

Belts and Coolant Hose for Medium/Heavy-Duty Trucks (1996 and Newer)

 Medium & Heavy-Duty Trucks
(1996 & Newer)

Application	Mfr. Part No.	Our No.
KENWORTH - Continued		
1996 - Continued		
Caterpillar C12 Diesel		
T600		
Belt - Fan, Alt. & Hub	D11080001	♣K080825HD
Belt - Fan & A.C.		♣9555HD
Tensioner Assy. - Fan, Alt. & Hub	1900649	38506
Idler Pulley - Fan & Alt.; W/Flat Idler Pulley	1337023	36091
Idler Pulley - Fan & Alt.; W/Multi-Grooved Idler Pulley	1731498	36231
Tensioner Pulley - Fan, Alt. & Hub	1900649	36091
Hose - Upper - Eng. To Rad.; (2 1/2" I.D.)		24240
Hose - Upper - Pipe To Rad.; (2 1/2" I.D.)		24240
Hose - Lower - Eng. To Pipe; (3" I.D.)		24248
Hose - Lower - Pipe To Rad.; (3" I.D.)		24248
T800		
Belt - Fan, Alt. & Hub	D11080033	♣K080825HD
Belt - A.C.		♣9555HD
Tensioner Assy. - Fan, Alt. & Hub	1481974	38506
Idler Pulley - Fan & Alt.; W/Flat Idler Pulley	1337023	36091
Idler Pulley - Fan & Alt.; W/Multi-Grooved Idler Pulley	1731498	36231
Tensioner Pulley - Fan, Alt. & Hub	1481974	36091
Hose - Upper; (2 1/2" I.D.)		24240
Hose - Lower - Eng. To Pipe; (2 1/2" I.D.)		24240
Hose - Lower - Pipe To Rad.; (3" I.D.)		24248
Cummins B Series 5.9 L Diesel		
K300		
Belt - Fan, W.P. & Alt.	3911579	♣K080675HD
Belt - Fan & A.C.	17481	♣9480HD
Cummins C Series 8.3 L Diesel		
K300		
Belt - W.P. & Alt.; W/58" Belt O.C.	3911562	♣K080575HD
Belt - W.P. & Alt.; W/59 1/2" Belt O.C. ...	3911558	♣K080590HD
Belt - A.C.		♣9390HD
T300		
Serpentine Belt; W/O A.C.	4081020	♣K081020HD
Tensioner Assy.	3976832	38513
Cummins L10 Diesel		
T400; T600; T800		
Belt - Fan; W/46 7/8" Belt O.C.	3034942	♣K080465HD
Belt - Fan; W/48 7/8" Belt O.C.	3034348	♣K080485HD
Belt - Alt.; W/34 3/8" Belt O.C.	3037425	♣K050340HD
Belt - Alt.; W/35 3/8" Belt O.C.	3039376	♣K050350HD
Belt - A.C.; W/53 3/8" Belt O.C.		♣9530HD
Belt - A.C.; W/56 3/8" Belt O.C.		♣9560HD
Cummins M11 Diesel		
T400		
Belt - Fan		♣K080485HD
Belt - Alt.	3028521	♣K050345HD
Belt - A.C.		♣9530HD
T600; T800		
Belt - Fan		♣K080485HD
Belt - Alt.	3028521	♣K050345HD
Belt - A.C.		♣9530HD
Hose - Upper; (2 1/2" I.D.)		24240
Hose - Lower - Eng. To Pipe; (2 1/2" I.D.)		24240
Hose - Lower - Pipe To Rad.; (3" I.D.)		24248
Cummins N14 Diesel		
T600		
Belt - W.P.; W/4-Ribbed Belt; W/43 1/2" Belt O.C.	3063817	♣K040430HD
Belt - W.P.; W/4-Ribbed Belt; W/45" Belt O.C.	3062620	♣K040445HD
Belt - W.P.; W/6-Ribbed Belt; W/43" Belt O.C.		♣K060425HD
Belt - W.P.; W/6-Ribbed Belt; W/44" Belt O.C.	217638	♣K060435HD
Belt - Fan; W/V-Belt Drive; W/40 5/8" Belt O.C.		TR28400

♣ Standard Belt Available. See Pages 630-631.

Application	Mfr. Part No.	Our No.
KENWORTH - Continued		
1996 - Continued		
Cummins N14 Diesel - Continued		
T600 - Continued		
Belt - Fan; W/V-Belt Drive; W/41 3/4" Belt O.C.; Preferred Belt		2/TR28411PB
Belt - Fan; W/V-Belt Drive; W/41 3/4" Belt O.C.; Optional Belt		②TR28412
Belt - Fan; W/V-Belt Drive; W/43 1/2" Belt O.C.; Preferred Belt		2/TR28429PB
Belt - Fan; W/V-Belt Drive; W/43 1/2" Belt O.C.; Optional Belt		②TR28429
Belt - Fan; W/V-Belt Drive; W/44 1/4" Belt O.C.; Preferred Belt		2/TR28437PB
Belt - Fan; W/V-Belt Drive; W/44 1/4" Belt O.C.; Optional Belt		②TR28437
Belt - Fan; W/V-Ribbed Belt Drive; W/42" Belt O.C.		♣K080415HD
Belt - Fan; W/V-Ribbed Belt Drive; W/43" Belt O.C.		♣K080427HD
Belt - Fan; W/V-Ribbed Belt Drive; W/47" Belt O.C.		♣K080465HD
Belt - Alt.; W/46 7/8" Belt O.C.; Preferred Belt		2/9463PB
Belt - Alt.; W/46 7/8" Belt O.C.; Optional Belt		②♣9463HD
Belt - Alt.; W/47 1/2" Belt O.C.; Preferred Belt		2/9470PB
Belt - Alt.; W/47 1/2" Belt O.C.; Optional Belt		②♣9470HD
Belt - A.C.; W/40 3/8" Belt O.C.		♣9400HD
Belt - A.C.; W/42 3/8" Belt O.C.		♣9420HD
Hose - Upper; (2 1/2" I.D.)		24240
Hose - Lower - Eng. To Pipe; (2 1/2" I.D.)		24240
Hose - Lower - Pipe To Rad.; (3" I.D.)		24248
T800		
Belt - W.P.; W/4-Ribbed Belt; W/43 1/2" Belt O.C.	3063817	♣K040430HD
Belt - W.P.; W/4-Ribbed Belt; W/45" Belt O.C.	3062620	♣K040445HD
Belt - W.P.; W/6-Ribbed Belt; W/43" Belt O.C.		♣K060425HD
Belt - W.P.; W/6-Ribbed Belt; W/44" Belt O.C.	217638	♣K060435HD
Belt - Fan; W/V-Belt Drive; W/40 5/8" Belt O.C.		TR28400
Belt - Fan; W/V-Belt Drive; W/41 3/4" Belt O.C.; Preferred Belt		2/TR28411PB
Belt - Fan; W/V-Belt Drive; W/41 3/4" Belt O.C.; Optional Belt		②TR28412
Belt - Fan; W/V-Belt Drive; W/43 1/2" Belt O.C.; Optional Belt		②TR28429
Belt - Fan; W/V-Belt Drive; W/43 1/2" Belt O.C.; Preferred Belt		2/TR28429PB
Belt - Fan; W/V-Belt Drive; W/44 1/4" Belt O.C.; Optional Belt		②TR28437
Belt - Fan; W/V-Belt Drive; W/44 1/4" Belt O.C.; Preferred Belt		2/TR28437PB
Belt - Fan; W/V-Ribbed Belt Drive; W/42" Belt O.C.		♣K080415HD
Belt - Fan; W/V-Ribbed Belt Drive; W/43" Belt O.C.		♣K080427HD
Belt - Fan; W/V-Ribbed Belt Drive; W/47" Belt O.C.		♣K080465HD
Belt - Alt.; W/46 7/8" Belt O.C.; Optional Belt		②♣9463HD
Belt - Alt.; W/46 7/8" Belt O.C.; Preferred Belt		2/9463PB
Belt - Alt.; W/47 1/2" Belt O.C.; Optional Belt		②♣9470HD
Belt - Alt.; W/47 1/2" Belt O.C.; Preferred Belt		2/9470PB
Belt - A.C.; W/40 3/8" Belt O.C.		♣9400HD
Belt - A.C.; W/42 3/8" Belt O.C.		♣9420HD
Hose - Upper; (2 1/2" I.D.)		24240
Hose - Lower - Eng. To Pipe; (2 1/2" I.D.)		24240
Hose - Lower - Pipe To Rad.; (3" I.D.)		24248
W900		
Belt - W.P.	3076492	♣K060425HD
Belt - Fan; W/48 1/2" Belt O.C.; Optional Belt		②TR28480
Belt - Fan; W/48 1/2" Belt O.C.; Preferred Belt		2/TR28480PB
Belt - Fan; W/50" Belt O.C.; Optional Belt		②TR28492
Belt - Fan; W/50" Belt O.C.; Preferred Belt		2/TR28492PB
Belt - Alt.; W/46 7/8" Belt O.C.; Optional Belt		②♣9463HD
Belt - Alt.; W/46 7/8" Belt O.C.; Preferred Belt		2/9463PB
Belt - Alt.; W/47 1/2" Belt O.C.; Optional Belt		②♣9470HD
Belt - Alt.; W/47 1/2" Belt O.C.; Preferred Belt		2/9470PB
Belt - A.C.		♣9425HD
Hose - Upper; (2 1/2" I.D.)		24240
Hose - Lower; (2 1/2" I.D.)		24240

② Two Required.

Belts and Coolant Hose for Medium/Heavy-Duty Trucks (1996 and Newer)

Medium & Heavy-Duty Trucks
(1996 & Newer)

Application	Mfr. Part No.	Our No.
KENWORTH - Continued		
1996 - Continued		
Detroit Diesel 6-Cyl. 11.1 L Diesel		
K100		
Belt - Alt.	2/9325PB	
Hose - Upper; (2 1/2" I.D.)	24240	
Hose - Lower - Eng. To Pipe; (2 1/2" I.D.)	24240	
Hose - Lower - Pipe To Rad.; (3" I.D.)	24248	
Hose - Heater Inlet; (3/4" I.D.)	28442	
Hose - Heater Outlet; (5/8" I.D.)	28441	
T600; T800		
Belt - Fan	♣9610HD	
Belt - Alt. & A.C.; Optional Belt	②♣9520HD	
Belt - Alt. & A.C.; Preferred Belt	2/9520PB	
Hose - Upper; (2 1/2" I.D.)	24240	
Hose - Lower - Eng. To Pipe; (2 1/2" I.D.)	24240	
Hose - Lower - Pipe To Rad.; (3" I.D.)	24248	
Hose - Heater Inlet; (3/4" I.D.)	28442	
Hose - Heater Outlet; (5/8" I.D.)	28441	
W900		
Belt - Fan; W/47 3/4" Belt O.C.; Optional Belt	③♣9470HD	
Belt - Fan; W/47 3/4" Belt O.C.; Preferred Belt	3/9470PB	
Belt - Alt. & A.C.; Optional Belt	②♣9520HD	
Belt - Alt. & A.C.; Preferred Belt	2/9520PB	
Belt - Alt.	2/9325PB	
Hose - Upper; (2 1/2" I.D.)	24240	
Hose - Lower - Eng. To Pipe; (2 1/2" I.D.)	24240	
Hose - Lower - Pipe To Rad.; (3" I.D.)	24248	
Hose - Heater Inlet; (3/4" I.D.)	28442	
Hose - Heater Outlet; (5/8" I.D.)	28441	
Detroit Diesel 6-Cyl. 12.7 L Diesel		
K100		
Belt - Alt.	2/9325PB	
Hose - Upper; (2 1/2" I.D.)	24240	
Hose - Lower - Eng. To Pipe; (2 1/2" I.D.)	24240	
Hose - Lower - Pipe To Rad.; (3" I.D.)	24248	
Hose - Heater Inlet; (3/4" I.D.)	28442	
Hose - Heater Outlet; (5/8" I.D.)	28441	
T600; T800		
Belt - Fan	♣9610HD	
Belt - Alt. & A.C.; Optional Belt	②♣9520HD	
Belt - Alt. & A.C.; Preferred Belt	2/9520PB	
Hose - Upper; (2 1/2" I.D.)	24240	
Hose - Lower - Eng. To Pipe; (2 1/2" I.D.)	24240	
Hose - Lower - Pipe To Rad.; (3" I.D.)	24248	
Hose - Heater Inlet; (3/4" I.D.)	28442	
Hose - Heater Outlet; (5/8" I.D.)	28441	
W900		
Belt - Fan; W/47 3/4" Belt O.C.; Optional Belt	③♣9470HD	
Belt - Fan; W/47 3/4" Belt O.C.; Preferred Belt	3/9470PB	
Belt - Alt. & A.C.; Optional Belt	②♣9520HD	
Belt - Alt. & A.C.; Preferred Belt	2/9520PB	
Belt - Alt.	2/9325PB	
Hose - Upper; (2 1/2" I.D.)	24240	
Hose - Lower - Eng. To Pipe; (2 1/2" I.D.)	24240	
Hose - Lower - Pipe To Rad.; (3" I.D.)	24248	
Hose - Heater Inlet; (3/4" I.D.)	28442	
Hose - Heater Outlet; (5/8" I.D.)	28441	

♣ Standard Belt Available. See Pages 630-631.
 ③ Three Required.
 * Durion® Silicone Hose Recommended.

Application	Mfr. Part No.	Our No.
MACK - Continued		
2013 - Continued		
Mack MP8 Diesel - Continued		
CXU Series - Continued		
Tensioner Assy. - Alt. & A.C.	21454379	38671
Hose - Upper - Pipe To Eng.		22714
2012		
Mack MP7 Diesel		
CXU Series		
Belt - Alt.	21460409	♣K080630HD
Tensioner Assy. - Fan	20935521	38607
Tensioner Assy. - Alt.	21454379	38671
GU Series		
Idler Pulley - Upper	20953521	36286
Mack MP8 Diesel		
CHU Series		
Belt - Fan & W.P.	21372815	K120786HD
Belt - Alt. & A.C.	21556637	♣K080630HD
Tensioner Assy. - Alt. & A.C.	21454379	38671
Tensioner Assy. - Fan & W.P.	21461221	38633
Hose - Upper - Pipe To Eng.		22714
CXU Series		
Belt - Fan	20582565	K120640HD
Belt - Alt. & A.C.	21556637	♣K080630HD
Tensioner Assy. - Fan	21461221	38633
Tensioner Assy. - Alt. & A.C.	21454379	38671
Hose - Upper - Pipe To Eng.		22714
Mack MP10 Diesel		
TD Series		
Belt - Fan & W.P.	21064733	K100578HD
Belt - Alt. & A.C.	21064734	♣K080550HD
Tensioner Assy. - Fan & W.P.	21631484	38581
Tensioner Assy. - Alt. & A.C.	21422767	38585
2011		
Cummins ISM Diesel		
CXU Series		
Belt - A.C. & Alt.	20545619	♣K080630HD
Tensioner Assy. - A.C.	21454379	38671
Mack MP7 Diesel		
CXU Series		
Belt - Alt.	21460409	♣K080630HD
Tensioner Assy. - Fan	20935521	38607
Tensioner Assy. - Alt.	21454379	38671
GU Series		
Belt - Alt. & A.C.	20545619	♣K080630HD
Idler Pulley - Upper (Smooth)	20953521	36286
LEU Series		
Belt - Fan	88GB469P672	♣K100675HD
Belt - Alt.; W/A.C.	88GB457P588	♣K080590HD
Tensioner Assy. - Fan	20935521	38607
Idler Pulley - Alt.; W/O A.C.	20747516	36285
Hose - Upper - Rad. To Pipe; (2 1/4" I.D.)		≈*24236
Hose - Upper - Pipe To Eng.; (2 3/8" I.D.)		≈*24838
Hose - Lower - Rad. To Pipe; (2 1/2" I.D.)		≈*24840
MRU Series		
Belt - Fan & W.P.	21056225	DK100709
Tensioner Assy. - Fan & W.P.	20935521	38607
Mack MP8 Diesel		
CHU Series		
Belt - Fan	21372815	K120786HD
Belt - Alt. & A.C.	21556637	♣K080630HD
Tensioner Assy. - Fan & W.P.	21461221	38633
Tensioner Assy. - A.C.	21454379	38671
CXU Series		
Belt - Fan	21372815	K120786HD
Belt - Alt. & A.C.	21556637	♣K080630HD
Tensioner Assy. - Fan & W.P.	21461221	38633
Tensioner Assy. - A.C.	21454379	38671

② Two Required.
 ≈ Cut to Fit.

Belts and Coolant Hose for Medium/Heavy-Duty Trucks (1996 and Newer)

 Medium & Heavy-Duty Trucks
(1996 & Newer)

Application	Mfr. Part No.	Our No.
MACK - Continued		
2011 - Continued		
Mack MP8 Diesel - Continued		
CXU Series - Continued		
Hose - Upper - Pipe To Eng.		22714
Hose - Lower		23563
GU Series		
Belt - Fan	21372815	K120786HD
Belt - Alt. & A.C.	21556637	▲K080630HD
Tensioner Assy. - Fan & W.P.	21461221	38633
Tensioner Assy. - A.C.	21454379	38671
Hose - Upper - Rad. To Pipe		23563
Hose - Upper - Pipe To Eng.		22714
MRU Series		
Belt - Fan	21372815	K120786HD
Belt - Alt. & A.C.	21556637	▲K080630HD
Tensioner Assy. - Fan & W.P.	21461221	38633
Tensioner Assy. - A.C.	21454379	38671
Mack MP10 Diesel		
TD Series		
Belt - Fan	21064733	K100578HD
Belt - Alt. & A.C.	21064734	▲K080550HD
Tensioner Assy. - Fan	21155561	38581
Tensioner Assy. - Alt. & A.C.	20966526	38585
Idler Pulley - Lower	20747516	36285
2010		
Cummins ISL G CNG		
LEU Series		
Hose - Upper - Pipe To Eng.; (2 3/8" I.D.)		※*24838
Cummins ISM Diesel		
CXU Series		
Belt - Alt. & A.C.	88GB457P630	▲K080630HD
Tensioner Assy. - Fan	20935521	38607
Mack MP7 Diesel		
CXU Series		
Belt - Alt.	21460409	▲K080630HD
Tensioner Assy. - Alt.	21454379	38671
Tensioner Assy. - Fan	20935521	38607
GU Series		
Belt - Alt. & A.C.	21460409	▲K080630HD
Tensioner Assy. - Alt. & A.C.	21454379	38671
Hose - Upper - Eng. To Pipe		22714
LEU Series		
Belt - Fan	88GB456P671	▲K100670HD
Belt - Alt.; W/A.C.	88GB457P588	▲K080590HD
Tensioner Assy. - Fan	20935521	38607
Idler Pulley; W/O A.C.	20747516	36285
Hose - Upper - Rad. To Pipe; (2 1/4" I.D.)		※<24236
Hose - Upper - Pipe To Eng.; (2 3/8" I.D.)		※<※24838
Hose - Lower - Rad. To Pipe; (2 1/2" I.D.)		※<※24840
MRU Series		
Belt - Fan & W.P.	21056225	DK100709
Belt - A.C. & Alt.	20545619	▲K080630HD
Tensioner Assy. - Fan & W.P.	20935521	38607
Mack MP8 Diesel		
CHU Series		
Belt - Fan & W.P.	20886339	K120786HD
Belt - A.C. & Alt.	20582552	▲K080630HD
Tensioner Assy. - Fan	20860873	38633
Hose - Upper - Eng. To Pipe		※<22714
GU Series		
Belt - Alt. & A.C.	20545619	▲K080630HD
Belt - Fan & W.P.; W/10-Ribbed Belt	20582563	K100764HD
Belt - Fan & W.P.; W/12-Ribbed Belt	20886339	K120786HD
Tensioner Assy. - Fan	20487079	38632
Idler Pulley - Fan; W/Flat Idler Pulley ...	20747516	36285
Hose - Upper - Eng. To Pipe		22714
MRU Series		
Belt - Fan & W.P.; W/10-Ribbed Belt	20582563	K100764HD

▲ Standard Belt Available. See Pages 630-631.
 ※ Durion® Silicone Hose Recommended.

Application	Mfr. Part No.	Our No.
MACK - Continued		
2010 - Continued		
Mack MP8 Diesel - Continued		
MRU Series - Continued		
Belt - Fan & W.P.; W/12-Ribbed Belt	20886339	K120786HD
Belt - Alt. & A.C.	20545619	▲K080630HD
Tensioner Assy. - Fan	20487079	38632
Idler Pulley - Fan; W/Flat Idler Pulley ...	20747516	36285
Hose - Upper - Eng. To Pipe		22714
Mack MP10 Diesel		
TD Series		
Belt - Alt. & A.C.	21064734	▲K080550HD
Belt - Fan & W.P.	21064733	K100578HD
Tensioner Assy. - Fan	21145261	38581
Idler Pulley - Fan	20747516	36285
2009		
Cummins ISM Diesel		
CXU Series		
Belt - Alt. & A.C.	88GB457P630	▲K080630HD
Tensioner Assy. - Fan	20935521	38607
Mack MP7 Diesel		
GU Series		
Belt - A.C. & Alt.	88GB457P630	▲K080630HD
Belt - Fan & W.P.; W/74 1/2" Belt O.C. . .	20887407	▲K100739HD
Belt - Fan & W.P.; W/75" Belt O.C.	20885394	K100745HD
Tensioner Assy. - Fan	20935521	38607
Idler Pulley - Smooth	20953521	36286
Hose - Upper - Eng. To Pipe		22714
LEU Series		
Belt - Fan & W.P.	88GB456P671	▲K100670HD
Belt - Alt. & A.C.	88GB457P588	▲K080590HD
Tensioner Assy.	20935521	38607
MRU Series		
Belt - Fan & W.P.	20927805	▲K100670HD
Belt - Alt.	20545619	▲K080630HD
Tensioner Assy. - Fan & W.P.	20935521	38607
Idler Pulley - Alt.; W/O A.C.	20747516	36285
Hose - Upper - Rad. To Pipe; (2 1/4" I.D.)		※<24236
Hose - Upper - Pipe To Eng.; (2 3/8" I.D.)		※<※24838
Mack MP8 Diesel		
CHU Series; CXU Series		
Belt - Fan & W.P.	20886339	K120786HD
Belt - A.C. & Alt.	20582552	▲K080630HD
Tensioner Assy. - Fan	20860873	38633
GU Series		
Belt - Alt. & A.C.	20545619	▲K080630HD
Belt - Fan & W.P.; W/10-Ribbed Belt	20582563	K100764HD
Belt - Fan & W.P.; W/12-Ribbed Belt	20886339	K120786HD
Tensioner Assy. - Fan; W/10-Ribbed Belt	20487079	38632
Tensioner Assy. - Fan; W/12-Ribbed Belt	20860873	38633
Idler Pulley - Fan; W/Flat Idler Pulley; W/10-Ribbed Belt	20747516	36285
Hose - Upper - Eng. To Pipe		22714
2008		
Mack AMI Diesel		
CV Series		
Belt - Fan	20870671	▲K100607HD
Mack MP7 Diesel		
GU Series		
Belt - Fan	20887407	▲K100739HD
Belt - Alt. & A.C.	20545619	▲K080630HD
Tensioner Assy. - Fan	20935521	38607
Idler Pulley - Smooth	20953521	36286
MRU Series		
Belt - Fan	88GB456P671	▲K100670HD
Belt - Alt. & A.C.	88GB457P630	▲K080630HD
Tensioner Assy. - Fan	20739751	38607

※< Cut to Fit.

Belts and Coolant Hose for Medium/Heavy-Duty Trucks (1996 and Newer)

Medium & Heavy-Duty Trucks
(1996 & Newer)

Application	Mfr. Part No.	Our No.
MACK - Continued		
2008 - Continued		
Mack MP7 Diesel - Continued		
MRU Series - Continued		
Tensioner Assy. - Alt. & A.C.	20762060	38671
Idler Pulley	20953521	36286
Mack MP8 Diesel		
CHU Series		
Belt - Fan & W.P.	88GB460P787	K120786HD
Belt - Alt. & A.C.	88GB457P630	▲K080630HD
Tensioner Assy. - Fan	20487079	38632
Tensioner Assy. - Alt. & A.C.	20762060	38671
Hose - Upper - Eng. To Rad.		≧21115
Hose - Upper - Rad. To Pipe		21891
CXU Series		
Belt - Fan & W.P.	88GB460P640	K120640HD
Belt - Alt. & A.C.	88GB457P630	▲K080630HD
Tensioner Assy. - Fan	20860873	38633
Tensioner Assy. - Alt. & A.C.	20762060	38671
GU Series		
Belt - Fan & W.P.; W/12-Ribbed Belt	20886339	K120786HD
Belt - Fan & W.P.; W/10-Ribbed Belt	20582563	K100764HD
Belt - Alt. & A.C.	88GB457P630	▲K080630HD
Tensioner Assy. - Fan	20487079	38632
Idler Pulley - Fan; W/Flat Idler Pulley ...	20747516	36285
Hose - Upper - Eng. To Pipe		22714
2007		
Cummins ISX Diesel		
CL Series		
Belt - Fan & Alt.	3100189	▲K120911HD
Belt - Hub & A.C.	3682261	▲K060660HD
Tensioner Assy. - Hub & A.C.	3682683	38610
Tensioner Assy. - Fan & Alt.	3682946	38587
Idler Pulley - A.C.	3682229	36223
Tensioner Pulley - Fan & Alt.	3682946	36165
Hose - Upper - Eng. To Pipe; (2 1/2" I.D.)		24240
Hose - Upper - Rad. To Pipe; (2 1/2" I.D.)		24240
Hose - Lower - Eng. To Pipe; (2 1/2" I.D.)		24240
Hose - Lower - Rad. To Pipe; (3" I.D.)		24248
Mack AC Diesel		
CH Series		
Belt - Alt. & A.C.	88GB450P847	▲K060849HD
Tensioner Assy. - Alt. & A.C.	87GB46	38589
CHN Series		
Belt - Fan	88GB449P687	K100686HD
Belt - Hub, Fan, Alt. & A.C.	88GB450P847	▲K060849HD
Tensioner Assy. - Fan	87GB41	38523
Tensioner Assy. - Hub, Fan, Alt. & A.C.	87GB46	38589
Idler Pulley - Fan, Alt. & A.C.	786GB41BM	36167
Tensioner Pulley - Fan	87GB41	36092
Hose - Upper - Eng. To Pipe; (2 1/2" I.D.)		24240
Hose - Upper - Rad. To Pipe		≧21115
Hose - Lower - Rad. To Pipe		21891
CXN Series		
Belt - Fan; W/Borg Warner, Horton Fan Clutch; W/1.39 To 1 Fan Ratio	88GB449P579	▲K100579HD
Belt - Fan; W/Behr Fan Clutch; W/1.51 To 1 Fan Ratio	88GB458P565	K100564HD
Belt - Fan, Alt. & A.C.; W/Borg Warner, Horton Fan Clutch	88GB453P746	▲K060747HD
Belt - Fan, Alt. & A.C.; W/Behr Fan Clutch	88GB459P738	▲K060739HD
Tensioner Assy. - Fan	87GB41A	38523
Tensioner Assy. - Fan, Alt. & A.C.	87GB46A	38589
Idler Pulley - Fan, Alt. & A.C.	786GB41BM	36167
Tensioner Pulley - Fan	87GB41A	36092
Hose - Upper - Eng. To Pipe; (2 1/4" I.D.)		24236
Hose - Upper - Rad. To Pipe		≧21115
Hose - Lower - Rad. To Pipe		≧21115

Application	Mfr. Part No.	Our No.
MACK - Continued		
2007 - Continued		
Mack AI Diesel		
CT Series		
Belt - Fan; W/Horton Fan Clutch; W/1.56 To 1 Fan Ratio	88GB449P657	▲K100658HD
Belt - Fan; W/Behr Fan Clutch; W/1.68 To 1 Fan Ratio	87GB458P650	K100649HD
Belt - Fan, Alt. & A.C.; W/Behr Fan Clutch; W/1.56 To 1 Fan Ratio	88GB450P831	▲K060832HD
Belt - Fan, Alt. & A.C.; W/Behr Fan Clutch; W/1.68 To 1 Fan Ratio	88GB459P825	K060828
Tensioner Assy. - Fan	87GB45A	38611
Tensioner Assy. - Hub, Fan, Alt. & A.C.	87GB46A	38589
Idler Pulley - Fan, Alt. & A.C.	786GB41BM	36167
Tensioner Pulley	87GB45A	36092
Hose - Upper - Eng. To Pipe; (2 1/2" I.D.)		24240
Hose - Upper - Rad. To Pipe		≧21115
Hose - Lower - Rad. To Pipe		≧21115
CV Series		
Belt - Fan; W/1.77 To 1 Fan Ratio	88GB449P605	▲K100607HD
Belt - Fan; W/1.68 To 1 Fan Ratio	88GB458P661	K100661HD
Belt - Fan, Alt. & A.C.	88GB450P795	▲K060795HD
Belt - Fan & Alt.	88GB459P625	▲K060625HD
Tensioner Assy. - Fan	87GB41A	38523
Tensioner Assy. - Fan, Alt. & A.C.	87GB46A	38589
Idler Pulley - Fan, Alt. & A.C.	786GB41BM	36167
Tensioner Pulley - Fan	87GB41A	36092
Hose - Upper - Eng. To Pipe; (2 1/4" I.D.)		24236
Hose - Upper - Rad. To Pipe; (2" I.D.)		24232
Hose - Lower - Rad. To Pipe		21891
Hose - Lower - Pipe To Cooler; (2" I.D.)		24232
Hose - Lower - Cooler To Pipe; (2 1/2" I.D.)		24240
Mack AMI Diesel		
LE Series		
Belt - Alt. & W.P.	88GB459P712	▲K060716HD
Belt - Fan & A.C.	88GB458P555	▲K100554HD
Tensioner Assy. - Alt. & W.P.	87GB414AM	38668
Idler Pulley - Alt.	786GB43M	36230
Idler Pulley - A.C.	786GB41BM	36167
MR Series		
Belt - Fan & A.C.	88GB458P555	▲K100554HD
Belt - Alt. & W.P.	88GB459P712	▲K060716HD
Tensioner Assy. - Fan & A.C.	87GB47A	38599
Tensioner Assy. - Alt. & W.P.	87GB414AM	38668
Idler Pulley - Fan, Alt. & A.C.	786GB41BM	36167
Idler Pulley - A.C.	786GB41BM	36167
Mack MP7 Diesel		
CTP Series		
Belt - Fan; W/73 5/8" Belt O.C.	88GB456P730	▲K100731HD
Belt - Fan; W/72 3/8" Belt O.C.	88GB456P719	▲K100719HD
Belt - Alt. & A.C.	88GB457P630	▲K080630HD
Tensioner Assy. - Fan; W/73 5/8" Belt O.C.	20739751	38607
Tensioner Assy. - Alt. & A.C.	20762060	38671
Tensioner Assy. - Fan; W/72 3/8" Belt O.C.	20935521	38607
Hose - Upper - Eng. To Pipe; (2 1/2" I.D.)		24240
Hose - Upper - Rad. To Pipe		≧21115
Hose - Lower - Eng. To Pipe		21891
CXP Series		
Belt - Fan	88GB456P650	▲K100630HD
Belt - Alt. & A.C.	88GB457P630	▲K080630HD
Tensioner Assy. - Fan	20739751	38607
Tensioner Assy. - Alt. & A.C.	20762060	38671
Hose - Upper - Eng. To Pipe; (2 1/2" I.D.)		24240
Hose - Upper - Rad. To Pipe		≧21115
GU Series		
Belt - Fan	88GB458P605	▲K100607HD
Belt - Alt. & A.C.	88GB450P831	▲K060832HD
Tensioner Assy. - Fan	87GB41C	38523
Tensioner Assy. - Alt. & A.C.	87GB46A	38589

▲ Standard Belt Available. See Pages 630-631.

≧ Cut to Fit.

Belts and Coolant Hose for Medium/Heavy-Duty Trucks (1996 and Newer)

 Medium & Heavy-Duty Trucks
(1996 & Newer)

Application	Mfr. Part No.	Our No.
MACK - Continued		
2006		
Cummins ISX Diesel		
CL Series		
Belt - Fan & Alt.	3100189	▲K120911HD
Belt - Hub & A.C.	3682261	▲K060660HD
Tensioner Assy. - Hub & A.C.	3682683	38610
Tensioner Assy. - Fan & Alt.	3682946	38587
Idler Pulley - A.C.	3682229	36223
Tensioner Pulley - Fan & Alt.	3682946	36165
Hose - Upper - Eng. To Pipe; (2 1/2" I.D.)		24240
Hose - Upper - Rad. To Pipe; (2 1/2" I.D.)		24240
Hose - Lower - Eng. To Pipe; (2 1/2" I.D.)		24240
Hose - Lower - Rad. To Pipe; (3" I.D.)		24248
Mack AC Diesel		
CH Series		
Belt - Fan	88GB458P678	▲K100677HD
Belt - Fan To Alt. & A.C.	88GB459P847	K060846HD
Belt - Fan & Alt.	88GB459P670	▲K060670HD
Tensioner Assy. - Fan	87GB41	38523
Tensioner Assy. - Hub, Fan, Alt. & A.C.	87GB46	38589
Idler Pulley - Fan, Alt. & A.C.	786GB41BM	36167
Tensioner Pulley - Fan	87GB41	36092
Hose - Upper - Eng. To Pipe; (2" I.D.)		24232
Hose - Upper - Rad. To Pipe; (2 1/4" I.D.)		24236
Hose - Lower - Rad. To Pipe		21891
CHN Series		
Belt - Fan	88GB449P687	K100686HD
Belt - Hub, Fan, Alt. & A.C.	88GB450P847	▲K060849HD
Tensioner Assy. - Fan	87GB41	38523
Tensioner Assy. - Hub, Fan, Alt. & A.C.	87GB46	38589
Idler Pulley - Fan, Alt. & A.C.	786GB41BM	36167
Tensioner Pulley - Fan	87GB41	36092
Hose - Upper - Eng. To Pipe; (2 1/2" I.D.)		24240
Hose - Upper - Rad. To Pipe		☞21115
Hose - Lower - Rad. To Pipe		21891
CX Series		
Belt - Fan	88GB458P555	▲K100554HD
Belt - Fan To Alt. & A.C.	88GB459P735	▲K060735HD
Belt - Fan & Alt.	88GB459P585	▲K060586HD
Tensioner Assy. - Fan, Alt. & A.C.	87GB46A	38589
Tensioner Assy. - Fan & Alt.	87GB44A	38617
Idler Pulley - Fan, Alt. & A.C.	786GB41BM	36167
Tensioner Pulley - Fan	87GB45A	36092
Hose - Upper - Eng. To Pipe; (2 1/4" I.D.)		24236
Hose - Upper - Pipe To Rad.; (2" I.D.)		24232
Hose - Lower - Pipe To Rad.; (2" I.D.)		24232
CXN Series		
Belt - Fan; W/Borg Warner, Horton Fan Clutch; W/1.39 To 1 Fan Ratio	88GB449P579	▲K100579HD
Belt - Fan; W/Behr Fan Clutch; W/1.51 To 1 Fan Ratio	88GB458P565	K100564HD
Belt - Fan, Alt. & A.C.; W/Borg Warner, Horton Fan Clutch	88GB453P746	▲K060747HD
Belt - Fan, Alt. & A.C.; W/Behr Fan Clutch	88GB459P738	▲K060739HD
Tensioner Assy. - Fan	87GB41A	38523
Tensioner Assy. - Fan, Alt. & A.C.	87GB46A	38589
Idler Pulley - Fan, Alt. & A.C.	786GB41BM	36167
Tensioner Pulley - Fan	87GB41A	36092
Hose - Upper - Eng. To Pipe; (2 1/4" I.D.)		24236
Hose - Upper - Rad. To Pipe		☞21115
Hose - Lower - Rad. To Pipe		☞21115
Mack AI Diesel		
CT Series		
Belt - Fan; W/Horton Fan Clutch; W/1.56 To 1 Fan Ratio	88GB449P657	▲K100658HD
Belt - Fan; W/Behr Fan Clutch; W/1.68 To 1 Fan Ratio	87GB458P650	K100649HD
Belt - Fan, Alt. & A.C.; W/Behr Fan Clutch; W/1.56 To 1 Fan Ratio	88GB450P831	▲K060832HD
Belt - Fan, Alt. & A.C.; W/Behr Fan Clutch; W/1.68 To 1 Fan Ratio	88GB459P825	K060828

▲ Standard Belt Available. See Pages 630-631.

Application	Mfr. Part No.	Our No.
MACK - Continued		
2006 - Continued		
Mack AI Diesel - Continued		
CT Series - Continued		
Tensioner Assy. - Fan	87GB45A	38611
Tensioner Assy. - Fan, Alt. & A.C.	87GB46A	38589
Idler Pulley - Fan, Alt. & A.C.	786GB41BM	36167
Tensioner Pulley	87GB45A	36092
Hose - Upper - Eng. To Pipe; (2 1/2" I.D.)		24240
Hose - Upper - Rad. To Pipe		☞21115
Hose - Lower - Rad. To Pipe		☞21115
CV Series		
Belt - Fan; W/1.77 To 1 Fan Ratio	88GB449P605	▲K100607HD
Belt - Fan; W/1.68 To 1 Fan Ratio	88GB458P661	K100661HD
Belt - Fan, Alt. & A.C.	88GB450P795	▲K060795HD
Belt - Fan & Alt.	88GB459P625	▲K060625HD
Tensioner Assy. - Fan	87GB41A	38523
Tensioner Assy. - Fan, Alt. & A.C.	87GB46A	38589
Idler Pulley - Fan, Alt. & A.C.	786GB41BM	36167
Tensioner Pulley - Fan	87GB41A	36092
Hose - Upper - Eng. To Pipe; (2 1/4" I.D.)		24236
Hose - Upper - Rad. To Pipe; (2" I.D.)		24232
Hose - Lower - Rad. To Pipe		21891
Hose - Lower - Pipe To Cooler; (2" I.D.)		24232
Hose - Lower - Cooler To Pipe; (2 1/2" I.D.)		24240
LE Series; MR Series		
Belt - Fan	88GB458P555	▲K100554HD
Belt - Fan, Alt. & A.C.	88GB459P712	▲K060716HD
Tensioner Assy. - Fan, Alt. & A.C.	87GB47A	38599
Idler Pulley - Fan, Alt. & A.C.	786GB41BM	36167
Mack AMI Diesel		
CT Series		
Belt - Fan; W/Horton Fan Clutch; W/1.44 To 1 Fan Ratio	88GB458P666	▲K100665HD
Belt - Fan; W/Behr Fan Clutch; W/1.56 To 1 Fan Ratio	88GB458P657	▲K100658HD
Belt - Fan, Alt. & A.C.; W/Behr Fan Clutch	88GB459P831	▲K060832HD
Belt - Fan, Alt. & A.C.; W/Borg Warner, Horton Fan Clutch	88GB459P839	K060840
Belt - Fan & Alt.; W/Behr Fan Clutch	88GB459P654	▲K060653HD
Belt - Fan & Alt.; W/Borg Warner, Horton Fan Clutch	88GB459P659	▲K060660HD
Tensioner Assy. - Fan	87GB45A	38611
Tensioner Assy. - Fan, Alt. & A.C.	87GB46A	38589
Idler Pulley - Fan, Alt. & A.C.	786GB41BM	36167
Tensioner Pulley	87GB45A	36092
CV Series		
Belt - Fan; W/Horton Fan Clutch	88GB458P615	K100615HD
Belt - Fan, Alt. & A.C.	88GB459P795	▲K060795HD
Belt - Fan & Alt.	88GB459P625	▲K060625HD
Tensioner Assy. - Fan	87GB41C	38523
Tensioner Assy. - Fan, Alt. & A.C.	87GB414M	38668
Idler Pulley - Fan, Alt. & A.C.	786GB41BM	36167
Tensioner Pulley - Fan	87GB41C	36092
MR Series		
Belt - Fan	88GB458P555	▲K100554HD
Belt - Fan, Alt. & A.C.	88GB459P716	▲K060716HD
Tensioner Assy. - Fan, Alt. & A.C.	87GB47A	38599
Idler Pulley - Fan, Alt. & A.C.	786GB41BM	36167
Mack MP7 Diesel		
CXP Series		
Belt - Fan & Hub	88GB456P660	K100661HD
Belt - Alt. & A.C.	88GB457P630	▲K080630HD
Tensioner Assy. - Fan & Hub	87GB46A	38589
Tensioner Assy. - Alt. & A.C.	87GB41A	38523
Hose - Upper - Eng. To Pipe; (2 1/2" I.D.)		24240
Hose - Upper - Rad. To Pipe; (2 1/2" I.D.)		24240
Hose - Lower - Eng. To Pipe		21891
Hose - Lower - Rad. To Pipe		21891

☞ Cut to Fit.

Belts and Coolant Hose for Medium/Heavy-Duty Trucks (1996 and Newer)

Medium & Heavy-Duty Trucks
(1996 & Newer)

Application	Mfr. Part No.	Our No.
MACK - Continued		
2005		
Cummins ISX Diesel		
CL Series		
Belt - Fan & Alt.	3100189	▲K120911HD
Belt - Hub & A.C.	3682261	▲K060660HD
Tensioner Assy. - Hub & A.C.	3682683	38610
Tensioner Assy. - Fan & Alt.	3682946	38587
Idler Pulley - A.C.	3682229	36223
Tensioner Pulley - Fan & Alt.	3682946	36165
Hose - Upper - Eng. To Pipe; (2 1/2" I.D.)		24240
Hose - Upper - Rad. To Pipe; (2 1/2" I.D.)		24240
Hose - Lower - Eng. To Pipe; (2 1/2" I.D.)		24240
Hose - Lower - Rad. To Pipe; (3" I.D.)		24248
Mack AC Diesel		
CH Series		
Belt - Fan	88GB449P678	▲K100677HD
Belt - Hub, Fan, Alt. & A.C.	88GB459P847	K060846HD
Belt - Fan, Alt. & Hub	88GB459P670	▲K060672HD
Tensioner Assy. - Fan	87GB41	38523
Tensioner Assy. - Hub, Fan, Alt. & A.C.	87GB46	38589
Idler Pulley - Fan, Alt. & A.C.	786GB41BM	36167
Tensioner Pulley - Fan	87GB41	36092
Hose - Upper - Eng. To Pipe; (2" I.D.)		24232
Hose - Upper - Rad. To Pipe; (2 1/4" I.D.)		24236
Hose - Lower - Rad. To Pipe		21891
CHN Series		
Belt - Fan	88GB449P687	K100686HD
Belt - Alt. & A.C.	88GB453P847	▲K060849HD
Tensioner Assy. - Fan	87GB41C	38523
Tensioner Assy. - Alt. & A.C.	87GB46	38589
Hose - Upper - Pipe To Eng.; (2 1/4" I.D.)		↔24836
CX Series		
Belt - Fan	88GB449P555	▲K100554HD
Belt - Fan To Alt. & A.C.	88GB450P735	▲K060735HD
Belt - Fan & Alt.	88GB459P585	▲K060586HD
Tensioner Assy. - Fan	87GB45	38611
Tensioner Assy. - Fan, Alt. & A.C.	87GB46	38589
Idler Pulley - Fan, Alt. & A.C.	786GB41BM	36167
Tensioner Pulley - Fan	87GB45	36092
Hose - Upper - Eng. To Pipe; (2 1/4" I.D.)		24236
Hose - Upper - Pipe To Rad.; (2" I.D.)		24232
Hose - Lower - Pipe To Rad.; (2" I.D.)		24232
CXN Series		
Belt - Fan, A.C., Alt. & W.P.	88GB453P746	▲K060747HD
Belt - Fan	88GB449P579	▲K100579HD
Tensioner Assy. - Fan, A.C., Alt. & W.P.	87GB46A	38589
Tensioner Assy. - Fan	87GB45A	38611
Idler Pulley - Fan, A.C., Alt. & W.P.	786GB41BM	36167
Mack AI Diesel		
CV Series		
Belt - Fan	20870671	▲K100607HD
Tensioner Assy. - Fan	87GB41	38523
Tensioner Pulley - Fan	87GB41	36092
LE Series		
Belt - Fan	88GB447P610	▲K100610HD
Belt - Fan, Alt. & A.C.	88GB459P712	▲K060716HD
Belt - A.C.	88GB439P396	▲9395HD
Tensioner Assy. - Fan, Alt. & A.C.	87GB47A	38599
Tensioner Assy. - Fan & Alt.	87GB41	38523
Idler Pulley - Fan, Alt. & A.C.	786GB41BM	36167
Tensioner Pulley - Fan & Alt.	87GB41	36092
MR Series		
Belt - Fan	88GB458P555	▲K100554HD
Belt - W.P., Alt. & A.C.	88GB459P712	▲K060716HD
Tensioner Assy. - Fan	21291243	38668
Tensioner Assy. - W.P., Alt. & A.C.	87GB47A	38599
Mack AMI Diesel		
CT Series		
Belt - Fan	88GB449P657	▲K100658HD
Belt - Alt. & A.C.	88GB450P831	▲K060832HD

Application	Mfr. Part No.	Our No.
MACK - Continued		
2005 - Continued		
Mack AMI Diesel - Continued		
CT Series - Continued		
Tensioner Assy. - Fan	87GB41	38523
Tensioner Assy. - Alt. & A.C.	87GB46	38589
Tensioner Pulley - Fan		38076
Hose - Upper - Rad. To Pipe		↔21891
Hose - Upper - Pipe To Eng.; (2 1/2" I.D.)		↔24240
CV Series		
Belt - Fan	88GB449P605	▲K100607HD
Belt - Fan, Alt. & A.C.	88GB450P795	▲K060795HD
Tensioner Assy. - Fan	87GB41	38523
Tensioner Assy. - Fan, Alt. & A.C.	87GB46	38589
Idler Pulley - Fan, Alt. & A.C.	786GB41BM	36167
Tensioner Pulley - Fan	87GB41	36092
Hose - Upper - Eng. To Pipe; (2 1/4" I.D.)		24236
Hose - Upper - Rad. To Pipe; (2" I.D.)		24232
Hose - Lower - Rad. To Pipe		21891
Hose - Lower - Pipe To Cooler; (2" I.D.)		24232
Hose - Lower - Cooler To Pipe; (2 1/2" I.D.)		24240
MR Series		
Belt - Fan	88GB458P555	▲K100554HD
Belt - W.P., Alt. & A.C.	88GB450P716	▲K060716HD
Tensioner Assy. - Fan	87GB47A	38599
Tensioner Assy. - W.P., Alt. & A.C.	87GB46	38589
2004		
Cummins ISX Diesel		
CL Series		
Belt - Fan & Alt.	3100189	▲K120911HD
Belt - Hub & A.C.	3682261	▲K060660HD
Tensioner Assy. - Hub & A.C.	3682683	38610
Tensioner Assy. - Fan & Alt.	3682946	38587
Idler Pulley - A.C.	3682229	36223
Tensioner Pulley - Fan & Alt.	3682946	36165
Hose - Upper - Eng. To Pipe; (2 1/2" I.D.)		24240
Hose - Upper - Rad. To Pipe; (2 1/2" I.D.)		24240
Hose - Lower - Eng. To Pipe; (2 1/2" I.D.)		24240
Hose - Lower - Rad. To Pipe; (3" I.D.)		24248
Mack AC Diesel		
CH Series		
Belt - Fan	88GB449P678	▲K100677HD
Belt - Hub, Fan, Alt. & A.C.	88GB450P847	▲K060849HD
Belt - Fan, Alt. & W.P.	88GB459P670	▲K060670HD
Tensioner Assy. - Fan	87GB41	38523
Tensioner Assy. - Hub, Fan, Alt. & A.C.	87GB46	38589
Idler Pulley - Fan, Alt. & A.C.	786GB41BM	36167
Tensioner Pulley - Fan	87GB41	36092
Hose - Upper - Eng. To Pipe; (2" I.D.)		24232
Hose - Upper - Rad. To Pipe; (2 1/4" I.D.)		24236
Hose - Lower - Rad. To Pipe		21891
CHN Series		
Belt - Fan	88GB449P687	K100686HD
Belt - Alt. & A.C.	88GB453P847	▲K060849HD
Tensioner Assy. - Fan	87GB41C	38523
Tensioner Assy. - Alt. & A.C.	87GB46	38589
Hose - Upper - Pipe To Eng.; (2 1/4" I.D.)		↔24836
CX Series		
Belt - Fan	88GB449P555	▲K100554HD
Belt - Fan To Alt. & A.C.	88GB450P735	▲K060735HD
Belt - Fan & Alt.	88GB459P585	▲K060586HD
Tensioner Assy. - Fan	87GB45	38611
Tensioner Assy. - Fan, Alt. & A.C.	87GB46	38589
Idler Pulley - Fan, Alt. & A.C.	786GB41BM	36167
Tensioner Pulley - Fan	87GB45	36092
Hose - Upper - Eng. To Pipe; (2 1/4" I.D.)		24236
Hose - Upper - Pipe To Rad.; (2" I.D.)		24232
Hose - Lower - Pipe To Rad.; (2" I.D.)		24232
CXN Series		
Belt - Fan, A.C., Alt. & W.P.	88GB453P746	▲K060747HD
Belt - Fan	88GB449P579	▲K100579HD
Tensioner Assy. - Fan, A.C., Alt. & W.P.	87GB46A	38589
Tensioner Assy. - Fan	87GB45A	38611
Idler Pulley - Fan, A.C., Alt. & W.P.	786GB41BM	36167
Mack AI Diesel		
CV Series		
Belt - Fan	20870671	▲K100607HD
Tensioner Assy. - Fan	87GB41	38523
Tensioner Pulley - Fan	87GB41	36092
LE Series		
Belt - Fan	88GB447P610	▲K100610HD
Belt - Fan, Alt. & A.C.	88GB459P712	▲K060716HD
Belt - A.C.	88GB439P396	▲9395HD
Tensioner Assy. - Fan, Alt. & A.C.	87GB47A	38599
Tensioner Assy. - Fan & Alt.	87GB41	38523
Idler Pulley - Fan, Alt. & A.C.	786GB41BM	36167
Tensioner Pulley - Fan & Alt.	87GB41	36092
MR Series		
Belt - Fan	88GB458P555	▲K100554HD
Belt - W.P., Alt. & A.C.	88GB459P712	▲K060716HD
Tensioner Assy. - Fan	21291243	38668
Tensioner Assy. - W.P., Alt. & A.C.	87GB47A	38599
Mack AMI Diesel		
CT Series		
Belt - Fan	88GB449P657	▲K100658HD
Belt - Alt. & A.C.	88GB450P831	▲K060832HD
Mack AMI Diesel		
CV Series		
Belt - Fan	88GB449P605	▲K100607HD
Belt - Fan, Alt. & A.C.	88GB450P795	▲K060795HD

▲ Standard Belt Available. See Pages 630-631.
* Durion® Silicone Hose Recommended.

↔ Cut to Fit.

Belts and Coolant Hose for Medium/Heavy-Duty Trucks (1996 and Newer)

 Medium & Heavy-Duty Trucks
(1996 & Newer)

Application	Mfr. Part No.	Our No.
MACK - Continued		
2004 - Continued		
Mack AMI Diesel - Continued		
CV Series - Continued		
Tensioner Assy. - Fan	87GB41	38523
Tensioner Assy. - Fan, Alt. & A.C.	87GB46	38589
Idler Pulley - Fan, Alt. & A.C.	786GB41BM	36167
Tensioner Pulley - Fan	87GB41	36092
Hose - Upper - Eng. To Pipe; (2 1/4" I.D.)		24236
Hose - Upper - Rad. To Pipe; (2" I.D.)		24232
Hose - Lower - Rad. To Pipe		21891
Hose - Lower - Pipe To Cooler; (2" I.D.)		24232
Hose - Lower - Cooler To Pipe; (2 1/2" I.D.)		24240
MR Series		
Belt - Fan	88GB458P555	♣K100554HD
Belt - W.P., Alt. & A.C.	88GB450P716	♣K060716HD
Tensioner Assy. - Fan	21291243	38668
Tensioner Assy. - W.P., Alt. & A.C.	87GB46	38589
Idler Pulley - Fan, Alt. & A.C.	786GB41BM	36167
2003		
Cummins Signature 600 Diesel		
CH Series; CL Series		
Belt - Fan	3681811	♣K100710HD
Belt - Hub, Alt. & A.C.	3681812	♣K060685HD
Tensioner Assy. - Fan	3681240	38535
Tensioner Assy. - Hub, Alt. & A.C.	3680194	38532
Idler Pulley - Alt. & A.C.	4026886	36226
Tensioner Pulley - Fan	3681240	36092
Tensioner Pulley - Hub, Alt. & A.C.	3680194	36095
Hose - Upper - Eng. To Pipe; (2 1/2" I.D.)		24240
Hose - Upper - Pipe To Rad.; (2 1/2" I.D.)		24240
Hose - Lower - Eng. To Pipe; (2 1/2" I.D.)		24240
Hose - Lower - Pipe To Rad.; (3" I.D.)		24248
Mack AC Diesel		
CH Series		
Belt - Fan	88GB449P678	♣K100677HD
Belt - Hub, Fan, Alt. & A.C.	88GB450P847	♣K060849HD
Belt - Fan, Alt. & W.P.	88GB459P670	♣K060670HD
Tensioner Assy. - Fan	87GB41	38523
Tensioner Assy. - Hub, Fan, Alt. & A.C.	87GB46	38589
Idler Pulley - Fan, Alt. & A.C.	786GB41BM	36167
Tensioner Pulley - Fan	87GB41	36092
Hose - Upper - Eng. To Pipe; (2" I.D.)		24232
Hose - Upper - Rad. To Pipe; (2 1/4" I.D.)		24236
Hose - Lower - Rad. To Pipe		21891
CS Series		
Belt - Fan & Alt.	88GB447P660	♣K100658HD
Belt - Fan To A.C.	88GB439P502	♣9500HD
Tensioner Assy. - Fan & Alt.	87GB41	38523
Tensioner Pulley - Fan & Alt.	87GB41	36092
Hose - Upper - Eng. To Pipe		22322
Hose - Upper - Pipe To Rad.; (2" I.D.)		24232
Hose - Lower - Pipe To Rad.; (2 1/2" I.D.)		24240
CX Series		
Belt - Fan	88GB449P555	♣K100554HD
Belt - Fan, Alt. & A.C.	88GB450P735	♣K060735HD
Tensioner Assy. - Fan	87GB45	38611
Tensioner Assy. - Fan, Alt. & A.C.	87GB46	38589
Idler Pulley - Fan, Alt. & A.C.	786GB41BM	36167
Tensioner Pulley - Fan	87GB45	36092
Hose - Upper - Eng. To Pipe; (2 1/4" I.D.)		24236
Hose - Upper - Pipe To Rad.; (2" I.D.)		24232
Hose - Lower - Pipe To Rad.; (2" I.D.)		24232
Mack AI Diesel		
CV Series		
Belt - Fan & Alt.	88GB447P660	♣K100658HD
Belt - Fan To A.C.	88GB439P502	♣9500HD
Tensioner Assy. - Fan & Alt.	87GB41	38523
Tensioner Pulley - Fan & Alt.	87GB41	36092
Hose - Upper - Eng. To Pipe; (2" I.D.)		24232
Hose - Upper - Rad. To Pipe; (2" I.D.)		24232

Application	Mfr. Part No.	Our No.
MACK - Continued		
2003 - Continued		
Mack AI Diesel - Continued		
CV Series - Continued		
Hose - Lower - Rad. To Pipe; (2 1/2" I.D.)		24240
LE Series		
Belt - Fan	88GB447P610	♣K100610HD
Tensioner Assy. - Fan & Alt.	87GB41	38523
Tensioner Pulley - Fan & Alt.	87GB41	36092
Mack AMI Diesel		
CV Series		
Belt - Fan & Alt.	88GB447P666	♣K100665HD
Belt - Fan To A.C.	88GB439P502	♣9500HD
Tensioner Assy. - Fan & Alt.	87GB41	38523
Tensioner Pulley - Fan & Alt.	87GB41	36092
Hose - Upper - Eng. To Pipe; (2" I.D.)		24232
Hose - Upper - Pipe To Rad.; (2" I.D.)		24232
Hose - Lower - Pipe To Rad.		21194
MR Series		
Belt - Fan	88GB458P555	♣K100554HD
Belt - W.P., Alt. & A.C.	88GB450P716	♣K060716HD
Tensioner Assy. - Fan	87GB47A	38599
Tensioner Assy. - W.P., Alt. & A.C.	87GB46	38589
Idler Pulley - Fan, Alt. & A.C.	786GB41BM	36167
Mack E7 Diesel		
MR Series		
Belt - Fan	88GB449P555	♣K100554HD
Belt - Alt.	88GB450P712	♣K060716HD
Belt - A.C.	88GB439P396	♣9395HD
Tensioner Assy. - Fan	87GB45A	38611
RD Series		
Belt - Fan	88GB449P655	♣K100655HD
Belt - A.C.	88GB439P431	♣9430HD
Tensioner Assy. - Fan	87GB41	38523
Tensioner Pulley - Fan	87GB41	36092
2002		
Cummins Signature 600 Diesel		
CH Series; CL Series		
Belt - Fan	3681811	♣K100710HD
Belt - Hub, Alt. & A.C.	3681812	♣K060685HD
Tensioner Assy. - Fan	3681240	38535
Tensioner Assy. - Hub, Alt. & A.C.	3680194	38532
Idler Pulley - Alt. & A.C.	4026886	36226
Tensioner Pulley - Fan	3681240	36092
Tensioner Pulley - Hub, Alt. & A.C.	3680194	36095
Hose - Upper - Eng. To Pipe; (2 1/2" I.D.)		24240
Hose - Upper - Pipe To Rad.; (2 1/2" I.D.)		24240
Hose - Lower - Eng. To Pipe; (2 1/2" I.D.)		24240
Hose - Lower - Pipe To Rad.; (3" I.D.)		24248
Mack 6-Cyl. 12.0 L Diesel		
CH Series		
Belt - Fan & Alt.	88GB447P732	♣K100731HD
Belt - Fan & A.C.	88GB439P506	♣9505HD
Tensioner Assy. - Fan & Alt.	87GB41	38523
Tensioner Pulley - Fan & Alt.	87GB41	36092
Hose - Upper - Pipe To Rad.; (2" I.D.)		24232
Hose - Upper - Eng. To Pipe; (2" I.D.)		24232
Hose - Lower - Eng. To Pipe; (2 1/2" I.D.)		24240
Hose - Lower - Pipe To Rad.		≈21891
CV Series		
Belt - Fan & Alt.	88GB447P655	♣K100655HD
Belt - Fan To A.C.	88GB439P502	♣9500HD
Tensioner Assy. - Fan & Alt.	87GB41	38523
Tensioner Pulley - Fan & Alt.	87GB41	36092
Hose - Upper - Eng. To Pipe; (2" I.D.)		24232
Hose - Upper - Pipe To Rad.; (2" I.D.)		24232
Hose - Lower - Eng. To Pipe		21194
Hose - Lower - Pipe To Rad.; (2 1/2" I.D.)		24240
CX Series		
Belt - Fan & Alt.	88GB449P605	♣K100607HD

♣ Standard Belt Available. See Pages 630-631.

≈ Cut to Fit.

Belts and Coolant Hose for Medium/Heavy-Duty Trucks (1996 and Newer)

Medium & Heavy-Duty Trucks
(1996 & Newer)

Application	Mfr. Part No.	Our No.
MACK - Continued		
2002 - Continued		
Mack 6-Cyl. 12.0 L Diesel - Continued		
CX Series - Continued		
Belt - Fan To Compr.	88GB439P491	▲9490HD
Tensioner Assy. - Fan & Alt.	87GB41	38523
Tensioner Pulley - Fan & Alt.	87GB41	36092
Hose - Upper - Eng. To Pipe; (2" I.D.)	24232	24232
Hose - Upper - Pipe To Rad.; (2" I.D.)	24232	24232
Hose - Lower - Pipe To Rad.; (2" I.D.)	24232	24232
DM Series		
Belt - Fan & Alt.	88GB447P655	▲K100655HD
Belt - A.C.	88GB439P502	▲9500HD
Tensioner Assy. - Fan & Alt.	87GB41	38523
LE Series		
Belt - Fan & Alt.	88GB447P610	▲K100610HD
Belt - A.C.	88GB439P386	▲9390HD
MR Series		
Belt - Fan & Alt.	88GB449P605	▲K100607HD
Belt - Fan To A.C.	88GB439P386	▲9390HD
Tensioner Assy. - Fan & Alt.	87GB41	38523
Tensioner Pulley - Fan & Alt.	87GB41	36092
Hose - Upper - Eng. To Pipe; (2" I.D.)	24232	24232
Hose - Upper - Pipe To Rad.; (2" I.D.)	24232	24232
Hose - Lower - Eng. To Pipe; (2 1/2" I.D.)	24240	24240
Hose - Lower - Pipe To Rad.; (2 1/2" I.D.)	24240	24240
RD Series		
Belt - Fan & Alt.	88GB449P655	▲K100655HD
Belt - Fan To A.C.	88GB439P431	▲9430HD
Tensioner Assy. - Fan & Alt.	87GB41	38523
Tensioner Pulley - Fan & Alt.	87GB41	36092
2001		
Cummins Signature 600 Diesel		
CH Series; CL Series		
Belt - Fan	3681811	▲K100710HD
Belt - Hub, Alt. & A.C.	3681812	▲K060685HD
Tensioner Assy. - Fan	3681240	38535
Tensioner Assy. - Hub, Alt. & A.C.	3680194	38532
Idler Pulley - Alt. & A.C.	4026886	36226
Tensioner Pulley - Fan	3681240	36092
Tensioner Pulley - Hub, Alt. & A.C.	3680194	36095
Hose - Upper - Eng. To Pipe; (2 1/2" I.D.)	24240	24240
Hose - Upper - Pipe To Rad.; (2 1/2" I.D.)	24240	24240
Hose - Lower - Eng. To Pipe; (2 1/2" I.D.)	24240	24240
Hose - Lower - Pipe To Rad.; (3" I.D.)	24248	24248
Mack 6-Cyl. 12.0 L Diesel		
CH Series		
Belt - Fan & Alt.	88GB447P732	▲K100731HD
Belt - Fan & A.C.	88GB439P506	▲9505HD
Tensioner Assy. - Fan & Alt.	87GB41	38523
Tensioner Pulley - Fan & Alt.	87GB41	36092
Hose - Upper - Pipe To Rad.; (2" I.D.)	24232	24232
Hose - Upper - Eng. To Pipe; (2" I.D.)	24232	24232
Hose - Lower - Eng. To Pipe; (2 1/2" I.D.)	24240	24240
Hose - Lower - Pipe To Rad.	24240	≡21891
CL Series		
Belt - Fan & Alt.	88GB447P655	▲K100655HD
Belt - Fan & A.C.	88GB439P431	▲9430HD
Tensioner Assy. - Fan & Alt.	87GB41	38523
Tensioner Pulley - Fan & Alt.	87GB41	36092
Hose - Lower - Eng. To Pipe; (2 1/2" I.D.)	24240	24240
Hose - Lower - Pipe To Eng.; (2 1/2" I.D.)	24240	24240
CV Series		
Belt - Fan & Alt.	88GB447P655	▲K100655HD
Belt - Fan To A.C.	88GB439P502	▲9500HD
Tensioner Assy. - Fan & Alt.	87GB41	38523
Tensioner Pulley - Fan & Alt.	87GB41	36092
Hose - Upper - Eng. To Pipe; (2" I.D.)	24232	24232
Hose - Upper - Pipe To Rad.; (2" I.D.)	24232	24232
Hose - Lower - Eng. To Pipe	21194	21194
Hose - Lower - Pipe To Rad.; (2 1/2" I.D.)	24240	24240

Application	Mfr. Part No.	Our No.
MACK - Continued		
2001 - Continued		
Mack 6-Cyl. 12.0 L Diesel - Continued		
CX Series		
Belt - Fan & Alt.	88GB447P666	▲K100665HD
Belt - Fan To Compr.	88GB439P491	▲9490HD
Tensioner Assy. - Fan & Alt.	87GB41	38523
Tensioner Pulley - Fan & Alt.	87GB41	36092
Hose - Upper - Eng. To Pipe; (2" I.D.)	24232	24232
Hose - Upper - Pipe To Rad.; (2" I.D.)	24232	24232
Hose - Lower - Eng. To Pipe; (2 1/2" I.D.)	24240	24240
Hose - Lower - Pipe To Rad.; (2" I.D.)	24232	24232
DM Series		
Belt - Fan & Alt.	88GB447P655	▲K100655HD
Belt - Fan & A.C.	88GB439P431	▲9430HD
Tensioner Assy. - Fan & Alt.	87GB41	38523
Tensioner Pulley - Fan & Alt.	87GB41	36092
Hose - Upper - Eng. To Pipe; (2 1/2" I.D.)	24240	24240
Hose - Upper - Pipe To Rad.; (2 1/2" I.D.)	24240	24240
Hose - Lower - Eng. To Pipe; (2 1/2" I.D.)	24240	24240
Hose - Lower - Pipe To Eng.	21891	21891
LE Series		
Belt - A.C.	88GB439P386	▲9390HD
Belt - Fan & Alt.	88GB447P610	▲K100610HD
MR Series		
Belt - Fan & Alt.	88GB447P605	▲K100607HD
Belt - Fan To A.C.	88GB439P386	▲9390HD
Tensioner Assy. - Fan & Alt.	87GB41	38523
Tensioner Pulley - Fan & Alt.	87GB41	36092
Hose - Upper - Eng. To Pipe; (2" I.D.)	24232	24232
Hose - Upper - Pipe To Rad.; (2" I.D.)	24232	24232
Hose - Lower - Eng. To Pipe; (2 1/2" I.D.)	24240	24240
Hose - Lower - Pipe To Rad.; (2 1/2" I.D.)	24240	24240
RD Series		
Belt - Fan & Alt.	88GB447P655	▲K100655HD
Belt - Fan & A.C.	88GB439P431	▲9430HD
Tensioner Assy. - Fan & Alt.	87GB41	38523
Tensioner Pulley - Fan & Alt.	87GB41	36092
Hose - Upper - Eng. To Pipe; (2" I.D.)	24232	24232
Hose - Upper - Pipe To Rad.; (2" I.D.)	24232	24232
Hose - Lower - Eng. To Pipe; (2 1/2" I.D.)	24240	24240
Hose - Lower - Pipe To Rad.; (2 1/2" I.D.)	24240	24240
Renault 6-Cyl. 6.2 L Diesel		
CS Series		
Belt - W.P. & Alt.; W/49 1/2" Belt O.C. ...	10X1250	7490
Belt - W.P. & Alt.; W/51 1/2" Belt O.C. ...	5000686853	7512
Belt - Air Compr.; W/48" Belt O.C.	AV131205	▲9476HD
Belt - Air Compr.; W/49 1/2" Belt O.C.		▲9490HD
2000		
Cummins Signature 600 Diesel		
CL Series		
Belt - Fan	3681811	▲K100710HD
Belt - Hub, Alt. & A.C.	3681812	▲K060685HD
Tensioner Assy. - Fan	3681240	38535
Tensioner Assy. - Hub, Alt. & A.C.	3680194	38532
Idler Pulley - Alt. & A.C.	4026886	36226
Tensioner Pulley - Fan	3681240	36092
Tensioner Pulley - Hub, Alt. & A.C.	3680194	36095
Hose - Upper - Eng. To Pipe; (2 1/2" I.D.)	24240	24240
Hose - Upper - Pipe To Rad.; (2 1/2" I.D.)	24240	24240
Hose - Lower - Eng. To Pipe; (2 1/2" I.D.)	24240	24240
Hose - Lower - Pipe To Rad.; (3" I.D.)	24248	24248
Mack 6-Cyl. 12.0 L Diesel		
CH Series		
Belt - Fan & Alt.	88GB447P732	▲K100731HD
Belt - Fan & A.C.	88GB439P506	▲9505HD
Tensioner Assy. - Fan & Alt.	87GB41	38523
Tensioner Pulley - Fan & Alt.	87GB41	36092
Hose - Upper - Pipe To Rad.; (2" I.D.)	24232	24232
Hose - Lower - Eng. To Pipe; (2 1/2" I.D.)	24240	24240
Hose - Lower - Pipe To Rad.	24240	≡21891

▲ Standard Belt Available. See Pages 630-631.

≡ Cut to Fit.

Belts and Coolant Hose for Medium/Heavy-Duty Trucks (1996 and Newer)

 Medium & Heavy-Duty Trucks
(1996 & Newer)

Application	Mfr. Part No.	Our No.
MACK - Continued		
2000 - Continued		
Mack 6-Cyl. 12.0 L Diesel - Continued		
CL Series		
Belt - Fan & Alt.	88GB447P655	▲K100655HD
Belt - Fan & A.C.	88GB439P431	▲9430HD
Tensioner Assy. - Fan & Alt.	87GB41	38523
Tensioner Pulley - Fan & Alt.	87GB41	36092
Hose - Lower - Eng. To Pipe; (2 1/2" I.D.)		24240
Hose - Lower - Pipe To Rad.; (2 1/2" I.D.)		24240
CX Series		
Belt - Fan & Alt.	88GB447P666	▲K100655HD
Belt - Fan To Compr.	88GB439P491	▲9490HD
Tensioner Assy. - Fan & Alt.	87GB41	38523
Tensioner Pulley - Fan & Alt.	87GB41	36092
Hose - Upper - Eng. To Pipe; (2" I.D.)		24232
Hose - Upper - Pipe To Rad.; (2" I.D.)		24232
Hose - Lower - Eng. To Pipe; (2 1/2" I.D.)		24240
Hose - Lower - Pipe To Rad.; (2 1/2" I.D.)		24240
DM Series		
Belt - Fan & Alt.	88GB447P655	▲K100655HD
Belt - A.C.	88GB439P431	▲9430HD
Tensioner Assy. - Fan & Alt.	87GB41	38523
Tensioner Pulley		36092
Hose - Upper - Rad. To Pipe; (2 3/4" I.D.)		*24844
Hose - Upper - Pipe To Eng.; (2 3/4" I.D.)		*24844
Hose - Lower - Rad. To Pipe; (2 1/2" I.D.)		*24840
Hose - Lower - Pipe To Eng.; (2 1/2" I.D.)		*24840
DMM Series		
Belt - Fan & Alt.	88GB447P655	▲K100655HD
Belt - A.C.	88GB439P431	▲9430HD
Tensioner Assy.	87GB41C	38523
Tensioner Pulley		36092
Hose - Upper - Rad. To Pipe; (2 3/4" I.D.)		*24844
Hose - Upper - Pipe To Eng.; (2 3/4" I.D.)		*24844
Hose - Lower - Rad. To Pipe; (2 1/2" I.D.)		*24840
Hose - Lower - Pipe To Eng.; (2 1/2" I.D.)		*24840
LE Series		
Belt - Fan & Alt.; W/V-Ribbed Belt	88GB447P615	K100615HD
Belt - Fan & Alt.; Preferred Belt; W/V-Belt Drive		2/9610PB
Belt - Fan & Alt.; Optional Belt; W/V-Belt Drive		②▲9610HD
Belt - A.C.	88GB439P391	▲9390HD
Hose - Upper - Rad. To Pipe; (2 3/4" I.D.)		*24844
Hose - Upper - Pipe To Eng.; (2 3/4" I.D.)		*24844
Hose - Lower - Rad. To Pipe; (2 1/2" I.D.)		*24840
MR Series		
Belt - Fan & Alt.; W/61" Belt O.C.	88GB447P605	▲K100607HD
Belt - Fan & Alt.; W/60 1/2" Belt O.C. ...	88GB447P600	K100600HD
Belt - Fan To A.C.	88GB439P386	▲9390HD
Tensioner Assy. - Fan & Alt.	87GB41	38523
Tensioner Pulley - Fan & Alt.	87GB41	36092
Hose - Upper - Eng. To Pipe; (2" I.D.)		24232
Hose - Upper - Pipe To Rad.; (2" I.D.)		24232
Hose - Lower - Eng. To Pipe; (2 1/2" I.D.)		24240
Hose - Lower - Pipe To Rad.; (2 1/2" I.D.)		24240
RB Series		
Belt - Alt.	88GB447P655	▲K100655HD
Belt - A.C.	88GB439P431	▲9430HD
Tensioner Assy. - Alt.	87GB41C	38523
Tensioner Pulley		36092
Hose - Upper - Rad. To Pipe; (2 3/4" I.D.)		*24844
Hose - Upper - Pipe To Eng.; (2 3/4" I.D.)		*24844
Hose - Lower - Rad. To Pipe; (2 1/2" I.D.)		*24840
Hose - Lower - Pipe To Eng.; (2 1/2" I.D.)		*24840
RD Series		
Belt - Fan & Alt.	88GB447P655	▲K100655HD
Belt - Fan & A.C.	88GB439P431	▲9430HD
Tensioner Assy. - Fan & Alt.	87GB41	38523
Tensioner Pulley - Fan & Alt.	87GB41	36092
Hose - Upper - Eng. To Pipe; (2" I.D.)		24232
Hose - Upper - Pipe To Rad.; (2" I.D.)		24232
Hose - Lower - Eng. To Pipe; (2 1/2" I.D.)		24240
Hose - Lower - Pipe To Rad.; (2 1/2" I.D.)		24240

Application	Mfr. Part No.	Our No.
MACK - Continued		
2000 - Continued		
Renault 6-Cyl. 6.2 L Diesel		
CS Series		
Belt - W.P. & Alt.; W/49 1/2" Belt O.C. ...	10X1250	7490
Belt - W.P. & Alt.; W/51 1/2" Belt O.C. ...	5000686853	7512
Belt - Air Compr.; W/48" Belt O.C.	AV131205	▲9476HD
Belt - Air Compr.; W/49 1/2" Belt O.C.		▲9490HD
1999		
Mack 6-Cyl. 12.0 L Diesel		
CH Series		
Belt - Fan & Alt.	88GB447P732	▲K100731HD
Belt - Fan & A.C.	88GB439P506	▲9505HD
Belt - A.C.	88GB439P506	▲9505HD
Tensioner Assy. - Fan & Alt.	87GB41	38523
Tensioner Pulley - Fan & Alt.	87GB41	36092
Hose - Upper		②-21378
		●26512
Hose - Upper - Pipe To Rad.; (2" I.D.)		24232
Hose - Lower - Eng. To Pipe; (2 1/2" I.D.)		24240
Hose - Lower - Pipe To Rad.		②-21891
Hose - By Pass - Inlet; (1 1/4" I.D.)		24220
Hose - By Pass - Outlet; (1 1/2" I.D.)		24224
Hose - Heater; (5/8" I.D.)		28441
CL Series		
Belt - Fan & Alt.	88GB447P650	▲K100655HD
Belt - Fan To A.C.	88GB439P431	▲9430HD
Tensioner Assy. - Fan & Alt.	87GB41C	38523
CX Series		
Belt - Fan & Alt.	88GB447P666	▲K100665HD
Belt - Fan To Compr.	88GB439P491	▲9490HD
Tensioner Assy. - Fan & Alt.	87GB41	38523
Tensioner Pulley - Fan & Alt.	87GB41	36092
Hose - Upper - Eng. To Pipe; (2" I.D.)		24232
Hose - Upper - Pipe To Rad.; (2" I.D.)		24232
Hose - Lower - Eng. To Pipe; (2 1/2" I.D.)		24240
Hose - Lower - Pipe To Rad.; (2 1/2" I.D.)		24240
LE Series		
Belt - Fan & Alt.; Preferred Belt		2/9610PB
Belt - Fan & Alt.; Optional Belt		②▲9610HD
Belt - A.C.	88GB439P391	▲9390HD
MR Series		
Belt - Fan & Alt.	88GB447P610	▲K100610HD
Belt - Fan & A.C.		▲9390HD
Tensioner Assy. - Fan & Alt.	87GB41	38523
Tensioner Pulley - Fan & Alt.	87GB41	36092
Hose - Upper - Eng. To Pipe; (2" I.D.)		24232
Hose - Upper - Pipe To Rad.; (2" I.D.)		24232
Hose - Lower - Eng. To Pipe; (2 1/2" I.D.)		24240
Hose - Lower - Pipe To Rad.; (2 1/2" I.D.)		24240
RB Series		
Belt - Fan & Alt.	88GB447P655	▲K100655HD
Belt - A.C.	88GB439P431	▲9430HD
Tensioner Assy. - Fan & Alt.	87GB41	38523
Tensioner Pulley - Fan & Alt.	87GB41	36092
Hose - Upper		②-21379
Hose - Upper; (2" I.D.)		24232
Hose - Lower - Eng. To Pipe; (2 1/2" I.D.)		24240
Hose - Lower - Pipe To Rad.; (2 1/2" I.D.)		24240
Hose - By Pass - Inlet; (1 1/4" I.D.)		24220
Hose - By Pass - Outlet; (1 1/2" I.D.)		24224
Hose - Heater; (5/8" I.D.)		28441
RD Series		
Belt - Fan & Alt.	88GB447P655	▲K100655HD
Belt - Fan & A.C.	88GB439P431	▲9430HD
Tensioner Assy. - Fan & Alt.	87GB41	38523
Tensioner Pulley - Fan & Alt.	87GB41	36092
Hose - Upper		②-21379
Hose - Upper - Pipe To Rad.; (2" I.D.)		24232
Hose - Lower - Eng. To Pipe; (2 1/2" I.D.)		24240
Hose - Lower - Pipe To Rad.		②-21891

▲ Standard Belt Available. See Pages 630-631.
 ② Two Required.
 ● Vulco-Flex® Coolant Hose.

* Durion® Silicone Hose Recommended.
 ② Cut to Fit.

Belts and Coolant Hose for Medium/Heavy-Duty Trucks (1996 and Newer)

Medium & Heavy-Duty Trucks
(1996 & Newer)

Application	Mfr. Part No.	Our No.
MACK - Continued		
1999 - Continued		
Mack 6-Cyl. 12.0 L Diesel - Continued		
RD Series - Continued		
Hose - Lower - Pipe To Rad.; (2 1/2" I.D.)		24240
Hose - By Pass - Inlet; (1 1/4" I.D.)		24220
Hose - By Pass - Outlet; (1 1/2" I.D.)		24224
Hose - Heater; (5/8" I.D.)		28441
Renault 6-Cyl. 6.2 L Diesel		
CS Series; MS Series		
Belt - W.P. & Alt.; W/49 1/2" Belt O.C. ... 10X1250		7490
Belt - W.P. & Alt.; W/51 1/2" Belt O.C. ... 5000686853		7512
Belt - Air Compr.; W/48" Belt O.C. AV131205		▲9476HD
Belt - Air Compr.; W/49 1/2" Belt O.C.		▲9490HD
1998		
Mack 6-Cyl. 12.0 L Diesel		
CH Series		
Belt - Fan & Alt. 88GB447P732		▲K100731HD
Belt - A.C. 88GB439P506		▲9505HD
Tensioner Assy. - Fan & Alt. 87GB41		38523
Tensioner Pulley - Fan & Alt. 87GB41		36092
Hose - Upper		≡21378
Hose - Upper; (2" I.D.)		24232
Hose - Upper		●26512
Hose - Lower - Eng. To Pipe; (2 1/2" I.D.)		24240
Hose - Lower - Pipe To Rad.		21891
Hose - By Pass - Inlet; (1 1/4" I.D.)		24220
Hose - By Pass - Outlet; (1 1/2" I.D.)		24224
Hose - Heater; (5/8" I.D.)		28441
CL Series		
Belt - Fan & Alt.; W/V-Ribbed Belt 88GB447P650		▲K100655HD
Belt - Fan & Alt.; W/Dual V-Belts 88GB439P642		②▲9640HD
Belt - Fan To A.C. 88GB439P431		▲9430HD
Tensioner Assy. - Fan & Alt. 87GB41C		38523
Tensioner Pulley - Fan & Alt.		36092
CX Series		
Belt - Fan & Alt. 88GB447P666		▲K100665HD
Belt - Fan To Compr. 88GB439P491		▲9490HD
Tensioner Assy. - Fan & Alt. 87GB41		38523
Tensioner Pulley - Fan & Alt. 87GB41		36092
Hose - Upper - Eng. To Pipe; (2" I.D.)		24232
Hose - Upper - Pipe To Rad.; (2" I.D.)		24232
Hose - Lower - Eng. To Pipe; (2 1/2" I.D.)		24240
Hose - Lower - Pipe To Rad.; (2 1/2" I.D.)		24240
DM Series; DMM Series		
Belt - Fan & Alt.; Preferred Belt 88GB445P645		2/9640PB
Belt - Fan & Alt.; Optional Belt		▲9640HD
Belt - A.C. 88GB439P431		▲9430HD
Hose - Upper - Eng. To Rad.		21379
Hose - Upper; (2" I.D.)		24232
Hose - Lower - Eng. To Pipe; (2 1/2" I.D.)		24240
Hose - Lower - Pipe To Rad.		21891
Hose - Lower - Pipe To Cooler; W/Auto. Trans.		21891
Hose - Lower - Rad. To Cooler; W/Auto. Trans.		●26529
Hose - By Pass - Inlet; (1 1/4" I.D.)		24220
Hose - By Pass - Outlet; (2 1/8" I.D.)		24234
Hose - Heater; (5/8" I.D.)		28441
LE Series		
Belt - Fan & Alt.; Preferred Belt		2/9610PB
Belt - Fan & Alt.; Optional Belt		②▲9610HD
Belt - A.C. 88GB439P391		▲9390HD
MR Series		
Belt - Fan & Alt. 88GB445P600		②▲9600HD
		2/9600PB
Belt - Fan To Alt. 88GB439P386		▲9390HD
Hose - Upper - Eng. To Pipe; (2" I.D.)		24232
Hose - Upper - Pipe To Rad.; (2" I.D.)		24232
Hose - Lower - Eng. To Pipe; (2 1/2" I.D.)		24240
Hose - Lower - Pipe To Rad.; (2 1/2" I.D.)		24240
RB Series; RD Series		
Belt - Fan & Alt. 88GB447P655		▲K100655HD

Application	Mfr. Part No.	Our No.
MACK - Continued		
1998 - Continued		
Mack 6-Cyl. 12.0 L Diesel - Continued		
RB Series; RD Series - Continued		
Belt - A.C. 88GB439P431		▲9430HD
Tensioner Assy. - Fan & Alt. 87GB41		38523
Tensioner Pulley - Fan & Alt. 87GB41		36092
Hose - Upper		≡21379
Hose - Upper; (2" I.D.)		24232
Hose - Lower - Eng. To Pipe; (2 1/2" I.D.)		24240
Hose - Lower - Pipe To Rad.; (2 1/2" I.D.)		24240
Hose - By Pass - Inlet; (1 1/4" I.D.)		24220
Hose - By Pass - Outlet; (1 1/2" I.D.)		24224
Hose - Heater; (5/8" I.D.)		28441
Renault 6-Cyl. 6.2 L Diesel		
CS Series; MS Series		
Belt - W.P. & Alt.; W/49 1/2" Belt O.C. ... 10X1250		7490
Belt - W.P. & Alt.; W/51 1/2" Belt O.C. ... 5000686853		7512
Belt - Air Compr.; W/48" Belt O.C. AV131205		▲9476HD
Belt - Air Compr.; W/49 1/2" Belt O.C.		▲9490HD
1997		
Mack 6-Cyl. 12.0 L Diesel		
CH Series		
Belt - Fan & Alt. 88GB439P722		2/9720PB
Belt - Fan & A.C. 88GB439P506		▲9505HD
Hose - Upper		≡21378
Hose - Upper; (2" I.D.)		24232
Hose - Upper		●26512
Hose - Lower - Eng. To Pipe; (2 1/2" I.D.)		24240
Hose - Lower - Pipe To Rad.		21891
Hose - By Pass - Inlet; (1 1/4" I.D.)		24220
Hose - By Pass - Outlet; (1 1/2" I.D.)		24224
Hose - Heater; (5/8" I.D.)		28441
CL Series		
Belt - Fan & Alt.; W/64 3/8" Belt O.C.; Preferred Belt		2/9640PB
Belt - Fan & Alt.; W/64 3/8" Belt O.C.; Optional Belt		②▲9640HD
Belt - Fan & Alt.; W/72 1/2" Belt O.C.; Preferred Belt		88GB439P722
		2/9720PB
Belt - Fan & Alt.; W/72 1/2" Belt O.C.; Optional Belt		②▲9720HD
Belt - A.C.; W/43 1/2" Belt O.C. 88GB354P26		▲9430HD
Belt - A.C.; W/51" Belt O.C. 88GB439P506		▲9505HD
DM Series; DMM Series		
Belt - Fan & Alt.; Preferred Belt 88GB445P645		2/9640PB
Belt - Fan & Alt.; Optional Belt		▲9640HD
Belt - A.C. 88GB439P431		▲9430HD
Hose - Upper - Eng. To Rad.		21379
Hose - Upper; (2" I.D.)		24232
Hose - Lower - Eng. To Pipe; (2 1/2" I.D.)		24240
Hose - Lower - Pipe To Rad.		21891
Hose - Lower - Pipe To Cooler; W/Auto. Trans.		21891
Hose - Lower - Rad. To Cooler; W/Auto. Trans.		●26529
Hose - By Pass - Inlet; (1 1/4" I.D.)		24220
Hose - By Pass - Outlet; (2 1/8" I.D.)		24234
Hose - Heater; (5/8" I.D.)		28441
LE Series		
Belt - Fan & Alt.; Preferred Belt		2/9610PB
Belt - Fan & Alt.; Optional Belt		②▲9610HD
Belt - A.C. 88GB439P391		▲9390HD
MR Series		
Belt - Fan & Alt. 88GB445P600		②▲9600HD
		2/9600PB
Belt - Fan To Alt. 88GB439P386		▲9390HD
Hose - Upper - Eng. To Pipe; (2" I.D.)		24232
Hose - Upper - Pipe To Rad.; (2" I.D.)		24232
Hose - Lower - Eng. To Pipe; (2 1/2" I.D.)		24240
Hose - Lower - Pipe To Rad.; (2 1/2" I.D.)		24240
RB Series; RD Series		
Belt - Fan & Alt. 88GB439P647		▲9650HD
Belt - A.C. 88GB439P431		▲9430HD
Hose - Upper		≡21379
Hose - Upper; (2" I.D.)		24232

▲ Standard Belt Available. See Pages 630-631.
● Vulco-Flex® Coolant Hose.

≡ Cut to Fit.
② Two Required.

Belts and Coolant Hose for Medium/Heavy-Duty Trucks (1996 and Newer)

 Medium & Heavy-Duty Trucks
(1996 & Newer)

Application	Mfr. Part No.	Our No.
MACK - Continued		
1997 - Continued		
Mack 6-Cyl. 12.0 L Diesel - Continued		
RB Series; RD Series - Continued		
Hose - Lower - Eng. To Pipe; (2 1/2" I.D.)		24240
Hose - Lower - Pipe To Rad.; (2 1/2" I.D.)		24240
Hose - By Pass - Inlet; (1 1/4" I.D.)		24220
Hose - By Pass - Outlet; (1 1/2" I.D.)		24224
Hose - Heater; (5/8" I.D.)		28441
Renault 6-Cyl. 6.2 L Diesel		
CS Series; MS Series		
Belt - W.P. & Alt.; W/49 1/2" Belt O.C. ... 10X1250		7490
Belt - W.P. & Alt.; W/51 1/2" Belt O.C. ... 5000686853		7512
Belt - Air Compr.; W/48" Belt O.C. AV131205		▲9476HD
Belt - Air Compr.; W/49 1/2" Belt O.C.		▲9490HD
1996		
Mack 6-Cyl. 12.0 L Diesel		
CH Series		
Belt - Fan & Alt.; W/64 1/2" Belt O.C. ... 88GB439P642		▲9640HD
Belt - Fan & Alt.; W/73 3/8" Belt O.C.;		
Preferred Belt	88GB439P732	2/9730PB
Belt - Fan & Alt.; W/73 3/8" Belt O.C.; Optional Belt		②▲9730HD
Belt - A.C.; W/43 1/2" Belt O.C. 88GB439P431		▲9430HD
Belt - A.C.; W/52" Belt O.C. 88GB354P63		▲9505HD
Belt - A.C.; W/53 1/2" Belt O.C. 88GB354P81		▲9530HD
Belt - A.C.; W/49 3/8" Belt O.C.		▲9490HD
Hose - Upper		≧21378
Hose - Upper; (2" I.D.)		24232
Hose - Upper		●26512
Hose - Lower - Eng. To Pipe; (2 1/2" I.D.)		24240
Hose - Lower - Pipe To Rad.		21891
Hose - By Pass - Inlet; (1 1/4" I.D.)		24220
Hose - By Pass - Outlet; (1 1/2" I.D.)		24224
Hose - Heater; (5/8" I.D.)		28441
CL Series		
Belt - Fan & Alt.; W/64 3/8" Belt O.C.; Preferred Belt		2/9640PB
Belt - Fan & Alt.; W/64 3/8" Belt O.C.; Optional Belt		②▲9640HD
Belt - Fan & Alt.; W/72 1/2" Belt O.C.;		
Preferred Belt	88GB439P722	2/9720PB
Belt - Fan & Alt.; W/72 1/2" Belt O.C.; Optional Belt		②▲9720HD
Belt - A.C.; W/43 1/2" Belt O.C. 88GB354P26		▲9430HD
Belt - A.C.; W/51" Belt O.C. 88GB439P506		▲9505HD
DM Series		
Belt - Fan & Alt.; Preferred Belt	88GB445P645	2/9640PB
Belt - Fan & Alt.; Optional Belt		▲9640HD
Belt - A.C. 88GB439P431		▲9430HD
Hose - Upper - Eng. To Rad.		21379
Hose - Upper; (2" I.D.)		24232
Hose - Lower - Eng. To Pipe; (2 1/2" I.D.)		24240
Hose - Lower - Pipe To Rad.		21891
Hose - Lower - Pipe To Cooler; W/Auto. Trans.		21891
Hose - Lower - Rad. To Cooler; W/Auto. Trans.		●26529
Hose - By Pass - Inlet; (1 1/4" I.D.)		24220
Hose - By Pass - Outlet; (2 1/8" I.D.)		24234
Hose - Heater; (5/8" I.D.)		28441
LE Series		
Belt - Fan & Alt. 88GB439P612		②▲9610HD
MR Series		
Belt - Fan & Alt.; Preferred Belt		2/9610PB
Belt - Fan & Alt.; Optional Belt	88GB439P612	②▲9610HD
Belt - A.C. 88GB439P391		▲9390HD
RB Series		
Belt - Fan & Alt.; W/73 3/8" Belt O.C.; Preferred Belt		2/9730PB
Belt - Fan & Alt.; W/73 3/8" Belt O.C.; Optional Belt		②▲9730HD
Belt - A.C.; W/39 1/2" Belt O.C. 88GB354P31		▲9390HD
Belt - A.C.; W/40 1/2" Belt O.C. 88GB354P29		▲9400HD
Belt - A.C.; W/42" Belt O.C. 88GB354P44		▲9415HD
Belt - A.C.; W/43 1/2" Belt O.C. 88GB354P26		▲9430HD
Belt - A.C.; W/53 1/2" Belt O.C. 88GB354P81		▲9530HD
Hose - Upper		≧21379
Hose - Upper; (2" I.D.)		24232

▲ Standard Belt Available. See Pages 630-631.
≧ Cut to Fit.

Application	Mfr. Part No.	Our No.
MACK - Continued		
1996 - Continued		
Mack 6-Cyl. 12.0 L Diesel - Continued		
RB Series - Continued		
Hose - Lower - Eng. To Pipe; (2 1/2" I.D.)		24240
Hose - Lower - Pipe To Rad.; (2 1/2" I.D.)		24240
Hose - By Pass - Inlet; (1 1/4" I.D.)		24220
Hose - By Pass - Outlet; (1 1/2" I.D.)		24224
Hose - Heater; (5/8" I.D.)		28441
RD Series		
Belt - Fan & Alt.; W/73 3/8" Belt O.C.; Optional Belt		②▲9730HD
Belt - A.C.; W/39 1/2" Belt O.C. 88GB354P31		▲9390HD
Belt - A.C.; W/40 1/2" Belt O.C. 88GB354P29		▲9400HD
Belt - A.C.; W/42" Belt O.C. 88GB354P44		▲9415HD
Belt - A.C.; W/43 1/2" Belt O.C. 88GB354P26		▲9430HD
Belt - A.C.; W/53 1/2" Belt O.C. 88GB354P81		▲9530HD
Hose - Upper		≧21379
Hose - Upper; (2" I.D.)		24232
Hose - Lower - Eng. To Pipe; (2 1/2" I.D.)		24240
Hose - Lower - Pipe To Rad.; (2 1/2" I.D.)		24240
Hose - By Pass - Inlet; (1 1/4" I.D.)		24220
Hose - By Pass - Outlet; (1 1/2" I.D.)		24224
Hose - Heater; (5/8" I.D.)		28441
Renault 6-Cyl. 6.2 L Diesel		
CS Series; MS Series		
Belt - W.P. & Alt.; W/49 1/2" Belt O.C. ... 10X1250		7490
Belt - W.P. & Alt.; W/51 1/2" Belt O.C. ... 5000686853		7512
Belt - Air Compr.; W/48" Belt O.C. AV131205		▲9476HD
Belt - Air Compr.; W/49 1/2" Belt O.C.		▲9490HD
MITSUBISHI FUSO		
2008		
Mitsubishi Fuso 4M50 Diesel		
FE		
Belt - Fan, Alt. & A.C. ME241670		▲K060480HD
2007		
Mitsubishi Fuso 4M50 Diesel		
FE; FG		
Belt - Fan, Alt. & A.C. ME241670		▲K060480HD
Hose - Upper - Eng. To Rad.		≧20957
Mitsubishi Fuso 6M60 Diesel		
FM		
Belt - A.C. MH014448		▲9395HD
Belt - Fan, Alt. & W.P. ME300899		TR22443
2006		
Mitsubishi Fuso 4M50 Diesel		
FE; FG		
Belt - Fan, Alt. & A.C. ME241670		▲K060480HD
Hose - Upper - Eng. To Rad.		≧20957
Mitsubishi Fuso 6M60 Diesel		
FK; FM		
Belt - Fan & Alt. ME300899		TR22443
Belt - A.C. MPMF6395		▲9405HD
2005		
Mitsubishi Fuso 4M50 Diesel		
FE; FG		
Belt - Fan, Alt. & A.C. ME241670		▲K060480HD
Hose - Upper - Eng. To Rad.		≧20957
FH		
Belt - Fan, Alt. & A.C. ME241666		▲K060495HD
Hose - Upper - Eng. To Rad.		≧20957
Mitsubishi Fuso 6M60 Diesel		
FK; FM		
Belt - Fan & Alt. ME300899		TR22443
Belt - A.C. MPMF6395		▲9405HD

② Two Required.
● Vulco-Flex® Coolant Hose.

Belts and Coolant Hose for Medium/Heavy-Duty Trucks (1996 and Newer)

Medium & Heavy-Duty Trucks
(1996 & Newer)

Application	Mfr. Part No.	Our No.
MITSUBISHI FUSO - Continued		
2004-2003		
Mitsubishi Fuso 4D34 Diesel		
FE; FG		
Belt - Fan & Alt.	MH014094	♣9465HD
Belt - A.C.	MPMF6560	♣9570HD
Mitsubishi Fuso 4M50 Diesel		
FE		
Belt - Fan, Alt. & A.C.	ME241670	♣K060480HD
Hose - Upper - Eng. To Rad.		≈<20957
FH		
Belt - Fan, Alt. & A.C.	ME241666	♣K060495HD
Hose - Upper - Eng. To Rad.		≈<20611
Mitsubishi Fuso 6D16 Diesel		
FK; FM		
Belt - Fan & Alt.		ⓉTR22416
Belt - A.C.	MPMF6390	♣9400HD
Hose - Upper - Eng. To Rad.		≈<21379
2002-2001		
Mitsubishi Fuso 4D34 Diesel		
FE; FG		
Belt - Fan & Alt.	MH014094	♣9465HD
Belt - A.C.	MPMF6560	♣9570HD
Mitsubishi Fuso 4M50 Diesel		
FE		
Belt - W.P., Alt. & A.C.	ME241666	♣K060495HD
Hose - Upper - Eng. To Rad.		≈<20611
Mitsubishi Fuso 6D16 Diesel		
FK; FM		
Belt - Fan & Alt.		ⓉTR22416
Belt - A.C.	MPMF6390	♣9400HD
Hose - Upper - Eng. To Rad.		≈<21379
Mitsubishi Fuso 6D34 Diesel		
FH		
Belt - Fan & Alt.	MH014379	♣9476HD
Belt - A.C.	MPMF6580	7590
2000-1999		
Mitsubishi Fuso 4D34 Diesel		
FE; FG		
Belt - Fan & Alt.	MH014094	♣9465HD
Belt - A.C.	MPMF6560	♣9570HD
Mitsubishi Fuso 6D16 Diesel		
FK; FM		
Belt - Fan & Alt.		ⓉTR22416
Belt - A.C.	MPMF6390	♣9400HD
Hose - Upper - Eng. To Rad.		≈<21379
Mitsubishi Fuso 6D34 Diesel		
FH		
Belt - Fan & Alt.	MH014379	♣9476HD
Belt - A.C.	MPMF6580	7590
1998		
Mitsubishi Fuso 4D31 Diesel		
FE; FG		
Belt - Fan & Alt.	MH014386	♣9463HD
Belt - A.C.	MPMF6560	♣9570HD
Mitsubishi Fuso 4D34 Diesel		
FE; FG		
Belt - Fan & Alt.	MH014386	♣9463HD
Belt - A.C.	MPMF6560	♣9570HD
Mitsubishi Fuso 6D16 Diesel		
FK; FM		
Belt - Fan & Alt.; W/Dual Belts		♣9420HD
Belt - Fan & Alt.; W/Single Belt		TR22416
Belt - P.S.		9265

Application	Mfr. Part No.	Our No.
MITSUBISHI FUSO - Continued		
1998 - Continued		
Mitsubishi Fuso 6D34 Diesel		
FH		
Belt - Fan & Alt.	MH014379	♣9476HD
Belt - A.C.	MPMF6580	7590
1997		
Mitsubishi Fuso 4D31 Diesel		
FE		
Belt - Fan & Alt.		♣9463HD
Belt - A.C.	MPMF6560	♣9570HD
FG		
Belt - Fan & Alt.	MH014386	♣9463HD
Belt - A.C.	MPMF6560	♣9570HD
Mitsubishi Fuso 4D34 Diesel		
FE; FG		
Belt - Fan & Alt.	MH014386	♣9463HD
Belt - A.C.	MPMF6560	♣9570HD
Mitsubishi Fuso 6D16 Diesel		
FK		
Belt - Fan & Alt.; W/Dual Belts		♣9420HD
Belt - Fan & Alt.; W/Single Belt		TR22416
Belt - P.S.		9265
Mitsubishi Fuso 6D31 Diesel		
FH		
Belt - Fan & Alt.; Optional Belt		Ⓣ♣9476HD
Belt - Fan & Alt.; Preferred Belt	ME900206	2/9476PB
Belt - P.S.	ME900221	9270
Belt - A.C.; W/58 1/2" Belt O.C.		TR22588
Belt - A.C.; W/62 1/4" Belt O.C.	MPMF8600	TR22607
1996		
Mitsubishi Fuso 4D31 Diesel		
FE		
Belt - Fan & Alt.		♣9463HD
Mitsubishi Fuso 4D34 Diesel		
FE		
Belt - Fan & Alt.		♣9463HD
Mitsubishi Fuso 6D14 Diesel		
FK; FM		
Belt - Fan & Alt.; W/Dual Belts		♣9420HD
Belt - Fan & Alt.; W/Single Belt		TR22416
Belt - P.S.		9265
Mitsubishi Fuso 6D16 Diesel		
FK; FM		
Belt - Fan & Alt.; W/Dual Belts		♣9420HD
Belt - Fan & Alt.; W/Single Belt		TR22416
Belt - P.S.		9265
Mitsubishi Fuso 6D31 Diesel		
FH		
Belt - Fan & Alt.; Optional Belt		Ⓣ♣9476HD
Belt - Fan & Alt.; Preferred Belt	ME900206	2/9476PB
Belt - P.S.	ME900221	9270
Belt - A.C.; W/58 1/2" Belt O.C.		TR22588
Belt - A.C.; W/62 1/4" Belt O.C.	MPMF8600	TR22607
PETERBILT		
2013		
Paccar MX Diesel		
579		
Belt - Fan	D841002121640	K120645HD
Belt - Alt. & A.C.	D841002071939	K070762HD
2012		
Cummins ISX11.9 Diesel		
320		
Belt - Fan	D8410006102375	K100935HD

♣ Standard Belt Available. See Pages 630-631.
Ⓣ Two Required.

≈< Cut to Fit.

Belts and Coolant Hose for Medium/Heavy-Duty Trucks (1996 and Newer)

 Medium & Heavy-Duty Trucks
(1996 & Newer)

Application	Mfr. Part No.	Our No.
PETERBILT - Continued		
2012 - Continued		
Cummins ISX11.9 Diesel - Continued		
320 - Continued		
Belt - A.C.	D8410006061535	♣K060605HD
Tensioner Assy. - Fan	2871294	38622
Tensioner Assy. - A.C.	3104149	38610
Idler Pulley - A.C.	3682229	36223
365		
Belt - Alt.	D8410006061535	♣K060605HD
Tensioner Assy. - Alt.	3104149	38610
Tensioner Assy. - Fan & A.C.	2871294	38622
Idler Pulley - Alt.	3682229	36223
Hose - Upper		☞21891
Hose - Lower; (2 1/2" I.D.)		☞*24840
Cummins ISX15 Diesel		
386		
Belt - Fan & Alt.	D8410006122180	K120858HD
Belt - A.C.	D8410006061620	♣K060637HD
Tensioner Assy. - Fan & Alt.	3682946	38587
Tensioner Assy. - A.C.	3104149	38610
Idler Pulley - A.C.	3682229	36223
Hose - Upper - Eng. To Pipe		21891
Hose - Lower; (2 1/2" I.D.)		☞*24840
DEF Hose Assy. - Pressure - Tank To Pump	M50602274320500	DEF7002
DEF Hose Assy. - Return - Tank To Pump	M50602274110500	DEF7001
DEF Hose Assy. - Pump To Exhaust	M50602071230800	DEF7000
388		
Belt - Fan	D8410006122310	♣K120911HD
Belt - A.C.	D8410006061620	♣K060637HD
Tensioner Assy. - Fan	2871292	38587
Tensioner Assy. - A.C.	3104149	38610
Idler Pulley - A.C.	3682229	36223
389; 587		
Belt - Fan & Alt.	D8410006122180	K120858HD
Belt - A.C.	D8410006061620	♣K060637HD
Tensioner Assy. - Fan & Alt.	3682946	38587
Tensioner Assy. - A.C.	3104149	38610
Tensioner Pulley - Fan & Alt.	3682946	36165
Idler Pulley - A.C.	3682229	36223
Paccar MX Diesel		
384; 386; 587		
Belt - Fan	D841002121640	K120645HD
Belt - Alt. & A.C.	D841002071939	K070762HD
Paccar PX-6 Diesel		
337		
Belt - Fan	3289864	♣K080825HD
Hose - Upper - Eng. To Pipe; (1 3/4" I.D.)		☞*24828
Hose - Upper - Pipe To Rad.; (2 1/2" I.D.)		☞*24840
2011		
Caterpillar C13 Diesel		
365		
Belt - Alt.	D8410006062175	♣K060858HD
Belt - Fan & A.C.	D8410006102405	K100946HD
Idler Pulley - Alt.	2790251	36227
Hose - Lower - Eng. To Pipe		☞21891
Cummins ISM Diesel		
384		
Belt - Fan	D8410006081735	K080683HD
Belt - A.C.	4004824	♣K060539HD
Cummins ISX15 Diesel		
367		
Belt - Fan, W.P. & Alt.	D8410006122310	♣K120911HD
Belt - A.C. - From W.P.	D8410006061620	♣K060637HD
Tensioner Assy. - Fan, W.P. & Alt.	3682946	38587
Tensioner Assy. - A.C.	3104149	38610
Tensioner Pulley - Fan, W.P. & Alt.	3682946	36165
Idler Pulley - A.C.	3682229	36223

Application	Mfr. Part No.	Our No.
PETERBILT - Continued		
2011 - Continued		
Cummins ISX15 Diesel - Continued		
386; 388		
Belt - Fan & Alt.	D8410006122180	K120858HD
Belt - A.C.	D8410006061620	♣K060637HD
Tensioner Assy. - Fan & Alt.	3682946	38587
Tensioner Assy. - A.C.	3104149	38610
Idler Pulley - A.C.	3682229	36223
Hose - Upper - Eng. To Pipe		21891
Hose - Lower - Eng. To Pipe; (2 1/2" I.D.)		☞24240
Hose - Lower - Pipe To Rad.; (2 1/2" I.D.)		☞24240
389		
Belt - Fan & Alt.	D8410006122310	♣K120911HD
Belt - A.C.	D8410006061620	♣K060637HD
Tensioner Assy. - Fan & Alt.	2871292	38587
Tensioner Assy. - A.C.	3104149	38610
Tensioner Pulley - Fan & Alt.	2871292	36165
Idler Pulley - A.C.	3682229	36223
Hose - Upper - Eng. To Pipe		21891
Hose - Lower - Eng. To Pipe; (2 1/2" I.D.)		☞24240
Hose - Lower - Pipe To Rad.; (2 1/2" I.D.)		☞24240
587		
Belt - Fan & Alt.	D8410006122180	K120858HD
Belt - A.C.	D8410006061620	♣K060637HD
Tensioner Assy. - Fan & Alt.	3682946	38587
Tensioner Assy. - A.C.	3104149	38610
Tensioner Pulley - Fan & Alt.	3682946	36165
Idler Pulley - A.C.	3682229	36223
Hose - Upper - Eng. To Pipe		21891
Hose - Lower - Eng. To Pipe; (2 1/2" I.D.)		☞24240
Hose - Lower - Pipe To Rad.; (2 1/2" I.D.)		☞24240
Paccar MX Diesel		
365; 367		
Belt - Fan	D841002121640	K120645HD
Belt - A.C.	D841002071939	K070762HD
384; 386		
Belt - Fan	D841002121640	K120645HD
Belt - A.C.	D841002071939	K070762HD
388; 587		
Belt - Fan	D841002121640	K120645HD
Belt - A.C.	D841002071939	K070762HD
Paccar PX-6 Diesel		
330		
Belt - Fan	3289864	♣K080825HD
Hose - Upper - Rad. To Pipe; (2 1/2" I.D.)		☞*24840
Hose - Upper - Pipe To Eng.; (1 3/4" I.D.)		☞*24828
Hose - Lower; (2" I.D.)		☞*24832
337		
Belt - Fan	3289864	♣K080825HD
Hose - Upper - Eng. To Pipe; (1 3/4" I.D.)		☞*24828
Hose - Upper - Pipe To Rad.; (2 1/2" I.D.)		☞*24840
Paccar PX-8 Diesel		
337		
Belt - Fan	4933083	♣K080842HD
Tensioner Assy.	3973819	38627
Idler Pulley	3970945	36283
348		
Belt - Fan	4933083	♣K080842HD
Tensioner Assy.	3973819	38627
Idler Pulley	3970945	36283
Hose - Upper - Eng. To Pipe; (2 1/2" x 6")		*24840
Hose - Lower - Eng. To Pipe; (2 1/4" x 6")		*24836
Hose - Lower - Pipe To Rad.; (2 1/4" x 6")		*24836
2010		
Caterpillar C13 Diesel		
387		
Belt - Alt.	D8410006062175	♣K060858HD
Belt - Fan & A.C.	D8410006102405	K100946HD
Tensioner Assy. - Alt.	2756558	38635

♣ Standard Belt Available. See Pages 630-631.
* Durion® Silicone Hose Recommended.

☞ Cut to Fit.

Belts and Coolant Hose for Medium/Heavy-Duty Trucks (1996 and Newer)

Medium & Heavy-Duty Trucks
(1996 & Newer)

Application	Mfr. Part No.	Our No.
PETERBILT - Continued		
2010 - Continued		
Caterpillar C13 Diesel - Continued		
387 - Continued		
Tensioner Assy. - Fan & A.C.	2873203	38646
Idler Pulley - Alt. (Upper)	2790251	36227
Idler Pulley - Alt. (Lower)	2790251	36227
Hose - Upper - Eng. To Pipe; (2 1/2" I.D.)	24240	24240
Hose - Upper - Pipe To Rad.; (2 1/2" I.D.)	24240	24240
Hose - Lower - Eng. To Pipe	21891	21891
Hose - Lower - Pipe To Rad.	21891	21891
Cummins ISL Diesel		
320		
Belt - Fan	3972337	♣K080765HD
Tensioner Assy.	3973819	38627
Cummins ISL9 Diesel		
365		
Belt - Fan	D8410006060970	K060970
Tensioner Assy. - Fan	3973819	38627
Cummins ISM Diesel		
320		
Belt - Fan	D8410006081930	♣K080760HD
Belt - A.C.	4004824	♣K060539HD
Tensioner Assy. - Fan	2871294	38622
384		
Belt - Fan & Alt.	D8410006081735	K080683HD
Belt - A.C.	4004824	♣K060539HD
Tensioner Assy. - Fan & Alt.	4920105	38622
Tensioner Assy. - A.C.	3102888	38505
Idler Pulley - Fan & Alt.	3400884	36308
Cummins ISX15 Diesel		
367		
Belt - Fan, W.P. & Alt.	D8410006122215	♣K120872HD
Belt - A.C.	D8410006061620	♣K060637HD
Tensioner Assy. - Fan, W.P. & Alt.	3682946	38587
Tensioner Assy. - A.C.	3104149	38610
Tensioner Pulley - Fan, W.P. & Alt.	3682946	36165
Idler Pulley - A.C.	3682229	36223
Hose - Upper - Eng. To Pipe	21891	21891
Hose - Lower - Eng. To Pipe; (2 1/2" I.D.)	♣24240	♣24240
Hose - Lower - Pipe To Rad.; (2 1/2" I.D.)	♣24240	♣24240
386		
Belt - Fan & Alt.	D8410006122215	♣K120872HD
Belt - A.C.	D8410006061620	♣K060637HD
Tensioner Assy. - Fan & Alt.	2871292	38587
Tensioner Assy. - A.C.	3104149	38610
Tensioner Pulley - Fan & Alt.	3682946	36165
Idler Pulley - A.C.	3682229	36223
Hose - Upper - Eng. To Pipe	21891	21891
Hose - Lower - Eng. To Pipe; (2 1/2" I.D.)	♣24240	♣24240
Hose - Lower - Pipe To Rad.; (2 1/2" I.D.)	♣24240	♣24240
387		
Belt - Fan & Alt.	D8410006122215	♣K120872HD
Belt - A.C.	D8410006061620	♣K060637HD
Tensioner Assy. - Fan & Alt.	3682946	38587
Tensioner Assy. - A.C.	3104149	38610
Tensioner Pulley - Fan & Alt.	3682946	36165
Idler Pulley - A.C.	3682229	36223
Hose - Upper - Eng. To Pipe	21891	21891
Hose - Lower - Eng. To Pipe; (2 1/2" I.D.)	♣24240	♣24240
Hose - Lower - Pipe To Rad.; (2 1/2" I.D.)	♣24240	♣24240
388; 389		
Belt - Fan & Alt.	D8410006122310	♣K120911HD
Belt - A.C.	D8410003061620	♣K060637HD
Tensioner Assy. - Fan & Alt.	3682946	38587
Tensioner Assy. - A.C.	3104149	38610
Tensioner Pulley - Fan & Alt.	2871292	36165
Idler Pulley - A.C.	3682229	36223
Hose - Upper - Eng. To Pipe	21891	21891
Hose - Lower - Eng. To Pipe; (2 1/2" I.D.)	♣24240	♣24240
Hose - Lower - Pipe To Rad.; (2 1/2" I.D.)	♣24240	♣24240

Application	Mfr. Part No.	Our No.
PETERBILT - Continued		
2010 - Continued		
Paccar PX-6 Diesel		
330; 335		
Belt - Fan	4945003	♣K080926HD
Tensioner Assy.	5264111	38631
Hose - Upper - Eng. To Pipe; (2 1/2" I.D.)		♣24840
Hose - Upper - Pipe To Rad.; (2" I.D.)		♣24832
Hose - Lower - Eng. To Pipe; (2 1/2" I.D.)		♣24840
Hose - Lower - Pipe To Rad.; (1 3/4" I.D.)		♣24828
Paccar PX-8 Diesel		
335; 337; 340; 348		
Belt - Fan	4933083	♣K080842HD
Tensioner Assy.	3973819	38627
Idler Pulley	3970945	36283
Hose - Upper - Eng. To Pipe; (2 1/2" I.D.)		♣24840
Hose - Lower - Eng. To Pipe; (2 1/4" I.D.)		♣24836
Hose - Lower - Pipe To Rad.; (2 1/4" I.D.)		♣24836
2009		
Caterpillar C13 Diesel		
384		
Belt - Alt.	D8410006062175	♣K060858HD
Belt - Fan & A.C.	D8410006102405	K100946HD
Tensioner Assy. - Alt.	2756558	38635
Tensioner Assy. - Fan & A.C.	2873203	38646
386; 387		
Belt - Alt.	D8410006062175	♣K060858HD
Belt - Fan & A.C.	D8410006102405	K100946HD
Tensioner Assy. - Alt.	2756558	38635
Tensioner Assy. - Fan & A.C.	2873203	38646
Idler Pulley - Alt. (Upper)	2790251	36227
Idler Pulley - Alt. (Lower)	2790251	36227
Hose - Upper - Eng. To Pipe; (2 1/2" I.D.)		24240
Hose - Upper - Pipe To Rad.; (2 1/2" I.D.)		24240
Hose - Lower - Eng. To Pipe		21891
Hose - Lower - Pipe To Rad.		21891
Caterpillar C15 Diesel		
388; 389		
Belt - Fan To Alt.	D8410006061750	♣K060690HD
Belt - Fan & A.C.	D8410006122665	K121049HD
Tensioner Assy. - Alt.	2790253	38636
Tensioner Assy. - Fan & A.C.	2362301	38609
Idler Pulley - Fan (Lower)	2850277	36282
Cummins ISL Diesel		
320		
Belt - Fan	3972337	♣K080765HD
Tensioner Assy.	3973819	38627
Cummins ISM Diesel		
320		
Belt - Fan & Alt.		♣K080740HD
Belt - A.C.	4004824	♣K060539HD
Tensioner Assy. - Fan & Alt.	3400885	38521
Tensioner Assy. - A.C.	3102888	38505
Idler Pulley - Fan & Alt.	3400884	36308
Idler Pulley - A.C.	3104139	36225
Tensioner Pulley - A.C.	3102888	36091
384		
Belt - Fan & Alt.	D8410006081735	K080683HD
Belt - A.C.	4004824	♣K060539HD
Tensioner Assy. - Fan & Alt.	4920105	38622
Tensioner Assy. - A.C.	3102888	38505
Idler Pulley - Fan & Alt.	3400884	36308
Idler Pulley - A.C.	3102888	36308
Cummins ISX Diesel		
367		
Belt - Fan, W.P. & Alt.	D8410006122215	♣K120872HD
Belt - A.C. - From W.P.	D8410006061620	♣K060637HD
Tensioner Assy. - Fan, W.P. & Alt.	3682946	38587
Tensioner Assy. - A.C.	3104149	38610
Tensioner Pulley - Fan, W.P. & Alt.	3682946	36165
Idler Pulley - A.C.	3682229	36223
Hose - Upper - Eng. To Pipe	21891	21891
Hose - Lower - Eng. To Pipe; (2 1/2" I.D.)	♣24240	♣24240
Hose - Lower - Pipe To Rad.; (2 1/2" I.D.)	♣24240	♣24240

♣ Standard Belt Available. See Pages 630-631.
* Durion® Silicone Hose Recommended.

♣ Cut to Fit.

Belts and Coolant Hose for Medium/Heavy-Duty Trucks (1996 and Newer)

 Medium & Heavy-Duty Trucks
(1996 & Newer)

Application	Mfr. Part No.	Our No.
PETERBILT - Continued		
2009 - Continued		
Cummins ISX Diesel - Continued		
367 - Continued		
Hose - Upper - Eng. To Pipe		☞21891
Hose - Lower - Eng. To Pipe; (2 1/2" I.D.)		☞24440
Hose - Lower - Pipe To Rad.		☞21891
386		
Belt - Fan, W.P. & Alt.	D8410006122215	♣K120872HD
Belt - A.C. - From W.P.	D8410006061620	♣K060637HD
Tensioner Assy. - Fan, W.P. & Alt.	3682946	38587
Tensioner Assy. - A.C.	3104149	38610
Tensioner Pulley - Fan, W.P. & Alt.	3682946	36165
Idler Pulley - A.C.	3682229	36223
Hose - Upper - Eng. To Pipe		☞21891
Hose - Lower - Eng. To Pipe; (2 1/2" I.D.)		24240
Hose - Lower - Pipe To Rad.		☞21891
387		
Belt - Fan, W.P. & Alt.	D8410006122215	♣K120872HD
Belt - A.C. - From W.P.	D8410006061620	♣K060637HD
Tensioner Assy. - Fan, W.P. & Alt.	3682946	38587
Tensioner Assy. - A.C.	3104149	38610
Tensioner Pulley - Fan, W.P. & Alt.	3682946	36165
Idler Pulley - A.C.	3682229	36223
Hose - Upper - Eng. To Pipe		21891
Hose - Lower - Eng. To Pipe; (2 1/2" I.D.)		☞24240
Hose - Lower - Pipe To Rad.; (2 1/2" I.D.)		☞24240
388		
Belt - Fan & Alt.	D841000612310	K120910HD
Belt - Hub & A.C.	D8410003061620	♣K060637HD
Tensioner Assy. - Fan & Alt.	3682946	38587
Tensioner Assy. - Hub & A.C.	3104149	38610
Hose - Upper - Pipe To Rad.; (2 1/2" I.D.)		☞24240
Hose - Lower - Eng. To Pipe; (2 1/2" I.D.)		☞24240
Hose - Lower - Pipe To Rad.; (2 1/2" I.D.)		☞24240
389		
Belt - Fan & Alt.	D8410006122310	♣K120911HD
Belt - A.C.	D8410006061620	♣K060637HD
Tensioner Assy. - Fan & Alt.	3682946	38587
Tensioner Assy. - A.C.	3104149	38610
Tensioner Pulley - Fan & Alt.	3682946	36165
Idler Pulley - A.C.	3682229	36223
Hose - Upper - Eng. To Pipe		☞21891
Hose - Lower - Eng. To Pipe; (2 1/2" I.D.)		☞24840
Hose - Lower - Pipe To Rad.		☞21891
Paccar PX-6 Diesel		
330; 335		
Belt - Fan	4945003	♣K080926HD
Tensioner Assy.	5264111	38631
Hose - Upper - Eng. To Pipe; (2 1/2" I.D.)		☞24840
Hose - Upper - Pipe To Rad.; (2" I.D.)		☞24832
Hose - Lower - Eng. To Pipe; (2 1/2" I.D.)		☞24840
Hose - Lower - Pipe To Rad.; (1 3/4" I.D.)		☞24828
Paccar PX-8 Diesel		
335		
Belt - Fan	D8410007082365	K080931HD
Tensioner Assy.	3973819	38627
Idler Pulley	3970945	36283
Hose - Upper - Eng. To Pipe; (2 1/4" I.D.)		☞24836
Hose - Upper - Pipe To Rad.; (2 1/2" I.D.)		☞24840
Hose - Lower - Eng. To Pipe; (2 1/4" I.D.)		☞24836
Hose - Lower - Pipe To Rad.; (2 1/4" I.D.)		☞24836
340		
Belt - Fan, Alt. & A.C.	3972381	K080931HD
Tensioner Assy. - Fan, Alt. & A.C.	3973819	38627
Idler Pulley	3970945	36283
Hose - Upper - Eng. To Pipe; (2 1/4" I.D.)		24236
Hose - Upper - Pipe To Rad.; (2 1/2" I.D.)		24240
Hose - Lower - Eng. To Pipe; (2 1/4" I.D.)		24236
Hose - Lower - Pipe To Cooler; (2 1/4" I.D.)		24236
Hose - Lower - Cooler To Rad.		21194

☞ Cut to Fit.
* Durion® Silicone Hose Recommended.

Application	Mfr. Part No.	Our No.
PETERBILT - Continued		
2008		
Caterpillar C9 Diesel		
365		
Belt - Fan, A.C., Alt. & W.P.; W/95 1/8" Belt O.C.	D8410006102415	K100950HD
Belt - Fan, A.C., Alt. & W.P.; W/130A. Alt.	D8410006102565	K101010HD
Idler Pulley - Upper (Smooth)	2078118	36269
Idler Pulley - Lower (Smooth)	2078118	36269
384		
Idler Pulley - Smooth	2078118	36269
Caterpillar C13 Diesel		
365		
Belt - Alt.	D8410006062175	♣K060858HD
Belt - Fan & A.C.	D8410006102405	K100946HD
Tensioner Assy. - Alt.	2756558	38635
Tensioner Assy. - Fan & A.C.	2873203	38646
Hose - Upper - Eng. To Pipe; (2 1/2" I.D.)		24240
Hose - Upper - Pipe To Rad.; (2 1/2" I.D.)		24240
Hose - Lower - Eng. To Pipe		21891
Hose - Lower - Pipe To Rad.		21891
384		
Belt - Alt.	D8410006062175	♣K060858HD
Belt - Fan & A.C.	D8410006102405	K100946HD
Tensioner Assy. - Alt.	2756558	38635
Tensioner Assy. - Fan & A.C.	2873203	38646
386		
Belt - Alt.	D8410003062175	♣K060858HD
Belt - Fan & A.C.	D8410006102405	K100946HD
Tensioner Assy. - Alt.	2756558	38635
Tensioner Assy. - Fan & A.C.	2873203	38646
Idler Pulley - Alt. (Upper)	2790251	36227
Idler Pulley - Alt. (Lower)	2790251	36227
Hose - Upper - Eng. To Pipe		21891
Hose - Upper - Pipe To Rad.; (2 1/2" I.D.)		24240
Hose - Lower - Eng. To Pipe		21891
Hose - Lower - Pipe To Rad.		21891
388		
Belt - Alt.	D8410006062175	♣K060858HD
Belt - Fan & A.C.	D8410006102565	K101010HD
Caterpillar C15 Diesel		
367; 386		
Belt - Fan & Alt.	D8410006061870	K060736HD
Belt - Fan & A.C.	D8410006122490	K120980HD
Tensioner Assy. - Fan & Alt.	2790253	38636
Tensioner Assy. - Fan & A.C.	2362301	38609
Idler Pulley - A.C.; W/V-Groove Idler Pulley	2850277	36282
Hose - Upper - Eng. To Pipe		21891
Hose - Upper - Pipe To Rad.; (2 1/2" I.D.)		24240
Hose - Lower - Eng. To Pipe; (2 1/2" I.D.)		24240
Hose - Lower - Pipe To Rad.		21891
387		
Belt - Fan & Alt.	D8410006061870	K060736HD
Belt - Fan & A.C.	D8410006122490	K120980HD
Tensioner Assy. - Fan & Alt.	2790253	38636
Tensioner Assy. - Fan & A.C.	2362301	38609
Idler Pulley - Fan & A.C. (Grooved)	2850277	36282
Hose - Upper - Eng. To Pipe		21891
Hose - Upper - Rad. To Pipe; (2 1/2" I.D.)		24240
Hose - Lower - Eng. To Pipe; (2 1/2" I.D.)		24240
Hose - Lower - Rad. To Pipe		21891
388		
Belt - Fan & Alt.	D8410001082420	♣K080952HD
Belt - Fan To A.C.	D8410006061750	K060568HD
Tensioner Assy. - Fan & Alt.	2002279	38569
Tensioner Assy. - Fan To A.C.	2178938	38511
Tensioner Pulley - Fan To A.C.	2178938	36091
Idler Pulley - Grooved	1979642	36341
Idler Pulley - Smooth	1979641	36091
Hose - Upper - Eng. To Pipe; (2 1/2" I.D.)		24240

♣ Standard Belt Available. See Pages 630-631.

Belts and Coolant Hose for Medium/Heavy-Duty Trucks (1996 and Newer)

Medium & Heavy-Duty Trucks
(1996 & Newer)

Application	Mfr. Part No.	Our No.
PETERBILT - Continued		
2008 - Continued		
Caterpillar C15 Diesel - Continued		
388 - Continued		
Hose - Upper - Pipe To Rad.; (2 1/2" I.D.)		24240
Hose - Lower - Eng. To Pipe; (3" I.D.)		24248
Hose - Lower - Pipe To Pipe; (2 1/2" I.D.)		24240
Hose - Lower - Pipe To Rad.		21891
389		
Belt - Fan & Alt.	D8410006061750	▲K060690HD
Belt - Fan & A.C.	D8410006122665	K121049HD
Tensioner Assy. - Fan & Alt.	2790253	38636
Tensioner Assy. - Fan & A.C.	2362301	38609
Idler Pulley - A.C.; WV-Groove Idler		
Pulley	2850277	36282
Hose - Upper - Eng. To Pipe; (2 1/2" I.D.)		24240
Hose - Upper - Pipe To Rad.; (2 1/2" I.D.)		24240
Hose - Lower - Eng. To Pipe; (2 1/2" I.D.)		24240
Hose - Lower - Pipe To Rad.		21891
Cummins ISM Diesel		
320		
Belt - Fan & Alt.		▲K080740HD
Belt - A.C.	4004824	▲K060539HD
Tensioner Assy. - Fan & Alt.	3400885	38521
Tensioner Assy. - A.C.	3102888	38505
Tensioner Pulley - A.C.	3102888	36091
Idler Pulley - Fan & Alt.	3400884	36308
Idler Pulley - A.C.	3104139	36225
365		
Belt - Fan & Alt.	D8410006081735	K080683HD
Belt - A.C.	4004824	▲K060539HD
Tensioner Assy. - Fan & Alt.	4920105	38622
Tensioner Assy. - A.C.	3102888	38505
Idler Pulley - Fan & Alt.	3400884	36308
Idler Pulley - A.C.	3104139	36225
384; 386; 388		
Idler Pulley - Fan & Alt.	3400884	36308
Cummins ISX Diesel		
367		
Belt - Fan & Alt.		▲K120872HD
Belt - Hub & A.C.	D11085527	▲K060637HD
Tensioner Assy. - Fan & Alt.	3682946	38587
Tensioner Assy. - Hub & A.C.	3682683	38610
Tensioner Pulley - Fan & Alt.	3682946	36165
Idler Pulley - A.C.	3682229	36223
Hose - Upper - Eng. To Pipe		≡<21891
Hose - Lower - Eng. To Pipe; (2 1/2" I.D.)		≡<24240
Hose - Lower - Pipe To Rad.; (2 1/2" I.D.)		≡<24240
386		
Belt - Fan & Alt.	D8410006122215	▲K120872HD
Belt - A.C.	D8410006061620	▲K060637HD
Tensioner Assy. - Fan & Alt.	3682946	38587
Tensioner Assy. - A.C.	3682683	38610
Tensioner Pulley - Fan & Alt.	3682946	36165
Idler Pulley - A.C.	3682229	36223
Hose - Upper - Eng. To Pipe		21891
Hose - Upper - Pipe To Rad.; (2 1/2" I.D.)		24240
Hose - Lower - Eng. To Pipe; (2 1/2" I.D.)		24240
Hose - Lower - Pipe To Rad.; (2 1/2" I.D.)		24240
387		
Belt - Fan & Alt.	D8410006122215	▲K120872HD
Belt - A.C.	D8410006061620	▲K060637HD
Tensioner Assy. - Fan & Alt.	3682946	38587
Tensioner Assy. - A.C.	3104149	38610
Tensioner Pulley - Fan & Alt.	3682946	36165
Idler Pulley - A.C.	3682229	36223
Hose - Upper - Eng. To Pipe		21891
Hose - Upper - Pipe To Rad.; (2 1/2" I.D.)		≡<24240
Hose - Lower - Eng. To Pipe; (2 1/2" I.D.)		≡<24240
Hose - Lower - Pipe To Rad.; (2 1/2" I.D.)		≡<24240
388		
Belt - Fan & Alt.	D8410006122310	▲K120911HD

Application	Mfr. Part No.	Our No.
PETERBILT - Continued		
2008 - Continued		
Cummins ISX Diesel - Continued		
388 - Continued		
Belt - A.C.	D8410006061620	▲K060637HD
Tensioner Assy. - Fan & Alt.	3682946	38587
Tensioner Assy. - A.C.	3104149	38610
Idler Pulley - A.C.	3682229	36223
389		
Belt - Fan & Alt.	D8410006122310	▲K120911HD
Belt - A.C.	D8410006061620	▲K060637HD
Tensioner Assy. - Fan & Alt.	3682946	38587
Tensioner Assy. - A.C.	3682683	38610
Tensioner Pulley - Fan & Alt.	3682946	36165
Idler Pulley - A.C.	3682229	36223
Hose - Upper - Eng. To Pipe		21891
Hose - Upper - Pipe To Rad.; (2 1/2" I.D.)		24240
Hose - Lower - Eng. To Pipe; (2 1/2" I.D.)		24240
Hose - Lower - Pipe To Rad.		21891
Paccar PX-6 Diesel		
330; 335		
Belt - Fan	4945003	▲K080926HD
Tensioner Assy.	5264111	38631
Hose - Upper - Eng. To Pipe; (2 1/2" I.D.)		≡<24840
Hose - Upper - Pipe To Rad.; (2" I.D.)		≡<24832
Hose - Lower - Eng. To Pipe; (2 1/2" I.D.)		≡<24840
Hose - Lower - Pipe To Rad.; (1 3/4" I.D.)		≡<24828
Paccar PX-8 Diesel		
335; 340		
Belt - Fan, Alt. & A.C.	3972381	K080931HD
Tensioner Assy. - Fan, Alt. & A.C.	3973819	38627
Idler Pulley	3970945	36283
Hose - Upper - Eng. To Pipe; (2 1/4" I.D.)		24236
Hose - Upper - Pipe To Rad.; (2 1/2" I.D.)		24240
Hose - Lower - Eng. To Pipe; (2 1/4" I.D.)		24236
Hose - Lower - Pipe To Cooler; (2 1/4" I.D.)		24236
Hose - Lower - Cooler To Rad.		21194
2007		
Caterpillar C7 Diesel		
320		
Idler Pulley - Upper	1979641	36091
Idler Pulley - Lower	2534525	36096
330		
Belt - Fan, A.C., Alt. & W.P.	D8410001082175	▲K080859HD
Tensioner Assy. - Fan, A.C., Alt. & W.P.	2222880	38586
Idler Pulley - Upper	1979641	36091
Idler Pulley - Lower	2534525	36096
Hose - Upper - Eng. To Pipe; (2" I.D.)		24232
Hose - Upper - Pipe To Rad.; (2 1/4" I.D.)		24236
Hose - Lower - Pipe To Rad.; (2 1/4" I.D.)		24236
335		
Belt - Fan, A.C., Alt. & W.P.	D8410001082175	▲K080859HD
Tensioner Assy. - Fan, A.C., Alt. & W.P.	2222880	38586
Idler Pulley - Upper	1979641	36091
Idler Pulley - Lower	2534525	36096
340		
Belt - Fan, A.C., Alt. & W.P.	D8410001082175	▲K080859HD
Tensioner Assy. - Fan, A.C., Alt. & W.P.	2222880	38586
Idler Pulley - Upper	1979641	36091
Idler Pulley - Lower	2534525	36096
Hose - Upper - Eng. To Pipe; (2" I.D.)		24232
Hose - Upper - Pipe To Rad.		20397
Hose - Lower - Pipe To Rad.; (2 1/4" I.D.)		24236
Caterpillar C11 Diesel		
357		
Belt - Fan, Alt. & A.C.	D11085891	▲K081020HD
Tensioner Assy. - Fan, Alt. & A.C.	2117895	38590
Tensioner Pulley - Fan, Alt. & A.C.	2117895	36164
Idler Pulley - Grooved	1979642	36341
Idler Pulley - Smooth	2078118	36269

▲ Standard Belt Available. See Pages 630-631.
* Durion® Silicone Hose Recommended.

≡< Cut to Fit.

Belts and Coolant Hose for Medium/Heavy-Duty Trucks (1996 and Newer)

 Medium & Heavy-Duty Trucks
(1996 & Newer)

Application	Mfr. Part No.	Our No.
PETERBILT - Continued		
2007 - Continued		
Caterpillar C11 Diesel - Continued		
357 - Continued		
Hose - Upper - Eng. To Pipe; (2 1/2" I.D.)		24240
Hose - Upper - Pipe To Rad.; (2 1/2" I.D.)		24240
Hose - Lower - Eng. To Pipe; (2 1/2" I.D.)		24240
Hose - Lower - Pipe To Rad.; (2 3/4" I.D.)		24244
378		
Belt - Fan, Alt. & A.C.	D11085891	▲K081020HD
Tensioner Assy. - Fan, Alt. & A.C.	2117895	38590
Tensioner Pulley - Fan, Alt. & A.C.	2117895	36164
Idler Pulley - Grooved	1979642	36341
Idler Pulley - Smooth	2078118	36269
385		
Idler Pulley - Grooved	1979642	36341
Idler Pulley - Smooth	2078118	36269
Caterpillar C13 Diesel		
357		
Belt - Fan, Alt. & A.C.	D11085891	▲K081020HD
Tensioner Assy. - Fan, Alt. & A.C.	2117895	38590
Tensioner Pulley - Fan, Alt. & A.C.	2117895	36164
Idler Pulley - Grooved	1979642	36341
Idler Pulley - Smooth	2078118	36269
Hose - Upper - Eng. To Pipe; (2 1/2" I.D.)		24240
Hose - Upper - Pipe To Rad.; (2 1/2" I.D.)		24240
Hose - Lower - Eng. To Pipe; (2 1/2" I.D.)		24240
Hose - Lower - Pipe To Rad.; (2 3/4" I.D.)		24244
378		
Belt - Fan, Alt. & A.C.	D8410003082560	▲K081005HD
Tensioner Assy. - Fan, Alt. & A.C.	2117895	38590
Tensioner Pulley - Fan, Alt. & A.C.	2117895	36164
Idler Pulley - Grooved	1979642	36341
Idler Pulley - Smooth	2078118	36269
379		
Belt - Fan, Alt., P.S. & A.C.	D8410006082600	▲K081023HD
Tensioner Assy. - Fan, Alt., P.S. & A.C.	2117895	38590
Tensioner Pulley - Fan, Alt., P.S. & A.C.	2117895	36164
Idler Pulley - Grooved	1979642	36341
Idler Pulley - Smooth	2078118	36269
385; 386		
Belt - Fan, Alt. & A.C.	4080957RPDYC	▲K080956HD
Tensioner Assy. - Fan, Alt. & A.C.	2117895	38590
Tensioner Pulley - Fan, Alt. & A.C.	2117895	36164
Idler Pulley - Grooved	1979642	36341
Idler Pulley - Smooth	2078118	36269
Caterpillar C15 Diesel		
357; 378		
Belt - Fan & Alt.	D8410003122640	▲K121039HD
Belt - Fan To A.C.	D8410003061310	▲K060516HD
Tensioner Assy. - Fan & Alt.	2362301	38609
Tensioner Assy. - Fan To A.C.	2178938	38511
Tensioner Pulley - Fan To A.C.	2178938	36091
Idler Pulley - Grooved	1979642	36341
Idler Pulley - Smooth	1979641	36091
Hose - Upper - Eng. To Pipe; (2 1/2" I.D.)		24240
Hose - Upper - Pipe To Rad.; (2 1/2" I.D.)		24240
Hose - Lower - Eng. To Pipe; (3" I.D.)		24248
Hose - Lower - Pipe To Pipe; (3" I.D.)		24248
Hose - Lower - Pipe To Rad.; (3" I.D.)		24248
379		
Belt - Fan & Alt.; W/8-Ribbed Belt	D8410001082520	▲K080991HD
Belt - Fan & Alt.; W/12-Ribbed Belt	D8410003122640	▲K121039HD
Belt - Fan To A.C.; W/52" Belt O.C.	D8410003061310	▲K060516HD
Belt - Fan To A.C.; W/53" Belt O.C.	D8410003061340	▲K060525HD
Tensioner Assy. - Fan & Alt.; W/8-Ribbed Belt	2002279	38569
Tensioner Assy. - Fan & Alt.; W/12-Ribbed Belt	2362301	38609
Tensioner Assy. - Fan To A.C.	2178938	38511
Tensioner Pulley - Fan To A.C.	2178938	36091
Idler Pulley - Grooved	1979642	36341

▲ Standard Belt Available. See Pages 630-631.

Application	Mfr. Part No.	Our No.
PETERBILT - Continued		
2007 - Continued		
Caterpillar C15 Diesel - Continued		
379 - Continued		
Idler Pulley - Smooth	1979641	36091
Hose - Upper - Eng. To Pipe; (2 1/2" I.D.)		24240
Hose - Upper - Pipe To Rad.; (2 1/2" I.D.)		24240
Hose - Lower - Eng. To Pipe; (3" I.D.)		24248
Hose - Lower - Pipe To Pipe; (3" I.D.)		24248
Hose - Lower - Pipe To Rad.; (3" I.D.)		24248
386		
Belt - Fan & Alt.	D8410003122500	K120985HD
Belt - A.C.	D11085664	K060568HD
Tensioner Assy. - Fan & Alt.	2362301	38609
Tensioner Assy. - A.C.	2178938	38511
Idler Pulley - Grooved	1979642	36341
Idler Pulley - Smooth	1979641	36091
Hose - Upper - Eng. To Pipe; (2 1/2" I.D.)		24240
Hose - Upper - Pipe To Rad.; (2 1/2" I.D.)		24240
Hose - Lower - Eng. To Pipe; (3" I.D.)		24248
Hose - Lower - Pipe To Rad.; (3" I.D.)		24248
387; 388		
Belt - Fan & Alt.	D8410001082420	▲K080952HD
Belt - Fan To A.C.	D8410003061440	K060568HD
Tensioner Assy. - Fan & Alt.	2002279	38569
Tensioner Assy. - Fan To A.C.	2178938	38511
Tensioner Pulley - Fan To A.C.	2178938	36091
Idler Pulley - Grooved	1979642	36341
Idler Pulley - Smooth	1979641	36091
Hose - Upper - Eng. To Rad.; (2 1/2" I.D.)		24240
Hose - Upper - Rad. To Pipe; (2 1/2" I.D.)		24240
Hose - Lower - Eng. To Pipe; (3" I.D.)		24248
Hose - Lower - Pipe To Pipe; (2 1/2" I.D.)		24240
Hose - Lower - Pipe To Rad.		21891
Cummins ISC Diesel		
320; 330		
Idler Pulley	3970945	36283
335		
Belt - Fan, Alt. & Hub	3972261	▲K080760HD
Belt - Fan To A.C.	D11023329	▲9390HD
Tensioner Assy. - Fan, Alt. & Hub	3936213	38516
Tensioner Pulley - Fan, Alt. & Hub	3936213	36093
Idler Pulley	3970945	36283
Hose - Upper - Eng. To Pipe		20748
Hose - Upper - Pipe To Rad.		≡21194
Hose - Lower - Eng. To Pipe		20748
Hose - Lower - Pipe To Rad.; (2 1/4" I.D.)		24236
Hose - Lower - Cooler To Pipe; (2 1/4" I.D.)		24236
357		
Idler Pulley	3970945	36283
Cummins ISM Diesel		
320		
Belt - Fan & Alt.		▲K080740HD
Belt - A.C.	4004824	▲K060539HD
Tensioner Assy. - Fan & Alt.	3400885	38521
Tensioner Assy. - A.C.	3102888	38505
Tensioner Pulley - A.C.	3102888	36091
Idler Pulley - Fan & Alt.	3400884	36308
Idler Pulley - A.C.	3104139	36225
357		
Belt - Fan & Alt.	D11084816	▲K080730HD
Belt - Hub & A.C.	4004824	▲K060539HD
Tensioner Assy. - Fan & Alt.	4920105	38622
Tensioner Assy. - Hub & A.C.	3102888	38505
Tensioner Pulley - Hub & A.C.	3102888	36091
Idler Pulley - Fan & Alt.	3400884	36308
Idler Pulley - A.C.	3104139	36225
Hose - Upper - Eng. To Pipe; (2 1/2" I.D.)		24240
Hose - Upper - Pipe To Rad.; (2 1/2" I.D.)		24240
Hose - Lower - Eng. To Pipe; (2 1/2" I.D.)		24240
Hose - Lower - Pipe To Rad.; (2 1/2" I.D.)		24240

≡ Cut to Fit.

Belts and Coolant Hose for Medium/Heavy-Duty Trucks [1996 and Newer]

Medium & Heavy-Duty Trucks
(1996 & Newer)

Application	Mfr. Part No.	Our No.
PETERBILT - Continued		
2007 - Continued		
Cummins ISM Diesel - Continued		
365		
Belt - Fan & Alt.	D11084816	▲K080730HD
Belt - Hub & A.C.	4004824	▲K060539HD
Tensioner Assy. - Fan & Alt.	4920105	38622
Tensioner Assy. - Hub & A.C.	3102888	38505
Tensioner Pulley - Hub & A.C.	3102888	36091
Idler Pulley - Fan & Alt.	3400884	36308
Idler Pulley - A.C.	3104139	36225
Hose - Upper - Eng. To Pipe; (2 1/2" I.D.)		24240
Hose - Upper - Pipe To Rad.; (2 1/2" I.D.)		24240
Hose - Lower - Eng. To Pipe; (2 1/2" I.D.)		24240
Hose - Lower - Pipe To Rad.		21891
378		
Belt - Fan & Alt.	D11084816	▲K080730HD
Belt - Hub & A.C.	4004824	▲K060539HD
Tensioner Assy. - Fan & Alt.	4920105	38622
Tensioner Assy. - Hub & A.C.	3102888	38505
Tensioner Pulley - Hub & A.C.	3102888	36091
Idler Pulley - Fan & Alt.	3400884	36308
Idler Pulley - A.C.	3104139	36225
Hose - Upper - Eng. To Pipe; (2 1/2" I.D.)		24240
Hose - Upper - Pipe To Rad.; (2 1/2" I.D.)		24240
Hose - Lower - Eng. To Pipe; (2 1/2" I.D.)		24240
Hose - Lower - Pipe To Rad.; (2 1/2" I.D.)		24240
379		
Idler Pulley - Fan & Alt.	3400884	36308
385		
Belt - Fan & Alt.		▲K080774HD
Belt - Hub & A.C.	4004824	▲K060539HD
Tensioner Assy. - Fan & Alt.	3400885	38521
Tensioner Assy. - Hub & A.C.	3102888	38505
Idler Pulley - Fan & Alt.	3400884	36308
Cummins ISX Diesel		
367		
Belt - Fan & Alt.		▲K120872HD
Belt - A.C.	D11085527	▲K060637HD
Tensioner Assy. - Fan & Alt.	3682946	38587
Tensioner Assy. - A.C.	3682683	38610
Tensioner Pulley - Fan & Alt.	3682946	36165
Idler Pulley - A.C.	3682229	36223
Hose - Upper - Eng. To Pipe		21891
Hose - Upper - Pipe To Rad.; (2 1/2" I.D.)		24240
Hose - Lower - Eng. To Pipe; (2 1/2" I.D.)		24240
Hose - Lower - Pipe To Rad.; (2 1/2" I.D.)		24240
378; 379		
Belt - Fan & Alt.; W/130A. Alt.	D8410001122295	▲K120903HD
Belt - Fan & Alt.; W/135A. Alt.	D11085234	▲K120891HD
Belt - Hub & A.C.	D8410003061620	▲K060637HD
Tensioner Assy. - Fan & Alt.	3682946	38587
Tensioner Assy. - Hub & A.C.	3682683	38610
Tensioner Pulley - Fan & Alt.	3682946	36165
Idler Pulley - A.C.	3682229	36223
Hose - Upper - Eng. To Pipe		24240
Hose - Upper - Pipe To Rad.; (2 1/2" I.D.)		24240
Hose - Lower - Eng. To Pipe; (2 1/2" I.D.)		24240
Hose - Lower - Pipe To Rad.; (2 1/2" I.D.)		24248
386		
Belt - Fan & Alt.	D8410006122215	▲K120872HD
Belt - Hub & A.C.	D8410006061620	▲K060637HD
Tensioner Assy. - Fan & Alt.	3682946	38587
Tensioner Assy. - Hub & A.C.	3682683	38610
Tensioner Pulley - Fan & Alt.	3682946	36165
Idler Pulley - A.C.	3682229	36223
Hose - Upper - Rad. To Pipe; (2 1/2" I.D.)		24240
Hose - Upper - Pipe To Eng.		21891
Hose - Lower - Rad. To Pipe; (2 1/2" I.D.)		24240
Hose - Lower - Pipe To Eng.; (2 1/2" I.D.)		24240
387		
Belt - Fan & Alt.	D8410006122215	▲K120872HD

Application	Mfr. Part No.	Our No.
PETERBILT - Continued		
2007 - Continued		
Cummins ISX Diesel - Continued		
387 - Continued		
Belt - Hub & A.C.	D8410003061620	▲K060637HD
Tensioner Assy. - Fan & Alt.	3682946	38587
Tensioner Assy. - Hub & A.C.	3104149	38610
Tensioner Pulley - Fan & Alt.	3682946	36165
Idler Pulley - A.C.	3682229	36223
Hose - Upper - Rad. To Pipe; (2 1/2" I.D.)		≈24240
Hose - Upper - Pipe To Eng.		21891
Hose - Lower - Rad. To Pipe; (2 1/2" I.D.)		≈24240
Hose - Lower - Pipe To Eng.; (2 1/2" I.D.)		≈24240
Paccar PX-8 Diesel		
340		
Idler Pulley	3970945	36283
2006		
Caterpillar C7 Diesel		
320		
Belt - Fan	D8410001082175	▲K080859HD
Tensioner Assy.	2222880	38586
Tensioner Pulley	2222880	36091
Idler Pulley - Upper	1979641	36091
Idler Pulley - Lower	2534525	36096
Hose - Upper - Rad. To Pipe; (2 1/2" I.D.)		≈24240
Hose - Upper - Pipe To Eng.; (2" I.D.)		≈24232
Hose - Lower - Rad. To Pipe; (3" I.D.)		≈24248
Hose - Lower - Pipe To Eng.; (2 1/2" I.D.)		≈24240
335		
Belt - Fan, A.C., Alt. & W.P.	D8410001082175	▲K080859HD
Tensioner Assy. - Fan, A.C., Alt. & W.P.	2222880	38586
Idler Pulley - Upper	1979641	36091
Idler Pulley - Lower	2534525	36096
Hose - Upper - Eng. To Pipe; (2" I.D.)		24232
Hose - Upper - Pipe To Rad.		20397
Hose - Lower - Pipe To Rad.; (2 1/4" I.D.)		24236
Caterpillar C11 Diesel		
357		
Belt - Fan, Alt. & A.C.	D11085891	▲K081020HD
Tensioner Assy. - Fan, Alt. & A.C.	2117895	38590
Tensioner Pulley - Fan, Alt. & A.C.	2117895	36164
Idler Pulley - Grooved	1979642	36341
Idler Pulley - Smooth	2078118	36269
Hose - Upper - Eng. To Pipe; (2 1/2" I.D.)		24240
Hose - Upper - Pipe To Rad.; (2 1/2" I.D.)		24240
Hose - Lower - Eng. To Pipe		21891
Hose - Lower - Pipe To Pipe; (3" I.D.)		24248
Hose - Lower - Pipe To Rad.; (3" I.D.)		24248
378		
Belt - Fan, Alt. & A.C.	D11085891	▲K081020HD
Tensioner Assy. - Fan, Alt. & A.C.	2117895	38590
Tensioner Pulley - Fan, Alt. & A.C.	2117895	36164
Idler Pulley - Grooved	1979642	36341
Idler Pulley - Smooth	2078118	36269
379		
Belt - Fan, Alt. & A.C.	D11086873	▲K081023HD
Tensioner Assy. - Fan, Alt. & A.C.	2117895	38590
Tensioner Pulley - Fan, Alt. & A.C.	2117895	36164
Idler Pulley - Grooved	1979642	36341
Idler Pulley - Smooth	2078118	36269
Hose - Upper - Eng. To Pipe; (2 1/2" I.D.)		24240
Hose - Upper - Pipe To Rad.; (2 1/2" I.D.)		24240
Hose - Lower - Eng. To Pipe; (2 1/2" I.D.)		24240
Hose - Lower - Pipe To Rad.; (2 3/4" I.D.)		24244
385; 387		
Idler Pulley - Grooved	1979642	36341
Idler Pulley - Smooth	2078118	36269
Caterpillar C13 Diesel		
357		
Belt - Fan, Alt. & A.C.	D11085891	▲K081020HD

▲ Standard Belt Available. See Pages 630-631.

≈ Cut to Fit.

Belts and Coolant Hose for Medium/Heavy-Duty Trucks (1996 and Newer)

 Medium & Heavy-Duty Trucks
(1996 & Newer)

Application	Mfr. Part No.	Our No.
PETERBILT - Continued		
2006 - Continued		
Caterpillar C13 Diesel - Continued		
357 - Continued		
Tensioner Assy. - Fan, Alt. & A.C.	2117895	38590
Tensioner Pulley - Fan, Alt. & A.C.	2117895	36164
Idler Pulley - Grooved	1979642	36341
Idler Pulley - Smooth	2078118	36269
Hose - Upper - Eng. To Pipe; (2 1/2" I.D.)		24240
Hose - Upper - Pipe To Rad.; (2 1/2" I.D.)		24240
Hose - Lower - Eng. To Pipe; (2 1/2" I.D.)		24240
Hose - Lower - Pipe To Rad.; (2 3/4" I.D.)		24244
378		
Idler Pulley - Grooved	1979642	36341
Idler Pulley - Smooth	2078118	36269
379		
Belt - Fan, Alt. & A.C.	D11086873	♣K081023HD
Tensioner Assy. - Fan, Alt. & A.C.	2117895	38590
Tensioner Pulley - Fan, Alt. & A.C.	2117895	36164
Idler Pulley - Grooved	1979642	36341
Idler Pulley - Smooth	2078118	36269
Hose - Upper - Eng. To Pipe; (2 1/2" I.D.)		24240
Hose - Upper - Pipe To Rad.; (2 1/2" I.D.)		24240
Hose - Lower - Eng. To Pipe; (2 1/2" I.D.)		24240
Hose - Lower - Pipe To Rad.; (2 3/4" I.D.)		24244
385		
Belt - Fan, Alt. & A.C.	D11085891	♣K081020HD
Tensioner Assy. - Fan, Alt. & A.C.	2117895	38590
Tensioner Pulley - Fan, Alt. & A.C.	2117895	36164
Idler Pulley - Grooved	1979642	36341
Idler Pulley - Smooth	2078118	36269
Hose - Upper - Eng. To Pipe; (2 1/2" I.D.)		24240
Hose - Upper - Pipe To Rad.; (2 1/2" I.D.)		24240
Hose - Lower - Eng. To Pipe; (2 1/2" I.D.)		24240
Hose - Lower - Pipe To Pipe; (2 3/4" I.D.)		24244
Hose - Lower - Pipe To Rad.; (2 3/4" I.D.)		24244
387		
Belt - Alt.		♣K060935HD
Belt - Fan & A.C.	D8410001082335	♣K080922HD
Idler Pulley - Grooved	1979642	36341
Idler Pulley - Smooth	2078118	36269
Hose - Upper - Eng. To Pipe		21891
Hose - Upper - Pipe To Rad.; (2 1/2" I.D.)		24240
Hose - Lower - Eng. To Pipe; (2 1/2" I.D.)		24240
Hose - Lower - Pipe To Rad.		21891
Caterpillar C15 Diesel		
357		
Belt - Fan & Alt.; W/8-Ribbed Belt	D8410001082520	♣K080991HD
Belt - Fan & Alt.; W/12-Ribbed Belt	D8410003122640	♣K121039HD
Belt - Fan To A.C.; W/52" Belt O.C.	D8410003061310	♣K060516HD
Belt - Fan To A.C.; W/53" Belt O.C.	D8410003061340	♣K060525HD
Tensioner Assy. - Fan & Alt.; W/8-Ribbed Belt	2002279	38569
Tensioner Assy. - Fan & Alt.; W/12-Ribbed Belt	2362301	38609
Tensioner Assy. - Fan To A.C.	2178938	38511
Tensioner Pulley - Fan To A.C.	2178938	36091
Idler Pulley - Grooved	1979642	36341
Idler Pulley - Smooth	1979641	36091
Hose - Upper - Eng. To Pipe; (2 1/2" I.D.)		24240
Hose - Upper - Pipe To Rad.; (2 1/2" I.D.)		24240
Hose - Lower - Eng. To Pipe; (3" I.D.)		24248
Hose - Lower - Pipe To Rad.; (3" I.D.)		24248
Hose - Lower - Pipe To Pipe; (3" I.D.)		24248
378; 379		
Belt - Fan & Alt.; W/8-Ribbed Belt	D8410001082520	♣K080991HD
Belt - Fan & Alt.; W/12-Ribbed Belt	D8410003122640	♣K121039HD
Belt - Fan To A.C.; W/52" Belt O.C.	D8410003061310	♣K060516HD
Belt - Fan To A.C.; W/53" Belt O.C.	D8410003061340	♣K060525HD
Tensioner Assy. - Fan & Alt.; W/8-Ribbed Belt	2002279	38569
Tensioner Assy. - Fan & Alt.; W/12-Ribbed Belt	2362301	38609

♣ Standard Belt Available. See Pages 630-631.

Application	Mfr. Part No.	Our No.
PETERBILT - Continued		
2006 - Continued		
Caterpillar C15 Diesel - Continued		
378; 379 - Continued		
Tensioner Assy. - Fan To A.C.	2178938	38511
Tensioner Pulley - Fan To A.C.	2178938	36091
Idler Pulley - Grooved	1979642	36341
Idler Pulley - Smooth	1979641	36091
Hose - Upper - Eng. To Pipe; (2 1/2" I.D.)		24240
Hose - Upper - Pipe To Rad.; (2 1/2" I.D.)		24240
Hose - Lower - Eng. To Pipe; (3" I.D.)		24248
Hose - Lower - Pipe To Pipe; (3" I.D.)		24248
Hose - Lower - Pipe To Rad.; (3" I.D.)		24248
386		
Belt - Fan & Alt.	D8410003122500	K120985HD
Belt - Fan To A.C.	D11085664	K060568HD
Tensioner Assy. - Fan & Alt.	2362301	38609
Tensioner Assy. - Fan To A.C.	2178938	38511
Idler Pulley - Grooved	1979642	36341
Idler Pulley - Smooth	1979641	36091
Hose - Upper - Eng. To Pipe; (2 1/2" I.D.)		24240
Hose - Upper - Pipe To Rad.; (2 1/2" I.D.)		24240
Hose - Lower - Eng. To Pipe; (3" I.D.)		24248
Hose - Lower - Pipe To Rad.; (3" I.D.)		24248
387		
Belt - Fan & Alt.	D8410001082420	♣K080952HD
Belt - Fan To A.C.	D11085664	K060568HD
Tensioner Assy. - Fan & Alt.	2002279	38569
Tensioner Assy. - Fan To A.C.	2178938	38511
Tensioner Pulley - Fan To A.C.	2178938	36091
Idler Pulley - Grooved	1979642	36341
Idler Pulley - Smooth	1979641	36091
Hose - Upper - Eng. To Pipe; (2 1/2" I.D.)		24240
Hose - Upper - Pipe To Rad.; (2 1/2" I.D.)		24240
Hose - Lower - Eng. To Pipe; (3" I.D.)		24248
Hose - Lower - Pipe To Pipe; (2 1/2" I.D.)		24240
Hose - Lower - Pipe To Rad.		21891
Cummins ISC Diesel		
320		
Idler Pulley	3970945	36283
335		
Belt - Fan, Alt. & Hub	3972261	♣K080760HD
Belt - Fan To A.C.	D11023329	♣9390HD
Tensioner Assy. - Fan, Alt. & Hub	3936213	38516
Tensioner Pulley - Fan, Alt. & Hub	3936213	36093
Idler Pulley	3970945	36283
Hose - Upper - Eng. To Pipe		20748
Hose - Upper - Pipe To Rad.		♣21194
Hose - Lower - Eng. To Pipe		20748
Hose - Lower - Pipe To Rad.; (2 1/4" I.D.)		24236
Hose - Lower - Cooler To Pipe; (2 1/4" I.D.)		24236
357		
Idler Pulley	3970945	36283
Cummins ISM Diesel		
320		
Belt - Fan & Alt.	D84100003081880	♣K080740HD
Belt - A.C.	4060537	K060535
Tensioner Assy. - Fan & Alt.	3400885	38521
Tensioner Assy. - A.C.	3102888	38505
Tensioner Pulley - A.C.	3102888	36091
Idler Pulley - Fan & Alt.	3400884	36308
Idler Pulley - A.C.	3104139	36225
357; 378		
Belt - Fan & Alt.	D11084816	♣K080730HD
Belt - Hub & A.C.	4004824	♣K060539HD
Tensioner Assy. - Fan & Alt.	4920105	38622
Tensioner Assy. - Hub & A.C.	3102888	38505
Tensioner Pulley - Hub & A.C.	3102888	36091
Idler Pulley - Fan & Alt.	3400884	36308
Idler Pulley - A.C.	3104139	36225
357; 378		
Belt - Fan & Alt.	D11084816	♣K080730HD
Belt - Hub & A.C.	4004824	♣K060539HD
Tensioner Assy. - Fan & Alt.	4920105	38622
Tensioner Assy. - Hub & A.C.	3102888	38505
Tensioner Pulley - Hub & A.C.	3102888	36091
Idler Pulley - Fan & Alt.	3400884	36308
Idler Pulley - A.C.	3104139	36225
Hose - Upper - Eng. To Pipe; (2 1/2" I.D.)		24240
Hose - Upper - Pipe To Rad.; (2 1/2" I.D.)		24240

≧ Cut to Fit.

Belts and Coolant Hose for Medium/Heavy-Duty Trucks (1996 and Newer)

Medium & Heavy-Duty Trucks
(1996 & Newer)

Application	Mfr. Part No.	Our No.
PETERBILT - Continued		
2006 - Continued		
Cummins ISM Diesel - Continued		
357; 378 - Continued		
Hose - Lower - Eng. To Pipe; (2 1/2" I.D.)		24240
Hose - Lower - Pipe To Rad.; (2 1/2" I.D.)		24240
379; 385		
Idler Pulley - Fan & Alt.	3400884	36308
Cummins ISX Diesel		
357		
Belt - Fan & Alt.	D8410001122215	♣K120872HD
Belt - Hub & A.C.	D8410003061620	♣K060637HD
Tensioner Assy. - Fan & Alt.	3682946	38587
Tensioner Assy. - Hub & A.C.	3682683	38610
Tensioner Pulley - Fan & Alt.	3682946	36165
Idler Pulley - A.C.	3682229	36223
Hose - Upper - Eng. To Pipe		21891
Hose - Upper - Pipe To Rad.; (2 1/2" I.D.)		24240
Hose - Lower - Eng. To Pipe; (2 1/2" I.D.)		24240
Hose - Lower - Pipe To Rad.		21891
378; 379		
Belt - Fan & Alt.; W/130A. Alt.	D8410001122295	♣K120903HD
Belt - Fan & Alt.; W/135A. Alt.	D11085234	♣K120891HD
Belt - Hub & A.C.	D8410003061620	♣K060637HD
Tensioner Assy. - Fan & Alt.	3682946	38587
Tensioner Assy. - Hub & A.C.	3682683	38610
Tensioner Pulley - Fan & Alt.	3682946	36165
Idler Pulley - A.C.	3682229	36223
Hose - Upper - Eng. To Pipe; (2 1/2" I.D.)		24240
Hose - Upper - Pipe To Rad.; (2 1/2" I.D.)		24240
Hose - Lower - Eng. To Pipe; (2 1/2" I.D.)		24240
Hose - Lower - Pipe To Rad.; (3" I.D.)		24248
387		
Belt - Fan & Alt.	D8410001122215	♣K120872HD
Belt - Hub & A.C.	D8410003061620	♣K060637HD
Tensioner Assy. - Fan & Alt.	3682946	38587
Tensioner Assy. - Hub & A.C.	3682683	38610
Tensioner Pulley - Fan & Alt.	3682946	36165
Idler Pulley - A.C.	3682229	36223
Hose - Upper - Eng. To Pipe; (2 1/2" I.D.)		24240
Hose - Upper - Pipe To Rad.; (2 1/2" I.D.)		24240
Hose - Lower - Eng. To Pipe; (2 1/2" I.D.)		24240
Hose - Lower - Pipe To Rad.; (2 1/2" I.D.)		24240
2005		
Caterpillar C7 Diesel		
320		
Belt - Fan	D8410001082175	♣K080859HD
Tensioner Assy.	2222880	38586
Tensioner Pulley	2222880	36091
Idler Pulley - Upper	1979641	36091
Idler Pulley - Lower	2534525	36096
Hose - Upper - Eng. To Pipe; (2" I.D.)		≡24232
Hose - Upper - Pipe To Rad.; (2 1/2" I.D.)		≡24240
Hose - Lower - Eng. To Pipe; (2 1/2" I.D.)		≡24240
Hose - Lower - Pipe To Rad.; (3" I.D.)		≡24248
330		
Belt - Fan, A.C., Alt. & W.P.	D8410001082175	♣K080859HD
Tensioner Assy. - Fan, A.C., Alt. & W.P.	2222880	38586
Idler Pulley - Upper	1979641	36091
Idler Pulley - Lower	2534525	36096
Hose - Upper - Eng. To Pipe; (2" I.D.)		24232
Hose - Upper - Pipe To Rad.		20397
Hose - Lower - Pipe To Rad.; (2 1/4" I.D.)		24236
335		
Belt - Fan, A.C., Alt. & W.P.	D8410001082175	♣K080859HD
Tensioner Assy. - Fan, A.C., Alt. & W.P.	2222880	38586
Idler Pulley - Upper	1979641	36091
Idler Pulley - Lower	2534525	36096
Hose - Upper - Eng. To Pipe; (2 1/4" I.D.)		≡24236
Hose - Upper - Pipe To Rad.		20397
Hose - Lower - Pipe To Rad.; (2 1/4" I.D.)		24236

Application	Mfr. Part No.	Our No.
PETERBILT - Continued		
2005 - Continued		
Caterpillar C11 Diesel		
357; 362; 378		
Belt - Fan, Alt. & A.C.	D11086873	♣K081023HD
Tensioner Assy. - Fan, Alt. & A.C.	2117895	38590
Tensioner Pulley - Fan, Alt. & A.C.	2117895	36164
Idler Pulley - Grooved	1979642	36341
Idler Pulley - Smooth	2078118	36269
379		
Belt - Fan, Alt. & A.C.	D11086873	♣K081023HD
Tensioner Assy. - Fan, Alt. & A.C.	2117895	38590
Tensioner Pulley - Fan, Alt. & A.C.	2117895	36164
Idler Pulley - Grooved	1979642	36341
Idler Pulley - Smooth	2078118	36269
Hose - Upper - Eng. To Pipe; (2 1/2" I.D.)		24240
Hose - Upper - Pipe To Rad.; (2 1/2" I.D.)		24240
Hose - Lower - Eng. To Pipe; (2 1/2" I.D.)		24240
Hose - Lower - Pipe To Rad.; (2 3/4" I.D.)		24244
385		
Idler Pulley - Grooved	1979642	36341
Idler Pulley - Smooth	2078118	36269
Caterpillar C13 Diesel		
357		
Belt - Fan, Alt. & A.C.	D8410003082590	♣K081020HD
Tensioner Assy. - Fan, Alt. & A.C.	2117895	38590
Tensioner Pulley - Fan, Alt. & A.C.	2117895	36164
Idler Pulley - Grooved	1979642	36341
Idler Pulley - Smooth	2078118	36269
Hose - Upper - Eng. To Pipe; (2 1/2" I.D.)		24240
Hose - Upper - Pipe To Rad.; (2 1/2" I.D.)		24240
Hose - Lower - Eng. To Pipe; (2 1/2" I.D.)		24240
Hose - Lower - Pipe To Rad.; (2 3/4" I.D.)		24244
378; 379		
Belt - Fan, Alt. & A.C.	D11086873	♣K081023HD
Tensioner Assy. - Fan, Alt. & A.C.	2117895	38590
Tensioner Pulley - Fan, Alt. & A.C.	2117895	36164
Idler Pulley - Grooved	1979642	36341
Idler Pulley - Smooth	2078118	36269
Hose - Upper - Eng. To Pipe; (2 1/2" I.D.)		24240
Hose - Upper - Pipe To Rad.; (2 1/2" I.D.)		24240
Hose - Lower - Eng. To Pipe; (2 1/2" I.D.)		24240
Hose - Lower - Pipe To Rad.; (2 3/4" I.D.)		24244
385		
Belt - Fan, Alt. & A.C.	D11085891	♣K081020HD
Tensioner Assy. - Fan, Alt. & A.C.	2117895	38590
Tensioner Pulley - Fan, Alt. & A.C.	2117895	36164
Idler Pulley - Grooved	1979642	36341
Idler Pulley - Smooth	2078118	36269
Hose - Upper - Eng. To Pipe; (2 1/2" I.D.)		24240
Hose - Upper - Pipe To Rad.; (2 1/2" I.D.)		24240
Hose - Lower - Eng. To Pipe; (2 1/2" I.D.)		24240
Hose - Lower - Pipe To Rad.; (2 3/4" I.D.)		24244
387		
Belt - Fan, Alt. & A.C.	D11084918	♣K080968HD
Tensioner Assy. - Fan, Alt. & A.C.	2117895	38590
Tensioner Pulley - Fan, Alt. & A.C.	2117895	36164
Idler Pulley - Grooved	1979642	36341
Idler Pulley - Smooth	2078118	36269
Hose - Upper - Eng. To Pipe; (2 1/2" I.D.)		24240
Hose - Upper - Pipe To Rad.; (2 1/2" I.D.)		24240
Hose - Lower - Eng. To Pipe; (2 1/2" I.D.)		24240
Hose - Lower - Pipe To Pipe; (2 3/4" I.D.)		24244
Hose - Lower - Pipe To Rad.; (2 3/4" I.D.)		24244
Caterpillar C15 Diesel		
357; 378		
Belt - Fan & Alt.	D11085222	♣K121039HD
Belt - Fan To A.C.	D11085658	♣K060516HD
Tensioner Assy. - Fan & Alt.	2002279	38569
Tensioner Assy. - Fan To A.C.	2178938	38511
Tensioner Pulley - Fan To A.C.	2178938	36091

♣ Standard Belt Available. See Pages 630-631.

≡ Cut to Fit.

Belts and Coolant Hose for Medium/Heavy-Duty Trucks (1996 and Newer)

 Medium & Heavy-Duty Trucks
(1996 & Newer)

Application	Mfr. Part No.	Our No.
PETERBILT - Continued		
2005 - Continued		
Caterpillar C15 Diesel - Continued		
357; 378 - Continued		
Idler Pulley - Grooved	1979642	36341
Idler Pulley - Smooth	1979641	36091
Hose - Upper - Eng. To Pipe; (2 1/2" I.D.)		24240
Hose - Upper - Pipe To Rad.; (2 1/2" I.D.)		24240
Hose - Lower - Eng. To Pipe; (3" I.D.)		24248
Hose - Lower - Pipe To Pipe; (3" I.D.)		24248
Hose - Lower - Pipe To Rad.; (3" I.D.)		24248
379		
Belt - Fan & Alt.; W/8-Ribbed Belt	D8410001082520	♣K080991HD
Belt - Fan & Alt.; W/12-Ribbed Belt	D8410003122640	♣K121039HD
Belt - Fan To A.C.; W/52" Belt O.C.	D8410003061310	♣K060516HD
Belt - Fan To A.C.; W/53" Belt O.C.	D8410003061340	♣K060525HD
Tensioner Assy. - Fan & Alt.; W/8-Ribbed Belt	2002279	38569
Tensioner Assy. - Fan & Alt.; W/12-Ribbed Belt	2362301	38609
Tensioner Assy. - Fan To A.C.	2178938	38511
Tensioner Pulley - Fan To A.C.	2178938	36091
Idler Pulley - Grooved	1979642	36341
Idler Pulley - Smooth	1979641	36091
Hose - Upper - Eng. To Pipe; (2 1/2" I.D.)		24240
Hose - Upper - Pipe To Rad.; (2 1/2" I.D.)		24240
Hose - Lower - Eng. To Pipe; (3" I.D.)		24248
Hose - Lower - Pipe To Pipe; (3" I.D.)		24248
Hose - Lower - Pipe To Rad.; (3" I.D.)		24248
387		
Belt - Fan & Alt.	D8410001082420	♣K080952HD
Belt - Fan To A.C.	D8410003061440	K060568HD
Tensioner Assy. - Fan & Alt.	2002279	38569
Tensioner Assy. - Fan To A.C.	2178938	38511
Tensioner Pulley - Fan To A.C.	2178938	36091
Idler Pulley - Grooved	1979642	36341
Idler Pulley - Smooth	1979641	36091
Hose - Upper - Eng. To Pipe; (2 1/2" I.D.)		24240
Hose - Upper - Pipe To Rad.; (2 1/2" I.D.)		24240
Hose - Lower - Eng. To Pipe; (3" I.D.)		24248
Hose - Lower - Pipe To Pipe; (3" I.D.)		24248
Hose - Lower - Pipe To Rad.; (3" I.D.)		24248
Cummins ISC Diesel		
320		
Belt - Fan	3289503	♣K080726HD
Belt - A.C.	17395	♣9395HD
Tensioner Assy. - Fan	3937553	38504
330		
Belt - Fan, Alt. & Hub	3944838	♣K080755HD
Belt - Fan To A.C.	D11023329	♣9390HD
Tensioner Assy. - Fan, Alt. & Hub	3945527	38516
Tensioner Pulley - Fan, Alt. & Hub	3945527	36093
Hose - Upper - Eng. To Pipe		21135
Hose - Upper - Pipe To Rad.		♣21115
Hose - Lower - Pipe To Rad.; (2 1/4" I.D.)		24236
335		
Belt - Fan, Alt. & Hub	3289659	♣K080760HD
Belt - Fan To A.C.	D11023329	♣9390HD
Tensioner Assy. - Fan, Alt. & Hub	3936213	38516
Tensioner Pulley - Fan, Alt. & Hub	3936213	36093
Idler Pulley	3970945	36283
Hose - Upper - Eng. To Pipe		20748
Hose - Upper - Pipe To Rad.		♣21194
Hose - Lower - Eng. To Pipe		20748
Hose - Lower - Pipe To Rad.; (2 1/4" I.D.)		24236
Hose - Lower - Cooler To Pipe; (2 1/4" I.D.)		24236
Cummins ISL Diesel		
357		
Tensioner Assy. - Alt.	3976831	38516
Cummins ISM Diesel		
357		
Belt - Fan & Alt.	D8410001081650	♣K080649HD

♣ Standard Belt Available. See Pages 630-631.

Application	Mfr. Part No.	Our No.
PETERBILT - Continued		
2005 - Continued		
Cummins ISM Diesel - Continued		
357 - Continued		
Belt - Hub & A.C.	4004824	♣K060539HD
Tensioner Assy. - Fan & Alt.	4920105	38622
Tensioner Assy. - Hub & A.C.	4004933	38505
Tensioner Pulley - Hub & A.C.	4004933	36091
Idler Pulley - Fan & Alt.	3400884	36308
Hose - Upper - Eng. To Pipe; (2 1/4" I.D.)		24236
Hose - Upper - Pipe To Rad.; (2 1/2" I.D.)		24240
Hose - Lower - Eng. To Pipe; (2 1/2" I.D.)		24240
Hose - Lower - Pipe To Cooler		21042
Hose - Lower - Cooler To Rad.		21042
Hose - Lower - Rad. To Cooler		21042
378		
Belt - Fan & Alt.	D11084816	♣K080730HD
Belt - Hub & A.C.	4004824	♣K060539HD
Tensioner Assy. - Fan & Alt.	4920105	38622
Tensioner Assy. - Hub & A.C.	3102888	38505
Tensioner Pulley - Hub & A.C.	3102888	36091
Idler Pulley - Fan & Alt.	3400884	36308
Idler Pulley - A.C.	3104139	36225
Hose - Upper - Eng. To Pipe; (2 1/2" I.D.)		24240
Hose - Upper - Pipe To Rad.; (2 1/2" I.D.)		24240
Hose - Lower - Eng. To Pipe; (2 1/2" I.D.)		24240
Hose - Lower - Pipe To Rad.; (2 1/2" I.D.)		24240
385		
Belt - Fan & Alt.		♣K080774HD
Belt - Hub & A.C.	4004824	♣K060539HD
Tensioner Assy. - Fan & Alt.	4920105	38622
Tensioner Assy. - Hub & A.C.		38505
Tensioner Pulley - Hub & A.C.	4004933	36091
Idler Pulley - Fan & Alt.	3400884	36308
Hose - Upper - Eng. To Pipe; (2 1/4" I.D.)		24236
Hose - Upper - Pipe To Rad.; (2 1/2" I.D.)		24240
Hose - Lower - Eng. To Pipe; (2 1/2" I.D.)		24240
Hose - Lower - Pipe To Rad.; (2 1/2" I.D.)		24240
Hose - Lower - Rad. To Cooler		21042
Hose - Lower - Pipe To Cooler		21042
Cummins ISX Diesel		
378		
Belt - Fan & Alt.; W/130A. Alt.	D8410001122295	♣K120903HD
Belt - Fan & Alt.; W/135A. Alt.	D11085234	♣K120891HD
Belt - Hub & A.C.	D8410003061620	♣K060637HD
Tensioner Assy. - Fan & Alt.	3682946	38587
Tensioner Assy. - Hub & A.C.	3682683	38610
Tensioner Pulley - Fan & Alt.	3682946	36165
Idler Pulley - A.C.	3682229	36223
Hose - Upper - Eng. To Pipe; (2 1/2" I.D.)		24240
Hose - Upper - Pipe To Rad.; (2 1/2" I.D.)		24240
Hose - Lower - Eng. To Pipe; (2 1/2" I.D.)		24240
Hose - Lower - Pipe To Rad.; (3" I.D.)		24248
379		
Belt - Fan & Alt.; W/130A. Alt.	D8410001122295	♣K120903HD
Belt - Fan & Alt.; W/135A. Alt.	D11085234	♣K120891HD
Belt - Hub & A.C.	D8410003061620	♣K060637HD
Tensioner Assy. - Fan & Alt.	3682946	38587
Tensioner Assy. - Hub & A.C.	3682683	38610
Tensioner Pulley - Fan & Alt.	3682946	36165
Idler Pulley - A.C.	3682229	36223
Hose - Upper - Eng. To Pipe; (2 1/2" I.D.)		24240
Hose - Upper - Pipe To Rad.; (2 1/2" I.D.)		24240
Hose - Lower - Eng. To Pipe; (2 1/2" I.D.)		24240
Hose - Lower - Pipe To Rad.; (2 1/2" I.D.)		24240
387		
Belt - Fan & Alt.	D8410001122215	♣K120872HD
Belt - Hub & A.C.	D8410003061620	♣K060637HD
Tensioner Assy. - Fan & Alt.	3682946	38587
Tensioner Assy. - Hub & A.C.	3682683	38610
Tensioner Pulley - Fan & Alt.	3682946	36165
Idler Pulley - A.C.	3682229	36223
Hose - Upper - Eng. To Pipe; (2 1/2" I.D.)		24240

♣ Cut to Fit.

Belts and Coolant Hose for Medium/Heavy-Duty Trucks (1996 and Newer)

Medium & Heavy-Duty Trucks
(1996 & Newer)

Application	Mfr. Part No.	Our No.
PETERBILT - Continued		
2005 - Continued		
Cummins ISX Diesel - Continued		
387 - Continued		
Hose - Upper - Pipe To Rad.; (2 1/2" I.D.)		24240
Hose - Lower - Eng. To Pipe; (2 1/2" I.D.)		24240
Hose - Lower - Pipe To Rad.; (2 1/2" I.D.)		24240
2004		
Caterpillar C7 Diesel		
320		
Belt - Fan	D8410001082175	♣K080859HD
Tensioner Assy.	2222880	38586
Tensioner Pulley	2222880	36091
Idler Pulley - Upper	1979641	36091
Idler Pulley - Lower	2534525	36096
Hose - Upper - Eng. To Pipe; (2" I.D.)		♣24232
Hose - Upper - Pipe To Rad.; (2 1/2" I.D.)		♣24240
Hose - Lower - Eng. To Pipe; (2 1/2" I.D.)		♣24240
Hose - Lower - Pipe To Rad.; (3" I.D.)		♣24248
330		
Belt - Fan, A.C., Alt. & W.P.	D8410001082175	♣K080859HD
Tensioner Assy. - Fan, A.C., Alt. & W.P.	2222880	38586
Idler Pulley - Upper	1979641	36091
Idler Pulley - Lower	2534525	36096
Hose - Upper - Eng. To Pipe; (2 1/4" I.D.)		♣24236
Hose - Upper - Pipe To Rad.		20397
Hose - Lower - Pipe To Rad.; (2 1/4" I.D.)		24236
Caterpillar C9 Diesel		
357		
Belt - Fan, Alt. & A.C.	D8410001082040	♣K080806HD
Hose - Upper - Eng. To Pipe; (2" I.D.)		24232
Hose - Upper - Pipe To Rad.; (2 1/2" I.D.)		24240
Hose - Lower - Eng. To Pipe; (2 1/2" I.D.)		24240
Hose - Lower - Pipe To Rad.		21891
Caterpillar C10 Diesel		
357; 378; 379		
Belt - Fan & Alt.	4080740	♣K080740HD
Belt - Fan To A.C.	17461	♣9463HD
Tensioner Assy. - Fan & Alt.	1333545	38506
Tensioner Pulley - Fan & Alt.	1333545	36091
Hose - Upper - Eng. To Pipe; (2 1/2" I.D.)		24240
Hose - Upper - Pipe To Rad.; (2 1/2" I.D.)		24240
Hose - Lower - Eng. To Pipe; (2 1/2" I.D.)		24240
Hose - Lower - Pipe To Rad.; (3" I.D.)		24248
385		
Belt - Fan & Alt.	D1102118337	♣K080726HD
Belt - Fan To A.C.	17461	♣9463HD
Tensioner Assy. - Fan & Alt.	1333545	38506
Tensioner Pulley - Fan & Alt.	1333545	36091
Hose - Upper - Eng. To Pipe; (2 1/2" I.D.)		24240
Hose - Upper - Pipe To Rad.; (2 1/2" I.D.)		24240
Hose - Lower - Eng. To Pipe; (2 1/2" I.D.)		24240
Hose - Lower - Pipe To Rad.; (3" I.D.)		24248
Caterpillar C11 Diesel		
378		
Idler Pulley - Grooved	1979642	36341
Idler Pulley - Smooth	2078118	36269
Caterpillar C12 Diesel		
357; 378; 379		
Belt - Fan & Alt.	4080740	♣K080740HD
Belt - Fan To A.C.	17461	♣9463HD
Tensioner Assy. - Fan & Alt.	1333545	38506
Tensioner Pulley - Fan & Alt.	1333545	36091
Hose - Upper - Eng. To Pipe; (2 1/2" I.D.)		24240
Hose - Upper - Pipe To Rad.; (2 1/2" I.D.)		24240
Hose - Lower - Eng. To Pipe; (2 1/2" I.D.)		24240
Hose - Lower - Pipe To Rad.; (3" I.D.)		24248
385		
Belt - Fan & Alt.	D1102118337	♣K080726HD
Belt - Fan To A.C.	17461	♣9463HD

Application	Mfr. Part No.	Our No.
PETERBILT - Continued		
2004 - Continued		
Caterpillar C12 Diesel - Continued		
385 - Continued		
Tensioner Assy. - Fan & Alt.	1333545	38506
Tensioner Pulley - Fan & Alt.	1333545	36091
Hose - Upper - Eng. To Pipe; (2 1/2" I.D.)		24240
Hose - Upper - Pipe To Rad.; (2 1/2" I.D.)		24240
Hose - Lower - Eng. To Pipe; (2 1/2" I.D.)		24240
Hose - Lower - Pipe To Rad.; (3" I.D.)		24248
Caterpillar C13 Diesel		
379		
Belt - Fan, Alt. & A.C.	D11086873	♣K081023HD
Tensioner Assy. - Fan, Alt. & A.C.	2117895	38590
Tensioner Pulley - Fan, Alt. & A.C.	2117895	36164
Idler Pulley - Grooved	1979642	36341
Idler Pulley - Smooth	2078118	36269
Hose - Upper - Eng. To Pipe; (2 1/2" I.D.)		24240
Hose - Upper - Pipe To Rad.; (2 1/2" I.D.)		24240
Hose - Lower - Eng. To Pipe; (2 1/2" I.D.)		24240
Hose - Lower - Pipe To Rad.; (2 3/4" I.D.)		24244
387		
Belt - Fan, Alt. & A.C.	D11084918	♣K080968HD
Tensioner Assy. - Fan, Alt. & A.C.	2117895	38590
Tensioner Pulley - Fan, Alt. & A.C.	2117895	36164
Idler Pulley - Grooved	1979642	36341
Idler Pulley - Smooth	2078118	36269
Hose - Upper - Eng. To Pipe; (2 1/2" I.D.)		24240
Hose - Upper - Pipe To Rad.		21891
Hose - Lower - Eng. To Pipe; (2 1/2" I.D.)		24240
Hose - Lower - Pipe To Pipe; (2 1/2" I.D.)		24240
Hose - Lower - Pipe To Rad.		21891
Caterpillar C15 Diesel		
357		
Belt - Fan & Alt.	D11085222	♣K121039HD
Belt - Fan To A.C.	D11085658	♣K060516HD
Tensioner Assy. - Fan & Alt.	2002279	38569
Tensioner Assy. - Fan To A.C.	2178938	38511
Tensioner Pulley - Fan To A.C.	2178938	36091
Idler Pulley - Grooved	1979642	36341
Idler Pulley - Smooth	1979641	36091
Hose - Upper - Eng. To Pipe; (2 1/2" I.D.)		24240
Hose - Upper - Pipe To Rad.; (2 1/2" I.D.)		24240
Hose - Lower - Eng. To Pipe; (3" I.D.)		24248
Hose - Lower - Pipe To Pipe; (3" I.D.)		24248
Hose - Lower - Pipe To Rad.; (3" I.D.)		24248
378		
Belt - Fan & Alt.; W/Clean Air Pkg.	D8410001082520	♣K080991HD
Belt - Fan; W/O Clean Air Pkg.	D11024799	TR22553
Belt - Fan To Alt. & A.C.; W/O Clean Air Pkg.		②♣9590HD
Belt - Fan To A.C.; W/Clean Air Pkg.	D8410003061340	♣K060525HD
Tensioner Assy. - Fan & Alt.; W/Clean Air Pkg.	2002279	38569
Tensioner Assy. - Fan To A.C.; W/Clean Air Pkg.	2178938	38511
Tensioner Pulley - Fan To A.C.; W/Clean Air Pkg.	2178938	36091
Idler Pulley - Grooved	1979642	36341
Idler Pulley - Smooth	1979641	36091
Hose - Upper - Eng. To Pipe; (2 1/2" I.D.)		24240
Hose - Upper - Pipe To Rad.; (2 1/2" I.D.)		24240
Hose - Lower - Eng. To Pipe; (3" I.D.)		24248
Hose - Lower - Pipe To Rad.; (3" I.D.)		24248
379		
Belt - Fan & Alt.; W/Clean Air Pkg.	D8410001082520	♣K080991HD
Belt - Fan; W/O Clean Air Pkg.		②TR22545
Belt - Fan To Alt. & A.C.; W/O Clean Air Pkg.		②♣9590HD
Belt - Fan To A.C.; W/Clean Air Pkg.	D8410003061340	♣K060525HD
Tensioner Assy. - Fan & Alt.; W/Clean Air Pkg.	2002279	38569
Tensioner Assy. - Fan To A.C.; W/Clean Air Pkg.	2178938	38511

♣ Standard Belt Available. See Pages 630-631.
② Two Required.

♣ Cut to Fit.

Belts and Coolant Hose for Medium/Heavy-Duty Trucks (1996 and Newer)

 Medium & Heavy-Duty Trucks
(1996 & Newer)

Application	Mfr. Part No.	Our No.
PETERBILT - Continued		
2004 - Continued		
Caterpillar C15 Diesel - Continued		
379 - Continued		
Tensioner Pulley - Fan To A.C.:		
W/Clean Air Pkg.	2178938	36091
Idler Pulley - Grooved	1979642	36341
Idler Pulley - Smooth	1979641	36091
Hose - Upper - Eng. To Pipe; (2 1/2" I.D.)		24240
Hose - Upper - Pipe To Rad.; (2 1/2" I.D.)		24240
Hose - Lower - Eng. To Pipe; (3" I.D.)		24248
Hose - Lower - Pipe To Rad.; (3" I.D.)		24248
387		
Belt - Fan & Alt.; W/91" Belt O.C.	D8410001082290	♣K080903HD
Belt - Fan & Alt.; W/96" Belt O.C.	D8410001082420	♣K080952HD
Belt - Fan To A.C.	D11026302	♣K060560HD
Tensioner Assy. - Fan & Alt.	2002279	38569
Tensioner Assy. - Fan To A.C.	2178938	38511
Tensioner Pulley - Fan To A.C.	2178938	36091
Idler Pulley - Grooved	1979642	36341
Idler Pulley - Smooth	1979641	36091
Hose - Upper - Eng. To Pipe; (2 1/2" I.D.)		24240
Hose - Upper - Pipe To Rad.; (2 1/2" I.D.)		24240
Hose - Lower - Eng. To Pipe; (3" I.D.)		24248
Hose - Lower - Pipe To Pipe; (2 1/2" I.D.)		24240
Hose - Lower - Pipe To Rad.		21891
Cummins ISC Diesel		
330		
Belt - Fan, Alt. & Hub	3944838	♣K080755HD
Belt - Fan To A.C.		♣9390HD
Tensioner Assy. - Fan, Alt. & Hub	3945527	38516
Tensioner Pulley - Fan, Alt. & Hub	3945527	36093
Hose - Upper - Eng. To Pipe		21135
Hose - Upper - Pipe To Rad.		♣21115
Hose - Lower - Pipe To Rad.; (2 1/4" I.D.)		24236
Cummins ISM Diesel		
357		
Belt - Fan & Alt.	D8410001081650	♣K080649HD
Belt - Hub & A.C.	4004824	♣K060539HD
Tensioner Assy. - Fan & Alt.	3400885	38521
Tensioner Assy. - Hub & A.C.	4004933	38505
Tensioner Pulley - Hub & A.C.	4004933	36091
Idler Pulley - Fan & Alt.	3400884	36308
Hose - Upper - Eng. To Pipe; (2 1/4" I.D.)		24236
Hose - Upper - Pipe To Rad.; (2 1/2" I.D.)		24240
Hose - Lower - Eng. To Pipe; (2 1/2" I.D.)		24240
Hose - Lower - Pipe To Rad.		21042
378		
Belt - Fan & Alt.	D11084816	♣K080730HD
Belt - Hub & A.C.	4004824	♣K060539HD
Tensioner Assy. - Fan & Alt.	4920105	38622
Tensioner Assy. - Hub & A.C.	3102888	38505
Tensioner Pulley - Hub & A.C.	3102888	36091
Idler Pulley - Fan & Alt.	3400884	36308
Idler Pulley - A.C.	3104139	36225
Hose - Upper - Eng. To Pipe; (2 1/2" I.D.)		24240
Hose - Upper - Pipe To Rad.; (2 1/2" I.D.)		24240
Hose - Lower - Eng. To Pipe; (2 1/2" I.D.)		24240
Hose - Lower - Pipe To Rad.; (2 1/2" I.D.)		24240
385		
Belt - Fan & Alt.		♣K080774HD
Belt - Hub & A.C.	4004824	♣K060539HD
Tensioner Assy. - Fan & Alt.	3400885	38521
Tensioner Assy. - Hub & A.C.		38505
Tensioner Pulley - Hub & A.C.	4004933	36091
Idler Pulley - Fan & Alt.	3400884	36308
Hose - Upper - Eng. To Pipe; (2 1/4" I.D.)		24236
Hose - Upper - Pipe To Rad.; (2 1/2" I.D.)		24240
Hose - Lower - Eng. To Pipe; (2 1/2" I.D.)		24240
Hose - Lower - Pipe To Rad.; (2 1/2" I.D.)		24240

♣ Standard Belt Available. See Pages 630-631.

Application	Mfr. Part No.	Our No.
PETERBILT - Continued		
2004 - Continued		
Cummins ISX Diesel		
378		
Belt - Fan & Alt.; W/130A. Alt.	D8410001122295	♣K120903HD
Belt - Fan & Alt.; W/135A. Alt.	D11085234	♣K120891HD
Belt - Hub & A.C.	D8410003061620	♣K060637HD
Tensioner Assy. - Fan & Alt.	3682946	38587
Tensioner Assy. - Hub & A.C.	3682683	38610
Tensioner Pulley - Fan & Alt.	3682946	36165
Idler Pulley - A.C.	3682229	36223
Hose - Upper - Eng. To Pipe; (2 1/2" I.D.)		24240
Hose - Upper - Pipe To Rad.; (2 1/2" I.D.)		24240
Hose - Lower - Eng. To Pipe; (2 1/2" I.D.)		24240
Hose - Lower - Pipe To Rad.; (3" I.D.)		24248
379		
Belt - Fan & Alt.	D8410001122295	♣K120903HD
Belt - Hub & A.C.	D8410003061620	♣K060637HD
Tensioner Assy. - Fan & Alt.	3682946	38587
Tensioner Assy. - Hub & A.C.	3682683	38610
Tensioner Pulley - Fan & Alt.	3682946	36165
Idler Pulley - A.C.	3682229	36223
Hose - Upper - Eng. To Pipe; (2 1/2" I.D.)		24240
Hose - Upper - Pipe To Rad.; (2 1/2" I.D.)		24240
Hose - Lower - Eng. To Pipe; (2 1/2" I.D.)		24240
Hose - Lower - Pipe To Rad.; (2 1/2" I.D.)		24240
387		
Belt - Fan & Alt.	D8410001122215	♣K120872HD
Belt - Hub & A.C.	D8410003061620	♣K060637HD
Tensioner Assy. - Fan & Alt.	3682946	38587
Tensioner Assy. - Hub & A.C.	3682683	38610
Tensioner Pulley - Fan & Alt.	3682946	36165
Idler Pulley - A.C.	3682229	36223
Hose - Upper - Eng. To Pipe; (2 1/2" I.D.)		24240
Hose - Upper - Pipe To Rad.; (2 1/2" I.D.)		24240
Hose - Lower - Eng. To Pipe; (2 1/2" I.D.)		24240
Hose - Lower - Pipe To Rad.; (2 1/2" I.D.)		24240
2003		
Caterpillar 3126 Diesel		
330		
Belt - Fan, Alt. & A.C.	4080803	♣K080806HD
Belt - Fan, A.C., Alt. & W.P.	D8410001082175	♣K080859HD
Belt - W.P.	0366775	♣9341HD
Tensioner Assy. - Fan, Alt. & A.C.	1352151	38511
Tensioner Pulley - Fan, Alt. & A.C.	1352151	36091
Hose - Upper - Eng. To Pipe; (2" I.D.)		24232
Hose - Upper - Pipe To Rad.; (2 1/2" I.D.)		24240
Hose - Lower - Eng. To Pipe; (2" I.D.)		24232
Hose - Lower - Pipe To Rad.; (2 1/2" I.D.)		24240
Caterpillar C10 Diesel		
357; 378; 379; 385		
Belt - Fan & Alt.	4080740	♣K080740HD
Belt - Fan To A.C.	17461	♣9463HD
Tensioner Assy. - Fan & Alt.	1333545	38506
Tensioner Pulley - Fan & Alt.	1333545	36091
Hose - Upper - Eng. To Pipe; (2 1/2" I.D.)		24240
Hose - Upper - Pipe To Rad.; (2 1/2" I.D.)		24240
Hose - Lower - Eng. To Pipe; (2 1/2" I.D.)		24240
Hose - Lower - Pipe To Rad.; (3" I.D.)		24248
Caterpillar C12 Diesel		
357; 378; 379; 385		
Belt - Fan & Alt.	4080740	♣K080740HD
Belt - Fan To A.C.	17461	♣9463HD
Tensioner Assy. - Fan & Alt.	1333545	38506
Tensioner Pulley - Fan & Alt.	1333545	36091
Hose - Upper - Eng. To Pipe; (2 1/2" I.D.)		24240
Hose - Upper - Pipe To Rad.; (2 1/2" I.D.)		24240
Hose - Lower - Eng. To Pipe; (2 1/2" I.D.)		24240
Hose - Lower - Pipe To Rad.; (3" I.D.)		24248

♣ Cut to Fit.

Belts and Coolant Hose for Medium/Heavy-Duty Trucks (1996 and Newer)

Medium & Heavy-Duty Trucks
(1996 & Newer)

Application	Mfr. Part No.	Our No.
PETERBILT - Continued		
2003 - Continued		
Caterpillar C15 Diesel		
378		
Belt - Fan & Alt.; W/Clean Air Pkg.	D8410001082520	♣K080991HD
Belt - Fan; W/O Clean Air Pkg.	D11024799	TR22553
Belt - Fan To Alt. & A.C.; W/O Clean Air Pkg.		②♣9590HD
Belt - Fan To A.C.; W/Clean Air Pkg.	D8410003061340	♣K060525HD
Tensioner Assy. - Fan & Alt.; W/Clean Air Pkg.	2002279	38569
Tensioner Assy. - Fan To A.C.; W/Clean Air Pkg.	2178938	38511
Tensioner Pulley - Fan To A.C.; W/Clean Air Pkg.	2178938	36091
Hose - Upper - Eng. To Pipe; (2 1/2" I.D.)		24240
Hose - Upper - Pipe To Rad.; (2 1/2" I.D.)		24240
Hose - Lower - Eng. To Pipe; (3" I.D.)		24248
Hose - Lower - Pipe To Rad.; (3" I.D.)		24248
379		
Belt - Fan		②TR22545
Belt - Fan To Alt. & A.C.		②♣9590HD
Hose - Upper - Eng. To Pipe; (2 1/2" I.D.)		24240
Hose - Upper - Pipe To Rad.; (2 1/2" I.D.)		24240
Hose - Lower - Eng. To Pipe; (3" I.D.)		24248
Hose - Lower - Pipe To Rad.; (3" I.D.)		24248
387		
Belt - Fan & Alt.		♣K080922HD
Belt - Fan To A.C.	D11026302	♣K060560HD
Tensioner Assy. - Fan & Alt.	1352142	38506
Tensioner Assy. - Fan To A.C.	1382514	38508
Tensioner Pulley - Fan & Alt.	1352142	36091
Tensioner Pulley - Fan To A.C.	1382514	36091
Hose - Upper - Eng. To Pipe		②<21115
Hose - Upper - Eng. To Pipe; (2 1/2" I.D.)		24240
Hose - Lower - Eng. To Pipe; (3" I.D.)		24248
Hose - Lower - Pipe To Pipe; (2 1/2" I.D.)		24240
Hose - Lower - Pipe To Rad.		21891
Caterpillar C16 Diesel		
379		
Belt - Fan		②TR22545
Belt - Fan To Alt. & A.C.		②♣9590HD
Hose - Upper - Eng. To Pipe; (2 1/2" I.D.)		24240
Hose - Upper - Pipe To Rad.; (2 1/2" I.D.)		24240
Hose - Lower - Eng. To Pipe; (3" I.D.)		24248
Hose - Lower - Pipe To Rad.; (3" I.D.)		24248
387		
Belt - Fan & Alt.		♣K080922HD
Belt - Fan To A.C.	D11026302	♣K060560HD
Tensioner Assy. - Fan & Alt.	1352142	38506
Tensioner Assy. - Fan To A.C.	1382514	38508
Tensioner Pulley - Fan & Alt.	1352142	36091
Tensioner Pulley - Fan To A.C.	1382514	36091
Hose - Upper - Eng. To Pipe		②<21115
Hose - Upper - Eng. To Pipe; (2 1/2" I.D.)		24240
Hose - Lower - Eng. To Pipe; (3" I.D.)		24248
Hose - Lower - Pipe To Pipe; (2 1/2" I.D.)		24240
Hose - Lower - Pipe To Rad.		21891
Cummins ISC Diesel		
330		
Belt - Fan, Alt. & Hub	3944838	♣K080755HD
Belt - Fan & A.C.		♣9390HD
Tensioner Assy. - Fan, Alt. & Hub	3945527	38516
Tensioner Pulley - Fan, Alt. & Hub	3945527	36093
Hose - Upper - Eng. To Pipe		21135
Hose - Upper - Pipe To Rad.; (2 1/2" I.D.)		24240
Hose - Lower - Eng. To Pipe		21891
Hose - Lower - Pipe To Rad.; (2 1/2" I.D.)		24240
Cummins ISM Diesel		
357		
Belt - Fan & Alt.	D8410001081650	♣K080649HD
Belt - Hub & A.C.	4004824	♣K060539HD
Tensioner Assy. - Fan & Alt.	3400885	38521

Application	Mfr. Part No.	Our No.
PETERBILT - Continued		
2003 - Continued		
Cummins ISM Diesel - Continued		
357 - Continued		
Tensioner Assy. - Hub & A.C.	4004933	38505
Tensioner Pulley - Hub & A.C.	4004933	36091
Idler Pulley - Fan & Alt.	3400884	36308
Hose - Upper - Eng. To Pipe; (2 1/4" I.D.)		24236
Hose - Upper - Pipe To Rad.; (2 1/2" I.D.)		24240
Hose - Lower - Eng. To Pipe; (2 1/2" I.D.)		24240
Hose - Lower - Pipe To Rad.; (3" I.D.)		24248
385		
Belt - Fan & Alt.		♣K080774HD
Belt - Hub & A.C.		♣K060539HD
Tensioner Assy. - Fan & Alt.	4004824	38521
Tensioner Assy. - Hub & A.C.	3400885	38505
Tensioner Pulley - Hub & A.C.	4004933	36091
Tensioner Pulley - Hub & A.C.	4004933	36091
Idler Pulley - Fan & Alt.	3400884	36308
Hose - Upper - Eng. To Pipe; (2 1/4" I.D.)		24236
Hose - Upper - Pipe To Rad.; (2 1/2" I.D.)		24240
Hose - Lower - Eng. To Pipe; (2 1/2" I.D.)		24240
Hose - Lower - Pipe To Rad.; (2 1/2" I.D.)		24240
Cummins ISX Diesel		
379		
Belt - Fan & Alt.	D8410003122315	♣K120911HD
Belt - Hub & A.C.	D8410003061620	♣K060637HD
Tensioner Assy. - Fan & Alt.	3682946	38587
Tensioner Assy. - Hub & A.C.	3682683	38610
Tensioner Pulley - Fan & Alt.	3682946	36165
Idler Pulley - A.C.	3682229	36223
Hose - Upper - Eng. To Pipe; (2 1/2" I.D.)		24240
Hose - Upper - Pipe To Rad.; (2 1/2" I.D.)		24240
Hose - Lower - Eng. To Pipe; (2 1/2" I.D.)		24240
Hose - Lower - Pipe To Rad.; (2 1/2" I.D.)		24240
Cummins N14 Diesel		
378; 379; 385		
Belt - Alt.		②♣9451HD
Belt - Fan		②TR28473
Belt - A.C.		♣9415HD
Belt - Hub & W.P.		♣K060425HD
Hose - Upper - Eng. To Pipe; (2 1/2" I.D.)		24240
Hose - Upper - Pipe To Rad.; (2 1/2" I.D.)		24240
Hose - Lower - Eng. To Pipe; (2 1/2" I.D.)		24240
Hose - Lower - Pipe To Rad.; (3" I.D.)		24248
2002		
Caterpillar 3126 Diesel		
330		
Belt - Fan, Alt. & A.C.	4080803	♣K080806HD
Belt - W.P.	0366775	♣9341HD
Tensioner Assy. - Fan, Alt. & A.C.	1352151	38511
Tensioner Pulley - Fan, Alt. & A.C.	1352151	36091
Hose - Upper - Eng. To Pipe; (2" I.D.)		24232
Hose - Upper - Pipe To Rad.; (2 1/2" I.D.)		24240
Hose - Lower - Eng. To Pipe; (2" I.D.)		24232
Hose - Lower - Pipe To Rad.; (2 1/2" I.D.)		24240
357		
Belt - Fan, Alt. & A.C.	4080790	♣K080790HD
Belt - W.P.		♣9341HD
Hose - Upper - Eng. To Pipe; (2" I.D.)		24232
Hose - Upper - Pipe To Rad.; (2 1/2" I.D.)		24240
Hose - Lower - Eng. To Pipe; (2" I.D.)		24232
Hose - Lower - Pipe To Rad.; (2 1/2" I.D.)		24240
Caterpillar C10 Diesel		
320		
Belt - Fan & Alt.	4080910	♣K080910HD
Belt - A.C.	4060490	♣K060490HD
Tensioner Assy. - Fan & Alt.	1900649	38506
Tensioner Assy. - A.C.	1481974	38506
Idler Pulley	1731498	36231
357		
Belt - Fan & Alt.	4080710	♣K080710HD

♣ Standard Belt Available. See Pages 630-631.
 < Cut to Fit.

② Two Required.

Belts and Coolant Hose for Medium/Heavy-Duty Trucks (1996 and Newer)

 Medium & Heavy-Duty Trucks
(1996 & Newer)

Application	Mfr. Part No.	Our No.
PETERBILT - Continued		
2002 - Continued		
Caterpillar C10 Diesel - Continued		
357 - Continued		
Belt - A.C.		♣9463HD
Tensioner Assy. - Fan & Alt.	1333545	38506
Tensioner Pulley - Fan & Alt.	1333545	36091
Hose - Upper - Eng. To Pipe; (2 1/2" I.D.)		24240
Hose - Upper - Pipe To Rad.; (2 1/2" I.D.)		24240
Hose - Lower - Eng. To Pipe; (2 1/2" I.D.)		24240
Hose - Lower - Pipe To Rad.; (3" I.D.)		24248
378; 379		
Belt - Fan & Alt.		♣K080740HD
Belt - Fan To A.C.		♣9463HD
Tensioner Assy. - Fan & Alt.	1333545	38506
Tensioner Pulley - Fan & Alt.	1333545	36091
Hose - Upper - Eng. To Pipe; (2 1/2" I.D.)		24240
Hose - Upper - Pipe To Rad.; (2 1/2" I.D.)		24240
Hose - Lower - Eng. To Pipe; (2 1/2" I.D.)		24240
Hose - Lower - Pipe To Rad.; (3" I.D.)		24248
385		
Belt - Fan & Alt.	4080710	♣K080710HD
Belt - A.C.		♣9463HD
Tensioner Assy. - Fan & Alt.	1333545	38506
Tensioner Pulley - Fan & Alt.	1333545	36091
Hose - Upper - Eng. To Pipe; (2 1/2" I.D.)		24240
Hose - Upper - Pipe To Rad.; (2 1/2" I.D.)		24240
Hose - Lower - Eng. To Pipe; (2 1/2" I.D.)		24240
Hose - Lower - Pipe To Rad.; (3" I.D.)		24248
387		
Belt - Fan & Alt.	4080805	♣K080806HD
Belt - Fan To A.C.	4060560	♣K060560HD
Tensioner Assy. - Fan & Alt.	1481974	38506
Tensioner Pulley - Fan & Alt.	1481974	36091
Idler Pulley - Fan & Alt.; W/Flat Idler Pulley	1337023	36091
Idler Pulley - Fan & Alt.; W/Multi-Grooved Idler Pulley	1731498	36231
Caterpillar C12 Diesel		
357		
Belt - Fan & Alt.	4080710	♣K080710HD
Belt - A.C.		♣9463HD
Tensioner Assy. - Fan & Alt.	1333545	38506
Tensioner Pulley - Fan & Alt.	1333545	36091
Hose - Upper - Eng. To Pipe; (2 1/2" I.D.)		24240
Hose - Upper - Pipe To Rad.; (2 1/2" I.D.)		24240
Hose - Lower - Eng. To Pipe; (2 1/2" I.D.)		24240
Hose - Lower - Pipe To Rad.; (3" I.D.)		24248
378; 379		
Belt - Fan & Alt.		♣K080740HD
Belt - Fan To A.C.		♣9463HD
Tensioner Assy. - Fan & Alt.	1333545	38506
Tensioner Pulley - Fan & Alt.	1333545	36091
Hose - Upper - Eng. To Pipe; (2 1/2" I.D.)		24240
Hose - Upper - Pipe To Rad.; (2 1/2" I.D.)		24240
Hose - Lower - Eng. To Pipe; (2 1/2" I.D.)		24240
Hose - Lower - Pipe To Rad.; (3" I.D.)		24248
385		
Belt - Fan & Alt.	4080710	♣K080710HD
Belt - A.C.		♣9463HD
Tensioner Assy. - Fan & Alt.	1333545	38506
Tensioner Pulley - Fan & Alt.	1333545	36091
Hose - Upper - Eng. To Pipe; (2 1/2" I.D.)		24240
Hose - Upper - Pipe To Rad.; (2 1/2" I.D.)		24240
Hose - Lower - Eng. To Pipe; (2 1/2" I.D.)		24240
Hose - Lower - Pipe To Rad.; (3" I.D.)		24248
387		
Belt - Fan & Alt.	4080805	♣K080806HD
Belt - Fan To A.C.	4060560	♣K060560HD
Tensioner Assy. - Fan & Alt.	1481974	38506
Tensioner Pulley - Fan & Alt.	1481974	36091
Idler Pulley - Fan & Alt.; W/Flat Idler Pulley	1337023	36091

Application	Mfr. Part No.	Our No.
PETERBILT - Continued		
2002 - Continued		
Caterpillar C12 Diesel - Continued		
387 - Continued		
Idler Pulley - Fan & Alt.; W/Multi-Grooved Idler Pulley	1731498	36231
Caterpillar C15 Diesel		
357		
Belt - Fan	011024800	②TR22545
Belt - Fan To Alt. & A.C.	D11023875	②♣9600HD
Hose - Upper - Eng. To Pipe; (2 1/2" I.D.)		24240
Hose - Upper - Pipe To Rad.; (2 1/2" I.D.)		24240
Hose - Lower - Eng. To Pipe; (3" I.D.)		24248
Hose - Lower - Pipe To Pipe; (3" I.D.)		24248
Hose - Lower - Pipe To Rad.; (3" I.D.)		24248
378; 379		
Belt - Fan		②TR22545
Belt - Fan, Alt. & A.C.		②♣9590HD
Hose - Upper - Eng. To Pipe; (2 1/2" I.D.)		24240
Hose - Upper - Pipe To Rad.; (2 1/2" I.D.)		24240
Hose - Lower - Eng. To Pipe; (3 1/4" I.D.)		24052
Hose - Lower - Pipe To Rad.; (3 1/4" I.D.)		24052
387		
Belt - Fan & Alt.		♣K080922HD
Belt - Fan To A.C.	D11026302	♣K060560HD
Tensioner Assy. - Fan & Alt.	1352142	38506
Tensioner Assy. - Fan To A.C.	1382514	38508
Tensioner Pulley - Fan & Alt.	1352142	36091
Tensioner Pulley - Fan To A.C.	1382514	36091
Hose - Upper - Eng. To Pipe		≧21115
Hose - Upper - Eng. To Pipe; (2 1/2" I.D.)		24240
Hose - Lower - Eng. To Pipe; (3" I.D.)		24248
Hose - Lower - Pipe To Pipe; (2 1/2" I.D.)		24240
Hose - Lower - Pipe To Rad.		21891
Caterpillar C16 Diesel		
357		
Belt - Fan	011024800	②TR22545
Belt - Fan To Alt. & A.C.	D11023875	②♣9600HD
Hose - Upper - Eng. To Pipe; (2 1/2" I.D.)		24240
Hose - Upper - Pipe To Rad.; (2 1/2" I.D.)		24240
Hose - Lower - Eng. To Pipe; (3" I.D.)		24248
Hose - Lower - Pipe To Pipe; (3" I.D.)		24248
Hose - Lower - Pipe To Rad.; (3" I.D.)		24248
379		
Belt - Fan		②TR22545
Belt - Fan To Alt. & A.C.		②♣9590HD
Hose - Upper - Eng. To Pipe; (2 1/2" I.D.)		24240
Hose - Upper - Pipe To Rad.; (2 1/2" I.D.)		24240
Hose - Lower - Eng. To Pipe; (3 1/4" I.D.)		24052
Hose - Lower - Pipe To Rad.; (3 1/4" I.D.)		24052
387		
Belt - Fan & Alt.		♣K080922HD
Belt - Fan To A.C.	D11026302	♣K060560HD
Tensioner Assy. - Fan & Alt.	1352142	38506
Tensioner Assy. - Fan To A.C.	1382514	38508
Tensioner Pulley - Fan & Alt.	1352142	36091
Tensioner Pulley - Fan To A.C.	1382514	36091
Hose - Upper - Eng. To Pipe		≧21115
Hose - Upper - Eng. To Pipe; (2 1/2" I.D.)		24240
Hose - Lower - Eng. To Pipe; (3" I.D.)		24248
Hose - Lower - Pipe To Pipe; (2 1/2" I.D.)		24240
Hose - Lower - Pipe To Rad.		21891
Cummins ISC Diesel		
330		
Belt - Fan, Alt. & Hub	3944838	♣K080755HD
Belt - Fan & A.C.		♣9390HD
Tensioner Assy. - Fan, Alt. & Hub	3945527	38516
Tensioner Pulley - Fan, Alt. & Hub	3945527	36093
Hose - Upper - Eng. To Pipe		21135
Hose - Upper - Pipe To Rad.; (2 1/2" I.D.)		24240
Hose - Lower - Eng. To Pipe		21891
Hose - Lower - Pipe To Rad.; (2 1/2" I.D.)		24240

 ♣ Standard Belt Available. See Pages 630-631.
 ≧ Cut to Fit.

② Two Required.

Belts and Coolant Hose for Medium/Heavy-Duty Trucks (1996 and Newer)

Medium & Heavy-Duty Trucks
(1996 & Newer)

Application	Mfr. Part No.	Our No.
PETERBILT - Continued		
2002 - Continued		
Cummins ISM Diesel		
357		
Belt - Fan & Alt.	5080775	♣K080776HD
Belt - Hub & A.C.	4004824	♣K060539HD
Tensioner Assy. - Fan & Alt.	3400885	38521
Tensioner Assy. - Hub & A.C.	4004933	38505
Idler Pulley - Fan & Alt.	3400884	36308
Hose - Upper - Eng. To Pipe; (2 1/4" I.D.)	24236	24236
Hose - Upper - Pipe To Rad.; (2 1/2" I.D.)	24240	24240
Hose - Lower - Eng. To Pipe; (2 1/2" I.D.)	24240	24240
Hose - Lower - Pipe To Rad.; (3" I.D.)	24248	24248
385		
Belt - Fan & Alt.		♣K080774HD
Belt - Hub & A.C.	4004824	♣K060539HD
Tensioner Assy. - Fan & Alt.	3400885	38521
Tensioner Assy. - Hub & A.C.	4004933	38505
Tensioner Pulley - Hub & A.C.	4004933	36091
Idler Pulley - Fan & Alt.	3400884	36308
Hose - Upper - Eng. To Pipe; (2 1/4" I.D.)	24236	24236
Hose - Upper - Pipe To Rad.; (2 1/2" I.D.)	24240	24240
Hose - Lower - Eng. To Pipe; (2 1/2" I.D.)	24240	24240
Hose - Lower - Pipe To Rad.; (2 1/2" I.D.)	24240	24240
Cummins ISX Diesel		
378; 379		
Belt - Fan & Hub	3682644	♣K120924HD
Belt - Hub, Alt. & A.C.	3682684	♣K060637HD
Tensioner Assy. - Fan & Hub	3681240	38535
Tensioner Assy. - Hub, Alt. & A.C.	3680194	38532
Tensioner Pulley - Fan & Hub	3681240	36092
Tensioner Pulley - Hub, Alt. & A.C.	3680194	36095
Idler Pulley - Alt. & A.C.	4026886	36226
Hose - Upper - Eng. To Pipe; (2 1/2" I.D.)	24240	24240
Hose - Upper - Pipe To Rad.; (2 1/2" I.D.)	24240	24240
Hose - Lower - Eng. To Pipe; (2 1/2" I.D.)	24240	24240
Hose - Lower - Pipe To Rad.; (2 1/2" I.D.)	24240	24240
387		
Belt - Fan	3681823	♣K100670HD
Belt - Hub, Alt. & A.C.	3682684	♣K060637HD
Tensioner Assy. - Fan	3681240	38535
Tensioner Assy. - Hub, Alt. & A.C.	3680194	38532
Tensioner Pulley - Fan	3681240	36092
Tensioner Pulley - Hub, Alt. & A.C.	3680194	36095
Idler Pulley - Alt. & A.C.	4026886	36226
Hose - Upper - Eng. To Pipe; (2 1/2" I.D.)	24240	24240
Hose - Upper - Pipe To Rad.; (2 1/2" I.D.)	24240	24240
Hose - Lower - Eng. To Pipe; (2 1/2" I.D.)	24240	24240
Hose - Lower - Pipe To Rad.; (2 1/2" I.D.)	24240	24240
Cummins N14 Diesel		
378; 379; 385		
Belt - Alt.		♣9451HD
Belt - Fan		ⓉTR28473
Belt - A.C.		♣9415HD
Belt - Hub & W.P.		♣K060425HD
Hose - Upper - Eng. To Pipe; (2 1/2" I.D.)	24240	24240
Hose - Upper - Pipe To Rad.; (2 1/2" I.D.)	24240	24240
Hose - Lower - Eng. To Pipe; (2 1/2" I.D.)	24240	24240
Hose - Lower - Pipe To Rad.; (3" I.D.)	24248	24248
Cummins Signature 600 Diesel		
378; 379		
Belt - Fan & Hub	3682644	♣K120924HD
Belt - Hub, Alt. & A.C.	3682684	♣K060637HD
Tensioner Assy. - Fan & Hub	3681240	38535
Tensioner Assy. - Hub, Alt. & A.C.	3680194	38532
Tensioner Pulley - Fan & Hub	3681240	36092
Tensioner Pulley - Hub, Alt. & A.C.	3680194	36095
Idler Pulley - Alt. & A.C.	4026886	36226
Hose - Upper - Eng. To Pipe; (2 1/2" I.D.)	24240	24240
Hose - Upper - Pipe To Rad.; (2 1/2" I.D.)	24240	24240
Hose - Lower - Eng. To Pipe; (2 1/2" I.D.)	24240	24240
Hose - Lower - Pipe To Rad.; (2 1/2" I.D.)	24240	24240

Application	Mfr. Part No.	Our No.
PETERBILT - Continued		
2002 - Continued		
Cummins Signature 600 Diesel - Continued		
387		
Belt - Fan	3681823	♣K100670HD
Belt - Hub, Alt. & A.C.	3682684	♣K060637HD
Tensioner Assy. - Fan	3681240	38535
Tensioner Assy. - Hub, Alt. & A.C.	3680194	38532
Tensioner Pulley - Fan	3681240	36092
Tensioner Pulley - Hub, Alt. & A.C.	3680194	36095
Idler Pulley - Alt. & A.C.	4026886	36226
Hose - Upper - Eng. To Pipe; (2 1/2" I.D.)	24240	24240
Hose - Upper - Pipe To Rad.; (2 1/2" I.D.)	24240	24240
Hose - Lower - Eng. To Pipe; (2 1/2" I.D.)	24240	24240
Hose - Lower - Pipe To Rad.; (2 1/2" I.D.)	24240	24240
2001		
Caterpillar 3126 Diesel		
330		
Belt - Fan, Alt. & A.C.	4080803	♣K080806HD
Belt - W.P.	0366775	♣9341HD
Tensioner Assy. - Fan, Alt. & A.C.	1352151	38511
Tensioner Pulley - Fan, Alt. & A.C.	1352151	36091
Hose - Upper - Eng. To Pipe; (2" I.D.)		24232
Hose - Upper - Pipe To Rad.; (2 1/2" I.D.)		24240
Hose - Lower - Eng. To Pipe; (2" I.D.)		24232
Hose - Lower - Pipe To Rad.; (2 1/2" I.D.)		24240
357		
Belt - Fan, Alt. & A.C.	4080790	♣K080790HD
Belt - W.P.	0366775	♣9341HD
Hose - Upper - Eng. To Pipe; (2" I.D.)		24232
Hose - Upper - Pipe To Rad.; (2 1/2" I.D.)		24240
Hose - Lower - Eng. To Pipe; (2" I.D.)		24232
Hose - Lower - Pipe To Rad.; (2 1/2" I.D.)		24240
Caterpillar C10 Diesel		
357		
Belt - Fan & Alt.	4080710	♣K080710HD
Belt - A.C.		♣9463HD
Tensioner Assy. - Fan & Alt.	1333545	38506
Tensioner Pulley - Fan & Alt.	1333545	36091
Hose - Upper - Eng. To Pipe; (2 1/2" I.D.)		24240
Hose - Upper - Pipe To Rad.; (2 1/2" I.D.)		24240
Hose - Lower - Eng. To Pipe; (2 1/2" I.D.)		24240
Hose - Lower - Pipe To Rad.; (3" I.D.)		24248
378; 379		
Belt - Fan & Alt.	4080740	♣K080740HD
Belt - Fan To A.C.		♣9463HD
Tensioner Assy. - Fan & Alt.	1333542	38514
Hose - Upper - Eng. To Pipe; (2 1/2" I.D.)		24240
Hose - Upper - Pipe To Rad.; (2 1/2" I.D.)		24240
Hose - Lower - Eng. To Pipe; (2 1/2" I.D.)		24240
Hose - Lower - Pipe To Rad.; (3" I.D.)		24248
385		
Belt - Fan & Alt.	4080710	♣K080710HD
Belt - A.C.		♣9463HD
Tensioner Assy. - Fan & Alt.	1333545	38506
Tensioner Pulley - Fan & Alt.	1333545	36091
Hose - Upper - Eng. To Pipe; (2 1/2" I.D.)		24240
Hose - Upper - Pipe To Rad.; (2 1/2" I.D.)		24240
Hose - Lower - Eng. To Pipe; (2 1/2" I.D.)		24240
Hose - Lower - Pipe To Rad.; (3" I.D.)		24248
387		
Belt - Fan & Alt.	4080805	♣K080806HD
Belt - Fan To A.C.	4060560	♣K060560HD
Tensioner Assy. - Fan & Alt.	1481974	38506
Tensioner Pulley - Fan & Alt.	1481974	36091
Idler Pulley - Fan & Alt.; W/Flat Idler Pulley	1337023	36091
Idler Pulley - Fan & Alt.; W/Multi-Grooved Idler Pulley	1731498	36231

♣ Standard Belt Available. See Pages 630-631.

Ⓣ Two Required.

Belts and Coolant Hose for Medium/Heavy-Duty Trucks (1996 and Newer)

 Medium & Heavy-Duty Trucks
(1996 & Newer)

Application	Mfr. Part No.	Our No.
PETERBILT - Continued		
2001 - Continued		
Caterpillar C12 Diesel		
357		
Belt - Fan & Alt.	4080710	♣K080710HD
Belt - A.C.		♣9463HD
Tensioner Assy. - Fan & Alt.	1333545	38506
Tensioner Pulley - Fan & Alt.	1333545	36091
Hose - Upper - Eng. To Pipe; (2 1/2" I.D.)		24240
Hose - Upper - Pipe To Rad.; (2 1/2" I.D.)		24240
Hose - Lower - Eng. To Pipe; (2 1/2" I.D.)		24240
Hose - Lower - Pipe To Rad.; (3" I.D.)		24248
378; 379		
Belt - Fan & Alt.	4080740	♣K080740HD
Belt - Fan To A.C.		♣9463HD
Tensioner Assy. - Fan & Alt.	1333542	38514
Hose - Upper - Eng. To Pipe; (2 1/2" I.D.)		24240
Hose - Upper - Pipe To Rad.; (2 1/2" I.D.)		24240
Hose - Lower - Eng. To Pipe; (2 1/2" I.D.)		24240
Hose - Lower - Pipe To Rad.; (3" I.D.)		24248
385		
Belt - Fan & Alt.	4080710	♣K080710HD
Belt - A.C.		♣9463HD
Tensioner Assy. - Fan & Alt.	1333545	38506
Tensioner Pulley - Fan & Alt.	1333545	36091
Hose - Upper - Eng. To Pipe; (2 1/2" I.D.)		24240
Hose - Upper - Pipe To Rad.; (2 1/2" I.D.)		24240
Hose - Lower - Eng. To Pipe; (2 1/2" I.D.)		24240
Hose - Lower - Pipe To Rad.; (3" I.D.)		24248
387		
Belt - Fan & Alt.	4080805	♣K080806HD
Belt - Fan To A.C.	4060560	♣K060560HD
Tensioner Assy. - Fan & Alt.	1481974	38506
Tensioner Pulley - Fan & Alt.	1481974	36091
Idler Pulley - Fan & Alt.; W/Flat Idler Pulley	1337023	36091
Idler Pulley - Fan & Alt.; W/Multi-Grooved Idler Pulley	1731498	36231
Caterpillar C15 Diesel		
378		
Belt - Fan		②TR22545
Belt - Fan, Alt. & A.C.		②♣9590HD
Hose - Upper - Eng. To Pipe; (2 1/2" I.D.)		24240
Hose - Upper - Pipe To Rad.; (2 1/2" I.D.)		24240
Hose - Lower - Eng. To Pipe; (3 1/4" I.D.)		24052
Hose - Lower - Pipe To Rad.; (3 1/4" I.D.)		24052
379		
Belt - Fan		②TR22545
Belt - Fan To Alt. & A.C.		②♣9590HD
Hose - Upper - Eng. To Pipe; (2 1/2" I.D.)		24240
Hose - Upper - Pipe To Rad.; (2 1/2" I.D.)		24240
Hose - Lower - Eng. To Pipe; (3 1/4" I.D.)		24052
Hose - Lower - Pipe To Rad.; (3 1/4" I.D.)		24052
387		
Belt - Fan & Alt.		♣K080922HD
Belt - Fan To A.C.		♣K060560HD
Tensioner Assy. - Fan & Alt.	1352142	38506
Tensioner Assy. - Fan To A.C.	1382514	38508
Tensioner Pulley - Fan & Alt.	1352142	36091
Tensioner Pulley - Fan To A.C.	1382514	36091
Hose - Upper - Eng. To Pipe		♣21115
Hose - Upper - Eng. To Pipe; (2 1/2" I.D.)		24240
Hose - Lower - Eng. To Pipe; (3 1/4" I.D.)		24052
Hose - Lower - Pipe To Rad.; (2 1/2" I.D.)		24240
Caterpillar C16 Diesel		
378		
Belt - Fan		②TR22545
Belt - Fan, Alt. & A.C.		②♣9590HD
Hose - Upper - Eng. To Pipe; (2 1/2" I.D.)		24240
Hose - Upper - Pipe To Rad.; (2 1/2" I.D.)		24240
Hose - Lower - Eng. To Pipe; (3 1/4" I.D.)		24052
Hose - Lower - Pipe To Rad.; (3 1/4" I.D.)		24052

Application	Mfr. Part No.	Our No.
PETERBILT - Continued		
2001 - Continued		
Caterpillar C16 Diesel - Continued		
379		
Belt - Fan		②TR22545
Belt - Fan To Alt. & A.C.		②♣9590HD
Hose - Upper - Eng. To Pipe; (2 1/2" I.D.)		24240
Hose - Upper - Pipe To Rad.; (2 1/2" I.D.)		24240
Hose - Lower - Eng. To Pipe; (3 1/4" I.D.)		24052
Hose - Lower - Pipe To Rad.; (3 1/4" I.D.)		24052
387		
Belt - Fan & Alt.		♣K080922HD
Belt - Fan To A.C.		♣K060560HD
Tensioner Assy. - Fan & Alt.	1352142	38506
Tensioner Assy. - Fan To A.C.	1382514	38508
Tensioner Pulley - Fan & Alt.	1352142	36091
Tensioner Pulley - Fan To A.C.	1382514	36091
Hose - Upper - Eng. To Pipe		♣21115
Hose - Upper - Eng. To Pipe; (2 1/2" I.D.)		24240
Hose - Lower - Eng. To Pipe; (3 1/4" I.D.)		24052
Hose - Lower - Pipe To Rad.; (2 1/2" I.D.)		24240
Cummins ISB Diesel		
270		
Belt - Hub & Alt.	3911579	♣K080675HD
Belt - A.C.		♣9480HD
Cummins ISC Diesel		
330		
Belt - Fan, Alt. & Hub	3944838	♣K080755HD
Belt - Fan & A.C.		♣9390HD
Tensioner Assy. - Fan, Alt. & Hub	3945527	38516
Tensioner Pulley - Fan, Alt. & Hub	3945527	36093
Hose - Upper - Eng. To Pipe		21135
Hose - Upper - Pipe To Rad.; (2 1/2" I.D.)		24240
Hose - Lower - Eng. To Pipe; W/Man. Trans.		21891
Hose - Lower - Pipe To Cooler; W/Auto. Trans. (2 1/4" I.D.) .		24236
Hose - Lower - Cooler To Pipe; W/Auto. Trans. (2 1/4" I.D.) .		24236
Hose - Lower - Pipe To Rad.; (2 1/2" I.D.)		24240
357		
Belt - Fan & Alt.	3944839	♣K080765HD
Tensioner Pulley - A.C.	4004933	36091
Hose - Upper - Eng. To Pipe		21194
Hose - Upper - Pipe To Rad.; (2 1/2" I.D.)		24240
Hose - Lower - Eng. To Pipe		21891
Hose - Lower - Pipe To Rad.; (2 1/2" I.D.)		24240
Cummins ISM Diesel		
320		
Belt - Fan	D8410003081970	♣K080776HD
Belt - Alt.	4004824	♣K060539HD
Tensioner Assy. - Fan	3102888	38505
357		
Belt - Fan & Alt.	5080775	♣K080776HD
Belt - Hub & A.C.	4004824	♣K060539HD
Tensioner Assy. - Fan & Alt.	3400885	38521
Tensioner Assy. - Hub & A.C.	4004933	38505
Idler Pulley - Fan & Alt.	3400884	36308
Hose - Upper - Eng. To Pipe; (2 1/4" I.D.)		24236
Hose - Upper - Pipe To Rad.; (2 1/2" I.D.)		24240
Hose - Lower - Eng. To Pipe; (2 1/2" I.D.)		24240
Hose - Lower - Pipe To Rad.; (3" I.D.)		24248
378		
Belt - Fan, Alt. & Hub	4080717	♣K080720HD
Belt - Hub & A.C.	4004824	♣K060539HD
Tensioner Assy. - Fan, Alt. & Hub	3400885	38521
Tensioner Assy. - Hub & A.C.	4004933	38505
Idler Pulley - Fan & Alt.	3400884	36308
Tensioner Pulley - Hub & A.C.	4004933	36091
Hose - Upper - Eng. To Pipe; (2 1/4" I.D.)		24236
Hose - Upper - Pipe To Rad.; (2 1/2" I.D.)		24240
Hose - Lower - Eng. To Pipe; (2 1/2" I.D.)		24240
Hose - Lower - Pipe To Rad.; (3" I.D.)		24248

 ♣ Standard Belt Available. See Pages 630-631.
 ♣< Cut to Fit.

② Two Required.

Belts and Coolant Hose for Medium/Heavy-Duty Trucks (1996 and Newer)

Medium & Heavy-Duty Trucks
(1996 & Newer)

Application	Mfr. Part No.	Our No.
PETERBILT - Continued		
2001 - Continued		
Cummins ISX Diesel		
378; 379; 387		
Belt - Fan & Hub	3681811	▲K100710HD
Belt - Hub, Alt. & A.C.	3681812	▲K060685HD
Tensioner Assy. - Fan & Hub	3681240	38535
Tensioner Assy. - Hub, Alt. & A.C.	3680194	38532
Tensioner Pulley - Fan & Hub	3681240	36092
Tensioner Pulley - Hub, Alt. & A.C.	3680194	36095
Idler Pulley - Alt. & A.C.	4026886	36226
Hose - Upper - Eng. To Pipe; (2 1/2" I.D.)		24240
Hose - Upper - Pipe To Rad.; (2 1/2" I.D.)		24240
Hose - Lower - Eng. To Pipe; (2 1/2" I.D.)		24240
Hose - Lower - Pipe To Rad.; (2 1/2" I.D.)		24240
Cummins N14 Diesel		
378; 379		
Belt - Alt.; W/130A. Delco Alt.		②▲9451HD
Belt - Alt.; W/135A. Delco Alt.		②▲9415HD
Belt - Hub & A.C.		▲9415HD
Belt - Hub & Fan		②TR28473
Belt - Hub & W.P.		▲K060425HD
Hose - Upper - Eng. To Pipe; (2 1/2" I.D.)		24240
Hose - Upper - Pipe To Rad.; (2 1/2" I.D.)		24240
Hose - Lower - Eng. To Pipe; (2 1/2" I.D.)		24240
Hose - Lower - Pipe To Pipe; (2 1/2" I.D.)		24240
Hose - Lower - Pipe To Rad.; (2 1/2" I.D.)		24240
Cummins Signature 600 Diesel		
378; 379; 387		
Belt - Fan & Hub	3681811	▲K100710HD
Belt - Hub, Alt. & A.C.	3681812	▲K060685HD
Tensioner Assy. - Fan & Hub	3681240	38535
Tensioner Assy. - Hub, Alt. & A.C.	3680194	38532
Tensioner Pulley - Fan & Hub	3681240	36092
Tensioner Pulley - Hub, Alt. & A.C.	3680194	36095
Idler Pulley - Alt. & A.C.	4026886	36226
Hose - Upper - Eng. To Pipe; (2 1/2" I.D.)		24240
Hose - Upper - Pipe To Rad.; (2 1/2" I.D.)		24240
Hose - Lower - Eng. To Pipe; (2 1/2" I.D.)		24240
Hose - Lower - Pipe To Rad.; (2 1/2" I.D.)		24240
Detroit Diesel 6-Cyl. 11.1 L Diesel		
379		
Belt - Fan; W/53 1/2" Belt O.C.; Preferred Belt		3/9530PB
Belt - Fan; W/53 1/2" Belt O.C.; Optional Belt		③▲9530HD
Belt - Hub & Alt.; W/V-Belt Drive		②▲9305HD
Belt - Hub, Alt. & A.C.; W/V-Ribbed Belt Drive	23524524	▲K080570HD
Tensioner Assy. - Hub, Alt. & A.C.	23520317	38501
Tensioner Pulley - Hub, Alt. & A.C.		38075
Hose - Upper - Eng. To Pipe; (2 1/2" I.D.)		24240
Hose - Upper - Pipe To Rad.; (2 1/2" I.D.)		24240
Hose - Lower - Eng. To Pipe; (2 1/2" I.D.)		24240
Hose - Lower - Pipe To Rad.; (3" I.D.)		24248
Detroit Diesel 6-Cyl. 12.7 L Diesel		
377		
Belt - Fan; W/53 1/2" Belt O.C.; Preferred Belt		3/9530PB
Belt - Fan; W/53 1/2" Belt O.C.; Optional Belt		③▲9530HD
Belt - Fan; W/54 1/2" Belt O.C.		③▲9540HD
Belt - Fan & A.C.	17544	▲9545HD
Belt - Hub & Alt.; V-Belt	17305	▲9305HD
Belt - Hub & Alt.; W/V-Ribbed Belt	23524524	▲K080570HD
Hose - Upper - Eng. To Pipe; (2 1/2" I.D.)		24240
Hose - Upper - Pipe To Rad.; (2 1/2" I.D.)		24240
Hose - Lower - Eng. To Pipe; (2 1/2" I.D.)		24240
Hose - Lower - Pipe To Rad.; (3" I.D.)		24248
379		
Belt - Fan; W/53 1/2" Belt O.C.; Preferred Belt		3/9530PB
Belt - Fan; W/53 1/2" Belt O.C.; Optional Belt		③▲9530HD
Belt - Hub & Alt.; W/V-Belt Drive		②▲9305HD
Belt - Hub, Alt. & A.C.; W/V-Ribbed Belt Drive	23524524	▲K080570HD
Tensioner Assy. - Hub, Alt. & A.C.	23520317	38501

Application	Mfr. Part No.	Our No.
PETERBILT - Continued		
2001 - Continued		
Detroit Diesel 6-Cyl. 12.7 L Diesel - Continued		
379 - Continued		
Tensioner Pulley - Hub, Alt. & A.C.		38075
Hose - Upper - Eng. To Pipe; (2 1/2" I.D.)		24240
Hose - Upper - Pipe To Rad.; (2 1/2" I.D.)		24240
Hose - Lower - Eng. To Pipe; (2 1/2" I.D.)		24240
Hose - Lower - Pipe To Rad.; (3" I.D.)		24248
2000		
Caterpillar 3126 Diesel		
330		
Belt - Fan, Alt. & A.C.	4080803	▲K080806HD
Belt - W.P.	0366775	▲9341HD
Tensioner Assy. - Fan, Alt. & A.C.	1352151	38511
Tensioner Pulley - Fan, Alt. & A.C.	1352151	36091
Hose - Upper - Pipe To Rad.; W/2" I.D. Hose(2" I.D.)		24232
Hose - Upper - Pipe To Rad.; W/2 1/2" I.D. Hose(2 1/2" I.D.)		24240
Hose - Lower - Eng. To Pipe; (2" I.D.)		24232
Hose - Lower - Pipe To Rad.; (2 1/2" I.D.)		24240
357		
Belt - Fan, Alt. & A.C.	4080790	▲K080790HD
Belt - W.P.	0366775	▲9341HD
Hose - Upper - Eng. To Pipe; (2" I.D.)		24232
Hose - Upper - Pipe To Rad.; (2 1/2" I.D.)		24240
Hose - Lower - Eng. To Pipe; (2" I.D.)		24232
Hose - Lower - Pipe To Rad.; (2 1/2" I.D.)		24240
Caterpillar 3406 Diesel		
330		
Belt - Fan		②TR22545
Belt - Fan, Alt. & A.C.; W/130A. Delco Alt.		②▲9590HD
379		
Belt - Fan		②TR22545
Belt - Fan, Alt. & A.C.		②▲9590HD
Hose - Upper - Eng. To Pipe; (2 1/2" I.D.)		24240
Hose - Upper - Pipe To Rad.; (2 1/2" I.D.)		24240
Hose - Lower - Eng. To Pipe; (3" I.D.)		24248
Hose - Lower - Pipe To Rad.; (3" I.D.)		24248
Caterpillar C10 Diesel		
357		
Belt - Fan & Alt.	4080710	▲K080710HD
Belt - A.C.		▲9463HD
Tensioner Assy. - Fan & Alt.	1333545	38506
Tensioner Pulley - Fan & Alt.	1333545	36091
Hose - Upper - Eng. To Pipe; (2 1/2" I.D.)		24240
Hose - Upper - Pipe To Rad.; (2 1/2" I.D.)		24240
Hose - Lower - Eng. To Pipe; (2 1/2" I.D.)		24240
Hose - Lower - Pipe To Rad.; (3" I.D.)		24248
378; 379		
Belt - Fan & Alt.		▲K080740HD
Belt - Fan To A.C.		▲9463HD
Tensioner Assy. - Fan & Alt.	1333542	38514
Tensioner Pulley	1333542	36091
Hose - Upper - Eng. To Pipe; (2 1/2" I.D.)		24240
Hose - Upper - Pipe To Rad.; (2 1/2" I.D.)		24240
Hose - Lower - Eng. To Pipe; (2 1/2" I.D.)		24240
Hose - Lower - Pipe To Rad.; (3" I.D.)		24248
385		
Belt - Fan & Alt.	4080710	▲K080710HD
Belt - A.C.		▲9463HD
Tensioner Assy. - Fan & Alt.	1333545	38506
Tensioner Pulley - Fan & Alt.	1333545	36091
Hose - Upper - Eng. To Pipe; (2 1/2" I.D.)		24240
Hose - Upper - Pipe To Rad.; (2 1/2" I.D.)		24240
Hose - Lower - Eng. To Pipe; (2 1/2" I.D.)		24240
Hose - Lower - Pipe To Rad.; (3" I.D.)		24248
387		
Belt - Fan & Alt.	4080805	▲K080806HD
Belt - Fan & A.C.		▲K060560HD
Tensioner Assy. - Fan & Alt.	1481974	38506

▲ Standard Belt Available. See Pages 630-631.
③ Three Required.

② Two Required.

Belts and Coolant Hose for Medium/Heavy-Duty Trucks (1996 and Newer)

 Medium & Heavy-Duty Trucks
(1996 & Newer)

Application	Mfr. Part No.	Our No.
PETERBILT - Continued		
2000 - Continued		
Caterpillar C10 Diesel - Continued		
387 - Continued		
Idler Pulley - Fan & Alt.; W/Flat Idler Pulley	1337023	36091
Idler Pulley - Fan & Alt.; W/Multi-Grooved Idler Pulley	1731498	36231
Tensioner Pulley - Fan & Alt.	1481974	36091
Caterpillar C12 Diesel		
357		
Belt - Fan & Alt.	4080710	♣K080710HD
Belt - A.C.		♣9463HD
Tensioner Assy. - Fan & Alt.	1333545	38506
Tensioner Pulley - Fan & Alt.	1333545	36091
Hose - Upper - Eng. To Pipe; (2 1/2" I.D.)		24240
Hose - Upper - Pipe To Rad.; (2 1/2" I.D.)		24240
Hose - Lower - Eng. To Pipe; (2 1/2" I.D.)		24240
Hose - Lower - Pipe To Rad.; (3" I.D.)		24248
378; 379		
Belt - Fan & Alt.		♣K080740HD
Belt - Fan To A.C.		♣9463HD
Tensioner Assy. - Fan & Alt.	1333542	38514
Tensioner Pulley	1333542	36091
Hose - Upper - Eng. To Pipe; (2 1/2" I.D.)		24240
Hose - Upper - Pipe To Rad.; (2 1/2" I.D.)		24240
Hose - Lower - Eng. To Pipe; (2 1/2" I.D.)		24240
Hose - Lower - Pipe To Rad.; (3" I.D.)		24248
385		
Belt - Fan & Alt.	4080710	♣K080710HD
Belt - A.C.		♣9463HD
Tensioner Assy. - Fan & Alt.	1333545	38506
Tensioner Pulley - Fan & Alt.	1333545	36091
Hose - Upper - Eng. To Pipe; (2 1/2" I.D.)		24240
Hose - Upper - Pipe To Rad.; (2 1/2" I.D.)		24240
Hose - Lower - Eng. To Pipe; (2 1/2" I.D.)		24240
Hose - Lower - Pipe To Rad.; (3" I.D.)		24248
387		
Belt - Fan & Alt.	4080805	♣K080806HD
Belt - Fan & A.C.		♣K060560HD
Tensioner Assy. - Fan & Alt.	1481974	38506
Idler Pulley - Fan & Alt.; W/Flat Idler Pulley	1337023	36091
Idler Pulley - Fan & Alt.; W/Multi-Grooved Idler Pulley	1731498	36231
Tensioner Pulley - Fan & Alt.	1481974	36091
Caterpillar C15 Diesel		
377		
Belt - Fan & A.C.	22534	②TR22534
Belt - Alt.	17591	②♣9590HD
378; 379		
Belt - Fan		TR22545
Belt - Fan, Alt. & A.C.		♣9590HD
Hose - Upper - Eng. To Pipe; (2 1/2" I.D.)		24240
Hose - Upper - Pipe To Rad.; (2 1/2" I.D.)		24240
Hose - Lower - Eng. To Pipe; (2 1/2" I.D.)		24240
Hose - Lower - Pipe To Rad.; (2 1/2" I.D.)		24240
Caterpillar C16 Diesel		
378; 379		
Belt - Fan		TR22545
Belt - Fan, Alt. & A.C.		♣9590HD
Hose - Upper - Eng. To Pipe; (2 1/2" I.D.)		24240
Hose - Upper - Pipe To Rad.; (2 1/2" I.D.)		24240
Hose - Lower - Eng. To Pipe; (2 1/2" I.D.)		24240
Hose - Lower - Pipe To Rad.; (2 1/2" I.D.)		24240
Cummins ISB Diesel		
330		
Belt - Fan, Alt. & Hub	3943349	♣K080785HD
Belt - Fan & A.C.		♣9395HD
Tensioner Assy. - Fan, Alt. & Hub	3936205	38525
Hose - Upper - Eng. To Pipe		21135
Hose - Upper - Pipe To Rad.		●26518

Application	Mfr. Part No.	Our No.
PETERBILT - Continued		
2000 - Continued		
Cummins ISB Diesel - Continued		
330 - Continued		
Hose - Lower - Eng. To Pipe; (2 1/2" I.D.)		24240
Hose - Lower - Pipe To Rad.; (2 1/2" I.D.)		24240
Cummins ISC Diesel		
320		
Belt - Fan	3289503	♣K080726HD
Tensioner Assy.	3978022	38504
330		
Belt - Fan, Alt. & Hub	3944838	♣K080755HD
Belt - Fan & A.C.		♣9390HD
Tensioner Assy. - Fan, Alt. & Hub	3945527	38516
Tensioner Pulley - Fan, Alt. & Hub	3945527	36093
Hose - Upper - Eng. To Pipe		21135
Hose - Upper - Pipe To Rad.; (2 1/2" I.D.)		24240
Hose - Lower - Eng. To Pipe		21891
Hose - Lower - Pipe To Rad.; (2 1/2" I.D.)		24240
Cummins ISL Diesel		
357		
Belt - Fan, W.P. & Alt.	4080775	♣K080776HD
Belt - Fan To A.C.		♣9463HD
Tensioner Assy. - Fan, W.P. & Alt.	3976831	38516
Tensioner Pulley - Fan, W.P. & Alt.	3936213	36093
Hose - Upper - Eng. To Pipe; (2 1/4" I.D.)		24236
Hose - Upper - Rad. To Pipe; (2 1/4" I.D.)		24236
Hose - Lower - Eng. To Pipe; (2" I.D.)		24232
Hose - Lower - Pipe To Cooler; (2 1/4" I.D.)		24236
Hose - Lower - Cooler To Pipe; (2 1/2" I.D.)		24240
Hose - Lower - Rad. To Pipe; (3 1/4" I.D.)		24052
Cummins ISM Diesel		
357		
Belt - Fan & Alt.	D8410003081970	♣K080776HD
Belt - Hub & A.C.	3099216	♣K060539HD
Tensioner Assy. - Fan & Alt.	3400885	38521
Tensioner Assy. - Hub & A.C.	4004933	38505
Idler Pulley - Fan & Alt.	3400884	36308
Hose - Upper - Eng. To Pipe; (2 1/4" I.D.)		24236
Hose - Upper - Pipe To Rad.; (2 1/2" I.D.)		24240
Hose - Lower - Eng. To Pipe; (2 1/2" I.D.)		24240
Hose - Lower - Pipe To Rad.; (3" I.D.)		24248
385		
Belt - Fan	4080775	♣K080776HD
387		
Belt - Fan, Alt. & Hub	4080717	♣K080720HD
Belt - Hub & A.C.	4004824	♣K060539HD
Tensioner Assy. - Fan, Alt. & Hub	3400885	38521
Tensioner Assy. - Hub & A.C.	4004933	38505
Idler Pulley - Fan & Alt.	3400884	36308
Tensioner Pulley - A.C.	4004933	36091
Cummins ISX Diesel		
378; 379		
Belt - Fan	3681811	♣K100710HD
Belt - Hub, Alt. & A.C.	3681812	♣K060685HD
Tensioner Assy. - Fan	3681240	38535
Tensioner Assy. - Hub, Alt. & A.C.	3680194	38532
Idler Pulley - Alt. & A.C.	4026886	36226
Tensioner Pulley - Fan	3681240	36092
Tensioner Pulley - Hub, Alt. & A.C.	3680194	36095
Hose - Upper - Eng. To Pipe; (2 1/2" I.D.)		24240
Hose - Upper - Pipe To Rad.; (2 1/2" I.D.)		24240
Hose - Lower - Eng. To Pipe; (2 1/2" I.D.)		24240
Hose - Lower - Pipe To Rad.; (2 1/2" I.D.)		24240
Cummins N14 Diesel		
378; 379		
Belt - Hub & W.P.		♣K060425HD
Belt - Hub & Fan		②TR28473
Belt - Alt.; W/130A. Delco Alt.		②♣9451HD
Belt - Alt.; W/135A. Delco Alt.		②♣9415HD
Belt - Hub & A.C.		♣9415HD

♣ Standard Belt Available. See Pages 630-631.
● Vulco-Flex® Coolant Hose.

② Two Required.

Belts and Coolant Hose for Medium/Heavy-Duty Trucks (1996 and Newer)

Medium & Heavy-Duty Trucks
(1996 & Newer)

Application	Mfr. Part No.	Our No.
PETERBILT - Continued		
2000 - Continued		
Cummins N14 Diesel - Continued		
378; 379 - Continued		
Hose - Upper - Eng. To Pipe; (2 1/2" I.D.)		24240
Hose - Upper - Pipe To Rad.; (2 1/2" I.D.)		24240
Hose - Lower - Eng. To Pipe; (2 1/2" I.D.)		24240
Hose - Lower - Pipe To Rad.; (2 1/2" I.D.)		24240
Hose - Lower - Pipe To Pipe; (2 1/2" I.D.)		24240
Cummins Signature 600 Diesel		
378		
Belt - Fan	3681811	▲K100710HD
Belt - Hub, Alt. & A.C.	3681812	▲K060685HD
Tensioner Assy. - Fan	3681240	38535
Tensioner Assy. - Hub, Alt. & A.C.	3680194	38532
Idler Pulley - Alt. & A.C.	4026886	36226
Tensioner Pulley - Fan	3681240	36092
Tensioner Pulley - Hub, Alt. & A.C.	3680194	36095
Hose - Upper - Eng. To Pipe; (2 1/2" I.D.)		24240
Hose - Upper - Pipe To Rad.; (2 1/2" I.D.)		24240
Hose - Lower - Eng. To Pipe; (2 1/2" I.D.)		24240
Hose - Lower - Pipe To Rad.; (2 1/2" I.D.)		24240
379		
Belt - Fan	3681234	▲K100710HD
Belt - Hub, Alt. & A.C.	3681238	▲K060685HD
Tensioner Assy. - Fan	3681240	38535
Tensioner Assy. - Hub, Alt. & A.C.	3680194	38532
Idler Pulley - Alt. & A.C.	4026886	36226
Tensioner Pulley - Fan	3681240	36092
Tensioner Pulley - Hub, Alt. & A.C.	3680194	36095
Hose - Upper - Eng. To Pipe; (2 1/2" I.D.)		24240
Hose - Upper - Pipe To Rad.; (2 1/2" I.D.)		24240
Hose - Lower - Eng. To Pipe; (2 1/2" I.D.)		24240
Hose - Lower - Pipe To Rad.; (2 1/2" I.D.)		24240
Detroit Diesel 6-Cyl. 11.1 L Diesel		
377		
Belt - Fan; W/53 1/2" Belt O.C.; Preferred Belt		3/9530PB
Belt - Fan; W/53 1/2" Belt O.C.; Optional Belt		③▲9530HD
Belt - Fan; W/54 1/2" Belt O.C.		③▲9540HD
Belt - Fan & A.C.	17544	▲9545HD
Belt - Hub & Alt.	17305	▲9305HD
Hose - Upper - Eng. To Pipe; (2 1/2" I.D.)		24240
Hose - Upper - Pipe To Rad.; (2 1/2" I.D.)		24240
Hose - Lower - Eng. To Pipe; (2 1/2" I.D.)		24240
Hose - Lower - Pipe To Rad.; (3" I.D.)		24248
379		
Belt - Fan; W/53 1/2" Belt O.C.; Preferred Belt		3/9530PB
Belt - Fan; W/53 1/2" Belt O.C.; Optional Belt		③▲9530HD
Belt - Fan To A.C.	17544	▲9545HD
Belt - Hub & Alt.		②▲9305HD
Belt - Hub, Alt. & A.C.	23524524	▲K080570HD
Tensioner Assy. - Hub, Alt. & A.C.	23520317	38501
Tensioner Pulley - Hub, Alt. & A.C.		38075
Hose - Upper - Eng. To Pipe; (2 1/2" I.D.)		24240
Hose - Upper - Pipe To Rad.; (2 1/2" I.D.)		24240
Hose - Lower - Eng. To Pipe; (2 1/2" I.D.)		24240
Hose - Lower - Pipe To Rad.; (3" I.D.)		24248
Hose - Lower - Pipe To Pipe; (3" I.D.)		24248
Detroit Diesel 6-Cyl. 12.7 L Diesel		
377		
Belt - Fan; W/53 1/2" Belt O.C.; Preferred Belt		3/9530PB
Belt - Fan; W/53 1/2" Belt O.C.; Optional Belt		③▲9530HD
Belt - Fan; W/54 1/2" Belt O.C.		③▲9540HD
Belt - Fan & A.C.	17544	▲9545HD
Belt - Hub & Alt.; V-Belt	17305	▲9305HD
Belt - Hub & Alt.; W/V-Ribbed Belt	23524524	▲K080570HD
Hose - Upper - Eng. To Pipe; (2 1/2" I.D.)		24240
Hose - Upper - Pipe To Rad.; (2 1/2" I.D.)		24240
Hose - Lower - Eng. To Pipe; (2 1/2" I.D.)		24240
Hose - Lower - Pipe To Rad.; (3" I.D.)		24248
379		
Belt - Fan; W/53 1/2" Belt O.C.; Preferred Belt		3/9530PB

Application	Mfr. Part No.	Our No.
PETERBILT - Continued		
2000 - Continued		
Detroit Diesel 6-Cyl. 12.7 L Diesel - Continued		
379 - Continued		
Belt - Fan; W/53 1/2" Belt O.C.; Optional Belt		③▲9530HD
Belt - Fan To A.C.	17544	▲9545HD
Belt - Hub & Alt.		②▲9305HD
Belt - Hub, Alt. & A.C.	23524524	▲K080570HD
Tensioner Assy. - Hub, Alt. & A.C.	23520317	38501
Tensioner Pulley - Hub, Alt. & A.C.		38075
Hose - Upper - Eng. To Pipe; (2 1/2" I.D.)		24240
Hose - Upper - Pipe To Rad.; (2 1/2" I.D.)		24240
Hose - Lower - Eng. To Pipe; (2 1/2" I.D.)		24240
Hose - Lower - Pipe To Rad.; (3" I.D.)		24248
Hose - Lower - Pipe To Pipe; (3" I.D.)		24248
1999		
Caterpillar 3126 Diesel		
330		
Belt - Fan, Alt. & A.C.; W/130A. Delco		
Alt.	4080803	▲K080806HD
Belt - W.P.	0366775	▲9341HD
Tensioner Assy. - Fan, Alt. & A.C.	1352151	38511
Tensioner Pulley - Fan, Alt. & A.C.	1352151	36091
Hose - Upper - Eng. To Pipe; (2" I.D.)		24232
Hose - Upper - Pipe To Rad.; (2 1/2" I.D.)		24240
Hose - Lower - Eng. To Pipe; (2" I.D.)		24232
Hose - Lower - Pipe To Rad.; (2 1/2" I.D.)		24240
357		
Belt - W.P.	0618384	▲9335HD
Belt - Fan & Alt.		▲K070673HD
Belt - Fan, Alt. & A.C.		▲K070735HD
Tensioner Assy. - Fan & Alt.		38507
Hose - Upper - Eng. To Pipe; (2" I.D.)		24232
Hose - Upper - Pipe To Rad.; (2 1/2" I.D.)		24240
Hose - Lower - Eng. To Pipe; (2" I.D.)		24232
Hose - Lower - Pipe To Rad.; (2 1/2" I.D.)		24240
Caterpillar 3406 Diesel		
330		
Belt - Fan		②TR22545
Belt - Fan, Alt. & A.C.; W/130A. Delco Alt.		②▲9590HD
357; 377; 378		
Belt - Fan; Preferred Belt; W/52 1/2" Belt O.C.		2/TR22517PB
Belt - Fan; Optional Belt; W/52 1/2" Belt O.C.		
O.C.	D11024730	②◆TR22517
Belt - Fan; W/54 1/2" Belt O.C.		②TR22534
Belt - Fan; W/55 1/2" Belt O.C.		②TR22553
Belt - Fan; W/55 1/8" Belt O.C.		②TR22545
Belt - Alt.; W/49 1/2" Belt O.C.; Preferred Belt		2/9490PB
Belt - Alt.; W/49 1/2" Belt O.C.; Optional Belt		②▲9490HD
Belt - Alt.; W/51 1/2" Belt O.C.; Preferred Belt		2/9510PB
Belt - Alt.; W/51 1/2" Belt O.C.; Optional Belt		②▲9510HD
Belt - Alt. & A.C.; Preferred Belt		2/9590PB
Belt - Alt. & A.C.; Optional Belt		②▲9590HD
379		
Belt - Fan; Preferred Belt; W/52 1/2" Belt O.C.		2/TR22517PB
Belt - Fan; Optional Belt; W/52 1/2" Belt O.C.		
O.C.	D11024730	②◆TR22517
Belt - Fan; W/55 1/8" Belt O.C.		②TR22545
Belt - Fan; W/54 1/2" Belt O.C.		②TR22534
Belt - Fan; W/55 1/2" Belt O.C.		②TR22553
Belt - Fan, Alt. & A.C.; Preferred Belt		2/9590PB
Belt - Fan, Alt. & A.C.; Optional Belt		②▲9590HD
Belt - Alt.; W/49 1/2" Belt O.C.; Preferred Belt		2/9490PB
Belt - Alt.; W/49 1/2" Belt O.C.; Optional Belt		②▲9490HD
Belt - Alt.; W/51 1/2" Belt O.C.; Preferred Belt		2/9510PB
Belt - Alt.; W/51 1/2" Belt O.C.; Optional Belt		②▲9510HD
Hose - Upper - Eng. To Pipe; (2 1/2" I.D.)		24240
Hose - Upper - Pipe To Rad.; (2 1/2" I.D.)		24240
Hose - Lower - Eng. To Pipe; (3" I.D.)		24248
Hose - Lower - Pipe To Rad.; (3" I.D.)		24248
Hose - Lower - Pipe To Pipe; (3" I.D.)		24248

▲ Standard Belt Available. See Pages 630-631.
② Two Required.

③ Three Required.
◆ Green Stripe® PowerBand® Belt May Work, Use Template to Check.

Belts and Coolant Hose for Medium/Heavy-Duty Trucks (1996 and Newer)

 Medium & Heavy-Duty Trucks
(1996 & Newer)

Application	Mfr. Part No.	Our No.
PETERBILT - Continued		
1999 - Continued		
Caterpillar C10 Diesel		
357; 385		
Belt - Fan & Alt.	4080710	♣K080710HD
Belt - A.C.		♣9463HD
Tensioner Assy. - Fan & Alt.	1333545	38506
Tensioner Pulley - Fan & Alt.	1333545	36091
Hose - Upper - Eng. To Pipe; (2 1/2" I.D.)		24240
Hose - Upper - Pipe To Rad.; (2 1/2" I.D.)		24240
Hose - Lower - Eng. To Pipe; (2 1/2" I.D.)		24240
Hose - Lower - Pipe To Rad.; (3" I.D.)		24248
Caterpillar C12 Diesel		
357		
Belt - Fan & Alt.	4080710	♣K080710HD
Belt - A.C.		♣9463HD
Tensioner Assy. - Fan & Alt.	1333545	38506
Tensioner Pulley - Fan & Alt.	1333545	36091
Hose - Upper - Eng. To Pipe; (2 1/2" I.D.)		24240
Hose - Upper - Pipe To Rad.; (2 1/2" I.D.)		24240
Hose - Lower - Eng. To Pipe; (2 1/2" I.D.)		24240
Hose - Lower - Pipe To Rad.; (3" I.D.)		24248
379		
Belt - Fan & Alt.	4080710	♣K080710HD
Belt - A.C.	17461	♣9463HD
385		
Belt - Fan & Alt.	4080710	♣K080710HD
Belt - A.C.		♣9463HD
Tensioner Assy. - Fan & Alt.	1333545	38506
Tensioner Pulley - Fan & Alt.	1333545	36091
Hose - Upper - Eng. To Pipe; (2 1/2" I.D.)		24240
Hose - Upper - Pipe To Rad.; (2 1/2" I.D.)		24240
Hose - Lower - Eng. To Pipe; (2 1/2" I.D.)		24240
Hose - Lower - Pipe To Rad.; (3" I.D.)		24248
Cummins ISC Diesel		
320		
Belt - Fan	3289503	♣K080726HD
Tensioner Assy.	3978022	38504
330		
Belt - Fan, Alt. & Hub	3926942	♣K080760HD
Belt - A.C.	17391	♣9390HD
Tensioner Assy. - Fan, Alt. & Hub	3945527	38516
Tensioner Pulley - Fan, Alt. & Hub	3945527	36093
Hose - Upper - Eng. To Pipe		21135
Hose - Upper - Pipe To Rad.; (2 1/2" I.D.)		24240
Hose - Lower - Eng. To Pipe		♣21131
Hose - Lower - Pipe To Rad.; (2 1/2" I.D.)		24240
Cummins N14 Diesel		
377; 378; 379		
Belt - W.P.	3095880	♣K060415HD
Belt - Fan; Optional Belt		②TR28483
Belt - Fan; Preferred Belt		2/TR28483PB
Belt - Alt.; Optional Belt		②♣9463HD
Belt - Alt.; Preferred Belt		2/9463PB
Belt - A.C.; W/41 7/8" Belt O.C.		♣9415HD
Belt - A.C.; W/42 3/8" Belt O.C.		♣9420HD
Detroit Diesel 6-Cyl. 11.1 L Diesel		
357; 377; 378		
Belt - Fan; W/53 1/2" Belt O.C.; Preferred Belt		3/9530PB
Belt - Fan; W/53 1/2" Belt O.C.; Optional Belt		③♣9530HD
Belt - Fan & A.C.		♣9540HD
Belt - Hub & Alt.		②♣9305HD
Hose - Upper - Eng. To Pipe; (2 1/2" I.D.)		24240
Hose - Upper - Pipe To Rad.; (2 1/2" I.D.)		24240
Hose - Lower - Eng. To Pipe; (2 1/2" I.D.)		24240
Hose - Lower - Pipe To Rad.; (3" I.D.)		24248
379		
Belt - Fan; W/53 1/2" Belt O.C.; Preferred Belt		3/9530PB
Belt - Fan; W/53 1/2" Belt O.C.; Optional Belt		③♣9530HD
Belt - Fan & A.C.		♣9540HD
Belt - Hub & Alt.		②♣9305HD

Application	Mfr. Part No.	Our No.
PETERBILT - Continued		
1999 - Continued		
Detroit Diesel 6-Cyl. 11.1 L Diesel - Continued		
379 - Continued		
Hose - Upper - Eng. To Pipe; (2 1/2" I.D.)		24240
Hose - Upper - Pipe To Rad.; (2 1/2" I.D.)		24240
Hose - Lower - Eng. To Pipe; (2 1/2" I.D.)		24240
Hose - Lower - Pipe To Rad.; (3" I.D.)		24248
Hose - Lower - Pipe To Pipe; (3" I.D.)		24248
Detroit Diesel 6-Cyl. 12.7 L Diesel		
357; 377; 378		
Belt - Fan; W/53 1/2" Belt O.C.; Preferred Belt		3/9530PB
Belt - Fan; W/53 1/2" Belt O.C.; Optional Belt		③♣9530HD
Belt - Fan & A.C.		♣9540HD
Belt - Hub & Alt.		②♣9305HD
Hose - Upper - Eng. To Pipe; (2 1/2" I.D.)		24240
Hose - Upper - Pipe To Rad.; (2 1/2" I.D.)		24240
Hose - Lower - Eng. To Pipe; (2 1/2" I.D.)		24240
Hose - Lower - Pipe To Rad.; (3" I.D.)		24248
379		
Belt - Fan; W/53 1/2" Belt O.C.; Preferred Belt		3/9530PB
Belt - Fan; W/53 1/2" Belt O.C.; Optional Belt		③♣9530HD
Belt - Fan & A.C.		♣9540HD
Belt - Hub & Alt.		②♣9305HD
Hose - Upper - Eng. To Pipe; (2 1/2" I.D.)		24240
Hose - Upper - Pipe To Rad.; (2 1/2" I.D.)		24240
Hose - Lower - Eng. To Pipe; (2 1/2" I.D.)		24240
Hose - Lower - Pipe To Rad.; (3" I.D.)		24248
Hose - Lower - Pipe To Pipe; (3" I.D.)		24248
1998		
Caterpillar 3116 Diesel		
330		
Belt - W.P.	7E0744	♣9345HD
Belt - Fan & Alt.		♣K070673HD
Belt - Fan, Alt. & A.C.		♣K070735HD
Tensioner Assy. - Fan & Alt.		38507
Hose - Upper - Eng. To Pipe; (2" I.D.)		24232
Hose - Upper - Pipe To Rad.; (2 1/2" I.D.)		24240
Hose - Lower - Eng. To Pipe; (2" I.D.)		24232
Hose - Lower - Pipe To Rad.; (2 1/2" I.D.)		24240
Caterpillar 3126 Diesel		
330		
Belt - Fan, Alt. & A.C.	4080803	♣K080806HD
Belt - W.P.	0366775	♣9341HD
Tensioner Assy. - Fan, Alt. & A.C.	1352151	38511
Tensioner Pulley - Fan, Alt. & A.C.	1352151	36091
Hose - Upper - Eng. To Pipe; (2 1/2" I.D.)		24240
Hose - Upper - Pipe To Rad.; (2" I.D.)		24232
Hose - Lower - Eng. To Pipe; (2" I.D.)		24232
Hose - Lower - Pipe To Rad.; (2 1/2" I.D.)		24240
357		
Belt - W.P.	0618384	♣9335HD
Belt - Fan & Alt.		♣K070673HD
Belt - Fan, Alt. & A.C.		♣K070735HD
Tensioner Assy. - Fan & Alt.		38507
Hose - Upper - Eng. To Pipe; (2" I.D.)		24232
Hose - Upper - Pipe To Rad.; (2 1/2" I.D.)		24240
Hose - Lower - Eng. To Pipe; (2" I.D.)		24232
Hose - Lower - Pipe To Rad.; (2 1/2" I.D.)		24240
Caterpillar 3306 Diesel		
379		
Belt - Fan		TR22545
Belt - Fan, Alt. & A.C.		♣9590HD
Hose - Upper - Eng. To Pipe; (2 1/2" I.D.)		24240
Hose - Upper - Pipe To Rad.; (2 1/2" I.D.)		24240
Hose - Lower - Eng. To Pipe; (3" I.D.)		24248
Hose - Lower - Pipe To Rad.; (3" I.D.)		24248
Caterpillar 3406 Diesel		
357; 377; 378; 379		
Belt - Fan; Preferred Belt; W/52 1/2" Belt O.C.		2/TR22517PB

♣ Standard Belt Available. See Pages 630-631.
② Two Required.

♣ Cut to Fit.
③ Three Required.

Belts and Coolant Hose for Medium/Heavy-Duty Trucks (1996 and Newer)

Medium & Heavy-Duty Trucks
(1996 & Newer)

Application	Mfr. Part No.	Our No.
PETERBILT - Continued		
1998 - Continued		
Caterpillar 3406 Diesel - Continued		
357; 377; 378; 379 - Continued		
Belt - Fan; Optional Belt; W/52 1/2" Belt		
O.C.	D11024730	②◆TR22517
Belt - Fan; W/54 1/2" Belt O.C.		②TR22534
Belt - Fan; W/55 1/2" Belt O.C.		②TR22553
Belt - Fan; W/55 1/8" Belt O.C.		②TR22545
Belt - Alt.; W/49 1/2" Belt O.C.; Preferred Belt		2/9490PB
Belt - Alt.; W/49 1/2" Belt O.C.; Optional Belt		②◆9490HD
Belt - Alt.; W/51 1/2" Belt O.C.; Preferred Belt		2/9510PB
Belt - Alt.; W/51 1/2" Belt O.C.; Optional Belt		②◆9510HD
Belt - Alt. & A.C.; Preferred Belt		2/9590PB
Belt - Alt. & A.C.; Optional Belt		②◆9590HD
Hose - Upper; (2 1/2" I.D.)		24240
Hose - Lower; (3" I.D.)		24248
Hose - By Pass; (1 1/2" I.D.)		24224
Hose - Heater Inlet; (3/4" I.D.)		28442
Hose - Heater Outlet; (5/8" I.D.)		28441
Caterpillar C10 Diesel		
357		
Belt - Fan & Alt.	4080710	◆K080710HD
Belt - A.C.		◆9463HD
Tensioner Assy. - Fan & Alt.	1333545	38506
Tensioner Pulley - Fan & Alt.	1333545	36091
Hose - Upper - Eng. To Pipe; (2 1/2" I.D.)		24240
Hose - Upper - Pipe To Rad.; (2 1/2" I.D.)		24240
Hose - Lower - Eng. To Pipe; (2 1/2" I.D.)		24240
Hose - Lower - Pipe To Rad.; (3" I.D.)		24248
362		
Belt - Fan & Alt.; W/68 5/8" Belt O.C.		◆K080690HD
Belt - Fan & Alt.; W/70 5/8" Belt O.C.		◆K080700HD
Belt - Fan & Alt.; W/71 5/8" Belt O.C.		◆K080710HD
Belt - A.C.		◆9463HD
Tensioner Assy. - Fan & Alt.	1333545	38506
Tensioner Pulley - Fan & Alt.	1333545	36091
Hose - Upper - Eng. To Pipe; (2 1/2" I.D.)		24240
Hose - Upper - Pipe To Rad.; (2 1/2" I.D.)		24240
Hose - Lower - Eng. To Pipe; (2 1/2" I.D.)		24240
Hose - Lower - Pipe To Rad.; (3" I.D.)		24248
377		
Belt - Fan & Alt.; W/68 5/8" Belt O.C.		◆K080690HD
Belt - Fan & Alt.; W/70 5/8" Belt O.C.		◆K080700HD
Belt - Fan & Alt.; W/71 5/8" Belt O.C.		◆K080710HD
Belt - A.C.		◆9463HD
Belt - Fan & Alt.; W/72 1/8" Belt O.C.		◆K080716HD
Tensioner Assy. - Fan & Alt.	1333545	38506
Tensioner Pulley - Fan & Alt.	1333545	36091
Hose - Upper - Eng. To Pipe; (2 1/2" I.D.)		24240
Hose - Upper - Pipe To Rad.; (2 1/2" I.D.)		24240
Hose - Lower - Eng. To Pipe; (2 1/2" I.D.)		24240
Hose - Lower - Pipe To Rad.; (3" I.D.)		24248
385		
Belt - Fan & Alt.	4080710	◆K080710HD
Belt - A.C.		◆9463HD
Tensioner Assy. - Fan & Alt.	1333545	38506
Tensioner Pulley - Fan & Alt.	1333545	36091
Hose - Upper - Eng. To Pipe; (2 1/2" I.D.)		24240
Hose - Upper - Pipe To Rad.; (2 1/2" I.D.)		24240
Hose - Lower - Eng. To Pipe; (2 1/2" I.D.)		24240
Hose - Lower - Pipe To Rad.; (3" I.D.)		24248
Caterpillar C12 Diesel		
357		
Belt - Fan & Alt.	4080710	◆K080710HD
Belt - A.C.		◆9463HD
Tensioner Assy. - Fan & Alt.	1333545	38506
Tensioner Pulley - Fan & Alt.	1333545	36091
Hose - Upper - Eng. To Pipe; (2 1/2" I.D.)		24240
Hose - Upper - Pipe To Rad.; (2 1/2" I.D.)		24240
Hose - Lower - Eng. To Pipe; (2 1/2" I.D.)		24240
Hose - Lower - Pipe To Rad.; (3" I.D.)		24248

Application	Mfr. Part No.	Our No.
PETERBILT - Continued		
1998 - Continued		
Caterpillar C12 Diesel - Continued		
362; 377		
Belt - Fan & Alt.; W/69 5/8" Belt O.C.		◆K080690HD
Belt - Fan & Alt.; W/70 5/8" Belt O.C.		◆K080700HD
Belt - Fan & Alt.; W/71 5/8" Belt O.C.		◆K080710HD
Belt - A.C.		◆9463HD
Tensioner Assy. - Fan & Alt.	1333545	38506
Tensioner Pulley - Fan & Alt.	1333545	36091
Hose - Upper - Eng. To Pipe; (2 1/2" I.D.)		24240
Hose - Upper - Pipe To Rad.; (2 1/2" I.D.)		24240
Hose - Lower - Eng. To Pipe; (2 1/2" I.D.)		24240
Hose - Lower - Pipe To Rad.; (3" I.D.)		24248
385		
Belt - Fan & Alt.	4080710	◆K080710HD
Belt - A.C.		◆9463HD
Tensioner Assy. - Fan & Alt.	1333545	38506
Tensioner Pulley - Fan & Alt.	1333545	36091
Hose - Upper - Eng. To Pipe; (2 1/2" I.D.)		24240
Hose - Upper - Pipe To Rad.; (2 1/2" I.D.)		24240
Hose - Lower - Eng. To Pipe; (2 1/2" I.D.)		24240
Hose - Lower - Pipe To Rad.; (3" I.D.)		24248
Cummins ISC Diesel		
320		
Belt - Fan & Alt.; W/69 5/8" Belt O.C. ...	3911581	◆K080690HD
Belt - Fan & Alt.; W/70 5/8" Belt O.C. ...	3911582	◆K080700HD
Belt - Fan & Alt.; W/73 1/8" Belt O.C. ...	3926861	◆K080726HD
Belt - A.C.; W/39 3/8" Belt O.C.		◆9390HD
Belt - A.C.; W/40 7/8" Belt O.C.		◆9405HD
Hose - Upper - Eng. To Pipe; (2 1/4" I.D.)		24236
Hose - Upper - Pipe To Rad.; (2 1/2" I.D.)		24240
Hose - Lower - Eng. To Pipe		21901
Hose - Lower - Pipe To Rad.; (2 1/2" I.D.)		24240
330		
Belt - Fan & Alt.; W/69 1/2" Belt O.C.		◆K080690HD
Belt - Fan & Alt.; W/72" Belt O.C.	3922562	◆K060716HD
Belt - A.C.	17391	◆9390HD
Hose - Upper - Eng. To Pipe; (2" I.D.)		24232
Hose - Upper - Pipe To Rad.; (2 1/2" I.D.)		24240
357		
Belt - Fan & Alt.; W/69 5/8" Belt O.C. ...	3911581	◆K080690HD
Belt - Fan & Alt.; W/70 5/8" Belt O.C. ...	3904029	◆K080700HD
Belt - Fan & Alt.; W/71 5/8" Belt O.C.		◆K080710HD
Belt - A.C.		◆9463HD
Cummins ISM Diesel		
320		
Belt - Fan	3288768	◆K080560HD
Belt - Alt. & W.P.		◆K050380HD
357; 378; 379; 385		
Belt - Fan; W/51" Belt O.C.	3034943	◆K080505HD
Belt - Fan; W/55" Belt O.C.		◆K080545HD
Belt - Alt.	3037425	◆K050340HD
Belt - A.C.		◆9520HD
Hose - Upper - Eng. To Pipe; (2 1/4" I.D.)		24236
Hose - Upper - Pipe To Rad.; (2 1/2" I.D.)		24240
Hose - Lower - Eng. To Pipe; (2 1/2" I.D.)		24240
Hose - Lower - Pipe To Rad.; (3" I.D.)		24248
Cummins ISX Diesel		
379		
Belt - Fan	3680275	◆K100570HD
Belt - Hub, Alt. & A.C.	3680197	◆K060660HD
Tensioner Assy. - Fan	3681240	38535
Tensioner Assy. - Hub, Alt. & A.C.	3680194	38532
Idler Pulley - Alt. & A.C.	4026886	36226
Tensioner Pulley - Fan	3681240	36092
Tensioner Pulley - Hub, Alt. & A.C.	3680194	36095
Cummins N14 Diesel		
377; 378; 379		
Belt - W.P.	3095880	◆K060415HD
Belt - Fan; Optional Belt		②TR28483

② Two Required.

◆ Standard Belt Available. See Pages 630-631.

◆ Green Stripe® PowerBand® Belt May Work, Use Template to Check.

Belts and Coolant Hose for Medium/Heavy-Duty Trucks (1996 and Newer)

 Medium & Heavy-Duty Trucks
(1996 & Newer)

Application	Mfr. Part No.	Our No.
PETERBILT - Continued		
1998 - Continued		
Cummins N14 Diesel - Continued		
377; 378; 379 - Continued		
Belt - Fan; Preferred Belt		2/TR28483PB
Belt - Alt.; Optional Belt	②▲9463HD	
Belt - Alt.; Preferred Belt		2/9463PB
Belt - A.C.; W/41 7/8" Belt O.C.	▲9415HD	
Belt - A.C.; W/42 3/8" Belt O.C.	▲9420HD	
Detroit Diesel 6-Cyl. 11.1 L Diesel		
357		
Belt - Fan; W/53 1/2" Belt O.C.; Preferred Belt		3/9530PB
Belt - Fan; W/53 1/2" Belt O.C.; Optional Belt	③▲9530HD	
Belt - Fan; W/56 3/8" Belt O.C.	③▲9560HD	
Belt - Alt.; Optional Belt	②▲9305HD	
Belt - Alt.; Preferred Belt		D11049518
Belt - A.C.; W/53 3/8" Belt O.C.	▲9530HD	
Belt - A.C.; W/54 7/8" Belt O.C.	▲9545HD	
Hose - Upper - Eng. To Pipe; (2 1/2" I.D.)		24240
Hose - Upper - Pipe To Rad.; (2 1/2" I.D.)		24240
Hose - Lower - Eng. To Pipe; (2 1/2" I.D.)		24240
Hose - Lower - Pipe To Rad.; (3" I.D.)		24248
377		
Belt - Fan; W/53 1/2" Belt O.C.; Preferred Belt		3/9530PB
Belt - Fan; W/53 1/2" Belt O.C.; Optional Belt	③▲9530HD	
Hose - Upper - Eng. To Pipe; (2 1/2" I.D.)		24240
Hose - Upper - Pipe To Rad.; (2 1/2" I.D.)		24240
Hose - Lower - Eng. To Pipe; (2 1/2" I.D.)		24240
Hose - Lower - Pipe To Rad.; (3" I.D.)		24248
378		
Belt - Fan; Preferred Belt		3/9525PB
Belt - Fan; Optional Belt	③▲9525HD	
Belt - Fan To A.C.	▲9560HD	
Belt - Hub & Alt.	②▲9313HD	
Hose - Upper - Eng. To Pipe; (2 1/2" I.D.)		24240
Hose - Upper - Pipe To Rad.; (2 1/2" I.D.)		24240
Hose - Lower - Eng. To Pipe; (2 1/2" I.D.)		24240
Hose - Lower - Pipe To Rad.; (3" I.D.)		24248
379		
Belt - Fan; W/53 1/2" Belt O.C.; Preferred Belt		3/9530PB
Belt - Fan; W/53 1/2" Belt O.C.; Optional Belt	③▲9530HD	
Belt - Fan & A.C.	▲9540HD	
Belt - Hub & Alt.	②▲9305HD	
Hose - Upper - Eng. To Pipe; (2 1/2" I.D.)		24240
Hose - Upper - Pipe To Rad.; (2 1/2" I.D.)		24240
Hose - Lower - Eng. To Pipe; (2 1/2" I.D.)		24240
Hose - Lower - Pipe To Rad.; (3" I.D.)		24248
Hose - Lower - Pipe To Pipe; (3" I.D.)		24248
Detroit Diesel 6-Cyl. 12.7 L Diesel		
357		
Belt - Fan; W/53 1/2" Belt O.C.; Preferred Belt		3/9530PB
Belt - Fan; W/53 1/2" Belt O.C.; Optional Belt	③▲9530HD	
Belt - Fan; W/56 3/8" Belt O.C.	③▲9560HD	
Belt - Alt.; Optional Belt	②▲9305HD	
Belt - Alt.; Preferred Belt		D11049518
Belt - A.C.; W/53 3/8" Belt O.C.	▲9530HD	
Belt - A.C.; W/54 7/8" Belt O.C.	▲9545HD	
Hose - Upper - Eng. To Pipe; (2 1/2" I.D.)		24240
Hose - Upper - Pipe To Rad.; (2 1/2" I.D.)		24240
Hose - Lower - Eng. To Pipe; (2 1/2" I.D.)		24240
Hose - Lower - Pipe To Rad.; (3" I.D.)		24248
377		
Belt - Fan; W/53 1/2" Belt O.C.; Preferred Belt		3/9530PB
Belt - Fan; W/53 1/2" Belt O.C.; Optional Belt	③▲9530HD	
Hose - Upper - Eng. To Pipe; (2 1/2" I.D.)		24240
Hose - Upper - Pipe To Rad.; (2 1/2" I.D.)		24240
Hose - Lower - Eng. To Pipe; (2 1/2" I.D.)		24240
Hose - Lower - Pipe To Rad.; (3" I.D.)		24248
378		
Belt - Fan; Preferred Belt		3/9525PB
Belt - Fan; Optional Belt	③▲9525HD	
Belt - Fan To A.C.	▲9560HD	

② Two Required.
③ Three Required.

Application	Mfr. Part No.	Our No.
PETERBILT - Continued		
1998 - Continued		
Detroit Diesel 6-Cyl. 12.7 L Diesel - Continued		
378 - Continued		
Belt - Hub & Alt.		②▲9313HD
Hose - Upper - Eng. To Pipe; (2 1/2" I.D.)		24240
Hose - Upper - Pipe To Rad.; (2 1/2" I.D.)		24240
Hose - Lower - Eng. To Pipe; (2 1/2" I.D.)		24240
Hose - Lower - Pipe To Rad.; (3" I.D.)		24248
379		
Belt - Fan; W/53 1/2" Belt O.C.; Preferred Belt		3/9530PB
Belt - Fan; W/53 1/2" Belt O.C.; Optional Belt	③▲9530HD	
Belt - Fan & A.C.	▲9540HD	
Belt - Hub & Alt.	②▲9305HD	
Hose - Upper - Eng. To Pipe; (2 1/2" I.D.)		24240
Hose - Upper - Pipe To Rad.; (2 1/2" I.D.)		24240
Hose - Lower - Eng. To Pipe; (2 1/2" I.D.)		24240
Hose - Lower - Pipe To Rad.; (3" I.D.)		24248
Hose - Lower - Pipe To Pipe; (3" I.D.)		24248
1997		
Caterpillar 3116 Diesel		
330		
Belt - W.P.	7E0744	▲9345HD
Belt - Fan & Alt.		▲K070673HD
Belt - Fan, Alt. & A.C.		▲K070735HD
Tensioner Assy. - Fan & Alt.		38507
Hose - Upper - Eng. To Pipe; (2" I.D.)		24232
Hose - Upper - Pipe To Rad.; (2 1/2" I.D.)		24240
Hose - Lower - Eng. To Pipe; (2" I.D.)		24232
Hose - Lower - Pipe To Rad.; (2 1/2" I.D.)		24240
Caterpillar 3126 Diesel		
330		
Belt - W.P.	7E0744	▲9345HD
Belt - Fan & Alt.; W/V-Ribbed Belt Drive		▲K070673HD
Belt - Fan, Alt. & A.C.		▲K070735HD
Tensioner Assy. - Fan & Alt.		38507
Hose - Upper - Eng. To Pipe; (2" I.D.)		24232
Hose - Upper - Pipe To Rad.; (2 1/2" I.D.)		24240
Hose - Lower - Eng. To Pipe; (2" I.D.)		24232
Hose - Lower - Pipe To Rad.; (2 1/2" I.D.)		24240
357		
Hose - Upper - Eng. To Pipe; (2" I.D.)		24232
Hose - Upper - Pipe To Rad.; (2 1/2" I.D.)		24240
Hose - Lower - Eng. To Pipe; (2" I.D.)		24232
Hose - Lower - Pipe To Rad.; (2 1/2" I.D.)		24240
Caterpillar 3306 Diesel		
379		
Belt - Fan		TR22545
Belt - Fan, Alt. & A.C.		▲9590HD
Hose - Upper - Eng. To Pipe; (2 1/2" I.D.)		24240
Hose - Upper - Pipe To Rad.; (2 1/2" I.D.)		24240
Hose - Lower - Eng. To Pipe; (3" I.D.)		24248
Hose - Lower - Pipe To Rad.; (3" I.D.)		24248
385		
Belt - Fan & Alt.	4080710	▲K080710HD
Belt - A.C.		▲9463HD
Tensioner Assy. - Fan & Alt.	1333545	38506
Tensioner Pulley - Fan & Alt.	1333545	36091
Caterpillar 3406 Diesel		
357		
Belt - Fan; Preferred Belt; W/52 1/2" Belt O.C.		2/TR22517PB
Belt - Fan; Optional Belt; W/52 1/2" Belt O.C.		D11024730
Belt - Fan; W/54 1/2" Belt O.C.		②▲TR22517
Belt - Fan; W/55 1/2" Belt O.C.		②TR22534
Belt - Fan; W/55 1/8" Belt O.C.		②TR22553
Belt - Alt.; W/49 1/2" Belt O.C.; Preferred Belt		②TR22545
Belt - Alt.; W/49 1/2" Belt O.C.; Optional Belt		2/9490PB
Belt - Alt.; W/51 1/2" Belt O.C.; Preferred Belt		②▲9490HD
Belt - Alt.; W/51 1/2" Belt O.C.; Optional Belt		2/9510PB
Belt - Alt. & A.C.; Preferred Belt		②▲9510HD
Belt - Alt. & A.C.; Preferred Belt		2/9590PB

▲ Standard Belt Available. See Pages 630-631.
◆ Green Stripe® PowerBand® Belt May Work, Use Template to Check.

Belts and Coolant Hose for Medium/Heavy-Duty Trucks (1996 and Newer)

Medium & Heavy-Duty Trucks
(1996 & Newer)

Application	Mfr. Part No.	Our No.
PETERBILT - Continued		
1997 - Continued		
Caterpillar 3406 Diesel - Continued		
357 - Continued		
Belt - Alt. & A.C.; Optional Belt		②▲9590HD
Hose - Upper; (2 1/2" I.D.)		24240
Hose - Lower; (3" I.D.)		24248
Hose - By Pass; (1 1/2" I.D.)		24224
Hose - Heater Inlet; (3/4" I.D.)		28442
Hose - Heater Outlet; (5/8" I.D.)		28441
362		
Belt - Fan; Preferred Belt; W/52 1/2" Belt O.C.		2/TR22517PB
Belt - Fan; Optional Belt; W/52 1/2" Belt O.C.	D11024730	②◆TR22517
Belt - Fan; W/55 1/8" Belt O.C.		②TR22545
Belt - Fan; W/55 7/8" Belt O.C.		②TR22553
Belt - Fan & Alt.; W/56 7/8" Belt O.C.		▲9565HD
Belt - Fan & Alt.; W/58 7/8" Belt O.C.		▲9585HD
377; 378; 379		
Belt - Fan; Preferred Belt; W/52 1/2" Belt O.C.		2/TR22517PB
Belt - Fan; Optional Belt; W/52 1/2" Belt O.C.	D11024730	②◆TR22517
Belt - Fan; W/54 1/2" Belt O.C.		②TR22534
Belt - Fan; W/55 1/2" Belt O.C.		②TR22553
Belt - Fan; W/55 1/8" Belt O.C.		②TR22545
Belt - Alt.; W/49 1/2" Belt O.C.; Preferred Belt		2/9490PB
Belt - Alt.; W/49 1/2" Belt O.C.; Optional Belt		②▲9490HD
Belt - Alt.; W/51 1/2" Belt O.C.; Preferred Belt		2/9510PB
Belt - Alt.; W/51 1/2" Belt O.C.; Optional Belt		②▲9510HD
Belt - Alt. & A.C.; Preferred Belt		2/9590PB
Belt - Alt. & A.C.; Optional Belt		②▲9590HD
Hose - Upper; (2 1/2" I.D.)		24240
Hose - Lower; (3" I.D.)		24248
Hose - By Pass; (1 1/2" I.D.)		24224
Hose - Heater Inlet; (3/4" I.D.)		28442
Hose - Heater Outlet; (5/8" I.D.)		28441
Caterpillar C10 Diesel		
357		
Belt - Fan & Alt.; W/68 5/8" Belt O.C.		▲K080690HD
Belt - Fan & Alt.; W/70 5/8" Belt O.C.		▲K080700HD
Belt - Fan & Alt.; W/71 5/8" Belt O.C.		▲K080710HD
Belt - Fan & Alt.; W/72 1/8" Belt O.C.		▲K080716HD
Tensioner Assy. - Fan & Alt.	1333545	38506
Tensioner Pulley - Fan & Alt.	1333545	36091
Hose - Upper - Eng. To Pipe; (2 1/2" I.D.)		24240
Hose - Upper - Pipe To Rad.; (2 1/2" I.D.)		24240
Hose - Lower - Eng. To Pipe; (2 1/2" I.D.)		24240
Hose - Lower - Pipe To Rad.; (3" I.D.)		24248
362; 377		
Belt - Fan & Alt.; W/68 5/8" Belt O.C.		▲K080690HD
Belt - Fan & Alt.; W/70 5/8" Belt O.C.		▲K080700HD
Belt - Fan & Alt.; W/71 5/8" Belt O.C.		▲K080710HD
Belt - Fan & Alt.; W/72 1/8" Belt O.C.		▲K080716HD
Belt - A.C.		▲9463HD
Tensioner Assy. - Fan & Alt.	1333545	38506
Tensioner Pulley - Fan & Alt.	1333545	36091
Hose - Upper - Eng. To Pipe; (2 1/2" I.D.)		24240
Hose - Upper - Pipe To Rad.; (2 1/2" I.D.)		24240
Hose - Lower - Eng. To Pipe; (2 1/2" I.D.)		24240
Hose - Lower - Pipe To Rad.; (3" I.D.)		24248
385		
Belt - Fan & Alt.	4080710	▲K080710HD
Belt - A.C.		▲9463HD
Tensioner Assy. - Fan & Alt.	1333545	38506
Tensioner Pulley - Fan & Alt.	1333545	36091
Hose - Upper - Eng. To Pipe; (2 1/2" I.D.)		24240
Hose - Upper - Pipe To Rad.; (2 1/2" I.D.)		24240
Hose - Lower - Eng. To Pipe; (2 1/2" I.D.)		24240
Hose - Lower - Pipe To Rad.; (3" I.D.)		24248
Caterpillar C12 Diesel		
357; 362; 377		
Belt - Fan & Alt.; W/69 5/8" Belt O.C.		▲K080690HD

Application	Mfr. Part No.	Our No.
PETERBILT - Continued		
1997 - Continued		
Caterpillar C12 Diesel - Continued		
357; 362; 377 - Continued		
Belt - Fan & Alt.; W/70 5/8" Belt O.C.		▲K080700HD
Belt - Fan & Alt.; W/71 5/8" Belt O.C.		▲K080710HD
Belt - A.C.		▲9463HD
Tensioner Assy. - Fan & Alt.	1333545	38506
Tensioner Pulley - Fan & Alt.	1333545	36091
Hose - Upper - Eng. To Pipe; (2 1/2" I.D.)		24240
Hose - Upper - Pipe To Rad.; (2 1/2" I.D.)		24240
Hose - Lower - Eng. To Pipe; (2 1/2" I.D.)		24240
Hose - Lower - Pipe To Rad.; (3" I.D.)		24248
385		
Belt - Fan & Alt.	4080710	▲K080710HD
Belt - A.C.		▲9463HD
Tensioner Assy. - Fan & Alt.	1333545	38506
Tensioner Pulley - Fan & Alt.	1333545	36091
Hose - Upper - Eng. To Pipe; (2 1/2" I.D.)		24240
Hose - Upper - Pipe To Rad.; (2 1/2" I.D.)		24240
Hose - Lower - Eng. To Pipe; (2 1/2" I.D.)		24240
Hose - Lower - Pipe To Rad.; (3" I.D.)		24248
Commins ISC Diesel		
320		
Belt - Fan & Alt.; W/69 5/8" Belt O.C. ...	3911581	▲K080690HD
Belt - Fan & Alt.; W/70 5/8" Belt O.C. ...	3911582	▲K080700HD
Belt - Fan & Alt.; W/73 1/8" Belt O.C. ...	3926861	▲K080726HD
Belt - A.C.; W/39 3/8" Belt O.C.		▲9390HD
Belt - A.C.; W/40 7/8" Belt O.C.		▲9405HD
Tensioner Assy. - Fan & Alt.		38507
Hose - Upper - Eng. To Pipe; (2 1/4" I.D.)		24236
Hose - Upper - Pipe To Rad.; (2 1/2" I.D.)		24240
Hose - Lower - Eng. To Pipe		21901
Hose - Lower - Pipe To Rad.; (2 1/2" I.D.)		24240
330		
Belt - Fan & Alt.; W/69 1/2" Belt O.C. ...	3911581	▲K080690HD
Belt - Fan & Alt.; W/72" Belt O.C.		▲K060716HD
Belt - A.C.		▲9390HD
Hose - Upper - Eng. To Pipe; (2" I.D.)		24232
Hose - Upper - Pipe To Rad.; (2 1/2" I.D.)		24240
357		
Belt - Fan & Alt.	3911580	▲K080685HD
Belt - A.C.		▲9365HD
Hose - Upper - Eng. To Pipe; (2 1/4" I.D.)		24236
Hose - Upper - Pipe To Rad.; (2 1/2" I.D.)		24240
Hose - Lower - Eng. To Pipe		21901
Hose - Lower - Pipe To Rad.; (2 1/2" I.D.)		24240
Commins L10 Diesel		
357		
Belt - Fan; W/51" Belt O.C.	3034943	▲K080505HD
Belt - Fan; W/55" Belt O.C.		▲K080545HD
Belt - Alt.	3037425	▲K050340HD
Belt - A.C.		▲9520HD
Hose - Upper - Eng. To Pipe; (2 1/4" I.D.)		24236
Hose - Upper - Pipe To Rad.; (2 1/2" I.D.)		24240
Hose - Lower - Eng. To Pipe; (2 1/2" I.D.)		24240
Hose - Lower - Pipe To Rad.; (3" I.D.)		24248
377		
Belt - Fan; W/51" Belt O.C.	3034943	▲K080505HD
Belt - Fan; W/55" Belt O.C.		▲K080545HD
Belt - Alt.	3037425	▲K050340HD
Belt - A.C.		▲9520HD
378		
Belt - Fan; W/55" Belt O.C.		▲K080545HD
Belt - Fan; W/51" Belt O.C.	3034943	▲K080505HD
Belt - Alt.	3037425	▲K050340HD
Belt - A.C.		▲9520HD
379; 385		
Belt - Fan; W/51" Belt O.C.	3034943	▲K080505HD
Belt - Fan; W/55" Belt O.C.		▲K080545HD
Belt - Alt.	3037425	▲K050340HD
Belt - A.C.		▲9520HD

② Two Required.

◆ Green Stripe® PowerBand® Belt May Work, Use Template to Check.

▲ Standard Belt Available. See Pages 630-631.

Belts and Coolant Hose for Medium/Heavy-Duty Trucks (1996 and Newer)

 Medium & Heavy-Duty Trucks
(1996 & Newer)

Application	Mfr. Part No.	Our No.
PETERBILT - Continued		
1997 - Continued		
Cummins L10 Diesel - Continued		
379; 385 - Continued		
Hose - Upper - Eng. To Pipe; (2 1/4" I.D.)		24236
Hose - Upper - Pipe To Rad.; (2 1/2" I.D.)		24240
Hose - Lower - Eng. To Pipe; (2 1/2" I.D.)		24240
Hose - Lower - Pipe To Rad.; (3" I.D.)		24248
Hose - By Pass; (1 5/8" I.D.)		24226
Hose - Oil Cooler; (3" I.D.)		24248
Hose - Heater Inlet; (3/4" I.D.)		28442
Hose - Heater Outlet; (5/8" I.D.)		28441
Cummins M11 Diesel		
357; 378; 379; 385		
Belt - Fan; W/51" Belt O.C.	3034943	♣K080505HD
Belt - Fan; W/55" Belt O.C.		♣K080545HD
Belt - Alt.	3037425	♣K050340HD
Belt - A.C.		♣9520HD
Hose - Upper - Eng. To Pipe; (2 1/4" I.D.)		24236
Hose - Upper - Pipe To Rad.; (2 1/2" I.D.)		24240
Hose - Lower - Eng. To Pipe; (2 1/2" I.D.)		24240
Hose - Lower - Pipe To Rad.; (3" I.D.)		24248
Cummins N14 Diesel		
357		
Belt - W.P.	3095880	♣K060415HD
Belt - Fan; Optional Belt		②TR28480
Belt - Fan; Preferred Belt		2/TR28480PB
Belt - Alt.; Optional Belt		②♣9463HD
Belt - Alt.; Preferred Belt		2/9463PB
Belt - A.C.		♣9420HD
Hose - Upper; (2 1/2" I.D.)		24240
Hose - Lower - Eng. To Pipe; (2 1/2" I.D.)		24240
Hose - Lower - Pipe To Rad.; (3" I.D.)		24248
377; 378		
Belt - W.P.	3095880	♣K060415HD
Belt - Fan; Optional Belt		②TR28483
Belt - Fan; Preferred Belt		2/TR28483PB
Belt - Alt.; Optional Belt		②♣9463HD
Belt - Alt.; Preferred Belt		2/9463PB
Belt - A.C.; W/41 7/8" Belt O.C.		♣9415HD
Belt - A.C.; W/42 3/8" Belt O.C.		♣9420HD
Hose - Upper; (2 1/2" I.D.)		24240
Hose - Lower - Eng. To Pipe; (2 1/2" I.D.)		24240
Hose - Lower - Pipe To Rad.; (3" I.D.)		24248
379		
Belt - Hub & W.P.		♣K060415HD
Belt - Hub & Fan; Optional Belt		②TR28483
Belt - Hub & Fan; Preferred Belt		2/TR28483PB
Belt - Alt.; Optional Belt		②♣9463HD
Belt - Alt.; Preferred Belt		2/9463PB
Belt - Hub & A.C.	17421	♣9420HD
Hose - Upper - Eng. To Pipe; (2 1/2" I.D.)		24240
Hose - Upper - Pipe To Rad.; (2 1/2" I.D.)		24240
Hose - Lower - Eng. To Pipe; (2 1/2" I.D.)		24240
Hose - Lower - Pipe To Rad.; (3" I.D.)		24248
Detroit Diesel 6-Cyl. 11.1 L Diesel		
357		
Belt - Fan; W/53 1/2" Belt O.C.; Preferred Belt		3/9530PB
Belt - Fan; W/53 1/2" Belt O.C.; Optional Belt		③♣9530HD
Belt - Fan; W/56 3/8" Belt O.C.		③♣9560HD
Belt - Alt.; Optional Belt		②♣9305HD
Belt - Alt.; Preferred Belt	D11049518	2/9305PB
Belt - A.C.; W/53 3/8" Belt O.C.		♣9530HD
Belt - A.C.; W/54 7/8" Belt O.C.		♣9545HD
Hose - Upper - Eng. To Pipe; (2 1/2" I.D.)		24240
Hose - Upper - Pipe To Rad.; (2 1/2" I.D.)		24240
Hose - Lower - Eng. To Pipe; (2 1/2" I.D.)		24240
Hose - Lower - Pipe To Rad.; (3" I.D.)		24248
377; 378		
Belt - Fan; W/53 1/2" Belt O.C.; Preferred Belt		3/9530PB
Belt - Fan; W/53 1/2" Belt O.C.; Optional Belt		③♣9530HD
Belt - Fan & A.C.		♣9540HD

Application	Mfr. Part No.	Our No.
PETERBILT - Continued		
1997 - Continued		
Detroit Diesel 6-Cyl. 11.1 L Diesel - Continued		
377; 378 - Continued		
Belt - Hub & Alt.		②♣9305HD
Hose - Upper - Eng. To Pipe; (2 1/2" I.D.)		24240
Hose - Upper - Pipe To Rad.; (2 1/2" I.D.)		24240
Hose - Lower - Eng. To Pipe; (2 1/2" I.D.)		24240
Hose - Lower - Pipe To Rad.; (3" I.D.)		24248
379		
Belt - Fan; W/53 1/2" Belt O.C.; Preferred Belt		3/9530PB
Belt - Fan; W/53 1/2" Belt O.C.; Optional Belt		③♣9530HD
Belt - Fan & A.C.		♣9540HD
Belt - Hub & Alt.		②♣9305HD
Hose - Upper - Eng. To Pipe; (2 1/2" I.D.)		24240
Hose - Upper - Pipe To Rad.; (2 1/2" I.D.)		24240
Hose - Lower - Eng. To Pipe; (2 1/2" I.D.)		24240
Hose - Lower - Pipe To Rad.; (3" I.D.)		24248
Detroit Diesel 6-Cyl. 12.7 L Diesel		
357		
Belt - Fan; W/53 1/2" Belt O.C.; Preferred Belt		3/9530PB
Belt - Fan; W/53 1/2" Belt O.C.; Optional Belt		③♣9530HD
Belt - Fan; W/56 3/8" Belt O.C.		③♣9560HD
Belt - Alt.; Optional Belt		②♣9305HD
Belt - Alt.; Preferred Belt	D11049518	2/9305PB
Belt - A.C.; W/53 3/8" Belt O.C.		♣9530HD
Belt - A.C.; W/54 7/8" Belt O.C.		♣9545HD
Hose - Upper - Eng. To Pipe; (2 1/2" I.D.)		24240
Hose - Upper - Pipe To Rad.; (2 1/2" I.D.)		24240
Hose - Lower - Eng. To Pipe; (2 1/2" I.D.)		24240
Hose - Lower - Pipe To Rad.; (3" I.D.)		24248
377; 378		
Belt - Fan; W/53 1/2" Belt O.C.; Preferred Belt		3/9530PB
Belt - Fan; W/53 1/2" Belt O.C.; Optional Belt		③♣9530HD
Belt - Fan & A.C.		♣9540HD
Belt - Hub & Alt.		②♣9305HD
Hose - Upper - Eng. To Pipe; (2 1/2" I.D.)		24240
Hose - Upper - Pipe To Rad.; (2 1/2" I.D.)		24240
Hose - Lower - Eng. To Pipe; (2 1/2" I.D.)		24240
Hose - Lower - Pipe To Rad.; (3" I.D.)		24248
379		
Belt - Fan; W/53 1/2" Belt O.C.; Preferred Belt		3/9530PB
Belt - Fan; W/53 1/2" Belt O.C.; Optional Belt		③♣9530HD
Belt - Fan & A.C.		♣9540HD
Belt - Hub & Alt.		②♣9305HD
Hose - Upper - Eng. To Pipe; (2 1/2" I.D.)		24240
Hose - Upper - Pipe To Rad.; (2 1/2" I.D.)		24240
Hose - Lower - Eng. To Pipe; (2 1/2" I.D.)		24240
Hose - Lower - Pipe To Rad.; (3" I.D.)		24248
1996		
Caterpillar 3116 Diesel		
330		
Belt - W.P.	7E0744	♣9345HD
Belt - Fan & Alt.		♣K070673HD
Belt - Fan, Alt. & A.C.		♣K070735HD
Tensioner Assy. - Fan & Alt.		38507
Hose - Upper - Eng. To Pipe; (2" I.D.)		24232
Hose - Upper - Pipe To Rad.; (2 1/2" I.D.)		24240
Hose - Lower - Eng. To Pipe; (2" I.D.)		24232
Hose - Lower - Pipe To Rad.; (2 1/2" I.D.)		24240
Caterpillar 3126 Diesel		
330		
Belt - W.P.	7E0744	♣9345HD
Belt - Fan & Alt.; W/V-Belt Drive	0618384	♣9335HD
Belt - Fan & Alt.; W/V-Ribbed Belt Drive		♣K070673HD
Belt - Fan, Alt. & A.C.		♣K060735HD
Tensioner Assy. - Fan & Alt.		38507
Hose - Upper - Eng. To Pipe; (2" I.D.)		24232
Hose - Upper - Pipe To Rad.; (2 1/2" I.D.)		24240

 ♣ Standard Belt Available. See Pages 630-631.
 ③ Three Required.

② Two Required.

Belts and Coolant Hose for Medium/Heavy-Duty Trucks (1996 and Newer)

Medium & Heavy-Duty Trucks
(1996 & Newer)

Application	Mfr. Part No.	Our No.
PETERBILT - Continued		
1996 - Continued		
Caterpillar 3126 Diesel - Continued		
330 - Continued		
Hose - Lower - Eng. To Pipe; (2" I.D.)		24232
Hose - Lower - Pipe To Rad.; (2 1/2" I.D.)		24240
Caterpillar 3306 Diesel		
357; 375; 378; 379		
Belt - Fan; W/57 3/8" Belt O.C.; Optional Belt	②	▲9570HD
Belt - Fan; W/57 3/8" Belt O.C.; Preferred Belt		2/9570PB
Belt - Fan; W/58 3/8" Belt O.C.		▲9580HD
Belt - Fan; W/59" Belt O.C.		▲9585HD
Belt - Fan; W/64 3/8" Belt O.C.; Optional Belt	②	▲9640HD
Belt - Fan; W/64 3/8" Belt O.C.; Preferred Belt		2/9640PB
Belt - Fan; W/66 3/8" Belt O.C.; Optional Belt	②	▲9660HD
Belt - Fan; W/66 3/8" Belt O.C.; Preferred Belt		2/9660PB
Belt - Alt.; W/43 7/8" Belt O.C.; Optional Belt	②	▲9435HD
Belt - Alt.; W/43 7/8" Belt O.C.; Preferred Belt		2/9435PB
Belt - Alt.; W/46 3/8" Belt O.C.; Optional Belt	②	▲9463HD
Belt - Alt.; W/46 3/8" Belt O.C.; Preferred Belt		2/9463PB
Belt - Alt. & A.C.; W/46 1/2" Belt O.C.; Optional Belt	②	▲9463HD
Belt - Alt. & A.C.; W/46 1/2" Belt O.C.; Preferred Belt		2/9463PB
Belt - Alt. & A.C.; W/50" Belt O.C.		▲9495HD
Belt - Alt. & A.C.; W/54 1/2" Belt O.C.; Optional Belt	②	▲9540HD
Belt - Alt. & A.C.; W/54 1/2" Belt O.C.; Preferred Belt		2/9540PB
Belt - Alt. & A.C.; W/56 1/2" Belt O.C.; Optional Belt	②	▲9560HD
Belt - Alt. & A.C.; W/56 1/2" Belt O.C.; Preferred Belt		2/9560PB
Belt - Alt. & A.C.; W/59 3/8" Belt O.C.; Optional Belt	②	▲9590HD
Belt - Alt. & A.C.; W/59 3/8" Belt O.C.; Preferred Belt		2/9590PB
Hose - Upper; (2 1/2" I.D.)		24240
Hose - Lower - Eng. To Pipe; (2 1/2" I.D.)		24240
Hose - Lower - Pipe To Rad.; (3" I.D.)		24248
Hose - Lower - Pipe To Pipe; (3" I.D.)		24248
Hose - Heater Inlet; (3/4" I.D.)		28442
Hose - Heater Outlet; (5/8" I.D.)		28441
Caterpillar 3406 Diesel		
357		
Belt - Fan; Preferred Belt; W/52 1/2" Belt O.C.		2/TR22517PB
Belt - Fan; Optional Belt; W/52 1/2" Belt O.C.		D11024730
Belt - Fan; W/54 1/2" Belt O.C.	②	◆TR22517
Belt - Fan; W/55 1/2" Belt O.C.	②	TR22534
Belt - Fan; W/55 1/8" Belt O.C.	②	TR22553
Belt - Fan; W/55 1/8" Belt O.C.	②	TR22545
Belt - Alt.; W/49 1/2" Belt O.C.; Preferred Belt		2/9490PB
Belt - Alt.; W/49 1/2" Belt O.C.; Optional Belt	②	▲9490HD
Belt - Alt.; W/51 1/2" Belt O.C.; Preferred Belt		2/9510PB
Belt - Alt.; W/51 1/2" Belt O.C.; Optional Belt	②	▲9510HD
Belt - Alt. & A.C.; Preferred Belt		2/9590PB
Belt - Alt. & A.C.; Optional Belt	②	▲9590HD
Hose - Upper; (2 1/2" I.D.)		24240
Hose - Lower; (3" I.D.)		24248
Hose - By Pass; (1 1/2" I.D.)		24224
Hose - Heater Inlet; (3/4" I.D.)		28442
Hose - Heater Outlet; (5/8" I.D.)		28441
362		
Belt - Fan; Preferred Belt; W/52 1/2" Belt O.C.		2/TR22517PB
Belt - Fan; Optional Belt; W/52 1/2" Belt O.C.		D11024730
Belt - Fan; W/55 1/8" Belt O.C.	②	◆TR22517
Belt - Fan; W/55 7/8" Belt O.C.	②	TR22545
Belt - Fan & Alt.; W/56 7/8" Belt O.C.	②	TR22553
Belt - Fan & Alt.; W/58 7/8" Belt O.C.		▲9565HD
Belt - Fan & Alt.; W/58 7/8" Belt O.C.		▲9585HD
377; 378; 379		
Belt - Fan; Preferred Belt; W/52 1/2" Belt O.C.		2/TR22517PB
Belt - Fan; Optional Belt; W/52 1/2" Belt O.C.		D11024730
Belt - Fan; W/54 1/2" Belt O.C.	②	◆TR22517
Belt - Fan; W/55 1/2" Belt O.C.	②	TR22534
Belt - Fan; W/55 1/2" Belt O.C.	②	TR22553
Belt - Fan; W/55 1/8" Belt O.C.	②	TR22545
Belt - Alt.; W/49 1/2" Belt O.C.; Preferred Belt		2/9490PB
Belt - Alt.; W/49 1/2" Belt O.C.; Optional Belt	②	▲9490HD
Belt - Alt.; W/51 1/2" Belt O.C.; Preferred Belt		2/9510PB
Belt - Alt.; W/51 1/2" Belt O.C.; Optional Belt	②	▲9510HD

Application	Mfr. Part No.	Our No.
PETERBILT - Continued		
1996 - Continued		
Caterpillar 3406 Diesel - Continued		
377; 378; 379 - Continued		
Belt - Alt. & A.C.; Preferred Belt		2/9590PB
Belt - Alt. & A.C.; Optional Belt	②	▲9590HD
Hose - Upper; (2 1/2" I.D.)		24240
Hose - Lower; (3" I.D.)		24248
Hose - By Pass; (1 1/2" I.D.)		24224
Hose - Heater Inlet; (3/4" I.D.)		28442
Hose - Heater Outlet; (5/8" I.D.)		28441
Caterpillar C10 Diesel		
362		
Belt - Fan & Alt.; W/68 5/8" Belt O.C.		▲K080690HD
Belt - Fan & Alt.; W/70 5/8" Belt O.C.		▲K080700HD
Belt - Fan & Alt.; W/71 5/8" Belt O.C.		▲K080710HD
Belt - Fan & Alt.; W/72 1/8" Belt O.C.		▲K080716HD
Tensioner Assy. - Fan & Alt.	1333545	38506
Tensioner Pulley - Fan & Alt.	1333545	36091
Hose - Upper - Eng. To Pipe; (2 1/2" I.D.)		24240
Hose - Upper - Pipe To Rad.; (2 1/2" I.D.)		24240
Hose - Lower - Eng. To Pipe; (2 1/2" I.D.)		24240
Hose - Lower - Pipe To Rad.; (3" I.D.)		24248
Caterpillar C12 Diesel		
362		
Belt - Fan & Alt.; W/68 5/8" Belt O.C.		▲K080690HD
Belt - Fan & Alt.; W/70 5/8" Belt O.C.		▲K080700HD
Belt - Fan & Alt.; W/71 5/8" Belt O.C.		▲K080710HD
Belt - Fan & Alt.; W/72 1/8" Belt O.C.		▲K080716HD
Tensioner Assy. - Fan & Alt.	1333545	38506
Tensioner Pulley - Fan & Alt.	1333545	36091
Hose - Upper - Eng. To Pipe; (2 1/2" I.D.)		24240
Hose - Upper - Pipe To Rad.; (2 1/2" I.D.)		24240
Hose - Lower - Eng. To Pipe; (2 1/2" I.D.)		24240
Hose - Lower - Pipe To Rad.; (3" I.D.)		24248
385		
Belt - Fan & Alt.	4080710	▲K080710HD
Belt - A.C.		▲9463HD
Tensioner Assy. - Fan & Alt.	1333545	38506
Tensioner Pulley - Fan & Alt.	1333545	36091
Hose - Upper - Eng. To Pipe; (2 1/2" I.D.)		24240
Hose - Upper - Pipe To Rad.; (2 1/2" I.D.)		24240
Hose - Lower - Eng. To Pipe; (2 1/2" I.D.)		24240
Hose - Lower - Pipe To Rad.; (3" I.D.)		24248
Cummins C Series 8.3 L Diesel		
200		
Hose - Upper - Eng. To Pipe; (2 1/4" I.D.)		24236
Hose - Upper - Pipe To Rad.; (2 1/2" I.D.)		24240
Hose - Lower - Eng. To Pipe		21901
Hose - Lower - Pipe To Rad.; (2 1/2" I.D.)		24240
320		
Belt - Fan & Alt.; W/69 5/8" Belt O.C. ...	3911581	▲K080690HD
Belt - Fan & Alt.; W/70 5/8" Belt O.C. ...	3911582	▲K080700HD
Belt - Fan & Alt.; W/73 1/8" Belt O.C. ...	3926861	▲K080726HD
Belt - A.C.; W/39 3/8" Belt O.C.		▲9390HD
Belt - A.C.; W/40 7/8" Belt O.C.		▲9405HD
Tensioner Assy. - Fan & Alt.		38507
Hose - Upper - Eng. To Pipe; (2 1/4" I.D.)		24236
Hose - Upper - Pipe To Rad.; (2 1/2" I.D.)		24240
Hose - Lower - Eng. To Pipe		21901
Hose - Lower - Pipe To Rad.; (2 1/2" I.D.)		24240
330		
Belt - Fan & Alt.	3911581	▲K080690HD
Belt - A.C.		▲9390HD
Hose - Upper - Eng. To Pipe; (2" I.D.)		24232
Hose - Upper - Pipe To Rad.; (2 1/2" I.D.)		24240
Hose - Lower - Eng. To Pipe		21473
Hose - Lower - Pipe To Rad.; (2 1/2" I.D.)		24240
357		
Belt - Fan & Alt.	3911580	▲K080685HD
Belt - A.C.		▲9365HD
Hose - Upper - Eng. To Pipe; (2 1/4" I.D.)		24236

② Two Required.

◆ Green Stripe® PowerBand® Belt May Work, Use Template to Check.

▲ Standard Belt Available. See Pages 630-631.

Belts and Coolant Hose for Medium/Heavy-Duty Trucks (1996 and Newer)

 Medium & Heavy-Duty Trucks
(1996 & Newer)

Application	Mfr. Part No.	Our No.
PETERBILT - Continued		
1996 - Continued		
Cummins C Series 8.3 L Diesel - Continued		
357 - Continued		
Hose - Upper - Pipe To Rad.; (2 1/2" I.D.)		24240
Hose - Lower - Eng. To Pipe		21901
Hose - Lower - Pipe To Rad.; (2 1/2" I.D.)		24240
375		
Belt - Fan & Alt.; W/69 1/2" Belt O.C.	3911581	♣K080690HD
Belt - Fan & Alt.; W/70 1/2" Belt O.C.	3904029	♣K080700HD
Belt - Fan & Alt.; W/72 1/2" Belt O.C.	3911585	♣K080720HD
Belt - A.C.; W/26 3/8" Belt O.C.		9260
Belt - A.C.; W/36 7/8" Belt O.C.		♣9365HD
Belt - A.C.; W/39 3/8" Belt O.C.	17391	♣9390HD
Hose - Upper - Eng. To Pipe; (2 1/4" I.D.)		24236
Hose - Upper - Pipe To Rad.; (2 1/2" I.D.)		24240
Hose - Lower - Eng. To Pipe		21901
Hose - Lower - Pipe To Rad.; (2 1/2" I.D.)		24240
385		
Belt - Fan & Alt.		♣K080710HD
Belt - A.C.		♣9463HD
Hose - Upper; (2 1/2" I.D.)		24240
Hose - Lower - Eng. To Pipe; (2 1/2" I.D.)		24240
Hose - Lower - Pipe To Rad.; (3" I.D.)		24248
Cummins L10 Diesel		
320		
Belt - Fan	3027697	♣K080560HD
Belt - Alt.		♣K050380HD
Belt - A.C.		♣9550HD
Hose - Upper - Eng. To Pipe; (2 1/4" I.D.)		24236
Hose - Upper - Pipe To Rad.; (2 1/2" I.D.)		24240
Hose - Lower - Eng. To Pipe; (2 1/2" I.D.)		24240
Hose - Lower - Pipe To Rad.; (2 1/2" I.D.)		24240
357		
Belt - Fan; W/51" Belt O.C.	3034943	♣K080505HD
Belt - Fan; W/55" Belt O.C.		♣K080545HD
Belt - Alt.	3037425	♣K050340HD
Belt - A.C.		♣9520HD
Hose - Upper - Eng. To Pipe; (2 1/4" I.D.)		24236
Hose - Upper - Pipe To Rad.; (2 1/2" I.D.)		24240
Hose - Lower - Eng. To Pipe; (2 1/2" I.D.)		24240
Hose - Lower - Pipe To Rad.; (3" I.D.)		24248
Hose - By Pass; (1 5/8" I.D.)		24226
Hose - Oil Cooler; (3" I.D.)		24248
Hose - Heater Inlet; (3/4" I.D.)		28442
Hose - Heater Outlet; (5/8" I.D.)		28441
377; 378		
Belt - Fan; W/51" Belt O.C.	3034943	♣K080505HD
Belt - Fan; W/55" Belt O.C.		♣K080545HD
Belt - Alt.	3037425	♣K050340HD
Belt - A.C.		♣9520HD
379		
Belt - Fan; W/51" Belt O.C.	3034943	♣K080505HD
Belt - Fan; W/55" Belt O.C.		♣K080545HD
Belt - Alt.	3037425	♣K050340HD
Belt - A.C.		♣9520HD
Hose - Upper - Eng. To Pipe; (2 1/4" I.D.)		24236
Hose - Upper - Pipe To Rad.; (2 1/2" I.D.)		24240
Hose - Lower - Eng. To Pipe; (2 1/2" I.D.)		24240
Hose - Lower - Pipe To Rad.; (3" I.D.)		24248
Hose - By Pass; (1 5/8" I.D.)		24226
Hose - Oil Cooler; (3" I.D.)		24248
Hose - Heater Inlet; (3/4" I.D.)		28442
Hose - Heater Outlet; (5/8" I.D.)		28441
385		
Belt - Fan; W/51" Belt O.C.	3034943	♣K080505HD
Belt - Fan; W/55" Belt O.C.		♣K080545HD

Application	Mfr. Part No.	Our No.
PETERBILT - Continued		
1996 - Continued		
Cummins L10 Diesel - Continued		
385 - Continued		
Belt - Alt.	3037425	♣K050340HD
Belt - A.C.		♣9520HD
Cummins M11 Diesel		
357; 378; 379; 385		
Belt - Fan; W/51" Belt O.C.	3034943	♣K080505HD
Belt - Fan; W/55" Belt O.C.		♣K080545HD
Belt - Alt.	3037425	♣K050340HD
Belt - A.C.		♣9520HD
Hose - Upper - Eng. To Pipe; (2 1/4" I.D.)		24236
Hose - Upper - Pipe To Rad.; (2 1/2" I.D.)		24240
Hose - Lower - Eng. To Pipe; (2 1/2" I.D.)		24240
Hose - Lower - Pipe To Rad.; (3" I.D.)		24248
Cummins N14 Diesel		
357		
Belt - W.P.; W/43 1/8" Belt O.C.	3076492	♣K060425HD
Belt - W.P.; W/44 1/8" Belt O.C.	217638	♣K060435HD
Belt - Fan; W/46" Belt O.C.	D11025710	TR28454
Belt - Fan; W/48 5/8" Belt O.C.; Optional Belt		②TR28480
Belt - Fan; W/48 5/8" Belt O.C.; Preferred Belt		2/TR28480PB
Belt - Alt.; Optional Belt		②♣9463HD
Belt - Alt.; Preferred Belt		2/9463PB
Belt - A.C.; W/38 7/8" Belt O.C.		♣9385HD
Belt - A.C.; W/42 3/8" Belt O.C.		♣9420HD
Hose - Upper; (2 1/2" I.D.)		24240
Hose - Lower - Eng. To Pipe; (2 1/2" I.D.)		24240
Hose - Lower - Pipe To Rad.; (3" I.D.)		24248
362		
Belt - W.P.; W/42" Belt O.C.	3095880	♣K060415HD
Belt - W.P.; W/43 1/8" Belt O.C.	3076492	♣K060425HD
Belt - W.P.; W/44" Belt O.C.	217638	♣K060435HD
Belt - Fan; W/48 5/8" Belt O.C.; Optional Belt		②TR28480
Belt - Fan; W/48 5/8" Belt O.C.; Preferred Belt		2/TR28480PB
Belt - Fan; W/49 7/8" Belt O.C.; Optional Belt		②TR28492
Belt - Fan; W/49 7/8" Belt O.C.; Preferred Belt	134809	2/TR28492PB
Belt - Fan; W/51" Belt O.C.		TR28501
Belt - Alt.; Optional Belt		②♣9463HD
Belt - Alt.; Preferred Belt		2/9463PB
Belt - A.C.; W/42 1/2" Belt O.C.		♣9420HD
Belt - A.C.; W/57 1/8" Belt O.C.		TR28565
Belt - A.C.; W/58 7/8" Belt O.C.		TR28583
Hose - Upper; (2 1/2" I.D.)		24240
Hose - Lower - Eng. To Pipe; (2 1/2" I.D.)		24240
Hose - Lower - Pipe To Rad.; (3" I.D.)		24248
Hose - By Pass; (1 1/2" I.D.)		24224
Hose - Aftercooler		21488
Hose - Heater Inlet; (3/4" I.D.)		28442
Hose - Heater Outlet; (5/8" I.D.)		28441
377; 378; 379		
Belt - W.P.	3095880	♣K060415HD
Belt - Fan; Optional Belt	D11025779	②TR28483
Belt - Fan; Preferred Belt		2/TR28483PB
Belt - Alt.		♣9463HD
Belt - A.C.; W/41 7/8" Belt O.C.		♣9415HD
Belt - A.C.; W/42 3/8" Belt O.C.	17421	♣9420HD
Hose - Upper; (2 1/2" I.D.)		24240
Hose - Lower - Eng. To Pipe; (2 1/2" I.D.)		24240
Hose - Lower - Pipe To Rad.; (3" I.D.)		24248
Detroit Diesel 6-Cyl. 11.1 L Diesel		
357		
Belt - Fan; W/53 1/2" Belt O.C.; Preferred Belt		3/9530PB
Belt - Fan; W/53 1/2" Belt O.C.; Optional Belt		③♣9530HD
Belt - Fan; W/56 3/8" Belt O.C.		③♣9560HD
Belt - Alt.; W/30 7/8" Belt O.C.; Optional Belt		②♣9305HD
Belt - Alt.; W/30 7/8" Belt O.C.; Preferred		
Belt	D11049518	2/9305PB
Belt - Alt.; W/31 7/8" Belt O.C.; Optional Belt		②♣9313HD
Belt - Alt.; W/31 7/8" Belt O.C.; Preferred Belt		2/9313PB

♣ Standard Belt Available. See Pages 630-631.
③ Three Required.

② Two Required.

Belts and Coolant Hose for Medium/Heavy-Duty Trucks [1996 and Newer]

Medium & Heavy-Duty Trucks
(1996 & Newer)

Application	Mfr. Part No.	Our No.
PETERBILT - Continued		
1996 - Continued		
Detroit Diesel 6-Cyl. 11.1 L Diesel - Continued		
357 - Continued		
Belt - A.C.; W/53 3/8" Belt O.C.		▲9530HD
Belt - A.C.; W/54 7/8" Belt O.C.		▲9545HD
Hose - Upper - Eng. To Pipe; (2 1/2" I.D.)		24240
Hose - Upper - Pipe To Rad.; (2 1/2" I.D.)		24240
Hose - Lower - Eng. To Pipe; (2 1/2" I.D.)		24240
Hose - Lower - Pipe To Rad.; (3" I.D.)		24248
362		
Belt - Alt.		2/9325PB
377; 378; 379		
Belt - Fan; W/53 1/2" Belt O.C.; Preferred Belt		3/9530PB
Belt - Fan; W/53 1/2" Belt O.C.; Optional Belt		③▲9530HD
Belt - Fan; W/56" Belt O.C.		③▲9560HD
Belt - Alt.; W/30 7/8" Belt O.C.; Optional Belt		②▲9305HD
Belt - Alt.; W/30 7/8" Belt O.C.; Preferred Belt		D11049518
Belt		2/9305PB
Belt - Alt.; W/31 7/8" Belt O.C.; Optional Belt		②▲9313HD
Belt - Alt.; W/31 7/8" Belt O.C.; Preferred Belt		2/9313PB
Belt - Alt.; W/32 7/8" Belt O.C.; Optional Belt		②▲9325HD
Belt - Alt.; W/32 7/8" Belt O.C.; Preferred Belt		2/9325PB
Belt - A.C.; W/53 3/8" Belt O.C.		▲9530HD
Belt - A.C.; W/54 7/8" Belt O.C.		▲9545HD
Hose - Upper - Eng. To Pipe; (2 1/2" I.D.)		24240
Hose - Upper - Pipe To Rad.; (2 1/2" I.D.)		24240
Hose - Lower - Eng. To Pipe; (2 1/2" I.D.)		24240
Hose - Lower - Pipe To Rad.; (3" I.D.)		24248
Detroit Diesel 6-Cyl. 12.7 L Diesel		
362		
Belt - Alt.		2/9325PB
377; 378; 379		
Belt - Fan; W/53 1/2" Belt O.C.; Preferred Belt		3/9530PB
Belt - Fan; W/53 1/2" Belt O.C.; Optional Belt		③▲9530HD
Belt - Fan; W/56" Belt O.C.		③▲9560HD
Belt - Alt.; W/30 7/8" Belt O.C.; Optional Belt		②▲9305HD
Belt - Alt.; W/30 7/8" Belt O.C.; Preferred Belt		D11049518
Belt		2/9305PB
Belt - Alt.; W/31 7/8" Belt O.C.; Optional Belt		②▲9313HD
Belt - Alt.; W/31 7/8" Belt O.C.; Preferred Belt		2/9313PB
Belt - Alt.; W/32 7/8" Belt O.C.; Optional Belt		②▲9325HD
Belt - Alt.; W/32 7/8" Belt O.C.; Preferred Belt		2/9325PB
Belt - A.C.; W/53 3/8" Belt O.C.		▲9530HD
Belt - A.C.; W/54 7/8" Belt O.C.		▲9545HD
Hose - Upper - Eng. To Pipe; (2 1/2" I.D.)		24240
Hose - Upper - Pipe To Rad.; (2 1/2" I.D.)		24240
Hose - Lower - Eng. To Pipe; (2 1/2" I.D.)		24240
Hose - Lower - Pipe To Rad.; (3" I.D.)		24248
STERLING		
2009		
Cummins ISC Diesel		
Acterra		
Belt - Fan, A.C., Alt. & W.P.	0123415100	▲K080820HD
Tensioner Assy. - Fan, A.C., Alt. & W.P.	3973819	38627
Idler Pulley - Fan, A.C., Alt. & W.P.	3970945	36283
Hose - Upper - Eng. To Pipe; (2 1/4" I.D.)		≧24436
Hose - Upper - Pipe To Rad.; (2" I.D.)		≧24432
Hose - Lower - Eng. To Pipe; (2 1/4" I.D.)		≧24436
Hose - Lower - Pipe To Rad.; (2" I.D.)		≧24432
L-Line		
Belt - Fan, Alt. & W.P.	0123415036	K080962HD
Tensioner Assy. - Fan, W.P. & Alt.	3973819	38627
Hose - Lower - Pipe To Rad.		21571
Detroit Diesel 6-Cyl. 14.0 L Diesel		
L-Line		
Belt - Alt.	0124587006	▲K080570HD
Belt - Fan	0124894004	▲K100502HD
Tensioner Assy. - Alt.	0127425000	38501
Tensioner Assy. - Fan	0127846000	38503

Application	Mfr. Part No.	Our No.
STERLING - Continued		
2009 - Continued		
Mercedes-Benz MBE 4000 Diesel		
A-Line		
Belt - A.C. & Alt.	0124587002	▲K080855HD
Belt - Fan & W.P.	0127116013	▲K080505HD
Tensioner Assy. - Fan	0127427001	38597
Tensioner Assy. - Alt. & A.C.	0127425000	38501
2008		
Caterpillar C15 Diesel		
L-Line		
Belt - Fan & A.C.	0130882000	K120985HD
Tensioner Assy. - Fan & A.C.	2362301	38609
Tensioner Assy. - Alt.	2790253	38636
Hose - Lower - Eng. To Pipe		≧22707
Hose - Lower - Rad. To Pipe		21891
Cummins ISB-07 Diesel		
Acterra		
Belt - Fan, Alt. & A.C.	0123415077	K080813HD
Tensioner Assy. - Fan, Alt. & A.C.	4937433	38631
Hose - Lower - Eng. To Pipe; (2" I.D.)		24232
Hose - Lower - Rad. To Pipe; (2" I.D.)		24232
Bullet		
Belt - A.C. To Fan & W.P.	K081359	▲K081359HD
Cummins ISC Diesel		
Acterra		
Belt - W.P., Fan, Alt. & A.C.	0123415100	▲K080820HD
Tensioner Assy. - Fan, W.P. & Alt.	3936213	38516
Idler Pulley	3970945	36283
Tensioner Pulley - Fan, W.P. & Alt.	3936213	36093
Hose - Upper - Eng. To Pipe; (2 1/4" I.D.)		24236
Hose - Upper - Rad. To Pipe; (2" I.D.)		24232
Hose - Lower - Eng. To Pipe; (2 1/4" I.D.)		24236
Hose - Lower - Rad. To Pipe; (2" I.D.)		24232
Detroit Diesel 6-Cyl. 12.7 L Diesel		
L-Line		
Belt - Fan	0124894004	▲K100502HD
Belt - Hub, Alt. & A.C.	0124587006	▲K080570HD
Tensioner Assy. - Fan	0127846000	38503
Tensioner Assy. - Hub, Alt. & A.C.	0127425000	38501
Tensioner Pulley - Fan	0127846000	38076
Tensioner Pulley - Hub, Alt. & A.C.	0127425000	38075
Hose - Upper - Eng. To Pipe; (2 1/2" I.D.)		24240
Hose - Upper - Rad. To Pipe; (2 1/2" I.D.)		24240
Hose - Lower - Eng. To Pipe; (2 1/2" I.D.)		24240
Detroit Diesel 6-Cyl. 14.0 L Diesel		
L-Line		
Belt - Fan	0124894004	▲K100502HD
Belt - Hub, Alt. & A.C.	0124587006	▲K080570HD
Tensioner Assy. - Fan	0127846000	38503
Tensioner Assy. - Hub, Alt. & A.C.	0127425000	38501
Tensioner Pulley - Fan	0127846000	38076
Tensioner Pulley - Hub, Alt. & A.C.	0127425000	38075
Hose - Upper - Eng. To Pipe; (2 1/2" I.D.)		24240
Hose - Upper - Rad. To Pipe; (2 1/2" I.D.)		24240
Hose - Lower - Eng. To Pipe; (2 1/2" I.D.)		24240
Mercedes-Benz MBE 4000 Diesel		
A-Line		
Belt - Fan	0127116013	▲K080505HD
Belt - W.P., Alt. & A.C.	0124587002	▲K080855HD
Tensioner Assy. - Fan	0127427001	38597
Tensioner Assy. - Accessory Drive	0127425000	38501
2007		
Caterpillar C7 Diesel		
Acterra		
Belt - Fan, Alt. & A.C.	0123415098	▲K080694HD
Belt - W.P.	0366775	▲9341HD
Idler Pulley - Upper	1979641	36091
Idler Pulley - Lower	2534525	36096

▲ Standard Belt Available. See Pages 630-631.
② Two Required.

③ Three Required.
≧ Cut to Fit.

Belts and Coolant Hose for Medium/Heavy-Duty Trucks (1996 and Newer)

 Medium & Heavy-Duty Trucks
(1996 & Newer)

Application	Mfr. Part No.	Our No.
STERLING - Continued		
2007 - Continued		
Caterpillar C7 Diesel - Continued		
Acterra - Continued		
Hose - Upper - Eng. To Pipe		20206
Hose - Upper - Rad. To Pipe; (2" I.D.)		24232
Hose - Lower - Eng. To Pipe		20206
Hose - Lower - Rad. To Pipe		20206
L-Line		
Belt - Fan & Alt.	0123415077	K080813HD
Tensioner Assy. - Fan & Alt.	2222880	38586
Idler Pulley - Upper	1979641	36091
Caterpillar C9 Diesel		
A-Line		
Idler Pulley - Smooth	2078118	36269
L-Line		
Belt - Fan, Alt. & A.C.	0123415082	♣K081079HD
Tensioner Assy. - Fan, Alt. & A.C.	2117895	38590
Tensioner Pulley - Fan, Alt. & A.C.	2117895	36164
Idler Pulley	2078118	36269
Hose - Upper - Eng. To Rad.		22980
Hose - Lower - Eng. To Rad.		22952
Caterpillar C11 Diesel		
A-Line		
Idler Pulley - Smooth	2078118	36269
Idler Pulley - Grooved	1979642	36341
L-Line		
Belt - Fan, Alt. & A.C.	0123415082	♣K081079HD
Tensioner Assy. - Fan, Alt. & A.C.	2117895	38590
Tensioner Pulley - Fan, Alt. & A.C.	2117895	36164
Idler Pulley - Smooth	2078118	36269
Idler Pulley - Grooved	1979642	36341
Hose - Upper - Eng. To Rad.		22980
Hose - Lower - Eng. To Rad.		22952
Caterpillar C13 Diesel		
A-Line		
Idler Pulley - Smooth	2078118	36269
Idler Pulley - Grooved	1979642	36341
L-Line		
Belt - Fan, Alt. & A.C.	0123415082	♣K081079HD
Belt - Fan To Alt. & A.C.	0123415080	♣K081005HD
Tensioner Assy. - Fan, Alt. & A.C.	2117895	38590
Tensioner Pulley - Fan, Alt. & A.C.	2117895	36164
Idler Pulley - Smooth	2078118	36269
Idler Pulley - Grooved	1979642	36341
Hose - Upper - Eng. To Rad.		22980
Hose - Lower - Eng. To Pipe; (2 1/2" I.D.)		24240
Hose - Lower - Rad. To Pipe; (2 1/2" I.D.)		24240
Hose - Lower - Cooler To Pipe		21891
Hose - Lower - Pipe To Cooler		21891
Caterpillar C15 Diesel		
A-Line		
Idler Pulley - Smooth	1979641	36091
Idler Pulley - Grooved	1979642	36341
L-Line		
Belt - Fan, Alt. & A.C.; W/Set Back Axle	0123415080	♣K081005HD
Belt - Fan, Alt. & A.C.; W/Set Forward Axle	0123415082	♣K081079HD
Tensioner Assy. - Fan, Alt. & A.C.	2117895	38590
Tensioner Pulley - Fan, Alt. & A.C.	2117895	36164
Idler Pulley - Smooth	1979641	36091
Idler Pulley - Grooved	1979642	36341
Hose - Upper - Eng. To Rad.		22980
Hose - Lower - Eng. To Pipe; W/Set Forward Axle		22980
Hose - Lower - Pipe To Cooler		21891
Hose - Lower - Cooler To Pipe		21891
Cummins ISB Diesel		
SC8000		
Belt - Accessory Drive	3290073	♣K080605HD
Tensioner Assy.	3957433	38517

♣ Standard Belt Available. See Pages 630-631.

Application	Mfr. Part No.	Our No.
STERLING - Continued		
2007 - Continued		
Cummins ISC Diesel		
Acterra		
Belt - W.P., Fan, Alt. & A.C.	0123415100	♣K080820HD
Belt - Fan, W.P. & Alt.	3289325	♣K080708HD
Belt - Fan To A.C.	2310001067	♣9480HD
Tensioner Assy. - Fan, W.P. & Alt.	3936213	38516
Idler Pulley	3970945	36283
Tensioner Pulley - Fan, W.P. & Alt.	3936213	36093
Hose - Lower - Rad. To Pipe		20206
L-Line		
Idler Pulley	3970945	36283
Cummins ISL Diesel		
Condor		
Belt - Fan & Alt.	0123415094	♣K080765HD
Detroit Diesel 6-Cyl. 12.7 L Diesel		
L-Line		
Belt - Fan	0124894000	♣K100579HD
Belt - Hub, Alt. & A.C.	0124587004	♣K080565HD
Tensioner Assy. - Fan	0127846000	38503
Tensioner Assy. - Hub, Alt. & A.C.	0127425000	38501
Tensioner Pulley - Fan	0127846000	38076
Tensioner Pulley - Hub, Alt. & A.C.	0127425000	38075
Hose - Upper - Rad. To Pipe		21115
Hose - Upper - Eng. To Pipe; (2 1/2" I.D.)		24240
Hose - Lower - Rad. To Pipe		21135
Hose - Lower - Eng. To Pipe; (2 1/4" I.D.)		24236
Detroit Diesel 6-Cyl. 14.0 L Diesel		
L-Line		
Belt - Fan	0124894000	♣K100579HD
Belt - Hub, Alt. & A.C.	0124587004	♣K080565HD
Tensioner Assy. - Fan	0127846000	38503
Tensioner Assy. - Hub, Alt. & A.C.	0127425000	38501
Tensioner Pulley - Fan	0127846000	38076
Tensioner Pulley - Hub, Alt. & A.C.	0127425000	38075
Hose - Upper - Eng. To Pipe; (2 1/2" I.D.)		24240
Hose - Upper - Rad. To Pipe		21115
Hose - Lower - Eng. To Pipe; (2 1/4" I.D.)		24236
Hose - Lower - Rad. To Pipe		21135
Mercedes-Benz MBE 900 Diesel		
Acterra		
Belt - Hub, Fan, Alt. & A.C.	0129866094	♣K080825HD
Tensioner Assy.	9062002470	38567
Hose - Lower - Eng. To Pipe		21559
Hose - Lower - Rad. To Cooler		20206
Mercedes-Benz MBE 4000 Diesel		
A-Line		
Belt - Fan	0127116017	♣K080570HD
Belt - Hub, Alt. & A.C.	0127116004	♣K080855HD
Tensioner Assy. - Fan	0127427001	38597
Tensioner Assy. - Hub, Alt. & A.C.	0127425000	38501
L-Line		
Belt - Fan; W/O P.T.O.	0127116013	♣K080505HD
Belt - Fan; W/P.T.O.	0127116012	♣K080660HD
Belt - Hub, Alt. & A.C.	0127116004	♣K080855HD
Tensioner Assy. - Fan	0127427001	38597
Tensioner Assy. - Hub, Alt. & A.C.	0127425000	38501
Tensioner Pulley - Hub, Alt. & A.C.	0127425000	38075
Hose - Upper - Eng. To Pipe; (2 1/2" I.D.)		24240
Hose - Upper - Rad. To Pipe		21891
Hose - Lower - Rad. To Pipe		21135
Mitsubishi Fuso 4M50 Diesel		
360		
Belt - Alt. & A.C.	ME241670	♣K060480HD
Hose - Upper - Eng. To Rad.		♣20957

≡ Cut to Fit.

Belts and Coolant Hose for Medium/Heavy-Duty Trucks (1996 and Newer)

Medium & Heavy-Duty Trucks
(1996 & Newer)

Application	Mfr. Part No.	Our No.
STERLING - Continued		
2006		
Caterpillar C7 Diesel		
Acterra		
Belt - Fan, Alt. & A.C.	0123415098	♣K080694HD
Belt - W.P.	0366775	♣9341HD
Idler Pulley - Upper	1979641	36091
Idler Pulley - Lower	2534525	36096
Hose - Upper - Eng. To Pipe		20206
Hose - Upper - Rad. To Pipe; (2" I.D.)		24232
Hose - Lower - Eng. To Pipe		20206
Hose - Lower - Rad. To Pipe		20206
Condor; L-Line		
Idler Pulley - Upper	1979641	36091
Caterpillar C9 Diesel		
A-Line; Acterra; Condor		
Idler Pulley - Smooth	2078118	36269
L-Line		
Idler Pulley	1979641	36091
Caterpillar C11 Diesel		
A-Line		
Belt - Fan, Alt. & A.C.	0123415080	♣K081005HD
Tensioner Assy. - Fan, Alt. & A.C.	2117895	38590
Tensioner Pulley - Fan, Alt. & A.C.	2117895	36164
Idler Pulley - Smooth	2078118	36269
Idler Pulley - Grooved	1979642	36341
Hose - Upper - Eng. To Rad.		22980
L-Line		
Belt - Fan, Alt. & A.C.	0123415082	♣K081079HD
Tensioner Assy. - Fan, Alt. & A.C.	2117895	38590
Tensioner Pulley - Fan, Alt. & A.C.	2117895	36164
Idler Pulley - Smooth	2078118	36269
Idler Pulley - Grooved	1979642	36341
Hose - Upper - Eng. To Rad.		22980
Hose - Lower - Eng. To Rad.		22952
Caterpillar C13 Diesel		
A-Line		
Belt - Fan, Alt. & A.C.	0123415080	♣K081005HD
Tensioner Assy. - Fan, Alt. & A.C.	2117895	38590
Tensioner Pulley - Fan, Alt. & A.C.	2117895	36164
Idler Pulley - Smooth	2078118	36269
Idler Pulley - Grooved	1979642	36341
Hose - Upper - Eng. To Rad.		22980
Acterra		
Belt - Fan & Alt.; W/P.T.O.	0123415083	♣K080926HD
Belt - Fan, Alt. & A.C.; W/O P.T.O.	0123415080	♣K081005HD
Tensioner Assy.	2117895	38590
Tensioner Pulley	2117895	36164
Idler Pulley - Smooth	2078118	36269
Idler Pulley - Grooved	1979642	36341
Hose - Upper - Eng. To Rad.		22980
Hose - Lower - Eng. To Rad.		22952
Condor		
Idler Pulley - Smooth	2078118	36269
Idler Pulley - Grooved	1979642	36341
L-Line		
Belt - Fan, Alt. & A.C.; W/Set Back Axle	0123415080	♣K081005HD
Belt - Fan, Alt. & A.C.; W/Set Forward		
Axle	0123415082	♣K081079HD
Tensioner Assy. - Fan, Alt. & A.C.	2117895	38590
Tensioner Pulley - Fan, Alt. & A.C.	2117895	36164
Idler Pulley - Smooth	2078118	36269
Idler Pulley - Grooved	1979642	36341
Hose - Upper - Eng. To Rad.		22980
Hose - Lower - Eng. To Pipe; W/Set Back Axle		21135
Hose - Lower - Rad. To Pipe; W/Set Back Axle		21135
Hose - Lower - Eng. To Rad.; W/Set Forward Axle		22952
Caterpillar C15 Diesel		
A-Line		
Belt - Fan, Alt. & A.C.	0123415080	♣K081005HD
Tensioner Assy. - Fan, Alt. & A.C.	2117895	38590

Application	Mfr. Part No.	Our No.
STERLING - Continued		
2006 - Continued		
Caterpillar C15 Diesel - Continued		
A-Line - Continued		
Tensioner Pulley - Fan, Alt. & A.C.	2117895	36164
Idler Pulley - Smooth	1979641	36091
Idler Pulley - Grooved	1979642	36341
Hose - Upper - Eng. To Rad.		22980
L-Line		
Belt - Fan, Alt. & A.C.; W/Set Back Axle	0123415080	♣K081005HD
Belt - Fan, Alt. & A.C.; W/Set Forward		
Axle	0123415082	♣K081079HD
Tensioner Assy. - Fan, Alt. & A.C.	2117895	38590
Tensioner Pulley - Fan, Alt. & A.C.	2117895	36164
Idler Pulley - Smooth	1979641	36091
Idler Pulley - Grooved	1979642	36341
Hose - Upper - Eng. To Rad.		22980
Hose - Lower - Eng. To Rad.		22952
Cummins ISB Diesel		
SC8000		
Belt - Accessory Drive	3290073	♣K080605HD
Tensioner Assy.	3957433	38517
Cummins ISC Diesel		
Acterra		
Belt - W.P., Fan, Alt. & A.C.	0123415100	♣K080820HD
Belt - Fan, W.P. & Alt.	3289325	♣K080708HD
Belt - Fan To A.C.	2310001067	♣9480HD
Tensioner Assy. - Fan, W.P. & Alt.	3936213	38516
Idler Pulley	3970945	36283
Tensioner Pulley - Fan, W.P. & Alt.	3936213	36093
Hose - Lower - Rad. To Pipe		20206
L-Line		
Idler Pulley	3970945	36283
Cummins ISL Diesel		
Condor		
Belt - Fan & Alt.	0123415094	♣K080765HD
Detroit Diesel 6-Cyl. 12.7 L Diesel		
A-Line; L-Line		
Belt - Fan	0124894000	♣K100579HD
Belt - Hub, Alt. & A.C.	0124587004	♣K080565HD
Tensioner Assy. - Fan	0127846000	38503
Tensioner Assy. - Hub, Alt. & A.C.	0127425000	38501
Tensioner Pulley - Fan	0127846000	38076
Tensioner Pulley - Hub, Alt. & A.C.	0127425000	38075
Hose - Upper - Rad. To Pipe		21115
Hose - Upper - Eng. To Pipe; (2 1/2" I.D.)		24240
Hose - Lower - Rad. To Pipe		21135
Hose - Lower - Eng. To Pipe; (2 1/4" I.D.)		24236
Detroit Diesel 6-Cyl. 14.0 L Diesel		
A-Line; L-Line		
Belt - Fan	0124894000	♣K100579HD
Belt - Hub, Alt. & A.C.	0124587004	♣K080565HD
Tensioner Assy. - Fan	0127846000	38503
Tensioner Assy. - Hub, Alt. & A.C.	0127425000	38501
Tensioner Pulley - Fan	0127846000	38076
Tensioner Pulley - Hub, Alt. & A.C.	0127425000	38075
Hose - Upper - Rad. To Pipe		21115
Hose - Upper - Eng. To Pipe; (2 1/2" I.D.)		24240
Hose - Lower - Rad. To Pipe		21135
Hose - Lower - Eng. To Pipe; (2 1/4" I.D.)		24236
Mercedes-Benz MBE 900 Diesel		
Acterra		
Belt - Hub, Fan, Alt. & A.C.	0129866094	♣K080825HD
Tensioner Assy.	9062002470	38567
Hose - Upper - Eng. To Rad.		≈21378
Hose - Lower - Rad. To Pipe; (2" I.D.)		24232
Mercedes-Benz MBE 4000 Diesel		
A-Line; L-Line		
Belt - Fan	0127116005	♣K080545HD
Belt - Hub, Alt. & A.C.	0127116004	♣K080855HD

♣ Standard Belt Available. See Pages 630-631.

≈ Cut to Fit.

Belts and Coolant Hose for Medium/Heavy-Duty Trucks (1996 and Newer)

 Medium & Heavy-Duty Trucks
(1996 & Newer)

Application	Mfr. Part No.	Our No.
STERLING - Continued		
2006 - Continued		
Mercedes-Benz MBE 4000 Diesel - Continued		
A-Line; L-Line - Continued		
Tensioner Assy. - Fan	0127427001	38597
Tensioner Assy. - Hub, Alt. & A.C.	0127425000	38501
Tensioner Pulley - Hub, Alt. & A.C.	0127425000	38075
Hose - Lower - Eng. To Rad.		23014
Mitsubishi Fuso 4M50 Diesel		
360		
Belt - Alt. & A.C.	ME241670	♣K060480HD
Hose - Upper - Eng. To Rad.		≈<20957
2005		
Caterpillar C7 Diesel		
Acterra		
Belt - Fan, Alt. & A.C.	0123415044	♣K080734HD
Belt - W.P.	0366775	♣9341HD
Idler Pulley - Upper	1979641	36091
Idler Pulley - Lower	2534525	36096
Hose - Upper - Eng. To Rad.		22668
Hose - Lower - Eng. To Pipe		20206
Hose - Lower - Rad. To Pipe		20206
Condor		
Belt - Alt.	0127110027	♣K080865HD
Tensioner Assy. - Alt.	2222880	38586
Idler Pulley - Upper	1979641	36091
L-Line		
Belt - Fan, Alt. & A.C.; W/140A. Alt.	0123415092	♣K080876HD
Belt - Fan, Alt. & A.C.; W/130A. Alt.	0123415091	K080885HD
Tensioner Assy. - Fan, Alt. & A.C.	2201209	38550
Idler Pulley - Upper	1979641	36091
Caterpillar C9 Diesel		
A-Line; Condor		
Idler Pulley	2078118	36269
L-Line		
Belt - Fan, Alt. & A.C.	0123415080	♣K081005HD
Tensioner Assy. - Fan, Alt. & A.C.	2117895	38590
Tensioner Pulley - Fan, Alt. & A.C.	2117895	36164
Idler Pulley	2078118	36269
Hose - Upper - Eng. To Rad.		22980
Caterpillar C11 Diesel		
A-Line		
Belt - Fan, Alt. & A.C.	0123415080	♣K081005HD
Tensioner Assy. - Fan, Alt. & A.C.	2117895	38590
Tensioner Pulley - Fan, Alt. & A.C.	2117895	36164
Idler Pulley - Smooth	2078118	36269
Idler Pulley - Grooved	1979642	36341
Hose - Upper - Eng. To Rad.		22980
Condor		
Idler Pulley - Smooth	2078118	36269
Idler Pulley - Grooved	1979642	36341
L-Line		
Belt - Fan, Alt. & A.C.	0123415082	♣K081079HD
Tensioner Assy. - Fan, Alt. & A.C.	2117895	38590
Tensioner Pulley - Fan, Alt. & A.C.	2117895	36164
Idler Pulley - Smooth	2078118	36269
Idler Pulley - Grooved	1979642	36341
Hose - Upper - Eng. To Rad.		22980
Hose - Lower - Eng. To Rad.		22952
Caterpillar C13 Diesel		
A-Line		
Belt - Fan, Alt. & A.C.	0123415080	♣K081005HD
Tensioner Assy. - Fan, Alt. & A.C.	2117895	38590
Tensioner Pulley - Fan, Alt. & A.C.	2117895	36164
Idler Pulley - Smooth	2078118	36269
Idler Pulley - Grooved	1979642	36341
Hose - Upper - Eng. To Rad.		22980
Condor		
Idler Pulley - Smooth	2078118	36269
Idler Pulley - Grooved	1979642	36341

Application	Mfr. Part No.	Our No.
STERLING - Continued		
2005 - Continued		
Caterpillar C13 Diesel - Continued		
L-Line		
Belt - Fan, Alt. & A.C.; W/O P.T.O.	0123415080	♣K081005HD
Belt - Fan, Alt. & A.C.; W/Front P.T.O. .	0123415082	♣K081079HD
Tensioner Assy. - Fan, Alt. & A.C.	2117895	38590
Tensioner Pulley - Fan, Alt. & A.C.	2117895	36164
Idler Pulley - Smooth	2078118	36269
Idler Pulley - Grooved	1979642	36341
Hose - Upper - Eng. To Rad.		22980
Caterpillar C15 Diesel		
A-Line		
Belt - Fan, Alt. & A.C.	0123415080	♣K081005HD
Tensioner Assy. - Fan, Alt. & A.C.	2117895	38590
Tensioner Pulley - Fan, Alt. & A.C.	2117895	36164
Idler Pulley - Smooth	1979641	36091
Idler Pulley - Grooved	1979642	36341
Hose - Upper - Eng. To Rad.		22980
L-Line		
Belt - Fan, Alt. & A.C.	0123415080	♣K081005HD
Tensioner Assy. - Fan, Alt. & A.C.	2117895	38590
Tensioner Pulley - Fan, Alt. & A.C.	2117895	36164
Idler Pulley - Smooth	1979641	36091
Idler Pulley - Grooved	1979642	36341
Hose - Upper - Eng. To Rad.		22980
Hose - Lower - Eng. To Pipe; (2 1/2" I.D.)		24240
Hose - Lower - Rad. To Pipe		21135
Hose - Lower - Pipe To Cooler		21891
Hose - Lower - Cooler To Pipe		21135
Cummins ISB Diesel		
SC8000		
Belt - Accessory Drive	3290073	♣K080605HD
Tensioner Assy.	3957433	38517
Cummins ISC Diesel		
Acterra		
Belt - W.P., Fan, Alt. & A.C.	0123415100	♣K080820HD
Belt - Fan, W.P. & Alt.	3289325	♣K080708HD
Belt - Fan To A.C.	2310001067	♣9480HD
Tensioner Assy. - Fan, W.P. & Alt.	3936213	38516
Idler Pulley	3970945	36283
Tensioner Pulley - Fan, W.P. & Alt.	3936213	36093
Hose - Upper - Eng. To Pipe; (2 1/4" I.D.)		24236
Hose - Upper - Rad. To Pipe		21571
Hose - Lower - Eng. To Pipe		20206
Hose - Lower - Rad. To Pipe		20206
L-Line		
Idler Pulley	3970945	36283
Detroit Diesel 6-Cyl. 12.7 L Diesel		
A-Line; L-Line		
Belt - Fan	0124894000	♣K100579HD
Belt - Hub, Alt. & A.C.	0124587004	♣K080565HD
Tensioner Assy. - Fan	0127846000	38503
Tensioner Assy. - Hub, Alt. & A.C.	0127425000	38501
Tensioner Pulley - Fan	0127846000	38076
Tensioner Pulley - Hub, Alt. & A.C.	0127425000	38075
Hose - Upper - Eng. To Pipe; (2 1/2" I.D.)		24240
Hose - Upper - Rad. To Pipe; (2 1/2" I.D.)		24240
Detroit Diesel 6-Cyl. 14.0 L Diesel		
A-Line; L-Line		
Belt - Fan	0124894000	♣K100579HD
Belt - Hub, Alt. & A.C.	0124587004	♣K080565HD
Tensioner Assy. - Fan	0127846000	38503
Tensioner Assy. - Hub, Alt. & A.C.	0127425000	38501
Tensioner Pulley - Fan	0127846000	38076
Tensioner Pulley - Hub, Alt. & A.C.	0127425000	38075
Hose - Upper - Eng. To Pipe; (2 1/2" I.D.)		24240
Hose - Upper - Rad. To Pipe; (2 1/2" I.D.)		24240
Mercedes-Benz MBE 900 Diesel		
Acterra		
Belt - Hub, Fan, Alt. & A.C.	0126246000	♣K080830HD

♣ Standard Belt Available. See Pages 630-631.

≈< Cut to Fit.

Belts and Coolant Hose for Medium/Heavy-Duty Trucks (1996 and Newer)

Medium & Heavy-Duty Trucks
(1996 & Newer)

Application	Mfr. Part No.	Our No.
STERLING - Continued		
2005 - Continued		
Mercedes-Benz MBE 900 Diesel - Continued		
Acterra - Continued		
Tensioner Assy.	9062002470	38567
Hose - Upper - Eng. To Rad.		≅21378
Hose - Lower - Eng. To Pipe		21571
Hose - Lower - Pipe To Cooler; (2" I.D.)		24232
Hose - Lower - Cooler To Pipe		≅20611
L-Line		
Belt - Fan	0127116011	♣K080615HD
Belt - Alt.	0127110048	♣K080839HD
Tensioner Assy. - Fan	0130441000	38589
Mercedes-Benz MBE 4000 Diesel		
A-Line; L-Line		
Belt - Fan	0127116005	♣K080545HD
Belt - Hub, Alt. & A.C.	0127116004	♣K080855HD
Tensioner Assy. - Fan	0127427001	38597
Tensioner Assy. - Hub, Alt. & A.C.	0127425000	38501
Tensioner Pulley - Hub, Alt. & A.C.	0127425000	38075
Hose - Upper - Eng. To Rad.		22850
Hose - Lower - Eng. To Pipe		21891
Hose - Lower - Pipe To Rad.; (2 1/2" I.D.)		24240
2004		
Caterpillar 3126 Diesel		
Acterra		
Belt - W.P.	0366775	♣9341HD
Belt - Fan, Alt. & A.C.; W/70 1/2" Belt		
O.C.	0123415000	♣K080702HD
Belt - Fan, Alt. & A.C.; W/78 1/2" Belt		
O.C.	F2HT8620FA	♣K080780HD
Tensioner Assy. - Fan, Alt. & A.C.	1352151	38511
Idler Pulley	1445612	36096
Tensioner Pulley - Fan, Alt. & A.C.	1352151	36091
Hose - Upper - Eng. To Pipe; (2" I.D.)		24232
Hose - Upper - Pipe To Rad.; (2" I.D.)		24232
Hose - Lower - Eng. To Pipe		21135
Hose - Lower - Pipe To Rad.; (2 1/2" I.D.)		24240
L-Line		
Belt - W.P.	0366775	♣9341HD
Belt - Fan, Alt. & A.C.	0123415048	♣K080776HD
Tensioner Assy. - Fan, Alt. & A.C.	1352151	38511
Tensioner Pulley - Fan, Alt. & A.C.	1352151	36091
Hose - Upper - Eng. To Pipe		≅20206
Hose - Upper - Pipe To Rad.		21571
Hose - Lower - Eng. To Pipe		21571
Hose - Lower - Pipe To Rad.; (2 1/2" I.D.)		24240
Caterpillar C7 Diesel		
Acterra		
Belt - Fan, Alt. & A.C.	0123415042	♣K080702HD
Belt - W.P.	0366775	♣9341HD
Tensioner Assy. - Fan, Alt. & A.C.		38511
Idler Pulley - Upper	1979641	36091
Idler Pulley	1445612	36096
Hose - Upper - Eng. To Rad.		22668
Hose - Lower - Eng. To Pipe		21891
Hose - Lower - Rad. To Pipe		21891
Condor		
Idler Pulley - Upper	1979641	36091
L-Line		
Belt - W.P.	0366775	♣9341HD
Belt - Fan, Alt. & A.C.	0123415048	♣K080776HD
Tensioner Assy. - Fan, Alt. & A.C.	1352151	38511
Tensioner Pulley - Fan, Alt. & A.C.	1352151	36091
Caterpillar C9 Diesel		
A-Line		
Belt - Fan, Alt. & A.C.	0123415065	♣K080825HD
Idler Pulley	2078118	36269
Hose - Upper - Eng. To Pipe		20206
Hose - Upper - Pipe To Rad.		21492
Hose - Lower - Eng. To Pipe		21891

Application	Mfr. Part No.	Our No.
STERLING - Continued		
2004 - Continued		
Caterpillar C9 Diesel - Continued		
A-Line - Continued		
Hose - Lower - Pipe To Rad.; (2 1/2" I.D.)		24240
Condor		
Idler Pulley	2078118	36269
L-Line		
Belt - Fan, Alt. & A.C.	0123415065	♣K080825HD
Idler Pulley	2078118	36269
Hose - Upper - Eng. To Pipe		20206
Hose - Upper - Pipe To Rad.		21492
Hose - Lower - Eng. To Pipe		21891
Hose - Lower - Pipe To Rad.; (2 1/2" I.D.)		24240
Caterpillar C10 Diesel		
A-Line		
Belt - Fan & Alt.	0127110026	♣K080897HD
Belt - A.C.	0126709002	♣K060523HD
Tensioner Assy. - Fan & Alt.	1900649	38506
Tensioner Assy. - A.C.		38524
Idler Pulley - Fan & Alt.; W/Flat Idler		
Pulley	1337023	36091
Idler Pulley - Fan & Alt.;		
W/Multi-Grooved Idler Pulley	1731498	36231
Tensioner Pulley - Fan & Alt.		36091
Tensioner Pulley - A.C.		36091
Hose - Upper - Eng. To Pipe; (2 1/2" I.D.)		24240
Hose - Upper - Rad. To Pipe; (2 1/2" I.D.)		24240
Hose - Lower - Eng. To Pipe; (2 1/2" I.D.)		24240
Hose - Lower - Rad. To Pipe; (2 1/2" I.D.)		24240
L-Line		
Belt - Fan	0127115002	♣K140603HD
Belt - Fan To Alt.	C5TS8620T	♣9440HD
Belt - Fan To A.C.	F6HT8620AKA	♣9465HD
Hose - Upper - Eng. To Pipe		22773
Hose - Lower - Eng. To Pipe; (2 1/2" I.D.)		24240
Hose - Lower - Pipe To Rad.; (2 1/2" I.D.)		24240
Caterpillar C11 Diesel		
A-Line		
Belt - Fan, Alt. & A.C.	0123415082	♣K081079HD
Tensioner Assy. - Fan, Alt. & A.C.	2117895	38590
Tensioner Pulley - Fan, Alt. & A.C.	2117895	36164
Idler Pulley - Smooth	2078118	36269
Idler Pulley - Grooved	1979642	36341
Hose - Upper - Eng. To Rad.		22980
Hose - Lower - Eng. To Rad.		22952
Condor		
Idler Pulley - Smooth	2078118	36269
Idler Pulley - Grooved	1979642	36341
L-Line		
Belt - Fan, Alt. & A.C.	0123415082	♣K081079HD
Tensioner Assy. - Fan, Alt. & A.C.	2117895	38590
Tensioner Pulley - Fan, Alt. & A.C.	2117895	36164
Idler Pulley - Smooth	2078118	36269
Idler Pulley - Grooved	1979642	36341
Hose - Upper - Eng. To Rad.		22980
Hose - Lower - Eng. To Rad.		22952
Caterpillar C12 Diesel		
A-Line		
Belt - Fan & Alt.	0127110026	♣K080897HD
Belt - A.C.	0126709002	♣K060523HD
Tensioner Assy. - Fan & Alt.	1900649	38506
Tensioner Assy. - A.C.		38524
Idler Pulley - Fan & Alt.; W/Flat Idler		
Pulley	1337023	36091
Idler Pulley - Fan & Alt.;		
W/Multi-Grooved Idler Pulley	1731498	36231
Tensioner Pulley - Fan & Alt.		36091
Tensioner Pulley - A.C.		36091
Hose - Upper - Eng. To Pipe; (2 1/2" I.D.)		24240
Hose - Upper - Rad. To Pipe; (2 1/2" I.D.)		24240
Hose - Lower - Eng. To Pipe; (2 1/2" I.D.)		24240

≅ Cut to Fit.

♣ Standard Belt Available. See Pages 630-631.

Belts and Coolant Hose for Medium/Heavy-Duty Trucks (1996 and Newer)

 Medium & Heavy-Duty Trucks
(1996 & Newer)

Application	Mfr. Part No.	Our No.
STERLING - Continued		
2004 - Continued		
Caterpillar C12 Diesel - Continued		
A-Line - Continued		
Hose - Lower - Rad. To Pipe; (2 1/2" I.D.)		24240
L-Line		
Belt - Fan	0127115002	♣K140603HD
Belt - Fan To Alt.	C5TS8620T	♣9440HD
Belt - Fan To A.C.	F6HT8620AKA	♣9465HD
Hose - Upper - Eng. To Pipe		22773
Hose - Lower - Eng. To Pipe; (2 1/2" I.D.)		24240
Hose - Lower - Pipe To Rad.; (2 1/2" I.D.)		24240
Caterpillar C13 Diesel		
A-Line; Acterra		
Belt - Fan, Alt. & A.C.	0123415080	♣K081005HD
Idler Pulley - Smooth	2078118	36269
Idler Pulley - Grooved	1979642	36341
Hose - Upper - Eng. To Rad.		22980
Hose - Lower - Eng. To Pipe; (2 1/2" I.D.)		24240
Hose - Lower - Rad. To Pipe		21891
Condor		
Idler Pulley - Smooth	2078118	36269
Idler Pulley - Grooved	1979642	36341
L-Line		
Belt - Fan, Alt. & A.C.	0123415080	♣K081005HD
Tensioner Assy. - Fan, Alt. & A.C.	2117895	38590
Tensioner Pulley - Fan, Alt. & A.C.	2117895	36164
Idler Pulley - Smooth	2078118	36269
Idler Pulley - Grooved	1979642	36341
Hose - Upper - Eng. To Rad.		22980
Caterpillar C15 Diesel		
A-Line; L-Line		
Idler Pulley - Smooth	1979641	36091
Idler Pulley - Grooved	1979642	36341
Cummins ISB Diesel		
SC8000		
Tensioner Assy. - Fan & Alt.	3978021	38517
Cummins ISC Diesel		
Acterra; L-Line		
Idler Pulley	3970945	36283
Detroit Diesel 6-Cyl. 12.7 L Diesel		
A-Line; L-Line		
Belt - Fan	0124894000	♣K100579HD
Belt - Hub, Alt. & A.C.	0127116005	♣K080545HD
Tensioner Assy. - Fan	0127846000	38503
Tensioner Assy. - Hub, Alt. & A.C.	0127425000	38501
Tensioner Pulley - Fan	0127846000	38076
Tensioner Pulley - Hub, Alt. & A.C.	0127425000	38075
Hose - Upper - Eng. To Pipe		21891
Hose - Upper; (2 1/2" I.D.)		24240
Detroit Diesel 6-Cyl. 14.0 L Diesel		
A-Line; L-Line		
Belt - Fan	0124894000	♣K100579HD
Belt - Hub, Alt. & A.C.	0127116005	♣K080545HD
Tensioner Assy. - Fan	0127846000	38503
Tensioner Assy. - Hub, Alt. & A.C.	0127425000	38501
Tensioner Pulley - Fan	0127846000	38076
Tensioner Pulley - Hub, Alt. & A.C.	0127425000	38075
Hose - Upper - Eng. To Pipe		21891
Hose - Upper; (2 1/2" I.D.)		24240
Mercedes-Benz MBE 900 Diesel		
Acterra		
Belt - Hub, Fan, Alt. & A.C.; W/O P.T.O.	0126246000	♣K080830HD
Belt - Hub, Fan, Alt. & A.C.; W/P.T.O. ..	0127116015	♣K080810HD
Tensioner Assy.	9062002470	38567
Hose - Upper - Eng. To Pipe		22701
Hose - Upper - Pipe To Rad.		21135
Hose - Lower - Eng. To Pipe		21571
Hose - Lower - Pipe To Rad.		22903

♣ Standard Belt Available. See Pages 630-631.

Application	Mfr. Part No.	Our No.
STERLING - Continued		
2004 - Continued		
Mercedes-Benz MBE 4000 Diesel		
A-Line; L-Line		
Belt - Fan	0127116005	♣K080545HD
Belt - Hub, Alt. & A.C.	0127116004	♣K080855HD
Tensioner Assy. - Fan	0127427001	38597
Tensioner Assy. - Hub, Alt. & A.C.	0127425000	38501
Tensioner Pulley - Hub, Alt. & A.C.	0127425000	38075
Hose - Upper - Eng. To Rad.		22850
Hose - Lower - Eng. To Pipe		21891
Hose - Lower - Pipe To Rad.; (2 1/2" I.D.)		24240
2003		
Caterpillar 3126 Diesel		
Acterra		
Belt - W.P.	0366775	♣9341HD
Belt - Fan, Alt. & A.C.; W/70 1/2" Belt		
O.C.	0123415000	♣K080702HD
Belt - Fan, Alt. & A.C.; W/78 1/2" Belt		
O.C.	F2HT8620FA	♣K080780HD
Tensioner Assy. - Fan, Alt. & A.C.	1352151	38511
Idler Pulley	1445612	36096
Tensioner Pulley - Fan, Alt. & A.C.	1352151	36091
Hose - Upper - Eng. To Pipe; (2" I.D.)		24232
Hose - Upper - Pipe To Rad.; (2" I.D.)		24232
Hose - Lower - Eng. To Pipe		21135
Hose - Lower - Pipe To Rad.; (2 1/2" I.D.)		24240
L-Line		
Belt - W.P.	0366775	♣9341HD
Belt - Fan, Alt. & A.C.	0123415048	♣K080776HD
Tensioner Assy. - Fan, Alt. & A.C.	1352151	38511
Tensioner Pulley - Fan, Alt. & A.C.	1352151	36091
Hose - Upper - Eng. To Pipe		♣20206
Hose - Upper - Pipe To Rad.		21571
Hose - Lower - Eng. To Pipe		21571
Hose - Lower - Pipe To Rad.; (2 1/2" I.D.)		24240
Caterpillar C10 Diesel		
A-Line		
Belt - Fan & Alt.	0127110026	♣K080897HD
Belt - A.C.	0126709002	♣K060523HD
Tensioner Assy. - Fan & Alt.	1900649	38506
Tensioner Assy. - A.C.		38524
Idler Pulley - Fan & Alt.; W/Flat Idler		
Pulley	1337023	36091
Idler Pulley - Fan & Alt.;		
W/Multi-Grooved Idler Pulley	1731498	36231
Tensioner Pulley - Fan & Alt.		36091
Tensioner Pulley - A.C.		36091
Hose - Upper - Eng. To Pipe; (2 1/2" I.D.)		24240
Hose - Upper - Rad. To Pipe; (2 1/2" I.D.)		24240
Hose - Lower - Eng. To Pipe; (2 1/2" I.D.)		24240
Hose - Lower - Rad. To Pipe; (2 1/2" I.D.)		24240
L-Line		
Belt - Fan	0127115002	♣K140603HD
Belt - Fan To Alt.	C5TS8620T	♣9440HD
Belt - Fan To A.C.	F6HT8620AKA	♣9465HD
Hose - Upper - Eng. To Pipe		22773
Hose - Lower - Eng. To Pipe; (2 1/2" I.D.)		24240
Hose - Lower - Pipe To Rad.; (2 1/2" I.D.)		24240
Caterpillar C12 Diesel		
A-Line		
Belt - Fan & Alt.	0127110026	♣K080897HD
Belt - A.C.	0126709002	♣K060523HD
Tensioner Assy. - Fan & Alt.	1900649	38506
Tensioner Assy. - A.C.		38524
Idler Pulley - Fan & Alt.; W/Flat Idler		
Pulley	1337023	36091
Idler Pulley - Fan & Alt.;		
W/Multi-Grooved Idler Pulley	1731498	36231
Tensioner Pulley - Fan & Alt.		36091
Tensioner Pulley - A.C.		36091
Hose - Upper - Eng. To Pipe; (2 1/2" I.D.)		24240

≡ Cut to Fit.

Belts and Coolant Hose for Medium/Heavy-Duty Trucks (1996 and Newer)

Medium & Heavy-Duty Trucks
(1996 & Newer)

Application	Mfr. Part No.	Our No.
STERLING - Continued		
2003 - Continued		
Caterpillar C12 Diesel - Continued		
A-Line - Continued		
Hose - Upper - Rad. To Pipe; (2 1/2" I.D.)		24240
Hose - Lower - Eng. To Pipe; (2 1/2" I.D.)		24240
Hose - Lower - Rad. To Pipe; (2 1/2" I.D.)		24240
Condor		
Belt - Fan & Alt.	0124587007	▲K080878HD
Belt - A.C.		▲K060495HD
Tensioner Assy. - Fan & Alt.	1900649	38506
Tensioner Assy. - A.C.	0127846000	38503
Hose - Upper - Eng. To Pipe		21891
Hose - Upper - Rad. To Pipe		21135
Hose - Lower - Eng. To Pipe		21891
Hose - Lower - Rad. To Pipe		21135
L-Line		
Belt - Fan	0127115002	▲K140603HD
Belt - Fan To Alt.	C5TS8620T	▲9440HD
Belt - Fan To A.C.	F6HT8620AKA	▲9465HD
Hose - Upper - Eng. To Pipe		22773
Hose - Lower - Eng. To Pipe; (2 1/2" I.D.)		24240
Hose - Lower - Pipe To Rad.; (2 1/2" I.D.)		24240
Cummins ISB Diesel		
SC7000; SC8000		
Tensioner Assy. - Fan & Alt.	3978021	38517
Cummins ISC Diesel		
L-Line		
Belt - Fan & Alt.	3939897	▲K080730HD
Belt - Fan To A.C.	178623	②▲9463HD
Tensioner Assy. - Fan, Alt. & Hub	3936206	38513
Tensioner Pulley - Fan, Alt. & Hub	3936206	36091
Hose - Upper - Eng. To Pipe; (2 1/2" I.D.)		24240
Hose - Upper - Pipe To Rad.; (2 1/2" I.D.)		24240
Hose - Lower - Eng. To Pipe		21891
Hose - Lower - Pipe To Rad.; (2 1/2" I.D.)		24240
Cummins ISM Diesel		
L-Line		
Belt - Fan	F6HT8620BA	▲K140516HD
Belt - Hub & Alt.	E7HT8620GA	▲K050360HD
Belt - Hub & A.C.	D0HA8620JA	▲9480HD
Hose - Upper - Eng. To Rad.; (2 1/2" I.D.)		24240
Hose - Upper - Eng. To Pipe; (2 1/2" I.D.)		24240
Hose - Lower - Eng. To Pipe; (2" I.D.)		24232
Hose - Lower - Pipe To Rad.; (2 1/2" I.D.)		24240
Cummins N14 Diesel		
A-Line; L-Line		
Belt - Hub & W.P.		▲K060415HD
Belt - Alt.	E5HT8A615EA	▲9435HD
Belt - Hub & A.C.	C6TA8620J	▲9420HD
Hose - Upper - Eng. To Pipe; (2 1/2" I.D.)		24240
Hose - Upper - Pipe To Rad.		21135
Hose - Lower - Eng. To Pipe; (2 1/2" I.D.)		24240
Hose - Lower - Pipe To Rad.; (2 1/2" I.D.)		24240
Detroit Diesel 6-Cyl. 12.7 L Diesel		
L-Line; Silver Star		
Belt - Fan	2310001117	③▲9495HD
Belt - Hub, Alt. & A.C.	0124587004	▲K080565HD
Tensioner Assy. - Hub, Alt. & A.C.	23524436	38502
Tensioner Pulley - Hub, Alt. & A.C.	0127425000	38075
Hose - Upper - Eng. To Pipe		21891
Hose - Upper - Pipe To Rad.; (2 1/2" I.D.)		24240
Hose - Lower - Eng. To Pipe		21891
Hose - Lower - Pipe To Rad.; (2 1/2" I.D.)		24240
Detroit Diesel 6-Cyl. 14.0 L Diesel		
L-Line		
Belt - Fan	2310001117	③▲9495HD
Belt - Hub, Alt. & A.C.	0124587004	▲K080565HD
Tensioner Assy. - Hub, Alt. & A.C.	23524436	38502
Tensioner Pulley - Hub, Alt. & A.C.	0127425000	38075
Hose - Upper - Eng. To Pipe		21891

▲ Standard Belt Available. See Pages 630-631.
③ Three Required.

Application	Mfr. Part No.	Our No.
STERLING - Continued		
2003 - Continued		
Detroit Diesel 6-Cyl. 14.0 L Diesel - Continued		
L-Line - Continued		
Hose - Upper - Pipe To Rad.; (2 1/2" I.D.)		24240
Hose - Lower - Eng. To Pipe		21891
Hose - Lower - Pipe To Rad.; (2 1/2" I.D.)		24240
Mercedes-Benz MBE 900 Diesel		
Acterra		
Belt - Hub, Fan, Alt. & A.C.	0126246000	▲K080830HD
Tensioner Assy.	9062002470	38567
Hose - Upper - Eng. To Pipe		22701
Hose - Upper - Pipe To Rad.		21135
Hose - Lower - Eng. To Pipe		21571
Hose - Lower - Pipe To Rad.		22903
Mercedes-Benz MBE 4000 Diesel		
L-Line		
Belt - Fan	0127116005	▲K080545HD
Belt - Hub, Alt. & A.C.	0127116004	▲K080855HD
Tensioner Assy. - Fan	0127427001	38597
Tensioner Assy. - Hub, Alt. & A.C.	0127425000	38501
Tensioner Pulley - Hub, Alt. & A.C.	0127425000	38075
Hose - Upper - Eng. To Rad.		22850
Hose - Lower - Eng. To Pipe		21891
Hose - Lower - Pipe To Rad.; (2 1/2" I.D.)		24240
2002		
Caterpillar 3126 Diesel		
Acterra		
Belt - W.P.	0366775	▲9341HD
Belt - Fan, Alt. & A.C.; W/70 1/2" Belt O.C.	0123415000	▲K080702HD
Belt - Fan, Alt. & A.C.; W/78 1/2" Belt O.C.	F2HT8620FA	▲K080780HD
Tensioner Assy. - Fan, Alt. & A.C.	1352151	38511
Idler Pulley	1445612	36096
Tensioner Pulley - Fan, Alt. & A.C.	1352151	36091
Hose - Upper - Eng. To Pipe; (2" I.D.)		24232
Hose - Upper - Pipe To Rad.; (2" I.D.)		24232
Hose - Lower - Eng. To Pipe		21135
Hose - Lower - Pipe To Rad.; (2 1/2" I.D.)		24240
L-Line		
Belt - W.P.	0366775	▲9341HD
Belt - Fan, Alt. & A.C.	0123415048	▲K080776HD
Tensioner Assy. - Fan, Alt. & A.C.	1352151	38511
Tensioner Pulley - Fan, Alt. & A.C.	1352151	36091
Hose - Upper - Eng. To Pipe		②<20206
Hose - Upper - Pipe To Rad.		21571
Hose - Lower - Eng. To Pipe		21571
Hose - Lower - Pipe To Rad.; (2 1/2" I.D.)		24240
Caterpillar C10 Diesel		
A-Line		
Belt - Fan & Alt.	0127110026	▲K080897HD
Belt - A.C.	0126709002	▲K060523HD
Tensioner Assy. - Fan & Alt.	1900649	38506
Tensioner Assy. - A.C.		38524
Idler Pulley - Fan & Alt.; W/Flat Idler Pulley	1337023	36091
Idler Pulley - Fan & Alt.; W/Multi-Grooved Idler Pulley	1731498	36231
Tensioner Pulley - Fan & Alt.		36091
Tensioner Pulley - A.C.		36091
Hose - Upper - Eng. To Pipe; (2 1/2" I.D.)		24240
Hose - Upper - Rad. To Pipe; (2 1/2" I.D.)		24240
Hose - Lower - Eng. To Pipe; (2 1/2" I.D.)		24240
Hose - Lower - Rad. To Pipe; (2 1/2" I.D.)		24240
L-Line		
Belt - Fan	0127115001	▲K140682HD
Belt - Fan To Alt.	F7HT8620YA	▲9440HD
Belt - Fan To A.C.	C5TS8620T	▲9440HD
Hose - Upper - Eng. To Pipe		21135
Hose - Upper - Pipe To Rad.; (2 1/2" I.D.)		24240

② Two Required.
②< Cut to Fit.

Belts and Coolant Hose for Medium/Heavy-Duty Trucks (1996 and Newer)

 Medium & Heavy-Duty Trucks
(1996 & Newer)

Application	Mfr. Part No.	Our No.
STERLING - Continued		
2002 - Continued		
Caterpillar C10 Diesel - Continued		
L-Line - Continued		
Hose - Lower - Eng. To Pipe; (2 1/2" I.D.)		24240
Hose - Lower - Pipe To Rad.; (2 1/2" I.D.)		24240
Caterpillar C12 Diesel		
A-Line		
Belt - Fan & Alt. 0127110026	♣K080897HD	
Belt - A.C. 0126709002	♣K060523HD	
Tensioner Assy. - Fan & Alt. 1900649	38506	
Tensioner Assy. - A.C.	38524	
Idler Pulley - Fan & Alt.; W/Flat Idler		
Pulley 1337023	36091	
Idler Pulley - Fan & Alt.;		
W/Multi-Grooved Idler Pulley	1731498	36231
Tensioner Pulley - Fan & Alt.	36091	
Tensioner Pulley - A.C.	36091	
Hose - Upper - Eng. To Pipe; (2 1/2" I.D.)	24240	
Hose - Upper - Rad. To Pipe; (2 1/2" I.D.)	24240	
Hose - Lower - Eng. To Pipe; (2 1/2" I.D.)	24240	
Hose - Lower - Rad. To Pipe; (2 1/2" I.D.)	24240	
L-Line		
Belt - Fan 0127115001	♣K140682HD	
Belt - Fan To Alt. F7HT8620YA	♣9440HD	
Belt - Fan To A.C. C5TS8620T	♣9440HD	
Hose - Upper - Eng. To Pipe	21135	
Hose - Upper - Pipe To Rad.; (2 1/2" I.D.)	24240	
Hose - Lower - Eng. To Pipe; (2 1/2" I.D.)	24240	
Hose - Lower - Pipe To Rad.; (2 1/2" I.D.)	24240	
Caterpillar C15 Diesel		
L-Line		
Belt - Fan F6HT8620KA	♣K140580HD	
Belt - Fan To Alt. 2310001116	♣9470HD	
Belt - Fan To A.C. F6HT8620AAB	♣9485HD	
Hose - Upper - Eng. To Pipe; (2 1/2" I.D.)	24240	
Hose - Upper - Pipe To Rad.	21135	
Hose - Lower - Eng. To Pipe	21891	
Hose - Lower - Pipe To Rad.; (2 1/2" I.D.)	24240	
Cummins ISB Diesel		
SC7000; SC8000		
Tensioner Assy. - Fan & Alt. 3978021	38517	
Cummins ISM Diesel		
A-Line		
Belt - Fan 0127115006	♣K140516HD	
Belt - Hub & Alt. 0127246000	♣K050360HD	
Belt - Hub & A.C. 17482	♣9480HD	
Hose - Upper - Eng. To Rad.; (2 1/2" I.D.)	24240	
Hose - Upper - Eng. To Pipe; (2 1/2" I.D.)	24240	
Hose - Lower - Eng. To Pipe; (2" I.D.)	24232	
Hose - Lower - Pipe To Rad.; (2 1/2" I.D.)	24240	
L-Line		
Belt - Fan F6HT8620BA	♣K140516HD	
Belt - Hub & Alt. E7HT8620GA	♣K050360HD	
Belt - Hub & A.C. D0HA8620JA	♣9480HD	
Hose - Upper - Eng. To Rad.; (2 1/2" I.D.)	24240	
Hose - Upper - Eng. To Pipe; (2 1/2" I.D.)	24240	
Hose - Lower - Eng. To Pipe; (2" I.D.)	24232	
Hose - Lower - Pipe To Rad.; (2 1/2" I.D.)	24240	
Cummins ISX Diesel		
Silver Star		
Idler Pulley - Alt. & A.C. 4026886	36226	
Cummins N14 Diesel		
A-Line; L-Line; Silver Star		
Belt - Hub & W.P.	♣K060415HD	
Belt - Alt. E5HT8A615EA	♣9435HD	
Belt - Hub & A.C. C6TA8620J	♣9420HD	
Hose - Upper - Eng. To Pipe; (2 1/2" I.D.)	24240	
Hose - Upper - Pipe To Rad.	21135	
Hose - Lower - Eng. To Pipe; (2 1/2" I.D.)	24240	
Hose - Lower - Pipe To Rad.; (2 1/2" I.D.)	24240	

♣ Standard Belt Available. See Pages 630-631.

Application	Mfr. Part No.	Our No.
STERLING - Continued		
2002 - Continued		
Detroit Diesel 6-Cyl. 11.1 L Diesel		
A-Line; L-Line		
Belt - Fan 0127115010	♣K140496HD	
Belt - Hub To Alt. & A.C. 0124587004	♣K080565HD	
Tensioner Assy. - Hub, Alt. & A.C. 23520317	38501	
Hose - Upper - Eng. To Pipe; (2 1/2" I.D.)	24240	
Hose - Upper - Pipe To Rad.	21891	
Hose - Lower - Eng. To Pipe	21891	
Hose - Lower - Pipe To Rad.; (2 1/2" I.D.)	24240	
Detroit Diesel 6-Cyl. 12.7 L Diesel		
A-Line; L-Line; Silver Star		
Belt - Fan 0127115010	♣K140496HD	
Belt - Hub To Alt. & A.C. 0124587004	♣K080565HD	
Tensioner Assy. - Hub, Alt. & A.C. 23520317	38501	
Hose - Upper - Eng. To Pipe; (2 1/2" I.D.)	24240	
Hose - Upper - Pipe To Rad.	21891	
Hose - Lower - Eng. To Pipe	21891	
Hose - Lower - Pipe To Rad.; (2 1/2" I.D.)	24240	
Mercedes-Benz MBE 900 Diesel		
Acterra		
Belt - Hub, Fan, Alt. & A.C. 0126246000	♣K080830HD	
Tensioner Assy. 9062002470	38567	
Hose - Upper - Eng. To Pipe	22701	
Hose - Upper - Pipe To Rad.	21135	
Hose - Lower - Eng. To Pipe	21571	
Hose - Lower - Pipe To Rad.	22903	
2001		
Caterpillar 3126 Diesel		
Acterra		
Belt - W.P. 0366775	♣9341HD	
Belt - Fan, Alt. & A.C.; W/70 1/2" Belt		
O.C. 0123415000	♣K080702HD	
Belt - Fan, Alt. & A.C.; W/78 1/2" Belt		
O.C. F2HT8620FA	♣K080780HD	
Tensioner Assy. - Fan, Alt. & A.C. 1352151	38511	
Idler Pulley 1445612	36096	
Tensioner Pulley - Fan, Alt. & A.C. 1352151	36091	
Hose - Upper - Eng. To Pipe; (2" I.D.)	24232	
Hose - Upper - Pipe To Rad.; (2" I.D.)	24232	
Hose - Lower - Eng. To Pipe	21135	
Hose - Lower - Pipe To Rad.; (2 1/2" I.D.)	24240	
L-Line		
Belt - W.P. 0366775	♣9341HD	
Belt - Fan, Alt. & A.C. F2HT8620FA	♣K080780HD	
Tensioner Assy. - Fan, Alt. & A.C. 1352151	38511	
Tensioner Pulley - Fan, Alt. & A.C. 1352151	36091	
Hose - Upper - Eng. To Pipe; (2" I.D.)	24232	
Hose - Upper - Pipe To Rad.; (2" I.D.)	24232	
Hose - Lower - Eng. To Pipe	21135	
Hose - Lower - Pipe To Rad.; (2 1/2" I.D.)	24240	
Caterpillar 3406 Diesel		
A-Line		
Belt - Fan F6H68620KA	♣K140580HD	
Belt - Alt. F6HT8620ANA	♣9480HD	
Belt - A.C. F6HT8620AAB	♣9485HD	
Hose - Upper; (2 1/2" I.D.)	24240	
Hose - Lower - Eng. To Pipe; (3" I.D.)	24248	
Hose - Lower - Pipe To Rad.; (2 1/2" I.D.)	24240	
L-Line		
Belt - Fan F7HT8620KA	♣K140662HD	
Belt - Fan To Alt. 2310001028	♣9451HD	
Belt - Fan To A.C. C6TA8620J	♣9420HD	
Hose - Upper - Eng. To Pipe; (2 1/2" I.D.)	24240	
Hose - Upper - Pipe To Rad.; (2 1/2" I.D.)	24240	
Hose - Lower - Eng. To Pipe; (3" I.D.)	24248	
Hose - Lower - Pipe To Rad.; (2 1/2" I.D.)	24240	

© Two Required.

Belts and Coolant Hose for Medium/Heavy-Duty Trucks (1996 and Newer)

Medium & Heavy-Duty Trucks
(1996 & Newer)

Application	Mfr. Part No.	Our No.
STERLING - Continued		
2001 - Continued		
Caterpillar C10 Diesel		
A-Line; L-Line		
Belt - Fan	F6HT8620JA	♣K140603HD
Belt - Fan To Alt.	C5TS8620T	Ⓣ♣9440HD
Belt - Fan To A.C.	F6HT8620AKA	♣9465HD
Hose - Upper - Eng. To Pipe		21135
Hose - Upper - Pipe To Rad.; (2 1/2" I.D.)		24240
Hose - Lower - Eng. To Pipe; (2 1/2" I.D.)		24240
Hose - Lower - Pipe To Rad.; (2 1/2" I.D.)		24240
Caterpillar C12 Diesel		
A-Line; L-Line		
Belt - Fan	F6HT8620JA	♣K140603HD
Belt - Fan To Alt.	C5TS8620T	Ⓣ♣9440HD
Belt - Fan To A.C.	F6HT8620AKA	♣9465HD
Hose - Upper - Eng. To Pipe		21135
Hose - Upper - Pipe To Rad.; (2 1/2" I.D.)		24240
Hose - Lower - Eng. To Pipe; (2 1/2" I.D.)		24240
Hose - Lower - Pipe To Rad.; (2 1/2" I.D.)		24240
Caterpillar C15 Diesel		
A-Line; L-Line		
Belt - Fan	F6HT8620KA	♣K140580HD
Belt - Fan To Alt.	2310001116	♣9470HD
Belt - Fan To A.C.	F6HT8620AAB	♣9485HD
Hose - Upper - Eng. To Pipe; (2 1/2" I.D.)		24240
Hose - Upper - Pipe To Rad.		21135
Hose - Lower - Eng. To Pipe		21891
Hose - Lower - Pipe To Rad.; (2 1/2" I.D.)		24240
Caterpillar C16 Diesel		
L-Line		
Belt - Fan	F6HT8620KA	♣K140580HD
Belt - Fan To Alt.	2310001116	♣9470HD
Belt - Fan To A.C.	F6HT8620AAB	♣9485HD
Hose - Upper - Eng. To Pipe; (2 1/2" I.D.)		24240
Hose - Upper - Pipe To Rad.		21135
Hose - Lower - Eng. To Pipe		21891
Hose - Lower - Pipe To Rad.; (2 1/2" I.D.)		24240
Cummins ISB Diesel		
SC7000; SC8000		
Belt - Alt. & A.C.	3922828	♣K080580HD
Tensioner Assy. - Fan & Alt.	3978021	38517
Cummins ISC Diesel		
L-Line		
Belt - Fan, Alt. & Hub	3918095	♣K080733HD
Belt - Fan To A.C.	3639613	Ⓣ♣9463HD
Belt - Fan & Hub	3681822	♣K100810HD
Belt - Hub, Alt. & A.C.	3681812	♣K060685HD
Tensioner Assy. - Fan, Alt. & Hub	3936206	38513
Tensioner Pulley - Fan, Alt. & Hub	3936206	36091
Hose - Upper - Eng. To Pipe; (2 1/2" I.D.)		24240
Hose - Upper - Pipe To Rad.; (2 1/2" I.D.)		24240
Hose - Lower - Eng. To Pipe		21891
Hose - Lower - Pipe To Rad.; (2 1/2" I.D.)		24240
Cummins ISM Diesel		
A-Line; L-Line		
Belt - Fan	F6HT8620BA	♣K140516HD
Belt - Hub & Alt.	E7HT8620GA	♣K050360HD
Belt - Hub & A.C.	D0HA8620JA	♣9480HD
Hose - Upper - Eng. To Rad.; (2 1/2" I.D.)		24240
Hose - Upper - Eng. To Pipe; (2 1/2" I.D.)		24240
Hose - Lower - Eng. To Pipe; (2" I.D.)		24232
Hose - Lower - Pipe To Rad.; (2 1/2" I.D.)		24240
Cummins ISX Diesel		
L-Line		
Belt - Fan	3681822	♣K100810HD
Belt - Hub, Alt. & A.C.	3681812	♣K060685HD
Tensioner Assy. - Fan	3681240	38535
Tensioner Assy. - Hub, Alt. & A.C.	3680194	38532
Idler Pulley - Alt. & A.C.	4026886	36226
Tensioner Pulley - Fan	3681240	36092

Application	Mfr. Part No.	Our No.
STERLING - Continued		
2001 - Continued		
Cummins ISX Diesel - Continued		
L-Line - Continued		
Tensioner Pulley - Hub, Alt. & A.C.	3680194	36095
Hose - Upper - Eng. To Pipe; (2 1/2" I.D.)		24240
Hose - Upper - Pipe To Rad.		≈21135
Hose - Lower - Eng. To Pipe		≈21894
Hose - Lower - Pipe To Rad.		≈21135
Cummins N14 Diesel		
A-Line; L-Line		
Belt - Hub & W.P.		♣K060415HD
Belt - Hub & Fan	F6HT8620DA	♣K140429HD
Belt - Alt.	E5HT8A615EA	♣9435HD
Belt - Hub & A.C.	C6TA8620J	♣9420HD
Hose - Upper - Eng. To Pipe; (2 1/2" I.D.)		24240
Hose - Upper - Pipe To Rad.		21135
Hose - Lower - Eng. To Pipe; (2 1/2" I.D.)		24240
Hose - Lower - Pipe To Rad.; (2 1/2" I.D.)		24240
Silver Star		
Belt - Hub & W.P.		♣K060415HD
Belt - Alt.	E5HT8A615EA	♣9435HD
Belt - Hub & A.C.	C6TA8620J	♣9420HD
Hose - Upper - Eng. To Pipe; (2 1/2" I.D.)		24240
Hose - Upper - Pipe To Rad.		21135
Hose - Lower - Eng. To Pipe; (2 1/2" I.D.)		24240
Hose - Lower - Pipe To Rad.; (2 1/2" I.D.)		24240
Cummins Signature 600 Diesel		
L-Line; Silver Star		
Belt - Fan	3681822	♣K100810HD
Belt - Hub, Alt. & A.C.	3681812	♣K060685HD
Tensioner Assy. - Fan	3681240	38535
Tensioner Assy. - Hub, Alt. & A.C.	3680194	38532
Idler Pulley - Alt. & A.C.	4026886	36226
Tensioner Pulley - Fan	3681240	36092
Tensioner Pulley - Hub, Alt. & A.C.	3680194	36095
Hose - Upper - Eng. To Pipe; (2 1/2" I.D.)		24240
Hose - Upper - Pipe To Rad.		≈21135
Hose - Lower - Eng. To Pipe		≈21894
Hose - Lower - Pipe To Rad.		≈21135
Detroit Diesel 6-Cyl. 11.1 L Diesel		
A-Line		
Belt - Fan	F6HT8620LA	♣K140496HD
Belt - Hub To Alt. & A.C.	0124587004	♣K080565HD
Tensioner Assy. - Hub, Alt. & A.C.	23520317	38501
Tensioner Pulley - Hub, Alt. & A.C.		38075
Hose - Upper - Pipe To Rad.; (2 1/2" I.D.)		24240
Hose - Lower - Eng. To Pipe; (2 1/2" I.D.)		24240
Hose - Lower - Pipe To Rad.; (2 1/2" I.D.)		24240
L-Line		
Belt - Fan	F6HT8620LA	♣K140496HD
Belt - Hub & Alt.; W/V-Belt Drive	F7HT8620VA	2/9485FPB
Belt - Hub & Alt.; W/V-Ribbed Belt Drive	23521143	K060420
Belt - Hub & A.C.	C8TA8620D	♣9370HD
Tensioner Assy. - Hub & Alt.	23524436	38502
Tensioner Pulley - Hub & Alt.		38075
Hose - Upper - Pipe To Rad.; (2 1/2" I.D.)		24240
Hose - Lower - Eng. To Pipe; (2 1/2" I.D.)		24240
Hose - Lower - Pipe To Rad.; (2 1/2" I.D.)		24240
Detroit Diesel 6-Cyl. 12.7 L Diesel		
A-Line		
Belt - Fan	F6HT8620LA	♣K140496HD
Belt - Hub To Alt. & A.C.	0124587004	♣K080565HD
Tensioner Assy. - Hub, Alt. & A.C.	23520317	38501
Tensioner Pulley - Hub, Alt. & A.C.		38075
Hose - Upper - Pipe To Rad.; (2 1/2" I.D.)		24240
Hose - Lower - Eng. To Pipe; (2 1/2" I.D.)		24240
Hose - Lower - Pipe To Rad.; (2 1/2" I.D.)		24240
L-Line		
Belt - Fan	F6HT8620LA	♣K140496HD
Belt - Hub & Alt.; W/V-Belt Drive	F7HT8620VA	2/9485FPB

♣ Standard Belt Available. See Pages 630-631.
≈ Cut to Fit.

Ⓣ Two Required.

Belts and Coolant Hose for Medium/Heavy-Duty Trucks (1996 and Newer)

 Medium & Heavy-Duty Trucks
(1996 & Newer)

Application	Mfr. Part No.	Our No.
STERLING - Continued		
2001 - Continued		
Detroit Diesel 6-Cyl. 12.7 L Diesel - Continued		
L-Line - Continued		
Belt - Hub & Alt.; W/V-Ribbed Belt Drive	23521143	K060420
Belt - Hub & A.C.	C8TA8620D	▲9370HD
Tensioner Assy. - Hub & Alt.	23524436	38502
Tensioner Pulley - Hub & Alt.		38075
Hose - Upper - Pipe To Rad.; (2 1/2" I.D.)		24240
Hose - Lower - Eng. To Pipe; (2 1/2" I.D.)		24240
Hose - Lower - Pipe To Rad.; (2 1/2" I.D.)		24240
Silver Star		
Belt - Fan	0127115010	▲K140496HD
Belt - Hub To Alt. & A.C.	0124587004	▲K080565HD
Tensioner Assy. - Hub, Alt. & A.C.	23520317	38501
Hose - Upper - Eng. To Pipe; (2 1/2" I.D.)		24240
Hose - Upper - Pipe To Rad.		21891
Hose - Lower - Eng. To Pipe		21891
Hose - Lower - Pipe To Rad.; (2 1/2" I.D.)		24240
Mercedes-Benz MBE 900 Diesel		
Acterra		
Belt - Hub, Fan, Alt. & A.C.	0126246000	▲K080830HD
Tensioner Assy.	9062002470	38567
Hose - Upper - Eng. To Pipe		22701
Hose - Upper - Pipe To Rad.		21135
Hose - Lower - Eng. To Pipe		21571
Hose - Lower - Pipe To Rad.		22903
2000		
Caterpillar 3126 Diesel		
L-Line		
Belt - W.P.	0366775	▲9341HD
Belt - Fan, Alt. & A.C.	F2HT8620FA	▲K080780HD
Tensioner Assy. - Fan, Alt. & A.C.	1352151	38511
Tensioner Pulley - Fan, Alt. & A.C.	1352151	36091
Hose - Upper - Eng. To Pipe; (2" I.D.)		24232
Hose - Upper - Pipe To Rad.; (2" I.D.)		24232
Hose - Lower - Eng. To Pipe		21135
Hose - Lower - Pipe To Rad.; (2 1/2" I.D.)		24240
Caterpillar 3306 Diesel		
L-Line		
Belt - Fan	F6HZ8620ALA	▲K080545HD
Belt - Alt.	F6HZ8620AA	▲9490HD
Belt - A.C.	E8HZ8620LA	▲9585HD
Caterpillar 3406 Diesel		
A-Line		
Belt - Fan	F6H68620KA	▲K140580HD
Belt - Alt.	F6HT8620ANA	②▲9480HD
Belt - A.C.	F6HT8620AAB	▲9485HD
Hose - Upper; (2 1/2" I.D.)		24240
Hose - Lower - Eng. To Pipe; (3" I.D.)		24248
Hose - Lower - Pipe To Rad.; (2 1/2" I.D.)		24240
L-Line		
Belt - Fan	F7HT8620KA	▲K140662HD
Belt - Fan To Alt.	2310001028	②▲9451HD
Belt - Fan To A.C.	C6TA8620J	▲9420HD
Hose - Upper - Eng. To Pipe; (2 1/2" I.D.)		24240
Hose - Upper - Pipe To Rad.; (2 1/2" I.D.)		24240
Hose - Lower - Eng. To Pipe; (3" I.D.)		24248
Hose - Lower - Pipe To Rad.; (2 1/2" I.D.)		24240
Silver Star		
Belt - Fan	F6HT8620KA	▲K140580HD
Belt - Fan & Alt.; W/130A. Delco Alt.		②▲9480HD
Belt - Fan & A.C.; W/48" Belt O.C.	F6HT8620AAB	▲9485HD
Hose - Upper - Eng. To Pipe; (2 1/2" I.D.)		24240
Hose - Upper - Pipe To Rad.; (2 1/2" I.D.)		24240
Hose - Lower - Eng. To Pipe; (3" I.D.)		24248
Hose - Lower - Pipe To Rad.; (2 1/2" I.D.)		24240
Caterpillar C10 Diesel		
A-Line; L-Line		
Belt - Fan	F6HT8620JA	▲K140603HD

▲ Standard Belt Available. See Pages 630-631.

Application	Mfr. Part No.	Our No.
STERLING - Continued		
2000 - Continued		
Caterpillar C10 Diesel - Continued		
A-Line; L-Line - Continued		
Belt - Fan & Alt.	C5TS8620T	②▲9440HD
Belt - Fan & A.C.	F6HT8620AKA	▲9465HD
Hose - Upper - Eng. To Pipe		21135
Hose - Upper - Pipe To Rad.; (2 1/2" I.D.)		24240
Hose - Lower - Eng. To Pipe; (2 1/2" I.D.)		24240
Hose - Lower - Pipe To Rad.; (2 1/2" I.D.)		24240
Caterpillar C12 Diesel		
A-Line; L-Line		
Belt - Fan	F6HT8620JA	▲K140603HD
Belt - Fan & Alt.	C5TS8620T	②▲9440HD
Belt - Fan & A.C.	F6HT8620AKA	▲9465HD
Hose - Upper - Eng. To Pipe		21135
Hose - Upper - Pipe To Rad.; (2 1/2" I.D.)		24240
Hose - Lower - Eng. To Pipe; (2 1/2" I.D.)		24240
Hose - Lower - Pipe To Rad.; (2 1/2" I.D.)		24240
Caterpillar C15 Diesel		
A-Line		
Belt - Fan	F6HT8620KA	▲K140580HD
Belt - Fan To Alt.	2310001116	▲9470HD
Belt - Fan & A.C.	F6HT8620AAB	▲9485HD
Hose - Upper - Eng. To Pipe; (2 1/2" I.D.)		24240
Hose - Upper - Pipe To Rad.		21135
Hose - Lower - Eng. To Pipe		21891
Hose - Lower - Pipe To Rad.; (2 1/2" I.D.)		24240
Silver Star		
Belt - Fan	F6HT8620CA	▲K140433HD
Belt - Fan & Alt.	F6HT8620ANA	▲9480HD
Belt - Fan & A.C.	F6HT8620AAB	▲9485HD
Hose - Upper - Eng. To Pipe; (2 1/2" I.D.)		24240
Hose - Upper - Pipe To Rad.		21891
Hose - Lower - Eng. To Pipe		21042
Hose - Lower - Pipe To Rad.; (3" I.D.)		24248
Caterpillar C16 Diesel		
A-Line		
Belt - Fan	F6HT8620KA	▲K140580HD
Belt - Fan To Alt.	2310001116	▲9470HD
Belt - Fan To A.C.	F6HT8620AAB	▲9485HD
Hose - Upper - Eng. To Pipe; (2 1/2" I.D.)		24240
Hose - Upper - Pipe To Rad.		21135
Hose - Lower - Eng. To Pipe		21891
Hose - Lower - Pipe To Rad.; (2 1/2" I.D.)		24240
Silver Star		
Belt - Fan	F6HT8620CA	▲K140433HD
Belt - Fan & Alt.	F6HT8620ANA	▲9480HD
Belt - Fan & A.C.	F6HT8620AAB	▲9485HD
Hose - Upper - Eng. To Pipe; (2 1/2" I.D.)		24240
Hose - Upper - Pipe To Rad.		21891
Hose - Lower - Eng. To Pipe		21042
Hose - Lower - Pipe To Rad.; (3" I.D.)		24248
Cummins ISB Diesel		
L-Line		
Belt - Fan, Alt. & Hub	3943214	▲K080726HD
Belt - Fan To A.C.		9775
Tensioner Assy. - Fan, Alt. & Hub	3934821	38516
Tensioner Pulley - Fan, Alt. & Hub	3934821	36093
Hose - Upper - Eng. To Pipe; (2" I.D.)		24232
Hose - Upper - Pipe To Rad.; (2 1/2" I.D.)		24240
Hose - Lower - Eng. To Pipe		21891
Hose - Lower - Pipe To Rad.; (2 1/2" I.D.)		24240
SC7000		
Belt - Alt. & A.C.	3922828	▲K080580HD
Tensioner Assy. - Fan & Alt.	3978021	38517
SC8000		
Belt - Alt. & A.C.	3922828	▲K080580HD
Tensioner Assy. - Fan & Alt.	3978021	38517
Hose - Upper - Pipe To Rad.; (2" I.D.)		24232
Hose - Lower - Eng. To Pipe; (2" I.D.)		24232

② Two Required.

Belts and Coolant Hose for Medium/Heavy-Duty Trucks (1996 and Newer)

Medium & Heavy-Duty Trucks
(1996 & Newer)

Application	Mfr. Part No.	Our No.
STERLING - Continued		
2000 - Continued		
Cummins ISB Diesel - Continued		
SC8000 - Continued		
Hose - Lower - Pipe To Rad.; (2" I.D.)		24232
Cummins ISC Diesel		
L-Line		
Belt - Fan, Alt. & Hub	3918095	♣K080733HD
Belt - Fan To A.C.	3639613	②♣9463HD
Tensioner Assy. - Fan, Alt. & Hub	3936206	38513
Tensioner Pulley - Fan, Alt. & Hub	3936206	36091
Hose - Upper - Eng. To Pipe; (2 1/2" I.D.)		24240
Hose - Upper - Pipe To Rad.; (2 1/2" I.D.)		24240
Hose - Lower - Eng. To Pipe		21891
Hose - Lower - Pipe To Rad.; (2 1/2" I.D.)		24240
Cummins ISM Diesel		
A-Line; L-Line		
Belt - Fan	F6HT8620BA	♣K140516HD
Belt - Hub & Alt.	E7HT8620GA	♣K050360HD
Belt - Hub & A.C.	D0HA8620JA	♣9480HD
Hose - Upper - Eng. To Rad.; (2 1/2" I.D.)		24240
Hose - Upper - Eng. To Pipe; (2 1/2" I.D.)		24240
Hose - Lower - Eng. To Pipe; (2" I.D.)		24232
Hose - Lower - Pipe To Rad.; (2 1/2" I.D.)		24240
Cummins N14 Diesel		
A-Line; L-Line		
Belt - Hub & W.P.		♣K060425HD
Belt - Hub & Fan	F6HZ8620M	♣K140429HD
Belt - Alt.	E5HT8A615EA	♣9435HD
Belt - Hub & A.C.	C6TA8620J	♣9420HD
Hose - Upper - Eng. To Pipe		21135
Hose - Upper - Pipe To Rad.; (2 1/2" I.D.)		24240
Hose - Upper - Pipe To Pipe		21135
Hose - Lower - Eng. To Pipe; (2 1/2" I.D.)		24240
Hose - Lower - Pipe To Rad.; (2 1/2" I.D.)		24240
Silver Star		
Belt - Hub & W.P.		♣K060415HD
Belt - Alt.	E5HT8A615EA	♣9435HD
Belt - Hub & A.C.	C6TA8620J	♣9420HD
Hose - Upper - Eng. To Pipe; (2 1/2" I.D.)		24240
Hose - Upper - Pipe To Rad.		21135
Hose - Lower - Eng. To Pipe; (2 1/2" I.D.)		24240
Hose - Lower - Pipe To Rad.; (2 1/2" I.D.)		24240
Detroit Diesel 6-Cyl. 11.1 L Diesel		
A-Line; L-Line		
Belt - Fan	F6HT8620LA	♣K140496HD
Belt - Hub & Alt.; W/V-Belt Drive	F7HT8620VA	2/9485FPB
Belt - Hub & Alt.; W/V-Ribbed Belt Drive	23521143	K060420
Belt - Hub & A.C.	C8TA8620D	♣9370HD
Tensioner Assy. - Hub & Alt.	23524436	38502
Tensioner Pulley - Hub & Alt.		38075
Hose - Upper - Pipe To Rad.; (2 1/2" I.D.)		24240
Hose - Lower - Eng. To Pipe; (2 1/2" I.D.)		24240
Hose - Lower - Pipe To Rad.; (2 1/2" I.D.)		24240
Detroit Diesel 6-Cyl. 12.7 L Diesel		
A-Line; L-Line; Silver Star		
Belt - Fan	F6HT8620LA	♣K140496HD
Belt - Hub & Alt.; W/V-Belt Drive	F7HT8620VA	2/9485FPB
Belt - Hub & Alt.; W/V-Ribbed Belt Drive	23521143	K060420
Belt - Hub & A.C.	C8TA8620D	♣9370HD
Tensioner Assy. - Hub & Alt.	23524436	38502
Tensioner Pulley - Hub & Alt.		38075
Hose - Upper - Pipe To Rad.; (2 1/2" I.D.)		24240
Hose - Lower - Eng. To Pipe; (2 1/2" I.D.)		24240
Hose - Lower - Pipe To Rad.; (2 1/2" I.D.)		24240

1999

Caterpillar 3126 Diesel

L-Line		
Belt - W.P.	0366775	♣9341HD
Belt - Fan, Alt. & A.C.	F2HT8620FA	♣K080780HD

Application	Mfr. Part No.	Our No.
STERLING - Continued		
1999 - Continued		
Caterpillar 3126 Diesel - Continued		
L-Line - Continued		
Tensioner Assy. - Fan, Alt. & A.C.	1352151	38511
Tensioner Pulley - Fan, Alt. & A.C.	1352151	36091
Hose - Upper; (2 1/2" I.D.)		24240
Hose - Upper - Eng. To Pipe; (2" I.D.)		24232
Hose - Upper - Pipe To Rad.; (2" I.D.)		24232
Hose - Lower - Eng. To Pipe		21135
Hose - Lower - Pipe To Rad.; (2 1/2" I.D.)		24240
Caterpillar 3306 Diesel		
L-Line		
Belt - Fan	F6HZ8620ALA	♣K080545HD
Belt - Alt.	F6HZ8620AA	♣9490HD
Belt - A.C.	E8HZ8620LA	♣9585HD
Caterpillar 3406 Diesel		
A-Line; L-Line		
Belt - Fan	F6H68620KA	♣K140580HD
Belt - Alt.	F6HT8620ANA	②♣9480HD
Belt - A.C.	F6HT8620AAB	♣9485HD
Hose - Upper; (2 1/2" I.D.)		24240
Hose - Lower - Eng. To Pipe; (3" I.D.)		24248
Hose - Lower - Pipe To Rad.; (2 1/2" I.D.)		24240
Silver Star		
Belt - Fan	F6HT8620KA	♣K140580HD
Belt - Fan & Alt.; W/130A. Delco Alt.		②♣9480HD
Belt - Fan & A.C.; W/48" Belt O.C.	F6HT8620AAB	♣9485HD
Hose - Upper - Eng. To Pipe; (2 1/2" I.D.)		24240
Hose - Upper - Pipe To Rad.; (2 1/2" I.D.)		24240
Hose - Lower - Eng. To Pipe; (3" I.D.)		24248
Hose - Lower - Pipe To Rad.; (2 1/2" I.D.)		24240
Caterpillar C10 Diesel		
A-Line; L-Line		
Belt - Fan	F6HT8620JA	♣K140603HD
Belt - Fan & Alt.	C5TS8620T	②♣9440HD
Belt - Fan & A.C.	F6HT8620AKA	♣9465HD
Hose - Upper - Eng. To Pipe		21135
Hose - Upper - Pipe To Rad.; (2 1/2" I.D.)		24240
Hose - Lower - Eng. To Pipe; (2 1/2" I.D.)		24240
Hose - Lower - Pipe To Rad.; (2 1/2" I.D.)		24240
Caterpillar C12 Diesel		
A-Line; L-Line		
Belt - Fan	F6HT8620JA	♣K140603HD
Belt - Fan & Alt.	C5TS8620T	②♣9440HD
Belt - Fan & A.C.	F6HT8620AKA	♣9465HD
Hose - Upper - Eng. To Pipe		21135
Hose - Upper - Pipe To Rad.; (2 1/2" I.D.)		24240
Hose - Lower - Eng. To Pipe; (2 1/2" I.D.)		24240
Hose - Lower - Pipe To Rad.; (2 1/2" I.D.)		24240
Cummins ISB Diesel		
L-Line		
Belt - Fan, Alt. & Hub	3943214	♣K080726HD
Belt - Fan To A.C.		9775
Tensioner Assy. - Fan, Alt. & Hub	3934821	38516
Tensioner Pulley - Fan, Alt. & Hub	3934821	36093
Hose - Upper - Eng. To Pipe; (2" I.D.)		24232
Hose - Upper - Pipe To Rad.; (2 1/2" I.D.)		24240
Hose - Lower - Eng. To Pipe		21891
Hose - Lower - Pipe To Rad.; (2 1/2" I.D.)		24240
SC7000		
Belt - Fan, Alt. & A.C.	3922828	♣K080580HD
Tensioner Assy. - Fan & Alt.	3978021	38517
SC8000		
Belt - Fan, Alt. & A.C.	3922828	♣K080580HD
Tensioner Assy. - Fan & Alt.	3978021	38517
Hose - Upper - Eng. To Pipe; (2" I.D.)		24232
Hose - Lower - Eng. To Pipe; (2" I.D.)		24232
Hose - Lower - Pipe To Rad.; (2" I.D.)		24232

♣ Standard Belt Available. See Pages 630-631.

② Two Required.

Belts and Coolant Hose for Medium/Heavy-Duty Trucks (1996 and Newer)

 Medium & Heavy-Duty Trucks
(1996 & Newer)

Application	Mfr. Part No.	Our No.
STERLING - Continued		
1999 - Continued		
Cummins ISC Diesel		
L-Line		
Belt - Fan, Alt. & Hub	3918095	♣K080733HD
Belt - Fan To A.C.	3639613	②♣9463HD
Tensioner Assy. - Fan, Alt. & Hub	3936206	38513
Tensioner Pulley - Fan, Alt. & Hub	3936206	36091
Hose - Upper - Eng. To Pipe; (2 1/2" I.D.)		24240
Hose - Upper - Pipe To Rad.; (2 1/2" I.D.)		24240
Hose - Lower - Eng. To Pipe		21891
Hose - Lower - Pipe To Rad.; (2 1/2" I.D.)		24240
Cummins ISM Diesel		
A-Line		
Belt - Fan	F6HZ8620G	♣K140516HD
Belt - Alt.	E4FZ8620C	♣K050360HD
Belt - A.C.	JC293	♣9290HD
L-Line		
Belt - Fan	F6HT8620BA	♣K140516HD
Belt - Hub & Alt.	E7HT8620GA	♣K050360HD
Belt - Hub & A.C.	DOHA8620JA	♣9480HD
Hose - Upper - Eng. To Pipe; (2 1/2" I.D.)		24240
Hose - Upper - Pipe To Rad.; (2 1/2" I.D.)		24240
Hose - Lower - Eng. To Pipe; (2" I.D.)		24232
Hose - Lower - Pipe To Rad.; (2 1/2" I.D.)		24240
Cummins N14 Diesel		
A-Line; L-Line		
Belt - Hub & W.P.		♣K060425HD
Belt - Hub & Fan	F6HZ8620M	♣K140429HD
Belt - Alt.	E5HT8A615EA	♣9435HD
Belt - Hub & A.C.	C6TA8620J	♣9420HD
Hose - Upper - Eng. To Pipe		21135
Hose - Upper - Pipe To Rad.; (2 1/2" I.D.)		24240
Hose - Upper - Pipe To Pipe		21135
Hose - Lower - Eng. To Pipe; (2 1/2" I.D.)		24240
Hose - Lower - Pipe To Rad.; (2 1/2" I.D.)		24240
Silver Star		
Belt - Hub & W.P.		♣K060415HD
Belt - Alt.	E5HT8A615EA	♣9435HD
Belt - Hub & A.C.	C6TA8620J	♣9420HD
Hose - Upper - Eng. To Pipe; (2 1/2" I.D.)		24240
Hose - Upper - Pipe To Rad.		21135
Hose - Lower - Eng. To Pipe; (2 1/2" I.D.)		24240
Hose - Lower - Pipe To Rad.; (2 1/2" I.D.)		24240
Cummins Signature 600 Diesel		
L-Line		
Belt - Fan	3680275	♣K100570HD
Belt - A.C.	3680197	♣K060660HD
Tensioner Assy. - Fan	3681240	38535
Tensioner Assy. - Hub, Alt. & A.C.	3680194	38532
Idler Pulley - Alt. & A.C.	4026886	36226
Tensioner Pulley - Fan	3681240	36092
Tensioner Pulley - Hub, Alt. & A.C.	3680194	36095
Detroit Diesel 6-Cyl. 11.1 L Diesel		
L-Line		
Belt - Fan	F6HT8620LA	♣K140496HD
Belt - Hub & Alt.; W/V-Belt Drive	F7HT8620VA	2/9485FPB
Belt - Hub & Alt.; W/V-Ribbed Belt Drive	23521143	K060420
Belt - Hub & A.C.	C8TA8620D	♣9370HD
Tensioner Assy. - Hub & Alt.	23524436	38502
Tensioner Pulley - Hub & Alt.		38075
Hose - Upper - Pipe To Rad.; (2 1/2" I.D.)		24240
Hose - Lower - Eng. To Pipe; (2 1/2" I.D.)		24240
Hose - Lower - Pipe To Rad.; (2 1/2" I.D.)		24240
Detroit Diesel 6-Cyl. 12.7 L Diesel		
L-Line		
Belt - Fan	F6HT8620LA	♣K140496HD
Belt - Hub & Alt.; W/V-Belt Drive	F7HT8620VA	2/9485FPB
Belt - Hub & Alt.; W/V-Ribbed Belt Drive	23521143	K060420
Belt - Hub & A.C.	C8TA8620D	♣9370HD
Tensioner Assy. - Hub & Alt.	23524436	38502

♣ Standard Belt Available. See Pages 630-631.

Application	Mfr. Part No.	Our No.
STERLING - Continued		
1999 - Continued		
Detroit Diesel 6-Cyl. 12.7 L Diesel - Continued		
L-Line - Continued		
Tensioner Pulley - Hub & Alt.		38075
Hose - Upper - Pipe To Rad.; (2 1/2" I.D.)		24240
Hose - Lower - Eng. To Pipe; (2 1/2" I.D.)		24240
Hose - Lower - Pipe To Rad.; (2 1/2" I.D.)		24240
1998		
Caterpillar 3126 Diesel		
L-Line		
Belt - W.P.		♣9341HD
Belt - Fan, Alt. & A.C.	F2HT8620FA	♣K080780HD
Tensioner Assy. - Fan, Alt. & A.C.	1352151	38511
Tensioner Pulley - Fan, Alt. & A.C.	1352151	36091
Hose - Upper; (2 1/2" I.D.)		24240
Hose - Upper - Eng. To Pipe; (2" I.D.)		24232
Hose - Upper - Pipe To Rad.; (2" I.D.)		24232
Hose - Lower - Eng. To Pipe		21135
Hose - Lower - Pipe To Rad.; (2 1/2" I.D.)		24240
Caterpillar 3306 Diesel		
L-Line		
Belt - Fan	F6HZ8620ALA	♣K080545HD
Belt - Alt.	F6HZ8620AA	♣9490HD
Belt - A.C.	E8HZ8620LA	♣9585HD
Caterpillar 3406 Diesel		
L-Line		
Belt - Fan	F6H68620KA	♣K140580HD
Belt - Alt.	F6HT8620ANA	②♣9480HD
Belt - A.C.	F6HT8620AAB	♣9485HD
Hose - Upper; (2 1/2" I.D.)		24240
Hose - Lower - Eng. To Pipe; (3" I.D.)		24248
Hose - Lower - Pipe To Rad.; (2 1/2" I.D.)		24240
Caterpillar C10 Diesel		
L-Line		
Belt - Fan	F6HT8620AZA	♣K140618HD
Belt - Alt.	C5TS8620T	♣9440HD
Belt - A.C.	F6HT8620AKA	♣9465HD
Hose - Upper; (2 1/2" I.D.)		24240
Hose - Lower; (2 1/2" I.D.)		24240
Caterpillar C12 Diesel		
L-Line		
Belt - Fan	F6HT8620AZA	♣K140618HD
Belt - Alt.	C5TS8620T	♣9440HD
Belt - A.C.	F6HT8620AKA	♣9465HD
Hose - Upper; (2 1/2" I.D.)		24240
Hose - Lower; (2 1/2" I.D.)		24240
Cummins ISB Diesel		
L-Line		
Belt - Alt.; W/210, 230 H.P. Eng.	F3HZ8620M	♣K080839HD
Belt - Fan	F1HZ8620C	♣K080710HD
Belt - A.C.	D5TZ8620C	♣9395HD
Hose - Upper - Eng. To Pipe; (2 5/8" I.D.)		24242
Hose - Upper - Pipe To Rad.; (2" I.D.)		24232
Hose - Lower - Eng. To Pipe; (2" I.D.)		24232
Hose - Lower - Rad. To Pipe; (2 3/8" I.D.)		24238
SC8000		
Belt - Fan, Alt. & A.C.	3922828	♣K080580HD
Tensioner Assy. - Fan & Alt.	3978021	38517
Cummins ISC Diesel		
L-Line		
Belt - Fan	F6HZ8620N	♣K080733HD
Belt - Fan & Alt.	F6HT8620AYA	♣K080726HD
Belt - P.S.	F6HT8620ASA	♣9465HD
Belt - A.C.; W/47" Belt O.C.		♣9465HD
Belt - A.C.; W/64" Belt O.C.	E8HT8620KA	♣9640HD
Hose - Upper - Eng. To Pipe; (2 1/4" I.D.)		24236
Hose - Upper - Pipe To Rad.; (2" I.D.)		24232
Hose - Lower - Eng. To Pipe; (2 1/2" I.D.)		24240
Hose - Lower - Rad. To Pipe; (2 3/8" I.D.)		24238

② Two Required.

Belts and Coolant Hose for Medium/Heavy-Duty Trucks (1996 and Newer)

Medium & Heavy-Duty Trucks
(1996 & Newer)

Application	Mfr. Part No.	Our No.	Application	Mfr. Part No.	Our No.
STERLING - Continued			UD (NISSAN) - Continued		
1998 - Continued			2008		
Cummins ISC Diesel - Continued			Nissan MD-175 Diesel		
L-Line - Continued			UD1400; UD1800CS		
Hose - Lower - Pipe To Cooler; (2" I.D.)		24232	Belt - Alt. & W.P.	21131Z500D	ⓂA46
Cummins M11 Diesel			Belt - A.C.	1192036D00	A37
L-Line			Nissan MD-230 Diesel		
Belt - Fan; W/52" Belt O.C.	F6HT8620BA	♣K140516HD	UD1800HD; UD2000; UD2300DH; UD2300LP; UD2600; UD2600LP; UD3300		
Belt - Fan; W/60" Belt O.C.	F6HZ8620F	♣K140594HD	Belt - Alt. & W.P.	21140Z502A	K080539HD
Belt - Alt.	E7HT8620GA	♣K050360HD	Belt - A.C.	1192036D01	A38
Belt - A.C.; W/29" Belt O.C.	DGHZ8620AA	♣9290HD	2007		
Belt - A.C.; W/48" Belt O.C.	C9PZ8620CD	♣9480HD	Nissan MD-175 Diesel		
Hose - Upper - Eng. To Pipe; (2 1/4" I.D.)		24236	UD1300; UD1400		
Hose - Upper - Pipe To Rad.; (2 1/2" I.D.)		24240	Belt - Alt. & W.P.	21140Z5075	A45
Hose - Lower - Eng. To Pipe; (2" I.D.)		24232	Belt - A.C.	1192036D00	A37
Hose - Lower - Pipe To Rad.; (2 1/2" I.D.)		24240	Hose - Upper		23754
Cummins N14 Diesel			UD1800CS		
L-Line			Belt - Alt. & W.P.		
Belt - Hub & Fan; W/1050 High Cool., 1300 Cool.	F6HZ8620M	♣K140429HD	Belt - A.C.	1192036D00	A37
Belt - Hub & Fan; W/900 Cool.	F6HZ8620L	♣K140433HD	Nissan MD-230 Diesel		
Belt - Alt.	E5HZ8620EA	♣9435HD	UD1800HD; UD2000; UD2300DH; UD2300LP		
Belt - Hub & A.C.	C6TZ8620JA	♣9420HD	Belt - Alt. & W.P.	21140Z5074	K080553HD
Hose - Upper - Eng. To Pipe; (2 1/2" I.D.)		24240	Belt - A.C.	1192036D01	A38
Hose - Upper - Pipe To Rad.; (2 1/2" I.D.)		24240	Tensioner Assy. - Alt. & W.P.	21100Z501C	38659
Hose - Lower - Eng. To Pipe; (2 1/2" I.D.)		24240	Hose - Upper		23753
Hose - Lower - Pipe To Rad.; (2 1/2" I.D.)		24240	Hose - Lower; W/Auto. Trans.		23752
Hose - Lower - Pipe To Pipe; (2 1/2" I.D.)		24240	UD2600; UD2600LP; UD3300		
Detroit Diesel 6-Cyl. 11.1 L Diesel			Belt - Alt. & W.P.	21140Z5074	K080553HD
L-Line			Belt - A.C.	1192036D01	A38
Belt - Fan; W/50" Belt O.C.	F6HT8620LA	♣K140496HD	Tensioner Assy. - Alt. & W.P.	21100Z501C	38659
Belt - Fan; W/59" Belt O.C.	F7HZ8620CA	♣K140580HD	Hose - Upper		23753
Belt - Alt.; Optional Belt		Ⓜ9485HD	Hose - Lower; W/Man. Trans.		23751
Belt - Alt.; Preferred Belt	F7HT8620VA	2/9485FPB	Hose - Lower; W/Auto. Trans.		23752
Belt - A.C.	C8TA8620D	♣9370HD	2006		
Hose - Upper - Pipe To Rad.; (2 1/2" I.D.)		24240	Nissan MD-175 Diesel		
Hose - Upper - Pipe To Pipe; (2 1/2" I.D.)		24240	UD1300; UD1400		
Hose - Lower; (2 1/2" I.D.)		24240	Belt - Alt. & W.P.	21140Z5075	A45
Detroit Diesel 6-Cyl. 12.7 L Diesel			Belt - A.C.	1192036D00	A37
L-Line			Hose - Upper		23754
Belt - Fan; W/50" Belt O.C.	F6HT8620LA	♣K140496HD	UD1800CS		
Belt - Fan; W/59" Belt O.C.	F7HZ8620CA	♣K140580HD	Belt - Alt. & W.P.	21140Z5075	A45
Belt - Alt.; Optional Belt		Ⓜ9485HD	Belt - A.C.	1192036D00	A37
Belt - Alt.; Preferred Belt	F7HT8620VA	2/9485FPB	Tensioner Assy. - Alt. & W.P.	21100Z501C	38659
Belt - A.C.	C8TA8620D	♣9370HD	Nissan MD-230 Diesel		
Hose - Upper - Pipe To Rad.; (2 1/2" I.D.)		24240	UD1800HD; UD2000; UD2300DH; UD2300LP		
Hose - Upper - Pipe To Pipe; (2 1/2" I.D.)		24240	Belt - Alt. & W.P.	21140Z5074	K080553HD
Hose - Lower; (2 1/2" I.D.)		24240	Belt - A.C.	1192036D01	A38
UD (NISSAN)			Tensioner Assy. - Alt. & W.P.	21100Z501C	38659
2010			Hose - Upper		23753
Nissan MD-175 Diesel			Hose - Lower; W/Auto. Trans.		23752
UD1400; UD1800CS			UD2600; UD3300		
Belt - Alt. & W.P.	21131Z500D	ⓂA46	Belt - Alt. & W.P.	21140Z5074	K080553HD
Belt - A.C.	1192036D00	A37	Belt - A.C.	1192036D01	A38
Nissan MD-230 Diesel			Tensioner Assy. - Alt. & W.P.	21100Z501C	38659
UD2000; UD2300DH; UD2300LP; UD2600; UD3300			Hose - Upper		23753
Belt - Alt. & W.P.	21140Z502A	K080539HD	Hose - Lower; W/Man. Trans.		23751
Belt - A.C.	1192036D01	A38	Hose - Lower; W/Auto. Trans.		23752
2009			2005		
Nissan MD-175 Diesel			Nissan MD-175 Diesel		
UD1400; UD1800CS			UD1300; UD1400		
Belt - Alt. & W.P.	21131Z500D	ⓂA46	Belt - Alt. & W.P.	21140Z5075	A45
Belt - A.C.	1192036D00	A37	Belt - A.C.	1192036D00	A37
Nissan MD-230 Diesel			Hose - Upper		23754
UD1800HD; UD2000; UD2300DH; UD2300LP; UD2600; UD3300			UD1800CS		
Belt - Alt. & W.P.	21140Z502A	K080539HD	Belt - Alt. & W.P.	21140Z5075	A45
Belt - A.C.	1192036D01	A38	Belt - A.C.	1192036D00	A37

♣ Standard Belt Available. See Pages 630-631.

Ⓜ Two Required.

Belts and Coolant Hose for Medium/Heavy-Duty Trucks (1996 and Newer)

 Medium & Heavy-Duty Trucks
(1996 & Newer)

Application	Mfr. Part No.	Our No.
UD (NISSAN) - Continued		
2005 - Continued		
Nissan MD-230 Diesel		
UD1800HD; UD2000; UD2300DH; UD2300LP		
Belt - Alt. & W.P.	21140Z5074	K080553HD
Belt - A.C.	1192036D01	A38
Tensioner Assy. - Alt. & W.P.	21100Z501C	38659
Hose - Upper		23753
Hose - Lower; W/Auto. Trans.		23752
UD2600; UD3300		
Belt - Alt. & W.P.	21140Z5074	K080553HD
Belt - A.C.	1192036D01	A38
Tensioner Assy. - Alt. & W.P.	21100Z501C	38659
Hose - Upper		23753
Hose - Lower; W/Man. Trans.		23751
Hose - Lower; W/Auto. Trans.		23752
2004-2002		
Nissan FD46TA Diesel		
UD1200; UD1400; UD1800CS		
Belt - Fan & Alt.		♣K090500HD
Belt - Fan & A.C.		♣K040388HD
Nissan FE6TA Diesel		
UD1800HD; UD2000; UD2300DH; UD2300LP; UD2600; UD3300		
Belt - Fan & Alt.		♣K090500HD
Belt - Fan & A.C.		♣K040388HD
2001		
Nissan FD46TA Diesel		
UD1200; UD1400; UD1800CS		
Belt - Fan & Alt.		♣K090500HD
Belt - Fan & A.C.		♣K040388HD
Nissan FE6TA Diesel		
UD1800HD; UD2000; UD2300DH; UD2300LP; UD2600		
Belt - Fan & Alt.		♣K090500HD
Belt - Fan & A.C.		♣K040388HD
2000		
Nissan FD46TA Diesel		
UD1200; UD1400; UD1800CS		
Belt - Fan & Alt.	117200T002	TR20451
Nissan FE6TA Diesel		
UD1800HD		
Belt - Fan & Alt.		ⓉTR22517
Belt - Fan & A.C.		TR22397
Hose - Lower - Eng. To Rad.		≧<20957
UD2000; UD2300DH; UD2300LP; UD2600; UD3000; UD3300		
Belt - Fan & Alt.		♣K090500HD
Belt - Fan & A.C.		♣K040388HD
1999		
Nissan FD46TA Diesel		
UD1200; UD1400; UD1800CS		
Belt - Fan & Alt.	117200T002	TR20451
Nissan FE6TA Diesel		
UD1800HD		
Belt - Fan & Alt.	21140Z5617	TR22517
Belt - Fan & A.C.		TR22397
Hose - Lower - Eng. To Rad.		≧<20957
UD2600		
Belt - Fan & Alt.	21140Z5676	♣K090500HD
Belt - Fan & A.C.	21140Z5701	♣K040388HD
1998		
Nissan FE6TA Diesel		
UD1800		
Belt - Fan & Alt.		ⓉTR22517
Belt - Fan & A.C.		TR22397
Hose - Lower - Eng. To Rad.		≧<20957

Application	Mfr. Part No.	Our No.
UD (NISSAN) - Continued		
1998 - Continued		
Nissan FE6TA Diesel - Continued		
UD2000		
Belt - Fan & Alt.	21140Z5676	♣K090500HD
Belt - Fan & A.C.	21140Z5701	♣K040388HD
Hose - Lower - Eng. To Rad.		≧<21378
UD2300DH; UD2300LP; UD2600; UD3000		
Belt - Fan & Alt.	21140Z5676	♣K090500HD
Belt - Fan & A.C.	21140Z5701	♣K040388HD
Nissan TD42 Diesel		
UD1400		
Belt - Fan & Alt.	117200T002	TR20451
1997-1996		
Nissan FE6TA Diesel		
UD1800; UD2300DH; UD2300LP; UD2600; UD3000		
Belt - Fan & Alt.		ⓉTR22517
Belt - Fan & A.C.		TR22397
Hose - Lower - Eng. To Rad.		≧<20957
Nissan TD42 Diesel		
UD1400		
Belt - Fan & Alt.		TR20451
VOLVO		
2013		
Cummins ISX15 Diesel		
VN Series		
Belt - Fan	21189554	♣K120842HD
Belt - A.C.	20457273	♣K060637HD
Tensioner Assy. - A.C.	3104149	38610
Idler Pulley - A.C.	3682229	36223
Hose - Lower - Pipe To Eng.: (2 3/4" I.D.)		≧<24244
Volvo D13 Diesel		
VHD		
Belt - Fan	21379938	K120786HD
Belt - Alt.	21556639	♣K080630HD
Tensioner Assy. - Fan	21714847	38633
Tensioner Assy. - Alt.	21454379	38671
Hose - Upper - Rad. To Pipe		23563
Hose - Upper - Pipe To Eng.		22714
2012		
Cummins ISX15 Diesel		
VN Series		
Belt - Fan	21189554	♣K120842HD
Belt - A.C.	20457273	♣K060637HD
Tensioner Assy. - A.C.	3104149	38610
Idler Pulley - A.C.	3682229	36223
Hose - Lower - Pipe To Eng.: (2 3/4" I.D.)		24244
Volvo D11 Diesel		
VHD		
Hose - Upper - Pipe To Eng.		22714
VN Series		
Belt - Alt.	21460410	♣K080630HD
Tensioner Assy. - Alt.	21454379	38671
Tensioner Assy. - Fan	20935521	38607
Idler Pulley - Upper	20953521	36286
Hose - Upper - Pipe To Eng.		22714
Hose - Lower		23563
Volvo D13 Diesel		
VHD		
Belt - Fan	21379938	K120786HD
Belt - Alt. & A.C.	21556639	♣K080630HD
Tensioner Assy.	21461221	38633
Tensioner Assy. - Alt. & A.C.	21454379	38671
Hose - Upper - Rad. To Pipe		23564
Hose - Upper - Pipe To Rad.		22714
Hose - Lower		23563

♣ Standard Belt Available. See Pages 630-631.
≧< Cut to Fit.

Ⓣ Two Required.

Belts and Coolant Hose for Medium/Heavy-Duty Trucks (1996 and Newer)

Medium & Heavy-Duty Trucks
(1996 & Newer)

Application	Mfr. Part No.	Our No.
VOLVO - Continued		
2012 - Continued		
Volvo D13 Diesel - Continued		
VN Series		
Belt - Fan & W.P.	20582557	K120640HD
Belt - Alt. & A.C.	21556639	▲K080630HD
Tensioner Assy. - Fan & W.P.	21461221	38633
Tensioner Assy. - Alt. & A.C.	21454379	38671
Hose - Upper - Rad. To Pipe		23564
Hose - Upper - Pipe To Rad.		22714
Hose - Lower		23563
Volvo D16 Diesel		
VN Series		
Belt - Fan	20882779	K100578HD
Belt - Alt. & A.C.	20464710	▲K080550HD
Tensioner Assy. - Fan	21155561	38581
Tensioner Assy. - Alt. & A.C.	21422767	38585
Idler Pulley - Fan (Lower)	20747516	36285
2011		
Cummins ISX15 Diesel		
VN Series		
Belt - Fan	21189554	▲K120842HD
Belt - A.C.	20457273	▲K060637HD
Tensioner Assy. - A.C.	3104149	38610
Idler Pulley - A.C.	3682229	36223
Hose - Lower - Pipe To Eng.; (2 3/4" I.D.)		≠24244
Volvo D11 Diesel		
VHD		
Belt - Alt. & A.C.	20582552	▲K080630HD
Tensioner Assy. - Alt.	21422767	38585
Tensioner Assy. - Fan	20935521	38607
VN Series		
Belt - Alt. & A.C.	20582552	▲K080630HD
Hose - Upper - Pipe To Eng.		22714
Hose - Lower		23563
Volvo D13 Diesel		
VHD		
Belt - Fan & W.P.	20582559	K120786HD
Belt - Alt. & A.C.	20582552	▲K080630HD
Tensioner Assy. - Fan & W.P.	21461221	38633
Tensioner Assy. - Alt. & A.C.	21454379	38671
Hose - Upper - Rad. To Pipe		23563
Hose - Upper - Eng. To Pipe		22714
VN Series		
Belt - Fan & W.P.	20582557	K120640HD
Belt - Alt. & A.C.	20582552	▲K080630HD
Tensioner Assy. - Fan & W.P.	21461221	38633
Tensioner Assy. - Alt. & A.C.	21454379	38671
Hose - Upper - Rad. To Pipe		23563
Hose - Upper - Eng. To Pipe		22714
Hose - Lower - Rad. To Pipe		23564
Volvo D16 Diesel		
VN Series		
Belt - Fan	20882779	K100578HD
Belt - Alt. & A.C.	20464710	▲K080550HD
Tensioner Assy. - Fan	20491753	38581
Tensioner Assy. - Alt. & A.C.	20935523	38585
Idler Pulley - Fan (Lower)	20747516	36285
2009		
Cummins ISX Diesel		
VN Series		
Belt - Fan, A.C., Alt. & W.P.	20481362	▲K120842HD
Tensioner Assy. - Fan, A.C., Alt. & W.P. (Left)	3104149	38610
Tensioner Assy. - Fan, A.C., Alt. & W.P. (Right)	3682946	38587
Tensioner Pulley - Fan, A.C., Alt. & W.P. (Right)	3682946	36165
Idler Pulley - Fan	20953521	36286
VT Series		
Belt - Fan & Alt.	20481362	▲K120842HD
Belt - Hub & A.C.	20457273	▲K060637HD
Tensioner Assy. - Hub & A.C.	3682683	38610
Tensioner Assy. - Fan & Alt.	3682946	38587
Tensioner Pulley - Fan & Alt.	3682946	36165
Idler Pulley - Fan	20953521	36286
Idler Pulley - A.C.	3682229	36223
Hose - Upper - Pipe To Eng.		*28212
Hose - Lower - Pipe To Eng.; (2 3/4" I.D.)		≠24244
Volvo D11 Diesel		
VN Series		
Belt - Alt. & A.C.	20582552	▲K080630HD
Hose - Upper - Pipe To Eng.		22714
Hose - Lower		23563
Volvo D13 Diesel		
VHD		
Belt - Fan & W.P.	20582559	K120786HD
Belt - Alt. & A.C.	20582552	▲K080630HD
Tensioner Assy. - Alt. & A.C.	21454379	38671

Application	Mfr. Part No.	Our No.
VOLVO - Continued		
2010 - Continued		
Cummins ISX15 Diesel - Continued		
VT Series - Continued		
Tensioner Assy. - A.C.	3104149	38610
Idler Pulley - A.C.	3682229	36223
Volvo D11 Diesel		
VHD		
Belt - Alt. & A.C.	20582552	▲K080630HD
Tensioner Assy. - Fan	20935521	38607
Hose - Upper - Pipe To Eng.		22714
Hose - Lower		23563
VN Series		
Belt - Alt. & A.C.	20582552	▲K080630HD
Hose - Upper - Pipe To Eng.		22714
Hose - Lower		23563
Volvo D13 Diesel		
VHD		
Belt - Fan & W.P.	20582559	K120786HD
Belt - Alt. & A.C.	20582552	▲K080630HD
Tensioner Assy. - Fan & W.P.	21461221	38633
Tensioner Assy. - Alt. & A.C.	21454379	38671
Hose - Upper - Rad. To Pipe		23563
Hose - Upper - Eng. To Pipe		22714
VN Series		
Belt - Fan & W.P.	20582557	K120640HD
Belt - Alt. & A.C.	20582552	▲K080630HD
Tensioner Assy. - Fan & W.P.	21461221	38633
Tensioner Assy. - Alt. & A.C.	21454379	38671
Hose - Upper - Rad. To Pipe		23563
Hose - Upper - Eng. To Pipe		22714
Hose - Lower - Rad. To Pipe		23564
Volvo D16 Diesel		
VN Series		
Belt - Fan	20882779	K100578HD
Belt - Alt. & A.C.	20464710	▲K080550HD
Tensioner Assy. - Fan	20491753	38581
Tensioner Assy. - Alt. & A.C.	20935523	38585
Idler Pulley - Fan (Lower)	20747516	36285

▲ Standard Belt Available. See Pages 630-631.
* Durion® Silicone Hose Recommended.

≠ Cut to Fit.

Belts and Coolant Hose for Medium/Heavy-Duty Trucks (1996 and Newer)

 Medium & Heavy-Duty Trucks
(1996 & Newer)

Application	Mfr. Part No.	Our No.
VOLVO - Continued		
2009 - Continued		
Volvo D13 Diesel - Continued		
VHD - Continued		
Tensioner Assy. - Fan	20860873	38633
Hose - Upper - Rad. To Pipe		23563
Hose - Upper - Eng. To Pipe		22714
Hose - Lower - Rad. To Pipe		23564
VN Series		
Belt - Fan & W.P.	20582557	K120640HD
Belt - Alt. & A.C.	20582552	♣K080630HD
Tensioner Assy. - Alt. & A.C.	21454379	38671
Tensioner Assy. - Fan & Hub	20860873	38633
Hose - Upper - Rad. To Pipe		23563
Hose - Upper - Eng. To Pipe		22714
Hose - Lower - Rad. To Pipe		23564
Volvo D16 Diesel		
VN Series		
Belt - Fan	20882779	K100578HD
Belt - Alt. & A.C.	20464710	♣K080550HD
Tensioner Assy. - Fan	20491753	38581
Tensioner Assy. - Alt. & A.C.	20935523	38585
Idler Pulley - Fan (Lower)	20747516	36285
VT Series		
Belt - Fan	20882779	K100578HD
Belt - Alt. & A.C.	20464710	♣K080550HD
Tensioner Assy. - Fan	20491753	38581
Tensioner Assy. - Alt. & A.C.	20935523	38585
Idler Pulley - Lower	20747516	36285
Volvo VE D12 Diesel		
VHD		
Belt - Fan	20440066	♣K100572HD
Belt - Hub To Alt. & A.C.	20451458	♣K080565HD
Tensioner Assy. - Fan	20491753	38581
Tensioner Assy. - Alt. & A.C.	8149855	38585
Idler Pulley - Fan	20457029	36286
Volvo VE D16 Diesel		
VN Series		
Belt - Fan	20882779	K100578HD
Belt - Alt.	20464710	♣K080550HD
Tensioner Assy. - Fan	21155561	38581
Tensioner Assy. - Alt.	21422767	38585
Idler Pulley - Lower	20747516	36285
VT Series		
Belt - Fan	20882779	K100578HD
Belt - Alt. & A.C.	20464710	♣K080550HD
Tensioner Assy. - Fan	20491753	38581
Tensioner Assy. - Alt. & A.C.	20935523	38585
Idler Pulley - Lower	20747516	36285
2008		
Cummins ISX Diesel		
VN Series		
Belt - Fan & Alt.	20481362	♣K120842HD
Belt - A.C.	20457273	♣K060637HD
Tensioner Assy. - Fan & Alt.	3682946	38587
Tensioner Assy. - A.C.	3682683	38610
Tensioner Pulley - Fan & Alt.	3682946	36165
Idler Pulley - Fan	20953521	36286
Idler Pulley - A.C.	3682229	36223
Hose - Lower - Eng. To Pipe; (2 3/4" I.D.)		24244
VT Series		
Belt - Fan & Alt.	20481362	♣K120842HD
Belt - Hub & A.C.	20457273	♣K060637HD
Tensioner Assy. - Fan & Alt.	3682946	38587
Tensioner Assy. - Hub & A.C.	3682683	38610
Tensioner Pulley - Fan & Alt.	3682946	36165
Idler Pulley - Fan	20953521	36286
Idler Pulley - A.C.	3682229	36223
Hose - Upper - Pipe To Eng.		*28212
Hose - Lower - Pipe To Eng.; (2 3/4" I.D.)		♣<24244

Application	Mfr. Part No.	Our No.
VOLVO - Continued		
2008 - Continued		
Volvo D11 Diesel		
VN Series		
Belt - Alt.	20582552	♣K080630HD
Tensioner Assy. - Fan	20739751	38607
Tensioner Assy. - Alt.	20762060	38671
Hose - Upper - Pipe To Rad.		22714
Hose - Upper - Pipe To Eng.		22714
Hose - Lower		23563
Volvo D13 Diesel		
VHD		
Belt - Fan & W.P.	20582559	K120786HD
Belt - Alt. & A.C.	20582552	♣K080630HD
Tensioner Assy. - Alt. & A.C.	21454379	38671
Tensioner Assy. - Fan	20860873	38633
Hose - Upper - Rad. To Pipe		23563
Hose - Upper - Eng. To Pipe		22714
Hose - Lower - Rad. To Pipe		23564
VN Series		
Belt - Fan	20582557	K120640HD
Belt - Alt. & A.C.	20582552	♣K080630HD
Tensioner Assy. - Fan	20860873	38633
Tensioner Assy. - Alt. & A.C.	20762060	38671
Hose - Upper - Rad. To Pipe		23563
Hose - Upper - Eng. To Pipe		22714
Hose - Lower - Rad. To Pipe		23564
Volvo D16 Diesel		
VN Series		
Belt - Fan & W.P.	20878554	♣K120610HD
Belt - Alt. & A.C.	20464710	♣K080550HD
Tensioner Assy. - Fan	20491753	38581
Tensioner Assy. - Alt. & A.C.	8149855	38585
Idler Pulley	20747516	36285
Hose - Upper - Eng. To Pipe		21891
Volvo VE D12 Diesel		
VHD		
Belt - Fan	20440066	♣K100572HD
Belt - Hub To Alt. & A.C.	20451458	♣K080565HD
Tensioner Assy. - Fan	20491753	38581
Tensioner Assy. - Alt. & A.C.	8149855	38585
Idler Pulley - Fan	20953521	36286
VN Series		
Belt - Fan	20491756	K100582HD
Belt - Alt. & A.C.	20430368	K080385HD
Tensioner Assy. - Fan	20491753	38581
Tensioner Assy. - Alt. & A.C.	8149855	38585
Idler Pulley - Fan	20457029	36286
Hose - Upper		22709
Volvo VE D16 Diesel		
VN Series; VT Series		
Belt - Fan & W.P.	21133804	K10051HD
Belt - Alt. & A.C.	20464710	♣K080550HD
Tensioner Assy. - Fan	20491753	38581
Tensioner Assy. - Alt. & A.C.	8149855	38585
Idler Pulley	20747516	36285
2007		
Cummins ISX Diesel		
VN Series		
Belt - Fan & Alt.	20481362	♣K120842HD
Belt - A.C.	20457273	♣K060637HD
Tensioner Assy. - Fan & Alt.	3682946	38587
Tensioner Assy. - A.C.	3682683	38610
Tensioner Pulley - Fan & Alt.	3682946	36165
Idler Pulley - Fan	20953521	36286
Idler Pulley - A.C.	3682229	36223
Hose - Lower - Eng. To Pipe; (2 3/4" I.D.)		24244
VT Series		
Belt - Fan & Alt.	20481362	♣K120842HD
Belt - Hub & A.C.	20457273	♣K060637HD

 ♣ Standard Belt Available. See Pages 630-631.
 ♣< Cut to Fit.

* Durion® Silicone Hose Recommended.

Belts and Coolant Hose for Medium/Heavy-Duty Trucks (1996 and Newer)

Medium & Heavy-Duty Trucks
(1996 & Newer)

Application	Mfr. Part No.	Our No.	Application	Mfr. Part No.	Our No.
VOLVO - Continued			VOLVO - Continued		
2007 - Continued			2006		
Cummins ISX Diesel - Continued			Cummins ISX Diesel		
VT Series - Continued			VN Series		
Tensioner Assy. - Fan & Alt.	3682946	38587	Belt - Fan & Alt.	20481362	♣K120842HD
Tensioner Assy. - Hub & A.C.	3682683	38610	Belt - Hub & A.C.	20457273	♣K060637HD
Tensioner Pulley - Fan & Alt.	3682946	36165	Tensioner Assy. - Fan & Alt.	3682946	38587
Idler Pulley - Fan 20953521	20953521	36286	Tensioner Assy. - Hub & A.C.	3682683	38610
Idler Pulley - A.C. 3682229	3682229	36223	Tensioner Pulley - Fan & Alt.	3682946	36165
Hose - Lower - Pipe To Eng.; (2 3/4" I.D.)		24244	Idler Pulley - Fan 20953521	20953521	36286
			Idler Pulley - A.C. 3682229	3682229	36223
			Hose - Lower - Eng. To Pipe; (2 3/4" I.D.)		24244
Volvo D11 Diesel			VT Series		
VN Series			Belt - Fan & Alt.		
Belt - Alt. 20582552	20582552	♣K080630HD	Belt - A.C. 20457273	20457273	♣K060637HD
Tensioner Assy. - Fan 20739751	20739751	38607	Tensioner Assy. - Fan & Alt.	3682946	38587
Tensioner Assy. - Alt. 21422767	21422767	38585	Tensioner Assy. - A.C. 3682683	3682683	38610
Hose - Upper - Pipe To Eng.		22714	Tensioner Pulley - Fan & Alt.	3682946	36165
Hose - Lower 23563		23563	Idler Pulley - Fan 20953521	20953521	36286
			Idler Pulley - A.C. 3682229	3682229	36223
			Hose - Lower - Eng. To Pipe; (2 3/4" I.D.)		24244
Volvo D13 Diesel			Volvo VE D12 Diesel		
VHD			VHD		
Belt - Fan & W.P. 20582559	20582559	K120786HD	Belt - Fan; W/57 1/2" Belt O.C.	20440066	♣K100572HD
Belt - Alt. & A.C. 20582552	20582552	♣K080630HD	Belt - Hub To Fan; W/58" Belt O.C.	20430385	K100578HD
Tensioner Assy. - Fan 20860873	20860873	38633	Belt - Alt. & A.C.; W/39" Belt O.C.	20430368	K080385HD
Tensioner Assy. - Alt. & A.C.	21454379	38671	Belt - Hub To Alt. & A.C.; W/57" Belt		
Hose - Upper - Rad. To Pipe		23563	O.C. 20451458	20451458	♣K080565HD
Hose - Upper - Eng. To Pipe		22714	Tensioner Assy. - Fan 20491753	20491753	38581
Hose - Lower - Rad. To Pipe		23564	Tensioner Assy. - Alt. & A.C.	8149855	38585
			Idler Pulley - Fan 20457029	20457029	36286
VN Series			VN Series		
Belt - Fan 20582557	20582557	K120640HD	Belt - Fan 20491756	20491756	K100582HD
Belt - Alt. 20582552	20582552	♣K080630HD	Belt - Alt. & A.C. 20430368	20430368	K080385HD
Tensioner Assy. - Fan 20860873	20860873	38633	Tensioner Assy. - Fan 20491753	20491753	38581
Tensioner Assy. - Alt. 21422767	21422767	38585	Tensioner Assy. - Alt. & A.C.	8149855	38585
Hose - Upper - Rad. To Pipe		23564	Idler Pulley - Fan 20457029	20457029	36286
Hose - Upper - Pipe To Eng.		22714	Hose - Upper - Eng. To Rad.		22709
Hose - Lower 23563		23563	Hose - Lower - Eng. To Rad.		♣22710
Volvo VE D12 Diesel			Volvo VE D16 Diesel		
VHD			VN Series; VT Series		
Belt - Fan; W/57 7/8" Belt O.C.	20440066	♣K100572HD	Belt - Fan & W.P. 21133804	21133804	K100551HD
Belt - Fan; W/58 3/8" Belt O.C.	20430385	K100578HD	Belt - Alt. & A.C. 20464710	20464710	♣K080550HD
Belt - Hub To Alt. & A.C.; W/130A. Alt.	20451458	♣K080565HD	Tensioner Assy. - Fan 20491753	20491753	38581
Belt - Hub To Alt. & A.C.; W/145A. Alt.	20430368	K080385HD	Tensioner Assy. - Alt. & A.C.	8149855	38585
Tensioner Assy. - Fan 20491753	20491753	38581	Idler Pulley 20747516	20747516	36285
Tensioner Assy. - Alt. & A.C.	8149855	38585			
Idler Pulley - Smooth 20953521	20953521	36286			
VN Series			2005		
Belt - Fan 20491756	20491756	K100582HD	Cummins ISL Diesel		
Belt - Alt. & A.C. 20430368	20430368	K080385HD	VHD		
Tensioner Assy. - Fan 20491753	20491753	38581	Belt - Alt. 20484570	20484570	♣K080774HD
Tensioner Assy. - Alt. & A.C.	8149855	38585	Tensioner Assy. 21631484	21631484	38581
Idler Pulley - Fan 20457029	20457029	36286	Idler Pulley 20457029	20457029	36286
Idler Pulley - Smooth 20953521	20953521	36286			
Hose - Upper - Eng. To Rad.		22709			
Hose - Lower - Eng. To Rad.		♣22710			
Volvo VE D13 Diesel			Cummins ISX Diesel		
VHD			VN Series		
Belt - Fan 20582559	20582559	K120786HD	Belt - Fan & Alt. 20481362	20481362	♣K120842HD
Belt - Alt. 20582552	20582552	♣K080630HD	Belt - A.C. 20457273	20457273	♣K060637HD
Tensioner Assy. - Fan 20860873	20860873	38633	Tensioner Assy. - Fan & Alt.	3682946	38587
Tensioner Assy. - Alt. 20762060	20762060	38671	Tensioner Assy. - A.C. 3682683	3682683	38610
Hose - Upper - Rad. To Pipe		23563	Tensioner Pulley - Fan & Alt.	3682946	36165
Hose - Upper - Pipe To Eng.		22714	Idler Pulley - Fan 20953521	20953521	36286
			Idler Pulley - A.C. 3682229	3682229	36223
			Hose - Lower - Rad. To Pipe		22717
			Hose - Lower - Eng. To Pipe; (2 3/4" I.D.)		24244
Volvo VE D16 Diesel			Volvo VE D12 Diesel		
VN Series; VT Series			VHD		
Belt - Fan & W.P. 21133804	21133804	K100551HD	Belt - Fan 20440066	20440066	♣K100579HD
Belt - Alt. & A.C. 20464710	20464710	♣K080550HD	Belt - Alt. & A.C. 20430368	20430368	K080385HD
Tensioner Assy. - Fan 20491753	20491753	38581	Tensioner Assy. - Fan 20491753	20491753	38581
Tensioner Assy. - Alt. & A.C.	8149855	38585	Tensioner Assy. - Alt. & A.C.	8149855	38585
Idler Pulley 20747516	20747516	36285	Idler Pulley - Fan 20457029	20457029	36286

♣ Standard Belt Available. See Pages 630-631.

♣ Cut to Fit.

Belts and Coolant Hose for Medium/Heavy-Duty Trucks (1996 and Newer)

 Medium & Heavy-Duty Trucks
(1996 & Newer)

Application	Mfr. Part No.	Our No.
VOLVO - Continued		
2005 - Continued		
Volvo VE D12 Diesel - Continued		
VN Series		
Belt - Fan	20491756	K100582HD
Belt - Alt. & A.C.	20430368	K080385HD
Tensioner Assy. - Fan	20491753	38581
Tensioner Assy. - Alt. & A.C.	8149855	38585
Idler Pulley - Fan	20457029	36286
Hose - Upper - Eng. To Rad.		22709
Hose - Lower - Eng. To Rad.		≈22710
2004		
Cummins ISL Diesel		
VHD		
Belt - Alt.	20484570	♣K080774HD
Tensioner Assy.	21631484	38581
Idler Pulley	20457029	36286
Cummins ISX Diesel		
VN Series		
Belt - Fan & Alt.	20481362	♣K120842HD
Belt - A.C.	20457273	♣K060637HD
Tensioner Assy. - Fan & Alt.	3682946	38587
Tensioner Assy. - A.C.	3682683	38610
Tensioner Pulley - Fan & Alt.	3682946	36165
Idler Pulley - Fan	20953521	36286
Idler Pulley - A.C.	3682229	36223
Hose - Lower - Rad. To Pipe		22717
Hose - Lower - Eng. To Pipe; (2 3/4" I.D.)		≈24244
Volvo VE D12 Diesel		
VHD		
Belt - Fan	20430382	♣K100437HD
Belt - Hub, Alt. & A.C.	978238	♣K080375HD
Tensioner Assy. - Fan	20491753	38581
Hose - Upper - Eng. To Rad.		22709
Hose - Lower - Eng. To Rad.		22710
VN Series		
Belt - Fan	20491756	K100582HD
Belt - Alt. & A.C.	20430367	♣K080384HD
Tensioner Assy. - Fan	20491753	38581
Tensioner Assy. - Alt. & A.C.	8149855	38585
Idler Pulley - Fan	20457029	36286
Hose - Upper - Eng. To Rad.		22709
Hose - Lower - Eng. To Rad.		≈22710
2003		
Cummins ISM Diesel		
VHD		
Belt - Fan & Alt.	982186	♣K100891HD
Belt - Hub & A.C.	982351	♣K060532HD
Tensioner Assy. - Fan & Alt.	8086969	38539
Tensioner Assy. - Hub & A.C.	3979979	38607
Tensioner Pulley - Fan & Alt.	8086969	36092
Hose - Upper - Eng. To Rad.		22711
Hose - Lower - Eng. To Rad.		22712
VN Series		
Belt - Fan & Alt.	981633	♣K100665HD
Belt - Hub & A.C.	981634	♣K060415HD
Tensioner Assy. - Fan & Alt.	8086969	38539
Tensioner Assy. - Hub & A.C.	3979979	38607
Tensioner Pulley - Fan & Alt.	8086969	36092
Hose - Upper - Eng. To Pipe; (2 1/4" I.D.)		24236
Hose - Upper - Pipe To Rad.; (2 1/4" I.D.)		24236
Hose - Lower - Eng. To Pipe; (2 1/2" I.D.)		24240
Hose - Lower - Pipe To Rad.; (2 1/2" I.D.)		24240
Cummins ISX Diesel		
VN Series		
Belt - Fan; W/Clean Air Pkg.	20481362	♣K120842HD
Belt - Fan; W/O Clean Air Pkg.	3681820	♣K100510HD
Belt - Hub, Alt. & A.C.; W/Clean Air Pkg.	20457273	♣K060637HD

≈ Cut to Fit.

Application	Mfr. Part No.	Our No.
VOLVO - Continued		
2003 - Continued		
Cummins ISX Diesel - Continued		
VN Series - Continued		
Belt - Hub, Alt. & A.C.; W/O Clean Air Pkg.	3681812	♣K060685HD
Tensioner Assy. - Fan & Alt.; W/Clean Air Pkg.	3682946	38587
Tensioner Assy. - A.C.; W/Clean Air Pkg.	3682683	38610
Tensioner Assy. - Fan; W/O Clean Air Pkg.	3681240	38535
Tensioner Assy. - Hub, Alt. & A.C.; W/O Clean Air Pkg.	3680194	38532
Tensioner Pulley - Fan & Alt.; W/Clean Air Pkg.	3682946	36165
Tensioner Pulley - Fan; W/O Clean Air Pkg.	3681240	36092
Tensioner Pulley - Hub, Alt. & A.C.; W/O Clean Air Pkg.	3680194	36095
Idler Pulley - Alt. & A.C.	4026886	36226
Idler Pulley; W/Clean Air Pkg.	3682229	36223
Hose - Lower - Eng. To Pipe; (2 1/2" I.D.)		24240
Cummins N14 Diesel		
VN Series		
Belt - Fan	3164780	♣K100630HD
Belt - Alt.	981953	♣K050420HD
Belt - Hub & W.P.		♣K060425HD
Belt - Hub & A.C.	8029802	♣9370HD
Tensioner Pulley - Fan	20461114	36098
Hose - Upper - Eng. To Pipe; (2 1/2" I.D.)		24240
Hose - Upper - Pipe To Rad.; (2 1/2" I.D.)		24240
Hose - Lower - Eng. To Pipe; (2 1/2" I.D.)		24240
Hose - Lower - Pipe To Rad.; (2 1/2" I.D.)		24240
Cummins Signature 600 Diesel		
VN Series		
Belt - Fan; W/Clean Air Pkg.	20481362	♣K120842HD
Belt - Fan; W/O Clean Air Pkg.	3681820	♣K100510HD
Belt - Hub, Alt. & A.C.; W/Clean Air Pkg.	20457273	♣K060637HD
Belt - Hub, Alt. & A.C.; W/O Clean Air Pkg.	3681812	♣K060685HD
Tensioner Assy. - Fan & Alt.; W/Clean Air Pkg.	3682946	38587
Tensioner Assy. - A.C.; W/Clean Air Pkg.	3682683	38610
Tensioner Assy. - Fan; W/O Clean Air Pkg.	3681240	38535
Tensioner Assy. - Hub, Alt. & A.C.; W/O Clean Air Pkg.	3680194	38532
Tensioner Pulley - Fan & Alt.; W/Clean Air Pkg.	3682946	36165
Tensioner Pulley - Fan; W/O Clean Air Pkg.	3681240	36092
Tensioner Pulley - Hub, Alt. & A.C.; W/O Clean Air Pkg.	3680194	36095
Idler Pulley - Alt. & A.C.	4026886	36226
Hose - Lower - Eng. To Pipe; (2 1/2" I.D.)		24240
Volvo VE D7 Diesel		
VHD		
Tensioner Assy. - Fan	3979980	38547
Tensioner Assy. - Alt. & A.C.	3979979	38607
Volvo VE D12 Diesel		
VHD		
Belt - Fan	20430382	♣K100437HD
Belt - Hub, Alt. & A.C.	978238	♣K080375HD
Tensioner Assy. - Fan	20491753	38581
Hose - Upper - Eng. To Rad.		22709
Hose - Lower - Eng. To Rad.		22710
VN Series		
Belt - Fan	981335	♣K100437HD
Belt - Hub, Alt. & A.C.	978238	♣K080375HD
Tensioner Assy. - Fan	21257889	38547
Hose - Upper - Eng. To Rad.		22709

♣ Standard Belt Available. See Pages 630-631.

Belts and Coolant Hose for Medium/Heavy-Duty Trucks (1996 and Newer)

Medium & Heavy-Duty Trucks
(1996 & Newer)

Application	Mfr. Part No.	Our No.
VOLVO - Continued		
2003 - Continued		
Volvo VE D12 Diesel - Continued		
VN Series - Continued		
Hose - Lower - Eng. To Rad.		22710
2002		
Cummins ISM Diesel		
VHD		
Belt - Fan & Alt.	982186	▲K100891HD
Belt - Hub & A.C.	982351	▲K060532HD
Tensioner Assy. - Fan & Alt.	8086969	38539
Tensioner Assy. - Hub & A.C.	3979979	38607
Tensioner Pulley - Fan & Alt.	8086969	36092
Hose - Upper - Eng. To Rad.		22711
Hose - Lower - Eng. To Rad.		22712
VN Series		
Belt - Fan & Alt.	982186	▲K100891HD
Belt - Hub & A.C.	982351	▲K060532HD
Tensioner Assy. - Fan & Alt.	8086969	38539
Tensioner Assy. - Hub & A.C.	3979979	38607
Tensioner Pulley - Fan & Alt.	8086969	36092
Cummins ISX Diesel		
VN Series		
Belt - Fan	3681820	▲K100510HD
Belt - Hub, Alt. & A.C.	3681812	▲K060685HD
Tensioner Assy. - Fan	3681240	38535
Tensioner Assy. - Hub, Alt. & A.C.	3680194	38532
Tensioner Pulley - Fan	3681240	36092
Tensioner Pulley - Hub, Alt. & A.C.	3680194	36095
Idler Pulley - Alt. & A.C.	4026886	36226
Hose - Upper - Eng. To Rad.		22716
Hose - Lower - Eng. To Pipe; (2 1/2" I.D.)		24240
Hose - Lower - Pipe To Rad.		22717
Cummins N14 Diesel		
VN Series		
Belt - Fan	3164780	▲K100630HD
Belt - Alt.	981953	▲K050420HD
Belt - Hub & W.P.		▲K060425HD
Belt - Hub & A.C.	8029802	▲9370HD
Tensioner Assy. - Fan	3164793	38536
Tensioner Pulley - Fan	3164793	36098
Hose - Upper - Eng. To Rad.		22726
Hose - Upper - Eng. To Pipe; (2 1/2" I.D.)		24240
Hose - Upper - Pipe To Rad.; (2 1/2" I.D.)		24240
Hose - Lower - Eng. To Pipe; (2 1/2" I.D.)		24240
Hose - Lower - Pipe To Rad.; (2 1/2" I.D.)		24240
Volvo VE 12 Diesel		
VHD		
Belt - Fan	982356	▲K100579HD
Belt - Hub To Alt. & A.C.	978242	▲K080382HD
Tensioner Assy. - Fan	20491753	38581
Hose - Upper - Eng. To Rad.		22724
Hose - Lower - Eng. To Rad.		22725
Volvo VE D7 Diesel		
VHD		
Tensioner Assy. - Fan	3979980	38547
Tensioner Assy. - Alt. & A.C.	3979979	38607
Volvo VE D12 Diesel		
VHD		
Belt - Fan	982356	▲K100579HD
Belt - Hub To Alt. & A.C.	982353	K080558
Tensioner Assy. - Fan	3979980	38547
Hose - Upper - Eng. To Rad.		22724
Hose - Lower - Eng. To Rad.		22725
VN Series		
Belt - Fan	981335	▲K100437HD
Belt - Hub, Alt. & A.C.	978238	▲K080375HD
Tensioner Assy. - Fan	21257889	38547
Hose - Upper - Eng. To Rad.		22709
Hose - Lower - Eng. To Rad.		22710

Application	Mfr. Part No.	Our No.
VOLVO - Continued		
2001		
Cummins ISM Diesel		
Autocar		
Belt - Fan	981938	▲K080645HD
Belt - Hub & Alt.	3028521	▲K050345HD
Belt - Hub & A.C.	027070550	▲9530HD
Hose - Upper - Eng. To Pipe; (2 1/2" I.D.)		24240
Hose - Upper - Pipe To Rad.; (2 1/2" I.D.)		24240
Hose - Lower - Eng. To Pipe; (2 1/2" I.D.)		24240
Hose - Lower - Pipe To Rad.; (2 1/2" I.D.)		24240
VN Series		
Belt - Fan	981937	▲K080610HD
Belt - Hub & Alt.	3028521	▲K050345HD
Belt - A.C.	V1091148	▲9530HD
Tensioner Assy. - A.C.; W/V-Ribbed Belt	8086971	38545
Hose - Upper - Eng. To Pipe; (2 1/2" I.D.)		24240
Hose - Upper - Pipe To Eng.; (2 1/2" I.D.)		24240
Hose - Lower - Eng. To Pipe		21891
Hose - Lower - Pipe To Rad.		21891
WG Series		
Belt - Fan	981937	▲K080610HD
Belt - Hub & Alt.	3028521	▲K050345HD
Belt - Hub & A.C.	027070550	▲9530HD
Hose - Upper - Eng. To Pipe; (2 1/2" I.D.)		24240
Hose - Upper - Pipe To Rad.; (2 1/2" I.D.)		24240
Hose - Lower - Eng. To Pipe; (2 1/2" I.D.)		24240
Hose - Lower - Pipe To Rad.		≈21042
Hose - Lower - Pipe To Pipe		≈21042
Cummins ISX Diesel		
VN Series		
Belt - Fan	3681820	▲K100510HD
Belt - Hub, Alt. & A.C.	3681812	▲K060685HD
Tensioner Assy. - Fan	3681240	38535
Tensioner Assy. - Hub, Alt. & A.C.	3680194	38532
Idler Pulley - Alt. & A.C.	4026886	36226
Tensioner Pulley - Fan	3681240	36092
Tensioner Pulley - Hub, Alt. & A.C.	3680194	36095
Hose - Upper - Eng. To Rad.		22716
Hose - Lower - Eng. To Pipe; (2 1/2" I.D.)		24240
Hose - Lower - Pipe To Rad.		22717
Cummins N14 Diesel		
Autocar		
Belt - Hub & W.P.	30764921	▲K060425HD
Belt - Hub & Fan	8057960	▲K080465HD
Belt - Alt.		②▲9451HD
Belt - Hub & A.C.	8029802	▲9370HD
Hose - Upper - Eng. To Pipe; (2 1/2" I.D.)		24240
Hose - Upper - Pipe To Rad.; (2 1/2" I.D.)		24240
Hose - Lower - Eng. To Pipe; (2 1/2" I.D.)		24240
Hose - Lower - Pipe To Rad.; (2 1/2" I.D.)		24240
VN Series		
Belt - Hub & W.P.		▲K060425HD
Belt - Fan	3164780	▲K100630HD
Belt - Alt.	981953	▲K050420HD
Belt - Hub & A.C.	8029802	▲9370HD
Tensioner Assy. - Fan	3164793	38536
Tensioner Pulley - Fan	3164793	36098
Hose - Upper - Eng. To Rad.		22726
Hose - Lower - Eng. To Pipe; (2 1/2" I.D.)		24240
Hose - Lower - Pipe To Rad.; (2 1/2" I.D.)		24240
WG Series		
Belt - W.P.	3865157	▲K060408HD
Belt - Fan	8060304	▲K080435HD
Detroit Diesel 6-Cyl. 11.1 L Diesel		
Autocar		
Belt - Fan		③▲9625HD
Belt - Hub, Alt. & A.C.		②▲9490HD
Hose - Upper - Eng. To Pipe; (2 1/2" I.D.)		24240
Hose - Upper - Pipe To Rad.; (2 1/2" I.D.)		24240
Hose - Lower - Eng. To Pipe; (3" I.D.)		24248
Hose - Lower - Pipe To Rad.; (3" I.D.)		24248

▲ Standard Belt Available. See Pages 630-631.
② Two Required.

≈ Cut to Fit.
③ Three Required.

Belts and Coolant Hose for Medium/Heavy-Duty Trucks (1996 and Newer)

 Medium & Heavy-Duty Trucks
(1996 & Newer)

Application	Mfr. Part No.	Our No.
VOLVO - Continued		
2001 - Continued		
Detroit Diesel 6-Cyl. 11.1 L Diesel - Continued		
VN Series		
Belt - Fan & Alt.	8397694	♣K080670HD
Belt - Fan & A.C.	967138	♣9555HD
Tensioner Assy. - Fan & Alt.	8079517	38505
Tensioner Pulley	8079517	36091
Hose - Upper - Eng. To Pipe; (2 1/2" I.D.)		24240
Hose - Upper - Pipe To Rad.; (2 1/2" I.D.)		24240
Hose - Lower - Eng. To Pipe; (2 1/2" I.D.)		24240
Hose - Lower - Pipe To Rad.; (2 1/2" I.D.)		24240
Detroit Diesel 6-Cyl. 12.7 L Diesel		
Autocar		
Belt - Fan		③♣9625HD
Belt - Hub, Alt. & A.C.		②♣9490HD
Hose - Upper - Eng. To Pipe; (2 1/2" I.D.)		24240
Hose - Upper - Pipe To Rad.; (2 1/2" I.D.)		24240
Hose - Lower - Eng. To Pipe; (3" I.D.)		24248
Hose - Lower - Pipe To Rad.; (3" I.D.)		24248
VN Series		
Belt - Fan & Alt.	8397694	♣K080670HD
Belt - Fan & A.C.	967138	♣9555HD
Tensioner Assy. - Fan & Alt.	8079517	38505
Tensioner Pulley	8079517	36091
Hose - Upper - Eng. To Pipe; (2 1/2" I.D.)		24240
Hose - Upper - Pipe To Rad.; (2 1/2" I.D.)		24240
Hose - Lower - Eng. To Pipe; (2 1/2" I.D.)		24240
Hose - Lower - Pipe To Rad.; (2 1/2" I.D.)		24240
Volvo VE D7 Diesel		
VHD		
Tensioner Assy. - Fan	3979980	38547
Tensioner Assy. - Alt. & A.C.	3979979	38607
Volvo VE D12 Diesel		
VHD		
Belt - Fan	982356	♣K100579HD
Belt - Hub To Alt. & A.C.	982353	K080558
Tensioner Assy. - Fan	3979980	38547
Hose - Upper - Eng. To Rad.		22724
Hose - Lower - Eng. To Rad.		22725
VN Series		
Belt - Fan	981335	♣K100437HD
Belt - Hub, Alt. & A.C.	978238	♣K080375HD
Tensioner Assy. - Fan	21257889	38547
Hose - Upper - Eng. To Rad.		22709
Hose - Lower - Eng. To Rad.		22710
WG Series		
Belt - Fan & Hub	980886	♣K080566HD
Belt - Fan - From C.S.	982356	♣K100579HD
Belt - Hub, Alt. & A.C.	1676272	♣K050380HD
Belt - Alt. & A.C.	978238	♣K080375HD
Tensioner Assy. - Fan & Hub	3154315	38531
Tensioner Assy. - Fan	21257889	38547
Hose - Upper - Eng. To Rad.		22713
Hose - Lower - Eng. To Pipe		22714
Hose - Lower - Pipe To Rad.		22715
2000		
Cummins ISM Diesel		
Autocar		
Belt - Fan		③♣9625HD
Belt - Hub, Alt. & A.C.		②♣9490HD
Hose - Upper - Eng. To Pipe; (2 1/2" I.D.)		24240
Hose - Upper - Pipe To Rad.; (2 1/2" I.D.)		24240
Hose - Lower - Eng. To Pipe; (3" I.D.)		24248
Hose - Lower - Pipe To Rad.; (3" I.D.)		24248
VN Series		
Belt - Fan & Alt.	8397694	♣K080670HD
Belt - Fan & A.C.	967138	♣9555HD
Tensioner Assy. - Fan & Alt.	8079517	38505
Tensioner Pulley	8079517	36091
Hose - Upper - Eng. To Pipe; (2 1/2" I.D.)		24240
Hose - Upper - Pipe To Rad.; (2 1/2" I.D.)		24240
Hose - Lower - Eng. To Pipe; (2 1/2" I.D.)		24240
Hose - Lower - Pipe To Rad.; (2 1/2" I.D.)		24240
Detroit Diesel 6-Cyl. 11.1 L Diesel		
Autocar		
Belt - Fan		③♣9625HD
Belt - Hub, Alt. & A.C.		②♣9490HD
Hose - Upper - Eng. To Pipe; (2 1/2" I.D.)		24240
Hose - Upper - Pipe To Rad.; (2 1/2" I.D.)		24240
Hose - Lower - Eng. To Pipe; (3" I.D.)		24248
Hose - Lower - Pipe To Rad.; (3" I.D.)		24248
VN Series		
Belt - Fan & Alt.	8397694	♣K080670HD
Belt - Fan & A.C.	967138	♣9555HD
Tensioner Assy. - Fan & Alt.	8079517	38505
Tensioner Pulley	8079517	36091
Hose - Upper - Eng. To Pipe; (2 1/2" I.D.)		24240
Hose - Upper - Pipe To Rad.; (2 1/2" I.D.)		24240
Hose - Lower - Eng. To Pipe; (2 1/2" I.D.)		24240
Hose - Lower - Pipe To Rad.; (2 1/2" I.D.)		24240
Detroit Diesel 6-Cyl. 12.7 L Diesel		
Autocar		
Belt - Fan		③♣9625HD
Belt - Hub, Alt. & A.C.		②♣9490HD
Hose - Upper - Eng. To Pipe; (2 1/2" I.D.)		24240
Hose - Upper - Pipe To Rad.; (2 1/2" I.D.)		24240

Application	Mfr. Part No.	Our No.
VOLVO - Continued		
2000 - Continued		
Cummins ISM Diesel - Continued		
WG Series		
Belt - Fan	981937	♣K080610HD
Belt - Hub & Alt.; W/130A. Delco Alt.	3028521	♣K050345HD
Belt - Hub & A.C.	027070550	♣9530HD
Hose - Upper - Eng. To Pipe; (2 1/2" I.D.)		24240
Hose - Upper - Pipe To Rad.; (2 1/2" I.D.)		24240
Hose - Lower - Eng. To Pipe; (3" I.D.)		24248
Hose - Lower - Pipe To Rad.		≡21042
Hose - Lower - Pipe To Pipe		≡21042
Cummins ISX Diesel		
VN Series		
Belt - Fan	3681820	♣K100510HD
Belt - Hub, Alt. & A.C.	3681812	♣K060685HD
Tensioner Assy. - Fan	3681240	38535
Tensioner Assy. - Hub, Alt. & A.C.	3680194	38532
Tensioner Pulley - Fan	3681240	36092
Tensioner Pulley - Hub, Alt. & A.C.	3680194	36095
Idler Pulley - Alt. & A.C.	4026886	36226
Hose - Upper - Eng. To Rad.		22716
Hose - Lower - Eng. To Pipe; (2 1/2" I.D.)		24240
Hose - Lower - Pipe To Rad.		22717
Cummins N14 Diesel		
Autocar		
Belt - Hub & W.P.	30764921	♣K060425HD
Belt - Hub & Fan	8057960	♣K080465HD
Belt - Alt.		②♣9451HD
Belt - Hub & A.C.	8029802	♣9370HD
Hose - Upper - Eng. To Pipe; (2 1/2" I.D.)		24240
Hose - Upper - Pipe To Rad.; (2 1/2" I.D.)		24240
Hose - Lower - Eng. To Pipe; (2 1/2" I.D.)		24240
Hose - Lower - Pipe To Rad.; (2 1/2" I.D.)		24240
VN Series		
Belt - Hub & W.P.		♣K060425HD
Belt - Fan	3164780	♣K100630HD
Belt - Alt.	981953	♣K050420HD
Belt - Hub & A.C.	8029802	♣9370HD
Tensioner Assy. - Fan	3164793	38536
Tensioner Pulley - Fan	3164793	36098
Hose - Upper - Eng. To Pipe; (2 1/2" I.D.)		24240
Hose - Upper - Pipe To Rad.; (2 1/2" I.D.)		24240
Hose - Lower - Eng. To Pipe; (2 1/2" I.D.)		24240
Hose - Lower - Pipe To Rad.; (2 1/2" I.D.)		24240
WG Series		
Belt - Fan	8060304	♣K080435HD
Belt - W.P.	3865157	♣K060408HD
Detroit Diesel 6-Cyl. 11.1 L Diesel		
Autocar		
Belt - Fan		③♣9625HD
Belt - Hub, Alt. & A.C.		②♣9490HD
Hose - Upper - Eng. To Pipe; (2 1/2" I.D.)		24240
Hose - Upper - Pipe To Rad.; (2 1/2" I.D.)		24240
Hose - Lower - Eng. To Pipe; (3" I.D.)		24248
Hose - Lower - Pipe To Rad.; (3" I.D.)		24248
VN Series		
Belt - Fan & Alt.	8397694	♣K080670HD
Belt - Fan & A.C.	967138	♣9555HD
Tensioner Assy. - Fan & Alt.	8079517	38505
Tensioner Pulley	8079517	36091
Hose - Upper - Eng. To Pipe; (2 1/2" I.D.)		24240
Hose - Upper - Pipe To Rad.; (2 1/2" I.D.)		24240
Hose - Lower - Eng. To Pipe; (2 1/2" I.D.)		24240
Hose - Lower - Pipe To Rad.; (2 1/2" I.D.)		24240
Detroit Diesel 6-Cyl. 12.7 L Diesel		
Autocar		
Belt - Fan		③♣9625HD
Belt - Hub, Alt. & A.C.		②♣9490HD
Hose - Upper - Eng. To Pipe; (2 1/2" I.D.)		24240
Hose - Upper - Pipe To Rad.; (2 1/2" I.D.)		24240

♣ Standard Belt Available. See Pages 630-631.
② Two Required.

③ Three Required.
≡ Cut to Fit.

Belts and Coolant Hose for Medium/Heavy-Duty Trucks (1996 and Newer)

Medium & Heavy-Duty Trucks
(1996 & Newer)

Application	Mfr. Part No.	Our No.
VOLVO - Continued		
2000 - Continued		
Detroit Diesel 6-Cyl. 12.7 L Diesel - Continued		
Autocar - Continued		
Hose - Lower - Eng. To Pipe; (3" I.D.)		24248
Hose - Lower - Pipe To Rad.; (3" I.D.)		24248
VN Series		
Belt - Fan & Alt.	8397694	▲K080670HD
Belt - Fan & A.C.	967138	▲9555HD
Tensioner Assy. - Fan & Alt.	8079517	38505
Tensioner Pulley	8079517	36091
Hose - Upper - Eng. To Pipe; (2 1/2" I.D.)		24240
Hose - Upper - Pipe To Rad.; (2 1/2" I.D.)		24240
Hose - Lower - Eng. To Pipe; (2 1/2" I.D.)		24240
Hose - Lower - Pipe To Rad.; (2 1/2" I.D.)		24240
WG Series		
Belt - Alt.	8163508	▲9319HD
Volvo VE 12 Diesel		
VN Series		
Belt - Fan & Hub	981335	▲K100437HD
Belt - Hub, Alt. & A.C.	978238	▲K080375HD
Hose - Upper - Eng. To Rad.		22709
Hose - Lower - Eng. To Rad.		22710
Volvo VE D7 Diesel		
Xpeditor		
Belt - Fan	978823	②▲9610HD
Belt - Fan & Alt.	966974	②7417
Belt - Fan To Alt.	966987	②7495
Volvo VE D12 Diesel		
VN Series		
Belt - Fan & Hub	981335	▲K100437HD
Belt - Hub, Alt. & A.C.	978238	▲K080375HD
Tensioner Assy. - Fan	21257889	38547
Hose - Upper - Eng. To Rad.		22709
Hose - Lower - Eng. To Rad.		22710
WG Series		
Belt - Fan & Hub	980886	▲K080566HD
Belt - Hub, Alt. & A.C.	1676272	▲K050380HD
Tensioner Assy. - Fan & Hub	3154315	38531
Hose - Upper - Eng. To Rad.		22713
Hose - Lower - Eng. To Pipe		22714
Hose - Lower - Pipe To Rad.		22715
1999		
Caterpillar 3306 Diesel		
Xpeditor		
Belt - Alt. & A.C.	02701539	▲9476HD
Caterpillar 3406 Diesel		
VN Series		
Belt - Fan & Alt.; W/130A. Delco Alt.	8397911	▲K080694HD
Belt - Fan & A.C.	977318	▲9510HD
Tensioner Assy. - Fan & Alt.	8079517	38505
Tensioner Pulley	8079517	36091
Hose - Upper - Eng. To Pipe		②-21115
Hose - Upper - Pipe To Rad.; (2 1/2" I.D.)		24240
Hose - Lower - Eng. To Pipe; (3" I.D.)		24248
Hose - Lower - Pipe To Rad.; (3" I.D.)		24248
Cummins ISM Diesel		
Autocar		
Belt - Fan	208043216	▲K080610HD
Belt - Alt.	3028521	▲K050345HD
Belt - A.C.	027070550	▲9530HD
VN Series		
Belt - Fan	981633	▲K100665HD
Belt - Alt. & A.C.	981634	▲K060415HD
WG Series		
Belt - Hub & Alt.; W/130A. Delco Alt.		▲K050345HD
Belt - Hub & A.C.		▲9530HD
Hose - Upper - Pipe To Rad.; (2 1/2" I.D.)		24240
Hose - Lower - Eng. To Pipe; W/2 1/2" I.D. Hose(2 1/2" I.D.)		24240

Application	Mfr. Part No.	Our No.
VOLVO - Continued		
1999 - Continued		
Cummins ISM Diesel - Continued		
WG Series - Continued		
Hose - Lower - Eng. To Pipe; W/3" I.D. Hose(3" I.D.)		24248
Hose - Lower - Pipe To Rad.; W/2 1/2" I.D. Hose		21115
Hose - Lower - Pipe To Rad.; W/3" I.D. Hose		21042
Hose - Lower - Pipe To Pipe; W/3" I.D. Hose		21042
WIA Series		
Belt - Fan; W/55" Belt O.C.	8058668	▲K080545HD
Belt - Fan; W/57" Belt O.C.	208040008	▲K080565HD
Belt - Alt.	3028521	▲K050345HD
Belt - A.C.; W/53 1/2" Belt O.C.	027070550	▲9530HD
Belt - A.C.; W/54 1/2" Belt O.C.	027068626	▲9540HD
Hose - Upper - Eng. To Pipe; (2 1/2" I.D.)		24240
Hose - Upper - Pipe To Rad.; (2 1/2" I.D.)		24240
Hose - Lower - Eng. To Pipe; (2 1/2" I.D.)		24240
Hose - Lower - Pipe To Rad.		21115
Cummins N14 Diesel		
Autocar		
Belt - Hub & W.P.	30764921	▲K060425HD
Belt - Hub & Fan	8057960	▲K080465HD
Belt - Alt.		②▲9451HD
Belt - Hub & A.C.	8029802	▲9370HD
Hose - Upper - Eng. To Pipe; (2 1/2" I.D.)		24240
Hose - Upper - Pipe To Rad.; (2 1/2" I.D.)		24240
Hose - Lower - Eng. To Pipe; (2 1/2" I.D.)		24240
Hose - Lower - Pipe To Rad.; (2 1/2" I.D.)		24240
VN Series		
Belt - Hub & W.P.	30764921	▲K060425HD
Belt - Hub & Fan	8397692	▲K080384HD
Belt - Alt.		②▲9451HD
Belt - Hub & A.C.	8029802	▲9370HD
Hose - Upper - Eng. To Pipe; (2 1/2" I.D.)		24240
Hose - Upper - Pipe To Rad.; (2 1/2" I.D.)		24240
Hose - Lower - Eng. To Pipe; (2 1/2" I.D.)		24240
Hose - Lower - Pipe To Rad.; (2 1/2" I.D.)		24240
WG Series		
Belt - Fan	8060304	▲K080435HD
Belt - W.P.	3865157	▲K060408HD
Detroit Diesel 6-Cyl. 11.1 L Diesel		
Autocar		
Belt - Fan & Alt.	208043209	③▲9625HD
Belt - Hub & A.C.	027015398	▲9490HD
Hose - Upper - Eng. To Pipe; (2 1/2" I.D.)		24240
Hose - Upper - Pipe To Rad.; (2 1/2" I.D.)		24240
Hose - Lower - Eng. To Pipe; (3" I.D.)		24248
Hose - Lower - Rad. To Cooler		21042
VN Series		
Belt - Fan & Alt.	8397694	▲K080670HD
Belt - Fan & A.C.	967138	▲9555HD
Tensioner Assy. - Fan & Alt.	8079517	38505
Tensioner Pulley	8079517	36091
Hose - Upper - Eng. To Pipe; (2 1/2" I.D.)		24240
Hose - Upper - Pipe To Rad.; (2 1/2" I.D.)		24240
Hose - Lower - Eng. To Pipe; (2 1/2" I.D.)		24240
Hose - Lower - Pipe To Rad.; (2 1/2" I.D.)		24240
Detroit Diesel 6-Cyl. 12.7 L Diesel		
Autocar		
Belt - Fan & Alt.	208043209	③▲9625HD
Belt - Hub & A.C.	027015398	▲9490HD
Hose - Upper - Eng. To Pipe; (2 1/2" I.D.)		24240
Hose - Upper - Pipe To Rad.; (2 1/2" I.D.)		24240
Hose - Lower - Eng. To Pipe; (3" I.D.)		24248
Hose - Lower - Rad. To Cooler		21042
VN Series		
Belt - Fan & Alt.	8397694	▲K080670HD
Belt - Fan & A.C.	967138	▲9555HD
Tensioner Assy. - Fan & Alt.	8079517	38505
Tensioner Pulley	8079517	36091
Hose - Upper - Eng. To Pipe; (2 1/2" I.D.)		24240
Hose - Upper - Pipe To Rad.; (2 1/2" I.D.)		24240
Hose - Lower - Eng. To Pipe; (2 1/2" I.D.)		24240
Hose - Lower - Pipe To Rad.; (2 1/2" I.D.)		24240

▲ Standard Belt Available. See Pages 630-631.
 < Cut to Fit.

② Two Required.
 ③ Three Required.

Belts and Coolant Hose for Medium/Heavy-Duty Trucks (1996 and Newer)

 Medium & Heavy-Duty Trucks
(1996 & Newer)

Application	Mfr. Part No.	Our No.
VOLVO - Continued		
1999 - Continued		
Detroit Diesel 6-Cyl. 12.7 L Diesel - Continued		
VN Series - Continued		
Hose - Lower - Eng. To Pipe; (2 1/2" I.D.)		24240
Hose - Lower - Pipe To Rad.; (2 1/2" I.D.)		24240
WG Series		
Belt - Alt.	8163508	♣9319HD
Volvo VE 12 Diesel		
VN Series		
Belt - Fan & Hub	977825	♣K080400HD
Belt - Hub, Alt. & A.C.	977828	K080408
Volvo VE D7 Diesel		
Xpeditor		
Belt - Fan; W/61 1/2" Belt O.C.	978823	②♣9610HD
Belt - Fan; W/63" Belt O.C.		②♣9625HD
Belt - Alt.	968934	②7425
Belt - A.C.	967182	♣9415HD
Volvo VE D12 Diesel		
VN Series		
Belt - Fan & Hub	981335	♣K100437HD
Belt - Hub, Alt. & A.C.	978238	♣K080375HD
Hose - Upper - Eng. To Rad.		22709
Hose - Lower - Eng. To Rad.		22710
WG Series		
Belt - Fan	1091107	♣K080565HD
Belt - Fan & Hub	980886	♣K080566HD
Belt - Hub, Alt. & A.C.	1676272	♣K050380HD
Tensioner Assy. - Fan & Hub	3154315	38531
Tensioner Assy. - Alt. & A.C.	8149798	38531
Hose - Upper - Eng. To Rad.		22713
Hose - Lower - Eng. To Pipe		22714
Hose - Lower - Pipe To Rad.		22715
1998		
Caterpillar 3406 Diesel		
VN Series		
Belt - Fan; W/48 3/8" Belt O.C.	978756	♣9480HD
Belt - Fan; W/50 3/8" Belt O.C.		♣9500HD
Hose - Upper - Eng. To Pipe		21115
Hose - Upper - Pipe To Rad.; (2 1/2" I.D.)		24240
Hose - Lower - Eng. To Pipe; (3" I.D.)		24248
Hose - Lower - Pipe To Rad.; (2 1/2" I.D.)		24240
WIA Series		
Belt - Fan		②TR22553
Belt - Fan, Alt. & A.C.		②♣9530HD
Hose - Upper - Eng. To Pipe; (2 1/2" I.D.)		24240
Hose - Upper - Pipe To Rad.; (2 1/2" I.D.)		24240
Hose - Lower - Eng. To Pipe; (3" I.D.)		24248
Hose - Lower - Pipe To Rad.; (3" I.D.)		24248
Cummins ISM Diesel		
VN Series		
Belt - Fan	8397693	♣K080623HD
Belt - A.C.	7068626	♣9540HD
WCA Series		
Belt - Fan; W/55" Belt O.C.	8058668	♣K080545HD
Belt - Fan; W/57" Belt O.C.	208040008	♣K080565HD
Belt - Alt.	3028521	♣K050345HD
Belt - A.C.; W/53 1/2" Belt O.C.	027070550	♣9530HD
Belt - A.C.; W/54 1/2" Belt O.C.	027068626	♣9540HD
WG Series		
Belt - Hub & Alt.; W/130A. Delco Alt.		♣K050345HD
Belt - Hub & A.C.		♣9530HD
Hose - Upper - Pipe To Rad.; (2 1/2" I.D.)		24240
Hose - Lower - Eng. To Pipe; W/2 1/2" I.D. Hose(2 1/2" I.D.)		24240
Hose - Lower - Eng. To Pipe; W/3" I.D. Hose(3" I.D.)		24248
Hose - Lower - Pipe To Rad.; W/2 1/2" I.D. Hose		21115
Hose - Lower - Pipe To Rad.; W/3" I.D. Hose		21042
Hose - Lower - Pipe To Pipe; W/3" I.D. Hose		21042
WIA Series		
Belt - Fan; W/55" Belt O.C.	8058668	♣K080545HD

Application	Mfr. Part No.	Our No.
VOLVO - Continued		
1998 - Continued		
Cummins ISM Diesel - Continued		
WIA Series - Continued		
Belt - Fan; W/57" Belt O.C.	208040008	♣K080565HD
Belt - Alt.	3028521	♣K050345HD
Belt - A.C.; W/53 1/2" Belt O.C.	027070550	♣9530HD
Belt - A.C.; W/54 1/2" Belt O.C.	027068626	♣9540HD
Hose - Upper - Eng. To Pipe; (2 1/2" I.D.)		24240
Hose - Upper - Pipe To Rad.; (2 1/2" I.D.)		24240
Hose - Lower - Eng. To Pipe; (2 1/2" I.D.)		24240
Hose - Lower - Pipe To Rad.		21115
Cummins N14 Diesel		
VN Series		
Belt - Hub & W.P.	30764921	♣K060425HD
Belt - Hub & Fan	8397692	♣K080384HD
Belt - Alt.	96712U	♣9451HD
Belt - Hub & A.C.	8029802	♣9370HD
Hose - Upper - Eng. To Pipe; (2 1/2" I.D.)		24240
Hose - Upper - Pipe To Rad.; (2 1/2" I.D.)		24240
Hose - Lower - Eng. To Pipe; (2 1/2" I.D.)		24240
Hose - Lower - Pipe To Rad.; (2 1/2" I.D.)		24240
WIA Series		
Belt - W.P.	3095880	♣K060415HD
Belt - Fan; W/40 5/8" Belt O.C.	977825	♣K080400HD
Belt - Fan; W/42 1/8" Belt O.C.	8057487	♣K080415HD
Belt - Fan; W/43 3/8" Belt O.C.	8057486	♣K080427HD
Belt - Alt.; W/45" Belt O.C.	802223801	♣9451HD
Belt - Alt.; W/46 3/8" Belt O.C.; Preferred Belt	8001797	2/9463PB
Belt - Alt.; W/46 3/8" Belt O.C.; Optional Belt		②♣9463HD
Belt - A.C.; W/37 7/8" Belt O.C.	8029802	♣9370HD
Belt - A.C.; W/39" Belt O.C.		TR28390
Hose - Upper - Pipe To Rad.; (2 1/2" I.D.)		24240
Hose - Upper - Eng. To Pipe		21115
Hose - Lower - Eng. To Pipe; (2 1/2" I.D.)		24240
Hose - Lower - Pipe To Rad.; (2 1/2" I.D.)		24240
Detroit Diesel 6-Cyl. 11.1 L Diesel		
Autocar		
Belt - Fan & Alt.	981568	♣K080670HD
Belt - Hub & A.C.	967138	♣9555HD
Tensioner Assy. - Fan & Alt.	8079517	38505
Tensioner Pulley	8079517	36091
Autohauler		
Belt - Fan	208040022	③♣9530HD
Belt - Alt.	8163508	②♣9319HD
Hose - Upper - Rad. To Pipe; (2 1/2" I.D.)		♣24840
Hose - Upper - Pipe To Eng.		♣28212
Hose - Lower - Rad. To Pipe		♣28212
VN Series		
Belt - Fan & Alt.	8397694	♣K080670HD
Belt - Fan & A.C.	967138	♣9555HD
Tensioner Assy. - Fan & Alt.	8079517	38505
Tensioner Pulley	8079517	36091
Hose - Upper - Eng. To Pipe; (2 1/2" I.D.)		24240
Hose - Upper - Pipe To Rad.; (2 1/2" I.D.)		24240
Hose - Lower - Eng. To Pipe; (2 1/2" I.D.)		24240
Hose - Lower - Pipe To Rad.; (2 1/2" I.D.)		24240
WIA Series		
Belt - W.P., Alt. & A.C.	027015398	♣9490HD
Belt - Fan; W/55 3/8" Belt O.C.	8003254	♣9550HD
Belt - Fan; W/58 3/8" Belt O.C.	208043206	♣9580HD
Belt - Alt. & A.C.; Preferred Belt	027015398	2/9490PB
Belt - Alt. & A.C.; Optional Belt		②♣9490HD
Hose - Upper - Eng. To Pipe; (2 1/2" I.D.)		24240
Hose - Upper - Pipe To Rad.; (2 1/2" I.D.)		24240
Hose - Lower - Eng. To Pipe; (2 1/2" I.D.)		24240
Hose - Lower - Pipe To Rad.; (2 1/2" I.D.)		24240
Detroit Diesel 6-Cyl. 12.7 L Diesel		
Autocar		
Belt - Fan & Alt.	981568	♣K080670HD
Belt - Hub & A.C.	967138	♣9555HD

♣ Standard Belt Available. See Pages 630-631.
 ③ Three Required.
 * Durion® Silicone Hose Recommended.

② Two Required.
 ≡ Cut to Fit.

Belts and Coolant Hose for Medium/Heavy-Duty Trucks (1996 and Newer)

Medium & Heavy-Duty Trucks
(1996 & Newer)

Application	Mfr. Part No.	Our No.
VOLVO - Continued		
1998 - Continued		
Detroit Diesel 6-Cyl. 12.7 L Diesel - Continued		
Autocar - Continued		
Tensioner Assy. - Fan & Alt.	8079517	38505
Tensioner Pulley	8079517	36091
VN Series		
Belt - Fan & Alt.	8397694	♣K080670HD
Belt - Fan & A.C.	967138	♣9555HD
Tensioner Assy. - Fan & Alt.	8079517	38505
Tensioner Pulley	8079517	36091
Hose - Upper - Eng. To Pipe; (2 1/2" I.D.)		24240
Hose - Upper - Pipe To Rad.; (2 1/2" I.D.)		24240
Hose - Lower - Eng. To Pipe; (2 1/2" I.D.)		24240
Hose - Lower - Pipe To Rad.; (2 1/2" I.D.)		24240
WIA Series		
Belt - W.P., Alt. & A.C.	027015398	♣9490HD
Belt - Fan; W/55 3/8" Belt O.C.	8003254	♣9550HD
Belt - Fan; W/58 3/8" Belt O.C.	208043206	♣9580HD
Belt - Alt. & A.C.; Preferred Belt	027015398	2/9490PB
Belt - Alt. & A.C.; Optional Belt		②♣9490HD
Hose - Upper - Eng. To Pipe; (2 1/2" I.D.)		24240
Hose - Upper - Pipe To Rad.; (2 1/2" I.D.)		24240
Hose - Lower - Eng. To Pipe; (2 1/2" I.D.)		24240
Hose - Lower - Pipe To Rad.; (2 1/2" I.D.)		24240
Volvo VE D7 Diesel		
WG Series		
Belt - Fan		②♣9650HD
Belt - Alt.		②7508
Volvo VE D12 Diesel		
VN Series		
Belt - Fan & Hub	981335	♣K100437HD
Belt - Hub, Alt. & A.C.	978238	♣K080375HD
Hose - Upper - Eng. To Rad.		22709
Hose - Lower - Eng. To Rad.		22710
WG Series		
Belt - Fan & Hub	980886	♣K080566HD
Belt - Hub, Alt. & A.C.	1676272	♣K050380HD
Tensioner Assy. - Fan & Hub	3154315	38531
Hose - Upper - Eng. To Rad.		22713
Hose - Lower - Eng. To Pipe		22714
Hose - Lower - Pipe To Rad.		22715
1997		
Caterpillar 3306 Diesel		
WG Series		
Belt - Fan	80029100	♣9610HD
Belt - Alt.; Preferred Belt	8001797	2/9463PB
Belt - Alt.; Optional Belt		②♣9463HD
Belt - A.C.	611370006	♣9570HD
Hose - Upper - Eng. To Pipe; (2 1/2" I.D.)		24240
Hose - Upper - Pipe To Rad.		≈<20987
Hose - Lower - Pipe To Rad.		≈<20987
Caterpillar 3406 Diesel		
VN Series		
Belt - Fan; W/48 3/8" Belt O.C.	978756	♣9480HD
Belt - Fan; W/50 3/8" Belt O.C.		♣9500HD
Hose - Upper - Eng. To Pipe		21115
Hose - Upper - Pipe To Rad.; (2 1/2" I.D.)		24240
Hose - Lower - Eng. To Pipe; (3" I.D.)		24248
Hose - Lower - Pipe To Rad.; (2 1/2" I.D.)		24240
WCA Series		
Belt - Fan	1091032	②TR22553
Belt - Fan, Alt. & A.C.	1119044	②♣9525HD
Hose - Upper - Eng. To Pipe; (2 1/2" I.D.)		24240
Hose - Upper - Pipe To Rad.; (2 1/2" I.D.)		24240
Hose - Lower - Eng. To Pipe; (3" I.D.)		24248
Hose - Lower - Pipe To Rad.; (3" I.D.)		24248
WIA Series		
Belt - Fan		②TR22553
Belt - Fan, Alt. & A.C.		②♣9530HD

Application	Mfr. Part No.	Our No.
VOLVO - Continued		
1997 - Continued		
Caterpillar 3406 Diesel - Continued		
WIA Series - Continued		
Hose - Upper - Eng. To Pipe; (2 1/2" I.D.)		24240
Hose - Upper - Pipe To Rad.; (2 1/2" I.D.)		24240
Hose - Lower - Eng. To Pipe; (3" I.D.)		24248
Hose - Lower - Pipe To Rad.; (3" I.D.)		24248
Cummins L10 Diesel		
WG Series		
Belt - Fan; W/55" Belt O.C.	8058668	♣K080545HD
Belt - Fan; W/57 1/2" Belt O.C.	208040008	♣K080565HD
Belt - Alt.; W/34 5/8" Belt O.C.	3037425	♣K050340HD
Belt - Alt.; W/35 1/8" Belt O.C.	3028521	♣K050345HD
Belt - A.C.; W/53 3/8" Belt O.C.	027070550	♣9530HD
Belt - A.C.; W/54 3/8" Belt O.C.	027068626	♣9540HD
Hose - Upper - Eng. To Pipe		22177
Hose - Upper - Pipe To Rad.; (2 1/2" I.D.)		24240
Hose - Lower - Eng. To Pipe; (2 1/2" I.D.)		24240
Hose - Lower - Pipe To Rad.		21115
WIA Series		
Belt - Fan; W/55" Belt O.C.		♣K080545HD
Belt - Fan; W/57" Belt O.C.		♣K080565HD
Belt - Alt.		♣K050345HD
Belt - A.C.; W/53 7/8" Belt O.C.		♣9530HD
Belt - A.C.; W/54 3/8" Belt O.C.		♣9540HD
Hose - Upper - Pipe To Rad.; (2 1/2" I.D.)		24240
Hose - Lower - Eng. To Pipe; (2 1/2" I.D.)		24240
Hose - Lower - Pipe To Rad.		21115
Cummins M11 Diesel		
VN Series		
Belt - Fan	8397693	♣K080623HD
Belt - A.C.	7068626	♣9540HD
WCA Series		
Belt - Fan; W/55" Belt O.C.	8058668	♣K080545HD
Belt - Fan; W/57" Belt O.C.	208040008	♣K080565HD
Belt - Alt.	3028521	♣K050345HD
Belt - A.C.; W/53 1/2" Belt O.C.	027070550	♣9530HD
Belt - A.C.; W/54 1/2" Belt O.C.	027068626	♣9540HD
Hose - Upper - Eng. To Pipe		22177
Hose - Upper - Pipe To Rad.; (2 1/2" I.D.)		24240
Hose - Lower - Eng. To Pipe; (2 1/2" I.D.)		24240
Hose - Lower - Pipe To Rad.		≈<21891
WG Series		
Belt - Hub & Alt.; W/130A. Delco Alt.		♣K050345HD
Belt - Hub & A.C.		♣9530HD
Hose - Upper - Pipe To Rad.; (2 1/2" I.D.)		24240
Hose - Lower - Eng. To Pipe; W/2 1/2" I.D. Hose(2 1/2" I.D.)		24240
Hose - Lower - Eng. To Pipe; W/3" I.D. Hose(3" I.D.)		24248
Hose - Lower - Pipe To Rad.; W/2 1/2" I.D. Hose		21115
Hose - Lower - Pipe To Rad.; W/3" I.D. Hose		21042
Hose - Lower - Pipe To Pipe; W/3" I.D. Hose		21042
WIA Series		
Belt - Fan; W/55" Belt O.C.	8058668	♣K080545HD
Belt - Fan; W/57" Belt O.C.	208040008	♣K080565HD
Belt - Alt.	3028521	♣K050345HD
Belt - A.C.; W/53 1/2" Belt O.C.	027070550	♣9530HD
Belt - A.C.; W/54 1/2" Belt O.C.	027068626	♣9540HD
Cummins N14 Diesel		
WG Series		
Belt - W.P.; W/43 1/8" Belt O.C.	3076492	♣K060425HD
Belt - Fan	8060304	♣K080435HD
Belt - Alt.; W/45 3/8" Belt O.C.; Preferred Belt		2/9451PB
Belt - Alt.; W/45 3/8" Belt O.C.; Optional Belt	802228003	②♣9451HD
Belt - Alt.; W/46 3/8" Belt O.C.; Preferred Belt		2/9463PB
Belt - Alt.; W/46 3/8" Belt O.C.; Optional Belt	8001797	②♣9463HD
Belt - A.C.	8029802	♣9370HD
WIA Series		
Belt - W.P.; W/41 1/2" Belt O.C.	3095880	♣K060415HD
Belt - W.P.; W/43 1/8" Belt O.C.	3076492	♣K060425HD

♣ Standard Belt Available. See Pages 630-631.
≈< Cut to Fit.

② Two Required.

Belts and Coolant Hose for Medium/Heavy-Duty Trucks (1996 and Newer)

 Medium & Heavy-Duty Trucks
(1996 & Newer)

Application	Mfr. Part No.	Our No.	Application	Mfr. Part No.	Our No.
VOLVO - Continued			VOLVO - Continued		
1997 - Continued			1996 - Continued		
Cummins N14 Diesel - Continued			Caterpillar 3306 Diesel - Continued		
WIA Series - Continued			WG Series - Continued		
Belt - W.P.; W/44 1/8" Belt O.C.	217638	♣K060435HD	Belt - Alt.; W/47" Belt O.C.; Preferred	8001797	2/9463PB
Belt - Fan; W/40 5/8" Belt O.C.	977825	♣K080400HD	Belt - Alt.; W/47" Belt O.C.; Optional Belt		②♣9463HD
Belt - Fan; W/42 1/8" Belt O.C.	8057487	♣K080415HD	Belt - A.C.; W/56 1/2" Belt O.C.	8003478	♣9560HD
Belt - Fan; W/43 3/8" Belt O.C.	8057486	♣K080427HD	Belt - A.C.; W/57 1/2" Belt O.C.	027000344	♣9570HD
Belt - Alt.; W/45" Belt O.C.	802223801	♣9451HD	Hose - Upper - Eng. To Pipe; (2 1/2" I.D.)		24240
Belt - Alt.; W/46 3/8" Belt O.C.; Preferred			Hose - Upper - Pipe To Rad.; Molded Hose		♣20987
Belt	8001797	2/9463PB	Hose - Upper - Pipe To Rad.; Strt. Hose(2 1/2" I.D.)		24240
Belt - Alt.; W/46 3/8" Belt O.C.; Optional Belt		②♣9463HD	Hose - Lower - Pipe To Rad.		♣20987
Belt - A.C.; W/37 3/8" Belt O.C.	8029802	♣9370HD	Xpeditor		
Belt - A.C.; W/39" Belt O.C.		TR28390	Belt - Fan; Preferred Belt	027069700	2/9500PB
Belt - A.C.; W/40 1/2" Belt O.C.	8003838	TR28400	Belt - Fan; Optional Belt		②♣9500HD
Hose - Upper - Eng. To Pipe; (2 1/2" I.D.)		24240	Belt - Fan; W/W-Ribbed Belt Drive	8058644	♣K080560HD
Hose - Upper - Pipe To Rad.; (2 1/2" I.D.)		24240	Belt - Alt.; W/40 7/8" Belt O.C.	978702	♣9405HD
Hose - Lower - Eng. To Pipe; (2 1/2" I.D.)		24240	Belt - Alt.; W/44 7/8" Belt O.C.; Preferred		
Hose - Lower - Pipe To Rad.; (2 1/2" I.D.)		24240	Belt	1PB0510	2/9447PB
Detroit Diesel 6-Cyl. 11.1 L Diesel			Belt - Alt.; W/44 7/8" Belt O.C.; Optional Belt		②♣9447HD
Autohauled			Belt - A.C.	027005398	♣9490HD
Belt - Fan	208040022	③♣9530HD	Hose - Upper - Eng. To Pipe		♣21115
Belt - Alt.	8163508	②♣9319HD	Hose - Upper - Pipe To Rad.; (2 1/2" I.D.)		24240
Hose - Upper - Rad. To Pipe; (2 1/2" I.D.)		♣24840	Hose - Lower - Pipe To Rad.		21116
Hose - Upper - Pipe To Eng.		♣28212	Hose - Lower - Pipe To Cooler		21042
Hose - Lower - Rad. To Pipe		♣28212	Hose - By Pass; (1 3/4" I.D.)		24228
WIA Series			Hose - Heater; (5/8" I.D.)		28441
Belt - W.P., Alt. & A.C.	027015398	♣9490HD	Caterpillar 3406 Diesel		
Belt - Fan; W/55 3/8" Belt O.C.	8003254	♣9550HD	WIA Series		
Belt - Fan; W/58 3/8" Belt O.C.	208043206	♣9580HD	Belt - Fan	8161346	TR22553
Belt - Alt. & A.C.; Preferred Belt	027015398	2/9490PB	Belt - Alt. & A.C.	027000233	♣9525HD
Belt - Alt. & A.C.; Optional Belt		②♣9490HD	Hose - Upper - Eng. To Pipe; (2 1/2" I.D.)		24240
Hose - Upper - Eng. To Pipe; (2 1/2" I.D.)		24240	Hose - Upper - Pipe To Rad.; (2 1/2" I.D.)		24240
Hose - Upper - Pipe To Rad.; (2 1/2" I.D.)		24240	Hose - Lower - Eng. To Pipe; (3" I.D.)		24248
Hose - Lower - Eng. To Pipe; (2 1/2" I.D.)		24240	Hose - Lower - Pipe To Rad.; (3" I.D.)		24248
Hose - Lower - Pipe To Rad.; (2 1/2" I.D.)		24240	Cummins C Series 8.3 L Diesel		
Detroit Diesel 6-Cyl. 12.7 L Diesel			Xpeditor		
WIA Series			Belt - Fan	3941395	♣K080670HD
Belt - W.P., Alt. & A.C.	027015398	♣9490HD	Belt - Alt.	3941395	♣K080670HD
Belt - Fan; W/55 3/8" Belt O.C.	8003254	♣9550HD	Cummins L10 Diesel		
Belt - Fan; W/58 3/8" Belt O.C.	208043206	♣9580HD	WG Series		
Belt - Alt. & A.C.; Preferred Belt	027015398	2/9490PB	Belt - Fan; W/55" Belt O.C.	8058668	♣K080545HD
Belt - Alt. & A.C.; Optional Belt		②♣9490HD	Belt - Fan; W/57 1/2" Belt O.C.	208040008	♣K080565HD
Hose - Upper - Eng. To Pipe; (2 1/2" I.D.)		24240	Belt - Alt.; W/34 5/8" Belt O.C.	3037425	♣K050340HD
Hose - Upper - Pipe To Rad.; (2 1/2" I.D.)		24240	Belt - Alt.; W/35 1/8" Belt O.C.	3028521	♣K050345HD
Hose - Lower - Eng. To Pipe; (2 1/2" I.D.)		24240	Belt - A.C.; W/53 3/8" Belt O.C.	027070550	♣9530HD
Hose - Lower - Pipe To Rad.; (2 1/2" I.D.)		24240	Belt - A.C.; W/54 3/8" Belt O.C.	027068626	♣9540HD
Volvo VE D7 Diesel			Hose - Upper - Eng. To Pipe		22177
FE Series			Hose - Upper - Pipe To Rad.; (2 1/2" I.D.)		24240
Belt - A.C.	967129	♣9500HD	Hose - Lower - Eng. To Pipe; (2 1/2" I.D.)		24240
Volvo VE D12 Diesel			Hose - Lower - Pipe To Rad.		21115
WCA Series			Xpeditor		
Belt - Fan	979066	♣K080575HD	Belt - Fan; W/7 To 1 Fan Ratio	3034944	♣K080545HD
Belt - Alt.	1676272	♣K050380HD	Belt - Fan; W/8 To 1 Fan Ratio	8003853	♣K080530HD
Tensioner Assy.	1664973	38531	Belt - Fan; W/1 To 1 Fan Ratio	8003852	♣K080510HD
WIA Series			Belt - Fan; W/56 1/8" Belt O.C.	3027697	♣K080560HD
Belt - Fan	979066	♣K080575HD	Belt - Fan; W/59" Belt O.C.	3081862	♣K080585HD
Belt - Alt. & A.C.	1676272	♣K050380HD	Belt - Alt.	3037425	♣K050340HD
Hose - Upper		♣21115	Belt - A.C.	8003836	♣9555HD
1996			Hose - Upper - Eng. To Pipe; (2 1/4" I.D.)		24236
Caterpillar 3306 Diesel			Hose - Upper - Pipe To Rad.; (2 1/2" I.D.)		24240
WG Series			Hose - Lower - Eng. To Pipe; (2 1/2" I.D.)		24240
Belt - Fan; W/61 3/8" Belt O.C.;			Hose - Lower - Pipe To Rad.; (2 1/2" I.D.)		24240
Preferred Belt	8029100	2/9610PB	Cummins M11 Diesel		
Belt - Fan; W/61 3/8" Belt O.C.; Optional Belt		②♣9610HD	WCA Series		
Belt - Alt.; W/45 1/4" Belt O.C.; Preferred Belt		2/9447PB	Belt - Fan; W/55" Belt O.C.	8058668	♣K080545HD
Belt - Alt.; W/45 1/4" Belt O.C.; Optional Belt		②♣9447HD	Belt - Fan; W/57" Belt O.C.	208040008	♣K080565HD
Belt - Alt.; W/45 7/8" Belt O.C.; Preferred Belt		2/9451PB	Belt - Alt.	3028521	♣K050345HD
Belt - Alt.; W/45 7/8" Belt O.C.; Optional Belt		②♣9451HD	Belt - A.C.; W/53 1/2" Belt O.C.	027070550	♣9530HD
			Belt - A.C.; W/54 1/2" Belt O.C.	027068626	♣9540HD
			Hose - Upper - Eng. To Pipe		22177

♣ Standard Belt Available. See Pages 630-631.
 ③ Three Required.
 * Durion® Silicone Hose Recommended.

② Two Required.
 ≍ Cut to Fit.

Belts and Coolant Hose for Medium/Heavy-Duty Trucks (1996 and Newer)

Medium & Heavy-Duty Trucks
(1996 & Newer)

Application	Mfr. Part No.	Our No.
VOLVO - Continued		
1996 - Continued		
Cummins M11 Diesel - Continued		
WCA Series - Continued		
Hose - Upper - Pipe To Rad.; (2 1/2" I.D.)		24240
Hose - Lower - Eng. To Pipe; (2 1/2" I.D.)		24240
Hose - Lower - Pipe To Rad.		≧21891
WG Series		
Belt - Fan; W/55" Belt O.C.	8058668	♣K080545HD
Belt - Fan; W/57 1/2" Belt O.C.	208040008	♣K080565HD
Belt - Alt.; W/34 5/8" Belt O.C.	3028521	♣K050345HD
Belt - Alt.; W/35 1/8" Belt O.C.	3028521	♣K050345HD
Belt - A.C.; W/53 3/8" Belt O.C.	027070550	♣9530HD
Belt - A.C.; W/54 3/8" Belt O.C.	027068626	♣9540HD
Hose - Upper - Eng. To Pipe		22177
Hose - Upper - Pipe To Rad.; (2 1/2" I.D.)		24240
Hose - Lower - Eng. To Pipe; (2 1/2" I.D.)		24240
Hose - Lower - Pipe To Rad.		21115
WIA Series		
Belt - Fan; W/55" Belt O.C.	8058668	♣K080545HD
Belt - Fan; W/57" Belt O.C.	208040008	♣K080565HD
Belt - Alt.	3028521	♣K050345HD
Belt - A.C.; W/53 1/2" Belt O.C.	027070550	♣9530HD
Belt - A.C.; W/54 1/2" Belt O.C.	027068626	♣9540HD
Cummins N14 Diesel		
WG Series		
Belt - W.P.		♣K060425HD
Belt - Fan	V8060304	♣K080435HD
Belt - Alt.; W/45 3/8" Belt O.C.; Preferred		
Belt	802223801	2/9451PB
Belt - Alt.; W/45 3/8" Belt O.C.; Optional Belt		②♣9451HD
Belt - Alt.; W/46 3/8" Belt O.C.; Preferred		
Belt	8001797	2/9463PB
Belt - Alt.; W/46 3/8" Belt O.C.; Optional Belt		②♣9463HD
Belt - A.C.; W/37 1/2" Belt O.C.	8029802	♣9370HD
Belt - A.C.; W/39 1/2" Belt O.C.		TR28390
Hose - Upper - Eng. To Pipe; (2 1/2" I.D.)		24240
Hose - Upper - Pipe To Rad.; (2 1/2" I.D.)		24240
Hose - Lower - Eng. To Pipe; (2 1/2" I.D.)		24240
Hose - Lower - Pipe To Rad.; (2 1/2" I.D.)		24240
WIA Series		
Belt - W.P.; W/43 1/8" Belt O.C.	3076492	♣K060425HD
Belt - W.P.; W/44 1/8" Belt O.C.	217638	♣K060435HD
Belt - Fan; W/40 5/8" Belt O.C.	977825	♣K080400HD
Belt - Fan; W/42 1/8" Belt O.C.	8057487	♣K080415HD
Belt - Fan; W/43 3/8" Belt O.C.	8057486	♣K080427HD
Belt - Alt.; W/45" Belt O.C.	802223801	♣9451HD
Belt - Alt.; W/46" Belt O.C.; Preferred		
Belt	8001797	2/9463PB
Belt - Alt.; W/46" Belt O.C.; Optional Belt		②♣9463HD
Belt - A.C.; W/37 3/8" Belt O.C.	8029802	♣9370HD
Belt - A.C.; W/39" Belt O.C.		TR28390
Belt - A.C.; W/40 1/2" Belt O.C.	8003838	TR28400
Hose - Upper - Eng. To Pipe; (2 1/2" I.D.)		24240
Hose - Upper - Pipe To Rad.; (2 1/2" I.D.)		24240
Hose - Lower - Eng. To Pipe; (2 1/2" I.D.)		24240
Hose - Lower - Pipe To Rad.; (2 1/2" I.D.)		24240
Detroit Diesel 6-Cyl. 11.1 L Diesel		
Autohailer		
Belt - Fan	208040022	③♣9530HD
Belt - Alt.	8163508	②♣9319HD
Hose - Upper - Rad. To Pipe; (2 1/2" I.D.)		≧♣24840
Hose - Upper - Pipe To Eng.		≧♣28212
Hose - Lower - Rad. To Pipe		≧♣28212
WIA Series		
Belt - W.P., Alt. & A.C.	027015398	♣9490HD
Belt - Fan; W/55 3/8" Belt O.C.	8003254	♣9550HD
Belt - Fan; W/58 3/8" Belt O.C.	208043206	♣9580HD
Belt - Alt. & A.C.; Preferred Belt	027015398	2/9490PB
Belt - Alt. & A.C.; Optional Belt		②♣9490HD
Hose - Upper - Eng. To Pipe; (2 1/2" I.D.)		24240
Hose - Upper - Pipe To Rad.; (2 1/2" I.D.)		24240

Application	Mfr. Part No.	Our No.
VOLVO - Continued		
1996 - Continued		
Detroit Diesel 6-Cyl. 11.1 L Diesel - Continued		
WIA Series - Continued		
Hose - Lower - Eng. To Pipe; (2 1/2" I.D.)		24240
Hose - Lower - Pipe To Rad.; (2 1/2" I.D.)		24240
Detroit Diesel 6-Cyl. 12.7 L Diesel		
WIA Series		
Belt - W.P., Alt. & A.C.	027015398	♣9490HD
Belt - Fan; W/55 3/8" Belt O.C.	8003254	♣9550HD
Belt - Fan; W/58 3/8" Belt O.C.	208043206	♣9580HD
Belt - Alt. & A.C.; Preferred Belt	027015398	2/9490PB
Belt - Alt. & A.C.; Optional Belt		②♣9490HD
Hose - Upper - Eng. To Pipe; (2 1/2" I.D.)		24240
Hose - Upper - Pipe To Rad.; (2 1/2" I.D.)		24240
Hose - Lower - Eng. To Pipe; (2 1/2" I.D.)		24240
Hose - Lower - Pipe To Rad.; (2 1/2" I.D.)		24240
Volvo VE D12 Diesel		
WIA Series		
Belt - Fan	979066	♣K080575HD
Belt - Alt. & A.C.	1676272	♣K050380HD
Hose - Upper		≧21115
Hose - Lower - Eng. To Rad.		21891
WESTERN STAR		
2012		
Detroit Diesel DD13 Diesel		
4900SA		
Belt - Fan	0132731635	K100643HD
Belt - Alt.	0132732680	K081055HD
2011		
Detroit Diesel DD15 Diesel		
4900FA; 4900SA		
Belt - Fan	0131893635	K100643HD
Belt - A.C. & Alt.	0132732700	K081065HD
2010		
Detroit Diesel DD15 Diesel		
4900SA		
Belt - Fan	0131893715	♣K100675HD
2009		
Caterpillar C15 Diesel		
4900EX		
Belt - Fan	0131008895	K121139HD
Belt - Alt.	0129730720	♣K060675HD
4900FA		
Belt - Fan & A.C.	0131008895	K121139HD
Belt - Alt.	0129730720	♣K060675HD
Tensioner Assy. - Fan & A.C.	2790253	38636
Tensioner Assy. - Alt.	3368955	38609
Idler Pulley - Alt. (Lower)	2850277	36282
4900SA		
Belt - Fan & A.C.	0131008895	K121139HD
Belt - Alt.	0129730720	♣K060675HD
Tensioner Assy. - Fan & A.C.	2362301	38609
Tensioner Assy. - Alt.	2790253	38636
Idler Pulley - A.C. (Lower)	2850277	36282
Hose - Upper - Eng. To Pipe; (2 1/2" I.D.)		≧24440
Hose - Upper - Pipe To Rad.; (2 1/2" I.D.)		≧24440
Hose - Lower - Eng. To Pipe		≧21891
Hose - Lower - Pipe To Rad.		≧21135
Detroit Diesel 6-Cyl. 14.0 L Diesel		
4900EX		
Belt - Fan	0124894002	♣K100675HD
Belt - Alt. & A.C.	0124587004	♣K080565HD
Tensioner Assy. - Fan	0127846000	38503
Tensioner Assy. - Alt. & A.C.	0127425000	38501
Hose - Upper - Eng. To Pipe; (2 1/2" I.D.)		≧24440

≧ Cut to Fit.
② Two Required.
* Durion® Silicone Hose Recommended.

♣ Standard Belt Available. See Pages 630-631.
③ Three Required.

Belts and Coolant Hose for Medium/Heavy-Duty Trucks (1996 and Newer)

 Medium & Heavy-Duty Trucks
(1996 & Newer)

Application	Mfr. Part No.	Our No.
WESTERN STAR - Continued		
2009 - Continued		
Detroit Diesel 6-Cyl. 14.0 L Diesel - Continued		
4900EX - Continued		
Hose - Upper - Pipe To Rad.; (2 1/2" I.D.)		≈<24440
Hose - Lower - Eng. To Pipe; (2 1/2" I.D.)		≈<24440
Hose - Lower - Pipe To Rad.; (2 1/2" I.D.)		≈<24440
4900FA		
Belt - Fan	0124894002	▲K100675HD
Belt - Alt. & A.C.	0124587004	▲K080565HD
Tensioner Assy. - Fan	0127846000	38503
Tensioner Assy. - Alt. & A.C.	0127425000	38501
4900SA		
Belt - Fan	0124894002	▲K100675HD
Tensioner Assy. - Hub, Alt. & A.C.	0127425000	38501
Detroit Diesel DD15 Diesel		
4900SA		
Belt - W.P., Alt. & A.C.	0131894642	▲K081035HD
Belt - Fan	0131893715	▲K100675HD
Hose - Upper - Eng. To Pipe; (2 1/2" I.D.)		≈<24440
Hose - Upper - Pipe To Rad.; (2 1/2" I.D.)		≈<24440
Hose - Lower - Eng. To Pipe; (2 1/2" I.D.)		≈<24440
Hose - Lower - Pipe To Rad.		≈<21891
2008		
Caterpillar C15 Diesel		
4900FA; 4900SA		
Belt - Fan & A.C.	0131008895	K121139HD
Belt - Fan To Alt.	0129730720	▲K060675HD
Tensioner Assy. - Fan & A.C.	2362301	38609
Tensioner Assy. - Fan & Alt.	2790253	38636
Hose - Upper - Eng. To Pipe; (2 1/2" I.D.)		24240
Hose - Upper - Rad. To Pipe; (2 1/2" I.D.)		24240
Hose - Lower		≈<21891
Detroit Diesel 6-Cyl. 12.7 L Diesel		
4900EX		
Belt - Fan	0124894002	▲K100675HD
Belt - Alt. & A.C.	0124587004	▲K080565HD
Tensioner Assy. - Fan	0127846000	38503
Tensioner Assy. - Alt. & A.C.	0127425000	38501
Hose - Upper - Eng. To Pipe; (2 1/2" I.D.)		24240
Hose - Upper - Rad. To Pipe; (2 1/2" I.D.)		24240
Hose - Lower - Eng. To Pipe; (2 1/2" I.D.)		24240
Hose - Lower - Rad. To Pipe; (2 1/2" I.D.)		24240
Detroit Diesel 6-Cyl. 14.0 L Diesel		
4900EX; 4900FA; 4900SA		
Belt - Fan	0124894002	▲K100675HD
Belt - Alt. & A.C.	0124587004	▲K080565HD
Tensioner Assy. - Fan	0127846000	38503
Tensioner Assy. - Alt. & A.C.	0127425000	38501
Hose - Upper - Eng. To Pipe; (2 1/2" I.D.)		24240
Hose - Upper - Rad. To Pipe; (2 1/2" I.D.)		24240
Hose - Lower - Eng. To Pipe; (2 1/2" I.D.)		24240
Hose - Lower - Rad. To Pipe; (2 1/2" I.D.)		24240
Mercedes-Benz MBE 4000 Diesel		
4900FA		
Belt - Alt.	0127116004	▲K080855HD
Tensioner Assy. - Alt.	0127425000	38501

≈< Cut to Fit.

Application	Mfr. Part No.	Our No.
WESTERN STAR - Continued		
2007 - Continued		
Caterpillar C15 Diesel		
4900EX; 4900FA		
Belt - Fan & Alt.	0123415073	▲K081088HD
Belt - Fan To A.C.	0127177007	▲K060547HD
Tensioner Assy. - Fan & Alt.	2002279	38569
Tensioner Assy. - Fan To A.C.	2178938	38511
Idler Pulley - Smooth	1979641	36091
Idler Pulley - Grooved	1979642	36341
Tensioner Pulley - Fan To A.C.	2178938	36091
Hose - Upper - Eng. To Pipe; (2 1/2" I.D.)		24240
Hose - Upper - Rad. To Pipe; (2 1/2" I.D.)		24240
Hose - Lower - Eng. To Pipe; (2 1/2" I.D.)		24240
Hose - Lower - Rad. To Pipe; (2 1/2" I.D.)		24240
4900SA		
Belt - Fan & Alt.	0123415073	▲K081088HD
Belt - Fan To A.C.	0129730314	▲K060516HD
Tensioner Assy. - Fan & Alt.	2002279	38569
Tensioner Assy. - Fan To A.C.	2178938	38511
Idler Pulley - Smooth	1979641	36091
Idler Pulley - Grooved	1979642	36341
Tensioner Pulley - Fan To A.C.	2178938	36091
Hose - Upper - Eng. To Pipe; (2 1/2" I.D.)		24240
Hose - Upper - Rad. To Pipe; (2 1/2" I.D.)		24240
Hose - Lower - Eng. To Pipe; (2 1/2" I.D.)		24240
Hose - Lower - Rad. To Pipe; (2 1/2" I.D.)		24240
6900XD		
Idler Pulley - Smooth	1979641	36091
Idler Pulley - Grooved	1979642	36341
Detroit Diesel 6-Cyl. 12.7 L Diesel		
4900FA		
Belt - Fan	0124894002	▲K100675HD
Belt - Hub, Alt. & A.C.	0124587004	▲K080565HD
Tensioner Assy. - Fan	0127846000	38503
Tensioner Assy. - Hub, Alt. & A.C.	0127425000	38501
Tensioner Pulley - Fan	0127846000	38076
Tensioner Pulley - Hub, Alt. & A.C.	0127425000	38075
Hose - Upper - Eng. To Pipe; (2 1/2" I.D.)		24240
Hose - Upper - Rad. To Pipe; (2 1/2" I.D.)		24240
Hose - Lower - Eng. To Pipe; (2 1/2" I.D.)		24240
Hose - Lower - Rad. To Pipe		21891
Hose - Lower - Pipe To Pipe; (2 1/2" I.D.)		24240
4900SA		
Belt - Fan	0124894002	▲K100675HD
Belt - Hub, Alt. & A.C.	0124587004	▲K080565HD
Tensioner Assy. - Fan	0127846000	38503
Tensioner Assy. - Hub, Alt. & A.C.	0127425000	38501
Tensioner Pulley - Fan	0127846000	38076
Tensioner Pulley - Hub, Alt. & A.C.	0127425000	38075
Hose - Upper - Eng. To Pipe; (2 1/2" I.D.)		24240
Hose - Upper - Rad. To Pipe; (2 1/2" I.D.)		24240
Hose - Lower - Eng. To Pipe; (2 1/2" I.D.)		24240
Hose - Lower - Rad. To Pipe; (2 1/2" I.D.)		24240
Detroit Diesel 6-Cyl. 14.0 L Diesel		
4900FA		
Belt - Fan	0124894002	▲K100675HD
Belt - Hub, Alt. & A.C.	0124587004	▲K080565HD
Tensioner Assy. - Fan	0127846000	38503
Tensioner Assy. - Hub, Alt. & A.C.	0127425000	38501
Tensioner Pulley - Fan	0127846000	38076
Tensioner Pulley - Hub, Alt. & A.C.	0127425000	38075
Hose - Upper - Eng. To Pipe; (2 1/2" I.D.)		24240
Hose - Upper - Rad. To Pipe; (2 1/2" I.D.)		24240
Hose - Lower - Eng. To Pipe; (2 1/2" I.D.)		24240
Hose - Lower - Rad. To Pipe		21891
Hose - Lower - Pipe To Pipe; (2 1/2" I.D.)		24240
4900SA		
Belt - Fan	0124894002	▲K100675HD
Belt - Hub, Alt. & A.C.	0124587004	▲K080565HD
Tensioner Assy. - Fan	0127846000	38503
Tensioner Assy. - Hub, Alt. & A.C.	0127425000	38501

▲ Standard Belt Available. See Pages 630-631.

Belts and Coolant Hose for Medium/Heavy-Duty Trucks (1996 and Newer)

Medium & Heavy-Duty Trucks
(1996 & Newer)

Application	Mfr. Part No.	Our No.
WESTERN STAR - Continued		
2007 - Continued		
Detroit Diesel 6-Cyl. 14.0 L Diesel - Continued		
4900SA - Continued		
Tensioner Pulley - Fan	0127846000	38076
Tensioner Pulley - Hub, Alt. & A.C.	0127425000	38075
Hose - Upper - Eng. To Pipe; (2 1/2" I.D.)		24240
Hose - Upper - Rad. To Pipe; (2 1/2" I.D.)		24240
Hose - Lower - Eng. To Pipe; (2 1/2" I.D.)		24240
Hose - Lower - Rad. To Pipe; (2 1/2" I.D.)		24240
2006		
Caterpillar C13 Diesel		
4900SA		
Belt - Fan, Alt. & A.C.	0127110059	▲K081124HD
Tensioner Assy. - Fan, Alt. & A.C.	2117895	38590
Tensioner Pulley - Fan, Alt. & A.C.	2117895	36164
Idler Pulley - Smooth	2078118	36269
Idler Pulley - Grooved	1979642	36341
Hose - Upper - Eng. To Pipe; (2 1/2" I.D.)		24240
Hose - Upper - Rad. To Pipe; (2 1/2" I.D.)		24240
Hose - Lower - Eng. To Pipe; (2 1/2" I.D.)		24240
Hose - Lower - Rad. To Pipe; (2 1/2" I.D.)		24240
Caterpillar C15 Diesel		
4900EX; 4900FA; 4900SA		
Belt - Fan & Alt.	0123415073	▲K081088HD
Belt - Fan To A.C.	0127177007	▲K060547HD
Tensioner Assy. - Fan & Alt.	2002279	38569
Tensioner Assy. - Fan To A.C.	2178938	38511
Idler Pulley - Smooth	1979641	36091
Idler Pulley - Grooved	1979642	36341
Tensioner Pulley - Fan To A.C.	2178938	36091
Hose - Upper - Eng. To Pipe; (2 1/2" I.D.)		24240
Hose - Upper - Rad. To Pipe; (2 1/2" I.D.)		24240
Hose - Lower - Eng. To Pipe; (2 1/2" I.D.)		24240
Hose - Lower - Rad. To Pipe; (2 1/2" I.D.)		24240
6900XD		
Idler Pulley - Smooth	1979641	36091
Idler Pulley - Grooved	1979642	36341
Detroit Diesel 6-Cyl. 12.7 L Diesel		
4900EX; 4900FA		
Belt - Fan	0124894002	▲K100675HD
Belt - Hub, Alt. & A.C.	0124587004	▲K080565HD
Tensioner Assy. - Fan	0127846000	38503
Tensioner Assy. - Hub, Alt. & A.C.	0127425000	38501
Tensioner Pulley - Fan	0127846000	38076
Tensioner Pulley - Hub, Alt. & A.C.	0127425000	38075
Hose - Upper - Eng. To Pipe; (2 1/2" I.D.)		24240
Hose - Upper - Rad. To Pipe; (2 1/2" I.D.)		24240
Hose - Lower - Eng. To Pipe; (2 1/2" I.D.)		24240
Hose - Lower - Rad. To Pipe		21891
Hose - Lower - Pipe To Pipe; (2 1/2" I.D.)		24240
4900SA		
Belt - Fan	0124894002	▲K100675HD
Belt - Hub, Alt. & A.C.	0124587004	▲K080565HD
Tensioner Assy. - Fan	0127846000	38503
Tensioner Assy. - Hub, Alt. & A.C.	0127425000	38501
Tensioner Pulley - Fan	0127846000	38076
Tensioner Pulley - Hub, Alt. & A.C.	0127425000	38075
Hose - Upper - Eng. To Pipe; (2 1/2" I.D.)		24240
Hose - Upper - Rad. To Pipe; (2 1/2" I.D.)		24240
Hose - Lower - Eng. To Pipe; (2 1/2" I.D.)		24240
Hose - Lower - Rad. To Pipe; (2 1/2" I.D.)		24240
Detroit Diesel 6-Cyl. 14.0 L Diesel		
4900EX; 4900FA		
Belt - Fan	0124894002	▲K100675HD
Belt - Hub, Alt. & A.C.	0124587004	▲K080565HD
Tensioner Assy. - Fan	0127846000	38503
Tensioner Assy. - Hub, Alt. & A.C.	0127425000	38501
Tensioner Pulley - Fan	0127846000	38076
Tensioner Pulley - Hub, Alt. & A.C.	0127425000	38075
Hose - Upper - Eng. To Pipe; (2 1/2" I.D.)		24240

Application	Mfr. Part No.	Our No.
WESTERN STAR - Continued		
2006 - Continued		
Detroit Diesel 6-Cyl. 14.0 L Diesel - Continued		
4900EX; 4900FA - Continued		
Hose - Upper - Rad. To Pipe; (2 1/2" I.D.)		24240
Hose - Lower - Eng. To Pipe; (2 1/2" I.D.)		24240
Hose - Lower - Rad. To Pipe		21891
Hose - Lower - Pipe To Pipe; (2 1/2" I.D.)		24240
4900SA		
Belt - Fan	0124894002	▲K100675HD
Belt - Hub, Alt. & A.C.	0124587004	▲K080565HD
Tensioner Assy. - Fan	0127846000	38503
Tensioner Assy. - Hub, Alt. & A.C.	0127425000	38501
Tensioner Pulley - Fan	0127846000	38076
Tensioner Pulley - Hub, Alt. & A.C.	0127425000	38075
Hose - Upper - Eng. To Pipe; (2 1/2" I.D.)		24240
Hose - Upper - Rad. To Pipe; (2 1/2" I.D.)		24240
Hose - Lower - Eng. To Pipe; (2 1/2" I.D.)		24240
Hose - Lower - Rad. To Pipe; (2 1/2" I.D.)		24240
Mercedes-Benz MBE 4000 Diesel		
4900FA; 4900SA		
Belt - Fan	0127116010	▲K080649HD
Belt - W.P., Alt. & A.C.	0127116004	▲K080855HD
Tensioner Assy. - Fan	0127427001	38597
Tensioner Assy. - Hub, Alt. & A.C.	0127425000	38501
Tensioner Pulley - Hub, Alt. & A.C.	0127425000	38075
Hose - Upper - Eng. To Pipe		21135
Hose - Lower - Eng. To Pipe; (2 1/2" I.D.)		24240
Hose - Lower - Rad. To Pipe		21135
Hose - Lower - Pipe To Pipe; (2 1/2" I.D.)		24240
2005		
Caterpillar C13 Diesel		
4900FA; 4900SA		
Belt - Fan, Alt. & A.C.	0127110058	▲K081088HD
Tensioner Assy. - Fan, Alt. & A.C.	2117895	38590
Tensioner Pulley - Fan, Alt. & A.C.	2117895	36164
Idler Pulley - Smooth	2078118	36269
Idler Pulley - Grooved	1979642	36341
Caterpillar C15 Diesel		
4900EX; 4900FA; 4900SA		
Belt - Fan & Alt.	0123415073	▲K081088HD
Belt - Fan To A.C.	0127177007	▲K060547HD
Tensioner Assy. - Fan & Alt.	2002279	38569
Tensioner Assy. - Fan To A.C.	2178938	38511
Idler Pulley - Smooth	1979641	36091
Idler Pulley - Grooved	1979642	36341
Tensioner Pulley - Fan To A.C.	2178938	36091
Hose - Upper - Eng. To Pipe; (2 1/2" I.D.)		24240
Hose - Upper - Rad. To Pipe; (2 1/2" I.D.)		24240
Hose - Lower - Eng. To Pipe; (2 1/2" I.D.)		24240
Hose - Lower - Rad. To Pipe; (2 1/2" I.D.)		24240
6900XD		
Idler Pulley - Smooth	1979641	36091
Idler Pulley - Grooved	1979642	36341
Detroit Diesel 6-Cyl. 12.7 L Diesel		
4900EX; 4900FA		
Belt - Fan	0124894002	▲K100675HD
Belt - Hub, Alt. & A.C.	0124587004	▲K080565HD
Tensioner Assy. - Fan	0127846000	38503
Tensioner Assy. - Hub, Alt. & A.C.	0127425000	38501
Tensioner Pulley - Fan	0127846000	38076
Tensioner Pulley - Hub, Alt. & A.C.	0127425000	38075
Hose - Upper - Eng. To Pipe; (2 1/2" I.D.)		24240
Hose - Upper - Rad. To Pipe; (2 1/2" I.D.)		24240
Hose - Lower - Eng. To Pipe; (2 1/2" I.D.)		24240
Hose - Lower - Rad. To Pipe		21891
Hose - Lower - Pipe To Pipe; (2 1/2" I.D.)		24240
4900SA		
Belt - Fan	0124894002	▲K100675HD
Belt - Hub, Alt. & A.C.	0124587004	▲K080565HD
Tensioner Assy. - Fan	0127846000	38503

▲ Standard Belt Available. See Pages 630-631.

Belts and Coolant Hose for Medium/Heavy-Duty Trucks (1996 and Newer)

 Medium & Heavy-Duty Trucks
(1996 & Newer)

Application	Mfr. Part No.	Our No.
WESTERN STAR - Continued		
2005 - Continued		
Detroit Diesel 6-Cyl. 12.7 L Diesel - Continued		
4900SA - Continued		
Tensioner Assy. - Hub, Alt. & A.C.	0127425000	38501
Tensioner Pulley - Fan	0127846000	38076
Tensioner Pulley - Hub, Alt. & A.C.	0127425000	38075
Hose - Upper - Eng. To Pipe; (2 1/2" I.D.)	24240	24240
Hose - Upper - Rad. To Pipe; (2 1/2" I.D.)	24240	24240
Hose - Lower - Eng. To Pipe; (2 1/2" I.D.)	24240	24240
Hose - Lower - Rad. To Pipe; (2 1/2" I.D.)	24240	24240
Detroit Diesel 6-Cyl. 14.0 L Diesel		
4900EX; 4900FA		
Belt - Fan	0124894002	♣K100675HD
Belt - Hub, Alt. & A.C.	0124587004	♣K080565HD
Tensioner Assy. - Fan	0127846000	38503
Tensioner Assy. - Hub, Alt. & A.C.	0127425000	38501
Tensioner Pulley - Fan	0127846000	38076
Tensioner Pulley - Hub, Alt. & A.C.	0127425000	38075
Hose - Upper - Eng. To Pipe; (2 1/2" I.D.)	24240	24240
Hose - Upper - Rad. To Pipe	21135	21135
Hose - Lower - Eng. To Pipe; (2 1/2" I.D.)	24240	24240
Hose - Lower - Rad. To Pipe	21891	21891
Hose - Lower - Pipe To Pipe; (2 1/2" I.D.)	24240	24240
4900SA		
Belt - Fan	0124894002	♣K100675HD
Belt - Hub, Alt. & A.C.	0124587004	♣K080565HD
Tensioner Assy. - Fan	0127846000	38503
Tensioner Assy. - Hub, Alt. & A.C.	0127425000	38501
Tensioner Pulley - Fan	0127846000	38076
Tensioner Pulley - Hub, Alt. & A.C.	0127425000	38075
Hose - Upper - Eng. To Pipe; (2 1/2" I.D.)	24240	24240
Hose - Upper - Rad. To Pipe; (2 1/2" I.D.)	24240	24240
Hose - Lower - Eng. To Pipe; (2 1/2" I.D.)	24240	24240
Hose - Lower - Rad. To Pipe; (2 1/2" I.D.)	24240	24240
Mercedes-Benz MBE 4000 Diesel		
4900FA; 4900SA		
Belt - Fan	0127116010	♣K080649HD
Belt - W.P., Alt. & A.C.	0127116004	♣K080855HD
Tensioner Assy. - Fan	0127427001	38597
Tensioner Assy. - Hub, Alt. & A.C.	0127425000	38501
Tensioner Pulley - Hub, Alt. & A.C.	0127425000	38075
Hose - Upper - Eng. To Pipe	21135	21135
Hose - Lower - Eng. To Pipe; (2 1/2" I.D.)	24240	24240
Hose - Lower - Rad. To Pipe	21135	21135
Hose - Lower - Pipe To Pipe; (2 1/2" I.D.)	24240	24240
2004		
Caterpillar C12 Diesel		
4900FA		
Belt - Fan & Alt.	208043494785	♣K080785HD
Tensioner Assy. - Fan & Alt.	1333545	38506
Caterpillar C13 Diesel		
4900SA		
Belt - Fan, Alt. & A.C.	0123415073	♣K081088HD
Tensioner Assy. - Fan, Alt. & A.C.	2117895	38590
Tensioner Pulley - Fan, Alt. & A.C.	2117895	36164
Idler Pulley - Accessory Drive (Smooth)	2078118	36269
Idler Pulley - Accessory Drive (Grooved)	1979642	36341
Caterpillar C15 Diesel		
4900EX; 4900FA; 4900SA		
Belt - Fan & Alt.; W/Clean Air Pkg.	0123415073	♣K081088HD
Belt - Fan To A.C.; W/Clean Air Pkg.	0127177007	♣K060547HD
Belt - Fan; W/O Clean Air Pkg.	208043503624	ⓉTR22625
Belt - Fan To Alt. & A.C.; W/O Clean Air Pkg.	208043502551	Ⓣ♣9550HD
Tensioner Assy. - Fan & Alt.; W/Clean Air Pkg.	2002279	38569
Tensioner Assy. - Fan To A.C.; W/Clean Air Pkg.	2178938	38511
Idler Pulley - Smooth	1979641	36091
Idler Pulley - Grooved	1979642	36341

♣ Standard Belt Available. See Pages 630-631.

Application	Mfr. Part No.	Our No.
WESTERN STAR - Continued		
2004 - Continued		
Caterpillar C15 Diesel - Continued		
4900EX; 4900FA; 4900SA - Continued		
Tensioner Pulley - Fan To A.C.; W/Clean Air Pkg.	2178938	36091
Hose - Upper - Eng. To Pipe		21891
Hose - Upper - Pipe To Rad.		21135
Hose - Lower - Eng. To Pipe; (3" I.D.)		24248
Hose - Lower - Pipe To Rad.		21891
Hose - Lower - Pipe To Pipe; (2 1/2" I.D.)		24240
Detroit Diesel 6-Cyl. 12.7 L Diesel		
4900EX; 4900FA; 4900SA		
Belt - Fan	0124894002	♣K100675HD
Belt - Hub, Alt. & A.C.	0124587004	♣K080565HD
Tensioner Assy. - Fan	0127846000	38503
Tensioner Assy. - Hub, Alt. & A.C.	0127425000	38501
Tensioner Pulley - Fan	0127846000	38076
Tensioner Pulley - Hub, Alt. & A.C.	0127425000	38075
Hose - Upper - Eng. To Pipe; (2 1/2" I.D.)	24240	24240
Hose - Upper - Rad. To Pipe	21135	21135
Hose - Lower - Eng. To Pipe; (2 1/2" I.D.)	24240	24240
Hose - Lower - Rad. To Pipe	21891	21891
Hose - Lower - Pipe To Pipe; (2 1/2" I.D.)	24240	24240
Detroit Diesel 6-Cyl. 14.0 L Diesel		
4900EX; 4900FA; 4900SA		
Belt - Fan	0124894002	♣K100675HD
Belt - Hub, Alt. & A.C.	0124587004	♣K080565HD
Tensioner Assy. - Fan	0127846000	38503
Tensioner Assy. - Hub, Alt. & A.C.	0127425000	38501
Tensioner Pulley - Fan	0127846000	38076
Tensioner Pulley - Hub, Alt. & A.C.	0127425000	38075
Hose - Upper - Eng. To Pipe; (2 1/2" I.D.)	24240	24240
Hose - Upper - Rad. To Pipe	21135	21135
Hose - Lower - Eng. To Pipe; (2 1/2" I.D.)	24240	24240
Hose - Lower - Rad. To Pipe	21891	21891
Hose - Lower - Pipe To Pipe; (2 1/2" I.D.)	24240	24240
Mercedes-Benz MBE 4000 Diesel		
4900EX; 4900FA; 4900SA		
Belt - Fan	0127116010	♣K080649HD
Belt - Hub, Alt. & A.C.	0127116004	♣K080855HD
Tensioner Assy. - Fan	0127427001	38597
Tensioner Assy. - Hub, Alt. & A.C.	0127425000	38501
Tensioner Pulley - Hub, Alt. & A.C.	0127425000	38075
Hose - Upper - Cap To Eng.		21135
Hose - Upper - Rad. To Pipe		21135
2003		
Caterpillar 3406 Diesel		
4900EX; 4900FA; 4900SA		
Belt - Fan	208043503624	ⓉTR22625
Belt - Fan, Alt. & A.C.	208043502551	Ⓣ♣9550HD
Hose - Upper - Eng. To Pipe; (2 1/2" I.D.)		24240
Hose - Upper - Pipe To Rad.; (2 1/2" I.D.)		24240
Hose - Lower - Eng. To Pipe; (3" I.D.)		24248
Hose - Lower - Pipe To Rad.; (3" I.D.)		24248
Caterpillar C15 Diesel		
4900EX; 4900FA; 4900SA		
Belt - Fan & Alt.; W/Clean Air Pkg.	0123415073	♣K081088HD
Belt - Fan To A.C.; W/Clean Air Pkg.	0127177007	♣K060547HD
Belt - Fan; W/O Clean Air Pkg.	208043503624	ⓉTR22625
Belt - Fan To Alt. & A.C.; W/O Clean Air Pkg.	208043502551	Ⓣ♣9550HD
Tensioner Assy. - Fan & Alt.; W/Clean Air Pkg.	2002279	38569
Tensioner Assy. - Fan To A.C.; W/Clean Air Pkg.	2178938	38511
Tensioner Pulley - Fan To A.C.; W/Clean Air Pkg.	2178938	36091
Hose - Upper - Eng. To Pipe		21891
Hose - Upper - Pipe To Rad.		21135
Hose - Lower - Eng. To Pipe; (3" I.D.)		24248

Ⓣ Two Required.

Belts and Coolant Hose for Medium/Heavy-Duty Trucks (1996 and Newer)

Medium & Heavy-Duty Trucks
(1996 & Newer)

Application	Mfr. Part No.	Our No.
WESTERN STAR - Continued		
2003 - Continued		
Caterpillar C15 Diesel - Continued		
4900EX; 4900FA; 4900SA - Continued		
Hose - Lower - Pipe To Rad.		21891
Hose - Lower - Pipe To Pipe; (2 1/2" I.D.)		24240
Caterpillar C16 Diesel		
4900EX		
Belt - Fan	208043503624	②TR20619
Belt - Fan To Alt. & A.C.	208043502551	②▲9550HD
Hose - Upper - Eng. To Pipe		21891
Hose - Upper - Pipe To Rad.		21135
Hose - Lower - Eng. To Pipe; (3" I.D.)		24248
Hose - Lower - Pipe To Rad.		21891
Hose - Lower - Pipe To Pipe; (2 1/2" I.D.)		24240
4900FA; 4900SA		
Belt - Fan	208043503624	②TR22625
Belt - Fan To Alt. & A.C.	208043502551	②▲9550HD
Hose - Upper - Eng. To Pipe		21891
Hose - Upper - Pipe To Rad.		21135
Hose - Lower - Eng. To Pipe; (3" I.D.)		24248
Hose - Lower - Pipe To Rad.		21891
Hose - Lower - Pipe To Pipe; (2 1/2" I.D.)		24240
Cummins ISX Diesel		
4900EX		
Belt - Fan	3681822	▲K100810HD
Belt - Hub, Alt. & A.C.	3681812	▲K060685HD
Tensioner Assy. - Fan	3681240	38535
Tensioner Assy. - Hub, Alt. & A.C.	3680194	38532
Tensioner Pulley - Fan	3681240	36092
Tensioner Pulley - Hub, Alt. & A.C.	3680194	36095
Idler Pulley - Alt. & A.C.	4026886	36226
Detroit Diesel 6-Cyl. 12.7 L Diesel		
4900EX; 4900FA; 4900SA		
Belt - Fan	0124894002	▲K100675HD
Belt - Hub, Alt. & A.C.	0124587004	▲K080565HD
Tensioner Assy. - Fan	0127846000	38503
Tensioner Assy. - Hub, Alt. & A.C.	0127425000	38501
Tensioner Pulley - Fan	0127846000	38076
Tensioner Pulley - Hub, Alt. & A.C.	0127425000	38075
Hose - Upper - Eng. To Pipe; (2 1/2" I.D.)		24240
Hose - Upper - Rad. To Pipe		21135
Hose - Lower - Eng. To Pipe; (2 1/2" I.D.)		24240
Hose - Lower - Rad. To Pipe		21891
Hose - Lower - Pipe To Pipe; (2 1/2" I.D.)		24240
Detroit Diesel 6-Cyl. 14.0 L Diesel		
4900EX; 4900FA; 4900SA		
Belt - Fan	0124894002	▲K100675HD
Belt - Hub, Alt. & A.C.	0124587004	▲K080565HD
Tensioner Assy. - Fan	0127846000	38503
Tensioner Assy. - Hub, Alt. & A.C.	0127425000	38501
Tensioner Pulley - Fan	0127846000	38076
Tensioner Pulley - Hub, Alt. & A.C.	0127425000	38075
Hose - Upper - Eng. To Pipe; (2 1/2" I.D.)		24240
Hose - Upper - Rad. To Pipe		21135
Hose - Lower - Eng. To Pipe; (2 1/2" I.D.)		24240
Hose - Lower - Rad. To Pipe		21891
Hose - Lower - Pipe To Pipe; (2 1/2" I.D.)		24240
2002		
Caterpillar 3406 Diesel		
4900 Series		
Belt - Fan	208043503624	②TR22625
Belt - Fan, Alt. & A.C.	208043502551	②▲9550HD
Hose - Upper - Eng. To Pipe; (2 1/2" I.D.)		24240
Hose - Upper - Pipe To Rad.; (2 1/2" I.D.)		24240
Hose - Lower - Eng. To Pipe; (3" I.D.)		24248
Hose - Lower - Pipe To Rad.; (3" I.D.)		24248
Caterpillar C10 Diesel		
4900SA		
Belt - Fan	5080760	▲K080760HD

Application	Mfr. Part No.	Our No.
WESTERN STAR - Continued		
2002 - Continued		
Caterpillar C10 Diesel - Continued		
4900SA - Continued		
Belt - A.C.	17505	▲9505HD
Tensioner Assy.	1333545	38506
Tensioner Pulley		36091
Hose - Upper - Eng. To Pipe; (2 1/2" I.D.)		24440
Hose - Upper - Pipe To Rad.; (2 1/2" I.D.)		24440
Hose - Lower - Pipe To Eng.; (2 1/2" I.D.)		24440
Hose - Lower - Pipe To Rad.; (2 1/2" I.D.)		24440
Caterpillar C12 Diesel		
4900 Series		
Belt - Fan & Alt.	2080434	▲K080785HD
Belt - Fan & A.C.	208043502505	▲9505HD
Tensioner Assy. - Fan & Alt.	1333545	38506
Tensioner Pulley - Fan & Alt.	1333545	36091
Hose - Upper - Eng. To Pipe; (2 1/2" I.D.)		24240
Hose - Upper - Pipe To Rad.; (2 1/2" I.D.)		24240
Hose - Lower - Eng. To Pipe; (2 1/2" I.D.)		24240
Hose - Lower - Pipe To Rad.; (2 1/2" I.D.)		24240
5800 Series		
Belt - Fan & Alt.	208043494785	▲K080785HD
Belt - A.C.	208043502505	▲9505HD
5900 Series		
Belt - Fan, Alt. & A.C.	208043494785	▲K080785HD
Tensioner Assy. - Fan, Alt. & A.C.	1333545	38506
Tensioner Pulley - Fan, Alt. & A.C.	1333545	36091
Caterpillar C15 Diesel		
4900 Series		
Belt - Fan	208043503624	②TR22625
Belt - Fan To Alt. & A.C.	208043502551	②▲9550HD
Hose - Upper - Eng. To Pipe		21891
Hose - Upper - Pipe To Rad.		21135
Hose - Lower - Eng. To Pipe; (3" I.D.)		24248
Hose - Lower - Pipe To Rad.		21891
Hose - Lower - Pipe To Pipe; (2 1/2" I.D.)		24240
4900EX; 4900FA		
Belt - Fan & Alt.; W/Clean Air Pkg.	0123415073	▲K081088HD
Belt - Fan To A.C.; W/Clean Air Pkg.	0127177007	▲K060547HD
Belt - Fan; W/O Clean Air Pkg.	208043503624	②TR22625
Belt - Fan To Alt. & A.C.; W/O Clean Air Pkg.	208043502551	②▲9550HD
Tensioner Assy. - Fan & Alt.; W/Clean Air Pkg.	2002279	38569
Tensioner Assy. - Fan To A.C.; W/Clean Air Pkg.	2178938	38511
Tensioner Pulley - Fan To A.C.; W/Clean Air Pkg.	2178938	36091
Hose - Upper - Eng. To Pipe		21891
Hose - Upper - Pipe To Rad.		21135
Hose - Lower - Eng. To Pipe; (3" I.D.)		24248
Hose - Lower - Pipe To Rad.		21891
Hose - Lower - Pipe To Pipe; (2 1/2" I.D.)		24240
4900SA		
Belt - Fan	208043503624	②TR22625
Belt - Fan To Alt. & A.C.	208043502551	②▲9550HD
Hose - Upper - Eng. To Pipe; (2 1/2" I.D.)		24240
Hose - Upper - Pipe To Rad.; (2 1/2" I.D.)		24240
Hose - Lower - Eng. To Pipe; (3" I.D.)		24248
Hose - Lower - Pipe To Rad.		21891
Hose - Lower - Pipe To Pipe; (2 1/2" I.D.)		24240
Caterpillar C16 Diesel		
4900 Series		
Belt - Fan	208043503624	②TR22625
Belt - Fan To Alt. & A.C.	208043502551	②▲9550HD
Hose - Upper - Eng. To Pipe		21891
Hose - Upper - Pipe To Rad.		21135
Hose - Lower - Eng. To Pipe; (3" I.D.)		24248
Hose - Lower - Pipe To Rad.		21891
Hose - Lower - Pipe To Pipe; (2 1/2" I.D.)		24240

② Two Required.

▲ Standard Belt Available. See Pages 630-631.

Belts and Coolant Hose for Medium/Heavy-Duty Trucks (1996 and Newer)

 Medium & Heavy-Duty Trucks
(1996 & Newer)

Application	Mfr. Part No.	Our No.
WESTERN STAR - Continued		
2002 - Continued		
Caterpillar C16 Diesel - Continued		
4900SA		
Belt - Fan	208043503624	②TR22625
Belt - Fan To Alt. & A.C.	208043502551	②▲9550HD
Hose - Upper - Eng. To Pipe; (2 1/2" I.D.)	24240	24240
Hose - Upper - Pipe To Rad.; (2 1/2" I.D.)	24240	24240
Hose - Lower - Eng. To Pipe; (3" I.D.)	24248	24248
Hose - Lower - Pipe To Rad.	21891	21891
Hose - Lower - Pipe To Pipe; (2 1/2" I.D.)	24240	24240
2001		
Caterpillar 3126 Diesel		
3700 Series		
Belt - Fan, Alt. & A.C.		▲K080745HD
Belt - W.P.		▲9341HD
Hose - Upper - Eng. To Pipe		≧21194
Caterpillar 3406 Diesel		
4900 Series		
Belt - Fan	208043503624	②TR22625
Belt - Fan, Alt. & A.C.	208043502551	②▲9550HD
Hose - Upper - Eng. To Pipe; (2 1/2" I.D.)	24240	24240
Hose - Upper - Pipe To Rad.; (2 1/2" I.D.)	24240	24240
Hose - Lower - Eng. To Pipe; (3" I.D.)	24248	24248
Hose - Lower - Pipe To Rad.; (3" I.D.)	24248	24248
Caterpillar C10 Diesel		
4900 Series		
Belt - Fan & Alt.	2080434	▲K080785HD
Belt - Fan & A.C.	208043502505	▲9505HD
Tensioner Assy. - Fan & Alt.	1333545	38506
Tensioner Pulley - Fan & Alt.	1333545	36091
Hose - Upper - Eng. To Pipe; (2 1/2" I.D.)	24240	24240
Hose - Upper - Pipe To Rad.; (2 1/2" I.D.)	24240	24240
Hose - Lower - Eng. To Pipe; (2 1/2" I.D.)	24240	24240
Hose - Lower - Pipe To Rad.; (2 1/2" I.D.)	24240	24240
5800 Series		
Belt - Fan	5080760	▲K080760HD
Belt - A.C.	17505	▲9505HD
Tensioner Assy. - Fan	1333545	38506
Caterpillar C12 Diesel		
4800 Series		
Tensioner Assy.	1333545	38506
4900 Series		
Belt - Fan & Alt.	2080434	▲K080785HD
Belt - Fan & A.C.	208043502505	▲9505HD
Tensioner Assy. - Fan & Alt.	1333545	38506
Tensioner Pulley - Fan & Alt.	1333545	36091
Hose - Upper - Eng. To Pipe; (2 1/2" I.D.)	24240	24240
Hose - Upper - Pipe To Rad.; (2 1/2" I.D.)	24240	24240
Hose - Lower - Eng. To Pipe; (2 1/2" I.D.)	24240	24240
Hose - Lower - Pipe To Rad.; (2 1/2" I.D.)	24240	24240
5800 Series		
Belt - Fan & Alt.	208043494785	▲K080785HD
Belt - A.C.	208043502505	▲9505HD
Caterpillar C15 Diesel		
4900 Series		
Belt - Fan	208043503624	②TR22625
Belt - Fan, Alt. & A.C.	208043502551	▲9550HD
Hose - Upper - Eng. To Pipe; (2 1/2" I.D.)	24240	24240
Hose - Upper - Pipe To Rad.; (2 1/2" I.D.)	24240	24240
Hose - Lower - Eng. To Pipe; (3" I.D.)	24248	24248
Hose - Lower - Pipe To Pipe; (3" I.D.)	24248	24248
Caterpillar C16 Diesel		
4900 Series		
Belt - Fan	208043503624	②TR22625
Belt - Fan, Alt. & A.C.	208043502551	▲9550HD
Hose - Upper - Eng. To Pipe; (2 1/2" I.D.)	24240	24240
Hose - Upper - Pipe To Rad.; (2 1/2" I.D.)	24240	24240
Hose - Lower - Eng. To Pipe; (3" I.D.)	24248	24248
Hose - Lower - Pipe To Rad.; (3" I.D.)	24248	24248

 ② Two Required.
 ≧ Cut to Fit.

Application	Mfr. Part No.	Our No.
WESTERN STAR - Continued		
2001 - Continued		
Cummins ISM Diesel		
4900 Series		
Belt - Fan & Alt.	3099259	▲K080785HD
Belt - A.C.	208043502534	▲9530HD
Tensioner Assy. - Fan & Alt.	3400885	38521
Idler Pulley - Fan & Alt.	3400884	36308
Hose - Upper - Eng. To Pipe; (2 1/2" I.D.)	24240	24240
Hose - Upper - Pipe To Rad.; (2 1/2" I.D.)	24240	24240
Hose - Lower - Eng. To Pipe; (2 1/2" I.D.)	24240	24240
Hose - Lower - Pipe To Rad.; (2 1/2" I.D.)	24240	24240
Cummins ISX Diesel		
4900 Series		
Belt - Fan	3681822	▲K100810HD
Belt - Hub, Alt. & A.C.	3681812	▲K060685HD
Tensioner Assy. - Fan	3681240	38535
Tensioner Assy. - Hub, Alt. & A.C.	3680194	38532
Tensioner Pulley - Fan	3681240	36092
Tensioner Pulley - Hub, Alt. & A.C.	3680194	36095
Idler Pulley - Alt. & A.C.	4026886	36226
Hose - Upper - Eng. To Pipe; (2 1/2" I.D.)	24240	24240
Hose - Upper - Pipe To Rad.; (2 1/2" I.D.)	24240	24240
Hose - Lower - Eng. To Pipe; (2 1/2" I.D.)	24240	24240
Hose - Lower - Pipe To Eng.; (2 1/2" I.D.)	24240	24240
Cummins N14 Diesel		
4900 Series		
Belt - Hub & W.P.		▲K060415HD
Belt - Fan & Hub	208043504513	②TR28510
Belt - Hub & Alt.		▲9400HD
Belt - Hub & A.C.	208043501495	②▲9495HD
Hose - Upper - Eng. To Pipe; (2 1/2" I.D.)	24240	24240
Hose - Upper - Pipe To Rad.; (2 1/2" I.D.)	24240	24240
Hose - Lower - Eng. To Pipe; (2 1/2" I.D.)	24240	24240
Hose - Lower - Pipe To Rad.; (2 1/2" I.D.)	24240	24240
Cummins Signature 600 Diesel		
4900 Series		
Belt - Fan	3681822	▲K100810HD
Belt - Hub, Alt. & A.C.	3681812	▲K060685HD
Tensioner Assy. - Fan	3681240	38535
Tensioner Assy. - Hub, Alt. & A.C.	3680194	38532
Tensioner Pulley - Fan	3681240	36092
Tensioner Pulley - Hub, Alt. & A.C.	3680194	36095
Idler Pulley - Alt. & A.C.	4026886	36226
Hose - Upper - Eng. To Pipe; (2 1/2" I.D.)	24240	24240
Hose - Upper - Pipe To Rad.; (2 1/2" I.D.)	24240	24240
Hose - Lower - Eng. To Pipe; (2 1/2" I.D.)	24240	24240
Hose - Lower - Pipe To Eng.; (2 1/2" I.D.)	24240	24240
Detroit Diesel 6-Cyl. 11.1 L Diesel		
4900 Series		
Belt - Fan	208043502615	③▲9620HD
Belt - Hub, Alt. & A.C.	23520615	▲K080580HD
Tensioner Assy. - Hub, Alt. & A.C.	23520317	38501
Tensioner Pulley - Hub, Alt. & A.C.		38075
Hose - Upper - Eng. To Pipe; (2 1/2" I.D.)	24240	24240
Hose - Upper - Pipe To Rad.; (2 1/2" I.D.)	24240	24240
Hose - Lower - Eng. To Pipe; (2 1/2" I.D.)	24240	24240
Hose - Lower - Pipe To Rad.; (2 1/2" I.D.)	24240	24240
Detroit Diesel 6-Cyl. 12.7 L Diesel		
4900 Series		
Belt - Fan	208043502615	③▲9620HD
Belt - Hub, Alt. & A.C.	23520615	▲K080580HD
Tensioner Assy. - Hub, Alt. & A.C.	23520317	38501
Tensioner Pulley - Hub, Alt. & A.C.		38075
Hose - Upper - Eng. To Pipe; (2 1/2" I.D.)	24240	24240
Hose - Upper - Pipe To Rad.; (2 1/2" I.D.)	24240	24240
Hose - Lower - Eng. To Pipe; (2 1/2" I.D.)	24240	24240
Hose - Lower - Pipe To Rad.; (2 1/2" I.D.)	24240	24240

 ▲ Standard Belt Available. See Pages 630-631.
 ③ Three Required.

Belts and Coolant Hose for Medium/Heavy-Duty Trucks (1996 and Newer)

Medium & Heavy-Duty Trucks
(1996 & Newer)

Application	Mfr. Part No.	Our No.
WESTERN STAR - Continued		
2000		
Caterpillar 3126 Diesel		
3700 Series		
Belt - Fan, Alt. & A.C.		♣K080745HD
Belt - W.P.		♣9341HD
Hose - Upper - Eng. To Pipe		≡21194
Caterpillar 3406 Diesel		
4900 Series		
Belt - Fan	208043503624	②TR22625
Belt - Fan, Alt. & A.C.	208043502551	②♣9550HD
Hose - Upper - Eng. To Pipe; (2 1/2" I.D.)		24240
Hose - Upper - Pipe To Rad.; (2 1/2" I.D.)		24240
Hose - Lower - Eng. To Pipe; (3" I.D.)		24248
Hose - Lower - Pipe To Rad.; (3" I.D.)		24248
Caterpillar C10 Diesel		
4800 Series		
Belt - Fan	5080760	♣K080760HD
Belt - A.C.	17505	♣9505HD
Tensioner Assy.	1333545	38506
4900 Series		
Belt - Fan & Alt.	2080434	♣K080785HD
Belt - Fan & A.C.	208043502505	♣9505HD
Tensioner Assy. - Fan & Alt.	1333545	38506
Tensioner Pulley - Fan & Alt.	1333545	36091
Hose - Upper - Eng. To Pipe; (2 1/2" I.D.)		24240
Hose - Upper - Pipe To Rad.; (2 1/2" I.D.)		24240
Hose - Lower - Eng. To Pipe; (2 1/2" I.D.)		24240
Hose - Lower - Pipe To Rad.; (2 1/2" I.D.)		24240
Caterpillar C12 Diesel		
4800 Series		
Tensioner Assy. - Alt.	1333545	38506
4900 Series		
Belt - Fan & Alt.	2080434	♣K080785HD
Belt - Fan & A.C.	208043502505	♣9505HD
Tensioner Assy. - Fan & Alt.	1333545	38506
Tensioner Pulley - Fan & Alt.	1333545	36091
Hose - Upper - Eng. To Pipe; (2 1/2" I.D.)		24240
Hose - Upper - Pipe To Rad.; (2 1/2" I.D.)		24240
Hose - Lower - Eng. To Pipe; (2 1/2" I.D.)		24240
Hose - Lower - Pipe To Rad.; (2 1/2" I.D.)		24240
5800 Series		
Belt - Fan & Alt.	208043494785	♣K080785HD
Belt - A.C.	208043502505	♣9505HD
Caterpillar C15 Diesel		
4900 Series		
Belt - Fan	208043503624	②TR22625
Belt - Fan, Alt. & A.C.	208043502551	♣9550HD
Hose - Upper - Eng. To Pipe; (2 1/2" I.D.)		24240
Hose - Upper - Pipe To Rad.; (2 1/2" I.D.)		24240
Hose - Lower - Eng. To Pipe; (2 1/2" I.D.)		24240
Hose - Lower - Pipe To Rad.; (2 1/2" I.D.)		24240
Caterpillar C16 Diesel		
4900 Series		
Belt - Fan	208043503624	②TR22625
Belt - Fan, Alt. & A.C.	208043502551	♣9550HD
Hose - Upper - Eng. To Pipe; (2 1/2" I.D.)		24240
Hose - Upper - Pipe To Rad.; (2 1/2" I.D.)		24240
Hose - Lower - Eng. To Pipe; (2 1/2" I.D.)		24240
Hose - Lower - Pipe To Rad.; (2 1/2" I.D.)		24240
Cummins ISM Diesel		
4800 Series		
Belt - Alt.	3099259	♣K080785HD
4900 Series		
Belt - Fan & Alt.	3099259	♣K080785HD
Belt - A.C.	208043502534	♣9530HD
Tensioner Assy. - Fan & Alt.	3400885	38521
Idler Pulley - Fan & Alt.	3400884	36308
Hose - Upper - Eng. To Pipe; (2 1/2" I.D.)		24240
Hose - Upper - Rad. To Pipe; (2 1/2" I.D.)		24240

♣ Standard Belt Available. See Pages 630-631.
② Two Required.

Application	Mfr. Part No.	Our No.
WESTERN STAR - Continued		
2000 - Continued		
Cummins ISM Diesel - Continued		
4900 Series - Continued		
Hose - Lower - Eng. To Pipe; (2 1/2" I.D.)		24240
Hose - Lower - Rad. To Pipe; (2 1/2" I.D.)		24240
Cummins ISX Diesel		
4900 Series		
Belt - Fan	3681822	♣K100810HD
Belt - Hub, Alt. & A.C.	3681812	♣K060685HD
Tensioner Assy. - Fan	3681240	38535
Tensioner Assy. - Hub, Alt. & A.C.	3680194	38532
Tensioner Pulley - Fan	3681240	36092
Tensioner Pulley - Hub, Alt. & A.C.	3680194	36095
Idler Pulley - Alt. & A.C.	4026886	36226
Hose - Upper - Eng. To Pipe; (2 1/2" I.D.)		24240
Hose - Upper - Pipe To Rad.; (2 1/2" I.D.)		24240
Hose - Lower - Eng. To Pipe; (2 1/2" I.D.)		24240
Hose - Lower - Pipe To Eng.; (2 1/2" I.D.)		24240
Cummins N14 Diesel		
4900 Series		
Belt - Hub & W.P.		♣K060415HD
Belt - Fan & Hub	208043504513	②TR28510
Belt - Hub & Alt.		♣9400HD
Belt - Hub & A.C.	208043501495	②♣9495HD
Hose - Upper - Eng. To Pipe; (2 1/2" I.D.)		24240
Hose - Upper - Pipe To Rad.; (2 1/2" I.D.)		24240
Hose - Lower - Eng. To Pipe; (2 1/2" I.D.)		24240
Hose - Lower - Pipe To Rad.; (2 1/2" I.D.)		24240
Detroit Diesel 6-Cyl. 11.1 L Diesel		
4900 Series		
Belt - Fan		③♣9610HD
Belt - Fan & A.C.	208043502544	♣9545HD
Belt - Hub & Alt.	17511	♣9510HD
Hose - Upper - Eng. To Pipe; (2 1/2" I.D.)		24240
Hose - Upper - Pipe To Rad.; (2 1/2" I.D.)		24240
Hose - Lower - Eng. To Pipe; (2 1/2" I.D.)		24240
Hose - Lower - Pipe To Rad.; (2 1/2" I.D.)		24240
Detroit Diesel 6-Cyl. 12.7 L Diesel		
4900 Series		
Belt - Fan		③♣9610HD
Belt - Fan & A.C.	208043502544	♣9545HD
Belt - Hub & Alt.	17511	♣9510HD
Hose - Upper - Eng. To Pipe; (2 1/2" I.D.)		24240
Hose - Upper - Pipe To Rad.; (2 1/2" I.D.)		24240
Hose - Lower - Eng. To Pipe; (2 1/2" I.D.)		24240
Hose - Lower - Pipe To Rad.; (2 1/2" I.D.)		24240
1999		
Caterpillar 3406 Diesel		
4900 Series		
Belt - Fan	208043503624	②TR22625
Belt - Fan, Alt. & A.C.	208043502505	②♣9505HD
Hose - Upper - Eng. To Pipe; (2 1/2" I.D.)		24240
Hose - Upper - Pipe To Rad.; (2 1/2" I.D.)		24240
Hose - Lower - Eng. To Pipe; (3" I.D.)		24248
Hose - Lower - Pipe To Rad.; (3" I.D.)		24248
Caterpillar C12 Diesel		
4900 Series		
Belt - Fan & Alt.	2080434	♣K080785HD
Belt - Fan & A.C.	208043502505	♣9505HD
Tensioner Assy. - Fan & Alt.	1333545	38506
Tensioner Pulley - Fan & Alt.	1333545	36091
Hose - Upper - Eng. To Pipe; (2 1/2" I.D.)		24240
Hose - Upper - Pipe To Rad.; (2 1/2" I.D.)		24240
Hose - Lower - Eng. To Pipe; (2 1/2" I.D.)		24240
Hose - Lower - Pipe To Rad.; (2 1/2" I.D.)		24240
Cummins ISM Diesel		
5800 Series		
Belt - Fan & Alt.	208043494785	♣K080785HD
Belt - A.C.	208043502505	♣9505HD

≡ Cut to Fit.
③ Three Required.

Belts and Coolant Hose for Medium/Heavy-Duty Trucks (1996 and Newer)

 Medium & Heavy-Duty Trucks
(1996 & Newer)

Application	Mfr. Part No.	Our No.
WESTERN STAR - Continued		
1999 - Continued		
Cummins N14 Diesel		
4900 Series		
Belt - Hub & W.P.		♣K060415HD
Belt - Fan		②♣9495HD
Belt - Fan & Hub		②TR28510
Belt - Hub & A.C.	208043501495	②♣9495HD
Belt - Hub & Alt.		♣9400HD
Hose - Upper - Eng. To Pipe; (2 1/2" I.D.)		24240
Hose - Upper - Pipe To Rad.; (2 1/2" I.D.)		24240
Hose - Lower - Eng. To Pipe; (2 1/2" I.D.)		24240
Hose - Lower - Pipe To Rad.; (2 1/2" I.D.)		24240
Detroit Diesel 6-Cyl. 11.1 L Diesel		
4900 Series		
Belt - Fan		③♣9610HD
Belt - Fan & A.C.	208043502544	♣9545HD
Belt - Hub & Alt.	17511	♣9510HD
Hose - Upper - Eng. To Pipe; (2 1/2" I.D.)		24240
Hose - Upper - Pipe To Rad.; (2 1/2" I.D.)		24240
Hose - Lower - Eng. To Pipe; (2 1/2" I.D.)		24240
Hose - Lower - Pipe To Rad.; (2 1/2" I.D.)		24240
Detroit Diesel 6-Cyl. 12.7 L Diesel		
4900 Series		
Belt - Fan		③♣9610HD
Belt - Fan & A.C.	208043502544	♣9545HD
Belt - Hub & Alt.	17511	♣9510HD
Hose - Upper - Eng. To Pipe; (2 1/2" I.D.)		24240
Hose - Upper - Pipe To Rad.; (2 1/2" I.D.)		24240
Hose - Lower - Eng. To Pipe; (2 1/2" I.D.)		24240
Hose - Lower - Pipe To Rad.; (2 1/2" I.D.)		24240
1998		
Caterpillar 3406 Diesel		
4900 Series		
Belt - Fan		②TR22625
Belt - Fan To Alt. & A.C.		②♣9570HD
Hose - Upper - Eng. To Pipe; (2 1/2" I.D.)		24240
Hose - Upper - Pipe To Rad.; (2 1/2" I.D.)		24240
Hose - Lower - Eng. To Pipe; (3" I.D.)		24248
Hose - Lower - Pipe To Rad.; (3" I.D.)		24248
Caterpillar C10 Diesel		
4800 Series		
Belt - Fan & Alt.	5080760	♣K080760HD
Belt - Fan & A.C.; W/56 5/8" Belt O.C. ...	17565	♣9565HD
Belt - Fan & A.C.; W/44 3/8" Belt O.C. ...	17443	♣9447HD
Tensioner Assy.	1333545	38506
Tensioner Pulley		36091
Caterpillar C12 Diesel		
4900 Series		
Belt - Fan & Alt.	2080434	♣K080785HD
Belt - Fan & A.C.	208043502505	♣9505HD
Tensioner Assy. - Fan & Alt.	1333545	38506
Tensioner Pulley - Fan & Alt.	1333545	36091
Hose - Upper - Eng. To Pipe; (2 1/2" I.D.)		24240
Hose - Upper - Pipe To Rad.; (2 1/2" I.D.)		24240
Hose - Lower - Eng. To Pipe; (2 1/2" I.D.)		24240
Hose - Lower - Pipe To Rad.; (2 1/2" I.D.)		24240
5800 Series		
Belt - Fan & Alt.	208043494785	♣K080785HD
Belt - A.C.	208043502505	♣9505HD
Cummins N14 Diesel		
4900 Series		
Belt - Hub & W.P.		♣K060415HD
Belt - Fan		②♣9495HD
Belt - Fan & Hub		②TR28510
Belt - Hub & A.C.	208043501495	②♣9495HD
Belt - Hub & Alt.		♣9400HD
Hose - Upper - Eng. To Pipe; (2 1/2" I.D.)		24240
Hose - Upper - Pipe To Rad.; (2 1/2" I.D.)		24240
Hose - Lower - Eng. To Pipe; (2 1/2" I.D.)		24240

Application	Mfr. Part No.	Our No.
WESTERN STAR - Continued		
1998 - Continued		
Cummins N14 Diesel - Continued		
4900 Series - Continued		
Hose - Lower - Pipe To Rad.; (2 1/2" I.D.)		24240
Detroit Diesel 6-Cyl. 11.1 L Diesel		
4900 Series		
Belt - Fan		③♣9610HD
Belt - Fan & A.C.	208043502544	♣9545HD
Belt - Hub & Alt.	17511	♣9510HD
Hose - Upper - Eng. To Pipe; (2 1/2" I.D.)		24240
Hose - Upper - Pipe To Rad.; (2 1/2" I.D.)		24240
Hose - Lower - Eng. To Pipe; (2 1/2" I.D.)		24240
Hose - Lower - Pipe To Rad.; (2 1/2" I.D.)		24240
Detroit Diesel 6-Cyl. 12.7 L Diesel		
4900 Series		
Belt - Fan		③♣9610HD
Belt - Fan & A.C.	208043502544	♣9545HD
Belt - Hub & Alt.	17511	♣9510HD
Hose - Upper - Eng. To Pipe; (2 1/2" I.D.)		24240
Hose - Upper - Pipe To Rad.; (2 1/2" I.D.)		24240
Hose - Lower - Eng. To Pipe; (2 1/2" I.D.)		24240
Hose - Lower - Pipe To Rad.; (2 1/2" I.D.)		24240
1997		
Caterpillar 3176 Diesel		
4800 Series		
Belt - Fan	5080760	♣K080760HD
Belt - A.C.	17443	♣9447HD
Tensioner Assy.	1333543	38506
Caterpillar 3406 Diesel		
4900 Series		
Belt - Fan		②TR22625
Belt - Fan To Alt. & A.C.		②♣9570HD
Hose - Upper - Eng. To Pipe; (2 1/2" I.D.)		24240
Hose - Upper - Pipe To Rad.; (2 1/2" I.D.)		24240
Hose - Lower - Eng. To Pipe; (3" I.D.)		24248
Hose - Lower - Pipe To Rad.; (3" I.D.)		24248
Caterpillar C10 Diesel		
4800 Series		
Belt - Fan	5080760	♣K080760HD
Belt - A.C.	17443	♣9447HD
Tensioner Assy.	1333543	38506
Idler Pulley	1481974	36091
Caterpillar C12 Diesel		
4900 Series		
Belt - Fan & Alt.	2080434	♣K080785HD
Belt - Fan & A.C.	208043502505	♣9505HD
Tensioner Assy. - Fan & Alt.	1333545	38506
Tensioner Pulley - Fan & Alt.	1333545	36091
Hose - Upper - Eng. To Pipe; (2 1/2" I.D.)		24240
Hose - Upper - Pipe To Rad.; (2 1/2" I.D.)		24240
Hose - Lower - Eng. To Pipe; (2 1/2" I.D.)		24240
Hose - Lower - Pipe To Rad.; (2 1/2" I.D.)		24240
Cummins M11 Diesel		
3800 Series; 4800 Series		
Belt - Fan; W/59" Belt O.C.	3034945	♣K080585HD
Belt - Fan; W/61 3/4" Belt O.C.		♣K080610HD
Belt - Alt.	3039376	♣K050350HD
Belt - A.C.		♣9525HD
Hose - Upper - Eng. To Pipe; (2 1/4" I.D.)		24236
Hose - Upper - Pipe To Rad.; (2 1/4" I.D.)		24236
Hose - Lower - Eng. To Pipe; (2 1/2" I.D.)		24240
Hose - Lower - Pipe To Rad.; (2 1/2" I.D.)		24240
Cummins N14 Diesel		
4900 Series		
Belt - Hub & W.P.		♣K060415HD
Belt - Fan		②♣9495HD
Belt - Fan & Hub		②TR28510
Belt - Hub & A.C.	208043501495	②♣9495HD

♣ Standard Belt Available. See Pages 630-631.
③ Three Required.

② Two Required.

Belts and Coolant Hose for Medium/Heavy-Duty Trucks (1996 and Newer)

Medium & Heavy-Duty Trucks
(1996 & Newer)

Application	Mfr. Part No.	Our No.
WESTERN STAR - Continued		
1997 - Continued		
Cummins N14 Diesel - Continued		
4900 Series - Continued		
Belt - Hub & Alt.		▲9400HD
Hose - Upper - Eng. To Pipe; (2 1/2" I.D.)		24240
Hose - Upper - Pipe To Rad.; (2 1/2" I.D.)		24240
Hose - Lower - Eng. To Pipe; (2 1/2" I.D.)		24240
Hose - Lower - Pipe To Rad.; (2 1/2" I.D.)		24240
Detroit Diesel 6-Cyl. 11.1 L Diesel		
4900 Series		
Belt - Fan		③▲9610HD
Belt - Fan & A.C. 208043502544		▲9545HD
Belt - Hub & Alt. 17511		▲9510HD
Hose - Upper - Eng. To Pipe; (2 1/2" I.D.)		24240
Hose - Upper - Pipe To Rad.; (2 1/2" I.D.)		24240
Hose - Lower - Eng. To Pipe; (2 1/2" I.D.)		24240
Hose - Lower - Pipe To Rad.; (2 1/2" I.D.)		24240
Detroit Diesel 6-Cyl. 12.7 L Diesel		
4900 Series		
Belt - Fan		③▲9610HD
Belt - Fan & A.C. 208043502544		▲9545HD
Belt - Hub & Alt. 17511		▲9510HD
Hose - Upper - Eng. To Pipe; (2 1/2" I.D.)		24240
Hose - Upper - Pipe To Rad.; (2 1/2" I.D.)		24240
Hose - Lower - Eng. To Pipe; (2 1/2" I.D.)		24240
Hose - Lower - Pipe To Rad.; (2 1/2" I.D.)		24240
1996		
Caterpillar 3176 Diesel		
4800 Series		
Belt - Fan	5080760	▲K080760HD
Belt - A.C.	17443	▲9447HD
Tensioner Assy. - Fan	1333543	38506
4900 Series		
Belt - Fan & Alt.	208043463	▲K080760HD
Cummins L10 Diesel		
3800 Series; 4800 Series		
Belt - Fan; W/59" Belt O.C.	3034945	▲K080585HD
Belt - Fan; W/61 3/4" Belt O.C.		▲K080610HD
Belt - Alt.	3039376	▲K050350HD
Belt - A.C.		▲9525HD
Hose - Upper - Eng. To Pipe; (2 1/4" I.D.)		24236
Hose - Upper - Pipe To Rad.; (2 1/2" I.D.)		24240
Hose - Lower - Eng. To Pipe; (2 1/2" I.D.)		24240
Hose - Lower - Pipe To Rad.; (2 1/2" I.D.)		24240
Cummins M11 Diesel		
3800 Series; 4800 Series		
Belt - Fan; W/59" Belt O.C.	3034945	▲K080585HD
Belt - Fan; W/61 3/4" Belt O.C.		▲K080610HD
Belt - Alt.	3039376	▲K050350HD
Belt - A.C.		▲9525HD
Hose - Upper - Eng. To Pipe; (2 1/4" I.D.)		24236
Hose - Upper - Pipe To Rad.; (2 1/2" I.D.)		24240
Hose - Lower - Eng. To Pipe; (2 1/2" I.D.)		24240
Hose - Lower - Pipe To Rad.; (2 1/2" I.D.)		24240
Cummins N14 Diesel		
4900 Series		
Belt - Hub & W.P.		▲K060415HD
Belt - Fan		②▲9495HD
Belt - Fan & Hub		②TR28510
Belt - Hub & A.C. 208043501495		②▲9495HD
Belt - Hub & Alt.		▲9400HD
Hose - Upper - Eng. To Pipe; (2 1/2" I.D.)		24240
Hose - Upper - Pipe To Rad.; (2 1/2" I.D.)		24240
Hose - Lower - Eng. To Pipe; (2 1/2" I.D.)		24240
Hose - Lower - Pipe To Rad.; (2 1/2" I.D.)		24240
Detroit Diesel 6-Cyl. 11.1 L Diesel		
4800 Series; 4900 Series		
Belt - Fan; W/63 1/2" Belt O.C.		▲9630HD
Belt - Fan; W/65 1/2" Belt O.C.; Preferred Belt		2/9650PB

Application	Mfr. Part No.	Our No.
WESTERN STAR - Continued		
1996 - Continued		
Detroit Diesel 6-Cyl. 11.1 L Diesel - Continued		
4800 Series; 4900 Series - Continued		
Belt - Fan; W/65 1/2" Belt O.C.; Optional Belt		②▲9650HD
Belt - Alt.		2/9510PB
Belt - A.C.		▲9545HD
Detroit Diesel 6-Cyl. 12.7 L Diesel		
4800 Series; 4900 Series		
Belt - Fan; W/63 1/2" Belt O.C.		▲9630HD
Belt - Fan; W/65 1/2" Belt O.C.; Preferred Belt		2/9650PB
Belt - Fan; W/65 1/2" Belt O.C.; Optional Belt		②▲9650HD
Belt - Alt.		2/9510PB
Belt - A.C.		▲9545HD
WORKHORSE		
2008		
GM V-8 4.8 L		
W42		
Serpentine Belt; W/145A. Alt.	12576753	▲K060988HD
Belt - A.C.	12576447	▲K040378HD
Tensioner Assy. - Serpentine	12580162	38158
Tensioner Assy. - A.C.	12565372	38159
Tensioner Pulley - Serpentine	12580162	38009
Tensioner Pulley - A.C.	12565372	36169
Idler Pulley	12580771	36299
Hose - Upper		23184
Hose - Heater To Valve; (5/8" x 36")		28411
Hose - Valve To Thermostat; (5/8" x 60")		28411
Hose - Thermostat To Heater; (5/8" x 60")		28411
Hose - Rad. To Reducer; (5/8" x 12")		28411
Hose - Reducer To Throttle Body; (3/8" x 20")		28409
Hose - Rad. To Reservoir; (3/8" x 20")		28409
2007		
GM V-8 4.8 L		
W42		
Serpentine Belt; W/145A. Alt.	12576753	▲K060988HD
Belt - A.C.	12576447	▲K040378HD
Tensioner Assy. - Serpentine	12580162	38158
Tensioner Assy. - A.C.	12565372	38159
Tensioner Pulley - Serpentine	12580162	38009
Tensioner Pulley - A.C.	12565372	36169
Idler Pulley	12580771	36299
Hose - Upper		23184
Hose - Heater To Valve; (5/8" x 36")		28411
Hose - Valve To Thermostat; (5/8" x 60")		28411
Hose - Thermostat To Heater; (5/8" x 60")		28411
Hose - Rad. To Reducer; (5/8" x 12")		28411
Hose - Reducer To Throttle Body; (3/8" x 20")		28409
Hose - Rad. To Reservoir; (3/8" x 20")		28409
International/Navistar MaxxForce 5 Diesel		
W42; W62		
Belt - Fan, Alt., P.S. & A.C.	1848715C1	▲K081331HD
Tensioner Assy.	1844538C1	38257
Hose - Lower - Connector To Eng.		21571
Hose - Heater To Valve; (5/8" x 30")		28411
Hose - Valve To Eng.; (5/8" x 72")		28411
Hose Connector - Connector To Heater; (3/4" x 12")		28442
Hose Connector - Connector To Eng.; (3/4" x 36")		28442
Hose - Reservoir To Connector; (3/8" x 3")		28409
2006		
GM V-8 4.8 L		
P Series		
Serpentine Belt; W/145A. Alt.	12576753	▲K060988HD
Belt - A.C.	12576447	▲K040378HD
Tensioner Assy. - Serpentine	12580162	38158
Tensioner Assy. - A.C.	12565372	38159
Tensioner Pulley - Serpentine	12580162	38009
Tensioner Pulley - A.C.	12565372	36169

▲ Standard Belt Available. See Pages 630-631.
② Two Required.

③ Three Required.

Belts and Coolant Hose for Medium/Heavy-Duty Trucks (1996 and Newer)

 Medium & Heavy-Duty Trucks
(1996 & Newer)

Application	Mfr. Part No.	Our No.
WORKHORSE - Continued		
2006 - Continued		
GM V-8 4.8 L - Continued		
P Series - Continued		
Idler Pulley	12580771	36299
Hose - Upper		22436
Hose - Lower		22437
Hose - Heater To Connector; (5/8" x 24")		28411
Hose Connector - Connector To Thermostat; (5/8" x 40") ...		28411
Hose - Thermostat To Heater; (5/8" x 60")		28411
Hose Connector - Connector To Heater		28466
Hose - Rad. To Reducer; (5/8" x 12")		28411
Hose - Reducer To Throttle Body; (3/8" x 20")		28409
Hose - Throttle Body To Eng.; (5/16" x 7")		28408
Hose - Rad. To Reservoir; (3/8" x 20")		28409
GM V-8 6.0 L		
P Series		
Belt - Fan, Alt. & P.S.		♣K060988HD
Belt - A.C.	12576447	♣K040378HD
Tensioner Assy. - Fan & Alt.	12580162	38158
Tensioner Assy. - A.C.	12580196	38159
Tensioner Pulley - Fan & Alt.	12580162	38009
Tensioner Pulley - A.C.	12580196	36169
Idler Pulley	12580771	36299
Hose - Upper - Rad. To Eng.		22436
Hose - Lower - Eng. To Rad.		22437
GM V-8 8.1 L		
P Series		
Serpentine Belt; W/A.C.	W0000581	♣K061080HD
Serpentine Belt; W/O A.C.	12563076	♣K060994HD
Tensioner Assy.; W/A.C.	12561094	38103
Tensioner Assy.; W/O A.C.	12581203	38258
Tensioner Pulley; W/A.C.	12561094	38008
Tensioner Pulley; W/O A.C.	12581203	38006
Idler Pulley - Smooth; W/A.C.	12555609	36299
Idler Pulley - Grooved; W/O A.C.	10239930	38008
Hose - Upper		23803
Hose - Lower		21442
Hose - By Pass		19802
International/Navistar VT275 Diesel		
P Series		
Belt - Fan, Alt., P.S. & A.C.	1846055C1	♣K081331HD
Tensioner Assy.	1844538C1	38257
2005		
Cummins B Series 3.9 L Diesel		
P Series		
Belt - Fan, W.P. & Alt.	3289257	♣K080694HD
Hose - Lower		22237
GM V-8 4.8 L		
P Series		
Belt - Fan, Alt. & P.S.	W0002987	♣K060935HD
Belt - A.C.	12576447	♣K040378HD
Tensioner Assy. - Fan & Alt.	12580162	38158
Tensioner Assy. - A.C.	12580196	38159
Tensioner Pulley - Fan & Alt.	12580162	38009
Tensioner Pulley - A.C.	12580196	36169
Idler Pulley	12580771	36299
Hose - Upper - Eng. To Rad.		22436
Hose - Lower - Eng. To Rad.		22437
GM V-8 6.0 L		
P Series		
Belt - Fan, Alt. & P.S.	W0002987	♣K060935HD
Belt - A.C.	12576447	♣K040378HD
Tensioner Assy. - Fan & Alt.	12580162	38158
Tensioner Assy. - A.C.	12580196	38159
Tensioner Pulley - Fan & Alt.	12580162	38009
Tensioner Pulley - A.C.	12580196	36169
Idler Pulley	12580771	36299
Hose - Upper - Rad. To Eng.		22436
Hose - Lower - Eng. To Rad.		22437

♣ Standard Belt Available. See Pages 630-631.

Application	Mfr. Part No.	Our No.
WORKHORSE - Continued		
2005 - Continued		
GM V-8 8.1 L		
P Series		
Serpentine Belt; W/A.C.	W0000581	♣K061080HD
Serpentine Belt; W/O A.C.	12563076	♣K060994HD
Tensioner Assy.; W/A.C.	12561094	38103
Tensioner Assy.; W/O A.C.	12581203	38258
Tensioner Pulley; W/A.C.	12561094	38008
Tensioner Pulley; W/O A.C.	12581203	38006
Idler Pulley - Smooth; W/A.C.	12555609	36299
Idler Pulley - Grooved; W/O A.C.	10239930	38008
Hose - Upper		23803
Hose - Lower		21442
Hose - By Pass		19802
2004		
Cummins B Series 3.9 L Diesel		
P Series		
Belt - Fan, W.P. & Alt.	3289257	♣K080694HD
Hose - Lower		22237
GM V-8 4.8 L		
P Series		
Belt - Fan, Alt. & P.S.	W0002987	♣K060935HD
Belt - A.C.	12576447	♣K040378HD
Tensioner Assy. - Fan & Alt.	12580162	38158
Tensioner Assy. - A.C.	12580196	38159
Tensioner Pulley - Fan & Alt.	12580162	38009
Tensioner Pulley - A.C.	12580196	36169
Idler Pulley	12580771	36299
Hose - Upper - Eng. To Rad.		22436
Hose - Lower - Eng. To Rad.		22437
GM V-8 5.7 L		
P Series		
Belt - Fan, Alt. & P.S.; W/200A. Alt.	12564760	♣K060875HD
Tensioner Assy. - Fan, Alt. & P.S.	12580296	38103
Hose - Upper - Eng. To Rad.		22266
Hose - Lower - Eng. To Rad.		20843
Hose - By Pass		19025
Hose - Heater To Connector		20605
Hose Connector - Connector To W.P.; (5/8" x 38")		28411
Hose - Eng. To Valve; (5/8" x 28")		28411
Hose - Valve To Heater		20605
Hose - Rad. To Reservoir; (3/8" x 20")		28409
GM V-8 6.5 L Diesel		
P Series		
Serpentine Belt; W/O A.C.; W/105A. Alt.	12555009	♣K061010HD
Serpentine Belt; W/O A.C.; W/145A. Alt.	12556338	♣K061020HD
Tensioner Assy.	12561092	38118
Tensioner Pulley	12561092	38006
Idler Pulley - Grooved; W/O A.C.	14102597	36177
Hose - Upper		22268
Hose - Lower		22237
Hose - By Pass		22210
Hose - Heater To Valve; W/Union City Body(5/8" x 36")		28411
Hose - Valve To Eng.; W/Union City Body(5/8" x 22")		28411
Hose - Rad. To Valve; W/Union City Body(3/4" x 18")		28412
Hose - Valve To Heater; W/Union City Body(5/8" x 36")		28411
Hose - Rad. To Reservoir		28465
GM V-8 8.1 L		
P Series		
Serpentine Belt; W/A.C.	W0000581	♣K061080HD
Serpentine Belt; W/O A.C.	12563076	♣K060994HD
Tensioner Assy.; W/A.C.	12561094	38103
Tensioner Assy.; W/O A.C.	12581203	38258
Tensioner Pulley; W/A.C.	12561094	38008
Tensioner Pulley; W/O A.C.	12581203	38006
Idler Pulley - Smooth; W/A.C.	12555609	36299
Idler Pulley - Grooved; W/O A.C.	10239930	38008
Hose - Upper		23803
Hose - Lower		21442
Hose - By Pass		19802

Belts and Coolant Hose for Medium/Heavy-Duty Trucks (1996 and Newer)

Medium & Heavy-Duty Trucks
(1996 & Newer)

Application	Mfr. Part No.	Our No.
WORKHORSE - Continued		
2003		
GM V-8 5.7 L		
P Series		
Serpentine Belt; W/A.C.; W/105A. Alt. ...	12564763	▲K060960HD
Serpentine Belt; W/O A.C.; W/105A. Alt. ...	12564759	▲K060870HD
Tensioner Assy.	12561094	38103
Tensioner Pulley	12561094	38008
Idler Pulley - Smooth	12557819	38001
Idler Pulley - Grooved; W/O A.C.	10239930	38008
Hose - Upper		22266
Hose - Lower		20843
Hose - By Pass		19025
Hose - Heater To Connector		20605
Hose Connector - Connector To W.P.; (5/8" x 38")		28411
Hose - Eng. To Valve; (5/8" x 28")		28411
Hose - Valve To Heater		20605
Hose - Rad. To Reservoir; (3/8" x 20")		28409
GM V-8 6.5 L Diesel		
P Series		
Serpentine Belt; W/O A.C.; W/105A. Alt. ...	12555009	▲K061010HD
Serpentine Belt; W/O A.C.; W/145A. Alt. ...	12556338	▲K061020HD
Tensioner Assy.	12561092	38118
Tensioner Pulley	12561092	38006
Idler Pulley - Grooved; W/O A.C.	14102597	36177
Hose - Upper		22268
Hose - Lower		22237
Hose - By Pass		22210
Hose - Heater To Valve; W/Grumman Body(5/8" x 36")		28411
Hose - Valve To Eng.; W/Grumman Body(3/4" x 32")		28412
Hose - Rad. To Connector; W/Grumman Body(3/4" x 9")		28412
Hose Connector - Connector To Valve; W/Grumman Body(3/4" x 11")		28412
Hose - Valve To Heater; W/Grumman Body(5/8" x 36")		28411
Hose - Rad. To Reservoir		28465
GM V-8 8.1 L		
P Series		
Serpentine Belt; W/A.C.	W0000581	▲K061080HD
Serpentine Belt; W/O A.C.	12563076	▲K060994HD
Tensioner Assy.; W/A.C.	12561094	38103
Tensioner Assy.; W/O A.C.	12581203	38258
Tensioner Pulley; W/A.C.	12561094	38008
Tensioner Pulley; W/O A.C.	12581203	38006
Idler Pulley - Smooth; W/A.C.	12555609	36299
Idler Pulley - Grooved; W/O A.C.	10239930	38008
Hose - Upper		23803
Hose - Lower		21442
Hose - By Pass		19802
W22		
Serpentine Belt; W/A.C.	W0000581	▲K061080HD
Serpentine Belt; W/O A.C.	12563076	▲K060994HD
Tensioner Assy.; W/A.C.	12561094	38103
Tensioner Assy.; W/O A.C.	12581203	38258
Hose - Upper		23803
Hose - Lower		21442
Hose - By Pass		19802
2002		
GM V-6 4.3 L		
P Series		
Serpentine Belt; W/A.C.; W/105A. Alt.		K060966
Serpentine Belt; W/O A.C.; W/105A. Alt.		▲K060870HD
Tensioner Assy.		38103
Tensioner Pulley		38008
Idler Pulley - Smooth		38001
Idler Pulley - Grooved; W/O A.C.		38008
Hose - Upper		22266
Hose - Lower		22169
Hose - By Pass		19025
Hose - Heater To Reducer; (3/4" x 13")		28412
Hose - Reducer To W.P.; (5/8" x 38")		28411
Hose - Eng. To Valve; (5/8" x 28")		28411

Application	Mfr. Part No.	Our No.
WORKHORSE - Continued		
2002 - Continued		
GM V-6 4.3 L - Continued		
P Series - Continued		
Hose - Valve To Heater; (5/8" x 17")		28411
Hose - Rad. To Reservoir; (3/8" x 20")		28409
GM V-8 5.7 L		
P Series		
Belt - Fan, Alt., P.S. & A.C.	12564764	K060966
Belt - Fan, Alt. & P.S.	12564759	▲K060870HD
Tensioner Assy. - Fan, Alt. & P.S.	12561094	38103
Idler Pulley - Smooth		38001
Idler Pulley - Grooved; W/O A.C.		38008
Hose - Upper		22266
Hose - Lower		20843
Hose - By Pass		19025
Hose - Heater To Reducer; (3/4" x 13")		28412
Hose - Reducer To W.P.; (5/8" x 38")		28411
Hose - Eng. To Valve; (5/8" x 28")		28411
Hose - Valve To Heater; (5/8" x 17")		28411
Hose - Rad. To Reservoir; (3/8" x 20")		28409
GM V-8 6.5 L Diesel		
P Series		
Serpentine Belt; W/O A.C.; W/105A. Alt. ...	12555009	▲K061010HD
Serpentine Belt; W/O A.C.; W/145A. Alt. ...	12556338	▲K061020HD
Tensioner Assy.	12561092	38118
Tensioner Pulley	12561092	38006
Idler Pulley - Grooved; W/O A.C.	14102597	36177
Hose - Upper		22268
Hose - Lower		22237
Hose - By Pass		22210
Hose - Heater To Valve; W/Grumman Body(5/8" x 36")		28411
Hose - Valve To Eng.; W/Grumman Body(3/4" x 32")		28412
Hose - Rad. To Connector; W/Grumman Body(3/4" x 9")		28412
Hose Connector - Connector To Valve; W/Grumman Body(3/4" x 11")		28412
Hose - Valve To Heater; W/Grumman Body(5/8" x 36")		28411
Hose - Rad. To Reservoir		28465
GM V-8 7.4 L		
P Series		
Serpentine Belt; W/A.C.; W/124A., 145A. Alt.		▲K061000HD
Serpentine Belt; W/O A.C.; W/124A., 145A. Alt.		K060919
Tensioner Assy.		38103
Tensioner Pulley		38008
Idler Pulley - Smooth		38001
Idler Pulley - Grooved; W/O A.C.		38008
Hose - Upper		22265
Hose - Lower		21442
Hose - By Pass		≧19670
GM V-8 8.1 L		
P Series		
Serpentine Belt; W/A.C.	W0000581	▲K061080HD
Serpentine Belt; W/O A.C.	12563076	▲K060994HD
Tensioner Assy.; W/A.C.	12561094	38103
Tensioner Assy.; W/O A.C.	12581203	38258
Tensioner Pulley; W/A.C.	12561094	38008
Tensioner Pulley; W/O A.C.	12581203	38006
Idler Pulley - Smooth; W/A.C.	12555609	36299
Idler Pulley - Grooved; W/O A.C.	10239930	38008
Hose - Upper		23803
Hose - Lower		21442
Hose - By Pass		19802
2001		
GM V-6 4.3 L		
P Series		
Serpentine Belt; W/A.C.; W/105A. Alt.		K060966
Serpentine Belt; W/O A.C.; W/105A. Alt.		▲K060870HD
Tensioner Assy.		38103
Tensioner Pulley		38008
Idler Pulley - Smooth		38001
Idler Pulley - Grooved; W/O A.C.		38008

▲ Standard Belt Available. See Pages 630-631.

≧ Cut to Fit.

Belts and Coolant Hose for Medium/Heavy-Duty Trucks (1996 and Newer)

Medium & Heavy-Duty Trucks
(1996 & Newer)

Application	Mfr. Part No.	Our No.
WORKHORSE - Continued		
2001 - Continued		
GM V-6 4.3 L - Continued		
P Series - Continued		
Hose - Upper		22266
Hose - Lower		22169
Hose - By Pass		19025
Hose - Heater To Reducer; (3/4" x 13")		28412
Hose - Reducer To W.P.; (5/8" x 38")		28411
Hose - Eng. To Valve; (5/8" x 28")		28411
Hose - Valve To Heater; (5/8" x 17")		28411
Hose - Rad. To Reservoir; (3/8" x 20")		28409
GM V-8 5.7 L		
P Series		
Belt - Fan, Alt., P.S. & A.C.	12564764	K060966
Belt - Fan, Alt. & P.S.	12564759	▲K060870HD
Tensioner Assy. - Fan, Alt. & P.S.	12561094	38103
Idler Pulley - Smooth		38001
Idler Pulley - Grooved; W/O A.C.		38008
Hose - Upper		22266
Hose - Lower		20843
Hose - By Pass		19025
Hose - Heater To Valve; W/Grumman Body(5/8" x 6")		28411
Hose - Valve To Eng.; W/Grumman Body(5/8" x 22")		28411
Hose - W.P. To Heater; W/Grumman Body(5/8" x 41")		28411
Hose - Heater To Reducer; W/Workhorse Body(3/4" x 13")		28412
Hose - Reducer To W.P.; W/Workhorse Body(5/8" x 38")		28411
Hose - Eng. To Valve; W/Workhorse Body(5/8" x 28")		28411
Hose - Valve To Heater; W/Workhorse Body(5/8" x 17")		28411
Hose - Rad. To Reservoir; (3/8" x 20")		28409
GM V-8 6.5 L Diesel		
P Series		
Serpentine Belt; W/O A.C.; W/105A. Alt.	12555009	▲K061010HD
Serpentine Belt; W/O A.C.; W/145A. Alt.	12556338	▲K061020HD
Tensioner Assy.	12561092	38118
Tensioner Pulley	12561092	38006
Idler Pulley - Grooved; W/O A.C.	14102597	36177
Hose - Upper		22268
Hose - Lower		22237
Hose - By Pass		22210
Hose - Heater To Valve; W/Grumman Body(5/8" x 36")		28411
Hose - Valve To Eng.; W/Grumman Body(5/8" x 32")		28411
Hose - Rad. To Connector; W/Grumman Body(3/4" x 9")		28412
Hose Connector - Connector To Valve; W/Grumman Body(3/4" x 11")		28412
Hose - Valve To Heater; W/Grumman Body(5/8" x 36")		28411
Hose - Rad. To Reservoir		28465
GM V-8 7.4 L		
P Series		
Serpentine Belt; W/A.C.; W/124A., 145A. Alt.		▲K061000HD
Serpentine Belt; W/O A.C.; W/124A., 145A. Alt.		K060919
Tensioner Assy.		38103
Tensioner Pulley		38008
Idler Pulley - Smooth		38001
Idler Pulley - Grooved; W/O A.C.		38008
Hose - Upper		22265
Hose - Lower		21442
Hose - By Pass		≧19670
GM V-8 8.1 L		
P Series		
Serpentine Belt; W/A.C.	W0000581	▲K061080HD
Tensioner Assy.	12561094	38103
Tensioner Pulley; W/A.C.	12561094	38008
Idler Pulley - Smooth; W/A.C.	12555609	36299
Idler Pulley - Grooved; W/O A.C.	10239930	38008
Hose - Upper		23803
Hose - Lower		21442
Hose - By Pass		19802

Application	Mfr. Part No.	Our No.
WORKHORSE - Continued		
2000		
GM V-6 4.3 L		
P Series		
Serpentine Belt; W/A.C.; W/105A. Alt.		K060966
Serpentine Belt; W/O A.C.; W/105A. Alt.		▲K060870HD
Tensioner Assy.		38103
Tensioner Pulley		38008
Idler Pulley - Smooth		38001
Idler Pulley - Grooved; W/O A.C.		38008
Hose - Upper		22266
Hose - Lower		22169
Hose - By Pass		19025
Hose - Heater To Reducer; (3/4" x 13")		28412
Hose - Reducer To W.P.; (5/8" x 38")		28411
Hose - Eng. To Valve; (5/8" x 28")		28411
Hose - Valve To Heater; (5/8" x 17")		28411
Hose - Rad. To Reservoir; (3/8" x 20")		28409
GM V-8 5.7 L		
P Series		
Belt - Fan, Alt., P.S. & A.C.	12564764	K060966
Belt - Fan, Alt. & P.S.	12564759	▲K060870HD
Tensioner Assy. - Fan, Alt. & P.S.	12561094	38103
Tensioner Pulley		38008
Idler Pulley - Smooth		38001
Idler Pulley - Grooved; W/O A.C.		38008
Hose - Upper		22266
Hose - Lower		20843
Hose - By Pass		19025
Hose - Heater To Eng.; W/Grumman Body(5/8" x 48")		28411
Hose - Eng. To Valve; W/Grumman Body(5/8" x 30")		28411
Hose - Valve To Heater; W/Grumman Body(5/8" x 6")		28411
Hose - Rad. To Reservoir; W/Grumman Body(3/8" x 20")		28409
Hose - Heater To Restrictor; W/Union City Body(3/4" x 9")		28412
Hose - Restrictor To W.P.; W/Union City Body(5/8" x 36")		28411
Hose - Eng. To Valve; W/Union City Body(5/8" x 27")		28411
Hose - Valve To Heater; W/Union City Body(5/8" x 13")		28411
GM V-8 6.5 L Diesel		
P Series		
Serpentine Belt; W/O A.C.; W/105A. Alt.	12555009	▲K061010HD
Serpentine Belt; W/O A.C.; W/145A. Alt.	12556338	▲K061020HD
Tensioner Assy.	12561092	38118
Tensioner Pulley	12561092	38006
Idler Pulley - Grooved; W/O A.C.	14102597	36177
Hose - Upper		22268
Hose - Lower		22237
Hose - By Pass		22210
Hose - Heater To Valve; W/Grumman Body(5/8" x 36")		28411
Hose - Valve To Eng.; W/Grumman Body(5/8" x 32")		28411
Hose - Rad. To Connector; W/Grumman Body(3/4" x 9")		28412
Hose Connector - Connector To Valve; W/Grumman Body(3/4" x 11")		28412
Hose - Valve To Heater; W/Grumman Body(5/8" x 36")		28411
Hose - Rad. To Reservoir		28465
GM V-8 7.4 L		
P Series		
Serpentine Belt; W/A.C.; W/124A., 145A. Alt.		▲K061000HD
Serpentine Belt; W/O A.C.; W/124A., 145A. Alt.		K060919
Tensioner Assy.		38103
Tensioner Pulley		38008
Idler Pulley - Smooth		38001
Idler Pulley - Grooved; W/O A.C.		38008
Hose - Upper		22265
Hose - Lower		21442
Hose - By Pass		≧19670
1999		
GM V-8 7.4 L		
P Series		
Serpentine Belt; W/A.C.; W/124A., 145A. Alt.		▲K061000HD
Serpentine Belt; W/O A.C.; W/124A., 145A. Alt.		K060919
Tensioner Assy.		38103
Tensioner Pulley		38008
Idler Pulley - Smooth		38001
Idler Pulley - Grooved; W/O A.C.		38008
Hose - Upper		22265
Hose - Lower		21442
Hose - By Pass		≧19670

▲ Standard Belt Available. See Pages 630-631.

≧ Cut to Fit.

Medium & Heavy-Duty Trucks
(1996 & Newer)

Application	Mfr. Part No.	Our No.
WORKHORSE - Continued		
1999 - Continued		
GM V-8 7.4 L - Continued		
P Series - Continued		
Tensioner Pulley		38008
Idler Pulley - Smooth		38001
Idler Pulley - Grooved; W/O A.C.		38008
Hose - Upper		22265
Hose - Lower		21442
Hose - By Pass		☞19670

☞ Cut to Fit.

Belts for Truck Refrigeration Units

Order Belts and Hose by Our Number. Manufacturers' Part Number is shown for reference only.

Application	Mfr. Part No.	Our No.	Application	Mfr. Part No.	Our No.
ARCTIC TRAVELER			THERMO KING - Continued		
B			D3 Series		
Gen.	S751	♣9370HD	W.P. & Alt.	78459	ⓂAX46
Challenger			D4M1		
Compr.	4750109	ⓂB42	Alt.	78285	Ⓜ♣9470HD
Mtr.	4750108	ⓂB46	Compr.	78385	ⓂB59
FD10			FB2; FB2-M5		
Fan; 1967 & Newer		BX133	Alt.	78317	♣9400HD
Alt.		♣9400HD	W.P.	78289	♣9319HD
TE750			Gen.	071242	♣9290HD
Alt.; 1967 & Newer		♣9400HD	GA		
CARRIER			Starter		
Supra 550				78195	♣9330HD
W.P.	253485600	3VX315	GL		
Supra 622; Supra 644			Fan & Compr.		
Mtr. To Compr.	500016253	AX47			ⓂBX90
Compr.; W/Standby Mtr.	500017823	BX45	HA		
Alt.	506000602	♣9365HD	Drive		
W.P.	506019704	3VX315		78144	ⓂA66
Supra 922; Supra 944			HK 30; HK 60; HK 100		
Mtr. To Compr.	500017857	BX54	W.P. & Alt.	78272	♣9380HD
Compr.; W/Standby Mtr.	500017858	BX56	HM		
Alt.	506000602	♣9365HD	Drive		
THERMO KING				78144	ⓂA66
B1			J		
Drive	78280	Ⓜ3VX450	Compr.		
C; CA				78164	♣9350HD
Gen.		♣9385HD	JD-I 30		
CB-I			W.P.		
Compr.	78544	AX42		78679	9279
CB-II			JD-I 50		
Compr.	78272	♣9380HD	W.P.		
CB-III				78272	♣9380HD
Compr.	78544	AX42	KD-I		
CBCI			Fan		
Compr.; W/York or Sanden Compr.	78733	5536		78498	AX64
CG			W.P.; W/O Alt.		
Gen.	78232	♣9341HD		78434	♣9313HD
Compr.	78267	♣9350HD	W.P. & Alt.		
Mtr.; W/Electric Mtr.	78244	Ⓜ♣9400HD		78341	5521
CGS1250			Compr.; W/Standby Mtr.		
Fan	78297	Ⓜ5516		78486	2/3VX630
CM			KD-II		
Gen.		♣9395HD	Fan - Right Side		
Crown 500				78684	3V315
Fan	78322	5524	Fan & Alt. - Left Side		
Alt.	78232	♣9341HD		78689	5508
D1 Series			W.P.		
Alt.; W/35A. Alt.	78511	AX37		78700	9279
W.P. & Alt.; W/125A. Alt.	78459	AX46	Elec. Mtr. To Compr.; Mar. 1988 & Older		
D2M2				78700	5529
Alt.	78285	Ⓜ♣9470HD	Evap. Fan & Alt.		
Compr.	78385	ⓂB59		78688	3V300
			Mtr. To Compr.		
				78688	5502
			KL 10		
			Fan & Compr.		
				78129	ⓂBX90
			KL 20		
			Fan & Compr.		
				78173	BX55
			KL 30; KL 40; KL 40S		
			Fan & Compr.		
				78129	ⓂBX90
			KL 50		
			Fan & Compr.		
				78173	BX55
			KL 62		
			Fan		
				78172	BX82
			Fan & Compr.; W/Single Phase		
				78173	BX55
			KLA		
			Fan		
				78172	BX82
			Alt.		
				78212	B48
			KR		
			Compr.		
				78205	ⓂB58

Refrigeration Units

♣ Standard Belt Available. See Pages 630-631.

Ⓜ Two Required.

Belts for Truck Refrigeration Units

Refrigeration Units

Application	Mfr. Part No.	Our No.
THERMO KING - Continued		
LC		
Mtr.	78238	B68
LND 30		
Fan & Alt.	78608	B71
W.P.	78513	▲9305HD
Idler To Fan Shaft	78606	B30
Clutch	78628	ⓂBX50
Mtr. To Idler; W/Single Belt	78607	B81
LND 30 PEG		
Fan & Alt.	78608	B71
W.P.	78513	▲9305HD
Idler	78606	B30
Mtr. To Idler	78607	B81
LND 50		
Fan - From Idler	78671	5510
W.P.; W/31" Belt O.C.		▲9305HD
W.P.; W/32" Belt O.C.		▲9313HD
Compr.	78628	ⓂBX50
Mtr. To Idler - Fan	78649	5538
LND 50 PEG		
W.P.	78513	▲9305HD
Mtr. To Idler	78649	5538
LR		
Fan & Alt.	78506	5509
W.P.	78513	▲9305HD
Drive	78518	5500
Elec. Mtr.; W/220/380V., 50 Hz Mtr.		5513
Elec. Mtr.; W/230/460V., 60 Hz Mtr.		5511
LR-I		
Alt.	78518	5509
W.P.; W/31" Belt O.C.		▲9305HD
W.P.; W/32" Belt O.C.		▲9313HD
Elec. Mtr. To Compr.; Mtr. No. 4640C44H02	78509	5511
Elec. Mtr. To Compr.; Mtr. No. 4107D31H02	78512	5513
Mtr. To Compr.	78518	5500
M13; M15		
Fan	78214	5525
Alt.	78232	▲9341HD
M22		
Compr.	78239	▲9530HD
MD-I		
Alt.	78561	5519
W.P. & Alt.; W/2-Pulley System	78513	▲9305HD
W.P. & Alt.; W/3-Pulley System	78503	▲9430HD
Evap. Fan, Elec. Mtr. & Idler	78436	5520
Compr.; W/Standby Mtr.	78436	5520
Compr. - From Clutch; 50D	78591	5522
MD-II		
Alt.; W/O KD-II Sheaves	78700	3V300
Fan - Right Side; W/KD-II Sheaves		3V315
Fan & Alt. - Left Side; W/KD-II Sheaves	78684	5508
W.P.		9279
Compr. & Idler; W/O KD-II Sheaves	78688	5502
Elec. Mtr. & Compr.; Feb. 1988 & Older	78689	5529
Elec. Mtr. & Compr.; Jan. 1989 & Newer; W/O KD-II Sheaves	78679	9279
Evap. Fan & Alt.; W/KD-II Sheaves	78700	3V300
Evap. Fan, Alt. & Compr.; W/O KD-II Sheaves	78684	5508
Mtr. To Compr.; W/KD-II Sheaves	78688	5502
MW		
Fan	78197	▲9510HD
Gen.	78111	▲9370HD

▲ Standard Belt Available. See Pages 630-631.

Application	Mfr. Part No.	Our No.
THERMO KING - Continued		
MWC 10		
Alt.	78232	▲9341HD
MWC 20		
Alt.	78265	9300
MWC 30		
Alt.	78232	▲9341HD
MWC 40; MWC 50		
Alt.	78265	9300
MWCL 25; MWCT		
Drive	78112	Ⓜ6234
NFD		
Gen.	78204	▲9480HD
NSD1-1012		
W.P. & Alt.	78397	ⓂA43
NWD		
Fan; New Style	78278	5524
Alt.; New Style	78272	▲9380HD
W.P.; New Style	78275	▲9447HD
W.P. & Gen.; Old Style	78204	▲9480HD
Drive; Ser. No. 101 Thru 126	78202	BX128
Drive; Ser. No. 127 Thru 206	78213	BX124
NWD 30 3000		
Fan & Idler	78278	5524
Alt.	78272	▲9380HD
W.P.	78315	9279
NWD 30 3005		
W.P.	78336	▲9290HD
Alt.	78272	▲9380HD
NWD 30 3006		
Alt.	78232	▲9341HD
NWD 30 3100 Series		
Fan & Idler	78278	5524
Alt.	78272	▲9380HD
Alt. To W.P.	78336	▲9290HD
NWD 30 AM4; NWD 30 AM6		
Alt.	78110	ⓂA45
NWD 30 AM7		
Alt.	78137	BX55
NWD 30 M4		
Fan; New Style	78214	5525
Fan; Old Style; W/115" Belt O.C.	78241	BX112
Fan; Old Style; W/118" Belt O.C.	78214	5525
Alt. - From Eng.; New Style	78272	▲9380HD
Alt. - From Fan; New Style	78223	▲9580HD
W.P.; New Style	78275	▲9447HD
W.P. & Gen.; Old Style	78204	▲9480HD
Drive; Old Style	78242	BX120
NWD 30 M10A		
Fan; W/115" Belt O.C.	78241	BX112
W.P. & Gen.	78204	▲9480HD
Drive; Old Style	78241	BX112
NWD 30 M20		
Fan	78241	BX112
Alt. - From Mtr.	78272	▲9380HD
Alt. - From Fan	78223	▲9580HD
W.P.	78275	▲9447HD
NWD 30 M22		
Fan	78241	BX112

Ⓜ Two Required.

Belts for Truck Refrigeration Units

Refrigeration Units

Application	Mfr. Part No.	Our No.
THERMO KING - Continued		
NWD 30 M22 - Continued		
Alt. - From Mtr.	78272	♣9380HD
W.P.	78275	♣9447HD
NWD 30 M30		
Alt. - From Fan	78223	♣9580HD
NWD 30 M35		
Fan	78241	BX112
Alt. - From Mtr.	78272	♣9380HD
Alt. - From Fan	78223	♣9580HD
W.P.	78275	♣9447HD
NWD 30 M46		
Fan	78241	BX112
Alt. - From Mtr.	78272	♣9380HD
Alt. - From Fan		♣9570HD
W.P.	78275	♣9447HD
NWD 30 M50		
W.P.	78275	♣9447HD
NWD 30 M100; NWD 30 M1212		
Fan & Idler	78278	5524
Alt.	78272	♣9380HD
W.P.	78315	9279
NWD 35 AM6; NWD 35 AM7; NWD 35 AM8		
Fan	78278	Ⓣ5524
Alt.	78110	ⓉAX48
W.P. & Gen.	78264	♣9570HD
NWD 35 M4		
Fan	78242	BX120
NWD 35 M5		
Fan: Old Style	78242	BX120
W.P.; New Style	78275	♣9447HD
W.P. & Alt.; New Style	78272	♣9380HD
W.P. & Gen.; New Style	78204	♣9480HD
NWD 35 M21		
W.P.	78275	♣9447HD
W.P. & Alt.	78272	♣9380HD
W.P. & Gen.	78204	♣9480HD
NWD 50		
Fan: Old Style	78270	BX144
Fan: New Style		A144
Alt.	78362	9260
W.P.	78275	♣9447HD
Compr.	78368	ⓉB50
NWD 50 3000		
Fan	78287	A144
Alt.	78362	9260
W.P.	78328	♣9476HD
Elec. Mtr.		ⓉB50
NWD 50 3011		
Fan	78287	A144
W.P.	78275	♣9447HD
NWD 50 3100 Series		
Fan & Idler	78287	A144
Alt.	78362	9260
W.P.	78328	♣9476HD
Elec. Mtr.		ⓉB50
NWD 50 M207		
Fan	78287	A144
W.P.	78275	♣9447HD
NWD 62		
W.P.	78268	♣9451HD

Application	Mfr. Part No.	Our No.
THERMO KING - Continued		
NWD 62 - Continued		
Gen.	78255	AX46
NWD 62 30M5		
Fan	78242	BX120
NWD 62 50		
Fan	78270	BX144
Alt.	78266	6825
W.P.	78268	♣9451HD
NWD 622 30M10A		
Fan	78241	BX112
W.P. & Gen.	78204	♣9480HD
NWD (Super & Crown)		
Alt.	78232	♣9341HD
W.P. & Alt.	78429	♣9420HD
NWD-AM1		
Alt.	78223	♣9580HD
Drive: W/30A. Alt.	78214	5525
NWD-AM3		
Fan	78278	Ⓣ5524
Alt.; Old Style; W/30A. Alt.	78223	♣9580HD
Alt.; Old Style; W/O 30A. Alt.	78110	ⓉA48
W.P. & Alt.	78223	♣9580HD
W.P. & Gen.	78264	♣9570HD
Drive: W/30A. Alt.	78214	5525
NWD-AM4		
Fan	78278	Ⓣ5524
Alt.; Old Style	78110	ⓉA48
W.P. & Alt.	78223	♣9580HD
W.P. & Gen.	78264	♣9570HD
Drive: Old Style; W/30A. Alt.	78214	5525
NWD-AM8		
Alt.; New Style	78110	A45
Alt.; Old Style	78110	ⓉA48
NWE MAX		
Fan	78487	A48
NWG		
Fan	78230	BX100
W.P.	78231	TR22386
RCD		
Fan	78287	A144
W.P.	78328	♣9476HD
RD-I 30; RD-I 50		
Fan	78494	5530
Alt.	78434	♣9440HD
W.P.; W/2-Pulley System	78513	♣9305HD
W.P.; W/3-Pulley System	78494	5530
Compr.; W/R12 Coolant	78495	5504
Compr.; W/R502 Coolant	78500	5512
Elec. Mtr. & Compr.; W/R12 Coolant	78436	5520
Elec. Mtr. & Compr.; W/R502 Coolant	78510	5503
RD-I SSIV		
W.P.	78513	♣9305HD
Compr.; W/R12 Coolant	78495	5504
Compr.; W/R502 Coolant	78500	5512
Elec. Mtr. & Compr.; W/R12 Coolant	78436	5520
Elec. Mtr. & Compr.; W/R502 Coolant	78510	5503
Evap. Fan & Alt.	78666	A53
Evap. Fan, Alt. & Compr.; W/R12 Coolant	78494	5530
Evap. Fan, Alt. & Compr.; W/R502 Coolant	78646	AX66
RD-II		
W.P. & Alt.	78434	♣9440HD

♣ Standard Belt Available. See Pages 630-631.

Ⓣ Two Required.

Belts for Truck Refrigeration Units

Refrigeration Units

Application	Mfr. Part No.	Our No.
THERMO KING - Continued		
RD-II - Continued		
Compr. To Fan	78494	5530
Elec. Mtr. To Compr.	78510	5503
Evap. Fan & Compr.	78698	3VX600
Evap. Fan & Alt.	78666	A53
Mtr. To Compr.; W/67" Belt O.C.	78500	5512
Mtr. To Compr.; W/65" Belt O.C.	78495	5504
RL		
Fan & Idler	78132	BX90
Elec. Mtr.	78153	ⓉB44
RL 20; RL 50		
Fan & Compr.	78132	BX90
Clutch	78146	♣9470HD
Compr.; Ser. No. 876756	78146	Ⓣ♣9470HD
Compr.; Old Style	78153	ⓉB44
RLA		
Drive	78212	B48
RLD		
Fan	78320	A112
W.P. & Alt.	78319	♣9510HD
ROL 30		
Fan; Ser. No. 1510 & After	78172	BX82
ROL 40		
Fan	78185	BX90
ROL 50		
Fan; Ser. No. 1510 & After	78172	BX82
RT		
Blower	78107	A68
SB-I 30		
Fan	78470	5523
W.P. & Alt.	78471	♣9465HD
SB-I 50		
Fan & Idler	78577	B190
Alt.	78521	A26
W.P.	78267	♣9350HD
Elec. Mtr.	78535	B49
SB-I 1000; SB-I 1200; SB-I 2000		
Fan; W/High Performance Output	78470	5523
Fan; W/O High Performance Output	78553	5535
W.P. & Alt.; W/47" Belt O.C.	78471	♣9465HD
W.P. & Alt.; W/57" Belt O.C.	78556	AX55
SB-I 5300		
Fan & Idler	78470	5523
Alt. To Compr.	78572	B60
W.P. & Alt.	78471	♣9465HD
SB-II 30		
Fan; W/2-Speed Fan	78695	A58
Fan; W/O 2-Speed Fan	78603	BX59
W.P. & Alt.; W/37A. Alt.	78751	♣9463HD
W.P. & Alt.; W/65A., 72A. Alt.	78471	♣9465HD
Idler; W/2-Speed Fan	78694	6884
Idler; W/O 2-Speed Fan	78604	BX83
SB-II 30 1500 AC; SB-II 30 1500 PEG		
Fan	78603	BX59
W.P. & Alt.; Nov. 1, 1987 & Older; W/37A. Alt.	78667	♣9476HD
W.P. & Alt.; Nov. 2, 1987 & Newer	78471	♣9465HD
Idler	78604	BX83
SB-II 30 DELTA		
Fan; W/2-Speed Fan	78695	A58
W.P. & Alt.	78751	♣9463HD

Application	Mfr. Part No.	Our No.
THERMO KING - Continued		
SB-II 30 DELTA - Continued		
Idler; W/2-Speed Fan	78694	6884
SB-II 30 PEG		
Fan; W/2-Speed Fan	78695	A58
Fan; W/O 2-Speed Fan	78603	BX59
W.P. & Alt.; W/37A. Alt.	78751	♣9463HD
W.P. & Alt.; W/65A., 72A. Alt.	78471	♣9465HD
Idler; W/2-Speed Fan	78694	6884
Idler; W/O 2-Speed Fan	78604	BX83
SB-II 50; SB-II 50 TC		
Fan & Idler; W/2-Speed Trans.	78731	A84
Fan & Idler; W/O 2-Speed Trans.	78629	5537
Alt.	78339	A38
W.P.	78289	♣9319HD
Compr.	78535	ⓉB49
SB-II C201		
Fan	78603	BX59
W.P. & Alt.; W/37A. Alt.	78751	♣9463HD
Idler	78604	BX83
SB-II Convertible		
Fan; W/Reverse Air	78637	BX61
Fan; W/O Reverse Air	78603	BX59
Fan; W/2-Speed Fan	78695	A58
W.P. & Alt.; W/37A. Alt.	78751	♣9463HD
W.P. & Alt.; W/65A., 72A. Alt.	78471	♣9465HD
Idler; W/2-Speed Fan	78694	6884
Idler; W/O 2-Speed Fan	78604	BX83
SB-II HP		
Fan	78603	BX59
Idler	78604	BX83
SB-II Max		
Fan	78629	5537
SB-II Max 30		
Fan & Idler; W/2-Speed Fan	78695	A58
Fan & Idler; W/O 2-Speed Fan	78603	BX59
W.P. & Alt.; W/37A. Alt.	78751	♣9463HD
W.P. & Alt.; W/65A. Alt.	78471	♣9465HD
Idler; W/2-Speed Fan	78694	6884
Idler; W/O 2-Speed Trans.	78604	BX83
SB-II Max 50 EEC		
Alt.		♣9440HD
W.P.		♣9319HD
SB-II Max Plus		
Fan	78603	BX59
W.P. & Alt.; W/37A. Alt.	78751	♣9463HD
Idler	78604	BX83
SB-II PE		
Fan; W/2-Speed Fan	78695	A58
Fan; W/O 2-Speed Fan	78603	BX59
W.P. & Alt.; W/37A. Alt.	78751	♣9463HD
W.P. & Alt.; W/65A., 72A. Alt.	78471	♣9465HD
Idler; W/2-Speed Fan	78694	6884
Idler; W/O 2-Speed Fan	78604	BX83
SB-II Reverse Air		
Fan	78637	BX61
W.P. & Alt.; W/37A. Alt.	78751	♣9463HD
W.P. & Alt.; W/65A., 72A. Alt.	78471	♣9465HD
Idler; W/2-Speed Fan	78694	6884
Idler; W/O 2-Speed Fan	78604	BX83
SB-II TC		
Fan; W/2-Speed Fan	78695	A58
Fan; W/O 2-Speed Fan	78603	BX59
W.P. & Alt.; W/37A. Alt.	78751	♣9463HD

Ⓣ Two Required.
Ⓣ Three Required.

♣ Standard Belt Available. See Pages 630-631.

Belts for Truck Refrigeration Units

Refrigeration Units

Application	Mfr. Part No.	Our No.
THERMO KING - Continued		
SB-II TC - Continued		
W.P. & Alt.; W/65A., 72A. Alt.	78471	♣9465HD
Idler; W/2-Speed Fan	78694	6884
Idler; W/O 2-Speed Fan	78604	BX83
SB-II Tracker		
Fan; W/Reverse Air	78637	BX61
Fan; W/O Reverse Air	78603	BX59
Fan; W/2-Speed Fan	78695	A58
W.P. & Alt.; W/37A. Alt.	78751	♣9463HD
W.P. & Alt.; W/65A., 72A. Alt.	78471	♣9465HD
Idler; W/2-Speed Fan	78694	6884
Idler; W/O 2-Speed Fan	78604	BX83
SB-III 30 TC		
Fan	78603	BX59
W.P. & Alt.	78629	5537
Idler	78604	BX83
SB-III Max 30		
Fan; W/Sound Insulation Pkg.	78637	BX61
Fan; W/O Sound Insulation Pkg.	78603	BX59
Fan & Idler	78629	5537
W.P. & Alt.; W/Sound Insulation Pkg.	78639	A48
SB-III Max 50		
Alt.	78434	♣9440HD
W.P.	78289	♣9319HD
Compr.	78535	ⓂB49
SB-III SR; SB-III SRMP Plus		
Fan	78603	BX59
W.P. & Alt.; Mar. 1991 & Older	78751	♣9463HD
Idler	78629	5537
SB-III TC Max		
Fan	78603	BX59
W.P. & Alt.	78751	♣9463HD
Idler	78604	BX83
SD-I 1012; SD-I 1013		
W.P. & Alt.; W/120A. Alt.	78459	Ⓜ♣9480HD
W.P. & Alt.; W/125A. Alt.	78397	ⓂA43
Sentry 30		
Fan; W/High Performance Output	78560	AX53
Fan; W/O High Performance Output	78556	AX55
W.P. & Alt.; W/37A. Alt.	78471	♣9465HD
Idler	78555	5517
Sentry 30 1000; Sentry 30 1200		
Fan; W/High Performance Output	78560	AX53
Fan; W/O High Performance Output	78556	AX55
W.P. & Alt.; W/12A. Alt.	78267	♣9350HD
Idler	78555	5517
Sentry 30 2000		
Fan; W/High Performance Output	78560	AX53
Fan; W/O High Performance Output	78556	AX55
W.P. & Alt.	78471	♣9465HD
Idler	78555	5517
Sentry 30 PEG		
Fan; W/High Performance Output	78560	AX53
Fan; W/O High Performance Output	78556	AX55
W.P. & Alt.; W/37A. Alt.	78471	♣9465HD
Idler	78555	5517
Sentry 50 1000; Sentry 50 1200		
Fan; W/High Performance Output	78560	AX53
Fan; W/O High Performance Output	78556	AX55
Fan - From Alt.	78583	A120
Alt.; W/12A. Alt.	78580	2210
W.P.	78267	♣9350HD
Elec. Mtr.	78368	ⓂB50

Application	Mfr. Part No.	Our No.
THERMO KING - Continued		
Sentry 50 1000; Sentry 50 1200 - Continued		
Idler	78655	A120
Sentry 50 2000		
Fan; W/High Performance Output	78560	AX53
Fan; W/O High Performance Output	78556	AX55
Fan - From Alt.	78583	A120
Alt.; W/37A. Alt.	78362	9260
W.P.	78267	♣9350HD
Elec. Mtr.	78368	ⓂB50
Idler	78655	A120
Sentry 50 Convertible		
Fan - From Mtr.	78654	6861
Fan - From Alt.	78655	A120
Alt.; W/13A. Alt.	78580	2210
Alt.; W/37A. Alt.; W/Remote Mount Regulator	78266	6825
Alt. - Evap. Unit	78497	Ⓜ5533
Idler	78656	Ⓜ5525
Sentry DI 30		
Fan; W/R12, R22 Coolant	78556	AX55
Fan; W/R502 Coolant	78560	AX53
W.P. & Alt.	78751	♣9463HD
W.P. & Alt.; W/65A. Alt.; Nov. 2, 1987 & Newer	78471	♣9465HD
W.P. & Alt.; Nov. 1, 1987 & Older	78667	♣9476HD
Sentry DI 30 PE; Sentry DI 30 PEG		
Fan; W/R12 Coolant	78556	AX55
Fan; W/R502 Coolant	78560	AX53
W.P. & Alt.; W/37A. Alt.; Nov. 2, 1987 & Newer	78751	♣9463HD
W.P. & Alt.; W/65A. Alt.; Nov. 2, 1987 & Newer	78471	♣9465HD
W.P. & Alt.; Nov. 1, 1987 & Older	78667	♣9476HD
Sentry DI 50		
Fan; W/Power Tray	78655	ⓂA120
Fan; W/O Power Tray	78654	6861
Alt.; W/Power Tray; W/13A. Alt.	78580	2210
Alt.; W/Power Tray; W/37A. Alt.; W/Remote Mount Regulator	78266	6825
W.P.	78648	A29
Idler	78656	5525
Mtr.; W/Power Tray	78617	Ⓜ5533
Sentry DI Convertible		
Fan; W/R502 Coolant	78560	AX53
W.P. & Alt.; W/37A. Alt.	78751	♣9463HD
W.P. & Alt.; W/65A. Alt.	78471	♣9465HD
Sentry DI Convertible PE		
Alt.	78671	Ⓜ5533
Sentry DI TC		
Fan	78666	A53
W.P. & Alt.; W/65A. Alt.; Nov. 2, 1987 & Newer	78471	♣9465HD
W.P. & Alt.; Nov. 1, 1987 & Older	78667	♣9476HD
Sentry TC Convertible		
Fan; W/R12 Coolant	78556	AX55
Fan; W/R502 Coolant	78560	AX53
W.P. & Alt.	78751	♣9463HD
SKF		
Drive	78187	A38
SRL		
Fan; Old Style	78132	BX90
Fan & Compr.; New Style	78132	BX90
Fan & Idler; New Style	78132	BX90
Elec. Mtr.; New Style	78153	ⓂB44
SRL-50		
Fan	78153	B44
SROL		
Fan	78261	BX82
Compr.	78262	ⓂBX128

♣ Standard Belt Available. See Pages 630-631.

Ⓜ Two Required.

Belts for Truck Refrigeration Units

Refrigeration Units

Application	Mfr. Part No.	Our No.
THERMO KING - Continued		
STB-I; STB-II; STB-III		
Elec. Mtr. To Compr.; W/1/2" Pulley	78587	AX35
Super GS		
Fan & Compr.	78232	▲9341HD
W.P.	78339	A38
Super II 30		
Fan	78717	5506
W.P. & Alt.; W/37A. Alt.	78751	▲9463HD
W.P. & Alt.; W/65A. Alt.	78471	▲9465HD
Super II 30 Dehumidifier; Super II 30 Max; Super II 30 TC		
Fan	78717	5506
W.P. & Alt.	78471	▲9465HD
Super II 50		
Alt.	78266	6825
W.P.	78648	A29
Clutch	78723	ⓉBX48
Super MAX		
Fan; W/Reverse Air	78637	BX61
Fan; W/O Reverse Air	78603	BX59
Fan; W/2-Speed Fan	78695	A58
W.P. & Alt.; W/37A. Alt.	78695	A58
Idler; W/2-Speed Fan	78694	6884
Idler; W/O 2-Speed Fan	78604	BX83
Super NWD		
Alt.	78232	▲9341HD
Gen.	78397	A43
Super NWD 30		
Fan	78278	5524
Fan - From Idler	78556	AX55
Alt.; W/34 1/2" Belt O.C.	78232	▲9341HD
Alt.; W/38 1/2" Belt O.C.	78272	▲9380HD
W.P.	78453	2300
Super NWD 30 5154 BP		
Fan & W.P.	78241	BX112
Alt.	78232	▲9341HD
Super NWD 30 5200 AMG		
Fan & W.P.	78214	5525
Alt.; W/55A. Alt.	78467	▲9341HD
Alt. - Evap. Unit	78497	Ⓣ5533
Super NWD 30 5237 ESP		
Fan & W.P.	78214	5525
Alt.	78467	▲9341HD
Super NWD 30 5300		
Fan & W.P.	78214	5525
Alt.	78467	▲9341HD
W.P. & Alt.	78471	▲9465HD
Super NWD 30 5300 AMG		
Fan	78214	5525
Alt. - Evap. Unit	78497	Ⓣ5533
W.P. & Alt.; W/55A. Alt.	78471	▲9465HD
Super NWD 30 PE 1000; Super NWD 30 PE 1200		
Fan; W/High Performance Output	78214	5525
Fan; W/O High Performance Output	78556	AX55
Alt. - Evap. Unit	78497	Ⓣ5533
W.P. & Alt.	78471	▲9465HD
Idler	78557	5518
Super NWD 30 PE 5000; Super NWD 30 PE 5100; Super NWD 30 PE 5200		
Fan & W.P.	78214	5525

Application	Mfr. Part No.	Our No.
THERMO KING - Continued		
Super NWD 30 PE 5000; Super NWD 30 PE 5100; Super NWD 30 PE 5200 - Continued		
Alt.	78467	▲9341HD
Super NWD 50		
Fan	78287	A144
Fan - From Alt.	78287	A144
Alt.	78362	9260
W.P.	78328	▲9476HD
Elec. Mtr.	78368	ⓉB50
Super NWD 50 5000; Super NWD 50 5100		
Fan	78287	A144
Alt.	78362	9260
W.P. & Idler	78339	A38
Elec. Mtr.	78368	ⓉB50
Super NWD 50 5200		
Fan; W/Power Tray	78655	ⓉA120
Fan; W/O Power Tray	78287	A144
Alt.; W/Power Tray; W/13A. Alt.	78580	2210
Alt.; W/Power Tray; W/37A. Alt.	78362	9260
Alt.; W/O Power Tray	78362	9260
W.P.	78267	▲9350HD
W.P. & Idler	78339	A38
Clutch	78368	ⓉB50
Mtr.; W/Power Tray	78617	Ⓣ5533
Super NWD 50 5200 AMG		
Fan	78287	A144
Alt.	78362	9260
W.P.	78267	▲9350HD
Clutch	78368	ⓉB50
Mtr.; W/Power Tray	78368	ⓉB50
Super NWD 50 5237 ESP		
Fan	78287	A144
Alt.	78362	9260
W.P. & Idler	78339	A38
Elec. Mtr.	78368	ⓉB50
Super NWD 50 5300		
Fan; W/Power Tray	78655	ⓉA120
Fan; W/O Power Tray	78287	A144
Alt.; W/Power Tray; W/13A. Alt.	78580	2210
Alt.; W/Power Tray; W/37A. Alt.	78583	A120
W.P.	78267	▲9350HD
Mtr.; W/Power Tray	78368	ⓉB50
Super NWD 50 5300 AMG		
Fan	78287	A144
Alt.	78362	9260
W.P.	78267	▲9350HD
Clutch	78368	ⓉB50
Mtr.; W/Power Tray	78368	ⓉB50
Super NWD 50 SS TV		
Fan	78362	9260
W.P.	78339	A38
Clutch	78368	ⓉB50
Super NWD 5137		
Fan & W.P.	78214	5525
Alt.	78467	▲9341HD
Super NWD 5137 AMG		
Fan	78287	A144
Alt.	78362	9260
W.P. & Idler	78339	A38
Elec. Mtr.	78368	ⓉB50
Super NWD LR		
Fan & Alt.		5509
Elec. Mtr. To Compr.; Mtr. No. 4640C44H02	78509	5511

▲ Standard Belt Available. See Pages 630-631.

Ⓣ Two Required.

Belts for Truck Refrigeration Units

Refrigeration Units

Application	Mfr. Part No.	Our No.
THERMO KING - Continued		
Super NWD LR - Continued		
Elec. Mtr. To Compr.; Mtr. No. 4107D31H002	78512	5513
Mtr. To Compr.	78518	5500
Super XMT		
Fan	78339	A38
Alt.	78232	▲9341HD
Compr.	78340	B46
T3M43		
Compr.	97609500011	5539
TD		
W.P.	78513	▲9305HD
Elec. Mtr. To Compr.	78436	5520
Evap. Fan, Alt. & Compr.	78494	5530
Mtr. To Compr.	78495	5504
TD-II		
Elec. Mtr. To Compr.; W/R12 Coolant	78510	5503
Evap. Fan & Compr.	78484	5508
Evap. Fan & Alt.	78766	3VX250
Mtr. To Compr.	78500	5512
TWD		
Fan	78448	2640
Alt.	78453	2300
W.P.	78324	▲9390HD
Compr.	78446	B69
Clutch	78447	ⓅB45
UK		
Alt.	78240	TR22588
US		
Alt.	78168	TR22508
Compr.	78173	BX55
US-50		
Alt.	78168	TR22508
Compr.	78177	ⓅBX55
UWD		
Fan, Alt. & W.P.	78466	5527
Alt.	78331	2410
Gen.; Ser. No. 2565 & Before	78222	▲9400HD
Gen.; Ser. No. 2566 & After	78224	▲9430HD
UWTD		
Fan, Alt. & W.P.	78466	5527
Alt.	78222	▲9400HD
Windjammer 500		
Fan	78428	5526
Alt.	78429	▲9420HD
XKL 10; XKL 10LT		
Fan	78301	B86
Compr.	78156	ⓅB62
XKL 20		
Compr.	78308	ⓅB90
XKL 20LT		
Fan	78301	B86
Compr.	78308	ⓅB90
XKL 30; XKL 30LT		
Fan	78301	B86
Compr.	78156	ⓅB62
XKL 50		
Compr.	78308	ⓅB90

Application	Mfr. Part No.	Our No.
THERMO KING - Continued		
XKL 50LT		
Fan	78301	B86
Compr.	78308	ⓅB90
XKW		
Fan	78376	3VX425
Compr.	78346	3V560
XMD		
Fan	78339	A38
Alt.	78449	7375
W.P.	78444	▲9350HD
Compr.	78340	B46
Evap. Fan & Idler; W/R12 Coolant	78436	5520
Evap. Fan & Idler; W/R502 Coolant	78485	5500
Mtr. To Compr.; W/R12 Coolant	78432	5522
Mtr. To Compr.; W/R502 Coolant	78486	2/3VX630
XMD 30; XMD 50		
Alt.	78449	7375
W.P.	78444	▲9350HD
Mtr. To Fan & Compr.	78436	5520
XMD 50D		
Fan	78339	A38
Alt.	78232	▲9341HD
Compr.	78340	B46
XMD-I		
W.P.	78444	▲9350HD
XMT		
Alt. & Compr.; W/Aenld Mtr.	78232	▲9341HD
Elec. Mtr. & Compr.	78340	B46
Evap. Fan & Idler	78339	A38
Mtr. To Compr.; W/Aenld Mtr.	78341	5521
Mtr. To Compr.; W/OH160 Mtr.	78436	5520
XNWD; XNWD 30		
Fan	78428	5526
Alt.	78429	▲9420HD
XNWE 100		
Fan	78487	A48
XROL 10; XROL 10HT		
Fan	78301	B86
Compr.	78156	ⓅB62
XROL 20		
Fan	78301	B86
Compr.	78308	ⓅB90
XROL 20HT		
Fan	78301	B86
Compr.	78155	ⓅB93
XROL 30; XROL 30 M5		
Fan	78301	B86
Compr. & Clutch; W/Pulley No. 77-347	78302	ⓅBX64
Compr. & Clutch; W/Pulley No. 77-342	78156	ⓅB62
XROL 30HT		
Fan	78301	B86
Compr.	78156	ⓅB62
XROL 50; XROL 50 M5		
Fan	78301	B86
Compr. & Clutch; W/Pulley No. 77-347	78155	ⓅB93
Compr. & Clutch; W/Pulley No. 77-342	78308	ⓅB89
XROL 50HT		
Fan	78301	B86
Compr.	78155	ⓅB93

▲ Standard Belt Available. See Pages 630-631.

Ⓟ Two Required.

Belts for Truck Refrigeration Units

Refrigeration Units

Application	Mfr. Part No.	Our No.
THERMO KING - Continued		
XRW; XRW 20D; XRWL		
Fan	78376	3VX425
W.P.	78454	2285
Compr.	78346	Ⓣ3V560
Eng. To Elec. Mtr.	78342	5501
XUK 50 M4		
Alt.	78333	3490
Compr.	78137	ⓉBX55
TRANSICOLD		
161; 200; 200B; 201; 202; 203; 204		
Gen.; W/Hercules Zxb Eng.	5000028	2240
220; 220B; 221; 222; 223; 224		
Gen.; W/Hercules lbx Eng.	5000026	9260
230; 230B; 230C		
Fan; W/Perkins 4-Cyl. 99 Eng.; Early	5000028	6824
Fan; W/Perkins 4-Cyl. 99 Eng.; Late; W/Single Belt ..	5000020	6833
Fan; W/Perkins 4-Cyl. 99 Eng.; Late; W/Dual Belts ..	5000020	Ⓣ6833
Fan; W/Perkins 4-Cyl. 99 Eng.; Conversion	5000062	Ⓣ6823
Gen.; W/Perkins 4-Cyl. 99 Eng.; W/39" Belt O.C.	5000059	♣9385HD
Gen.; W/Perkins 4-Cyl. 99 Eng.; W/40" Belt O.C.	5000021	♣9395HD
230CM		
Alt.; W/Mercedes-Benz OM636 Eng.	5000077	7480
230CP		
Fan; W/Mercedes-Benz OM636 Eng.	5000062	Ⓣ6823
W.P.; W/Mercedes-Benz OM636 Eng.	5000093	♣9385HD
231; 234; 250; 250C		
Fan; W/Perkins 4-Cyl. 99 Eng.; Early	5000028	6824
Fan; W/Perkins 4-Cyl. 99 Eng.; Late; W/Single Belt ..	5000020	6833
Fan; W/Perkins 4-Cyl. 99 Eng.; Late; W/Dual Belts ..	5000020	Ⓣ6833
Fan; W/Perkins 4-Cyl. 99 Eng.; Conversion	5000062	Ⓣ6823
Gen.; W/Perkins 4-Cyl. 99 Eng.; W/39" Belt O.C.	5000059	♣9385HD
Gen.; W/Perkins 4-Cyl. 99 Eng.; W/40" Belt O.C.	5000021	♣9395HD
250CM		
Alt.; W/Mercedes-Benz OM636 Eng.	5000077	7480
251; 254		
Fan; W/Perkins 4-Cyl. 99 Eng.; Early	5000028	6824
Fan; W/Perkins 4-Cyl. 99 Eng.; Late; W/Single Belt ..	5000020	6833
Fan; W/Perkins 4-Cyl. 99 Eng.; Late; W/Dual Belts ..	5000020	Ⓣ6833
Fan; W/Perkins 4-Cyl. 99 Eng.; Conversion	5000062	Ⓣ6823
Gen.; W/Perkins 4-Cyl. 99 Eng.; W/39" Belt O.C.	5000059	♣9385HD
Gen.; W/Perkins 4-Cyl. 99 Eng.; W/40" Belt O.C.	5000021	♣9395HD
260		
Fan; W/Perkins 4-Cyl. 99 Eng.; Early	5000028	6824
Fan; W/Perkins 4-Cyl. 99 Eng.; Late; W/Single Belt ..	5000020	6833
Fan; W/Perkins 4-Cyl. 99 Eng.; Late; W/Dual Belts ..	5000020	Ⓣ6833
Fan; W/Perkins 4-Cyl. 99 Eng.; Conversion	5000062	Ⓣ6823
Gen.; W/Hercules lbx Eng.	5000026	9260
Gen.; W/Perkins 4-Cyl. 99 Eng.; W/39" Belt O.C.	5000059	♣9385HD
Gen.; W/Perkins 4-Cyl. 99 Eng.; W/40" Belt O.C.	5000021	♣9395HD
270		
Gen.; W/Hercules lbx Eng.	5000026	9260
640; 645; 650; 655		
Fan & Alt.; W/Mercedes-Benz OM636 Eng.	5000085	♣9447HD
Fan & Alt.; W/Perkins 4-Cyl. 99 Eng.; W/Flat Idler Pulley	5000059	♣9385HD
Fan & Alt.; W/Perkins 4-Cyl. 99 Eng.; W/V-Groove Idler Pulley	5000085	♣9447HD
Drive; W/Mercedes-Benz OM636 Eng.	5000081	A92
Drive; W/Perkins 4-Cyl. 99 Eng.	5000081	A92
660; 670		
Fan & Alt.; W/Hercules lbx Eng.	5000063	♣9430HD

Ⓣ Two Required.

Application	Mfr. Part No.	Our No.
TRANSICOLD - Continued		
1001		
Fan; W/Perkins 4-Cyl. 99 Eng.; Early	5000028	6824
Fan; W/Perkins 4-Cyl. 99 Eng.; Late; W/Single Belt ..	5000020	6833
Fan; W/Perkins 4-Cyl. 99 Eng.; Late; W/Dual Belts ..	5000020	Ⓣ6833
Fan; W/Perkins 4-Cyl. 99 Eng.; Conversion	5000062	Ⓣ6823
Gen.; W/Perkins 4-Cyl. 99 Eng.; W/39" Belt O.C.	5000059	♣9385HD
Gen.; W/Perkins 4-Cyl. 99 Eng.; W/40" Belt O.C.	5000021	♣9395HD
1003; 2005		
Fan; W/Mercedes-Benz OM636 Eng.	5000062	Ⓣ6823
Fan; W/Perkins 4-Cyl. 108 Eng.	5000062	Ⓣ6823
W.P. & Alt.; W/Mercedes-Benz OM636 Eng.	5000077	7480
W.P. & Alt.; W/Perkins 4-Cyl. 108 Eng.	5000093	♣9385HD
6000A		
W.P.; W/Mercedes-Benz OM636 Eng.	5000077	7480
W.P. & Alt.; W/Perkins 4-Cyl. 108 Eng.	5000059	♣9385HD
J.S.; W/Mercedes-Benz OM636 Eng.	5001001	A43
J.S.; W/Perkins 4-Cyl. 108 Eng.	5001001	A43
Mtr.; W/Mercedes-Benz OM636 Eng.	5000103	ⓉB53
6004A		
Fan; W/Mercedes-Benz OM636 Eng.; W/Flat Idler Pulley		♣9395HD
Fan; W/Mercedes-Benz OM636 Eng.; W/V-Groove Idler Pulley	5000085	♣9447HD
Fan; W/Perkins 4-Cyl. 108 Eng.; W/Flat Idler Pulley		♣9395HD
Fan; W/Perkins 4-Cyl. 108 Eng.; W/V-Groove Idler Pulley	5000085	♣9447HD
Alt.; W/Mercedes-Benz OM636 Eng.	5010048	9279
Fan & Alt.; W/Perkins 4-Cyl. 108 Eng.	5000059	♣9385HD
Alt.; W/Perkins 4-Cyl. 108 Eng.; W/Standby Mtr.		A26
Drive; W/Mercedes-Benz OM636 Eng.	5000104	A100
Mtr.; W/Perkins 4-Cyl. 108 Eng.	5000103	ⓉB53
6007; 6007A		
Fan & Alt.; W/Mercedes-Benz OM636 Eng.	5000149	7470
Fan & Alt.; W/Perkins 4-Cyl. 108 Eng.	5000059	♣9385HD
6008; 6008A		
Compr.; W/Kohler K301S Eng.	500108601	Ⓣ3VX560
Mtr.; W/Kohler K301S Eng.	500108602	Ⓣ3VX450
Genesis TM1000		
Alt.		♣9360HD
W.P.		♣9405HD
Fan		BX90
Compr.		BX64
NDB40		
Alt.; W/Mercedes-Benz OM636 Eng.	5000162	♣9290HD
Alt.; W/Perkins 4-Cyl. 108 Eng.	5000162	♣9290HD
Compr.; W/Perkins Ct4-114 Eng.	500110101	BX48
W.P.; W/Mercedes-Benz OM636 Eng.	5000149	7470
W.P.; W/Perkins Ct4-114 Eng.	500016204	A39
W.P.; W/Perkins 4-Cyl. 108 Eng.	5000093	♣9385HD
Drive; W/Mercedes-Benz OM636 Eng.	5001001	A43
Drive; W/Perkins Ct4-114 Eng.	500016206	A52
Drive; W/Perkins 4-Cyl. 108 Eng.	5001001	A43
NDE40		
Alt.; W/Perkins 4-Cyl. 108 Eng.	500016202	7330
W.P.; W/Perkins 4-Cyl. 108 Eng.	5000093	♣9385HD
NDJ40		
Fan; W/Perkins 4-Cyl. 108 Eng.	500100112	A65
W.P.; W/Perkins 4-Cyl. 108 Eng.	5000093	♣9385HD
Drive; W/Perkins 4-Cyl. 108 Eng.	500100110	A60
NDS40		
W.P.; W/Perkins 4-Cyl. 108 Eng.	5000093	♣9385HD
Drive; W/Perkins 4-Cyl. 108 Eng.	5000160	ⓉB49
J.S.; W/Perkins 4-Cyl. 108 Eng.	500100103	A46
NDT40		
Fan; W/Perkins 4-Cyl. 108 Eng.	500016203	AX62

♣ Standard Belt Available. See Pages 630-631.

Belts for Truck Refrigeration Units

Application Mfr. Part No. Our No.

TRANSICOLD - Continued

NDT40 - Continued

Alt.; W/Perkins 4-Cyl. 108 Eng.	500016202	7330
W.P.; W/Perkins 4-Cyl. 108 Eng.	5000093	♣9385HD
Drive; W/Perkins 4-Cyl. 108 Eng.	500100108	A51

TDB; TDS

Alt.; W/Kubota Zb600C Eng.	5001094	7380
Clutch; W/Kubota Zb600C Eng.	500108603	Ⓜ3VX500
Mtr.; W/Kubota Zb600C Eng.	500108602	Ⓜ3VX450

TGS

Compr.; W/Kohler K301S Eng.	500108601	Ⓜ3VX560
Mtr.; W/Kohler K301S Eng.	500108602	Ⓜ3VX450

UDE; UDG

Fan; W/Mercedes-Benz OM636 Eng.	5000062	Ⓜ6823
Fan; W/Perkins 4-Cyl. 108 Eng.	5000062	Ⓜ6823
W.P. & Alt.; W/Mercedes-Benz OM636 Eng.	5000077	7480
W.P. & Alt.; W/Perkins 4-Cyl. 108 Eng.	5000093	♣9385HD

Refrigeration
Units

♣ Standard Belt Available. See Pages 630-631.

Ⓜ Two Required.

Belts and Coolant Hose for School Buses

Order Belts and Hose by Our Number. Manufacturers' Part Number is shown for reference only.

Application	Mfr. Part No.	Our No.	Application	Mfr. Part No.	Our No.
AMTRAN			AMTRAN - Continued		
2003			1998 - Continued		
International/Navistar DT466 Diesel			International/Navistar DT466 Diesel - Continued		
Conventional			3800 - Continued		
Belt - Fan, Alt. & Hub	1830727C2	♣K080690HD	Hose - Upper - Eng. To Rad.		22140
Tensioner Assy. - Fan, Alt. & Hub	1830033C1	38514	Hose - Lower - Eng. To Rad.		≈<21115
Tensioner Pulley - Fan, Alt. & Hub	1830033C1	36091	Genesis		
Hose - Upper - Eng. To Rad.		22776	Serpentine Belt		♣K080740HD
Hose - Lower - Eng. To Rad.		21115	Hose - Upper - Eng. To Rad.		22140
2002			Hose - Lower - Eng. To Rad.		22762
International/Navistar DT466 Diesel			International/Navistar T444 Diesel		
Conventional			3800		
Belt - Fan, Alt. & Hub	1830727C1	♣K080690HD	Hose - Upper - Eng. To Pipe		22159
Tensioner Assy. - Fan, Alt. & Hub	1830033C1	38514	Hose - Lower - Eng. To Pipe		≈<21042
Tensioner Pulley - Fan, Alt. & Hub	1830033C1	36091	Hose - Lower - Pipe To Pipe; (3" I.D.)		24248
FE			Hose - Lower - Pipe To Rad.		≈<21042
Belt - Fan, Alt. & Hub	1819391C1	♣K080730HD	RE		
Tensioner Assy. - Fan, Alt. & Hub	1830033C1	38514	Serpentine Belt	1822832C1	♣K081124HD
Tensioner Pulley - Fan, Alt. & Hub	1830033C1	36091	1997		
Hose - Lower - Eng. To Rad.		22783	International/Navistar DT466 Diesel		
International/Navistar T444 Diesel			Genesis		
FE			Serpentine Belt		
Serpentine Belt	1822832C1	♣K081124HD	♣K080740HD		
Tensioner Assy.	1822679C4	38510	International/Navistar T444 Diesel		
Tensioner Pulley	1822679C4	36092	3800		
Hose - Lower - Eng. To Rad.		22785	Hose - Upper - Eng. To Pipe		
RE			Hose - Lower - Eng. To Pipe		
Serpentine Belt	1822832C1	♣K081124HD	Hose - Lower - Pipe To Pipe; (3" I.D.)		
Tensioner Assy.	1822679C4	38510	Hose - Lower - Pipe To Rad.		
Tensioner Pulley	1822679C4	36092	≈<21042		
Hose - Upper - Eng. To Rad.		22781	RE		
Hose - Lower - Eng. To Rad.		22784	Belt - Fan & Alt.; W/O Schwitzer Fan Clutch;		
2001			W/A.C.		
International/Navistar DT466 Diesel			1822832C1		
Genesis			♣K081124HD		
Serpentine Belt			♣K080740HD		
International/Navistar T444 Diesel			Belt - Fan & Alt.; W/O Schwitzer Fan Clutch;		
3800			W/O A.C.		
Serpentine Belt	1822832C1	♣K081124HD	1822830C1		
Tensioner Assy.	1822679C3	38510	♣K080893HD		
Hose - Upper - Eng. To Pipe		22159	♣K080760HD		
Hose - Lower - Eng. To Pipe		≈<21042	Belt - Fan & Alt.; W/Schwitzer Fan Clutch		
Hose - Lower - Pipe To Pipe; (3" I.D.)		24248	1682697C1		
Hose - Lower - Pipe To Rad.		≈<21042	1822679C4		
RE			Tensioner Assy. - Fan & Alt.		
Serpentine Belt	1822832C1	♣K081124HD	1822679C4		
2000-1999			Tensioner Pulley - Fan & Alt.		
International/Navistar DT466 Diesel			1822679C4		
Genesis			1822652C91		
Serpentine Belt			♣K080740HD		
International/Navistar T444 Diesel			1822653C91		
3800			Hose - Upper		
Hose - Upper - Eng. To Pipe		22159	22781		
Hose - Lower - Eng. To Pipe		≈<21042	Hose - Lower		
Hose - Lower - Pipe To Pipe; (3" I.D.)		24248	22784		
Hose - Lower - Pipe To Rad.		≈<21042	1996		
RE			International/Navistar DT466 Diesel		
Serpentine Belt	1822832C1	♣K081124HD	Genesis		
1998			Serpentine Belt		
International/Navistar DT466 Diesel			♣K080740HD		
3800			International/Navistar T444 Diesel		
Serpentine Belt	1822503C1	♣K080726HD	RE		
Tensioner Assy.	1830033C1	38514	Serpentine Belt		
Tensioner Pulley	1830033C1	36091	1822832C1		
1998			♣K081124HD		
International/Navistar DT466 Diesel			1995-1994		
3800			International/Navistar DT408 Diesel		
Serpentine Belt	1822503C1	♣K080726HD	Genesis		
Tensioner Assy.	1830033C1	38514	Belt - Fan; Nov. 14, 1994 & Older		
Tensioner Pulley	1830033C1	36091	1841575C1		
1998			♣K080730HD		
International/Navistar DT466 Diesel			♣K080726HD		
3800			Belt - Fan; Nov. 15, 1994 & Newer		
Serpentine Belt	1822503C1	♣K080726HD	1819391C2		
Tensioner Assy.	1830033C1	38514	Tensioner Assy. - Fan		
Tensioner Pulley	1830033C1	36091	1830033C2		
1998			Tensioner Pulley - Fan		
International/Navistar DT466 Diesel			1830033C2		
3800			Hose - Lower; W/Frame Mounted Rad.		
Serpentine Belt	1822503C1	♣K080726HD	20987		
Tensioner Assy.	1830033C1	38514	International/Navistar DT466 Diesel		
Tensioner Pulley	1830033C1	36091	Genesis		
1998			Serpentine Belt		
International/Navistar DT466 Diesel			♣K080740HD		
3800			International/Navistar T444 Diesel		
Serpentine Belt	1822503C1	♣K080726HD	RE		
Tensioner Assy.	1830033C1	38514	Serpentine Belt		
Tensioner Pulley	1830033C1	36091	1822832C1		
1998			♣K081124HD		

♣ Standard Belt Available. See Pages 630-631.
 © Two Required.

≈< Cut to Fit.

Belts and Coolant Hose for School Buses

School Buses

Application	Mfr. Part No.	Our No.
AMTRAN - Continued		
1993		
International/Navistar DT466 Diesel		
Genesis		
Serpentine Belt		♣K080740HD
International/Navistar T444 Diesel		
RE		
Serpentine Belt	1822832C1	♣K081124HD
1992-1991		
International/Navistar DT466 Diesel		
Genesis		
Serpentine Belt		♣K080740HD
BLUEBIRD		
2011		
Cummins ISC Diesel		
All American RE		
Belt - Alt. & W.P.	3290018	♣K080716HD
Belt - Fan; W/A.C.	10004148	3/3V879
Tensioner Assy. - Fan	10009072	38555
Tensioner Pulley - Fan		36350
2010		
Cummins ISB-07 Diesel		
Vision		
Belt - W.P., Fan & Alt.	4940003	♣K080806HD
Belt - A.C.; W/Dual A.C.	5060770	K060772
Tensioner Assy. - Fan, W.P. & Alt.	4937433	38631
2009		
Caterpillar C7 Diesel		
Vision		
Belt - Accessory Drive	2920678	♣K080649HD
Cummins ISB-07 Diesel		
All American FE		
Belt - Alt.	3972382	♣K080817HD
Tensioner Assy. - Alt.	4937433	38631
Vision		
Belt - W.P., Fan & Alt.	4940003	♣K080806HD
Belt - A.C.; W/Dual A.C.	5060770	K060772
Tensioner Assy. - Fan, W.P. & Alt.	4937433	38631
2008		
Cummins ISB-07 Diesel		
Vision		
Belt - Accessory Drive	4940003	♣K080806HD
Tensioner Assy. - Fan, Alt. & A.C.	4937433	38631
2007		
Caterpillar C7 Diesel		
All American FE; All American RE		
Belt - Fan & Alt.	1454636	♣K080580HD
Belt - W.P.	0366775	♣9341HD
Tensioner Assy. - Fan & Alt.	7E3999	38509
Vision		
Belt - Alt.	0064546	♣K080776HD
Tensioner Assy. - Alt.	2201209	38550
Cummins ISB Diesel		
All American FE		
Belt - W.P., Fan & Alt.	3289746	♣K080785HD
Tensioner Assy. - Fan, W.P. & Alt.	3976833	38517
2006		
Caterpillar C7 Diesel		
All American FE		
Belt - Alt.	1454636	♣K080580HD
Belt - W.P.	0366775	♣9341HD
Tensioner Assy. - Alt.	7E3999	38509

Application	Mfr. Part No.	Our No.
BLUEBIRD - Continued		
2006 - Continued		
Caterpillar C7 Diesel - Continued		
All American RE		
Belt - Hub & Alt.	5080510	♣K080510HD
Belt - W.P.	0366775	♣9341HD
Tensioner Assy. - Hub & Alt.	7E3999	38509
Tensioner Pulley	7E3999	36091
Vision		
Belt - Fan, Alt. & W.P.	0064546	♣K080776HD
Tensioner Assy. - Alt.	2201209	38550
Cummins ISB Diesel		
Vision		
Belt - Fan & Alt.	4937693	♣K080785HD
Tensioner Assy. - Fan & Alt.	3936205	38525
Ford V-8 6.0 L Diesel		
Micro Bird		
Belt - Fan, Alt. & A.C.	3C2E8620AB	♣K081298HD
John Deere 6-Cyl. 8.1 L Diesel		
All American RE		
Belt - Alt.	R128197	♣K080680HD
Tensioner Assy. - Alt.	RE518097	38507
2005		
Caterpillar C7 Diesel		
All American FE		
Belt - Alt.	1454636	♣K080580HD
Belt - W.P.	0366775	♣9341HD
Tensioner Assy. - Alt.	7E3999	38509
All American RE		
Belt - Hub & Alt.		♣K080510HD
Belt - W.P.	0366775	♣9341HD
Tensioner Assy. - Hub & Alt.	7E3999	38509
Tensioner Pulley	7E3999	36091
Vision		
Belt - Alt.	0064546	♣K080776HD
Tensioner Assy. - Fan, W.P. & Alt.	2201209	38550
Ford V-8 6.0 L Diesel		
Micro Bird		
Belt - Fan, Alt. & A.C.	3C2E8620AB	♣K081298HD
International/Navistar DT466 Diesel		
Conventional		
Serpentine Belt		♣K080740HD
2004		
Caterpillar 3126 Diesel		
All American FE		
Belt - Fan & Alt.	1454636	♣K080580HD
Tensioner Assy. - Fan & Alt.	1450261	38509
All American RE		
Belt - Hub & Alt.		♣K080510HD
Belt - W.P.	0366775	♣9341HD
Tensioner Assy. - Hub & Alt.	7E3999	38509
Tensioner Pulley	7E3999	36091
Vision		
Belt - Alt.	0061258	♣K080700HD
Belt - W.P.	0366775	♣9341HD
Caterpillar C7 Diesel		
All American FE		
Belt - Alt.	1454636	♣K080580HD
Belt - W.P.	0366775	♣9341HD
Tensioner Assy. - Fan & Alt.	1450261	38509
Hose - Lower - Pipe To Rad.		●26512
Cummins ISC Diesel		
All American RE		
Serpentine Belt	3926856	♣K080694HD
Tensioner Assy.	3937555	38525

♣ Standard Belt Available. See Pages 630-631.

● Vulco-Flex® Coolant Hose.

Belts and Coolant Hose for School Buses

School Buses

Application	Mfr. Part No.	Our No.
BLUEBIRD - Continued		
2004 - Continued		
Ford V-8 6.0 L Diesel		
Micro Bird		
Belt - Fan, Alt. & A.C.	3C2E8620AB	▲K081298HD
International/Navistar DT466 Diesel		
Conventional		
Serpentine Belt	1822503C2	▲K080720HD
Tensioner Assy.	1830033C1	38514
Tensioner Pulley	1830033C1	36091
Hose - Upper - Eng. To Rad.		22140
2003		
Caterpillar 3126 Diesel		
All American RE		
Belt - Hub & Alt.		▲K080510HD
Belt - W.P.	0366775	▲9341HD
Tensioner Assy. - Hub & Alt.	7E3999	38509
Tensioner Pulley	7E3999	36091
Cummins ISB Diesel		
TC2000		
Belt - Fan & Alt.; W/49 1/8" Belt O.C.		▲K080485HD
Belt - Fan & Alt.; W/51 1/2" Belt O.C.	1454628	▲K080510HD
Belt - Fan & Alt.; W/54 3/8" Belt O.C.	1373281	▲K080537HD
Belt - Fan & Alt.; W/58 5/8" Belt O.C.	2791517325	▲K080580HD
Belt - Fan & Alt.; W/74 5/8" Belt O.C.	1373323	▲K080740HD
Tensioner Assy.	3936213	38516
Cummins ISC Diesel		
All American RE		
Serpentine Belt	3911581	▲K080690HD
Tensioner Assy.	3936213	38516
Tensioner Pulley	3936213	36093
International/Navistar DT466 Diesel		
Conventional		
Serpentine Belt	1822503C1	▲K080726HD
Tensioner Assy.	1830033C1	38514
Tensioner Pulley	1830033C1	36091
Hose - Upper - Eng. To Rad.		22140
Hose - Lower - Eng. To Rad.		20987
John Deere 6-Cyl. 8.1 L CNG		
All American RE		
Belt - Eng. To Alt.	R128197	▲K080680HD
Belt - A.C.		BX83
Belt - A.C. To Alt.		▲9476HD
Tensioner Assy. - Eng. To Alt.	RE70535	38507
Tensioner Pulley - Eng. To Alt.	RE70535	36091
2002		
Cummins ISB Diesel		
TC2000		
Belt - Fan & Alt.; W/49 1/8" Belt O.C.		▲K080485HD
Belt - Fan & Alt.; W/54 3/8" Belt O.C.	1373281	▲K080537HD
Belt - Fan & Alt.; W/58 5/8" Belt O.C.	2791517325	▲K080580HD
Belt - Fan & Alt.; W/74 5/8" Belt O.C.	1373323	▲K080740HD
Hose - Upper - Eng. To Pipe		●26601
Hose - Upper - Pipe To Rad.		≧21891
Hose - Lower - Eng. To Pipe		≧21194
Hose - Lower - Pipe To Cooler		≧21194
Hose - Lower - Cooler To Pipe; (2 1/4" I.D.)		24236
Hose - Lower - Pipe To Rad.		22177
Cummins ISC Diesel		
All American RE		
Serpentine Belt	3926856	▲K080694HD
Tensioner Assy.	3936213	38516
Tensioner Pulley	3936213	36093
Ford V-8 7.3 L 444 CID Diesel		
Micro Bird		
Serpentine Belt	1C2E8620JA	▲K081223HD

▲ Standard Belt Available. See Pages 630-631.
≧ Cut to Fit.

Application	Mfr. Part No.	Our No.
BLUEBIRD - Continued		
2002 - Continued		
International/Navistar DT466 Diesel		
Conventional		
Serpentine Belt	1822503C1	▲K080726HD
Tensioner Assy.	1830033C1	38514
Tensioner Pulley	1830033C1	36091
Hose - Upper - Eng. To Rad.		22140
Hose - Lower - Eng. To Rad.		20987
John Deere 6-Cyl. 8.1 L CNG		
All American RE		
Serpentine Belt	R128197	▲K080680HD
Tensioner Assy.	RE70535	38507
Tensioner Pulley	RE70535	36091
2001		
Cummins ISB Diesel		
Conventional		
Belt - Alt. & W.P.	3926856	▲K080694HD
Tensioner Assy. - Alt. & W.P.	3936213	38516
Tensioner Pulley - Alt. & W.P.	3936213	36093
TC2000		
Belt - Fan & Alt.; W/49 1/8" Belt O.C.		▲K080485HD
Belt - Fan & Alt.; W/54 3/8" Belt O.C.	1373281	▲K080537HD
Belt - Fan & Alt.; W/58 5/8" Belt O.C.	2791517325	▲K080580HD
Belt - Fan & Alt.; W/74 5/8" Belt O.C.	1373323	▲K080740HD
Hose - Upper - Eng. To Pipe		●26601
Hose - Upper - Pipe To Rad.		≧21891
Hose - Lower - Eng. To Pipe		≧21194
Hose - Lower - Pipe To Cooler		≧21194
Hose - Lower - Cooler To Pipe; (2 1/4" I.D.)		24236
Hose - Lower - Pipe To Rad.		22177
Cummins ISC Diesel		
All American RE		
Serpentine Belt	3911620	▲K080680HD
Tensioner Assy.	3936213	38516
Tensioner Pulley	3936213	36093
International/Navistar DT466 Diesel		
Conventional		
Serpentine Belt	1822503C1	▲K080726HD
Tensioner Assy.	1830033C1	38514
Tensioner Pulley	1830033C1	36091
Hose - Upper - Eng. To Rad.		22140
Hose - Lower - Eng. To Rad.		≧21115
John Deere 6-Cyl. 8.1 L CNG		
All American RE		
Serpentine Belt	R128197	▲K080680HD
Tensioner Assy.	RE70535	38507
Tensioner Pulley	RE70535	36091
Envirobus 2000		
Serpentine Belt	1682693C1	▲K080708HD
Hose - Upper; (2" I.D.)		②24232
Hose - Lower - Eng. To Pipe		≧20206
Hose - Lower - Heat Exch. To Pipe; (2" I.D.)		24232
Hose - Lower - Pipe To Heat Exch.; (2" I.D.)		24232
Hose - Lower - Pipe To Pipe; (2" I.D.)		24232
Hose - Lower - Pipe To Rad.		≧20206
2000		
Cummins ISB Diesel		
TC2000		
Belt - Alt. & W.P.; W/49 1/8" Belt O.C.		▲K080485HD
Belt - Alt. & W.P.; W/54 3/8" Belt O.C.	1373281	▲K080537HD
Belt - Alt. & W.P.; W/58 5/8" Belt O.C.	2791517325	▲K080580HD
Belt - Alt. & W.P.; W/74 5/8" Belt O.C.	1373323	▲K080740HD
Tensioner Assy. - Alt. & W.P.	3945527	38516
Tensioner Pulley - Alt. & W.P.	3945527	36093
Hose - Upper - Eng. To Pipe		●26601
Hose - Upper - Pipe To Rad.		≧21891
Hose - Lower - Eng. To Pipe		≧21194
Hose - Lower - Pipe To Cooler		≧21194

● Vulco-Flex® Coolant Hose.
② Two Required.

Belts and Coolant Hose for School Buses

Application	Mfr. Part No.	Our No.	Application	Mfr. Part No.	Our No.
BLUEBIRD - Continued			BLUEBIRD - Continued		
2000 - Continued			1999 - Continued		
Cummins ISB Diesel - Continued			International/Navistar DT466 Diesel - Continued		
TC2000 - Continued			Conventional - Continued		
Hose - Lower - Cooler To Pipe; (2 1/4" I.D.)		24236	Tensioner Assy.	1830033C1	38514
Hose - Lower - Pipe To Rad.		22177	Tensioner Pulley	1830033C1	36091
Cummins ISC Diesel			Hose - Upper - Eng. To Rad.		
All American RE			22140		
Belt - Fan & Alt.; W/61 3/4" Belt O.C.	3911572	♣K080610HD	1998		
Belt - Fan & Alt.; W/63 5/8" Belt O.C.		♣K080630HD	Caterpillar 3126 Diesel		
Belt - Fan & Alt.; W/64 1/4" Belt O.C.	8304073	♣K080638HD	TC2000		
Tensioner Assy.	3976832	38513	Belt - Fan & Alt.		
Tensioner Pulley	3976832	36091	Belt - W.P.		
Hose - Upper; Strt. Hose(2 1/4" I.D.)		24236	Tensioner Assy. - Fan & Alt.		
Hose - Upper; Molded Hose		●26528	Tensioner Pulley - Fan & Alt.		
Hose - Lower		●25804	Hose - Upper - Eng. To Rad.		
International/Navistar DT466 Diesel			20735		
Conventional			Cummins ISB Diesel		
Tensioner Assy.	1830033C1	38514	TC1000		
Tensioner Pulley	1830033C1	36091	Serpentine Belt		
Hose - Upper - Eng. To Rad.		22140	Belt - Upper - Eng. To Pipe		
John Deere 6-Cyl. 8.1 L CNG			Hose - Upper - Pipe To Rad.		
All American RE			Hose - Lower - Eng. To Pipe		
Serpentine Belt	R128197	♣K080680HD	Hose - Lower - Heat Exch. To Pipe; (2 1/4" I.D.)		
Tensioner Assy.	RE70535	38507	Hose - Lower - Pipe To Heat Exch.		
Tensioner Pulley	RE70535	36091	Hose - Lower - Pipe To Rad.; (2" I.D.)		
Envirobus 2000			24232		
Serpentine Belt	1682693C1	♣K080708HD	TC2000		
Hose - Upper; (2" I.D.)		②24232	Belt - Alt. & W.P.; W/49 1/8" Belt O.C.		
Hose - Lower - Eng. To Pipe		⊗<20206	Belt - Alt. & W.P.; W/54 3/8" Belt O.C.		
Hose - Lower - Heat Exch. To Pipe; (2" I.D.)		24232	Belt - Alt. & W.P.; W/58 5/8" Belt O.C.		
Hose - Lower - Pipe To Heat Exch.; (2" I.D.)		24232	Belt - Alt. & W.P.; W/74 5/8" Belt O.C.		
Hose - Lower - Pipe To Pipe; (2" I.D.)		24232	Tensioner Assy. - Alt. & W.P.		
Hose - Lower - Pipe To Rad.		⊗<20206	Tensioner Pulley - Alt. & W.P.		
1999			Hose - Upper - Eng. To Pipe		
Cummins ISB Diesel			Hose - Upper - Pipe To Rad.		
All American RE			Hose - Lower - Eng. To Pipe		
Belt - Alt. & W.P.	3922562	♣K080716HD	Hose - Lower - Pipe To Cooler		
Belt - A.C.		♣9455HD	Hose - Lower - Cooler To Pipe; (2 1/4" I.D.)		
Belt - Fan & Alt.; W/64" Belt O.C.		K080635	Hose - Lower - Pipe To Rad.		
Tensioner Assy. - Alt. & W.P.	3945527	38516	22177		
Tensioner Pulley - Alt. & W.P.	3945527	36093	Cummins ISC Diesel		
Hose - Upper - Eng. To Pipe		20206	All American RE		
Hose - Upper - Pipe To Rad.		20172	Belt - Alt. & W.P.; W/61 3/4" Belt O.C.		
TC2000			Belt - Alt. & W.P.; W/63 5/8" Belt O.C.		
Belt - Alt. & W.P.; W/49 1/8" Belt O.C.		♣K080485HD	Belt - Fan & Alt.; W/64 1/4" Belt O.C.		
Belt - Alt. & W.P.; W/54 3/8" Belt O.C.	1373281	♣K080537HD	Belt - A.C. - Right Side		
Belt - Alt. & W.P.; W/58 5/8" Belt O.C.	2791517325	♣K080580HD	Belt - A.C. - Left Side		
Belt - Alt. & W.P.; W/74 5/8" Belt O.C.	1373323	♣K080740HD	Tensioner Assy. - Alt. & W.P.		
Tensioner Assy. - Alt. & W.P.	3945527	38516	Tensioner Pulley - Alt. & W.P.		
Tensioner Pulley - Alt. & W.P.	3945527	36093	Hose - Upper; Strt. Hose(2 1/4" I.D.)		
Hose - Upper - Eng. To Pipe		●26601	Hose - Upper; Molded Hose		
Hose - Upper - Pipe To Rad.		⊗<21891	Hose - Lower		
Hose - Lower - Eng. To Pipe		⊗<21194	●26528		
Hose - Lower - Pipe To Cooler		⊗<21194	●25804		
Hose - Lower - Cooler To Pipe; (2 1/4" I.D.)		24236	GM V-8 5.7 L		
Hose - Lower - Pipe To Rad.		22177	Mini Bird		
Cummins ISC Diesel			Serpentine Belt; W/A.C.; W/105A. Alt.		
All American RE			Serpentine Belt; W/A.C.; W/124A., 145A. Alt.		
Belt - Alt. & W.P.	3922562	♣K080716HD	Serpentine Belt; W/O A.C.; W/105A. Alt.		
Belt - A.C.		♣9455HD	Serpentine Belt; W/O A.C.; W/124A., 145A. Alt.		
Belt - Fan & Alt.; W/64" Belt O.C.		K080635	Tensioner Assy.		
Tensioner Assy. - Alt. & W.P.	3945527	38516	Tensioner Pulley		
Tensioner Pulley - Alt. & W.P.	3945527	36093	Idle Pulley - Smooth		
Hose - Upper - Eng. To Pipe		20206	Idle Pulley - Grooved; W/O A.C.		
Hose - Upper - Pipe To Rad.		20172	Hose - Upper		
TC2000			Hose - Lower		
Belt - Alt. & W.P.; W/49 1/8" Belt O.C.		♣K080485HD	Hose - By Pass		
Belt - Alt. & W.P.; W/54 3/8" Belt O.C.	1373281	♣K080537HD	19025		
Belt - Alt. & W.P.; W/58 5/8" Belt O.C.	2791517325	♣K080580HD	John Deere 6-Cyl. 8.1 L CNG		
Belt - Alt. & W.P.; W/74 5/8" Belt O.C.	1373323	♣K080740HD	All American RE		
Tensioner Assy. - Alt. & W.P.	3945527	38516	Serpentine Belt		
Tensioner Pulley - Alt. & W.P.	3945527	36093	Tensioner Assy.		
Hose - Upper - Eng. To Pipe		●26601	R128197		
Hose - Upper - Pipe To Rad.		⊗<21891	RE518097		
Hose - Lower - Eng. To Pipe		⊗<21194	♣K080680HD		
Hose - Lower - Pipe To Cooler		⊗<21194	38507		
Hose - Lower - Cooler To Pipe; (2 1/4" I.D.)		24236			
Hose - Lower - Pipe To Rad.		22177			
Cummins ISC Diesel					
All American RE					
Belt - Fan & Alt.; W/61 3/4" Belt O.C.	3911572	♣K080610HD			
Belt - Fan & Alt.; W/63 5/8" Belt O.C.		♣K080630HD			
Belt - Fan & Alt.; W/64 1/4" Belt O.C.	8304073	♣K080638HD			
Tensioner Assy.	3976832	38513			
Tensioner Pulley	3976832	36091			
Hose - Upper; Strt. Hose(2 1/4" I.D.)		24236			
Hose - Upper; Molded Hose		●26528			
Hose - Lower		●25804			
International/Navistar DT466 Diesel					
Conventional					
Serpentine Belt	1819391C1	♣K080730HD			

School Buses

♣ Standard Belt Available. See Pages 630-631.
 ② Two Required.
 ♣ Protective Sleeve Required. Use OEM Sleeve or Other Abrasion/Heat Protection.

● Vulco-Flex® Coolant Hose.
 ⊗< Cut to Fit.

Belts and Coolant Hose for School Buses

School Buses

Application	Mfr. Part No.	Our No.
BLUEBIRD - Continued		
1997		
Cummins ISB Diesel		
TC2000		
Serpentine Belt	3911563	▲K080605HD
Cummins ISC Diesel		
All American RE		
Belt - Fan & Alt.; W/61 3/4" Belt O.C.	3911572	▲K080610HD
Belt - Fan & Alt.; W/63 5/8" Belt O.C.		▲K080630HD
Belt - Fan & Alt.; W/64 1/4" Belt O.C.	8304073	▲K080638HD
Tensioner Assy.	3976832	38513
Tensioner Pulley	3976832	36091
Hose - Upper; Strt. Hose(2 1/4" I.D.)		24236
Hose - Upper; Molded Hose		●26528
Hose - Lower		●25804
1996		
Cummins B Series 5.9 L Diesel		
TC2000		
Belt - Fan & Alt.; W/49 1/8" Belt O.C.		▲K080485HD
Belt - Fan & Alt.; W/54 3/8" Belt O.C.	1373281	▲K080537HD
Belt - Fan & Alt.; W/58 5/8" Belt O.C.	2791517325	▲K080580HD
Belt - Fan & Alt.; W/74 5/8" Belt O.C.	1373323	▲K080740HD
Hose - Upper - Eng. To Pipe		●26601
Hose - Upper - Pipe To Rad.		≧21891
Hose - Lower - Eng. To Pipe		≧21194
Hose - Lower - Pipe To Cooler		≧21194
Hose - Lower - Cooler To Pipe; (2 1/4" I.D.)		24236
Hose - Lower - Pipe To Rad.		22177
Cummins C Series 8.3 L Diesel		
All American RE		
Belt - Fan & Alt.; W/61 3/4" Belt O.C.	3911572	▲K080610HD
Belt - Fan & Alt.; W/63 5/8" Belt O.C.		▲K080630HD
Tensioner Assy.	3976832	38513
Tensioner Pulley	3976832	36091
Hose - Upper; Strt. Hose(2 1/4" I.D.)		24236
Hose - Upper; Molded Hose		●26528
Hose - Lower		●25804
TC2000		
Serpentine Belt		▲K080610HD
Tensioner Assy.	3934818	38504
Tensioner Pulley	3934818	36091
1995		
Cummins B Series 5.9 L Diesel		
TC2000		
Belt - Fan & Alt.; W/49 1/8" Belt O.C.		▲K080485HD
Belt - Fan & Alt.; W/54 3/8" Belt O.C.	1373281	▲K080537HD
Belt - Fan & Alt.; W/58 5/8" Belt O.C.	2791517325	▲K080580HD
Belt - Fan & Alt.; W/74 5/8" Belt O.C.	1373323	▲K080740HD
Hose - Upper - Eng. To Pipe		●26601
Hose - Upper - Pipe To Rad.		≧21891
Hose - Lower - Eng. To Pipe		≧21194
Hose - Lower - Pipe To Cooler		≧21194
Hose - Lower - Cooler To Pipe; (2 1/4" I.D.)		24236
Hose - Lower - Pipe To Rad.		22177
Cummins C Series 8.3 L Diesel		
All American RE		
Belt - Fan & Alt.; W/61 3/4" Belt O.C.	3911572	▲K080610HD
Belt - Fan & Alt.; W/63 5/8" Belt O.C.		▲K080630HD
Tensioner Assy.	3976832	38513
Tensioner Pulley	3976832	36091
Hose - Upper; Strt. Hose(2 1/4" I.D.)		24236
Hose - Upper; Molded Hose		●26528
Hose - Lower		●25804
1994		
Cummins B Series 5.9 L Diesel		
All American FE		
Belt - Eng. To Alt.		▲K080600HD
Belt - A.C. - Right Side		▲9440HD

Application	Mfr. Part No.	Our No.
BLUEBIRD - Continued		
1994 - Continued		
Cummins B Series 5.9 L Diesel - Continued		
All American FE - Continued		
Belt - A.C. - Left Side		▲9440HD
TC2000		
Belt - Fan & Alt.; W/49 1/8" Belt O.C.		▲K080485HD
Belt - Fan & Alt.; W/54 3/8" Belt O.C.	1373281	▲K080537HD
Belt - Fan & Alt.; W/58 5/8" Belt O.C.	2791517325	▲K080580HD
Belt - Fan & Alt.; W/74 5/8" Belt O.C.	1373323	▲K080740HD
Hose - Upper - Eng. To Pipe		22898
Hose - Upper - Pipe To Rad.		≧21891
Hose - Lower - Eng. To Pipe		≧21194
Hose - Lower - Pipe To Cooler		≧21194
Hose - Lower - Cooler To Pipe; (2 1/4" I.D.)		24236
Hose - Lower - Pipe To Rad.		22177
Cummins C Series 8.3 L Diesel		
All American RE		
Belt - Fan & Alt.; W/61 3/4" Belt O.C.	3911572	▲K080610HD
Belt - Fan & Alt.; W/63 5/8" Belt O.C.		▲K080630HD
Tensioner Assy.	3976832	38513
Tensioner Pulley	3976832	36091
Hose - Upper; Strt. Hose(2 1/4" I.D.)		24236
Hose - Upper; Molded Hose		●26528
Hose - Lower		●25804
GM V-8 5.7 L		
Mini Bird		
Belt - Fan & Alt.; W/105A. Alt.		K050435
Belt - Fan & Alt.; W/120A. Alt.		K050446
Belt - P.S.; W/A.C.		7355
Belt - Fan & P.S.; W/O A.C.		7440
Belt - Fan & A.C.		7585
Tensioner Pulley - Fan & Alt.		38037
Hose - Upper; Exc. Cutaway HD		21191
Hose - Upper; Cutaway HD		22171
Hose - Lower; Exc. Cutaway HD		20843
Hose - Lower; Cutaway HD		22170
1993		
Cummins B Series 5.9 L Diesel		
All American FE		
Belt - Eng. To Alt.		▲K080600HD
Belt - A.C. - Right Side		▲9435HD
TC2000		
Belt - Fan & Alt.; W/49 1/8" Belt O.C.		▲K080485HD
Belt - Fan & Alt.; W/54 3/8" Belt O.C.	1373281	▲K080537HD
Belt - Fan & Alt.; W/58 5/8" Belt O.C.	2791517325	▲K080580HD
Belt - Fan & Alt.; W/74 5/8" Belt O.C.	1373323	▲K080740HD
Tensioner Assy. - Fan & Alt.	3922900	38504
Hose - Upper - Eng. To Pipe		22898
Hose - Upper - Pipe To Rad.		≧21891
Hose - Lower - Eng. To Pipe		≧21194
Hose - Lower - Pipe To Cooler		≧21194
Hose - Lower - Cooler To Pipe; (2 1/4" I.D.)		24236
Hose - Lower - Pipe To Rad.		22177
Cummins C Series 8.3 L Diesel		
All American RE		
Belt - Fan & Alt.; W/61 3/4" Belt O.C.	3911572	▲K080610HD
Belt - Fan & Alt.; W/63 5/8" Belt O.C.		▲K080630HD
Tensioner Assy.	3976832	38513
Tensioner Pulley	3976832	36091
Hose - Upper; Strt. Hose(2 1/4" I.D.)		24236
Hose - Upper; Molded Hose		●26528
Hose - Lower		●25804
1992		
Cummins B Series 5.9 L CNG		
All American RE		
Serpentine Belt		▲K080605HD
Tensioner Assy.	3922901	38513
Tensioner Pulley	3922901	36091

▲ Standard Belt Available. See Pages 630-631.
 ≧ Cut to Fit.

● Vulco-Flex® Coolant Hose.

Belts and Coolant Hose for School Buses

School Buses

Application	Mfr. Part No.	Our No.
BLUEBIRD - Continued		
1992 - Continued		
Cummins B Series 5.9 L Diesel		
All American FE		
Belt - A.C. - Right Side		▲9451HD
Belt - A.C. - Left Side		▲9455HD
Belt - Eng. To Alt.		▲K080580HD
TC2000		
Belt - Fan & Alt.; W/49 1/8" Belt O.C.		▲K080485HD
Belt - Fan & Alt.; W/54 3/8" Belt O.C.	1373281	▲K080537HD
Belt - Fan & Alt.; W/58 5/8" Belt O.C.	2791517325	▲K080580HD
Belt - Fan & Alt.; W/74 5/8" Belt O.C.	1373323	▲K080740HD
Hose - Upper - Eng. To Pipe		22898
Hose - Upper - Pipe To Rad.		≧21891
Hose - Lower - Eng. To Pipe		≧21194
Hose - Lower - Pipe To Cooler		≧21194
Hose - Lower - Cooler To Pipe; (2 1/4" I.D.)		24236
Hose - Lower - Pipe To Rad.		22177
Cummins C Series 8.3 L Diesel		
All American FE		
Belt - Alt. - From Eng.		▲K080605HD
Belt - A.C. - Right Side		▲9463HD
Belt - A.C. - Left Side		▲9451HD
All American RE		
Belt - Fan & Alt.; W/61 3/4" Belt O.C.	3911572	▲K080610HD
Belt - Fan & Alt.; W/63 5/8" Belt O.C.		▲K080630HD
Tensioner Assy.	3976832	38513
Tensioner Pulley	3976832	36091
Hose - Upper; Strt. Hose(2 1/4" I.D.)		24236
Hose - Upper; Molded Hose		●26528
Hose - Lower		●25804
John Deere 6-Cyl. 6.8 L Diesel		
All American RE		
Serpentine Belt		▲K080653HD
Tensioner Assy.	RE70536	38522
		or 38654
John Deere 6-Cyl. 8.1 L CNG		
All American RE		
Serpentine Belt	R128197	▲K080680HD
1991		
Cummins B Series 5.9 L Diesel		
All American FE		
Belt - Eng. To Alt.		▲K080575HD
Belt - A.C. - Right Side		▲9451HD
Belt - A.C. - Left Side		▲9455HD
TC2000		
Belt - Fan & Alt.; W/49 1/8" Belt O.C.		▲K080485HD
Belt - Fan & Alt.; W/54 3/8" Belt O.C.	1373281	▲K080537HD
Belt - Fan & Alt.; W/58 5/8" Belt O.C.	2791517325	▲K080580HD
Belt - Fan & Alt.; W/74 5/8" Belt O.C.	1373323	▲K080740HD
Hose - Upper - Eng. To Pipe		22898
Hose - Upper - Pipe To Rad.		≧21891
Hose - Lower - Eng. To Pipe		≧21194
Hose - Lower - Pipe To Cooler		≧21194
Hose - Lower - Cooler To Pipe; (2 1/4" I.D.)		24236
Hose - Lower - Pipe To Rad.		22177
Cummins 6-Cyl. 8.3 L Diesel		
All American RE		
Belt - Fan & Alt.; W/61 3/4" Belt O.C.	3911572	▲K080610HD
Belt - Fan & Alt.; W/63 5/8" Belt O.C.		▲K080630HD
Tensioner Assy.	3976832	38513
Tensioner Pulley	3976832	36091
Hose - Upper; Strt. Hose(2 1/4" I.D.)		24236
Hose - Upper; Molded Hose		●26528
Hose - Lower		●25804
1990		
Cummins B Series 5.9 L Diesel		
TC2000		
Belt - Fan & Alt.; W/49 1/8" Belt O.C.		▲K080485HD

Application	Mfr. Part No.	Our No.
BLUEBIRD - Continued		
1990 - Continued		
Cummins B Series 5.9 L Diesel - Continued		
TC2000 - Continued		
Belt - Fan & Alt.; W/54 3/8" Belt O.C.	1373281	▲K080537HD
Belt - Fan & Alt.; W/58 5/8" Belt O.C.	2791517325	▲K080580HD
Belt - Fan & Alt.; W/74 5/8" Belt O.C.	1373323	▲K080740HD
Hose - Upper - Eng. To Pipe		22898
Hose - Upper - Pipe To Rad.		≧21891
Hose - Lower - Eng. To Pipe		21194
Hose - Lower - Pipe To Cooler		≧21194
Hose - Lower - Cooler To Pipe; (2 1/4" I.D.)		24236
Hose - Lower - Pipe To Rad.		22177
Cummins 6-Cyl. 8.3 L Diesel		
All American RE		
Belt - Fan & Alt.; W/61 3/4" Belt O.C.	3911572	▲K080610HD
Belt - Fan & Alt.; W/63 5/8" Belt O.C.		▲K080630HD
Hose - Upper; Strt. Hose(2 1/4" I.D.)		24236
Hose - Upper; Molded Hose		●26528
Hose - Lower		●25804
1989-1987		
Caterpillar 3208 Diesel		
All American		
Belt - Fan; Preferred Belt		2/9430PB
Belt - Fan; Optional Belt		②▲9430HD
Belt - W.P.; Preferred Belt		2/9490PB
Belt - W.P.; Optional Belt		②▲9490HD
Belt - Alt. & Air Brake Compr.; Preferred Belt		2/9660PB
Belt - Alt. & Air Brake Compr.; Optional Belt		②▲9660HD
Belt - P.S.; W/37 3/8" Belt O.C.		▲9370HD
Belt - P.S.; W/48 7/8" Belt O.C.		▲9485HD
Hose - Upper - Eng. To Pipe; (2" I.D.)		24232
Hose - Upper - Pipe To Pipe; (2" I.D.)		24232
Hose - Lower; Molded Hose		≧20731
Hose - Lower - Eng. To Pipe; (2 1/4" I.D.)		24236
Hose - Lower - Pipe To Pipe; (2 1/4" I.D.)		24236
Hose - Lower - Pipe To Cooler; (2 1/4" I.D.)		24236
Hose - Lower - Cooler To Pipe; (2" I.D.)		24232
Hose - Lower - Pipe To Rad.; (2" I.D.)		24232
Cummins B Series 5.9 L Diesel		
TC2000		
Belt - Fan & Alt.; W/49 1/8" Belt O.C.		▲K080485HD
Belt - Fan & Alt.; W/54 3/8" Belt O.C.	1373281	▲K080537HD
Belt - Fan & Alt.; W/58 5/8" Belt O.C.	2791517325	▲K080580HD
Belt - Fan & Alt.; W/74 5/8" Belt O.C.	1373323	▲K080740HD
Hose - Upper - Eng. To Pipe		●26601
Hose - Upper - Pipe To Rad.		≧21891
Hose - Lower - Eng. To Pipe		≧21194
Hose - Lower - Pipe To Cooler		≧21194
Hose - Lower - Cooler To Pipe; (2 1/4" I.D.)		24236
Hose - Lower - Pipe To Rad.		22177
Cummins V555 Diesel		
All American		
Belt - Fan & Air Brake Compr.		②▲9480HD
Belt - Fan To W.P. & Alt.		②7400
Belt - P.S.		▲9585HD
Hose - Upper - Eng. To Tee; (2" I.D.)		24232
International/Navistar DT466 Diesel		
Conventional		
Belt - Fan & Alt.; Chassis No. S1800		②◆▲9660HD
Belt - Fan & Alt.; Exc. Chassis No. S1800		②◆▲9640HD
Belt - P.S.; Chassis No. S1800		▲9755HD
Belt - P.S.; Exc. Chassis No. S1800		②▲9440HD
Belt - Air Brake Compr.; Chassis No. S1800		▲9500HD
Belt - Air Brake Compr.; Exc. Chassis No. S1800		▲9490HD
Hose - Upper - Eng. To Pipe; Chassis No. S1800(2 1/4" I.D.)		24236
Hose - Upper - Pipe To Rad.; Chassis No. S1800(2 1/2" I.D.)		24240
Hose - Upper; Exc. Chassis No. S1800		21372
Hose - Lower; Chassis No. S1800		●26531
Hose - Lower; Exc. Chassis No. S1800		21766

▲ Standard Belt Available. See Pages 630-631.
 ● Vulco-Flex® Coolant Hose.
 ◆ Green Stripe® PowerBand® Belt May Work, Use Template to Check.

≧ Cut to Fit.
 ② Two Required.

Belts and Coolant Hose for School Buses

School Buses

Application	Mfr. Part No.	Our No.
BLUEBIRD - Continued		
1986-1948		
Caterpillar 3208 Diesel		
All American		
Belt - Fan; Preferred Belt	2/9430PB	
Belt - Fan; Optional Belt	②▲9430HD	
Belt - W.P.; Preferred Belt	2/9490PB	
Belt - W.P.; Optional Belt	②▲9490HD	
Belt - Alt. & Air Brake Compr.; Preferred Belt	2/9660PB	
Belt - Alt. & Air Brake Compr.; Optional Belt	②▲9660HD	
Belt - P.S.; W/37 3/8" Belt O.C.	▲9370HD	
Belt - P.S.; W/48 7/8" Belt O.C.	▲9485HD	
Hose - Upper - Eng. To Pipe; (2" I.D.)	24232	
Hose - Upper - Pipe To Pipe; (2" I.D.)	24232	
Hose - Lower; Molded Hose	≅20731	
Hose - Lower - Eng. To Pipe; (2 1/4" I.D.)	24236	
Hose - Lower - Pipe To Pipe; (2 1/4" I.D.)	24236	
Hose - Lower - Pipe To Cooler; (2 1/4" I.D.)	24236	
Hose - Lower - Cooler To Pipe; (2" I.D.)	24232	
Hose - Lower - Pipe To Rad.; (2" I.D.)	24232	
Cummins V555 Diesel		
All American		
Belt - Fan & Air Brake Compr.	②▲9480HD	
Belt - Fan To W.P. & Alt.	②7400	
Belt - P.S.	▲9585HD	
Hose - Upper - Eng. To Tee; (2" I.D.)	24232	
International/Navistar DT466 Diesel		
Conventional		
Belt - Fan & Alt.; Chassis No. S1800	②◆▲9660HD	
Belt - Fan & Alt.; Exc. Chassis No. S1800	②◆▲9640HD	
Belt - P.S.; Chassis No. S1800	▲9755HD	
Belt - P.S.; Exc. Chassis No. S1800	②▲9440HD	
Belt - Air Brake Compr.; Chassis No. S1800	▲9500HD	
Belt - Air Brake Compr.; Exc. Chassis No. S1800	▲9490HD	
Hose - Upper - Eng. To Pipe; Chassis No. S1800(2 1/4" I.D.)	24236	
Hose - Upper - Pipe To Rad.; Chassis No. S1800(2 1/2" I.D.)	24240	
Hose - Upper; Exc. Chassis No. S1800	21372	
Hose - Lower; Chassis No. S1800	●26531	
Hose - Lower; Exc. Chassis No. S1800	21766	
CARPENTER		
1994		
International/Navistar V-8 7.3 L Diesel		
Classic		
Belt - Fan & P.S.	▲9585HD	
Belt - Alt.	7575	
Hose - Upper - Eng. To Rad.	21454	
Hose - Lower - Eng. To Rad.	21455	
CHEVROLET		
2000		
Caterpillar 3126 Diesel		
B7 Series		
Belt - Fan & Alt.	15670937	▲K070705HD
Belt - W.P.	0366775	▲9341HD
1999		
Caterpillar 3116 Diesel		
B7 Series		
Belt - Fan & Alt.; W/70" Belt O.C.	15670937	▲K070705HD
B60 B6P Series		
Belt - Fan & Alt.	15670937	▲K070705HD
Hose - Upper	22134	
Hose - Lower	21985	
Caterpillar 3126 Diesel		
B7 Series		
Belt - Fan & Alt.	15670937	▲K070705HD
Belt - W.P.	0366775	▲9341HD

Application	Mfr. Part No.	Our No.
CHEVROLET - Continued		
1999 - Continued		
Caterpillar 3126 Diesel - Continued		
B60 B6P Series		
Hose - Upper		22134
Hose - Lower		21985
GM V-8 7.4 L		
B7 Series		
Belt - Air Compr.	11502412	▲9680HD
Belt - P.S. & Air Brake Compr.	9433884	▲9395HD
Belt - Fan & Gen.	15722647	▲K060660HD
Belt - P.S. & Hyd. Brake	11502405	▲9640HD
Hose - Upper - Eng. To Rad.		22663
Hose - Lower - Eng. To Rad.		22135
1998		
Caterpillar 3116 Diesel		
B7 Series		
Belt - Fan & Alt.; W/70" Belt O.C.	15670937	▲K070705HD
Hose - Upper - Eng. To Rad.		22134
Hose - Lower - Eng. To Rad.		21985
B60 B6P Series		
Belt - Fan & Alt.	15670937	▲K070705HD
Hose - Upper		22134
Hose - Lower		21985
Caterpillar 3126 Diesel		
B7 Series		
Belt - Fan & Alt.	15670937	▲K070705HD
Belt - W.P.	0366775	▲9341HD
Hose - Upper - Eng. To Rad.		22664
Hose - Lower - Eng. To Rad.		21985
B60 B6P Series		
Belt - Fan & Alt.	15670937	▲K070705HD
Hose - Upper		22134
Hose - Lower		21985
1997		
Caterpillar 3116 Diesel		
B7 Series		
Belt - Fan & Alt.; W/70" Belt O.C.	15670937	▲K070705HD
Hose - Upper - Eng. To Rad.		22134
Hose - Lower - Eng. To Rad.		21985
B60 B6P Series		
Belt - Fan & Alt.	15670937	▲K070705HD
Hose - Upper		22134
Hose - Lower		21985
Caterpillar 3126 Diesel		
B60 B6P Series		
Belt - Fan & Alt.	15670937	▲K070705HD
Hose - Upper		22134
Hose - Lower		21985
1996		
Caterpillar 3116 Diesel		
B60 B6P Series		
Belt - Fan & Alt.	15670937	▲K070705HD
Hose - Upper		22134
Hose - Lower		21985
Caterpillar 3126 Diesel		
B60 B6P Series		
Belt - Fan & Alt.	15670937	▲K070705HD
Hose - Upper		22134
Hose - Lower		21985
GM V-8 6.0 L		
B60 B6P Series		
Belt - Fan & Alt.; W/124A., 145A. Alt.	15608928	▲K060672HD
Belt - Fan & P.S.; W/Air Brakes	9433884	▲9395HD
Belt - Fan & P.S.; W/Hyd. Brakes	11502406	▲9650HD
Belt - Fan & A.C.	10230259	▲K060670HD
Belt - Air Brake Compr.	11502413	▲9690HD

② Two Required.
 ≅ Cut to Fit.
 ● Vulco-Flex® Coolant Hose.

▲ Standard Belt Available. See Pages 630-631.
 ◆ Green Stripe® PowerBand® Belt May Work, Use Template to Check.

Belts and Coolant Hose for School Buses

School Buses

Application	Mfr. Part No.	Our No.
CHEVROLET - Continued		
1996 - Continued		
GM V-8 6.0 L - Continued		
B60 B6P Series - Continued		
Hose - Upper		22136
Hose - Lower		22135
GM V-8 7.0 L		
B60 B6P Series		
Belt - Fan & Alt.; W/124A., 145A. Alt.	15608928	▲K060672HD
Belt - Fan & P.S.; W/Air Brakes	9433884	▲9395HD
Belt - Fan & P.S.; W/Hyd. Brakes	11502406	▲9650HD
Belt - Fan & A.C.	10230259	▲K060670HD
Belt - Air Brake Compr.	11502413	▲9690HD
Hose - Upper		22136
Hose - Lower		22135
GM V-8 7.4 L		
B60 B6P Series		
Belt - Fan & Alt.; W/124A., 145A. Alt.	15608928	▲K060672HD
Belt - Fan & P.S.; W/Air Brakes	9433884	▲9395HD
Belt - Fan & P.S.; W/Hyd. Brakes	11502406	▲9650HD
Belt - Fan & A.C.	10230259	▲K060670HD
Belt - Air Brake Compr.	11502413	▲9690HD
Hose - Upper		22136
Hose - Lower		22135
1995		
Caterpillar 3116 Diesel		
B60 B6P Series		
Belt - Fan & Alt.	15670937	▲K070705HD
Hose - Upper		22134
Hose - Lower		21985
GM V-8 6.0 L		
B60 B6P Series		
Belt - Fan & Alt.; W/124A., 145A. Alt.	15608928	▲K060672HD
Belt - Fan & P.S.; W/Air Brakes	9433884	▲9395HD
Belt - Fan & P.S.; W/Hyd. Brakes	11502406	▲9650HD
Belt - Fan & A.C.	10230259	▲K060670HD
Belt - Air Brake Compr.	11502413	▲9690HD
Hose - Upper		22136
Hose - Lower		22135
GM V-8 7.0 L		
B60 B6P Series		
Belt - Fan & Alt.; W/124A., 145A. Alt.	15608928	▲K060672HD
Belt - Fan & P.S.; W/Air Brakes	9433884	▲9395HD
Belt - Fan & P.S.; W/Hyd. Brakes	11502406	▲9650HD
Belt - Fan & A.C.	10230259	▲K060670HD
Belt - Air Brake Compr.	11502413	▲9690HD
Hose - Upper		22136
Hose - Lower		22135
GM V-8 7.4 L		
B60 B6P Series		
Belt - Fan & Alt.; W/124A., 145A. Alt.	15608928	▲K060672HD
Belt - Fan & P.S.; W/Air Brakes	9433884	▲9395HD
Belt - Fan & P.S.; W/Hyd. Brakes	11502406	▲9650HD
Belt - Fan & A.C.	10230259	▲K060670HD
Belt - Air Brake Compr.	11502413	▲9690HD
Hose - Upper		22136
Hose - Lower		22135
1994-1992		
Caterpillar 3116 Diesel		
B60 B6P Series		
Belt - Fan & Alt.	15670937	▲K070705HD
Hose - Upper		22134
Hose - Lower		21985
Caterpillar 3126 Diesel		
B60 B6P Series		
Belt - Fan & Alt.	15670937	▲K070705HD
Hose - Upper		22134
Hose - Lower		21985

▲ Standard Belt Available. See Pages 630-631.

Application	Mfr. Part No.	Our No.
CHEVROLET - Continued		
1994-1992 - Continued		
GM V-8 6.0 L		
B60 B6P Series		
Belt - Fan & Alt.; W/124A., 145A. Alt.	15608928	▲K060672HD
Belt - Fan & P.S.; W/Air Brakes	9433884	▲9395HD
Belt - Fan & P.S.; W/Hyd. Brakes	11502406	▲9650HD
Belt - Fan & A.C.	10230259	▲K060670HD
Belt - Air Brake Compr.	11502413	▲9690HD
Hose - Upper		22136
Hose - Lower		22135
GM V-8 7.0 L		
B60 B6P Series		
Belt - Fan & Alt.; W/124A., 145A. Alt.	15608928	▲K060672HD
Belt - Fan & P.S.; W/Air Brakes	9433884	▲9395HD
Belt - Fan & P.S.; W/Hyd. Brakes	11502406	▲9650HD
Belt - Fan & A.C.	10230259	▲K060670HD
Belt - Air Brake Compr.	11502413	▲9690HD
Hose - Upper		22136
Hose - Lower		22135
GM V-8 7.4 L		
B60 B6P Series		
Belt - Fan & Alt.; W/124A., 145A. Alt.	15608928	▲K060672HD
Belt - Fan & P.S.; W/Air Brakes	9433884	▲9395HD
Belt - Fan & P.S.; W/Hyd. Brakes	11502406	▲9650HD
Belt - Fan & A.C.	10230259	▲K060670HD
Belt - Air Brake Compr.	11502413	▲9690HD
Hose - Upper		22136
Hose - Lower		22135
1991		
Detroit Diesel V-8 8.2 L Diesel		
S60 B6P Series		
Belt - Fan & Alt.; W/71 1/2" Belt O.C.	2099791	▲9710HD
Belt - Fan & Alt.; W/97 1/2" Belt O.C.	2056956	②▲9700HD
Belt - Fan & Air Brake Compr.		▲9720HD
Belt - P.S.	11502340	▲9385HD
Hose - Upper - Eng. To Pipe; (2" I.D.)		24232
Hose - Upper - Pipe To Rad.		21473
Hose - Lower - Eng. To Pipe; (2 1/4" I.D.)		24236
Hose - Lower - Pipe To Rad.; (2 3/8" I.D.)		24238
Hose - By Pass - Left Side; (1 3/8" I.D.)		24222
Hose - By Pass - Right Side		21457
GM V-8 6.0 L		
B60 B6P Series		
Hose - Upper		22136
Hose - Lower		22135
S60 B6P Series		
Belt - Fan & Alt.; W/63A., 108A. Alt.; Preferred Belt		2/9640PB
Belt - Fan & Alt.; W/63A., 108A. Alt.; Optional Belt		②▲9640HD
Belt - Fan & Alt.; W/80A., 100A. Alt.; Preferred Belt		2/9660PB
Belt - Fan & Alt.; W/80A., 100A. Alt.; Optional Belt		②▲9660HD
Belt - Fan & Alt.; W/105A., 130A., 160A. Alt.; Preferred Belt ..		2/9670PB
Belt - Fan & Alt.; W/105A., 130A., 160A. Alt.; Optional Belt		②▲9670HD
Belt - Fan & P.S.		▲9630HD
Belt - Fan & Hyd. Pump		▲9630HD
Belt - Fan & Air Brake Compr.	2027569	5700
Belt - Fan To A.P.	9433881	▲9380HD
Belt - Alt. & A.P.; W/108A. Alt.		▲9630HD
Belt - Alt. & A.P.; W/80A., 100A. Alt.		▲9640HD
Belt - Alt. & A.P.; W/105A., 130A., 160A. Alt.		▲9650HD
Belt - P.S.; W/40" Belt O.C.	9433884	▲9395HD
Belt - P.S.; W/Air Brakes; W/59 1/2" Belt O.C.		▲9590HD
Belt - P.S.; W/Hyd. Brakes; W/64 3/4" Belt O.C.		▲9640HD
Belt - A.P. - From C.S.; W/39" Belt O.C.		▲9385HD
Belt - A.P. - From C.S.; W/54 1/2" Belt O.C. ...	9433913	▲9540HD
Belt - Air Brake Compr.		▲9720HD
GM V-8 7.0 L		
B60 B6P Series		
Hose - Upper		22136
Hose - Lower		22135

② Two Required.

Belts and Coolant Hose for School Buses

School Buses

Application	Mfr. Part No.	Our No.
CHEVROLET - Continued		
1991 - Continued		
GM V-8 7.0 L - Continued		
S60 B6P Series		
Belt - Fan & Alt.; W/63A., 108A. Alt.; Preferred Belt		2/9640PB
Belt - Fan & Alt.; W/63A., 108A. Alt.; Optional Belt	②	▲9640HD
Belt - Fan & Alt.; W/80A., 100A. Alt.; Preferred Belt		2/9660PB
Belt - Fan & Alt.; W/80A., 100A. Alt.; Optional Belt	②	▲9660HD
Belt - Fan & Alt.; W/105A., 130A., 160A. Alt.; Preferred Belt ..		2/9670PB
Belt - Fan & Alt.; W/105A., 130A., 160A. Alt.; Optional Belt ...	②	▲9670HD
Belt - Fan & P.S.		▲9630HD
Belt - Fan & Hyd. Pump		▲9630HD
Belt - Fan & Air Brake Compr.	2027569	5700
Belt - Fan To A.P.	9433881	▲9380HD
Belt - Alt. & A.P.; W/108A. Alt.		▲9630HD
Belt - Alt. & A.P.; W/80A., 100A. Alt.		▲9640HD
Belt - Alt. & A.P.; W/105A., 130A., 160A. Alt.		▲9650HD
Belt - P.S.; W/40" Belt O.C.	9433884	▲9395HD
Belt - P.S.; W/Air Brakes; W/59 1/2" Belt O.C.		▲9590HD
Belt - P.S.; W/Hyd. Brakes; W/64 3/4" Belt O.C.		▲9640HD
Belt - A.P. - From C.S.; W/39" Belt O.C.		▲9385HD
Belt - A.P. - From C.S.; W/54 1/2" Belt O.C. ...	9433913	▲9540HD
Belt - Air Brake Compr.		▲9720HD
GM V-8 7.4 L		
B60 B6P Series		
Hose - Upper		22136
Hose - Lower		22135
S60 B6P Series		
Belt - Fan & Alt.; W/63A., 108A. Alt.; Preferred Belt		2/9640PB
Belt - Fan & Alt.; W/63A., 108A. Alt.; Optional Belt	②	▲9640HD
Belt - Fan & Alt.; W/80A., 100A. Alt.; Preferred Belt		2/9660PB
Belt - Fan & Alt.; W/80A., 100A. Alt.; Optional Belt	②	▲9660HD
Belt - Fan & Alt.; W/105A., 130A., 160A. Alt.; Preferred Belt ..		2/9670PB
Belt - Fan & Alt.; W/105A., 130A., 160A. Alt.; Optional Belt ...	②	▲9670HD
Belt - Fan & P.S.		▲9630HD
Belt - Fan & Hyd. Pump		▲9630HD
Belt - Fan & Air Brake Compr.	2027569	5700
Belt - Fan To A.P.	9433881	▲9380HD
Belt - Alt. & A.P.; W/108A. Alt.		▲9630HD
Belt - Alt. & A.P.; W/80A., 100A. Alt.		▲9640HD
Belt - Alt. & A.P.; W/105A., 130A., 160A. Alt.		▲9650HD
Belt - P.S.; W/40" Belt O.C.	9433884	▲9395HD
Belt - P.S.; W/Air Brakes; W/59 1/2" Belt O.C.		▲9590HD
Belt - P.S.; W/Hyd. Brakes; W/64 3/4" Belt O.C.		▲9640HD
Belt - A.P. - From C.S.; W/39" Belt O.C.		▲9385HD
Belt - A.P. - From C.S.; W/54 1/2" Belt O.C. ...	9433913	▲9540HD
Belt - Air Brake Compr.		▲9720HD
1990		
Detroit Diesel V-8 8.2 L Diesel		
B60 B6P Series		
Belt - Fan & Alt.; W/71 1/2" Belt O.C.	2099791	▲9710HD
Belt - Fan & Alt.; W/97 1/2" Belt O.C.	2056956	②▲9700HD
Belt - Fan & Air Brake Compr.		▲9720HD
Belt - P.S.	11502340	▲9385HD
Hose - Upper - Eng. To Pipe; (2" I.D.)		24232
Hose - Upper - Pipe To Rad.		21473
Hose - Lower - Eng. To Pipe; (2 1/4" I.D.)		24236
Hose - Lower - Pipe To Rad.; (2 3/8" I.D.)		24238
Hose - By Pass - Left Side; (1 3/8" I.D.)		24222
Hose - By Pass - Right Side		21457
S7 S7T Series		
Belt - Fan & Alt.; W/71 1/2" Belt O.C.	2099791	▲9710HD
Belt - Fan & Alt.; W/97 1/2" Belt O.C.	2056956	②▲9700HD
Belt - Fan & Air Brake Compr.		▲9720HD
Belt - P.S.	11502340	▲9385HD
Belt - Air Brake Compr.; W/71 1/2" Belt O.C. .	11502416	▲9710HD
Belt - Air Brake Compr.; W/75" Belt O.C.	11502340	▲9745HD
Hose - Upper - Eng. To Pipe; (2" I.D.)		24232
Hose - Upper - Pipe To Rad.		21473
Hose - Lower - Eng. To Pipe; (2 1/4" I.D.)		24236
Hose - Lower - Pipe To Rad.; (2 3/8" I.D.)		24238
Hose - By Pass - Left Side; (1 3/8" I.D.)		24222

Application	Mfr. Part No.	Our No.
CHEVROLET - Continued		
1990 - Continued		
Detroit Diesel V-8 8.2 L Diesel - Continued		
S7 S7T Series - Continued		
Hose - By Pass - Right Side		21457
GM V-8 5.7 L		
B60 B6P Series		
Belt - Fan & Alt.; W/70A., 108A. Alt.	11502375	▲9525HD
Belt - Fan & Alt.; W/80A., 100A. Alt.	2005476	②◆▲9550HD
Belt - Fan & Alt.; W/105A., 130A., 160A. Alt.; Preferred Belt	11502386	2/9570PB
Belt - Fan & Alt.; W/105A., 130A., 160A. Alt.; Optional Belt	11502386	②▲9570HD
Belt - Fan, Alt. & A.P.; W/80A. Alt.	11502410	▲9670HD
Belt - Fan, Alt. & A.P.; W/105A., 130A., 160A. Alt.	11502411	▲9680HD
Belt - Fan & P.S.; W/Hyd. Brakes	9433923	▲9590HD
Belt - P.S. & A.P.		▲9640HD
Belt - P.S.; W/Air Brakes	9433881	▲9380HD
Belt - Air Brake Compr. & A.P.		▲9670HD
Belt - A.P.		▲9540HD
GM V-8 6.0 L		
B60 B6P Series		
Belt - Fan & Alt.; W/63A., 108A. Alt.; Preferred Belt		2/9640PB
Belt - Fan & Alt.; W/63A., 108A. Alt.; Optional Belt	②	▲9640HD
Belt - Fan & Alt.; W/80A., 100A. Alt.; Preferred Belt		2/9660PB
Belt - Fan & Alt.; W/80A., 100A. Alt.; Optional Belt	②	▲9660HD
Belt - Fan & Alt.; W/105A., 130A., 160A. Alt.; Preferred Belt ..		2/9670PB
Belt - Fan & Alt.; W/105A., 130A., 160A. Alt.; Optional Belt ...	②	▲9670HD
Belt - Fan & P.S.		▲9630HD
Belt - Fan & Hyd. Pump		▲9630HD
Belt - Fan & Air Brake Compr.	2027569	5700
Belt - Fan To A.P.	9433881	▲9380HD
Belt - Alt. & A.P.; W/108A. Alt.		▲9630HD
Belt - Alt. & A.P.; W/80A., 100A. Alt.		▲9640HD
Belt - Alt. & A.P.; W/105A., 130A., 160A. Alt.		▲9650HD
Belt - P.S.; W/40" Belt O.C.	9433884	▲9395HD
Belt - P.S.; W/Air Brakes; W/59 1/2" Belt O.C.		▲9590HD
Belt - P.S.; W/Hyd. Brakes; W/64 3/4" Belt O.C.		▲9640HD
Belt - A.P. - From C.S.; W/39" Belt O.C.		▲9385HD
Belt - A.P. - From C.S.; W/54 1/2" Belt O.C. ...	9433913	▲9540HD
Belt - Air Brake Compr.		▲9720HD
Hose - Upper - Eng. To Pipe		≈21307
Hose - Upper - Pipe To Rad.; W/Auto. Trans.		21523
Hose - Upper - Pipe To Rad.; W/Man. Trans.		21521
Hose - Lower - Eng. To Pipe; (2 1/4" I.D.)		24236
Hose - Lower - Pipe To Rad.		21556
Hose - By Pass; (1 3/8" I.D.)		24222
S7 S7T Series		
Belt - Fan & Alt.		▲9640HD
Belt - P.S.	9433923	▲9590HD
Belt - Air Brake Compr.	11502417	▲9720HD
Belt - A.P.	11502340	▲9385HD
Belt - A.P. & Alt.	11502402	▲9630HD
Hose - Upper - Eng. To Pipe		≈21307
Hose - Upper - Pipe To Rad.; W/Auto. Trans.		21523
Hose - Upper - Pipe To Rad.; W/Man. Trans.		21521
Hose - Lower - Pipe To Rad.		21556
Hose - By Pass; (1 3/8" I.D.)		24222
GM V-8 7.0 L		
B60 B6P Series		
Belt - Fan & Alt.; W/63A., 108A. Alt.; Preferred Belt		2/9640PB
Belt - Fan & Alt.; W/63A., 108A. Alt.; Optional Belt	②	▲9640HD
Belt - Fan & Alt.; W/80A., 100A. Alt.; Preferred Belt		2/9660PB
Belt - Fan & Alt.; W/80A., 100A. Alt.; Optional Belt	②	▲9660HD
Belt - Fan & Alt.; W/105A., 130A., 160A. Alt.; Preferred Belt ..		2/9670PB
Belt - Fan & Alt.; W/105A., 130A., 160A. Alt.; Optional Belt ...	②	▲9670HD
Belt - Fan & P.S.		▲9630HD
Belt - Fan & Hyd. Pump		▲9630HD
Belt - Fan & Air Brake Compr.	2027569	5700
Belt - Fan To A.P.	9433881	▲9380HD
Belt - Alt. & A.P.; W/108A. Alt.		▲9630HD

② Two Required.
◆ Green Stripe® PowerBand® Belt May Work, Use Template to Check.

▲ Standard Belt Available. See Pages 630-631.
≈ Cut to Fit.

Belts and Coolant Hose for School Buses

School Buses

Application	Mfr. Part No.	Our No.
CHEVROLET - Continued		
1987-1986 - Continued		
Detroit Diesel V-8 8.2 L Diesel - Continued		
B60 B6P Series - Continued		
Hose - Upper - Eng. To Pipe; (2" I.D.)		24232
Hose - Upper - Pipe To Rad.		21473
Hose - Lower - Eng. To Pipe; (2 1/4" I.D.)		24236
Hose - Lower - Pipe To Rad.; (2 3/8" I.D.)		24238
Hose - By Pass - Left Side; (1 3/8" I.D.)		24222
Hose - By Pass - Right Side		21457
GM V-8 5.7 L		
B60 B6P Series		
Belt - Fan & Alt.; W/70A., 108A. Alt.	11502375	▲9525HD
Belt - Fan & Alt.; W/80A., 100A. Alt.	2005476	②▲9550HD
Belt - Fan & Alt.; W/105A., 130A., 160A. Alt. .	11502386	②▲9570HD
Belt - Fan, Alt. & A.P.; W/80A. Alt.	11502410	▲9670HD
Belt - Fan, Alt. & A.P.; W/105A., 130A., 160A. Alt.	11502411	▲9680HD
Belt - Fan & P.S.; W/Hyd. Brakes	9433923	▲9590HD
Belt - P.S. & A.P.		▲9640HD
Belt - P.S.; W/Air Brakes	9433881	▲9380HD
Belt - Air Brake Compr. & A.P.		▲9670HD
Belt - A.P.		▲9540HD
Hose - Upper		21095
Hose - Lower		21409
Hose - By Pass		≧20777
GM V-8 6.0 L		
B60 B6P Series		
Belt - Fan & Alt.; W/63A., 108A. Alt.		②▲▲9640HD
Belt - Fan & Alt.; W/80A., 100A. Alt.		②▲▲9660HD
Belt - Fan & Alt.; W/105A., 130A., 160A. Alt.		②▲▲9670HD
Belt - Fan & P.S.		▲9630HD
Belt - Fan & Hyd. Pump		▲9630HD
Belt - Fan & Air Brake Compr.	2027569	5700
Belt - Fan To A.P.	9433881	▲9380HD
Belt - Alt. & A.P.; W/108A. Alt.		▲9630HD
Belt - Alt. & A.P.; W/80A., 100A. Alt.		▲9640HD
Belt - Alt. & A.P.; W/105A., 130A., 160A. Alt.		▲9650HD
Belt - P.S.; W/40" Belt O.C.	9433884	▲9395HD
Belt - P.S.; W/Air Brakes; W/59 1/2" Belt O.C.		▲9590HD
Belt - P.S.; W/Hyd. Brakes; W/64 3/4" Belt O.C.		▲9640HD
Belt - A.P. - From C.S.; W/39" Belt O.C.		▲9385HD
Belt - A.P. - From C.S.; W/54 1/2" Belt O.C. ...	9433913	▲9540HD
Belt - Air Brake Compr.		▲9720HD
Hose - Upper - Eng. To Pipe		≧21307
Hose - Upper - Pipe To Rad.; W/Auto. Trans.		21523
Hose - Upper - Pipe To Rad.; W/Man. Trans.		21521
Hose - Lower - Eng. To Pipe; (2 1/4" I.D.)		24236
Hose - Lower - Pipe To Rad.		21556
Hose - By Pass; (1 3/8" I.D.)		24222
1985-1983		
Detroit Diesel V-8 8.2 L Diesel		
B60 B6P Series		
Belt - Fan & Alt.; W/71 1/2" Belt O.C.	2099791	▲9710HD
Belt - Fan & Alt.; W/97 1/2" Belt O.C.	2056956	②▲9700HD
Belt - Fan & Air Brake Compr.		▲9720HD
Belt - P.S.	11502340	▲9385HD
Hose - Upper - Eng. To Pipe; (2" I.D.)		24232
Hose - Upper - Pipe To Rad.		21473
Hose - Lower - Eng. To Pipe; (2 1/4" I.D.)		24236
Hose - Lower - Pipe To Rad.; (2 3/8" I.D.)		24238
Hose - By Pass - Left Side; (1 3/8" I.D.)		24222
Hose - By Pass - Right Side		21457
GM V-8 5.7 L		
B60 B6P Series		
Belt - Fan & Alt.; W/70A., 108A. Alt.	11502375	▲9525HD
Belt - Fan & Alt.; W/80A., 100A. Alt.	2005476	②▲9550HD
Belt - Fan & Alt.; W/105A., 130A., 160A. Alt. .	11502386	②▲9570HD
Belt - Fan, Alt. & A.P.; W/80A. Alt.	11502410	▲9670HD
Belt - Fan, Alt. & A.P.; W/105A., 130A., 160A. Alt.	11502411	▲9680HD

Application	Mfr. Part No.	Our No.
CHEVROLET - Continued		
1985-1983 - Continued		
GM V-8 5.7 L - Continued		
B60 B6P Series - Continued		
Belt - Fan & P.S.; W/Hyd. Brakes	9433923	▲9590HD
Belt - P.S. & A.P.		▲9640HD
Belt - P.S.; W/Air Brakes	9433881	▲9380HD
Belt - Air Brake Compr. & A.P.		▲9670HD
Belt - A.P.		▲9540HD
Hose - Upper		21095
Hose - Lower		21409
Hose - By Pass		≧20777
GM V-8 6.0 L		
B60 B6P Series		
Belt - Fan & Alt.; W/63A., 108A. Alt.		②▲▲9640HD
Belt - Fan & Alt.; W/80A., 100A. Alt.		②▲▲9660HD
Belt - Fan & Alt.; W/105A., 130A., 160A. Alt.		②▲▲9670HD
Belt - Fan & P.S.		▲9630HD
Belt - Fan & Hyd. Pump		▲9630HD
Belt - Fan & Air Brake Compr.	2027569	5700
Belt - Fan To A.P.	9433881	▲9380HD
Belt - Alt. & A.P.; W/108A. Alt.		▲9630HD
Belt - Alt. & A.P.; W/80A., 100A. Alt.		▲9640HD
Belt - Alt. & A.P.; W/105A., 130A., 160A. Alt.		▲9650HD
Belt - P.S.; W/40" Belt O.C.	9433884	▲9395HD
Belt - P.S.; W/Air Brakes; W/59 1/2" Belt O.C.		▲9590HD
Belt - P.S.; W/Hyd. Brakes; W/64 3/4" Belt O.C.		▲9640HD
Belt - A.P. - From C.S.; W/39" Belt O.C.		▲9385HD
Belt - A.P. - From C.S.; W/54 1/2" Belt O.C. ...	9433913	▲9540HD
Belt - Air Brake Compr.		▲9720HD
Hose - Upper		21107
Hose - Lower - Eng. To Pipe; (2 1/4" I.D.)		24236
Hose - Lower - Pipe To Rad.		21556
Hose - By Pass; (1 3/8" I.D.)		24222
GM V-8 7.0 L		
B60 B6P Series		
Belt - Fan & Alt.; W/63A., 108A. Alt.		②▲▲9640HD
Belt - Fan & Alt.; W/80A., 100A. Alt.		②▲▲9660HD
Belt - Fan & Alt.; W/105A., 130A., 160A. Alt.		②▲▲9670HD
Belt - Fan & P.S.		▲9630HD
Belt - Fan & Hyd. Pump		▲9630HD
Belt - Fan & Air Brake Compr.	2027569	5700
Belt - Fan To A.P.	9433881	▲9380HD
Belt - Alt. & A.P.; W/108A. Alt.		▲9630HD
Belt - Alt. & A.P.; W/80A., 100A. Alt.		▲9640HD
Belt - Alt. & A.P.; W/105A., 130A., 160A. Alt.		▲9650HD
Belt - P.S.; W/40" Belt O.C.	9433884	▲9395HD
Belt - P.S.; W/Air Brakes; W/59 1/2" Belt O.C.		▲9590HD
Belt - P.S.; W/Hyd. Brakes; W/64 3/4" Belt O.C.		▲9640HD
Belt - A.P. - From C.S.; W/39" Belt O.C.		▲9385HD
Belt - A.P. - From C.S.; W/54 1/2" Belt O.C. ...	9433913	▲9540HD
Belt - Air Brake Compr.		▲9720HD
Hose - Upper		21107
Hose - Lower - Eng. To Pipe; (2 1/4" I.D.)		24236
Hose - Lower - Pipe To Rad.		21556
Hose - By Pass; (1 3/8" I.D.)		24222
1982		
Detroit Diesel V-8 8.2 L Diesel		
B60 B6P Series		
Belt - Fan & Alt.; W/71 1/2" Belt O.C.	2099791	▲9710HD
Belt - Fan & Alt.; W/97 1/2" Belt O.C.	2056956	②▲9700HD
Belt - Fan & Air Brake Compr.; Jan. 10, 1982 & Older	11502414	▲9700HD
Belt - Fan & Air Brake Compr.; Jan. 11, 1982 & Newer		▲9720HD
Belt - P.S.	11502340	▲9385HD
Hose - Upper - Eng. To Pipe; (2" I.D.)		24232
Hose - Upper - Pipe To Rad.		21473
Hose - Lower - Eng. To Pipe; (2 1/4" I.D.)		24236
Hose - Lower - Pipe To Rad.; (2 3/8" I.D.)		24238
Hose - By Pass - Left Side; (1 3/8" I.D.)		24222
Hose - By Pass - Right Side		21457

▲ Standard Belt Available. See Pages 630-631.
◆ Green Stripe® PowerBand® Belt May Work, Use Template to Check.

② Two Required.
≧ Cut to Fit.

Belts and Coolant Hose for School Buses

Application	Mfr. Part No.	Our No.	Application	Mfr. Part No.	Our No.
CHEVROLET - Continued			CHEVROLET - Continued		
1982 - Continued			1981-1980 - Continued		
GM V-8 5.7 L			Detroit Diesel V-8 8.2 L Diesel - Continued		
B60 B6P Series			B60 B6P Series - Continued		
Belt - Fan & Alt.; W/70A., 108A. Alt.	11502375	▲9525HD	Hose - Lower - Pipe To Rad.; (2 3/8" I.D.)		24238
Belt - Fan & Alt.; W/80A., 100A. Alt.	2005476	②◆▲9550HD	Hose - By Pass - Left Side; (1 3/8" I.D.)		24222
Belt - Fan & Alt.; W/105A., 130A., 160A. Alt. .	11502386	②◆▲9570HD	Hose - By Pass - Right Side		21457
Belt - Fan, Alt. & A.P.; W/80A. Alt.	11502410	▲9670HD			
Belt - Fan, Alt. & A.P.; W/105A., 130A., 160A. Alt.	11502411	▲9680HD			
Belt - Fan & P.S.; W/Hyd. Brakes	9433923	▲9590HD			
Belt - P.S. & A.P.		▲9640HD			
Belt - P.S.; W/Air Brakes	9433881	▲9380HD			
Belt - Air Brake Compr. & A.P.		▲9670HD			
Belt - A.P.		▲9540HD			
Hose - Upper		21095			
Hose - Lower		21409			
Hose - By Pass		≡20777			
GM V-8 6.0 L			GM V-8 5.7 L		
B60 B6P Series			B60 B6P Series		
Belt - Fan & Alt.; W/63A., 108A. Alt.		②◆▲9640HD	Belt - Fan & Alt.; W/70A., 108A. Alt.	11502375	▲9525HD
Belt - Fan & Alt.; W/80A., 100A. Alt.		②◆▲9660HD	Belt - Fan & Alt.; W/80A., 100A. Alt.	2005476	②◆▲9550HD
Belt - Fan & Alt.; W/105A., 130A., 160A. Alt.		②◆▲9670HD	Belt - Fan & Alt.; W/105A., 130A., 160A. Alt. .	11502386	②◆▲9570HD
Belt - Fan & P.S.		▲9630HD	Belt - Fan, Alt. & A.P.; W/80A. Alt.	11502410	▲9670HD
Belt - Fan & Hyd. Pump		▲9630HD	Belt - Fan, Alt. & A.P.; W/105A., 130A., 160A. Alt.	11502411	▲9680HD
Belt - Fan & Air Brake Compr.	2027569	5700	Belt - Fan & P.S.; W/Hyd. Brakes	9433923	▲9590HD
Belt - Fan To A.P.	9433881	▲9380HD	Belt - P.S. & A.P.		▲9640HD
Belt - Alt. & A.P.; W/108A. Alt.		▲9630HD	Belt - P.S.; W/Air Brakes	9433881	▲9380HD
Belt - Alt. & A.P.; W/80A., 100A. Alt.		▲9640HD	Belt - Air Brake Compr. & A.P.		▲9670HD
Belt - Alt. & A.P.; W/105A., 130A., 160A. Alt.		▲9650HD	Belt - A.P.		▲9540HD
Belt - P.S.; W/40" Belt O.C.	9433884	▲9395HD	Hose - Upper		21095
Belt - P.S.; W/Air Brakes; W/59 1/2" Belt O.C.		▲9590HD	Hose - Lower		21409
Belt - P.S.; W/Hyd. Brakes; W/64 3/4" Belt O.C.		▲9640HD	Hose - By Pass		≡20777
Belt - A.P. - From C.S.; W/39" Belt O.C.		▲9385HD			
Belt - A.P. - From C.S.; W/54 1/2" Belt O.C. .	9433913	▲9540HD			
Belt - Air Brake Compr.		▲9720HD			
Hose - Upper		21107			
Hose - Lower - Eng. To Pipe; (2 1/4" I.D.)		24236			
Hose - Lower - Pipe To Rad.		21556			
Hose - By Pass; (1 3/8" I.D.)		24222			
GM V-8 7.0 L			GM V-8 6.0 L		
B60 B6P Series			B60 B6P Series		
Belt - Fan & Alt.; W/63A., 108A. Alt.		②◆▲9640HD	Belt - Fan & Alt.; W/63A., 108A. Alt.		②◆▲9640HD
Belt - Fan & Alt.; W/80A., 100A. Alt.		②◆▲9660HD	Belt - Fan & Alt.; W/80A., 100A. Alt.		②◆▲9660HD
Belt - Fan & Alt.; W/105A., 130A., 160A. Alt.		②◆▲9670HD	Belt - Fan & Alt.; W/105A., 130A., 160A. Alt.		②◆▲9670HD
Belt - Fan & P.S.		▲9630HD	Belt - Fan & P.S.		▲9630HD
Belt - Fan & Hyd. Pump		▲9630HD	Belt - Fan & Hyd. Pump		▲9630HD
Belt - Fan & Air Brake Compr.	2027569	5700	Belt - Fan & Air Brake Compr.	2027569	5700
Belt - Fan To A.P.	9433881	▲9380HD	Belt - Fan To A.P.	9433881	▲9380HD
Belt - Alt. & A.P.; W/108A. Alt.		▲9630HD	Belt - Alt. & A.P.; W/108A. Alt.		▲9630HD
Belt - Alt. & A.P.; W/80A., 100A. Alt.		▲9640HD	Belt - Alt. & A.P.; W/80A., 100A. Alt.		▲9640HD
Belt - Alt. & A.P.; W/105A., 130A., 160A. Alt.		▲9650HD	Belt - Alt. & A.P.; W/105A., 130A., 160A. Alt.		▲9650HD
Belt - P.S.; W/40" Belt O.C.	9433884	▲9395HD	Belt - P.S.; W/40" Belt O.C.	9433884	▲9395HD
Belt - P.S.; W/Air Brakes; W/59 1/2" Belt O.C.		▲9590HD	Belt - P.S.; W/Air Brakes; W/59 1/2" Belt O.C.		▲9590HD
Belt - P.S.; W/Hyd. Brakes; W/64 3/4" Belt O.C.		▲9640HD	Belt - P.S.; W/Hyd. Brakes; W/64 3/4" Belt O.C.		▲9640HD
Belt - A.P. - From C.S.; W/39" Belt O.C.		▲9385HD	Belt - A.P. - From C.S.; W/39" Belt O.C.		▲9385HD
Belt - A.P. - From C.S.; W/54 1/2" Belt O.C. .	9433913	▲9540HD	Belt - A.P. - From C.S.; W/54 1/2" Belt O.C. .	9433913	▲9540HD
Belt - Air Brake Compr.		▲9720HD	Belt - Air Brake Compr.		▲9720HD
Hose - Upper		21107	Hose - Upper		21107
Hose - Lower - Eng. To Pipe; (2 1/4" I.D.)		24236	Hose - Lower - Eng. To Pipe; (2 1/4" I.D.)		24236
Hose - Lower - Pipe To Rad.		21556	Hose - Lower - Pipe To Rad.		21556
Hose - By Pass; (1 3/8" I.D.)		24222	Hose - By Pass; (1 3/8" I.D.)		24222
1981-1980			GM V-8 7.0 L		
Detroit Diesel V-8 8.2 L Diesel			B60 B6P Series		
B60 B6P Series			Belt - Fan & Alt.; W/63A., 108A. Alt.		
Belt - Fan & Alt.; W/71 1/2" Belt O.C.	2099791	▲9710HD	Belt - Fan & Alt.; W/80A., 100A. Alt.		②◆▲9660HD
Belt - Fan & Alt.; W/97 1/2" Belt O.C.	2056956	②◆▲9700HD	Belt - Fan & Alt.; W/105A., 130A., 160A. Alt.		②◆▲9670HD
Belt - Fan & Air Brake Compr.	11502414	▲9700HD	Belt - Fan & P.S.		▲9630HD
Belt - P.S.	11502340	▲9385HD	Belt - Fan & Hyd. Pump		▲9630HD
Hose - Upper - Eng. To Pipe; (2" I.D.)		24232	Belt - Fan & Air Brake Compr.	2027569	5700
Hose - Upper - Pipe To Rad.		21473	Belt - Fan To A.P.	9433881	▲9380HD
Hose - Lower - Eng. To Pipe; (2 1/4" I.D.)		24236	Belt - Alt. & A.P.; W/108A. Alt.		▲9630HD
			Belt - Alt. & A.P.; W/80A., 100A. Alt.		▲9640HD
			Belt - Alt. & A.P.; W/105A., 130A., 160A. Alt.		▲9650HD
			Belt - P.S.; W/40" Belt O.C.	9433884	▲9395HD
			Belt - P.S.; W/Air Brakes; W/59 1/2" Belt O.C.		▲9590HD
			Belt - P.S.; W/Hyd. Brakes; W/64 3/4" Belt O.C.		▲9640HD
			Belt - A.P. - From C.S.; W/39" Belt O.C.		▲9385HD
			Belt - A.P. - From C.S.; W/54 1/2" Belt O.C. .	9433913	▲9540HD
			Belt - Air Brake Compr.		▲9720HD
			Hose - Upper		21107
			Hose - Lower - Eng. To Pipe; (2 1/4" I.D.)		24236
			Hose - Lower - Pipe To Rad.		21556
			Hose - By Pass; (1 3/8" I.D.)		24222
			1979		
			GM 6-Cyl. 292		
			S60 B6P Series		
			Belt - Fan & Alt.; W/Std. Alt.	3887682	②◆▲9395HD

◆ Standard Belt Available. See Pages 630-631.

◆ Green Stripe® PowerBand® Belt May Work, Use Template to Check.

② Two Required.

≡ Cut to Fit.

School Buses

Belts and Coolant Hose for School Buses

School Buses

Application	Mfr. Part No.	Our No.
CHEVROLET - Continued		
1979 - Continued		
GM 6-Cyl. 292 - Continued		
S60 B6P Series - Continued		
Belt - Fan & Alt.; W/80A. Alt.	3911543	②▲9412HD
Belt - Fan & Alt.; W/100A. Alt.	690407	②▲9435HD
Belt - Fan, Alt. & P.S.; W/Std. Alt.	3947152	▲9500HD
Belt - Fan, Alt. & P.S.; W/80A. Alt.	3885457	▲9510HD
Belt - Fan & A.P.	3947150	▲9530HD
Belt - P.S.	9433884	▲9395HD
Belt - Hyd. Brake Boost Pump	9433896	▲9455HD
Belt - A.C.	3888403	7560
Hose - Upper		≧20686
Hose - Lower		20489
	or	●26611
Hose - By Pass		20563
Hose - Heater Inlet; (3/4" I.D.)		28442
Hose - Heater Outlet; (5/8" I.D.)		28441
GM V-8 350		
B60 B6P Series		
Belt - Fan & Alt.; W/70A., 108A. Alt.	11502375	▲9525HD
Belt - Fan & Alt.; W/80A., 100A. Alt.	2005476	②◆▲9550HD
Belt - Fan & Alt.; W/105A., 130A., 160A. Alt.	11502386	②◆▲9570HD
Belt - Fan, Alt. & A.P.; W/80A. Alt.	11502410	▲9670HD
Belt - Fan, Alt. & A.P.; W/105A., 130A., 160A. Alt.	11502411	▲9680HD
Belt - Fan & P.S.; W/Hyd. Brakes	9433923	▲9590HD
Belt - P.S. & A.P.		▲9640HD
Belt - P.S.; W/Air Brakes	9433881	▲9380HD
Belt - Air Brake Compr. & A.P.		▲9670HD
Belt - A.P.		▲9540HD
Hose - Upper		21095
Hose - Lower		21409
Hose - By Pass		≧20777
GM V-8 366		
B60 B6P Series		
Belt - Fan & Alt.; W/63A., 108A. Alt.		②◆▲9640HD
Belt - Fan & Alt.; W/80A., 100A. Alt.		②◆▲9660HD
Belt - Fan & Alt.; W/105A., 130A., 160A. Alt.		②◆▲9670HD
Belt - Fan & P.S.		▲9630HD
Belt - Fan & Hyd. Pump		▲9630HD
Belt - Fan & Air Brake Compr.	2027569	5700
Belt - Fan To A.P.	9433881	▲9380HD
Belt - Alt. & A.P.; W/108A. Alt.		▲9630HD
Belt - Alt. & A.P.; W/80A., 100A. Alt.		▲9640HD
Belt - Alt. & A.P.; W/105A., 130A., 160A. Alt.		▲9650HD
Belt - P.S.; W/40" Belt O.C.	9433884	▲9395HD
Belt - P.S.; W/Air Brakes; W/59 1/2" Belt O.C.		▲9590HD
Belt - P.S.; W/Hyd. Brakes; W/64 3/4" Belt O.C.		▲9640HD
Belt - A.P. - From C.S.; W/39" Belt O.C.		▲9385HD
Belt - A.P. - From C.S.; W/54 1/2" Belt O.C. ...	9433913	▲9540HD
Belt - Air Brake Compr.		▲9720HD
Hose - Upper		21107
Hose - Lower - Eng. To Pipe; (2 1/4" I.D.)		24236
Hose - Lower - Pipe To Rad.		21556
Hose - By Pass; (1 3/8" I.D.)		24222
GM V-8 427		
B60 B6P Series		
Belt - Fan & Alt.; W/63A., 108A. Alt.		②◆▲9640HD
Belt - Fan & Alt.; W/80A., 100A. Alt.		②◆▲9660HD
Belt - Fan & Alt.; W/105A., 130A., 160A. Alt.		②◆▲9670HD
Belt - Fan & P.S.		▲9630HD
Belt - Fan & Hyd. Pump		▲9630HD
Belt - Fan & Air Brake Compr.	2027569	5700
Belt - Fan To A.P.	9433881	▲9380HD
Belt - Alt. & A.P.; W/108A. Alt.		▲9630HD
Belt - Alt. & A.P.; W/80A., 100A. Alt.		▲9640HD
Belt - Alt. & A.P.; W/105A., 130A., 160A. Alt.		▲9650HD
Belt - P.S.; W/40" Belt O.C.	9433884	▲9395HD
Belt - P.S.; W/Air Brakes; W/59 1/2" Belt O.C.		▲9590HD
Belt - P.S.; W/Hyd. Brakes; W/64 3/4" Belt O.C.		▲9640HD
Belt - A.P. - From C.S.; W/39" Belt O.C.		▲9385HD
Belt - A.P. - From C.S.; W/54 1/2" Belt O.C. ...	9433913	▲9540HD

Application	Mfr. Part No.	Our No.
CHEVROLET - Continued		
1979 - Continued		
GM V-8 427 - Continued		
B60 B6P Series - Continued		
Belt - Air Brake Compr.		▲9720HD
Hose - Upper		21107
Hose - Lower - Eng. To Pipe; (2 1/4" I.D.)		24236
Hose - Lower - Pipe To Rad.		21556
Hose - By Pass; (1 3/8" I.D.)		24222
GM V-8 454		
B60 B6P Series		
Belt - Fan & Alt.; W/63A., 108A. Alt.		②◆▲9640HD
Belt - Fan & Alt.; W/80A., 100A. Alt.		②◆▲9660HD
Belt - Fan & Alt.; W/105A., 130A., 160A. Alt.		②◆▲9670HD
Belt - Fan & P.S.		▲9630HD
Belt - Fan & Hyd. Pump		▲9630HD
Belt - Fan & Air Brake Compr.	2027569	5700
Belt - Fan To A.P.	9433881	▲9380HD
Belt - Alt. & A.P.; W/108A. Alt.		▲9630HD
Belt - Alt. & A.P.; W/80A., 100A. Alt.		▲9640HD
Belt - Alt. & A.P.; W/105A., 130A., 160A. Alt.		▲9650HD
Belt - P.S.; W/40" Belt O.C.	9433884	▲9395HD
Belt - P.S.; W/Air Brakes; W/59 1/2" Belt O.C.		▲9590HD
Belt - P.S.; W/Hyd. Brakes; W/64 3/4" Belt O.C.		▲9640HD
Belt - A.P. - From C.S.; W/39" Belt O.C.		▲9385HD
Belt - A.P. - From C.S.; W/54 1/2" Belt O.C. ...	9433913	▲9540HD
Belt - Air Brake Compr.		▲9720HD
Hose - Upper		21107
Hose - Lower - Eng. To Pipe; (2 1/4" I.D.)		24236
Hose - Lower - Pipe To Rad.		21556
Hose - By Pass; (1 3/8" I.D.)		24222
1978-1977		
GM 6-Cyl. 292		
SS60		
Belt - Fan & Alt.; W/Std. Alt.	3887682	②▲9395HD
Belt - Fan & Alt.; W/80A. Alt.	3911543	②▲9412HD
Belt - Fan & Alt.; W/100A. Alt.	690407	②▲9435HD
Belt - Fan, Alt. & P.S.; W/Std. Alt.	3947152	▲9500HD
Belt - Fan, Alt. & P.S.; W/80A. Alt.	3885457	▲9510HD
Belt - Fan & A.P.	3947150	▲9530HD
Belt - P.S.	9433884	▲9395HD
Belt - Hyd. Brake Boost Pump	9433896	▲9455HD
Belt - A.C.	3888403	7560
Hose - Upper		≧20686
Hose - Lower		20489
	or	●26611
Hose - By Pass		20563
Hose - Heater Inlet; (3/4" I.D.)		28442
Hose - Heater Outlet; (5/8" I.D.)		28441
GM V-8 350		
SE60		
Belt - Fan & Alt.; W/65A., 70A. Alt.	9433915	②◆▲9550HD
Belt - Fan & Alt.; W/105A., 130A. Alt.	3887691	②◆▲9570HD
Belt - P.S.		▲9385HD
Belt - Hyd. Brake Boost Pump; W/56 1/4" Belt O.C.	9433917	▲9560HD
Belt - Hyd. Brake Boost Pump; W/59 1/4" Belt O.C.	9433923	▲9590HD
Belt - Hyd. Brake Boost Pump & A.P.; W/65 1/4" Belt O.C.	9433935	▲9650HD
Belt - Hyd. Brake Boost Pump & A.P.; W/68 1/4" Belt O.C.	2027569	▲9680HD
Belt - Air Brake Compr.	3888480	▲9560HD
Belt - A.P.		▲9530HD
Hose - Upper		21095
	or	≧●25487
Hose - Lower		21409
Hose - By Pass - Left Side		20565
Hose - By Pass - Right Side		≧20777

② Two Required.
 ≧ Cut to Fit.
 ◆ Green Stripe® PowerBand® Belt May Work, Use Template to Check.

▲ Standard Belt Available. See Pages 630-631.
 ● Vulco-Flex® Coolant Hose.

Belts and Coolant Hose for School Buses

Application	Mfr. Part No.	Our No.
CHEVROLET - Continued		
1978-1977 - Continued		
GM V-8 366		
SE60		
Belt - Fan & Alt.; W/61A. Alt.		②▲9560HD
Belt - Fan & Alt.; W/A.P.; W/61A. Alt.	9433936	▲9660HD
Belt - Fan & Alt.; W/A.P.; W/100A., 105A., 130A. Alt.	9433937	▲9670HD
Belt - Fan & Alt.; W/O A.P.; W/80A. Alt.	9433936	②◆▲9660HD
Belt - Fan & Alt.; W/O A.P.; W/100A., 105A., 130A. Alt.	9433937	②◆▲9670HD
Belt - Fan & A.P.	9433932	▲9630HD
Belt - Fan & V.P.	3883005	▲9690HD
Belt - P.S.	9433884	▲9395HD
Belt - Air Brake Compr.	2027569	5700
Belt - Air Brake Compr. & A.P.		▲9720HD
Belt - Hyd. Brake Boost Pump	9433929	▲9620HD
Belt - A.P.	9433881	▲9380HD
Hose - Upper		≈<20933
Hose - Lower		21011
Hose - By Pass; (1 3/4" I.D.)		24228
GM V-8 427		
SE60		
Belt - Fan & Alt.; W/61A. Alt.		②▲9560HD
Belt - Fan & Alt.; W/A.P.; W/61A. Alt.	9433936	▲9660HD
Belt - Fan & Alt.; W/A.P.; W/100A., 105A., 130A. Alt.	9433937	▲9670HD
Belt - Fan & Alt.; W/O A.P.; W/80A. Alt.	9433936	②◆▲9660HD
Belt - Fan & Alt.; W/O A.P.; W/100A., 105A., 130A. Alt.	9433937	②◆▲9670HD
Belt - Fan & A.P.	9433932	▲9630HD
Belt - Fan & V.P.	3883005	▲9690HD
Belt - P.S.	9433884	▲9395HD
Belt - Air Brake Compr.	2027569	5700
Belt - Air Brake Compr. & A.P.		▲9720HD
Belt - Hyd. Brake Boost Pump	9433929	▲9620HD
Belt - A.P.	9433881	▲9380HD
Hose - Upper		≈<20933
Hose - Lower		21011
Hose - By Pass; (1 3/4" I.D.)		24228
GM V-8 454		
SE60		
Belt - Fan & Alt.; W/61A. Alt.		②▲9560HD
Belt - Fan & Alt.; W/A.P.; W/61A. Alt.	9433936	▲9660HD
Belt - Fan & Alt.; W/A.P.; W/100A., 105A., 130A. Alt.	9433937	▲9670HD
Belt - Fan & Alt.; W/O A.P.; W/80A. Alt.	9433936	②◆▲9660HD
Belt - Fan & Alt.; W/O A.P.; W/100A., 105A., 130A. Alt.	9433937	②◆▲9670HD
Belt - Fan & A.P.	9433932	▲9630HD
Belt - Fan & V.P.	3883005	▲9690HD
Belt - P.S.	9433884	▲9395HD
Belt - Air Brake Compr.	2027569	5700
Belt - Air Brake Compr. & A.P.		▲9720HD
Belt - Hyd. Brake Boost Pump	9433929	▲9620HD
Belt - A.P.	9433881	▲9380HD
Hose - Upper		≈<20933
Hose - Lower		21011
Hose - By Pass; (1 3/4" I.D.)		24228

② Two Required.
 ◆ Green Stripe® PowerBand® Belt May Work, Use Template to Check.
 ● Vulco-Flex® Coolant Hose.

Application	Mfr. Part No.	Our No.
CHEVROLET - Continued		
1976 - Continued		
GM 6-Cyl. 292 - Continued		
SS60 - Continued		
Hose - Lower		20489
	or	●26611
Hose - By Pass		20563
Hose - Heater Inlet; (3/4" I.D.)		28442
Hose - Heater Outlet; (5/8" I.D.)		28441
GM V-8 350		
SE60		
Belt - Fan & Alt.; W/56 3/8" Belt O.C.		▲9560HD
Belt - Fan & Alt.; W/58 3/8" Belt O.C.	3891359	▲9580HD
Belt - P.S.		▲9385HD
Belt - Hyd. Brake Boost Pump	9433923	▲9590HD
Belt - Hyd. Brake Boost Pump & A.P.	2027569	▲9680HD
Belt - Air Brake Compr.		▲9640HD
Belt - A.P.		▲9530HD
Hose - Upper		20607
	or	●25484
Hose - Lower; W/Hyd. Brakes		20558
	or	●26611
Hose - By Pass - Left Side		20565
Hose - By Pass - Right Side		20566
GM V-8 366		
SE60		
Belt - Fan & Alt.; W/61A. Alt.; W/Single Belt ..	690409	▲9510HD
Belt - Fan & Alt.; W/61A. Alt.; W/Dual Belts ...	3891365	②◆▲9610HD
Belt - Fan & Alt.; W/80A. Alt.		▲9560HD
Belt - Fan & Alt.; W/A.P.; W/100A., 105A., 130A. Alt.	9433921	▲9580HD
Belt - Fan & Alt.; W/O A.P.; W/100A., 105A., 130A. Alt.	9433921	②▲9580HD
Belt - Fan & P.S.	9433884	▲9560HD
Belt - Fan & A.P.	9433921	▲9580HD
Belt - P.S.	9433884	▲9395HD
Belt - Air Brake Compr.	3883005	▲9690HD
Belt - Air Brake Compr. & A.P.		▲9720HD
Belt - Hyd. Brake Boost Pump		▲9630HD
Belt - A.P.	2459498	▲9370HD
Hose - Upper		≈<20933
Hose - Lower		21011
Hose - By Pass; (1 3/4" I.D.)		24228
GM V-8 427		
SE60		
Belt - Fan & Alt.; W/61A. Alt.; W/Single Belt ..	690409	▲9510HD
Belt - Fan & Alt.; W/61A. Alt.; W/Dual Belts ...	3891365	②◆▲9610HD
Belt - Fan & Alt.; W/80A. Alt.		▲9560HD
Belt - Fan & Alt.; W/A.P.; W/100A., 105A., 130A. Alt.	9433921	▲9580HD
Belt - Fan & Alt.; W/O A.P.; W/100A., 105A., 130A. Alt.	9433921	②▲9580HD
Belt - Fan & P.S.	9433884	▲9560HD
Belt - Fan & A.P.	9433921	▲9580HD
Belt - P.S.	9433884	▲9395HD
Belt - Air Brake Compr.	3883005	▲9690HD
Belt - Air Brake Compr. & A.P.		▲9720HD
Belt - Hyd. Brake Boost Pump		▲9630HD
Belt - A.P.	2459498	▲9370HD
Hose - Upper		≈<20933
Hose - Lower		21011
Hose - By Pass; (1 3/4" I.D.)		24228
GM V-8 454		
SE60		
Belt - Fan & Alt.; W/61A. Alt.; W/Single Belt ..	690409	▲9510HD
Belt - Fan & Alt.; W/61A. Alt.; W/Dual Belts ...	3891365	②◆▲9610HD
Belt - Fan & Alt.; W/80A. Alt.		▲9560HD
Belt - Fan & Alt.; W/A.P.; W/100A., 105A., 130A. Alt.	9433921	▲9580HD
Belt - Fan & Alt.; W/O A.P.; W/100A., 105A., 130A. Alt.	9433921	②▲9580HD
Belt - Fan & P.S.	9433884	▲9560HD
Belt - Fan & A.P.	9433921	▲9580HD
Belt - P.S.	9433884	▲9395HD
Belt - Air Brake Compr.	3883005	▲9690HD
Belt - Air Brake Compr. & A.P.		▲9720HD
Belt - Hyd. Brake Boost Pump		▲9630HD
Belt - A.P.	2459498	▲9370HD
Hose - Upper		≈<20933
Hose - Lower		21011
Hose - By Pass; (1 3/4" I.D.)		24228

▲ Standard Belt Available. See Pages 630-631.
 ≈< Cut to Fit.

School Buses

Belts and Coolant Hose for School Buses

School Buses

Application	Mfr. Part No.	Our No.
CHEVROLET - Continued		
1976 - Continued		
GM V-8 454 - Continued		
SE60 - Continued		
Belt - Fan & A.P.	9433921	▲9580HD
Belt - P.S.	9433884	▲9395HD
Belt - Air Brake Compr.	3883005	▲9690HD
Belt - Air Brake Compr. & A.P.		▲9720HD
Belt - Hyd. Brake Boost Pump		▲9630HD
Belt - A.P.	2459498	▲9370HD
Hose - Upper		≡<20933
Hose - Lower		21011
Hose - By Pass; (1 3/4" I.D.)		24228
1975		
GM 6-Cyl. 292		
SS60		
Belt - Fan & Alt.; W/Std. Alt.	3887682	②▲9395HD
Belt - Fan & Alt.; W/80A. Alt.	3911543	②▲9412HD
Belt - Fan & Alt.; W/100A. Alt.	690407	②▲9435HD
Belt - Fan, Alt. & P.S.; W/Std. Alt.	3947152	▲9500HD
Belt - Fan, Alt. & P.S.; W/80A. Alt.	3885457	▲9510HD
Belt - Fan & A.P.	3947150	▲9530HD
Belt - P.S.	9433884	▲9395HD
Belt - Hyd. Brake Boost Pump	9433896	▲9455HD
Belt - A.C.	3888403	7560
Hose - Upper		≡<20686
Hose - Lower		20489
	or	●26611
Hose - By Pass		20563
Hose - Heater Inlet; (3/4" I.D.)		28442
Hose - Heater Outlet; (5/8" I.D.)		28441
GM V-8 350		
SE60		
Belt - Fan & Alt.; W/56 3/8" Belt O.C.		▲9560HD
Belt - Fan & Alt.; W/58 3/8" Belt O.C.	3891359	▲9580HD
Belt - P.S.		▲9385HD
Belt - Hyd. Brake Boost Pump	9433923	▲9590HD
Belt - Hyd. Brake Boost Pump & A.P.	2027569	▲9680HD
Belt - Air Brake Compr.		▲9640HD
Belt - A.P.		▲9530HD
Hose - Upper		20607
	or	●25484
Hose - Lower; W/Hyd. Brakes		20558
	or	●26611
Hose - By Pass - Left Side		20565
Hose - By Pass - Right Side		20566
GM V-8 366		
SE60		
Belt - Fan & Alt.; W/61A. Alt.; W/Single Belt ..	690409	▲9510HD
Belt - Fan & Alt.; W/61A. Alt.; W/Dual Belts ...	3891365	②◆▲9610HD
Belt - Fan & Alt.; W/80A. Alt.		▲9560HD
Belt - Fan & Alt.; W/A.P.; W/100A., 105A., 130A. Alt.	9433921	▲9580HD
Belt - Fan & Alt.; W/O A.P.; W/100A., 105A., 130A. Alt.	9433921	②▲9580HD
Belt - Fan & P.S.	9433884	▲9560HD
Belt - Fan & A.P.	9433921	▲9580HD
Belt - P.S.	9433884	▲9395HD
Belt - Air Brake Compr.	3883005	▲9690HD
Belt - Air Brake Compr. & A.P.		▲9720HD
Belt - Hyd. Brake Boost Pump		▲9630HD
Belt - A.P.	2459498	▲9370HD
Hose - Upper		≡<20933
Hose - Lower		21011
Hose - By Pass; (1 3/4" I.D.)		24228
GM V-8 427		
SE60		
Belt - Fan & Alt.; W/61A. Alt.; W/Single Belt ..	690409	▲9510HD
Belt - Fan & Alt.; W/61A. Alt.; W/Dual Belts ...	3891365	②◆▲9610HD
Belt - Fan & Alt.; W/80A. Alt.		▲9560HD

Application	Mfr. Part No.	Our No.
CHEVROLET - Continued		
1975 - Continued		
GM V-8 427 - Continued		
SE60 - Continued		
Belt - Fan & Alt.; W/A.P.; W/100A., 105A., 130A. Alt.	9433921	▲9580HD
Belt - Fan & Alt.; W/O A.P.; W/100A., 105A., 130A. Alt.	9433921	②▲9580HD
Belt - Fan & P.S.	9433884	▲9560HD
Belt - Fan & A.P.	9433921	▲9580HD
Belt - P.S.	9433884	▲9395HD
Belt - Air Brake Compr.	3883005	▲9690HD
Belt - Air Brake Compr. & A.P.		▲9720HD
Belt - Hyd. Brake Boost Pump		▲9630HD
Belt - A.P.	2459498	▲9370HD
Hose - Upper		≡<20933
Hose - Lower		21011
Hose - By Pass; (1 3/4" I.D.)		24228
GM V-8 454		
SE60		
Belt - Fan & Alt.; W/61A. Alt.; W/Single Belt ..	690409	▲9510HD
Belt - Fan & Alt.; W/61A. Alt.; W/Dual Belts ...	3891365	②◆▲9610HD
Belt - Fan & Alt.; W/80A. Alt.		▲9560HD
Belt - Fan & Alt.; W/A.P.; W/100A., 105A., 130A. Alt.	9433921	▲9580HD
Belt - Fan & Alt.; W/O A.P.; W/100A., 105A., 130A. Alt.	9433921	②▲9580HD
Belt - Fan & P.S.	9433884	▲9560HD
Belt - Fan & A.P.	9433921	▲9580HD
Belt - P.S.	9433884	▲9395HD
Belt - Air Brake Compr.	3883005	▲9690HD
Belt - Air Brake Compr. & A.P.		▲9720HD
Belt - Hyd. Brake Boost Pump		▲9630HD
Belt - A.P.	2459498	▲9370HD
Hose - Upper		≡<20933
Hose - Lower		21011
Hose - By Pass; (1 3/4" I.D.)		24228
GMC V-6 478 Diesel		
SG60		
Belt - Fan & Alt.	2483870	②◆▲9590HD
Belt - P.S.	3887676	▲9451HD
Belt - Air Brake Compr.	3883002	▲9600HD
Belt - V.P.	3905091	▲9580HD
1974		
GM 6-Cyl. 292		
SS60		
Belt - Fan & Alt.; W/Std. Alt.	3887682	②▲9395HD
Belt - Fan & Alt.; W/80A. Alt.	3911543	②▲9412HD
Belt - Fan & Alt.; W/100A. Alt.	690407	②▲9435HD
Belt - Fan, Alt. & P.S.; W/Std. Alt.	3947152	▲9500HD
Belt - Fan, Alt. & P.S.; W/80A. Alt.	3885457	▲9510HD
Belt - Fan & A.P.	3947150	▲9530HD
Belt - P.S.	9433884	▲9395HD
Belt - Hyd. Brake Boost Pump	9433896	▲9455HD
Belt - A.C.	3888403	7560
Hose - Upper		≡<20686
Hose - Lower		20489
	or	●26611
Hose - By Pass		20563
Hose - Heater Inlet; (3/4" I.D.)		28442
Hose - Heater Outlet; (5/8" I.D.)		28441
GM V-8 350		
SE60		
Belt - Fan & Alt.; W/56 3/8" Belt O.C.		▲9560HD
Belt - Fan & Alt.; W/58 3/8" Belt O.C.	3891359	▲9580HD
Belt - P.S.		▲9385HD
Belt - Hyd. Brake Boost Pump	9433923	▲9590HD
Belt - Hyd. Brake Boost Pump & A.P.	2027569	▲9680HD
Belt - Air Brake Compr.		▲9640HD
Belt - A.P.		▲9530HD
Hose - Upper		20607

▲ Standard Belt Available. See Pages 630-631.

② Two Required.

◆ Green Stripe® PowerBand® Belt May Work, Use Template to Check.

≡< Cut to Fit.

● Vulco-Flex® Coolant Hose.

Belts and Coolant Hose for School Buses

Application	Mfr. Part No.	Our No.
CHEVROLET - Continued		
1974 - Continued		
GM V-8 350 - Continued		
SE60 - Continued		
Hose - Upper		●25484
Hose - Lower; W/Hyd. Brakes		20558
	or	●26611
Hose - By Pass - Left Side		20565
Hose - By Pass - Right Side		20566
GM V-8 366		
SE60		
Belt - Fan & Alt.; W/61A. Alt.; W/Single Belt ..	690409	▲9510HD
Belt - Fan & Alt.; W/61A. Alt.; W/Dual Belts ...	3891365	②◆▲9610HD
Belt - Fan & Alt.; W/80A. Alt.		▲9560HD
Belt - Fan & Alt.; W/A.P.; W/100A., 105A., 130A. Alt.	9433921	▲9580HD
Belt - Fan & Alt.; W/O A.P.; W/100A., 105A., 130A. Alt.	9433921	②▲9580HD
Belt - Fan & P.S.	9433884	▲9560HD
Belt - Fan & A.P.	9433921	▲9580HD
Belt - P.S.	9433884	▲9395HD
Belt - Air Brake Compr.	3883005	▲9690HD
Belt - Air Brake Compr. & A.P.		▲9720HD
Belt - Hyd. Brake Boost Pump		▲9630HD
Belt - A.P.	2459498	▲9370HD
GM V-8 427		
SE60		
Belt - Fan & Alt.; W/61A. Alt.; W/Single Belt ..	690409	▲9510HD
Belt - Fan & Alt.; W/61A. Alt.; W/Dual Belts ...	3891365	②◆▲9610HD
Belt - Fan & Alt.; W/80A. Alt.		▲9560HD
Belt - Fan & Alt.; W/A.P.; W/100A., 105A., 130A. Alt.	9433921	▲9580HD
Belt - Fan & Alt.; W/O A.P.; W/100A., 105A., 130A. Alt.	9433921	②▲9580HD
Belt - Fan & P.S.	9433884	▲9560HD
Belt - Fan & A.P.	9433921	▲9580HD
Belt - P.S.	9433884	▲9395HD
Belt - Air Brake Compr.	3883005	▲9690HD
Belt - Air Brake Compr. & A.P.		▲9720HD
Belt - Hyd. Brake Boost Pump		▲9630HD
Belt - A.P.	2459498	▲9370HD
GM V-8 454		
SE60		
Belt - Fan & Alt.; W/61A. Alt.; W/Single Belt ..	690409	▲9510HD
Belt - Fan & Alt.; W/61A. Alt.; W/Dual Belts ...	3891365	②◆▲9610HD
Belt - Fan & Alt.; W/80A. Alt.		▲9560HD
Belt - Fan & Alt.; W/A.P.; W/100A., 105A., 130A. Alt.	9433921	▲9580HD
Belt - Fan & Alt.; W/O A.P.; W/100A., 105A., 130A. Alt.	9433921	②▲9580HD
Belt - Fan & P.S.	9433884	▲9560HD
Belt - Fan & A.P.	9433921	▲9580HD
Belt - P.S.	9433884	▲9395HD
Belt - Air Brake Compr.	3883005	▲9690HD
Belt - Air Brake Compr. & A.P.		▲9720HD
Belt - Hyd. Brake Boost Pump		▲9630HD
Belt - A.P.	2459498	▲9370HD
GMC V-6 478 Diesel		
SG60		
Belt - Fan & Alt.	2483870	②◆▲9590HD
Belt - P.S.	3887676	▲9451HD
Belt - Air Brake Compr.	3883002	▲9600HD
Belt - V.P.	3905091	▲9580HD
Hose - Upper		●26611
1973		
GM 6-Cyl. 292		
SS60		
Belt - Fan & Alt.; W/Std. Alt.	3887682	②▲9395HD
Belt - Fan & Alt.; W/80A. Alt.	3911543	②▲9412HD
Belt - Fan & Alt.; W/100A. Alt.	690407	②▲9435HD
Belt - Fan, Alt. & P.S.; W/Std. Alt.	3947152	▲9500HD

Application	Mfr. Part No.	Our No.
CHEVROLET - Continued		
1973 - Continued		
GM 6-Cyl. 292 - Continued		
SS60 - Continued		
Belt - Fan, Alt. & P.S.; W/80A. Alt.	3885457	▲9510HD
Belt - Fan & A.P.	3947150	▲9530HD
Belt - P.S.	9433884	▲9395HD
Belt - Hyd. Brake Boost Pump	9433896	▲9455HD
Belt - A.C.	3888403	7560
Hose - Upper		≠20686
Hose - Lower		20489
	or	●26611
Hose - By Pass		20563
Hose - Heater Inlet; (3/4" I.D.)		28442
Hose - Heater Outlet; (5/8" I.D.)		28441
GM V-8 307		
SE60		
Belt - Fan & Alt.; W/56 3/8" Belt O.C.		▲9560HD
Belt - Fan & Alt.; W/58 3/8" Belt O.C.	3891359	▲9580HD
Belt - P.S.		▲9385HD
Belt - Hyd. Brake Boost Pump	9433923	▲9590HD
Belt - Hyd. Brake Boost Pump & A.P.	2027569	▲9680HD
Belt - Air Brake Compr.		▲9640HD
Belt - A.P.		▲9530HD
Hose - Upper		20607
	or	●25484
Hose - Lower; W/Hyd. Brakes		20558
	or	●26611
Hose - By Pass - Left Side		20565
Hose - By Pass - Right Side		20566
GM V-8 350		
SE60		
Belt - Fan & Alt.; W/56 3/8" Belt O.C.		▲9560HD
Belt - Fan & Alt.; W/58 3/8" Belt O.C.	3891359	▲9580HD
Belt - P.S.		▲9385HD
Belt - Hyd. Brake Boost Pump	9433923	▲9590HD
Belt - Hyd. Brake Boost Pump & A.P.	2027569	▲9680HD
Belt - Air Brake Compr.		▲9640HD
Belt - A.P.		▲9530HD
Hose - Upper		20607
	or	●25484
Hose - Lower; W/Hyd. Brakes		20558
	or	●26611
Hose - By Pass - Left Side		20565
Hose - By Pass - Right Side		20566
GM V-8 366		
SE60		
Belt - Fan & Alt.; W/61A. Alt.; W/Single Belt ..	690409	▲9510HD
Belt - Fan & Alt.; W/61A. Alt.; W/Dual Belts ...	3891365	②◆▲9610HD
Belt - Fan & Alt.; W/80A. Alt.		▲9560HD
Belt - Fan & Alt.; W/A.P.; W/100A., 105A., 130A. Alt.	9433921	▲9580HD
Belt - Fan & Alt.; W/O A.P.; W/100A., 105A., 130A. Alt.	9433921	②▲9580HD
Belt - Fan & P.S.	9433884	▲9560HD
Belt - Fan & A.P.	9433921	▲9580HD
Belt - P.S.	9433884	▲9395HD
Belt - Air Brake Compr.	3883005	▲9690HD
Belt - Air Brake Compr. & A.P.		▲9720HD
Belt - Hyd. Brake Boost Pump		▲9630HD
Belt - A.P.	2459498	▲9370HD
GM V-8 427		
SE60		
Belt - Fan & Alt.; W/61A. Alt.; W/Single Belt ..	690409	▲9510HD
Belt - Fan & Alt.; W/61A. Alt.; W/Dual Belts ...	3891365	②◆▲9610HD
Belt - Fan & Alt.; W/80A. Alt.		▲9560HD
Belt - Fan & Alt.; W/A.P.; W/100A., 105A., 130A. Alt.	9433921	▲9580HD
Belt - Fan & Alt.; W/O A.P.; W/100A., 105A., 130A. Alt.	9433921	②▲9580HD
Belt - Fan & P.S.	9433884	▲9560HD
Belt - Fan & A.P.	9433921	▲9580HD
Belt - P.S.	9433884	▲9395HD
Belt - Air Brake Compr.	3883005	▲9690HD
Belt - Air Brake Compr. & A.P.		▲9720HD
Belt - Hyd. Brake Boost Pump		▲9630HD
Belt - A.P.	2459498	▲9370HD
GM V-8 427		
SE60		
Belt - Fan & Alt.; W/61A. Alt.; W/Single Belt ..	690409	▲9510HD
Belt - Fan & Alt.; W/61A. Alt.; W/Dual Belts ...	3891365	②◆▲9610HD
Belt - Fan & Alt.; W/80A. Alt.		▲9560HD
Belt - Fan & Alt.; W/A.P.; W/100A., 105A., 130A. Alt.	9433921	▲9580HD
Belt - Fan & Alt.; W/O A.P.; W/100A., 105A., 130A. Alt.	9433921	②▲9580HD
Belt - Fan & P.S.	9433884	▲9560HD
Belt - Fan & A.P.	9433921	▲9580HD
Belt - P.S.	9433884	▲9395HD
Belt - Air Brake Compr.	3883005	▲9690HD
Belt - Air Brake Compr. & A.P.		▲9720HD
Belt - Hyd. Brake Boost Pump		▲9630HD
Belt - A.P.	2459498	▲9370HD

● Vulco-Flex® Coolant Hose.
② Two Required.
≠ Cut to Fit.

▲ Standard Belt Available. See Pages 630-631.
◆ Green Stripe® PowerBand® Belt May Work, Use Template to Check.

Belts and Coolant Hose for School Buses

School Buses

Application	Mfr. Part No.	Our No.
CHEVROLET - Continued		
1973 - Continued		
GM V-8 427 - Continued		
SE60 - Continued		
Belt - P.S.	9433884	▲9395HD
Belt - Air Brake Compr.	3883005	▲9690HD
Belt - Air Brake Compr. & A.P.		▲9720HD
Belt - Hyd. Brake Boost Pump		▲9630HD
Belt - A.P.	2459498	▲9370HD
GM V-8 454		
SE60		
Belt - Fan & Alt.; W/61A. Alt.; W/Single Belt ..	690409	▲9510HD
Belt - Fan & Alt.; W/61A. Alt.; W/Dual Belts ...	3891365	②◆▲9610HD
Belt - Fan & Alt.; W/80A. Alt.		▲9560HD
Belt - Fan & Alt.; W/A.P.; W/100A., 105A., 130A. Alt.	9433921	▲9580HD
Belt - Fan & Alt.; W/O A.P.; W/100A., 105A., 130A. Alt.	9433921	②▲9580HD
Belt - Fan & P.S.	9433884	▲9560HD
Belt - Fan & A.P.	9433921	▲9580HD
Belt - P.S.	9433884	▲9395HD
Belt - Air Brake Compr.	3883005	▲9690HD
Belt - Air Brake Compr. & A.P.		▲9720HD
Belt - Hyd. Brake Boost Pump		▲9630HD
Belt - A.P.	2459498	▲9370HD
GMC V-6 478 Diesel		
SG60		
Belt - Fan & Alt.	2483870	②◆▲9590HD
Belt - P.S.	3887676	▲9451HD
Belt - Air Brake Compr.	3883002	▲9600HD
Belt - V.P.	3905091	▲9580HD
Hose - Upper		●26611
1972		
GM 6-Cyl. 292		
SS50		
Belt - Fan & Alt.	3887682	▲9395HD
Belt - Fan, Alt. & P.S.	3947152	▲9500HD
Belt - Fan & Air Brake Compr.	3943162	▲9660HD
Hose - Upper		≅20686
Hose - Lower		20489
		or ●26611
Hose - By Pass		20563
Hose - Heater Inlet; (3/4" I.D.)		28442
Hose - Heater Outlet; (5/8" I.D.)		28441
GM V-8 307		
S50; SE50		
Belt - Fan & Alt.; W/42A. Alt.	3888480	②▲9560HD
Belt - Fan & Alt.; W/62A., 100A. Alt.	3891358	②◆▲9590HD
Belt - Fan & Alt.; W/130A. Alt.	3891369	②▲9590HD
Belt - P.S.	3888401	▲9412HD
Belt - Air Brake Compr.	3885457	▲9510HD
Belt - Air Brake Compr. & A.P.	3887683	▲9670HD
Belt - A.P.	3885457	▲9510HD
GM V-8 350		
S50; SE50		
Belt - Fan & Alt.; W/42A. Alt.	3888480	②▲9560HD
Belt - Fan & Alt.; W/62A., 100A. Alt.	3891358	②◆▲9590HD
Belt - Fan & Alt.; W/130A. Alt.	3891369	②▲9590HD
Belt - P.S.	3888401	▲9412HD
Belt - Air Brake Compr.	3885457	▲9510HD
Belt - Air Brake Compr. & A.P.	3887683	▲9670HD
Belt - A.P.	3885457	▲9510HD
1971		
GM 6-Cyl. 250		
SS40		
Belt - Fan & Alt.; W/P.S.	3850801	7390
Belt - Fan & Alt.; W/O P.S.	3850801	②7390
Belt - Fan, Alt. & P.S.	3925530	7500
Belt - Fan & A.C.	3847709	7550

Application	Mfr. Part No.	Our No.
CHEVROLET - Continued		
1971 - Continued		
GM 6-Cyl. 250 - Continued		
SS40 - Continued		
Hose - Upper		≅20686
Hose - Lower		20489
		or ●26611
GM 6-Cyl. 292		
SS50		
Belt - Fan & Alt.	3887682	▲9395HD
Belt - Fan, Alt. & P.S.	3947152	▲9500HD
Belt - Fan & Air Brake Compr.	3943162	▲9660HD
Hose - Upper		≅20686
Hose - Lower		20489
		or ●26611
Hose - By Pass		20563
Hose - Heater Inlet; (3/4" I.D.)		28442
Hose - Heater Outlet; (5/8" I.D.)		28441
GM V-8 307		
S50; SE50		
Belt - Fan & Alt.; W/42A. Alt.	3888480	②▲9560HD
Belt - Fan & Alt.; W/62A., 100A. Alt.	3891358	②◆▲9590HD
Belt - Fan & Alt.; W/130A. Alt.	3891369	②▲9590HD
Belt - P.S.	3888401	▲9412HD
Belt - Air Brake Compr.	3885457	▲9510HD
Belt - Air Brake Compr. & A.P.	3887683	▲9670HD
Belt - A.P.	3885457	▲9510HD
GM V-8 350		
S50; SE50		
Belt - Fan & Alt.; W/42A. Alt.	3888480	②▲9560HD
Belt - Fan & Alt.; W/62A., 100A. Alt.	3891358	②◆▲9590HD
Belt - Fan & Alt.; W/130A. Alt.	3891369	②▲9590HD
Belt - P.S.	3888401	▲9412HD
Belt - Air Brake Compr.	3885457	▲9510HD
Belt - Air Brake Compr. & A.P.	3887683	▲9670HD
Belt - A.P.	3885457	▲9510HD
1970		
GM 6-Cyl. 250		
S50		
Belt - Alt.; W/O 62A. Alt.; W/O A.C.; W/O P.S.	3888458	②7390
Belt - Alt.; W/O 62A. Alt.; W/A.C.; W/P.S.		7390
Belt - Alt.; W/62A. Alt.; W/O A.C.; W/O P.S. ...	3947154	②7400
Belt - Alt.; W/62A. Alt.; W/A.C.; W/P.S.		7400
Belt - Alt. & P.S.	3925530	7500
Hose - Upper		●25482
Hose - Lower		20489
SS40		
Belt - Fan & Alt.; W/P.S.	3850801	7390
Belt - Fan & Alt.; W/O P.S.	3850801	②7390
Belt - Fan, Alt. & P.S.	3925530	7500
Belt - Fan & A.C.	3847709	7550
Hose - Upper		≅20686
Hose - Lower		20489
		or ●26611
GM 6-Cyl. 292		
SS50		
Belt - Fan & Alt.	3887682	▲9395HD
Belt - Fan, Alt. & P.S.	3947152	▲9500HD
Belt - Fan & Air Brake Compr.	3943162	▲9660HD
Hose - Upper		≅20686
Hose - Lower		20489
		or ●26611
Hose - By Pass		20563
Hose - Heater Inlet; (3/4" I.D.)		28442
Hose - Heater Outlet; (5/8" I.D.)		28441
GM V-8 307		
S50; SE50		
Belt - Fan & Alt.; W/42A. Alt.	3888480	②▲9560HD
Belt - Fan & Alt.; W/62A., 100A. Alt.	3891358	②◆▲9590HD
Belt - Fan & Alt.; W/130A. Alt.	3891369	②▲9590HD

▲ Standard Belt Available. See Pages 630-631.
 ◆ Green Stripe® PowerBand® Belt May Work, Use Template to Check.
 ≅ Cut to Fit.

② Two Required.
 ● Vulco-Flex® Coolant Hose.

Belts and Coolant Hose for School Buses

School Buses

Application	Mfr. Part No.	Our No.
CHEVROLET - Continued		
1970 - Continued		
GM V-8 307 - Continued		
S50; SE50 - Continued		
Belt - P.S.	3888401	▲9412HD
Belt - Air Brake Compr.	3885457	▲9510HD
Belt - Air Brake Compr. & A.P.	3887683	▲9670HD
Belt - A.P.	3885457	▲9510HD
GM V-8 350		
S50; SE50		
Belt - Fan & Alt.; W/42A. Alt.	3888480	②▲9560HD
Belt - Fan & Alt.; W/62A., 100A. Alt.	3891358	②◆▲9590HD
Belt - Fan & Alt.; W/130A. Alt.	3891369	②▲9590HD
Belt - P.S.	3888401	▲9412HD
Belt - Air Brake Compr.	3885457	▲9510HD
Belt - Air Brake Compr. & A.P.	3887683	▲9670HD
Belt - A.P.	3885457	▲9510HD
1969		
GM 6-Cyl. 230		
SS40		
Belt - Fan & Alt.; W/P.S.	3850801	7390
Belt - Fan & Alt.; W/O P.S.	3850801	②7390
Belt - Fan, Alt. & P.S.	3871257	7545
Belt - Fan, Alt. & A.P.	3861940	7512
Belt - Fan & A.C.	3847709	7550
Hose - Upper	≈20686	
Hose - Lower	20489	●26611
	or	
GM 6-Cyl. 250		
SS40		
Belt - Fan & Alt.; W/P.S.	3850801	7390
Belt - Fan & Alt.; W/O P.S.	3850801	②7390
Belt - Fan, Alt. & P.S.	3871257	7545
Belt - Fan, Alt. & A.P.	3861940	7512
Belt - Fan & A.C.	3847709	7550
Hose - Upper	≈20686	
Hose - Lower	20489	●26611
	or	
GM 6-Cyl. 292		
SS50		
Belt - Fan & Alt.	3887682	▲9395HD
Belt - Fan, Alt. & P.S.		▲9530HD
Belt - Fan & Air Brake Compr.; W/O P.S.	3887683	▲9670HD
Hose - Upper	≈20686	
Hose - Lower	20489	●26611
	or	
Hose - By Pass	20563	
Hose - Heater Inlet; (3/4" I.D.)	28442	
Hose - Heater Outlet; (5/8" I.D.)	28441	
GM V-8 307		
S50; SE50		
Belt - Fan & Alt.; W/42A. Alt.	3888480	②▲9560HD
Belt - Fan & Alt.; W/62A., 100A. Alt.	3891358	②◆▲9590HD
Belt - Fan & Alt.; W/130A. Alt.	3891369	②▲9590HD
Belt - P.S.	3888401	▲9412HD
Belt - Air Brake Compr.	3885457	▲9510HD
Belt - Air Brake Compr. & A.P.	3887683	▲9670HD
Belt - A.P.	3885457	▲9510HD
SE60		
Hose - Upper	20607	
	or	●25484
Hose - Lower; W/Hyd. Brakes	20558	
	or	●26611
Hose - By Pass - Left Side	20565	
Hose - By Pass - Right Side	20566	
GM V-8 350		
S50; SE50		
Belt - Fan & Alt.; W/42A. Alt.	3888480	②▲9560HD
Belt - Fan & Alt.; W/62A., 100A. Alt.	3891358	②◆▲9590HD
Belt - Fan & Alt.; W/130A. Alt.	3891369	②▲9590HD

Application	Mfr. Part No.	Our No.
CHEVROLET - Continued		
1969 - Continued		
GM V-8 350 - Continued		
S50; SE50 - Continued		
Belt - P.S.	3888401	▲9412HD
Belt - Air Brake Compr.	3885457	▲9510HD
Belt - Air Brake Compr. & A.P.	3887683	▲9670HD
Belt - A.P.	3885457	▲9510HD
SE60		
Hose - Upper	20607	
	or	●25484
Hose - Lower; W/Hyd. Brakes	20558	
	or	●26611
Hose - By Pass - Left Side	20565	
Hose - By Pass - Right Side	20566	
GM V-8 366		
SE60		
Hose - Upper	20933	
Hose - Lower; W/Auto. Trans.	20587	
GM V-8 427		
SE60		
Hose - Upper	20933	
Hose - Lower; W/Auto. Trans.	20587	
1968		
GM 6-Cyl. 230		
SS40		
Belt - Fan & Alt.; W/P.S.	3850801	7390
Belt - Fan & Alt.; W/O P.S.	3850801	②7390
Belt - Fan, Alt. & P.S.	3871257	7545
Belt - Fan, Alt. & A.P.	3861940	7512
Belt - Fan & A.C.	3847709	7550
Hose - Upper	≈20686	
Hose - Lower	20489	●26611
	or	
GM 6-Cyl. 250		
SS40		
Belt - Fan & Alt.; W/P.S.	3850801	7390
Belt - Fan & Alt.; W/O P.S.	3850801	②7390
Belt - Fan, Alt. & P.S.	3871257	7545
Belt - Fan, Alt. & A.P.	3861940	7512
Belt - Fan & A.C.	3847709	7550
Hose - Upper	≈20686	
Hose - Lower	20489	●26611
	or	
GM 6-Cyl. 292		
SS50		
Belt - Fan & Alt.	3887682	▲9395HD
Belt - Fan, Alt. & P.S.		▲9530HD
Belt - Fan & Air Brake Compr.; W/O P.S.	3887683	▲9670HD
Hose - Upper	≈20686	
Hose - Lower	20489	●26611
	or	
Hose - By Pass	20563	
Hose - Heater Inlet; (3/4" I.D.)	28442	
Hose - Heater Outlet; (5/8" I.D.)	28441	
GM V-8 307		
S50; SE50		
Belt - Fan & Alt.; W/42A. Alt.	3888480	②▲9560HD
Belt - Fan & Alt.; W/62A., 100A. Alt.	3891358	②◆▲9590HD
Belt - Fan & Alt.; W/130A. Alt.	3891369	②▲9590HD
Belt - P.S.	3888401	▲9412HD
Belt - Air Brake Compr.	3885457	▲9510HD
Belt - Air Brake Compr. & A.P.	3887683	▲9670HD
Belt - A.P.	3885457	▲9510HD
SE60		
Hose - Upper	20607	
	or	●25484
Hose - Lower; W/Hyd. Brakes	20558	
	or	●26611
Hose - By Pass - Left Side	20565	
Hose - By Pass - Right Side	20566	
GM V-8 350		
S50; SE50		
Belt - Fan & Alt.; W/42A. Alt.	3888480	②▲9560HD
Belt - Fan & Alt.; W/62A., 100A. Alt.	3891358	②◆▲9590HD
Belt - Fan & Alt.; W/130A. Alt.	3891369	②▲9590HD

▲ Standard Belt Available. See Pages 630-631.
 ◆ Green Stripe® PowerBand® Belt May Work, Use Template to Check.
 ● Vulco-Flex® Coolant Hose.

② Two Required.
 ≈ Cut to Fit.

Belts and Coolant Hose for School Buses

School Buses

Application	Mfr. Part No.	Our No.
CHEVROLET - Continued		
1968 - Continued		
GM V-8 366		
SE60		
Hose - Upper		20933
Hose - Lower; W/Auto. Trans.		20587
GM V-8 427		
SE60		
Hose - Upper		20933
Hose - Lower; W/Auto. Trans.		20587
1967		
GM 6-Cyl. 230		
SS40		
Belt - Fan & Alt.; W/P.S.	3850801	7390
Belt - Fan & Alt.; W/O P.S.	3850801	②7390
Belt - Fan, Alt. & P.S.	3871257	7545
Belt - Fan, Alt. & A.P.	3861940	7512
Belt - Fan & A.C.	3847709	7550
Hose - Upper		≅20686
Hose - Lower		20489
	or	●26611
GM 6-Cyl. 250		
SS40		
Belt - Fan & Alt.; W/P.S.	3850801	7390
Belt - Fan & Alt.; W/O P.S.	3850801	②7390
Belt - Fan, Alt. & P.S.	3871257	7545
Belt - Fan, Alt. & A.P.	3861940	7512
Belt - Fan & A.C.	3847709	7550
Hose - Upper		≅20686
Hose - Lower		20489
	or	●26611
GM 6-Cyl. 292		
SS50		
Belt - Fan & Alt.	3887682	▲9395HD
Belt - Fan, Alt. & P.S.		▲9530HD
Belt - Fan & Air Brake Compr.; W/O P.S.	3887683	▲9670HD
Hose - Upper		≅20686
Hose - Lower		20489
	or	●26611
Hose - By Pass		20563
Hose - Heater Inlet; (3/4" I.D.)		28442
Hose - Heater Outlet; (5/8" I.D.)		28441
GM V-6 401		
RM8000		
Belt - W.P. & Alt.; W/60 1/4" Belt O.C.	2485210	②▲9600HD
Belt - W.P. & Alt.; W/61 1/4" Belt O.C.	3891365	②◆▲9610HD
Belt - W.P. & Alt.; W/62 1/4" Belt O.C.	3888486	②▲9620HD
Belt - W.P. & Alt.; W/66 1/4" Belt O.C.	2479287	②◆▲9660HD
Belt - W.P. & Alt.; W/67 1/4" Belt O.C.	2483914	②◆▲9670HD
Belt - P.S.; W/39 3/4" Belt O.C.	2477462	▲9395HD
Belt - P.S.; W/40 3/4" Belt O.C.	3887674	▲9405HD
Belt - Air Brake Compr.		▲9660HD
GM V-6 478		
RM8000		
Belt - W.P. & Alt.; W/60 1/4" Belt O.C.	2485210	②▲9600HD
Belt - W.P. & Alt.; W/61 1/4" Belt O.C.	3891365	②◆▲9610HD
Belt - W.P. & Alt.; W/62 1/4" Belt O.C.	3888486	②▲9620HD
Belt - W.P. & Alt.; W/66 1/4" Belt O.C.	2479287	②◆▲9660HD
Belt - W.P. & Alt.; W/67 1/4" Belt O.C.	2483914	②◆▲9670HD
Belt - P.S.; W/39 3/4" Belt O.C.	2477462	▲9395HD
Belt - P.S.; W/40 3/4" Belt O.C.	3887674	▲9405HD
Belt - Air Brake Compr.		▲9660HD
GM V-8 283		
S50; SE50		
Belt - Fan & Alt.; 1st Design	3887684	②◆▲9550HD
Belt - Fan & Alt.; 2nd Design	3888480	②▲9560HD

Application	Mfr. Part No.	Our No.
CHEVROLET - Continued		
1967 - Continued		
GM V-8 327		
S50; SE50		
Belt - Fan & Alt.; W/O 62A. Alt.	3888480	②▲9560HD
Belt - Fan & Alt.; W/62A. Alt.	3887690	②◆▲9570HD
Belt - P.S.	3888401	▲9412HD
Belt - Air Brake Compr.	3887683	▲9670HD
Belt - Air Brake Compr. & P.S.	3902101	▲9720HD
GM V-8 366		
SE60		
Hose - Upper		20933
Hose - Lower; W/Auto. Trans.		20587
1966		
GM 6-Cyl. 292		
SS50		
Hose - Upper; W/Auto. Trans.		≅21660
	or	●25474
Hose - Upper; W/Man. Trans.		●25530
Hose - Lower		20584
	or	●26612
Hose - By Pass		20563
Hose - Heater Inlet; (3/4" I.D.)		28442
Hose - Heater Outlet; (5/8" I.D.)		28441
GM V-6 401		
RM8000		
Belt - W.P. & Alt.; W/60 1/4" Belt O.C.	2485210	②▲9600HD
Belt - W.P. & Alt.; W/61 1/4" Belt O.C.	3891365	②◆▲9610HD
Belt - W.P. & Alt.; W/62 1/4" Belt O.C.	3888486	②▲9620HD
Belt - W.P. & Alt.; W/66 1/4" Belt O.C.	2479287	②◆▲9660HD
Belt - W.P. & Alt.; W/67 1/4" Belt O.C.	2483914	②◆▲9670HD
Belt - P.S.; W/39 3/4" Belt O.C.	2477462	▲9395HD
Belt - P.S.; W/40 3/4" Belt O.C.	3887674	▲9405HD
Belt - Air Brake Compr.		▲9660HD
GM V-6 478		
RM8000		
Belt - W.P. & Alt.; W/60 1/4" Belt O.C.	2485210	②▲9600HD
Belt - W.P. & Alt.; W/61 1/4" Belt O.C.	3891365	②◆▲9610HD
Belt - W.P. & Alt.; W/62 1/4" Belt O.C.	3888486	②▲9620HD
Belt - W.P. & Alt.; W/66 1/4" Belt O.C.	2479287	②◆▲9660HD
Belt - W.P. & Alt.; W/67 1/4" Belt O.C.	2483914	②◆▲9670HD
Belt - P.S.; W/39 3/4" Belt O.C.	2477462	▲9395HD
Belt - P.S.; W/40 3/4" Belt O.C.	3887674	▲9405HD
Belt - Air Brake Compr.		▲9660HD
GM V-8 283		
S50; SE50		
Belt - Fan & Alt.; 1st Design	3887684	②◆▲9550HD
Belt - Fan & Alt.; 2nd Design	3888480	②▲9560HD
GM V-8 327		
S50; SE50		
Belt - Fan & Alt.; 1st Design	3887684	②◆▲9550HD
Belt - Fan & Alt.; 2nd Design	3888480	②▲9560HD
1965		
GM 6-Cyl. 292		
SS50		
Hose - Upper; W/Auto. Trans.		≅21660
	or	●25474
Hose - Upper; W/Man. Trans.		●25530
Hose - Lower		20584
	or	●26612
Hose - By Pass		20563
Hose - Heater Inlet; (3/4" I.D.)		28442
Hose - Heater Outlet; (5/8" I.D.)		28441
GM V-8 283		
S50; SE50		
Belt - Fan & Alt.	3826586	②◆▲9550HD

② Two Required.
 ● Vulco-Flex® Coolant Hose.
 ◆ Green Stripe® PowerBand® Belt May Work, Use Template to Check.

≅ Cut to Fit.
 ▲ Standard Belt Available. See Pages 630-631.

Belts and Coolant Hose for School Buses

School Buses

Application	Mfr. Part No.	Our No.
CHEVROLET - Continued		
1965 - Continued		
GM V-8 327		
S50; SE50		
Belt - Fan & Alt.	3826586	②◆◆9550HD
GM V-8 348		
S60 B6P Series		
Belt - Fan & Alt.; W/Std. Alt.		②◆9625HD
Belt - Fan & Alt.; W/62A. Alt.		②◆◆9610HD
Belt - Fan, Alt. & P.S.		②◆9680HD
Hose - Upper; W/Rad. Shutters		≈<20685
		or ≈<20420
Hose - Upper; W/O Rad. Shutters		20420
		or ●26511
Hose - Lower		●26536
Hose - By Pass - Left Side		20567
Hose - By Pass - Right Side		20568
GM V-8 409		
S60 B6P Series		
Belt - Fan & Alt.; W/Std. Alt.		②◆9625HD
Belt - Fan & Alt.; W/62A. Alt.		②◆◆9610HD
Belt - Fan, Alt. & P.S.		②◆9680HD
Hose - Upper; W/Rad. Shutters		≈<20685
		or ≈<20420
Hose - Upper; W/O Rad. Shutters		20420
		or ●26511
Hose - Lower		●26536
Hose - By Pass - Left Side		20567
Hose - By Pass - Right Side		20568
1964		
GM V-8 283		
S50; SE50		
Belt - Fan & Alt.	3826586	②◆◆9550HD
GM V-8 327		
S50; SE50		
Belt - Fan & Alt.	3826586	②◆◆9550HD
GM V-8 348		
S60 B6P Series		
Belt - Fan & Alt.; W/Std. Alt.		②◆9625HD
Belt - Fan & Alt.; W/62A. Alt.		②◆◆9610HD
Belt - Fan, Alt. & P.S.		②◆9680HD
Hose - Upper; W/Rad. Shutters		≈<20685
		or ≈<20420
Hose - Upper; W/O Rad. Shutters		20420
		or ●26511
Hose - Lower		●26536
Hose - By Pass - Left Side		20567
Hose - By Pass - Right Side		20568
GM V-8 409		
S60 B6P Series		
Belt - Fan & Alt.; W/Std. Alt.		②◆9625HD
Belt - Fan & Alt.; W/62A. Alt.		②◆◆9610HD
Belt - Fan, Alt. & P.S.		②◆9680HD
Hose - Upper; W/Rad. Shutters		≈<20685
		or ≈<20420
Hose - Upper; W/O Rad. Shutters		20420
		or ●26511
Hose - Lower		●26536
Hose - By Pass - Left Side		20567
Hose - By Pass - Right Side		20568
1963		
GM V-8 283		
S50; SE50		
Belt - Fan & Alt.	3826586	②◆◆9550HD
GM V-8 327		
S50; SE50		
Belt - Fan & Alt.	3826586	②◆◆9550HD

Application	Mfr. Part No.	Our No.
CHEVROLET - Continued		
1963 - Continued		
GM V-8 348		
S60 B6P Series		
Hose - Upper; W/Rad. Shutters		≈<20685
		or ≈<20420
Hose - Upper; W/O Rad. Shutters		20420
		or ●26511
Hose - Lower		●26536
Hose - By Pass - Left Side		20567
Hose - By Pass - Right Side		20568
GM V-8 409		
S60 B6P Series		
Hose - Upper; W/Rad. Shutters		≈<20685
		or ≈<20420
Hose - Upper; W/O Rad. Shutters		20420
		or ●26511
Hose - Lower		●26536
Hose - By Pass - Left Side		20567
Hose - By Pass - Right Side		20568
1962		
GM 6-Cyl. 235		
S60 B6P Series		
Belt - Fan & Alt.; W/P.S.	3759223	◆9451HD
Belt - Fan & Alt.; W/O P.S.	3759218	◆9412HD
Belt - Fan & Gen.; W/O Air Brake Compr.	3759204	◆9425HD
Belt - Fan & Gen.; W/Air Brakes	3759207	◆9463HD
Belt - Fan, Gen. & Air Brake Compr.;		
W/16,000 Lb. Axle	3761883	◆9650HD
Belt - P.S.	3771316	◆9600HD
Belt - Air Brake Compr.	3764984	◆9625HD
Hose - Upper; W/Man. Trans.		≈<21660
		or ●25474
Hose - Lower; W/Man. Trans.		20417
		or ●26612
GM 6-Cyl. 261		
S60 B6P Series		
Belt - Fan & Alt.; W/P.S.	3759223	◆9451HD
Belt - Fan & Alt.; W/O P.S.	3759218	◆9412HD
Belt - Fan & Gen.; W/O Air Brake Compr.	3759204	◆9425HD
Belt - Fan & Gen.; W/Air Brakes	3759207	◆9463HD
Belt - Fan, Gen. & Air Brake Compr.;		
W/16,000 Lb. Axle	3761883	◆9650HD
Belt - P.S.	3771316	◆9600HD
Belt - Air Brake Compr.	3764984	◆9625HD
Hose - Upper; W/Man. Trans.		≈<21660
		or ●25474
Hose - Lower; W/Man. Trans.		20417
		or ●26612
GM V-8 283		
S50; SE50		
Belt - Fan & Gen.	3764145	◆9580HD
GM V-8 327		
S50; SE50		
Belt - Fan & Gen.	3764145	◆9580HD
GM V-8 348		
S60 B6P Series		
Hose - Upper; W/Rad. Shutters		≈<20685
		or ≈<20420
Hose - Upper; W/O Rad. Shutters		20420
		or ●26511
Hose - Lower		●26536
Hose - By Pass - Left Side		20567
Hose - By Pass - Right Side		20568
GM V-8 409		
S60 B6P Series		
Hose - Upper; W/Rad. Shutters		≈<20685
		or ≈<20420
Hose - Upper; W/O Rad. Shutters		20420
		or ●26511

② Two Required.
 ◆ Standard Belt Available. See Pages 630-631.
 ● Vulco-Flex® Coolant Hose.

◆ Green Stripe® PowerBand® Belt May Work, Use Template to Check.
 ≈< Cut to Fit.

Belts and Coolant Hose for School Buses

School Buses

Application	Mfr. Part No.	Our No.
CHEVROLET - Continued		
1962 - Continued		
GM V-8 409 - Continued		
S60 B6P Series - Continued		
Hose - Lower		●26536
Hose - By Pass - Left Side		20567
Hose - By Pass - Right Side		20568
1961-1960		
GM 6-Cyl. 235		
S60 B6P Series		
Belt - Fan & Alt.; W/P.S.	3759223	▲9451HD
Belt - Fan & Alt.; W/O P.S.	3759218	▲9412HD
Belt - Fan & Gen.; W/O Air Brake Compr.	3759204	▲9425HD
Belt - Fan & Gen.; W/Air Brakes	3759207	▲9463HD
Belt - Fan, Gen. & Air Brake Compr.; W/16,000 Lb. Axle	3761883	▲9650HD
Belt - P.S.	3771316	▲9600HD
Belt - Air Brake Compr.	3764984	▲9625HD
Hose - Upper; W/Man. Trans.		≡<21660
		or ●25474
Hose - Lower; W/Man. Trans.		20417
		or ●26612
GM 6-Cyl. 261		
S60 B6P Series		
Belt - Fan & Alt.; W/P.S.	3759223	▲9451HD
Belt - Fan & Alt.; W/O P.S.	3759218	▲9412HD
Belt - Fan & Gen.; W/O Air Brake Compr.	3759204	▲9425HD
Belt - Fan & Gen.; W/Air Brakes	3759207	▲9463HD
Belt - Fan, Gen. & Air Brake Compr.; W/16,000 Lb. Axle	3761883	▲9650HD
Belt - P.S.	3771316	▲9600HD
Belt - Air Brake Compr.	3764984	▲9625HD
Hose - Upper; W/Man. Trans.		≡<21660
		or ●25474
Hose - Lower; W/Man. Trans.		20417
		or ●26612
GM V-8 283		
S50; SE50		
Belt - Fan & Gen.	3764145	▲9580HD
GM V-8 327		
S50; SE50		
Belt - Fan & Gen.	3764145	▲9580HD
GM V-8 348		
S60 B6P Series		
Belt - Fan & Gen.; W/P.S.		▲9630HD
Belt - Fan & Gen.; W/O P.S.		②◆▲9640HD
Belt - Fan & P.S.		▲9600HD
Hose - Upper; W/Rad. Shutters		≡<20685
		or ≡<20420
Hose - Upper; W/O Rad. Shutters		20420
		or ●26511
Hose - Lower		●26536
Hose - By Pass - Left Side		20567
Hose - By Pass - Right Side		20568
S70		
Belt - Fan & Gen.		②▲9630HD
Belt - Air Brake Compr.		▲9660HD
Hose - Upper; W/Rad. Shutters		≡<20685
		or ≡<20420
Hose - Upper; W/O Rad. Shutters		20420
		or ●26511
Hose - Lower		●26536
Hose - By Pass - Left Side		20567
Hose - By Pass - Right Side		20568
GM V-8 409		
S60 B6P Series		
Belt - Fan & Gen.; W/P.S.		▲9630HD
Belt - Fan & Gen.; W/O P.S.		②◆▲9640HD
Belt - Fan & P.S.		▲9600HD
Hose - Upper; W/Rad. Shutters		≡<20685

Application	Mfr. Part No.	Our No.
CHEVROLET - Continued		
1961-1960 - Continued		
GM V-8 409 - Continued		
S60 B6P Series - Continued		
Hose - Upper; W/Rad. Shutters		≡<20420
Hose - Upper; W/O Rad. Shutters		20420
		or ●26511
Hose - Lower		●26536
Hose - By Pass - Left Side		20567
Hose - By Pass - Right Side		20568
S70		
Belt - Fan & Gen.		②▲9630HD
Belt - Air Brake Compr.		▲9660HD
Hose - Upper; W/Rad. Shutters		≡<20685
		or ≡<20420
Hose - Upper; W/O Rad. Shutters		20420
		or ●26511
Hose - Lower		●26536
Hose - By Pass - Left Side		20567
Hose - By Pass - Right Side		20568
1959		
GM 6-Cyl. 235		
4000 Series		
Belt - Fan & Gen.; W/42 7/8" Belt O.C.	3718614	▲9425HD
Belt - Fan & Gen.; W/44 3/8" Belt O.C.	3759205	▲9440HD
Hose - Upper; 2nd Design		20267
Hose - Lower; 2nd Design		≡<20584
6000 Series		
Belt - Fan & Gen.; W/42 7/8" Belt O.C.	3718614	▲9425HD
Belt - Fan & Gen.; W/46 3/8" Belt O.C.	3724316	▲9463HD
Belt - Air Brake Compr.	3740516	▲9610HD
Hose - Upper; 2nd Design		20267
Hose - Lower; 2nd Design		≡<20584
GM 6-Cyl. 261		
4000 Series		
Belt - Fan & Gen.; W/42 7/8" Belt O.C.	3718614	▲9425HD
Belt - Fan & Gen.; W/44 3/8" Belt O.C.	3759205	▲9440HD
Hose - Upper; 2nd Design		20267
Hose - Lower; 2nd Design		≡<20584
6000 Series		
Belt - Fan & Gen.; W/42 7/8" Belt O.C.	3718614	▲9425HD
Belt - Fan & Gen.; W/46 3/8" Belt O.C.	3724316	▲9463HD
Belt - Air Brake Compr.	3740516	▲9610HD
Hose - Upper; 2nd Design		20267
Hose - Lower; 2nd Design		≡<20584
GM V-8 265		
4000 Series		
Belt - Fan & Gen.	3718616	▲9570HD
Belt - Air Brake Compr.	3728664	▲9680HD
GM V-8 283		
4000 Series		
Belt - Fan & Gen.	3718616	▲9570HD
Belt - Air Brake Compr.		▲9680HD
Hose - Upper		≡<20416
		or ●25478
Hose - Lower; W/Man. Trans.		≡<20046
		or ●26611
6000 Series		
Belt - Fan & Gen.	3732450	②7570
Belt - Air Brake Compr.	3759229	▲9630HD
Hose - Upper		≡<21794
		or ●25478
Hose - Lower		●26611
GM V-8 322		
10000 Series		
Belt - Fan & Gen.		②7575
Belt - Air Brake Compr.		▲9640HD

● Vulco-Flex® Coolant Hose.

≡< Cut to Fit.

◆ Green Stripe® PowerBand® Belt May Work, Use Template to Check.

▲ Standard Belt Available. See Pages 630-631.

② Two Required.

Belts and Coolant Hose for School Buses

Application	Mfr. Part No.	Our No.
CHEVROLET - Continued		
1959 - Continued		
GM V-8 327		
4000 Series		
Belt - Fan & Gen.	3718616	▲9570HD
Belt - Air Brake Compr.		▲9680HD
Hose - Upper		≧<20416
	or	●25478
Hose - Lower; W/Man. Trans.		≧<20046
	or	●26611
6000 Series		
Belt - Fan & Gen.	3732450	◎7570
Belt - Air Brake Compr.	3759229	▲9630HD
Hose - Upper		≧<21794
	or	●25478
Hose - Lower		●26611
1958		
GM 6-Cyl. 235		
4000 Series		
Belt - Fan & Gen.; W/42 7/8" Belt O.C.	3718614	▲9425HD
Belt - Fan & Gen.; W/44 3/8" Belt O.C.	3759205	▲9440HD
Hose - Upper; 2nd Design		20267
Hose - Lower; 2nd Design		≧<20584
6000 Series		
Belt - Fan & Gen.; W/42 7/8" Belt O.C.	3718614	▲9425HD
Belt - Fan & Gen.; W/46 3/8" Belt O.C.	3724316	▲9463HD
Belt - Air Brake Compr.	3740516	▲9610HD
Hose - Upper; 2nd Design		20267
Hose - Lower; 2nd Design		≧<20584
GM 6-Cyl. 261		
4000 Series		
Belt - Fan & Gen.; W/42 7/8" Belt O.C.	3718614	▲9425HD
Belt - Fan & Gen.; W/44 3/8" Belt O.C.	3759205	▲9440HD
Hose - Upper; 2nd Design		20267
Hose - Lower; 2nd Design		≧<20584
6000 Series		
Belt - Fan & Gen.; W/42 7/8" Belt O.C.	3718614	▲9425HD
Belt - Fan & Gen.; W/46 3/8" Belt O.C.	3724316	▲9463HD
Belt - Air Brake Compr.	3740516	▲9610HD
Hose - Upper; 2nd Design		20267
Hose - Lower; 2nd Design		≧<20584
GM V-8 265		
4000 Series		
Belt - Fan & Gen.	3718616	▲9570HD
Belt - Air Brake Compr.	3728664	▲9680HD
GM V-8 283		
4000 Series		
Belt - Fan & Gen.	3718616	▲9570HD
Belt - Air Brake Compr.		▲9680HD
Hose - Upper		≧<20416
	or	●25478
Hose - Lower; W/Man. Trans.		≧<20046
	or	●26611
6000 Series		
Belt - Fan & Gen.	3732450	◎7570
Belt - Air Brake Compr.	3759229	▲9630HD
GM V-8 322		
10000 Series		
Belt - Fan & Gen.		◎7575
Belt - Air Brake Compr.		▲9640HD
Hose - Upper		●25476
Hose - Lower		●25478
GM V-8 327		
4000 Series		
Belt - Fan & Gen.	3718616	▲9570HD
Belt - Air Brake Compr.		▲9680HD
Hose - Upper		≧<20416
	or	●25478
Hose - Lower; W/Man. Trans.		≧<20046

▲ Standard Belt Available. See Pages 630-631.
● Vulco-Flex® Coolant Hose.

Application	Mfr. Part No.	Our No.
CHEVROLET - Continued		
1958 - Continued		
GM V-8 327 - Continued		
4000 Series - Continued		
Hose - Lower; W/Man. Trans.		●26611
6000 Series		
Belt - Fan & Gen.	3732450	◎7570
Belt - Air Brake Compr.	3759229	▲9630HD
1957		
GM 6-Cyl. 235		
4000 Series		
Belt - Fan & Gen.; W/41 3/8" Belt O.C.	3727510	▲9412HD
Belt - Fan & Gen.; W/42 7/8" Belt O.C.	3718614	▲9425HD
Hose - Upper; 2nd Design		20267
Hose - Lower; 2nd Design		≧<20584
6000 Series		
Belt - Fan & Gen.; W/42 7/8" Belt O.C.	3718614	▲9425HD
Belt - Fan & Gen.; W/46 3/8" Belt O.C.	3724316	▲9463HD
Belt - Air Brake Compr.	3740516	▲9610HD
Hose - Upper; 2nd Design		20267
Hose - Lower; 2nd Design		≧<20584
GM 6-Cyl. 261		
4000 Series		
Belt - Fan & Gen.; W/41 3/8" Belt O.C.	3727510	▲9412HD
Belt - Fan & Gen.; W/42 7/8" Belt O.C.	3718614	▲9425HD
Hose - Upper; 2nd Design		20267
Hose - Lower; 2nd Design		≧<20584
6000 Series		
Belt - Fan & Gen.; W/42 7/8" Belt O.C.	3718614	▲9425HD
Belt - Fan & Gen.; W/46 3/8" Belt O.C.	3724316	▲9463HD
Belt - Air Brake Compr.	3740516	▲9610HD
Hose - Upper; 2nd Design		20267
Hose - Lower; 2nd Design		≧<20584
GM V-8 265		
4000 Series		
Belt - Fan & Gen.	3718616	▲9570HD
Belt - Air Brake Compr.	3728664	▲9680HD
Hose - Upper		≧<20416
	or	●25477
Hose - Lower		≧<20475
	or	●26501
GM V-8 283		
4000 Series		
Belt - Fan & Gen.	3718616	▲9570HD
Belt - Air Brake Compr.		▲9680HD
6000 Series		
Belt - Fan & Gen.	3732450	◎7570
Belt - Air Brake Compr.	3759229	▲9630HD
GM V-8 322		
10000 Series		
Hose - Upper		●25476
Hose - Lower		●25478
GM V-8 327		
4000 Series		
Belt - Fan & Gen.	3718616	▲9570HD
Belt - Air Brake Compr.		▲9680HD
6000 Series		
Belt - Fan & Gen.	3732450	◎7570
Belt - Air Brake Compr.	3759229	▲9630HD
1956		
GM 6-Cyl. 235		
4000 Series		
Belt - Fan & Gen.; W/41 3/8" Belt O.C.	3727510	▲9412HD
Belt - Fan & Gen.; W/42 7/8" Belt O.C.	3718614	▲9425HD
Hose - Upper; 2nd Design		20267
Hose - Lower; 2nd Design		≧<20584
6000 Series		
Belt - Fan & Gen.; W/42 7/8" Belt O.C.	3718614	▲9425HD

≧< Cut to Fit.
◎ Two Required.

School Buses

Belts and Coolant Hose for School Buses

School Buses

Application	Mfr. Part No.	Our No.	Application	Mfr. Part No.	Our No.
CHEVROLET - Continued			COLLINS		
1956 - Continued			2005		
GM 6-Cyl. 235 - Continued			GM V-8 4.8 L		
6000 Series - Continued			Bantam		
Belt - Fan & Gen.; W/46 3/8" Belt O.C.	3724316	▲9463HD	Belt - Alt. & W.P.	12576451	▲K060930HD
Belt - Air Brake Compr.	3740516	▲9610HD	Tensioner Assy. - Alt. & W.P.	12580162	38158
Hose - Upper; 2nd Design		20267	2002		
Hose - Lower; 2nd Design		✕20584	Ford V-8 7.3 L Diesel		
GM 6-Cyl. 261			Grand Bantam		
4000 Series			Serpentine Belt	1C2E8620JA	▲K081223HD
Belt - Fan & Gen.; W/41 3/8" Belt O.C.	3727510	▲9412HD	GM V-8 5.7 L		
Belt - Fan & Gen.; W/42 7/8" Belt O.C.	3718614	▲9425HD	Bantam		
Hose - Upper; 2nd Design		20267	Serpentine Belt	12564763	▲K060960HD
Hose - Lower; 2nd Design		✕20584	Tensioner Assy.	12561094	38103
6000 Series			Tensioner Pulley		38008
Belt - Fan & Gen.; W/42 7/8" Belt O.C.	3718614	▲9425HD	Hose - Upper - Eng. To Rad.		22357
Belt - Fan & Gen.; W/46 3/8" Belt O.C.	3724316	▲9463HD	1998-1997		
Belt - Air Brake Compr.	3740516	▲9610HD	Ford V-8 7.3 L Diesel		
Hose - Upper; 2nd Design		20267	Grand Bantam		
Hose - Lower; 2nd Design		✕20584	Serpentine Belt; W/Ambulance Prep. Pkg.		▲K081196HD
GM V-8 265			Serpentine Belt; W/O Ambulance Prep. Pkg.		▲K081177HD
4000 Series			Hose - Upper		23308
Belt - Fan & Gen.	3718616	▲9570HD	Hose - Lower		22319
Belt - Air Brake Compr.	3728664	▲9680HD	CORBEIL		
Hose - Upper		✕20416	2003		
		or	Ford V-8 7.3 L Diesel		
Hose - Lower		●25477	Corbeil Ford		
		or	Serpentine Belt; W/O Ambulance Prep. Pkg.;		
			W/Single Alt.; W/122.2" Belt O.C.	1C2Z8620LA	▲K081223HD
GM V-8 283			Serpentine Belt; W/121.3" Belt O.C.	1C2Z8620NA	▲K081213HD
4000 Series			Serpentine Belt; W/Ambulance Prep. Pkg.;		
Belt - Fan & Gen.	3718616	▲9570HD	W/Dual Alts.	F8TZ8620GC	▲K081377HD
Belt - Air Brake Compr.		▲9680HD	Tensioner Assy.	F8TZ6B209BA	38191
GM V-8 322			Tensioner Pulley - Smooth		38023
10000 Series			GM V-8 6.5 L Diesel		
Hose - Upper		●25476	Corbeil GM/Chevrolet		
Hose - Lower		●25478	Serpentine Belt; W/O A.C.; W/145A. Alt.	12556338	▲K061020HD
GM V-8 327			Tensioner Assy.	12561092	38118
4000 Series			Idler Pulley - Grooved; W/O A.C.	14102597	36177
Belt - Fan & Gen.	3718616	▲9570HD	Tensioner Pulley	12561092	38006
Belt - Air Brake Compr.		▲9680HD	CROWN COACH		
1955			1999-1997		
GM 6-Cyl. 235			Cummins B Series 3.9 L Diesel		
4000 Series ; 6000 Series			Counselor FE		
Hose - Upper; 2nd Design		20267	Serpentine Belt	3921753	▲K080550HD
Hose - Lower; 2nd Design		✕20584	Hose - Upper; (1 3/4" I.D.)		②24228
GM 6-Cyl. 261			Hose - Lower - Eng. To Pipe; (1 3/4" I.D.)		24228
4000 Series ; 6000 Series			Hose - Lower - Pipe To Rad.; (2" I.D.)		24232
Hose - Upper; 2nd Design		20267	Cummins ISB Diesel		
Hose - Lower; 2nd Design		✕20584	Counselor FE		
GM V-8 265			Serpentine Belt		
4000 Series			3921753		
Belt - Fan & Gen.	3718616	▲9570HD	▲K080550HD		
Belt - Air Brake Compr.	3728664	▲9680HD	Hose - Upper; (1 3/4" I.D.)		
Hose - Upper		✕20416	②24228		
		or	Hose - Lower - Eng. To Pipe; (1 3/4" I.D.)		
Hose - Lower		●25477	24228		
		or	Hose - Lower - Pipe To Rad.; (2" I.D.)		
			24232		
GM V-8 283			1996-1992		
4000 Series			Cummins B Series 3.9 L Diesel		
Belt - Fan & Gen.	3718616	▲9570HD	Counselor FE		
Belt - Air Brake Compr.		▲9680HD	Serpentine Belt		
GM V-8 327			3921753		
4000 Series			▲K080550HD		
Belt - Fan & Gen.	3718616	▲9570HD	Hose - Upper; (1 3/4" I.D.)		
Belt - Air Brake Compr.		▲9680HD	②24228		
			Hose - Lower - Eng. To Pipe; (1 3/4" I.D.)		
			24228		
			Hose - Lower - Pipe To Rad.; (2" I.D.)		
			24232		

▲ Standard Belt Available. See Pages 630-631.
● Vulco-Flex® Coolant Hose.

✕ Cut to Fit.
② Two Required.

Belts and Coolant Hose for School Buses

School Buses

Application	Mfr. Part No.	Our No.
CROWN COACH - Continued		
1996-1992 - Continued		
Cummins B Series 5.9 L Diesel		
Counselor FE		
Serpentine Belt	3921753	♣K080550HD
Hose - Upper; (1 3/4" I.D.)		②24228
Hose - Lower - Eng. To Pipe; (1 3/4" I.D.)		24228
Hose - Lower - Pipe To Rad.; (2" I.D.)		24232
1991		
Cummins B Series 3.9 L Diesel		
Counselor FE		
Serpentine Belt	3921753	♣K080550HD
Hose - Upper; (1 3/4" I.D.)		②24228
Hose - Lower - Eng. To Pipe; (1 3/4" I.D.)		24228
Hose - Lower - Pipe To Rad.; (2" I.D.)		24232
Cummins B Series 5.9 L Diesel		
Counselor FE		
Serpentine Belt	3921753	♣K080550HD
Hose - Upper; (1 3/4" I.D.)		②24228
Hose - Lower - Eng. To Pipe; (1 3/4" I.D.)		24228
Hose - Lower - Pipe To Rad.; (2" I.D.)		24232
Detroit Diesel 6-71 Diesel		
A426-10; A426-11		
Belt - Fan		②AX85
Belt - Alt.		②♣9500HD
1990-1985		
Detroit Diesel 6-71 Diesel		
A426-10; A426-11		
Belt - Fan		②AX85
Belt - Alt.		②♣9500HD
1984-1979		
Detroit Diesel 6-71 Diesel		
A426-10; A426-11		
Belt - Fan		②AX85
Belt - Alt.		②♣9500HD
International/Navistar RD450 Diesel		
R450		
Belt - Fan		TR30543
Belt - W.P. & Gen.		②TR24562
Belt - Air Brake Compr.		TR32571
1978-1975		
Cummins NH220 Diesel		
A743-31; A743T-11		
Belt - Fan		C78
Belt - W.P.		TR22363
Belt - P.S.		TR28376
Cummins NHHB Diesel		
AD743-11		
Belt - Fan		C78
Belt - W.P.	69585	7470
Belt - Gen. & Air Brake Compr.		②TR28616
Cummins NHHTC Diesel		
2A855T-11; A855T-11		
Belt - W.P.		②6596
Belt - Alt.		②♣9480HD
Detroit Diesel 6-71 Diesel		
A426-10; A426-11		
Belt - Fan		②AX85
Belt - Alt.		②♣9500HD
International/Navistar RD450 Diesel		
R450		
Belt - Fan		TR30543
Belt - W.P. & Gen.		②TR24562
Belt - Air Brake Compr.		TR32571

Application	Mfr. Part No.	Our No.
CROWN COACH - Continued		
1974-1973		
Cummins NH220 Diesel		
A743-31; A743T-11		
Belt - Fan		C78
Belt - W.P.		TR22363
Belt - P.S.		TR28376
Cummins NHHB Diesel		
AD743-11		
Belt - Fan		C78
Belt - W.P.	69585	7470
Belt - Gen. & Air Brake Compr.		②TR28616
Cummins NHHTC Diesel		
2A855T-11; A855T-11		
Belt - W.P.		②6596
Belt - Alt.		②♣9480HD
Detroit Diesel 6-71 Diesel		
A426-10; A426-11		
Belt - Fan		②AX85
Belt - Alt.		②♣9500HD
1972-1966		
Cummins NH220 Diesel		
A743-31; A743T-11		
Belt - Fan		C78
Belt - W.P.		TR22363
Belt - P.S.		TR28376
Cummins NHHB Diesel		
AD743-11		
Belt - Fan		C78
Belt - W.P.	69585	7470
Belt - Gen. & Air Brake Compr.		②TR28616
Cummins NHHTC Diesel		
2A855T-11; A855T-11		
Belt - W.P.		②6596
Belt - Alt.		②♣9480HD
1960-1951		
Detroit Diesel 6V-71 Diesel		
RD6V71-11		
Belt - Gen.; W/41 3/4" Belt O.C.		♣9415HD
Belt - Gen.; W/42 3/4" Belt O.C.		♣9425HD
Detroit Diesel 8V-71 Diesel		
RD8V71-11		
Belt - Gen.; W/41 3/4" Belt O.C.		♣9415HD
Belt - Gen.; W/42 3/4" Belt O.C.		♣9425HD
International/Navistar RD450 Diesel		
A450-11		
Belt - W.P. & Gen.		②TR22508
Belt - P.S.		TR28376
A450C		
Belt - Fan		TR28616
Belt - W.P. & Gen.		②TR22517
Belt - Air Brake Compr.		TR30448
International/Navistar RD501 Diesel		
A501-10; A501-11		
Belt - W.P. & Gen.		②TR22508
Belt - P.S.		TR28376
1950		
Detroit Diesel 6V-71 Diesel		
RD6V71-11		
Belt - Gen.; W/41 3/4" Belt O.C.		♣9415HD
Belt - Gen.; W/42 3/4" Belt O.C.		♣9425HD
Detroit Diesel 8V-71 Diesel		
RD8V71-11		
Belt - Gen.; W/41 3/4" Belt O.C.		♣9415HD
Belt - Gen.; W/42 3/4" Belt O.C.		♣9425HD

♣ Standard Belt Available. See Pages 630-631.

◆ Green Stripe® PowerBand® Belt May Work, Use Template to Check.

② Two Required.

Belts and Coolant Hose for School Buses

Application	Mfr. Part No.	Our No.
CROWN COACH - Continued		
1950 - Continued		
Hall Scott 190 Diesel		
A190-11		
Belt - W.P. & Gen.	②TR22517	
Belt - Gen.; W/Reverse Gen.	②BX54	
Belt - Air Brake Compr.	TR28429	
Hall Scott 504 Diesel		
A504-11		
Belt - W.P. & Gen.	②TR22517	
Belt - Gen.; W/Reverse Gen.	②BX54	
Belt - Air Brake Compr.	TR28429	
Hall Scott 590 Diesel		
A590-10		
Belt - Alt. & Air Brake Compr.	②TR28514	
Belt - P.S.	TR28666	
International/Navistar RD450 Diesel		
A450-11		
Belt - W.P. & Gen.	②TR22508	
Belt - P.S.	TR28376	
A450C		
Belt - Fan	TR28616	
Belt - W.P. & Gen.	②TR22517	
Belt - Air Brake Compr.	TR30448	
International/Navistar RD501 Diesel		
A501-10; A501-11		
Belt - W.P. & Gen.	②TR22508	
Belt - P.S.	TR28376	
DODGE		
1977-1976		
Dodge V-8 318		
S600		
Belt - Fan & Alt.; W/Cast Iron W.P.	2846941	②◆▲9470HD
Belt - Fan & Alt.; W/Aluminum W.P.	3671524	②7480
Belt - Fan & Alt.; W/105A. Alt.	3462082	②◆▲9570HD
Belt - Fan & P.S.; W/Cast Iron W.P.	3641756	▲9476HD
Belt - Fan & P.S.; W/Aluminum W.P.	2951893	7470
Belt - P.S.	2268386	▲9395HD
Belt - Air Brake Compr.	3736858	▲9680HD
Belt - A.P.	4037161	▲9570HD
Hose - Upper; W/Std. Cool.	21113	
	or ✕	●25484
Hose - Upper; W/X.C.		●25482
Hose - Lower; W/Std. Cool.		20974
Hose - Lower; W/X.C.		20559
	or ✕	●25528
Hose - By Pass		20693
Dodge V-8 360		
S600; S700		
Belt - Fan & Alt.	②◆▲9470HD	
Belt - P.S.	▲9463HD	
Hose - Lower	20559	
	or ✕	●25528
Hose - By Pass		20693
Dodge V-8 361		
S600; S700		
Belt - Fan & Alt.	②◆▲9650HD	
Belt - P.S.	▲9412HD	
Belt - Air Brake Compr.	▲9755HD	
Hose - Upper	✕20611	
	or	●26509
Hose - Lower		●26531
Dodge V-8 413		
S600; S700		
Belt - Fan & Alt.	②◆▲9650HD	
Belt - P.S.	▲9412HD	
Belt - Air Brake Compr.	▲9755HD	
Hose - Upper	✕20611	
	or	●26509
Hose - Lower		●26531

Application	Mfr. Part No.	Our No.
DODGE - Continued		
1977-1976 - Continued		
Dodge V-8 413 - Continued		
S600; S700 - Continued		
Hose - Upper		●26509
Hose - Lower		●26531
Perkins 6-Cyl. 354 Diesel		
S600		
Belt - Fan & Alt.	3634904	▲9540HD
Belt - P.S.	3641909	▲9660HD
1975		
Dodge V-8 318		
S600		
Belt - Fan & Alt.; W/Cast Iron W.P.	2846941	②◆▲9470HD
Belt - Fan & Alt.; W/Aluminum W.P.	3671524	②7480
Belt - Fan & Alt.; W/105A. Alt.	3462082	②◆▲9570HD
Belt - Fan & P.S.; W/Cast Iron W.P.	3638926	▲9463HD
Belt - Fan & P.S.; W/Aluminum W.P.	2951893	7470
Belt - Air Brake Compr.	3736858	▲9680HD
Hose - Upper; W/Std. Cool.		●25484
Hose - Lower; W/Std. Cool.		20974
	or	●26501
Hose - Lower; W/H.D. W.P.		20931
	or	●25530
Hose - By Pass		20693
Dodge V-8 360		
S700		
Belt - Fan & Alt.		②◆▲9470HD
Belt - P.S.		▲9463HD
Hose - Lower		20559
	or ✕	●25528
Hose - By Pass		20693
Dodge V-8 361		
S600; S700		
Belt - Fan & Alt.	②◆▲9650HD	
Belt - P.S.	▲9412HD	
Belt - Air Brake Compr.	▲9755HD	
Hose - Upper	✕20611	
	or	●26509
Hose - Lower		●26531
Dodge V-8 413		
S600; S700		
Belt - Fan & Alt.	②◆▲9650HD	
Belt - P.S.	▲9412HD	
Belt - Air Brake Compr.	▲9755HD	
Hose - Upper	✕20611	
	or	●26509
Hose - Lower		●26531
Perkins 6-Cyl. 354 Diesel		
S600		
Belt - Fan & Alt.	3634904	▲9540HD
Belt - P.S.	3641909	▲9660HD
1974		
Dodge V-8 318		
S600		
Belt - Fan & Alt.; W/Cast Iron W.P.	2846941	②◆▲9470HD
Belt - Fan & Alt.; W/Aluminum W.P.	3671524	②7480
Belt - Fan & Alt.; W/105A. Alt.	3462082	②◆▲9570HD
Belt - Fan & P.S.	3733345	▲9470HD
Belt - Air Brake Compr.	2946719	▲9740HD
Hose - Upper; W/Std. Cool.		●25484
Hose - Lower; W/Std. Cool.		20974
	or	●26501
Hose - Lower; W/H.D. W.P.		20931
	or	●25530
Hose - By Pass		20693

② Two Required.

▲ Standard Belt Available. See Pages 630-631.

● Vulco-Flex® Coolant Hose.

◆ Green Stripe® PowerBand® Belt May Work, Use Template to Check.

✕ Cut to Fit.

Belts and Coolant Hose for School Buses

School Buses

Application	Mfr. Part No.	Our No.
DODGE - Continued		
1974 - Continued		
Dodge V-8 360		
S600		
Belt - Fan & Alt.	②◆◆9470HD	
Belt - P.S.	◆9463HD	
Hose - Lower	20559	
	or	◆25528
Hose - By Pass		20693
Dodge V-8 361		
S600		
Belt - Fan & Alt.	②◆◆9650HD	
Belt - P.S.	◆9412HD	
Belt - Air Brake Compr.	◆9755HD	
Hose - Upper	⊘<20611	
	or	◆26510
Hose - Lower		⊘<20760
	or	◆26529
Dodge V-8 413		
S600		
Belt - Fan & Alt.	②◆◆9650HD	
Belt - P.S.	◆9412HD	
Belt - Air Brake Compr.	◆9755HD	
Hose - Upper	⊘<20611	
	or	◆26510
Hose - Lower		⊘<20760
	or	◆26529
Perkins 6-Cyl. 354 Diesel		
S600		
Belt - Fan & Alt.	3634904	◆9540HD
Belt - P.S.	3641909	◆9660HD
1973-1972		
Dodge V-8 318		
S600		
Belt - Fan & Alt.; W/Cast Iron W.P.	2846941	②◆◆9470HD
Belt - Fan & Alt.; W/Aluminum W.P.	3671524	②7480
Belt - Fan & Alt.; W/105A. Alt.	3462082	②◆◆9570HD
Belt - Fan & P.S.	3733345	◆9470HD
Belt - Air Brake Compr.	2946719	◆9740HD
Hose - Upper; W/Std. Cool.		◆25480
Hose - Upper; W/X.C.		⊘<20620
Hose - Lower		◆25528
Hose - By Pass		20693
Dodge V-8 361		
S600		
Belt - Fan & Alt.	②◆◆9650HD	
Belt - P.S.	◆9412HD	
Belt - Air Brake Compr.	◆9755HD	
Hose - Upper	⊘<20611	
	or	◆26510
Hose - Lower		⊘<20760
	or	◆26529
Dodge V-8 413		
S600		
Belt - Fan & Alt.	②◆◆9650HD	
Belt - P.S.	◆9412HD	
Belt - Air Brake Compr.	◆9755HD	
Hose - Upper	⊘<20611	
	or	◆26510
Hose - Lower		⊘<20760
	or	◆26529
1971-1970		
Dodge 6-Cyl. 225		
S500		
Belt - Fan & Alt.		7570
Belt - P.S.		7390
Hose - Upper		⊘<21660
	or	◆25474
Hose - Lower		20229
	or	◆25482

Application	Mfr. Part No.	Our No.
DODGE - Continued		
1971-1970 - Continued		
Dodge 6-Cyl. 225 - Continued		
S500 - Continued		
Hose - Lower		◆25482
Dodge V-8 318		
S500; S600		
Belt - Fan & Alt.; W/Cast Iron W.P.	2846941	②◆◆9470HD
Belt - Fan & Alt.; W/Aluminum W.P.	3671524	②7480
Belt - Fan & Alt.; W/105A. Alt.	3462082	②◆◆9570HD
Belt - Fan & P.S.	2206417	◆9447HD
Hose - Upper; W/Std. Cool.		◆25480
Hose - Upper; W/X.C.		⊘<20620
Hose - Lower		◆25528
Hose - By Pass		20693
Dodge V-8 361		
S500; S600		
Belt - Fan & Alt.	②◆◆9650HD	
Belt - P.S.	◆9412HD	
Belt - Air Brake Compr.	◆9755HD	
Hose - Upper	⊘<20611	
	or	◆26510
Hose - Lower		⊘<20760
	or	◆26529
Dodge V-8 413		
S500; S600		
Belt - Fan & Alt.	②◆◆9650HD	
Belt - P.S.	◆9412HD	
Belt - Air Brake Compr.	◆9755HD	
Hose - Upper	⊘<20611	
	or	◆26510
Hose - Lower		⊘<20760
	or	◆26529
1969		
Dodge 6-Cyl. 225		
S500		
Belt - Fan & Alt.		7570
Belt - P.S.		7390
Hose - Upper		⊘<21660
	or	◆25474
Hose - Lower		20229
	or	◆25482
Dodge V-8 318		
S500; S600		
Belt - Fan & Alt.; W/Cast Iron W.P.	2846941	②◆◆9470HD
Belt - Fan & Alt.; W/Aluminum W.P.	3671524	②7480
Belt - Fan & Alt.; W/105A. Alt.	3462082	②◆◆9570HD
Belt - Fan & P.S.	2206417	◆9447HD
Hose - Upper		20620
Hose - Lower		20559
	or	◆25527
Hose - By Pass		20693
Dodge V-8 361		
S500; S600		
Belt - Fan & Alt.	②◆◆9650HD	
Belt - P.S.	◆9412HD	
Belt - Air Brake Compr.	◆9755HD	
Hose - Upper	⊘<20611	
	or	◆26510
Hose - Lower		⊘<20760
	or	◆26529
Dodge V-8 413		
S500; S600		
Belt - Fan & Alt.	②◆◆9650HD	
Belt - P.S.	◆9412HD	
Belt - Air Brake Compr.	◆9755HD	
Hose - Upper	⊘<20611	
	or	◆26510
Hose - Lower		⊘<20760
	or	◆26529

② Two Required.
 ◆ Standard Belt Available. See Pages 630-631.
 ● Vulco-Flex® Coolant Hose.

◆ Green Stripe® PowerBand® Belt May Work, Use Template to Check.
 ⊘< Cut to Fit.

Belts and Coolant Hose for School Buses

School Buses

Application	Mfr. Part No.	Our No.
DODGE - Continued		
1968		
Dodge 6-Cyl. 225		
S500		
Belt - Fan & Alt.		7570
Belt - P.S.		7360
Hose - Upper		≅21660
	or	●25474
Hose - Lower		20229
	or	●25482
Dodge V-8 318		
S500; S550; S600		
Belt - Fan & Alt.; W/Cast Iron W.P.	2846941	②◆▲9470HD
Belt - Fan & Alt.; W/Aluminum W.P.	3671524	②7480
Belt - Fan & Alt.; W/105A. Alt.	3462082	②◆▲9570HD
Belt - Fan & P.S.	2206417	▲9447HD
Hose - Upper		20620
Hose - Lower		20559
	or	●25527
Hose - By Pass		20693
Dodge V-8 361		
S500; S550; S600		
Belt - Fan & Alt.	②◆▲9660HD	
Belt - P.S.	▲9400HD	
Hose - Upper		≅20611
	or	●26509
Hose - Lower		21256
	or	●26504
Dodge V-8 413		
S500; S600		
Belt - Fan & Alt.	②◆▲9660HD	
Belt - P.S.	▲9400HD	
Hose - Upper		≅20611
	or	●26509
Hose - Lower		21256
	or	●26504
1967		
Dodge 6-Cyl. 225		
S500		
Belt - Fan & Alt.		7570
Belt - P.S.		7360
Hose - Upper		≅21660
	or	●25474
Hose - Lower		20229
	or	●25482
Dodge V-8 318		
S400; S500; S550; S600		
Belt - Fan & Alt.	2202795	②◆▲9550HD
Belt - P.S.	2206417	▲9447HD
Hose - Upper		20620
Hose - Lower		20559
	or	●25527
Hose - By Pass		20693
Dodge V-8 361		
S500; S550; S600		
Belt - Fan & Alt.	②◆▲9660HD	
Belt - P.S.	▲9400HD	
Hose - Upper		≅20611
	or	●26509
Hose - Lower		21256
	or	●26504
Dodge V-8 413		
S500; S600		
Belt - Fan & Alt.	②◆▲9660HD	
Belt - P.S.	▲9400HD	
Hose - Upper		≅20611
	or	●26509
Hose - Lower		21256
	or	●26504

Application	Mfr. Part No.	Our No.
DODGE - Continued		
1967 - Continued		
Perkins 6-Cyl. 354 Diesel		
S600		
Belt - Fan & Alt.; W/O P.S.		▲9550HD
1966-1963		
Dodge 6-Cyl. 225		
S500		
Belt - Fan & Alt.		7570
Belt - P.S.		7360
Hose - Upper		≅21660
	or	●25474
Hose - Lower		20229
	or	●25482
Dodge V-8 318		
S400; S500; S550; S600		
Belt - Fan & Alt.	2202795	②◆▲9550HD
Belt - P.S.	2206417	▲9447HD
Hose - Upper		20452
Hose - Lower		20559
	or	●25527
Dodge V-8 361		
S500; S550; S600		
Belt - Fan & Alt.	②◆▲9660HD	
Belt - P.S.	▲9400HD	
Hose - Upper		≅20611
	or	●26509
Hose - Lower		21256
	or	●26504
Dodge V-8 413		
S500; S600		
Belt - Fan & Alt.	②◆▲9660HD	
Belt - P.S.	▲9400HD	
Hose - Upper		≅20611
	or	●26509
Hose - Lower		21256
	or	●26504
Perkins 6-Cyl. 354 Diesel		
S600		
Belt - Fan & Alt.; W/O P.S.		▲9550HD
1962		
Dodge 6-Cyl. 225		
S500		
Belt - Fan & Alt.		7570
Belt - P.S.		7360
Dodge V-8 318		
S400; S500; S550; S600		
Belt - Fan & Alt.	2202795	②◆▲9550HD
Belt - P.S.	2206417	▲9447HD
Hose - Upper		20452
Hose - Lower		20559
	or	●25527
Dodge V-8 361		
S500; S550; S600		
Belt - Fan & Alt.	②◆▲9660HD	
Belt - P.S.	▲9400HD	
Hose - Upper		≅20611
	or	●26509
Hose - Lower		21256
	or	●26504
Dodge V-8 413		
S500; S600		
Belt - Fan & Alt.	②◆▲9660HD	
Belt - P.S.	▲9400HD	
Hose - Upper		≅20611
	or	●26509
Hose - Lower		21256
	or	●26504

≅ Cut to Fit.
 ② Two Required.
 ▲ Standard Belt Available. See Pages 630-631.

● Vulco-Flex® Coolant Hose.
 ◆ Green Stripe® PowerBand® Belt May Work, Use Template to Check.

Belts and Coolant Hose for School Buses

School Buses

Application	Mfr. Part No.	Our No.
DODGE - Continued		
1962 - Continued		
Perkins 6-Cyl. 354 Diesel		
S600		
Belt - Fan & Alt.; W/O P.S.		▲9550HD
1961		
Dodge 6-Cyl. 225		
S500		
Belt - Fan & Alt.	7570	
Belt - P.S.	7360	
Dodge V-8 318		
S400; S500; S600		
Belt - Fan & Alt.	2202795	②◆▲9550HD
Belt - P.S.	2206417	▲9447HD
Hose - Upper	20452	
Hose - Lower	20559	
	or	●25527
Dodge V-8 361		
S500; S600		
Belt - Fan & Alt.		②◆▲9660HD
Belt - P.S.		▲9400HD
Hose - Upper		≈<20611
	or	●26509
Hose - Lower		21256
	or	●26504
Dodge V-8 413		
S500; S600		
Belt - Fan & Alt.		②◆▲9660HD
Belt - P.S.		▲9400HD
Hose - Upper		≈<20611
	or	●26509
Hose - Lower		21256
	or	●26504
Perkins 6-Cyl. 354 Diesel		
S600		
Belt - Fan & Alt.; W/O P.S.		▲9550HD
1960		
Dodge 6-Cyl. 251		
S400		
Belt - Fan & Gen.; W/50 5/8" Belt O.C.	TR24500	
Belt - Fan & Gen.; W/54 3/4" Belt O.C.	TR24538	
Belt - Fan & Gen.; W/52" Belt O.C.	TR24515	
Belt - P.S.	▲9505HD	
Hose - Upper	●26603	
Hose - Lower	●25480	
Hose - By Pass	≈<20568	
S500; S600		
Belt - Fan & Gen.; W/50 5/8" Belt O.C.	TR24500	
Belt - Fan & Gen.; W/54 3/8" Belt O.C.	TR24538	
Belt - Fan & Gen.; W/52" Belt O.C.	TR24515	
Belt - P.S.	▲9505HD	
Hose - Upper	●26603	
Hose - Lower	●25480	
Hose - By Pass	≈<20568	
Dodge 6-Cyl. 265		
S400; S500; S600		
Belt - Fan & Gen.; W/50 5/8" Belt O.C.	TR24500	
Belt - Fan & Gen.; W/54 3/8" Belt O.C.	TR24538	
Belt - Fan & Gen.; W/52" Belt O.C.	TR24515	
Belt - P.S.	▲9505HD	
Hose - Upper	●26603	
Hose - Lower	●25480	
Hose - By Pass	≈<20568	
Dodge V-8 318		
S400; S500; S600		
Belt - Fan & Gen.; W/35A., 40A. Alt.	1851525	②▲9680HD
Belt - Fan & Gen.; W/O 35A., 40A. Alt.	1852208	②◆▲9670HD
Belt - P.S.	1855867	▲9610HD
Belt - Air Brake Compr.	1614690	▲9440HD
Hose - Upper		●25527
Hose - Lower		20386

Application	Mfr. Part No.	Our No.
DODGE - Continued		
1960 - Continued		
Dodge V-8 318 - Continued		
S400; S500; S600 - Continued		
Belt - Air Brake Compr.	1947372	9765
Hose - Upper		●25527
Hose - Lower		≈<20386
	or	●25476
Hose - By Pass		≈<20618
Hose - By Pass; (3/4" I.D.)		28442
Dodge V-8 361		
S500; S600		
Belt - Fan & Gen.		②◆▲9670HD
Belt - P.S.		▲9400HD
Belt - Air Brake Compr.		9765
Dodge V-8 413		
S500; S600		
Belt - Fan & Gen.		②◆▲9670HD
Belt - P.S.		▲9400HD
Belt - Air Brake Compr.		9765
1959		
Dodge 6-Cyl. 251		
S400; S500; S600		
Belt - Fan & Gen.; W/50 5/8" Belt O.C.		TR24500
Belt - Fan & Gen.; W/54 3/8" Belt O.C.		TR24538
Belt - Fan & Gen.; W/52" Belt O.C.		TR24515
Belt - P.S.		▲9505HD
Hose - Upper		●26603
Hose - Lower		●25480
Hose - By Pass		≈<20568
Dodge 6-Cyl. 265		
S400; S500; S600		
Belt - Fan & Gen.; W/50 5/8" Belt O.C.		TR24500
Belt - Fan & Gen.; W/54 3/8" Belt O.C.		TR24538
Belt - Fan & Gen.; W/52" Belt O.C.		TR24515
Belt - P.S.		▲9505HD
Hose - Upper		●26603
Hose - Lower		●25480
Hose - By Pass		≈<20568
Dodge V-8 315		
S400; S500		
Belt - Fan & Gen.; W/35A., 40A. Alt.		②▲9680HD
Belt - Fan & Gen.; W/O 35A., 40A. Alt.		②◆▲9670HD
Belt - P.S.		▲9610HD
Belt - Air Brake Compr.		▲9440HD
Hose - Upper		≈<20046
	or	●26501
Hose - Lower; W/Man. Trans.		≈<20763
	or	●25476
Hose - Lower; W/Auto. Trans.		20386
	or	●25478
S600		
Belt - Fan & Gen.; W/35A., 40A. Alt.		②▲9680HD
Belt - Fan & Gen.; W/O 35A., 40A. Alt.		②◆▲9670HD
Belt - P.S.		▲9610HD
Belt - Air Brake Compr.		▲9440HD
Hose - Upper; W/Man. Trans.		≈<20046
	or	●26501
Hose - Upper; W/Auto. Trans.		≈<20957
	or	●26501
Hose - Lower		≈<20763
	or	●25476
Dodge V-8 318		
S400; S500; S600		
Belt - Fan & Gen.; W/35A., 40A. Alt.	1851525	②▲9680HD
Belt - Fan & Gen.; W/O 35A., 40A. Alt.	1852208	②◆▲9670HD
Belt - P.S.	1855867	▲9610HD
Belt - Air Brake Compr.	1614690	▲9440HD
Hose - Upper		●25527
Hose - Lower		20386

▲ Standard Belt Available. See Pages 630-631.

◆ Green Stripe® PowerBand® Belt May Work, Use Template to Check.

≈< Cut to Fit.

② Two Required.

● Vulco-Flex® Coolant Hose.

Belts and Coolant Hose for School Buses

School Buses

Application	Mfr. Part No.	Our No.
DODGE - Continued		
1959 - Continued		
Dodge V-8 318 - Continued		
S400; S500; S600 - Continued		
Hose - Lower		●25478
Hose - By Pass		✂20618
Hose - By Pass; (3/4" I.D.)		28442
Dodge V-8 331		
S700		
Belt - Fan & Gen.		②BX65
Belt - P.S.	1855482	②7619
Belt - Air Brake Compr.	1117611	TR24438
Hose - Upper; W/Auto. Trans.		✂20957
	or	●26501
Hose - Lower; W/Auto. Trans.		✂20763
Hose - Lower; W/Man. Trans.		20145
Hose - By Pass		✂21942
Dodge V-8 354		
S700		
Belt - Fan & Gen.		②BX65
Belt - P.S.	1855482	②7619
Belt - Air Brake Compr.	1117611	TR24438
Hose - Upper; W/Auto. Trans.		✂20957
	or	●26501
Hose - Lower; W/Auto. Trans.		✂20763
Hose - Lower; W/Man. Trans.		20145
Hose - By Pass		✂21942
1958		
Dodge 6-Cyl. 251		
S400; S500; S600		
Belt - Fan & Gen.; W/40A. Alt.		TR24515
Belt - Fan & Gen.; W/O 40A. Alt.		TR24500
Belt - P.S.		7390
Hose - Upper		●26603
Hose - Lower		●25480
Hose - By Pass		✂20568
Dodge 6-Cyl. 265		
S400; S500; S600		
Belt - Fan & Gen.; W/40A. Alt.		TR24515
Belt - Fan & Gen.; W/O 40A. Alt.		TR24500
Belt - P.S.		7390
Hose - Upper		●26603
Hose - Lower		●25480
Hose - By Pass		✂20568
Dodge V-8 315		
S400; S500		
Belt - Fan & Gen.; W/35A., 40A. Alt.		②▲9680HD
Belt - Fan & Gen.; W/O 35A., 40A. Alt.		②◆▲9670HD
Belt - P.S.		▲9610HD
Belt - Air Brake Compr.		▲9440HD
Hose - Upper		✂20046
	or	●26501
Hose - Lower; W/Man. Trans.		✂20763
	or	●25476
Hose - Lower; W/Auto. Trans.		20386
	or	●25478
S600		
Belt - Fan & Gen.; W/35A., 40A. Alt.		②▲9680HD
Belt - Fan & Gen.; W/O 35A., 40A. Alt.		②◆▲9670HD
Belt - P.S.		▲9610HD
Belt - Air Brake Compr.		▲9440HD
Hose - Upper; W/Man. Trans.		✂20046
	or	●26501
Hose - Upper; W/Auto. Trans.		✂20957
	or	●26501
Hose - Lower		✂20763
	or	●25476
Dodge V-8 331		
S700		
Belt - Fan & Gen.		②BX65

Application	Mfr. Part No.	Our No.
DODGE - Continued		
1958 - Continued		
Dodge V-8 331 - Continued		
S700 - Continued		
Belt - P.S.	1855482	②7619
Belt - Air Brake Compr.	1117611	TR24438
Hose - Upper; W/Auto. Trans.		✂20957
	or	●26501
Hose - Lower; W/Auto. Trans.		✂20763
Hose - Lower; W/Man. Trans.		20145
Hose - By Pass		✂21942
Dodge V-8 354		
S700		
Belt - Fan & Gen.		②BX65
Belt - P.S.	1855482	②7619
Belt - Air Brake Compr.	1117611	TR24438
Hose - Upper; W/Auto. Trans.		✂20957
	or	●26501
Hose - Lower; W/Auto. Trans.		✂20763
Hose - Lower; W/Man. Trans.		20145
Hose - By Pass		✂21942
1957		
Dodge 6-Cyl. 251		
S400; S500; S600		
Belt - Fan & Gen.; W/50 5/8" Belt O.C.		TR24500
Belt - Fan & Gen.; W/52" Belt O.C.		TR24515
Belt - P.S.		7370
Hose - Upper		●26603
Hose - Lower		●25480
Hose - By Pass		✂20568
Dodge 6-Cyl. 265		
S400; S500; S600		
Belt - Fan & Gen.; W/50 5/8" Belt O.C.		TR24500
Belt - Fan & Gen.; W/52" Belt O.C.		TR24515
Belt - P.S.		7370
Hose - Upper		●26603
Hose - Lower		●25480
Hose - By Pass		✂20568
Dodge V-8 315		
S400; S500		
Belt - Fan & Gen.; W/65 3/8" Belt O.C.		②◆▲9650HD
Belt - Fan & Gen.; W/66 3/8" Belt O.C.		②◆▲9660HD
Belt - P.S.		▲9580HD
Belt - Air Brake Compr.		▲9440HD
Hose - Upper		✂20046
	or	●26501
Hose - Lower; W/Man. Trans.		✂20763
	or	●25476
Hose - Lower; W/Auto. Trans.		20386
	or	●25478
S600		
Belt - Fan & Gen.; W/65 3/8" Belt O.C.		②◆▲9650HD
Belt - Fan & Gen.; W/66 3/8" Belt O.C.		②◆▲9660HD
Belt - P.S.		▲9580HD
Belt - Air Brake Compr.		▲9440HD
Hose - Upper; W/Man. Trans.		✂20046
	or	●26501
Hose - Upper; W/Auto. Trans.		✂20957
	or	●26501
Hose - Lower		✂20763
	or	●25476
Dodge V-8 331		
S700		
Belt - Fan & Gen.		②BX65
Belt - P.S.; W/Air Brakes	1393494	TR24562
Belt - P.S.; W/O Air Brakes	1191449	TR24476
Belt - Air Brake Compr.	1117611	TR24438
Hose - Lower		●26510

- Vulco-Flex® Coolant Hose.
- ② Two Required.
- ◆ Green Stripe® PowerBand® Belt May Work, Use Template to Check.

- ✂ Cut to Fit.
- ▲ Standard Belt Available. See Pages 630-631.

Belts and Coolant Hose for School Buses

Application	Mfr. Part No.	Our No.	Application	Mfr. Part No.	Our No.
DODGE - Continued			FORD - Continued		
1957 - Continued			1994 - Continued		
Dodge V-8 354			Ford 6-Cyl. 6.6 L Diesel - Continued		
S700			B700 - Continued		
Belt - Fan & Gen.		ⓂBX65	Hose - Lower; W/Auto. Trans.; W/O 210 H.P.		21961
Belt - P.S.; W/Air Brakes	1393494	TR24562	Hose - Lower; W/Man. Trans.; W/O P.T.O.		21845
Belt - P.S.; W/O Air Brakes	1191449	TR24476	Hose - Heater; (5/8" I.D.)		28441
Belt - Air Brake Compr.	1117611	TR24438	Ford 6-Cyl. 7.8 L Diesel		
Hose - Lower		●26510	B700		
FORD			Belt - Fan & Alt.; W/O W.P. Mtd. Fan;		
1998-1997			Preferred Belt		
Ford FD1060 Diesel			E8HZ8620B		
B800			2/9710PB		
Belt - Alt., W.P. & P.S.	JK8836	♣K080830HD	Belt - Fan & Alt.; W/O W.P. Mtd. Fan; Optional		
Belt - A.C.	F4HT8620GA	♣9412HD	Belt		
Tensioner Assy. - Alt., W.P. & P.S.	3978021	38517	E8HZ8620B		
Hose - Upper - Eng. To Rad.; (1 5/8" I.D.)		24226	♣9710HD		
1996			E8HZ8620H		
Ford FD1060 Diesel			♣9640HD		
B800			♣9630HD		
Belt - Alt., W.P. & P.S.	JK8836	♣K080830HD	♣9590HD		
Belt - A.C.	F3HZ8620A	♣9420HD	7575		
Tensioner Assy. - Alt., W.P. & P.S.	3978021	38517	21943		
1995			22034		
Ford FD1060 Diesel			21961		
B800			22033		
Belt - Alt., W.P. & P.S.	JK8836	♣K080830HD	21845		
Belt - A.C.	F3HZ8620A	♣9420HD	28441		
Tensioner Assy. - Alt., W.P. & P.S.	3978021	38517	1993-1992		
1994			Ford FD1060 Diesel		
Ford V-8 7.3 L Diesel			B600; B700		
B600; B700			Belt - Fan & Alt.		
Belt - Fan & Alt.	1822630C1	♣K080893HD	F3HZ8620B		
1995			♣K080830HD		
Ford FD1060 Diesel			Ford 6-Cyl. 6.6 L Diesel		
B800			B600; B700		
Belt - Alt., W.P. & P.S.	JK8836	♣K080830HD	Belt - Fan & Alt.; W/60A., 75A., 90A. Alt.;		
Belt - A.C.	F3HZ8620A	♣9420HD	W/W.P. Mtd. Fan; Preferred Belt		
Tensioner Assy. - Alt., W.P. & P.S.	3978021	38517	C9PZ8620DF		
1994			2/9610PB		
Ford FD1060 Diesel			Belt - Fan & Alt.; W/60A., 75A., 90A. Alt.;		
B600; B700			W/W.P. Mtd. Fan; Optional Belt		
Belt - Fan & Alt.	F3HZ8620B	♣K080830HD	C9PZ8620DF		
Ford 6-Cyl. 6.6 L Diesel			♣9610HD		
B700			Belt - Fan & Alt.; W/130A. Alt.; W/W.P. Mtd.		
Belt - Fan & Alt.; W/60A., 75A., 90A. Alt.;	C9PZ8620DF	2/9610PB	Fan		
W/W.P. Mtd. Fan; Preferred Belt			D8PZ8620N		
Belt - Fan & Alt.; W/60A., 75A., 90A. Alt.;	C9PZ8620DF	♣9610HD	♣9625HD		
W/W.P. Mtd. Fan; Optional Belt			Belt - Fan & Alt.; W/60A., 75A., 90A. Alt.; W/O		
Belt - Fan & Alt.; W/130A. Alt.; W/W.P. Mtd.			W.P. Mtd. Fan; Preferred Belt		
Fan			F0HZ8620G		
D8PZ8620N		♣9625HD	2/9690PB		
Belt - Fan & Alt.; W/60A., 75A., 90A. Alt.; W/O			Belt - Fan & Alt.; W/60A., 75A., 90A. Alt.; W/O		
W.P. Mtd. Fan; Preferred Belt			W.P. Mtd. Fan; Optional Belt		
F0HZ8620G		2/9690PB	F0HZ8620G		
Belt - Fan & Alt.; W/60A., 75A., 90A. Alt.; W/O			♣9690HD		
W.P. Mtd. Fan; Optional Belt			Belt - Fan & Alt.; W/130A. Alt.; W/O W.P. Mtd.		
F0HZ8620G		♣9690HD	Fan		
Belt - Fan & Alt.; W/130A. Alt.; W/O W.P. Mtd.			D8PZ8620Y		
Fan			♣9570HD		
D8PZ8620Y		♣9570HD	♣9630HD		
Belt - P.S.; W/O W.P. Mtd. Fan			♣9630HD		
E8HZ8620Y		♣9630HD	♣9545HD		
Belt - P.S.; W/W.P. Mtd. Fan			♣9640HD		
E6HZ8620E		♣9545HD	Belt - Hyd. Brake Boost Pump		
E8HZ8620H		♣9640HD	E8HZ8620H		
Belt - Hyd. Brake Boost Pump			♣9635HD		
E7HZ8620B		♣9635HD	Belt - Air Brake Compr.; W/Auto. Trans.;		
Belt - Air Brake Compr.; W/Auto. Trans.;			W/2150 Air Brake Compr.		
E7HZ8620B		♣9635HD	E7HZ8620B		
Belt - Air Brake Compr.; W/Man. Trans.;			♣9635HD		
W/A.C.; W/2150 Air Brake Compr.			E7HZ8620B		
E7HZ8620B		♣9635HD	Belt - Air Brake Compr.; W/Man. Trans.; W/O		
Belt - Air Brake Compr.; W/Man. Trans.; W/O			A.C.; W/2150 Air Brake Compr.		
C9PZ8620GN		♣9550HD	C9PZ8620GN		
Belt - Air Brake Compr.; W/550 Air Brake			Belt - Air Brake Compr.; W/550 Air Brake		
Compr.			Compr.		
E3AZ8620D		♣9565HD	E3AZ8620D		
Belt - A.C.; W/59 1/2" Belt O.C.		♣9590HD	♣9565HD		
E8HZ8620N		♣9590HD	♣9590HD		
Belt - A.C.; W/57 1/8" Belt O.C.		7565	Belt - A.C.; W/57 1/8" Belt O.C.		
D9PZ8620E		7565	D9PZ8620E		
Hose - Upper; W/O Air To Air Aftercooler		21943	Hose - Upper; W/O Air To Air Aftercooler		
21943		♣21943	21943		
Hose - Upper; W/Air To Air Aftercooler		♣21943	Hose - Upper; W/Air To Air Aftercooler		
♣21943		♣21943	♣21943		
Hose - Lower; W/Auto. Trans.; W/210 H.P.		22034	Hose - Lower; W/Auto. Trans.; W/210 H.P.		
22034		22034	22034		
Hose - Lower; W/Man. Trans.; W/O Aftercooler		21961	Hose - Lower; W/Man. Trans.; W/O Aftercooler		
21961		21961	21961		
Hose - Lower; W/Auto. Trans.; W/O 210 H.P.		21845	Hose - Lower; W/Auto. Trans.; W/O 210 H.P.		
21845		21845	21845		
Hose - Lower; W/Man. Trans.; W/O P.T.O.		28441	Hose - Lower; W/Man. Trans.; W/O P.T.O.		
28441		28441	28441		
Hose - Heater; (5/8" I.D.)		28441	Hose - Heater; (5/8" I.D.)		
28441		28441	28441		
Ford 6-Cyl. 7.8 L Diesel			Ford 6-Cyl. 7.8 L Diesel		
B700			B700		
Belt - Fan & Alt.; W/O W.P. Mtd. Fan;			Belt - Fan & Alt.; W/O W.P. Mtd. Fan;		
Preferred Belt			Preferred Belt		
E8HZ8620B		2/9710PB	E8HZ8620B		
Belt - Fan & Alt.; W/O W.P. Mtd. Fan; Optional			Belt - Fan & Alt.; W/O W.P. Mtd. Fan; Optional		
Belt			Belt		
E8HZ8620B		♣9710HD	E8HZ8620B		
♣9710HD		♣9710HD	♣9710HD		
Belt - Hyd. Brake Boost Pump		♣9640HD	Belt - Hyd. Brake Boost Pump		
E8HZ8620H		♣9640HD	E8HZ8620H		
♣9640HD		♣9640HD	♣9640HD		
Belt - Air Brake Compr.		♣9630HD	Belt - Air Brake Compr.		
E8HZ8620Y		♣9630HD	E8HZ8620Y		
♣9630HD		♣9630HD	♣9630HD		
Belt - A.C.; W/59 1/2" Belt O.C.		♣9590HD	Belt - A.C.; W/59 1/2" Belt O.C.		
E8HZ8620N		♣9590HD	E8HZ8620N		
♣9590HD		♣9590HD	♣9590HD		
Belt - A.C.; W/57 1/8" Belt O.C.		7575	Belt - A.C.; W/57 1/8" Belt O.C.		
D7PZ8620J		7575	D7PZ8620J		
7575		7575	7575		

Ⓜ Two Required.
♣ Standard Belt Available. See Pages 630-631.

● Vulco-Flex® Coolant Hose.
♣ Cut to Fit.

Belts and Coolant Hose for School Buses

Application	Mfr. Part No.	Our No.
FORD - Continued		
1993-1992 - Continued		
Ford 6-Cyl. 7.8 L Diesel - Continued		
B700 - Continued		
Hose - Upper; W/O Air To Air Aftercooler		21943
Hose - Upper; W/Air To Air Aftercooler	≧21943	
Hose - Lower; W/Auto. Trans.; W/210 H.P.		22034
Hose - Lower; W/Auto. Trans.; W/O 210 H.P.		21961
Hose - Lower; W/Man. Trans.; W/O Aftercooler		22033
Hose - Lower; W/Man. Trans.; W/O P.T.O.		21845
Hose - Heater; (5/8" I.D.)		28441
1991		
Ford 6-Cyl. 6.6 L Diesel		
B600; B700		
Belt - Fan & Alt.; W/60A., 75A., 90A. Alt.; W/W.P. Mtd. Fan; Preferred Belt	C9PZ8620DF	2/9610PB
Belt - Fan & Alt.; W/60A., 75A., 90A. Alt.; W/W.P. Mtd. Fan; Optional Belt	C9PZ8620DF	②♣9610HD
Belt - Fan & Alt.; W/130A. Alt.; W/W.P. Mtd. Fan	D8PZ8620N	②♣9625HD
Belt - Fan & Alt.; W/60A., 75A., 90A. Alt.; W/O W.P. Mtd. Fan; Preferred Belt	F0HZ8620G	2/9690PB
Belt - Fan & Alt.; W/60A., 75A., 90A. Alt.; W/O W.P. Mtd. Fan; Optional Belt	F0HZ8620G	②♣9690HD
Belt - Fan & Alt.; W/130A. Alt.; W/O W.P. Mtd. Fan	D8PZ8620Y	②♣9570HD
Belt - P.S.; W/O W.P. Mtd. Fan	E8HZ8620Y	♣9630HD
Belt - P.S.; W/W.P. Mtd. Fan	E6HZ8620E	♣9545HD
Belt - Hyd. Brake Boost Pump	E8HZ8620H	♣9640HD
Belt - Air Brake Compr.; W/Auto. Trans.; W/2150 Air Brake Compr.	E7HZ8620B	♣9635HD
Belt - Air Brake Compr.; W/Man. Trans.; W/A.C.; W/2150 Air Brake Compr.	E7HZ8620B	♣9635HD
Belt - Air Brake Compr.; W/Man. Trans.; W/O A.C.; W/2150 Air Brake Compr.	C9PZ8620GN	♣9550HD
Belt - Air Brake Compr.; W/550 Air Brake Compr.	E3AZ8620D	♣9565HD
Belt - A.C.; W/59 1/2" Belt O.C.	E8HZ8620N	♣9590HD
Belt - A.C.; W/57 1/8" Belt O.C.	D9PZ8620E	7565
Hose - Upper; W/O Air To Air Aftercooler		21943
Hose - Upper; W/Air To Air Aftercooler		≧21943
Hose - Lower; W/Auto. Trans.; W/210 H.P.		22034
Hose - Lower; W/Man. Trans.; W/O Aftercooler		22033
Hose - Lower; W/Auto. Trans.; W/O 210 H.P.		21961
Hose - Lower; W/Man. Trans.; W/O P.T.O.		21845
Hose - Heater; (5/8" I.D.)		28441
Ford 6-Cyl. 7.8 L Diesel		
B700		
Belt - Fan & Alt.; W/O W.P. Mtd. Fan; Preferred Belt	E8HZ8620B	2/9710PB
Belt - Fan & Alt.; W/O W.P. Mtd. Fan; Optional Belt	E8HZ8620B	②♣9710HD
Belt - Hyd. Brake Boost Pump	E8HZ8620H	♣9640HD
Belt - Air Brake Compr.	E8HZ8620Y	♣9630HD
Belt - A.C.; W/59 1/2" Belt O.C.	E8HZ8620N	♣9590HD
Belt - A.C.; W/57 1/8" Belt O.C.	D7PZ8620J	7575
Hose - Upper; W/O Air To Air Aftercooler		21943
Hose - Upper; W/Air To Air Aftercooler		≧21943
Hose - Lower; W/Auto. Trans.; W/210 H.P.		22034
Hose - Lower; W/Auto. Trans.; W/O 210 H.P.		21961
Hose - Lower; W/Man. Trans.; W/O Aftercooler		22033
Hose - Lower; W/Man. Trans.; W/O P.T.O.		21845
Hose - Heater; (5/8" I.D.)		28441
1990		
Ford 6-Cyl. 6.6 L Diesel		
B600; B700		
Belt - Fan & Alt.; W/60A., 75A., 90A. Alt.; W/W.P. Mtd. Fan; Preferred Belt	C9PZ8620DF	2/9610PB
Belt - Fan & Alt.; W/60A., 75A., 90A. Alt.; W/W.P. Mtd. Fan; Optional Belt	C9PZ8620DF	②♣9610HD
Belt - Fan & Alt.; W/130A. Alt.; W/W.P. Mtd. Fan	D8PZ8620N	②♣9625HD

Application	Mfr. Part No.	Our No.
FORD - Continued		
1990 - Continued		
Ford 6-Cyl. 6.6 L Diesel - Continued		
B600; B700 - Continued		
Belt - Fan & Alt.; W/60A., 75A., 90A. Alt.; W/O W.P. Mtd. Fan; Preferred Belt	F0HZ8620G	2/9690PB
Belt - Fan & Alt.; W/60A., 75A., 90A. Alt.; W/O W.P. Mtd. Fan; Optional Belt	F0HZ8620G	②♣9690HD
Belt - Fan & Alt.; W/130A. Alt.; W/O W.P. Mtd. Fan	D8PZ8620Y	②♣9570HD
Belt - P.S.; Dec. 1, 1990 & Older	E8HZ8620Y	♣9630HD
Belt - P.S.; Dec. 2, 1990 & Newer; W/O W.P. Mtd. Fan	E8HZ8620Y	♣9630HD
Belt - P.S.; Dec. 2, 1990 & Newer; W/W.P. Mtd. Fan	E6HZ8620E	♣9545HD
Belt - Hyd. Brake Boost Pump	E8HZ8620H	♣9640HD
Belt - Air Brake Compr.; Oct. 1, 1990 & Older Belt - Air Brake Compr.; W/Auto. Trans.; W/2150 Air Brake Compr.; Oct. 2, 1990 & Newer	E7HZ8620B	♣9635HD
Belt - Air Brake Compr.; W/Man. Trans.; W/A.C.; W/2150 Air Brake Compr.; Oct. 2, 1990 & Newer	E7HZ8620B	♣9635HD
Belt - Air Brake Compr.; W/Man. Trans.; W/O A.C.; W/2150 Air Brake Compr.; Oct. 2, 1990 & Newer	C9PZ8620GN	♣9550HD
Belt - Air Brake Compr.; W/550 Air Brake Compr.; Dec. 1, 1990 & Newer	E3AZ8620D	♣9565HD
Belt - A.C.; W/59 1/2" Belt O.C.	E8HZ8620N	♣9590HD
Belt - A.C.; W/57 1/8" Belt O.C.	D9PZ8620E	7565
Hose - Upper; W/O Air To Air Aftercooler		21943
Hose - Upper; W/Air To Air Aftercooler		≧21943
Hose - Lower; W/Auto. Trans.; W/210 H.P.		22034
Hose - Lower; W/Man. Trans.; W/O Aftercooler		22033
Hose - Lower; W/Auto. Trans.; W/O 210 H.P.		21961
Hose - Lower; W/Man. Trans.; W/O P.T.O.		21845
Hose - Heater; (5/8" I.D.)		28441
Ford 6-Cyl. 7.8 L Diesel		
B700		
Belt - Fan & Alt.; W/O W.P. Mtd. Fan; Preferred Belt	E8HZ8620B	2/9710PB
Belt - Fan & Alt.; W/O W.P. Mtd. Fan; Optional Belt	E8HZ8620B	②♣9710HD
Belt - Hyd. Brake Boost Pump	E8HZ8620H	♣9640HD
Belt - Air Brake Compr.	E8HZ8620Y	♣9630HD
Belt - A.C.; W/59 1/2" Belt O.C.	E8HZ8620N	♣9590HD
Belt - A.C.; W/57 1/8" Belt O.C.	D7PZ8620J	7575
Hose - Upper; W/O Air To Air Aftercooler		21943
Hose - Upper; W/Air To Air Aftercooler		≧21943
Hose - Lower; W/Auto. Trans.; W/210 H.P.		22034
Hose - Lower; W/Auto. Trans.; W/O 210 H.P.		21961
Hose - Lower; W/Man. Trans.; W/O Aftercooler		22033
Hose - Lower; W/Man. Trans.; W/O P.T.O.		21845
Hose - Heater; (5/8" I.D.)		28441
1989		
Ford 6-Cyl. 6.6 L Diesel		
B600; B700		
Belt - Fan & Alt.; W/60A., 70A., 90A. Alt.; W/W.P. Mtd. Fan	F2HT8620FA	②♣9610HD
Belt - Fan & Alt.; W/60A., 75A., 90A. Alt.; W/O W.P. Mtd. Fan Belt - Fan & Alt.; W/130A. Alt.; W/W.P. Mtd. Fan	D8PZ8620N	②♣9625HD
Belt - Fan & Alt.; W/130A. Alt.; W/O W.P. Mtd. Fan	D8PZ8620Y	②7570
Belt - W.P. & Hyd. Brake Boost Pump	E8HZ8620H	♣9640HD
Belt - P.S.	E8HZ8620Y	♣9635HD
Belt - Air Brake Compr.	E7HZ8620C	♣9640HD
Belt - A.C.	D6PZ8620E	7565
Belt - Idler; W/Air Brake Compr.	E8HZ8620H	♣9640HD
Hose - Upper		21810
Hose - Lower; W/Man. Trans.		21845

≧ Cut to Fit.

♣ Standard Belt Available. See Pages 630-631.

② Two Required.

◆ Green Stripe® PowerBand® Belt May Work, Use Template to Check.

Belts and Coolant Hose for School Buses

School Buses

Application	Mfr. Part No.	Our No.
FORD - Continued		
1989 - Continued		
Ford 6-Cyl. 6.6 L Diesel - Continued		
B600; B700 - Continued		
Hose - By Pass; (1 1/2" I.D.)		24224
Hose - Heater; (5/8" I.D.)		28441
Ford 6-Cyl. 7.8 L Diesel		
B700		
Belt - Fan & Alt.; W/O W.P. Mtd. Fan	E8HZ8620B	②◆◆9710HD
Belt - W.P. & Hyd. Brake Boost Pump	E8HZ8620H	◆9640HD
Belt - P.S.	E8HZ8620Y	◆9630HD
Belt - Air Brake Compr.	E8HZ8620M	◆9650HD
Belt - A.C.	D7PZ8620J	7575
Belt - Idler; W/Air Brake Compr.	E8HZ8620H	◆9640HD
Hose - Upper		21810
Hose - Lower; W/Man. Trans.		21845
Hose - By Pass; (1 1/2" I.D.)		24224
Hose - Heater; (5/8" I.D.)		28441
Ford V-8 6.1 L		
B600; B700		
Belt - Fan & Alt.; W/60A. Alt.; W/O Fan Clutch	D2TE8620AEA	◆9451HD
Belt - Fan & Alt.; W/60A. Alt.; W/Fan Clutch		◆9435HD
Belt - Fan & Alt.; W/75A. Alt.; W/O Fan Clutch		◆9463HD
Belt - Fan & Alt.; W/75A. Alt.; W/Fan Clutch		◆9447HD
Belt - Fan & Alt.; W/90A., 130A. Alt.; W/O Fan Clutch		◆9463HD
Belt - Fan & Alt.; W/90A., 130A. Alt.; W/Fan Clutch		◆9451HD
Belt - Fan & P.S.; W/Single A.P.		②◆◆9530HD
Belt - Fan, P.S. & A.P.		②◆◆9650HD
Belt - Fan, A.P. & Air Brake Compr.		◆9640HD
Belt - Fan, A.P. & Hyd. Brake Boost Pump	E0TE8620KA	◆9610HD
Belt - A.P.		◆9330HD
Hose - Upper; W/Auto. Trans.		≈<21936
	or	●26512
Hose - Upper; W/Man. Trans.		21305
	or	●26512
Hose - Lower - Eng. To Pipe		21969
Hose - Lower - Pipe To Rad.; W/Auto. Trans.		21368
Hose - Lower - Pipe To Rad.; W/Man. Trans.		≈<20452
Hose - By Pass		≈<21942
Hose - Heater; (1" I.D.)		24216
Ford V-8 7.0 L		
B600; B700		
Belt - Fan & Alt.; W/60A. Alt.; W/O Fan Clutch	D2TE8620AEA	◆9451HD
Belt - Fan & Alt.; W/60A. Alt.; W/Fan Clutch		◆9435HD
Belt - Fan & Alt.; W/75A. Alt.; W/O Fan Clutch		◆9463HD
Belt - Fan & Alt.; W/75A. Alt.; W/Fan Clutch		◆9447HD
Belt - Fan & Alt.; W/90A., 130A. Alt.; W/O Fan Clutch		◆9463HD
Belt - Fan & Alt.; W/90A., 130A. Alt.; W/Fan Clutch		◆9451HD
Belt - Fan & P.S.; W/Single A.P.		②◆◆9530HD
Belt - Fan, P.S. & A.P.		②◆◆9650HD
Belt - Fan, A.P. & Air Brake Compr.		◆9640HD
Belt - Fan, A.P. & Hyd. Brake Boost Pump	E0TE8620KA	◆9610HD
Belt - A.P.		◆9330HD
Hose - Upper		≈<21936
	or	●26512
Hose - Lower - Eng. To Pipe		21969
Hose - Lower - Pipe To Rad.; W/Auto. Trans.		21368
Hose - Lower - Pipe To Rad.; W/Man. Trans.		≈<20452
Hose - By Pass		≈<21942
Hose - Heater; (1" I.D.)		24216

② Two Required.
 ◆ Standard Belt Available. See Pages 630-631.
 ● Vulco-Flex® Coolant Hose.

Application	Mfr. Part No.	Our No.
FORD - Continued		
1988 - Continued		
Ford 6-Cyl. 6.6 L Diesel - Continued		
B600; B700 - Continued		
Belt - P.S.	E8HZ8620Y	◆9635HD
Belt - Air Brake Compr.	E7HZ8620C	◆9640HD
Belt - A.C.	D6PZ8620E	7565
Belt - Idler; W/Air Brake Compr.	E8HZ8620H	◆9640HD
Hose - Upper		21810
Hose - Lower; W/Man. Trans.		21845
Hose - By Pass; (1 1/2" I.D.)		24224
Hose - Heater; (5/8" I.D.)		28441
Ford 6-Cyl. 7.8 L Diesel		
B700		
Belt - Fan & Alt.; W/O W.P. Mtd. Fan	E8HZ8620B	②◆◆9710HD
Belt - W.P. & Hyd. Brake Boost Pump	E8HZ8620H	◆9640HD
Belt - P.S.	E8HZ8620Y	◆9630HD
Belt - Air Brake Compr.	E8HZ8620M	◆9650HD
Belt - A.C.	D7PZ8620J	7575
Belt - Idler; W/Air Brake Compr.	E8HZ8620H	◆9640HD
Hose - Upper		21810
Hose - Lower; W/Man. Trans.		21845
Hose - By Pass; (1 1/2" I.D.)		24224
Hose - Heater; (5/8" I.D.)		28441
Ford V-8 6.1 L		
B600; B700		
Belt - Fan & Alt.; W/40A., 60A. Alt.; W/22" Fan Clutch	E0TE8A615EA	②◆◆9447HD
Belt - Fan & Alt.; W/40A., 60A. Alt.; W/O 22" Fan Clutch	D2TE8A615CA	②◆9440HD
Belt - Fan & Alt.; W/40A., 60A. Alt.; W/Fixed Fan	D2TE8620AEA	②◆◆9451HD
Belt - Fan & Alt.; W/75A. Alt.; W/22" Fan Clutch	E0TE8A615FA	②◆9455HD
Belt - Fan & Alt.; W/75A. Alt.; W/O 22" Fan Clutch	D9TE8A615AA	②◆◆9447HD
Belt - Fan & Alt.; W/75A. Alt.; W/Fixed Fan	D2TE8A615VA	②◆◆9463HD
Belt - Fan & Alt.; W/90A. Alt.; W/22" Fan Clutch	E2TE8A615AA	②◆◆9463HD
Belt - Fan & Alt.; W/90A. Alt.; W/O 22" Fan Clutch	D2TE8A615MA	②◆◆9451HD
Belt - Fan & Alt.; W/90A. Alt.; W/Fixed Fan	D2TE8A615BA	②◆9465HD
Belt - Fan & Alt.; W/105A., 130A. Alt.; W/22" Fan Clutch		②◆9465HD
Belt - Fan & Alt.; W/105A., 130A. Alt.; W/O 22" Fan Clutch		②◆9455HD
Belt - Fan & Alt.; W/105A., 130A. Alt.; W/Fixed Fan	D2TE8A615VA	②◆◆9463HD
Belt - Fan & P.S.; W/Single A.P.; W/Fan Clutch		②◆◆9530HD
Belt - Fan & P.S.; W/22" Fan Clutch		◆9565HD
Belt - Fan & P.S.; W/O Fan Clutch		◆9530HD
Belt - Fan, P.S. & A.P.		②◆◆9650HD
Belt - Fan, A.P. & Air Brake Compr.		◆9640HD
Belt - Fan, A.P. & Hyd. Brake Boost Pump	E0TE8620KA	◆9610HD
Belt - A.C.		◆9330HD
Belt - A.P.; W/Fan Clutch	D4TE8620AA	◆9385HD
Belt - A.P.; W/O Fan Clutch	D2TE8620BNA	◆9370HD
Hose - Upper; W/Auto. Trans.		≈<21936
	or	●26512
Hose - Upper; W/Man. Trans.		21305
	or	●26512
Hose - Lower - Eng. To Pipe		21969
Hose - Lower - Pipe To Rad.; W/Auto. Trans.		21368
Hose - Lower - Pipe To Rad.; W/Man. Trans.		≈<20452
Hose - By Pass		≈<21942
Hose - Heater; (1" I.D.)		24216
Ford V-8 7.0 L		
B600; B700		
Belt - Fan & Alt.; W/40A., 60A. Alt.; W/22" Fan Clutch	E0TE8A615EA	②◆◆9447HD
Belt - Fan & Alt.; W/40A., 60A. Alt.; W/O 22" Fan Clutch	D2TE8A615CA	②◆9440HD
Belt - Fan & Alt.; W/40A., 60A. Alt.; W/Fixed Fan	D2TE8620AEA	②◆◆9451HD

◆ Green Stripe® PowerBand® Belt May Work, Use Template to Check.
 ≈< Cut to Fit.

Belts and Coolant Hose for School Buses

Application	Mfr. Part No.	Our No.
FORD - Continued		
1988 - Continued		
Ford V-8 7.0 L - Continued		
B600; B700 - Continued		
Belt - Fan & Alt.; W/75A. Alt.; W/22" Fan Clutch	E0TE8A615FA	②◆▲9455HD
Belt - Fan & Alt.; W/75A. Alt.; W/O 22" Fan Clutch	D9TE8A615AA	②◆▲9447HD
Belt - Fan & Alt.; W/75A. Alt.; W/Fixed Fan ...	D2TE8A615VA	②◆▲9463HD
Belt - Fan & Alt.; W/90A. Alt.; W/22" Fan Clutch	E2TE8A615AA	②◆▲9463HD
Belt - Fan & Alt.; W/90A. Alt.; W/O 22" Fan Clutch	D2TE8A615MA	②◆▲9451HD
Belt - Fan & Alt.; W/90A. Alt.; W/Fixed Fan ...	D2TE8A615BA	②◆▲9465HD
Belt - Fan & Alt.; W/105A., 130A. Alt.; W/22" Fan Clutch		②◆▲9465HD
Belt - Fan & Alt.; W/105A., 130A. Alt.; W/O 22" Fan Clutch		②◆▲9455HD
Belt - Fan & Alt.; W/105A., 130A. Alt.; W/Fixed Fan	D2TE8A615VA	②◆▲9463HD
Belt - Fan & P.S.; W/Single A.P.; W/Fan Clutch		②◆▲9530HD
Belt - Fan & P.S.; W/22" Fan Clutch		▲9565HD
Belt - Fan & P.S.; W/O Fan Clutch		▲9530HD
Belt - Fan, P.S. & A.P.		②◆▲9650HD
Belt - Fan, A.P. & Air Brake Compr.		▲9640HD
Belt - Fan, A.P. & Hyd. Brake Boost Pump	E0TE8620KA	▲9610HD
Belt - A.C.		▲9330HD
Belt - A.P.; W/Fan Clutch	D4TE8620AA	▲9385HD
Belt - A.P.; W/O Fan Clutch	D2TE8620BNA	▲9370HD
Hose - Upper		≠21936
	or	●26512
Hose - Lower - Eng. To Pipe		21969
Hose - Lower - Pipe To Rad.; W/Auto. Trans.		21368
Hose - Lower - Pipe To Rad.; W/Man. Trans.		≠20452
Hose - By Pass		≠21942
Hose - Heater; (1" I.D.)		24216
1987		
Caterpillar 3208 Diesel		
B7000		
Belt - Fan & P.S.	D3HA8620CA	②◆▲9670HD
Belt - W.P. & Alt.; W/Motorola 130A. Alt.		②◆▲9610HD
Belt - W.P. & Alt.; W/O Motorola 130A. Alt.		▲9570HD
Belt - P.S.	D7HT8620LA	▲9375HD
Belt - Air Brake Compr.	D5HA8620GA	▲9580HD
Belt - A.C.; W/42 7/8" Belt O.C.	E4HT8620GB	▲9425HD
Belt - A.C.; W/53 3/8" Belt O.C.		▲9530HD
Belt - Hyd. Brake Boost Pump	C8HA8620A	▲9560HD
Belt - V.P.	D0HA8620U	▲9550HD
Hose - Upper		21569
Hose - Lower		21562
Hose - Oil Cooler - Front Inlet		21824
Hose - Oil Cooler - Rear Inlet		21381
Hose - Oil Cooler Outlet		21380
Hose - Heater; (5/8" I.D.)		28441
Detroit Diesel V-8 8.2 L Diesel		
B600; B700		
Belt - Fan & Alt.; W/O A.C.; W/40A., 60A. Alt.	E1HZ8620A	②◆▲9660HD
Belt - Fan & Alt.; W/O A.C.; W/70A., 90A. Alt.	E1HZ8620B	②◆▲9670HD
Belt - Fan & Alt.; W/A.C.; W/105A., 130A. Alt.		②◆▲9670HD
Belt - P.S.; W/O 5500 Lb. Axle	E0HT8620DA	②◆▲9430HD
Belt - P.S.; W/5500 Lb. Axle		②◆▲9395HD
Belt - Air Brake Compr.	E0HT8620LA	▲9720HD
Belt - A.C.	E0HZ8620R	▲9720HD
Belt - Hyd. Brake Boost Pump; W/69 1/4" Belt O.C.		▲9680HD
Belt - Hyd. Brake Boost Pump; W/70 1/4" Belt O.C.		▲9700HD
Belt - V.P.; W/High Mount V.P.	D9PZ8620B	▲9435HD
Belt - V.P.; W/Low Mount V.P.	E0HZ8620S	▲9680HD
Hose - Upper; W/A.C.		21470
Hose - Upper; W/O A.C.		≠21470
Hose - Lower - Eng. To Pipe		21363
Hose - Lower - Pipe To Rad.		21307
Hose - By Pass - Left Side; (1 3/8" I.D.)		24222
Hose - By Pass - Right Side		21457
Hose - Oil Cooler; (7/8" I.D.)		③28443

② Two Required.
 ◆ Green Stripe® PowerBand® Belt May Work, Use Template to Check.
 ● Vulco-Flex® Coolant Hose.

Application	Mfr. Part No.	Our No.
FORD - Continued		
1987 - Continued		
Detroit Diesel V-8 8.2 L Diesel - Continued		
B600; B700 - Continued		
Hose - Heater; (5/8" I.D.)		28441
Ford 6-Cyl. 6.6 L Diesel		
B600; B700		
Belt - Fan & Alt.; W/60A., 70A., 90A. Alt.; W/W.P. Mtd. Fan	F2HT8620FA	②◆▲9610HD
Belt - Fan & Alt.; W/60A., 75A., 90A. Alt.; W/O W.P. Mtd. Fan		②◆▲9600HD
Belt - Fan & Alt.; W/130A. Alt.; W/W.P. Mtd. Fan	D8PZ8620N	②◆▲9625HD
Belt - Fan & Alt.; W/130A. Alt.; W/O W.P. Mtd. Fan	D8PZ8620Y	②7570
Belt - W.P. & Hyd. Brake Boost Pump	E8HZ8620H	▲9640HD
Belt - P.S.	E8HZ8620Y	▲9635HD
Belt - Air Brake Compr.	E7HZ8620C	▲9640HD
Belt - A.C.	D6PZ8620E	7565
Belt - Idler; W/Air Brake Compr.	E8HZ8620H	▲9640HD
Hose - Upper		21810
Hose - Lower; W/Man. Trans.		21845
Hose - By Pass; (1 1/2" I.D.)		24224
Hose - Heater; (5/8" I.D.)		28441
Ford 6-Cyl. 7.8 L Diesel		
B700		
Belt - Fan & Alt.; W/O W.P. Mtd. Fan	E8HZ8620B	②◆▲9710HD
Belt - W.P. & Hyd. Brake Boost Pump	E8HZ8620H	▲9640HD
Belt - P.S.	E8HZ8620Y	▲9630HD
Belt - Air Brake Compr.	E8HZ8620M	▲9650HD
Belt - A.C.	D7PZ8620J	7575
Belt - Idler; W/Air Brake Compr.	E8HZ8620H	▲9640HD
Hose - Upper		21810
Hose - Lower; W/Man. Trans.		21845
Hose - By Pass; (1 1/2" I.D.)		24224
Hose - Heater; (5/8" I.D.)		28441
Ford V-8 6.1 L		
B600; B700		
Belt - Fan & Alt.; W/40A., 60A. Alt.; W/22" Fan Clutch	E0TE8A615EA	②◆▲9447HD
Belt - Fan & Alt.; W/40A., 60A. Alt.; W/O 22" Fan Clutch	D2TE8A615CA	②◆▲9440HD
Belt - Fan & Alt.; W/40A., 60A. Alt.; W/Fixed Fan	D2TE8620AEA	②◆▲9451HD
Belt - Fan & Alt.; W/75A. Alt.; W/22" Fan Clutch	E0TE8A615FA	②◆▲9455HD
Belt - Fan & Alt.; W/75A. Alt.; W/O 22" Fan Clutch	D9TE8A615AA	②◆▲9447HD
Belt - Fan & Alt.; W/75A. Alt.; W/Fixed Fan ...	D2TE8A615VA	②◆▲9463HD
Belt - Fan & Alt.; W/90A. Alt.; W/22" Fan Clutch	E2TE8A615AA	②◆▲9463HD
Belt - Fan & Alt.; W/90A. Alt.; W/O 22" Fan Clutch	D2TE8A615MA	②◆▲9451HD
Belt - Fan & Alt.; W/90A. Alt.; W/Fixed Fan ...	D2TE8A615BA	②◆▲9465HD
Belt - Fan & Alt.; W/105A., 130A. Alt.; W/22" Fan Clutch		②◆▲9465HD
Belt - Fan & Alt.; W/105A., 130A. Alt.; W/O 22" Fan Clutch		②◆▲9455HD
Belt - Fan & Alt.; W/105A., 130A. Alt.; W/Fixed Fan	D2TE8A615VA	②◆▲9463HD
Belt - Fan & P.S.; W/Single A.P.; W/Fan Clutch		②◆▲9530HD
Belt - Fan & P.S.; W/22" Fan Clutch		▲9565HD
Belt - Fan & P.S.; W/O Fan Clutch		▲9530HD
Belt - Fan, P.S. & A.P.		②◆▲9650HD
Belt - Fan, A.P. & Air Brake Compr.		▲9640HD
Belt - Fan, A.P. & Hyd. Brake Boost Pump	E0TE8620KA	▲9610HD
Belt - A.C.		▲9330HD
Belt - A.P.; W/Fan Clutch	D4TE8620AA	▲9385HD
Belt - A.P.; W/O Fan Clutch	D2TE8620BNA	▲9370HD
Hose - Upper; W/Auto. Trans.		≠21936
	or	●26512
Hose - Upper; W/Man. Trans.		21305
	or	●26512
Hose - Lower - Eng. To Pipe		21969
Hose - Lower - Pipe To Rad.; W/Auto. Trans.		21368
Hose - Lower - Pipe To Rad.; W/Man. Trans.		≠20452

◆ Standard Belt Available. See Pages 630-631.
 ≠ Cut to Fit.
 ③ Three Required.

Belts and Coolant Hose for School Buses

Application	Mfr. Part No.	Our No.
FORD - Continued		
1987 - Continued		
Ford V-8 6.1 L - Continued		
B600; B700 - Continued		
Hose - By Pass		≈<21942
Hose - Heater; (1" I.D.)		24216
Ford V-8 7.0 L		
B700		
Belt - Fan & Alt.; W/40A., 60A. Alt.; W/22" Fan Clutch	E0TE8A615EA	②◆◆9447HD
Belt - Fan & Alt.; W/40A., 60A. Alt.; W/O 22" Fan Clutch	D2TE8A615CA	②◆9440HD
Belt - Fan & Alt.; W/40A., 60A. Alt.; W/Fixed Fan	D2TE8620AEA	②◆◆9451HD
Belt - Fan & Alt.; W/75A. Alt.; W/22" Fan Clutch	E0TE8A615FA	②◆9455HD
Belt - Fan & Alt.; W/75A. Alt.; W/O 22" Fan Clutch	D9TE8A615AA	②◆◆9447HD
Belt - Fan & Alt.; W/75A. Alt.; W/Fixed Fan ...	D2TE8A615VA	②◆◆9463HD
Belt - Fan & Alt.; W/90A. Alt.; W/22" Fan Clutch	E2TE8A615AA	②◆◆9463HD
Belt - Fan & Alt.; W/90A. Alt.; W/O 22" Fan Clutch	D2TE8A615MA	②◆◆9451HD
Belt - Fan & Alt.; W/90A. Alt.; W/Fixed Fan ...	D2TE8A615BA	②◆9465HD
Belt - Fan & Alt.; W/105A., 130A. Alt.; W/22" Fan Clutch		②◆9465HD
Belt - Fan & Alt.; W/105A., 130A. Alt.; W/O 22" Fan Clutch		②◆9455HD
Belt - Fan & Alt.; W/105A., 130A. Alt.; W/Fixed Fan	D2TE8A615VA	②◆◆9463HD
Belt - Fan & P.S.; W/Single A.P.; W/Fan Clutch		②◆◆9530HD
Belt - Fan & P.S.; W/22" Fan Clutch		◆9565HD
Belt - Fan & P.S.; W/O Fan Clutch		◆9530HD
Belt - Fan, P.S. & A.P.		②◆◆9650HD
Belt - Fan, A.P. & Air Brake Compr.		◆9640HD
Belt - Fan, A.P. & Hyd. Brake Boost Pump	E0TE8620KA	◆9610HD
Belt - A.C.		◆9330HD
Belt - A.P.; W/Fan Clutch	D4TE8620AA	◆9385HD
Belt - A.P.; W/O Fan Clutch	D2TE8620BNA	◆9370HD
Hose - Upper		≈<21936
	or	●26512
Hose - Lower - Eng. To Pipe		21969
Hose - Lower - Pipe To Rad.; W/Auto. Trans.		21368
Hose - Lower - Pipe To Rad.; W/Man. Trans.		≈<20452
Hose - By Pass		≈<21942
Hose - Heater; (1" I.D.)		24216
1986		
Caterpillar 3208 Diesel		
B7000		
Belt - Fan & P.S.	D3HA8620CA	②◆◆9670HD
Belt - W.P. & Alt.; W/Motorola 130A. Alt.		②◆◆9610HD
Belt - W.P. & Alt.; W/O Motorola 130A. Alt.		◆9570HD
Belt - P.S.	D7HT8620LA	◆9375HD
Belt - Air Brake Compr.	D5HA8620GA	◆9580HD
Belt - A.C.; W/42 7/8" Belt O.C.	E4HT8620GB	◆9425HD
Belt - A.C.; W/53 3/8" Belt O.C.		◆9530HD
Belt - Hyd. Brake Boost Pump	C8HA8620AA	◆9560HD
Belt - V.P.	D0HA8620U	◆9550HD
Hose - Upper		21569
Hose - Lower		21562
Hose - Oil Cooler - Front Inlet		21824
Hose - Oil Cooler - Rear Inlet		21381
Hose - Oil Cooler Outlet		21380
Hose - Heater; (5/8" I.D.)		28441
Detroit Diesel V-8 8.2 L Diesel		
B600; B700		
Belt - Fan & Alt.; W/O A.C.; W/40A., 60A. Alt.	E1HZ8620A	②◆◆9660HD
Belt - Fan & Alt.; W/O A.C.; W/70A., 90A. Alt.	E1HZ8620B	②◆◆9670HD
Belt - Fan & Alt.; W/A.C.; W/105A., 130A. Alt.		②◆◆9670HD
Belt - P.S.; W/5500 Lb. Axle		②◆9395HD
Belt - P.S.; W/O 5500 Lb. Axle	E0HT8620DA	②◆◆9430HD
Belt - Air Brake Compr.; W/70 1/4" Belt O.C.		◆9700HD
Belt - Air Brake Compr.; W/71 1/4" Belt O.C.		◆9710HD
Belt - A.C.	E0HZ8620R	◆9720HD

- ≈< Cut to Fit.
 ◆ Green Stripe® PowerBand® Belt May Work, Use Template to Check.
 ● Vulco-Flex® Coolant Hose.

Application	Mfr. Part No.	Our No.
FORD - Continued		
1986 - Continued		
Detroit Diesel V-8 8.2 L Diesel - Continued		
B600; B700 - Continued		
Belt - Hyd. Brake Boost Pump; W/69 1/4" Belt O.C.		◆9680HD
Belt - Hyd. Brake Boost Pump; W/70 1/4" Belt O.C.		◆9700HD
Belt - V.P.; W/High Mount V.P.	D9PZ8620B	◆9435HD
Belt - V.P.; W/Low Mount V.P.	E0HZ8620S	◆9680HD
Hose - Upper; W/A.C.		21470
Hose - Upper; W/O A.C.		≈<21470
Hose - Lower - Eng. To Pipe		21363
Hose - Lower - Pipe To Rad.		21307
Hose - By Pass - Left Side; (1 3/8" I.D.)		24222
Hose - By Pass - Right Side		21457
Hose - Oil Cooler; (7/8" I.D.)		③28443
Hose - Heater; (5/8" I.D.)		28441
Ford V-8 6.1 L		
B600; B700		
Belt - Fan & Alt.; W/40A., 60A. Alt.; W/22" Fan Clutch	E0TE8A615EA	②◆◆9447HD
Belt - Fan & Alt.; W/40A., 60A. Alt.; W/O 22" Fan Clutch	D2TE8A615CA	②◆9440HD
Belt - Fan & Alt.; W/40A., 60A. Alt.; W/Fixed Fan	D2TE8620AEA	②◆◆9451HD
Belt - Fan & Alt.; W/75A. Alt.; W/22" Fan Clutch	E0TE8A615FA	②◆9455HD
Belt - Fan & Alt.; W/75A. Alt.; W/O 22" Fan Clutch	D9TE8A615AA	②◆◆9447HD
Belt - Fan & Alt.; W/75A. Alt.; W/Fixed Fan ...	D2TE8A615VA	②◆◆9463HD
Belt - Fan & Alt.; W/90A. Alt.; W/22" Fan Clutch	E2TE8A615AA	②◆◆9463HD
Belt - Fan & Alt.; W/90A. Alt.; W/O 22" Fan Clutch	D2TE8A615MA	②◆◆9451HD
Belt - Fan & Alt.; W/90A. Alt.; W/Fixed Fan ...	D2TE8A615BA	②◆9465HD
Belt - Fan & Alt.; W/105A., 130A. Alt.; W/22" Fan Clutch		②◆9465HD
Belt - Fan & Alt.; W/105A., 130A. Alt.; W/O 22" Fan Clutch		②◆9455HD
Belt - Fan & Alt.; W/105A., 130A. Alt.; W/Fixed Fan	D2TE8A615VA	②◆◆9463HD
Belt - Fan & P.S.; W/Single A.P.; W/Fan Clutch		②◆◆9530HD
Belt - Fan & P.S.; W/22" Fan Clutch		◆9565HD
Belt - Fan & P.S.; W/O Fan Clutch		◆9530HD
Belt - Fan, P.S. & A.P.		②◆◆9650HD
Belt - Fan, A.P. & Air Brake Compr.		◆9640HD
Belt - Fan, A.P. & Hyd. Brake Boost Pump	E0TE8620KA	◆9610HD
Belt - A.C.		◆9330HD
Belt - A.P.; W/Fan Clutch	D4TE8620AA	◆9385HD
Belt - A.P.; W/O Fan Clutch	D2TE8620BNA	◆9370HD
Hose - Upper; W/Auto. Trans.		≈<21936
	or	●26512
Hose - Upper; W/Man. Trans.		21305
	or	●26512
Hose - Lower - Eng. To Pipe		21969
Hose - Lower - Pipe To Rad.; W/Auto. Trans.		21368
Hose - Lower - Pipe To Rad.; W/Man. Trans.		≈<20452
Hose - By Pass		≈<21942
Hose - Heater; (1" I.D.)		24216
Ford V-8 7.0 L		
B700		
Belt - Fan & Alt.; W/40A., 60A. Alt.; W/22" Fan Clutch	E0TE8A615EA	②◆◆9447HD
Belt - Fan & Alt.; W/40A., 60A. Alt.; W/O 22" Fan Clutch	D2TE8A615CA	②◆9440HD
Belt - Fan & Alt.; W/40A., 60A. Alt.; W/Fixed Fan	D2TE8620AEA	②◆◆9451HD
Belt - Fan & Alt.; W/75A. Alt.; W/22" Fan Clutch	E0TE8A615FA	②◆9455HD
Belt - Fan & Alt.; W/75A. Alt.; W/O 22" Fan Clutch	D9TE8A615AA	②◆◆9447HD
Belt - Fan & Alt.; W/75A. Alt.; W/Fixed Fan ...	D2TE8A615VA	②◆◆9463HD
Belt - Fan & Alt.; W/90A. Alt.; W/22" Fan Clutch	E2TE8A615AA	②◆◆9463HD
Belt - Fan & Alt.; W/90A. Alt.; W/O 22" Fan Clutch	D2TE8A615MA	②◆◆9451HD
Belt - Fan & Alt.; W/90A. Alt.; W/Fixed Fan ...	D2TE8A615BA	②◆9465HD

- ② Two Required.
 ◆ Standard Belt Available. See Pages 630-631.
 ③ Three Required.

School Buses

Belts and Coolant Hose for School Buses

School Buses

Application	Mfr. Part No.	Our No.
FORD - Continued		
1986 - Continued		
Ford V-8 7.0 L - Continued		
B700 - Continued		
Belt - Fan & Alt.; W/105A., 130A. Alt.; W/22" Fan Clutch		②◆▲9465HD
Belt - Fan & Alt.; W/105A., 130A. Alt.; W/O 22" Fan Clutch		②◆▲9455HD
Belt - Fan & Alt.; W/105A., 130A. Alt.; W/Fixed Fan	D2TE8A615VA	②◆▲9463HD
Belt - Fan & P.S.; W/Single A.P.; W/Fan Clutch		②◆▲9530HD
Belt - Fan & P.S.; W/22" Fan Clutch		▲9565HD
Belt - Fan & P.S.; W/O Fan Clutch		▲9530HD
Belt - Fan, P.S. & A.P.		②◆▲9650HD
Belt - Fan, A.P. & Air Brake Compr.		▲9640HD
Belt - Fan, A.P. & Hyd. Brake Boost Pump	E0TE8620KA	▲9610HD
Belt - A.C.		▲9330HD
Belt - A.P.; W/Fan Clutch	D4TE8620AA	▲9385HD
Belt - A.P.; W/O Fan Clutch	D2TE8620BNA	▲9370HD
Hose - Upper		≍21936
	or	●26512
Hose - Lower - Eng. To Pipe		21969
Hose - Lower - Pipe To Rad.; W/Auto. Trans.		21368
Hose - Lower - Pipe To Rad.; W/Man. Trans.		≍20452
Hose - By Pass		≍21942
Hose - Heater; (1" I.D.)		24216
1985		
Caterpillar 3208 Diesel		
B7000		
Belt - Fan & P.S.	D3HA8620CA	②◆▲9670HD
Belt - W.P. & Alt.; W/Motorola 130A. Alt.		②◆▲9610HD
Belt - W.P. & Alt.; W/O Motorola 130A. Alt.		▲9570HD
Belt - P.S.	D7HT8620LA	▲9375HD
Belt - Air Brake Compr.	D5HA8620GA	▲9580HD
Belt - A.C.; W/42 7/8" Belt O.C.	E4HT8620GB	▲9425HD
Belt - A.C.; W/53 3/8" Belt O.C.		▲9530HD
Belt - Hyd. Brake Boost Pump	C8HA8620A	▲9560HD
Belt - V.P.	D0HA8620U	▲9550HD
Hose - Upper		21569
Hose - Lower		21562
Hose - Oil Cooler - Front Inlet		21824
Hose - Oil Cooler - Rear Inlet		21381
Hose - Oil Cooler Outlet		21380
Hose - Heater; (5/8" I.D.)		28441
Detroit Diesel V-8 8.2 L Diesel		
B600; B700		
Belt - Fan & Alt.; W/O A.C.; W/40A., 60A. Alt.	E1HZ8620A	②◆▲9660HD
Belt - Fan & Alt.; W/70A., 90A. Alt.	E1HZ8620B	②◆▲9670HD
Belt - Fan & Alt.; W/105A., 130A. Alt.		②◆▲9670HD
Belt - P.S.; W/5500 Lb. Axle		②◆▲9395HD
Belt - P.S.; W/O 5500 Lb. Axle		②◆▲9425HD
Belt - Air Brake Compr.; W/70 1/4" Belt O.C.		▲9700HD
Belt - Air Brake Compr.; W/72 1/4" Belt O.C.	E0HT8620LA	▲9720HD
Belt - A.C.	E0HZ8620R	▲9720HD
Belt - Hyd. Brake Boost Pump; W/69 1/4" Belt O.C.		▲9680HD
Belt - Hyd. Brake Boost Pump; W/70 1/4" Belt O.C.		▲9700HD
Belt - V.P.; W/High Mount V.P.	D9PZ8620B	▲9435HD
Belt - V.P.; W/Low Mount V.P.	E0HZ8620S	▲9680HD
Hose - Upper; W/A.C.		21470
Hose - Upper; W/O A.C.		≍21470
Hose - Lower - Eng. To Pipe		21363
Hose - Lower - Pipe To Rad.		21307
Hose - By Pass - Left Side; (1 3/8" I.D.)		24222
Hose - By Pass - Right Side		21457
Hose - Oil Cooler; (7/8" I.D.)		③28443
Hose - Heater; (5/8" I.D.)		28441
Ford V-8 6.1 L		
B600; B700		
Belt - Fan & Alt.; W/40A., 60A. Alt.; W/22" Fan Clutch	E0TE8A615EA	②◆▲9447HD
Belt - Fan & Alt.; W/40A., 60A. Alt.; W/O 22" Fan Clutch	D2TE8A615CA	②◆▲9440HD
Belt - Fan & Alt.; W/40A., 60A. Alt.; W/Fixed Fan	D2TE8620AEA	②◆▲9451HD

Application	Mfr. Part No.	Our No.
FORD - Continued		
1985 - Continued		
Ford V-8 6.1 L - Continued		
B600; B700 - Continued		
Belt - Fan & Alt.; W/75A. Alt.; W/22" Fan Clutch	E0TE8A615FA	②◆▲9455HD
Belt - Fan & Alt.; W/75A. Alt.; W/O 22" Fan Clutch	D9TE8A615AA	②◆▲9447HD
Belt - Fan & Alt.; W/75A. Alt.; W/Fixed Fan ...	D2TE8A615VA	②◆▲9463HD
Belt - Fan & Alt.; W/90A. Alt.; W/22" Fan Clutch	E2TE8A615AA	②◆▲9463HD
Belt - Fan & Alt.; W/90A. Alt.; W/O 22" Fan Clutch	D2TE8A615MA	②◆▲9451HD
Belt - Fan & Alt.; W/90A. Alt.; W/Fixed Fan ...	D2TE8A615BA	②◆▲9465HD
Belt - Fan & Alt.; W/105A., 130A. Alt.; W/22" Fan Clutch		②◆▲9465HD
Belt - Fan & Alt.; W/105A., 130A. Alt.; W/O 22" Fan Clutch		②◆▲9455HD
Belt - Fan & Alt.; W/105A., 130A. Alt.; W/Fixed Fan	D2TE8A615VA	②◆▲9463HD
Belt - Fan & P.S.; W/Single A.P.; W/Fan Clutch		②◆▲9530HD
Belt - Fan & P.S.; W/22" Fan Clutch		▲9565HD
Belt - Fan & P.S.; W/O Fan Clutch		▲9530HD
Belt - Fan, P.S. & A.P.		②◆▲9650HD
Belt - Fan, A.P. & Air Brake Compr.		▲9640HD
Belt - Fan, A.P. & Hyd. Brake Boost Pump	E0TE8620KA	▲9610HD
Belt - A.C.		▲9330HD
Belt - A.P.; W/Fan Clutch	D4TE8620AA	▲9385HD
Belt - A.P.; W/O Fan Clutch	D2TE8620BNA	▲9370HD
Hose - Upper; W/Auto. Trans.		≍21936
	or	●26512
Hose - Upper; W/Man. Trans.		21305
	or	●26512
Hose - Lower - Eng. To Pipe		21969
Hose - Lower - Pipe To Rad.; W/Auto. Trans.		21368
Hose - Lower - Pipe To Rad.; W/Man. Trans.		≍20452
Hose - By Pass		≍21942
Hose - Heater; (1" I.D.)		24216
Ford V-8 7.0 L		
B700		
Belt - Fan & Alt.; W/40A., 60A. Alt.; W/22" Fan Clutch	E0TE8A615EA	②◆▲9447HD
Belt - Fan & Alt.; W/40A., 60A. Alt.; W/O 22" Fan Clutch	D2TE8A615CA	②◆▲9440HD
Belt - Fan & Alt.; W/40A., 60A. Alt.; W/Fixed Fan	D2TE8620AEA	②◆▲9451HD
Belt - Fan & Alt.; W/75A. Alt.; W/22" Fan Clutch	E0TE8A615FA	②◆▲9455HD
Belt - Fan & Alt.; W/75A. Alt.; W/O 22" Fan Clutch	D9TE8A615AA	②◆▲9447HD
Belt - Fan & Alt.; W/75A. Alt.; W/Fixed Fan ...	D2TE8A615VA	②◆▲9463HD
Belt - Fan & Alt.; W/90A. Alt.; W/22" Fan Clutch	E2TE8A615AA	②◆▲9463HD
Belt - Fan & Alt.; W/90A. Alt.; W/O 22" Fan Clutch	D2TE8A615MA	②◆▲9451HD
Belt - Fan & Alt.; W/90A. Alt.; W/Fixed Fan ...	D2TE8A615BA	②◆▲9465HD
Belt - Fan & Alt.; W/105A., 130A. Alt.; W/22" Fan Clutch		②◆▲9465HD
Belt - Fan & Alt.; W/105A., 130A. Alt.; W/O 22" Fan Clutch		②◆▲9455HD
Belt - Fan & Alt.; W/105A., 130A. Alt.; W/Fixed Fan	D2TE8A615VA	②◆▲9463HD
Belt - Fan & P.S.; W/Single A.P.; W/Fan Clutch		②◆▲9530HD
Belt - Fan & P.S.; W/22" Fan Clutch		▲9565HD
Belt - Fan & P.S.; W/O Fan Clutch		▲9530HD
Belt - Fan, P.S. & A.P.		②◆▲9650HD
Belt - Fan, A.P. & Air Brake Compr.		▲9640HD
Belt - Fan, A.P. & Hyd. Brake Boost Pump	E0TE8620KA	▲9610HD
Belt - A.C.		▲9330HD
Belt - A.P.; W/Fan Clutch	D4TE8620AA	▲9385HD
Belt - A.P.; W/O Fan Clutch	D2TE8620BNA	▲9370HD
Hose - Upper		≍21936
	or	●26512
Hose - Lower - Eng. To Pipe		21969
Hose - Lower - Pipe To Rad.; W/Auto. Trans.		21368
Hose - Lower - Pipe To Rad.; W/Man. Trans.		≍20452
Hose - By Pass		≍21942
Hose - Heater; (1" I.D.)		24216

② Two Required.
 ◆ Green Stripe® PowerBand® Belt May Work, Use Template to Check.
 ● Vulco-Flex® Coolant Hose.

▲ Standard Belt Available. See Pages 630-631.
 ≍ Cut to Fit.
 ③ Three Required.

Belts and Coolant Hose for School Buses

Application	Mfr. Part No.	Our No.
FORD - Continued		
1984		
Caterpillar 3208 Diesel		
B7000		
Belt - Fan & P.S.	D3HA8620CA	②◆◆9670HD
Belt - W.P. & Alt.; W/Motorola 130A. Alt.		②◆◆9610HD
Belt - W.P. & Alt.; W/O Motorola 130A. Alt.		◆9570HD
Belt - P.S.	D7HT8620LA	◆9375HD
Belt - Air Brake Compr.	D5HA8620GA	◆9580HD
Belt - A.C.; W/42 7/8" Belt O.C.	E4HT8620GB	◆9425HD
Belt - A.C.; W/53 3/8" Belt O.C.		◆9530HD
Belt - Hyd. Brake Boost Pump	C8HA8620A	◆9560HD
Belt - V.P.	D0HA8620U	◆9550HD
Hose - Upper		21569
Hose - Lower		21562
Hose - Oil Cooler - Front Inlet		21824
Hose - Oil Cooler - Rear Inlet		21381
Hose - Oil Cooler Outlet		21380
Hose - Heater; (5/8" I.D.)		28441
Detroit Diesel V-8 8.2 L Diesel		
B600; B700		
Belt - Fan & Alt.; W/O A.C.; W/40A., 60A. Alt.	E1HZ8620A	②◆◆9660HD
Belt - Fan & Alt.; W/70A., 90A. Alt.	E1HZ8620B	②◆◆9670HD
Belt - Fan & Alt.; W/105A., 130A. Alt.; Aug. 1984 & Older	E0HZ8620P	②◆◆9680HD
Belt - Fan & Alt.; W/105A., 130A. Alt.; Sept. 1984 & Newer		②◆◆9670HD
Belt - P.S.; W/5500 Lb. Axle		②◆◆9395HD
Belt - P.S.; W/O 5500 Lb. Axle		②◆◆9425HD
Belt - Air Brake Compr.; W/70 1/4" Belt O.C.		◆9700HD
Belt - Air Brake Compr.; W/72 1/4" Belt O.C.	E0HT8620LA	◆9720HD
Belt - A.C.	E0HZ8620R	◆9720HD
Belt - Hyd. Brake Boost Pump; W/69 1/4" Belt O.C.		◆9680HD
Belt - Hyd. Brake Boost Pump; W/70 1/4" Belt O.C.		◆9700HD
Belt - V.P.; W/High Mount V.P.	D9PZ8620B	◆9435HD
Belt - V.P.; W/Low Mount V.P.	E0HZ8620S	◆9680HD
Hose - Upper; W/A.C.		21470
Hose - Upper; W/O A.C.		②<21470
Hose - Lower - Eng. To Pipe		21363
Hose - Lower - Pipe To Rad.		21307
Hose - By Pass - Left Side; (1 3/8" I.D.)		24222
Hose - By Pass - Right Side		21457
Hose - Oil Cooler; (7/8" I.D.)		③28443
Hose - Heater; (5/8" I.D.)		28441
Ford V-8 6.1 L		
B600; B700		
Belt - Fan & Alt.; W/40A., 60A. Alt.; W/22" Fan Clutch	E0TE8A615EA	②◆◆9447HD
Belt - Fan & Alt.; W/40A., 60A. Alt.; W/O 22" Fan Clutch	D2TE8A615CA	②◆◆9440HD
Belt - Fan & Alt.; W/40A., 60A. Alt.; W/Fixed Fan	D2TE8620AEA	②◆◆9451HD
Belt - Fan & Alt.; W/75A. Alt.; W/22" Fan Clutch	E0TE8A615FA	②◆◆9455HD
Belt - Fan & Alt.; W/75A. Alt.; W/O 22" Fan Clutch	D9TE8A615AA	②◆◆9447HD
Belt - Fan & Alt.; W/75A. Alt.; W/Fixed Fan ...	D2TE8A615VA	②◆◆9463HD
Belt - Fan & Alt.; W/90A. Alt.; W/22" Fan Clutch	E2TE8A615AA	②◆◆9463HD
Belt - Fan & Alt.; W/90A. Alt.; W/O 22" Fan Clutch	D2TE8A615MA	②◆◆9451HD
Belt - Fan & Alt.; W/90A. Alt.; W/Fixed Fan ...	D2TE8A615BA	②◆◆9465HD
Belt - Fan & Alt.; W/105A., 130A. Alt.; W/22" Fan Clutch		②◆◆9465HD
Belt - Fan & Alt.; W/105A., 130A. Alt.; W/O 22" Fan Clutch		②◆◆9455HD
Belt - Fan & Alt.; W/105A., 130A. Alt.; W/Fixed Fan	D2TE8A615VA	②◆◆9463HD
Belt - Fan & P.S.; W/Single A.P.; W/Fan Clutch		②◆◆9530HD
Belt - Fan & P.S.; W/22" Fan Clutch		◆9565HD
Belt - Fan & P.S.; W/O Fan Clutch		◆9530HD
Belt - Fan, P.S. & A.P.		②◆◆9650HD
Belt - Fan, A.P. & Air Brake Compr.		◆9640HD
Belt - Fan, A.P. & Hyd. Brake Boost Pump	E0TE8620KA	◆9610HD
Belt - A.C.		◆9330HD
Belt - A.P.; W/Fan Clutch	D4TE8620AA	◆9385HD
Belt - A.P.; W/O Fan Clutch	D2TE8620BNA	◆9370HD
Hose - Upper		②<21936
		or
Hose - Lower - Eng. To Pipe		21969
Hose - Lower - Pipe To Rad.; W/Auto. Trans.		21368
Hose - Lower - Pipe To Rad.; W/Man. Trans.		②<20452
Hose - By Pass		②<21942
Hose - Heater; (1" I.D.)		24216

② Two Required.
◆ Standard Belt Available. See Pages 630-631.
③ Three Required.

Application	Mfr. Part No.	Our No.
FORD - Continued		
1984 - Continued		
Ford V-8 6.1 L - Continued		
B600; B700 - Continued		
Belt - A.P.; W/O Fan Clutch	D2TE8620BNA	◆9370HD
Hose - Upper; W/Auto. Trans.		②<21936
		or
Hose - Upper; W/Man. Trans.		◆26512
		or
		◆21305
Hose - Lower - Eng. To Pipe		21969
Hose - Lower - Pipe To Rad.; W/Auto. Trans.		21368
Hose - Lower - Pipe To Rad.; W/Man. Trans.		②<20452
Hose - By Pass		②<21942
Hose - Heater; (1" I.D.)		24216
Ford V-8 7.0 L		
B700		
Belt - Fan & Alt.; W/40A., 60A. Alt.; W/22" Fan Clutch	E0TE8A615EA	②◆◆9447HD
Belt - Fan & Alt.; W/40A., 60A. Alt.; W/O 22" Fan Clutch	D2TE8A615CA	②◆◆9440HD
Belt - Fan & Alt.; W/40A., 60A. Alt.; W/Fixed Fan	D2TE8620AEA	②◆◆9451HD
Belt - Fan & Alt.; W/75A. Alt.; W/22" Fan Clutch	E0TE8A615FA	②◆◆9455HD
Belt - Fan & Alt.; W/75A. Alt.; W/O 22" Fan Clutch	D9TE8A615AA	②◆◆9447HD
Belt - Fan & Alt.; W/75A. Alt.; W/Fixed Fan ...	D2TE8A615VA	②◆◆9463HD
Belt - Fan & Alt.; W/90A. Alt.; W/22" Fan Clutch	E2TE8A615AA	②◆◆9463HD
Belt - Fan & Alt.; W/90A. Alt.; W/O 22" Fan Clutch	D2TE8A615MA	②◆◆9451HD
Belt - Fan & Alt.; W/90A. Alt.; W/Fixed Fan ...	D2TE8A615BA	②◆◆9465HD
Belt - Fan & Alt.; W/105A., 130A. Alt.; W/22" Fan Clutch		②◆◆9465HD
Belt - Fan & Alt.; W/105A., 130A. Alt.; W/O 22" Fan Clutch		②◆◆9455HD
Belt - Fan & Alt.; W/105A., 130A. Alt.; W/Fixed Fan	D2TE8A615VA	②◆◆9463HD
Belt - Fan & P.S.; W/Single A.P.; W/Fan Clutch		②◆◆9530HD
Belt - Fan & P.S.; W/22" Fan Clutch		◆9565HD
Belt - Fan & P.S.; W/O Fan Clutch		◆9530HD
Belt - Fan, P.S. & A.P.		②◆◆9650HD
Belt - Fan, A.P. & Air Brake Compr.		◆9640HD
Belt - Fan, A.P. & Hyd. Brake Boost Pump	E0TE8620KA	◆9610HD
Belt - A.C.		◆9330HD
Belt - A.P.; W/Fan Clutch	D4TE8620AA	◆9385HD
Belt - A.P.; W/O Fan Clutch	D2TE8620BNA	◆9370HD
Hose - Upper		②<21936
		or
Hose - Lower - Eng. To Pipe		21969
Hose - Lower - Pipe To Rad.; W/Auto. Trans.		21368
Hose - Lower - Pipe To Rad.; W/Man. Trans.		②<20452
Hose - By Pass		②<21942
Hose - Heater; (1" I.D.)		24216
1983		
Caterpillar 3208 Diesel		
B7000		
Belt - Fan & P.S.; Apr. 1983 & Older		②◆◆9650HD
Belt - Fan & P.S.; May 1983 & Newer	D3HA8620CA	②◆◆9670HD
Belt - W.P. & Alt.; W/Motorola 130A. Alt.		②◆◆9610HD
Belt - W.P. & Alt.; W/O Motorola 130A. Alt.		◆9570HD
Belt - P.S.	D7HT8620LA	◆9375HD
Belt - Air Brake Compr.	D5HA8620GA	◆9580HD
Belt - A.C.; W/42 7/8" Belt O.C.	E4HT8620GB	◆9425HD
Belt - A.C.; W/53 3/8" Belt O.C.		◆9530HD
Belt - Hyd. Brake Boost Pump	C8HA8620A	◆9560HD
Belt - V.P.	D0HA8620U	◆9550HD
Hose - Upper		21569
Hose - Lower		21562
Hose - Oil Cooler - Front Inlet		21824
Hose - Oil Cooler - Rear Inlet		21381
Hose - Oil Cooler Outlet		21380
Hose - Heater; (5/8" I.D.)		28441

◆ Green Stripe® PowerBand® Belt May Work, Use Template to Check.
②< Cut to Fit.
● Vulco-Flex® Coolant Hose.

School Buses

Belts and Coolant Hose for School Buses

School Buses

Application	Mfr. Part No.	Our No.
FORD - Continued		
1983 - Continued		
Detroit Diesel V-8 8.2 L Diesel		
B600; B700		
Belt - Fan & Alt.; W/O A.C.; W/40A., 60A. Alt.	E1HZ8620A	②◆▲9660HD
Belt - Fan & Alt.; W/70A., 90A. Alt.	E1HZ8620B	②◆▲9670HD
Belt - Fan & Alt.; W/105A., 130A. Alt.	E0HZ8620P	②▲9680HD
Belt - P.S.; W/5500 Lb. Axle		②▲9395HD
Belt - P.S.; W/O 5500 Lb. Axle		②▲9425HD
Belt - Air Brake Compr.; W/70 1/4" Belt O.C.		▲9700HD
Belt - Air Brake Compr.; W/71 1/4" Belt O.C.		▲9710HD
Belt - Air Brake Compr.; W/72 1/4" Belt O.C.	E0HT8620LA	▲9720HD
Belt - A.C.	E0HZ8620R	▲9720HD
Belt - Hyd. Brake Boost Pump; W/69 1/4" Belt O.C.		▲9680HD
Belt - Hyd. Brake Boost Pump; W/70 1/4" Belt O.C.		▲9700HD
Belt - V.P.; W/High Mount V.P.	D9PZ8620B	▲9435HD
Belt - V.P.; W/Low Mount V.P.	E0HZ8620S	▲9680HD
Hose - Upper; W/A.C.		21470
Hose - Upper; W/O A.C.		≠21470
Hose - Lower - Eng. To Pipe		21363
Hose - Lower - Pipe To Rad.		21307
Hose - By Pass - Left Side; (1 3/8" I.D.)		24222
Hose - By Pass - Right Side		21457
Hose - Oil Cooler; (7/8" I.D.)		③28443
Hose - Heater; (5/8" I.D.)		28441
Ford V-8 6.1 L		
B600; B700		
Belt - Fan & Alt.; W/40A., 60A. Alt.; W/22" Fan	D2AE8620CAA	②◆▲9447HD
Belt - Fan & Alt.; W/40A., 60A. Alt.; W/O 22" Fan Clutch		②◆▲9435HD
Belt - Fan & Alt.; W/70A., 90A. Alt.; W/22" Fan	D2DE8620GA	②▲9455HD
Belt - Fan & Alt.; W/70A., 90A. Alt.; W/O 22" Fan Clutch		②◆▲9447HD
Belt - Fan & Alt.; W/105A., 130A. Alt.		②◆▲9463HD
Belt - Fan & P.S.	D2ZE8620AHA	▲9525HD
Belt - Fan & A.P.; W/O Air Brakes		▲9720HD
Belt - A.C.		▲9330HD
Belt - Air Brake Compr. & A.P.; W/7 1/4 Cu. Ft. Air Brake Compr.	E0TE8620MA	▲9650HD
Belt - Air Brake Compr. & A.P.; W/12 Cu. Ft. Air Brake Compr.	D9TE8620CB	▲9640HD
Belt - Hyd. Brake Boost Pump & A.P.	E0TE8620KA	▲9610HD
Belt - A.P.; W/Fan Clutch	C9PZ8620BH	▲9370HD
Belt - A.P.; W/O Fan Clutch	D7PZ8620P	▲9390HD
Hose - Upper; W/Auto. Trans.		≠21936
	or	●26512
Hose - Upper; W/Man. Trans.		21305
	or	●26512
Hose - Lower - Eng. To Pipe		21969
Hose - Lower - Pipe To Rad.; W/Auto. Trans.		21368
Hose - Lower - Pipe To Rad.; W/Man. Trans.		≠20452
Hose - By Pass		≠21942
Hose - Heater; (1" I.D.)		24216
Ford V-8 7.0 L		
B700		
Belt - Fan & Alt.; W/40A., 60A. Alt.; W/22" Fan Clutch	D2AE8620CAA	②◆▲9447HD
Belt - Fan & Alt.; W/40A., 60A. Alt.; W/O 22" Fan Clutch		②◆▲9435HD
Belt - Fan & Alt.; W/70A., 90A. Alt.; W/22" Fan Clutch	D2DE8620GA	②▲9455HD
Belt - Fan & Alt.; W/70A., 90A. Alt.; W/O 22" Fan Clutch		②◆▲9447HD
Belt - Fan & Alt.; W/105A., 130A. Alt.		②◆▲9463HD
Belt - Fan & P.S.	D2ZE8620AHA	▲9525HD
Belt - Fan & A.P.; W/O Air Brakes		▲9720HD
Belt - A.C.		▲9330HD
Belt - Air Brake Compr. & A.P.; W/7 1/4 Cu. Ft. Air Brake Compr.	E0TE8620MA	▲9650HD
Belt - Air Brake Compr. & A.P.; W/12 Cu. Ft. Air Brake Compr.	D9TE8620CB	▲9640HD
Belt - Hyd. Brake Boost Pump & A.P.	E0TE8620KA	▲9610HD
Belt - A.P.; W/Fan Clutch	C9PZ8620BH	▲9370HD
Belt - A.P.; W/O Fan Clutch	D7PZ8620P	▲9390HD
Hose - Upper		≠21936
	or	●26512
Hose - Lower - Eng. To Pipe		21969

Application	Mfr. Part No.	Our No.
FORD - Continued		
1983 - Continued		
Ford V-8 7.0 L - Continued		
B700 - Continued		
Hose - Lower - Pipe To Rad.; W/Auto. Trans.		21368
Hose - Lower - Pipe To Rad.; W/Man. Trans.		≠20452
Hose - By Pass		≠21942
Hose - Heater; (1" I.D.)		24216
1982-1981		
Detroit Diesel V-8 8.2 L Diesel		
B600; B700		
Belt - Fan & Alt.; W/40A., 60A. Alt.	E1HZ8620A	②◆▲9660HD
Belt - Fan & Alt.; W/70A., 90A. Alt.	E1HZ8620B	②◆▲9670HD
Belt - Fan & Alt.; W/105A., 130A. Alt.	E0HZ8620P	②▲9680HD
Belt - P.S.; W/5500 Lb. Axle		②▲9395HD
Belt - P.S.; W/O 5500 Lb. Axle		②▲9425HD
Belt - Air Brake Compr.		▲9700HD
Belt - A.C.	E0HZ8620R	▲9720HD
Belt - Hyd. Brake Boost Pump		▲9700HD
Belt - V.P.; W/High Mount V.P.	D9PZ8620B	▲9435HD
Belt - V.P.; W/Low Mount V.P.	E0HZ8620S	▲9680HD
Hose - Upper		21469
	or	●26512
Hose - Lower - Eng. To Pipe		21363
Hose - Lower - Pipe To Rad.		21307
Hose - By Pass - Left Side; (1 3/8" I.D.)		24222
Hose - By Pass - Right Side		21457
Hose - Oil Cooler; (7/8" I.D.)		③28443
Hose - Heater; (5/8" I.D.)		28441
Ford V-8 6.1 L		
B600; B700		
Belt - Fan & Alt.; W/40A., 60A. Alt.; W/22" Fan	D2AE8620CAA	②◆▲9447HD
Belt - Fan & Alt.; W/40A., 60A. Alt.; W/O 22" Fan Clutch		②◆▲9435HD
Belt - Fan & Alt.; W/70A., 90A. Alt.; W/22" Fan	D2DE8620GA	②▲9455HD
Belt - Fan & Alt.; W/70A., 90A. Alt.; W/O 22" Fan Clutch		②◆▲9447HD
Belt - Fan & Alt.; W/105A., 130A. Alt.		②◆▲9463HD
Belt - Fan & P.S.	D2ZE8620AHA	▲9525HD
Belt - Fan & A.P.; W/O Air Brakes		▲9720HD
Belt - A.C.		▲9330HD
Belt - Air Brake Compr. & A.P.; W/7 1/4 Cu. Ft. Air Brake Compr.	E0TE8620MA	▲9650HD
Belt - Air Brake Compr. & A.P.; W/12 Cu. Ft. Air Brake Compr.	D9TE8620CB	▲9640HD
Belt - Hyd. Brake Boost Pump & A.P.	E0TE8620KA	▲9610HD
Belt - A.P.; W/Fan Clutch	C9PZ8620BH	▲9370HD
Belt - A.P.; W/O Fan Clutch	D7PZ8620P	▲9390HD
Hose - Upper; W/Auto. Trans.		≠21936
	or	●26512
Hose - Upper; W/Man. Trans.		21305
	or	●26512
Hose - Lower - Eng. To Pipe		21969
Hose - Lower - Pipe To Rad.; W/Auto. Trans.		21368
Hose - Lower - Pipe To Rad.; W/Man. Trans.		≠20452
Hose - By Pass		≠21942
Hose - Heater; (1" I.D.)		24216
Ford V-8 7.0 L		
B700		
Belt - Fan & Alt.; W/40A., 60A. Alt.; W/22" Fan Clutch	D2AE8620CAA	②◆▲9447HD
Belt - Fan & Alt.; W/40A., 60A. Alt.; W/O 22" Fan Clutch		②◆▲9435HD
Belt - Fan & Alt.; W/70A., 90A. Alt.; W/22" Fan Clutch	D2DE8620GA	②▲9455HD
Belt - Fan & Alt.; W/70A., 90A. Alt.; W/O 22" Fan Clutch		②◆▲9447HD
Belt - Fan & Alt.; W/105A., 130A. Alt.		②◆▲9463HD
Belt - Fan & P.S.	D2ZE8620AHA	▲9525HD
Belt - Fan & A.P.; W/O Air Brakes		▲9720HD
Belt - A.C.		▲9330HD
Belt - Air Brake Compr. & A.P.; W/7 1/4 Cu. Ft. Air Brake Compr.	E0TE8620MA	▲9650HD
Belt - Air Brake Compr. & A.P.; W/12 Cu. Ft. Air Brake Compr.	D9TE8620CB	▲9640HD
Belt - Hyd. Brake Boost Pump & A.P.	E0TE8620KA	▲9610HD
Belt - A.P.; W/Fan Clutch	C9PZ8620BH	▲9370HD
Belt - A.P.; W/O Fan Clutch	D7PZ8620P	▲9390HD
Hose - Upper		≠21936
	or	●26512
Hose - Lower - Eng. To Pipe		21969
Hose - Lower - Pipe To Rad.; W/Auto. Trans.		21368
Hose - Lower - Pipe To Rad.; W/Man. Trans.		≠20452
Hose - By Pass		≠21942
Hose - Heater; (1" I.D.)		24216

② Two Required.
 ▲ Standard Belt Available. See Pages 630-631.
 ③ Three Required.

◆ Green Stripe® PowerBand® Belt May Work, Use Template to Check.
 ≠ Cut to Fit.
 ● Vulco-Flex® Coolant Hose.

Belts and Coolant Hose for School Buses

Application	Mfr. Part No.	Our No.
FORD - Continued		
1982-1981 - Continued		
Ford V-8 7.0 L - Continued		
B700 - Continued		
Belt - A.P.; W/Fan Clutch	C9PZ8620BH	▲9370HD
Belt - A.P.; W/O Fan Clutch	D7PZ8620P	▲9390HD
Hose - Upper		≈<21936
	or	●26512
Hose - Lower - Eng. To Pipe		21969
Hose - Lower - Pipe To Rad.; W/Auto. Trans.		21368
Hose - Lower - Pipe To Rad.; W/Man. Trans.		≈<20452
Hose - By Pass		≈<21942
Hose - Heater; (1" I.D.)		24216
1980		
Detroit Diesel V-8 8.2 L Diesel		
B600; B700		
Belt - Fan & Alt.; W/40A., 60A. Alt.	E1HZ8620A	②◆▲9660HD
Belt - Fan & Alt.; W/70A., 90A. Alt.	E1HZ8620B	②◆▲9670HD
Belt - Fan & Alt.; W/105A., 130A. Alt.	E0HZ8620P	②▲9680HD
Belt - P.S.; W/5500 Lb. Axle		②▲9395HD
Belt - P.S.; W/O 5500 Lb. Axle		②▲9425HD
Belt - Air Brake Compr.		▲9700HD
Belt - A.C.	E0HZ8620R	▲9720HD
Belt - Hyd. Brake Boost Pump		▲9700HD
Belt - V.P.; W/High Mount V.P.	D9PZ8620B	▲9435HD
Belt - V.P.; W/Low Mount V.P.	E0HZ8620S	▲9680HD
Hose - Upper		21469
	or	●26512
Hose - Lower - Eng. To Pipe		21363
Hose - Lower - Pipe To Rad.		21307
Hose - By Pass - Left Side; (1 3/8" I.D.)		24222
Hose - By Pass - Right Side		21457
Hose - Oil Cooler; (7/8" I.D.)		③28443
Hose - Heater; (5/8" I.D.)		28441
Ford V-8 6.1 L		
B600; B700		
Belt - Fan & Alt.; W/40A., 60A. Alt.		②◆▲9435HD
Belt - Fan & Alt.; W/70A., 90A. Alt.		②◆▲9447HD
Belt - Fan & Alt.; W/105A., 130A. Alt.		②▲9455HD
Belt - Fan & P.S.	D2ZE8620AHA	▲9525HD
Belt - Fan, A.P. & Air Brake Compr.		▲9640HD
Belt - A.C.		▲9330HD
Belt - A.P.; W/Fan Clutch		▲9370HD
Belt - A.P.; W/O Fan Clutch		▲9385HD
Belt - Hyd. Brake Boost Pump & A.P.		▲9640HD
Hose - Upper; W/Auto. Trans.		≈<21936
	or	●26512
Hose - Upper; W/Man. Trans.		21305
	or	●26512
Hose - Lower - Eng. To Pipe		21969
Hose - Lower - Pipe To Rad.; W/Auto. Trans.		21368
Hose - Lower - Pipe To Rad.; W/Man. Trans.		≈<20452
Hose - By Pass		≈<21942
Hose - Heater; (1" I.D.)		24216
Ford V-8 7.0 L		
B700		
Belt - Fan & Alt.; W/40A., 60A. Alt.; W/22" Fan Clutch	D2AE8620CAA	②◆▲9447HD
Belt - Fan & Alt.; W/40A., 60A. Alt.; W/O 22" Fan Clutch		②◆▲9435HD
Belt - Fan & Alt.; W/70A., 90A. Alt.; W/22" Fan Clutch		②▲9455HD
Belt - Fan & Alt.; W/70A., 90A. Alt.; W/O 22" Fan Clutch	D2DE8620GA	②▲9455HD
Belt - Fan & Alt.; W/105A., 130A. Alt.		②◆▲9447HD
Belt - Fan & Alt.; W/105A., 130A. Alt.		②◆▲9463HD
Belt - Fan & P.S.	D2ZE8620AHA	▲9525HD
Belt - Fan & A.P.; W/O Air Brakes		▲9720HD
Belt - A.C.		▲9330HD
Belt - Air Brake Compr. & A.P.; W/7 1/4 Cu. Ft. Air Brake Compr.	E0TE8620MA	▲9650HD
Belt - Air Brake Compr. & A.P.; W/12 Cu. Ft. Air Brake Compr.	D9TE8620CB	▲9640HD
Belt - Hyd. Brake Boost Pump & A.P.	E0TE8620KA	▲9610HD
Belt - A.P.; W/Fan Clutch	C9PZ8620BH	▲9370HD

Application	Mfr. Part No.	Our No.
FORD - Continued		
1980 - Continued		
Ford V-8 7.0 L - Continued		
B700 - Continued		
Belt - A.P.; W/O Fan Clutch	D7PZ8620P	▲9390HD
Hose - Upper		≈<21936
	or	●26512
Hose - Lower - Eng. To Pipe		21969
Hose - Lower - Pipe To Rad.; W/Auto. Trans.		21368
Hose - Lower - Pipe To Rad.; W/Man. Trans.		≈<20452
Hose - By Pass		≈<21942
Hose - Heater; (1" I.D.)		24216
1979		
Caterpillar 3208 Diesel		
B7000		
Belt - Fan & Alt.; W/42A., 55A., 61A., 70A. Alt.	D0HA8620AA	②◆▲9610HD
Belt - Fan & Alt.; W/65A. Alt.	C9PZ8620DG	②▲9620HD
Belt - Fan & Alt.; W/105A. Leece Neville Alt.	C9PZ8620GV	②▲9630HD
Belt - P.S.	D7HT8620LA	▲9375HD
Belt - Air Brake Compr.	D0HA8620U	▲9550HD
Belt - Hyd. Brake Boost Pump	D0HA8620U	▲9550HD
Belt - V.P.	D0HA8620AG	▲9525HD
Hose - Upper		≈<21256
Hose - Lower		≈<21379
Hose - Oil Cooler - Front Inlet		21824
Hose - Oil Cooler - Rear Inlet		21381
Hose - Oil Cooler Outlet		21380
Hose - Heater; (5/8" I.D.)		28441
Ford 6-Cyl. 300		
B600		
Belt - Fan & Alt.; W/42A., 55A. Alt.	C9PZ8620V	②7417
Belt - Fan & Alt.; W/70A. Alt.	C9PZ8620GJ	②7435
Belt - P.S.	C9PZ8620BH	▲9370HD
Belt - A.P.	D5PZ8620B	7381
Hose - Upper		≈<20450
	or	●25476
Hose - Lower		20475
	or	●26502
Ford V-8 361		
B700		
Belt - Fan & Alt.; W/40A., 42A., 55A., 60A., 61A. Alt.		②◆▲9447HD
Belt - Fan & Alt.; W/70A., 90A., 105A. Alt.; W/O Noise Restrictions	C9PZ8620BV	②▲9440HD
Belt - Fan & Alt.; W/70A., 90A., 105A. Alt.; W/Noise Restriction	C9PZ8620CB	②◆▲9463HD
Belt - P.S.	C9PZ8620BM	▲9400HD
Belt - Air Brake Compr.	C9PZ8620CM	▲9520HD
Belt - A.C.	D5PZ8620W	▲9360HD
Belt - A.P.	D4PZ8620C	7348
Hose - Upper; Single I.D. Hose		≈<20957
Hose - Upper; Dual I.D. Hose; W/1 3/4" Offset		21118
Hose - Upper; Dual I.D. Hose; W/3 5/8" Offset		21078
Hose - Lower - Eng. To Pipe; Strt. Hose(2" I.D.)		24232
Hose - Lower - Eng. To Pipe; Molded Hose		≈<20685
Hose - Lower - Pipe To Rad.		≈<20685
Hose - By Pass - Left Side; Ser. No. T40001 & After		21257
Hose - By Pass - Left Side; Ser. No. T40001 & After(5/8" I.D.)		28441
Hose - By Pass - Right Side; Ser. No. T40001 & After		21258
Ford V-8 370		
B600; B700		
Belt - Fan & Alt.; W/40A., 60A. Alt.		②◆▲9435HD
Belt - Fan & Alt.; W/70A., 90A. Alt.		②◆▲9447HD
Belt - Fan & Alt.; W/105A., 130A. Alt.		②▲9455HD
Belt - Fan & P.S.	D2ZE8620AHA	▲9525HD
Belt - Fan, A.P. & Air Brake Compr.		▲9640HD
Belt - A.C.		▲9330HD
Belt - A.P.; W/Fan Clutch		▲9370HD
Belt - A.P.; W/O Fan Clutch		▲9385HD
Belt - Hyd. Brake Boost Pump & A.P.		▲9640HD
Hose - Upper; W/2V. Carb.		≈<21944
Hose - Upper; W/4V. Carb.; W/Std. Cool.		≈<20579

◆ Standard Belt Available. See Pages 630-631.
 ● Vulco-Flex® Coolant Hose.
 ◆ Green Stripe® PowerBand® Belt May Work, Use Template to Check.

≈< Cut to Fit.
 ② Two Required.
 ③ Three Required.

School Buses

Belts and Coolant Hose for School Buses

School Buses

Application	Mfr. Part No.	Our No.
FORD - Continued		
1979 - Continued		
Ford V-8 370 - Continued		
B600; B700 - Continued		
Hose - Upper; W/4V. Carb.; W/X.C.		≠21944
Hose - Lower - Pipe To Rad.		≠20520
Hose - By Pass		≠21942
Hose - Heater; (5/8" I.D.)		28441
Ford V-8 391		
B700		
Belt - Fan & Alt.; W/40A., 42A., 55A., 60A., 61A. Alt.		②◆♠9447HD
Belt - Fan & Alt.; W/70A., 90A., 105A. Alt.; W/O Noise Restrictions C9PZ8620BV		②♠9440HD
Belt - Fan & Alt.; W/70A., 90A., 105A. Alt.; W/Noise Restriction C9PZ8620CB		②◆♠9463HD
Belt - P.S.	C9PZ8620BM	♠9400HD
Belt - Air Brake Compr.	C9PZ8620CM	♠9520HD
Belt - A.C.	D5PZ8620W	♠9360HD
Belt - A.P.	D4PZ8620C	7348
Hose - Upper; Single I.D. Hose		≠20957
Hose - Upper; Dual I.D. Hose; W/1 3/4" Offset		21118
Hose - Upper; Dual I.D. Hose; W/3 5/8" Offset		21078
Hose - Lower - Eng. To Pipe; Strt. Hose(2" I.D.)		24232
Hose - Lower - Eng. To Pipe; Molded Hose		≠20685
Hose - Lower - Pipe To Rad.		≠20685
Hose - By Pass - Left Side; Ser. No. T40001 & After		21257
Hose - By Pass - Left Side; Ser. No. T40001 & After(5/8" I.D.)		28441
Hose - By Pass - Right Side; Ser. No. T40001 & After		21258
Ford V-8 429		
B600; B700		
Belt - Fan & Alt.; W/40A., 60A. Alt.		②◆♠9435HD
Belt - Fan & Alt.; W/70A., 90A. Alt.		②◆♠9447HD
Belt - Fan & Alt.; W/105A., 130A. Alt.		②♠9455HD
Belt - Fan & P.S.	D2ZE8620AHA	♠9525HD
Belt - Fan, A.P. & Air Brake Compr.		♠9640HD
Belt - A.C.		♠9330HD
Belt - A.P.; W/Fan Clutch		♠9370HD
Belt - A.P.; W/O Fan Clutch		♠9385HD
Belt - Hyd. Brake Boost Pump & A.P.		♠9640HD
Hose - Upper		≠21944
Hose - Lower - Pipe To Rad.		≠20520
Hose - By Pass		≠21942
Hose - Heater; (5/8" I.D.)		28441
1978		
Caterpillar 3208 Diesel		
B7000		
Belt - Fan & Alt.; W/42A., 55A., 61A., 70A. Alt. D0HA8620AA		②◆♠9610HD
Belt - Fan & Alt.; W/65A. Alt.	C9PZ8620DG	②♠9620HD
Belt - Fan & Alt.; W/105A. Leece Neville Alt. .	C9PZ8620GV	②♠9630HD
Belt - P.S.	D7HT8620LA	♠9375HD
Belt - Air Brake Compr.	D0HA8620U	♠9550HD
Belt - Hyd. Brake Boost Pump	D0HA8620U	♠9550HD
Belt - V.P.	D0HA8620AG	♠9525HD
Hose - Upper		≠21256
Hose - Lower		≠21379
Hose - Oil Cooler - Front Inlet		21824
Hose - Oil Cooler - Rear Inlet		21381
Hose - Oil Cooler Outlet		21380
Hose - Heater; (5/8" I.D.)		28441
Ford 6-Cyl. 300		
B600		
Belt - Fan & Alt.; W/42A., 55A. Alt.	C9PZ8620V	②7417
Belt - Fan & Alt.; W/70A. Alt.	C9PZ8620GJ	②7435
Belt - P.S.	C9PZ8620BH	♠9370HD
Belt - A.P.	D5PZ8620B	7381
Hose - Upper		≠20450
	or	●25476
Hose - Lower		20475
	or	●26502

Application	Mfr. Part No.	Our No.
FORD - Continued		
1978 - Continued		
Ford V-8 330		
B600; B700		
Belt - Fan & Alt.; W/40A., 42A., 55A., 60A., 61A. Alt.		②◆♠9447HD
Belt - Fan & Alt.; W/70A., 90A., 105A. Alt.; W/O Noise Restrictions C9PZ8620BV		②♠9440HD
Belt - Fan & Alt.; W/70A., 90A., 105A. Alt.; W/Noise Restriction C9PZ8620CB		②◆♠9463HD
Belt - P.S.	C9PZ8620BM	♠9400HD
Belt - Air Brake Compr.	C9PZ8620CM	♠9520HD
Belt - A.C.	D5PZ8620W	♠9360HD
Belt - A.P.	D4PZ8620C	7348
Hose - Upper; Single I.D. Hose		≠20957
Hose - Upper; Dual I.D. Hose; W/1 3/4" Offset		21118
Hose - Upper; Dual I.D. Hose; W/3 5/8" Offset		21078
Hose - Lower - Eng. To Pipe; Strt. Hose(2" I.D.)		24232
Hose - Lower - Eng. To Pipe; Molded Hose		≠20685
Hose - Lower - Pipe To Rad.		≠20685
Hose - By Pass - Left Side; Ser. No. T40001 & After		21257
Hose - By Pass - Left Side; Ser. No. T40001 & After(5/8" I.D.)		28441
Hose - By Pass - Right Side; Ser. No. T40001 & After		21258
Ford V-8 361		
B600; B700		
Belt - Fan & Alt.; W/40A., 42A., 55A., 60A., 61A. Alt.		②◆♠9447HD
Belt - Fan & Alt.; W/70A., 90A., 105A. Alt.; W/O Noise Restrictions C9PZ8620BV		②♠9440HD
Belt - Fan & Alt.; W/70A., 90A., 105A. Alt.; W/Noise Restriction C9PZ8620CB		②◆♠9463HD
Belt - P.S.	C9PZ8620BM	♠9400HD
Belt - Air Brake Compr.	C9PZ8620CM	♠9520HD
Belt - A.C.	D5PZ8620W	♠9360HD
Belt - A.P.	D4PZ8620C	7348
Hose - Upper; Single I.D. Hose		≠20957
Hose - Upper; Dual I.D. Hose; W/1 3/4" Offset		21118
Hose - Upper; Dual I.D. Hose; W/3 5/8" Offset		21078
Hose - Lower - Eng. To Pipe; Strt. Hose(2" I.D.)		24232
Hose - Lower - Eng. To Pipe; Molded Hose		≠20685
Hose - Lower - Pipe To Rad.		≠20685
Hose - By Pass - Left Side; Ser. No. T40001 & After		21257
Hose - By Pass - Left Side; Ser. No. T40001 & After(5/8" I.D.)		28441
Hose - By Pass - Right Side; Ser. No. T40001 & After		21258
Ford V-8 391		
B700		
Belt - Fan & Alt.; W/40A., 42A., 55A., 60A., 61A. Alt.		②◆♠9447HD
Belt - Fan & Alt.; W/70A., 90A., 105A. Alt.; W/O Noise Restrictions C9PZ8620BV		②♠9440HD
Belt - Fan & Alt.; W/70A., 90A., 105A. Alt.; W/Noise Restriction C9PZ8620CB		②◆♠9463HD
Belt - P.S.	C9PZ8620BM	♠9400HD
Belt - Air Brake Compr.	C9PZ8620CM	♠9520HD
Belt - A.C.	D5PZ8620W	♠9360HD
Belt - A.P.	D4PZ8620C	7348
Hose - Upper; Single I.D. Hose		≠20957
Hose - Upper; Dual I.D. Hose; W/1 3/4" Offset		21118
Hose - Upper; Dual I.D. Hose; W/3 5/8" Offset		21078
Hose - Lower - Eng. To Pipe; Strt. Hose(2" I.D.)		24232
Hose - Lower - Eng. To Pipe; Molded Hose		≠20685
Hose - Lower - Pipe To Rad.		≠20685
Hose - By Pass - Left Side; Ser. No. T40001 & After		21257
Hose - By Pass - Left Side; Ser. No. T40001 & After(5/8" I.D.)		28441
Hose - By Pass - Right Side; Ser. No. T40001 & After		21258
1977		
Caterpillar 3208 Diesel		
B7000		
Belt - Fan & Alt.; W/42A., 55A., 61A., 70A. Alt. D0HA8620AA		②◆♠9610HD
Belt - Fan & Alt.; W/65A. Alt.	C9PZ8620DG	②♠9620HD
Belt - Fan & Alt.; W/105A. Leece Neville Alt. .	C9PZ8620GV	②♠9630HD
Belt - P.S.	D7HT8620LA	♠9375HD
Belt - Air Brake Compr.	D0HA8620U	♠9550HD
Belt - Hyd. Brake Boost Pump	D0HA8620U	♠9550HD
Belt - V.P.	D0HA8620AG	♠9525HD

≠ Cut to Fit.
◆ Green Stripe® PowerBand® Belt May Work, Use Template to Check.
● Vulco-Flex® Coolant Hose.

② Two Required.
♠ Standard Belt Available. See Pages 630-631.

Belts and Coolant Hose for School Buses

School Buses

Application	Mfr. Part No.	Our No.
FORD - Continued		
1977 - Continued		
Caterpillar 3208 Diesel - Continued		
B7000 - Continued		
Hose - Upper		≈<21256
Hose - Lower		≈<21379
Hose - Oil Cooler - Front Inlet		21824
Hose - Oil Cooler - Rear Inlet		21381
Hose - Oil Cooler Outlet		21380
Hose - Heater; (5/8" I.D.)		28441
Ford 6-Cyl. 300		
B500; B600		
Belt - Fan & Alt.; W/42A., 55A. Alt.	C9PZ8620V	②7417
Belt - Fan & Alt.; W/70A. Alt.	C9PZ8620GJ	②7435
Belt - P.S.	C9PZ8620BH	▲9370HD
Belt - A.P.	D5PZ8620B	7381
Hose - Upper		≈<20450
	or	●25476
Hose - Lower		20475
	or	●26502
Ford V-8 330		
B500		
Belt - Fan & Alt.; W/40A., 42A., 55A., 60A., 61A. Alt.		②◆▲9447HD
Belt - Fan & Alt.; W/70A., 90A., 105A. Alt.; W/O Noise Restrictions	C9PZ8620BV	②▲9440HD
Belt - Fan & Alt.; W/70A., 90A., 105A. Alt.; W/Noise Restriction	C9PZ8620CB	②◆▲9463HD
Belt - P.S.	C9PZ8620BM	▲9400HD
Belt - Air Brake Compr.	C9PZ8620CM	▲9520HD
Belt - A.C.	D5PZ8620W	▲9360HD
Belt - A.P.	D4PZ8620C	7348
B600; B700; B750		
Belt - Fan & Alt.; W/40A., 42A., 55A., 60A., 61A. Alt.		②◆▲9447HD
Belt - Fan & Alt.; W/70A., 90A., 105A. Alt.; W/O Noise Restrictions	C9PZ8620BV	②▲9440HD
Belt - Fan & Alt.; W/70A., 90A., 105A. Alt.; W/Noise Restriction	C9PZ8620CB	②◆▲9463HD
Belt - P.S.	C9PZ8620BM	▲9400HD
Belt - Air Brake Compr.	C9PZ8620CM	▲9520HD
Belt - A.C.	D5PZ8620W	▲9360HD
Belt - A.P.	D4PZ8620C	7348
Hose - Upper; Single I.D. Hose		≈<20957
Hose - Upper; Dual I.D. Hose; W/1 3/4" Offset		21118
Hose - Upper; Dual I.D. Hose; W/3 5/8" Offset		21078
Hose - Lower - Eng. To Pipe; Strt. Hose(2" I.D.)		24232
Hose - Lower - Eng. To Pipe; Molded Hose		≈<20685
Hose - Lower - Pipe To Rad.		≈<20685
Hose - By Pass - Left Side; Ser. No. T40001 & After		21257
Hose - By Pass - Left Side; Ser. No. T40001 & After(5/8" I.D.)		28441
Hose - By Pass - Right Side; Ser. No. T40001 & After		21258
Ford V-8 361		
B600; B700; B750		
Belt - Fan & Alt.; W/40A., 42A., 55A., 60A., 61A. Alt.		②◆▲9447HD
Belt - Fan & Alt.; W/70A., 90A., 105A. Alt.; W/O Noise Restrictions	C9PZ8620BV	②▲9440HD
Belt - Fan & Alt.; W/70A., 90A., 105A. Alt.; W/Noise Restriction	C9PZ8620CB	②◆▲9463HD
Belt - P.S.	C9PZ8620BM	▲9400HD
Belt - Air Brake Compr.	C9PZ8620CM	▲9520HD
Belt - A.C.	D5PZ8620W	▲9360HD
Belt - A.P.	D4PZ8620C	7348
Hose - Upper; Single I.D. Hose		≈<20957
Hose - Upper; Dual I.D. Hose; W/1 3/4" Offset		21118
Hose - Upper; Dual I.D. Hose; W/3 5/8" Offset		21078
Hose - Lower - Eng. To Pipe; Strt. Hose(2" I.D.)		24232
Hose - Lower - Eng. To Pipe; Molded Hose		≈<20685
Hose - Lower - Pipe To Rad.		≈<20685
Hose - By Pass - Left Side; Ser. No. T40001 & After		21257
Hose - By Pass - Left Side; Ser. No. T40001 & After(5/8" I.D.)		28441
Hose - By Pass - Right Side; Ser. No. T40001 & After		21258

≈< Cut to Fit.
 ▲ Standard Belt Available. See Pages 630-631.
 ◆ Green Stripe® PowerBand® Belt May Work, Use Template to Check.

Application	Mfr. Part No.	Our No.
FORD - Continued		
1977 - Continued		
Ford V-8 391		
B700; B750		
Belt - Fan & Alt.; W/40A., 42A., 55A., 60A., 61A. Alt.		②◆▲9447HD
Belt - Fan & Alt.; W/70A., 90A., 105A. Alt.; W/O Noise Restrictions	C9PZ8620BV	②▲9440HD
Belt - Fan & Alt.; W/70A., 90A., 105A. Alt.; W/Noise Restriction	C9PZ8620CB	②◆▲9463HD
Belt - P.S.	C9PZ8620BM	▲9400HD
Belt - Air Brake Compr.	C9PZ8620CM	▲9520HD
Belt - A.C.	D5PZ8620W	▲9360HD
Belt - A.P.	D4PZ8620C	7348
Hose - Upper; Single I.D. Hose		≈<20957
Hose - Upper; Dual I.D. Hose; W/1 3/4" Offset		21118
Hose - Upper; Dual I.D. Hose; W/3 5/8" Offset		21078
Hose - Lower - Eng. To Pipe; Strt. Hose(2" I.D.)		24232
Hose - Lower - Eng. To Pipe; Molded Hose		≈<20685
Hose - Lower - Pipe To Rad.		≈<20685
Hose - By Pass - Left Side; Ser. No. T40001 & After		21257
Hose - By Pass - Left Side; Ser. No. T40001 & After(5/8" I.D.)		28441
Hose - By Pass - Right Side; Ser. No. T40001 & After		21258
1976		
Caterpillar 3208 Diesel		
B7000		
Belt - Fan & Alt.; W/42A., 55A., 61A., 70A. Alt.	DOHA8620AA	②◆▲9610HD
Belt - Fan & Alt.; W/65A. Alt.	C9PZ8620DG	②▲9620HD
Belt - Fan & Alt.; W/105A. Leece Neville Alt.	C9PZ8620GV	②▲9630HD
Belt - P.S.	C8TA8620F	▲9370HD
Belt - Air Brake Compr.	DOHA8620U	▲9550HD
Belt - Hyd. Brake Boost Pump	DOHA8620U	▲9550HD
Belt - V.P.	DOHA8620AG	▲9525HD
Hose - Upper		≈<21256
Hose - Lower		≈<21379
Hose - Oil Cooler - Front Inlet		21824
Hose - Oil Cooler - Rear Inlet		21381
Hose - Oil Cooler Outlet		21380
Hose - Heater; (5/8" I.D.)		28441
Ford 6-Cyl. 300		
B500; B600		
Belt - Fan & Alt.; W/42A., 55A. Alt.	C9PZ8620V	②7417
Belt - Fan & Alt.; W/70A. Alt.	C9PZ8620GJ	②7435
Belt - P.S.	C9PZ8620BH	▲9370HD
Belt - A.P.	D5PZ8620B	7381
Hose - Upper		≈<20450
	or	●25476
Hose - Lower		20475
	or	●26502
Ford V-8 330		
B500		
Belt - Fan & Alt.; W/40A., 42A., 55A., 60A., 61A. Alt.		②◆▲9447HD
Belt - Fan & Alt.; W/70A., 90A., 105A. Alt.; W/O Noise Restrictions	C9PZ8620BV	②▲9440HD
Belt - Fan & Alt.; W/70A., 90A., 105A. Alt.; W/Noise Restriction	C9PZ8620CB	②◆▲9463HD
Belt - P.S.	C9PZ8620BM	▲9400HD
Belt - Air Brake Compr.	C9PZ8620CM	▲9520HD
Belt - A.C.	D5PZ8620W	▲9360HD
Belt - A.P.	D4PZ8620C	7348
B600; B700		
Belt - Fan & Alt.; W/40A., 42A., 55A., 60A., 61A. Alt.		②◆▲9447HD
Belt - Fan & Alt.; W/70A., 90A., 105A. Alt.; W/O Noise Restrictions	C9PZ8620BV	②▲9440HD
Belt - Fan & Alt.; W/70A., 90A., 105A. Alt.; W/Noise Restriction	C9PZ8620CB	②◆▲9463HD
Belt - P.S.	C9PZ8620BM	▲9400HD
Belt - Air Brake Compr.	C9PZ8620CM	▲9520HD
Belt - A.C.	D5PZ8620W	▲9360HD
Belt - A.P.	D4PZ8620C	7348
B600; B700		
Belt - Fan & Alt.; W/40A., 42A., 55A., 60A., 61A. Alt.		②◆▲9447HD
Belt - Fan & Alt.; W/70A., 90A., 105A. Alt.; W/O Noise Restrictions	C9PZ8620BV	②▲9440HD
Belt - Fan & Alt.; W/70A., 90A., 105A. Alt.; W/Noise Restriction	C9PZ8620CB	②◆▲9463HD
Belt - P.S.	C9PZ8620BM	▲9400HD
Belt - Air Brake Compr.	C9PZ8620CM	▲9520HD
Belt - A.C.	D5PZ8620W	▲9360HD
Belt - A.P.	D4PZ8620C	7348
Hose - Upper; Single I.D. Hose		≈<20957
Hose - Upper; Dual I.D. Hose; W/1 3/4" Offset		21118
Hose - Upper; Dual I.D. Hose; W/3 5/8" Offset		21078
Hose - Lower - Eng. To Pipe; Strt. Hose(2" I.D.)		24232
Hose - Lower - Eng. To Pipe; Molded Hose		≈<20685
Hose - Lower - Pipe To Rad.		≈<20685
Hose - By Pass - Left Side; Ser. No. T40001 & After		21257
Hose - By Pass - Left Side; Ser. No. T40001 & After(5/8" I.D.)		28441
Hose - By Pass - Right Side; Ser. No. T40001 & After		21258

② Two Required.
 ● Vulco-Flex® Coolant Hose.

Belts and Coolant Hose for School Buses

School Buses

Application	Mfr. Part No.	Our No.
FORD - Continued		
1976 - Continued		
Ford V-8 330 - Continued		
B600; B700 - Continued		
Hose - Lower - Eng. To Pipe; Strt. Hose(2" I.D.)		24232
Hose - Lower - Eng. To Pipe; Molded Hose	≍	20685
Hose - Lower - Pipe To Rad.	≍	20685
Hose - By Pass - Left Side; Ser. No. T40001 & After		21257
Hose - By Pass - Left Side; Ser. No. T40001 & After(5/8" I.D.)		28441
Hose - By Pass - Right Side; Ser. No. T40001 & After		21258
Ford V-8 361		
B600; B700; B750		
Belt - Fan & Alt.; W/40A., 42A., 55A., 60A., 61A. Alt.	②◆♣	9447HD
Belt - Fan & Alt.; W/70A., 90A., 105A. Alt.; W/O Noise Restrictions	C9PZ8620BV	②♣
Belt - Fan & Alt.; W/70A., 90A., 105A. Alt.; W/Noise Restriction	C9PZ8620CB	②◆♣
Belt - P.S.	C9PZ8620BM	♣
Belt - Air Brake Compr.	C9PZ8620CM	♣
Belt - A.C.	D5PZ8620W	♣
Belt - A.P.	D4PZ8620C	7348
Hose - Upper; Single I.D. Hose		≍20957
Hose - Upper; Dual I.D. Hose; W/1 3/4" Offset		21118
Hose - Upper; Dual I.D. Hose; W/3 5/8" Offset		21078
Hose - Lower - Eng. To Pipe; Strt. Hose(2" I.D.)		24232
Hose - Lower - Eng. To Pipe; Molded Hose	≍	20685
Hose - Lower - Pipe To Rad.	≍	20685
Hose - By Pass - Left Side; Ser. No. T40001 & After		21257
Hose - By Pass - Left Side; Ser. No. T40001 & After(5/8" I.D.)		28441
Hose - By Pass - Right Side; Ser. No. T40001 & After		21258
Ford V-8 391		
B700; B750		
Belt - Fan & Alt.; W/40A., 42A., 55A., 60A., 61A. Alt.	②◆♣	9447HD
Belt - Fan & Alt.; W/70A., 90A., 105A. Alt.; W/O Noise Restrictions	C9PZ8620BV	②♣
Belt - Fan & Alt.; W/70A., 90A., 105A. Alt.; W/Noise Restriction	C9PZ8620CB	②◆♣
Belt - P.S.	C9PZ8620BM	♣
Belt - Air Brake Compr.	C9PZ8620CM	♣
Belt - A.C.	D5PZ8620W	♣
Belt - A.P.	D4PZ8620C	7348
Hose - Upper; Single I.D. Hose		≍20957
Hose - Upper; Dual I.D. Hose; W/1 3/4" Offset		21118
Hose - Upper; Dual I.D. Hose; W/3 5/8" Offset		21078
Hose - Lower - Eng. To Pipe; Strt. Hose(2" I.D.)		24232
Hose - Lower - Eng. To Pipe; Molded Hose	≍	20685
Hose - Lower - Pipe To Rad.	≍	20685
Hose - By Pass - Left Side; Ser. No. T40001 & After		21257
Hose - By Pass - Left Side; Ser. No. T40001 & After(5/8" I.D.)		28441
Hose - By Pass - Right Side; Ser. No. T40001 & After		21258
1975		
Caterpillar 3208 Diesel		
B700		
Belt - Fan & Alt.; W/42A., 55A., 61A., 70A. Alt.	D0HA8620AA	②◆♣
Belt - Fan & Alt.; W/65A. Alt.	C9PZ8620DG	②♣
Belt - Fan & Alt.; W/105A. Leece Neville Alt. .	C9PZ8620GV	②♣
Belt - P.S.	C8TA8620F	♣
Belt - Air Brake Compr.	D0HA8620U	♣
Belt - Hyd. Brake Boost Pump	D0HA8620U	♣
Belt - V.P.	D0HA8620AG	♣
Hose - Upper		≍21256
Hose - Lower		≍21379
Hose - Oil Cooler - Front Inlet		21824
Hose - Oil Cooler - Rear Inlet		21381
Hose - Oil Cooler Outlet		21380
Hose - Heater; (5/8" I.D.)		28441
Ford 6-Cyl. 300		
B500; B600; B700		
Belt - Fan & Alt.; W/42A., 55A. Alt.	C9PZ8620V	②
Belt - Fan & Alt.; W/70A. Alt.	C9PZ8620GJ	②
Belt - P.S.	C9PZ8620BH	♣

Application	Mfr. Part No.	Our No.
FORD - Continued		
1975 - Continued		
Ford 6-Cyl. 300 - Continued		
B500; B600; B700 - Continued		
Belt - A.P.	D5PZ8620B	7381
Hose - Upper		≍20450
	or	●25476
Hose - Lower		20475
	or	●26502
Ford V-8 330		
B500		
Belt - Fan & Alt.; W/40A., 42A., 55A., 60A., 61A. Alt.	②◆♣	9447HD
Belt - Fan & Alt.; W/70A., 90A., 105A. Alt.; W/O Noise Restrictions	C9PZ8620BV	②♣
Belt - Fan & Alt.; W/70A., 90A., 105A. Alt.; W/Noise Restriction	C9PZ8620CB	②◆♣
Belt - P.S.	C9PZ8620BM	♣
Belt - Air Brake Compr.	C9PZ8620CM	♣
Belt - A.C.	D5PZ8620W	♣
Belt - A.P.	D4PZ8620C	7348
B600; B700		
Belt - Fan & Alt.; W/40A., 42A., 55A., 60A., 61A. Alt.	②◆♣	9447HD
Belt - Fan & Alt.; W/70A., 90A., 105A. Alt.; W/O Noise Restrictions	C9PZ8620BV	②♣
Belt - Fan & Alt.; W/70A., 90A., 105A. Alt.; W/Noise Restriction	C9PZ8620CB	②◆♣
Belt - P.S.	C9PZ8620BM	♣
Belt - Air Brake Compr.	C9PZ8620CM	♣
Belt - A.C.	D5PZ8620W	♣
Belt - A.P.	D4PZ8620C	7348
Hose - Upper; Single I.D. Hose		≍20957
Hose - Upper; Dual I.D. Hose; W/1 3/4" Offset		21118
Hose - Upper; Dual I.D. Hose; W/3 5/8" Offset		21078
Hose - Lower - Eng. To Pipe; Strt. Hose(2" I.D.)		24232
Hose - Lower - Eng. To Pipe; Molded Hose		≍20685
Hose - Lower - Pipe To Rad.		≍20685
Hose - By Pass - Left Side; Ser. No. T40001 & After		21257
Hose - By Pass - Left Side; Ser. No. T40001 & After(5/8" I.D.)		28441
Hose - By Pass - Right Side; Ser. No. T40001 & After		21258
Ford V-8 361		
B600; B700; B750		
Belt - Fan & Alt.; W/40A., 42A., 55A., 60A., 61A. Alt.	②◆♣	9447HD
Belt - Fan & Alt.; W/70A., 90A., 105A. Alt.; W/O Noise Restrictions	C9PZ8620BV	②♣
Belt - Fan & Alt.; W/70A., 90A., 105A. Alt.; W/Noise Restriction	C9PZ8620CB	②◆♣
Belt - P.S.	C9PZ8620BM	♣
Belt - Air Brake Compr.	C9PZ8620CM	♣
Belt - A.C.	D5PZ8620W	♣
Belt - A.P.	D4PZ8620C	7348
Hose - Upper; Single I.D. Hose		≍20957
Hose - Upper; Dual I.D. Hose; W/1 3/4" Offset		21118
Hose - Upper; Dual I.D. Hose; W/3 5/8" Offset		21078
Hose - Lower - Eng. To Pipe; Strt. Hose(2" I.D.)		24232
Hose - Lower - Eng. To Pipe; Molded Hose		≍20685
Hose - Lower - Pipe To Rad.		≍20685
Hose - By Pass - Left Side; Ser. No. T40001 & After		21257
Hose - By Pass - Left Side; Ser. No. T40001 & After(5/8" I.D.)		28441
Hose - By Pass - Right Side; Ser. No. T40001 & After		21258
Ford V-8 391		
B700; B750		
Belt - Fan & Alt.; W/40A., 42A., 55A., 60A., 61A. Alt.	②◆♣	9447HD
Belt - Fan & Alt.; W/70A., 90A., 105A. Alt.; W/O Noise Restrictions	C9PZ8620BV	②♣
Belt - Fan & Alt.; W/70A., 90A., 105A. Alt.; W/Noise Restriction	C9PZ8620CB	②◆♣
Belt - P.S.	C9PZ8620BM	♣
Belt - Air Brake Compr.	C9PZ8620CM	♣
Belt - A.C.	D5PZ8620W	♣
Belt - A.P.	D4PZ8620C	7348
Hose - Upper; Single I.D. Hose		≍20957
Hose - Upper; Dual I.D. Hose; W/1 3/4" Offset		21118
Hose - Upper; Dual I.D. Hose; W/3 5/8" Offset		21078
Hose - Lower - Eng. To Pipe; Strt. Hose(2" I.D.)		24232
Hose - Lower - Eng. To Pipe; Molded Hose		≍20685
Hose - Lower - Pipe To Rad.		≍20685
Hose - By Pass - Left Side; Ser. No. T40001 & After		21257
Hose - By Pass - Left Side; Ser. No. T40001 & After(5/8" I.D.)		28441
Hose - By Pass - Right Side; Ser. No. T40001 & After		21258
Ford V-8 391		
B700; B750		
Belt - Fan & Alt.; W/40A., 42A., 55A., 60A., 61A. Alt.	②◆♣	9447HD
Belt - Fan & Alt.; W/70A., 90A., 105A. Alt.; W/O Noise Restrictions	C9PZ8620BV	②♣
Belt - Fan & Alt.; W/70A., 90A., 105A. Alt.; W/Noise Restriction	C9PZ8620CB	②◆♣
Belt - P.S.	C9PZ8620BM	♣
Belt - Air Brake Compr.	C9PZ8620CM	♣
Belt - A.C.	D5PZ8620W	♣
Belt - A.P.	D4PZ8620C	7348
Hose - Upper; Single I.D. Hose		≍20957
Hose - Upper; Dual I.D. Hose; W/1 3/4" Offset		21118
Hose - Upper; Dual I.D. Hose; W/3 5/8" Offset		21078

≍ Cut to Fit.
◆ Green Stripe® PowerBand® Belt May Work, Use Template to Check.
● Vulco-Flex® Coolant Hose.

② Two Required.
♣ Standard Belt Available. See Pages 630-631.

Belts and Coolant Hose for School Buses

Application	Mfr. Part No.	Our No.
FORD - Continued		
1975 - Continued		
Ford V-8 391 - Continued		
B700; B750 - Continued		
Hose - Lower - Eng. To Pipe; Strt. Hose(2" I.D.)		24232
Hose - Lower - Eng. To Pipe; Molded Hose		≈<20685
Hose - Lower - Pipe To Rad.		≈<20685
Hose - By Pass - Left Side; Ser. No. T40001 & After		21257
Hose - By Pass - Left Side; Ser. No. T40001 & After(5/8" I.D.)		28441
Hose - By Pass - Right Side; Ser. No. T40001 & After		21258
1974-1973		
Caterpillar V-8 522 Diesel		
B7000		
Belt - Fan & Alt.; W/40A., 42A., 55A., 60A. 70A. Alt.	C9PZ8620DE	②◆◆9610HD
Belt - Fan & Alt.; W/65A. Alt.	C9PZ8620DG	②◆9625HD
Belt - Fan & Alt.; W/105A. Alt.	C9PZ8620GV	②◆9630HD
Belt - P.S.	C9PZ8620BH	◆9370HD
Belt - Air Brake Compr.	D0HA8620U	◆9550HD
Belt - Hyd. Brake Boost Pump	D0AZ8620E	◆9525HD
Hose - Lower		≈<21379
Hose - Oil Cooler Inlet		21381
Hose - Oil Cooler Outlet		21380
Hose - Heater; (5/8" I.D.)		28441
Caterpillar V-8 573 Diesel		
B7000		
Belt - Fan & Alt.; W/42A., 55A., 61A., 70A. Alt. D0HA8620AA		②◆◆9610HD
Belt - Fan & Alt.; W/65A. Alt.		②◆9620HD
Belt - Fan & Alt.; W/105A. Alt.		②◆9630HD
Belt - P.S.		◆9370HD
Belt - Air Brake Compr.	D0HA8620U	◆9550HD
Belt - V.P.	D0HA8620AG	◆9525HD
Hose - Lower		≈<21379
Hose - Oil Cooler Inlet		21381
Hose - Oil Cooler Outlet		21380
Ford 6-Cyl. 240		
B500; B600		
Belt - Fan & Alt.; W/38A., 42A., Y45A., 55A. Alt.	C9PZ8620V	②7417
Belt - Fan & Alt.; W/65A., 70A. Alt.	C9PZ8620GJ	②7430
Belt - P.S.	C9PZ8620BH	◆9370HD
Belt - Air Brake Compr.	C9PZ8620BH	◆9412HD
Hose - Upper		≈<20450
	or	●25476
Hose - Lower		20475
	or	●26502
Ford 6-Cyl. 300		
B500; B600		
Belt - Fan & Alt.; W/38A., 42A., Y45A., 55A. Alt.; W/L.D. Eng.	C9PZ8620V	②7417
Belt - Fan & Alt.; W/38A., 42A., 45A., 55A. Alt.; W/H.D. Eng.	C9PZ8620BS	②◆9425HD
Belt - Fan & Alt.; W/65A., 70A. Alt.; W/H.D. Eng.	C9PZ8620GJ	②7430
Belt - Fan & Alt.; W/60A., 65A. Alt.; W/H.D. Eng.	C9PZ8620BY	②◆◆9447HD
Belt - P.S.	C9PZ8620BH	◆9370HD
Belt - Air Brake Compr.	C9PZ8620BH	◆9412HD
Hose - Upper		≈<20450
	or	●25476
Hose - Lower		20475
	or	●26502
Ford V-8 330		
B500		
Belt - Fan & Alt.; W/40A., 42A., 55A., 60A., 61A. Alt.		②◆◆9447HD
Belt - Fan & Alt.; W/70A., 90A., 105A. Alt.; W/O Noise Restrictions	C9PZ8620BV	②◆9440HD
Belt - Fan & Alt.; W/70A., 90A., 105A. Alt.; W/Noise Restriction	C9PZ8620CB	②◆◆9463HD
Belt - P.S.	C9PZ8620BM	◆9400HD
Belt - Air Brake Compr.	C9PZ8620CM	◆9520HD

Application	Mfr. Part No.	Our No.
FORD - Continued		
1974-1973 - Continued		
Ford V-8 330 - Continued		
B500 - Continued		
Belt - A.C.	D5PZ8620W	◆9360HD
Belt - A.P.	D4PZ8620C	7348
B600; B700; B750		
Belt - Fan & Alt.; W/40A., 42A., 55A., 60A., 61A. Alt.		②◆◆9447HD
Belt - Fan & Alt.; W/70A., 90A., 105A. Alt.; W/O Noise Restrictions	C9PZ8620BV	②◆9440HD
Belt - Fan & Alt.; W/70A., 90A., 105A. Alt.; W/Noise Restriction	C9PZ8620CB	②◆◆9463HD
Belt - P.S.	C9PZ8620BM	◆9400HD
Belt - Air Brake Compr.	C9PZ8620CM	◆9520HD
Belt - A.C.	D5PZ8620W	◆9360HD
Belt - A.P.	D4PZ8620C	7348
Hose - Upper; Single I.D. Hose		≈<20957
Hose - Upper; Dual I.D. Hose; W/1 3/4" Offset		21118
Hose - Upper; Dual I.D. Hose; W/3 5/8" Offset		21078
Hose - Lower - Eng. To Pipe; Strt. Hose(2" I.D.)		24232
Hose - Lower - Eng. To Pipe; Molded Hose		≈<20685
Hose - Lower - Pipe To Rad.		≈<20685
Hose - By Pass - Left Side; Ser. No. T40001 & After		21257
Hose - By Pass - Left Side; Ser. No. T40001 & After(5/8" I.D.)		28441
Hose - By Pass - Right Side; Ser. No. T40001 & After		21258
Ford V-8 361		
B500		
Belt - Fan & Alt.; W/40A., 42A., 55A., 60A., 61A. Alt.		②◆◆9447HD
Belt - Fan & Alt.; W/70A., 90A., 105A. Alt.; W/O Noise Restrictions	C9PZ8620BV	②◆9440HD
Belt - Fan & Alt.; W/70A., 90A., 105A. Alt.; W/Noise Restriction	C9PZ8620CB	②◆◆9463HD
Belt - P.S.	C9PZ8620BM	◆9400HD
Belt - Air Brake Compr.	C9PZ8620CM	◆9520HD
Belt - A.C.	D5PZ8620W	◆9360HD
Belt - A.P.	D4PZ8620C	7348
B600; B700; B750		
Belt - Fan & Alt.; W/40A., 42A., 55A., 60A., 61A. Alt.		②◆◆9447HD
Belt - Fan & Alt.; W/70A., 90A., 105A. Alt.; W/O Noise Restrictions	C9PZ8620BV	②◆9440HD
Belt - Fan & Alt.; W/70A., 90A., 105A. Alt.; W/Noise Restriction	C9PZ8620CB	②◆◆9463HD
Belt - P.S.	C9PZ8620BM	◆9400HD
Belt - Air Brake Compr.	C9PZ8620CM	◆9520HD
Belt - A.C.	D5PZ8620W	◆9360HD
Belt - A.P.	D4PZ8620C	7348
Hose - Upper; Single I.D. Hose		≈<20957
Hose - Upper; Dual I.D. Hose; W/1 3/4" Offset		21118
Hose - Upper; Dual I.D. Hose; W/3 5/8" Offset		21078
Hose - Lower - Eng. To Pipe; Strt. Hose(2" I.D.)		24232
Hose - Lower - Eng. To Pipe; Molded Hose		≈<20685
Hose - Lower - Pipe To Rad.		≈<20685
Hose - By Pass - Left Side; Ser. No. T40001 & After		21257
Hose - By Pass - Left Side; Ser. No. T40001 & After(5/8" I.D.)		28441
Hose - By Pass - Right Side; Ser. No. T40001 & After		21258
Ford V-8 391		
B500		
Belt - Fan & Alt.; W/40A., 42A., 55A., 60A., 61A. Alt.		②◆◆9447HD
Belt - Fan & Alt.; W/70A., 90A., 105A. Alt.; W/O Noise Restrictions	C9PZ8620BV	②◆9440HD
Belt - Fan & Alt.; W/70A., 90A., 105A. Alt.; W/Noise Restriction	C9PZ8620CB	②◆◆9463HD
Belt - P.S.	C9PZ8620BM	◆9400HD
Belt - Air Brake Compr.	C9PZ8620CM	◆9520HD
Belt - A.C.	D5PZ8620W	◆9360HD
Belt - A.P.	D4PZ8620C	7348
B600; B700; B750		
Belt - Fan & Alt.; W/40A., 42A., 55A., 60A., 61A. Alt.		②◆◆9447HD
Belt - Fan & Alt.; W/70A., 90A., 105A. Alt.; W/O Noise Restrictions	C9PZ8620BV	②◆9440HD
Belt - Fan & Alt.; W/70A., 90A., 105A. Alt.; W/Noise Restriction	C9PZ8620CB	②◆◆9463HD
Belt - P.S.	C9PZ8620BM	◆9400HD

≈ Cut to Fit.

◆ Green Stripe® PowerBand® Belt May Work, Use Template to Check.

● Vulco-Flex® Coolant Hose.

② Two Required.

◆ Standard Belt Available. See Pages 630-631.

Belts and Coolant Hose for School Buses

School Buses

Application	Mfr. Part No.	Our No.
FORD - Continued		
1974-1973 - Continued		
Ford V-8 391 - Continued		
B600; B700; B750 - Continued		
Belt - Air Brake Compr.	C9PZ8620CM	▲9520HD
Belt - A.C.	D5PZ8620W	▲9360HD
Belt - A.P.	D4PZ8620C	7348
Hose - Upper; Single I.D. Hose		≪20957
Hose - Upper; Dual I.D. Hose; W/1 3/4" Offset		21118
Hose - Upper; Dual I.D. Hose; W/3 5/8" Offset		21078
Hose - Lower - Eng. To Pipe; Strt. Hose(2" I.D.)		24232
Hose - Lower - Eng. To Pipe; Molded Hose		≪20685
Hose - Lower - Pipe To Rad.		≪20685
Hose - By Pass - Left Side; Ser. No. T40001 & After		21257
Hose - By Pass - Left Side; Ser. No. T40001 & After(5/8" I.D.)		28441
Hose - By Pass - Right Side; Ser. No. T40001 & After		21258
1972		
Caterpillar V-8 522 Diesel		
B7000		
Belt - Fan & Alt.; W/40A., 42A., 55A., 60A. 70A. Alt.	C9PZ8620DE	②◆▲9610HD
Belt - Fan & Alt.; W/65A. Alt.	C9PZ8620DG	②◆▲9625HD
Belt - Fan & Alt.; W/105A. Alt.	C9PZ8620GV	②◆▲9630HD
Belt - P.S.	C9PZ8620BH	▲9370HD
Belt - Air Brake Compr.	D0HA8620U	▲9550HD
Belt - Hyd. Brake Boost Pump	D0AZ8620E	▲9525HD
Belt - V.P.	D2AE8620HA	▲9580HD
Hose - Lower		≪21379
Hose - Oil Cooler Inlet		21381
Hose - Oil Cooler Outlet		21380
Hose - Heater; (5/8" I.D.)		28441
Caterpillar V-8 573 Diesel		
B7000		
Belt - Fan & Alt.; W/42A., 55A., 61A., 70A. Alt. D0HA8620AA	②◆▲9610HD	
Belt - Fan & Alt.; W/65A. Alt.	②◆▲9620HD	
Belt - Fan & Alt.; W/105A. Alt.	②◆▲9630HD	
Belt - P.S.	▲9370HD	
Belt - Air Brake Compr.	D0HA8620U	▲9550HD
Belt - V.P.	D0HA8620AG	▲9525HD
Hose - Lower		≪21379
Hose - Oil Cooler Inlet		21381
Hose - Oil Cooler Outlet		21380
Ford 6-Cyl. 240		
B500; B600		
Belt - Fan & Alt.; W/38A., 42A., Y45A., 55A. Alt.	C9PZ8620V	②7417
Belt - Fan & Alt.; W/65A., 70A. Alt.	C9PZ8620GJ	②7430
Belt - P.S.	C9PZ8620BH	▲9370HD
Belt - Air Brake Compr.	C9PZ8620BH	▲9412HD
Hose - Upper		≪20450
	or	●25476
Hose - Lower		20475
	or	●26502
Ford 6-Cyl. 300		
B500; B600		
Belt - Fan & Alt.; W/38A., 42A., Y45A., 55A. Alt.; W/L.D. Eng.	C9PZ8620V	②7417
Belt - Fan & Alt.; W/38A., 42A., 45A., 55A. Alt.; W/H.D. Eng.	C9PZ8620BS	②◆▲9425HD
Belt - Fan & Alt.; W/65A., 70A. Alt.; W/H.D. Eng.	C9PZ8620GJ	②7430
Belt - Fan & Alt.; W/60A., 65A. Alt.; W/H.D. Eng.	C9PZ8620BY	②◆▲9447HD
Belt - P.S.	C9PZ8620BH	▲9370HD
Belt - Air Brake Compr.	C9PZ8620BH	▲9412HD
Hose - Upper		≪20450
	or	●25476
Hose - Lower		20475
	or	●26502

Application	Mfr. Part No.	Our No.
FORD - Continued		
1972 - Continued		
Ford V-8 330		
B500		
Belt - Fan & Alt.; W/42A., 55A., 61A., 65A. Alt.	C9PZ8620BV	②◆▲9440HD
Belt - Fan & Alt.; W/105A. Alt.	C9PZ8620CB	②◆▲9463HD
Belt - P.S.	C9PZ8620BM	▲9400HD
Belt - Air Brake Compr.	C9PZ8620CM	▲9520HD
Belt - A.C.	C9PZ8620BH	▲9370HD
Belt - A.P.	C9PZ8620FY	7455
Hose - Upper; Single I.D. Hose		≪20957
Hose - Upper; Dual I.D. Hose; W/1 3/4" Offset		21118
Hose - Upper; Dual I.D. Hose; W/3 5/8" Offset		21078
Hose - Lower - Eng. To Pipe; Strt. Hose(2" I.D.)		24232
Hose - Lower - Eng. To Pipe; Molded Hose		≪20685
Hose - Lower - Pipe To Rad.		≪20685
Hose - By Pass - Left Side; Ser. No. T40001 & After; Molded Hose		21257
Hose - By Pass - Left Side; Ser. No. T40001 & After; Strt. Hose(5/8" I.D.)		28441
Hose - By Pass - Right Side; Ser. No. T40001 & After		21258
Ford V-8 361		
B500		
Belt - Fan & Alt.; W/42A., 55A., 61A., 65A. Alt.	C9PZ8620BV	②◆▲9440HD
Belt - Fan & Alt.; W/105A. Alt.	C9PZ8620CB	②◆▲9463HD
Belt - P.S.	C9PZ8620BM	▲9400HD
Belt - Air Brake Compr.	C9PZ8620CM	▲9520HD
Belt - A.C.	C9PZ8620BH	▲9370HD
Belt - A.P.	C9PZ8620FY	7455
B600; B700; B750		
Belt - Fan & Alt.; W/42A., 55A., 61A., 65A. Alt.	C9PZ8620BV	②◆▲9440HD
Belt - Fan & Alt.; W/105A. Alt.	C9PZ8620CB	②◆▲9463HD
Belt - P.S.	C9PZ8620BM	▲9400HD
Belt - Air Brake Compr.	C9PZ8620CM	▲9520HD
Belt - A.C.	C9PZ8620BH	▲9370HD
Belt - A.P.	C9PZ8620FY	7455
Hose - Upper; Single I.D. Hose		≪20957
Hose - Upper; Dual I.D. Hose; W/1 3/4" Offset		21118
Hose - Upper; Dual I.D. Hose; W/3 5/8" Offset		21078
Hose - Lower - Eng. To Pipe; Strt. Hose(2" I.D.)		24232
Hose - Lower - Eng. To Pipe; Molded Hose		≪20685
Hose - Lower - Pipe To Rad.		≪20685
Hose - By Pass - Left Side; Ser. No. T40001 & After; Molded Hose		21257
Hose - By Pass - Left Side; Ser. No. T40001 & After; Strt. Hose(5/8" I.D.)		28441
Hose - By Pass - Right Side; Ser. No. T40001 & After		21258
Ford V-8 391		
B500		
Belt - Fan & Alt.; W/42A., 55A., 61A., 65A. Alt.	C9PZ8620BV	②◆▲9440HD
Belt - Fan & Alt.; W/105A. Alt.	C9PZ8620CB	②◆▲9463HD
Belt - P.S.	C9PZ8620BM	▲9400HD
Belt - Air Brake Compr.	C9PZ8620CM	▲9520HD
Belt - A.C.	C9PZ8620BH	▲9370HD
Belt - A.P.	C9PZ8620FY	7455
B600; B700; B750		
Belt - Fan & Alt.; W/42A., 55A., 61A., 65A. Alt.	C9PZ8620BV	②◆▲9440HD
Belt - Fan & Alt.; W/105A. Alt.	C9PZ8620CB	②◆▲9463HD
Belt - P.S.	C9PZ8620BM	▲9400HD
Belt - Air Brake Compr.	C9PZ8620CM	▲9520HD
Belt - A.C.	C9PZ8620BH	▲9370HD
Belt - A.P.	C9PZ8620FY	7455
Hose - Upper; Single I.D. Hose		≪20957
Hose - Upper; Dual I.D. Hose; W/1 3/4" Offset		21118
Hose - Upper; Dual I.D. Hose; W/3 5/8" Offset		21078
Hose - Lower - Eng. To Pipe; Strt. Hose(2" I.D.)		24232

▲ Standard Belt Available. See Pages 630-631.
 ② Two Required.
 ● Vulco-Flex® Coolant Hose.

≪ Cut to Fit.
 ◆ Green Stripe® PowerBand® Belt May Work, Use Template to Check.

Belts and Coolant Hose for School Buses

School Buses

Application	Mfr. Part No.	Our No.
FORD - Continued		
1972 - Continued		
Ford V-8 391 - Continued		
B600; B700; B750 - Continued		
Hose - Lower - Eng. To Pipe; Molded Hose		☞20685
Hose - Lower - Pipe To Rad.		☞20685
Hose - By Pass - Left Side; Ser. No. T40001 & After; Molded Hose		21257
Hose - By Pass - Left Side; Ser. No. T40001 & After; Strt. Hose(5/8" I.D.)		28441
Hose - By Pass - Right Side; Ser. No. T40001 & After		21258
1971		
Caterpillar V-8 522 Diesel		
B6000; B7000		
Belt - Fan & Alt.; W/40A., 42A., 55A., 60A. 70A. Alt.	C9PZ8620DE	②◆▲9610HD
Belt - Fan & Alt.; W/65A. Alt.	C9PZ8620DG	②▲9625HD
Belt - Fan & Alt.; W/105A. Alt.	C9PZ8620GV	②▲9630HD
Belt - P.S.	C9PZ8620BH	▲9370HD
Belt - Air Brake Compr.	D0HA8620U	▲9550HD
Belt - A.P.	C7TA8620S	▲9530HD
Belt - Hyd. Brake Boost Pump	D0AZ8620E	▲9525HD
Hose - Lower		☞21379
Hose - Oil Cooler Inlet		21381
Hose - Oil Cooler Outlet		21380
Hose - Heater; (5/8" I.D.)		28441
Caterpillar V-8 573 Diesel		
B7000		
Belt - Fan & Alt.; W/42A., 55A., 61A., 70A. Alt. D0HA8620AA		②◆▲9610HD
Belt - Fan & Alt.; W/65A. Alt.		②▲9620HD
Belt - Fan & Alt.; W/105A. Alt.		②▲9630HD
Belt - P.S.		▲9370HD
Belt - Air Brake Compr.	D0HA8620U	▲9550HD
Belt - V.P.	D0HA8620AG	▲9525HD
Hose - Lower		☞21379
Hose - Oil Cooler Inlet		21381
Hose - Oil Cooler Outlet		21380
Ford 6-Cyl. 240		
B500; B600		
Belt - Fan & Alt.; W/38A., 42A., Y45A., 55A. Alt.	C9PZ8620V	②7417
Belt - Fan & Alt.; W/65A., 70A. Alt.	C9PZ8620GJ	②7430
Belt - P.S.	C9PZ8620BH	▲9370HD
Belt - Air Brake Compr.	C9PZ8620BH	▲9412HD
Hose - Upper		☞20450
	or	●25476
Hose - Lower		20475
	or	●26502
Ford 6-Cyl. 300		
B500; B600		
Belt - Fan & Alt.; W/38A., 42A., Y45A., 55A. Alt.; W/L.D. Eng.	C9PZ8620V	②7417
Belt - Fan & Alt.; W/38A., 42A., 45A., 55A. Alt.; W/H.D. Eng.	C9PZ8620BS	②▲9425HD
Belt - Fan & Alt.; W/65A., 70A. Alt.; W/H.D. Eng.	C9PZ8620GJ	②7430
Belt - Fan & Alt.; W/60A., 65A. Alt.; W/H.D. Eng.	C9PZ8620BY	②◆▲9447HD
Belt - P.S.	C9PZ8620BH	▲9370HD
Belt - Air Brake Compr.	C9PZ8620BH	▲9412HD
Hose - Upper		☞20450
	or	●25476
Hose - Lower		20475
	or	●26502
Ford V-8 330		
B500		
Belt - Fan & Alt.; W/42A., 55A., 61A., 65A. Alt.	C9PZ8620BV	②▲9440HD
Belt - Fan & Alt.; W/105A. Alt.	C9PZ8620CB	②◆▲9463HD
Belt - P.S.	C9PZ8620BM	▲9400HD
Belt - Air Brake Compr.	C9PZ8620CM	▲9520HD
Belt - A.C.	C9PZ8620BH	▲9370HD

☞ Cut to Fit.
 ◆ Green Stripe® PowerBand® Belt May Work, Use Template to Check.
 ● Vulco-Flex® Coolant Hose.

Application	Mfr. Part No.	Our No.
FORD - Continued		
1971 - Continued		
Ford V-8 330 - Continued		
B500 - Continued		
Belt - A.P.	C9PZ8620FY	7455
B600; B700; B750		
Belt - Fan & Alt.; W/42A., 55A., 61A., 65A. Alt.	C9PZ8620BV	②▲9440HD
Belt - Fan & Alt.; W/105A. Alt.	C9PZ8620CB	②◆▲9463HD
Belt - P.S.	C9PZ8620BM	▲9400HD
Belt - Air Brake Compr.	C9PZ8620CM	▲9520HD
Belt - A.C.	C9PZ8620BH	▲9370HD
Belt - A.P.	C9PZ8620FY	7455
Hose - Upper; Single I.D. Hose		☞20957
Hose - Upper; Dual I.D. Hose; W/1 3/4" Offset		21118
Hose - Upper; Dual I.D. Hose; W/3 5/8" Offset		21078
Hose - Lower - Eng. To Pipe; Strt. Hose(2" I.D.)		24232
Hose - Lower - Eng. To Pipe; Molded Hose		☞20685
Hose - Lower - Pipe To Rad.		☞20685
Hose - By Pass - Left Side; Ser. No. T40001 & After; Molded Hose		21257
Hose - By Pass - Left Side; Ser. No. T40001 & After; Strt. Hose(5/8" I.D.)		28441
Hose - By Pass - Right Side; Ser. No. T40001 & After		21258
Ford V-8 361		
B500		
Belt - Fan & Alt.; W/42A., 55A., 61A., 65A. Alt.	C9PZ8620BV	②▲9440HD
Belt - Fan & Alt.; W/105A. Alt.	C9PZ8620CB	②◆▲9463HD
Belt - P.S.	C9PZ8620BM	▲9400HD
Belt - Air Brake Compr.	C9PZ8620CM	▲9520HD
Belt - A.C.	C9PZ8620BH	▲9370HD
Belt - A.P.	C9PZ8620FY	7455
B600; B700; B750		
Belt - Fan & Alt.; W/42A., 55A., 61A., 65A. Alt.	C9PZ8620BV	②▲9440HD
Belt - Fan & Alt.; W/105A. Alt.	C9PZ8620CB	②◆▲9463HD
Belt - P.S.	C9PZ8620BM	▲9400HD
Belt - Air Brake Compr.	C9PZ8620CM	▲9520HD
Belt - A.C.	C9PZ8620BH	▲9370HD
Belt - A.P.	C9PZ8620FY	7455
Hose - Upper; Single I.D. Hose		☞20957
Hose - Upper; Dual I.D. Hose; W/1 3/4" Offset		21118
Hose - Upper; Dual I.D. Hose; W/3 5/8" Offset		21078
Hose - Lower - Eng. To Pipe; Strt. Hose(2" I.D.)		24232
Hose - Lower - Eng. To Pipe; Molded Hose		☞20685
Hose - Lower - Pipe To Rad.		☞20685
Hose - By Pass - Left Side; Ser. No. T40001 & After; Molded Hose		21257
Hose - By Pass - Left Side; Ser. No. T40001 & After; Strt. Hose(5/8" I.D.)		28441
Hose - By Pass - Right Side; Ser. No. T40001 & After		21258
Ford V-8 391		
B500		
Belt - Fan & Alt.; W/42A., 55A., 61A., 65A. Alt.	C9PZ8620BV	②▲9440HD
Belt - Fan & Alt.; W/105A. Alt.	C9PZ8620CB	②◆▲9463HD
Belt - P.S.	C9PZ8620BM	▲9400HD
Belt - Air Brake Compr.	C9PZ8620CM	▲9520HD
Belt - A.C.	C9PZ8620BH	▲9370HD
Belt - A.P.	C9PZ8620FY	7455
B600; B700; B750		
Belt - Fan & Alt.; W/42A., 55A., 61A., 65A. Alt.	C9PZ8620BV	②▲9440HD
Belt - Fan & Alt.; W/105A. Alt.	C9PZ8620CB	②◆▲9463HD
Belt - P.S.	C9PZ8620BM	▲9400HD
Belt - Air Brake Compr.	C9PZ8620CM	▲9520HD
Belt - A.C.	C9PZ8620BH	▲9370HD
Belt - A.P.	C9PZ8620FY	7455
Hose - Upper; Single I.D. Hose		☞20957
Hose - Upper; Dual I.D. Hose; W/1 3/4" Offset		21118
Hose - Upper; Dual I.D. Hose; W/3 5/8" Offset		21078
Hose - Lower - Eng. To Pipe; Strt. Hose(2" I.D.)		24232
Hose - Lower - Eng. To Pipe; Molded Hose		☞20685
Hose - Lower - Pipe To Rad.		☞20685
Hose - By Pass - Left Side; Ser. No. T40001 & After; Molded Hose		21257

② Two Required.
 ▲ Standard Belt Available. See Pages 630-631.

Belts and Coolant Hose for School Buses

School Buses

Application	Mfr. Part No.	Our No.
FORD - Continued		
1971 - Continued		
Ford V-8 391 - Continued		
B600; B700; B750 - Continued		
Hose - By Pass - Left Side; Ser. No. T40001 & After; Strt. Hose(5/8" I.D.)		28441
Hose - By Pass - Right Side; Ser. No. T40001 & After		21258
1970		
Caterpillar V-8 522 Diesel		
B6000; B7000		
Belt - Fan & Alt.; W/40A., 42A., 55A., 60A., 70A. Alt.	C9PZ8620DE	②◆▲9610HD
Belt - Fan & Alt.; W/65A. Alt.	C9PZ8620DG	②▲9625HD
Belt - Fan & Alt.; W/105A. Alt.	C9PZ8620DP	②◆▲9670HD
Belt - P.S.	C9PZ8620BH	▲9370HD
Belt - Air Brake Compr.	D0HA8620U	▲9550HD
Belt - A.P.	C7TA8620S	▲9530HD
Belt - Hyd. Brake Boost Pump	D0AZ8620E	▲9525HD
Hose - Lower		≧21379
Hose - Oil Cooler Inlet		21381
Hose - Oil Cooler Outlet		21380
Hose - Heater; (5/8" I.D.)		28441
Caterpillar V-8 573 Diesel		
B7000		
Belt - Fan & Alt.; W/42A., 55A., 61A., 70A. Alt.	D0HA8620AA	②◆▲9610HD
Belt - Fan & Alt.; W/65A. Alt.		②▲9620HD
Belt - Fan & Alt.; W/105A. Alt.		②▲9630HD
Belt - P.S.		▲9370HD
Belt - Air Brake Compr.	D0HA8620U	▲9550HD
Belt - V.P.	D0HA8620AG	▲9525HD
Hose - Lower		≧21379
Hose - Oil Cooler Inlet		21381
Hose - Oil Cooler Outlet		21380
Ford 6-Cyl. 240		
B500; B600		
Belt - Fan & Alt.; W/38A., 42A., Y45A., 55A. Alt.	C9PZ8620V	②7417
Belt - Fan & Alt.; W/65A., 70A. Alt.	C9PZ8620GJ	②7430
Belt - P.S.	C9PZ8620BH	▲9370HD
Belt - Air Brake Compr.	C9PZ8620BH	▲9412HD
Hose - Upper		≧20450
		or ●25476
Hose - Lower		20475
		or ●26502
Ford 6-Cyl. 300		
B500; B600		
Belt - Fan & Alt.; W/38A., 42A., Y45A., 55A. Alt.; W/L.D. Eng.	C9PZ8620V	②7417
Belt - Fan & Alt.; W/38A., 42A., 45A., 55A. Alt.; W/H.D. Eng.	C9PZ8620BS	②▲9425HD
Belt - Fan & Alt.; W/65A., 70A. Alt.; W/H.D. Eng.	C9PZ8620GJ	②7430
Belt - Fan & Alt.; W/60A., 65A. Alt.; W/H.D. Eng.	C9PZ8620BY	②◆▲9447HD
Belt - P.S.	C9PZ8620BH	▲9370HD
Belt - Air Brake Compr.	C9PZ8620BH	▲9412HD
Hose - Upper		≧20450
		or ●25476
Hose - Lower		20475
		or ●26502
Ford V-8 330		
B500		
Belt - Fan & Alt.; W/42A., 55A., 61A., 65A. Alt.	C9PZ8620BV	②▲9440HD
Belt - Fan & Alt.; W/105A. Alt.	C9PZ8620CB	②◆▲9463HD
Belt - P.S.	C9PZ8620BM	▲9400HD
Belt - Air Brake Compr.	C9PZ8620CM	▲9520HD
Belt - A.C.	C9PZ8620BH	▲9370HD
Belt - A.P.	C9PZ8620FY	7455
B600; B700; B750		
Belt - Fan & Alt.; W/42A., 55A., 61A., 65A. Alt.	C9PZ8620BV	②▲9440HD
Belt - Fan & Alt.; W/105A. Alt.	C9PZ8620CB	②◆▲9463HD

Application	Mfr. Part No.	Our No.
FORD - Continued		
1970 - Continued		
Ford V-8 330 - Continued		
B600; B700; B750 - Continued		
Belt - P.S.	C9PZ8620BM	▲9400HD
Belt - Air Brake Compr.	C9PZ8620CM	▲9520HD
Belt - A.C.	C9PZ8620BH	▲9370HD
Belt - A.P.	C9PZ8620FY	7455
Hose - Upper; Single I.D. Hose		≧20957
Hose - Upper; Dual I.D. Hose; W/1 3/4" Offset		21118
Hose - Upper; Dual I.D. Hose; W/3 5/8" Offset		21078
Hose - Lower - Eng. To Pipe; Strt. Hose(2" I.D.)		24232
Hose - Lower - Eng. To Pipe; Molded Hose		≧20685
Hose - Lower - Pipe To Rad.		≧20685
Hose - By Pass - Left Side; Ser. No. T40001 & After; Molded Hose		21257
Hose - By Pass - Left Side; Ser. No. T40001 & After; Strt. Hose(5/8" I.D.)		28441
Hose - By Pass - Right Side; Ser. No. T40001 & After		21258
Ford V-8 361		
B500		
Belt - Fan & Alt.; W/42A., 55A., 61A., 65A. Alt.	C9PZ8620BV	②▲9440HD
Belt - Fan & Alt.; W/105A. Alt.	C9PZ8620CB	②◆▲9463HD
Belt - P.S.	C9PZ8620BM	▲9400HD
Belt - Air Brake Compr.	C9PZ8620CM	▲9520HD
Belt - A.C.	C9PZ8620BH	▲9370HD
Belt - A.P.	C9PZ8620FY	7455
B600; B700; B750		
Belt - Fan & Alt.; W/42A., 55A., 61A., 65A. Alt.	C9PZ8620BV	②▲9440HD
Belt - Fan & Alt.; W/105A. Alt.	C9PZ8620CB	②◆▲9463HD
Belt - P.S.	C9PZ8620BM	▲9400HD
Belt - Air Brake Compr.	C9PZ8620CM	▲9520HD
Belt - A.C.	C9PZ8620BH	▲9370HD
Belt - A.P.	C9PZ8620FY	7455
Hose - Upper; Single I.D. Hose		≧20957
Hose - Upper; Dual I.D. Hose; W/1 3/4" Offset		21118
Hose - Upper; Dual I.D. Hose; W/3 5/8" Offset		21078
Hose - Lower - Eng. To Pipe; Strt. Hose(2" I.D.)		24232
Hose - Lower - Eng. To Pipe; Molded Hose		≧20685
Hose - Lower - Pipe To Rad.		≧20685
Hose - By Pass - Left Side; Ser. No. T40001 & After; Molded Hose		21257
Hose - By Pass - Left Side; Ser. No. T40001 & After; Strt. Hose(5/8" I.D.)		28441
Hose - By Pass - Right Side; Ser. No. T40001 & After		21258
Ford V-8 391		
B500		
Belt - Fan & Alt.; W/42A., 55A., 61A., 65A. Alt.	C9PZ8620BV	②▲9440HD
Belt - Fan & Alt.; W/105A. Alt.	C9PZ8620CB	②◆▲9463HD
Belt - P.S.	C9PZ8620BM	▲9400HD
Belt - Air Brake Compr.	C9PZ8620CM	▲9520HD
Belt - A.C.	C9PZ8620BH	▲9370HD
Belt - A.P.	C9PZ8620FY	7455
B600; B700; B750		
Belt - Fan & Alt.; W/42A., 55A., 61A., 65A. Alt.	C9PZ8620BV	②▲9440HD
Belt - Fan & Alt.; W/105A. Alt.	C9PZ8620CB	②◆▲9463HD
Belt - P.S.	C9PZ8620BM	▲9400HD
Belt - Air Brake Compr.	C9PZ8620CM	▲9520HD
Belt - A.C.	C9PZ8620BH	▲9370HD
Belt - A.P.	C9PZ8620FY	7455
Hose - Upper; Single I.D. Hose		≧20957
Hose - Upper; Dual I.D. Hose; W/1 3/4" Offset		21118
Hose - Upper; Dual I.D. Hose; W/3 5/8" Offset		21078
Hose - Lower - Eng. To Pipe; Strt. Hose(2" I.D.)		24232
Hose - Lower - Eng. To Pipe; Molded Hose		≧20685
Hose - Lower - Pipe To Rad.		≧20685
Hose - By Pass - Left Side; Ser. No. T40001 & After; Molded Hose		21257
Hose - By Pass - Left Side; Ser. No. T40001 & After; Strt. Hose(5/8" I.D.)		28441
Hose - By Pass - Right Side; Ser. No. T40001 & After		21258

② Two Required.

▲ Standard Belt Available. See Pages 630-631.

● Vulco-Flex® Coolant Hose.

◆ Green Stripe® PowerBand® Belt May Work, Use Template to Check.

≧ Cut to Fit.

Belts and Coolant Hose for School Buses

Application	Mfr. Part No.	Our No.
FORD - Continued		
1969-1968		
Caterpillar V-8 522 Diesel		
B6000; B7000		
Belt - Fan & Alt.; W/40A., 42A., 55A., 60A., 70A. Alt.	C9PZ8620DE	②◆◆9610HD
Belt - Fan & Alt.; W/65A. Alt.	C9PZ8620DG	②◆9625HD
Belt - Fan & Alt.; W/105A. Alt.	C9PZ8620DP	②◆◆9670HD
Belt - P.S.	C9PZ8620BH	◆9370HD
Belt - Air Brake Compr.	D0HA8620U	◆9550HD
Belt - A.P.	C7TA8620S	◆9530HD
Belt - Hyd. Brake Boost Pump	D0AZ8620E	◆9525HD
Hose - Lower		≈<21379
Hose - Oil Cooler Inlet		21381
Hose - Oil Cooler Outlet		21380
Hose - Heater; (5/8" I.D.)		28441
Caterpillar V-8 573 Diesel		
B7000		
Belt - Fan & Alt.; W/42A., 55A., 61A., 70A. Alt. D0HA8620AA	②◆◆9610HD	
Belt - Fan & Alt.; W/65A. Alt.	②◆9620HD	
Belt - Fan & Alt.; W/105A. Alt.	②◆9630HD	
Belt - P.S.	◆9370HD	
Belt - Air Brake Compr.	D0HA8620U	◆9550HD
Belt - V.P.	D0HA8620AG	◆9525HD
Hose - Lower		≈<21379
Hose - Oil Cooler Inlet		21381
Hose - Oil Cooler Outlet		21380
Dorset 6-Cyl. 363 Diesel		
B6000; B7000		
Belt - Alt.; W/45A., 55A. Alt.	C7TA8620A	◆9490HD
Belt - Alt.; W/65A. Alt.	C7TA8620B	◆9500HD
Belt - P.S.	C7TA8620S	◆9540HD
Hose - Upper		≈<20475
Hose - Lower; (1 3/4" I.D.)		24228
Ford 6-Cyl. 240		
B500; B600		
Belt - Fan & Alt.; W/38A., 42A., Y45A., 55A. Alt.	C9PZ8620V	②7417
Belt - Fan & Alt.; W/65A., 70A. Alt.	C9PZ8620GJ	②7430
Belt - P.S.	C9PZ8620BH	◆9370HD
Belt - Air Brake Compr.	C9PZ8620BH	◆9412HD
Hose - Upper		≈<20450
		or ●25476
Hose - Lower		20475
		or ●26502
Ford 6-Cyl. 300		
B500; B600		
Belt - Fan & Alt.; W/38A., 42A., Y45A., 55A. Alt.; W/L.D. Eng.	C9PZ8620V	②7417
Belt - Fan & Alt.; W/38A., 42A., 45A., 55A. Alt.; W/H.D. Eng.	C9PZ8620BS	②◆9425HD
Belt - Fan & Alt.; W/65A., 70A. Alt.; W/H.D. Eng.	C9PZ8620GJ	②7430
Belt - Fan & Alt.; W/60A., 65A. Alt.; W/H.D. Eng.	C9PZ8620BY	②◆◆9447HD
Belt - P.S.	C9PZ8620BH	◆9370HD
Belt - Air Brake Compr.	C9PZ8620BH	◆9412HD
Hose - Upper		≈<20450
		or ●25476
Hose - Lower		20475
		or ●26502
Ford V-8 330		
B500		
Belt - Fan; W/High Mount Fan	C9PZ8620FK	TR28480
Belt - Fan & Alt.; W/O 60A., 100A. Alt.	C9PZ8620CB	②◆◆9463HD
Belt - Fan & Alt.; W/60A., 100A. Alt.	C9PZ8620CF	②◆◆9476HD
Belt - P.S.	C9PZ8620BM	◆9400HD
Belt - Air Brake Compr.	C9PZ8620CM	◆9520HD
B600; B700; B750		
Belt - Fan; W/High Mount Fan	C9PZ8620FK	TR28480
Belt - Fan & Alt.; W/O 60A., 100A. Alt.	C9PZ8620CB	②◆◆9463HD

Application	Mfr. Part No.	Our No.
FORD - Continued		
1969-1968 - Continued		
Ford V-8 330 - Continued		
B600; B700; B750 - Continued		
Belt - Fan & Alt.; W/60A., 100A. Alt.	C9PZ8620CF	②◆◆9476HD
Belt - P.S.	C9PZ8620BM	◆9400HD
Belt - Air Brake Compr.	C9PZ8620CM	◆9520HD
Hose - Upper; Single I.D. Hose		≈<20957
Hose - Upper; Dual I.D. Hose; W/1 3/4" Offset		21118
Hose - Upper; Dual I.D. Hose; W/3 5/8" Offset		21078
Hose - Lower - Eng. To Pipe; Strt. Hose(2" I.D.)		24232
Hose - Lower - Eng. To Pipe; Molded Hose		≈<20685
Hose - Lower - Pipe To Rad.		≈<20685
Hose - By Pass - Left Side; Ser. No. T40001 & After; Molded Hose		21257
Hose - By Pass - Left Side; Ser. No. T40001 & After; Strt. Hose(5/8" I.D.)		28441
Hose - By Pass - Right Side; Ser. No. T40001 & After		21258
Ford V-8 361		
B500		
Belt - Fan; W/High Mount Fan	C9PZ8620FK	TR28480
Belt - Fan & Alt.; W/O 60A., 100A. Alt.	C9PZ8620CB	②◆◆9463HD
Belt - Fan & Alt.; W/60A., 100A. Alt.	C9PZ8620CF	②◆◆9476HD
Belt - P.S.	C9PZ8620BM	◆9400HD
Belt - Air Brake Compr.	C9PZ8620CM	◆9520HD
B600; B700; B750		
Belt - Fan; W/High Mount Fan	C9PZ8620FK	TR28480
Belt - Fan & Alt.; W/O 60A., 100A. Alt.	C9PZ8620CB	②◆◆9463HD
Belt - Fan & Alt.; W/60A., 100A. Alt.	C9PZ8620CF	②◆◆9476HD
Belt - P.S.	C9PZ8620BM	◆9400HD
Belt - Air Brake Compr.	C9PZ8620CM	◆9520HD
Hose - Upper; Single I.D. Hose		≈<20957
Hose - Upper; Dual I.D. Hose; W/1 3/4" Offset		21118
Hose - Upper; Dual I.D. Hose; W/3 5/8" Offset		21078
Hose - Lower - Eng. To Pipe; Strt. Hose(2" I.D.)		24232
Hose - Lower - Eng. To Pipe; Molded Hose		≈<20685
Hose - Lower - Pipe To Rad.		≈<20685
Hose - By Pass - Left Side; Ser. No. T40001 & After; Molded Hose		21257
Hose - By Pass - Left Side; Ser. No. T40001 & After; Strt. Hose(5/8" I.D.)		28441
Hose - By Pass - Right Side; Ser. No. T40001 & After		21258
Ford V-8 391		
B500		
Belt - Fan; W/High Mount Fan	C9PZ8620FK	TR28480
Belt - Fan & Alt.; W/O 60A., 100A. Alt.	C9PZ8620CB	②◆◆9463HD
Belt - Fan & Alt.; W/60A., 100A. Alt.	C9PZ8620CF	②◆◆9476HD
Belt - P.S.	C9PZ8620BM	◆9400HD
Belt - Air Brake Compr.	C9PZ8620CM	◆9520HD
B600; B700; B750		
Belt - Fan; W/High Mount Fan	C9PZ8620FK	TR28480
Belt - Fan & Alt.; W/O 60A., 100A. Alt.	C9PZ8620CB	②◆◆9463HD
Belt - Fan & Alt.; W/60A., 100A. Alt.	C9PZ8620CF	②◆◆9476HD
Belt - P.S.	C9PZ8620BM	◆9400HD
Belt - Air Brake Compr.	C9PZ8620CM	◆9520HD
Hose - Upper; Single I.D. Hose		≈<20957
Hose - Upper; Dual I.D. Hose; W/1 3/4" Offset		21118
Hose - Upper; Dual I.D. Hose; W/3 5/8" Offset		21078
Hose - Lower - Eng. To Pipe; Strt. Hose(2" I.D.)		24232
Hose - Lower - Eng. To Pipe; Molded Hose		≈<20685
Hose - Lower - Pipe To Rad.		≈<20685
Hose - By Pass - Left Side; Ser. No. T40001 & After; Molded Hose		21257
Hose - By Pass - Left Side; Ser. No. T40001 & After; Strt. Hose(5/8" I.D.)		28441
Hose - By Pass - Right Side; Ser. No. T40001 & After		21258
1967		
Caterpillar V-8 522 Diesel		
B6000		
Belt - Fan & Alt.; W/40A., 42A., 55A., 60A., 70A. Alt.	C9PZ8620DE	②◆◆9610HD
Belt - Fan & Alt.; W/65A. Alt.	C9PZ8620DG	②◆9625HD

② Two Required.
 ◆ Standard Belt Available. See Pages 630-631.
 ● Vulco-Flex® Coolant Hose.

◆ Green Stripe® PowerBand® Belt May Work, Use Template to Check.
 ≈< Cut to Fit.

School Buses

Belts and Coolant Hose for School Buses

School Buses

Application	Mfr. Part No.	Our No.
FORD - Continued		
1967 - Continued		
Caterpillar V-8 522 Diesel - Continued		
B6000 - Continued		
Belt - Fan & Alt.; W/105A. Alt.	C9PZ8620DP	②◆▲9670HD
Belt - P.S.	C9PZ8620BH	▲9370HD
Belt - Air Brake Compr.	D0HA8620U	▲9550HD
Belt - A.P.	C7TA8620S	▲9530HD
Belt - Hyd. Brake Boost Pump	D0AZ8620E	▲9525HD
Hose - Lower		≠21379
Hose - Oil Cooler Inlet		21381
Hose - Oil Cooler Outlet		21380
Hose - Heater; (5/8" I.D.)		28441
Dorset 6-Cyl. 363 Diesel		
B6000; B7000		
Belt - Alt.; W/45A., 55A. Alt.	C7TA8620A	▲9490HD
Belt - Alt.; W/65A. Alt.	C7TA8620B	▲9500HD
Belt - P.S.	C7TA8620S	▲9540HD
Hose - Upper		≠20475
Hose - Lower; (1 3/4" I.D.)		24228
Ford 6-Cyl. 240		
B500; B600		
Belt - Fan & Alt.; W/38A., 42A., Y45A., 55A.		
Alt.	C9PZ8620V	②7417
Belt - Fan & Alt.; W/65A., 70A. Alt.	C9PZ8620GJ	②7430
Belt - P.S.	C9PZ8620BH	▲9370HD
Belt - Air Brake Compr.	C9PZ8620BH	▲9412HD
Hose - Upper		≠20450
		or ●25476
Hose - Lower		20475
		or ●26502
Ford 6-Cyl. 300		
B500; B600		
Belt - Fan & Alt.; W/38A., 42A., Y45A., 55A.		
Alt.; W/L.D. Eng.	C9PZ8620V	②7417
Belt - Fan & Alt.; W/38A., 42A., 45A., 55A.		
Alt.; W/H.D. Eng.	C9PZ8620BS	②▲9425HD
Belt - Fan & Alt.; W/65A., 70A. Alt.; W/H.D.		
Eng.	C9PZ8620GJ	②7430
Belt - Fan & Alt.; W/60A., 65A. Alt.; W/H.D.		
Eng.	C9PZ8620BY	②◆▲9447HD
Belt - P.S.	C9PZ8620BH	▲9370HD
Belt - Air Brake Compr.	C9PZ8620BH	▲9412HD
Hose - Upper		≠20450
		or ●25476
Hose - Lower		20475
		or ●26502
Ford V-8 330		
B500		
Belt - Fan; W/High Mount Fan	C9PZ8620FK	TR28480
Belt - Fan & Alt.; W/O 60A., 100A. Alt.	C9PZ8620CB	②◆▲9463HD
Belt - Fan & Alt.; W/60A., 100A. Alt.	C9PZ8620CF	②◆▲9476HD
Belt - P.S.	C9PZ8620BM	▲9400HD
Belt - Air Brake Compr.	C9PZ8620CM	▲9520HD
B600; B700; B750		
Belt - Fan; W/High Mount Fan	C9PZ8620FK	TR28480
Belt - Fan & Alt.; W/O 60A., 100A. Alt.	C9PZ8620CB	②◆▲9463HD
Belt - Fan & Alt.; W/60A., 100A. Alt.	C9PZ8620CF	②◆▲9476HD
Belt - P.S.	C9PZ8620BM	▲9400HD
Belt - Air Brake Compr.	C9PZ8620CM	▲9520HD
Hose - Upper; Single I.D. Hose		≠20957
Hose - Upper; Dual I.D. Hose; W/1 3/4" Offset		21118
Hose - Upper; Dual I.D. Hose; W/3 5/8" Offset		21078
Hose - Lower - Eng. To Pipe; Strt. Hose(2" I.D.)		24232
Hose - Lower - Eng. To Pipe; Molded Hose		≠20685
Hose - Lower - Pipe To Rad.		≠20685
Hose - By Pass - Left Side; Ser. No. T40001 & After; Molded Hose		21257
Hose - By Pass - Left Side; Ser. No. T40001 & After; Strt. Hose(5/8" I.D.)		28441
Hose - By Pass - Right Side; Ser. No. T40001 & After		21258

Application	Mfr. Part No.	Our No.
FORD - Continued		
1967 - Continued		
Ford V-8 361		
B500		
Belt - Fan; W/High Mount Fan	C9PZ8620FK	TR28480
Belt - Fan & Alt.; W/O 60A., 100A. Alt.	C9PZ8620CB	②◆▲9463HD
Belt - Fan & Alt.; W/60A., 100A. Alt.	C9PZ8620CF	②◆▲9476HD
Belt - P.S.	C9PZ8620BM	▲9400HD
Belt - Air Brake Compr.	C9PZ8620CM	▲9520HD
B600; B700; B750		
Belt - Fan; W/High Mount Fan	C9PZ8620FK	TR28480
Belt - Fan & Alt.; W/O 60A., 100A. Alt.	C9PZ8620CB	②◆▲9463HD
Belt - Fan & Alt.; W/60A., 100A. Alt.	C9PZ8620CF	②◆▲9476HD
Belt - P.S.	C9PZ8620BM	▲9400HD
Belt - Air Brake Compr.	C9PZ8620CM	▲9520HD
Hose - Upper; Single I.D. Hose		≠20957
Hose - Upper; Dual I.D. Hose; W/1 3/4" Offset		21118
Hose - Upper; Dual I.D. Hose; W/3 5/8" Offset		21078
Hose - Lower - Eng. To Pipe; Strt. Hose(2" I.D.)		24232
Hose - Lower - Eng. To Pipe; Molded Hose		≠20685
Hose - Lower - Pipe To Rad.		≠20685
Hose - By Pass - Left Side; Ser. No. T40001 & After; Molded Hose		21257
Hose - By Pass - Left Side; Ser. No. T40001 & After; Strt. Hose(5/8" I.D.)		28441
Hose - By Pass - Right Side; Ser. No. T40001 & After		21258
Ford V-8 391		
B500		
Belt - Fan; W/High Mount Fan	C9PZ8620FK	TR28480
Belt - Fan & Alt.; W/O 60A., 100A. Alt.	C9PZ8620CB	②◆▲9463HD
Belt - Fan & Alt.; W/60A., 100A. Alt.	C9PZ8620CF	②◆▲9476HD
Belt - P.S.	C9PZ8620BM	▲9400HD
Belt - Air Brake Compr.	C9PZ8620CM	▲9520HD
B600; B700; B750		
Belt - Fan; W/High Mount Fan	C9PZ8620FK	TR28480
Belt - Fan & Alt.; W/O 60A., 100A. Alt.	C9PZ8620CB	②◆▲9463HD
Belt - Fan & Alt.; W/60A., 100A. Alt.	C9PZ8620CF	②◆▲9476HD
Belt - P.S.	C9PZ8620BM	▲9400HD
Belt - Air Brake Compr.	C9PZ8620CM	▲9520HD
Hose - Upper; Single I.D. Hose		≠20957
Hose - Upper; Dual I.D. Hose; W/1 3/4" Offset		21118
Hose - Upper; Dual I.D. Hose; W/3 5/8" Offset		21078
Hose - Lower - Eng. To Pipe; Strt. Hose(2" I.D.)		24232
Hose - Lower - Eng. To Pipe; Molded Hose		≠20685
Hose - Lower - Pipe To Rad.		≠20685
Hose - By Pass - Left Side; Ser. No. T40001 & After; Molded Hose		21257
Hose - By Pass - Left Side; Ser. No. T40001 & After; Strt. Hose(5/8" I.D.)		28441
Hose - By Pass - Right Side; Ser. No. T40001 & After		21258
1966-1965		
Ford 6-Cyl. 240		
B500; B600		
Belt - Fan & Alt.; W/38A., 42A., Y45A., 55A.		
Alt.	C9PZ8620V	②7417
Belt - Fan & Alt.; W/65A., 70A. Alt.	C9PZ8620GJ	②7430
Belt - P.S.	C9PZ8620BH	▲9370HD
Belt - Air Brake Compr.	C9PZ8620BH	▲9412HD
Hose - Upper		≠20450
		or ●25476
Hose - Lower		20475
		or ●26502
Ford 6-Cyl. 300		
B500; B600		
Belt - Fan & Alt.; W/38A., 42A., Y45A., 55A.		
Alt.; W/L.D. Eng.	C9PZ8620V	②7417
Belt - Fan & Alt.; W/38A., 42A., 45A., 55A.		
Alt.; W/H.D. Eng.	C9PZ8620BS	②▲9425HD
Belt - Fan & Alt.; W/65A., 70A. Alt.; W/H.D.		
Eng.	C9PZ8620GJ	②7430
Belt - Fan & Alt.; W/60A., 65A. Alt.; W/H.D.		
Eng.	C9PZ8620BY	②◆▲9447HD

② Two Required.
 ▲ Standard Belt Available. See Pages 630-631.
 ● Vulco-Flex® Coolant Hose.

◆ Green Stripe® PowerBand® Belt May Work, Use Template to Check.
 ≠ Cut to Fit.

Belts and Coolant Hose for School Buses

School Buses

Application	Mfr. Part No.	Our No.
FORD - Continued		
1966-1965 - Continued		
Ford 6-Cyl. 300 - Continued		
B500; B600 - Continued		
Belt - P.S.	C9PZ8620BH	▲9370HD
Belt - Air Brake Compr.	C9PZ8620BH	▲9412HD
Hose - Upper		≈<20450
	or	●25476
Hose - Lower		20475
	or	●26502
Ford V-8 330		
B500		
Belt - Fan; W/High Mount Fan	C9PZ8620FK	TR28480
Belt - Fan & Alt.; W/O 60A., 100A. Alt.	C9PZ8620CB	②◆▲9463HD
Belt - Fan & Alt.; W/60A., 100A. Alt.	C9PZ8620CF	②◆▲9476HD
Belt - P.S.	C9PZ8620BM	▲9400HD
Belt - Air Brake Compr.	C9PZ8620CM	▲9520HD
B600; B700; B750		
Belt - Fan; W/High Mount Fan	C9PZ8620FK	TR28480
Belt - Fan & Alt.; W/O 60A., 100A. Alt.	C9PZ8620CB	②◆▲9463HD
Belt - Fan & Alt.; W/60A., 100A. Alt.	C9PZ8620CF	②◆▲9476HD
Belt - P.S.	C9PZ8620BM	▲9400HD
Belt - Air Brake Compr.	C9PZ8620CM	▲9520HD
Hose - Upper; Single I.D. Hose		≈<20957
Hose - Upper; Dual I.D. Hose; W/1 3/4" Offset		21118
Hose - Upper; Dual I.D. Hose; W/3 5/8" Offset		21078
Hose - Lower - Eng. To Pipe; Strt. Hose(2" I.D.)		24232
Hose - Lower - Eng. To Pipe; Molded Hose		≈<20685
Hose - Lower - Pipe To Rad.		≈<20685
Hose - By Pass - Left Side; Ser. No. T40001 & After		21257
Hose - By Pass - Left Side; Ser. No. T40001 & After(5/8" I.D.)		28441
Hose - By Pass - Right Side; Ser. No. T40001 & After		21258
Ford V-8 361		
B500		
Belt - Fan; W/High Mount Fan	C9PZ8620FK	TR28480
Belt - Fan & Alt.; W/O 60A., 100A. Alt.	C9PZ8620CB	②◆▲9463HD
Belt - Fan & Alt.; W/60A., 100A. Alt.	C9PZ8620CF	②◆▲9476HD
Belt - P.S.	C9PZ8620BM	▲9400HD
Belt - Air Brake Compr.	C9PZ8620CM	▲9520HD
B600; B700; B750		
Belt - Fan; W/High Mount Fan	C9PZ8620FK	TR28480
Belt - Fan & Alt.; W/O 60A., 100A. Alt.	C9PZ8620CB	②◆▲9463HD
Belt - Fan & Alt.; W/60A., 100A. Alt.	C9PZ8620CF	②◆▲9476HD
Belt - P.S.	C9PZ8620BM	▲9400HD
Belt - Air Brake Compr.	C9PZ8620CM	▲9520HD
Hose - Upper; Single I.D. Hose		≈<20957
Hose - Upper; Dual I.D. Hose; W/1 3/4" Offset		21118
Hose - Upper; Dual I.D. Hose; W/3 5/8" Offset		21078
Hose - Lower - Eng. To Pipe; Strt. Hose(2" I.D.)		24232
Hose - Lower - Eng. To Pipe; Molded Hose		≈<20685
Hose - Lower - Pipe To Rad.		≈<20685
Hose - By Pass - Left Side; Ser. No. T40001 & After		21257
Hose - By Pass - Left Side; Ser. No. T40001 & After(5/8" I.D.)		28441
Hose - By Pass - Right Side; Ser. No. T40001 & After		21258
Ford V-8 391		
B500		
Belt - Fan; W/High Mount Fan	C9PZ8620FK	TR28480
Belt - Fan & Alt.; W/O 60A., 100A. Alt.	C9PZ8620CB	②◆▲9463HD
Belt - Fan & Alt.; W/60A., 100A. Alt.	C9PZ8620CF	②◆▲9476HD
Belt - P.S.	C9PZ8620BM	▲9400HD
Belt - Air Brake Compr.	C9PZ8620CM	▲9520HD
B600; B700; B750		
Belt - Fan; W/High Mount Fan	C9PZ8620FK	TR28480
Belt - Fan & Alt.; W/O 60A., 100A. Alt.	C9PZ8620CB	②◆▲9463HD
Belt - Fan & Alt.; W/60A., 100A. Alt.	C9PZ8620CF	②◆▲9476HD
Belt - P.S.	C9PZ8620BM	▲9400HD
Belt - Air Brake Compr.	C9PZ8620CM	▲9520HD
Hose - Upper; Single I.D. Hose		≈<20957
Hose - Upper; Dual I.D. Hose; W/1 3/4" Offset		21118
Hose - Upper; Dual I.D. Hose; W/3 5/8" Offset		21078
Hose - Lower - Eng. To Pipe; Strt. Hose(2" I.D.)		24232
Hose - Lower - Eng. To Pipe; Molded Hose		≈<20685

Application	Mfr. Part No.	Our No.
FORD - Continued		
1966-1965 - Continued		
Ford V-8 391 - Continued		
B600; B700; B750 - Continued		
Hose - Lower - Pipe To Rad.		≈<20685
Hose - By Pass - Left Side; Ser. No. T40001 & After		21257
Hose - By Pass - Left Side; Ser. No. T40001 & After(5/8" I.D.)		28441
Hose - By Pass - Right Side; Ser. No. T40001 & After		21258
1964		
Ford 6-Cyl. 223		
B500; B600		
Belt - Fan & Alt.	C4TE8620S	②7405
Belt - Fan & Gen.	C4TE8620S	7405
Hose - Upper		20450
	or	●25474
Hose - Lower		≈<20584
	or	●26611
Ford 6-Cyl. 262		
B500; B600		
Belt - Fan & Alt.	C6TE8620D	②7450
Belt - Fan & Gen.	C8DE8620B	②7450
Belt - P.S.	EAM2890A	▲9341HD
Belt - Air Brake Compr.	C2AE8620S	▲9365HD
Hose - Upper		20450
	or	●25474
Ford V-8 292		
B500; B600; B700		
Belt - Fan & Alt.; W/Single Belt	C4TE8620AD	7450
Belt - Fan & Alt.; W/Dual Belts	C4TE8620AD	②7450
Belt - P.S.	C2AE8620L	▲9415HD
Belt - Air Brake Compr.	C2TE8620U	▲9500HD
Hose - Upper		≈<20380
	or	●25478
Hose - Lower		≈<20276
	or	●26504
Hose - By Pass; (5/8" I.D.)		28441
Ford V-8 330		
B500		
Belt - Fan; W/High Mount Fan	C9PZ8620FK	TR28480
Belt - Fan & Alt.; W/O 60A., 100A. Alt.	C9PZ8620CB	②◆▲9463HD
Belt - Fan & Alt.; W/60A., 100A. Alt.	C9PZ8620CF	②◆▲9476HD
Belt - P.S.	C9PZ8620BM	▲9400HD
Belt - Air Brake Compr.	C9PZ8620CM	▲9520HD
B600; B700; B750		
Belt - Fan; W/High Mount Fan	C9PZ8620FK	TR28480
Belt - Fan & Alt.; W/O 60A., 100A. Alt.	C9PZ8620CB	②◆▲9463HD
Belt - Fan & Alt.; W/60A., 100A. Alt.	C9PZ8620CF	②◆▲9476HD
Belt - P.S.	C9PZ8620BM	▲9400HD
Belt - Air Brake Compr.	C9PZ8620CM	▲9520HD
Hose - Upper; Single I.D. Hose		≈<20957
Hose - Upper; Dual I.D. Hose; W/1 3/4" Offset		21118
Hose - Upper; Dual I.D. Hose; W/3 5/8" Offset		21078
Hose - Lower - Eng. To Pipe; Strt. Hose(2" I.D.)		24232
Hose - Lower - Eng. To Pipe; Molded Hose		≈<20685
Hose - Lower - Pipe To Rad.		≈<20685
Hose - By Pass - Left Side; Ser. No. T40001 & After		21257
Hose - By Pass - Left Side; Ser. No. T40001 & After(5/8" I.D.)		28441
Hose - By Pass - Right Side; Ser. No. T40001 & After		21258
Ford V-8 359		
B500		
Belt - Fan; W/High Mount Fan	C9PZ8620FK	TR28480
Belt - Fan & Alt.; W/O 60A., 100A. Alt.	C9PZ8620CB	②◆▲9463HD
Belt - Fan & Alt.; W/60A., 100A. Alt.	C9PZ8620CF	②◆▲9476HD
Belt - P.S.	C9PZ8620BM	▲9400HD
Belt - Air Brake Compr.	C9PZ8620CM	▲9520HD
B600; B700; B750		
Belt - Fan; W/High Mount Fan	C9PZ8620FK	TR28480
Belt - Fan & Alt.; W/O 60A., 100A. Alt.	C9PZ8620CB	②◆▲9463HD
Belt - Fan & Alt.; W/60A., 100A. Alt.	C9PZ8620CF	②◆▲9476HD
Belt - P.S.	C9PZ8620BM	▲9400HD

◆ Standard Belt Available. See Pages 630-631.
 ● Vulco-Flex® Coolant Hose.
 ◆ Green Stripe® PowerBand® Belt May Work, Use Template to Check.

≈< Cut to Fit.
 ② Two Required.

Belts and Coolant Hose for School Buses

School Buses

Application	Mfr. Part No.	Our No.
FORD - Continued		
1964 - Continued		
Ford V-8 359 - Continued		
B600; B700; B750 - Continued		
Belt - Air Brake Compr.	C9PZ8620CM	▲9520HD
Hose - Upper; Single I.D. Hose		≡20957
Hose - Upper; Dual I.D. Hose; W/1 3/4" Offset		21118
Hose - Upper; Dual I.D. Hose; W/3 5/8" Offset		21078
Hose - Lower - Eng. To Pipe; Strt. Hose(2" I.D.)		24232
Hose - Lower - Eng. To Pipe; Molded Hose		≡20685
Hose - Lower - Pipe To Rad.		≡20685
Hose - By Pass - Left Side; Ser. No. T40001 & After		21257
Hose - By Pass - Left Side; Ser. No. T40001 & After(5/8" I.D.)		28441
Hose - By Pass - Right Side; Ser. No. T40001 & After		21258
Ford V-8 361		
B500		
Belt - Fan; W/High Mount Fan	C9PZ8620FK	TR28480
Belt - Fan & Alt.; W/O 60A., 100A. Alt.	C9PZ8620CB	②◆▲9463HD
Belt - Fan & Alt.; W/60A., 100A. Alt.	C9PZ8620CF	②◆▲9476HD
Belt - P.S.	C9PZ8620BM	▲9400HD
Belt - Air Brake Compr.	C9PZ8620CM	▲9520HD
B600; B700; B750		
Belt - Fan; W/High Mount Fan	C9PZ8620FK	TR28480
Belt - Fan & Alt.; W/O 60A., 100A. Alt.	C9PZ8620CB	②◆▲9463HD
Belt - Fan & Alt.; W/60A., 100A. Alt.	C9PZ8620CF	②◆▲9476HD
Belt - P.S.	C9PZ8620BM	▲9400HD
Belt - Air Brake Compr.	C9PZ8620CM	▲9520HD
Hose - Upper; Single I.D. Hose		≡20957
Hose - Upper; Dual I.D. Hose; W/1 3/4" Offset		21118
Hose - Upper; Dual I.D. Hose; W/3 5/8" Offset		21078
Hose - Lower - Eng. To Pipe; Strt. Hose(2" I.D.)		24232
Hose - Lower - Eng. To Pipe; Molded Hose		≡20685
Hose - Lower - Pipe To Rad.		≡20685
Hose - By Pass - Left Side; Ser. No. T40001 & After		21257
Hose - By Pass - Left Side; Ser. No. T40001 & After(5/8" I.D.)		28441
Hose - By Pass - Right Side; Ser. No. T40001 & After		21258
Ford V-8 389		
B500		
Belt - Fan; W/High Mount Fan	C9PZ8620FK	TR28480
Belt - Fan & Alt.; W/O 60A., 100A. Alt.	C9PZ8620CB	②◆▲9463HD
Belt - Fan & Alt.; W/60A., 100A. Alt.	C9PZ8620CF	②◆▲9476HD
Belt - P.S.	C9PZ8620BM	▲9400HD
Belt - Air Brake Compr.	C9PZ8620CM	▲9520HD
B600; B700; B750		
Belt - Fan; W/High Mount Fan	C9PZ8620FK	TR28480
Belt - Fan & Alt.; W/O 60A., 100A. Alt.	C9PZ8620CB	②◆▲9463HD
Belt - Fan & Alt.; W/60A., 100A. Alt.	C9PZ8620CF	②◆▲9476HD
Belt - P.S.	C9PZ8620BM	▲9400HD
Belt - Air Brake Compr.	C9PZ8620CM	▲9520HD
Hose - Upper; Single I.D. Hose		≡20957
Hose - Upper; Dual I.D. Hose; W/1 3/4" Offset		21118
Hose - Upper; Dual I.D. Hose; W/3 5/8" Offset		21078
Hose - Lower - Eng. To Pipe; Strt. Hose(2" I.D.)		24232
Hose - Lower - Eng. To Pipe; Molded Hose		≡20685
Hose - Lower - Pipe To Rad.		≡20685
Hose - By Pass - Left Side; Ser. No. T40001 & After		21257
Hose - By Pass - Left Side; Ser. No. T40001 & After(5/8" I.D.)		28441
Hose - By Pass - Right Side; Ser. No. T40001 & After		21258
Ford V-8 391		
B500		
Belt - Fan; W/High Mount Fan	C9PZ8620FK	TR28480
Belt - Fan & Alt.; W/O 60A., 100A. Alt.	C9PZ8620CB	②◆▲9463HD
Belt - Fan & Alt.; W/60A., 100A. Alt.	C9PZ8620CF	②◆▲9476HD
Belt - P.S.	C9PZ8620BM	▲9400HD
Belt - Air Brake Compr.	C9PZ8620CM	▲9520HD
B600; B700; B750		
Belt - Fan; W/High Mount Fan	C9PZ8620FK	TR28480
Belt - Fan & Alt.; W/O 60A., 100A. Alt.	C9PZ8620CB	②◆▲9463HD
Belt - Fan & Alt.; W/60A., 100A. Alt.	C9PZ8620CF	②◆▲9476HD
Belt - P.S.	C9PZ8620BM	▲9400HD
Belt - Air Brake Compr.	C9PZ8620CM	▲9520HD
Hose - Upper; Single I.D. Hose		≡20957

Application	Mfr. Part No.	Our No.
FORD - Continued		
1964 - Continued		
Ford V-8 391 - Continued		
B600; B700; B750 - Continued		
Hose - Upper; Dual I.D. Hose; W/1 3/4" Offset		21118
Hose - Upper; Dual I.D. Hose; W/3 5/8" Offset		21078
Hose - Lower - Eng. To Pipe; Strt. Hose(2" I.D.)		24232
Hose - Lower - Eng. To Pipe; Molded Hose		≡20685
Hose - Lower - Pipe To Rad.		≡20685
Hose - By Pass - Left Side; Ser. No. T40001 & After		21257
Hose - By Pass - Left Side; Ser. No. T40001 & After(5/8" I.D.)		28441
Hose - By Pass - Right Side; Ser. No. T40001 & After		21258
1963		
Ford 6-Cyl. 223		
B500; B600		
Belt - Fan & Alt.	C2TE8620AD	②7390
Belt - Fan & Gen.; W/40A. Autolite Gen.	C2TE8620T	②7380
Belt - Fan & Gen.; W/O 40A. Autolite Gen.	C6ZE8620E	7370
Belt - P.S.		▲9385HD
Hose - Upper		20450
	or	●25474
Hose - Lower		≡20584
	or	●26611
Ford 6-Cyl. 262		
B500; B600		
Belt - Fan & Gen.; W/P.S.	C2TE8620H	②7460
Belt - Fan & Gen.; W/O P.S.	C4TE8620N	②7405
Belt - P.S.	EAM2890A	▲9341HD
Hose - Upper		20450
	or	●25474
Ford V-8 292		
B500; B600; B700		
Belt - Fan & Alt.; W/Single Belt	C4TE8620AD	7450
Belt - Fan & Alt.; W/Dual Belts	C4TE8620AD	②7450
Belt - P.S.	C2AE8620L	▲9415HD
Belt - Air Brake Compr.	C2TE8620U	▲9500HD
Hose - Upper		≡20380
	or	●25478
Hose - Lower		≡20276
	or	●26504
Hose - By Pass; (5/8" I.D.)		28441
Ford V-8 302		
B750		
Belt - Fan & Gen.; W/44 3/4" Belt O.C.	C2TE8620V	②◆▲9447HD
Belt - Fan & Gen.; W/46 1/4" Belt O.C.	ECY8620A	②◆▲9463HD
Belt - Fan & Gen.; W/47 1/4" Belt O.C.	C5TE8620H	②◆▲9470HD
Belt - P.S.	C3TA8620F	▲9380HD
Belt - Air Brake Compr.; W/45 1/4" Belt O.C. .	C5TE8620A	②◆▲9451HD
Belt - Air Brake Compr.; W/46 1/4" Belt O.C. .	C2TE8620AG	②◆▲9463HD
Hose - Upper - Eng. To Pipe		≡20357
Hose - Upper - Pipe To Rad.; (1 3/4" I.D.)		②24228
Hose - Lower - Eng. To Pipe		≡20685
Hose - Lower - Pipe To Rad.; (2" I.D.)		24232
Hose - By Pass; (7/8" I.D.)		28443
Ford V-8 332		
B750		
Belt - Fan & Gen.; W/44 3/4" Belt O.C.	C2TE8620V	②◆▲9447HD
Belt - Fan & Gen.; W/46 1/4" Belt O.C.	ECY8620A	②◆▲9463HD
Belt - Fan & Gen.; W/47 1/4" Belt O.C.	C5TE8620H	②◆▲9470HD
Belt - P.S.	C3TA8620F	▲9380HD
Belt - Air Brake Compr.; W/45 1/4" Belt O.C. .	C5TE8620A	②◆▲9451HD
Belt - Air Brake Compr.; W/46 1/4" Belt O.C. .	C2TE8620AG	②◆▲9463HD
Hose - Upper - Eng. To Pipe		≡20357
Hose - Upper - Pipe To Rad.; (1 3/4" I.D.)		②24228
Hose - Lower - Eng. To Pipe		≡20685
Hose - Lower - Pipe To Rad.; (2" I.D.)		24232
Hose - By Pass; (7/8" I.D.)		28443

▲ Standard Belt Available. See Pages 630-631.
 ② Two Required.
 ● Vulco-Flex® Coolant Hose.

≡ Cut to Fit.
 ◆ Green Stripe® PowerBand® Belt May Work, Use Template to Check.

Belts and Coolant Hose for School Buses

School Buses

Application	Mfr. Part No.	Our No.
FORD - Continued		
1962-1961		
Ford 6-Cyl. 223		
B500; B600		
Belt - Fan & Alt.	C2TE8620AD	②7390
Belt - Fan & Gen.; W/40A. Autolite Gen.	C2TE8620T	②7380
Belt - Fan & Gen.; W/O 40A. Autolite Gen.	C6ZE8620E	7370
Belt - P.S.		▲9385HD
Hose - Upper		20450
		or ●25474
Hose - Lower; W/Man. Trans.		20145
		or ●26611
Ford 6-Cyl. 262		
B500; B600		
Belt - Fan & Gen.; W/P.S.	C2TE8620H	②7460
Belt - Fan & Gen.; W/O P.S.	C4TE8620N	②7405
Belt - P.S.	EAM2890A	▲9341HD
Hose - Upper		20450
		or ●25474
Ford V-8 292		
B500; B600; B700		
Belt - Fan & Alt.; W/Single Belt	C4TE8620AD	7450
Belt - Fan & Alt.; W/Dual Belts	C4TE8620AD	②7450
Belt - P.S.	C2AE8620L	▲9415HD
Belt - Air Brake Compr.	C2TE8620U	▲9500HD
Hose - Upper		②20380
		or ●25478
Hose - Lower		②20276
		or ●26504
Hose - By Pass; (5/8" I.D.)		28441
Ford V-8 302		
B750		
Belt - Fan & Gen.; W/44 3/4" Belt O.C.	C2TE8620V	②◆▲9447HD
Belt - Fan & Gen.; W/46 1/4" Belt O.C.	ECY8620A	②◆▲9463HD
Belt - Fan & Gen.; W/47 1/4" Belt O.C.	C5TE8620H	②◆▲9470HD
Belt - P.S.	C3TA8620F	▲9380HD
Belt - Air Brake Compr.; W/45 1/4" Belt O.C.	C5TE8620A	②◆▲9451HD
Belt - Air Brake Compr.; W/46 1/4" Belt O.C.	C2TE8620AG	②◆▲9463HD
Hose - Upper - Eng. To Pipe		②<20357
Hose - Upper - Pipe To Rad.; (1 3/4" I.D.)		②24228
Hose - Lower - Eng. To Pipe		②<20685
Hose - Lower - Pipe To Rad.; (2" I.D.)		24232
Hose - By Pass; (7/8" I.D.)		28443
Ford V-8 332		
B750		
Belt - Fan & Gen.; W/44 3/4" Belt O.C.	C2TE8620V	②◆▲9447HD
Belt - Fan & Gen.; W/46 1/4" Belt O.C.	ECY8620A	②◆▲9463HD
Belt - Fan & Gen.; W/47 1/4" Belt O.C.	C5TE8620H	②◆▲9470HD
Belt - P.S.	C3TA8620F	▲9380HD
Belt - Air Brake Compr.; W/45 1/4" Belt O.C.	C5TE8620A	②◆▲9451HD
Belt - Air Brake Compr.; W/46 1/4" Belt O.C.	C2TE8620AG	②◆▲9463HD
Hose - Upper - Eng. To Pipe		②<20357
Hose - Upper - Pipe To Rad.; (1 3/4" I.D.)		②24228
Hose - Lower - Eng. To Pipe		②<20685
Hose - Lower - Pipe To Rad.; (2" I.D.)		24232
Hose - By Pass; (7/8" I.D.)		28443
1960		
Ford 6-Cyl. 223		
B500; B600		
Belt - Fan & Alt.	C2TE8620AD	②7390
Belt - Fan & Gen.; W/40A. Autolite Gen.	C2TE8620T	②7380
Belt - Fan & Gen.; W/O 40A. Autolite Gen.	C6ZE8620E	7370
Belt - P.S.		▲9385HD
Hose - Upper		20065
		or ●25473
Hose - Lower		②20145
		or ●26611
Ford V-8 292		
B500; B600		
Belt - Fan & Alt./Gen.; W/Single Belt	C4TE8620AD	7450

Application	Mfr. Part No.	Our No.
FORD - Continued		
1960 - Continued		
Ford V-8 292 - Continued		
B500; B600 - Continued		
Belt - Fan & Alt./Gen.; W/Dual Belts	C4TE8620AD	②7450
Belt - P.S.	C7AE8620D	▲9430HD
Belt - Air Brake Compr.	ECY8620A	▲9463HD
Hose - Upper		②20088
		or ●25476
Hose - Lower; W/Auto. Trans.		②21256
Hose - Lower; W/Man. Trans.		②20276
		or ●26504
Hose - By Pass; W/Auto. Trans.(7/8" I.D.)		28443
Hose - By Pass; W/Man. Trans.(5/8" I.D.)		28441
B700		
Belt - Fan & Alt./Gen.; W/Single Belt	C4TE8620AD	7450
Belt - Fan & Alt./Gen.; W/Dual Belts	C4TE8620AD	②7450
Belt - P.S.		▲9405HD
Belt - Air Brake Compr.	ECY8620A	▲9463HD
Hose - Upper		20088
		or ●25478
Hose - Lower; W/Man. Trans.		20276
		or ●26504
Hose - By Pass; W/Auto. Trans.(7/8" I.D.)		28443
Hose - By Pass; W/Man. Trans.(5/8" I.D.)		28441
Ford V-8 302		
B750		
Belt - Fan	C2TE8620AN	TR28454
Belt - W.P. & Alt.	C4TE8620AD	7450
Belt - W.P. & Gen.; W/43 1/8" Belt O.C.	C3ME8620A	7430
Belt - W.P. & Gen.; W/45 1/8" Belt O.C.	C6AE8620E	7448
Belt - P.S.	B8TZ8620D	▲9405HD
Belt - Air Brake Compr.	C1TT8620F	▲9330HD
Hose - Upper; (1 3/4" I.D.)		24228
Hose - Lower; W/Auto. Trans.		②20685
Hose - Lower - Pipe To Rad.; W/Man. Trans.(2" I.D.)		24232
Hose - By Pass; (7/8" I.D.)		28443
Ford V-8 332		
B750		
Belt - Fan	C2TE8620AN	TR28454
Belt - W.P. & Alt.	C4TE8620AD	7450
Belt - W.P. & Gen.; W/43 1/8" Belt O.C.	C3ME8620A	7430
Belt - W.P. & Gen.; W/45 1/8" Belt O.C.	C6AE8620E	7448
Belt - P.S.	B8TZ8620D	▲9405HD
Belt - Air Brake Compr.	C1TT8620F	▲9330HD
Hose - Upper; (1 3/4" I.D.)		24228
Hose - Lower; W/Auto. Trans.		②20685
Hose - Lower - Pipe To Rad.; W/Man. Trans.(2" I.D.)		24232
Hose - By Pass; (7/8" I.D.)		28443
1959		
Ford 6-Cyl. 223		
B500; B600		
Belt - Fan & Alt.	C2TE8620AD	②7390
Belt - Fan & Gen.; W/40A. Autolite Gen.	C2TE8620T	②7380
Belt - Fan & Gen.; W/O 40A. Autolite Gen.	C6ZE8620E	7370
Belt - P.S.		▲9385HD
Hose - Upper		20065
		or ●25473
Hose - Lower		②20145
		or ●26611
Ford V-8 292		
B500		
Belt - Fan & Alt./Gen.; W/Single Belt	C4TE8620AD	7450
Belt - Fan & Alt./Gen.; W/Dual Belts	C4TE8620AD	②7450
Belt - P.S.	C7AE8620D	▲9430HD
Belt - Air Brake Compr.	ECY8620A	▲9463HD
Hose - Upper		②20088
		or ●25476
Hose - Lower; W/Auto. Trans.		②21256
Hose - Lower; W/Man. Trans.		②20276
		or ●26504

② Two Required.
 ● Vulco-Flex® Coolant Hose.
 ◆ Green Stripe® PowerBand® Belt May Work, Use Template to Check.

▲ Standard Belt Available. See Pages 630-631.
 ② Cut to Fit.

Belts and Coolant Hose for School Buses

School Buses

Application	Mfr. Part No.	Our No.
FORD - Continued		
1959 - Continued		
Ford V-8 292 - Continued		
B500 - Continued		
Hose - By Pass; W/Auto. Trans.(7/8" I.D.)		28443
Hose - By Pass; W/Man. Trans.(5/8" I.D.)		28441
B600		
Belt - Fan & Alt./Gen.; W/Single Belt	C4TE8620AD	7450
Belt - Fan & Alt./Gen.; W/Dual Belts	C4TE8620AD	②7450
Belt - P.S.	C7AE8620D	▲9430HD
Belt - Air Brake Compr.; Jan. 1 & Older	C5TE8620A	▲9451HD
Belt - Air Brake Compr.; Jan. 1 & Newer	ECY8620A	▲9463HD
Hose - Upper		≧20088
		or ●25476
Hose - Lower; W/Auto. Trans.		≧21256
Hose - Lower; W/Man. Trans.		≧20276
		or ●26504
Hose - By Pass; W/Auto. Trans.(7/8" I.D.)		28443
Hose - By Pass; W/Man. Trans.(5/8" I.D.)		28441
B700		
Belt - Fan & Alt./Gen.; W/Single Belt	C4TE8620AD	7450
Belt - Fan & Alt./Gen.; W/Dual Belts	C4TE8620AD	②7450
Belt - P.S.		▲9405HD
Belt - Air Brake Compr.; Jan. 1 & Older	C5TE8620A	▲9451HD
Belt - Air Brake Compr.; Jan. 1 & Newer	ECY8620A	▲9463HD
Hose - Upper		20088
		or ●25478
Hose - Lower; W/Man. Trans.		20276
		or ●26504
Hose - By Pass; W/Auto. Trans.(7/8" I.D.)		28443
Hose - By Pass; W/Man. Trans.(5/8" I.D.)		28441
Ford V-8 302		
B750		
Belt - Fan	C2TE8620AN	TR28454
Belt - W.P. & Alt.	C4TE8620AD	7450
Belt - W.P. & Gen.; W/43 1/8" Belt O.C.	C3ME8620A	7430
Belt - W.P. & Gen.; W/45 1/8" Belt O.C.	C6AE8620E	7448
Belt - P.S.	B8TZ8620D	▲9405HD
Belt - Air Brake Compr.	C1TT8620F	▲9330HD
Hose - Upper; (1 3/4" I.D.)		24228
Hose - Lower; W/Auto. Trans.		≧20685
Hose - Lower - Pipe To Rad.; W/Man. Trans.(2" I.D.)		24232
Hose - By Pass; (7/8" I.D.)		28443
Ford V-8 332		
B750		
Belt - Fan	C2TE8620AN	TR28454
Belt - W.P. & Alt.	C4TE8620AD	7450
Belt - W.P. & Gen.; W/43 1/8" Belt O.C.	C3ME8620A	7430
Belt - W.P. & Gen.; W/45 1/8" Belt O.C.	C6AE8620E	7448
Belt - P.S.	B8TZ8620D	▲9405HD
Belt - Air Brake Compr.	C1TT8620F	▲9330HD
Hose - Upper; (1 3/4" I.D.)		24228
Hose - Lower; W/Auto. Trans.		≧20685
Hose - Lower - Pipe To Rad.; W/Man. Trans.(2" I.D.)		24232
Hose - By Pass; (7/8" I.D.)		28443
1958		
Ford 6-Cyl. 223		
B500; B600		
Belt - Fan & Alt.	C4AE8620B	7390
Belt - Fan & Gen.		7370
Belt - P.S.	C6AE8620J	▲9385HD
Hose - Upper		20065
		or ●25473
Hose - Lower		≧20145
		or ●26611
Ford V-8 272		
B500; B600		
Belt - Fan & Alt./Gen.; W/Single Belt	C4TE8620AD	7450
Belt - Fan & Alt./Gen.; W/Dual Belts	C4TE8620AD	②7450
Belt - P.S.	C7AE8620D	▲9430HD
Belt - Air Brake Compr.; W/Alt.	C4TE8620AD	7450

Application	Mfr. Part No.	Our No.
FORD - Continued		
1958 - Continued		
Ford V-8 272 - Continued		
B500; B600 - Continued		
Belt - Air Brake Compr.; W/Gen.	C2TE8620AG	▲9463HD
Hose - Upper		≧21794
		or ●25478
Hose - Lower		≧20276
		or ●26504
Hose - By Pass; W/Auto. Trans.(7/8" I.D.)		28443
Hose - By Pass; W/Man. Trans.(5/8" I.D.)		28441
B700		
Belt - Fan & Alt./Gen.; W/Single Belt	C4TE8620AD	7450
Belt - Fan & Alt./Gen.; W/Dual Belts	C4TE8620AD	②7450
Belt - P.S.	B8TZ8620D	▲9405HD
Belt - Air Brake Compr.; W/Alt.	C4TE8620AD	7450
Belt - Air Brake Compr.; W/Gen.	C2TE8620AG	▲9463HD
Hose - Upper		≧21794
		or ●25478
Hose - Lower		≧20276
		or ●26504
Hose - By Pass; W/Auto. Trans.(7/8" I.D.)		28443
Hose - By Pass; W/Man. Trans.(5/8" I.D.)		28441
Ford V-8 302		
B750		
Belt - Fan	EAM8577A	TR28423
Belt - W.P. & Alt.	C4ZE8620C	7460
Belt - W.P. & Gen.; W/40A. Alt.	EDC8620A	7440
Belt - W.P. & Gen.; W/30A., 50A. Alt.	C6TE8620D	7450
Belt - P.S.	B8TZ8620D	▲9405HD
Belt - Air Brake Compr.	EAM2890A	▲9341HD
Hose - Upper; (1 3/4" I.D.)		24228
Hose - Lower; W/Auto. Trans.; Feb. 1 & Newer		≧20685
Hose - Lower; W/Man. Trans.; Jan. 31 & Older		≧20523
Hose - Lower - Pipe To Rad.; W/Man. Trans.; Feb. 1 & Newer(2" I.D.)		24232
Hose - By Pass; (7/8" I.D.)		28443
Ford V-8 332		
B750		
Belt - Fan	EAM8577A	TR28423
Belt - W.P. & Alt.	C4ZE8620C	7460
Belt - W.P. & Gen.; W/40A. Alt.	EDC8620A	7440
Belt - W.P. & Gen.; W/30A., 50A. Alt.	C6TE8620D	7450
Belt - P.S.	B8TZ8620D	▲9405HD
Belt - Air Brake Compr.	EAM2890A	▲9341HD
Hose - Upper; (1 3/4" I.D.)		24228
Hose - Lower; W/Auto. Trans.; Feb. 1 & Newer		≧20685
Hose - Lower; W/Man. Trans.; Jan. 31 & Older		≧20523
Hose - Lower - Pipe To Rad.; W/Man. Trans.; Feb. 1 & Newer(2" I.D.)		24232
Hose - By Pass; (7/8" I.D.)		28443
1957		
Ford 6-Cyl. 223		
B500; B600		
Belt - Fan & Alt.	C4AE8620B	7390
Belt - Fan & Gen.		7370
Belt - P.S.	C6AE8620J	▲9385HD
Hose - Upper		20065
		or ●25473
Hose - Lower		≧20145
		or ●26611
Ford V-8 272		
B500; B600		
Belt - Fan & Alt./Gen.; W/Single Belt	C4TE8620AD	7450
Belt - Fan & Alt./Gen.; W/Dual Belts	C4TE8620AD	②7450
Belt - P.S.	C7AE8620D	▲9430HD
Belt - Air Brake Compr.; W/Alt.	C4TE8620AD	7450
Belt - Air Brake Compr.; W/Gen.	C2TE8620AG	▲9463HD
Hose - Upper; (1 1/2" I.D.)		②24224
Hose - Lower		≧20276
		or ●26504

② Two Required.
≧ Cut to Fit.

▲ Standard Belt Available. See Pages 630-631.
● Vulco-Flex® Coolant Hose.

Belts and Coolant Hose for School Buses

School Buses

Application	Mfr. Part No.	Our No.
FORD - Continued		
1957 - Continued		
Ford V-8 272 - Continued		
B500; B600 - Continued		
Hose - By Pass; W/Auto. Trans.(7/8" I.D.)		28443
Hose - By Pass; W/Man. Trans.(5/8" I.D.)		28441
B700		
Belt - Fan & Alt./Gen.; W/Single Belt	C4TE8620AD	7450
Belt - Fan & Alt./Gen.; W/Dual Belts	C4TE8620AD	②7450
Belt - P.S.	B8TZ8620D	▲9405HD
Belt - Air Brake Compr.; W/Alt.	C4TE8620AD	7450
Belt - Air Brake Compr.; W/Gen.	C2TE8620AG	▲9463HD
Hose - Upper; (1 1/2" I.D.)		②24224
Hose - Lower		③<20276
	or	●26504
Hose - By Pass; W/Auto. Trans.(7/8" I.D.)		28443
Hose - By Pass; W/Man. Trans.(5/8" I.D.)		28441
Ford V-8 302		
B750		
Belt - Fan	EAM8577A	TR28423
Belt - W.P. & Alt.	C4ZE8620C	7460
Belt - W.P. & Gen.; W/40A. Alt.	EDC8620A	7440
Belt - W.P. & Gen.; W/30A., 50A. Alt.	C6TE8620D	7450
Belt - P.S.	B8TZ8620D	▲9405HD
Belt - Air Brake Compr.	C6TE8620D	7450
Hose - Upper; (1 3/4" I.D.)		24228
Hose - Lower; W/Man. Trans.		③<20523
Hose - By Pass; (7/8" I.D.)		28443
Ford V-8 332		
B750		
Belt - Fan	EAM8577A	TR28423
Belt - W.P. & Alt.	C4ZE8620C	7460
Belt - W.P. & Gen.; W/40A. Alt.	EDC8620A	7440
Belt - W.P. & Gen.; W/30A., 50A. Alt.	C6TE8620D	7450
Belt - P.S.	B8TZ8620D	▲9405HD
Belt - Air Brake Compr.	C6TE8620D	7450
Hose - Upper; (1 3/4" I.D.)		24228
Hose - Lower; W/Man. Trans.		③<20523
Hose - By Pass; (7/8" I.D.)		28443
1956		
Ford 6-Cyl. 223		
B500; B600		
Belt - Fan	C2TE8620T	7380
Belt - W.P. & Gen.	EAG8620B	7360
Hose - Upper		③<21794
	or	●25476
Hose - Lower		③<20145
	or	●26502
Ford V-8 272		
B500; B600		
Belt - Fan & Gen.	C2TE8620M	▲9447HD
Belt - Air Brake Compr.	C2AE8620C	▲9370HD
Hose - Upper; (1 1/2" I.D.)		②24224
Hose - Lower; W/L.D. Eng.		20276
	or	●26504
Hose - Lower; W/H.D. Eng.		●26501
Hose - By Pass; (5/8" I.D.)		28441
B700		
Belt - Fan	EAT8577A	TR28400
Belt - W.P. & Alt.	▲9463HD	
Belt - W.P. & Gen.	ECG8620C	▲9451HD
Belt - Air Brake Compr.	C2AE8620C	▲9370HD
Hose - Upper; (1 1/2" I.D.)		②24224
Hose - Lower; W/L.D. Eng.		20276
	or	●26504
Hose - Lower; W/H.D. Eng.		●26501
Hose - By Pass; (5/8" I.D.)		28441
Ford V-8 302		
B750		
Belt - Fan	EAM8577A	TR28423

② Two Required.
③< Cut to Fit.

Application	Mfr. Part No.	Our No.
FORD - Continued		
1956 - Continued		
Ford V-8 302 - Continued		
B750 - Continued		
Belt - W.P. & Gen.; W/40A. Alt.	EDC8620A	7440
Belt - W.P. & Gen.; W/30A., 50A. Alt.	C6TE8620D	7450
Hose - Upper; (1 3/4" I.D.)		24228
Hose - Lower; W/Man. Trans.		③<20523
Hose - By Pass; (7/8" I.D.)		28443
Ford V-8 332		
B750		
Belt - Fan	EAM8577A	TR28423
Belt - W.P. & Gen.; W/40A. Alt.	EDC8620A	7440
Belt - W.P. & Gen.; W/30A., 50A. Alt.	C6TE8620D	7450
Hose - Upper; (1 3/4" I.D.)		24228
Hose - Lower; W/Man. Trans.		③<20523
Hose - By Pass; (7/8" I.D.)		28443
1955		
Ford 6-Cyl. 223		
B500		
Belt - Fan	C2TE8620T	7380
Belt - W.P. & Gen.	EAG8620B	7360
Hose - Upper		③<21794
	or	●25476
Hose - Lower		③<20145
	or	●26502
B600		
Belt - Fan	C2TE8620T	7380
Belt - W.P. & Gen.	EAG8620B	7360
Hose - Upper; (1 1/2" I.D.)		②24224
Hose - Lower		③<20145
	or	●26502
Ford V-8 239		
B500; B600; B700		
Belt - Fan	EAT8577A	TR28400
Belt - W.P. & Gen.	OHA8620A	7430
Hose - Upper; (1 1/2" I.D.)		②24224
Hose - Lower		●26501
Ford V-8 256		
B500; B600; B700		
Belt - Fan	EAT8577A	TR28400
Belt - W.P. & Gen.	OHA8620A	7430
Hose - Upper; (1 1/2" I.D.)		②24224
Hose - Lower		●26501
Ford V-8 272		
B500		
Belt - Fan & Gen.	C2TE8620M	▲9447HD
Belt - Air Brake Compr.	C2AE8620C	▲9370HD
Hose - Upper; (1 1/2" I.D.)		②24224
Hose - Lower; W/L.D. Eng.		20276
	or	●26504
Hose - Lower; W/H.D. Eng.		●26501
Hose - By Pass; (5/8" I.D.)		28441
Ford V-8 279		
B750		
Belt - Fan	EAM8577A	TR28423
Belt - W.P. & Gen.; Apr. & Older	C2TE8620AA	7450
Belt - W.P. & Gen.; May & Newer	EDC8620A	7440
Belt - P.S.	B8TZ8620D	▲9405HD
Belt - Air Brake Compr.		TR28346
Hose - Upper; (1 3/4" I.D.)		②24228
Hose - Lower		③<20523
Ford V-8 317		
B750		
Belt - Fan	EAM8577A	TR28423
Belt - W.P. & Gen.; Apr. & Older	C2TE8620AA	7450
Belt - W.P. & Gen.; May & Newer	EDC8620A	7440
Belt - P.S.	B8TZ8620D	▲9405HD
Belt - Air Brake Compr.		TR28346
Hose - Upper; (1 3/4" I.D.)		②24228

▲ Standard Belt Available. See Pages 630-631.
● Vulco-Flex® Coolant Hose.

Belts and Coolant Hose for School Buses

School Buses

Application	Mfr. Part No.	Our No.
FORD - Continued		
1955 - Continued		
Ford V-8 317 - Continued		
B750 - Continued		
Hose - Lower		≈<20523
FREIGHTLINER		
2011		
Cummins ISB6.7 Diesel		
B2		
Belt - Fan & Alt.	0132241065	K080813HD
Hose - Lower; (2" I.D.)		≈<24232
2010		
Cummins ISB6.7 Diesel		
B2		
Belt - Fan & Alt.	0132241065	K080813HD
Hose - Lower; (2" I.D.)		≈<24232
Mercedes-Benz MBE 926 Diesel		
B2		
Tensioner Assy. - W.P.	A9062003170	38567
Hose - Upper		21379
2009		
Cummins ISB-07 Diesel		
B2		
Belt - Fan	0123415077	K080813HD
Tensioner Assy.	5264111	38631
Idler Pulley	4991240	36093
Hose - Lower; (2" I.D.)		≈<24232
Mercedes-Benz MBE 926 Diesel		
B2		
Tensioner Assy. - W.P.	A9062003170	38567
Hose - Upper		21379
2008		
Cummins ISB-07 Diesel		
B2		
Belt - Fan, Alt. & A.C.	0123415077	K080813HD
Tensioner Assy. - Fan, Alt. & A.C.	4937433	38631
Idler Pulley - Fan, Alt. & A.C.	4991240	36093
Hose - Upper - Eng. To Rad.		≈<22743
Hose - Lower - Eng. To Pipe; (2" I.D.)		≈<24232
Hose - Lower - Rad. To Pipe; (2" I.D.)		≈<24232
Mercedes-Benz MBE 900 Diesel		
FS65		
Belt - Fan & Alt.	0129859724	▲K080680HD
Tensioner Assy. - Fan & Alt.	A9062003170	38567
Hose - Lower - Eng. To Pipe		21124
Hose - Lower - Pipe To Cooler		20206
Hose - Lower - Cooler To Rad.		≈<21378
Mercedes-Benz MBE 924 Diesel		
B2		
Tensioner Assy. - W.P.	A9062003170	38567
Hose - Upper		21379
Mercedes-Benz MBE 926 Diesel		
B2		
Tensioner Assy. - W.P.	A9062003170	38567
Hose - Upper		21379
2007		
Caterpillar C7 Diesel		
FS65		
Belt - Fan & Alt.	0127110003	▲K080708HD
Belt - W.P.	0366775	▲9341HD
Tensioner Assy. - Fan & Alt.	1352151	38511
Tensioner Pulley - Fan & Alt.		36091

Application	Mfr. Part No.	Our No.
FREIGHTLINER - Continued		
2007 - Continued		
Mercedes-Benz MBE 900 Diesel		
FS65		
Belt - Fan & Alt.	0129859718	▲K080675HD
Tensioner Assy. - Alt.	9062003170	38567
Mercedes-Benz MBE 904 Diesel		
B2		
Tensioner Assy. - W.P.	A9062003170	38567
Hose - Upper		21379
2006		
Caterpillar C7 Diesel		
FS65		
Belt - Fan & Alt.	0127110030	▲K080872HD
Belt - W.P.	0366775	▲9341HD
Tensioner Assy. - Fan & Alt.	1352151	38511
Tensioner Pulley - Fan & Alt.		36091
Mercedes-Benz MBE 900 Diesel		
FS65		
Belt - Fan & Alt.	0129859718	▲K080675HD
Tensioner Assy. - Alt.	9062003170	38567
Hose - Lower - Eng. To Pipe		22702
2005		
Caterpillar C7 Diesel		
FS65		
Belt - Fan & Alt.	0127110030	▲K080872HD
Belt - W.P.	0366775	▲9341HD
Tensioner Assy. - Fan & Alt.	1352151	38511
Tensioner Pulley - Fan & Alt.		36091
Mercedes-Benz MBE 900 Diesel		
FS65		
Belt - Fan & Alt.; W/O A.C.	0127110043	▲K080680HD
Belt - Fan & Alt.; W/A.C.	0127110042	▲K080839HD
Belt - A.C.; W/Carrier, TransAir A.C. Compr.		K081044HD
Hose - Upper - Eng. To Rad.		22992
Hose - Lower - Pipe To W.P.		22991
2004		
Caterpillar 3126 Diesel		
FS65		
Belt - Fan, Alt. & A.C.	0127110003	▲K080708HD
Belt - Fan & Alt.	0127110002	▲K080702HD
Belt - W.P.	0366775	▲9341HD
Tensioner Assy. - Fan, Alt. & A.C.	1352151	38511
Tensioner Pulley - Fan, Alt. & A.C.	1352151	36091
Hose - Upper - Eng. To Rad.		20735
Hose - Lower - Pipe To Rad.		21473
Caterpillar C7 Diesel		
FS65		
Belt - Fan, Alt. & A.C.	0127110030	▲K080872HD
Belt - Fan & Alt.	0127110002	▲K080702HD
Belt - W.P.	0366775	▲9341HD
Tensioner Assy. - Fan & Alt.	1352151	38511
Tensioner Pulley - Fan & Alt.	1352151	36091
Idler Pulley - Fan & Alt.	2534525	36096
Mercedes-Benz MBE 900 Diesel		
FS65		
Serpentine Belt	0127110043	▲K080680HD
Belt - A.C.; W/Carrier, TransAir A.C. Compr.		K081044HD
Hose - Upper - Eng. To Rad.		22701
Hose - Lower - Eng. To Pipe		20611
Hose - Lower - Pipe To Rad.		22702
2003-2002		
Caterpillar 3126 Diesel		
FS65		
Belt - Fan, Alt. & A.C.	0127110003	▲K080708HD
Belt - W.P.	0366775	▲9341HD

≈< Cut to Fit.

▲ Standard Belt Available. See Pages 630-631.

Belts and Coolant Hose for School Buses

School Buses

Application	Mfr. Part No.	Our No.
FREIGHTLINER - Continued		
2003-2002 - Continued		
Caterpillar 3126 Diesel - Continued		
FS65 - Continued		
Tensioner Assy. - Fan, Alt. & A.C.	1352151	38511
Tensioner Pulley - Fan, Alt. & A.C.	1352151	36091
Hose - Upper - Eng. To Rad.		20735
Hose - Lower - Pipe To Rad.		21473
Cummins ISB Diesel		
FS65		
Serpentine Belt	3926856	♣K080694HD
Tensioner Assy.	3936213	38516
Tensioner Pulley	3936213	36093
Hose - Upper - Eng. To Rad.		22700
Hose - Lower		21473
Mercedes-Benz MBE 900 Diesel		
FS65		
Serpentine Belt	0127110043	♣K080680HD
Belt - A.C.: W/Carrier, TransAir A.C. Compr.		K081044HD
Hose - Upper - Eng. To Rad.		22701
Hose - Lower - Pipe To Rad.		22702
2001		
Caterpillar 3126 Diesel		
FS65		
Belt - Fan, Alt. & A.C.	0127110003	♣K080708HD
Belt - W.P.	0366775	♣9341HD
Tensioner Assy. - Fan, Alt. & A.C.	1352151	38511
Tensioner Pulley - Fan, Alt. & A.C.	1352151	36091
Hose - Upper - Eng. To Rad.		20735
Hose - Lower - Pipe To Rad.		21473
Cummins ISB Diesel		
FS65		
Serpentine Belt	3926856	♣K080694HD
Tensioner Assy.	3936213	38516
Tensioner Pulley	3936213	36093
2000		
Caterpillar 3126 Diesel		
FS65		
Belt - Fan, Alt. & A.C.	0127110003	♣K080708HD
Belt - W.P.	0366775	♣9341HD
Tensioner Assy. - Fan, Alt. & A.C.	1352151	38511
Tensioner Pulley - Fan, Alt. & A.C.	1352151	36091
Hose - Upper - Eng. To Rad.		22668
Hose - Lower - Pipe To Rad.		21473
Cummins ISB Diesel		
FS65		
Serpentine Belt	3926856	♣K080694HD
Tensioner Assy.	3936213	38516
Tensioner Pulley	3936213	36093
1999-1998		
Caterpillar 3126 Diesel		
FS65		
Belt - W.P.	0366775	♣9341HD
Belt - Fan, Alt. & A.C.	0123415043	♣K080708HD
Tensioner Assy. - Fan, Alt. & A.C.	1352151	38511
Tensioner Pulley - Fan, Alt. & A.C.	1352151	36091
Hose - Upper - Eng. To Rad.		22668
Hose - Lower - Pipe To Rad.		21473
Cummins ISB Diesel		
FS65		
Serpentine Belt	3926856	♣K080694HD
Tensioner Assy.	3936213	38516
Tensioner Pulley	3936213	36093

Application	Mfr. Part No.	Our No.
FREIGHTLINER - Continued		
1997		
Cummins B Series 5.9 L Diesel		
FS65		
Belt - Fan, Alt. & A.C.	3288812	♣K080575HD
Tensioner Assy. - Fan, Alt. & A.C.	3976832	38513
Hose - Upper - Eng. To Rad.		22025
Hose - Lower - Rad. To Pipe		21194
GMC		
2002		
Caterpillar 3116 Diesel		
B7 Series		
Belt - Fan & Alt.; W/70" Belt O.C.	15670937	♣K070705HD
Caterpillar 3126 Diesel		
B7 Series		
Belt - Fan & Alt.	15670937	♣K070705HD
Belt - W.P.	0366775	♣9341HD
GM V-8 8.1 L		
B7 Series		
Belt - Fan, W.P., Gen. & P.S.	15021740	♣K071056HD
Belt - Air Compr.	15060753	♣K040762HD
Hose - Upper - Eng. To Rad.		22678
Hose - Lower - Eng. To Rad.		22679
2001		
Caterpillar 3116 Diesel		
B7 Series		
Belt - Fan & Alt.; W/70" Belt O.C.	15670937	♣K070705HD
Caterpillar 3126 Diesel		
B7 Series		
Belt - Fan & Alt.	15670937	♣K070705HD
Belt - W.P.	0366775	♣9341HD
GM V-8 5.7 L		
B7 Series		
Serpentine Belt; W/O A.C.; W/130A. Alt.	12564760	♣K060875HD
Tensioner Assy.		38103
Tensioner Pulley		38008
Hose - Upper		22357
Hose - Lower		22425
GM V-8 8.1 L		
B7 Series		
Belt - Fan, W.P., Gen. & P.S.	15021740	♣K071056HD
Belt - Air Compr.	15060753	♣K040762HD
Tensioner Pulley	15021742	38033
Hose - Upper - Eng. To Rad.		22678
Hose - Lower - Eng. To Rad.		22679
2000-1999		
Caterpillar 3116 Diesel		
B7 Series		
Belt - Fan & Alt.; W/70" Belt O.C.	15670937	♣K070705HD
Caterpillar 3126 Diesel		
B7 Series		
Belt - Fan & Alt.	15670937	♣K070705HD
Belt - W.P.	0366775	♣9341HD
GM V-8 7.4 L		
B7 Series		
Belt - Fan & Gen.	15722647	♣K060660HD
Belt - Air Compr.	11502412	♣9680HD
Belt - P.S. & Air Brake Compr.	9433884	♣9395HD
Belt - P.S. & Hyd. Brake	11502405	♣9640HD
Hose - Upper - Eng. To Rad.		22663
Hose - Lower - Eng. To Rad.		22135

♣ Standard Belt Available. See Pages 630-631.

Belts and Coolant Hose for School Buses

School Buses

Application	Mfr. Part No.	Our No.
GMC - Continued		
1998		
Caterpillar 3116 Diesel		
B7 Series		
Belt - Fan & Alt.; W/70" Belt O.C.	15670937	▲K070705HD
Hose - Upper - Eng. To Rad.		22134
Hose - Lower - Eng. To Rad.		21985
B6000 B6P Series		
Belt - Fan & Alt.	15670937	▲K070705HD
Hose - Upper		22134
Hose - Lower		21985
Caterpillar 3126 Diesel		
B7 Series		
Belt - Fan & Alt.	15670937	▲K070705HD
Belt - W.P.	0366775	▲9341HD
Hose - Upper - Eng. To Rad.		22664
Hose - Lower - Eng. To Rad.		21985
B6000 B6P Series		
Belt - Fan & Alt.	15670937	▲K070705HD
Hose - Upper		22134
Hose - Lower		21985
GM V-8 6.0 L		
B7 Series		
Belt - Fan & Alt.	15608928	▲K060672HD
Belt - Fan & P.S.; W/Air Brakes	9433884	▲9395HD
Belt - Fan & P.S.; W/Hyd. Brakes	11502406	▲9650HD
Belt - Fan, A.C. & P.S.	14033869	7603
Belt - Air Brake Compr.	11502412	▲9680HD
Hose - Upper - Eng. To Rad.		22136
Hose - Lower		22135
GM V-8 6.5 L Diesel		
B7 Series		
Belt - Fan	15994965	▲K060547HD
Belt - Alt., W.P. & P.S.	12555011	▲K061015HD
Tensioner Assy. - Alt., W.P. & P.S.	12561092	38118
GM V-8 7.0 L		
B7 Series		
Belt - Fan & Alt.	15608928	▲K060672HD
Belt - Fan & P.S.; W/Air Brakes	9433884	▲9395HD
Belt - Fan & P.S.; W/Hyd. Brakes	11502406	▲9650HD
Belt - Air Brake Compr.	11502412	▲9680HD
Hose - Upper - Eng. To Rad.		22136
Hose - Lower		22135
GM V-8 7.4 L		
B7 Series		
Belt - Air Compr.	11502412	▲9680HD
1997		
Caterpillar 3116 Diesel		
B7 Series		
Belt - Fan & Alt.; W/70" Belt O.C.	15670937	▲K070705HD
Hose - Upper - Eng. To Rad.		22134
Hose - Lower - Eng. To Rad.		21985
GM V-8 6.0 L		
B7 Series		
Belt - Fan & Alt.	15608928	▲K060672HD
Belt - Fan & P.S.; W/Air Brakes	9433884	▲9395HD
Belt - Fan & P.S.; W/Hyd. Brakes	11502406	▲9650HD
Belt - Fan, A.C. & P.S.	14033869	7603
Belt - Air Brake Compr.	11502412	▲9680HD
Hose - Upper - Eng. To Rad.		22136
Hose - Lower		22135
B6000 B6P Series		
Belt - Fan & Alt.; W/124A., 145A. Alt.	15608928	▲K060672HD
Belt - Fan & P.S.; W/Air Brakes	9433884	▲9395HD
Belt - Fan & P.S.; W/Hyd. Brakes	11502406	▲9650HD
Belt - Fan & A.C.	10230259	▲K060670HD
Belt - Air Brake Compr.	11502413	▲9690HD
Hose - Upper		22136
Hose - Lower		22135

Application	Mfr. Part No.	Our No.
GMC - Continued		
1997 - Continued		
GM V-8 6.5 L Diesel		
B7 Series		
Belt - Fan	15994965	▲K060547HD
Belt - Alt., W.P. & P.S.	12555011	▲K061015HD
GM V-8 7.0 L		
B7 Series		
Belt - Fan & Alt.	15608928	▲K060672HD
Belt - Fan & P.S.; W/Air Brakes	9433884	▲9395HD
Belt - Fan & P.S.; W/Hyd. Brakes	11502406	▲9650HD
Belt - Air Brake Compr.	11502412	▲9680HD
Hose - Upper - Eng. To Rad.		22136
Hose - Lower		22135
1996		
Caterpillar 3116 Diesel		
B7 Series		
Belt - Fan & Alt.; W/70" Belt O.C.	15670937	▲K070705HD
Belt - A.C.		▲9345HD
Hose - Upper - Eng. To Rad.		22134
Hose - Lower - Eng. To Rad.		21985
B6000 B6P Series		
Belt - Fan & Alt.	15670937	▲K070705HD
Belt - A.C.		▲9345HD
Hose - Upper		22134
Hose - Lower		21985
GM V-8 6.0 L		
B7 Series		
Belt - Fan & Alt.	15608928	▲K060672HD
Belt - Fan & P.S.; W/Air Brakes	9433884	▲9395HD
Belt - Fan & P.S.; W/Hyd. Brakes	11502406	▲9650HD
Belt - Fan, A.C. & P.S.	14033869	7603
Belt - Air Brake Compr.	11502412	▲9680HD
Hose - Upper - Eng. To Rad.		22136
Hose - Lower		22135
B6000 B6P Series		
Belt - Fan & Alt.; W/124A., 145A. Alt.	15608928	▲K060672HD
Belt - Fan & P.S.; W/Air Brakes	9433884	▲9395HD
Belt - Fan & P.S.; W/Hyd. Brakes	11502406	▲9650HD
Belt - Fan & A.C.	10230259	▲K060670HD
Belt - Air Brake Compr.	11502413	▲9690HD
Hose - Upper		22136
Hose - Lower		22135
GM V-8 7.0 L		
B7 Series		
Belt - Fan & Alt.	15608928	▲K060672HD
Belt - Fan & P.S.; W/Air Brakes	9433884	▲9395HD
Belt - Fan & P.S.; W/Hyd. Brakes	11502406	▲9650HD
Belt - Air Brake Compr.	11502412	▲9680HD
Hose - Upper - Eng. To Rad.		22136
Hose - Lower		22135
B6000 B6P Series		
Belt - Fan & Alt.; W/124A., 145A. Alt.	15608928	▲K060672HD
Belt - Fan & P.S.; W/Air Brakes	9433884	▲9395HD
Belt - Fan & P.S.; W/Hyd. Brakes	11502406	▲9650HD
Belt - Fan & A.C.	10230259	▲K060670HD
Belt - Air Brake Compr.	11502413	▲9690HD
Hose - Upper		22136
Hose - Lower		22135
GM V-8 7.4 L		
B6000 B6P Series		
Belt - Fan & Alt.; W/124A., 145A. Alt.	15608928	▲K060672HD
Belt - Fan & P.S.; W/Air Brakes	9433884	▲9395HD
Belt - Fan & P.S.; W/Hyd. Brakes	11502406	▲9650HD
Belt - Fan & A.C.	10230259	▲K060670HD
Belt - Air Brake Compr.	11502413	▲9690HD
Hose - Upper		22136
Hose - Lower		22135

▲ Standard Belt Available. See Pages 630-631.

Belts and Coolant Hose for School Buses

School Buses

Application	Mfr. Part No.	Our No.
GMC - Continued		
1995-1993		
Caterpillar 3116 Diesel		
B7 Series		
Belt - Fan & Alt.; W/70" Belt O.C.	15670937	♣K070705HD
Hose - Upper - Eng. To Rad.		22134
Hose - Lower - Eng. To Rad.		21985
B6000 B6P Series		
Belt - Fan & Alt.	15670937	♣K070705HD
Hose - Upper		22134
Hose - Lower		21985
GM V-8 6.0 L		
B7 Series		
Belt - Fan & Alt.	15608928	♣K060672HD
Belt - Fan & P.S.; W/Air Brakes	9433884	♣9395HD
Belt - Fan & P.S.; W/Hyd. Brakes	11502406	♣9650HD
Belt - Fan, A.C. & P.S.	14033869	7603
Belt - Air Brake Compr.	11502412	♣9680HD
Hose - Upper - Eng. To Rad.		22136
Hose - Lower		22135
B6000 B6P Series		
Belt - Fan & Alt.; W/124A., 145A. Alt.	15608928	♣K060672HD
Belt - Fan & P.S.; W/Air Brakes	9433884	♣9395HD
Belt - Fan & P.S.; W/Hyd. Brakes	11502406	♣9650HD
Belt - Fan & A.C.	10230259	♣K060670HD
Belt - Air Brake Compr.	11502413	♣9690HD
Hose - Upper		22136
Hose - Lower		22135
GM V-8 7.0 L		
B7 Series		
Belt - Fan & Alt.	15608928	♣K060672HD
Belt - Fan & P.S.; W/Air Brakes	9433884	♣9395HD
Belt - Fan & P.S.; W/Hyd. Brakes	11502406	♣9650HD
Belt - Air Brake Compr.	11502412	♣9680HD
Hose - Upper - Eng. To Rad.		22136
Hose - Lower		22135
B6000 B6P Series		
Belt - Fan & Alt.; W/124A., 145A. Alt.	15608928	♣K060672HD
Belt - Fan & P.S.; W/Air Brakes	9433884	♣9395HD
Belt - Fan & P.S.; W/Hyd. Brakes	11502406	♣9650HD
Belt - Fan & A.C.	10230259	♣K060670HD
Belt - Air Brake Compr.	11502413	♣9690HD
Hose - Upper		22136
Hose - Lower		22135
GM V-8 7.4 L		
B6000 B6P Series		
Belt - Fan & Alt.; W/124A., 145A. Alt.	15608928	♣K060672HD
Belt - Fan & P.S.; W/Air Brakes	9433884	♣9395HD
Belt - Fan & P.S.; W/Hyd. Brakes	11502406	♣9650HD
Belt - Fan & A.C.	10230259	♣K060670HD
Belt - Air Brake Compr.	11502413	♣9690HD
Hose - Upper		22136
Hose - Lower		22135
1992		
Caterpillar 3116 Diesel		
B6000 B6P Series		
Belt - Fan & Alt.	15670937	♣K070705HD
Hose - Upper		22134
Hose - Lower		21985
Detroit Diesel V-8 8.2 L Diesel		
S7000 S7T Series		
Belt - Fan & Alt.; W/71 1/2" Belt O.C.	2099791	♣9710HD
Belt - Fan & Alt.; W/97 1/2" Belt O.C.	2056956	Ⓜ♣9700HD
Belt - Fan & Air Brake Compr.		♣9720HD
Belt - P.S.	11502340	♣9385HD
Belt - Air Brake Compr.; W/71 1/2" Belt O.C.	11502416	♣9710HD
Belt - Air Brake Compr.; W/75" Belt O.C.	11502340	♣9745HD
Hose - Upper - Eng. To Pipe; (2" I.D.)		24232
Hose - Upper - Pipe To Rad.		21473
Hose - Lower - Eng. To Pipe; (2 1/4" I.D.)		24236
Hose - Lower - Pipe To Rad.; (2 3/8" I.D.)		24238
Hose - By Pass - Left Side; (1 3/8" I.D.)		24222
Hose - By Pass - Right Side		21457

Application	Mfr. Part No.	Our No.
GMC - Continued		
1992 - Continued		
Detroit Diesel V-8 8.2 L Diesel - Continued		
S7000 S7T Series - Continued		
Hose - Lower - Pipe To Rad.; (2 3/8" I.D.)		24238
Hose - By Pass - Left Side; (1 3/8" I.D.)		24222
Hose - By Pass - Right Side		21457
GM V-8 6.0 L		
B6000 B6P Series		
Belt - Fan & Alt.; W/124A., 145A. Alt.	15608928	♣K060672HD
Belt - Fan & P.S.; W/Air Brakes	9433884	♣9395HD
Belt - Fan & P.S.; W/Hyd. Brakes	11502406	♣9650HD
Belt - Fan & A.C.	10230259	♣K060670HD
Belt - Air Brake Compr.	11502413	♣9690HD
Hose - Upper		22136
Hose - Lower		22135
S7000 S7T Series		
Belt - Fan & Alt.	11502410	♣9670HD
Hose - Upper - Eng. To Pipe		Ⓜ<21307
Hose - Upper - Pipe To Rad.; W/Auto. Trans.		21523
Hose - Upper - Pipe To Rad.; W/Man. Trans.		21521
Hose - Lower - Pipe To Rad.		21556
Hose - By Pass; (1 3/8" I.D.)		24222
GM V-8 7.0 L		
B6000 B6P Series		
Belt - Fan & Alt.; W/124A., 145A. Alt.	15608928	♣K060672HD
Belt - Fan & P.S.; W/Air Brakes	9433884	♣9395HD
Belt - Fan & P.S.; W/Hyd. Brakes	11502406	♣9650HD
Belt - Fan & A.C.	10230259	♣K060670HD
Belt - Air Brake Compr.	11502413	♣9690HD
Hose - Upper		22136
Hose - Lower		22135
GM V-8 7.4 L		
B6000 B6P Series		
Belt - Fan & Alt.; W/124A., 145A. Alt.	15608928	♣K060672HD
Belt - Fan & P.S.; W/Air Brakes	9433884	♣9395HD
Belt - Fan & P.S.; W/Hyd. Brakes	11502406	♣9650HD
Belt - Fan & A.C.	10230259	♣K060670HD
Belt - Air Brake Compr.	11502413	♣9690HD
Hose - Upper		22136
Hose - Lower		22135
1991		
Detroit Diesel V-8 8.2 L Diesel		
B6000 B6P Series		
Belt - Fan & Alt.; W/71 1/2" Belt O.C.	2099791	♣9710HD
Belt - Fan & Alt.; W/97 1/2" Belt O.C.	2056956	Ⓜ♣9700HD
Belt - Fan & Air Brake Compr.		♣9720HD
Belt - P.S.	11502340	♣9385HD
Belt - Air Brake Compr.	11502419	♣9740HD
Hose - Upper - Eng. To Pipe; (2" I.D.)		24232
Hose - Upper - Pipe To Rad.		21473
Hose - Lower - Eng. To Pipe; (2 1/4" I.D.)		24236
Hose - Lower - Pipe To Rad.; (2 3/8" I.D.)		24238
Hose - By Pass - Left Side; (1 3/8" I.D.)		24222
Hose - By Pass - Right Side		21457
S7000 S7T Series		
Belt - Fan & Alt.; W/71 1/2" Belt O.C.	2099791	♣9710HD
Belt - Fan & Alt.; W/97 1/2" Belt O.C.	2056956	Ⓜ♣9700HD
Belt - Fan & Air Brake Compr.		♣9720HD
Belt - P.S.	11502340	♣9385HD
Belt - Air Brake Compr.; W/71 1/2" Belt O.C.	11502416	♣9710HD
Belt - Air Brake Compr.; W/75" Belt O.C.	11502340	♣9745HD
Hose - Upper - Eng. To Pipe; (2" I.D.)		24232
Hose - Upper - Pipe To Rad.		21473
Hose - Lower - Eng. To Pipe; (2 1/4" I.D.)		24236
Hose - Lower - Pipe To Rad.; (2 3/8" I.D.)		24238
Hose - By Pass - Left Side; (1 3/8" I.D.)		24222
Hose - By Pass - Right Side		21457

♣ Standard Belt Available. See Pages 630-631.
 Ⓜ Cut to Fit.

Ⓜ Two Required.

Belts and Coolant Hose for School Buses

School Buses

Application	Mfr. Part No.	Our No.
GMC - Continued		
1991 - Continued		
GM V-8 6.0 L		
B6000 B6P Series		
Belt - Fan & Alt.; W/63A., 108A. Alt.; Preferred Belt		2/9640PB
Belt - Fan & Alt.; W/63A., 108A. Alt.; Optional Belt	②	▲9640HD
Belt - Fan & Alt.; W/80A., 100A. Alt.; Preferred Belt		2/9660PB
Belt - Fan & Alt.; W/80A., 100A. Alt.; Optional Belt	②	▲9660HD
Belt - Fan & Alt.; W/105A., 130A., 160A. Alt.; Preferred Belt ..		2/9670PB
Belt - Fan & Alt.; W/105A., 130A., 160A. Alt.; Optional Belt ...	②	▲9670HD
Belt - Fan & P.S.		▲9630HD
Belt - Fan & Hyd. Pump		▲9630HD
Belt - Fan & Air Brake Compr.	2027569	5700
Belt - Fan To A.P.	9433881	▲9380HD
Belt - Alt. & A.P.; W/108A. Alt.		▲9630HD
Belt - Alt. & A.P.; W/80A., 100A. Alt.		▲9640HD
Belt - Alt. & A.P.; W/105A., 130A., 160A. Alt.		▲9650HD
Belt - P.S.; W/40" Belt O.C.	9433884	▲9395HD
Belt - P.S.; W/Air Brakes; W/59 1/2" Belt O.C.		▲9590HD
Belt - P.S.; W/Hyd. Brakes; W/64 3/4" Belt O.C.		▲9640HD
Belt - A.P. - From C.S.; W/39" Belt O.C.		▲9385HD
Belt - A.P. - From C.S.; W/54 1/2" Belt O.C. ...	9433913	▲9540HD
Belt - Air Brake Compr.		▲9720HD
Hose - Upper		22136
Hose - Lower		22135
S7000 S7T Series		
Belt - Fan & Alt.	11502410	▲9670HD
Hose - Upper - Eng. To Pipe		≧21307
Hose - Upper - Pipe To Rad.; W/Auto. Trans.		21523
Hose - Upper - Pipe To Rad.; W/Man. Trans.		21521
Hose - Lower - Pipe To Rad.		21556
Hose - By Pass; (1 3/8" I.D.)		24222
GM V-8 7.0 L		
B6000 B6P Series		
Belt - Fan & Alt.; W/63A., 108A. Alt.; Preferred Belt		2/9640PB
Belt - Fan & Alt.; W/63A., 108A. Alt.; Optional Belt	②	▲9640HD
Belt - Fan & Alt.; W/80A., 100A. Alt.; Preferred Belt		2/9660PB
Belt - Fan & Alt.; W/80A., 100A. Alt.; Optional Belt	②	▲9660HD
Belt - Fan & Alt.; W/105A., 130A., 160A. Alt.; Preferred Belt ..		2/9670PB
Belt - Fan & Alt.; W/105A., 130A., 160A. Alt.; Optional Belt ...	②	▲9670HD
Belt - Fan & P.S.		▲9630HD
Belt - Fan & Hyd. Pump		▲9630HD
Belt - Fan & Air Brake Compr.	2027569	5700
Belt - Fan To A.P.	9433881	▲9380HD
Belt - Alt. & A.P.; W/108A. Alt.		▲9630HD
Belt - Alt. & A.P.; W/80A., 100A. Alt.		▲9640HD
Belt - Alt. & A.P.; W/105A., 130A., 160A. Alt.		▲9650HD
Belt - P.S.; W/40" Belt O.C.	9433884	▲9395HD
Belt - P.S.; W/Air Brakes; W/59 1/2" Belt O.C.		▲9590HD
Belt - P.S.; W/Hyd. Brakes; W/64 3/4" Belt O.C.		▲9640HD
Belt - A.P. - From C.S.; W/39" Belt O.C.		▲9385HD
Belt - A.P. - From C.S.; W/54 1/2" Belt O.C. ...	9433913	▲9540HD
Belt - Air Brake Compr.		▲9720HD
Hose - Upper		22136
Hose - Lower		22135
S7000 S7T Series		
Belt - Fan & Alt.	11502410	▲9670HD
Hose - Upper - Eng. To Pipe		≧21307
Hose - Upper - Pipe To Rad.; W/Auto. Trans.		21523
Hose - Upper - Pipe To Rad.; W/Man. Trans.		21521
Hose - Lower - Pipe To Rad.		21556
Hose - By Pass; (1 3/8" I.D.)		24222
GM V-8 7.4 L		
B6000 B6P Series		
Belt - Fan & Alt.; W/63A., 108A. Alt.; Preferred Belt		2/9640PB
Belt - Fan & Alt.; W/63A., 108A. Alt.; Optional Belt	②	▲9640HD
Belt - Fan & Alt.; W/80A., 100A. Alt.; Preferred Belt		2/9660PB
Belt - Fan & Alt.; W/80A., 100A. Alt.; Optional Belt	②	▲9660HD
Belt - Fan & Alt.; W/105A., 130A., 160A. Alt.; Preferred Belt ..		2/9670PB
Belt - Fan & Alt.; W/105A., 130A., 160A. Alt.; Optional Belt ...	②	▲9670HD
Belt - Fan & P.S.		▲9630HD
Belt - Fan & Hyd. Pump		▲9630HD
Belt - Fan & Air Brake Compr.	2027569	5700

Application	Mfr. Part No.	Our No.
GMC - Continued		
1991 - Continued		
GM V-8 7.4 L - Continued		
B6000 B6P Series - Continued		
Belt - Fan To A.P.	9433881	▲9380HD
Belt - Alt. & A.P.; W/108A. Alt.		▲9630HD
Belt - Alt. & A.P.; W/80A., 100A. Alt.		▲9640HD
Belt - Alt. & A.P.; W/105A., 130A., 160A. Alt.		▲9650HD
Belt - P.S.; W/40" Belt O.C.	9433884	▲9395HD
Belt - P.S.; W/Air Brakes; W/59 1/2" Belt O.C.		▲9590HD
Belt - P.S.; W/Hyd. Brakes; W/64 3/4" Belt O.C.		▲9640HD
Belt - A.P. - From C.S.; W/39" Belt O.C.		▲9385HD
Belt - A.P. - From C.S.; W/54 1/2" Belt O.C. ...	9433913	▲9540HD
Belt - Air Brake Compr.		▲9720HD
Hose - Upper		22136
Hose - Lower		22135
S7000 S7T Series		
Belt - Fan & Alt.	11502410	▲9670HD
Hose - Upper - Eng. To Pipe		≧21307
Hose - Upper - Pipe To Rad.; W/Auto. Trans.		21523
Hose - Upper - Pipe To Rad.; W/Man. Trans.		21521
Hose - Lower - Pipe To Rad.		21556
Hose - By Pass; (1 3/8" I.D.)		24222
1990		
Detroit Diesel V-8 8.2 L Diesel		
B6000 B6P Series		
Belt - Fan & Alt.; W/71 1/2" Belt O.C.	2099791	▲9710HD
Belt - Fan & Alt.; W/97 1/2" Belt O.C.	2056956	②▲9700HD
Belt - Fan & Air Brake Compr.		▲9720HD
Belt - P.S.	11502340	▲9385HD
Belt - Air Brake Compr.	11502419	▲9740HD
Hose - Upper - Eng. To Pipe; (2" I.D.)		24232
Hose - Upper - Pipe To Rad.		21473
Hose - Lower - Eng. To Pipe; (2 1/4" I.D.)		24236
Hose - Lower - Pipe To Rad.; (2 3/8" I.D.)		24238
Hose - By Pass - Left Side; (1 3/8" I.D.)		24222
Hose - By Pass - Right Side		21457
S7000 S7T Series		
Belt - Fan & Alt.; W/71 1/2" Belt O.C.	2099791	▲9710HD
Belt - Fan & Alt.; W/97 1/2" Belt O.C.	2056956	②▲9700HD
Belt - Fan & Air Brake Compr.		▲9720HD
Belt - P.S.	11502340	▲9385HD
Belt - Air Brake Compr.; W/71 1/2" Belt O.C. ...	11502416	▲9710HD
Belt - Air Brake Compr.; W/75" Belt O.C.	11502340	▲9745HD
Hose - Upper - Eng. To Pipe; (2" I.D.)		24232
Hose - Upper - Pipe To Rad.		21473
Hose - Lower - Eng. To Pipe; (2 1/4" I.D.)		24236
Hose - Lower - Pipe To Rad.; (2 3/8" I.D.)		24238
Hose - By Pass - Left Side; (1 3/8" I.D.)		24222
Hose - By Pass - Right Side		21457
GM V-8 5.0 L		
B6000 B6P Series		
Belt - Fan & Alt.; W/70A., 108A. Alt.	11502375	▲9525HD
Belt - Fan & Alt.; W/80A., 100A. Alt.	2005476	②◆▲9550HD
Belt - Fan & Alt.; W/105A., 130A., 160A. Alt.; Preferred Belt	11502386	2/9570PB
Belt - Fan & Alt.; W/105A., 130A., 160A. Alt.; Optional Belt	11502386	②▲9570HD
Belt - Fan, Alt. & A.P.; W/80A. Alt.	11502410	▲9670HD
Belt - Fan, Alt. & A.P.; W/105A., 130A., 160A. Alt.	11502411	▲9680HD
Belt - Fan & P.S.; W/Hyd. Brakes	9433923	▲9590HD
Belt - P.S. & A.P.		▲9640HD
Belt - P.S.; W/Air Brakes	9433881	▲9380HD
Belt - Air Brake Compr. & A.P.		▲9670HD
Belt - A.P.		▲9540HD
Hose - Upper		21095
Hose - Lower		21409
Hose - By Pass		≧20777

② Two Required.
≧ Cut to Fit.

◆ Standard Belt Available. See Pages 630-631.
◆ Green Stripe® PowerBand® Belt May Work, Use Template to Check.

Belts and Coolant Hose for School Buses

Application	Mfr. Part No.	Our No.	Application	Mfr. Part No.	Our No.
GMC - Continued			GMC - Continued		
1990 - Continued			1990 - Continued		
GM V-8 5.7 L			GM V-8 7.0 L - Continued		
B6000 B6P Series			B6000 B6P Series - Continued		
Belt - Fan & Alt.; W/70A., 108A. Alt.	11502375	♣9525HD	Belt - Alt. & A.P.; W/105A., 130A., 160A. Alt.		♣9650HD
Belt - Fan & Alt.; W/80A., 100A. Alt.	2005476	②♣9550HD	Belt - P.S.; W/40" Belt O.C.	9433884	♣9395HD
Belt - Fan & Alt.; W/105A., 130A., 160A. Alt.; Preferred Belt	11502386	2/9570PB	Belt - P.S.; W/Air Brakes; W/59 1/2" Belt O.C.		♣9590HD
Belt - Fan & Alt.; W/105A., 130A., 160A. Alt.; Optional Belt	11502386	②♣9570HD	Belt - P.S.; W/Hyd. Brakes; W/64 3/4" Belt O.C.		♣9640HD
Belt - Fan, Alt. & A.P.; W/80A. Alt.	11502410	♣9670HD	Belt - A.P. - From C.S.; W/39" Belt O.C.		♣9385HD
Belt - Fan, Alt. & A.P.; W/105A., 130A., 160A. Alt.	11502411	♣9680HD	Belt - A.P. - From C.S.; W/54 1/2" Belt O.C. ...	9433913	♣9540HD
Belt - Fan & P.S.; W/Hyd. Brakes	9433923	♣9590HD	Belt - Air Brake Compr.		♣9720HD
Belt - P.S. & A.P.		♣9640HD	Hose - Upper - Eng. To Pipe		♣21307
Belt - P.S.; W/Air Brakes	9433881	♣9380HD	Hose - Upper - Pipe To Rad.; W/Auto. Trans.		21523
Belt - Air Brake Compr. & A.P.		♣9670HD	Hose - Upper - Pipe To Rad.; W/Man. Trans.		21521
Belt - A.P.		♣9540HD	Hose - Lower - Eng. To Pipe; (2 1/4" I.D.)		24236
Hose - Upper		21095	Hose - Lower - Pipe To Rad.		21556
Hose - Lower		21409	Hose - By Pass; (1 3/8" I.D.)		24222
Hose - By Pass		♣20777	S7000 S7T Series		
GM V-8 6.0 L			Belt - Fan & Alt.		♣9640HD
B6000 B6P Series			Belt - P.S.	9433923	♣9590HD
Belt - Fan & Alt.; W/63A., 108A. Alt.; Preferred Belt		2/9640PB	Belt - Air Brake Compr.	11502417	♣9720HD
Belt - Fan & Alt.; W/63A., 108A. Alt.; Optional Belt		②♣9640HD	Belt - A.P.	11502340	♣9385HD
Belt - Fan & Alt.; W/80A., 100A. Alt.; Preferred Belt		2/9660PB	Belt - A.P. & Alt.	11502402	♣9630HD
Belt - Fan & Alt.; W/80A., 100A. Alt.; Optional Belt		②♣9660HD	Hose - Upper - Eng. To Pipe		♣21307
Belt - Fan & Alt.; W/105A., 130A., 160A. Alt.; Preferred Belt ..		2/9670PB	Hose - Upper - Pipe To Rad.; W/Auto. Trans.		21523
Belt - Fan & Alt.; W/105A., 130A., 160A. Alt.; Optional Belt ...		②♣9670HD	Hose - Upper - Pipe To Rad.; W/Man. Trans.		21521
Belt - Fan & P.S.		♣9630HD	Hose - Lower - Pipe To Rad.		21556
Belt - Fan & Hyd. Pump		♣9630HD	Hose - By Pass; (1 3/8" I.D.)		24222
Belt - Fan & Air Brake Compr.	2027569	5700	GM V-8 7.4 L		
Belt - Fan To A.P.	9433881	♣9380HD	B6000 B6P Series		
Belt - Alt. & A.P.; W/108A. Alt.		♣9630HD	Belt - Fan & Alt.; W/63A., 108A. Alt.; Preferred Belt		2/9640PB
Belt - Alt. & A.P.; W/80A., 100A. Alt.		♣9640HD	Belt - Fan & Alt.; W/63A., 108A. Alt.; Optional Belt		②♣9640HD
Belt - Alt. & A.P.; W/105A., 130A., 160A. Alt.		♣9650HD	Belt - Fan & Alt.; W/80A., 100A. Alt.; Preferred Belt		2/9660PB
Belt - P.S.; W/40" Belt O.C.	9433884	♣9395HD	Belt - Fan & Alt.; W/80A., 100A. Alt.; Optional Belt		②♣9660HD
Belt - P.S.; W/Air Brakes; W/59 1/2" Belt O.C.		♣9590HD	Belt - Fan & Alt.; W/105A., 130A., 160A. Alt.; Preferred Belt ..		2/9670PB
Belt - P.S.; W/Hyd. Brakes; W/64 3/4" Belt O.C.		♣9640HD	Belt - Fan & Alt.; W/105A., 130A., 160A. Alt.; Optional Belt ...		②♣9670HD
Belt - A.P. - From C.S.; W/39" Belt O.C.		♣9385HD	Belt - Fan & P.S.		♣9630HD
Belt - A.P. - From C.S.; W/54 1/2" Belt O.C. ...	9433913	♣9540HD	Belt - Fan & Hyd. Pump		♣9630HD
Belt - Air Brake Compr.		♣9720HD	Belt - Fan & Air Brake Compr.	2027569	5700
Hose - Upper - Eng. To Pipe		♣21307	Belt - Fan To A.P.	9433881	♣9380HD
Hose - Upper - Pipe To Rad.; W/Auto. Trans.		21523	Belt - Alt. & A.P.; W/108A. Alt.		♣9630HD
Hose - Upper - Pipe To Rad.; W/Man. Trans.		21521	Belt - Alt. & A.P.; W/80A., 100A. Alt.		♣9640HD
Hose - Lower - Eng. To Pipe; (2 1/4" I.D.)		24236	Belt - Alt. & A.P.; W/105A., 130A., 160A. Alt.		♣9650HD
Hose - Lower - Pipe To Rad.		21556	Belt - P.S.; W/40" Belt O.C.	9433884	♣9395HD
Hose - By Pass; (1 3/8" I.D.)		24222	Belt - P.S.; W/Air Brakes; W/59 1/2" Belt O.C.		♣9590HD
S7000 S7T Series			Belt - P.S.; W/Hyd. Brakes; W/64 3/4" Belt O.C.		♣9640HD
Belt - Fan & Alt.		♣9640HD	Belt - A.P. - From C.S.; W/39" Belt O.C.		♣9385HD
Belt - P.S.	9433923	♣9590HD	Belt - A.P. - From C.S.; W/54 1/2" Belt O.C. ...	9433913	♣9540HD
Belt - Air Brake Compr.	11502417	♣9720HD	Belt - Air Brake Compr.		♣9720HD
Belt - A.P.	11502340	♣9385HD	Hose - Upper - Eng. To Pipe		♣21307
Belt - A.P. & Alt.	11502402	♣9630HD	Hose - Upper - Pipe To Rad.; W/Auto. Trans.		21523
Hose - Upper - Eng. To Pipe		♣21307	Hose - Upper - Pipe To Rad.; W/Man. Trans.		21521
Hose - Upper - Pipe To Rad.; W/Auto. Trans.		21523	Hose - Lower - Eng. To Pipe; (2 1/4" I.D.)		24236
Hose - Upper - Pipe To Rad.; W/Man. Trans.		21521	Hose - Lower - Pipe To Rad.		21556
Hose - Lower - Pipe To Rad.		21556	Hose - By Pass; (1 3/8" I.D.)		24222
Hose - By Pass; (1 3/8" I.D.)		24222	S7000 S7T Series		
GM V-8 7.0 L			Belt - Fan & Alt.		♣9640HD
B6000 B6P Series			Belt - P.S.	9433923	♣9590HD
Belt - Fan & Alt.; W/63A., 108A. Alt.; Preferred Belt		2/9640PB	Belt - Air Brake Compr.	11502417	♣9720HD
Belt - Fan & Alt.; W/63A., 108A. Alt.; Optional Belt		②♣9640HD	Belt - A.P.	11502340	♣9385HD
Belt - Fan & Alt.; W/80A., 100A. Alt.; Preferred Belt		2/9660PB	Belt - A.P. & Alt.	11502402	♣9630HD
Belt - Fan & Alt.; W/80A., 100A. Alt.; Optional Belt		②♣9660HD	Hose - Upper - Eng. To Pipe		♣21307
Belt - Fan & Alt.; W/105A., 130A., 160A. Alt.; Preferred Belt ..		2/9670PB	Hose - Upper - Pipe To Rad.; W/Auto. Trans.		21523
Belt - Fan & Alt.; W/105A., 130A., 160A. Alt.; Optional Belt ...		②♣9670HD	Hose - Upper - Pipe To Rad.; W/Man. Trans.		21521
Belt - Fan & P.S.		♣9630HD	Hose - Lower - Eng. To Pipe; (2 1/4" I.D.)		24236
Belt - Fan & Hyd. Pump		♣9630HD	Hose - Lower - Pipe To Rad.		21556
Belt - Fan & Air Brake Compr.	2027569	5700	Hose - By Pass; (1 3/8" I.D.)		24222
Belt - Fan To A.P.	9433881	♣9380HD	1989		
Belt - Alt. & A.P.; W/108A. Alt.		♣9630HD	Detroit Diesel V-8 8.2 L Diesel		
Belt - Alt. & A.P.; W/80A., 100A. Alt.		♣9640HD	B6000 B6P Series		
♣ Standard Belt Available. See Pages 630-631.			Belt - Fan & Alt.; W/71 1/2" Belt O.C.	2099791	♣9710HD
◆ Green Stripe® PowerBand® Belt May Work, Use Template to Check.			Belt - Fan & Alt.; W/97 1/2" Belt O.C.	2056956	②♣9700HD
			Belt - Fan & Air Brake Compr.		♣9720HD
			② Two Required.		
			♣ Cut to Fit.		

School Buses

Belts and Coolant Hose for School Buses

School Buses

Application	Mfr. Part No.	Our No.
GMC - Continued		
1989 - Continued		
Detroit Diesel V-8 8.2 L Diesel - Continued		
B6000 B6P Series - Continued		
Belt - P.S.	11502340	▲9385HD
Belt - Air Brake Compr.	11502419	▲9740HD
Hose - Upper - Eng. To Pipe; (2" I.D.)		24232
Hose - Upper - Pipe To Rad.		21473
Hose - Lower - Eng. To Pipe; (2 1/4" I.D.)		24236
Hose - Lower - Pipe To Rad.; (2 3/8" I.D.)		24238
Hose - By Pass - Left Side; (1 3/8" I.D.)		24222
Hose - By Pass - Right Side		21457
S7000 S7T Series		
Belt - Fan & Alt.; W/71 1/2" Belt O.C.	2099791	▲9710HD
Belt - Fan & Alt.; W/97 1/2" Belt O.C.	2056956	②▲9700HD
Belt - Fan & Air Brake Compr.		▲9720HD
Belt - P.S.	11502340	▲9385HD
Belt - Air Brake Compr.; W/71 1/2" Belt O.C. .	11502416	▲9710HD
Belt - Air Brake Compr.; W/75" Belt O.C.	11502340	▲9745HD
Hose - Upper - Eng. To Pipe; (2" I.D.)		24232
Hose - Upper - Pipe To Rad.		21473
Hose - Lower - Eng. To Pipe; (2 1/4" I.D.)		24236
Hose - Lower - Pipe To Rad.; (2 3/8" I.D.)		24238
Hose - By Pass - Left Side; (1 3/8" I.D.)		24222
Hose - By Pass - Right Side		21457
GM V-8 5.7 L		
B6000 B6P Series		
Belt - Fan & Alt.; W/70A., 108A. Alt.	11502375	▲9525HD
Belt - Fan & Alt.; W/80A., 100A. Alt.	2005476	②◆▲9550HD
Belt - Fan & Alt.; W/105A., 130A., 160A. Alt. .	11502386	②◆▲9570HD
Belt - Fan, Alt. & A.P.; W/80A. Alt.	11502410	▲9670HD
Belt - Fan, Alt. & A.P.; W/105A., 130A., 160A. Alt.	11502411	▲9680HD
Belt - Fan & P.S.; W/Hyd. Brakes	9433923	▲9590HD
Belt - P.S. & A.P.		▲9640HD
Belt - P.S.; W/Air Brakes	9433881	▲9380HD
Belt - Air Brake Compr. & A.P.		▲9670HD
Belt - A.P.		▲9540HD
Hose - Upper		21095
Hose - Lower		21409
Hose - By Pass		≈20777
GM V-8 6.0 L		
B6000 B6P Series		
Belt - Fan & Alt.; W/63A., 108A. Alt.; Preferred Belt		2/9640PB
Belt - Fan & Alt.; W/63A., 108A. Alt.; Optional Belt	②▲9640HD	
Belt - Fan & Alt.; W/80A., 100A. Alt.; Preferred Belt		2/9660PB
Belt - Fan & Alt.; W/80A., 100A. Alt.; Optional Belt	②▲9660HD	
Belt - Fan & Alt.; W/105A., 130A., 160A. Alt.; Preferred Belt ..		2/9670PB
Belt - Fan & Alt.; W/105A., 130A., 160A. Alt.; Optional Belt ...	②▲9670HD	
Belt - Fan & P.S.		▲9630HD
Belt - Fan & Hyd. Pump		▲9630HD
Belt - Fan & Air Brake Compr.	2027569	5700
Belt - Fan To A.P.	9433881	▲9380HD
Belt - Alt. & A.P.; W/108A. Alt.		▲9630HD
Belt - Alt. & A.P.; W/80A., 100A. Alt.		▲9640HD
Belt - Alt. & A.P.; W/105A., 130A., 160A. Alt.		▲9650HD
Belt - P.S.; W/40" Belt O.C.	9433884	▲9395HD
Belt - P.S.; W/Air Brakes; W/59 1/2" Belt O.C.		▲9590HD
Belt - P.S.; W/Hyd. Brakes; W/64 3/4" Belt O.C.		▲9640HD
Belt - A.P. - From C.S.; W/39" Belt O.C.		▲9385HD
Belt - A.P. - From C.S.; W/54 1/2" Belt O.C. ..	9433913	▲9540HD
Belt - Air Brake Compr.		▲9720HD
Hose - Upper - Eng. To Pipe		≈21307
Hose - Upper - Pipe To Rad.; W/Auto. Trans.		21523
Hose - Upper - Pipe To Rad.; W/Man. Trans.		21521
Hose - Lower - Eng. To Pipe; (2 1/4" I.D.)		24236
Hose - Lower - Pipe To Rad.		21556
Hose - By Pass; (1 3/8" I.D.)		24222
S7000 S7T Series		
Belt - Fan & Alt.		▲9640HD
Belt - P.S.	9433923	▲9590HD
Belt - Air Brake Compr.	11502417	▲9720HD
Belt - A.P.	11502340	▲9385HD

Application	Mfr. Part No.	Our No.
GMC - Continued		
1989 - Continued		
GM V-8 6.0 L - Continued		
S7000 S7T Series - Continued		
Belt - A.P. & Alt.	11502402	▲9630HD
Hose - Upper - Eng. To Pipe		≈21307
Hose - Upper - Pipe To Rad.; W/Auto. Trans.		21523
Hose - Upper - Pipe To Rad.; W/Man. Trans.		21521
Hose - Lower - Pipe To Rad.		21556
Hose - By Pass; (1 3/8" I.D.)		24222
1988		
Detroit Diesel V-8 8.2 L Diesel		
B6000 B6P Series		
Belt - Fan & Alt.; W/71 1/2" Belt O.C.	2099791	▲9710HD
Belt - Fan & Alt.; W/97 1/2" Belt O.C.	2056956	②▲9700HD
Belt - Fan & Air Brake Compr.		▲9720HD
Belt - P.S.	11502340	▲9385HD
Belt - Air Brake Compr.	11502419	▲9740HD
Hose - Upper - Eng. To Pipe; (2" I.D.)		24232
Hose - Upper - Pipe To Rad.		21473
Hose - Lower - Eng. To Pipe; (2 1/4" I.D.)		24236
Hose - Lower - Pipe To Rad.; (2 3/8" I.D.)		24238
Hose - By Pass - Left Side; (1 3/8" I.D.)		24222
Hose - By Pass - Right Side		21457
S7000 S7T Series		
Belt - Fan & Alt.; W/71 1/2" Belt O.C.	2099791	▲9710HD
Belt - Fan & Alt.; W/97 1/2" Belt O.C.	2056956	②▲9700HD
Belt - Fan & Air Brake Compr.		▲9720HD
Belt - P.S.	11502340	▲9385HD
Belt - Air Brake Compr.; W/71 1/2" Belt O.C. .	11502416	▲9710HD
Belt - Air Brake Compr.; W/75" Belt O.C.	11502340	▲9745HD
Hose - Upper - Eng. To Pipe; (2" I.D.)		24232
Hose - Upper - Pipe To Rad.		21473
Hose - Lower - Eng. To Pipe; (2 1/4" I.D.)		24236
Hose - Lower - Pipe To Rad.; (2 3/8" I.D.)		24238
Hose - By Pass - Left Side; (1 3/8" I.D.)		24222
Hose - By Pass - Right Side		21457
GM V-8 5.7 L		
B6000 B6P Series		
Belt - Fan & Alt.; W/70A., 108A. Alt.	11502375	▲9525HD
Belt - Fan & Alt.; W/80A., 100A. Alt.	2005476	②◆▲9550HD
Belt - Fan & Alt.; W/105A., 130A., 160A. Alt. .	11502386	②◆▲9570HD
Belt - Fan, Alt. & A.P.; W/80A. Alt.	11502410	▲9670HD
Belt - Fan, Alt. & A.P.; W/105A., 130A., 160A. Alt.	11502411	▲9680HD
Belt - Fan & P.S.; W/Hyd. Brakes	9433923	▲9590HD
Belt - P.S. & A.P.		▲9640HD
Belt - P.S.; W/Air Brakes	9433881	▲9380HD
Belt - Air Brake Compr. & A.P.		▲9670HD
Belt - A.P.		▲9540HD
Hose - Upper		21095
Hose - Lower		21409
Hose - By Pass		≈20777
GM V-8 6.0 L		
B6000 B6P Series		
Belt - Fan & Alt.; W/63A., 108A. Alt.		②◆▲9640HD
Belt - Fan & Alt.; W/80A., 100A. Alt.		②◆▲9660HD
Belt - Fan & Alt.; W/105A., 130A., 160A. Alt.		②◆▲9670HD
Belt - Fan & P.S.		▲9630HD
Belt - Fan & Hyd. Pump		▲9630HD
Belt - Fan & Air Brake Compr.	2027569	5700
Belt - Fan To A.P.	9433881	▲9380HD
Belt - Alt. & A.P.; W/108A. Alt.		▲9630HD
Belt - Alt. & A.P.; W/80A., 100A. Alt.		▲9640HD
Belt - Alt. & A.P.; W/105A., 130A., 160A. Alt.		▲9650HD
Belt - P.S.; W/40" Belt O.C.	9433884	▲9395HD
Belt - P.S.; W/Air Brakes; W/59 1/2" Belt O.C.		▲9590HD
Belt - P.S.; W/Hyd. Brakes; W/64 3/4" Belt O.C.		▲9640HD
Belt - A.P. - From C.S.; W/39" Belt O.C.		▲9385HD
Belt - A.P. - From C.S.; W/54 1/2" Belt O.C. ..	9433913	▲9540HD
Belt - Air Brake Compr.		▲9720HD
Hose - Upper - Eng. To Pipe		≈21307
Hose - Upper - Pipe To Rad.; W/Auto. Trans.		21523
Hose - Upper - Pipe To Rad.; W/Man. Trans.		21521
Hose - Lower - Eng. To Pipe; (2 1/4" I.D.)		24236
Hose - Lower - Pipe To Rad.		21556
Hose - By Pass; (1 3/8" I.D.)		24222
S7000 S7T Series		
Belt - Fan & Alt.		▲9640HD
Belt - P.S.	9433923	▲9590HD
Belt - Air Brake Compr.	11502417	▲9720HD
Belt - A.P.	11502340	▲9385HD

▲ Standard Belt Available. See Pages 630-631.

◆ Green Stripe® PowerBand® Belt May Work, Use Template to Check.

② Two Required.

≈ Cut to Fit.

Belts and Coolant Hose for School Buses

Application	Mfr. Part No.	Our No.	Application	Mfr. Part No.	Our No.
GMC - Continued			GMC - Continued		
1988 - Continued			1987-1986 - Continued		
GM V-8 6.0 L - Continued			GM V-8 6.0 L - Continued		
B6000 B6P Series - Continued			B6000 B6P Series - Continued		
Hose - Upper - Eng. To Pipe		≈21307	Hose - Upper - Pipe To Rad.; W/Man. Trans.		21521
Hose - Upper - Pipe To Rad.; W/Auto. Trans.		21523	Hose - Lower - Eng. To Pipe; (2 1/4" I.D.)		24236
Hose - Upper - Pipe To Rad.; W/Man. Trans.		21521	Hose - Lower - Pipe To Rad.		21556
Hose - Lower - Eng. To Pipe; (2 1/4" I.D.)		24236	Hose - By Pass; (1 3/8" I.D.)		24222
Hose - Lower - Pipe To Rad.		21556			
Hose - By Pass; (1 3/8" I.D.)		24222			
S7000 S7T Series					
Belt - Fan & Alt.		◆9640HD			
Belt - P.S.	9433923	◆9590HD			
Belt - Air Brake Compr.	11502417	◆9720HD			
Belt - A.P.	11502340	◆9385HD			
Belt - A.P. & Alt.	11502402	◆9630HD			
Hose - Upper - Eng. To Pipe		≈21307			
Hose - Upper - Pipe To Rad.; W/Auto. Trans.		21523			
Hose - Upper - Pipe To Rad.; W/Man. Trans.		21521			
Hose - Lower - Pipe To Rad.		21556			
Hose - By Pass; (1 3/8" I.D.)		24222			
1987-1986			1985-1983		
Detroit Diesel V-8 8.2 L Diesel			Detroit Diesel V-8 8.2 L Diesel		
B6000 B6P Series			B6000 B6P Series		
Belt - Fan & Alt.; W/71 1/2" Belt O.C.	2099791	◆9710HD	Belt - Fan & Alt.; W/71 1/2" Belt O.C.	2099791	◆9710HD
Belt - Fan & Alt.; W/97 1/2" Belt O.C.	2056956	②◆9700HD	Belt - Fan & Alt.; W/97 1/2" Belt O.C.	2056956	②◆9700HD
Belt - Fan & Air Brake Compr.		◆9720HD	Belt - Fan & Air Brake Compr.		◆9720HD
Belt - P.S.	11502340	◆9385HD	Belt - P.S.	11502340	◆9385HD
Belt - Air Brake Compr.	11502419	◆9740HD	Belt - Air Brake Compr.	11502419	◆9740HD
Hose - Upper - Eng. To Pipe; (2" I.D.)		24232	Hose - Upper - Eng. To Pipe; (2" I.D.)		24232
Hose - Upper - Pipe To Rad.		21473	Hose - Upper - Pipe To Rad.		21473
Hose - Lower - Eng. To Pipe; (2 1/4" I.D.)		24236	Hose - Lower - Eng. To Pipe; (2 1/4" I.D.)		24236
Hose - Lower - Pipe To Rad.; (2 3/8" I.D.)		24238	Hose - Lower - Pipe To Rad.; (2 3/8" I.D.)		24238
Hose - By Pass - Left Side; (1 3/8" I.D.)		24222	Hose - By Pass - Left Side; (1 3/8" I.D.)		24222
Hose - By Pass - Right Side		21457	Hose - By Pass - Right Side		21457
GM V-8 5.7 L			GM V-8 5.7 L		
B6000 B6P Series			B6000 B6P Series		
Belt - Fan & Alt.; W/70A., 108A. Alt.	11502375	◆9525HD	Belt - Fan & Alt.; W/70A., 108A. Alt.	11502375	◆9525HD
Belt - Fan & Alt.; W/80A., 100A. Alt.	2005476	②◆9550HD	Belt - Fan & Alt.; W/80A., 100A. Alt.	2005476	②◆9550HD
Belt - Fan & Alt.; W/105A., 130A., 160A. Alt.	11502386	②◆9570HD	Belt - Fan & Alt.; W/105A., 130A., 160A. Alt.	11502386	②◆9570HD
Belt - Fan, Alt. & A.P.; W/80A. Alt.	11502410	◆9670HD	Belt - Fan, Alt. & A.P.; W/80A. Alt.	11502410	◆9670HD
Belt - Fan, Alt. & A.P.; W/105A., 130A., 160A. Alt.	11502411	◆9680HD	Belt - Fan, Alt. & A.P.; W/105A., 130A., 160A. Alt.	11502411	◆9680HD
Belt - Fan & P.S.; W/Hyd. Brakes	9433923	◆9590HD	Belt - Fan & P.S.; W/Hyd. Brakes	9433923	◆9590HD
Belt - P.S. & A.P.		◆9640HD	Belt - P.S. & A.P.		◆9640HD
Belt - P.S.; W/Air Brakes	9433881	◆9380HD	Belt - P.S.; W/Air Brakes	9433881	◆9380HD
Belt - Air Brake Compr. & A.P.		◆9670HD	Belt - Air Brake Compr. & A.P.		◆9670HD
Belt - A.P.		◆9540HD	Belt - A.P.		◆9540HD
Hose - Upper		21095	Hose - Upper		21095
Hose - Lower		21409	Hose - Lower		21409
Hose - By Pass		≈20777	Hose - By Pass		≈20777
GM V-8 6.0 L			GM V-8 6.0 L		
B6000 B6P Series			B6000 B6P Series		
Belt - Fan & Alt.; W/63A., 108A. Alt.		②◆9640HD	Belt - Fan & Alt.; W/63A., 108A. Alt.		②◆9640HD
Belt - Fan & Alt.; W/80A., 100A. Alt.		②◆9660HD	Belt - Fan & Alt.; W/80A., 100A. Alt.		②◆9660HD
Belt - Fan & Alt.; W/105A., 130A., 160A. Alt.		②◆9670HD	Belt - Fan & Alt.; W/105A., 130A., 160A. Alt.		②◆9670HD
Belt - Fan & P.S.		◆9630HD	Belt - Fan & P.S.		◆9630HD
Belt - Fan & Hyd. Pump		◆9630HD	Belt - Fan & Hyd. Pump		◆9630HD
Belt - Fan & Air Brake Compr.	2027569	5700	Belt - Fan & Air Brake Compr.	2027569	5700
Belt - Fan To A.P.	9433881	◆9380HD	Belt - Fan To A.P.	9433881	◆9380HD
Belt - Alt. & A.P.; W/108A. Alt.		◆9630HD	Belt - Alt. & A.P.; W/108A. Alt.		◆9630HD
Belt - Alt. & A.P.; W/80A., 100A. Alt.		◆9640HD	Belt - Alt. & A.P.; W/80A., 100A. Alt.		◆9640HD
Belt - Alt. & A.P.; W/105A., 130A., 160A. Alt.		◆9650HD	Belt - Alt. & A.P.; W/105A., 130A., 160A. Alt.		◆9650HD
Belt - P.S.; W/40" Belt O.C.	9433884	◆9395HD	Belt - P.S.; W/40" Belt O.C.	9433884	◆9395HD
Belt - P.S.; W/Air Brakes; W/59 1/2" Belt O.C.		◆9590HD	Belt - P.S.; W/Air Brakes; W/59 1/2" Belt O.C.		◆9590HD
Belt - P.S.; W/Hyd. Brakes; W/64 3/4" Belt O.C.		◆9640HD	Belt - P.S.; W/Hyd. Brakes; W/64 3/4" Belt O.C.		◆9640HD
Belt - A.P. - From C.S.; W/39" Belt O.C.		◆9385HD	Belt - A.P. - From C.S.; W/39" Belt O.C.		◆9385HD
Belt - A.P. - From C.S.; W/54 1/2" Belt O.C. ...	9433913	◆9540HD	Belt - A.P. - From C.S.; W/54 1/2" Belt O.C. ...	9433913	◆9540HD
Belt - Air Brake Compr.		◆9720HD	Belt - Air Brake Compr.		◆9720HD
Hose - Upper		21107	Hose - Upper		21107
Hose - Lower - Eng. To Pipe; (2 1/4" I.D.)		24236	Hose - Lower - Eng. To Pipe; (2 1/4" I.D.)		24236
Hose - Lower - Pipe To Rad.		21556	Hose - Lower - Pipe To Rad.		21556
Hose - By Pass; (1 3/8" I.D.)		24222	Hose - By Pass; (1 3/8" I.D.)		24222
GM V-8 7.0 L			GM V-8 7.0 L		
B6000 B6P Series			B6000 B6P Series		
Belt - Fan & Alt.; W/63A., 108A. Alt.		②◆9640HD	Belt - Fan & Alt.; W/63A., 108A. Alt.		②◆9640HD
Belt - Fan & Alt.; W/80A., 100A. Alt.		②◆9660HD	Belt - Fan & Alt.; W/80A., 100A. Alt.		②◆9660HD
Belt - Fan & Alt.; W/105A., 130A., 160A. Alt.		②◆9670HD	Belt - Fan & Alt.; W/105A., 130A., 160A. Alt.		②◆9670HD
Belt - Fan & P.S.		◆9630HD	Belt - Fan & P.S.		◆9630HD
Belt - Fan & Hyd. Pump		◆9630HD	Belt - Fan & Hyd. Pump		◆9630HD
Belt - Fan & Air Brake Compr.	2027569	5700	Belt - Fan & Air Brake Compr.	2027569	5700
Belt - Fan To A.P.	9433881	◆9380HD	Belt - Fan To A.P.	9433881	◆9380HD
Belt - Alt. & A.P.; W/108A. Alt.		◆9630HD	Belt - Alt. & A.P.; W/108A. Alt.		◆9630HD
Belt - Alt. & A.P.; W/80A., 100A. Alt.		◆9640HD	Belt - Alt. & A.P.; W/80A., 100A. Alt.		◆9640HD

≈ Cut to Fit.
② Two Required.

◆ Standard Belt Available. See Pages 630-631.
◆ Green Stripe® PowerBand® Belt May Work, Use Template to Check.

School Buses

Belts and Coolant Hose for School Buses

School Buses

Application	Mfr. Part No.	Our No.
GMC - Continued		
1985-1983 - Continued		
GM V-8 7.0 L - Continued		
B6000 B6P Series - Continued		
Belt - Alt. & A.P.; W/105A., 130A., 160A. Alt.		▲9650HD
Belt - P.S.; W/40" Belt O.C. 9433884		▲9395HD
Belt - P.S.; W/Air Brakes; W/59 1/2" Belt O.C.		▲9590HD
Belt - P.S.; W/Hyd. Brakes; W/64 3/4" Belt O.C.		▲9640HD
Belt - A.P. - From C.S.; W/39" Belt O.C.		▲9385HD
Belt - A.P. - From C.S.; W/54 1/2" Belt O.C. ... 9433913		▲9540HD
Belt - Air Brake Compr.		▲9720HD
Hose - Upper		21107
Hose - Lower - Eng. To Pipe; (2 1/4" I.D.)		24236
Hose - Lower - Pipe To Rad.		21556
Hose - By Pass; (1 3/8" I.D.)		24222
1982		
Detroit Diesel V-8 8.2 L Diesel		
B6000 B6P Series		
Belt - Fan & Alt.; W/71 1/2" Belt O.C. 2099791		▲9710HD
Belt - Fan & Alt.; W/97 1/2" Belt O.C. 2056956		②▲9700HD
Belt - Fan & Air Brake Compr.; Jan. 10, 1982 & Older 11502414		▲9700HD
Belt - Fan & Air Brake Compr.; Jan. 11, 1982 & Newer		▲9720HD
Belt - P.S. 11502340		▲9385HD
Belt - Air Brake Compr. 11502419		▲9740HD
Hose - Upper - Eng. To Pipe; (2" I.D.)		24232
Hose - Upper - Pipe To Rad.		21473
Hose - Lower - Eng. To Pipe; (2 1/4" I.D.)		24236
Hose - Lower - Pipe To Rad.; (2 3/8" I.D.)		24238
Hose - By Pass - Left Side; (1 3/8" I.D.)		24222
Hose - By Pass - Right Side		21457
GM V-8 5.7 L		
B6000 B6P Series		
Belt - Fan & Alt.; W/70A., 108A. Alt. 11502375		▲9525HD
Belt - Fan & Alt.; W/80A., 100A. Alt. 2005476		②▲9550HD
Belt - Fan & Alt.; W/105A., 130A., 160A. Alt. . 11502386		②▲9570HD
Belt - Fan, Alt. & A.P.; W/80A. Alt. 11502410		▲9670HD
Belt - Fan, Alt. & A.P.; W/105A., 130A., 160A. Alt. 11502411		▲9680HD
Belt - Fan & P.S.; W/Hyd. Brakes 9433923		▲9590HD
Belt - P.S. & A.P.		▲9640HD
Belt - P.S.; W/Air Brakes 9433881		▲9380HD
Belt - Air Brake Compr. & A.P.		▲9670HD
Belt - A.P.		▲9540HD
Hose - Upper		21095
Hose - Lower		21409
Hose - By Pass		≡20777
GM V-8 6.0 L		
B6000 B6P Series		
Belt - Fan & Alt.; W/63A., 108A. Alt.		②▲9640HD
Belt - Fan & Alt.; W/80A., 100A. Alt.		②▲9660HD
Belt - Fan & Alt.; W/105A., 130A., 160A. Alt.		②▲9670HD
Belt - Fan & P.S.		▲9630HD
Belt - Fan & Hyd. Pump		▲9630HD
Belt - Fan & Air Brake Compr. 2027569		5700
Belt - Fan To A.P. 9433881		▲9380HD
Belt - Alt. & A.P.; W/108A. Alt.		▲9630HD
Belt - Alt. & A.P.; W/80A., 100A. Alt.		▲9640HD
Belt - Alt. & A.P.; W/105A., 130A., 160A. Alt.		▲9650HD
Belt - P.S.; W/40" Belt O.C. 9433884		▲9395HD
Belt - P.S.; W/Air Brakes; W/59 1/2" Belt O.C.		▲9590HD
Belt - P.S.; W/Hyd. Brakes; W/64 3/4" Belt O.C.		▲9640HD
Belt - A.P. - From C.S.; W/39" Belt O.C.		▲9385HD
Belt - A.P. - From C.S.; W/54 1/2" Belt O.C. ... 9433913		▲9540HD
Belt - Air Brake Compr.		▲9720HD
Hose - Upper		21107
Hose - Lower - Eng. To Pipe; (2 1/4" I.D.)		24236
Hose - Lower - Pipe To Rad.		21556
Hose - By Pass; (1 3/8" I.D.)		24222

Application	Mfr. Part No.	Our No.
GMC - Continued		
1982 - Continued		
GM V-8 7.0 L		
B6000 B6P Series		
Belt - Fan & Alt.; W/63A., 108A. Alt.		②▲9640HD
Belt - Fan & Alt.; W/80A., 100A. Alt.		②▲9660HD
Belt - Fan & Alt.; W/105A., 130A., 160A. Alt.		②▲9670HD
Belt - Fan & P.S.		▲9630HD
Belt - Fan & Hyd. Pump		▲9630HD
Belt - Fan & Air Brake Compr. 2027569		5700
Belt - Fan To A.P. 9433881		▲9380HD
Belt - Alt. & A.P.; W/108A. Alt.		▲9630HD
Belt - Alt. & A.P.; W/80A., 100A. Alt.		▲9640HD
Belt - Alt. & A.P.; W/105A., 130A., 160A. Alt.		▲9650HD
Belt - P.S.; W/40" Belt O.C. 9433884		▲9395HD
Belt - P.S.; W/Air Brakes; W/59 1/2" Belt O.C.		▲9590HD
Belt - P.S.; W/Hyd. Brakes; W/64 3/4" Belt O.C.		▲9640HD
Belt - A.P. - From C.S.; W/39" Belt O.C.		▲9385HD
Belt - A.P. - From C.S.; W/54 1/2" Belt O.C. ... 9433913		▲9540HD
Belt - Air Brake Compr.		▲9720HD
Hose - Upper		21107
Hose - Lower - Eng. To Pipe; (2 1/4" I.D.)		24236
Hose - Lower - Pipe To Rad.		21556
Hose - By Pass; (1 3/8" I.D.)		24222
1981-1980		
Detroit Diesel V-8 8.2 L Diesel		
B6000 B6P Series		
Belt - Fan & Alt.; W/71 1/2" Belt O.C. 2099791		▲9710HD
Belt - Fan & Alt.; W/97 1/2" Belt O.C. 2056956		②▲9700HD
Belt - Fan & Air Brake Compr. 11502414		▲9700HD
Belt - P.S. 11502340		▲9385HD
Belt - Air Brake Compr. 11502419		▲9740HD
Hose - Upper - Eng. To Pipe; (2" I.D.)		24232
Hose - Upper - Pipe To Rad.		21473
Hose - Lower - Eng. To Pipe; (2 1/4" I.D.)		24236
Hose - Lower - Pipe To Rad.; (2 3/8" I.D.)		24238
Hose - By Pass - Left Side; (1 3/8" I.D.)		24222
Hose - By Pass - Right Side		21457
GM V-8 5.7 L		
B6000 B6P Series		
Belt - Fan & Alt.; W/70A., 108A. Alt. 11502375		▲9525HD
Belt - Fan & Alt.; W/80A., 100A. Alt. 2005476		②▲9550HD
Belt - Fan & Alt.; W/105A., 130A., 160A. Alt. . 11502386		②▲9570HD
Belt - Fan, Alt. & A.P.; W/80A. Alt. 11502410		▲9670HD
Belt - Fan, Alt. & A.P.; W/105A., 130A., 160A. Alt. 11502411		▲9680HD
Belt - Fan & P.S.; W/Hyd. Brakes 9433923		▲9590HD
Belt - P.S. & A.P.		▲9640HD
Belt - P.S.; W/Air Brakes 9433881		▲9380HD
Belt - Air Brake Compr. & A.P.		▲9670HD
Belt - A.P.		▲9540HD
Hose - Upper		21095
Hose - Lower		21409
Hose - By Pass		≡20777
GM V-8 6.0 L		
B6000 B6P Series		
Belt - Fan & Alt.; W/63A., 108A. Alt.		②▲9640HD
Belt - Fan & Alt.; W/80A., 100A. Alt.		②▲9660HD
Belt - Fan & Alt.; W/105A., 130A., 160A. Alt.		②▲9670HD
Belt - Fan & P.S.		▲9630HD
Belt - Fan & Hyd. Pump		▲9630HD
Belt - Fan & Air Brake Compr. 2027569		5700
Belt - Fan To A.P. 9433881		▲9380HD
Belt - Alt. & A.P.; W/108A. Alt.		▲9630HD
Belt - Alt. & A.P.; W/80A., 100A. Alt.		▲9640HD
Belt - Alt. & A.P.; W/105A., 130A., 160A. Alt.		▲9650HD
Belt - P.S.; W/40" Belt O.C. 9433884		▲9395HD
Belt - P.S.; W/Air Brakes; W/59 1/2" Belt O.C.		▲9590HD
Belt - P.S.; W/Hyd. Brakes; W/64 3/4" Belt O.C.		▲9640HD
Belt - A.P. - From C.S.; W/39" Belt O.C.		▲9385HD
Belt - A.P. - From C.S.; W/54 1/2" Belt O.C. ... 9433913		▲9540HD
Belt - Air Brake Compr.		▲9720HD
Hose - Upper		21095
Hose - Lower		21409
Hose - By Pass		≡20777

▲ Standard Belt Available. See Pages 630-631.
◆ Green Stripe® PowerBand® Belt May Work, Use Template to Check.

② Two Required.
≡ Cut to Fit.

Belts and Coolant Hose for School Buses

School Buses

Application	Mfr. Part No.	Our No.
GMC - Continued		
1981-1980 - Continued		
GM V-8 6.0 L - Continued		
B6000 B6P Series - Continued		
Hose - Upper		21107
Hose - Lower - Eng. To Pipe; (2 1/4" I.D.)		24236
Hose - Lower - Pipe To Rad.		21556
Hose - By Pass; (1 3/8" I.D.)		24222
GM V-8 7.0 L		
B6000 B6P Series		
Belt - Fan & Alt.; W/63A., 108A. Alt.	②◆◆	9640HD
Belt - Fan & Alt.; W/80A., 100A. Alt.	②◆◆	9660HD
Belt - Fan & Alt.; W/105A., 130A., 160A. Alt.	②◆◆	9670HD
Belt - Fan & P.S.		9630HD
Belt - Fan & Hyd. Pump		9630HD
Belt - Fan & Air Brake Compr.	2027569	5700
Belt - Fan To A.P.	9433881	9380HD
Belt - Alt. & A.P.; W/108A. Alt.		9630HD
Belt - Alt. & A.P.; W/80A., 100A. Alt.		9640HD
Belt - Alt. & A.P.; W/105A., 130A., 160A. Alt.		9650HD
Belt - P.S.; W/40" Belt O.C.	9433884	9395HD
Belt - P.S.; W/Air Brakes; W/59 1/2" Belt O.C.		9590HD
Belt - P.S.; W/Hyd. Brakes; W/64 3/4" Belt O.C.		9640HD
Belt - A.P. - From C.S.; W/39" Belt O.C.		9385HD
Belt - A.P. - From C.S.; W/54 1/2" Belt O.C. ...	9433913	9540HD
Belt - Air Brake Compr.		9720HD
Hose - Upper		21107
Hose - Lower - Eng. To Pipe; (2 1/4" I.D.)		24236
Hose - Lower - Pipe To Rad.		21556
Hose - By Pass; (1 3/8" I.D.)		24222
1979		
GM 6-Cyl. 292		
SS6000		
Belt - Fan & Alt.; W/Std. Alt.	3887682	②◆◆9395HD
Belt - Fan & Alt.; W/80A. Alt.	3911543	②◆◆9412HD
Belt - Fan & Alt.; W/100A. Alt.	690407	②◆◆9435HD
Belt - Fan, Alt. & P.S.; W/Std. Alt.	3947152	◆9500HD
Belt - Fan, Alt. & P.S.; W/80A. Alt.	3885457	◆9510HD
Belt - Fan & A.P.	3947150	◆9530HD
Belt - P.S.	9433884	◆9395HD
Belt - Hyd. Brake Boost Pump	9433896	◆9455HD
Belt - A.C.	3888403	7560
Hose - Upper		≈20686
Hose - Lower		20489
	or	●26611
Hose - By Pass		20563
Hose - Heater Inlet; (3/4" I.D.)		28442
Hose - Heater Outlet; (5/8" I.D.)		28441
GM V-8 350		
B6000 B6P Series		
Belt - Fan & Alt.; W/70A., 108A. Alt.	11502375	◆9525HD
Belt - Fan & Alt.; W/80A., 100A. Alt.	2005476	②◆◆9550HD
Belt - Fan & Alt.; W/105A., 130A., 160A. Alt. .	11502386	②◆◆9570HD
Belt - Fan, Alt. & A.P.; W/80A. Alt.	11502410	◆9670HD
Belt - Fan, Alt. & A.P.; W/105A., 130A., 160A. Alt.	11502411	◆9680HD
Belt - Fan & P.S.; W/Hyd. Brakes	9433923	◆9590HD
Belt - P.S. & A.P.		◆9640HD
Belt - P.S.; W/Air Brakes	9433881	◆9380HD
Belt - Air Brake Compr. & A.P.		◆9670HD
Belt - A.P.		◆9540HD
Hose - Upper		21095
Hose - Lower		21409
Hose - By Pass		≈20777
GM V-8 366		
B6000 B6P Series		
Belt - Fan & Alt.; W/63A., 108A. Alt.		②◆◆9640HD
Belt - Fan & Alt.; W/80A., 100A. Alt.		②◆◆9660HD
Belt - Fan & Alt.; W/105A., 130A., 160A. Alt.		②◆◆9670HD
Belt - Fan & P.S.		◆9630HD
Belt - Fan & Hyd. Pump		◆9630HD

Application	Mfr. Part No.	Our No.
GMC - Continued		
1979 - Continued		
GM V-8 366 - Continued		
B6000 B6P Series - Continued		
Belt - Fan & Air Brake Compr.	2027569	5700
Belt - Fan To A.P.	9433881	◆9380HD
Belt - Alt. & A.P.; W/108A. Alt.		◆9630HD
Belt - Alt. & A.P.; W/80A., 100A. Alt.		◆9640HD
Belt - Alt. & A.P.; W/105A., 130A., 160A. Alt.		◆9650HD
Belt - P.S.; W/40" Belt O.C.	9433884	◆9395HD
Belt - P.S.; W/Air Brakes; W/59 1/2" Belt O.C.		◆9590HD
Belt - P.S.; W/Hyd. Brakes; W/64 3/4" Belt O.C.		◆9640HD
Belt - A.P. - From C.S.; W/39" Belt O.C.		◆9385HD
Belt - A.P. - From C.S.; W/54 1/2" Belt O.C. ...	9433913	◆9540HD
Belt - Air Brake Compr.		◆9720HD
Hose - Upper		21107
Hose - Lower - Eng. To Pipe; (2 1/4" I.D.)		24236
Hose - Lower - Pipe To Rad.		21556
Hose - By Pass; (1 3/8" I.D.)		24222
GM V-8 427		
B6000 B6P Series		
Belt - Fan & Alt.; W/63A., 108A. Alt.		②◆◆9640HD
Belt - Fan & Alt.; W/80A., 100A. Alt.		②◆◆9660HD
Belt - Fan & Alt.; W/105A., 130A., 160A. Alt.		②◆◆9670HD
Belt - Fan & P.S.		◆9630HD
Belt - Fan & Hyd. Pump		◆9630HD
Belt - Fan & Air Brake Compr.	2027569	5700
Belt - Fan To A.P.	9433881	◆9380HD
Belt - Alt. & A.P.; W/108A. Alt.		◆9630HD
Belt - Alt. & A.P.; W/80A., 100A. Alt.		◆9640HD
Belt - Alt. & A.P.; W/105A., 130A., 160A. Alt.		◆9650HD
Belt - P.S.; W/40" Belt O.C.	9433884	◆9395HD
Belt - P.S.; W/Air Brakes; W/59 1/2" Belt O.C.		◆9590HD
Belt - P.S.; W/Hyd. Brakes; W/64 3/4" Belt O.C.		◆9640HD
Belt - A.P. - From C.S.; W/39" Belt O.C.		◆9385HD
Belt - A.P. - From C.S.; W/54 1/2" Belt O.C. ...	9433913	◆9540HD
Belt - Air Brake Compr.		◆9720HD
Hose - Upper		21107
Hose - Lower - Eng. To Pipe; (2 1/4" I.D.)		24236
Hose - Lower - Pipe To Rad.		21556
Hose - By Pass; (1 3/8" I.D.)		24222
1978		
GM 6-Cyl. 292		
SS6000		
Belt - Fan & Alt.; W/Std. Alt.	3887682	②◆◆9395HD
Belt - Fan & Alt.; W/80A. Alt.	3911543	②◆◆9412HD
Belt - Fan & Alt.; W/100A. Alt.	690407	②◆◆9435HD
Belt - Fan, Alt. & P.S.; W/Std. Alt.	3947152	◆9500HD
Belt - Fan, Alt. & P.S.; W/80A. Alt.	3885457	◆9510HD
Belt - Fan & A.P.	3947150	◆9530HD
Belt - P.S.	9433884	◆9395HD
Belt - Hyd. Brake Boost Pump	9433896	◆9455HD
Belt - A.C.	3888403	7560
Hose - Upper		≈20686
Hose - Lower		20489
	or	●26611
Hose - By Pass		20563
Hose - Heater Inlet; (3/4" I.D.)		28442
Hose - Heater Outlet; (5/8" I.D.)		28441
GM V-8 307		
SE6000		
Belt - Fan & Alt.; W/65A., 70A. Alt.	9433915	②◆◆9550HD
Belt - Fan & Alt.; W/105A., 130A. Alt.	3887691	②◆◆9570HD
Belt - P.S.		◆9385HD
Belt - Hyd. Brake Boost Pump; W/56 1/4" Belt O.C.	9433917	◆9560HD
Belt - Hyd. Brake Boost Pump; W/59 1/4" Belt O.C.	9433923	◆9590HD
Belt - Hyd. Brake Boost Pump & A.P.; W/65 1/4" Belt O.C.	9433935	◆9650HD
Belt - Hyd. Brake Boost Pump & A.P.; W/68 1/4" Belt O.C.	2027569	◆9680HD

② Two Required.
 ◆ Standard Belt Available. See Pages 630-631.
 ● Vulco-Flex® Coolant Hose.

◆ Green Stripe® PowerBand® Belt May Work, Use Template to Check.
 ≈ Cut to Fit.

Belts and Coolant Hose for School Buses

School Buses

Application	Mfr. Part No.	Our No.
GMC - Continued		
1978 - Continued		
GM V-8 307 - Continued		
SE6000 - Continued		
Belt - Air Brake Compr.	3888480	▲9560HD
Belt - A.P.		▲9530HD
Hose - Upper		21095
	or	✕●25487
Hose - Lower		21409
Hose - By Pass - Left Side		20565
Hose - By Pass - Right Side		✕20777
GM V-8 350		
B6000 B6P Series		
Belt - Fan & Alt.; W/70A., 108A. Alt.	11502375	▲9525HD
Belt - Fan & Alt.; W/80A., 100A. Alt.	2005476	②◆▲9550HD
Belt - Fan & Alt.; W/105A., 130A., 160A. Alt. .	11502386	②◆▲9570HD
Belt - Fan, Alt. & A.P.; W/80A. Alt.	11502410	▲9670HD
Belt - Fan, Alt. & A.P.; W/105A., 130A., 160A. Alt.	11502411	▲9680HD
Belt - Fan & P.S.; W/Hyd. Brakes	9433923	▲9590HD
Belt - P.S. & A.P.		▲9640HD
Belt - P.S.; W/Air Brakes	9433881	▲9380HD
Belt - Air Brake Compr. & A.P.		▲9670HD
Belt - A.P.		▲9540HD
Hose - Upper		21095
Hose - Lower		21409
Hose - By Pass		✕20777
SE6000		
Belt - Fan & Alt.; W/65A., 70A. Alt.	9433915	②◆▲9550HD
Belt - Fan & Alt.; W/105A., 130A. Alt.	3887691	②◆▲9570HD
Belt - P.S.		▲9385HD
Belt - Hyd. Brake Boost Pump; W/56 1/4" Belt O.C.	9433917	▲9560HD
Belt - Hyd. Brake Boost Pump; W/59 1/4" Belt O.C.	9433923	▲9590HD
Belt - Hyd. Brake Boost Pump & A.P.; W/65 1/4" Belt O.C.	9433935	▲9650HD
Belt - Hyd. Brake Boost Pump & A.P.; W/68 1/4" Belt O.C.	2027569	▲9680HD
Belt - Air Brake Compr.	3888480	▲9560HD
Belt - A.P.		▲9530HD
Hose - Upper		21095
	or	✕●25487
Hose - Lower		21409
Hose - By Pass - Left Side		20565
Hose - By Pass - Right Side		✕20777
GM V-8 366		
SE6000		
Belt - Fan & Alt.; W/61A. Alt.		②▲9560HD
Belt - Fan & Alt.; W/A.P.; W/61A. Alt.	9433936	▲9660HD
Belt - Fan & Alt.; W/A.P.; W/100A., 105A., 130A. Alt.	9433937	▲9670HD
Belt - Fan & Alt.; W/O A.P.; W/80A. Alt.	9433936	②◆▲9660HD
Belt - Fan & Alt.; W/O A.P.; W/100A., 105A., 130A. Alt.	9433937	②◆▲9670HD
Belt - Fan & A.P.	9433932	▲9630HD
Belt - Fan & V.P.	3883005	▲9690HD
Belt - P.S.	9433884	▲9395HD
Belt - Air Brake Compr.	2027569	5700
Belt - Air Brake Compr. & A.P.		▲9720HD
Belt - Hyd. Brake Boost Pump	9433929	▲9620HD
Belt - A.P.	9433881	▲9380HD
Hose - Upper		✕20933
Hose - Lower		21011
Hose - By Pass; (1 3/4" I.D.)		24228
GM V-8 427		
SE6000		
Belt - Fan & Alt.; W/61A. Alt.		②▲9560HD
Belt - Fan & Alt.; W/A.P.; W/61A. Alt.	9433936	▲9660HD
Belt - Fan & Alt.; W/A.P.; W/100A., 105A., 130A. Alt.	9433937	▲9670HD
Belt - Fan & Alt.; W/O A.P.; W/80A. Alt.	9433936	②◆▲9660HD

Application	Mfr. Part No.	Our No.
GMC - Continued		
1978 - Continued		
GM V-8 427 - Continued		
SE6000 - Continued		
Belt - Fan & Alt.; W/O A.P.; W/100A., 105A., 130A. Alt.	9433937	②◆▲9670HD
Belt - Fan & A.P.	9433932	▲9630HD
Belt - Fan & V.P.	3883005	▲9690HD
Belt - P.S.	9433884	▲9395HD
Belt - Air Brake Compr.	2027569	5700
Belt - Air Brake Compr. & A.P.		▲9720HD
Belt - Hyd. Brake Boost Pump	9433929	▲9620HD
Belt - A.P.	9433881	▲9380HD
Hose - Upper		✕20933
Hose - Lower		21011
Hose - By Pass; (1 3/4" I.D.)		24228
GM V-8 454		
SE6000		
Belt - Fan & Alt.; W/61A. Alt.		②▲9560HD
Belt - Fan & Alt.; W/A.P.; W/61A. Alt.	9433936	▲9660HD
Belt - Fan & Alt.; W/A.P.; W/100A., 105A., 130A. Alt.	9433937	▲9670HD
Belt - Fan & Alt.; W/O A.P.; W/80A. Alt.	9433936	②◆▲9660HD
Belt - Fan & Alt.; W/O A.P.; W/100A., 105A., 130A. Alt.	9433937	②◆▲9670HD
Belt - Fan & A.P.	9433932	▲9630HD
Belt - Fan & V.P.	3883005	▲9690HD
Belt - P.S.	9433884	▲9395HD
Belt - Air Brake Compr.	2027569	5700
Belt - Air Brake Compr. & A.P.		▲9720HD
Belt - Hyd. Brake Boost Pump	9433929	▲9620HD
Belt - A.P.	9433881	▲9380HD
Hose - Upper		✕20933
Hose - Lower		21011
Hose - By Pass; (1 3/4" I.D.)		24228
1977		
GM 6-Cyl. 292		
SS6000		
Belt - Fan & Alt.; W/Std. Alt.	3887682	②▲9395HD
Belt - Fan & Alt.; W/80A. Alt.	3911543	②▲9412HD
Belt - Fan & Alt.; W/100A. Alt.	690407	②▲9435HD
Belt - Fan, Alt. & P.S.; W/Std. Alt.	3947152	▲9500HD
Belt - Fan, Alt. & P.S.; W/80A. Alt.	3885457	▲9510HD
Belt - Fan & A.P.	3947150	▲9530HD
Belt - P.S.	9433884	▲9395HD
Belt - Hyd. Brake Boost Pump	9433896	▲9455HD
Belt - A.C.	3888403	7560
Hose - Upper		✕20686
Hose - Lower		20489
	or	●26611
Hose - By Pass		20563
Hose - Heater Inlet; (3/4" I.D.)		28442
Hose - Heater Outlet; (5/8" I.D.)		28441
GM V-8 307		
SE6000		
Belt - Fan & Alt.; W/65A., 70A. Alt.	9433915	②◆▲9550HD
Belt - Fan & Alt.; W/105A., 130A. Alt.	3887691	②◆▲9570HD
Belt - P.S.		▲9385HD
Belt - Hyd. Brake Boost Pump; W/56 1/4" Belt O.C.	9433917	▲9560HD
Belt - Hyd. Brake Boost Pump; W/59 1/4" Belt O.C.	9433923	▲9590HD
Belt - Hyd. Brake Boost Pump & A.P.; W/65 1/4" Belt O.C.	9433935	▲9650HD
Belt - Hyd. Brake Boost Pump & A.P.; W/68 1/4" Belt O.C.	2027569	▲9680HD
Belt - Air Brake Compr.	3888480	▲9560HD
Belt - A.P.		▲9530HD
Hose - Upper		21095
	or	✕●25487
Hose - Lower		21409
Hose - By Pass - Left Side		20565

▲ Standard Belt Available. See Pages 630-631.
 ● Vulco-Flex® Coolant Hose.
 ◆ Green Stripe® PowerBand® Belt May Work, Use Template to Check.

✕ Cut to Fit.
 ② Two Required.

Belts and Coolant Hose for School Buses

Application	Mfr. Part No.	Our No.
GMC - Continued		
1977 - Continued		
GM V-8 307 - Continued		
SE6000 - Continued		
Hose - By Pass - Right Side		≈20777
GM V-8 350		
SE6000		
Belt - Fan & Alt.; W/65A., 70A. Alt.	9433915	②◆▲9550HD
Belt - Fan & Alt.; W/105A., 130A. Alt.	3887691	②◆▲9570HD
Belt - P.S.		▲9385HD
Belt - Hyd. Brake Boost Pump; W/56 1/4" Belt O.C.	9433917	▲9560HD
Belt - Hyd. Brake Boost Pump; W/59 1/4" Belt O.C.	9433923	▲9590HD
Belt - Hyd. Brake Boost Pump & A.P.; W/65 1/4" Belt O.C.	9433935	▲9650HD
Belt - Hyd. Brake Boost Pump & A.P.; W/68 1/4" Belt O.C.	2027569	▲9680HD
Belt - Air Brake Compr.	3888480	▲9560HD
Belt - A.P.		▲9530HD
Hose - Upper		21095
	or	●25487
Hose - Lower		21409
Hose - By Pass - Left Side		20565
Hose - By Pass - Right Side		≈20777
GM V-8 366		
SE6000		
Belt - Fan & Alt.; W/61A. Alt.		②▲9560HD
Belt - Fan & Alt.; W/A.P.; W/61A. Alt.	9433936	▲9660HD
Belt - Fan & Alt.; W/A.P.; W/100A., 105A., 130A. Alt.	9433937	▲9670HD
Belt - Fan & Alt.; W/O A.P.; W/80A. Alt.	9433936	②◆▲9660HD
Belt - Fan & Alt.; W/O A.P.; W/100A., 105A., 130A. Alt.	9433937	②◆▲9670HD
Belt - Fan & A.P.	9433932	▲9630HD
Belt - Fan & V.P.	3883005	▲9690HD
Belt - P.S.	9433884	▲9395HD
Belt - Air Brake Compr.	2027569	5700
Belt - Air Brake Compr. & A.P.		▲9720HD
Belt - Hyd. Brake Boost Pump	9433929	▲9620HD
Belt - A.P.	9433881	▲9380HD
Hose - Upper		≈20933
Hose - Lower		21011
Hose - By Pass; (1 3/4" I.D.)		24228
GM V-8 427		
SE6000		
Belt - Fan & Alt.; W/61A. Alt.		②▲9560HD
Belt - Fan & Alt.; W/A.P.; W/61A. Alt.	9433936	▲9660HD
Belt - Fan & Alt.; W/A.P.; W/100A., 105A., 130A. Alt.	9433937	▲9670HD
Belt - Fan & Alt.; W/O A.P.; W/80A. Alt.	9433936	②◆▲9660HD
Belt - Fan & Alt.; W/O A.P.; W/100A., 105A., 130A. Alt.	9433937	②◆▲9670HD
Belt - Fan & A.P.	9433932	▲9630HD
Belt - Fan & V.P.	3883005	▲9690HD
Belt - P.S.	9433884	▲9395HD
Belt - Air Brake Compr.	2027569	5700
Belt - Air Brake Compr. & A.P.		▲9720HD
Belt - Hyd. Brake Boost Pump	9433929	▲9620HD
Belt - A.P.	9433881	▲9380HD
Hose - Upper		≈20933
Hose - Lower		21011
Hose - By Pass; (1 3/4" I.D.)		24228
GM V-8 454		
SE6000		
Belt - Fan & Alt.; W/61A. Alt.		②▲9560HD
Belt - Fan & Alt.; W/A.P.; W/61A. Alt.	9433936	▲9660HD
Belt - Fan & Alt.; W/A.P.; W/100A., 105A., 130A. Alt.	9433937	▲9670HD
Belt - Fan & Alt.; W/O A.P.; W/80A. Alt.	9433936	②◆▲9660HD
Belt - Fan & Alt.; W/O A.P.; W/100A., 105A., 130A. Alt.	9433937	②◆▲9670HD
Belt - Fan & A.P.	9433932	▲9630HD

Application	Mfr. Part No.	Our No.
GMC - Continued		
1977 - Continued		
GM V-8 454 - Continued		
SE6000 - Continued		
Belt - Fan & V.P.	3883005	▲9690HD
Belt - P.S.	9433884	▲9395HD
Belt - Air Brake Compr.	2027569	5700
Belt - Air Brake Compr. & A.P.		▲9720HD
Belt - Hyd. Brake Boost Pump	9433929	▲9620HD
Belt - A.P.	9433881	▲9380HD
Hose - Upper		≈20933
Hose - Lower		21011
Hose - By Pass; (1 3/4" I.D.)		24228
1976		
GM 6-Cyl. 292		
SS6000		
Belt - Fan & Alt.; W/Std. Alt.	3887682	②▲9395HD
Belt - Fan & Alt.; W/80A. Alt.	3911543	②▲9412HD
Belt - Fan & Alt.; W/100A. Alt.	690407	②▲9435HD
Belt - Fan, Alt. & P.S.; W/Std. Alt.	3947152	▲9500HD
Belt - Fan, Alt. & P.S.; W/80A. Alt.	3885457	▲9510HD
Belt - Fan & A.P.	3947150	▲9530HD
Belt - P.S.	9433884	▲9395HD
Belt - Hyd. Brake Boost Pump	9433896	▲9455HD
Belt - A.C.	3888403	7560
Hose - Upper		≈20686
Hose - Lower		20489
	or	●26611
Hose - By Pass		20563
Hose - Heater Inlet; (3/4" I.D.)		28442
Hose - Heater Outlet; (5/8" I.D.)		28441
GM V-8 307		
SE6000		
Belt - Fan & Alt.; W/56 3/8" Belt O.C.		▲9560HD
Belt - Fan & Alt.; W/58 3/8" Belt O.C.	3891359	▲9580HD
Belt - P.S.		▲9385HD
Belt - Hyd. Brake Boost Pump	9433923	▲9590HD
Belt - Hyd. Brake Boost Pump & A.P.	2027569	▲9680HD
Belt - Air Brake Compr.		▲9640HD
Belt - A.P.		▲9530HD
Hose - Upper		20607
	or	●25484
Hose - Lower; W/Hyd. Brakes		20558
	or	●26611
Hose - By Pass - Left Side		20565
Hose - By Pass - Right Side		20566
GM V-8 350		
SE6000		
Belt - Fan & Alt.; W/56 3/8" Belt O.C.		▲9560HD
Belt - Fan & Alt.; W/58 3/8" Belt O.C.	3891359	▲9580HD
Belt - P.S.		▲9385HD
Belt - Hyd. Brake Boost Pump	9433923	▲9590HD
Belt - Hyd. Brake Boost Pump & A.P.	2027569	▲9680HD
Belt - Air Brake Compr.		▲9640HD
Belt - A.P.		▲9530HD
Hose - Upper		20607
	or	●25484
Hose - Lower; W/Hyd. Brakes		20558
	or	●26611
Hose - By Pass - Left Side		20565
Hose - By Pass - Right Side		20566
GM V-8 366		
SE6000		
Belt - Fan & Alt.; W/61A. Alt.; W/Single Belt ..	690409	▲9510HD
Belt - Fan & Alt.; W/61A. Alt.; W/Dual Belts ...	3891365	②◆▲9610HD
Belt - Fan & Alt.; W/80A. Alt.		▲9560HD
Belt - Fan & Alt.; W/A.P.; W/100A., 105A., 130A. Alt.	9433921	▲9580HD
Belt - Fan & Alt.; W/O A.P.; W/100A., 105A., 130A. Alt.	9433921	②▲9580HD
Belt - Fan & P.S.	9433884	▲9560HD

≈ Cut to Fit.

- ◆ Green Stripe® PowerBand® Belt May Work, Use Template to Check.
- Vulco-Flex® Coolant Hose.

② Two Required.

- ▲ Standard Belt Available. See Pages 630-631.

School Buses

Belts and Coolant Hose for School Buses

School Buses

Application	Mfr. Part No.	Our No.
GMC - Continued		
1976 - Continued		
GM V-8 366 - Continued		
SE6000 - Continued		
Belt - Fan & A.P.	9433921	▲9580HD
Belt - P.S.	9433884	▲9395HD
Belt - Air Brake Compr.	3883005	▲9690HD
Belt - Air Brake Compr. & A.P.		▲9720HD
Belt - Hyd. Brake Boost Pump		▲9630HD
Belt - A.P.	2459498	▲9370HD
Hose - Upper		≧20933
Hose - Lower		21011
Hose - By Pass; (1 3/4" I.D.)		24228
GM V-8 427		
SE6000		
Belt - Fan & Alt.; W/61A. Alt.; W/Single Belt ..	690409	▲9510HD
Belt - Fan & Alt.; W/61A. Alt.; W/Dual Belts ...	3891365	②◆▲9610HD
Belt - Fan & Alt.; W/80A. Alt.		▲9560HD
Belt - Fan & Alt.; W/A.P.; W/100A., 105A., 130A. Alt.	9433921	▲9580HD
Belt - Fan & Alt.; W/O A.P.; W/100A., 105A., 130A. Alt.	9433921	②▲9580HD
Belt - Fan & P.S.	9433884	▲9560HD
Belt - Fan & A.P.	9433921	▲9580HD
Belt - P.S.	9433884	▲9395HD
Belt - Air Brake Compr.	3883005	▲9690HD
Belt - Air Brake Compr. & A.P.		▲9720HD
Belt - Hyd. Brake Boost Pump		▲9630HD
Belt - A.P.	2459498	▲9370HD
Hose - Upper		≧20933
Hose - Lower		21011
Hose - By Pass; (1 3/4" I.D.)		24228
GM V-8 454		
SE6000		
Belt - Fan & Alt.; W/61A. Alt.; W/Single Belt ..	690409	▲9510HD
Belt - Fan & Alt.; W/61A. Alt.; W/Dual Belts ...	3891365	②◆▲9610HD
Belt - Fan & Alt.; W/80A. Alt.		▲9560HD
Belt - Fan & Alt.; W/A.P.; W/100A., 105A., 130A. Alt.	9433921	▲9580HD
Belt - Fan & Alt.; W/O A.P.; W/100A., 105A., 130A. Alt.	9433921	②▲9580HD
Belt - Fan & P.S.	9433884	▲9560HD
Belt - Fan & A.P.	9433921	▲9580HD
Belt - P.S.	9433884	▲9395HD
Belt - Air Brake Compr.	3883005	▲9690HD
Belt - Air Brake Compr. & A.P.		▲9720HD
Belt - Hyd. Brake Boost Pump		▲9630HD
Belt - A.P.	2459498	▲9370HD
Hose - Upper		≧20933
Hose - Lower		21011
Hose - By Pass; (1 3/4" I.D.)		24228
1975		
GM 6-Cyl. 292		
SS6000		
Belt - Fan & Alt.; W/Std. Alt.	3887682	②▲9395HD
Belt - Fan & Alt.; W/80A. Alt.	3911543	②▲9412HD
Belt - Fan & Alt.; W/100A. Alt.	690407	②▲9435HD
Belt - Fan, Alt. & P.S.; W/Std. Alt.	3947152	▲9500HD
Belt - Fan, Alt. & P.S.; W/80A. Alt.	3885457	▲9510HD
Belt - Fan & A.P.	3947150	▲9530HD
Belt - P.S.	9433884	▲9395HD
Belt - Hyd. Brake Boost Pump	9433896	▲9455HD
Belt - A.C.	3888403	7560
Hose - Upper		≧20686
Hose - Lower		20489
		or ●26611
Hose - By Pass		20563
Hose - Heater Inlet; (3/4" I.D.)		28442
Hose - Heater Outlet; (5/8" I.D.)		28441

Application	Mfr. Part No.	Our No.
GMC - Continued		
1975 - Continued		
GM V-8 307		
SE6000		
Belt - Fan & Alt.; W/56 3/8" Belt O.C.		▲9560HD
Belt - Fan & Alt.; W/58 3/8" Belt O.C.	3891359	▲9580HD
Belt - P.S.		▲9385HD
Belt - Hyd. Brake Boost Pump	9433923	▲9590HD
Belt - Hyd. Brake Boost Pump & A.P.	2027569	▲9680HD
Belt - Air Brake Compr.		▲9640HD
Belt - A.P.		▲9530HD
Hose - Upper		20607
		or ●25484
Hose - Lower; W/Hyd. Brakes		20558
		or ●26611
Hose - By Pass - Left Side		20565
Hose - By Pass - Right Side		20566
GM V-8 350		
SE6000		
Belt - Fan & Alt.; W/56 3/8" Belt O.C.		▲9560HD
Belt - Fan & Alt.; W/58 3/8" Belt O.C.	3891359	▲9580HD
Belt - P.S.		▲9385HD
Belt - Hyd. Brake Boost Pump	9433923	▲9590HD
Belt - Hyd. Brake Boost Pump & A.P.	2027569	▲9680HD
Belt - Air Brake Compr.		▲9640HD
Belt - A.P.		▲9530HD
Hose - Upper		20607
		or ●25484
Hose - Lower; W/Hyd. Brakes		20558
		or ●26611
Hose - By Pass - Left Side		20565
Hose - By Pass - Right Side		20566
GM V-8 366		
SE6000		
Belt - Fan & Alt.; W/61A. Alt.; W/Single Belt ..	690409	▲9510HD
Belt - Fan & Alt.; W/61A. Alt.; W/Dual Belts ...	3891365	②◆▲9610HD
Belt - Fan & Alt.; W/80A. Alt.		▲9560HD
Belt - Fan & Alt.; W/A.P.; W/100A., 105A., 130A. Alt.	9433921	▲9580HD
Belt - Fan & Alt.; W/O A.P.; W/100A., 105A., 130A. Alt.	9433921	②▲9580HD
Belt - Fan & P.S.	9433884	▲9560HD
Belt - Fan & A.P.	9433921	▲9580HD
Belt - P.S.	9433884	▲9395HD
Belt - Air Brake Compr.	3883005	▲9690HD
Belt - Air Brake Compr. & A.P.		▲9720HD
Belt - Hyd. Brake Boost Pump		▲9630HD
Belt - A.P.	2459498	▲9370HD
Hose - Upper		≧20933
Hose - Lower		21011
Hose - By Pass; (1 3/4" I.D.)		24228
GM V-8 427		
SE6000		
Belt - Fan & Alt.; W/61A. Alt.; W/Single Belt ..	690409	▲9510HD
Belt - Fan & Alt.; W/61A. Alt.; W/Dual Belts ...	3891365	②◆▲9610HD
Belt - Fan & Alt.; W/80A. Alt.		▲9560HD
Belt - Fan & Alt.; W/A.P.; W/100A., 105A., 130A. Alt.	9433921	▲9580HD
Belt - Fan & Alt.; W/O A.P.; W/100A., 105A., 130A. Alt.	9433921	②▲9580HD
Belt - Fan & P.S.	9433884	▲9560HD
Belt - Fan & A.P.	9433921	▲9580HD
Belt - P.S.	9433884	▲9395HD
Belt - Air Brake Compr.	3883005	▲9690HD
Belt - Air Brake Compr. & A.P.		▲9720HD
Belt - Hyd. Brake Boost Pump		▲9630HD
Belt - A.P.	2459498	▲9370HD
Hose - Upper		≧20933
Hose - Lower		21011
Hose - By Pass; (1 3/4" I.D.)		24228

▲ Standard Belt Available. See Pages 630-631.
 ② Two Required.
 ● Vulco-Flex® Coolant Hose.

≧ Cut to Fit.
 ◆ Green Stripe® PowerBand® Belt May Work, Use Template to Check.

Belts and Coolant Hose for School Buses

Application	Mfr. Part No.	Our No.	Application	Mfr. Part No.	Our No.
GMC - Continued			GMC - Continued		
1975 - Continued			1974 - Continued		
GM V-8 454			GM V-6 478 - Continued		
SE6000			RM7500 - Continued		
Belt - Fan & Alt.; W/61A. Alt.; W/Single Belt ..	690409	♣9510HD	Belt - W.P. & Alt.; W/67 1/4" Belt O.C.	2483914	②♣♣9670HD
Belt - Fan & Alt.; W/61A. Alt.; W/Dual Belts ...	3891365	②♣♣9610HD	Belt - P.S.; W/39 3/4" Belt O.C.	2477462	♣9395HD
Belt - Fan & Alt.; W/80A. Alt.		♣9560HD	Belt - P.S.; W/40 3/4" Belt O.C.	3887674	♣9405HD
Belt - Fan & Alt.; W/A.P.; W/100A., 105A., 130A. Alt.	9433921	♣9580HD	Belt - Air Brake Compr.		♣9600HD
Belt - Fan & Alt.; W/O A.P.; W/100A., 105A., 130A. Alt.	9433921	②♣9580HD	GM V-8 307		
Belt - Fan & P.S.	9433884	♣9560HD	SE6000		
Belt - Fan & A.P.	9433921	♣9580HD	Belt - Fan & Alt.; W/56 3/8" Belt O.C.		
Belt - P.S.	9433884	♣9395HD	Belt - Fan & Alt.; W/58 3/8" Belt O.C.		
Belt - Air Brake Compr.	3883005	♣9690HD	Belt - P.S.		
Belt - Air Brake Compr. & A.P.		♣9720HD	Belt - Hyd. Brake Boost Pump		
Belt - Hyd. Brake Boost Pump		♣9630HD	Belt - Hyd. Brake Boost Pump & A.P.		
Belt - A.P.	2459498	♣9370HD	Belt - Air Brake Compr.		
Hose - Upper		≈<20933	Belt - A.P.		
Hose - Lower		21011	Hose - Upper		
Hose - By Pass; (1 3/4" I.D.)		24228	Hose - Lower; W/Hyd. Brakes		
GMC V-6 478 Diesel			Hose - By Pass - Left Side		
SG6000			Hose - By Pass - Right Side		
Belt - Fan & Alt.	2483870	②♣♣9590HD	or ♣25484		
Belt - P.S.	3887676	♣9451HD	20558		
Belt - Air Brake Compr.	3883002	♣9600HD	or ♣26611		
Belt - V.P.	3905091	♣9580HD	20565		
1974			20566		
GM 6-Cyl. 292			GM V-8 350		
SS6000			SE6000		
Belt - Fan & Alt.; W/Std. Alt.	3887682	②♣9395HD	Belt - Fan & Alt.; W/56 3/8" Belt O.C.		
Belt - Fan & Alt.; W/80A. Alt.	3911543	②♣9412HD	Belt - Fan & Alt.; W/58 3/8" Belt O.C.		
Belt - Fan & Alt.; W/100A. Alt.	690407	②♣9435HD	Belt - P.S.		
Belt - Fan, Alt. & P.S.; W/Std. Alt.	3947152	♣9500HD	Belt - Hyd. Brake Boost Pump		
Belt - Fan, Alt. & P.S.; W/80A. Alt.	3885457	♣9510HD	Belt - Hyd. Brake Boost Pump & A.P.		
Belt - Fan & A.P.	3947150	♣9530HD	Belt - Air Brake Compr.		
Belt - P.S.	9433884	♣9395HD	Belt - A.P.		
Belt - Hyd. Brake Boost Pump	9433896	♣9455HD	Hose - Upper		
Belt - A.C.	3888403	7560	or ♣25484		
Hose - Upper		≈<20686	20558		
Hose - Lower		20489	or ♣26611		
		or ♣26611	20565		
Hose - By Pass		20563	20566		
Hose - Heater Inlet; (3/4" I.D.)		28442	GM V-8 366		
Hose - Heater Outlet; (5/8" I.D.)		28441	SE6000		
GM V-6 401			Belt - Fan & Alt.; W/61A. Alt.; W/Single Belt ..		
RM7500			690409		
Belt - W.P. & Alt.; W/60 1/4" Belt O.C.	2485210	②♣9600HD	♣9510HD		
Belt - W.P. & Alt.; W/61 1/4" Belt O.C.	3891365	②♣♣9610HD	②♣♣9610HD		
Belt - W.P. & Alt.; W/62 1/4" Belt O.C.	3888486	②♣9620HD	♣9560HD		
Belt - W.P. & Alt.; W/66 1/4" Belt O.C.	2479287	②♣♣9660HD	♣9580HD		
Belt - W.P. & Alt.; W/67 1/4" Belt O.C.	2483914	②♣♣9670HD	130A. Alt.		
Belt - P.S.; W/39 3/4" Belt O.C.	2477462	♣9395HD	9433921		
Belt - P.S.; W/40 3/4" Belt O.C.	3887674	♣9405HD	♣9580HD		
Belt - Air Brake Compr.		♣9600HD	Belt - Fan & Alt.; W/O A.P.; W/100A., 105A., 130A. Alt.		
GM V-6 432			9433921		
RM7500			②♣9580HD		
Belt - W.P. & Alt.; W/60 1/4" Belt O.C.	2485210	②♣9600HD	♣9560HD		
Belt - W.P. & Alt.; W/61 1/4" Belt O.C.	3891365	②♣♣9610HD	♣9580HD		
Belt - W.P. & Alt.; W/62 1/4" Belt O.C.	3888486	②♣9620HD	♣9395HD		
Belt - W.P. & Alt.; W/66 1/4" Belt O.C.	2479287	②♣♣9660HD	♣9690HD		
Belt - W.P. & Alt.; W/67 1/4" Belt O.C.	2483914	②♣♣9670HD	♣9720HD		
Belt - P.S.; W/39 3/4" Belt O.C.	2477462	♣9395HD	♣9630HD		
Belt - P.S.; W/40 3/4" Belt O.C.	3887674	♣9405HD	♣9370HD		
Belt - Air Brake Compr.		♣9600HD	GM V-8 427		
GM V-6 478			SE6000		
RM7500			Belt - Fan & Alt.; W/61A. Alt.; W/Single Belt ..		
Belt - W.P. & Alt.; W/60 1/4" Belt O.C.	2485210	②♣9600HD	690409		
Belt - W.P. & Alt.; W/61 1/4" Belt O.C.	3891365	②♣♣9610HD	♣9510HD		
Belt - W.P. & Alt.; W/62 1/4" Belt O.C.	3888486	②♣9620HD	②♣♣9610HD		
Belt - W.P. & Alt.; W/66 1/4" Belt O.C.	2479287	②♣♣9660HD	♣9560HD		
Belt - W.P. & Alt.; W/67 1/4" Belt O.C.	2483914	②♣♣9670HD	♣9580HD		
Belt - P.S.; W/39 3/4" Belt O.C.	2477462	♣9395HD	130A. Alt.		
Belt - P.S.; W/40 3/4" Belt O.C.	3887674	♣9405HD	9433921		
Belt - Air Brake Compr.		♣9600HD	♣9580HD		
GM V-6 478			Belt - Fan & Alt.; W/O A.P.; W/100A., 105A., 130A. Alt.		
RM7500			9433921		
Belt - W.P. & Alt.; W/60 1/4" Belt O.C.	2485210	②♣9600HD	②♣9580HD		
Belt - W.P. & Alt.; W/61 1/4" Belt O.C.	3891365	②♣♣9610HD	♣9560HD		
Belt - W.P. & Alt.; W/62 1/4" Belt O.C.	3888486	②♣9620HD	♣9580HD		
Belt - W.P. & Alt.; W/66 1/4" Belt O.C.	2479287	②♣♣9660HD	♣9395HD		
Belt - W.P. & Alt.; W/67 1/4" Belt O.C.	2483914	②♣♣9670HD	♣9690HD		
Belt - P.S.; W/39 3/4" Belt O.C.	2477462	♣9395HD	♣9720HD		
Belt - P.S.; W/40 3/4" Belt O.C.	3887674	♣9405HD	♣9630HD		
Belt - Air Brake Compr.		♣9600HD	♣9370HD		

♣ Standard Belt Available. See Pages 630-631.
 ◆ Green Stripe® PowerBand® Belt May Work, Use Template to Check.
 ● Vulco-Flex® Coolant Hose.

② Two Required.
 ≈< Cut to Fit.

School Buses

Belts and Coolant Hose for School Buses

School Buses

Application	Mfr. Part No.	Our No.
GMC - Continued		
1974 - Continued		
GM V-8 454		
SE6000		
Belt - Fan & Alt.; W/61A. Alt.; W/Single Belt ..	690409	▲9510HD
Belt - Fan & Alt.; W/61A. Alt.; W/Dual Belts ...	3891365	②◆▲9610HD
Belt - Fan & Alt.; W/80A. Alt.		▲9560HD
Belt - Fan & Alt.; W/A.P.; W/100A., 105A., 130A. Alt.	9433921	▲9580HD
Belt - Fan & Alt.; W/O A.P.; W/100A., 105A., 130A. Alt.	9433921	②▲9580HD
Belt - Fan & P.S.	9433884	▲9560HD
Belt - Fan & A.P.	9433921	▲9580HD
Belt - P.S.	9433884	▲9395HD
Belt - Air Brake Compr.	3883005	▲9690HD
Belt - Air Brake Compr. & A.P.		▲9720HD
Belt - Hyd. Brake Boost Pump		▲9630HD
Belt - A.P.	2459498	▲9370HD
GMC V-6 478 Diesel		
SG6000		
Belt - Fan & Alt.	2483870	②◆▲9590HD
Belt - P.S.	3887676	▲9451HD
Belt - Air Brake Compr.	3883002	▲9600HD
Belt - V.P.	3905091	▲9580HD
Hose - Upper		●26611
1973		
GM 6-Cyl. 292		
SS6000		
Belt - Fan & Alt.; W/Std. Alt.	3887682	②▲9395HD
Belt - Fan & Alt.; W/80A. Alt.	3911543	②▲9412HD
Belt - Fan & Alt.; W/100A. Alt.	690407	②▲9435HD
Belt - Fan, Alt. & P.S.; W/Std. Alt.	3947152	▲9500HD
Belt - Fan, Alt. & P.S.; W/80A. Alt.	3885457	▲9510HD
Belt - Fan & A.P.	3947150	▲9530HD
Belt - P.S.	9433884	▲9395HD
Belt - Hyd. Brake Boost Pump	9433896	▲9455HD
Belt - A.C.	3888403	7560
Hose - Upper		≠20686
Hose - Lower		20489
		or ●26611
Hose - By Pass		20563
Hose - Heater Inlet; (3/4" I.D.)		28442
Hose - Heater Outlet; (5/8" I.D.)		28441
GM V-6 401		
RM7500		
Belt - W.P. & Alt.; W/60 1/4" Belt O.C.	2485210	②▲9600HD
Belt - W.P. & Alt.; W/61 1/4" Belt O.C.	3891365	②◆▲9610HD
Belt - W.P. & Alt.; W/62 1/4" Belt O.C.	3888486	②▲9620HD
Belt - W.P. & Alt.; W/66 1/4" Belt O.C.	2479287	②◆▲9660HD
Belt - W.P. & Alt.; W/67 1/4" Belt O.C.	2483914	②◆▲9670HD
Belt - P.S.; W/39 3/4" Belt O.C.	2477462	▲9395HD
Belt - P.S.; W/40 3/4" Belt O.C.	3887674	▲9405HD
Belt - Air Brake Compr.		▲9600HD
Hose - Upper - Eng. To Pipe		23531
Hose - Upper - Pipe To Rad.; (2" I.D.)		24232
Hose - Lower - Eng. To Pipe; (2 1/2" I.D.)		24240
Hose - Lower - Pipe To Rad.; (2 1/4" I.D.)		24236
GM V-6 432		
RM7500		
Belt - W.P. & Alt.; W/60 1/4" Belt O.C.	2485210	②▲9600HD
Belt - W.P. & Alt.; W/61 1/4" Belt O.C.	3891365	②◆▲9610HD
Belt - W.P. & Alt.; W/62 1/4" Belt O.C.	3888486	②▲9620HD
Belt - W.P. & Alt.; W/66 1/4" Belt O.C.	2479287	②◆▲9660HD
Belt - W.P. & Alt.; W/67 1/4" Belt O.C.	2483914	②◆▲9670HD
Belt - P.S.; W/39 3/4" Belt O.C.	2477462	▲9395HD
Belt - P.S.; W/40 3/4" Belt O.C.	3887674	▲9405HD
Belt - Air Brake Compr.		▲9600HD
Hose - Upper - Eng. To Pipe		23531
Hose - Upper - Pipe To Rad.; (2" I.D.)		24232
Hose - Lower - Eng. To Pipe; (2 1/2" I.D.)		24240
Hose - Lower - Pipe To Rad.; (2 1/4" I.D.)		24236

▲ Standard Belt Available. See Pages 630-631.
◆ Green Stripe® PowerBand® Belt May Work, Use Template to Check.
≠ Cut to Fit.

Application	Mfr. Part No.	Our No.
GMC - Continued		
1973 - Continued		
GM V-6 478		
RM7500		
Belt - W.P. & Alt.; W/60 1/4" Belt O.C.	2485210	②▲9600HD
Belt - W.P. & Alt.; W/61 1/4" Belt O.C.	3891365	②◆▲9610HD
Belt - W.P. & Alt.; W/62 1/4" Belt O.C.	3888486	②▲9620HD
Belt - W.P. & Alt.; W/66 1/4" Belt O.C.	2479287	②◆▲9660HD
Belt - W.P. & Alt.; W/67 1/4" Belt O.C.	2483914	②◆▲9670HD
Belt - P.S.; W/39 3/4" Belt O.C.	2477462	▲9395HD
Belt - P.S.; W/40 3/4" Belt O.C.	3887674	▲9405HD
Belt - Air Brake Compr.		▲9600HD
Hose - Upper - Eng. To Pipe		23531
Hose - Upper - Pipe To Rad.; (2" I.D.)		24232
Hose - Lower - Eng. To Pipe; (2 1/2" I.D.)		24240
Hose - Lower - Pipe To Rad.; (2 1/4" I.D.)		24236
GM V-8 307		
SE6000		
Belt - Fan & Alt.; W/56 3/8" Belt O.C.		▲9560HD
Belt - Fan & Alt.; W/58 3/8" Belt O.C.	3891359	▲9580HD
Belt - P.S.		▲9385HD
Belt - Hyd. Brake Boost Pump	9433923	▲9590HD
Belt - Hyd. Brake Boost Pump & A.P.	2027569	▲9680HD
Belt - Air Brake Compr.		▲9640HD
Belt - A.P.		▲9530HD
Hose - Upper		20607
		or ●25484
Hose - Lower; W/Hyd. Brakes		20558
		or ●26611
Hose - By Pass - Left Side		20565
Hose - By Pass - Right Side		20566
GM V-8 350		
SE6000		
Belt - Fan & Alt.; W/56 3/8" Belt O.C.		▲9560HD
Belt - Fan & Alt.; W/58 3/8" Belt O.C.	3891359	▲9580HD
Belt - P.S.		▲9385HD
Belt - Hyd. Brake Boost Pump	9433923	▲9590HD
Belt - Hyd. Brake Boost Pump & A.P.	2027569	▲9680HD
Belt - Air Brake Compr.		▲9640HD
Belt - A.P.		▲9530HD
Hose - Upper		20607
		or ●25484
Hose - Lower; W/Hyd. Brakes		20558
		or ●26611
Hose - By Pass - Left Side		20565
Hose - By Pass - Right Side		20566
GM V-8 366		
SE6000		
Belt - Fan & Alt.; W/61A. Alt.; W/Single Belt ..	690409	▲9510HD
Belt - Fan & Alt.; W/61A. Alt.; W/Dual Belts ...	3891365	②◆▲9610HD
Belt - Fan & Alt.; W/80A. Alt.		▲9560HD
Belt - Fan & Alt.; W/A.P.; W/100A., 105A., 130A. Alt.	9433921	▲9580HD
Belt - Fan & Alt.; W/O A.P.; W/100A., 105A., 130A. Alt.	9433921	②▲9580HD
Belt - Fan & P.S.	9433884	▲9560HD
Belt - Fan & A.P.	9433921	▲9580HD
Belt - P.S.	9433884	▲9395HD
Belt - Air Brake Compr.	3883005	▲9690HD
Belt - Air Brake Compr. & A.P.		▲9720HD
Belt - Hyd. Brake Boost Pump		▲9630HD
Belt - A.P.	2459498	▲9370HD
GM V-8 427		
SE6000		
Belt - Fan & Alt.; W/61A. Alt.; W/Single Belt ..	690409	▲9510HD
Belt - Fan & Alt.; W/61A. Alt.; W/Dual Belts ...	3891365	②◆▲9610HD
Belt - Fan & Alt.; W/80A. Alt.		▲9560HD
Belt - Fan & Alt.; W/A.P.; W/100A., 105A., 130A. Alt.	9433921	▲9580HD
Belt - Fan & Alt.; W/O A.P.; W/100A., 105A., 130A. Alt.	9433921	②▲9580HD
Belt - Fan & P.S.	9433884	▲9560HD

② Two Required.
● Vulco-Flex® Coolant Hose.

Belts and Coolant Hose for School Buses

Application	Mfr. Part No.	Our No.	Application	Mfr. Part No.	Our No.
GMC - Continued			GMC - Continued		
1973 - Continued			1972-1971 - Continued		
GM V-8 427 - Continued			GM V-6 351 - Continued		
SE6000 - Continued			RM7500 - Continued		
Belt - Fan & A.P.	9433921	▲9580HD	Hose - Upper - Eng. To Pipe		23531
Belt - P.S.	9433884	▲9395HD	Hose - Upper - Pipe To Rad.; (2" I.D.)		24232
Belt - Air Brake Compr.	3883005	▲9690HD	Hose - Lower - Eng. To Pipe; (2 1/2" I.D.)		24240
Belt - Air Brake Compr. & A.P.		▲9720HD	Hose - Lower - Pipe To Rad.; (2 1/4" I.D.)		24236
Belt - Hyd. Brake Boost Pump		▲9630HD	SM5500		
Belt - A.P.	2459498	▲9370HD	Belt - Fan & Alt.; W/61A. Alt.	②◆▲9590HD	
GM V-8 454			Belt - Fan & Alt.; W/Air Brakes; W/105A. Alt. .	2483932	②◆▲9660HD
SE6000			Belt - Fan & Alt.; W/Hyd. Brakes; W/105A. Alt.	8876092	②◆▲9650HD
Belt - Fan & Alt.; W/61A. Alt.; W/Single Belt ..	690409	▲9510HD	Belt - P.S.; W/Air Brakes	8867788	▲9420HD
Belt - Fan & Alt.; W/61A. Alt.; W/Dual Belts ...	3891365	②◆▲9610HD	Belt - P.S.; W/Hyd. Brakes	2459789	▲9476HD
Belt - Fan & Alt.; W/80A. Alt.		▲9560HD	Belt - Air Brake Compr.	3883002	▲9605HD
Belt - Fan & Alt.; W/A.P.; W/100A., 105A.,			Hose - Upper; W/A.P.		20761
130A. Alt.	9433921	▲9580HD	GM V-6 379		
Belt - Fan & Alt.; W/O A.P.; W/100A., 105A.,			RM7500		
130A. Alt.	9433921	②▲9580HD	Belt - W.P. & Alt.; W/61A. Alt.; W/Single Belt .	2485210	▲9600HD
Belt - Fan & P.S.	9433884	▲9560HD	Belt - W.P. & Alt.; W/61A. Alt.; W/Dual Belts .	3891365	▲9610HD
Belt - Fan & A.P.	9433921	▲9580HD	Belt - W.P. & Alt.; W/130A. Alt.	2483914	▲9670HD
Belt - P.S.	9433884	▲9395HD	Belt - P.S.	2477462	▲9395HD
Belt - Air Brake Compr.	3883005	▲9690HD	Belt - Air Brake Compr.		▲9650HD
Belt - Air Brake Compr. & A.P.		▲9720HD	Hose - Upper - Eng. To Pipe		23531
Belt - Hyd. Brake Boost Pump		▲9630HD	Hose - Upper - Pipe To Rad.; (2" I.D.)		24232
Belt - A.P.	2459498	▲9370HD	Hose - Lower - Eng. To Pipe; (2 1/2" I.D.)		24240
GMC V-6 478 Diesel			Hose - Lower - Pipe To Rad.; (2 1/4" I.D.)		24236
SG6000			SM5500		
Belt - Fan & Alt.	2483870	②◆▲9590HD	Belt - Fan & Alt.; W/61A. Alt.	②◆▲9590HD	
Belt - P.S.	3887676	▲9451HD	Belt - Fan & Alt.; W/Air Brakes; W/105A. Alt. .	2483932	②◆▲9660HD
Belt - Air Brake Compr.	3883002	▲9600HD	Belt - Fan & Alt.; W/Hyd. Brakes; W/105A. Alt.	8876092	②◆▲9650HD
Belt - V.P.	3905091	▲9580HD	Belt - P.S.; W/Air Brakes	8867788	▲9420HD
Hose - Upper		●26611	Belt - P.S.; W/Hyd. Brakes	2459789	▲9476HD
1972-1971			Belt - Air Brake Compr.	3883002	▲9605HD
GM 6-Cyl. 292			Hose - Upper; W/A.P.		20761
SS5500			GM V-6 401		
Belt - Fan & Alt.	3887682	▲9395HD	RM7500		
Belt - Fan, Alt. & P.S.	3947152	▲9500HD	Belt - W.P. & Alt.; W/60 1/4" Belt O.C.	2485210	②▲9600HD
Belt - Fan & Air Brake Compr.	3943162	▲9660HD	Belt - W.P. & Alt.; W/61 1/4" Belt O.C.	3891365	②◆▲9610HD
Hose - Upper		≈<20686	Belt - W.P. & Alt.; W/62 1/4" Belt O.C.	3888486	②▲9620HD
Hose - Lower		20489	Belt - W.P. & Alt.; W/66 1/4" Belt O.C.	2479287	②◆▲9660HD
		or	Belt - W.P. & Alt.; W/67 1/4" Belt O.C.	2483914	②◆▲9670HD
		●26611	Belt - P.S.; W/39 3/4" Belt O.C.	2477462	▲9395HD
Hose - By Pass		20563	Belt - P.S.; W/40 3/4" Belt O.C.	3887674	▲9405HD
Hose - Heater Inlet; (3/4" I.D.)		28442	Belt - Air Brake Compr.		▲9600HD
Hose - Heater Outlet; (5/8" I.D.)		28441	Hose - Upper - Eng. To Pipe		23531
GM V-6 305			Hose - Upper - Pipe To Rad.; (2" I.D.)		24232
RM7500			Hose - Lower - Eng. To Pipe; (2 1/2" I.D.)		24240
Belt - W.P. & Alt.; W/61A. Alt.; W/Single Belt .	2485210	▲9600HD	Hose - Lower - Pipe To Rad.; (2 1/4" I.D.)		24236
Belt - W.P. & Alt.; W/61A. Alt.; W/Dual Belts .	3891365	▲9610HD	GM V-6 432		
Belt - W.P. & Alt.; W/130A. Alt.	2483914	▲9670HD	RM7500		
Belt - P.S.	2477462	▲9395HD	Belt - W.P. & Alt.; W/60 1/4" Belt O.C.	2485210	②▲9600HD
Belt - Air Brake Compr.		▲9650HD	Belt - W.P. & Alt.; W/61 1/4" Belt O.C.	3891365	②◆▲9610HD
Hose - Upper - Eng. To Pipe		23531	Belt - W.P. & Alt.; W/62 1/4" Belt O.C.	3888486	②▲9620HD
Hose - Upper - Pipe To Rad.; (2" I.D.)		24232	Belt - W.P. & Alt.; W/66 1/4" Belt O.C.	2479287	②◆▲9660HD
Hose - Lower - Eng. To Pipe; (2 1/2" I.D.)		24240	Belt - W.P. & Alt.; W/67 1/4" Belt O.C.	2483914	②◆▲9670HD
Hose - Lower - Pipe To Rad.; (2 1/4" I.D.)		24236	Belt - P.S.; W/39 3/4" Belt O.C.	2477462	▲9395HD
SM5500			Belt - P.S.; W/40 3/4" Belt O.C.	3887674	▲9405HD
Belt - Fan & Alt.; W/61A. Alt.		②◆▲9590HD	Belt - Air Brake Compr.		▲9600HD
Belt - Fan & Alt.; W/Air Brakes; W/105A. Alt. .	2483932	②◆▲9660HD	Hose - Upper - Eng. To Pipe		23531
Belt - Fan & Alt.; W/Hyd. Brakes; W/105A. Alt.	8876092	②◆▲9650HD	Hose - Upper - Pipe To Rad.; (2" I.D.)		24232
Belt - P.S.; W/Air Brakes	8867788	▲9420HD	Hose - Lower - Eng. To Pipe; (2 1/2" I.D.)		24240
Belt - P.S.; W/Hyd. Brakes	2459789	▲9476HD	Hose - Lower - Pipe To Rad.; (2 1/4" I.D.)		24236
Belt - Air Brake Compr.	3883002	▲9605HD	GM V-6 478		
Hose - Upper; W/A.P.		20761	RM7500		
GM V-6 351			Belt - W.P. & Alt.; W/60 1/4" Belt O.C.	2485210	②▲9600HD
RM7500			Belt - W.P. & Alt.; W/61 1/4" Belt O.C.	3891365	②◆▲9610HD
Belt - W.P. & Alt.; W/61A. Alt.; W/Single Belt .	2485210	▲9600HD	Belt - W.P. & Alt.; W/62 1/4" Belt O.C.	3888486	②▲9620HD
Belt - W.P. & Alt.; W/61A. Alt.; W/Dual Belts .	3891365	▲9610HD	Belt - W.P. & Alt.; W/66 1/4" Belt O.C.	2479287	②◆▲9660HD
Belt - W.P. & Alt.; W/130A. Alt.	2483914	▲9670HD	Belt - W.P. & Alt.; W/67 1/4" Belt O.C.	2483914	②◆▲9670HD
Belt - P.S.	2477462	▲9395HD	Belt - P.S.; W/39 3/4" Belt O.C.	2477462	▲9395HD
Belt - Air Brake Compr.		▲9650HD	Belt - P.S.; W/40 3/4" Belt O.C.	3887674	▲9405HD

▲ Standard Belt Available. See Pages 630-631.

◆ Green Stripe® PowerBand® Belt May Work, Use Template to Check.

≈< Cut to Fit.

② Two Required.

● Vulco-Flex® Coolant Hose.

School Buses

Belts and Coolant Hose for School Buses

School Buses

Application	Mfr. Part No.	Our No.
GMC - Continued		
1972-1971 - Continued		
GM V-6 478 - Continued		
RM7500 - Continued		
Belt - Air Brake Compr.		▲9600HD
Hose - Upper - Eng. To Pipe		23531
Hose - Upper - Pipe To Rad.; (2" I.D.)		24232
Hose - Lower - Eng. To Pipe; (2 1/2" I.D.)		24240
Hose - Lower - Pipe To Rad.; (2 1/4" I.D.)		24236
GM V-8 307		
SE5500		
Belt - Fan & Alt.	3888480	②▲9560HD
Belt - Fan & A.P.	3906417	▲9520HD
Belt - P.S.	3888401	▲9412HD
Hose - Upper		20607
		or ●25484
Hose - Lower; W/Hyd. Brakes		20558
		or ●26611
Hose - By Pass - Left Side		20565
Hose - By Pass - Right Side		20566
GM V-8 350		
SE5500		
Belt - Fan & Alt.	3888480	②▲9560HD
Belt - Fan & A.P.	3906417	▲9520HD
Belt - P.S.	3888401	▲9412HD
Hose - Upper		20607
		or ●25484
Hose - Lower; W/Hyd. Brakes		20558
		or ●26611
Hose - By Pass - Left Side		20565
Hose - By Pass - Right Side		20566
GMC V-6 478 Diesel		
SG5500		
Belt - Fan & Alt.; W/62A. Alt.	2439805	②▲9580HD
Belt - Fan & Alt.; W/105A, 130A. Alt.	8867641	②▲9670HD
Belt - P.S.	3887676	▲9451HD
Belt - Air Brake Compr.	3883002	▲9600HD
Belt - V.P.	8867790	▲9580HD
Hose - Upper		●26611
1970		
GM 6-Cyl. 292		
SS5500		
Belt - Fan & Alt.	3887682	▲9395HD
Belt - Fan, Alt. & P.S.	3947152	▲9500HD
Belt - Fan & Air Brake Compr.	3943162	▲9660HD
Hose - Upper		≠20686
Hose - Lower		20489
		or ●26611
Hose - By Pass		20563
Hose - Heater Inlet; (3/4" I.D.)		28442
Hose - Heater Outlet; (5/8" I.D.)		28441
GM V-6 305		
RM7500		
Belt - W.P. & Alt.; W/61A. Alt.; W/Single Belt .	2485210	▲9600HD
Belt - W.P. & Alt.; W/61A. Alt.; W/Dual Belts .	3891365	▲9610HD
Belt - W.P. & Alt.; W/130A. Alt.	2483914	▲9670HD
Belt - P.S.	2477462	▲9395HD
Belt - Air Brake Compr.		▲9650HD
Hose - Upper - Eng. To Pipe		23531
Hose - Upper - Pipe To Rad.; (2" I.D.)		24232
Hose - Lower - Eng. To Pipe; (2 1/2" I.D.)		24240
Hose - Lower - Pipe To Rad.; (2 1/4" I.D.)		24236
SM5500		
Belt - Fan & Alt.; W/61A. Alt.		②◆▲9590HD
Belt - Fan & Alt.; W/Air Brakes; W/105A. Alt. .	2483932	②◆▲9660HD
Belt - Fan & Alt.; W/Hyd. Brakes; W/105A. Alt.	8876092	②◆▲9650HD
Belt - P.S.; W/Air Brakes	8867788	▲9420HD
Belt - P.S.; W/Hyd. Brakes	2459789	▲9476HD
Belt - Air Brake Compr.	3883002	▲9605HD
Hose - Upper; W/A.P.		20761

Application	Mfr. Part No.	Our No.
GMC - Continued		
1970 - Continued		
GM V-6 351		
RM7500		
Belt - W.P. & Alt.; W/61A. Alt.; W/Single Belt .	2485210	▲9600HD
Belt - W.P. & Alt.; W/61A. Alt.; W/Dual Belts .	3891365	▲9610HD
Belt - W.P. & Alt.; W/130A. Alt.	2483914	▲9670HD
Belt - P.S.	2477462	▲9395HD
Belt - Air Brake Compr.		▲9650HD
Hose - Upper - Eng. To Pipe		23531
Hose - Upper - Pipe To Rad.; (2" I.D.)		24232
Hose - Lower - Eng. To Pipe; (2 1/2" I.D.)		24240
Hose - Lower - Pipe To Rad.; (2 1/4" I.D.)		24236
SM5500		
Belt - Fan & Alt.; W/61A. Alt.		②◆▲9590HD
Belt - Fan & Alt.; W/Air Brakes; W/105A. Alt. .	2483932	②◆▲9660HD
Belt - Fan & Alt.; W/Hyd. Brakes; W/105A. Alt.	8876092	②◆▲9650HD
Belt - P.S.; W/Air Brakes	8867788	▲9420HD
Belt - P.S.; W/Hyd. Brakes	2459789	▲9476HD
Belt - Air Brake Compr.	3883002	▲9605HD
Hose - Upper; W/A.P.		20761
GM V-6 379		
RM7500		
Belt - W.P. & Alt.; W/61A. Alt.; W/Single Belt .	2485210	▲9600HD
Belt - W.P. & Alt.; W/61A. Alt.; W/Dual Belts .	3891365	▲9610HD
Belt - W.P. & Alt.; W/130A. Alt.	2483914	▲9670HD
Belt - P.S.	2477462	▲9395HD
Belt - Air Brake Compr.		▲9650HD
Hose - Upper - Eng. To Pipe		23531
Hose - Upper - Pipe To Rad.; (2" I.D.)		24232
Hose - Lower - Eng. To Pipe; (2 1/2" I.D.)		24240
Hose - Lower - Pipe To Rad.; (2 1/4" I.D.)		24236
SM5500		
Belt - Fan & Alt.; W/61A. Alt.		②◆▲9590HD
Belt - Fan & Alt.; W/Air Brakes; W/105A. Alt. .	2483932	②◆▲9660HD
Belt - Fan & Alt.; W/Hyd. Brakes; W/105A. Alt.	8876092	②◆▲9650HD
Belt - P.S.; W/Air Brakes	8867788	▲9420HD
Belt - P.S.; W/Hyd. Brakes	2459789	▲9476HD
Belt - Air Brake Compr.	3883002	▲9605HD
Hose - Upper; W/A.P.		20761
GM V-6 401		
RM7500		
Belt - W.P. & Alt.; W/60 1/4" Belt O.C.	2485210	②▲9600HD
Belt - W.P. & Alt.; W/61 1/4" Belt O.C.	3891365	②◆▲9610HD
Belt - W.P. & Alt.; W/62 1/4" Belt O.C.	3888486	②▲9620HD
Belt - W.P. & Alt.; W/66 1/4" Belt O.C.	2479287	②◆▲9660HD
Belt - W.P. & Alt.; W/67 1/4" Belt O.C.	2483914	②◆▲9670HD
Belt - P.S.; W/39 3/4" Belt O.C.	2477462	▲9395HD
Belt - P.S.; W/40 3/4" Belt O.C.	3887674	▲9405HD
Belt - Air Brake Compr.		▲9600HD
Hose - Upper - Eng. To Pipe		23531
Hose - Upper - Pipe To Rad.; (2" I.D.)		24232
Hose - Lower - Eng. To Pipe; (2 1/2" I.D.)		24240
Hose - Lower - Pipe To Rad.; (2 1/4" I.D.)		24236
GM V-6 432		
RM7500		
Belt - W.P. & Alt.; W/60 1/4" Belt O.C.	2485210	②▲9600HD
Belt - W.P. & Alt.; W/61 1/4" Belt O.C.	3891365	②◆▲9610HD
Belt - W.P. & Alt.; W/62 1/4" Belt O.C.	3888486	②▲9620HD
Belt - W.P. & Alt.; W/66 1/4" Belt O.C.	2479287	②◆▲9660HD
Belt - W.P. & Alt.; W/67 1/4" Belt O.C.	2483914	②◆▲9670HD
Belt - P.S.; W/39 3/4" Belt O.C.	2477462	▲9395HD
Belt - P.S.; W/40 3/4" Belt O.C.	3887674	▲9405HD
Belt - Air Brake Compr.		▲9600HD
Hose - Upper - Eng. To Pipe		23531
Hose - Upper - Pipe To Rad.; (2" I.D.)		24232
Hose - Lower - Eng. To Pipe; (2 1/2" I.D.)		24240
Hose - Lower - Pipe To Rad.; (2 1/4" I.D.)		24236
GM V-6 478		
RM7500		
Belt - W.P. & Alt.; W/60 1/4" Belt O.C.	2485210	②▲9600HD
Belt - W.P. & Alt.; W/61 1/4" Belt O.C.	3891365	②◆▲9610HD

▲ Standard Belt Available. See Pages 630-631.
 ● Vulco-Flex® Coolant Hose.
 ≠ Cut to Fit.

② Two Required.
 ◆ Green Stripe® PowerBand® Belt May Work, Use Template to Check.

Belts and Coolant Hose for School Buses

School Buses

Application	Mfr. Part No.	Our No.
GMC - Continued		
1970 - Continued		
GM V-6 478 - Continued		
RM7500 - Continued		
Belt - W.P. & Alt.; W/62 1/4" Belt O.C.	3888486	②▲9620HD
Belt - W.P. & Alt.; W/66 1/4" Belt O.C.	2479287	②◆▲9660HD
Belt - W.P. & Alt.; W/67 1/4" Belt O.C.	2483914	②◆▲9670HD
Belt - P.S.; W/39 3/4" Belt O.C.	2477462	▲9395HD
Belt - P.S.; W/40 3/4" Belt O.C.	3887674	▲9405HD
Belt - Air Brake Compr.		▲9600HD
Hose - Upper - Eng. To Pipe		23531
Hose - Upper - Pipe To Rad.; (2" I.D.)		24232
Hose - Lower - Eng. To Pipe; (2 1/2" I.D.)		24240
Hose - Lower - Pipe To Rad.; (2 1/4" I.D.)		24236
GM V-8 283		
SE5500		
Belt - Fan & Alt.	3888480	②▲9560HD
Belt - Fan & A.P.	3906417	▲9520HD
Belt - P.S.	3888401	▲9412HD
GM V-8 307		
SE5500		
Belt - Fan & Alt.	3888480	②▲9560HD
Belt - Fan & A.P.	3906417	▲9520HD
Belt - P.S.	3888401	▲9412HD
GM V-8 327		
SE5500		
Belt - Fan & Alt.	3888480	②▲9560HD
Belt - Fan & A.P.	3906417	▲9520HD
Belt - P.S.	3888401	▲9412HD
GM V-8 350		
SE5500		
Belt - Fan & Alt.	3888480	②▲9560HD
Belt - Fan & A.P.	3906417	▲9520HD
Belt - P.S.	3888401	▲9412HD
GMC V-6 478 Diesel		
SG5500		
Belt - Fan & Alt.; W/62A. Alt.	2439805	②▲9580HD
Belt - Fan & Alt.; W/105A, 130A. Alt.	8867641	②◆▲9670HD
Belt - P.S.	3887676	▲9451HD
Belt - Air Brake Compr.	3883002	▲9600HD
Belt - V.P.	8867790	▲9580HD
Hose - Upper		●26611
1969-1968		
GM 6-Cyl. 292		
SS5500		
Belt - Fan & Alt.	3887682	▲9395HD
Belt - Fan, Alt. & P.S.		▲9530HD
Belt - Fan & Air Brake Compr.; W/O P.S.	3887683	▲9670HD
Hose - Upper		≈<20686
Hose - Lower		20489
		or
Hose - By Pass		●26611
Hose - Heater Inlet; (3/4" I.D.)		20563
Hose - Heater Outlet; (5/8" I.D.)		28442
		28441
GM V-6 305		
RM7500		
Belt - W.P. & Alt.; W/61A. Alt.; W/Single Belt .	2485210	▲9600HD
Belt - W.P. & Alt.; W/61A. Alt.; W/Dual Belts .	3891365	▲9610HD
Belt - W.P. & Alt.; W/130A. Alt.	2483914	▲9670HD
Belt - P.S.	2477462	▲9395HD
Belt - Air Brake Compr.		▲9650HD
Hose - Upper - Eng. To Pipe		23531
Hose - Upper - Pipe To Rad.; (2" I.D.)		24232
Hose - Lower - Eng. To Pipe; (2 1/2" I.D.)		24240
Hose - Lower - Pipe To Rad.; (2 1/4" I.D.)		24236
SM5500		
Belt - Fan & Alt.; W/61A. Alt.		②◆▲9590HD
Belt - Fan & Alt.; W/Air Brakes; W/105A. Alt. .	2483932	②◆▲9660HD
Belt - Fan & Alt.; W/Hyd. Brakes; W/105A. Alt. .	8876092	②◆▲9650HD
Belt - P.S.; W/Air Brakes	8867788	▲9420HD
Belt - P.S.; W/Hyd. Brakes	2459789	▲9476HD
Belt - Air Brake Compr.	3883002	▲9605HD
SM6500		
Belt - Fan & Alt.; W/61A. Alt.; W/Single Belt ..	2485210	▲9600HD
Belt - Fan & Alt.; W/61A. Alt.; W/Dual Belts ...	3891365	▲9610HD
Belt - Fan & Alt.; W/130A. Alt.	2483914	②◆▲9670HD
Belt - P.S.; W/Air Brakes	8867788	▲9420HD
Belt - P.S.; W/Hyd. Brakes	2459789	▲9476HD
Belt - Air Brake Compr.		▲9650HD

Application	Mfr. Part No.	Our No.
GMC - Continued		
1969-1968 - Continued		
GM V-6 305 - Continued		
SM5500 - Continued		
Belt - P.S.; W/Hyd. Brakes	2459789	▲9476HD
Belt - Air Brake Compr.	3883002	▲9605HD
SM6500		
Belt - Fan & Alt.; W/61A. Alt.; W/Single Belt ..	2485210	▲9600HD
Belt - Fan & Alt.; W/61A. Alt.; W/Dual Belts ...	3891365	▲9610HD
Belt - Fan & Alt.; W/130A. Alt.	2483914	②◆▲9670HD
Belt - P.S.; W/Air Brakes	8867788	▲9420HD
Belt - P.S.; W/Hyd. Brakes	2459789	▲9476HD
Belt - Air Brake Compr.		▲9650HD
GM V-6 351		
RM7500		
Belt - W.P. & Alt.; W/61A. Alt.; W/Single Belt .	2485210	▲9600HD
Belt - W.P. & Alt.; W/61A. Alt.; W/Dual Belts .	3891365	▲9610HD
Belt - W.P. & Alt.; W/130A. Alt.	2483914	▲9670HD
Belt - P.S.	2477462	▲9395HD
Belt - Air Brake Compr.		▲9650HD
Hose - Upper - Eng. To Pipe		23531
Hose - Upper - Pipe To Rad.; (2" I.D.)		24232
Hose - Lower - Eng. To Pipe; (2 1/2" I.D.)		24240
Hose - Lower - Pipe To Rad.; (2 1/4" I.D.)		24236
SM5500		
Belt - Fan & Alt.; W/61A. Alt.		②◆▲9590HD
Belt - Fan & Alt.; W/Air Brakes; W/105A. Alt. .	2483932	②◆▲9660HD
Belt - Fan & Alt.; W/Hyd. Brakes; W/105A. Alt. .	8876092	②◆▲9650HD
Belt - P.S.; W/Air Brakes	8867788	▲9420HD
Belt - P.S.; W/Hyd. Brakes	2459789	▲9476HD
Belt - Air Brake Compr.	3883002	▲9605HD
SM6500		
Belt - Fan & Alt.; W/61A. Alt.; W/Single Belt ..	2485210	▲9600HD
Belt - Fan & Alt.; W/61A. Alt.; W/Dual Belts ...	3891365	▲9610HD
Belt - Fan & Alt.; W/130A. Alt.	2483914	②◆▲9670HD
Belt - P.S.; W/Air Brakes	8867788	▲9420HD
Belt - P.S.; W/Hyd. Brakes	2459789	▲9476HD
Belt - Air Brake Compr.		▲9650HD
GM V-6 379		
RM7500		
Belt - W.P. & Alt.; W/61A. Alt.; W/Single Belt .	2485210	▲9600HD
Belt - W.P. & Alt.; W/61A. Alt.; W/Dual Belts .	3891365	▲9610HD
Belt - W.P. & Alt.; W/130A. Alt.	2483914	▲9670HD
Belt - P.S.	2477462	▲9395HD
Belt - Air Brake Compr.		▲9650HD
Hose - Upper - Eng. To Pipe		23531
Hose - Upper - Pipe To Rad.; (2" I.D.)		24232
Hose - Lower - Eng. To Pipe; (2 1/2" I.D.)		24240
Hose - Lower - Pipe To Rad.; (2 1/4" I.D.)		24236
SM5500		
Belt - Fan & Alt.; W/61A. Alt.		②◆▲9590HD
Belt - Fan & Alt.; W/Air Brakes; W/105A. Alt. .	2483932	②◆▲9660HD
Belt - Fan & Alt.; W/Hyd. Brakes; W/105A. Alt. .	8876092	②◆▲9650HD
Belt - P.S.; W/Air Brakes	8867788	▲9420HD
Belt - P.S.; W/Hyd. Brakes	2459789	▲9476HD
Belt - Air Brake Compr.	3883002	▲9605HD
SM6500		
Belt - Fan & Alt.; W/61A. Alt.; W/Single Belt ..	2485210	▲9600HD
Belt - Fan & Alt.; W/61A. Alt.; W/Dual Belts ...	3891365	▲9610HD
Belt - Fan & Alt.; W/130A. Alt.	2483914	②◆▲9670HD
Belt - P.S.; W/Air Brakes	8867788	▲9420HD
Belt - P.S.; W/Hyd. Brakes	2459789	▲9476HD
Belt - Air Brake Compr.		▲9650HD
GM V-6 401		
RM7500		
Belt - W.P. & Alt.; W/60 1/4" Belt O.C.	2485210	②▲9600HD
Belt - W.P. & Alt.; W/61 1/4" Belt O.C.	3891365	②◆▲9610HD
Belt - W.P. & Alt.; W/62 1/4" Belt O.C.	3888486	②▲9620HD
Belt - W.P. & Alt.; W/66 1/4" Belt O.C.	2479287	②◆▲9660HD
Belt - W.P. & Alt.; W/67 1/4" Belt O.C.	2483914	②◆▲9670HD
Belt - P.S.; W/39 3/4" Belt O.C.	2477462	▲9395HD
Belt - P.S.; W/40 3/4" Belt O.C.	3887674	▲9405HD

② Two Required.
 ◆ Green Stripe® PowerBand® Belt May Work, Use Template to Check.
 ≈ Cut to Fit.

▲ Standard Belt Available. See Pages 630-631.
 ● Vulco-Flex® Coolant Hose.

Belts and Coolant Hose for School Buses

School Buses

Application	Mfr. Part No.	Our No.
GMC - Continued		
1969-1968 - Continued		
GM V-6 401 - Continued		
RM7500 - Continued		
Belt - Air Brake Compr.		▲9660HD
Hose - Upper - Eng. To Pipe		23531
Hose - Upper - Pipe To Rad.; (2" I.D.)		24232
Hose - Lower - Eng. To Pipe; (2 1/2" I.D.)		24240
Hose - Lower - Pipe To Rad.; (2 1/4" I.D.)		24236
GM V-6 432		
RM7500		
Belt - W.P. & Alt.; W/60 1/4" Belt O.C.	2485210	②▲9600HD
Belt - W.P. & Alt.; W/61 1/4" Belt O.C.	3891365	②◆▲9610HD
Belt - W.P. & Alt.; W/62 1/4" Belt O.C.	3888486	②▲9620HD
Belt - W.P. & Alt.; W/66 1/4" Belt O.C.	2479287	②◆▲9660HD
Belt - W.P. & Alt.; W/67 1/4" Belt O.C.	2483914	②◆▲9670HD
Belt - P.S.; W/39 3/4" Belt O.C.	2477462	▲9395HD
Belt - P.S.; W/40 3/4" Belt O.C.	3887674	▲9405HD
Belt - Air Brake Compr.		▲9660HD
Hose - Upper - Eng. To Pipe		23531
Hose - Upper - Pipe To Rad.; (2" I.D.)		24232
Hose - Lower - Eng. To Pipe; (2 1/2" I.D.)		24240
Hose - Lower - Pipe To Rad.; (2 1/4" I.D.)		24236
GM V-6 478		
RM7500		
Belt - W.P. & Alt.; W/60 1/4" Belt O.C.	2485210	②▲9600HD
Belt - W.P. & Alt.; W/61 1/4" Belt O.C.	3891365	②◆▲9610HD
Belt - W.P. & Alt.; W/62 1/4" Belt O.C.	3888486	②▲9620HD
Belt - W.P. & Alt.; W/66 1/4" Belt O.C.	2479287	②◆▲9660HD
Belt - W.P. & Alt.; W/67 1/4" Belt O.C.	2483914	②◆▲9670HD
Belt - P.S.; W/39 3/4" Belt O.C.	2477462	▲9395HD
Belt - P.S.; W/40 3/4" Belt O.C.	3887674	▲9405HD
Belt - Air Brake Compr.		▲9660HD
Hose - Upper - Eng. To Pipe		23531
Hose - Upper - Pipe To Rad.; (2" I.D.)		24232
Hose - Lower - Eng. To Pipe; (2 1/2" I.D.)		24240
Hose - Lower - Pipe To Rad.; (2 1/4" I.D.)		24236
GMC V-6 478 Diesel		
RG7500		
Belt - W.P. & Alt.; W/85A., 105A., 130A. Alt. .	2453896	②◆▲9670HD
Belt - P.S.	3887682	▲9395HD
Belt - Air Brake Compr.	2471922	▲9600HD
Belt - V.P.	3764340	▲9550HD
1967		
GM 6-Cyl. 292		
SS5500		
Belt - Fan & Alt.	3887682	▲9395HD
Belt - Fan, Alt. & P.S.		▲9530HD
Belt - Fan & Air Brake Compr.; W/O P.S.	3887683	▲9670HD
Hose - Upper		≅20686
Hose - Lower		20489
	or	●26611
Hose - By Pass		20563
Hose - Heater Inlet; (3/4" I.D.)		28442
Hose - Heater Outlet; (5/8" I.D.)		28441
GM V-6 305		
RM7500		
Belt - W.P. & Alt.; W/61A. Alt.; W/Single Belt .	2485210	▲9600HD
Belt - W.P. & Alt.; W/61A. Alt.; W/Dual Belts .	3891365	▲9610HD
Belt - W.P. & Alt.; W/130A. Alt.	2483914	▲9670HD
Belt - P.S.	2477462	▲9395HD
Belt - Air Brake Compr.		▲9650HD
Hose - Upper - Eng. To Pipe		23531
Hose - Upper - Pipe To Rad.; (2" I.D.)		24232
Hose - Lower - Eng. To Pipe; (2 1/2" I.D.)		24240
Hose - Lower - Pipe To Rad.; (2 1/4" I.D.)		24236
SM5500		
Belt - Fan & Alt.; W/61A. Alt.		②◆▲9590HD
Belt - Fan & Alt.; W/Air Brakes; W/105A. Alt. .	2483932	②◆▲9660HD
Belt - Fan & Alt.; W/Hyd. Brakes; W/105A. Alt. .	8876092	②◆▲9650HD
Belt - P.S.; W/Air Brakes	8867788	▲9420HD
Belt - P.S.; W/Hyd. Brakes	2459789	▲9476HD
Belt - Air Brake Compr.	3883002	▲9605HD
SM6500		
Belt - Fan & Alt.; W/61A. Alt.; W/Single Belt ..	2485210	▲9600HD
Belt - Fan & Alt.; W/61A. Alt.; W/Dual Belts ...	3891365	▲9610HD
Belt - Fan & Alt.; W/130A. Alt.	2483914	②◆▲9670HD
Belt - P.S.; W/Air Brakes	8867788	▲9420HD
Belt - P.S.; W/Hyd. Brakes	2459789	▲9476HD
Belt - Air Brake Compr.		▲9650HD

Application	Mfr. Part No.	Our No.
GMC - Continued		
1967 - Continued		
GM V-6 305 - Continued		
SM5500 - Continued		
Belt - P.S.; W/Air Brakes	8867788	▲9420HD
Belt - P.S.; W/Hyd. Brakes	2459789	▲9476HD
Belt - Air Brake Compr.	3883002	▲9605HD
SM6500		
Belt - Fan & Alt.; W/61A. Alt.; W/Single Belt ..	2485210	▲9600HD
Belt - Fan & Alt.; W/61A. Alt.; W/Dual Belts ...	3891365	▲9610HD
Belt - Fan & Alt.; W/130A. Alt.	2483914	②◆▲9670HD
Belt - P.S.; W/Air Brakes	8867788	▲9420HD
Belt - P.S.; W/Hyd. Brakes	2459789	▲9476HD
Belt - Air Brake Compr.		▲9650HD
GM V-6 351		
RM7500		
Belt - W.P. & Alt.; W/61A. Alt.; W/Single Belt .	2485210	▲9600HD
Belt - W.P. & Alt.; W/61A. Alt.; W/Dual Belts .	3891365	▲9610HD
Belt - W.P. & Alt.; W/130A. Alt.	2483914	▲9670HD
Belt - P.S.	2477462	▲9395HD
Belt - Air Brake Compr.		▲9650HD
Hose - Upper - Eng. To Pipe		23531
Hose - Upper - Pipe To Rad.; (2" I.D.)		24232
Hose - Lower - Eng. To Pipe; (2 1/2" I.D.)		24240
Hose - Lower - Pipe To Rad.; (2 1/4" I.D.)		24236
SM5500		
Belt - Fan & Alt.; W/61A. Alt.		②◆▲9590HD
Belt - Fan & Alt.; W/Air Brakes; W/105A. Alt. .	2483932	②◆▲9660HD
Belt - Fan & Alt.; W/Hyd. Brakes; W/105A. Alt. .	8876092	②◆▲9650HD
Belt - P.S.; W/Air Brakes	8867788	▲9420HD
Belt - P.S.; W/Hyd. Brakes	2459789	▲9476HD
Belt - Air Brake Compr.	3883002	▲9605HD
SM6500		
Belt - Fan & Alt.; W/61A. Alt.; W/Single Belt ..	2485210	▲9600HD
Belt - Fan & Alt.; W/61A. Alt.; W/Dual Belts ...	3891365	▲9610HD
Belt - Fan & Alt.; W/130A. Alt.	2483914	②◆▲9670HD
Belt - P.S.; W/Air Brakes	8867788	▲9420HD
Belt - P.S.; W/Hyd. Brakes	2459789	▲9476HD
Belt - Air Brake Compr.		▲9650HD
GM V-6 379		
RM7500		
Belt - W.P. & Alt.; W/61A. Alt.; W/Single Belt .	2485210	▲9600HD
Belt - W.P. & Alt.; W/61A. Alt.; W/Dual Belts .	3891365	▲9610HD
Belt - W.P. & Alt.; W/130A. Alt.	2483914	▲9670HD
Belt - P.S.	2477462	▲9395HD
Belt - Air Brake Compr.		▲9650HD
Hose - Upper - Eng. To Pipe		23531
Hose - Upper - Pipe To Rad.; (2" I.D.)		24232
Hose - Lower - Eng. To Pipe; (2 1/2" I.D.)		24240
Hose - Lower - Pipe To Rad.; (2 1/4" I.D.)		24236
SM5500		
Belt - Fan & Alt.; W/61A. Alt.		②◆▲9590HD
Belt - Fan & Alt.; W/Air Brakes; W/105A. Alt. .	2483932	②◆▲9660HD
Belt - Fan & Alt.; W/Hyd. Brakes; W/105A. Alt. .	8876092	②◆▲9650HD
Belt - P.S.; W/Air Brakes	8867788	▲9420HD
Belt - P.S.; W/Hyd. Brakes	2459789	▲9476HD
Belt - Air Brake Compr.	3883002	▲9605HD
SM6500		
Belt - Fan & Alt.; W/61A. Alt.; W/Single Belt ..	2485210	▲9600HD
Belt - Fan & Alt.; W/61A. Alt.; W/Dual Belts ...	3891365	▲9610HD
Belt - Fan & Alt.; W/130A. Alt.	2483914	②◆▲9670HD
Belt - P.S.; W/Air Brakes	8867788	▲9420HD
Belt - P.S.; W/Hyd. Brakes	2459789	▲9476HD
Belt - Air Brake Compr.		▲9650HD
GM V-6 401		
RM7500		
Belt - W.P. & Alt.; W/60 1/4" Belt O.C.	2485210	②▲9600HD
Belt - W.P. & Alt.; W/61 1/4" Belt O.C.	3891365	②◆▲9610HD
Belt - W.P. & Alt.; W/62 1/4" Belt O.C.	3888486	②▲9620HD
Belt - W.P. & Alt.; W/66 1/4" Belt O.C.	2479287	②◆▲9660HD
Belt - W.P. & Alt.; W/67 1/4" Belt O.C.	2483914	②◆▲9670HD
Belt - P.S.; W/39 3/4" Belt O.C.	2477462	▲9395HD

▲ Standard Belt Available. See Pages 630-631.
 ◆ Green Stripe® PowerBand® Belt May Work, Use Template to Check.
 ● Vulco-Flex® Coolant Hose.

② Two Required.
 ≅ Cut to Fit.

Belts and Coolant Hose for School Buses

School Buses

Application	Mfr. Part No.	Our No.
GMC - Continued		
1967 - Continued		
GM V-6 401 - Continued		
RM7500 - Continued		
Belt - P.S.; W/40 3/4" Belt O.C.	3887674	♣9405HD
Belt - Air Brake Compr.		♣9660HD
Hose - Upper - Eng. To Pipe		23531
Hose - Upper - Pipe To Rad.; (2" I.D.)		24232
Hose - Lower - Eng. To Pipe; (2 1/2" I.D.)		24240
Hose - Lower - Pipe To Rad.; (2 1/4" I.D.)		24236
GM V-6 432		
RM7500		
Belt - W.P. & Alt.; W/60 1/4" Belt O.C.	2485210	②♣9600HD
Belt - W.P. & Alt.; W/61 1/4" Belt O.C.	3891365	②♣9610HD
Belt - W.P. & Alt.; W/62 1/4" Belt O.C.	3888486	②♣9620HD
Belt - W.P. & Alt.; W/66 1/4" Belt O.C.	2479287	②♣9660HD
Belt - W.P. & Alt.; W/67 1/4" Belt O.C.	2483914	②♣9670HD
Belt - P.S.; W/39 3/4" Belt O.C.	2477462	♣9395HD
Belt - P.S.; W/40 3/4" Belt O.C.	3887674	♣9405HD
Belt - Air Brake Compr.		♣9660HD
Hose - Upper - Eng. To Pipe		23531
Hose - Upper - Pipe To Rad.; (2" I.D.)		24232
Hose - Lower - Eng. To Pipe; (2 1/2" I.D.)		24240
Hose - Lower - Pipe To Rad.; (2 1/4" I.D.)		24236
GM V-6 478		
RM7500		
Belt - W.P. & Alt.; W/60 1/4" Belt O.C.	2485210	②♣9600HD
Belt - W.P. & Alt.; W/61 1/4" Belt O.C.	3891365	②♣9610HD
Belt - W.P. & Alt.; W/62 1/4" Belt O.C.	3888486	②♣9620HD
Belt - W.P. & Alt.; W/66 1/4" Belt O.C.	2479287	②♣9660HD
Belt - W.P. & Alt.; W/67 1/4" Belt O.C.	2483914	②♣9670HD
Belt - P.S.; W/39 3/4" Belt O.C.	2477462	♣9395HD
Belt - P.S.; W/40 3/4" Belt O.C.	3887674	♣9405HD
Belt - Air Brake Compr.		♣9660HD
Hose - Upper - Eng. To Pipe		23531
Hose - Upper - Pipe To Rad.; (2" I.D.)		24232
Hose - Lower - Eng. To Pipe; (2 1/2" I.D.)		24240
Hose - Lower - Pipe To Rad.; (2 1/4" I.D.)		24236
GMC V-6 478 Diesel		
RG7500		
Belt - W.P. & Alt.; W/85A., 105A., 130A. Alt. .	2453896	②♣9670HD
Belt - P.S.	3887682	♣9395HD
Belt - Air Brake Compr.	2471922	♣9600HD
Belt - V.P.	3764340	♣9550HD
Hose - Upper; (2" I.D.)		24232
Hose - Lower; (2 1/4" I.D.)		24236
Hose - By Pass		②♣20904
1966		
GM V-6 305		
RM7500		
Belt - W.P. & Alt.; W/61A. Alt.; W/Single Belt .	2485210	♣9600HD
Belt - W.P. & Alt.; W/61A. Alt.; W/Dual Belts .	3891365	♣9610HD
Belt - W.P. & Alt.; W/130A. Alt.	2483914	♣9670HD
Belt - P.S.	2477462	♣9395HD
Belt - Air Brake Compr.		♣9650HD
Hose - Upper - Eng. To Pipe		23531
Hose - Upper - Pipe To Rad.; (2" I.D.)		24232
Hose - Lower - Eng. To Pipe; (2 1/2" I.D.)		24240
Hose - Lower - Pipe To Rad.; (2 1/4" I.D.)		24236
GM V-6 351		
RM7500		
Belt - W.P. & Alt.; W/61A. Alt.; W/Single Belt .	2485210	♣9600HD
Belt - W.P. & Alt.; W/61A. Alt.; W/Dual Belts .	3891365	♣9610HD
Belt - W.P. & Alt.; W/130A. Alt.	2483914	♣9670HD
Belt - P.S.	2477462	♣9395HD
Belt - Air Brake Compr.		♣9650HD
Hose - Upper - Eng. To Pipe		23531
Hose - Upper - Pipe To Rad.; (2" I.D.)		24232
Hose - Lower - Eng. To Pipe; (2 1/2" I.D.)		24240
Hose - Lower - Pipe To Rad.; (2 1/4" I.D.)		24236

♣ Standard Belt Available. See Pages 630-631.
 ◆ Green Stripe® PowerBand® Belt May Work, Use Template to Check.

Application	Mfr. Part No.	Our No.
GMC - Continued		
1966 - Continued		
GM V-6 379		
RM7500		
Belt - W.P. & Alt.; W/61A. Alt.; W/Single Belt .	2485210	♣9600HD
Belt - W.P. & Alt.; W/61A. Alt.; W/Dual Belts .	3891365	♣9610HD
Belt - W.P. & Alt.; W/130A. Alt.	2483914	♣9670HD
Belt - P.S.	2477462	♣9395HD
Belt - Air Brake Compr.		♣9650HD
Hose - Upper - Eng. To Pipe		23531
Hose - Upper - Pipe To Rad.; (2" I.D.)		24232
Hose - Lower - Eng. To Pipe; (2 1/2" I.D.)		24240
Hose - Lower - Pipe To Rad.; (2 1/4" I.D.)		24236
GM V-6 401		
RM7500		
Belt - W.P. & Alt.; W/60 1/4" Belt O.C.	2485210	②♣9600HD
Belt - W.P. & Alt.; W/61 1/4" Belt O.C.	3891365	②♣9610HD
Belt - W.P. & Alt.; W/62 1/4" Belt O.C.	3888486	②♣9620HD
Belt - W.P. & Alt.; W/66 1/4" Belt O.C.	2479287	②♣9660HD
Belt - W.P. & Alt.; W/67 1/4" Belt O.C.	2483914	②♣9670HD
Belt - P.S.; W/39 3/4" Belt O.C.	2477462	♣9395HD
Belt - P.S.; W/40 3/4" Belt O.C.	3887674	♣9405HD
Belt - Air Brake Compr.		♣9660HD
Hose - Upper - Eng. To Pipe		23531
Hose - Upper - Pipe To Rad.; (2" I.D.)		24232
Hose - Lower - Eng. To Pipe; (2 1/2" I.D.)		24240
Hose - Lower - Pipe To Rad.; (2 1/4" I.D.)		24236
GM V-6 432		
RM7500		
Belt - W.P. & Alt.; W/60 1/4" Belt O.C.	2485210	②♣9600HD
Belt - W.P. & Alt.; W/61 1/4" Belt O.C.	3891365	②♣9610HD
Belt - W.P. & Alt.; W/62 1/4" Belt O.C.	3888486	②♣9620HD
Belt - W.P. & Alt.; W/66 1/4" Belt O.C.	2479287	②♣9660HD
Belt - W.P. & Alt.; W/67 1/4" Belt O.C.	2483914	②♣9670HD
Belt - P.S.; W/39 3/4" Belt O.C.	2477462	♣9395HD
Belt - P.S.; W/40 3/4" Belt O.C.	3887674	♣9405HD
Belt - Air Brake Compr.		♣9660HD
Hose - Upper - Eng. To Pipe		23531
Hose - Upper - Pipe To Rad.; (2" I.D.)		24232
Hose - Lower - Eng. To Pipe; (2 1/2" I.D.)		24240
Hose - Lower - Pipe To Rad.; (2 1/4" I.D.)		24236
GM V-6 478		
RM7500		
Belt - W.P. & Alt.; W/60 1/4" Belt O.C.	2485210	②♣9600HD
Belt - W.P. & Alt.; W/61 1/4" Belt O.C.	3891365	②♣9610HD
Belt - W.P. & Alt.; W/62 1/4" Belt O.C.	3888486	②♣9620HD
Belt - W.P. & Alt.; W/66 1/4" Belt O.C.	2479287	②♣9660HD
Belt - W.P. & Alt.; W/67 1/4" Belt O.C.	2483914	②♣9670HD
Belt - P.S.; W/39 3/4" Belt O.C.	2477462	♣9395HD
Belt - P.S.; W/40 3/4" Belt O.C.	3887674	♣9405HD
Belt - Air Brake Compr.		♣9660HD
Hose - Upper - Eng. To Pipe		23531
Hose - Upper - Pipe To Rad.; (2" I.D.)		24232
Hose - Lower - Eng. To Pipe; (2 1/2" I.D.)		24240
Hose - Lower - Pipe To Rad.; (2 1/4" I.D.)		24236
GMC V-6 478 Diesel		
RG7500		
Belt - W.P. & Alt.; W/85A., 105A., 130A. Alt. .	2453896	②♣9670HD
Belt - P.S.	3887682	♣9395HD
Belt - Air Brake Compr.	2471922	♣9600HD
Belt - V.P.	3764340	♣9550HD
Hose - Upper; (2" I.D.)		24232
Hose - Lower; (2 1/4" I.D.)		24236
Hose - By Pass		②♣20904
INTERNATIONAL/NAVISTAR		
2012		
International/Navistar MaxxForce 7 Diesel		
BE		
Tensioner Assy. - Fan	1833688C2	38556
Idler Pulley - Fan	1832710C1	36351

② Two Required.
 ≍ Cut to Fit.

Belts and Coolant Hose for School Buses

School Buses

Application	Mfr. Part No.	Our No.
INTERNATIONAL/NAVISTAR - Continued		
2012 - Continued		
International/Navistar MaxxForce 7 Diesel - Continued		
BE - Continued		
Hose - Upper		23795
Hose - Lower		23793
2011		
International/Navistar MaxxForce 7 Diesel		
BE		
Belt - Fan	3565413C3	▲K080991HD
Tensioner Assy.	1833688C2	38556
Idler Pulley	1832710C1	36351
Hose - Upper		23795
Hose - Lower		23793
CE		
Belt - Fan, W.P. & Alt.	1832194C2	K080962HD
Belt - A.C.	1847509C1	▲K060696HD
Tensioner Assy. - Fan, W.P. & Alt.	1833688C2	38556
Tensioner Assy. - A.C.	1832711C2	38629
Idler Pulley - Fan & Alt.	1832710C1	36351
Idler Pulley - A.C. (Left)	1832712C1	38006
Idler Pulley - A.C. (Right)	1832712C1	38006
Hose - Upper		23795
Hose - Lower		23793
International/Navistar MaxxForce DT Diesel		
CE		
Belt - Fan	1888631C1	K100702HD
Tensioner Assy.	1873217C2	38634
Hose - Upper		23794
FE		
Belt - Fan & Alt.	1847732C1	K100745HD
Tensioner Assy. - Fan & Alt.	1873217C1	38634
RE		
Belt - Fan, A.C., Alt. & W.P.	1881079C1	K101091HD
Tensioner Assy. - Fan, A.C., Alt. & W.P.	1873217C1	38634
2010		
International/Navistar MaxxForce 7 Diesel		
BE		
Belt - Fan	1832194C2	K080962HD
Tensioner Assy.	1833688C2	38556
Idler Pulley	1832710C1	36351
Hose - Upper		23795
Hose - Lower		23793
CE		
Belt - Fan, W.P. & Alt.	1832194C2	K080962HD
Belt - A.C.	1847509C1	▲K060696HD
Tensioner Assy. - Fan, W.P. & Alt.	1833688C2	38556
Tensioner Assy. - A.C.	1832711C2	38629
Idler Pulley - Fan & Alt.	1832710C1	36351
Idler Pulley - A.C. (Left)	1832712C1	38006
Idler Pulley - A.C. (Right)	1832712C1	38006
Hose - Upper		23795
Hose - Lower		23793
International/Navistar MaxxForce DT Diesel		
CE		
Belt - Fan, Alt. & W.P.; W/Prestolite Alt.	1847736C1	K100726HD
Belt - Fan, Alt. & W.P.; W/Bosch Alt.	1847678C1	K100720HD
Tensioner Assy. - Fan, W.P. & Alt.	1873217C2	38634
Hose - Upper		23794
FE		
Belt - Fan & Alt.	1847732C1	K100745HD
Tensioner Assy. - Fan & Alt.	1873217C1	38634
RE		
Belt - Fan, A.C., Alt. & W.P.	1881079C1	K101091HD
Tensioner Assy. - Fan, A.C., Alt. & W.P.	1873217C1	38634

Application	Mfr. Part No.	Our No.
INTERNATIONAL/NAVISTAR - Continued		
2009		
International/Navistar MaxxForce 7 Diesel		
BE		
Belt - Fan	1832194C2	K080962HD
Tensioner Assy.	1833688C2	38556
Idler Pulley	1832710C1	36351
Hose - Upper		23795
Hose - Lower		23793
CE		
Belt - Fan, W.P. & Alt.	1832194C2	K080962HD
Belt - A.C.	1847509C1	▲K060696HD
Tensioner Assy. - Fan, W.P. & Alt.	1833688C2	38556
Tensioner Assy. - A.C.	1832711C2	38629
Idler Pulley - Fan & Alt.	1832710C1	36351
Idler Pulley - A.C. (Left)	1832712C1	38006
Idler Pulley - A.C. (Right)	1832712C1	38006
Hose - Upper		23795
Hose - Lower		23793
International/Navistar MaxxForce DT Diesel		
CE		
Belt - Fan, W.P. & Alt.; W/Bosch Alt.	1888631C1	K100702HD
Belt - Fan, W.P. & Alt.; W/Prestolite Alt.	1847677C1	▲K100731HD
Tensioner Assy.	1873217C2	38634
Tensioner Assy. - Fan, W.P. & Alt.	1873217C2	38634
Hose - Upper - Eng. To Rad.		23794
Hose - Lower - Cooler To Pipe		≈21302
FE		
Belt - Fan	1842463C1	▲K080774HD
Tensioner Assy. - Fan	1841760C1	38620
RE		
Belt - Fan, A.C., Alt. & W.P.	1881079C1	K101091HD
Tensioner Assy. - Fan, A.C., Alt. & W.P.	1873217C1	38634
2008		
International/Navistar DT466 Diesel		
CE		
Belt - Fan, W.P. & Alt.; W/73" Belt O.C.	1842455C1	K080723HD
Belt - Fan, W.P. & Alt.; W/73 1/2" Belt O.C. ...	1847677C1	▲K100731HD
Tensioner Assy.; W/73" Belt O.C.	1841760C1	38620
Tensioner Assy.; W/73 1/2" Belt O.C.	1873217C1	38634
Hose - Upper - Eng. To Rad.		20731
International/Navistar MaxxForce 7 Diesel		
BE		
Belt - Fan & Alt.	1839964C1	▲K080702HD
Tensioner Assy. - Fan & Alt.	1833688C2	38556
Idler Pulley	1832710C1	36351
Hose - Lower - Eng. To W.P.		22775
CE		
Belt - Fan, W.P. & Alt.	1832194C2	K080962HD
Belt - A.C.	1847509C1	▲K060696HD
Tensioner Assy. - Fan, W.P. & Alt.	1833688C2	38556
Tensioner Assy. - A.C.	1832711C2	38629
Idler Pulley - Fan & Alt.	1832710C1	36351
Idler Pulley - A.C. (Left)	1832712C1	38006
Idler Pulley - A.C. (Right)	1832712C1	38006
Hose - Upper		23795
Hose - Lower		23793
International/Navistar MaxxForce DT Diesel		
CE		
Belt - Fan, W.P. & Alt.; W/73" Belt O.C.	1842455C1	K080723HD
Belt - Fan, W.P. & Alt.; W/73 1/2" Belt O.C. ...	1847677C1	▲K100731HD
Tensioner Assy.; W/73" Belt O.C.	1841760C1	38620
Tensioner Assy.; W/73 1/2" Belt O.C.	1873217C1	38634
Hose - Upper - Eng. To Rad.		20731
FE		
Belt - Fan	1842463C1	▲K080774HD
Tensioner Assy. - Fan	1841760C1	38620
International/Navistar VT365 Diesel		
BE		
Belt - Fan & Alt.	1839964C1	▲K080702HD

▲ Standard Belt Available. See Pages 630-631.

≈< Cut to Fit.

Belts and Coolant Hose for School Buses

School Buses

Application	Mfr. Part No.	Our No.
INTERNATIONAL/NAVISTAR - Continued		
2008 - Continued		
International/Navistar VT365 Diesel - Continued		
BE - Continued		
Tensioner Assy. - Fan & Alt.	1833688C2	38556
Hose - Lower - Eng. To W.P.		22775
CE		
Belt - Fan & Alt.	1839964C1	♣K080702HD
Tensioner Assy. - Fan & Alt.	1833688C2	38556
Idler Pulley	1822653C92	36288
Hose - Upper		22775
Hose - Lower		22774
2007		
International/Navistar DT466 Diesel		
CE		
Belt - W.P., Fan & Alt.	1842455C1	K080723HD
Tensioner Assy. - Fan, W.P. & Alt.	1841760C1	38620
Hose - Upper - Eng. To Rad.		20731
RE		
Belt - Fan, Alt. & W.P.; W/200A. Alt.	1842930C1	♣K080830HD
Tensioner Assy. - Fan, W.P. & Alt.; W/200A. Alt.	1841760C1	38620
International/Navistar VT365 Diesel		
BE		
Belt - Fan & Alt.	1839964C1	♣K080702HD
Tensioner Assy. - Fan & Alt.	1833688C2	38556
Hose - Lower - Eng. To W.P.		22775
CE		
Belt - Fan & Alt.	1839964C1	♣K080702HD
Belt - Fan & Air Brake Compr.	1843218C1	♣K060509HD
Tensioner Assy. - Fan & Alt.	1833688C2	38556
Tensioner Assy. - Fan & Air Brake Compr.	1833688C2	38556
RE		
Belt - A.C.	1843218C1	♣K060509HD
Belt - Fan	1842720C1	♣K080897HD
Tensioner Assy.	1833688C2	38556
2006		
International/Navistar DT466 Diesel		
CE		
Belt - Fan, W.P. & Alt.	1842455C1	K080723HD
Tensioner Assy. - Fan, W.P. & Alt.	1841760C1	38620
Hose - Lower - Cooler To Rad.		23175
Hose - Lower - Eng. To Cooler		23176
RE		
Belt - Fan, W.P. & Alt.; W/200A. Alt.	1842930C1	♣K080830HD
Tensioner Assy. - Fan, W.P. & Alt.	1841760C1	38620
2005		
International/Navistar DT466 Diesel		
3300		
Serpentine Belt		♣K080740HD
CE		
Belt - Fan, Alt. & W.P.; W/145A. Alt.	1842455C1	K080723HD
Belt - Fan, Alt. & W.P.; W/200A. Alt.		♣K080922HD
Tensioner Assy. - Fan, W.P. & Alt.	1841760C1	38620
FE		
Belt - Fan, W.P. & Alt.	1842463C1	♣K080774HD
Tensioner Assy.	1841760C1	38620
RE		
Belt - Fan, W.P. & Alt.	1842464C1	♣K080842HD
Tensioner Assy. - Fan, W.P. & Alt.	1841760C1	38620
International/Navistar VT365 Diesel		
CE		
Belt - Fan & Compr.	1843218C1	♣K060509HD
Belt - Fan, Alt. & A.C.		♣K080855HD
Belt - Fan & Alt.; W/O A.C.	1839964C1	♣K080702HD
Tensioner Assy.	1833688C2	38556

Application	Mfr. Part No.	Our No.
INTERNATIONAL/NAVISTAR - Continued		
2004		
International/Navistar 530 Diesel		
RE		
Belt - Fan & Alt.	1841577C1	♣K080765HD
Tensioner Assy. - Fan & Alt.	1830033C1	38514
Tensioner Pulley - Fan & Alt.	1830033C1	36091
International/Navistar DT466 Diesel		
3300		
Tensioner Assy.	1830033C1	38514
Tensioner Pulley	1830033C1	36091
3800		
Belt - Alt.	1819391C2	♣K080726HD
Tensioner Assy.	1830033C2	38514
CE		
Belt - Fan & Alt.	1830727C2	♣K080690HD
Belt - A.C.; W/Dual A.C.		♣K060675HD
Tensioner Assy. - Fan & Alt.	1830033C1	38514
Tensioner Pulley - Fan & Alt.	1830033C1	36091
Hose - Upper - Eng. To Rad.		22776
Hose - Lower - Eng. To Rad.		20987
FE		
Belt - Fan, W.P. & Alt.	1819391C2	♣K080726HD
Tensioner Assy.	1830033C2	38514
Tensioner Pulley	1830033C2	36091
Hose - Lower		22783
RE		
Belt - Fan, W.P. & Alt.	1842464C1	♣K080842HD
Tensioner Assy. - Fan, W.P. & Alt.	1841760C1	38620
International/Navistar T444 Diesel		
3800		
Idler Pulley; W/Flat Idler Pulley	1822652C91	36287
Idler Pulley; W/V-Groove Idler Pulley	1822653C91	36288
CE		
Belt - Fan & Alt.	1822832C1	♣K081124HD
Tensioner Assy. - Fan & Alt.	1822679C1	38510
Idler Pulley; W/Flat Idler Pulley	1822652C91	36287
Idler Pulley; W/V-Groove Idler Pulley	1822653C91	36288
Hose - Upper - Eng. To Rad.		22785
Hose - Lower		22782
2003		
International/Navistar 530 Diesel		
RE		
Belt - Fan & Alt.	1841577C1	♣K080765HD
Tensioner Assy. - Fan & Alt.	1830033C1	38514
Tensioner Pulley - Fan & Alt.	1830033C1	36091
International/Navistar DT466 Diesel		
3800		
Serpentine Belt	1822503C1	♣K080726HD
Tensioner Assy.	1830033C1	38514
Tensioner Pulley	1830033C1	36091
Hose - Upper - Eng. To Rad.		22140
Hose - Lower - Eng. To Rad.		20987
CE		
Belt - Fan & Alt.	1830727C2	♣K080690HD
Belt - A.C.; W/Dual A.C.		♣K060675HD
Tensioner Assy. - Fan & Alt.	1830033C1	38514
Tensioner Pulley - Fan & Alt.	1830033C1	36091
Hose - Upper - Eng. To Rad.		22776
Hose - Lower - Eng. To Rad.		20987
Conventional IC		
Belt - Fan, Alt. & Hub	1830727C2	♣K080690HD
Tensioner Assy. - Fan, Alt. & Hub	1830033C1	38514
Tensioner Pulley - Fan, Alt. & Hub	1830033C1	36091
Hose - Upper - Eng. To Rad.		22776
Hose - Lower - Eng. To Rad.		20987
FE		
Belt - Fan, W.P. & Alt.	1819391C2	♣K080726HD
Tensioner Assy.	1830033C2	38514

♣ Standard Belt Available. See Pages 630-631.

Belts and Coolant Hose for School Buses

School Buses

Application	Mfr. Part No.	Our No.
INTERNATIONAL/NAVISTAR - Continued		
2003 - Continued		
International/Navistar DT466 Diesel - Continued		
FE - Continued		
Tensioner Pulley	1830033C2	36091
Hose - Lower		22783
RE		
Belt - Fan, W.P. & Alt.	1842464C1	♣K080842HD
Tensioner Assy. - Fan, W.P. & Alt.	1841760C1	38620
International/Navistar T444 Diesel		
3800		
Belt - W.P., Fan & Alt.; W/O Air Brake Compr.	1822830C1	♣K080893HD
Tensioner Assy.	1822679C4	38510
Idler Pulley; W/Flat Idler Pulley	1822652C91	36287
Idler Pulley; W/V-Groove Idler Pulley	1822653C91	36288
CE		
Belt - Fan & Alt.	1822832C1	♣K081124HD
Tensioner Assy. - Fan & Alt.	1822679C1	38510
Idler Pulley; W/Flat Idler Pulley	1822652C91	36287
Idler Pulley; W/V-Groove Idler Pulley	1822653C91	36288
Hose - Upper - Eng. To Rad.		22785
Hose - Lower		22782
Conventional IC		
Serpentine Belt		♣K081377HD
Tensioner Assy.	1822679C4	38510
Idler Pulley; W/Flat Idler Pulley	1822652C91	36287
Idler Pulley; W/V-Groove Idler Pulley	1822653C91	36288
Tensioner Pulley	1822679C4	36092
Hose - Lower - Eng. To Rad.		22782
2002		
International/Navistar 530 Diesel		
RE		
Tensioner Assy. - Fan & Alt.	1830033C1	38514
Tensioner Pulley - Fan & Alt.	1830033C1	36091
International/Navistar DT466 Diesel		
3800		
Belt - Fan	1830727C1	♣K080690HD
Conventional IC		
Belt - Fan, Alt. & Hub	1830727C1	♣K080690HD
Tensioner Assy. - Fan, Alt. & Hub	1830033C1	38514
Tensioner Pulley - Fan, Alt. & Hub	1830033C1	36091
Hose - Upper - Eng. To Rad.		22776
Hose - Lower - Eng. To Rad.		20987
FE		
Belt - Fan, W.P. & Alt.	1819391C2	♣K080726HD
Tensioner Assy.	1830033C2	38514
Tensioner Pulley	1830033C2	36091
Hose - Lower		22783
RE		
Belt - Fan, W.P. & Alt.	1842464C1	♣K080842HD
Tensioner Assy. - Fan, W.P. & Alt.	1841760C1	38620
International/Navistar T444 Diesel		
3400		
Idler Pulley; W/Flat Idler Pulley	1822652C91	36287
Idler Pulley; W/V-Groove Idler Pulley	1822653C91	36288
3800		
Belt - W.P., Fan & Alt.; W/Air Brake Compr. ...	1822832C1	♣K081124HD
Belt - W.P., Fan & Alt.; W/O Air Brake Compr.	1822830C1	♣K080893HD
Tensioner Assy.	1822679C3	38510
Idler Pulley; W/Flat Idler Pulley	1822652C91	36287
Idler Pulley; W/V-Groove Idler Pulley	1822653C91	36288
Conventional IC		
Belt - Fan, Alt. & Hub	1822830C1	♣K080893HD
Tensioner Assy. - Fan, Alt. & Hub	1822679C3	38510
Idler Pulley; W/Flat Idler Pulley	1822652C91	36287
Idler Pulley; W/V-Groove Idler Pulley	1822653C91	36288
Hose - Upper - Eng. To Rad.		21042
Hose - Lower - Eng. To Rad.		22782

Application	Mfr. Part No.	Our No.
INTERNATIONAL/NAVISTAR - Continued		
2001		
International/Navistar 530 Diesel		
RE		
Belt - Fan & Alt.	1682697C1	♣K080760HD
Tensioner Assy. - Fan & Alt.	1830033C1	38514
Tensioner Pulley - Fan & Alt.	1830033C1	36091
International/Navistar DT466 Diesel		
3800		
Belt - Fan, Alt. & Hub	1822503C1	♣K080726HD
Tensioner Assy. - Fan, Alt. & Hub	1830033C1	38514
Tensioner Pulley - Fan, Alt. & Hub	1830033C1	36091
Hose - Upper - Eng. To Rad.		22140
Hose - Lower - Eng. To Rad.		20987
RE		
Belt - Fan, W.P. & Alt.	1842464C1	♣K080842HD
Tensioner Assy. - Fan, W.P. & Alt.	1841760C1	38620
International/Navistar T444 Diesel		
3400		
Idler Pulley; W/Flat Idler Pulley	1822652C91	36287
Idler Pulley; W/V-Groove Idler Pulley	1822653C91	36288
3800		
Belt - W.P., Fan & Alt.; W/Air Brake Compr. ...	1822832C1	♣K081124HD
Belt - W.P., Fan & Alt.; W/O Air Brake Compr.	1822830C1	♣K080893HD
Tensioner Assy.	1822679C3	38510
Idler Pulley; W/Flat Idler Pulley	1822652C91	36287
Idler Pulley; W/V-Groove Idler Pulley	1822653C91	36288
Hose - Upper - Eng. To Pipe		22159
Hose - Lower - Eng. To Pipe		≈<21042
Hose - Lower - Pipe To Pipe; (3" I.D.)		24248
Hose - Lower - Pipe To Rad.		≈<21042
RE		
Belt - W.P., Fan & Alt.; W/Air Brake Compr. ...	1822832C1	♣K081124HD
Belt - W.P., Fan & Alt.; W/O Air Brake Compr.	1822830C1	♣K080893HD
Tensioner Assy.	1822679C4	38510
Idler Pulley; W/Flat Idler Pulley	1822652C91	36287
Idler Pulley; W/V-Groove Idler Pulley	1822653C91	36288
2000		
International/Navistar 530 Diesel		
RE		
Belt - Fan & Alt.	1682697C1	♣K080760HD
Tensioner Assy. - Fan & Alt.	1830033C1	38514
Tensioner Pulley - Fan & Alt.	1830033C1	36091
International/Navistar DT466 Diesel		
3800		
Belt - Fan, Alt. & Hub	1822503C1	♣K080726HD
Tensioner Assy. - Fan, Alt. & Hub	1830033C1	38514
Tensioner Pulley - Fan, Alt. & Hub	1830033C1	36091
Hose - Upper - Eng. To Rad.		22140
Hose - Lower - Eng. To Rad.		22762
RE		
Belt - Fan, W.P. & Alt.	1842464C1	♣K080842HD
Tensioner Assy. - Fan, W.P. & Alt.	1841760C1	38620
International/Navistar T444 Diesel		
3400		
Idler Pulley; W/Flat Idler Pulley	1822652C91	36287
Idler Pulley; W/V-Groove Idler Pulley	1822653C91	36288
3800		
Belt - W.P., Fan & Alt.; W/Air Brake Compr. ...	1822832C1	♣K081124HD
Belt - W.P., Fan & Alt.; W/O Air Brake Compr.	1822830C1	♣K080893HD
Tensioner Assy.	1822679C3	38510
Idler Pulley; W/Flat Idler Pulley	1822652C91	36287
Idler Pulley; W/V-Groove Idler Pulley	1822653C91	36288
Hose - Upper - Rad. To Eng.		22159
Hose - Lower - Eng. To Pipe		22782

♣ Standard Belt Available. See Pages 630-631.

≈< Cut to Fit.

Belts and Coolant Hose for School Buses

School Buses

Application	Mfr. Part No.	Our No.
INTERNATIONAL/NAVISTAR - Continued		
1999		
International/Navistar 530 Diesel		
RE		
Belt - Fan & Alt.	1682697C1	♣K080760HD
Tensioner Assy. - Fan & Alt.	1830033C1	38514
Tensioner Pulley - Fan & Alt.	1830033C1	36091
International/Navistar DT466 Diesel		
3800		
Serpentine Belt	1819391C1	♣K080730HD
Tensioner Assy.	1830033C1	38514
Tensioner Pulley	1830033C1	36091
Hose - Upper - Eng. To Rad.		22140
Hose - Lower - Eng. To Rad.		22762
RE		
Belt - Fan, W.P. & Alt.	1842464C1	♣K080842HD
Tensioner Assy. - Fan, W.P. & Alt.	1841760C1	38620
International/Navistar T444 Diesel		
3400		
Serpentine Belt	1822832C1	♣K081124HD
Idler Pulley; W/Flat Idler Pulley	1822652C91	36287
Idler Pulley; W/V-Groove Idler Pulley	1822653C91	36288
Hose - Upper		22159
Hose - Lower - Eng. To Rad.		22843
3600		
Idler Pulley; W/Flat Idler Pulley	1822652C91	36287
Idler Pulley; W/V-Groove Idler Pulley	1822653C91	36288
3800		
Belt - W.P., Fan & Alt.; W/Air Brake Compr. ..	1822832C1	♣K081124HD
Belt - W.P., Fan & Alt.; W/O Air Brake Compr. ..	1822830C1	♣K080893HD
Belt - A.C.; W/Aux. A.C.		♣K081265HD
Tensioner Assy.	1822679C3	38510
Idler Pulley; W/Flat Idler Pulley	1822652C91	36287
Idler Pulley; W/V-Groove Idler Pulley	1822653C91	36288
Hose - Lower - Eng. To Rad.		22843
1998		
International/Navistar 530 Diesel		
RE		
Belt - Fan & Alt.	1682697C1	♣K080760HD
Tensioner Assy. - Fan & Alt.	1830033C1	38514
Tensioner Pulley - Fan & Alt.	1830033C1	36091
International/Navistar DT466 Diesel		
3800		
Serpentine Belt	1819391C1	♣K080730HD
Tensioner Assy.	1830033C1	38514
Tensioner Pulley	1830033C1	36091
Hose - Upper - Eng. To Rad.		22140
Hose - Lower		22762
Hose - By Pass		21457
RE		
Belt - Fan, W.P. & Alt.	1842464C1	♣K080842HD
Tensioner Assy. - Fan, W.P. & Alt.	1841760C1	38620
International/Navistar T444 Diesel		
3400		
Serpentine Belt	1822832C1	♣K081124HD
Idler Pulley; W/Flat Idler Pulley	1822652C91	36287
Idler Pulley; W/V-Groove Idler Pulley	1822653C91	36288
Hose - Upper		22159
3600		
Idler Pulley; W/Flat Idler Pulley	1822652C91	36287
Idler Pulley; W/V-Groove Idler Pulley	1822653C91	36288
3800		
Belt - W.P., Fan & Alt.; W/Air Brake Compr. ..	1822832C1	♣K081124HD
Belt - W.P., Fan & Alt.; W/O Air Brake Compr. ..	1822830C1	♣K080893HD
Tensioner Assy.	1822679C3	38510
Idler Pulley; W/Flat Idler Pulley	1822652C91	36287
Idler Pulley; W/V-Groove Idler Pulley	1822653C91	36288
Hose - Lower - Eng. To Rad.		22671

Application	Mfr. Part No.	Our No.
INTERNATIONAL/NAVISTAR - Continued		
1997		
International/Navistar 530 Diesel		
RE		
Belt - Fan & Alt.	1682697C1	♣K080760HD
Tensioner Assy. - Fan & Alt.	1830033C1	38514
Tensioner Pulley - Fan & Alt.	1830033C1	36091
International/Navistar DT466 Diesel		
3600		
Serpentine Belt	204563	♣K080730HD
3800		
Serpentine Belt	204563	♣K080730HD
Hose - Upper - Eng. To Rad.		22140
Hose - Lower - Eng. To Rad.		21115
International/Navistar T444 Diesel		
3000FE		
Idler Pulley; W/Flat Idler Pulley	1822652C91	36287
Idler Pulley; W/V-Groove Idler Pulley	1822653C91	36288
3400		
Serpentine Belt	1822832C1	♣K081124HD
Idler Pulley; W/Flat Idler Pulley	1822652C91	36287
Idler Pulley; W/V-Groove Idler Pulley	1822653C91	36288
Hose - Upper		22159
3600		
Idler Pulley; W/Flat Idler Pulley	1822652C91	36287
Idler Pulley; W/V-Groove Idler Pulley	1822653C91	36288
3800		
Belt - W.P., Fan & Alt.; W/Air Brake Compr. ..	1822832C1	♣K081124HD
Belt - W.P., Fan & Alt.; W/O Air Brake Compr. ..	1822830C1	♣K080893HD
Tensioner Assy.	1822679C3	38510
Idler Pulley; W/Flat Idler Pulley	1822652C91	36287
Idler Pulley; W/V-Groove Idler Pulley	1822653C91	36288
Hose - Lower - Eng. To Rad.		22671
1996		
International/Navistar DT466 Diesel		
3600		
Serpentine Belt	1682696C1	♣K080738HD
3800		
Serpentine Belt	1682696C1	♣K080738HD
Hose - Upper		22140
Hose - Lower		≈21115
International/Navistar T444 Diesel		
3000FE		
Idler Pulley; W/Flat Idler Pulley	1822652C91	36287
Idler Pulley; W/V-Groove Idler Pulley	1822653C91	36288
3400		
Serpentine Belt	1822831C2	♣K081000HD
Idler Pulley; W/Flat Idler Pulley	1822652C91	36287
Idler Pulley; W/V-Groove Idler Pulley	1822653C91	36288
Hose - Upper		22159
3600		
Idler Pulley; W/Flat Idler Pulley	1822652C91	36287
Idler Pulley; W/V-Groove Idler Pulley	1822653C91	36288
3800		
Belt - W.P., Fan & Alt.; W/Air Brake Compr. ..	1822832C1	♣K081124HD
Belt - W.P., Fan & Alt.; W/O Air Brake Compr. ..	1822830C1	♣K080893HD
Tensioner Assy.	1822679C3	38510
Idler Pulley; W/Flat Idler Pulley	1822652C91	36287
Idler Pulley; W/V-Groove Idler Pulley	1822653C91	36288
Hose - Upper		22159
Hose - Lower - Eng. To Rad.		22671
1995		
International/Navistar DT466 Diesel		
3600		
Belt - Fan & Alt.	1682696C1	♣K080738HD
Tensioner Assy. - Fan & Alt.	1814719C1	38514
Tensioner Assy. - Fan To A.C.	1687819C91	38511
Tensioner Pulley - Fan & Alt.	1814719C1	36091

♣ Standard Belt Available. See Pages 630-631.

≈ Cut to Fit.

Belts and Coolant Hose for School Buses

School Buses

Application	Mfr. Part No.	Our No.
INTERNATIONAL/NAVISTAR - Continued		
1995 - Continued		
International/Navistar DT466 Diesel - Continued		
3600 - Continued		
Tensioner Pulley - Fan To A.C.	1687819C91	36091
Hose - Upper - Eng. To Rad.		22059
Hose - Lower - Eng. To Rad.		21115
3700		
Serpentine Belt	1682696C1	▲K080738HD
3800		
Serpentine Belt	1682696C1	▲K080738HD
Hose - Upper		22140
Hose - Lower		≡21115
3900FC		
Serpentine Belt	1682696C1	▲K080738HD
International/Navistar T444 Diesel		
3700		
Belt - Fan & Alt.; W/A.C.	1803209C1	②7575
Belt - Fan & Alt.; W/O A.C.	1803207C1	7520
Belt - Fan & P.S.; W/Eaton, Ross P.S. Pump; Preferred Belt ..		2/9570PB
Belt - Fan & P.S.; W/Eaton, Ross P.S. Pump; Optional Belt ...		②▲9570HD
Belt - Fan & P.S.; W/Vickers P.S. Pump	446950C1	②▲9585HD
Belt - Fan & P.S.; W/60 1/2" Belt O.C.		②▲9600HD
Belt - Fan & P.S.; W/62" Belt O.C.		②▲9620HD
Belt - P.S., A.C. & Idler		▲9720HD
Belt - Air Brake Compr.	339700C2	▲9565HD
Hose - Upper		21454
Hose - Lower		21455
3800		
Belt - W.P., Fan & Alt.; W/Air Brake Compr. ...	1822832C1	▲K081124HD
Belt - W.P., Fan & Alt.; W/O Air Brake Compr.	1822830C1	▲K080893HD
Tensioner Assy.	1822679C3	
Hose - Upper		22159
1994		
International/Navistar DT360 Diesel		
3600		
Belt - Fan & Alt.; W/71 1/4" Belt O.C.; Preferred Belt	1812743C1	2/9700PB
Belt - Fan & Alt.; W/71 1/4" Belt O.C.; Optional Belt	1812743C1	②▲9700HD
Belt - Fan & Air Brake Compr.; W/50" Belt O.C.	168128R1	TR22495
Hose - Upper		≡21765
Hose - Lower		≡21842
Hose - By Pass		21461
3800		
Belt - Fan & Alt.; W/71 1/4" Belt O.C.; Preferred Belt	1812743C1	2/9700PB
Belt - Fan & Alt.; W/71 1/4" Belt O.C.; Optional Belt	1812743C1	②▲9700HD
Belt - Fan & Air Brake Compr.; W/50" Belt O.C.	168128R1	TR22495
Belt - Fan & Air Brake Compr.; W/77 5/8" Belt O.C.	1803172C1	TR22770
Belt - A.C.	201825R2	▲9435HD
Hose - Upper		≡21765
Hose - Lower		≡21842
Hose - By Pass		21461
International/Navistar DT408 Diesel		
3800		
Belt - Fan & Alt.	1819988C2	▲K080745HD
Tensioner Assy. - Fan & Alt.	1830033C2	38514
Tensioner Pulley - Fan & Alt.	1830033C2	36091
International/Navistar DT466 Diesel		
3600		
Belt - Fan & Alt.		②◆▲9690HD
Belt - Fan & Air Brake Compr.	1812519C1	TR22770
Hose - Upper - Eng. To Rad.		22059
Hose - Lower		21842
Hose - By Pass		≡21457
3700		
Belt - Fan & Alt.; W/69 1/2" Belt O.C.	1810680C1	②◆▲9690HD
Belt - Fan & Alt.; W/70 1/4" Belt O.C.	1812743C1	②◆▲9700HD
Belt - Fan & Air Brake Compr.; W/50" Belt O.C.		TR22495
Belt - Fan & Air Brake Compr.; W/77" Belt O.C.	1812519C1	TR22770
Hose - Upper - Eng. To Rad.		22059
Hose - Lower		21842
Hose - By Pass		≡21457
3800		
Belt - Fan & Alt.; W/69 1/2" Belt O.C.	1810680C1	②◆▲9690HD
Belt - Fan & Alt.; W/70 1/4" Belt O.C.	1812743C1	②◆▲9700HD
Belt - Fan & Air Brake Compr.; W/50" Belt O.C.		TR22495
Belt - Fan & Air Brake Compr.; W/77" Belt O.C.	1812519C1	TR22770
Hose - Upper - Eng. To Rad.		22059
Hose - Lower		21842
Hose - By Pass		≡21457

Application	Mfr. Part No.	Our No.
INTERNATIONAL/NAVISTAR - Continued		
1994 - Continued		
International/Navistar DT466 Diesel - Continued		
3700; 3800; 3900FC - Continued		
Belt - Fan & Air Brake Compr.	1812519C1	TR22770
International/Navistar V-8 7.3 L Diesel		
3700		
Belt - Fan & Alt.; W/A.C.	1803209C1	②7575
Belt - Fan & Alt.; W/O A.C.	1803207C1	7520
Belt - Fan & P.S.; W/Eaton, Ross P.S. Pump; Preferred Belt ..		2/9570PB
Belt - Fan & P.S.; W/Eaton, Ross P.S. Pump; Optional Belt ...		②▲9570HD
Belt - Fan & P.S.; W/Vickers P.S. Pump	446950C1	②▲9585HD
Belt - Fan & P.S.; W/60 1/2" Belt O.C.		②▲9600HD
Belt - Fan & P.S.; W/62" Belt O.C.		②▲9620HD
Belt - P.S., A.C. & Idler		▲9720HD
Belt - Air Brake Compr.	339700C2	▲9565HD
Hose - Upper		21454
Hose - Lower		21455
3800		
Serpentine Belt	1822832C1	▲K081124HD
1993		
International/Navistar DT360 Diesel		
3600; 3700		
Belt - Fan & Alt.; W/71 1/4" Belt O.C.; Preferred Belt	1812743C1	2/9700PB
Belt - Fan & Alt.; W/71 1/4" Belt O.C.; Optional Belt	1812743C1	②▲9700HD
Belt - Fan & Air Brake Compr.; W/50" Belt O.C.	168128R1	TR22495
Hose - Upper		≡21765
Hose - Lower		≡21842
Hose - By Pass		21461
3800		
Belt - Fan & Alt.; W/71 1/4" Belt O.C.; Preferred Belt	1812743C1	2/9700PB
Belt - Fan & Alt.; W/71 1/4" Belt O.C.; Optional Belt	1812743C1	②▲9700HD
Belt - Fan & Air Brake Compr.; W/50" Belt O.C.	168128R1	TR22495
Belt - Fan & Air Brake Compr.; W/77 5/8" Belt O.C.	1803172C1	TR22770
Belt - A.C.	201825R2	▲9435HD
Hose - Upper		≡21765
Hose - Lower		≡21842
Hose - By Pass		21461
3900FC		
Belt - Fan & Alt.; W/71 1/4" Belt O.C.; Preferred Belt	1812743C1	2/9700PB
Belt - Fan & Alt.; W/71 1/4" Belt O.C.; Optional Belt	1812743C1	②▲9700HD
Belt - Fan & Air Brake Compr.; W/50" Belt O.C.	168128R1	TR22495
Hose - Upper		≡21765
Hose - Lower		≡21842
Hose - By Pass		21461
International/Navistar DT466 Diesel		
3600		
Belt - Fan & Alt.; W/69 1/2" Belt O.C.	1810680C1	②◆▲9690HD
Belt - Fan & Alt.; W/70 1/4" Belt O.C.	1812743C1	②◆▲9700HD
Belt - Fan & Air Brake Compr.; W/50" Belt O.C.		TR22495
Belt - Fan & Air Brake Compr.; W/77" Belt O.C.	1812519C1	TR22770
Hose - Upper - Eng. To Rad.		22059
Hose - Lower		21842
Hose - By Pass		≡21457
3700		
Belt - Fan & Alt.; W/69 1/2" Belt O.C.	1810680C1	②◆▲9690HD
Belt - Fan & Alt.; W/70 1/4" Belt O.C.	1812743C1	②◆▲9700HD
Belt - Fan & Air Brake Compr.; W/50" Belt O.C.		TR22495
Belt - Fan & Air Brake Compr.; W/77" Belt O.C.	1812519C1	TR22770
Hose - Upper - Eng. To Rad.		22059
Hose - Lower		21842
Hose - By Pass		≡21457

▲ Standard Belt Available. See Pages 630-631.
 ② Two Required.

≡ Cut to Fit.
 ◆ Green Stripe® PowerBand® Belt May Work, Use Template to Check.

Belts and Coolant Hose for School Buses

Application	Mfr. Part No.	Our No.	Application	Mfr. Part No.	Our No.
INTERNATIONAL/NAVISTAR - Continued			INTERNATIONAL/NAVISTAR - Continued		
1993 - Continued			1992 - Continued		
International/Navistar DT466 Diesel - Continued			International/Navistar DT466 Diesel		
3800			3600; 3700; 3800; 3900FC		
Belt - Fan & Alt.; W/69 1/2" Belt O.C.	1810680C1	②◆◆9690HD	Belt - Fan & Alt.; W/69 1/2" Belt O.C.	1810680C1	②◆◆9690HD
Belt - Fan & Alt.; W/70 1/4" Belt O.C.	1812743C1	②◆◆9700HD	Belt - Fan & Alt.; W/70 1/4" Belt O.C.	1812743C1	②◆◆9700HD
Belt - Fan & Air Brake Compr.; W/50" Belt O.C.		TR22495	Belt - Fan & Air Brake Compr.; W/50" Belt O.C.		TR22495
Belt - Fan & Air Brake Compr.; W/77" Belt O.C.	1812519C1	TR22770	Belt - Fan & Air Brake Compr.; W/77" Belt O.C.	1812519C1	TR22770
Hose - Upper		21372	Hose - Upper; W/Aftercooler		21372
Hose - Lower		21842	Hose - Upper; W/O Aftercooler		21765
Hose - By Pass		✂21457	Hose - Lower		✂21842
3900FC			Hose - By Pass; Ser. No. 567491 & Before		21461
Belt - Fan & Alt.; W/69 1/2" Belt O.C.	1810680C1	②◆◆9690HD	Hose - By Pass; Ser. No. 567492 & After		✂21457
Belt - Fan & Alt.; W/70 1/4" Belt O.C.	1812743C1	②◆◆9700HD	Hose - Reservoir To Eng.; (1 1/4" I.D.)		24220
Belt - Fan & Air Brake Compr.; W/50" Belt O.C.		TR22495	Hose - Heater Inlet; (3/4" I.D.)		28442
Belt - Fan & Air Brake Compr.; W/77" Belt O.C.	1812519C1	TR22770	Hose - Heater Outlet; (5/8" I.D.)		28441
Hose - Upper		✂21765	International/Navistar V-8 7.3 L Diesel		
Hose - Lower		✂21842	3600		
Hose - By Pass		✂21457	Hose - Lower		21455
International/Navistar V-8 7.3 L Diesel			3700		
3600			Belt - Fan & Alt.; W/A.C.	1803209C1	②7575
Hose - Lower		21455	Belt - Fan & Alt.; W/O A.C.	1803207C1	7520
3700			Belt - Fan & P.S.; W/Eaton, Ross P.S. Pump; Preferred Belt ..		2/9570PB
Belt - Fan & Alt.; W/A.C.	1803209C1	②7575	Belt - Fan & P.S.; W/Eaton, Ross P.S. Pump; Optional Belt ...		②◆9570HD
Belt - Fan & Alt.; W/O A.C.	1803207C1	7520	Belt - Fan & P.S.; W/Vickers P.S. Pump	446950C1	②◆9585HD
Belt - Fan & P.S.; W/Eaton, Ross P.S. Pump; Preferred Belt ..		2/9570PB	Belt - Fan & P.S.; W/60 1/2" Belt O.C.		②◆9600HD
Belt - Fan & P.S.; W/Eaton, Ross P.S. Pump; Optional Belt ...		②◆9570HD	Belt - Fan & P.S.; W/62" Belt O.C.		②◆9620HD
Belt - Fan & P.S.; W/Vickers P.S. Pump	446950C1	②◆9585HD	Belt - P.S., A.C. & Idler		◆9720HD
Belt - Fan & P.S.; W/60 1/2" Belt O.C.		②◆9600HD	Belt - Air Brake Compr.	339700C2	◆9565HD
Belt - Fan & P.S.; W/62" Belt O.C.		②◆9620HD	Hose - Upper		21454
Belt - P.S., A.C. & Idler		◆9720HD	Hose - Lower		21455
Belt - Air Brake Compr.	339700C2	◆9565HD	1991		
Hose - Upper		21454	International/Navistar DT360 Diesel		
Hose - Lower		21455	3600; 3700		
1992			Belt - Fan & Alt.; W/71 1/4" Belt O.C.;		
International/Navistar DT360 Diesel			Preferred Belt	1812743C1	2/9700PB
3600; 3700			Belt - Fan & Alt.; W/71 1/4" Belt O.C.; Optional		
Belt - Fan & Alt.; W/71 1/4" Belt O.C.;			Belt	1812743C1	②◆9700HD
Preferred Belt	1812743C1	2/9700PB	Belt - Fan & Air Brake Compr.; W/50" Belt		
Belt - Fan & Alt.; W/71 1/4" Belt O.C.; Optional			O.C.	168128R1	TR22495
Belt	1812743C1	②◆9700HD	Hose - Upper		✂21765
Belt - Fan & Air Brake Compr.; W/50" Belt			Hose - Lower		✂21842
O.C.	168128R1	TR22495	Hose - By Pass		21461
Hose - Upper		✂21765	3800		
Hose - Lower		✂21842	Belt - Fan & Alt.; W/71 1/4" Belt O.C.;		
Hose - By Pass		21461	Preferred Belt	1812743C1	2/9700PB
3800			Belt - Fan & Alt.; W/71 1/4" Belt O.C.; Optional		
Belt - Fan & Alt.; W/71 1/4" Belt O.C.;			Belt	1812743C1	②◆9700HD
Preferred Belt	1812743C1	2/9700PB	Belt - Fan & Air Brake Compr.; W/50" Belt		
Belt - Fan & Alt.; W/71 1/4" Belt O.C.; Optional			O.C.	168128R1	TR22495
Belt	1812743C1	②◆9700HD	Belt - Fan & Air Brake Compr.; W/77 5/8" Belt		
Belt - Fan & Air Brake Compr.; W/50" Belt			O.C.	1803172C1	TR22770
O.C.	168128R1	TR22495	Belt - A.C.	201825R2	◆9435HD
Belt - Fan & Air Brake Compr.; W/77 5/8" Belt			Hose - Upper		✂21765
O.C.	1803172C1	TR22770	Hose - Lower		✂21842
Belt - A.C.	201825R2	◆9435HD	Hose - By Pass		21461
Hose - Upper		✂21765	3900FC		
Hose - Lower		✂21842	Belt - Fan & Alt.; W/71 1/4" Belt O.C.;		
Hose - By Pass		21461	Preferred Belt	1812743C1	2/9700PB
3900FC			Belt - Fan & Alt.; W/71 1/4" Belt O.C.; Optional		
Belt - Fan & Alt.; W/71 1/4" Belt O.C.;			Belt	1812743C1	②◆9700HD
Preferred Belt	1812743C1	2/9700PB	Belt - Fan & Air Brake Compr.; W/50" Belt		
Belt - Fan & Alt.; W/71 1/4" Belt O.C.; Optional			O.C.	168128R1	TR22495
Belt	1812743C1	②◆9700HD	Hose - Upper		✂21765
Belt - Fan & Air Brake Compr.; W/50" Belt			Hose - Lower		✂21842
O.C.	168128R1	TR22495	Hose - By Pass		21461
Hose - Upper		✂21765	International/Navistar DT466 Diesel		
Hose - Lower		✂21842	3600		
Hose - By Pass		21461	Belt - Fan & Alt.; W/69 1/2" Belt O.C.	1810680C1	②◆◆9690HD
1991			Belt - Fan & Alt.; W/70 1/4" Belt O.C.	1812743C1	②◆◆9700HD
International/Navistar DT360 Diesel			Belt - Fan & Air Brake Compr.; W/50" Belt O.C.		TR22495
3600; 3700			1992		
Belt - Fan & Alt.; W/71 1/4" Belt O.C.;			International/Navistar DT466 Diesel		
Preferred Belt	1812743C1	2/9700PB	3600		
Belt - Fan & Alt.; W/71 1/4" Belt O.C.; Optional			Belt - Fan & Alt.; W/69 1/2" Belt O.C.	1810680C1	②◆◆9690HD
Belt	1812743C1	②◆9700HD	Belt - Fan & Alt.; W/70 1/4" Belt O.C.	1812743C1	②◆◆9700HD
Belt - Fan & Air Brake Compr.; W/50" Belt			Belt - Fan & Air Brake Compr.; W/50" Belt O.C.		TR22495
O.C.	168128R1	TR22495	1991		
Hose - Upper		✂21765	International/Navistar DT360 Diesel		
Hose - Lower		✂21842	3600; 3700		
Hose - By Pass		21461	Belt - Fan & Alt.; W/71 1/4" Belt O.C.;		
3800			Preferred Belt	1812743C1	2/9700PB
Belt - Fan & Alt.; W/71 1/4" Belt O.C.;			Belt - Fan & Alt.; W/71 1/4" Belt O.C.; Optional		
Preferred Belt	1812743C1	2/9700PB	Belt	1812743C1	②◆9700HD
Belt - Fan & Alt.; W/71 1/4" Belt O.C.; Optional			Belt - Fan & Air Brake Compr.; W/50" Belt		
Belt	1812743C1	②◆9700HD	O.C.	168128R1	TR22495
Belt - Fan & Air Brake Compr.; W/50" Belt			Belt - Fan & Air Brake Compr.; W/77 5/8" Belt		
O.C.	168128R1	TR22495	O.C.	1803172C1	TR22770
Belt - Fan & Air Brake Compr.; W/77 5/8" Belt			Belt - A.C.	201825R2	◆9435HD
O.C.	1803172C1	TR22770	Hose - Upper		✂21765
Belt - A.C.	201825R2	◆9435HD	Hose - Lower		✂21842
Hose - Upper		✂21765	Hose - By Pass		21461
Hose - Lower		✂21842	3900FC		
Hose - By Pass		21461	Belt - Fan & Alt.; W/71 1/4" Belt O.C.;		
3900FC			Preferred Belt	1812743C1	2/9700PB
Belt - Fan & Alt.; W/71 1/4" Belt O.C.;			Belt - Fan & Alt.; W/71 1/4" Belt O.C.; Optional		
Preferred Belt	1812743C1	2/9700PB	Belt	1812743C1	②◆9700HD
Belt - Fan & Alt.; W/71 1/4" Belt O.C.; Optional			Belt - Fan & Air Brake Compr.; W/50" Belt		
Belt	1812743C1	②◆9700HD	O.C.	168128R1	TR22495
Belt - Fan & Air Brake Compr.; W/50" Belt			Hose - Upper		✂21765
O.C.	168128R1	TR22495	Hose - Lower		✂21842
Hose - Upper		✂21765	Hose - By Pass		21461
Hose - Lower		✂21842	International/Navistar DT466 Diesel		
Hose - By Pass		21461	3600		
1991			Belt - Fan & Alt.; W/69 1/2" Belt O.C.	1810680C1	②◆◆9690HD
International/Navistar DT360 Diesel			Belt - Fan & Alt.; W/70 1/4" Belt O.C.	1812743C1	②◆◆9700HD
3600; 3700			Belt - Fan & Air Brake Compr.; W/50" Belt O.C.		TR22495
Belt - Fan & Alt.; W/71 1/4" Belt O.C.;			1992		
Preferred Belt	1812743C1	2/9700PB	International/Navistar DT466 Diesel		
Belt - Fan & Alt.; W/71 1/4" Belt O.C.; Optional			3600		
Belt	1812743C1	②◆9700HD	Belt - Fan & Alt.; W/69 1/2" Belt O.C.	1810680C1	②◆◆9690HD
Belt - Fan & Air Brake Compr.; W/50" Belt			Belt - Fan & Alt.; W/70 1/4" Belt O.C.	1812743C1	②◆◆9700HD
O.C.	168128R1	TR22495	Belt - Fan & Air Brake Compr.; W/50" Belt O.C.		TR22495
Hose - Upper		✂21765	1991		
Hose - Lower		✂21842	International/Navistar DT360 Diesel		
Hose - By Pass		21461	3600; 3700		
3800			Belt - Fan & Alt.; W/71 1/4" Belt O.C.;		
Belt - Fan & Alt.; W/71 1/4" Belt O.C.;			Preferred Belt	1812743C1	2/9700PB
Preferred Belt	1812743C1	2/9700PB	Belt - Fan & Alt.; W/71 1/4" Belt O.C.; Optional		
Belt - Fan & Alt.; W/71 1/4" Belt O.C.; Optional			Belt	1812743C1	②◆9700HD
Belt	1812743C1	②◆9700HD	Belt - Fan & Air Brake Compr.; W/50" Belt		
Belt - Fan & Air Brake Compr.; W/50" Belt			O.C.	168128R1	TR22495
O.C.	168128R1	TR22495	Hose - Upper		✂21765
Hose - Upper		✂21765	Hose - Lower		✂21842
Hose - Lower		✂21842	Hose - By Pass		21461
Hose - By Pass		21461	3900FC		
3900FC			Belt - Fan & Alt.; W/71 1/4" Belt O.C.;		
Belt - Fan & Alt.; W/71 1/4" Belt O.C.;			Preferred Belt	1812743C1	2/9700PB
Preferred Belt	1812743C1	2/9700PB	Belt - Fan & Alt.; W/71 1/4" Belt O.C.; Optional		
Belt - Fan & Alt.; W/71 1/4" Belt O.C.; Optional			Belt	1812743C1	②◆9700HD
Belt	1812743C1	②◆9700HD	Belt - Fan & Air Brake Compr.; W/50" Belt		
Belt - Fan & Air Brake Compr.; W/50" Belt			O.C.	168128R1	TR22495
O.C.	168128R1	TR22495	Hose - Upper		✂21765
Hose - Upper		✂21765	Hose - Lower		✂21842
Hose - Lower		✂21842	Hose - By Pass		21461
Hose - By Pass		21461	International/Navistar DT466 Diesel		
1991			3600		
International/Navistar DT360 Diesel			Belt - Fan & Alt.; W/69 1/2" Belt O.C.	1810680C1	②◆◆9690HD
3600; 3700			Belt - Fan & Alt.; W/70 1/4" Belt O.C.	1812743C1	②◆◆9700HD
Belt - Fan & Alt.; W/71 1/4" Belt O.C.;			Belt - Fan & Air Brake Compr.; W/50" Belt O.C.		TR22495
Preferred Belt	1812743C1	2/9700PB	1992		
Belt - Fan & Alt.; W/71 1/4" Belt O.C.; Optional			International/Navistar DT466 Diesel		
Belt	1812743C1	②◆9700HD	3600		
Belt - Fan & Air Brake Compr.; W/50" Belt			Belt - Fan & Alt.; W/69 1/2" Belt O.C.	1810680C1	②◆◆9690HD
O.C.	168128R1	TR22495	Belt - Fan & Alt.; W/70 1/4" Belt O.C.	1812743C1	②◆◆9700HD
Hose - Upper		✂21765	Belt - Fan & Air Brake Compr.; W/50" Belt O.C.		TR22495
Hose - Lower		✂21842	1991		
Hose - By Pass		21461	International/Navistar DT360 Diesel		
3800			3600; 3700		
Belt - Fan & Alt.; W/71 1/4" Belt O.C.;			Belt - Fan & Alt.; W/71 1/4" Belt O.C.;		
Preferred Belt	1812743C1	2/9700PB	Preferred Belt	1812743C1	2/9700PB
Belt - Fan & Alt.; W/71 1/4" Belt O.C.; Optional			Belt - Fan & Alt.; W/71 1/4" Belt O.C.; Optional		
Belt	1812743C1	②◆9700HD	Belt	1812743C1	②◆9700HD
Belt - Fan & Air Brake Compr.; W/50" Belt			Belt - Fan & Air Brake Compr.; W/50" Belt		
O.C.	168128R1	TR22495	O.C.	168128R1	TR22495
Hose - Upper		✂21765	Hose - Upper		✂21765
Hose - Lower		✂21842	Hose - Lower		✂21842
Hose - By Pass		21461	Hose - By Pass		21461
3900FC			3900FC		
Belt - Fan & Alt.; W/71 1/4" Belt O.C.;			Belt - Fan & Alt.; W/71 1/4" Belt O.C.;		
Preferred Belt	1812743C1	2/9700PB	Preferred Belt	1812743C1	2/9700PB
Belt - Fan & Alt.; W/71 1/4" Belt O.C.; Optional			Belt - Fan & Alt.; W/71 1/4" Belt O.C.; Optional		
Belt	1812743C1	②◆9700HD	Belt	1812743C1	②◆9700HD
Belt - Fan & Air Brake Compr.; W/50" Belt			Belt - Fan & Air Brake Compr.; W/50" Belt		
O.C.	168128R1	TR22495	O.C.	168128R1	TR22495
Hose - Upper		✂21765	Hose - Upper		

Belts and Coolant Hose for School Buses

School Buses

Application	Mfr. Part No.	Our No.
INTERNATIONAL/NAVISTAR - Continued		
1991 - Continued		
International/Navistar DT466 Diesel - Continued		
3600 - Continued		
Belt - Fan & Air Brake Compr.; W/77" Belt O.C.	1812519C1	TR22770
Hose - Upper; W/Aftercooler		21372
Hose - Upper; W/O Aftercooler		21765
Hose - Lower		≈21842
Hose - By Pass; Ser. No. 567491 & Before		21461
Hose - By Pass; Ser. No. 567492 & After		≈21457
Hose - Reservoir To Eng.; (1 1/4" I.D.)		24220
Hose - Heater Inlet; (3/4" I.D.)		28442
Hose - Heater Outlet; (5/8" I.D.)		28441
3700		
Belt - Fan & Alt.; W/69 1/2" Belt O.C.	1810680C1	②◆◆9690HD
Belt - Fan & Alt.; W/70 1/4" Belt O.C.	1812743C1	②◆◆9700HD
Belt - Fan & Air Brake Compr.; W/50" Belt O.C.		TR22495
Belt - Fan & Air Brake Compr.; W/77" Belt O.C.	1812519C1	TR22770
Hose - Upper; W/Aftercooler		21372
Hose - Upper; W/O Aftercooler		21765
Hose - Lower		21842
Hose - By Pass; Ser. No. 567491 & Before		21461
Hose - By Pass; Ser. No. 567492 & After		≈21457
Hose - Reservoir To Eng.; (1 1/4" I.D.)		24220
Hose - Heater Inlet; (3/4" I.D.)		28442
Hose - Heater Outlet; (5/8" I.D.)		28441
3800; 3900FC		
Belt - Fan & Alt.; W/69 1/2" Belt O.C.	1810680C1	②◆◆9690HD
Belt - Fan & Alt.; W/70 1/4" Belt O.C.	1812743C1	②◆◆9700HD
Belt - Fan & Air Brake Compr.; W/50" Belt O.C.		TR22495
Belt - Fan & Air Brake Compr.; W/77" Belt O.C.	1812519C1	TR22770
Hose - Upper; W/Aftercooler		21372
Hose - Upper; W/O Aftercooler		21765
Hose - Lower		≈21842
Hose - By Pass; Ser. No. 567491 & Before		21461
Hose - By Pass; Ser. No. 567492 & After		≈21457
Hose - Reservoir To Eng.; (1 1/4" I.D.)		24220
Hose - Heater Inlet; (3/4" I.D.)		28442
Hose - Heater Outlet; (5/8" I.D.)		28441
International/Navistar V-8 7.3 L Diesel		
3600		
Hose - Lower		21455
3700		
Belt - Fan & Alt.; W/A.C.	1803209C1	②7575
Belt - Fan & Alt.; W/O A.C.	1803207C1	7520
Belt - Fan & P.S.; W/Eaton, Ross P.S. Pump; Preferred Belt ..		2/9570PB
Belt - Fan & P.S.; W/Eaton, Ross P.S. Pump; Optional Belt ...		②◆◆9570HD
Belt - Fan & P.S.; W/Vickers P.S. Pump	446950C1	②◆◆9585HD
Belt - Fan & P.S.; W/60 1/2" Belt O.C.		②◆◆9600HD
Belt - Fan & P.S.; W/62" Belt O.C.		②◆◆9620HD
Belt - P.S., A.C. & Idler		◆9720HD
Belt - Air Brake Compr.	339700C2	◆9565HD
Hose - Upper		21454
Hose - Lower		21455
1990		
International/Navistar DT360 Diesel		
3800		
Belt - Fan & Alt.; W/69 1/2" Belt O.C.	1810886C1	②◆◆9690HD
Belt - Fan & Alt.; W/71 1/4" Belt O.C.	1812743C1	②◆◆9700HD
Belt - Fan & Air Brake Compr.; W/50" Belt O.C.	168128R1	TR22495
Belt - Fan & Air Brake Compr.; W/77 5/8" Belt O.C.	1803172C1	TR22770
Belt - A.C.	201825R2	◆9435HD
Hose - Upper		≈21765
Hose - Lower		≈21842
Hose - By Pass		21461

Application	Mfr. Part No.	Our No.
INTERNATIONAL/NAVISTAR - Continued		
1990 - Continued		
International/Navistar DT466 Diesel		
3800		
Belt - Fan & Alt.; W/69 1/2" Belt O.C.	1810680C1	②◆◆9690HD
Belt - Fan & Alt.; W/70 1/4" Belt O.C.		②◆◆9700HD
Belt - Fan & Air Brake Compr.; W/1 To 1 Fan Ratio	1812519C1	TR22770
Belt - Fan & Air Brake Compr.; W/1.2 To 1 Fan Ratio	1814927C1	TR22792
Hose - Upper; W/Aftercooler		21372
Hose - Upper; W/O Aftercooler		21765
Hose - Lower		≈21842
Hose - By Pass; Ser. No. 567491 & Before		21461
Hose - By Pass; Ser. No. 567492 & After		≈21457
Hose - Reservoir To Eng.; (1 1/4" I.D.)		24220
Hose - Heater Inlet; (3/4" I.D.)		28442
Hose - Heater Outlet; (5/8" I.D.)		28441
International/Navistar V-8 7.3 L Diesel		
3700		
Belt - Fan & Alt.; W/A.C.	1803209C1	②7575
Belt - Fan & Alt.; W/O A.C.	1803207C1	7520
Belt - Fan & P.S.; W/Eaton, Ross P.S. Pump; Preferred Belt ..		2/9570PB
Belt - Fan & P.S.; W/Eaton, Ross P.S. Pump; Optional Belt ...		②◆◆9570HD
Belt - Fan & P.S.; W/Vickers P.S. Pump	446950C1	②◆◆9585HD
Belt - Fan & P.S.; W/60 1/2" Belt O.C.		②◆◆9600HD
Belt - Fan & P.S.; W/62" Belt O.C.		②◆◆9620HD
Belt - P.S., A.C. & Idler		◆9720HD
Belt - Air Brake Compr.	339700C2	◆9565HD
Hose - Upper		21454
Hose - Lower		21455
1989		
International/Navistar DT360 Diesel		
1853		
Belt - Fan & Alt.; W/71 5/8" Belt O.C.	1812743C1	②◆◆9710HD
Belt - Fan & Alt.; W/69 5/8" Belt O.C.	1810886C1	②◆◆9690HD
Belt - Fan & Air Brake Compr.	1803172C1	TR22770
Belt - A.C.	133758R2	◆9440HD
Belt - V.P.		◆9490HD
Hose - Upper		≈21765
Hose - Lower		≈21766
International/Navistar V-8 7.3 L Diesel		
1753		
Belt - Fan & Alt.; W/52 1/8" Belt O.C.	1803207C1	②7520
Belt - Fan & Alt.; W/57 5/8" Belt O.C.	1803209C1	②7575
Belt - Fan & P.S.; W/A.C.		◆9640HD
Belt - Fan & P.S.; W/O A.C.	479217C1	②◆◆9635HD
Belt - P.S. & A.C.		◆9740HD
Belt - Air Brake Compr.		◆9560HD
Hose - Upper		21454
Hose - Lower		21455
1988		
International/Navistar DT360 Diesel		
1853		
Belt - Fan & Alt.; W/71 5/8" Belt O.C.	1812743C1	②◆◆9710HD
Belt - Fan & Alt.; W/69 5/8" Belt O.C.	1810886C1	②◆◆9690HD
Belt - Fan & Air Brake Compr.	1803172C1	TR22770
Belt - A.C.	133758R2	◆9440HD
Belt - V.P.		◆9490HD
Hose - Upper		≈21765
Hose - Lower		≈21766
International/Navistar DT466 Diesel		
1853		
Belt - Fan & Alt.; W/65 1/4" Belt O.C.		②◆◆9650HD
Belt - Fan & Alt.; W/69 1/2" Belt O.C.	1810680C1	②◆◆9690HD
Belt - Fan & Alt.; W/70 1/4" Belt O.C.		②◆◆9700HD
Belt - Fan & P.S.	689444C1	②◆◆9745HD
Belt - Fan & Air Brake Compr.	1812519C1	TR22770
Belt - Fan To Air Brake Compr.		◆9485HD
Belt - P.S.	429274C91	②7390

≈ Cut to Fit.

◆ Green Stripe® PowerBand® Belt May Work, Use Template to Check.

② Two Required.

◆ Standard Belt Available. See Pages 630-631.

Belts and Coolant Hose for School Buses

Application	Mfr. Part No.	Our No.
INTERNATIONAL/NAVISTAR - Continued		
1988 - Continued		
International/Navistar DT466 Diesel - Continued		
1853 - Continued		
Belt - V.P.	190502R2	▲9490HD
Belt - A.C.	133758R2	▲9440HD
Hose - Upper; W/Aftercooler	21372	
Hose - Upper; W/O Aftercooler	21765	
Hose - Lower	≈21842	
Hose - By Pass	21258	
Hose - Reservoir To Eng.; (1 1/4" I.D.)	24220	
Hose - Heater Inlet; (3/4" I.D.)	28442	
Hose - Heater Outlet; (5/8" I.D.)	28441	
International/Navistar V-8 6.9 L Diesel		
1753		
Belt - Fan & Alt.; W/52 1/8" Belt O.C.	1803207C1	②7520
Belt - Fan & Alt.; W/57 5/8" Belt O.C.	1803209C1	②7575
Belt - Fan & P.S.; W/A.C.		▲9590HD
Belt - Fan & P.S.; W/O A.C.	479217C1	②▲9635HD
Belt - P.S. & A.C.		▲9740HD
Belt - Air Brake Compr.		▲9560HD
Hose - Upper	21454	
Hose - Lower	21455	
International/Navistar V-8 7.3 L Diesel		
1753		
Belt - Fan & Alt.; W/52 1/8" Belt O.C.	1803207C1	②7520
Belt - Fan & Alt.; W/57 5/8" Belt O.C.	1803209C1	②7575
Belt - Fan & P.S.; W/A.C.		▲9640HD
Belt - Fan & P.S.; W/O A.C.	479217C1	②▲9635HD
Belt - P.S. & A.C.		▲9740HD
Belt - Air Brake Compr.		▲9560HD
Hose - Upper	21454	
Hose - Lower	21455	
International/Navistar V-8 9.0 L Diesel		
1853		
Belt - Fan & W.P.		②◆▲9570HD
Belt - Fan, Alt. & Air Brake Compr.	489324C1	②7485
Belt - Fan, Alt. & V.P.; W/O A.C.		②7603
Belt - Fan To Alt. & Air Brake Compr.	1806180C91	②7585
Belt - Fan To Alt. & A.C.; W/O Air Brakes	7480	
Belt - Alt.	132058R3	②7350
Belt - P.S.; W/Eaton P.S. Pump		②7535
Belt - P.S.; W/Rexroth P.S. Pump		②7650
Belt - P.S.; W/Saginaw P.S. Pump		②7500
Belt - V.P.	864931R2	▲9319HD
Hose - Upper	21452	
Hose - Lower	21290	
1987		
International/Navistar DT360 Diesel		
1853		
Belt - Fan & Alt.; W/71 5/8" Belt O.C.	1812743C1	②◆▲9710HD
Belt - Fan & Alt.; W/69 5/8" Belt O.C.	1810886C1	②◆▲9690HD
Belt - Fan & Air Brake Compr.	1803172C1	TR22770
Belt - A.C.	133758R2	▲9440HD
Belt - V.P.		▲9490HD
Hose - Upper	≈21765	
Hose - Lower	≈21766	
International/Navistar DT466 Diesel		
1853		
Belt - Fan & Alt.; W/65 1/4" Belt O.C.		②◆▲9650HD
Belt - Fan & Alt.; W/69 1/2" Belt O.C.	1810680C1	②◆▲9690HD
Belt - Fan & Alt.; W/70 1/4" Belt O.C.		②◆▲9700HD
Belt - Fan & P.S.	689444C1	②▲9745HD
Belt - Fan & Air Brake Compr.	1812519C1	TR22770
Belt - Fan To Air Brake Compr.		▲9485HD
Belt - P.S.	429274C91	②7390
Belt - V.P.	190502R2	▲9490HD
Belt - A.C.	133758R2	▲9440HD
Hose - Upper; W/Aftercooler	21372	
Hose - Upper; W/O Aftercooler	21765	
Hose - Lower	≈21842	

Application	Mfr. Part No.	Our No.
INTERNATIONAL/NAVISTAR - Continued		
1987 - Continued		
International/Navistar DT466 Diesel - Continued		
1853 - Continued		
Hose - By Pass		21258
Hose - Reservoir To Eng.; (1 1/4" I.D.)		24220
Hose - Heater Inlet; (3/4" I.D.)		28442
Hose - Heater Outlet; (5/8" I.D.)		28441
International/Navistar V-8 6.9 L Diesel		
1753		
Belt - Fan & Alt.; W/52 1/8" Belt O.C.	1803207C1	②7520
Belt - Fan & Alt.; W/57 5/8" Belt O.C.	1803209C1	②7575
Belt - Fan & P.S.; W/A.C.		▲9590HD
Belt - Fan & P.S.; W/O A.C.	479217C1	②▲9635HD
Belt - P.S. & A.C.		▲9740HD
Belt - Air Brake Compr.		▲9560HD
Hose - Upper		21454
Hose - Lower		21455
International/Navistar V-8 9.0 L Diesel		
1853		
Belt - Fan & W.P.		②◆▲9570HD
Belt - Fan, Alt. & Air Brake Compr.	489324C1	②7485
Belt - Fan, Alt. & V.P.; W/O A.C.		②7603
Belt - Fan To Alt. & Air Brake Compr.	1806180C91	②7585
Belt - Fan To Alt. & A.C.; W/O Air Brakes	7480	
Belt - Alt.	132058R3	②7350
Belt - P.S.; W/Eaton P.S. Pump		②7535
Belt - P.S.; W/Rexroth P.S. Pump		②7650
Belt - P.S.; W/Saginaw P.S. Pump		②7500
Belt - V.P.	864931R2	▲9319HD
Hose - Upper		21452
Hose - Lower		21290
1986		
International/Navistar DT466 Diesel		
1853		
Belt - Fan & Alt.; W/65 1/4" Belt O.C.		②◆▲9650HD
Belt - Fan & Alt.; W/69 1/2" Belt O.C.	1810680C1	②◆▲9690HD
Belt - Fan & Alt.; W/70 1/4" Belt O.C.		②◆▲9700HD
Belt - Fan & P.S.	689444C1	②▲9745HD
Belt - Fan & Air Brake Compr.	1812519C1	TR22770
Belt - Fan To Air Brake Compr.		▲9485HD
Belt - P.S.	429274C91	②7390
Belt - V.P.	190502R2	▲9490HD
Belt - A.C.	133758R2	▲9440HD
Hose - Upper		21372
Hose - Lower; Double Dia. Hose; W/3/4" Offset		or ●26528
Hose - Lower; Double Dia. Hose; W/2 3/4" Offset		21766
Hose - Lower; Single Dia. Hose		21291
Hose - By Pass		21042
		21461
International/Navistar V-8 6.9 L Diesel		
1753		
Belt - Fan & Alt.; W/52 1/8" Belt O.C.	1803207C1	②7520
Belt - Fan & Alt.; W/57 5/8" Belt O.C.	1803209C1	②7575
Belt - Fan & P.S.; W/A.C.		▲9590HD
Belt - Fan & P.S.; W/O A.C.	479217C1	②▲9635HD
Belt - P.S. & A.C.		▲9740HD
Belt - Air Brake Compr.		▲9560HD
Hose - Upper		21454
Hose - Lower		21455
International/Navistar V-8 9.0 L Diesel		
1853		
Belt - Fan & W.P.		②◆▲9570HD
Belt - Fan, Alt. & Air Brake Compr.	489324C1	②7485
Belt - Fan, Alt. & V.P.; W/O A.C.		②7603
Belt - Fan To Alt. & Air Brake Compr.	1806180C91	②7585
Belt - Fan To Alt. & A.C.; W/O Air Brakes	7480	
Belt - Alt.	132058R3	②7350
Belt - P.S.; W/Eaton P.S. Pump		②7535
Belt - P.S.; W/Rexroth P.S. Pump		②7650
Belt - P.S.; W/Saginaw P.S. Pump		②7500

▲ Standard Belt Available. See Pages 630-631.
 ② Two Required.
 ● Vulco-Flex® Coolant Hose.

≈ Cut to Fit.
 ◆ Green Stripe® PowerBand® Belt May Work, Use Template to Check.

School Buses

Belts and Coolant Hose for School Buses

School Buses

Application	Mfr. Part No.	Our No.
INTERNATIONAL/NAVISTAR - Continued		
1986 - Continued		
International/Navistar V-8 9.0 L Diesel - Continued		
1853 - Continued		
Belt - V.P.	864931R2	▲9319HD
Hose - Upper		21452
Hose - Lower		21290
1985-1984		
International/Navistar DT466 Diesel		
1853		
Belt - Fan & Alt.; W/65 1/4" Belt O.C.		②◆▲9650HD
Belt - Fan & Alt.; W/69 1/2" Belt O.C.	1810680C1	②◆▲9690HD
Belt - Fan & Alt.; W/70 1/4" Belt O.C.		②◆▲9700HD
Belt - Fan & P.S.	689444C1	②▲9745HD
Belt - Fan & Air Brake Compr.	1812519C1	TR22770
Belt - Fan To Air Brake Compr.		▲9485HD
Belt - P.S.	429274C91	②7390
Belt - V.P.	190502R2	▲9490HD
Belt - A.C.	133758R2	▲9440HD
Hose - Upper		21372
	or	●26528
Hose - Lower; Double Dia. Hose; W/3/4" Offset		21766
Hose - Lower; Double Dia. Hose; W/2 3/4" Offset		21291
Hose - Lower; Single Dia. Hose		21042
Hose - By Pass		21461
International/Navistar V-8 6.9 L Diesel		
1753		
Belt - Fan & Alt.; W/52 1/8" Belt O.C.	1803207C1	②7520
Belt - Fan & Alt.; W/57 5/8" Belt O.C.	1803209C1	②7575
Belt - Fan & P.S.; W/A.C.		▲9590HD
Belt - Fan & P.S.; W/O A.C.	479217C1	②▲9635HD
Belt - P.S. & A.C.		▲9740HD
Belt - Air Brake Compr.		▲9560HD
Hose - Upper		21454
Hose - Lower		21455
International/Navistar V-8 9.0 L Diesel		
1853		
Belt - Fan & W.P.		②◆▲9570HD
Belt - Fan, Alt. & Air Brake Compr.	489324C1	②7485
Belt - Fan, Alt. & V.P.; W/O A.C.		②7603
Belt - Fan To Alt. & Air Brake Compr.	1806180C91	②7585
Belt - Fan To Alt. & A.C.; W/O Air Brakes		7480
Belt - Alt.	132058R3	②7350
Belt - P.S.; W/Eaton P.S. Pump		②7535
Belt - P.S.; W/Rexroth P.S. Pump		②7650
Belt - P.S.; W/Saginaw P.S. Pump		②7500
Belt - V.P.	864931R2	▲9319HD
Hose - Upper		21452
Hose - Lower		21290
International/Navistar V345		
1723		
Belt - Fan & Alt.; W/42A., 61A., 65A., 80A., 85A. Alt.	255266C3	②7640
Belt - Fan & Alt.; W/105A., 145A. Alt.	369722C1	②7630
Belt - P.S.	967907R2	②7565
Belt - Air Brake Compr.	227703R2	7475
Belt - A.C.	284453C2	▲9495HD
Belt - A.P. - Left Side; W/Calif. Emission System	255810R2	7390
Belt - A.P. - Right Side; W/Calif. Emission System	149636R2	▲9480HD
Belt - A.P.; W/O Calif. Emission System; W/Air Brakes; W/Gov.	182048R1	7360
Belt - A.P.; W/O Calif. Emission System; W/Air Brakes; W/O Gov.	333382C2	7385
Belt - A.P.; W/O Calif. Emission System; W/O Air Brakes; W/Gov.	323612C2	7380
Belt - A.P.; W/O Calif. Emission System; W/O Air Brakes; W/O Gov.	282989C2	7410
Hose - Upper		21293
Hose - Lower		21292

Application	Mfr. Part No.	Our No.
INTERNATIONAL/NAVISTAR - Continued		
1985-1984 - Continued		
International/Navistar V392		
1723		
Belt - Fan & Alt.; W/42A., 61A., 65A., 80A., 85A. Alt.	255266C3	②7640
Belt - Fan & Alt.; W/105A., 145A. Alt.	369722C1	②7630
Belt - P.S.	967907R2	②7565
Belt - Air Brake Compr.	227703R2	7475
Belt - A.C.	284453C2	▲9495HD
Belt - A.P. - Left Side; W/Calif. Emission System	255810R2	7390
Belt - A.P. - Right Side; W/Calif. Emission System	149636R2	▲9480HD
Belt - A.P.; W/O Calif. Emission System; W/Air Brakes; W/Gov.	182048R1	7360
Belt - A.P.; W/O Calif. Emission System; W/Air Brakes; W/O Gov.	333382C2	7385
Belt - A.P.; W/O Calif. Emission System; W/O Air Brakes; W/Gov.	323612C2	7380
Belt - A.P.; W/O Calif. Emission System; W/O Air Brakes; W/O Gov.	282989C2	7410
Hose - Upper		21293
Hose - Lower		21292
1983		
International/Navistar DT466 Diesel		
1853		
Belt - Fan & Alt.; W/65 1/4" Belt O.C.		②◆▲9650HD
Belt - Fan & Alt.; W/69 1/2" Belt O.C.	1810680C1	②◆▲9690HD
Belt - Fan & Alt.; W/70 1/4" Belt O.C.		②◆▲9700HD
Belt - Fan & P.S.	689444C1	②▲9745HD
Belt - Fan & Air Brake Compr.	1812519C1	TR22770
Belt - Fan To Air Brake Compr.		▲9485HD
Belt - P.S.	429274C91	②7390
Belt - V.P.	190502R2	▲9490HD
Belt - A.C.	133758R2	▲9440HD
Hose - Upper		21372
	or	●26528
Hose - Lower; Double Dia. Hose; W/3/4" Offset		21766
Hose - Lower; Double Dia. Hose; W/2 3/4" Offset		21291
Hose - Lower; Single Dia. Hose		21042
Hose - By Pass		21461
1853FC		
Belt - Alt.		③▲9650HD
Belt - P.S.	358328C91	②◆▲9463HD
Belt - Air Brake Compr.		▲9490HD
Belt - V.P.	190502R2	▲9490HD
Hose - Upper		≈20682
Hose - Lower		≈21291
International/Navistar V-8 6.9 L Diesel		
1753		
Belt - Fan & Alt.; W/52 1/8" Belt O.C.	1803207C1	②7520
Belt - Fan & Alt.; W/57 5/8" Belt O.C.	1803209C1	②7575
Belt - Fan & P.S.; W/A.C.		▲9590HD
Belt - Fan & P.S.; W/O A.C.	479217C1	②▲9635HD
Belt - P.S. & A.C.		▲9740HD
Belt - Air Brake Compr.		▲9560HD
Hose - Upper		21454
Hose - Lower		21455
International/Navistar V-8 9.0 L Diesel		
1853		
Belt - Fan & W.P.		②◆▲9570HD
Belt - Fan, Alt. & Air Brake Compr.	489324C1	②7485
Belt - Fan, Alt. & V.P.; W/O A.C.		②7603
Belt - Fan To Alt. & Air Brake Compr.	1806180C91	②7585
Belt - Fan To Alt. & A.C.; W/O Air Brakes		7480
Belt - Alt.	132058R3	②7350
Belt - P.S.; W/Eaton P.S. Pump		②7535
Belt - P.S.; W/Rexroth P.S. Pump		②7650
Belt - P.S.; W/Saginaw P.S. Pump		②7500
Belt - V.P.	864931R2	▲9319HD
Hose - Upper		21452

▲ Standard Belt Available. See Pages 630-631.
 ◆ Green Stripe® PowerBand® Belt May Work, Use Template to Check.
 ③ Three Required.

② Two Required.
 ● Vulco-Flex® Coolant Hose.
 ≈ Cut to Fit.

Belts and Coolant Hose for School Buses

Application	Mfr. Part No.	Our No.	Application	Mfr. Part No.	Our No.
INTERNATIONAL/NAVISTAR - Continued			INTERNATIONAL/NAVISTAR - Continued		
1983 - Continued			1982 - Continued		
International/Navistar V-8 9.0 L Diesel - Continued			International/Navistar DT466 Diesel - Continued		
1853 - Continued			1853 - Continued		
Hose - Lower		21290	Belt - A.C.	133758R2	▲9440HD
International/Navistar V345			Hose - Upper		21372
1723; 1823			or		●26528
Belt - Fan & Alt.; W/42A., 61A., 65A., 80A.,			Hose - Lower; Double Dia. Hose; W/3/4" Offset		21766
85A. Alt.	255266C3	②7640	Hose - Lower; Double Dia. Hose; W/2 3/4" Offset		21291
Belt - Fan & Alt.; W/105A., 145A. Alt.	369722C1	②7630	Hose - Lower; Single Dia. Hose		21042
Belt - P.S.	967907R2	②7565	Hose - By Pass		21461
Belt - Air Brake Compr.	227703R2	7475	1853FC		
Belt - A.C.	284453C2	▲9495HD	Belt - Alt.		③▲9650HD
Belt - A.P. - Left Side; W/Calif. Emission			Belt - P.S.	358328C91	②▲9463HD
System	255810R2	7390	Belt - Air Brake Compr.		▲9490HD
Belt - A.P. - Right Side; W/Calif. Emission			Belt - V.P.	190502R2	▲9490HD
System	149636R2	▲9480HD	Hose - Upper		≧20682
Belt - A.P.; W/O Calif. Emission System; W/Air			Hose - Lower		≧21291
Brakes; W/Gov.	182048R1	7360	International/Navistar MV404		
Belt - A.P.; W/O Calif. Emission System; W/Air			1823		
Brakes; W/O Gov.	333382C2	7385	Belt - Fan & Alt.; W/Front P.T.O.; W/42A.,		
Belt - A.P.; W/O Calif. Emission System; W/O			61A. Alt.	863751R2	②7580
Air Brakes; W/Gov.	323612C2	7380	Belt - Fan & Alt.; W/O Front P.T.O.; W/42A.,		
Belt - A.P.; W/O Calif. Emission System; W/O			61A. Alt.	355478C91	②7512
Air Brakes; W/O Gov.	282989C2	7410	Belt - Fan & Alt.; W/65A., 80A., 85A., 105A.,		
Hose - Upper		21293	145A. Alt.	510238C91	②7585
Hose - Lower		21292	Belt - Fan & P.S.; W/64" Belt O.C.	479217C1	②▲9635HD
International/Navistar V392			Belt - Fan & P.S.; W/66 1/2" Belt O.C.	488882C1	②▲9660HD
1723; 1823			Belt - Fan & P.S.; W/A.P.; W/60 1/4" Belt O.C.	446707C1	▲9600HD
Belt - Fan & Alt.; W/42A., 61A., 65A., 80A.,			Belt - Fan & P.S.; W/A.P.; W/63 1/4" Belt O.C.	395539R1	▲9630HD
85A. Alt.	255266C3	②7640	Belt - Fan & P.S.; W/O A.P.		▲9510HD
Belt - Fan & Alt.; W/105A., 145A. Alt.	369722C1	②7630	Belt - Fan & A.P.; W/O Calif. Emission System		▲9540HD
Belt - P.S.	967907R2	②7565	Belt - P.S. & A.P.; W/Saginaw P.S. Pump		▲9720HD
Belt - Air Brake Compr.	227703R2	7475	Belt - P.S. & A.P.; W/Ross, Sheppard P.S.		
Belt - A.C.	284453C2	▲9495HD	Pump	465244C1	▲9740HD
Belt - A.P. - Left Side; W/Calif. Emission			Belt - Air Brake Compr.		▲9610HD
System	255810R2	7390	Belt - A.P.; W/Air Brakes; W/Calif. Emission		
Belt - A.P. - Right Side; W/Calif. Emission			System	132058R3	7350
System	149636R2	▲9480HD	Belt - A.P.; W/Hyd. Brakes; W/Calif. Emission		
Belt - A.P.; W/O Calif. Emission System; W/Air			System	468505C91	7490
Brakes; W/Gov.	182048R1	7360	Belt - A.P.; W/O P.T.O.; W/O Calif. Emission		
Belt - A.P.; W/O Calif. Emission System; W/Air			System	270094C2	▲9580HD
Brakes; W/O Gov.	333382C2	7385	Hose - Upper		21289
Belt - A.P.; W/O Calif. Emission System; W/O			Hose - Lower		21288
Air Brakes; W/Gov.	323612C2	7380	International/Navistar MV446		
Belt - A.P.; W/O Calif. Emission System; W/O			1823		
Air Brakes; W/O Gov.	282989C2	7410	Belt - Fan & Alt.; W/Front P.T.O.; W/42A.,		
Hose - Upper		21293	61A. Alt.	863751R2	②7580
Hose - Lower		21292	Belt - Fan & Alt.; W/O Front P.T.O.; W/42A.,		
1982			61A. Alt.	355478C91	②7512
Caterpillar 3208 Diesel			Belt - Fan & Alt.; W/65A., 80A., 85A., 105A.,		
1853			145A. Alt.	510238C91	②7585
Belt - Fan	355707C91	②▲9520HD	Belt - Fan & P.S.; W/64" Belt O.C.	479217C1	②▲9635HD
Belt - W.P.	150560R2	▲9451HD	Belt - Fan & P.S.; W/66 1/2" Belt O.C.	488882C1	②▲9660HD
Belt - W.P. & P.S.	446707C1	②▲9600HD	Belt - Fan & P.S.; W/A.P.; W/60 1/4" Belt O.C.	446707C1	▲9600HD
Belt - P.S.		7390	Belt - Fan & P.S.; W/A.P.; W/63 1/4" Belt O.C.	395539R1	▲9630HD
Belt - Alt.	306219C2	②7370	Belt - Fan & P.S.; W/O A.P.		▲9510HD
Belt - Alt. & Air Brake Compr.	468455C1	②7508	Belt - Fan & A.P.; W/O Calif. Emission System		▲9540HD
Belt - Alt. & V.P.	468460C91	②7480	Belt - P.S. & A.P.; W/Saginaw P.S. Pump		▲9720HD
Belt - A.C.	190502R2	▲9490HD	Belt - P.S. & A.P.; W/Ross, Sheppard P.S.		
Hose - Upper		21453	Pump	465244C1	▲9740HD
Hose - Lower		21451	Belt - Air Brake Compr.		▲9610HD
International/Navistar DT466 Diesel			Belt - A.P.; W/Air Brakes; W/Calif. Emission		
1853			System	132058R3	7350
Belt - Fan & Alt.; W/65 1/4" Belt O.C.		②▲9650HD	Belt - A.P.; W/Hyd. Brakes; W/Calif. Emission		
Belt - Fan & Alt.; W/69 1/2" Belt O.C.	1810680C1	②▲9690HD	System	468505C91	7490
Belt - Fan & Alt.; W/70 1/4" Belt O.C.		②▲9700HD	Belt - A.P.; W/O P.T.O.; W/O Calif. Emission		
Belt - Fan & P.S.	689444C1	②▲9745HD	System	270094C2	▲9580HD
Belt - Fan & Air Brake Compr.	1812519C1	TR22770	Hose - Upper		21289
Belt - Fan To Air Brake Compr.		▲9485HD	Hose - Lower		21288
Belt - P.S.	429274C91	②7390	International/Navistar V-8 9.0 L Diesel		
Belt - V.P.	190502R2	▲9490HD	1853		
			Belt - Fan		
			355707C91		
			②▲9520HD		

② Two Required.
 ◆ Green Stripe® PowerBand® Belt May Work, Use Template to Check.
 ③ Three Required.

▲ Standard Belt Available. See Pages 630-631.
 ● Vulco-Flex® Coolant Hose.
 ≧ Cut to Fit.

School Buses

Belts and Coolant Hose for School Buses

School Buses

Application	Mfr. Part No.	Our No.
INTERNATIONAL/NAVISTAR - Continued		
1982 - Continued		
International/Navistar V-8 9.0 L Diesel - Continued		
1853 - Continued		
Belt - Alt.; W/42A., 61A. Alt.		②7535
Belt - Alt.; W/65A., 80A. Alt.		②7555
Belt - Alt. & Air Brake Compr.; W/42A., 61A. Alt.		②7560
Belt - Alt. & Air Brake Compr.; W/65A., 80A. Alt.		②7580
Belt - Alt. & Hyd. Brake Boost Pump; W/42A., 61A. Alt.; W/P.S.		②7560
Belt - Alt. & Hyd. Brake Boost Pump; W/65A., 80A. Alt.; W/P.S.		②7575
Belt - Alt. & Hyd. Brake Boost Pump; W/42A., 61A. Alt.; W/O P.S.		②7545
Belt - Alt. & Hyd. Brake Boost Pump; W/65A., 80A. Alt.; W/O P.S.		②7570
Belt - P.S.; W/Hyd. Brake Boost Pump 491384C91		②7355
Belt - P.S.; W/O Hyd. Brake Boost Pump 429274C91		②7390
Hose - Upper; W/Single Hose		②21123
Hose - Upper - Eng. To Pipe; (2 1/2" I.D.)		24240
Hose - Upper - Pipe To Rad.; (2 1/2" I.D.)		24240
Hose - Lower		21290
International/Navistar V345		
1723		
Belt - Fan & Alt.; W/42A., 61A., 65A., 80A., 85A. Alt. 255266C3		②7640
Belt - Fan & Alt.; W/105A., 145A. Alt. 369722C1		②7630
Belt - P.S.; W/41 1/8" Belt O.C. 408144C1		7405
Belt - P.S.; W/41 5/8" Belt O.C. 282989C2		7410
Belt - Air Brake Compr. 227703R2		7475
Belt - A.C. 284453C2		▲9495HD
Belt - A.P. - Left Side; W/Calif. Emission System 255810R2		7390
Belt - A.P. - Right Side; W/Calif. Emission System 149636R2		▲9480HD
Belt - A.P.; W/O Calif. Emission System; W/Air Brakes; W/Gov. 182048R1		7360
Belt - A.P.; W/O Calif. Emission System; W/Air Brakes; W/O Gov. 333382C2		7385
Belt - A.P.; W/O Calif. Emission System; W/O Air Brakes; W/Gov. 323612C2		7380
Belt - A.P.; W/O Calif. Emission System; W/O Air Brakes; W/O Gov. 282989C2		7410
Hose - Upper		21293
Hose - Lower		21292
International/Navistar V392		
1723		
Belt - Fan & Alt.; W/42A., 61A., 65A., 80A., 85A. Alt. 255266C3		②7640
Belt - Fan & Alt.; W/105A., 145A. Alt. 369722C1		②7630
Belt - P.S.; W/41 1/8" Belt O.C. 408144C1		7405
Belt - P.S.; W/41 5/8" Belt O.C. 282989C2		7410
Belt - Air Brake Compr. 227703R2		7475
Belt - A.C. 284453C2		▲9495HD
Belt - A.P. - Left Side; W/Calif. Emission System 255810R2		7390
Belt - A.P. - Right Side; W/Calif. Emission System 149636R2		▲9480HD
Belt - A.P.; W/O Calif. Emission System; W/Air Brakes; W/Gov. 182048R1		7360
Belt - A.P.; W/O Calif. Emission System; W/Air Brakes; W/O Gov. 333382C2		7385
Belt - A.P.; W/O Calif. Emission System; W/O Air Brakes; W/Gov. 323612C2		7380
Belt - A.P.; W/O Calif. Emission System; W/O Air Brakes; W/O Gov. 282989C2		7410
Hose - Upper		21293
Hose - Lower		21292
1981		
Caterpillar 3208 Diesel		
1853		
Belt - Fan	355707C91	②◆▲9520HD
Belt - W.P.	150560R2	▲9451HD

Application	Mfr. Part No.	Our No.
INTERNATIONAL/NAVISTAR - Continued		
1981 - Continued		
Caterpillar 3208 Diesel - Continued		
1853 - Continued		
Belt - W.P. & P.S.	446707C1	②▲9600HD
Belt - P.S.		7390
Belt - Alt.	306219C2	②7370
Belt - Alt. & Air Brake Compr.	468455C1	②7508
Belt - Alt. & V.P.	468460C91	②7480
Belt - A.C.	190502R2	▲9490HD
Hose - Upper - Eng. To Pipe; (2" I.D.)		24230
Hose - Upper - Pipe To Rad.; (2 1/2" I.D.)		24240
International/Navistar DT466 Diesel		
1853		
Belt - Fan & Alt.; W/65 1/4" Belt O.C.		②◆▲9650HD
Belt - Fan & Alt.; W/69 1/2" Belt O.C. 1810680C1		②◆▲9690HD
Belt - Fan & Alt.; W/70 1/4" Belt O.C.		②◆▲9700HD
Belt - Fan & P.S. 689444C1		②▲9745HD
Belt - Fan & Air Brake Compr. 1812519C1		TR22770
Belt - Fan To Air Brake Compr.		▲9485HD
Belt - P.S. 429274C91		②7390
Belt - V.P. 190502R2		▲9490HD
Belt - A.C. 133758R2		▲9440HD
Hose - Upper - Eng. To Pipe; W/A.C.; Mar. 7, 1981 & Older ..		②21135
Hose - Upper - Eng. To Pipe; W/O A.C.; Mar. 7, 1981 & Older(2 1/4" I.D.)		24236
Hose - Upper - Pipe To Rad.; Mar. 7, 1981 & Older(2 1/4" I.D.)		24236
Hose - Upper; Mar. 8, 1981 & Newer		21372
	or	●26528
Hose - Lower; Double Dia. Hose; W/3/4" Offset		21766
Hose - Lower; Double Dia. Hose; W/2 3/4" Offset		21291
Hose - Lower; Single Dia. Hose		21042
Hose - By Pass		21461
International/Navistar MV404		
1723; 1823		
Belt - Fan & Alt.; W/Front P.T.O.; W/42A., 61A. Alt. 863751R2		②7580
Belt - Fan & Alt.; W/O Front P.T.O.; W/42A., 61A. Alt. 355478C91		②7512
Belt - Fan & Alt.; W/65A., 80A., 85A., 105A., 145A. Alt. 510238C91		②7585
Belt - Fan & P.S.; W/64" Belt O.C. 479217C1		②▲9635HD
Belt - Fan & P.S.; W/66 1/2" Belt O.C. 488882C1		②◆▲9660HD
Belt - Fan & P.S.; W/A.P.; W/60 1/4" Belt O.C. 446707C1		▲9600HD
Belt - Fan & P.S.; W/A.P.; W/63 1/4" Belt O.C. 395539R1		▲9630HD
Belt - Fan & P.S.; W/O A.P.		▲9510HD
Belt - Fan & A.P.; W/O Calif. Emission System		▲9540HD
Belt - P.S. & A.P.; W/Saginaw P.S. Pump		▲9720HD
Belt - P.S. & A.P.; W/Ross, Sheppard P.S. Pump	465244C1	▲9740HD
Belt - Air Brake Compr.; Jun. 19, 1980 & Older		▲9570HD
Belt - Air Brake Compr.; Jun. 20, 1980 & Newer		▲9610HD
Belt - A.P.; W/Air Brakes; W/Calif. Emission System	132058R3	7350
Belt - A.P.; W/Hyd. Brakes; W/Calif. Emission System	468505C91	7490
Belt - A.P.; W/O P.T.O.; W/O Calif. Emission System	270094C2	▲9580HD
Hose - Upper		21289
Hose - Lower		21288
International/Navistar MV446		
1823		
Belt - Fan & Alt.; W/Front P.T.O.; W/42A., 61A. Alt. 863751R2		②7580
Belt - Fan & Alt.; W/O Front P.T.O.; W/42A., 61A. Alt. 355478C91		②7512
Belt - Fan & Alt.; W/65A., 80A., 85A., 105A., 145A. Alt. 510238C91		②7585
Belt - Fan & P.S.; W/64" Belt O.C. 479217C1		②▲9635HD
Belt - Fan & P.S.; W/66 1/2" Belt O.C. 488882C1		②◆▲9660HD
Belt - Fan & P.S.; W/A.P.; W/60 1/4" Belt O.C. 446707C1		▲9600HD
Belt - Fan & P.S.; W/A.P.; W/63 1/4" Belt O.C. 395539R1		▲9630HD
Belt - Fan & P.S.; W/O A.P.		▲9510HD

② Two Required.
 ▲ Standard Belt Available. See Pages 630-631.
 ● Vulco-Flex® Coolant Hose.

② Cut to Fit.
 ◆ Green Stripe® PowerBand® Belt May Work, Use Template to Check.

Belts and Coolant Hose for School Buses

Application	Mfr. Part No.	Our No.
INTERNATIONAL/NAVISTAR - Continued		
1981 - Continued		
International/Navistar MV446 - Continued		
1823 - Continued		
Belt - Fan & A.P.; W/O Calif. Emission System		▲9540HD
Belt - P.S. & A.P.; W/Saginaw P.S. Pump		▲9720HD
Belt - P.S. & A.P.; W/Ross, Sheppard P.S. Pump	465244C1	▲9740HD
Belt - Air Brake Compr.; Jun. 19, 1980 & Older		▲9570HD
Belt - Air Brake Compr.; Jun. 20, 1980 & Newer		▲9610HD
Belt - A.P.; W/Air Brakes; W/Calif. Emission System	132058R3	7350
Belt - A.P.; W/Hyd. Brakes; W/Calif. Emission System	468505C91	7490
Belt - A.P.; W/O P.T.O.; W/O Calif. Emission System	270094C2	▲9580HD
Hose - Upper		21289
Hose - Lower		21288
International/Navistar V-8 9.0 L Diesel		
1853		
Belt - Fan	355707C91	②◆▲9520HD
Belt - Alt.; W/42A., 61A. Alt.		②7535
Belt - Alt.; W/65A., 80A. Alt.		②7555
Belt - Alt. & Air Brake Compr.; W/42A., 61A. Alt.		②7560
Belt - Alt. & Air Brake Compr.; W/65A., 80A. Alt.		②7580
Belt - Alt. & Hyd. Brake Boost Pump; W/42A., 61A. Alt.; W/P.S.		②7560
Belt - Alt. & Hyd. Brake Boost Pump; W/65A., 80A. Alt.; W/P.S.		②7575
Belt - Alt. & Hyd. Brake Boost Pump; W/42A., 61A. Alt.; W/O P.S.		②7545
Belt - Alt. & Hyd. Brake Boost Pump; W/65A., 80A. Alt.; W/O P.S.		②7570
Belt - P.S.; W/Hyd. Brake Boost Pump	491384C91	②7355
Belt - P.S.; W/O Hyd. Brake Boost Pump	429274C91	②7390
Hose - Upper; W/Single Hose		≈21123
Hose - Upper - Eng. To Pipe; (2 1/2" I.D.)		24240
Hose - Upper - Pipe To Rad.; (2 1/2" I.D.)		24240
Hose - Lower		21290
International/Navistar V345		
1723		
Belt - Fan & Alt.; W/42A., 61A., 80A., 85A., 105A., 130A. Alt.	369722C1	7630
Belt - P.S.	967907R2	②7565
Belt - Air Brake Compr.	227703R2	7475
Belt - A.C.	284453C2	▲9495HD
Belt - A.P.; W/Air Brakes; W/Gov.	182048R1	7360
Belt - A.P.; W/O Air Brakes; W/Gov.; W/38 5/8" Belt O.C.	323612C2	7380
Belt - A.P.; W/O Air Brakes; W/Gov.; W/39 1/8" Belt O.C.	333382C2	7385
Belt - A.P.; W/O Air Brakes; W/O Gov.	282989C2	7410
Belt - A.P. - Left Side; W/Calif. Emission System	225810R2	7390
Belt - A.P. - Right Side; W/Calif. Emission System	149636R2	▲9480HD
Hose - Upper		21293
Hose - Lower		21292
International/Navistar V392		
1723		
Belt - Fan & Alt.; W/42A., 61A., 80A., 85A., 105A., 130A. Alt.	369722C1	7630
Belt - P.S.	967907R2	②7565
Belt - Air Brake Compr.	227703R2	7475
Belt - A.C.	284453C2	▲9495HD
Belt - A.P.; W/Air Brakes; W/Gov.	182048R1	7360
Belt - A.P.; W/O Air Brakes; W/Gov.; W/38 5/8" Belt O.C.	323612C2	7380
Belt - A.P.; W/O Air Brakes; W/Gov.; W/39 1/8" Belt O.C.	333382C2	7385
Belt - A.P.; W/O Air Brakes; W/O Gov.	282989C2	7410
Belt - A.P. - Left Side; W/Calif. Emission System	225810R2	7390

◆ Standard Belt Available. See Pages 630-631.
◆ Green Stripe® PowerBand® Belt May Work, Use Template to Check.

Application	Mfr. Part No.	Our No.
INTERNATIONAL/NAVISTAR - Continued		
1981 - Continued		
International/Navistar V392 - Continued		
1723 - Continued		
Belt - A.P. - Right Side; W/Calif. Emission System	149636R2	▲9480HD
Hose - Upper		21293
Hose - Lower		21292
1980		
Caterpillar 3208 Diesel		
1853		
Belt - Fan	355707C91	②◆▲9520HD
Belt - W.P.	150560R2	▲9451HD
Belt - W.P. & P.S.	446707C1	②▲9600HD
Belt - P.S.		7390
Belt - Alt.	306219C2	②7370
Belt - Alt. & Air Brake Compr.	468455C1	②7508
Belt - Alt. & V.P.	468460C91	②7480
Belt - A.C.	190502R2	▲9490HD
Hose - Upper - Eng. To Pipe; (2" I.D.)		24232
Hose - Upper - Pipe To Rad.; (2 1/2" I.D.)		24240
International/Navistar DT466 Diesel		
1853		
Belt - Fan & Alt.; W/65 1/4" Belt O.C.		②◆▲9650HD
Belt - Fan & Alt.; W/69 1/2" Belt O.C.	1810680C1	②◆▲9690HD
Belt - Fan & Alt.; W/70 1/4" Belt O.C.		②◆▲9700HD
Belt - Fan & P.S.	689444C1	②▲9745HD
Belt - Fan & Air Brake Compr.	1812519C1	TR22770
Belt - Fan To Air Brake Compr.		▲9485HD
Belt - P.S.	429274C91	②7390
Belt - V.P.	190502R2	▲9490HD
Belt - A.C.	133758R2	▲9440HD
Hose - Upper - Eng. To Pipe; W/A.C.		≈21135
Hose - Upper - Eng. To Pipe; W/O A.C. (2 1/4" I.D.)		24236
Hose - Upper - Pipe To Rad.; (2 1/4" I.D.)		24236
Hose - Lower; Double Dia. Hose; W/3/4" Offset		21766
Hose - Lower; Double Dia. Hose; W/2 3/4" Offset		21291
Hose - Lower; Single Dia. Hose		21042
Hose - By Pass		21461
International/Navistar MV404		
1723; 1823		
Belt - Fan & Alt.; W/Front P.T.O.; W/42A., 61A. Alt.	863751R2	②7580
Belt - Fan & Alt.; W/O Front P.T.O.; W/42A., 61A. Alt.	355478C91	②7512
Belt - Fan & Alt.; W/65A., 80A., 85A., 105A., 145A. Alt.	510238C91	②7585
Belt - Fan & P.S.; W/64" Belt O.C.	479217C1	②▲9635HD
Belt - Fan & P.S.; W/66 1/2" Belt O.C.	488882C1	②◆▲9660HD
Belt - Fan & P.S.; W/A.P.; W/60 1/4" Belt O.C.	446707C1	▲9600HD
Belt - Fan & P.S.; W/A.P.; W/63 1/4" Belt O.C.	395539R1	▲9630HD
Belt - Fan & P.S.; W/O A.P.		▲9510HD
Belt - Fan & A.P.; W/O Calif. Emission System		▲9540HD
Belt - P.S. & A.P.; W/Saginaw P.S. Pump		▲9720HD
Belt - P.S. & A.P.; W/Ross, Sheppard P.S. Pump	465244C1	▲9740HD
Belt - Air Brake Compr.; Jun. 19, 1980 & Older		▲9570HD
Belt - Air Brake Compr.; Jun. 20, 1980 & Newer		▲9610HD
Belt - A.P.; W/Air Brakes; W/Calif. Emission System	132058R3	7350
Belt - A.P.; W/Hyd. Brakes; W/Calif. Emission System	468505C91	7490
Belt - A.P.; W/O P.T.O.; W/O Calif. Emission System	270094C2	▲9580HD
Hose - Upper		21289
Hose - Lower		21288
International/Navistar MV446		
1823		
Belt - Fan & Alt.; W/Front P.T.O.; W/42A., 61A. Alt.	863751R2	②7580
Belt - Fan & Alt.; W/O Front P.T.O.; W/42A., 61A. Alt.	355478C91	②7512

② Two Required.
≈ Cut to Fit.

School Buses

Belts and Coolant Hose for School Buses

School Buses

Application	Mfr. Part No.	Our No.
INTERNATIONAL/NAVISTAR - Continued		
1980 - Continued		
International/Navistar MV446 - Continued		
1823 - Continued		
Belt - Fan & Alt.; W/65A., 80A., 85A., 105A., 145A. Alt.	510238C91	②7585
Belt - Fan & P.S.; W/64" Belt O.C.	479217C1	②◆▲9635HD
Belt - Fan & P.S.; W/66 1/2" Belt O.C.	488882C1	②◆▲9660HD
Belt - Fan & P.S.; W/A.P.; W/60 1/4" Belt O.C.	446707C1	▲9600HD
Belt - Fan & P.S.; W/A.P.; W/63 1/4" Belt O.C.	395539R1	▲9630HD
Belt - Fan & P.S.; W/O A.P.		▲9510HD
Belt - Fan & A.P.; W/O Calif. Emission System		▲9540HD
Belt - P.S. & A.P.; W/Saginaw P.S. Pump		▲9720HD
Belt - P.S. & A.P.; W/Ross, Sheppard P.S. Pump	465244C1	▲9740HD
Belt - Air Brake Compr.; Jun. 19, 1980 & Older		▲9570HD
Belt - Air Brake Compr.; Jun. 20, 1980 & Newer		▲9610HD
Belt - A.P.; W/Air Brakes; W/Calif. Emission System	132058R3	7350
Belt - A.P.; W/Hyd. Brakes; W/Calif. Emission System	468505C91	7490
Belt - A.P.; W/O P.T.O.; W/O Calif. Emission System	270094C2	▲9580HD
Hose - Upper		21289
Hose - Lower		21288
International/Navistar V-8 9.0 L Diesel		
1853		
Belt - Fan	355707C91	②◆▲9520HD
Belt - Alt.; W/42A., 61A. Alt.		②7535
Belt - Alt.; W/65A., 80A. Alt.		②7555
Belt - Alt. & Air Brake Compr.; W/42A., 61A. Alt.		②7560
Belt - Alt. & Air Brake Compr.; W/65A., 80A. Alt.		②7580
Belt - Alt. & Hyd. Brake Boost Pump; W/42A., 61A. Alt.; W/P.S.		②7560
Belt - Alt. & Hyd. Brake Boost Pump; W/65A., 80A. Alt.; W/P.S.		②7575
Belt - Alt. & Hyd. Brake Boost Pump; W/42A., 61A. Alt.; W/O P.S.		②7545
Belt - Alt. & Hyd. Brake Boost Pump; W/65A., 80A. Alt.; W/O P.S.		②7570
Belt - P.S.; W/Hyd. Brake Boost Pump	491384C91	②7355
Belt - P.S.; W/O Hyd. Brake Boost Pump	429274C91	②7390
Hose - Upper; W/Single Hose		≈<21123
Hose - Upper - Eng. To Pipe; (2 1/2" I.D.)		24240
Hose - Upper - Pipe To Rad.; (2 1/2" I.D.)		24240
Hose - Lower		21290
International/Navistar V345		
1723		
Belt - Fan & Alt.; W/42A., 61A., 65A., 80A., 85A. Alt.	255266C2	7640
Belt - Fan & Alt.; W/105A., 145A. Alt.	369722C1	7630
Belt - P.S.	967907R2	7565
Belt - Air Brake Compr.	227703R2	7475
Belt - A.C.	284453C2	▲9495HD
Belt - A.P.; W/Air Brakes; W/Gov.	182048R1	7360
Belt - A.P.; W/Air Brakes; W/O Gov.	333382C2	7385
Belt - A.P.; W/O Air Brakes; W/Gov.	323612C2	7380
Belt - A.P.; W/O Air Brakes; W/O Gov.	282989C2	7410
Hose - Upper		21293
Hose - Lower		21292
International/Navistar V392		
1723		
Belt - Fan & Alt.; W/42A., 61A., 65A., 80A., 85A. Alt.	255266C2	7640
Belt - Fan & Alt.; W/105A., 145A. Alt.	369722C1	7630
Belt - P.S.	967907R2	7565
Belt - Air Brake Compr.	227703R2	7475
Belt - A.C.	284453C2	▲9495HD
Belt - A.P.; W/Air Brakes; W/Gov.	182048R1	7360
Belt - A.P.; W/Air Brakes; W/O Gov.	333382C2	7385
Belt - A.P.; W/O Air Brakes; W/Gov.	323612C2	7380
Belt - A.P.; W/O Air Brakes; W/O Gov.	282989C2	7410
Hose - Upper		21293

Application	Mfr. Part No.	Our No.
INTERNATIONAL/NAVISTAR - Continued		
1980 - Continued		
International/Navistar V392 - Continued		
1723 - Continued		
Hose - Lower		21292
1979		
Caterpillar 3208 Diesel		
1853		
Belt - Fan	355707C91	②◆▲9520HD
Belt - W.P.	150560R2	▲9451HD
Belt - W.P. & P.S.	446707C1	②▲9600HD
Belt - P.S.		7390
Belt - Alt.	306219C2	②7370
Belt - Alt. & Air Brake Compr.	468455C1	②7508
Belt - Alt. & V.P.	468460C91	②7480
Belt - A.C.	190502R2	▲9490HD
Hose - Upper - Eng. To Pipe; (2" I.D.)		24232
Hose - Upper - Pipe To Rad.; (2 1/2" I.D.)		24240
International/Navistar DT466 Diesel		
1753		
Belt - Fan & Alt.; W/65 1/4" Belt O.C.		②◆▲9650HD
Belt - Fan & Alt.; W/69 1/2" Belt O.C.	1810680C1	②◆▲9690HD
Belt - Fan & Alt.; W/70 1/4" Belt O.C.		②◆▲9700HD
Belt - Fan & P.S.	689444C1	②▲9745HD
Belt - Fan & Air Brake Compr.	1812519C1	TR22770
Belt - Fan To Air Brake Compr.		▲9485HD
Belt - P.S.	429274C91	②7390
Belt - V.P.	190502R2	▲9490HD
Belt - A.C.	133758R2	▲9440HD
1853		
Belt - Fan & Alt.; W/65 1/4" Belt O.C.		②◆▲9650HD
Belt - Fan & Alt.; W/69 1/2" Belt O.C.	1810680C1	②◆▲9690HD
Belt - Fan & Alt.; W/70 1/4" Belt O.C.		②◆▲9700HD
Belt - Fan & P.S.	689444C1	②▲9745HD
Belt - Fan & Air Brake Compr.		TR22770
Belt - Fan To Air Brake Compr.		▲9485HD
Belt - P.S.	429274C91	②7390
Belt - V.P.	190502R2	▲9490HD
Belt - A.C.	133758R2	▲9440HD
Hose - Upper - Eng. To Pipe; W/A.C.; Mar. 7, 1981 & Older ..		≈<21135
Hose - Upper - Eng. To Pipe; W/O A.C.; Mar. 7, 1981 & Older(2 1/4" I.D.)		24236
Hose - Upper - Pipe To Rad.; Mar. 7, 1981 & Older(2 1/4" I.D.)		24236
Hose - Upper; Mar. 8, 1981 & Newer		21372
	or	●26528
Hose - Lower; Double Dia. Hose; W/3/4" Offset		21766
Hose - Lower; Double Dia. Hose; W/2 3/4" Offset		21291
Hose - Lower; Single Dia. Hose		21042
Hose - By Pass		21461
1853FC		
Belt - Alt.		③▲9650HD
Belt - P.S.	358328C91	②◆▲9463HD
Belt - Air Brake Compr.		▲9490HD
Belt - V.P.	190502R2	▲9490HD
Hose - Upper		≈<20682
Hose - Lower		≈<21291
International/Navistar MV404		
1723; 1823		
Belt - Fan & Alt.; W/Front P.T.O.; W/42A., 61A. Alt.	863751R2	②7580
Belt - Fan & Alt.; W/O Front P.T.O.; W/42A., 61A. Alt.	355478C91	②7512
Belt - Fan & Alt.; W/65A., 80A., 85A., 105A., 145A. Alt.	510238C91	②7585
Belt - Fan & P.S.; W/64" Belt O.C.	479217C1	②▲9635HD
Belt - Fan & P.S.; W/66 1/2" Belt O.C.	488882C1	②◆▲9660HD
Belt - Fan & P.S.; W/A.P.; W/60 1/4" Belt O.C.	446707C1	▲9600HD
Belt - Fan & P.S.; W/A.P.; W/63 1/4" Belt O.C.	395539R1	▲9630HD
Belt - Fan & P.S.; W/O A.P.		▲9510HD
Belt - Fan & A.P.; W/O Calif. Emission System		▲9540HD
Belt - P.S. & A.P.; W/Saginaw P.S. Pump		▲9720HD

② Two Required.
 ◆ Green Stripe® PowerBand® Belt May Work, Use Template to Check.
 ● Vulco-Flex® Coolant Hose.

▲ Standard Belt Available. See Pages 630-631.
 ≈< Cut to Fit.
 ③ Three Required.

Belts and Coolant Hose for School Buses

Application	Mfr. Part No.	Our No.	Application	Mfr. Part No.	Our No.
INTERNATIONAL/NAVISTAR - Continued			INTERNATIONAL/NAVISTAR - Continued		
1979 - Continued			1979 - Continued		
International/Navistar MV404 - Continued			International/Navistar V345 - Continued		
1723; 1823 - Continued			1723; 1823 - Continued		
Belt - P.S. & A.P.; W/Ross, Sheppard P.S. Pump	465244C1	▲9740HD	Belt - A.P.; W/Air Brakes; W/O Gov.	333382C2	7385
Belt - Air Brake Compr.; Jun. 19, 1980 & Older		▲9570HD	Belt - A.P.; W/O Air Brakes; W/Gov.	323612C2	7380
Belt - Air Brake Compr.; Jun. 20, 1980 & Newer		▲9610HD	Belt - A.P.; W/O Air Brakes; W/O Gov.	282989C2	7410
Belt - A.P.; W/Air Brakes; W/Calif. Emission System	132058R3	7350	Hose - Upper		21293
Belt - A.P.; W/Hyd. Brakes; W/Calif. Emission System	468505C91	7490	Hose - Lower		21292
Belt - A.P.; W/O P.T.O.; W/O Calif. Emission System	270094C2	▲9580HD	International/Navistar V392		
Hose - Upper		21289	1723; 1823		
Hose - Lower		21288	Belt - Fan & Alt.; W/42A., 61A., 65A., 80A., 85A. Alt.		
International/Navistar MV446			Belt - Fan & Alt.; W/105A., 145A. Alt.		
1723; 1823			Belt - P.S.		
Belt - Fan & Alt.; W/Front P.T.O.; W/42A., 61A. Alt.	863751R2	②7580	Belt - Air Brake Compr.		
Belt - Fan & Alt.; W/O Front P.T.O.; W/42A., 61A. Alt.	355478C91	②7512	Belt - A.C.		
Belt - Fan & Alt.; W/65A., 80A., 85A., 105A., 145A. Alt.	510238C91	②7585	Belt - A.P.; W/Air Brakes; W/Gov.		
Belt - Fan & P.S.; W/64" Belt O.C.	479217C1	②▲9635HD	Belt - A.P.; W/Air Brakes; W/O Gov.		
Belt - Fan & P.S.; W/66 1/2" Belt O.C.	488882C1	②◆▲9660HD	Belt - A.P.; W/O Air Brakes; W/Gov.		
Belt - Fan & P.S.; W/A.P.; W/60 1/4" Belt O.C.	446707C1	▲9600HD	Belt - A.P.; W/O Air Brakes; W/O Gov.		
Belt - Fan & P.S.; W/A.P.; W/63 1/4" Belt O.C.	395539R1	▲9630HD	Hose - Upper		
Belt - Fan & P.S.; W/O A.P.		▲9510HD	Hose - Lower		
Belt - Fan & A.P.; W/O Calif. Emission System		▲9540HD			
Belt - P.S. & A.P.; W/Saginaw P.S. Pump		▲9720HD			
Belt - P.S. & A.P.; W/Ross, Sheppard P.S. Pump	465244C1	▲9740HD			
Belt - Air Brake Compr.; Jun. 19, 1980 & Older		▲9570HD			
Belt - Air Brake Compr.; Jun. 20, 1980 & Newer		▲9610HD			
Belt - A.P.; W/Air Brakes; W/Calif. Emission System	132058R3	7350			
Belt - A.P.; W/Hyd. Brakes; W/Calif. Emission System	468505C91	7490			
Belt - A.P.; W/O P.T.O.; W/O Calif. Emission System	270094C2	▲9580HD			
Hose - Upper		21289			
Hose - Lower		21288			
International/Navistar V-8 9.0 L Diesel			1978		
1853			Caterpillar 3208 Diesel		
Belt - Fan	355707C91	②◆▲9520HD	1853		
Belt - Alt.; W/42A., 61A. Alt.		②7535	Hose - Upper - Eng. To Pipe; (2" I.D.)		
Belt - Alt.; W/65A., 80A. Alt.		②7555	Hose - Upper - Pipe To Rad.; (2 1/2" I.D.)		
Belt - Alt. & Air Brake Compr.; W/42A., 61A. Alt.		②7560			
Belt - Alt. & Air Brake Compr.; W/65A., 80A. Alt.		②7580			
Belt - Alt. & Hyd. Brake Boost Pump; W/42A., 61A. Alt.; W/P.S.		②7560			
Belt - Alt. & Hyd. Brake Boost Pump; W/65A., 80A. Alt.; W/P.S.		②7575			
Belt - Alt. & Hyd. Brake Boost Pump; W/42A., 61A. Alt.; W/O P.S.		②7545			
Belt - Alt. & Hyd. Brake Boost Pump; W/65A., 80A. Alt.; W/O P.S.		②7570			
Belt - P.S.; W/Hyd. Brake Boost Pump	491384C91	②7355			
Belt - P.S.; W/O Hyd. Brake Boost Pump	429274C91	②7390			
Hose - Upper; W/Single Hose		≈21123			
Hose - Upper - Eng. To Pipe; (2 1/2" I.D.)		24240			
Hose - Upper - Pipe To Rad.; (2 1/2" I.D.)		24240			
Hose - Lower		21290			
International/Navistar V345					
1723; 1823					
Belt - Fan & Alt.; W/42A., 61A., 65A., 80A., 85A. Alt.	255266C2	7640			
Belt - Fan & Alt.; W/105A., 145A. Alt.	369722C1	7630			
Belt - P.S.	967907R2	7565			
Belt - Air Brake Compr.	227703R2	7475			
Belt - A.C.	284453C2	▲9495HD			
Belt - A.P.; W/Air Brakes; W/Gov.	182048R1	7360			

▲ Standard Belt Available. See Pages 630-631.
 ◆ Green Stripe® PowerBand® Belt May Work, Use Template to Check.
 ● Vulco-Flex® Coolant Hose.

② Two Required.
 ≈ Cut to Fit.

School Buses

Belts and Coolant Hose for School Buses

School Buses

Application	Mfr. Part No.	Our No.
INTERNATIONAL/NAVISTAR - Continued		
1978 - Continued		
International/Navistar MV446 - Continued		
1723; 1823 - Continued		
Belt - Fan & P.S.; W/64" Belt O.C.	479217C1	②▲9635HD
Belt - Fan & P.S.; W/66 1/2" Belt O.C.	488882C1	②◆▲9660HD
Belt - Fan & P.S.; W/A.P.; W/60 1/4" Belt O.C.	446707C1	▲9600HD
Belt - Fan & P.S.; W/A.P.; W/63 1/4" Belt O.C.	395539R1	▲9630HD
Belt - Fan & P.S.; W/O A.P.		▲9510HD
Belt - Fan & A.P.; W/O Calif. Emission System		▲9540HD
Belt - P.S. & A.P.; W/Saginaw P.S. Pump		▲9720HD
Belt - P.S. & A.P.; W/Ross, Sheppard P.S. Pump	465244C1	▲9740HD
Belt - Air Brake Compr.; Jun. 19, 1980 & Older		▲9570HD
Belt - Air Brake Compr.; Jun. 20, 1980 & Newer		▲9610HD
Belt - A.P.; W/Air Brakes; W/Calif. Emission System	132058R3	7350
Belt - A.P.; W/Hyd. Brakes; W/Calif. Emission System	468505C91	7490
Belt - A.P.; W/O P.T.O.; W/O Calif. Emission System	270094C2	▲9580HD
Hose - Upper - To Center of Rad.		21132
		or ●26528
Hose - Upper - To Right Hand Side of Rad.		21133
		or ●26528
Hose - Lower; W/Auto. Trans.		●26532
Hose - Lower; W/Man. Trans.		21129
International/Navistar V345		
1603; 1703		
Belt - Fan & Alt.; W/37A., 52A., 61A. Alt.; C, G, H Chassis; W/P.T.O.	968815R11	②7650
Belt - Fan & Alt.; W/37A., 52A., 61A. Alt.; C, G, H Chassis; W/O P.T.O.	373457C91	②7612
Belt - Fan & Alt.; W/37A., 52A., 61A. Alt.; FD, SB Chassis	968815R1	②7650
Belt - Fan & Alt.; W/37A., 61A. Alt.; W/O Air Brakes; W/O P.T.O.; W/O X.C.	373456C1	7612
Belt - Fan & Alt.; W/55A., 62A. Alt.; C, G, H Chassis	369723C91	②7630
Belt - Fan & Alt.; W/55A., 62A. Alt.; FD, SB Chassis	361975C91	②7673
Belt - Fan & Alt.; W/60A. Alt.	359009C91	②7680
Belt - Fan & Alt.; W/65A., 80A., 105A., 145A. Alt.; W/P.T.O.	361975C91	②7673
Belt - Fan & Alt.; W/65A., 80A., 105A., 145A. Alt.; W/O P.T.O.		②7630
Belt - P.S.; W/2WD		7460
Belt - P.S.; W/4WD	285522C2	7435
Belt - Air Brake Compr.	359007C91	7475
Belt - A.P.; W/Air Brakes; W/Gov.	388139C1	7330
Belt - A.P.; W/Air Brakes; W/O Gov.	256062C2	7340
Belt - A.P.; W/Hyd. Brakes; W/Gov.	355653C91	7380
Belt - A.P.; W/Hyd. Brakes; W/O Gov.	362887C91	7410
Hose - Upper; W/Rad. Shutters; W/Metal Hood		●26515
Hose - Upper; W/O Rad. Shutters; W/Metal Hood		20493
Hose - Lower - Eng. To Pipe; W/Auto. Trans.		20532
Hose - Lower; W/Man. Trans.		21308
Hose - By Pass		≅20357
1723		
Belt - Fan & Alt.; W/37A., 52A., 61A. Alt.; C, G, H Chassis; W/P.T.O.	968815R11	②7650
Belt - Fan & Alt.; W/37A., 52A., 61A. Alt.; C, G, H Chassis; W/O P.T.O.	373457C91	②7612
Belt - Fan & Alt.; W/37A., 52A., 61A. Alt.; FD, SB Chassis	968815R1	②7650
Belt - Fan & Alt.; W/37A., 61A. Alt.; W/O Air Brakes; W/O P.T.O.; W/O X.C.	373456C1	7612
Belt - Fan & Alt.; W/55A., 62A. Alt.; C, G, H Chassis	369723C91	②7630
Belt - Fan & Alt.; W/55A., 62A. Alt.; FD, SB Chassis	361975C91	②7673
Belt - Fan & Alt.; W/60A. Alt.	359009C91	②7680
Belt - Fan & Alt.; W/65A., 80A., 105A., 145A. Alt.; W/P.T.O.	361975C91	②7673
Belt - Fan & Alt.; W/65A., 80A., 105A., 145A. Alt.; W/O P.T.O.		②7630

② Two Required.
◆ Green Stripe® PowerBand® Belt May Work, Use Template to Check.
≅ Cut to Fit.

Application	Mfr. Part No.	Our No.
INTERNATIONAL/NAVISTAR - Continued		
1978 - Continued		
International/Navistar V345 - Continued		
1723 - Continued		
Belt - P.S.; W/2WD		7460
Belt - P.S.; W/4WD	285522C2	7435
Belt - Air Brake Compr.	359007C91	7475
Belt - A.P.; W/Air Brakes; W/Gov.	388139C1	7330
Belt - A.P.; W/Air Brakes; W/O Gov.	256062C2	7340
Belt - A.P.; W/Hyd. Brakes; W/Gov.	355653C91	7380
Belt - A.P.; W/Hyd. Brakes; W/O Gov.	362887C91	7410
Hose - Upper		21293
Hose - Lower		21292
1803		
Belt - Fan & Alt.; W/37A., 52A., 61A. Alt.; C, G, H Chassis; W/P.T.O.	968815R11	②7650
Belt - Fan & Alt.; W/37A., 52A., 61A. Alt.; C, G, H Chassis; W/O P.T.O.	373457C91	②7612
Belt - Fan & Alt.; W/37A., 52A., 61A. Alt.; FD, SB Chassis	968815R1	②7650
Belt - Fan & Alt.; W/37A., 61A. Alt.; W/O Air Brakes; W/O P.T.O.; W/O X.C.	373456C1	7612
Belt - Fan & Alt.; W/55A., 62A. Alt.; C, G, H Chassis	369723C91	②7630
Belt - Fan & Alt.; W/55A., 62A. Alt.; FD, SB Chassis	361975C91	②7673
Belt - Fan & Alt.; W/60A. Alt.	359009C91	②7680
Belt - Fan & Alt.; W/65A., 80A., 105A., 145A. Alt.; W/P.T.O.	361975C91	②7673
Belt - Fan & Alt.; W/65A., 80A., 105A., 145A. Alt.; W/O P.T.O.		②7630
Belt - P.S.; W/2WD		7460
Belt - P.S.; W/4WD	285522C2	7435
Belt - Air Brake Compr.	359007C91	7475
Belt - A.P.; W/Air Brakes; W/Gov.	388139C1	7330
Belt - A.P.; W/Air Brakes; W/O Gov.	256062C2	7340
Belt - A.P.; W/Hyd. Brakes; W/Gov.	355653C91	7380
Belt - A.P.; W/Hyd. Brakes; W/O Gov.	362887C91	7410
Hose - Upper; W/Rad. Shutters; W/Metal Hood		●26515
Hose - Upper; W/O Rad. Shutters; W/Metal Hood		20493
Hose - Lower - Eng. To Pipe; W/Auto. Trans.		20532
Hose - Lower; W/Man. Trans.		21308
Hose - By Pass		≅20357
1823		
Belt - Fan & Alt.; W/37A., 52A., 61A. Alt.; C, G, H Chassis; W/P.T.O.	968815R11	②7650
Belt - Fan & Alt.; W/37A., 52A., 61A. Alt.; C, G, H Chassis; W/O P.T.O.	373457C91	②7612
Belt - Fan & Alt.; W/37A., 52A., 61A. Alt.; FD, SB Chassis	968815R1	②7650
Belt - Fan & Alt.; W/37A., 61A. Alt.; W/O Air Brakes; W/O P.T.O.; W/O X.C.	373456C1	7612
Belt - Fan & Alt.; W/55A., 62A. Alt.; C, G, H Chassis	369723C91	②7630
Belt - Fan & Alt.; W/55A., 62A. Alt.; FD, SB Chassis	361975C91	②7673
Belt - Fan & Alt.; W/60A. Alt.	359009C91	②7680
Belt - Fan & Alt.; W/65A., 80A., 105A., 145A. Alt.; W/P.T.O.	361975C91	②7673
Belt - Fan & Alt.; W/65A., 80A., 105A., 145A. Alt.; W/O P.T.O.		②7630
Belt - P.S.; W/2WD		7460
Belt - P.S.; W/4WD	285522C2	7435
Belt - Air Brake Compr.	359007C91	7475
Belt - A.P.; W/Air Brakes; W/Gov.	388139C1	7330
Belt - A.P.; W/Air Brakes; W/O Gov.	256062C2	7340
Belt - A.P.; W/Hyd. Brakes; W/Gov.	355653C91	7380
Belt - A.P.; W/Hyd. Brakes; W/O Gov.	362887C91	7410
Hose - Upper		21293
Hose - Lower		21292
International/Navistar V392		
1603; 1703		
Belt - Fan & Alt.; W/37A., 52A., 61A. Alt.; C, G, H Chassis; W/P.T.O.	968815R11	②7650
Belt - Fan & Alt.; W/37A., 52A., 61A. Alt.; C, G, H Chassis; W/O P.T.O.	373457C91	②7612

▲ Standard Belt Available. See Pages 630-631.
● Vulco-Flex® Coolant Hose.

Belts and Coolant Hose for School Buses

Application	Mfr. Part No.	Our No.	Application	Mfr. Part No.	Our No.
INTERNATIONAL/NAVISTAR - Continued			INTERNATIONAL/NAVISTAR - Continued		
1978 - Continued			1978 - Continued		
International/Navistar V392 - Continued			International/Navistar V392 - Continued		
1603; 1703 - Continued					
Belt - Fan & Alt.; W/37A., 52A., 61A. Alt.; FD, SB Chassis	968815R1	②7650	Belt - A.P.; W/Air Brakes; W/O Gov.	256062C2	7340
Belt - Fan & Alt.; W/37A., 61A. Alt.; W/O Air Brakes; W/O P.T.O.; W/O X.C.	373456C1	7612	Belt - A.P.; W/Hyd. Brakes; W/Gov.	355653C91	7380
Belt - Fan & Alt.; W/55A., 62A. Alt.; C, G, H Chassis	369723C91	②7630	Belt - A.P.; W/Hyd. Brakes; W/O Gov.	362887C91	7410
Belt - Fan & Alt.; W/55A., 62A. Alt.; FD, SB Chassis	361975C91	②7673	Hose - Upper; W/Rad. Shutters; W/Metal Hood		●26515
Belt - Fan & Alt.; W/60A. Alt.	359009C91	②7680	Hose - Upper; W/O Rad. Shutters; W/Metal Hood		20493
Belt - Fan & Alt.; W/65A., 80A., 105A., 145A. Alt.; W/P.T.O.	361975C91	②7673	Hose - Lower - Eng. To Pipe; W/Auto. Trans.		20532
Belt - Fan & Alt.; W/65A., 80A., 105A., 145A. Alt.; W/O P.T.O.		②7630	Hose - Lower; W/Man. Trans.		21308
Belt - P.S.; W/2WD		7460	Hose - By Pass		≡20357
Belt - P.S.; W/4WD	285522C2	7435			
Belt - Air Brake Compr.	359007C91	7475	1823		
Belt - A.P.; W/Air Brakes; W/Gov.	388139C1	7330	Belt - Fan & Alt.; W/37A., 52A., 61A. Alt.; C, G, H Chassis; W/P.T.O.	968815R11	②7650
Belt - A.P.; W/Air Brakes; W/O Gov.	256062C2	7340	Belt - Fan & Alt.; W/37A., 52A., 61A. Alt.; C, G, H Chassis; W/O P.T.O.	373457C91	②7612
Belt - A.P.; W/Hyd. Brakes; W/Gov.	355653C91	7380	Belt - Fan & Alt.; W/37A., 52A., 61A. Alt.; FD, SB Chassis	968815R1	②7650
Belt - A.P.; W/Hyd. Brakes; W/O Gov.	362887C91	7410	Belt - Fan & Alt.; W/37A., 61A. Alt.; W/O Air Brakes; W/O P.T.O.; W/O X.C.	373456C1	7612
Hose - Upper; W/Rad. Shutters; W/Metal Hood		●26515	Belt - Fan & Alt.; W/55A., 62A. Alt.; C, G, H Chassis	369723C91	②7630
Hose - Upper; W/O Rad. Shutters; W/Metal Hood		20493	Belt - Fan & Alt.; W/55A., 62A. Alt.; FD, SB Chassis	361975C91	②7673
Hose - Lower - Eng. To Pipe; W/Auto. Trans.		20532	Belt - Fan & Alt.; W/60A. Alt.	359009C91	②7680
Hose - Lower; W/Man. Trans.		21308	Belt - Fan & Alt.; W/65A., 80A., 105A., 145A. Alt.; W/P.T.O.	361975C91	②7673
Hose - By Pass		≡20357	Belt - Fan & Alt.; W/65A., 80A., 105A., 145A. Alt.; W/O P.T.O.		②7630
1723			Belt - P.S.; W/2WD		7460
Belt - Fan & Alt.; W/37A., 52A., 61A. Alt.; C, G, H Chassis; W/P.T.O.	968815R11	②7650	Belt - P.S.; W/4WD	285522C2	7435
Belt - Fan & Alt.; W/37A., 52A., 61A. Alt.; C, G, H Chassis; W/O P.T.O.	373457C91	②7612	Belt - Air Brake Compr.	359007C91	7475
Belt - Fan & Alt.; W/37A., 52A., 61A. Alt.; FD, SB Chassis	968815R1	②7650	Belt - A.P.; W/Air Brakes; W/Gov.	388139C1	7330
Belt - Fan & Alt.; W/37A., 61A. Alt.; W/O Air Brakes; W/O P.T.O.; W/O X.C.	373456C1	7612	Belt - A.P.; W/Air Brakes; W/O Gov.	256062C2	7340
Belt - Fan & Alt.; W/55A., 62A. Alt.; C, G, H Chassis	369723C91	②7630	Belt - A.P.; W/Hyd. Brakes; W/Gov.	355653C91	7380
Belt - Fan & Alt.; W/55A., 62A. Alt.; FD, SB Chassis	361975C91	②7673	Belt - A.P.; W/Hyd. Brakes; W/O Gov.	362887C91	7410
Belt - Fan & Alt.; W/60A. Alt.	359009C91	②7680	Hose - Upper		21293
Belt - Fan & Alt.; W/65A., 80A., 105A., 145A. Alt.; W/P.T.O.	361975C91	②7673	Hose - Lower		21292
Belt - Fan & Alt.; W/65A., 80A., 105A., 145A. Alt.; W/O P.T.O.		②7630			
Belt - P.S.; W/2WD		7460	1977		
Belt - P.S.; W/4WD	285522C2	7435	International/Navistar DT466 Diesel		
Belt - Air Brake Compr.	359007C91	7475	1853FC		
Belt - A.P.; W/Air Brakes; W/Gov.	388139C1	7330	Hose - Upper		≡20682
Belt - A.P.; W/Air Brakes; W/O Gov.	256062C2	7340	Hose - Lower		≡21291
Belt - A.P.; W/Hyd. Brakes; W/Gov.	355653C91	7380	International/Navistar FTV549		
Belt - A.P.; W/Hyd. Brakes; W/O Gov.	362887C91	7410	1603; 1703 ; 1803		
Hose - Upper		21293	Belt - Fan		②◆◆9476HD
Hose - Lower		21292	Belt - Alt.; W/37A., 61A. Alt.	359006C91	②7417
1803			Belt - Alt.; W/65A., 80A. Alt.	151531R2	②7450
Belt - Fan & Alt.; W/37A., 52A., 61A. Alt.; C, G, H Chassis; W/P.T.O.	968815R11	②7650	Belt - Alt. & Air Brake Compr.; W/37A., 61A. Alt.		②7541
Belt - Fan & Alt.; W/37A., 52A., 61A. Alt.; C, G, H Chassis; W/O P.T.O.	373457C91	②7612	Belt - Alt. & Air Brake Compr.; W/65A., 80A. Alt.	358344C91	②7560
Belt - Fan & Alt.; W/37A., 52A., 61A. Alt.; FD, SB Chassis	968815R1	②7650	Belt - P.S.	358335C91	②◆◆9490HD
Belt - Fan & Alt.; W/37A., 61A. Alt.; W/O Air Brakes; W/O P.T.O.; W/O X.C.	373456C1	7612	International/Navistar FTVS549		
Belt - Fan & Alt.; W/55A., 62A. Alt.; C, G, H Chassis	369723C91	②7630	1603; 1703 ; 1803		
Belt - Fan & Alt.; W/55A., 62A. Alt.; FD, SB Chassis	361975C91	②7673	Belt - Fan		②◆◆9476HD
Belt - Fan & Alt.; W/60A. Alt.	359009C91	②7680	Belt - Alt.; W/37A., 61A. Alt.	359006C91	②7417
Belt - Fan & Alt.; W/65A., 80A., 105A., 145A. Alt.; W/P.T.O.	361975C91	②7673	Belt - Alt.; W/65A., 80A. Alt.	151531R2	②7450
Belt - Fan & Alt.; W/65A., 80A., 105A., 145A. Alt.; W/O P.T.O.		②7630	Belt - Alt. & Air Brake Compr.; W/37A., 61A. Alt.		②7541
Belt - P.S.; W/2WD		7460	Belt - Alt. & Air Brake Compr.; W/65A., 80A. Alt.	358344C91	②7560
Belt - P.S.; W/4WD	285522C2	7435	Belt - P.S.	358335C91	②◆◆9490HD
Belt - Air Brake Compr.	359007C91	7475	International/Navistar MV404		
Belt - A.P.; W/Air Brakes; W/Gov.	388139C1	7330	1723; 1823		
Belt - A.P.; W/Air Brakes; W/O Gov.	256062C2	7340	Belt - Fan & Alt.; W/Front P.T.O.; W/42A., 61A. Alt.	863751R2	②7580
Belt - A.P.; W/Hyd. Brakes; W/Gov.	355653C91	7380	Belt - Fan & Alt.; W/O Front P.T.O.; W/42A., 61A. Alt.	355478C91	②7512
Belt - A.P.; W/Hyd. Brakes; W/O Gov.	362887C91	7410	Belt - Fan & Alt.; W/65A., 80A., 85A., 105A., 145A. Alt.	510238C91	②7585
Hose - Upper		21293	Belt - Fan & P.S.; W/64" Belt O.C.	479217C1	②◆◆9635HD
Hose - Lower		21292	Belt - Fan & P.S.; W/66 1/2" Belt O.C.	488882C1	②◆◆9660HD
			Belt - Fan & P.S.; W/A.P.; W/60 1/4" Belt O.C.	446707C1	◆9600HD

School Buses

② Two Required.
 ≡ Cut to Fit.
 ◆ Standard Belt Available. See Pages 630-631.

◆ Vulco-Flex® Coolant Hose.
 ◆ Green Stripe® PowerBand® Belt May Work, Use Template to Check.

Belts and Coolant Hose for School Buses

School Buses

Application	Mfr. Part No.	Our No.
INTERNATIONAL/NAVISTAR - Continued		
1977 - Continued		
International/Navistar MV404 - Continued		
1723; 1823 - Continued		
Belt - Fan & P.S.; W/A.P.; W/63 1/4" Belt O.C. 395539R1		▲9630HD
Belt - Fan & P.S.; W/O A.P.		▲9510HD
Belt - Fan & A.P.; W/O Calif. Emission System		▲9540HD
Belt - P.S. & A.P.; W/Saginaw P.S. Pump		▲9720HD
Belt - P.S. & A.P.; W/Ross, Sheppard P.S. Pump	465244C1	▲9740HD
Belt - Air Brake Compr.; Jun. 19, 1980 & Older		▲9570HD
Belt - Air Brake Compr.; Jun. 20, 1980 & Newer		▲9610HD
Belt - A.P.; W/Air Brakes; W/Calif. Emission System	132058R3	7350
Belt - A.P.; W/Hyd. Brakes; W/Calif. Emission System	468505C91	7490
Belt - A.P.; W/O P.T.O.; W/O Calif. Emission System	270094C2	▲9580HD
Hose - Upper - To Center of Rad.		21132
		or ●26528
Hose - Upper - To Right Hand Side of Rad.		21133
		or ●26528
Hose - Lower; W/Auto. Trans.		●26532
Hose - Lower; W/Man. Trans.		21129
International/Navistar MV446		
1723; 1823		
Belt - Fan & Alt.; W/Front P.T.O.; W/42A., 61A. Alt.	863751R2	②7580
Belt - Fan & Alt.; W/O Front P.T.O.; W/42A., 61A. Alt.	355478C91	②7512
Belt - Fan & Alt.; W/65A., 80A., 85A., 105A., 145A. Alt.	510238C91	②7585
Belt - Fan & P.S.; W/64" Belt O.C.	479217C1	②▲9635HD
Belt - Fan & P.S.; W/66 1/2" Belt O.C.	488882C1	②▲9660HD
Belt - Fan & P.S.; W/A.P.; W/60 1/4" Belt O.C. 446707C1		▲9600HD
Belt - Fan & P.S.; W/A.P.; W/63 1/4" Belt O.C. 395539R1		▲9630HD
Belt - Fan & P.S.; W/O A.P.		▲9510HD
Belt - Fan & A.P.; W/O Calif. Emission System		▲9540HD
Belt - P.S. & A.P.; W/Saginaw P.S. Pump		▲9720HD
Belt - P.S. & A.P.; W/Ross, Sheppard P.S. Pump	465244C1	▲9740HD
Belt - Air Brake Compr.; Jun. 19, 1980 & Older		▲9570HD
Belt - Air Brake Compr.; Jun. 20, 1980 & Newer		▲9610HD
Belt - A.P.; W/Air Brakes; W/Calif. Emission System	132058R3	7350
Belt - A.P.; W/Hyd. Brakes; W/Calif. Emission System	468505C91	7490
Belt - A.P.; W/O P.T.O.; W/O Calif. Emission System	270094C2	▲9580HD
Hose - Upper - To Center of Rad.		21132
		or ●26528
Hose - Upper - To Right Hand Side of Rad.		21133
		or ●26528
Hose - Lower; W/Auto. Trans.		●26532
Hose - Lower; W/Man. Trans.		21129
International/Navistar RD372		
1823		
Belt - Fan & Alt.	359014C91	②TR22514
Belt - W.P. & Alt.; W/37A. Alt.; Chassis No. FD61626 & Before	193826R11	②TR22508
Belt - W.P. & Alt.; W/37A. Alt.; Chassis No. FD61626 & Up & G Chassis No.	223794R11	②TR22514
Belt - W.P. & Alt.; W/60A. Alt.	243604R11	②TR22517
Belt - P.S.	240354R2	TR22336
Belt - Air Brake Compr.; W/Wagner Compr.	92836HA	TR32491
Belt - Air Brake Compr.; W/Westinghouse Compr.	83816HA	TR34467
International/Navistar RD406		
1823		
Belt - Fan & Alt.	359014C91	②TR22514
Belt - W.P. & Alt.; W/37A. Alt.; Chassis No. FD61626 & Before	193826R11	②TR22508

Application	Mfr. Part No.	Our No.
INTERNATIONAL/NAVISTAR - Continued		
1977 - Continued		
International/Navistar RD406 - Continued		
1823 - Continued		
Belt - W.P. & Alt.; W/37A. Alt.; Chassis No. FD61626 & Up & G Chassis No.	223794R11	②TR22514
Belt - W.P. & Alt.; W/60A. Alt.	243604R11	②TR22517
Belt - P.S.	240354R2	TR22336
Belt - Air Brake Compr.; W/Wagner Compr.	92836HA	TR32491
Belt - Air Brake Compr.; W/Westinghouse Compr.	83816HA	TR34467
International/Navistar RD450		
1823		
Belt - Fan & Alt.	359014C91	②TR22514
Belt - W.P. & Alt.; W/37A. Alt.; Chassis No. FD61626 & Before	193826R11	②TR22508
Belt - W.P. & Alt.; W/37A. Alt.; Chassis No. FD61626 & Up & G Chassis No.	223794R11	②TR22514
Belt - W.P. & Alt.; W/60A. Alt.	243604R11	②TR22517
Belt - P.S.	240354R2	TR22336
Belt - Air Brake Compr.; W/Wagner Compr.	92836HA	TR32491
Belt - Air Brake Compr.; W/Westinghouse Compr.	83816HA	TR34467
International/Navistar RD501		
1823		
Belt - Fan & Alt.	359014C91	②TR22514
Belt - W.P. & Alt.; W/37A. Alt.; Chassis No. FD61626 & Before	193826R11	②TR22508
Belt - W.P. & Alt.; W/37A. Alt.; Chassis No. FD61626 & Up & G Chassis No.	223794R11	②TR22514
Belt - W.P. & Alt.; W/60A. Alt.	243604R11	②TR22517
Belt - P.S.	240354R2	TR22336
Belt - Air Brake Compr.; W/Wagner Compr.	92836HA	TR32491
Belt - Air Brake Compr.; W/Westinghouse Compr.	83816HA	TR34467
International/Navistar V266		
1603; 1703; 1803		
Belt - Fan & Alt.; W/37A., 52A., 61A. Alt.; C, G, H Chassis		②7603
Belt - Fan & Alt.; W/37A., 52A., 61A. Alt.; FD, SB Chassis	255266C3	②7640
Belt - Fan & Alt.; W/55A., 62A. Alt.; C, G, H Chassis	369725C91	②7619
Belt - Fan & Alt.; W/55A., 62A. Alt.; FD, SB Chassis	358998C91	②7650
Belt - P.S.; W/2WD	151529R2	7440
Belt - P.S.; W/4WD	151531R2	7450
Belt - Air Brake Compr.	236572R2	7460
Hose - Upper; W/Rad. Shutters; W/Metal Hood		●26515
Hose - Upper; W/O Rad. Shutters; W/Metal Hood		20493
Hose - Lower - Eng. To Pipe; W/Auto. Trans.		20532
Hose - Lower; W/Man. Trans.		21308
Hose - By Pass		≅20357
International/Navistar V304		
1603; 1703; 1803		
Belt - Fan & Alt.; W/37A., 52A., 61A. Alt.; C, G, H Chassis		②7603
Belt - Fan & Alt.; W/37A., 52A., 61A. Alt.; FD, SB Chassis	255266C3	②7640
Belt - Fan & Alt.; W/55A., 62A. Alt.; C, G, H Chassis	369725C91	②7619
Belt - Fan & Alt.; W/55A., 62A. Alt.; FD, SB Chassis	358998C91	②7650
Belt - P.S.; W/2WD	151529R2	7440
Belt - P.S.; W/4WD	151531R2	7450
Belt - Air Brake Compr.	236572R2	7460
Hose - Upper; W/Rad. Shutters; W/Metal Hood		●26515
Hose - Upper; W/O Rad. Shutters; W/Metal Hood		20493
Hose - Lower - Eng. To Pipe; W/Auto. Trans.		20532
Hose - Lower; W/Man. Trans.		21308
Hose - By Pass		≅20357

▲ Standard Belt Available. See Pages 630-631.
 ② Two Required.
 ≅ Cut to Fit.

● Vulco-Flex® Coolant Hose.
 ◆ Green Stripe® PowerBand® Belt May Work, Use Template to Check.

Belts and Coolant Hose for School Buses

Application	Mfr. Part No.	Our No.	Application	Mfr. Part No.	Our No.
INTERNATIONAL/NAVISTAR - Continued			INTERNATIONAL/NAVISTAR - Continued		
1977 - Continued			1977 - Continued		
International/Navistar V345			International/Navistar V345 - Continued		
1603; 1703			1803 - Continued		
Belt - Fan & Alt.; W/37A., 52A., 61A. Alt.; C, G, H Chassis; W/P.T.O.	968815R11	②7650	Belt - Air Brake Compr.	359007C91	7475
Belt - Fan & Alt.; W/37A., 52A., 61A. Alt.; C, G, H Chassis; W/O P.T.O.	373457C91	②7612	Belt - A.P.; W/Air Brakes; W/Gov.	388139C1	7330
Belt - Fan & Alt.; W/37A., 52A., 61A. Alt.; FD, SB Chassis	968815R1	②7650	Belt - A.P.; W/Air Brakes; W/O Gov.	256062C2	7340
Belt - Fan & Alt.; W/37A., 61A. Alt.; W/O Air Brakes; W/O P.T.O.; W/O X.C.	373456C1	7612	Belt - A.P.; W/Hyd. Brakes; W/Gov.	355653C91	7380
Belt - Fan & Alt.; W/55A., 62A. Alt.; C, G, H Chassis	369723C91	②7630	Belt - A.P.; W/Hyd. Brakes; W/O Gov.	362887C91	7410
Belt - Fan & Alt.; W/55A., 62A. Alt.; FD, SB Chassis	361975C91	②7673	Hose - Upper; W/Rad. Shutters; W/Metal Hood	●26515	20493
Belt - Fan & Alt.; W/60A. Alt.	359009C91	②7680	Hose - Upper; W/O Rad. Shutters; W/Metal Hood	20493	20532
Belt - Fan & Alt.; W/65A., 80A., 105A., 145A. Alt.; W/P.T.O.	361975C91	②7673	Hose - Lower - Eng. To Pipe; W/Auto. Trans.	21308	21308
Belt - Fan & Alt.; W/65A., 80A., 105A., 145A. Alt.; W/O P.T.O.	②7630	②7630	Hose - Lower; W/Man. Trans.	21308	21308
Belt - P.S.; W/2WD	7460	7460	Hose - By Pass	≈20357	≈20357
Belt - P.S.; W/4WD	285522C2	7435			
Belt - Air Brake Compr.	359007C91	7475	1823		
Belt - A.P.; W/Air Brakes; W/Gov.	388139C1	7330	Belt - Fan & Alt.; W/37A., 52A., 61A. Alt.; C, G, H Chassis; W/P.T.O.	968815R11	②7650
Belt - A.P.; W/Air Brakes; W/O Gov.	256062C2	7340	Belt - Fan & Alt.; W/37A., 52A., 61A. Alt.; C, G, H Chassis; W/O P.T.O.	373457C91	②7612
Belt - A.P.; W/Hyd. Brakes; W/Gov.	355653C91	7380	Belt - Fan & Alt.; W/37A., 52A., 61A. Alt.; FD, SB Chassis	968815R1	②7650
Belt - A.P.; W/Hyd. Brakes; W/O Gov.	362887C91	7410	Belt - Fan & Alt.; W/37A., 61A. Alt.; W/O Air Brakes; W/O P.T.O.; W/O X.C.	373456C1	7612
Hose - Upper; W/Rad. Shutters; W/Metal Hood	●26515	20493	Belt - Fan & Alt.; W/55A., 62A. Alt.; C, G, H Chassis	369723C91	②7630
Hose - Upper; W/O Rad. Shutters; W/Metal Hood	20493	20493	Belt - Fan & Alt.; W/55A., 62A. Alt.; FD, SB Chassis	361975C91	②7673
Hose - Lower - Eng. To Pipe; W/Auto. Trans.	20532	20532	Belt - Fan & Alt.; W/60A. Alt.	359009C91	②7680
Hose - Lower; W/Man. Trans.	21308	21308	Belt - Fan & Alt.; W/65A., 80A., 105A., 145A. Alt.; W/P.T.O.	361975C91	②7673
Hose - By Pass	≈20357	≈20357	Belt - Fan & Alt.; W/65A., 80A., 105A., 145A. Alt.; W/O P.T.O.	②7630	②7630
			Belt - P.S.; W/2WD	7460	7460
1723			Belt - P.S.; W/4WD	285522C2	7435
Belt - Fan & Alt.; W/37A., 52A., 61A. Alt.; C, G, H Chassis; W/P.T.O.	968815R11	②7650	Belt - Air Brake Compr.	359007C91	7475
Belt - Fan & Alt.; W/37A., 52A., 61A. Alt.; C, G, H Chassis; W/O P.T.O.	373457C91	②7612	Belt - A.P.; W/Air Brakes; W/Gov.	388139C1	7330
Belt - Fan & Alt.; W/37A., 52A., 61A. Alt.; FD, SB Chassis	968815R1	②7650	Belt - A.P.; W/Air Brakes; W/O Gov.	256062C2	7340
Belt - Fan & Alt.; W/37A., 61A. Alt.; W/O Air Brakes; W/O P.T.O.; W/O X.C.	373456C1	7612	Belt - A.P.; W/Hyd. Brakes; W/Gov.	355653C91	7380
Belt - Fan & Alt.; W/55A., 62A. Alt.; C, G, H Chassis	369723C91	②7630	Belt - A.P.; W/Hyd. Brakes; W/O Gov.	362887C91	7410
Belt - Fan & Alt.; W/55A., 62A. Alt.; FD, SB Chassis	361975C91	②7673			
Belt - Fan & Alt.; W/60A. Alt.	359009C91	②7680	International/Navistar V392		
Belt - Fan & Alt.; W/65A., 80A., 105A., 145A. Alt.; W/P.T.O.	361975C91	②7673	1603; 1703		
Belt - Fan & Alt.; W/65A., 80A., 105A., 145A. Alt.; W/O P.T.O.	②7630	②7630	Belt - Fan & Alt.; W/37A., 52A., 61A. Alt.; C, G, H Chassis; W/P.T.O.	968815R11	②7650
Belt - P.S.; W/2WD	7460	7460	Belt - Fan & Alt.; W/37A., 52A., 61A. Alt.; C, G, H Chassis; W/O P.T.O.	373457C91	②7612
Belt - P.S.; W/4WD	285522C2	7435	Belt - Fan & Alt.; W/37A., 52A., 61A. Alt.; FD, SB Chassis	968815R1	②7650
Belt - Air Brake Compr.	359007C91	7475	Belt - Fan & Alt.; W/37A., 61A. Alt.; W/O Air Brakes; W/O P.T.O.; W/O X.C.	373456C1	7612
Belt - A.P.; W/Air Brakes; W/Gov.	388139C1	7330	Belt - Fan & Alt.; W/55A., 62A. Alt.; C, G, H Chassis	369723C91	②7630
Belt - A.P.; W/Air Brakes; W/O Gov.	256062C2	7340	Belt - Fan & Alt.; W/55A., 62A. Alt.; FD, SB Chassis	361975C91	②7673
Belt - A.P.; W/Hyd. Brakes; W/Gov.	355653C91	7380	Belt - Fan & Alt.; W/60A. Alt.	359009C91	②7680
Belt - A.P.; W/Hyd. Brakes; W/O Gov.	362887C91	7410	Belt - Fan & Alt.; W/65A., 80A., 105A., 145A. Alt.; W/P.T.O.	361975C91	②7673
			Belt - Fan & Alt.; W/65A., 80A., 105A., 145A. Alt.; W/O P.T.O.	②7630	②7630
1803			Belt - P.S.; W/2WD	7460	7460
Belt - Fan & Alt.; W/37A., 52A., 61A. Alt.; C, G, H Chassis; W/P.T.O.	968815R11	②7650	Belt - P.S.; W/4WD	285522C2	7435
Belt - Fan & Alt.; W/37A., 52A., 61A. Alt.; C, G, H Chassis; W/O P.T.O.	373457C91	②7612	Belt - Air Brake Compr.	359007C91	7475
Belt - Fan & Alt.; W/37A., 52A., 61A. Alt.; FD, SB Chassis	968815R1	②7650	Belt - A.P.; W/Air Brakes; W/Gov.	388139C1	7330
Belt - Fan & Alt.; W/37A., 61A. Alt.; W/O Air Brakes; W/O P.T.O.; W/O X.C.	373456C1	7612	Belt - A.P.; W/Air Brakes; W/O Gov.	256062C2	7340
Belt - Fan & Alt.; W/55A., 62A. Alt.; C, G, H Chassis	369723C91	②7630	Belt - A.P.; W/Hyd. Brakes; W/Gov.	355653C91	7380
Belt - Fan & Alt.; W/55A., 62A. Alt.; FD, SB Chassis	361975C91	②7673	Belt - A.P.; W/Hyd. Brakes; W/O Gov.	362887C91	7410
Belt - Fan & Alt.; W/60A. Alt.	359009C91	②7680	Hose - Upper; W/Rad. Shutters; W/Metal Hood	●26515	20493
Belt - Fan & Alt.; W/65A., 80A., 105A., 145A. Alt.; W/P.T.O.	361975C91	②7673	Hose - Upper; W/O Rad. Shutters; W/Metal Hood	20493	20532
Belt - Fan & Alt.; W/65A., 80A., 105A., 145A. Alt.; W/O P.T.O.	②7630	②7630	Hose - Lower - Eng. To Pipe; W/Auto. Trans.	20532	20532
Belt - P.S.; W/2WD	7460	7460	Hose - Lower; W/Man. Trans.	21308	21308
Belt - P.S.; W/4WD	285522C2	7435	Hose - By Pass	≈20357	≈20357

② Two Required.
≈ Cut to Fit.

● Vulco-Flex® Coolant Hose.

Belts and Coolant Hose for School Buses

School Buses

Application	Mfr. Part No.	Our No.
INTERNATIONAL/NAVISTAR - Continued		
1977 - Continued		
International/Navistar V392 - Continued		
1723 - Continued		
Belt - Fan & Alt.; W/37A., 52A., 61A. Alt.; FD, SB Chassis	968815R1	②7650
Belt - Fan & Alt.; W/37A., 61A. Alt.; W/O Air Brakes; W/O P.T.O.; W/O X.C.	373456C1	7612
Belt - Fan & Alt.; W/55A., 62A. Alt.; C, G, H Chassis	369723C91	②7630
Belt - Fan & Alt.; W/55A., 62A. Alt.; FD, SB Chassis	361975C91	②7673
Belt - Fan & Alt.; W/60A. Alt.	359009C91	②7680
Belt - Fan & Alt.; W/65A., 80A., 105A., 145A. Alt.; W/P.T.O.	361975C91	②7673
Belt - Fan & Alt.; W/65A., 80A., 105A., 145A. Alt.; W/O P.T.O.		7460
Belt - P.S.; W/2WD	285522C2	7435
Belt - P.S.; W/4WD	359007C91	7475
Belt - Air Brake Compr.	388139C1	7330
Belt - A.P.; W/Air Brakes; W/Gov.	256062C2	7340
Belt - A.P.; W/Hyd. Brakes; W/Gov.	355653C91	7380
Belt - A.P.; W/Hyd. Brakes; W/O Gov.	362887C91	7410
1803		
Belt - Fan & Alt.; W/37A., 52A., 61A. Alt.; C, G, H Chassis; W/P.T.O.	968815R11	②7650
Belt - Fan & Alt.; W/37A., 52A., 61A. Alt.; C, G, H Chassis; W/O P.T.O.	373457C91	②7612
Belt - Fan & Alt.; W/37A., 52A., 61A. Alt.; FD, SB Chassis	968815R1	②7650
Belt - Fan & Alt.; W/37A., 61A. Alt.; W/O Air Brakes; W/O P.T.O.; W/O X.C.	373456C1	7612
Belt - Fan & Alt.; W/55A., 62A. Alt.; C, G, H Chassis	369723C91	②7630
Belt - Fan & Alt.; W/55A., 62A. Alt.; FD, SB Chassis	361975C91	②7673
Belt - Fan & Alt.; W/60A. Alt.	359009C91	②7680
Belt - Fan & Alt.; W/65A., 80A., 105A., 145A. Alt.; W/P.T.O.	361975C91	②7673
Belt - Fan & Alt.; W/65A., 80A., 105A., 145A. Alt.; W/O P.T.O.		7460
Belt - P.S.; W/2WD	285522C2	7435
Belt - P.S.; W/4WD	359007C91	7475
Belt - Air Brake Compr.	388139C1	7330
Belt - A.P.; W/Air Brakes; W/O Gov.	256062C2	7340
Belt - A.P.; W/Hyd. Brakes; W/Gov.	355653C91	7380
Belt - A.P.; W/Hyd. Brakes; W/O Gov.	362887C91	7410
Hose - Upper; W/Rad. Shutters; W/Metal Hood	●26515	
Hose - Upper; W/O Rad. Shutters; W/Metal Hood	20493	
Hose - Lower - Eng. To Pipe; W/Auto. Trans.	20532	
Hose - Lower; W/Man. Trans.	21308	
Hose - By Pass	≠20357	
1823		
Belt - Fan & Alt.; W/37A., 52A., 61A. Alt.; C, G, H Chassis; W/P.T.O.	968815R11	②7650
Belt - Fan & Alt.; W/37A., 52A., 61A. Alt.; C, G, H Chassis; W/O P.T.O.	373457C91	②7612
Belt - Fan & Alt.; W/37A., 52A., 61A. Alt.; FD, SB Chassis	968815R1	②7650
Belt - Fan & Alt.; W/37A., 61A. Alt.; W/O Air Brakes; W/O P.T.O.; W/O X.C.	373456C1	7612
Belt - Fan & Alt.; W/55A., 62A. Alt.; C, G, H Chassis	369723C91	②7630
Belt - Fan & Alt.; W/55A., 62A. Alt.; FD, SB Chassis	361975C91	②7673
Belt - Fan & Alt.; W/60A. Alt.	359009C91	②7680
Belt - Fan & Alt.; W/65A., 80A., 105A., 145A. Alt.; W/P.T.O.	361975C91	②7673
Belt - Fan & Alt.; W/65A., 80A., 105A., 145A. Alt.; W/O P.T.O.		7460
Belt - P.S.; W/2WD	285522C2	7435
Belt - P.S.; W/4WD	359007C91	7475
Belt - Air Brake Compr.	388139C1	7330
Belt - A.P.; W/Air Brakes; W/O Gov.	256062C2	7340
Belt - A.P.; W/Hyd. Brakes; W/Gov.	355653C91	7380

Application	Mfr. Part No.	Our No.
INTERNATIONAL/NAVISTAR - Continued		
1977 - Continued		
International/Navistar V392 - Continued		
1823 - Continued		
Belt - A.P.; W/Hyd. Brakes; W/O Gov.	362887C91	7410
International/Navistar V401		
1603; 1703 ; 1803		
Belt - Fan		②◆▲9476HD
Belt - Alt.; W/37A., 61A. Alt.	359006C91	②7417
Belt - Alt.; W/65A., 80A. Alt.	151531R2	②7450
Belt - Alt. & Air Brake Compr.; W/37A., 61A. Alt.		②7541
Belt - Alt. & Air Brake Compr.; W/65A., 80A. Alt.	358344C91	②7560
Belt - P.S.	358335C91	②◆▲9490HD
International/Navistar V461		
1603; 1703 ; 1803		
Belt - Fan		②◆▲9476HD
Belt - Alt.; W/37A., 61A. Alt.	359006C91	②7417
Belt - Alt.; W/65A., 80A. Alt.	151531R2	②7450
Belt - Alt. & Air Brake Compr.; W/37A., 61A. Alt.		②7541
Belt - Alt. & Air Brake Compr.; W/65A., 80A. Alt.	358344C91	②7560
Belt - P.S.	358335C91	②◆▲9490HD
International/Navistar V478		
1603; 1703 ; 1803		
Belt - Fan		②◆▲9476HD
Belt - Alt.; W/37A., 61A. Alt.	359006C91	②7417
Belt - Alt.; W/65A., 80A. Alt.	151531R2	②7450
Belt - Alt. & Air Brake Compr.; W/37A., 61A. Alt.		②7541
Belt - Alt. & Air Brake Compr.; W/65A., 80A. Alt.	358344C91	②7560
Belt - P.S.	358335C91	②◆▲9490HD
International/Navistar V549		
1603; 1703 ; 1803		
Belt - Fan		②◆▲9476HD
Belt - Alt.; W/37A., 61A. Alt.	359006C91	②7417
Belt - Alt.; W/65A., 80A. Alt.	151531R2	②7450
Belt - Alt. & Air Brake Compr.; W/37A., 61A. Alt.		②7541
Belt - Alt. & Air Brake Compr.; W/65A., 80A. Alt.	358344C91	②7560
Belt - P.S.	358335C91	②◆▲9490HD
International/Navistar VS401		
1603; 1703 ; 1803		
Belt - Fan		②◆▲9476HD
Belt - Alt.; W/37A., 61A. Alt.	359006C91	②7417
Belt - Alt.; W/65A., 80A. Alt.	151531R2	②7450
Belt - Alt. & Air Brake Compr.; W/37A., 61A. Alt.		②7541
Belt - Alt. & Air Brake Compr.; W/65A., 80A. Alt.	358344C91	②7560
Belt - P.S.	358335C91	②◆▲9490HD
International/Navistar VS478		
1603; 1703 ; 1803		
Belt - Fan		②◆▲9476HD
Belt - Alt.; W/37A., 61A. Alt.	359006C91	②7417
Belt - Alt.; W/65A., 80A. Alt.	151531R2	②7450
Belt - Alt. & Air Brake Compr.; W/37A., 61A. Alt.		②7541
Belt - Alt. & Air Brake Compr.; W/65A., 80A. Alt.	358344C91	②7560
Belt - P.S.	358335C91	②◆▲9490HD
International/Navistar VS549		
1603; 1703 ; 1803		
Belt - Fan		②◆▲9476HD
Belt - Alt.; W/37A., 61A. Alt.	359006C91	②7417
Belt - Alt.; W/65A., 80A. Alt.	151531R2	②7450
Belt - Alt. & Air Brake Compr.; W/37A., 61A. Alt.		②7541
Belt - Alt. & Air Brake Compr.; W/65A., 80A. Alt.	358344C91	②7560
Belt - P.S.	358335C91	②◆▲9490HD

② Two Required.

≠ Cut to Fit

◆ Standard Belt Available. See Pages 630-631.

● Vulco-Flex® Coolant Hose.

◆ Green Stripe® PowerBand® Belt May Work, Use Template to Check.

Belts and Coolant Hose for School Buses

Application	Mfr. Part No.	Our No.
INTERNATIONAL/NAVISTAR - Continued		
1976		
International/Navistar DT466 Diesel		
1853FC		
Hose - Upper		≈20682
Hose - Lower		≈21291
International/Navistar FTV549		
1603; 1703; 1803		
Belt - Fan	②◆◆9476HD	
Belt - Alt.; W/37A., 61A. Alt.	359006C91	②7417
Belt - Alt.; W/65A., 80A. Alt.	151531R2	②7450
Belt - Alt. & Air Brake Compr.; W/37A., 61A. Alt.		②7541
Belt - Alt. & Air Brake Compr.; W/65A., 80A. Alt.	358344C91	②7560
Belt - P.S.	358335C91	②◆◆9490HD
International/Navistar FTVS549		
1603; 1703; 1803		
Belt - Fan	②◆◆9476HD	
Belt - Alt.; W/37A., 61A. Alt.	359006C91	②7417
Belt - Alt.; W/65A., 80A. Alt.	151531R2	②7450
Belt - Alt. & Air Brake Compr.; W/37A., 61A. Alt.		②7541
Belt - Alt. & Air Brake Compr.; W/65A., 80A. Alt.	358344C91	②7560
Belt - P.S.	358335C91	②◆◆9490HD
International/Navistar MV404		
1723; 1823		
Belt - Fan & Alt.; W/A.P.	863751R2	②7580
Belt - Fan & Alt.; W/O A.P.	151532R2	②7512
Belt - P.S.	270094C2	◆9580HD
Belt - Air Brake Compr.; W/Front P.T.O.	379422C1	◆9540HD
Belt - Air Brake Compr.; W/O Front P.T.O.	261710C2	◆9570HD
Hose - Upper - To Center of Rad.		21132
		●26528
Hose - Upper - To Right Hand Side of Rad.		21133
		●26528
Hose - Lower; W/Auto. Trans.		●26532
Hose - Lower; W/Man. Trans.		21129
International/Navistar MV446		
1723; 1823		
Belt - Fan & Alt.; W/A.P.	863751R2	②7580
Belt - Fan & Alt.; W/O A.P.	151532R2	②7512
Belt - P.S.	270094C2	◆9580HD
Belt - Air Brake Compr.; W/Front P.T.O.	379422C1	◆9540HD
Belt - Air Brake Compr.; W/O Front P.T.O.	261710C2	◆9570HD
Hose - Upper - To Center of Rad.		21132
		●26528
Hose - Upper - To Right Hand Side of Rad.		21133
		●26528
Hose - Lower; W/Auto. Trans.		●26532
Hose - Lower; W/Man. Trans.		21129
International/Navistar RD372		
1823		
Belt - Fan & Alt.	359014C91	②TR22514
Belt - W.P. & Alt.; W/37A. Alt.; Chassis No.		
FD61626 & Before	193826R11	②TR22508
Belt - W.P. & Alt.; W/37A. Alt.; Chassis No.		
FD61626 & Up & G Chassis No.	223794R11	②TR22514
Belt - W.P. & Alt.; W/60A. Alt.	243604R11	②TR22517
Belt - P.S.	240354R2	TR22336
Belt - Air Brake Compr.; W/Wagner Compr. ...	92836HA	TR32491
Belt - Air Brake Compr.; W/Westinghouse Compr.	83816HA	TR34467
International/Navistar RD406		
1823		
Belt - Fan & Alt.	359014C91	②TR22514
Belt - W.P. & Alt.; W/37A. Alt.; Chassis No.		
FD61626 & Before	193826R11	②TR22508
Belt - W.P. & Alt.; W/37A. Alt.; Chassis No.		
FD61626 & Up & G Chassis No.	223794R11	②TR22514
Belt - W.P. & Alt.; W/60A. Alt.	243604R11	②TR22517
Belt - P.S.	240354R2	TR22336

≈ Cut to Fit.
 ◆ Green Stripe® PowerBand® Belt May Work, Use Template to Check.
 ● Vulco-Flex® Coolant Hose.

Application	Mfr. Part No.	Our No.
INTERNATIONAL/NAVISTAR - Continued		
1976 - Continued		
International/Navistar RD406 - Continued		
1823 - Continued		
Belt - Air Brake Compr.; W/Wagner Compr. ...	92836HA	TR32491
Belt - Air Brake Compr.; W/Westinghouse Compr.	83816HA	TR34467
International/Navistar RD450		
1823		
Belt - Fan & Alt.	359014C91	②TR22514
Belt - W.P. & Alt.; W/37A. Alt.; Chassis No.		
FD61626 & Before	193826R11	②TR22508
Belt - W.P. & Alt.; W/37A. Alt.; Chassis No.		
FD61626 & Up & G Chassis No.	223794R11	②TR22514
Belt - W.P. & Alt.; W/60A. Alt.	243604R11	②TR22517
Belt - P.S.	240354R2	TR22336
Belt - Air Brake Compr.; W/Wagner Compr. ...	92836HA	TR32491
Belt - Air Brake Compr.; W/Westinghouse Compr.	83816HA	TR34467
International/Navistar RD501		
1823		
Belt - Fan & Alt.	359014C91	②TR22514
Belt - W.P. & Alt.; W/37A. Alt.; Chassis No.		
FD61626 & Before	193826R11	②TR22508
Belt - W.P. & Alt.; W/37A. Alt.; Chassis No.		
FD61626 & Up & G Chassis No.	223794R11	②TR22514
Belt - W.P. & Alt.; W/60A. Alt.	243604R11	②TR22517
Belt - P.S.	240354R2	TR22336
Belt - Air Brake Compr.; W/Wagner Compr. ...	92836HA	TR32491
Belt - Air Brake Compr.; W/Westinghouse Compr.	83816HA	TR34467
International/Navistar V266		
1603; 1703; 1803		
Belt - Fan & Alt.; W/37A., 52A., 61A. Alt.; C, G, H Chassis		②7603
Belt - Fan & Alt.; W/37A., 52A., 61A. Alt.; FD, SB Chassis	255266C3	②7640
Belt - Fan & Alt.; W/55A., 62A. Alt.; C, G, H Chassis		
Chassis	369725C91	②7619
Belt - Fan & Alt.; W/55A., 62A. Alt.; FD, SB Chassis		
Chassis	358998C91	②7650
Belt - P.S.; W/2WD	151529R2	7440
Belt - P.S.; W/4WD	151531R2	7450
Belt - Air Brake Compr.	236572R2	7460
Hose - Upper; W/Rad. Shutters; W/Metal Hood		●26515
Hose - Upper; W/O Rad. Shutters; W/Metal Hood		20493
Hose - Lower - Eng. To Pipe; W/Auto. Trans.		20532
Hose - Lower; W/Man. Trans.		21308
Hose - By Pass		≈20357
International/Navistar V304		
1603; 1703; 1803		
Belt - Fan & Alt.; W/37A., 52A., 61A. Alt.; C, G, H Chassis		②7603
Belt - Fan & Alt.; W/37A., 52A., 61A. Alt.; FD, SB Chassis		
Chassis	255266C3	②7640
Belt - Fan & Alt.; W/55A., 62A. Alt.; C, G, H Chassis		
Chassis	369725C91	②7619
Belt - Fan & Alt.; W/55A., 62A. Alt.; FD, SB Chassis		
Chassis	358998C91	②7650
Belt - P.S.; W/2WD	151529R2	7440
Belt - P.S.; W/4WD	151531R2	7450
Belt - Air Brake Compr.	236572R2	7460
Hose - Upper; W/Rad. Shutters; W/Metal Hood		●26515
Hose - Upper; W/O Rad. Shutters; W/Metal Hood		20493
Hose - Lower - Eng. To Pipe; W/Auto. Trans.		20532
Hose - Lower; W/Man. Trans.		21308
Hose - By Pass		≈20357
International/Navistar V345		
1603; 1703		
Belt - Fan & Alt.; W/37A., 52A., 61A. Alt.; C, G, H Chassis; W/P.T.O.	968815R11	②7650
Belt - Fan & Alt.; W/37A., 52A., 61A. Alt.; C, G, H Chassis; W/O P.T.O.	373457C91	②7612

② Two Required.
 ◆ Standard Belt Available. See Pages 630-631.

School Buses

Belts and Coolant Hose for School Buses

School Buses

Application	Mfr. Part No.	Our No.
INTERNATIONAL/NAVISTAR - Continued		
1976 - Continued		
International/Navistar V345 - Continued		
1603; 1703 - Continued		
Belt - Fan & Alt.; W/37A., 52A., 61A. Alt.; FD, SB Chassis	968815R1	②7650
Belt - Fan & Alt.; W/37A., 61A. Alt.; W/O Air Brakes; W/O P.T.O.; W/O X.C.	373456C1	7612
Belt - Fan & Alt.; W/55A., 62A. Alt.; C, G, H Chassis	369723C91	②7630
Belt - Fan & Alt.; W/55A., 62A. Alt.; FD, SB Chassis	361975C91	②7673
Belt - Fan & Alt.; W/60A. Alt.	359009C91	②7680
Belt - Fan & Alt.; W/65A., 80A., 105A., 145A. Alt.; W/P.T.O.	361975C91	②7673
Belt - Fan & Alt.; W/65A., 80A., 105A., 145A. Alt.; W/O P.T.O.	7460	②7630
Belt - P.S.; W/2WD	7435	7460
Belt - P.S.; W/4WD	285522C2	7435
Belt - Air Brake Compr.	359007C91	7475
Belt - A.P.; W/Air Brakes; W/Gov.	388139C1	7330
Belt - A.P.; W/Air Brakes; W/O Gov.	256062C2	7340
Belt - A.P.; W/Hyd. Brakes; W/Gov.	355653C91	7380
Belt - A.P.; W/Hyd. Brakes; W/O Gov.	362887C91	7410
Hose - Upper; W/Rad. Shutters; W/Metal Hood	●26515	20493
Hose - Upper; W/O Rad. Shutters; W/Metal Hood	20493	20532
Hose - Lower - Eng. To Pipe; W/Auto. Trans.	21308	②20357
Hose - Lower; W/Man. Trans.	21308	②20357
Hose - By Pass	②20357	②20357
1723		
Belt - Fan & Alt.; W/37A., 52A., 61A. Alt.; C, G, H Chassis; W/P.T.O.	968815R11	②7650
Belt - Fan & Alt.; W/37A., 52A., 61A. Alt.; C, G, H Chassis; W/O P.T.O.	373457C91	②7612
Belt - Fan & Alt.; W/37A., 52A., 61A. Alt.; FD, SB Chassis	968815R1	②7650
Belt - Fan & Alt.; W/37A., 61A. Alt.; W/O Air Brakes; W/O P.T.O.; W/O X.C.	373456C1	7612
Belt - Fan & Alt.; W/55A., 62A. Alt.; C, G, H Chassis	369723C91	②7630
Belt - Fan & Alt.; W/55A., 62A. Alt.; FD, SB Chassis	361975C91	②7673
Belt - Fan & Alt.; W/60A. Alt.	359009C91	②7680
Belt - Fan & Alt.; W/65A., 80A., 105A., 145A. Alt.; W/P.T.O.	361975C91	②7673
Belt - Fan & Alt.; W/65A., 80A., 105A., 145A. Alt.; W/O P.T.O.	7460	②7630
Belt - P.S.; W/2WD	7435	7460
Belt - P.S.; W/4WD	285522C2	7435
Belt - Air Brake Compr.	359007C91	7475
Belt - A.P.; W/Air Brakes; W/Gov.	388139C1	7330
Belt - A.P.; W/Air Brakes; W/O Gov.	256062C2	7340
Belt - A.P.; W/Hyd. Brakes; W/Gov.	355653C91	7380
Belt - A.P.; W/Hyd. Brakes; W/O Gov.	362887C91	7410
1803		
Belt - Fan & Alt.; W/37A., 52A., 61A. Alt.; C, G, H Chassis; W/P.T.O.	968815R11	②7650
Belt - Fan & Alt.; W/37A., 52A., 61A. Alt.; C, G, H Chassis; W/O P.T.O.	373457C91	②7612
Belt - Fan & Alt.; W/37A., 52A., 61A. Alt.; FD, SB Chassis	968815R1	②7650
Belt - Fan & Alt.; W/37A., 61A. Alt.; W/O Air Brakes; W/O P.T.O.; W/O X.C.	373456C1	7612
Belt - Fan & Alt.; W/55A., 62A. Alt.; C, G, H Chassis	369723C91	②7630
Belt - Fan & Alt.; W/55A., 62A. Alt.; FD, SB Chassis	361975C91	②7673
Belt - Fan & Alt.; W/60A. Alt.	359009C91	②7680
Belt - Fan & Alt.; W/65A., 80A., 105A., 145A. Alt.; W/P.T.O.	361975C91	②7673
Belt - Fan & Alt.; W/65A., 80A., 105A., 145A. Alt.; W/O P.T.O.	7460	②7630
Belt - P.S.; W/2WD	7435	7460
Belt - P.S.; W/4WD	285522C2	7435
Belt - Air Brake Compr.	359007C91	7475
Belt - A.P.; W/Air Brakes; W/Gov.	388139C1	7330
Belt - A.P.; W/Air Brakes; W/O Gov.	256062C2	7340
Belt - A.P.; W/Hyd. Brakes; W/Gov.	355653C91	7380
Belt - A.P.; W/Hyd. Brakes; W/O Gov.	362887C91	7410

Application	Mfr. Part No.	Our No.
INTERNATIONAL/NAVISTAR - Continued		
1976 - Continued		
International/Navistar V345 - Continued		
1803 - Continued		
Belt - A.P.; W/Hyd. Brakes; W/O Gov.	362887C91	7410
Hose - Upper; W/Rad. Shutters; W/Metal Hood	●26515	20493
Hose - Upper; W/O Rad. Shutters; W/Metal Hood	20493	20532
Hose - Lower - Eng. To Pipe; W/Auto. Trans.	21308	②20357
Hose - Lower; W/Man. Trans.	21308	②20357
Hose - By Pass	②20357	②20357
1823		
Belt - Fan & Alt.; W/37A., 52A., 61A. Alt.; C, G, H Chassis; W/P.T.O.	968815R11	②7650
Belt - Fan & Alt.; W/37A., 52A., 61A. Alt.; C, G, H Chassis; W/O P.T.O.	373457C91	②7612
Belt - Fan & Alt.; W/37A., 52A., 61A. Alt.; FD, SB Chassis	968815R1	②7650
Belt - Fan & Alt.; W/37A., 61A. Alt.; W/O Air Brakes; W/O P.T.O.; W/O X.C.	373456C1	7612
Belt - Fan & Alt.; W/55A., 62A. Alt.; C, G, H Chassis	369723C91	②7630
Belt - Fan & Alt.; W/55A., 62A. Alt.; FD, SB Chassis	361975C91	②7673
Belt - Fan & Alt.; W/60A. Alt.	359009C91	②7680
Belt - Fan & Alt.; W/65A., 80A., 105A., 145A. Alt.; W/P.T.O.	361975C91	②7673
Belt - Fan & Alt.; W/65A., 80A., 105A., 145A. Alt.; W/O P.T.O.	7460	②7630
Belt - P.S.; W/2WD	7435	7460
Belt - P.S.; W/4WD	285522C2	7435
Belt - Air Brake Compr.	359007C91	7475
Belt - A.P.; W/Air Brakes; W/Gov.	388139C1	7330
Belt - A.P.; W/Air Brakes; W/O Gov.	256062C2	7340
Belt - A.P.; W/Hyd. Brakes; W/Gov.	355653C91	7380
Belt - A.P.; W/Hyd. Brakes; W/O Gov.	362887C91	7410
International/Navistar V392		
1603; 1703		
Belt - Fan & Alt.; W/37A., 52A., 61A. Alt.; C, G, H Chassis; W/P.T.O.	968815R11	②7650
Belt - Fan & Alt.; W/37A., 52A., 61A. Alt.; C, G, H Chassis; W/O P.T.O.	373457C91	②7612
Belt - Fan & Alt.; W/37A., 52A., 61A. Alt.; FD, SB Chassis	968815R1	②7650
Belt - Fan & Alt.; W/37A., 61A. Alt.; W/O Air Brakes; W/O P.T.O.; W/O X.C.	373456C1	7612
Belt - Fan & Alt.; W/55A., 62A. Alt.; C, G, H Chassis	369723C91	②7630
Belt - Fan & Alt.; W/55A., 62A. Alt.; FD, SB Chassis	361975C91	②7673
Belt - Fan & Alt.; W/60A. Alt.	359009C91	②7680
Belt - Fan & Alt.; W/65A., 80A., 105A., 145A. Alt.; W/P.T.O.	361975C91	②7673
Belt - Fan & Alt.; W/65A., 80A., 105A., 145A. Alt.; W/O P.T.O.	7460	②7630
Belt - P.S.; W/2WD	7435	7460
Belt - P.S.; W/4WD	285522C2	7435
Belt - Air Brake Compr.	359007C91	7475
Belt - A.P.; W/Air Brakes; W/Gov.	388139C1	7330
Belt - A.P.; W/Air Brakes; W/O Gov.	256062C2	7340
Belt - A.P.; W/Hyd. Brakes; W/Gov.	355653C91	7380
Belt - A.P.; W/Hyd. Brakes; W/O Gov.	362887C91	7410
Hose - Upper; W/Rad. Shutters; W/Metal Hood	●26515	20493
Hose - Upper; W/O Rad. Shutters; W/Metal Hood	20493	20532
Hose - Lower - Eng. To Pipe; W/Auto. Trans.	21308	②20357
Hose - Lower; W/Man. Trans.	21308	②20357
Hose - By Pass	②20357	②20357
1723		
Belt - Fan & Alt.; W/37A., 52A., 61A. Alt.; C, G, H Chassis; W/P.T.O.	968815R11	②7650
Belt - Fan & Alt.; W/37A., 52A., 61A. Alt.; C, G, H Chassis; W/O P.T.O.	373457C91	②7612
Belt - Fan & Alt.; W/37A., 52A., 61A. Alt.; FD, SB Chassis	968815R1	②7650
Belt - Fan & Alt.; W/37A., 61A. Alt.; W/O Air Brakes; W/O P.T.O.; W/O X.C.	373456C1	7612

② Two Required.
 ⓧ Cut to Fit.

● Vulco-Flex® Coolant Hose.

Belts and Coolant Hose for School Buses

Application	Mfr. Part No.	Our No.	Application	Mfr. Part No.	Our No.
INTERNATIONAL/NAVISTAR - Continued			INTERNATIONAL/NAVISTAR - Continued		
1976 - Continued			1976 - Continued		
International/Navistar V392 - Continued			International/Navistar V401		
1723 - Continued			1603; 1703 ; 1803		
Belt - Fan & Alt.; W/55A., 62A. Alt.; C, G, H			Belt - Fan	②◆◆9476HD	
Chassis	369723C91	②7630	Belt - Alt.; W/37A., 61A. Alt.	359006C91	②7417
Belt - Fan & Alt.; W/55A., 62A. Alt.; FD, SB			Belt - Alt.; W/65A., 80A. Alt.	151531R2	②7450
Chassis	361975C91	②7673	Belt - Alt. & Air Brake Compr.; W/37A., 61A. Alt.		②7541
Belt - Fan & Alt.; W/60A. Alt.	359009C91	②7680	Belt - Alt. & Air Brake Compr.; W/65A., 80A.		
Belt - Fan & Alt.; W/65A., 80A., 105A., 145A.			Alt.	358344C91	②7560
Alt.; W/P.T.O.	361975C91	②7673	Belt - P.S.	358335C91	②◆◆9490HD
Belt - Fan & Alt.; W/65A., 80A., 105A., 145A. Alt.; W/O P.T.O.		②7630			
Belt - P.S.; W/2WD		7460	International/Navistar V461		
Belt - P.S.; W/4WD	285522C2	7435	1603; 1703 ; 1803		
Belt - Air Brake Compr.	359007C91	7475	Belt - Fan	②◆◆9476HD	
Belt - A.P.; W/Air Brakes; W/Gov.	388139C1	7330	Belt - Alt.; W/37A., 61A. Alt.	359006C91	②7417
Belt - A.P.; W/Air Brakes; W/O Gov.	256062C2	7340	Belt - Alt.; W/65A., 80A. Alt.	151531R2	②7450
Belt - A.P.; W/Hyd. Brakes; W/Gov.	355653C91	7380	Belt - Alt. & Air Brake Compr.; W/37A., 61A. Alt.		②7541
Belt - A.P.; W/Hyd. Brakes; W/O Gov.	362887C91	7410	Belt - Alt. & Air Brake Compr.; W/65A., 80A.		
			Alt.	358344C91	②7560
1803			Belt - P.S.	358335C91	②◆◆9490HD
Belt - Fan & Alt.; W/37A., 52A., 61A. Alt.; C, G, H Chassis; W/P.T.O.	968815R11	②7650	International/Navistar V478		
Belt - Fan & Alt.; W/37A., 52A., 61A. Alt.; C, G, H Chassis; W/O P.T.O.	373457C91	②7612	1603; 1703 ; 1803		
Belt - Fan & Alt.; W/37A., 52A., 61A. Alt.; FD, SB Chassis	968815R1	②7650	Belt - Fan	②◆◆9476HD	
Belt - Fan & Alt.; W/37A., 61A. Alt.; W/O Air Brakes; W/O P.T.O.; W/O X.C.	373456C1	7612	Belt - Alt.; W/37A., 61A. Alt.	359006C91	②7417
Belt - Fan & Alt.; W/55A., 62A. Alt.; C, G, H Chassis	369723C91	②7630	Belt - Alt.; W/65A., 80A. Alt.	151531R2	②7450
Belt - Fan & Alt.; W/55A., 62A. Alt.; FD, SB Chassis	361975C91	②7673	Belt - Alt. & Air Brake Compr.; W/37A., 61A. Alt.		②7541
Belt - Fan & Alt.; W/60A. Alt.	359009C91	②7680	Belt - Alt. & Air Brake Compr.; W/65A., 80A.		
Belt - Fan & Alt.; W/65A., 80A., 105A., 145A. Alt.; W/P.T.O.	361975C91	②7673	Alt.	358344C91	②7560
Belt - Fan & Alt.; W/65A., 80A., 105A., 145A. Alt.; W/O P.T.O.		②7630	Belt - P.S.	358335C91	②◆◆9490HD
Belt - P.S.; W/2WD		7460			
Belt - P.S.; W/4WD	285522C2	7435	International/Navistar V549		
Belt - Air Brake Compr.	359007C91	7475	1603; 1703 ; 1803		
Belt - A.P.; W/Air Brakes; W/Gov.	388139C1	7330	Belt - Fan	②◆◆9476HD	
Belt - A.P.; W/Air Brakes; W/O Gov.	256062C2	7340	Belt - Alt.; W/37A., 61A. Alt.	359006C91	②7417
Belt - A.P.; W/Hyd. Brakes; W/Gov.	355653C91	7380	Belt - Alt.; W/65A., 80A. Alt.	151531R2	②7450
Belt - A.P.; W/Hyd. Brakes; W/O Gov.	362887C91	7410	Belt - Alt. & Air Brake Compr.; W/37A., 61A. Alt.		②7541
Hose - Upper; W/Rad. Shutters; W/Metal Hood	●26515		Belt - Alt. & Air Brake Compr.; W/65A., 80A.		
Hose - Upper; W/O Rad. Shutters; W/Metal Hood	20493		Alt.	358344C91	②7560
Hose - Lower - Eng. To Pipe; W/Auto. Trans.	20532		Belt - P.S.	358335C91	②◆◆9490HD
Hose - Lower; W/Man. Trans.	21308				
Hose - By Pass	≈20357		International/Navistar VS401		
			1603; 1703 ; 1803		
1823			Belt - Fan	②◆◆9476HD	
Belt - Fan & Alt.; W/37A., 52A., 61A. Alt.; C, G, H Chassis; W/P.T.O.	968815R11	②7650	Belt - Alt.; W/37A., 61A. Alt.	359006C91	②7417
Belt - Fan & Alt.; W/37A., 52A., 61A. Alt.; C, G, H Chassis; W/O P.T.O.	373457C91	②7612	Belt - Alt.; W/65A., 80A. Alt.	151531R2	②7450
Belt - Fan & Alt.; W/37A., 52A., 61A. Alt.; FD, SB Chassis	968815R1	②7650	Belt - Alt. & Air Brake Compr.; W/37A., 61A. Alt.		②7541
Belt - Fan & Alt.; W/37A., 61A. Alt.; W/O Air Brakes; W/O P.T.O.; W/O X.C.	373456C1	7612	Belt - Alt. & Air Brake Compr.; W/65A., 80A.		
Belt - Fan & Alt.; W/55A., 62A. Alt.; C, G, H Chassis	369723C91	②7630	Alt.	358344C91	②7560
Belt - Fan & Alt.; W/55A., 62A. Alt.; FD, SB Chassis	361975C91	②7673	Belt - P.S.	358335C91	②◆◆9490HD
Belt - Fan & Alt.; W/60A. Alt.	359009C91	②7680			
Belt - Fan & Alt.; W/65A., 80A., 105A., 145A. Alt.; W/P.T.O.	361975C91	②7673	International/Navistar VS478		
Belt - Fan & Alt.; W/65A., 80A., 105A., 145A. Alt.; W/O P.T.O.		②7630	1603; 1703 ; 1803		
Belt - P.S.; W/2WD		7460	Belt - Fan	②◆◆9476HD	
Belt - P.S.; W/4WD	285522C2	7435	Belt - Alt.; W/37A., 61A. Alt.	359006C91	②7417
Belt - Air Brake Compr.	359007C91	7475	Belt - Alt.; W/65A., 80A. Alt.	151531R2	②7450
Belt - A.P.; W/Air Brakes; W/Gov.	388139C1	7330	Belt - Alt. & Air Brake Compr.; W/37A., 61A. Alt.		②7541
Belt - A.P.; W/Air Brakes; W/O Gov.	256062C2	7340	Belt - Alt. & Air Brake Compr.; W/65A., 80A.		
Belt - A.P.; W/Hyd. Brakes; W/Gov.	355653C91	7380	Alt.	358344C91	②7560
Belt - A.P.; W/Hyd. Brakes; W/O Gov.	362887C91	7410	Belt - P.S.	358335C91	②◆◆9490HD
			International/Navistar VS549		
			1603; 1703 ; 1803		
			Belt - Fan	②◆◆9476HD	
			Belt - Alt.; W/37A., 61A. Alt.	359006C91	②7417
			Belt - Alt.; W/65A., 80A. Alt.	151531R2	②7450
			Belt - Alt. & Air Brake Compr.; W/37A., 61A. Alt.		②7541
			Belt - Alt. & Air Brake Compr.; W/65A., 80A.		
			Alt.	358344C91	②7560
			Belt - P.S.	358335C91	②◆◆9490HD
			1975		
			Caterpillar 1145 Diesel		
			1853		
			Belt - Fan	426222C91	②◆◆9530HD
			Belt - Alt.; W/37A., 61A. Alt.	398601C91	②◆◆9440HD

② Two Required.
 ≈ Cut to Fit.
 ◆ Standard Belt Available. See Pages 630-631.

● Vulco-Flex® Coolant Hose.
 ◆ Green Stripe® PowerBand® Belt May Work, Use Template to Check.

School Buses

Belts and Coolant Hose for School Buses

School Buses

Application	Mfr. Part No.	Our No.
INTERNATIONAL/NAVISTAR - Continued		
1975 - Continued		
Caterpillar 1145 Diesel - Continued		
1853 - Continued		
Belt - Alt.; W/65A., 80A. Alt.	354029C91	②◆▲9476HD
Belt - Alt. & Air Brake Compr.; W/37A., 61A. Alt.		②▲9465HD
Belt - Alt. & Air Brake Compr.; W/65A., 80A. Alt.	427205C91	②◆▲9500HD
Belt - P.S.		▲9465HD
Hose - Upper		●26532
Caterpillar 1150 Diesel		
1853		
Belt - Fan	426222C91	②◆▲9530HD
Belt - Alt.; W/37A., 61A. Alt.	398601C91	②▲9440HD
Belt - Alt.; W/65A., 80A. Alt.	354029C91	②◆▲9476HD
Belt - Alt. & Air Brake Compr.; W/37A., 61A. Alt.		②▲9465HD
Belt - Alt. & Air Brake Compr.; W/65A., 80A. Alt.	427205C91	②◆▲9500HD
Belt - P.S.		▲9465HD
Hose - Upper		●26532
Caterpillar 1160 Diesel		
1853		
Belt - Fan	426222C91	②◆▲9530HD
Belt - Alt.; W/37A., 61A. Alt.	398601C91	②▲9440HD
Belt - Alt.; W/65A., 80A. Alt.	354029C91	②◆▲9476HD
Belt - Alt. & Air Brake Compr.; W/37A., 61A. Alt.		②▲9465HD
Belt - Alt. & Air Brake Compr.; W/65A., 80A. Alt.	427205C91	②◆▲9500HD
Belt - P.S.		▲9465HD
Hose - Upper		●26532
International/Navistar DT466 Diesel		
1853FC		
Hose - Upper		≡20682
Hose - Lower		≡21291
International/Navistar FTV549		
1603; 1703 ; 1803		
Belt - Fan		②◆▲9476HD
Belt - Alt.; W/37A., 61A. Alt.	359006C91	②7417
Belt - Alt.; W/65A., 80A. Alt.	151531R2	②7450
Belt - Alt. & Air Brake Compr.; W/37A., 61A. Alt.		②7541
Belt - Alt. & Air Brake Compr.; W/65A., 80A. Alt.	358344C91	②7560
Belt - P.S.	358335C91	②◆▲9490HD
International/Navistar FTVS549		
1603; 1703 ; 1803		
Belt - Fan		②◆▲9476HD
Belt - Alt.; W/37A., 61A. Alt.	359006C91	②7417
Belt - Alt.; W/65A., 80A. Alt.	151531R2	②7450
Belt - Alt. & Air Brake Compr.; W/37A., 61A. Alt.		②7541
Belt - Alt. & Air Brake Compr.; W/65A., 80A. Alt.	358344C91	②7560
Belt - P.S.	358335C91	②◆▲9490HD
International/Navistar MV404		
1723; 1823		
Hose - Upper - To Center of Rad.		21132
	or	●26528
Hose - Upper - To Right Hand Side of Rad.		21133
	or	●26528
Hose - Lower; W/Auto. Trans.		●26532
Hose - Lower; W/Man. Trans.		21129
International/Navistar MV446		
1723; 1823		
Hose - Upper - To Center of Rad.		21132
	or	●26528
Hose - Upper - To Right Hand Side of Rad.		21133
	or	●26528
Hose - Lower; W/Auto. Trans.		●26532
Hose - Lower; W/Man. Trans.		21129

Application	Mfr. Part No.	Our No.
INTERNATIONAL/NAVISTAR - Continued		
1975 - Continued		
International/Navistar RD372		
1823		
Belt - Fan & Alt.	359014C91	②TR22514
Belt - W.P. & Alt.; W/37A. Alt.; Chassis No. FD61626 & Before	193826R11	②TR22508
Belt - W.P. & Alt.; W/37A. Alt.; Chassis No. FD61626 & Up & G Chassis No.	223794R11	②TR22514
Belt - W.P. & Alt.; W/60A. Alt.	243604R11	②TR22517
Belt - P.S.	240354R2	TR22336
Belt - Air Brake Compr.; W/Wagner Compr. ..	92836HA	TR32491
Belt - Air Brake Compr.; W/Westinghouse Compr.	83816HA	TR34467
Hose - Upper		●26515
Hose - Lower; (2" I.D.)		24232
International/Navistar RD406		
1823		
Belt - Fan & Alt.	359014C91	②TR22514
Belt - W.P. & Alt.; W/37A. Alt.; Chassis No. FD61626 & Before	193826R11	②TR22508
Belt - W.P. & Alt.; W/37A. Alt.; Chassis No. FD61626 & Up & G Chassis No.	223794R11	②TR22514
Belt - W.P. & Alt.; W/60A. Alt.	243604R11	②TR22517
Belt - P.S.	240354R2	TR22336
Belt - Air Brake Compr.; W/Wagner Compr. ..	92836HA	TR32491
Belt - Air Brake Compr.; W/Westinghouse Compr.	83816HA	TR34467
Hose - Upper		●26515
Hose - Lower; (2" I.D.)		24232
International/Navistar RD450		
1823		
Belt - Fan & Alt.	359014C91	②TR22514
Belt - W.P. & Alt.; W/37A. Alt.; Chassis No. FD61626 & Before	193826R11	②TR22508
Belt - W.P. & Alt.; W/37A. Alt.; Chassis No. FD61626 & Up & G Chassis No.	223794R11	②TR22514
Belt - W.P. & Alt.; W/60A. Alt.	243604R11	②TR22517
Belt - P.S.	240354R2	TR22336
Belt - Air Brake Compr.; W/Wagner Compr. ..	92836HA	TR32491
Belt - Air Brake Compr.; W/Westinghouse Compr.	83816HA	TR34467
Hose - Upper		●26515
Hose - Lower; (2" I.D.)		24232
International/Navistar RD501		
1823		
Belt - Fan & Alt.	359014C91	②TR22514
Belt - W.P. & Alt.; W/37A. Alt.; Chassis No. FD61626 & Before	193826R11	②TR22508
Belt - W.P. & Alt.; W/37A. Alt.; Chassis No. FD61626 & Up & G Chassis No.	223794R11	②TR22514
Belt - W.P. & Alt.; W/60A. Alt.	243604R11	②TR22517
Belt - P.S.	240354R2	TR22336
Belt - Air Brake Compr.; W/Wagner Compr. ..	92836HA	TR32491
Belt - Air Brake Compr.; W/Westinghouse Compr.	83816HA	TR34467
Hose - Upper		●26515
Hose - Lower; (2" I.D.)		24232
International/Navistar V266		
1603; 1703 ; 1803		
Belt - Fan & Alt.; W/37A., 52A., 61A. Alt.; C, G, H Chassis		②7603
Belt - Fan & Alt.; W/37A., 52A., 61A. Alt.; FD, SB Chassis	255266C3	②7640
Belt - Fan & Alt.; W/55A., 62A. Alt.; C, G, H Chassis	369725C91	②7619
Belt - Fan & Alt.; W/55A., 62A. Alt.; FD, SB Chassis	358998C91	②7650
Belt - P.S.; W/2WD	151529R2	7440
Belt - P.S.; W/4WD	151531R2	7450
Belt - Air Brake Compr.	236572R2	7460
Hose - Upper; W/Rad. Shutters; W/Metal Hood		●26515
Hose - Upper; W/O Rad. Shutters; W/Metal Hood		20493
Hose - Lower - Eng. To Pipe; W/Auto. Trans.		20532

② Two Required.

▲ Standard Belt Available. See Pages 630-631.

≡ Cut to Fit.

◆ Green Stripe® PowerBand® Belt May Work, Use Template to Check.

● Vulco-Flex® Coolant Hose.

Belts and Coolant Hose for School Buses

Application	Mfr. Part No.	Our No.	Application	Mfr. Part No.	Our No.
INTERNATIONAL/NAVISTAR - Continued			INTERNATIONAL/NAVISTAR - Continued		
1975 - Continued			1975 - Continued		
International/Navistar V266 - Continued			International/Navistar V345 - Continued		
1603; 1703 ; 1803 - Continued			1723 - Continued		
Hose - Lower; W/Man. Trans.		21308	Belt - A.P.; W/Air Brakes; W/O Gov.	256062C2	7340
Hose - By Pass		≈20357	Belt - A.P.; W/Hyd. Brakes; W/Gov.	355653C91	7380
International/Navistar V304			Belt - A.P.; W/Hyd. Brakes; W/O Gov.	362887C91	7410
1603; 1703 ; 1803			1803		
Belt - Fan & Alt.; W/37A., 52A., 61A. Alt.; C, G, H Chassis	255266C3	27603	Belt - Fan & Alt.; W/37A., 52A., 61A. Alt.; C, G, H Chassis; W/P.T.O.	968815R11	27650
Belt - Fan & Alt.; W/37A., 52A., 61A. Alt.; FD, SB Chassis	369725C91	27640	Belt - Fan & Alt.; W/37A., 52A., 61A. Alt.; C, G, H Chassis; W/O P.T.O.	373457C91	27612
Belt - Fan & Alt.; W/55A., 62A. Alt.; C, G, H Chassis	358998C91	27619	Belt - Fan & Alt.; W/37A., 52A., 61A. Alt.; FD, SB Chassis	968815R1	27650
Belt - Fan & Alt.; W/55A., 62A. Alt.; FD, SB Chassis	151529R2	27650	Belt - Fan & Alt.; W/37A., 61A. Alt.; W/O Air Brakes; W/O P.T.O.; W/O X.C.	373456C1	7612
Belt - P.S.; W/2WD	151531R2	7440	Belt - Fan & Alt.; W/55A., 62A. Alt.; C, G, H Chassis	369723C91	27630
Belt - P.S.; W/4WD	236572R2	7450	Belt - Fan & Alt.; W/55A., 62A. Alt.; FD, SB Chassis	361975C91	27673
Belt - Air Brake Compr.		7460	Belt - Fan & Alt.; W/60A. Alt.	359009C91	27680
Hose - Upper; W/Rad. Shutters; W/Metal Hood		●26515	Belt - Fan & Alt.; W/65A., 80A., 105A., 145A. Alt.; W/P.T.O.	361975C91	27673
Hose - Upper; W/O Rad. Shutters; W/Metal Hood		20493	Belt - Fan & Alt.; W/65A., 80A., 105A., 145A. Alt.; W/O P.T.O.		27630
Hose - Lower - Eng. To Pipe; W/Auto. Trans.		20532	Belt - P.S.; W/2WD	285522C2	7460
Hose - Lower; W/Man. Trans.		21308	Belt - P.S.; W/4WD	285522C2	7435
Hose - By Pass		≈20357	Belt - Air Brake Compr.	359007C91	7475
International/Navistar V345			Belt - A.P.; W/Air Brakes; W/Gov.	388139C1	7330
1603; 1703			Belt - A.P.; W/Air Brakes; W/O Gov.	256062C2	7340
Belt - Fan & Alt.; W/37A., 52A., 61A. Alt.; C, G, H Chassis; W/P.T.O.	968815R11	27650	Belt - A.P.; W/Hyd. Brakes; W/Gov.	355653C91	7380
Belt - Fan & Alt.; W/37A., 52A., 61A. Alt.; C, G, H Chassis; W/O P.T.O.	373457C91	27612	Belt - A.P.; W/Hyd. Brakes; W/O Gov.	362887C91	7410
Belt - Fan & Alt.; W/37A., 52A., 61A. Alt.; FD, SB Chassis	968815R1	27650	Hose - Upper; W/Rad. Shutters; W/Metal Hood		●26515
Belt - Fan & Alt.; W/37A., 61A. Alt.; W/O Air Brakes; W/O P.T.O.; W/O X.C.	373456C1	7612	Hose - Upper; W/O Rad. Shutters; W/Metal Hood		20493
Belt - Fan & Alt.; W/55A., 62A. Alt.; C, G, H Chassis	369723C91	27630	Hose - Lower - Eng. To Pipe; W/Auto. Trans.		20532
Belt - Fan & Alt.; W/55A., 62A. Alt.; FD, SB Chassis	361975C91	27673	Hose - Lower; W/Man. Trans.		21308
Belt - Fan & Alt.; W/60A. Alt.	359009C91	27680	Hose - By Pass		≈20357
Belt - Fan & Alt.; W/65A., 80A., 105A., 145A. Alt.; W/P.T.O.	361975C91	27673	1823		
Belt - Fan & Alt.; W/65A., 80A., 105A., 145A. Alt.; W/O P.T.O.		27630	Belt - Fan & Alt.; W/37A., 52A., 61A. Alt.; C, G, H Chassis; W/P.T.O.	968815R11	27650
Belt - P.S.; W/2WD	7460		Belt - Fan & Alt.; W/37A., 52A., 61A. Alt.; C, G, H Chassis; W/O P.T.O.	373457C91	27612
Belt - P.S.; W/4WD	285522C2	7435	Belt - Fan & Alt.; W/37A., 52A., 61A. Alt.; FD, SB Chassis	968815R1	27650
Belt - Air Brake Compr.	359007C91	7475	Belt - Fan & Alt.; W/37A., 61A. Alt.; W/O Air Brakes; W/O P.T.O.; W/O X.C.	373456C1	7612
Belt - A.P.; W/Air Brakes; W/Gov.	388139C1	7330	Belt - Fan & Alt.; W/55A., 62A. Alt.; C, G, H Chassis	369723C91	27630
Belt - A.P.; W/Air Brakes; W/O Gov.	256062C2	7340	Belt - Fan & Alt.; W/55A., 62A. Alt.; FD, SB Chassis	361975C91	27673
Belt - A.P.; W/Hyd. Brakes; W/Gov.	355653C91	7380	Belt - Fan & Alt.; W/60A. Alt.	359009C91	27680
Belt - A.P.; W/Hyd. Brakes; W/O Gov.	362887C91	7410	Belt - Fan & Alt.; W/65A., 80A., 105A., 145A. Alt.; W/P.T.O.	361975C91	27673
Hose - Upper; W/Rad. Shutters; W/Metal Hood		●26515	Belt - Fan & Alt.; W/65A., 80A., 105A., 145A. Alt.; W/O P.T.O.		27630
Hose - Upper; W/O Rad. Shutters; W/Metal Hood		20493	Belt - P.S.; W/2WD	285522C2	7460
Hose - Lower - Eng. To Pipe; W/Auto. Trans.		20532	Belt - P.S.; W/4WD	285522C2	7435
Hose - Lower; W/Man. Trans.		21308	Belt - Air Brake Compr.	359007C91	7475
Hose - By Pass		≈20357	Belt - A.P.; W/Air Brakes; W/Gov.	388139C1	7330
1723			International/Navistar V392		
Belt - Fan & Alt.; W/37A., 52A., 61A. Alt.; C, G, H Chassis; W/P.T.O.	968815R11	27650	1603; 1703		
Belt - Fan & Alt.; W/37A., 52A., 61A. Alt.; C, G, H Chassis; W/O P.T.O.	373457C91	27612	Belt - Fan & Alt.; W/37A., 52A., 61A. Alt.; C, G, H Chassis; W/P.T.O.	968815R11	27650
Belt - Fan & Alt.; W/37A., 52A., 61A. Alt.; FD, SB Chassis	968815R1	27650	Belt - Fan & Alt.; W/37A., 52A., 61A. Alt.; C, G, H Chassis; W/O P.T.O.	373457C91	27612
Belt - Fan & Alt.; W/37A., 61A. Alt.; W/O Air Brakes; W/O P.T.O.; W/O X.C.	373456C1	7612	Belt - Fan & Alt.; W/37A., 52A., 61A. Alt.; FD, SB Chassis	968815R1	27650
Belt - Fan & Alt.; W/55A., 62A. Alt.; C, G, H Chassis	369723C91	27630	Belt - Fan & Alt.; W/37A., 61A. Alt.; W/O Air Brakes; W/O P.T.O.; W/O X.C.	373456C1	7612
Belt - Fan & Alt.; W/55A., 62A. Alt.; FD, SB Chassis	361975C91	27673	Belt - Fan & Alt.; W/55A., 62A. Alt.; C, G, H Chassis	369723C91	27630
Belt - Fan & Alt.; W/60A. Alt.	359009C91	27680	Belt - Fan & Alt.; W/55A., 62A. Alt.; FD, SB Chassis	361975C91	27673
Belt - Fan & Alt.; W/65A., 80A., 105A., 145A. Alt.; W/P.T.O.	361975C91	27673	1603; 1703		
Belt - Fan & Alt.; W/65A., 80A., 105A., 145A. Alt.; W/O P.T.O.		27630	Belt - Fan & Alt.; W/37A., 52A., 61A. Alt.; C, G, H Chassis; W/P.T.O.	968815R11	27650
Belt - P.S.; W/2WD	7460		Belt - Fan & Alt.; W/37A., 52A., 61A. Alt.; C, G, H Chassis; W/O P.T.O.	373457C91	27612
Belt - P.S.; W/4WD	285522C2	7435	Belt - Fan & Alt.; W/37A., 52A., 61A. Alt.; FD, SB Chassis	968815R1	27650
Belt - Air Brake Compr.	359007C91	7475	Belt - Fan & Alt.; W/37A., 61A. Alt.; W/O Air Brakes; W/O P.T.O.; W/O X.C.	373456C1	7612
Belt - A.P.; W/Air Brakes; W/Gov.	388139C1	7330	Belt - Fan & Alt.; W/55A., 62A. Alt.; C, G, H Chassis	369723C91	27630
Belt - A.P.; W/Air Brakes; W/O Gov.	256062C2	7340	Belt - Fan & Alt.; W/55A., 62A. Alt.; FD, SB Chassis	361975C91	27673
Belt - A.P.; W/Hyd. Brakes; W/Gov.	355653C91	7380	1603; 1703		
Belt - A.P.; W/Hyd. Brakes; W/O Gov.	362887C91	7410	Belt - Fan & Alt.; W/37A., 52A., 61A. Alt.; C, G, H Chassis; W/P.T.O.	968815R11	27650

≈ Cut to Fit.
● Vulco-Flex® Coolant Hose.

② Two Required.

School Buses

Belts and Coolant Hose for School Buses

School Buses

Application	Mfr. Part No.	Our No.
INTERNATIONAL/NAVISTAR - Continued		
1975 - Continued		
International/Navistar V392 - Continued		
1603; 1703 - Continued		
Belt - Fan & Alt.; W/60A. Alt.	359009C91	②7680
Belt - Fan & Alt.; W/65A., 80A., 105A., 145A. Alt.; W/P.T.O.	361975C91	②7673
Belt - P.S.; W/2WD	285522C2	7460
Belt - P.S.; W/4WD	359007C91	7435
Belt - Air Brake Compr.	388139C1	7475
Belt - A.P.; W/Air Brakes; W/Gov.	256062C2	7330
Belt - A.P.; W/Air Brakes; W/O Gov.	355653C91	7340
Belt - A.P.; W/Hyd. Brakes; W/Gov.	362887C91	7380
Belt - A.P.; W/Hyd. Brakes; W/O Gov.		7410
Hose - Upper; W/Rad. Shutters; W/Metal Hood		●26515
Hose - Upper; W/O Rad. Shutters; W/Metal Hood		20493
Hose - Lower - Eng. To Pipe; W/Auto. Trans.		20532
Hose - Lower; W/Man. Trans.		21308
Hose - By Pass		≠20357
1723		
Belt - Fan & Alt.; W/37A., 52A., 61A. Alt.; C, G, H Chassis; W/P.T.O.	968815R11	②7650
Belt - Fan & Alt.; W/37A., 52A., 61A. Alt.; C, G, H Chassis; W/O P.T.O.	373457C91	②7612
Belt - Fan & Alt.; W/37A., 52A., 61A. Alt.; FD, SB Chassis	968815R1	②7650
Belt - Fan & Alt.; W/37A., 61A. Alt.; W/O Air Brakes; W/O P.T.O.; W/O X.C.	373456C1	7612
Belt - Fan & Alt.; W/55A., 62A. Alt.; C, G, H Chassis	369723C91	②7630
Belt - Fan & Alt.; W/55A., 62A. Alt.; FD, SB Chassis	361975C91	②7673
Belt - Fan & Alt.; W/60A. Alt.	359009C91	②7680
Belt - Fan & Alt.; W/65A., 80A., 105A., 145A. Alt.; W/P.T.O.	361975C91	②7673
Belt - Fan & Alt.; W/65A., 80A., 105A., 145A. Alt.; W/O P.T.O.	361975C91	②7630
Belt - P.S.; W/2WD	285522C2	7460
Belt - P.S.; W/4WD	285522C2	7435
Belt - Air Brake Compr.	359007C91	7475
Belt - A.P.; W/Air Brakes; W/Gov.	388139C1	7330
Belt - A.P.; W/Air Brakes; W/O Gov.	256062C2	7340
Belt - A.P.; W/Hyd. Brakes; W/Gov.	355653C91	7380
Belt - A.P.; W/Hyd. Brakes; W/O Gov.	362887C91	7410
1803		
Belt - Fan & Alt.; W/37A., 52A., 61A. Alt.; C, G, H Chassis; W/P.T.O.	968815R11	②7650
Belt - Fan & Alt.; W/37A., 52A., 61A. Alt.; C, G, H Chassis; W/O P.T.O.	373457C91	②7612
Belt - Fan & Alt.; W/37A., 52A., 61A. Alt.; FD, SB Chassis	968815R1	②7650
Belt - Fan & Alt.; W/37A., 61A. Alt.; W/O Air Brakes; W/O P.T.O.; W/O X.C.	373456C1	7612
Belt - Fan & Alt.; W/55A., 62A. Alt.; C, G, H Chassis	369723C91	②7630
Belt - Fan & Alt.; W/55A., 62A. Alt.; FD, SB Chassis	361975C91	②7673
Belt - Fan & Alt.; W/60A. Alt.	359009C91	②7680
Belt - Fan & Alt.; W/65A., 80A., 105A., 145A. Alt.; W/P.T.O.	361975C91	②7673
Belt - Fan & Alt.; W/65A., 80A., 105A., 145A. Alt.; W/O P.T.O.	361975C91	②7630
Belt - P.S.; W/2WD	285522C2	7460
Belt - P.S.; W/4WD	285522C2	7435
Belt - Air Brake Compr.	359007C91	7475
Belt - A.P.; W/Air Brakes; W/Gov.	388139C1	7330
Belt - A.P.; W/Air Brakes; W/O Gov.	256062C2	7340
Belt - A.P.; W/Hyd. Brakes; W/Gov.	355653C91	7380
Belt - A.P.; W/Hyd. Brakes; W/O Gov.	362887C91	7410
Hose - Upper; W/Rad. Shutters; W/Metal Hood		●26515
Hose - Upper; W/O Rad. Shutters; W/Metal Hood		20493
Hose - Lower - Eng. To Pipe; W/Auto. Trans.		20532
Hose - Lower; W/Man. Trans.		21308
Hose - By Pass		≠20357

Application	Mfr. Part No.	Our No.
INTERNATIONAL/NAVISTAR - Continued		
1975 - Continued		
International/Navistar V392 - Continued		
1823		
Belt - Fan & Alt.; W/37A., 52A., 61A. Alt.; C, G, H Chassis; W/P.T.O.	968815R11	②7650
Belt - Fan & Alt.; W/37A., 52A., 61A. Alt.; C, G, H Chassis; W/O P.T.O.	373457C91	②7612
Belt - Fan & Alt.; W/37A., 52A., 61A. Alt.; FD, SB Chassis	968815R1	②7650
Belt - Fan & Alt.; W/37A., 61A. Alt.; W/O Air Brakes; W/O P.T.O.; W/O X.C.	373456C1	7612
Belt - Fan & Alt.; W/55A., 62A. Alt.; C, G, H Chassis	369723C91	②7630
Belt - Fan & Alt.; W/55A., 62A. Alt.; FD, SB Chassis	361975C91	②7673
Belt - Fan & Alt.; W/60A. Alt.	359009C91	②7680
Belt - Fan & Alt.; W/65A., 80A., 105A., 145A. Alt.; W/P.T.O.	361975C91	②7673
Belt - Fan & Alt.; W/65A., 80A., 105A., 145A. Alt.; W/O P.T.O.	361975C91	②7630
Belt - P.S.; W/2WD	285522C2	7460
Belt - P.S.; W/4WD	285522C2	7435
Belt - Air Brake Compr.	359007C91	7475
Belt - A.P.; W/Air Brakes; W/Gov.	388139C1	7330
Belt - A.P.; W/Air Brakes; W/O Gov.	256062C2	7340
Belt - A.P.; W/Hyd. Brakes; W/Gov.	355653C91	7380
Belt - A.P.; W/Hyd. Brakes; W/O Gov.	362887C91	7410
International/Navistar V401		
1603; 1703; 1803		
Belt - Fan		②◆◆9476HD
Belt - Alt.; W/37A., 61A. Alt.	359006C91	②7417
Belt - Alt.; W/65A., 80A. Alt.	151531R2	②7450
Belt - Alt. & Air Brake Compr.; W/37A., 61A. Alt.		②7541
Belt - Alt. & Air Brake Compr.; W/65A., 80A. Alt.	358344C91	②7560
Belt - P.S.	358335C91	②◆◆9490HD
International/Navistar V461		
1603; 1703; 1803		
Belt - Fan		②◆◆9476HD
Belt - Alt.; W/37A., 61A. Alt.	359006C91	②7417
Belt - Alt.; W/65A., 80A. Alt.	151531R2	②7450
Belt - Alt. & Air Brake Compr.; W/37A., 61A. Alt.		②7541
Belt - Alt. & Air Brake Compr.; W/65A., 80A. Alt.	358344C91	②7560
Belt - P.S.	358335C91	②◆◆9490HD
International/Navistar V478		
1603; 1703; 1803		
Belt - Fan		②◆◆9476HD
Belt - Alt.; W/37A., 61A. Alt.	359006C91	②7417
Belt - Alt.; W/65A., 80A. Alt.	151531R2	②7450
Belt - Alt. & Air Brake Compr.; W/37A., 61A. Alt.		②7541
Belt - Alt. & Air Brake Compr.; W/65A., 80A. Alt.	358344C91	②7560
Belt - P.S.	358335C91	②◆◆9490HD
International/Navistar V549		
1603; 1703; 1803		
Belt - Fan		②◆◆9476HD
Belt - Alt.; W/37A., 61A. Alt.	359006C91	②7417
Belt - Alt.; W/65A., 80A. Alt.	151531R2	②7450
Belt - Alt. & Air Brake Compr.; W/37A., 61A. Alt.		②7541
Belt - Alt. & Air Brake Compr.; W/65A., 80A. Alt.	358344C91	②7560
Belt - P.S.	358335C91	②◆◆9490HD
International/Navistar VS401		
1603; 1703; 1803		
Belt - Fan		②◆◆9476HD
Belt - Alt.; W/37A., 61A. Alt.	359006C91	②7417
Belt - Alt.; W/65A., 80A. Alt.	151531R2	②7450
Belt - Alt. & Air Brake Compr.; W/37A., 61A. Alt.		②7541
Belt - Alt. & Air Brake Compr.; W/65A., 80A. Alt.	358344C91	②7560
Belt - P.S.	358335C91	②◆◆9490HD

② Two Required.

≠ Cut to Fit

◆ Standard Belt Available. See Pages 630-631.

● Vulco-Flex® Coolant Hose.

◆ Green Stripe® PowerBand® Belt May Work, Use Template to Check.

Belts and Coolant Hose for School Buses

Application	Mfr. Part No.	Our No.	Application	Mfr. Part No.	Our No.
INTERNATIONAL/NAVISTAR - Continued			INTERNATIONAL/NAVISTAR - Continued		
1975 - Continued			1974 - Continued		
International/Navistar VS478			International/Navistar FTVS549 - Continued		
1603; 1703; 1803			1603; 1703; 1803 - Continued		
Belt - Fan		②◆◆9476HD	Hose - Upper		●26531
Belt - Alt.; W/37A., 61A. Alt.	359006C91	②7417	Hose - Lower		≈<20530
Belt - Alt.; W/65A., 80A. Alt.	151531R2	②7450			
Belt - Alt. & Air Brake Compr.; W/37A., 61A. Alt.		②7541	International/Navistar RD372		
Belt - Alt. & Air Brake Compr.; W/65A., 80A. Alt.	358344C91	②7560	1823		
Belt - P.S.	358335C91	②◆◆9490HD	Belt - Fan & Alt.	359014C91	②TR22514
			Belt - W.P. & Alt.; W/37A. Alt.; Chassis No.		
International/Navistar VS549			FD61626 & Before	193826R11	②TR22508
1603; 1703; 1803			Belt - W.P. & Alt.; W/37A. Alt.; Chassis No.		
Belt - Fan		②◆◆9476HD	FD61626 & Up & G Chassis No.	223794R11	②TR22514
Belt - Alt.; W/37A., 61A. Alt.	359006C91	②7417	Belt - W.P. & Alt.; W/60A. Alt.	243604R11	②TR22517
Belt - Alt.; W/65A., 80A. Alt.	151531R2	②7450	Belt - P.S.	240354R2	TR22336
Belt - Alt. & Air Brake Compr.; W/37A., 61A. Alt.		②7541	Belt - Air Brake Compr.; W/Wagner Compr. ...	92836HA	TR32491
Belt - Alt. & Air Brake Compr.; W/65A., 80A. Alt.	358344C91	②7560	Belt - Air Brake Compr.; W/Westinghouse Compr.	83816HA	TR34467
Belt - P.S.	358335C91	②◆◆9490HD	Hose - Upper		●26515
			Hose - Lower; (2" I.D.)		24232
1974			International/Navistar RD406		
Caterpillar 1145 Diesel			1823		
1853			Belt - Fan & Alt.	359014C91	②TR22514
Belt - Fan	426222C91	②◆◆9530HD	Belt - W.P. & Alt.; W/37A. Alt.; Chassis No.		
Belt - Alt.; W/37A., 61A. Alt.	398601C91	②◆9440HD	FD61626 & Before	193826R11	②TR22508
Belt - Alt.; W/65A., 80A. Alt.	354029C91	②◆◆9476HD	Belt - W.P. & Alt.; W/37A. Alt.; Chassis No.		
Belt - Alt. & Air Brake Compr.; W/37A., 61A. Alt.		②◆9465HD	FD61626 & Up & G Chassis No.	223794R11	②TR22514
Belt - Alt. & Air Brake Compr.; W/65A., 80A. Alt.	427205C91	②◆◆9500HD	Belt - W.P. & Alt.; W/60A. Alt.	243604R11	②TR22517
Belt - P.S.		◆9465HD	Belt - P.S.	240354R2	TR22336
Hose - Upper		●26532	Belt - Air Brake Compr.; W/Wagner Compr. ...	92836HA	TR32491
			Belt - Air Brake Compr.; W/Westinghouse Compr.	83816HA	TR34467
Caterpillar 1150 Diesel			Hose - Upper		●26515
1853			Hose - Lower; (2" I.D.)		24232
Belt - Fan	426222C91	②◆◆9530HD	International/Navistar RD450		
Belt - Alt.; W/37A., 61A. Alt.	398601C91	②◆9440HD	1823		
Belt - Alt.; W/65A., 80A. Alt.	354029C91	②◆◆9476HD	Belt - Fan & Alt.	359014C91	②TR22514
Belt - Alt. & Air Brake Compr.; W/37A., 61A. Alt.		②◆9465HD	Belt - W.P. & Alt.; W/37A. Alt.; Chassis No.		
Belt - Alt. & Air Brake Compr.; W/65A., 80A. Alt.	427205C91	②◆◆9500HD	FD61626 & Before	193826R11	②TR22508
Belt - P.S.		◆9465HD	Belt - W.P. & Alt.; W/37A. Alt.; Chassis No.		
Hose - Upper		●26532	FD61626 & Up & G Chassis No.	223794R11	②TR22514
			Belt - W.P. & Alt.; W/60A. Alt.	243604R11	②TR22517
Caterpillar 1160 Diesel			Belt - P.S.	240354R2	TR22336
1853			Belt - Air Brake Compr.; W/Wagner Compr. ...	92836HA	TR32491
Belt - Fan	426222C91	②◆◆9530HD	Belt - Air Brake Compr.; W/Westinghouse Compr.	83816HA	TR34467
Belt - Alt.; W/37A., 61A. Alt.	398601C91	②◆9440HD	Hose - Upper		●26515
Belt - Alt.; W/65A., 80A. Alt.	354029C91	②◆◆9476HD	Hose - Lower; (2" I.D.)		24232
Belt - Alt. & Air Brake Compr.; W/37A., 61A. Alt.		②◆9465HD	International/Navistar RD501		
Belt - Alt. & Air Brake Compr.; W/65A., 80A. Alt.	427205C91	②◆◆9500HD	1823		
Belt - P.S.		◆9465HD	Belt - Fan & Alt.	359014C91	②TR22514
Hose - Upper		●26532	Belt - W.P. & Alt.; W/37A. Alt.; Chassis No.		
			FD61626 & Before	193826R11	②TR22508
International/Navistar FTV549			Belt - W.P. & Alt.; W/37A. Alt.; Chassis No.		
1603; 1703; 1803			FD61626 & Up & G Chassis No.	223794R11	②TR22514
Belt - Fan		②◆◆9476HD	Belt - W.P. & Alt.; W/60A. Alt.	243604R11	②TR22517
Belt - Alt.; W/37A., 61A. Alt.	359006C91	②7417	Belt - P.S.	240354R2	TR22336
Belt - Alt.; W/65A., 80A. Alt.	151531R2	②7450	Belt - Air Brake Compr.; W/Wagner Compr. ...	92836HA	TR32491
Belt - Alt. & Air Brake Compr.; W/37A., 61A. Alt.		②7541	Belt - Air Brake Compr.; W/Westinghouse Compr.	83816HA	TR34467
Belt - Alt. & Air Brake Compr.; W/65A., 80A. Alt.	358344C91	②7560	Hose - Upper		●26515
Belt - P.S.	358335C91	②◆◆9490HD	Hose - Lower; (2" I.D.)		24232
Hose - Upper		●26531	International/Navistar V266		
Hose - Lower		≈<20530	1603; 1703; 1803		
			Belt - Fan & Alt.; W/37A., 52A., 61A. Alt.; C, G, H Chassis		②7603
International/Navistar FTVS549			Belt - Fan & Alt.; W/37A., 52A., 61A. Alt.; FD, SB Chassis	255266C3	②7640
1603; 1703; 1803			Belt - Fan & Alt.; W/55A., 62A. Alt.; C, G, H Chassis	369725C91	②7619
Belt - Fan		②◆◆9476HD	Belt - Fan & Alt.; W/55A., 62A. Alt.; FD, SB Chassis	358998C91	②7650
Belt - Alt.; W/37A., 61A. Alt.	359006C91	②7417	Belt - P.S.; W/2WD	151529R2	7440
Belt - Alt.; W/65A., 80A. Alt.	151531R2	②7450			
Belt - Alt. & Air Brake Compr.; W/37A., 61A. Alt.		②7541			
Belt - Alt. & Air Brake Compr.; W/65A., 80A. Alt.	358344C91	②7560			
Belt - P.S.	358335C91	②◆◆9490HD			

② Two Required.
 ◆ Standard Belt Available. See Pages 630-631.
 ≈< Cut to Fit.

◆ Green Stripe® PowerBand® Belt May Work, Use Template to Check.
 ● Vulco-Flex® Coolant Hose.

School Buses

Belts and Coolant Hose for School Buses

School Buses

Application	Mfr. Part No.	Our No.
INTERNATIONAL/NAVISTAR - Continued		
1974 - Continued		
International/Navistar V266 - Continued		
1603; 1703; 1803 - Continued		
Belt - P.S.; W/4WD	151531R2	7450
Belt - Air Brake Compr.	236572R2	7460
Hose - Upper; W/Rad. Shutters; W/Metal Hood		●26515
Hose - Upper; W/O Rad. Shutters; W/Metal Hood		20493
Hose - Lower - Eng. To Pipe; W/Auto. Trans.		20532
Hose - Lower; W/Man. Trans.		21308
Hose - By Pass		≧20357
International/Navistar V304		
1603; 1703; 1803		
Belt - Fan & Alt.; W/37A., 52A., 61A. Alt.; C, G, H Chassis		②7603
Belt - Fan & Alt.; W/37A., 52A., 61A. Alt.; FD, SB Chassis	255266C3	②7640
Belt - Fan & Alt.; W/55A., 62A. Alt.; C, G, H Chassis	369725C91	②7619
Belt - Fan & Alt.; W/55A., 62A. Alt.; FD, SB Chassis	358998C91	②7650
Belt - P.S.; W/2WD	151529R2	7440
Belt - P.S.; W/4WD	151531R2	7450
Belt - Air Brake Compr.	236572R2	7460
Hose - Upper; W/Rad. Shutters; W/Metal Hood		●26515
Hose - Upper; W/O Rad. Shutters; W/Metal Hood		20493
Hose - Lower - Eng. To Pipe; W/Auto. Trans.		20532
Hose - Lower; W/Man. Trans.		21308
Hose - By Pass		≧20357
International/Navistar V345		
1603; 1703		
Belt - Fan & Alt.; W/37A., 52A., 61A. Alt.; C, G, H Chassis; W/P.T.O.	968815R11	②7650
Belt - Fan & Alt.; W/37A., 52A., 61A. Alt.; C, G, H Chassis; W/O P.T.O.	373457C91	②7612
Belt - Fan & Alt.; W/37A., 52A., 61A. Alt.; FD, SB Chassis	968815R1	②7650
Belt - Fan & Alt.; W/37A., 61A. Alt.; W/O Air Brakes; W/O P.T.O.; W/O X.C.	373456C1	7612
Belt - Fan & Alt.; W/55A., 62A. Alt.; C, G, H Chassis	369723C91	②7630
Belt - Fan & Alt.; W/55A., 62A. Alt.; FD, SB Chassis	361975C91	②7673
Belt - Fan & Alt.; W/60A. Alt.	359009C91	②7680
Belt - Fan & Alt.; W/65A., 80A., 105A., 145A. Alt.; W/P.T.O.	361975C91	②7673
Belt - Fan & Alt.; W/65A., 80A., 105A., 145A. Alt.; W/O P.T.O.		②7630
Belt - P.S.; W/2WD		7460
Belt - P.S.; W/4WD	285522C2	7435
Belt - Air Brake Compr.	359007C91	7475
Belt - A.P.; W/Air Brakes; W/Gov.	388139C1	7330
Belt - A.P.; W/Air Brakes; W/O Gov.	256062C2	7340
Belt - A.P.; W/Hyd. Brakes; W/Gov.	355653C91	7380
Belt - A.P.; W/Hyd. Brakes; W/O Gov.	362887C91	7410
Hose - Upper; W/Rad. Shutters; W/Metal Hood		●26515
Hose - Upper; W/O Rad. Shutters; W/Metal Hood		20493
Hose - Lower - Eng. To Pipe; W/Auto. Trans.		20532
Hose - Lower; W/Man. Trans.		21308
Hose - By Pass		≧20357
1723		
Belt - Fan & Alt.; W/37A., 52A., 61A. Alt.; C, G, H Chassis; W/P.T.O.	968815R11	②7650
Belt - Fan & Alt.; W/37A., 52A., 61A. Alt.; C, G, H Chassis; W/O P.T.O.	373457C91	②7612
Belt - Fan & Alt.; W/37A., 52A., 61A. Alt.; FD, SB Chassis	968815R1	②7650
Belt - Fan & Alt.; W/37A., 61A. Alt.; W/O Air Brakes; W/O P.T.O.; W/O X.C.	373456C1	7612
Belt - Fan & Alt.; W/55A., 62A. Alt.; C, G, H Chassis	369723C91	②7630
Belt - Fan & Alt.; W/55A., 62A. Alt.; FD, SB Chassis	361975C91	②7673
Belt - Fan & Alt.; W/60A. Alt.	359009C91	②7680
Belt - Fan & Alt.; W/65A., 80A., 105A., 145A. Alt.; W/P.T.O.	361975C91	②7673
Belt - Fan & Alt.; W/65A., 80A., 105A., 145A. Alt.; W/O P.T.O.		②7630
Belt - P.S.; W/2WD		7460
Belt - P.S.; W/4WD	285522C2	7435
Belt - Air Brake Compr.	359007C91	7475
Belt - A.P.; W/Air Brakes; W/Gov.	388139C1	7330
Belt - A.P.; W/Air Brakes; W/O Gov.	256062C2	7340
Belt - A.P.; W/Hyd. Brakes; W/Gov.	355653C91	7380
Belt - A.P.; W/Hyd. Brakes; W/O Gov.	362887C91	7410

Application	Mfr. Part No.	Our No.
INTERNATIONAL/NAVISTAR - Continued		
1974 - Continued		
International/Navistar V345 - Continued		
1723 - Continued		
Belt - Fan & Alt.; W/65A., 80A., 105A., 145A. Alt.; W/O P.T.O.		②7630
Belt - P.S.; W/2WD		7460
Belt - P.S.; W/4WD	285522C2	7435
Belt - Air Brake Compr.	359007C91	7475
Belt - A.P.; W/Air Brakes; W/Gov.	388139C1	7330
Belt - A.P.; W/Air Brakes; W/O Gov.	256062C2	7340
Belt - A.P.; W/Hyd. Brakes; W/Gov.	355653C91	7380
Belt - A.P.; W/Hyd. Brakes; W/O Gov.	362887C91	7410
1803		
Belt - Fan & Alt.; W/37A., 52A., 61A. Alt.; C, G, H Chassis; W/P.T.O.	968815R11	②7650
Belt - Fan & Alt.; W/37A., 52A., 61A. Alt.; C, G, H Chassis; W/O P.T.O.	373457C91	②7612
Belt - Fan & Alt.; W/37A., 52A., 61A. Alt.; FD, SB Chassis	968815R1	②7650
Belt - Fan & Alt.; W/37A., 61A. Alt.; W/O Air Brakes; W/O P.T.O.; W/O X.C.	373456C1	7612
Belt - Fan & Alt.; W/55A., 62A. Alt.; C, G, H Chassis	369723C91	②7630
Belt - Fan & Alt.; W/55A., 62A. Alt.; FD, SB Chassis	361975C91	②7673
Belt - Fan & Alt.; W/60A. Alt.	359009C91	②7680
Belt - Fan & Alt.; W/65A., 80A., 105A., 145A. Alt.; W/P.T.O.	361975C91	②7673
Belt - Fan & Alt.; W/65A., 80A., 105A., 145A. Alt.; W/O P.T.O.		②7630
Belt - P.S.; W/2WD		7460
Belt - P.S.; W/4WD	285522C2	7435
Belt - Air Brake Compr.	359007C91	7475
Belt - A.P.; W/Air Brakes; W/Gov.	388139C1	7330
Belt - A.P.; W/Air Brakes; W/O Gov.	256062C2	7340
Belt - A.P.; W/Hyd. Brakes; W/Gov.	355653C91	7380
Belt - A.P.; W/Hyd. Brakes; W/O Gov.	362887C91	7410
Hose - Upper; W/Rad. Shutters; W/Metal Hood		●26515
Hose - Upper; W/O Rad. Shutters; W/Metal Hood		20493
Hose - Lower - Eng. To Pipe; W/Auto. Trans.		20532
Hose - Lower; W/Man. Trans.		21308
Hose - By Pass		≧20357
1823		
Belt - Fan & Alt.; W/37A., 52A., 61A. Alt.; C, G, H Chassis; W/P.T.O.	968815R11	②7650
Belt - Fan & Alt.; W/37A., 52A., 61A. Alt.; C, G, H Chassis; W/O P.T.O.	373457C91	②7612
Belt - Fan & Alt.; W/37A., 52A., 61A. Alt.; FD, SB Chassis	968815R1	②7650
Belt - Fan & Alt.; W/37A., 61A. Alt.; W/O Air Brakes; W/O P.T.O.; W/O X.C.	373456C1	7612
Belt - Fan & Alt.; W/55A., 62A. Alt.; C, G, H Chassis	369723C91	②7630
Belt - Fan & Alt.; W/55A., 62A. Alt.; FD, SB Chassis	361975C91	②7673
Belt - Fan & Alt.; W/60A. Alt.	359009C91	②7680
Belt - Fan & Alt.; W/65A., 80A., 105A., 145A. Alt.; W/P.T.O.	361975C91	②7673
Belt - Fan & Alt.; W/65A., 80A., 105A., 145A. Alt.; W/O P.T.O.		②7630
Belt - P.S.; W/2WD		7460
Belt - P.S.; W/4WD	285522C2	7435
Belt - Air Brake Compr.	359007C91	7475
Belt - A.P.; W/Air Brakes; W/Gov.	388139C1	7330
Belt - A.P.; W/Air Brakes; W/O Gov.	256062C2	7340
Belt - A.P.; W/Hyd. Brakes; W/Gov.	355653C91	7380
Belt - A.P.; W/Hyd. Brakes; W/O Gov.	362887C91	7410
International/Navistar V392		
1603; 1703		
Belt - Fan & Alt.; W/37A., 52A., 61A. Alt.; C, G, H Chassis; W/P.T.O.	968815R11	②7650
Belt - Fan & Alt.; W/37A., 52A., 61A. Alt.; C, G, H Chassis; W/O P.T.O.	373457C91	②7612
Belt - Fan & Alt.; W/37A., 52A., 61A. Alt.; FD, SB Chassis	968815R1	②7650

● Vulco-Flex® Coolant Hose.
 ② Two Required.

≧ Cut to Fit.

Belts and Coolant Hose for School Buses

Application	Mfr. Part No.	Our No.	Application	Mfr. Part No.	Our No.
INTERNATIONAL/NAVISTAR - Continued			INTERNATIONAL/NAVISTAR - Continued		
1974 - Continued			1974 - Continued		
International/Navistar V392 - Continued			International/Navistar V392 - Continued		
1603; 1703 - Continued			1803 - Continued		
Belt - Fan & Alt.; W/37A., 61A. Alt.; W/O Air Brakes; W/O P.T.O.; W/O X.C.	373456C1	7612	Hose - Upper; W/O Rad. Shutters; W/Metal Hood		20493
Belt - Fan & Alt.; W/55A., 62A. Alt.; C, G, H Chassis	369723C91	②7630	Hose - Lower - Eng. To Pipe; W/Auto. Trans.		20532
Belt - Fan & Alt.; W/55A., 62A. Alt.; FD, SB Chassis	361975C91	②7673	Hose - Lower; W/Man. Trans.		21308
Belt - Fan & Alt.; W/60A. Alt.	359009C91	②7680	Hose - By Pass		②20357
Belt - Fan & Alt.; W/65A., 80A., 105A., 145A. Alt.; W/P.T.O.	361975C91	②7673	1823		
Belt - Fan & Alt.; W/65A., 80A., 105A., 145A. Alt.; W/O P.T.O.		②7630	Belt - Fan & Alt.; W/37A., 52A., 61A. Alt.; C, G, H Chassis; W/P.T.O.	968815R11	②7650
Belt - P.S.; W/2WD		7460	Belt - Fan & Alt.; W/37A., 52A., 61A. Alt.; C, G, H Chassis; W/O P.T.O.	373457C91	②7612
Belt - P.S.; W/4WD	285522C2	7435	Belt - Fan & Alt.; W/37A., 52A., 61A. Alt.; FD, SB Chassis	968815R1	②7650
Belt - Air Brake Compr.	359007C91	7475	Belt - Fan & Alt.; W/37A., 61A. Alt.; W/O Air Brakes; W/O P.T.O.; W/O X.C.	373456C1	7612
Belt - A.P.; W/Air Brakes; W/Gov.	388139C1	7330	Belt - Fan & Alt.; W/55A., 62A. Alt.; C, G, H Chassis	369723C91	②7630
Belt - A.P.; W/Air Brakes; W/O Gov.	256062C2	7340	Belt - Fan & Alt.; W/55A., 62A. Alt.; FD, SB Chassis	361975C91	②7673
Belt - A.P.; W/Hyd. Brakes; W/Gov.	355653C91	7380	Belt - Fan & Alt.; W/60A. Alt.	359009C91	②7680
Belt - A.P.; W/Hyd. Brakes; W/O Gov.	362887C91	7410	Belt - Fan & Alt.; W/65A., 80A., 105A., 145A. Alt.; W/P.T.O.	361975C91	②7673
Hose - Upper; W/Rad. Shutters; W/Metal Hood	●26515		Belt - Fan & Alt.; W/65A., 80A., 105A., 145A. Alt.; W/O P.T.O.		②7630
Hose - Upper; W/O Rad. Shutters; W/Metal Hood	20493		Belt - P.S.; W/2WD		7460
Hose - Lower - Eng. To Pipe; W/Auto. Trans.	20532		Belt - P.S.; W/4WD	285522C2	7435
Hose - Lower; W/Man. Trans.	21308		Belt - Air Brake Compr.	359007C91	7475
Hose - By Pass	②20357		Belt - A.P.; W/Air Brakes; W/Gov.	388139C1	7330
1723			Belt - A.P.; W/Air Brakes; W/O Gov.	256062C2	7340
Belt - Fan & Alt.; W/37A., 52A., 61A. Alt.; C, G, H Chassis; W/P.T.O.	968815R11	②7650	Belt - A.P.; W/Hyd. Brakes; W/Gov.	355653C91	7380
Belt - Fan & Alt.; W/37A., 52A., 61A. Alt.; C, G, H Chassis; W/O P.T.O.	373457C91	②7612	Belt - A.P.; W/Hyd. Brakes; W/O Gov.	362887C91	7410
Belt - Fan & Alt.; W/37A., 52A., 61A. Alt.; FD, SB Chassis	968815R1	②7650	International/Navistar V401		
Belt - Fan & Alt.; W/37A., 61A. Alt.; W/O Air Brakes; W/O P.T.O.; W/O X.C.	373456C1	7612	1603; 1703; 1803		
Belt - Fan & Alt.; W/55A., 62A. Alt.; C, G, H Chassis	369723C91	②7630	Belt - Fan	②◆◆9476HD	
Belt - Fan & Alt.; W/55A., 62A. Alt.; FD, SB Chassis	361975C91	②7673	Belt - Alt.; W/37A., 61A. Alt.	359006C91	②7417
Belt - Fan & Alt.; W/60A. Alt.	359009C91	②7680	Belt - Alt.; W/65A., 80A. Alt.	151531R2	②7450
Belt - Fan & Alt.; W/65A., 80A., 105A., 145A. Alt.; W/P.T.O.	361975C91	②7673	Belt - Alt. & Air Brake Compr.; W/37A., 61A. Alt.		②7541
Belt - Fan & Alt.; W/65A., 80A., 105A., 145A. Alt.; W/O P.T.O.		②7630	Belt - Alt. & Air Brake Compr.; W/65A., 80A. Alt.	358344C91	②7560
Belt - P.S.; W/2WD		7460	Belt - P.S.	358335C91	②◆◆9490HD
Belt - P.S.; W/4WD	285522C2	7435	Hose - Upper	●26531	
Belt - Air Brake Compr.	359007C91	7475	Hose - Lower	②20530	
Belt - A.P.; W/Air Brakes; W/Gov.	388139C1	7330	International/Navistar V461		
Belt - A.P.; W/Air Brakes; W/O Gov.	256062C2	7340	1603; 1703; 1803		
Belt - A.P.; W/Hyd. Brakes; W/Gov.	355653C91	7380	Belt - Fan	②◆◆9476HD	
Belt - A.P.; W/Hyd. Brakes; W/O Gov.	362887C91	7410	Belt - Alt.; W/37A., 61A. Alt.	359006C91	②7417
1803			Belt - Alt.; W/65A., 80A. Alt.	151531R2	②7450
Belt - Fan & Alt.; W/37A., 52A., 61A. Alt.; C, G, H Chassis; W/P.T.O.	968815R11	②7650	Belt - Alt. & Air Brake Compr.; W/37A., 61A. Alt.		②7541
Belt - Fan & Alt.; W/37A., 52A., 61A. Alt.; C, G, H Chassis; W/O P.T.O.	373457C91	②7612	Belt - Alt. & Air Brake Compr.; W/65A., 80A. Alt.	358344C91	②7560
Belt - Fan & Alt.; W/37A., 52A., 61A. Alt.; FD, SB Chassis	968815R1	②7650	Belt - P.S.	358335C91	②◆◆9490HD
Belt - Fan & Alt.; W/37A., 61A. Alt.; W/O Air Brakes; W/O P.T.O.; W/O X.C.	373456C1	7612	Hose - Upper	●26531	
Belt - Fan & Alt.; W/55A., 62A. Alt.; C, G, H Chassis	369723C91	②7630	Hose - Lower	②20530	
Belt - Fan & Alt.; W/55A., 62A. Alt.; FD, SB Chassis	361975C91	②7673	International/Navistar V478		
Belt - Fan & Alt.; W/60A. Alt.	359009C91	②7680	1603; 1703; 1803		
Belt - Fan & Alt.; W/65A., 80A., 105A., 145A. Alt.; W/P.T.O.	361975C91	②7673	Belt - Fan	②◆◆9476HD	
Belt - Fan & Alt.; W/65A., 80A., 105A., 145A. Alt.; W/O P.T.O.		②7630	Belt - Alt.; W/37A., 61A. Alt.	359006C91	②7417
Belt - P.S.; W/2WD		7460	Belt - Alt.; W/65A., 80A. Alt.	151531R2	②7450
Belt - P.S.; W/4WD	285522C2	7435	Belt - Alt. & Air Brake Compr.; W/37A., 61A. Alt.		②7541
Belt - Air Brake Compr.	359007C91	7475	Belt - Alt. & Air Brake Compr.; W/65A., 80A. Alt.	358344C91	②7560
Belt - A.P.; W/Air Brakes; W/Gov.	388139C1	7330	Belt - P.S.	358335C91	②◆◆9490HD
Belt - A.P.; W/Air Brakes; W/O Gov.	256062C2	7340	Hose - Upper	●26531	
Belt - A.P.; W/Hyd. Brakes; W/Gov.	355653C91	7380	Hose - Lower	②20530	
Belt - A.P.; W/Hyd. Brakes; W/O Gov.	362887C91	7410	International/Navistar V478		
Hose - Upper; W/Rad. Shutters; W/Metal Hood	●26515		1603; 1703; 1803		
			Belt - Fan	②◆◆9476HD	
			Belt - Alt.; W/37A., 61A. Alt.	359006C91	②7417
			Belt - Alt.; W/65A., 80A. Alt.	151531R2	②7450
			Belt - Alt. & Air Brake Compr.; W/37A., 61A. Alt.		②7541
			Belt - Alt. & Air Brake Compr.; W/65A., 80A. Alt.	358344C91	②7560
			Belt - P.S.	358335C91	②◆◆9490HD
			Hose - Upper	●26531	
			Hose - Lower	②20530	
			International/Navistar V549		
			1603; 1703; 1803		
			Belt - Fan	②◆◆9476HD	
			Belt - Alt.; W/37A., 61A. Alt.	359006C91	②7417
			Belt - Alt.; W/65A., 80A. Alt.	151531R2	②7450
			Belt - Alt. & Air Brake Compr.; W/37A., 61A. Alt.		②7541

② Two Required.
 Ⓜ Cut to Fit.
 ◆ Standard Belt Available. See Pages 630-631.

● Vulco-Flex® Coolant Hose.
 ◆ Green Stripe® PowerBand® Belt May Work, Use Template to Check.

School Buses

Belts and Coolant Hose for School Buses

School Buses

Application	Mfr. Part No.	Our No.
INTERNATIONAL/NAVISTAR - Continued		
1974 - Continued		
International/Navistar V549 - Continued		
1603; 1703; 1803 - Continued		
Belt - Alt. & Air Brake Compr.; W/65A., 80A.		
Alt.	358344C91	②7560
Belt - P.S.	358335C91	②◆▲9490HD
Hose - Upper		●26531
Hose - Lower		≅20530
International/Navistar VS401		
1603; 1703; 1803		
Belt - Fan		②◆▲9476HD
Belt - Alt.; W/37A., 61A. Alt.	359006C91	②7417
Belt - Alt.; W/65A., 80A. Alt.	151531R2	②7450
Belt - Alt. & Air Brake Compr.; W/37A., 61A. Alt.		②7541
Belt - Alt. & Air Brake Compr.; W/65A., 80A.		
Alt.	358344C91	②7560
Belt - P.S.	358335C91	②◆▲9490HD
Hose - Upper		●26531
Hose - Lower		≅20530
International/Navistar VS478		
1603; 1703; 1803		
Belt - Fan		②◆▲9476HD
Belt - Alt.; W/37A., 61A. Alt.	359006C91	②7417
Belt - Alt.; W/65A., 80A. Alt.	151531R2	②7450
Belt - Alt. & Air Brake Compr.; W/37A., 61A. Alt.		②7541
Belt - Alt. & Air Brake Compr.; W/65A., 80A.		
Alt.	358344C91	②7560
Belt - P.S.	358335C91	②◆▲9490HD
Hose - Upper		●26531
Hose - Lower		≅20530
International/Navistar VS549		
1603; 1703; 1803		
Belt - Fan		②◆▲9476HD
Belt - Alt.; W/37A., 61A. Alt.	359006C91	②7417
Belt - Alt.; W/65A., 80A. Alt.	151531R2	②7450
Belt - Alt. & Air Brake Compr.; W/37A., 61A. Alt.		②7541
Belt - Alt. & Air Brake Compr.; W/65A., 80A.		
Alt.	358344C91	②7560
Belt - P.S.	358335C91	②◆▲9490HD
Hose - Upper		●26531
Hose - Lower		≅20530
1973		
Caterpillar 1145 Diesel		
1853		
Belt - Fan	426222C91	②◆▲9530HD
Belt - Alt.; W/37A., 61A. Alt.	398601C91	②▲9440HD
Belt - Alt.; W/65A., 80A. Alt.	354029C91	②◆▲9476HD
Belt - Alt. & Air Brake Compr.; W/37A., 61A. Alt.		②▲9465HD
Belt - Alt. & Air Brake Compr.; W/65A., 80A.		
Alt.	427205C91	②◆▲9500HD
Belt - P.S.		▲9465HD
Hose - Upper		●26532
Caterpillar 1150 Diesel		
1853		
Belt - Fan	426222C91	②◆▲9530HD
Belt - Alt.; W/37A., 61A. Alt.	398601C91	②▲9440HD
Belt - Alt.; W/65A., 80A. Alt.	354029C91	②◆▲9476HD
Belt - Alt. & Air Brake Compr.; W/37A., 61A. Alt.		②▲9465HD
Belt - Alt. & Air Brake Compr.; W/65A., 80A.		
Alt.	427205C91	②◆▲9500HD
Belt - P.S.		▲9465HD
Hose - Upper		●26532
Caterpillar 1160 Diesel		
1853		
Belt - Fan	426222C91	②◆▲9530HD
Belt - Alt.; W/37A., 61A. Alt.	398601C91	②▲9440HD
Belt - Alt.; W/65A., 80A. Alt.	354029C91	②◆▲9476HD
Belt - Alt. & Air Brake Compr.; W/37A., 61A. Alt.		②▲9465HD
Belt - Alt. & Air Brake Compr.; W/65A., 80A.		
Alt.	427205C91	②◆▲9500HD

Application	Mfr. Part No.	Our No.
INTERNATIONAL/NAVISTAR - Continued		
1973 - Continued		
Caterpillar 1160 Diesel - Continued		
1853 - Continued		
Belt - P.S.		▲9465HD
Hose - Upper		●26532
International/Navistar FTV549		
193RE		
Belt - Fan	358319C91	②◆▲9570HD
Belt - W.P.	359021C91	②TR22434
Belt - Alt.; W/37A. Alt.	256346C11	②▲9350HD
Belt - Alt.; W/55A., 60A., 62A., 105A., 130A. Alt.		②▲9365HD
Belt - Alt. & Air Brake Compr.	243605R11	②◆▲9451HD
Belt - P.S.	164550R2	▲9425HD
Hose - Upper - Eng. To Pipe; (1 3/4" I.D.)		24228
Hose - Upper - Eng. To Pipe		●26501
Hose - Upper - Pipe To Rad.; (2 1/4" I.D.)		24236
Hose - Lower; (2 5/8" I.D.)		☆24942
Hose - By Pass		≅20618
Hose - By Pass; (3/4" I.D.)		28442
Hose - Heater; (1" I.D.)		24216
1603; 1703; 1803		
Belt - Fan		②◆▲9476HD
Belt - Alt.; W/37A., 61A. Alt.	359006C91	②7417
Belt - Alt.; W/65A., 80A. Alt.	151531R2	②7450
Belt - Alt. & Air Brake Compr.; W/37A., 61A. Alt.		②7541
Belt - Alt. & Air Brake Compr.; W/65A., 80A.		
Alt.	358344C91	②7560
Belt - P.S.	358335C91	②◆▲9490HD
Hose - Upper		●26531
Hose - Lower		≅20530
International/Navistar FTVS549		
193RE		
Belt - Fan	358319C91	②◆▲9570HD
Belt - W.P.	359021C91	②TR22434
Belt - Alt.; W/37A. Alt.	256346C11	②▲9350HD
Belt - Alt.; W/55A., 60A., 62A., 105A., 130A. Alt.		②▲9365HD
Belt - Alt. & Air Brake Compr.	243605R11	②◆▲9451HD
Belt - P.S.	164550R2	▲9425HD
Hose - Upper - Eng. To Pipe; (1 3/4" I.D.)		24228
Hose - Upper - Eng. To Pipe		●26501
Hose - Upper - Pipe To Rad.; (2 1/4" I.D.)		24236
Hose - Lower; (2 5/8" I.D.)		☆24942
Hose - By Pass		≅20618
Hose - By Pass; (3/4" I.D.)		28442
Hose - Heater; (1" I.D.)		24216
1603; 1703; 1803		
Belt - Fan		②◆▲9476HD
Belt - Alt.; W/37A., 61A. Alt.	359006C91	②7417
Belt - Alt.; W/65A., 80A. Alt.	151531R2	②7450
Belt - Alt. & Air Brake Compr.; W/37A., 61A. Alt.		②7541
Belt - Alt. & Air Brake Compr.; W/65A., 80A.		
Alt.	358344C91	②7560
Belt - P.S.	358335C91	②◆▲9490HD
Hose - Upper		●26531
Hose - Lower		≅20530
International/Navistar RD372		
1823		
Belt - Fan & Alt.	359014C91	②TR22514
Belt - W.P. & Alt.; W/37A. Alt.; Chassis No.		
FD61626 & Before	193826R11	②TR22508
Belt - W.P. & Alt.; W/37A. Alt.; Chassis No.		
FD61626 & Up & G Chassis No.	223794R11	②TR22514
Belt - W.P. & Alt.; W/60A. Alt.	243604R11	②TR22517
Belt - P.S.	240354R2	TR22336
Belt - Air Brake Compr.; W/Wagner Compr. ...	92836HA	TR32491
Belt - Air Brake Compr.; W/Westinghouse		
Compr.	83816HA	TR34467
Hose - Upper		●26515
Hose - Lower; (2" I.D.)		24232
1853		
Belt - Alt.; W/55A., 62A., 145A. Alt.	223794K21	②TR22514

② Two Required.

▲ Standard Belt Available. See Pages 630-631.

≅ Cut to Fit.

◆ Green Stripe® PowerBand® Belt May Work, Use Template to Check.

● Vulco-Flex® Coolant Hose.

☆ Use Wire Inserted Green Stripe® Coolant Hose.

Belts and Coolant Hose for School Buses

Application	Mfr. Part No.	Our No.	Application	Mfr. Part No.	Our No.
INTERNATIONAL/NAVISTAR - Continued			INTERNATIONAL/NAVISTAR - Continued		
1973 - Continued			1973 - Continued		
International/Navistar RD372 - Continued			International/Navistar RD501 - Continued		
1853 - Continued			1823 - Continued		
Belt - Gen.; W/37A. Gen.	193826R11	TR22508	Belt - W.P. & Alt.; W/37A. Alt.; Chassis No. FD61626 & Before	193826R11	②TR22508
Belt - P.S.	240354R1	TR22344	Belt - W.P. & Alt.; W/37A. Alt.; Chassis No. FD61626 & Up & G Chassis No.	223794R11	②TR22514
1853FC			Belt - W.P. & Alt.; W/60A. Alt.	243604R11	②TR22517
Belt - Alt.; W/55A., 62A., 145A. Alt.	223794K21	②TR22514	Belt - P.S.	240354R2	TR22336
Belt - Gen.; W/37A. Gen.	193826R11	TR22508	Belt - Air Brake Compr.; W/Wagner Compr. ...	92836HA	TR32491
Belt - P.S.	240354R1	TR22344	Belt - Air Brake Compr.; W/Westinghouse Compr.	83816HA	TR34467
Hose - Upper; Late FD Chassis; Chassis No. FA66376	●26509		Hose - Upper	●26515	
Hose - Lower; Early FD Chassis; Chassis No. FA66376	●26508		Hose - Lower; (2" I.D.)	24232	
Hose - Lower; Late FD Chassis; Chassis No. FA66376(2 1/8" I.D.)	24234				
Hose - Lower; Late FD Chassis; Chassis No. FA66376	●26508		1853		
International/Navistar RD406			1823		
1823			Belt - Alt.; W/55A., 62A., 145A. Alt.		
Belt - Fan & Alt.	359014C91	②TR22514	Belt - Gen.; W/37A. Gen.	193826R11	TR22508
Belt - W.P. & Alt.; W/37A. Alt.; Chassis No. FD61626 & Before	193826R11	②TR22508	Belt - P.S.	240354R1	TR22344
Belt - W.P. & Alt.; W/37A. Alt.; Chassis No. FD61626 & Up & G Chassis No.	223794R11	②TR22514	1853FC		
Belt - W.P. & Alt.; W/60A. Alt.	243604R11	②TR22517	Belt - Alt.; W/55A., 62A., 145A. Alt.	223794K21	②TR22514
Belt - P.S.	240354R2	TR22336	Belt - Gen.; W/37A. Gen.	193826R11	TR22508
Belt - Air Brake Compr.; W/Wagner Compr. ...	92836HA	TR32491	Belt - P.S.	240354R1	TR22344
Belt - Air Brake Compr.; W/Westinghouse Compr.	83816HA	TR34467	Hose - Upper; Late FD Chassis; Chassis No. FA66376	●26509	
Hose - Upper	●26515		Hose - Lower; Early FD Chassis; Chassis No. FA66376	●26508	
Hose - Lower; (2" I.D.)	24232		Hose - Lower; Late FD Chassis; Chassis No. FA66376(2 1/8" I.D.)	24234	
			Hose - Lower; Late FD Chassis; Chassis No. FA66376	●26508	
International/Navistar RD450			International/Navistar V266		
1823			1603; 1703 ; 1803		
Belt - Fan & Alt.	359014C91	②TR22514	Belt - Fan & Alt.; W/37A., 52A., 61A. Alt.; C, G, H Chassis		②7603
Belt - W.P. & Alt.; W/37A. Alt.; Chassis No. FD61626 & Before	193826R11	②TR22508	Belt - Fan & Alt.; W/37A., 52A., 61A. Alt.; FD, SB Chassis	255266C3	②7640
Belt - W.P. & Alt.; W/37A. Alt.; Chassis No. FD61626 & Up & G Chassis No.	223794R11	②TR22514	Belt - Fan & Alt.; W/55A., 62A. Alt.; C, G, H Chassis	369725C91	②7619
Belt - W.P. & Alt.; W/60A. Alt.	243604R11	②TR22517	Belt - Fan & Alt.; W/55A., 62A. Alt.; FD, SB Chassis	358998C91	②7650
Belt - P.S.	240354R2	TR22336	Belt - P.S.; W/2WD	151529R2	7440
Belt - Air Brake Compr.; W/Wagner Compr. ...	92836HA	TR32491	Belt - P.S.; W/4WD	151531R2	7450
Belt - Air Brake Compr.; W/Westinghouse Compr.	83816HA	TR34467	Belt - Air Brake Compr.	236572R2	7460
Hose - Upper	●26515		Hose - Upper; W/Rad. Shutters; W/Metal Hood	●26515	
Hose - Lower; (2" I.D.)	24232		Hose - Upper; W/O Rad. Shutters; W/Metal Hood	20493	
			Hose - Lower - Eng. To Pipe; W/Auto. Trans.	20532	
International/Navistar RD501			International/Navistar V304		
1823			1603; 1703 ; 1803		
Belt - Fan & Alt.	359014C91	②TR22514	Belt - Fan & Alt.; W/37A., 52A., 61A. Alt.; C, G, H Chassis		②7603
Belt - W.P. & Alt.; W/37A. Alt.; Chassis No. FD61626 & Before	193826R11	②TR22508	Belt - Fan & Alt.; W/37A., 52A., 61A. Alt.; FD, SB Chassis	255266C3	②7640
Belt - W.P. & Alt.; W/37A. Alt.; Chassis No. FD61626 & Up & G Chassis No.	223794R11	②TR22514	Belt - Fan & Alt.; W/55A., 62A. Alt.; C, G, H Chassis	369725C91	②7619
Belt - W.P. & Alt.; W/60A. Alt.	243604R11	②TR22517	Belt - Fan & Alt.; W/55A., 62A. Alt.; FD, SB Chassis	358998C91	②7650
Belt - P.S.	240354R2	TR22336	Belt - P.S.; W/2WD	151529R2	7440
Belt - Air Brake Compr.; W/Wagner Compr. ...	92836HA	TR32491	Belt - P.S.; W/4WD	151531R2	7450
Belt - Air Brake Compr.; W/Westinghouse Compr.	83816HA	TR34467	Belt - Air Brake Compr.	236572R2	7460
Hose - Upper	●26515		Hose - Upper; W/Rad. Shutters; W/Metal Hood	●26515	
Hose - Lower; (2" I.D.)	24232		Hose - Upper; W/O Rad. Shutters; W/Metal Hood	20493	
			Hose - Lower - Eng. To Pipe; W/Auto. Trans.	20532	
1853			International/Navistar V345		
Belt - Alt.; W/55A., 62A., 145A. Alt.	223794K21	②TR22514	1603; 1703		
Belt - Gen.; W/37A. Gen.	193826R11	TR22508	Belt - Fan & Alt.; W/37A., 52A., 61A. Alt.; C, G, H Chassis; W/P.T.O.		
Belt - P.S.	240354R1	TR22344	968815R11		
1853FC			②7650		
Belt - Alt.; W/55A., 62A., 145A. Alt.	223794K21	②TR22514	Belt - Fan & Alt.; W/37A., 52A., 61A. Alt.; C, G, H Chassis; W/O P.T.O.		
Belt - Gen.; W/37A. Gen.	193826R11	TR22508	373457C91		
Belt - P.S.	240354R1	TR22344	②7612		
Hose - Upper; Late FD Chassis; Chassis No. FA66376	●26509		Belt - Fan & Alt.; W/37A., 52A., 61A. Alt.; FD, SB Chassis		
Hose - Lower; Early FD Chassis; Chassis No. FA66376	●26508		968815R1		
Hose - Lower; Late FD Chassis; Chassis No. FA66376(2 1/8" I.D.)	24234		②7650		
Hose - Lower; Late FD Chassis; Chassis No. FA66376	●26508		Belt - Fan & Alt.; W/37A., 61A. Alt.; W/O Air Brakes; W/O P.T.O.; W/O X.C.		
International/Navistar RD501			373456C1		
1823			7612		
Belt - Fan & Alt.	359014C91	②TR22514			

② Two Required.
 ≡ Cut to Fit.

● Vulco-Flex® Coolant Hose.

Belts and Coolant Hose for School Buses

School Buses

Application	Mfr. Part No.	Our No.
INTERNATIONAL/NAVISTAR - Continued		
1973 - Continued		
International/Navistar V345 - Continued		
1603; 1703 - Continued		
Belt - Fan & Alt.; W/55A., 62A. Alt.; C, G, H		
Chassis	369723C91	②7630
Belt - Fan & Alt.; W/55A., 62A. Alt.; FD, SB		
Chassis	361975C91	②7673
Belt - Fan & Alt.; W/60A. Alt.	359009C91	②7680
Belt - Fan & Alt.; W/65A., 80A., 105A., 145A.		
Alt.; W/P.T.O.	361975C91	②7673
Belt - Fan & Alt.; W/65A., 80A., 105A., 145A. Alt.; W/O P.T.O.		②7630
Belt - P.S.; W/2WD		7460
Belt - P.S.; W/4WD	285522C2	7435
Belt - Air Brake Compr.	359007C91	7475
Belt - A.P.; W/Air Brakes; W/Gov.	388139C1	7330
Belt - A.P.; W/Air Brakes; W/O Gov.	256062C2	7340
Belt - A.P.; W/Hyd. Brakes; W/Gov.	355653C91	7380
Belt - A.P.; W/Hyd. Brakes; W/O Gov.	362887C91	7410
Hose - Upper; W/Rad. Shutters; W/Metal Hood		●26515
Hose - Upper; W/O Rad. Shutters; W/Metal Hood		20493
Hose - Lower - Eng. To Pipe; W/Auto. Trans.		20532
Hose - Lower; W/Man. Trans.		21308
Hose - By Pass		≅20357
1723		
Belt - Fan & Alt.; W/37A., 52A., 61A. Alt.; C, G, H Chassis; W/P.T.O.	968815R11	②7650
Belt - Fan & Alt.; W/37A., 52A., 61A. Alt.; C, G, H Chassis; W/O P.T.O.	373457C91	②7612
Belt - Fan & Alt.; W/37A., 52A., 61A. Alt.; FD, SB Chassis	968815R1	②7650
Belt - Fan & Alt.; W/37A., 61A. Alt.; W/O Air Brakes; W/O P.T.O.; W/O X.C.	373456C1	7612
Belt - Fan & Alt.; W/55A., 62A. Alt.; C, G, H Chassis	369723C91	②7630
Belt - Fan & Alt.; W/55A., 62A. Alt.; FD, SB Chassis	361975C91	②7673
Belt - Fan & Alt.; W/60A. Alt.	359009C91	②7680
Belt - Fan & Alt.; W/65A., 80A., 105A., 145A.		
Alt.; W/P.T.O.	361975C91	②7673
Belt - Fan & Alt.; W/65A., 80A., 105A., 145A. Alt.; W/O P.T.O.		②7630
Belt - P.S.; W/2WD		7460
Belt - P.S.; W/4WD	285522C2	7435
Belt - Air Brake Compr.	359007C91	7475
Belt - A.P.; W/Air Brakes; W/Gov.	388139C1	7330
Belt - A.P.; W/Air Brakes; W/O Gov.	256062C2	7340
Belt - A.P.; W/Hyd. Brakes; W/Gov.	355653C91	7380
Belt - A.P.; W/Hyd. Brakes; W/O Gov.	362887C91	7410
1803		
Belt - Fan & Alt.; W/37A., 52A., 61A. Alt.; C, G, H Chassis; W/P.T.O.	968815R11	②7650
Belt - Fan & Alt.; W/37A., 52A., 61A. Alt.; C, G, H Chassis; W/O P.T.O.	373457C91	②7612
Belt - Fan & Alt.; W/37A., 52A., 61A. Alt.; FD, SB Chassis	968815R1	②7650
Belt - Fan & Alt.; W/37A., 61A. Alt.; W/O Air Brakes; W/O P.T.O.; W/O X.C.	373456C1	7612
Belt - Fan & Alt.; W/55A., 62A. Alt.; C, G, H Chassis	369723C91	②7630
Belt - Fan & Alt.; W/55A., 62A. Alt.; FD, SB Chassis	361975C91	②7673
Belt - Fan & Alt.; W/60A. Alt.	359009C91	②7680
Belt - Fan & Alt.; W/65A., 80A., 105A., 145A.		
Alt.; W/P.T.O.	361975C91	②7673
Belt - Fan & Alt.; W/65A., 80A., 105A., 145A. Alt.; W/O P.T.O.		②7630
Belt - P.S.; W/2WD		7460
Belt - P.S.; W/4WD	285522C2	7435
Belt - Air Brake Compr.	359007C91	7475
Belt - A.P.; W/Air Brakes; W/Gov.	388139C1	7330
Belt - A.P.; W/Air Brakes; W/O Gov.	256062C2	7340
Belt - A.P.; W/Hyd. Brakes; W/Gov.	355653C91	7380
Belt - A.P.; W/Hyd. Brakes; W/O Gov.	362887C91	7410
Hose - Upper; W/Rad. Shutters; W/Metal Hood		●26515
Hose - Upper; W/O Rad. Shutters; W/Metal Hood		20493
Hose - Lower - Eng. To Pipe; W/Auto. Trans.		20532

Application	Mfr. Part No.	Our No.
INTERNATIONAL/NAVISTAR - Continued		
1973 - Continued		
International/Navistar V345 - Continued		
1803 - Continued		
Hose - Lower; W/Man. Trans.		21308
Hose - By Pass		≅20357
1823		
Belt - Fan & Alt.; W/37A., 52A., 61A. Alt.; C, G, H Chassis; W/P.T.O.	968815R11	②7650
Belt - Fan & Alt.; W/37A., 52A., 61A. Alt.; C, G, H Chassis; W/O P.T.O.	373457C91	②7612
Belt - Fan & Alt.; W/37A., 52A., 61A. Alt.; FD, SB Chassis	968815R1	②7650
Belt - Fan & Alt.; W/37A., 61A. Alt.; W/O Air Brakes; W/O P.T.O.; W/O X.C.	373456C1	7612
Belt - Fan & Alt.; W/55A., 62A. Alt.; C, G, H Chassis	369723C91	②7630
Belt - Fan & Alt.; W/55A., 62A. Alt.; FD, SB Chassis	361975C91	②7673
Belt - Fan & Alt.; W/60A. Alt.	359009C91	②7680
Belt - Fan & Alt.; W/65A., 80A., 105A., 145A.		
Alt.; W/P.T.O.	361975C91	②7673
Belt - Fan & Alt.; W/65A., 80A., 105A., 145A. Alt.; W/O P.T.O.		②7630
Belt - P.S.; W/2WD		7460
Belt - P.S.; W/4WD	285522C2	7435
Belt - Air Brake Compr.	359007C91	7475
Belt - A.P.; W/Air Brakes; W/Gov.	388139C1	7330
Belt - A.P.; W/Air Brakes; W/O Gov.	256062C2	7340
Belt - A.P.; W/Hyd. Brakes; W/Gov.	355653C91	7380
Belt - A.P.; W/Hyd. Brakes; W/O Gov.	362887C91	7410
International/Navistar V392		
1603; 1703		
Belt - Fan & Alt.; W/37A., 52A., 61A. Alt.; C, G, H Chassis; W/P.T.O.	968815R11	②7650
Belt - Fan & Alt.; W/37A., 52A., 61A. Alt.; C, G, H Chassis; W/O P.T.O.	373457C91	②7612
Belt - Fan & Alt.; W/37A., 52A., 61A. Alt.; FD, SB Chassis	968815R1	②7650
Belt - Fan & Alt.; W/37A., 61A. Alt.; W/O Air Brakes; W/O P.T.O.; W/O X.C.	373456C1	7612
Belt - Fan & Alt.; W/55A., 62A. Alt.; C, G, H Chassis	369723C91	②7630
Belt - Fan & Alt.; W/55A., 62A. Alt.; FD, SB Chassis	361975C91	②7673
Belt - Fan & Alt.; W/60A. Alt.	359009C91	②7680
Belt - Fan & Alt.; W/65A., 80A., 105A., 145A.		
Alt.; W/P.T.O.	361975C91	②7673
Belt - Fan & Alt.; W/65A., 80A., 105A., 145A. Alt.; W/O P.T.O.		②7630
Belt - P.S.; W/2WD		7460
Belt - P.S.; W/4WD	285522C2	7435
Belt - Air Brake Compr.	359007C91	7475
Belt - A.P.; W/Air Brakes; W/Gov.	388139C1	7330
Belt - A.P.; W/Air Brakes; W/O Gov.	256062C2	7340
Belt - A.P.; W/Hyd. Brakes; W/Gov.	355653C91	7380
Belt - A.P.; W/Hyd. Brakes; W/O Gov.	362887C91	7410
Hose - Upper; W/Rad. Shutters; W/Metal Hood		●26515
Hose - Upper; W/O Rad. Shutters; W/Metal Hood		20493
Hose - Lower - Eng. To Pipe; W/Auto. Trans.		20532
Hose - Lower; W/Man. Trans.		21308
Hose - By Pass		≅20357
1723		
Belt - Fan & Alt.; W/37A., 52A., 61A. Alt.; C, G, H Chassis; W/P.T.O.	968815R11	②7650
Belt - Fan & Alt.; W/37A., 52A., 61A. Alt.; C, G, H Chassis; W/O P.T.O.	373457C91	②7612
Belt - Fan & Alt.; W/37A., 52A., 61A. Alt.; FD, SB Chassis	968815R1	②7650
Belt - Fan & Alt.; W/37A., 61A. Alt.; W/O Air Brakes; W/O P.T.O.; W/O X.C.	373456C1	7612
Belt - Fan & Alt.; W/55A., 62A. Alt.; C, G, H Chassis	369723C91	②7630
Belt - Fan & Alt.; W/55A., 62A. Alt.; FD, SB Chassis	361975C91	②7673
Belt - Fan & Alt.; W/60A. Alt.	359009C91	②7680

② Two Required.
≅ Cut to Fit.

● Vulco-Flex® Coolant Hose.

Belts and Coolant Hose for School Buses

Application	Mfr. Part No.	Our No.
INTERNATIONAL/NAVISTAR - Continued		
1973 - Continued		
International/Navistar V392 - Continued		
1723 - Continued		
Belt - Fan & Alt.; W/65A., 80A., 105A., 145A. Alt.; W/P.T.O.	361975C91	②7673
Belt - Fan & Alt.; W/65A., 80A., 105A., 145A. Alt.; W/O P.T.O.	②7630	
Belt - P.S.; W/2WD	7460	7435
Belt - P.S.; W/4WD	285522C2	7475
Belt - Air Brake Compr.	359007C91	7330
Belt - A.P.; W/Air Brakes; W/Gov.	388139C1	7340
Belt - A.P.; W/Air Brakes; W/O Gov.	256062C2	7380
Belt - A.P.; W/Hyd. Brakes; W/Gov.	355653C91	7410
Belt - A.P.; W/Hyd. Brakes; W/O Gov.	362887C91	
1803		
Belt - Fan & Alt.; W/37A., 52A., 61A. Alt.; C, G, H Chassis; W/P.T.O.	968815R11	②7650
Belt - Fan & Alt.; W/37A., 52A., 61A. Alt.; C, G, H Chassis; W/O P.T.O.	373457C91	②7612
Belt - Fan & Alt.; W/37A., 52A., 61A. Alt.; FD, SB Chassis	968815R1	②7650
Belt - Fan & Alt.; W/37A., 61A. Alt.; W/O Air Brakes; W/O P.T.O.; W/O X.C.	373456C1	7612
Belt - Fan & Alt.; W/55A., 62A. Alt.; C, G, H Chassis	369723C91	②7630
Belt - Fan & Alt.; W/55A., 62A. Alt.; FD, SB Chassis	361975C91	②7673
Belt - Fan & Alt.; W/60A. Alt.	359009C91	②7680
Belt - Fan & Alt.; W/65A., 80A., 105A., 145A. Alt.; W/P.T.O.	361975C91	②7673
Belt - Fan & Alt.; W/65A., 80A., 105A., 145A. Alt.; W/O P.T.O.	②7630	
Belt - P.S.; W/2WD	7460	7435
Belt - P.S.; W/4WD	285522C2	7475
Belt - Air Brake Compr.	359007C91	7330
Belt - A.P.; W/Air Brakes; W/Gov.	388139C1	7340
Belt - A.P.; W/Air Brakes; W/O Gov.	256062C2	7380
Belt - A.P.; W/Hyd. Brakes; W/Gov.	355653C91	7410
Belt - A.P.; W/Hyd. Brakes; W/O Gov.	362887C91	
Hose - Upper; W/Rad. Shutters; W/Metal Hood	●26515	
Hose - Upper; W/O Rad. Shutters; W/Metal Hood	20493	
Hose - Lower - Eng. To Pipe; W/Auto. Trans.	20532	
Hose - Lower; W/Man. Trans.	21308	
Hose - By Pass	≅20357	
1823		
Belt - Fan & Alt.; W/37A., 52A., 61A. Alt.; C, G, H Chassis; W/P.T.O.	968815R11	②7650
Belt - Fan & Alt.; W/37A., 52A., 61A. Alt.; C, G, H Chassis; W/O P.T.O.	373457C91	②7612
Belt - Fan & Alt.; W/37A., 52A., 61A. Alt.; FD, SB Chassis	968815R1	②7650
Belt - Fan & Alt.; W/37A., 61A. Alt.; W/O Air Brakes; W/O P.T.O.; W/O X.C.	373456C1	7612
Belt - Fan & Alt.; W/55A., 62A. Alt.; C, G, H Chassis	369723C91	②7630
Belt - Fan & Alt.; W/55A., 62A. Alt.; FD, SB Chassis	361975C91	②7673
Belt - Fan & Alt.; W/60A. Alt.	359009C91	②7680
Belt - Fan & Alt.; W/65A., 80A., 105A., 145A. Alt.; W/P.T.O.	361975C91	②7673
Belt - Fan & Alt.; W/65A., 80A., 105A., 145A. Alt.; W/O P.T.O.	②7630	
Belt - P.S.; W/2WD	7460	7435
Belt - P.S.; W/4WD	285522C2	7475
Belt - Air Brake Compr.	359007C91	7330
Belt - A.P.; W/Air Brakes; W/Gov.	388139C1	7340
Belt - A.P.; W/Air Brakes; W/O Gov.	256062C2	7380
Belt - A.P.; W/Hyd. Brakes; W/Gov.	355653C91	7410
Belt - A.P.; W/Hyd. Brakes; W/O Gov.	362887C91	
International/Navistar V401		
193RE		
Belt - Fan	358319C91	②◆◆9570HD
Belt - W.P.	359021C91	②TR22434
Belt - Alt.; W/37A. Alt.	256346C11	②◆9350HD
Belt - Alt.; W/55A., 60A., 62A., 105A., 130A. Alt.	②◆9365HD	
Belt - Alt. & Air Brake Compr.	243605R11	②◆◆9451HD
Belt - P.S.	164550R2	◆9425HD
Hose - Upper - Eng. To Pipe; (1 3/4" I.D.)	24228	
Hose - Upper - Eng. To Pipe	●26501	
Hose - Upper - Pipe To Rad.; (2 1/4" I.D.)	24236	
Hose - Lower; (2 5/8" I.D.)	◆24942	
Hose - By Pass	≅20618	
Hose - By Pass; (3/4" I.D.)	28442	
Hose - Heater; (1" I.D.)	24216	
1603; 1703; 1803		
Belt - Fan	②◆◆9476HD	
Belt - Alt.; W/37A., 61A. Alt.	②7417	
Belt - Alt.; W/65A., 80A. Alt.	②7450	
Belt - Alt. & Air Brake Compr.; W/37A., 61A. Alt.	②7541	
Belt - Alt. & Air Brake Compr.; W/65A., 80A. Alt.	②7560	
Belt - P.S.	358335C91	②◆◆9490HD
Hose - Upper	●26531	
Hose - Lower	≅20530	

Application	Mfr. Part No.	Our No.
INTERNATIONAL/NAVISTAR - Continued		
1973 - Continued		
International/Navistar V401 - Continued		
193RE - Continued		
Belt - P.S.	164550R2	◆9425HD
Hose - Upper - Eng. To Pipe; (1 3/4" I.D.)	24228	
Hose - Upper - Eng. To Pipe	●26501	
Hose - Upper - Pipe To Rad.; (2 1/4" I.D.)	24236	
Hose - Lower; (2 5/8" I.D.)	◆24942	
Hose - By Pass	≅20618	
Hose - By Pass; (3/4" I.D.)	28442	
Hose - Heater; (1" I.D.)	24216	
1603; 1703; 1803		
Belt - Fan	②◆◆9476HD	
Belt - Alt.; W/37A., 61A. Alt.	359006C91	②7417
Belt - Alt.; W/65A., 80A. Alt.	151531R2	②7450
Belt - Alt. & Air Brake Compr.; W/37A., 61A. Alt.	②7541	
Belt - Alt. & Air Brake Compr.; W/65A., 80A. Alt.	358344C91	②7560
Belt - P.S.	358335C91	②◆◆9490HD
Hose - Upper	●26531	
Hose - Lower	≅20530	
International/Navistar V461		
193RE		
Belt - Fan	358319C91	②◆◆9570HD
Belt - W.P.	359021C91	②TR22434
Belt - Alt.; W/37A. Alt.	256346C11	②◆9350HD
Belt - Alt.; W/55A., 60A., 62A., 105A., 130A. Alt.	②◆9365HD	
Belt - Alt. & Air Brake Compr.	243605R11	②◆◆9451HD
Belt - P.S.	164550R2	◆9425HD
Hose - Upper - Eng. To Pipe; (1 3/4" I.D.)	24228	
Hose - Upper - Eng. To Pipe	●26501	
Hose - Upper - Pipe To Rad.; (2 1/4" I.D.)	24236	
Hose - Lower; (2 5/8" I.D.)	◆24942	
Hose - By Pass	≅20618	
Hose - By Pass; (3/4" I.D.)	28442	
Hose - Heater; (1" I.D.)	24216	
1603; 1703; 1803		
Belt - Fan	②◆◆9476HD	
Belt - Alt.; W/37A., 61A. Alt.	359006C91	②7417
Belt - Alt.; W/65A., 80A. Alt.	151531R2	②7450
Belt - Alt. & Air Brake Compr.; W/37A., 61A. Alt.	②7541	
Belt - Alt. & Air Brake Compr.; W/65A., 80A. Alt.	358344C91	②7560
Belt - P.S.	358335C91	②◆◆9490HD
Hose - Upper	●26531	
Hose - Lower	≅20530	
International/Navistar V478		
193RE		
Belt - Fan	358319C91	②◆◆9570HD
Belt - W.P.	359021C91	②TR22434
Belt - Alt.; W/37A. Alt.	256346C11	②◆9350HD
Belt - Alt.; W/55A., 60A., 62A., 105A., 130A. Alt.	②◆9365HD	
Belt - Alt. & Air Brake Compr.	243605R11	②◆◆9451HD
Belt - P.S.	164550R2	◆9425HD
Hose - Upper - Eng. To Pipe; (1 3/4" I.D.)	24228	
Hose - Upper - Eng. To Pipe	●26501	
Hose - Upper - Pipe To Rad.; (2 1/4" I.D.)	24236	
Hose - Lower; (2 5/8" I.D.)	◆24942	
Hose - By Pass	≅20618	
Hose - By Pass; (3/4" I.D.)	28442	
Hose - Heater; (1" I.D.)	24216	
1603; 1703; 1803		
Belt - Fan	②◆◆9476HD	
Belt - Alt.; W/37A., 61A. Alt.	359006C91	②7417
Belt - Alt.; W/65A., 80A. Alt.	151531R2	②7450
Belt - Alt. & Air Brake Compr.; W/37A., 61A. Alt.	②7541	
Belt - Alt. & Air Brake Compr.; W/65A., 80A. Alt.	358344C91	②7560
Belt - P.S.	358335C91	②◆◆9490HD
Hose - Upper	●26531	
Hose - Lower	≅20530	

② Two Required.
 ≅ Cut to Fit.
 ◆ Standard Belt Available. See Pages 630-631.

● Vulco-Flex® Coolant Hose.
 ◆ Green Stripe® PowerBand® Belt May Work, Use Template to Check.
 ◆ Use Wire Inserted Green Stripe® Coolant Hose.

School Buses

Belts and Coolant Hose for School Buses

School Buses

Application	Mfr. Part No.	Our No.
INTERNATIONAL/NAVISTAR - Continued		
1973 - Continued		
International/Navistar V549		
193RE		
Belt - Fan	358319C91	②◆▲9570HD
Belt - W.P.	359021C91	②TR22434
Belt - Alt.; W/37A. Alt.	256346C11	②▲9350HD
Belt - Alt.; W/55A., 60A., 62A., 105A., 130A. Alt.		②▲9365HD
Belt - Alt. & Air Brake Compr.	243605R11	②◆▲9451HD
Belt - P.S.	164550R2	▲9425HD
Hose - Upper - Eng. To Pipe; (1 3/4" I.D.)		24228
Hose - Upper - Eng. To Pipe		●26501
Hose - Upper - Pipe To Rad.; (2 1/4" I.D.)		24236
Hose - Lower; (2 5/8" I.D.)		⊕24942
Hose - By Pass		≠20618
Hose - By Pass; (3/4" I.D.)		28442
Hose - Heater; (1" I.D.)		24216
1603; 1703 ; 1803		
Belt - Fan		②◆▲9476HD
Belt - Alt.; W/37A., 61A. Alt.	359006C91	②7417
Belt - Alt.; W/65A., 80A. Alt.	151531R2	②7450
Belt - Alt. & Air Brake Compr.; W/37A., 61A. Alt.		②7541
Belt - Alt. & Air Brake Compr.; W/65A., 80A. Alt.	358344C91	②7560
Belt - P.S.	358335C91	②◆▲9490HD
Hose - Upper		●26531
Hose - Lower		≠20530
International/Navistar VS401		
193RE		
Belt - Fan	358319C91	②◆▲9570HD
Belt - W.P.	359021C91	②TR22434
Belt - Alt.; W/37A. Alt.	256346C11	②▲9350HD
Belt - Alt.; W/55A., 60A., 62A., 105A., 130A. Alt.		②▲9365HD
Belt - Alt. & Air Brake Compr.	243605R11	②◆▲9451HD
Belt - P.S.	164550R2	▲9425HD
Hose - Upper - Eng. To Pipe; (1 3/4" I.D.)		24228
Hose - Upper - Eng. To Pipe		●26501
Hose - Upper - Pipe To Rad.; (2 1/4" I.D.)		24236
Hose - Lower; (2 5/8" I.D.)		⊕24942
Hose - By Pass		≠20618
Hose - By Pass; (3/4" I.D.)		28442
Hose - Heater; (1" I.D.)		24216
1603; 1703 ; 1803		
Belt - Fan		②◆▲9476HD
Belt - Alt.; W/37A., 61A. Alt.	359006C91	②7417
Belt - Alt.; W/65A., 80A. Alt.	151531R2	②7450
Belt - Alt. & Air Brake Compr.; W/37A., 61A. Alt.		②7541
Belt - Alt. & Air Brake Compr.; W/65A., 80A. Alt.	358344C91	②7560
Belt - P.S.	358335C91	②◆▲9490HD
Hose - Upper		●26531
Hose - Lower		≠20530
International/Navistar VS478		
193RE		
Belt - Fan	358319C91	②◆▲9570HD
Belt - W.P.	359021C91	②TR22434
Belt - Alt.; W/37A. Alt.	256346C11	②▲9350HD
Belt - Alt.; W/55A., 60A., 62A., 105A., 130A. Alt.		②▲9365HD
Belt - Alt. & Air Brake Compr.	243605R11	②◆▲9451HD
Belt - P.S.	164550R2	▲9425HD
Hose - Upper - Eng. To Pipe; (1 3/4" I.D.)		24228
Hose - Upper - Eng. To Pipe		●26501
Hose - Upper - Pipe To Rad.; (2 1/4" I.D.)		24236
Hose - Lower; (2 5/8" I.D.)		⊕24942
Hose - By Pass		≠20618
Hose - By Pass; (3/4" I.D.)		28442
Hose - Heater; (1" I.D.)		24216
1603; 1703 ; 1803		
Belt - Fan		②◆▲9476HD
Belt - Alt.; W/37A., 61A. Alt.	359006C91	②7417
Belt - Alt.; W/65A., 80A. Alt.	151531R2	②7450
Belt - Alt. & Air Brake Compr.; W/37A., 61A. Alt.		②7541

Application	Mfr. Part No.	Our No.
INTERNATIONAL/NAVISTAR - Continued		
1973 - Continued		
International/Navistar VS478 - Continued		
1603; 1703 ; 1803 - Continued		
Belt - Alt. & Air Brake Compr.; W/65A., 80A. Alt.	358344C91	②7560
Belt - P.S.	358335C91	②◆▲9490HD
Hose - Upper		●26531
Hose - Lower		≠20530
International/Navistar VS549		
193RE		
Belt - Fan	358319C91	②◆▲9570HD
Belt - W.P.	359021C91	②TR22434
Belt - Alt.; W/37A. Alt.	256346C11	②▲9350HD
Belt - Alt.; W/55A., 60A., 62A., 105A., 130A. Alt.		②▲9365HD
Belt - Alt. & Air Brake Compr.	243605R11	②◆▲9451HD
Belt - P.S.	164550R2	▲9425HD
Hose - Upper - Eng. To Pipe; (1 3/4" I.D.)		24228
Hose - Upper - Eng. To Pipe		●26501
Hose - Upper - Pipe To Rad.; (2 1/4" I.D.)		24236
Hose - Lower; (2 5/8" I.D.)		⊕24942
Hose - By Pass		≠20618
Hose - By Pass; (3/4" I.D.)		28442
Hose - Heater; (1" I.D.)		24216
1603; 1703 ; 1803		
Belt - Fan		②◆▲9476HD
Belt - Alt.; W/37A., 61A. Alt.	359006C91	②7417
Belt - Alt.; W/65A., 80A. Alt.	151531R2	②7450
Belt - Alt. & Air Brake Compr.; W/37A., 61A. Alt.		②7541
Belt - Alt. & Air Brake Compr.; W/65A., 80A. Alt.	358344C91	②7560
Belt - P.S.	358335C91	②◆▲9490HD
Hose - Upper		●26531
Hose - Lower		≠20530
1972		
Caterpillar 1145 Diesel		
1853		
Belt - Fan	426222C91	②◆▲9530HD
Belt - Alt.; W/37A., 61A. Alt.	398601C91	②▲9440HD
Belt - Alt.; W/65A., 80A. Alt.	354029C91	②◆▲9476HD
Belt - Alt. & Air Brake Compr.; W/37A., 61A. Alt.		②▲9465HD
Belt - Alt. & Air Brake Compr.; W/65A., 80A. Alt.	427205C91	②◆▲9500HD
Belt - P.S.		▲9465HD
Hose - Upper		●26532
Caterpillar 1150 Diesel		
1853		
Belt - Fan	426222C91	②◆▲9530HD
Belt - Alt.; W/37A., 61A. Alt.	398601C91	②▲9440HD
Belt - Alt.; W/65A., 80A. Alt.	354029C91	②◆▲9476HD
Belt - Alt. & Air Brake Compr.; W/37A., 61A. Alt.		②▲9465HD
Belt - Alt. & Air Brake Compr.; W/65A., 80A. Alt.	427205C91	②◆▲9500HD
Belt - P.S.		▲9465HD
Hose - Upper		●26532
Caterpillar 1160 Diesel		
1853		
Belt - Fan	426222C91	②◆▲9530HD
Belt - Alt.; W/37A., 61A. Alt.	398601C91	②▲9440HD
Belt - Alt.; W/65A., 80A. Alt.	354029C91	②◆▲9476HD
Belt - Alt. & Air Brake Compr.; W/37A., 61A. Alt.		②▲9465HD
Belt - Alt. & Air Brake Compr.; W/65A., 80A. Alt.	427205C91	②◆▲9500HD
Belt - P.S.		▲9465HD
Hose - Upper		●26532
International/Navistar FTV549		
193RE		
Belt - Fan	358319C91	②◆▲9570HD
Belt - W.P.	359021C91	②TR22434
Belt - Alt.; W/37A. Alt.	256346C11	②▲9350HD
Belt - Alt.; W/55A., 60A., 62A., 105A., 130A. Alt.		②▲9365HD

② Two Required.
 ▲ Standard Belt Available. See Pages 630-631.
 ⊕ Use Wire Inserted Green Stripe® Coolant Hose.

◆ Green Stripe® PowerBand® Belt May Work, Use Template to Check.
 ● Vulco-Flex® Coolant Hose.
 ≠ Cut to Fit.

Belts and Coolant Hose for School Buses

Application	Mfr. Part No.	Our No.
INTERNATIONAL/NAVISTAR - Continued		
1972 - Continued		
International/Navistar FTV549 - Continued		
193RE - Continued		
Belt - Alt. & Air Brake Compr.	243605R11	②◆▲9451HD
Belt - P.S.	164550R2	▲9425HD
Hose - Upper - Eng. To Pipe; (1 3/4" I.D.)		24228
Hose - Upper - Eng. To Pipe		●26501
Hose - Upper - Pipe To Rad.; (2 1/4" I.D.)		24236
Hose - Lower; (2 5/8" I.D.)		⊕24942
Hose - By Pass		≈<20618
Hose - By Pass; (3/4" I.D.)		28442
Hose - Heater; (1" I.D.)		24216
1603; 1703; 1803		
Hose - Upper		●26531
Hose - Lower		≈<20530
International/Navistar FTVS549		
193RE		
Belt - Fan	358319C91	②◆▲9570HD
Belt - W.P.	359021C91	②TR22434
Belt - Alt.; W/37A. Alt.	256346C11	②▲9350HD
Belt - Alt.; W/55A., 60A., 62A., 105A., 130A. Alt.		②▲9365HD
Belt - Alt. & Air Brake Compr.	243605R11	②◆▲9451HD
Belt - P.S.	164550R2	▲9425HD
Hose - Upper - Eng. To Pipe; (1 3/4" I.D.)		24228
Hose - Upper - Eng. To Pipe		●26501
Hose - Upper - Pipe To Rad.; (2 1/4" I.D.)		24236
Hose - Lower; (2 5/8" I.D.)		⊕24942
Hose - By Pass		≈<20618
Hose - By Pass; (3/4" I.D.)		28442
Hose - Heater; (1" I.D.)		24216
1603; 1703; 1803		
Hose - Upper		●26531
Hose - Lower		≈<20530
International/Navistar RD372		
1823		
Belt - Fan & Alt.	359014C91	②TR22514
Belt - W.P. & Alt.; W/37A. Alt.; Chassis No. FD61626 & Before	193826R11	②TR22508
Belt - W.P. & Alt.; W/37A. Alt.; Chassis No. FD61626 & Up & G Chassis No.	223794R11	②TR22514
Belt - W.P. & Alt.; W/60A. Alt.	243604R11	②TR22517
Belt - P.S.	240354R2	TR22336
Belt - Air Brake Compr.; W/Wagner Compr.	92836HA	TR32491
Belt - Air Brake Compr.; W/Westinghouse Compr.	83816HA	TR34467
Hose - Upper		●26515
Hose - Lower; (2" I.D.)		24232
1853		
Belt - Alt.; W/55A., 62A., 145A. Alt.	223794K21	②TR22514
Belt - Gen.; W/37A. Gen.	193826R11	TR22508
Belt - P.S.	240354R1	TR22344
1853FC		
Belt - Alt.; W/55A., 62A., 145A. Alt.	223794K21	②TR22514
Belt - Gen.; W/37A. Gen.	193826R11	TR22508
Belt - P.S.	240354R1	TR22344
Hose - Upper; Late FD Chassis; Chassis No. FA66376		●26509
Hose - Lower; Early FD Chassis; Chassis No. FA66376		●26508
Hose - Lower; Late FD Chassis; Chassis No. FA66376(2 1/8" I.D.)		24234
Hose - Lower; Late FD Chassis; Chassis No. FA66376		●26508
International/Navistar RD406		
1823		
Belt - Fan & Alt.	359014C91	②TR22514
Belt - W.P. & Alt.; W/37A. Alt.; Chassis No. FD61626 & Before	193826R11	②TR22508
Belt - W.P. & Alt.; W/37A. Alt.; Chassis No. FD61626 & Up & G Chassis No.	223794R11	②TR22514
Belt - W.P. & Alt.; W/60A. Alt.	243604R11	②TR22517
Belt - P.S.	240354R2	TR22336
Belt - Air Brake Compr.; W/Wagner Compr.	92836HA	TR32491

Application	Mfr. Part No.	Our No.
INTERNATIONAL/NAVISTAR - Continued		
1972 - Continued		
International/Navistar RD406 - Continued		
1823 - Continued		
Belt - Air Brake Compr.; W/Westinghouse Compr.	83816HA	TR34467
Hose - Upper		●26515
Hose - Lower; (2" I.D.)		24232
1853		
Belt - Alt.; W/55A., 62A., 145A. Alt.	223794K21	②TR22514
Belt - Gen.; W/37A. Gen.	193826R11	TR22508
Belt - P.S.	240354R1	TR22344
1853FC		
Belt - Alt.; W/55A., 62A., 145A. Alt.	223794K21	②TR22514
Belt - Gen.; W/37A. Gen.	193826R11	TR22508
Belt - P.S.	240354R1	TR22344
Hose - Upper; Late FD Chassis; Chassis No. FA66376		●26509
Hose - Lower; Early FD Chassis; Chassis No. FA66376		●26508
Hose - Lower; Late FD Chassis; Chassis No. FA66376(2 1/8" I.D.)		24234
Hose - Lower; Late FD Chassis; Chassis No. FA66376		●26508
International/Navistar RD450		
1823		
Belt - Fan & Alt.	359014C91	②TR22514
Belt - W.P. & Alt.; W/37A. Alt.; Chassis No. FD61626 & Before	193826R11	②TR22508
Belt - W.P. & Alt.; W/37A. Alt.; Chassis No. FD61626 & Up & G Chassis No.	223794R11	②TR22514
Belt - W.P. & Alt.; W/60A. Alt.	243604R11	②TR22517
Belt - P.S.	240354R2	TR22336
Belt - Air Brake Compr.; W/Wagner Compr.	92836HA	TR32491
Belt - Air Brake Compr.; W/Westinghouse Compr.	83816HA	TR34467
Hose - Upper		●26515
Hose - Lower; (2" I.D.)		24232
1853		
Belt - Alt.; W/55A., 62A., 145A. Alt.	223794K21	②TR22514
Belt - Gen.; W/37A. Gen.	193826R11	TR22508
Belt - P.S.	240354R1	TR22344
1853FC		
Belt - Alt.; W/55A., 62A., 145A. Alt.	223794K21	②TR22514
Belt - Gen.; W/37A. Gen.	193826R11	TR22508
Belt - P.S.	240354R1	TR22344
Hose - Upper; Late FD Chassis; Chassis No. FA66376		●26509
Hose - Lower; Early FD Chassis; Chassis No. FA66376		●26508
Hose - Lower; Late FD Chassis; Chassis No. FA66376(2 1/8" I.D.)		24234
Hose - Lower; Late FD Chassis; Chassis No. FA66376		●26508
International/Navistar RD501		
1823		
Belt - Fan & Alt.	359014C91	②TR22514
Belt - W.P. & Alt.; W/37A. Alt.; Chassis No. FD61626 & Before	193826R11	②TR22508
Belt - W.P. & Alt.; W/37A. Alt.; Chassis No. FD61626 & Up & G Chassis No.	223794R11	②TR22514
Belt - W.P. & Alt.; W/60A. Alt.	243604R11	②TR22517
Belt - P.S.	240354R2	TR22336
Belt - Air Brake Compr.; W/Wagner Compr.	92836HA	TR32491
Belt - Air Brake Compr.; W/Westinghouse Compr.	83816HA	TR34467
Hose - Upper		●26515
Hose - Lower; (2" I.D.)		24232
1853		
Belt - Alt.; W/55A., 62A., 145A. Alt.	223794K21	②TR22514
Belt - Gen.; W/37A. Gen.	193826R11	TR22508
Belt - P.S.	240354R1	TR22344
1853FC		
Belt - Alt.; W/55A., 62A., 145A. Alt.	223794K21	②TR22514
Belt - Gen.; W/37A. Gen.	193826R11	TR22508
Belt - P.S.	240354R1	TR22344
Hose - Upper; Late FD Chassis; Chassis No. FA66376		●26509
Hose - Lower; Early FD Chassis; Chassis No. FA66376		●26508

② Two Required.
 ▲ Standard Belt Available. See Pages 630-631.
 ⊕ Use Wire Inserted Green Stripe® Coolant Hose.

◆ Green Stripe® PowerBand® Belt May Work, Use Template to Check.
 ● Vulco-Flex® Coolant Hose.
 ≈< Cut to Fit.

School Buses

Belts and Coolant Hose for School Buses

School Buses

Application	Mfr. Part No.	Our No.
INTERNATIONAL/NAVISTAR - Continued		
1972 - Continued		
International/Navistar RD501 - Continued		
1853FC - Continued		
Hose - Lower; Late FD Chassis; Chassis No. FA66376(2 1/8" I.D.)		24234
Hose - Lower; Late FD Chassis; Chassis No. FA66376		●26508
International/Navistar V266		
1603; 1703 ; 1803		
Belt - Fan & Alt.; W/37A., 52A., 61A. Alt.; C, G, H Chassis		②7603
Belt - Fan & Alt.; W/37A., 52A., 61A. Alt.; FD, SB Chassis	255266C3	②7640
Belt - Fan & Alt.; W/55A., 62A. Alt.; C, G, H Chassis	369725C91	②7619
Belt - Fan & Alt.; W/55A., 62A. Alt.; FD, SB Chassis	358998C91	②7650
Belt - P.S.; W/2WD	151529R2	7440
Belt - P.S.; W/4WD	151531R2	7450
Belt - Air Brake Compr.	236572R2	7460
Hose - Upper; W/Rad. Shutters; W/Metal Hood		●26515
Hose - Upper; W/O Rad. Shutters; W/Metal Hood		20493
Hose - Lower - Eng. To Pipe; W/Auto. Trans.		20532
Hose - Lower; W/Man. Trans.		21308
Hose - By Pass		✂20357
International/Navistar V304		
1603; 1703 ; 1803		
Belt - Fan & Alt.; W/37A., 52A., 61A. Alt.; C, G, H Chassis		②7603
Belt - Fan & Alt.; W/37A., 52A., 61A. Alt.; FD, SB Chassis	255266C3	②7640
Belt - Fan & Alt.; W/55A., 62A. Alt.; C, G, H Chassis	369725C91	②7619
Belt - Fan & Alt.; W/55A., 62A. Alt.; FD, SB Chassis	358998C91	②7650
Belt - P.S.; W/2WD	151529R2	7440
Belt - P.S.; W/4WD	151531R2	7450
Belt - Air Brake Compr.	236572R2	7460
Hose - Upper; W/Rad. Shutters; W/Metal Hood		●26515
Hose - Upper; W/O Rad. Shutters; W/Metal Hood		20493
Hose - Lower - Eng. To Pipe; W/Auto. Trans.		20532
Hose - Lower; W/Man. Trans.		21308
Hose - By Pass		✂20357
International/Navistar V345		
1603; 1703		
Belt - Fan & Alt.; W/37A., 52A., 61A. Alt.; C, G, H Chassis; W/P.T.O.	968815R11	②7650
Belt - Fan & Alt.; W/37A., 52A., 61A. Alt.; C, G, H Chassis; W/O P.T.O.	373457C91	②7612
Belt - Fan & Alt.; W/37A., 52A., 61A. Alt.; FD, SB Chassis	968815R1	②7650
Belt - Fan & Alt.; W/37A., 61A. Alt.; W/O Air Brakes; W/O P.T.O.; W/O X.C.	373456C1	7612
Belt - Fan & Alt.; W/55A., 62A. Alt.; C, G, H Chassis	369723C91	②7630
Belt - Fan & Alt.; W/55A., 62A. Alt.; FD, SB Chassis	361975C91	②7673
Belt - Fan & Alt.; W/60A. Alt.	359009C91	②7680
Belt - Fan & Alt.; W/65A., 80A., 105A., 145A. Alt.; W/P.T.O.	361975C91	②7673
Belt - Fan & Alt.; W/65A., 80A., 105A., 145A. Alt.; W/O P.T.O.		②7630
Belt - P.S.; W/2WD	7460	
Belt - P.S.; W/4WD	285522C2	7435
Belt - Air Brake Compr.	359007C91	7475
Belt - A.P.; W/Air Brakes; W/Gov.	388139C1	7330
Belt - A.P.; W/Air Brakes; W/O Gov.	256062C2	7340
Belt - A.P.; W/Hyd. Brakes; W/Gov.	355653C91	7380
Belt - A.P.; W/Hyd. Brakes; W/O Gov.	362887C91	7410
Hose - Upper; W/Rad. Shutters; W/Metal Hood		●26515
Hose - Upper; W/O Rad. Shutters; W/Metal Hood		20493
Hose - Lower - Eng. To Pipe; W/Auto. Trans.		20532
Hose - Lower; W/Man. Trans.		21308
Hose - By Pass		✂20357

Application	Mfr. Part No.	Our No.
INTERNATIONAL/NAVISTAR - Continued		
1972 - Continued		
International/Navistar V345 - Continued		
1723		
Belt - Fan & Alt.; W/37A., 52A., 61A. Alt.; C, G, H Chassis; W/P.T.O.	968815R11	②7650
Belt - Fan & Alt.; W/37A., 52A., 61A. Alt.; C, G, H Chassis; W/O P.T.O.	373457C91	②7612
Belt - Fan & Alt.; W/37A., 52A., 61A. Alt.; FD, SB Chassis	968815R1	②7650
Belt - Fan & Alt.; W/37A., 61A. Alt.; W/O Air Brakes; W/O P.T.O.; W/O X.C.	373456C1	7612
Belt - Fan & Alt.; W/55A., 62A. Alt.; C, G, H Chassis	369723C91	②7630
Belt - Fan & Alt.; W/55A., 62A. Alt.; FD, SB Chassis	361975C91	②7673
Belt - Fan & Alt.; W/60A. Alt.	359009C91	②7680
Belt - Fan & Alt.; W/65A., 80A., 105A., 145A. Alt.; W/P.T.O.	361975C91	②7673
Belt - Fan & Alt.; W/65A., 80A., 105A., 145A. Alt.; W/O P.T.O.		②7630
Belt - P.S.; W/2WD	7460	
Belt - P.S.; W/4WD	285522C2	7435
Belt - Air Brake Compr.	359007C91	7475
Belt - A.P.; W/Air Brakes; W/Gov.	388139C1	7330
Belt - A.P.; W/Air Brakes; W/O Gov.	256062C2	7340
Belt - A.P.; W/Hyd. Brakes; W/Gov.	355653C91	7380
Belt - A.P.; W/Hyd. Brakes; W/O Gov.	362887C91	7410
1803		
Belt - Fan & Alt.; W/37A., 52A., 61A. Alt.; C, G, H Chassis; W/P.T.O.	968815R11	②7650
Belt - Fan & Alt.; W/37A., 52A., 61A. Alt.; C, G, H Chassis; W/O P.T.O.	373457C91	②7612
Belt - Fan & Alt.; W/37A., 52A., 61A. Alt.; FD, SB Chassis	968815R1	②7650
Belt - Fan & Alt.; W/37A., 61A. Alt.; W/O Air Brakes; W/O P.T.O.; W/O X.C.	373456C1	7612
Belt - Fan & Alt.; W/55A., 62A. Alt.; C, G, H Chassis	369723C91	②7630
Belt - Fan & Alt.; W/55A., 62A. Alt.; FD, SB Chassis	361975C91	②7673
Belt - Fan & Alt.; W/60A. Alt.	359009C91	②7680
Belt - Fan & Alt.; W/65A., 80A., 105A., 145A. Alt.; W/P.T.O.	361975C91	②7673
Belt - Fan & Alt.; W/65A., 80A., 105A., 145A. Alt.; W/O P.T.O.		②7630
Belt - P.S.; W/2WD	7460	
Belt - P.S.; W/4WD	285522C2	7435
Belt - Air Brake Compr.	359007C91	7475
Belt - A.P.; W/Air Brakes; W/Gov.	388139C1	7330
Belt - A.P.; W/Air Brakes; W/O Gov.	256062C2	7340
Belt - A.P.; W/Hyd. Brakes; W/Gov.	355653C91	7380
Belt - A.P.; W/Hyd. Brakes; W/O Gov.	362887C91	7410
Hose - Upper; W/Rad. Shutters; W/Metal Hood		●26515
Hose - Upper; W/O Rad. Shutters; W/Metal Hood		20493
Hose - Lower - Eng. To Pipe; W/Auto. Trans.		20532
Hose - Lower; W/Man. Trans.		21308
Hose - By Pass		✂20357
1823		
Belt - Fan & Alt.; W/37A., 52A., 61A. Alt.; C, G, H Chassis; W/P.T.O.	968815R11	②7650
Belt - Fan & Alt.; W/37A., 52A., 61A. Alt.; C, G, H Chassis; W/O P.T.O.	373457C91	②7612
Belt - Fan & Alt.; W/37A., 52A., 61A. Alt.; FD, SB Chassis	968815R1	②7650
Belt - Fan & Alt.; W/37A., 61A. Alt.; W/O Air Brakes; W/O P.T.O.; W/O X.C.	373456C1	7612
Belt - Fan & Alt.; W/55A., 62A. Alt.; C, G, H Chassis	369723C91	②7630
Belt - Fan & Alt.; W/55A., 62A. Alt.; FD, SB Chassis	361975C91	②7673
Belt - Fan & Alt.; W/60A. Alt.	359009C91	②7680
Belt - Fan & Alt.; W/65A., 80A., 105A., 145A. Alt.; W/P.T.O.	361975C91	②7673
Belt - Fan & Alt.; W/65A., 80A., 105A., 145A. Alt.; W/O P.T.O.		②7630
Belt - P.S.; W/2WD	7460	
Belt - P.S.; W/4WD	285522C2	7435

● Vulco-Flex® Coolant Hose.
✂ Cut to Fit.

② Two Required.

Belts and Coolant Hose for School Buses

Application	Mfr. Part No.	Our No.	Application	Mfr. Part No.	Our No.
INTERNATIONAL/NAVISTAR - Continued			INTERNATIONAL/NAVISTAR - Continued		
1972 - Continued			1972 - Continued		
International/Navistar V345 - Continued			International/Navistar V392 - Continued		
1823 - Continued			1803 - Continued		
Belt - Air Brake Compr.	359007C91	7475	Belt - Fan & Alt.; W/55A., 62A. Alt.; FD, SB Chassis	361975C91	②7673
Belt - A.P.; W/Air Brakes; W/Gov.	388139C1	7330	Belt - Fan & Alt.; W/60A. Alt.	359009C91	②7680
Belt - A.P.; W/Air Brakes; W/O Gov.	256062C2	7340	Belt - Fan & Alt.; W/65A., 80A., 105A., 145A. Alt.; W/P.T.O.	361975C91	②7673
Belt - A.P.; W/Hyd. Brakes; W/Gov.	355653C91	7380	Belt - Fan & Alt.; W/65A., 80A., 105A., 145A. Alt.; W/O P.T.O.		7460
Belt - A.P.; W/Hyd. Brakes; W/O Gov.	362887C91	7410	Belt - P.S.; W/2WD		7435
International/Navistar V392			1823		
1603; 1703			Belt - Fan & Alt.; W/37A., 52A., 61A. Alt.; C, G, H Chassis; W/P.T.O.		
Belt - Fan & Alt.; W/37A., 52A., 61A. Alt.; C, G, H Chassis; W/P.T.O.	968815R11	②7650	Belt - Fan & Alt.; W/37A., 52A., 61A. Alt.; C, G, H Chassis; W/O P.T.O.	373457C91	②7612
Belt - Fan & Alt.; W/37A., 52A., 61A. Alt.; FD, SB Chassis	968815R1	②7650	Belt - Fan & Alt.; W/37A., 52A., 61A. Alt.; FD, SB Chassis	968815R1	②7650
Belt - Fan & Alt.; W/37A., 61A. Alt.; W/O Air Brakes; W/O P.T.O.; W/O X.C.	373456C1	7612	Belt - Fan & Alt.; W/37A., 61A. Alt.; W/O Air Brakes; W/O P.T.O.; W/O X.C.	373456C1	7612
Belt - Fan & Alt.; W/55A., 62A. Alt.; C, G, H Chassis	369723C91	②7630	Belt - Fan & Alt.; W/55A., 62A. Alt.; C, G, H Chassis	369723C91	②7630
Belt - Fan & Alt.; W/55A., 62A. Alt.; FD, SB Chassis	361975C91	②7673	Belt - Fan & Alt.; W/55A., 62A. Alt.; FD, SB Chassis	361975C91	②7673
Belt - Fan & Alt.; W/60A. Alt.	359009C91	②7680	Belt - Fan & Alt.; W/60A. Alt.	359009C91	②7680
Belt - Fan & Alt.; W/65A., 80A., 105A., 145A. Alt.; W/P.T.O.	361975C91	②7673	Belt - Fan & Alt.; W/65A., 80A., 105A., 145A. Alt.; W/O P.T.O.	361975C91	②7673
Belt - Fan & Alt.; W/65A., 80A., 105A., 145A. Alt.; W/O P.T.O.		7460	Belt - P.S.; W/2WD		7460
Belt - P.S.; W/2WD		7435	Belt - P.S.; W/4WD		7475
Belt - Air Brake Compr.	359007C91	7475	Belt - Air Brake Compr.	359007C91	7475
Belt - A.P.; W/Air Brakes; W/Gov.	388139C1	7330	Belt - A.P.; W/Air Brakes; W/Gov.	388139C1	7330
Belt - A.P.; W/Air Brakes; W/O Gov.	256062C2	7340	Belt - A.P.; W/Air Brakes; W/O Gov.	256062C2	7340
Belt - A.P.; W/Hyd. Brakes; W/Gov.	355653C91	7380	Belt - A.P.; W/Hyd. Brakes; W/Gov.	355653C91	7380
Belt - A.P.; W/Hyd. Brakes; W/O Gov.	362887C91	7410	Belt - A.P.; W/Hyd. Brakes; W/O Gov.	362887C91	7410
Hose - Upper; W/Rad. Shutters; W/Metal Hood	●26515		Hose - Upper; W/Rad. Shutters; W/Metal Hood	●26515	
Hose - Upper; W/O Rad. Shutters; W/Metal Hood	20493		Hose - Upper; W/O Rad. Shutters; W/Metal Hood	20493	
Hose - Lower - Eng. To Pipe; W/Auto. Trans.	20532		Hose - Lower - Eng. To Pipe; W/Auto. Trans.	20532	
Hose - Lower; W/Man. Trans.	21308		Hose - Lower; W/Man. Trans.	21308	
Hose - By Pass	≡20357		Hose - By Pass	≡20357	
1723			1823		
Belt - Fan & Alt.; W/37A., 52A., 61A. Alt.; C, G, H Chassis; W/P.T.O.	968815R11	②7650	Belt - Fan & Alt.; W/37A., 52A., 61A. Alt.; C, G, H Chassis; W/P.T.O.	968815R11	②7650
Belt - Fan & Alt.; W/37A., 52A., 61A. Alt.; C, G, H Chassis; W/O P.T.O.	373457C91	②7612	Belt - Fan & Alt.; W/37A., 52A., 61A. Alt.; C, G, H Chassis; W/O P.T.O.	373457C91	②7612
Belt - Fan & Alt.; W/37A., 52A., 61A. Alt.; FD, SB Chassis	968815R1	②7650	Belt - Fan & Alt.; W/37A., 52A., 61A. Alt.; FD, SB Chassis	968815R1	②7650
Belt - Fan & Alt.; W/37A., 61A. Alt.; W/O Air Brakes; W/O P.T.O.; W/O X.C.	373456C1	7612	Belt - Fan & Alt.; W/37A., 61A. Alt.; W/O Air Brakes; W/O P.T.O.; W/O X.C.	373456C1	7612
Belt - Fan & Alt.; W/55A., 62A. Alt.; C, G, H Chassis	369723C91	②7630	Belt - Fan & Alt.; W/55A., 62A. Alt.; C, G, H Chassis	369723C91	②7630
Belt - Fan & Alt.; W/55A., 62A. Alt.; FD, SB Chassis	361975C91	②7673	Belt - Fan & Alt.; W/55A., 62A. Alt.; FD, SB Chassis	361975C91	②7673
Belt - Fan & Alt.; W/60A. Alt.	359009C91	②7680	Belt - Fan & Alt.; W/60A. Alt.	359009C91	②7680
Belt - Fan & Alt.; W/65A., 80A., 105A., 145A. Alt.; W/P.T.O.	361975C91	②7673	Belt - Fan & Alt.; W/65A., 80A., 105A., 145A. Alt.; W/O P.T.O.	361975C91	②7673
Belt - Fan & Alt.; W/65A., 80A., 105A., 145A. Alt.; W/O P.T.O.		7460	Belt - P.S.; W/2WD		7460
Belt - P.S.; W/2WD		7435	Belt - P.S.; W/4WD		7475
Belt - Air Brake Compr.	359007C91	7475	Belt - Air Brake Compr.	359007C91	7475
Belt - A.P.; W/Air Brakes; W/Gov.	388139C1	7330	Belt - A.P.; W/Air Brakes; W/Gov.	388139C1	7330
Belt - A.P.; W/Air Brakes; W/O Gov.	256062C2	7340	Belt - A.P.; W/Air Brakes; W/O Gov.	256062C2	7340
Belt - A.P.; W/Hyd. Brakes; W/Gov.	355653C91	7380	Belt - A.P.; W/Hyd. Brakes; W/Gov.	355653C91	7380
Belt - A.P.; W/Hyd. Brakes; W/O Gov.	362887C91	7410	Belt - A.P.; W/Hyd. Brakes; W/O Gov.	362887C91	7410
1803			International/Navistar V401		
Belt - Fan & Alt.; W/37A., 52A., 61A. Alt.; C, G, H Chassis; W/P.T.O.	968815R11	②7650	193RE		
Belt - Fan & Alt.; W/37A., 52A., 61A. Alt.; C, G, H Chassis; W/O P.T.O.	373457C91	②7612	Belt - Fan	358319C91	②◆◆9570HD
Belt - Fan & Alt.; W/37A., 52A., 61A. Alt.; FD, SB Chassis	968815R1	②7650	Belt - W.P.	359021C91	②TR22434
Belt - Fan & Alt.; W/37A., 61A. Alt.; W/O Air Brakes; W/O P.T.O.; W/O X.C.	373456C1	7612	Belt - Alt.; W/37A. Alt.	256346C11	②◆9350HD
Belt - Fan & Alt.; W/55A., 62A. Alt.; C, G, H Chassis	369723C91	②7630	Belt - Alt.; W/55A., 60A., 62A., 105A., 130A. Alt.		②◆9365HD
Belt - Fan & Alt.; W/55A., 62A. Alt.; FD, SB Chassis	361975C91	②7673	Belt - Alt. & Air Brake Compr.	243605R11	②◆◆9451HD
Belt - Fan & Alt.; W/60A. Alt.	359009C91	②7680	Belt - P.S.	164550R2	◆9425HD
Belt - Fan & Alt.; W/65A., 80A., 105A., 145A. Alt.; W/P.T.O.	361975C91	②7673	Hose - Upper - Eng. To Pipe; (1 3/4" I.D.)		24228
Belt - Fan & Alt.; W/65A., 80A., 105A., 145A. Alt.; W/O P.T.O.		7460	Hose - Upper - Eng. To Pipe	●26501	
Belt - P.S.; W/2WD		7435	Hose - Upper - Pipe To Rad.; (2 1/4" I.D.)		24236
Belt - P.S.; W/4WD		7475	Hose - Lower; (2 5/8" I.D.)	◆24942	
Belt - Air Brake Compr.	359007C91	7475	Hose - By Pass	≡20618	
Belt - A.P.; W/Air Brakes; W/Gov.	388139C1	7330	Hose - By Pass; (3/4" I.D.)		28442
Belt - A.P.; W/Air Brakes; W/O Gov.	256062C2	7340	Hose - Heater; (1" I.D.)		24216
Belt - A.P.; W/Hyd. Brakes; W/Gov.	355653C91	7380	1603; 1703; 1803		
Belt - A.P.; W/Hyd. Brakes; W/O Gov.	362887C91	7410	Hose - Upper	●26531	
1803			Hose - Lower	≡20530	
Belt - Fan & Alt.; W/37A., 52A., 61A. Alt.; C, G, H Chassis; W/P.T.O.	968815R11	②7650	International/Navistar V461		
Belt - Fan & Alt.; W/37A., 52A., 61A. Alt.; C, G, H Chassis; W/O P.T.O.	373457C91	②7612	193RE		
Belt - Fan & Alt.; W/37A., 52A., 61A. Alt.; FD, SB Chassis	968815R1	②7650	Belt - Fan	358319C91	②◆◆9570HD
Belt - Fan & Alt.; W/37A., 61A. Alt.; W/O Air Brakes; W/O P.T.O.; W/O X.C.	373456C1	7612	Belt - W.P.	359021C91	②TR22434
Belt - Fan & Alt.; W/55A., 62A. Alt.; C, G, H Chassis	369723C91	②7630	Belt - Alt.; W/37A. Alt.	256346C11	②◆9350HD
Belt - Fan & Alt.; W/55A., 62A. Alt.; FD, SB Chassis	361975C91	②7673	Belt - Alt.; W/55A., 60A., 62A., 105A., 130A. Alt.		②◆9365HD
Belt - Fan & Alt.; W/60A. Alt.	359009C91	②7680	Belt - Alt. & Air Brake Compr.	243605R11	②◆◆9451HD
Belt - Fan & Alt.; W/65A., 80A., 105A., 145A. Alt.; W/P.T.O.	361975C91	②7673	Belt - P.S.	164550R2	◆9425HD
Belt - Fan & Alt.; W/65A., 80A., 105A., 145A. Alt.; W/O P.T.O.		7460	Hose - Upper - Eng. To Pipe; (1 3/4" I.D.)		24228
Belt - P.S.; W/2WD		7435	International/Navistar V461		
Belt - P.S.; W/4WD		7475	193RE		
Belt - Air Brake Compr.	359007C91	7475	Belt - Fan	358319C91	②◆◆9570HD
Belt - A.P.; W/Air Brakes; W/Gov.	388139C1	7330	Belt - W.P.	359021C91	②TR22434
Belt - A.P.; W/Air Brakes; W/O Gov.	256062C2	7340	Belt - Alt.; W/37A. Alt.	256346C11	②◆9350HD
Belt - A.P.; W/Hyd. Brakes; W/Gov.	355653C91	7380	Belt - Alt.; W/55A., 60A., 62A., 105A., 130A. Alt.		②◆9365HD
Belt - A.P.; W/Hyd. Brakes; W/O Gov.	362887C91	7410	Belt - Alt. & Air Brake Compr.	243605R11	②◆◆9451HD
1803			Belt - P.S.	164550R2	◆9425HD
Belt - Fan & Alt.; W/37A., 52A., 61A. Alt.; C, G, H Chassis; W/P.T.O.	968815R11	②7650	Hose - Upper - Eng. To Pipe; (1 3/4" I.D.)		24228
Belt - Fan & Alt.; W/37A., 52A., 61A. Alt.; C, G, H Chassis; W/O P.T.O.	373457C91	②7612	1603; 1703; 1803		
Belt - Fan & Alt.; W/37A., 52A., 61A. Alt.; FD, SB Chassis	968815R1	②7650	Hose - Upper	●26531	
Belt - Fan & Alt.; W/37A., 61A. Alt.; W/O Air Brakes; W/O P.T.O.; W/O X.C.	373456C1	7612	Hose - Lower	≡20530	
Belt - Fan & Alt.; W/55A., 62A. Alt.; C, G, H Chassis	369723C91	②7630	International/Navistar V461		
Belt - Fan & Alt.; W/55A., 62A. Alt.; FD, SB Chassis	361975C91	②7673	193RE		
Belt - Fan & Alt.; W/60A. Alt.	359009C91	②7680	Belt - Fan	358319C91	②◆◆9570HD
Belt - Fan & Alt.; W/65A., 80A., 105A., 145A. Alt.; W/P.T.O.	361975C91	②7673	Belt - W.P.	359021C91	②TR22434
Belt - Fan & Alt.; W/65A., 80A., 105A., 145A. Alt.; W/O P.T.O.		7460	Belt - Alt.; W/37A. Alt.	256346C11	②◆9350HD
Belt - P.S.; W/2WD		7435	Belt - Alt.; W/55A., 60A., 62A., 105A., 130A. Alt.		②◆9365HD
Belt - P.S.; W/4WD		7475	Belt - Alt. & Air Brake Compr.	243605R11	②◆◆9451HD
Belt - Air Brake Compr.	359007C91	7475	Belt - P.S.	164550R2	◆9425HD
Belt - A.P.; W/Air Brakes; W/Gov.	388139C1	7330	Hose - Upper - Eng. To Pipe; (1 3/4" I.D.)		24228
Belt - A.P.; W/Air Brakes; W/O Gov.	256062C2	7340	1603; 1703; 1803		
Belt - A.P.; W/Hyd. Brakes; W/Gov.	355653C91	7380	Hose - Upper	●26531	
Belt - A.P.; W/Hyd. Brakes; W/O Gov.	362887C91	7410	Hose - Lower	≡20530	

School Buses

② Two Required.
 ≡ Cut to Fit.
 ◆ Standard Belt Available. See Pages 630-631.

● Vulco-Flex® Coolant Hose.
 ◆ Green Stripe® PowerBand® Belt May Work, Use Template to Check.
 ≡ Use Wire Inserted Green Stripe® Coolant Hose.

Belts and Coolant Hose for School Buses

School Buses

Application	Mfr. Part No.	Our No.
INTERNATIONAL/NAVISTAR - Continued		
1972 - Continued		
International/Navistar V461 - Continued		
193RE - Continued		
Hose - Upper - Eng. To Pipe		●26501
Hose - Upper - Pipe To Rad.; (2 1/4" I.D.)		24236
Hose - Lower; (2 5/8" I.D.)		⊕24942
Hose - By Pass		≍20618
Hose - By Pass; (3/4" I.D.)		28442
Hose - Heater; (1" I.D.)		24216
1603; 1703 ; 1803		
Hose - Upper		●26531
Hose - Lower		≍20530
International/Navistar V478		
193RE		
Belt - Fan	358319C91	②◆▲9570HD
Belt - W.P.	359021C91	②TR22434
Belt - Alt.; W/37A. Alt.	256346C11	②▲9350HD
Belt - Alt.; W/55A., 60A., 62A., 105A., 130A. Alt.		②▲9365HD
Belt - Alt. & Air Brake Compr.	243605R11	②◆▲9451HD
Belt - P.S.	164550R2	▲9425HD
Hose - Upper - Eng. To Pipe; (1 3/4" I.D.)		24228
Hose - Upper - Eng. To Pipe		●26501
Hose - Upper - Pipe To Rad.; (2 1/4" I.D.)		24236
Hose - Lower; (2 5/8" I.D.)		⊕24942
Hose - By Pass		≍20618
Hose - By Pass; (3/4" I.D.)		28442
Hose - Heater; (1" I.D.)		24216
1603; 1703 ; 1803		
Hose - Upper		●26531
Hose - Lower		≍20530
International/Navistar V549		
193RE		
Belt - Fan	358319C91	②◆▲9570HD
Belt - W.P.	359021C91	②TR22434
Belt - Alt.; W/37A. Alt.	256346C11	②▲9350HD
Belt - Alt.; W/55A., 60A., 62A., 105A., 130A. Alt.		②▲9365HD
Belt - Alt. & Air Brake Compr.	243605R11	②◆▲9451HD
Belt - P.S.	164550R2	▲9425HD
Hose - Upper - Eng. To Pipe; (1 3/4" I.D.)		24228
Hose - Upper - Eng. To Pipe		●26501
Hose - Upper - Pipe To Rad.; (2 1/4" I.D.)		24236
Hose - Lower; (2 5/8" I.D.)		⊕24942
Hose - By Pass		≍20618
Hose - By Pass; (3/4" I.D.)		28442
Hose - Heater; (1" I.D.)		24216
1603; 1703 ; 1803		
Hose - Upper		●26531
Hose - Lower		≍20530
International/Navistar VS401		
193RE		
Belt - Fan	358319C91	②◆▲9570HD
Belt - W.P.	359021C91	②TR22434
Belt - Alt.; W/37A. Alt.	256346C11	②▲9350HD
Belt - Alt.; W/55A., 60A., 62A., 105A., 130A. Alt.		②▲9365HD
Belt - Alt. & Air Brake Compr.	243605R11	②◆▲9451HD
Belt - P.S.	164550R2	▲9425HD
Hose - Upper - Eng. To Pipe; (1 3/4" I.D.)		24228
Hose - Upper - Eng. To Pipe		●26501
Hose - Upper - Pipe To Rad.; (2 1/4" I.D.)		24236
Hose - Lower; (2 5/8" I.D.)		⊕24942
Hose - By Pass		≍20618
Hose - By Pass; (3/4" I.D.)		28442
Hose - Heater; (1" I.D.)		24216
1603; 1703 ; 1803		
Hose - Upper		●26531
Hose - Lower		≍20530
International/Navistar VS478		
193RE		
Belt - Fan	358319C91	②◆▲9570HD
Belt - W.P.	359021C91	②TR22434

Application	Mfr. Part No.	Our No.
INTERNATIONAL/NAVISTAR - Continued		
1972 - Continued		
International/Navistar VS478 - Continued		
193RE - Continued		
Belt - Alt.; W/37A. Alt.	256346C11	②▲9350HD
Belt - Alt.; W/55A., 60A., 62A., 105A., 130A. Alt.		②▲9365HD
Belt - Alt. & Air Brake Compr.	243605R11	②◆▲9451HD
Belt - P.S.	164550R2	▲9425HD
Hose - Upper - Eng. To Pipe; (1 3/4" I.D.)		24228
Hose - Upper - Eng. To Pipe		●26501
Hose - Upper - Pipe To Rad.; (2 1/4" I.D.)		24236
Hose - Lower; (2 5/8" I.D.)		⊕24942
Hose - By Pass		≍20618
Hose - By Pass; (3/4" I.D.)		28442
Hose - Heater; (1" I.D.)		24216
1603; 1703 ; 1803		
Hose - Upper		●26531
Hose - Lower		≍20530
International/Navistar VS549		
193RE		
Belt - Fan	358319C91	②◆▲9570HD
Belt - W.P.	359021C91	②TR22434
Belt - Alt.; W/37A. Alt.	256346C11	②▲9350HD
Belt - Alt.; W/55A., 60A., 62A., 105A., 130A. Alt.		②▲9365HD
Belt - Alt. & Air Brake Compr.	243605R11	②◆▲9451HD
Belt - P.S.	164550R2	▲9425HD
Hose - Upper - Eng. To Pipe; (1 3/4" I.D.)		24228
Hose - Upper - Eng. To Pipe		●26501
Hose - Upper - Pipe To Rad.; (2 1/4" I.D.)		24236
Hose - Lower; (2 5/8" I.D.)		⊕24942
Hose - By Pass		≍20618
Hose - By Pass; (3/4" I.D.)		28442
Hose - Heater; (1" I.D.)		24216
1603; 1703 ; 1803		
Hose - Upper		●26531
Hose - Lower		≍20530
1971		
International/Navistar FTV549		
193RE		
Belt - Fan	358319C91	②◆▲9570HD
Belt - W.P.	359021C91	②TR22434
Belt - Alt.; W/37A. Alt.	256346C11	②▲9350HD
Belt - Alt.; W/55A., 60A., 62A., 105A., 130A. Alt.		②▲9365HD
Belt - Alt. & Air Brake Compr.	243605R11	②◆▲9451HD
Belt - P.S.	164550R2	▲9425HD
Hose - Upper - Eng. To Pipe; (1 3/4" I.D.)		24228
Hose - Upper - Eng. To Pipe		●26501
Hose - Upper - Pipe To Rad.; (2 1/4" I.D.)		24236
Hose - Lower; (2 5/8" I.D.)		⊕24942
Hose - By Pass		≍20618
Hose - By Pass; (3/4" I.D.)		28442
Hose - Heater; (1" I.D.)		24216
International/Navistar FTVS549		
193RE		
Belt - Fan	358319C91	②◆▲9570HD
Belt - W.P.	359021C91	②TR22434
Belt - Alt.; W/37A. Alt.	256346C11	②▲9350HD
Belt - Alt.; W/55A., 60A., 62A., 105A., 130A. Alt.		②▲9365HD
Belt - Alt. & Air Brake Compr.	243605R11	②◆▲9451HD
Belt - P.S.	164550R2	▲9425HD
Hose - Upper - Eng. To Pipe; (1 3/4" I.D.)		24228
Hose - Upper - Eng. To Pipe		●26501
Hose - Upper - Pipe To Rad.; (2 1/4" I.D.)		24236
Hose - Lower; (2 5/8" I.D.)		⊕24942
Hose - By Pass		≍20618
Hose - By Pass; (3/4" I.D.)		28442
Hose - Heater; (1" I.D.)		24216
International/Navistar RD372		
1823		
Belt - Fan & Alt.	359014C91	②TR22514

● Vulco-Flex® Coolant Hose.
 ≍ Cut to Fit.
 ◆ Green Stripe® PowerBand® Belt May Work, Use Template to Check.

⊕ Use Wire Inserted Green Stripe® Coolant Hose.
 ② Two Required.
 ▲ Standard Belt Available. See Pages 630-631.

Belts and Coolant Hose for School Buses

Application	Mfr. Part No.	Our No.	Application	Mfr. Part No.	Our No.
INTERNATIONAL/NAVISTAR - Continued			INTERNATIONAL/NAVISTAR - Continued		
1971 - Continued			1971 - Continued		
International/Navistar RD372 - Continued			International/Navistar RD450 - Continued		
1823 - Continued			1853FC		
Belt - W.P. & Alt.; W/37A. Alt.; Chassis No. FD61626 & Before	193826R11	ⓉTR22508	Belt - Alt.; W/55A., 62A., 145A. Alt.	223794K21	ⓉTR22514
Belt - W.P. & Alt.; W/37A. Alt.; Chassis No. FD61626 & Up & G Chassis No.	223794R11	ⓉTR22514	Belt - Gen.; W/37A. Gen.	193826R11	TR22508
Belt - W.P. & Alt.; W/60A. Alt.	243604R11	ⓉTR22517	Belt - P.S.	240354R1	TR22344
Belt - P.S.	240354R2	TR22336	Hose - Upper; Late FD Chassis; Chassis No. FA66376		●26509
Belt - Air Brake Compr.; W/Wagner Compr. ..	92836HA	TR32491	Hose - Lower; Early FD Chassis; Chassis No. FA66376		●26508
Belt - Air Brake Compr.; W/Westinghouse Compr.	83816HA	TR34467	Hose - Lower; Late FD Chassis; Chassis No. FA66376(2 1/8" I.D.)	24234	
Hose - Upper		●26515	Hose - Lower; Late FD Chassis; Chassis No. FA66376		●26508
Hose - Lower; (2" I.D.)		24232			
1853			International/Navistar RD501		
Belt - Alt.; W/55A., 62A., 145A. Alt.	223794K21	ⓉTR22514	1823		
Belt - Gen.; W/37A. Gen.	193826R11	TR22508	Belt - Fan & Alt.	359014C91	ⓉTR22514
Belt - P.S.	240354R1	TR22344	Belt - W.P. & Alt.; W/37A. Alt.; Chassis No. FD61626 & Before	193826R11	ⓉTR22508
1853FC			Belt - W.P. & Alt.; W/37A. Alt.; Chassis No. FD61626 & Up & G Chassis No.	223794R11	ⓉTR22514
Belt - Alt.; W/55A., 62A., 145A. Alt.	223794K21	ⓉTR22514	Belt - W.P. & Alt.; W/60A. Alt.	243604R11	ⓉTR22517
Belt - Gen.; W/37A. Gen.	193826R11	TR22508	Belt - P.S.	240354R2	TR22336
Belt - P.S.	240354R1	TR22344	Belt - Air Brake Compr.; W/Wagner Compr. ..	92836HA	TR32491
Hose - Upper; Late FD Chassis; Chassis No. FA66376		●26509	Belt - Air Brake Compr.; W/Westinghouse Compr.	83816HA	TR34467
Hose - Lower; Early FD Chassis; Chassis No. FA66376		●26508	Hose - Upper		●26515
Hose - Lower; Late FD Chassis; Chassis No. FA66376(2 1/8" I.D.)	24234		Hose - Lower; (2" I.D.)		24232
Hose - Lower; Late FD Chassis; Chassis No. FA66376		●26508			
International/Navistar RD406			1853		
1823			Belt - Alt.; W/55A., 62A., 145A. Alt.	223794K21	ⓉTR22514
Belt - Fan & Alt.	359014C91	ⓉTR22514	Belt - Gen.; W/37A. Gen.	193826R11	TR22508
Belt - W.P. & Alt.; W/37A. Alt.; Chassis No. FD61626 & Before	193826R11	ⓉTR22508	Belt - P.S.	240354R1	TR22344
Belt - W.P. & Alt.; W/37A. Alt.; Chassis No. FD61626 & Up & G Chassis No.	223794R11	ⓉTR22514	1853FC		
Belt - W.P. & Alt.; W/60A. Alt.	243604R11	ⓉTR22517	Belt - Alt.; W/55A., 62A., 145A. Alt.	223794K21	ⓉTR22514
Belt - P.S.	240354R2	TR22336	Belt - Gen.; W/37A. Gen.	193826R11	TR22508
Belt - Air Brake Compr.; W/Wagner Compr. ..	92836HA	TR32491	Belt - P.S.	240354R1	TR22344
Belt - Air Brake Compr.; W/Westinghouse Compr.	83816HA	TR34467	Hose - Upper; Late FD Chassis; Chassis No. FA66376		●26509
Hose - Upper		●26515	Hose - Lower; Early FD Chassis; Chassis No. FA66376		●26508
Hose - Lower; (2" I.D.)		24232	Hose - Lower; Late FD Chassis; Chassis No. FA66376(2 1/8" I.D.)	24234	
1853			Hose - Lower; Late FD Chassis; Chassis No. FA66376		●26508
Belt - Alt.; W/55A., 62A., 145A. Alt.	223794K21	ⓉTR22514			
Belt - Gen.; W/37A. Gen.	193826R11	TR22508	International/Navistar V266		
Belt - P.S.	240354R1	TR22344	1603; 1703 ; 1803		
1853FC			Belt - Fan & Alt.; W/37A., 52A., 61A. Alt.; C, G, H Chassis		Ⓣ7603
Belt - Alt.; W/55A., 62A., 145A. Alt.	223794K21	ⓉTR22514	Belt - Fan & Alt.; W/37A., 52A., 61A. Alt.; FD, SB Chassis	255266C3	Ⓣ7640
Belt - Gen.; W/37A. Gen.	193826R11	TR22508	Belt - Fan & Alt.; W/55A., 62A. Alt.; C, G, H Chassis	369725C91	Ⓣ7619
Belt - P.S.	240354R1	TR22344	Belt - Fan & Alt.; W/55A., 62A. Alt.; FD, SB Chassis	358998C91	Ⓣ7650
Hose - Upper; Late FD Chassis; Chassis No. FA66376		●26509	Belt - P.S.; W/2WD	151529R2	7440
Hose - Lower; Early FD Chassis; Chassis No. FA66376		●26508	Belt - P.S.; W/4WD	151531R2	7450
Hose - Lower; Late FD Chassis; Chassis No. FA66376(2 1/8" I.D.)	24234		Belt - Air Brake Compr.	236572R2	7460
Hose - Lower; Late FD Chassis; Chassis No. FA66376		●26508	Hose - Upper; W/Rad. Shutters; W/Metal Hood		●26515
			Hose - Upper; W/O Rad. Shutters; W/Metal Hood		20493
			Hose - Lower - Eng. To Pipe; W/Auto. Trans.		20532
			Hose - Lower; W/Man. Trans.		21308
			Hose - By Pass		≅20357
International/Navistar RD450			International/Navistar V266		
1823			1603; 1703 ; 1803		
Belt - Fan & Alt.	359014C91	ⓉTR22514	Belt - Fan & Alt.; W/37A., 52A., 61A. Alt.; C, G, H Chassis		Ⓣ7603
Belt - W.P. & Alt.; W/37A. Alt.; Chassis No. FD61626 & Before	193826R11	ⓉTR22508	Belt - Fan & Alt.; W/37A., 52A., 61A. Alt.; FD, SB Chassis	255266C3	Ⓣ7640
Belt - W.P. & Alt.; W/37A. Alt.; Chassis No. FD61626 & Up & G Chassis No.	223794R11	ⓉTR22514	Belt - Fan & Alt.; W/55A., 62A. Alt.; C, G, H Chassis	369725C91	Ⓣ7619
Belt - W.P. & Alt.; W/60A. Alt.	243604R11	ⓉTR22517	Belt - Fan & Alt.; W/55A., 62A. Alt.; FD, SB Chassis	358998C91	Ⓣ7650
Belt - P.S.	240354R2	TR22336	Belt - P.S.; W/2WD	151529R2	7440
Belt - Air Brake Compr.; W/Wagner Compr. ..	92836HA	TR32491	Belt - P.S.; W/4WD	151531R2	7450
Belt - Air Brake Compr.; W/Westinghouse Compr.	83816HA	TR34467	Belt - Air Brake Compr.	236572R2	7460
Hose - Upper		●26515	Hose - Upper; W/Rad. Shutters; W/Metal Hood		●26515
Hose - Lower; (2" I.D.)		24232	Hose - Upper; W/O Rad. Shutters; W/Metal Hood		20493
1853			Hose - Lower - Eng. To Pipe; W/Auto. Trans.		20532
Belt - Alt.; W/55A., 62A., 145A. Alt.	223794K21	ⓉTR22514	Hose - Lower; W/Man. Trans.		21308
Belt - Gen.; W/37A. Gen.	193826R11	TR22508	Hose - By Pass		≅20357
Belt - P.S.	240354R1	TR22344			

Ⓣ Two Required.
≅ Cut to Fit.

● Vulco-Flex® Coolant Hose.

Belts and Coolant Hose for School Buses

School Buses

Application	Mfr. Part No.	Our No.
INTERNATIONAL/NAVISTAR - Continued		
1971 - Continued		
International/Navistar V345		
1603; 1703		
Belt - Fan & Alt.; W/37A., 52A., 61A. Alt.; C, G, H Chassis; W/P.T.O.	968815R11	②7650
Belt - Fan & Alt.; W/37A., 52A., 61A. Alt.; C, G, H Chassis; W/O P.T.O.	373457C91	②7612
Belt - Fan & Alt.; W/37A., 52A., 61A. Alt.; FD, SB Chassis	968815R1	②7650
Belt - Fan & Alt.; W/37A., 61A. Alt.; W/O Air Brakes; W/O P.T.O.; W/O X.C.	373456C1	7612
Belt - Fan & Alt.; W/55A., 62A. Alt.; C, G, H Chassis	369723C91	②7630
Belt - Fan & Alt.; W/55A., 62A. Alt.; FD, SB Chassis	361975C91	②7673
Belt - Fan & Alt.; W/60A. Alt.	359009C91	②7680
Belt - Fan & Alt.; W/65A., 80A., 105A., 145A. Alt.; W/P.T.O.	361975C91	②7673
Belt - Fan & Alt.; W/65A., 80A., 105A., 145A. Alt.; W/O P.T.O.	②7630	
Belt - P.S.; W/2WD	7460	7460
Belt - P.S.; W/4WD	285522C2	7435
Belt - Air Brake Compr.	359007C91	7475
Belt - A.P.; W/Air Brakes; W/Gov.	388139C1	7330
Belt - A.P.; W/Air Brakes; W/O Gov.	256062C2	7340
Belt - A.P.; W/Hyd. Brakes; W/Gov.	355653C91	7380
Belt - A.P.; W/Hyd. Brakes; W/O Gov.	362887C91	7410
Hose - Upper; W/Rad. Shutters; W/Metal Hood	●26515	20493
Hose - Upper; W/O Rad. Shutters; W/Metal Hood		20493
Hose - Lower - Eng. To Pipe; W/Auto. Trans.		20532
Hose - Lower; W/Man. Trans.		21308
Hose - By Pass		≈20357
1723		
Belt - Fan & Alt.; W/37A., 52A., 61A. Alt.; C, G, H Chassis; W/P.T.O.	968815R11	②7650
Belt - Fan & Alt.; W/37A., 52A., 61A. Alt.; C, G, H Chassis; W/O P.T.O.	373457C91	②7612
Belt - Fan & Alt.; W/37A., 52A., 61A. Alt.; FD, SB Chassis	968815R1	②7650
Belt - Fan & Alt.; W/37A., 61A. Alt.; W/O Air Brakes; W/O P.T.O.; W/O X.C.	373456C1	7612
Belt - Fan & Alt.; W/55A., 62A. Alt.; C, G, H Chassis	369723C91	②7630
Belt - Fan & Alt.; W/55A., 62A. Alt.; FD, SB Chassis	361975C91	②7673
Belt - Fan & Alt.; W/60A. Alt.	359009C91	②7680
Belt - Fan & Alt.; W/65A., 80A., 105A., 145A. Alt.; W/P.T.O.	361975C91	②7673
Belt - Fan & Alt.; W/65A., 80A., 105A., 145A. Alt.; W/O P.T.O.	②7630	
Belt - P.S.; W/2WD	7460	7460
Belt - P.S.; W/4WD	285522C2	7435
Belt - Air Brake Compr.	359007C91	7475
Belt - A.P.; W/Air Brakes; W/Gov.	388139C1	7330
Belt - A.P.; W/Air Brakes; W/O Gov.	256062C2	7340
Belt - A.P.; W/Hyd. Brakes; W/Gov.	355653C91	7380
Belt - A.P.; W/Hyd. Brakes; W/O Gov.	362887C91	7410
1803		
Belt - Fan & Alt.; W/37A., 52A., 61A. Alt.; C, G, H Chassis; W/P.T.O.	968815R11	②7650
Belt - Fan & Alt.; W/37A., 52A., 61A. Alt.; C, G, H Chassis; W/O P.T.O.	373457C91	②7612
Belt - Fan & Alt.; W/37A., 52A., 61A. Alt.; FD, SB Chassis	968815R1	②7650
Belt - Fan & Alt.; W/37A., 61A. Alt.; W/O Air Brakes; W/O P.T.O.; W/O X.C.	373456C1	7612
Belt - Fan & Alt.; W/55A., 62A. Alt.; C, G, H Chassis	369723C91	②7630
Belt - Fan & Alt.; W/55A., 62A. Alt.; FD, SB Chassis	361975C91	②7673
Belt - Fan & Alt.; W/60A. Alt.	359009C91	②7680
Belt - Fan & Alt.; W/65A., 80A., 105A., 145A. Alt.; W/P.T.O.	361975C91	②7673
Belt - Fan & Alt.; W/65A., 80A., 105A., 145A. Alt.; W/O P.T.O.	②7630	
Belt - P.S.; W/2WD	7460	7460
Belt - P.S.; W/4WD	285522C2	7435

Application	Mfr. Part No.	Our No.
INTERNATIONAL/NAVISTAR - Continued		
1971 - Continued		
International/Navistar V345 - Continued		
1803 - Continued		
Belt - Air Brake Compr.	359007C91	7475
Belt - A.P.; W/Air Brakes; W/Gov.	388139C1	7330
Belt - A.P.; W/Air Brakes; W/O Gov.	256062C2	7340
Belt - A.P.; W/Hyd. Brakes; W/Gov.	355653C91	7380
Belt - A.P.; W/Hyd. Brakes; W/O Gov.	362887C91	7410
Hose - Upper; W/Rad. Shutters; W/Metal Hood		●26515
Hose - Upper; W/O Rad. Shutters; W/Metal Hood		20493
Hose - Lower - Eng. To Pipe; W/Auto. Trans.		20532
Hose - Lower; W/Man. Trans.		21308
Hose - By Pass		≈20357
1823		
Belt - Fan & Alt.; W/37A., 52A., 61A. Alt.; C, G, H Chassis; W/P.T.O.	968815R11	②7650
Belt - Fan & Alt.; W/37A., 52A., 61A. Alt.; C, G, H Chassis; W/O P.T.O.	373457C91	②7612
Belt - Fan & Alt.; W/37A., 52A., 61A. Alt.; FD, SB Chassis	968815R1	②7650
Belt - Fan & Alt.; W/37A., 61A. Alt.; W/O Air Brakes; W/O P.T.O.; W/O X.C.	373456C1	7612
Belt - Fan & Alt.; W/55A., 62A. Alt.; C, G, H Chassis	369723C91	②7630
Belt - Fan & Alt.; W/55A., 62A. Alt.; FD, SB Chassis	361975C91	②7673
Belt - Fan & Alt.; W/60A. Alt.	359009C91	②7680
Belt - Fan & Alt.; W/65A., 80A., 105A., 145A. Alt.; W/P.T.O.	361975C91	②7673
Belt - Fan & Alt.; W/65A., 80A., 105A., 145A. Alt.; W/O P.T.O.	②7630	
Belt - P.S.; W/2WD	7460	7460
Belt - P.S.; W/4WD	285522C2	7435
Belt - Air Brake Compr.	359007C91	7475
Belt - A.P.; W/Air Brakes; W/Gov.	388139C1	7330
Belt - A.P.; W/Air Brakes; W/O Gov.	256062C2	7340
Belt - A.P.; W/Hyd. Brakes; W/Gov.	355653C91	7380
Belt - A.P.; W/Hyd. Brakes; W/O Gov.	362887C91	7410
International/Navistar V392		
1603; 1703		
Belt - Fan & Alt.; W/37A., 52A., 61A. Alt.; C, G, H Chassis; W/P.T.O.	968815R11	②7650
Belt - Fan & Alt.; W/37A., 52A., 61A. Alt.; C, G, H Chassis; W/O P.T.O.	373457C91	②7612
Belt - Fan & Alt.; W/37A., 52A., 61A. Alt.; FD, SB Chassis	968815R1	②7650
Belt - Fan & Alt.; W/37A., 61A. Alt.; W/O Air Brakes; W/O P.T.O.; W/O X.C.	373456C1	7612
Belt - Fan & Alt.; W/55A., 62A. Alt.; C, G, H Chassis	369723C91	②7630
Belt - Fan & Alt.; W/55A., 62A. Alt.; FD, SB Chassis	361975C91	②7673
Belt - Fan & Alt.; W/60A. Alt.	359009C91	②7680
Belt - Fan & Alt.; W/65A., 80A., 105A., 145A. Alt.; W/P.T.O.	361975C91	②7673
Belt - Fan & Alt.; W/65A., 80A., 105A., 145A. Alt.; W/O P.T.O.	②7630	
Belt - P.S.; W/2WD	7460	7460
Belt - P.S.; W/4WD	285522C2	7435
Belt - Air Brake Compr.	359007C91	7475
Belt - A.P.; W/Air Brakes; W/Gov.	388139C1	7330
Belt - A.P.; W/Air Brakes; W/O Gov.	256062C2	7340
Belt - A.P.; W/Hyd. Brakes; W/Gov.	355653C91	7380
Belt - A.P.; W/Hyd. Brakes; W/O Gov.	362887C91	7410
Hose - Upper; W/Rad. Shutters; W/Metal Hood		●26515
Hose - Upper; W/O Rad. Shutters; W/Metal Hood		20493
Hose - Lower - Eng. To Pipe; W/Auto. Trans.		20532
Hose - Lower; W/Man. Trans.		21308
Hose - By Pass		≈20357
1723		
Belt - Fan & Alt.; W/37A., 52A., 61A. Alt.; C, G, H Chassis; W/P.T.O.	968815R11	②7650
Belt - Fan & Alt.; W/37A., 52A., 61A. Alt.; C, G, H Chassis; W/O P.T.O.	373457C91	②7612

② Two Required.
≈ Cut to Fit.

● Vulco-Flex® Coolant Hose.

Belts and Coolant Hose for School Buses

Application	Mfr. Part No.	Our No.
INTERNATIONAL/NAVISTAR - Continued		
1971 - Continued		
International/Navistar V392 - Continued		
1723 - Continued		
Belt - Fan & Alt.; W/37A., 52A., 61A. Alt.; FD, SB Chassis	968815R1	②7650
Belt - Fan & Alt.; W/37A., 61A. Alt.; W/O Air Brakes; W/O P.T.O.; W/O X.C.	373456C1	7612
Belt - Fan & Alt.; W/55A., 62A. Alt.; C, G, H Chassis	369723C91	②7630
Belt - Fan & Alt.; W/55A., 62A. Alt.; FD, SB Chassis	361975C91	②7673
Belt - Fan & Alt.; W/60A. Alt.	359009C91	②7680
Belt - Fan & Alt.; W/65A., 80A., 105A., 145A. Alt.; W/P.T.O.	361975C91	②7673
Belt - Fan & Alt.; W/65A., 80A., 105A., 145A. Alt.; W/O P.T.O.		②7630
Belt - P.S.; W/2WD		7460
Belt - P.S.; W/4WD	285522C2	7435
Belt - Air Brake Compr.	359007C91	7475
Belt - A.P.; W/Air Brakes; W/Gov.	388139C1	7330
Belt - A.P.; W/Air Brakes; W/O Gov.	256062C2	7340
Belt - A.P.; W/Hyd. Brakes; W/Gov.	355653C91	7380
Belt - A.P.; W/Hyd. Brakes; W/O Gov.	362887C91	7410
1803		
Belt - Fan & Alt.; W/37A., 52A., 61A. Alt.; C, G, H Chassis; W/P.T.O.	968815R11	②7650
Belt - Fan & Alt.; W/37A., 52A., 61A. Alt.; C, G, H Chassis; W/O P.T.O.	373457C91	②7612
Belt - Fan & Alt.; W/37A., 52A., 61A. Alt.; FD, SB Chassis	968815R1	②7650
Belt - Fan & Alt.; W/37A., 61A. Alt.; W/O Air Brakes; W/O P.T.O.; W/O X.C.	373456C1	7612
Belt - Fan & Alt.; W/55A., 62A. Alt.; C, G, H Chassis	369723C91	②7630
Belt - Fan & Alt.; W/55A., 62A. Alt.; FD, SB Chassis	361975C91	②7673
Belt - Fan & Alt.; W/60A. Alt.	359009C91	②7680
Belt - Fan & Alt.; W/65A., 80A., 105A., 145A. Alt.; W/P.T.O.	361975C91	②7673
Belt - Fan & Alt.; W/65A., 80A., 105A., 145A. Alt.; W/O P.T.O.		②7630
Belt - P.S.; W/2WD		7460
Belt - P.S.; W/4WD	285522C2	7435
Belt - Air Brake Compr.	359007C91	7475
Belt - A.P.; W/Air Brakes; W/Gov.	388139C1	7330
Belt - A.P.; W/Air Brakes; W/O Gov.	256062C2	7340
Belt - A.P.; W/Hyd. Brakes; W/Gov.	355653C91	7380
Belt - A.P.; W/Hyd. Brakes; W/O Gov.	362887C91	7410
Hose - Upper; W/Rad. Shutters; W/Metal Hood		●26515
Hose - Upper; W/O Rad. Shutters; W/Metal Hood		20493
Hose - Lower - Eng. To Pipe; W/Auto. Trans.		20532
Hose - Lower; W/Man. Trans.		21308
Hose - By Pass		≡20357
1823		
Belt - Fan & Alt.; W/37A., 52A., 61A. Alt.; C, G, H Chassis; W/P.T.O.	968815R11	②7650
Belt - Fan & Alt.; W/37A., 52A., 61A. Alt.; C, G, H Chassis; W/O P.T.O.	373457C91	②7612
Belt - Fan & Alt.; W/37A., 52A., 61A. Alt.; FD, SB Chassis	968815R1	②7650
Belt - Fan & Alt.; W/37A., 61A. Alt.; W/O Air Brakes; W/O P.T.O.; W/O X.C.	373456C1	7612
Belt - Fan & Alt.; W/55A., 62A. Alt.; C, G, H Chassis	369723C91	②7630
Belt - Fan & Alt.; W/55A., 62A. Alt.; FD, SB Chassis	361975C91	②7673
Belt - Fan & Alt.; W/60A. Alt.	359009C91	②7680
Belt - Fan & Alt.; W/65A., 80A., 105A., 145A. Alt.; W/P.T.O.	361975C91	②7673
Belt - Fan & Alt.; W/65A., 80A., 105A., 145A. Alt.; W/O P.T.O.		②7630
Belt - P.S.; W/2WD		7460
Belt - P.S.; W/4WD	285522C2	7435
Belt - Air Brake Compr.	359007C91	7475
Belt - A.P.; W/Air Brakes; W/Gov.	388139C1	7330
Belt - A.P.; W/Air Brakes; W/O Gov.	256062C2	7340
Belt - A.P.; W/Hyd. Brakes; W/Gov.	355653C91	7380

Application	Mfr. Part No.	Our No.
INTERNATIONAL/NAVISTAR - Continued		
1971 - Continued		
International/Navistar V392 - Continued		
1823 - Continued		
Belt - A.P.; W/Hyd. Brakes; W/O Gov.	362887C91	7410
International/Navistar V401		
193RE		
Belt - Fan	358319C91	②◆◆9570HD
Belt - W.P.	359021C91	②TR22434
Belt - Alt.; W/37A. Alt.	256346C11	②◆9350HD
Belt - Alt.; W/55A., 60A., 62A., 105A., 130A. Alt.		②◆9365HD
Belt - Alt. & Air Brake Compr.	243605R11	②◆◆9451HD
Belt - P.S.	164550R2	◆9425HD
Hose - Upper - Eng. To Pipe; (1 3/4" I.D.)		24228
Hose - Upper - Eng. To Pipe		●26501
Hose - Upper - Pipe To Rad.; (2 1/4" I.D.)		24236
Hose - Lower; (2 5/8" I.D.)		⊕24942
Hose - By Pass		≡20618
Hose - By Pass; (3/4" I.D.)		28442
Hose - Heater; (1" I.D.)		24216
International/Navistar V461		
193RE		
Belt - Fan	358319C91	②◆◆9570HD
Belt - W.P.	359021C91	②TR22434
Belt - Alt.; W/37A. Alt.	256346C11	②◆9350HD
Belt - Alt.; W/55A., 60A., 62A., 105A., 130A. Alt.		②◆9365HD
Belt - Alt. & Air Brake Compr.	243605R11	②◆◆9451HD
Belt - P.S.	164550R2	◆9425HD
Hose - Upper - Eng. To Pipe; (1 3/4" I.D.)		24228
Hose - Upper - Eng. To Pipe		●26501
Hose - Upper - Pipe To Rad.; (2 1/4" I.D.)		24236
Hose - Lower; (2 5/8" I.D.)		⊕24942
Hose - By Pass		≡20618
Hose - By Pass; (3/4" I.D.)		28442
Hose - Heater; (1" I.D.)		24216
International/Navistar V478		
193RE		
Belt - Fan	358319C91	②◆◆9570HD
Belt - W.P.	359021C91	②TR22434
Belt - Alt.; W/37A. Alt.	256346C11	②◆9350HD
Belt - Alt.; W/55A., 60A., 62A., 105A., 130A. Alt.		②◆9365HD
Belt - Alt. & Air Brake Compr.	243605R11	②◆◆9451HD
Belt - P.S.	164550R2	◆9425HD
Hose - Upper - Eng. To Pipe; (1 3/4" I.D.)		24228
Hose - Upper - Eng. To Pipe		●26501
Hose - Upper - Pipe To Rad.; (2 1/4" I.D.)		24236
Hose - Lower; (2 5/8" I.D.)		⊕24942
Hose - By Pass		≡20618
Hose - By Pass; (3/4" I.D.)		28442
Hose - Heater; (1" I.D.)		24216
International/Navistar V549		
193RE		
Belt - Fan	358319C91	②◆◆9570HD
Belt - W.P.	359021C91	②TR22434
Belt - Alt.; W/37A. Alt.	256346C11	②◆9350HD
Belt - Alt.; W/55A., 60A., 62A., 105A., 130A. Alt.		②◆9365HD
Belt - Alt. & Air Brake Compr.	243605R11	②◆◆9451HD
Belt - P.S.	164550R2	◆9425HD
Hose - Upper - Eng. To Pipe; (1 3/4" I.D.)		24228
Hose - Upper - Eng. To Pipe		●26501
Hose - Upper - Pipe To Rad.; (2 1/4" I.D.)		24236
Hose - Lower; (2 5/8" I.D.)		⊕24942
Hose - By Pass		≡20618
Hose - By Pass; (3/4" I.D.)		28442
Hose - Heater; (1" I.D.)		24216
International/Navistar VS401		
193RE		
Belt - Fan	358319C91	②◆◆9570HD
Belt - W.P.	359021C91	②TR22434
Belt - Alt.; W/37A. Alt.	256346C11	②◆9350HD
Belt - Alt.; W/55A., 60A., 62A., 105A., 130A. Alt.		②◆9365HD
Belt - Alt. & Air Brake Compr.	243605R11	②◆◆9451HD

② Two Required.
 ≡ Cut to Fit.
 ◆ Standard Belt Available. See Pages 630-631.

● Vulco-Flex® Coolant Hose.
 ◆ Green Stripe® PowerBand® Belt May Work, Use Template to Check.
 ⊕ Use Wire Inserted Green Stripe® Coolant Hose.

School Buses

Belts and Coolant Hose for School Buses

School Buses

Application	Mfr. Part No.	Our No.
INTERNATIONAL/NAVISTAR - Continued		
1971 - Continued		
International/Navistar VS401 - Continued		
193RE - Continued		
Belt - P.S.	164550R2	▲9425HD
Hose - Upper - Eng. To Pipe; (1 3/4" I.D.)		24228
Hose - Upper - Eng. To Pipe		●26501
Hose - Upper - Pipe To Rad.; (2 1/4" I.D.)		24236
Hose - Lower; (2 5/8" I.D.)		⊕24942
Hose - By Pass		≡<20618
Hose - By Pass; (3/4" I.D.)		28442
Hose - Heater; (1" I.D.)		24216
International/Navistar VS478		
193RE		
Belt - Fan	358319C91	②◆▲9570HD
Belt - W.P.	359021C91	②TR22434
Belt - Alt.; W/37A. Alt.	256346C11	②▲9350HD
Belt - Alt.; W/55A., 60A., 62A., 105A., 130A. Alt.		②▲9365HD
Belt - Alt. & Air Brake Compr.	243605R11	②◆▲9451HD
Belt - P.S.	164550R2	▲9425HD
Hose - Upper - Eng. To Pipe; (1 3/4" I.D.)		24228
Hose - Upper - Eng. To Pipe		●26501
Hose - Upper - Pipe To Rad.; (2 1/4" I.D.)		24236
Hose - Lower; (2 5/8" I.D.)		⊕24942
Hose - By Pass		≡<20618
Hose - By Pass; (3/4" I.D.)		28442
Hose - Heater; (1" I.D.)		24216
International/Navistar VS549		
193RE		
Belt - Fan	358319C91	②◆▲9570HD
Belt - W.P.	359021C91	②TR22434
Belt - Alt.; W/37A. Alt.	256346C11	②▲9350HD
Belt - Alt.; W/55A., 60A., 62A., 105A., 130A. Alt.		②▲9365HD
Belt - Alt. & Air Brake Compr.	243605R11	②◆▲9451HD
Belt - P.S.	164550R2	▲9425HD
Hose - Upper - Eng. To Pipe; (1 3/4" I.D.)		24228
Hose - Upper - Eng. To Pipe		●26501
Hose - Upper - Pipe To Rad.; (2 1/4" I.D.)		24236
Hose - Lower; (2 5/8" I.D.)		⊕24942
Hose - By Pass		≡<20618
Hose - By Pass; (3/4" I.D.)		28442
Hose - Heater; (1" I.D.)		24216
1970		
International/Navistar BD220		
1603		
Belt - Fan & Alt.; W/37A., 52A., 61A., 62A. Alt.	151532R1	②7512
Belt - Fan & Alt.; W/60A. Alt.	861779R11	②▲9440HD
Belt - Gen.; W/20A., 50A. Alt.	20594VA	TR24438
Belt - Gen.; W/30A. Alt.	81572R2	TR28437
Belt - Gen.; W/35A., 50A. L.C.I. Gen.	164550R1	②▲9425HD
Belt - P.S.; W/Air Brakes	149636R1	▲9480HD
Belt - P.S.; W/Hyd. Brakes	864931R2	▲9319HD
Belt - Air Brake Compr.; W/4 Cu. Ft. Air Brake Compr.	201825R1	▲9440HD
Belt - Air Brake Compr.; W/20A., 30A., 50A. Gen.	115505HA	TR22363
International/Navistar BD240		
1603		
Belt - Fan & Alt.; W/37A., 52A., 61A., 62A. Alt.	151532R1	②7512
Belt - Fan & Alt.; W/60A. Alt.	861779R11	②▲9440HD
Belt - Gen.; W/20A., 50A. Alt.	20594VA	TR24438
Belt - Gen.; W/30A. Alt.	81572R2	TR28437
Belt - Gen.; W/35A., 50A. L.C.I. Gen.	164550R1	②▲9425HD
Belt - P.S.; W/Air Brakes	149636R1	▲9480HD
Belt - P.S.; W/Hyd. Brakes	864931R2	▲9319HD
Belt - Air Brake Compr.; W/4 Cu. Ft. Air Brake Compr.	201825R1	▲9440HD
Belt - Air Brake Compr.; W/20A., 30A., 50A. Gen.	115505HA	TR22363

Application	Mfr. Part No.	Our No.
INTERNATIONAL/NAVISTAR - Continued		
1970 - Continued		
International/Navistar BD264		
1603		
Belt - Fan & Alt.; W/37A., 52A., 61A., 62A. Alt.	151532R1	②7512
Belt - Fan & Alt.; W/60A. Alt.	861779R11	②▲9440HD
Belt - Gen.; W/20A., 50A. Alt.	20594VA	TR24438
Belt - Gen.; W/30A. Alt.	81572R2	TR28437
Belt - Gen.; W/35A., 50A. L.C.I. Gen.	164550R1	②▲9425HD
Belt - P.S.; W/Air Brakes	149636R1	▲9480HD
Belt - P.S.; W/Hyd. Brakes	864931R2	▲9319HD
Belt - Air Brake Compr.; W/4 Cu. Ft. Air Brake Compr.	201825R1	▲9440HD
Belt - Air Brake Compr.; W/20A., 30A., 50A. Gen.	115505HA	TR22363
International/Navistar BD269		
1603		
Belt - Fan & Alt.	862880R11	②▲9490HD
Belt - Fan To Air Brake Compr.; W/P.S.	280210C1	▲9530HD
Belt - Fan To Air Brake Compr.; W/O P.S.	242270R1	▲9380HD
Belt - P.S.	242269R1	▲9405HD
Belt - Air Brake Compr.	280210C1	▲9540HD
Hose - Upper; (2" I.D.)		24232
Hose - Lower		≡<20611
Hose - By Pass; (2" I.D.)		or ●26509 24232
1703 ; 1803		
Belt - Fan & Alt.	862880R11	②▲9490HD
Belt - Fan To Air Brake Compr.; W/P.S.	280210C1	▲9530HD
Belt - Fan To Air Brake Compr.; W/O P.S.	242270R1	▲9380HD
Belt - P.S.	242269R1	▲9405HD
Belt - Air Brake Compr.	280210C1	▲9540HD
Hose - Upper; (2" I.D.)		24232
Hose - Lower - Eng. To Pipe		≡<20206
Hose - Lower - Pipe To Rad.; (2" I.D.)		24232
Hose - By Pass; (2" I.D.)		24232
International/Navistar BD282		
1603		
Belt - Fan & Alt.	862880R11	②▲9490HD
Belt - Fan To Air Brake Compr.; W/P.S.	280210C1	▲9530HD
Belt - Fan To Air Brake Compr.; W/O P.S.	242270R1	▲9380HD
Belt - P.S.	242269R1	▲9405HD
Belt - Air Brake Compr.	280210C1	▲9540HD
Hose - Upper; (2" I.D.)		24232
Hose - Lower		≡<20611
Hose - By Pass; (2" I.D.)		or ●26509 24232
1703 ; 1803		
Belt - Fan & Alt.	862880R11	②▲9490HD
Belt - Fan To Air Brake Compr.; W/P.S.	280210C1	▲9530HD
Belt - Fan To Air Brake Compr.; W/O P.S.	242270R1	▲9380HD
Belt - P.S.	242269R1	▲9405HD
Belt - Air Brake Compr.	280210C1	▲9540HD
Hose - Upper; (2" I.D.)		24232
Hose - Lower - Eng. To Pipe		≡<20206
Hose - Lower - Pipe To Rad.; (2" I.D.)		24232
Hose - By Pass; (2" I.D.)		24232
International/Navistar BD308		
1603		
Belt - Fan & Alt.	862880R11	②▲9490HD
Belt - Fan To Air Brake Compr.; W/P.S.	280210C1	▲9530HD
Belt - Fan To Air Brake Compr.; W/O P.S.	242270R1	▲9380HD
Belt - P.S.	242269R1	▲9405HD
Belt - Air Brake Compr.	280210C1	▲9540HD
Hose - Upper; (2" I.D.)		24232
Hose - Lower		≡<20611
Hose - By Pass; (2" I.D.)		or ●26509 24232
1703 ; 1803		
Belt - Fan & Alt.	862880R11	②▲9490HD
Belt - Fan To Air Brake Compr.; W/P.S.	280210C1	▲9530HD
Belt - Fan To Air Brake Compr.; W/O P.S.	242270R1	▲9380HD

▲ Standard Belt Available. See Pages 630-631.
 ⊕ Use Wire Inserted Green Stripe® Coolant Hose.
 ② Two Required.

● Vulco-Flex® Coolant Hose.
 ≡< Cut to Fit.
 ◆ Green Stripe® PowerBand® Belt May Work, Use Template to Check.

Belts and Coolant Hose for School Buses

Application	Mfr. Part No.	Our No.
INTERNATIONAL/NAVISTAR - Continued		
1970 - Continued		
International/Navistar BD308 - Continued		
1703 ; 1803 - Continued		
Belt - P.S.	242269R1	◆9405HD
Belt - Air Brake Compr.	280210C1	◆9540HD
Hose - Upper; (2" I.D.)		24232
Hose - Lower - Eng. To Pipe		≡20206
Hose - Lower - Pipe To Rad.; (2" I.D.)		24232
Hose - By Pass; (2" I.D.)		24232
International/Navistar BG220		
1603		
Belt - Fan & Alt.; W/37A., 52A., 61A., 62A. Alt.	151532R1	②7512
Belt - Fan & Alt.; W/60A. Alt.	861779R11	②◆9440HD
Belt - Gen.; W/20A., 50A. Alt.	20594VA	TR24438
Belt - Gen.; W/30A. Alt.	81572R2	TR28437
Belt - Gen.; W/35A., 50A. L.C.I. Gen.	164550R1	②◆9425HD
Belt - P.S.; W/Air Brakes	149636R1	◆9480HD
Belt - P.S.; W/Hyd. Brakes	864931R2	◆9319HD
Belt - Air Brake Compr.; W/4 Cu. Ft. Air Brake Compr.	201825R1	◆9440HD
Belt - Air Brake Compr.; W/20A., 30A., 50A. Gen.	115505HA	TR22363
International/Navistar BG241		
1603		
Belt - Fan & Alt.; W/37A., 52A., 61A., 62A. Alt.	151532R1	②7512
Belt - Fan & Alt.; W/60A. Alt.	861779R11	②◆9440HD
Belt - Gen.; W/20A., 50A. Alt.	20594VA	TR24438
Belt - Gen.; W/30A. Alt.	81572R2	TR28437
Belt - Gen.; W/35A., 50A. L.C.I. Gen.	164550R1	②◆9425HD
Belt - P.S.; W/Air Brakes	149636R1	◆9480HD
Belt - P.S.; W/Hyd. Brakes	864931R2	◆9319HD
Belt - Air Brake Compr.; W/4 Cu. Ft. Air Brake Compr.	201825R1	◆9440HD
Belt - Air Brake Compr.; W/20A., 30A., 50A. Gen.	115505HA	TR22363
International/Navistar BG265		
1603		
Belt - Fan & Alt.; W/37A., 52A., 61A., 62A. Alt.	151532R1	②7512
Belt - Fan & Alt.; W/60A. Alt.	861779R11	②◆9440HD
Belt - Gen.; W/20A., 50A. Alt.	20594VA	TR24438
Belt - Gen.; W/30A. Alt.	81572R2	TR28437
Belt - Gen.; W/35A., 50A. L.C.I. Gen.	164550R1	②◆9425HD
Belt - P.S.; W/Air Brakes	149636R1	◆9480HD
Belt - P.S.; W/Hyd. Brakes	864931R2	◆9319HD
Belt - Air Brake Compr.; W/4 Cu. Ft. Air Brake Compr.	201825R1	◆9440HD
Belt - Air Brake Compr.; W/20A., 30A., 50A. Gen.	115505HA	TR22363
International/Navistar FTV549		
193RE		
Belt - Fan	358319C91	②◆◆9570HD
Belt - W.P.	359021C91	②TR22434
Belt - Alt.; W/37A. Alt.	256346C11	②◆9350HD
Belt - Alt.; W/55A., 60A., 62A., 105A., 130A. Alt.		②◆9365HD
Belt - Alt. & Air Brake Compr.	243605R11	②◆◆9451HD
Belt - P.S.	164550R2	◆9425HD
Hose - Upper - Eng. To Pipe; (1 3/4" I.D.)		24228
Hose - Upper - Eng. To Pipe		●26501
Hose - Upper - Pipe To Rad.; (2 1/4" I.D.)		24236
Hose - Lower; (2 5/8" I.D.)		⊕24942
Hose - By Pass		≡20618
Hose - By Pass; (3/4" I.D.)		28442
Hose - Heater; (1" I.D.)		24216
International/Navistar FTVS549		
193RE		
Belt - Fan	358319C91	②◆◆9570HD
Belt - W.P.	359021C91	②TR22434
Belt - Alt.; W/37A. Alt.	256346C11	②◆9350HD
Belt - Alt.; W/55A., 60A., 62A., 105A., 130A. Alt.		②◆9365HD
Belt - Alt. & Air Brake Compr.	243605R11	②◆◆9451HD
Belt - P.S.	164550R2	◆9425HD

Application	Mfr. Part No.	Our No.
INTERNATIONAL/NAVISTAR - Continued		
1970 - Continued		
International/Navistar FTVS549 - Continued		
193RE - Continued		
Hose - Upper - Eng. To Pipe; (1 3/4" I.D.)		24228
Hose - Upper - Eng. To Pipe		●26501
Hose - Upper - Pipe To Rad.; (2 1/4" I.D.)		24236
Hose - Lower; (2 5/8" I.D.)		⊕24942
Hose - By Pass		≡20618
Hose - By Pass; (3/4" I.D.)		28442
Hose - Heater; (1" I.D.)		24216
International/Navistar RD372		
1823		
Belt - Fan & Alt.	359014C91	②TR22514
Belt - W.P. & Alt.; W/37A. Alt.; Chassis No. FD61626 & Before	193826R11	②TR22508
Belt - W.P. & Alt.; W/37A. Alt.; Chassis No. FD61626 & Up & G Chassis No.	223794R11	②TR22514
Belt - W.P. & Alt.; W/60A. Alt.	243604R11	②TR22517
Belt - P.S.	240354R2	TR22336
Belt - Air Brake Compr.; W/Wagner Compr. ...	92836HA	TR32491
Belt - Air Brake Compr.; W/Westinghouse Compr.	83816HA	TR34467
Hose - Upper		●26515
Hose - Lower; (2" I.D.)		24232
1853		
Belt - Alt.; W/55A., 62A., 145A. Alt.	223794K21	②TR22514
Belt - Gen.; W/37A. Gen.	193826R11	TR22508
Belt - P.S.	240354R1	TR22344
1853FC		
Belt - Alt.; W/55A., 62A., 145A. Alt.	223794K21	②TR22514
Belt - Gen.; W/37A. Gen.	193826R11	TR22508
Belt - P.S.	240354R1	TR22344
Hose - Upper; Late FD Chassis; Chassis No. FA66376		●26509
Hose - Lower; Early FD Chassis; Chassis No. FA66376		●26508
Hose - Lower; Late FD Chassis; Chassis No. FA66376(2 1/8" I.D.)		24234
Hose - Lower; Late FD Chassis; Chassis No. FA66376		●26508
International/Navistar RD406		
1823		
Belt - Fan & Alt.	359014C91	②TR22514
Belt - W.P. & Alt.; W/37A. Alt.; Chassis No. FD61626 & Before	193826R11	②TR22508
Belt - W.P. & Alt.; W/37A. Alt.; Chassis No. FD61626 & Up & G Chassis No.	223794R11	②TR22514
Belt - W.P. & Alt.; W/60A. Alt.	243604R11	②TR22517
Belt - P.S.	240354R2	TR22336
Belt - Air Brake Compr.; W/Wagner Compr. ...	92836HA	TR32491
Belt - Air Brake Compr.; W/Westinghouse Compr.	83816HA	TR34467
Hose - Upper		●26515
Hose - Lower; (2" I.D.)		24232
1853		
Belt - Alt.; W/55A., 62A., 145A. Alt.	223794K21	②TR22514
Belt - Gen.; W/37A. Gen.	193826R11	TR22508
Belt - P.S.	240354R1	TR22344
1853FC		
Belt - Alt.; W/55A., 62A., 145A. Alt.	223794K21	②TR22514
Belt - Gen.; W/37A. Gen.	193826R11	TR22508
Belt - P.S.	240354R1	TR22344
Hose - Upper; Late FD Chassis; Chassis No. FA66376		●26509
Hose - Lower; Early FD Chassis; Chassis No. FA66376		●26508
Hose - Lower; Late FD Chassis; Chassis No. FA66376(2 1/8" I.D.)		24234
Hose - Lower; Late FD Chassis; Chassis No. FA66376		●26508
International/Navistar RD450		
1823		
Belt - Fan & Alt.	359014C91	②TR22514
Belt - W.P. & Alt.; W/37A. Alt.; Chassis No. FD61626 & Before	193826R11	②TR22508
Belt - W.P. & Alt.; W/37A. Alt.; Chassis No. FD61626 & Up & G Chassis No.	223794R11	②TR22514

◆ Standard Belt Available. See Pages 630-631.
 ② Two Required.
 ● Vulco-Flex® Coolant Hose.

≡ Cut to Fit.
 ◆ Green Stripe® PowerBand® Belt May Work, Use Template to Check.
 ⊕ Use Wire Inserted Green Stripe® Coolant Hose.

School Buses

Belts and Coolant Hose for School Buses

School Buses

Application	Mfr. Part No.	Our No.
INTERNATIONAL/NAVISTAR - Continued		
1970 - Continued		
International/Navistar RD450 - Continued		
1823 - Continued		
Belt - W.P. & Alt.; W/60A. Alt.	243604R11	②TR22517
Belt - P.S.	240354R2	TR22336
Belt - Air Brake Compr.; W/Wagner Compr. ..	92836HA	TR32491
Belt - Air Brake Compr.; W/Westinghouse Compr.	83816HA	TR34467
Hose - Upper		●26515
Hose - Lower; (2" I.D.)		24232
1853		
Belt - Alt.; W/55A., 62A., 145A. Alt.	223794K21	②TR22514
Belt - Gen.; W/37A. Gen.	193826R11	TR22508
Belt - P.S.	240354R1	TR22344
1853FC		
Belt - Alt.; W/55A., 62A., 145A. Alt.	223794K21	②TR22514
Belt - Gen.; W/37A. Gen.	193826R11	TR22508
Belt - P.S.	240354R1	TR22344
Hose - Upper; Late FD Chassis; Chassis No. FA66376		●26509
Hose - Lower; Early FD Chassis; Chassis No. FA66376		●26508
Hose - Lower; Late FD Chassis; Chassis No. FA66376(2 1/8" I.D.)		24234
Hose - Lower; Late FD Chassis; Chassis No. FA66376		●26508
International/Navistar RD501		
1823		
Belt - Fan & Alt.	359014C91	②TR22514
Belt - W.P. & Alt.; W/37A. Alt.; Chassis No. FD61626 & Before	193826R11	②TR22508
Belt - W.P. & Alt.; W/37A. Alt.; Chassis No. FD61626 & Up & G Chassis No.	223794R11	②TR22514
Belt - W.P. & Alt.; W/60A. Alt.	243604R11	②TR22517
Belt - P.S.	240354R2	TR22336
Belt - Air Brake Compr.; W/Wagner Compr. ..	92836HA	TR32491
Belt - Air Brake Compr.; W/Westinghouse Compr.	83816HA	TR34467
Hose - Upper		●26515
Hose - Lower; (2" I.D.)		24232
1853		
Belt - Alt.; W/55A., 62A., 145A. Alt.	223794K21	②TR22514
Belt - Gen.; W/37A. Gen.	193826R11	TR22508
Belt - P.S.	240354R1	TR22344
1853FC		
Belt - Alt.; W/55A., 62A., 145A. Alt.	223794K21	②TR22514
Belt - Gen.; W/37A. Gen.	193826R11	TR22508
Belt - P.S.	240354R1	TR22344
Hose - Upper; Late FD Chassis; Chassis No. FA66376		●26509
Hose - Lower; Early FD Chassis; Chassis No. FA66376		●26508
Hose - Lower; Late FD Chassis; Chassis No. FA66376(2 1/8" I.D.)		24234
Hose - Lower; Late FD Chassis; Chassis No. FA66376		●26508
International/Navistar V266		
1603; 1703 ; 1803		
Belt - Fan & Alt.; W/37A., 52A., 61A. Alt.; C, G, H Chassis		②7603
Belt - Fan & Alt.; W/37A., 52A., 61A. Alt.; FD, SB Chassis	255266C3	②7640
Belt - Fan & Alt.; W/55A., 62A. Alt.; C, G, H Chassis	369725C91	②7619
Belt - Fan & Alt.; W/55A., 62A. Alt.; FD, SB Chassis	358998C91	②7650
Belt - P.S.; W/2WD	151529R2	7440
Belt - P.S.; W/4WD	151531R2	7450
Belt - Air Brake Compr.	236572R2	7460
Hose - Upper; W/Rad. Shutters; W/Metal Hood		●26515
Hose - Upper; W/O Rad. Shutters; W/Metal Hood		20493
Hose - Lower - Eng. To Pipe; W/Auto. Trans.		20532
Hose - Lower; W/Man. Trans.		21308
Hose - By Pass		≧20357
International/Navistar V304		
1603; 1703 ; 1803		
Belt - Fan & Alt.; W/37A., 52A., 61A. Alt.; C, G, H Chassis		②7603

Application	Mfr. Part No.	Our No.
INTERNATIONAL/NAVISTAR - Continued		
1970 - Continued		
International/Navistar V304 - Continued		
1603; 1703 ; 1803 - Continued		
Belt - Fan & Alt.; W/37A., 52A., 61A. Alt.; FD, SB Chassis	255266C3	②7640
Belt - Fan & Alt.; W/55A., 62A. Alt.; C, G, H Chassis	369725C91	②7619
Belt - Fan & Alt.; W/55A., 62A. Alt.; FD, SB Chassis	358998C91	②7650
Belt - P.S.; W/2WD	151529R2	7440
Belt - P.S.; W/4WD	151531R2	7450
Belt - Air Brake Compr.	236572R2	7460
Hose - Upper; W/Rad. Shutters; W/Metal Hood		●26515
Hose - Upper; W/O Rad. Shutters; W/Metal Hood		20493
Hose - Lower - Eng. To Pipe; W/Auto. Trans.		20532
Hose - Lower; W/Man. Trans.		21308
Hose - By Pass		≧20357
International/Navistar V345		
1603; 1703		
Belt - Fan & Alt.; W/37A., 52A., 61A. Alt.; C, G, H Chassis; W/P.T.O.	968815R11	②7650
Belt - Fan & Alt.; W/37A., 52A., 61A. Alt.; C, G, H Chassis; W/O P.T.O.	373457C91	②7612
Belt - Fan & Alt.; W/37A., 52A., 61A. Alt.; FD, SB Chassis	968815R1	②7650
Belt - Fan & Alt.; W/37A., 61A. Alt.; W/O Air Brakes; W/O P.T.O.; W/O X.C.	373456C1	7612
Belt - Fan & Alt.; W/55A., 62A. Alt.; C, G, H Chassis	369723C91	②7630
Belt - Fan & Alt.; W/55A., 62A. Alt.; FD, SB Chassis	361975C91	②7673
Belt - Fan & Alt.; W/60A. Alt.	359009C91	②7680
Belt - Fan & Alt.; W/65A., 80A., 105A., 145A. Alt.; W/P.T.O.	361975C91	②7673
Belt - Fan & Alt.; W/65A., 80A., 105A., 145A. Alt.; W/O P.T.O.		7460
Belt - P.S.; W/2WD	285522C2	7435
Belt - Air Brake Compr.	359007C91	7475
Belt - A.P.; W/Air Brakes; W/Gov.	388139C1	7330
Belt - A.P.; W/Air Brakes; W/O Gov.	256062C2	7340
Belt - A.P.; W/Hyd. Brakes; W/Gov.	355653C91	7380
Belt - A.P.; W/Hyd. Brakes; W/O Gov.	362887C91	7410
Hose - Upper; W/Rad. Shutters; W/Metal Hood		●26515
Hose - Upper; W/O Rad. Shutters; W/Metal Hood		20493
Hose - Lower - Eng. To Pipe; W/Auto. Trans.		20532
Hose - Lower; W/Man. Trans.		21308
Hose - By Pass		≧20357
1723		
Belt - Fan & Alt.; W/37A., 52A., 61A. Alt.; C, G, H Chassis; W/P.T.O.	968815R11	②7650
Belt - Fan & Alt.; W/37A., 52A., 61A. Alt.; C, G, H Chassis; W/O P.T.O.	373457C91	②7612
Belt - Fan & Alt.; W/37A., 52A., 61A. Alt.; FD, SB Chassis	968815R1	②7650
Belt - Fan & Alt.; W/37A., 61A. Alt.; W/O Air Brakes; W/O P.T.O.; W/O X.C.	373456C1	7612
Belt - Fan & Alt.; W/55A., 62A. Alt.; C, G, H Chassis	369723C91	②7630
Belt - Fan & Alt.; W/55A., 62A. Alt.; FD, SB Chassis	361975C91	②7673
Belt - Fan & Alt.; W/60A. Alt.	359009C91	②7680
Belt - Fan & Alt.; W/65A., 80A., 105A., 145A. Alt.; W/P.T.O.	361975C91	②7673
Belt - Fan & Alt.; W/65A., 80A., 105A., 145A. Alt.; W/O P.T.O.		7460
Belt - P.S.; W/2WD	285522C2	7435
Belt - Air Brake Compr.	359007C91	7475
Belt - A.P.; W/Air Brakes; W/Gov.	388139C1	7330
Belt - A.P.; W/Air Brakes; W/O Gov.	256062C2	7340
Belt - A.P.; W/Hyd. Brakes; W/Gov.	355653C91	7380
Belt - A.P.; W/Hyd. Brakes; W/O Gov.	362887C91	7410

② Two Required.
≧ Cut to Fit.

● Vulco-Flex® Coolant Hose.

Belts and Coolant Hose for School Buses

Application	Mfr. Part No.	Our No.	Application	Mfr. Part No.	Our No.
INTERNATIONAL/NAVISTAR - Continued			INTERNATIONAL/NAVISTAR - Continued		
1970 - Continued			1970 - Continued		
International/Navistar V345 - Continued			International/Navistar V392 - Continued		
1803			1603; 1703 - Continued		
Belt - Fan & Alt.; W/37A., 52A., 61A. Alt.; C, G, H Chassis; W/P.T.O.	968815R11	Ⓢ7650	Belt - P.S.; W/2WD	285522C2	7460
Belt - Fan & Alt.; W/37A., 52A., 61A. Alt.; C, G, H Chassis; W/O P.T.O.	373457C91	Ⓢ7612	Belt - P.S.; W/4WD	359007C91	7475
Belt - Fan & Alt.; W/37A., 52A., 61A. Alt.; FD, SB Chassis	968815R1	Ⓢ7650	Belt - Air Brake Compr.	388139C1	7330
Belt - Fan & Alt.; W/37A., 61A. Alt.; W/O Air Brakes; W/O P.T.O.; W/O X.C.	373456C1	7612	Belt - A.P.; W/Air Brakes; W/O Gov.	256062C2	7340
Belt - Fan & Alt.; W/55A., 62A. Alt.; C, G, H Chassis	369723C91	Ⓢ7630	Belt - A.P.; W/Hyd. Brakes; W/O Gov.	355653C91	7380
Belt - Fan & Alt.; W/55A., 62A. Alt.; FD, SB Chassis	361975C91	Ⓢ7673	Belt - A.P.; W/Hyd. Brakes; W/O Gov.	362887C91	7410
Belt - Fan & Alt.; W/60A. Alt.	359009C91	Ⓢ7680	Hose - Upper; W/Rad. Shutters; W/Metal Hood	●26515	
Belt - Fan & Alt.; W/65A., 80A., 105A., 145A. Alt.; W/P.T.O.	361975C91	Ⓢ7673	Hose - Upper; W/O Rad. Shutters; W/Metal Hood	20493	
Belt - Fan & Alt.; W/65A., 80A., 105A., 145A. Alt.; W/O P.T.O.	7460		Hose - Lower - Eng. To Pipe; W/Auto. Trans.	20532	
Belt - P.S.; W/2WD	285522C2	7435	Hose - Lower; W/Man. Trans.	21308	
Belt - Air Brake Compr.	359007C91	7475	Hose - By Pass	Ⓢ20357	
Belt - A.P.; W/Air Brakes; W/O Gov.	388139C1	7330			
Belt - A.P.; W/Air Brakes; W/O Gov.	256062C2	7340	1723		
Belt - A.P.; W/Hyd. Brakes; W/O Gov.	355653C91	7380	Belt - Fan & Alt.; W/37A., 52A., 61A. Alt.; C, G, H Chassis; W/P.T.O.	968815R11	Ⓢ7650
Belt - A.P.; W/Hyd. Brakes; W/O Gov.	362887C91	7410	Belt - Fan & Alt.; W/37A., 52A., 61A. Alt.; C, G, H Chassis; W/O P.T.O.	373457C91	Ⓢ7612
Hose - Upper; W/Rad. Shutters; W/Metal Hood	●26515		Belt - Fan & Alt.; W/37A., 52A., 61A. Alt.; FD, SB Chassis	968815R1	Ⓢ7650
Hose - Upper; W/O Rad. Shutters; W/Metal Hood	20493		Belt - Fan & Alt.; W/37A., 61A. Alt.; W/O Air Brakes; W/O P.T.O.; W/O X.C.	373456C1	7612
Hose - Lower - Eng. To Pipe; W/Auto. Trans.	20532		Belt - Fan & Alt.; W/55A., 62A. Alt.; C, G, H Chassis	369723C91	Ⓢ7630
Hose - Lower; W/Man. Trans.	21308		Belt - Fan & Alt.; W/55A., 62A. Alt.; FD, SB Chassis	361975C91	Ⓢ7673
Hose - By Pass	Ⓢ20357		Belt - Fan & Alt.; W/60A. Alt.	359009C91	Ⓢ7680
			Belt - Fan & Alt.; W/65A., 80A., 105A., 145A. Alt.; W/P.T.O.	361975C91	Ⓢ7673
1823			Belt - Fan & Alt.; W/65A., 80A., 105A., 145A. Alt.; W/O P.T.O.	7460	
Belt - Fan & Alt.; W/37A., 52A., 61A. Alt.; C, G, H Chassis; W/P.T.O.	968815R11	Ⓢ7650	Belt - P.S.; W/2WD	285522C2	7435
Belt - Fan & Alt.; W/37A., 52A., 61A. Alt.; C, G, H Chassis; W/O P.T.O.	373457C91	Ⓢ7612	Belt - P.S.; W/4WD	359007C91	7475
Belt - Fan & Alt.; W/37A., 52A., 61A. Alt.; FD, SB Chassis	968815R1	Ⓢ7650	Belt - Air Brake Compr.	388139C1	7330
Belt - Fan & Alt.; W/37A., 61A. Alt.; W/O Air Brakes; W/O P.T.O.; W/O X.C.	373456C1	7612	Belt - A.P.; W/Air Brakes; W/O Gov.	256062C2	7340
Belt - Fan & Alt.; W/55A., 62A. Alt.; C, G, H Chassis	369723C91	Ⓢ7630	Belt - A.P.; W/Hyd. Brakes; W/O Gov.	355653C91	7380
Belt - Fan & Alt.; W/55A., 62A. Alt.; FD, SB Chassis	361975C91	Ⓢ7673	Belt - A.P.; W/Hyd. Brakes; W/O Gov.	362887C91	7410
Belt - Fan & Alt.; W/60A. Alt.	359009C91	Ⓢ7680			
Belt - Fan & Alt.; W/65A., 80A., 105A., 145A. Alt.; W/P.T.O.	361975C91	Ⓢ7673	1803		
Belt - Fan & Alt.; W/65A., 80A., 105A., 145A. Alt.; W/O P.T.O.	7460		Belt - Fan & Alt.; W/37A., 52A., 61A. Alt.; C, G, H Chassis; W/P.T.O.	968815R11	Ⓢ7650
Belt - P.S.; W/2WD	285522C2	7435	Belt - Fan & Alt.; W/37A., 52A., 61A. Alt.; C, G, H Chassis; W/O P.T.O.	373457C91	Ⓢ7612
Belt - P.S.; W/4WD	359007C91	7475	Belt - Fan & Alt.; W/37A., 52A., 61A. Alt.; FD, SB Chassis	968815R1	Ⓢ7650
Belt - Air Brake Compr.	388139C1	7330	Belt - Fan & Alt.; W/37A., 61A. Alt.; W/O Air Brakes; W/O P.T.O.; W/O X.C.	373456C1	7612
Belt - A.P.; W/Air Brakes; W/O Gov.	256062C2	7340	Belt - Fan & Alt.; W/55A., 62A. Alt.; C, G, H Chassis	369723C91	Ⓢ7630
Belt - A.P.; W/Hyd. Brakes; W/O Gov.	355653C91	7380	Belt - Fan & Alt.; W/55A., 62A. Alt.; FD, SB Chassis	361975C91	Ⓢ7673
Belt - A.P.; W/Hyd. Brakes; W/O Gov.	362887C91	7410	Belt - Fan & Alt.; W/60A. Alt.	359009C91	Ⓢ7680
			Belt - Fan & Alt.; W/65A., 80A., 105A., 145A. Alt.; W/P.T.O.	361975C91	Ⓢ7673
			Belt - Fan & Alt.; W/65A., 80A., 105A., 145A. Alt.; W/O P.T.O.	7460	
			Belt - P.S.; W/2WD	285522C2	7435
			Belt - P.S.; W/4WD	359007C91	7475
			Belt - Air Brake Compr.	388139C1	7330
			Belt - A.P.; W/Air Brakes; W/O Gov.	256062C2	7340
			Belt - A.P.; W/Hyd. Brakes; W/O Gov.	355653C91	7380
			Belt - A.P.; W/Hyd. Brakes; W/O Gov.	362887C91	7410
			Hose - Upper; W/Rad. Shutters; W/Metal Hood	●26515	
			Hose - Upper; W/O Rad. Shutters; W/Metal Hood	20493	
			Hose - Lower - Eng. To Pipe; W/Auto. Trans.	20532	
			Hose - Lower; W/Man. Trans.	21308	
			Hose - By Pass	Ⓢ20357	
			1823		
			Belt - Fan & Alt.; W/37A., 52A., 61A. Alt.; C, G, H Chassis; W/P.T.O.	968815R11	Ⓢ7650
			Belt - Fan & Alt.; W/37A., 52A., 61A. Alt.; C, G, H Chassis; W/O P.T.O.	373457C91	Ⓢ7612

Ⓢ Two Required.
Ⓢ Cut to Fit.

● Vulco-Flex® Coolant Hose.

School Buses

Belts and Coolant Hose for School Buses

School Buses

Application	Mfr. Part No.	Our No.
INTERNATIONAL/NAVISTAR - Continued		
1970 - Continued		
International/Navistar V392 - Continued		
1823 - Continued		
Belt - Fan & Alt.; W/37A., 52A., 61A. Alt.; FD, SB Chassis	968815R1	②7650
Belt - Fan & Alt.; W/37A., 61A. Alt.; W/O Air Brakes; W/O P.T.O.; W/O X.C.	373456C1	7612
Belt - Fan & Alt.; W/55A., 62A. Alt.; C, G, H Chassis	369723C91	②7630
Belt - Fan & Alt.; W/55A., 62A. Alt.; FD, SB Chassis	361975C91	②7673
Belt - Fan & Alt.; W/60A. Alt.	359009C91	②7680
Belt - Fan & Alt.; W/65A., 80A., 105A., 145A. Alt.; W/P.T.O.	361975C91	②7673
Belt - Fan & Alt.; W/65A., 80A., 105A., 145A. Alt.; W/O P.T.O.	7460	②7630
Belt - P.S.; W/2WD	285522C2	7435
Belt - P.S.; W/4WD	359007C91	7475
Belt - Air Brake Compr.	388139C1	7330
Belt - A.P.; W/Air Brakes; W/Gov.	256062C2	7340
Belt - A.P.; W/Hyd. Brakes; W/Gov.	355653C91	7380
Belt - A.P.; W/Hyd. Brakes; W/O Gov.	362887C91	7410
International/Navistar V401		
193RE		
Belt - Fan	358319C91	②◆▲9570HD
Belt - W.P.	359021C91	②TR22434
Belt - Alt.; W/37A. Alt.	256346C11	②▲9350HD
Belt - Alt.; W/55A., 60A., 62A., 105A., 130A. Alt.	256346C11	②▲9365HD
Belt - Alt. & Air Brake Compr.	243605R11	②◆▲9451HD
Belt - P.S.	164550R2	▲9425HD
Hose - Upper - Eng. To Pipe; (1 3/4" I.D.)	24228	24228
Hose - Upper - Eng. To Pipe	●26501	●26501
Hose - Upper - Pipe To Rad.; (2 1/4" I.D.)	24236	24236
Hose - Lower; (2 5/8" I.D.)	⊕24942	⊕24942
Hose - By Pass	≠<20618	≠<20618
Hose - By Pass; (3/4" I.D.)	28442	28442
Hose - Heater; (1" I.D.)	24216	24216
International/Navistar V461		
193RE		
Belt - Fan	358319C91	②◆▲9570HD
Belt - W.P.	359021C91	②TR22434
Belt - Alt.; W/37A. Alt.	256346C11	②▲9350HD
Belt - Alt.; W/55A., 60A., 62A., 105A., 130A. Alt.	256346C11	②▲9365HD
Belt - Alt. & Air Brake Compr.	243605R11	②◆▲9451HD
Belt - P.S.	164550R2	▲9425HD
Hose - Upper - Eng. To Pipe; (1 3/4" I.D.)	24228	24228
Hose - Upper - Eng. To Pipe	●26501	●26501
Hose - Upper - Pipe To Rad.; (2 1/4" I.D.)	24236	24236
Hose - Lower; (2 5/8" I.D.)	⊕24942	⊕24942
Hose - By Pass	≠<20618	≠<20618
Hose - By Pass; (3/4" I.D.)	28442	28442
Hose - Heater; (1" I.D.)	24216	24216
International/Navistar V478		
193RE		
Belt - Fan	358319C91	②◆▲9570HD
Belt - W.P.	359021C91	②TR22434
Belt - Alt.; W/37A. Alt.	256346C11	②▲9350HD
Belt - Alt.; W/55A., 60A., 62A., 105A., 130A. Alt.	256346C11	②▲9365HD
Belt - Alt. & Air Brake Compr.	243605R11	②◆▲9451HD
Belt - P.S.	164550R2	▲9425HD
Hose - Upper - Eng. To Pipe; (1 3/4" I.D.)	24228	24228
Hose - Upper - Eng. To Pipe	●26501	●26501
Hose - Upper - Pipe To Rad.; (2 1/4" I.D.)	24236	24236
Hose - Lower; (2 5/8" I.D.)	⊕24942	⊕24942
Hose - By Pass	≠<20618	≠<20618
Hose - By Pass; (3/4" I.D.)	28442	28442
Hose - Heater; (1" I.D.)	24216	24216
International/Navistar V549		
193RE		
Belt - Fan	358319C91	②◆▲9570HD
Belt - W.P.	359021C91	②TR22434

Application	Mfr. Part No.	Our No.
INTERNATIONAL/NAVISTAR - Continued		
1970 - Continued		
International/Navistar V549 - Continued		
193RE - Continued		
Belt - Alt.; W/37A. Alt.	256346C11	②◆▲9350HD
Belt - Alt.; W/55A., 60A., 62A., 105A., 130A. Alt.	256346C11	②▲9365HD
Belt - Alt. & Air Brake Compr.	243605R11	②◆▲9451HD
Belt - P.S.	164550R2	▲9425HD
Hose - Upper - Eng. To Pipe; (1 3/4" I.D.)	24228	24228
Hose - Upper - Eng. To Pipe	●26501	●26501
Hose - Upper - Pipe To Rad.; (2 1/4" I.D.)	24236	24236
Hose - Lower; (2 5/8" I.D.)	⊕24942	⊕24942
Hose - By Pass	≠<20618	≠<20618
Hose - By Pass; (3/4" I.D.)	28442	28442
Hose - Heater; (1" I.D.)	24216	24216
International/Navistar VS401		
193RE		
Belt - Fan	358319C91	②◆▲9570HD
Belt - W.P.	359021C91	②TR22434
Belt - Alt.; W/37A. Alt.	256346C11	②▲9350HD
Belt - Alt.; W/55A., 60A., 62A., 105A., 130A. Alt.	256346C11	②▲9365HD
Belt - Alt. & Air Brake Compr.	243605R11	②◆▲9451HD
Belt - P.S.	164550R2	▲9425HD
Hose - Upper - Eng. To Pipe; (1 3/4" I.D.)	24228	24228
Hose - Upper - Eng. To Pipe	●26501	●26501
Hose - Upper - Pipe To Rad.; (2 1/4" I.D.)	24236	24236
Hose - Lower; (2 5/8" I.D.)	⊕24942	⊕24942
Hose - By Pass	≠<20618	≠<20618
Hose - By Pass; (3/4" I.D.)	28442	28442
Hose - Heater; (1" I.D.)	24216	24216
International/Navistar VS478		
193RE		
Belt - Fan	358319C91	②◆▲9570HD
Belt - W.P.	359021C91	②TR22434
Belt - Alt.; W/37A. Alt.	256346C11	②▲9350HD
Belt - Alt.; W/55A., 60A., 62A., 105A., 130A. Alt.	256346C11	②▲9365HD
Belt - Alt. & Air Brake Compr.	243605R11	②◆▲9451HD
Belt - P.S.	164550R2	▲9425HD
Hose - Upper - Eng. To Pipe; (1 3/4" I.D.)	24228	24228
Hose - Upper - Eng. To Pipe	●26501	●26501
Hose - Upper - Pipe To Rad.; (2 1/4" I.D.)	24236	24236
Hose - Lower; (2 5/8" I.D.)	⊕24942	⊕24942
Hose - By Pass	≠<20618	≠<20618
Hose - By Pass; (3/4" I.D.)	28442	28442
Hose - Heater; (1" I.D.)	24216	24216
International/Navistar VS549		
193RE		
Belt - Fan	358319C91	②◆▲9570HD
Belt - W.P.	359021C91	②TR22434
Belt - Alt.; W/37A. Alt.	256346C11	②▲9350HD
Belt - Alt.; W/55A., 60A., 62A., 105A., 130A. Alt.	256346C11	②▲9365HD
Belt - Alt. & Air Brake Compr.	243605R11	②◆▲9451HD
Belt - P.S.	164550R2	▲9425HD
Hose - Upper - Eng. To Pipe; (1 3/4" I.D.)	24228	24228
Hose - Upper - Eng. To Pipe	●26501	●26501
Hose - Upper - Pipe To Rad.; (2 1/4" I.D.)	24236	24236
Hose - Lower; (2 5/8" I.D.)	⊕24942	⊕24942
Hose - By Pass	≠<20618	≠<20618
Hose - By Pass; (3/4" I.D.)	28442	28442
Hose - Heater; (1" I.D.)	24216	24216
1969		
International/Navistar BD220		
1603		
Belt - Fan & Alt.; W/37A., 52A., 61A., 62A. Alt.	151532R1	②7512
Belt - Fan & Alt.; W/60A. Alt.	861779R11	②▲9440HD
Belt - Gen.; W/20A., 50A. Alt.	20594VA	TR24438
Belt - Gen.; W/30A. Alt.	81572R2	TR28437
Belt - Gen.; W/35A., 50A. L.C.I. Gen.	164550R1	②▲9425HD
Belt - P.S.; W/Air Brakes	149636R1	▲9480HD
Belt - P.S.; W/Hyd. Brakes	864931R2	▲9319HD

② Two Required.
 ▲ Standard Belt Available. See Pages 630-631.
 ⊕ Use Wire Inserted Green Stripe® Coolant Hose.

◆ Green Stripe® PowerBand® Belt May Work, Use Template to Check.
 ● Vulco-Flex® Coolant Hose.
 ≠< Cut to Fit.

Belts and Coolant Hose for School Buses

Application	Mfr. Part No.	Our No.
INTERNATIONAL/NAVISTAR - Continued		
1969 - Continued		
International/Navistar BD220 - Continued		
1603 - Continued		
Belt - Air Brake Compr.; W/4 Cu. Ft. Air Brake Compr.	201825R1	▲9440HD
Belt - Air Brake Compr.; W/20A., 30A., 50A. Gen.	115505HA	TR22363
Hose - Upper		●26510
Hose - Lower - Eng. To Pipe		●26508
Hose - Lower - Pipe To Rad.		●26514
Hose - By Pass		20338
Hose - By Pass; (5/8" I.D.)		28441
International/Navistar BD240		
1603		
Belt - Fan & Alt.; W/37A., 52A., 61A., 62A. Alt.	151532R1	②7512
Belt - Fan & Alt.; W/60A. Alt.	861779R11	②▲9440HD
Belt - Gen.; W/20A., 50A. Alt.	20594VA	TR24438
Belt - Gen.; W/30A. Alt.	81572R2	TR28437
Belt - Gen.; W/35A., 50A. L.C.I. Gen.	164550R1	②▲9425HD
Belt - P.S.; W/Air Brakes	149636R1	▲9480HD
Belt - P.S.; W/Hyd. Brakes	864931R2	▲9319HD
Belt - Air Brake Compr.; W/4 Cu. Ft. Air Brake Compr.	201825R1	▲9440HD
Belt - Air Brake Compr.; W/20A., 30A., 50A. Gen.	115505HA	TR22363
Hose - Upper		●26510
Hose - Lower - Eng. To Pipe		●26508
Hose - Lower - Pipe To Rad.		●26514
Hose - By Pass		20338
Hose - By Pass; (5/8" I.D.)		28441
International/Navistar BD264		
1603		
Belt - Fan & Alt.; W/37A., 52A., 61A., 62A. Alt.	151532R1	②7512
Belt - Fan & Alt.; W/60A. Alt.	861779R11	②▲9440HD
Belt - Gen.; W/20A., 50A. Alt.	20594VA	TR24438
Belt - Gen.; W/30A. Alt.	81572R2	TR28437
Belt - Gen.; W/35A., 50A. L.C.I. Gen.	164550R1	②▲9425HD
Belt - P.S.; W/Air Brakes	149636R1	▲9480HD
Belt - P.S.; W/Hyd. Brakes	864931R2	▲9319HD
Belt - Air Brake Compr.; W/4 Cu. Ft. Air Brake Compr.	201825R1	▲9440HD
Belt - Air Brake Compr.; W/20A., 30A., 50A. Gen.	115505HA	TR22363
Hose - Upper		●26510
Hose - Lower - Eng. To Pipe		●26508
Hose - Lower - Pipe To Rad.		●26514
Hose - By Pass		20338
Hose - By Pass; (5/8" I.D.)		28441
International/Navistar BD269		
1603		
Belt - Fan & Alt.	862880R11	②▲9490HD
Belt - Fan To Air Brake Compr.; W/P.S.	280210C1	▲9530HD
Belt - Fan To Air Brake Compr.; W/O P.S.	242270R1	▲9380HD
Belt - P.S.	242269R1	▲9405HD
Belt - Air Brake Compr.	280210C1	▲9540HD
Hose - Upper; (2" I.D.)		24232
Hose - Lower		≅20611
		or ●26509
Hose - By Pass; (2" I.D.)		24232
1703 ; 1803		
Belt - Fan & Alt.	862880R11	②▲9490HD
Belt - Fan To Air Brake Compr.; W/P.S.	280210C1	▲9530HD
Belt - Fan To Air Brake Compr.; W/O P.S.	242270R1	▲9380HD
Belt - P.S.	242269R1	▲9405HD
Belt - Air Brake Compr.	280210C1	▲9540HD
Hose - Upper; (2" I.D.)		24232
Hose - Lower - Eng. To Pipe		≅20206
Hose - Lower - Pipe To Rad.; (2" I.D.)		24232
Hose - By Pass; (2" I.D.)		24232

Application	Mfr. Part No.	Our No.
INTERNATIONAL/NAVISTAR - Continued		
1969 - Continued		
International/Navistar BD282		
1603		
Belt - Fan & Alt.	862880R11	②▲9490HD
Belt - Fan To Air Brake Compr.; W/P.S.	280210C1	▲9530HD
Belt - Fan To Air Brake Compr.; W/O P.S.	242270R1	▲9380HD
Belt - P.S.	242269R1	▲9405HD
Belt - Air Brake Compr.	280210C1	▲9540HD
Hose - Upper; (2" I.D.)		24232
Hose - Lower		≅20611
		or ●26509
Hose - By Pass; (2" I.D.)		24232
1703 ; 1803		
Belt - Fan & Alt.	862880R11	②▲9490HD
Belt - Fan To Air Brake Compr.; W/P.S.	280210C1	▲9530HD
Belt - Fan To Air Brake Compr.; W/O P.S.	242270R1	▲9380HD
Belt - P.S.	242269R1	▲9405HD
Belt - Air Brake Compr.	280210C1	▲9540HD
Hose - Upper; (2" I.D.)		24232
Hose - Lower - Eng. To Pipe		≅20206
Hose - Lower - Pipe To Rad.; (2" I.D.)		24232
Hose - By Pass; (2" I.D.)		24232
International/Navistar BD308		
1603		
Belt - Fan & Alt.	862880R11	②▲9490HD
Belt - Fan To Air Brake Compr.; W/P.S.	280210C1	▲9530HD
Belt - Fan To Air Brake Compr.; W/O P.S.	242270R1	▲9380HD
Belt - P.S.	242269R1	▲9405HD
Belt - Air Brake Compr.	280210C1	▲9540HD
Hose - Upper; (2" I.D.)		24232
Hose - Lower		≅20611
		or ●26509
Hose - By Pass; (2" I.D.)		24232
1703 ; 1803		
Belt - Fan & Alt.	862880R11	②▲9490HD
Belt - Fan To Air Brake Compr.; W/P.S.	280210C1	▲9530HD
Belt - Fan To Air Brake Compr.; W/O P.S.	242270R1	▲9380HD
Belt - P.S.	242269R1	▲9405HD
Belt - Air Brake Compr.	280210C1	▲9540HD
Hose - Upper; (2" I.D.)		24232
Hose - Lower - Eng. To Pipe		≅20206
Hose - Lower - Pipe To Rad.; (2" I.D.)		24232
Hose - By Pass; (2" I.D.)		24232
International/Navistar BG220		
1603		
Belt - Fan & Alt.; W/37A., 52A., 61A., 62A. Alt.	151532R1	②7512
Belt - Fan & Alt.; W/60A. Alt.	861779R11	②▲9440HD
Belt - Gen.; W/20A., 50A. Alt.	20594VA	TR24438
Belt - Gen.; W/30A. Alt.	81572R2	TR28437
Belt - Gen.; W/35A., 50A. L.C.I. Gen.	164550R1	②▲9425HD
Belt - P.S.; W/Air Brakes	149636R1	▲9480HD
Belt - P.S.; W/Hyd. Brakes	864931R2	▲9319HD
Belt - Air Brake Compr.; W/4 Cu. Ft. Air Brake Compr.	201825R1	▲9440HD
Belt - Air Brake Compr.; W/20A., 30A., 50A. Gen.	115505HA	TR22363
Hose - Upper		●26510
Hose - Lower - Eng. To Pipe		●26508
Hose - Lower - Pipe To Rad.		●26514
Hose - By Pass		20338
Hose - By Pass; (5/8" I.D.)		28441
International/Navistar BG241		
1603		
Belt - Fan & Alt.; W/37A., 52A., 61A., 62A. Alt.	151532R1	②7512
Belt - Fan & Alt.; W/60A. Alt.	861779R11	②▲9440HD
Belt - Gen.; W/20A., 50A. Alt.	20594VA	TR24438
Belt - Gen.; W/30A. Alt.	81572R2	TR28437
Belt - Gen.; W/35A., 50A. L.C.I. Gen.	164550R1	②▲9425HD
Belt - P.S.; W/Air Brakes	149636R1	▲9480HD
Belt - P.S.; W/Hyd. Brakes	864931R2	▲9319HD

▲ Standard Belt Available. See Pages 630-631.
② Two Required.

● Vulco-Flex® Coolant Hose.
≅ Cut to Fit.

School Buses

Belts and Coolant Hose for School Buses

School Buses

Application	Mfr. Part No.	Our No.
INTERNATIONAL/NAVISTAR - Continued		
1969 - Continued		
International/Navistar BG241 - Continued		
1603 - Continued		
Belt - Air Brake Compr.; W/4 Cu. Ft. Air Brake Compr.	201825R1	◆9440HD
Belt - Air Brake Compr.; W/20A., 30A., 50A. Gen.	115505HA	TR22363
Hose - Upper		●26510
Hose - Lower - Eng. To Pipe		●26508
Hose - Lower - Pipe To Rad.		●26514
Hose - By Pass		20338
Hose - By Pass; (5/8" I.D.)		28441
International/Navistar BG265		
1603		
Belt - Fan & Alt.; W/37A., 52A., 61A., 62A. Alt.	151532R1	②7512
Belt - Fan & Alt.; W/60A. Alt.	861779R11	②◆9440HD
Belt - Gen.; W/20A., 50A. Alt.	20594VA	TR24438
Belt - Gen.; W/30A. Alt.	81572R2	TR28437
Belt - Gen.; W/35A., 50A. L.C.I. Gen.	164550R1	②◆9425HD
Belt - P.S.; W/Air Brakes	149636R1	◆9480HD
Belt - P.S.; W/Hyd. Brakes	864931R2	◆9319HD
Belt - Air Brake Compr.; W/4 Cu. Ft. Air Brake Compr.	201825R1	◆9440HD
Belt - Air Brake Compr.; W/20A., 30A., 50A. Gen.	115505HA	TR22363
Hose - Upper		●26510
Hose - Lower - Eng. To Pipe		●26508
Hose - Lower - Pipe To Rad.		●26514
Hose - By Pass		20338
Hose - By Pass; (5/8" I.D.)		28441
International/Navistar FTV549		
193RE		
Belt - Fan	358319C91	②◆◆9570HD
Belt - W.P.	359021C91	②TR22434
Belt - Alt.; W/37A. Alt.	256346C11	②◆9350HD
Belt - Alt.; W/55A., 60A., 62A., 105A., 130A. Alt.		②◆9365HD
Belt - Alt. & Air Brake Compr.	243605R11	②◆◆9451HD
Belt - P.S.	164550R2	◆9425HD
Hose - Upper - Eng. To Pipe; (1 3/4" I.D.)		24228
Hose - Upper - Eng. To Pipe		●26501
Hose - Upper - Pipe To Rad.; (2 1/4" I.D.)		24236
Hose - Lower; (2 5/8" I.D.)		②24942
Hose - By Pass		≠20618
Hose - By Pass; (3/4" I.D.)		28442
Hose - Heater; (1" I.D.)		24216
International/Navistar FTVS549		
193RE		
Belt - Fan	358319C91	②◆◆9570HD
Belt - W.P.	359021C91	②TR22434
Belt - Alt.; W/37A. Alt.	256346C11	②◆9350HD
Belt - Alt.; W/55A., 60A., 62A., 105A., 130A. Alt.		②◆9365HD
Belt - Alt. & Air Brake Compr.	243605R11	②◆◆9451HD
Belt - P.S.	164550R2	◆9425HD
Hose - Upper - Eng. To Pipe; (1 3/4" I.D.)		24228
Hose - Upper - Eng. To Pipe		●26501
Hose - Upper - Pipe To Rad.; (2 1/4" I.D.)		24236
Hose - Lower; (2 5/8" I.D.)		②24942
Hose - By Pass		≠20618
Hose - By Pass; (3/4" I.D.)		28442
Hose - Heater; (1" I.D.)		24216
International/Navistar RD372		
1823		
Belt - Fan & Alt.	359014C91	②TR22514
Belt - W.P. & Alt.; W/37A. Alt.; Chassis No. FD61626 & Before	193826R11	②TR22508
Belt - W.P. & Alt.; W/37A. Alt.; Chassis No. FD61626 & Up & G Chassis No.	223794R11	②TR22514
Belt - W.P. & Alt.; W/60A. Alt.	243604R11	②TR22517
Belt - P.S.	240354R2	TR22336
Belt - Air Brake Compr.; W/Wagner Compr. ...	92836HA	TR32491

Application	Mfr. Part No.	Our No.
INTERNATIONAL/NAVISTAR - Continued		
1969 - Continued		
International/Navistar RD372 - Continued		
1823 - Continued		
Belt - Air Brake Compr.; W/Westinghouse Compr.	83816HA	TR34467
Hose - Upper		●26515
Hose - Lower; (2" I.D.)		24232
1853		
Belt - Alt.; W/55A., 62A., 145A. Alt.	223794K21	②TR22514
Belt - Gen.; W/37A. Gen.	193826R11	TR22508
Belt - P.S.	240354R1	TR22344
1853FC		
Belt - Alt.; W/55A., 62A., 145A. Alt.	223794K21	②TR22514
Belt - Gen.; W/37A. Gen.	193826R11	TR22508
Belt - P.S.	240354R1	TR22344
Hose - Upper; Late FD Chassis; Chassis No. FA66376		●26509
Hose - Lower; Early FD Chassis; Chassis No. FA66376		●26508
Hose - Lower; Late FD Chassis; Chassis No. FA66376(2 1/8" I.D.)		24234
Hose - Lower; Late FD Chassis; Chassis No. FA66376		●26508
International/Navistar RD406		
1823		
Belt - Fan & Alt.	359014C91	②TR22514
Belt - W.P. & Alt.; W/37A. Alt.; Chassis No. FD61626 & Before	193826R11	②TR22508
Belt - W.P. & Alt.; W/37A. Alt.; Chassis No. FD61626 & Up & G Chassis No.	223794R11	②TR22514
Belt - W.P. & Alt.; W/60A. Alt.	243604R11	②TR22517
Belt - P.S.	240354R2	TR22336
Belt - Air Brake Compr.; W/Wagner Compr. ...	92836HA	TR32491
Belt - Air Brake Compr.; W/Westinghouse Compr.	83816HA	TR34467
Hose - Upper		●26515
Hose - Lower; (2" I.D.)		24232
1853		
Belt - Alt.; W/55A., 62A., 145A. Alt.	223794K21	②TR22514
Belt - Gen.; W/37A. Gen.	193826R11	TR22508
Belt - P.S.	240354R1	TR22344
1853FC		
Belt - Alt.; W/55A., 62A., 145A. Alt.	223794K21	②TR22514
Belt - Gen.; W/37A. Gen.	193826R11	TR22508
Belt - P.S.	240354R1	TR22344
Hose - Upper; Late FD Chassis; Chassis No. FA66376		●26509
Hose - Lower; Early FD Chassis; Chassis No. FA66376		●26508
Hose - Lower; Late FD Chassis; Chassis No. FA66376(2 1/8" I.D.)		24234
Hose - Lower; Late FD Chassis; Chassis No. FA66376		●26508
International/Navistar RD450		
1823		
Belt - Fan & Alt.	359014C91	②TR22514
Belt - W.P. & Alt.; W/37A. Alt.; Chassis No. FD61626 & Before	193826R11	②TR22508
Belt - W.P. & Alt.; W/37A. Alt.; Chassis No. FD61626 & Up & G Chassis No.	223794R11	②TR22514
Belt - W.P. & Alt.; W/60A. Alt.	243604R11	②TR22517
Belt - P.S.	240354R2	TR22336
Belt - Air Brake Compr.; W/Wagner Compr. ...	92836HA	TR32491
Belt - Air Brake Compr.; W/Westinghouse Compr.	83816HA	TR34467
Hose - Upper		●26515
Hose - Lower; (2" I.D.)		24232
1853		
Belt - Alt.; W/55A., 62A., 145A. Alt.	223794K21	②TR22514
Belt - Gen.; W/37A. Gen.	193826R11	TR22508
Belt - P.S.	240354R1	TR22344
1853FC		
Belt - Alt.; W/55A., 62A., 145A. Alt.	223794K21	②TR22514
Belt - Gen.; W/37A. Gen.	193826R11	TR22508
Belt - P.S.	240354R1	TR22344
Hose - Upper; Late FD Chassis; Chassis No. FA66376		●26509
Hose - Lower; Early FD Chassis; Chassis No. FA66376		●26508

◆ Standard Belt Available. See Pages 630-631.
 ② Two Required.
 ⚡ Use Wire Inserted Green Stripe® Coolant Hose.

● Vulco-Flex® Coolant Hose.
 ◆ Green Stripe® PowerBand® Belt May Work, Use Template to Check.
 ≠ Cut to Fit.

Belts and Coolant Hose for School Buses

Application	Mfr. Part No.	Our No.	Application	Mfr. Part No.	Our No.
INTERNATIONAL/NAVISTAR - Continued			INTERNATIONAL/NAVISTAR - Continued		
1969 - Continued			1969 - Continued		
International/Navistar RD450 - Continued			International/Navistar V345 - Continued		
1853FC - Continued			1603; 1703 - Continued		
Hose - Lower; Late FD Chassis; Chassis No. FA66376(2 1/8" I.D.)		24234	Belt - Fan & Alt.; W/37A., 52A., 61A. Alt.; C, G, H Chassis; W/O P.T.O.	373457C91	②7612
Hose - Lower; Late FD Chassis; Chassis No. FA66376	●	26508	Belt - Fan & Alt.; W/37A., 52A., 61A. Alt.; FD, SB Chassis	968815R1	②7650
International/Navistar RD501			Belt - Fan & Alt.; W/37A., 61A. Alt.; W/O Air Brakes; W/O P.T.O.; W/O X.C.		
1823			Belt - Fan & Alt.; W/55A., 62A. Alt.; C, G, H Chassis	369723C91	②7630
Belt - Fan & Alt.	359014C91	②TR22514	Belt - Fan & Alt.; W/55A., 62A. Alt.; FD, SB Chassis	361975C91	②7673
Belt - W.P. & Alt.; W/37A. Alt.; Chassis No. FD61626 & Before	193826R11	②TR22508	Belt - Fan & Alt.; W/60A. Alt.	359009C91	②7680
Belt - W.P. & Alt.; W/37A. Alt.; Chassis No. FD61626 & Up & G Chassis No.	223794R11	②TR22514	Belt - Fan & Alt.; W/65A., 80A., 105A., 145A. Alt.; W/P.T.O.	361975C91	②7673
Belt - W.P. & Alt.; W/60A. Alt.	243604R11	②TR22517	Belt - Fan & Alt.; W/65A., 80A., 105A., 145A. Alt.; W/O P.T.O.	359007C91	7475
Belt - P.S.	240354R2	TR22336	Belt - A.P.; W/Air Brakes; W/Gov.	388139C1	7330
Belt - Air Brake Compr.; W/Wagner Compr. ..	92836HA	TR32491	Belt - A.P.; W/Hyd. Brakes; W/Gov.	355653C91	7380
Belt - Air Brake Compr.; W/Westinghouse Compr.	83816HA	TR34467	Belt - A.P.; W/Hyd. Brakes; W/O Gov.	362887C91	7410
Hose - Upper		●	Hose - Upper; W/Rad. Shutters; W/Metal Hood	●	26515
Hose - Lower; (2" I.D.)		24232	Hose - Upper; W/O Rad. Shutters; W/Metal Hood		20493
1853			Hose - Lower - Eng. To Pipe; W/Auto. Trans.		20532
Belt - Alt.; W/55A., 62A., 145A. Alt.	223794K21	②TR22514	Hose - Lower; W/Man. Trans.		21308
Belt - Gen.; W/37A. Gen.	193826R11	TR22508	Hose - By Pass	≠	20357
Belt - P.S.	240354R1	TR22344	1723		
1853FC			Belt - Fan & Alt.; W/37A., 52A., 61A. Alt.; C, G, H Chassis; W/P.T.O.	968815R11	②7650
Belt - Alt.; W/55A., 62A., 145A. Alt.	223794K21	②TR22514	Belt - Fan & Alt.; W/37A., 52A., 61A. Alt.; C, G, H Chassis; W/O P.T.O.	373457C91	②7612
Belt - Gen.; W/37A. Gen.	193826R11	TR22508	Belt - Fan & Alt.; W/37A., 52A., 61A. Alt.; FD, SB Chassis	968815R1	②7650
Belt - P.S.	240354R1	TR22344	Belt - Fan & Alt.; W/37A., 61A. Alt.; W/O Air Brakes; W/O P.T.O.; W/O X.C.	373456C1	7612
Hose - Upper; Late FD Chassis; Chassis No. FA66376		●	Belt - Fan & Alt.; W/55A., 62A. Alt.; C, G, H Chassis	369723C91	②7630
Hose - Lower; Early FD Chassis; Chassis No. FA66376		●	Belt - Fan & Alt.; W/55A., 62A. Alt.; FD, SB Chassis	361975C91	②7673
Hose - Lower; Late FD Chassis; Chassis No. FA66376(2 1/8" I.D.)		24234	Belt - Fan & Alt.; W/60A. Alt.	359009C91	②7680
Hose - Lower; Late FD Chassis; Chassis No. FA66376		●	Belt - Fan & Alt.; W/65A., 80A., 105A., 145A. Alt.; W/P.T.O.	361975C91	②7673
International/Navistar V266			Belt - Fan & Alt.; W/65A., 80A., 105A., 145A. Alt.; W/O P.T.O.		7460
1603; 1703; 1803			Belt - P.S.; W/4WD	285522C2	7435
Belt - Fan & Alt.; W/37A., 52A., 61A. Alt.; C, G, H Chassis		②7603	Belt - Air Brake Compr.	359007C91	7475
Belt - Fan & Alt.; W/37A., 52A., 61A. Alt.; FD, SB Chassis	255266C3	②7640	Belt - A.P.; W/Air Brakes; W/Gov.	388139C1	7330
Belt - Fan & Alt.; W/55A., 62A. Alt.; C, G, H Chassis	369725C91	②7619	Belt - A.P.; W/Air Brakes; W/O Gov.	256062C2	7340
Belt - Fan & Alt.; W/55A., 62A. Alt.; FD, SB Chassis	358998C91	②7650	Belt - A.P.; W/Hyd. Brakes; W/Gov.	355653C91	7380
Belt - P.S.; W/2WD	151529R2	7440	Belt - A.P.; W/Hyd. Brakes; W/O Gov.	362887C91	7410
Belt - P.S.; W/4WD	151531R2	7450	1803		
Belt - Air Brake Compr.	236572R2	7460	Belt - Fan & Alt.; W/37A., 52A., 61A. Alt.; C, G, H Chassis; W/P.T.O.	968815R11	②7650
Hose - Upper; W/Rad. Shutters; W/Metal Hood		●	Belt - Fan & Alt.; W/37A., 52A., 61A. Alt.; C, G, H Chassis; W/O P.T.O.	373457C91	②7612
Hose - Upper; W/O Rad. Shutters; W/Metal Hood		20493	Belt - Fan & Alt.; W/37A., 52A., 61A. Alt.; FD, SB Chassis	968815R1	②7650
Hose - Lower - Eng. To Pipe; W/Auto. Trans.		20532	Belt - Fan & Alt.; W/37A., 61A. Alt.; W/O Air Brakes; W/O P.T.O.; W/O X.C.	373456C1	7612
Hose - Lower; W/Man. Trans.		21308	Belt - Fan & Alt.; W/55A., 62A. Alt.; C, G, H Chassis	369723C91	②7630
Hose - By Pass		≠	Belt - Fan & Alt.; W/55A., 62A. Alt.; FD, SB Chassis	361975C91	②7673
International/Navistar V304			Belt - Fan & Alt.; W/60A. Alt.	359009C91	②7680
1603; 1703; 1803			Belt - Fan & Alt.; W/65A., 80A., 105A., 145A. Alt.; W/P.T.O.	361975C91	②7673
Belt - Fan & Alt.; W/37A., 52A., 61A. Alt.; C, G, H Chassis		②7603	Belt - Fan & Alt.; W/65A., 80A., 105A., 145A. Alt.; W/O P.T.O.		7460
Belt - Fan & Alt.; W/37A., 52A., 61A. Alt.; FD, SB Chassis	255266C3	②7640	Belt - P.S.; W/4WD	285522C2	7435
Belt - Fan & Alt.; W/55A., 62A. Alt.; C, G, H Chassis	369725C91	②7619	Belt - Air Brake Compr.	359007C91	7475
Belt - Fan & Alt.; W/55A., 62A. Alt.; FD, SB Chassis	358998C91	②7650	Belt - A.P.; W/Air Brakes; W/Gov.	388139C1	7330
Belt - P.S.; W/2WD	151529R2	7440	Belt - A.P.; W/Air Brakes; W/O Gov.	256062C2	7340
Belt - P.S.; W/4WD	151531R2	7450	Belt - A.P.; W/Hyd. Brakes; W/Gov.	355653C91	7380
Belt - Air Brake Compr.	236572R2	7460	Belt - A.P.; W/Hyd. Brakes; W/O Gov.	362887C91	7410
Hose - Upper; W/Rad. Shutters; W/Metal Hood		●	1803		
Hose - Upper; W/O Rad. Shutters; W/Metal Hood		20493	Belt - Fan & Alt.; W/37A., 52A., 61A. Alt.; C, G, H Chassis; W/P.T.O.	968815R11	②7650
Hose - Lower - Eng. To Pipe; W/Auto. Trans.		20532	Belt - Fan & Alt.; W/37A., 52A., 61A. Alt.; C, G, H Chassis; W/O P.T.O.	373457C91	②7612
Hose - Lower; W/Man. Trans.		21308	Belt - Fan & Alt.; W/37A., 52A., 61A. Alt.; FD, SB Chassis	968815R1	②7650
Hose - By Pass		≠	Belt - Fan & Alt.; W/37A., 61A. Alt.; W/O Air Brakes; W/O P.T.O.; W/O X.C.	373456C1	7612
International/Navistar V345			Belt - Fan & Alt.; W/55A., 62A. Alt.; C, G, H Chassis	369723C91	②7630
1603; 1703			Belt - Fan & Alt.; W/55A., 62A. Alt.; FD, SB Chassis	361975C91	②7673
Belt - Fan & Alt.; W/37A., 52A., 61A. Alt.; C, G, H Chassis; W/P.T.O.	968815R11	②7650	Belt - Fan & Alt.; W/60A. Alt.	359009C91	②7680
			Belt - Fan & Alt.; W/65A., 80A., 105A., 145A. Alt.; W/P.T.O.	361975C91	②7673
			Belt - Fan & Alt.; W/65A., 80A., 105A., 145A. Alt.; W/O P.T.O.		7460
			Belt - P.S.; W/4WD	285522C2	7435
			Belt - Air Brake Compr.	359007C91	7475
			Belt - A.P.; W/Air Brakes; W/Gov.	388139C1	7330

● Vulco-Flex® Coolant Hose.
≠ Cut to Fit.

② Two Required.

School Buses

Belts and Coolant Hose for School Buses

School Buses

Application	Mfr. Part No.	Our No.
INTERNATIONAL/NAVISTAR - Continued		
1969 - Continued		
International/Navistar V345 - Continued		
1803 - Continued		
Belt - A.P.; W/Air Brakes; W/O Gov.	256062C2	7340
Belt - A.P.; W/Hyd. Brakes; W/Gov.	355653C91	7380
Belt - A.P.; W/Hyd. Brakes; W/O Gov.	362887C91	7410
Hose - Upper; W/Rad. Shutters; W/Metal Hood		●26515
Hose - Upper; W/O Rad. Shutters; W/Metal Hood		20493
Hose - Lower - Eng. To Pipe; W/Auto. Trans.		20532
Hose - Lower; W/Man. Trans.		21308
Hose - By Pass		≧20357
1823		
Belt - Fan & Alt.; W/37A., 52A., 61A. Alt.; C, G, H Chassis; W/P.T.O.	968815R11	②7650
Belt - Fan & Alt.; W/37A., 52A., 61A. Alt.; C, G, H Chassis; W/O P.T.O.	373457C91	②7612
Belt - Fan & Alt.; W/37A., 52A., 61A. Alt.; FD, SB Chassis	968815R1	②7650
Belt - Fan & Alt.; W/37A., 61A. Alt.; W/O Air Brakes; W/O P.T.O.; W/O X.C.	373456C1	7612
Belt - Fan & Alt.; W/55A., 62A. Alt.; C, G, H Chassis	369723C91	②7630
Belt - Fan & Alt.; W/55A., 62A. Alt.; FD, SB Chassis	361975C91	②7673
Belt - Fan & Alt.; W/60A. Alt.	359009C91	②7680
Belt - Fan & Alt.; W/65A., 80A., 105A., 145A. Alt.; W/P.T.O.	361975C91	②7673
Belt - Fan & Alt.; W/65A., 80A., 105A., 145A. Alt.; W/O P.T.O.		②7630
Belt - P.S.; W/2WD		7460
Belt - P.S.; W/4WD	285522C2	7435
Belt - Air Brake Compr.	359007C91	7475
Belt - A.P.; W/Air Brakes; W/Gov.	388139C1	7330
Belt - A.P.; W/Air Brakes; W/O Gov.	256062C2	7340
Belt - A.P.; W/Hyd. Brakes; W/Gov.	355653C91	7380
Belt - A.P.; W/Hyd. Brakes; W/O Gov.	362887C91	7410
International/Navistar V392		
1603; 1703		
Belt - Fan & Alt.; W/37A., 52A., 61A. Alt.; C, G, H Chassis; W/P.T.O.	968815R11	②7650
Belt - Fan & Alt.; W/37A., 52A., 61A. Alt.; C, G, H Chassis; W/O P.T.O.	373457C91	②7612
Belt - Fan & Alt.; W/37A., 52A., 61A. Alt.; FD, SB Chassis	968815R1	②7650
Belt - Fan & Alt.; W/37A., 61A. Alt.; W/O Air Brakes; W/O P.T.O.; W/O X.C.	373456C1	7612
Belt - Fan & Alt.; W/55A., 62A. Alt.; C, G, H Chassis	369723C91	②7630
Belt - Fan & Alt.; W/55A., 62A. Alt.; FD, SB Chassis	361975C91	②7673
Belt - Fan & Alt.; W/60A. Alt.	359009C91	②7680
Belt - Fan & Alt.; W/65A., 80A., 105A., 145A. Alt.; W/P.T.O.	361975C91	②7673
Belt - Fan & Alt.; W/65A., 80A., 105A., 145A. Alt.; W/O P.T.O.		②7630
Belt - P.S.; W/2WD		7460
Belt - P.S.; W/4WD	285522C2	7435
Belt - Air Brake Compr.	359007C91	7475
Belt - A.P.; W/Air Brakes; W/Gov.	388139C1	7330
Belt - A.P.; W/Air Brakes; W/O Gov.	256062C2	7340
Belt - A.P.; W/Hyd. Brakes; W/Gov.	355653C91	7380
Belt - A.P.; W/Hyd. Brakes; W/O Gov.	362887C91	7410
Hose - Upper; W/Rad. Shutters; W/Metal Hood		●26515
Hose - Upper; W/O Rad. Shutters; W/Metal Hood		20493
Hose - Lower - Eng. To Pipe; W/Auto. Trans.		20532
Hose - Lower; W/Man. Trans.		21308
Hose - By Pass		≧20357
1723		
Belt - Fan & Alt.; W/37A., 52A., 61A. Alt.; C, G, H Chassis; W/P.T.O.	968815R11	②7650
Belt - Fan & Alt.; W/37A., 52A., 61A. Alt.; C, G, H Chassis; W/O P.T.O.	373457C91	②7612
Belt - Fan & Alt.; W/37A., 52A., 61A. Alt.; FD, SB Chassis	968815R1	②7650

Application	Mfr. Part No.	Our No.
INTERNATIONAL/NAVISTAR - Continued		
1969 - Continued		
International/Navistar V392 - Continued		
1723 - Continued		
Belt - Fan & Alt.; W/37A., 61A. Alt.; W/O Air Brakes; W/O P.T.O.; W/O X.C.	373456C1	7612
Belt - Fan & Alt.; W/55A., 62A. Alt.; C, G, H Chassis	369723C91	②7630
Belt - Fan & Alt.; W/55A., 62A. Alt.; FD, SB Chassis	361975C91	②7673
Belt - Fan & Alt.; W/60A. Alt.	359009C91	②7680
Belt - Fan & Alt.; W/65A., 80A., 105A., 145A. Alt.; W/P.T.O.	361975C91	②7673
Belt - Fan & Alt.; W/65A., 80A., 105A., 145A. Alt.; W/O P.T.O.		②7630
Belt - P.S.; W/2WD		7460
Belt - P.S.; W/4WD	285522C2	7435
Belt - Air Brake Compr.	359007C91	7475
Belt - A.P.; W/Air Brakes; W/Gov.	388139C1	7330
Belt - A.P.; W/Air Brakes; W/O Gov.	256062C2	7340
Belt - A.P.; W/Hyd. Brakes; W/Gov.	355653C91	7380
Belt - A.P.; W/Hyd. Brakes; W/O Gov.	362887C91	7410
1803		
Belt - Fan & Alt.; W/37A., 52A., 61A. Alt.; C, G, H Chassis; W/P.T.O.	968815R11	②7650
Belt - Fan & Alt.; W/37A., 52A., 61A. Alt.; C, G, H Chassis; W/O P.T.O.	373457C91	②7612
Belt - Fan & Alt.; W/37A., 52A., 61A. Alt.; FD, SB Chassis	968815R1	②7650
Belt - Fan & Alt.; W/37A., 61A. Alt.; W/O Air Brakes; W/O P.T.O.; W/O X.C.	373456C1	7612
Belt - Fan & Alt.; W/55A., 62A. Alt.; C, G, H Chassis	369723C91	②7630
Belt - Fan & Alt.; W/55A., 62A. Alt.; FD, SB Chassis	361975C91	②7673
Belt - Fan & Alt.; W/60A. Alt.	359009C91	②7680
Belt - Fan & Alt.; W/65A., 80A., 105A., 145A. Alt.; W/P.T.O.	361975C91	②7673
Belt - Fan & Alt.; W/65A., 80A., 105A., 145A. Alt.; W/O P.T.O.		②7630
Belt - P.S.; W/2WD		7460
Belt - P.S.; W/4WD	285522C2	7435
Belt - Air Brake Compr.	359007C91	7475
Belt - A.P.; W/Air Brakes; W/Gov.	388139C1	7330
Belt - A.P.; W/Air Brakes; W/O Gov.	256062C2	7340
Belt - A.P.; W/Hyd. Brakes; W/Gov.	355653C91	7380
Belt - A.P.; W/Hyd. Brakes; W/O Gov.	362887C91	7410
Hose - Upper; W/Rad. Shutters; W/Metal Hood		●26515
Hose - Upper; W/O Rad. Shutters; W/Metal Hood		20493
Hose - Lower - Eng. To Pipe; W/Auto. Trans.		20532
Hose - Lower; W/Man. Trans.		21308
Hose - By Pass		≧20357
1823		
Belt - Fan & Alt.; W/37A., 52A., 61A. Alt.; C, G, H Chassis; W/P.T.O.	968815R11	②7650
Belt - Fan & Alt.; W/37A., 52A., 61A. Alt.; C, G, H Chassis; W/O P.T.O.	373457C91	②7612
Belt - Fan & Alt.; W/37A., 52A., 61A. Alt.; FD, SB Chassis	968815R1	②7650
Belt - Fan & Alt.; W/37A., 61A. Alt.; W/O Air Brakes; W/O P.T.O.; W/O X.C.	373456C1	7612
Belt - Fan & Alt.; W/55A., 62A. Alt.; C, G, H Chassis	369723C91	②7630
Belt - Fan & Alt.; W/55A., 62A. Alt.; FD, SB Chassis	361975C91	②7673
Belt - Fan & Alt.; W/60A. Alt.	359009C91	②7680
Belt - Fan & Alt.; W/65A., 80A., 105A., 145A. Alt.; W/P.T.O.	361975C91	②7673
Belt - Fan & Alt.; W/65A., 80A., 105A., 145A. Alt.; W/O P.T.O.		②7630
Belt - P.S.; W/2WD		7460
Belt - P.S.; W/4WD	285522C2	7435
Belt - Air Brake Compr.	359007C91	7475
Belt - A.P.; W/Air Brakes; W/Gov.	388139C1	7330
Belt - A.P.; W/Air Brakes; W/O Gov.	256062C2	7340
Belt - A.P.; W/Hyd. Brakes; W/Gov.	355653C91	7380
Belt - A.P.; W/Hyd. Brakes; W/O Gov.	362887C91	7410

● Vulco-Flex® Coolant Hose.
 ② Two Required.

≧ Cut to Fit.

Belts and Coolant Hose for School Buses

Application	Mfr. Part No.	Our No.
INTERNATIONAL/NAVISTAR - Continued		
1969 - Continued		
International/Navistar V401		
193RE		
Belt - Fan	358319C91	②◆▲9570HD
Belt - W.P.	359021C91	②TR22434
Belt - Alt.; W/37A. Alt.	256346C11	②▲9350HD
Belt - Alt.; W/55A., 60A., 62A., 105A., 130A. Alt.		②▲9365HD
Belt - Alt. & Air Brake Compr.	243605R11	②◆▲9451HD
Belt - P.S.	164550R2	▲9425HD
Hose - Upper - Eng. To Pipe; (1 3/4" I.D.)		24228
Hose - Upper - Eng. To Pipe		●26501
Hose - Upper - Pipe To Rad.; (2 1/4" I.D.)		24236
Hose - Lower; (2 5/8" I.D.)		②24942
Hose - By Pass		≡<20618
Hose - By Pass; (3/4" I.D.)		28442
Hose - Heater; (1" I.D.)		24216
International/Navistar V461		
193RE		
Belt - Fan	358319C91	②◆▲9570HD
Belt - W.P.	359021C91	②TR22434
Belt - Alt.; W/37A. Alt.	256346C11	②▲9350HD
Belt - Alt.; W/55A., 60A., 62A., 105A., 130A. Alt.		②▲9365HD
Belt - Alt. & Air Brake Compr.	243605R11	②◆▲9451HD
Belt - P.S.	164550R2	▲9425HD
Hose - Upper - Eng. To Pipe; (1 3/4" I.D.)		24228
Hose - Upper - Eng. To Pipe		●26501
Hose - Upper - Pipe To Rad.; (2 1/4" I.D.)		24236
Hose - Lower; (2 5/8" I.D.)		②24942
Hose - By Pass		≡<20618
Hose - By Pass; (3/4" I.D.)		28442
Hose - Heater; (1" I.D.)		24216
International/Navistar V478		
193RE		
Belt - Fan	358319C91	②◆▲9570HD
Belt - W.P.	359021C91	②TR22434
Belt - Alt.; W/37A. Alt.	256346C11	②▲9350HD
Belt - Alt.; W/55A., 60A., 62A., 105A., 130A. Alt.		②▲9365HD
Belt - Alt. & Air Brake Compr.	243605R11	②◆▲9451HD
Belt - P.S.	164550R2	▲9425HD
Hose - Upper - Eng. To Pipe; (1 3/4" I.D.)		24228
Hose - Upper - Eng. To Pipe		●26501
Hose - Upper - Pipe To Rad.; (2 1/4" I.D.)		24236
Hose - Lower; (2 5/8" I.D.)		②24942
Hose - By Pass		≡<20618
Hose - By Pass; (3/4" I.D.)		28442
Hose - Heater; (1" I.D.)		24216
International/Navistar V549		
193RE		
Belt - Fan	358319C91	②◆▲9570HD
Belt - W.P.	359021C91	②TR22434
Belt - Alt.; W/37A. Alt.	256346C11	②▲9350HD
Belt - Alt.; W/55A., 60A., 62A., 105A., 130A. Alt.		②▲9365HD
Belt - Alt. & Air Brake Compr.	243605R11	②◆▲9451HD
Belt - P.S.	164550R2	▲9425HD
Hose - Upper - Eng. To Pipe; (1 3/4" I.D.)		24228
Hose - Upper - Eng. To Pipe		●26501
Hose - Upper - Pipe To Rad.; (2 1/4" I.D.)		24236
Hose - Lower; (2 5/8" I.D.)		②24942
Hose - By Pass		≡<20618
Hose - By Pass; (3/4" I.D.)		28442
Hose - Heater; (1" I.D.)		24216
International/Navistar VS401		
193RE		
Belt - Fan	358319C91	②◆▲9570HD
Belt - W.P.	359021C91	②TR22434
Belt - Alt.; W/37A. Alt.	256346C11	②▲9350HD
Belt - Alt.; W/55A., 60A., 62A., 105A., 130A. Alt.		②▲9365HD
Belt - Alt. & Air Brake Compr.	243605R11	②◆▲9451HD
Belt - P.S.	164550R2	▲9425HD
Hose - Upper - Eng. To Pipe; (1 3/4" I.D.)		24228
Hose - Upper - Eng. To Pipe		●26501

Application	Mfr. Part No.	Our No.
INTERNATIONAL/NAVISTAR - Continued		
1969 - Continued		
International/Navistar VS401 - Continued		
193RE - Continued		
Hose - Upper - Pipe To Rad.; (2 1/4" I.D.)		24236
Hose - Lower; (2 5/8" I.D.)		②24942
Hose - By Pass		≡<20618
Hose - By Pass; (3/4" I.D.)		28442
Hose - Heater; (1" I.D.)		24216
International/Navistar VS478		
193RE		
Belt - Fan	358319C91	②◆▲9570HD
Belt - W.P.	359021C91	②TR22434
Belt - Alt.; W/37A. Alt.	256346C11	②▲9350HD
Belt - Alt.; W/55A., 60A., 62A., 105A., 130A. Alt.		②▲9365HD
Belt - Alt. & Air Brake Compr.	243605R11	②◆▲9451HD
Belt - P.S.	164550R2	▲9425HD
Hose - Upper - Eng. To Pipe; (1 3/4" I.D.)		24228
Hose - Upper - Eng. To Pipe		●26501
Hose - Upper - Pipe To Rad.; (2 1/4" I.D.)		24236
Hose - Lower; (2 5/8" I.D.)		②24942
Hose - By Pass		≡<20618
Hose - By Pass; (3/4" I.D.)		28442
Hose - Heater; (1" I.D.)		24216
International/Navistar VS549		
193RE		
Belt - Fan	358319C91	②◆▲9570HD
Belt - W.P.	359021C91	②TR22434
Belt - Alt.; W/37A. Alt.	256346C11	②▲9350HD
Belt - Alt.; W/55A., 60A., 62A., 105A., 130A. Alt.		②▲9365HD
Belt - Alt. & Air Brake Compr.	243605R11	②◆▲9451HD
Belt - P.S.	164550R2	▲9425HD
Hose - Upper - Eng. To Pipe; (1 3/4" I.D.)		24228
Hose - Upper - Eng. To Pipe		●26501
Hose - Upper - Pipe To Rad.; (2 1/4" I.D.)		24236
Hose - Lower; (2 5/8" I.D.)		②24942
Hose - By Pass		≡<20618
Hose - By Pass; (3/4" I.D.)		28442
Hose - Heater; (1" I.D.)		24216
1968		
International/Navistar BD220		
1603		
Belt - Fan & Alt.; W/37A., 52A., 61A., 62A. Alt.	151532R1	②7512
Belt - Fan & Alt.; W/60A. Alt.	861779R11	②▲9440HD
Belt - Gen.; W/20A., 50A. Alt.	20594VA	TR24438
Belt - Gen.; W/30A. Alt.	81572R2	TR28437
Belt - Gen.; W/35A., 50A. L.C.I. Gen.	164550R1	②▲9425HD
Belt - P.S.; W/Air Brakes	149636R1	▲9480HD
Belt - P.S.; W/Hyd. Brakes	864931R2	▲9319HD
Belt - Air Brake Compr.; W/4 Cu. Ft. Air Brake Compr.	201825R1	▲9440HD
Belt - Air Brake Compr.; W/20A., 30A., 50A. Gen.	115505HA	TR22363
Hose - Upper		●26510
Hose - Lower - Eng. To Pipe		●26508
Hose - Lower - Pipe To Rad.		●26514
Hose - By Pass		20338
Hose - By Pass; (5/8" I.D.)		28441
International/Navistar BD240		
1603		
Belt - Fan & Alt.; W/37A., 52A., 61A., 62A. Alt.	151532R1	②7512
Belt - Fan & Alt.; W/60A. Alt.	861779R11	②▲9440HD
Belt - Gen.; W/20A., 50A. Alt.	20594VA	TR24438
Belt - Gen.; W/30A. Alt.	81572R2	TR28437
Belt - Gen.; W/35A., 50A. L.C.I. Gen.	164550R1	②▲9425HD
Belt - P.S.; W/Air Brakes	149636R1	▲9480HD
Belt - P.S.; W/Hyd. Brakes	864931R2	▲9319HD
Belt - Air Brake Compr.; W/4 Cu. Ft. Air Brake Compr.	201825R1	▲9440HD
Belt - Air Brake Compr.; W/20A., 30A., 50A. Gen.	115505HA	TR22363

② Two Required.
 ▲ Standard Belt Available. See Pages 630-631.
 ≡< Use Wire Inserted Green Stripe® Coolant Hose.

◆ Green Stripe® PowerBand® Belt May Work, Use Template to Check.
 ● Vulco-Flex® Coolant Hose.
 ≡< Cut to Fit.

School Buses

Belts and Coolant Hose for School Buses

School Buses

Application	Mfr. Part No.	Our No.
INTERNATIONAL/NAVISTAR - Continued		
1968 - Continued		
International/Navistar BD240 - Continued		
1603 - Continued		
Hose - Upper		●26510
Hose - Lower - Eng. To Pipe		●26508
Hose - Lower - Pipe To Rad.		●26514
Hose - By Pass		20338
Hose - By Pass; (5/8" I.D.)		28441
International/Navistar BD264		
1603		
Belt - Fan & Alt.; W/37A., 52A., 61A., 62A. Alt.	151532R1	②7512
Belt - Fan & Alt.; W/60A. Alt.	861779R11	②▲9440HD
Belt - Gen.; W/20A., 50A. Alt.	20594VA	TR24438
Belt - Gen.; W/30A. Alt.	81572R2	TR28437
Belt - Gen.; W/35A., 50A. L.C.I. Gen.	164550R1	②▲9425HD
Belt - P.S.; W/Air Brakes	149636R1	▲9480HD
Belt - P.S.; W/Hyd. Brakes	864931R2	▲9319HD
Belt - Air Brake Compr.; W/4 Cu. Ft. Air Brake Compr.	201825R1	▲9440HD
Belt - Air Brake Compr.; W/20A., 30A., 50A. Gen.	115505HA	TR22363
Hose - Upper		●26510
Hose - Lower - Eng. To Pipe		●26508
Hose - Lower - Pipe To Rad.		●26514
Hose - By Pass		20338
Hose - By Pass; (5/8" I.D.)		28441
International/Navistar BD269		
1603		
Belt - Fan & Alt.	862880R11	②▲9490HD
Belt - P.S.	242269R1	▲9405HD
Belt - Air Brake Compr.	280210C1	▲9540HD
Hose - Upper; (2" I.D.)		24232
Hose - Lower		≋20611
	or	●26509
Hose - By Pass; (2" I.D.)		24232
1703 ; 1803		
Belt - Fan & Alt.	862880R11	②▲9490HD
Belt - P.S.	242269R1	▲9405HD
Belt - Air Brake Compr.	280210C1	▲9540HD
Hose - Upper; (2" I.D.)		24232
Hose - Lower - Eng. To Pipe		≋20206
Hose - Lower - Pipe To Rad.; (2" I.D.)		24232
Hose - By Pass; (2" I.D.)		24232
International/Navistar BD282		
1603		
Belt - Fan & Alt.	862880R11	②▲9490HD
Belt - P.S.	242269R1	▲9405HD
Belt - Air Brake Compr.	280210C1	▲9540HD
Hose - Upper; (2" I.D.)		24232
Hose - Lower		≋20611
	or	●26509
Hose - By Pass; (2" I.D.)		24232
1703 ; 1803		
Belt - Fan & Alt.	862880R11	②▲9490HD
Belt - P.S.	242269R1	▲9405HD
Belt - Air Brake Compr.	280210C1	▲9540HD
Hose - Upper; (2" I.D.)		24232
Hose - Lower - Eng. To Pipe		≋20206
Hose - Lower - Pipe To Rad.; (2" I.D.)		24232
Hose - By Pass; (2" I.D.)		24232
International/Navistar BD308		
1603		
Belt - Fan & Alt.	862880R11	②▲9490HD
Belt - P.S.	242269R1	▲9405HD
Belt - Air Brake Compr.	280210C1	▲9540HD
Hose - Upper; (2" I.D.)		24232
Hose - Lower		≋20611
	or	●26509
Hose - By Pass; (2" I.D.)		24232
1703 ; 1803		
Belt - Fan & Alt.	862880R11	②▲9490HD

Application	Mfr. Part No.	Our No.
INTERNATIONAL/NAVISTAR - Continued		
1968 - Continued		
International/Navistar BD308 - Continued		
1703 ; 1803 - Continued		
Belt - P.S.	242269R1	▲9405HD
Belt - Air Brake Compr.	280210C1	▲9540HD
Hose - Upper; (2" I.D.)		24232
Hose - Lower - Eng. To Pipe		≋20206
Hose - Lower - Pipe To Rad.; (2" I.D.)		24232
Hose - By Pass; (2" I.D.)		24232
International/Navistar BG220		
1603		
Belt - Fan & Alt.; W/37A., 52A., 61A., 62A. Alt.	151532R1	②7512
Belt - Fan & Alt.; W/60A. Alt.	861779R11	②▲9440HD
Belt - Gen.; W/20A., 50A. Alt.	20594VA	TR24438
Belt - Gen.; W/30A. Alt.	81572R2	TR28437
Belt - Gen.; W/35A., 50A. L.C.I. Gen.	164550R1	②▲9425HD
Belt - P.S.; W/Air Brakes	149636R1	▲9480HD
Belt - P.S.; W/Hyd. Brakes	864931R2	▲9319HD
Belt - Air Brake Compr.; W/4 Cu. Ft. Air Brake Compr.	201825R1	▲9440HD
Belt - Air Brake Compr.; W/20A., 30A., 50A. Gen.	115505HA	TR22363
Hose - Upper		●26510
Hose - Lower - Eng. To Pipe		●26508
Hose - Lower - Pipe To Rad.		●26514
Hose - By Pass		20338
Hose - By Pass; (5/8" I.D.)		28441
International/Navistar BG241		
1603		
Belt - Fan & Alt.; W/37A., 52A., 61A., 62A. Alt.	151532R1	②7512
Belt - Fan & Alt.; W/60A. Alt.	861779R11	②▲9440HD
Belt - Gen.; W/20A., 50A. Alt.	20594VA	TR24438
Belt - Gen.; W/30A. Alt.	81572R2	TR28437
Belt - Gen.; W/35A., 50A. L.C.I. Gen.	164550R1	②▲9425HD
Belt - P.S.; W/Air Brakes	149636R1	▲9480HD
Belt - P.S.; W/Hyd. Brakes	864931R2	▲9319HD
Belt - Air Brake Compr.; W/4 Cu. Ft. Air Brake Compr.	201825R1	▲9440HD
Belt - Air Brake Compr.; W/20A., 30A., 50A. Gen.	115505HA	TR22363
Hose - Upper		●26510
Hose - Lower - Eng. To Pipe		●26508
Hose - Lower - Pipe To Rad.		●26514
Hose - By Pass		20338
Hose - By Pass; (5/8" I.D.)		28441
International/Navistar BG265		
1603		
Belt - Fan & Alt.; W/37A., 52A., 61A., 62A. Alt.	151532R1	②7512
Belt - Fan & Alt.; W/60A. Alt.	861779R11	②▲9440HD
Belt - Gen.; W/20A., 50A. Alt.	20594VA	TR24438
Belt - Gen.; W/30A. Alt.	81572R2	TR28437
Belt - Gen.; W/35A., 50A. L.C.I. Gen.	164550R1	②▲9425HD
Belt - P.S.; W/Air Brakes	149636R1	▲9480HD
Belt - P.S.; W/Hyd. Brakes	864931R2	▲9319HD
Belt - Air Brake Compr.; W/4 Cu. Ft. Air Brake Compr.	201825R1	▲9440HD
Belt - Air Brake Compr.; W/20A., 30A., 50A. Gen.	115505HA	TR22363
Hose - Upper		●26510
Hose - Lower - Eng. To Pipe		●26508
Hose - Lower - Pipe To Rad.		●26514
Hose - By Pass		20338
Hose - By Pass; (5/8" I.D.)		28441
International/Navistar FTV549		
193RE		
Belt - Fan	358319C91	②◆▲9570HD
Belt - W.P.	359021C91	②TR22434
Belt - Alt.; W/37A. Alt.	256346C11	②▲9350HD
Belt - Alt.; W/55A., 60A., 62A., 105A., 130A. Alt.		②▲9365HD
Belt - Alt. & Air Brake Compr.	243605R11	②◆▲9451HD
Belt - P.S.	164550R2	▲9425HD

- Vulco-Flex® Coolant Hose.
- ▲ Standard Belt Available. See Pages 630-631.
- ◆ Green Stripe® PowerBand® Belt May Work, Use Template to Check.

- ② Two Required.
- ≋ Cut to Fit.

Belts and Coolant Hose for School Buses

Application	Mfr. Part No.	Our No.
INTERNATIONAL/NAVISTAR - Continued		
1968 - Continued		
International/Navistar FTV549 - Continued		
193RE - Continued		
Hose - Upper - Eng. To Pipe; (1 3/4" I.D.)		24228
Hose - Upper - Eng. To Pipe	●26501	
Hose - Upper - Pipe To Rad.; (2 1/4" I.D.)		24236
Hose - Lower; (2 5/8" I.D.)	⊕24942	
Hose - By Pass	≠20618	
Hose - By Pass; (3/4" I.D.)		28442
Hose - Heater; (1" I.D.)		24216
International/Navistar FTVS549		
193RE		
Belt - Fan	358319C91	⊕◆▲9570HD
Belt - W.P.	359021C91	⊕TR22434
Belt - Alt.; W/37A. Alt.	256346C11	⊕▲9350HD
Belt - Alt.; W/55A., 60A., 62A., 105A., 130A. Alt.		⊕▲9365HD
Belt - Alt. & Air Brake Compr.	243605R11	⊕◆▲9451HD
Belt - P.S.	164550R2	▲9425HD
Hose - Upper - Eng. To Pipe; (1 3/4" I.D.)		24228
Hose - Upper - Eng. To Pipe	●26501	
Hose - Upper - Pipe To Rad.; (2 1/4" I.D.)		24236
Hose - Lower; (2 5/8" I.D.)	⊕24942	
Hose - By Pass	≠20618	
Hose - By Pass; (3/4" I.D.)		28442
Hose - Heater; (1" I.D.)		24216
International/Navistar RD372		
1823		
Belt - Fan & Alt.	359014C91	⊕TR22514
Belt - W.P. & Alt.; W/37A. Alt.; Chassis No. FD61626 & Before	193826R11	⊕TR22508
Belt - W.P. & Alt.; W/37A. Alt.; Chassis No. FD61626 & Up & G Chassis No.	223794R11	⊕TR22514
Belt - W.P. & Alt.; W/60A. Alt.	243604R11	⊕TR22517
Belt - P.S.	240354R2	TR22336
Belt - Air Brake Compr.; W/Wagner Compr. ...	92836HA	TR32491
Belt - Air Brake Compr.; W/Westinghouse Compr.	83816HA	TR34467
Hose - Upper		●26515
Hose - Lower; (2" I.D.)		24232
1853		
Belt - Alt.; W/55A., 62A., 145A. Alt.	223794K21	⊕TR22514
Belt - Gen.; W/37A. Gen.	193826R11	TR22508
Belt - P.S.	240354R1	TR22344
1853FC		
Belt - Alt.; W/55A., 62A., 145A. Alt.	223794K21	⊕TR22514
Belt - Gen.; W/37A. Gen.	193826R11	TR22508
Belt - P.S.	240354R1	TR22344
Hose - Upper; Late FD Chassis; Chassis No. FA66376		●26509
Hose - Lower; Early FD Chassis; Chassis No. FA66376		●26508
Hose - Lower; Late FD Chassis; Chassis No. FA66376(2 1/8" I.D.)		24234
Hose - Lower; Late FD Chassis; Chassis No. FA66376		●26508
International/Navistar RD406		
1823		
Belt - Fan & Alt.	359014C91	⊕TR22514
Belt - W.P. & Alt.; W/37A. Alt.; Chassis No. FD61626 & Before	193826R11	⊕TR22508
Belt - W.P. & Alt.; W/37A. Alt.; Chassis No. FD61626 & Up & G Chassis No.	223794R11	⊕TR22514
Belt - W.P. & Alt.; W/60A. Alt.	243604R11	⊕TR22517
Belt - P.S.	240354R2	TR22336
Belt - Air Brake Compr.; W/Wagner Compr. ...	92836HA	TR32491
Belt - Air Brake Compr.; W/Westinghouse Compr.	83816HA	TR34467
Hose - Upper		●26515
Hose - Lower; (2" I.D.)		24232
1853		
Belt - Alt.; W/55A., 62A., 145A. Alt.	223794K21	⊕TR22514
Belt - Gen.; W/37A. Gen.	193826R11	TR22508
Belt - P.S.	240354R1	TR22344

Application	Mfr. Part No.	Our No.
INTERNATIONAL/NAVISTAR - Continued		
1968 - Continued		
International/Navistar RD406 - Continued		
1853FC		
Belt - Alt.; W/55A., 62A., 145A. Alt.	223794K21	⊕TR22514
Belt - Gen.; W/37A. Gen.	193826R11	TR22508
Belt - P.S.	240354R1	TR22344
Hose - Upper; Late FD Chassis; Chassis No. FA66376		●26509
Hose - Lower; Early FD Chassis; Chassis No. FA66376		●26508
Hose - Lower; Late FD Chassis; Chassis No. FA66376(2 1/8" I.D.)		24234
Hose - Lower; Late FD Chassis; Chassis No. FA66376		●26508
International/Navistar RD450		
1823		
Belt - Fan & Alt.	359014C91	⊕TR22514
Belt - W.P. & Alt.; W/37A. Alt.; Chassis No. FD61626 & Before	193826R11	⊕TR22508
Belt - W.P. & Alt.; W/37A. Alt.; Chassis No. FD61626 & Up & G Chassis No.	223794R11	⊕TR22514
Belt - W.P. & Alt.; W/60A. Alt.	243604R11	⊕TR22517
Belt - P.S.	240354R2	TR22336
Belt - Air Brake Compr.; W/Wagner Compr. ...	92836HA	TR32491
Belt - Air Brake Compr.; W/Westinghouse Compr.	83816HA	TR34467
Hose - Upper		●26515
Hose - Lower; (2" I.D.)		24232
1853		
Belt - Alt.; W/55A., 62A., 145A. Alt.	223794K21	⊕TR22514
Belt - Gen.; W/37A. Gen.	193826R11	TR22508
Belt - P.S.	240354R1	TR22344
1853FC		
Belt - Alt.; W/55A., 62A., 145A. Alt.	223794K21	⊕TR22514
Belt - Gen.; W/37A. Gen.	193826R11	TR22508
Belt - P.S.	240354R1	TR22344
Hose - Upper; Late FD Chassis; Chassis No. FA66376		●26509
Hose - Lower; Early FD Chassis; Chassis No. FA66376		●26508
Hose - Lower; Late FD Chassis; Chassis No. FA66376(2 1/8" I.D.)		24234
Hose - Lower; Late FD Chassis; Chassis No. FA66376		●26508
International/Navistar RD501		
1823		
Belt - Fan & Alt.	359014C91	⊕TR22514
Belt - W.P. & Alt.; W/37A. Alt.; Chassis No. FD61626 & Before	193826R11	⊕TR22508
Belt - W.P. & Alt.; W/37A. Alt.; Chassis No. FD61626 & Up & G Chassis No.	223794R11	⊕TR22514
Belt - W.P. & Alt.; W/60A. Alt.	243604R11	⊕TR22517
Belt - P.S.	240354R2	TR22336
Belt - Air Brake Compr.; W/Wagner Compr. ...	92836HA	TR32491
Belt - Air Brake Compr.; W/Westinghouse Compr.	83816HA	TR34467
Hose - Upper		●26515
Hose - Lower; (2" I.D.)		24232
1853		
Belt - Alt.; W/55A., 62A., 145A. Alt.	223794K21	⊕TR22514
Belt - Gen.; W/37A. Gen.	193826R11	TR22508
Belt - P.S.	240354R1	TR22344
1853FC		
Belt - Alt.; W/55A., 62A., 145A. Alt.	223794K21	⊕TR22514
Belt - Gen.; W/37A. Gen.	193826R11	TR22508
Belt - P.S.	240354R1	TR22344
Hose - Upper; Late FD Chassis; Chassis No. FA66376		●26509
Hose - Lower; Early FD Chassis; Chassis No. FA66376		●26508
Hose - Lower; Late FD Chassis; Chassis No. FA66376(2 1/8" I.D.)		24234
Hose - Lower; Late FD Chassis; Chassis No. FA66376		●26508
International/Navistar V266		
1603; 1703; 1803		
Belt - Fan & Alt.; W/37A., 52A., 61A. Alt.; C, G, H Chassis		⊕7603
Belt - Fan & Alt.; W/37A., 52A., 61A. Alt.; FD, SB Chassis	255266C3	⊕7640

● Vulco-Flex® Coolant Hose.
 ≠ Cut to Fit.
 ◆ Green Stripe® PowerBand® Belt May Work, Use Template to Check.

⊕ Use Wire Inserted Green Stripe® Coolant Hose.
 ⊕ Two Required.
 ▲ Standard Belt Available. See Pages 630-631.

School Buses

Belts and Coolant Hose for School Buses

Application	Mfr. Part No.	Our No.
INTERNATIONAL/NAVISTAR - Continued		
1968 - Continued		
International/Navistar V266 - Continued		
1603; 1703 ; 1803 - Continued		
Belt - Fan & Alt.; W/55A., 62A. Alt.; C, G, H		
Chassis	369725C91	②7619
Belt - Fan & Alt.; W/55A., 62A. Alt.; FD, SB		
Chassis	358998C91	②7650
Belt - P.S.; W/2WD	151529R2	7440
Belt - P.S.; W/4WD	151531R2	7450
Belt - Air Brake Compr.	236572R2	7460
Hose - Upper; W/Rad. Shutters; W/Metal Hood		●26515
Hose - Upper; W/O Rad. Shutters; W/Metal Hood		20493
Hose - Lower - Eng. To Pipe; W/Auto. Trans.		20532
Hose - Lower; W/Man. Trans.		21308
Hose - By Pass		≧20357
International/Navistar V304		
1603; 1703 ; 1803		
Belt - Fan & Alt.; W/37A., 52A., 61A. Alt.; C, G, H Chassis		②7603
Belt - Fan & Alt.; W/37A., 52A., 61A. Alt.; FD, SB Chassis	255266C3	②7640
Belt - Fan & Alt.; W/55A., 62A. Alt.; C, G, H Chassis	369725C91	②7619
Belt - Fan & Alt.; W/55A., 62A. Alt.; FD, SB Chassis	358998C91	②7650
Belt - P.S.; W/2WD	151529R2	7440
Belt - P.S.; W/4WD	151531R2	7450
Belt - Air Brake Compr.	236572R2	7460
Hose - Upper; W/Rad. Shutters; W/Metal Hood		●26515
Hose - Upper; W/O Rad. Shutters; W/Metal Hood		20493
Hose - Lower - Eng. To Pipe; W/Auto. Trans.		20532
Hose - Lower; W/Man. Trans.		21308
Hose - By Pass		≧20357
International/Navistar V345		
1603; 1703		
Belt - Fan & Alt.; W/37A., 52A., 61A. Alt.; C, G, H Chassis; W/P.T.O.	968815R11	②7650
Belt - Fan & Alt.; W/37A., 52A., 61A. Alt.; C, G, H Chassis; W/O P.T.O.	373457C91	②7612
Belt - Fan & Alt.; W/37A., 52A., 61A. Alt.; FD, SB Chassis	968815R1	②7650
Belt - Fan & Alt.; W/37A., 61A. Alt.; W/O Air Brakes; W/O P.T.O.; W/O X.C.	373456C1	7612
Belt - Fan & Alt.; W/55A., 62A. Alt.; C, G, H Chassis	369723C91	②7630
Belt - Fan & Alt.; W/55A., 62A. Alt.; FD, SB Chassis	361975C91	②7673
Belt - Fan & Alt.; W/60A. Alt.	359009C91	②7680
Belt - Fan & Alt.; W/65A., 80A., 105A., 145A. Alt.; W/P.T.O.	361975C91	②7673
Belt - Fan & Alt.; W/65A., 80A., 105A., 145A. Alt.; W/O P.T.O.		②7630
Belt - P.S.; W/2WD	7460	
Belt - P.S.; W/4WD	285522C2	7435
Belt - Air Brake Compr.	359007C91	7475
Belt - A.P.; W/Air Brakes; W/Gov.	388139C1	7330
Belt - A.P.; W/Air Brakes; W/O Gov.	256062C2	7340
Belt - A.P.; W/Hyd. Brakes; W/Gov.	355653C91	7380
Belt - A.P.; W/Hyd. Brakes; W/O Gov.	362887C91	7410
Hose - Upper; W/Rad. Shutters; W/Metal Hood		●26515
Hose - Upper; W/O Rad. Shutters; W/Metal Hood		20493
Hose - Lower - Eng. To Pipe; W/Auto. Trans.		20532
Hose - Lower; W/Man. Trans.		21308
Hose - By Pass		≧20357
1723		
Belt - Fan & Alt.; W/37A., 52A., 61A. Alt.; C, G, H Chassis; W/P.T.O.	968815R11	②7650
Belt - Fan & Alt.; W/37A., 52A., 61A. Alt.; C, G, H Chassis; W/O P.T.O.	373457C91	②7612
Belt - Fan & Alt.; W/37A., 52A., 61A. Alt.; FD, SB Chassis	968815R1	②7650
Belt - Fan & Alt.; W/37A., 61A. Alt.; W/O Air Brakes; W/O P.T.O.; W/O X.C.	373456C1	7612
Belt - Fan & Alt.; W/55A., 62A. Alt.; C, G, H Chassis	369723C91	②7630

Application	Mfr. Part No.	Our No.
INTERNATIONAL/NAVISTAR - Continued		
1968 - Continued		
International/Navistar V345 - Continued		
1723 - Continued		
Belt - Fan & Alt.; W/55A., 62A. Alt.; FD, SB		
Chassis	361975C91	②7673
Belt - Fan & Alt.; W/60A. Alt.	359009C91	②7680
Belt - Fan & Alt.; W/65A., 80A., 105A., 145A. Alt.; W/P.T.O.	361975C91	②7673
Belt - Fan & Alt.; W/65A., 80A., 105A., 145A. Alt.; W/O P.T.O.		②7630
Belt - P.S.; W/2WD		7460
Belt - P.S.; W/4WD	285522C2	7435
Belt - Air Brake Compr.	359007C91	7475
Belt - A.P.; W/Air Brakes; W/Gov.	388139C1	7330
Belt - A.P.; W/Air Brakes; W/O Gov.	256062C2	7340
Belt - A.P.; W/Hyd. Brakes; W/Gov.	355653C91	7380
Belt - A.P.; W/Hyd. Brakes; W/O Gov.	362887C91	7410
1803		
Belt - Fan & Alt.; W/37A., 52A., 61A. Alt.; C, G, H Chassis; W/P.T.O.	968815R11	②7650
Belt - Fan & Alt.; W/37A., 52A., 61A. Alt.; C, G, H Chassis; W/O P.T.O.	373457C91	②7612
Belt - Fan & Alt.; W/37A., 52A., 61A. Alt.; FD, SB Chassis	968815R1	②7650
Belt - Fan & Alt.; W/37A., 61A. Alt.; W/O Air Brakes; W/O P.T.O.; W/O X.C.	373456C1	7612
Belt - Fan & Alt.; W/55A., 62A. Alt.; C, G, H Chassis	369723C91	②7630
Belt - Fan & Alt.; W/55A., 62A. Alt.; FD, SB Chassis	361975C91	②7673
Belt - Fan & Alt.; W/60A. Alt.	359009C91	②7680
Belt - Fan & Alt.; W/65A., 80A., 105A., 145A. Alt.; W/P.T.O.	361975C91	②7673
Belt - Fan & Alt.; W/65A., 80A., 105A., 145A. Alt.; W/O P.T.O.		②7630
Belt - P.S.; W/2WD		7460
Belt - P.S.; W/4WD	285522C2	7435
Belt - Air Brake Compr.	359007C91	7475
Belt - A.P.; W/Air Brakes; W/Gov.	388139C1	7330
Belt - A.P.; W/Air Brakes; W/O Gov.	256062C2	7340
Belt - A.P.; W/Hyd. Brakes; W/Gov.	355653C91	7380
Belt - A.P.; W/Hyd. Brakes; W/O Gov.	362887C91	7410
Hose - Upper; W/Rad. Shutters; W/Metal Hood		●26515
Hose - Upper; W/O Rad. Shutters; W/Metal Hood		20493
Hose - Lower - Eng. To Pipe; W/Auto. Trans.		20532
Hose - Lower; W/Man. Trans.		21308
Hose - By Pass		≧20357
1823		
Belt - Fan & Alt.; W/37A., 52A., 61A. Alt.; C, G, H Chassis; W/P.T.O.	968815R11	②7650
Belt - Fan & Alt.; W/37A., 52A., 61A. Alt.; C, G, H Chassis; W/O P.T.O.	373457C91	②7612
Belt - Fan & Alt.; W/37A., 52A., 61A. Alt.; FD, SB Chassis	968815R1	②7650
Belt - Fan & Alt.; W/37A., 61A. Alt.; W/O Air Brakes; W/O P.T.O.; W/O X.C.	373456C1	7612
Belt - Fan & Alt.; W/55A., 62A. Alt.; C, G, H Chassis	369723C91	②7630
Belt - Fan & Alt.; W/55A., 62A. Alt.; FD, SB Chassis	361975C91	②7673
Belt - Fan & Alt.; W/60A. Alt.	359009C91	②7680
Belt - Fan & Alt.; W/65A., 80A., 105A., 145A. Alt.; W/P.T.O.	361975C91	②7673
Belt - Fan & Alt.; W/65A., 80A., 105A., 145A. Alt.; W/O P.T.O.		②7630
Belt - P.S.; W/2WD		7460
Belt - P.S.; W/4WD	285522C2	7435
Belt - Air Brake Compr.	359007C91	7475
Belt - A.P.; W/Air Brakes; W/Gov.	388139C1	7330
Belt - A.P.; W/Air Brakes; W/O Gov.	256062C2	7340
Belt - A.P.; W/Hyd. Brakes; W/Gov.	355653C91	7380
Belt - A.P.; W/Hyd. Brakes; W/O Gov.	362887C91	7410
International/Navistar V392		
1603; 1703		
Belt - Fan & Alt.; W/37A., 52A., 61A. Alt.; C, G, H Chassis; W/P.T.O.	968815R11	②7650

② Two Required.
≧ Cut to Fit.

● Vulco-Flex® Coolant Hose.

Belts and Coolant Hose for School Buses

Application	Mfr. Part No.	Our No.	Application	Mfr. Part No.	Our No.
INTERNATIONAL/NAVISTAR - Continued			INTERNATIONAL/NAVISTAR - Continued		
1968 - Continued			1968 - Continued		
International/Navistar V392 - Continued			International/Navistar V392 - Continued		
1603; 1703 - Continued			1803 - Continued		
Belt - Fan & Alt.; W/37A., 52A., 61A. Alt.; C, G, H Chassis; W/O P.T.O.	373457C91	②7612	Belt - A.P.; W/Air Brakes; W/O Gov.	256062C2	7340
Belt - Fan & Alt.; W/37A., 52A., 61A. Alt.; FD, SB Chassis	968815R1	②7650	Belt - A.P.; W/Hyd. Brakes; W/Gov.	355653C91	7380
Belt - Fan & Alt.; W/37A., 61A. Alt.; W/O Air Brakes; W/O P.T.O.; W/O X.C.	373456C1	7612	Belt - A.P.; W/Hyd. Brakes; W/O Gov.	362887C91	7410
Belt - Fan & Alt.; W/55A., 62A. Alt.; C, G, H Chassis	369723C91	②7630	Hose - Upper; W/Rad. Shutters; W/Metal Hood		●26515
Belt - Fan & Alt.; W/55A., 62A. Alt.; FD, SB Chassis	361975C91	②7673	Hose - Upper; W/O Rad. Shutters; W/Metal Hood		20493
Belt - Fan & Alt.; W/60A. Alt.	359009C91	②7680	Hose - Lower - Eng. To Pipe; W/Auto. Trans.		20532
Belt - Fan & Alt.; W/65A., 80A., 105A., 145A. Alt.; W/P.T.O.	361975C91	②7673	Hose - Lower; W/Man. Trans.		21308
Belt - Fan & Alt.; W/65A., 80A., 105A., 145A. Alt.; W/O P.T.O.		②7630	Hose - By Pass		≈20357
Belt - P.S.; W/2WD		7460	1823		
Belt - P.S.; W/4WD	285522C2	7435	Belt - Fan & Alt.; W/37A., 52A., 61A. Alt.; C, G, H Chassis; W/P.T.O.	968815R11	②7650
Belt - Air Brake Compr.	359007C91	7475	Belt - Fan & Alt.; W/37A., 52A., 61A. Alt.; C, G, H Chassis; W/O P.T.O.	373457C91	②7612
Belt - A.P.; W/Air Brakes; W/Gov.	388139C1	7330	Belt - Fan & Alt.; W/37A., 52A., 61A. Alt.; FD, SB Chassis	968815R1	②7650
Belt - A.P.; W/Air Brakes; W/O Gov.	256062C2	7340	Belt - Fan & Alt.; W/37A., 61A. Alt.; W/O Air Brakes; W/O P.T.O.; W/O X.C.	373456C1	7612
Belt - A.P.; W/Hyd. Brakes; W/Gov.	355653C91	7380	Belt - Fan & Alt.; W/55A., 62A. Alt.; C, G, H Chassis	369723C91	②7630
Belt - A.P.; W/Hyd. Brakes; W/O Gov.	362887C91	7410	Belt - Fan & Alt.; W/55A., 62A. Alt.; FD, SB Chassis	361975C91	②7673
Hose - Upper; W/Rad. Shutters; W/Metal Hood		●26515	Belt - Fan & Alt.; W/60A. Alt.	359009C91	②7680
Hose - Upper; W/O Rad. Shutters; W/Metal Hood		20493	Belt - Fan & Alt.; W/65A., 80A., 105A., 145A. Alt.; W/P.T.O.	361975C91	②7673
Hose - Lower - Eng. To Pipe; W/Auto. Trans.		20532	Belt - Fan & Alt.; W/65A., 80A., 105A., 145A. Alt.; W/O P.T.O.		②7630
Hose - Lower; W/Man. Trans.		21308	Belt - P.S.; W/2WD		7460
Hose - By Pass		≈20357	Belt - P.S.; W/4WD	285522C2	7435
1723			Belt - Air Brake Compr.	359007C91	7475
Belt - Fan & Alt.; W/37A., 52A., 61A. Alt.; C, G, H Chassis; W/P.T.O.	968815R11	②7650	Belt - A.P.; W/Air Brakes; W/Gov.	388139C1	7330
Belt - Fan & Alt.; W/37A., 52A., 61A. Alt.; C, G, H Chassis; W/O P.T.O.	373457C91	②7612	Belt - A.P.; W/Air Brakes; W/O Gov.	256062C2	7340
Belt - Fan & Alt.; W/37A., 52A., 61A. Alt.; FD, SB Chassis	968815R1	②7650	Belt - A.P.; W/Hyd. Brakes; W/Gov.	355653C91	7380
Belt - Fan & Alt.; W/37A., 61A. Alt.; W/O Air Brakes; W/O P.T.O.; W/O X.C.	373456C1	7612	Belt - A.P.; W/Hyd. Brakes; W/O Gov.	362887C91	7410
Belt - Fan & Alt.; W/55A., 62A. Alt.; C, G, H Chassis	369723C91	②7630	International/Navistar V401		
Belt - Fan & Alt.; W/55A., 62A. Alt.; FD, SB Chassis	361975C91	②7673	193RE		
Belt - Fan & Alt.; W/60A. Alt.	359009C91	②7680	Belt - Fan	358319C91	②◆◆9570HD
Belt - Fan & Alt.; W/65A., 80A., 105A., 145A. Alt.; W/P.T.O.	361975C91	②7673	Belt - W.P.	359021C91	②TR22434
Belt - Fan & Alt.; W/65A., 80A., 105A., 145A. Alt.; W/O P.T.O.		②7630	Belt - Alt.; W/37A. Alt.	256346C11	②◆9350HD
Belt - P.S.; W/2WD		7460	Belt - Alt.; W/55A., 60A., 62A., 105A., 130A. Alt.		②◆9365HD
Belt - P.S.; W/4WD	285522C2	7435	Belt - Alt. & Air Brake Compr.	243605R11	②◆◆9451HD
Belt - Air Brake Compr.	359007C91	7475	Belt - P.S.	164550R2	◆9425HD
Belt - A.P.; W/Air Brakes; W/Gov.	388139C1	7330	Hose - Upper - Eng. To Pipe; (1 3/4" I.D.)		24228
Belt - A.P.; W/Air Brakes; W/O Gov.	256062C2	7340	Hose - Upper - Eng. To Pipe		●26501
Belt - A.P.; W/Hyd. Brakes; W/Gov.	355653C91	7380	Hose - Upper - Pipe To Rad.; (2 1/4" I.D.)		24236
Belt - A.P.; W/Hyd. Brakes; W/O Gov.	362887C91	7410	Hose - Lower; (2 5/8" I.D.)		◆24942
1803			Hose - By Pass		≈20618
Belt - Fan & Alt.; W/37A., 52A., 61A. Alt.; C, G, H Chassis; W/P.T.O.	968815R11	②7650	Hose - By Pass; (3/4" I.D.)		28442
Belt - Fan & Alt.; W/37A., 52A., 61A. Alt.; C, G, H Chassis; W/O P.T.O.	373457C91	②7612	Hose - Heater; (1" I.D.)		24216
Belt - Fan & Alt.; W/37A., 52A., 61A. Alt.; FD, SB Chassis	968815R1	②7650	International/Navistar V461		
Belt - Fan & Alt.; W/37A., 61A. Alt.; W/O Air Brakes; W/O P.T.O.; W/O X.C.	373456C1	7612	193RE		
Belt - Fan & Alt.; W/55A., 62A. Alt.; C, G, H Chassis	369723C91	②7630	Belt - Fan	358319C91	②◆◆9570HD
Belt - Fan & Alt.; W/55A., 62A. Alt.; FD, SB Chassis	361975C91	②7673	Belt - W.P.	359021C91	②TR22434
Belt - Fan & Alt.; W/60A. Alt.	359009C91	②7680	Belt - Alt.; W/37A. Alt.	256346C11	②◆9350HD
Belt - Fan & Alt.; W/65A., 80A., 105A., 145A. Alt.; W/P.T.O.	361975C91	②7673	Belt - Alt.; W/55A., 60A., 62A., 105A., 130A. Alt.		②◆9365HD
Belt - Fan & Alt.; W/65A., 80A., 105A., 145A. Alt.; W/O P.T.O.		②7630	Belt - Alt. & Air Brake Compr.	243605R11	②◆◆9451HD
Belt - P.S.; W/2WD		7460	Belt - P.S.	164550R2	◆9425HD
Belt - P.S.; W/4WD	285522C2	7435	Hose - Upper - Eng. To Pipe; (1 3/4" I.D.)		24228
Belt - Air Brake Compr.	359007C91	7475	Hose - Upper - Eng. To Pipe		●26501
Belt - A.P.; W/Air Brakes; W/Gov.	388139C1	7330	Hose - Upper - Pipe To Rad.; (2 1/4" I.D.)		24236
Belt - A.P.; W/Air Brakes; W/O Gov.	256062C2	7340	Hose - Lower; (2 5/8" I.D.)		◆24942
Belt - A.P.; W/Hyd. Brakes; W/Gov.	355653C91	7380	Hose - By Pass		≈20618
Belt - A.P.; W/Hyd. Brakes; W/O Gov.	362887C91	7410	Hose - By Pass; (3/4" I.D.)		28442
1803			Hose - Heater; (1" I.D.)		24216
Belt - Fan & Alt.; W/37A., 52A., 61A. Alt.; C, G, H Chassis; W/P.T.O.	968815R11	②7650	International/Navistar V478		
Belt - Fan & Alt.; W/37A., 52A., 61A. Alt.; C, G, H Chassis; W/O P.T.O.	373457C91	②7612	193RE		
Belt - Fan & Alt.; W/37A., 52A., 61A. Alt.; FD, SB Chassis	968815R1	②7650	Belt - Fan	358319C91	②◆◆9570HD
Belt - Fan & Alt.; W/37A., 61A. Alt.; W/O Air Brakes; W/O P.T.O.; W/O X.C.	373456C1	7612	Belt - W.P.	359021C91	②TR22434
Belt - Fan & Alt.; W/55A., 62A. Alt.; C, G, H Chassis	369723C91	②7630	Belt - Alt.; W/37A. Alt.	256346C11	②◆9350HD
Belt - Fan & Alt.; W/55A., 62A. Alt.; FD, SB Chassis	361975C91	②7673	Belt - Alt.; W/55A., 60A., 62A., 105A., 130A. Alt.		②◆9365HD
Belt - Fan & Alt.; W/60A. Alt.	359009C91	②7680	Belt - Alt. & Air Brake Compr.	243605R11	②◆◆9451HD
Belt - Fan & Alt.; W/65A., 80A., 105A., 145A. Alt.; W/P.T.O.	361975C91	②7673	Belt - P.S.	164550R2	◆9425HD
Belt - Fan & Alt.; W/65A., 80A., 105A., 145A. Alt.; W/O P.T.O.		②7630	Hose - Upper - Eng. To Pipe; (1 3/4" I.D.)		24228
Belt - P.S.; W/2WD		7460	Hose - Upper - Eng. To Pipe		●26501
Belt - P.S.; W/4WD	285522C2	7435	Hose - Upper - Pipe To Rad.; (2 1/4" I.D.)		24236
Belt - Air Brake Compr.	359007C91	7475	Hose - Lower; (2 5/8" I.D.)		◆24942
Belt - A.P.; W/Air Brakes; W/Gov.	388139C1	7330	Hose - By Pass		≈20618
Belt - A.P.; W/Air Brakes; W/O Gov.	256062C2	7340	Hose - By Pass; (3/4" I.D.)		28442
Belt - A.P.; W/Hyd. Brakes; W/Gov.	355653C91	7380	Hose - Heater; (1" I.D.)		24216
Belt - A.P.; W/Hyd. Brakes; W/O Gov.	362887C91	7410	International/Navistar V478		
1803			193RE		
Belt - Fan & Alt.; W/37A., 52A., 61A. Alt.; C, G, H Chassis; W/P.T.O.	968815R11	②7650	Belt - Fan	358319C91	②◆◆9570HD
Belt - Fan & Alt.; W/37A., 52A., 61A. Alt.; C, G, H Chassis; W/O P.T.O.	373457C91	②7612	Belt - W.P.	359021C91	②TR22434
Belt - Fan & Alt.; W/37A., 52A., 61A. Alt.; FD, SB Chassis	968815R1	②7650	Belt - Alt.; W/37A. Alt.	256346C11	②◆9350HD
Belt - Fan & Alt.; W/37A., 61A. Alt.; W/O Air Brakes; W/O P.T.O.; W/O X.C.	373456C1	7612	Belt - Alt.; W/55A., 60A., 62A., 105A., 130A. Alt.		②◆9365HD
Belt - Fan & Alt.; W/55A., 62A. Alt.; C, G, H Chassis	369723C91	②7630	Belt - Alt. & Air Brake Compr.	243605R11	②◆◆9451HD
Belt - Fan & Alt.; W/55A., 62A. Alt.; FD, SB Chassis	361975C91	②7673	Belt - P.S.	164550R2	◆9425HD
Belt - Fan & Alt.; W/60A. Alt.	359009C91	②7680	Hose - Upper - Eng. To Pipe; (1 3/4" I.D.)		24228
Belt - Fan & Alt.; W/65A., 80A., 105A., 145A. Alt.; W/P.T.O.	361975C91	②7673	Hose - Upper - Eng. To Pipe		●26501
Belt - Fan & Alt.; W/65A., 80A., 105A., 145A. Alt.; W/O P.T.O.		②7630	Hose - Upper - Pipe To Rad.; (2 1/4" I.D.)		24236
Belt - P.S.; W/2WD		7460	Hose - Lower; (2 5/8" I.D.)		◆24942
Belt - P.S.; W/4WD	285522C2	7435	Hose - By Pass		≈20618
Belt - Air Brake Compr.	359007C91	7475	Hose - By Pass; (3/4" I.D.)		28442
Belt - A.P.; W/Air Brakes; W/Gov.	388139C1	7330	Hose - Heater; (1" I.D.)		24216

② Two Required.
 ≈ Cut to Fit.
 ◆ Standard Belt Available. See Pages 630-631.

● Vulco-Flex® Coolant Hose.
 ◆ Green Stripe® PowerBand® Belt May Work, Use Template to Check.
 ◎ Use Wire Inserted Green Stripe® Coolant Hose.

School Buses

Belts and Coolant Hose for School Buses

School Buses

Application	Mfr. Part No.	Our No.
INTERNATIONAL/NAVISTAR - Continued		
1968 - Continued		
International/Navistar V478 - Continued		
193RE - Continued		
Belt - P.S.	164550R2	▲9425HD
Hose - Upper - Eng. To Pipe; (1 3/4" I.D.)		24228
Hose - Upper - Eng. To Pipe		●26501
Hose - Upper - Pipe To Rad.; (2 1/4" I.D.)		24236
Hose - Lower; (2 5/8" I.D.)		⊕24942
Hose - By Pass		≠20618
Hose - By Pass; (3/4" I.D.)		28442
Hose - Heater; (1" I.D.)		24216
International/Navistar V549		
193RE		
Belt - Fan	358319C91	②◆▲9570HD
Belt - W.P.	359021C91	②TR22434
Belt - Alt.; W/37A. Alt.	256346C11	②▲9350HD
Belt - Alt.; W/55A., 60A., 62A., 105A., 130A. Alt.		②▲9365HD
Belt - Alt. & Air Brake Compr.	243605R11	②◆▲9451HD
Belt - P.S.	164550R2	▲9425HD
Hose - Upper - Eng. To Pipe; (1 3/4" I.D.)		24228
Hose - Upper - Eng. To Pipe		●26501
Hose - Upper - Pipe To Rad.; (2 1/4" I.D.)		24236
Hose - Lower; (2 5/8" I.D.)		⊕24942
Hose - By Pass		≠20618
Hose - By Pass; (3/4" I.D.)		28442
Hose - Heater; (1" I.D.)		24216
International/Navistar VS401		
193RE		
Belt - Fan	358319C91	②◆▲9570HD
Belt - W.P.	359021C91	②TR22434
Belt - Alt.; W/37A. Alt.	256346C11	②▲9350HD
Belt - Alt.; W/55A., 60A., 62A., 105A., 130A. Alt.		②▲9365HD
Belt - Alt. & Air Brake Compr.	243605R11	②◆▲9451HD
Belt - P.S.	164550R2	▲9425HD
Hose - Upper - Eng. To Pipe; (1 3/4" I.D.)		24228
Hose - Upper - Eng. To Pipe		●26501
Hose - Upper - Pipe To Rad.; (2 1/4" I.D.)		24236
Hose - Lower; (2 5/8" I.D.)		⊕24942
Hose - By Pass		≠20618
Hose - By Pass; (3/4" I.D.)		28442
Hose - Heater; (1" I.D.)		24216
International/Navistar VS478		
193RE		
Belt - Fan	358319C91	②◆▲9570HD
Belt - W.P.	359021C91	②TR22434
Belt - Alt.; W/37A. Alt.	256346C11	②▲9350HD
Belt - Alt.; W/55A., 60A., 62A., 105A., 130A. Alt.		②▲9365HD
Belt - Alt. & Air Brake Compr.	243605R11	②◆▲9451HD
Belt - P.S.	164550R2	▲9425HD
Hose - Upper - Eng. To Pipe; (1 3/4" I.D.)		24228
Hose - Upper - Eng. To Pipe		●26501
Hose - Upper - Pipe To Rad.; (2 1/4" I.D.)		24236
Hose - Lower; (2 5/8" I.D.)		⊕24942
Hose - By Pass		≠20618
Hose - By Pass; (3/4" I.D.)		28442
Hose - Heater; (1" I.D.)		24216
International/Navistar VS549		
193RE		
Belt - Fan	358319C91	②◆▲9570HD
Belt - W.P.	359021C91	②TR22434
Belt - Alt.; W/37A. Alt.	256346C11	②▲9350HD
Belt - Alt.; W/55A., 60A., 62A., 105A., 130A. Alt.		②▲9365HD
Belt - Alt. & Air Brake Compr.	243605R11	②◆▲9451HD
Belt - P.S.	164550R2	▲9425HD
Hose - Upper - Eng. To Pipe; (1 3/4" I.D.)		24228
Hose - Upper - Eng. To Pipe		●26501
Hose - Upper - Pipe To Rad.; (2 1/4" I.D.)		24236
Hose - Lower; (2 5/8" I.D.)		⊕24942
Hose - By Pass		≠20618
Hose - By Pass; (3/4" I.D.)		28442
Hose - Heater; (1" I.D.)		24216

Application	Mfr. Part No.	Our No.
INTERNATIONAL/NAVISTAR - Continued		
1967-1966		
International/Navistar BD220		
1603		
Belt - Fan & Alt.; W/37A., 52A., 61A., 62A. Alt.	151532R1	②7512
Belt - Fan & Alt.; W/60A. Alt.	861779R11	②▲9440HD
Belt - Gen.; W/20A., 50A. Alt.	20594VA	TR24438
Belt - Gen.; W/30A. Alt.	81572R2	TR28437
Belt - Gen.; W/35A., 50A. L.C.I. Gen.	164550R1	②▲9425HD
Belt - P.S.; W/Air Brakes	149636R1	▲9480HD
Belt - P.S.; W/Hyd. Brakes	864931R2	▲9319HD
Belt - Air Brake Compr.; W/4 Cu. Ft. Air Brake Compr.	201825R1	▲9440HD
Belt - Air Brake Compr.; W/20A., 30A., 50A. Gen.	115505HA	TR22363
Hose - Upper		●26510
Hose - Lower - Eng. To Pipe		●26508
Hose - Lower - Pipe To Rad.		●26514
Hose - By Pass		20338
Hose - By Pass; (5/8" I.D.)		28441
International/Navistar BD240		
1603		
Belt - Fan & Alt.; W/37A., 52A., 61A., 62A. Alt.	151532R1	②7512
Belt - Fan & Alt.; W/60A. Alt.	861779R11	②▲9440HD
Belt - Gen.; W/20A., 50A. Alt.	20594VA	TR24438
Belt - Gen.; W/30A. Alt.	81572R2	TR28437
Belt - Gen.; W/35A., 50A. L.C.I. Gen.	164550R1	②▲9425HD
Belt - P.S.; W/Air Brakes	149636R1	▲9480HD
Belt - P.S.; W/Hyd. Brakes	864931R2	▲9319HD
Belt - Air Brake Compr.; W/4 Cu. Ft. Air Brake Compr.	201825R1	▲9440HD
Belt - Air Brake Compr.; W/20A., 30A., 50A. Gen.	115505HA	TR22363
Hose - Upper		●26510
Hose - Lower - Eng. To Pipe		●26508
Hose - Lower - Pipe To Rad.		●26514
Hose - By Pass		20338
Hose - By Pass; (5/8" I.D.)		28441
International/Navistar BD264		
1603		
Belt - Fan & Alt.; W/37A., 52A., 61A., 62A. Alt.	151532R1	②7512
Belt - Fan & Alt.; W/60A. Alt.	861779R11	②▲9440HD
Belt - Gen.; W/20A., 50A. Alt.	20594VA	TR24438
Belt - Gen.; W/30A. Alt.	81572R2	TR28437
Belt - Gen.; W/35A., 50A. L.C.I. Gen.	164550R1	②▲9425HD
Belt - P.S.; W/Air Brakes	149636R1	▲9480HD
Belt - P.S.; W/Hyd. Brakes	864931R2	▲9319HD
Belt - Air Brake Compr.; W/4 Cu. Ft. Air Brake Compr.	201825R1	▲9440HD
Belt - Air Brake Compr.; W/20A., 30A., 50A. Gen.	115505HA	TR22363
Hose - Upper		●26510
Hose - Lower - Eng. To Pipe		●26508
Hose - Lower - Pipe To Rad.		●26514
Hose - By Pass		20338
Hose - By Pass; (5/8" I.D.)		28441
International/Navistar BD269		
1603		
Belt - Fan & Alt.	862880R11	②▲9490HD
Belt - P.S.	242269R1	▲9405HD
Belt - Air Brake Compr.	280210C1	▲9540HD
Hose - Upper; (2" I.D.)		24232
Hose - Lower		≠20611
Hose - By Pass; (2" I.D.)		●26509
		24232
1703 ; 1803		
Belt - Fan & Alt.	862880R11	②▲9490HD
Belt - P.S.	242269R1	▲9405HD
Belt - Air Brake Compr.	280210C1	▲9540HD
Hose - Upper; (2" I.D.)		24232
Hose - Lower - Eng. To Pipe		≠20206
Hose - Lower - Pipe To Rad.; (2" I.D.)		24232

▲ Standard Belt Available. See Pages 630-631.
 ⊕ Use Wire Inserted Green Stripe® Coolant Hose.
 ② Two Required.

● Vulco-Flex® Coolant Hose.
 ≠ Cut to Fit.
 ◆ Green Stripe® PowerBand® Belt May Work, Use Template to Check.

Belts and Coolant Hose for School Buses

Application	Mfr. Part No.	Our No.
INTERNATIONAL/NAVISTAR - Continued		
1967-1966 - Continued		
International/Navistar BD269 - Continued		
1703 ; 1803 - Continued		
Hose - By Pass; (2" I.D.)		24232
International/Navistar BD282		
1603		
Belt - Fan & Alt.	862880R11	②▲9490HD
Belt - P.S.	242269R1	▲9405HD
Belt - Air Brake Compr.	280210C1	▲9540HD
Hose - Upper; (2" I.D.)		24232
Hose - Lower		≡<20611
	or	●26509
Hose - By Pass; (2" I.D.)		24232
1703 ; 1803		
Belt - Fan & Alt.	862880R11	②▲9490HD
Belt - P.S.	242269R1	▲9405HD
Belt - Air Brake Compr.	280210C1	▲9540HD
Hose - Upper; (2" I.D.)		24232
Hose - Lower - Eng. To Pipe		≡<20206
Hose - Lower - Pipe To Rad.; (2" I.D.)		24232
Hose - By Pass; (2" I.D.)		24232
International/Navistar BD308		
1603		
Belt - Fan & Alt.	862880R11	②▲9490HD
Belt - P.S.	242269R1	▲9405HD
Belt - Air Brake Compr.	280210C1	▲9540HD
Hose - Upper; (2" I.D.)		24232
Hose - Lower		≡<20611
	or	●26509
Hose - By Pass; (2" I.D.)		24232
1703 ; 1803		
Belt - Fan & Alt.	862880R11	②▲9490HD
Belt - P.S.	242269R1	▲9405HD
Belt - Air Brake Compr.	280210C1	▲9540HD
Hose - Upper; (2" I.D.)		24232
Hose - Lower - Eng. To Pipe		≡<20206
Hose - Lower - Pipe To Rad.; (2" I.D.)		24232
Hose - By Pass; (2" I.D.)		24232
International/Navistar BG220		
1603		
Belt - Fan & Alt.; W/37A., 52A., 61A., 62A. Alt.	151532R1	②7512
Belt - Fan & Alt.; W/60A. Alt.	861779R11	②▲9440HD
Belt - Gen.; W/20A., 50A. Alt.	20594VA	TR24438
Belt - Gen.; W/30A. Alt.	81572R2	TR28437
Belt - Gen.; W/35A., 50A. L.C.I. Gen.	164550R1	②▲9425HD
Belt - P.S.; W/Air Brakes	149636R1	▲9480HD
Belt - P.S.; W/Hyd. Brakes	864931R2	▲9319HD
Belt - Air Brake Compr.; W/4 Cu. Ft. Air Brake Compr.	201825R1	▲9440HD
Belt - Air Brake Compr.; W/20A., 30A., 50A. Gen.	115505HA	TR22363
Hose - Upper		●26510
Hose - Lower - Eng. To Pipe		●26508
Hose - Lower - Pipe To Rad.		●26514
Hose - By Pass		20338
Hose - By Pass; (5/8" I.D.)		28441
International/Navistar BG241		
1603		
Belt - Fan & Alt.; W/37A., 52A., 61A., 62A. Alt.	151532R1	②7512
Belt - Fan & Alt.; W/60A. Alt.	861779R11	②▲9440HD
Belt - Gen.; W/20A., 50A. Alt.	20594VA	TR24438
Belt - Gen.; W/30A. Alt.	81572R2	TR28437
Belt - Gen.; W/35A., 50A. L.C.I. Gen.	164550R1	②▲9425HD
Belt - P.S.; W/Air Brakes	149636R1	▲9480HD
Belt - P.S.; W/Hyd. Brakes	864931R2	▲9319HD
Belt - Air Brake Compr.; W/4 Cu. Ft. Air Brake Compr.	201825R1	▲9440HD
Belt - Air Brake Compr.; W/20A., 30A., 50A. Gen.	115505HA	TR22363
Hose - Upper		●26510
Hose - Lower - Eng. To Pipe		●26508

Application	Mfr. Part No.	Our No.
INTERNATIONAL/NAVISTAR - Continued		
1967-1966 - Continued		
International/Navistar BG241 - Continued		
1603 - Continued		
Hose - Lower - Pipe To Rad.		●26514
Hose - By Pass		20338
Hose - By Pass; (5/8" I.D.)		28441
International/Navistar BG265		
1603		
Belt - Fan & Alt.; W/37A., 52A., 61A., 62A. Alt.	151532R1	②7512
Belt - Fan & Alt.; W/60A. Alt.	861779R11	②▲9440HD
Belt - Gen.; W/20A., 50A. Alt.	20594VA	TR24438
Belt - Gen.; W/30A. Alt.	81572R2	TR28437
Belt - Gen.; W/35A., 50A. L.C.I. Gen.	164550R1	②▲9425HD
Belt - P.S.; W/Air Brakes	149636R1	▲9480HD
Belt - P.S.; W/Hyd. Brakes	864931R2	▲9319HD
Belt - Air Brake Compr.; W/4 Cu. Ft. Air Brake Compr.	201825R1	▲9440HD
Belt - Air Brake Compr.; W/20A., 30A., 50A. Gen.	115505HA	TR22363
Hose - Upper		●26510
Hose - Lower - Eng. To Pipe		●26508
Hose - Lower - Pipe To Rad.		●26514
Hose - By Pass		20338
Hose - By Pass; (5/8" I.D.)		28441
International/Navistar FTV549		
193RE		
Belt - Fan; W/52 5/8" Belt O.C.	680611R11	②◆▲9520HD
Belt - Fan; W/57 5/8" Belt O.C.	261710C11	▲9570HD
Belt - Alt. To Compr.; W/37A., 60A. Alt.	243605R11	▲9451HD
Belt - Alt. To Compr.; W/55A. Alt.	264975C11	▲9455HD
Belt - Gen. To Compr.; W/30A. Gen.	133758R1	▲9440HD
Belt - Gen. To Compr.; W/35A. Gen.	150560R11	▲9451HD
Belt - Gen. To Compr.; W/50A. Gen.	201825R11	▲9435HD
Belt - Gen.; W/Hyd. Brakes	133732R1	▲9360HD
Belt - P.S.; W/43 1/8" Belt O.C.	164550R11	▲9425HD
Belt - P.S.; W/44 5/8" Belt O.C.	133758R1	▲9440HD
Belt - Idler; W/56 1/8" Belt O.C.	968645R11	▲9555HD
Belt - Idler; W/57 5/8" Belt O.C.	261710C11	▲9570HD
International/Navistar FTVS549		
193RE		
Belt - Fan; W/52 5/8" Belt O.C.	680611R11	②◆▲9520HD
Belt - Fan; W/57 5/8" Belt O.C.	261710C11	▲9570HD
Belt - Alt. To Compr.; W/37A., 60A. Alt.	243605R11	▲9451HD
Belt - Alt. To Compr.; W/55A. Alt.	264975C11	▲9455HD
Belt - Gen. To Compr.; W/30A. Gen.	133758R1	▲9440HD
Belt - Gen. To Compr.; W/35A. Gen.	150560R11	▲9451HD
Belt - Gen. To Compr.; W/50A. Gen.	201825R11	▲9435HD
Belt - Gen.; W/Hyd. Brakes	133732R1	▲9360HD
Belt - P.S.; W/43 1/8" Belt O.C.	164550R11	▲9425HD
Belt - P.S.; W/44 5/8" Belt O.C.	133758R1	▲9440HD
Belt - Idler; W/56 1/8" Belt O.C.	968645R11	▲9555HD
Belt - Idler; W/57 5/8" Belt O.C.	261710C11	▲9570HD
International/Navistar RD372		
1823		
Belt - Fan & Alt.	359014C91	②TR22514
Belt - W.P. & Alt.; W/37A. Alt.; Chassis No. FD61626 & Before	193826R11	②TR22508
Belt - W.P. & Alt.; W/37A. Alt.; Chassis No. FD61626 & Up & G Chassis No.	223794R11	②TR22514
Belt - W.P. & Alt.; W/60A. Alt.	243604R11	②TR22517
Belt - P.S.	240354R2	TR22336
Belt - Air Brake Compr.; W/Wagner Compr.	92836HA	TR32491
Belt - Air Brake Compr.; W/Westinghouse Compr.	83816HA	TR34467
Hose - Upper		●26515
Hose - Lower; (2" I.D.)		24232
1853		
Belt - Alt.; W/55A., 62A., 145A. Alt.	223794K21	②TR22514
Belt - Gen.; W/37A. Gen.	193826R11	TR22508
Belt - P.S.	240354R1	TR22344

School Buses

② Two Required.
 ≡< Cut to Fit.
 ◆ Green Stripe® PowerBand® Belt May Work, Use Template to Check.

▲ Standard Belt Available. See Pages 630-631.
 ● Vulco-Flex® Coolant Hose.

Belts and Coolant Hose for School Buses

School Buses

Application	Mfr. Part No.	Our No.
INTERNATIONAL/NAVISTAR - Continued		
1967-1966 - Continued		
International/Navistar RD372 - Continued		
1853FC		
Belt - Alt.; W/55A., 62A., 145A. Alt.	223794K21	②TR22514
Belt - Gen.; W/37A. Gen.	193826R11	TR22508
Belt - P.S.	240354R1	TR22344
Hose - Upper; Late FD Chassis; Chassis No. FA66376	●26509	
Hose - Lower; Early FD Chassis; Chassis No. FA66376	●26508	
Hose - Lower; Late FD Chassis; Chassis No. FA66376(2 1/8" I.D.)	24234	
Hose - Lower; Late FD Chassis; Chassis No. FA66376	●26508	
International/Navistar RD406		
1823		
Belt - Fan & Alt.	359014C91	②TR22514
Belt - W.P. & Alt.; W/37A. Alt.; Chassis No. FD61626 & Before	193826R11	②TR22508
Belt - W.P. & Alt.; W/37A. Alt.; Chassis No. FD61626 & Up & G Chassis No.	223794R11	②TR22514
Belt - W.P. & Alt.; W/60A. Alt.	243604R11	②TR22517
Belt - P.S.	240354R2	TR22336
Belt - Air Brake Compr.; W/Wagner Compr. ...	92836HA	TR32491
Belt - Air Brake Compr.; W/Westinghouse Compr.	83816HA	TR34467
Hose - Upper	●26515	
Hose - Lower; (2" I.D.)	24232	
1853		
Belt - Alt.; W/55A., 62A., 145A. Alt.	223794K21	②TR22514
Belt - Gen.; W/37A. Gen.	193826R11	TR22508
Belt - P.S.	240354R1	TR22344
1853FC		
Belt - Alt.; W/55A., 62A., 145A. Alt.	223794K21	②TR22514
Belt - Gen.; W/37A. Gen.	193826R11	TR22508
Belt - P.S.	240354R1	TR22344
Hose - Upper; Late FD Chassis; Chassis No. FA66376	●26509	
Hose - Lower; Early FD Chassis; Chassis No. FA66376	●26508	
Hose - Lower; Late FD Chassis; Chassis No. FA66376(2 1/8" I.D.)	24234	
Hose - Lower; Late FD Chassis; Chassis No. FA66376	●26508	
International/Navistar RD450		
1823		
Belt - Fan & Alt.	359014C91	②TR22514
Belt - W.P. & Alt.; W/37A. Alt.; Chassis No. FD61626 & Before	193826R11	②TR22508
Belt - W.P. & Alt.; W/37A. Alt.; Chassis No. FD61626 & Up & G Chassis No.	223794R11	②TR22514
Belt - W.P. & Alt.; W/60A. Alt.	243604R11	②TR22517
Belt - P.S.	240354R2	TR22336
Belt - Air Brake Compr.; W/Wagner Compr. ...	92836HA	TR32491
Belt - Air Brake Compr.; W/Westinghouse Compr.	83816HA	TR34467
Hose - Upper	●26515	
Hose - Lower; (2" I.D.)	24232	
1853		
Belt - Alt.; W/55A., 62A., 145A. Alt.	223794K21	②TR22514
Belt - Gen.; W/37A. Gen.	193826R11	TR22508
Belt - P.S.	240354R1	TR22344
1853FC		
Belt - Alt.; W/55A., 62A., 145A. Alt.	223794K21	②TR22514
Belt - Gen.; W/37A. Gen.	193826R11	TR22508
Belt - P.S.	240354R1	TR22344
Hose - Upper; Late FD Chassis; Chassis No. FA66376	●26509	
Hose - Lower; Early FD Chassis; Chassis No. FA66376	●26508	
Hose - Lower; Late FD Chassis; Chassis No. FA66376(2 1/8" I.D.)	24234	
Hose - Lower; Late FD Chassis; Chassis No. FA66376	●26508	
International/Navistar RD501		
1823		
Belt - Fan & Alt.	359014C91	②TR22514
Belt - W.P. & Alt.; W/37A. Alt.; Chassis No. FD61626 & Before	193826R11	②TR22508

Application	Mfr. Part No.	Our No.
INTERNATIONAL/NAVISTAR - Continued		
1967-1966 - Continued		
International/Navistar RD501 - Continued		
1823 - Continued		
Belt - W.P. & Alt.; W/37A. Alt.; Chassis No. FD61626 & Up & G Chassis No.	223794R11	②TR22514
Belt - W.P. & Alt.; W/60A. Alt.	243604R11	②TR22517
Belt - P.S.	240354R2	TR22336
Belt - Air Brake Compr.; W/Wagner Compr. ...	92836HA	TR32491
Belt - Air Brake Compr.; W/Westinghouse Compr.	83816HA	TR34467
Hose - Upper	●26515	
Hose - Lower; (2" I.D.)	24232	
1853		
Belt - Alt.; W/55A., 62A., 145A. Alt.	223794K21	②TR22514
Belt - Gen.; W/37A. Gen.	193826R11	TR22508
Belt - P.S.	240354R1	TR22344
1853FC		
Belt - Alt.; W/55A., 62A., 145A. Alt.	223794K21	②TR22514
Belt - Gen.; W/37A. Gen.	193826R11	TR22508
Belt - P.S.	240354R1	TR22344
Hose - Upper; Late FD Chassis; Chassis No. FA66376	●26509	
Hose - Lower; Early FD Chassis; Chassis No. FA66376	●26508	
Hose - Lower; Late FD Chassis; Chassis No. FA66376(2 1/8" I.D.)	24234	
Hose - Lower; Late FD Chassis; Chassis No. FA66376	●26508	
International/Navistar V266		
1603; 1703; 1803		
Belt - Fan & Alt.; W/37A., 52A., 61A. Alt.; C, G, H Chassis		②7603
Belt - Fan & Alt.; W/37A., 52A., 61A. Alt.; FD, SB Chassis	255266C3	②7640
Belt - Fan & Alt.; W/55A., 62A. Alt.; C, G, H Chassis	369725C91	②7619
Belt - Fan & Alt.; W/55A., 62A. Alt.; FD, SB Chassis	358998C91	②7650
Belt - P.S.; W/2WD	151529R2	7440
Belt - P.S.; W/4WD	151531R2	7450
Belt - Air Brake Compr.	236572R2	7460
Hose - Upper; W/Rad. Shutters; W/Metal Hood		●26515
Hose - Upper; W/O Rad. Shutters; W/Metal Hood		20493
Hose - Lower - Eng. To Pipe; W/Auto. Trans.		20532
Hose - Lower; W/Man. Trans.		21308
Hose - By Pass		≈20357
International/Navistar V304		
1603; 1703; 1803		
Belt - Fan & Alt.; W/37A., 52A., 61A. Alt.; C, G, H Chassis		②7603
Belt - Fan & Alt.; W/37A., 52A., 61A. Alt.; FD, SB Chassis	255266C3	②7640
Belt - Fan & Alt.; W/55A., 62A. Alt.; C, G, H Chassis	369725C91	②7619
Belt - Fan & Alt.; W/55A., 62A. Alt.; FD, SB Chassis	358998C91	②7650
Belt - P.S.; W/2WD	151529R2	7440
Belt - P.S.; W/4WD	151531R2	7450
Belt - Air Brake Compr.	236572R2	7460
Hose - Upper; W/Rad. Shutters; W/Metal Hood		●26515
Hose - Upper; W/O Rad. Shutters; W/Metal Hood		20493
Hose - Lower - Eng. To Pipe; W/Auto. Trans.		20532
Hose - Lower; W/Man. Trans.		21308
Hose - By Pass		≈20357
International/Navistar V345		
1603; 1703		
Belt - Fan & Alt.; W/37A., 52A., 61A. Alt.; C, G, H Chassis; W/P.T.O.	968815R11	②7650
Belt - Fan & Alt.; W/37A., 52A., 61A. Alt.; C, G, H Chassis; W/O P.T.O.	373457C91	②7612
Belt - Fan & Alt.; W/37A., 52A., 61A. Alt.; FD, SB Chassis	968815R1	②7650
Belt - Fan & Alt.; W/37A., 61A. Alt.; W/O Air Brakes; W/O P.T.O.; W/O X.C.	373456C1	7612
Belt - Fan & Alt.; W/55A., 62A. Alt.; C, G, H Chassis	369723C91	②7630

② Two Required.
≈ Cut to Fit.

● Vulco-Flex® Coolant Hose.

Belts and Coolant Hose for School Buses

Application	Mfr. Part No.	Our No.	Application	Mfr. Part No.	Our No.
INTERNATIONAL/NAVISTAR - Continued			INTERNATIONAL/NAVISTAR - Continued		
1967-1966 - Continued			1967-1966 - Continued		
International/Navistar V345 - Continued			International/Navistar V345 - Continued		
1603; 1703 - Continued			1803 - Continued		
Belt - Fan & Alt.; W/55A., 62A. Alt.; FD, SB			Belt - Fan & Gen.; W/50A. Alt.	151536R11	②7715
Chassis	361975C91	②7673	Belt - P.S.; W/2WD		7460
Belt - Fan & Alt.; W/60A. Alt.	359009C91	②7680	Belt - P.S.; W/4WD	285522C2	7435
Belt - Fan & Alt.; W/65A., 80A., 105A., 145A.			Belt - Air Brake Compr.	359007C91	7475
Alt; W/P.T.O.	361975C91	②7673	Belt - A.P.; W/Air Brakes; W/Gov.	388139C1	7330
Belt - Fan & Alt.; W/65A., 80A., 105A., 145A. Alt.; W/O P.T.O.		②7630	Belt - A.P.; W/Air Brakes; W/O Gov.	256062C2	7340
Belt - Fan & Gen.; W/20A. Alt.	151534R11	②7680	Belt - A.P.; W/Hyd. Brakes; W/Gov.	355653C91	7380
Belt - Fan & Gen.; W/30A. Alt.	224638R11	②7695	Belt - A.P.; W/Hyd. Brakes; W/O Gov.	362887C91	7410
Belt - Fan & Gen.; W/35A. Alt.	151535R11	②7695	Hose - Upper; W/Rad. Shutters; W/Metal Hood		●26515
Belt - Fan & Gen.; W/50A. Alt.	151536R11	②7715	Hose - Upper; W/O Rad. Shutters; W/Metal Hood		20493
Belt - P.S.; W/2WD		7460	Hose - Lower - Eng. To Pipe; W/Auto. Trans.		20532
Belt - P.S.; W/4WD	285522C2	7435	Hose - Lower; W/Man. Trans.		21308
Belt - Air Brake Compr.	359007C91	7475	Hose - By Pass		≈20357
Belt - A.P.; W/Air Brakes; W/Gov.	388139C1	7330			
Belt - A.P.; W/Air Brakes; W/O Gov.	256062C2	7340	1823		
Belt - A.P.; W/Hyd. Brakes; W/Gov.	355653C91	7380	Belt - Fan & Alt.; W/37A., 52A., 61A. Alt.; C, G, H Chassis; W/P.T.O.	968815R11	②7650
Belt - A.P.; W/Hyd. Brakes; W/O Gov.	362887C91	7410	Belt - Fan & Alt.; W/37A., 52A., 61A. Alt.; C, G, H Chassis; W/O P.T.O.		②7612
Hose - Upper; W/Rad. Shutters; W/Metal Hood		●26515	Belt - Fan & Alt.; W/37A., 52A., 61A. Alt.; FD, SB Chassis	968815R1	②7650
Hose - Upper; W/O Rad. Shutters; W/Metal Hood		20493	Belt - Fan & Alt.; W/37A., 61A. Alt.; W/O Air Brakes; W/O P.T.O.; W/O X.C.	373456C1	7612
Hose - Lower - Eng. To Pipe; W/Auto. Trans.		20532	Belt - Fan & Alt.; W/55A., 62A. Alt.; C, G, H Chassis	369723C91	②7630
Hose - Lower; W/Man. Trans.		21308	Belt - Fan & Alt.; W/55A., 62A. Alt.; FD, SB Chassis	361975C91	②7673
Hose - By Pass		≈20357	Belt - Fan & Alt.; W/60A. Alt.	359009C91	②7680
			Belt - Fan & Alt.; W/65A., 80A., 105A., 145A.		
1723			Alt; W/P.T.O.	361975C91	②7673
Belt - Fan & Alt.; W/37A., 52A., 61A. Alt.; C, G, H Chassis; W/P.T.O.	968815R11	②7650	Belt - Fan & Alt.; W/65A., 80A., 105A., 145A. Alt.; W/O P.T.O.		②7630
Belt - Fan & Alt.; W/37A., 52A., 61A. Alt.; C, G, H Chassis; W/O P.T.O.		②7612	Belt - Fan & Gen.; W/20A. Alt.	151534R11	②7680
Belt - Fan & Alt.; W/37A., 52A., 61A. Alt.; FD, SB Chassis	968815R1	②7650	Belt - Fan & Gen.; W/30A. Alt.	224638R11	②7695
Belt - Fan & Alt.; W/37A., 61A. Alt.; W/O Air Brakes; W/O P.T.O.; W/O X.C.	373456C1	7612	Belt - Fan & Gen.; W/35A. Alt.	151535R11	②7695
Belt - Fan & Alt.; W/55A., 62A. Alt.; C, G, H Chassis	369723C91	②7630	Belt - Fan & Gen.; W/50A. Alt.	151536R11	②7715
Belt - Fan & Alt.; W/55A., 62A. Alt.; FD, SB Chassis	361975C91	②7673	Belt - P.S.; W/2WD		7460
Belt - Fan & Alt.; W/60A. Alt.	359009C91	②7680	Belt - P.S.; W/4WD	285522C2	7435
Belt - Fan & Alt.; W/65A., 80A., 105A., 145A.			Belt - Air Brake Compr.	359007C91	7475
Alt; W/P.T.O.	361975C91	②7673	Belt - A.P.; W/Air Brakes; W/Gov.	388139C1	7330
Belt - Fan & Alt.; W/65A., 80A., 105A., 145A. Alt.; W/O P.T.O.		②7630	Belt - A.P.; W/Air Brakes; W/O Gov.	256062C2	7340
Belt - Fan & Gen.; W/20A. Alt.	151534R11	②7680	Belt - A.P.; W/Hyd. Brakes; W/Gov.	355653C91	7380
Belt - Fan & Gen.; W/30A. Alt.	224638R11	②7695	Belt - A.P.; W/Hyd. Brakes; W/O Gov.	362887C91	7410
Belt - Fan & Gen.; W/35A. Alt.	151535R11	②7695			
Belt - Fan & Gen.; W/50A. Alt.	151536R11	②7715	International/Navistar V392		
Belt - P.S.; W/2WD		7460	1603; 1703		
Belt - P.S.; W/4WD	285522C2	7435	Belt - Fan & Alt.; W/37A., 52A., 61A. Alt.; C, G, H Chassis; W/P.T.O.	968815R11	②7650
Belt - Air Brake Compr.	359007C91	7475	Belt - Fan & Alt.; W/37A., 52A., 61A. Alt.; C, G, H Chassis; W/O P.T.O.	373457C91	②7612
Belt - A.P.; W/Air Brakes; W/Gov.	388139C1	7330	Belt - Fan & Alt.; W/37A., 52A., 61A. Alt.; FD, SB Chassis	968815R1	②7650
Belt - A.P.; W/Air Brakes; W/O Gov.	256062C2	7340	Belt - Fan & Alt.; W/37A., 61A. Alt.; W/O Air Brakes; W/O P.T.O.; W/O X.C.	373456C1	7612
Belt - A.P.; W/Hyd. Brakes; W/Gov.	355653C91	7380	Belt - Fan & Alt.; W/55A., 62A. Alt.; C, G, H Chassis	369723C91	②7630
Belt - A.P.; W/Hyd. Brakes; W/O Gov.	362887C91	7410	Belt - Fan & Alt.; W/55A., 62A. Alt.; FD, SB Chassis	361975C91	②7673
			Belt - Fan & Alt.; W/60A. Alt.	359009C91	②7680
1803			Belt - Fan & Alt.; W/65A., 80A., 105A., 145A.		
Belt - Fan & Alt.; W/37A., 52A., 61A. Alt.; C, G, H Chassis; W/P.T.O.	968815R11	②7650	Alt; W/P.T.O.	361975C91	②7673
Belt - Fan & Alt.; W/37A., 52A., 61A. Alt.; C, G, H Chassis; W/O P.T.O.		②7612	Belt - Fan & Alt.; W/65A., 80A., 105A., 145A. Alt.; W/O P.T.O.		②7630
Belt - Fan & Alt.; W/37A., 52A., 61A. Alt.; FD, SB Chassis	968815R1	②7650	Belt - Fan & Gen.; W/20A. Alt.	151534R11	②7680
Belt - Fan & Alt.; W/37A., 61A. Alt.; W/O Air Brakes; W/O P.T.O.; W/O X.C.	373456C1	7612	Belt - Fan & Gen.; W/30A. Alt.	224638R11	②7695
Belt - Fan & Alt.; W/55A., 62A. Alt.; C, G, H Chassis	369723C91	②7630	Belt - Fan & Gen.; W/35A. Alt.	151535R11	②7695
Belt - Fan & Alt.; W/55A., 62A. Alt.; FD, SB Chassis	361975C91	②7673	Belt - Fan & Gen.; W/50A. Alt.	151536R11	②7715
Belt - Fan & Alt.; W/60A. Alt.	359009C91	②7680	Belt - P.S.; W/2WD		7460
Belt - Fan & Alt.; W/65A., 80A., 105A., 145A.			Belt - P.S.; W/4WD	285522C2	7435
Alt; W/P.T.O.	361975C91	②7673	Belt - Air Brake Compr.	359007C91	7475
Belt - Fan & Alt.; W/65A., 80A., 105A., 145A. Alt.; W/O P.T.O.		②7630	Belt - A.P.; W/Air Brakes; W/Gov.	388139C1	7330
Belt - Fan & Gen.; W/20A. Alt.	151534R11	②7680	Belt - A.P.; W/Air Brakes; W/O Gov.	256062C2	7340
Belt - Fan & Gen.; W/30A. Alt.	224638R11	②7695	Belt - A.P.; W/Hyd. Brakes; W/Gov.	355653C91	7380
Belt - Fan & Gen.; W/35A. Alt.	151535R11	②7695	Belt - A.P.; W/Hyd. Brakes; W/O Gov.	362887C91	7410
Belt - Fan & Gen.; W/50A. Alt.	151536R11	②7715			

② Two Required.
≈ Cut to Fit.

● Vulco-Flex® Coolant Hose.

School Buses

Belts and Coolant Hose for School Buses

School Buses

Application	Mfr. Part No.	Our No.
INTERNATIONAL/NAVISTAR - Continued		
1967-1966 - Continued		
International/Navistar V392 - Continued		
1603; 1703 - Continued		
Hose - Upper; W/Rad. Shutters; W/Metal Hood	●26515	
Hose - Upper; W/O Rad. Shutters; W/Metal Hood	20493	
Hose - Lower - Eng. To Pipe; W/Auto. Trans.	20532	
Hose - Lower; W/Man. Trans.	21308	
Hose - By Pass	✂20357	
1723		
Belt - Fan & Alt.; W/37A., 52A., 61A. Alt.; C, G, H Chassis; W/P.T.O.	968815R11	②7650
Belt - Fan & Alt.; W/37A., 52A., 61A. Alt.; C, G, H Chassis; W/O P.T.O.	373457C91	②7612
Belt - Fan & Alt.; W/37A., 52A., 61A. Alt.; FD, SB Chassis	968815R1	②7650
Belt - Fan & Alt.; W/37A., 61A. Alt.; W/O Air Brakes; W/O P.T.O.; W/O X.C.	373456C1	7612
Belt - Fan & Alt.; W/55A., 62A. Alt.; C, G, H Chassis	369723C91	②7630
Belt - Fan & Alt.; W/55A., 62A. Alt.; FD, SB Chassis	361975C91	②7673
Belt - Fan & Alt.; W/60A. Alt.	359009C91	②7680
Belt - Fan & Alt.; W/65A., 80A., 105A., 145A. Alt.; W/P.T.O.	361975C91	②7673
Belt - Fan & Alt.; W/65A., 80A., 105A., 145A. Alt.; W/O P.T.O.	②7630	
Belt - Fan & Gen.; W/20A. Alt.	151534R11	②7680
Belt - Fan & Gen.; W/30A. Alt.	224638R11	②7695
Belt - Fan & Gen.; W/35A. Alt.	151535R11	②7695
Belt - Fan & Gen.; W/50A. Alt.	151536R11	②7715
Belt - P.S.; W/2WD	7460	
Belt - P.S.; W/4WD	285522C2	7435
Belt - Air Brake Compr.	359007C91	7475
Belt - A.P.; W/Air Brakes; W/Gov.	388139C1	7330
Belt - A.P.; W/Air Brakes; W/O Gov.	256062C2	7340
Belt - A.P.; W/Hyd. Brakes; W/Gov.	355653C91	7380
Belt - A.P.; W/Hyd. Brakes; W/O Gov.	362887C91	7410
1803		
Belt - Fan & Alt.; W/37A., 52A., 61A. Alt.; C, G, H Chassis; W/P.T.O.	968815R11	②7650
Belt - Fan & Alt.; W/37A., 52A., 61A. Alt.; C, G, H Chassis; W/O P.T.O.	373457C91	②7612
Belt - Fan & Alt.; W/37A., 52A., 61A. Alt.; FD, SB Chassis	968815R1	②7650
Belt - Fan & Alt.; W/37A., 61A. Alt.; W/O Air Brakes; W/O P.T.O.; W/O X.C.	373456C1	7612
Belt - Fan & Alt.; W/55A., 62A. Alt.; C, G, H Chassis	369723C91	②7630
Belt - Fan & Alt.; W/55A., 62A. Alt.; FD, SB Chassis	361975C91	②7673
Belt - Fan & Alt.; W/60A. Alt.	359009C91	②7680
Belt - Fan & Alt.; W/65A., 80A., 105A., 145A. Alt.; W/P.T.O.	361975C91	②7673
Belt - Fan & Alt.; W/65A., 80A., 105A., 145A. Alt.; W/O P.T.O.	②7630	
Belt - Fan & Gen.; W/20A. Alt.	151534R11	②7680
Belt - Fan & Gen.; W/30A. Alt.	224638R11	②7695
Belt - Fan & Gen.; W/35A. Alt.	151535R11	②7695
Belt - Fan & Gen.; W/50A. Alt.	151536R11	②7715
Belt - P.S.; W/2WD	7460	
Belt - P.S.; W/4WD	285522C2	7435
Belt - Air Brake Compr.	359007C91	7475
Belt - A.P.; W/Air Brakes; W/Gov.	388139C1	7330
Belt - A.P.; W/Air Brakes; W/O Gov.	256062C2	7340
Belt - A.P.; W/Hyd. Brakes; W/Gov.	355653C91	7380
Belt - A.P.; W/Hyd. Brakes; W/O Gov.	362887C91	7410
Hose - Upper; W/Rad. Shutters; W/Metal Hood	●26515	
Hose - Upper; W/O Rad. Shutters; W/Metal Hood	20493	
Hose - Lower - Eng. To Pipe; W/Auto. Trans.	20532	
Hose - Lower; W/Man. Trans.	21308	
Hose - By Pass	✂20357	
1823		
Belt - Fan & Alt.; W/37A., 52A., 61A. Alt.; C, G, H Chassis; W/P.T.O.	968815R11	②7650

Application	Mfr. Part No.	Our No.
INTERNATIONAL/NAVISTAR - Continued		
1967-1966 - Continued		
International/Navistar V392 - Continued		
1823 - Continued		
Belt - Fan & Alt.; W/37A., 52A., 61A. Alt.; C, G, H Chassis; W/O P.T.O.	373457C91	②7612
Belt - Fan & Alt.; W/37A., 52A., 61A. Alt.; FD, SB Chassis	968815R1	②7650
Belt - Fan & Alt.; W/37A., 61A. Alt.; W/O Air Brakes; W/O P.T.O.; W/O X.C.	373456C1	7612
Belt - Fan & Alt.; W/55A., 62A. Alt.; C, G, H Chassis	369723C91	②7630
Belt - Fan & Alt.; W/55A., 62A. Alt.; FD, SB Chassis	361975C91	②7673
Belt - Fan & Alt.; W/60A. Alt.	359009C91	②7680
Belt - Fan & Alt.; W/65A., 80A., 105A., 145A. Alt.; W/P.T.O.	361975C91	②7673
Belt - Fan & Alt.; W/65A., 80A., 105A., 145A. Alt.; W/O P.T.O.	②7630	
Belt - Fan & Gen.; W/20A. Alt.	151534R11	②7680
Belt - Fan & Gen.; W/30A. Alt.	224638R11	②7695
Belt - Fan & Gen.; W/35A. Alt.	151535R11	②7695
Belt - Fan & Gen.; W/50A. Alt.	151536R11	②7715
Belt - P.S.; W/2WD	7460	
Belt - P.S.; W/4WD	285522C2	7435
Belt - Air Brake Compr.	359007C91	7475
Belt - A.P.; W/Air Brakes; W/Gov.	388139C1	7330
Belt - A.P.; W/Air Brakes; W/O Gov.	256062C2	7340
Belt - A.P.; W/Hyd. Brakes; W/Gov.	355653C91	7380
Belt - A.P.; W/Hyd. Brakes; W/O Gov.	362887C91	7410
International/Navistar V401		
193RE		
Belt - Fan; W/52 5/8" Belt O.C.	680611R11	②◆▲9520HD
Belt - Fan; W/57 5/8" Belt O.C.	261710C11	▲9570HD
Belt - Alt. To Compr.; W/37A., 60A. Alt.	243605R11	▲9451HD
Belt - Alt. To Compr.; W/55A. Alt.	264975C11	▲9455HD
Belt - Gen. To Compr.; W/30A. Gen.	133758R1	▲9440HD
Belt - Gen. To Compr.; W/35A. Gen.	150560R11	▲9451HD
Belt - Gen. To Compr.; W/50A. Gen.	201825R11	▲9435HD
Belt - Gen.; W/Hyd. Brakes	133732R1	▲9360HD
Belt - P.S.; W/43 1/8" Belt O.C.	164550R11	▲9425HD
Belt - P.S.; W/44 5/8" Belt O.C.	133758R1	▲9440HD
Belt - Idler; W/56 1/8" Belt O.C.	968645R11	▲9555HD
Belt - Idler; W/57 5/8" Belt O.C.	261710C11	▲9570HD
International/Navistar V461		
193RE		
Belt - Fan; W/52 5/8" Belt O.C.	680611R11	②◆▲9520HD
Belt - Fan; W/57 5/8" Belt O.C.	261710C11	▲9570HD
Belt - Alt. To Compr.; W/37A., 60A. Alt.	243605R11	▲9451HD
Belt - Alt. To Compr.; W/55A. Alt.	264975C11	▲9455HD
Belt - Gen. To Compr.; W/30A. Gen.	133758R1	▲9440HD
Belt - Gen. To Compr.; W/35A. Gen.	150560R11	▲9451HD
Belt - Gen. To Compr.; W/50A. Gen.	201825R11	▲9435HD
Belt - Gen.; W/Hyd. Brakes	133732R1	▲9360HD
Belt - P.S.; W/43 1/8" Belt O.C.	164550R11	▲9425HD
Belt - P.S.; W/44 5/8" Belt O.C.	133758R1	▲9440HD
Belt - Idler; W/56 1/8" Belt O.C.	968645R11	▲9555HD
Belt - Idler; W/57 5/8" Belt O.C.	261710C11	▲9570HD
International/Navistar V478		
193RE		
Belt - Fan; W/52 5/8" Belt O.C.	680611R11	②◆▲9520HD
Belt - Fan; W/57 5/8" Belt O.C.	261710C11	▲9570HD
Belt - Alt. To Compr.; W/37A., 60A. Alt.	243605R11	▲9451HD
Belt - Alt. To Compr.; W/55A. Alt.	264975C11	▲9455HD
Belt - Gen. To Compr.; W/30A. Gen.	133758R1	▲9440HD
Belt - Gen. To Compr.; W/35A. Gen.	150560R11	▲9451HD
Belt - Gen. To Compr.; W/50A. Gen.	201825R11	▲9435HD
Belt - Gen.; W/Hyd. Brakes	133732R1	▲9360HD
Belt - P.S.; W/43 1/8" Belt O.C.	164550R11	▲9425HD
Belt - P.S.; W/44 5/8" Belt O.C.	133758R1	▲9440HD
Belt - Idler; W/56 1/8" Belt O.C.	968645R11	▲9555HD
Belt - Idler; W/57 5/8" Belt O.C.	261710C11	▲9570HD

● Vulco-Flex® Coolant Hose.
 ② Two Required.
 ▲ Standard Belt Available. See Pages 630-631.

✂ Cut to Fit.
 ◆ Green Stripe® PowerBand® Belt May Work, Use Template to Check.

Belts and Coolant Hose for School Buses

Application	Mfr. Part No.	Our No.
INTERNATIONAL/NAVISTAR - Continued		
1967-1966 - Continued		
International/Navistar V549		
193RE		
Belt - Fan; W/52 5/8" Belt O.C.	680611R11	②◆▲9520HD
Belt - Fan; W/57 5/8" Belt O.C.	261710C11	▲9570HD
Belt - Alt. To Compr.; W/37A., 60A. Alt.	243605R11	▲9451HD
Belt - Alt. To Compr.; W/55A. Alt.	264975C11	▲9455HD
Belt - Gen. To Compr.; W/30A. Gen.	133758R1	▲9440HD
Belt - Gen. To Compr.; W/35A. Gen.	150560R11	▲9451HD
Belt - Gen. To Compr.; W/50A. Gen.	201825R11	▲9435HD
Belt - Gen.; W/Hyd. Brakes	133732R1	▲9360HD
Belt - P.S.; W/43 1/8" Belt O.C.	164550R11	▲9425HD
Belt - P.S.; W/44 5/8" Belt O.C.	133758R1	▲9440HD
Belt - Idler; W/56 1/8" Belt O.C.	968645R11	▲9555HD
Belt - Idler; W/57 5/8" Belt O.C.	261710C11	▲9570HD
International/Navistar VS401		
193RE		
Belt - Fan; W/52 5/8" Belt O.C.	680611R11	②◆▲9520HD
Belt - Fan; W/57 5/8" Belt O.C.	261710C11	▲9570HD
Belt - Alt. To Compr.; W/37A., 60A. Alt.	243605R11	▲9451HD
Belt - Alt. To Compr.; W/55A. Alt.	264975C11	▲9455HD
Belt - Gen. To Compr.; W/30A. Gen.	133758R1	▲9440HD
Belt - Gen. To Compr.; W/35A. Gen.	150560R11	▲9451HD
Belt - Gen. To Compr.; W/50A. Gen.	201825R11	▲9435HD
Belt - Gen.; W/Hyd. Brakes	133732R1	▲9360HD
Belt - P.S.; W/43 1/8" Belt O.C.	164550R11	▲9425HD
Belt - P.S.; W/44 5/8" Belt O.C.	133758R1	▲9440HD
Belt - Idler; W/56 1/8" Belt O.C.	968645R11	▲9555HD
Belt - Idler; W/57 5/8" Belt O.C.	261710C11	▲9570HD
International/Navistar VS478		
193RE		
Belt - Fan; W/52 5/8" Belt O.C.	680611R11	②◆▲9520HD
Belt - Fan; W/57 5/8" Belt O.C.	261710C11	▲9570HD
Belt - Alt. To Compr.; W/37A., 60A. Alt.	243605R11	▲9451HD
Belt - Alt. To Compr.; W/55A. Alt.	264975C11	▲9455HD
Belt - Gen. To Compr.; W/30A. Gen.	133758R1	▲9440HD
Belt - Gen. To Compr.; W/35A. Gen.	150560R11	▲9451HD
Belt - Gen. To Compr.; W/50A. Gen.	201825R11	▲9435HD
Belt - Gen.; W/Hyd. Brakes	133732R1	▲9360HD
Belt - P.S.; W/43 1/8" Belt O.C.	164550R11	▲9425HD
Belt - P.S.; W/44 5/8" Belt O.C.	133758R1	▲9440HD
Belt - Idler; W/56 1/8" Belt O.C.	968645R11	▲9555HD
Belt - Idler; W/57 5/8" Belt O.C.	261710C11	▲9570HD
International/Navistar VS549		
193RE		
Belt - Fan; W/52 5/8" Belt O.C.	680611R11	②◆▲9520HD
Belt - Fan; W/57 5/8" Belt O.C.	261710C11	▲9570HD
Belt - Alt. To Compr.; W/37A., 60A. Alt.	243605R11	▲9451HD
Belt - Alt. To Compr.; W/55A. Alt.	264975C11	▲9455HD
Belt - Gen. To Compr.; W/30A. Gen.	133758R1	▲9440HD
Belt - Gen. To Compr.; W/35A. Gen.	150560R11	▲9451HD
Belt - Gen. To Compr.; W/50A. Gen.	201825R11	▲9435HD
Belt - Gen.; W/Hyd. Brakes	133732R1	▲9360HD
Belt - P.S.; W/43 1/8" Belt O.C.	164550R11	▲9425HD
Belt - P.S.; W/44 5/8" Belt O.C.	133758R1	▲9440HD
Belt - Idler; W/56 1/8" Belt O.C.	968645R11	▲9555HD
Belt - Idler; W/57 5/8" Belt O.C.	261710C11	▲9570HD
1965		
International/Navistar BD220		
1603		
Belt - Fan & Alt.; W/37A., 52A., 61A., 62A. Alt.	151532R1	②7512
Belt - Fan & Alt.; W/60A. Alt.	861779R11	②▲9440HD
Belt - Gen.; W/20A., 50A. Alt.	20594VA	TR24438
Belt - Gen.; W/30A. Alt.	81572R2	TR28437
Belt - Gen.; W/35A., 50A. L.C.I. Gen.	164550R1	②▲9425HD
Belt - P.S.; W/Air Brakes	149636R1	▲9480HD
Belt - P.S.; W/Hyd. Brakes	864931R2	▲9319HD
Belt - Air Brake Compr.; W/4 Cu. Ft. Air Brake Compr.	201825R1	▲9440HD

Application	Mfr. Part No.	Our No.
INTERNATIONAL/NAVISTAR - Continued		
1965 - Continued		
International/Navistar BD220 - Continued		
1603 - Continued		
Belt - Air Brake Compr.; W/20A., 30A., 50A. Gen.	115505HA	TR22363
Hose - Upper		●26510
Hose - Lower - Eng. To Pipe		●26508
Hose - Lower - Pipe To Rad.		●26514
Hose - By Pass		20338
Hose - By Pass; (5/8" I.D.)		28441
International/Navistar BD240		
1603		
Belt - Fan & Alt.; W/37A., 52A., 61A., 62A. Alt.	151532R1	②7512
Belt - Fan & Alt.; W/60A. Alt.	861779R11	②▲9440HD
Belt - Gen.; W/20A., 50A. Alt.	20594VA	TR24438
Belt - Gen.; W/30A. Alt.	81572R2	TR28437
Belt - Gen.; W/35A., 50A. L.C.I. Gen.	164550R1	②▲9425HD
Belt - P.S.; W/Air Brakes	149636R1	▲9480HD
Belt - P.S.; W/Hyd. Brakes	864931R2	▲9319HD
Belt - Air Brake Compr.; W/4 Cu. Ft. Air Brake Compr.	201825R1	▲9440HD
Belt - Air Brake Compr.; W/20A., 30A., 50A. Gen.	115505HA	TR22363
Hose - Upper		●26510
Hose - Lower - Eng. To Pipe		●26508
Hose - Lower - Pipe To Rad.		●26514
Hose - By Pass		20338
Hose - By Pass; (5/8" I.D.)		28441
International/Navistar BD264		
1603		
Belt - Fan & Alt.; W/37A., 52A., 61A., 62A. Alt.	151532R1	②7512
Belt - Fan & Alt.; W/60A. Alt.	861779R11	②▲9440HD
Belt - Gen.; W/20A., 50A. Alt.	20594VA	TR24438
Belt - Gen.; W/30A. Alt.	81572R2	TR28437
Belt - Gen.; W/35A., 50A. L.C.I. Gen.	164550R1	②▲9425HD
Belt - P.S.; W/Air Brakes	149636R1	▲9480HD
Belt - P.S.; W/Hyd. Brakes	864931R2	▲9319HD
Belt - Air Brake Compr.; W/4 Cu. Ft. Air Brake Compr.	201825R1	▲9440HD
Belt - Air Brake Compr.; W/20A., 30A., 50A. Gen.	115505HA	TR22363
Hose - Upper		●26510
Hose - Lower - Eng. To Pipe		●26508
Hose - Lower - Pipe To Rad.		●26514
Hose - By Pass		20338
Hose - By Pass; (5/8" I.D.)		28441
International/Navistar BD269		
1603		
Belt - Fan & Alt.	862880R11	②▲9490HD
Belt - P.S.	242269R1	▲9405HD
Belt - Air Brake Compr.	280210C1	▲9540HD
Hose - Upper; (2" I.D.)		24232
Hose - Lower		≡20611
		or
		●26509
Hose - By Pass; (2" I.D.)		24232
1703 ; 1803		
Belt - Fan & Alt.	862880R11	②▲9490HD
Belt - P.S.	242269R1	▲9405HD
Belt - Air Brake Compr.	280210C1	▲9540HD
Hose - Upper; (2" I.D.)		24232
Hose - Lower - Eng. To Pipe		≡20206
Hose - Lower - Pipe To Rad.; (2" I.D.)		24232
Hose - By Pass; (2" I.D.)		24232
International/Navistar BD282		
1603		
Belt - Fan & Alt.	862880R11	②▲9490HD
Belt - P.S.	242269R1	▲9405HD
Belt - Air Brake Compr.	280210C1	▲9540HD
Hose - Upper; (2" I.D.)		24232
Hose - Lower		≡20611
		or
		●26509

② Two Required.
 ▲ Standard Belt Available. See Pages 630-631.
 ≡ Cut to Fit.

◆ Green Stripe® PowerBand® Belt May Work, Use Template to Check.
 ● Vulco-Flex® Coolant Hose.

School Buses

Belts and Coolant Hose for School Buses

School Buses

Application	Mfr. Part No.	Our No.
INTERNATIONAL/NAVISTAR - Continued		
1965 - Continued		
International/Navistar BD282 - Continued		
1603 - Continued		
Hose - By Pass; (2" I.D.)		24232
1703 ; 1803		
Belt - Fan & Alt.	862880R11	②▲9490HD
Belt - P.S.	242269R1	▲9405HD
Belt - Air Brake Compr.	280210C1	▲9540HD
Hose - Upper; (2" I.D.)		24232
Hose - Lower - Eng. To Pipe		≡20206
Hose - Lower - Pipe To Rad.; (2" I.D.)		24232
Hose - By Pass; (2" I.D.)		24232
International/Navistar BD308		
1603		
Belt - Fan & Alt.	862880R11	②▲9490HD
Belt - P.S.	242269R1	▲9405HD
Belt - Air Brake Compr.	280210C1	▲9540HD
Hose - Upper; (2" I.D.)		24232
Hose - Lower		≡20611
		or ●26509
Hose - By Pass; (2" I.D.)		24232
1703 ; 1803		
Belt - Fan & Alt.	862880R11	②▲9490HD
Belt - P.S.	242269R1	▲9405HD
Belt - Air Brake Compr.	280210C1	▲9540HD
Hose - Upper; (2" I.D.)		24232
Hose - Lower - Eng. To Pipe		≡20206
Hose - Lower - Pipe To Rad.; (2" I.D.)		24232
Hose - By Pass; (2" I.D.)		24232
International/Navistar BG220		
1603		
Belt - Fan & Alt.; W/37A., 52A., 61A., 62A. Alt.	151532R1	②7512
Belt - Fan & Alt.; W/60A. Alt.	861779R11	②▲9440HD
Belt - Gen.; W/20A., 50A. Alt.	20594VA	TR24438
Belt - Gen.; W/30A. Alt.	81572R2	TR28437
Belt - Gen.; W/35A., 50A. L.C.I. Gen.	164550R1	②▲9425HD
Belt - P.S.; W/Air Brakes	149636R1	▲9480HD
Belt - P.S.; W/Hyd. Brakes	864931R2	▲9319HD
Belt - Air Brake Compr.; W/4 Cu. Ft. Air Brake Compr.	201825R1	▲9440HD
Belt - Air Brake Compr.; W/20A., 30A., 50A. Gen.	115505HA	TR22363
Hose - Upper		●26510
Hose - Lower - Eng. To Pipe		●26508
Hose - Lower - Pipe To Rad.		●26514
Hose - By Pass		20338
Hose - By Pass; (5/8" I.D.)		28441
International/Navistar BG241		
1603		
Belt - Fan & Alt.; W/37A., 52A., 61A., 62A. Alt.	151532R1	②7512
Belt - Fan & Alt.; W/60A. Alt.	861779R11	②▲9440HD
Belt - Gen.; W/20A., 50A. Alt.	20594VA	TR24438
Belt - Gen.; W/30A. Alt.	81572R2	TR28437
Belt - Gen.; W/35A., 50A. L.C.I. Gen.	164550R1	②▲9425HD
Belt - P.S.; W/Air Brakes	149636R1	▲9480HD
Belt - P.S.; W/Hyd. Brakes	864931R2	▲9319HD
Belt - Air Brake Compr.; W/4 Cu. Ft. Air Brake Compr.	201825R1	▲9440HD
Belt - Air Brake Compr.; W/20A., 30A., 50A. Gen.	115505HA	TR22363
Hose - Upper		●26510
Hose - Lower - Eng. To Pipe		●26508
Hose - Lower - Pipe To Rad.		●26514
Hose - By Pass		20338
Hose - By Pass; (5/8" I.D.)		28441
International/Navistar BG265		
1603		
Belt - Fan & Alt.; W/37A., 52A., 61A., 62A. Alt.	151532R1	②7512
Belt - Fan & Alt.; W/60A. Alt.	861779R11	②▲9440HD
Belt - Gen.; W/20A., 50A. Alt.	20594VA	TR24438
Belt - Gen.; W/30A. Alt.	81572R2	TR28437

Application	Mfr. Part No.	Our No.
INTERNATIONAL/NAVISTAR - Continued		
1965 - Continued		
International/Navistar BG265 - Continued		
1603 - Continued		
Belt - Gen.; W/35A., 50A. L.C.I. Gen.	164550R1	②▲9425HD
Belt - P.S.; W/Air Brakes	149636R1	▲9480HD
Belt - P.S.; W/Hyd. Brakes	864931R2	▲9319HD
Belt - Air Brake Compr.; W/4 Cu. Ft. Air Brake Compr.	201825R1	▲9440HD
Belt - Air Brake Compr.; W/20A., 30A., 50A. Gen.	115505HA	TR22363
Hose - Upper		●26510
Hose - Lower - Eng. To Pipe		●26508
Hose - Lower - Pipe To Rad.		●26514
Hose - By Pass		20338
Hose - By Pass; (5/8" I.D.)		28441
International/Navistar FTV549		
193RE		
Belt - Fan; W/52 5/8" Belt O.C.	680611R11	②◆▲9520HD
Belt - Fan; W/57 5/8" Belt O.C.	261710C11	▲9570HD
Belt - Alt. To Compr.; W/37A., 60A. Alt.	243605R11	▲9451HD
Belt - Alt. To Compr.; W/55A. Alt.	264975C11	▲9455HD
Belt - Gen. To Compr.; W/30A. Gen.	133758R1	▲9440HD
Belt - Gen. To Compr.; W/35A. Gen.	150560R11	▲9451HD
Belt - Gen. To Compr.; W/50A. Gen.	201825R11	▲9435HD
Belt - Gen.; W/Hyd. Brakes	133732R1	▲9360HD
Belt - P.S.; W/43 1/8" Belt O.C.	164550R11	▲9425HD
Belt - P.S.; W/44 5/8" Belt O.C.	133758R1	▲9440HD
Belt - Idler; W/56 1/8" Belt O.C.	968645R11	▲9555HD
Belt - Idler; W/57 5/8" Belt O.C.	261710C11	▲9570HD
International/Navistar FTVS549		
193RE		
Belt - Fan; W/52 5/8" Belt O.C.	680611R11	②◆▲9520HD
Belt - Fan; W/57 5/8" Belt O.C.	261710C11	▲9570HD
Belt - Alt. To Compr.; W/37A., 60A. Alt.	243605R11	▲9451HD
Belt - Alt. To Compr.; W/55A. Alt.	264975C11	▲9455HD
Belt - Gen. To Compr.; W/30A. Gen.	133758R1	▲9440HD
Belt - Gen. To Compr.; W/35A. Gen.	150560R11	▲9451HD
Belt - Gen. To Compr.; W/50A. Gen.	201825R11	▲9435HD
Belt - Gen.; W/Hyd. Brakes	133732R1	▲9360HD
Belt - P.S.; W/43 1/8" Belt O.C.	164550R11	▲9425HD
Belt - P.S.; W/44 5/8" Belt O.C.	133758R1	▲9440HD
Belt - Idler; W/56 1/8" Belt O.C.	968645R11	▲9555HD
Belt - Idler; W/57 5/8" Belt O.C.	261710C11	▲9570HD
International/Navistar RD372		
1823		
Hose - Upper		●26515
Hose - Lower; (2" I.D.)		24232
1853		
Belt - Alt.; W/55A., 62A., 145A. Alt.	223794K21	②TR22514
Belt - Gen.; W/37A. Gen.	193826R11	TR22508
Belt - P.S.	240354R1	TR22344
1853FC		
Belt - Alt.; W/55A., 62A., 145A. Alt.	223794K21	②TR22514
Belt - Gen.; W/37A. Gen.	193826R11	TR22508
Belt - P.S.	240354R1	TR22344
Hose - Upper; Late FD Chassis; Chassis No. FA66376		●26509
Hose - Lower; Early FD Chassis; Chassis No. FA66376		●26508
Hose - Lower; Late FD Chassis; Chassis No. FA66376(2 1/8" I.D.)		24234
Hose - Lower; Late FD Chassis; Chassis No. FA66376		●26508
International/Navistar RD406		
1823		
Hose - Upper		●26515
Hose - Lower; (2" I.D.)		24232
1853		
Belt - Alt.; W/55A., 62A., 145A. Alt.	223794K21	②TR22514
Belt - Gen.; W/37A. Gen.	193826R11	TR22508
Belt - P.S.	240354R1	TR22344
1853FC		
Belt - Alt.; W/55A., 62A., 145A. Alt.	223794K21	②TR22514

② Two Required.

≡ Cut to Fit.

◆ Green Stripe® PowerBand® Belt May Work, Use Template to Check.

▲ Standard Belt Available. See Pages 630-631.

● Vulco-Flex® Coolant Hose.

Belts and Coolant Hose for School Buses

Application	Mfr. Part No.	Our No.
INTERNATIONAL/NAVISTAR - Continued		
1965 - Continued		
International/Navistar RD406 - Continued		
1853FC - Continued		
Belt - Gen.; W/37A. Gen.	193826R11	TR22508
Belt - P.S.	240354R1	TR22344
Hose - Upper; Late FD Chassis; Chassis No. FA66376	●26509	
Hose - Lower; Early FD Chassis; Chassis No. FA66376	●26508	
Hose - Lower; Late FD Chassis; Chassis No. FA66376(2 1/8" I.D.)	24234	
Hose - Lower; Late FD Chassis; Chassis No. FA66376	●26508	
International/Navistar RD450		
1823		
Hose - Upper	●26515	
Hose - Lower; (2" I.D.)	24232	
1853		
Belt - Alt.; W/55A., 62A., 145A. Alt.	223794K21	②TR22514
Belt - Gen.; W/37A. Gen.	193826R11	TR22508
Belt - P.S.	240354R1	TR22344
1853FC		
Belt - Alt.; W/55A., 62A., 145A. Alt.	223794K21	②TR22514
Belt - Gen.; W/37A. Gen.	193826R11	TR22508
Belt - P.S.	240354R1	TR22344
Hose - Upper; Late FD Chassis; Chassis No. FA66376	●26509	
Hose - Lower; Early FD Chassis; Chassis No. FA66376	●26508	
Hose - Lower; Late FD Chassis; Chassis No. FA66376(2 1/8" I.D.)	24234	
Hose - Lower; Late FD Chassis; Chassis No. FA66376	●26508	
International/Navistar RD501		
1823		
Hose - Upper	●26515	
Hose - Lower; (2" I.D.)	24232	
1853		
Belt - Alt.; W/55A., 62A., 145A. Alt.	223794K21	②TR22514
Belt - Gen.; W/37A. Gen.	193826R11	TR22508
Belt - P.S.	240354R1	TR22344
1853FC		
Belt - Alt.; W/55A., 62A., 145A. Alt.	223794K21	②TR22514
Belt - Gen.; W/37A. Gen.	193826R11	TR22508
Belt - P.S.	240354R1	TR22344
Hose - Upper; Late FD Chassis; Chassis No. FA66376	●26509	
Hose - Lower; Early FD Chassis; Chassis No. FA66376	●26508	
Hose - Lower; Late FD Chassis; Chassis No. FA66376(2 1/8" I.D.)	24234	
Hose - Lower; Late FD Chassis; Chassis No. FA66376	●26508	
International/Navistar V266		
1603; 1703; 1803		
Belt - Fan & Alt.; W/37A., 52A., 61A. Alt.; C, G, H Chassis		②7603
Belt - Fan & Alt.; W/37A., 52A., 61A. Alt.; FD, SB Chassis	255266C3	②7640
Belt - Fan & Alt.; W/55A., 62A. Alt.; C, G, H Chassis	369725C91	②7619
Belt - Fan & Alt.; W/55A., 62A. Alt.; FD, SB Chassis	358998C91	②7650
Belt - P.S.; W/2WD	151529R2	7440
Belt - P.S.; W/4WD	151531R2	7450
Belt - Air Brake Compr.	236572R2	7460
Hose - Upper; W/Rad. Shutters; W/Metal Hood	●26515	
Hose - Upper; W/O Rad. Shutters; W/Metal Hood	20493	
Hose - Lower - Eng. To Pipe; W/Auto. Trans.	20532	
Hose - Lower; W/Man. Trans.	21308	
Hose - By Pass	≈20357	
International/Navistar V304		
1603; 1703; 1803		
Belt - Fan & Alt.; W/37A., 52A., 61A. Alt.; C, G, H Chassis		②7603
Belt - Fan & Alt.; W/37A., 52A., 61A. Alt.; FD, SB Chassis	255266C3	②7640
Belt - Fan & Alt.; W/55A., 62A. Alt.; C, G, H Chassis	369725C91	②7619
Belt - Fan & Alt.; W/55A., 62A. Alt.; FD, SB Chassis	358998C91	②7650
Belt - P.S.; W/2WD	151529R2	7440

Application	Mfr. Part No.	Our No.
INTERNATIONAL/NAVISTAR - Continued		
1965 - Continued		
International/Navistar V304 - Continued		
1603; 1703; 1803 - Continued		
Belt - P.S.; W/4WD	151531R2	7450
Belt - Air Brake Compr.	236572R2	7460
Hose - Upper; W/Rad. Shutters; W/Metal Hood	●26515	
Hose - Upper; W/O Rad. Shutters; W/Metal Hood	20493	
Hose - Lower - Eng. To Pipe; W/Auto. Trans.	20532	
Hose - Lower; W/Man. Trans.	21308	
Hose - By Pass	≈20357	
International/Navistar V345		
1603; 1703		
Belt - Fan & Alt.; W/37A., 52A., 61A. Alt.; C, G, H Chassis; W/P.T.O.	968815R11	②7650
Belt - Fan & Alt.; W/37A., 52A., 61A. Alt.; C, G, H Chassis; W/O P.T.O.	373457C91	②7612
Belt - Fan & Alt.; W/37A., 52A., 61A. Alt.; FD, SB Chassis	968815R1	②7650
Belt - Fan & Alt.; W/37A., 61A. Alt.; W/O Air Brakes; W/O P.T.O.; W/O X.C.	373456C1	7612
Belt - Fan & Alt.; W/55A., 62A. Alt.; C, G, H Chassis	369723C91	②7630
Belt - Fan & Alt.; W/55A., 62A. Alt.; FD, SB Chassis	361975C91	②7673
Belt - Fan & Alt.; W/60A. Alt.	359009C91	②7680
Belt - Fan & Alt.; W/65A., 80A., 105A., 145A. Alt.; W/P.T.O.	361975C91	②7673
Belt - Fan & Alt.; W/65A., 80A., 105A., 145A. Alt.; W/O P.T.O.	151534R11	②7680
Belt - Fan & Gen.; W/20A. Alt.	224638R11	②7695
Belt - Fan & Gen.; W/30A. Alt.	151535R11	②7695
Belt - Fan & Gen.; W/35A. Alt.	151536R11	②7715
Belt - P.S.; W/2WD	7460	
Belt - P.S.; W/4WD	285522C2	7435
Belt - Air Brake Compr.	359007C91	7475
Belt - A.P.; W/Air Brakes; W/Gov.	388139C1	7330
Belt - A.P.; W/Air Brakes; W/O Gov.	256062C2	7340
Belt - A.P.; W/Hyd. Brakes; W/Gov.	355653C91	7380
Belt - A.P.; W/Hyd. Brakes; W/O Gov.	362887C91	7410
Hose - Upper; W/Rad. Shutters; W/Metal Hood	●26515	
Hose - Upper; W/O Rad. Shutters; W/Metal Hood	20493	
Hose - Lower - Eng. To Pipe; W/Auto. Trans.	20532	
Hose - Lower; W/Man. Trans.	21308	
Hose - By Pass	≈20357	
1723		
Belt - Fan & Alt.; W/37A., 52A., 61A. Alt.; C, G, H Chassis; W/P.T.O.	968815R11	②7650
Belt - Fan & Alt.; W/37A., 52A., 61A. Alt.; C, G, H Chassis; W/O P.T.O.	373457C91	②7612
Belt - Fan & Alt.; W/37A., 52A., 61A. Alt.; FD, SB Chassis	968815R1	②7650
Belt - Fan & Alt.; W/37A., 61A. Alt.; W/O Air Brakes; W/O P.T.O.; W/O X.C.	373456C1	7612
Belt - Fan & Alt.; W/55A., 62A. Alt.; C, G, H Chassis	369723C91	②7630
Belt - Fan & Alt.; W/55A., 62A. Alt.; FD, SB Chassis	361975C91	②7673
Belt - Fan & Alt.; W/60A. Alt.	359009C91	②7680
Belt - Fan & Alt.; W/65A., 80A., 105A., 145A. Alt.; W/P.T.O.	361975C91	②7673
Belt - Fan & Alt.; W/65A., 80A., 105A., 145A. Alt.; W/O P.T.O.	151534R11	②7680
Belt - Fan & Gen.; W/20A. Alt.	224638R11	②7695
Belt - Fan & Gen.; W/30A. Alt.	151535R11	②7695
Belt - Fan & Gen.; W/35A. Alt.	151536R11	②7715
Belt - P.S.; W/2WD	7460	
Belt - P.S.; W/4WD	285522C2	7435
Belt - Air Brake Compr.	359007C91	7475
Belt - A.P.; W/Air Brakes; W/Gov.	388139C1	7330
Belt - A.P.; W/Air Brakes; W/O Gov.	256062C2	7340
Belt - A.P.; W/Hyd. Brakes; W/Gov.	355653C91	7380
Belt - A.P.; W/Hyd. Brakes; W/O Gov.	362887C91	7410

● Vulco-Flex® Coolant Hose.
≈ Cut to Fit.

② Two Required.

School Buses

Belts and Coolant Hose for School Buses

School Buses

Application	Mfr. Part No.	Our No.
INTERNATIONAL/NAVISTAR - Continued		
1965 - Continued		
International/Navistar V345 - Continued		
1803		
Belt - Fan & Alt.; W/37A., 52A., 61A. Alt.; C, G, H Chassis; W/P.T.O.	968815R11	②7650
Belt - Fan & Alt.; W/37A., 52A., 61A. Alt.; C, G, H Chassis; W/O P.T.O.	373457C91	②7612
Belt - Fan & Alt.; W/37A., 52A., 61A. Alt.; FD, SB Chassis	968815R1	②7650
Belt - Fan & Alt.; W/37A., 61A. Alt.; W/O Air Brakes; W/O P.T.O.; W/O X.C.	373456C1	7612
Belt - Fan & Alt.; W/55A., 62A. Alt.; C, G, H Chassis	369723C91	②7630
Belt - Fan & Alt.; W/55A., 62A. Alt.; FD, SB Chassis	361975C91	②7673
Belt - Fan & Alt.; W/60A. Alt.	359009C91	②7680
Belt - Fan & Alt.; W/65A., 80A., 105A., 145A. Alt.; W/P.T.O.	361975C91	②7673
Belt - Fan & Alt.; W/65A., 80A., 105A., 145A. Alt.; W/O P.T.O.	②7630	
Belt - Fan & Gen.; W/20A. Alt.	151534R11	②7680
Belt - Fan & Gen.; W/30A. Alt.	224638R11	②7695
Belt - Fan & Gen.; W/35A. Alt.	151535R11	②7695
Belt - Fan & Gen.; W/50A. Alt.	151536R11	②7715
Belt - P.S.; W/2WD	7460	7460
Belt - P.S.; W/4WD	285522C2	7435
Belt - Air Brake Compr.	359007C91	7475
Belt - A.P.; W/Air Brakes; W/Gov.	388139C1	7330
Belt - A.P.; W/Air Brakes; W/O Gov.	256062C2	7340
Belt - A.P.; W/Hyd. Brakes; W/Gov.	355653C91	7380
Belt - A.P.; W/Hyd. Brakes; W/O Gov.	362887C91	7410
Hose - Upper; W/Rad. Shutters; W/Metal Hood	●26515	
Hose - Upper; W/O Rad. Shutters; W/Metal Hood	20493	
Hose - Lower - Eng. To Pipe; W/Auto. Trans.	20532	
Hose - Lower; W/Man. Trans.	21308	
Hose - By Pass	≧20357	
1823		
Belt - Fan & Alt.; W/37A., 52A., 61A. Alt.; C, G, H Chassis; W/P.T.O.	968815R11	②7650
Belt - Fan & Alt.; W/37A., 52A., 61A. Alt.; C, G, H Chassis; W/O P.T.O.	373457C91	②7612
Belt - Fan & Alt.; W/37A., 52A., 61A. Alt.; FD, SB Chassis	968815R1	②7650
Belt - Fan & Alt.; W/37A., 61A. Alt.; W/O Air Brakes; W/O P.T.O.; W/O X.C.	373456C1	7612
Belt - Fan & Alt.; W/55A., 62A. Alt.; C, G, H Chassis	369723C91	②7630
Belt - Fan & Alt.; W/55A., 62A. Alt.; FD, SB Chassis	361975C91	②7673
Belt - Fan & Alt.; W/60A. Alt.	359009C91	②7680
Belt - Fan & Alt.; W/65A., 80A., 105A., 145A. Alt.; W/P.T.O.	361975C91	②7673
Belt - Fan & Alt.; W/65A., 80A., 105A., 145A. Alt.; W/O P.T.O.	②7630	
Belt - Fan & Gen.; W/20A. Alt.	151534R11	②7680
Belt - Fan & Gen.; W/30A. Alt.	224638R11	②7695
Belt - Fan & Gen.; W/35A. Alt.	151535R11	②7695
Belt - Fan & Gen.; W/50A. Alt.	151536R11	②7715
Belt - P.S.; W/2WD	7460	7460
Belt - P.S.; W/4WD	285522C2	7435
Belt - Air Brake Compr.	359007C91	7475
Belt - A.P.; W/Air Brakes; W/Gov.	388139C1	7330
Belt - A.P.; W/Air Brakes; W/O Gov.	256062C2	7340
Belt - A.P.; W/Hyd. Brakes; W/Gov.	355653C91	7380
Belt - A.P.; W/Hyd. Brakes; W/O Gov.	362887C91	7410
International/Navistar V392		
1603; 1703		
Belt - Fan & Alt.; W/37A., 52A., 61A. Alt.; C, G, H Chassis; W/P.T.O.	968815R11	②7650
Belt - Fan & Alt.; W/37A., 52A., 61A. Alt.; C, G, H Chassis; W/O P.T.O.	373457C91	②7612
Belt - Fan & Alt.; W/37A., 52A., 61A. Alt.; FD, SB Chassis	968815R1	②7650
Belt - Fan & Alt.; W/37A., 61A. Alt.; W/O Air Brakes; W/O P.T.O.; W/O X.C.	373456C1	7612

Application	Mfr. Part No.	Our No.
INTERNATIONAL/NAVISTAR - Continued		
1965 - Continued		
International/Navistar V392 - Continued		
1603; 1703 - Continued		
Belt - Fan & Alt.; W/55A., 62A. Alt.; C, G, H Chassis	369723C91	②7630
Belt - Fan & Alt.; W/55A., 62A. Alt.; FD, SB Chassis	361975C91	②7673
Belt - Fan & Alt.; W/60A. Alt.	359009C91	②7680
Belt - Fan & Alt.; W/65A., 80A., 105A., 145A. Alt.; W/P.T.O.	361975C91	②7673
Belt - Fan & Alt.; W/65A., 80A., 105A., 145A. Alt.; W/O P.T.O.	②7630	
Belt - Fan & Gen.; W/20A. Alt.	151534R11	②7680
Belt - Fan & Gen.; W/30A. Alt.	224638R11	②7695
Belt - Fan & Gen.; W/35A. Alt.	151535R11	②7695
Belt - Fan & Gen.; W/50A. Alt.	151536R11	②7715
Belt - P.S.; W/2WD	7460	7460
Belt - P.S.; W/4WD	285522C2	7435
Belt - Air Brake Compr.	359007C91	7475
Belt - A.P.; W/Air Brakes; W/Gov.	388139C1	7330
Belt - A.P.; W/Air Brakes; W/O Gov.	256062C2	7340
Belt - A.P.; W/Hyd. Brakes; W/Gov.	355653C91	7380
Belt - A.P.; W/Hyd. Brakes; W/O Gov.	362887C91	7410
Hose - Upper; W/Rad. Shutters; W/Metal Hood	●26515	
Hose - Upper; W/O Rad. Shutters; W/Metal Hood	20493	
Hose - Lower - Eng. To Pipe; W/Auto. Trans.	20532	
Hose - Lower; W/Man. Trans.	21308	
Hose - By Pass	≧20357	
1723		
Belt - Fan & Alt.; W/37A., 52A., 61A. Alt.; C, G, H Chassis; W/P.T.O.	968815R11	②7650
Belt - Fan & Alt.; W/37A., 52A., 61A. Alt.; C, G, H Chassis; W/O P.T.O.	373457C91	②7612
Belt - Fan & Alt.; W/37A., 52A., 61A. Alt.; FD, SB Chassis	968815R1	②7650
Belt - Fan & Alt.; W/37A., 61A. Alt.; W/O Air Brakes; W/O P.T.O.; W/O X.C.	373456C1	7612
Belt - Fan & Alt.; W/55A., 62A. Alt.; C, G, H Chassis	369723C91	②7630
Belt - Fan & Alt.; W/55A., 62A. Alt.; FD, SB Chassis	361975C91	②7673
Belt - Fan & Alt.; W/60A. Alt.	359009C91	②7680
Belt - Fan & Alt.; W/65A., 80A., 105A., 145A. Alt.; W/P.T.O.	361975C91	②7673
Belt - Fan & Alt.; W/65A., 80A., 105A., 145A. Alt.; W/O P.T.O.	②7630	
Belt - Fan & Gen.; W/20A. Alt.	151534R11	②7680
Belt - Fan & Gen.; W/30A. Alt.	224638R11	②7695
Belt - Fan & Gen.; W/35A. Alt.	151535R11	②7695
Belt - Fan & Gen.; W/50A. Alt.	151536R11	②7715
Belt - P.S.; W/2WD	7460	7460
Belt - P.S.; W/4WD	285522C2	7435
Belt - Air Brake Compr.	359007C91	7475
Belt - A.P.; W/Air Brakes; W/Gov.	388139C1	7330
Belt - A.P.; W/Air Brakes; W/O Gov.	256062C2	7340
Belt - A.P.; W/Hyd. Brakes; W/Gov.	355653C91	7380
Belt - A.P.; W/Hyd. Brakes; W/O Gov.	362887C91	7410
1803		
Belt - Fan & Alt.; W/37A., 52A., 61A. Alt.; C, G, H Chassis; W/P.T.O.	968815R11	②7650
Belt - Fan & Alt.; W/37A., 52A., 61A. Alt.; C, G, H Chassis; W/O P.T.O.	373457C91	②7612
Belt - Fan & Alt.; W/37A., 52A., 61A. Alt.; FD, SB Chassis	968815R1	②7650
Belt - Fan & Alt.; W/37A., 61A. Alt.; W/O Air Brakes; W/O P.T.O.; W/O X.C.	373456C1	7612
Belt - Fan & Alt.; W/55A., 62A. Alt.; C, G, H Chassis	369723C91	②7630
Belt - Fan & Alt.; W/55A., 62A. Alt.; FD, SB Chassis	361975C91	②7673
Belt - Fan & Alt.; W/60A. Alt.	359009C91	②7680
Belt - Fan & Alt.; W/65A., 80A., 105A., 145A. Alt.; W/P.T.O.	361975C91	②7673
Belt - Fan & Alt.; W/65A., 80A., 105A., 145A. Alt.; W/O P.T.O.	②7630	
Belt - Fan & Gen.; W/20A. Alt.	151534R11	②7680
Belt - Fan & Gen.; W/30A. Alt.	224638R11	②7695

② Two Required.
≧ Cut to Fit.

● Vulco-Flex® Coolant Hose.

Belts and Coolant Hose for School Buses

Application	Mfr. Part No.	Our No.
INTERNATIONAL/NAVISTAR - Continued		
1965 - Continued		
International/Navistar V392 - Continued		
1803 - Continued		
Belt - Fan & Gen.; W/35A. Alt.	151535R11	②7695
Belt - Fan & Gen.; W/50A. Alt.	151536R11	②7715
Belt - P.S.; W/2WD		7460
Belt - P.S.; W/4WD	285522C2	7435
Belt - Air Brake Compr.	359007C91	7475
Belt - A.P.; W/Air Brakes; W/Gov.	388139C1	7330
Belt - A.P.; W/Air Brakes; W/O Gov.	256062C2	7340
Belt - A.P.; W/Hyd. Brakes; W/Gov.	355653C91	7380
Belt - A.P.; W/Hyd. Brakes; W/O Gov.	362887C91	7410
Hose - Upper; W/Rad. Shutters; W/Metal Hood	●26515	
Hose - Upper; W/O Rad. Shutters; W/Metal Hood	20493	
Hose - Lower - Eng. To Pipe; W/Auto. Trans.	20532	
Hose - Lower; W/Man. Trans.	21308	
Hose - By Pass	≈20357	
1823		
Belt - Fan & Alt.; W/37A., 52A., 61A. Alt.; C, G, H Chassis; W/P.T.O.	968815R11	②7650
Belt - Fan & Alt.; W/37A., 52A., 61A. Alt.; C, G, H Chassis; W/O P.T.O.	373457C91	②7612
Belt - Fan & Alt.; W/37A., 52A., 61A. Alt.; FD, SB Chassis	968815R1	②7650
Belt - Fan & Alt.; W/37A., 61A. Alt.; W/O Air Brakes; W/O P.T.O.; W/O X.C.	373456C1	7612
Belt - Fan & Alt.; W/55A., 62A. Alt.; C, G, H Chassis	369723C91	②7630
Belt - Fan & Alt.; W/55A., 62A. Alt.; FD, SB Chassis	361975C91	②7673
Belt - Fan & Alt.; W/60A. Alt.	359009C91	②7680
Belt - Fan & Alt.; W/65A., 80A., 105A., 145A. Alt.; W/P.T.O.	361975C91	②7673
Belt - Fan & Alt.; W/65A., 80A., 105A., 145A. Alt.; W/O P.T.O.		②7630
Belt - Fan & Gen.; W/20A. Alt.	151534R11	②7680
Belt - Fan & Gen.; W/30A. Alt.	224638R11	②7695
Belt - Fan & Gen.; W/35A. Alt.	151535R11	②7695
Belt - Fan & Gen.; W/50A. Alt.	151536R11	②7715
Belt - P.S.; W/2WD		7460
Belt - P.S.; W/4WD	285522C2	7435
Belt - Air Brake Compr.	359007C91	7475
Belt - A.P.; W/Air Brakes; W/Gov.	388139C1	7330
Belt - A.P.; W/Air Brakes; W/O Gov.	256062C2	7340
Belt - A.P.; W/Hyd. Brakes; W/Gov.	355653C91	7380
Belt - A.P.; W/Hyd. Brakes; W/O Gov.	362887C91	7410
International/Navistar V401		
193RE		
Belt - Fan; W/52 5/8" Belt O.C.	680611R11	②◆▲9520HD
Belt - Fan; W/57 5/8" Belt O.C.	261710C11	▲9570HD
Belt - Alt. To Compr.; W/37A., 60A. Alt.	243605R11	▲9451HD
Belt - Alt. To Compr.; W/55A. Alt.	264975C11	▲9455HD
Belt - Gen. To Compr.; W/30A. Gen.	133758R1	▲9440HD
Belt - Gen. To Compr.; W/35A. Gen.	150560R11	▲9451HD
Belt - Gen. To Compr.; W/50A. Gen.	201825R11	▲9435HD
Belt - Gen.; W/Hyd. Brakes	133732R1	▲9360HD
Belt - P.S.; W/43 1/8" Belt O.C.	164550R11	▲9425HD
Belt - P.S.; W/44 5/8" Belt O.C.	133758R1	▲9440HD
Belt - Idler; W/56 1/8" Belt O.C.	968645R11	▲9555HD
Belt - Idler; W/57 5/8" Belt O.C.	261710C11	▲9570HD
International/Navistar V461		
193RE		
Belt - Fan; W/52 5/8" Belt O.C.	680611R11	②◆▲9520HD
Belt - Fan; W/57 5/8" Belt O.C.	261710C11	▲9570HD
Belt - Alt. To Compr.; W/37A., 60A. Alt.	243605R11	▲9451HD
Belt - Alt. To Compr.; W/55A. Alt.	264975C11	▲9455HD
Belt - Gen. To Compr.; W/30A. Gen.	133758R1	▲9440HD
Belt - Gen. To Compr.; W/35A. Gen.	150560R11	▲9451HD
Belt - Gen. To Compr.; W/50A. Gen.	201825R11	▲9435HD
Belt - Gen.; W/Hyd. Brakes	133732R1	▲9360HD
Belt - P.S.; W/43 1/8" Belt O.C.	164550R11	▲9425HD
Belt - P.S.; W/44 5/8" Belt O.C.	133758R1	▲9440HD
Belt - Idler; W/56 1/8" Belt O.C.	968645R11	▲9555HD

Application	Mfr. Part No.	Our No.
INTERNATIONAL/NAVISTAR - Continued		
1965 - Continued		
International/Navistar V461 - Continued		
193RE - Continued		
Belt - Idler; W/57 5/8" Belt O.C.	261710C11	▲9570HD
International/Navistar V478		
193RE		
Belt - Fan; W/52 5/8" Belt O.C.	680611R11	②◆▲9520HD
Belt - Fan; W/57 5/8" Belt O.C.	261710C11	▲9570HD
Belt - Alt. To Compr.; W/37A., 60A. Alt.	243605R11	▲9451HD
Belt - Alt. To Compr.; W/55A. Alt.	264975C11	▲9455HD
Belt - Gen. To Compr.; W/30A. Gen.	133758R1	▲9440HD
Belt - Gen. To Compr.; W/35A. Gen.	150560R11	▲9451HD
Belt - Gen. To Compr.; W/50A. Gen.	201825R11	▲9435HD
Belt - Gen.; W/Hyd. Brakes	133732R1	▲9360HD
Belt - P.S.; W/43 1/8" Belt O.C.	164550R11	▲9425HD
Belt - P.S.; W/44 5/8" Belt O.C.	133758R1	▲9440HD
Belt - Idler; W/56 1/8" Belt O.C.	968645R11	▲9555HD
Belt - Idler; W/57 5/8" Belt O.C.	261710C11	▲9570HD
International/Navistar V549		
193RE		
Belt - Fan; W/52 5/8" Belt O.C.	680611R11	②◆▲9520HD
Belt - Fan; W/57 5/8" Belt O.C.	261710C11	▲9570HD
Belt - Alt. To Compr.; W/37A., 60A. Alt.	243605R11	▲9451HD
Belt - Alt. To Compr.; W/55A. Alt.	264975C11	▲9455HD
Belt - Gen. To Compr.; W/30A. Gen.	133758R1	▲9440HD
Belt - Gen. To Compr.; W/35A. Gen.	150560R11	▲9451HD
Belt - Gen. To Compr.; W/50A. Gen.	201825R11	▲9435HD
Belt - Gen.; W/Hyd. Brakes	133732R1	▲9360HD
Belt - P.S.; W/43 1/8" Belt O.C.	164550R11	▲9425HD
Belt - P.S.; W/44 5/8" Belt O.C.	133758R1	▲9440HD
Belt - Idler; W/56 1/8" Belt O.C.	968645R11	▲9555HD
Belt - Idler; W/57 5/8" Belt O.C.	261710C11	▲9570HD
International/Navistar VS401		
193RE		
Belt - Fan; W/52 5/8" Belt O.C.	680611R11	②◆▲9520HD
Belt - Fan; W/57 5/8" Belt O.C.	261710C11	▲9570HD
Belt - Alt. To Compr.; W/37A., 60A. Alt.	243605R11	▲9451HD
Belt - Alt. To Compr.; W/55A. Alt.	264975C11	▲9455HD
Belt - Gen. To Compr.; W/30A. Gen.	133758R1	▲9440HD
Belt - Gen. To Compr.; W/35A. Gen.	150560R11	▲9451HD
Belt - Gen. To Compr.; W/50A. Gen.	201825R11	▲9435HD
Belt - Gen.; W/Hyd. Brakes	133732R1	▲9360HD
Belt - P.S.; W/43 1/8" Belt O.C.	164550R11	▲9425HD
Belt - P.S.; W/44 5/8" Belt O.C.	133758R1	▲9440HD
Belt - Idler; W/56 1/8" Belt O.C.	968645R11	▲9555HD
Belt - Idler; W/57 5/8" Belt O.C.	261710C11	▲9570HD
International/Navistar VS478		
193RE		
Belt - Fan; W/52 5/8" Belt O.C.	680611R11	②◆▲9520HD
Belt - Fan; W/57 5/8" Belt O.C.	261710C11	▲9570HD
Belt - Alt. To Compr.; W/37A., 60A. Alt.	243605R11	▲9451HD
Belt - Alt. To Compr.; W/55A. Alt.	264975C11	▲9455HD
Belt - Gen. To Compr.; W/30A. Gen.	133758R1	▲9440HD
Belt - Gen. To Compr.; W/35A. Gen.	150560R11	▲9451HD
Belt - Gen. To Compr.; W/50A. Gen.	201825R11	▲9435HD
Belt - Gen.; W/Hyd. Brakes	133732R1	▲9360HD
Belt - P.S.; W/43 1/8" Belt O.C.	164550R11	▲9425HD
Belt - P.S.; W/44 5/8" Belt O.C.	133758R1	▲9440HD
Belt - Idler; W/56 1/8" Belt O.C.	968645R11	▲9555HD
Belt - Idler; W/57 5/8" Belt O.C.	261710C11	▲9570HD
International/Navistar VS549		
193RE		
Belt - Fan; W/52 5/8" Belt O.C.	680611R11	②◆▲9520HD
Belt - Fan; W/57 5/8" Belt O.C.	261710C11	▲9570HD
Belt - Alt. To Compr.; W/37A., 60A. Alt.	243605R11	▲9451HD
Belt - Alt. To Compr.; W/55A. Alt.	264975C11	▲9455HD
Belt - Gen. To Compr.; W/30A. Gen.	133758R1	▲9440HD
Belt - Gen. To Compr.; W/35A. Gen.	150560R11	▲9451HD
Belt - Gen. To Compr.; W/50A. Gen.	201825R11	▲9435HD
Belt - Gen.; W/Hyd. Brakes	133732R1	▲9360HD
Belt - P.S.; W/43 1/8" Belt O.C.	164550R11	▲9425HD
Belt - P.S.; W/44 5/8" Belt O.C.	133758R1	▲9440HD
Belt - Idler; W/56 1/8" Belt O.C.	968645R11	▲9555HD
Belt - Idler; W/57 5/8" Belt O.C.	261710C11	▲9570HD

② Two Required.
 ≈ Cut to Fit.
 ▲ Standard Belt Available. See Pages 630-631.

◆ Vulco-Flex® Coolant Hose.
 ◆ Green Stripe® PowerBand® Belt May Work, Use Template to Check.

School Buses

Belts and Coolant Hose for School Buses

School Buses

Application	Mfr. Part No.	Our No.
INTERNATIONAL/NAVISTAR - Continued		
1965 - Continued		
International/Navistar VS549 - Continued		
193RE - Continued		
Belt - P.S.; W/44 5/8" Belt O.C.	133758R1	▲9440HD
Belt - Idler; W/56 1/8" Belt O.C.	968645R11	▲9555HD
Belt - Idler; W/57 5/8" Belt O.C.	261710C11	▲9570HD
1964-1963		
International/Navistar BD220		
1603		
Belt - Fan & Alt.; W/37A., 52A., 61A., 62A. Alt.	151532R1	②7512
Belt - Fan & Alt.; W/60A. Alt.	861779R11	②▲9440HD
Belt - Gen.; W/20A., 50A. Alt.	20594VA	TR24438
Belt - Gen.; W/30A. Alt.	81572R2	TR28437
Belt - Gen.; W/35A., 50A. L.C.I. Gen.	164550R1	②▲9425HD
Belt - P.S.; W/Air Brakes	149636R1	▲9480HD
Belt - P.S.; W/Hyd. Brakes	864931R2	▲9319HD
Belt - Air Brake Compr.; W/4 Cu. Ft. Air Brake Compr.	201825R1	▲9440HD
Belt - Air Brake Compr.; W/20A., 30A., 50A. Gen.	115505HA	TR22363
Hose - Upper		●26510
Hose - Lower - Eng. To Pipe		●26508
Hose - Lower - Pipe To Rad.		●26514
Hose - By Pass		20338
Hose - By Pass; (5/8" I.D.)		28441
International/Navistar BD240		
1603		
Belt - Fan & Alt.; W/37A., 52A., 61A., 62A. Alt.	151532R1	②7512
Belt - Fan & Alt.; W/60A. Alt.	861779R11	②▲9440HD
Belt - Gen.; W/20A., 50A. Alt.	20594VA	TR24438
Belt - Gen.; W/30A. Alt.	81572R2	TR28437
Belt - Gen.; W/35A., 50A. L.C.I. Gen.	164550R1	②▲9425HD
Belt - P.S.; W/Air Brakes	149636R1	▲9480HD
Belt - P.S.; W/Hyd. Brakes	864931R2	▲9319HD
Belt - Air Brake Compr.; W/4 Cu. Ft. Air Brake Compr.	201825R1	▲9440HD
Belt - Air Brake Compr.; W/20A., 30A., 50A. Gen.	115505HA	TR22363
Hose - Upper		●26510
Hose - Lower - Eng. To Pipe		●26508
Hose - Lower - Pipe To Rad.		●26514
Hose - By Pass		20338
Hose - By Pass; (5/8" I.D.)		28441
International/Navistar BD264		
1603		
Belt - Fan & Alt.; W/37A., 52A., 61A., 62A. Alt.	151532R1	②7512
Belt - Fan & Alt.; W/60A. Alt.	861779R11	②▲9440HD
Belt - Gen.; W/20A., 50A. Alt.	20594VA	TR24438
Belt - Gen.; W/30A. Alt.	81572R2	TR28437
Belt - Gen.; W/35A., 50A. L.C.I. Gen.	164550R1	②▲9425HD
Belt - P.S.; W/Air Brakes	149636R1	▲9480HD
Belt - P.S.; W/Hyd. Brakes	864931R2	▲9319HD
Belt - Air Brake Compr.; W/4 Cu. Ft. Air Brake Compr.	201825R1	▲9440HD
Belt - Air Brake Compr.; W/20A., 30A., 50A. Gen.	115505HA	TR22363
Hose - Upper		●26510
Hose - Lower - Eng. To Pipe		●26508
Hose - Lower - Pipe To Rad.		●26514
Hose - By Pass		20338
Hose - By Pass; (5/8" I.D.)		28441
International/Navistar BD269		
1603		
Belt - Fan & Alt.	862880R11	②▲9490HD
Belt - P.S.	242269R1	▲9405HD
Belt - Air Brake Compr.	280210C1	▲9540HD
Hose - Upper; (2" I.D.)		24232
Hose - Lower		≧20611
	or	●26509
Hose - By Pass; (2" I.D.)		24232

Application	Mfr. Part No.	Our No.
INTERNATIONAL/NAVISTAR - Continued		
1964-1963 - Continued		
International/Navistar BD269 - Continued		
1703 ; 1803		
Belt - Fan & Alt.	862880R11	②▲9490HD
Belt - P.S.	242269R1	▲9405HD
Belt - Air Brake Compr.	280210C1	▲9540HD
Hose - Upper; (2" I.D.)		24232
Hose - Lower - Eng. To Pipe		≧20206
Hose - Lower - Pipe To Rad.; (2" I.D.)		24232
Hose - By Pass; (2" I.D.)		24232
International/Navistar BD282		
1603		
Belt - Fan & Alt.	862880R11	②▲9490HD
Belt - P.S.	242269R1	▲9405HD
Belt - Air Brake Compr.	280210C1	▲9540HD
Hose - Upper; (2" I.D.)		24232
Hose - Lower		≧20611
	or	●26509
Hose - By Pass; (2" I.D.)		24232
1703 ; 1803		
Belt - Fan & Alt.	862880R11	②▲9490HD
Belt - P.S.	242269R1	▲9405HD
Belt - Air Brake Compr.	280210C1	▲9540HD
Hose - Upper; (2" I.D.)		24232
Hose - Lower - Eng. To Pipe		≧20206
Hose - Lower - Pipe To Rad.; (2" I.D.)		24232
Hose - By Pass; (2" I.D.)		24232
International/Navistar BD308		
1603		
Belt - Fan & Alt.	862880R11	②▲9490HD
Belt - P.S.	242269R1	▲9405HD
Belt - Air Brake Compr.	280210C1	▲9540HD
Hose - Upper; (2" I.D.)		24232
Hose - Lower		≧20611
	or	●26509
Hose - By Pass; (2" I.D.)		24232
1703 ; 1803		
Belt - Fan & Alt.	862880R11	②▲9490HD
Belt - P.S.	242269R1	▲9405HD
Belt - Air Brake Compr.	280210C1	▲9540HD
Hose - Upper; (2" I.D.)		24232
Hose - Lower - Eng. To Pipe		≧20206
Hose - Lower - Pipe To Rad.; (2" I.D.)		24232
Hose - By Pass; (2" I.D.)		24232
International/Navistar BG220		
1603		
Belt - Fan & Alt.; W/37A., 52A., 61A., 62A. Alt.	151532R1	②7512
Belt - Fan & Alt.; W/60A. Alt.	861779R11	②▲9440HD
Belt - Gen.; W/20A., 50A. Alt.	20594VA	TR24438
Belt - Gen.; W/30A. Alt.	81572R2	TR28437
Belt - Gen.; W/35A., 50A. L.C.I. Gen.	164550R1	②▲9425HD
Belt - P.S.; W/Air Brakes	149636R1	▲9480HD
Belt - P.S.; W/Hyd. Brakes	864931R2	▲9319HD
Belt - Air Brake Compr.; W/4 Cu. Ft. Air Brake Compr.	201825R1	▲9440HD
Belt - Air Brake Compr.; W/20A., 30A., 50A. Gen.	115505HA	TR22363
Hose - Upper		●26510
Hose - Lower - Eng. To Pipe		●26508
Hose - Lower - Pipe To Rad.		●26514
Hose - By Pass		20338
Hose - By Pass; (5/8" I.D.)		28441
International/Navistar BG241		
1603		
Belt - Fan & Alt.; W/37A., 52A., 61A., 62A. Alt.	151532R1	②7512
Belt - Fan & Alt.; W/60A. Alt.	861779R11	②▲9440HD
Belt - Gen.; W/20A., 50A. Alt.	20594VA	TR24438
Belt - Gen.; W/30A. Alt.	81572R2	TR28437
Belt - Gen.; W/35A., 50A. L.C.I. Gen.	164550R1	②▲9425HD
Belt - P.S.; W/Air Brakes	149636R1	▲9480HD
Belt - P.S.; W/Hyd. Brakes	864931R2	▲9319HD

▲ Standard Belt Available. See Pages 630-631.
● Vulco-Flex® Coolant Hose.

② Two Required.
≧ Cut to Fit.

Belts and Coolant Hose for School Buses

School Buses

Application	Mfr. Part No.	Our No.
INTERNATIONAL/NAVISTAR - Continued		
1964-1963 - Continued		
International/Navistar V266 - Continued		
1603 - Continued		
Hose - By Pass		✂20357
1703		
Belt - Fan & Alt.; W/37A., 52A. Alt.	255266C11	②7640
Belt - Fan & Alt.; W/55A., 62A. Alt.	968815R11	②7650
Belt - Fan & Alt.; W/60A. Alt.	151533R11	②7673
Belt - P.S.; W/4WD	681956R1	7425
Belt - Air Brake Compr.; W/46 5/8" Belt O.C. .	236572R1	7460
Belt - Air Brake Compr.; W/45 5/8" Belt O.C. .	151531R1	7450
Hose - Upper; W/Rad. Shutters; W/Metal Hood		●26515
Hose - Upper; W/O Rad. Shutters; W/Metal Hood		20493
Hose - Lower - Eng. To Pipe; W/Auto. Trans.		20532
Hose - Lower; W/Man. Trans.		21308
Hose - By Pass		✂20357
1803		
Belt - Fan & Alt.; W/37A., 52A. Alt.	255266C11	②7640
Belt - Fan & Alt.; W/55A., 62A. Alt.	968815R11	②7650
Belt - Fan & Alt.; W/60A. Alt.	151533R11	②7673
Belt - P.S.	151529R1	7440
Belt - Air Brake Compr.; W/46 5/8" Belt O.C. .	236572R1	7460
Belt - Air Brake Compr.; W/45 5/8" Belt O.C. .	151531R1	7450
Hose - Upper; W/Rad. Shutters; W/Metal Hood		●26515
Hose - Upper; W/O Rad. Shutters; W/Metal Hood		20493
Hose - Lower - Eng. To Pipe; W/Auto. Trans.		20532
Hose - Lower; W/Man. Trans.		21308
Hose - By Pass		✂20357
International/Navistar V304		
1603		
Belt - Fan & Alt.; W/37A., 52A. Alt.	255266C11	②7640
Belt - Fan & Alt.; W/55A., 62A. Alt.	968815R11	②7650
Belt - Fan & Alt.; W/60A. Alt.	151533R11	②7673
Belt - P.S.	225532R1	7450
Belt - Air Brake Compr.; W/46 5/8" Belt O.C. .	236572R1	7460
Belt - Air Brake Compr.; W/45 5/8" Belt O.C. .	151531R1	7450
Hose - Upper; W/Rad. Shutters; W/Metal Hood		●26515
Hose - Upper; W/O Rad. Shutters; W/Metal Hood		20493
Hose - Lower - Eng. To Pipe; W/Auto. Trans.		20532
Hose - Lower; W/Man. Trans.		21308
Hose - By Pass		✂20357
1703		
Belt - Fan & Alt.; W/37A., 52A. Alt.	255266C11	②7640
Belt - Fan & Alt.; W/55A., 62A. Alt.	968815R11	②7650
Belt - Fan & Alt.; W/60A. Alt.	151533R11	②7673
Belt - P.S.; W/4WD	681956R1	7425
Belt - Air Brake Compr.; W/46 5/8" Belt O.C. .	236572R1	7460
Belt - Air Brake Compr.; W/45 5/8" Belt O.C. .	151531R1	7450
Hose - Upper; W/Rad. Shutters; W/Metal Hood		●26515
Hose - Upper; W/O Rad. Shutters; W/Metal Hood		20493
Hose - Lower - Eng. To Pipe; W/Auto. Trans.		20532
Hose - Lower; W/Man. Trans.		21308
Hose - By Pass		✂20357
1803		
Belt - Fan & Alt.; W/37A., 52A. Alt.	255266C11	②7640
Belt - Fan & Alt.; W/55A., 62A. Alt.	968815R11	②7650
Belt - Fan & Alt.; W/60A. Alt.	151533R11	②7673
Belt - P.S.	225532R1	7450
Belt - Air Brake Compr.; W/46 5/8" Belt O.C. .	236572R1	7460
Belt - Air Brake Compr.; W/45 5/8" Belt O.C. .	151531R1	7450
Hose - Upper; W/Rad. Shutters; W/Metal Hood		●26515
Hose - Upper; W/O Rad. Shutters; W/Metal Hood		20493
Hose - Lower - Eng. To Pipe; W/Auto. Trans.		20532
Hose - Lower; W/Man. Trans.		21308
Hose - By Pass		✂20357
International/Navistar V345		
1603; 1703		
Belt - Fan & Alt.; W/37A., 52A., 61A. Alt.; C, G, H Chassis; W/P.T.O.	968815R11	②7650
Belt - Fan & Alt.; W/37A., 52A., 61A. Alt.; C, G, H Chassis; W/O P.T.O.	373457C91	②7612

Application	Mfr. Part No.	Our No.
INTERNATIONAL/NAVISTAR - Continued		
1964-1963 - Continued		
International/Navistar V345 - Continued		
1603; 1703 - Continued		
Belt - Fan & Alt.; W/37A., 52A., 61A. Alt.; FD, SB Chassis	968815R1	②7650
Belt - Fan & Alt.; W/37A., 61A. Alt.; W/O Air Brakes; W/O P.T.O.; W/O X.C.	373456C1	7612
Belt - Fan & Alt.; W/55A., 62A. Alt.; C, G, H Chassis	369723C91	②7630
Belt - Fan & Alt.; W/55A., 62A. Alt.; FD, SB Chassis	361975C91	②7673
Belt - Fan & Alt.; W/60A. Alt.	359009C91	②7680
Belt - Fan & Alt.; W/65A., 80A., 105A., 145A. Alt.; W/P.T.O.	361975C91	②7673
Belt - Fan & Alt.; W/65A., 80A., 105A., 145A. Alt.; W/O P.T.O.		②7630
Belt - Fan & Gen.; W/20A. Alt.	151534R11	②7680
Belt - Fan & Gen.; W/30A. Alt.	224638R11	②7695
Belt - Fan & Gen.; W/35A. Alt.	151535R11	②7695
Belt - Fan & Gen.; W/50A. Alt.	151536R11	②7715
Belt - P.S.; W/2WD		7460
Belt - P.S.; W/4WD	285522C2	7435
Belt - Air Brake Compr.	359007C91	7475
Belt - A.P.; W/Air Brakes; W/Gov.	388139C1	7330
Belt - A.P.; W/Air Brakes; W/O Gov.	256062C2	7340
Belt - A.P.; W/Hyd. Brakes; W/Gov.	355653C91	7380
Belt - A.P.; W/Hyd. Brakes; W/O Gov.	362887C91	7410
Hose - Upper; W/Rad. Shutters; W/Metal Hood		●26515
Hose - Upper; W/O Rad. Shutters; W/Metal Hood		20493
Hose - Lower - Eng. To Pipe; W/Auto. Trans.		20532
Hose - Lower; W/Man. Trans.		21308
Hose - By Pass		✂20357
1723		
Belt - Fan & Alt.; W/37A., 52A., 61A. Alt.; C, G, H Chassis; W/P.T.O.	968815R11	②7650
Belt - Fan & Alt.; W/37A., 52A., 61A. Alt.; C, G, H Chassis; W/O P.T.O.	373457C91	②7612
Belt - Fan & Alt.; W/37A., 52A., 61A. Alt.; FD, SB Chassis	968815R1	②7650
Belt - Fan & Alt.; W/37A., 61A. Alt.; W/O Air Brakes; W/O P.T.O.; W/O X.C.	373456C1	7612
Belt - Fan & Alt.; W/55A., 62A. Alt.; C, G, H Chassis	369723C91	②7630
Belt - Fan & Alt.; W/55A., 62A. Alt.; FD, SB Chassis	361975C91	②7673
Belt - Fan & Alt.; W/60A. Alt.	359009C91	②7680
Belt - Fan & Alt.; W/65A., 80A., 105A., 145A. Alt.; W/P.T.O.	361975C91	②7673
Belt - Fan & Alt.; W/65A., 80A., 105A., 145A. Alt.; W/O P.T.O.		②7630
Belt - Fan & Gen.; W/20A. Alt.	151534R11	②7680
Belt - Fan & Gen.; W/30A. Alt.	224638R11	②7695
Belt - Fan & Gen.; W/35A. Alt.	151535R11	②7695
Belt - Fan & Gen.; W/50A. Alt.	151536R11	②7715
Belt - P.S.; W/2WD		7460
Belt - P.S.; W/4WD	285522C2	7435
Belt - Air Brake Compr.	359007C91	7475
Belt - A.P.; W/Air Brakes; W/Gov.	388139C1	7330
Belt - A.P.; W/Air Brakes; W/O Gov.	256062C2	7340
Belt - A.P.; W/Hyd. Brakes; W/Gov.	355653C91	7380
Belt - A.P.; W/Hyd. Brakes; W/O Gov.	362887C91	7410
1803		
Belt - Fan & Alt.; W/37A., 52A., 61A. Alt.; C, G, H Chassis; W/P.T.O.	968815R11	②7650
Belt - Fan & Alt.; W/37A., 52A., 61A. Alt.; C, G, H Chassis; W/O P.T.O.	373457C91	②7612
Belt - Fan & Alt.; W/37A., 52A., 61A. Alt.; FD, SB Chassis	968815R1	②7650
Belt - Fan & Alt.; W/37A., 61A. Alt.; W/O Air Brakes; W/O P.T.O.; W/O X.C.	373456C1	7612
Belt - Fan & Alt.; W/55A., 62A. Alt.; C, G, H Chassis	369723C91	②7630
Belt - Fan & Alt.; W/55A., 62A. Alt.; FD, SB Chassis	361975C91	②7673
Belt - Fan & Alt.; W/60A. Alt.	359009C91	②7680

✂ Cut to Fit.

● Vulco-Flex® Coolant Hose.

② Two Required.

Belts and Coolant Hose for School Buses

Application	Mfr. Part No.	Our No.	Application	Mfr. Part No.	Our No.
INTERNATIONAL/NAVISTAR - Continued			INTERNATIONAL/NAVISTAR - Continued		
1964-1963 - Continued			1964-1963 - Continued		
International/Navistar V345 - Continued			International/Navistar V392 - Continued		
1803 - Continued			1603; 1703 - Continued		
Belt - Fan & Alt.; W/65A., 80A., 105A., 145A. Alt; W/P.T.O.	361975C91	②7673	Belt - P.S.; W/4WD	285522C2	7435
Belt - Fan & Alt.; W/65A., 80A., 105A., 145A. Alt.; W/O P.T.O.	151534R11	②7630	Belt - Air Brake Compr.	359007C91	7475
Belt - Fan & Gen.; W/20A. Alt.	224638R11	②7695	Belt - A.P.; W/Air Brakes; W/Gov.	388139C1	7330
Belt - Fan & Gen.; W/30A. Alt.	151535R11	②7695	Belt - A.P.; W/Air Brakes; W/O Gov.	256062C2	7340
Belt - Fan & Gen.; W/35A. Alt.	151536R11	②7715	Belt - A.P.; W/Hyd. Brakes; W/Gov.	355653C91	7380
Belt - Fan & Gen.; W/50A. Alt.	151536R11	②7715	Belt - A.P.; W/Hyd. Brakes; W/O Gov.	362887C91	7410
Belt - P.S.; W/2WD	7460		Hose - Upper; W/Rad. Shutters; W/Metal Hood	●26515	
Belt - P.S.; W/4WD	285522C2	7435	Hose - Upper; W/O Rad. Shutters; W/Metal Hood	20493	
Belt - Air Brake Compr.	359007C91	7475	Hose - Lower - Eng. To Pipe; W/Auto. Trans.	20532	
Belt - A.P.; W/Air Brakes; W/Gov.	388139C1	7330	Hose - Lower; W/Man. Trans.	21308	
Belt - A.P.; W/Air Brakes; W/O Gov.	256062C2	7340	Hose - By Pass	≧20357	
Belt - A.P.; W/Hyd. Brakes; W/Gov.	355653C91	7380			
Belt - A.P.; W/Hyd. Brakes; W/O Gov.	362887C91	7410	1723		
Hose - Upper; W/Rad. Shutters; W/Metal Hood	●26515		Belt - Fan & Alt.; W/37A., 52A., 61A. Alt.; C, G, H Chassis; W/P.T.O.	968815R11	②7650
Hose - Upper; W/O Rad. Shutters; W/Metal Hood	20493		Belt - Fan & Alt.; W/37A., 52A., 61A. Alt.; C, G, H Chassis; W/O P.T.O.	373457C91	②7612
Hose - Lower - Eng. To Pipe; W/Auto. Trans.	20532		Belt - Fan & Alt.; W/37A., 52A., 61A. Alt.; FD, SB Chassis	968815R1	②7650
Hose - Lower; W/Man. Trans.	21308		Belt - Fan & Alt.; W/37A., 61A. Alt.; W/O Air Brakes; W/O P.T.O.; W/O X.C.	373456C1	7612
Hose - By Pass	≧20357		Belt - Fan & Alt.; W/55A., 62A. Alt.; C, G, H Chassis	369723C91	②7630
			Belt - Fan & Alt.; W/55A., 62A. Alt.; FD, SB Chassis	361975C91	②7673
1823			Belt - Fan & Alt.; W/60A. Alt.	359009C91	②7680
Belt - Fan & Alt.; W/37A., 52A., 61A. Alt.; C, G, H Chassis; W/P.T.O.	968815R11	②7650	Belt - Fan & Alt.; W/65A., 80A., 105A., 145A. Alt; W/P.T.O.	361975C91	②7673
Belt - Fan & Alt.; W/37A., 52A., 61A. Alt.; C, G, H Chassis; W/O P.T.O.	373457C91	②7612	Belt - Fan & Alt.; W/65A., 80A., 105A., 145A. Alt.; W/O P.T.O.	151534R11	②7680
Belt - Fan & Alt.; W/37A., 52A., 61A. Alt.; FD, SB Chassis	968815R1	②7650	Belt - Fan & Gen.; W/20A. Alt.	224638R11	②7695
Belt - Fan & Alt.; W/37A., 61A. Alt.; W/O Air Brakes; W/O P.T.O.; W/O X.C.	373456C1	7612	Belt - Fan & Gen.; W/30A. Alt.	151535R11	②7695
Belt - Fan & Alt.; W/55A., 62A. Alt.; C, G, H Chassis	369723C91	②7630	Belt - Fan & Gen.; W/35A. Alt.	151536R11	②7715
Belt - Fan & Alt.; W/55A., 62A. Alt.; FD, SB Chassis	361975C91	②7673	Belt - P.S.; W/2WD	7460	
Belt - Fan & Alt.; W/60A. Alt.	359009C91	②7680	Belt - P.S.; W/4WD	285522C2	7435
Belt - Fan & Alt.; W/65A., 80A., 105A., 145A. Alt; W/P.T.O.	361975C91	②7673	Belt - Air Brake Compr.	359007C91	7475
Belt - Fan & Alt.; W/65A., 80A., 105A., 145A. Alt.; W/O P.T.O.	151534R11	②7680	Belt - A.P.; W/Air Brakes; W/Gov.	388139C1	7330
Belt - Fan & Gen.; W/20A. Alt.	224638R11	②7695	Belt - A.P.; W/Air Brakes; W/O Gov.	256062C2	7340
Belt - Fan & Gen.; W/30A. Alt.	151535R11	②7695	Belt - A.P.; W/Hyd. Brakes; W/Gov.	355653C91	7380
Belt - Fan & Gen.; W/35A. Alt.	151536R11	②7715	Belt - A.P.; W/Hyd. Brakes; W/O Gov.	362887C91	7410
Belt - Fan & Gen.; W/50A. Alt.	151536R11	②7715			
Belt - P.S.; W/2WD	7460		1803		
Belt - P.S.; W/4WD	285522C2	7435	Belt - Fan & Alt.; W/37A., 52A., 61A. Alt.; C, G, H Chassis; W/P.T.O.	968815R11	②7650
Belt - Air Brake Compr.	359007C91	7475	Belt - Fan & Alt.; W/37A., 52A., 61A. Alt.; C, G, H Chassis; W/O P.T.O.	373457C91	②7612
Belt - A.P.; W/Air Brakes; W/Gov.	388139C1	7330	Belt - Fan & Alt.; W/37A., 52A., 61A. Alt.; FD, SB Chassis	968815R1	②7650
Belt - A.P.; W/Air Brakes; W/O Gov.	256062C2	7340	Belt - Fan & Alt.; W/37A., 61A. Alt.; W/O Air Brakes; W/O P.T.O.; W/O X.C.	373456C1	7612
Belt - A.P.; W/Hyd. Brakes; W/Gov.	355653C91	7380	Belt - Fan & Alt.; W/55A., 62A. Alt.; C, G, H Chassis	369723C91	②7630
Belt - A.P.; W/Hyd. Brakes; W/O Gov.	362887C91	7410	Belt - Fan & Alt.; W/55A., 62A. Alt.; FD, SB Chassis	361975C91	②7673
			Belt - Fan & Alt.; W/60A. Alt.	359009C91	②7680
International/Navistar V392			Belt - Fan & Alt.; W/65A., 80A., 105A., 145A. Alt; W/P.T.O.	361975C91	②7673
1603; 1703			Belt - Fan & Alt.; W/65A., 80A., 105A., 145A. Alt.; W/O P.T.O.	151534R11	②7680
Belt - Fan & Alt.; W/37A., 52A., 61A. Alt.; C, G, H Chassis; W/P.T.O.	968815R11	②7650	Belt - Fan & Gen.; W/20A. Alt.	224638R11	②7695
Belt - Fan & Alt.; W/37A., 52A., 61A. Alt.; C, G, H Chassis; W/O P.T.O.	373457C91	②7612	Belt - Fan & Gen.; W/30A. Alt.	151535R11	②7695
Belt - Fan & Alt.; W/37A., 52A., 61A. Alt.; FD, SB Chassis	968815R1	②7650	Belt - Fan & Gen.; W/35A. Alt.	151536R11	②7715
Belt - Fan & Alt.; W/37A., 61A. Alt.; W/O Air Brakes; W/O P.T.O.; W/O X.C.	373456C1	7612	Belt - P.S.; W/2WD	7460	
Belt - Fan & Alt.; W/55A., 62A. Alt.; C, G, H Chassis	369723C91	②7630	Belt - P.S.; W/4WD	285522C2	7435
Belt - Fan & Alt.; W/55A., 62A. Alt.; FD, SB Chassis	361975C91	②7673	Belt - Air Brake Compr.	359007C91	7475
Belt - Fan & Alt.; W/60A. Alt.	359009C91	②7680	Belt - A.P.; W/Air Brakes; W/Gov.	388139C1	7330
Belt - Fan & Alt.; W/65A., 80A., 105A., 145A. Alt; W/P.T.O.	361975C91	②7673	Belt - A.P.; W/Air Brakes; W/O Gov.	256062C2	7340
Belt - Fan & Alt.; W/65A., 80A., 105A., 145A. Alt.; W/O P.T.O.	151534R11	②7680	Belt - A.P.; W/Hyd. Brakes; W/Gov.	355653C91	7380
Belt - Fan & Gen.; W/20A. Alt.	224638R11	②7695	Belt - A.P.; W/Hyd. Brakes; W/O Gov.	362887C91	7410
Belt - Fan & Gen.; W/30A. Alt.	151535R11	②7695	Hose - Upper; W/Rad. Shutters; W/Metal Hood	●26515	
Belt - Fan & Gen.; W/35A. Alt.	151536R11	②7715	Hose - Upper; W/O Rad. Shutters; W/Metal Hood	20493	
Belt - Fan & Gen.; W/50A. Alt.	151536R11	②7715	Hose - Lower - Eng. To Pipe; W/Auto. Trans.	20532	
Belt - P.S.; W/2WD	7460				

② Two Required.
≧ Cut to Fit.

● Vulco-Flex® Coolant Hose.

Belts and Coolant Hose for School Buses

School Buses

Application	Mfr. Part No.	Our No.
INTERNATIONAL/NAVISTAR - Continued		
1964-1963 - Continued		
International/Navistar V392 - Continued		
1803 - Continued		
Hose - Lower; W/Man. Trans.		21308
Hose - By Pass		≈20357
1823		
Belt - Fan & Alt.; W/37A., 52A., 61A. Alt.; C, G, H Chassis; W/P.T.O.	968815R11	②7650
Belt - Fan & Alt.; W/37A., 52A., 61A. Alt.; C, G, H Chassis; W/O P.T.O.	373457C91	②7612
Belt - Fan & Alt.; W/37A., 52A., 61A. Alt.; FD, SB Chassis	968815R1	②7650
Belt - Fan & Alt.; W/37A., 61A. Alt.; W/O Air Brakes; W/O P.T.O.; W/O X.C.	373456C1	7612
Belt - Fan & Alt.; W/55A., 62A. Alt.; C, G, H Chassis	369723C91	②7630
Belt - Fan & Alt.; W/55A., 62A. Alt.; FD, SB Chassis	361975C91	②7673
Belt - Fan & Alt.; W/60A. Alt.	359009C91	②7680
Belt - Fan & Alt.; W/65A., 80A., 105A., 145A. Alt.; W/P.T.O.	361975C91	②7673
Belt - Fan & Alt.; W/65A., 80A., 105A., 145A. Alt.; W/O P.T.O.		②7630
Belt - Fan & Gen.; W/20A. Alt.	151534R11	②7680
Belt - Fan & Gen.; W/30A. Alt.	224638R11	②7695
Belt - Fan & Gen.; W/35A. Alt.	151535R11	②7695
Belt - Fan & Gen.; W/50A. Alt.	151536R11	②7715
Belt - P.S.; W/2WD		7460
Belt - P.S.; W/4WD	285522C2	7435
Belt - Air Brake Compr.	359007C91	7475
Belt - A.P.; W/Air Brakes; W/Gov.	388139C1	7330
Belt - A.P.; W/Air Brakes; W/O Gov.	256062C2	7340
Belt - A.P.; W/Hyd. Brakes; W/Gov.	355653C91	7380
Belt - A.P.; W/Hyd. Brakes; W/O Gov.	362887C91	7410
International/Navistar V401		
193RE		
Belt - Fan; W/52 5/8" Belt O.C.	680611R11	②◆▲9520HD
Belt - Fan; W/57 5/8" Belt O.C.	261710C11	▲9570HD
Belt - Alt. To Compr.; W/37A., 60A. Alt.	243605R11	▲9451HD
Belt - Alt. To Compr.; W/55A. Alt.	264975C11	▲9455HD
Belt - Gen. To Compr.; W/30A. Gen.	133758R1	▲9440HD
Belt - Gen. To Compr.; W/35A. Gen.	150560R11	▲9451HD
Belt - Gen. To Compr.; W/50A. Gen.	201825R11	▲9435HD
Belt - Gen.; W/Hyd. Brakes	133732R1	▲9360HD
Belt - P.S.; W/43 1/8" Belt O.C.	164550R11	▲9425HD
Belt - P.S.; W/44 5/8" Belt O.C.	133758R1	▲9440HD
Belt - Idler; W/56 1/8" Belt O.C.	968645R11	▲9555HD
Belt - Idler; W/57 5/8" Belt O.C.	261710C11	▲9570HD
International/Navistar V461		
193RE		
Belt - Fan; W/52 5/8" Belt O.C.	680611R11	②◆▲9520HD
Belt - Fan; W/57 5/8" Belt O.C.	261710C11	▲9570HD
Belt - Alt. To Compr.; W/37A., 60A. Alt.	243605R11	▲9451HD
Belt - Alt. To Compr.; W/55A. Alt.	264975C11	▲9455HD
Belt - Gen. To Compr.; W/30A. Gen.	133758R1	▲9440HD
Belt - Gen. To Compr.; W/35A. Gen.	150560R11	▲9451HD
Belt - Gen. To Compr.; W/50A. Gen.	201825R11	▲9435HD
Belt - Gen.; W/Hyd. Brakes	133732R1	▲9360HD
Belt - P.S.; W/43 1/8" Belt O.C.	164550R11	▲9425HD
Belt - P.S.; W/44 5/8" Belt O.C.	133758R1	▲9440HD
Belt - Idler; W/56 1/8" Belt O.C.	968645R11	▲9555HD
Belt - Idler; W/57 5/8" Belt O.C.	261710C11	▲9570HD
International/Navistar V478		
193RE		
Belt - Fan; W/52 5/8" Belt O.C.	680611R11	②◆▲9520HD
Belt - Fan; W/57 5/8" Belt O.C.	261710C11	▲9570HD
Belt - Alt. To Compr.; W/37A., 60A. Alt.	243605R11	▲9451HD
Belt - Alt. To Compr.; W/55A. Alt.	264975C11	▲9455HD
Belt - Gen. To Compr.; W/30A. Gen.	133758R1	▲9440HD
Belt - Gen. To Compr.; W/35A. Gen.	150560R11	▲9451HD
Belt - Gen. To Compr.; W/50A. Gen.	201825R11	▲9435HD
Belt - Gen.; W/Hyd. Brakes	133732R1	▲9360HD
Belt - P.S.; W/43 1/8" Belt O.C.	164550R11	▲9425HD
Belt - P.S.; W/44 5/8" Belt O.C.	133758R1	▲9440HD
Belt - Idler; W/56 1/8" Belt O.C.	968645R11	▲9555HD
Belt - Idler; W/57 5/8" Belt O.C.	261710C11	▲9570HD

Application	Mfr. Part No.	Our No.
INTERNATIONAL/NAVISTAR - Continued		
1964-1963 - Continued		
International/Navistar V478 - Continued		
193RE - Continued		
Belt - P.S.; W/44 5/8" Belt O.C.	133758R1	▲9440HD
Belt - Idler; W/56 1/8" Belt O.C.	968645R11	▲9555HD
Belt - Idler; W/57 5/8" Belt O.C.	261710C11	▲9570HD
International/Navistar V549		
193RE		
Belt - Fan; W/52 5/8" Belt O.C.	680611R11	②◆▲9520HD
Belt - Fan; W/57 5/8" Belt O.C.	261710C11	▲9570HD
Belt - Alt. To Compr.; W/37A., 60A. Alt.	243605R11	▲9451HD
Belt - Alt. To Compr.; W/55A. Alt.	264975C11	▲9455HD
Belt - Gen. To Compr.; W/30A. Gen.	133758R1	▲9440HD
Belt - Gen. To Compr.; W/35A. Gen.	150560R11	▲9451HD
Belt - Gen. To Compr.; W/50A. Gen.	201825R11	▲9435HD
Belt - Gen.; W/Hyd. Brakes	133732R1	▲9360HD
Belt - P.S.; W/43 1/8" Belt O.C.	164550R11	▲9425HD
Belt - P.S.; W/44 5/8" Belt O.C.	133758R1	▲9440HD
Belt - Idler; W/56 1/8" Belt O.C.	968645R11	▲9555HD
Belt - Idler; W/57 5/8" Belt O.C.	261710C11	▲9570HD
International/Navistar VS401		
193RE		
Belt - Fan; W/52 5/8" Belt O.C.	680611R11	②◆▲9520HD
Belt - Fan; W/57 5/8" Belt O.C.	261710C11	▲9570HD
Belt - Alt. To Compr.; W/37A., 60A. Alt.	243605R11	▲9451HD
Belt - Alt. To Compr.; W/55A. Alt.	264975C11	▲9455HD
Belt - Gen. To Compr.; W/30A. Gen.	133758R1	▲9440HD
Belt - Gen. To Compr.; W/35A. Gen.	150560R11	▲9451HD
Belt - Gen. To Compr.; W/50A. Gen.	201825R11	▲9435HD
Belt - Gen.; W/Hyd. Brakes	133732R1	▲9360HD
Belt - P.S.; W/43 1/8" Belt O.C.	164550R11	▲9425HD
Belt - P.S.; W/44 5/8" Belt O.C.	133758R1	▲9440HD
Belt - Idler; W/56 1/8" Belt O.C.	968645R11	▲9555HD
Belt - Idler; W/57 5/8" Belt O.C.	261710C11	▲9570HD
International/Navistar VS478		
193RE		
Belt - Fan; W/52 5/8" Belt O.C.	680611R11	②◆▲9520HD
Belt - Fan; W/57 5/8" Belt O.C.	261710C11	▲9570HD
Belt - Alt. To Compr.; W/37A., 60A. Alt.	243605R11	▲9451HD
Belt - Alt. To Compr.; W/55A. Alt.	264975C11	▲9455HD
Belt - Gen. To Compr.; W/30A. Gen.	133758R1	▲9440HD
Belt - Gen. To Compr.; W/35A. Gen.	150560R11	▲9451HD
Belt - Gen. To Compr.; W/50A. Gen.	201825R11	▲9435HD
Belt - Gen.; W/Hyd. Brakes	133732R1	▲9360HD
Belt - P.S.; W/43 1/8" Belt O.C.	164550R11	▲9425HD
Belt - P.S.; W/44 5/8" Belt O.C.	133758R1	▲9440HD
Belt - Idler; W/56 1/8" Belt O.C.	968645R11	▲9555HD
Belt - Idler; W/57 5/8" Belt O.C.	261710C11	▲9570HD
International/Navistar VS549		
193RE		
Belt - Fan; W/52 5/8" Belt O.C.	680611R11	②◆▲9520HD
Belt - Fan; W/57 5/8" Belt O.C.	261710C11	▲9570HD
Belt - Alt. To Compr.; W/37A., 60A. Alt.	243605R11	▲9451HD
Belt - Alt. To Compr.; W/55A. Alt.	264975C11	▲9455HD
Belt - Gen. To Compr.; W/30A. Gen.	133758R1	▲9440HD
Belt - Gen. To Compr.; W/35A. Gen.	150560R11	▲9451HD
Belt - Gen. To Compr.; W/50A. Gen.	201825R11	▲9435HD
Belt - Gen.; W/Hyd. Brakes	133732R1	▲9360HD
Belt - P.S.; W/43 1/8" Belt O.C.	164550R11	▲9425HD
Belt - P.S.; W/44 5/8" Belt O.C.	133758R1	▲9440HD
Belt - Idler; W/56 1/8" Belt O.C.	968645R11	▲9555HD
Belt - Idler; W/57 5/8" Belt O.C.	261710C11	▲9570HD
1962		
International/Navistar BD220		
1603		
Belt - Fan & Alt.; W/37A., 52A., 61A., 62A. Alt.	151532R1	②7512
Belt - Fan & Alt.; W/60A. Alt.	861779R11	②▲9440HD
Belt - Gen.; W/20A., 50A. Alt.	20594VA	TR24438
Belt - Gen.; W/30A. Alt.	81572R2	TR28437
Belt - Gen.; W/35A., 50A. L.C.I. Gen.	164550R1	②▲9425HD

≈ Cut to Fit.
◆ Green Stripe® PowerBand® Belt May Work, Use Template to Check.

② Two Required.
▲ Standard Belt Available. See Pages 630-631.

Belts and Coolant Hose for School Buses

Application	Mfr. Part No.	Our No.
INTERNATIONAL/NAVISTAR - Continued		
1962 - Continued		
International/Navistar BD220 - Continued		
1603 - Continued		
Belt - P.S.; W/Air Brakes	149636R1	▲9480HD
Belt - P.S.; W/Hyd. Brakes	864931R2	▲9319HD
Belt - Air Brake Compr.; W/4 Cu. Ft. Air Brake Compr.	201825R1	▲9440HD
Belt - Air Brake Compr.; W/20A., 30A., 50A. Gen.	115505HA	TR22363
Hose - Upper		●26510
Hose - Lower - Eng. To Pipe		●26508
Hose - Lower - Pipe To Rad.		●26514
Hose - By Pass		20338
Hose - By Pass; (5/8" I.D.)		28441
International/Navistar BD240		
1603		
Belt - Fan & Alt.; W/37A., 52A., 61A., 62A. Alt.	151532R1	②7512
Belt - Fan & Alt.; W/60A. Alt.	861779R11	②▲9440HD
Belt - Gen.; W/20A., 50A. Alt.	20594VA	TR24438
Belt - Gen.; W/30A. Alt.	81572R2	TR28437
Belt - Gen.; W/35A., 50A. L.C.I. Gen.	164550R1	②▲9425HD
Belt - P.S.; W/Air Brakes	149636R1	▲9480HD
Belt - P.S.; W/Hyd. Brakes	864931R2	▲9319HD
Belt - Air Brake Compr.; W/4 Cu. Ft. Air Brake Compr.	201825R1	▲9440HD
Belt - Air Brake Compr.; W/20A., 30A., 50A. Gen.	115505HA	TR22363
Hose - Upper		●26510
Hose - Lower - Eng. To Pipe		●26508
Hose - Lower - Pipe To Rad.		●26514
Hose - By Pass		20338
Hose - By Pass; (5/8" I.D.)		28441
International/Navistar BD264		
1603		
Belt - Fan & Alt.; W/37A., 52A., 61A., 62A. Alt.	151532R1	②7512
Belt - Fan & Alt.; W/60A. Alt.	861779R11	②▲9440HD
Belt - Gen.; W/20A., 50A. Alt.	20594VA	TR24438
Belt - Gen.; W/30A. Alt.	81572R2	TR28437
Belt - Gen.; W/35A., 50A. L.C.I. Gen.	164550R1	②▲9425HD
Belt - P.S.; W/Air Brakes	149636R1	▲9480HD
Belt - P.S.; W/Hyd. Brakes	864931R2	▲9319HD
Belt - Air Brake Compr.; W/4 Cu. Ft. Air Brake Compr.	201825R1	▲9440HD
Belt - Air Brake Compr.; W/20A., 30A., 50A. Gen.	115505HA	TR22363
Hose - Upper		●26510
Hose - Lower - Eng. To Pipe		●26508
Hose - Lower - Pipe To Rad.		●26514
Hose - By Pass		20338
Hose - By Pass; (5/8" I.D.)		28441
International/Navistar BD269		
1603		
Belt - Fan & Alt.	862880R11	②▲9490HD
Belt - P.S.	242269R1	▲9405HD
Belt - Air Brake Compr.	280210C1	▲9540HD
Hose - Upper; (2" I.D.)		24232
Hose - Lower		≧20611
		or ●26509
Hose - By Pass; (2" I.D.)		24232
1703 ; 1803		
Belt - Fan & Alt.	862880R11	②▲9490HD
Belt - P.S.	242269R1	▲9405HD
Belt - Air Brake Compr.	280210C1	▲9540HD
Hose - Upper; (2" I.D.)		24232
Hose - Lower - Eng. To Pipe		≧20206
Hose - Lower - Pipe To Rad.; (2" I.D.)		24232
Hose - By Pass; (2" I.D.)		24232
International/Navistar BD282		
1603		
Belt - Fan & Alt.	862880R11	②▲9490HD
Belt - P.S.	242269R1	▲9405HD

▲ Standard Belt Available. See Pages 630-631.
② Two Required.

Application	Mfr. Part No.	Our No.
INTERNATIONAL/NAVISTAR - Continued		
1962 - Continued		
International/Navistar BD282 - Continued		
1603 - Continued		
Belt - Air Brake Compr.	280210C1	▲9540HD
Hose - Upper; (2" I.D.)		24232
Hose - Lower		≧20611
		or ●26509
Hose - By Pass; (2" I.D.)		24232
1703 ; 1803		
Belt - Fan & Alt.	862880R11	②▲9490HD
Belt - P.S.	242269R1	▲9405HD
Belt - Air Brake Compr.	280210C1	▲9540HD
Hose - Upper; (2" I.D.)		24232
Hose - Lower - Eng. To Pipe		≧20206
Hose - Lower - Pipe To Rad.; (2" I.D.)		24232
Hose - By Pass; (2" I.D.)		24232
International/Navistar BD308		
1603		
Belt - Fan & Alt.	862880R11	②▲9490HD
Belt - P.S.	242269R1	▲9405HD
Belt - Air Brake Compr.	280210C1	▲9540HD
Hose - Upper; (2" I.D.)		24232
Hose - Lower		≧20611
		or ●26509
Hose - By Pass; (2" I.D.)		24232
1703 ; 1803		
Belt - Fan & Alt.	862880R11	②▲9490HD
Belt - P.S.	242269R1	▲9405HD
Belt - Air Brake Compr.	280210C1	▲9540HD
Hose - Upper; (2" I.D.)		24232
Hose - Lower - Eng. To Pipe		≧20206
Hose - Lower - Pipe To Rad.; (2" I.D.)		24232
Hose - By Pass; (2" I.D.)		24232
International/Navistar BG220		
1603		
Belt - Fan & Alt.; W/37A., 52A., 61A., 62A. Alt.	151532R1	②7512
Belt - Fan & Alt.; W/60A. Alt.	861779R11	②▲9440HD
Belt - Gen.; W/20A., 50A. Alt.	20594VA	TR24438
Belt - Gen.; W/30A. Alt.	81572R2	TR28437
Belt - Gen.; W/35A., 50A. L.C.I. Gen.	164550R1	②▲9425HD
Belt - P.S.; W/Air Brakes	149636R1	▲9480HD
Belt - P.S.; W/Hyd. Brakes	864931R2	▲9319HD
Belt - Air Brake Compr.; W/4 Cu. Ft. Air Brake Compr.	201825R1	▲9440HD
Belt - Air Brake Compr.; W/20A., 30A., 50A. Gen.	115505HA	TR22363
Hose - Upper		●26510
Hose - Lower - Eng. To Pipe		●26508
Hose - Lower - Pipe To Rad.		●26514
Hose - By Pass		20338
Hose - By Pass; (5/8" I.D.)		28441
International/Navistar BG241		
1603		
Belt - Fan & Alt.; W/37A., 52A., 61A., 62A. Alt.	151532R1	②7512
Belt - Fan & Alt.; W/60A. Alt.	861779R11	②▲9440HD
Belt - Gen.; W/20A., 50A. Alt.	20594VA	TR24438
Belt - Gen.; W/30A. Alt.	81572R2	TR28437
Belt - Gen.; W/35A., 50A. L.C.I. Gen.	164550R1	②▲9425HD
Belt - P.S.; W/Air Brakes	149636R1	▲9480HD
Belt - P.S.; W/Hyd. Brakes	864931R2	▲9319HD
Belt - Air Brake Compr.; W/4 Cu. Ft. Air Brake Compr.	201825R1	▲9440HD
Belt - Air Brake Compr.; W/20A., 30A., 50A. Gen.	115505HA	TR22363
Hose - Upper		●26510
Hose - Lower - Eng. To Pipe		●26508
Hose - Lower - Pipe To Rad.		●26514
Hose - By Pass		20338
Hose - By Pass; (5/8" I.D.)		28441

● Vulco-Flex® Coolant Hose.
≧ Cut to Fit.

School Buses

Belts and Coolant Hose for School Buses

School Buses

Application	Mfr. Part No.	Our No.
INTERNATIONAL/NAVISTAR - Continued		
1962 - Continued		
International/Navistar BG265		
1603		
Belt - Fan & Alt.; W/37A., 52A., 61A., 62A. Alt.	151532R1	②7512
Belt - Fan & Alt.; W/60A. Alt.	861779R11	②▲9440HD
Belt - Gen.; W/20A., 50A. Alt.	20594VA	TR24438
Belt - Gen.; W/30A. Alt.	81572R2	TR28437
Belt - Gen.; W/35A., 50A. L.C.I. Gen.	164550R1	②▲9425HD
Belt - P.S.; W/Air Brakes	149636R1	▲9480HD
Belt - P.S.; W/Hyd. Brakes	864931R2	▲9319HD
Belt - Air Brake Compr.; W/4 Cu. Ft. Air Brake Compr.	201825R1	▲9440HD
Belt - Air Brake Compr.; W/20A., 30A., 50A. Gen.	115505HA	TR22363
Hose - Upper		●26510
Hose - Lower - Eng. To Pipe		●26508
Hose - Lower - Pipe To Rad.		●26514
Hose - By Pass		20338
Hose - By Pass; (5/8" I.D.)		28441
International/Navistar FTV549		
193RE		
Belt - Fan; W/52 5/8" Belt O.C.	680611R11	②◆▲9520HD
Belt - Fan; W/57 5/8" Belt O.C.	261710C11	▲9570HD
Belt - Alt. To Compr.; W/37A., 60A. Alt.	243605R11	▲9451HD
Belt - Alt. To Compr.; W/55A. Alt.	264975C11	▲9455HD
Belt - Gen. To Compr.; W/30A. Gen.	133758R1	▲9440HD
Belt - Gen. To Compr.; W/35A. Gen.	150560R11	▲9451HD
Belt - Gen. To Compr.; W/50A. Gen.	201825R11	▲9435HD
Belt - Gen.; W/Hyd. Brakes	133732R1	▲9360HD
Belt - P.S.; W/43 1/8" Belt O.C.	164550R11	▲9425HD
Belt - P.S.; W/44 5/8" Belt O.C.	133758R1	▲9440HD
Belt - Idler; W/56 1/8" Belt O.C.	968645R11	▲9555HD
Belt - Idler; W/57 5/8" Belt O.C.	261710C11	▲9570HD
International/Navistar FTVS549		
193RE		
Belt - Fan; W/52 5/8" Belt O.C.	680611R11	②◆▲9520HD
Belt - Fan; W/57 5/8" Belt O.C.	261710C11	▲9570HD
Belt - Alt. To Compr.; W/37A., 60A. Alt.	243605R11	▲9451HD
Belt - Alt. To Compr.; W/55A. Alt.	264975C11	▲9455HD
Belt - Gen. To Compr.; W/30A. Gen.	133758R1	▲9440HD
Belt - Gen. To Compr.; W/35A. Gen.	150560R11	▲9451HD
Belt - Gen. To Compr.; W/50A. Gen.	201825R11	▲9435HD
Belt - Gen.; W/Hyd. Brakes	133732R1	▲9360HD
Belt - P.S.; W/43 1/8" Belt O.C.	164550R11	▲9425HD
Belt - P.S.; W/44 5/8" Belt O.C.	133758R1	▲9440HD
Belt - Idler; W/56 1/8" Belt O.C.	968645R11	▲9555HD
Belt - Idler; W/57 5/8" Belt O.C.	261710C11	▲9570HD
International/Navistar RD372		
1853		
Belt - Alt.; W/55A., 62A., 145A. Alt.	223794K21	②TR22514
Belt - Gen.; W/37A. Gen.	193826R11	TR22508
Belt - P.S.	240354R1	TR22344
1853FC		
Belt - Alt.; W/55A., 62A., 145A. Alt.	223794K21	②TR22514
Belt - Gen.; W/37A. Gen.	193826R11	TR22508
Belt - P.S.	240354R1	TR22344
Hose - Upper; Late FD Chassis; Chassis No. FA66376		●26509
Hose - Lower; Early FD Chassis; Chassis No. FA66376		●26508
Hose - Lower; Late FD Chassis; Chassis No. FA66376(2 1/8" I.D.)		24234
Hose - Lower; Late FD Chassis; Chassis No. FA66376		●26508
International/Navistar RD406		
1853		
Belt - Alt.; W/55A., 62A., 145A. Alt.	223794K21	②TR22514
Belt - Gen.; W/37A. Gen.	193826R11	TR22508
Belt - P.S.	240354R1	TR22344
1853FC		
Belt - Alt.; W/55A., 62A., 145A. Alt.	223794K21	②TR22514
Belt - Gen.; W/37A. Gen.	193826R11	TR22508
Belt - P.S.	240354R1	TR22344
Hose - Upper; Late FD Chassis; Chassis No. FA66376		●26509

Application	Mfr. Part No.	Our No.
INTERNATIONAL/NAVISTAR - Continued		
1962 - Continued		
International/Navistar RD406 - Continued		
1853FC - Continued		
Hose - Lower; Early FD Chassis; Chassis No. FA66376		●26508
Hose - Lower; Late FD Chassis; Chassis No. FA66376(2 1/8" I.D.)		24234
Hose - Lower; Late FD Chassis; Chassis No. FA66376		●26508
International/Navistar RD450		
1853		
Belt - Alt.; W/55A., 62A., 145A. Alt.	223794K21	②TR22514
Belt - Gen.; W/37A. Gen.	193826R11	TR22508
Belt - P.S.	240354R1	TR22344
1853FC		
Belt - Alt.; W/55A., 62A., 145A. Alt.	223794K21	②TR22514
Belt - Gen.; W/37A. Gen.	193826R11	TR22508
Belt - P.S.	240354R1	TR22344
Hose - Upper; Late FD Chassis; Chassis No. FA66376		●26509
Hose - Lower; Early FD Chassis; Chassis No. FA66376		●26508
Hose - Lower; Late FD Chassis; Chassis No. FA66376(2 1/8" I.D.)		24234
Hose - Lower; Late FD Chassis; Chassis No. FA66376		●26508
International/Navistar RD501		
1853		
Belt - Alt.; W/55A., 62A., 145A. Alt.	223794K21	②TR22514
Belt - Gen.; W/37A. Gen.	193826R11	TR22508
Belt - P.S.	240354R1	TR22344
1853FC		
Belt - Alt.; W/55A., 62A., 145A. Alt.	223794K21	②TR22514
Belt - Gen.; W/37A. Gen.	193826R11	TR22508
Belt - P.S.	240354R1	TR22344
Hose - Upper; Late FD Chassis; Chassis No. FA66376		●26509
Hose - Lower; Early FD Chassis; Chassis No. FA66376		●26508
Hose - Lower; Late FD Chassis; Chassis No. FA66376(2 1/8" I.D.)		24234
Hose - Lower; Late FD Chassis; Chassis No. FA66376		●26508
International/Navistar V266		
1603		
Belt - Fan & Alt.; W/37A., 52A. Alt.	255266C11	②7640
Belt - Fan & Alt.; W/55A., 62A. Alt.	968815R11	②7650
Belt - Fan & Alt.; W/60A. Alt.	151533R11	②7673
Belt - P.S.	151529R1	7440
Belt - Air Brake Compr.; W/46 5/8" Belt O.C.	236572R1	7460
Belt - Air Brake Compr.; W/45 5/8" Belt O.C.	151531R1	7450
Hose - Upper; W/Rad. Shutters; W/Metal Hood		●26515
Hose - Upper; W/O Rad. Shutters; W/Metal Hood		20493
Hose - Lower - Eng. To Pipe; W/Auto. Trans.		20532
Hose - Lower; W/Man. Trans.		21308
Hose - By Pass		≈<20357
1703		
Belt - Fan & Alt.; W/37A., 52A. Alt.	255266C11	②7640
Belt - Fan & Alt.; W/55A., 62A. Alt.	968815R11	②7650
Belt - Fan & Alt.; W/60A. Alt.	151533R11	②7673
Belt - P.S.; W/4WD	681956R1	7425
Belt - Air Brake Compr.; W/46 5/8" Belt O.C.	236572R1	7460
Belt - Air Brake Compr.; W/45 5/8" Belt O.C.	151531R1	7450
Hose - Upper; W/Rad. Shutters; W/Metal Hood		●26515
Hose - Upper; W/O Rad. Shutters; W/Metal Hood		20493
Hose - Lower - Eng. To Pipe; W/Auto. Trans.		20532
Hose - Lower; W/Man. Trans.		21308
Hose - By Pass		≈<20357
1803		
Belt - Fan & Alt.; W/37A., 52A. Alt.	255266C11	②7640
Belt - Fan & Alt.; W/55A., 62A. Alt.	968815R11	②7650
Belt - Fan & Alt.; W/60A. Alt.	151533R11	②7673
Belt - P.S.	151529R1	7440
Belt - Air Brake Compr.; W/46 5/8" Belt O.C.	236572R1	7460
Belt - Air Brake Compr.; W/45 5/8" Belt O.C.	151531R1	7450
Hose - Upper; W/Rad. Shutters; W/Metal Hood		●26515
Hose - Upper; W/O Rad. Shutters; W/Metal Hood		20493
Hose - Lower - Eng. To Pipe; W/Auto. Trans.		20532
Hose - Lower; W/Man. Trans.		21308

② Two Required.
 ● Vulco-Flex® Coolant Hose.
 ≈< Cut to Fit.

◆ Standard Belt Available. See Pages 630-631.
 ◆ Green Stripe® PowerBand® Belt May Work, Use Template to Check.

Belts and Coolant Hose for School Buses

Application	Mfr. Part No.	Our No.
INTERNATIONAL/NAVISTAR - Continued		
1962 - Continued		
International/Navistar V266 - Continued		
1803 - Continued		
Hose - By Pass		≈20357
International/Navistar V304		
1603		
Belt - Fan & Alt.; W/37A., 52A. Alt.	255266C11	②7640
Belt - Fan & Alt.; W/55A., 62A. Alt.	968815R11	②7650
Belt - Fan & Alt.; W/60A. Alt.	151533R11	②7673
Belt - P.S.	225532R1	7450
Belt - Air Brake Compr.; W/46 5/8" Belt O.C. .	236572R1	7460
Belt - Air Brake Compr.; W/45 5/8" Belt O.C. .	151531R1	7450
Hose - Upper; W/Rad. Shutters; W/Metal Hood		●26515
Hose - Upper; W/O Rad. Shutters; W/Metal Hood		20493
Hose - Lower - Eng. To Pipe; W/Auto. Trans.		20532
Hose - Lower; W/Man. Trans.		21308
Hose - By Pass		≈20357
1703		
Belt - Fan & Alt.; W/37A., 52A. Alt.	255266C11	②7640
Belt - Fan & Alt.; W/55A., 62A. Alt.	968815R11	②7650
Belt - Fan & Alt.; W/60A. Alt.	151533R11	②7673
Belt - P.S.; W/4WD	681956R1	7425
Belt - Air Brake Compr.; W/46 5/8" Belt O.C. .	236572R1	7460
Belt - Air Brake Compr.; W/45 5/8" Belt O.C. .	151531R1	7450
Hose - Upper; W/Rad. Shutters; W/Metal Hood		●26515
Hose - Upper; W/O Rad. Shutters; W/Metal Hood		20493
Hose - Lower - Eng. To Pipe; W/Auto. Trans.		20532
Hose - Lower; W/Man. Trans.		21308
Hose - By Pass		≈20357
1803		
Belt - Fan & Alt.; W/37A., 52A. Alt.	255266C11	②7640
Belt - Fan & Alt.; W/55A., 62A. Alt.	968815R11	②7650
Belt - Fan & Alt.; W/60A. Alt.	151533R11	②7673
Belt - P.S.	225532R1	7450
Belt - Air Brake Compr.; W/46 5/8" Belt O.C. .	236572R1	7460
Belt - Air Brake Compr.; W/45 5/8" Belt O.C. .	151531R1	7450
Hose - Upper; W/Rad. Shutters; W/Metal Hood		●26515
Hose - Upper; W/O Rad. Shutters; W/Metal Hood		20493
Hose - Lower - Eng. To Pipe; W/Auto. Trans.		20532
Hose - Lower; W/Man. Trans.		21308
Hose - By Pass		≈20357
International/Navistar V345		
1603; 1703		
Belt - Fan & Alt.; W/37A., 52A., 61A. Alt.; C, G, H Chassis; W/P.T.O.	968815R11	②7650
Belt - Fan & Alt.; W/37A., 52A., 61A. Alt.; C, G, H Chassis; W/O P.T.O.	373457C91	②7612
Belt - Fan & Alt.; W/37A., 52A., 61A. Alt.; FD, SB Chassis	968815R1	②7650
Belt - Fan & Alt.; W/37A., 61A. Alt.; W/O Air Brakes; W/O P.T.O.; W/O X.C.	373456C1	7612
Belt - Fan & Alt.; W/55A., 62A. Alt.; C, G, H Chassis	369723C91	②7630
Belt - Fan & Alt.; W/55A., 62A. Alt.; FD, SB Chassis	361975C91	②7673
Belt - Fan & Alt.; W/60A. Alt.	359009C91	②7680
Belt - Fan & Alt.; W/65A., 80A., 105A., 145A. Alt; W/P.T.O.	361975C91	②7673
Belt - Fan & Alt.; W/65A., 80A., 105A., 145A. Alt.; W/O P.T.O.		②7630
Belt - Fan & Gen.; W/20A. Alt.	151534R11	②7680
Belt - Fan & Gen.; W/30A. Alt.	224638R11	②7695
Belt - Fan & Gen.; W/35A. Alt.	151535R11	②7695
Belt - Fan & Gen.; W/50A. Alt.	151536R11	②7715
Belt - P.S.; W/2WD		7460
Belt - P.S.; W/4WD	285522C2	7435
Belt - Air Brake Compr.	359007C91	7475
Belt - A.P.; W/Air Brakes; W/Gov.	388139C1	7330
Belt - A.P.; W/Air Brakes; W/O Gov.	256062C2	7340
Belt - A.P.; W/Hyd. Brakes; W/Gov.	355653C91	7380
Belt - A.P.; W/Hyd. Brakes; W/O Gov.	362887C91	7410
Hose - Upper; W/Rad. Shutters; W/Metal Hood		●26515
Hose - Upper; W/O Rad. Shutters; W/Metal Hood		20493
Hose - Lower - Eng. To Pipe; W/Auto. Trans.		20532
Hose - Lower; W/Man. Trans.		21308
Hose - By Pass		≈20357

≈ Cut to Fit.
● Vulco-Flex® Coolant Hose.

Application	Mfr. Part No.	Our No.
INTERNATIONAL/NAVISTAR - Continued		
1962 - Continued		
International/Navistar V345 - Continued		
1603; 1703 - Continued		
Hose - Lower - Eng. To Pipe; W/Auto. Trans.		20532
Hose - Lower; W/Man. Trans.		21308
Hose - By Pass		≈20357
1723		
Belt - Fan & Alt.; W/37A., 52A., 61A. Alt.; C, G, H Chassis; W/P.T.O.	968815R11	②7650
Belt - Fan & Alt.; W/37A., 52A., 61A. Alt.; C, G, H Chassis; W/O P.T.O.	373457C91	②7612
Belt - Fan & Alt.; W/37A., 52A., 61A. Alt.; FD, SB Chassis	968815R1	②7650
Belt - Fan & Alt.; W/37A., 61A. Alt.; W/O Air Brakes; W/O P.T.O.; W/O X.C.	373456C1	7612
Belt - Fan & Alt.; W/55A., 62A. Alt.; C, G, H Chassis	369723C91	②7630
Belt - Fan & Alt.; W/55A., 62A. Alt.; FD, SB Chassis	361975C91	②7673
Belt - Fan & Alt.; W/60A. Alt.	359009C91	②7680
Belt - Fan & Alt.; W/65A., 80A., 105A., 145A. Alt; W/P.T.O.	361975C91	②7673
Belt - Fan & Alt.; W/65A., 80A., 105A., 145A. Alt.; W/O P.T.O.		②7630
Belt - Fan & Gen.; W/20A. Alt.	151534R11	②7680
Belt - Fan & Gen.; W/30A. Alt.	224638R11	②7695
Belt - Fan & Gen.; W/35A. Alt.	151535R11	②7695
Belt - Fan & Gen.; W/50A. Alt.	151536R11	②7715
Belt - P.S.; W/2WD		7460
Belt - P.S.; W/4WD	285522C2	7435
Belt - Air Brake Compr.	359007C91	7475
Belt - A.P.; W/Air Brakes; W/Gov.	388139C1	7330
Belt - A.P.; W/Air Brakes; W/O Gov.	256062C2	7340
Belt - A.P.; W/Hyd. Brakes; W/Gov.	355653C91	7380
Belt - A.P.; W/Hyd. Brakes; W/O Gov.	362887C91	7410
Hose - Upper; W/Rad. Shutters; W/Metal Hood		●26515
Hose - Upper; W/O Rad. Shutters; W/Metal Hood		20493
Hose - Lower - Eng. To Pipe; W/Auto. Trans.		20532
Hose - Lower; W/Man. Trans.		21308
Hose - By Pass		≈20357
1823		
Belt - Fan & Alt.; W/37A., 52A., 61A. Alt.; C, G, H Chassis; W/P.T.O.	968815R11	②7650
Belt - Fan & Alt.; W/37A., 52A., 61A. Alt.; C, G, H Chassis; W/O P.T.O.	373457C91	②7612

② Two Required.

School Buses

Belts and Coolant Hose for School Buses

School Buses

Application	Mfr. Part No.	Our No.
INTERNATIONAL/NAVISTAR - Continued		
1962 - Continued		
International/Navistar V345 - Continued		
1823 - Continued		
Belt - Fan & Alt.; W/37A., 52A., 61A. Alt.; FD, SB Chassis	968815R1	②7650
Belt - Fan & Alt.; W/37A., 61A. Alt.; W/O Air Brakes; W/O P.T.O.; W/O X.C.	373456C1	7612
Belt - Fan & Alt.; W/55A., 62A. Alt.; C, G, H Chassis	369723C91	②7630
Belt - Fan & Alt.; W/55A., 62A. Alt.; FD, SB Chassis	361975C91	②7673
Belt - Fan & Alt.; W/60A. Alt.	359009C91	②7680
Belt - Fan & Alt.; W/65A., 80A., 105A., 145A. Alt.; W/P.T.O.	361975C91	②7673
Belt - Fan & Alt.; W/65A., 80A., 105A., 145A. Alt.; W/O P.T.O.	361975C91	②7673
Belt - Fan & Gen.; W/20A. Alt.	151534R11	②7680
Belt - Fan & Gen.; W/30A. Alt.	224638R11	②7695
Belt - Fan & Gen.; W/35A. Alt.	151535R11	②7695
Belt - Fan & Gen.; W/50A. Alt.	151536R11	②7715
Belt - P.S.; W/2WD	7460	7460
Belt - P.S.; W/4WD	285522C2	7435
Belt - Air Brake Compr.	359007C91	7475
Belt - A.P.; W/Air Brakes; W/Gov.	388139C1	7330
Belt - A.P.; W/Air Brakes; W/O Gov.	256062C2	7340
Belt - A.P.; W/Hyd. Brakes; W/Gov.	355653C91	7380
Belt - A.P.; W/Hyd. Brakes; W/O Gov.	362887C91	7410
International/Navistar V392		
1603; 1703		
Belt - Fan & Alt.; W/37A., 52A., 61A. Alt.; C, G, H Chassis; W/P.T.O.	968815R11	②7650
Belt - Fan & Alt.; W/37A., 52A., 61A. Alt.; C, G, H Chassis; W/O P.T.O.	373457C91	②7612
Belt - Fan & Alt.; W/37A., 52A., 61A. Alt.; FD, SB Chassis	968815R1	②7650
Belt - Fan & Alt.; W/37A., 61A. Alt.; W/O Air Brakes; W/O P.T.O.; W/O X.C.	373456C1	7612
Belt - Fan & Alt.; W/55A., 62A. Alt.; C, G, H Chassis	369723C91	②7630
Belt - Fan & Alt.; W/55A., 62A. Alt.; FD, SB Chassis	361975C91	②7673
Belt - Fan & Alt.; W/60A. Alt.	359009C91	②7680
Belt - Fan & Alt.; W/65A., 80A., 105A., 145A. Alt.; W/P.T.O.	361975C91	②7673
Belt - Fan & Alt.; W/65A., 80A., 105A., 145A. Alt.; W/O P.T.O.	361975C91	②7630
Belt - Fan & Gen.; W/20A. Alt.	151534R11	②7680
Belt - Fan & Gen.; W/30A. Alt.	224638R11	②7695
Belt - Fan & Gen.; W/35A. Alt.	151535R11	②7695
Belt - Fan & Gen.; W/50A. Alt.	151536R11	②7715
Belt - P.S.; W/2WD	7460	7460
Belt - P.S.; W/4WD	285522C2	7435
Belt - Air Brake Compr.	359007C91	7475
Belt - A.P.; W/Air Brakes; W/Gov.	388139C1	7330
Belt - A.P.; W/Air Brakes; W/O Gov.	256062C2	7340
Belt - A.P.; W/Hyd. Brakes; W/Gov.	355653C91	7380
Belt - A.P.; W/Hyd. Brakes; W/O Gov.	362887C91	7410
Hose - Upper; W/Rad. Shutters; W/Metal Hood	●26515	26515
Hose - Upper; W/O Rad. Shutters; W/Metal Hood	20493	20493
Hose - Lower - Eng. To Pipe; W/Auto. Trans.	20532	20532
Hose - Lower; W/Man. Trans.	21308	21308
Hose - By Pass	≈20357	≈20357
1723		
Belt - Fan & Alt.; W/37A., 52A., 61A. Alt.; C, G, H Chassis; W/P.T.O.	968815R11	②7650
Belt - Fan & Alt.; W/37A., 52A., 61A. Alt.; C, G, H Chassis; W/O P.T.O.	373457C91	②7612
Belt - Fan & Alt.; W/37A., 52A., 61A. Alt.; FD, SB Chassis	968815R1	②7650
Belt - Fan & Alt.; W/37A., 61A. Alt.; W/O Air Brakes; W/O P.T.O.; W/O X.C.	373456C1	7612
Belt - Fan & Alt.; W/55A., 62A. Alt.; C, G, H Chassis	369723C91	②7630
Belt - Fan & Alt.; W/55A., 62A. Alt.; FD, SB Chassis	361975C91	②7673
Belt - Fan & Alt.; W/60A. Alt.	359009C91	②7680
Belt - Fan & Alt.; W/65A., 80A., 105A., 145A. Alt.; W/P.T.O.	361975C91	②7673
Belt - Fan & Alt.; W/65A., 80A., 105A., 145A. Alt.; W/O P.T.O.	361975C91	②7630
Belt - Fan & Gen.; W/20A. Alt.	151534R11	②7680
Belt - Fan & Gen.; W/30A. Alt.	224638R11	②7695
Belt - Fan & Gen.; W/35A. Alt.	151535R11	②7695
Belt - Fan & Gen.; W/50A. Alt.	151536R11	②7715
Belt - P.S.; W/2WD	7460	7460

Application	Mfr. Part No.	Our No.
INTERNATIONAL/NAVISTAR - Continued		
1962 - Continued		
International/Navistar V392 - Continued		
1723 - Continued		
Belt - Fan & Alt.; W/60A. Alt.	359009C91	②7680
Belt - Fan & Alt.; W/65A., 80A., 105A., 145A. Alt.; W/P.T.O.	361975C91	②7673
Belt - Fan & Alt.; W/65A., 80A., 105A., 145A. Alt.; W/O P.T.O.	361975C91	②7630
Belt - Fan & Gen.; W/20A. Alt.	151534R11	②7680
Belt - Fan & Gen.; W/30A. Alt.	224638R11	②7695
Belt - Fan & Gen.; W/35A. Alt.	151535R11	②7695
Belt - Fan & Gen.; W/50A. Alt.	151536R11	②7715
Belt - P.S.; W/2WD	7460	7460
Belt - P.S.; W/4WD	285522C2	7435
Belt - Air Brake Compr.	359007C91	7475
Belt - A.P.; W/Air Brakes; W/Gov.	388139C1	7330
Belt - A.P.; W/Air Brakes; W/O Gov.	256062C2	7340
Belt - A.P.; W/Hyd. Brakes; W/Gov.	355653C91	7380
Belt - A.P.; W/Hyd. Brakes; W/O Gov.	362887C91	7410
1803		
Belt - Fan & Alt.; W/37A., 52A., 61A. Alt.; C, G, H Chassis; W/P.T.O.	968815R11	②7650
Belt - Fan & Alt.; W/37A., 52A., 61A. Alt.; C, G, H Chassis; W/O P.T.O.	373457C91	②7612
Belt - Fan & Alt.; W/37A., 52A., 61A. Alt.; FD, SB Chassis	968815R1	②7650
Belt - Fan & Alt.; W/37A., 61A. Alt.; W/O Air Brakes; W/O P.T.O.; W/O X.C.	373456C1	7612
Belt - Fan & Alt.; W/55A., 62A. Alt.; C, G, H Chassis	369723C91	②7630
Belt - Fan & Alt.; W/55A., 62A. Alt.; FD, SB Chassis	361975C91	②7673
Belt - Fan & Alt.; W/60A. Alt.	359009C91	②7680
Belt - Fan & Alt.; W/65A., 80A., 105A., 145A. Alt.; W/P.T.O.	361975C91	②7673
Belt - Fan & Alt.; W/65A., 80A., 105A., 145A. Alt.; W/O P.T.O.	361975C91	②7630
Belt - Fan & Gen.; W/20A. Alt.	151534R11	②7680
Belt - Fan & Gen.; W/30A. Alt.	224638R11	②7695
Belt - Fan & Gen.; W/35A. Alt.	151535R11	②7695
Belt - Fan & Gen.; W/50A. Alt.	151536R11	②7715
Belt - P.S.; W/2WD	7460	7460
Belt - P.S.; W/4WD	285522C2	7435
Belt - Air Brake Compr.	359007C91	7475
Belt - A.P.; W/Air Brakes; W/Gov.	388139C1	7330
Belt - A.P.; W/Air Brakes; W/O Gov.	256062C2	7340
Belt - A.P.; W/Hyd. Brakes; W/Gov.	355653C91	7380
Belt - A.P.; W/Hyd. Brakes; W/O Gov.	362887C91	7410
Hose - Upper; W/Rad. Shutters; W/Metal Hood	●26515	26515
Hose - Upper; W/O Rad. Shutters; W/Metal Hood	20493	20493
Hose - Lower - Eng. To Pipe; W/Auto. Trans.	20532	20532
Hose - Lower; W/Man. Trans.	21308	21308
Hose - By Pass	≈20357	≈20357
1823		
Belt - Fan & Alt.; W/37A., 52A., 61A. Alt.; C, G, H Chassis; W/P.T.O.	968815R11	②7650
Belt - Fan & Alt.; W/37A., 52A., 61A. Alt.; C, G, H Chassis; W/O P.T.O.	373457C91	②7612
Belt - Fan & Alt.; W/37A., 52A., 61A. Alt.; FD, SB Chassis	968815R1	②7650
Belt - Fan & Alt.; W/37A., 61A. Alt.; W/O Air Brakes; W/O P.T.O.; W/O X.C.	373456C1	7612
Belt - Fan & Alt.; W/55A., 62A. Alt.; C, G, H Chassis	369723C91	②7630
Belt - Fan & Alt.; W/55A., 62A. Alt.; FD, SB Chassis	361975C91	②7673
Belt - Fan & Alt.; W/60A. Alt.	359009C91	②7680
Belt - Fan & Alt.; W/65A., 80A., 105A., 145A. Alt.; W/P.T.O.	361975C91	②7673
Belt - Fan & Alt.; W/65A., 80A., 105A., 145A. Alt.; W/O P.T.O.	361975C91	②7630
Belt - Fan & Gen.; W/20A. Alt.	151534R11	②7680
Belt - Fan & Gen.; W/30A. Alt.	224638R11	②7695
Belt - Fan & Gen.; W/35A. Alt.	151535R11	②7695
Belt - Fan & Gen.; W/50A. Alt.	151536R11	②7715
Belt - P.S.; W/2WD	7460	7460

② Two Required.
≈ Cut to Fit.

● Vulco-Flex® Coolant Hose.

Belts and Coolant Hose for School Buses

School Buses

Application	Mfr. Part No.	Our No.
INTERNATIONAL/NAVISTAR - Continued		
1961-1958 - Continued		
International/Navistar V401		
193RE		
Belt - Fan; W/52 5/8" Belt O.C.	680611R11	②◆▲9520HD
Belt - Fan; W/57 5/8" Belt O.C.	261710C11	▲9570HD
Belt - Alt. To Compr.; W/37A., 60A. Alt.	243605R11	▲9451HD
Belt - Alt. To Compr.; W/55A. Alt.	264975C11	▲9455HD
Belt - Gen. To Compr.; W/30A. Gen.	133758R1	▲9440HD
Belt - Gen. To Compr.; W/35A. Gen.	150560R11	▲9451HD
Belt - Gen. To Compr.; W/50A. Gen.	201825R11	▲9435HD
Belt - Gen.; W/Hyd. Brakes	133732R1	▲9360HD
Belt - P.S.; W/43 1/8" Belt O.C.	164550R11	▲9425HD
Belt - P.S.; W/44 5/8" Belt O.C.	133758R1	▲9440HD
Belt - Idler; W/56 1/8" Belt O.C.	968645R11	▲9555HD
Belt - Idler; W/57 5/8" Belt O.C.	261710C11	▲9570HD
International/Navistar V461		
193RE		
Belt - Fan; W/52 5/8" Belt O.C.	680611R11	②◆▲9520HD
Belt - Fan; W/57 5/8" Belt O.C.	261710C11	▲9570HD
Belt - Alt. To Compr.; W/37A., 60A. Alt.	243605R11	▲9451HD
Belt - Alt. To Compr.; W/55A. Alt.	264975C11	▲9455HD
Belt - Gen. To Compr.; W/30A. Gen.	133758R1	▲9440HD
Belt - Gen. To Compr.; W/35A. Gen.	150560R11	▲9451HD
Belt - Gen. To Compr.; W/50A. Gen.	201825R11	▲9435HD
Belt - Gen.; W/Hyd. Brakes	133732R1	▲9360HD
Belt - P.S.; W/43 1/8" Belt O.C.	164550R11	▲9425HD
Belt - P.S.; W/44 5/8" Belt O.C.	133758R1	▲9440HD
Belt - Idler; W/56 1/8" Belt O.C.	968645R11	▲9555HD
Belt - Idler; W/57 5/8" Belt O.C.	261710C11	▲9570HD
International/Navistar V478		
193RE		
Belt - Fan; W/52 5/8" Belt O.C.	680611R11	②◆▲9520HD
Belt - Fan; W/57 5/8" Belt O.C.	261710C11	▲9570HD
Belt - Alt. To Compr.; W/37A., 60A. Alt.	243605R11	▲9451HD
Belt - Alt. To Compr.; W/55A. Alt.	264975C11	▲9455HD
Belt - Gen. To Compr.; W/30A. Gen.	133758R1	▲9440HD
Belt - Gen. To Compr.; W/35A. Gen.	150560R11	▲9451HD
Belt - Gen. To Compr.; W/50A. Gen.	201825R11	▲9435HD
Belt - Gen.; W/Hyd. Brakes	133732R1	▲9360HD
Belt - P.S.; W/43 1/8" Belt O.C.	164550R11	▲9425HD
Belt - P.S.; W/44 5/8" Belt O.C.	133758R1	▲9440HD
Belt - Idler; W/56 1/8" Belt O.C.	968645R11	▲9555HD
Belt - Idler; W/57 5/8" Belt O.C.	261710C11	▲9570HD
International/Navistar V549		
193RE		
Belt - Fan; W/52 5/8" Belt O.C.	680611R11	②◆▲9520HD
Belt - Fan; W/57 5/8" Belt O.C.	261710C11	▲9570HD
Belt - Alt. To Compr.; W/37A., 60A. Alt.	243605R11	▲9451HD
Belt - Alt. To Compr.; W/55A. Alt.	264975C11	▲9455HD
Belt - Gen. To Compr.; W/30A. Gen.	133758R1	▲9440HD
Belt - Gen. To Compr.; W/35A. Gen.	150560R11	▲9451HD
Belt - Gen. To Compr.; W/50A. Gen.	201825R11	▲9435HD
Belt - Gen.; W/Hyd. Brakes	133732R1	▲9360HD
Belt - P.S.; W/43 1/8" Belt O.C.	164550R11	▲9425HD
Belt - P.S.; W/44 5/8" Belt O.C.	133758R1	▲9440HD
Belt - Idler; W/56 1/8" Belt O.C.	968645R11	▲9555HD
Belt - Idler; W/57 5/8" Belt O.C.	261710C11	▲9570HD
International/Navistar VS401		
193RE		
Belt - Fan; W/52 5/8" Belt O.C.	680611R11	②◆▲9520HD
Belt - Fan; W/57 5/8" Belt O.C.	261710C11	▲9570HD
Belt - Alt. To Compr.; W/37A., 60A. Alt.	243605R11	▲9451HD
Belt - Alt. To Compr.; W/55A. Alt.	264975C11	▲9455HD
Belt - Gen. To Compr.; W/30A. Gen.	133758R1	▲9440HD
Belt - Gen. To Compr.; W/35A. Gen.	150560R11	▲9451HD
Belt - Gen. To Compr.; W/50A. Gen.	201825R11	▲9435HD
Belt - Gen.; W/Hyd. Brakes	133732R1	▲9360HD
Belt - P.S.; W/43 1/8" Belt O.C.	164550R11	▲9425HD
Belt - P.S.; W/44 5/8" Belt O.C.	133758R1	▲9440HD
Belt - Idler; W/56 1/8" Belt O.C.	968645R11	▲9555HD
Belt - Idler; W/57 5/8" Belt O.C.	261710C11	▲9570HD

② Two Required.
 ▲ Standard Belt Available. See Pages 630-631.
 ≍ Cut to Fit.

Application	Mfr. Part No.	Our No.
INTERNATIONAL/NAVISTAR - Continued		
1961-1958 - Continued		
International/Navistar VS478		
193RE		
Belt - Fan; W/52 5/8" Belt O.C.	680611R11	②◆▲9520HD
Belt - Fan; W/57 5/8" Belt O.C.	261710C11	▲9570HD
Belt - Alt. To Compr.; W/37A., 60A. Alt.	243605R11	▲9451HD
Belt - Alt. To Compr.; W/55A. Alt.	264975C11	▲9455HD
Belt - Gen. To Compr.; W/30A. Gen.	133758R1	▲9440HD
Belt - Gen. To Compr.; W/35A. Gen.	150560R11	▲9451HD
Belt - Gen. To Compr.; W/50A. Gen.	201825R11	▲9435HD
Belt - Gen.; W/Hyd. Brakes	133732R1	▲9360HD
Belt - P.S.; W/43 1/8" Belt O.C.	164550R11	▲9425HD
Belt - P.S.; W/44 5/8" Belt O.C.	133758R1	▲9440HD
Belt - Idler; W/56 1/8" Belt O.C.	968645R11	▲9555HD
Belt - Idler; W/57 5/8" Belt O.C.	261710C11	▲9570HD
International/Navistar VS549		
193RE		
Belt - Fan; W/52 5/8" Belt O.C.	680611R11	②◆▲9520HD
Belt - Fan; W/57 5/8" Belt O.C.	261710C11	▲9570HD
Belt - Alt. To Compr.; W/37A., 60A. Alt.	243605R11	▲9451HD
Belt - Alt. To Compr.; W/55A. Alt.	264975C11	▲9455HD
Belt - Gen. To Compr.; W/30A. Gen.	133758R1	▲9440HD
Belt - Gen. To Compr.; W/35A. Gen.	150560R11	▲9451HD
Belt - Gen. To Compr.; W/50A. Gen.	201825R11	▲9435HD
Belt - Gen.; W/Hyd. Brakes	133732R1	▲9360HD
Belt - P.S.; W/43 1/8" Belt O.C.	164550R11	▲9425HD
Belt - P.S.; W/44 5/8" Belt O.C.	133758R1	▲9440HD
Belt - Idler; W/56 1/8" Belt O.C.	968645R11	▲9555HD
Belt - Idler; W/57 5/8" Belt O.C.	261710C11	▲9570HD
1952-1950		
International/Navistar BG220		
L153		
Belt - Fan & Gen.; W/O 20A., 25A., 40A., 50A. Gen.		TR28445
Belt - Fan & Gen.; W/20A., 25A., 40A., 50A. Gen.		TR28437
Belt - P.S.		7350
Hose - Upper		20206
	or	●26508
Hose - Lower		●26509
Hose - By Pass		20338
MID BUS		
1998		
GM V-8 5.7 L		
SW		
Serpentine Belt; W/O A.C.; W/130A. Alt.	12564760	▲K060875HD
Tensioner Assy.		38103
Tensioner Pulley		38008
Hose - Upper		22357
Hose - Lower		22425
THOMAS BUILT		
2010		
Mercedes-Benz MBE 900 Diesel		
Saf-T-Liner C2		
Belt - Fan & Alt.	0129859724	▲K080680HD
Tensioner Assy. - Fan & Alt.	A9062003170	38567
Hose - Upper - Eng. To Rad.		≍21379
Hose - Lower - Eng. To Pipe		≍21124
Hose - Lower - Pipe To Rad.		≍21521
2009		
Cummins ISB-07 Diesel		
Saf-T-Liner C2		
Belt - Fan, Alt. & A.C.	0123415077	K080813HD
Idler Pulley	4991240	36093
Cummins ISC Diesel		
Saf-T-Liner MVP EF		
Belt - Accessory Drive	3972378	K080889HD

◆ Green Stripe® PowerBand® Belt May Work, Use Template to Check.
 ● Vulco-Flex® Coolant Hose.

Belts and Coolant Hose for School Buses

School Buses

Application	Mfr. Part No.	Our No.
THOMAS BUILT - Continued		
2009 - Continued		
Mercedes-Benz MBE 900 Diesel		
Saf-T-Liner C2		
Belt - Fan & Alt.	0129859724	♣K080680HD
Belt - Fan, Alt. & A.C.	0129859699	♣K080670HD
Tensioner Assy.	A9062003170	38567
Hose - Upper		≈<21379
Hose - Upper - Eng. To Rad.		≈<21379
Hose - Lower - Eng. To Pipe		≈<21124
2008		
Caterpillar C7 Diesel		
Saf-T-Liner C2		
Belt - Fan, Alt. & W.P.	0123415060	♣K080760HD
Tensioner Assy. - Fan, W.P. & Alt.	2201209	38550
Idler Pulley - Grooved	1979642	36341
Idler Pulley - Upper	1979641	36091
Hose - Upper - Eng. To Rad.		22745
Hose - Lower - Rad. To Cooler		20206
Saf-T-Liner HDX		
Belt - Fan & Alt.	61160554	♣K080780HD
Belt - W.P.	0366775	♣9341HD
Tensioner Assy. - Fan & Alt.	1352151	38511
Idler Pulley - W.P.	1154237	36349
Idler Pulley - Fan & Alt.	2534525	36096
Cummins ISB-07 Diesel		
Saf-T-Liner C2		
Belt - Fan, Alt. & W.P.	0123415077	K080813HD
Tensioner Assy. - Fan, W.P. & Alt.	4937433	38631
Mercedes-Benz MBE 900 Diesel		
Saf-T-Liner C2		
Belt - Fan & Alt.	0129859724	♣K080680HD
Tensioner Assy. - Fan & Alt.	A9062003170	38567
Hose - Lower - Eng. To Pipe		≈<21124
Hose - Lower - Pipe To Cooler		20206
Hose - Lower - Cooler To Rad.		≈<21378
2007		
Caterpillar C7 Diesel		
Conventional		
Belt - Fan & Alt.	0127110003	♣K080708HD
Belt - W.P.	0366775	♣9341HD
Saf-T-Liner HDX		
Belt - Fan & Alt.	61160554	♣K080780HD
Belt - W.P.	0366775	♣9341HD
Tensioner Assy. - Fan & Alt.	1352151	38511
Idler Pulley - W.P.	1154237	36349
Idler Pulley - Fan & Alt.	2534525	36096
Saf-T-Liner MVP EF		
Belt - Alt. & W.P.	2737533	♣K080690HD
John Deere 6-Cyl. 8.1 L CNG		
Saf-T-Liner MVP ER		
Tensioner Assy. - A.C.; W/Dual A.C.	RE518097	38507
Mercedes-Benz MBE 900 Diesel		
Conventional		
Belt - Fan & Alt.	0129859718	♣K080675HD
Hose - Upper - Eng. To Rad.		22992
Hose - Lower - Pipe To W.P.		22991
Hose - Lower - Eng. To Pipe		22702
Saf-T-Liner C2		
Belt - Fan & Alt.	0129859724	♣K080680HD
Tensioner Assy. - Fan & Alt.	A9062003170	38567
Hose - Upper		≈<21378
Hose - Lower - Eng. To Pipe		≈<21124
Hose - Lower - Pipe To Rad.		20206

Application	Mfr. Part No.	Our No.
THOMAS BUILT - Continued		
2006		
Caterpillar C7 Diesel		
Saf-T-Liner HDX		
Belt - Fan & Alt.	61160554	♣K080780HD
Belt - W.P.	0366775	♣9341HD
Tensioner Assy. - Fan & Alt.	1352151	38511
Idler Pulley - W.P.	1154237	36349
Idler Pulley - Fan & Alt.	2534525	36096
Saf-T-Liner MVP EF		
Belt - Alt.	2390238	♣K080776HD
Tensioner Assy. - Alt.	2201209	38550
Cummins ISB Diesel		
Saf-T-Liner MVP EF		
Belt - Accessory Drive	3289779	♣K080785HD
Tensioner Assy.	3976833	38517
Idler Pulley	4991240	36093
GM V-8 6.0 L		
Minotour		
Serpentine Belt; W/105A. Alt.	12576450	♣K060923HD
Serpentine Belt; W/145A. Alt.	12576451	♣K060930HD
Belt - A.C.	12576447	♣K040378HD
Tensioner Assy. - A.C.	12580196	38159
Tensioner Assy. - Serpentine	12580162	38158
Tensioner Pulley - Serpentine	12580162	38009
Tensioner Pulley - A.C.	12580196	36169
Idler Pulley - Serpentine	12580771	36299
Hose - Upper		22755
Hose - Lower		22756
John Deere 6-Cyl. 8.1 L CNG		
Saf-T-Liner MVP ER		
Belt - Eng. To Alt.	R128197	♣K080680HD
Tensioner Assy. - Alt.	RE518097	38507
Mercedes-Benz MBE 900 Diesel		
Conventional		
Belt - Fan & Alt.	0129859718	♣K080675HD
Tensioner Assy. - Alt.	9062003170	38567
Hose - Upper - Eng. To Rad.		22992
Hose - Lower - Pipe To W.P.		22991
Hose - Lower - Eng. To Pipe		22702
Saf-T-Liner C2		
Belt - A.C. - Right Side		♣K080820HD
2005		
Caterpillar C7 Diesel		
Saf-T-Liner HDX		
Belt - Fan & Alt.	61160554	♣K080780HD
Belt - W.P.	0366775	♣9341HD
Tensioner Assy. - Fan & Alt.	1352151	38511
Idler Pulley - W.P.	1154237	36349
Idler Pulley - Fan & Alt.	2534525	36096
Saf-T-Liner MVP EF		
Belt - Alt.	2390238	♣K080776HD
Tensioner Assy. - Alt.	2201209	38550
Saf-T-Liner MVP ER		
Belt - Alt. & W.P.	2193303	♣K080733HD
Tensioner Assy. - Alt. & W.P.	2201209	38550
Cummins ISB Diesel		
Saf-T-Liner MVP EF		
Belt - Accessory Drive	3289779	♣K080785HD
Tensioner Assy.	3976833	38517
Idler Pulley	4991240	36093
GM V-8 4.8 L		
Minotour		
Belt - Alt. & W.P.	12576451	♣K060930HD
Belt - A.C.	12576447	♣K040378HD
Tensioner Assy. - Alt. & W.P.	12580162	38158
Tensioner Assy. - A.C.	12580196	38159
Hose - Rad. To Throttle Body		18129

♣ Standard Belt Available. See Pages 630-631.

≈< Cut to Fit.

Belts and Coolant Hose for School Buses

School Buses

Application	Mfr. Part No.	Our No.
THOMAS BUILT - Continued		
2005 - Continued		
GM V-8 6.0 L		
Minotour		
Serpentine Belt; W/105A. Alt.	12576450	▲K060923HD
Serpentine Belt; W/145A. Alt.	12576451	▲K060930HD
Belt - A.C.	12576447	▲K040378HD
Tensioner Assy. - A.C.	12580196	38159
Tensioner Assy. - Serpentine	12580162	38158
Idler Pulley - Serpentine	12580771	36299
Tensioner Pulley - Serpentine	12580162	38009
Tensioner Pulley - A.C.	12580196	36169
Hose - Upper		22755
Hose - Lower		22756
John Deere 6-Cyl. 8.1 L CNG		
Saf-T-Liner MVP ER		
Belt - Eng. To Alt.	R128197	▲K080680HD
Tensioner Assy. - Alt.	RE518097	38507
Mercedes-Benz MBE 900 Diesel		
Conventional		
Belt - Fan & Alt.; W/O A.C.	0127110043	▲K080680HD
Belt - Fan & Alt.; W/A.C.	0127110042	▲K080839HD
Hose - Upper - Eng. To Rad.		22992
Hose - Lower - Pipe To W.P.		22991
Hose - Lower - Eng. To Pipe		22702
Saf-T-Liner C2		
Belt - A.C. - Right Side		▲K080820HD
2004		
Caterpillar 3126 Diesel		
Saf-T-Liner MVP EF		
Belt - Hub & Fan	61160554	▲K080780HD
Belt - W.P.	0366775	▲9341HD
Belt - Alt.	61160587	▲K080797HD
Tensioner Assy. - Fan, Alt. & A.C.	1352151	38511
Tensioner Pulley - Fan, Alt. & A.C.	1352151	36091
Hose - Upper - Eng. To Rad.		≧22668
Hose - Lower - Eng. To Rad.		22996
Saf-T-Liner MVP ER		
Belt - Alt.	61160554	▲K080780HD
Belt - W.P.	0366775	▲9341HD
Belt - A.C.; W/Dual A.C.		▲K060716HD
Tensioner Assy. - Alt.	1352151	38511
Tensioner Pulley - Alt.	1352151	36091
Caterpillar C7 Diesel		
Conventional		
Belt - Fan & Alt.	0127110003	▲K080708HD
Belt - W.P.	0366775	▲9341HD
Hose - Upper - Eng. To Rad.		22668
Saf-T-Liner HDX		
Belt - Fan & Alt.	61160554	▲K080780HD
Belt - W.P.	0366775	▲9341HD
Tensioner Assy. - Fan & Alt.	1352151	38511
Idler Pulley - W.P.	1154237	36349
Idler Pulley - Fan & Alt.	2534525	36096
Saf-T-Liner MVP ER		
Belt - Alt. & W.P.	2193303	▲K080733HD
Tensioner Assy. - Alt. & W.P.	2201209	38550
Cummins ISC Diesel		
Saf-T-Liner MVP ER		
Belt - Eng. To Alt.	3911581	▲K080690HD
GM V-8 4.8 L		
Minotour		
Serpentine Belt; W/105A. Alt.	12576450	▲K060923HD
Serpentine Belt; W/145A. Alt.	12576451	▲K060930HD
Belt - A.C.	12576447	▲K040378HD
Tensioner Assy. - A.C.	12565372	38159
Tensioner Assy. - Serpentine	12554027	38158
Idler Pulley - Serpentine	12580771	36299
Tensioner Pulley - Serpentine	12554027	38009

Application	Mfr. Part No.	Our No.
THOMAS BUILT - Continued		
2004 - Continued		
GM V-8 4.8 L - Continued		
Minotour - Continued		
Tensioner Pulley - A.C.	12565372	36169
Hose - Upper		22755
Hose - Lower		22756
Hose - Heater To Valve		≧28466
John Deere 6-Cyl. 8.1 L CNG		
Saf-T-Liner MVP ER		
Belt - Eng. To Alt.	R128197	▲K080680HD
Tensioner Assy. - Alt.	RE518097	38507
Mercedes-Benz MBE 900 Diesel		
Conventional		
Serpentine Belt	0127110043	▲K080680HD
Hose - Upper - Eng. To Rad.		22701
Hose - Lower - Eng. To Pipe		20611
Hose - Lower - Pipe To Rad.		22702
Saf-T-Liner MVP ER		
Belt - W.P. & Alt.		▲K080680HD
2003		
Caterpillar 3126 Diesel		
Conventional		
Belt - Fan, Alt. & A.C.	0127110003	▲K080708HD
Belt - W.P.	0366775	▲9341HD
Tensioner Assy. - Fan, Alt. & A.C.	1352151	38511
Tensioner Pulley - Fan, Alt. & A.C.	1352151	36091
Hose - Upper - Eng. To Rad.		20735
Hose - Lower - Pipe To Rad.		21473
Saf-T-Liner MVP EF		
Belt - Fan, Alt. & A.C.	61160554	▲K080780HD
Belt - W.P.	0366775	▲9341HD
Tensioner Assy. - Fan, Alt. & A.C.	1352151	38511
Tensioner Pulley - Fan, Alt. & A.C.	1352151	36091
Saf-T-Liner MVP ER		
Belt - Hub & Alt.	61160554	▲K080780HD
Belt - W.P. & Idler	0366775	▲9341HD
Belt - Fan - Left Side	61160591	2/B86
Tensioner Assy. - Hub & Alt.	1352151	38511
Tensioner Pulley - Hub & Alt.	1352151	36091
Cummins ISB Diesel		
Conventional		
Serpentine Belt	3926856	▲K080694HD
Tensioner Assy.	3936213	38516
Tensioner Pulley	3936213	36093
Hose - Upper - Eng. To Rad.		22700
Hose - Lower		21473
Saf-T-Liner MVP ER		
Belt - Alt.	3925953	▲K080585HD
Belt - Fan - From C.S.	61160591	2/B86
Cummins ISC Diesel		
Saf-T-Liner MVP ER		
Serpentine Belt	3911581	▲K080690HD
John Deere 6-Cyl. 8.1 L CNG		
Saf-T-Liner MVP ER		
Belt - Eng. To Alt.	R128197	▲K080680HD
Belt - A.C. To Alt.	13A1105	▲9435HD
Belt - A.C.		BX99
Tensioner Assy. - Eng. To Alt.	RE70535	38507
Tensioner Pulley - Eng. To Alt.	RE70535	36091
Mercedes-Benz MBE 900 Diesel		
Conventional		
Serpentine Belt	0127110043	▲K080680HD
Hose - Upper - Eng. To Rad.		22701
Hose - Lower - Eng. To Pipe		20611
Hose - Lower - Pipe To Rad.		22702
Saf-T-Liner MVP ER		
Belt - W.P. & Alt.		▲K080680HD

▲ Standard Belt Available. See Pages 630-631.

≧ Cut to Fit.

Belts and Coolant Hose for School Buses

Application	Mfr. Part No.	Our No.
THOMAS BUILT - Continued		
2002		
Caterpillar 3116 Diesel		
Saf-T-Liner MVP ER		
Belt - Fan & Alt.		♣K080780HD
Belt - W.P.	7E0744DF	②♣9350HD
Caterpillar 3126 Diesel		
Conventional		
Belt - Fan, Alt. & A.C.	0127110003	♣K080708HD
Belt - W.P.	0366775	♣9341HD
Tensioner Assy. - Fan, Alt. & A.C.	1352151	38511
Tensioner Pulley - Fan, Alt. & A.C.	1352151	36091
Hose - Upper - Eng. To Rad.		20735
Hose - Lower - Pipe To Rad.		21473
Saf-T-Liner MVP EF		
Belt - Fan, Alt. & A.C.	61160554	♣K080780HD
Belt - W.P.		♣9341HD
Tensioner Assy. - Fan, Alt. & A.C.	1352151	38511
Tensioner Pulley - Fan, Alt. & A.C.	1352151	36091
Saf-T-Liner MVP ER		
Belt - Hub & Alt.	61160554	♣K080780HD
Belt - W.P. & Idler	0366775	♣9341HD
Tensioner Assy. - Hub & Alt.	1352151	38511
Tensioner Pulley - Hub & Alt.	1352151	36091
Caterpillar 3208 Diesel		
Saf-T-Liner MVP ER		
Belt - Fan		②♣9730HD
Belt - Alt.	449667C1	②♣9650HD
Belt - P.S.	862880R2	♣9490HD
Cummins ISB Diesel		
Conventional		
Serpentine Belt	3926856	♣K080694HD
Tensioner Assy.	3936213	38516
Tensioner Pulley	3936213	36093
Hose - Upper - Eng. To Rad.		22700
Hose - Lower		21473
Saf-T-Liner MVP EF		
Belt - Fan, Alt. & Hub	3926856	♣K080694HD
Tensioner Assy. - Fan & A.C.	3934823	38513
Tensioner Assy. - Fan, Alt. & Hub	3936213	38516
Tensioner Pulley - Fan, Alt. & Hub	3936213	36093
Tensioner Pulley - Fan & A.C.	3934823	36091
Saf-T-Liner MVP ER		
Belt - Alt.	3925953	♣K080585HD
Belt - Fan - From C.S.	61160591	2/B86
John Deere 6-Cyl. 8.1 L CNG		
Saf-T-Liner MVP ER		
Serpentine Belt	R128197	♣K080680HD
Tensioner Assy.	RE70535	38507
Tensioner Pulley	RE70535	36091
Hose - Upper - Pipe To Rad.: (2" I.D.)		24232
Hose - Upper - Eng. To Pipe		21891

2001

Caterpillar 3116 Diesel		
Saf-T-Liner MVP ER		
Belt - Fan & Alt.		♣K080780HD
Belt - W.P.	7E0744DF	②♣9350HD
Caterpillar 3126 Diesel		
Conventional		
Belt - Fan, Alt. & A.C.	0127110003	♣K080708HD
Belt - W.P.	0366775	♣9341HD
Tensioner Assy. - Fan, Alt. & A.C.	1352151	38511
Tensioner Pulley - Fan, Alt. & A.C.	1352151	36091
Hose - Upper - Eng. To Rad.		20735
Hose - Lower - Pipe To Rad.		21473
Saf-T-Liner MVP EF		
Belt - Fan, Alt. & A.C.	61160554	♣K080780HD
Belt - W.P.		♣9341HD
Tensioner Assy. - Fan, Alt. & A.C.	1352151	38511

♣ Standard Belt Available. See Pages 630-631.

Application	Mfr. Part No.	Our No.
THOMAS BUILT - Continued		
2001 - Continued		
Caterpillar 3126 Diesel - Continued		
Saf-T-Liner MVP EF - Continued		
Tensioner Pulley - Fan, Alt. & A.C.	1352151	36091
Saf-T-Liner MVP ER		
Belt - Hub & Alt.	61160554	♣K080780HD
Belt - W.P. & Idler	0366775	♣9341HD
Belt - Fan	61160591	2/B86
Tensioner Assy. - Hub & Alt.	1352151	38511
Tensioner Pulley - Hub & Alt.	1352151	36091
Caterpillar 3208 Diesel		
Saf-T-Liner MVP ER		
Belt - Fan		②♣9730HD
Belt - Alt.	449667C1	②♣9650HD
Belt - P.S.	862880R2	♣9490HD
Cummins ISB Diesel		
Conventional		
Serpentine Belt	3926856	♣K080694HD
Tensioner Assy.	3936213	38516
Tensioner Pulley	3936213	36093
Hose - Upper - Eng. To Rad.		22669
Hose - Lower - Eng. To Rad.		22670
Saf-T-Liner MVP EF		
Belt - Fan, Alt. & Hub	3926856	♣K080694HD
Belt - Fan & A.C.	2310001067	♣9480HD
Tensioner Assy. - Fan & A.C.	3934823	38513
Tensioner Assy. - Fan, Alt. & Hub	3936213	38516
Tensioner Pulley - Fan, Alt. & Hub	3936213	36093
Tensioner Pulley - Fan & A.C.	3934823	36091
Saf-T-Liner MVP ER		
Belt - Alt.	3925953	♣K080585HD
Belt - Fan - From C.S.	61160591	2/B86
GM V-8 5.7 L		
Minotour		
Serpentine Belt; W/A.C.	12564763	♣K060960HD
Serpentine Belt; W/O A.C.; W/130A. Alt.	12564760	♣K060875HD
Tensioner Assy.; W/O A.C.; W/130A. Alt.		38103
Tensioner Pulley; W/O A.C.; W/130A. Alt.		38008
Hose - Upper		22357
Hose - Lower		22425
John Deere 6-Cyl. 8.1 L CNG		
Saf-T-Liner MVP ER		
Tensioner Assy. - Hub & Alt.	RE70535	38507
Tensioner Pulley - Hub & Alt.	RE70535	36091
2000		
Caterpillar 3116 Diesel		
Saf-T-Liner MVP ER		
Belt - Fan & Alt.		♣K080780HD
Belt - W.P.	7E0744DF	②♣9350HD
Caterpillar 3126 Diesel		
Conventional		
Belt - Fan, Alt. & A.C.	0127110003	♣K080708HD
Belt - W.P.	0366775	♣9341HD
Tensioner Assy. - Fan, Alt. & A.C.	1352151	38511
Tensioner Pulley - Fan, Alt. & A.C.	1352151	36091
Hose - Upper - Eng. To Rad.		22668
Hose - Lower - Pipe To Rad.		21473
Saf-T-Liner MVP EF		
Belt - Fan, Alt. & A.C.	61160554	♣K080780HD
Belt - W.P.	0366775	♣9341HD
Tensioner Assy. - Fan, Alt. & A.C.	1352151	38511
Tensioner Pulley - Fan, Alt. & A.C.	1352151	36091
Caterpillar 3208 Diesel		
Saf-T-Liner MVP ER		
Belt - Fan		②♣9730HD
Belt - Alt.	449667C1	②♣9650HD
Belt - P.S.	862880R2	♣9490HD

② Two Required.

Belts and Coolant Hose for School Buses

School Buses

Application	Mfr. Part No.	Our No.
THOMAS BUILT - Continued		
2000 - Continued		
Cummins ISB Diesel		
Conventional		
Serpentine Belt	3926856	▲K080694HD
Tensioner Assy.	3936213	38516
Tensioner Pulley	3936213	36093
Hose - Upper - Eng. To Rad.	22669	22669
Hose - Lower - Eng. To Rad.	22670	22670
Saf-T-Liner MVP EF		
Belt - Fan, Alt. & Hub	3926856	▲K080694HD
Belt - Fan & A.C.	2310001067	▲9480HD
Tensioner Assy. - Fan & A.C.	3934823	38513
Tensioner Assy. - Fan, Alt. & Hub	3936213	38516
Tensioner Pulley - Fan, Alt. & Hub	3936213	36093
Tensioner Pulley - Fan & A.C.	3934823	36091
Hose - Upper - Eng. To Rad.	22846	22846
Hose - Lower - Eng. To Rad.	22847	22847
Saf-T-Liner MVP ER		
Tensioner Assy. - Alt. & W.P.	3945527	38516
Tensioner Pulley - Alt. & W.P.	3945527	36093
Cummins ISC Diesel		
Saf-T-Liner MVP ER		
Belt - Alt. & W.P.	3911581	▲K080690HD
Belt - A.C. - Left Side		▲9550HD
Belt - A.C. - Right Side		▲9505HD
Tensioner Assy. - Alt. & W.P.	3945527	38516
Tensioner Pulley - Alt. & W.P.	3945527	36093
1999		
Caterpillar 3116 Diesel		
Saf-T-Liner MVP ER		
Belt - Fan & Alt.		▲K080780HD
Belt - W.P.	7E0744DF	②▲9350HD
Belt - A.C.	D137Y070027	2/BX85
Caterpillar 3126 Diesel		
Conventional		
Belt - W.P.	0366775	▲9341HD
Belt - Fan, Alt. & A.C.	0123415043	▲K080708HD
Tensioner Assy. - Fan, Alt. & A.C.	1352151	38511
Tensioner Pulley - Fan, Alt. & A.C.	1352151	36091
Hose - Upper - Eng. To Rad.	22668	22668
Hose - Lower - Pipe To Rad.	21473	21473
Saf-T-Liner MVP EF		
Belt - Fan, Alt. & A.C.	61160554	▲K080780HD
Belt - W.P.	0366775	▲9341HD
Tensioner Assy. - Fan, Alt. & A.C.	1352151	38511
Tensioner Pulley - Fan, Alt. & A.C.	1352151	36091
Caterpillar 3208 Diesel		
Saf-T-Liner MVP ER		
Belt - Fan		②▲9730HD
Belt - Alt.	449667C1	②▲9650HD
Belt - P.S.	862880R2	▲9490HD
Cummins ISB Diesel		
Saf-T-Liner MVP EF		
Serpentine Belt	3926856	▲K080694HD
Saf-T-Liner MVP ER		
Tensioner Assy. - Alt. & W.P.	3945527	38516
Tensioner Pulley - Alt. & W.P.	3945527	36093
1998		
Caterpillar 3116 Diesel		
Saf-T-Liner MVP ER		
Belt - Fan & Alt.		▲K080780HD
Belt - W.P.	7E0744DF	②▲9350HD
Caterpillar 3126 Diesel		
Conventional		
Belt - W.P.	0366775	▲9341HD
Belt - Fan, Alt. & A.C.	0123415043	▲K080708HD
Tensioner Assy. - Fan, Alt. & A.C.	1352151	38511

▲ Standard Belt Available. See Pages 630-631.

Application	Mfr. Part No.	Our No.
THOMAS BUILT - Continued		
1998 - Continued		
Caterpillar 3126 Diesel - Continued		
Conventional - Continued		
Tensioner Pulley - Fan, Alt. & A.C.	1352151	36091
Hose - Upper - Eng. To Rad.		22668
Hose - Lower - Pipe To Rad.		21473
Saf-T-Liner MVP EF		
Belt - Fan, Alt. & A.C.	61160554	▲K080780HD
Tensioner Assy. - Fan, Alt. & A.C.	1352151	38511
Tensioner Pulley - Fan, Alt. & A.C.	1352151	36091
Cummins ISB Diesel		
Saf-T-Liner MVP EF		
Serpentine Belt	3926856	▲K080694HD
Cummins ISC Diesel		
Saf-T-Liner MVP ER		
Belt - Fan		BX85
Belt - A.C. - Left Side		▲9463HD
Belt - Alt. & W.P.		▲K080660HD
Belt - A.C. - Right Side		▲9455HD
Tensioner Assy. - Alt. & W.P.	3937556	38513
Tensioner Pulley - Hub & Alt.	3937556	36091
1997		
Caterpillar 3116 Diesel		
Saf-T-Liner MVP ER		
Belt - Fan & Alt.		▲K080780HD
Belt - W.P.	7E0744DF	②▲9350HD
Caterpillar 3126 Diesel		
Saf-T-Liner MVP EF		
Belt - Fan, Alt. & A.C.	61160554	▲K080780HD
Cummins ISB Diesel		
Saf-T-Liner MVP EF		
Serpentine Belt	3926856	▲K080694HD
1996		
Caterpillar 3116 Diesel		
Saf-T-Liner MVP ER		
Belt - Fan & Alt.		▲K080780HD
Belt - W.P.	7E0744DF	②▲9350HD
Caterpillar 3126 Diesel		
Saf-T-Liner MVP EF		
Belt - Fan, Alt. & A.C.	61160554	▲K080780HD
Cummins B Series 5.9 L Diesel		
Saf-T-Liner MVP EF		
Belt - Alt. & W.P.	3911572	▲K080615HD
Saf-T-Liner MVP ER		
Belt - Eng. To Fan		2/B85
Belt - Alt. & W.P.	3930254	▲K080780HD
Belt - A.C. - Right Side		▲9470HD
Belt - A.C. - Left Side		▲9455HD
International/Navistar T444 Diesel		
Vista		
Serpentine Belt	1822830C1	▲K080893HD
1995		
Caterpillar 3116 Diesel		
Saf-T-Liner MVP ER		
Belt - Fan & Alt.		▲K080780HD
Belt - W.P.	7E0744DF	②▲9350HD
Westcoast-ER		
Belt - Fan & Alt.	61160531	K070685
Caterpillar 3126 Diesel		
Saf-T-Liner MVP EF		
Belt - Fan, Alt. & A.C.	61160554	▲K080780HD
Cummins B Series 5.9 L Diesel		
Saf-T-Liner MVP EF		
Belt - Alt. & W.P.	3911572	▲K080615HD

② Two Required.

Belts and Coolant Hose for School Buses

Application	Mfr. Part No.	Our No.
THOMAS BUILT - Continued		
1995 - Continued		
International/Navistar T444 Diesel		
Vista		
Hose - Upper		22159
Hose - Lower - Eng. To Pipe	21042	21042
Hose - Lower - Pipe To Pipe; (3" I.D.)	24248	24248
Hose - Lower - Pipe To Rad.	21042	21042
1994-1993		
Caterpillar 3116 Diesel		
Saf-T-Liner MVP ER		
Belt - Fan & Alt.		▲K080780HD
Belt - W.P.	7E0744DF	②▲9350HD
Cummins B Series 5.9 L Diesel		
Saf-T-Liner MVP EF		
Belt - Alt. & W.P.	3911572	▲K080615HD
GM V-8 5.7 L		
Minotour		
Serpentine Belt; W/A.C.		▲K060988HD
Serpentine Belt; W/O A.C.		▲K060905HD
Tensioner Assy.; W/A.C.	38107	38107
Tensioner Assy.; W/O A.C.	38106	38106
Idler Pulley	38001	38001
Tensioner Pulley; W/A.C.	38001	38001
Tensioner Pulley; W/O A.C.	38009	38009
Hose - Upper	21191	21191
Hose - Lower	21618	21618
	or	●25530
1992		
Caterpillar 3116 Diesel		
Saf-T-Liner MVP ER		
Belt - Fan & Alt.		▲K080780HD
Belt - W.P.	7E0744DF	②▲9350HD
1991		
Caterpillar 3116 Diesel		
Saf-T-Liner MVP ER		
Belt - Fan & Alt.		▲K080780HD
Belt - W.P.	7E0744DF	②▲9350HD
Cummins B Series 5.9 L Diesel		
Saf-T-Liner MVP ER		
Belt - Alt. & W.P.	5080730	▲K080730HD
Tensioner Assy. - Alt. & W.P.	3914854	38518
Cummins C Series 8.3 L Diesel		
Westcoast-ER		
Serpentine Belt		▲K080610HD
Tensioner Assy.	3936201	38504
Tensioner Pulley	3936201	36091
1990		
Caterpillar 3116 Diesel		
Saf-T-Liner MVP ER		
Belt - Fan & Alt.		▲K080780HD
Belt - W.P.	7E0744DF	②▲9350HD
Caterpillar 3208 Diesel		
Saf-T-Liner MVP ER		
Belt - W.P., Alt. & A.C.; Preferred Belt		2/9650PB
Belt - W.P., Alt. & A.C.; Optional Belt		②▲9650HD
Belt - A.C.		▲9500HD
Belt - Fan		②▲9730HD
Belt - P.S.		▲9385HD
Cummins C Series 8.3 L Diesel		
Westcoast-ER		
Serpentine Belt		▲K080610HD
Tensioner Assy.	3937556	38513
Tensioner Pulley	3937556	36091

✂ Cut to Fit.
 ② Two Required.
 ◆ Green Stripe® PowerBand® Belt May Work, Use Template to Check.

Application	Mfr. Part No.	Our No.
THOMAS BUILT - Continued		
1988		
Caterpillar 3208 Diesel		
Saf-T-Liner MVP ER		
Belt - P.S.		▲9395HD
Belt - J.S.		②▲9495HD
Belt - W.P. & Idler		②▲9495HD
Belt - W.P., Alt. & A.C.; Preferred Belt		2/9650PB
Belt - W.P., Alt. & A.C.; Optional Belt		②▲9650HD
1986		
Caterpillar 3208 Diesel		
22123		
Belt - Fan		②▲9730HD
Belt - W.P.		②▲9470HD
Belt - Alt. & Air Brake Compr.		②▲9650HD
Belt - P.S.		▲9385HD
Hose - Upper - Eng. To Pipe; (2" I.D.)		24232
Hose - Upper - Pipe To Rad.; (2 1/4" I.D.)		24236
Hose - Lower; (2" I.D.)		③24232
Hose - Oil Cooler - Front Inlet		21824
Hose - Oil Cooler - Rear Inlet		21381
Hose - Oil Cooler Outlet		21380
WARD		
1999-1991		
GM V-8 7.4 L		
Volunteer		
Belt - Fan & Alt.		②▲9640HD
Belt - Fan To Air Brake Compr.		▲9470HD
Belt - Fan To P.S.		▲9395HD
Hose - Upper		21107
Hose - Lower - Eng. To Pipe; (2 1/4" I.D.)		24236
Hose - Lower - Pipe To Rad.		✂20756
International/Navistar DT466 Diesel		
Volunteer		
Belt - Fan & Alt.		②▲9690HD
Belt - Fan & Air Brake Compr.		TR22770
Hose - Upper		✂21765
Hose - Lower - Pipe To Rad.		✂20987
1990-1989		
GM V-8 7.4 L		
Volunteer		
Belt - Fan & Alt.		②▲9640HD
Belt - Fan To Air Brake Compr.		▲9470HD
Belt - Fan To P.S.		▲9395HD
Hose - Upper		21107
Hose - Lower - Eng. To Pipe; (2 1/4" I.D.)		24236
Hose - Lower - Pipe To Rad.		✂20756
International/Navistar DT466 Diesel		
Volunteer		
Belt - Fan & Alt.		②▲9690HD
Belt - Fan & Air Brake Compr.		TR22770
Hose - Upper		✂21765
Hose - Lower - Pipe To Rad.		✂20987
International/Navistar DTA360 Diesel		
Senator		
Belt - Fan & Alt.		②▲9700HD
Hose - Upper		●26532
1988-1980		
GM V-8 7.4 L		
Volunteer		
Belt - Fan & Alt.		②▲9640HD
Belt - Fan To Air Brake Compr.		▲9470HD
Belt - Fan To P.S.		▲9395HD
Hose - Upper		21107
Hose - Lower - Eng. To Pipe; (2 1/4" I.D.)		24236
Hose - Lower - Pipe To Rad.		✂20756

▲ Standard Belt Available. See Pages 630-631.
 ● Vulco-Flex® Coolant Hose.
 ③ Three Required.

School Buses

Belts and Coolant Hose for School Buses

Application	Mfr. Part No.	Our No.
WARD - Continued		
1988-1980 - Continued		
International/Navistar DT466 Diesel		
Volunteer		
Belt - Fan & Alt.		②♣9690HD
Belt - Fan & Air Brake Compr.		TR22770
Hose - Upper		✂21765
Hose - Lower - Pipe To Rad.		✂20987

School Buses

② Two Required.
✂ Cut to Fit.

♣ Standard Belt Available. See Pages 630-631.

Belts and Coolant Hose for Transit Buses

Application	Mfr. Part No.	NAPA No.	Application	Mfr. Part No.	NAPA No.
BLUEBIRD - Continued			CHANCE MFG. CO. - Continued		
1996-1994			1985-1983		
Cummins B Series 5.9 L CNG			Caterpillar 3208 Diesel		
Q-Bus RE			RT50; VS24		
Belt - Hub & Alt.		♣K080605HD	Belt - W.P. & P.S.		♣9555HD
Belt - A.C.		②♣9451HD	Belt - W.P. & A.C.		♣9625HD
Tensioner Assy. - Hub & Alt.	3937556	38513	Belt - Alt. & Air Brake Compr.; W/160A. Leece Neville Alt.		②A78
Tensioner Pulley - Hub & Alt.	3937556	36091	Belt - Alt. & Air Brake Compr.; W/190A. Leece Neville Alt.		②9830
CHAMPION BUS			1982-1978		
2003			Caterpillar 3208 Diesel		
Cummins ISB Diesel			RT50		
CTS RE			Belt - W.P. & P.S.		
Belt - A.C.		♣K080585HD	Belt - W.P. & A.C.		♣9625HD
Belt - Alt.	3943348	♣K080738HD	Belt - Alt. & Air Brake Compr.; W/160A. Leece Neville Alt.		②A78
Tensioner Assy. - Alt.	3936213	38516	Belt - Alt. & Air Brake Compr.; W/190A. Leece Neville Alt.		②9830
Tensioner Pulley - Alt.	3936213	36093	CHEVROLET		
2002			1968-1964		
Ford V-10 6.8 L			GMC D478 Diesel		
Challenger; Crusader			TDH3501; TDH3502; TDH3502A		
Serpentine Belt; W/A.C.		♣K080991HD	Belt - Fan	2465849	TR22792
Serpentine Belt; W/O A.C.		♣K080806HD	Belt - W.P. & Alt.	2466318	③♣9630HD
Tensioner Assy.; W/A.C.		38133	Belt - Alt.; W/A.C.	668850	♣9425HD
Idler Pulley		38022	Belt - Air Brake Compr.	2463090	♣9660HD
Tensioner Pulley - Smooth; W/A.C.		38023	Belt - A.C.	78283	5VX850
Hose - Upper		22316	GMC DH478 Diesel		
Hose - Lower		22371	TDH3501; TDH3502; TDH3502A		
CHANCE MFG. CO.			Belt - Fan		
2000-1993			Belt - W.P. & Alt.		
Caterpillar 3208 Diesel			Belt - Alt.; W/A.C.		
RT52			Belt - Air Brake Compr.		
Belt - W.P. & P.S.		♣9555HD	Belt - A.C.		5VX850
Belt - W.P. & A.C.		♣9625HD	EAGLE		
Belt - Alt. & Air Brake Compr.; W/160A. Leece Neville Alt.		②A78	1990-1989		
Belt - Alt. & Air Brake Compr.; W/190A. Leece Neville Alt.		②9830	Detroit Diesel 6V-92 Diesel		
1992			Eagle 12		
American Motors 6-Cyl. 258			Belt - Alt.		
Sunliner			③3VX450		
Belt - W.P. & Alt.		♣9470HD	Detroit Diesel 8V-71 Diesel		
Belt - W.P. & Air Compr.		♣9530HD	Eagle 12		
Belt - P.S.		♣9405HD	Belt - Alt.		
Caterpillar 3208 Diesel			③3VX450		
RT52			1988-1980		
Belt - W.P. & P.S.		♣9555HD	Detroit Diesel 6V-92 Diesel		
Belt - W.P. & A.C.		♣9625HD	Eagle 10		
Belt - Alt. & Air Brake Compr.; W/160A. Leece Neville Alt.		②A78	Belt - Alt.		
Belt - Alt. & Air Brake Compr.; W/190A. Leece Neville Alt.		②9830	③3VX450		
1991-1990			Detroit Diesel 8V-71 Diesel		
Caterpillar 3208 Diesel			Eagle 10		
RT52			Belt - Alt.		
Belt - W.P. & P.S.		♣9555HD	③3VX450		
Belt - W.P. & A.C.		♣9625HD	1979-1974		
Belt - Alt. & Air Brake Compr.; W/160A. Leece Neville Alt.		②A78	Detroit Diesel 6V-92 Diesel		
Belt - Alt. & Air Brake Compr.; W/190A. Leece Neville Alt.		②9830	Eagle 05; Eagle 07		
1989-1986			Belt - Alt.		
Caterpillar 3208 Diesel			③3VX450		
RT52; VS24			1988-1980		
Belt - W.P. & P.S.		♣9555HD	Detroit Diesel 6V-92 Diesel		
Belt - W.P. & A.C.		♣9625HD	Eagle 10		
Belt - Alt. & Air Brake Compr.; W/160A. Leece Neville Alt.		②A78	Belt - Alt.		
Belt - Alt. & Air Brake Compr.; W/190A. Leece Neville Alt.		②9830	③3VX450		
1989-1986			1972		
Caterpillar 3208 Diesel			Detroit Diesel 6V-92 Diesel		
RT52; VS24			Silver Eagle		
Belt - W.P. & P.S.		♣9555HD	Belt - Gen.		
Belt - W.P. & A.C.		♣9625HD	②TR24438		
Belt - Alt. & Air Brake Compr.; W/160A. Leece Neville Alt.		②A78	Detroit Diesel 8V-71 Diesel		
Belt - Alt. & Air Brake Compr.; W/190A. Leece Neville Alt.		②9830	Silver Eagle		
			Belt - Gen.		
			②TR24438		

♣ Standard Belt Available. See Pages 630-631.
 ③ Three Required.

② Two Required.

Belts and Coolant Hose for Transit Buses

Transit Buses

Application	Mfr. Part No.	NAPA No.	Application	Mfr. Part No.	NAPA No.
EAGLE - Continued			FLXIBLE		
1971-1968			1996-1995		
Detroit Diesel 6V-92 Diesel Golden Eagle; Silver Eagle Belt - Gen.			Cummins L10 Diesel Metro Belt - Alt.; W/OEM Alt. Mount Belt - Alt.; W/O OEM Alt. Mount		
		②TR24438			♣K120606HD ♣K120610HD
Detroit Diesel 8V-71 Diesel Golden Eagle; Silver Eagle Belt - Gen.			Metro 106 Belt - Alt. Belt - Compr.		
		②TR24438		97607900002 97607900001	K040360 ♣K120525HD
1967			Cummins M11 Diesel		
Detroit Diesel 6V-92 Diesel Eagle 01 Belt - Alt.			Metro Belt - Alt.; W/OEM Alt. Mount Belt - Alt.; W/O OEM Alt. Mount		
		③3VX450			♣K120606HD ♣K120610HD
Golden Eagle; Silver Eagle Belt - Gen.			1994		
		②TR24438	Cummins L10 Diesel		
Detroit Diesel 8V-71 Diesel Eagle 01 Belt - Alt.			Metro Belt - Alt.; W/OEM Alt. Mount Belt - Alt.; W/O OEM Alt. Mount		
		③3VX450			♣K120606HD ♣K120610HD
Golden Eagle; Silver Eagle Belt - Gen.			Metro 106 Belt - Alt. Belt - Compr.		
		②TR24438		97607900002 97607900001	K040360 ♣K120525HD
1966-1963			Cummins M11 Diesel		
Detroit Diesel 6V-92 Diesel Golden Eagle Belt - Gen.			Metro Belt - Alt.; W/OEM Alt. Mount Belt - Alt.; W/O OEM Alt. Mount		
		②TR24438			♣K120606HD ♣K120610HD
Detroit Diesel 8V-71 Diesel Golden Eagle Belt - Gen.			Detroit Diesel 6V-71 Diesel		
		②TR24438	53101 Belt - Alt.; W/Charging System Belt - Alt.; W/A.C.; W/39 1/2" Belt O.C. Belt - Alt.; W/A.C.; W/40 1/2" Belt O.C.		
EL DORADO					③TR22664 ♣K060390HD ♣K060400HD
2006			Detroit Diesel 8V-71 Diesel		
International/Navistar DT466 Diesel Aero Elite Belt - Fan, Alt. & A.C.			53101 Belt - Alt.; W/Charging System Belt - Alt.; W/A.C.; W/39 1/2" Belt O.C. Belt - Alt.; W/A.C.; W/40 1/2" Belt O.C.		
	1842457C1	♣K080825HD			③TR22664 ♣K060390HD ♣K060400HD
2005			Detroit Diesel Series 50 Diesel		
Cummins ISB Diesel EZ-Rider II Belt - Eng. To J.S. Tensioner Assy. - Alt. & W.P. Tensioner Pulley - Alt. & W.P.			40102-4D Belt - A.C. Metro Belt - Hub & Alt. Tensioner Assy. - Hub & Alt. Tensioner Pulley - Hub & Alt.		
		2/B90 3936213 3936213			6601 ♣K100381HD 38505 36091
2003			1993-1992		
Cummins ISC Diesel EZ-Rider Belt - Eng. To J.S. Belt - A.C.			Cummins L10 Diesel Metro Belt - Alt.; W/OEM Alt. Mount Belt - Alt.; W/O OEM Alt. Mount		
		6599 ②B90			♣K120606HD ♣K120610HD
1997			Metro 106 Belt - Alt. Belt - Compr.		
Cummins ISC Diesel EZ-Rider Belt - Eng. To Alt. Belt - A.C. Belt - A.C. To Alt. Tensioner Assy. - Eng. To Alt.			97607900002 97607900001		
		♣K080653HD 2/B85 ②♣9463HD 38525			K040360 ♣K120525HD
1990-1984			Cummins M11 Diesel		
Ford V-8 7.5 L MST2600 Belt - Fan & P.S. Belt - Fan & A.C. Belt - Alt. Belt - A.P.			Metro Belt - Alt.; W/OEM Alt. Mount Belt - Alt.; W/O OEM Alt. Mount		
	RW23830	7500 ♣9600HD 7395 7340			♣K120606HD ♣K120610HD
			Detroit Diesel 6V-71 Diesel		
			53101 Belt - Alt.; W/Charging System Belt - Alt.; W/A.C.; W/39 1/2" Belt O.C. Belt - Alt.; W/A.C.; W/40 1/2" Belt O.C.		
					③TR22664 ♣K060390HD ♣K060400HD
			Detroit Diesel 8V-71 Diesel		
			53101 Belt - Alt.; W/Charging System Belt - Alt.; W/A.C.; W/39 1/2" Belt O.C. Belt - Alt.; W/A.C.; W/40 1/2" Belt O.C.		
					③TR22664 ♣K060390HD ♣K060400HD

② Two Required.

♣ Standard Belt Available. See Pages 630-631.

③ Three Required.

Belts and Coolant Hose for Transit Buses

Application	Mfr. Part No.	NAPA No.
FLXIBLE - Continued		
1991		
Cummins L10 Diesel		
Metro		
Belt - Alt.; W/OEM Alt. Mount		♣K120606HD
Belt - Alt.; W/O OEM Alt. Mount		♣K120610HD
Cummins M11 Diesel		
Metro		
Belt - Alt.; W/OEM Alt. Mount		♣K120606HD
Belt - Alt.; W/O OEM Alt. Mount		♣K120610HD
Detroit Diesel 6V-71 Diesel		
53101		
Belt - Alt.; W/Charging System		③TR22664
Belt - Alt.; W/A.C.; W/39 1/2" Belt O.C.	9120626	♣K060390HD
Belt - Alt.; W/A.C.; W/40 1/2" Belt O.C.	9120625	♣K060400HD
Detroit Diesel 8V-71 Diesel		
53101		
Belt - Alt.; W/Charging System		③TR22664
Belt - Alt.; W/A.C.; W/39 1/2" Belt O.C.	9120626	♣K060390HD
Belt - Alt.; W/A.C.; W/40 1/2" Belt O.C.	9120625	♣K060400HD
1990		
Cummins L10 Diesel		
40096-6C		
Belt - Alt.	3097268	♣K100575HD
Metro		
Belt - Alt.	97607900015	♣K100607HD
Belt - A.C.	97609500010	2/5VX800
Tensioner Assy. - Alt.	23512829	38505
Tensioner Pulley - Alt.	23512829	36091
Detroit Diesel Series 60 Diesel		
Metro		
Belt - A.C.		2/5VX710
1989-1988		
Cummins L10 Diesel		
Metro		
Belt - Alt.	97607900015	♣K100607HD
Belt - A.C.	97609500010	2/5VX800
Tensioner Assy. - Alt.	23512829	38505
Tensioner Pulley - Alt.	23512829	36091
Metro Flex		
Serpentine Belt	3097270	♣K100594HD
1987		
Cummins L10 Diesel		
Metro Flex		
Serpentine Belt	3097270	♣K100594HD
1978-1974		
Detroit Diesel 6V-71 Diesel		
3135096		
Belt - Alt.; W/Charging System		③TR22664
Belt - Alt.; W/A.C.; W/39 1/2" Belt O.C.	9120626	♣K060390HD
Belt - Alt.; W/A.C.; W/40 1/2" Belt O.C.	9120625	♣K060400HD
Detroit Diesel 8V-71 Diesel		
3135096		
Belt - Alt.; W/Charging System		③TR22664
Belt - Alt.; W/A.C.; W/39 1/2" Belt O.C.	9120626	♣K060390HD
Belt - Alt.; W/A.C.; W/40 1/2" Belt O.C.	9120625	♣K060400HD
1973-1969		
Detroit Diesel 6V-71 Diesel		
111CC0061		
Belt - Alt.; W/Charging System		③TR22664
Belt - Alt.; W/A.C.; W/39 1/2" Belt O.C.	9120626	♣K060390HD
Belt - Alt.; W/A.C.; W/40 1/2" Belt O.C.	9120625	♣K060400HD

Application	Mfr. Part No.	NAPA No.
FLXIBLE - Continued		
1973-1969 - Continued		
Detroit Diesel 8V-71 Diesel		
111CC0061		
Belt - Alt.; W/Charging System		③TR22664
Belt - Alt.; W/A.C.; W/39 1/2" Belt O.C.	9120626	♣K060390HD
Belt - Alt.; W/A.C.; W/40 1/2" Belt O.C.	9120625	♣K060400HD
1968-1966		
Detroit Diesel 6V-71 Diesel		
111CC0061		
Belt - Alt.; W/Charging System		③TR22664
Belt - Alt.; W/A.C.; W/39 1/2" Belt O.C.	9120626	♣K060390HD
Belt - Alt.; W/A.C.; W/40 1/2" Belt O.C.	9120625	♣K060400HD
F2D6V		
Belt - Fan	104021	②TR22711
Belt - Alt.; W/4 1/8", 4 3/8" Dia. Alt. Pulleys ...	910133	③TR22648
Belt - Alt.; W/5 1/2" Dia. Alt. Pulley	99061	③TR22664
Belt - Air Brake Compr.	99841	②TR22770
Detroit Diesel 8V-71 Diesel		
111CC0061		
Belt - Alt.; W/Charging System		③TR22664
Belt - Alt.; W/A.C.; W/39 1/2" Belt O.C.	9120626	♣K060390HD
Belt - Alt.; W/A.C.; W/40 1/2" Belt O.C.	9120625	♣K060400HD
F2D6V		
Belt - Fan	104021	②TR22711
Belt - Alt.; W/4 1/8", 4 3/8" Dia. Alt. Pulleys ...	910133	③TR22648
Belt - Alt.; W/5 1/2" Dia. Alt. Pulley	99061	③TR22664
Belt - Air Brake Compr.	99841	②TR22770
1965-1961		
Detroit Diesel 6V-71 Diesel		
F2D6V		
Belt - Fan	104021	②TR22711
Belt - Alt.; W/4 1/8", 4 3/8" Dia. Alt. Pulleys ...	910133	③TR22648
Belt - Alt.; W/5 1/2" Dia. Alt. Pulley	99061	③TR22664
Belt - Air Brake Compr.	99841	②TR22770
Detroit Diesel 8V-71 Diesel		
F2D6V		
Belt - Fan	104021	②TR22711
Belt - Alt.; W/4 1/8", 4 3/8" Dia. Alt. Pulleys ...	910133	③TR22648
Belt - Alt.; W/5 1/2" Dia. Alt. Pulley	99061	③TR22664
Belt - Air Brake Compr.	99841	②TR22770
1948-1947		
Chrysler V-8 413		
TC31 Twin Coach		
Belt - Fan	10114	♣9540HD
Belt - W.P. & Alt.; W/12V. System		②◆9660HD
Belt - Alt.; W/24V. System	A19348	②7430
Belt - Air Brake Compr.		♣9740HD
Belt - A.C.; W/6 1/4" Dia. Pulley		♣9451HD
Belt - A.C.; W/10 1/4" Dia. Pulley	A19347	♣9500HD
Chrysler V-8 440		
PC31 Twin Coach		
Belt - W.P. & Alt.; W/12V. System	962653	②7580
Belt - Alt.; W/24V. System	68597	7560
Belt - Air Brake Compr.		9765
Belt - A.C.	962651	♣9720HD
1946-1943		
Chrysler V-8 413		
TC25 Twin Coach		
Belt - Fan	10114	♣9540HD
Belt - W.P. & Alt.; W/12V. System		②◆9660HD
Belt - Alt.; W/24V. System	A19348	②7430
Belt - Air Brake Compr.		♣9740HD
Belt - A.C.; W/6 1/4" Dia. Pulley		♣9451HD
Belt - A.C.; W/10 1/4" Dia. Pulley	A19347	♣9500HD
Hose - Upper		≈<20611
Hose - Lower - Eng. To Pipe; (2" I.D.)		24232

♣ Standard Belt Available. See Pages 630-631.
 ② Two Required.
 ≈< Cut to Fit.

③ Three Required.
 ◆ PowerBand® Belt May Work, Use Template to Check.

Belts and Coolant Hose for Transit Buses

Transit Buses

Application	Mfr. Part No.	NAPA No.
FLXIBLE - Continued		
1946-1943 - Continued		
Chrysler V-8 413 - Continued		
TC25 Twin Coach - Continued		
Hose - Lower - Pipe To Rad.; (2" I.D.)		24232
TC31 Twin Coach		
Belt - Fan	10114	◆9540HD
Belt - W.P. & Alt.; W/12V. System		②◆9660HD
Belt - Alt.; W/24V. System	A19348	②7430
Belt - Air Brake Compr.		◆9740HD
Belt - A.C.; W/6 1/4" Dia. Pulley		◆9451HD
Belt - A.C.; W/10 1/4" Dia. Pulley	A19347	◆9500HD
Chrysler V-8 440		
PC31 Twin Coach		
Belt - W.P. & Alt.; W/12V. System	962653	②7580
Belt - Alt.; W/24V. System	68597	7560
Belt - Air Brake Compr.		9765
Belt - A.C.	962651	◆9720HD
1942		
Chrysler V-8 413		
TC25 Twin Coach		
Belt - Fan	10114	◆9540HD
Belt - W.P. & Alt.; W/12V. System		②◆9660HD
Belt - Alt.; W/24V. System	A19348	②7430
Belt - Air Brake Compr.		◆9740HD
Belt - A.C.; W/6 1/4" Dia. Pulley		◆9451HD
Belt - A.C.; W/10 1/4" Dia. Pulley	A19347	◆9500HD
Hose - Upper		≅20611
Hose - Lower - Eng. To Pipe; (2" I.D.)		24232
Hose - Lower - Pipe To Rad.; (2" I.D.)		24232
GILLIG		
2010		
Cummins ISL Diesel		
Low Floor		
Belt - A.C.	530222076	2/5V1020
Tensioner Assy. - A.C.		38655
2009-2006		
Cummins ISL Diesel		
Low Floor		
Belt - A.C.	530222076	2/5V1020
Tensioner Assy. - A.C.		38655
Cummins ISM Diesel		
Low Floor		
Belt - A.C.	530222076	2/5V1020
Tensioner Assy. - A.C.		38655
2005		
Cummins ISB Diesel		
Phantom		
Belt - Alt.	3288598	◆K080471HD
Cummins ISL Diesel		
Low Floor		
Belt - A.C.	530222076	2/5V1020
Tensioner Assy. - A.C.		38655
Cummins ISM Diesel		
Low Floor		
Belt - A.C.	530222076	2/5V1020
Tensioner Assy. - A.C.		38655
Detroit Diesel Series 50 Diesel		
Low Floor		
Belt - A.C.	530222076	2/5V1020
Tensioner Assy. - A.C.		38655

◆ Standard Belt Available. See Pages 630-631.
◆ PowerBand® Belt May Work, Use Template to Check.

Application	Mfr. Part No.	NAPA No.
GILLIG - Continued		
2004		
Cummins ISL Diesel		
Low Floor		
Belt - A.C.	530222076	2/5V1020
Tensioner Assy. - A.C.		38655
Detroit Diesel Series 50 Diesel		
Low Floor		
Belt - A.C.	530222076	2/5V1020
Tensioner Assy. - A.C.		38655
2003		
Cummins ISL Diesel		
Low Floor		
Belt - A.C.	530222076	2/5V1020
Tensioner Assy. - A.C.		38655
Detroit Diesel Series 40 Diesel		
Low Floor		
Belt - A.C.	530222076	2/5V1020
Tensioner Assy. - A.C.		38655
Detroit Diesel Series 50 Diesel		
Low Floor		
Belt - A.C.	530222076	2/5V1020
Tensioner Assy. - A.C.		38655
2002		
Cummins ISC Diesel		
Low Floor		
Tensioner Assy.	3936212	38552
Cummins ISL Diesel		
Low Floor		
Belt - A.C.	530222076	2/5V1020
Tensioner Assy. - A.C.		38655
2001		
Cummins ISC Diesel		
Low Floor		
Tensioner Assy.	3936212	38552
Cummins ISL Diesel		
Low Floor		
Belt - A.C.	530222076	2/5V1020
Tensioner Assy. - A.C.		38655
Detroit Diesel 6V-92 Diesel		
Phantom 96TB		
Belt - Fan & P.S.; W/Aftercooler		BX55
Belt - Alt.; W/O Aftercooler		A79
Hose - Upper - Eng. To Pipe; (2 1/4" I.D.)		24236
Hose - Lower - Eng. To Pipe; (3" I.D.)		24248
Hose - Lower - Pipe To Rad.		≅23575
Phantom 102TB		
Belt - Eng. To J.S.		②B73
Belt - A.C.		2/5V975
Detroit Diesel Series 40 Diesel		
Low Floor		
Belt - A.C.	530222076	2/5V1020
Tensioner Assy. - A.C.		38655
Tensioner Assy.	23521638	38551
Tensioner Pulley	23521638	36091
2000		
Cummins ISC Diesel		
Low Floor		
Tensioner Assy.	3936212	38552
Detroit Diesel 6V-92 Diesel		
Phantom 96TB		
Belt - Fan & P.S.; W/Aftercooler		BX55
Belt - Alt.; W/O Aftercooler		A79
Hose - Upper - Eng. To Pipe; (2 1/4" I.D.)		24236

② Two Required.
≅ Cut to Fit.

Belts and Coolant Hose for Transit Buses

Application	Mfr. Part No.	NAPA No.	Application	Mfr. Part No.	NAPA No.
GILLIG - Continued			GILLIG - Continued		
2000 - Continued			1997		
Detroit Diesel 6V-92 Diesel - Continued			Cummins L10 Diesel		
Phantom 96TB - Continued			Phantom		
Hose - Lower - Eng. To Pipe; (3" I.D.)		24248	Belt - A.C.		2/5VX950
Hose - Lower - Pipe To Rad.		≈23575	Hose - Upper; (2 1/4" I.D.)		24436
Detroit Diesel Series 40 Diesel			Hose - Lower; (2 1/4" I.D.)		24436
Low Floor			Cummins M11 Diesel		
Belt - A.C.	530222076	2/5V1020	Phantom		
Tensioner Assy. - A.C.		38655	Belt - A.C.		2/5V950
Tensioner Assy.	23521638	38551	Tensioner Assy.	3102889	38537
Tensioner Pulley	23521638	36091	Cummins N14 Diesel		
1999			Phantom		
Cummins ISC Diesel			Belt - A.C.		2/5V950
Low Floor			Detroit Diesel 6V-92 Diesel		
Tensioner Assy.	3936212	38552	Phantom 96TB		
Detroit Diesel 6V-92 Diesel			Belt - Fan & P.S.; W/Aftercooler		BX55
Phantom 96TB			Belt - Alt.; W/O Aftercooler		A79
Belt - Fan & P.S.; W/Aftercooler		BX55	Hose - Upper - Eng. To Pipe; (2 1/4" I.D.)		24236
Belt - Alt.; W/O Aftercooler		A79	Hose - Lower - Eng. To Pipe; (3" I.D.)		24248
Hose - Upper - Eng. To Pipe; (2 1/4" I.D.)		24236	Hose - Lower - Pipe To Rad.		≈23575
Hose - Lower - Eng. To Pipe; (3" I.D.)		24248	Detroit Diesel Series 50 Diesel		
Hose - Lower - Pipe To Rad.		≈23575	Phantom 96TB		
Detroit Diesel Series 40 Diesel			Belt - Hub & A.C.		2/5VX950
Low Floor			Belt - Hub & Alt.		▲K120720HD
Belt - A.C.	530222076	2/5V1020	Belt - Hyd. Pump		2/5VX600
Tensioner Assy. - A.C.		38655	Tensioner Assy. - Hub & A.C.	23512829	38505
Tensioner Assy.	23521638	38551	Tensioner Assy. - Hub & Alt.	23526034	38520
Tensioner Pulley	23521638	36091	Tensioner Pulley - Hub & A.C.	23512829	36091
Detroit Diesel Series 50 Diesel			1996		
Low Floor; Phantom			Cummins L10 Diesel		
Belt - A.C.	530222076	2/5V1020	Phantom		
Belt - Alt.; W/450A. Alt.	23521000	▲K120738HD	Belt - A.C.		2/5VX950
Tensioner Assy. - A.C.		38655	Hose - Upper; (2 1/4" I.D.)		24436
Phantom 96TB			Hose - Lower; (2 1/4" I.D.)		24436
Belt - A.C.	530222076	2/5V1020	Cummins M11 Diesel		
Belt - Hub & A.C.		2/5VX950	Phantom		
Belt - Hub & Alt.		▲K120720HD	Belt - A.C.		2/5V950
Belt - Hyd. Pump		2/5VX600	Tensioner Assy.	3102889	38537
Tensioner Assy. - A.C.		38655	Cummins N14 Diesel		
Tensioner Assy. - Hub & A.C.	23512829	38505	Phantom		
Tensioner Assy. - Hub & Alt.	23526034	38520	Belt - A.C.		2/5V950
Tensioner Pulley - Hub & A.C.	23512829	36091	Detroit Diesel 6V-92 Diesel		
1998			Phantom 96TB		
Cummins L10 Diesel			Belt - Fan & P.S.; W/Aftercooler		BX55
Phantom			Belt - Alt.; W/O Aftercooler		A79
Belt - A.C.		2/5VX950	Hose - Upper - Eng. To Pipe; (2 1/4" I.D.)		24236
Hose - Upper; (2 1/4" I.D.)		24436	Hose - Lower - Eng. To Pipe; (3" I.D.)		24248
Hose - Lower; (2 1/4" I.D.)		24436	Hose - Lower - Pipe To Rad.		≈23575
Detroit Diesel 6V-92 Diesel			Detroit Diesel Series 50 Diesel		
Phantom 96TB			Phantom		
Belt - Fan & P.S.; W/Aftercooler		BX55	Belt - A.C.		2/B99
Belt - Alt.; W/O Aftercooler		A79	Phantom 96TB		
Hose - Upper - Eng. To Pipe; (2 1/4" I.D.)		24236	Belt - Hub & A.C.		2/5VX950
Hose - Lower - Eng. To Pipe; (3" I.D.)		24248	Belt - Hub & Alt.		▲K120720HD
Hose - Lower - Pipe To Rad.		≈23575	Belt - Hyd. Pump		2/5VX600
Detroit Diesel Series 50 Diesel			Tensioner Assy. - Hub & A.C.	23512829	38505
Low Floor; Phantom			Tensioner Assy. - Hub & Alt.	23526034	38520
Belt - Alt.; W/450A. Alt.	23521000	▲K120738HD	Tensioner Pulley - Hub & A.C.	23512829	36091
Phantom 96TB			1995		
Belt - Hub & A.C.		2/5VX950	Cummins M11 Diesel		
Belt - Hub & Alt.		▲K120720HD	Phantom		
Belt - Hyd. Pump		2/5VX600	Belt - A.C.		2/5V950
Tensioner Assy. - Hub & A.C.	23512829	38505	Tensioner Assy.	3102889	38537
Tensioner Assy. - Hub & Alt.	23526034	38520	Cummins N14 Diesel		
Tensioner Pulley - Hub & A.C.	23512829	36091	Phantom		
1995			Belt - A.C.		
Cummins M11 Diesel			2/5V950		
Phantom					
Belt - A.C.			2/5V950		
Tensioner Assy.			3102889		
Cummins N14 Diesel			Phantom		
Phantom			Belt - A.C.		
Belt - A.C.			2/5V950		

≈ Cut to Fit.

▲ Standard Belt Available. See Pages 630-631.

Belts and Coolant Hose for Transit Buses

Transit Buses

Application	Mfr. Part No.	NAPA No.
GILLIG - Continued		
1995 - Continued		
Detroit Diesel 6V-92 Diesel		
Phantom 96TB		
Belt - Fan & P.S.; W/Aftercooler		BX55
Belt - Alt.; W/O Aftercooler		A79
Hose - Upper - Eng. To Pipe; (2 1/4" I.D.)		24236
Hose - Lower - Eng. To Pipe; (3" I.D.)		24248
Hose - Lower - Pipe To Rad.		≈23575
Detroit Diesel Series 50 Diesel		
Phantom 96TB		
Belt - Hub & A.C.		2/5VX950
Belt - Hub & Alt.		♣K120720HD
Belt - Hyd. Pump		2/5VX600
Tensioner Assy. - Hub & A.C.	23512829	38505
Tensioner Assy. - Hub & Alt.	23526034	38520
Tensioner Pulley - Hub & A.C.	23512829	36091
1994		
Cummins M11 Diesel		
Phantom		
Belt - A.C.		2/5V950
Cummins N14 Diesel		
Phantom		
Belt - A.C.		2/5V950
Detroit Diesel 6V-92 Diesel		
Phantom 96TB		
Belt - Fan & P.S.; W/Aftercooler		BX55
Belt - Alt.; W/O Aftercooler		A79
Hose - Upper - Eng. To Pipe; (2 1/4" I.D.)		24236
Hose - Lower - Eng. To Pipe; (3" I.D.)		24248
Hose - Lower - Pipe To Rad.		≈23575
Detroit Diesel Series 50 Diesel		
Phantom 96TB		
Belt - Hub & A.C.		2/5VX950
Belt - Hub & Alt.		♣K120720HD
Belt - Hyd. Pump		2/5VX600
Tensioner Assy. - Hub & A.C.	23512829	38505
Tensioner Assy. - Hub & Alt.	23526034	38520
Tensioner Pulley - Hub & A.C.	23512829	36091
1993		
Cummins L10 Diesel		
Phantom		
Belt - Alt.; W/O OEM Alt. Mount		♣K120594HD
Belt - Alt.; W/OEM Alt. Mount		♣K120559HD
Cummins M11 Diesel		
Phantom		
Belt - A.C.		2/5V950
Cummins N14 Diesel		
Phantom		
Belt - A.C.		2/5V950
Detroit Diesel 6V-92 Diesel		
Phantom 96TB		
Belt - Fan & P.S.; W/Aftercooler		BX55
Belt - Alt.; W/O Aftercooler		A79
Hose - Upper - Eng. To Pipe; (2 1/4" I.D.)		24236
Hose - Lower - Eng. To Pipe; (3" I.D.)		24248
Hose - Lower - Pipe To Rad.		≈23575
1992		
Cummins L10 Diesel		
Phantom		
Belt - Alt.; W/O OEM Alt. Mount		♣K120594HD
Belt - Alt.; W/OEM Alt. Mount		♣K120559HD
Detroit Diesel 6V-92 Diesel		
Phantom 96TB		
Belt - Fan & P.S.; W/Aftercooler		BX55
Belt - Alt.; W/O Aftercooler		A79

Application	Mfr. Part No.	NAPA No.
GILLIG - Continued		
1992 - Continued		
Detroit Diesel 6V-92 Diesel - Continued		
Phantom 96TB - Continued		
Hose - Upper - Eng. To Pipe; (2 1/4" I.D.)		24236
Hose - Lower - Eng. To Pipe; (3" I.D.)		24248
Hose - Lower - Pipe To Rad.		≈23575
1991		
Cummins L10 Diesel		
Phantom		
Belt - Alt.; W/O OEM Alt. Mount		♣K120594HD
Belt - Alt.; W/OEM Alt. Mount		♣K120559HD
Detroit Diesel 6V-92 Diesel		
Phantom 96TB		
Belt - Fan & P.S.; W/Aftercooler		BX55
Belt - Alt.; W/O Aftercooler		A79
Hose - Upper - Eng. To Pipe; (2 1/4" I.D.)		24236
Hose - Lower - Eng. To Pipe; (3" I.D.)		24248
Hose - Lower - Pipe To Rad.		≈23575
Detroit Diesel Series 60 Diesel		
Phantom		
Belt - A.C.		2/5V975
1990		
Cummins L10 Diesel		
Phantom		
Belt - Alt.; W/O OEM Alt. Mount		♣K120594HD
Belt - Alt.; W/OEM Alt. Mount		♣K120559HD
Detroit Diesel 6V-92 Diesel		
Phantom 96TB		
Belt - Fan & P.S.; W/Aftercooler		BX55
Belt - Alt.; W/O Aftercooler		A79
Hose - Upper - Eng. To Pipe; (2 1/4" I.D.)		24236
Hose - Lower - Eng. To Pipe; (3" I.D.)		24248
Hose - Lower - Pipe To Rad.		≈23575
1989		
Detroit Diesel 6V-92 Diesel		
Phantom 96TB		
Belt - Fan & P.S.; W/Aftercooler		BX55
Belt - Alt.; W/O Aftercooler		A79
Hose - Upper - Eng. To Pipe; (2 1/4" I.D.)		24236
Hose - Lower - Eng. To Pipe; (3" I.D.)		24248
Hose - Lower - Pipe To Rad.		≈23575
1988-1985		
Detroit Diesel 6V-92 Diesel		
Phantom 96TB		
Belt - Fan & P.S.; W/Aftercooler		BX55
Belt - Alt.; W/O Aftercooler		A79
Hose - Upper - Eng. To Pipe; (2 1/4" I.D.)		24236
Hose - Lower - Eng. To Pipe; (3" I.D.)		24248
Hose - Lower - Pipe To Rad.		≈23575
Phantom 102TB		
Belt - A.C.		ⓂB94
Belt - Hyd. Pump		ⓂB74
1984-1980		
Detroit Diesel 6V-92 Diesel		
Phantom 96TB		
Belt - Fan & P.S.; W/Aftercooler		BX55
Belt - Alt.; W/O Aftercooler		A79
Hose - Upper - Eng. To Pipe; (2 1/4" I.D.)		24236
Hose - Lower - Eng. To Pipe; (3" I.D.)		24248
Hose - Lower - Pipe To Rad.		≈23575

≈ Cut to Fit.
Ⓜ Two Required.

♣ Standard Belt Available. See Pages 630-631.

Belts and Coolant Hose for Transit Buses

Application	Mfr. Part No.	NAPA No.	Application	Mfr. Part No.	NAPA No.
GMC			GMC - Continued		
1988			1978 - Continued		
Detroit Diesel 6V-92 Diesel			Detroit Diesel 6V-71 Diesel - Continued		
T70204; T70604; T80204; T80604			TW7601 - Continued		
Belt - Fan	2099698	▲K120400HD	Hose - Lower - Pipe To Rad.; (2 3/4" I.D.)		24244
Belt - A.C.	2016617	6572	Detroit Diesel 8V-71 Diesel		
Detroit Diesel 8V-71 Diesel			TH8201; TH8601		
T70204; T70604; T80204; T80604			Hose - Upper - Eng. To Pipe; (2 3/4" I.D.)		24244
Belt - Fan	2099698	▲K120400HD	Hose - Upper - Pipe To Rad.; (2 3/4" I.D.)		24244
Belt - A.C.	2016617	6572	Hose - Lower - Eng. To Pipe; (2 3/4" I.D.)		24244
1987-1985			Hose - Lower - Pipe To Rad.; (2 3/4" I.D.)		
Detroit Diesel 6V-71 Diesel			24244		
T70204; T70604; T80604			1977		
Belt - Fan	2099698	▲K120400HD	Detroit Diesel 6V-71 Diesel		
Belt - A.C.	2016617	6572	TW7601		
Detroit Diesel 6V-92 Diesel			Hose - Upper - Eng. To Pipe; (2 3/4" I.D.)		
T70204; T70604; T80204; T80604			24244		
Belt - Fan	2099698	▲K120400HD	Hose - Upper - Pipe To Rad.; (2 3/4" I.D.)		
Belt - A.C.	2016617	6572	24244		
Detroit Diesel 8V-71 Diesel			Hose - Lower - Eng. To Pipe; (2 3/4" I.D.)		
T70204; T70604; T80204; T80604			24244		
Belt - Fan	2099698	▲K120400HD	Hose - Lower - Pipe To Rad.; (2 3/4" I.D.)		
Belt - A.C.	2016617	6572	24244		
1984			1976		
Detroit Diesel 6V-71 Diesel			Detroit Diesel 6V-71 Diesel		
T70204; T70604; T80604			T6H4523A; T6H5307A; T6H5308A		
Belt - Fan	2057625	▲K120390HD	Belt - Alt.; W/A.C.; W/Pulley No. 664713	610986	②▲9420HD
Belt - A.C.	2016617	6572	Belt - Alt.; W/A.C.; W/Pulley No. 669856	794452	K070390
Detroit Diesel 6V-92 Diesel			Belt - Alt.; W/A.C.; W/Pulley No. 669866		
T70204; T70604; T80204; T80604			669722		
Belt - Fan	2057625	▲K120390HD	K070370		
Belt - A.C.	2016617	6572	Detroit Diesel 8V-71 Diesel		
Detroit Diesel 8V-71 Diesel			S8H5304A; S8M5304A; T8H5307A; T8H5308A		
T70204; T70604; T80204; T80604			Belt - Alt.; W/A.C.		
Belt - Fan	2057625	▲K120390HD	669722		
Belt - A.C.	2016617	6572	K070370		
1983-1981			1972		
Detroit Diesel 6V-71 Diesel			GMC DH478 Diesel		
T70204; T70604; T80604			TDH3302A; TDH3302N		
Belt - Fan	2057625	▲K120390HD	Belt - Fan	2465849	TR22792
Belt - A.C.	2016617	6572	Belt - W.P. & Alt.	2466318	③▲9630HD
Detroit Diesel 6V-92 Diesel			Belt - Alt.; W/A.C.		
T70204; T70604; T80204; T80604			668850		
Belt - Fan	2057625	▲K120390HD	Belt - Air Brake Compr.		
Belt - A.C.	2016617	6572	8867793		
Detroit Diesel 8V-71 Diesel			Belt - A.C.		
T70204; T70604; T80204; T80604			668300		
Belt - Fan	2057625	▲K120390HD	▲9630HD		
Belt - A.C.	2016617	6572	1971-1970		
1983-1981			GMC DH478 Diesel		
Detroit Diesel 6V-71 Diesel			TDH3301; TDH3301A		
T70204; T70604; T80604			Belt - Fan	2465849	TR22792
Belt - Fan	2057625	▲K120390HD	Belt - W.P. & Alt.	2466318	③▲9630HD
Belt - A.C.	2016617	6572	Belt - Alt.; W/A.C.	668850	▲9425HD
Detroit Diesel 6V-92 Diesel			Belt - Air Brake Compr.		
T70204; T70604; T80204; T80604			8867793		
Belt - Fan	2057625	▲K120390HD	Belt - A.C.		
Belt - A.C.	2016617	6572	668300		
1980-1979			▲9630HD		
Detroit Diesel 6V-71 Diesel			1969		
T7H603; T7W203; T7W603; T8W203; T8W603			Detroit Diesel 8V-71 Diesel		
Hose - Upper - Eng. To Pipe; (2 3/4" I.D.)		24244	PD4106		
Hose - Upper - Pipe To Rad.; (2 3/4" I.D.)		24244	Belt - Alt.		
Hose - Lower - Eng. To Pipe; (2 3/4" I.D.)		24244	2434116		
Hose - Lower - Pipe To Rad.; (2 3/4" I.D.)		24244	▲9370HD		
Detroit Diesel 8V-71 Diesel			PD4107		
T7H203; T8H203; T8H603			Belt - Alt.; W/A.C.		
Hose - Upper - Eng. To Pipe; (2 3/4" I.D.)		24244	610987		
Hose - Upper - Pipe To Rad.; (2 3/4" I.D.)		24244	②◆▲9430HD		
Hose - Lower - Eng. To Pipe; (2 3/4" I.D.)		24244	TD4106		
Hose - Lower - Pipe To Rad.; (2 3/4" I.D.)		24244	Belt - Alt.		
1978			2434116		
Detroit Diesel 6V-71 Diesel			▲9370HD		
TW7601			TD4107		
Hose - Upper - Eng. To Pipe; (2 3/4" I.D.)		24244	Belt - Alt.; W/A.C.		
Hose - Upper - Pipe To Rad.; (2 3/4" I.D.)		24244	610987		
Hose - Lower - Eng. To Pipe; (2 3/4" I.D.)		24244	②◆▲9430HD		
Hose - Lower - Pipe To Rad.; (2 3/4" I.D.)		24244	GM V-6 305		
1978			TGH3301		
Detroit Diesel 6V-71 Diesel			Belt - Fan		
TW7601			2465849		
Hose - Upper - Eng. To Pipe; (2 3/4" I.D.)		24244	Belt - W.P. & Gen.		
Hose - Upper - Pipe To Rad.; (2 3/4" I.D.)		24244	2463090		
Hose - Lower - Eng. To Pipe; (2 3/4" I.D.)		24244	Belt - Compr.		
Hose - Lower - Pipe To Rad.; (2 3/4" I.D.)		24244	▲9640HD		
1978			TGH3501; TGH3502		
Detroit Diesel 6V-71 Diesel			Belt - Fan		
TW7601			2465849		
Hose - Upper - Eng. To Pipe; (2 3/4" I.D.)		24244	Belt - W.P. & Gen.		
Hose - Upper - Pipe To Rad.; (2 3/4" I.D.)		24244	2463090		
Hose - Lower - Eng. To Pipe; (2 3/4" I.D.)		24244	Belt - Compr.		
Hose - Lower - Pipe To Rad.; (2 3/4" I.D.)		24244	8867793		
1978			▲9640HD		
Detroit Diesel 6V-71 Diesel			GM V-6 351		
TW7601			TGH3301		
Hose - Upper - Eng. To Pipe; (2 3/4" I.D.)		24244	Belt - Fan		
Hose - Upper - Pipe To Rad.; (2 3/4" I.D.)		24244	2465849		
Hose - Lower - Eng. To Pipe; (2 3/4" I.D.)		24244	TR22792		
Hose - Lower - Pipe To Rad.; (2 3/4" I.D.)		24244	②▲9660HD		
1978			▲9640HD		
Detroit Diesel 6V-71 Diesel			TGH3301		
TW7601			Belt - Fan		
Hose - Upper - Eng. To Pipe; (2 3/4" I.D.)		24244	2465849		
Hose - Upper - Pipe To Rad.; (2 3/4" I.D.)		24244	TR22792		
Hose - Lower - Eng. To Pipe; (2 3/4" I.D.)		24244	②▲9660HD		
Hose - Lower - Pipe To Rad.; (2 3/4" I.D.)		24244	▲9640HD		

▲ Standard Belt Available. See Pages 630-631.
 ③ Three Required.

② Two Required.
 ◆ PowerBand® Belt May Work, Use Template to Check.

Belts and Coolant Hose for Transit Buses

Application	Mfr. Part No.	NAPA No.	Application	Mfr. Part No.	NAPA No.
GMC - Continued			GMC - Continued		
1969 - Continued			1968 - Continued		
GM V-6 351 - Continued			GM V-6 379 - Continued		
TGH3301 - Continued			TGH3501; TGH3502 - Continued		
Belt - W.P. & Gen.	2463090	②▲9660HD	Belt - W.P. & Gen.	2463090	②▲9660HD
Belt - Compr.		▲9640HD	Belt - Compr.	8867793	▲9640HD
TGH3501; TGH3502			GMC D478 Diesel		
Belt - Fan	2465849	TR22792	TDH3501; TDH3502		
Belt - W.P. & Gen.	2463090	②▲9660HD	Belt - Fan	2465849	TR22792
Belt - Compr.	8867793	▲9640HD	Belt - W.P. & Alt.	2466318	③▲9630HD
GM V-6 379			Belt - Alt.; W/A.C.		
TGH3301			668850		
Belt - Fan	2465849	TR22792	Belt - Air Brake Compr.		
Belt - W.P. & Gen.	2463090	②▲9660HD	2463090		
Belt - Compr.		▲9640HD	Belt - A.C.		
TGH3501; TGH3502			78283		
Belt - Fan	2465849	TR22792	TDH3502A		
Belt - W.P. & Gen.	2463090	②▲9660HD	Belt - Fan		
Belt - Compr.	8867793	▲9640HD	2465849		
GMC D478 Diesel			TR22792		
TDH3301; TDH3301A			Belt - W.P. & Alt.		
Belt - Fan	2465849	TR22792	2466318		
Belt - W.P. & Alt.	2466318	③▲9630HD	668850		
Belt - Alt.; W/A.C.	668850	▲9425HD	Belt - Air Brake Compr.		
Belt - Air Brake Compr.	8867793	▲9640HD	2463090		
Belt - A.C.	668300	▲9630HD	Belt - A.C.		
GMC DH478 Diesel			78283		
TDH3301; TDH3301A			TDH3502A		
Belt - Fan	2465849	TR22792	Belt - Fan		
Belt - W.P. & Alt.	2466318	③▲9630HD	2465849		
Belt - Alt.; W/A.C.	668850	▲9425HD	Belt - W.P. & Alt.		
Belt - Air Brake Compr.	8867793	▲9640HD	2466318		
Belt - A.C.	668300	▲9630HD	668850		
1968			Belt - Air Brake Compr.		
Detroit Diesel 8V-71 Diesel			2463090		
PD4106			78283		
Belt - Alt.	2434116	▲9370HD	5VX850		
PD4107			TDH3501A		
Belt - Alt.; W/A.C.	610987	②◆▲9430HD	Belt - Fan		
TD4106			2465849		
Belt - Alt.	2434116	▲9370HD	Belt - W.P. & Gen.		
TD4107			2463090		
Belt - Alt.; W/A.C.	610987	②◆▲9430HD	Belt - Compr.		
GM V-6 305			▲9640HD		
TGH3301			GM V-6 305		
Belt - Fan	2465849	TR22792	TGH3301		
Belt - W.P. & Gen.	2463090	②▲9660HD	Belt - Fan		
Belt - Compr.		▲9640HD	2465849		
TGH3501; TGH3502			TR22792		
Belt - Fan	2465849	TR22792	Belt - W.P. & Gen.		
Belt - W.P. & Gen.	2463090	②▲9660HD	2463090		
Belt - Compr.	8867793	▲9640HD	Belt - Compr.		
GM V-6 351			▲9640HD		
TGH3301			GM V-6 351		
Belt - Fan	2465849	TR22792	TGH3301		
Belt - W.P. & Gen.	2463090	②▲9660HD	Belt - Fan		
Belt - Compr.		▲9640HD	2465849		
TGH3501; TGH3502			TR22792		
Belt - Fan	2465849	TR22792	Belt - W.P. & Gen.		
Belt - W.P. & Gen.	2463090	②▲9660HD	2463090		
Belt - Compr.	8867793	▲9640HD	Belt - Compr.		
GM V-6 379			▲9640HD		
TGH3301			GM V-6 379		
Belt - Fan	2465849	TR22792	TGH3301		
Belt - W.P. & Gen.	2463090	②▲9660HD	Belt - Fan		
Belt - Compr.		▲9640HD	2465849		
TGH3501; TGH3502			TR22792		
Belt - Fan	2465849	TR22792	Belt - W.P. & Gen.		
Belt - W.P. & Gen.	2463090	②▲9660HD	2463090		
Belt - Compr.	8867793	▲9640HD	Belt - Compr.		
1967			8867793		
Detroit Diesel 8V-71 Diesel			TDH3501A		
PD4106			Belt - Fan		
Belt - Alt.	2434116	▲9370HD	2465849		
PD4107			TR22792		
Belt - Alt.; W/A.C.	610987	②◆▲9430HD	Belt - W.P. & Gen.		
TD4106			2463090		
Belt - Alt.	2434116	▲9370HD	Belt - Compr.		
TD4107			▲9640HD		
Belt - Alt.; W/A.C.	610987	②◆▲9430HD	GM V-6 379		
GM V-6 305			TGH3301		
TGH3301			Belt - Fan		
Belt - Fan	2465849	TR22792	2465849		
Belt - W.P. & Gen.	2463090	②▲9660HD	TR22792		
Belt - Compr.		▲9640HD	Belt - W.P. & Gen.		
TGH3501; TGH3502			2463090		
Belt - Fan	2465849	TR22792	Belt - Compr.		
Belt - W.P. & Gen.	2463090	②▲9660HD	8867793		
Belt - Compr.	8867793	▲9640HD	GM V-6 351		
GM V-6 351			TGH3301		
TGH3301			Belt - Fan		
Belt - Fan	2465849	TR22792	2465849		
Belt - W.P. & Gen.	2463090	②▲9660HD	TR22792		
Belt - Compr.		▲9640HD	Belt - W.P. & Gen.		
TGH3501; TGH3502			2463090		
Belt - Fan	2465849	TR22792	Belt - Compr.		
Belt - W.P. & Gen.	2463090	②▲9660HD	8867793		
Belt - Compr.	8867793	▲9640HD	GM V-6 379		
GM V-6 379			TGH3301		
TGH3301			Belt - Fan		
Belt - Fan	2465849	TR22792	2465849		
Belt - W.P. & Gen.	2463090	②▲9660HD	TR22792		
Belt - Compr.		▲9640HD	Belt - W.P. & Gen.		
TGH3501; TGH3502			2463090		
Belt - Fan	2465849	TR22792	Belt - Compr.		
Belt - W.P. & Gen.	2463090	②▲9660HD	8867793		
Belt - Compr.	8867793	▲9640HD	GM V-6 305		

② Two Required.
③ Three Required.

▲ Standard Belt Available. See Pages 630-631.
◆ PowerBand® Belt May Work, Use Template to Check.

Belts and Coolant Hose for Transit Buses

Application	Mfr. Part No.	NAPA No.	Application	Mfr. Part No.	NAPA No.
GMC - Continued			INTERNATIONAL/NAVISTAR - Continued		
1964 - Continued			2008 - Continued		
GM V-6 351 - Continued			International/Navistar VT365 Diesel - Continued		
TGH3501; TGH3502 - Continued			HC Series - Continued		
Belt - Compr.	8867793	▲9640HD	Hose - Upper - Eng. To Rad.		22774
GM V-6 379			Hose - Lower - Eng. To Rad.		22775
TGH3301			LAG		
Belt - Fan	2465849	TR22792	1991-1988		
Belt - W.P. & Gen.	2463090	②▲9660HD	Cummins L10 Diesel		
Belt - Compr.		▲9640HD	LAG350T		
TGH3501; TGH3502			Belt - Compr.		
Belt - Fan	2465849	TR22792	3046518		▲K120525HD
Belt - W.P. & Gen.	2463090	②▲9660HD	1987-1985		
Belt - Compr.	8867793	▲9640HD	Cummins L10 Diesel		
GMC D478 Diesel			LAG300T; LAG350T		
TDH3501; TDH3502; TDH3502A			Belt - Compr.		
Belt - Fan	2465849	TR22792	3046518		▲K120525HD
Belt - W.P. & Alt.	2466318	③▲9630HD	1984		
Belt - Alt.; W/A.C.	668850	▲9425HD	Cummins L10 Diesel		
Belt - Air Brake Compr.	2463090	▲9660HD	LAG350T		
Belt - A.C.	78283	5VX850	Belt - Compr.		
GMC DH478 Diesel			3046518		▲K120525HD
TDH3501; TDH3502; TDH3502A			M.A.N.		
Belt - Fan	2465849	TR22792	1989-1984		
Belt - W.P. & Alt.	2466318	③▲9630HD	M.A.N. D2566MLUH Diesel		
Belt - Alt.; W/A.C.	668850	▲9425HD	40 Ft. Americana		
Belt - Air Brake Compr.	2463090	▲9660HD	Belt - Eng. To Fan		
Belt - A.C.	78283	5VX850	Belt - Fan To Fan		
GOSHEN COACH			Belt - W.P.		
1999			Belt - Alt.		
Cummins ISB Diesel			M.A.N. D2566MTUM Diesel		
Sentry			BUS		
Belt - Alt. & W.P.		▲K080780HD	Belt - Fan - Eng. To Idler		
Belt - A.C.		AX45	Belt - Fan - Idler To Fan		
Tensioner Assy. - Alt. & W.P.	3924026	38517	Belt - W.P.		
Tensioner Pulley - Alt. & W.P.	3924026	36095	Belt - Alt.		
GRAF & STIFT			Belt - Air Brake Compr.		
1985-1984			②◆▲9530HD		
M.A.N. 6-Cyl. Diesel			1983-1978		
D2566			M.A.N. D2566MTUM Diesel		
Belt - Alt.		②▲9480HD	BUS		
Belt - P.S.		③▲9630HD	Belt - Fan - Eng. To Idler		
IKARUS			Belt - Fan - Idler To Fan		
1995			Belt - W.P.		
Cummins M11 Diesel			Belt - Alt.		
436-06			Belt - Air Brake Compr.		
Belt - Hub & Alt.	3097269	▲K100610HD	②◆▲9447HD		
Tensioner Assy. - Alt.	3401041	38537	②▲9395HD		
INTERNATIONAL/NAVISTAR			②◆▲9500HD		
2009			③▲9560HD		
International/Navistar MaxxForce DT Diesel			②◆▲9530HD		
3200			MARCOPOLO		
Belt - Alt.	1847708C1	K100870HD	1996		
Tensioner Assy. - Fan	1873217C2	38634	Detroit Diesel Series 60 Diesel		
Idler Pulley - Fan	1841930C1	36164	Viaggio 1000		
2008			Belt - Hub & Alt.		
International/Navistar VT365 Diesel			Belt - A.C.		
HC Series			Belt - Fan - Left Side		
Belt - Fan, Alt. & A.C.	1839963C1	▲K080830HD	23521337		▲K120720HD
Belt - Fan & Air Compr.	1843218C1	▲K060509HD	394124665		B97
Tensioner Assy. - Fan, Alt. & A.C.	1833688C2	38556	394124665		B97
Tensioner Assy. - Air Brake Compr.	1832711C2	38629	MCI		
INTERNATIONAL/NAVISTAR			2008		
2008			Caterpillar C13 Diesel		
International/Navistar VT365 Diesel			D4500		
HC Series			Belt - Alt.		
Belt - Fan, Alt. & A.C.	1839963C1	▲K080830HD	8L27132		
Belt - Fan & Air Compr.	1843218C1	▲K060509HD	8L27157		
Tensioner Assy. - Fan, Alt. & A.C.	1833688C2	38556	08271090		
Tensioner Assy. - Air Brake Compr.	1832711C2	38629	▲K120738HD		

Transit Buses

▲ Standard Belt Available. See Pages 630-631.
③ Three Required.

② Two Required.
◆ PowerBand® Belt May Work, Use Template to Check.

Belts and Coolant Hose for Transit Buses

Application	Mfr. Part No.	NAPA No.
MCI - Continued		
2007		
Detroit Diesel 6-Cyl. 12.7 L Diesel		
D4500 Belt - Fan	M800347	7360
2006		
Detroit Diesel 6-Cyl. 12.7 L Diesel		
D4500 Belt - Alt.	23530282	▲K100789HD
J4500 Belt - A.C.	08271029	CX100
Belt - Alt.; W/Dual Alts.	23530281	K100879HD
2005		
Detroit Diesel 6-Cyl. 12.7 L Diesel		
J4500 Belt - A.C.	08271029	CX100
Belt - Alt.; W/Dual Alts.	23530281	K100879HD
2004		
Detroit Diesel 6-Cyl. 12.7 L Diesel		
D4000 Belt - Alt.	23530282	▲K100789HD
J4500 Belt - A.C.	08271029	CX100
Belt - Alt.; W/Dual Alts.	23530281	K100879HD
2003		
Detroit Diesel 6-Cyl. 12.7 L Diesel		
D4500 Belt - Alt.	23530282	▲K100789HD
Belt - Fan	8L27163	3/5VP2000
G4500 Belt - A.C.	08276028	2/5VX1075
Belt - Idler To Fan Shaft	08276027	2/5VX686
Belt - Fan	08276015	C100
J4500 Belt - A.C.	08271029	CX100
Belt - Alt.; W/Dual Alts.	23530281	K100879HD
2002		
Detroit Diesel 6-Cyl. 12.7 L Diesel		
G4500 Belt - A.C.	08276028	2/5VX1075
Belt - Fan - From Idler	08276027	2/5VX686
Belt - Eng. To Idler	08276027	2/5VX686
Belt - Alt.	8L27132	▲K120738HD
Belt - Fan - From C.S.	08276015	C100
Tensioner Assy. - Alt.	23526034	38520
2001		
Detroit Diesel Series 60 Diesel		
102-DL3 Belt - Fan To Fan	8L27144	C95
Belt - Eng. To Fan	8L27155	C152
2000		
Detroit Diesel Series 60 CNG		
102-D3 Belt - A.C. & Idler	8L2788	②CX96
Tensioner Assy. - Alt.	23526034	38520
Detroit Diesel Series 60 Diesel		
102-DL3 Belt - Fan To Fan	8L27144	C95
Belt - Eng. To Fan	8L27155	C152
102-EL3 Belt - A.C.	08271029	CX100
Belt - Alt. - Left Side	23525817	K060295
Belt - Alt. - Right Side	8L27132	▲K120738HD

Application	Mfr. Part No.	NAPA No.
MCI - Continued		
2000 - Continued		
Detroit Diesel Series 60 Diesel - Continued		
102-EL3 - Continued Tensioner Assy. - Alt. - Right Side	23521020	38520
1999		
Detroit Diesel Series 60 Diesel		
102-DL3 Belt - Alt.	23521000	▲K120738HD
Belt - A.C.	8L2788	CX96
Belt - Fan To Fan	8L27144	C95
Belt - Eng. To Fan	8L27155	C152
Tensioner Assy. - Alt.	23526034	38520
102-EL3 Belt - Alt. - Left Side	23525817	K060295
Belt - Alt. - Right Side	8L27132	▲K120738HD
Belt - A.C. - Right Side	08271029	CX100
Tensioner Assy. - Alt. - Right Side	23526034	38520
1998		
Detroit Diesel Series 60 Diesel		
102-DL3 Belt - Alt.	23521000	▲K120738HD
Belt - A.C.	8L2788	CX96
Belt - Fan To Fan	8L27144	C95
Tensioner Assy. - Alt.	23526034	38520
102-EL3 Belt - Alt. - Left Side	23525817	K060295
Belt - Alt. - Right Side	8L27132	▲K120738HD
Belt - A.C. - Right Side	08271029	CX100
Tensioner Assy. - Alt. - Right Side	23526034	38520
1996		
Detroit Diesel Series 60 Diesel		
102-DL3 Belt - A.C.	8L2788	②CX96
Belt - Fan To Fan	8L27144	C95
1995		
Cummins L10 Diesel		
102-D3 Belt - A.C.	8G276	②CX90
Belt - Alt.		▲K100610HD
Belt - Fan - Right Side	8L27148	C148
Belt - Fan To Fan	8L2798	C93
Tensioner Assy. - Alt.	3401041	38537
Detroit Diesel Series 60 Diesel		
102-DL3 Belt - A.C.	8L2788	②CX96
Belt - Fan To Fan	8L27144	C95
1994		
Detroit Diesel Series 60 Diesel		
102-D3 Belt - Alt.	23521000	▲K120738HD
Belt - A.C.	8L2788	②CX96
Belt - Fan To Fan	8L27144	C95
Tensioner Assy. - Alt.	23526034	38520
1987		
Detroit Diesel 8V-71 Diesel		
96-A3 Belt - A.C.		2/B93
1986		
Detroit Diesel 6V-92 Diesel		
102-A3 Belt - A.C.	8G276	CX90

▲ Standard Belt Available. See Pages 630-631.

② Two Required.

Belts and Coolant Hose for Transit Buses

Application	Mfr. Part No.	NAPA No.	Application	Mfr. Part No.	NAPA No.
MCI - Continued			NABI - Continued		
1985			1997		
Detroit Diesel 6V-92 Diesel			Detroit Diesel Series 50 Diesel		
102-A3			416		
Belt - A.C.		2/C90	Belt - Alt.		▲K120738HD
MCR			Tensioner Assy. - Alt. 23533015 38520		
1985			NATIONAL COACH		
Detroit Diesel V-8 8.2 L Diesel			1991-1984		
7000 Series 2			Detroit Diesel V-8 8.2 L Diesel		
Belt - Fan & Alt.		②▲9700HD	Transmark		
Belt - P.S.		▲9425HD	Belt - Alt.; W/O A.C.		
Belt - Air Brake Compr.		▲9700HD	Belt - Alt.; W/A.C.; Preferred Belt ②▲9700HD		
NABI			Belt - Alt.; W/A.C.; Optional Belt ②▲9570HD		
2006-2005			Belt - P.S. ②▲9430HD		
Cummins ISM Diesel			Belt - Air Brake Compr. ▲9700HD		
40-LFW			Belt - A.C. ②B88		
Belt - Alt. 3097269		▲K100610HD	NEOPLAN		
Tensioner Assy. - Alt. 3102889		38537	2003		
2004-2002			Detroit Diesel Series 50 Diesel		
Detroit Diesel Series 50 Diesel			AN460		
40-LFW			Belt - Hub & Alt. 23521000		
Belt - Alt.		▲K120738HD	Tensioner Assy. - Alt. 23526034		
Belt - A.C. 2/5VX1040		2/5VX1042	2002		
Tensioner Assy. - Alt. 23533015		38520	Cummins ISC CNG		
2001			AN440		
Detroit Diesel Series 50 Diesel			Belt - A.C. PV0107122		
40-LFW			Belt - Hub & Alt. 3939711		
Belt - Alt.		▲K120738HD	Belt - W.P. 3939709		
Belt - A.C. 2/5VX1040		2/5VX1042	Detroit Diesel Series 50 Diesel		
Tensioner Assy. - Alt. 23533015		38520	AN460		
Detroit Diesel Series 60 Diesel			Belt - A.C. 2/5VX950		
40			Belt - A.C. To Alt. 2/3VX375		
Belt - Alt. & W.P. 23521000		▲K120738HD	Belt - Hub & Alt. 23521000		
Tensioner Assy. - Alt. & W.P. 23526034		38520	Belt - Eng. To J.S. OV0107120		
2000			Tensioner Assy. - Hub & Alt. 23526034		
Cummins ISM Diesel			2001-2000		
436			Detroit Diesel 6V-92 Diesel		
Tensioner Assy. - Hub & Alt. 4004933		38505	BUS		
Tensioner Pulley - Hub & Alt. 4004933		36091	Belt - Fan 2/B90		
Detroit Diesel Series 50 Diesel			Detroit Diesel Series 50 Diesel		
40-LFW			BUS		
Belt - Alt.		▲K120738HD	Belt - Fan 2/5VX800		
Belt - A.C. 2/5VX1040		2/5VX1042	Belt - Alt. ▲K120720HD		
Tensioner Assy. - Alt. 23533015		38520	Belt - A.C. 2/5VX1000		
1999			1999-1998		
Detroit Diesel Series 50 Diesel			Detroit Diesel 6V-92 Diesel		
40			BUS		
Belt - Alt.; W/450A. Alt. 23521000		▲K120738HD	Belt - Fan 2/B90		
Belt - A.C.		2/5VX1000	Detroit Diesel Series 50 Diesel		
Tensioner Assy. - Alt.; W/450A. Alt. 23526034		38520	BUS		
1998			Belt - Fan 2/5VX800		
Detroit Diesel Series 50 Diesel			Belt - Alt. ▲K120720HD		
40			Belt - A.C. 2/5VX1000		
Belt - Alt.; W/450A. Alt. 23521000		▲K120738HD	Metroliner 40 Ft.; Transliner 40 Ft.		
436			Belt - Alt.; W/450A. Alt. 23521000		
Belt - W.P. & Alt. (Main Eng.) 8L27132		▲K120738HD	1997-1996		
Belt - A.C. (Main Eng.)		2/5VX1000	Detroit Diesel 6V-92 Diesel		
Belt - Alt. (Aux. Eng.)		A39	BUS		
Belt - W.P. (Aux. Eng.)		A48	Belt - Fan 2/B90		
Tensioner Assy. - W.P. & Alt. (Main Eng.) 23526034		38520	Detroit Diesel Series 50 Diesel		
1997			BUS		
Detroit Diesel 6V-92 Diesel			Belt - Fan 2/5VX800		

② Two Required.

◆ PowerBand® Belt May Work, Use Template to Check.

▲ Standard Belt Available. See Pages 630-631.

Transit Buses

Belts and Coolant Hose for Transit Buses

Application	Mfr. Part No.	NAPA No.	Application	Mfr. Part No.	NAPA No.
NEOPLAN - Continued			NEW FLYER - Continued		
1997-1996 - Continued			2001		
Detroit Diesel Series 50 Diesel - Continued			Cummins L10 Diesel		
BUS - Continued			D40		
Belt - Alt.		▲K120720HD	Hose - Upper; (2 1/4" I.D.)		③24436
Belt - A.C.		2/5VX1000	Hose - Lower - Eng. To Pipe; (2 1/2" I.D.)		24440
1995			Detroit Diesel Series 50 CNG		
Detroit Diesel 6V-92 Diesel			C40LF		
BUS			Belt - Alt. & W.P. 6330349		
Belt - Fan		2/B90	Belt - A.C.	6323488	▲K120720HD
Detroit Diesel Series 50 Diesel			Belt - Eng. To Fan		
BUS			Tensioner Assy. - Alt. & W.P. 23526034		
Belt - Fan		2/5VX800	2000		
Belt - Alt.		▲K120720HD	Cummins L10 Diesel		
Belt - A.C.		2/5VX1000	D40		
Detroit Diesel Series 60 Diesel			Hose - Upper; (2 1/4" I.D.)		
Citiliner			Hose - Lower - Eng. To Pipe; (2 1/2" I.D.)		
Belt - Compr.		②5VX1000	1999-1998		
Belt - Hub To Fan; W/Dual Fans		②5VX850	Cummins L10 Diesel		
Belt - Hub		②5VX800	D40		
Belt - Hub & Alt.	23521337	▲K120720HD	Hose - Upper; (2 1/4" I.D.)		
1994-1984			Hose - Lower - Eng. To Pipe; (2 1/2" I.D.)		
Detroit Diesel 6V-92 Diesel			24440		
BUS			Detroit Diesel Series 50 Diesel		
Belt - Fan		2/B90	C35LF		
Detroit Diesel Series 50 Diesel			Belt - Hub & A.C.		
BUS			Belt - Hub & Alt.		
Belt - Fan		2/5VX800	Belt - Hyd. Pump		
Belt - Alt.		▲K120720HD	Tensioner Assy. - Hub & A.C.		
Belt - A.C.		2/5VX1000	Tensioner Pulley - Hub & A.C.		
NEW FLYER			D40: Transliner 40 Ft.		
2005			Belt - Alt.; W/450A. Alt.		
Cummins ISL Diesel			23521000		
DE40LF			▲K120738HD		
Belt - Alt.	3288634	▲K080496HD	1997-1996		
Belt - W.P.	3288834	▲K080580HD	Cummins L10 Diesel		
2004			D40		
Cummins ISC LNG			Hose - Upper; (2 1/4" I.D.)		
L40LF			Hose - Lower - Eng. To Pipe; (2 1/2" I.D.)		
Belt - A.C.	R5VX830/2	2/5VX830	24440		
2003			Detroit Diesel Series 50 Diesel		
Cummins ISC CNG			C35LF		
C40LF			Belt - Hub & A.C.		
Belt - Hub & Alt.	3939711	▲K080514HD	Belt - Hub & Alt.		
Tensioner Assy. - Hub & Alt.	3937553	38504	Belt - Hyd. Pump		
Tensioner Assy. - W.P.	3936203	38504	Tensioner Assy. - Hub & A.C.		
Tensioner Pulley - W.P.	3936203	36091	Tensioner Pulley - Hub & A.C.		
Tensioner Pulley - Hub & Alt.	3937553	36091	24440		
John Deere 6-Cyl. 8.1 L CNG			1995		
C40LF			Cummins L10 Diesel		
Tensioner Assy. - Alt.	RE506352	38591	D40		
2002			Hose - Upper; (2 1/4" I.D.)		
Cummins ISC CNG			Hose - Lower - Eng. To Pipe; (2 1/2" I.D.)		
C40LF			24440		
Belt - Hub & Alt.	3939711	▲K080514HD	Detroit Diesel Series 50 Diesel		
Tensioner Assy. - Hub & Alt.	3937553	38504	D40		
Tensioner Assy. - W.P.	3936203	38504	Belt - Fan		
Tensioner Pulley - W.P.	3936203	36091	Belt - Alt.		
Tensioner Pulley - Hub & Alt.	3937553	36091	Belt - A.C.		
Cummins ISL Diesel			6323488		
DE40LF			D60		
Tensioner Assy.	3945527	38516	Belt - Alt. & W.P.		
Tensioner Assy.	3945527	36093	Belt - A.C.		
			24436		
			24440		

▲ Standard Belt Available. See Pages 630-631.
 ③ Three Required.

② Two Required.

Belts and Coolant Hose for Transit Buses

Application	Mfr. Part No.	NAPA No.	Application	Mfr. Part No.	NAPA No.
NEW FLYER - Continued			OPTIMA BUS CORPORATION		
1994 - Continued			2004		
Detroit Diesel Series 50 Diesel			Cummins ISB Diesel		
D40			Opus 29		
Belt - Fan		029584	Belt - Hub & Alt.		3288598
			▲K120410HD		
1993			ORION		
Cummins L10 Diesel			2011		
D40			Cummins ISL CNG		
Hose - Upper; (2 1/4" I.D.)		③24436	Orion V; Orion VII		
Hose - Lower - Eng. To Pipe; (2 1/2" I.D.)		24440	Tensioner Assy.		
			081310508		38555
1992			Tensioner Pulley		
Cummins L10 Diesel			24440		
D40			2010		
Hose - Upper; (2 1/4" I.D.)		③24436	Cummins ISL CNG		
Hose - Lower - Eng. To Pipe; (2 1/2" I.D.)		24440	Orion V; Orion VII		
1991			Tensioner Assy.		
Cummins L10 Diesel			081310508		38555
D40			Tensioner Pulley		
Hose - Upper; (2 1/4" I.D.)		③24436	24440		
Hose - Lower - Eng. To Pipe; (2 1/2" I.D.)		24440	2009		
1990-1987			Cummins ISL CNG		
Detroit Diesel Series 50 Diesel			Orion V; Orion VII		
D40			Tensioner Assy.		
Belt - A.C.		6335557	081310508		38555
Belt - Alt.		23521338	Tensioner Pulley		
			081310523		36352
			▲K100381HD		
1991			2008		
Cummins L10 Diesel			Cummins ISL CNG		
D40			Orion VII		
Hose - Upper; (2 1/4" I.D.)		③24436	Belt - Alt.		3288656
Hose - Lower - Eng. To Pipe; (2 1/2" I.D.)		24440	Belt - A.C.		081310062
1990-1987			Belt - Fan		070803122
Cummins L10 Diesel			K080948		
D40			2005		
Hose - Upper; (2 1/4" I.D.)		③24436	Cummins ISL Diesel		
Hose - Lower - Eng. To Pipe; (2 1/2" I.D.)		24440	Orion VII		
NOVA BUS			Belt - Alt.		3288634
2004			Belt - W.P.		3288834
Cummins ISL Diesel			Tensioner Assy. - Alt.		3976831
Nova LFS			Tensioner Assy. - W.P.		3976831
Belt - Hub & Alt.		3288634	38516		
Belt - Eng.		3288812	38516		
Tensioner Assy. - Hub & Alt.		3936212	38516		
			▲K080514HD		
2003			2003-2002		
Cummins ISC Diesel			Cummins ISC CNG		
Nova LFS			Orion VII		
Belt - Hub & W.P.		3939580	Belt - Hub & Alt.		3939711
Belt - Hub & Alt.		3937661	Belt - Hub & W.P.		3939709
Tensioner Assy. - Hub & Alt.		3936213	Belt - A.C.		2/B90
Tensioner Assy. - Hub & W.P.		3936212	Tensioner Assy. - Hub & Alt.		3937553
Tensioner Pulley - Hub & Alt.		3936213	Tensioner Assy. - Hub & W.P.		3936203
			Tensioner Pulley - W.P.		3936203
			Tensioner Pulley - Hub & Alt.		3937553
			36091		
			36091		
OPTARE			2001		
2003			Detroit Diesel 6V-92 Diesel		
Cummins ISB Diesel			Orion		
30-LFN			Belt - Alt.; W/Electrodyne 300A. Alt.		
Belt - Alt. & A.C.		2/A36			
Hose - Upper - Pipe To Pipe; Reducer Hose		23282	▲K120281HD		
			2000		
			Cummins ISM Diesel		
			Orion V		
Tensioner Assy. - Hub & Alt.		4004933	Tensioner Assy. - Hub & Alt.		4004933
Tensioner Pulley - Hub & Alt.		4004933	Tensioner Pulley - Hub & Alt.		4004933
			38505		
			36091		
			2000		
			Detroit Diesel 6V-92 Diesel		
			Orion		
Belt - Alt.; W/Electrodyne 300A. Alt.			Belt - Alt.; W/Electrodyne 300A. Alt.		
			▲K120281HD		

Transit Buses

▲ Standard Belt Available. See Pages 630-631.

③ Three Required.

Belts and Coolant Hose for Transit Buses

Application	Mfr. Part No.	NAPA No.	Application	Mfr. Part No.	NAPA No.
ORION - Continued			ORION - Continued		
2000 - Continued			1995 - Continued		
Detroit Diesel Series 50 Diesel			Detroit Diesel V-8 8.2 L Diesel		
Orion V			Orion II		
Belt - Hub & Alt.	23521000	♣K120738HD	Belt - W.P. & Air Brake Compr.	3097269	♣K100710HD
Belt - Hyd.		2/BX97	Belt - Alt.		♣K080330HD
Tensioner Assy. - Hub & Alt.	23526034	38520	1994		
Orion VI			Cummins L10 Diesel		
Belt - Hub & Alt.	23521000	♣K120738HD	Orion V		
Belt - A.C.	060713026	2/B92	Belt - Alt.	3097269	♣K100610HD
Tensioner Assy. - Hub & Alt.	23526034	38520	Belt - Compr.		6599
Detroit Diesel V-8 8.2 L Diesel			Detroit Diesel 6V-92 Diesel		
Orion II			Orion		
Belt - W.P. & Air Brake Compr.		♣K100710HD	Belt - Alt.; W/Electrodyne 300A. Alt.		♣K120281HD
Belt - Alt.		♣K080330HD	1993		
1999			Cummins L10 Diesel		
Cummins ISB Diesel			Orion V		
Orion II			Belt - Alt.	3097269	♣K100610HD
Belt - Alt.	5080415	♣K080415HD	Belt - Compr.		6599
Belt - A.C.	020736040	♣K080910HD	Tensioner Assy. - Alt.	3401041	38537
Tensioner Assy. - A.C.; W/Dual A.C.	3945527	38516	Detroit Diesel 6V-92 Diesel		
Tensioner Pulley - A.C.; W/Dual A.C.	3945527	36093	Orion		
Cummins L10 Diesel			Belt - Alt.; W/Electrodyne 300A. Alt.		♣K120281HD
Orion V			Detroit Diesel V-8 8.2 L Diesel		
Belt - Alt.	3097269	♣K100610HD	Orion II		
Belt - Compr.		6599	Belt - W.P. & Air Brake Compr.		♣K100710HD
Detroit Diesel 6V-92 Diesel			Belt - Alt.		♣K080330HD
Orion			1998-1996		
Belt - Alt.; W/Electrodyne 300A. Alt.		♣K120281HD	Cummins L10 Diesel		
Detroit Diesel V-8 8.2 L Diesel			Orion V		
Orion II			Belt - Alt.	3097269	♣K100610HD
Belt - W.P. & Air Brake Compr.		♣K100710HD	Belt - Compr.		6599
Belt - Alt.		♣K080330HD	Detroit Diesel 6V-92 Diesel		
1998-1996			Orion		
Cummins L10 Diesel			Belt - Alt.; W/Electrodyne 300A. Alt.		♣K120281HD
Orion V			Detroit Diesel Series 50 Diesel		
Belt - Alt.	3097269	♣K100610HD	Orion V		
Belt - Compr.		6599	Belt - Hub & Alt.	23521000	♣K120738HD
Detroit Diesel 6V-92 Diesel			Belt - P.S.		♣K080465HD
Orion			Tensioner Assy. - P.S.	3937553	38504
Belt - Alt.; W/Electrodyne 300A. Alt.		♣K120281HD	Tensioner Assy. - Hub & Alt.	23526034	38520
Detroit Diesel Series 50 Diesel			Tensioner Pulley - P.S.	3937553	36091
Orion V			Detroit Diesel V-8 8.2 L Diesel		
Belt - Hyd. Pump - Left Side		2/5VX600	Orion II		
Belt - Hub & A.C.		2/5VX950	Belt - W.P. & Air Brake Compr.		♣K100710HD
Tensioner Assy. - Hub & A.C.	5326278000	38506	Belt - Alt.		♣K080330HD
Tensioner Assy. - Alt.	23526034	38520	1991		
Tensioner Pulley - Hub & A.C.	5326278000	36091	Detroit Diesel 6V-92 Diesel		
Detroit Diesel V-8 8.2 L Diesel			Orion		
Orion II			Belt - Alt.; W/Electrodyne 300A. Alt.		♣K120281HD
Belt - W.P. & Air Brake Compr.		♣K100710HD	Detroit Diesel V-8 8.2 L Diesel		
Belt - Alt.		♣K080330HD	Orion II		
1995			Belt - W.P. & Air Brake Compr.		♣K100710HD
Cummins L10 Diesel			Belt - Alt.		♣K080330HD
Orion V			1990		
Belt - Alt.	3097269	♣K100610HD	Detroit Diesel 6V-92 Diesel		
Belt - Compr.		6599	Orion		
Detroit Diesel 6V-92 Diesel			Belt - Alt.; W/Electrodyne 300A. Alt.		♣K120281HD
Orion			Detroit Diesel Series 50 Diesel		
Belt - Alt.; W/Electrodyne 300A. Alt.		♣K120281HD	Orion V		
Detroit Diesel Series 50 Diesel			Belt - Alt. & Air Brake Compr.	050764005	K080455
Orion V			Belt - Hyd. Pump	050764601	K080458
Belt - Alt. & Air Brake Compr.	050764005	K080455			
Belt - Hyd. Pump	050764601	K080458			

♣ Standard Belt Available. See Pages 630-631.

Belts and Coolant Hose for Transit Buses

Transit Buses

Application	Mfr. Part No.	NAPA No.
ORION - Continued		
1989-1983		
Detroit Diesel 6V-92 Diesel		
Orion		
Belt - Alt.; W/Electrodyne 300A. Alt.		♣K120281HD
Detroit Diesel V-8 8.2 L Diesel		
Orion II		
Belt - W.P. & Air Brake Compr.		♣K100710HD
Belt - Alt.		♣K080330HD
PREVOST		
2004		
Detroit Diesel Series 60 Diesel		
H3-45		
Belt - A.C.		②BX100
Belt - Gear Box		③AX74
Belt - Gear Box To Fan		♣K100495HD
Belt - Alt.; W/Dual Alts.	23523003	♣K120815HD
Tensioner Assy. - Alt.; W/Dual Alts.	23526034	38520
2003		
Detroit Diesel Series 60 Diesel		
H3-45		
Belt - Gear Box To Fan		♣K100495HD
Belt - Eng. To Gear Box		③AX72
Tensioner Assy.; W/Dual Alts.	23526034	38520
2000		
Detroit Diesel Series 60 Diesel		
H3-45		
Belt - A.C.		②BX100
Belt - Eng. To Gear Box		③AX72
Belt - Gear Box To Fan		♣K100495HD
Belt - Alt.; W/Dual Alts.	23523003	♣K120815HD
Tensioner Assy. - Alt.; W/Dual Alts.	23526034	38520
LeMirage XL		
Belt - Gear Box To Fan		♣K100510HD
Belt - Eng. To Gear Box		③AX73
Belt - A.C. - Right Side		②BX100
Belt - Gear Box; W/Aux. A.C.; W/A.C.		A35
Belt - Hub & Alt.	23523003	♣K120815HD
Tensioner Assy. - Hub & Alt.	23526034	38520
1999		
Detroit Diesel Series 60 Diesel		
H3-45		
Belt - Alt.; W/Dual Alts.	23523003	♣K120815HD
1997		
Detroit Diesel Series 60 Diesel		
H3-45		
Belt - A.C.		②BX97
Belt - Eng. To Gear Box		③AX73
Belt - Gear Box To Fan		♣K100495HD
Belt - Alt.	8L27132	♣K120738HD
Tensioner Assy. - Alt.		38520
SETRA		
2004		
Detroit Diesel Series 60 Diesel		
S417		
Tensioner Assy. - Alt.; W/Dual Alts.	23527677	38569
2002		
Detroit Diesel Series 60 Diesel		
S215		
Belt - A.C.		A87
Belt - Hub To Fan		A52
Belt - Hub & Alt.		A50

Application	Mfr. Part No.	NAPA No.
SETRA - Continued		
2002 - Continued		
Detroit Diesel Series 60 Diesel - Continued		
S215 - Continued		
Belt - Hub		A76
Belt - Alt. To Alt.		A43
Tensioner Assy. - Hub & A.C.	5326278000	38506
Tensioner Pulley - Hub & A.C.	5326278000	36091
1994		
Detroit Diesel Series 60 Diesel		
S215		
Belt - Eng. To Pulley		②AX74
Belt - A.C.		②5VX950
Belt - Fan		②♣9520HD
Belt - Alt. To Alt.		♣9447HD
1993-1992		
Detroit Diesel Series 60 Diesel		
S215		
Belt - Hub	4.767.882.002	②A76
Belt - Hub To Fan	4.767.723.002	②A49
Belt - Alt. To Alt.	4.767.717.102	A44
THOMAS BUILT		
2003		
Cummins ISB CNG		
SLF 200		
Belt - Hub		2/5VX850
Belt - Hub & A.C.		②BX40
Belt - A.C. To Alt.		②AX36
Cummins ISB Diesel		
SLF 200		
Belt - J.S. To Compr.		BX40
Belt - Compr. & Alt.		AX39
Tensioner Assy. - Hub & Alt.	3936213	38516
Tensioner Pulley - Hub & Alt.	3936213	36093
Hose - Upper - Eng. To Rad.		21473
2000-1999		
Cummins ISB Diesel		
SLF 200		
Belt - Alt. & W.P.	3911583	♣K080708HD
Belt - A.C.		A43
Tensioner Assy. - Alt. & W.P.	3945627	38516
Hose - Upper		20611
Hose - Lower		21891
TMC		
1995-1987		
Detroit Diesel Series 50 Diesel		
RTS06		
Belt - Alt.	23516111	♣K120702HD
1981		
Detroit Diesel 6V-53 Diesel		
T30		
Belt - W.P.	5133177	②7370
Belt - Alt.; W/O A.C.	07TA03090	②AX60
Belt - Alt.; W/A.C.	16TA03001	②AX46
Belt - A.C.		②C81
TURTLE TOP		
2006		
Ford V-10 6.8 L		
Odyssey		
Belt - Fan, Alt., P.S. & A.C.; W/Dual A.C.	204398	K061203

♣ Standard Belt Available. See Pages 630-631.
③ Three Required.

② Two Required.

Belts and Coolant Hose for Transit Buses

Transit Buses

Application	Mfr. Part No.	NAPA No.	Application	Mfr. Part No.	NAPA No.
TURTLE TOP - Continued			VAN HOOL - Continued		
2005			2000 - Continued		
Ford V-10 6.8 L			Cummins ISM Diesel - Continued		
Odyssey			C2045 - Continued		
Belt - Fan, Alt., P.S. & A.C.; W/Dual A.C.	204398	K061203	Belt - A.C. To Alt.		AX44
GM V-8 6.0 L			Belt - A.C.		②5VX950
Spirit			Belt - Hub & Alt.	10K1230	♣K100485HD
Serpentine Belt; W/105A. Alt.	12576450	♣K060923HD	1999		
Serpentine Belt; W/145A. Alt.	12576451	♣K060930HD	Detroit Diesel Series 60 Diesel		
Belt - A.C.	12576447	♣K040378HD	T2140		
Tensioner Assy. - A.C.	12580196	38159	Belt - A.C. To Alt.		②AX44
Tensioner Assy. - Serpentine	12580162	38158	Belt - Eng. To Pulley		②BX65
Idler Pulley - Serpentine	12580771	36299	Belt - Fan		②5VX630
Tensioner Pulley - Serpentine	12580162	38009	Belt - A.C.		②BX97
Tensioner Pulley - A.C.	12580196	36169			
Hose - Upper	22755				
Hose - Lower	22756				
GM V-8 6.6 L Diesel					
Odyssey XL					
Belt - Fan	201727	K061490			
Tensioner Assy.	97288625	38172			
Tensioner Pulley	97288625	36239			
Hose - Upper - Eng. To Rad.		22763			
Hose - Lower - Eng. To Rad.		22771			
2000					
Ford V-10 6.8 L					
Odyssey					
Belt - Fan, Alt., P.S. & A.C.	F7UE8620EB	♣K080991HD			
Belt - Fan, Alt. & P.S.		♣K080806HD			
Tensioner Assy.; W/A.C.		38133			
Idler Pulley		38022			
Tensioner Pulley; W/A.C.		38023			
Hose - Upper		22316			
Hose - Lower		22371			
1998					
Ford V-8 5.4 L					
Van Terra					
Serpentine Belt; W/A.C.		♣K080991HD			
Serpentine Belt; W/O A.C.		♣K080806HD			
Tensioner Assy.; W/A.C.		38133			
Tensioner Assy.; W/O A.C.	F75Z6B209EA	38330			
Idler Pulley		38022			
Tensioner Pulley; W/A.C.		38023			
Tensioner Pulley; W/O A.C.		38053			
Hose - Upper		22315			
Hose - Lower		22318			
U.S. BUS					
1995-1991					
International/Navistar T444 Diesel					
BUS					
Serpentine Belt		♣K080897HD			
Hose - Upper		22159			
		or			
		●26518			
Hose - Lower - Pipe To Rad.		♣21042			
VAN HOOL					
2003-2002					
Detroit Diesel Series 60 Diesel					
C2045					
Belt - Alt.; W/Dual Alts.	23523003	♣K120815HD			
2000					
Cummins ISM Diesel					
C2045					
Belt - Eng. To Pulley		②5VX670			
Belt - Fan		②5VX650			

♣ Standard Belt Available. See Pages 630-631.
 Ⓢ< Cut to Fit.

● Flexible Hose.
 ② Two Required.

Belts and Coolant Hose for Road & Construction Equipment

Order Belts and Hose by Our Number. Manufacturers' Part Number is shown for reference only.

Application	Mfr. Part No.	Our No.	Application	Mfr. Part No.	Our No.
ADVANCE SWEEPER			ALLIS-CHALMERS - Continued		
5600G			460C - Continued		
Ford 2274E			Detroit Diesel 12V-71 Diesel - Continued		
Belt - Fan & Alt.	3903090	7320	Hose - Lower - Pipe To W.P.; (3 3/4" I.D.)		24460
Hose - Upper		●25305	Hose - Lower - Heat Exch. To Pipe; (3" I.D.)		24448
ALLIS-CHALMERS			Hose - Lower - Pipe To Rad.; (3" I.D.)		
45			24448		
Allis-Chalmers 10000 Diesel			545		
Belt - Fan; Ser. No. 1780 & After	4363593	②TR28616	Allis-Chalmers 2900 Diesel		
Belt - Fan; Alt. & W.P.		TR28522	Belt - Fan & Alt.		
Belt - W.P. & Gen.; Ser. No. 1780 & After	4336629	TR28565	Belt - Fan & Hyd. Pump		
Belt - P.T.O.; Ser. No. 1780 & After	097159	③TR22508	Hose - Upper		
Belt - Aux. Drive To Supercharger & Idler		③TR24562	Hose - Lower		
Belt - Hyd. Pump		②B51	●9550HD		
Hose - Upper; (2 1/2" I.D.)		24440	●9620HD		
Hose - Lower; (2 1/2" I.D.)		24440	③20401		
Hose - By Pass; (1" I.D.)		24216	●26523		
145			545H		
Allis-Chalmers 6000 Diesel			Allis-Chalmers 2900 Diesel		
Belt - Fan; Ser. No. 145-400 & Before	4348694	TR28628	Belt - Fan & Alt.		
Belt - Fan; Ser. No. 145-401 & After	4363593	②TR28616	Belt - Fan & Hyd. Pump		
Belt - P.T.O.	097159	③TR22508	Hose - Upper		
Hose - Upper		23547	Hose - Lower		
Hose - Lower; (2 1/2" I.D.)		24240	●9550HD		
145T			●9620HD		
Allis-Chalmers 7000 Diesel			③20731		
Belt - Fan; Ser. No. 145-400 & Before	4348694	TR28628	●26523		
Belt - Fan; Ser. No. 145-401 & After	4363593	②TR28616			
Belt - P.T.O.	097159	③TR22508			
Hose - Upper		23547			
Hose - Lower; (2 1/2" I.D.)		24240			
260			560		
Allis-Chalmers 19000 Mark II Diesel			Allis-Chalmers 21000 Diesel; Allis-Chalmers 25000 Diesel		
Belt - W.P. & Gen.	4356965	TR28583	Belt - W.P.		
Hose - Upper; (2 1/2" I.D.)		24240	4386813		
Hose - Lower; (2 1/2" I.D.)		●24940	TR22495		
260A; 260AE; 260E; 260EA			Belt - Air Brake Compr.		
Allis-Chalmers 21000 Mark II Diesel			4339463		
Belt - Fan		②TR28657	TR28545		
Belt - W.P.		7500			
Belt - Alt.		●9430HD			
Belt - Air Brake Compr.		TR28501			
Hose - Upper		●26532			
Hose - Lower - Eng. To Pipe; (2 1/2" I.D.)		24240			
Hose - Lower - Pipe To Rad.; (2 1/2" I.D.)		24240			
460			615 Backhoe; 615 Wheel Loader		
Allis-Chalmers 21000H Diesel			Allis-Chalmers 4-Cyl. 160		
Belt - Air Brake Compr.	4386304	TR28545	Belt - Fan & Gen.		
460B			233432		
Allis-Chalmers 25000 Mark II Diesel			7380		
Belt - W.P.	4386813	TR22495	Hose - Upper		
Belt - Air Brake Compr.	4339463	TR28545	③20661		
Belt - Hyd. Pump	4388326	7500	or ●25251		
Hose - Upper		●26533	●25252		
Hose - Lower; (2 1/2" I.D.)		●24940			
460C			Allis-Chalmers 4-Cyl. 175 Diesel; Allis-Chalmers 4-Cyl. 200 Diesel		
Detroit Diesel 12V-71 Diesel			Belt - Fan & Gen.		
Belt - Fan		②●9740HD	254075		
Belt - Gen.	5133516	●9380HD	●9520HD		
Hose - Upper - Left Side; (2 1/2" I.D.)		●24940	Hose - Upper		
Hose - Upper - Right Side; (2 1/2" I.D.)		●24940	③20498		
Hose - Lower - Eng. To Pipe; (3 3/4" I.D.)		24460			
			645		
			Allis-Chalmers 3500 Diesel		
			Belt - Fan & Gen.; W/61 3/8" Belt O.C.		
			4025618		
			②●9610HD		
			Belt - Fan & Gen.; W/62 1/4" Belt O.C.		
			4025609		
			②●9620HD		
			Belt - Fan & Gen.; W/64 1/4" Belt O.C.		
			4025623		
			②●9640HD		
			Belt - Air Brake Compr.		
			TR22570		
			Hose - Upper; (2" I.D.)		
			②24232		
			Hose - Lower		
			●26511		
			645B		
			Allis-Chalmers 3500 Diesel		
			Belt - Fan & Gen.; W/61 3/8" Belt O.C.		
			4025618		
			②●9610HD		
			Belt - Fan & Gen.; W/62 1/4" Belt O.C.		
			4025609		
			②●9620HD		
			Belt - Fan & Gen.; W/64 1/4" Belt O.C.		
			4025623		
			②●9640HD		
			Belt - Air Brake Compr.		
			TR22570		
			Hose - Upper; (2 1/4" I.D.)		
			②24236		
			Hose - Lower		
			●26512		
			715 Backhoe; 715 Wheel Loader		
			Perkins 4-Cyl. 236 Diesel		
			Belt - Fan & Alt.		
			1007024		
			●9510HD		
			Hose - Upper		
			●26603		
			Hose - Lower		
			●25484		
			715D		
			Cummins 4-Cyl. 3.9 L Diesel		
			Belt - Fan & Alt.		
			1007024		
			●9510HD		
			745		
			Allis-Chalmers 11000 Diesel		
			Belt - Fan		
			②TR28583		
			Belt - Fan & Alt.		
			3059309		
			●9370HD		
			Hose - Upper; (2 1/4" I.D.)		
			②24236		

Road & Construction Equipment

● Vulco-Flex® Coolant Hose.
 ③ Three Required.
 ▲ Standard Belt Available. See Pages 630-631.

② Two Required.
 ● Use Wire Inserted Green Stripe® Coolant Hose.
 ③ Cut to Fit.

Belts and Coolant Hose for Road & Construction Equipment

Application	Mfr. Part No.	Our No.
ALLIS-CHALMERS - Continued		
745 - Continued		
Allis-Chalmers 11000 Diesel - Continued		
Hose - Lower		●26536
816 Backhoe; 816 Wheel Loader		
Perkins 4-Cyl. 248 Diesel		
Belt - Fan & Alt.	1007024	▲9510HD
Hose - Upper		≡20957
	or	●26501
840 Articulated		
Perkins 4-Cyl. 248 Diesel		
Belt - Fan & Alt.; Ser. No. 3099 & Before	1011991	▲9480HD
Belt - Fan & Alt.; Ser. No. 3100 & After	4021269	▲9525HD
Hose - Upper; (1 3/4" I.D.)		24228
Hose - Lower		●25484
840B Articulated		
Allis-Chalmers 2800 Diesel		
Belt - Fan & Gen.; W/30A. Alt.		TR22461
Hose - Upper		≡20611
	or	●26511
918		
Allis-Chalmers 2800 Diesel		
Belt - Fan & Alt.	252145	▲9525HD
Hose - Upper		21256
	or	●26504
Hose - Lower		●26504
940 Articulated		
Allis-Chalmers 2900 Diesel		
Belt - Fan & Alt.	3046916	▲9550HD
Hose - Upper		●26510
Hose - Lower		●26523
AD; AD3; AD4; AD30		
Detroit Diesel 3-71 Diesel; Detroit Diesel 4-71 Diesel		
Belt - Fan	602944	②TR22578
Belt - Gen.; W/Sealed Type Gen.	040549	TR20451
Belt - Gen.; W/Ventilated Type Gen.	604929	TR22485
Belt - Hyd. Pump	604929	③TR22485
Hose - Upper; W/2" I.D. Hose(2" I.D.)		24232
Hose - Upper; W/2 1/4" I.D. Hose(2 1/4" I.D.)		24236
Hose - Lower; (2 1/4" I.D.)		24236
AD40		
Detroit Diesel 3-71 Diesel; Detroit Diesel 4-71 Diesel		
Belt - Fan	602944	②TR22578
Belt - Gen.; W/Sealed Type Gen.	040549	TR20451
Belt - Gen.; W/Ventilated Type Gen.	604929	TR22485
Belt - Hyd. Pump	604929	③TR22485
Hose - Upper; W/2" I.D. Hose(2" I.D.)		24232
Hose - Upper; W/2 1/4" I.D. Hose(2 1/4" I.D.)		24236
Hose - Lower; (2 1/4" I.D.)		24236
Detroit Diesel 6-71 Diesel		
Hose - Upper; Ser. No. 648 & Before(2" I.D.)		24232
Hose - Upper; Ser. No. 649 & After		≡20206
Hose - Upper; Ser. No. 649 & After(2" I.D.)		24232
Hose - Lower; (2 1/4" I.D.)		24236
BD		
GM 2-Cyl. 142 Diesel		
Belt - Fan & Gen.	033138	②TR22625
Belt - P.T.O.	604929	③TR22485
BD2		
GM 2-Cyl. 142 Diesel		
Belt - Fan & Gen.	033138	②TR22625
Belt - P.T.O.	604929	③TR22485
Hose - Upper; (1 1/2" I.D.)		24224

Application	Mfr. Part No.	Our No.
ALLIS-CHALMERS - Continued		
BD2 - Continued		
GM 2-Cyl. 142 Diesel - Continued		
Hose - Lower; (1 3/4" I.D.)		24228
BD3		
Detroit Diesel 3-71 Diesel		
Belt - Fan	602944	②TR22578
Belt - Gen.	040549	TR20451
Hose - Upper; W/2" I.D. Hose(2" I.D.)		24232
Hose - Upper; W/2 1/4" I.D. Hose(2 1/4" I.D.)		24236
Hose - Lower; (2 1/4" I.D.)		24236
D30		
Allis-Chalmers 11000 Diesel		
Belt - Fan	4335865	②TR28583
Belt - Gen.	4613571	▲9451HD
Belt - P.S.	3029700	②▲9405HD
Belt - Air Brake Compr.	4640285	TR28583
Hose - Upper; (2 1/4" I.D.)		24236
Hose - Lower; (2 1/4" I.D.)		24236
D40		
Allis-Chalmers 21000H Diesel		
Belt - Fan	4348162	②TR28657
Belt - Gen.	4616583	▲9430HD
Belt - W.P.	4386813	TR22495
Belt - Air Brake Compr.	4612058	TR28514
Hose - Upper; (2 1/2" I.D.)		②24240
Hose - Lower; (2 1/2" I.D.)		②24240
M70		
Allis-Chalmers 7000 Diesel		
Belt - Fan	4348911	②TR28596
Belt - W.P. & Gen.	4336629	TR28565
Hose - Upper		23547
Hose - Lower		23550
M100		
Allis-Chalmers 10000 Diesel		
Belt - Fan	4348911	②TR28596
Belt - W.P. & Gen.	4349778	TR28522
Belt - Hyd. Pump; W/44 3/4" Belt O.C.		④TR22443
Belt - Hyd. Pump; W/45 7/8" Belt O.C.		④TR22455
Hose - Upper; (2 1/4" I.D.)		24236
Hose - Lower		23550
M100B		
Allis-Chalmers 11000 Diesel		
Hose - Upper		●26519
Hose - Lower; (2 1/2" I.D.)		②24940
TL10		
Allis-Chalmers 6-Cyl. 262 Diesel		
Belt - Fan & Gen.	3026011	②▲9480HD
Belt - P.S.	24834	▲9350HD
Belt - V.P.	24834	▲9350HD
Hose - Upper; (1 3/4" I.D.)		②24228
Hose - Lower; (1 3/4" I.D.)		②24228
Hose - By Pass; (1" I.D.)		②24216
West Allis 4-Cyl. 226		
Belt - Fan & Gen.; Ser. No. 17-1001M-G Thru		
2502	226935	▲9476HD
Belt - Fan & Gen.; Ser. No. 2503 & After	14841	▲9470HD
Belt - P.S.	24834	▲9350HD
Belt - V.P.	3025960	▲9330HD
Hose - Upper; (1 1/2" I.D.)		24224
Hose - Lower; (1 1/2" I.D.)		24224
TL11		
West Allis 4-Cyl. 226		
Belt - Fan & Gen.; W/47 1/4" Belt O.C.	14841	▲9470HD

● Vulco-Flex® Coolant Hose.

≡ Cut to Fit.

③ Three Required.

④ Use Wire Inserted Green Stripe® Coolant Hose.

▲ Standard Belt Available. See Pages 630-631.

② Two Required.

④ Four Required.

Belts and Coolant Hose for Road & Construction Equipment

Application	Mfr. Part No.	Our No.	Application	Mfr. Part No.	Our No.
ALLIS-CHALMERS - Continued			ALLIS-CHALMERS - Continued		
TL11 - Continued			TL16A		
West Allis 4-Cyl. 226 - Continued			Allis-Chalmers 7000 Diesel		
Belt - Fan & Gen.; W/49" Belt O.C.	5828	TR22485	Belt - Fan; Ser. No. 205 Thru 554	4373586	TR28565
Hose - Upper; (1 1/2" I.D.)		24224	Belt - Fan; Ser. No. 555 Thru 1800	4613099	②TR28565
Hose - Lower; (1 1/2" I.D.)		24224	Belt - Fan; Ser. No. 1801 & After	4373586	TR28565
TL12			Belt - W.P. & Gen.; Ser. No. 205 Thru 554 ...	4348408	TR28522
Allis-Chalmers 6DA273 Diesel; Allis-Chalmers 6-Cyl. 262 Diesel			Belt - P.S.	24834	▲9350HD
Belt - Fan & Gen.; Ser. No. 2002 & Before ...	14841	▲9470HD	Belt - V.P.	3024834	▲9350HD
Belt - Fan & Gen.; Ser. No. 2003 & After	3026011	②▲9480HD	Belt - Converter	3024834	▲9350HD
Belt - P.S.	24834	▲9350HD	Hose - Upper; Ser. No. 627 & After(2 1/4" I.D.)		24236
Belt - V.P.	24834	▲9350HD	Hose - Lower; Ser. No. 626 & Before		23550
Belt - Converter	12990	7300	Hose - Lower; Ser. No. 627 & After(2 1/2" I.D.)		24240
Hose - Upper; (1 3/4" I.D.)		②24228	TL20		
Hose - Lower; Ser. No. 2002 & Before(1 1/2" I.D.)		24224	Allis-Chalmers 10000 Diesel		
Hose - Lower; Ser. No. 2003 & After(1 3/4" I.D.)		②24228	Belt - Fan; Ser. No. 535 & Before	4616523	②TR28596
Hose - By Pass; (1" I.D.)		24216	Belt - Fan; Ser. No. 536 & After	4335865	②TR28583
West Allis 4-Cyl. 226			Belt - W.P. & Gen.; Ser. No. 535 & Before ...	4348851	TR28514
Belt - Fan & Gen.; Ser. No. 45-1001-G & Before	5828	TR22485	Belt - W.P. & Gen.; Ser. No. 536 Thru 996 ...	4348408	TR28522
Belt - Fan & Gen.; Ser. No. 17-1001-M & After 226935		▲9476HD	Belt - Gen.; Ser. No. 997 & After	4613571	▲9451HD
Belt - Fan & Gen.; Ser. No. 2003 & After	14841	▲9470HD	Belt - P.S.	23878	▲9390HD
Belt - P.S.	24834	▲9350HD	Belt - Air Brake Compr.; Ser. No. 997 & After 4640285		TR28583
Belt - V.P.	3025960	▲9330HD	Belt - V.P.; Ser. No. 536 Thru 996	26421	▲9400HD
Belt - Converter	13031	TR22485	Hose - Upper; Ser. No. 535 & Before		23547
Hose - Upper; (1 1/2" I.D.)		24224	Hose - Upper; Ser. No. 536 & After(2 1/4" I.D.)		24236
Hose - Lower; (1 1/2" I.D.)		24224	Hose - Lower; Ser. No. 996 & Before		23550
TL14			Hose - Lower; Ser. No. 997 & After(2 1/4" I.D.)		24236
Allis-Chalmers 6-Cyl. 262			Hose - By Pass; (1 7/8" I.D.)		24230
Belt - Fan & Gen.; Ser. No. 1524 & Before ...	26011	②▲9476HD	TL30		
Belt - P.S.	25960	▲9330HD	Allis-Chalmers 11000 Diesel		
Hose - Upper; (1 3/4" I.D.)		②24228	Belt - Fan	4335864	②TR28583
Hose - Lower; (1 3/4" I.D.)		②24228	Belt - Gen.	4613571	▲9451HD
Hose - By Pass; (1" I.D.)		②24216	Belt - P.S.	3029700	②▲9405HD
Allis-Chalmers 6000 Diesel			Belt - Air Brake Compr.	4640285	TR28583
Belt - Fan; Ser. No. 1525 & After	4339461	②TR28565	Hose - Upper; (2 1/4" I.D.)		24236
Belt - Fan & Gen.; Ser. No. 101 Thru 1524 ...	26011	②▲9476HD	Hose - Lower; (2 1/4" I.D.)		24236
Belt - W.P. & Gen.; Ser. No. 1525 & After	4347818	TR30543	TL40		
Belt - P.S.	3025960	▲9330HD	Allis-Chalmers 21000H Diesel		
Belt - V.P.	3024834	▲9350HD	Belt - Fan	4348162	②TR28657
Hose - Upper; Ser. No. 1524 & Before(1 3/4" I.D.)		②24228	Belt - W.P.	4386813	TR22495
Hose - Upper; Ser. No. 1525 & After(2 1/4" I.D.)		24236	Belt - Gen.	4616583	▲9430HD
Hose - Lower; Ser. No. 1524 & Before(1 3/4" I.D.)		②24228	Belt - Air Brake Compr.	4612058	TR28514
Hose - Lower; Ser. No. 1525 & After(2 1/4" I.D.)		24236	Hose - Upper; (2 1/2" I.D.)		②24240
Hose - By Pass; (1" I.D.)		②24216	Hose - Lower; (2 1/2" I.D.)		②24240
TL14A			TL545		
Allis-Chalmers 6-Cyl. 262			Allis-Chalmers 2800 Diesel		
Belt - Fan & Gen.	26011	②▲9476HD	Belt - Fan	4020984	▲9545HD
Belt - P.S.	24834	▲9350HD	TR260		
Hose - Upper; Ser. No. 323 & Before		●26502	Allis-Chalmers 16000 Diesel		
Hose - Upper; Ser. No. 324 & After(1 3/4" I.D.)		②24228	Belt - Fan & Air Brake Compr.	4372752	②TR28786
Hose - Lower; Ser. No. 154 & Before		●25527	Belt - W.P.	4356965	TR28583
Hose - Lower; Ser. No. 155 & After(1 3/4" I.D.)		②24228	Belt - Gen.	4372798	TR28545
Hose - By Pass; Ser. No. 323 & Before(1" I.D.)		②24216	Hose - Upper; (2 1/2" I.D.)		24240
Hose - By Pass; Ser. No. 324 & After(1 1/4" I.D.)		24220	Hose - Lower; (2 1/2" I.D.)		④24940
TL16			TS160		
Allis-Chalmers 7000 Diesel			Allis-Chalmers TDS516 Diesel		
Belt - Fan; Ser. No. 555 Thru 1800	4613099	②TR28565	Belt - Fan	4335177	②TR28657
Belt - Fan & Gen.; Ser. No. 554 & Before		②▲9540HD	Belt - Gen.	4335242	TR28423
Belt - Gen.; Ser. No. 555 Thru 1800	4349728	TR22514	Belt - Air Brake Compr.	4341903	TR28473
Belt - W.P. & Gen.; Ser. No. 1801 & After	4386304	TR28545	Belt - Supercharger	4348693	③TR22553
Belt - P.S.	3024834	▲9350HD	Hose - Upper; (2 1/2" I.D.)		24240
Belt - V.P.	3024834	▲9350HD	Hose - Lower; (2 1/2" I.D.)		24240
Hose - Upper; Ser. No. 1801 & After(2 1/4" I.D.)		②24236	Hose - By Pass; (1 7/8" I.D.)		24230
Hose - Lower; Ser. No. 1800 & Before		23550	TS200		
Hose - Lower; Ser. No. 1801 & After(2 1/4" I.D.)		②24236	Allis-Chalmers TD779 Diesel		
Hose - By Pass; (1 7/8" I.D.)		24230	Belt - Fan	73889	②TR28406

▲ Standard Belt Available. See Pages 630-631.
 ● Vulco-Flex® Coolant Hose.
 ③ Three Required.

② Two Required.
 ④ Use Wire Inserted Green Stripe® Coolant Hose.

Road & Construction Equipment

Belts and Coolant Hose for Road & Construction Equipment

Application	Mfr. Part No.	Our No.
ALLIS-CHALMERS - Continued		
TS200 - Continued		
Allis-Chalmers TD779 Diesel - Continued		
Belt - W.P.	S2861	TR22434
TS260		
Allis-Chalmers 15000 Diesel		
Belt - Fan & Air Brake Compr.	4372752	②TR28786
Belt - W.P.	4356965	TR28583
Belt - Gen.	4372798	TR28545
Allis-Chalmers 16000 Diesel; Allis-Chalmers TD844 Diesel		
Belt - Fan & Air Brake Compr.	4372752	②TR28786
Belt - W.P.	4356965	TR28583
Belt - Gen.	4372798	TR28545
Hose - Upper; 2nd Design(2 1/2" I.D.)		24240
Hose - Lower; 2nd Design(2 1/2" I.D.)		⊛24940
TS360		
Allis-Chalmers 21000 Diesel		
Belt - Fan & Air Brake Compr.; Ser. No. 2000 & Before	4616613	③TR28743
Belt - Fan & Air Brake Compr.; Ser. No. 2001 & After	4372752	③TR28786
Belt - Gen.; Ser. No. 2000 & Before; W/39 5/8" Belt O.C.	4374914	TR22392
Belt - Gen.; Ser. No. 2000 & Before; W/40 1/8" Belt O.C.	4014631	TR22397
Belt - Gen.; Ser. No. 2001 & After	4372798	TR28545
Hose - Upper; Ser. No. 2001 & After(2 1/2" I.D.)		24240
Hose - Lower; (2 1/2" I.D.)		24240
AMERICAN CRANE CORP.		
25		
Detroit Diesel 6V-53 Diesel		
Belt - Fan	5126763	②♣9400HD
Belt - W.P. & Idler	5139228	②7370
Belt - Alt.		②7360
35		
Detroit Diesel 6V-71 Diesel		
Belt - Fan		③♣9510HD
Belt - Alt.		②9279
597C		
Detroit Diesel 4-71 Diesel		
Belt - Fan	5170972	②TR22455
Belt - Gen.	5133515	♣9370HD
5530		
Detroit Diesel 4-71 Diesel		
Belt - Fan - Upper Structure		②♣9640HD
Belt - Alt. - Upper Structure	5140928	♣9400HD
Detroit Diesel 6-71 Diesel		
Belt - Fan & Air Brake Compr. - Lower Structure	5136265	②♣9690HD
Belt - Alt. - Lower Structure	5145150	♣9430HD
ARROW-MASTER, INC.		
HG1250		
Ford 6-Cyl. 240		
Belt - Fan		♣9447HD
Belt - W.P. To Alt.		7420
HJ1250R		
John Deere 4219D Diesel		
Belt - Fan & Alt.		TR22485
Hose - Upper		⊛<20957

Application	Mfr. Part No.	Our No.
AUSTIN-WESTERN		
40		
IH GAD223		
Belt - W.P. & Gen.	ASF5923	TR30408
Belt - Hyd. Pump	ASF6087	TR28514
IH SD240 Diesel		
Belt - W.P. & Alt.; W/40A. Alt.	81572R1	TR28437
Belt - W.P. & Alt.; W/50A. Alt.	78010R1	TR28445
Belt - Hyd. Pump		TR30589
IH UB240		
Belt - W.P. & Gen.	ASF6262	TR28445
Belt - Hyd. Pump	ASF6264	TR28570
55		
IH IU4		
Belt - Fan	48032D	TR28386
Belt - Gen.	48878D	♣9313HD
Belt - Hyd. Pump		TR28333
60		
IH BD264 Diesel		
Belt - Fan & Gen.	ASF6262	TR28445
66		
Buda 6DT275 Diesel		
Belt - Fan	PGF3062	TR32571
Belt - Hyd. Pump	PGF3058	TR30408
77		
McD. PD30		
Belt - Fan		TR34506
Belt - Hyd. Pump		TR30467
McD. PD40		
Belt - Fan		TR32571
Belt - Gen.	PGF3061	TR22553
Belt - Hyd. Pump	PGF3055	TR28583
83		
Detroit Diesel 2-71 Diesel		
Belt - Gen.	5166844	②TR22625
Belt - Gov.	WRF1166	♣9350HD
Belt - Hyd. Pump	PGF7307	TR28522
Ford 6-Cyl. 272		
Belt - Gen.	B6T8620A	♣9451HD
Belt - Gov.	WRF1166	♣9350HD
Belt - Hyd. Pump	PGF7307	TR28522
99SW		
Detroit Diesel 3055 Diesel; Detroit Diesel 3080 Diesel		
Belt - Fan	PGF12200	②TR22517
Belt - Gen.	PGF13820	TR28390
Belt - Hyd. Pump	PGF12357	TR28492
Detroit Diesel 4080 Diesel		
Belt - Fan	5176420	②TR22588
Belt - Gen.	PGF13820	TR28390
Belt - Hyd. Pump	PGF14558	TR28522
102		
Detroit Diesel 2-71 Diesel		
Belt - Gen.	5166844	②TR22625
Belt - Gov.	WRF1166	♣9350HD
Belt - Hyd. Pump	PGF7307	TR28522
Ford 6-Cyl. 272		
Belt - Gen.	B6T8620A	♣9451HD
Belt - Gov.	WRF1166	♣9350HD
Belt - Hyd. Pump	PGF7307	TR28522
110		
Ford 6-Cyl. 240		
Belt - Fan	HCF7293	7512
Belt - Hyd. Pump	HCF6774	♣9463HD

② Two Required.
 ③ Three Required.
 ⋈ Cut to Fit.

⊛ Use Wire Inserted Green Stripe® Coolant Hose.
 ♣ Standard Belt Available. See Pages 630-631.

Belts and Coolant Hose for Road & Construction Equipment

Application	Mfr. Part No.	Our No.
AUSTIN-WESTERN - Continued		
110 - Continued		
Ford 6-Cyl. 240 - Continued		
Hose - Upper		●25480
122		
Detroit Diesel 2-71 Diesel		
Belt - Gen.	5166844	ⓉTR22625
Belt - Gov.	WRF1166	♣9350HD
Belt - Hyd. Pump	PGF7307	TR28522
Ford 6-Cyl. 272		
Belt - Gen.	B6T8620A	♣9451HD
Belt - Gov.	WRF1166	♣9350HD
Belt - Hyd. Pump	PGF7307	TR28522
210		
Ford 6-Cyl. 272		
Belt - Hyd. Pump; W/5" Dia. Pulley	HCF6060	TR28423
Belt - Hyd. Pump; W/6 1/2" Dia. Pulley	PGF3057	TR28454
Hose - Upper; (1 1/2" I.D.)		Ⓣ24224
Hose - Lower; (1 3/4" I.D.)		Ⓣ24228
Ford 6-Cyl. 317		
Belt - Hyd. Pump; W/5" Dia. Pulley	HCF6060	TR28423
Belt - Hyd. Pump; W/6 1/2" Dia. Pulley	PGF3057	TR28454
Hose - Upper; (2" I.D.)		24232
Hose - Lower; (2 1/8" I.D.)		24234
Hose - Lower		●26612
Ford 6-Cyl. 332		
Belt - Hyd. Pump; W/5" Dia. Pulley	HCF6060	TR28423
Belt - Hyd. Pump; W/6 1/2" Dia. Pulley	PGF3057	TR28454
Hose - Upper		●26612
Hose - Lower; Molded Hose		≈<20523
Hose - Lower; Strt. Hose(2" I.D.)		24232
IH UB264		
Belt - Gen.	HCF7443	♣9451HD
Belt - Hyd. Pump	PGF12161	TR30448
Hose - Upper		●26509
Hose - Lower		●26508
IH UD282 Diesel		
Belt - Fan & Gen.; W/Std. Gen.	53934HA	TR32491
Belt - Fan & Gen.; W/H.D. Gen.	PGF12037	TR30484
Hose - Upper		●26509
Hose - Lower; (2" I.D.)		24232
410		
Detroit Diesel 3-71 Diesel		
Belt - Fan	HCF6230	TR24562
Belt - Gen.	PGF13820	TR28390
Belt - Hyd. Pump	PGF15154	TR28492
Hose - Upper		●26603
Hose - Lower; (1 3/4" I.D.)		24228
Ford 6-Cyl. 332		
Belt - Hyd. Pump	HCF6060	TR28423
Hose - Upper		●26612
Hose - Lower; Molded Hose		≈<20523
Hose - Lower; Strt. Hose(2" I.D.)		24232
IH UB264		
Belt - Fan	HCF7443	♣9451HD
Belt - Gen.		♣9447HD
Belt - Hyd. Pump	PGF12161	TR30448
Hose - Upper		●26509
Hose - Lower		●26508
714		
Detroit Diesel 4-53 Diesel		
Belt - Fan		Ⓣ♣9470HD
Belt - W.P. & Alt		Ⓣ7410
Hose - Upper		●26509
Hose - Lower		●26507

Application	Mfr. Part No.	Our No.
AUSTIN-WESTERN - Continued		
720		
Detroit Diesel 6V-53 Diesel		
Belt - Fan & Air Brake Compr.	5135942	Ⓣ♣9550HD
Belt - W.P.	5139228	Ⓣ7370
Belt - Alt	5133177	Ⓣ7370
Hose - Upper - Left Side		●26506
Hose - Upper - Right Side		●26506
Hose - Lower		●26508
Badger Shovel		
IH WD9		
Belt - Gen.	PGF8422	9300
CADET		
IH GRD233		
Belt - Fan	AJF3438	TR28390
Belt - Hyd. Pump	AJF2476	TR28693
G12		
IH U269; IH U282		
Hose - Upper		●26509
Hose - Lower; (2" I.D.)		24232
IH UV345		
Hose - Upper		●26525
Hose - Lower		●26523
Pacer 100		
Cummins JN130 Diesel		
Belt - Fan	70888	Ⓣ♣9360HD
Belt - W.P.	101427	TR22299
Belt - Gen.	70885	TR22495
Belt - Hyd. Pump	PGF15156	TR28522
Hose - Upper		●26509
Hose - Lower		●26522
Detroit Diesel 3-71 Diesel		
Belt - Fan	PGF17680	ⓉTR22514
Belt - Gen.	PGF13820	TR28390
Belt - Gov.	PGF16698	♣9480HD
Belt - Hyd. Pump	PGF15154	TR28492
Hose - Upper		●26512
Hose - Lower		●26511
Pacer 200		
Cummins JN130 Diesel		
Belt - Fan	70888	Ⓣ♣9360HD
Belt - W.P.	101427	TR22299
Belt - Gen.	70885	TR22461
Belt - Hyd. Pump	PGF15156	TR28522
Hose - Upper		●26509
Hose - Lower		●26522
Detroit Diesel 3-71 Diesel		
Belt - Fan	PGF17680	ⓉTR22514
Belt - Gen.	PGF13820	TR28390
Belt - Gov.	PGF16698	♣9480HD
Belt - Hyd. Pump	PGF15154	TR28492
Hose - Upper		●26512
Hose - Lower		●26511
Pacer 300		
Cummins C160 Diesel		
Belt - Fan	124466	ⓉTR24365
Belt - W.P.	101427	TR22299
Belt - Gen.; W/46 5/8" Belt O.C.	70885	TR22461
Belt - Gen.; W/47 7/8" Belt O.C.	106070	TR22474
Belt - Gov.	PGF15971	♣9463HD
Belt - Hyd. Pump	PGF15156	TR28522
Hose - Upper		●26509
Hose - Lower		●26522
Detroit Diesel 4-71 Diesel		
Belt - Fan; W/52 1/4" Belt O.C.		Ⓣ♣9520HD
Belt - Fan; W/59 1/8" Belt O.C.	5176420	ⓉTR22588

● Vulco-Flex® Coolant Hose.
♣ Standard Belt Available. See Pages 630-631.

Ⓣ Two Required.
≈< Cut to Fit.

Belts and Coolant Hose for Road & Construction Equipment

Application	Mfr. Part No.	Our No.
AUSTIN-WESTERN - Continued		
Pacer 300 - Continued		
Detroit Diesel 4-71 Diesel - Continued		
Belt - Alt.		▲9380HD
Belt - Gen.	PGF13820	TR28390
Belt - Gov.; W/Allison Trans.	PGF16698	▲9480HD
Belt - Gov.; W/Torcson Trans.	PGF15971	▲9463HD
Belt - Hyd. Pump; W/1/2" Belt T.W.; W/52 1/4" Belt O.C.		②▲9520HD
Belt - Hyd. Pump; W/1/2" Belt T.W.; W/53 1/4" Belt O.C.	PGF16985	②▲9530HD
Belt - Hyd. Pump; W/21/32" Belt T.W.; W/52 7/8" Belt O.C.	PGF15156	TR28522
Hose - Upper; W/12" Hose		●26508
Hose - Upper; W/17" Hose		●26510
Hose - Lower; W/8 3/4" Hose(2" I.D.)		24232
Hose - Lower; W/12" Hose		●26508
IH UD14A Diesel		
Belt - Fan	PGF3062	TR32571
Belt - Gen.	PGF8422	9300
Hose - Upper		●26522
Hose - Lower; (2" I.D.)		24232
Pacer 301		
Detroit Diesel 4-71 Diesel		
Belt - Fan		②▲9530HD
Belt - Alt.		▲9590HD
Hose - Upper		●26511
Hose - Lower		●26510
Pacer 400		
Cummins C160 Diesel		
Belt - Fan	124466	②TR24365
Belt - W.P.	101427	TR22299
Belt - Gen.; W/46 5/8" Belt O.C.	70885	TR22461
Belt - Gen.; W/47 7/8" Belt O.C.	106070	TR22474
Belt - Gov.	PGF15971	▲9463HD
Belt - Hyd. Pump	PGF15156	TR28522
Hose - Upper		●26509
Hose - Lower		●26522
Detroit Diesel 4-71 Diesel		
Belt - Fan; W/52 1/4" Belt O.C.		②▲9520HD
Belt - Fan; W/59 1/8" Belt O.C.	5176420	②TR22588
Belt - Alt.		▲9380HD
Belt - Gen.	PGF13820	TR28390
Belt - Gov.; W/Allison Trans.	PGF16698	▲9480HD
Belt - Gov.; W/Torcson Trans.	PGF15971	▲9463HD
Belt - Hyd. Pump; W/1/2" Belt T.W.; W/52 1/4" Belt O.C.		②▲9520HD
Belt - Hyd. Pump; W/1/2" Belt T.W.; W/53 1/4" Belt O.C.	PGF16985	②▲9530HD
Belt - Hyd. Pump; W/21/32" Belt T.W.; W/52 7/8" Belt O.C.	PGF15156	TR28522
Hose - Upper; W/12" Hose		●26508
Hose - Upper; W/17" Hose		●26510
Hose - Lower; W/8 3/4" Hose(2" I.D.)		24232
Hose - Lower; W/12" Hose		●26508
IH UD14A Diesel		
Belt - Fan	PGF3062	TR32571
Belt - Gen.	PGF8422	9300
Hose - Upper		●26522
Hose - Lower; (2" I.D.)		24232
Super 400		
Cummins C160 Diesel		
Belt - Fan	124466	②TR24365
Belt - W.P.	101427	TR22299
Belt - Gen.; W/46 5/8" Belt O.C.	70885	TR22461
Belt - Gen.; W/47 7/8" Belt O.C.	106070	TR22474
Belt - Gov.	PGF15971	▲9463HD
Belt - Hyd. Pump	PGF15156	TR28522
Hose - Upper		●26509
Hose - Lower		●26522
Detroit Diesel 4-71 Diesel		
Belt - Fan; W/52 1/4" Belt O.C.		②▲9520HD
Belt - Fan; W/59 1/8" Belt O.C.	5176420	②TR22588
Belt - Alt.		▲9380HD
Belt - Gen.	PGF13820	TR28390
Belt - Gov.; W/Allison Trans.	PGF16698	▲9480HD
Belt - Gov.; W/Torcson Trans.	PGF15971	▲9463HD
Belt - Hyd. Pump; W/1/2" Belt T.W.; W/52 1/4" Belt O.C.		②▲9520HD
Belt - Hyd. Pump; W/1/2" Belt T.W.; W/53 1/4" Belt O.C.	PGF16985	②▲9530HD
Belt - Hyd. Pump; W/21/32" Belt T.W.; W/52 7/8" Belt O.C.	PGF15156	TR28522
Hose - Upper		●26509
Hose - Lower		●26509
Pacer 500		
Detroit Diesel 6V-71 Diesel		
Belt - Fan	5176420	②TR22588
Belt - Gen.	PGF17017	▲9380HD
Belt - Gov.	PGF15971	▲9463HD
Belt - Hyd. Pump	PGF16984	▲9530HD
Hose - Upper		●26523
Hose - Lower; (2 3/4" I.D.)		②24244
PR11		
Ford 6-Cyl. 223		
Belt - Fan; W/38 1/8" Belt O.C.		7380
Belt - Fan; W/40 1/8" Belt O.C.	B7PZ8620A	7400
Belt - Gen.	EAG8620B	7360
Belt - Hyd. Pump	PGF15971	▲9463HD
Hose - Upper; (1 1/2" I.D.)		24224

Application	Mfr. Part No.	Our No.
AUSTIN-WESTERN - Continued		
Super 100; Super 200		
Cummins JN130 Diesel		
Belt - Fan	70888	②▲9360HD
Belt - W.P.	101427	TR22299
Belt - Gen.	70885	TR22461
Belt - Hyd. Pump	PGF15156	TR28522
Hose - Upper		●26509
Hose - Lower		●26522
Detroit Diesel 3-71 Diesel		
Belt - Fan	PGF17680	②TR22514
Belt - Gen.	PGF13820	TR28390
Belt - Gov.	PGF16698	▲9480HD
Belt - Hyd. Pump	PGF15154	TR28492
Hose - Upper		●26512
Hose - Lower		●26511
Super 300		
Cummins C160 Diesel		
Belt - Fan	124466	②TR24365
Belt - W.P.	101427	TR22299
Belt - Gen.; W/46 5/8" Belt O.C.	70885	TR22461
Belt - Gen.; W/47 7/8" Belt O.C.	106070	TR22474
Belt - Gov.	PGF15971	▲9463HD
Belt - Hyd. Pump	PGF15156	TR28522
Hose - Upper		●26509
Hose - Lower		●26522
Detroit Diesel 4-71 Diesel		
Belt - Fan; W/52 1/4" Belt O.C.		②▲9520HD
Belt - Fan; W/59 1/8" Belt O.C.	5176420	②TR22588
Belt - Alt.		▲9380HD
Belt - Gen.	PGF13820	TR28390
Belt - Gov.; W/Allison Trans.	PGF16698	▲9480HD
Belt - Gov.; W/Torcson Trans.	PGF15971	▲9463HD
Belt - Hyd. Pump; W/1/2" Belt T.W.; W/52 1/4" Belt O.C.		②▲9520HD
Belt - Hyd. Pump; W/1/2" Belt T.W.; W/53 1/4" Belt O.C.	PGF16985	②▲9530HD
Belt - Hyd. Pump; W/21/32" Belt T.W.; W/52 7/8" Belt O.C.	PGF15156	TR28522
Hose - Upper; W/12" Hose		●26508
Hose - Upper; W/17" Hose		●26510
Hose - Lower; W/8 3/4" Hose(2" I.D.)		24232
Hose - Lower; W/12" Hose		●26508
IH UD14A Diesel		
Belt - Fan	PGF3062	TR32571
Belt - Gen.	PGF8422	9300
Hose - Upper		●26522
Hose - Lower; (2" I.D.)		24232
Super 400		
Cummins C160 Diesel		
Belt - Fan	124466	②TR24365
Belt - W.P.	101427	TR22299
Belt - Gen.; W/46 5/8" Belt O.C.	70885	TR22461
Belt - Gen.; W/47 7/8" Belt O.C.	106070	TR22474
Belt - Gov.	PGF15971	▲9463HD
Belt - Hyd. Pump	PGF15156	TR28522
Hose - Upper		●26509
Hose - Lower		●26522
Detroit Diesel 4-71 Diesel		
Belt - Fan; W/52 1/4" Belt O.C.		②▲9520HD
Belt - Fan; W/59 1/8" Belt O.C.	5176420	②TR22588
Belt - Alt.		▲9380HD
Belt - Gen.	PGF13820	TR28390
Belt - Gov.; W/Allison Trans.	PGF16698	▲9480HD
Belt - Gov.; W/Torcson Trans.	PGF15971	▲9463HD
Belt - Hyd. Pump; W/1/2" Belt T.W.; W/52 1/4" Belt O.C.		②▲9520HD
Belt - Hyd. Pump; W/1/2" Belt T.W.; W/53 1/4" Belt O.C.	PGF16985	②▲9530HD
Belt - Hyd. Pump; W/21/32" Belt T.W.; W/52 7/8" Belt O.C.	PGF15156	TR28522
Hose - Upper		●26509
Hose - Lower		●26509

▲ Standard Belt Available. See Pages 630-631.
● Vulco-Flex® Coolant Hose.

② Two Required.

Belts and Coolant Hose for Road & Construction Equipment

Road & Construction Equipment

Application	Mfr. Part No.	Our No.
AUSTIN-WESTERN - Continued		
Super 500		
Detroit Diesel 6V-71 Diesel		
Belt - Fan	5176420	②TR22588
Belt - Gen.	PGF17017	▲9380HD
Belt - Gov.	PGF15971	▲9463HD
Belt - Hyd. Pump	PGF16984	▲9530HD
Hose - Upper		●26523
Hose - Lower; (2 3/4" I.D.)		②24244
T53		
Detroit Diesel 2-71 Diesel		
Hose - Upper		②●25473
Ford 6-Cyl. 272		
Belt - Fan	WRF1128	TR24461
Belt - Gen.		▲9451HD
Belt - Gov.	WRF1166	▲9350HD
Belt - Hyd. Pump	PGF7307	TR28522
Hose - Upper		●25473
T84; T104		
Detroit Diesel 2-71 Diesel		
Hose - Upper		②●25473
Ford 6-Cyl. 272		
Belt - Fan	WRF1128	TR24461
Belt - Gen.		▲9451HD
Belt - Gov.	WRF1166	▲9350HD
Belt - Hyd. Pump	PGF7307	TR28522
Hose - Upper		●25480
T1386		
Continental 6-Cyl.		
Hose - Upper; (1 7/8" I.D.)		24230
Hose - Lower		≈21794
		or ●25474
Detroit Diesel 2-71 Diesel		
Belt - Gen.	5166844	②TR22625
Belt - Gov.	WRF1166	▲9350HD
Belt - Hyd. Pump	PGF7307	TR28522
BADGER		
1085C		
Cummins 6-Cyl. 5.9 L Diesel		
Belt - Fan, Alt. & W.P.		▲K080560HD
BANTAM		
304		
Ford V-8 330		
Belt - Fan & Alt. - Lower Structure (Truck)		②▲9430HD
Belt - Compr. - Lower Structure (Truck)		▲9525HD
Belt - Hyd. Pump - Lower Structure (Truck)		▲9425HD
Hose - Upper - Lower Structure (Truck)		●26611
Hose - Lower - Lower Structure (Truck)		●26504
424		
Chrysler LB318 Diesel		
Belt - Fan & Alt. - Lower Structure (Truck)	1614690	▲9440HD
Belt - Fan, Compr. & Idler - Lower Structure (Truck)		7625
Belt - Fan To Hyd. Pump - Lower Structure (Truck)		②▲9435HD
Hose - Upper - Lower Structure (Truck)		●26612
Hose - Lower - Lower Structure (Truck)		●26611
IH DV549 Diesel		
Belt - Fan & Idler - Lower Structure (Truck) ..	133500R1	②TR22434
Belt - Fan To Compr. & Alt. - Lower Structure (Truck)	243605R2	②▲9451HD
Belt - Hyd. Pump - Lower Structure (Truck)		②TR22425
Hose - Upper - Lower Structure (Truck)		②●26611

② Two Required.
● Vulco-Flex® Coolant Hose.

Application	Mfr. Part No.	Our No.
BANTAM - Continued		
C166		
Detroit Diesel 4-53 Diesel		
Belt - Fan	5119188	②▲9390HD
Belt - W.P. & Gen.		②7410
Hose - Upper		●26511
C266		
Detroit Diesel 4-71 Diesel		
Belt - Fan	5130528	②▲9451HD
Belt - Alt.	5140928	▲9400HD
Hose - Upper		●26511
Hose - Lower		●26509
C366		
Detroit Diesel 6V-53 Diesel		
Belt - Fan	5126763	②▲9400HD
Belt - Alt.		▲9375HD
Hose - Upper		②●25482
Hose - Lower		●26511
C451		
Detroit Diesel 4-53 Diesel		
Belt - Fan	5119188	②▲9390HD
Belt - W.P. & Gen.	5133174	②7405
Hose - Upper		●26511
Hose - Lower		●26523
C475		
Detroit Diesel 4-71 Diesel		
Belt - Fan		②▲9451HD
Belt - Gen.		▲9370HD
Hose - Upper		●26510
Hose - Lower		●26509
S588 Telekruiser		
Detroit Diesel 4-53 Diesel		
Belt - Fan & Hyd. Pump	5136273	②▲9510HD
Belt - W.P. & Alt.	5133172	②7430
Hose - Upper		●26612
S626 Telekruiser; S628 Telekruiser		
Detroit Diesel 4-53 Diesel		
Belt - Alt.		7300
Belt - W.P. & Idler		②7365
Belt - Fan & Hyd. Pump		②▲9451HD
Hose - Upper; (1 3/4" I.D.)		24228
Hose - Lower		●26611
T644 Teleskoop		
Detroit Diesel 3-53 Diesel		
Belt - Fan - Upper Structure		②▲9412HD
Belt - W.P. & Gen. - Upper Structure	5133174	②7405
Hose - Upper - Upper Structure		●26512
Hose - Lower - Upper Structure		●26512
T725A Teleskoop		
Detroit Diesel 4-53 Diesel		
Belt - Fan		②▲9313HD
Belt - W.P. & Gen.		②7405
Hose - Upper; (2" I.D.) (Truck)		24232
Hose - Lower		●26509
Detroit Diesel 4-71 Diesel		
Belt - Fan	5119188	②▲9390HD
Belt - W.P. & Gen.	5133174	②7405
Hose - Upper		●26511
Hose - Lower		●26509
TD588 Telekrane		
Detroit Diesel 4-53 Diesel		
Belt - Fan	5119188	②▲9390HD
Belt - W.P. & Gen.	5133174	②7405

▲ Standard Belt Available. See Pages 630-631.
≈ Cut to Fit.

Belts and Coolant Hose for Road & Construction Equipment

Application	Mfr. Part No.	Our No.	Application	Mfr. Part No.	Our No.
BANTAM - Continued			BARBER-GREENE - Continued		
TD588 Telekrane - Continued			852; 857 - Continued		
Detroit Diesel 4-53 Diesel - Continued			Detroit Diesel 3-71 Diesel; Detroit Diesel 4-71 Diesel; Detroit Diesel 6-71 Diesel - Continued		
Hose - Upper		●26511	Belt - Gen.; W/24V. Gen.	5125811	▲9380HD
Hose - Lower		●26511	D		
BARBER-GREENE			Le Roi		
2			Belt - Fan & Gen. TR22416		
Hercules IXE			F48		
Belt - Fan		②TR24489	IH UD18		
38D			Belt - Belt; W/63 3/4" Belt O.C. 251180R1 TR28628		
Buda HP217			SA41		
Belt - Fan		TR28514	IH D282 Diesel		
44			Belt - Fan & Alt. 610363C1 ▲9530HD		
Buda K393			TA77		
Belt - Fan		TR30467	Caterpillar 3306T Diesel		
82A			Belt - Fan & Alt. 5L8312 ③▲9540HD		
Buda HP217			Hose - Lower - Eng. To Pipe; (2 1/2" I.D.) 24440		
Belt - Fan		TR28514	Hose - Lower - Pipe To Rad.; (2 1/2" I.D.) 24440		
Chrysler T118			Caterpillar D333C Diesel		
Belt - Fan & Gen.		TR24500	Belt - Fan & Alt. 5L8312 ③▲9540HD		
IH UD281.4 Diesel			Hose - Upper ●26531		
Belt - Fan	16131DA	TR30467	Hose - Lower; (2 1/2" I.D.) ②24440		
Belt - Gen.	52318DA	9279	TC30		
82AG			Detroit Diesel 3-53 Diesel		
Buda HP298; Buda HP326			Belt - Fan ②▲9412HD		
Belt - Belt; W/55 1/8" Belt O.C.	H12096	TR28545	Belt - W.P. & Gen. ②7405		
552; 705			Hose - Upper ≧21794		
IH UD281.4 Diesel			or ●25474		
Belt - Fan	16131DA	TR30467	Hose - Lower; (1 7/8" I.D.) ②24230		
Belt - Gen.	52318DA	9279	BAY CITY		
774			10		
Detroit Diesel 3-71 Diesel			Hercules JHC		
Belt - Fan; W/Low Mount Fan	5170972	②TR22455	Belt - Belt; W/43 1/2" Belt O.C. 30003 TR28429		
Belt - Gen.; W/12V. Gen.	3224367	TR28390	Waukesha 6BK		
Belt - Gen.; W/24V. Gen.	5155911	TR24400	Belt - Belt; W/47 1/8" Belt O.C. 27948 TR30467		
Belt - Compr.	3224451	TR34700	15		
777			Hercules JXD		
Caterpillar D333 Diesel			Belt - Belt; W/41 1/8" Belt O.C. 40352A TR28406		
Belt - Fan		②▲9600HD	15A		
Belt - Fan & Gen.		▲9447HD	IH U21		
Hose - Upper; (2 1/2" I.D.)		24440	Belt - Belt; W/49 3/4" Belt O.C. 22705D TR32491		
Hose - Lower; (2 3/8" I.D.)		24438	20; 25		
835; 837; 838; 845; 847; 848A			Caterpillar 4400 Diesel		
Detroit Diesel 3-71 Diesel; Detroit Diesel 4-71 Diesel; Detroit Diesel 6-71 Diesel			Belt - Belt; W/46" Belt O.C. 6B1039 TR34456		
Belt - Fan; W/42 3/4" Belt O.C.	5119186	▲9425HD	Hercules DJXB Diesel; Hercules DJXC Diesel		
Belt - Fan; W/46 1/8" Belt O.C.	5170972	②TR22455	Belt - Belt; W/41 1/4" Belt O.C. 40276A TR30408		
Belt - Gen.; W/12V. Gen.	5108883	▲9365HD	IH U21		
Belt - Gen.; W/24V. Gen.	5125811	▲9380HD	Belt - Belt; W/49 3/4" Belt O.C. 22705D TR32491		
850			30		
IH UD281.4 Diesel			Caterpillar D4400 Diesel		
Belt - Fan	16131DA	TR30467	Belt - Gov. 2A4062 ▲9385HD		
Belt - Gen.	52318DA	9279	Belt - Fan 6B1039 TR34456		
852; 857			IH U21		
Detroit Diesel 3-71 Diesel; Detroit Diesel 4-71 Diesel; Detroit Diesel 6-71 Diesel			Belt - Belt; W/49 3/4" Belt O.C. 22705DA TR32491		
Belt - Fan; W/42 3/4" Belt O.C.	5119186	▲9425HD	32		
Belt - Fan; W/46 1/8" Belt O.C.	5170972	②TR22455	Caterpillar D4600 Diesel		
Belt - Gen.; W/12V. Gen.	5108883	▲9365HD	Belt - Gov. 4B2544 ▲9425HD		

● Vulco-Flex® Coolant Hose.
 ▲ Standard Belt Available. See Pages 630-631.
 ≧ Cut to Fit.

② Two Required.
 ③ Three Required.

Belts and Coolant Hose for Road & Construction Equipment

Application	Mfr. Part No.	Our No.
BAY CITY - Continued		
32 - Continued		
Hercules DJXC Diesel Belt - Belt; W/41 1/4" Belt O.C.	40276A	TR30408
33		
Caterpillar D4600 Diesel Belt - Gov.	4B2544	▲9425HD
37		
Buda K428 Belt - Belt; W/47 1/8" Belt O.C.	1624	TR30467
45; 60		
Detroit Diesel 3-71 Diesel; Detroit Diesel 4-71 Diesel; Detroit Diesel 6-71 Diesel		
Belt - Fan; W/Low Mount Fan; W/46 1/8" Belt O.C.; W/3/4 Thru 1 1/2 Yard Crawler	5170972	②TR22455
Belt - Fan; W/High Mount Fan; W/59 1/8" Belt O.C.; W/3/4 Thru 1 1/2 Yard Crawler	5176420	②TR22588
Belt - Fan; W/High Mount Fan; W/70 1/4" Belt O.C.; W/3/4 Thru 1 1/2 Yard Crawler	3224451	TR34700
Belt - Fan; W/High Mount Fan; W/74 1/2" Belt O.C.; W/3/4 Thru 1 1/2 Yard Crawler	5175105	②BX71
Belt - Gen.; W/12V. Gen.; W/3/4 Thru 1 1/2 Yard Crawler	3224367	TR28390
Belt - Gen.; W/12V., 250W. Gen.; W/3/4 Thru 1 1/2 Yard Crawler	5164293	TR22322
Belt - Gen.; W/24V. Gen.; W/3/4 Thru 1 1/2 Yard Crawler	5155911	TR24400
62		
IH PA100 Belt - Belt; W/54 5/8" Belt O.C.	30748H	②TR30543
63; 72		
Detroit Diesel 3-71 Diesel; Detroit Diesel 4-71 Diesel; Detroit Diesel 6-71 Diesel		
Belt - Fan; W/Low Mount Fan; W/46 1/8" Belt O.C.; W/3/4 Thru 1 1/2 Yard Crawler	5170972	②TR22455
Belt - Fan; W/High Mount Fan; W/59 1/8" Belt O.C.; W/3/4 Thru 1 1/2 Yard Crawler	5176420	②TR22588
Belt - Fan; W/High Mount Fan; W/70 1/4" Belt O.C.; W/3/4 Thru 1 1/2 Yard Crawler	3224451	TR34700
Belt - Fan; W/High Mount Fan; W/74 1/2" Belt O.C.; W/3/4 Thru 1 1/2 Yard Crawler	5175105	②BX71
Belt - Gen.; W/12V. Gen.; W/3/4 Thru 1 1/2 Yard Crawler	3224367	TR28390
Belt - Gen.; W/12V., 250W. Gen.; W/3/4 Thru 1 1/2 Yard Crawler	5164293	TR22322
Belt - Gen.; W/24V. Gen.; W/3/4 Thru 1 1/2 Yard Crawler	5155911	TR24400
151-T41		
Detroit Diesel 2-71 Diesel		
Belt - Fan; W/Truck Mtd. Shovel	5166844	TR22625
Belt - Gen.; W/24V. Gen.; W/Truck Mtd. Shovel	5166844	TR22625
Belt - Compr.; W/Truck Mtd. Shovel	5168993	TR24515
Detroit Diesel 4-71 Diesel		
Belt - Gen.; W/Truck Mtd. Shovel	3224367	TR30408
180; 185		
Waukesha 6SRKR Belt - Gen.		
	78382	TR34545
190-T52; 190-T6430		
Detroit Diesel 3-71 Diesel; Detroit Diesel 4-71 Diesel; Detroit Diesel 6-71 Diesel		
Belt - Fan; W/Low Mount Fan; W/46 1/8" Belt O.C.; W/Truck Mtd. Crane	5170972	②TR22455
Belt - Fan; W/High Mount Fan; W/70 1/4" Belt O.C.; W/Truck Mtd. Crane	3224451	TR34700
Belt - Fan; W/High Mount Fan; W/74 1/2" Belt O.C.; W/Truck Mtd. Crane	5175105	②BX71
Belt - Gen.; W/12V. Gen.; W/Truck Mtd. Crane	3224367	TR28390
Belt - Gen.; W/12V., 250W. Gen.; W/Truck Mtd. Crane	5164293	TR22322
Belt - Gen.; W/24V. Gen.; W/Truck Mtd. Crane	5155911	TR24400

▲ Standard Belt Available. See Pages 630-631.

Application	Mfr. Part No.	Our No.
BAY CITY - Continued		
190-T52; 190-T6430 - Continued		
Detroit Diesel 3-71 Diesel; Detroit Diesel 4-71 Diesel; Detroit Diesel 6-71 Diesel - Continued		
Belt - Fan; W/High Mount Fan; W/74 1/2" Belt O.C.; W/Truck Mtd. Crane	5175105	②BX71
Belt - Gen.; W/12V. Gen.; W/Truck Mtd. Crane	3224367	TR28390
Belt - Gen.; W/12V., 250W. Gen.; W/Truck Mtd. Crane	5164293	TR22322
Belt - Gen.; W/24V. Gen.; W/Truck Mtd. Crane	5155911	TR24400
255A; 425; 440		
Detroit Diesel 3-71 Diesel; Detroit Diesel 4-71 Diesel		
Belt - Fan; W/Low Mount Fan; W/46 1/8" Belt O.C.	5170972	②TR22455
Belt - Fan; W/High Mount Fan; W/70 1/4" Belt O.C.	3224451	TR34700
Belt - Fan; W/High Mount Fan; W/74 1/2" Belt O.C.	5175105	②BX71
Belt - Gen.; W/12V. Gen.	3224367	TR28390
Belt - Gen.; W/12V., 250W. Gen.	5164293	TR22322
Belt - Gen.; W/24V. Gen.	5155911	TR24400
450		
Detroit Diesel 3-71 Diesel		
Belt - Fan; W/Low Mount Fan; W/46 1/8" Belt O.C.	5170972	②TR22455
Belt - Fan; W/High Mount Fan; W/70 1/4" Belt O.C.	3224451	TR34700
Belt - Fan; W/High Mount Fan; W/74 1/2" Belt O.C.	5175105	②BX71
Belt - Gen.; W/12V. Gen.	3224367	TR28390
Belt - Gen.; W/12V., 250W. Gen.	5164293	TR22322
Belt - Gen.; W/24V. Gen.	5155911	TR24400
535		
Detroit Diesel 3-71 Diesel; Detroit Diesel 4-71 Diesel		
Belt - Fan; W/Low Mount Fan; W/46 1/8" Belt O.C.	5170972	②TR22455
Belt - Fan; W/High Mount Fan; W/70 1/4" Belt O.C.	3224451	TR34700
Belt - Fan; W/High Mount Fan; W/74 1/2" Belt O.C.	5175105	②BX71
Belt - Gen.; W/12V. Gen.	3224367	TR28390
Belt - Gen.; W/12V., 250W. Gen.	5164293	TR22322
Belt - Gen.; W/24V. Gen.	5155911	TR24400
600		
Detroit Diesel 3-71 Diesel		
Belt - Fan; W/Low Mount Fan; W/46 1/8" Belt O.C.	5170972	②TR22455
Belt - Fan; W/High Mount Fan; W/70 1/4" Belt O.C.	3224451	TR34700
Belt - Fan; W/High Mount Fan; W/74 1/2" Belt O.C.	5175105	②BX71
Belt - Gen.; W/12V. Gen.	3224367	TR28390
Belt - Gen.; W/12V., 250W. Gen.	5164293	TR22322
Belt - Gen.; W/24V. Gen.	5155911	TR24400
610-T6435; 610-T8445		
Detroit Diesel 3-71 Diesel; Detroit Diesel 4-71 Diesel; Detroit Diesel 6-71 Diesel		
Belt - Fan; W/Low Mount Fan; W/46 1/8" Belt O.C.; W/Truck Mtd. Crane	5170972	②TR22455
Belt - Fan; W/High Mount Fan; W/70 1/4" Belt O.C.; W/Truck Mtd. Crane	3224451	TR34700
Belt - Fan; W/High Mount Fan; W/74 1/2" Belt O.C.; W/Truck Mtd. Crane	5175105	②BX71
Belt - Gen.; W/12V. Gen.; W/Truck Mtd. Crane	3224367	TR28390
Belt - Gen.; W/12V., 250W. Gen.; W/Truck Mtd. Crane	5164293	TR22322

② Two Required.

Belts and Coolant Hose for Road & Construction Equipment

Application	Mfr. Part No.	Our No.
BAY CITY - Continued		
610-T6435; 610-T8445 - Continued		
Detroit Diesel 3-71 Diesel; Detroit Diesel 4-71 Diesel; Detroit Diesel 6-71 Diesel - Continued		
Belt - Gen.; W/24V. Gen.; W/Truck Mtd. Crane	5155911	TR24400
720		
Detroit Diesel 6-71 Diesel		
Belt - Fan; W/Low Mount Fan; W/46 1/8" Belt O.C.	5170972	②TR22455
Belt - Fan; W/High Mount Fan; W/70 1/4" Belt O.C.	3224451	TR34700
Belt - Fan; W/High Mount Fan; W/74 1/2" Belt O.C.	5175105	②BX71
Belt - Gen.; W/12V. Gen.	3224367	TR28390
Belt - Gen.; W/12V., 250W. Gen.	5164293	TR22322
Belt - Gen.; W/24V. Gen.	5155911	TR24400
BLAW-KNOX		
195 Road Widener		
Detroit Diesel 4-53 Diesel		
Belt - Fan & Compr.	5136272	②▲9520HD
Belt - W.P. & Alt.	5133601	②7410
Belt - Hyd. Pump		②3VX355
Ford 6-Cyl. 300		
Belt - Fan		▲9405HD
Belt - Alt. & W.P.		7420
Belt - Gov.		7260
Belt - Compr.		7450
Belt - Hyd. Pump		▲9550HD
PF25		
Ford V-4 104		
Belt - Fan, Alt. & W.P.		7430
Belt - Fan, W.P. & Idler		7430
Belt - Gov.		7350
PF65		
Ford 6-Cyl. 172		
Belt - Fan & Alt.		▲9420HD
Belt - Compr. & Hyd. Pump		7640
Ford 6-Cyl. 172 Diesel		
Belt - Fan & Alt.		▲9415HD
Belt - Compr. & Hyd. Pump		7640
PF120		
Detroit Diesel 4-53 Diesel		
Belt - Fan & Compr.	5136272	②▲9520HD
Belt - W.P. & Alt.	5133601	②7410
Belt - Hyd. Pump		②3VX355
Hose - Upper		≅21794
		or ●25474
Hose - Lower - Eng. To Pipe; (2" I.D.)		24432
Hose - Lower - Pipe To Rad.; (2" I.D.)		24432
Ford 6-Cyl. 300		
Belt - Fan		▲9405HD
Belt - Alt. & W.P.		7420
Belt - Gov.		7260
Belt - Compr.		7450
Belt - Hyd. Pump		③7355
PF500		
Detroit Diesel 4-53 Diesel		
Belt - W.P. & Alt.	5133601	②7410
Hose - Upper		≅21794
		or ●25474
Hose - Lower - Eng. To Pipe; (2" I.D.)		24432
Hose - Lower - Pipe To Rad.; (2" I.D.)		24432

Application	Mfr. Part No.	Our No.
BOBCAT-MELROE		
225		
Kubota D1402B Diesel		
Belt - Fan & Alt.	6657279	7440
Hose - Upper		≅20137
331		
Kubota V2203E Diesel		
Belt - Fan & Alt.	6657279	7440
Hose - Upper		≅21660
		or ●25474
335		
Kubota V2203 Diesel		
Belt - Fan	7101067	▲K060425HD
425		
Kubota V1505 Diesel		
Belt - Fan	6690691	7380
430; 430H		
Kubota V2203 Diesel		
Belt - Fan	6815019	K060445
641		
Deutz F2L511 Diesel		
1990-1981		
Belt - Blower & Alt.		②▲9375HD
642		
Ford 4-Cyl. 98		
1986-1981		
Belt - Fan & Gov.	6554888	7420
Belt - Alt.	6551743	7312
642B		
Mitsubishi 4G32		
1993-1986		
Belt - W.P. To Alt.		7400
Belt - Gov.		7315
643		
Kubota D1402BA Diesel		
1992-1981		
Belt - W.P. & Alt.		▲9451HD
Hose - Upper		●25487
Hose - Lower		●25487
742		
Ford 4-Cyl. 98		
1990-1981		
Belt - W.P. & Gov.	6554888	7420
Belt - Alt.	6557143	7300
Hose - Upper		●25482
743		
Kubota V1702BA Diesel		
1990-1981		
Belt - Fan & Alt.	6562693	▲9451HD
743B		
Kubota V1702BA Diesel		
1994-1991		
Belt - Fan & Alt.	6562693	▲9451HD
753		
Kubota V2203B Diesel		
2003-1990		
Belt - Fan		7410
Hose - Upper		●25251

② Two Required.
 ≅ Cut to Fit.
 ③ Three Required.

▲ Standard Belt Available. See Pages 630-631.
 ● Vulco-Flex® Coolant Hose.

Belts and Coolant Hose for Road & Construction Equipment

Application	Mfr. Part No.	Our No.	Application	Mfr. Part No.	Our No.
BOBCAT-MELROE - Continued			BOBCAT-MELROE - Continued		
763H			M970 - Continued		
Kubota V2203B Diesel 2000-1995 Hose - Upper ●25251			Perkins 4-Cyl. 236 Diesel 1975-1970 Belt - Fan & Alt. TR22508		
843			MT52		
Perkins 4-Cyl. 154 Diesel 1986-1981 Hose - Lower - Pipe To Rad. ≍21794 or ●25473			Kubota D722E Diesel 2007-2004 Belt - Fan 6686683 7340		
843B			S130		
Isuzu 4-Cyl. 169 Diesel 1992-1990 Belt - W.P. To Alt. 8942568000 TR24407 Hose - By Pass ≍20802			Kubota 4-Cyl. 134 Diesel 2006-2003 Belt - Alt. 7100572 7435		
853			S300		
Isuzu 4JB1PK-03 Diesel 1999-1991 Belt - Fan 6701265 7673 Belt - Alt. 8942568000 TR24407			Kubota 4-Cyl. 203 Diesel 2006-2003 Belt - Fan 6686655 7516		
975			BOMAG		
John Deere 4-Cyl. 276 Diesel 1990-1974 Belt - Fan & Alt. 6511876 ▲9500HD			BW142PD		
2000			Deutz F3L912 Diesel Belt - Alt. 7445		
Perkins 4-Cyl. 154 Diesel Belt - Fan & Alt. 7470			BW161AD		
3023			Deutz BF4L913 Diesel Belt - Blower 7530 Belt - Alt. 7465		
Kubota V1702BA Diesel Belt - W.P. To Alt. ▲9451HD Hose - Upper ≍20137			BW210AVA		
7753			Deutz F6L912 Diesel Belt - Blower 7535 Belt - Gen. 7445		
Kubota V2203B Diesel 1993-1990 Hose - Upper ●25251			BW213D		
A300			Deutz F6L912 Diesel Belt - Alt. 7448		
Deutz 4-Cyl. 178 Diesel 2006-2002 Belt - Fan 6686655 7516			K45		
M600D			Cummins JN6B Diesel Belt - Fan 124421 ②TR24365 Belt - W.P. 101427 TR22299 Hose - Upper ●26511		
Deutz F2L410 Diesel 1975-1967 Belt - Fan & Alt. 7365			Detroit Diesel 4-71 Diesel Belt - Fan; W/Air Brake Compr.; W/High Mount Fan 3224451 TR34700 Belt - Fan; W/O Air Brake Compr.; W/High Mount Fan 3224368 TR34545 Belt - Fan; W/Low Mount Fan TR22455 Belt - Gen.; W/25A. Gen. 3224367 TR28390		
M620			K300		
Wisconsin VH4D 1976-1975 Belt - Alt. 6541943 9279			Cummins V555 Diesel Belt - Fan & W.P. 178497 ②TR24476 Belt - Alt. 178459 ▲9319HD Hose - Upper ●26509 Hose - Lower ●26509		
M700			KT7B; KT8		
Wisconsin VH4D; Wisconsin VH4D LPG 1976-1972 Belt - Alt. 6541943 9279			Continental Y112 Belt - Fan & Gen. 11653 TR22386 Belt - Hyd. Pump 11894 TR30428		
M970			Hercules DIXC Diesel Belt - Fan TR24438 Belt - Hyd. Pump 11894 TR30428		
Continental F227 Diesel 1975-1970 Belt - Fan & Alt. ▲9500HD			Hercules IXB5 Belt - Fan & Gen.; W/35 1/2" Belt O.C. 11402 TR26353 Belt - Fan & Gen.; W/41 7/8" Belt O.C. 11023 TR24414		

● Vulco-Flex® Coolant Hose.
▲ Standard Belt Available. See Pages 630-631.

≍ Cut to Fit.
② Two Required.

Belts and Coolant Hose for Road & Construction Equipment

Application	Mfr. Part No.	Our No.	Application	Mfr. Part No.	Our No.
BOMAG - Continued			BROS		
KT7B; KT8 - Continued			LSPRM8A		
Hercules IXB5 - Continued			Caterpillar D334TAC Diesel		
Belt - Hyd. Pump; Ser. No. 23713 & Before ..	11280	TR28429	Hose - Upper		●26532
Belt - Hyd. Pump; Ser. No. 23714 & After	11609	TR28390	Cummins NT855 Diesel		
KT15			Belt - Fan	178684	②TR28693
Continental F226			Hose - Upper		●26525
Belt - Fan	F600K267	TR24465	Hose - Lower		●26525
MPH100S			Detroit Diesel 8V-71N Diesel		
Detroit Diesel 6V-92 Diesel			Hose - Lower; (2 3/4" I.D.)		24444
Belt - Fan		③▲9710HD	Hose - Lower		●26525
PSR9			LSPRM84A		
Continental F226			Cummins NHRS6P Diesel		
Belt - Fan & Gen.	F226K280	②7460	Belt - Fan	178611	②TR28550
Hose - Upper; (1 1/2" I.D.)		24224	Belt - W.P.	200328	TR24438
Hose - Lower; (1 1/2" I.D.)		24224	Belt - Hyd. Pump		TR28423
Hose - Lower		●25476	Hose - Upper - Eng. To Pipe; (2 1/4" I.D.)		24236
PSR30			Hose - Upper - Pipe To Rad.; (2 1/4" I.D.)		24236
Cummins JN6B Diesel			Hose - Lower; (2 1/4" I.D.)		24236
Belt - Fan	124421	②TR24365	SP54C		
Belt - W.P.	101427	TR22299	Continental F162		
PSRC10			Belt - Fan & Gen.		
Ford 6-Cyl.			F600K267		TR24465
Belt - Fan		▲9412HD	SP255		
Belt - W.P. & Gen.		7360	Cummins C160 Diesel		
Belt - Gov.		7250	Belt - Fan		②TR22358
S46			Belt - W.P.		TR22329
Ford V-4 104			Belt - Gen.		TR22495
Belt - Fan, Alt. & W.P.		7445	SP730B		
Belt - Gov.		7350	Cummins JN6IP Diesel		
Belt - Hyd. Pump		7380	Belt - Fan	124421	②TR24365
Hose - Upper		●25473	Belt - W.P.; W/33 3/8" Belt O.C.	178490	TR22329
VM33			Belt - W.P.; W/36 3/8" Belt O.C.	178530	②TR22358
Waukesha BKR			Belt - Alt.	178685	TR22485
Belt - Fan & Gen.		TR30448	Belt - Gen.; W/44 3/4" Belt O.C.	101426	TR22443
VT48			Belt - Gen.; W/46 5/8" Belt O.C.	70885	TR22461
Waukesha 6SRKR			Belt - Gen.; W/47 7/8" Belt O.C.	178470	TR22474
Belt - Fan	12910	C78	Belt - Gen. & V.P.		7550
Belt - Hyd. Pump	11894	TR30428	Belt - Hyd. Pump		TR24438
BRODERSON			Hose - Upper - Eng. To Pipe; (2" I.D.)		24232
IC701A			Hose - Upper - Pipe To Rad.; (2" I.D.)		24232
Ford 4-Cyl. 172 Diesel			Hose - Lower - Pipe To Rad.; (2 1/4" I.D.)		②24236
Belt - Fan & Alt.		7390	Hose - Lower - W.P. To Water Manifold; (2 1/4" I.D.)		24236
Belt - Hyd. Pump		TR22461	Hose - Lower - Water Manifold To Pipe; (1 7/8" I.D.)		②24230
Hose - Upper - Eng. To Pipe		≠21942	SP735		
Hose - Upper - Pipe To Rad.		≠21942	Cummins Diesel		
Hose - Lower - Pipe To Rad.		●25253	Belt - Fan	124479	②TR22363
MH42A			Belt - W.P.	101427	TR22299
Chrysler 6-Cyl. 225			Belt - Gen.	134788	TR22517
Belt - Fan & Alt.		7570	SP4000		
Belt - P.S.		▲9415HD	Perkins 4-Cyl. 236		
Hose - Upper		≠20137	Belt - Fan & Alt.		▲9560HD
Hose - Lower		20229	Hose - Upper		●25482
MH42B			SP6000		
Perkins 4-Cyl. Diesel			Detroit Diesel 3-53 Diesel		
Belt - Fan & Alt.		▲9590HD	Belt - Fan		②▲9412HD
Hose - Upper		●26506	Belt - W.P. & Gen.	5126356	②TR22373
Hose - Lower		●25487	Hose - Upper		20065
					or ●25474
			Hose - Lower - Eng. To Pipe; (2" I.D.)		24232
			Hose - Lower - Pipe To Rad.; (2" I.D.)		24232
			SP6000B		
			Detroit Diesel 3-53 Diesel		
			Belt - Fan		②▲9415HD
			Belt - W.P. & Alt.	5133174	②7400

③ Three Required.
 ② Two Required.
 ≠ Cut to Fit.

▲ Standard Belt Available. See Pages 630-631.
 ● Vulco-Flex® Coolant Hose.

Belts and Coolant Hose for Road & Construction Equipment

Application	Mfr. Part No.	Our No.	Application	Mfr. Part No.	Our No.
BROS - Continued			BUCYRUS-ERIE		
SP6000B - Continued			10B		
Detroit Diesel 3-53 Diesel - Continued			Hercules		
Hose - Upper		●26504	Belt - Fan & Gen		TR30467
Hose - Lower - Eng. To Pipe; (2" I.D.)		24232	IH UD281.4 Diesel		
Hose - Lower - Pipe To Rad.		≈<20206	Belt - Fan	16131DA	TR30467
SPV627; SPV627VA			Belt - Gen.	52318DA	9279
John Deere 4276D Diesel			10R		
Hose - Upper		≈<20065	Detroit Diesel 6-71 Diesel		
	or	●25526	Belt - Fan; W/42 3/4" Belt O.C.	5119186	②▲9425HD
Hose - Lower		●26501	Belt - Fan; W/46 1/8" Belt O.C.	5170972	②TR22455
SPV735			Belt - Gen.; W/18A. Gen.	5125811	▲9380HD
Detroit Diesel 3-53 Diesel			Belt - Gen.; W/25A. Gen.	5108883	▲9365HD
Belt - W.P.	5133173	7420	15B		
Hose - Upper		●26501	Detroit Diesel 2-71 Diesel		
Hose - Lower - Eng. To Pipe		≈<20882	Belt - Fan	5166844	TR22625
Hose - Lower - Pipe To Rad.		≈<20882	Belt - Gen.	5166844	TR22625
SPV735VA			Belt - Compr.	5168993	TR24515
Detroit Diesel 3-53 Diesel			IH UD9		
Belt - Fan	5119188	②▲9390HD	Belt - Fan	48042D	TR30484
Belt - W.P. & Gen.		②7400	Belt - Gen.	54857DB	9300
Belt - Hyd. Pump		7340	19B		
Hose - Upper		●26504	Caterpillar D318 Diesel		
Hose - Lower - Eng. To Pipe		≈<20206	Belt - Gov.	4B2544	▲9425HD
Hose - Lower - Pipe To Rad.		≈<20206	Belt - Starter	6B2746	TR22485
Detroit Diesel 4-53 Diesel			20B		
Belt - W.P. & Alt.	5133174	7400	Detroit Diesel 3-71 Diesel		
Hose - Upper		●26501	Belt - Fan; W/High Mount Fan; W/70 1/4" Belt		
Hose - Lower; (2" I.D.)		24232	O.C.; W/3/4 Thru 1 1/2 Yard	3224451	TR34700
SPV850			Belt - Fan; W/Low Mount Fan; W/46 1/8" Belt		
Detroit Diesel 4-53 Diesel			O.C.; W/3/4 Thru 1 1/2 Yard	5170972	②TR22455
Hose - Lower		≈<20882	Belt - Gen.; W/12V. Gen.; W/3/4 Thru 1 1/2		
SSPRIN1-7			Yard	3224367	TR28390
Cummins C160 Diesel			Belt - Gen.; W/24V. Gen.; W/3/4 Thru 1 1/2		
Hose - Upper		●26504	Yard	5155911	TR24400
SSPRN7			20H		
Cummins C160 Diesel			Detroit Diesel 6-71 Diesel		
Belt - Fan		②TR24407	Belt - Fan	5131395	②▲9400HD
Belt - W.P.	178584	TR22350	Belt - W.P. & Alt.		②7417
Belt - Gen.		TR22495	Belt - Hyd. Pump		7350
Belt - Hyd. Pump		②TR22495	Hose - Upper		≈<20957
TE4			Hose - Lower		or ●26603
Ford 6-Cyl. 300 Diesel					≈<20206
Belt - Fan & Alt.		7417	20H III		
Hose - Upper		●25478	Cummins V504 Diesel		
Hose - Lower		●26504	Belt - Fan & W.P.	212585	②TR22517
Ford 6-Cyl. 330 Diesel			Belt - Fan To Alt.	178453	②7400
Belt - Fan & Alt.		7495	Hose - Upper		●26511
Hose - Upper		●26505	Hose - Lower		●26519
Hose - Lower		●26510	20R		
BROWN			Detroit Diesel 6-71 Diesel		
1200 Series			Belt - Fan; W/42 3/4" Belt O.C.	5119186	②▲9425HD
Honda 9 H.P.			Belt - Fan; W/46 1/8" Belt O.C.	5170972	②TR22455
Belt - Drive		BX71	Belt - Gen.; W/18A. Gen.	5125811	▲9380HD
The Articulator			Belt - Gen.; W/25A. Gen.	5108883	▲9365HD
Honda 8 H.P.			21H		
Belt - Drive; W/60" Belt O.C.	B57	⑤6960	Cummins V903 Diesel		
Belt - Drive; W/93" Belt O.C.	B90	6993	Belt - Fan & W.P.		②TR22525
			Belt - Alt.	178453	②7400
			Detroit Diesel 4-71 Diesel		
			Belt - Fan		②▲9500HD
			Belt - Alt.		▲9370HD
			Hose - Upper		●26509
			Hose - Lower		●26510

- Vulco-Flex® Coolant Hose.
- ② Two Required.
- ⑤ Five Required.

- ≈< Cut to Fit.
- ▲ Standard Belt Available. See Pages 630-631.

Road & Construction Equipment

Belts and Coolant Hose for Road & Construction Equipment

Application	Mfr. Part No.	Our No.
BUCYRUS-ERIE - Continued		
21H IV		
Cummins V903 Diesel		
Hose - Upper		●26512
Hose - Lower		●26519
22B		
Caterpillar D318 Diesel		
Belt - Gov.	4B2544	▲9425HD
Belt - Starter	6B2746	TR22485
Detroit Diesel 3-71 Diesel		
Belt - Fan; W/High Mount Fan; W/70 1/4" Belt		
O.C.; W/3/4 Thru 1 1/2 Yard	3224451	TR34700
Belt - Fan; W/Low Mount Fan; W/46 1/8" Belt		
O.C.; W/3/4 Thru 1 1/2 Yard	5170972	②TR22455
Belt - Gen.; W/12V. Gen.; W/3/4 Thru 1 1/2		
Yard	3224367	TR28390
Belt - Gen.; W/24V. Gen.; W/3/4 Thru 1 1/2		
Yard	5155911	TR24400
22BM-2		
Cummins C464P160 Diesel		
Belt - Fan; W/36 5/8" Belt O.C.		②TR22358
Belt - Fan; W/37 3/8" Belt O.C.	178576	②TR24365
Belt - W.P.		TR22299
Belt - Alt.	178470	TR22474
25B		
Detroit Diesel 4-71 Diesel		
Belt - Fan; W/High Mount Fan; W/70 1/4" Belt		
O.C.; W/3/4 Thru 1 1/2 Yard	3224451	TR34700
Belt - Fan; W/Low Mount Fan; W/46 1/8" Belt		
O.C.; W/3/4 Thru 1 1/2 Yard	5170972	②TR22455
Belt - Gen.; W/12V. Gen.; W/3/4 Thru 1 1/2		
Yard	3224367	TR28390
Belt - Gen.; W/24V. Gen.; W/3/4 Thru 1 1/2		
Yard	5155911	TR24400
30H II		
Detroit Diesel 6V-71N Diesel		
Belt - Fan		②▲9455HD
Belt - Gen.		▲9360HD
Belt - Hyd. Pump		7355
Hose - Upper		≅20731
Hose - Lower; (2 3/4" I.D.)		24244
Hose - Lower		●26521
37B		
Wisconsin D3		
Belt - Fan	15834	TR28628
38B		
Detroit Diesel 6-71 Diesel		
Belt - Fan; W/High Mount Fan; W/Compr.	3224451	TR34700
Belt - Fan; W/High Mount Fan; W/O Compr. .	3224368	TR34545
Belt - Fan; W/Low Mount Fan; W/Compr.	5177290	TR22455
Belt - Fan; W/Low Mount Fan; W/O Compr. .	5170972	TR22455
Belt - Gen.; W/20A. Gen.	5155911	TR28406
Belt - Gen.; W/25A. Gen.	3224367	TR28390
38TC		
Detroit Diesel 6-71 Diesel		
Belt - Fan; W/High Mount Fan; W/70 1/4" Belt		
O.C.; W/3/4 Thru 1 1/2 Yard	3224451	TR34700
Belt - Fan; W/Low Mount Fan; W/46 1/8" Belt		
O.C.; W/3/4 Thru 1 1/2 Yard	5170972	②TR22455
Belt - Gen.; W/12V. Gen.; W/3/4 Thru 1 1/2		
Yard	3224367	TR28390
Belt - Gen.; W/24V. Gen.; W/3/4 Thru 1 1/2		
Yard	5155911	TR24400

Application	Mfr. Part No.	Our No.
BUCYRUS-ERIE - Continued		
45CIIB100		
Detroit Diesel 6V-53 Diesel		
Hose - Upper - Right (Upper Structure)		●26502
Hose - Upper - Left (Upper Structure)		●26502
Hose - Lower - Upper Structure		●26509
Detroit Diesel 6V-53N Diesel		
Belt - Fan - Upper Structure	5135299	②▲9360HD
Belt - W.P. & Idler - Upper Structure		②7365
Belt - Alt. - Upper Structure		②7365
Belt - Hyd. Pump - Upper Structure		②7400
Detroit Diesel 6V-71N Diesel		
Belt - Fan - Lower Structure	5135942	②▲9550HD
Belt - Alt. - Lower Structure		▲9390HD
Hose - Upper - Lower Structure		●26524
Hose - Lower - Lower Structure		●26520
45R		
Cummins NT380 Diesel		
Belt - Fan	178611	②TR28545
Belt - W.P.		TR22434
Belt - Gen.		TR22410
Cummins NT855 Diesel		
Belt - Fan		②TR24562
Belt - W.P.	S3163	TR22434
Belt - Gen.	178599	TR22410
51B		
Buda 6-Cyl. Diesel		
Belt - Fan	DP1597	②TR28666
Belt - Compr.		TR30589
Belt - Starter		TR28437
54B		
Buda 6-Cyl. Diesel		
Belt - Fan	DP1597	②TR28666
60L		
IH UD281.4 Diesel		
Belt - Fan	16131DA	TR30467
Belt - Gen.	52318DA	9279
71B		
Detroit Diesel 6-110 Diesel		
Belt - Fan	2304818	7470
Belt - Gen.	6107416	TR28429
88B		
Cummins VT12 Diesel		
Belt - Fan	69201	②▲9650HD
Belt - Gen.	S3133	②TR22344
280CSP		
Detroit Diesel 4-53N Diesel		
Belt - Fan	5119188	▲9390HD
Belt - W.P. & Alt.		7417
Hose - Upper		≅20611
		or ●26509
500H		
Cummins VT1710 Diesel		
Belt - W.P. & Alt.	178520	②▲9390HD
Belt - A.C.	178663	②▲9365HD
Belt - Compr.		③5VX800
BUFFALO SPRINGFIELD		
K		
Ford V-8 361		
Belt - Fan		TR28483
Belt - Fan & Alt.		②TR24438

● Vulco-Flex® Coolant Hose.
 ② Two Required.
 ③ Three Required.

▲ Standard Belt Available. See Pages 630-631.
 ≅ Cut to Fit.

Belts and Coolant Hose for Road & Construction Equipment

Application	Mfr. Part No.	Our No.	Application	Mfr. Part No.	Our No.
BUFFALO SPRINGFIELD - Continued			CASE - Continued		
K - Continued			320 Loader Backhoe - Continued		
Ford V-8 361 - Continued			Case 4-Cyl. 148 Diesel		
Belt - Hyd. Pump		TR22508	Belt - Fan & Gen.	VT4886	TR24449
Hose - Upper - Eng. To Pipe	●26504		Belt - P.S.	G46124	1230
Hose - Upper - Pipe To Rad.	●25527		Hose - Upper; (1 3/4" I.D.)		24428
KF30			Hose - Lower; (1 5/8" I.D.)		
Detroit Diesel 6-71 Diesel			②24226		
Belt - Fan; W/36 3/4" Belt O.C.	5108883	♣9365HD	320 Wheel Loader		
Belt - Fan; W/42 3/4" Belt O.C.	5119186	♣9425HD	Case 4-Cyl. 148		
Belt - Gen.; W/25A. Gen.	5170972	TR22455	Belt - Fan & Gen.		
CASE			Belt - Fan, Gen. & S.P.		
12+2			Belt - P.S.		
Kohl 12 H.P.			Hose - Upper; (1 3/4" I.D.)		
Belt - Fan & Alt.	A38824	♣9490HD	Hose - Lower; (1 5/8" I.D.)		
Belt - Pump Drive		3VX355	24226		
25+4XP			Continental 4-Cyl. 157 Diesel		
Wisconsin VH4D			Belt - Fan & Gen.; W/O P.S.		
Belt - Alt.		6723	G11233		
30+4			♣9447HD		
Deutz F2L511 Diesel			320B Loader Backhoe		
Belt - Alt.		6723	Case 4-Cyl. 148		
40XT; 60XT; 70XT			Belt - Fan & Gen. - Left Side		
Case 4-390 Diesel			Belt - Fan & Gen. - Right Side		
2004-2002			Belt - Fan, Gen. & P.S.		
Belt - Fan	J911559	♣K080620HD	Hose - Upper; (1 3/4" I.D.)		
Tensioner Assy. - Fan	J936203	38504	Hose - Lower; (1 3/4" I.D.)		
75XT			24228		
Case 4-390 Diesel			②24228		
2004-1998			Continental 4-Cyl. 157 Diesel		
Belt - Fan	J911559	♣K080620HD	Belt - Fan & Gen.		
Tensioner Assy. - Fan	J934817	38504	G11233		
85XT; 90XT; 95XT			Belt - P.S.		
Case 4T390 Diesel			G46124		
2004-1998			1230		
Belt - Fan	J911559	♣K080620HD	350 Crawler		
Tensioner Assy. - Fan	J934817	38504	Case 4-Cyl. 188 Diesel		
125B			Belt - Fan & Alt.		
Deutz BF6L913 Diesel			G46238		
Belt - Alt.	P939740	7450	♣9476HD		
Belt - Blower	P938746	7430	≈20206		
170B			Hose - Upper		
Deutz BF6L913 Diesel			or ●26507		
Belt - Alt.	P938740	7450	Hose - Lower; (1 3/4" I.D.)		
Belt - Blower	P938746	7430	②24228		
220			380		
Deutz F10L413F Diesel			David Brown 3-Cyl. 164 Diesel		
Belt - Alt.	T0138776	②7380	Belt - Fan & Alt.		
220B			A912196		
Deutz F10L413F Diesel			7430		
Belt - Alt.	P938762	7380	Hose - Upper; (1 1/2" I.D.)		
320 Loader Backhoe			24224		
Case 4-Cyl. 148			410 Skid Steer; 420 Skid Steer		
Belt - Fan & Gen.	VT4886	TR24449	Case 422/M2 Diesel		
Belt - Fan, Gen. & S.P.	G46083	7270	2006-2005		
Belt - P.S.	G46124	1230	Belt - Fan & Alt.		
Hose - Upper; (1 3/4" I.D.)		24428	SBA080109061		
Hose - Lower; (1 5/8" I.D.)		24226	A38		
320 Wheel Loader			430 Scatback		
Case 4-Cyl. 148			Wisconsin VH4D		
Belt - Fan & Gen.	VT4886	TR24449	Belt - Alt.		
Belt - Fan, Gen. & S.P.	G46083	7270	3V400		
Belt - P.S.	G46124	1230	3VX400		
Hose - Upper; (1 3/4" I.D.)		24428	430 Skid Steer		
Hose - Lower; (1 5/8" I.D.)		24226	Case 445/M2 Diesel		
320B Loader Backhoe			2006-2005		
Case 4-Cyl. 148			Belt - Fan & Alt.		
Belt - Fan & Gen.	VT4886	TR24449	85826230		
Belt - Fan, Gen. & S.P.	G46083	7270	♣K080570HD		
Belt - P.S.	G46124	1230	♣9420HD		
Hose - Upper; (1 3/4" I.D.)		24428	Tensioner Assy. - Fan & Alt.		
Hose - Lower; (1 5/8" I.D.)		24226	2852161		
320B Wheel Loader			38639		
Case 4-Cyl. 148			430CK Loader Backhoe		
Belt - Fan & Gen.	VT4886	TR24449	Case 4-Cyl. 148		
Belt - Fan, Gen. & S.P.	G46083	7270	Belt - Fan & Gen.		
Belt - P.S.	G46124	1230	G46238		
Hose - Upper; (1 3/4" I.D.)		24428	♣9476HD		
Hose - Lower; (1 5/8" I.D.)		24226	Hose - Upper; (2" I.D.)		
320B Wheel Loader			Hose - Lower		
Case 4-Cyl. 148			20957		
Belt - Fan & Gen.	VT4886	TR24449			
Belt - Fan, Gen. & S.P.	G46083	7270			
Belt - P.S.	G46124	1230			
Hose - Upper; (1 3/4" I.D.)		24428			
Hose - Lower; (1 5/8" I.D.)		24226			

● Vulco-Flex® Coolant Hose.
② Two Required.

♣ Standard Belt Available. See Pages 630-631.
≈ Cut to Fit.

Belts and Coolant Hose for Road & Construction Equipment

Application	Mfr. Part No.	Our No.	Application	Mfr. Part No.	Our No.
CASE - Continued			CASE - Continued		
430CK Loader Backhoe - Continued			480B		
Case 4-Cyl. 188 Diesel			Case 4-Cyl. 148		
Belt - Fan & Gen. G46238	▲9476HD		Belt - Fan & Alt. A38824	▲9490HD	
Hose - Upper; (2" I.D.)	24432		Hose - Lower	20957	
Hose - Lower; (1 3/4" I.D.)	24428				
435 Skid Steer			Case 4-Cyl. 188 Diesel		
Case 334T/M2 Diesel			Belt - Fan & Alt.; W/Prestolite Alt. A38824	▲9490HD	
2006-2005			Belt - Fan & Alt.; W/Delco Alt. A139089	▲9490HD	
Belt - Fan & Alt. 86982540	▲K080590HD		Hose - Upper; (2" I.D.)	24432	
			Hose - Lower; (2" I.D.)	24432	
440 Skid Steer			480CK		
Case 445/M2 Diesel			Case 4-Cyl. 148		
2006-2005			Belt - Fan & Gen. G46238	▲9476HD	
Belt - Fan & Alt. 85826230	▲K080570HD		Belt - Fan & Alt. A38824	▲9490HD	
Belt - A.C. 87454410	▲9420HD		Hose - Upper; (2" I.D.)	24432	
Tensioner Assy. - Fan & Alt. 2852161	38639		Hose - Lower	20957	
445 Skid Steer			Case 4-Cyl. 188 Diesel		
Case 445/M2 Diesel			Belt - Fan & Gen. G46238	▲9476HD	
2006-2005			Hose - Upper; (2" I.D.)	24432	
Tensioner Assy. - Fan 2852161	38639		Hose - Lower; (1 3/4" I.D.)	24428	
450 Crawler			480D		
Case 4-Cyl. 188 Diesel			Case 4-Cyl. 188 Diesel		
Belt - Fan & Gen. G46238	▲9476HD		Belt - Fan & Alt. D73446	▲9510HD	
Hose - Upper	≅20611		Hose - Upper	≅21379	
	or				
Hose - Lower; (1 3/4" I.D.)	●26508		480E; 480ELL		
	24228		Case 4-Cyl. 390 Diesel		
450 Skid Steer			Belt - Fan J911559		
Case 445/M2 Diesel			Belt - Fan & Alt. J903099	▲K080620HD	
2006-2005			Tensioner Assy. J914086	▲K080620HD	
Belt - Fan 86982450	▲K080590HD			38504	
Tensioner Assy. - Fan 2852161	38639		480F		
450B Crawler			Case 4-Cyl. 390 Diesel		
Case 4-Cyl. 188			Belt - Fan & Alt. J911559	▲K080620HD	
Belt - Fan & Alt.; W/O Turbo A11444	▲9505HD		Tensioner Assy. - Fan & Alt. J918944	38504	
Belt - Fan & Alt.; W/Turbo A22608	②▲9520HD		Hose - Upper	●26502	
Hose - Upper	≅20611		480FLL		
	or		Case 4-Cyl. 390 Diesel		
Hose - Lower	≅20957		Belt - Fan & Alt. J903099	▲K080620HD	
	or		Tensioner Assy. J914086	38504	
	●26603		500 Travelift; 500B Travelift		
450C; 455C			Detroit Diesel 3-53 Diesel		
Case 4-390 Diesel			Belt - W.P. & Alt.	②7425	
Belt - Fan & Alt. J911563	▲K080605HD		530CK		
Tensioner Assy. - Fan & Alt. J918944	38504		Case 4-Cyl. 159; Case 4-Cyl. 188 Diesel		
465 Skid Steer			Belt - Fan & Gen. G46238		
Case 445/M2 Diesel			Hose - Upper; (2" I.D.)	24432	
2006-2005			Hose - Lower	20957	
Tensioner Assy. - Fan 2852161	38639		550		
480			Case 4-390 Diesel		
Case 4-Cyl. 148			Belt - Fan, W.P. & Alt. J911563	▲K080605HD	
Belt - Fan & Alt. A38824	▲9490HD		Tensioner Assy. - Fan, W.P. & Alt. J918944	38504	
Hose - Upper; (2" I.D.)	24432		580		
Hose - Lower	●26602		Case 4-Cyl. 188 Diesel		
	or		Hose - Upper; (2" I.D.)		
	20957		Hose - Lower; (1 3/4" I.D.)		
Case 4-Cyl. 188 Diesel			24232		
Belt - Fan & Alt.; W/Prestolite Alt. A38824	▲9490HD		24228		
Belt - Fan & Alt.; W/Delco Alt. A139089	▲9490HD		580BCK		
Hose - Upper; (2" I.D.)	24432		Case 4-Cyl. 188 Diesel		
Hose - Lower	●26602		Belt - Fan & Alt. A38824		
	or		Hose - Upper; (2" I.D.)		
	20957		Hose - Lower; (1 3/4" I.D.)		
			▲9490HD		
			24232		
			②24228		

▲ Standard Belt Available. See Pages 630-631.
 ● Vulco-Flex® Coolant Hose.

≅ Cut to Fit.
 ② Two Required.

Belts and Coolant Hose for Road & Construction Equipment

Application	Mfr. Part No.	Our No.	Application	Mfr. Part No.	Our No.
CASE - Continued			CASE - Continued		
580C			680E; 680G		
Case 4-Cyl. 207 Diesel			Case 4-Cyl. 336 Diesel		
Belt - Fan & Alt.	D73446	▲9510HD	Belt - Fan & Alt.	A59296	②TR24597
Hose - Upper		20206	Belt - Air Brake Compr.	L55580	7417
			Hose - Lower		20970
580CK			680H		
Case 4-Cyl. 159			Case A336BDT Diesel		
Belt - Fan & Alt.	A38824	▲9490HD	Belt - Alt.	A059296	②TR24597
Hose - Upper; (2" I.D.)		24432	Belt - A.C.	L104202	▲9480HD
Hose - Lower		20957	Belt - Air Brake Compr.	L72739	▲9430HD
Case 4-Cyl. 188; Case 4-Cyl. 188 Diesel			680L		
Belt - Fan & Alt.	A38824	▲9490HD	Case 6-Cyl. 590 Diesel		
Hose - Upper - Eng. To W.P.; (2" I.D.)		24432	Belt - Fan & Alt.	J911559	▲K080620HD
Hose - Upper - Eng. To Rad.; (2" I.D.)		24432	688		
Hose - Lower - Eng. To Rad.; (1 3/4" I.D.)		24428	Case 4T390 Diesel		
580D			Belt - Fan & Alt.	J903091	▲K080560HD
Case 4-Cyl. 207 Diesel			Tensioner Assy. - Fan & Alt.	J914086	38504
Belt - Fan & Alt.; W/O A.C.	D73446	▲9510HD	Hose - Upper		●26510
Belt - Fan & Alt.; W/A.C.	D127502	②▲9550HD	Hose - Lower		●26521
Belt - A.C.	D84316	▲9400HD	721D		
Hose - Upper		21379	Case 6T830 Diesel		
580E			Serpentine Belt	J911567	▲K080670HD
Case 4-Cyl. 390 Diesel			Belt - Fan To A.C.		▲9390HD
Belt - Fan & Alt.	J903099	▲K080620HD	Hose - Upper		●26524
580K			Hose - Lower - Pipe To Pipe		≡21379
Case 4-Cyl. 390 Diesel			Hose - Lower - Pipe To Rad.		≡21115
Belt - Fan & Alt.	J903099	▲K080620HD			or ●26531
Belt - A.C.	A169970	▲9390HD	760		
Tensioner Assy. - Fan & Alt.	J914086	38504	Case 4-Cyl. 390 Diesel		
Hose - Upper		●26611	Belt - Fan & Alt.	J903091	▲K080560HD
600 Skid Steer			Hose - Upper		●26502
Case A336BD Diesel			Hose - Lower		●26520
1974-1972			780		
Belt - Fan & Alt.	A61048	②TR22578	Case A336BD Diesel		
621			Belt - Fan & Alt.	L19082	②▲9550HD
Case 6T590 Diesel			Belt - Air Brake Compr.	L47236	7440
Belt - Fan & Alt.	J911566	K080635	780B		
Hose - Lower		●26522	Case A336BDT Diesel		
621B			Belt - Fan & Alt.	L45532	▲9520HD
Case 6T590 Diesel			Belt - Air Brake Compr.	L108218	▲9465HD
Belt - Fan & Alt.	J911566	K080635	780C		
Belt - Fan To A.C.	S82985	②▲9365HD	Case 6-Cyl. 590 Diesel		
Hose - Lower		●26521	Belt - Fan & Alt.	J903099	▲K080620HD
650			Belt - Air Brake Compr.	D129916	▲9440HD
Case 4T390 Diesel			Belt - A.C.	S94499	▲9530HD
Belt - Fan & Alt.	J911559	▲K080620HD	Tensioner Pulley - Fan & Alt.	J912246	36091
Tensioner Assy. - Fan & Alt.	J918944	38504	780D		
650G Crawler			Case 6-Cyl. 590 Diesel		
Case 4T390 Diesel			Belt - Fan & Alt.	J903099	▲K080620HD
Belt - Fan, W.P. & Alt.	J911559	▲K080620HD	Belt - Air Brake Compr.	D129916	▲9440HD
Belt - A.C.	S82985	②▲9365HD	Tensioner Assy. - Fan & Alt.	J912246	38504
Tensioner Assy. - Fan, W.P. & Alt.	J918944	38504	Tensioner Pulley - Fan & Alt.	J912246	36091
680C			800 Skid Steer; 825		
Case A301BD Diesel			Case A336BD Diesel		
Belt - Fan & Alt.		②▲9570HD	1976-1972		
Belt - V.P.	L11403	7365	Belt - Fan & Alt.	A61048	②TR22578
Belt - A.C.	L53604	▲9412HD	850B Crawler		
Hose - Upper		●26529	Case A336BD Diesel		
Hose - Lower		●26529	Belt - Fan & Alt.	D47563	②TR22570
			Hose - Lower - Eng. To Pipe; (2 3/4" I.D.)		24444

▲ Standard Belt Available. See Pages 630-631.
● Vulco-Flex® Coolant Hose.

② Two Required.
≡ Cut to Fit.

Belts and Coolant Hose for Road & Construction Equipment

Application	Mfr. Part No.	Our No.	Application	Mfr. Part No.	Our No.
CASE - Continued			CASE - Continued		
850D Crawler			1150E - Continued		
Case 4-Cyl. 301 Diesel			Case 6T830 Diesel		
Belt - Fan & Alt.	D43913	②TR22545	Belt - Fan & Alt.	J911561	K080655
Case 6T590 Diesel			Belt - A.C.	R50426	▲9390HD
Belt - Fan, W.P. & Alt.	J911559	▲K080620HD	Tensioner Assy. - Fan & Alt.	J918944	38504
Belt - A.C.	S82985	▲9365HD			
Tensioner Assy. - Fan, W.P. & Alt.	J918944	38504	1150G Crawler		
850G Crawler; 855D			Case 6T590 Diesel		
Case 6T590 Diesel			Belt - Fan & Alt.	J911559	▲K080620HD
Belt - Fan, W.P. & Alt.	J911559	▲K080620HD	Belt - A.C.	S82985	②▲9365HD
Belt - A.C.	S82985	▲9365HD	Tensioner Assy. - Fan & Alt.	J918944	38504
Tensioner Assy. - Fan, W.P. & Alt.	J918944	38504	1155E		
880			Case 6T590 Diesel		
Case 4-Cyl. 336 Diesel			Belt - Fan & Alt.; W/65 1/2" Belt O.C.	J911561	K080655
Belt - Fan	J911557	▲K080560HD	Belt - Fan & Alt.; W/67 1/2" Belt O.C.	J911567	▲K080670HD
Tensioner Assy. - Fan	J914086	38504	Belt - A.C.	S82985	▲9365HD
880B			Tensioner Assy. - Fan & Alt.	J912246	38504
Case 4-Cyl. 336 Diesel			Tensioner Pulley	J912246	36091
Belt - Fan	S86287	TR22625	Case 6T830 Diesel		
880C			Belt - Fan & Alt.	J911561	K080655
Case 6-Cyl. 504 Diesel			Belt - A.C.	R50426	▲9390HD
Belt - Fan & Alt.	L71057	TR22625	Tensioner Assy. - Fan & Alt.	J918944	38504
Hose - Lower - Eng. To Pipe; (2 1/2" I.D.)		24440	1280		
Hose - Lower - Rad. To Pipe		●26530	Case 6-Cyl. 504 Diesel		
or		≠21115	Belt - Fan & Alt.	A59296	②TR24597
880D			1280B		
Case 6-Cyl. 504 Diesel			Case 6-Cyl. 504 Diesel		
Belt - Fan & Alt.	J903091	▲K080560HD	Belt - Fan & Alt.	A59296	②TR24597
Tensioner Assy. - Fan & Alt.	J907469	38504	Detroit Diesel 6V-53 Diesel		
888			Belt - Fan	S211672	7375
Case 6T590 Diesel			Belt - Alt.	S211672	7375
Belt - Fan	J911557	▲K080560HD	1550		
Tensioner Assy. - Fan	J914086	38504	Case 6T830 Diesel		
980			Belt - Fan & Alt.; W/65 1/2" Belt O.C.	J911561	K080655
Case 6-Cyl. 504 Diesel			Belt - Fan & Alt.; W/76 1/2" Belt O.C.	J911567	▲K080670HD
Belt - Fan & Alt.	A65143	TR22588	Belt - A.C.	R50426	▲9390HD
Hose - Lower; (2 1/2" I.D.)		②24940	Tensioner Assy. - Fan & Alt.	J914086	38504
980B			1737		
Case 6-Cyl. 504 Diesel			Case 4-Cyl. 148		
Belt - Alt.	S104812	TR22578	1975-1971		
1088			Belt - Fan		▲9570HD
Case 6T590 Diesel			Belt - Fan & Alt.		▲9490HD
Belt - Fan, W.P. & Alt.	J911557	▲K080560HD	1740		
Tensioner Assy. - Fan, W.P. & Alt.	J918944	38504	Case 4-Cyl. 188 Diesel		
1150B Crawler			1975-1971		
Case 451BD Diesel			Belt - Fan		▲9570HD
Belt - Fan & Alt.	R27266	TR22578	Belt - Fan & Alt.		▲9490HD
Hose - Upper		●26530	Hose - Upper		●26521
or		21115	Hose - Lower		21256
Hose - Lower		●26532	or		●26504
Hose - By Pass; (1 1/4" I.D.)		24220	1740 Wheel Loader		
1150E			Case 4-Cyl. 188 Diesel		
Case 6T590 Diesel			Belt - Fan		▲9570HD
Belt - Fan & Alt.; W/65 1/2" Belt O.C.	J911561	K080655	Belt - Fan & Alt.		▲9490HD
Belt - Fan & Alt.; W/67 1/2" Belt O.C.	J911567	▲K080670HD	Hose - Upper		●26521
Belt - A.C.	S82985	▲9365HD	Hose - Lower		21256
Tensioner Assy. - Fan & Alt.	J912246	38504	or		●26504
Tensioner Pulley	J912246	36091	1816		
1150E			Tecumseh OH160		
Case 6T590 Diesel			1977-1973		
Belt - Fan & Alt.; W/65 1/2" Belt O.C.	J911561	K080655	Belt - Fan & Alt.	D56917	▲9330HD
Belt - Fan & Alt.; W/67 1/2" Belt O.C.	J911567	▲K080670HD	Belt - Hyd. Pump - Loader	D56917	▲9330HD
Belt - A.C.	S82985	▲9365HD			
Tensioner Assy. - Fan & Alt.	J912246	38504			
Tensioner Pulley	J912246	36091			

② Two Required.
 ● Vulco-Flex® Coolant Hose.
 ⚙ Use Wire Inserted Green Stripe® Coolant Hose.

▲ Standard Belt Available. See Pages 630-631.
 ≡ Cut to Fit.

Belts and Coolant Hose for Road & Construction Equipment

Application	Mfr. Part No.	Our No.	Application	Mfr. Part No.	Our No.
CASE - Continued			CASE - Continued		
1816 - Continued			7760		
Tecumseh OH160 - Continued			Detroit Diesel 6-71 Diesel		
1977-1973 - Continued			Hose - Upper - Eng. To Pipe ●26516		
Belt - Hyd. Pump - Steering D60572			Hose - Lower - Eng. To Pipe; (2" I.D.) 24432		
1816C			Hose - Lower - Pipe To Rad.; (2 1/4" I.D.) ②24436		
Onan 543M			9010; 9010B; 9020; 9020B		
1984-1982			Case 4T390 Diesel		
Belt - Fan & Alt. D56917			Belt - Fan, W.P. & Alt. J911557		
Belt - Hyd. Pump - Loader D56917			Tensioner Assy. - Fan, W.P. & Alt. J918944		
Belt - Hyd. Pump - Steering D60572			38504		
1818			9030; 9030B		
Kubota Diesel			Case 6T590 Diesel		
1997			Belt - Fan, W.P. & Alt. J911557		
Belt - Fan 1959646C1			Tensioner Assy. - Fan, W.P. & Alt. J918944		
Belt - Eng. To Hyd. Pump S202900			38504		
Belt - Variable Displacement Pump - Left H438262			9040; 9040B		
Belt - Variable Displacement Pump - Right ... H438262			Case 6T830 Diesel		
Onan 2-Cyl. 48			Belt - Fan, W.P. & Alt. J911572		
1997-1987			Tensioner Assy. - Fan, W.P. & Alt. J918944		
Belt - Eng. To Hyd. Pump H437092			38504		
Belt - Variable Displacement Pump - Left H438262			9050		
Belt - Variable Displacement Pump - Right ... H438262			Mitsubishi 6D22T Diesel		
1825			Belt - W.P. 134755A1		
Nissan 4-Cyl. 71			TR22434		
1997-1987			9050B		
Belt - Fan 1972211C1			Mitsubishi 6D22T Diesel		
Belt - Gov. 1960027C1			Belt - W.P. 134755A1		
7385			Belt - Fan & Alt. 134828A1		
▲9309HD			Belt - A.C. 162458A1		
1825B			TR22495		
Kubota 4-Cyl. 91 Diesel			9060		
2003-1997			Mitsubishi 6D22T Diesel		
Belt - Fan 125570A1			Belt - W.P. 134616A1		
7375			Belt - Fan & Alt. 134828A1		
1835C			TR30589		
Teledyne 3-Cyl. 123			9060B		
1997-1987			Cummins M11 Diesel		
Belt - Fan & Alt. X27019500			Belt - Fan 171285A1		
Hose - Lower ●26502			▲K050340HD		
Hose - By Pass; (5/8" I.D.) 28441			DH4B		
1840			Mitsubishi 4DQ50 Diesel		
Case 4-390 Diesel			Belt - Fan & Alt. TR22410		
2001-1989			Hose - Upper ●25476		
Belt - Fan & Alt. J911558			DH5		
Tensioner Assy. - Fan J918944			Case 4-Cyl. 207 Diesel		
Hose - Upper 20046			Belt - Fan & Alt. AP47		
1845			Hose - Upper ●26512		
Case 4-Cyl. 188			Hose - Lower ●26511		
1982-1974			W5		
Hose - Lower ≧20957			Case 4-Cyl. 164		
Case 4-Cyl. 188 Diesel			Belt - Fan G46234		
1982-1974			Hose - Lower TR24476		
Belt - Fan & Alt. A11444			20357		
▲9505HD			W5A		
1845C			Case 4-Cyl. 188; Case 4-Cyl. 188 Diesel		
Case 4-390 Diesel			Belt - Fan G46238		
2001-1998			Belt - Fan & Alt. A20383		
Belt - Fan & Alt. J911558			▲9476HD		
Hose - Upper ≧21379			▲9510HD		
1997-1985			W7		
Belt - Fan & Alt. J911558			Case 4-Cyl. 284		
Tensioner Assy. - Fan J918944			Belt - Fan & Alt. A22608		
Hose - Upper 20046			Belt - Fan & Gen. A17490		
▲K080590HD			Hose - Upper ●26510		
38504			Hose - Lower ●26510		
20046			Hose - By Pass; (1 3/4" I.D.) 24228		
1845C			Case 4-Cyl. 301 Diesel		
Case 4-390 Diesel			Belt - Fan & Alt. A21457		
2001-1998			▲9505HD		
Belt - Fan & Alt. J911558					
Hose - Upper ≧21379					
1997-1985					
Belt - Fan & Alt. J911558					
Tensioner Assy. - Fan J918944					
Hose - Upper 20046					
▲K080590HD					
38504					
20046					

Road & Construction Equipment

▲ Standard Belt Available. See Pages 630-631.
≧ Cut to Fit.

● Vulco-Flex® Coolant Hose.
② Two Required.

Belts and Coolant Hose for Road & Construction Equipment

Application	Mfr. Part No.	Our No.
CASE - Continued		
W7 - Continued		
Case 4-Cyl. 301 Diesel - Continued		
Belt - Fan & Gen.	A17490	②▲9490HD
Hose - Upper		●26510
Hose - Lower		●26510
Hose - By Pass; (1 3/4" I.D.)		24228
W7E		
Case 4-Cyl. 301		
Belt - Fan & Alt.	L19082	②▲9550HD
Hose - By Pass; (1 1/4" I.D.)		24220
Case 4-Cyl. 301 Diesel		
Belt - Fan & Alt.	L19082	②▲9550HD
Belt - V.P.	A18537	7390
Hose - By Pass; (1 1/4" I.D.)		24220
W8B		
Case 6-Cyl. 377; Case 6-Cyl. 401 Diesel		
Belt - Fan & Alt.		②▲9530HD
Belt - Fan & Gen.	A22608	②▲9520HD
Belt - V.P.	A18537	7390
Hose - Upper		23550
Hose - Lower		●26522
Hose - By Pass; (1 1/2" I.D.)		24224
W8C		
Case 6-Cyl. 377		
Belt - Fan & Alt.	A22608	②▲9520HD
Hose - Upper		23550
Hose - Lower		●26522
Hose - By Pass; (1 1/2" I.D.)		24224
Case 6-Cyl. 401 Diesel		
Belt - Fan & Alt.	A21457	▲9505HD
Belt - V.P.	A18537	7390
Hose - Upper		23550
Hose - Lower		●26522
Hose - By Pass; (1 1/2" I.D.)		24224
W8E		
Case 6-Cyl. 377		
Belt - Fan & Alt.	L19082	②▲9550HD
Case 6-Cyl. 401 Diesel		
Belt - V.P.	L41636	7400
W9		
Case 4-Cyl. 284		
Belt - Fan & Alt.		②▲9530HD
Belt - Fan & Gen.; Ser. No. 816001 & Before	A11444	▲9505HD
Belt - Fan & Gen.; Ser. No. 816002 & After;		
W/50 3/4" Belt O.C.	A21457	②▲9505HD
Belt - Fan & Gen.; Ser. No. 816002 & After;		
W/52 1/4" Belt O.C.	A22608	②▲9520HD
Belt - P.S.; Ser. No. 816001 & Before	A11441	7290
Belt - P.S.; Ser. No. 816002 & After	A14505	7375
Hose - Lower; W/22" Rad.		●26510
Hose - By Pass; (1 3/4" I.D.)		24228
Case 4-Cyl. 301 Diesel		
Belt - Fan & Alt.		②▲9530HD
Belt - Fan & Gen.; Ser. No. 816001 & Before	A11444	▲9505HD
Belt - Fan & Gen.; Ser. No. 816002 & After;		
W/50 3/4" Belt O.C.	A21457	②▲9505HD
Belt - Fan & Gen.; Ser. No. 816002 & After;		
W/52 1/4" Belt O.C.	A22608	②▲9520HD
Belt - P.S.; Ser. No. 816001 & Before	A11441	7290
Belt - P.S.; Ser. No. 816002 & After	A14505	7375
Hose - Upper; (2 1/2" I.D.)		☆24940
Hose - Lower		●26516
Hose - By Pass; (1 3/4" I.D.)		24228

Application	Mfr. Part No.	Our No.
CASE - Continued		
W9A		
Case 4-Cyl. 284		
Belt - Fan & Alt.		②▲9530HD
Belt - Fan & Gen.	A22608	②▲9520HD
Belt - P.S.	A16759	7375
Belt - V.P.	A18537	7390
Hose - Upper		23550
Hose - Lower		●26516
Hose - By Pass; (1 3/4" I.D.)		24228
Case 4-Cyl. 301 Diesel		
Belt - Fan & Alt.		②▲9530HD
Belt - Fan & Gen.; Ser. No. 816002 & After;		
W/50 3/4" Belt O.C.	A21457	②▲9505HD
Belt - Fan & Gen.; Ser. No. 816002 & After;		
W/52 1/4" Belt O.C.	A22608	②▲9520HD
Belt - P.S.; Ser. No. 816001 & Before	A11441	7290
Belt - P.S.; Ser. No. 816002 & After	A14505	7375
Hose - Upper; (2 1/2" I.D.)		☆24940
Hose - Lower		●26516
Hose - By Pass; (1 3/4" I.D.)		24228
W9B		
Case 6-Cyl. 377; Case 6-Cyl. 401 Diesel		
Belt - Fan & Alt.		②▲9530HD
Belt - Fan & Gen.; Ser. No. 816001 & Before	A11444	▲9505HD
Belt - Fan & Gen.; Ser. No. 816002 & After;		
W/50 3/4" Belt O.C.	A21457	②▲9505HD
Belt - Fan & Gen.; Ser. No. 816002 & After;		
W/52 1/4" Belt O.C.	A22608	②▲9520HD
Belt - P.S.; Ser. No. 816001 & Before	A11441	7290
Belt - P.S.; Ser. No. 816002 & After	A14505	7375
Hose - Upper; (2 1/2" I.D.)		☆24940
Hose - Lower		●26522
Hose - By Pass; (1 3/4" I.D.)		24228
W9E		
Case 6-Cyl. 377		
Belt - Fan & Alt.	L19082	②▲9550HD
Case 6-Cyl. 401 Diesel		
Belt - V.P.	L41636	7400
W10		
Case 6-Cyl. 401 Diesel		
Belt - Fan & Gen.	A21647	▲9510HD
Belt - P.S.	A16759	7375
Hose - Upper		23550
Hose - Lower		●26522
W10B		
Case 6-Cyl. 377; Case 6-Cyl. 401 Diesel		
Belt - Fan & Alt.		②▲9530HD
Belt - Fan & Gen.	A22608	②▲9520HD
Belt - V.P.	A18537	7390
Hose - Upper		23550
Hose - Lower		●26522
Hose - By Pass; (1 1/2" I.D.)		24224
W10E		
Case 6-Cyl. 401 Diesel		
Belt - V.P.	L41636	7400
W11B		
Case 4-Cyl. 390 Diesel		
Belt - Fan & Alt.	J911557	▲K080560HD
W12		
Case 6-Cyl. 451 Diesel		
Belt - Fan & Gen.	A21647	②▲9510HD
Belt - P.S.	A16759	②7375
Belt - Air Brake Compr.	A18537	7390
Hose - Upper		23550

② Two Required.
● Vulco-Flex® Coolant Hose.

▲ Standard Belt Available. See Pages 630-631.
☆ Use Wire Inserted Green Stripe® Coolant Hose.

Belts and Coolant Hose for Road & Construction Equipment

Road & Construction Equipment

Application	Mfr. Part No.	Our No.
CASE - Continued		
W12 - Continued		
Case 6-Cyl. 451 Diesel - Continued		
Hose - Lower		●26522
Hose - By Pass; (1 1/2" I.D.)		24224
W14		
Case A336BD Diesel		
Belt - Fan & Alt.; W/40A. Alt.	L51181	ⓉTR22553
Belt - Fan & Alt.; W/65A. Alt.	L74972	ⓉTR22570
Belt - Air Brake Compr.; W/42 7/8" Belt O.C.		♣9425HD
Belt - Air Brake Compr.; W/49 3/8" Belt O.C.		♣9490HD
Hose - Upper; (2 1/2" I.D.)		24240
Hose - Lower		≧21115
	or	●26531
Hose - By Pass; (1 1/4" I.D.)		24220
W14B		
Case 6-Cyl. 590 Diesel		
Belt - Fan & Alt.; W/40A. Alt.	J903091	♣K080560HD
Belt - Fan & Alt.; W/65A. Alt.	J903093	♣K080580HD
Belt - A.C.	L110265	♣9463HD
W18		
Case A401BD Diesel		
Belt - Fan & Alt.; W/30A., 35A. Alt.	L48204	ⓉTR22625
Belt - Fan & Alt.; W/70A. Alt.	L51524	ⓉTR22607
Belt - Air Brake Compr.; W/Tru-Flow 300 Compr.	L48195	♣9500HD
Belt - Air Brake Compr.; W/Tru-Flow 400 Compr.	L57804	♣9500HD
Hose - Upper		21115
Hose - Lower		≧20760
Hose - By Pass; (1 1/4" I.D.)		24220
W18B		
Case 6-Cyl. 504 Diesel		
Belt - Fan & Alt.; W/40A. Alt.	A59296	ⓉTR24597
Belt - Air Brake Compr.	L112651	♣9480HD
Belt - A.C.	L59258	TR22578
Hose - Upper		21115
Hose - Lower		21115
W20		
Case A401BD Diesel		
Belt - Fan & Alt.; W/30A., 35A. Alt.	L48204	ⓉTR22625
Belt - Fan & Alt.; W/70A. Alt.	L51524	TR22607
Belt - Air Brake Compr.; W/Tru-Flow 300 Compr.	L48195	♣9500HD
Belt - Air Brake Compr.; W/Tru-Flow 400 Compr.	L57804	♣9500HD
Belt - A.C.	L59258	TR22578
Hose - Upper		21115
Hose - Lower		20760
Hose - By Pass; (1 1/4" I.D.)		24220
W20B		
Case A401BD Diesel		
Belt - Fan & Alt.	L48204	ⓉTR22625
Belt - Air Brake Compr.	L48195	♣9500HD
Hose - Upper		21115
Hose - Lower		20760
W20C		
Case A401BD Diesel		
Belt - Fan & Alt.; W/40A. Alt.	A59296	ⓉTR24597
Belt - Fan & Alt.; W/65A. Alt.	L71057	ⓉTR22625
Belt - Air Brake Compr.	L112651	♣9480HD
Belt - A.C.	L59258	TR22578
Hose - Upper		21115
Hose - Lower		21115

● Vulco-Flex® Coolant Hose.
♣ Standard Belt Available. See Pages 630-631.

Application	Mfr. Part No.	Our No.
CASE - Continued		
W24B		
Case A504BD Diesel		
Belt - Fan & Alt.	T38456	ⓉTR22664
Belt - Air Brake Compr.; W/L14814 Air Compr.	L50593	Ⓣ♣9490HD
Belt - Air Brake Compr.; W/L57774 Air Compr.	T38546	TR22657
Belt - A.C.	L58838	♣9570HD
Hose - Upper		●26531
	or	21115
Hose - Lower		20530
	or	●26529
Hose - By Pass; (1 1/4" I.D.)		24220
W24C		
Case A504BD Diesel		
Belt - Fan & Alt.	T38546	TR22657
Belt - Compr.	L57802	♣9490HD
Belt - A.C.	L58838	♣9570HD
Hose - Upper		21115
Hose - Lower; W/L15781, L109500 Rad.		●26529
Hose - By Pass; (1 1/4" I.D.)		24220
W26B		
Case A504BDT Diesel		
Belt - Fan & Alt.; Ser. No. 9107521 & After ...	T38546	TR22657
Belt - Air Brake Compr.	L45826	♣9520HD
Belt - A.C.	L16462	♣9400HD
Hose - Lower		●26530
Hose - By Pass; (1 1/4" I.D.)		24220
W30		
Case A504BDT Diesel		
Belt - Fan & Alt.; W/40A. Alt.	L71057	ⓉTR22625
Belt - Fan & Alt.; W/65A. Alt.	T38546	ⓉTR22657
Belt - Compr.	L105654	♣9463HD
Belt - A.C.	L71058	♣9470HD
Hose - Upper		21115
Hose - By Pass; (1 1/4" I.D.)		24220
W36		
Case A504BDTI Diesel		
Belt - Fan & Alt.; Ser. No. 17754000 & After .	J903113	K080644
Belt - Fan & Alt.; Ser. No. 17753999 & Before	L71057	ⓉTR22625
Belt - A.C.; Ser. No. 17754000 & After	396829R1	♣9440HD
Belt - A.C.; Ser. No. 17753999 & Before	L57804	♣9500HD
Tensioner Pulley - Fan & Alt.; Ser. No. 17754000 & After	J912246	36091
CATERPILLAR		
12E (99E)		
Caterpillar D333 Diesel		
Belt - Gen.; W/47" Belt O.C.	1S5138	TR24465
Belt - Gen.; W/48 1/8" Belt O.C.	5M5345	TR24476
12F (13K)		
Caterpillar D333 Diesel		
Belt - Fan; Ser. No. 13K1 Thru 13K907	5S9506	ⓉTR24688
Belt - Fan; Ser. No. 13K908 Thru 13K2275 ..	5S9505	ⓉBX65
Belt - Fan & Alt.; Ser. No. 13K2276 & After; W/67" Belt O.C.	8M1715	ⓉTR24664
Belt - Fan & Alt.; W/68 3/8" Belt O.C.	5S9505	ⓉBX65
Belt - Fan & Gen.	5S9505	ⓉBX65
Belt - Air Brake Compr.	4M9386	ⓉTR24709
Belt - A.C.; W/49 1/4" Belt O.C.	1P3085	♣9490HD
Belt - A.C.; W/54 1/4" Belt O.C.	4N6013	♣9540HD
Hose - Upper; (2 1/2" I.D.)		24440
Hose - Lower; (3" I.D.)		24448
12F (73G)		
Caterpillar D333 Diesel		
Belt - Gen.; W/47" Belt O.C.	1S5138	TR24465
Belt - Gen.; W/48 1/8" Belt O.C.	5M5345	TR24476

Ⓣ Two Required.
≧ Cut to Fit.

Belts and Coolant Hose for Road & Construction Equipment

Application	Mfr. Part No.	Our No.
CATERPILLAR - Continued		
12F (89H)		
Caterpillar D333 Diesel		
Belt - Fan; Ser. No. 89H1 Thru 89H405	5S9506	②TR24688
Belt - Fan; Ser. No. 89H406 Thru 89H572	5S9505	②BX65
Belt - Fan; Ser. No. 89H573 & After	8M1715	②TR24664
Belt - Alt.; W/67" Belt O.C.	8M1715	②TR24664
Belt - Alt.; W/68 3/8" Belt O.C.	5S9505	②BX65
Belt - Air Brake Compr.	4M9386	②TR24709
Belt - A.C.; W/49 1/4" Belt O.C.	1P3085	▲9490HD
Belt - A.C.; W/54 1/4" Belt O.C.	4N6013	▲9540HD
Hose - Upper; Ser. No. 89H1 & After(2 3/4" I.D.)		24444
Hose - Lower; Ser. No. 89H1 & After(3" I.D.)		24448
12G (61M)		
Caterpillar 3306 Diesel		
Belt - Fan & Alt.; W/72 5/8" Belt O.C.	5H7448	②TR30722
Hose - Upper - Eng. To Pipe; (2 1/2" I.D.)		24440
Hose - Upper - Pipe To Rad.; (2 1/2" I.D.)		24440
Hose - Lower - Eng. To Pipe; (3" I.D.)		24448
Hose - Lower - Pipe To Rad.; (3" I.D.)		24448
14B (64C)		
Caterpillar D333T Diesel		
Belt - Gov.	4B2544	▲9425HD
14D (96F)		
Caterpillar D333T Diesel		
Belt - Gen.; W/47" Belt O.C.	1S5138	TR24465
Belt - Gen.; W/48 1/8" Belt O.C.	5M5345	TR24476
14E (12K)		
Caterpillar D333T Diesel		
Belt - Fan & Alt.; Ser. No. 12K1 Thru 12K364	5S9505	②BX65
Belt - Fan & Alt.; Ser. No. 12K365 Thru 12K1002	5S9506	②TR24688
14E (72G)		
Caterpillar D333T Diesel		
Belt - Fan & Alt.; Ser. No. 72G1 Thru 72G244	5S9506	②TR24688
Belt - Fan & Alt.; Ser. No. 72G245 & After	5S9505	②BX65
Belt - Air Brake Compr.	4M9386	②TR24709
Belt - A.C.; W/52 3/4" Belt O.C.	2P4191	▲9525HD
Belt - A.C.; W/54 1/4" Belt O.C.	4N6013	▲9540HD
Hose - Upper; Ser. No. 72G1 & After(2 3/4" I.D.)		24444
Hose - Lower; Ser. No. 72G1 & After(3" I.D.)		24448
14E (99G)		
Caterpillar D333T Diesel		
Belt - Gen.; W/47" Belt O.C.	1S5138	TR24465
Belt - Gen.; W/48 1/8" Belt O.C.	5M5345	TR24476
14G (96U)		
Caterpillar 3306T Diesel		
Belt - Fan & Alt.	7B344	TR30722
Belt - A.C.	1P9744	▲9415HD
Hose - Upper; (2 1/2" I.D.)		②24440
Hose - Lower; (3" I.D.)		②24448
15 (4W)		
Caterpillar D326 Diesel		
Belt - Gov.	5B7168	▲9390HD
16 (49G)		
Caterpillar D343T Diesel		
Belt - W.P. & Alt.	8M8335	②▲9640HD
Belt - Alt./Gen.	5S1817	②▲9650HD
Belt - A.C.	4N6130	▲9520HD
Hose - Upper; Ser. No. 49G1 & After(3" I.D.)		24448
Hose - Lower; Ser. No. 49G1 & After(3 3/4" I.D.)		24460

Application	Mfr. Part No.	Our No.
CATERPILLAR - Continued		
66 (4D)		
Caterpillar Diesel		
Belt - Fan	3B6909	③TR24578
70 (8C)		
Caterpillar Diesel		
Belt - Gov.	4B2544	▲9425HD
77 (4D)		
Caterpillar Diesel		
Belt - Fan	3B6909	③TR24578
80 (5W)		
Caterpillar Diesel		
Belt - Gov.; W/39 1/4" Belt O.C.	5B7168	▲9390HD
Belt - Gov.; W/42 3/4" Belt O.C.	4B2544	▲9425HD
112E (91G)		
Caterpillar D330 Diesel		
Belt - Gen.	6B8536	TR28628
112F (89J)		
Caterpillar D333 Diesel		
Belt - Fan; Ser. No. 89J1 Thru 89J707	7S9802	②TR24664
Belt - Fan; Ser. No. 89J708 & After	7S9812	②TR24647
Belt - Gen.	7S9857	②TR24638
Belt - A.C.	2P6818	▲9470HD
120 (10R); 120 (13U)		
Caterpillar D333 Diesel		
Belt - Fan	8M1715	②TR24664
Belt - Fan & A.C.	7M5535	②TR24709
Belt - A.C.		▲9490HD
120 (14K)		
Caterpillar D333 Diesel		
Belt - Fan; Ser. No. 14K1 Thru 14K1103	5S9506	②TR24688
Belt - Fan; Ser. No. 14K1104 Thru 14K1569 ..	5S9505	②BX65
Belt - Fan; Ser. No. 14K1570 & After	8M1715	②TR24664
Belt - Fan & A.C.	4M9386	②TR24709
Belt - Alt.; W/67" Belt O.C.	8M1715	②TR24664
Belt - Alt.; W/68 3/8" Belt O.C.	5S9505	②BX65
Belt - Gen.	5S9505	②BX65
Belt - A.C.	1P3085	▲9490HD
120 (89G)		
Caterpillar D333 Diesel		
Belt - Gen.; W/47" Belt O.C.	1S5138	TR24465
Belt - Gen.; W/48 1/8" Belt O.C.	5M5345	TR24476
120G (87V)		
Caterpillar 3304T Diesel		
Belt - A.C.	1P9744	▲9415HD
130G (74V)		
Caterpillar 3304T Diesel		
Belt - Fan & Alt.		②TR30722
Belt - A.C.	1P9744	▲9415HD
Hose - Upper; (2 1/2" I.D.)		②24440
Hose - Lower; (3" I.D.)		③24448
140 (11R)		
Caterpillar D333 Diesel		
Belt - Fan		②TR24664
Belt - Fan & A.C.	4M9386	②TR24709
Belt - A.C.	4N6013	▲9540HD
140 (14U)		
Caterpillar D333 Diesel		
Belt - Fan; W/68 3/8" Belt O.C.	5S9505	②BX65
Belt - Fan; W/71 1/8" Belt O.C.	4M9386	②TR24709

② Two Required.
③ Three Required.

▲ Standard Belt Available. See Pages 630-631.

Belts and Coolant Hose for Road & Construction Equipment

Application	Mfr. Part No.	Our No.	Application	Mfr. Part No.	Our No.
CATERPILLAR - Continued			CATERPILLAR - Continued		
140 (14U) - Continued			561C (85H) Pipelayer		
Caterpillar D333 Diesel - Continued			Caterpillar D333 Diesel		
Belt - Fan & A.C.	4M9386	②TR24709	Belt - Gen.	5M6096	②TR24709
Belt - Air Brake Compr.	4M9386	②TR24709	571E PS (64A) Pipelayer		
Belt - A.C.; W/52 3/4" Belt O.C.	2P4191	▲9525HD	Caterpillar D333 Diesel		
Belt - A.C.; W/54 1/4" Belt O.C.	4N6013	▲9540HD	Belt - Fan; Ser. No. 64A1 Thru 64A151; W/81 1/8" Belt O.C.	3L6052	②TR30808
Hose - Upper; (2 1/2" I.D.)		24440	Belt - Fan; Ser. No. 64A1 Thru 64A151; W/85 5/8" Belt O.C.	5H7371	②CX81
Hose - Lower; (3 1/4" I.D.)		24452	Belt - Alt.	2S9778	▲9590HD
140 (24R)			Belt - Gen.; Ser. No. 64A152 Thru 64A221 ...	3S6272	▲9530HD
Caterpillar D333 Diesel			Belt - Gen.; Ser. No. 64A222 & After	2S5218	▲9580HD
Belt - Fan		②TR24664	571F (95N) Pipelayer		
Belt - Fan & A.C.	4M9386	②TR24709	Caterpillar D333 Diesel		
Belt - A.C.	4N6013	▲9540HD	Belt - Fan	3L6052	②TR30808
140G (13W)			571G (16W) Pipelayer		
Caterpillar 3306T Diesel			Caterpillar D3306 Diesel		
Belt - Fan & Alt.		②TR28733	Belt - Fan & Alt.		②CX81
Hose - Upper; (2 1/2" I.D.)		②24440	Hose - Upper; (2 7/8" I.D.)		24446
Hose - Lower; (3" I.D.)		②24448	Hose - Lower; (2 1/2" I.D.)		24440
140G (72V)			572C (21A) Pipelayer		
Caterpillar 3306 Diesel			Caterpillar D399 Diesel		
Belt - Fan & Alt.	5H7448	TR30722	Belt - Fan; Ser. No. 21A270 Thru 21A331	2M8183	TR30672
Belt - A.C.	1P9744	▲9415HD	572D (21A) Pipelayer		
Hose - Upper; (2 1/2" I.D.)		②24440	Caterpillar D339 Diesel		
Hose - Lower; (3" I.D.)		②24448	Belt - Fan; Ser. No. 21A270 Thru 21A331	2M8183	TR30672
160H			572E (65A) Pipelayer		
Caterpillar 3306 Diesel			Caterpillar D399T Diesel		
Belt - Fan To Alt.	1663351	▲9710HD	Belt - Fan; W/81 1/8" Belt O.C.	3L6052	②TR30808
215D (9TF)			Belt - Fan; W/85 5/8" Belt O.C.	5H7371	②CX81
Caterpillar 3304 Diesel			Belt - Alt.	2S9778	▲9590HD
Hose - Upper; (2 1/2" I.D.)		④24940	Belt - Gen.; Ser. No. 65A151 Thru 65A313 ...	3S6272	▲9530HD
Hose - Lower		④21115	Belt - Gen.; Ser. No. 65A314 & After	2S5218	▲9580HD
Hose - By Pass; (2 1/4" I.D.)		24236	572F PS (96N) Pipelayer		
225 (51U)			Caterpillar D333T Diesel		
Caterpillar 3208 Diesel			Belt - Fan	3L6052	②TR30808
Belt - Fan & Alt.	3N1490	④▲9510HD	Belt - Alt.	5M8135	②▲9520HD
Belt - A.C.	3P130	▲9500HD	572G Pipelayer		
235 (64R)			Caterpillar 3306T Diesel		
Caterpillar 3306 Diesel			Hose - Upper; (2 3/4" I.D.)		24444
Belt - Fan	5L9902	TR28570	Hose - Lower - Eng. To Pipe; (2 1/2" I.D.)		24440
Belt - Alt.		20744	Hose - Lower - Pipe To Rad.; (2 1/2" I.D.)		24440
Hose - Upper		or ●26535	583H (61A) Pipelayer		
Hose - Lower; (2 1/2" I.D.)		24440	Caterpillar D343T Diesel		
245 (95V)			Belt - Fan; W/75 7/8" Belt O.C.	2M8255	③TR30754
Caterpillar 3406 Diesel			Belt - Fan; W/81 1/8" Belt O.C.	3L6052	③TR30808
Belt - Alt.	6N73	TR22720	Belt - Alt.; W/62 1/2" Belt O.C.	3P25	TR24619
Hose - Upper; (2 1/2" I.D.)		24440	Belt - Alt.; W/3/4" Belt T.W.; W/64" Belt O.C.	1P2421	TR24638
Hose - Lower; (3" I.D.)		24448	Belt - Alt.; W/1/2" Belt T.W.; W/64 1/4" Belt O.C.	8M8335	②▲9640HD
414E			Belt - Gen.; Ser. No. 61A1 Thru 61A96	3S3961	▲9570HD
Caterpillar 3054C Diesel			Belt - Gen.; Ser. No. 61A97 Thru 61A120	2S2743	②▲9550HD
Belt - Fan	0617140	②▲9540HD	Belt - Gen.; Ser. No. 61A121 Thru 61A192 ...	2S5218	▲9580HD
416 (5PC)			Belt - Gen.; Ser. No. 61A193 Thru 61A679 ...	8M8335	▲9640HD
Perkins 4-Cyl. 236 Diesel			594 (62H) Pipelayer		
Belt - Alt.	2S9506	②▲9600HD	Caterpillar D353TA Diesel		
Belt - A.C.	7W5207	②▲9720HD	Belt - Fan; W/85 5/8" Belt O.C.	2P8624	②CX81
561B (62A) Pipelayer			Belt - Alt.; W/47" Belt O.C.	1S5138	TR24465
Caterpillar D333 Diesel			Belt - Alt.; W/48 1/8" Belt O.C.	5M5345	TR24476
Belt - W.P.	4M9386	②TR24709	Belt - Alt.; W/66 1/4" Belt O.C.	5S5249	▲9660HD
Belt - Gen.; W/69 1/4" Belt O.C.	7M5972	②TR24688			
Belt - Gen.; W/71 1/8" Belt O.C.	5M6096	②TR24709			
Belt - Starter; Ser. No. 62A1 Thru 62A191 ...	5M6096	②TR24709			

Road & Construction Equipment

② Two Required.
 ⚙ Use Wire Inserted Green Stripe® Coolant Hose.
 ④ Four Required.
 ③ Three Required.

▲ Standard Belt Available. See Pages 630-631.
 ⚙ Cut to Fit.
 ● Vulco-Flex® Coolant Hose.

Belts and Coolant Hose for Road & Construction Equipment

Application	Mfr. Part No.	Our No.
CATERPILLAR - Continued		
613		
Caterpillar 3208 Diesel		
Belt - Fan & Alt.	2P5617	②▲9710HD
Belt - W.P.	3P130	②▲9500HD
Belt - Hyd. Pump		▲9610HD
613A (71M)		
Caterpillar 3208 Diesel		
Belt - Fan; W/Noise Restriction	6F2590	▲9700HD
Belt - Fan & Alt.	5M8135	③▲9520HD
Belt - Air Brake Compr.	9M1091	▲9463HD
Belt - A.C.	4N2745	▲9600HD
Hose - Lower - Eng. To Pipe; (2" I.D.)		24432
Hose - Lower - Pipe To Rad.; (2" I.D.)		24432
613B (38W)		
Caterpillar 3208 Diesel		
Belt - Fan & Alt.	2P5617	②▲9710HD
Belt - W.P.	3P130	②▲9500HD
Belt - Hyd. Pump		▲9610HD
Hose - Upper		✂21379
Hose - Lower - Pipe To Rad.		✂20882
613C		
Caterpillar 3208 Diesel		
Belt - Fan & Alt.	2P5617	②▲9710HD
Belt - W.P.	3P130	②▲9500HD
Belt - Hyd. Pump		▲9610HD
613C (92X)		
Caterpillar 3208 Diesel		
Hose - Upper		✂21379
Hose - Lower - Eng. To Pipe		✂20206
Hose - Lower - Pipe To Rad.		✂20206
615 (46Z)		
Caterpillar 3306 Diesel		
Belt - Fan & Alt.		②BX78
Hose - Lower - Pipe To Rad.		✂21891
Hose - By Pass		23520
619C (61F)		
Caterpillar D340T Diesel		
Belt - Gen.	9M1091	③▲9463HD
Hose - Upper; Ser. No. 61F1 & After(3" I.D.)		24448
Hose - Lower; Ser. No. 61F1 & After(3 1/4" I.D.)		24452
621 (23H)		
Caterpillar D336 Diesel		
Belt - Fan; Ser. No. 23H1 Thru 23H4278	3S9652	③▲9680HD
Belt - Fan; Ser. No. 23H4279 & After	2P5619	③▲9720HD
Belt - Alt.	2S2481	②▲9700HD
Belt - Gen.	1S4761	▲9720HD
Hose - Upper; Ser. No. 23H1 & After(3 1/4" I.D.)		24452
621B (45P)		
Caterpillar 3406 Diesel		
Belt - Fan		③TR22720
Belt - Alt.		TR22720
Belt - A.C.	4N2745	▲9600HD
Hose - Upper		23550
Hose - Lower; (3" I.D.)		②24448
623 (52U)		
Caterpillar 3306 Diesel		
Belt - Fan	2P5619	③▲9720HD
Belt - Alt.	2P5617	②▲9700HD
623B (46P)		
Caterpillar 3406 Diesel		
Belt - A.C.	4N2745	▲9600HD

Application	Mfr. Part No.	Our No.
CATERPILLAR - Continued		
623B (46P) - Continued		
Caterpillar 3406 Diesel - Continued		
Hose - Upper		23550
Hose - Lower - Eng. To Pipe; (3" I.D.)		24448
Hose - Lower - Pipe To Rad.; (3" I.D.)		24448
623E (5SG); 623E (6CB); 623E (6DB); 623E (6YF)		
Caterpillar 3406 Diesel		
Belt - Fan		③BX71
Belt - Alt.		TR22657
Hose - Upper; (2 1/2" I.D.)		②24440
Hose - Lower; (3" I.D.)		②24448
627 (54K)		
Caterpillar D333T Diesel		
Belt - Fan; Ser. No. 54K1 Thru 54K785	2M8183	②TR30672
Belt - Fan; Ser. No. 54K786 & After	4M9386	②TR24709
627 (68M)		
Caterpillar 3306 Diesel		
Belt - Fan & Alt.; Ser. No. 68M1 Thru 68M702	2M8183	②TR30672
Belt - Fan & Alt.; Ser. No. 68M703 & After	4M9386	②TR24709
627B (14S)		
Caterpillar 3306T Diesel		
Belt - Fan & Alt.	35H4207	TR30698
Belt - A.C.	2P4191	▲9525HD
627B (15S)		
Caterpillar 3306 Diesel		
Belt - Fan & Alt.	35H4207	TR30698
Belt - A.C.	2P4191	▲9525HD
627B (38V)		
Caterpillar 3306 Diesel		
Belt - Fan	2M8183	②TR30672
630B (14G)		
Caterpillar D343 Diesel		
Belt - Fan; Ser. No. 14G1 Thru 14G333	5M1044	③TR30770
Belt - Alt.; W/62 1/4" Belt O.C.	8M8336	②▲9620HD
Belt - Alt.; W/65 1/4" Belt O.C.	5S1817	②▲9650HD
Belt - Gen.; W/64 1/4" Belt O.C.	8M8335	②▲9640HD
Belt - Gen.; W/65 1/4" Belt O.C.	5S1817	②▲9650HD
631B (13G)		
Caterpillar D343 Diesel		
Belt - Fan; Ser. No. 13G1 Thru 13G1693	5M1044	③TR30770
Belt - W.P. & Gen.	1S4699	②▲9660HD
Belt - Alt.; W/62 1/4" Belt O.C.	8M8336	②▲9620HD
Belt - Alt.; W/65 1/4" Belt O.C.	5S1817	②▲9650HD
Belt - Gen.; W/64 1/4" Belt O.C.	8M8335	②▲9640HD
Belt - Gen.; W/65 1/4" Belt O.C.	5S1817	②▲9650HD
632 (14G)		
Caterpillar D343 Diesel		
Belt - Fan; Ser. No. 14G1 Thru 14G333	5M1044	③TR30770
Belt - Alt.; W/62 1/4" Belt O.C.	8M8336	②▲9620HD
Belt - Alt.; W/65 1/4" Belt O.C.	5S1817	②▲9650HD
Belt - Gen.; W/64 1/4" Belt O.C.	8M8335	②▲9640HD
Belt - Gen.; W/65 1/4" Belt O.C.	5S1817	②▲9650HD
633		
Caterpillar D343 Diesel		
Hose - Upper; (3" I.D.)		24448
Hose - Lower; (3 3/4" I.D.)		24460
633 (44J)		
Caterpillar D343 Diesel		
Belt - Alt.	5S1817	②▲9650HD

② Two Required.
③ Three Required.

▲ Standard Belt Available. See Pages 630-631.
✂ Cut to Fit.

Belts and Coolant Hose for Road & Construction Equipment

Application	Mfr. Part No.	Our No.	Application	Mfr. Part No.	Our No.
CATERPILLAR - Continued			CATERPILLAR - Continued		
633C (66M)			657 (19G)		
Caterpillar D343 Diesel			Caterpillar D346 Diesel		
Belt - W.P. & Alt.		②▲9640HD	Belt - Fan; Ser. No. 19G1 Thru 19G217	5M1044	③TR30770
637 (79P)			Belt - W.P.; Ser. No. 19G1 Thru 19G91	8M8335	②▲9640HD
Caterpillar D343 Diesel			Belt - W.P.; Ser. No. 19G92 & After	5S1817	②▲9650HD
Belt - Alt.	8M8335	②▲9640HD	657 (31G)		
Belt - A.C.	2P4230	▲9580HD	Caterpillar D343 Diesel		
637D (23W)			Belt - Fan; Ser. No. 31G1 Thru 31G273		
Caterpillar D343 Diesel			Belt - W.P.	4M6292	③TR30672
Belt - Fan	1L5681	②TR30652	Belt - Gen.; Ser. No. 31G1 Thru 31G143	8M3092	TR24619 9765
637D (27W)			657 (46M)		
Caterpillar 3408 Diesel			Caterpillar D343 Diesel		
Belt - Fan	6N5338	②BX77	Belt - W.P.	4M6292	TR24619
Belt - Alt.	9L6639	TR22570	657B (47M)		
641 (41M)			Caterpillar D346 Diesel		
Caterpillar D346 Diesel			Belt - W.P.	5S1817	②▲9650HD
Belt - W.P.	4M6292	TR24619	657B (68K)		
Hose - Upper - Eng. To Water Manifold; (2 1/4" I.D.)	24436		Caterpillar D346 Diesel		
Hose - Upper - Eng. To Pipe; (3 3/4" I.D.)	24460		Belt - A.C.	2P8720	▲9650HD
Hose - Lower - Eng. To Pipe; (5" I.D.)	24480		657E (86Z)		
Hose - Lower - Water Manifold To Pipe; (3" I.D.)	24448		Caterpillar 3408/3412 Diesel		
641 (50G)			Belt - Fan - Front & Rear Eng.		
Caterpillar D346 Diesel			Belt - Alt - Front Eng.	6N0073	③TR22720
Hose - Upper - Eng. To Water Manifold; (2 1/4" I.D.)	24436		Belt - Alt - Rear Eng.	9L6639	▲9570HD TR22570
Hose - Upper - Eng. To Pipe; (3 3/4" I.D.)	24460		Belt - A.C.		▲9500HD
Hose - Lower - Eng. To Pipe; (5" I.D.)	24480		Hose - Upper - Front Eng.; (2 1/2" I.D.)		④24440
Hose - Lower - Water Manifold To Pipe; (3" I.D.)	24448		Hose - Upper - Rear Eng.; (2 1/2" I.D.)		②24440
641 (64F)			Hose - Lower - Front Eng.; (4" I.D.)		②24464
Caterpillar D346 Diesel			Hose - Lower - Rear Eng.; (3 1/2" I.D.)		②24456
Belt - Fan; Ser. No. 64F1 Thru 64F586	2H1383	③TR30672	660B (58K)		
Belt - W.P.	4M6292	TR24619	Caterpillar D346 Diesel		
Belt - Gen.; Ser. No. 64F1 Thru 64F194	8M3092	9765	Belt - A.C.	2P8720	▲9650HD
Hose - Upper - Eng. To Water Manifold; (2 1/4" I.D.)	24436		666 (77F)		
Hose - Upper - Eng. To Pipe; (3 3/4" I.D.)	24460		Caterpillar D346 Diesel		
Hose - Lower - Eng. To Pipe; (5" I.D.)	24480		Belt - Fan; Ser. No. 77F1 Thru 77F246	2H1383	③TR30672
Hose - Lower - Water Manifold To Pipe; (3" I.D.)	24448		Belt - W.P.	4M6292	TR24619
641 (70G); 641 (80F)			666B (66K)		
Caterpillar D346 Diesel			Caterpillar D346 Diesel		
Hose - Upper - Eng. To Water Manifold; (2 1/4" I.D.)	24436		Belt - A.C.	2P8720	▲9650HD
Hose - Upper - Eng. To Pipe; (3 3/4" I.D.)	24460		768C (02X)		
Hose - Lower - Eng. To Pipe; (5" I.D.)	24480		Caterpillar 3408 Diesel		
Hose - Lower - Water Manifold To Pipe; (3" I.D.)	24448		Belt - Fan	1L5681	②TR30652
641B (65K)			Belt - W.P. & Gen.	1S4699	②▲9660HD
Caterpillar D346 Diesel			Belt - Alt.	5S1817	②▲9650HD
Belt - A.C.	2P8720	▲9650HD	769 (99F)		
651 (33G)			Caterpillar D343T Diesel		
Caterpillar D346 Diesel			Belt - Fan	1L5681	②TR30652
Belt - Fan; Ser. No. 33G1 Thru 33G199	2H1383	③TR30672	Belt - W.P. & Gen.	1S4699	②▲9660HD
Belt - W.P.	4M6292	TR24619	Belt - Alt.	5S1817	②▲9650HD
Belt - Gen.; Ser. No. 33G1 Thru 33G143	8M3092	9765	773 (63G)		
651 (44M)			Caterpillar D346T Diesel		
Caterpillar D346 Diesel			Belt - A.C.; W/63 1/4" Belt O.C.	2P6161	▲9630HD
Belt - W.P.	4M6292	TR24619	Belt - A.C.; W/65 1/4" Belt O.C.	2P8720	▲9650HD
651B (67K)			814 (90P)		
Caterpillar D346 Diesel			Caterpillar 3306 Diesel		
Belt - Alt.		BX50	Belt - Fan & Alt.; Ser. No. 90P120 & After	5H1678	②TR30722
Belt - A.C.	2P8720	▲9650HD	Belt - A.C.; Ser. No. 90P1 Thru 90P202	2P4191	▲9525HD
651B (67K)			Belt - A.C.; Ser. No. 90P203 & After	4N6130	▲9520HD
Caterpillar D346 Diesel			Hose - Upper; (2 7/8" I.D.)		24446

② Two Required.
③ Three Required.

▲ Standard Belt Available. See Pages 630-631.
④ Four Required.

Belts and Coolant Hose for Road & Construction Equipment

Application	Mfr. Part No.	Our No.
CATERPILLAR - Continued		
814 (90P) - Continued		
Caterpillar 3306 Diesel - Continued		
Hose - Lower; (2 1/2" I.D.)		24440
815 (91P)		
Caterpillar 3306 Diesel		
Belt - Fan & Gen.; Ser. No. 91P129 & After ..	5H1678	②TR30722
Belt - A.C.; Ser. No. 91P129 Thru 91P527	2P4191	▲9525HD
Belt - A.C.; Ser. No. 91P528 & After	4N6130	▲9520HD
Hose - Upper - Eng. To Pipe; (2 3/4" I.D.)		24444
Hose - Upper - Pipe To Rad.; (2 3/4" I.D.)		24444
Hose - Lower - Pipe To Rad.; (2 5/8" I.D.)		24442
816 (57U)		
Caterpillar 3306 Diesel		
Belt - Fan & Alt.	5H1678	②TR30722
Belt - A.C.	4N6130	▲9520HD
824		
Caterpillar D340 Diesel		
Hose - Upper; (3" I.D.)		24448
824 (29G)		
Caterpillar D340 Diesel		
Belt - Alt.	3L5751	TR24500
Belt - W.P.	8M1715	TR24664
824B		
Caterpillar D343 Diesel		
Hose - Upper; (3" I.D.)		24448
824B (36H)		
Caterpillar D343 Diesel		
Belt - Alt.; W/64 1/4" Belt O.C.	8M8335	②▲9640HD
Belt - Alt.; W/65 1/4" Belt O.C.	5S1817	②▲9650HD
Hose - Upper; (3" I.D.)		24448
Hose - Lower; Ser. No. 36H1 Thru 36H192(2 3/4" I.D.)		24444
Hose - Lower; Ser. No. 36H193 Thru 36H580(2 3/4" I.D.)		24444
825B (43N)		
Caterpillar D343T Diesel		
Belt - W.P. & Alt.	8M8335	②▲9640HD
834		
Caterpillar D343 Diesel		
Hose - Upper; (3" I.D.)		24448
Hose - Lower; (3 1/4" I.D.)		24452
834 (43E)		
Caterpillar D343 Diesel		
Belt - W.P. & Gen.	8M8335	②▲9640HD
Belt - Alt.	5S1817	②▲9650HD
835 (44N)		
Caterpillar D343 Diesel		
Belt - Alt.	8M8335	②▲9640HD
910 (80U)		
Caterpillar 3204 Diesel		
Belt - Fan & Alt.; W/3/4" Belt T.W.; W/60 7/8" Belt O.C.	7M3921	②TR24597
Belt - Fan & Alt.; W/1/2" Belt T.W.; W/62 1/4" Belt O.C.	8M8336	③▲9620HD
Hose - Upper		ⓧ20046
		or ●26501
Hose - Lower		ⓧ20431
920 (41J)		
Caterpillar 3304 Diesel		
Hose - Upper; (2 3/4" I.D.)		24444
Hose - Lower; (2 3/4" I.D.)		24444

Application	Mfr. Part No.	Our No.
CATERPILLAR - Continued		
920 (62K)		
Caterpillar 3304 Diesel		
Belt - Fan & Alt.; Ser. No. 62K2479 & After		②TR22711
Belt - A.C.; W/46 3/8" Belt O.C.	2P6819	▲9463HD
Belt - A.C.; W/47 3/8" Belt O.C.	2P6818	▲9470HD
Hose - Upper; (2 3/4" I.D.)		24444
Hose - Lower; (2 3/4" I.D.)		24444
920 (75J)		
Caterpillar 3304 Diesel		
Belt - Fan & Alt.	5H1678	TR30722
Hose - Upper; (2 3/4" I.D.)		24444
Hose - Lower; (2 3/4" I.D.)		24444
922A (59A)		
Caterpillar D320 Diesel		
Belt - Gen.	8M760	9775
Belt - Air Brake Compr.	5M923	▲9740HD
Hose - Upper; (3" I.D.)		24448
Hose - Lower; (3" I.D.)		24448
922A (63A)		
Caterpillar D320 Diesel		
Belt - Fan; Ser. No. 63A1 Thru 63A604	3K8774	②TR24578
Belt - Gen.	3K9746	②TR24578
Belt - Air Brake Compr.	3K3408	▲9490HD
Hose - Upper; (3" I.D.)		24448
Hose - Lower; (3" I.D.)		24448
922B (88J)		
Caterpillar D330 Diesel		
Belt - Fan	4M6292	②TR24619
Belt - Gen.	1M2045	②TR24607
Hose - Upper; (3" I.D.)		24448
Hose - Lower; (3" I.D.)		24448
922B (94A)		
Caterpillar D330 Diesel		
Belt - Fan	2N1493	②▲9425HD
Belt - W.P.	8M9708	TR30589
Belt - Gen.	1S5138	TR24465
926 (4NB); 926 (4TC); 926 (7TC); 926 (8NB); 926 (94Z)		
Caterpillar 3204 Diesel		
Hose - Upper - Eng. To Pipe; (1 3/4" I.D.)		24428
Hose - Upper - Pipe To Rad.; (1 3/4" I.D.)		24428
Hose - Lower - Eng. To Pipe; (2 1/4" I.D.)		24436
Hose - Lower - Pipe To Rad.; (2 1/4" I.D.)		24436
926E (94Z)		
Caterpillar 3204 Diesel		
Belt - Fan & Alt.		②▲9680HD
Belt - W.P.		▲9485HD
Hose - Upper; (1 3/4" I.D.)		②24428
Hose - Lower; (2 1/4" I.D.)		②24436
930 (8CB); 930 (17B)		
Caterpillar 3304 Diesel		
Hose - Upper; (2 3/4" I.D.)		24444
Hose - Lower; (3" I.D.)		24248
930 (41K)		
Caterpillar 3304 Diesel		
Belt - Fan; Ser. No. 41K1708 & After	7M5535	②TR24709
Belt - Fan & Alt.; W/68 5/8" Belt O.C.		②TR28680
Belt - Fan & Alt.; W/11/16" Belt T.W.; W/72 5/8" Belt O.C.		②TR22720
Belt - Fan & Alt.; W/15/16" Belt T.W.; W/72 5/8" Belt O.C.	5H1678	TR30722
Belt - Fan & A.C.; Ser. No. 41K1 Thru 41K3207	7M5535	②TR24709

② Two Required.
 ③ Three Required.
 ● Vulco-Flex® Coolant Hose.

▲ Standard Belt Available. See Pages 630-631.
 ⓧ Cut to Fit.

Belts and Coolant Hose for Road & Construction Equipment

Application	Mfr. Part No.	Our No.	Application	Mfr. Part No.	Our No.
CATERPILLAR - Continued			CATERPILLAR - Continued		
930 (41K) - Continued			944 (87J) - Continued		
Caterpillar 3304 Diesel - Continued			Caterpillar D330 Diesel - Continued		
Hose - Upper; (2 5/8" I.D.)		24242	Belt - Alt.	1P2421	②TR24638
Hose - Lower; (2 5/8" I.D.)		24242	Belt - Gen.	7S9857	②TR24638
930 (57Z); 930 (60G); 930 (71H); 930 (73U); 930 (79J)			950 (58H)		
Caterpillar 3304 Diesel			Caterpillar 3304 Diesel		
Hose - Upper; (2 3/4" I.D.)		24444	Hose - Upper; Ser. No. 58H1 Thru 58H520(2 3/4" I.D.)		24444
Hose - Lower; (3" I.D.)		24248	950 (81J)		
930G			Caterpillar 3304 Diesel		
Caterpillar 3056 Diesel			Belt - Fan; W/62 1/2" Belt O.C.	4M6292	②TR24619
Belt - Fan	0617140	②▲9540HD	Belt - Fan; W/64" Belt O.C.	7M6100	②TR24638
Belt - A.C.	1W2934	▲9476HD	Belt - Fan & Alt.	6N735	②TR30652
933C (11A); 933E (11A)			Belt - Alt.	2P1233	②TR24619
Caterpillar D311 Diesel			Belt - Gen.	7S9857	②TR24638
Belt - Alt.	5B7168	▲9390HD	Belt - A.C.; W/54 1/4" Belt O.C.	4N6013	▲9540HD
Belt - Gov.	5B7168	▲9390HD	Belt - A.C.; W/56 1/4" Belt O.C.	2P4685	▲9560HD
Belt - Starter	6B5653	TR24438	950 (90A)		
933G (42A)			Caterpillar 3304 Diesel		
Caterpillar D320T Diesel			Hose - Upper; Ser. No. 90A1 Thru 90A3142(2 3/4" I.D.)		24444
Belt - W.P.	8H9832	②TR24638	950B (22Z)		
Belt - W.P. & Gen.	2M8502	②TR24638	Caterpillar 3304 Diesel		
936 (2ZB); 936 (4SB); 936 (5GC); 936 (33Z); 936 (45Z)			Belt - Fan & Alt.		②BX81
Caterpillar 3304 Diesel			Belt - A.C.		▲9440HD
Hose - Upper - Eng. To Pipe; (2 1/2" I.D.)		24440	Hose - Upper; (1 3/4" I.D.)		②24428
Hose - Upper - Pipe To Rad.; (2 1/2" I.D.)		24440	Hose - Lower; (2 1/2" I.D.)		②24440
Hose - Lower - Eng. To Pipe		21891	951B (69H)		
Hose - Lower - Pipe To Rad.; (2 1/2" I.D.)		24440	Caterpillar D330 Diesel		
936E (33Z)			Belt - Fan & Gen.	1P2421	②TR24638
Caterpillar 3304 Diesel			951B (79H)		
Hose - Upper; (2 1/2" I.D.)		②24440	Caterpillar D330 Diesel		
938G			Belt - W.P.	4S7755	②TR24647
Caterpillar 3126 Diesel			Belt - Gen.; W/47" Belt O.C.	1S5138	TR24465
Belt - W.P.	0366775	▲9341HD	Belt - Gen.; W/48 1/8" Belt O.C.	5M5345	TR24476
Belt - Fan & Alt.		2/9447PB	951C (69H)		
Belt - A.C.	1P4334	▲9495HD	Caterpillar 3304 Diesel		
941 (80H)			Belt - Fan & Gen.	1P2421	②TR24638
Caterpillar D330 Diesel			951C (86J)		
Belt - Fan; Ser. No. 80H1 Thru 80H2461	2M8502	②TR24638	Caterpillar 3304 Diesel		
Belt - Fan; Ser. No. 80H2462 & After	4M6292	②TR24619	Belt - Fan & Alt.; Ser. No. 86J1902 Thru 86J1991	2P1385	②TR24619
Belt - Alt.	4M6292	②TR24619	Belt - Fan & Alt.; Ser. No. 86J1992 & After ...	7S9812	②TR24647
Belt - Gen.	7S9857	②TR24638	Belt - Fan & Gen.; Ser. No. 86J1 Thru 86J1901	7S9857	②TR24638
Belt - A.C.; Ser. No. 80H2462 Thru 80H3039	2P6819	▲9463HD	Belt - A.C.; Ser. No. 86J1 Thru 86J1991	2P6819	▲9463HD
Belt - A.C.; Ser. No. 80H3040 & After	2P6818	▲9470HD	Belt - A.C.; Ser. No. 86J1992 & After	2P6818	▲9470HD
941B (80H)			953 (76Y)		
Caterpillar 3304 Diesel			Caterpillar 3204T Diesel		
Belt - Fan; Ser. No. 80H1 Thru 80H2461	2M8502	②TR24638	Belt - Fan	2S2481	②▲9700HD
Belt - Fan; Ser. No. 80H2462 & After	4M6292	②TR24619	Belt - Alt.	8M8341	②▲9620HD
Belt - Alt.	4M6292	②TR24619	955C (12A)		
Belt - Gen.	7S9857	②TR24638	Caterpillar D315 Diesel		
Belt - A.C.; Ser. No. 80H2462 Thru 80H3039	2P6819	▲9463HD	Belt - Fan & W.P.; Ser. No. 12A1 Thru 12A5737	4F7956	TR34506
Belt - A.C.; Ser. No. 80H3040 & After	2P6818	▲9470HD	Belt - W.P.; Ser. No. 12A5738 Thru 12A8418		TR34506
943 (19Z)			Belt - Alt.	5B7168	▲9390HD
Caterpillar 3204 Diesel			Belt - Gov.	5B7168	▲9390HD
Belt - W.P. & Alt.	8M8336	②▲9620HD	Belt - Starter	6B5653	TR24438
Hose - Upper; (1 3/4" I.D.)		②24428	944 (87J)		
Hose - Lower; (2 1/4" I.D.)		②24436	Caterpillar D330 Diesel		
944 (87J)			Belt - Fan	7S9812	②TR24647
Caterpillar D330 Diesel					

② Two Required.

▲ Standard Belt Available. See Pages 630-631.

Belts and Coolant Hose for Road & Construction Equipment

Application	Mfr. Part No.	Our No.
CATERPILLAR - Continued		
955E (12A)		
Caterpillar D330 Diesel		
Belt - Fan & W.P.; Ser. No. 12A1 Thru 12A5737	4F7956	TR34506
Belt - W.P.; Ser. No. 12A5738 Thru 12A8418		TR34506
Belt - Alt.	5B7168	▲9390HD
Belt - Gov.	5B7168	▲9390HD
Belt - Starter	6B5653	TR24438
955H (60A)		
Caterpillar D330T Diesel		
Belt - W.P.; Ser. No. 60A1 Thru 60A220	4M9678	②TR24578
Belt - W.P.; Ser. No. 60A3263 Thru 60A10341 8M1715		②TR24664
Belt - W.P.; Ser. No. 60A10342 Thru 60A11298	2M8502	②TR24638
Belt - W.P.; Ser. No. 60A11299 & After	4S7755	②TR24647
Belt - Gen.; W/41 7/8" Belt O.C.	5M5344	TR24414
Belt - Gen.; W/47" Belt O.C.	1S5138	TR24465
Belt - Gen.; W/48 1/8" Belt O.C.	5M5345	TR24476
955K (61H)		
Caterpillar D330T Diesel		
Belt - W.P.	4S7755	②TR24647
Belt - Gen.	1S5138	TR24465
955L (85J)		
Caterpillar D330T Diesel		
Belt - Fan	7S9812	②TR24647
Belt - Fan & Alt.	1P2421	②TR24638
966A (33A)		
Caterpillar D333T Diesel		
Hose - Upper; Ser. No. 33A1 Thru 33A2110(2 3/4" I.D.)		24444
Hose - Lower; Ser. No. 33A1 Thru 33A2110(3" I.D.)		24448
966B (75A)		
Caterpillar D333T Diesel		
Belt - Fan	5H1678	TR30722
Belt - Gen. & Air Brake Compr.	1S4760	②▲9720HD
Hose - Upper; Ser. No. 75A1 & After(2 3/4" I.D.)		24444
Hose - Lower; Ser. No. 75A1 & After(3" I.D.)		24448
966C (9KC); 966C (18B); 966C (25U)		
Caterpillar 3306 Diesel		
Hose - Upper; W/2 1/2" I.D. Hose(2 1/2" I.D.)		24440
Hose - Upper; W/2 3/4" I.D. Hose(2 3/4" I.D.)		24444
Hose - Upper; W/3" I.D. Hose(3" I.D.)		24448
Hose - Lower; W/2 1/4" I.D. Hose(2 1/4" I.D.)		24436
Hose - Lower; W/2 1/2" I.D. Hose(2 1/2" I.D.)		24440
Hose - Lower; W/3" I.D. Hose		≅23575
966C (30K)		
Caterpillar 3306 Diesel		
Hose - Upper; Ser. No. 30K1 & After(2 3/4" I.D.)		24444
Hose - Lower; Ser. No. 30K1 & After(3" I.D.)		24448
966C (42J)		
Caterpillar 3306 Diesel		
Hose - Upper; W/2 1/2" I.D. Hose(2 1/2" I.D.)		24440
Hose - Upper; W/2 3/4" I.D. Hose(2 3/4" I.D.)		24444
Hose - Upper; W/3" I.D. Hose(3" I.D.)		24448
Hose - Lower; W/2 1/4" I.D. Hose(2 1/4" I.D.)		24436
Hose - Lower; W/2 1/2" I.D. Hose(2 1/2" I.D.)		24440
Hose - Lower; W/3" I.D. Hose		≅23575
966C (76J)		
Caterpillar 3306 Diesel		
Belt - Fan; Ser. No. 76J1 Thru 76J2516	1H6929	②TR30770
Belt - Fan & Alt.; Ser. No. 76J2517 Thru 76J4250		②TR30710
Belt - Fan & Alt.; Ser. No. 76J4251 & After ...	5H1678	②TR30722
Belt - A.C.; Ser. No. 76J4251 Thru 76J6388 ..	2P4191	▲9525HD

Application	Mfr. Part No.	Our No.
CATERPILLAR - Continued		
966C (76J) - Continued		
Caterpillar 3306 Diesel - Continued		
Belt - A.C.; Ser. No. 76J6389 & After	4N6130	▲9520HD
Hose - Upper; Ser. No. 76J1 & After(2 3/4" I.D.)		24444
Hose - Lower; Ser. No. 76J1 & After(3" I.D.)		24448
966C (78G)		
Caterpillar 3306 Diesel		
Hose - Upper; W/2 1/2" I.D. Hose(2 1/2" I.D.)		24440
Hose - Upper; W/2 3/4" I.D. Hose(2 3/4" I.D.)		24444
Hose - Upper; W/3" I.D. Hose(3" I.D.)		24448
Hose - Lower; W/2 1/4" I.D. Hose(2 1/4" I.D.)		24436
Hose - Lower; W/2 1/2" I.D. Hose(2 1/2" I.D.)		24440
Hose - Lower; W/3" I.D. Hose		≅23575
966D (99Y)		
Caterpillar 3306 Diesel		
Belt - A.C.		▲9451HD
Hose - Upper; W/2 1/2" I.D. Hose(2 1/2" I.D.)		24440
Hose - Upper; W/3" I.D. Hose(3" I.D.)		24448
Hose - Lower; (2 1/2" I.D.)		24440
973 (66G); 973 (86G)		
Caterpillar 3306 Diesel		
Belt - Fan & Alt.		②B86
Hose - Upper; (2 1/2" I.D.)		②24440
Hose - Lower - Eng. To Pipe; (2 1/2" I.D.)		24440
977D (20A); 977E (20A)		
Caterpillar D318 Diesel		
Belt - Gov.	4B2544	②▲9425HD
977H (53A)		
Caterpillar D333T Diesel		
Belt - Alt.	2S2743	▲9550HD
Belt - Gen.; Ser. No. 53A1 Thru 53A2271	7M169	TR24530
Hose - Upper; Ser. No. 53A3000 Thru 53A8886(2 3/4" I.D.)		24444
Hose - Lower; Ser. No. 53A3000 Thru 53A8886(3" I.D.)		24448
977K (11K)		
Caterpillar D333T Diesel		
Belt - Fan; Ser. No. 11K1 Thru 11K3219	2M8255	②TR30754
977L (11K)		
Caterpillar D318 Diesel		
Belt - Fan; Ser. No. 11K1 Thru 11K3219	2M8255	②TR30754
980 (42H)		
Caterpillar D336 Diesel		
Belt - Alt.	4S8353	②▲9700HD
Belt - Gen.	1S4761	②▲9720HD
Hose - Upper; Ser. No. 42H1 & After(3 1/4" I.D.)		24452
Hose - Lower; Ser. No. 42H1 & After(4" I.D.)		24464
980B (89P)		
Caterpillar 3306 Diesel		
Belt - A.C.; W/54 1/4" Belt O.C.	4N6013	▲9540HD
Belt - A.C.; W/58 1/4" Belt O.C.	2P4230	▲9580HD
Hose - Lower; Ser. No. 89P1 & After(3" I.D.)		24448
980C		
Caterpillar 3306DITA Diesel		
Hose - Upper; (2 1/2" I.D.)		24440
Hose - Lower; (3" I.D.)		24448
980C (63X)		
Caterpillar 3406 Diesel		
Belt - Fan	4N8219	③B72
Belt - Alt.	6N0341	TR22514

▲ Standard Belt Available. See Pages 630-631.
≅ Cut to Fit.

② Two Required.
③ Three Required.

Belts and Coolant Hose for Road & Construction Equipment

Application	Mfr. Part No.	Our No.
CATERPILLAR - Continued		
983 (38K)		
Caterpillar D343T Diesel		
Belt - Alt.	4S6209	②▲9650HD
Belt - A.C.	2P4685	▲9560HD
988 (87A)		
Caterpillar D343T Diesel		
Belt - Alt.; W/64 1/4" Belt O.C.	8M8335	②▲9640HD
Belt - Alt.; W/65 1/4" Belt O.C.	5S1817	②▲9650HD
Hose - Upper; Ser. No. 87A531 & After(3" I.D.)		24448
988B (50W)		
Caterpillar 3408 Diesel		
Belt - Fan		③TR22770
Belt - Alt.	9L6639	TR22570
Belt - Hyd. Pump	3P130	▲9500HD
Hose - Upper		②23550
Hose - Lower		23585
992 (25K)		
Caterpillar D348T Diesel		
Belt - Fan	3L6052	④TR30808
Belt - A.C.	9M1091	▲9463HD
Hose - Upper; Ser. No. 25K1 & After(4" I.D.)		24464
Hose - Lower; Ser. No. 25K1 & After(5" I.D.)		24480
CB514 (6YD)		
Detroit Diesel 3-53 Diesel		
Belt - Fan & Alt.	5133173	②7420
Hose - Upper		③<20957
		or ●26501
D2 (4U)		
Caterpillar D311 Diesel		
1957-1948		
Belt - Fan; Ser. No. 4U1 Thru 4U6905	5F7676	TR30484
Belt - Fan; Ser. No. 5U1 Thru 5U15474	5F7676	TR30484
Belt - Fan; Ser. No. 4U6906 Thru 4U7560	5H2896	TR30506
Belt - Fan; Ser. No. 5U15475 Thru 5U18894 .	5H2896	TR30506
Belt - Gov.	5B7168	▲9390HD
Belt - Starter	5B5653	TR24438
D2 (5U)		
Caterpillar D311 Diesel		
1958-1948		
Belt - Fan; Ser. No. 4U1 Thru 4U6905	5F7676	TR30484
Belt - Fan; Ser. No. 5U1 Thru 5U15474	5F7676	TR30484
Belt - Fan; Ser. No. 4U6906 Thru 4U7560	5H2896	TR30506
Belt - Fan; Ser. No. 5U15475 Thru 5U18894 .	5H2896	TR30506
Belt - Starter	5B5653	TR24438
D3 (79U)		
Caterpillar 3204 Diesel		
1979-1973		
Belt - Fan & Alt.	7M3921	TR24597
D3B (27Y)		
Caterpillar 3204 Diesel		
1988-1979		
Belt - Fan & Alt.		②▲9620HD
Hose - Upper		●26501
D3C		
Caterpillar 3204 Diesel		
1990-1988		
Belt - Fan		▲9463HD
Belt - W.P. & Alt.		▲9580HD

② Two Required.
 ③ Three Required.
 < Cut to Fit.

Application	Mfr. Part No.	Our No.
CATERPILLAR - Continued		
D4 (6U)		
Caterpillar 4-Cyl. 350 Diesel		
1959-1947		
Belt - Fan & W.P.; Ser. No. 6U1 Thru		
6U10843	4F7956	TR34506
Belt - Fan & W.P.; Ser. No. 7U1 Thru		
7U31974	4F7956	TR34506
Belt - Alt. & Gov.		▲9390HD
Belt - Starter	6B5653	TR24438
D4 (7J)		
Caterpillar D4400 Diesel		
1944-1939		
Belt - Fan & W.P.	7B4032	TR34495
Belt - Alt.	5B7168	▲9390HD
Belt - Starter		TR24438
D4 (7U)		
Caterpillar 4-Cyl. 350 Diesel		
1959-1947		
Belt - Fan & W.P.; Ser. No. 6U1 Thru		
6U10843	4F7956	TR34506
Belt - Fan & W.P.; Ser. No. 7U1 Thru		
7U31974	4F7956	TR34506
Belt - Alt. & Gov.		▲9390HD
Belt - Starter	6B5653	TR24438
D4C (39A)		
Caterpillar D330 Diesel		
1966-1959		
Belt - W.P.	8M1715	TR24664
Belt - W.P. & Gen.; Ser. No. 39A1 Thru		
39A581	8M1715	TR24664
Belt - W.P. & Gen.; Ser. No. 40A1 Thru		
40A5253	8M1715	TR24664
D4C (40A)		
Caterpillar D330 Diesel		
1963-1959		
Belt - W.P.	8M1715	TR24664
Belt - W.P. & Gen.; Ser. No. 39A1 Thru		
39A581	8M1715	TR24664
Belt - W.P. & Gen.; Ser. No. 40A1 Thru		
40A5253	8M1715	TR24664
D4D		
Caterpillar 3304 Diesel		
1977-1963		
Hose - Upper; (2 3/4" I.D.)		24444
Hose - Lower; (2 1/2" I.D.)		24440
D4D (22C)		
Caterpillar 3304 Diesel; Caterpillar D315 Diesel; Caterpillar D330 Diesel		
1968-1967		
Belt - W.P.	5S1817	②▲9650HD
Belt - Gen.	4M6291	▲9415HD
D4D (78A)		
Caterpillar 3304 Diesel		
1968-1963		
Belt - Fan	5S1817	②▲9650HD
Belt - W.P.; Ser. No. 78A1 & After	8M1715	TR24664
Belt - Gen.		▲9415HD
D4D (82J)		
Caterpillar 3304 Diesel		
1977-1968		
Belt - Fan; Ser. No. 82J1 Thru 82J2979	2M8502	②TR24638
Belt - Fan; Ser. No. 82J2980 Thru 82J3259 ..	2P1385	②TR24619

▲ Standard Belt Available. See Pages 630-631.
 ④ Four Required.
 ● Vulco-Flex® Coolant Hose.

Road & Construction Equipment

Belts and Coolant Hose for Road & Construction Equipment

Application	Mfr. Part No.	Our No.
CATERPILLAR - Continued		
D4D (82J) - Continued		
Caterpillar 3304 Diesel - Continued		
1977-1968 - Continued		
Belt - Fan; Ser. No. 82J3260 & After	1P2421	②TR24638
Belt - Alt.	4M6292	②TR24619
Belt - Gen.; Ser. No. 82J1 Thru 82J2979	7S9857	②TR24638
Belt - A.C.; Ser. No. 82J1 Thru 82J3259; W/47 1/4" Belt O.C.	2P6818	♣9470HD
Belt - A.C.; Ser. No. 82J1 Thru 82J3259; W/62 1/2" Belt O.C.	2P1385	②TR24619
Belt - A.C.; Ser. No. 82J3260 & After; W/47 1/4" Belt O.C.	2P6818	♣9470HD
Belt - A.C.; Ser. No. 82J3260 & After; W/64" Belt O.C.	1P2421	②TR24638
Belt - A.C.; Ser. No. 82J3260 & After; W/72 1/4" Belt O.C.	2P5619	♣9720HD
D4D (83J)		
Caterpillar 3304 Diesel		
1977-1968		
Belt - Fan; Ser. No. 83J1 Thru 83J1455	2M8502	②TR24638
Belt - Fan; Ser. No. 83J1456 Thru 83J1821 ..	2P1385	②TR24619
Belt - Fan; Ser. No. 83J1822 & After	1P2421	②TR24638
Belt - Alt.	4M6292	②TR24619
Belt - Gen.; Ser. No. 83J1 Thru 83J1455	7S9857	②TR24638
Belt - A.C.; W/45 1/4" Belt O.C.	2P6820	♣9451HD
Belt - A.C.; W/62 1/2" Belt O.C.	2P1385	②TR24619
Belt - A.C.; W/72 1/4" Belt O.C.	2P5619	♣9720HD
D4D LGP (7R)		
Caterpillar 3304 Diesel		
1977-1970		
Belt - Fan; Ser. No. 7R1 Thru 7R414	2M8502	②TR24638
Belt - Fan; Ser. No. 7R415 Thru 7R433	4M6292	②TR24619
Belt - Fan; Ser. No. 7R434 Thru 7R507	1P2421	②TR24638
D4D LGP (61J)		
Caterpillar 3304 Diesel		
1978-1967		
Belt - Fan; W/64" Belt O.C.	7M6100	②TR24638
Belt - Fan; W/67 1/2" Belt O.C.	3L7540	②TR30672
Belt - Gen.	7S9858	②TR24638
D4D SA (20J)		
Caterpillar 3304 Diesel		
1968-1966		
Belt - W.P.	8M8335	②♣9640HD
Belt - Gen.	4M6291	♣9415HD
Belt - Starter	5B8473	TR24515
D4D SA (84J)		
Caterpillar 3304 Diesel		
1977-1968		
Belt - Fan; Ser. No. 84J1 Thru 84J1290	2M8502	②TR24638
Belt - Fan; Ser. No. 84J1291 Thru 84J1390 ..	2P1385	②TR24619
Belt - Fan; Ser. No. 84J1391 & After	1P2421	②TR24638
Belt - Alt.	4M6292	②TR24619
Belt - Gen.; Ser. No. 84J1 Thru 84J1200	7S9857	②TR24638
Belt - A.C.; W/45 1/4" Belt O.C.	2P6820	♣9451HD
Belt - A.C.; W/47 1/4" Belt O.C.	2P6818	♣9470HD
Belt - A.C.; W/62 1/2" Belt O.C.	2P1385	②TR24619
Belt - A.C.; W/64" Belt O.C.	1P2423	②TR24638
Belt - A.C.; W/72 1/4" Belt O.C.	2P5619	♣9720HD
D4E		
Caterpillar 3304 Diesel		
1987-1977		
Hose - Upper; (2 3/4" I.D.)		24444
Hose - Lower; (2 1/2" I.D.)		24440

Application	Mfr. Part No.	Our No.
CATERPILLAR - Continued		
D4E (28X)		
Caterpillar 3304 Diesel		
1984-1977		
Hose - Upper; (2 3/4" I.D.)		24244
D4E (29X)		
Caterpillar 3304 Diesel		
1984-1978		
Belt - Fan & Alt.	5M5965	②TR30624
D4E (70X)		
Caterpillar 3304 Diesel		
1987-1978		
Belt - Fan & Alt.	2P1272	②CX60
Belt - A.C.		♣9510HD
Hose - Upper; (2 1/2" I.D.)		24440
Hose - Lower; (2 1/2" I.D.)		24440
D4H (8PB)		
Caterpillar 3204 Diesel		
1995-1985		
Belt - Fan & Alt.	5S3244	②♣9670HD
Belt - W.P.		♣9490HD
Hose - Upper - Eng. To Pipe; (1 5/8" I.D.)		24226
Hose - Lower - Eng. To Pipe		≈21194
Hose - Lower - Pipe To Rad.; (2 1/4" I.D.)		24436
D5 (21J)		
Caterpillar D333 Diesel		
1968-1967		
Belt - Gen.	5M6096	②TR24709
D5 (81H)		
Caterpillar D333 Diesel		
1969-1967		
Belt - Gen.	5M6096	②TR24709
D5 (82H); D5 (83H); D5 (84H)		
Caterpillar D333 Diesel		
1968-1967		
Belt - Gen.	5M6096	②TR24709
D5B		
Caterpillar 3306 Diesel		
1987-1977		
Hose - Upper; (2 3/4" I.D.)		24444
Hose - Lower; (2 1/2" I.D.)		24440
D5B LGP (46X)		
Caterpillar 3306 Diesel		
1987-1977		
Belt - A.C.		♣9470HD
D6		
Caterpillar 6-Cyl. 525 Diesel		
1956-1942		
Hose - Upper; W/Power Shift Trans.; Ser. No. 76A1 Thru 76A6061(2 3/4" I.D.)		24444
Hose - Upper; W/Power Shift Trans.; Ser. No. 9U10270 & After(2 1/4" I.D.)		24236
Hose - Lower; W/Power Shift Trans.; Ser. No. 76A1 Thru 76A6061(3" I.D.)		24448
D6 (8U); D6 (9U)		
Caterpillar D318 Diesel		
1959-1947		
Belt - Fan	1M2045	②TR24607
Belt - Gen.	8F2434	TR24500
Belt - Gov.; Ser. No. 9U1 Thru 9U29764	4B2544	♣9425HD

② Two Required.
≈ Cut to Fit.

♣ Standard Belt Available. See Pages 630-631.

Belts and Coolant Hose for Road & Construction Equipment

Application	Mfr. Part No.	Our No.	Application	Mfr. Part No.	Our No.
CATERPILLAR - Continued			CATERPILLAR - Continued		
D6 (8U); D6 (9U) - Continued			D6D SA (5X)		
Caterpillar D318 Diesel - Continued			Caterpillar 3306 Diesel		
1959-1947 - Continued			1990-1976		
Belt - Starter; Ser. No. 9U1 Thru 9U29764 ...		5B8473	Belt - Fan & Alt.		②TR28706
			Belt - A.C.		♣9540HD
D6B (37A); D6B (44A)			Hose - Upper; (2 3/4" I.D.)		
Caterpillar D333 Diesel			Hose - Lower; (2 1/2" I.D.)		
1967-1959			D6H (3ZF)		
Belt - Fan		5M6096	Caterpillar 3306 Diesel		
Belt - Fan & Gen.		7M5972	1990-1987		
Belt - Starter; W/50 5/8" Belt O.C.		8F2434	Belt - Fan & Alt.		②CX81
Belt - Starter; W/71 1/8" Belt O.C.		5M6096	D6H (4RC)		
D6C (10K)			Caterpillar 3306 Diesel		
Caterpillar D333 Diesel			1995-1986		
1976-1967			Hose - Upper; (2 1/2" I.D.)		②24440
Belt - Fan & Alt.		7B344	Hose - Lower; (2 1/2" I.D.)		②24440
Belt - A.C.		2P4191	D7		
D6C (71A)			Caterpillar D8800 Diesel		
Caterpillar D333 Diesel			1955-1947		
1967-1963			Hose - Upper; Ser. No. 17A1 & After(2 3/4" I.D.)		24444
Belt - W.P.		7M169	Hose - Upper; W/Power Shift Trans.; Ser. No. 48A6393 &		
Belt - Alt.		7M169	After(2 1/2" I.D.)		24440
Belt - Gen.; W/49 3/8" Belt O.C.		3L9717	Hose - Lower; (3" I.D.)		24448
Belt - Gen.; W/53 5/8" Belt O.C.		7M169	D7C (17A); D7D (17A)		
Belt - Clutch		8M8335	Caterpillar D339 Diesel		
D6C (73A)			1962-1954		
Caterpillar D333 Diesel			Belt - Fan; Ser. No. 17A11981 Thru		
1968-1964			17A19442		2M8183
Belt - W.P.		7M169	Belt - Gen.		8H9832
Belt - Alt.		7M169	②TR30672		
Belt - Gen.; W/49 3/8" Belt O.C.		3L9717	②TR24638		
Belt - Gen.; W/53 5/8" Belt O.C.		7M169	D7E (47A)		
Belt - Clutch		8M8335	Caterpillar D339 Diesel		
D6C (74A); D6C (76A)			1969-1961		
Caterpillar D333 Diesel			Belt - Fan; Ser. No. 47A1 Thru 47A1309		3L6052
1967-1963			Belt - Fan; Ser. No. 47A1310 Thru 47A3395 .		7H9806
Belt - W.P.		7M169	Belt - Alt.; W/59 1/4" Belt O.C.		2S9778
Belt - Alt.		7M169	Belt - Alt.; W/60 1/4" Belt O.C.		2S9506
Belt - Gen.; W/49 3/8" Belt O.C.		3L9717	Belt - Gen.; W/50 1/4" Belt O.C.		5M8137
Belt - Gen.; W/53 5/8" Belt O.C.		7M169	Belt - Gen.; W/52 1/4" Belt O.C.		5M8135
Belt - Clutch		8M8335	Belt - Gen.; W/53 1/4" Belt O.C.		3S6272
D6C (99J)			Belt - Gen.; W/58 1/4" Belt O.C.		2S5218
Caterpillar D333 Diesel			②TR30808		
1977-1967			②TR30770		
Belt - Fan; Ser. No. 99J830 Thru 99J1549		5S9506	②♣9590HD		
Belt - Alt.		5S9506	②♣9600HD		
Belt - A.C.		2P4191	♣9500HD		
D6C LGP (69U)			♣9520HD		
Caterpillar 3306 Diesel			♣9530HD		
1977-1972			♣9580HD		
Belt - A.C.		4N6013	D7E (48A)		
D6D (3X)			Caterpillar D339 Diesel		
Caterpillar 3306 Diesel			1970-1961		
1988-1977			Belt - Fan; W/81 1/8" Belt O.C.		3L6052
Belt - Fan & Alt.		4M5413	Belt - Fan; W/85 5/8" Belt O.C.		5H7371
D6D (4X)			Belt - Alt.; W/59 1/4" Belt O.C.		2S9778
Caterpillar 3306 Diesel			Belt - Alt.; W/60 1/4" Belt O.C.		2S9506
1987-1977			Belt - Gen.; Ser. No. 48A6393 Thru 48A9314		3S6272
Belt - Fan & Alt.		4M5413	Belt - Gen.; Ser. No. 48A9315 & After		2S5218
Hose - Upper; (2 3/4" I.D.)			②TR30808		
Hose - Lower; (2 1/2" I.D.)			②CX81		
D6D (3X)			②♣9590HD		
Caterpillar 3306 Diesel			♣9600HD		
1974-1969			♣9500HD		
Belt - Fan		3L6052	♣9520HD		
Belt - A.C.		1P3085	♣9530HD		
D7F			♣9580HD		
Caterpillar 3306 Diesel			D7E (93N)		
1974-1969			Caterpillar D339 Diesel		
Hose - Upper; (2 3/4" I.D.)			1974-1969		
Hose - Lower; (3" I.D.)			Belt - Fan		3L6052
D7E (93N)			Belt - A.C.		1P3085
Caterpillar D339 Diesel			②TR30808		
1974-1969			♣9490HD		
Belt - Fan		3L6052	D7F		
Belt - A.C.		1P3085	Caterpillar 3306 Diesel		
D7F			1974-1969		
Caterpillar 3306 Diesel			Hose - Upper; (2 3/4" I.D.)		24444
1974-1969			Hose - Lower; (3" I.D.)		24448
Belt - Fan & Alt.		4M5413	D7E (93N)		
Hose - Upper; (2 3/4" I.D.)			Caterpillar D339 Diesel		
Hose - Lower; (2 1/2" I.D.)			1974-1969		
D7E (93N)			1974-1969		
Caterpillar D339 Diesel			Belt - Fan		3L6052
1974-1969			Belt - A.C.		1P3085
Belt - Fan & Alt.		4M5413	②TR30808		
Hose - Upper; (2 3/4" I.D.)			♣9490HD		
Hose - Lower; (2 1/2" I.D.)			D7F		
D7F			Caterpillar 3306 Diesel		
1974-1969			Hose - Upper; (2 3/4" I.D.)		24444
Belt - Fan & Alt.		4M5413	Hose - Lower; (3" I.D.)		24448
Hose - Upper; (2 3/4" I.D.)			D7E (93N)		
Hose - Lower; (2 1/2" I.D.)			Caterpillar D339 Diesel		
D7E (93N)			1974-1969		
Caterpillar D339 Diesel			Belt - Fan		3L6052
1974-1969			Belt - A.C.		1P3085
Belt - Fan & Alt.		4M5413	②TR30808		
Hose - Upper; (2 3/4" I.D.)			♣9490HD		
Hose - Lower; (2 1/2" I.D.)			D7F		

Road & Construction Equipment

② Two Required.

♣ Standard Belt Available. See Pages 630-631.

Belts and Coolant Hose for Road & Construction Equipment

Application	Mfr. Part No.	Our No.
CATERPILLAR - Continued		
D7F (93N); D7F (94N)		
Caterpillar 3306 Diesel		
1975-1969		
Belt - Fan	3L6052	②TR30808
Belt - A.C.	1P3085	♣9490HD
D7G		
Caterpillar 3306 Diesel		
1998-1974		
Hose - Upper; (2 3/4" I.D.)		24444
Hose - Lower - Eng. To Pipe; (2 1/2" I.D.)		24440
Hose - Lower - Pipe To Rad.; (2 1/2" I.D.)		24440
D7G (92V)		
Caterpillar 3306 Diesel		
1988-1975		
Belt - Fan & Alt.	5H7371	②CX81
D7H (79Z)		
Caterpillar 3306 Diesel		
Belt - Fan & Alt.		CX85
Belt - A.C.		♣9430HD
Hose - Upper; (2 1/2" I.D.)		②24440
Hose - Lower; (2 1/2" I.D.)		②24440
D8		
Caterpillar D13000 Diesel		
1955-1945		
Hose - Upper; W/Direct Drive Trans.; Ser. No. 36A1 Thru 36A3215(2 3/4" I.D.)		24444
Hose - Upper; W/Power Shift Trans.; Ser. No. 46A1 Thru 46A10724(2 3/4" I.D.)		24444
Hose - Upper; W/Power Shift Trans.; Ser. No. 46A10725 Thru 46A24432(2 1/2" I.D.)		24440
Hose - Lower; W/Power Shift Trans.; Ser. No. 46A10725 Thru 46A24432(2 3/4" I.D.)		24444
Hose - Lower; W/O Power Shift Trans.; Ser. No. 46A10725 Thru 46A24432(3" I.D.)		24448
D8 (14A)		
Caterpillar D13000 Diesel		
1958-1954		
Belt - Fan; W/72 5/8" Belt O.C.		②CX68
Belt - Fan; W/77 1/8" Belt O.C.	7H9806	②TR30770
D8E (14A)		
Caterpillar D342 Diesel		
1958-1955		
Belt - Fan; W/72 5/8" Belt O.C.		②CX68
Belt - Fan; W/77 1/8" Belt O.C.	7H9806	②TR30770
D8G (15A)		
Caterpillar D342 Diesel		
1959-1955		
Belt - Fan; W/72 5/8" Belt O.C.		②CX68
Belt - Fan; W/77 1/8" Belt O.C.	7H9806	②TR30770
D8H (22A)		
Caterpillar D342 Diesel		
1969-1959		
Belt - Fan; Ser. No. 22A1 Thru 22A1145	2M7863	②TR30770
Belt - Fan; Ser. No. 22A1146 & After	3L6052	③TR30808
Belt - Alt.; W/59 1/4" Belt O.C.	2S9778	②♣9590HD
Belt - Alt.; W/62 1/4" Belt O.C.	8M8336	②♣9620HD
Belt - Alt.; W/64 1/4" Belt O.C.	8M8335	②♣9640HD
Belt - Gen.; W/60 1/4" Belt O.C.	2S9506	♣9600HD
Belt - Gen.; W/64 1/4" Belt O.C.	8M8335	♣9640HD

Application	Mfr. Part No.	Our No.
CATERPILLAR - Continued		
D8H (35A)		
Caterpillar D342 Diesel		
1961-1958		
Belt - Fan	2M8255	③TR30754
Belt - Gen.	8H9832	②TR24638
D8H (36A)		
Caterpillar D342 Diesel		
1974-1958		
Belt - Fan; Ser. No. 36A1 Thru 36A4468	2M7863	②TR30770
Belt - Fan; Ser. No. 36A4649 & After	3L6052	③TR30808
D8H (46A)		
Caterpillar D342 Diesel		
1974-1959		
Belt - Alt.; Ser. No. 46A1 Thru 46A28136; W/59 1/4" Belt O.C.	2S9778	②♣9590HD
Belt - Alt.; Ser. No. 46A1 Thru 46A28136; W/62 1/4" Belt O.C.	8M8336	②♣9620HD
Belt - Alt.; Ser. No. 46A1 Thru 46A28136; W/64 1/4" Belt O.C.	8M8335	♣9640HD
Belt - Alt.; Ser. No. 46A28137 Thru 46A32842 1P2421		TR24638
Belt - Alt.; Ser. No. 46A32843 & After	3P25	TR24619
Belt - Gen.; Ser. No. 46A1 Thru 46A8081	3S3961	♣9570HD
Belt - Gen.; Ser. No. 46A8082 Thru 46A10725 2S2743		②♣9550HD
Belt - Gen.; Ser. No. 46A10726 Thru 46A12671	2S5218	♣9580HD
Belt - Gen.; Ser. No. 46A12672 & After	8M8335	♣9640HD
Belt - A.C.; Ser. No. 46A12085 Thru 46A28136		♣9610HD
Belt - A.C.; Ser. No. 46A12137 & After	1P4334	♣9490HD
D8H (52A)		
Caterpillar D342 Diesel		
1961-1959		
Belt - Fan; W/Blower	2M8255	③TR30754
D8H (68A)		
Caterpillar D342 Diesel		
1974-1960		
Belt - Fan; Ser. No. 68A1 Thru 68A759	2M8255	③TR30754
Belt - Fan; Ser. No. 68A1003 Thru 68A4586	3L6052	③TR30808
Belt - Alt.; W/62 1/4" Belt O.C.	8M8336	②♣9620HD
Belt - Alt.; W/64 1/4" Belt O.C.	8M8335	②♣9640HD
Belt - Gen.; Ser. No. 68A1003 Thru 68A1187	2S5218	♣9580HD
Belt - Gen.; Ser. No. 68A1188 Thru 68A3846	8M8335	♣9640HD
D8K (77V)		
Caterpillar D342 Diesel		
1984-1974		
Belt - Fan; W/74 1/2" Belt O.C.	6N4548	③BX71
Belt - Fan; W/81" Belt O.C.		③BX78
Belt - Alt.		TR22657
Hose - Upper; (2 3/4" I.D.)		24444
Hose - Lower; (2 3/4" I.D.)		24444
D8L		
Caterpillar 3408 Diesel		
1992-1982		
Belt - Fan	6N6650	③BX71
Belt - Alt.	3S9652	②♣9680HD
Hose - Upper; (2 3/8" I.D.)		24438
Hose - Lower; (3" I.D.)		24448
D8L (53Y)		
Caterpillar 3408 Diesel		
1987-1981		
Belt - Fan		B79
Belt - Alt.		TR22711
Hose - Upper; (2 1/2" I.D.)		②24440
Hose - Lower; (4" I.D.)		②24464

② Two Required.
③ Three Required.

♣ Standard Belt Available. See Pages 630-631.

Belts and Coolant Hose for Road & Construction Equipment

Application	Mfr. Part No.	Our No.	Application	Mfr. Part No.	Our No.
CATERPILLAR - Continued			CATERPILLAR - Continued		
D8N (9TC)			IT28B (1HF)		
Caterpillar 3406 Diesel			Caterpillar 3204 Diesel		
Belt - Fan		BX79	Belt - Fan & Alt.		②▲9690HD
Hose - Upper; (2 1/2" I.D.)		②24440	Belt - W.P.	6N3113	▲9485HD
Hose - Lower; (4" I.D.)		②24464	Hose - Upper; (1 3/4" I.D.)		②24428
D9			Hose - Lower; (2 1/4" I.D.)		
Caterpillar 6-Cyl. 1473 Diesel			②24436		
1959-1955			CEDAR RAPIDS		
Hose - Lower; W/Power Shift Trans.; Ser. No. 66A1 Thru			BSF2		
66A8408(3" I.D.)			Continental F244		
24448			Belt - Fan		
Hose - Lower; W/Power Shift Trans.; Ser. No. 66A8409 Thru			F600K267		
66A9417(3 1/2" I.D.)			TR24465		
24456			Belt - Gen.; W/12V. Gen.; W/49 1/4" Belt O.C.		
D9G (66A)			▲9490HD		
Caterpillar D353TA Diesel			Belt - Gen.; W/12V. Gen.; W/50 1/4" Belt O.C.		
1974-1961			▲9500HD		
Belt - Fan & W.P.; Ser. No. 66A1905 Thru			Belt - Gen.; W/115V. Gen.		
66A3143; W/81 1/8" Belt O.C.			B71		
9M7800			Continental F245		
Belt - Alt.; W/47" Belt O.C.			Belt - Fan		
1S5138			G193K201		
Belt - Alt.; W/48 1/8" Belt O.C.			▲9463HD		
5M5345			▲9490HD		
Belt - Gen.; Ser. No. 66A1209 Thru 66A3846			▲9500HD		
8M8335			Belt - Gen.; W/12V. Gen.; W/50 1/4" Belt O.C.		
Belt - Gen.; Ser. No. 66A8509 Thru 66A9418			TR22578		
9S9010			Belt - Gen.; W/115V., 120V. Gen.		
Belt - Air Brake Compr.			B71		
8M8335			Hose - Upper		
②▲9640HD			●25526		
Hose - Upper; (2 3/4" I.D.)			Hose - Lower; W/1800 R.P.M.		
24444			≈20623		
Hose - Lower - Eng. To Pipe; (3" I.D.)			Continental FA244		
24448			Belt - Fan		
Hose - By Pass; (2 1/2" I.D.)			F600K267		
24240			TR24465		
D9G (90J)			Belt - Gen.; W/12V. Gen.; W/49 1/4" Belt O.C.		
Caterpillar D353TA Diesel			▲9490HD		
1975-1969			Belt - Gen.; W/12V. Gen.; W/50 1/4" Belt O.C.		
Belt - Fan; Ser. No. 90J106 & After			▲9500HD		
5H7371			Belt - Gen.; W/115V. Gen.		
③CX81			B71		
Belt - Alt.; Ser. No. 90J1 Thru 90J105			Continental HD277 Diesel		
1S5138			Belt - Gen.; W/120V. Gen.		
Belt - Alt.; Ser. No. 90J106 & After			B78		
5M5345			Detroit Diesel 3-53 Diesel		
Belt - Gen.; Ser. No. 90J86 Thru 90J99			Belt - Fan		
9S9010			5131395		
TR24457			②▲9412HD		
D9H (90V)			②3VX400		
Caterpillar D353 Diesel			3VX400		
1981-1974			Belt - Gen.; W/115V., 120V. Gen.; W/1800 R.P.M.		
Belt - Fan & W.P.; W/85 5/8" Belt O.C.			B85		
5H7371			Belt - Gen.; W/115V., 120V. Gen.; W/2000 R.P.M.		
③CX81			B68		
Belt - Alt.			Hose - Upper		
5M5345			≈20957		
Belt - Fan To A.C.			Hose - Lower; (2" I.D.)		
2P6532			24232		
Hose - Upper - Eng. To Pipe; (2 3/4" I.D.)			Ford 4-Cyl. 256; Ford 4-Cyl. 256 Diesel		
24444			Belt - Fan		
Hose - Upper - Pipe To Rad.; (3 1/2" I.D.)			3VX530		
24456			Belt - Alt./Gen.; W/12V. Gen.		
Hose - By Pass; (2 1/2" I.D.)			3VX530		
24440			B68		
D9L (14Y)			Hose - Upper		
Caterpillar 3416 Diesel			or		
1987-1980			●25526		
Belt - Fan			●26502		
4N8277			Ford 6-Cyl. 240		
③BX70			Belt - Fan		
④24440			C7JZ8620A		
②24464			▲9395HD		
EL240B (5WG)			Belt - Alt.		
Caterpillar 3116DIT Diesel			7417		
Belt - Fan & Alt.			Belt - Gen.; W/12V. Gen.		
▲9600HD			C4AZ8620A		
Belt - W.P.			7417		
618384			Belt - Gen.; W/115V., 120V. Gen.; W/1800 R.P.M.		
▲9335HD			B78		
IT12B (1KF)			Belt - Gen.; W/115V., 120V. Gen.; W/2000 R.P.M.		
Caterpillar 3114 Diesel			B68		
Belt - Fan & Alt.			BSF2H		
8M8336			Detroit Diesel 3-71 Diesel		
②▲9620HD			Belt - Alt.		
▲9350HD			3VX530		
Hose - Upper			Belt - Gen.; W/12V. Gen.		
●26511			2420		
Hose - Lower			Belt - Gen.; W/120V. Gen.; W/43" Belt O.C.		
●26511			2430		
IT14B (3NJ)			Belt - Gen.; W/120V. Gen.; W/53" Belt O.C.		
Caterpillar 3114 Diesel			3VX530		
Belt - Fan & Alt.			Hose - Upper		
8M8336			●26504		
②▲9620HD			Hose - Lower		
▲9350HD			●26510		
Hose - Upper			●26510		
Hose - Lower			BSF3R		
●26512			Caterpillar D330 Diesel		
IT12B (1KF)			Belt - Alt./Gen.; W/12V. Gen.		
Caterpillar 3114 Diesel			2460		
Belt - Fan & Alt.			Belt - Gen.; W/120V. Gen.		
8M8336			2590		
②▲9620HD			Detroit Diesel 4-53 Diesel		
▲9350HD			Belt - Alt./Gen.; W/12V. Gen.		
Hose - Upper			3VX400		
●26511			Belt - Gen.; W/120V. Gen.		
Hose - Lower			3VX375		
●26512			IH UC301		
IT14B (3NJ)			Belt - Alt./Gen.; W/12V. Gen.		
Caterpillar 3114 Diesel			312515R1		
Belt - Fan & Alt.			▲9525HD		
8M8336					
②▲9620HD					
▲9350HD					
Hose - Upper					
Hose - Lower					

② Two Required.
 ▲ Standard Belt Available. See Pages 630-631.
 ● Vulco-Flex® Coolant Hose.

③ Three Required.
 ④ Four Required.
 ≈ Cut to Fit.

Road & Construction Equipment

Belts and Coolant Hose for Road & Construction Equipment

Application	Mfr. Part No.	Our No.	Application	Mfr. Part No.	Our No.
CEDAR RAPIDS - Continued			CHICAGO PNEUMATIC - Continued		
BSF3R - Continued			85RGH1 - Continued		
IH UC301 - Continued			Continental F163 - Continued		
Belt - Gen.; W/120V. Gen.; W/53" Belt O.C.		3VX530	Hose - Lower		●25478
Belt - Gen.; W/120V. Gen.; W/59" Belt O.C.		2590	Hose - By Pass		⊗<20605
IH UD282 Diesel			125RG2		
Belt - Alt./Gen.; W/12V. Gen.	312515R1	▲9520HD	Hercules GO198		
Belt - Gen.; W/120V. Gen.; W/53" Belt O.C.		3VX530	Belt - Fan	1PS1090	▲9470HD
Belt - Gen.; W/120V. Gen.; W/59" Belt O.C.		2590	Hercules JX4D		
BSF4			Belt - Fan		
Detroit Diesel 4-71 Diesel			Belt - Fan		
Belt - Alt.		3VX530	18PS398		
Belt - Gen.; W/12V. Gen.		2420	TR22508		
Belt - Gen.; W/120V. Gen.; W/43" Belt O.C.		2430	Hercules JX4D3		
Belt - Gen.; W/120V. Gen.; W/53" Belt O.C.		3VX530	Belt - Fan		
Hose - Upper		●26504	1PS863		
Hose - Lower		●26510	TR24489		
CR331			125RO2		
Cummins 4-Cyl. 3.9 L Diesel			Hercules DD198		
Belt - Fan & Alt.	3911560	▲K080550HD	Belt - Fan		
CR461			7550		
Cummins 4-Cyl. 3.9 L Diesel			175RG1		
Hose - Upper		●26611	Ford 6-Cyl. 300		
CHAMPION			Belt - Fan & Alt.		
560			Belt - Gov.		
Detroit Diesel 3-71 Diesel			Hose - Upper		
Belt - Fan & Alt.		②B60	⊗<●25527		
Belt - Hyd. Pump; W/36 3/4" Belt O.C.		▲9365HD	Hose - Lower - Eng. To Pipe; (1 3/4" I.D.)		
Belt - Hyd. Pump; W/42" Belt O.C.		TR22416	24228		
600			Hose - Lower - Pipe To Rad.; (1 3/4" I.D.)		
Detroit Diesel 6-71C Diesel			24228		
Belt - Fan	172856	②TR24457	210RG2		
Belt - Alt.		TR22392	Hercules GO339		
Belt - Hyd. Pump; W/40 3/8" Belt O.C.		TR22397	Belt - Fan		
Belt - Hyd. Pump; W/43" Belt O.C.		TR22425	1PS1090		
Belt - Hyd. Pump; W/50 1/4" Belt O.C.		▲9500HD	▲9470HD		
Hose - Upper		●26511	Hercules JXLD		
Hose - Lower		⊗<20401	Belt - Fan		
	or	●26523	19PS398		
720A			TR28545		
Cummins 6-Cyl. 8.3 L Diesel			250RG2		
Belt - Fan, Alt. & Idler; W/70 5/8" Belt O.C. ...	3911582	▲K080700HD	Hercules GO339A		
Belt - Fan, Alt. & Idler; W/72 5/8" Belt O.C. ...	3911585	▲K080720HD	Belt - Fan		
Belt - A.C.		▲9370HD	6PS398		
Hose - Lower - Eng. To Pipe		21901	②TR22485		
Hose - Lower - Pipe To Cooler; (2 3/8" I.D.)		24438	250RO2		
Hose - Lower - Cooler To Rad.		⊗<20731	Detroit Diesel 4-51 Diesel; Detroit Diesel 4-53 Diesel		
730A			Belt - Fan		
Cummins 6-Cyl. 8.3 L Diesel			1PS398		
Hose - Lower - Eng. To Pipe		21901	②▲9480HD		
Hose - Lower - Pipe To Cooler; (2 3/8" I.D.)		24438	365RO2		
Hose - Lower - Cooler To Rad.		⊗<20731	Detroit Diesel 4-71 Diesel		
C80A			Belt - Fan		
Cummins 4-Cyl. 3.9 L Diesel			14PS398		
Belt - Fan & Alt.		▲K080550HD	5133515		
CHICAGO PNEUMATIC			②TR22578		
85RGH1			▲9370HD		
Continental F163			600RO2		
Belt - Fan & Alt.		▲9480HD	Detroit Diesel 6-71 Diesel		
Hose - Upper		⊗<20088	Belt - Fan		
	or	●25474	14PS398		
CHICAGO PNEUMATIC			②TR22578		
85RGH1			▲9370HD		
Continental F163			Hose - Upper; (2" I.D.)		
Belt - Fan & Alt.		▲9480HD	24232		
Hose - Upper		⊗<20088	Hose - Lower; (2" I.D.)		
	or	●25474	24232		
CHICAGO PNEUMATIC			900RO2		
85RGH1			Cummins NRT0 Diesel; Detroit Diesel 6-110 Diesel		
Continental F163			Belt - Fan; W/71 1/8" Belt O.C.		
Belt - Fan & Alt.		▲9480HD	②TR28706		
Hose - Upper		⊗<20088	Belt - Fan; W/73 3/8" Belt O.C.		
	or	●25474	②TR28733		
CHICAGO PNEUMATIC			CPS130		
85RGH1			Isuzu 3KR1 Diesel		
Continental F163			Belt - Fan & Alt.		
Belt - Fan & Alt.		▲9480HD	7405		
Hose - Upper		⊗<20088	Hose - Upper		
	or	●25474	●25252		
CHICAGO PNEUMATIC			CPS270		
85RGH1			Isuzu 4BD1 Diesel		
Continental F163			Belt - Fan & Alt.		
Belt - Fan & Alt.		▲9480HD	TR22474		
Hose - Upper		⊗<20088	CLARK-LIMA		
	or	●25474	500TC		
CHICAGO PNEUMATIC			Cummins H743 Diesel		
85RGH1			Belt - Fan - Upper Structure		
Continental F163			172856		
Belt - Fan & Alt.		▲9480HD	②TR24457		
Hose - Upper		⊗<20088			
	or	●25474			

▲ Standard Belt Available. See Pages 630-631.
 ⊗ Two Required.

● Vulco-Flex® Coolant Hose.
 ⊗< Cut to Fit.

Belts and Coolant Hose for Road & Construction Equipment

Application	Mfr. Part No.	Our No.
CLARK-LIMA - Continued		
500TC - Continued		
Cummins H743 Diesel - Continued		
Belt - Alt. - Upper Structure	178436	TR22358
Belt - Hyd. Pump - Upper Structure	178554	▲9375HD
Hose - Upper - Upper Structure; (2 1/4" I.D.)		24236
Hose - Lower - Upper Structure; (2 1/4" I.D.)		24236
Cummins NHF240 Diesel		
Belt - Fan - Lower Structure	172856	②TR24457
Belt - Alt. - Lower Structure; W/36 1/2" Belt O.C.		TR22358
Belt - Alt. - Lower Structure; W/38" Belt O.C.	178655	TR22373
Belt - Hyd. Pump - Lower Structure	178544	TR28463
Hose - Upper - Lower Structure		●26522
Hose - Lower - Lower Structure		●26526
700TC		
Cummins H743 Diesel		
Belt - Fan - Upper Structure	172856	②TR24457
Belt - Alt. - Upper Structure	178436	TR22358
Belt - Hyd. Pump - Upper Structure	178554	▲9375HD
Hose - Upper - Upper Structure; (2 1/4" I.D.)		24236
Hose - Lower - Upper Structure; (2 1/4" I.D.)		24236
Cummins NHF240 Diesel		
Belt - Fan - Lower Structure	172856	②TR24457
Belt - Alt. - Lower Structure; W/36 1/2" Belt O.C.		TR22358
Belt - Alt. - Lower Structure; W/38" Belt O.C.	178655	TR22373
Belt - Hyd. Pump - Lower Structure	178544	TR28463
Hose - Upper - Lower Structure; (2 3/8" I.D.)		24238
Hose - Lower - Lower Structure		●26528
703SC		
Cummins NHC250 Diesel		
Belt - Fan		②TR22455
Belt - Fan To Alt.		TR22448
Hose - Upper		●26526
Hose - Lower; (2 1/4" I.D.)		③24436
720		
Detroit Diesel 6V-53N Diesel		
Belt - Fan & Air Brake Compr. - Upper Structure	5135942	②▲9550HD
Belt - Alt. - Upper Structure	5133177	②7370
Belt - Hyd. Pump - Upper Structure	5133177	②7370
Hose - Upper - Upper Structure		●26612
Hose - Lower - Upper Structure		●26508
Detroit Diesel 8V-71 Diesel		
Belt - Fan & W.P. - Lower Structure		②TR22508
Belt - Fan To Alt. - Lower Structure		7530
Hose - Upper - Lower Structure		●26524
Hose - Lower - Lower Structure; (2 1/4" I.D.)		④24936
CLARK-MICHIGAN-VME		
12B		
Waukesha 180GKB		
Belt - Fan & Gen.; W/41 3/4" Belt O.C.	0155103	②▲9415HD
Belt - Fan & Gen.; W/42 1/4" Belt O.C.	730226	②▲9420HD
Belt - Fan & Gen.; W/42 3/4" Belt O.C.	0190303	▲9430HD
Belt - Fan & Gen.; W/43 1/4" Belt O.C.		②▲9430HD
Belt - Fan	212588	③TR24379
Belt - W.P.	178519	TR22299
Belt - Alt.	178571	TR22434
Hose - Upper		≧20267
	or	●25472
Hose - Lower; Ser. No. 1386 Thru 1816		≧21660
	or	●25474
Hose - Lower; Ser. No. 7423 Thru 7617		≧21660
	or	●25474
Hose - Lower; Ser. No. 1AA681 & After		≧21660
	or	●25474

Application	Mfr. Part No.	Our No.
CLARK-MICHIGAN-VME - Continued		
12BR Control		
Waukesha 180DLC Diesel		
Belt - Fan & Gen.; W/41 3/4" Belt O.C.	0155103	②▲9415HD
Belt - Fan & Gen.; W/42 1/4" Belt O.C.	730226	②▲9420HD
Belt - Fan & Gen.; W/42 3/4" Belt O.C.	0190303	▲9430HD
Belt - Fan & Gen.; W/43 1/4" Belt O.C.		②▲9430HD
Belt - Fan	212588	③TR24379
Belt - W.P.	178519	TR22299
Belt - Alt.	178571	TR22434
Hose - Upper		≧20267
	or	●25472
Hose - Lower; Ser. No. 1386 Thru 1816		≧21660
	or	●25474
Hose - Lower; Ser. No. 7423 Thru 7617		≧21660
	or	●25474
Hose - Lower; Ser. No. 1AA681 & After		≧21660
	or	●25474
35A		
Detroit Diesel 3-53 Diesel		
Belt - Fan; W/48 1/4" Belt O.C.		②▲9480HD
Belt - Fan; W/65 1/4" Belt O.C.	948146	②▲9650HD
Belt - W.P. & Alt.; W/41 5/8" Belt O.C.	5133601	②7410
Belt - W.P. & Alt.; W/42 1/4" Belt O.C.		▲9420HD
Belt - W.P. & Gen.	5116450	②7405
Hose - Upper		≧21794
	or	●25474
Hose - Lower		●26508
35AWS		
Continental F226		
Hose - Upper		≧20727
	or	●26502
Hose - Lower		≧21794
	or	●25480
Detroit Diesel 3-53 Diesel		
Hose - Upper		≧21794
	or	●25474
Hose - Lower		●26508
Waukesha 190GLB		
Hose - Upper		≧20727
	or	●26502
Hose - Lower		≧21794
	or	●25480
35B		
Continental F226		
Hose - Upper		≧20727
	or	●26502
Hose - Lower		≧21794
	or	●25480
Detroit Diesel 3-53 Diesel		
Hose - Upper		≧21794
	or	●25474
Hose - Lower		●26508
45; 45A		
Waukesha 190GLB		
Hose - Upper		≧21794
	or	●25476
Hose - Lower; Ser. No. C3ZA9-10 & After		≧21794
	or	●25477
45B		
Detroit Diesel 4-53 Diesel		
Hose - Upper		≧21794
	or	●25474
Hose - Lower		●26508

▲ Standard Belt Available. See Pages 630-631.
 ● Vulco-Flex® Coolant Hose.
 Ⓞ Use Wire Inserted Green Stripe® Coolant Hose.

② Two Required.
 ③ Three Required.
 ≧ Cut to Fit.

Road & Construction Equipment

Belts and Coolant Hose for Road & Construction Equipment

Application	Mfr. Part No.	Our No.
CLARK-MICHIGAN-VME - Continued		
45BP		
Perkins 6-Cyl. 354 Diesel		
Hose - Upper; (2" I.D.)		②24432
Hose - Lower		②④20611
45C		
Detroit Diesel 3-53T Diesel		
Hose - Upper - Eng. To Pipe; (2" I.D.)		24232
Hose - Upper - Pipe To Rad.; (2" I.D.)		24232
Hose - Lower - Eng. To Pipe		④20882
Hose - Lower - Pipe To Rad.; (2" I.D.)		24232
55		
Detroit Diesel 3-53 Diesel		
Hose - Upper		●25476
Hose - Lower		●26509
55 III		
Detroit Diesel 3-53 Diesel		
Hose - Upper		④21794 or ●25476
Hose - Lower		●26508
55A I; 55A II		
Continental F244		
Hose - Upper		④20727 or ●26502
Hose - Lower		④21794 or ●25480
Detroit Diesel 3-53 Diesel		
Hose - Upper		④21794 or ●25476
55A III		
Detroit Diesel 3-53 Diesel		
Hose - Upper - Eng. To Pipe; Ser. No. 416A101 & After		④20065 or ●25472
Hose - Upper - Pipe To Rad.; (1 5/8" I.D.)		24226
Hose - Lower - Eng. To Pipe; Ser. No. 416A101 Thru 416A395(2" I.D.)		24232
Hose - Lower - Eng. To Pipe; Ser. No. 416A400 Thru 416A413(2" I.D.)		24232
Hose - Lower - Eng. To Pipe; Ser. No. 416A415, 416A101FSC & After(2" I.D.)		24232
Hose - Lower - Eng. To Pipe; Ser. No. 416A396 Thru 416A399		●26508
Hose - Lower - Eng. To Pipe; Ser. No. 416A414, 416A416 & After		●26508
Hose - Lower - Eng. To Pipe; Ser. No. 416C101FSU & After ...		●26508
Hose - Lower - Pipe To Rad.; (2" I.D.)		24232
55B		
Detroit Diesel 4-53N Diesel		
Hose - Upper; (2" I.D.)		②24432
Hose - Lower; (2 1/4" I.D.)		②24436
55C		
Detroit Diesel 4-53 Diesel		
Hose - Upper; (2" I.D.)		②24232
Hose - Lower; (2" I.D.)		③24232
75		
Detroit Diesel 4-53 Diesel		
Hose - Upper; Ser. No. C-91800 & After		●26509
Hose - Lower; Ser. No. C-91800 & After		④21794 or ●25480
75 III		
Detroit Diesel 4-53 Diesel		
Hose - Upper		④20065 or ●25472
Hose - Lower		20685

Application	Mfr. Part No.	Our No.
CLARK-MICHIGAN-VME - Continued		
75 III - Continued		
Detroit Diesel 4-53 Diesel - Continued		
Hose - Lower		●26507
75A II		
Detroit Diesel 4-53 Diesel		
Hose - Upper		20065 or ●25473
Hose - Lower		●26507
Waukesha F283		
Hose - Upper		④20611 or ●26510
Hose - Lower - Eng. To Pipe; Ser. No. 2CA101 Thru 3CA175(1 3/4" I.D.)		24228
Hose - Lower - Pipe To Rad.; (1 3/4" I.D.)		24228
75A III		
Cummins LT464C Diesel		
Hose - Upper; Ser. No. 408A101 & After		●26508
Hose - Upper; Ser. No. 1ACC101 & After		●26508
Hose - Lower; Ser. No. 408A101 & After		●26523
Detroit Diesel 4-71N Diesel		
Hose - Upper - Eng. To Pipe		④20206 or ●26507
Hose - Lower - Eng. To Pipe; (2" I.D.)		24232
Hose - Lower - Pipe To Rad.; (2" I.D.)		24232
75B		
Cummins V504 Diesel		
Hose - Upper		●26508
Hose - Lower		●26523
75C		
Cummins V504 Diesel		
Belt - Fan & W.P.		②TR22534
Belt - Alt.	554876	②7450
Hose - Upper - Eng. To Pipe; (2" I.D.)		24232
Hose - Upper - Pipe To Rad.; (2" I.D.)		24232
Hose - Lower - Eng. To Pipe; (2" I.D.)		24232
Hose - Lower - Pipe To Rad.; (2" I.D.)		24232
Detroit Diesel 4-53 Diesel		
Belt - Fan & Air Brake Compr.		②▲9680HD
Belt - Alt.		②7430
85A I		
Detroit Diesel 4-53 Diesel		
Belt - Fan	124466	②TR24365
Belt - W.P.; W/30 1/2" Belt O.C.	101427	TR22299
Belt - W.P.; W/34 1/8" Belt O.C.	111726	TR22329
Belt - Gen.; W/46 5/8" Belt O.C.	70885	TR22461
Belt - Gen.; W/47 7/8" Belt O.C.	106070	TR22474
Hose - Upper; Ser. No. 1DG26 Thru 1DG999		④21794 or ●25473
Hose - Lower; Ser. No. 1DG26 Thru 1DG999		●26507
Waukesha 190GL		
Hose - Upper		●26508
Hose - Lower - Pipe To Rad.; (2" I.D.)		24232
Waukesha 197DLC		
Belt - Fan; W/49 1/4" Belt O.C.	A197003	②▲9490HD
Belt - Fan; W/56 1/4" Belt O.C.	0152423	②▲9560HD
Belt - Gen.	195203	▲9451HD
Belt - Air Brake Compr.; W/40 3/4" Belt O.C.	151466	▲9405HD
Belt - Air Brake Compr.; W/41 3/4" Belt O.C.	155103	▲9415HD
85A II		
Cummins JN130CI Diesel		
Hose - Upper; Ser. No. 2DC101 Thru 4DC999		●26509
Hose - Lower; Ser. No. 2DC101 Thru 4DC999(2 1/4" I.D.)		②24236
Cummins JN6CI Diesel		
Belt - Fan	124466	②TR24365

② Two Required.

● Vulco-Flex® Coolant Hose.

▲ Standard Belt Available. See Pages 630-631.

④ Cut to Fit.

③ Three Required.

Belts and Coolant Hose for Road & Construction Equipment

Application	Mfr. Part No.	Our No.
CLARK-MICHIGAN-VME - Continued		
85A II - Continued		
Cummins JN6CI Diesel - Continued		
Belt - W.P.; W/30 1/2" Belt O.C.	101427	TR22299
Belt - W.P.; W/34 1/8" Belt O.C.	111726	TR22329
Belt - Gen.; W/46 5/8" Belt O.C.	70885	TR22461
Belt - Gen.; W/47 7/8" Belt O.C.	106070	TR22474
Detroit Diesel 4-53 Diesel		
Hose - Upper; Ser. No. 2DG101 Thru 4DG999	≈<21794	
	or ●25476	
Hose - Lower; Ser. No. 2DG101 Thru 4DG999	20685	
	or ●26507	
Waukesha 135GZ		
Belt - Fan; W/49 1/4" Belt O.C.	A197003	②▲9490HD
Belt - Fan; W/56 1/4" Belt O.C.	0152423	②▲9560HD
Belt - Gen.	195203	▲9451HD
Belt - Air Brake Compr.; W/40 3/4" Belt O.C. .	151466	▲9405HD
Belt - Air Brake Compr.; W/41 3/4" Belt O.C. .	155103	▲9415HD
Hose - Upper		●26508
Hose - Lower - Eng. To Pipe; (2 1/2" I.D.)		24240
Hose - Lower - Pipe To Rad.; (2 1/4" I.D.)		24236
85A III		
Cummins V785 Diesel		
Belt - Fan	178532	③TR24562
Belt - W.P.; W/3/8" Belt T.W.; W/37 1/8" Belt O.C.	947952	②7370
Belt - W.P.; W/23/32" Belt T.W.; W/37 1/8" Belt O.C.	178530	TR24365
Belt - Alt.; W/37 1/8" Belt O.C.	557527	7370
Belt - Alt.; W/46 5/8" Belt O.C.	178593	TR22461
Hose - Upper - Eng. To Pipe; (2 1/4" I.D.)		②24236
Hose - Upper - Pipe To Rad.; (2 1/4" I.D.)		②24236
Hose - Lower - Eng. To Pipe; (2 1/4" I.D.)		24236
Hose - Lower - Pipe To Rad.		≈<20172
Detroit Diesel 6V-53N Diesel		
Belt - W.P.	5116451	7370
Belt - Alt.	5133177	7370
Hose - Upper; (1 5/8" I.D.)		②24226
Hose - Lower; (2" I.D.)		②24232
85C		
Cummins V785 Diesel		
Belt - Fan	178532	③TR24562
Belt - W.P.	178530	TR24365
Belt - Alt.	178593	TR22461
Hose - Upper; (2 1/4" I.D.)		④24436
Hose - Lower - Eng. To Pipe		≈<20172
Hose - Lower - Pipe To Rad.; (2 1/4" I.D.)		24436
110 III-H14		
Detroit Diesel 4-71 Diesel		
Hose - Upper; Ser. No. 6TGH101 Thru 6TGH999(2 1/4" I.D.) ..		④24236
Hose - Lower; Ser. No. 6TGH101 Thru 6TGH999(2 3/4" I.D.) ..		②24244
110-9		
Cummins V504 Diesel		
Belt - Fan & W.P.		②TR22495
Belt - Alt.; W/34 7/8" Belt O.C.		TR22344
Belt - Alt.; W/68 3/8" Belt O.C.	178543	②▲9680HD
Hose - Upper; Ser. No. 222A101 & After		●26511
Hose - Lower - Eng. To Pipe; Ser. No. 222A101 & After(2 1/4" I.D.)		24436
Hose - Lower - Pipe To Rad.; Ser. No. 222A101 & After		●26519
110-11		
Detroit Diesel 4-71 Diesel		
Belt - Fan & Air Brake Compr.		TR34700
Hose - Upper; Ser. No. 415A101 & After		●26510
Hose - Lower; Ser. No. 415A101 & After		●26504

≈< Cut to Fit.
 ② Two Required.
 ③ Three Required.
 ④ Use Wire Inserted Green Stripe® Coolant Hose.

Application	Mfr. Part No.	Our No.
CLARK-MICHIGAN-VME - Continued		
110-11B		
Cummins V504 Diesel		
Belt - Fan & W.P.		②TR22495
Belt - Alt.; W/34 7/8" Belt O.C.		TR22344
Belt - Alt.; W/68 3/8" Belt O.C.	178543	②▲9680HD
Hose - Upper; W/1 3/4" I.D. Hose		●26612
Hose - Upper; W/2" I.D. Hose		●26512
Hose - Lower; W/1 3/4" I.D. Hose		●26612
Hose - Lower; W/2" I.D. Hose		●26512
110-15		
Detroit Diesel 6V-71 Diesel		
Belt - Fan	5133761	③▲9530HD
Belt - Alt.	5140927	②9279
Hose - Upper; Ser. No. 224A101 & After(2 1/4" I.D.)		④24236
Hose - Lower - Eng. To Pipe; (2 1/8" I.D.)		②24234
Hose - Lower - Pipe To Rad.; (2 1/8" I.D.)		②24234
110HT		
Detroit Diesel 4-71N Diesel		
Belt - Fan		②▲9550HD
Belt - Fan & Air Brake Compr.; W/69 1/4" Belt O.C.		②▲9690HD
Belt - Fan & Air Brake Compr.; W/70 1/4" Belt O.C.	5138868	TR34700
Belt - Gen.		▲9395HD
Hose - Upper; (2" I.D.)		④24932
Hose - Upper		●26510
Hose - Lower - Eng. To Pipe; (2" I.D.)		④24932
Hose - Lower - Pipe To Rad.		●26504
125A I		
Cummins C175 Diesel		
Belt - Fan	124466	②TR24365
Belt - W.P.; W/30 1/2" Belt O.C.	101427	TR22299
Belt - W.P.; W/34 1/8" Belt O.C.	111726	TR22329
Belt - Gen.; W/46 5/8" Belt O.C.	70885	TR22461
Belt - Gen.; W/47 7/8" Belt O.C.	106070	TR22474
Hose - Upper; Ser. No. 39123 Thru 2FC999		②≈<20685
Hose - Lower; Ser. No. 39123 Thru 2FC999(2 1/4" I.D.)		②24236
Waukesha 135GZB		
Belt - Fan; W/49 1/4" Belt O.C.	A197003	②▲9490HD
Belt - Fan; W/56 1/4" Belt O.C.	0152423	②▲9560HD
Belt - Gen.	195203	▲9451HD
Belt - Air Brake Compr.; W/40 3/4" Belt O.C. .	151466	▲9405HD
Belt - Air Brake Compr.; W/41 3/4" Belt O.C. .	155103	▲9415HD
Hose - Upper; Ser. No. 12123 Thru 14130		≈<20611
		or ●26508
Hose - Upper; Ser. No. 14131 & After		●26511
Hose - Lower; Ser. No. 12123 Thru 14130(2" I.D.)		②24232
Hose - Lower; Ser. No. 14131 & After(2 1/4" I.D.)		②24236
Waukesha 135GZB Diesel		
Hose - Upper; Ser. No. 12123D Thru 13559D		≈<20611
		or ●26508
Hose - Lower; (2" I.D.)		②24232
125A II		
Cummins C175CI Diesel		
Belt - Fan	124466	②TR24365
Belt - W.P.; W/30 1/2" Belt O.C.	101427	TR22299
Belt - W.P.; W/34 1/8" Belt O.C.	111726	TR22329
Belt - Gen.; W/46 5/8" Belt O.C.	70885	TR22461
Belt - Gen.; W/47 7/8" Belt O.C.	106070	TR22474
Hose - Upper; Ser. No. 39123 Thru 2FC999		②≈<20685
Hose - Lower; Ser. No. 39123 Thru 2FC999(2 1/4" I.D.)		②24236
Detroit Diesel 6V-53 Diesel		
Belt - Fan	5116778	②▲9470HD
Belt - W.P.	5116451	②7370
Belt - Gen.	5124814	7365
Belt - V.P.	672073	▲9350HD
Hose - Upper; Ser. No. 13337 Thru 16417		●26507
Hose - Upper; Ser. No. 2FG1 Thru 2FG999(2" I.D.)		24232

● Vulco-Flex® Coolant Hose.
 ▲ Standard Belt Available. See Pages 630-631.
 ④ Four Required.

Road & Construction Equipment

Belts and Coolant Hose for Road & Construction Equipment

Application	Mfr. Part No.	Our No.
CLARK-MICHIGAN-VME - Continued		
125A II - Continued		
Detroit Diesel 6V-53 Diesel - Continued		
Hose - Lower; Ser. No. 13337 Thru 16417		●26508
Hose - Lower; Ser. No. 2FG1 Thru 2FG999		●26508
125A III		
Cummins C175CI Diesel		
Belt - Fan	178717	TR24562
Belt - W.P.	178530	TR24365
Belt - Alt.	178435	TR22455
Hose - Upper; Ser. No. 39123 Thru 2FC999		②③<20685
Hose - Upper - Eng. To Pipe; Ser. No. 7AFC101 Thru 13AFC999(2 1/4" I.D.)		②24236
Hose - Upper - Eng. To Pipe; Ser. No. 404A101 & After(2 1/4" I.D.)		②24236
Hose - Upper - Pipe To Rad.; Ser. No. 7AFC101 Thru 13AFC999(2 1/4" I.D.)		②24236
Hose - Upper - Pipe To Rad.; Ser. No. 404A101 & After(2 1/4" I.D.)		②24236
Hose - Lower; Ser. No. 39123 Thru 2FC999(2 1/4" I.D.)		②24236
Hose - Lower - Eng. To Pipe; Ser. No. 7AFC101 Thru 13AFC999(2 1/4" I.D.)		24236
Hose - Lower - Eng. To Pipe; Ser. No. 404A101 & After(2 1/4" I.D.)		24236
Hose - Lower - Pipe To Rad.; Ser. No. 7AFC101 Thru 13AFC999(2 3/4" I.D.)		24244
Hose - Lower - Pipe To Rad.; Ser. No. 404A101 & After(2 3/4" I.D.)		24244
Detroit Diesel 6V-53 Diesel		
Belt - Fan		▲9620HD
Belt - Alt.		7370
Belt - Air Brake Compr.		TR28473
Hose - Upper; Ser. No. 11AFG101 Thru 12AFG999(2 1/4" I.D.)		④24236
Hose - Upper; Ser. No. 403A101 & After(2 1/4" I.D.)		④24236
Hose - Lower; Ser. No. 11AFG101 Thru 12AFG999(2 3/4" I.D.)		②24244
Hose - Lower; Ser. No. 403A101 & After(2 3/4" I.D.)		②24244
125B		
Cummins 6-Cyl. 8.3 L Diesel		
Belt - Fan & Alt.	3911567	▲K080670HD
Cummins VT555C Diesel		
Belt - Fan & W.P.		③▲9590HD
Belt - Alt.		②7500
Hose - Upper - Eng. To Pipe; (2" I.D.)		24432
Hose - Upper - Pipe To Rad.; (2" I.D.)		24432
Hose - Lower - Eng. To Pipe; (2 1/4" I.D.)		24436
Hose - Lower - Pipe To Rad.; (2 1/4" I.D.)		24436
125C		
Cummins LT10-225 Diesel		
Belt - Fan	178717	③TR24562
Belt - W.P.	178530	TR24365
Belt - Alt.	178435	TR22455
Hose - Upper - Eng. To Pipe; (2 1/4" I.D.)		24436
Hose - Upper - Pipe To Rad.; (2 1/4" I.D.)		24436
Hose - Lower - Eng. To Pipe		21901
Hose - Lower - Pipe To Rad.		●26511
175A		
Cummins JT6BI Diesel		
Belt - Fan	109179	②▲9385HD
Belt - W.P.	111726	TR22329
Belt - Gen.	70885	TR22461
Hose - Upper		②③<20685
Hose - Lower; (2 1/4" I.D.)		②24236
Detroit Diesel 4-71 Diesel		
Belt - Fan & Compr.		TR28657
Belt - Gen.		TR30408
Hose - Upper; Ser. No. 18340 Thru 25540		③<20611
Hose - Upper; Ser. No. 25541 Thru 25730		●26508
Hose - Upper; Ser. No. 2HG191 & After		●26508
Hose - Lower; Ser. No. 18340 Thru 25540		●26508

Application	Mfr. Part No.	Our No.
CLARK-MICHIGAN-VME - Continued		
175A - Continued		
Detroit Diesel 4-71 Diesel - Continued		
Hose - Lower; Ser. No. 25541 Thru 25730(2" I.D.)		24232
Hose - Lower; Ser. No. 25541 Thru 25730		●26509
Hose - Lower; Ser. No. 2HG191 & After(2" I.D.)		24232
Hose - Lower; Ser. No. 2HG191 & After		●26509
Waukesha 135DK Diesel		
Belt - Fan; W/49 1/4" Belt O.C.	A197003	②▲9490HD
Belt - Fan; W/56 1/4" Belt O.C.	0152423	②▲9560HD
Belt - Gen.	195203	▲9451HD
Hose - Upper - Eng. To Pipe; W/Turbo; Ser. No. 17123D Thru 18568D(2" I.D.)		24232
Hose - Upper - Eng. To Pipe; W/Turbo; Ser. No. 18570D Thru 18575D, 18603D, 18608D(2" I.D.)		24232
Hose - Upper - Eng. To Pipe; Ser. No. 18569D		③<20611
		or ●26508
Hose - Upper - Eng. To Pipe; Ser. No. 18576D Thru 18602D ..		or ●26508
Hose - Upper - Eng. To Pipe; Ser. No. 18604D Thru 18607D ..		③<20611
		or ●26508
Hose - Upper - Eng. To Pipe; Ser. No. 18609D Thru 19127D ..		③<20611
		or ●26508
Hose - Upper - Eng. To Pipe; Ser. No. 19128D Thru 19177D ..		●26509
Hose - Upper - Eng. To Pipe; Ser. No. 2HB50 & After		●26509
Hose - Upper - Pipe To Rad.; Ser. No. 17123 Thru 19127(2" I.D.)		24232
Hose - Lower - Eng. To Pipe; W/O Turbo; Ser. No. 17123D Thru 18568D(2 1/4" I.D.)		24236
Hose - Lower - Eng. To Pipe; W/O Turbo; Ser. No. 18570D Thru 18575D, 18603D, 18608D(2 1/4" I.D.)		24236
Hose - Lower - Eng. To Pipe; W/Turbo; Ser. No. 17123D Thru 18568D(2" I.D.)		24232
Hose - Lower - Eng. To Pipe; W/Turbo; Ser. No. 18570D Thru 18575D, 18603D, 18608D(2" I.D.)		24232
Hose - Lower - Eng. To Pipe; Ser. No. 18569D, 18576D Thru 18602D(2 1/4" I.D.)		24236
Hose - Lower - Eng. To Pipe; Ser. No. 18604D Thru 18607D(2 1/4" I.D.)		24236
Hose - Lower - Eng. To Pipe; Ser. No. 18609D Thru 19177D(2 1/4" I.D.)		24236
Hose - Lower - Eng. To Pipe; Ser. No. 2HB50 & After(2 1/4" I.D.)		24236
Hose - Lower - Pipe To Rad.; Ser. No. 17123 Thru 19127(2 1/4" I.D.)		24236
Hose - Lower - Pipe To Rad.; Ser. No. 17123D Thru 18568D(2 1/4" I.D.)		24236
Hose - Lower - Pipe To Rad.; Ser. No. 18570D Thru 18575D(2 1/4" I.D.)		24236
Hose - Lower - Pipe To Rad.; Ser. No. 18603D, 18608D, 19128D Thru 19177D(2 1/4" I.D.)		24236
Hose - Lower - Pipe To Rad.; Ser. No. 2HB50 & After(2 1/4" I.D.)		24236
Hose - Lower - Pipe To Rad.; Ser. No. 18569D, 18576D Thru 18602D		●26520
Hose - Lower - Pipe To Rad.; Ser. No. 18604D Thru 18607D ..		●26520
Hose - Lower - Pipe To Rad.; Ser. No. 18609D Thru 19127D ..		●26520
Waukesha 135GK		
Belt - Fan; W/49 1/4" Belt O.C.	A197003	②▲9490HD
Belt - Fan; W/56 1/4" Belt O.C.	0152423	②▲9560HD
Belt - Gen.	195203	▲9451HD
Hose - Upper - Pipe To Rad.; Ser. No. 17123 Thru 19127(2" I.D.)		24232
Hose - Lower - Pipe To Rad.; Ser. No. 17123 Thru 19127(2 1/4" I.D.)		24236
175A III		
Cummins C175 Diesel		
Belt - Fan	197028	TR24379
Belt - W.P.	178461	TR22299
Belt - Alt.	178571	TR22434
Hose - Upper; Ser. No. 5HC101 Thru 6HC999(2 1/4" I.D.)		④24236
Hose - Lower; Ser. No. 5HC101 Thru 6HC999		●26520

● Vulco-Flex® Coolant Hose.
 ③ Cut to Fit.
 ④ Four Required.

② Two Required.
 ▲ Standard Belt Available. See Pages 630-631.
 ③ Three Required.

Belts and Coolant Hose for Road & Construction Equipment

Application	Mfr. Part No.	Our No.
CLARK-MICHIGAN-VME - Continued		
175A III - Continued		
Detroit Diesel 8V-71 Diesel		
Belt - Fan	5133761	③▲9530HD
Belt - Alt.; W/V-Ribbed Belt Drive		K080370
Belt - Alt.; W/V-Belt Drive	556878	②7370
Belt - Air Brake Compr.	5126405	TR28473
Hose - Upper; Ser. No. 5AHG101 Thru 7AHG999(2 1/4" I.D.) .		④24236
Hose - Upper; Ser. No. 8AHG101 Thru 13AHG999(2 3/4" I.D.)		②24244
Hose - Lower; Ser. No. 8AHG101 Thru 13AHG999(2 3/4" I.D.)		②24244
175B		
Detroit Diesel 8V-71 Diesel		
Belt - Fan		④▲9530HD
Belt - Alt.; W/30 5/8" Belt O.C.	949282	K080300
Belt - Alt.; W/37 5/8" Belt O.C.	5138935	K080370
Belt - Air Brake Compr.	5145730	TR28480
Hose - Upper - Eng. To Pipe; (2 1/4" I.D.)		②24236
Hose - Upper - Pipe To Rad.; (2 1/4" I.D.)		②24236
Hose - Lower - Eng. To Pipe; (2 3/4" I.D.)		24244
Hose - Lower - Pipe To Rad.; (2 3/4" I.D.)		24244
175C		
Cummins NTA855 Diesel		
Belt - Fan	178662	③▲9510HD
Belt - Alt.		②▲9463HD
Belt - W.P.		②6596
Hose - Upper; (2 1/4" I.D.)		②24436
Hose - Lower; (2 1/2" I.D.)		②24440
180		
Cummins C175 Diesel		
Belt - Fan	124466	②TR24365
Belt - W.P.	101427	TR22299
Belt - Gen.	70885	TR22461
Hose - Upper; Ser. No. 1896, 1898 Thru 1902		②②<20685
Hose - Upper; Ser. No. 2823 Thru 2891		②②<20685
Hose - Lower; Ser. No. 1896, 1898 Thru 1902(2 1/4" I.D.)		②24236
Hose - Lower; Ser. No. 2823 Thru 2891(2 1/4" I.D.)		②24236
Cummins JT6BI Diesel		
Belt - Fan	109179	②▲9385HD
Belt - W.P.	111726	TR22329
Belt - Gen.	134816	TR22495
Detroit Diesel 6V-53 Diesel		
Belt - Fan	5109052	②▲9600HD
Belt - W.P.	5116451	②7370
Belt - Gen.	5124814	7375
Waukesha 135DK Diesel		
Hose - Upper; Ser. No. 1823 Thru 1895, 1897, 1903, 1904(2" I.D.)		②24232
Hose - Lower; Ser. No. 1823 Thru 1895, 1897, 1903, 1904(2 1/4" I.D.)		②24236
180 I		
Cummins C175 Diesel; Cummins JT6BI Diesel		
Hose - Upper; Ser. No. 2892 Thru 2942		②②<20685
Hose - Upper; Ser. No. 2LC52 Thru 2LC999		②②<20685
Hose - Lower; Ser. No. 2892 Thru 2942(2 1/4" I.D.)		②24236
Hose - Lower; Ser. No. 2LC52 Thru 2LC999(2 1/4" I.D.)		②24236
180 III		
Cummins C175 Diesel; Cummins JT6BI Diesel		
Hose - Upper - Eng. To Pipe; Ser. No. 3LC101 Thru 3LC999(2" I.D.)		24232
Hose - Upper - Eng. To Pipe; Ser. No. 5LC101 & After(2" I.D.) .		24232
Hose - Upper - Pipe To Rad.; Ser. No. 3LC101 Thru 3LC999 ..		②<20685
Hose - Upper - Pipe To Rad.; Ser. No. 5LC101 & After		②<20685
Hose - Upper; Ser. No. 4MC102 Thru 6MC999(2 1/4" I.D.)		②24236
Hose - Lower - Eng. To Pipe; Ser. No. 3LC101 Thru 3LC999(2 1/4" I.D.)		24236
Hose - Lower - Eng. To Pipe; Ser. No. 5LC101 & After(2 1/4" I.D.)		24236

③ Three Required.
 ② Two Required.
 < Cut to Fit.

Application	Mfr. Part No.	Our No.
CLARK-MICHIGAN-VME - Continued		
180 III - Continued		
Cummins C175 Diesel; Cummins JT6BI Diesel - Continued		
Hose - Lower - Pipe To Rad.; Ser. No. 3LC101 Thru 3LC999(2 1/4" I.D.)		24236
Hose - Lower - Pipe To Rad.; Ser. No. 5LC101 & After(2 1/4" I.D.)		24236
Hose - Lower; Ser. No. 4MC102 Thru 6MC999(2 1/4" I.D.)		②24236
Detroit Diesel 6V-53 Diesel		
Hose - Upper; Ser. No. 4MG101 Thru 8MG999(2 1/4" I.D.)		②24236
Hose - Lower; Ser. No. 5LG101 & After(2" I.D.)		②24232
Hose - Lower; Ser. No. 4MG101 Thru 8MG999(2 3/4" I.D.)		②24244
210H		
Cummins NT855 Diesel		
Hose - Upper - Eng. To Pipe; Ser. No. 5UCH165 & After(2 1/4" I.D.)		24236
Hose - Upper - Eng. To Pipe; Ser. No. 411A101 & After(2 1/4" I.D.)		24236
Hose - Upper - Pipe To Rad.; Ser. No. 5UCH165 & After(2 1/4" I.D.)		24236
Hose - Upper - Pipe To Rad.; Ser. No. 411A101 & After(2 1/4" I.D.)		24236
Hose - Lower - Eng. To Pipe; Ser. No. 5UCH165 & After(2 1/4" I.D.)		24236
Hose - Lower - Eng. To Pipe; Ser. No. 411A101 & After(2 1/4" I.D.)		24236
Hose - Lower - Pipe To Pipe; Ser. No. 5UCH165 & After(2 3/4" I.D.)		24244
Hose - Lower - Pipe To Pipe; Ser. No. 411A101 & After(2 3/4" I.D.)		24244
275 Articulated		
Cummins NT855 Diesel		
Belt - Fan; W/51 7/8" Belt O.C.	S3094	②TR28514
Belt - Fan; W/55 1/8" Belt O.C.	178725	③TR28545
Belt - Fan; W/58 1/4" Belt O.C.	178626	③TR24578
Belt - Fan; W/61 1/8" Belt O.C.	178526	③TR24607
Belt - W.P.	200328	TR24438
Belt - Alt.	200549	②▲9465HD
Belt - Gen.; W/36 3/8" Belt O.C.	70350	TR22358
Belt - Gen.; W/40 1/8" Belt O.C.	178573	TR22397
Belt - Gen.; W/41 1/2" Belt O.C.	178599	TR22410
275 III		
Cummins NT310 Diesel		
Hose - Upper; Ser. No. 4JC101 & After(2 1/4" I.D.)		②24236
Hose - Lower; Ser. No. 4JC101 & After(2 1/4" I.D.)		②24236
Detroit Diesel 8V-71N Diesel		
Hose - Upper; Ser. No. 6JG101 Thru 8JG999(2 1/4" I.D.)		④24236
275A I		
Cummins NTO6BI Diesel		
Belt - Fan; W/51 7/8" Belt O.C.	S3094	②TR28514
Belt - Fan; W/55 1/8" Belt O.C.	178725	③TR28545
Belt - Fan; W/58 1/4" Belt O.C.	178626	③TR24578
Belt - Fan; W/61 1/8" Belt O.C.	178526	③TR24607
Belt - W.P.	200328	TR24438
Belt - Alt.	200549	②▲9465HD
Belt - Gen.; W/36 3/8" Belt O.C.	70350	TR22358
Belt - Gen.; W/40 1/8" Belt O.C.	178573	TR22397
Belt - Gen.; W/41 1/2" Belt O.C.	178599	TR22410
275A III		
Cummins NT310 Diesel		
Belt - Fan; W/51 7/8" Belt O.C.	S3094	②TR28514
Belt - Fan; W/55 1/8" Belt O.C.	178725	③TR28545
Belt - Fan; W/58 1/4" Belt O.C.	178626	③TR24578
Belt - Fan; W/61 1/8" Belt O.C.	178526	③TR24607
Belt - W.P.	200328	TR24438
Belt - Alt.	200549	②▲9465HD
Belt - Gen.; W/36 3/8" Belt O.C.	70350	TR22358
Belt - Gen.; W/40 1/8" Belt O.C.	178573	TR22397

▲ Standard Belt Available. See Pages 630-631.
 ④ Four Required.

Road & Construction Equipment

Belts and Coolant Hose for Road & Construction Equipment

Application	Mfr. Part No.	Our No.
CLARK-MICHIGAN-VME - Continued		
275A III - Continued		
Cummins NT310 Diesel - Continued		
Belt - Gen.; W/41 1/2" Belt O.C.	178599	TR22410
Cummins NT855 Diesel		
Hose - Upper - Eng. To Pipe; Ser. No. 5AJC101 & After(2 1/4" I.D.)		24236
Hose - Upper - Pipe To Rad.; Ser. No. 5AJC101 & After(2 1/4" I.D.)		24236
Hose - Lower - Eng. To Pipe; Ser. No. 5AJC101 & After(2 1/4" I.D.)		24236
Hose - Lower - Pipe To Rad.; Ser. No. 5AJC101 Thru 9ACJ999(2 1/4" I.D.)		24236
Hose - Lower - Pipe To Rad.; Ser. No. 10AJC101 & After	≈20172	or ●26519
275B		
Cummins KT1150C Diesel		
Hose - Upper - Eng. To Pipe; (2 1/2" I.D.)		24440
Hose - Upper - Pipe To Rad.; (2 1/2" I.D.)		24440
Hose - Lower - Eng. To Pipe; (3 1/2" I.D.)		24256
Hose - Lower - Pipe To Rad.; (3 1/2" I.D.)		24256
Cummins NTA855 Diesel		
Belt - Fan	③▲9525HD	
Belt - Alt.	②7465	
Belt - W.P.	②▲9451HD	
275C		
Cummins KT1150C Diesel		
Belt - Alt.		K050370
Cummins KT19C Diesel		
Hose - Upper - Eng. To Pipe; (2 1/2" I.D.)		24440
Hose - Upper - Pipe To Rad.; (2 1/2" I.D.)		24440
Hose - Lower - Eng. To Pipe; (3 1/2" I.D.)		24256
Hose - Lower - Pipe To Rad.; (3 1/2" I.D.)		24256
Detroit Diesel 8V-92 Diesel		
Belt - Fan	③▲9640HD	
Belt - Alt.	②7475	
280		
Cummins NH Diesel; Cummins NT Diesel		
Belt - Fan; W/51 7/8" Belt O.C.	S3094	②TR28514
Belt - Fan; W/55 1/8" Belt O.C.	178725	③TR28545
Belt - Fan; W/58 1/4" Belt O.C.	178626	③TR24578
Belt - Fan; W/61 1/8" Belt O.C.	178526	③TR24607
Belt - W.P.	200328	TR24438
Belt - Alt.	200549	②▲9465HD
Belt - Gen.; W/36 3/8" Belt O.C.	70350	TR22358
Belt - Gen.; W/40 1/8" Belt O.C.	178573	TR22397
Belt - Gen.; W/41 1/2" Belt O.C.	178599	TR22410
280 I		
Cummins NH Diesel; Cummins NT Diesel		
Hose - Lower; Ser. No. 32123 Thru 32999(2 1/4" I.D.)		②24236
Hose - Lower; Ser. No. 1MC156 Thru 3MC999(2 1/4" I.D.)		②24236
Detroit Diesel 8V-71 Diesel		
Hose - Upper; Ser. No. 1MG1 Thru 3MG999(2 1/4" I.D.)		②24236
280 III		
Detroit Diesel 8V-71 Diesel		
Belt - Fan	③▲9610HD	
Belt - Alt.	7380	
Belt - Hyd. Pump		TR28463
280A III		
Detroit Diesel 8V-71 Diesel		
Hose - Upper; Ser. No. 8AMG101 Thru 9AMG999(2 1/4" I.D.) .		②24236
Hose - Lower; Ser. No. 8AMG101 Thru 9AMG999(2 3/4" I.D.) .		②24244
301S		
Detroit Diesel 4-71 Diesel		
Belt - Fan	②▲9530HD	

Application	Mfr. Part No.	Our No.
CLARK-MICHIGAN-VME - Continued		
301S - Continued		
Detroit Diesel 4-71 Diesel - Continued		
Belt - Alt.		▲9385HD
Hose - Upper		●26511
Hose - Lower - Eng. To Pipe; (2" I.D.)		24432
310		
Detroit Diesel 12V-71 Diesel		
Belt - Fan		③▲9630HD
Belt - Alt.		②▲9405HD
Belt - Air Brake Compr.		TR28473
Hose - Upper - Eng. To Pipe; (2 1/2" I.D.)		24440
Hose - Upper - Pipe To Rad.; (2 1/2" I.D.)		24440
Hose - Lower - Eng. To Pipe; (3 1/2" I.D.)		24456
Hose - Lower - Pipe To Rad.; (3 1/2" I.D.)		24456
310 III		
Detroit Diesel 12V-71 Diesel		
Hose - Upper; Ser. No. 4VG101 Thru 6VG999(2 1/2" I.D.)		④24240
Hose - Upper; Ser. No. 8VG101 & After(2 1/2" I.D.)		④24240
Hose - Lower; Ser. No. 8VG101 & After(3 1/2" I.D.)		②24256
375A		
Cummins NRT06BI Diesel		
Belt - Fan	134809	②TR28492
Belt - W.P.	178628	TR24438
Belt - Gen.	132010	TR22363
380 I		
Cummins NFT6BI Diesel		
Belt - Fan	532778	③▲9640HD
Belt - W.P.	S3163	TR22434
Belt - Gen.	70350	TR22358
Hose - Lower; Ser. No. 42123 & After(2 1/4" I.D.)		②24236
Cummins NHH12BI Diesel		
Belt - Fan	S3094	②TR28514
Belt - Gen.	70350	TR22358
Hose - Lower; Ser. No. 42123 & After(2 1/4" I.D.)		②24236
Cummins NT380 Diesel		
Belt - Fan	134835	②TR24578
Belt - W.P.	132013	TR22434
Belt - Gen.	132010	TR22363
Hose - Lower; Ser. No. 42123 & After(2 1/4" I.D.)		②24236
380 II		
Cummins NFT6BI Diesel		
Belt - Fan	532778	③▲9640HD
Belt - W.P.	S3163	TR22434
Belt - Gen.	70350	TR22358
Hose - Lower - Pipe To Rad.; Ser. No. 2RC1 Thru 2RC999(2 1/2" I.D.)		②24240
Cummins NHH12BI Diesel		
Belt - Fan	S3094	②TR28514
Belt - Gen.	70350	TR22358
Hose - Lower - Pipe To Rad.; Ser. No. 2RC1 Thru 2RC999(2 1/2" I.D.)		②24240
Cummins NT380 Diesel		
Belt - Fan	134835	②TR24578
Belt - W.P.	132013	TR22434
Belt - Gen.	132010	TR22363
Hose - Lower - Pipe To Rad.; Ser. No. 2RC1 Thru 2RC999(2 1/2" I.D.)		②24240
Detroit Diesel 8V-71 Diesel		
Hose - Upper; Ser. No. 2RG1 Thru 4RG999(2 1/2" I.D.)		②24240
Hose - Upper; Ser. No. 5RG101 & After(2 1/2" I.D.)		②24240
Hose - Lower; Ser. No. 5RG101 & After(3 1/2" I.D.)		②24256

≈ Cut to Fit.
 ③ Three Required.
 ② Two Required.

● Vulco-Flex® Coolant Hose.
 ▲ Standard Belt Available. See Pages 630-631.
 ④ Four Required.

Belts and Coolant Hose for Road & Construction Equipment

Application	Mfr. Part No.	Our No.
CLARK-MICHIGAN-VME - Continued		
380 III		
Cummins NFT6BI Diesel; Cummins NHH12BI Diesel; Cummins NT380 Diesel		
Hose - Lower - Pipe To Rad.; Ser. No. 2RC1 Thru 2RC999(2 1/2" I.D.)		②24240
Detroit Diesel 8V-71 Diesel		
Hose - Upper; Ser. No. 2RG1 Thru 4RG999(2 1/2" I.D.)		②24240
Hose - Upper; Ser. No. 5RG101 & After(2 1/2" I.D.)		②24240
Hose - Lower; Ser. No. 5RG101 & After(3 1/2" I.D.)		②24256
475 Articulated		
Cummins VT1710 Diesel		
Belt - Fan; Ser. No. 421E290 & After		③TR28666
Belt - W.P.; Ser. No. 421E101 & After	178665	②TR28390
Belt - Alt.; Ser. No. 421E101 & After	178520	②▲9380HD
475A III		
Cummins VT1710 Diesel		
Hose - Upper - Eng. To Pipe; Ser. No. 421F101 & After		②23572
Hose - Upper - Pipe To Rad.; Ser. No. 1AYC101 Thru 1AYC999		②23572
Hose - Upper - Pipe To Rad.; Ser. No. 421E101 Thru 421E999		②23572
Hose - Upper - Pipe To Rad.; Ser. No. 421F101 & After		②23572
Hose - Lower - Eng. To Pipe; Ser. No. 421F101 & After(3 1/2" I.D.)		②24456
Hose - Lower - Pipe To Rad.; Ser. No. 421F101 & After(3 1/2" I.D.)		②24456
475B		
Cummins VTA1710C Diesel		
Belt - Fan; Ser. No. 421E290 & After		③TR28666
Belt - W.P.; Ser. No. 421E101 & After	178665	②TR28390
Belt - Alt.; Ser. No. 421E101 & After	178520	②▲9380HD
Hose - Upper - Eng. To Pipe; Ser. No. 421F101 & After		②23572
Hose - Upper - Pipe To Rad.; Ser. No. 1AYC101 Thru 1AYC999		②23572
Hose - Upper - Pipe To Rad.; Ser. No. 421E101 Thru 421E999		②23572
Hose - Upper - Pipe To Rad.; Ser. No. 421F101 & After		②23572
Hose - Lower - Eng. To Pipe; Ser. No. 421F101 & After(3 1/2" I.D.)		②24456
Hose - Lower - Pipe To Rad.; Ser. No. 421F101 & After(3 1/2" I.D.)		②24456
480		
Cummins VT12 Diesel		
Belt - Fan	522125	③▲9610HD
Belt - W.P.	125367	TR28376
Belt - Gen.; W/34 3/4" Belt O.C.	134813	TR22344
Belt - Gen.; W/36 3/8" Belt O.C.	70350	TR22358
Hose - Upper - Pipe To Rad.; Ser. No. 3SC101 Thru 4SC999(2 1/2" I.D.)		②24240
Hose - Lower - Pipe To Rad.; Ser. No. 43123 Thru 43999(2 1/2" I.D.)		②24240
Hose - Lower - Pipe To Rad.; Ser. No. 2SC1 Thru 2SC999(2 1/2" I.D.)		②24240
Hose - Lower - Pipe To Rad.; Ser. No. 4SG101 Thru 4SG999(2 1/2" I.D.)		②24240
501S		
Detroit Diesel 6V-71 Diesel		
Hose - Upper		②●26524
Hose - Lower; (2 1/2" I.D.)		②24940
662		
Cummins V378 Diesel		
Hose - Lower - Eng. To Pipe		≅20172
Hose - Lower - Pipe To Rad.; (2 1/4" I.D.)		24236
Detroit Diesel 3-53 Diesel		
Belt - Fan		②▲9330HD
Belt - W.P. & Alt.	1305106	②7410
Hose - Upper		●26502
Hose - Lower - Eng. To Pipe; (2" I.D.)		24232

② Two Required.
 ▲ Standard Belt Available. See Pages 630-631.
 ● Use Wire Inserted Green Stripe® Coolant Hose.

Application	Mfr. Part No.	Our No.
CLARK-MICHIGAN-VME - Continued		
662 - Continued		
Detroit Diesel 3-53 Diesel - Continued		
Hose - Lower - Pipe To Rad.		●26508
Detroit Diesel 4-53 Diesel		
Hose - Upper		●26502
Hose - Lower - Eng. To Pipe; (2" I.D.)		24232
Hose - Lower - Pipe To Rad.		●26508
664		
Cummins V378 Diesel		
Belt - Fan	178685	②TR22485
Belt - Alt.	178471	▲9365HD
Hose - Lower - Eng. To Pipe		≅20172
Hose - Lower - Pipe To Rad.; (2 1/4" I.D.)		24236
Detroit Diesel 3-53 Diesel; Detroit Diesel 4-53 Diesel		
Belt - Fan; W/31 1/8" Belt O.C.	5134094	②▲9309HD
Belt - Fan; W/31 3/4" Belt O.C.	5135298	②▲9313HD
Belt - Fan; W/35 1/4" Belt O.C.	5126447	②▲9350HD
Belt - W.P. & Alt.	1305106	②7410
Hose - Upper		●26502
Hose - Lower - Eng. To Pipe; (2" I.D.)		24232
Hose - Lower - Pipe To Rad.		●26508
664B		
Cummins V378 Diesel		
Belt - Fan	178685	②TR22485
Belt - Alt.	178471	▲9365HD
Detroit Diesel 3-53 Diesel		
Belt - Fan; W/31 1/8" Belt O.C.	5134094	②▲9309HD
Belt - Fan; W/31 3/4" Belt O.C.	5135298	②▲9313HD
Belt - Fan; W/35 1/4" Belt O.C.	5126447	②▲9350HD
Belt - W.P. & Alt.	1305106	②7410
Hose - Upper - Pipe To Rad.		20351
Hose - Lower - Eng. To Pipe		≅20206
Hose - Lower - Pipe To Rad.; (2" I.D.)		24232
Detroit Diesel 4-53 Diesel		
Belt - Fan; W/31 1/8" Belt O.C.	5134094	②▲9309HD
Belt - Fan; W/31 3/4" Belt O.C.	5135298	②▲9313HD
Belt - Fan; W/35 1/4" Belt O.C.	5126447	②▲9350HD
Belt - W.P. & Alt.	1305106	②7410
664C		
Detroit Diesel 4-53 Diesel		
Belt - Fan		②▲9290HD
Belt - W.P. & Alt.		7430
Hose - Lower - Eng. To Pipe		≅20611
Hose - Lower - Pipe To Rad.; (2" I.D.)		24432
666		
Cummins V378 Diesel		
Belt - Fan	178685	②TR22485
Belt - Alt.	178471	▲9365HD
Hose - Lower - Eng. To Pipe		≅20172
Hose - Lower - Pipe To Rad.; (2 1/4" I.D.)		24236
Detroit Diesel 3-53 Diesel; Detroit Diesel 4-53 Diesel		
Belt - Fan; W/31 1/8" Belt O.C.	5134094	②▲9309HD
Belt - Fan; W/31 3/4" Belt O.C.	5135298	②▲9313HD
Belt - Fan; W/35 1/4" Belt O.C.	5126447	②▲9350HD
Belt - W.P. & Alt.	1305106	②7410
Hose - Upper		●26502
Hose - Lower - Eng. To Pipe; (2" I.D.)		24232
Hose - Lower - Pipe To Rad.		●26508
666B		
Cummins V378 Diesel		
Belt - Fan	178685	②TR22485
Belt - Alt.	178471	▲9365HD
Detroit Diesel 3-53 Diesel; Detroit Diesel 4-53 Diesel		
Belt - Fan; W/31 1/8" Belt O.C.	5134094	②▲9309HD
Belt - Fan; W/31 3/4" Belt O.C.	5135298	②▲9313HD

③ Three Required.
 ● Vulco-Flex® Coolant Hose.
 ≅ Cut to Fit.

Road & Construction Equipment

Belts and Coolant Hose for Road & Construction Equipment

Application	Mfr. Part No.	Our No.
CLARK-MICHIGAN-VME - Continued		
666B - Continued		
Detroit Diesel 3-53 Diesel; Detroit Diesel 4-53 Diesel - Continued		
Belt - Fan; W/35 1/4" Belt O.C.	5126447	②▲9350HD
Belt - W.P. & Alt.	1305106	②7410
666C		
Detroit Diesel 6-71 Diesel		
Belt - Fan		②▲9330HD
Belt - W.P. & Alt.		②7417
Hose - Lower - Pipe To Rad.; (2" I.D.)		24432
675		
Cummins VT1710 Diesel		
Belt - Fan	210118	③TR28666
Belt - W.P.		②TR28390
Belt - Alt.		②▲9380HD
Hose - Upper - Eng. To Pipe; Ser. No. 421F101 & After		②23572
Hose - Upper - Pipe To Rad.; Ser. No. 1AYC101 Thru 1AYC999		②23572
Hose - Upper - Pipe To Rad.; Ser. No. 421E101 Thru 421E999		②23572
Hose - Upper - Pipe To Rad.; Ser. No. 421F101 & After		②23572
Hose - Lower - Eng. To Pipe; Ser. No. 421F101 & After(3 1/2" I.D.)		②24456
Hose - Lower - Pipe To Rad.; Ser. No. 421F101 & After(3 1/2" I.D.)		②24456
CS70		
Detroit Diesel 4-53 Diesel		
Belt - Fan & Alt.	1305106	②7410
RW181		
Deutz F6L514 Diesel		
Belt - Fan		②7640
CLEVELAND		
247		
Detroit Diesel 4-53 Diesel		
Belt - Fan		②▲9415HD
Belt - W.P. & Alt.		②7430
Hose - Upper		≅20065
J36HD		
Detroit Diesel 3-53 Diesel		
Belt - Fan		②▲9412HD
Belt - W.P. & Alt.		②7425
Hose - Upper		≅21660
		or ●25474
Hose - Lower - Eng. To Pipe		≅20882
Hose - Lower - Pipe To Rad.		≅20882
CMI		
AG65		
Caterpillar D343TA Diesel		
Belt - Fan; W/54 1/4" Belt O.C.		③▲9540HD
Belt - Fan; W/55" Belt O.C.		③TR22545
Belt - Alt.		TR22495
Hose - Upper; (3" I.D.)		24448
Hose - Lower; (3" I.D.)		②24448
Hose - By Pass; (1 1/2" I.D.)		24224
RS425		
Caterpillar 3406BDITA Diesel		
Belt - Fan		5V1500
TR225		
Caterpillar 3160 Diesel		
Belt - Fan & Alt.		③▲9550HD
Belt - V.P.		TR22625
Belt - Hyd. Pump		③BX71

Application	Mfr. Part No.	Our No.
CMI - Continued		
TR225 - Continued		
Caterpillar 3160 Diesel - Continued		
Hose - Upper; (2 1/2" I.D.)		④24940
Hose - Lower; (2" I.D.)		④24932
DART		
D600B		
Cummins V1710 Diesel		
Belt - Alt.	178520	②▲9380HD
Belt - W.P.	178665	②TR28390
Belt - A.C.		5VX560
Belt - Hyd. Pump		②TR22363
Hose - Upper - Eng. To Pipe; (3" I.D.)		②24448
Hose - Upper - Pipe To Pipe; (3" I.D.)		②24448
Hose - Upper - Pipe To Rad.; (3" I.D.)		②24448
Hose - Lower - Eng. To Pipe; (3 1/2" I.D.)		24456
Hose - Lower - Pipe To Pipe; (3 1/2" I.D.)		24456
Hose - Lower - Pipe To Rad.; (3 1/2" I.D.)		24456
D2551		
Cummins VT1710 Diesel		
Belt - Fan; W/64" Belt O.C.		②TR24638
Belt - Fan; W/71 1/8" Belt O.C.	132896	③TR28706
Belt - Alt.	148270	②TR22329
Belt - Gen.	101427	②TR22299
Belt - W.P.; W/38 3/8" Belt O.C.	125367	TR28376
Belt - W.P.; W/39 3/4" Belt O.C.	171583	②TR28390
Belt - Compr.		②▲9560HD
Belt - Converter	129949	▲9309HD
Belt - V.P.		④▲9590HD
D2552		
Detroit Diesel 16V-71N Diesel		
Belt - Fan	5133771	③▲9690HD
Belt - Alt.	5133175	②7390
Belt - Gen.	5133517	▲9390HD
Belt - Compr.	5134212	②▲9480HD
D2561; D2562; D2661		
Cummins VTA1710C Diesel		
Belt - Fan; W/64" Belt O.C.		②TR24638
Belt - Fan; W/71 1/8" Belt O.C.	132896	③TR28706
Belt - Alt.	148270	②TR22329
Belt - Gen.	101427	②TR22299
Belt - W.P.; W/38 3/8" Belt O.C.	125367	TR28376
Belt - W.P.; W/39 3/4" Belt O.C.	171583	②TR28390
Belt - Compr.		②▲9560HD
Belt - Converter	129949	▲9309HD
Belt - V.P.		④▲9590HD
D2662		
Detroit Diesel 16V-71T Diesel		
Belt - Fan	5133771	③▲9690HD
Belt - Alt.	5133175	②7390
Belt - Gen.	5133517	▲9390HD
Belt - Compr.	5134212	②▲9480HD
DE2772		
Cummins VTA1710C Diesel		
Belt - Fan; W/64" Belt O.C.		②TR24638
Belt - Fan; W/71 1/8" Belt O.C.	132896	③TR28706
Belt - Alt.	148270	②TR22329
Belt - Gen.	101427	②TR22299
Belt - W.P.; W/38 3/8" Belt O.C.	125367	TR28376
Belt - W.P.; W/39 3/4" Belt O.C.	171583	②TR28390
Belt - Compr.		②▲9560HD
Belt - Converter	129949	▲9309HD
Belt - V.P.		④▲9590HD

② Two Required.
 ③ Three Required.
 ● Vulco-Flex® Coolant Hose.
 ④ Four Required.

▲ Standard Belt Available. See Pages 630-631.
 ≅ Cut to Fit.
 Ⓢ Use Wire Inserted Green Stripe® Coolant Hose.

Belts and Coolant Hose for Road & Construction Equipment

Application	Mfr. Part No.	Our No.	Application	Mfr. Part No.	Our No.
DITCH WITCH			DRESSER-DRESSTA - Continued		
1025SK			125E		
Continental TMD20 Diesel			IH DT239 Diesel		
Belt - Fan & Alt.		♣9440HD	Belt - Fan & W.P.		♣9555HD
Hose - Upper		≈21660	125G		
2020			KDC 410T Diesel		
Kohler M20QS			Belt - Fan & Alt.; W/56 5/8" Belt O.C.		1240873H1
Belt - Hyd. Pump		3VX335	Belt - Fan & Alt.; W/62 5/8" Belt O.C.		1257759H1
2300			150		
Wisconsin VH4D			IH DT282 Diesel		
Belt - Alt.		2180	Belt - Fan		328539R1
2310			Belt - Alt.		670572C1
Deutz F2L511 Diesel			Belt - Gen.		306658R1
Belt - Blower & Alt.		170036			TR28616
					TR22495
					TR22514
3500			165		
Deutz F3L1011 Diesel			IH D310 Diesel		
Belt - Blower & Alt.		7470	Belt - Fan		3117726R91
4010; 5010			175B		
Deutz F3L912 Diesel			IH DT407 Diesel		
Belt - Blower		2235175	Belt - Fan & Alt.; Ser. No. 32317 & After		670711C1
Belt - Alt.		170053			7512
					7417
8020			175C		
John Deere 4045D Diesel			IH DT466 Diesel		
Hose - Upper		●25477	Belt - Alt.; Ser. No. 17398 & Before		673481C1
Hose - Lower		●25530	Belt - Alt.; Ser. No. 17399 & After		1213134H91
R30					TR22648
Wisconsin VH4D			Belt - Alt.; Ser. No. 17399 & After		②TR22664
Belt - Alt.		6821	Komatsu 610T Diesel		
R65			Belt - Fan & Alt.		1257762H1
Ford 4-Cyl. 192; Ford 4-Cyl. 192 Diesel					
Belt - Fan & Alt.		170043			
R100D			200		
Detroit Diesel 4-53 Diesel			Dresser D505T Diesel		
Belt - Fan		♣9380HD	Belt - Fan & Alt.		1257778H1
Belt - W.P.		7360			
Belt - Alt.		7312			
V30			210M		
Wisconsin VH4D			Cummins KTA19C Diesel		
Belt - Alt.		6821	Belt - A.C.		②♣9380HD
DRESSER-DRESSTA			Hose - Upper - Eng. To Pipe		②23562
100C			Hose - Upper - Pipe To Rad.; (1 3/4" I.D.)		②23562
IH D206 Diesel			Hose - Lower - Eng. To Pipe		23585
Belt - Fan & W.P.		621770C1	Hose - Lower - Pipe To Rad.		23585
Belt - Alt.		670572C1			
100E			250B		
IH D239 Diesel			IH DT429 Diesel		
Belt - Fan & W.P.		621770C1	Belt - Fan & Alt.		670741C1
			Belt - Fan & Gen.		1800001C91
			Belt - W.P.		328502R1
100G					TR22485
KDC 410T Diesel			250C		
Belt - Fan & Alt.		1240873H1	IH DVT573B Diesel		
			Belt - Alt.; Ser. No. 7500 & After		673947C1
			Hose - Upper - Eng. To Pipe; (1 3/4" I.D.)		♣9447HD
			Hose - Upper - Pipe To Rad.; (1 3/4" I.D.)		24228
			Hose - Lower - Eng. To Pipe; (3" I.D.)		24228
			Hose - Lower - Pipe To Rad.; (3" I.D.)		24248
125C					24248
IH D239 Diesel					
Belt - Fan & W.P.		♣9555HD			
125E					
IH D239 Diesel					
Belt - Fan & W.P.		♣9555HD			
125G					
KDC 410T Diesel					
Belt - Fan & Alt.		1240873H1			
150					
IH DT282 Diesel					
Belt - Fan		328539R1			
Belt - Alt.		670572C1			
Belt - Gen.		306658R1			
165					
IH D310 Diesel					
Belt - Fan		3117726R91			
175B					
IH DT407 Diesel					
Belt - Fan & Alt.; Ser. No. 32317 & After		670711C1			
175C					
IH DT466 Diesel					
Belt - Alt.; Ser. No. 17398 & Before		673481C1			
Belt - Alt.; Ser. No. 17399 & After		1213134H91			
8020					
John Deere 4045D Diesel					
Hose - Upper		●25477			
Hose - Lower		●25530			
R30					
Wisconsin VH4D					
Belt - Alt.		6821			
R65					
Ford 4-Cyl. 192; Ford 4-Cyl. 192 Diesel					
Belt - Fan & Alt.		170043			
R100D					
Detroit Diesel 4-53 Diesel					
Belt - Fan		♣9380HD			
Belt - W.P.		7360			
Belt - Alt.		7312			
V30					
Wisconsin VH4D					
Belt - Alt.		6821			
DRESSER-DRESSTA					
100C					
IH D206 Diesel					
Belt - Fan & W.P.		621770C1			
Belt - Alt.		670572C1			
100E					
IH D239 Diesel					
Belt - Fan & W.P.		621770C1			
100G					
KDC 410T Diesel					
Belt - Fan & Alt.		1240873H1			
125C					
IH D239 Diesel					
Belt - Fan & W.P.		♣9555HD			
125E					
IH D239 Diesel					
Belt - Fan & W.P.		♣9555HD			
125G					
KDC 410T Diesel					
Belt - Fan & Alt.		1240873H1			
150					
IH DT282 Diesel					
Belt - Fan		328539R1			
Belt - Alt.		670572C1			
Belt - Gen.		306658R1			
165					
IH D310 Diesel					
Belt - Fan		3117726R91			
175B					
IH DT407 Diesel					
Belt - Fan & Alt.; Ser. No. 32317 & After		670711C1			
175C					
IH DT466 Diesel					
Belt - Alt.; Ser. No. 17398 & Before		673481C1			
Belt - Alt.; Ser. No. 17399 & After		1213134H91			
8020					
John Deere 4045D Diesel					
Hose - Upper		●25477			
Hose - Lower		●25530			
R30					
Wisconsin VH4D					
Belt - Alt.		6821			
R65					
Ford 4-Cyl. 192; Ford 4-Cyl. 192 Diesel					
Belt - Fan & Alt.		170043			
R100D					
Detroit Diesel 4-53 Diesel					
Belt - Fan		♣9380HD			
Belt - W.P.		7360			
Belt - Alt.		7312			
V30					
Wisconsin VH4D					
Belt - Alt.		6821			
DRESSER-DRESSTA					
100C					
IH D206 Diesel					
Belt - Fan & W.P.		621770C1			
Belt - Alt.		670572C1			
100E					
IH D239 Diesel					
Belt - Fan & W.P.		621770C1			
100G					
KDC 410T Diesel					
Belt - Fan & Alt.		1240873H1			
125C					
IH D239 Diesel					
Belt - Fan & W.P.		♣9555HD			
125E					
IH D239 Diesel					
Belt - Fan & W.P.		♣9555HD			
125G					
KDC 410T Diesel					
Belt - Fan & Alt.		1240873H1			
150					
IH DT282 Diesel					
Belt - Fan		328539R1			
Belt - Alt.		670572C1			
Belt - Gen.		306658R1			
165					
IH D310 Diesel					
Belt - Fan		3117726R91			
175B					
IH DT407 Diesel					
Belt - Fan & Alt.; Ser. No. 32317 & After		670711C1			
175C					
IH DT466 Diesel					
Belt - Alt.; Ser. No. 17398 & Before		673481C1			
Belt - Alt.; Ser. No. 17399 & After		1213134H91			
8020					
John Deere 4045D Diesel					
Hose - Upper		●25477			
Hose - Lower		●25530			
R30					
Wisconsin VH4D					
Belt - Alt.		6821			
R65					
Ford 4-Cyl. 192; Ford 4-Cyl. 192 Diesel					
Belt - Fan & Alt.		170043			
R100D					
Detroit Diesel 4-53 Diesel					
Belt - Fan		♣9380HD			
Belt - W.P.		7360			
Belt - Alt.		7312			
V30					
Wisconsin VH4D					
Belt - Alt.		6821			
DRESSER-DRESSTA					
100C					
IH D206 Diesel					
Belt - Fan & W.P.		621770C1			
Belt - Alt.		670572C1			
100E					
IH D239 Diesel					
Belt - Fan & W.P.		621770C1			
100G					
KDC 410T Diesel					
Belt - Fan & Alt.		1240873H1			
125C					
IH D239 Diesel					
Belt - Fan & W.P.		♣9555HD			
125E					
IH D239 Diesel					
Belt - Fan & W.P.		♣9555HD			
125G					
KDC 410T Diesel					
Belt - Fan & Alt.		1240873H1			
150					
IH DT282 Diesel					
Belt - Fan		328539R1			
Belt - Alt.		670572C1			
Belt - Gen.		306658R1			
165					
IH D310 Diesel					
Belt - Fan		3117726R91			
175B					
IH DT407 Diesel					
Belt - Fan & Alt.; Ser. No. 32317 & After		670711C1			
175C					
IH DT466 Diesel					
Belt - Alt.; Ser. No. 17398 & Before		673481C1			
Belt - Alt.; Ser. No. 17399 & After		1213134H91			
8020					
John Deere 4045D Diesel					
Hose - Upper		●25477			
Hose - Lower		●25530			
R3					

Belts and Coolant Hose for Road & Construction Equipment

Application	Mfr. Part No.	Our No.
DRESSER-DRESSTA - Continued		
500C		
IH D155 Belt - Fan & Alt.	596313R1	7445
IH D155 Diesel Belt - Fan & Alt.	676835R1	▲9520HD
500E		
IH D155 Diesel Belt - Fan & Alt.	676835R1	▲9520HD
510B		
IH D268 Diesel Belt - Alt.		②▲9670HD
510C		
Dresser D240T Diesel Hose - Upper; (1 3/4" I.D.)		②24428
Hose - Lower - Eng. To Pipe; (2 1/4" I.D.)		24436
515B		
Dresser D359T Diesel Belt - Fan & Alt.	1257765H1	K080635
Hose - Upper - Eng. To Pipe; (1 3/4" I.D.)		24428
Hose - Upper - Pipe To Rad.; (2" I.D.)		24432
Hose - Lower - Eng. To Pipe; (2 1/4" I.D.)		24436
Hose - Lower - Pipe To Rad.; (2 3/4" I.D.)		24444
IH D358 Diesel Belt - Alt.		②▲9680HD
520B		
Dresser D359T Diesel Belt - Fan & Alt.	1257765H1	K080635
IH D358 Diesel Belt - Alt.		②▲9680HD
IH DT358 Diesel Belt - Fan & Alt.		②▲9690HD
530		
Dresser D505T Diesel Belt - Fan & Alt.		▲K080685HD
Belt - A.C.	1251357H1	▲9425HD
Tensioner Assy. - Fan & Alt.	3978022	38504
Hose - Upper; (2 1/4" I.D.)		②24436
Hose - Lower - Eng. To Pipe		21901
Hose - Lower - Pipe To Rad.; (3" I.D.)		24448
IH DT414 Diesel Belt - Fan & Alt.	683548C91	②TR22664
Belt - Air Brake Compr.		TR22770
540		
Dresser D505T Diesel Belt - Fan & Alt.	1257778H1	▲K080685HD
Belt - A.C.	1251357H1	▲9425HD
IH DT466 Diesel Belt - Fan & Alt.	683548C91	②TR22664
Belt - Air Brake Compr.		TR22770
550		
Cummins NTA855 Diesel Belt - Fan	1238447H1	K060450
Belt - W.P.	1238934H1	▲K060435HD
Belt - Alt.	1239751H1	K040460
Belt - A.C.		▲9415HD
IH DVT800 Diesel Belt - Fan	673949C91	②TR22692
Belt - Alt.	686613C91	②▲9530HD

Application	Mfr. Part No.	Our No.
DRESSER-DRESSTA - Continued		
555		
Cummins NTA855 Diesel Belt - Fan	1238447H1	K060450
Belt - W.P.	1238934H1	▲K060435HD
Belt - A.C.; W/1/2" Belt T.W.	1251357H1	▲9425HD
Belt - A.C.; W/3/4" Belt T.W.	1232822H1	TR24414
560		
IH DT817C Diesel Belt - Fan & Alt.	670464C1	TR22578
Belt - Air Brake Compr.	672445C1	TR24538
Belt - A.C.	670740C1	TR22570
560B		
Cummins KT1150C Diesel Belt - Alt.	1238776H1	K050370
Belt - A.C.		TR22664
570		
Cummins VT1710 Diesel Belt - Fan	1238446H1	▲K060615HD
Belt - W.P.	1259899H1	K050450
630; 630W; 635		
Case 6-Cyl. 358 Diesel Belt - Fan, Alt. & W.P.	3144098R91	②▲9660HD
635B		
Dresser D359T Diesel Belt - Fan & Alt.	1250454H1	▲K080560HD
635E		
Dresser D359T Diesel Belt - Fan & Alt.	1257784H1	▲K080550HD
635W		
Case 6-Cyl. 358 Diesel Belt - Fan, Alt. & W.P.	3144098R91	②▲9660HD
640		
Case 6-Cyl. 358 Diesel Belt - Fan, Alt. & W.P.	3139157R91	②▲9630HD
645		
Dresser D359TA Diesel Belt - Fan & Alt.	1257765H1	K080635
970; 970 Turbo Articulated; 970C		
Cummins VTA28C Diesel Belt - Alt.		②▲9380HD
Belt - A.C.		TR22461
Hose - Upper - Eng. To Pipe; (3" I.D.)		24448
Hose - Upper - Pipe To Rad.; (3" I.D.)		24448
Hose - Lower - Eng. To Pipe; (3 1/2" I.D.)		24456
Hose - Lower - Pipe To Rad.; (3 1/2" I.D.)		24456
Hose - By Pass; (2 5/8" I.D.)		③24242
6200LC; 6220LC		
Komatsu 610T Diesel Belt - Fan & Alt.	3911557	▲K080560HD
D90C		
Cummins V-6 200 Diesel Belt - Fan	178720	②TR24597
Belt - W.P.	178530	TR24365
Belt - Gen.	178571	TR22434
Hose - Upper; (2 1/4" I.D.)		24236
Hose - Lower		●26520
Detroit Diesel 6V-53 Diesel Belt - Fan	5136268	②▲9610HD

▲ Standard Belt Available. See Pages 630-631.
③ Three Required.

② Two Required.
● Vulco-Flex® Coolant Hose.

Belts and Coolant Hose for Road & Construction Equipment

Application	Mfr. Part No.	Our No.	Application	Mfr. Part No.	Our No.
DRESSER-DRESSTA - Continued			DRESSER-DRESSTA - Continued		
D90C - Continued			TD8C		
Detroit Diesel 6V-53 Diesel - Continued			IH D239 Diesel		
Hose - Upper - Eng. To Pipe; (2 1/4" I.D.)		24236	Belt - Fan	621770C1	♣9555HD
Hose - Upper - Pipe To Rad.; (1 5/8" I.D.)		24226	TD8E Crawler		
D100B			IH DT239 Diesel		
Cummins NT310CI Diesel			Belt - Fan	621770C1	♣9555HD
Belt - Fan	178617	②TR30506	TD8G Crawler		
Belt - W.P.	178628	TR24438	Dresser D240T Diesel		
Belt - Gen.	178599	TR22410	Belt - Fan & Alt.; W/56 5/8" Belt O.C.	1240873H1	♣K080560HD
Detroit Diesel 6V-71 Diesel			Belt - Fan & Alt.; W/62 5/8" Belt O.C.	1257759H1	♣K080620HD
Belt - Fan	5130662	③♣9580HD	TD12 Crawler		
D120C			IH D466B Diesel		
Cummins NT310CI Diesel			Belt - Fan & Alt.	1213134H91	②TR22664
Belt - Fan	178617	②TR30506	TD12B		
Belt - W.P.	178628	TR24438	Dresser D505N Diesel		
Belt - Gen.	178599	TR22410	Belt - Fan & Alt.	1257778H1	♣K080685HD
Detroit Diesel 8V-71 Diesel			TD15B		
Belt - Fan	5130662	③♣9580HD	IH DT407 Diesel		
Hose - Upper; (2 1/4" I.D.)		24236	Belt - Fan & Alt.	612134C11	TR24688
Hose - Lower; (2 3/4" I.D.)		24244	TD15C Articulated Crawler		
D400			Dresser D505T Diesel		
Cummins V12-525-CI Diesel			Belt - Fan & Alt.	1257762H1	♣K080605HD
Belt - Fan; W/57" Belt O.C.	178674	③TR28565	TD15C Crawler		
Belt - Fan; W/62 1/8" Belt O.C.	178629	③TR28616	Dresser D505T Diesel		
Belt - W.P.	178665	②TR28390	Belt - Fan & Alt.	1257770H1	♣K080610HD
Belt - Gen.	178613	TR22344	TD15E Crawler		
Detroit Diesel 12V-71 Diesel			Dresser D505T Diesel		
Belt - Fan		③♣9570HD	Belt - Fan & Alt.	1253462H1	♣K080670HD
D500			Belt - A.C.	1251357H1	♣9425HD
Cummins VT1710 Diesel			Hose - Upper - Eng. To Pipe; (2 1/4" I.D.)		24436
Belt - Fan	178578	③TR28706	Hose - Upper - Pipe To Rad.; (2 1/2" I.D.)		24436
Belt - W.P.; W/38" Belt O.C.	125367	TR28376	Hose - Lower - Eng. To Pipe; (3" I.D.)		24448
Belt - W.P.; W/39 1/2" Belt O.C.	178665	②TR28390	Hose - Lower - Pipe To Rad.; (3 1/4" I.D.)		24452
Belt - Alt.		②TR22350	Detroit Diesel 16V-71 Diesel		
Belt - Gen.	178613	TR22344	Belt - Fan	5133768	②♣9640HD
Hose - Upper - Eng. To Pipe; (3" I.D.)		24448	S7		
Hose - Upper - Pipe To Rad.; (2 1/2" I.D.)		24440	Detroit Diesel 3-53 Diesel		
Hose - Lower - Eng. To Pipe; (3" I.D.)		24448	Belt - Fan		②♣9390HD
Hose - Lower - Pipe To Rad.; (3 1/4" I.D.)		24452	Ford 4-Cyl. 172		
Detroit Diesel 16V-71 Diesel			Belt - Fan	207463H1	♣9425HD
Belt - Fan	5133768	②♣9640HD	Ford 4-Cyl. 172 Diesel		
S7			Belt - Fan	206307H1	♣9415HD
Detroit Diesel 3-53 Diesel			S8		
Belt - Fan		②♣9390HD	Detroit Diesel 3-53 Diesel		
Ford 4-Cyl. 172			Belt - Fan		②♣9390HD
Belt - Fan	207463H1	♣9425HD	Belt - W.P. & Alt.		②7410
Ford 4-Cyl. 172 Diesel			TD7C		
Belt - Fan	206307H1	♣9415HD	IH D206 Diesel		
S8			Belt - Fan	621770C1	♣9555HD
Detroit Diesel 3-53 Diesel			TD7E Crawler		
Belt - Fan		②♣9390HD	IH D239 Diesel		
Belt - W.P. & Alt.		②7410	Belt - Fan	621770C1	♣9555HD
TD7C			TD7G Crawler		
IH D206 Diesel			Dresser D240N Diesel		
Belt - Fan	621770C1	♣9555HD	Belt - Fan & Alt.	1240873H1	♣K080560HD
TD7E Crawler			TD20B		
IH D239 Diesel			IH DT429 Diesel		
Belt - Fan	621770C1	♣9555HD	Belt - Fan & Alt.	670741C1	②TR22570
TD7G Crawler			Belt - Fan & Gen.	1800001C91	②TR22578
Dresser D240N Diesel			Belt - W.P.	328502R1	TR22485
Belt - Fan & Alt.	1240873H1	♣K080560HD	TD20C		
TD20E Crawler			IH DV573B Diesel		
IH DVT800 Diesel			Belt - Fan	673946C91	④TR22752
Belt - Fan	673946C91	④TR22752	Belt - Alt.; Ser. No. 7500 & After	673947C1	♣9447HD
Belt - Alt.; Ser. No. 30277 & Before	683723C1	♣9476HD	TD20G Crawler		
Belt - Alt.; Ser. No. 30278 & After	673029C1	♣9470HD	Cummins LTA10C Diesel		
Belt - A.C.		♣9680HD	Belt - Fan	1246274H1	♣K080605HD
TD20G Crawler			Belt - Alt.	1246253H1	K050317
Cummins LTA10C Diesel			Belt - A.C.		TR24562
Belt - Fan	1246274H1	♣K080605HD			
Belt - Alt.	1246253H1	K050317			
Belt - A.C.		TR24562			

② Two Required.
 ♣ Standard Belt Available. See Pages 630-631.
 ④ Four Required.

③ Three Required.
 ≋ Cut to Fit.

Belts and Coolant Hose for Road & Construction Equipment

Application	Mfr. Part No.	Our No.
DRESSER-DRESSTA - Continued		
TD25B		
IH DT817B Diesel Belt - Fan & Gen.	403348R1	▲9463HD
TD25C		
IH DT817C Diesel Belt - Alt.	326998R1	②TR22570
TD25E Crawler		
IH DT817C Diesel Belt - Fan & Alt.; Ser. No. 12007 & Before Belt - Fan & Alt.; Ser. No. 12008 & After	326998R1	TR22517 ②TR22570
TD25G Crawler		
Cummins KT19C Diesel Belt - Alt. Belt - A.C. Hose - Upper - Eng. To Pipe; (2 1/2" I.D.) Hose - Upper - Pipe To Rad.; (2 1/2" I.D.)	1238776H1	K050370 TR22664 ②24440 ②24440
TD40 Crawler		
Cummins KTA1150C Diesel Belt - Alt. Belt - A.C.	1238776H1	K050370 TR22664
TD40B Crawler		
Cummins KTA19C Diesel Belt - Alt. Belt - A.C.	1238776H1	K050370 TR22664
DRESSER-GALION		
3-5 Ton; 4-6 TON		
Continental Y112 Belt - Fan Belt - Gen.	Y112K368 Y112K367	▲9451HD ▲9415HD
Waukesha VRG155 Belt - Fan Belt - Hyd. Pump	RD50739 R20011	TR22386 TR28423
5 Ton		
IH UD281.4 Diesel Belt - Gen.	52318DA	9279
5-8 Ton; 8-10 Ton		
Continental F162 Belt - Fan Belt - Hyd. Pump Hose - Upper; (1 1/4" I.D.) Hose - Lower; (1 1/2" I.D.)	RD40434 R20011	TR24465 TR28423 24220 24224
Continental F226 Belt - Fan Belt - Hyd. Pump	R30767 R20011	TR24476 TR28423
IH UB220 Belt - Fan & Gen. Belt - Hyd. Pump Hose - Upper Hose - Lower	R20011	TR24578 TR28423 ●26511 ●26511
IH UD6 Diesel; IH UD6A Diesel Belt - Fan Belt - Hyd. Pump	16131D R20011	TR30467 TR28423
8-12 Ton; 10-14 Ton		
IH UD9 Diesel; IH UD350 Diesel Belt - Fan Belt - Gen. Belt - Hyd. Pump	48042DA 54857DA R20011	TR30484 9300 TR28423

Application	Mfr. Part No.	Our No.
DRESSER-GALION - Continued		
14-20 Ton		
Continental M330 Belt - Fan & Gen. Belt - Hyd. Pump	RD34611 R20011	TR24562 TR28423
80		
IH UB264; IH UC263; IH UD282 Belt - Fan & Alt. Hose - Upper Hose - Lower	151532R1	②7512 ●26509 ●26512
85RM2		
Case 4-Cyl. 188 Hose - Upper Hose - Lower		●25477 ●25530
Case 4-Cyl. 188 Diesel Hose - Upper Hose - Lower		●25480 ●25530
Continental F163 Belt - Fan & Gen. Belt - P.S. Hose - Upper; W/12" Hose Hose - Upper; W/20" Hose Hose - Lower	80928 74799	▲9425HD 7425 ●25474 ●25480 ●25480
Ford 4-Cyl. 172 Diesel; Ford 4-Cyl. 220 Diesel Hose - Upper; W/12" Hose Hose - Upper; W/20" Hose Hose - Lower		●25474 ●25480 ●25484
104		
Cummins J6 Diesel Belt - Fan	S1792	②TR22405
Cummins J6BI Diesel Belt - Fan Belt - Gen.	106258 112203	②▲9365HD TR24449
Cummins NH6-4BI Diesel Belt - Fan	S1792	②TR22405
Detroit Diesel 3-71 Diesel Belt - Fan Hose - Upper	5170972	②TR22455 ●26509
IH UD14A Diesel Belt - Fan Belt - Gen. Belt - Hyd. Pump Hose - Upper; (2 1/4" I.D.) Hose - Lower	30982D 54857DA D23474	TR32571 9300 TR28390 24236 ●26509
118		
Cummins H743C Diesel Belt - Fan Belt - Alt.		②TR24457 TR22392
Cummins NH6-4BI Diesel Belt - P.S. Hose - Upper Hose - Lower	D51276	TR28596 ●26509 ●26531
Detroit Diesel 3-71 Diesel Belt - Fan Hose - Upper Hose - Lower	5170972	②TR22455 ●26509 ●26516
Detroit Diesel 4-71 Diesel Belt - Fan Belt - Gen. Hose - Upper Hose - Lower	5176420 3224367	②TR22588 TR28390 ●26509 ●26516
IH UD16 Diesel Belt - Fan & Gen.	251753R11	②TR28616
IH UD525 Diesel; IH UD554 Diesel Belt - Fan & Gen. Hose - Upper	251753R11	②TR28616 ●26531

▲ Standard Belt Available. See Pages 630-631.
● Vulco-Flex® Coolant Hose.

② Two Required.

Belts and Coolant Hose for Road & Construction Equipment

Application	Mfr. Part No.	Our No.
DRESSER-GALION - Continued		
118 - Continued		
IH UD525 Diesel; IH UD554 Diesel - Continued Hose - Lower; (2 1/4" I.D.)		24236
118C		
Detroit Diesel 4-71 Diesel		
Belt - Fan	5176420	ⓉTR22588
Belt - Gen.	3224367	TR28390
Hose - Upper		●26509
Hose - Lower		●26516
125; 125A		
Detroit Diesel 4-71 Diesel		
Belt - Fan		▲9470HD
Belt - W.P. & Alt.		7410
Hose - Upper		●26510
Hose - Lower		●26529
IH UB264		
Belt - Fan		▲9463HD
Belt - W.P. & Alt.		▲9451HD
Hose - Upper		●26511
Hose - Lower		●26511
150		
Detroit Diesel 4-53N Diesel		
Belt - Fan & W.P.		ⓉTR22570
Belt - Alt.		▲9330HD
Hose - Upper		●26517
Hose - Lower - Pipe To Pipe		≅<20206
	or	●26507
Hose - Lower - Pipe To Rad.		≅<20206
	or	●26507
150A		
Detroit Diesel 4-53N Diesel		
Belt - Fan	89816	Ⓣ▲9476HD
KDC 359T Diesel		
Belt - Fan & Alt.; W/59 5/8" Belt O.C.	1250637H1	▲K080590HD
Belt - Fan & Alt.; W/62 5/8" Belt O.C.	1257759H1	▲K080620HD
150F		
Cummins 6BTA Diesel		
Belt - Fan & Alt.		▲K080630HD
Hose - Upper; (2" I.D.)		Ⓣ24232
Hose - Lower		●26523
150FA		
Detroit Diesel 4-53N Diesel		
Belt - Fan	89816	Ⓣ▲9476HD
KDC 359T Diesel		
Belt - Fan & Alt.; W/59 5/8" Belt O.C.	1250637H1	▲K080590HD
Belt - Fan & Alt.; W/62 5/8" Belt O.C.	1257759H1	▲K080620HD
160		
Cummins H6BI Diesel; Cummins HC6I Diesel		
Belt - Fan	70524	ⓉTR22410
Belt - W.P.	70524	ⓉTR22410
Belt - P.S.	D51276	TR28596
Belt - Hyd. Pump	D50926	TR28628
Detroit Diesel 3-71 Diesel		
Belt - P.S.	D51277	TR28412
160RF2		
Detroit Diesel 3-53 Diesel		
Belt - Fan	205839	Ⓣ7425
Belt - V.P.	208005	Ⓣ▲9510HD
Hose - Upper		●26509
Hose - Lower		20685
IH D282 Diesel		
Hose - Upper		●26511

Application	Mfr. Part No.	Our No.
DRESSER-GALION - Continued		
160RF2 - Continued		
IH D282 Diesel - Continued		
Hose - Lower		●26509
IH UC263		
Hose - Upper		●26511
Hose - Lower		●26508
200RF2		
Cummins V352 Diesel		
Belt - V.P.	83343	▲9400HD
Hose - Upper		●26512
Detroit Diesel 4-53 Diesel		
Belt - Alt.	205839	7425
Belt - P.S.	81958	▲9350HD
Belt - V.P.	208005	▲9510HD
Hose - Upper		●26511
Hose - Lower		●26509
IH 6-Cyl. 301		
Belt - Fan & Alt.	81044	▲9490HD
Belt - P.S.	81914	7500
IH UC301		
Hose - Upper		●26511
Hose - Lower		●26512
Perkins 6-Cyl. 354		
Belt - V.P.	82753	▲9570HD
Hose - Upper		●26512
220S		
Detroit Diesel 6V-53N Diesel		
Belt - Fan	5126763	Ⓣ▲9400HD
Belt - W.P.		Ⓣ7370
Belt - Alt.	D126431	Ⓣ7410
Hose - Upper		Ⓣ●26612
Hose - Lower; (2" I.D.)		Ⓣ24932
Hose - By Pass; (1 1/8" I.D.)		24218
250RF2		
Cummins V352 Diesel		
Belt - V.P.	83343	▲9400HD
Hose - Upper		●26512
Detroit Diesel 4-53 Diesel		
Belt - Alt.	205839	7425
Belt - P.S.	81958	▲9350HD
Belt - V.P.	208005	▲9510HD
Hose - Upper		●26511
Hose - Lower		●26509
IH 6-Cyl. 301		
Belt - Fan & Alt.	81044	▲9490HD
Belt - P.S.	81914	7500
IH UC301		
Hose - Upper		●26511
Hose - Lower		●26512
Perkins 6-Cyl. 354		
Belt - V.P.	82753	▲9570HD
Hose - Upper		●26512
303		
IH U281		
Belt - Fan	16131DA	TR28454
Belt - Gen.	49341D	▲9335HD
IH UB282		
Hose - Upper		●26509
IH UD281.4 Diesel		
Belt - Fan	16131DA	TR28454
Belt - Gen.	54857DB	9300
IH UD282 Diesel		
Hose - Upper		●26509
IH UD6 Diesel		
Belt - Fan	69490DA	TR30467

Ⓣ Two Required.
 ▲ Standard Belt Available. See Pages 630-631.
 ≅ Use Wire Inserted Green Stripe® Coolant Hose.

● Vulco-Flex® Coolant Hose.
 ≅ Cut to Fit.

Belts and Coolant Hose for Road & Construction Equipment

Application	Mfr. Part No.	Our No.	Application	Mfr. Part No.	Our No.
DRESSER-GALION - Continued			DRESSER-GALION - Continued		
303 - Continued			A600		
IH UD6 Diesel - Continued			Dresser D505T Diesel		
Belt - Gen.	54857DB	9300	Belt - Fan & Alt.	1257782H1	♣K080710HD
503A			IH DT466 Diesel		
IH UD236 Diesel			Belt - Fan & Alt.		②TR22657
Hose - Upper		●26510	Hose - Upper		●26525
Hose - Lower		♣20611	Hose - Lower; (2 1/2" I.D.)		24440
503L			A606		
Continental F162			Dresser D505T Diesel		
Belt - Fan & Gen.	F162K208	②TR22386	Belt - Fan & Alt.	1257782H1	♣K080710HD
Continental F226			IH DT466 Diesel		
Belt - Fan & Gen.		TR24461	Belt - Fan & Alt.		②TR22657
IH UD236 Diesel			CHIEF		
Belt - Fan	149635R2	♣9463HD	Continental F226		
Belt - W.P. & Alt.	304436R1	♣9505HD	Belt - Fan & Gen.	A600K206	TR24424
708			Belt - Hyd. Pump	R20011	TR28423
Dresser D240T Diesel			Continental F244; Continental FA244		
Belt - Fan & Alt.	1257759H1	♣K080620HD	Belt - Fan	RD40434	TR24465
Hose - Upper - Eng. To Pipe; (1 1/2" I.D.)		24224	Belt - Hyd. Pump	R20011	TR28423
Hose - Upper - Pipe To Rad.; (1 1/2" I.D.)		24224	Continental HD260 Diesel		
Hose - Lower; (2 1/2" I.D.)		24440	Belt - Fan	RD43268	TR24500
710; 712; 714			Belt - Hyd. Pump	R20011	TR28423
Dresser D240T Diesel			Cummins J4BT Diesel		
Belt - Fan & Alt.	1257759H1	♣K080620HD	Belt - Fan & W.P.	118637	②♣9440HD
830			Hercules WXLC3		
Dresser D359T Diesel			Belt - Gen.	54857DA	9300
Belt - Fan & Alt.	1240874H1	K080655	IH UD14A Diesel		
850; 870			Belt - Fan & W.P.	30982DA	TR32571
Dresser D505T Diesel			Belt - Gen.	54857DB	9300
Belt - Fan & Alt.; W/71 5/8" Belt O.C.	1257782H1	♣K080710HD	CR-D		
Belt - Fan & Alt.; W/72 5/8" Belt O.C.	1257783H1	♣K080720HD	IH UD282 Diesel		
Belt - Fan To Hyd. Pump		♣9400HD	Belt - Fan & Alt.		♣9505HD
Hose - Upper		●26517	Belt - Hyd. Pump		TR28423
Hose - Lower - Eng. To Pipe		21901	Hose - Upper		●26508
Hose - Lower - Pipe To Rad.; (2" I.D.)		24432	Hose - Lower		●26512
A400E			K1D		
IH D466 Diesel			IH UD16 Diesel		
Belt - Fan & Alt.	120304	②TR22648	Belt - Fan	251753R21	②TR28616
A450E			Pneumatic Tire Roller		
Dresser D359T Diesel			IH UB220		
Belt - Fan & Alt.	1240874H1	K080655	Belt - P.S.	RD53075	TR28346
IH D466 Diesel			Belt - Gov.	RD57423	7380
Belt - Fan & Alt.	120304	②TR22648	Hose - Upper		♣20611
A500			Hose - Lower		or ●26509
IH D466 Diesel					●26510
Belt - Fan & Alt.	120304	②TR22648	RP60		
A550			Waukesha 6-Cyl. Diesel		
IH DT466 Diesel			Belt - Fan		♣9640HD
Belt - Fan & Alt.		②TR22657	Belt - Hyd. Pump		9300
Hose - Upper		●26517	Hose - Upper		●26517
Hose - Lower; (2 1/4" I.D.)		24236	Hose - Lower - Eng. To Pipe		♣21124
A560E			Hose - Lower - Pipe To Rad.		♣20882
IH D466 Diesel			Rubber Tire Compactor		
Belt - Fan & Alt.	120304	②TR22648	IH UB220		
Hose - Upper		●26517	Belt - Fan & Alt.	274705R1	TR28445
Hose - Lower; (2 1/4" I.D.)		24436	Belt - Gov.		7380
			Belt - Hyd. Pump	RD53075	TR28346
			S5-8A; S8-10.5A; S8-12A; S10-14A		
			Cummins 4-Cyl. 3.9 L Diesel		
			Belt - Fan & Alt.	1257759H1	♣K080620HD

Road & Construction Equipment

● Vulco-Flex® Coolant Hose.
 ② Two Required.

♣ Cut to Fit.
 ♣ Standard Belt Available. See Pages 630-631.

Belts and Coolant Hose for Road & Construction Equipment

Application	Mfr. Part No.	Our No.	Application	Mfr. Part No.	Our No.
DRESSER-GALION - Continued			DRESSER-GALION - Continued		
S5-8A; S8-10.5A; S8-12A; S10-14A - Continued			T700		
Detroit Diesel 3-53 Diesel			Cummins HRF6BI Diesel		
Belt - Fan	88834	▲9425HD	Belt - Fan	S3115	②TR28492
Belt - Alt.	126431	②7410	Belt - Gen.	S3095	TR24400
T400A			TH8-12D		
IH UD407 Diesel			Hercules WXC; Hercules WXLC		
Belt - Fan & Alt.; W/Single Belt		TR22664	Hose - Upper		●25480
Belt - Fan & Alt.; W/Dual Belts		②TR22664	Hose - Lower		●25478
Hose - Upper		●26517	IH UD282 Diesel		
Hose - Lower		●26523	Belt - Fan & Alt.		▲9505HD
Hose - By Pass		≈<20573	Belt - Hyd. Pump		TR28423
T500			Hose - Upper		●26507
Cummins C160CI Diesel			Hose - Lower		●26513
Belt - Fan	124466	②TR24365	TH8-12G		
Belt - W.P.	178437	TR22336	IH UB264		
Belt - Alt.	178450	TR22461	Belt - Fan & Alt.	274705R1	TR28445
Hose - Upper		●26509	Belt - Gov.		7380
Hose - Lower		●26524	Belt - Hyd. Pump		TR28376
Cummins JN6BI Diesel			Hose - Upper		●26508
Belt - Fan	70888	②▲9360HD	Hose - Lower		●26513
Belt - W.P.	101427	TR22299	Hose - By Pass		20338
Belt - Gen.; W/49 3/8" Belt O.C.	112202	TR24489	VOS2-42A		
Belt - Gen.; W/50" Belt O.C.	70885	TR22495	Dresser D140N Diesel		
Belt - P.S.	D51277	TR28406	Belt - Fan & Alt.	156051	②7470
Cummins JT6B Diesel			Belt - P.S.	155936	7312
Belt - Fan	70888	②▲9360HD	VOS2-66B		
Belt - W.P.	101427	TR22299	Dresser D359T Diesel		
Belt - Gen.	70886	TR22299	Belt - Fan	89816	②▲9476HD
Belt - P.S.	D51277	TR28412	Belt - Alt.	69437	7410
T500A			VOS66A		
IH DT407 Diesel			Detroit Diesel 3-53 Diesel		
Belt - Fan & Gen.		②TR22664	Belt - Fan		②▲9490HD
Hose - Upper		●26517	Belt - W.P. & Alt.		②7410
Hose - Lower		●26523	Belt - Hyd. Pump		7370
T500C			Hose - Upper		●26515
IH D466 Diesel			Hose - Lower		●26523
Belt - Fan & Alt.	673409C1	②TR22648	Dresser D240T Diesel		
T500L			Belt - Fan	135009	②▲9490HD
IH DT407 Diesel			Belt - Alt.	126431	②7410
Belt - Fan & Alt.; W/Single Belt		TR22664	VOS84A		
Belt - Fan & Alt.; W/Dual Belts		②TR22664	Detroit Diesel 4-53N Diesel		
Hose - Upper		●26517	Belt - Fan	89816	②▲9476HD
Hose - Lower - Eng. To Pipe		●26523	Belt - Alt.	126431	②7410
Hose - Lower - Pipe To Rad.; (2 1/4" I.D.)		24236	VOSA66A		
Hose - By Pass		≈<20573	Dresser D240T Diesel		
T600			Belt - Fan	135009	②▲9490HD
Cummins JB15 Diesel			Belt - Alt.	126431	②7410
Belt - Fan	106258	②▲9365HD	VOSA84A		
Belt - Gen.	101426	TR22443	Detroit Diesel 4-53N Diesel		
Belt - P.S.	D51277	TR28412	Belt - Fan	89816	②▲9476HD
Cummins JBS600 Diesel			Belt - Alt.	126431	②7410
Belt - Fan		▲9375HD	VOVD66A		
Belt - Gen.	101426	TR22443	Dresser D240T Diesel		
Belt - P.S.	D51277	TR28412	Belt - Fan	135009	②▲9490HD
Cummins JNS6BI Diesel			Belt - Alt.	126431	②7410
Belt - Fan	124421	②TR24365	VOVD84A		
Belt - Gen.	S1944	TR22443	Detroit Diesel 4-53N Diesel		
Belt - P.S.	D51277	TR28412	Belt - Fan	89816	②▲9476HD
Cummins JS6BI Diesel			Belt - Alt.	126431	②7410
Belt - Fan		②▲9365HD	Detroit Diesel 4-53N Diesel		
Belt - Gen.	112203	TR24449	Belt - Fan	89816	②▲9476HD
Belt - P.S.	D51277	TR28412	Belt - Alt.	126431	②7410

▲ Standard Belt Available. See Pages 630-631.
● Vulco-Flex® Coolant Hose.

② Two Required.
≈< Cut to Fit.

Belts and Coolant Hose for Road & Construction Equipment

Application	Mfr. Part No.	Our No.
DRESSER-GALION - Continued		
VOSPD66A		
Dresser D240T Diesel		
Belt - Fan	135009	②▲9490HD
Belt - Alt.	126431	②7410
VOSPD84A		
Detroit Diesel 4-53 Diesel		
Hose - Lower		●26509
Detroit Diesel 4-53N Diesel		
Belt - Fan	89816	②▲9476HD
Belt - Alt.	126431	②7410
VOST2-42A		
Dresser D140N Diesel		
Belt - Fan & Alt.	156051	②7470
Belt - P.S.	155936	7312
VR84H		
IH UD407 Diesel		
Belt - Fan & Alt.	612134C1	TR22692
Belt - Hyd. Pump	D104126	②▲9435HD
Hose - Upper		●26517
Hose - Lower		●26517
Warrior		
Continental F162		
Belt - Fan & Gen.	RD40434	TR24465
Belt - Hyd. Pump	R20011	TR28423
Hercules WXLC3		
Belt - Fan & Gen.; W/P.S.	76305A	TR28565
Belt - Fan & Gen.; W/O P.S.	40278A	TR28483
IH UD6 Diesel		
Belt - Gen.	54857DA	9300
Belt - Hyd. Pump	R20011	TR28423
DRESSER-HOUGH		
510		
IH D268 Diesel		
Belt - Fan & Alt.	683826C1	②▲9670HD
Hose - Upper - Eng. To Pipe; (2" I.D.)		24432
Hose - Upper - Pipe To Rad.; (2" I.D.)		24432
Hose - Lower - Eng. To Pipe; (2 1/4" I.D.)		24436
Hose - Lower - Pipe To Rad.; (2 1/4" I.D.)		24436
510B		
IH D268 Diesel		
Belt - Alt.	683826C1	②▲9670HD
510C		
Dresser D240T Diesel		
Hose - Upper; (1 3/4" I.D.)		②24428
Hose - Lower - Eng. To Pipe; (2 1/4" I.D.)		24436
515		
IH D358 Diesel		
Belt - Fan & Alt.	673417C1	②TR22648
515B		
Dresser D359T Diesel		
Belt - Fan & Alt.	1257765H1	K080635
Hose - Upper - Eng. To Pipe; (1 3/4" I.D.)		24428
Hose - Upper - Pipe To Rad.; (2" I.D.)		24432
Hose - Lower - Eng. To Pipe; (2 1/4" I.D.)		24436
Hose - Lower - Pipe To Rad.; (2 3/4" I.D.)		24444
IH D358 Diesel		
Belt - Alt.		②▲9680HD

Application	Mfr. Part No.	Our No.
DRESSER-HOUGH - Continued		
520B		
Dresser D359T Diesel		
Belt - Fan & Alt.	1257765H1	K080635
IH D358 Diesel		
Belt - Alt.		②▲9680HD
IH DT358 Diesel		
Belt - Fan & Alt.		②▲9690HD
530		
Dresser D505T Diesel		
Belt - Fan & Alt.		▲K080685HD
Belt - A.C.	1251357H1	▲9425HD
Hose - Upper; (2 1/4" I.D.)		②24436
Hose - Lower - Eng. To Pipe		21901
Hose - Lower - Pipe To Rad.; (3" I.D.)		24448
IH DT414 Diesel		
Belt - Fan & Alt.	683548C91	②TR22664
Belt - Air Brake Compr.		TR22770
540		
Dresser D505T Diesel		
Belt - Fan & Alt.	1257778H1	▲K080685HD
Belt - A.C.	1251357H1	▲9425HD
IH DT466 Diesel		
Belt - Fan & Alt.	683548C91	②TR22664
Belt - Air Brake Compr.		TR22770
550		
Cummins NTA855 Diesel		
Belt - Fan	1238447H1	K060450
Belt - W.P.	1238934H1	▲K060435HD
Belt - Alt.	1239751H1	K040460
Belt - A.C.		▲9415HD
IH DVT800 Diesel		
Belt - Fan	673949C91	②TR22692
Belt - Alt.	686613C91	②▲9530HD
555		
Cummins NTA855 Diesel		
Belt - Fan	1238447H1	K060450
Belt - W.P.	1238934H1	▲K060435HD
Belt - A.C.; W/1/2" Belt T.W.	1251357H1	▲9425HD
Belt - A.C.; W/3/4" Belt T.W.	1232822H1	TR24414
560		
IH DT817 Diesel		
Hose - Upper - Eng. To Pipe; (2 3/4" I.D.)		24444
Hose - Upper - Pipe To Rad.; (2 3/4" I.D.)		24444
Hose - Lower - Eng. To Pipe; (3 1/2" I.D.)		24456
Hose - Lower - Pipe To Rad.; (3 1/2" I.D.)		24456
IH DT817B Diesel		
Belt - Alt.	670464C1	TR22578
Belt - A.C.	670741C1	②TR22570
IH DT817C Diesel		
Belt - Fan & Alt.	670464C1	TR22578
Belt - Air Brake Compr.	672445C1	TR24538
Belt - A.C.	670740C1	TR22570
560B		
Cummins KT1150C Diesel		
Belt - Alt.	1238776H1	K050370
Belt - A.C.		TR22664
570		
Cummins VT1710 Diesel		
Belt - Fan	1238446H1	▲K060615HD
Belt - W.P.	1259899H1	K050450

② Two Required.

● Vulco-Flex® Coolant Hose.

▲ Standard Belt Available. See Pages 630-631.

Belts and Coolant Hose for Road & Construction Equipment

Application	Mfr. Part No.	Our No.	Application	Mfr. Part No.	Our No.
DRESSER-HOUGH - Continued			DRESSER-HOUGH - Continued		
580			H25B		
Detroit Diesel 16V-149 Diesel			IH 4-Cyl. 153		
Hose - Upper; (4 1/2" I.D.)		24272	Belt - Fan		149636R2 ♣9480HD
D90C			Belt - Alt./Gen.		349175R1 7440
IH DT573 Diesel			Belt - W.P. & Alt.		7440
Belt - Fan		328927R11 TR28680	Hose - Upper		●26509
Belt - W.P.		345013R1 TR22455	Hose - Lower - Eng. To Pipe; (1 3/8" I.D.)		24222
Belt - Gen. & Air Brake Compr.		341190R1 TR22474	Hose - Lower - Pipe To Rad.; (2" I.D.)		24232
Hose - Upper; (2 1/4" I.D.)		24236	IH D188 Diesel		
Hose - Lower; (3" I.D.)		24248	Belt - Fan		♣9480HD
D100B			Belt - Gen. & W.P.; Ser. No. 6800 & Before ..		315969R1 ♣9490HD
IH D817 Diesel			Belt - Gen. & W.P.; Ser. No. 6801 & After		672908C1 ♣9485HD
Belt - Gen.		323987R1 ♣9465HD	Hose - Upper		●26509
Belt - Air Brake Compr.; W/50 5/8" Belt O.C.		601684C1 TR24500	Hose - Lower		●26509
Belt - Air Brake Compr.; W/51 7/8" Belt O.C.		278714R1 TR24515	Waukesha 180GKB		
Hose - Upper; (3" I.D.)		♣24948	Belt - Fan		♣9455HD
Hose - Lower - Eng. To Pipe; (3 1/2" I.D.)		24256	Belt - W.P. & Gen.		190303 ♣9425HD
Hose - Lower - Pipe To Rad.; (3 1/2" I.D.)		24256	H30		
D120C			Detroit Diesel 3-53 Diesel		
IH DT817 Diesel			Belt - Fan		5126447 ♣9350HD
Belt - Gen.		323987R1 ♣9465HD	Belt - W.P. & Gen.		②7430
Belt - Air Brake Compr.; W/50 5/8" Belt O.C.		601684C1 TR24500	Hose - Upper; (2" I.D.)		24232
Belt - Air Brake Compr.; W/51 7/8" Belt O.C.		278714R1 TR24515	Hose - Upper		●26507
Hose - Upper; (2 7/8" I.D.)		♣24946	Hose - Lower		●26507
Hose - Lower - Eng. To Pipe; (3 1/2" I.D.)		24256	Hercules QXD3		
Hose - Lower - Pipe To Rad.; (3 1/2" I.D.)		24256	Hose - Lower		≡20206
D400			IH 4-Cyl. 263		
Detroit Diesel 12V-71 Diesel			Belt - Fan & Gen.		372596R1 ♣9480HD
Belt - Fan		♣9570HD	Belt - Fan, W.P. & Gen.		378113R2 ♣9480HD
D500			Hose - Upper		●26509
Cummins VT1710 Diesel			Hose - Lower		●26508
Belt - Fan		178578 ③TR28706	IH D236 Diesel		
Belt - W.P.; W/38" Belt O.C.		125367 TR28376	Belt - Fan & Alt.		670261C1 ♣9500HD
Belt - W.P.; W/39 1/2" Belt O.C.		178665 ②TR28390	Belt - Fan & Gen.		304436R1 ♣9505HD
Belt - Alt.		②TR22350	Hose - Upper		●26509
Belt - Gen.		178613 TR22344	Hose - Lower		●26509
Hose - Upper - Eng. To Pipe; (3" I.D.)		24448	IH U240		
Hose - Upper - Pipe To Rad.; (2 1/2" I.D.)		24440	Hose - Upper		●26509
Hose - Lower - Eng. To Pipe; (3" I.D.)		24448	Hose - Lower		●26508
Hose - Lower - Pipe To Rad.; (3 1/4" I.D.)		24452	H30A		
H12			Detroit Diesel 3-53 Diesel		
IH UD350 Diesel			Belt - Fan		5126447 ♣9350HD
Belt - Fan		48042DA TR30484	Belt - W.P. & Gen.		②7430
Belt - Gen.		54857DB 9300	Hose - Upper; (2" I.D.)		24232
H25			Hose - Upper		●26507
IH 4-Cyl. 153			Hose - Lower		●26507
Belt - Fan		149636R2 ♣9480HD	Hercules QXD3		
Belt - W.P. & Alt.		7440	Belt - Fan		109847 TR30467
IH D188 Diesel			Hose - Lower		≡20206
Belt - Fan		149636R2 ♣9480HD	IH 4-Cyl. 263		
Belt - W.P. & Gen.		315969R1 ♣9490HD	Belt - Fan & Gen.		372596R1 ♣9480HD
Waukesha 180DLC Diesel			Hose - Upper		●26509
Belt - Fan		♣9455HD	Hose - Lower		●26508
Belt - W.P. & Gen.		190303 ♣9425HD	IH D236 Diesel		
Hose - Upper		●25476	Belt - Fan & Alt.		670261C1 ♣9500HD
Hose - Lower		●25476	Belt - Fan & Gen.		304436R1 ♣9505HD
Waukesha 180GKB			Hose - Upper		●26509
Belt - Fan		♣9455HD	Hose - Lower		●26509
Belt - W.P. & Gen.		190303 ♣9425HD	IH U240		
Waukesha 180GLB			Belt - Fan & Gen.		TR28445
Hose - Upper		●25476	Hose - Upper		●26509
Hose - Lower		●25476	Hose - Lower		●26508
			IH UD236 Diesel		
Belt - Fan & Gen.		304436R1 ♣9505HD	IH UD240 Diesel		
			Belt - Fan & Gen.		TR28445

Road & Construction Equipment

♣ Standard Belt Available. See Pages 630-631.
 ③ Three Required.
 ● Vulco-Flex® Coolant Hose.

♣ Use Wire Inserted Green Stripe® Coolant Hose.
 ② Two Required.
 ≡ Cut to Fit.

Belts and Coolant Hose for Road & Construction Equipment

Application	Mfr. Part No.	Our No.
DRESSER-HOUGH - Continued		
H30B		
Detroit Diesel 3-53 Diesel		
Belt - Fan	5126447	②▲9350HD
Belt - W.P. & Gen.		②7430
Hose - Upper; (2" I.D.)		24232
Hose - Upper		●26507
Hose - Lower		●26507
Hercules QXD3		
Hose - Lower		≡20206
IH 4-Cyl. 263		
Belt - Fan & Gen.	372596R1	▲9480HD
Belt - Fan, W.P. & Gen.	378113R2	▲9480HD
Hose - Upper		●26509
Hose - Lower		●26508
IH D236 Diesel		
Belt - Fan & Alt.	670261C1	▲9500HD
Belt - Fan & Gen.	304436R1	▲9505HD
Hose - Upper		●26509
Hose - Lower		●26509
IH U240		
Belt - Fan, W.P. & Gen.	274705R1	TR28445
Hose - Upper		●26509
Hose - Lower		●26508
H30F		
Detroit Diesel 3-53 Diesel		
Belt - Fan	5126447	②▲9350HD
Belt - W.P. & Gen.		②7430
Hose - Upper; (2" I.D.)		24232
Hose - Upper		●26507
Hose - Lower		●26507
Hercules QXD3		
Belt - Fan	109847	TR30467
Hose - Lower		≡20206
IH 4-Cyl. 263		
Belt - Fan & Gen.	372596R1	▲9480HD
Hose - Upper		●26509
Hose - Lower		●26508
IH D236 Diesel		
Belt - Fan & Alt.	670261C1	▲9500HD
Belt - Fan & Gen.	304436R1	▲9505HD
Hose - Upper		●26509
Hose - Lower		●26509
IH U240		
Belt - Fan & Gen.		TR28445
Hose - Upper		●26509
Hose - Lower		●26508
IH UD236 Diesel		
Belt - Fan & Gen.	304436R1	▲9505HD
IH UD240 Diesel		
Belt - Fan & Gen.		TR28445
H30FB		
IH 4-Cyl. 263		
Belt - Fan & Gen.	372596R1	▲9480HD
H30R		
Detroit Diesel 3-53 Diesel		
Belt - Fan	5126447	②▲9350HD
Belt - W.P. & Gen.		②7430
Hose - Upper; (2" I.D.)		24232
Hose - Upper		●26507
Hose - Lower		●26507
Hercules QXD3		
Belt - Fan	109847	TR30467
Hose - Lower		≡20206
IH 4-Cyl. 263		
Belt - Fan & Gen.	372596R1	▲9480HD
Hose - Upper		●26509

Application	Mfr. Part No.	Our No.
DRESSER-HOUGH - Continued		
H30R - Continued		
IH 4-Cyl. 263 - Continued		
Hose - Lower		●26508
IH D236 Diesel		
Belt - Fan & Alt.	670261C1	▲9500HD
Belt - Fan & Gen.	304436R1	▲9505HD
Hose - Upper		●26509
Hose - Lower		●26509
IH U240		
Belt - Fan & Gen.		TR28445
Hose - Upper		●26509
Hose - Lower		●26508
IH UD236 Diesel		
Belt - Fan & Gen.	304436R1	▲9505HD
IH UD240 Diesel		
Belt - Fan & Gen.		TR28445
H30RB		
IH 4-Cyl. 263		
Belt - Fan & Gen.	372596R1	▲9480HD
H40		
IH 4-Cyl. 264		
Belt - Fan	274705R1	TR28445
IH D282 Diesel		
Belt - Fan; Ser. No. 17BH-2286 & After	149636R1	▲9480HD
Belt - W.P. & Gen.; Ser. No. 17BH-2286 & After	601379C1	▲9510HD
Belt - Fan & Gen.; Ser. No. 17BH-2285 & Before	304436R1	▲9505HD
IH U240		
Belt - Fan & Gen.	155836	TR28445
Belt - Air Brake Compr.	176106	▲9415HD
Hose - Upper - Eng. To Pipe; (1 7/8" I.D.)		24230
Hose - Upper - Pipe To Rad.; (1 7/8" I.D.)		24230
Hose - Lower		●26509
IH UD236 Diesel		
Belt - Fan & Gen.	304436R1	▲9505HD
Belt - Air Brake Compr.	191615	▲9400HD
Hose - Upper - Eng. To Pipe; (1 7/8" I.D.)		24230
Hose - Upper - Pipe To Rad.; (1 7/8" I.D.)		24230
Hose - Lower		●26508
H50		
Detroit Diesel 3-53 Diesel		
Belt - Fan	5137300	②▲9390HD
IH 4-Cyl. 263		
Belt - Fan & Gen.	372596R1	▲9480HD
Belt - Air Brake Compr.	176106	▲9415HD
IH U264		
Belt - Fan		TR28445
Belt - Fan & Gen.	155836	TR28445
Belt - Air Brake Compr.	176106	▲9415HD
Hose - Upper		●26509
Hose - Lower		●26509
IH UD282 Diesel		
Belt - Fan; Ser. No. 17BH-2286 & After	149636R1	▲9480HD
Belt - W.P. & Gen.; Ser. No. 17BH-2286 & After	612089C1	▲9510HD
Belt - Fan & Gen.; Ser. No. 17BH-2285 & Before	304436R1	▲9505HD
Belt - Air Brake Compr.	176106	▲9415HD
Hose - Upper		●26509
H50B		
Detroit Diesel 3-53 Diesel		
Belt - Fan	5137300	②▲9390HD
Hose - Upper; (2" I.D.)		24232
Hose - Lower		●26507

② Two Required.
● Vulco-Flex® Coolant Hose.

▲ Standard Belt Available. See Pages 630-631.
≡ Cut to Fit.

Belts and Coolant Hose for Road & Construction Equipment

Application	Mfr. Part No.	Our No.	Application	Mfr. Part No.	Our No.
DRESSER-HOUGH - Continued			DRESSER-HOUGH - Continued		
H50B - Continued			H60B - Continued		
IH 4-Cyl. 263			Cummins V352 Diesel - Continued		
Belt - Fan & Gen.	372596R1	▲9480HD	Hose - Upper		●26511
Belt - Air Brake Compr.	176106	▲9415HD	Hose - Lower - Eng. To Pipe		≡20172
Hose - Upper		●26508	Hose - Lower - Pipe To Rad.		≡20172
Hose - Lower		●26509	Cummins V378 Diesel		
IH U240			Belt - Fan & W.P.	178595	②TR22570
Hose - Upper		●26508	Belt - Alt.		TR24365
Hose - Lower		●26509	Hose - Upper		●26511
IH U264			Hose - Lower - Eng. To Pipe		≡20172
Belt - Fan		TR28445	Hose - Lower - Pipe To Rad.		≡20172
Belt - Fan & Gen.	155836	TR28445	IH 6-Cyl. 301		
Belt - Air Brake Compr.	176106	▲9415HD	Belt - Fan	401192R1	▲9670HD
IH UD282 Diesel			Belt - W.P. & Alt.	170481R2	▲9463HD
Belt - Fan; Ser. No. 17BH-2286 & After	149636R1	▲9480HD	Belt - Air Brake Compr.; Ser. No. 1322 & Before	181492H1	▲9440HD
Belt - W.P. & Gen.; Ser. No. 17BH-2286 & After	612089C1	▲9510HD	Belt - Air Brake Compr.; Ser. No. 1323 & After	891831C1	▲9451HD
Belt - Fan & Gen.; Ser. No. 17BH-2285 & Before	304436R1	▲9505HD	IH D301 Diesel		
Belt - Air Brake Compr.	176106	▲9415HD	Belt - Fan	358326C91	▲9480HD
Hose - Upper		●26507	Belt - W.P. & Alt.	670261C1	▲9505HD
Hose - Lower		●26507	Belt - Air Brake Compr.; Ser. No. 1322 & Before	181492H1	▲9440HD
H50C			Belt - Air Brake Compr.; Ser. No. 1323 & After	891831C1	▲9451HD
IH 6-Cyl. 301			H60E		
Belt - Fan	208033H1	▲9476HD	IH D360 Diesel		
Belt - Fan, W.P. & Gen.	378113R2	▲9480HD	Belt - Fan & Alt.; W/65 3/8" Belt O.C.	680600C1	②TR22648
Belt - W.P. & Alt./Gen.		▲9480HD	Belt - Fan & Alt.; W/66 1/8" Belt O.C.		②TR22657
Belt - Alt. & W.P.	188839H1	▲9480HD	Belt - Air Brake Compr.; Ser. No. 4407 & Before	673029C1	▲9470HD
Belt - Air Brake Compr.; Ser. No. 2795 Thru 3186		▲9400HD	Belt - Air Brake Compr.; Ser. No. 4408 & After	683457C1	TR22770
Belt - Air Brake Compr.; Ser. No. 3199 Thru 3209		▲9400HD	Hose - Upper - Eng. To Pipe; (2 1/4" I.D.)		24436
Belt - Air Brake Compr.; Ser. No. 3187 Thru 3198	170780R21	▲9470HD	Hose - Upper - Pipe To Rad.; (2 1/4" I.D.)		24436
Belt - Air Brake Compr.; Ser. No. 3210 & After	170780R21	▲9470HD	Hose - Lower - Eng. To Pipe; (3" I.D.)		24448
Hose - Lower		●26511	Hose - Lower - Pipe To Rad.; (3" I.D.)		24448
IH D282 Diesel			H65		
Belt - Fan & Alt.	670261R1	▲9505HD	Cummins C160CI Diesel; Cummins JN130 Diesel		
Belt - Fan & Gen.	612089C1	▲9510HD	Belt - Fan	124479	②TR22363
Belt - Air Brake Compr.; Ser. No. 3186 & Before	191615H1	▲9400HD	Belt - W.P.; W/3/4" Belt T.W.; W/31 3/4" Belt O.C.	124424	TR24315
Belt - V.P.	170780R2	▲9470HD	Belt - W.P.; W/5/8" Belt T.W.; W/32 1/4" Belt O.C.	178456	6932
Hose - Upper - Eng. To Pipe; (2" I.D.)		24432	Belt - Gen.	70885	TR22461
Hose - Upper - Pipe To Rad.; (2" I.D.)		24432	Cummins JN6CI Diesel		
Hose - Lower		●26509	Hose - Upper		●26509
H60			IH G372		
Cummins JF6CI Diesel			Belt - Fan & Gen.	147985H2	②TR22517
Belt - Fan	124479	②TR22363	Belt - Air Brake Compr.	189527	▲9490HD
Belt - W.P.	124424	TR24315	Hose - Upper; (2" I.D.)		24232
Belt - Gen.		TR22461	Hose - Lower; (2" I.D.)		24232
Hose - Upper		●26509	IH U372		
Hose - Lower - Eng. To Pipe; (2 1/4" I.D.)		24236	Hose - Upper; (2" I.D.)		24232
Hose - Lower - Pipe To Rad.; (2 1/4" I.D.)		24236	Hose - Lower; (2 7/8" I.D.)		24246
Detroit Diesel 3-71 Diesel			H65B		
Belt - Fan	5128579	②▲9500HD	Cummins JN130 Diesel		
Belt - Gen.	5164293	②TR22322	Belt - Fan	124479	②TR22363
Hose - Upper		●26508	Belt - W.P.; W/3/4" Belt T.W.; W/31 3/4" Belt O.C.	124424	TR24315
Hose - Lower		●26508	Belt - W.P.; W/5/8" Belt T.W.; W/32 1/4" Belt O.C.	178456	6932
IH G372			Belt - Gen.	70885	TR22461
Belt - Fan & Gen.	147985H3	②TR22517	Cummins JN6CI Diesel		
Belt - Air Brake Compr.		▲9490HD	Hose - Upper		●26509
Hose - Upper; (2" I.D.)		24232	IH G372		
Hose - Lower; (2" I.D.)		24232	Belt - Fan & Gen.	147985H2	②TR22517
IH RD372 Diesel			Belt - Air Brake Compr.	189527	▲9490HD
Hose - Upper; (2" I.D.)		24232	Hose - Upper; (2" I.D.)		24232
Hose - Lower; (2" I.D.)		24232	Hose - Lower; (2" I.D.)		24232
H60B			Cummins V352 Diesel		
Cummins V352 Diesel			Belt - Fan & W.P.	178605	②TR22553
Belt - Fan & W.P.	178605	②TR22553	Belt - Alt.	178376	▲9330HD
Belt - Alt.	178376	▲9330HD			

Road & Construction Equipment

▲ Standard Belt Available. See Pages 630-631.
② Two Required.

● Vulco-Flex® Coolant Hose.
≡ Cut to Fit.

Belts and Coolant Hose for Road & Construction Equipment

Application	Mfr. Part No.	Our No.
DRESSER-HOUGH - Continued		
H65B - Continued		
IH U372		
Hose - Upper; (2" I.D.)		24232
Hose - Lower; (2 7/8" I.D.)		24246
H65C		
Cummins JN6CI Diesel		●26509
Hose - Upper		●26509
IH DT361 Diesel		
Belt - Fan & Alt. 612134C11		②TR24688
Belt - Air Brake Compr. 612142C1		7520
IH DT407 Diesel		
Hose - Upper - Eng. To Pipe; (2 3/8" I.D.)		24238
Hose - Upper - Pipe To Rad.; (2 3/8" I.D.)		24238
Hose - Lower - Eng. To Pipe; (2 1/4" I.D.)		24236
Hose - Lower - Pipe To Rad.; (2 1/4" I.D.)		24236
IH G372		
Hose - Upper; (2" I.D.)		24232
Hose - Lower; (2" I.D.)		24232
IH U372		
Hose - Upper; (2" I.D.)		24232
Hose - Lower; (2 7/8" I.D.)		24246
H65G		
Cummins C160CI Diesel; Cummins JN130 Diesel		
Belt - Fan 124479		②TR22363
Belt - W.P.; W/3/4" Belt T.W.; W/31 3/4" Belt O.C. 124424		TR24315
Belt - W.P.; W/5/8" Belt T.W.; W/32 1/4" Belt O.C. 178456		6932
Belt - Gen. 70885		TR22461
IH G372		
Belt - Fan & Gen. 147985H2		②TR22517
Belt - Air Brake Compr. 189527		♣9490HD
H70		
Cummins CI6CI Diesel		●26509
Hose - Upper		●26509
Hose - Lower		●26522
Cummins JF6BI Diesel		
Belt - Fan 124479		②TR22363
Belt - W.P. 124478		TR22322
Belt - Gen.		TR22461
Hose - Upper - Eng. To Pipe; (2" I.D.)		24232
Hose - Upper - Pipe To Rad.; (2" I.D.)		24232
Hose - Lower; (2 1/4" I.D.)		24236
Cummins JN6BI Diesel		
Hose - Upper - Eng. To Pipe; (2" I.D.)		24232
Hose - Upper - Pipe To Rad.; (2" I.D.)		24232
Hose - Lower; (2 1/4" I.D.)		24236
IH U372		
Belt - Fan 87878HA		②TR22517
Hose - Upper - Eng. To Pipe; (2" I.D.)		24232
Hose - Upper - Pipe To Rad.; (2" I.D.)		24232
H70B		
Cummins JF6BI Diesel		
Belt - Fan 124479		②TR22363
Belt - W.P. 124478		TR22322
Belt - Gen.		TR22461
IH U372		
Belt - Fan 87878HA		②TR22517
H70C		
Cummins C160CI Diesel		
Belt - Fan 124479		②TR22363
Belt - W.P. 124424		TR24315
Belt - Gen. 178450		TR22495

Application	Mfr. Part No.	Our No.
DRESSER-HOUGH - Continued		
H70C - Continued		
Cummins CI6CI Diesel		
Hose - Upper		●26509
Hose - Lower		●26522
Cummins JF6BI Diesel; Cummins JN6BI Diesel		
Hose - Upper - Eng. To Pipe; (2" I.D.)		24232
Hose - Upper - Pipe To Rad.; (2" I.D.)		24232
Hose - Lower; (2 1/4" I.D.)		24236
Detroit Diesel 4-71 Diesel		
Belt - Gen.; W/12V. Gen. 3224367		TR28390
Belt - V.P. 151167		TR28570
IH U372		
Hose - Upper - Eng. To Pipe; (2" I.D.)		24232
Hose - Upper - Pipe To Rad.; (2" I.D.)		24232
H70D		
Cummins CI6CI Diesel		
Hose - Upper		●26509
Hose - Lower		●26522
Cummins JF6BI Diesel; Cummins JN6BI Diesel		
Hose - Upper - Eng. To Pipe; (2" I.D.)		24232
Hose - Upper - Pipe To Rad.; (2" I.D.)		24232
Hose - Lower; (2 1/4" I.D.)		24236
IH U372		
Hose - Upper - Eng. To Pipe; (2" I.D.)		24232
Hose - Upper - Pipe To Rad.; (2" I.D.)		24232
H80A		
Cummins CS464C Diesel		
Belt - Fan 178530		②TR24365
Belt - Alt. 178470		TR22474
IH DT429 Diesel		
Belt - Fan & Alt. 670914C91		②TR22553
Belt - W.P. 328502R1		TR22485
H80B		
IH DT466 Diesel		
Belt - Fan & Alt. 673481C1		②TR22648
Belt - Fan, Alt. & W.P.; Ser. No. 10210 & Before 674117C1		TR22657
Belt - Fan, Alt. & W.P.; Ser. No. 10211 & After 683548C91		②TR22664
Belt - Air Brake Compr. 673029C1		♣9470HD
H90B		
Cummins C175 Diesel		
Belt - Fan 124421		②TR24365
Belt - W.P. 101427		TR22299
Belt - Gen. 70885		TR22461
Hose - Lower - Eng. To Pipe; (2 1/4" I.D.)		24236
Hose - Lower - Pipe To Rad.; (2 1/4" I.D.)		24236
Cummins JN6BI Diesel		
Belt - Fan 70888		②♣9360HD
Belt - Gen. 70885		TR22461
Belt - V.P. 70886		TR22299
Hose - Lower - Eng. To Pipe; (2 1/4" I.D.)		24236
Hose - Lower - Pipe To Rad.; (2 1/4" I.D.)		24236
Detroit Diesel 4055C Diesel		
Hose - Upper		●26507
Hose - Lower		●26509
H90C		
Cummins V588C		
Hose - Upper; (2 1/4" I.D.)		24236
Hose - Lower		●26520
Detroit Diesel 6V-53 Diesel		
Hose - Upper; (2 1/4" I.D.)		24236
IH DT573 Diesel		
Belt - Fan 328927R11		TR28680
Belt - W.P. 345013R1		TR22455

● Vulco-Flex® Coolant Hose.
♣ Standard Belt Available. See Pages 630-631.

② Two Required.

Road & Construction Equipment

Belts and Coolant Hose for Road & Construction Equipment

Application	Mfr. Part No.	Our No.
DRESSER-HOUGH - Continued		
H90C - Continued		
IH DT573 Diesel - Continued		
Belt - Gen. & Air Brake Compr.	341190R1	TR22474
Hose - Upper; (2 1/4" I.D.)		24236
H90D		
Cummins C175 Diesel		
Belt - Fan	124421	②TR24365
Belt - W.P.	101427	TR22299
Belt - Gen.	70885	TR22461
Hose - Lower - Eng. To Pipe; (2 1/4" I.D.)		24236
Hose - Lower - Pipe To Rad.; (2 1/4" I.D.)		24236
Cummins JH6BI Diesel		
Belt - Fan	70888	②▲9360HD
Belt - Gen.	70885	TR22461
Belt - V.P.	70886	TR22299
Cummins JN6BI Diesel		
Hose - Lower - Eng. To Pipe; (2 1/4" I.D.)		24236
Hose - Lower - Pipe To Rad.; (2 1/4" I.D.)		24236
Detroit Diesel 4055C Diesel		
Hose - Upper		●26507
Hose - Lower		●26509
H90E		
IH DT573 Diesel		
Hose - Upper - Eng. To Pipe; (2" I.D.)		24232
Hose - Upper - Pipe To Rad.; (2" I.D.)		24232
Hose - Lower - Eng. To Pipe; (3" I.D.)		24248
Hose - Lower - Pipe To Rad.; (3" I.D.)		24248
IH DVT573 Diesel		
Belt - Fan	670340C11	②TR28596
Belt - W.P.	345013R1	TR22455
Belt - Alt./Gen. & Air Brake Compr.	670339C1	TR22517
Hose - Upper - Eng. To Pipe; (2" I.D.)		24232
Hose - Upper - Pipe To Rad.; (2" I.D.)		24232
Hose - Lower - Eng. To Pipe; (3" I.D.)		24248
Hose - Lower - Pipe To Rad.; (3" I.D.)		24248
IH DVT573B Diesel		
Belt - Fan; Ser. No. 7500 & After	673949C91	②TR22692
Belt - Alt.; Ser. No. 7500 Thru 9487	673950C1	▲9495HD
Belt - Alt.; Ser. No. 9488 & After	877414R11	②▲9485HD
H100		
Cummins NH220CF Diesel		
Belt - Fan	178617	②TR28498
Belt - W.P.	178570	TR24400
Belt - Gen.	178567	TR22350
Detroit Diesel 6V-71 Diesel; Detroit Diesel 8V-71 Diesel		
Belt - Fan; W/51 7/8" Belt O.C.	5168993	TR24515
Belt - Fan; W/58 1/4" Belt O.C.	5130662	③▲9580HD
Belt - Gen.	5164293	②TR22322
IH D817 Diesel		
Belt - Gen.	323987R1	▲9465HD
Belt - Air Brake Compr.	278714R1	TR24515
Hose - Upper; (3" I.D.)		②24948
Hose - Lower - Eng. To Pipe; (3 1/4" I.D.)		24252
Hose - Lower - Pipe To Rad.; (3 1/4" I.D.)		24252
H100A		
Cummins NH220CF Diesel		
Belt - Fan	178617	②TR28498
Belt - W.P.	178570	TR24400
Belt - Gen.	178567	TR22350
Detroit Diesel 6V-71 Diesel; Detroit Diesel 8V-71 Diesel		
Belt - Fan; W/51 7/8" Belt O.C.	5168993	TR24515
Belt - Fan; W/58 1/4" Belt O.C.	5130662	③▲9580HD
Belt - Gen.	5164293	②TR22322
IH D817 Diesel		
Belt - Gen.	323987R1	▲9465HD
Belt - Air Brake Compr.	278714R1	TR24515

Application	Mfr. Part No.	Our No.
DRESSER-HOUGH - Continued		
H100B		
Cummins NH220CF Diesel		
Belt - Fan	178617	②TR28498
Belt - W.P.	178570	TR24400
Belt - Gen.	178567	TR22350
Cummins NH220CI Diesel; Cummins NH250CI Diesel		
Hose - Upper		●26511
Hose - Lower; (2 1/4" I.D.)		24236
Detroit Diesel 6V-71 Diesel		
Belt - Fan; W/51 7/8" Belt O.C.	5168993	TR24515
Belt - Fan; W/58 1/4" Belt O.C.	5130662	③▲9580HD
Belt - Gen.	5164293	②TR22322
Hose - Lower; (2 1/4" I.D.)		24236
Detroit Diesel 8V-71 Diesel		
Belt - Fan; W/51 7/8" Belt O.C.	5168993	TR24515
Belt - Fan; W/58 1/4" Belt O.C.	5130662	③▲9580HD
Belt - Gen.	5164293	②TR22322
IH D817 Diesel		
Belt - Gen.	323987R1	▲9465HD
Belt - Air Brake Compr.	278714R1	TR24515
Hose - Upper; (2 7/8" I.D.)		②24946
Hose - Lower; (3 1/2" I.D.)		24256
H100C		
IH DT817C Diesel		
Belt - Air Brake Compr.	601684C1	TR24500
Hose - Lower - Eng. To Pipe; (3 1/2" I.D.)		24256
Hose - Lower - Pipe To Rad.; (3 1/2" I.D.)		24256
H120		
Cummins NRT6BI Diesel		
Belt - Fan	178617	TR28498
Belt - W.P.	178628	TR24438
Belt - Gen.	178568	TR22363
Hose - Upper		●26509
Hose - Lower - Eng. To Pipe; (2 1/4" I.D.)		24236
Hose - Lower - Pipe To Rad.; (2 1/4" I.D.)		24236
Cummins NRT6CI Diesel		
Belt - Fan	178617	TR28498
Belt - W.P.	178628	TR24438
Belt - Gen.	178568	TR22363
Cummins NT310CI Diesel		
Belt - Fan	178617	②TR28498
Belt - W.P.	178628	TR24438
Belt - Gen.	178599	TR22410
Detroit Diesel 6V-71 Diesel		
Belt - Fan	5130662	③▲9580HD
Detroit Diesel 8V-71 Diesel		
Belt - Fan	5130662	③▲9580HD
Hose - Upper; (2 1/4" I.D.)		24236
Hose - Lower; (2 3/4" I.D.)		24244
IH D817 Diesel		
Belt - Fan & Gen.	310081R1	▲9480HD
Belt - Air Brake Compr.	278714R1	TR24515
IH DT817 Diesel		
Belt - Fan & Gen.	310081R1	▲9480HD
Belt - Air Brake Compr.	278714R1	TR24515
Hose - Upper; (2 7/8" I.D.)		②24946
Hose - Lower; (3 1/2" I.D.)		24256
H120A		
IH DT817 Diesel		
Belt - Fan, W.P. & Gen.	323987R1	▲9465HD
Belt - Air Brake Compr.		TR24500
H120B		
Cummins NRT6BI Diesel		
Belt - Fan	178617	TR28498
Belt - W.P.	178628	TR24438

Road & Construction Equipment

② Two Required.
 ● Vulco-Flex® Coolant Hose.
 ⚙ Use Wire Inserted Green Stripe® Coolant Hose.

▲ Standard Belt Available. See Pages 630-631.
 ③ Three Required.

Belts and Coolant Hose for Road & Construction Equipment

Application	Mfr. Part No.	Our No.
DRESSER-HOUGH - Continued		
H120B - Continued		
Cummins NRT6BI Diesel - Continued		
Belt - Gen.	178568	TR22363
Hose - Upper		●26509
Hose - Lower - Eng. To Pipe; (2 1/4" I.D.)		24236
Hose - Lower - Pipe To Rad.; (2 1/4" I.D.)		24236
Cummins NRT6CI Diesel		
Belt - Fan	178617	TR28498
Belt - W.P.	178628	TR24438
Belt - Gen.	178568	TR22363
Cummins NT310CI Diesel		
Belt - Fan	178617	②TR28498
Belt - W.P.	178628	TR24438
Belt - Gen.	178599	TR22410
Detroit Diesel 6V-71 Diesel		
Belt - Fan	5130662	③▲9580HD
Detroit Diesel 8V-71 Diesel		
Belt - Fan	5130662	③▲9580HD
Hose - Upper; (2 1/4" I.D.)		24236
Hose - Lower; (2 3/4" I.D.)		24244
IH D817 Diesel		
Belt - Fan & Gen.	310081R1	▲9480HD
Belt - Air Brake Compr.	278714R1	TR24515
IH DT817 Diesel		
Belt - Fan & Gen.	310081R1	▲9480HD
Belt - Air Brake Compr.	278714R1	TR24515
Hose - Upper; (2 7/8" I.D.)		⊛24946
Hose - Lower; (3 1/2" I.D.)		24256
H120C		
IH 817H Diesel		
Belt - Fan, W.P. & Gen.; Ser. No. 501 Thru 3876	323987R1	▲9465HD
Belt - Fan, W.P. & Gen.; Ser. No. 3877 & After	385738R1	▲9490HD
Belt - Air Brake Compr.		TR24500
IH DT817 Diesel		
Belt - Fan & Gen.	316250R1	▲9490HD
Belt - Air Brake Compr.	601684C1	TR24500
IH DT817B Diesel		
Belt - Fan & Alt.	670939C2	TR22553
Belt - Air Brake Compr.	601684C1	TR24500
H400		
Detroit Diesel 12V-71 Diesel		
Belt - Fan; W/55 1/4" Belt O.C.	5133763	③▲9550HD
Belt - Fan; W/57 1/4" Belt O.C.	5133765	③▲9570HD
Belt - Gen.		TR22392
Belt - Air Brake Compr.		TR28473
Hose - Upper - Eng. To Pipe; (2 1/2" I.D.)		24240
Hose - Upper - Pipe To Rad.; (2 1/2" I.D.)		24240
Hose - Lower - Eng. To Pipe; (3 1/2" I.D.)		24256
Hose - Lower - Pipe To Rad.; (3 1/2" I.D.)		24256
H400B		
Cummins VT1710 Diesel		
Belt - Fan; W/57" Belt O.C.	178674	③TR28565
Belt - Fan; W/62 1/8" Belt O.C.	135415	③TR28616
Belt - W.P.; W/39 1/2" Belt O.C.	178665	②TR28390
Belt - W.P.; W/40 1/2" Belt O.C.	178657	②TR28400
Belt - Alt.	178520	②▲9380HD
Belt - Gen.; W/33 3/8" Belt O.C.		②TR22329
Belt - Gen.; W/34 3/4" Belt O.C.	178613	②TR22344
H400C		
Cummins VT1710 Diesel		
Belt - Fan; W/57" Belt O.C.	178674	③TR28565
Belt - Fan; W/62 1/8" Belt O.C.	135415	③TR28616
Belt - W.P.; W/39 1/2" Belt O.C.	178665	②TR28390
Belt - W.P.; W/40 1/2" Belt O.C.	178657	②TR28400

Application	Mfr. Part No.	Our No.
DRESSER-HOUGH - Continued		
H400C - Continued		
Cummins VT1710 Diesel - Continued		
Belt - Alt.	178520	②▲9380HD
Belt - Gen.; W/33 3/8" Belt O.C.		②TR22329
Belt - Gen.; W/34 3/4" Belt O.C.	178613	②TR22344
Hose - Upper - Eng. To Pipe; (3" I.D.)		24448
Hose - Upper - Pipe To Rad.; (3" I.D.)		24448
Hose - Lower - Eng. To Pipe; (3 1/2" I.D.)		24456
Hose - Lower - Pipe To Rad.; (3 1/2" I.D.)		24456
H560		
IH DT817B Diesel		
Belt - Alt.	670464C1	TR22578
Belt - Air Brake Compr.	672445C1	TR24538
Belt - A.C.	670741C1	TR22570
HF		
IH UD281.4 Diesel		
Belt - Fan	16131DA	TR28454
Belt - Gen.	52318DA	9279
HH		
Hercules JXD Diesel		
Belt - Fan & V.P.	40515A	②TR28522
Belt - Gen.		TR28346
HM		
Hercules DJXH Diesel		
Belt - Fan & Gen.; Ser. No. 90490 & Before		TR30448
Belt - Fan & Gen.; Ser. No. 90491 & After	113177	TR30467
Belt - Gen.; Ser. No. 90491 & After	113175	TR26353
HO		
Cummins JN6BI Diesel		
Belt - Fan; W/30 1/2" Belt O.C.	101427	TR22299
Belt - Fan; W/36 1/4" Belt O.C.	70888	②▲9360HD
Belt - Gen.	70885	TR22461
Belt - Hyd. Pump	70886	TR22299
TC60		
IH U240		
Belt - Fan	78910R1	TR28445
DROTT		
30DH		
Cummins NH230 Diesel		
Belt - Fan		②TR24457
Belt - Alt.		TR22363
Belt - Hyd. Pump	178509	②TR28454
30YC		
IH C263 Diesel		
Belt - Fan & Alt.	64231	▲9476HD
Hose - Upper		⊚20611
		or
		●26508
Hose - Lower		●26511
35		
Allis-Chalmers 2900 Diesel		
Hose - Upper; W/20" Hose		●26511
Hose - Upper; W/24" Hose		●26512
Hose - Lower		●26511
Cummins 6V-53 Diesel		
Belt - Fan	178685	②TR22485
Belt - Alt.	178471	▲9365HD
Cummins V352 Diesel		
Hose - Upper		●26512
Hose - Lower; W/19" Hose		●26523
Hose - Lower; W/24" Hose		●26512

- Vulco-Flex® Coolant Hose.
- ③ Three Required.
- ⊛ Use Wire Inserted Green Stripe® Coolant Hose.

- ② Two Required.
- ▲ Standard Belt Available. See Pages 630-631.
- ⊚ Cut to Fit.

Belts and Coolant Hose for Road & Construction Equipment

Application	Mfr. Part No.	Our No.	Application	Mfr. Part No.	Our No.
DROTT - Continued			DROTT - Continued		
35 - Continued			40 Cruz-Air - Continued		
Detroit Diesel 3-53 Diesel			Cummins V378 Diesel - Continued		
Belt - Fan	62939M1	▲9430HD	Hose - Upper		●26511
Belt - Alt.	27955	7425	Hose - Lower		●26521
Hose - Upper		●26511	Detroit Diesel 4-53N Diesel		
Detroit Diesel 4-53N Diesel			Belt - Fan & Air Brake Compr. 5137637		
Belt - Alt.	S27955	②▲9390HD	Belt - W.P. & Alt.		②7445
Hose - Upper; W/8 1/2" Hose(2 1/2" I.D.)		24240	Belt - Alt.		②7425
Hose - Upper; W/14 1/2" Hose		●26509	Belt - P.S.	71811	②7400
Hose - Lower; W/9 1/2" Hose		●26507	Belt - V.P.	208005	②▲9510HD
Hose - Lower; W/12 1/4" Hose		●26508	Hose - Upper; W/14 1/2" Hose		●26509
IH D263 Diesel			Hose - Upper; W/17" Hose		●26510
Hose - Upper		●26508	Hose - Lower; W/9 1/2" Hose		●26507
IH D282 Diesel			Hose - Lower; W/12 1/4" Hose		●26508
Hose - Upper		●26508	Detroit Diesel 4-71 Diesel		
Hose - Lower		●26511	Hose - Upper		●26502
IH D301 Diesel			Hose - Lower; W/12 1/4" Hose		●26508
Belt - Fan & Alt.	81044	▲9490HD	Hose - Lower; W/14 1/2" Hose		●26509
Hose - Upper; W/14 1/2" Hose		●26509	Ford V-8 330		
Hose - Upper; W/24" Hose		●26512	Belt - Fan & Alt.	84149	②▲9451HD
Hose - Lower		●26512	Belt - P.S.	84150	②▲9590HD
Perkins 6-Cyl. 354 Diesel			Hose - Upper		●26512
Belt - Fan & Alt.	81486	▲9540HD	Hose - Lower		20685
Hose - Upper; W/14 1/2" Hose		●26509	Perkins 6-Cyl. 354 Diesel		
Hose - Upper; W/24" Hose		●26512	Belt - Fan & Alt.	69966	▲9510HD
Hose - Lower		●26512	Belt - V.P.	83695	▲9560HD
35D			Hose - Upper		●26509
Case A336BDT Diesel			Hose - Lower; W/20" Hose		●26511
Hose - Lower		●26531	Hose - Lower; W/24" Hose		●26512
35EC			40C		
Detroit Diesel 4-53 Diesel			Allis-Chalmers 2900 Diesel		
Belt - Fan & Alt.	27955	②7425	Hose - Upper		●26512
Hose - Upper		●26511	Cummins V352 Diesel		
Hose - Lower		●26510	Hose - Upper		●26512
40 Crawler			Hose - Lower		●26522
Case A504BDT Diesel			Detroit Diesel 4-53 Diesel		
Belt - Fan & Alt.	S88836	TR22607	Belt - Alt.	205839	7425
Cummins V352 Diesel			Detroit Diesel 4-71 Diesel		
Belt - Fan	178685	②TR22485	Hose - Upper		●26501
Belt - Alt.	178471	▲9365HD	Hose - Lower		●26508
Detroit Diesel 4-53N Diesel			Perkins 6-Cyl. 354 Diesel		
Belt - Fan		②▲9430HD	Hose - Upper		●26512
Belt - Alt.	27955	②7425	40R		
Detroit Diesel 4-71 Diesel			Cummins V352 Diesel		
Belt - Fan		②7420	Belt - Pump	83343	▲9400HD
Belt - Alt.	82985	②▲9365HD	Detroit Diesel 4-53 Diesel		
40 Cruz-Air			Belt - Fan		
Allis-Chalmers 2900 Diesel			Belt - P.S.		
Belt - V.P.	82628	▲9620HD	71811		
Hose - Upper		●26512	Ford V-8 361		
Hose - Lower		●26511	Hose - Upper		
Case A504BDT Diesel			Hose - Upper		
Hose - Upper; W/14" Hose		●26530	Hose - Lower		
Hose - Upper; W/16" Hose		●26531	●26512		
Hose - Lower; W/16" Hose		●26531	40YR		
Hose - Lower; W/24" Hose		●26532	Detroit Diesel 4-53 Diesel		
Cummins V352 Diesel			Belt - Fan & Air Brake Compr.		
Belt - Fan	178685	②TR22485	27955		
Belt - Alt.; W/36 3/4" Belt O.C.	178471	▲9365HD	Belt - W.P. & Alt.		
Belt - Alt.; W/39 1/4" Belt O.C.		▲9390HD	7425		
Belt - P.S.	71811	7400	Belt - P.S.		
Hose - Lower		●26522	7405		
Cummins V378 Diesel			Hose - Upper		
Belt - Fan	178685	②TR22485	●26509		
Belt - Alt.	178471	▲9365HD	Hose - Lower		
50			●26507		
Case A504BDT Diesel			Case A504BDT Diesel		
Belt - Fan & Alt.	S88836	TR22607	Belt - Fan & Alt.	S88836	TR22607
Hose - Upper		●26530	Hose - Upper		●26530
Hose - Lower; W/21" Hose(2 1/2" I.D.)		②24940	Hose - Lower; W/21" Hose(2 1/2" I.D.)		②24940

▲ Standard Belt Available. See Pages 630-631.
② Two Required.

● Vulco-Flex® Coolant Hose.
② Use Wire Inserted Green Stripe® Coolant Hose.

Road & Construction Equipment

Belts and Coolant Hose for Road & Construction Equipment

Application	Mfr. Part No.	Our No.
DROTT - Continued		
50 - Continued		
Case A504BDT Diesel - Continued		
Hose - Lower; W/24" Hose		●26532
Detroit Diesel 6V-53N Diesel		
Belt - Fan	S84944	②▲9420HD
Belt - Alt.		②7375
Hose - Upper; W/15 1/2" Hose		●25477
Hose - Upper; W/20" Hose		●25480
Hose - Lower		●26511
50BEC		
Detroit Diesel 6V-53 Diesel		
Belt - Fan	5139026	②▲9420HD
Belt - W.P.	5139228	②7370
Belt - Alt.	211672	②7375
Hose - Upper		②●25480
Hose - Lower		●26511
80 Cruz-Air		
Cummins V785 Diesel		
Belt - Fan	178691	③TR22517
Belt - W.P.	178530	TR24365
Belt - Alt.	178685	TR22485
Hose - Upper		②●26523
Hose - Lower		●26523
Detroit Diesel 8V-53 Diesel		
Hose - Upper		②●26525
Detroit Diesel 8V-71 Diesel		
Hose - Upper		②●26522
Hose - Lower		●26536
250 Travelift		
Continental F163		
Hose - Upper		●25480
Hose - Lower		●25476
Detroit Diesel 3-53 Diesel		
Hose - Upper		●26509
Hose - Lower		20685
250AI Travelift		
Continental F163		
Belt - Fan & Gen.	74799	7425
Detroit Diesel 3-53 Diesel; Detroit Diesel 4-53 Diesel		
Belt - Fan	62939M1	▲9430HD
Belt - Alt.	27955	7425
500A Travelift		
Detroit Diesel 3-53 Diesel		
Hose - Upper; Ser. No. 999 & Before		●26509
Hose - Upper; Ser. No. 1000 & After		●26512
Hose - Lower; Ser. No. 999 & Before		●26507
Hose - Lower; Ser. No. 1000 & After		●26511
IH		
Hose - Upper		●26508
Hose - Lower		●26511
IH Diesel		
Hose - Upper		●26508
Hose - Lower		●26508
500AI Travelift; 600A Travelift		
Continental F163		
Belt - Fan & Gen.	74799	7425
Detroit Diesel 3-53 Diesel; Detroit Diesel 4-53 Diesel		
Belt - Fan	62939M1	▲9430HD
Belt - Alt.	27955	7425
650A Travelift		
Continental F163		
Belt - Fan & Gen.	74799	7425

Application	Mfr. Part No.	Our No.
DROTT - Continued		
650A Travelift - Continued		
Detroit Diesel 3-53 Diesel		
Belt - Fan	62939M1	▲9430HD
Belt - Alt.	27955	7425
Detroit Diesel 4-53 Diesel		
Belt - Fan	62939M1	▲9430HD
Belt - Alt.	27955	7425
Hose - Upper; Ser. No. 1000 & After		●26511
Hose - Lower; Ser. No. 1000 & After		●26508
Ford V-8 361		
Hose - Upper		●26512
Hose - Lower		●26509
800AC Travelift		
Detroit Diesel 4-71 Diesel		
Belt - Alt.	74061	TR26366
990TC		
Cummins 6-Cyl. 855 Diesel		
Hose - Upper - Eng. To Pipe; (2 1/4" I.D.)		24436
Hose - Lower - Eng. To Pipe; (2 3/8" I.D.)		24438
Hose - Lower - Pipe To Rad.; (2 1/4" I.D.)		24436
Cummins NTC290 Diesel		
Hose - Lower - Eng. To Pipe		●26533
1000A Travelift		
Cummins V504 Diesel		
Hose - Upper		●26515
Hose - Lower		●26522
Detroit Diesel 4-71 Diesel		
Hose - Upper		●26508
Hose - Lower		●26509
Ford V-8 361		
Hose - Upper		●26508
Hose - Lower		●26508
1000AI Travelift		
Detroit Diesel 4-71 Diesel		
Belt - Alt.	74061	TR26366
1500; 1800		
Case A504BDT Diesel		
Belt - Fan & Alt.	S88836	TR22607
Belt - Air Brake Compr.; W/35 1/8" Belt O.C.	S88837	7350
Belt - Air Brake Compr.; W/55 1/4" Belt O.C.		▲9550HD
Hose - Upper		●26529
Hose - Lower - Eng. To Pipe; (2 1/2" I.D.)		24240
Hose - Lower - Pipe To Rad.		●26531
Cummins V504 Diesel		
Belt - Fan	178685	②TR22485
Belt - Alt.	178471	▲9365HD
Hose - Lower		●26521
Detroit Diesel 6V-53 Diesel		
Hose - Upper		●25480
Hose - Lower		●26511
2500		
Case A504BDT Diesel		
Belt - P.S.	S86046	②▲9660HD
Belt - Air Brake Compr.	S86213	▲9490HD
Hose - Upper		●26529
Hose - Lower - Eng. To Pipe; (2 1/2" I.D.)		24240
Hose - Lower - Pipe To Rad.		●26531
Detroit Diesel 6V-53 Diesel		
Belt - Fan	S84944	②▲9420HD
Belt - Alt.	S71811	②7400
Belt - P.S.		②▲9690HD
Hose - Upper		●25480
Hose - Lower		●26511

● Vulco-Flex® Coolant Hose.
 ▲ Standard Belt Available. See Pages 630-631.

② Two Required.
 ③ Three Required.

Belts and Coolant Hose for Road & Construction Equipment

Application	Mfr. Part No.	Our No.	Application	Mfr. Part No.	Our No.
DROTT - Continued			EASI-DOER - Continued		
2510			SW77 - Continued		
Detroit Diesel 6-71N Diesel			Detroit Diesel ST6 Diesel - Continued		
Belt - Fan	5135882	②▲9570HD	Hose - Lower - Pipe To Rad.; (2" I.D.)		24432
Belt - Alt.		▲9400HD	ELGIN		
Hose - Upper		●26516	L; M		
Hose - Lower - Eng. To Y; (2" I.D.)		24232	IH BD264 Diesel		
Hose - Lower - Y To Rad. (Left Side); (2 1/4" I.D.)		24236	Belt - Fan & Gen.	81572R2	TR28437
Hose - Lower - Y To Rad. (Right Side); (2 1/4" I.D.)		24236	Belt - Hyd. Pump	S9074	②▲9463HD
7760			N; S; T		
Detroit Diesel 6-71 Diesel			IH BD264 Diesel		
Hose - Upper - Eng. To Pipe		●26516	Belt - Fan & Gen.	81572R2	TR28437
Hose - Lower - Eng. To Pipe; (2" I.D.)		24432	Belt - Hyd. Pump	S9060	②▲9470HD
Hose - Lower - Pipe To Rad.; (2 1/4" I.D.)		②24436	ELITE		
DYNAHOE			DD6		
140; 160			Honda 3.5 H.P.		
Detroit Diesel 3-53 Diesel			Belt - Belt		②3VX280
Belt - Fan	5172384	②▲9470HD	DD8		
Belt - W.P. & Alt.	5133601	②7410	Honda 5.5 H.P.		
Hose - Upper		③<20611	Belt - Belt		③3VX335
		or ③<●26509	DD10		
Hose - Lower		20685	Honda 6.5 H.P.		
		or ●26507	Belt - Belt		③3VX315
190 4			EUCLID		
Detroit Diesel 4-53 Diesel			2FD; 2LDT; 3LDT; 4FD; 5FD; 5LDT		
Belt - Fan & Compr.	5135655	②▲9580HD	Cummins HB Diesel		
Belt - W.P. & Alt.		②7410	Belt - Fan	9043021	②TR22405
Hose - Upper		●26511	Belt - Supercharger	9108209	③TR28522
Hose - Lower		●26509	12RT		
		or ●26507	Detroit Diesel 6-71 Diesel		
CA12PD; CA12PDB			Belt - Fan & Air Brake Compr.		
John Deere 3179DF Diesel			5177909		②TR22625
Belt - Fan & Alt.		TR22474	16TDT; 21LDT		
CA15PD			Detroit Diesel 6-71 Diesel		
Detroit Diesel 4-53 Diesel			Belt - Fan	5175105	②BX71
Belt - Fan		▲9470HD	Belt - Gen.	2068846	TR22336
Belt - W.P. & Alt.		7430	21TD; 21TDT; 22TD; 22TDT		
John Deere 4-Cyl. 239 Diesel			Detroit Diesel 6-110 Diesel		
Belt - Fan & Alt.	T24473	TR22514	Belt - Fan	5114268	④7590
Hose - Upper		●25484	Belt - Fan & Air Brake Compr.	5188884	②TR22711
Hose - Lower		●25478	Belt - Gen.	3222608	TR28429
Hose - By Pass; (5/8" I.D.)		28441	24TDT		
CA25PD			Cummins NRT6BI Diesel		
Caterpillar 3208 Diesel			Belt - Fan	S3116	②TR28557
Belt - Fan & Alt.; W/55A. Alt.		▲9520HD	Belt - W.P.	S3163	TR22434
Hose - Upper		●26523	Belt - P.S.; W/Vickers P.S. Pump	S2295	②TR22461
Hose - Lower		●26511	Cummins NVHBI1200 Diesel		
CT25			Belt - Fan	69159	②▲9550HD
Detroit Diesel 6V-53T Diesel			28TDT		
Belt - Fan		②▲9412HD	Cummins NRT6BI Diesel		
Belt - W.P.	5133177	②7370	Belt - Fan	9020495	②TR28545
Belt - Alt.		②7370	Belt - W.P.	9021241	TR22434
Hose - Upper - Eng. To Pipe		●25528	31TD		
Hose - Lower - Cooler To Rad.		③<21115	Cummins NHRS Diesel		
Hose - Lower - Eng. To Cooler		③<21115	Belt - Fan	9045097	②TR28514
EASI-DOER			Belt - W.P.	9021241	TR22434
SW77			Belt - P.S.; W/46 5/8" Belt O.C.	9021578	②TR22461
Detroit Diesel ST6 Diesel			Belt - P.S.; W/50" Belt O.C.	9040981	②TR22495
Belt - Fan		②▲9420HD			
Belt - Alt.		▲9390HD			
Hose - Lower - Eng. To Pipe; (2" I.D.)		24432			

Road & Construction Equipment

② Two Required.
 ● Vulco-Flex® Coolant Hose.
 ③ Three Required.

▲ Standard Belt Available. See Pages 630-631.
 ③< Cut to Fit.
 ④ Four Required.

Belts and Coolant Hose for Road & Construction Equipment

Application	Mfr. Part No.	Our No.
EUCLID - Continued		
31TD - Continued		
Cummins NHRS Diesel - Continued		
Belt - Air Brake Compr.	9045099	②TR24355
82-40 Crawler		
Detroit Diesel 8V-71N Diesel		
Belt - Fan & Gen.	9177465	②BX77
C61; C62; C63; C64; C65		
Detroit Diesel 6-71 Diesel		
Belt - Gen.; W/34 1/8" Belt O.C.	2068846	TR22336
Belt - Gen.; W/44 3/4" Belt O.C.	9174657	TR22443
R15 (91FD); R18 (91FD)		
Detroit Diesel 6-71 Diesel		
Belt - Fan	5175105	②BX71
Belt - Gen.	5164293	TR22322
Hose - Upper; (2" I.D.)		④24932
Hose - Lower; (2" I.D.)		④24932
R22 (59TD); R22 (63TD)		
Detroit Diesel 6-110 Diesel		
Belt - Fan; W/3/8" Belt T.W.; W/59 1/8" Belt O.C.	5114268	④7590
Belt - Fan; W/1/2" Belt T.W.; W/59 1/4" Belt O.C.	9185576	③▲9590HD
Belt - Fan; W/11/16" Belt T.W.; W/61 1/4" Belt O.C.	5167565	②TR22607
Belt - Fan; W/3/8" Belt T.W.; W/68 1/8" Belt O.C.	5114266	④7680
Belt - Fan; W/1/2" Belt T.W.; W/68 1/4" Belt O.C.	5115053	③▲9680HD
Belt - Gen.; W/40 3/8" Belt O.C.	5155911	TR24400
Belt - Gen.; W/43 3/8" Belt O.C.	3222608	TR28429
R30 (71TD)		
Detroit Diesel 8V-71 Diesel		
Belt - Fan; W/61 1/4" Belt O.C.	5133828	③▲9610HD
Belt - Fan; W/62 3/4" Belt O.C.	5125467	③▲9625HD
Belt - Gen.	5133516	▲9380HD
Belt - Air Brake Compr.	5137905	TR28473
R35 (74TD)		
Cummins KT1150C Diesel		
Belt - Alt.	206996	K050370
Detroit Diesel 12V-71 Diesel		
Belt - Fan	5137906	③▲9630HD
Belt - Alt.	5133516	②▲9380HD
Belt - Air Brake Compr.	5137905	TR28473
R35 (201TD)		
Cummins KT1150C Diesel		
Belt - Alt.	206996	K050370
Hose - Upper; (2 1/2" I.D.)		24440
Hose - Lower - Eng. To Pipe; (3 1/2" I.D.)		24456
Hose - Lower - Pipe To Rad.; (3 1/2" I.D.)		24456
Detroit Diesel 12V-71 Diesel		
Belt - Fan	5137906	③▲9630HD
Belt - Alt.	5133516	②▲9380HD
Belt - Air Brake Compr.	5137905	TR28473
Hose - Upper - Eng. To Pipe; (2 1/2" I.D.)		24440
Hose - Upper - Pipe To Rad.; (2 1/2" I.D.)		24440
Hose - Lower - Eng. To Pipe; (3 1/2" I.D.)		24456
Hose - Lower - Pipe To Rad.; (3 1/2" I.D.)		24456
R40 (9FFD); R45 (9FFD)		
Detroit Diesel 6-71 Diesel		
Belt - Fan	9185986	③▲9550HD
Belt - Gen.	5183923	TR24424

Application	Mfr. Part No.	Our No.
EUCLID - Continued		
R50 (201LD)		
Detroit Diesel 16V-149 Diesel		
Hose - Upper; (3" I.D.)		24448
Hose - Lower - Eng. To Pipe; (4" I.D.)		24464
Hose - Lower - Pipe To Rad.; (4" I.D.)		24464
Detroit Diesel 16V-71N Diesel		
Belt - Alt.	5134212	②▲9480HD
Belt - Air Brake Compr.	5133175	7390
Hose - Upper - Left Side; (3" I.D.)		④24948
Hose - Upper - Right Side; (3" I.D.)		④24948
Hose - Lower - Eng. To Pipe (Left Side); (2 1/2" I.D.)		24440
Hose - Lower - Pipe To Pipe (Left Side); (2 1/2" I.D.)		24440
Hose - Lower - Pipe To Rad. (Left Side); (2 1/2" I.D.)		24440
Hose - Lower - Eng. To Pipe (Right Side); (3 3/4" I.D.)		24460
Hose - Lower - Pipe To Rad. (Right Side); (3 3/4" I.D.)		24460
S12 (77FDT)		
Detroit Diesel 6-71 Diesel		
Belt - Fan; W/46 5/8" Belt O.C.	5110267	③TR22461
Belt - Fan; W/74 1/2" Belt O.C.	5175105	②BX71
Belt - Gen.; W/32 3/4" Belt O.C.	5164293	TR22322
Belt - Gen.; W/39 1/2" Belt O.C.	3224367	TR28390
Belt - Gen.; W/41 1/4" Belt O.C.	9176958	▲9412HD
Belt - P.S.	9125309	TR28454
S12 (78FDT)		
Detroit Diesel 6-71 Diesel		
Belt - Fan; W/46 5/8" Belt O.C.	5110267	③TR22461
Belt - Fan; W/74 1/2" Belt O.C.	5175105	②BX71
Belt - Gen.; W/32 3/4" Belt O.C.	5164293	TR22322
Belt - Gen.; W/39 1/2" Belt O.C.	3224367	TR28390
Belt - Gen.; W/41 1/4" Belt O.C.	9176958	▲9412HD
Belt - P.S.	9125309	TR28454
Hose - Upper; (2" I.D.)		④24932
Hose - Lower; (2" I.D.)		④24932
SS12 (77FDT)		
Detroit Diesel 6-71 Diesel		
Belt - Fan; Ser. No. 16714 Thru E Series	5175105	②BX71
Belt - Gen.; W/32 3/4" Belt O.C.; Ser. No. 16714 Thru E Series	5164293	TR22322
Belt - Gen.; W/39 1/2" Belt O.C.; Ser. No. 16714 Thru E Series	3224367	TR28390
SS12 (78FDT)		
Detroit Diesel 6-71 Diesel		
Hose - Upper; (2" I.D.)		④24932
Hose - Lower; (2" I.D.)		④24932
SS18 (23TDT)		
Detroit Diesel 6-110 Diesel		
Belt - Fan; W/59 1/8" Belt O.C.	5111547	④7590
Belt - Fan; W/68 1/4" Belt O.C.	5115053	③▲9680HD
Belt - Fan; W/71 1/4" Belt O.C.	5188884	②TR22711
Belt - Fan; W/77 1/8" Belt O.C.	5114267	④7775
Belt - Gen.; W/40 3/8" Belt O.C.	5155911	TR24400
Belt - Gen.; W/43 3/8" Belt O.C.	3222608	TR28429
Hose - Upper; (2 3/4" I.D.)		④24944
Hose - Lower; (2 3/4" I.D.)		④24944
SS24 (33LOT)		
Cummins NRTO6BI Diesel		
Belt - Fan; Ser. No. 23474 Thru 26773	9021068	②TR28545
Belt - W.P.; Ser. No. 23474 Thru 26773	9026236	TR22434
TC12		
Detroit Diesel 6-71 Twin Diesel		
Belt - Fan	9151954	②TR22711

Road & Construction Equipment

② Two Required.
④ Four Required.
▲ Standard Belt Available. See Pages 630-631.

⊛ Use Wire Inserted Green Stripe® Coolant Hose.
③ Three Required.

Belts and Coolant Hose for Road & Construction Equipment

Application	Mfr. Part No.	Our No.	Application	Mfr. Part No.	Our No.
FERGUSON SHOVEL SUPPLY			FIAT-ALLIS - Continued		
5-8A			100C; 150C		
John Deere 4-Cyl. 276 Diesel			Allis-Chalmers 11000 Diesel		
Hose - Upper	●25476		Belt - Fan	4320755	②TR28596
Hose - Lower - Eng. To Pipe; (1 3/4" I.D.)	24228		Belt - Fan, Alt. & W.P.	4349778	TR28522
Hose - Lower - Pipe To Rad.; (1 3/4" I.D.)	24228		Belt - Fan, W.P. & Gen.		TR28545
8-12 Ton			Belt - Hyd. Pump	675084	④TR22443
Ford 6-Cyl. 240			Hose - Upper		●26520
Belt - Fan	▲9412HD		Hose - Lower; (2 1/2" I.D.)		24440
Belt - W.P. & Alt.	7420		Hose - By Pass; (1 7/8" I.D.)		24430
Belt - Alt. To Gov.	7260		161		
Belt - Hyd. Pump	▲9385HD		Cummins V903 Diesel		
46			Hose - Upper - Eng. To Pipe; (2 1/4" I.D.)		②24436
Continental TM27 Diesel			Hose - Upper - Pipe To Rad.; (2 1/4" I.D.)		②24436
Belt - Fan & Alt.	▲9463HD		Hose - Lower - Eng. To Pipe; (2 3/4" I.D.)		24444
Belt - Hyd. Pump	▲9451HD		Hose - Lower - Pipe To Rad.; (2 3/4" I.D.)		24444
Hose - Upper	●25527		200C		
Hose - Lower	●26603		Allis-Chalmers 11000 Diesel		
SP75D			Belt - Fan	4320755	②TR28596
Detroit Diesel 4-53N Diesel			Belt - Fan, Alt. & W.P.	4349778	TR28522
Hose - Upper	●25476		Belt - Fan, W.P. & Gen.		TR28545
Hose - Lower - Eng. To Pipe; (1 3/4" I.D.)	24228		Belt - Hyd. Pump	675084	④TR22443
Hose - Lower - Pipe To Rad.; (1 3/4" I.D.)	24228		Hose - Upper		●26520
SP120B			Hose - Lower; (2 1/2" I.D.)		24440
Detroit Diesel 6V-53 Diesel			Hose - By Pass; (1 7/8" I.D.)		24430
Belt - Fan	78	②▲9395HD	261B		
Belt - Gen.		②7580	Allis-Chalmers 25000 Mark II Diesel		
Belt - W.P. & Idler	5139228	②7370	Belt - Fan & Air Brake Compr.	4394324	③CX81
Hose - Upper - Left Side		●26611	Belt - Alt.	4394323	▲9425HD
Hose - Upper - Right Side		●26611	Belt - Hyd. Pump	4391351	7490
Hose - Lower		●26508	Hose - Upper		●26532
FIAT-ALLIS			605B		
11B			Allis-Chalmers 2900 Mark II Diesel		
Allis-Chalmers 11000 Diesel			Belt - Fan & Alt.	73046916	▲9550HD
Hose - By Pass; (1 7/8" I.D.)	24430		Hose - Upper		●26525
16B			645B		
Allis-Chalmers 17000 Diesel			Allis-Chalmers 3500 Diesel		
Belt - Fan & Alt.		TR28786	Belt - Fan & Alt.		③▲9610HD
Hose - Upper - Eng. To Pipe; (2 5/8" I.D.)		24442	Belt - Air Brake Compr.		TR22578
Hose - Upper - Pipe To Rad.; (2 5/8" I.D.)		24442	745B		
41B			Allis-Chalmers 11000 Diesel		
Cummins VT1710 Diesel			Belt - Fan		②TR28583
Belt - Alt.	70663945	TR22358	Belt - W.P. & Air Brake Compr.		TR28583
Belt - W.P.	178665	②TR28390	Belt - Alt.		▲9370HD
Hose - Upper - Eng. To Pipe (Left Side); (3" I.D.)		24448	Hose - Upper - Eng. To Pipe; (2" I.D.)		24432
Hose - Upper - Eng. To Pipe (Right Side); (3" I.D.)		24448	Hose - Upper - Pipe To Rad.; (2" I.D.)		24432
Hose - Upper - Pipe To Rad. (Left Side); (3" I.D.)		24448	745HB		
Hose - Upper - Pipe To Rad. (Right Side); (3" I.D.)		24448	Allis-Chalmers 11000 Diesel		
Hose - Lower - Eng. To Pipe; (3 1/2" I.D.)		24456	Belt - Fan		②TR28583
Hose - Lower - Pipe To Rad.; (3 1/2" I.D.)		24456	Belt - W.P. & Air Brake Compr.		TR28583
65			Belt - Alt.		▲9370HD
Allis-Chalmers 6-Cyl. 262 Diesel			Hose - Upper - Eng. To Pipe; (2 1/4" I.D.)		24436
Belt - Fan & Alt.		▲9480HD	Hose - Upper - Pipe To Rad.; (2 1/4" I.D.)		24436
Hose - Upper; (1 3/4" I.D.)		24428	Hose - Lower		●26536
Hose - Lower		●25526	945B		
65B			Allis-Chalmers 25000 Diesel		
Fiat-Iveco 8061 Diesel			Belt - W.P.	4391351	7490
Belt - Fan & Alt.	73117688	②7508	Belt - Alt.		▲9560HD
Hose - Upper		②21794	Hose - Upper - Eng. To Pipe; (2 3/4" I.D.)		24444
		or ②●25480	Hose - Upper - Pipe To Rad.; (2 3/4" I.D.)		24444
Hose - Lower - Eng. To Pipe; (1 1/2" I.D.)		24224	Hose - Lower - Eng. To Pipe; (2 1/2" I.D.)		24440
Hose - Lower - Pipe To Rad.; (1 1/2" I.D.)		24224	Hose - Lower - Pipe To Rad.; (2 1/2" I.D.)		24440

Road & Construction Equipment

● Vulco-Flex® Coolant Hose.
 ② Two Required.
 ④ Four Required.

▲ Standard Belt Available. See Pages 630-631.
 ② Cut to Fit.
 ③ Three Required.

Belts and Coolant Hose for Road & Construction Equipment

Application	Mfr. Part No.	Our No.	Application	Mfr. Part No.	Our No.
FIAT-ALLIS - Continued			FORD - Continued		
FR12B			345C		
Fiat 6-Cyl. 335 Diesel			Ford 4-Cyl. 192 Diesel		
Belt - W.P. & Alt.		▲9470HD	Belt - Fan & Alt.	D3NN10C318C	▲9555HD
Belt - Fan & Hyd. Pump		②▲9650HD	420		
Hose - Upper; (1 3/4" I.D.)		⊕24928	Ford 4-Cyl. 183 Diesel		
Hose - Lower - Eng. To Pipe; (1 1/2" I.D.)		*24824	Belt - Fan & Alt.	C9NN10C318A	▲9555HD
Hose - Lower - Pipe To Rad.		●25477	Hose - Upper		≈21794
Hose - By Pass; (5/8" I.D.)		*26241	or		●25474
FR15B			445C Backhoe		
Fiat 6-Cyl. 494 Diesel			Ford 4-Cyl. 192 Diesel		
Belt - Fan & Alt.		②▲9670HD	Belt - Fan & Alt.	D3NN10C318C	▲9555HD
Belt - W.P.		7450	Hose - Upper		≈20065
Belt - A.C.		7445	445C Wheel		
Hose - Upper		②23533	Ford 3-Cyl. 201 Diesel		
Hose - Lower		②23533	Belt - Fan & Alt.	D3NN10C318C	▲9555HD
HD16DP			Hose - Upper		≈20065
Allis-Chalmers 16000H Diesel			545C; 545C Backhoe		
Hose - Upper - Eng. To Pipe; (2 1/2" I.D.)		24440	Ford 3-Cyl. 201 Diesel		
Hose - Upper - Pipe To Rad.; (2 1/2" I.D.)		24440	Belt - Fan & Alt.	D3NN10C318C	▲9555HD
FMC			Hose - Upper		≈21794
Vanguard 4000SP			545D Backhoe; 545D Wheel		
Detroit Diesel V-8 8.2 L Diesel			Ford 3-Cyl. 201 Diesel		
Belt - Fan & Alt.		②▲9680HD	Belt - Fan & Alt.	D3NN10C318C	▲9555HD
Hose - Upper - Eng. To Pipe		≈20611	Hose - Upper		20957
Hose - Upper - Pipe To Rad.		●26513	550		
Hose - Lower - Eng. To Pipe		●26522	Ford 3-Cyl. 201		
Hose - Lower - Pipe To Rad.		●26521	Belt - Fan & Alt.; May 1977 & Older	D3NN10C318D	▲9555HD
Vanguard V3000SP			Belt - Fan & Alt.; W/O 72A. Alt.; Jun. 1977 & Newer	D6NN8620A	▲9463HD
John Deere 4-Cyl. Diesel			Belt - W.P. & Alt.; W/72A. Alt.; Jun. 1977 & Newer	D7NN10C318A	▲9313HD
Belt - Fan & Alt.	H79235	②▲9590HD	555C		
Belt - Fan To A.C.		▲9480HD	Ford 3-Cyl. 201 Diesel		
Hose - Upper - Pipe To Rad.		●26513	Belt - Fan & Alt.	D3NN10C318C	▲9555HD
Hose - Lower - Eng. To Pipe		●26523	Ford 4-Cyl. 256 Diesel		
Hose - Lower - Pipe To Rad.		●26521	Hose - Upper		≈20065
FORD			655D		
8N			Ford 4-Cyl. 256 Diesel		
Ford 4-Cyl. 120			Belt - Fan & Alt.	D3NN10C318C	▲9555HD
1952-1947			750; 755		
Belt - Fan & Gen.; Ser. No. 8N263843 & Before	9N8620B	TR20451	Ford 4-Cyl. 256		
Belt - Fan & Gen.; Ser. No. 8N263844 & After 8N8620		TR20412	Belt - Fan & Alt.	D3NN10C318D	▲9555HD
Hose - Upper; (1 1/2" I.D.)		24224	1800		
Hose - Lower; Ser. No. 8N263843 & Before		20065	Ford 3-Cyl. 158 Diesel		
Hose - Lower; Ser. No. 8N263844 & After		20166	Belt - Fan & Gen.	EAF8577A	▲9415HD
or		●25476	Belt - P.S.; W/45 7/8" Belt O.C.	CONN8620C	TR20451
250C			Belt - P.S.; W/47 7/8" Belt O.C.	313149	TR22474
Ford 3-Cyl. 201 Diesel			Hose - Upper; (1 1/4" I.D.)		24220
Belt - Fan & Alt.	D3NN10C318C	▲9555HD	4040		
Hose - Upper		≈21794	Ford 4000; Ford 4000 Diesel		
260C			Belt - P.S.; Ser. No. 144291 & Before	313149	TR22474
Ford 3-Cyl. 201 Diesel			Belt - P.S.; Ser. No. 144292 & After	CONN8620C	TR20451
Belt - Fan & Alt.	D3NN10C318C	▲9555HD	6500		
Hose - Upper		≈20065	Ford 4-Cyl. 256 Diesel		
340			Belt - Fan & Alt.		▲9560HD
Ford V-4 140			Hose - Upper		≈21794
Belt - Fan, Alt. & W.P.		7460	or		●25474
Hose - Lower		●25474			
Hose - By Pass; (5/8" I.D.)		28441			

▲ Standard Belt Available. See Pages 630-631.
 ⊕ Use Wire Inserted Green Stripe® Coolant Hose.
 ● Vulco-Flex® Coolant Hose.

② Two Required.
 * Durion® Silicone Hose Recommended.
 ≈ Cut to Fit.

Belts and Coolant Hose for Road & Construction Equipment

Application	Mfr. Part No.	Our No.	Application	Mfr. Part No.	Our No.
FORD - Continued			FORD - Continued		
6500 - Continued			CL40		
Ford 4-Cyl. 256 Diesel - Continued			Ford 104GF		
Hose - Lower ●26502			1984-1974		
7500			Belt - Fan, Alt. & W.P. ♣9490HD		
Ford 3-Cyl.; Ford 3-Cyl. Diesel; Ford 4-Cyl.			Belt - Gov. 7350		
Belt - Fan & Alt.; W/55 1/4" Belt O.C. ♣9550HD			CL65		
Belt - Fan & Alt.; W/56 1/4" Belt O.C. ♣9560HD			Shibaura V1004 Diesel		
Belt - W.P. & Alt. D5NN10C318A ♣9325HD			1986-1983		
Ford 4-Cyl. Diesel			Belt - Fan, Alt. & W.P. ♣9490HD		
Belt - Fan & Alt.; W/55 1/4" Belt O.C. ♣9550HD			Belt - Gov. 7350		
Belt - Fan & Alt.; W/56 1/4" Belt O.C. ♣9560HD			H48		
Belt - W.P. & Alt. D5NN10C318A ♣9325HD			Ford 6-Cyl. Diesel		
Hose - Upper ⚡<21794			Belt - Fan & Alt. ♣9550HD		
or			Hose - Upper - Eng. To Pipe ⚡<20573		
Hose - Lower ●25477			Hose - Upper - Pipe To Rad. ⚡<20573		
●26611			Hose - Lower - Eng. To Pipe ⚡<20957		
A62			Hose - Lower - Pipe To Pipe ⚡<20957		
Ford 4-Cyl. 256 Diesel			Hose - Lower - Pipe To Rad.; (2 3/8" I.D.) 24438		
Belt - Fan & W.P. D3NN8620A ♣9463HD			FRESIA		
Belt - W.P. & Alt.; W/A.C. D3NN10C318E ♣9480HD			F90		
Belt - W.P. & Alt.; W/O A.C.; May 1976 & Older D3NN10C318F ♣9555HD			Detroit Diesel 8V-92 Diesel		
Belt - W.P. & Alt.; W/O A.C.; Jun. 1976 Thru Apr. 1978 D5NN10C318A ♣9325HD			Belt - Fan ♣9580HD		
Belt - W.P. & Alt.; W/O A.C.; May 1978 & Newer D8NN10C318AA ♣9309HD			FC100; LM200		
Hose - Upper ●25530			Cummins 6-Cyl. 8.3 L Diesel		
Hose - Lower - Eng. To Pipe; (1 3/4" I.D.) 24428			Belt - Fan & Alt. 3911573 ♣K080615HD		
Hose - Lower - Pipe To Pipe ⚡<20357			Hose - Lower - Eng. To Pipe 21901		
A64			Hose - Lower - Pipe To Rad. ⚡<20611		
Ford 6-Cyl. 401 Diesel			GARDNER-DENVER		
Belt - Fan; Aug. 1976 & Older D3NN8620B ♣9610HD			450		
Belt - Fan; Sept. 1976 & Newer D5NN8620E ♣9625HD			Caterpillar 3204 Diesel		
Belt - W.P. & Alt.; W/A.C. D3NN10C318E ♣9480HD			Belt - Fan & Alt. ③♣9660HD		
Belt - W.P. & Alt.; W/O A.C.; May 1976 & Older C9NN10C318A ♣9555HD			AAG		
Belt - W.P. & Alt.; W/O A.C.; Jun. 1976 Thru Apr. 1978 D6NN8620B ♣9585HD			Buda JH; Buda JV		
Belt - W.P. & Alt.; W/O A.C.; May 1978 Thru Feb. 1979 D8NN10C318DA ♣9600HD			Belt - Fan 13C39 TR34506		
Belt - W.P. & Alt.; W/O A.C.; Mar. 1979 & Newer D8NN10C318AA ♣9580HD			D125		
Belt - A.C. D3NN8620B ♣9610HD			John Deere 3179D Diesel		
Hose - Upper - Eng. To Pipe; (1 1/2" I.D.) 24224			Belt - Fan & Alt. T20334 TR22474		
Hose - Upper - Pipe To Rad. ⚡<20945			Hose - By Pass ⚡<20802		
Hose - Lower - Eng. To Pipe; (1 5/8" I.D.) 24226			John Deere 4239D Diesel		
Hose - Lower - Pipe To Rad. 20357			Hose - By Pass ⚡<20802		
A66			D250		
Ford 6-Cyl. 401 Diesel			John Deere 3179D Diesel		
Belt - Fan; Aug. 1976 & Older D3NN8620B ♣9610HD			Hose - By Pass ⚡<20802		
Belt - Fan; Sept. 1976 & Newer D5NN8620E ♣9625HD			John Deere 4239D Diesel		
Belt - W.P. & Alt.; W/A.C. D3NN10C318E ♣9480HD			Belt - Fan & Alt. TR22495		
Belt - W.P. & Alt.; W/O A.C.; May 1976 & Older D4NN10C318A ♣9540HD			Hose - By Pass ⚡<20802		
Belt - W.P. & Alt.; W/O A.C.; Jun. 1976 Thru Apr. 1978 D6NN8620B ♣9585HD			D300		
Belt - W.P. & Alt.; W/O A.C.; May 1978 Thru Feb. 1979 D8NN10C318DA ♣9600HD			Perkins 4-Cyl. Diesel		
Belt - W.P. & Alt.; W/O A.C.; Mar. 1979 & Newer D8NN10C318AA ♣9580HD			Belt - Fan & Alt. 2614B059 ♣9545HD		
Belt - A.C. D3NN8620B ♣9610HD			D825		
Hose - Upper - Eng. To Pipe; (1 1/2" I.D.) 24224			Caterpillar 3306B Diesel		
Hose - Upper - Pipe To Rad. ⚡<20945			Belt - Fan & Alt. 5M0923 A73		
Hose - Lower - Eng. To Pipe; (1 5/8" I.D.) 24226			HT3100		
Hose - Lower - Pipe To Rad. 20357			Caterpillar 4-Cyl. Diesel		
			Belt - Fan & Alt. ③♣9660HD		

● Vulco-Flex® Coolant Hose.
⚡< Cut to Fit.

♣ Standard Belt Available. See Pages 630-631.
③ Three Required.

Belts and Coolant Hose for Road & Construction Equipment

Application	Mfr. Part No.	Our No.
GARDNER-DENVER - Continued		
RP125DA		
Hercules DD198 Diesel Belt - Fan	13C178	B48
RP125G		
Hercules GO198A Belt - Fan	13C178	B48
RP210DA		
Hercules DD339 Diesel Belt - Fan	13C61	B51
Belt - Aux. Pump	13C58	2480
RP210GA		
Hercules GO339 Belt - Fan	13C85	TR22625
Belt - Aux. Pump	13C84	B55
RP365		
Detroit Diesel 4-53 Diesel; Detroit Diesel 4-71 Diesel Belt - Fan	13E342	②B64
RP600; RP600D; RP600DB		
Detroit Diesel 4-53 Diesel; Detroit Diesel 4-71 Diesel Belt - Fan	13E7	②B60
RP900		
Detroit Diesel 6-110 Diesel Belt - Fan		TR28743
SP600DK		
Caterpillar D333CT Diesel; Caterpillar M3306T Diesel Belt - Fan & Alt.		②▲9540HD
SP1200DE		
Detroit Diesel 8V-71 Diesel; Detroit Diesel 12V-71 Diesel Belt - Fan		②5VX630
Belt - Gen.	5133516	▲9380HD
SP1200DF		
Caterpillar D343T Diesel; Caterpillar D343TA Diesel Belt - Fan		②5VX630
Belt - Alt.	6L3408	▲9476HD
SPCGA		
IH UC135B Belt - Fan & Alt.; W/44 1/4" Belt O.C.	349175R1	7440
Belt - Fan & Alt.; W/45 1/8" Belt O.C.	678200C1	7450
SPFGA; SPFGB; SPFGC		
Ford V-4 104 Belt - Fan & Alt.	C9PZ8620GF	7380
Belt - Gov.		7350
SPHDA		
Ford 6-Cyl. 254 Diesel Belt - W.P. & Alt.		▲9455HD
SPHGA; SPHGC		
Ford 6-Cyl. 240 Belt - W.P. & Alt.	C7JZ8620D	7405
Belt - Gov.	C7JZ8620D	7405
Ford 6-Cyl. 300 Belt - Fan & Alt.	C9PZ8620T	②7417
Belt - Gov.	C7JZ8620P	7260
SPKDB		
Detroit Diesel 4-53 Diesel Belt - Fan; W/41 3/4" Belt O.C.		②7417
Belt - Fan; W/42 3/4" Belt O.C.		②7425

Application	Mfr. Part No.	Our No.
GARDNER-DENVER - Continued		
SPKDB - Continued		
Detroit Diesel 4-53 Diesel - Continued Belt - Alt.	5133173	②7420
Belt - Gen.	5116450	②7405
SPNDA		
Detroit Diesel 4-71 Diesel; Detroit Diesel 6-71 Diesel Belt - Fan	13AE2	②TR22461
Belt - Gen.	5133516	▲9380HD
SPNDB		
Detroit Diesel 4-71 Diesel; Detroit Diesel 6-71 Diesel Belt - Fan		②TR20451
Belt - Gen.	5133516	▲9380HD
SPQDA		
Detroit Diesel 6-71 Diesel Belt - Fan	13AE2	②TR22461
Belt - Gen.	13AE1	AX38
SPQDB		
Detroit Diesel 4-71 Diesel; Detroit Diesel 6-71 Diesel Belt - Fan	13AE2	②TR22461
Belt - Gen.	5133516	▲9380HD
SPQDC		
Detroit Diesel 4-71 Diesel; Detroit Diesel 6-71 Diesel Belt - Fan		②TR20451
Belt - Gen.	5133516	▲9380HD
SPQDD		
Cummins V903 Diesel Belt - Fan & W.P.	202051	②▲9670HD
Belt - Alt.		②▲9520HD
SPTDA		
Detroit Diesel 8V-71 Diesel; Detroit Diesel 12V-71 Diesel Belt - Fan		②5VX630
Belt - Gen.	5133516	▲9380HD
SPTDB		
Caterpillar D343T Diesel; Caterpillar D343TA Diesel Belt - Fan		②5VX630
Belt - Alt.	6L3408	▲9476HD
SPTDC		
Detroit Diesel 8V-71 Diesel; Detroit Diesel 12V-71 Diesel Belt - Fan		②5VX630
Belt - Gen.	5133516	▲9380HD
SPTDD		
Caterpillar 3406DI Diesel Belt - Fan		②5VX630
Belt - Alt.	8F2434	TR22485
SPWDA; SPWDB		
Detroit Diesel 8V-71 Diesel; Detroit Diesel 12V-71 Diesel Belt - Fan		②5VX630
Belt - Gen.	5133516	▲9380HD
SPWDC		
Caterpillar D343T Diesel; Caterpillar D343TA Diesel Belt - Fan		②5VX630
Belt - Alt.	6L3408	▲9476HD
WBD		
Buda 6DT317 Diesel Belt - Fan	13C161	TR28522
Belt - Intercooler	13C50	TR24461

② Two Required.

▲ Standard Belt Available. See Pages 630-631.

Belts and Coolant Hose for Road & Construction Equipment

Application	Mfr. Part No.	Our No.
GARDNER-DENVER - Continued		
WBD - Continued		
Buda HP326 Belt - Fan	13C153	TR28473
Buda HP351 Belt - Fan		TR30467
WBG		
Buda JK4; Buda JL4; Buda JL877 Belt - Fan	13C39	TR34506
Caterpillar D11000 Diesel Belt - Intercooler	13C39	②TR34506
WBH; WBK		
Caterpillar D11000 Diesel; Caterpillar D13000 Diesel Belt - Intercooler	13C39	TR34506
WGH		
Buda Belt - Intercooler	13C162	TR28501
WH105GB; WH105GC; WH105GJ; WH105GK		
Buda Belt - Fan	13C152	TR28514
WH105GP; WH105GQ		
Buda Belt - Fan	13C146	TR28437
WH315G		
Caterpillar D339 Diesel Belt - Fan		②TR30652
Belt - Compr.	13C154	TR28406
WH600		
Buda Belt - Fan	13C39	②TR34506
WHD		
Buda 6B230 Belt - Compr.; W/Man. Start	13C146	TR28437
Buda HP234 Belt - Compr.; W/Elec. Start	13C152	TR28514
Belt - Compr.; W/Man. Start	13C153	TR28473
Detroit Diesel 2055 Diesel Belt - Fan	13C85	②TR22625
Hercules QXD5 Belt - Fan	13C169	TR28454
WHF		
Buda L525 Belt - Fan	13C161	TR28522
Belt - Intercooler	13C154	TR28406
WHHDA		
Buda Belt - Fan	13C162	TR28501
WHHDB		
Buda Belt - Fan	13C154	TR28406
WHHDC		
Buda Belt - Fan	13C162	TR28501
WHHDD		
Buda Belt - Fan	13C154	TR28406

Application	Mfr. Part No.	Our No.
GARDNER-DENVER - Continued		
WHK		
Buda Belt - Intercooler	13C39	②TR34506
WHL		
Buda Belt - Fan	13C162	TR28501
WHX		
Buda Belt - Intercooler	13C39	②TR34506
GEHL		
SL6625		
Perkins 4-Cyl. 154 Diesel		
1996-1987 Belt - Fan & Alt.	A45	▲9463HD
Hose - Upper		②20957
		or ●26603
Hose - Lower - Eng. To Pipe: (1 3/4" I.D.)		24228
GOMACO		
GT6000-66		
Detroit Diesel 2-53 Diesel		
Belt - Fan	5119188	②▲9390HD
Belt - W.P. & Gen.		②7410
Hose - Upper; (1 1/2" I.D.)		②24924
Hose - Lower - Eng. To Pipe: (2" I.D.)		②24932
Hose - Lower - Pipe To Rad.; (2" I.D.)		②24932
GT6000-78		
Detroit Diesel 3-53 Diesel		
Belt - Fan	5126447	②▲9350HD
Belt - W.P. & Alt.	5133172	②7430
Hose - Upper; (1 5/8" I.D.)		②24926
Hose - Lower - Eng. To Pipe		②20882
Hose - Lower - Pipe To Rad.		②20882
GRIMMER-SCHMIDT		
175		
Ford V-8 351		
Belt - Fan & Alt.; W/42A. Alt.		7420
Hose - Upper		●25477
Hose - Lower		●26502
210		
Cummins V378		
Belt - Fan To Alt.	178473	▲9350HD
Belt - Fan & W.P.	178685	②TR22485
Hose - Upper - Eng. To Pipe (Left Side)		②20206
Hose - Upper - Pipe To Rad. (Left Side); (2" I.D.)		②24932
Hose - Upper - Right Side		●26511
Hose - Lower		●26521
GROVE		
64-18		
Detroit Diesel 6V-53 Diesel		
Belt - Fan	5126768	②▲9505HD
Belt - W.P. & Idler	5139228	②7370
Belt - Alt.		②7375
Hose - Upper - Right Side		●26502
Hose - Upper - Left Side		●26502
Hose - Lower		●26507
68		
Ford 6-Cyl. 300		
Belt - Fan		▲9447HD
Belt - W.P. & Alt.		7417

② Two Required.
 ② Cut to Fit.
 ▲ Use Wire Inserted Green Stripe® Coolant Hose.

▲ Standard Belt Available. See Pages 630-631.
 ● Vulco-Flex® Coolant Hose.

Belts and Coolant Hose for Road & Construction Equipment

Application	Mfr. Part No.	Our No.
GROVE - Continued		
68 - Continued		
Ford 6-Cyl. 300 - Continued		
Belt - Alt. To Gov.	C7JZ8620P	7260
Belt - Compr.		▲9476HD
Hose - Upper		●25530
Hose - Lower		●26505
4420G		
Cummins V-8 210 Diesel		
Belt - Fan & W.P.	178598	②TR22495
Hose - Upper - Eng. To Pipe; (2" I.D.)		24232
Hose - Upper - Pipe To Rad.; (2" I.D.)		24232
Hose - Lower		●26510
8435G		
Detroit Diesel 6-71 Diesel		
Belt - Fan		②▲9560HD
Belt - Gen.		▲9412HD
Hose - Upper		●26517
Hose - Lower		●26517
AP206		
Continental TMD27 Diesel		
Belt - Fan & Alt.		▲9480HD
Hose - Upper		●25804
Hose - Lower; (1 3/4" I.D.)		②24228
RT48		
Ford 6-Cyl. 300 Diesel		
Belt - Fan		TR22405
Belt - W.P. & Alt.		7410
Belt - Gov.		7260
Hose - Upper		●26505
Hose - Lower		●26505
RT59S		
Detroit Diesel 4-53 Diesel		
Belt - Fan & Compr.		②▲9490HD
Belt - W.P. & Alt.		②7448
Hose - Upper		●26611
Hose - Lower		●26508
RT400		
Cummins 4-Cyl. 3.9 L Diesel		
Hose - Upper - Eng. To Pipe; (1 3/4" I.D.)		24428
Hose - Upper - Pipe To Rad.; (1 3/4" I.D.)		24428
Hose - Lower		●26522
RT500C		
Cummins 6-Cyl. 5.9 L Diesel		
Belt - Fan & Alt.	3911563	▲K080605HD
Hose - Upper; (2" I.D.)		②24432
Hose - Lower - Eng. To Pipe; (2 1/4" I.D.)		24436
Hose - Lower - Pipe To Rad.; (2 1/2" I.D.)		24440
RT500DXL		
Cummins 6-Cyl. 5.9 L Diesel		
Belt - Fan & Alt.		②▲9690HD
RT522		
Detroit Diesel 4-53 Diesel		
Belt - Fan & Compr.; W/60 1/4" Belt O.C.		②▲9600HD
Belt - W.P. & Alt.; W/90A. Alt.; W/43 1/8" Belt O.C.		②7430
Hose - Upper - Eng. To Pipe; (1 3/4" I.D.)		24228
Hose - Upper - Pipe To Rad.; (1 3/4" I.D.)		24228
Hose - Lower - Eng. To Pipe; (2" I.D.)		24232
Hose - Lower - Pipe To Rad.; (2" I.D.)		24232
RT625		
Cummins V504 Diesel		
Belt - Fan To Alt.; W/50 1/8" Belt O.C.		②7500

Application	Mfr. Part No.	Our No.
GROVE - Continued		
RT625 - Continued		
Cummins V504 Diesel - Continued		
Belt - Fan & W.P.; W/50" Belt O.C.		②TR22495
Hose - Upper		●26511
Hose - Lower		●26529
RT630		
Caterpillar 3208 Diesel		
Belt - Fan & W.P.; W/43 1/4" Belt O.C.		②▲9430HD
Belt - W.P., Alt. & Compr.; W/68 1/4" Belt O.C.		▲9680HD
Hose - Upper		●26510
Hose - Lower - Eng. To Pipe; (2" I.D.)		24232
Hose - Lower - Pipe To Rad.; (2 1/4" I.D.)		24236
Cummins V504 Diesel		
Belt - Fan & W.P.		②TR22392
Belt - Fan To Alt.		②7395
Hose - Upper		●26523
RT745		
Caterpillar 3208 Diesel		
Belt - Fan		②▲9400HD
Belt - W.P.		②▲9495HD
Belt - W.P., Alt. & Hyd. Pump		②▲9650HD
Hose - Upper		●26526
Hose - Lower - Eng. To Pipe; (2" I.D.)		24432
Hose - Lower - Pipe To Rad.; (2" I.D.)		24432
TM2500		
M.A.N. D2566MTE Diesel		
Belt - Fan & Idler		▲9490HD
Belt - Alt.		②▲9470HD
HAMM		
2210		
Deutz F3L912 Diesel		
Belt - Alt.		7590
HC100; HC120		
Deutz F2L511 Diesel		
Belt - Alt.		7370
HERC		
14YD		
Detroit Diesel 4-53 Diesel		
Belt - Fan - Front Eng.		③▲9451HD
Belt - Fan - Rear Eng.	13AV1075	②▲9425HD
Belt - Alt. - Front Eng.	A33	②▲9341HD
Belt - Alt. - Rear Eng.	5133173	②7420
Hose - Upper - Front Eng.; (2" I.D.)		★24932
Hose - Upper - Rear Eng.; (2" I.D.)		★24932
Hose - Lower - Front Eng.; (2" I.D.)		★24932
Hose - Lower - Rear Eng.; (2" I.D.)		★24932
Hose - By Pass; (1" I.D.)		24216
HITACHI		
UH20; UH30		
Isuzu E120 Diesel		
Belt - Fan & Alt.; W/Left & Right Eng.	9136713380	③TR20619
Belt - Hyd. Pump; W/Left Eng.		TR22570
Belt - Hyd. Pump; W/Right Eng.		TR22485
UH062		
Isuzu 6BD1 Diesel		
Belt - Fan & Alt.	5136710160	②TR22474
UH122; UH172		
Isuzu E120 Diesel		
Belt - Fan & Alt.; W/Left & Right Eng.	9136713380	③TR20619
Hose - Lower		21115

▲ Standard Belt Available. See Pages 630-631.
 ② Two Required.
 ★ Use Wire Inserted Green Stripe® Coolant Hose.

● Vulco-Flex® Coolant Hose.
 ③ Three Required.

Belts and Coolant Hose for Road & Construction Equipment

Application	Mfr. Part No.	Our No.	Application	Mfr. Part No.	Our No.
HUBER-WARCO			HUBER-WARCO - Continued		
3-5 Ton			8-12 Ton - Continued		
Hercules IXB			Detroit Diesel 2-71 Diesel		
Belt - Fan & Gen.	3T1613	TR28423	Hose - Upper		●25476
Hose - Lower		≧20563	Hose - Lower		●25480
Hose - By Pass; (1 1/4" I.D.)		24220	Hercules GO226		
4-6 TON			Belt - Fan & Gen.		♣9530HD
Hercules IXB			Belt - W.P.	8T1356	♣9530HD
Belt - Fan & Gen.	81294A	TR28423	Hercules JXD		
Hose - Lower		≧20563	Belt - W.P.	8T1356	♣9530HD
Hose - By Pass; (1 1/4" I.D.)		24220	Hercules QXC5		
5 Ton			Belt - Fan		TR28483
Hercules DOOC Diesel			Belt - W.P.	8T1356	♣9530HD
Belt - Fan; W/3-Wheels	L3403	TR28514	9D		
Belt - Gen.; W/3-Wheels	27290A	TR28390	Detroit Diesel 3-71 Diesel		
5-6 Ton			Belt - Fan	5170972	②TR22455
Hercules QXC5			Belt - Gen.	3224367	TR28390
Belt - Fan; W/3-Wheels	BG989	TR28492	10 Ton		
5-8 Ton			Caterpillar D311H Diesel		
Detroit Diesel 2-71 Diesel			Belt - Fan	B762	TR30428
Hose - Upper		●25473	Belt - Hyd. Pump	L7399	TR28557
Hose - Lower; (1 5/8" I.D.)		24226	Hercules GO339		
Hercules DOOC Diesel			Belt - Fan		TR24438
Belt - Fan & Hyd. Pump	L3403	TR28514	Belt - Hyd. Pump	L3585	TR24400
Belt - Gen.	27290A	TR28390	10-14 Ton		
Hercules G2000			Continental F226		
Belt - Fan & Gen.	204163A	♣9530HD	Hose - Upper		●25480
Hose - Upper		●25480	Hose - Lower		●25480
Hose - Lower; (1 5/8" I.D.)		24226	Detroit Diesel 2-71 Diesel		
Hercules GO173			Hose - Upper		●25476
Belt - Fan & Gen.		♣9520HD	Hose - Lower		●25480
Hercules QXC5			Hercules GO226		
Belt - Fan & Hyd. Pump	BG989	TR28492	Belt - Fan & Gen.		♣9530HD
Belt - W.P.	8T1356	♣9530HD	Belt - W.P.	8T1356	♣9530HD
6D2			10D		
Cummins JN6BI Diesel			Cummins C160CI Diesel		
Belt - Fan	109179	②♣9385HD	Belt - Fan	124421	②TR24365
Belt - W.P.	111726	TR22329	Belt - Gen.	70885	TR22461
Belt - Gen.	70885	TR22461	Cummins H135CI Diesel		
7D2			Belt - Fan	70524	②TR22410
Cummins JB15 Diesel			Detroit Diesel 4-71 Diesel		
Belt - Fan	106258	②♣9365HD	Belt - Fan	5170972	②TR22455
8-10 Ton			Belt - Gen.	3224367	TR28390
Detroit Diesel 2-71 Diesel			11D		
Hose - Upper		●25473	Cummins H6CI Diesel		
Hose - Lower; (1 5/8" I.D.)		24226	Belt - Fan	70524	②TR22410
Hercules DOOC Diesel			Detroit Diesel 6-71 Diesel		
Belt - Fan & Hyd. Pump	L3403	TR28514	Belt - Fan	5170972	②TR22455
Belt - Gen.	27290A	TR28390	Belt - Gen.	3224367	TR28390
Hercules G2000			D1700		
Belt - Fan & Gen.	204163A	♣9530HD	Cummins HR160CI Diesel		
Hose - Upper		●25480	Belt - Fan	172856	②TR24457
Hose - Lower; (1 5/8" I.D.)		24226	Belt - Alt		TR22350
Hercules GO173			Hose - Upper		●26509
Belt - Fan & Gen.		♣9520HD	Hose - Lower		●26516
Hercules QXC5			F1500		
Belt - Fan & Hyd. Pump	BG989	TR28492	Cummins V-8 470 Diesel		
Belt - W.P.	8T1356	♣9530HD	Belt - Fan & W.P.	178600	②TR22525
8-12 Ton			Belt - Alt	178409	♣9341HD
Continental F226			Hose - Upper		≧20401
Hose - Upper		●25480			or ●26524
Hose - Lower		●25480	Hose - Lower; (2" I.D.)		24232

≧ Cut to Fit.

♣ Standard Belt Available. See Pages 630-631.

● Vulco-Flex® Coolant Hose.

② Two Required.

Belts and Coolant Hose for Road & Construction Equipment

Application	Mfr. Part No.	Our No.
HUBER-WARCO - Continued		
F1500 - Continued		
Cummins V504 Diesel		
Belt - Fan & W.P.	178600	②TR22525
Belt - Alt.	178409	▲9341HD
Hose - Upper		●26511
Hose - Lower		●26514
M120		
Hercules QXC5		
Belt - Fan	BG989	TR28492
M150; M180		
Continental F162		
Belt - Fan	BG1215	TR28545
Maintainer		
Continental F162		
Belt - Fan & Gen.	F401K200	TR24465
Hose - Upper		●25473
Hose - Lower		●25478
Continental GD193 Diesel		
Belt - Fan & Gen.	GD193K210	▲9440HD
Hose - Lower		●25473
Three Wheel		
Detroit Diesel 2-71 Diesel		
Hose - Upper		●26508
Hose - Lower		●26508
Hercules G3400		
Belt - Fan & Gen.	204163A	▲9530HD
Hose - Upper		●26512
Hose - Lower		●26512
Hercules GO339		
Belt - Fan & Gen.	204163A	▲9530HD
HUGHES-KEENAN		
V6 Roustabout; V10 Roustabout		
Chrysler Ind.		
Belt - Fan		TR22648
Belt - W.P. & Gen.		TR22485
VH10 Roustabout		
Chrysler Ind.		
Belt - Fan		BX71
Belt - W.P. & Gen.		TR22455
VH20 Roustabout		
Chrysler Ind.		
Belt - W.P. & Gen.		TR22455
HYDRA-MAC		
14C-VD		
Isuzu 3-Cyl. 43 Diesel		
1989-1984		
Belt - Fan & Alt.		▲9390HD
Hose - Upper		●25476
Hose - Lower		●25487
HYHOE		
695		
Detroit Diesel 4-53 Diesel		
Belt - Fan	5131395	②▲9412HD
Belt - Gen. & W.P.	5133172	7430
Hose - Upper		≠21794
		or ●25474
Hose - Lower - Eng. To Pipe; (2" I.D.)		24232
Hose - Lower - Pipe To Rad.; (2" I.D.)		24232

Application	Mfr. Part No.	Our No.
HYHOE - Continued		
895		
Detroit Diesel 6V-53 Diesel		
Belt - Fan		②▲9405HD
Belt - W.P. & Idler		②7365
Belt - Gen.		7360
Hose - Upper		②●25530
Hose - Lower		●26508
HYSTER		
C330A; C330B		
Onan L423 Diesel		
Belt - Fan & Alt.	511014713	7490
Belt - Hyd. Pump	172895	7375
C340A		
Chevrolet 6-Cyl. 250		
Belt - Fan & P.S.	86071	②7470
Belt - Alt.	148370	7330
Hose - Upper		●25474
Hose - Lower		●25528
Perkins 4-Cyl. 236 Diesel		
Belt - Fan & Alt.	142526	▲9490HD
Hose - Upper - Eng. To Pipe		●25473
Hose - Lower - Eng. To Pipe		20121
		or ●25480
Hose - Lower - Pipe To Rad.		●25472
C350		
Chevrolet 6-Cyl. 250		
Hose - Upper		●25474
Hose - Lower		●25530
Detroit Diesel 3-53 Diesel		
Hose - Upper		●26502
Hose - Lower		●26508
Perkins 4-Cyl. 236 Diesel		
Hose - Upper		●25474
Hose - Lower - Eng. To Pipe		20573
		or ●25527
Hose - Lower - Pipe To Rad.		●25472
C350A; C350AD		
Chevrolet 6-Cyl. 250		
Belt - Fan & P.S.; W/37 1/8" Belt O.C.	170087	②7370
Belt - Fan & P.S.; W/38 1/8" Belt O.C.	155465	②7380
Belt - Fan & P.S.; W/46 1/8" Belt O.C.	61807	②7460
Belt - Alt.; W/38 1/8" Belt O.C.	155442	7380
Belt - Alt.; W/66 1/4" Belt O.C.	148370	▲9660HD
Perkins 4-Cyl. 236 Diesel		
Belt - Fan & Alt.	142526	▲9490HD
Hose - Upper		●25478
Hose - Lower		●25528
C350D		
Chevrolet 6-Cyl. 250		
Belt - Fan & P.S.; W/37 1/8" Belt O.C.	170087	②7370
Belt - Fan & P.S.; W/38 1/8" Belt O.C.	155465	②7380
Belt - Fan & P.S.; W/46 1/8" Belt O.C.	61807	②7460
Belt - Alt.; W/38 1/8" Belt O.C.	155442	7380
Belt - Alt.; W/66 1/4" Belt O.C.	148370	▲9660HD
Perkins 4-Cyl. 236 Diesel		
Belt - Fan & Alt.	142526	▲9490HD
Hose - Upper		●25527
C450A		
Caterpillar D311H Diesel		
Hose - Upper		●25480
Hose - Lower		●25480
Caterpillar D330 Diesel		
Belt - Fan & Alt.		TR22517

② Two Required.
 ● Vulco-Flex® Coolant Hose.

▲ Standard Belt Available. See Pages 630-631.
 ≠ Cut to Fit.

Belts and Coolant Hose for Road & Construction Equipment

Application	Mfr. Part No.	Our No.	Application	Mfr. Part No.	Our No.
HYSTER - Continued			HYSTER - Continued		
C450A - Continued			C727A		
Caterpillar D330 Diesel - Continued			John Deere 6466D Diesel		
Hose - Upper		●26526	Hose - Lower		●26528
Hose - Lower		●26526	C748A		
C500			Cummins 4-Cyl. 3.9 L Diesel		
Continental F244			Belt - Fan & Alt.	3911563	▲K080605HD
Hose - Upper; Ser. No. A78L-1535, P-1530 & Before		●25473	C832A		
Hose - Upper; Ser. No. A78L-1536, P-1531 & After		●25474	Cummins 4-Cyl. 3.9 L Diesel		
Hose - Lower; Ser. No. A78L-1535, P-1530 & Before		●25473	Hose - Upper		●26611
Hose - Lower - Eng. To Pipe; Ser. No. A78L-1536, P1531 & After		●25480	C852A		
Hose - Lower - Pipe To Rad.; Ser. No. A78L-1536, P1531 & After		●25474	Caterpillar 3208 Diesel		
C500A			Belt - Fan		②▲9500HD
Caterpillar D311H Diesel			Hose - Lower		≧21194
Belt - Fan	78378	7520	Detroit Diesel V-8 8.2 L Diesel		
Continental F244			Belt - Fan & Alt.		②▲9740HD
Belt - W.P.	79853	▲9520HD	Hose - Upper		●26516
C530			C852B		
Chevrolet 6-Cyl. 230			Caterpillar 3208 Diesel		
Hose - Upper		●25474	Hose - Lower		≧21194
Hose - Lower		●26612	Detroit Diesel V-8 8.2 L Diesel		
Perkins 4-Cyl. 236 Diesel			Belt - Fan & Alt.		②▲9700HD
Hose - Upper		●25474	Hose - Upper		●26516
Hose - Lower		≧21794	K360B		
		or ●25477	Detroit Diesel 4-53N Diesel		
C530A			Belt - W.P. & Alt.		②7417
Chevrolet 6-Cyl. 250			Belt - Air Brake Compr. & Idler		②▲9530HD
Belt - Fan & Alt.	155442	②7380	KE		
Belt - P.S.	A170087	②7370	Continental F162; Continental F163		
Perkins 4-Cyl. 236 Diesel			Hose - Upper; W/10 1/2" Hose		●25473
Belt - Fan & Alt.	142526	▲9490HD	Hose - Upper; W/15 1/2" Hose		●25477
C610B; C612B			Hose - Lower; (1 1/2" I.D.)		24224
Detroit Diesel 3-53 Diesel			Perkins 4-Cyl. 203 Diesel		
Hose - Upper		●25474	Hose - Upper		●25474
Perkins 4-Cyl. 236 Diesel			Hose - Lower		≧20450
Hose - Upper		●25526			or ●25474
C615A			Perkins P4 Diesel		
Detroit Diesel 3-53 Diesel			Hose - Lower		≧20065
Belt - Fan	122466	②▲9455HD	ICC		
Belt - W.P. & Alt.		②7410	6000W		
Hose - Upper		●25474	Kubota 900 Diesel		
Hose - Lower - Eng. To Pipe; (2" I.D.)		24232	Belt - Fan		7365
Hose - Lower - Pipe To Rad.; (2" I.D.)		24232	D6000; DL6000		
C615B			Continental TMD27 Diesel		
Detroit Diesel 3-53 Diesel			Hose - Upper		20121
Hose - Upper		●25474	DL7000		
Perkins 4-Cyl. 236 Diesel			Cummins 4-Cyl. 3.9 L Diesel		
Hose - Upper		●25526	Hose - Upper		20573
C617B			INGERSOLL		
Detroit Diesel 3-53 Diesel			185		
Belt - Fan		②▲9440HD	John Deere 4239D Diesel		
Belt - W.P. & Alt.		②7430	Belt - Fan		7425
Hose - Upper		●25474	Belt - Alt.		TR22495
Perkins 4-Cyl. 236 Diesel			Hose - Upper - Eng. To Pipe		●25478
Hose - Upper		●25526	Hose - Upper - Pipe To Rad.; (1 1/2" I.D.)		24224
C624B; C625B; C627B			Hose - Lower - Eng. To Pipe		≧20452
Detroit Diesel 3-53 Diesel			Hose - Lower - Pipe To Pipe; (1 1/2" I.D.)		24224
Hose - Upper		●25474	Hose - Lower - Pipe To Rad.		●25477
Perkins 4-Cyl. 236 Diesel					
Hose - Upper		●25526			

● Vulco-Flex® Coolant Hose.
≧ Cut to Fit.

▲ Standard Belt Available. See Pages 630-631.
② Two Required.

Belts and Coolant Hose for Road & Construction Equipment

Application	Mfr. Part No.	Our No.
INGERSOLL - Continued		
CM695D		
Caterpillar 3306 Diesel Belt - Fan, Alt. & A.C.		②BX71
D5000		
Detroit Diesel 4-71 Diesel		
Belt - Fan	5139026	②▲9420HD
Belt - Gen.		▲9463HD
Belt - Compr.		▲9480HD
D6000		
Detroit Diesel 6-71 Diesel		
Belt - Fan		②▲9430HD
Belt - Gen.	5133515	▲9370HD
Hose - Upper		≠20046
Hose - Lower - Eng. To Pipe; (2" I.D.)		24432
Hose - Lower - Pipe To Rad.; (2" I.D.)		24432
D7505		
Cummins V903 Diesel		
Belt - Alt.	178662	②▲9510HD
Hose - Upper - Eng. To Pipe (Left)		≠20397
Hose - Upper - Eng. To Pipe (Right); (2 1/4" I.D.)		24436
Hose - Upper - Pipe To Rad.; (2 1/4" I.D.)		⊕24936
Hose - Lower; (2 3/4" I.D.)		24444
DA40		
Detroit Diesel 3-53 Diesel		
Belt - Fan & Alt.	5133172	7430
L64MH		
Kubota D905PG		
Belt - Fan	FM376	7385
SD70		
Cummins 4-Cyl. 3.9 L Diesel		
Belt - Fan & Alt.		▲K080537HD
SP42		
Ford 2514E		
Hose - Upper		≠20573
		or ●25473
Hose - Lower		●26502
IH UD236 Diesel		
Belt - Fan & Alt.	670261C1	▲9505HD
Hose - Upper		●26510
SP54		
Detroit Diesel 4-53 Diesel		
Belt - Fan	5130529	②▲9451HD
Belt - W.P. & Gen.		7410
Hose - Upper		≠20046
		or ●26502
Hose - Lower		●26507
T4		
Detroit Diesel 12V-71 Diesel		
Hose - Upper		②●26532
Hose - Lower; (3 1/2" I.D.)		24256
Detroit Diesel 8V-71 Diesel		
Belt - Gen.	5133516	②▲9380HD
XP750		
Detroit Diesel 6V-71N Diesel		
Hose - Upper - Eng. To Pipe; (2 1/4" I.D.)		②24436
Hose - Upper - Pipe To Rad.; (2 1/4" I.D.)		②24436
Hose - Lower - Eng. To Pipe; (2 1/2" I.D.)		24440

Application	Mfr. Part No.	Our No.
INGERSOLL - Continued		
XP750WJD		
John Deere 6076A Diesel		
Belt - Fan		▲9710HD
INGRAM		
9-2800		
IH 6-Cyl. 221 Diesel		
Hose - Upper		≠20611
Hose - Lower - Eng. To Pipe; (2" I.D.)		24232
Hose - Lower - Pipe To Rad.; (2" I.D.)		24232
10 Ton		
Detroit Diesel 3-53 Diesel		
Belt - Fan		②▲9412HD
Belt - W.P. & Alt.		②▲9420HD
Hose - Upper		≠20957
Hose - Lower - Eng. To Pipe		≠20882
Hose - Lower - Pipe To Rad.		≠20882
11-5400		
Detroit Diesel 3-71 Diesel		
Belt - Fan	5139026	②▲9420HD
Belt - Gen.	5133517	▲9390HD
Hose - Upper		●26603
Hose - Lower - Eng. To Pipe; (2" I.D.)		24232
Hose - Lower - Pipe To Rad.; (2" I.D.)		24232
INSLEY		
H560B		
Detroit Diesel 4-53 Diesel		
Belt - Fan		②▲9390HD
Belt - W.P. & Gen.		②7405
Hose - Upper		●25474
Hose - Lower		●26507
H875		
Detroit Diesel 6-71 Diesel		
Belt - Fan	5126767	②▲9455HD
Belt - Gen.		▲9380HD
Hose - Upper		●26611
Hose - Lower		●26520
H1500		
Detroit Diesel 6-71 Diesel		
Belt - Fan		②▲9440HD
Belt - Alt.		▲9480HD
Belt - A.C.		②▲9400HD
Hose - Upper		●26516
Hose - Lower		●26518
INTERNATIONAL		
2T551		
Cummins HRBI Diesel		
Belt - Fan	S1792	②TR22405
Belt - Gen.	134814	TR22350
55		
Cummins HRBI Diesel; Cummins NTO6BI Diesel		
Belt - Fan & W.P.	S1792	TR22405
Hose - Upper - Eng. To Pipe		23533
Hose - Upper - Pipe To Rad.		23533
Hose - Lower		23533
65		
Cummins NRT6BI Diesel; Cummins NRTO6BI Diesel		
Belt - Fan; W/11/16" Belt T.W.; W/46 5/8" Belt O.C.	S2295	②TR22461
Belt - Fan; W/5/8" Belt T.W.; W/47 1/8" Belt O.C.		TR24465

② Two Required.
≠ Cut to Fit.
● Vulco-Flex® Coolant Hose.

▲ Standard Belt Available. See Pages 630-631.
⊕ Use Wire Inserted Green Stripe® Coolant Hose.

Belts and Coolant Hose for Road & Construction Equipment

Application	Mfr. Part No.	Our No.	Application	Mfr. Part No.	Our No.
INTERNATIONAL - Continued			INTERNATIONAL - Continued		
65 - Continued			175 - Continued		
Cummins NRT6BI Diesel; Cummins NRT06BI Diesel - Continued			IH DT361 Diesel - Continued		
Belt - Fan; W/15/16" Belt T.W.; W/54 3/4" Belt O.C.	S3180	ⓉTR30543	Hose - Lower - Eng. To Pipe; Ser. No. 9601 & After(2 1/4" I.D.)		24236
Belt - W.P.	S3163	TR22434	Hose - Lower - Pipe To Rad.; Ser. No. 9601 & After(1 3/4" I.D.)		24228
			Hose - By Pass; Ser. No. 9601 Thru 10125(1 1/2" I.D.)		24224
65C			IH DT407 Diesel		
IH DVT573 Diesel			Belt - Fan & Gen.		
Belt - Fan	328927R11	ⓉTR28680		304071R11	ⓉTR24709
Belt - W.P.	345013R1	TR22455	175B		
Belt - Gen. & Air Brake Compr.	341190R1	TR22474	IH DT361 Diesel; IH DT407 Diesel		
IH DVT573B Diesel			Belt - Fan & Alt.; Eng. No. 32317 & After		
Belt - Fan; Eng. No. 7500 & After	673949C91	ⓉTR22692		670711C1	ⓉTR22692
Belt - Alt.; Eng. No. 7500 & After	673950C1	▲9490HD	Belt - Fan & Gen.; Eng. No. 32317 & Before .	326758R11	ⓉTR22720
Belt - P.S.	611802C1	TR28545	175C		
75			IH DT466 Diesel		
Cummins HRBI Diesel; Cummins NTO6BI Diesel			Belt - Fan & Alt.		
Belt - Fan & W.P.	S1792	TR22405		673482C1	ⓉTR22648
Hose - Upper - Eng. To Pipe		23533	Hose - Upper		21308
Hose - Upper - Pipe To Rad.		23533	Hose - Lower		≈20744
Hose - Lower		23533	180		
95			Cummins VT1710 Diesel		
IH D817 Diesel; IH DT817 Diesel			Belt - Fan		
Belt - Fan & Gen.; W/48 1/4" Belt O.C.	310081R2	▲9480HD			③▲9610HD
Belt - Fan & Gen.; W/52 3/8" Belt O.C.		TR22517	Belt - W.P.	178665	ⓉTR28390
Belt - Air Brake Compr.	278714R1	TR24515	Belt - Alt.	178520	Ⓣ▲9380HD
100 Hauler			Hose - Upper - Eng. To Pipe; (2 1/2" I.D.)		
IH DT817 Diesel			Hose - Upper - Pipe To Rad.; (2 1/2" I.D.)		
Belt - Fan & Alt.	323987R3	▲9465HD	Hose - Lower - Eng. To Pipe; (4" I.D.)		
Belt - Air Brake Compr.	278714R1	TR24515	Hose - Lower - Pipe To Rad.; (3 1/2" I.D.)		
100B			Detroit Diesel 12V-71 Diesel		
IH DT817B Diesel			Belt - Fan		
Belt - Fan & Alt.	670464C1	TR22578		600168C1	③▲9610HD
Belt - Air Brake Compr.	278714R1	TR24515	Belt - Alt.	643446C1	▲9305HD
100E			Hose - Upper - Eng. To Pipe; (2 1/2" I.D.)		
IH D239 Diesel			Hose - Upper - Pipe To Rad.; (2 1/2" I.D.)		
Belt - Fan	621770C1	▲9555HD	Hose - Lower - Eng. To Pipe; (3" I.D.)		
Hose - By Pass		≈20267	Hose - Lower - Pipe To Rad.; (3" I.D.)		
125C			Hose - By Pass; (1 1/2" I.D.)		
IH D239 Diesel			IH DT429 Diesel		
Belt - Fan & W.P.	621770C1	▲9555HD	Belt - Fan & Gen.		
Hose - Lower		●26508		326998R1	③TR22570
140			Belt - W.P.		
IH DT817B Diesel			Hose - Upper - Eng. To Pipe; (2 1/2" I.D.)		
Belt - Fan	600168C11	Ⓣ▲9610HD	Hose - Upper - Pipe To Rad.; (2 1/2" I.D.)		
Belt - Alt.	670464C1	TR22578	Hose - Lower - Eng. To Pipe; (3" I.D.)		
Belt - Air Brake Compr.	332338R1	TR24489	Hose - Lower - Pipe To Rad.; (3" I.D.)		
150 Crawler			Hose - By Pass; (1 1/2" I.D.)		
IH DT282 Diesel			Detroit Diesel 16V-71 Diesel		
Belt - Fan; W/Man. Trans.	328540R1	TR28575	Hose - Upper - Eng. To Pipe; (3" I.D.)		
Belt - Fan; W/Power Shift Trans.		TR28616	Hose - Lower - Pipe To Rad.; (3" I.D.)		
Belt - Alt.	670572C1	TR22495	Hose - By Pass; (1 1/2" I.D.)		
Belt - Gen.	306658R1	TR22514	IH DT429 Diesel		
Hose - Upper		●26511	Belt - Fan & Alt./Gen.		
Hose - Lower		●26507		670741C1	ⓉTR22570
Hose - By Pass; (5/8" I.D.)		28441	Belt - W.P.		
175			250B		
IH DT361 Diesel			IH DT429 Diesel		
Hose - Upper; Ser. No. 9601 Thru 10125		●26520	Belt - Fan & Gen.		
Hose - Upper; Ser. No. 10126 & After		≈20459		328502R1	TR22485
		or ●26521	Hose - Upper - Eng. To Pipe; (2 1/2" I.D.)		
			Hose - Upper - Pipe To Rad.; (2 1/2" I.D.)		
			Hose - Lower - Eng. To Pipe; (3" I.D.)		
			Hose - Lower - Pipe To Rad.; (3" I.D.)		
			Hose - By Pass; (1 1/2" I.D.)		
			IH DVT573B Diesel		
			Belt - Alt.; Eng. No. 7500 & After		
			673947C1		
			▲9447HD		
			270		
			IH DVT573B Diesel		
			Belt - Fan; Eng. No. 7500 & After		
			673949C91		
			TR22692		
			Belt - Alt.; Eng. No. 7500 & After		
			673950C1		
			▲9490HD		
			Hose - Upper - Eng. To Pipe; (1 3/4" I.D.)		
			24228		
			Hose - Upper - Pipe To Rad.; (1 3/4" I.D.)		
			24228		
			Hose - Lower; (3" I.D.)		
			24248		
			295		
			IH DT817 Diesel		
			Belt - Fan & Gen.		
				323987R1	▲9465HD
			Belt - Air Brake Compr.		
				332338R1	TR24489
			Hose - Upper - Eng. To Pipe; (2 7/8" I.D.)		
			24246		
			Hose - Upper - Pipe To Rad.; (2 7/8" I.D.)		
			24246		
			Hose - Lower; (3 1/2" I.D.)		
			24256		

Road & Construction Equipment

Ⓣ Two Required.
≈ Cut to Fit.
③ Three Required.

▲ Standard Belt Available. See Pages 630-631.
● Vulco-Flex® Coolant Hose.

Belts and Coolant Hose for Road & Construction Equipment

Application	Mfr. Part No.	Our No.
INTERNATIONAL - Continued		
295B		
IH DT817B Diesel		
Belt - Fan & Alt.	670464C1	TR22578
Belt - Air Brake Compr.	332338R1	TR24489
Hose - Upper - Eng. To Pipe; (2 1/4" I.D.)		24236
Hose - Upper - Pipe To Rad.; (2 1/4" I.D.)		24236
Hose - Lower; (3 1/2" I.D.)		24256
330; 340		
IH DT817B Diesel		
Belt - Fan	600168C11	②▲9610HD
Belt - Alt.	670464C1	TR22578
Belt - Air Brake Compr.	332338R1	TR24489
350		
Detroit Diesel 12V-71 Diesel		
Belt - Fan	600168C11	③▲9610HD
Belt - Alt.; W/30A. Alt.	643446C1	▲9305HD
Belt - Alt.; W/50A. Alt.	284583C2	▲9313HD
Belt - Air Brake Compr.	670740C1	TR22570
Hose - Upper - Eng. To Pipe; (3" I.D.)		24448
Hose - Upper - Pipe To Rad.; (3" I.D.)		24448
Hose - Lower - Eng. To Pipe; (4" I.D.)		24464
Hose - Lower - Pipe To Rad.; (4" I.D.)		24464
412		
IH DT466 Diesel		
Belt - Alt.	673489C1	②TR22625
Belt - Fan & Alt.	683548C91	②TR22664
Belt - Air Brake Compr.	673089C1	TR22405
Belt - A.C.	683448C1	TR22448
Hose - Upper - Eng. To Pipe; (2 1/2" I.D.)		24240
Hose - Upper - Pipe To Rad.; (2 1/2" I.D.)		24240
431		
IH DT466 Diesel		
Belt - Fan	673949C91	③TR22692
Belt - Alt.	673950C1	TR22485
IH DVT800 Diesel		
Belt - Fan & W.P.	673948C1	③TR22692
Belt - Fan & Air Brake Compr.		③BX71
Belt - Alt.	673947C1	▲9447HD
Belt - A.C.	683341C91	②▲9590HD
Hose - Upper - Eng. To Pipe; (1 3/4" I.D.)		24428
Hose - Upper - Pipe To Rad.; (1 3/4" I.D.)		24428
Hose - Lower; (3" I.D.)		24448
431B		
IH DVT800 Diesel		
Belt - Alt.	673947C1	▲9447HD
Belt - A.C.	683341C91	②▲9590HD
433		
IH DT466 Diesel		
Belt - Fan	673949C91	③TR22692
Belt - Alt.	673950C1	TR22485
Belt - Fan & Alt.	673481C91	②TR22648
Hose - Upper - Eng. To Pipe; (2 1/4" I.D.)		24436
Hose - Upper - Pipe To Rad.; (2 1/4" I.D.)		24436
Hose - Lower; (2 7/8" I.D.)		24446
IH DVT800 Diesel		
Belt - Fan & W.P.	673948C1	③TR22692
Belt - Fan & Air Brake Compr.		③BX71
Belt - Alt.	673947C1	▲9447HD
Belt - A.C.	683341C91	②▲9590HD
Hose - Upper - Eng. To Pipe; (1 3/4" I.D.)		24428
Hose - Upper - Pipe To Rad.; (1 3/4" I.D.)		24428
Hose - Lower; (3" I.D.)		24448

Application	Mfr. Part No.	Our No.
INTERNATIONAL - Continued		
433B		
IH DT466 Diesel		
Belt - Fan		②▲9670HD
Belt - Fan & Alt.	673481C91	②TR22648
Hose - Upper - Eng. To Pipe; (2 1/4" I.D.)		24436
Hose - Upper - Pipe To Rad.; (2 1/4" I.D.)		24436
Hose - Lower; (2 7/8" I.D.)		24446
IH DVT800 Diesel		
Belt - Alt.	673947C1	▲9447HD
Belt - A.C.	683341C91	②▲9590HD
Hose - Upper - Eng. To Pipe; (1 3/4" I.D.)		24428
Hose - Upper - Pipe To Rad.; (1 3/4" I.D.)		24428
Hose - Lower; (3" I.D.)		24448
442		
IH DT466 Diesel		
Belt - Fan	673949C91	③TR22692
Belt - Alt.	673950C1	TR22485
IH DVT800 Diesel		
Belt - Fan & W.P.	673948C1	③TR22692
Belt - Fan & Air Brake Compr.		③BX71
Belt - Alt.	673947C1	▲9447HD
Belt - A.C.	683341C91	②▲9590HD
Hose - Upper - Eng. To Pipe; (1 3/4" I.D.)		24428
Hose - Upper - Pipe To Rad.; (1 3/4" I.D.)		24428
Hose - Lower; (3" I.D.)		24448
442B		
IH DVT800 Diesel		
Belt - Alt.	673947C1	▲9447HD
Belt - A.C.	683341C91	②▲9590HD
444		
IH DT466 Diesel		
Belt - Fan	673949C91	③TR22692
Belt - Fan & Alt.	673481C91	②TR22648
Belt - Alt.	673950C1	TR22485
Hose - Upper - Eng. To Pipe; (2 1/4" I.D.)		24236
Hose - Upper - Pipe To Rad.; (2 1/4" I.D.)		24236
IH DVT800 Diesel		
Belt - Fan & W.P.	673948C1	③TR22692
Belt - Fan & Air Brake Compr.		③BX71
Belt - Alt.	673947C1	▲9447HD
Belt - A.C.	683341C91	②▲9590HD
Hose - Upper - Eng. To Pipe (Front Eng.)		②<20046
Hose - Upper - Pipe To Rad. (Front Eng.); (1 3/4" I.D.)		②24228
Hose - Upper - Eng. To Pipe (Rear Eng.); (2 1/4" I.D.)		24236
Hose - Upper - Pipe To Rad. (Rear Eng.); (2 1/4" I.D.)		24236
Hose - Lower; (3" I.D.)		24248
444B		
IH DT466 Diesel		
Belt - Fan & Alt.	673481C91	②TR22648
IH DVT800 Diesel		
Belt - Alt.	673947C1	▲9447HD
Belt - A.C.	683341C91	②▲9590HD
495		
IH DT817 Diesel; IH DT817B Diesel		
Belt - Fan & Gen.	304312R1	▲9510HD
Belt - Air Brake Compr.	278714R1	TR24515
Hose - Upper - Eng. To Pipe; (2 7/8" I.D.)		24246
Hose - Upper - Pipe To Rad.; (2 7/8" I.D.)		24246
Hose - Lower; (3 1/2" I.D.)		24256
2500 Constructall		
IH C153		
Belt - Fan & Alt.	378113R2	▲9480HD
Belt - Fan & Gen.	151529R1	7440
Hose - Upper		≈<20206
Hose - Lower; (1 3/8" I.D.)		24222

② Two Required.
③ Three Required.

▲ Standard Belt Available. See Pages 630-631.
≈< Cut to Fit.

Belts and Coolant Hose for Road & Construction Equipment

Application	Mfr. Part No.	Our No.	Application	Mfr. Part No.	Our No.
INTERNATIONAL - Continued			INTERNATIONAL - Continued		
2500 Constructall - Continued			3800 - Continued		
IH C153 - Continued			IH D282 Diesel		
Hose - By Pass; (1/2" I.D.)		28439	Belt - Fan	385674R1	▲9490HD
IH D188 Diesel			Belt - W.P. & Gen.	316250R1	▲9490HD
Belt - Fan	385119R1	▲9490HD	3820		
Belt - W.P. & Gen.	315969R1	▲9490HD	IH D310 Diesel		
Hose - Upper		≅20206	Hose - Lower - Eng. To Pipe		≅20206
Hose - Lower - Eng. To Pipe; (2" I.D.)		24232	Hose - Lower - Pipe To Rad.		≅20206
Hose - Lower - Pipe To Rad.; (1 1/2" I.D.)		24224	3820A		
Hose - By Pass		20338	IH D310 Diesel		
3400A			Belt - Fan & Alt.	530076R1	▲9640HD
IH C175			Belt - W.P. & Alt.	396543R1	▲9640HD
Belt - Fan & Alt.	532030R2	7516	Hose - Upper		●26509
Hose - Lower		≅21660	Hose - Lower - Eng. To Pipe		≅20611
		or ●25474	Hose - Lower - Pipe To Rad.		≅20611
IH D179 Diesel			3850		
Belt - Fan & Alt.	534310R1	▲9630HD	IH C263		
Hose - Upper		●26503	Belt - Fan	378113R2	▲9480HD
3444			Belt - W.P. & Gen.	403348R1	▲9463HD
IH BC144; IH BD154 Diesel			Hose - By Pass		20338
Belt - Fan; W/31 3/4" Belt O.C.	48878D	▲9313HD	IH D282 Diesel		
Belt - Fan; W/34 3/4" Belt O.C.	376371R1	TR22344	Belt - Fan	385674R1	▲9490HD
Belt - Alt.	401691R1	▲9341HD	Belt - W.P. & Gen.	316250R1	▲9490HD
3514			3964		
IH 4-Cyl. 153			IH 6-Cyl. 358 Diesel		
Belt - Fan		▲9490HD	Belt - Fan & Alt.		②▲9630HD
Belt - W.P. & Gen.	151529R1	7440	Hose - Upper		●26512
Hose - Upper		●26510	Hose - Lower		●26511
Hose - Lower; (1 3/8" I.D.)		24222	Hose - By Pass; (2" I.D.)		24232
Hose - By Pass; (1/2" I.D.)		28439	3984		
IH 4-Cyl. 175			IH 6-Cyl. 358 Diesel		
Belt - Fan & Alt.	403303R1	7545	Belt - Fan & Alt.		②▲9625HD
IH 4-Cyl. 188 Diesel			Hose - Upper		●26508
Belt - Fan	385674R1	▲9490HD	Hose - Lower		●26511
Belt - W.P. & Gen.	315969R1	▲9490HD	C9A		
Hose - Upper		●26510	IH Diesel		
Hose - Lower; (2" I.D.)		24232	Belt - Fan & Alt.	886010C91	▲9360HD
Hose - By Pass		20338	E200		
IH 4-Cyl. 239 Diesel			IH DT414 Diesel		
Belt - Fan & Alt.; W/Syncro Mesh Trans.	403303R1	7545	Belt - Fan & Alt.	673489C1	②TR22625
Belt - Fan & Alt.; W/O Syncro Mesh Trans.	401128R1	▲9580HD	Belt - Fan & Gen.	612175C11	②TR22664
3600; 3600A			Belt - Air Brake Compr.	673089C1	TR22405
IH C263			E211		
Belt - Fan	406097R1	▲9570HD	IH DT407 Diesel		
Belt - W.P. & Alt.	393415R1	▲9470HD	Belt - Fan & Gen.	612175C11	②TR22664
IH D282 Diesel			Belt - A.C.	345236R1	7420
Belt - Fan	406097R1	▲9570HD	E270		
Belt - W.P. & Alt.		▲9490HD	IH DVT573 Diesel		
Hose - Upper		●26510	Belt - Fan	328927R11	②TR28680
Hose - Lower		●26507	Belt - W.P.	345013R1	TR22455
3616			Belt - Gen. & Air Brake Compr.	341190R1	TR22474
IH 6-Cyl. 221			Hose - Upper - Eng. To Pipe; (1 3/4" I.D.)		24228
Belt - Fan	403348R1	▲9463HD	Hose - Upper - Pipe To Rad.; (1 3/4" I.D.)		24228
Belt - W.P. & Gen.	403348R1	▲9463HD	Hose - Lower; (3" I.D.)		24248
Hose - By Pass		20338	S8		
IH 6-Cyl. 236 Diesel			Detroit Diesel 3-53 Diesel		
Belt - Fan	403348R1	▲9463HD	Hose - Upper		●26509
Belt - W.P. & Gen.		▲9490HD	Hose - Lower		●26507
3800					
IH C263					
Belt - Fan	378113R2	▲9480HD			
Belt - W.P. & Gen.	403348R1	▲9463HD			
Hose - By Pass		20338			

▲ Standard Belt Available. See Pages 630-631.
● Vulco-Flex® Coolant Hose.

≅ Cut to Fit.
② Two Required.

Belts and Coolant Hose for Road & Construction Equipment

Application	Mfr. Part No.	Our No.
INTERNATIONAL - Continued		
T180F; T180FB		
IH V-8 401		
Belt - Fan	133500R11	②TR22434
Belt - Fan & W.P.	359021C91	②TR22434
Belt - Alt.; Eng. No. 233 & Before	154849H2	♣9319HD
Belt - Alt.; Eng. No. 234 & After	358330C91	♣9365HD
T225; T225SL; T300; T300SL		
IH		
Belt - Fan & W.P.	133500R11	TR22434
Belt - Alt.; Eng. No. 335 & Before	154849H2	♣9319HD
Belt - Alt.; Eng. No. 336 & After	243608R1	♣9365HD
T500S		
Detroit Diesel 6V-53 Diesel		
Belt - Fan & Alt.	528419R91	②TR22664
Belt - Air Brake Compr.	5130529	②♣9455HD
Hose - Upper - Eng. To Pipe; (2 3/4" I.D.)	24244	24244
Hose - Upper - Pipe To Rad.; (2 1/4" I.D.)	24236	24236
Hose - Lower - Eng. To Pipe; (3 1/2" I.D.)	24256	24256
Hose - Lower - Pipe To Rad.; (2 3/4" I.D.)	24244	24244
T800S		
IH V-8 401		
Belt - Fan	678186C1	②TR22455
Belt - Alt.	358324C91	♣9455HD
IH V-8 402		
Belt - Alt.	358324C91	♣9455HD
TD7C		
IH D206 Diesel		
Belt - Fan	621770C1	♣9555HD
TD7E; TD8C		
IH D239 Diesel		
Belt - Fan	621770C1	♣9555HD
TD8E		
IH DT239 Diesel		
Belt - Fan	621770C1	♣9555HD
TD12		
IH D466B Diesel		
Belt - Fan & Alt.	1213134H91	②TR22664
TD15B		
IH DT407 Diesel		
Belt - Fan & Alt.	612134C11	TR24688
TD15C		
IH DT466B Diesel		
Belt - Alt.; Ser. No. 17399 & Before	673481C1	TR22648
Belt - Alt.; Ser. No. 17400 & After	1213134H91	②TR22664
TD20B		
IH DT429 Diesel		
Belt - Fan & Alt.	670741C1	②TR22570
Belt - Fan & Gen.	1800001C91	②TR22578
Belt - W.P.	328502R1	TR22485
TD20C		
IH DV573B Diesel		
Belt - Fan	673946C91	④TR22752
Belt - Alt.; Ser. No. 7500 & After	673947C1	♣9447HD
TD20E		
IH DVT800 Diesel		
Belt - Fan	673946C91	④TR22752
Belt - Alt.; Ser. No. 30277 & Before	683723C1	♣9476HD
Belt - Alt.; Ser. No. 30278 & After	673029C1	♣9470HD

Application	Mfr. Part No.	Our No.
INTERNATIONAL - Continued		
TD20E - Continued		
IH DVT800 Diesel - Continued		
Belt - A.C.		♣9680HD
TD25B		
IH DT817 Diesel		
Belt - Fan & Gen.	403348R1	♣9463HD
TD25C		
IH DT817 Diesel		
Belt - Alt.	326998R1	②TR22570
TD25E		
IH DT817C Diesel		
Belt - Fan & Alt.; Ser. No. 12007 & Before		TR22517
Belt - Fan & Alt.; Ser. No. 12008 & After	326998R1	②TR22570
TD180FB; TD225SL		
Detroit Diesel 6V-53 Diesel		
Belt - Fan	5136268	②♣9610HD
TD300SL		
Detroit Diesel 6V-53 Diesel		
Belt - Fan	5136273	②♣9510HD
JAEGER		
60; 75		
Continental F140		
Belt - Fan	F140K215	TR28483
75A; 75B; 85A; 85B		
Continental F140; Continental F162		
Belt - Fan	G157K208	TR24461
105		
Continental F226		
Belt - Fan	F140K215	TR28483
Belt - Intercooler		TR24438
IH UD6; IH UD6A		
Belt - Fan	16131D	TR30467
Belt - Fuel Pump	48878D	♣9309HD
Belt - Intercooler		TR24438
125		
Continental F226		
Belt - Fan	F140K215	TR28483
Continental G193		
Belt - Fan	G193K201	♣9463HD
Continental HD260 Diesel		
Belt - Fan		TR28501
IH UD6; IH UD6A		
Belt - Fan	16131D	TR30467
Belt - Fuel Pump		♣9309HD
Belt - Intercooler		TR24438
160		
Continental M330		
Belt - Fan	M330K229	TR30506
Belt - Intercooler		TR24438
IH UD9; IH UD9A		
Belt - Fan	48042D	TR30484
Belt - Fuel Pump	49341D	♣9335HD
Belt - Intercooler		TR24438
175A		
White G2300		
Belt - Fan & Alt.		♣9490HD
Hose - Upper; (1 3/4" I.D.)		♣24928
Hose - Lower; (1 3/4" I.D.)		♣24928

② Two Required.
④ Four Required.

♣ Standard Belt Available. See Pages 630-631.
⊗ Use Wire Inserted Green Stripe® Coolant Hose.

Belts and Coolant Hose for Road & Construction Equipment

Application	Mfr. Part No.	Our No.
JAEGER - Continued		
180		
Continental M330		
Belt - Fan	M330K229	TR30506
Belt - Intercooler		TR24438
IH UD9; IH UD9A		
Belt - Fan	48042D	TR30484
Belt - Fuel Pump	49341D	▲9335HD
Belt - Intercooler		TR24438
210		
Caterpillar D318 Diesel; Caterpillar D4600 Diesel		
Belt - Intercooler		TR24500
Continental B427		
Belt - Fan	M330K229	TR30506
Belt - Intercooler		TR24500
IH UD14 Diesel; IH UD14A Diesel		
Belt - Fan	30982D	TR32571
Belt - Fuel Pump	48878D	▲9309HD
Belt - Intercooler		TR24500
250		
Caterpillar D318 Diesel; Caterpillar D4600 Diesel		
Belt - Intercooler		TR24500
Continental B427		
Belt - Fan	M330K200	TR32491
Belt - Intercooler		TR24500
Detroit Diesel 3-71 Diesel		
Belt - Fan		②3600
Belt - Gen.	3224367	TR28390
IH UD14 Diesel; IH UD14A Diesel		
Belt - Fan	30982D	TR32571
Belt - Fuel Pump	48878D	▲9309HD
Belt - Intercooler		TR24500
315		
Continental R602		
Belt - Fan	R602K208	②TR28657
IH UD18		
Belt - Fan	42937DX	②TR28616
Belt - Fuel Pump	49341D	▲9335HD
Belt - Intercooler		TR24530
IH UD18A		
Belt - Fan	251180R11	②TR28628
Belt - Fuel Pump	49341D	▲9335HD
Belt - Intercooler		TR24530
365		
Cummins HRBI Diesel		
Belt - Fan		TR22405
Detroit Diesel 4-71 Diesel		
Belt - Fan		②3610
Belt - Gen.	3224367	TR28390
600		
Detroit Diesel 6-71 Diesel		
Belt - Fan		②3600
Belt - Gen.	3224367	TR28390
IH UD24		
Belt - Fan		②CX68
Belt - Intercooler		TR32571
Murphy ME66		
Belt - Fan	MD6595	TR28733
Belt - Intercooler		TR32571
900		
Detroit Diesel 6-110 Diesel		
Belt - Fan		③TR22664
Belt - Gen.	5155911	TR28406

▲ Standard Belt Available. See Pages 630-631.
 ③ Three Required.
 ≡ Cut to Fit.

Application	Mfr. Part No.	Our No.
JAEGER - Continued		
H		
Continental		
Belt - Front P.T.O.; W/6-8 Yard Mixing Capacity	30601188	3490
Belt - Front P.T.O.; W/9-10 Yard Mixing Capacity	30601188	3490
Belt - Flywheel P.T.O.; W/6-8 Yard Mixing Capacity	30601225	3680
Belt - Flywheel P.T.O.; W/9-10 Yard Mixing Capacity	30601227	3690
Belt - Eng. Drive; W/6-8 Yard Mixing Capacity	30601187	3480
JCB		
210S		
Perkins 1004 Diesel		
Belt - Fan & Alt.		▲9590HD
406		
Perkins 3-Cyl. Diesel		
Belt - Fan & Alt.	2614B556	▲9530HD
Hose - Upper		●25528
Hose - Lower - Eng. To Pipe		≡21794
Hose - Lower - Cooler To Rad.		≡21794
1550B		
Perkins 4-Cyl. 236 Diesel		
Belt - Fan & Alt.		▲9680HD
1700B		
Perkins 4-Cyl. 236 Diesel		
Belt - Fan & Alt.		▲9570HD
Belt - A.C.		▲9313HD
JOHN DEERE		
15		
Yanmar 3TNA72 Diesel		
Belt - Fan	M800347	7360
24		
John Deere 3-Cyl. 152 Diesel		
1975-1970		
Belt - Fan & Alt.	T20334	TR22474
Hose - Upper; Early		●25480
Hose - Upper; Late		≡20065
		●25526
Hose - Lower - Eng. To Pipe; (1 7/8" I.D.)		②24930
Hose - Lower - Pipe To Rad.		≡20357
Hose - By Pass; (1/2" I.D.)		28439
Wisconsin VG4D		
1975-1970		
Belt - Alt.	GG02032156	▲9319HD
25		
Yanmar 3TN78 Diesel		
Belt - Fan	M801821	▲9390HD
84		
Yanmar 4TN100 Diesel		
Belt - Fan & Alt.	T113931	TR22474
125		
Teledyne TM20 Diesel		
1984-1976		
Belt - Fan	GG02032188	▲9385HD
170		
Wisconsin VG4D		
1977-1975		
Belt - Fan	M81037	6832

② Two Required.
 ● Vulco-Flex® Coolant Hose.
 ≡ Use Wire Inserted Green Stripe® Coolant Hose.

Road & Construction Equipment

Belts and Coolant Hose for Road & Construction Equipment

Application	Mfr. Part No.	Our No.
JOHN DEERE - Continued		
210C Backhoe		
John Deere 4-Cyl. 239 Diesel		
Belt - Fan & Alt.; W/51 1/2" Belt O.C.	T24757	TR22508
Belt - Fan & Alt.; W/52 1/2" Belt O.C.	R82602	TR22517
Belt - Fan & Alt.; W/52 3/4" Belt O.C.	T24473	TR22514
210C Wheel Loader		
John Deere 4039D Diesel		
Belt - Fan & Alt.	R82602	TR22517
210LE		
John Deere 4045D Diesel		
Belt - Fan & Alt.	R135195	▲K080645HD
Tensioner Assy. - Fan & Alt.	RE518097	38507
Tensioner Pulley - Fan & Alt.	RE518097	36091
240 Skid Steer		
John Deere 3-Cyl. 179 Diesel		
2004-1999		
Belt - Fan; W/52" Belt O.C.	R97939	TR22517
Belt - Fan; W/55" Belt O.C.	R87153	TR22545
Belt - A.C.	H87459	▲9395HD
244J		
John Deere 4-Cyl. 149 Diesel		
Belt - Fan	R505810	▲K060923HD
250 Skid Steer		
John Deere 3-Cyl. 179 Diesel		
2004-1999		
Belt - Fan; W/52" Belt O.C.	R97939	TR22517
Belt - Fan; W/55" Belt O.C.	R87153	TR22545
Belt - A.C.	H87459	▲9395HD
250D		
John Deere 6-Cyl. 549 Diesel		
Belt - Fan & A.C.	H166870	▲K080878HD
260 Skid Steer		
John Deere 3-Cyl. 179 Diesel		
2004		
Belt - Fan; W/52" Belt O.C.	R97939	TR22517
Belt - Fan; W/O High Performance Output	R97939	TR22517
Belt - Fan; W/High Performance Output	R505792	TR22545
Belt - Fan; W/55" Belt O.C.	R505792	TR22545
Belt - A.C.	H87459	▲9395HD
2003-1999		
Belt - A.C.	H87459	▲9395HD
Belt - Fan; W/O High Performance Output	R97939	TR22517
Belt - Fan; W/High Performance Output	R505792	TR22545
270 Skid Steer		
John Deere 4045D Diesel		
2004-1999		
Belt - Fan; W/57 1/2" Belt O.C.	R503726	▲K080566HD
Belt - Fan; W/60 1/2" Belt O.C.	R123439	▲K080605HD
Belt - A.C.	H87459	▲9395HD
Tensioner Assy.	RE518097	38507
280 Skid Steer		
John Deere 4-Cyl. 276 Diesel		
2004-2002		
Belt - A.C.	R128206	▲K080790HD
Tensioner Assy.	RE518097	38507
300 Backhoe		
John Deere 3-Cyl. 135		
Belt - Fan & Alt.	T20334T	TR22474
Hose - Upper		●25477
Hose - Lower		●26502

Application	Mfr. Part No.	Our No.
JOHN DEERE - Continued		
300 Backhoe - Continued		
John Deere 3-Cyl. 152 Diesel		
Belt - Fan & Alt.	T20334T	TR22474
Hose - Upper		≅20065
		or ●25473
Hose - Lower		●26502
		or 21182
Hose - By Pass; (1/2" I.D.)		28439
300 Wheel Loader		
John Deere 3-Cyl. 135		
Belt - Fan & Alt.	R97758	TR22485
Hose - Upper		●25477
Hose - Lower		●26502
John Deere 3-Cyl. 152 Diesel		
Belt - Fan & Alt.	T20334T	TR22474
Hose - Lower		21182
Hose - By Pass; (1/2" I.D.)		28439
300B Backhoe		
John Deere 3-Cyl. 152 Diesel		
Belt - Fan & Alt.	T20334T	TR22474
Hose - Upper		≅20065
		or ●25473
Hose - Lower		●26502
		or 21182
Hose - By Pass; (1/2" I.D.)		28439
300B Wheel Loader		
John Deere 3-Cyl. 152 Diesel		
Belt - Fan & Alt.	T20334T	TR22474
Hose - Upper		≅20065
		or ●25473
Hose - Lower		21182
300D		
John Deere 4039D Diesel		
Belt - Fan	RE51551	②▲9585HD
Belt - A.C.	T60985	▲9420HD
Hose - Upper		●26508
301 Backhoe		
John Deere 3-Cyl. 135		
Belt - Fan & Alt.	T20334T	TR22474
Hose - Upper		●25477
Hose - Lower		●26502
John Deere 3-Cyl. 152 Diesel		
Belt - Fan & Alt.	T20334T	TR22474
Hose - Lower		●26502
		or 21182
Hose - By Pass; (1/2" I.D.)		28439
301 Wheel Loader		
John Deere 3-Cyl. 135		
Belt - Fan & Alt.	R97758	TR22485
Hose - Upper		●25477
Hose - Lower		●26502
John Deere 3-Cyl. 152 Diesel		
Belt - Fan & Alt.	T20334T	TR22474
Hose - Lower		21182
Hose - By Pass; (1/2" I.D.)		28439
301A Backhoe		
John Deere 3-Cyl. 135		
Belt - Fan & Alt.	T20334T	TR22474
Hose - Upper		20450
		or ●25474
Hose - Lower		●26502
John Deere 3-Cyl. 152 Diesel		
Belt - Fan & Alt.	T20334T	TR22474
Hose - Upper		●25477

▲ Standard Belt Available. See Pages 630-631.
≅ Cut to Fit.

● Vulco-Flex® Coolant Hose.
② Two Required.

Belts and Coolant Hose for Road & Construction Equipment

Application	Mfr. Part No.	Our No.	Application	Mfr. Part No.	Our No.
JOHN DEERE - Continued			JOHN DEERE - Continued		
301A Backhoe - Continued			302A Wheel Loader - Continued		
John Deere 3-Cyl. 152 Diesel - Continued			John Deere 3-Cyl. 164 Diesel - Continued		
Hose - Upper		20065	Hose - By Pass; (172" I.D.)		28439
Hose - Lower		21182	310		
Hose - By Pass; (1/2" I.D.)		28439	John Deere 3-Cyl.		
301A Wheel Loader			Belt - Fan & Alt. T20334T		
John Deere 3-Cyl. 135			TR22474		
Belt - Fan & Alt. R97758		TR22485	Hose - Upper		
Hose - Upper		20450	●25476		
	or	●25474	Hose - Lower		
Hose - Lower		●26502	or		
			21182		
John Deere 3-Cyl. 152 Diesel			John Deere 3-Cyl. Diesel		
Belt - Fan & Alt. R97758		TR22485	Belt - Fan & Alt. T20334T		
Hose - Upper		●25477	TR22474		
	or	20065	Hose - Upper		
Hose - Lower		21182	21794		
Hose - By Pass; (1/2" I.D.)		28439	Hose - Lower		
			or		
			21182		
302 Backhoe			310D		
John Deere 3-Cyl. 147			John Deere 4039D Diesel		
Belt - Fan & Alt. T20334T		TR22474	Belt - Fan & Alt. RE44538		
Hose - Upper		20450	Belt - A.C. T60985		
	or	●25474	Hose - Upper		
Hose - Lower		●26502	●9580HD		
	or	21182	●9420HD		
			●26509		
John Deere 3-Cyl. 164 Diesel			310G		
Belt - Fan & Alt. T20334T		TR22474	John Deere 4045D Diesel		
Hose - Upper		●25477	Belt - Fan, Alt. & A.C. T225495		
	or	21794	Belt - Fan & Alt. T225494		
Hose - Lower		21182	Tensioner Assy. - Fan & Alt. RE70535		
Hose - By Pass; (1/2" I.D.)		28439	Tensioner Pulley - Fan & Alt. RE70535		
			38507		
			36091		
302 Wheel Loader			313; 315		
John Deere 3-Cyl. 147			John Deere 4-Cyl. 149 Diesel		
Belt - Fan & Alt. R97758		TR22485	2011-2007		
Hose - Upper		20450	Belt - Fan		
	or	●25474	R505810		
Hose - Lower		21182	●K060923HD		
	or	21182	315SG		
			John Deere 4045D Diesel		
John Deere 3-Cyl. 164 Diesel			Belt - Fan, Alt. & A.C. T225495		
Belt - Fan & Alt. T20334T		TR22474	Belt - Fan & Alt. T225494		
Hose - Upper		●25477	Tensioner Assy. - Fan & Alt. RE70535		
	or	21794	Tensioner Pulley - Fan & Alt. RE70535		
Hose - Lower		21182	38507		
Hose - By Pass; (1/2" I.D.)		28439	36091		
			317 Skid Steer		
302A Backhoe			John Deere 4-Cyl. 149 Diesel		
John Deere 3-Cyl. 147			2006-2005		
Belt - Fan & Alt. T20334T		TR22474	Belt - Fan, Alt. & A.C. R505809		
Hose - Upper		20450	K060966		
	or	●25474	319D		
Hose - Lower		●26502	John Deere 4-Cyl. 149 Diesel		
	or	21182	2011-2009		
			Belt - Fan		
John Deere 3-Cyl. 164 Diesel			R528335		
Belt - Fan & Alt. T20334T		TR22474	K060926		
Hose - Upper		●25477	320 Skid Steer		
	or	21794	John Deere 4-Cyl. 149 Diesel		
Hose - Lower		21182	2006-2005		
Hose - By Pass; (1/2" I.D.)		28439	Belt - Fan, Alt. & A.C. R505809		
			K060966		
			323D		
302A Wheel Loader			John Deere 4-Cyl. 149 Diesel		
John Deere 3-Cyl. 147			2011-2009		
Belt - Fan & Alt. R97758		TR22485	Belt - Fan		
Hose - Upper		20450	R528335		
	or	●25474	K060926		
Hose - Lower		21182	325 Skid Steer		
	or	21182	John Deere 5-Cyl. 186 Diesel		
			2006-2005		
John Deere 3-Cyl. 164 Diesel			Belt - Fan, Alt. & A.C. R515221		
Belt - Fan & Alt. R97758		TR22485	K060980		
Hose - Upper		●25477	328 Skid Steer		
	or	21794	John Deere 5-Cyl. 186 Diesel		
Hose - Lower		21182	2006-2005		
			Belt - Fan, Alt. & A.C. R519408		
			K060984		

● Vulco-Flex® Coolant Hose.
 ♣ Standard Belt Available. See Pages 630-631.

Ⓜ Two Required.

Road & Construction Equipment

Belts and Coolant Hose for Road & Construction Equipment

Application	Mfr. Part No.	Our No.	Application	Mfr. Part No.	Our No.
JOHN DEERE - Continued			JOHN DEERE - Continued		
410 - Continued			440B Skidder - Continued		
John Deere 4-Cyl. 180 - Continued			John Deere 4-Cyl. 219 Diesel - Continued		
Hose - Upper		●25476	Hose - Upper; W/Syncro Mesh Trans.; Dubuque; Ser. No. 49999 & Before		●25477
Hose - Lower		●26502	Hose - Upper; W/Syncro Mesh Trans.; Welland; Ser. No. 19999 & Before		●25477
		or 21182	Hose - Upper; W/Syncro Mesh Trans.; Dubuque; Ser. No. 50000 & After		20065
John Deere 4-Cyl. 219 Diesel			John Deere 4-Cyl. 276 Diesel		
Belt - Fan & Alt.; W/50" Belt O.C.	T20161	TR22495	Belt - Fan & Alt.; Ser. No. 15142 & Before	T20334	TR22474
Belt - Fan & Alt.; W/51 1/4" Belt O.C.	T24757	TR22508	Belt - Fan & Alt.; Ser. No. 15143 Thru 49999 .	T25130	TR22495
Belt - Fan & Alt.; W/51 7/8" Belt O.C.	T24473	TR22514	Belt - Fan & Alt.; Ser. No. 50000 Thru 81723 .	T24757	TR22508
Hose - Upper		●25474	Belt - Fan & Alt.; Ser. No. 81724 & After	T24473	TR22514
Hose - Lower		●26502	440C Skidder		
		or 21182	John Deere 4-Cyl. 276 Diesel		
Hose - By Pass; (1/2" I.D.)		28439	Belt - Fan & Alt.; W/56 1/4" Belt O.C.	AT31820	②●9560HD
410B			Belt - Fan & Alt.; W/57 1/4" Belt O.C.	T26755	②●9570HD
John Deere 4-Cyl. 219 Diesel			Hose - Upper		●26521
Belt - Fan & Alt.	AR69141	②●9640HD	444C		
410C			John Deere 6-Cyl. 329 Diesel		
John Deere 4-Cyl. 276 Diesel			Belt - Fan & Alt.	AT24833	②●9570HD
Hose - Upper		●25473	Belt - A.C.	H79236	▲9635HD
Hose - By Pass; (1/2" I.D.)		28439	Hose - Upper - Eng. To Pipe		●26522
410D			Hose - Upper - Pipe To Rad.		●26519
John Deere 4-Cyl. 180			Hose - Lower - Eng. To Pipe; (1 3/8" I.D.)		*24822
Hose - Upper		●25476	444E		
Hose - Lower		●26502	John Deere 4-Cyl. 276 Diesel		
John Deere 4-Cyl. 219 Diesel			Belt - Fan	RE44538	▲9580HD
Hose - Upper		●25474	Belt - A.C.	AT121408	▲9490HD
Hose - Lower		●26502	Hose - Upper		●26515
Hose - By Pass; (1/2" I.D.)		28439	450 Crawler Loader		
John Deere 4045D Diesel			John Deere 4-Cyl. 180		
Belt - Fan & Alt.	AR54592	②●9625HD	Belt - Fan & Alt.; W/50" Belt O.C.	T20161	TR22495
Hose - Upper		●26509	Belt - Fan & Alt.; W/51 1/4" Belt O.C.	T24757	TR22508
410G			Belt - Fan & Alt.; W/51 7/8" Belt O.C.	T24473	TR22514
John Deere 4045D Diesel			John Deere 4-Cyl. 202 Diesel		
Tensioner Assy. - Fan & Alt.	RE70535	38507	Belt - Fan & Alt.; W/50" Belt O.C.	T20161	TR22495
Tensioner Pulley - Fan & Alt.	RE70535	36091	Belt - Fan & Alt.; W/51 1/4" Belt O.C.	T24757	TR22508
440 Skidder			Belt - Fan & Alt.; W/51 7/8" Belt O.C.	T24473	TR22514
John Deere 4-Cyl. 180			John Deere 4-Cyl. 180; John Deere 4-Cyl. 202 Diesel		
Belt - Fan & Alt.; Ser. No. 15142 & Before	T20334	TR22474	Belt - Fan & Alt.; W/50" Belt O.C.	T20161	TR22495
Belt - Fan & Alt.; Ser. No. 15143 Thru 49999 .	T25130	TR22495	Belt - Fan & Alt.; W/51 1/4" Belt O.C.	T24757	TR22508
Belt - Fan & Alt.; Ser. No. 50000 Thru 81723 .	T24757	TR22508	Belt - Fan & Alt.; W/51 7/8" Belt O.C.	T24473	TR22514
Belt - Fan & Alt.; Ser. No. 81724 & After	T24473	TR22514	Hose - Upper		20065
Hose - Upper		●25474	450 Crawler Tractor		
Hose - Lower		●26603	John Deere 4-Cyl. 180; John Deere 4-Cyl. 202 Diesel		
John Deere 4-Cyl. 276 Diesel			Belt - Fan & Alt.; W/50" Belt O.C.	T20161	TR22495
Belt - Fan & Alt.; Ser. No. 15142 & Before	T20334	TR22474	Belt - Fan & Alt.; W/51 1/4" Belt O.C.	T24757	TR22508
Belt - Fan & Alt.; Ser. No. 15143 Thru 49999 .	T25130	TR22495	Belt - Fan & Alt.; W/51 7/8" Belt O.C.	T24473	TR22514
Belt - Fan & Alt.; Ser. No. 50000 Thru 81723 .	T24757	TR22508	450B Crawler Tractor		
Belt - Fan & Alt.; Ser. No. 81724 & After	T24473	TR22514	John Deere 4-Cyl. 219 Diesel		
Hose - Upper; W/Syncro Mesh Trans.		●25477	Belt - Fan	T24473	TR22514
Hose - Upper; W/Power Shift Trans.		≈21660	Hose - Upper		20065
		or ●25474	450C Crawler Loader		
Hose - Lower		●26502	John Deere 4-Cyl. 219 Diesel		
440B Skidder			John Deere 4-Cyl. 219 Diesel		
John Deere 4-Cyl. 180			John Deere 4-Cyl. 219 Diesel		
Belt - Fan & Alt.; Ser. No. 15142 & Before	T20334	TR22474	Belt - Fan & Alt.	T24473	TR22514
Belt - Fan & Alt.; Ser. No. 15143 Thru 49999 .	T25130	TR22495	Hose - Upper		20065
Belt - Fan & Alt.; Ser. No. 50000 Thru 81723 .	T24757	TR22508	450C Crawler Tractor		
Belt - Fan & Alt.; Ser. No. 81724 & After	T24473	TR22514	John Deere 4-Cyl. 219 Diesel		
John Deere 4-Cyl. 219 Diesel			John Deere 4-Cyl. 219 Diesel		
Belt - Fan & Alt.; Ser. No. 15142 & Before	T20334	TR22474	Belt - Fan; Ser. No. 13560 & Before	T20161	TR22495
Belt - Fan & Alt.; Ser. No. 15143 Thru 49999 .	T25130	TR22495	Belt - Fan; Ser. No. 13561 Thru 15484	T24473	TR22514
Belt - Fan & Alt.; Ser. No. 50000 Thru 81723 .	T24757	TR22508	Belt - Fan; Ser. No. 15485 & After	T24757	TR22508
Belt - Fan & Alt.; Ser. No. 81724 & After	T24473	TR22514			
Hose - Upper; W/Power Shift Trans.		≈21660			
		or ●25474			

Road & Construction Equipment

● Vulco-Flex® Coolant Hose.
 ▲ Standard Belt Available. See Pages 630-631.
 * Durion® Silicone Hose Recommended.

② Two Required.
 ≈ Cut to Fit.

Belts and Coolant Hose for Road & Construction Equipment

Application	Mfr. Part No.	Our No.
JOHN DEERE - Continued		
455G		
John Deere 4-Cyl. 276 Diesel Belt - Fan & Alt.	T184594	▲K080653HD
490D		
John Deere 4-Cyl. 276 Diesel Belt - Fan & Alt. Hose - By Pass: (1 1/4" I.D.)	R82602	TR22517 24220
500 Backhoe		
John Deere 4-Cyl. 241 Belt - Fan & Alt./Gen. Hose - Upper Hose - Lower	AR32659R	②7555 ●26509 20590
John Deere 4-Cyl. 270 Diesel Belt - Fan & Alt./Gen.; W/56 5/8" Belt O.C. ... Belt - Fan & Alt./Gen.; W/57 5/8" Belt O.C. ... Hose - Upper Hose - Lower	AR41576 AR41629	②7560 ②7570 ●26509 20590
500 Wheel Loader		
John Deere 4-Cyl. 227 Belt - Fan & Alt./Gen. Hose - Upper Hose - Lower	AR41628	7555 ●26509 20590
500 Wheel Tractor		
John Deere 4-Cyl. 241 Belt - Fan & Gen. Hose - Upper Hose - Lower	AR32659R	7555 ●26509 20590
John Deere 4-Cyl. 270 Diesel Belt - Fan & Gen. Hose - Upper Hose - Lower	AR32661R	7560 ●26509 20590
500C Backhoe		
John Deere 4-Cyl. 219 Diesel Hose - Upper; (2" I.D.) Hose - Lower		24432 20590
John Deere 4-Cyl. 270 Diesel Belt - Fan & Alt. Hose - Upper	AR41576	②7560 ●26509
John Deere 6-Cyl. 329 Diesel Hose - Upper; Ser. No. 001699 & Before Hose - Upper; Ser. No. 001700 & After Hose - Lower Hose - By Pass		●26524 ●26512 ●26515 ≧20338
510		
John Deere 4-Cyl. 241 Belt - Fan & Alt./Gen.	AR32659R	②7555
John Deere 4-Cyl. 270 Diesel Belt - Fan & Alt./Gen.; W/56 5/8" Belt O.C. ... Belt - Fan & Alt./Gen.; W/57 5/8" Belt O.C. ... Hose - Upper; (2" I.D.) Hose - Upper	AR41576 AR41629	②7560 ②7570 24232 ●26509
510B		
John Deere 4039D Diesel Belt - Fan Belt - A.C. Hose - Upper	AR54592 T79843	②▲9625HD ▲9390HD ●26515
524K		
John Deere 6-Cyl. 414 Diesel Belt - Alt.; W/A.C. Belt - Alt.; W/O A.C.	T210568 T186776	▲K080780HD K080638HD

Application	Mfr. Part No.	Our No.
JOHN DEERE - Continued		
540; 540A		
John Deere 4-Cyl. 276 Diesel Belt - Fan & Alt.; W/56 1/4" Belt O.C. Belt - Fan & Alt.; W/57 1/4" Belt O.C.	AT31820 T26755	②▲9560HD ②▲9570HD
540B		
John Deere 4-Cyl. 276 Diesel Belt - Fan & Alt.; W/56 1/4" Belt O.C. Belt - Fan & Alt.; W/57 1/4" Belt O.C. Hose - Upper	AT31820 T26755	②▲9560HD ②▲9570HD ●26521
540D		
John Deere 4015T Diesel Belt - Fan & Alt.; W/56 1/4" Belt O.C. Belt - Fan & Alt.; W/57 1/4" Belt O.C. Hose - Upper	AT31820 T26755	②▲9560HD ②▲9570HD ●26509
544 Skidder		
John Deere 6-Cyl. 414 Diesel Belt - Fan & Alt.; W/56 1/4" Belt O.C. Belt - Fan & Alt.; W/57 1/4" Belt O.C. Hose - Upper; Ser. No. 165809 Thru 171243 Hose - Lower Hose - By Pass: (3/4" I.D.)	AT31820 T26755	②▲9560HD ②▲9570HD ●26522 ●26523 28442
544 Wheel Loader		
John Deere 6-Cyl. 414 Diesel Belt - Fan & Alt. Hose - Upper; Ser. No. 165809 Thru 171243 Hose - Lower Hose - By Pass: (3/4" I.D.)	AT24833	②▲9570HD ●26522 ●26523 28442
544B Skidder		
John Deere 6-Cyl. 414 Diesel Hose - Upper - Cooler To Rad. Hose - Lower		≧20685 ●25528
544B Wheel Loader		
John Deere 6-Cyl. 414 Diesel Belt - Fan Belt - A.C. Hose - Upper - Cooler To Rad. Hose - Lower	AT24833 H79236	▲9570HD ▲9635HD ≧20685 ●25528
544C		
John Deere 6-Cyl. 414 Diesel Belt - Fan & Alt. Belt - A.C.	AT24833 H79236	②▲9570HD ▲9635HD
544E		
John Deere 6-Cyl. 359 Diesel Belt - Fan & Alt.; W/65A. Alt. Belt - Fan & Alt.; W/105A. Alt. Belt - Fan & Alt.; W/130A. Alt.; W/63 1/2" Belt O.C. Belt - Fan & Alt.; W/130A. Alt.; W/63" Belt O.C. Belt - A.C. Hose - Upper	AR43219 AR54592 AR57266 AR54592 H63772	②▲9600HD ②▲9625HD ②▲9630HD ②▲9625HD ②▲9540HD ●26511
544G		
John Deere 6059T Diesel Belt - Fan & Alt.; W/95A. Alt. Belt - Fan & Alt.; W/135A. Alt. Belt - A.C.; W/R134 Coolant Belt - A.C.; W/R12 Coolant Hose - Upper	AR54592 AR69141 T149108 H63772	②▲9625HD ②▲9635HD ▲9530HD ▲9540HD ④21115
555		
John Deere 4-Cyl. 276 Diesel Belt - Fan & Alt.	AT31820	②▲9560HD

▲ Standard Belt Available. See Pages 630-631.
● Vulco-Flex® Coolant Hose.
④ Four Required.

② Two Required.
≧ Cut to Fit.

Belts and Coolant Hose for Road & Construction Equipment

Application	Mfr. Part No.	Our No.	Application	Mfr. Part No.	Our No.
JOHN DEERE - Continued			JOHN DEERE - Continued		
570			640		
John Deere 6-Cyl. 303 Diesel			John Deere 6-Cyl. 414 Diesel		
Belt - Fan & Alt.; W/56 1/8" Belt O.C.	AT27169	②7560	Belt - Fan & Alt.	T26755	♣9570HD
Belt - Fan & Alt.; W/57" Belt O.C.	AR49925	②A55	644 Wheel Loader		
Belt - Fan & Alt.; W/57 5/8" Belt O.C.	T25619	②7575	John Deere 6-Cyl. 404 Diesel		
Hose - Upper		●26524	Belt - Fan	AT30181	②TR22607
Hose - Lower		●26521	Belt - Alt.	T31165	7335
570A			Hose - Upper; Ser. No. 164554 & After		
John Deere 6-Cyl. 329 Diesel			Hose - Lower		
Belt - Fan & Alt.; W/56 1/8" Belt O.C.	AT27169	②7560	644B Wheel Loader		
Belt - Fan & Alt.; W/57" Belt O.C.	AR49925	②A55	John Deere 6466A Diesel; John Deere 6-Cyl. 531 Diesel		
Belt - Fan & Alt.; W/57 5/8" Belt O.C.	T25619	②7575	Belt - Fan	AR93013	②TR24619
Hose - Upper		●26524	Belt - Alt.	R55084	TR22350
Hose - Lower		●26516	Belt - A.C.	T60985	♣9420HD
600 Backhoe			Hose - Upper		
John Deere 6-Cyl. 341			Hose - By Pass		
Belt - Fan & Alt./Gen.	AR32659R	②7555	644C Wheel Loader		
Hose - Upper		●26509	John Deere 6-Cyl. 466 Diesel		
Hose - Lower		20590	Belt - Fan	AR92182	TR22625
John Deere 6-Cyl. 404 Diesel			Belt - Fan & Hyd. Brake Boost Pump		
Belt - Fan & Alt./Gen.; W/56 5/8" Belt O.C. ...	AR41576	②7560	Belt - Alt.	T52753	♣9380HD
Belt - Fan & Alt./Gen.; W/57 5/8" Belt O.C. ...	AR41629	②7570	Belt - A.C.	T54060	♣9420HD
Hose - Upper		●26509	Hose - Upper		
Hose - Lower		20590	Hose - Lower		
600 Wheel Loader			644EH		
John Deere 6-Cyl. 341			John Deere 6076A Diesel		
Belt - Fan & Alt./Gen.	AR41628	7555	Belt - Fan & Alt.	AR87671	②♣9700HD
Hose - Upper		●26509	644J		
John Deere 6-Cyl. 404 Diesel			John Deere 6081 Powertech Diesel		
Belt - Fan & Alt./Gen.; W/56 1/2" Belt O.C. ...	AR41576	7560	Serpentine Belt		
Belt - Fan & Alt./Gen.; W/57 1/2" Belt O.C.	AR41629	7570	T178419		
Hose - Upper		●26509	♣K080755HD		
Hose - Lower		20590	645C		
610B			John Deere 6-Cyl. 466 Diesel		
John Deere 4-Cyl. 241			Hose - Upper		
Belt - Fan & Alt.	AR54592	②♣9625HD	●26523		
624E			670 Grader		
John Deere 6068T Powertech Diesel			John Deere 6-Cyl. 414 Diesel		
Belt - Fan & Alt.; W/65A. Alt.	AR43219	②♣9600HD	Belt - Fan & Alt.		
Belt - Fan & Alt.; W/78A., 105A., 130A. Alt.;			②♣9570HD		
W/63" Belt O.C.	AR54592	②♣9625HD	670A		
Belt - Fan & Alt.; W/130A. Alt.; W/63 1/2" Belt			John Deere 6-Cyl. 414 Diesel		
O.C.	AR57266	②♣9630HD	Hose - Upper		
Belt - A.C.	H63772	♣9540HD	●26525		
624G			672B		
John Deere 6068T Powertech Diesel			John Deere 6068T Powertech Diesel		
Belt - Fan & Alt.; W/95A. Alt.	AR54592	②♣9625HD	Belt - Fan & Alt.		
Belt - Fan & Alt.; W/135A. Alt.	AR69141	②♣9635HD	H79235		
Belt - A.C.; W/R134 Coolant	T149108	♣9530HD	②♣9590HD		
Belt - A.C.; W/R12 Coolant	H63772	♣9540HD	675		
624GH			Yanmar 4-Cyl. 111 Diesel		
John Deere 6068T Powertech Diesel			1989-1987		
Belt - Fan & Alt.	AR54592	②♣9625HD	Belt - Fan & Alt.		
624H			♣9390HD		
John Deere 6068T Powertech Diesel			675B		
Belt - Fan, Alt. & A.C.; W/55A., 80A. Alt.	T178416	♣K081005HD	Yanmar 4-Cyl. 111 Diesel		
Belt - Fan & Alt.; W/55A. Alt.	T178415	♣K080626HD	1994-1987		
Belt - Fan & Alt.; W/80A. Alt.	T178417	♣K080645HD	Belt - Fan & Alt.		
Belt - Fan & Alt.; W/100A. Alt.	T184594	♣K080653HD	♣9390HD		
Tensioner Assy. - Fan & Alt.; W/O A.C.	RE70536	38522	690		
		or 38654	John Deere 6-Cyl. 404 Diesel		
			Belt - Fan; Ser. No. 280800 & Before		
			AR43648		
			②♣9550HD		
			Belt - Fan & Alt.; Ser. No. 280801 & After		
			AR43219		
			②♣9600HD		
			Belt - Alt.; Ser. No. 280800 & Before		
			U46257		
			♣9309HD		
			690A		
			John Deere 6-Cyl. 404 Diesel		
			Belt - Fan; Ser. No. 280800 & Before		
			AR43648		
			②♣9550HD		

Road & Construction Equipment

② Two Required.
♣ Standard Belt Available. See Pages 630-631.

● Vulco-Flex® Coolant Hose.
≅ Cut to Fit.

Belts and Coolant Hose for Road & Construction Equipment

Application	Mfr. Part No.	Our No.	Application	Mfr. Part No.	Our No.
JOHN DEERE - Continued			JOHN DEERE - Continued		
690A - Continued			760A - Continued		
John Deere 6-Cyl. 404 Diesel - Continued			John Deere 6-Cyl. 531 Diesel - Continued		
Belt - Fan & Alt.; Ser. No. 280801 & After	AR43219	②▲9600HD	Hose - Upper; (2" I.D.)		24232
Belt - Alt.; Ser. No. 280800 & Before	U46257	▲9309HD	Hose - Lower		●26535
Hose - Upper		≡<20523		or	20967
		or ●26515	Hose - By Pass - Front Eng.; (1 3/8" I.D.)		24222
Hose - By Pass; Molded Hose		≡<20802	Hose - By Pass - Rear Eng.		≡<21942
Hose - By Pass; Strt. Hose(7/8" I.D.)		28443			
690B			762 Scaper		
John Deere 6-Cyl. 404 Diesel			John Deere 6619T Diesel		
Belt - Fan & Alt.	AR53099	②▲9650HD	Belt - Fan & Hyd. Pump	AR93011	②TR22607
			Belt - Alt.		▲9325HD
690DLC			Hose - Upper		
John Deere 6-Cyl. 414 Diesel			Hose - By Pass		
Belt - Fan & Alt.	RE22470	②▲9580HD			≡<20504
710B			762A		
John Deere 6-Cyl. 359 Diesel			John Deere 6466A Diesel		
Belt - Fan & Alt.	AR69141	▲9635HD	Belt - Fan & Hyd. Pump	AR91135	②BX65
Belt - Hyd. Pump	H84745	▲9620HD	764HSD Dozer		
710C			John Deere 6-Cyl. 414 Diesel		
John Deere 6059T Diesel			Belt - Alt.	T210568	▲K080780HD
Belt - Fan & Alt.	AR54592	②▲9625HD	Tensioner Assy.	RE518097	38507
Belt - Hyd. Pump; W/39 7/8" Belt O.C.	R82437	▲9395HD	770 Grader		
Belt - Hyd. Pump; W/62 3/8" Belt O.C.	H84745	▲9620HD	John Deere 6-Cyl. 531 Diesel		
Hose - Upper		●26509	Belt - Fan & Alt.	AR69141	②▲9640HD
710D			Hose - Upper		
John Deere 6068T Powertech Diesel			Hose - By Pass		
Belt - Fan	T148208	▲K080720HD			or ●26510
Belt - Fan, Alt. & A.C.	R135198	▲K080986HD			≡<20573
Belt - Fan & Alt.	R135200	▲K080680HD	770B		
Belt - Charge Pump	R82437	▲9395HD	John Deere 6059T Diesel		
Tensioner Assy. - Fan & Alt.	RE70535	38507	Belt - Fan & Alt.	T25619	②7575
Tensioner Pulley - Fan & Alt.	RE70535	36091	John Deere 6466T Diesel		
724J			Belt - Fan & Alt.		
John Deere 6081 Powertech Diesel			②▲9660HD		
Serpentine Belt	T178419	▲K080755HD	770BH		
740			John Deere 6076A Diesel		
John Deere 6-Cyl. 404 Diesel			Belt - Fan & Alt.	AT76490	②▲9660HD
Belt - Alt.	T37416	▲9350HD	Hose - Lower		●26531
744E			John Deere 6466AT Diesel		
John Deere 6101AT Diesel			Belt - Fan & Alt.	AR87671	②▲9700HD
Belt - Fan	AR93012	②TR24578	Hose - Lower		●26521
Belt - Fan & Alt.	T37416	▲9350HD	772A		
Hose - By Pass		≡<20065	John Deere 6-Cyl. 466 Diesel		
755D			Belt - Fan & Alt.; W/42A. Alt.		
John Deere 6-Cyl. 414 Diesel			AR69141		
Tensioner Assy.	RE518097	38507	Belt - Fan & Alt.; W/50A. Alt.	AR86496	②▲9670HD
760			Hose - Upper - Eng. To Pipe		
John Deere 6-Cyl. 531 Diesel			or ●25472		
Belt - Fan & Alt.	AR56638	②7612	Hose - Upper - Pipe To Rad.		
Hose - Upper; (2" I.D.)		24232	Hose - By Pass		
Hose - Lower		●26535			≡<21378
		or 20967			≡<20065
Hose - By Pass - Front Eng.; (1 3/8" I.D.)		24222	772AH		
Hose - By Pass - Rear Eng.		≡<21942	John Deere 6466AT Diesel		
760A			Belt - Fan & Alt.		
John Deere 4-141T Diesel			AR87671		
Belt - Fan & Alt.		▲9570HD	790D		
John Deere 6-Cyl. 531 Diesel			John Deere 6466A Diesel		
Belt - Fan & Alt.; W/47 7/8" Belt O.C.	T20334	TR22474	Belt - Fan & Alt.		②▲9570HD
Belt - Fan & Alt.; W/61 7/8" Belt O.C.	AR41574	②7612	Hose - Upper		●26532

② Two Required.
≡< Cut to Fit.

▲ Standard Belt Available. See Pages 630-631.
● Vulco-Flex® Coolant Hose.

Belts and Coolant Hose for Road & Construction Equipment

Application	Mfr. Part No.	Our No.	Application	Mfr. Part No.	Our No.
JOHN DEERE - Continued			JOHN DEERE - Continued		
850B Crawler Tractor			5575		
John Deere 6-Cyl. 466 Diesel			John Deere 3-Cyl. 100 Diesel		
Belt - Fan	AT31010	③▲9620HD	1998-1995		
Belt - Fan To Alt.		▲9350HD	Belt - Fan	M806512	▲9420HD
Hose - Upper		●26532			
850K Crawler Dozer			6675		
John Deere 6-Cyl. 414 Diesel			John Deere 4-Cyl. 122 Diesel		
Tensioner Assy.	RE518097	38507	1998-1994		
			Belt - Fan; W/41" Belt O.C.	M806512	▲9420HD
			Belt - Fan; W/40" Belt O.C.	M802627	▲9412HD
860			7775		
Detroit Diesel 6-71N Diesel			John Deere 4-Cyl. 134 Diesel		
Hose - Upper		≈<20420	1998-1994		
		or ●26507	Belt - Fan; W/41" Belt O.C.	M806512	▲9420HD
Hose - Lower		●26509	Belt - Fan; W/40" Belt O.C.	M802627	▲9412HD
860A			8875		
Detroit Diesel 6-71N Diesel			John Deere 3-Cyl. 179 Diesel		
Belt - Fan; W/41 1/8" Belt O.C.	T38174	②TR22405	1998-1994		
Belt - Fan; W/45 3/8" Belt O.C.	AU43145	②▲9451HD	Belt - Fan	R73784	TR22525
Belt - Alt./Gen.	B2893R	▲9405HD			
Belt - P.S.	U44409	▲9390HD			
Hose - Upper		≈<20420			
		or ●26507			
Hose - Lower		●26509			
862			CT315		
John Deere 6619A Diesel			John Deere 4-Cyl. 149 Diesel		
Belt - Fan & Alt.		▲9610HD	2011-2009		
Belt - A.C.		▲9500HD	Belt - Fan	R505810	▲K060923HD
Hose - Upper; (2 1/2" I.D.)		24440			
990 Excavator			JD646		
John Deere 8955T Diesel			John Deere 6-Cyl. 531 Diesel		
Belt - Fan	AT75425	③TR22607	Belt - Fan & Alt.	AT30181	②TR22607
Belt - Alt.		▲9440HD	Hose - Upper - Cooler To Rad.		●26522
Belt - Fan To A.C.		▲9625HD	Hose - Lower		●26532
1010C			JD646B		
John Deere 4-Cyl. 115			John Deere 6-Cyl. 531 Diesel		
Belt - Fan & Gen.; Ser. No. 21900 & Before .	T12530T	7440	Belt - Fan & Alt.	AR63876	②TR20619
Belt - Fan & Gen.; Ser. No. 21091 & After	T626T	7480			
John Deere 4-Cyl. 145 Diesel			TC44H		
Belt - Fan & Gen.; Ser. No. 21900 & Before .	T11961T	7435	John Deere 4045T Powertech Diesel		
Belt - Fan & Gen.; Ser. No. 21901 & After	T626T	7480	Belt - Alt.; W/55A. Alt.; W/O A.C.	R135595	▲K080708HD
			Belt - Alt.; W/80A. Alt.; W/O A.C.	T178413	▲K080716HD
			Tensioner Assy.; W/O A.C.	RE70536	38522
					or 38654
2010 Crawler			TC54H		
John Deere 4-Cyl. 145; John Deere 4-Cyl. 165 Diesel			John Deere 6068T Powertech Diesel		
Belt - Fan & Gen.	T17918T	TR22514	Belt - Alt.; W/55A. Alt.; W/O A.C.	T178537	▲K080730HD
			Belt - Alt.; W/80A. Alt.; W/A.C.	T178548	▲K081088HD
			Belt - Alt.; W/80A. Alt.; W/O A.C.	T178536	▲K080734HD
			Tensioner Assy.; W/O A.C.	RE70536	38522
					or 38654
3375			TC62H		
John Deere 3-Cyl. 42 Diesel			John Deere 6068T Powertech Diesel		
1999-1994			Belt - Alt.; W/55A, 80A. Alt.; W/A.C.	T178416	▲K081005HD
Belt - W.P.	M800048	7340	Belt - Alt.; W/55A. Alt.; W/O A.C.	R500242	▲K080626HD
Belt - Hyd. Pump	M125661	3VX425	Belt - Alt.; W/80A. Alt.; W/O A.C.	T178417	▲K080645HD
			Tensioner Assy.; W/O A.C.	RE70536	38522
					or 38654
4475			JOY		
John Deere 3-Cyl. 91 Diesel			RP125G51		
1998-1994			Continental FA162		
Belt - Fan	M801821	▲9390HD	Belt - Fan	F401K204	TR24414
			RP250D31		
5010 Scraper			Hercules D3400 Diesel		
John Deere 6-Cyl. 531 Diesel			Belt - Fan	270632A	②▲9425HD
Belt - Fan & Alt.	AR56638	②7612			
Hose - Upper; (2" I.D.)		24232			
Hose - Lower		●26535			
		or 20967			

③ Three Required.
 ● Vulco-Flex® Coolant Hose.
 ② Two Required.

▲ Standard Belt Available. See Pages 630-631.
 ≈< Cut to Fit.

Belts and Coolant Hose for Road & Construction Equipment

Application	Mfr. Part No.	Our No.	Application	Mfr. Part No.	Our No.
JOY - Continued			KOBELCO - Continued		
RP250G31			K909LC Mark II		
Hercules G3400			Mitsubishi 6D22T Diesel		
Belt - Fan	270632A	②▲9425HD	Belt - Fan & Alt.		②TR22416
RPS185			Hose - Upper		●26510
IH			Hose - Lower - Eng. To Pipe		≡<21115
Belt - Fan & Alt.	275301C2	▲9470HD	Hose - Lower - Pipe To Rad.		≡<21115
Hose - Upper - Eng. To Pipe; (2" I.D.)		24232	LK350 Mark II		
Hose - Upper - Pipe To Rad.; (1 1/2" I.D.)		24224	Isuzu 4BD1-T Diesel		
Hose - Lower - Eng. To Pipe; (1 3/4" I.D.)		24228	Belt - Fan & Alt.		②TR22495
Hose - Lower - Pipe To Rad.		●25482	Hose - Upper		●26511
RPS750			LK700A		
Caterpillar D333 Diesel			Nissan PE604 Diesel		
Hose - Upper - Eng. To Pipe		≡<20369	Hose - Upper - Eng. To Pipe; (2 1/8" I.D.)		24234
Hose - Upper - Pipe To Rad.; (2 1/4" I.D.)		24436	Hose - Upper - Pipe To Rad.; (2 1/8" I.D.)		24234
Hose - Lower - Eng. To Pipe; (2 3/4" I.D.)		24444	Hose - Lower - Eng. To Pipe; (2 3/8" I.D.)		24238
Hose - Lower - Pipe To Rad.; (2 3/4" I.D.)		24444	Hose - Lower - Pipe To Rad.; (2 3/8" I.D.)		24238
RPS900DB30			KOEHRING		
Detroit Diesel 8V-71 Diesel			166		
Belt - Fan	5133764	▲9560HD	Detroit Diesel 4-53T Diesel		
RPS1050			Belt - Fan & Alt.		▲9440HD
Detroit Diesel 8V-71 Diesel			Hose - Upper		≡<20957
Belt - Fan	5133764	③▲9560HD	255A		
Belt - Gen.		▲9380HD	Detroit Diesel 4-53 Diesel		
Hose - Upper - Eng. To Pipe; (2 1/4" I.D.)		②24236	Belt - Fan		②▲9480HD
Hose - Upper - Pipe To Rad.; (2 1/4" I.D.)		②24236	Belt - W.P. & Alt.		②▲9430HD
Hose - Lower - Eng. To Pipe; (2 3/4" I.D.)		24244	Hose - Upper		≡<21794
Hose - Lower - Pipe To Rad.; (2 3/4" I.D.)		24244	Hose - Lower; (2" I.D.)		②24432
RPS1200; RPS1300			304		
Caterpillar D343 Diesel			Caterpillar D318 Diesel		
Belt - Fan	6L9903	③TR24578	Belt - Gov.	4B2544	▲9425HD
Belt - Alt.	6L3408	▲9476HD	Detroit Diesel 3-71 Diesel		
Hose - Upper - Eng. To Pipe; (3" I.D.)		24448	Belt - Fan	3224368	TR34545
Hose - Upper - Pipe To Rad.; (2 5/8" I.D.)		②24442	305		
Hose - Lower - Eng. To Pipe; (3" I.D.)		24448	Detroit Diesel 4-71 Diesel		
Hose - Lower - Pipe To Rad.; (3" I.D.)		24448	Hose - Upper		●26510
RPV100GA20			Hose - Lower		●26508
Continental			Detroit Diesel 6-71 Diesel		
Belt - Fan	X27019454	▲9451HD	Belt - Fan & Compr.	5136265	②▲9690HD
RPV160DA23			Belt - Alt.	5133515	▲9370HD
Continental			405-2A		
Belt - Fan	206373A	▲9480HD	Buda LO525		
RPV160GA20			Belt - Fan	DP1597	TR28666
Continental			Belt - Gen.	K40285	TR28583
Belt - Fan		▲9476HD	Caterpillar D318 Diesel		
RSP750			Belt - Gen.	4B2544	▲9425HD
Caterpillar D333 Diesel			Detroit Diesel 4-71 Diesel		
Belt - Fan & Alt.		③▲9540HD	Belt - Fan	3224368	TR34545
KAWASAKI			428		
115ZIII			Caterpillar 3208 Diesel		
Cummins KT19C Diesel			Belt - W.P. & Alt.	3N1490	②▲9510HD
Belt - W.P. & Alt.	206996	K050370	Belt - Fan, Hyd. Pump & Air Brake Compr.		②▲9670HD
Belt - A.C.		TR22692	Hose - Upper		●26511
Hose - Lower; (3 1/2" I.D.)		24456	Hose - Lower		●26510
KOBELCO			600WD		
K907LC Mark II			Detroit Diesel 4-71 Diesel		
Mitsubishi 6D31T Diesel			Belt - Fan	3224368	TR34545
Belt - Fan & Alt.		▲9476HD	Belt - Gen.	3224367	TR28390

Road & Construction Equipment

② Two Required.
 ● Vulco-Flex® Coolant Hose.
 ③ Three Required.

▲ Standard Belt Available. See Pages 630-631.
 ≡< Cut to Fit.

Belts and Coolant Hose for Road & Construction Equipment

Application	Mfr. Part No.	Our No.	Application	Mfr. Part No.	Our No.
KOEHRING - Continued			KOMATSU - Continued		
666D			D31A		
Detroit Diesel 8V-71N Diesel			Komatsu 4D105-3 Diesel		
Belt - Fan		③▲9550HD	Belt - Fan & Alt.		TR22508
Belt - Alt.		②7280	Hose - Upper		③<20957
6620			or ●26501		
Isuzu 6BG1T Diesel			Hose - Lower		
Belt - Fan & Alt.		②▲9480HD	●26510		
Hose - Upper		●26511	D37E2		
LRT18U			Komatsu 6D95L-1 Diesel		
Detroit Diesel 4-53N Diesel			Belt - Fan		
Belt - Fan & Hyd. Pump		②▲9451HD	Belt - Fan To Alt.		
Belt - Alt.		②7425	TR22525		
Hose - Upper; (1 3/4" I.D.)		24428	TR22322		
LRT180			D40P1; D45P1		
Detroit Diesel 6V-53 Diesel			Komatsu S4D105 Diesel		
Belt - Fan		▲9375HD	Belt - Fan & Alt.; W/350W. Starter; Ser. No.		
Belt - W.P.		②7370	18273 & After		0412102239
Belt - Alt.		②7370	Belt - Fan & Alt.; W/350W. Starter; Ser. No.		②TR28570
Belt - A.C.		▲9370HD	19078 & After		0412102239
LRT275			②TR28570		
Cummins 6-Cyl. 5.9 L Diesel			D50A15; D50P15; D50S15		
Belt - Fan & Alt.		3903091	Komatsu 4D120-11A Diesel; Komatsu 4D120-11S Diesel		
Hose - Upper; (2" I.D.)		▲K080560HD	Belt - Fan & Gen.; W/Cold Weather Start; Ser.		
Hose - Lower		②24932	No. 85343 & After		0412032266
		●26525	Belt - Fan & Gen.; W/Std. Start; Ser. No.		TR28657
LRT1600			85343 & After		0412032266
Detroit Diesel 6V-53 Diesel			Belt - Alt.; W/800W. Cold Weather Start; Ser.		TR28657
Belt - Fan		▲9375HD	No. 85343 & After		0412032235
Belt - W.P.		②7370	D53A1; D53S1		
Belt - Alt.		②7370	Komatsu S4D120-11 Diesel		
Belt - A.C.		▲9370HD	Belt - Fan & Alt.; W/800W. Cold Weather		
Hose - Upper		②●25482	Start; Ser. No. 87351 & After		0412132266
Hose - Lower		●26510	Belt - Fan & Gen.; W/Cold Weather Start; Ser.		②TR28657
MPH-1			No. 87351 & After		0412132266
Detroit Diesel 8V-71 Diesel			Belt - Fan & Gen.; W/Std. Start; Ser. No.		②TR28657
Belt - Fan		5143493	87351 & After		0412122266
Belt - Gen.		③▲9740HD	87351 & After		0412122266
Belt - Lower		▲9415HD	D55S		
		●26537	Komatsu S4D120 Diesel		
KOMATSU			Belt - Fan & Gen.		
CK35-1			Hose - Upper		
Komatsu S4D98E Diesel			Hose - Lower - Eng. To Pipe; (2" I.D.)		②TR30672
2007			Hose - Lower - Pipe To Rad.; (2" I.D.)		③<20611
Belt - Fan & A.C.		AVX13X1145LA	or ●26509		
Belt - A.C. To Alt.		AVX13X930LA	24232		
D10A			24232		
Komatsu 2D92-1B Diesel			D55S3		
Belt - Fan & Gen.; Ser. No. 11225 & After		6140812622	Komatsu S4D120-11S Diesel		
		7455	Belt - Alt.; W/800W. Cold Weather Start; Ser.		
D20A3; D20P3; D20PL3; D20Q3; D20S3			No. 85513 & After		
Komatsu 4D91-1A Diesel			0412132235		
Belt - Fan & Alt.; W/Cold Weather Start; Ser.			②TR28346		
No. 33517 & After		0412001723	D60A6		
D21A3; D21P3; D21Q3; D21S3			Cummins NH220CI Diesel		
Komatsu 4D92-1B Diesel			Belt - Fan; W/Cold Weather Start; Ser. No.		
Belt - Fan & Alt.; W/Cold Weather Start; Ser.			18542 & After		0412112260
No. 11008 & After		0412001723	Belt - W.P. & Gen.; W/Std. Start; Ser. No.		②TR28733
D30A15; D30P15; D30Q15; D30S15			18542 & After		6676836160
Komatsu 4D105-1C Diesel			TR24500		
Belt - Fan & Alt.; W/500W. Cold Weather			D60P		
Start; Ser. No. 19669 & After		0412032250	Cummins NH220CI Diesel		
		TR28498	Hose - Upper		
			Hose - Lower		

③ Three Required.
 ② Two Required.
 ▲ Use Wire Inserted Green Stripe® Coolant Hose.

▲ Standard Belt Available. See Pages 630-631.
 ● Vulco-Flex® Coolant Hose.
 ③< Cut to Fit.

Road & Construction Equipment

Belts and Coolant Hose for Road & Construction Equipment

Application	Mfr. Part No.	Our No.	Application	Mfr. Part No.	Our No.
KOMATSU - Continued			KOMATSU - Continued		
D65A6			D135A		
Cummins NH220CI Diesel			Komatsu SA6D125 Diesel		
Belt - Fan; W/Cold Weather Start; Ser. No. 18542 & After	0412112260	②TR28733	Belt - Fan		②TR28786
Belt - W.P. & Gen.; W/Std. Start; Ser. No. 18542 & After	6676836160	TR24500	D135A2		
Belt - W.P. & Alt.; W/500W. Starter; Ser. No. 18542 & After	0412011926	TR24489	Komatsu S6D140 Diesel	0412022276	②C72
D65E			D155A; D155A1; D355A; D355A1		
Cummins NH220CI Diesel			Komatsu S6D155-4 Diesel		♣9309HD
Hose - Upper		≧20731	D355A3		
		or	Komatsu SA6D155-4A Diesel		
		●26523	Belt - Alt.; W/Cold Weather Start; Ser. No. 20338 & After	0412031950	TR24500
Cummins NH22CI Diesel			Belt - Alt.; W/Std. Start; Ser. No. 20338 & After	0412031950	TR24500
Belt - Fan		②TR28693	D375A		
Belt - W.P. & Gen.		TR24500	Komatsu SA6D170 Diesel		
D65E6			Belt - Fan	0412022577	②TR30770
Cummins NH220CI Diesel			Belt - W.P. To Alt.		TR24379
Belt - Fan & Gen.; W/Std. Start; Ser. No. 40447 & After	0412102238	②TR28565	Belt - A.C.	0412021740	TR22397
D65EX			Hose - Upper; (3" I.D.)		24448
Komatsu SD125E2 Diesel			GD22H-1		
Hose - Upper		●26533	Komatsu 4D105-1C Diesel		
D65P			Belt - Fan & Alt.; W/800W. Cold Weather Start	0412002236	TR28557
Cummins NH220CI Diesel			Belt - Fan & Gen.; W/350W. Starter		TR28522
Hose - Upper		●26521	GD30-5M		
Hose - Lower		●26520	Komatsu 4D120-11G Diesel		
D65S			Belt - Fan & Alt.; W/800W. Cold Weather Start; Ser. No. 85343 & After	0412032266	②TR28657
Cummins NH220CI Diesel			GD31-5H		
Belt - Fan & Gen.		②TR28616	Komatsu S4D120-11G Diesel		
Hose - Upper		●26522	Belt - Fan & Alt.; W/800W. Cold Weather Start; Ser. No. 84832 & After	0412132266	②TR28657
Hose - Lower; (2 1/4" I.D.)		24236	Belt - Fan & Gen.; W/Cold Weather Start; Ser. No. 84832 & After	0412132266	②TR28657
D65S6			Belt - Fan & Gen.; W/Std. Start	0412122266	②TR28657
Cummins NH220CI Diesel			GD37-5H		
Belt - Fan & Gen.; W/Std. Start; Ser. No. 40447 & After	0412102238	②TR28565	Komatsu S4D120-11F Diesel		
D66S1			Belt - Fan & Gen.; Ser. No. 85044 & After	0412122266	②TR28657
Komatsu SA6D110-1 Diesel			GD615A		
Belt - Fan & Alt.		②TR22625	Komatsu S6D110 Diesel		
Hose - Upper		●26524	Belt - Fan & Alt.		②TR22607
Hose - By Pass		≧21942	Hose - Upper		●26524
D75S			Hose - Lower		●26532
Cummins NH220CI Diesel			GD655-3		
Belt - Fan & Gen.		②TR24709	Komatsu SAA6D114E Diesel		
Belt - W.P.; Ser. No. 15598 & After; W/Cold Weather Start	0412011914	TR24400	Belt - Alt.	3289536	♣K080734HD
Hose - Upper		●26524	Belt - A.C.	0412021748	TR22485
D80A; D85A12			GD705A		
Cummins NH220CI Diesel			Cummins NTO6B Diesel		
Belt - Fan; Ser. No. 118539 & After	0412102261	TR28743	Belt - Fan & Alt.		②TR28628
Belt - W.P. & Gen.; Ser. No. 118539 & After .	6682836170	TR24500	Belt - W.P.	0412021949	TR24489
D85E			Hose - Upper; (2 3/8" I.D.)		★24838
Cummins NT855 Diesel			Hose - Lower; (2 3/8" I.D.)		★24838
Belt - Alt.		TR24476	HD180-4		
Hose - Upper; (2 3/8" I.D.)		24438	Cummins NTO6B Diesel		
D95S1			Belt - W.P.; W/Std. Start; Ser. No. 119381 & After	6610816111	TR24400
Komatsu S4D155-4 Diesel					
Belt - Alt.; W/Cold Weather Start; Ser. No. 50061 & After	0412001921	TR24449			

② Two Required.
 ● Vulco-Flex® Coolant Hose.
 ★ Durion® Silicone Hose Recommended.

≧ Cut to Fit.
 ♣ Standard Belt Available. See Pages 630-631.

Belts and Coolant Hose for Road & Construction Equipment

Application	Mfr. Part No.	Our No.	Application	Mfr. Part No.	Our No.
KOMATSU - Continued			KOMATSU - Continued		
HD320-2			SK1020-5		
Cummins NTA855 Diesel Belt - Gen.; W/Std. Start; Ser. No. 112754 & After 0412001923 TR24461			Komatsu 4SD98E Diesel 2007 Belt - Alt. ♣9405HD 2006 Belt - Alt. 13X1040LA ♣9412HD 2005-2004 Belt - Alt. ♣9405HD		
HD680			SK1026-5		
Cummins VTA1710C Diesel Belt - W.P.; W/Std. Start 178665 TR28390 Belt - Alt.; W/Std. Start 178558 ♣9341HD			Komatsu 4SD98E Diesel 2007-2006 Belt - Fan & A.C. AVX13X1145LA ♣9451HD Belt - A.C. To Alt. AVX13X930LA ♣9365HD 2005 Belt - Fan & A.C. ♣9451HD Belt - A.C. To Alt. ♣9365HD		
PC05-5			WA30		
Komatsu 3D72-2B Diesel Belt - Fan & Alt. YM1196442290 7360 Hose - Upper ●25150			Komatsu 3D84 Diesel Belt - Fan & Alt. 7380		
PC120			WA40		
Komatsu 6D95L-1 Diesel Belt - Fan & Alt. 0412021746 ⊗TR22461			Komatsu 4D105-5 Diesel Belt - Fan & Alt. TR22485		
PC180LC			WA70		
Komatsu S6D95L Diesel Belt - Fan & Alt. ⊗TR22461			Komatsu 4D95L Diesel Belt - Fan & Alt. 0412040118 7470		
PC200LC			Komatsu 4D95L-W1 Diesel Hose - Upper ●25305 Hose - Lower ●25484		
Komatsu S6D105 Diesel Belt - Fan & Alt. 0412021748 TR22485			WA100		
Komatsu SA6D95L-1 Diesel Serpentine Belt ♣K060735HD			Komatsu 6D95L Diesel Belt - Fan & Alt. ⊗TR22508		
PC220LC			WA120		
Komatsu S6D105 Diesel Belt - Fan & Alt. 0412021748 TR22485			Komatsu 6D95L Diesel Belt - Fan & Alt.; W/50 1/8" Belt O.C. ⊗TR22495 Belt - Fan & Alt.; W/58 1/4" Belt O.C. 0412021758 ⊗TR22578 Hose - Lower - Eng. To Pipe Ⓢ<20065 or ●25473 Hose - Lower - Pipe To Rad.; (1 5/8" I.D.) 24226		
Komatsu SA6D95L-1 Diesel Serpentine Belt ♣K060735HD Hose - Upper Ⓢ<21378			WA150		
PC300LC			Komatsu 6D105 Diesel Belt - Fan & Alt. ⊗TR22508		
Komatsu SA6D108 Diesel Hose - Upper ●26525 Hose - By Pass; (1 1/4" I.D.) 24220			WA180		
PC360LC			Komatsu S6D95L Diesel Belt - Fan & Alt.; W/50 1/8" Belt O.C. 0412021750 ⊗TR22495 Belt - Fan & Alt.; W/58 1/4" Belt O.C. 0412021758 ⊗TR22578 Hose - Lower - Eng. To Pipe 20904 Hose - Lower - Pipe To Rad.; (1 5/8" I.D.) 24226		
Komatsu S6D125 Diesel Belt - Fan & Alt. ⊗TR30624			WA250		
PC400LC3			Komatsu 610T Diesel Hose - Upper - Eng. To Pipe Ⓢ<21379 Hose - Upper - Pipe To Rad.; (2" I.D.) 24432		
Komatsu S6D125 Diesel Belt - Fan & Alt. 0412022262 ⊗TR28616 Hose - Upper ●26525 Hose - By Pass; (1 3/4" I.D.) 24228			Komatsu S6D105 Diesel Belt - Fan & Alt. 0412021761 ⊗TR22607 Hose - Upper; (2" I.D.) ⊗24432 Hose - Lower; (2 1/4" I.D.) ⊗24436		
PC650			WA250-5		
Komatsu SA6D140-1 Diesel Belt - Alt. TR22299 Belt - A.C. 0412021735 TR22344 Hose - Upper; (2 1/2" I.D.) 24440			Komatsu SAA6D102E Diesel Belt - Fan & Alt. 3288889 ♣K080600HD Belt - Fan To A.C. 0412021744 TR22443		
SK815-5					
Komatsu S4D84E Diesel 2007-2003 Belt - Alt. A37					
SK820-5					
Komatsu S4D84E Diesel 2007-2004 Belt - Alt. A37					

Road & Construction Equipment

♣ Standard Belt Available. See Pages 630-631.
⊗ Two Required.

● Vulco-Flex® Coolant Hose.
Ⓢ< Cut to Fit.

Belts and Coolant Hose for Road & Construction Equipment

Application	Mfr. Part No.	Our No.	Application	Mfr. Part No.	Our No.
KOMATSU - Continued			KUBOTA - Continued		
WA320			KH35		
Komatsu S6D105 Diesel			Kubota D850BHW1 Diesel		
Belt - Fan & Alt.	0412121760	ⓉB57	Belt - Fan & Alt.	FM355	7355
Hose - Upper; (2" I.D.)		Ⓣ24432	KH41		
Hose - Lower; (2 1/4" I.D.)		Ⓣ24436	Kubota D950BH1 Diesel		
Hose - By Pass		Ⓣ21942	Belt - Fan & Alt.	FM355	7355
WA320-5			KH60		
Komatsu SAA6D102E Diesel			Kubota D1302BH2 Diesel		
Belt - Fan & Alt.	3288889	▲K080600HD	Belt - Fan & Alt.	FM415	7417
Belt - Fan To A.C.	0412021744	TR22443	Hose - Upper		●26603
WA350			KH90		
Komatsu S6D110 Diesel			Kubota V1702BH Diesel		
Belt - Fan & Alt.	0412021763	ⓉTR22625	Belt - Fan & Alt.; W/1/2" Belt T.W.	A41	▲9420HD
Hose - Upper - Eng. To Pipe; (2 3/8" I.D.)		24438	Belt - Fan & Alt.; W/21/32" Belt T.W.		TR22416
Hose - Upper - Pipe To Rad.; (2 5/8" I.D.)		24442	Hose - Upper		Ⓣ20661
Hose - Lower; (2 5/8" I.D.)		Ⓣ24442		or	●25251
Hose - By Pass		Ⓣ20065	KH91		
WA380			KH91		
Komatsu SA6D110 Diesel			Kubota D1402BH5 Diesel		
Belt - Fan & Alt.	0412021758	ⓉTR22578	Hose - Upper		Ⓣ21660
Hose - Upper; (2 3/8" I.D.)		Ⓣ24438		or	●25473
Hose - Lower; (2 3/8" I.D.)		Ⓣ24438	Hose - By Pass; (5/8" I.D.)		28441
Hose - By Pass		Ⓣ20065	KH170L		
WA380-6			KH170L		
Komatsu SAA6D107E Diesel			Kubota S2600D Diesel		
Belt - Alt.	3289078	▲K080653HD	Belt - Fan & Alt.		▲9435HD
Belt - A.C.	0412021746	TR22461	Hose - Upper		Ⓣ20661
Tensioner Assy. - Alt.	3976834	38516		or	●25251
WA600			KH191		
Komatsu S6D170 Diesel			Kubota S2800D Diesel		
Belt - Fan		ⓉTR30672	Belt - Fan & Alt.; W/1/2" Belt T.W.	A41	▲9420HD
Belt - W.P. To Alt.		TR26341	Belt - Fan & Alt.; W/21/32" Belt T.W.		TR22416
Hose - Upper; (3" I.D.)		Ⓣ24448	KH191L		
Hose - Lower; (3" I.D.)		Ⓣ24948	Kubota S2800D Diesel		
WB140-2N			Hose - Upper		Ⓣ20137
Komatsu S4D106-2XFH Diesel				or	●25251
Belt - Fan & Alt.	12390042480	TR22495	KX41		
WB146PS; WB156PS			KX41		
Komatsu S4D102LE-2 Diesel			Kubota D1105BH Diesel		
Belt - Fan To A.C.	AVX13X1125LA	▲9440HD	Belt - Fan & Alt.	2375	7375
KUBOTA			Hose - Upper		●25251
K400			KX71		
Kubota Diesel			Kubota V1505BH Diesel		
Belt - Fan & Alt.; W/1/2" Belt T.W.	A41	▲9420HD	Belt - Fan & Alt.	2375	7375
Belt - Fan & Alt.; W/21/32" Belt T.W.		TR22416	Hose - Upper		●25251
KH007			KX101; KX151		
Kubota Z430K1 Diesel			Kubota V1902 Diesel		
Belt - Fan & Alt.	FM32	7320	Belt - Fan & Alt.		▲9420HD
Hose - Upper		Ⓣ20782	Hose - Upper		Ⓣ21660
Hose - Lower		Ⓣ20782		or	●25473
KH10D			Hose - By Pass; (5/8" I.D.)		28441
Kubota S2600D Diesel			L35 Backhoe		
Belt - Fan & Alt.	FM41	7420	Kubota D1703 Diesel		
KH18L; KH28L			Belt - Fan & Alt.	REMF6415	▲9425HD
Kubota S2600D Diesel			Hose - Upper		Ⓣ21660
Belt - Fan & Alt.	A43	▲9440HD		or	●25476
KUBOTA			Hose - Lower		Ⓣ21794
K400			R310		
Kubota Diesel			Kubota V1305 Diesel		
Belt - Fan & Alt.; W/1/2" Belt T.W.	A41	▲9420HD	Belt - Fan & Alt.	2350	7365
Belt - Fan & Alt.; W/21/32" Belt T.W.		TR22416			

Ⓣ Two Required.
 ▲ Standard Belt Available. See Pages 630-631.
 Ⓣ Use Wire Inserted Green Stripe® Coolant Hose.

Ⓣ Cut to Fit.
 Ⓣ Three Required.
 ● Vulco-Flex® Coolant Hose.

Belts and Coolant Hose for Road & Construction Equipment

Application	Mfr. Part No.	Our No.	Application	Mfr. Part No.	Our No.
KUBOTA - Continued			LE TOURNEAU - Continued		
R410			Roadster C		
Kubota V1902 Diesel			Detroit Diesel 6055C Diesel		
Belt - Fan & Alt.; W/11/16" Belt T.W.; W/42 1/4" Belt O.C.		TR22416	Belt - Fan	DD82781	②TR28596
Belt - Fan & Alt.; W/1/2" Belt T.W.; W/42 3/8" Belt O.C.	REMF6410	▲9420HD	Belt - Compr.	DD8278	TR28545
R510			Roadster D		
Kubota V2203 Diesel			Detroit Diesel 4-71 Diesel		
Belt - Fan & Alt.; W/39 7/8" Belt O.C.	RPF3410	▲9395HD	Belt - Fan	3224368	TR34545
Belt - Fan & Alt.; W/41 7/8" Belt O.C.		▲9415HD	Belt - Compr.		TR28483
Hose - Lower		●25251	Super C		
Hose - By Pass; (1/2" I.D.)		*26240	Cummins HBIS Diesel		
LE ROI			Belt - Fan & W.P.		
170RD2			Belt - P.S.		
Detroit Diesel 3-53 Diesel			S1792		
Belt - Fan	5119188	②▲9390HD	S3130		
Belt - W.P. & Gen.		7420	②TR22405		
Hose - Upper		③<20957	②TR22485		
		or ●26501	Super C Tornadozer		
A219-89			Buda 6-Cyl. Diesel		
Perkins 4-Cyl. Diesel			Belt - Fan		
Belt - Fan & Alt.		▲9530HD	Belt - Compr.	HC1712	②TR28628
Hose - Upper - Pipe To Rad.; (2 1/4" I.D.)		24436	HC1146		
Hose - Lower		●25482	TR28616		
HDR12EH			Detroit Diesel 6055C Diesel		
Deutz F4L912 Diesel			Belt - Compr.		
Belt - Fan		▲9440HD	HD8004		
Q125DJE			TR30537		
John Deere 3179D Diesel			Tornadozer		
Belt - Fan & Alt.	T20334	TR22474	Cummins NTO262 Diesel		
LE TOURNEAU			Belt - Fan		
666			Belt - W.P.		
Cummins H135 Diesel			178570		
Belt - Fan	178489	②TR22461	TR30506		
Belt - Gen.	134816	TR22495	TR24400		
B70			Tournapull		
Detroit Diesel 12V-71 Diesel			Cummins HBID Diesel		
Belt - Fan	721421	②TR22525	Belt - Fan		
CR			Belt - Compr.		
Detroit Diesel 6-71 Diesel			70524		
Belt - Fan		②TR30672	HC2387		
Belt - Compr.		TR28545	TR28545		
F602B			Tournapull B		
Detroit Diesel 6V-71 Diesel			Cummins NHRBIS600 Diesel; Cummins NRT6BI Diesel		
Hose - Upper; (2 1/4" I.D.)		24236	Belt - Fan		
Hose - Lower; (2 3/4" I.D.)		24244	Belt - W.P.		
F802A; F804A			S3115		
Cummins NT855 Diesel			S3163		
Hose - Upper; (2" I.D.)		24232	②TR28492		
Hose - Lower; (2 1/4" I.D.)		24236	TR22434		
Detroit Diesel 8V-71 Diesel			Detroit Diesel 4055 Diesel		
Belt - Fan		③▲9440HD	Hose - Upper; W/15" Hose		
Hose - Upper; (2 1/4" I.D.)		24236	●26509		
Hose - Lower; (2 3/4" I.D.)		24244	Hose - Lower; W/15" Hose		
F1204			●26509		
Detroit Diesel 12V-71 Diesel			Detroit Diesel 4055C Diesel		
Belt - Fan		③▲9570HD	Belt - Fan		
Hose - Upper; (2 1/2" I.D.)		24240	Belt - Compr.		
Hose - Lower; (3 1/2" I.D.)		24256	3224368		
			TR34545		
			TR24461		
			Detroit Diesel 4055D Diesel		
			Belt - Fan & Compr.		
			3224451		
			TR34700		
			Tournatractor B		
			Cummins NRT6BI Diesel		
			Belt - Fan		
			Belt - W.P.		
			S3115		
			S3163		
			②TR28492		
			TR22434		
			Detroit Diesel 6-71 Diesel		
			Belt - Fan		
			Belt - Compr.		
			②TR30672		
			TR28545		
			Tournatractor C		
			Cummins HBIS Diesel		
			Belt - Fan		
			Belt - Compr.		
			S1792		
			HC2387		
			②TR22405		
			TR28545		

▲ Standard Belt Available. See Pages 630-631.
 * Durion® Silicone Hose Recommended.
 < Cut to Fit.

● Vulco-Flex® Coolant Hose.
 ② Two Required.
 ③ Three Required.

Road & Construction Equipment

Belts and Coolant Hose for Road & Construction Equipment

Application	Mfr. Part No.	Our No.	Application	Mfr. Part No.	Our No.
LIEBHERR			LINK-BELT - Continued		
R911LC			HT450		
Deutz F4L912 Diesel			Detroit Diesel 6-71N Diesel		
Belt - Blower & Idler		7508	Belt - Fan	5135942	②▲9550HD
Belt - Gen.	▲9415HD		Belt - Gen.	5133517	▲9390HD
Belt - Compr.	7425		LS78		
R925			Detroit Diesel 3-71N Diesel		
Deutz F6L912 Diesel			Belt - Fan		②▲9420HD
Belt - Alt.		7480	Belt - Alt.		▲9430HD
Belt - Compr.		7425	Belt - Hyd. Pump		▲9405HD
R961LC			LS98		
Deutz F6L413 Diesel			Caterpillar D333 Diesel		
Belt - Alt.		7380	Belt - Fan & Alt.	3S6272	③▲9540HD
Belt - Compr.	②▲9400HD		Belt - Hyd. Pump		②TR22508
LINK-BELT			Belt - Fan & Idler	3L9717	②TR24489
HC18			Belt - Fan To Alt.	4B2544	▲9430HD
Detroit Diesel 8V-71 Diesel			LS98H		
Belt - Fan		③▲9540HD	Caterpillar D333 Diesel		
Belt - Alt.		②9279	Belt - Fan & Alt.	3S6217	③▲9540HD
Hose - Upper		≠21115	LS108B		
Hose - Lower; (2 1/4" I.D.)		②24436	Detroit Diesel 4-71 Diesel		
HC78B			Belt - Fan	5139026	②▲9420HD
Caterpillar D330C Diesel			Belt - Alt.		▲9430HD
Belt - Fan & Alt.	③▲9530HD		Belt - Hyd. Pump		▲9425HD
Belt - Hyd. Pump	②B38		LS128DLC		
Hose - Lower - Eng. To Pipe; (2 1/2" I.D.)	②24440		Detroit Diesel 6-71N Diesel		
Detroit Diesel 6V-53N Diesel			Belt - Fan		③▲9420HD
Belt - Fan		②▲9400HD	LS2700		
Belt - Alt.		②7370	Isuzu 4BD1-T Diesel		
Hose - Upper		②●26501	Belt - Fan & Alt.	5136710430	TR22448
Hose - Lower		●26501	Hose - By Pass		≠20802
HC108C			LS2800CII		
Detroit Diesel 4-71 Diesel			Isuzu 6BD1T Diesel		
Belt - Fan - Upper Structure	5139026	②▲9420HD	Belt - Fan & Alt.		②TR22485
Belt - Alt. - Upper Structure	5145150	▲9430HD	LS4000		
Belt - Hyd. Pump		▲9425HD	Caterpillar D330 Diesel		
Detroit Diesel 6-71 Diesel			Belt - Fan & Alt.	3S6272	③▲9540HD
Belt - Fan - Lower Structure		②▲9550HD	Belt - Hyd. Pump		TR22578
Belt - Alt. - Lower Structure		▲9390HD	LS4300CII		
HC218			Isuzu 6SD1T Diesel		
Detroit Diesel 6-71 Diesel			Belt - Fan & Alt.		②TR22495
Belt - Fan - Upper Structure	5139026	②▲9420HD	LS5800		
Belt - Alt. - Upper Structure	5145150	▲9430HD	Detroit Diesel 8V-71 Diesel		
Belt - Hyd. Pump	1J2041	▲9425HD	Belt - Fan		③▲9447HD
Hose - Upper		●26511	Hose - Upper		≠21115
Hose - Lower; (2" I.D.)		②24432	Hose - Lower - Eng. To Pipe; (2 3/4" I.D.)		24444
Detroit Diesel 8V-71 Diesel			Hose - Lower - Pipe To Rad.; (2 3/4" I.D.)		24444
Belt - Fan - Lower Structure	5133762	③▲9540HD	LS5800CII		
Belt - Alt. - Lower Structure	5135298	②▲9313HD	Isuzu 6RB1T Diesel		
HSP8018			Hose - Upper		●26512
Detroit Diesel 4-53 Diesel			LS7400		
Belt - W.P. & Alt.		②7417	Detroit Diesel 12V-71 Diesel		
HSP8028S			Belt - Fan	5133769	③▲9650HD
Detroit Diesel V-8 8.2 L Diesel			YC38		
Belt - Hyd. Pump		AX42	Detroit Diesel 4-53N Diesel		
HSP8040			Belt - Fan		②▲9390HD
Detroit Diesel 6V-53 Diesel			Belt - W.P. & Alt.		7448
Belt - Fan	5148223	②▲9463HD	Belt - V.P.		②7320
Belt - Alt.	5133177	7370			

▲ Standard Belt Available. See Pages 630-631.
 ③ Three Required.
 ● Vulco-Flex® Coolant Hose.

② Two Required.
 ≠ Cut to Fit.

Belts and Coolant Hose for Road & Construction Equipment

Application	Mfr. Part No.	Our No.	Application	Mfr. Part No.	Our No.
LITTLE GIANT			MASSEY FERGUSON - Continued		
C48			MF44B		
Detroit Diesel 3-71 Diesel			Perkins 6-Cyl. 354 Diesel		
Belt - Fan		②▲9420HD	Belt - Fan & Alt.		②▲9590HD
Belt - Alt.		▲9370HD	Hose - Upper		≡<20611
LONG			or ●26509		
5N1			●26511		
Leyland 38TD Diesel			Hose - Lower		
Belt - Fan & Alt.		▲K060525HD	Hose - By Pass		≡<20685
Hose - Upper		●25473	MF50A		
Hose - Lower		●25480	Perkins 4-Cyl. 203 Diesel		
LORAIN			Belt - Fan & Alt. 843198M1 ▲9525HD		
LC790			MF66		
Detroit Diesel 6-71 Diesel			Detroit Diesel 6V-53N Diesel		
Belt - Fan - Upper Structure	5136269	②▲9600HD	Belt - Fan		③▲9490HD
Belt - Alt. - Upper Structure	5140928	▲9400HD	Belt - W.P. & Air Brake Compr.		②▲9490HD
Belt - Hyd. Pump - Upper Structure		7535	Belt - Alt.		▲9380HD
Detroit Diesel 8V-71 Diesel			Hose - Upper - Eng. To Pipe; (2 3/8" I.D.)		
Belt - Fan - Lower Structure	5116779	③▲9600HD	Hose - Upper - Pipe To Rad.; (2 3/8" I.D.)		24238
Belt - Alt. - Lower Structure		K080370	Hose - Lower - Eng. To Pipe; (2 3/8" I.D.)		24238
MC30H			MF70		
Detroit Diesel 4-71N Diesel			Perkins 4-Cyl. 318 Diesel		
Belt - Fan - Upper Structure	5128579	②▲9500HD	Belt - Fan & Alt./Gen.	726015M91	②7530
Belt - Alt. - Upper Structure		▲9415HD	MF77C		
Detroit Diesel 6-71N Diesel			Cummins N855 Diesel		
Belt - Fan - Lower Structure		②▲9550HD	Belt - Fan		③▲9463HD
Belt - Alt. - Lower Structure		▲9375HD	Belt - W.P. & Alt.		▲9425HD
MC320			Belt - Air Brake Compr.		
Ford V-8 391			②▲9476HD		
Belt - W.P. & Alt.; W/Drive Eng.	C2TZ8620Z	▲9451HD	MF80		
Hose - Lower; W/Drive Eng.		≡<21379	Perkins 6-Cyl. 354 Diesel		
MC540A			Belt - Fan & Alt./Gen.		
Cummins 6-Cyl. Diesel			726323M91		
Belt - Fan - Upper Structure	178530	②TR24365	MF202		
Belt - W.P. - Upper Structure	178658	TR22329	Continental Z134		
Belt - Alt. - Upper Structure	178470	TR22474	Belt - Fan & Gen.	181523M1	▲9430HD
M-R-S			Hose - Upper; (1 1/2" I.D.)		
I105S; I110S			24224		
Detroit Diesel 12V-71 Diesel			Hose - Lower		
Belt - Fan		③▲9740HD	≡<20416		
Hose - Upper; (2 1/2" I.D.)		②④24940	or ●25473		
Hose - Lower; (3 1/2" I.D.)		④24956	MF203		
MASSEY FERGUSON			Perkins 3-Cyl. 152 Diesel		
777			Belt - Fan & Gen.		
Cummins N855 Diesel			186976M1		
Hose - Upper - Eng. To Pipe; (1 3/4" I.D.)		24428	▲9490HD		
Hose - Upper - Pipe To Rad.		23520	24224		
Hose - Lower - Eng. To Pipe; (2 3/8" I.D.)		24438	24218		
Hose - Lower - Pipe To Rad.; (2 1/8" I.D.)		24434	MF204		
MF11			Continental Z134		
Perkins 4-Cyl. 248 Diesel			Belt - Fan & Gen.		
Belt - Fan & Alt.; Ser. No. J1399 & Before	1446201M1	▲9505HD	181523M1		
Belt - Fan & Alt.; Ser. No. J1400 & After	2614087RF	②7512	Hose - Upper; (1 1/2" I.D.)		
Hose - Lower		●25476	24224		
Hose - By Pass		●25249	Hose - Lower		
MF20C; MF30B			≡<20416		
Perkins 3-Cyl. 152 Diesel			or ●25473		
Belt - Fan & Alt.	531371M1	▲9525HD	MF205		
MF11			Perkins 3-Cyl. 152 Diesel		
Perkins 4-Cyl. 248 Diesel			Belt - Fan & Gen.		
Belt - Fan & Alt.; Ser. No. 248UA6333 & Before			186976M1		
Belt - Fan & Alt.; Ser. No. 248UA6334 & After			▲9490HD		
Hose - Lower			24224		
Hose - By Pass			24218		
MF20C; MF30B			MF220		
Perkins 3-Cyl. 152 Diesel			Perkins 4-Cyl. 248		
Belt - Fan & Alt.	531371M1	▲9525HD	1972-1970		
MF20C; MF30B			Belt - Fan & Alt.; Ser. No. 248UA6333 & Before		
Perkins 3-Cyl. 152 Diesel			186976M1		
Belt - Fan & Alt.	531371M1	▲9525HD	▲9490HD		
MF20C; MF30B			Belt - Fan & Alt.; Ser. No. 248UA6334 & After		
Perkins 3-Cyl. 152 Diesel			1840685M91		
Belt - Fan & Alt.	531371M1	▲9525HD	②7500		
MF20C; MF30B			MF300 Backhoe		
Perkins 3-Cyl. 152 Diesel			Perkins 4-Cyl. 248 Diesel		
Belt - Fan & Alt.	531371M1	▲9525HD	Belt - Fan & Alt.; Ser. No. 248UA14402L & Before		
MF20C; MF30B			▲9470HD		

Road & Construction Equipment

② Two Required.
 ● Vulco-Flex® Coolant Hose.
 ≡< Cut to Fit.

▲ Standard Belt Available. See Pages 630-631.
 ③ Three Required.
 ④ Use Wire Inserted Green Stripe® Coolant Hose.

Belts and Coolant Hose for Road & Construction Equipment

Application	Mfr. Part No.	Our No.	Application	Mfr. Part No.	Our No.
MASSEY FERGUSON - Continued			MULTIQUIP		
MF300 Backhoe - Continued			DPS-90SS		
Perkins 4-Cyl. 248 Diesel - Continued			Isuzu 3-Cyl. Diesel		
Belt - Fan & Alt.; Ser. No. 248UA17092 Thru 248UA88561	1446046M1	②7470	Belt - Fan & Gen.		7355
Belt - Fan & Alt.; Ser. No. 248UA88561 & After		②7475	DPS-180SST		
Hose - Upper		●26504	Isuzu C240 Diesel		
Hose - Lower		⊗20957	Belt - Fan & Alt.	5136710400	▲9400HD
	or	●26603	MUSTANG		
MF320			545		
Perkins 6-Cyl. 354 Diesel			Perkins 4-Cyl. 154 Diesel		
1977-1976			1985-1982		
Belt - Fan & Alt.	726015M91	②7530	Belt - Fan & Alt.		▲9510HD
MF450; MF450S			Hose - Upper		●26501
Perkins 6-Cyl. 354 Diesel			NEW HOLLAND		
Belt - Fan & Alt.	2614668	②▲9605HD	C175		
Hose - Upper		⊗20206	New Holland N844 Diesel		
Hose - Lower - Eng. To Pipe; (2 1/8" I.D.)		24434	2007		
Hose - Lower - Pipe To Rad.; (2 1/8" I.D.)		24434	Belt - Fan & Alt.		▲9370HD
MF470			L35		
Perkins 4-Cyl. 193			Wisconsin VG4D		
Belt - Fan & Gen.		②7490	1984-1971		
Perkins 4-Cyl. 193 Diesel			Belt - Alt.	72440	6719
Belt - Fan & Gen.	1030166M1	▲9480HD	L175		
MF811			New Holland NH844LT Diesel		
Perkins 4-Cyl. 108 Diesel			2007		
1976-1974			Belt - Fan & Alt.		▲9370HD
Belt - Fan & Alt.		7405	L185		
Hose - Upper		⊗21794	New Holland 344TM2 Diesel		
	or	●25476	2007		
Hose - Lower		●25476	Belt - Fan & Alt.	J925953	▲K080590HD
MDI/YUTANI			L225		
MD140			Wisconsin TJD		
Mitsubishi 4D31T Diesel			1977-1975		
Belt - Fan & Alt.; W/46 5/8" Belt O.C.		TR22461	Belt - Alt.		7360
Belt - Fan & Alt.; W/48" Belt O.C.		TR22474	L553		
Hose - Upper		●26511	Kubota V1902 Diesel		
Hose - Lower		●26512	1996-1985		
MD200			Belt - Fan & Alt.	783511	7435
Mitsubishi 6D31T Diesel			L555		
Belt - Fan & Alt.		②▲9476HD	Kubota V1902 Diesel		
Hose - Upper		●26511	1995-1981		
Hose - Lower		●26512	Belt - Fan & Alt.; W/46 7/8" Belt O.C.	9807449	▲9465HD
MD240			Belt - Fan & Alt.; W/45 5/8" Belt O.C.	9612805	7450
Mitsubishi 6D15T Diesel			Hose - Upper		⊗20065
Belt - Fan & Alt.		TR22425	Hose - Lower		⊗20065
Hose - Upper		●26511			or
Hose - Lower		●26512	Hose - By Pass; (1/2" I.D.)		●25251
MD320					28439
Mitsubishi 6D22T Diesel			L565		
Belt - Fan & W.P.		②TR28570	New Holland N844 Diesel		
Belt - Alt.		TR20426	1999-1989		
MULTIHOE			Belt - Fan & Alt.		▲9355HD
MDA			L775		
Detroit Diesel 3-53 Diesel			Deutz F3L912 Diesel		
Belt - Fan		②▲9350HD	1984-1977		
Belt - W.P.		②7360	Belt - Blower & Alt.	259347	7417
Belt - Alt.		7312			
Hose - Upper		●25472			
Hose - Lower - Eng. To Water Manifold; (1 3/4" I.D.)		24228			
Hose - Lower - Water Manifold To Rad.		●26507			

Road & Construction Equipment

② Two Required.
⊗ Cut to Fit.

● Vulco-Flex® Coolant Hose.
▲ Standard Belt Available. See Pages 630-631.

Belts and Coolant Hose for Road & Construction Equipment

Application	Mfr. Part No.	Our No.	Application	Mfr. Part No.	Our No.
NEW HOLLAND - Continued			OWATONNA - Continued		
L781			1700		
Deutz F3L912 Diesel			Ford V-4 104 Diesel		
1995-1984			1980-1978		
Belt - Blower	2235775	7512	Belt - Fan & Alt.		7430
Belt - Alt.		7430	Belt - Fan, Alt. & W.P.		7410
L785			Belt - Fan & Gov.		
Perkins 4-Cyl. 203 Diesel			Hose - Upper		
1994-1983			Hose - Lower		
Belt - Fan & Alt.	632880	▲9451HD		●25305	
Hose - Upper		●26501		●26602	
LB90			P & H		
New Holland BSD 450T			20-20		
Serpentine Belt	85826230	▲K080570HD	Detroit Diesel 4-53 Diesel		
LS190			Belt - Fan		
New Holland 4-Cyl. 304 Diesel			Belt - W.P. & Alt.		
2004-2000			Hose - Upper		
Tensioner Assy.	87801689	38672		②▲9630HD	
LX665			Belt - W.P. & Alt.		
New Holland N844 Diesel			Hose - Upper		
1999-1993			Hose - Lower - Rad. To Pipe (Crane); (1 1/2" I.D.)		
Belt - Fan & Alt.	AX365	▲9375HD	Hose - Lower - Pipe To W.P. (Crane); (1 1/2" I.D.)		
LX985			150; 150TC		
Genesis 4-Cyl. 304 Diesel			Buda 6DT278 Diesel; Buda 6DT317 Diesel		
1999-1998			Belt - Fan		
Belt - Fan & Alt.		▲9470HD		22128	TR28501
Tensioner Assy.	87801689	38672	215		
T330			Chrysler 6-Cyl. 225		
Wisconsin TJD			Belt - Fan & Gen. - Crane		
Belt - Alt.			Belt - Gov. - Crane		
	235084	7280	Hose - Upper - Crane; (2 1/4" I.D.)		
T550			Hose - Lower - Rad. To Pipe (Crane); (1 1/2" I.D.)		
Wisconsin VG4D			Hose - Lower - Pipe To W.P. (Crane); (1 1/2" I.D.)		
Belt - Alt.			IH RD450 Diesel		
	72440	6819	Belt - Fan & Alt. - Truck		
Belt - Hyd. Pump	234653	7360	Belt - Fan To P.S. - Truck		
OWATONNA			Hose - Upper - Truck		
445			Hose - Lower - Truck		
Ford 4-Cyl. 98			255A; 255ATC		
1987-1979			Buda 6DT468 Diesel		
Belt - Fan & Alt.	02032167	3VX315	Belt - Fan		
Belt - Gov.		7380	Belt - Gen.		
Perkins 4-Cyl. 108 Diesel			7Z1D2		
1987-1979			TR28522		
Belt - Fan & Alt.	2612019	7410	TR28423		
545			455A		
Perkins 4-Cyl. 154 Diesel			Chrysler Ind. 12-69		
1987-1982			Belt - Fan		
Belt - Fan & Alt.		▲9510HD	928408		
Hose - Upper		●26501	②TR24476		
880			655A; 655B		
Ford 4-Cyl. 256 Diesel			Caterpillar D13000 Diesel		
Belt - Fan & Alt.			Belt - Belt; W/Leece Neville Alt.		
		▲9550HD	CX68		
Hose - Upper		●26504	855		
Hose - Lower; (1 1/2" I.D.)		②24924	Caterpillar D17000 Diesel		
1200			Belt - Starter		
Wisconsin VH4D			TR28628		
1980-1978			955A		
Belt - Alt.		▲9319HD	Waukesha 6WAKD Diesel		
			Belt - Gen.		
			②TR22350		
			1055		
			Caterpillar D343 Diesel		
			Belt - Fan		
			Belt - Gen.		
			②TR24500		
			TR28583		
			9125TC		
			Cummins V903 Diesel		
			Belt - Fan & W.P. - Upper Structure		
			178543		
			③▲9680HD		
			Belt - Alt. - Upper Structure; Front Mount		
			②7555		
			Belt - Alt. - Upper Structure; Rear Mount		
			178472		
			②▲9390HD		
			Belt - Hyd. Pump - Upper Structure		
			7555		
			Hose - Upper - Pipe To Rad. (Upper Structure)		
			≈21194		
			Hose - Upper - Eng. To Pipe (Upper Structure); (2 1/4" I.D.)		
			24436		

Road & Construction Equipment

▲ Standard Belt Available. See Pages 630-631.
 Ⓜ Use Wire Inserted Green Stripe® Coolant Hose.
 ③ Three Required.

● Vulco-Flex® Coolant Hose.
 ② Two Required.
 ≈ Cut to Fit.

Belts and Coolant Hose for Road & Construction Equipment

Application	Mfr. Part No.	Our No.
P & H - Continued		
9254		
Cummins NTF365 Diesel		
Belt - Fan - Lower Structure		②TR28429
Belt - Alt. - Lower Structure		②▲9470HD
Belt - W.P. & Idler - Lower Structure	215356	②6596
Belt - Hyd. Pump - Lower Structure		②TR22495
Hose - Upper - Eng. To Pipe (Lower Structure)		●26521
Hose - Lower - Eng. To Pipe (Lower Structure); (2 1/2" I.D.)		24440
H312		
Detroit Diesel 4-53N Diesel		
Belt - Fan	5131395	②▲9412HD
Belt - W.P. & Gen.	5133174	7405
Hose - Upper		20065
		or ●25473
H418		
Detroit Diesel 6V-53N Diesel		
Belt - Fan	5126763	②▲9400HD
Belt - Alt.		7375
Belt - W.P. & Idler	5139228	②7370
Hose - Upper		●26611
Hose - Lower		●26522
K935		
Detroit Diesel 6-71 Diesel		
Belt - Fan	512676	③▲9470HD
Belt - Alt.		TR22405
WN300		
Continental F186		
Belt - Fan		TR28483
PARSONS		
75		
Ford 4-Cyl.		
Belt - Fan & Alt.		▲9463HD
Belt - Fan & Idler		▲9430HD
Hose - Upper		●25473
Hose - Lower		●26612
166-15		
Perkins 4-Cyl. 236 Diesel		
Belt - Fan & Alt.		▲9330HD
Hose - Upper		②<20957
		or ●26501
Hose - Lower		●25480
255L		
Detroit Diesel 4-53 Diesel		
Belt - Fan	5131395	②▲9412HD
Belt - W.P. & Gen.	5133174	②7405
Belt - Hyd. Pump		7312
Hose - Upper		②<20065
		or ●25473
Hose - Lower - Eng. To Pipe; (2" I.D.)		24232
Hose - Lower - Pipe To Rad.; (2" I.D.)		24232
T750		
John Deere 4039D Diesel		
Belt - Fan & Alt.	T24473	TR24465
UH119		
Detroit Diesel 3-53 Diesel		
Belt - Fan	5135884	②▲9440HD
Belt - W.P., Alt. & Hyd. Pump		②7420
Hose - Upper		②<20957
		or ●26501
Hose - Lower		●26507

Application	Mfr. Part No.	Our No.
PETTIBONE		
29		
Detroit Diesel 4-53 Diesel		
Belt - Fan		②▲9455HD
Belt - W.P. & Alt.		②7405
Belt - V.P.		7280
36		
Detroit Diesel 6V-53 Diesel		
Belt - Fan		②▲9400HD
Belt - Alt.		②▲9375HD
Belt - W.P.		②▲9375HD
40		
Detroit Diesel 6V-53 Diesel		
Belt - Fan		②▲9400HD
Belt - Alt.		②▲9375HD
Belt - W.P.		②▲9375HD
Hose - Upper - Left Side		●26502
Hose - Upper - Right Side		●26502
Hose - Lower		●26523
402; 402C; 403; 404; 502; 502C		
Detroit Diesel 3082 Diesel; Detroit Diesel 4082 Diesel		
Belt - Fan	5170972	②TR22455
Belt - Gen.	3224367	TR28390
C200		
Detroit Diesel 3-53 Diesel		
Belt - Fan	5131395	②▲9412HD
Belt - W.P. & Gen.		7430
Belt - Hyd. Pump		▲9341HD
Hose - Upper		②<21794
		or ●25474
Hose - Lower - Eng. To Pipe; (2" I.D.)		24432
Hose - Lower - Pipe To Rad.; (2" I.D.)		24432
SB68		
John Deere 4276D Diesel		
Belt - Fan & Alt.	T24473	TR22514
Belt - Hyd. Pump		▲9380HD
Hose - Upper		●26502
Hose - Lower - Eng. To Pipe; (2" I.D.)		24232
Hose - Lower - Pipe To Rad.; (2" I.D.)		④24932
SM710		
Detroit Diesel 4-53 Diesel		
Hose - Upper		●26504
Hose - Lower		●26510
POCLAIN		
160; 200		
Deutz F11L413 Diesel		
Belt - Alt.		②7380
220		
Deutz F6L912 Diesel		
Belt - Alt.		7385
FC		
Deutz F3L912 Diesel		
Belt - Fan & Gen.	P0138728	7580
Belt - Hyd. Pump; GV30	M0038743	②TR28628
Deutz F4L812 Diesel		
Belt - Fan		▲9530HD
Belt - Fan & Gen.	H0038739	▲9610HD
Belt - Gen.	Z0038731	▲9451HD
Belt - Hyd. Pump; GV30	M0038743	②TR28628

② Two Required.
 ● Vulco-Flex® Coolant Hose.
 < Cut to Fit.

▲ Standard Belt Available. See Pages 630-631.
 ③ Three Required.
 ④ Use Wire Inserted Green Stripe® Coolant Hose.

Belts and Coolant Hose for Road & Construction Equipment

Application	Mfr. Part No.	Our No.	Application	Mfr. Part No.	Our No.
POCLAIN - Continued			POCLAIN - Continued		
FY			RC		
Deutz F3L912 Diesel			Deutz F6L413 Diesel		
Belt - Fan & Gen.	P0138726	7580	Belt - Hyd. Pump	C0138761	④TR22792
Belt - Fan; 1st Mounting; W/Almm. Rad.	U0038727	TR22485	RC200		
Belt - Air Brake Compr.; 2nd Mounting	W0038729	TR22508	Deutz F6L413 Diesel		
Belt - Hyd. Pump - Front	N0038744	②TR28680	Belt - Alt.		7390
Belt - Hyd. Pump - Rear	M0038743	②TR28628	SC		
Deutz F4L812 Diesel			Deutz F6L413 Diesel		
Belt - Fan; 1st Mounting	S0038725	♣9520HD	Belt - Fan; W/55 1/8" Belt O.C.	V0138755	7550
Belt - Fan; 2nd Mounting		♣9530HD	Belt - Fan; W/59 1/8" Belt O.C.	W0138756	7590
Belt - Fan & Gen.	H0038739	♣9610HD	Belt - Oil Pump	A0138759	7490
Belt - Gen.	Z0038731	♣9451HD	TC		
Belt - A.C.; 1st Mounting	U0038727	TR22485	Agrom		
Belt - A.C.; 2nd Mounting	W0038729	TR22508	Belt - Fan & Gen.; W/57 1/4" Belt O.C.	K0038718	②♣9570HD
Belt - Hyd. Pump - Front	N0038744	②TR28680	Belt - Fan & Gen.; W/58 1/4" Belt O.C.	R0138705	②♣9580HD
Belt - Hyd. Pump - Rear	M0038743	②TR28628	Deutz F4L712 Diesel		
GC			Belt - Fan	S0038725	♣9520HD
Deutz F6L514 Diesel			Belt - Gen.		♣9425HD
Belt - Fan; W/Hyd. Cooler; Ser. No. 485 & After; W/56 1/4" Belt O.C.	G0038715	TR22578	Deutz F4L812 Diesel		
Belt - Fan; W/Hyd. Cooler; Ser. No. 500 & After; W/79" Belt O.C.	W0038706	④BX77	Belt - Fan	T0038726	♣9530HD
Belt - Blower; Ser. No. 4.524.029 & Before ...	F0038737	③TR22648	Belt - Gen.	Z0038731	♣9451HD
Belt - Blower; Ser. No. 4.524.030 & After	S0138706	②7660	Deutz F4L912 Diesel		
Belt - Gen.	G0038738	♣9360HD	Belt - Fan	M0138724	7500
GC120			Belt - Gen.	L0138723	7417
Deutz F6L514 Diesel			TCB		
Belt - Blower		②7640	Deutz F3L912 Diesel		
Belt - Alt.		♣9380HD	Belt - Gen.	P0138726	7580
GY			Belt - Hyd. Pump; W/H.POC 23X23 2X23P		
Deutz F6L514 Diesel			Hyd. Pump	K0138722	③TR28706
Belt - Fan; W/Hyd. Cooler; Ser. No. 485 & After; W/56 1/4" Belt O.C.	G0038715	TR22578	TCS		
Belt - Fan; W/Hyd. Cooler; Ser. No. 500 & After; W/79" Belt O.C.	W0038706	④BX77	Agrom		
Belt - Blower; Ser. No. 4.524.029 & Before ...	F0038737	③TR22648	Belt - Fan & Gen.; W/57 1/4" Belt O.C.	K0038718	②♣9570HD
Belt - Blower; Ser. No. 4.524.030 & After	S0138706	②7660	Belt - Fan & Gen.; W/58 1/4" Belt O.C.	R0138705	②♣9580HD
Belt - Gen.	G0038738	♣9360HD	Deutz F4L712 Diesel		
Belt - Air Brake Compr.; W/51 1/4" Belt O.C. .	W0038729	TR22508	Belt - Fan	S0038725	♣9520HD
Belt - Air Brake Compr.; W/54 3/4" Belt O.C. .	P0138703	TR22553	Belt - Gen.		♣9425HD
HC			Deutz F4L812 Diesel		
Detroit Diesel 8V-71 Diesel; Deutz F12L413 Diesel			Belt - Fan	T0038726	♣9530HD
Belt - Fan - Rear Eng.; W/Hyd. Cooler	U0138708	♣9650HD	Belt - Gen.	Z0038731	♣9451HD
Belt - Fan; W/Optional 4th Hyd. Cooler	U0138708	♣9650HD	Deutz F4L912 Diesel		
Belt - A.C.	N0138725	②♣9580HD	Belt - Fan	M0138724	7500
HC300			Belt - Gen.	L0138723	7417
Detroit Diesel 8V-71 Diesel			Belt - Hyd. Pump; GV15, GV30	L0038742	②TR28706
Belt - Fan		③♣9560HD	TCS-M1		
Belt - Alt.	5109794	♣9375HD	Deutz F4L912 Diesel		
LC; LY			Belt - Fan	M0138724	7500
Agrom			Belt - Gen.	L0138723	7417
Belt - Fan & Gen.	M0138701	③♣9620HD	Belt - Hyd. Pump; W/H.POC 32 1X32 Hyd. Pump	R0138728	③TR28786
Deutz F6L812 Diesel			Belt - Hyd. Pump; W/H.POC 18X18 2X3P Hyd. Pump	K0138722	③TR28706
Belt - Fan; W/Hyd. Cooler	E0038713	♣9470HD	TCS-M2		
Belt - Fan; W/O Hyd. Cooler	N0138702	♣9540HD	Deutz F4L912 Diesel		
Belt - Gen.; Ser. No. 4746212 & Before	J0138721	7430	Belt - Fan	M0138724	7500
Belt - Gen.; Ser. No. 4746213 & After	N0138748	7450	Belt - Gen.	L0138723	7417
Belt - Hyd. Pump; TGV 115	P0038745	⑥TR28706	TX		
M			Deutz F3L912 Diesel		
Deutz F6L514 Diesel			Belt - Gen.	P0138726	7580
Belt - Fan; W/51 5/8" Belt O.C.	P0138749	7516	Belt - Air Brake Compr.	J0038717	TR22461
Belt - Fan; W/55 1/8" Belt O.C.	V0138755	7550	Belt - Hyd. Pump; W/H.POC 23 1X3P Hyd. Pump	L0038742	②TR28706
Belt - Oil Pump	B0138760	♣9530HD			

Road & Construction Equipment

② Two Required.
④ Four Required.
⑤ Five Required.

♣ Standard Belt Available. See Pages 630-631.
③ Three Required.

Belts and Coolant Hose for Road & Construction Equipment

Application	Mfr. Part No.	Our No.
POCLAIN - Continued		
TY		
Agrom		
Belt - Fan & Gen.; W/57 1/4" Belt O.C.	K0038718	②▲9570HD
Belt - Fan & Gen.; W/58 1/4" Belt O.C.	R0138705	②▲9580HD
Deutz F4L712 Diesel		
Belt - Fan	S0038725	▲9520HD
Belt - Gen.		▲9425HD
Deutz F4L812 Diesel		
Belt - Fan	T0038726	▲9530HD
Belt - Gen.	Z0038731	▲9451HD
Deutz F4L912 Diesel		
Belt - Fan	M0138724	7500
Belt - Gen.	L0138723	7417
TY45		
Agrom		
Belt - Air Brake Compr.; W/42 7/8" Belt O.C. .	H0038716	TR22425
Belt - Air Brake Compr.; W/46 5/8" Belt O.C. .	J0038717	TR22461
Belt - Hyd. Pump	K0038741	②TR28786
Deutz F4L912 Diesel		
Belt - Air Brake Compr.	J0038717	TR22461
Belt - Hyd. Pump	K0038741	②TR28786
Ford		
Belt - Air Brake Compr.	C0038734	TR22416
Belt - Hyd. Pump		②TR28786
TYS		
Agrom		
Belt - Fan & Gen.; W/57 1/4" Belt O.C.	K0038718	②▲9570HD
Belt - Fan & Gen.; W/58 1/4" Belt O.C.	R0138705	②▲9580HD
Belt - Air Brake Compr.	H0038716	TR22425
Belt - Hyd. Pump; W/H.POC 18X18 2X3P		
Hyd. Pump	K0138722	②TR28706
Belt - Hyd. Pump; W/H.POC 32 1X3P Hyd.		
Pump	R0138728	③TR28786
Deutz F4L912 Diesel		
Belt - Fan	M0138724	7500
Belt - Gen.	L0138723	7417
Belt - Air Brake Compr.	H0038716	TR22425
Belt - Hyd. Pump; W/H.POC 18X18 2X3P		
Hyd. Pump	K0138722	③TR28706
Belt - Hyd. Pump; W/32 1XP Hyd. Pump	R0138728	③TR28786
PUMPMASTER		
4000		
Detroit Diesel 2-53 Diesel		
Belt - Fan	5119188	▲9390HD
Belt - Gen. & W.P.	5133172	②6596
Hose - Upper; (1 3/4" I.D.)		24228
Hose - Lower - Eng. To Pipe; (2" I.D.)		24232
Hose - Lower - Pipe To Rad.; (2" I.D.)		24232
Ford 4-Cyl. 172 Diesel		
Belt - Fan & Gen.		▲9420HD
Hose - Upper; (1 1/4" I.D.)		24220
Hose - Lower - Eng. To Pipe; (1 3/4" I.D.)		24228
Hose - Lower - Pipe To Rad.		≈20957
RAYGO		
2-36 Romper		
Deutz F2L410 Diesel		
Belt - Blower		②7355
2-66 Ranger		
Detroit Diesel 4-53 Diesel		
Belt - Fan		②▲9415HD
Belt - Alt. & W.P.		②7425
Belt - Hyd. Pump		7330
Hose - Upper		≈21794

Application	Mfr. Part No.	Our No.
RAYGO - Continued		
2-66 Ranger - Continued		
Detroit Diesel 4-53 Diesel - Continued		
Hose - Upper		●25476
Hose - Lower - Eng. To Pipe; (2" I.D.)		24232
Hose - Lower - Pipe To Rad.; (2" I.D.)		24232
300A; 320A		
John Deere 4219D Diesel		
Belt - Fan & Alt.		TR22517
Belt - Hyd. Pump		▲9395HD
GATOR		
Detroit Diesel 8V-71 Diesel		
Belt - Fan		③▲9630HD
Belt - Gen.		▲9380HD
Hose - Upper - Eng. To Pipe; (2 1/4" I.D.)		②24236
Hose - Upper - Rad. To Pipe; (2 1/4" I.D.)		②24236
Hose - Lower - Eng. To Pipe; (2 3/4" I.D.)		24244
Hose - Lower - Rad. To Pipe; (2 3/4" I.D.)		24244
Ram 30		
Cummins V504 Diesel		
Belt - Fan & W.P.	178628	②TR22448
Belt - Alt.	554876	②7450
Hose - Upper - Eng. To Pipe; (2" I.D.)		24232
Hose - Upper - Pipe To Rad.; (2" I.D.)		24232
Hose - Lower		●26509
Rascal 220B		
John Deere 4219D Diesel		
Hose - Upper		●25528
Hose - Lower		●26501
Rascal 300A		
Ford 4-Cyl. 256 Diesel		
Belt - Fan & Alt.		▲9560HD
Belt - Hyd. Pump		▲9412HD
John Deere 4219D Diesel		
Belt - Fan & Alt.		TR22517
Belt - Hyd. Pump		▲9395HD
Rascal 320A		
Ford 4-Cyl. 256 Diesel		
Belt - Fan & Alt.		▲9560HD
Belt - Hyd. Pump		▲9412HD
Rascal 400A		
Detroit Diesel 3-53 Diesel		
Belt - Fan		②▲9412HD
Belt - Gen. & W.P.	5133174	7405
Belt - Hyd. Pump		7320
Hose - Upper		≈20957
Rascal 420B		
Detroit Diesel 4-53 Diesel		
Belt - Fan	5131395	②▲9412HD
Belt - Alt. & W.P.	5133173	7420
Hose - Upper		≈21794
		or ●25476
Hose - Lower; (2" I.D.)		②24432
Rascal 600A		
Detroit Diesel 4-53 Diesel		
Belt - Fan		②▲9405HD
Belt - Gen. & W.P.		②7400
Hose - Upper		≈21794
		or ●25474
Hose - Lower		≈20685

② Two Required.
 ③ Three Required.
 ● Vulco-Flex® Coolant Hose.

▲ Standard Belt Available. See Pages 630-631.
 ≈ Cut to Fit.

Belts and Coolant Hose for Road & Construction Equipment

Application	Mfr. Part No.	Our No.	Application	Mfr. Part No.	Our No.
RAYGO - Continued			SMITH CO. - Continued		
Razor 350; Roadster 120			300		
Deutz F2L511 Diesel			John Deere 4239D Diesel		
Belt - Blower		②7355	Belt - Fan & Alt.	T24473	TR22514
Rustler 304A			Hose - Upper		●25477
Ford 4-Cyl. 256 Diesel			Hose - Lower		●26504
Belt - Fan & Alt.		▲9560HD	SULLAIR		
Belt - Hyd. Pump		▲9412HD	85		
Hose - Upper		●25478	Volkswagen 4-Cyl.		
Hose - Lower; (1 3/4" I.D.)		③24928	Belt - Gen.		7355
John Deere 4219D Diesel			150		
Belt - Fan & Alt.		TR22517	Ford 4-Cyl. 172		
Belt - Hyd. Pump		▲9395HD	Belt - Fan & Gen.		▲9420HD
Hose - Upper		●25473	Hose - Upper		●25250
Hose - Lower		●26501	Hose - Lower		●25484
Rustler 404B			Ford 4-Cyl. 172 Diesel		
Detroit Diesel 3-53 Diesel			Belt - Fan & Gen.		▲9420HD
Belt - Fan	②▲9412HD		Hose - Upper		●25251
Belt - Gen. & W.P.	7410		185		
Belt - Hyd. Pump	7320		John Deere 4219D Diesel		
Hose - Upper	②<21794		Belt - Fan & Alt.	T20334T	TR22474
	or ●25474		Hose - Upper		●25474
Hose - Lower	●26507		900		
REX			Detroit Diesel 12V-71 Diesel		
HM250			Belt - Fan	5115053	③▲9680HD
Detroit Diesel 8V-71 Diesel	5133770	③▲9660HD	RC8		
Belt - Alt.		▲9380HD	Caterpillar 3304 Diesel		
Belt - Hyd. Pump		TR22416	Belt - Fan & Alt.		③▲9570HD
Hose - Upper		②●26525	TAKEUCHI		
Hose - Lower		●26536	TB025		
Pactor			Yanmar 3TN84L Diesel		
Detroit Diesel 8V-71 Diesel			Hose - Upper		②<20137
Belt - Fan		③▲9570HD			or ●25250
SP600; SP700			TB68S		
John Deere 4219D Diesel			Nissan SD33 Diesel		
Belt - Fan & Alt.	120334T	TR22474	Belt - Fan & Alt.		②▲9440HD
Belt - Hyd. Pump		②7400	Hose - Upper		●25474
Hose - Upper; (1 1/2" I.D.)		24224	TB650S		
Hose - Lower; Strt. Hose(1 3/4" I.D.)		24228	Yanmar 3T72LTBS Diesel		
Hose - Lower; Molded Hose		②<20685	Belt - Fan & Alt.		▲9325HD
		or ●25474	TB800		
SAMSUNG			Yanmar 3T72LTB Diesel		
SL150-2			Belt - Fan & Gen.		▲9345HD
Cummins 6-Cyl. 5.9 L Diesel			TL26		
Belt - Fan & Alt.	3911577	▲K080653HD	Isuzu 4JB1 Diesel		
Belt - A.C.		A42	1998-1992		
SL180-2			Belt - Fan & Alt.	8942568000	TR24407
Cummins 6-Cyl. 8.3 L Diesel			Hose - Upper		●25300
Belt - Fan & Alt.	3911620	▲K080680HD	TAMPO		
Belt - W.P.	3034349	▲K080525HD	RP16D		
Belt - A.C.		A42	Detroit Diesel 3-53 Diesel		
SMITH CO.			Belt - Fan	5131395	②▲9412HD
125			Belt - W.P. & Alt.	5133601	7410
Hercules RCX21			Belt - Hyd. Pump		7300
Belt - Gov.		TR22517	Hose - Upper		②<20046
Hose - Upper - Eng. To Pipe		●26509			or ●26501
Hose - Upper - Pipe To Rad.		●26509	Hose - Lower; (2" I.D.)		24232
Hose - Lower - Eng. To W.P.; (1 3/4" I.D.)		24228			
Hose - Lower - W.P. To Pipe; (1 3/4" I.D.)		24228			
Hose - Lower - Pipe To Rad.		②<20357			

② Two Required.
 ● Vulco-Flex® Coolant Hose.
 < Cut to Fit.

▲ Standard Belt Available. See Pages 630-631.
 ③ Use Wire Inserted Green Stripe® Coolant Hose.
 ③ Three Required.

Road & Construction Equipment

Belts and Coolant Hose for Road & Construction Equipment

Application	Mfr. Part No.	Our No.
TAMPO - Continued		
RS16A		
Detroit Diesel 3-53 Diesel		
Belt - Fan	5131395	②▲9412HD
Belt - W.P. & Alt.	5133601	7410
Belt - Hyd. Pump		7300
Hose - Upper		②21794
		or ●25474
Hose - Lower - Eng. To Pipe; (2" I.D.)		24232
Hose - Lower - Pipe To Rad.; (2" I.D.)		24232
RS28		
Detroit Diesel 4-53 Diesel		
Belt - Fan		②▲9440HD
Belt - Gen. & W.P.	5133174	7405
Hose - Upper		20065
		or ②20433
		or ●25473
Hose - Lower - Eng. To Pipe; (2" I.D.)		24232
Hose - Lower - Pipe To Rad.; (2" I.D.)		24232
TAMROCK		
Ranger 500		
Caterpillar Diesel		
Belt - Fan & Alt.	2S5218	▲9585HD
TA341		
Kubota K4E		
Belt - Fan		7360
TCI		
747		
Isuzu QD60 Diesel		
Belt - Fan & Alt.	5136710400	②▲9400HD
Belt - Hyd. Pump		②▲9330HD
Hose - Upper		●25806
TEREX		
35		
Detroit Diesel 16V-71 Diesel		
Belt - Fan	5133761	③▲9530HD
Belt - Alt.	5133735	③7405
35E		
Detroit Diesel 12V-71 Diesel		
Belt - Fan		③▲9480HD
72-20		
Detroit Diesel 4-71 Diesel		
Belt - Fan & Alt./Gen.	5127669	②▲9530HD
72-21		
Detroit Diesel 3-71N Diesel		
Belt - Fan & Alt.; W/62 1/4" Belt O.C.	5138055	②▲9620HD
Belt - Fan & Alt.; W/63 1/4" Belt O.C.	5135883	②▲9630HD
Hose - Upper; (2" I.D.)		②24932
Hose - Lower; (2" I.D.)		24432
72-31		
Detroit Diesel 4-71N Diesel		
Belt - Fan & Alt.; W/59 1/4" Belt O.C.		③▲9590HD
Belt - Fan & Alt.; W/62 1/4" Belt O.C.	5138055	②▲9620HD
Hose - Upper; (2" I.D.)		②24932
Hose - Lower; (2" I.D.)		24432
72-31B		
Detroit Diesel 4-71T Diesel		
Belt - Fan & Alt.		▲9690HD
Hose - Upper; (2" I.D.)		②24932

Application	Mfr. Part No.	Our No.
TEREX - Continued		
72-31B - Continued		
Detroit Diesel 4-71T Diesel - Continued		
Hose - Lower; (2" I.D.)		24432
72-40		
Detroit Diesel 6V-53N Diesel		
Belt - Fan & Air Brake Compr.		②▲9540HD
Belt - W.P.	5116451	②7370
Belt - Gen.	5124708	▲9360HD
72-41		
Detroit Diesel 4-71N Diesel		
Belt - Fan & Alt.; W/60 1/4" Belt O.C.	9249167	②▲9600HD
Belt - Fan & Alt.; W/61 1/4" Belt O.C.	5136268	②▲9610HD
Hose - Upper; (2" I.D.)		②24932
Hose - Lower; (2" I.D.)		24432
72-51		
Detroit Diesel 6-71N Diesel		
Belt - Fan & Alt./Gen.	5127669	②▲9530HD
Belt - Fan & Alt.; W/58 3/4" Belt O.C.	9249166	②▲9585HD
Belt - Fan & Alt.; W/60 1/4" Belt O.C.	5136269	②▲9600HD
Hose - Upper; (2" I.D.)		②24932
Hose - Lower; (2" I.D.)		24432
72-51B		
Detroit Diesel 6V-71T Diesel		
Belt - Fan		③▲9650HD
Belt - Alt.	5133172	②7430
Hose - Upper - Eng. To Pipe; (2 1/4" I.D.)		②24936
Hose - Upper - Pipe To Rad.; (2 1/4" I.D.)		②24936
Hose - Lower - Eng. To Pipe; (2 3/4" I.D.)		24444
Hose - Lower - Pipe To Rad.; (2 3/4" I.D.)		24444
72-61		
Detroit Diesel 8V-71T Diesel		
Belt - Fan		②▲9580HD
Belt - Alt.		②7445
Hose - Upper - Eng. To Pipe; (2 1/4" I.D.)		24236
Hose - Upper - Pipe To Rad.; (2 1/4" I.D.)		24236
Hose - Lower - Eng. To Pipe; (2 3/4" I.D.)		24244
Hose - Lower - Pipe To Rad.; (2 3/4" I.D.)		24244
72-71		
Detroit Diesel 8V-71T Diesel		
Belt - Fan	5133769	③▲9650HD
Belt - Alt.	5137635	②7440
Hose - Upper - Eng. To Pipe; (2 1/4" I.D.)		24236
Hose - Upper - Pipe To Rad.; (2 1/4" I.D.)		24236
Hose - Lower - Eng. To Pipe; (2 3/4" I.D.)		24244
Hose - Lower - Pipe To Rad.; (2 3/4" I.D.)		24244
72-81		
Detroit Diesel 12V-71T Diesel		
Belt - Fan	5133760	③▲9480HD
Belt - Alt.	9003154	▲9330HD
Hose - Upper; (2 1/2" I.D.)		24240
Hose - Lower; (3 1/2" I.D.)		24256
82-30		
Detroit Diesel 6-71 Diesel		
Belt - Fan & Alt.	9249814	②BX77
82-40		
Detroit Diesel 8V-71N Diesel		
Belt - Fan & Gen.	9177465	②BX77
3305		
Detroit Diesel 8V-71 Diesel		
Belt - Fan		②▲9550HD
Belt - Alt.		②▲9447HD

② Two Required.
 ②< Cut to Fit.
 ③ Three Required.

▲ Standard Belt Available. See Pages 630-631.
 ● Vulco-Flex® Coolant Hose.
 Ⓢ Use Wire Inserted Green Stripe® Coolant Hose.

Belts and Coolant Hose for Road & Construction Equipment

Application	Mfr. Part No.	Our No.	Application	Mfr. Part No.	Our No.
TEREX - Continued			TEREX - Continued		
3305 - Continued			S18 - Continued		
Detroit Diesel 8V-71 Diesel - Continued			Detroit Diesel 6-110 Diesel - Continued		
Belt - A.C.		7420	Belt - Gen.	3222608	TR28429
Hose - Upper - Eng. To Pipe; (2 1/4" I.D.)		24436	S23E		
Hose - Upper - Pipe To Rad.; (2 1/4" I.D.)		24436	Detroit Diesel 8V-71T Diesel		
Hose - Lower - Eng. To Pipe; (2 3/4" I.D.)		24444	Belt - Fan; W/48 1/4" Belt O.C.	5133760	③▲9480HD
Hose - Lower - Pipe To Rad.; (2 3/4" I.D.)		24444	Belt - Fan; W/57 1/4" Belt O.C.	5133765	②▲9570HD
Detroit Diesel 8V-71T Diesel			Belt - Alt.; W/44 1/4" Belt O.C.		②7440
Belt - Fan	5133765	③▲9570HD	Belt - Alt.; W/47 3/4" Belt O.C.	5132591	②7470
Belt - Alt.		②7440	Hose - Upper - Eng. To Pipe; (2 1/4" I.D.)		24436
Hose - Upper - Eng. To Pipe; (2 1/4" I.D.)		24436	Hose - Upper - Pipe To Rad.; (2 1/4" I.D.)		24436
Hose - Upper - Pipe To Rad.; (2 1/4" I.D.)		24436	Hose - Lower - Eng. To Pipe; (2 3/4" I.D.)		24444
Hose - Lower - Eng. To Pipe; (2 3/4" I.D.)		24444	Hose - Lower - Pipe To Rad.; (2 3/4" I.D.)		24444
Hose - Lower - Pipe To Rad.; (2 3/4" I.D.)		24444	S24		
3307			Detroit Diesel 12V-71T Diesel		
Detroit Diesel 12V-71 Diesel			Belt - Fan; W/44 3/4" Belt O.C.	9189718	②TR22443
Belt - Fan	5140787	③▲9580HD	Belt - Fan; W/48 1/4" Belt O.C.	9201651	③▲9480HD
Belt - Alt.		②7445	Belt - Gen.	5125811	▲9380HD
Hose - Upper - Eng. To Pipe; (2 1/2" I.D.)		24440	Belt - Air Brake Compr.	5126405	TR28473
Hose - Upper - Pipe To Rad.; (2 1/2" I.D.)		24440	S28		
Hose - Lower - Eng. To Pipe; (2 1/2" I.D.)		24456	Detroit Diesel 12V-71N Diesel		
Hose - Lower - Pipe To Rad.; (3 1/2" I.D.)		24456	Belt - Fan; W/44 3/4" Belt O.C.	9189718	②TR22443
3309			Belt - Fan; W/48 1/4" Belt O.C.	9201651	③▲9480HD
Detroit Diesel 16V-71 Diesel			Belt - Gen.	5125811	▲9380HD
Belt - Fan	5133761	③▲9530HD	Belt - Air Brake Compr.	5126405	TR28473
Belt - Alt.	5133735	③7405	S32		
Hose - Lower - Eng. To Pipe; (4" I.D.)		24464	Detroit Diesel 12V-71T Diesel		
Hose - Lower - Pipe To Rad.; (4" I.D.)		24464	Belt - Fan	5133760	③▲9480HD
3315			Belt - Alt.	5137635	②7440
Detroit Diesel 16V-149 Diesel			S35E		
Belt - Alt.	5138935	K080370	Detroit Diesel 12V-71T Diesel		
4066			Belt - Fan	5133760	③▲9480HD
Deutz B10L513 Diesel			Belt - Alt.	5137635	②7440
Belt - Alt.		②7395	Hose - Lower; (3 1/2" I.D.)		②24956
Belt - A.C.		▲9451HD	SS24 (33LOT)		
S7			Cummins NRT06BI Diesel		
Detroit Diesel 4-71 Diesel			Belt - Fan; Ser. No. 23474 Thru 26773	9021068	②TR28545
Belt - Fan	5170972	②TR22455	Belt - W.P.; Ser. No. 23474 Thru 26773	9026236	TR22434
Belt - Gen.	3224367	TR28390	SS40 (49LDT)		
S11E			Detroit Diesel 12V-71N Diesel		
Detroit Diesel 4-71N Diesel			Belt - Fan	5133765	③▲9570HD
Belt - Fan & Air Brake Compr.		②▲9690HD	Belt - Gen.	5133516	▲9380HD
Belt - Alt.		7435	TS14		
Hose - Upper		●26510	Detroit Diesel 4-71 Twin Diesel		
Hose - Lower		●26504	Belt - Fan	9191558	②TR22434
S12			Belt - Gen.; W/11/16" Belt T.W.; W/40 3/8" Belt O.C.	9230092	TR22397
Detroit Diesel 3-53 Diesel			Belt - Gen.; W/3/4" Belt T.W.; W/40 3/4" Belt O.C.		TR24400
Hose - Upper - Rear Eng.; (1 7/8" I.D.)		24230	Detroit Diesel 4-71N Twin Diesel		
Hose - Lower - Eng. To Pipe (Rear Eng.); (2" I.D.)		24232	Hose - Upper; (2" I.D.)		②24932
Hose - Lower - Pipe To Rad. (Rear); (2" I.D.)		24232	Hose - Upper		●26511
Detroit Diesel 6-71 Diesel			Hose - Lower; (2" I.D.)		②24932
Hose - Upper - Front Eng.; (2" I.D.)		②24932	Hose - Lower		●26511
Hose - Upper - Front Eng.		●26509	TS14B		
Hose - Lower - Front Eng.; (2" I.D.)		②24932	Detroit Diesel 4-53 Diesel		
Hose - Lower - Front Eng.		●26509	Belt - Fan		③▲9451HD
S18			Belt - Alt.		②7425
Detroit Diesel 6-110 Diesel			Detroit Diesel 4-71N Twin Diesel		
Belt - Fan & Air Brake Compr.; W/61 1/4" Belt O.C.	5115056	③▲9610HD	Belt - Fan	5134215	③▲9451HD
Belt - Fan & Air Brake Compr.; W/61 5/8" Belt O.C.	5122849	④7612	Belt - Gen.	5133173	②7420
Belt - Fan & Air Brake Compr.; W/62 3/4" Belt O.C.	5111546	③▲9625HD	Belt - Alt.		7425
			Hose - Upper; (2" I.D.)		②24932

Road & Construction Equipment

③ Three Required.
 ② Two Required.
 ▲ Use Wire Inserted Green Stripe® Coolant Hose.

▲ Standard Belt Available. See Pages 630-631.
 ● Vulco-Flex® Coolant Hose.
 ④ Four Required.

Belts and Coolant Hose for Road & Construction Equipment

Application	Mfr. Part No.	Our No.	Application	Mfr. Part No.	Our No.
TEREX - Continued			THEW SHOVEL - Continued		
TS14B - Continued			820KS; 820MC		
Detroit Diesel 4-71N Twin Diesel - Continued			Waukesha WAKD		
Hose - Upper		●26511	Belt - Gen.; W/Truck Eng.	140703	TR34604
Hose - Lower; (2" I.D.)		⊛24932	L27		
Hose - Lower		●26511	Waukesha 6BL		
TS18			Belt - Fan		
Detroit Diesel 6V-71N Diesel			Belt - Fan		
Belt - Fan	5133760	③▲9480HD	Belt - Fan		
Hose - Upper; (2 1/4" I.D.)		⊛24936	Belt - Fan		
Hose - Lower; (2 3/4" I.D.)		⊛24944	L30; L37		
Detroit Diesel 8V-71N Diesel			Waukesha 6BK; Waukesha 6BKH		
Belt - Fan	5133760	③▲9480HD	Belt - Fan		
Belt - Alt.	5132591	②7470	Belt - Fan		
Hose - Upper; (2 1/4" I.D.)		⊛24936	Belt - Fan		
Hose - Lower; (2 3/4" I.D.)		⊛24944	L40		
TS18 (29LOT)			Waukesha VBKH		
Detroit Diesel 6-110 Diesel			Belt - Fan		
Belt - Gen.	2068846	TR22336	Belt - Fan		
TS24			L41; L41MC		
Cummins NRT06BI Diesel			Waukesha SRKR		
Belt - Fan; Ser. No. 23474 Thru 26773	9021068	②TR28545	Belt - Fan & Compr.		
Belt - W.P.; Ser. No. 23474 Thru 26773	9026236	TR22434	Belt - Fan & Compr.		
Detroit Diesel 12V-71 Diesel			L45		
Belt - Fan	5133760	③▲9480HD	Waukesha 6SRL		
Belt - Alt.	5133516	▲9380HD	Belt - Fan		
Belt - Air Brake Compr.	5137905	TR28473	Belt - Fan		
Hose - Upper; (2 1/2" I.D.)		⊛24940	Belt - Fan		
Hose - Lower; (3 1/2" I.D.)		⊛24956	L50		
Detroit Diesel 6-110 Diesel			Cummins JS61P Diesel		
Belt - Fan & Air Brake Compr.; W/1/2" Belt			Belt - Fan		
T.W.; W/61 1/4" Belt O.C.	5115056	③▲9610HD	Belt - Fan		
Belt - Fan & Air Brake Compr.; W/7/16" Belt			Belt - Fan		
T.W.; W/61 5/8" Belt O.C.	5111546	④7612	Belt - Fan		
Belt - Fan & Air Brake Compr.; W/1/2" Belt			Belt - Fan		
T.W.; W/62 1/4" Belt O.C.	5122849	③▲9620HD	Belt - Fan		
Belt - Gen.	3222608	TR28429	Belt - Fan		
Detroit Diesel 6-71 Diesel			L56		
Belt - Fan	9189718	②TR22443	Cummins JIS6TC Diesel		
Hose - Upper; (2" I.D.)		⊛24932	Belt - Fan		
TS32			Belt - Gen.		
Detroit Diesel 12V-71T Diesel			Belt - Gen.		
Belt - Fan	5133760	③▲9480HD	Belt - Fan		
Belt - Alt.	5137635	②7440	Belt - Gen.		
Hose - Upper; (2 1/2" I.D.)		⊛24940	Belt - Gen.		
Hose - Lower; (3 1/2" I.D.)		⊛24956	Belt - Gen.		
Detroit Diesel 8V-71T Diesel			Cummins JS61P Diesel		
Belt - Fan		③▲9570HD	Belt - Fan		
Belt - Alt.	5143240	②▲9341HD	Belt - Fan		
Hose - Upper; (2 1/4" I.D.)		24236	Belt - Fan		
Hose - Lower; (2 3/4" I.D.)		24244	Belt - Fan		
THEW SHOVEL			L66		
15T-MC			Cummins NH61P Diesel		
Waukesha SRKR			Belt - Fan		
Belt - Fan	7169	②TR32491	Belt - W.P.		
50J; 50K			Belt - Belt; W/Barnes Pump		
Caterpillar D318 Diesel			Belt - Fan		
Belt - Gov.	4B2544	▲9425HD	Belt - Fan		
Belt - Starter	6B2746	TR22485	Belt - Fan		
414MC			L85A		
Waukesha SRKR			Cummins NTO61P Diesel		
Belt - Fan & Compr.	C30741	②TR32491	Belt - Fan		
THEW SHOVEL - Continued			Belt - Fan		
15T-MC			L87; L95		
Waukesha SRKR			Waukesha EKH		
Belt - Fan	7169	②TR32491	Belt - Fan		
50J; 50K			L501		
Caterpillar D318 Diesel			Caterpillar D318 Diesel		
Belt - Gov.	4B2544	▲9425HD	Belt - Gov.		
Belt - Starter	6B2746	TR22485	Belt - Starter		
414MC			Belt - Starter		
Waukesha SRKR			Belt - Starter		
Belt - Fan & Compr.	C30741	②TR32491	Belt - Starter		
THEW SHOVEL - Continued			Belt - Starter		
15T-MC			MC2; MC3; MC4		
Waukesha SRKR			Hercules DRXC		
Belt - Fan	7169	②TR32491	Belt - Fan		
50J; 50K			Hercules HXC		
Caterpillar D318 Diesel			Belt - Fan		
Belt - Gov.	4B2544	▲9425HD	Belt - Fan		
Belt - Starter	6B2746	TR22485	Belt - Fan		
414MC			Waukesha 145GK		
Waukesha SRKR			Belt - Fan & Compr.		
Belt - Fan & Compr.	C30741	②TR32491	Belt - Fan & Compr.		
THEW SHOVEL - Continued			Belt - Fan & Compr.		
15T-MC			MC107		
Waukesha SRKR			Cummins J4BI Diesel		
Belt - Fan & Compr.	C30741	②TR32491	Belt - Fan & W.P.		

Road & Construction Equipment

● Vulco-Flex® Coolant Hose.
 ③ Three Required.
 ② Two Required.

⊛ Use Wire Inserted Green Stripe® Coolant Hose.
 ▲ Standard Belt Available. See Pages 630-631.
 ④ Four Required.

Belts and Coolant Hose for Road & Construction Equipment

Application	Mfr. Part No.	Our No.	Application	Mfr. Part No.	Our No.
THEW SHOVEL - Continued			THEW SHOVEL - Continued		
MC107 - Continued			TL25K; TL254W		
Cummins J4BI Diesel - Continued			Caterpillar D315 Diesel		
Belt - Hyd. Pump; W/Vickers Hyd. Pump	101638	6932	Belt - Gov.	5B7168	▲9385HD
MC430			Belt - Starter	6B5653	TR22416
Cummins JT6BI Diesel			Detroit Diesel 2-71 Diesel		
Belt - Fan	107547	②▲9395HD	Belt - Fan & Gen.	5166844	②TR22625
Belt - W.P.	111724	TR22336	THOMAS		
Belt - Hyd. Pump	S1792	②TR22405	T183HD		
MC504; MC504W			Kubota V2203 Diesel		
Waukesha 145GKB			1997-1988		
Belt - Gen.	A25515	TR34545	Belt - Fan & Alt.		▲9430HD
MC520			Hose - Upper		≡<20137
Cummins JIS6TC Diesel			Hose - Lower - Eng. To Pipe		≡<20065
Belt - Fan	106258	②▲9365HD	Hose - Lower - Pipe To Rad.: (1 1/2" I.D.)		24224
Belt - Gen.	101426	TR22443	TOYOTA		
Cummins NT6BI Diesel			2SDK7; 2SDK8		
Belt - Fan & W.P.	70524	②TR22405	Toyota 2J		
MC524			1992-1986		
Cummins NT6B Diesel			Belt - Fan & Alt.		TR22448
Belt - Fan & W.P.	70524	②TR22405	3SDK5		
Waukesha 140GK			Yanmar 3TN82 Diesel		
Belt - Fan; W/Power Units	140003	TR32491	1995-1986		
Belt - Gen.; W/Truck Eng.	A31856	TR32491	Belt - Fan & Alt.		▲9412HD
MC530W			TROJAN-YALE		
Cummins JIS6TC Diesel			1700; 1900		
Belt - Fan	106258	②▲9365HD	Cummins V378 Diesel		
Belt - Gen.	101426	TR22443	Belt - Fan		②7355
Cummins NT6BI Diesel			Belt - Alt.		▲9360HD
Belt - Fan & W.P.	70524	②TR22405	Hose - Upper		●26511
MC660			Hose - Lower; (2 1/4" I.D.)		24236
Cummins NTO6BI Diesel			Detroit Diesel 4-53 Diesel		
Belt - Fan & W.P.	70524	②TR22405	Belt - Fan & Air Brake Compr.		②▲9510HD
MC794			Belt - Fan & Hyd. Pump		▲9510HD
Waukesha 145GKB			Belt - W.P. & Alt.; W/40 5/8" Belt O.C.		②7405
Belt - Gen.	A25515	TR34545	Belt - W.P. & Alt.; W/42 5/8" Belt O.C.		②7425
MC875			Belt - Alt.; W/V-Belt Drive		②▲9425HD
Cummins NRT6BI Diesel			Belt - Alt.; W/V-Ribbed Belt Drive	5143319	K080360
Belt - Fan	S3209	TR28473	Hose - Upper		●26510
Belt - Gen.	69489	▲9309HD	Hose - Lower		●26508
Belt - Belt; W/Vickers P.S. Pump	S3149	②TR22495	2000		
ML153			Cummins V555C Diesel		
Cummins JF6BI Diesel			Hose - Upper		●26512
Belt - Fan & V.P.	106070	②TR22474	Hose - Lower		≡<20401
SP107					or ●26522
Cummins J4BI Diesel			Detroit Diesel 4-71 Diesel		
Belt - Fan & W.P.	70018	②▲9425HD	Hose - Upper		●26512
Belt - Hyd. Pump; W/Vickers Hyd. Pump	101638	6932	Hose - Lower		●26508
SP524			Detroit Diesel 4-71N Diesel		
Cummins NT6B Diesel			Hose - Upper		●26512
Belt - Fan & W.P.	70524	②TR22405	Hose - Lower		●26515
Waukesha 140GK			2500		
Belt - Fan; W/Power Units	140003	TR32491	Detroit Diesel 6V-71N Diesel		
Belt - Gen.; W/Truck Eng.	A31856	TR32491	Hose - Upper - Left Side		●26522
SP530			Hose - Upper - Right Side		●26522
Cummins JIS6BI Diesel			3000		
Belt - Fan	106258	②▲9365HD	Cummins V903 Diesel		
Belt - Gen.	101426	TR22443	Hose - Upper - Eng. To Pipe; W/19" Hose		●26523

Road & Construction Equipment

② Two Required.
≡< Cut to Fit.

▲ Standard Belt Available. See Pages 630-631.
● Vulco-Flex® Coolant Hose.

Belts and Coolant Hose for Road & Construction Equipment

Application	Mfr. Part No.	Our No.	Application	Mfr. Part No.	Our No.
TROJAN-YALE - Continued			VERMEER		
3000 - Continued			BH700		
Cummins V903 Diesel - Continued			Ford 4-Cyl.		
Hose - Lower		●26522	Belt - Fan & Gen.		▲9415HD
Detroit Diesel 6V-71N Diesel			Belt - Hyd. Pump		②TR22363
Hose - Upper - Eng. To Pipe		●26523	Hose - Upper		●25473
Hose - Upper - Pipe To Rad.		●26523	Hose - Lower		20065
Hose - Lower - Eng. To Pipe; (2 3/4" I.D.)		24244		or	≅<20433
Hose - Lower - Pipe To Rad.; (2 3/4" I.D.)		24244		or	●25474
4000			VERSA		
Cummins V-8 265 Diesel			6300		
Belt - Fan		②TR28445	Ford 4-Cyl. Diesel		
Belt - W.P.		TR24449	Belt - Fan & Alt.		▲9412HD
Belt - Alt.		TR22373	Hose - Upper; (1 1/4" I.D.)		24220
Hose - Upper		●26521	Hose - Lower		≅<21749
Hose - Lower - Eng. To Pipe		●26523	VIBRO-PLUS		
Hose - Lower - Pipe To Rad.; (2 1/4" I.D.)		24236	CA20		
Detroit Diesel 8V-71 Diesel			Ford		
Belt - Fan		③▲9560HD	Belt - Fan		7395
Belt - Fan & Air Brake Compr.	5133771	②▲9690HD	Belt - Gen.		7360
Belt - W.P.	5133177	②7370	Belt - P.S.		TR22448
Belt - Alt.	5133174	②7400	Hose - Upper - Rad. To Pipe; (1 1/2" I.D.)		24224
Detroit Diesel 8V-71N Diesel			Hose - Upper - Pipe To Eng.; (1 1/2" I.D.)		24224
Hose - Upper - Eng. To Pipe		20401	Hose - Lower		●26504
Hose - Upper - Pipe To Rad.		20401	CA25		
Hose - Lower; (2 1/4" I.D.)		24236	Caterpillar 3145 Diesel		
6000			Belt - Fan & Alt.	3N1490	②▲9520HD
Cummins NT855 Diesel			Hose - Upper		●26511
Belt - Fan		②TR28514	Hose - Lower		●26511
Belt - W.P.		②TR24438	Cummins V352BI Diesel		
Belt - Gen.		TR22410	Belt - Fan	178678	②TR22448
Hose - Upper		●26523	Belt - Alt.	178630	②▲9390HD
Hose - Lower		●26521	Hose - Lower; (3" I.D.)		24248
7500			VIBROMAX		
Cummins KT1150C Diesel			253		
Hose - Upper		●26532	Kubota D1403B Diesel		
Hose - Lower		●26532	Belt - Fan & Alt.	REMF6400	▲9412HD
UNIMOG			602		
406			Cummins 4-Cyl. 3.9 L Diesel		
Mercedes-Benz OM352 Diesel			Serpentine Belt		▲K080560HD
Belt - Fan	0049976992	▲9440HD	1103		
Belt - Fan To Hyd. Pump	0059976892	▲9390HD	Cummins 6-Cyl. 5.9 L Diesel		
Belt - W.P. & Alt.	0049976992	▲9440HD	Serpentine Belt		▲K080560HD
Hose - Upper		●25478	VME		
Hose - Lower - Pipe To Rad.		≅<20433	L20		
U1200			Detroit Diesel 4-71 Diesel		
Mercedes-Benz OM352 Diesel			Belt - Fan & Gen.	5127669	②▲9530HD
Belt - Fan - Eng. To Idler	0049976192	▲9640HD	L30		
Belt - Fan - Idler To Fan	0049976992	▲9440HD	Detroit Diesel 6V-53 Diesel		
Belt - Alt.	0049971292	▲9505HD	Belt - Fan & Gen.	5127669	②▲9530HD
Belt - P.S.	0049970592	▲9375HD	VOLVO		
Belt - Hyd. Pump		▲9375HD	180 I; 180 II		
Hose - Lower		●25474	Detroit Diesel 6V-53 Diesel		
UNIT CRANE & SHOVEL			Belt - Fan	5109052	②▲9600HD
H202C			Belt - W.P.	5116451	②7370
Detroit Diesel 4-71N Diesel			Belt - Gen.	5124814	7375
Belt - Fan		②▲9500HD	Hose - Upper; Ser. No. 4MG101 Thru 8MG999(2 1/4" I.D.)		②24236
Belt - Alt.		▲9365HD	Hose - Lower; Ser. No. 5LG101 & After(2" I.D.)		②24232
Hose - Upper		≅<20206	Hose - Lower; Ser. No. 4MG101 Thru 8MG999(2 3/4" I.D.)		②24244
Hose - Lower - Eng. To Pipe; (2" I.D.)		24232			
Hose - Lower - Pipe To Rad.; (2" I.D.)		24232			

● Vulco-Flex® Coolant Hose.
 ③ Three Required.
 ≅< Cut to Fit.

② Two Required.
 ▲ Standard Belt Available. See Pages 630-631.

Belts and Coolant Hose for Road & Construction Equipment

Application	Mfr. Part No.	Our No.	Application	Mfr. Part No.	Our No.
VOLVO - Continued			VOLVO - Continued		
280			380 II - Continued		
Cummins NT855 Diesel			Cummins 12V-71 Diesel - Continued		
Belt - Fan; W/51 7/8" Belt O.C.	S3094	②TR28514	Belt - Gen.	70350	TR22358
Belt - Fan; W/55 1/8" Belt O.C.	178725	③TR28545	Hose - Lower - Pipe To Rad.; Ser. No. 2RC1 Thru 2RC999(2 1/2" I.D.)		②24240
Belt - Fan; W/58 1/4" Belt O.C.	178626	③TR24578	380 III		
Belt - Fan; W/61 1/8" Belt O.C.	178526	③TR24607	Cummins 72V-71 Diesel		
Belt - W.P.	200328	TR24438	Hose - Lower - Pipe To Rad.; Ser. No. 2RC1 Thru 2RC999(2 1/2" I.D.)		②24240
Belt - Alt.	200549	②▲9465HD	480 I		
Belt - Gen.; W/36 3/8" Belt O.C.	70350	TR22358	Cummins VT12635 Diesel		
Belt - Gen.; W/40 1/8" Belt O.C.	178573	TR22397	Belt - Fan	522125	③▲9610HD
Belt - Gen.; W/41 1/2" Belt O.C.	178599	TR22410	Belt - W.P.	125367	TR28376
Hose - Lower; Ser. No. 32123 Thru 32999(2 1/4" I.D.)		②24236	Belt - Gen.; W/34 3/4" Belt O.C.	134813	TR22344
Hose - Lower; Ser. No. 1MC156 Thru 3MC999(2 1/4" I.D.)		②24236	Belt - Gen.; W/36 3/8" Belt O.C.	70350	TR22358
280 Articulated			480 I		
Detroit Diesel 8V-71N Diesel			Cummins VT12635 Diesel		
Belt - Fan		③▲9610HD	Belt - Fan	522125	③▲9610HD
Belt - Alt.		7380	Belt - W.P.	125367	TR28376
Belt - Hyd. Pump		TR28463	Belt - Gen.; W/34 3/4" Belt O.C.	134813	TR22344
Hose - Upper; Ser. No. 8AMG101 Thru 9AMG999(2 1/4" I.D.) .		②24236	Belt - Gen.; W/36 3/8" Belt O.C.	70350	TR22358
Hose - Lower; Ser. No. 8AMG101 Thru 9AMG999(2 3/4" I.D.) .		②24244	Hose - Upper - Pipe To Rad.; Ser. No. 3SC101 Thru 4SC999(2 1/2" I.D.)		②24240
280 I			Hose - Lower - Pipe To Rad.; Ser. No. 43123 Thru 43999(2 1/2" I.D.)		
Detroit Diesel 8V-71N Diesel			Hose - Lower - Pipe To Rad.; Ser. No. 2SC1 Thru 2SC999(2 1/2" I.D.)		
Hose - Upper; Ser. No. 1MG1 Thru 3MG999(2 1/4" I.D.)		②24236	Hose - Lower - Pipe To Rad.; Ser. No. 4SG101 Thru 4SG999(2 1/2" I.D.)		
280 II; 280 III			24240		
Detroit Diesel 8V-71N Diesel			A25C		
Belt - Fan		③▲9610HD	Volvo TD73KCE Diesel		
Belt - Alt.		7380	Belt - W.P.	967119	▲9570HD
Belt - Hyd. Pump		TR28463	Belt - Alt.	966695	②7445
Hose - Upper; Ser. No. 8AMG101 Thru 9AMG999(2 1/4" I.D.) .		②24236	Belt - A.C.	978793	▲9555HD
Hose - Lower; Ser. No. 8AMG101 Thru 9AMG999(2 3/4" I.D.) .		②24244	Hose - Upper - Eng. To Pipe		≅20206
280B			Hose - Upper - Pipe To Pipe; (2" I.D.)		
Cummins NT855 Diesel			Hose - Lower - Eng. To Pipe		
Belt - Fan; W/51 7/8" Belt O.C.	S3094	②TR28514	≅20206		
Belt - Fan; W/55 1/8" Belt O.C.	178725	③TR28545	L30		
Belt - Fan; W/58 1/4" Belt O.C.	178626	③TR24578	Perkins 4-Cyl. 236 Diesel		
Belt - Fan; W/61 1/8" Belt O.C.	178526	③TR24607	Belt - Fan & Alt.		▲9510HD
Belt - W.P.	200328	TR24438	Hose - Upper		●26502
Belt - Alt.	200549	②▲9465HD	L50		
Belt - Gen.; W/36 3/8" Belt O.C.	70350	TR22358	Volvo D45B Diesel		
Belt - Gen.; W/40 1/8" Belt O.C.	178573	TR22397	Belt - Fan & Alt.	966933	②7560
Belt - Gen.; W/41 1/2" Belt O.C.	178599	TR22410	Belt - A.C.	958496	▲9455HD
Hose - Lower; Ser. No. 32123 Thru 32999(2 1/4" I.D.)		②24236	L50B		
Hose - Lower; Ser. No. 1MC156 Thru 3MC999(2 1/4" I.D.)		②24236	Volvo TD40GA Diesel		
280C			Belt - Fan & Alt.		
Cummins NTA855 Diesel			Belt - Fan To A.C.		
Belt - Fan; W/51 7/8" Belt O.C.	S3094	②TR28514	Hose - Lower - Eng. To Pipe; (2" I.D.)		
Belt - Fan; W/55 1/8" Belt O.C.	178725	③TR28545	②▲9530HD		
Belt - Fan; W/58 1/4" Belt O.C.	178626	③TR24578	▲9480HD		
Belt - Fan; W/61 1/8" Belt O.C.	178526	③TR24607	24432		
Belt - W.P.	200328	TR24438	L70		
Belt - Alt.	200549	②▲9465HD	Volvo TD45B Diesel		
Belt - Gen.; W/36 3/8" Belt O.C.	70350	TR22358	Belt - Fan & Alt.	966933	②7560
Belt - Gen.; W/40 1/8" Belt O.C.	178573	TR22397	Belt - A.C.	958496	▲9455HD
Belt - Gen.; W/41 1/2" Belt O.C.	178599	TR22410	L70B		
Hose - Lower; Ser. No. 32123 Thru 32999(2 1/4" I.D.)		②24236	Volvo TD61GD Diesel		
Hose - Lower; Ser. No. 1MC156 Thru 3MC999(2 1/4" I.D.)		②24236	Belt - Fan & Alt.		
380 I			Belt - A.C.		
Cummins NFT6CL Diesel			②7453		
Belt - Fan	532778	③▲9640HD	②▲9465HD		
Belt - W.P.	S3163	TR22434	7450		
Belt - Gen.	70350	TR22358	▲9430HD		
Hose - Lower; Ser. No. 42123 & After(2 1/4" I.D.)		②24236	≅20206		
380 II			●26508		
Cummins 12V-71 Diesel			24432		
Belt - Fan	S3094	②TR28514	Volvo TD61GL Diesel		
② Two Required.			Belt - Fan		
▲ Standard Belt Available. See Pages 630-631.			Belt - Alt.		
● Vulco-Flex® Coolant Hose.			Belt - A.C.		
			Hose - Upper - Eng. To Pipe		
			Hose - Lower - Pipe To Cooler		
			Hose - Lower - Cooler To Pipe; (2" I.D.)		
			② Three Required.		
			≅ Cut to Fit.		

Road & Construction Equipment

Belts and Coolant Hose for Road & Construction Equipment

Application	Mfr. Part No.	Our No.
VOLVO - Continued		
L90B		
Volvo TD61GB Diesel		
Hose - Upper		●26507
Hose - Lower - Pipe To Cooler; (2" I.D.)		24432
L120		
Volvo TD71G Diesel		
Belt - Fan	967122	②▲9465HD
Belt - Alt.	958316	②7450
Belt - A.C.	958494	▲9435HD
Hose - Upper - Eng. To Pipe; (2" I.D.)		24432
Hose - Upper - Pipe To Pipe		≡20206
Hose - Lower - Cooler To Pipe; (2" I.D.)		24432
L150		
Volvo TD102 Diesel		
Belt - Fan & Idler		②▲9560HD
Belt - Alt.	966385	②7490
Belt - A.C.		②▲9430HD
Hose - Upper - Eng. To Pipe		≡21891
WABCO		
35; 35C		
Cummins KT1150C Diesel		
Hose - Upper - Pipe To Rad.; (2 1/2" I.D.)		24440
Hose - Lower - Eng. To Pipe; (3 1/2" I.D.)		24456
Cummins NTA855 Diesel		
Hose - Upper - Eng. To Pipe		●26529
Hose - Upper - Pipe To Rad.; (2 1/2" I.D.)		24440
Hose - Lower - Pipe To Rad.; (3 1/2" I.D.)		⊕24956
Detroit Diesel 12V-71 Diesel		
Hose - Upper - Eng. To Pipe		23550
Hose - Upper - Pipe To Rad.		23550
101F		
Cummins V504 Diesel		
Hose - Upper		≡20611
		or ●26511
Hose - Lower		≡20731
		or ●26521
150RG1		
IH JC200		
Hose - Lower - Eng. To Pipe; (2" I.D.)		24232
Hose - Lower - Pipe To Rad.; (1 1/2" I.D.)		24224
170RD2		
Ford 6-Cyl. 254 Diesel		
Hose - Upper		●25527
Hose - Lower - Eng. To Pipe; (2" I.D.)		24232
Hose - Lower - Pipe To Pipe; (1 3/4" I.D.)		24228
Hose - Lower - Pipe To Rad.; (1 3/4" I.D.)		24228
222G; 229G		
Detroit Diesel 8V-71T Diesel		
Hose - Upper - Eng. To Pipe; (2 1/4" I.D.)		24236
Hose - Upper - Pipe To Rad.; (2 1/4" I.D.)		24236
Hose - Lower - Eng. To Pipe; (2 3/4" I.D.)		24244
Hose - Lower - Pipe To Rad.; (2 3/4" I.D.)		24244
300		
Detroit Diesel 6V-53 Diesel		
Hose - Upper - Eng. To Pipe		●26611
Hose - Upper - Pipe To Rad.		●26611
Hose - Lower		●26510
330H		
Cummins JBSI Diesel		
Belt - Fan	109179	②▲9385HD
Belt - W.P.	111726	TR22329

Application	Mfr. Part No.	Our No.
WABCO - Continued		
330H - Continued		
Cummins JBSI Diesel - Continued		
Belt - Gen.	101426	TR22443
Detroit Diesel 3-71 Diesel		
Belt - Fan; W/45 7/8" Belt O.C.	5170972	②TR22455
Belt - Fan; W/55" Belt O.C.	3224368	TR34545
Belt - Fan; W/70 1/4" Belt O.C.	3224451	TR34700
Belt - Gen.; W/39 1/2" Belt O.C.	3224367	TR28390
Belt - Gen.; W/40 3/8" Belt O.C.	5155911	TR24400
Belt - Compr.	3224451	TR34700
IH UD9A Diesel; IH UD350 Diesel		
Belt - Fan & W.P.	48042D	TR30484
Belt - Gen.	466856	9300
400		
Detroit Diesel 6V-71 Diesel		
Hose - Upper - Eng. To Pipe		●26522
Hose - Upper - Pipe To Rad.		●26522
Hose - Lower; (2 3/4" I.D.)		⊕24944
440		
Cummins JF6BI Diesel		
Belt - Fan; Ser. No. 1500 & After	109179	②▲9385HD
Belt - W.P.; Ser. No. 1500 & After	110896	TR22329
Belt - Gen.; Ser. No. 1500 & After	101426	TR22443
Detroit Diesel 4-71 Diesel		
Belt - Fan; W/45 7/8" Belt O.C.	5170972	②TR22455
Belt - Fan; W/55" Belt O.C.	3224368	TR34545
Belt - Fan; W/70 1/4" Belt O.C.	3224451	TR34700
Belt - Gen.; W/39 1/2" Belt O.C.	3224367	TR28390
Belt - Gen.; W/40 3/8" Belt O.C.	5155911	TR24400
IH UD14A Diesel		
Belt - Fan & W.P.	30982DB	TR32571
Belt - Gen.	426856	9279
500		
Detroit Diesel 8V-71 Diesel		
Hose - Upper - Eng. To Pipe; (2 1/4" I.D.)		24436
Hose - Upper - Pipe To Rad.; (2 1/4" I.D.)		24436
Hose - Lower - Eng. To Pipe; (2 3/4" I.D.)		24244
Hose - Lower - Pipe To Rad.; (2 1/4" I.D.)		24436
555		
Cummins H743C Diesel		
Belt - Fan	172856	②TR24457
Belt - Alt.	178727	▲9420HD
Cummins N855 Diesel		
Belt - Fan		②TR24457
Belt - Alt.		▲9405HD
Detroit Diesel 6-71 Diesel		
Belt - Fan		②▲9550HD
Belt - Alt.		▲9570HD
Hose - Upper		●26509
Hose - Lower		●26515
666		
Cummins H743C Diesel		
Belt - Fan	172856	②TR24457
Belt - Alt.	178727	▲9420HD
Hose - Upper		●26511
Hose - Lower		●26523
Cummins N855 Diesel		
Belt - Fan		②TR24457
Belt - Alt.		▲9405HD
Detroit Diesel 4-71 Diesel		
Belt - Fan; W/Dual Belts	5170972	TR22455
Belt - Gen.; W/39 1/2" Belt O.C.	3224367	TR28390
Belt - Gen.; W/40 3/8" Belt O.C.	5155911	TR24400
Belt - Compr.	3224451	TR34700

- Vulco-Flex® Coolant Hose.
- ▲ Standard Belt Available. See Pages 630-631.
- ⊕ Use Wire Inserted Green Stripe® Coolant Hose.

- ② Two Required.
- ≡ Cut to Fit.

Belts and Coolant Hose for Road & Construction Equipment

Application	Mfr. Part No.	Our No.	Application	Mfr. Part No.	Our No.
WABCO - Continued			WABCO - Continued		
666 - Continued			AFE6 - Continued		
Detroit Diesel 6-71 Diesel			Detroit Diesel 16V-149 Diesel - Continued		
Belt - Fan		②▲9550HD	Hose - Lower - Eng. To Pipe; (4 1/2" I.D.)		24272
Belt - Alt.		▲9570HD	Hose - Lower - Pipe To Rad.; (4 1/2" I.D.)		24272
666 Power Flow			BF43		
Detroit Diesel 4-71 Diesel			Detroit Diesel 16V-71 Diesel		
Belt - Fan; W/Dual Belts	5170972	TR22455	Hose - Upper - Water Manifold To Pipe; (3" I.D.)		24448
Belt - Gen.; W/39 1/2" Belt O.C.	3224367	TR28390	Hose - Upper - Pipe To Rad.		●26538
Belt - Gen.; W/40 3/8" Belt O.C.	5155911	TR24400	Hose - Lower - Eng. To Pipe (Upper); (3 1/2" I.D.)		②24456
Belt - Compr.	3224451	TR34700	Hose - Lower - Eng. To Pipe (Lower); (4" I.D.)		24464
666B			Hose - Lower - Pipe To Rad.; (4" I.D.)		
Detroit Diesel 4-71 Diesel			24464		
Belt - Fan	5136270	②▲9560HD	BFA6		
Belt - Alt.		▲9570HD	Cummins VT1710 Diesel		
Hose - Upper		●26510	Hose - Upper - Eng. To Pipe		
Hose - Lower		●26510	Hose - Upper - Pipe To Rad.; (3" I.D.)		
666C			Hose - Lower; (4" I.D.)		
Cummins H135C Diesel			24464		
Belt - Fan		②TR24457	Cummins VT1710 Diesel		
Belt - Fan To Alt.		▲9420HD	Hose - Upper - Eng. To Pipe		
Hose - Upper		●26517	Hose - Upper - Pipe To Rad.		
Hose - Lower		●26523	Hose - Lower - Eng. To Pipe; (3 1/4" I.D.)		
Hose - By Pass; (1 1/2" I.D.)		24224	24452		
777			C		
Cummins H743C Diesel			Detroit Diesel 8V-71 Diesel		
Belt - Fan	172856	②TR24457	Hose - Upper - Eng. To Pipe; (2 1/4" I.D.)		
Belt - Alt.	178727	▲9420HD	Hose - Upper - Pipe To Rad.; (2 1/4" I.D.)		
Detroit Diesel 6-71 Diesel			Hose - Lower - Eng. To Pipe; (2 3/4" I.D.)		
Belt - Fan		②▲9550HD	Hose - Lower - Pipe To Rad.; (2 3/4" I.D.)		
Belt - Alt.		▲9570HD	24436		
777 Power Flow			24436		
Detroit Diesel 6-71 Diesel			24444		
Belt - Fan; W/Dual Belts	5170972	TR22455	24444		
Belt - Gen.; W/39 1/2" Belt O.C.	3224367	TR28390	CFA19; CFA20B		
Belt - Gen.; W/40 3/8" Belt O.C.	5155911	TR24400	Detroit Diesel 12V-71 Diesel		
Belt - Compr.	3224451	TR34700	Hose - Upper - Eng. To Pipe		
777B			Hose - Upper - Pipe To Rad.		
Cummins N855 Diesel			Hose - Lower - Eng. To Pipe; (3 1/2" I.D.)		
Belt - Fan		②TR24457	Hose - Lower - Pipe To Rad.; (3 1/2" I.D.)		
Belt - Alt.		▲9405HD	23562		
Detroit Diesel 6-71N Diesel			23562		
Belt - Fan		②▲9550HD	24456		
Belt - Alt.		▲9570HD	24456		
Hose - Upper		●26509	F		
Hose - Lower		●26511	Cummins HRF6 Diesel		
AFE1			Belt - Fan		
Detroit Diesel 16V-149 Diesel			Belt - Fan To Alt.		
Belt - Gen.		▲9400HD	Hose - Upper		
Belt - Hyd. Pump		TR28473	Hose - Lower - Eng. To Cooler		
AFE5			Hose - Lower - Cooler To Rad.; (2 1/4" I.D.)		
Detroit Diesel 16V-149 Diesel			Hose - By Pass; (1 5/8" I.D.)		
Belt - Fan		③▲9650HD	24226		
Belt - Gen.		▲9400HD	WALDON		
Belt - Hyd. Pump		TR28473	100H		
Hose - Upper - Eng. To Pipe; (3 1/2" I.D.)		24456	Continental 3-Cyl. Diesel		
Hose - Upper - Pipe To Rad.; (3 1/2" I.D.)		24456	Belt - Fan & Alt.		
Hose - Lower - Eng. To Pipe; (4 1/2" I.D.)		24272	Hose - Upper		
Hose - Lower - Pipe To Rad.; (4 1/2" I.D.)		24272	▲9500HD		
AFE6			●25474		
Detroit Diesel 16V-149 Diesel			4100		
Hose - Upper - Eng. To Pipe; (3 1/2" I.D.)		24456	Continental TM27		
Hose - Upper - Pipe To Rad.; (3 1/2" I.D.)		24456	Belt - Fan & Alt.		
Hose - Lower - Eng. To Pipe; (4 1/2" I.D.)		24272	Hose - Upper		
Hose - Lower - Pipe To Rad.; (4 1/2" I.D.)		24272	▲9470HD		
AFE6			●26501		
Detroit Diesel 16V-149 Diesel			5000		
Hose - Upper - Eng. To Pipe; (3 1/2" I.D.)		24456	Ford 4-Cyl. Diesel		
Hose - Upper - Pipe To Rad.; (3 1/2" I.D.)		24456	Belt - Fan & Alt.		
Hose - Lower - Eng. To Pipe; (4 1/2" I.D.)		24272	▲9415HD		
Hose - Lower - Pipe To Rad.; (4 1/2" I.D.)		24272	5100		
AFE6			Continental TM27		
Detroit Diesel 16V-149 Diesel			Belt - Fan		
Hose - Upper - Eng. To Pipe; (3 1/2" I.D.)		24456	Hose - Upper		
Hose - Upper - Pipe To Rad.; (3 1/2" I.D.)		24456	▲9465HD		
AFE6			●26501		

② Two Required.
 ● Vulco-Flex® Coolant Hose.
 ⚙ Use Wire Inserted Green Stripe® Coolant Hose.

▲ Standard Belt Available. See Pages 630-631.
 ③ Three Required.

Road & Construction Equipment

Belts and Coolant Hose for Road & Construction Equipment

Application	Mfr. Part No.	Our No.
WALDON - Continued		
6000		
Ford 4-Cyl. 172		
Belt - Fan & Alt.		▲9415HD
Hose - Upper		●25250
8500		
Perkins 6-Cyl. 354 Diesel		
Belt - Fan & Alt.		▲9510HD
Hose - Upper		●26501
Hose - Lower - Eng. To Pipe		≡<21660
Hose - Lower - Pipe To Rad.		≡<21794
Hose - By Pass		≡<20065
WARNER & SWASEY		
300 Hydro-Cruiser		
Detroit Diesel 3-53N Diesel		
Belt - Fan	②▲9390HD	
Belt - W.P. & Alt.		7417
Hose - Upper		●26603
Hose - Lower		●26507
300 Hydro-Scopic		
Chrysler V-8 318		
Belt - Fan & Alt. - Lower Structure		▲9540HD
Belt - Fan & P.S. - Lower Structure		7530
Belt - Air Brake Compr. & Idler		▲9660HD
Hose - Upper - Lower Structure		●26506
Hose - Lower - Lower Structure		●26506
Hose - By Pass - Lower Structure		20693
Detroit Diesel 3-53N Diesel		
Belt - Fan - Upper Structure	②▲9390HD	
Belt - W.P. & Alt. - Upper Structure		7410
Hose - Upper - Upper Structure		≡<20957
	or	●26603
Hose - Lower - Upper Structure		●26507
300TM-C		
Chrysler V-8 361		
Belt - Fan & Alt. - Upper Structure	②▲9550HD	
Hose - Upper - Upper Structure		●25527
Hose - Lower - Upper Structure; (1 1/2" I.D.)		②24224
Continental M6363		
Belt - Compr. - Lower Structure		TR22508
Hose - Upper - Lower Structure		●26603
Hose - Lower - Lower Structure		●26603
G660		
Chrysler V-8 413		
Belt - Fan & Alt. - Lower Structure	1855867	②▲9610HD
Belt - Compr. & Idler - Lower Structure	2946719	▲9740HD
Hose - Upper - Lower Structure		●26510
Detroit Diesel 4-53 Diesel		
Belt - Fan - Upper Structure		②▲9412HD
Belt - W.P. & Alt. - Upper Structure	186671076	②7417
Hose - Upper - Upper Structure		●26504
Hose - Lower - Upper Structure		●26522
H550		
Detroit Diesel 4-71N Diesel		
Belt - Fan		②▲9500HD
Belt - Alt.		▲9600HD
Hose - Upper		●26509
Hose - Lower		●26508
H900A		
Detroit Diesel 8V-71N Diesel		
Belt - Fan		③▲9451HD
Belt - Alt.		K080370
Hose - Upper		②≡<20731
	or	②●26522

Application	Mfr. Part No.	Our No.
WARNER & SWASEY - Continued		
H900A - Continued		
Detroit Diesel 8V-71N Diesel - Continued		
Hose - Lower; (2 1/2" I.D.)		④24940
HT4418		
Detroit Diesel 4-53 Diesel		
Belt - Fan		②▲9405HD
Belt - W.P. & Alt.		②7405
Hose - Lower		●26507
Hose - By Pass; (7/8" I.D.)		28443
WELDON		
Sweepmaster		
Cummins 4-Cyl. 3.9 L Diesel		
Belt - Fan & Alt.	3903090	▲K080550HD
ZETTLEMEYER		
ZL602		
Deutz BF4L1011T Diesel		
Belt - Blower & Idler		7445

Road & Construction Equipment

▲ Standard Belt Available. See Pages 630-631.
 ≡< Cut to Fit
 ③ Three Required.

● Vulco-Flex® Coolant Hose.
 ② Two Required.
 ④ Use Wire Inserted Green Stripe® Coolant Hose.

Belts and Hose for Power Units

Order Belts and Hose by Our Number. Manufacturers' Part Number is shown for reference only.

Application	Mfr. Part No.	Our No.	Application	Mfr. Part No.	Our No.
AGGREKO			ALLIS-CHALMERS - Continued		
8031.05			6DH691		
Hose - Upper; (1 5/8" I.D.)		②24226	Belt - Fan	DP745	③TR28666
Hose - Lower; (1 1/2" I.D.)		②24224	Belt - Gen.	H12145	TR28454
8061.25R			6DH909		
Belt - Fan & Alt.		②7450	Belt - Fan	DP773	③TR28628
ALLIS-CHALMERS			6DT389; 6DT488		
4B153; 4B182			Belt - Fan		
Belt - Fan & W.P.; Auto.	DE51295	TR28463	Belt - Gen.	DE41321	②TR28570
Belt - Fan; Ind.	H12094	TR28473	Belt - Fan & Compr.	M60312	②TR28657
4BD153; 4BD182			6DTS468		
Belt - Fan & W.P.; Auto.	DE51295	TR28463	Belt - Fan & Compr.	M60312	②TR28657
Belt - Fan & Gen.; Ind.	4612234	TR28437	Belt - Supercharger	DE45068	③TR22392
Belt - Fan; W/O Gen.; Ind.	H12094	TR28473	6MO672; 6MO779; 6MO893; 6MO970		
4DA153; 4DA182			Belt - Fan		
Belt - Fan; W/49 7/8" Belt O.C.	4351190	TR28492	Belt - Fan & Compr.; W/66 1/8" Belt O.C.	4660312	②TR28657
Belt - Fan & Gen.	4351295	TR28463	Belt - Fan & Compr.; W/77 1/8" Belt O.C.		②TR30770
Belt - Fan; W/O Gen.	4612234	TR28437	Belt - Compr.	4363346	TR28733
4DC645; 4MO645			Belt - Starter		
Belt - Fan	4660312	②TR28657		4662778	②TR30448
6B230; 6B273			8DA1125		
Belt - Fan; Auto.	DE51295	TR28463	Belt - Fan	DE63593	③TR28616
Belt - Fan; Ind.	H12094	TR28473	8DA1290		
6BD230; 6BD273			Belt - Fan		
Belt - Fan; Auto.	DE51295	TR28463		DE63869	③TR28743
Belt - Fan & Gen.; Ind.	H12234	TR28437	8DAS1125		
Belt - Fan; W/O Gen.; Ind.	H12094	TR28473	Belt - Fan	DE63593	③TR28616
6DA230; 6DA273			8DAS1290		
Belt - Fan & Gen.; Ser. No. 104665 & Before	4351295	TR28463	Belt - Fan	DE63869	③TR28743
Belt - Fan; W/O Gen.; Ser. No. 104665 & Before ..	4612234	TR28437	8DC1125; 8DC1290; 8DCS1125; 8DCS1290		
Belt - Fan & Gen.; Ser. No. 104666 & After	4641213	TR28483	Belt - Fan; Auto.; W/68 5/8" Belt O.C.	DE64787	②TR28680
Belt - Fan; W/O Gen.; Ser. No. 104666 & After	4612145	TR28454	Belt - Fan; Auto.; W/79 1/8" Belt O.C.		③TR28786
Belt - Fan; W/8 1/4" C.S. Pulley	4351190	TR28492	Belt - Fan & Compr.; Auto.	DE41456	②C78
6DA779; 6DA844; 6DA970			Belt - Fan; Ind.		
Belt - Fan & Compr.; W/8-Blade Fan	M60312	②TR28657		DE63592	③TR28733
Belt - Fan; W/O Compr.		②TR22474	8DCS2505		
6DAS510; 6DAS516; 6DAS844			Belt - Gen.		
Belt - Fan; Auto.	DE46764	②TR22578		AP4631	TR24400
Belt - Gen.; Auto.	DE46762	TR24315	8MO1290; 8MOS1290		
Belt - Compr.; Auto.	DE46763	TR28583	Belt - Fan; W/Blower Type Fan	4356965	TR28583
Belt - Blower; Auto.	DE46765	②TR28514	Belt - Starter	4662778	②TR30448
Belt - Fan; Ind.; W/8-Blade Fan	M60312	②TR28657	Belt - Compr.	4368110	TR22373
6DC844; 6DC970			8PC2505		
Belt - Fan	K40285	②TR28583	Belt - Gen.	AP4631	TR24400
6DCB879			10000; 11000		
Belt - Fan; W/67" Belt O.C.; W/2-Belt Drive	4031597	②TR28666	Belt - Fan	4335452	②TR28649
Belt - Fan; W/67 1/8" Belt O.C.; W/3-Belt Drive	4034031	③TR28666	Belt - Gen.; W/43 1/4" Belt O.C.	4707730	♣9430HD
Belt - Fan; W/85 5/8" Belt O.C.	4331717	③CX81	Belt - Gen.; W/45 3/8" Belt O.C.	4613571	♣9451HD
6DCS844			Belt - Compr.		
Belt - Fan & Compr.; Auto.	DE65732	②TR28693		4349109	TR28473
Belt - Fan; W/O Compr.; Auto.		②TR22474	16000		
Belt - Fan; Ind.	K40285	②TR28583	Belt - Fan; W/63 3/4" Belt O.C.	4348694	②TR28628
6DCS1879			Belt - Fan; W/62 1/2" Belt O.C.		
Belt - Fan; W/67" Belt O.C.; W/2-Belt Drive	4031597	②TR28666	Belt - Fan; W/Air Actuated Fan; W/63 3/4" Belt O.C.	4348694	②TR28628
Belt - Fan; W/67 1/8" Belt O.C.; W/3-Belt Drive	4034031	③TR28666	Belt - Fan; W/Air Actuated Fan; W/65 1/2" Belt O.C.	4335452	②TR28649
Belt - Fan; W/85 5/8" Belt O.C.	4331717	③CX81	Belt - W.P.; W/50" Belt O.C.	4386813	TR22495
			Belt - W.P.; W/56 1/2" Belt O.C.		
			Belt - Gen.; W/24V. 10A., 18A., 32V. 10A. Std.		
			Gen.		
			Belt - Gen.; W/12V. 50A., 24V. 10A. Dust Proof		
			Gen.		
			Belt - Gen.; W/24V. 10A., 18A. Std. Gen.; W/O Crank Pulley Drive		
			Belt - Gen.; W/24V. 10A., 18A. Std. Gen.; W/Crank Pulley Drive		
			4613099		
			TR28565		
			4346763		
			TR28570		

Power Units

② Two Required.
♣ Standard Belt Available. See Pages 630-631.

③ Three Required.

Belts and Hose for Power Units

Application	Mfr. Part No.	Our No.
ALLIS-CHALMERS - Continued		
16000 - Continued		
Belt - Gen.; W/36 3/4" Belt O.C.	4379880	▲9365HD
Belt - Gen.; W/39 1/4" Belt O.C.	4707728	▲9390HD
Belt - Gen.; W/40 3/4" Belt O.C.	4707731	▲9405HD
Belt - Gen.; W/41 3/4" Belt O.C.	4378806	▲9415HD
Belt - Gen.; W/48 1/4" Belt O.C.	4512419	▲9480HD
Belt - Gen.; W/59" Belt O.C.	4339458	TR28583
Belt - P.S.	4368110	③TR22373
Belt - Compr.; W/7 1/4, 12 Cu. Ft. Compr.; W/32" Fan	4612058	TR28514
Belt - Compr.; W/24 Cu. Ft. Compr.	4347818	TR30543
16000H		
Belt - Fan; W/62 1/2" Belt O.C.	4366448	②TR28616
Belt - Fan; W/Air Actuated Fan; W/63 3/4" Belt O.C.	4348694	②TR28628
Belt - Fan; W/Air Actuated Fan; W/65 1/2" Belt O.C.	4335452	②TR28649
Belt - W.P.; W/50" Belt O.C.	4386813	TR22495
Belt - W.P.; W/56 1/2" Belt O.C.	4338380	TR28557
Belt - Gen.; W/24V. 10A., 18A., 32V. 10A. Std. Gen.	4616583	▲9430HD
Belt - Gen.; W/12V. 50A., 24V. 10A. Dust Proof Gen.	4707726	▲9440HD
Belt - Gen.; W/24V. 10A., 18A. Std. Gen.; W/O Crank Pulley Drive	4613099	TR28565
Belt - Gen.; W/24V. 10A., 18A. Std. Gen.; W/Crank Pulley Drive	4346763	TR28570
Belt - Gen.; W/36 3/4" Belt O.C.	4379880	▲9365HD
Belt - Gen.; W/39 1/4" Belt O.C.	4707728	▲9390HD
Belt - Gen.; W/40 3/4" Belt O.C.	4707731	▲9405HD
Belt - Gen.; W/41 3/4" Belt O.C.	4378806	▲9415HD
Belt - Gen.; W/48 1/4" Belt O.C.	4512419	▲9480HD
Belt - Gen.; W/59" Belt O.C.	4339458	TR28583
Belt - P.S.	4368110	③TR22373
Belt - Compr.; W/7 1/4, 12 Cu. Ft. Compr.; W/32" Fan	4612058	TR28514
21000		
Belt - Fan; W/62 1/2" Belt O.C.	4366448	②TR28616
Belt - Fan; W/Air Actuated Fan; W/63 3/4" Belt O.C.	4348694	②TR28628
Belt - Fan; W/Air Actuated Fan; W/65 1/2" Belt O.C.	4335452	②TR28649
Belt - Fan; W/66 1/8" Belt O.C.	4616522	②TR28657
Belt - W.P.; W/50" Belt O.C.	4386813	TR22495
Belt - W.P.; W/56 1/2" Belt O.C.	4338380	TR28557
Belt - Gen.; W/24V. 10A., 18A., 32V. 10A. Std. Gen.	4616583	▲9430HD
Belt - Gen.; W/12V. 50A., 24V. 10A. Dust Proof Gen.	4707726	▲9440HD
Belt - Gen.; W/24V. 10A., 18A. Std. Gen.; W/O Crank Pulley Drive	4613099	TR28565
Belt - Gen.; W/24V. 10A., 18A. Std. Gen.; W/Crank Pulley Drive	4346763	TR28570
Belt - Gen.; W/36 3/4" Belt O.C.	4379880	▲9365HD
Belt - Gen.; W/39 1/4" Belt O.C.	4707728	▲9390HD
Belt - Gen.; W/40 3/4" Belt O.C.	4707731	▲9405HD
Belt - Gen.; W/41 3/4" Belt O.C.	4378806	▲9415HD
Belt - Gen.; W/48 1/4" Belt O.C.	4512419	▲9480HD
Belt - Gen.; W/59" Belt O.C.	4339458	TR28583
Belt - P.S.	4368110	③TR22373
Belt - Compr.; W/7 1/4, 12 Cu. Ft. Compr.; W/32" Fan	4612058	TR28514
Belt - Compr.; W/24 Cu. Ft. Compr.	4612058	TR28514
21000H; 25000		
Belt - Fan; W/62 1/2" Belt O.C.	4366448	②TR28616
Belt - Fan; W/Air Actuated Fan; W/63 3/4" Belt O.C.	4348694	②TR28628
Belt - Fan; W/Air Actuated Fan; W/65 1/2" Belt O.C.	4335452	②TR28649
Belt - W.P.; W/50" Belt O.C.	4386813	TR22495
Belt - W.P.; W/56 1/2" Belt O.C.	4338380	TR28557
Belt - Gen.; W/24V. 10A., 18A., 32V. 10A. Std. Gen.	4616583	▲9430HD
Belt - Gen.; W/12V. 50A., 24V. 10A. Dust Proof Gen.	4707726	▲9440HD
Belt - Gen.; W/24V. 10A., 18A. Std. Gen.; W/O Crank Pulley Drive	4613099	TR28565

Application	Mfr. Part No.	Our No.
ALLIS-CHALMERS - Continued		
21000H; 25000 - Continued		
Belt - Gen.; W/24V. 10A., 18A. Std. Gen.; W/Crank Pulley Drive	4346763	TR28570
Belt - Gen.; W/36 3/4" Belt O.C.	4379880	▲9365HD
Belt - Gen.; W/39 1/4" Belt O.C.	4707728	▲9390HD
Belt - Gen.; W/40 3/4" Belt O.C.	4707731	▲9405HD
Belt - Gen.; W/41 3/4" Belt O.C.	4378806	▲9415HD
Belt - Gen.; W/48 1/4" Belt O.C.	4512419	▲9480HD
Belt - Gen.; W/59" Belt O.C.	4339458	TR28583
Belt - P.S.	4368110	③TR22373
Belt - Compr.; W/7 1/4, 12 Cu. Ft. Compr.; W/32" Fan	4612058	TR28514
25000 Mark II		
Belt - Fan	4392613	②TR24647
Belt - Fan To Alt.	4392614	▲9463HD
Belt - Fan To Compr.	4612058	TR28514
Belt - W.P. To Idler	4391351	7495
B125		
Belt - Fan & Gen.	207003	TR22322
Belt - Fan; W/O Gen.	209656	TR22363
D153		
Belt - Fan	4351295	TR28463
D175		
Belt - Fan & Gen.; W/41 3/4" Belt O.C.	4378806	▲9415HD
Belt - Fan & Gen.; W/44 7/8" Belt O.C.	4514232	▲9447HD
Belt - Fan & Gen.; W/45 3/8" Belt O.C.	4511434	▲9451HD
D230		
Belt - Fan	4351295	TR28463
D262		
Belt - Fan & Gen.; W/46" Belt O.C.	4612145	TR28454
Belt - Fan & Gen.; W/47" Belt O.C.	4351295	TR28463
Belt - Fan & Gen.; W/50" Belt O.C.	4351190	TR28492
Belt - Fan & Gen.; W/44 3/8" Belt O.C.	4612234	TR28437
D344; D516		
Belt - Fan	4335864	②TR28583
Belt - Gen. & W.P.; W/52 1/4" Belt O.C.	4348851	TR28514
Belt - Gen. & W.P.; W/53" Belt O.C.	4348408	TR28522
Belt - Gen. & Compr.	4335242	TR28423
Belt - Compr.	4335864	TR28583
D779; D844; DS844		
Belt - Fan	4660312	②TR28657
G138; G149		
Belt - Fan & Gen.	209656	TR22363
Belt - Fan; W/O Gen.	207003	TR22322
G226		
Belt - Fan & Gen.	229211	▲9463HD
G262		
Belt - Fan & Gen.	4514232	▲9447HD
H173; H199; H205; H217		
Belt - Fan; Auto.; Ser. No. 239680 & Before	H12145	TR28454
Belt - Fan; Auto.; Ser. No. 239681 & After	H12094	TR28473
Belt - Fan; Ind.; Ser. No. 239681 & Before		TR28514
Belt - Fan; Ind.; Ser. No. 239682 & After	H12094	TR28473
H260; H298; H326		
Belt - Fan; Auto.; Ser. No. 239762 & Before	H12145	TR28454
Belt - Fan; Auto.; Ser. No. 239763 & After	H12094	TR28473
Belt - Fan; Ind.; Ser. No. 239762 & Before	DE55926	TR28514
Belt - Fan; Ind.; Ser. No. 239763 & After		TR28473
HD344		
Belt - Fan	4349777	②TR28483

▲ Standard Belt Available. See Pages 630-631.
 ② Two Required.

③ Three Required.

Belts and Hose for Power Units

Application	Mfr. Part No.	Our No.
ALLIS-CHALMERS - Continued		
HD344 - Continued		
Belt - Gen.	4349729	TR22485
HD516		
Belt - Fan 4349778	②TR28522	
Belt - Gen. 4349728	TR22514	
HP205; HP217; HP234		
Belt - Fan & Gen.; Auto. DE55926	TR28514	
Belt - Fan; W/O Gen. H12094	TR28473	
Belt - Fan & Gen.; Ind. H12095	TR28522	
HP260; HP298; HP326; HP351		
Belt - Fan & Gen.; Auto. DE55926	TR28514	
Belt - Fan; W/O Gen. H12094	TR28473	
K428		
Belt - Fan DE41321	②TR28570	
LO525		
Belt - Fan; Auto. KE567	TR28483	
Belt - Fan; Ind. DP1597	②TR28666	
W201; W226		
Belt - Fan & Gen. 209824	TR22461	
Belt - Fan; W/O Gen. 203073	TR22416	
AMITA		
G25		
Belt - Alt.; W/Isuzu Eng. 8942568000	TR24407	
BEDFORD		
220FF		
Belt - Fan & Alt.; W/4-Cyl. Diesel Eng.	②7500	
330FF		
Belt - Fan & Gen.; W/6-Cyl. Diesel Eng.	②7490	
CATERPILLAR		
348 (36J); 348 (38J)		
Belt - Alt.; W/49 1/4" Belt O.C. 7L5090	②7490	
Belt - Alt.; W/50 1/4" Belt O.C. 1N9310	②7500	
1170		
Belt - Fan 9L894	②③9520HD	
Belt - W.P. & Idler 9L894	②③9520HD	
Belt - W.P. To Compr. & Alt. 6L3294	②③9650HD	
1670		
Belt - Fan 9L894	②③9520HD	
Belt - Alt. 4M6291	③9425HD	
Belt - Compr. 9L2266	②③9313HD	
1673 (1L)		
Belt - Fan; W/52 1/4" Belt O.C. 5B8473	②TR24515	
Belt - Fan; W/58 3/4" Belt O.C. 9L304	TR24578	
Belt - P.S. 9L2248	②③9480HD	
1673 (69D)		
Belt - Fan; W/52 1/4" Belt O.C. 9L894	②③9520HD	
Belt - Fan; W/58 1/4" Belt O.C. 7L5001	②③9580HD	
Belt - Alt.; W/41 3/4" Belt O.C. 4M6291	②③9415HD	
Belt - Alt.; W/57 1/4" Belt O.C. 9L1128	②③9570HD	
Belt - Alt.; W/64 1/4" Belt O.C. 9L1213	②③9640HD	
Belt - Fan; W/78 1/8" Belt O.C. 9L4265	③9775	
Belt - Compr. & Alt. 9L1553	②③9550HD	
1673 (70B)		
Belt - Fan; W/32 1/8" Belt O.C.	②③9319HD	
Belt - Fan; W/41 3/4" Belt O.C. 4M6291	③9415HD	
Belt - Fan; W/45 3/8" Belt O.C. 9L1740	②③9451HD	
Belt - Fan; W/1/2" Belt T.W.; W/52 1/4" Belt O.C. ... 9L894	②③9520HD	
Belt - Fan; W/3/4" Belt T.W.; W/52 1/4" Belt O.C. ... 3H9862	②TR24515	
Belt - Fan; W/58 1/4" Belt O.C. 7L5001	③9580HD	
Belt - Fan; W/58 3/4" Belt O.C. 9L304	②TR24578	
Belt - W.P.; W/54 1/4" Belt O.C. 9L1731	②③9540HD	
Belt - W.P.; W/60 1/4" Belt O.C. 9L1105	②③9600HD	
Belt - Alt.; W/57 1/4" Belt O.C. 9L1128	②③9570HD	
Belt - Alt.; W/62 1/4" Belt O.C. 9L1183	②③9620HD	
Belt - Alt.; W/64 1/4" Belt O.C. 9L1213	②③9640HD	
Belt - Alt.; W/67 1/4" Belt O.C. 9L1130	②③9670HD	
Belt - Alt. & Compr.; W/52 1/4" Belt O.C. 9L894	②③9520HD	
Belt - Alt. & Compr.; W/55 1/4" Belt O.C. 9L1553	②③9550HD	
Belt - Gen.; W/39 1/4" Belt O.C. 5B7168	③9390HD	
Belt - Gen.; W/40 1/4" Belt O.C. 3L6309	③9400HD	
Belt - Gen.; W/41 3/4" Belt O.C. 4M6291	③9415HD	
Belt - Compr.; W/O Kenworth Compr. 9L1502	③9319HD	
Belt - Compr.; W/Kenworth Compr. 9L2266	②③9313HD	

Application	Mfr. Part No.	Our No.
CATERPILLAR - Continued		
1673 (70B) - Continued		
Belt - Fan; W/3/4" Belt T.W.; W/52 1/4" Belt O.C. ... 3H9862		②TR24515
Belt - Fan; W/58 1/4" Belt O.C. 7L5001		③9580HD
Belt - Fan; W/58 3/4" Belt O.C. 9L304		②TR24578
Belt - W.P.; W/54 1/4" Belt O.C. 9L1731		②③9540HD
Belt - W.P.; W/60 1/4" Belt O.C. 9L1105		②③9600HD
Belt - Alt.; W/57 1/4" Belt O.C. 9L1128		②③9570HD
Belt - Alt.; W/62 1/4" Belt O.C. 9L1183		②③9620HD
Belt - Alt.; W/64 1/4" Belt O.C. 9L1213		②③9640HD
Belt - Alt.; W/67 1/4" Belt O.C. 9L1130		②③9670HD
Belt - Alt. & Compr.; W/52 1/4" Belt O.C. 9L894		②③9520HD
Belt - Alt. & Compr.; W/55 1/4" Belt O.C. 9L1553		②③9550HD
Belt - Gen.; W/39 1/4" Belt O.C. 5B7168		③9390HD
Belt - Gen.; W/40 1/4" Belt O.C. 3L6309		③9400HD
Belt - Gen.; W/41 3/4" Belt O.C. 4M6291		③9415HD
Belt - Compr.; W/O Kenworth Compr. 9L1502		③9319HD
Belt - Compr.; W/Kenworth Compr. 9L2266		②③9313HD
1673B (1L)		
Belt - Fan; W/52 1/4" Belt O.C. 5B8473		②TR24515
Belt - Fan; W/58 3/4" Belt O.C. 9L304		TR24578
Belt - P.S. 9L2248		②③9480HD
1673B (69D)		
Belt - Fan; W/32 1/4" Belt O.C. 9L894		②③9520HD
Belt - Fan; W/58 1/4" Belt O.C. 7L5001		②③9580HD
Belt - Alt.; W/41 3/4" Belt O.C. 4M6291		②③9415HD
Belt - Alt.; W/57 1/4" Belt O.C. 9L1128		②③9570HD
Belt - Alt.; W/64 1/4" Belt O.C. 9L1213		②③9640HD
Belt - Fan; W/78 1/8" Belt O.C. 9L4265		③9775
Belt - Compr. & Alt. 9L1553		②③9550HD
1673B (70B)		
Belt - Fan; W/32 1/8" Belt O.C.		②③9319HD
Belt - Fan; W/41 3/4" Belt O.C. 4M6291		③9415HD
Belt - Fan; W/45 3/8" Belt O.C. 9L1740		②③9451HD
Belt - Fan; W/1/2" Belt T.W.; W/52 1/4" Belt O.C. ... 9L894		②③9520HD
Belt - Fan; W/3/4" Belt T.W.; W/52 1/4" Belt O.C. ... 3H9862		②TR24515
Belt - Fan; W/58 1/4" Belt O.C. 7L5001		③9580HD
Belt - Fan; W/58 3/4" Belt O.C. 9L304		②TR24578
Belt - W.P.; W/54 1/4" Belt O.C. 9L1731		②③9540HD
Belt - W.P.; W/60 1/4" Belt O.C. 9L1105		②③9600HD
Belt - Alt.; W/57 1/4" Belt O.C. 9L1128		②③9570HD
Belt - Alt.; W/62 1/4" Belt O.C. 9L1183		②③9620HD
Belt - Alt.; W/64 1/4" Belt O.C. 9L1213		②③9640HD
Belt - Alt.; W/67 1/4" Belt O.C. 9L1130		②③9670HD
Belt - Alt. & Compr.; W/52 1/4" Belt O.C. 9L894		②③9520HD
Belt - Alt. & Compr.; W/55 1/4" Belt O.C. 9L1553		②③9550HD
Belt - Gen.; W/39 1/4" Belt O.C. 5B7168		③9390HD
Belt - Gen.; W/40 1/4" Belt O.C. 3L6309		③9400HD
Belt - Gen.; W/41 3/4" Belt O.C. 4M6291		③9415HD
Belt - Compr.; W/O Kenworth Compr. 9L1502		③9319HD
Belt - Compr.; W/Kenworth Compr. 9L2266		②③9313HD
1673C (1L)		
Belt - Fan; W/52 1/4" Belt O.C. 5B8473		②TR24515
Belt - Fan; W/58 3/4" Belt O.C. 9L304		TR24578
Belt - P.S. 9L2248		②③9480HD
1673C (69D)		
Belt - Fan; W/52 1/4" Belt O.C. 9L894		②③9520HD
Belt - Fan; W/58 1/4" Belt O.C. 7L5001		②③9580HD
Belt - Alt.; W/41 3/4" Belt O.C. 4M6291		②③9415HD
Belt - Alt.; W/57 1/4" Belt O.C. 9L1128		②③9570HD
Belt - Alt.; W/64 1/4" Belt O.C. 9L1213		②③9640HD
Belt - Fan; W/78 1/8" Belt O.C. 9L4265		③9775
Belt - Compr. & Alt. 9L1553		②③9550HD
1673C (70B)		
Belt - Fan; W/32 1/8" Belt O.C.		②③9319HD
Belt - Fan; W/41 3/4" Belt O.C. 4M6291		③9415HD
Belt - Fan; W/45 3/8" Belt O.C. 9L1740		②③9451HD
Belt - Fan; W/1/2" Belt T.W.; W/52 1/4" Belt O.C. ... 9L894		②③9520HD

② Two Required.
③ Three Required.

▲ Standard Belt Available. See Pages 630-631.

Belts and Hose for Power Units

Application	Mfr. Part No.	Our No.
CATERPILLAR - Continued		
1673C (70B) - Continued		
Belt - Fan; W/3/4" Belt T.W.; W/52 1/4" Belt O.C. ...	3H9862	②TR24515
Belt - Fan; W/58 1/4" Belt O.C.	7L5001	▲9580HD
Belt - Fan; W/58 3/4" Belt O.C.	9L304	②TR24578
Belt - W.P.; W/54 1/4" Belt O.C.	9L1731	②▲9540HD
Belt - W.P.; W/60 1/4" Belt O.C.	9L1105	②▲9600HD
Belt - Alt.; W/57 1/4" Belt O.C.	9L1128	②▲9570HD
Belt - Alt.; W/62 1/4" Belt O.C.	9L1183	②▲9620HD
Belt - Alt.; W/64 1/4" Belt O.C.	9L1213	②▲9640HD
Belt - Alt.; W/67 1/4" Belt O.C.	9L1130	②▲9670HD
Belt - Alt. & Compr.; W/52 1/4" Belt O.C.	9L894	②▲9520HD
Belt - Alt. & Compr.; W/55 1/4" Belt O.C.	9L1553	②▲9550HD
Belt - Gen.; W/39 1/4" Belt O.C.	5B7168	▲9390HD
Belt - Gen.; W/40 1/4" Belt O.C.	3L6309	▲9400HD
Belt - Gen.; W/41 3/4" Belt O.C.	4M6291	▲9415HD
Belt - Compr.; W/O Kenworth Compr.	9L1502	▲9319HD
Belt - Compr.; W/Kenworth Compr.	9L2266	②▲9313HD
1676		
Belt - Fan	9L1128	③▲9570HD
Belt - Alt.; W/36 1/4" Belt O.C.	7B7973	▲9360HD
Belt - Alt.; W/46 1/2" Belt O.C.	9M1091	▲9463HD
Belt - Alt.; W/47 7/8" Belt O.C.	6L3408	②▲9476HD
Belt - Gen.; W/50 1/4" Belt O.C.	9L2057	▲9500HD
Belt - A.C.	9L2248	▲9480HD
1693		
Belt - Fan; W/70 1/2" Belt O.C.	9L2215	③▲9700HD
Belt - Fan; W/74 1/4" Belt O.C.	9L1629	③▲9740HD
Belt - Gen.	9L1582	▲9463HD
3145 (65P)		
Belt - W.P. & Alt.	3N1491	②▲9510HD
Belt - Alt.	2N1434	②▲9510HD
Belt - Compr. & Idler; W/54 1/4" Belt O.C.	9L1732	②▲9540HD
Belt - Compr. & Idler; W/55 1/4" Belt O.C.	9L1557	②▲9550HD
3150 (97M)		
Belt - Fan & Alt.; W/51 1/4" Belt O.C.	3N1491	②▲9510HD
Belt - Fan & Alt.; W/52 1/4" Belt O.C.	3S8447	②▲9520HD
Belt - Alt.	2N1434	②▲9510HD
Belt - Compr.; W/Low Mount Fan	9L1732	②▲9540HD
Belt - Compr.; W/High Mount Fan	9L1557	②▲9550HD
3208 (79V)		
Belt - Fan & Alt.	2P5617	②▲9700HD
Belt - W.P. & Idler	3P130	②▲9500HD
Belt - W.P., Air Brake Compr. & Idler	4N2745	▲9600HD
3304 (2B)		
Belt - Fan & Alt.; W/54 1/4" Belt O.C.		③▲9540HD
Hose - Lower - Eng. To Pipe; (2 1/2" I.D.)		24440
Hose - Lower - Pipe To Rad.; (2 1/2" I.D.)		24440
3304 (66D); 3306 (2B)		
Hose - Lower - Eng. To Pipe; (2 1/2" I.D.)		24440
Hose - Lower - Pipe To Rad.; (2 1/2" I.D.)		24440
3306 (66D)		
Belt - Fan		③▲9540HD
Hose - Lower - Eng. To Pipe; (2 1/2" I.D.)		24440
Hose - Lower - Pipe To Rad.; (2 1/2" I.D.)		24440
3406 (90V)		
Belt - Alt.		②TR22570
Hose - Upper - Eng. To Pipe; (2 1/2" I.D.)		24440
Hose - Upper - Pipe To Rad.; (2 1/2" I.D.)		24440
Hose - Lower - Eng. To Pipe; (3" I.D.)		24448
Hose - Lower - Pipe To Rad.; (3 1/2" I.D.)		24456
3408 (67U)		
Belt - Fan		③TR22648
Hose - Upper		●26529
Hose - Lower - Eng. To Pipe; (3 1/2" I.D.)		24456

Application	Mfr. Part No.	Our No.
CATERPILLAR - Continued		
3408 (67U) - Continued		
Hose - Lower - Pipe To Rad.; (3 1/2" I.D.)		24456
3412 (38S)		
Hose - Upper		●26529
Hose - Lower; (3 3/4" I.D.)		24460
Hose - Lower; (4" I.D.)		24264
3412 Generator		
Hose - Upper		≈20760
D311		
Hose - Upper; Ser. No. 4H3269 To 4H4000; W/4L6512 Rad.		●26532
Hose - Lower; Ser. No. 4H3269 To 4H4000; W/3L3877 Rad.(2" I.D.)		24432
Hose - Lower; Ser. No. 4H3269 To 4H4000; W/4L6512 Rad.(2" I.D.)		24432
D311 (4V)		
Belt - W.P.; W/49" Belt O.C.	5F7676	TR30484
Belt - W.P.; W/64" Belt O.C.	8B4881	TR24638
Belt - Alt.	5B7168	▲9390HD
Belt - Gen.; W/44 1/4" Belt O.C.	3H3897	②▲9440HD
Belt - Gen.; W/50 1/4" Belt O.C.	6F1992	②▲9500HD
Belt - Gen.; W/60 1/4" Belt O.C.		②▲9600HD
Belt - Starter	6B5653	TR24438
D311 (7S)		
Belt - W.P.	5F7676	TR30484
Belt - Alt.	5B7168	▲9390HD
Belt - Starter	6B5653	TR24438
D311 (51B)		
Belt - Fan	3L9717	②TR24489
Belt - Fan & Alt.	5L4660	TR24489
Belt - W.P.	3L5751	TR24500
Belt - Alt.	5L3834	②▲9440HD
Belt - Gen.; W/39 1/4" Belt O.C.	5B7168	▲9390HD
Belt - Gen.; W/40 1/4" Belt O.C.	3L6309	▲9400HD
Belt - Gen.; W/41 3/4" Belt O.C.	4M6291	▲9415HD
Belt - Gen.; W/43" Belt O.C.	5L3337	TR24424
Belt - Gen.; W/44 1/4" Belt O.C.	5L3834	②▲9440HD
Belt - Gen.; W/57 1/4" Belt O.C.	2L5345	②▲9570HD
Belt - Gen.; W/60 1/4" Belt O.C.	2L4855	②▲9600HD
Belt - Compr.	5L1584	TR24449
Belt - Starter	4B5738	TR24400
D315 (4V)		
Belt - W.P.	4F7956	TR34506
Belt - Alt.	5B7168	▲9390HD
Belt - Gen.	2L5730	②▲9580HD
Belt - Starter	6B5653	TR24438
D315 (9S)		
Belt - W.P.	4F7956	TR34506
Belt - Alt.	5B7168	▲9390HD
Belt - Gen.; W/Centrifugal W.P.	1H9348	③▲9480HD
Belt - Gen.; W/O Centrifugal W.P.	2L5730	②▲9580HD
Belt - Starter	6B5653	TR24438
D315 (48B); D315 (52B)		
Belt - W.P.; W/51" Belt O.C.	4F7956	TR34506
Belt - W.P.; W/67" Belt O.C.		TR24664
Belt - Gen.; W/67 1/8" Belt O.C.		②TR24664
Belt - Gen.; Conversion	2L5730	②▲9580HD
Belt - Starter	6B5653	TR24438
Belt - Compr.	8F2434	TR24500
D315C (4V)		
Belt - W.P.	4F7956	TR34506
Belt - Alt.	5B7168	▲9390HD
Belt - Gen.	2L5730	②▲9580HD
Belt - Starter	6B5653	TR24438

② Two Required.
 ③ Three Required.
 ≈ Cut to Fit.

▲ Standard Belt Available. See Pages 630-631.
 ● Vulco-Flex® Coolant Hose.

Belts and Hose for Power Units

Application	Mfr. Part No.	Our No.
CATERPILLAR - Continued		
D315C (9S)		
Belt - W.P.	4F7956	TR34506
Belt - Alt.	5B7168	▲9390HD
Belt - Gen.; W/Centrifugal W.P.	1H9348	③▲9480HD
Belt - Gen.; W/O Centrifugal W.P.	2L5730	②▲9580HD
Belt - Starter	6B5653	TR24438
D315C (48B); D315C (52B)		
Belt - W.P.; W/51" Belt O.C.	4F7956	TR34506
Belt - W.P.; W/67" Belt O.C.		TR24664
Belt - Gen.; W/67 1/8" Belt O.C.		②TR24664
Belt - Gen.; Conversion	2L5730	②▲9580HD
Belt - Starter	6B5653	TR24438
Belt - Compr.	8F2434	TR24500
D318		
Hose - Upper; Ser. No. 5V5001 & After(2" I.D.)		24432
D318 (3V); D318 (5V); D318 (6V)		
Belt - Alt.	5B7168	▲9390HD
Belt - Gen.; W/48 15/32" Belt O.C.	1H9348	③▲9480HD
Belt - Gen.; W/58 3/8" Belt O.C.	2L5730	②▲9580HD
Belt - Gov.	4B2544	▲9425HD
Belt - Starter	6B2746	TR24489
D318 (45B)		
Belt - Gen.; Conversion	2L5730	②▲9580HD
Belt - Compr.	8F2434	TR24500
D318 (53B)		
Belt - Gen.		②TR24664
D318G (3V); D318G (5V); D318G (6V)		
Belt - Alt.	5B7168	▲9390HD
Belt - Gen.; W/48 15/32" Belt O.C.	1H9348	③▲9480HD
Belt - Gen.; W/58 3/8" Belt O.C.	2L5730	②▲9580HD
Belt - Gov.	4B2544	▲9425HD
Belt - Starter	6B2746	TR24489
D319G (45B)		
Belt - Gen.; Conversion	2L5730	②▲9580HD
Belt - Compr.	8F2434	TR24500
D319G (53B)		
Belt - Gen.		②TR24664
D320 (63B)		
Belt - Fan	3L9717	②TR24489
Belt - W.P.; W/50 3/4" Belt O.C.	3L5751	TR24500
Belt - Alt.; W/44 1/4" Belt O.C.	5L3834	②▲9440HD
Belt - Alt.; W/57 1/4" Belt O.C.	9L1128	②▲9570HD
Belt - Gen.; W/39 1/4" Belt O.C.	5B7168	▲9390HD
Belt - Gen.; W/40 1/4" Belt O.C.	3L6309	▲9400HD
Belt - Gen.; W/41 3/4" Belt O.C.	4M6291	▲9415HD
Belt - Gen.; W/44 1/4" Belt O.C.	5L3834	②▲9440HD
Belt - Gen.; W/45 3/8" Belt O.C.	9L1739	②▲9451HD
Belt - Gen.; Conversion	2L5730	②▲9580HD
Belt - Compr.	5L1584	TR24449
D326 (25B)		
Belt - Fan; W/58 3/4" Belt O.C.	8F5164	②TR30589
D326 (39B)		
Belt - Gen.; W/36" Belt O.C.	1L6557	TR24355
Belt - Gen.; W/66 1/4" Belt O.C.	2L6332	②▲9660HD
Belt - Gen.; W/82 1/2" Belt O.C.	3L9489	②C78
D326F (25B)		
Belt - Fan; W/58 3/4" Belt O.C.	8F5164	②TR30589
D326F (39B)		
Belt - Gen.; W/36" Belt O.C.	1L6557	TR24355
Belt - Gen.; W/66 1/4" Belt O.C.	2L6332	②▲9660HD
Belt - Gen.; W/82 1/2" Belt O.C.	3L9489	②C78

Application	Mfr. Part No.	Our No.
CATERPILLAR - Continued		
D330 (2B); D330 (4B); D330 (5B)		
Belt - Fan; W/52 1/4" Belt O.C.	9L894	③▲9520HD
Belt - Fan; W/54 1/4" Belt O.C.	5L8312	③▲9540HD
Belt - Alt.; W/37 3/4" Belt O.C.	5L3979	②▲9375HD
Belt - Alt.; W/39 1/4" Belt O.C.	5B7168	▲9390HD
Belt - Alt.; W/44 1/4" Belt O.C.	7L2449	▲9440HD
Belt - Alt.; W/44 7/8" Belt O.C.	9L677	②▲9447HD
Belt - Alt.; W/47 7/8" Belt O.C.	8L8982	②▲9476HD
Belt - Alt.; W/49 1/4" Belt O.C.	9L4091	②▲9490HD
Belt - Gen.; W/50 1/4" Belt O.C.	5M8137	▲9500HD
Belt - Gen.; W/56 1/4" Belt O.C.	3S3964	▲9560HD
D330 (56B)		
Belt - Fan; W/41 3/4" Belt O.C.	4M6291	▲9415HD
Belt - Fan; W/49 5/8" Belt O.C.	3L9717	②TR24489
Belt - Fan; W/52 1/4" Belt O.C.	9L894	②▲9520HD
Belt - Gen.; W/39 1/4" Belt O.C.	5B7168	▲9390HD
Belt - Gen.; W/41 3/4" Belt O.C.	4M6291	▲9415HD
Belt - Gen.; Conversion	2L5730	②▲9580HD
Belt - Compr.; W/31 1/2" Belt O.C.	9L2266	②▲9313HD
Belt - Compr.; W/45 3/4" Belt O.C.	5L1584	TR24449
D330 (81B)		
Belt - Alt.	7L4527	②7400
D330 (82B)		
Belt - Gen.	5L3337	TR24424
D330 (85B)		
Belt - Gen.; W/Expansion Tank	5B7168	▲9390HD
Belt - Gen.; W/O Expansion Tank	4B2544	▲9425HD
D330A (2B); D330A (4B); D330A (5B)		
Belt - Fan; W/52 1/4" Belt O.C.	9L894	③▲9520HD
Belt - Fan; W/54 1/4" Belt O.C.	5L8312	③▲9540HD
Belt - Alt.; W/37 3/4" Belt O.C.	5L3979	②▲9375HD
Belt - Alt.; W/39 1/4" Belt O.C.	5B7168	▲9390HD
Belt - Alt.; W/44 1/4" Belt O.C.	7L2449	▲9440HD
Belt - Alt.; W/44 7/8" Belt O.C.	9L677	②▲9447HD
Belt - Alt.; W/47 7/8" Belt O.C.	8L8982	②▲9476HD
Belt - Alt.; W/49 1/4" Belt O.C.	9L4091	②▲9490HD
Belt - Gen.; W/50 1/4" Belt O.C.	5M8137	▲9500HD
Belt - Gen.; W/56 1/4" Belt O.C.	3S3964	▲9560HD
D330A (56B)		
Belt - Fan; W/41 3/4" Belt O.C.	4M6291	▲9415HD
Belt - Fan; W/49 5/8" Belt O.C.	3L9717	②TR24489
Belt - Fan; W/52 1/4" Belt O.C.	9L894	②▲9520HD
Belt - Gen.; W/39 1/4" Belt O.C.	5B7168	▲9390HD
Belt - Gen.; W/41 3/4" Belt O.C.	4M6291	▲9415HD
Belt - Gen.; Conversion	2L5730	②▲9580HD
Belt - Compr.; W/31 1/2" Belt O.C.	9L2266	②▲9313HD
Belt - Compr.; W/45 3/4" Belt O.C.	5L1584	TR24449
D330A (81B)		
Belt - Alt.	7L4527	②7400
D330A (82B)		
Belt - Gen.	5L3337	TR24424
D330A (85B)		
Belt - Gen.; W/Expansion Tank	5B7168	▲9390HD
Belt - Gen.; W/O Expansion Tank	4B2544	▲9425HD
D333 (23C)		
Belt - Fan; W/52 1/4" Belt O.C.	9L894	③▲9520HD
Belt - Fan; W/53 1/4" Belt O.C.	3S6272	③▲9530HD
Belt - Fan; W/54 1/4" Belt O.C.	5L8312	③▲9540HD
Belt - Alt.; W/37 1/4" Belt O.C.	5L3979	②▲9375HD
Belt - Alt.; W/39 1/4" Belt O.C.	5B7168	▲9390HD
Belt - Alt.; W/44 1/4" Belt O.C.	7L2449	▲9440HD
Belt - Alt.; W/44 7/8" Belt O.C.	9L677	②▲9447HD
Belt - Alt.; W/47 7/8" Belt O.C.	8L8982	②▲9476HD

Power Units

▲ Standard Belt Available. See Pages 630-631.
② Two Required.

③ Three Required.

Belts and Hose for Power Units

Application	Mfr. Part No.	Our No.
CATERPILLAR - Continued		
D333 (23C) - Continued		
Belt - Alt.; W/49 1/4" Belt O.C.	9L4091	②▲9490HD
Belt - Alt.; W/51 1/4" Belt O.C.	5M8137	②▲9510HD
Belt - Gen.	3S3964	▲9560HD
D333 (58B)		
Belt - Fan		②TR24489
Belt - Gen.; W/39 1/4" Belt O.C.	5B7168	▲9390HD
Belt - Gen.; W/41 3/4" Belt O.C.	4M6291	▲9415HD
D333 (59B)		
Belt - Gen.; W/40 1/4" Belt O.C.	3L6309	▲9400HD
Belt - Gen.; W/41 3/4" Belt O.C.	4M6291	▲9415HD
Belt - Gen.; W/43" Belt O.C.	5L3337	TR24424
Belt - Gen.; W/44 1/4" Belt O.C.	5L3834	②▲9440HD
Belt - Gen.; W/53 1/4" Belt O.C.	5L3307	②▲9530HD
D333 (66D); D333 (67D)		
Belt - Fan; W/52 1/4" Belt O.C.	9L894	③▲9520HD
Belt - Fan; W/53 1/4" Belt O.C.	3S6272	③▲9530HD
Belt - Fan; W/54 1/4" Belt O.C.	5L8312	③▲9540HD
Belt - Alt.; W/37 1/4" Belt O.C.	5L3979	②▲9375HD
Belt - Alt.; W/39 1/4" Belt O.C.	5B7168	▲9390HD
Belt - Alt.; W/44 1/4" Belt O.C.	7L2449	▲9440HD
Belt - Alt.; W/44 7/8" Belt O.C.	9L677	②▲9447HD
Belt - Alt.; W/47 7/8" Belt O.C.	8L8982	②▲9476HD
Belt - Alt.; W/49 1/4" Belt O.C.	9L4091	②▲9490HD
Belt - Alt.; W/51 1/4" Belt O.C.	5M8137	②▲9510HD
Belt - Gen.	3S3964	▲9560HD
D333 (79B)		
Belt - Alt./Gen.; W/Expansion Tank	5B7168	▲9390HD
Belt - Alt./Gen.; W/O Expansion Tank	4B2544	▲9425HD
D333 (79C)		
Belt - Fan & W.P.	5F7676	TR30484
D333 (80B)		
Belt - Alt.	5L3826	②▲9440HD
Belt - Gen.	5L3337	TR24424
D333 (87B)		
Belt - Fan & Idler	5L4660	②TR24489
Belt - Alt.	7L4528	②7400
Belt - Gen.; W/Expansion Tank	5B7168	▲9390HD
Belt - Gen.; W/O Expansion Tank	4B2544	▲9425HD
D333A (23C)		
Belt - Fan; W/52 1/4" Belt O.C.	9L894	③▲9520HD
Belt - Fan; W/53 1/4" Belt O.C.	3S6272	③▲9530HD
Belt - Fan; W/54 1/4" Belt O.C.	5L8312	③▲9540HD
Belt - Alt.; W/37 1/4" Belt O.C.	5L3979	②▲9375HD
Belt - Alt.; W/39 1/4" Belt O.C.	5B7168	▲9390HD
Belt - Alt.; W/44 1/4" Belt O.C.	7L2449	▲9440HD
Belt - Alt.; W/44 7/8" Belt O.C.	9L677	②▲9447HD
Belt - Alt.; W/47 7/8" Belt O.C.	8L8982	②▲9476HD
Belt - Alt.; W/49 1/4" Belt O.C.	9L4091	②▲9490HD
Belt - Alt.; W/51 1/4" Belt O.C.	5M8137	②▲9510HD
Belt - Gen.	3S3964	▲9560HD
D333A (58B)		
Belt - Fan		②TR24489
Belt - Gen.; W/39 1/4" Belt O.C.	5B7168	▲9390HD
Belt - Gen.; W/41 3/4" Belt O.C.	4M6291	▲9415HD
D333A (59B)		
Belt - Gen.; W/40 1/4" Belt O.C.	3L6309	▲9400HD
Belt - Gen.; W/41 3/4" Belt O.C.	4M6291	▲9415HD
Belt - Gen.; W/43" Belt O.C.	5L3337	TR24424
Belt - Gen.; W/44 1/4" Belt O.C.	5L3834	②▲9440HD
Belt - Gen.; W/53 1/4" Belt O.C.	5L3307	②▲9530HD
D333A (66D); D333A (67D)		
Belt - Fan; W/52 1/4" Belt O.C.	9L894	③▲9520HD

Application	Mfr. Part No.	Our No.
CATERPILLAR - Continued		
D333A (66D); D333A (67D) - Continued		
Belt - Fan; W/53 1/4" Belt O.C.	3S6272	③▲9530HD
Belt - Fan; W/54 1/4" Belt O.C.	5L8312	③▲9540HD
Belt - Alt.; W/37 1/4" Belt O.C.	5L3979	②▲9375HD
Belt - Alt.; W/39 1/4" Belt O.C.	5B7168	▲9390HD
Belt - Alt.; W/44 1/4" Belt O.C.	7L2449	▲9440HD
Belt - Alt.; W/44 7/8" Belt O.C.	9L677	②▲9447HD
Belt - Alt.; W/47 7/8" Belt O.C.	8L8982	②▲9476HD
Belt - Alt.; W/49 1/4" Belt O.C.	9L4091	②▲9490HD
Belt - Alt.; W/51 1/4" Belt O.C.	5M8137	②▲9510HD
Belt - Gen.	3S3964	▲9560HD
D333A (79B)		
Belt - Alt./Gen.; W/Expansion Tank	5B7168	▲9390HD
Belt - Alt./Gen.; W/O Expansion Tank	4B2544	▲9425HD
D333A (79C)		
Belt - Fan & W.P.	5F7676	TR30484
D333A (80B)		
Belt - Alt.	5L3826	②▲9440HD
Belt - Gen.	5L3337	TR24424
D333A (87B)		
Belt - Fan & Idler	5L4660	②TR24489
Belt - Alt.	7L4528	②7400
Belt - Gen.; W/Expansion Tank	5B7168	▲9390HD
Belt - Gen.; W/O Expansion Tank	4B2544	▲9425HD
D334 (92B)		
Belt - Fan	6L3294	③▲9650HD
Belt - W.P.	9L1731	②▲9540HD
Belt - Alt.	5L3337	TR24424
D334 (93B)		
Belt - Alt.; W/47 7/8" Belt O.C.	6L3408	②▲9476HD
Belt - Alt.; W/49 1/4" Belt O.C.	9L4091	②▲9490HD
D337F (37B)		
Belt - Gen.; W/36" Belt O.C.	1L6557	TR24355
D339 (34B)		
Belt - Fan	1L5681	②TR30652
Belt - Gen.	1L6557	②TR24355
D342 (5A)		
Belt - Fan; Ser. No. 5A8403 To 5A8462	5L5015	②TR30672
Belt - Alt.; Ser. No. 5A8403 To 5A8462	1N8405	②7365
D342 (31B); D342 (49B)		
Belt - Fan; W/63 3/4" Belt O.C.	6B8536	TR28628
Belt - Fan; W/65 1/2" Belt O.C.	1L5681	②TR30652
Belt - Fan; W/77 1/8" Belt O.C.	1H6929	②TR30770
Belt - Alt.		②7365
Belt - Gen.	1L6557	TR24355
D342 (71B)		
Belt - Fan	2M8183	②TR30672
D342C (5A)		
Belt - Fan; Ser. No. 5A8403 To 5A8462	5L5015	②TR30672
Belt - Alt.; Ser. No. 5A8403 To 5A8462	1N8405	②7365
D342C (31B); D342C (49B)		
Belt - Fan; W/63 3/4" Belt O.C.	6B8536	TR28628
Belt - Fan; W/65 1/2" Belt O.C.	1L5681	②TR30652
Belt - Fan; W/77 1/8" Belt O.C.	1H6929	②TR30770
Belt - Alt.		②7365
Belt - Gen.	1L6557	TR24355
D342C (71B)		
Belt - Fan	2M8183	②TR30672

② Two Required.
③ Three Required.

▲ Standard Belt Available. See Pages 630-631.

Belts and Hose for Power Units

Application	Mfr. Part No.	Our No.
CATERPILLAR - Continued		
D343 (33B)		
Belt - Alt.; W/47 7/8" Belt O.C.	6L3408	♣9476HD
Belt - Alt.; W/50 3/4" Belt O.C.	5L4996	②♣9505HD
Belt - Alt.; W/55 1/4" Belt O.C.	6L4394	②♣9550HD
Belt - Gen.; W/44 1/4" Belt O.C.	5L3834	♣9440HD
Belt - Gen.; W/48 1/4" Belt O.C.	9L2248	♣9480HD
D343 (62B)		
Belt - Fan; W/56 1/2" Belt O.C.	4L4648	②TR24562
Belt - Fan; W/58 3/4" Belt O.C.	6L9903	③TR24578
Belt - Alt.	6L3408	♣9476HD
D346 (39J)		
Belt - Alt.	1N9310	②7500
D346 (40J)		
Belt - Alt.	7L5091	②7490
D346 (77F)		
Belt - Fan; Ser. No. 77F1 Thru 77F246	2H1383	③TR30672
Belt - W.P.	4M6292	TR24619
D353 (46B); D353 (77B); D353C (46B); D353C (77B)		
Belt - Fan; W/75 1/2" Belt O.C.	2M8255	②TR30754
Belt - Fan; W/81 1/8" Belt O.C.	3L6052	②TR30808
Belt - Fan; W/85 5/8" Belt O.C.	5H7371	②CX81
Belt - Alt.	8M1715	TR24664
D364 (19B); D364 (21B)		
Belt - Gov.	3L3853	♣9341HD
Belt - Starter	5B8473	③TR24515
D375		
Hose - Lower; Ser. No. 16B238 & After(4" I.D.)		24464
D375 (16B); D375 (18B)		
Belt - Starter	5B8473	③TR24515
D375 (43B)		
Belt - Gov.	3L3853	♣9341HD
D375D (16B); D375D (18B)		
Belt - Starter	5B8473	③TR24515
D375D (43B)		
Belt - Gov.	3L3853	♣9341HD
D379 (68B); D379 (76B)		
Belt - Gen.; W/40 1/4" Belt O.C.	3L6309	♣9400HD
Belt - Gen.; W/43" Belt O.C.	5L3337	TR24424
Belt - Fan	4M5413	TR30710
D386 (10B); D386 (12B); D386 (15B)		
Belt - Fan; W/71 1/2" Belt O.C.	4M5413	TR30710
Belt - Gov.	3L3853	♣9341HD
Belt - Starter	5B8473	TR24515
D397		
Hose - Lower; Ser. No. 12B221 To 12B399(4" I.D.)		24464
D397 (10B); D397 (12B); D397 (15B); D397D (10B); D397D (12B); D397D (15B)		
Belt - Fan; W/71 1/2" Belt O.C.	4M5413	TR30710
Belt - Gov.	3L3853	♣9341HD
Belt - Starter	5B8473	TR24515
D398 (66B)		
Belt - Alt.	5L3979	♣9375HD
Belt - Gen.; W/40 1/4" Belt O.C.	3L6309	♣9400HD
Belt - Gen.; W/43" Belt O.C.	5L3337	TR24424
D398 (75B)		
Belt - Gen.; W/40 1/4" Belt O.C.	3L6309	♣9400HD
Belt - Gen.; W/43" Belt O.C.	5L3337	TR24424

Application	Mfr. Part No.	Our No.
CATERPILLAR - Continued		
D399 (91B)		
Belt - Alt.	5L3979	②♣9375HD
D1402		
Belt - Fan & Alt.	REMF1420	7420
D3400 (1T)		
Belt - W.P.	5B8473	③TR24515
Belt - Alt.	5B7168	♣9390HD
Belt - Starter	6B5653	③TR24438
D3400 (3R)		
Belt - Fan; W/71 1/2" Belt O.C.	5L5656	TR30710
Belt - Fan; W/72 5/8" Belt O.C.	7B344	②CX68
Belt - W.P.; W/52 1/4" Belt O.C.	5B8473	③TR24515
Belt - Alt.	5B7168	♣9390HD
Belt - Starter; Ser. No. 3R6001 Thru 3R7000	6B5653	TR24438
Belt - Starter; Ser. No. 3R7001 Thru 3R7532	6B2746	TR24489
D3400 (3S)		
Belt - Fan; W/72 5/8" Belt O.C.	7B344	②CX68
Belt - Fan; W/77 1/8" Belt O.C.	7H9806	②TR30770
Belt - W.P.; W/52 1/4" Belt O.C.	5B8473	③TR24515
Belt - W.P.; W/85 5/8" Belt O.C.	8B9947	CX81
Belt - Alt.	5B7168	♣9390HD
Belt - Gen.; W/63 3/4" Belt O.C.	6B8536	TR28628
D3400 (9J)		
Belt - Gen.	6B8536	TR28628
D4400 (1S); D4400 (3R); D4400 (5S); D4400 (6S); D4600 (1S); D4600 (3R); D4600 (5S); D4600 (6S)		
Belt - W.P.; W/49 3/4" Belt O.C.	7B4032	TR34495
Belt - W.P.; W/58 3/4" Belt O.C.	4B8598	TR24578
Belt - W.P.; W/64 1/8" Belt O.C.	8B4881	TR24638
Belt - Alt.; W/39 1/2" Belt O.C.	5B7168	♣9390HD
Belt - Alt.; W/71 1/2" Belt O.C.	5L5656	TR30710
Belt - Gen. & V.P.	8B5457	②♣9313HD
Belt - Starter; W/43 7/8" Belt O.C.	6B5653	TR24438
Belt - Starter; W/49 5/8" Belt O.C.	6B2746	TR24489
D8800 (3V)		
Belt - Fan & W.P.	4F7956	TR34506
D13000		
Hose - Upper; Ser. No. 1N9001 To 1N9999(2" I.D.)		24432
Hose - Upper; Ser. No. 3R7001 To 3R9999(2" I.D.)		24432
Hose - Upper; Ser. No. 3S2001 To 3S7000(2" I.D.)		24432
Hose - Lower; Ser. No. 1N9001 To 1N9999(1 5/8" I.D.)		24226
Hose - Lower; Ser. No. 3R7001 To 3R9999(1 5/8" I.D.)		24226
Hose - Lower; Ser. No. 3S2001 To 3S7000(1 5/8" I.D.)		24226
D13000 (1N)		
Belt - Fan; W/71 1/2" Belt O.C.	7M4709	TR30710
Belt - Fan; W/72 5/8" Belt O.C.	7B344	②CX68
D13000 (2V)		
Belt - Fan; W/71 1/2" Belt O.C.	7M4709	TR30710
D13000 (3R); D13000 (3S); D13000 (4S)		
Belt - Fan; W/71 1/2" Belt O.C.	7M4709	TR30710
Belt - Fan; W/72 5/8" Belt O.C.	7B344	②CX68
Belt - Fan; W/77 1/8" Belt O.C.	7H9806	②TR30770
Belt - Starter	6B2746	TR24489
D17000		
Hose - Upper; Ser. No. 9J5214 To 9J6000; W/4F6354 Rad.(2 1/2" I.D.)		24440
Hose - Upper; Ser. No. 3S1 To 3S2000; W/4F6354 Rad.(2 1/2" I.D.)		24440
D17000 (2V); D17000 (3S); D17000 (8S)		
Belt - Fan; W/71 1/2" Belt O.C.	7M4709	TR30710

Power Units

♣ Standard Belt Available. See Pages 630-631.

③ Three Required.

② Two Required.

Belts and Hose for Power Units

Application	Mfr. Part No.	Our No.
CATERPILLAR - Continued		
D17000 (2V); D17000 (3S); D17000 (8S) - Continued		
Belt - W.P.; W/Aux. W.P.	8B9947	CX81
Belt - Gen.; W/63 3/4" Belt O.C.	6B8536	TR28628
Belt - Starter	6B2746	TR24489
S135 (4V)		
Belt - W.P.	4F7956	TR34506
Belt - Alt.	5B7168	▲9390HD
Belt - Gen.	2L5730	②▲9580HD
Belt - Starter	6B5653	TR24438
S318 (3V)		
Belt - Fan & W.P.	4F7956	TR34506
Belt - Gen.	2L5730	②▲9580HD
Belt - Gov.	4B2544	▲9425HD
CUMMINS		
6CTA 8.3 L GST		
Hose - Upper - Eng. To Pipe; (2 1/4" I.D.)		24436
Hose - Upper - Pipe To Rad.; (2 1/4" I.D.)		24436
Hose - Lower - Eng. To Pipe; (2" I.D.)		24432
Hose - Lower - Pipe To Rad.; (2" I.D.)		24432
65BT61; 80BT61; 85BT61; 100BT62		
Belt - Fan & Alt.	3911560	▲K080550HD
150CTA61; 175CTA62		
Belt - Fan & Alt.	3911573	▲K080615HD
Belt - Alt.	3911560	▲K080550HD
Hose - Lower; W/Cummins 6Cta8.3G Eng.		21901
220NT5; 250NT5; 275NTA2; 300NTA2; 310NTA3; 350NTA3		
Belt - Fan	5110160	②TR28412
Belt - Alt.; W/35A. Alt.	5110084	▲9470HD
Belt - Alt.; W/75A. Alt.	5110156	②▲9463HD
620KTA31; 660KTA32; 750KTA31; 800KTA32; 800KTA33; 900KTA33		
Belt - Alt.; W/35A. Alt.	511016102	▲K050345HD
C-90-B; C-90-BI		
Belt - Fan & Gen.	132013	②TR22434
C-90-I; C-90-IP		
Belt - Fan & Gen.	124927	②TR22588
C-105-B; C-105-BI		
Belt - Fan & Gen.	132013	②TR22434
C-105-I; C-105-IP		
Belt - Fan & Gen.	124927	②TR22588
C-140-B		
Belt - Fan & Gen.	132013	②TR22434
C-145		
Belt - W.P.	172856	②TR24457
Belt - Alt.	178387	TR22392
C-160		
Belt - Fan; Auto.; W/2800 R.P.M.	178539	②TR24379
C-160-B		
Belt - Fan; Auto.; W/O 2800 R.P.M.	124466	②TR24365
Belt - Fan; Auto.; W/2800 R.P.M.	178539	②TR22363
Belt - W.P.; Auto.	178455	TR22299
Belt - Gen.; Auto.	134778	TR22517
Belt - Alt.; Auto.; W/2500 R.P.M.	178470	TR22474
Belt - Alt.; W/2500 R.P.M.	178685	TR22485
Belt - Alt.; Auto.; W/2800 R.P.M.	178601	TR22534

Application	Mfr. Part No.	Our No.
CUMMINS - Continued		
C-160-BI; C-160-CI		
Belt - Fan; Auto.; W/O 2800 R.P.M.	124466	②TR24365
Belt - Fan; Auto.; W/2800 R.P.M.	178539	②TR22363
Belt - W.P.; Auto.	178455	TR22299
Belt - Gen.	70885	TR22495
Belt - Alt.; W/2500 R.P.M.	178685	TR22485
C-160-IP		
Belt - Fan	178530	②TR22358
Belt - W.P.	178490	TR22329
Belt - Alt.	178470	TR22474
C-175-B; C-175-BI; C-175-CI		
Belt - Fan	178530	②TR22358
Belt - W.P.; W/30 3/4" Belt O.C.	178455	TR22299
Belt - W.P.; W/34 1/4" Belt O.C.	178488	TR22336
Belt - W.P.; W/35 5/8" Belt O.C.	178567	TR22350
Belt - Alt.; Auto.	178685	TR22485
C-175-IP		
Belt - Fan	178530	②TR22358
Belt - W.P.; W/30 3/4" Belt O.C.	178455	TR22299
Belt - W.P.; W/34 1/4" Belt O.C.	178488	TR22336
Belt - W.P.; W/35 5/8" Belt O.C.	178567	TR22350
Belt - Alt.	178490	TR22329
C-180		
Belt - Fan	178530	②TR22358
Belt - Alt.	178470	TR22474
C-180-B; C-180-BI		
Belt - Fan	178530	②TR22358
Belt - Gen.; Auto.	70885	TR22495
Belt - Alt.	178470	TR22474
C-180-CI		
Belt - Fan	178530	②TR22358
Belt - Gen.	70184	2270
Belt - Alt.	178470	TR22474
C-180-IP		
Belt - Fan	178530	②TR22358
Belt - Alt.	178470	TR22474
C-190		
Belt - Fan	124426	②TR24400
Belt - W.P.; W/30 3/4" Belt O.C.	178455	TR22299
Belt - W.P.; W/34 1/4" Belt O.C.	178488	TR22336
Belt - W.P.; W/35 5/8" Belt O.C.	178567	TR22350
Belt - Alt.	178571	TR22434
C-464-B160		
Belt - Fan; Auto.; W/O 2800 R.P.M.	124466	②TR24365
Belt - Fan; Auto.; W/2800 R.P.M.	178539	②TR22363
Belt - W.P.; Auto.	178455	TR22299
Belt - Gen.; Auto.	134778	TR22517
Belt - Alt.; Auto.; W/2500 R.P.M.	178470	TR22474
Belt - Alt.; W/2500 R.P.M.	178685	TR22485
Belt - Alt.; Auto.; W/2800 R.P.M.	178601	TR22534
C-464-C160		
Belt - Fan; Auto.; W/O 2800 R.P.M.	124466	②TR24365
Belt - Fan; Auto.; W/2800 R.P.M.	178539	②TR22363
Belt - W.P.; Auto.	178455	TR22299
Belt - Alt.; W/2500 R.P.M.	178685	TR22485
C-464-P160		
Belt - Fan	178530	②TR22358
Belt - W.P.	178490	TR22329
Belt - Alt.	178470	TR22474
CF-160		
Belt - Fan; Auto.; W/2800 R.P.M.	178539	②TR22363

▲ Standard Belt Available. See Pages 630-631.

② Two Required.

Belts and Hose for Power Units

Application	Mfr. Part No.	Our No.	Application	Mfr. Part No.	Our No.
CUMMINS - Continued			CUMMINS - Continued		
CF-160-B			H-6-B - Continued		
Belt - Fan; Auto.; W/O 2800 R.P.M.	124466	ⓉTR24365	Belt - Gen.	70350	TR22358
Belt - Fan; Auto.; W/2800 R.P.M.	178539	ⓉTR22363	Belt - V.P.; W/27" Belt O.C.	S2465	2270
Belt - W.P.; Auto.	178455	TR22299	Belt - V.P.; W/32 1/8" Belt O.C.	69311	♣9319HD
Belt - Gen.; Auto.	134778	TR22517	H-6-BI; H-6-CI		
Belt - Alt.; Auto.; W/2500 R.P.M.	178470	TR22474	Belt - Fan & W.P.; W/41 1/8" Belt O.C.	134773	ⓉTR22405
Belt - Alt.; W/2500 R.P.M.	178685	TR22485	Belt - Fan & W.P.; W/46 3/8" Belt O.C.	172856	ⓉTR24457
Belt - Alt.; Auto.; W/2800 R.P.M.	178601	TR22534	Belt - Gen.	70350	TR22358
CR-160-CI			Belt - Alt.	178556	TR22363
Belt - Fan	178530	ⓉTR22358	Belt - V.P.; W/27" Belt O.C.	S2465	2270
Belt - Gen.; Auto.	70885	TR22495	Belt - V.P.; W/32 1/8" Belt O.C.	69311	♣9319HD
Belt - Alt.	178470	TR22474	H-6-G		
CS-195			Belt - Fan & W.P.	70524	ⓉTR22405
Belt - Fan	178530	ⓉTR22358	Belt - Gen.	70350	TR22358
Belt - Alt.	178470	TR22474	H-6-I		
CS-195-B			Belt - Fan	178617	ⓉTR30506
Belt - Fan	178530	ⓉTR22358	Belt - Fan & W.P.; W/41 1/8" Belt O.C.	134773	ⓉTR22405
Belt - Gen.; Auto.	70885	TR22495	Belt - Fan & W.P.; W/46 3/8" Belt O.C.	172856	ⓉTR24457
Belt - Alt.	178470	TR22474	Belt - Gen.	70350	TR22358
CS-195-CI			Belt - V.P.; W/27" Belt O.C.	S2465	2270
Belt - Fan	178530	ⓉTR22358	Belt - V.P.; W/32 1/8" Belt O.C.	69311	♣9319HD
Belt - Alt.	178470	TR22474	H-6-IF		
CS-464-B180			Belt - Fan & W.P.; W/41 1/8" Belt O.C.	134773	ⓉTR22405
Belt - Fan	178530	ⓉTR22358	Belt - Fan & W.P.; W/46 3/8" Belt O.C.	172856	ⓉTR24457
Belt - Gen.; Auto.	70885	TR22495	Belt - Gen.	134797	TR22410
Belt - Alt.	178470	TR22474	H-6-IP; H-6-P		
CS-464-C160			Belt - Fan & W.P.	70524	ⓉTR22405
Belt - Fan	178530	ⓉTR22358	Belt - Gen.	70350	TR22358
Belt - Alt.	178470	TR22474	H-135-CI		
CS-464-C180			Belt - W.P.	172856	TR24457
Belt - Fan	178530	ⓉTR22358	Belt - Alt.	178556	TR22363
Belt - Gen.; Auto.	70885	TR22495	H-743-C		
Belt - Alt.	178470	TR22474	Belt - Fan		ⓉTR30506
CS-464-C195; CS-464-P180			Belt - W.P.	178570	TR24400
Belt - Fan	178530	ⓉTR22358	Belt - Gen.	178567	TR22350
Belt - Alt.	178470	TR22474	H-743-L		
CT-464-B175			Belt - Fan		ⓉTR24457
Belt - Fan	178530	ⓉTR22358	Belt - Gen.	178436	TR22358
Belt - W.P.; W/30 3/4" Belt O.C.	178455	TR22299	HR-4-B; HR-4-BI		
Belt - W.P.; W/34 1/4" Belt O.C.	178488	TR22336	Belt - Fan & W.P.; W/41 1/8" Belt O.C.	134773	ⓉTR22405
Belt - W.P.; W/35 5/8" Belt O.C.	178567	TR22350	Belt - Fan & W.P.; W/46 3/8" Belt O.C.	172856	ⓉTR24457
Belt - Alt.; Auto.	178685	TR22485	Belt - Gen.	70350	TR22358
CT-464-C175			Belt - V.P.; W/27" Belt O.C.	S2465	2270
Belt - Fan	178530	ⓉTR22358	Belt - V.P.; W/32 1/8" Belt O.C.	69311	♣9319HD
Belt - W.P.; W/30 3/4" Belt O.C.	178455	TR22299	HR-4-G		
Belt - W.P.; W/34 1/4" Belt O.C.	178488	TR22336	Belt - Fan	134817	ⓉTR30506
Belt - W.P.; W/35 5/8" Belt O.C.	178567	TR22350	Belt - W.P.	132012	TR24400
Belt - Gen.	70885	TR22495	Belt - Gen.	178567	TR22350
CT-464-P175			HR-4-I		
Belt - Fan	178530	ⓉTR22358	Belt - Fan & W.P.; W/41 1/8" Belt O.C.	134773	ⓉTR22405
Belt - W.P.; W/30 3/4" Belt O.C.	178455	TR22299	Belt - Fan & W.P.; W/46 3/8" Belt O.C.	172856	ⓉTR24457
Belt - W.P.; W/34 1/4" Belt O.C.	178488	TR22336	Belt - Gen.	70350	TR22358
Belt - W.P.; W/35 5/8" Belt O.C.	178567	TR22350	Belt - V.P.; W/27" Belt O.C.	S2465	2270
Belt - Alt.	178490	TR22329	Belt - V.P.; W/32 1/8" Belt O.C.	69311	♣9319HD
CTA61; CTA62			HR-4-IP; HR-4-P		
Belt - Fan & Alt.	3911573	♣K080615HD	Belt - Fan	134817	ⓉTR30506
Belt - Alt.	3911560	♣K080550HD	Belt - W.P.	132012	TR24400
Hose - Lower; W/Cummins 6Cta8.3G Eng.		21901	Belt - Gen.	178567	TR22350
H-6-B			HR-6-B; HR-6-BI; HR-6-CI		
Belt - Fan & W.P.; W/41 1/8" Belt O.C.	134773	ⓉTR22405	Belt - Fan & W.P.; W/41 1/8" Belt O.C.	134773	ⓉTR22405
Belt - Fan & W.P.; W/46 3/8" Belt O.C.	172856	ⓉTR24457	Belt - Fan & W.P.; W/46 3/8" Belt O.C.	172856	ⓉTR24457

Ⓣ Two Required.

♣ Standard Belt Available. See Pages 630-631.

Power Units

Belts and Hose for Power Units

Application	Mfr. Part No.	Our No.
CUMMINS - Continued		
HR-6-B; HR-6-BI; HR-6-CI - Continued		
Belt - Gen.	70350	TR22358
Belt - V.P.; W/27" Belt O.C.	S2465	2270
Belt - V.P.; W/32 1/8" Belt O.C.	69311	▲9319HD
HR-6-G		
Belt - Fan & W.P.	70524	②TR22405
Belt - Gen.	70350	TR22358
HR-6-I		
Belt - Fan & W.P.; W/41 1/8" Belt O.C.	134773	②TR22405
Belt - Fan & W.P.; W/46 3/8" Belt O.C.	172856	②TR24457
Belt - Gen.	70350	TR22358
Belt - V.P.; W/27" Belt O.C.	S2465	2270
Belt - V.P.; W/32 1/8" Belt O.C.	69311	▲9319HD
HR-6-IP; HR-6-P		
Belt - Fan & W.P.	70524	②TR22405
Belt - Gen.	70350	TR22358
HRC-4-B; HRC-4-BI		
Belt - Fan & W.P.; W/41 1/8" Belt O.C.	134773	②TR22405
Belt - Fan & W.P.; W/46 3/8" Belt O.C.	172856	②TR24457
Belt - Gen.	70350	TR22358
Belt - V.P.; W/27" Belt O.C.	S2465	2270
Belt - V.P.; W/32 1/8" Belt O.C.	69311	▲9319HD
HRC-4-G		
Belt - Fan	134817	②TR30506
Belt - W.P.	132012	TR24400
Belt - Gen.	178567	TR22350
HRC-4-I		
Belt - Fan & W.P.; W/41 1/8" Belt O.C.	134773	②TR22405
Belt - Fan & W.P.; W/46 3/8" Belt O.C.	172856	②TR24457
Belt - Gen.	70350	TR22358
Belt - V.P.; W/27" Belt O.C.	S2465	2270
Belt - V.P.; W/32 1/8" Belt O.C.	69311	▲9319HD
HRC-4-IP; HRC-4-P		
Belt - Fan	134817	②TR30506
Belt - W.P.	132012	TR24400
Belt - Gen.	178567	TR22350
HRF-6-B; HRF-6-BI; HRF-6-CI		
Belt - Fan & W.P.; W/41 1/8" Belt O.C.	134773	②TR22405
Belt - Fan & W.P.; W/46 3/8" Belt O.C.	172856	②TR24457
Belt - Gen.	70350	TR22358
Belt - V.P.; W/27" Belt O.C.	S2465	2270
Belt - V.P.; W/32 1/8" Belt O.C.	69311	▲9319HD
HRF-6-G		
Belt - Fan & W.P.	70524	②TR22405
Belt - Gen.	70350	TR22358
HRF-6-I		
Belt - Fan & W.P.; W/41 1/8" Belt O.C.	134773	②TR22405
Belt - Fan & W.P.; W/46 3/8" Belt O.C.	172856	②TR24457
Belt - Gen.	70350	TR22358
Belt - V.P.; W/27" Belt O.C.	S2465	2270
Belt - V.P.; W/32 1/8" Belt O.C.	69311	▲9319HD
HRF-6-IP; HRF-6-P		
Belt - Fan & W.P.	70524	②TR22405
Belt - Gen.	70350	TR22358
HRS-6-B; HRS-6-BI; HRS-6-CI		
Belt - Fan & W.P.; W/41 1/8" Belt O.C.	134773	②TR22405
Belt - Fan & W.P.; W/46 3/8" Belt O.C.	172856	②TR24457
Belt - Gen.	134797	TR22410
HRS-6-G		
Belt - Fan	134817	②TR30506
Belt - W.P.	132012	TR24400

Application	Mfr. Part No.	Our No.
CUMMINS - Continued		
HRS-6-G - Continued		
Belt - Gen.	134797	TR22410
HRS-6-I		
Belt - Fan & W.P.; W/41 1/8" Belt O.C.	134773	②TR22405
Belt - Fan & W.P.; W/46 3/8" Belt O.C.	172856	②TR24457
Belt - Gen.	134797	TR22410
HRS-6-IP; HRS-6-P		
Belt - Fan	134817	②TR30506
Belt - W.P.	132012	TR24400
Belt - Gen.	134797	TR22410
HS-6-B; HS-6-BI; HS-6-CI		
Belt - Fan & W.P.; W/41 1/8" Belt O.C.	134773	②TR22405
Belt - Fan & W.P.; W/46 3/8" Belt O.C.	172856	②TR24457
Belt - Gen.	134797	TR22410
HS-6-G		
Belt - Fan	134817	②TR30506
Belt - W.P.	132012	TR24400
Belt - Gen.	134797	TR22410
HS-6-I		
Belt - Fan & W.P.; W/41 1/8" Belt O.C.	134773	②TR22405
Belt - Fan & W.P.; W/46 3/8" Belt O.C.	172856	②TR24457
Belt - Gen.	134797	TR22410
HS-6-IP; HS-6-P		
Belt - Fan	134817	②TR30506
Belt - W.P.	132012	TR24400
Belt - Gen.	134797	TR22410
J-4		
Belt - Fan & Gen.; W/39 3/4" Belt O.C.	124928	②TR22392
Belt - Fan & Gen.; W/44 1/4" Belt O.C.	118637	②▲9440HD
Belt - Gen.	129592	②TR22344
Belt - Gen. & V.P.	106070	TR22474
Belt - Compr. & Hyd. Pump	124929	6932
J-6		
Belt - Gen.; W/45" Belt O.C.	101426	TR22443
Belt - Gen.; W/48" Belt O.C.	178470	TR22474
Belt - Gen.; W/50" Belt O.C.	70885	TR22495
J-6-BI; J-6-CI		
Belt - Fan; Auto.; W/O 130 H.P.; W/O 2800 R.P.M.	124466	②TR24365
Belt - Fan; Auto.; W/130 H.P.; W/2800 R.P.M.	178539	②TR22363
Belt - W.P.; Auto.	178455	TR22299
Belt - Gen.; W/45" Belt O.C.	101426	TR22443
Belt - Gen.; W/48" Belt O.C.	178470	TR22474
Belt - Gen.; W/50" Belt O.C.	70885	TR22495
Belt - Alt.; Auto.; W/130 H.P.; W/2800 R.P.M.	178470	TR22474
Belt - Alt.; Auto.; W/Turbo, Super Turbo	178685	TR22485
J-6-I		
Belt - Fan	124421	TR24365
Belt - W.P.; W/33 1/2" Belt O.C.	178490	TR22329
Belt - W.P.; W/36 5/8" Belt O.C.	178530	②TR22358
Belt - Gen.; W/45" Belt O.C.	101426	TR22443
Belt - Gen.; W/48" Belt O.C.	178470	TR22474
Belt - Gen.; W/50" Belt O.C.	70885	TR22495
J-6-IP		
Belt - Fan	124421	TR24365
Belt - W.P.; W/33 1/2" Belt O.C.	178490	TR22329
Belt - W.P.; W/36 5/8" Belt O.C.	178530	②TR22358
Belt - Gen.; W/45" Belt O.C.	101426	TR22443
Belt - Gen.; W/48" Belt O.C.	178470	TR22474
Belt - Gen.; W/50" Belt O.C.	70885	TR22495
Belt - Alt.; Auto.; W/Turbo, Super Turbo	178685	TR22485
J-6-P		
Belt - Fan	124421	TR24365

▲ Standard Belt Available. See Pages 630-631.

② Two Required.

Belts and Hose for Power Units

Application	Mfr. Part No.	Our No.	Application	Mfr. Part No.	Our No.
CUMMINS - Continued			CUMMINS - Continued		
J-6-P - Continued			JN-6-IP		
Belt - W.P.; W/33 1/2" Belt O.C.	178490	TR22329	Belt - Fan	124421	TR24365
Belt - W.P.; W/36 5/8" Belt O.C.	178530	②TR22358	Belt - W.P.; W/33 1/2" Belt O.C.	178490	TR22329
Belt - Gen.; W/45" Belt O.C.	101426	TR22443	Belt - W.P.; W/36 5/8" Belt O.C.	178530	②TR22358
Belt - Gen.; W/48" Belt O.C.	178470	TR22474	Belt - Gen.; W/45" Belt O.C.	101426	TR22443
Belt - Gen.; W/50" Belt O.C.	70885	TR22495	Belt - Gen.; W/48" Belt O.C.	178470	TR22474
J-70-B; J-70-BI			Belt - Gen.; W/50" Belt O.C.	70885	TR22495
Belt - Fan & Gen.	132013	②TR22434	Belt - Alt.; Auto.; W/Turbo, Super Turbo	178685	TR22485
J-70-I; J-70-IP			JN-6-P		
Belt - Fan & Gen.	124927	②TR22588	Belt - Fan	124421	TR24365
J-80-B; J-80-BI			Belt - W.P.; W/33 1/2" Belt O.C.	178490	TR22329
Belt - Fan & Gen.	132013	②TR22434	Belt - W.P.; W/36 5/8" Belt O.C.	178530	②TR22358
J-80-I; J-80-IP			Belt - Gen.; W/45" Belt O.C.	101426	TR22443
Belt - Fan & Gen.	124927	②TR22588	Belt - Gen.; W/48" Belt O.C.	178470	TR22474
J-120-B			Belt - Gen.; W/50" Belt O.C.	70885	TR22495
Belt - Fan & Gen.	132013	②TR22434	JN-130; JNF-130		
JF-6-B; JF-6-BI; JF-6-CI			Belt - Gen.; W/45" Belt O.C.	101426	TR22443
Belt - Fan; Auto.; W/37 1/8" Belt O.C.	124466	②TR24365	Belt - Gen.; W/48" Belt O.C.	178470	TR22474
Belt - Fan; Auto.; W/36 7/8" Belt O.C.	178539	②TR22363	Belt - Gen.; W/50" Belt O.C.	70885	TR22495
Belt - W.P.; Auto.	178455	TR22299	JNR-6-BI		
Belt - Gen.; W/45" Belt O.C.	101426	TR22443	Belt - Fan; Auto.; W/37 1/8" Belt O.C.	124466	②TR24365
Belt - Gen.; W/48" Belt O.C.	178470	TR22474	Belt - Fan; Auto.; W/36 7/8" Belt O.C.	178539	②TR22363
Belt - Gen.; W/50" Belt O.C.	70885	TR22495	Belt - W.P.; Auto.	178455	TR22299
Belt - Alt.; Auto.; W/O Turbo, Super Turbo	178470	TR22474	Belt - Gen.; W/45" Belt O.C.	101426	TR22443
Belt - Alt.; Auto.; W/Turbo, Super Turbo	178685	TR22485	Belt - Gen.; W/48" Belt O.C.	178470	TR22474
JF-6-I			Belt - Gen.; W/50" Belt O.C.	70885	TR22495
Belt - Fan	124421	TR24365	JNR-100		
Belt - W.P.; W/33 1/2" Belt O.C.	178490	TR22329	Belt - Gen.; W/45" Belt O.C.	101426	TR22443
Belt - W.P.; W/36 5/8" Belt O.C.	178530	②TR22358	Belt - Gen.; W/48" Belt O.C.	178470	TR22474
Belt - Gen.; W/45" Belt O.C.	101426	TR22443	Belt - Gen.; W/50" Belt O.C.	70885	TR22495
Belt - Gen.; W/48" Belt O.C.	178470	TR22474	JNS-6-B; JNS-6-BI; JNS-6-CI		
Belt - Gen.; W/50" Belt O.C.	70885	TR22495	Belt - Fan; Auto.; W/37 1/8" Belt O.C.	124466	②TR24365
JF-6-IP			Belt - Fan; Auto.; W/36 7/8" Belt O.C.	178539	②TR22363
Belt - Fan	124421	TR24365	Belt - W.P.; Auto.	178455	TR22299
Belt - W.P.; W/33 1/2" Belt O.C.	178490	TR22329	Belt - Gen.; W/45" Belt O.C.	101426	TR22443
Belt - W.P.; W/36 5/8" Belt O.C.	178530	②TR22358	Belt - Gen.; W/48" Belt O.C.	178470	TR22474
Belt - Gen.; W/45" Belt O.C.	101426	TR22443	Belt - Gen.; W/50" Belt O.C.	70885	TR22495
Belt - Gen.; W/48" Belt O.C.	178470	TR22474	Belt - Alt.; Auto.; W/O Turbo, Super Turbo	178470	TR22474
Belt - Gen.; W/50" Belt O.C.	70885	TR22495	Belt - Alt.; Auto.; W/Turbo, Super Turbo	178685	TR22485
Belt - Alt.; Auto.; W/Turbo, Super Turbo	178685	TR22485	JNS-6-IP		
JF-6-P			Belt - Fan	124421	TR24365
Belt - Fan	124421	TR24365	Belt - W.P.; W/33 1/2" Belt O.C.	178490	TR22329
Belt - W.P.; W/33 1/2" Belt O.C.	178490	TR22329	Belt - W.P.; W/36 5/8" Belt O.C.	178530	②TR22358
Belt - W.P.; W/36 5/8" Belt O.C.	178530	②TR22358	Belt - Gen.; W/45" Belt O.C.	101426	TR22443
Belt - Gen.; W/45" Belt O.C.	101426	TR22443	Belt - Gen.; W/48" Belt O.C.	178470	TR22474
Belt - Gen.; W/48" Belt O.C.	178470	TR22474	Belt - Gen.; W/50" Belt O.C.	70885	TR22495
Belt - Gen.; W/50" Belt O.C.	70885	TR22495	Belt - Alt.; Auto.; W/Turbo, Super Turbo	178685	TR22485
JN-6-B; JN-6-BI; JN-6-CI			JNS-6-P		
Belt - Fan; Auto.; W/37 1/8" Belt O.C.	124466	②TR24365	Belt - Fan	124421	TR24365
Belt - Fan; Auto.; W/36 7/8" Belt O.C.	178539	②TR22363	Belt - W.P.; W/33 1/2" Belt O.C.	178490	TR22329
Belt - W.P.; Auto.	178455	TR22299	Belt - W.P.; W/36 5/8" Belt O.C.	178530	②TR22358
Belt - Gen.; W/45" Belt O.C.	101426	TR22443	Belt - Gen.; W/45" Belt O.C.	101426	TR22443
Belt - Gen.; W/48" Belt O.C.	178470	TR22474	Belt - Gen.; W/48" Belt O.C.	178470	TR22474
Belt - Gen.; W/50" Belt O.C.	70885	TR22495	Belt - Gen.; W/50" Belt O.C.	70885	TR22495
Belt - Alt.; Auto.; W/O Turbo, Super Turbo	178470	TR22474	Belt - Alt.; Auto.; W/Turbo, Super Turbo	178685	TR22485
Belt - Alt.; Auto.; W/Turbo, Super Turbo	178685	TR22485	JNS-6-B		
JN-6-I			Belt - Fan	124421	TR24365
Belt - Fan	124421	TR24365	Belt - W.P.; W/33 1/2" Belt O.C.	178490	TR22329
Belt - W.P.; W/33 1/2" Belt O.C.	178490	TR22329	Belt - W.P.; W/36 5/8" Belt O.C.	178530	②TR22358
Belt - W.P.; W/36 5/8" Belt O.C.	178530	②TR22358	Belt - Gen.; W/45" Belt O.C.	101426	TR22443
Belt - Gen.; W/45" Belt O.C.	101426	TR22443	Belt - Gen.; W/48" Belt O.C.	178470	TR22474
Belt - Gen.; W/48" Belt O.C.	178470	TR22474	Belt - Gen.; W/50" Belt O.C.	70885	TR22495
Belt - Gen.; W/50" Belt O.C.	70885	TR22495	Belt - Alt.; Auto.; W/Turbo, Super Turbo	178685	TR22485
Belt - Alt.; Auto.; W/O Turbo, Super Turbo	178470	TR22474	JS-6-B; JS-6-BI; JS-6-CI		
Belt - Alt.; Auto.; W/Turbo, Super Turbo	178685	TR22485	Belt - Fan; Auto.; W/37 1/8" Belt O.C.	124466	②TR24365
JN-6-I			Belt - Fan; Auto.; W/36 7/8" Belt O.C.	178539	②TR22363
Belt - Fan	124421	TR24365	Belt - W.P.; Auto.	178455	TR22299
Belt - W.P.; W/33 1/2" Belt O.C.	178490	TR22329	Belt - Gen.; W/45" Belt O.C.	101426	TR22443
Belt - W.P.; W/36 5/8" Belt O.C.	178530	②TR22358	Belt - Gen.; W/48" Belt O.C.	178470	TR22474
Belt - Gen.; W/45" Belt O.C.	101426	TR22443	Belt - Gen.; W/50" Belt O.C.	70885	TR22495
Belt - Gen.; W/48" Belt O.C.	178470	TR22474	Belt - Alt.; Auto.; W/O Turbo, Super Turbo	178470	TR22474
Belt - Gen.; W/50" Belt O.C.	70885	TR22495	Belt - Alt.; Auto.; W/Turbo, Super Turbo	178685	TR22485

② Two Required.

Power Units

Belts and Hose for Power Units

Application	Mfr. Part No.	Our No.
CUMMINS - Continued		
JS-6-IP		
Belt - Fan	124421	TR24365
Belt - W.P.; W/33 1/2" Belt O.C.	178490	TR22329
Belt - W.P.; W/36 5/8" Belt O.C.	178530	②TR22358
Belt - Gen.; W/45" Belt O.C.	101426	TR22443
Belt - Gen.; W/48" Belt O.C.	178470	TR22474
Belt - Gen.; W/50" Belt O.C.	70885	TR22495
Belt - Alt.; Auto.; W/Turbo, Super Turbo	178685	TR22485
JS-6-P		
Belt - Fan	124421	TR24365
Belt - W.P.; W/33 1/2" Belt O.C.	178490	TR22329
Belt - W.P.; W/36 5/8" Belt O.C.	178530	②TR22358
Belt - Gen.; W/45" Belt O.C.	101426	TR22443
Belt - Gen.; W/48" Belt O.C.	178470	TR22474
Belt - Gen.; W/50" Belt O.C.	70885	TR22495
JT-6-B; JT-6-BI; JT-6-CI		
Belt - Fan; Auto.; W/37 1/8" Belt O.C.	124466	②TR24365
Belt - Fan; Auto.; W/36 7/8" Belt O.C.	178539	②TR22363
Belt - W.P.; Auto.	178455	TR22299
Belt - Gen.; W/45" Belt O.C.	101426	TR22443
Belt - Gen.; W/48" Belt O.C.	178470	TR22474
Belt - Gen.; W/50" Belt O.C.	70885	TR22495
Belt - Alt.; Auto.; W/O Turbo, Super Turbo	178470	TR22474
Belt - Alt.; Auto.; W/Turbo, Super Turbo	178685	TR22485
JT-6-I		
Belt - Fan	124421	TR24365
Belt - W.P.; W/33 1/2" Belt O.C.	178490	TR22329
Belt - W.P.; W/36 5/8" Belt O.C.	178530	②TR22358
Belt - Gen.; W/45" Belt O.C.	101426	TR22443
Belt - Gen.; W/48" Belt O.C.	178470	TR22474
Belt - Gen.; W/50" Belt O.C.	70885	TR22495
JT-6-IP		
Belt - Fan	124421	TR24365
Belt - W.P.; W/33 1/2" Belt O.C.	178490	TR22329
Belt - W.P.; W/36 5/8" Belt O.C.	178530	②TR22358
Belt - Gen.; W/45" Belt O.C.	101426	TR22443
Belt - Gen.; W/48" Belt O.C.	178470	TR22474
Belt - Gen.; W/50" Belt O.C.	70885	TR22495
Belt - Alt.; Auto.; W/Turbo, Super Turbo	178685	TR22485
JT-6-P		
Belt - Fan	124421	TR24365
Belt - W.P.; W/33 1/2" Belt O.C.	178490	TR22329
Belt - W.P.; W/36 5/8" Belt O.C.	178530	②TR22358
Belt - Gen.; W/45" Belt O.C.	101426	TR22443
Belt - Gen.; W/48" Belt O.C.	178470	TR22474
Belt - Gen.; W/50" Belt O.C.	70885	TR22495
K-6		
Belt - Alt.; W/36" Belt O.C.	205913	▲K050360HD
Belt - Alt.; W/37" Belt O.C.	206996	K050370
Belt - Alt.; W/44" Belt O.C.	214701	K050440
KT19G		
Belt - Alt.	5110161	K050370
KT38		
Belt - Alt.; W/38A. Alt.	5110163	▲9330HD
KTA12		
Belt - Alt.; W/35A. Alt.	5110119	K050290
Belt - Alt.; W/45A. Alt.	511016105	K050355
Belt - Alt.; W/75A. Alt.	5110161	K050370
Hose - Upper - Eng. To Pipe; (2 1/2" I.D.)		24440
Hose - Upper - Pipe To Rad.; (2 1/2" I.D.)		24440
Hose - Lower - Eng. To Pipe; (3 1/2" I.D.)		24456
Hose - Lower - Pipe To Rad.; (3 1/2" I.D.)		24456

Application	Mfr. Part No.	Our No.
CUMMINS - Continued		
KTA19		
Belt - Alt.; W/35A. Alt.	5110119	K050290
Belt - Alt.; W/45A. Alt.	511016105	K050355
Belt - Alt.; W/75A. Alt.	5110161	K050370
KTA19G		
Belt - Alt.	5110161	K050370
KTA38		
Belt - Alt.; W/38A. Alt.	5110163	▲9330HD
KTA38G1		
Belt - Alt.; W/35A. Alt.	511016102	▲K050345HD
KTA50		
Belt - Alt.	5110163	②▲9330HD
KTA52		
Belt - Alt.; W/35A., 75A. Alt.; W/Cummins KTA50-G2 Eng.	511016102	▲K050345HD
KTA53		
Belt - Alt.; W/75A. Alt.; W/Cummins KTA50-G2 Eng.	511016102	▲K050345HD
KTT11		
Belt - Alt.; W/35A. Alt.	5110119	K050290
Belt - Alt.; W/45A. Alt.	511016105	K050355
Belt - Alt.; W/75A. Alt.	5110161	K050370
Hose - Upper - Eng. To Pipe; (2 1/2" I.D.)		24440
Hose - Upper - Pipe To Rad.; (2 1/2" I.D.)		24440
Hose - Lower - Eng. To Pipe; (3 1/2" I.D.)		24456
Hose - Lower - Pipe To Rad.; (3 1/2" I.D.)		24456
KTT12		
Hose - Upper - Eng. To Pipe; (2 1/2" I.D.)		24440
Hose - Upper - Pipe To Rad.; (2 1/2" I.D.)		24440
Hose - Lower - Eng. To Pipe; (3 1/2" I.D.)		24456
Hose - Lower - Pipe To Rad.; (3 1/2" I.D.)		24456
KTTA19		
Belt - Alt.; W/35A. Alt.	5110119	K050290
Belt - Alt.; W/45A. Alt.	511016105	K050355
Belt - Alt.; W/75A. Alt.	5110161	K050370
KTTA19G		
Belt - Alt.	5110161	K050370
KTTA38		
Belt - Alt.; W/38A. Alt.	5110163	▲9330HD
KTTA50		
Belt - Alt.	5110163	②▲9330HD
KTTT12		
Belt - Alt.; W/35A. Alt.	5110119	K050290
Belt - Alt.; W/45A. Alt.	511016105	K050355
Belt - Alt.; W/75A. Alt.	5110161	K050370
L; LM; LR; LRM; LRT; LRTM		
Belt - Fan; 900 R.P.M. & Under	S1898	②TR28786
Belt - Fan; Over 900 R.P.M.	S2362	②TR28733
Belt - W.P.; W/Centrifugal W.P.	S2877	TR22553
Belt - W.P.; W/Gear Drive	S2878	③▲9530HD
Belt - Gen.		②TR30770
Belt - Compr.	69307	②▲9570HD
N-495-B130; N-495-C130		
Belt - Fan & W.P.	172856	②TR24457
Belt - Alt.	172856	TR24457
N-495-P130		
Belt - Fan & W.P.	172856	②TR24457
Belt - Alt.	178436	TR22358

② Two Required.
③ Three Required.

▲ Standard Belt Available. See Pages 630-631.

Belts and Hose for Power Units

Application	Mfr. Part No.	Our No.
CUMMINS - Continued		
N-927		
Belt - Fan	134809	TR28492
Belt - W.P. & Idler	215356	②6596
Belt - Alt.	178623	②▲9463HD
NH250-B		
Belt - Fan; W/40 5/8" Belt O.C.	178657	②TR28400
Belt - Fan; W/50" Belt O.C.	134809	②TR28492
Belt - Fan & W.P.; W/41 1/8" Belt O.C.	134773	②TR22405
Belt - Fan & W.P.; W/46 3/8" Belt O.C.	172856	②TR24457
Belt - W.P.; W/40 3/4" Belt O.C.	178570	TR24400
Belt - W.P.; W/44" Belt O.C.	132013	TR22434
Belt - W.P.; W/44 3/8" Belt O.C.	200328	TR24438
Belt - Gen.	70350	TR22358
Belt - Alt.		TR22363
NH250-BI		
Belt - Fan; W/40 5/8" Belt O.C.	178657	②TR28400
Belt - Fan; W/50" Belt O.C.	134809	②TR28492
Belt - Fan & W.P.; W/41 1/8" Belt O.C.	134773	②TR22405
Belt - Fan & W.P.; W/46 3/8" Belt O.C.	172856	②TR24457
Belt - W.P.; W/40 3/4" Belt O.C.	178570	TR24400
Belt - W.P.; W/44" Belt O.C.	132013	TR22434
Belt - W.P.; W/44 3/8" Belt O.C.	200328	TR24438
Belt - Gen.	70350	TR22358
NH250-C		
Belt - Fan; W/40 5/8" Belt O.C.	178657	②TR28400
Belt - Fan; W/50" Belt O.C.	134809	②TR28492
Belt - Fan & W.P.; W/41 1/8" Belt O.C.	134773	②TR22405
Belt - Fan & W.P.; W/46 3/8" Belt O.C.	172856	②TR24457
Belt - W.P.; W/40 3/4" Belt O.C.	178570	TR24400
Belt - W.P.; W/44" Belt O.C.	132013	TR22434
Belt - W.P.; W/44 3/8" Belt O.C.	200328	TR24438
Belt - Gen.	70350	TR22358
Belt - Alt.		TR22363
NH250-CI		
Belt - Fan; W/40 5/8" Belt O.C.	178657	②TR28400
Belt - Fan; W/50" Belt O.C.	134809	②TR28492
Belt - Fan & W.P.; W/41 1/8" Belt O.C.	134773	②TR22405
Belt - Fan & W.P.; W/46 3/8" Belt O.C.	172856	②TR24457
Belt - W.P.; W/40 3/4" Belt O.C.	178570	TR24400
Belt - W.P.; W/44" Belt O.C.	132013	TR22434
Belt - W.P.; W/44 3/8" Belt O.C.	200328	TR24438
Belt - Gen.	70350	TR22358
NH-6-IF		
Belt - W.P.	132012	TR24400
NH-180-B; NH-195-B		
Belt - Fan; W/40 5/8" Belt O.C.	178657	②TR28400
Belt - Fan; W/50" Belt O.C.	134809	②TR28492
Belt - Fan & W.P.; W/41 1/8" Belt O.C.	134773	②TR22405
Belt - Fan & W.P.; W/46 3/8" Belt O.C.	172856	②TR24457
Belt - W.P.; W/40 3/4" Belt O.C.	178570	TR24400
Belt - W.P.; W/44" Belt O.C.	132013	TR22434
Belt - W.P.; W/44 3/8" Belt O.C.	200328	TR24438
Belt - Gen.	70350	TR22358
NH-220		
Belt - Fan; W/40 5/8" Belt O.C.	178657	②TR28400
Belt - Fan; W/50" Belt O.C.	134809	②TR28492
Belt - Fan & W.P.; W/41 1/8" Belt O.C.	134773	②TR22405
Belt - Fan & W.P.; W/46 3/8" Belt O.C.	172856	②TR24457
Belt - W.P.; W/40 3/4" Belt O.C.	178570	TR24400
Belt - W.P.; W/44" Belt O.C.	132013	TR22434
Belt - W.P.; W/44 3/8" Belt O.C.	200328	TR24438
Belt - Gen.	70350	TR22358
Belt - Alt.		TR22350
NH-220-B; NH-220-BI; NH-220-CI		
Belt - Fan; W/40 5/8" Belt O.C.	178657	②TR28400

② Two Required.

Application	Mfr. Part No.	Our No.
CUMMINS - Continued		
NH-220-B; NH-220-BI; NH-220-CI - Continued		
Belt - Fan; W/50" Belt O.C.	134809	②TR28492
Belt - Fan & W.P.; W/41 1/8" Belt O.C.	134773	②TR22405
Belt - Fan & W.P.; W/46 3/8" Belt O.C.	172856	②TR24457
Belt - W.P.; W/40 3/4" Belt O.C.	178570	TR24400
Belt - W.P.; W/44" Belt O.C.	132013	TR22434
Belt - W.P.; W/44 3/8" Belt O.C.	200328	TR24438
Belt - Gen.	70350	TR22358
NH-220-G		
Belt - Fan	134817	②TR30506
Belt - W.P.	132012	TR24400
Belt - Gen.	178567	TR22350
NH-220-I		
Belt - Fan; W/40 5/8" Belt O.C.	178657	②TR28400
Belt - Fan; W/50" Belt O.C.	134809	②TR28492
Belt - Fan & W.P.; W/41 1/8" Belt O.C.	134773	②TR22405
Belt - Fan & W.P.; W/46 3/8" Belt O.C.	172856	②TR24457
Belt - W.P.; W/40 3/4" Belt O.C.	178570	TR24400
Belt - W.P.; W/44" Belt O.C.	132013	TR22434
Belt - W.P.; W/44 3/8" Belt O.C.	200328	TR24438
Belt - Gen.	70350	TR22358
NH-220-IP; NH-220-P		
Belt - Fan	134817	②TR30506
Belt - W.P.	132012	TR24400
Belt - Gen.	178567	TR22350
NH-230		
Belt - Fan; W/40 5/8" Belt O.C.	178657	②TR28400
Belt - Fan; W/50" Belt O.C.	134809	②TR28492
Belt - Fan & W.P.; W/41 1/8" Belt O.C.	134773	②TR22405
Belt - Fan & W.P.; W/46 3/8" Belt O.C.	172856	②TR24457
Belt - W.P.; W/40 3/4" Belt O.C.	178570	TR24400
Belt - W.P.; W/44" Belt O.C.	132013	TR22434
Belt - W.P.; W/44 3/8" Belt O.C.	200328	TR24438
Belt - Gen.	70350	TR22358
Belt - Alt.		TR22363
NH-230-B		
Belt - W.P.	172856	②TR24457
Belt - Alt.	178556	TR22363
NH-250		
Belt - Fan; W/40 5/8" Belt O.C.	178657	②TR28400
Belt - Fan; W/50" Belt O.C.	134809	②TR28492
Belt - Fan & W.P.; W/41 1/8" Belt O.C.	134773	②TR22405
Belt - Fan & W.P.; W/46 3/8" Belt O.C.	172856	②TR24457
Belt - W.P.; W/40 3/4" Belt O.C.	178570	TR24400
Belt - W.P.; W/44" Belt O.C.	132013	TR22434
Belt - W.P.; W/44 3/8" Belt O.C.	200328	TR24438
Belt - Gen.	70350	TR22358
Belt - Alt./Gen.	178436	TR22358
NH-250-IP; NH-250-P		
Belt - Fan	134817	②TR30506
Belt - W.P.	132012	TR24400
Belt - Gen.	178567	TR22350
NHC-4-B; NHC-4-BI		
Belt - Fan; W/40 5/8" Belt O.C.	178657	②TR28400
Belt - Fan; W/50" Belt O.C.	134809	②TR28492
Belt - Fan & W.P.; W/41 1/8" Belt O.C.	134773	②TR22405
Belt - Fan & W.P.; W/46 3/8" Belt O.C.	172856	②TR24457
Belt - W.P.; W/40 3/4" Belt O.C.	178570	TR24400
Belt - W.P.; W/44" Belt O.C.	132013	TR22434
Belt - W.P.; W/44 3/8" Belt O.C.	200328	TR24438
Belt - Gen.	70350	TR22358
NHC-4-G		
Belt - Fan & W.P.; W/41 1/8" Belt O.C.	70524	②TR22405
Belt - Fan & W.P.; W/46 3/8" Belt O.C.	172856	②TR24457

▲ Standard Belt Available. See Pages 630-631.

Power Units

Belts and Hose for Power Units

Application	Mfr. Part No.	Our No.
CUMMINS - Continued		
NHC-4-G - Continued		
Belt - Alt./Gen.	70350	TR22358
NHC-4-I		
Belt - Fan; W/40 5/8" Belt O.C.	178657	②TR28400
Belt - Fan; W/50" Belt O.C.	134809	②TR28492
Belt - Fan & W.P.; W/41 1/8" Belt O.C.	134773	②TR22405
Belt - Fan & W.P.; W/46 3/8" Belt O.C.	172856	②TR24457
Belt - W.P.; W/40 3/4" Belt O.C.	178570	TR24400
Belt - W.P.; W/44" Belt O.C.	132013	TR22434
Belt - W.P.; W/44 3/8" Belt O.C.	200328	TR24438
Belt - Gen.	70350	TR22358
NHC-4-IP; NHC-4-P		
Belt - Fan & W.P.; W/41 1/8" Belt O.C.	70524	②TR22405
Belt - Fan & W.P.; W/46 3/8" Belt O.C.	172856	②TR24457
Belt - Alt./Gen.	70350	TR22358
NHC-250		
Belt - Fan; W/40 5/8" Belt O.C.	178657	②TR28400
Belt - Fan; W/50" Belt O.C.	134809	②TR28492
Belt - Fan & W.P.; W/41 1/8" Belt O.C.	134773	②TR22405
Belt - Fan & W.P.; W/46 3/8" Belt O.C.	172856	②TR24457
Belt - W.P.; W/40 3/4" Belt O.C.	178570	TR24400
Belt - W.P.; W/44" Belt O.C.	132013	TR22434
Belt - W.P.; W/44 3/8" Belt O.C.	200328	TR24438
Belt - Gen.	70350	TR22358
NHCT-270-B		
Belt - W.P.	172856	②TR24457
Belt - Alt.	172856	TR24457
NHD-180-B		
Belt - W.P.	172856	②TR24457
Belt - Alt.	178556	TR22363
NHE-180-B; NHE-180-CI; NHE-180-I; NHE-195-B; NHE-220-B		
Belt - Fan; W/40 5/8" Belt O.C.	178657	②TR28400
Belt - Fan; W/50" Belt O.C.	134809	②TR28492
Belt - Fan & W.P.; W/41 1/8" Belt O.C.	134773	②TR22405
Belt - Fan & W.P.; W/46 3/8" Belt O.C.	172856	②TR24457
Belt - W.P.; W/40 3/4" Belt O.C.	178570	TR24400
Belt - W.P.; W/44" Belt O.C.	132013	TR22434
Belt - W.P.; W/44 3/8" Belt O.C.	200328	TR24438
Belt - Gen.	70350	TR22358
NHE-225		
Belt - W.P.	172856	②TR24457
Belt - Alt.; Auto.		②▲9451HD
NHE-225-B		
Belt - W.P.	172856	②TR24457
Belt - Alt.	178556	TR22363
NHR-195-CI		
Belt - Fan; W/40 5/8" Belt O.C.	178657	②TR28400
Belt - Fan; W/50" Belt O.C.	134809	②TR28492
Belt - Fan & W.P.; W/41 1/8" Belt O.C.	134773	②TR22405
Belt - Fan & W.P.; W/46 3/8" Belt O.C.	172856	②TR24457
Belt - W.P.; W/40 3/4" Belt O.C.	178570	TR24400
Belt - W.P.; W/44" Belt O.C.	132013	TR22434
Belt - W.P.; W/44 3/8" Belt O.C.	200328	TR24438
Belt - Gen.	70350	TR22358
NHRS-6-B; NHRS-6-BI; NHRS-6-CI		
Belt - Fan	134809	②TR28492
Belt - W.P.; W/44" Belt O.C.	132013	TR22434
Belt - W.P.; W/44 3/8" Belt O.C.	178628	TR24438
NHRS-6-G		
Belt - Fan	134817	②TR30506
Belt - W.P.	132012	TR24400

Application	Mfr. Part No.	Our No.
CUMMINS - Continued		
NHRS-6-I; NHRS-6-IP; NHRS-6-P		
Belt - Fan	134810	②TR28545
Belt - W.P.	178628	TR24438
NHS-6-B; NHS-6-BI; NHS-6-CI		
Belt - Fan	134809	②TR28492
Belt - W.P.; W/44" Belt O.C.	132013	TR22434
Belt - W.P.; W/44 3/8" Belt O.C.	178628	TR24438
NHS-6-I; NHS-6-IP; NHS-6-P		
Belt - Fan	134810	②TR28545
Belt - W.P.	178628	TR24438
NRT-6-B; NRT-6-BI; NRT-6-CI		
Belt - Fan; W/44 3/8" Belt O.C.	178707	②TR28437
Belt - Fan; W/50" Belt O.C.	134809	②TR28492
Belt - Fan; W/51 1/8" Belt O.C.	178597	②TR28501
Belt - W.P.; W/41 1/8" Belt O.C.	134773	TR22405
Belt - W.P.; W/44" Belt O.C.; W/Dual Belts	215356	②6596
Belt - W.P.; W/44" Belt O.C.; W/Single Belt	132013	TR22434
Belt - W.P.; W/44 3/8" Belt O.C.	178628	TR24438
Belt - W.P.; W/46 3/8" Belt O.C.	172856	TR24457
Belt - Gen.	132010	TR22363
Belt - Alt.; W/36 1/2" Belt O.C.	178436	TR22358
Belt - Alt.; W/38 3/8" Belt O.C.		TR22380
Belt - Alt.; W/45 3/8" Belt O.C.		▲9451HD
NRT-6-I; NRT-6-IP; NRT-6-P		
Belt - Fan	134817	②TR30506
Belt - W.P.	178628	TR24438
Belt - Gen.	132010	TR22363
NRTO-6-B; NRTO-6-BI; NRTO-6-CI		
Belt - Fan; W/44 3/8" Belt O.C.	178707	②TR28437
Belt - Fan; W/50" Belt O.C.	134809	②TR28492
Belt - Fan; W/51 1/8" Belt O.C.	178597	②TR28501
Belt - W.P.; W/41 1/8" Belt O.C.	134773	TR22405
Belt - W.P.; W/44" Belt O.C.; W/Dual Belts	215356	②6596
Belt - W.P.; W/44" Belt O.C.; W/Single Belt	132013	TR22434
Belt - W.P.; W/44 3/8" Belt O.C.	178628	TR24438
Belt - W.P.; W/46 3/8" Belt O.C.	172856	TR24457
Belt - Gen.	132010	TR22363
Belt - Alt.; W/36 1/2" Belt O.C.	178436	TR22358
Belt - Alt.; W/38 3/8" Belt O.C.		TR22380
Belt - Alt.; W/45 3/8" Belt O.C.		▲9451HD
NRTO-6-I; NRTO-6-IP		
Belt - Fan	134810	②TR28545
Belt - W.P.	178628	TR24438
Belt - Gen.; W/40 3/4" Belt O.C.	132012	TR24400
Belt - Gen.; W/41 5/8" Belt O.C.	134797	TR22410
NT-6-B; NT-6-BI; NT-6-CI		
Belt - Fan; W/40 5/8" Belt O.C.	178657	②TR28400
Belt - Fan; W/50" Belt O.C.	134809	②TR28492
Belt - Fan & W.P.; W/41 1/8" Belt O.C.	134773	②TR22405
Belt - Fan & W.P.; W/46 3/8" Belt O.C.	172856	②TR24457
Belt - W.P.; W/40 3/4" Belt O.C.	178570	TR24400
Belt - W.P.; W/44" Belt O.C.	132013	TR22434
Belt - W.P.; W/44 3/8" Belt O.C.	200328	TR24438
Belt - Gen.	70350	TR22358
NT-6-I; NT-6-IP; NT-6-P		
Belt - Fan	134817	②TR30506
Belt - W.P.	132012	TR24400
Belt - Gen.	178567	TR22350
NT-165-BI; NT-180-B; NT-180-BI; NT-200-B; NT-200-BI		
Belt - Fan; W/40 5/8" Belt O.C.	178657	②TR28400
Belt - Fan; W/50" Belt O.C.	134809	②TR28492
Belt - Fan & W.P.; W/41 1/8" Belt O.C.	134773	②TR22405
Belt - Fan & W.P.; W/46 3/8" Belt O.C.	172856	②TR24457

② Two Required.

▲ Standard Belt Available. See Pages 630-631.

Belts and Hose for Power Units

Application	Mfr. Part No.	Our No.
CUMMINS - Continued		
NT-165-BI; NT-180-B; NT-180-BI; NT-200-B; NT-200-BI - Continued		
Belt - W.P.; W/40 3/4" Belt O.C.	178570	TR24400
Belt - W.P.; W/44" Belt O.C.	132013	TR22434
Belt - W.P.; W/44 3/8" Belt O.C.	200328	TR24438
Belt - Gen.	70350	TR22358
NT-270-CT		
Belt - Fan; W/48" Belt O.C.	178624	②TR28473
Belt - Fan; W/48 3/4" Belt O.C.	178620	②TR28480
Belt - Fan; W/50" Belt O.C.	134809	②TR28492
Belt - W.P.; W/43 3/4" Belt O.C.	215356	7430
Belt - W.P.; W/44 3/8" Belt O.C.	178628	TR24438
Belt - Gen.; W/36 7/8" Belt O.C.	132010	TR22363
Belt - Gen.; W/41 5/8" Belt O.C.	134797	TR22410
Belt - Alt.; W/36 1/2" Belt O.C.	178436	TR22358
Belt - Alt.; W/45 3/8" Belt O.C.		♣9451HD
Belt - Alt.; W/46 1/2" Belt O.C.	178623	♣9463HD
NT-280; NT-280-B; NT-280-BI; NT-280-CI		
Belt - Fan; W/44 3/8" Belt O.C.	178707	②TR28437
Belt - Fan; W/50" Belt O.C.	134809	②TR28492
Belt - Fan; W/51 1/8" Belt O.C.	178597	②TR28501
Belt - W.P.; W/41 1/8" Belt O.C.	134773	TR22405
Belt - W.P.; W/44" Belt O.C.; W/Dual Belts	215356	②6596
Belt - W.P.; W/44" Belt O.C.; W/Single Belt	132013	TR22434
Belt - W.P.; W/44 3/8" Belt O.C.	178628	TR24438
Belt - W.P.; W/46 3/8" Belt O.C.	172856	TR24457
Belt - Gen.	132010	TR22363
Belt - Alt.; W/36 1/2" Belt O.C.	178436	TR22358
Belt - Alt.; W/38 3/8" Belt O.C.		TR22380
Belt - Alt.; W/45 3/8" Belt O.C.		♣9451HD
NT-300-B; NT-300-BI; NT-300-CI; NT-310; NT-310-CI; NT-335; NT-335-B; NT-335-BI; NT-335-CI; NT-335-G; NT-380-B; NT-380-BI		
Belt - Fan; W/48" Belt O.C.	178624	②TR28473
Belt - Fan; W/48 3/4" Belt O.C.	178620	②TR28480
Belt - Fan; W/50" Belt O.C.	134809	②TR28492
Belt - W.P.; W/43 3/4" Belt O.C.	215356	7430
Belt - W.P.; W/44 3/8" Belt O.C.	178628	TR24438
Belt - Gen.; W/36 7/8" Belt O.C.	132010	TR22363
Belt - Gen.; W/41 5/8" Belt O.C.	134797	TR22410
Belt - Alt.; W/36 1/2" Belt O.C.	178436	TR22358
Belt - Alt.; W/45 3/8" Belt O.C.		♣9451HD
Belt - Alt.; W/46 1/2" Belt O.C.	178623	♣9463HD
NT-380-G		
Belt - Fan	134822	②TR30543
Belt - W.P.	178628	TR24438
Belt - Gen.	132010	TR22363
NT-380-I		
Belt - Fan	178611	②TR28545
Belt - W.P.	200328	TR24438
Belt - Alt.	178593	TR22461
NT-380-IP		
Belt - Fan	134810	②TR28545
Belt - W.P.	178628	TR24438
Belt - Gen.; W/40 3/4" Belt O.C.	132012	TR24400
Belt - Gen.; W/41 5/8" Belt O.C.	134797	TR22410
NT-855-B335; NT-855-B380; NT-855-C310; NT-855-C335; NT-855-C380		
Belt - Fan	134809	②TR28492
Belt - W.P.	200328	TR24438
Belt - Alt.	278436	TR22358
NT-855-G5		
Belt - Fan	5110160	②TR28412
Belt - Alt.; W/35A. Alt.	5110084	♣9470HD

Application	Mfr. Part No.	Our No.
CUMMINS - Continued		
NT-855-G5 - Continued		
Belt - Alt.; W/75A. Alt.	5110156	②♣9463HD
NT-855-P280; NT-855-P335; NT-855-P380		
Belt - Fan	178611	②TR28545
Belt - W.P.	200328	TR24438
Belt - Gen.		TR22410
NTA-370; NTA-370-B		
Belt - Fan	134809	②TR28492
Belt - W.P.; W/62 1/4" Belt O.C.		②♣9620HD
Belt - W.P.; W/62 3/4" Belt O.C.	204481	②♣9625HD
Belt - Alt.; W/44 1/4" Belt O.C.	201450	②♣9440HD
Belt - Alt.; W/46" Belt O.C.	212589	②♣9451HD
NTA-380		
Belt - Fan; W/48" Belt O.C.	178624	②TR28473
Belt - Fan; W/48 3/4" Belt O.C.	178620	②TR28480
Belt - Fan; W/50" Belt O.C.	134809	②TR28492
Belt - W.P.; W/43 3/4" Belt O.C.	215356	7430
Belt - W.P.; W/44 3/8" Belt O.C.	178628	TR24438
Belt - Gen.; W/36 7/8" Belt O.C.	132010	TR22363
Belt - Gen.; W/41 5/8" Belt O.C.	134797	TR22410
Belt - Alt.; W/36 1/2" Belt O.C.	178436	TR22358
Belt - Alt.; W/45 3/8" Belt O.C.		♣9451HD
Belt - Alt.; W/46 1/2" Belt O.C.	178623	♣9463HD
NTA-400; NTA-420; NTA-420-C		
Belt - Fan	134809	②TR28492
Belt - W.P.; W/62 1/4" Belt O.C.		②♣9620HD
Belt - W.P.; W/62 3/4" Belt O.C.	204481	②♣9625HD
Belt - Alt.; W/44 1/4" Belt O.C.	201450	②♣9440HD
Belt - Alt.; W/46" Belt O.C.	212589	②♣9451HD
NTC-290		
Belt - Fan; W/44 3/8" Belt O.C.	178707	②TR28437
Belt - Fan; W/50" Belt O.C.	134809	②TR28492
Belt - Fan; W/51 1/8" Belt O.C.	178597	②TR28501
Belt - W.P.; W/41 1/8" Belt O.C.	134773	TR22405
Belt - W.P.; W/44" Belt O.C.; W/Dual Belts	215356	②6596
Belt - W.P.; W/44" Belt O.C.; W/Single Belt	132013	TR22434
Belt - W.P.; W/44 3/8" Belt O.C.	178628	TR24438
Belt - W.P.; W/46 3/8" Belt O.C.	172856	TR24457
Belt - Gen.	132010	TR22363
Belt - Alt.; W/36 1/2" Belt O.C.	178436	TR22358
Belt - Alt.; W/38 3/8" Belt O.C.		TR22380
Belt - Alt.; W/45 3/8" Belt O.C.		♣9451HD
Belt - Alt.; W/46 3/8" Belt O.C.	178623	②♣9463HD
NTC-335; NTC-335-B; NTC-350		
Belt - Fan; W/48" Belt O.C.	178624	②TR28473
Belt - Fan; W/48 3/4" Belt O.C.	178620	②TR28480
Belt - Fan; W/50" Belt O.C.	134809	②TR28492
Belt - W.P.; W/43 3/4" Belt O.C.	215356	7430
Belt - W.P.; W/44 3/8" Belt O.C.	178628	TR24438
Belt - Gen.; W/36 7/8" Belt O.C.	132010	TR22363
Belt - Gen.; W/41 5/8" Belt O.C.	134797	TR22410
Belt - Alt.; W/36 1/2" Belt O.C.	178436	TR22358
Belt - Alt.; W/45 3/8" Belt O.C.		♣9451HD
Belt - Alt.; W/46 1/2" Belt O.C.	178623	♣9463HD
NTE-235-B; NTE-235-BI		
Belt - Fan	134809	②TR28492
Belt - W.P.	172856	②TR24457
Belt - Alt.	70350	TR22358
NTO-6-B; NTO-6-BI; NTO-6-CI		
Belt - Fan; W/40 5/8" Belt O.C.	178657	②TR28400
Belt - Fan; W/50" Belt O.C.	134809	②TR28492
Belt - Fan & W.P.; W/41 1/8" Belt O.C.	134773	②TR22405
Belt - Fan & W.P.; W/46 3/8" Belt O.C.	172856	②TR24457
Belt - W.P.; W/40 3/4" Belt O.C.	178570	TR24400
Belt - W.P.; W/44" Belt O.C.	132013	TR22434

Power Units

② Two Required.

♣ Standard Belt Available. See Pages 630-631.

Belts and Hose for Power Units

Application	Mfr. Part No.	Our No.
CUMMINS - Continued		
NTO-6-B; NTO-6-BI; NTO-6-CI - Continued		
Belt - W.P.; W/44 3/8" Belt O.C.	200328	TR24438
Belt - Gen.	70350	TR22358
NTO-6-I; NTO-6-IP; NTO-6-P		
Belt - Fan 134817		②TR30506
Belt - W.P. 132012		TR24400
Belt - Gen. 178567		TR22350
NTO-262		
Belt - Fan; W/44 3/8" Belt O.C.	178707	②TR28437
Belt - Fan; W/50" Belt O.C.	134809	②TR28492
Belt - Fan; W/51 1/8" Belt O.C.	178597	②TR28501
Belt - W.P.; W/41 1/8" Belt O.C.	134773	TR22405
Belt - W.P.; W/44" Belt O.C.; W/Dual Belts	215356	②6596
Belt - W.P.; W/44" Belt O.C.; W/Single Belt	132013	TR22434
Belt - W.P.; W/44 3/8" Belt O.C.	178628	TR24438
Belt - W.P.; W/46 3/8" Belt O.C.	172856	TR24457
Belt - Gen. 132010		TR22363
Belt - Alt.; W/36 1/2" Belt O.C.	178436	TR22358
Belt - Alt.; W/38 3/8" Belt O.C.		TR22380
Belt - Alt.; W/45 3/8" Belt O.C.		▲9451HD
NTO-262-B; NTO-262-BI; NTO-262-CI		
Belt - Fan; W/40 5/8" Belt O.C.	178657	②TR28400
Belt - Fan; W/50" Belt O.C.	134809	②TR28492
Belt - Fan & W.P.; W/41 1/8" Belt O.C.	134773	②TR22405
Belt - Fan & W.P.; W/46 3/8" Belt O.C.	172856	②TR24457
Belt - W.P.; W/40 3/4" Belt O.C.	178570	TR24400
Belt - W.P.; W/44" Belt O.C.	132013	TR22434
Belt - W.P.; W/44 3/8" Belt O.C.	200328	TR24438
Belt - Gen. 70350		TR22358
NTO-262-I; NTO-262-IP; NTO-262-P		
Belt - Fan 134817		②TR30506
Belt - W.P. 132012		TR24400
Belt - Gen. 178567		TR22350
NTO-280-B; NTO-280-CI		
Belt - Fan; W/44 3/8" Belt O.C.	178707	②TR28437
Belt - Fan; W/50" Belt O.C.	134809	②TR28492
Belt - Fan; W/51 1/8" Belt O.C.	178597	②TR28501
Belt - W.P.; W/41 1/8" Belt O.C.	134773	TR22405
Belt - W.P.; W/44" Belt O.C.; W/Dual Belts	215356	②6596
Belt - W.P.; W/44" Belt O.C.; W/Single Belt	132013	TR22434
Belt - W.P.; W/44 3/8" Belt O.C.	178628	TR24438
Belt - W.P.; W/46 3/8" Belt O.C.	172856	TR24457
Belt - Gen. 132010		TR22363
Belt - Alt.; W/36 1/2" Belt O.C.	178436	TR22358
Belt - Alt.; W/38 3/8" Belt O.C.		TR22380
Belt - Alt.; W/45 3/8" Belt O.C.		▲9451HD
NTR0-6-P		
Belt - Fan 134810		②TR28545
Belt - W.P. 178628		TR24438
Belt - Gen.; W/40 3/4" Belt O.C.	132012	TR24400
Belt - Gen.; W/41 5/8" Belt O.C.	134797	TR22410
NVH12-450		
Belt - Fan 134821		②TR22711
Belt - W.P. 125367		TR28376
Belt - Gen. 134813		②TR22344
Belt - Alt. 70362		②6929
Belt - P.S.; W/Vickers P.S. Pump; Under 1800 R.P.M.	S2698	②TR22363
Belt - P.S.; W/Vickers P.S. Pump; 1800 R.P.M. & Over	126597	②TR22380
NVH-12		
Belt - Fan S3175		②TR22711
Belt - W.P. 125367		TR28376
Belt - Gen.; W/High Mount Std. Gen.	134813	②TR22344
Belt - Gen.; W/High Mount Optional Gen.	70350	②TR22358

Application	Mfr. Part No.	Our No.
CUMMINS - Continued		
NVH-12 - Continued		
Belt - Alt.	70362	②6929
Belt - Belt; W/Barnes Pump	129949	②▲9309HD
Super 250/270		
Belt - Fan 134809		TR28492
Belt - W.P. & Idler	215356	②6596
Belt - Alt. 178623		②▲9463HD
V6-140		
Belt - Fan; W/High Mount Fan	178678	②TR22448
Belt - W.P.; W/Low Mount W.P.	70885	TR22495
Belt - Gen.; W/Low Mount Gen.	70885	TR22495
V6-155		
Belt - Alt. 178471		▲9365HD
V6-200-B		
Belt - Fan; W/49 5/8" Belt O.C.	141712	②TR24489
Belt - Fan; W/61 3/8" Belt O.C.	178526	②TR24607
Belt - Fan; W/High Mount Fan	141712	②TR24489
Belt - Fan & W.P.; W/Low Mount Fan	122868	②TR24619
Belt - Gen.; W/Low Mount Gen.	122868	TR24619
Belt - Gen.; W/High Mount Gen.	149265	TR24647
Belt - Alt. 178488		TR22336
V6-200-CI		
Belt - Fan; W/High Mount Fan	141712	②TR24489
Belt - Fan; W/Low Mount Fan	178691	②TR22517
Belt - W.P. 178530		②TR22358
Belt - Gen.; W/Low Mount Gen.	122868	TR24619
Belt - Gen.; W/High Mount Gen.	178685	TR22485
V6-378		
Belt - Alt. 178471		▲9365HD
V6-B		
Belt - Fan; W/High Mount Fan	178678	②TR22448
Belt - Fan; W/Low Mount Fan	178685	②TR22485
Belt - W.P.; W/Low Mount W.P.	70885	TR22495
Belt - W.P. To Alt.	178660	②▲9490HD
Belt - Gen.; W/Low Mount Gen.	70885	TR22495
V6-CI		
Belt - Fan; W/High Mount Fan	178678	②TR22448
Belt - Fan; W/Low Mount Fan	178685	②TR22485
Belt - W.P.; W/Low Mount W.P.	70885	TR22495
Belt - W.P. To Alt.	178471	▲9365HD
Belt - Gen.; W/Low Mount Gen.	70885	TR22495
V6-SVC-B		
Belt - Fan; W/Low Mount Fan	154377	②TR24619
Belt - Fan; W/High Mount Fan	141712	②TR24489
Belt - W.P. 154593		②TR22358
Belt - Gen.; W/Low Mount Gen.	122868	TR24619
Belt - Gen.; W/High Mount Gen.	123818	TR24607
V6-SVC-CI		
Belt - Fan; W/Low Mount Fan	157857	②TR22517
Belt - Fan; W/High Mount Fan	141712	②TR24489
Belt - W.P. 154593		②TR22358
Belt - Gen.; W/Low Mount Gen.	122868	TR24619
Belt - Gen.; W/High Mount Gen.	123818	TR24607
V6E-195-B		
Belt - Fan; W/49 5/8" Belt O.C.	141712	②TR24489
Belt - Fan; W/61 3/8" Belt O.C.	178526	②TR24607
Belt - Fan; W/High Mount Fan	141712	②TR24489
Belt - Fan & W.P.; W/Low Mount Fan	122868	②TR24619
Belt - Gen.; W/Low Mount Gen.	122868	TR24619
Belt - Gen.; W/High Mount Gen.	149265	TR24647
Belt - Alt. 178488		TR22336

② Two Required.

▲ Standard Belt Available. See Pages 630-631.

Belts and Hose for Power Units

Application	Mfr. Part No.	Our No.	Application	Mfr. Part No.	Our No.
CUMMINS - Continued			CUMMINS - Continued		
V6E-195-BI			V8E-235-B		
Belt - Fan; W/61 3/8" Belt O.C.	178526	②TR24607	Belt - Fan; W/High Mount Fan; Auto.	141712	②TR24489
Belt - Fan; W/High Mount Fan	141712	②TR24489	Belt - Fan; Auto.	178526	②TR24607
Belt - Gen.; W/Low Mount Gen.	122868	TR24619	Belt - Fan & W.P.; W/Low Mount Fan	141713	②TR24530
Belt - Alt.	178488	TR22336	Belt - Gen.; W/Low Mount Fan	141713	TR24530
V6R-180-CI			V8R-220-C		
Belt - Fan; W/High Mount Fan	141712	②TR24489	Belt - Fan; W/High Mount Fan; Auto.	141712	②TR24489
Belt - Fan; W/Low Mount Fan	178691	③TR22517	Belt - Fan; W/Low Mount Fan	178691	③TR22517
Belt - W.P.	178530	②TR22358	Belt - Fan & W.P.; W/Low Mount Fan	141713	②TR24530
Belt - Gen.; W/Low Mount Gen.	122868	TR24619	Belt - W.P.	178530	TR22358
Belt - Gen.; W/High Mount Gen.	178685	TR22485	Belt - Gen.; W/Low Mount Gen.	141713	TR24530
V8-185			V12-525		
Belt - Fan; W/High Mount Fan	154805	②TR22448	Belt - W.P.	125367	TR28376
Belt - Fan; Auto.	178685	TR22485	Belt - Gen.	134813	②TR22344
Belt - Gen.	11725	TR22461	Belt - Alt.	70362	②6929
Belt - Alt.; Auto.; W/35 3/8" Belt O.C.	178473	♣9350HD	Belt - P.S.; W/Vickers P.S. Pump; Under 1800 R.P.M.	S2698	②TR22363
Belt - Alt.; W/36 7/8" Belt O.C.	178471	♣9365HD	Belt - P.S.; W/Vickers P.S. Pump; 1800 R.P.M. & Over	126597	②TR22380
V8-210			V785-B235; V785-B265		
Belt - Fan	178685	②TR22485	Belt - Fan; W/High Mount Fan; Auto.	141712	②TR24489
Belt - Alt.; Auto.; W/35 3/8" Belt O.C.	178473	♣9350HD	Belt - Fan; Auto.	178526	②TR24607
Belt - Alt.; W/36 7/8" Belt O.C.	178471	♣9365HD	Belt - Fan & W.P.; W/Low Mount Fan	141713	②TR24530
V8-265			V785-C220; V785-C265		
Belt - Fan; W/High Mount Fan; Auto.	141712	②TR24489	Belt - Fan; W/High Mount Fan; Auto.	141712	②TR24489
Belt - Fan & W.P.; W/Low Mount Fan	141713	②TR24530	Belt - Fan; W/Low Mount Fan	178691	③TR22517
Belt - Gen.; W/Low Mount Gen.	141713	TR24530	Belt - Fan & W.P.; W/Low Mount Fan	141713	②TR24530
V8-265-B			V785-P265		
Belt - Fan; W/High Mount Fan; Auto.	141712	②TR24489	Belt - Fan; W/High Mount Fan; Auto.	141712	②TR24489
Belt - Fan; W/20" Fan Center	154377	②TR24619	Belt - Fan; W/Low Mount Fan	178691	③TR22517
Belt - Fan & W.P.; W/Low Mount Fan	141713	②TR24530	Belt - Fan & W.P.; W/Low Mount Fan	141713	②TR24530
Belt - Gen.; W/Low Mount Gen.	141713	TR24530	Belt - W.P.	178530	TR22358
V8-265-C			V785-C265		
Belt - Fan; W/High Mount Fan; Auto.	141712	②TR24489	Belt - Gen.; W/Low Mount Gen.	141713	TR24530
Belt - Fan; W/Low Mount Fan	178691	③TR22517	Belt - Alt.	178685	TR22485
Belt - Fan & W.P.; W/Low Mount Fan	141713	②TR24530	V785-P265		
Belt - W.P.	178530	TR22358	Belt - Fan; W/High Mount Fan; Auto.	141712	②TR24489
Belt - Gen.; W/Low Mount Gen.	141713	TR24530	Belt - Fan; W/Low Mount Fan	178691	③TR22517
Belt - Alt.	178685	TR22485	Belt - Fan & W.P.; W/Low Mount Fan	141713	②TR24530
V8-265-P			V785-C265		
Belt - Fan; W/High Mount Fan; Auto.	141712	②TR24489	Belt - Gen.; W/Low Mount Gen.	141713	TR24530
Belt - Fan; W/Low Mount Fan	178691	③TR22517	Belt - Alt.	178587	TR22405
Belt - Fan & W.P.; W/Low Mount Fan	141713	②TR24530	V-155		
Belt - Gen.; W/Low Mount Gen.	141713	TR24530	Belt - Fan	178685	②TR22485
Belt - Alt.	178587	TR22405	Belt - Alt.; Auto.	178473	♣9350HD
V8-350-B; V8-350-BI; V8-350-CI			V-352-C140		
Belt - Fan	132237	②TR28743	Belt - Fan; W/High Mount Fan	178678	②TR22448
Belt - W.P.	132010	TR22363	Belt - W.P.; W/Low Mount W.P.	70885	TR22495
Belt - Gen.	111724	TR22336	Belt - Gen.; W/Low Mount Gen.	70885	TR22495
V8-350-IP			V-378		
Belt - Fan	133089	②CX68	Belt - Fan	178685	②TR22485
Belt - W.P.	132012	TR24400	Belt - Alt.; Auto.	178473	♣9350HD
Belt - Gen.	111724	TR22336	V-470		
V8E-170			V-504		
Belt - Fan; W/High Mount Fan	154805	②TR22448	Belt - Fan; W/High Mount Fan	154805	②TR22448
Belt - Fan; Auto.	178685	TR22485	Belt - Fan; Auto.	178685	TR22485
Belt - Gen.	11725	TR22461	Belt - Gen.	11725	TR22461
Belt - Alt.; Auto.; W/35 3/8" Belt O.C.	178473	♣9350HD	Belt - Alt.; Auto.; W/35 3/8" Belt O.C.	178473	♣9350HD
Belt - Alt.; W/36 7/8" Belt O.C.	178471	♣9365HD	Belt - Alt.; W/36 7/8" Belt O.C.	178471	♣9365HD
V8E-235			V-555C		
Belt - Fan; W/High Mount Fan; Auto.	141712	②TR24489	Belt - Fan; Auto.	189917	②♣9490HD
Belt - Fan & W.P.; W/Low Mount Fan	141713	②TR24530	Belt - Alt.; Auto.; W/35 3/8" Belt O.C.	178473	♣9350HD
Belt - Gen.; W/Low Mount Gen.	141713	TR24530	Belt - Alt.; W/36 7/8" Belt O.C.	178471	♣9365HD
			Belt - Alt.; Auto.		
			7530		

② Two Required.
③ Three Required.

♣ Standard Belt Available. See Pages 630-631.

Belts and Hose for Power Units

Application	Mfr. Part No.	Our No.
CUMMINS - Continued		
V-588-B195; V-588-B200		
Belt - Fan; W/49 5/8" Belt O.C.	141712	②TR24489
Belt - Fan; W/61 3/8" Belt O.C.	178526	②TR24607
Belt - Fan; W/High Mount Fan	141712	②TR24489
Belt - Fan & W.P.; W/Low Mount Fan	122868	②TR24619
Belt - Gen.; W/Low Mount Gen.	122868	TR24619
Belt - Gen.; W/High Mount Gen.	149265	TR24647
Belt - Alt.	178488	TR22336
V-588-C180; V-588-C200		
Belt - Fan; W/High Mount Fan	141712	②TR24489
Belt - Gen.; W/Low Mount Fan	122868	TR24619
V-903		
Belt - Fan; Auto.	202051	③♣9670HD
Belt - W.P.; Auto.; W/36 1/4" Belt O.C.		②♣9360HD
Belt - W.P.; Auto.; W/67 1/8" Belt O.C.	189586	②TR28666
Belt - Alt.; Auto.; W/36 1/4" Belt O.C.		②♣9360HD
Belt - Alt.; Auto.; W/33 1/2" Belt O.C.	178658	②TR22329
Belt - Alt.; Auto.; W/46 1/2" Belt O.C.	200549	②♣9463HD
V-903-C		
Belt - Fan; Auto.	202051	③♣9670HD
Belt - Fan; W/58 1/4" Belt O.C.	178499	③♣9580HD
Belt - Fan; W/62 1/2" Belt O.C.	178629	③TR28616
Belt - W.P.; Auto.; W/36 1/4" Belt O.C.		②♣9360HD
Belt - W.P.; Auto.; W/39 3/4" Belt O.C.	197583	TR22392
Belt - W.P.; Auto.; W/67 1/8" Belt O.C.	189586	②TR28666
Belt - Alt.; Auto.; W/36 1/4" Belt O.C.		②♣9360HD
Belt - Alt.; Auto.; W/33 1/2" Belt O.C.	178658	②TR22329
Belt - Alt.; Auto.; W/46 1/2" Belt O.C.	200549	②♣9463HD
Belt - Alt.; W/38 3/4" Belt O.C.	178479	②♣9385HD
Belt - Alt.; W/52 1/4" Belt O.C.	197171	②♣9520HD
V-1710-B500; V-1710-C500		
Belt - Fan	178621	②TR22711
Belt - W.P.	178665	②TR28390
Belt - Gen.	178613	②TR22344
V-1710-P500		
Belt - W.P.	178665	②TR28390
Belt - Gen.	178613	②TR22344
VT8-430-B; VT8-430-BI; VT8-430-CI		
Belt - Fan	117230	②TR30754
Belt - W.P.	129643	TR22363
Belt - Gen.	111724	TR22336
VT8-460-BI		
Belt - Fan	132237	②TR28743
Belt - W.P.	132010	TR22363
Belt - Gen. & Aux. Pump	132611	②TR24438
VT12-600; VT12-700		
Belt - Fan; W/71 5/8" Belt O.C.	134821	②TR22711
Belt - Fan; W/74 3/8" Belt O.C.	69995	②♣9740HD
Belt - W.P.	125367	TR28376
Belt - Gen.	134813	②TR22344
Belt - Alt.	70362	②6929
Belt - P.S.; W/Vickers P.S. Pump; Under 1800 R.P.M.	S2698	②TR22363
Belt - P.S.; W/Vickers P.S. Pump; 1800 R.P.M. & Over	126597	②TR22380
VT28		
Belt - Alt.	5110163	②♣9330HD
VT1710-C635		
Belt - Fan	178424	②♣9740HD
Belt - W.P.	178665	②TR28390
Belt - Gen.	178613	②TR22344
VT-12		
Belt - Fan	69995	②♣9740HD

Application	Mfr. Part No.	Our No.
CUMMINS - Continued		
VT-12 - Continued		
Belt - W.P.	125367	TR28376
Belt - Gen.; W/High Mount Std. Gen.	134813	②TR22344
Belt - Gen.; W/High Mount Optional Gen.	70350	②TR22358
Belt - Alt.	70362	②6929
Belt - Belt; W/Barnes Pump	129949	②♣9309HD
VT-903		
Belt - Fan; Auto.	202051	③♣9670HD
Belt - W.P.; Auto.; W/36 1/4" Belt O.C.		②♣9360HD
Belt - W.P.; Auto.; W/67 1/8" Belt O.C.	189586	②TR28666
Belt - Alt.; Auto.; W/36 1/4" Belt O.C.		②♣9360HD
Belt - Alt.; Auto.; W/33 1/2" Belt O.C.	178658	②TR22329
Belt - Alt.; Auto.; W/46 1/2" Belt O.C.	200549	②♣9463HD
VT-1710-P635		
Belt - W.P.	178665	②TR28390
Belt - Gen.	178613	②TR22344
VTA28		
Belt - Alt.	5110163	②♣9330HD
VTA-1710-B700; VTA-1710-C700		
Belt - Fan	178424	②♣9740HD
Belt - W.P.	178665	②TR28390
Belt - Gen.	178613	②TR22344
VTA-1710-C800		
Belt - Fan	178578	③TR28706
Belt - W.P.	178665	②TR28390
Belt - Gen.	178613	②TR22344
VTA-1710-P700; VTA-1710-P800		
Belt - W.P.	178665	②TR28390
Belt - Gen.	178613	②TR22344
DEUTZ-ALLIS		
BF12L 714		
Belt - Alt./Gen.; W/41 3/8" Belt O.C.		♣9412HD
Belt - Alt./Gen.; W/42 1/4" Belt O.C.		♣9420HD
Belt - Alt./Gen.; W/44 3/8" Belt O.C.		♣9440HD
Belt - Alt./Gen.; W/49 3/8" Belt O.C.		♣9490HD
Belt - Compr.		②♣9430HD
F1L 310		
Belt - Gen. & Blower		7350
F1L 410		
Belt - Alt./Gen. & Blower; W/34 1/8" Belt O.C.		7340
Belt - Alt./Gen. & Blower; W/35 1/4" Belt O.C.		7350
Belt - Alt./Gen. & Blower; W/36 1/4" Belt O.C.		7360
Belt - Alt./Gen. & Blower; W/37 5/8" Belt O.C.		7375
F1L 712		
Belt - Gen.		7312
F1L 714		
Belt - Alt./Gen.; W/41 3/8" Belt O.C.		♣9412HD
Belt - Alt./Gen.; W/42 1/4" Belt O.C.		♣9420HD
Belt - Alt./Gen.; W/44 3/8" Belt O.C.		♣9440HD
Belt - Alt./Gen.; W/49 3/8" Belt O.C.		♣9490HD
Belt - Compr.		②♣9430HD
F1L 812		
Belt - Alt./Gen.; W/28 1/8" Belt O.C.		7280
Belt - Alt./Gen.; W/29 5/8" Belt O.C.		7295
Belt - Alt./Gen.; W/32 1/4" Belt O.C.		7320
F2L 310		
Belt - Gen. & Blower		7350
F2L 410		
Belt - Alt./Gen. & Blower; W/34 1/8" Belt O.C.		7340

② Two Required.

♣ Standard Belt Available. See Pages 630-631.

③ Three Required.

Belts and Hose for Power Units

Application	Mfr. Part No.	Our No.
DEUTZ-ALLIS - Continued		
F2L 410 - Continued		
Belt - Alt./Gen. & Blower; W/35 1/4" Belt O.C.		7350
Belt - Alt./Gen. & Blower; W/36 1/4" Belt O.C.		7360
Belt - Alt./Gen. & Blower; W/37 5/8" Belt O.C.		7375
F2L 514		
Belt - Alt./Gen. & Blower		TR22625
F2L 712		
Belt - Gen.		7295
F2L 812		
Belt - Alt./Gen.; W/28 1/8" Belt O.C.		7280
Belt - Alt./Gen.; W/29 5/8" Belt O.C.		7295
Belt - Alt./Gen.; W/32 1/4" Belt O.C.		7320
F2L 812S		
Belt - Gen. & Blower; W/44 1/4" Belt O.C.		7440
Belt - Gen. & Blower; W/45 1/8" Belt O.C.		7450
F2L 912		
Belt - Alt./Gen. & Blower; W/44 1/4" Belt O.C.		7440
Belt - Alt./Gen. & Blower; W/45 1/8" Belt O.C.		7450
Belt - Alt./Gen. & Blower; W/54 1/2" Belt O.C.		7541
F3L 514		
Belt - Alt./Gen. & Blower		7660
F3L 712		
Belt - Alt./Gen.; W/42 1/4" Belt O.C.		♣9420HD
Belt - Alt./Gen.; W/43 3/4" Belt O.C.		♣9435HD
Belt - Blower		♣9510HD
Belt - Compr.		♣9420HD
F3L 812		
Belt - Blower; W/52 1/4" Belt O.C.		♣9520HD
Belt - Blower; W/53 1/4" Belt O.C.		♣9530HD
Belt - Blower; W/59 1/4" Belt O.C.		♣9590HD
Belt - Blower; W/60 1/4" Belt O.C.		♣9600HD
Belt - Compr.		♣9420HD
F3L 911; F3L 912		
Belt - Blower; W/42 3/4" Belt O.C.		7425
Belt - Blower; W/43 1/8" Belt O.C.		7430
Belt - Blower; W/49 3/8" Belt O.C.		7490
Belt - Blower; W/50 1/8" Belt O.C.		7500
Belt - Blower; W/50 7/8" Belt O.C.		7508
Belt - Blower; W/52 1/8" Belt O.C.		7520
Belt - Blower; W/53 3/8" Belt O.C.		7530
Belt - Blower; W/57 1/4" Belt O.C.		7570
Belt - Blower; W/58 1/8" Belt O.C.		7580
Belt - Blower; W/59 1/8" Belt O.C.		7590
Belt - Alt./Gen.; W/42 3/4" Belt O.C.		7425
Belt - Alt./Gen.; W/43 1/8" Belt O.C.		7430
Belt - Alt./Gen.; W/44 1/4" Belt O.C.		7440
Belt - Alt./Gen.; W/38" Belt T.W.; W/45 1/8" Belt O.C.		7450
Belt - Alt./Gen.; W/12" Belt T.W.; W/45 3/8" Belt O.C.		♣9451HD
Belt - Alt./Gen.; W/46 1/4" Belt O.C.		7460
Belt - Alt./Gen.; W/57 1/4" Belt O.C.		7570
Belt - Alt./Gen.; W/59 1/8" Belt O.C.		7590
Belt - Alt./Gen.; W/59 3/4" Belt O.C.		7597
Belt - Alt./Gen.; W/60 7/8" Belt O.C.		7612
Belt - Compr.; W/39 1/4" Belt O.C.		♣9390HD
Belt - Compr.; W/42 1/4" Belt O.C.		♣9420HD
Belt - Compr.; W/43 1/4" Belt O.C.		♣9430HD
F4L 514		
Belt - Alt.		♣9350HD
Belt - Blower		7640
F4L 712		
Belt - Alt./Gen.; W/42 1/4" Belt O.C.		♣9420HD
Belt - Alt./Gen.; W/43 3/4" Belt O.C.		♣9435HD
Belt - Blower		♣9510HD
Belt - Compr.		♣9420HD

Application	Mfr. Part No.	Our No.
DEUTZ-ALLIS - Continued		
F4L 712 - Continued		
Belt - Compr.		♣9420HD
F4L 812		
Belt - Blower; W/52 1/4" Belt O.C.		♣9520HD
Belt - Blower; W/53 1/4" Belt O.C.		♣9530HD
Belt - Blower; W/59 1/4" Belt O.C.		♣9590HD
Belt - Blower; W/60 1/4" Belt O.C.		♣9600HD
Belt - Compr.		♣9420HD
F4L 912		
Belt - Blower; W/42 3/4" Belt O.C.		7425
Belt - Blower; W/43 1/8" Belt O.C.		7430
Belt - Blower; W/49 3/8" Belt O.C.		7490
Belt - Blower; W/50 1/8" Belt O.C.		7500
Belt - Blower; W/50 7/8" Belt O.C.		7508
Belt - Blower; W/52 1/8" Belt O.C.		7520
Belt - Blower; W/53 3/8" Belt O.C.		7530
Belt - Blower; W/57 1/4" Belt O.C.		7570
Belt - Blower; W/58 1/8" Belt O.C.		7580
Belt - Blower; W/59 1/8" Belt O.C.		7590
Belt - Alt./Gen.; W/42 3/4" Belt O.C.		7425
Belt - Alt./Gen.; W/43 1/8" Belt O.C.		7430
Belt - Alt./Gen.; W/44 1/4" Belt O.C.		7440
Belt - Alt./Gen.; W/38" Belt T.W.; W/45 1/8" Belt O.C.		7450
Belt - Alt./Gen.; W/12" Belt T.W.; W/45 3/8" Belt O.C.		♣9451HD
Belt - Alt./Gen.; W/46 1/4" Belt O.C.		7460
Belt - Alt./Gen.; W/57 1/4" Belt O.C.		7570
Belt - Alt./Gen.; W/59 1/8" Belt O.C.		7590
Belt - Alt./Gen.; W/59 3/4" Belt O.C.		7597
Belt - Alt./Gen.; W/60 7/8" Belt O.C.		7612
Belt - Compr.; W/39 1/4" Belt O.C.		♣9390HD
Belt - Compr.; W/42 1/4" Belt O.C.		♣9420HD
Belt - Compr.; W/43 1/4" Belt O.C.		♣9430HD
F4M 716		
Belt - Fan; W/51 1/4" Belt O.C.		♣9510HD
Belt - Fan; W/53 1/4" Belt O.C.		♣9530HD
Belt - Fan; W/54 1/4" Belt O.C.		♣9540HD
Belt - Fan; W/55 1/4" Belt O.C.		♣9550HD
F6L 413		
Belt - Alt./Gen.; W/38 1/8" Belt O.C.; W/Single Belt		7380
Belt - Alt./Gen.; W/38 1/8" Belt O.C.; W/Dual Belts		②7380
Belt - Alt./Gen.; W/39 1/8" Belt O.C.		7390
Belt - Alt./Gen.; W/43 1/8" Belt O.C.		7430
Belt - Alt./Gen.; W/44 1/4" Belt O.C.		7440
Belt - Alt./Gen.; W/45 1/8" Belt O.C.; W/Single Belt		7450
Belt - Alt./Gen.; W/45 1/8" Belt O.C.; W/Dual Belts		②7450
Belt - Compr.; W/37 1/4" Belt O.C.		②♣9370HD
Belt - Compr.; W/38 1/4" Belt O.C.		②♣9380HD
Belt - Compr.; W/40 1/4" Belt O.C.; W/Single Belt		♣9400HD
Belt - Compr.; W/40 1/4" Belt O.C.; W/Dual Belts		②♣9400HD
F6L 514		
Belt - Alt.		♣9350HD
Belt - Blower		7640
F6L 712		
Belt - Alt./Gen.; W/42 1/4" Belt O.C.		♣9420HD
Belt - Alt./Gen.; W/43 3/4" Belt O.C.		♣9435HD
Belt - Blower		♣9510HD
Belt - Compr.		♣9420HD
F6L 714		
Belt - Alt./Gen.; W/40 3/8" Belt O.C.		TR22397
Belt - Alt./Gen.; W/41 5/8" Belt O.C.		TR22410
Belt - Alt./Gen.; W/42 1/4" Belt O.C.		♣9420HD
Belt - Alt./Gen.; W/49 1/4" Belt O.C.		♣9490HD
Belt - Compr.		②♣9430HD
F6L 812		
Belt - Blower; W/52 1/4" Belt O.C.		♣9520HD

Power Units

♣ Standard Belt Available. See Pages 630-631.

② Two Required.

Belts and Hose for Power Units

Application	Mfr. Part No.	Our No.
DEUTZ-ALLIS - Continued		
F6L 812 - Continued		
Belt - Blower; W/53 1/4" Belt O.C.		▲9530HD
Belt - Blower; W/59 1/4" Belt O.C.		▲9590HD
Belt - Blower; W/60 1/4" Belt O.C.		▲9600HD
Belt - Compr.		▲9420HD
F6L 911; F6L 912		
Belt - Blower; W/42 3/4" Belt O.C.		7425
Belt - Blower; W/43 1/8" Belt O.C.		7430
Belt - Blower; W/49 3/8" Belt O.C.		7490
Belt - Blower; W/50 1/8" Belt O.C.		7500
Belt - Blower; W/50 7/8" Belt O.C.		7508
Belt - Blower; W/52 1/8" Belt O.C.		7520
Belt - Blower; W/53 3/8" Belt O.C.		7530
Belt - Blower; W/57 1/4" Belt O.C.		7570
Belt - Blower; W/58 1/8" Belt O.C.		7580
Belt - Blower; W/59 1/8" Belt O.C.		7590
Belt - Alt./Gen.; W/42 3/4" Belt O.C.		7425
Belt - Alt./Gen.; W/43 1/8" Belt O.C.		7430
Belt - Alt./Gen.; W/44 1/4" Belt O.C.		7440
Belt - Alt./Gen.; W/3/8" Belt T.W.; W/45 1/8" Belt O.C.		7450
Belt - Alt./Gen.; W/1/2" Belt T.W.; W/45 3/8" Belt O.C.		▲9451HD
Belt - Alt./Gen.; W/46 1/4" Belt O.C.		7460
Belt - Alt./Gen.; W/57 1/4" Belt O.C.		7570
Belt - Alt./Gen.; W/59 1/8" Belt O.C.		7590
Belt - Alt./Gen.; W/59 3/4" Belt O.C.		7597
Belt - Alt./Gen.; W/60 7/8" Belt O.C.		7612
Belt - Compr.; W/39 1/4" Belt O.C.		▲9390HD
Belt - Compr.; W/42 1/4" Belt O.C.		▲9420HD
Belt - Compr.; W/43 1/4" Belt O.C.		▲9430HD
F6M 716		
Belt - Fan; W/51 1/4" Belt O.C.		▲9510HD
Belt - Fan; W/53 1/4" Belt O.C.		▲9530HD
Belt - Fan; W/54 1/4" Belt O.C.		▲9540HD
Belt - Fan; W/55 1/4" Belt O.C.		▲9550HD
F8L 413		
Belt - Alt./Gen.; W/38 1/8" Belt O.C.; W/Single Belt		7380
Belt - Alt./Gen.; W/38 1/8" Belt O.C.; W/Dual Belts		②7380
Belt - Alt./Gen.; W/39 1/8" Belt O.C.		7390
Belt - Alt./Gen.; W/43 1/8" Belt O.C.		7430
Belt - Alt./Gen.; W/44 1/4" Belt O.C.		7440
Belt - Alt./Gen.; W/45 1/8" Belt O.C.; W/Single Belt		7450
Belt - Alt./Gen.; W/45 1/8" Belt O.C.; W/Dual Belts		②7450
Belt - Compr.; W/37 1/4" Belt O.C.		②▲9370HD
Belt - Compr.; W/38 1/4" Belt O.C.		②▲9380HD
Belt - Compr.; W/40 1/4" Belt O.C.; W/Single Belt		▲9400HD
Belt - Compr.; W/40 1/4" Belt O.C.; W/Dual Belts		②▲9400HD
F8L 714		
Belt - Alt./Gen.; W/40 3/8" Belt O.C.		TR22397
Belt - Alt./Gen.; W/41 5/8" Belt O.C.		TR22410
Belt - Alt./Gen.; W/42 1/4" Belt O.C.		▲9420HD
Belt - Alt./Gen.; W/49 1/4" Belt O.C.		▲9490HD
Belt - Compr.		②▲9430HD
F8M 716		
Belt - Fan; W/51 1/4" Belt O.C.		▲9510HD
Belt - Fan; W/53 1/4" Belt O.C.		▲9530HD
Belt - Fan; W/54 1/4" Belt O.C.		▲9540HD
Belt - Fan; W/55 1/4" Belt O.C.		▲9550HD
F10L 714		
Belt - Compr.		▲9400HD
F12M 716		
Belt - Fan; W/43 1/4" Belt O.C.		▲9430HD
Belt - Fan; W/44 1/4" Belt O.C.		▲9440HD
Belt - Fan; W/45 3/8" Belt O.C.		▲9451HD
Belt - Fan; W/46 1/2" Belt O.C.		▲9463HD
Belt - Fan; W/47 1/4" Belt O.C.		▲9470HD
Belt - Fan; W/48 1/4" Belt O.C.		▲9480HD

Application	Mfr. Part No.	Our No.
DEUTZ-ALLIS - Continued		
F12M 716 - Continued		
Belt - W.P. (Raw); W/59 1/4" Belt O.C.		▲9590HD
Belt - W.P. (Raw); W/61 1/4" Belt O.C.		▲9610HD
INTERNATIONAL		
EUBH		
Belt - Fan	48032D	TR28386
Belt - Gen.	48878D	▲9313HD
R372; R406; R450		
Belt - Fan	35974HA	②TR22517
S220; S240		
Belt - Fan & Gen.	78910R1	TR28445
U1		
Belt - Fan	60712D	TR26353
U2; U2A		
Belt - Fan	46869D	TR28346
Belt - Fan & W.P.	60712D	TR26353
Belt - Gen.; W/Delco Gen.	49291D	6826
U4		
Belt - Fan	48032D	TR28386
U6		
Belt - Fan	69490DA	TR30467
Belt - Gen.; W/Delco Gen.	49341D	▲9335HD
Belt - Gen.; W/Bosch Gen.	54857DB	9300
U9		
Belt - Fan	48042D	TR30484
Belt - Gen.	54867D	▲9355HD
U14		
Belt - Fan	30982D	TR32571
U21		
Belt - Fan	22705D	TR32491
U123		
Belt - Fan	46869D	TR28346
Belt - Fan & W.P.	60712D	TR26353
Belt - Gen.	52318DA	9279
U164; U169; U175		
Belt - Fan	48032DA	TR28386
Belt - Gen.	48878D	▲9309HD
U220; U240		
Belt - Fan & Gen.	20594VA	TR24449
U264		
Belt - Fan; W/4-Cyl. Eng.	69490DA	TR30467
Belt - Fan & Gen.; W/6-Cyl. Eng.	274521R1	TR24438
Belt - Gen.; W/4-Cyl. Eng.	49341D	▲9335HD
U281		
Belt - Fan	16131DA	TR30467
Belt - Gen.	49341D	▲9335HD
U350		
Belt - Fan	48042DA	TR30484
Belt - Gen.	54857DB	9300
U372; U406; U450; U501		
Belt - Fan & Gen.	35974HA	②TR22517
U1091		
Belt - Fan & Gen.	250678R41	②CX68
UB220; UB240; UB264		
Belt - Fan & Gen.	274705R1	TR24438

▲ Standard Belt Available. See Pages 630-631.

② Two Required.

Belts and Hose for Power Units

Application	Mfr. Part No.	Our No.
INTERNATIONAL - Continued		
UB220; UB240; UB264 - Continued		
Belt - Gov.	312017R1	7380
UC60		
Belt - Fan	60712D	TR26353
Belt - Gen.	351321R1	6821
UC135		
Belt - Fan & Gen.	367697R1	7417
UC221; UC263		
Belt - Fan & Gen.; W/46 1/2" Belt O.C.	305177R1	▲9463HD
Belt - Fan & Gen.; W/49 1/4" Belt O.C.	190502R1	▲9490HD
Belt - Fan & Gen.; W/52 1/4" Belt O.C.	312515R1	▲9525HD
UD6; UD6A		
Belt - Fan & W.P.	69490DA	TR30467
Belt - Gen.	54857DB	9300
Belt - Fuel Pump	48878D	▲9309HD
UD9		
Belt - Fan	48042D	TR30484
Belt - Gen.	54857DB	9300
UD9A		
Belt - Fan	48042D	TR30484
Belt - Gen.	54867D	▲9355HD
UD14; UD14A		
Belt - Fan	30982D	TR32571
Belt - Gen.	54857DB	9300
Belt - Fuel Pump	48878D	▲9309HD
UD16		
Belt - Fan & Gen.; W/3 7/8" Pulley	251753R11	◎TR28616
UD18; UD18A		
Belt - Fan; W/8 7/8" C.S. Pulley	251180R2	◎TR28628
Belt - Fan; W/9 1/2" C.S. Pulley	258275R11	◎TR30652
Belt - Fuel Pump	49341D	▲9335HD
UD24		
Belt - Fan	250678R31	◎CX68
UD236		
Belt - Fan & Gen.; W/50 3/4" Belt O.C.	304436R1	▲9505HD
Belt - Fan & Gen.; W/52 1/4" Belt O.C.	312515R1	▲9525HD
UD264		
Belt - Fan	69490DA	TR30467
Belt - Gen.	52318DA	9279
Belt - Fuel Pump	48878D	▲9309HD
UD281		
Belt - Fan	48042DA	TR30484
Belt - Gen.	52318DA	9279
Belt - Fuel Pump	48878D	▲9309HD
UD282		
Belt - Fan & Gen.; W/50 3/4" Belt O.C.	304436R1	▲9505HD
Belt - Fan & Gen.; W/52 1/4" Belt O.C.	312515R1	▲9525HD
UD350; UD370		
Belt - Fan	48042DA	TR30484
Belt - Gen.	54857DB	9300
Belt - Fuel Pump	48878D	▲9309HD
UD525; UD554		
Belt - Fan & Gen.	251753R21	◎TR28616
UD691		
Belt - Fan & Gen.	251180R41	◎TR28628
UD817		
Belt - Gen.; W/48 1/4" Belt O.C.	310081R2	▲9480HD

Application	Mfr. Part No.	Our No.
INTERNATIONAL - Continued		
UD817 - Continued		
Belt - Gen.; W/52 1/2" Belt O.C.	304312R1	TR22517
UD1091		
Belt - Fan; Ser. No. 1960 & Before	250678R51	◎CX68
Belt - Fan; Ser. No. 1691 To 10143	275475R11	◎TR28733
Belt - Fan; Ser. No. 10144 & After	310357R11	◎TR30754
UDT817		
Belt - Gen.; W/48 1/4" Belt O.C.	310081R2	▲9480HD
Belt - Gen.; W/52 1/2" Belt O.C.	304312R1	TR22517
UDT1091		
Belt - Fan; Ser. No. 1960 & Before	250678R51	◎CX68
Belt - Fan; Ser. No. 1691 To 10143	275475R11	◎TR28733
Belt - Fan; Ser. No. 10144 & After	310357R11	◎TR30754
UV345		
Belt - Fan & Gen.	151534R1	7680
UV401; UV461; UV549		
Belt - Fan	133500R11	◎TR22434
Belt - Gen.	133732R1	▲9360HD
ISUZU		
2AB		
Belt - Fan & Alt.	13671809	▲9385HD
C201; C221; C240		
Belt - Fan & Alt.; W/40 1/4" Belt O.C.	13671215	▲9400HD
Belt - Fan & Alt.; W/40 3/4" Belt O.C.	13671801	▲9405HD
DA120; DA220; DA640		
Belt - Fan & Alt.; W/54" Belt O.C.	13671125	TR22534
Belt - Fan & Alt.; W/55" Belt O.C.	13671198	◎TR22545
DH100		
Belt - W.P. & Alt.	13671156	◎TR30672
JOHN DEERE		
4039D		
Belt - Fan & Alt.; W/3.9 L Eng.	R73784	TR22525
6619A		
Belt - Fan & Alt.; W/10.1 L Eng.	RE12086	◎▲9690HD
LISTER		
HR3		
Belt - Alt.; W/33.5 H.P. Eng.		▲9400HD
Quicksilver QS-5.0G; Quicksilver QS-7.5G 0.9 L		
Belt - W.P. (Raw) & Alt.; W/4-Cyl. Eng.	15310	7312
Quicksilver QS-8.0D 1.0 L		
Belt - W.P., W.P. (Raw) & Alt.; W/3-Cyl. Diesel Eng.		7365
Quicksilver QS-8.0G 0.9 L		
Belt - W.P. (Raw) & Alt.; W/4-Cyl. Eng.	15310	7312
Quicksilver QS-10.G 1.2 L		
Belt - W.P. (Raw) & Alt.; W/4-Cyl. 75 Eng.		7312
SR4		
Belt - Alt. & Blower; W/24 H.P. Eng.		7435
MKT MFG. INC.		
HP175		
Belt - Fan & Alt.; W/John Deere 6068 Turbodiesel Eng.	RE44538	◎▲9580HD
Hose - Upper; W/John Deere 6068 Turbodiesel Eng.		●26511
Hose - Lower; W/John Deere 6068 Turbodiesel Eng.		●26512

▲ Standard Belt Available. See Pages 630-631.
● Vulco-Flex® Coolant Hose.

◎ Two Required.

Belts and Hose for Power Units

Application	Mfr. Part No.	Our No.
NORTHERN LIGHTS		
M643		
Belt - W.P. & Alt.; W/3-Cyl. Diesel Eng.	REMF1280	7280
M753		
Belt - W.P. & Alt.; W/3-Cyl. Diesel Eng.	REMF1310	7312
M843N		
Belt - W.P. & Alt.; W/3-Cyl. Diesel Eng.		▲9385HD
M964		
Belt - W.P. & Alt.; W/4-Cyl. Diesel Eng.		TR22474
M4276T		
Belt - W.P. & Alt.; W/4-Cyl. Diesel Eng.	T26755	▲9570HD
ONAN		
5GO		
Belt - Fan	5117	TR22336
6GO		
Belt - Fan	5118	TR22386
150DGFA		
Hose - Lower; W/Cummins 6Cta8.3C Eng.		21901
175DFBD		
Belt - Fan; W/Cummins NT855G4, NT855G5 Eng.	5110160	②TR28412
Belt - Alt.; W/35A. Alt.; W/Cummins NT855G4, NT855G5 Eng.	5110084	▲9470HD
Belt - Alt.; W/75A. Alt.; W/Cummins NT855G4, NT855G5 Eng.	5110156	▲9463HD
175DGFA		
Hose - Lower; W/Cummins 6Cta8.3C Eng.		21901
200DFBD; 220DFBE; 230DFBD; 250DFB6; 275DFCB; 300DFCB; 310DFCC; 350DFCC		
Belt - Fan; W/Cummins NT855G4, NT855G5 Eng.	5110160	②TR28412
Belt - Alt.; W/35A. Alt.; W/Cummins NT855G4, NT855G5 Eng.	5110084	▲9470HD
Belt - Alt.; W/75A. Alt.; W/Cummins NT855G4, NT855G5 Eng.	5110156	▲9463HD
620.750DFJA; 660DFJB; 800DFJB; 800DFJC; 900DFJC		
Belt - Alt.; W/35A. Alt.; W/Cummins KTA38GI Eng.	511016102	▲K050345HD
A61		
Belt - Alt.; W/6A3.4 Eng.	511014713	②7490
AJ		
Belt - Gen.	511P53	7320
CCK		
Belt - Gen.	511P51	7380
DFEB; DFFA; DFFB		
Belt - Alt.; W/35A. Alt.; W/Cummins KTA19, KTTA19G Eng.	5110119	K050290
Belt - Alt.; W/45A. Alt.; W/Cummins KTA19, KTTA19G Eng.	511016105	K050355
Belt - Alt.; W/75A. Alt.; W/Cummins KTA19, KTTA19G Eng.	5110161	K050370
Hose - Upper - Eng. To Pipe; W/Cummins KTA19, KTTA19 Eng.(2 1/2" I.D.)		24440
Hose - Upper - Pipe To Rad.; W/Cummins KTA19, KTTA19 Eng.(2 1/2" I.D.)		24440
Hose - Lower - Eng. To Pipe; W/Cummins KTA19, KTTA19 Eng.(3 1/2" I.D.)		24456
Hose - Lower - Pipe To Rad.; W/Cummins KTA19, KTTA19 Eng.(3 1/2" I.D.)		24456

Application	Mfr. Part No.	Our No.
ONAN - Continued		
DFLB		
Belt - Alt.; W/35A. Alt.; W/Cummins KTA50-G2 Eng.	511016102	▲K050345HD
Belt - Alt.; W/75A. Alt.; W/Cummins KTA50-G2 Eng.	511016102	②▲K050345HD
DFLC		
Belt - Alt.; W/75A. Alt.; W/Cummins KTA50-G2 Eng.	511016102	②▲K050345HD
DFLD		
Belt - Alt.; W/35A. Alt.; W/Cummins KTA50-G2 Eng.	511016102	▲K050345HD
Belt - Alt.; W/75A. Alt.; W/Cummins KTA50-G2 Eng.	511016102	②▲K050345HD
DRP		
Belt - Fan	511P42	TR22373
DZB		
Belt - Gen.; W/44 1/4" Belt O.C.	511P56	7440
Belt - Gen.; W/47 1/4" Belt O.C.	511P60	▲9470HD
DZC; DZD		
Belt - Gen.	511P60	▲9470HD
EC		
Belt - Fan	51138	7390
Belt - Gen.	51139	7435
ED		
Belt - Fan	511P40	TR24489
Belt - Gov.	511P41	7400
EF		
Belt - Fan	511P40	TR24489
HK; HN		
Belt - Fan	5119	3460
JC		
Belt - Gen.	511P67	7350
KB; KR		
Belt - Fan; W/44" Belt O.C.	511P59	TR22434
Belt - Fan; W/48 1/4" Belt O.C.	51118	▲9480HD
Belt - Gen.	511P58	▲9360HD
L423		
Belt - W.P. & Alt.; W/High Mount Alt.		7495
Belt - W.P. & Alt.; W/Low Mount Alt.		7512
L634		
Belt - W.P. & Alt.; W/Low Mount Alt.		7525
LK		
Belt - Gen.	511P55	7410
RDJC		
Belt - Gen.	511P66	7450
RJC		
Belt - Pump	511P66	7450
P & H		
187C; 287C		
Belt - Gen.; W/Keel Cooled Eng.	T20773	TR28616
Belt - Fan, Gen. & Gov.; W/Keel Cooled Eng.		TR24638
387A		
Belt - Fan & Gen.		TR28596
387B		
Belt - Fan & Gen.	T11343	TR28616

▲ Standard Belt Available. See Pages 630-631.

② Two Required.

Belts and Hose for Power Units

Application	Mfr. Part No.	Our No.	Application	Mfr. Part No.	Our No.
P & H - Continued			PERKINS - Continued		
387C			6.305		
Belt - Fan; W/261, 348, 522 Diesel Eng.	T18821	TR28483	Belt - Fan & Gen.; Ser. No. 3500251 & After; List		
Belt - Fan; Auto.; W/261, 348, 522 Diesel Eng.	T28782	②▲9490HD	162, 171; W/Vehicle Eng.	2612430	▲9540HD
Belt - Gen.; W/261, 348, 522 Diesel Eng.	T15054	TR28437	Belt - Fan & Gen.; Ser. No. 3500251 & After; List		
Belt - Gen. & Compr.; Auto.; W/261, 348, 522 Diesel Eng.		②7541	172, 174; W/Vehicle Eng.	2612419	▲9480HD
Belt - Fan & Gen.; W/261, 348, 522 Diesel Eng.	T13058	②TR28570	6.354		
387H			Belt - Fan & Gen.; W/Industrial Eng.		
Belt - Fan; W/261, 348, 522 Diesel Eng.	T18821	TR28483		2612432	▲9550HD
Belt - Fan; Auto.; W/261, 348, 522 Diesel Eng.	T28782	②▲9490HD	Belt - Fan & Gen.; Ser. No. 8000251 & After; List		
Belt - Gen.; W/261, 348, 522 Diesel Eng.	T15054	TR28437	199, 206, 217; W/Vehicle Eng.	2612422	▲9500HD
Belt - Gen. & Compr.; Auto.; W/261, 348, 522 Diesel Eng.		②7541	Belt - Fan & Gen.; Ser. No. 8000251 & After; List		
487C			207, 208, 216; W/Vehicle Eng.	2612432	▲9550HD
Belt - Fan; W/261, 348, 522 Diesel Eng.	T18821	TR28483	L4		
Belt - Fan; Auto.; W/261, 348, 522 Diesel Eng.	T28782	②▲9490HD	Belt - Fan & Gen.		
Belt - Gen.; W/261, 348, 522 Diesel Eng.	T15054	TR28437		0070052	TR22517
Belt - Gen. & Compr.; Auto.; W/261, 348, 522 Diesel Eng.		②7541	P3		
Belt - Fan & Gen.; W/261, 348, 522 Diesel Eng.	T13058	②TR28570	Belt - Fan & Gen.; W/46 3/4" Belt O.C.		
487H				0070063	TR24461
Belt - Fan; W/261, 348, 522 Diesel Eng.	T18821	TR28483	Belt - Fan & Gen.; W/51 1/8" Belt O.C.		
Belt - Fan; Auto.; W/261, 348, 522 Diesel Eng.	T28782	②▲9490HD		0070053	TR28501
Belt - Gen.; W/261, 348, 522 Diesel Eng.	T15054	TR28437	P4		
Belt - Gen. & Compr.; Auto.; W/261, 348, 522 Diesel Eng.		②7541	Belt - Fan & Gen.; Ser. No. 2101013 & After		
687B				0070087	▲9415HD
Belt - Fan & Gen.		②TR28616	P6		
687C			Belt - Fan & Gen.; Ser. No. 3024802 & After;		
Belt - Fan; W/261, 348, 522 Diesel Eng.	T18821	TR28483	W/Vehicle Eng.	0070001	TR28501
Belt - Fan; Auto.; W/261, 348, 522 Diesel Eng.	T28782	②▲9490HD	R6		
Belt - Gen.; W/261, 348, 522 Diesel Eng.	T15054	TR28437	Belt - Fan & Gen.		
Belt - Gen. & Compr.; Auto.; W/261, 348, 522 Diesel Eng.		②7541		0070052	TR22517
Belt - Fan & Gen.; W/261, 348, 522 Diesel Eng.	T13058	②TR28570	SHEPPARD		
687H			6C; 6D; 6E; 6F		
Belt - Fan; W/261, 348, 522 Diesel Eng.	T18821	TR28483	Belt - Fan & Gen.		
Belt - Fan; Auto.; W/261, 348, 522 Diesel Eng.	T28782	②▲9490HD		0400251	TR22570
Belt - Gen.; W/261, 348, 522 Diesel Eng.	T15054	TR28437	7D; 7E		
Belt - Gen. & Compr.; Auto.; W/261, 348, 522 Diesel Eng.		②7541	Belt - Fan & Gen.		
Belt - Fan & Gen.; W/261, 348, 522 Diesel Eng.	T13058	②TR28570		0400180	TR22625
PERKINS			8; 9		
3.152			Belt - Fan		
Belt - W.P. & Gen.; W/48 1/4" Belt O.C.; W/Diesel				0400140	▲9425HD
Eng.	2612419	▲9480HD	Belt - Gen.		
Belt - W.P. & Gen.; W/50 1/4" Belt O.C.; W/Diesel				0400220	TR22322
Eng.	2612422	▲9500HD	13C; 13D; 13E; 13F		
Belt - W.P. & Gen.; W/53 1/4" Belt O.C.; W/Diesel			Belt - Fan & Gen.		
Eng.	2612429	▲9530HD			TR22570
Belt - W.P. & Gen.; W/54 1/4" Belt O.C.; W/Diesel		▲9540HD	14; 14C		
Eng.			Belt - Gen.		
4.99				0400220	TR22322
Belt - Fan & Gen.; Ser. No. 7004038 & Before;			16		
W/Agricultural, Vehicle Eng.	0070168	▲9385HD	Belt - Fan & Gen.		
Belt - Fan & Gen.; Ser. No. 7004039 & After;				0400050	7575
W/Agricultural, Vehicle Eng.	0070077	▲9390HD	17		
4.192			Belt - Fan, Gen. & W.P.		
Belt - Fan & Gen.; W/Vehicle Eng.	0070113	▲9550HD		0400130	TR22495
4.203			Belt - Cooler	0400130	7495
Belt - Fan & Gen.; Ser. No. 2600251 & After; List			17A; 19		
156, 163; W/Vehicle Eng.	0070113	▲9550HD	Belt - Fan, Gen. & W.P.		
Belt - Fan & Gen.; Ser. No. 2600251 & After; List				0400301	7405
165, 166; W/Vehicle Eng.	0070167	▲9440HD	UNIVERSAL		
4.270D			5 KW		
Belt - Fan & Gen.; Ser. No. 6200251 & After;			Belt - W.P. & Alt.		
W/Agricultural, Industrial Eng.	0070052	TR22517			7325

Power Units

② Two Required.

▲ Standard Belt Available. See Pages 630-631.

Belts and Coolant Hose for Lift & Industrial Trucks

Order Belts and Hose by Our Number. Manufacturers' Part Number is shown for reference only.

Application	Mfr. Part No.	Our No.	Application	Mfr. Part No.	Our No.
ALLIS-CHALMERS			ALLIS-CHALMERS - Continued		
510; 512			706; 706B		
Allis-Chalmers 4-Cyl. 160			Ford 4-Cyl.		
Belt - Fan & Alt.	233432	7380	Belt - Fan 1017907		▲9313HD
Belt - W.P.	254075	▲9520HD	Belt - Fan & Alt. 1016309		▲9525HD
Hose - Upper		≈20661	Hose - Upper		●25253
		or	Perkins 4-Cyl. 203; Perkins 4-Cyl. 203 Diesel		
Hose - Lower		●25251	Hose - Upper		●25476
		●25252	706C		
Allis-Chalmers 4-Cyl. 175 Diesel; Allis-Chalmers 4-Cyl. 200 Diesel			Perkins 4-Cyl. 203		
Belt - Fan & Alt. 233489		②▲9420HD	Hose - Upper		≈20226
Belt - W.P. 254075		▲9520HD			or
Hose - Upper - Eng. To Pipe; (1 1/2" I.D.)		24224			●25474
Hose - Upper - Pipe To Rad.; (1 1/2" I.D.)		24224	Perkins 4-Cyl. 203 Diesel		
Hose - Lower - Eng. To Pipe		20267	Belt - Fan; Ser. No. 2618 & Before, Exc. Ser.		
Hose - Lower - Pipe To Rad.; (1 1/2" I.D.)		24224	No. 2615 & 2617	1011991	▲9480HD
600			Belt - Fan; Ser. No. 2615, 2617, 2619 & After	1013057	▲9465HD
Allis-Chalmers 4-Cyl. 160			Belt - Fan & Alt. 255200		▲9510HD
Belt - Fan & Alt. 233432		7380	706D		
Belt - W.P. 254075		▲9520HD	Allis-Chalmers 4-Cyl. 200 Diesel		
Hose - Upper		≈20661	Belt - Fan & Alt.; W/42A. Alt. 1011335		▲9525HD
		or	Hose - Upper		≈21944
Hose - Lower		●25251			or
		●25252			●26504
Allis-Chalmers 4-Cyl. 175 Diesel; Allis-Chalmers 4-Cyl. 200 Diesel			708C		
Belt - Fan & Alt. 233489		②▲9420HD	Perkins 4-Cyl. 203		
Belt - W.P. 254075		▲9520HD	Hose - Upper		≈20226
Hose - Upper - Eng. To Pipe; (1 1/2" I.D.)		24224			or
Hose - Upper - Pipe To Rad.; (1 1/2" I.D.)		24224	Perkins 4-Cyl. 203 Diesel		
Hose - Lower - Eng. To Pipe		20267	Belt - Fan; Ser. No. 2618 & Before, Exc. Ser.		
Hose - Lower - Pipe To Rad.; (1 1/2" I.D.)		24224	No. 2615 & 2617	1011991	▲9480HD
614; 621			Belt - Fan; Ser. No. 2615, 2617, 2619 & After	1013057	▲9465HD
Allis-Chalmers 4-Cyl. 160			Belt - Fan & Alt. 255200		▲9510HD
Belt - Fan & Alt. 233432		7380	Perkins 4-Cyl. 236 Diesel		
Belt - W.P. 254075		▲9520HD	Belt - Fan & Alt.; W/55A. Alt.		▲9520HD
Hose - Upper		≈20661	Hose - Upper		●26519
		or	708D		
Hose - Lower		●25251	Allis-Chalmers 4-Cyl. 200 Diesel		
		●25252	Belt - Fan & Alt.; W/42A. Alt. 1011335		▲9525HD
Allis-Chalmers 4-Cyl. 175 Diesel; Allis-Chalmers 4-Cyl. 200 Diesel			Hose - Upper		≈21944
Belt - Fan & Alt. 233489		②▲9420HD			or
Belt - W.P. 254075		▲9520HD			●26504
Hose - Upper - Eng. To Pipe; (1 1/2" I.D.)		24224	ACP100		
Hose - Upper - Pipe To Rad.; (1 1/2" I.D.)		24224	Allis-Chalmers 4-Cyl. 153		
Hose - Lower - Eng. To Pipe		20267	Hose - Upper		●25530
Hose - Lower - Pipe To Rad.; (1 1/2" I.D.)		24224	Allis-Chalmers 6-Cyl. 230		
705C			Hose - Upper; (1 3/4" I.D.)		24228
Perkins 4-Cyl. 203			Allis-Chalmers 6-Cyl. 262 Diesel		
Hose - Upper		≈20226	Belt - Fan & Alt. 4791039		▲9470HD
		or	Hose - Upper; (1 3/4" I.D.)		24228
		●25474	Continental 4-Cyl. 135; Continental 4-Cyl. 163		
Perkins 4-Cyl. 203 Diesel			Hose - Upper		≈21794
Belt - Fan; Ser. No. 2618 & Before, Exc. Ser.					or
No. 2615 & 2617	1011991	▲9480HD	Continental D262 Diesel		
Belt - Fan; Ser. No. 2615, 2617, 2619 & After	1013057	▲9465HD	Hose - Upper		●26611
Belt - Fan & Alt. 255200		▲9510HD	Hose - Lower; (1 3/4" I.D.)		24228
705D			Continental F163		
Allis-Chalmers 4-Cyl. 200 Diesel			Hose - Upper		●25478
Belt - Fan & Alt.; W/42A. Alt. 1011335		▲9525HD	Hose - Lower		●25476
Hose - Upper		≈21944	Continental F245		
		or	Hose - Upper		●25478
		●26504	Waukesha FC133		
			Hose - Upper		≈20573
					or
			Hose - Lower; (1 1/2" I.D.)		●25473
					24224

▲ Standard Belt Available. See Pages 630-631.
● Vulco-Flex® Coolant Hose.

≈ Cut to Fit.
② Two Required.

Belts and Coolant Hose for Lift & Industrial Trucks

Application	Mfr. Part No.	Our No.
ALLIS-CHALMERS - Continued		
AT		
Allis-Chalmers 4-Cyl. 153; Allis-Chalmers 4-Cyl. 175 Diesel; Allis-Chalmers 6-Cyl. 230; Allis-Chalmers 6-Cyl. 230 Diesel; Allis-Chalmers 6-Cyl. 262 Diesel; Waukesha FC	Belt - Fan & Alt. 4791039 Belt - Fan & Gen. 4707727	▲9470HD ▲9451HD
ATD; ATM; ATMD		
Allis-Chalmers 6-Cyl. 230; Allis-Chalmers 6-Cyl. 230 Diesel; Allis-Chalmers 6-Cyl. 262 Diesel	Belt - Fan & Alt. 4791039 Belt - Fan & Gen. 4707727	▲9470HD ▲9451HD
C40E		
Continental F163	Belt - Fan & Alt. 4895398 Hose - Upper	▲9451HD ≅20957 or ●26501
C40X		
Mitsubishi G420	Hose - Upper	●26601
F		
Allis-Chalmers 4-Cyl. 153; Allis-Chalmers 4-Cyl. 175 Diesel	Belt - Fan & Alt. 4791039 Belt - Fan & Gen. 4707727	▲9470HD ▲9451HD
Hose - Upper; Early(1 3/4" I.D.)	24228	
Hose - Upper; Late(1 1/2" I.D.)	24224	
Hose - Lower; Early(1 3/4" I.D.)	24228	
Hose - Lower; Early	●26602	
Allis-Chalmers 6-Cyl. 230; Allis-Chalmers 6-Cyl. 230 Diesel; Allis-Chalmers 6-Cyl. 262 Diesel	Belt - Fan & Alt. 4791039 Belt - Fan & Gen. 4707727	▲9470HD ▲9451HD
Hose - Upper; (1 3/4" I.D.)	24228	
Hose - Lower; Early(1 3/4" I.D.)	24228	
Hose - Lower; Early	●26602	
Waukesha FC	Belt - Fan & Alt. 4791039 Belt - Fan & Gen. 4707727	▲9470HD ▲9451HD
Hose - Upper	≅21256	or ●26503
F40; F50; F60		
Allis-Chalmers 4-Cyl. 153; Allis-Chalmers 6-Cyl. 230	Belt - Fan & Alt.	▲9470HD
IH U4		
Belt - Fan	48032D	TR28386
Belt - Gen.	48878D	▲9309HD
FC; FD; FDS		
Allis-Chalmers 4-Cyl. 153; Allis-Chalmers 4-Cyl. 175 Diesel	Hose - Upper; Early(1 3/4" I.D.)	24228
Hose - Upper; Late(1 1/2" I.D.)	24224	
Hose - Lower; Early(1 3/4" I.D.)	24228	
Hose - Lower; Early	●26602	
Allis-Chalmers 6-Cyl. 230; Allis-Chalmers 6-Cyl. 230 Diesel; Allis-Chalmers 6-Cyl. 262 Diesel	Belt - Fan & Alt. 4791039 Belt - Fan & Gen. 4707727	▲9470HD ▲9451HD
Hose - Upper; (1 3/4" I.D.)	24228	
Hose - Lower; Early(1 3/4" I.D.)	24228	
Hose - Lower; Early	●26602	
Waukesha FC	Hose - Upper	≅21256 or ●26503

Application	Mfr. Part No.	Our No.
ALLIS-CHALMERS - Continued		
FDX; FL		
Allis-Chalmers 4-Cyl. 153; Allis-Chalmers 4-Cyl. 175 Diesel	Belt - Fan & Alt. 4791039 Belt - Fan & Gen. 4707727	▲9470HD ▲9451HD
Hose - Upper; Early(1 3/4" I.D.)	24228	
Hose - Upper; Late(1 1/2" I.D.)	24224	
Hose - Lower; Early(1 3/4" I.D.)	24228	
Hose - Lower; Early	●26602	
Allis-Chalmers 6-Cyl. 230; Allis-Chalmers 6-Cyl. 230 Diesel; Allis-Chalmers 6-Cyl. 262 Diesel	Belt - Fan & Alt. 4791039 Belt - Fan & Gen. 4707727	▲9470HD ▲9451HD
Hose - Upper; (1 3/4" I.D.)	24228	
Hose - Lower; Early(1 3/4" I.D.)	24228	
Hose - Lower; Early	●26602	
Waukesha FC	Belt - Fan & Alt. 4791039 Belt - Fan & Gen. 4707727	▲9470HD ▲9451HD
Hose - Upper	≅21256	or ●26503
FL120		
Allis-Chalmers 6-Cyl. 230; Allis-Chalmers 6-Cyl. 230 Diesel; Allis-Chalmers 6-Cyl. 262 Diesel	Belt - Fan & Alt. 4791039 Belt - Fan & Gen. 4707727	▲9470HD ▲9451HD
FLS		
Allis-Chalmers 4-Cyl. 153; Allis-Chalmers 4-Cyl. 175 Diesel	Hose - Upper; Early(1 3/4" I.D.)	24228
Hose - Upper; Late(1 1/2" I.D.)	24224	
Hose - Lower; Early(1 3/4" I.D.)	24228	
Hose - Lower; Early	●26602	
Allis-Chalmers 6-Cyl. 230; Allis-Chalmers 6-Cyl. 230 Diesel; Allis-Chalmers 6-Cyl. 262 Diesel	Belt - Fan & Alt. 4791039 Belt - Fan & Gen. 4707727	▲9470HD ▲9451HD
Hose - Upper; (1 3/4" I.D.)	24228	
Hose - Lower; Early(1 3/4" I.D.)	24228	
Hose - Lower; Early	●26602	
Waukesha FC	Hose - Upper	≅21256 or ●26503
FP; FPD		
Allis-Chalmers 4-Cyl. 153; Allis-Chalmers 4-Cyl. 175 Diesel	Belt - Fan & Alt. 4791039 Belt - Fan & Gen. 4707727	▲9470HD ▲9451HD
Hose - Upper; Early(1 3/4" I.D.)	24228	
Hose - Upper; Late(1 1/2" I.D.)	24224	
Hose - Lower; Early(1 3/4" I.D.)	24228	
Hose - Lower; Early	●26602	
Allis-Chalmers 6-Cyl. 230; Allis-Chalmers 6-Cyl. 230 Diesel; Allis-Chalmers 6-Cyl. 262 Diesel	Belt - Fan & Alt. 4791039 Belt - Fan & Gen. 4707727	▲9470HD ▲9451HD
Hose - Upper; (1 3/4" I.D.)	24228	
Hose - Lower; Early(1 3/4" I.D.)	24228	
Hose - Lower; Early	●26602	
Waukesha FC	Belt - Fan & Alt. 4791039 Belt - Fan & Gen. 4707727	▲9470HD ▲9451HD
Hose - Upper	≅21256	or ●26503
FPD60; FPD70; FPD80		
Allis-Chalmers 4-Cyl. 153; Allis-Chalmers 4-Cyl. 175 Diesel	Belt - Fan & Alt. 4791039 Belt - Fan & Gen. 4707727	▲9470HD ▲9451HD

▲ Standard Belt Available. See Pages 630-631.
● Vulco-Flex® Coolant Hose.

≅ Cut to Fit.

Belts and Coolant Hose for Lift & Industrial Trucks

Application	Mfr. Part No.	Our No.
ALLIS-CHALMERS - Continued		
FPD60; FPD70; FPD80 - Continued		
Allis-Chalmers 6-Cyl. 230; Allis-Chalmers 6-Cyl. 230 Diesel; Allis-Chalmers 6-Cyl. 262 Diesel		
Belt - Fan & Alt.	4791039	▲9470HD
Belt - Fan & Gen.	4707727	▲9451HD
Belt - Hyd. Pump	4802115	▲9335HD
Waukesha FC		
Belt - Fan & Alt.	4791039	▲9470HD
Belt - Fan & Gen.	4707727	▲9451HD
FPDX		
Allis-Chalmers 4-Cyl. 153; Allis-Chalmers 4-Cyl. 175 Diesel		
Belt - Fan & Alt.	4791039	▲9470HD
Belt - Fan & Gen.	4707727	▲9451HD
Hose - Upper; Early(1 3/4" I.D.)		24228
Hose - Upper; Late(1 1/2" I.D.)		24224
Hose - Lower; Early(1 3/4" I.D.)		24228
Hose - Lower; Early		●26602
Allis-Chalmers 6-Cyl. 230; Allis-Chalmers 6-Cyl. 230 Diesel; Allis-Chalmers 6-Cyl. 262 Diesel		
Belt - Fan & Alt.	4791039	▲9470HD
Belt - Fan & Gen.	4707727	▲9451HD
Hose - Upper; (1 3/4" I.D.)		24228
Hose - Lower; Early(1 3/4" I.D.)		24228
Hose - Lower; Early		●26602
Waukesha FC		
Belt - Fan & Alt.	4791039	▲9470HD
Belt - Fan & Gen.	4707727	▲9451HD
Hose - Upper		≧21256
	or	●26503
FPDX60; FPD70; FPD80		
Allis-Chalmers 4-Cyl. 153; Allis-Chalmers 4-Cyl. 175 Diesel		
Belt - Fan & Alt.	4791039	▲9470HD
Belt - Fan & Gen.	4707727	▲9451HD
Allis-Chalmers 6-Cyl. 230; Allis-Chalmers 6-Cyl. 230 Diesel; Allis-Chalmers 6-Cyl. 262 Diesel		
Belt - Fan & Alt.	4791039	▲9470HD
Belt - Fan & Gen.	4707727	▲9451HD
Belt - Hyd. Pump	4802115	▲9335HD
Waukesha FC		
Belt - Fan & Alt.	4791039	▲9470HD
Belt - Fan & Gen.	4707727	▲9451HD
FPL		
Allis-Chalmers 4-Cyl. 153; Allis-Chalmers 4-Cyl. 175 Diesel		
Belt - Fan & Alt.	4791039	▲9470HD
Belt - Fan & Gen.	4707727	▲9451HD
Hose - Upper; Early(1 3/4" I.D.)		24228
Hose - Upper; Late(1 1/2" I.D.)		24224
Hose - Lower; Early(1 3/4" I.D.)		24228
Hose - Lower; Early		●26602
Allis-Chalmers 6-Cyl. 230; Allis-Chalmers 6-Cyl. 230 Diesel; Allis-Chalmers 6-Cyl. 262 Diesel		
Belt - Fan & Alt.	4791039	▲9470HD
Belt - Fan & Gen.	4707727	▲9451HD
Hose - Upper; (1 3/4" I.D.)		24228
Hose - Lower; Early(1 3/4" I.D.)		24228
Hose - Lower; Early		●26602
Waukesha FC		
Belt - Fan & Alt.	4791039	▲9470HD
Belt - Fan & Gen.	4707727	▲9451HD
Hose - Upper		≧21256
	or	●26503
FPL20; FPL25; FPL50		
Allis-Chalmers 4-Cyl. 153; Allis-Chalmers 4-Cyl. 175 Diesel; Waukesha FC		
Belt - Fan & Alt.	4791039	▲9470HD

Application	Mfr. Part No.	Our No.
ALLIS-CHALMERS - Continued		
FPL20; FPL25; FPL50 - Continued		
Allis-Chalmers 4-Cyl. 153; Allis-Chalmers 4-Cyl. 175 Diesel; Waukesha FC - Continued		
Belt - Fan & Gen.	4707727	▲9451HD
FS; FSD		
Allis-Chalmers 4-Cyl. 153; Allis-Chalmers 4-Cyl. 175 Diesel		
Hose - Upper; Early(1 3/4" I.D.)		24228
Hose - Upper; Late(1 1/2" I.D.)		24224
Hose - Lower; Early(1 3/4" I.D.)		24228
Hose - Lower; Early		●26602
Allis-Chalmers 6-Cyl. 230; Allis-Chalmers 6-Cyl. 230 Diesel; Allis-Chalmers 6-Cyl. 262 Diesel		
Belt - Fan & Alt.	4791039	▲9470HD
Belt - Fan & Gen.	4707727	▲9451HD
Hose - Upper; (1 3/4" I.D.)		24228
Hose - Lower; Early(1 3/4" I.D.)		24228
Hose - Lower; Early		●26602
Waukesha FC		
Hose - Upper		≧21256
	or	●26503
FSL		
Allis-Chalmers 6-Cyl. 230; Allis-Chalmers 6-Cyl. 230 Diesel; Allis-Chalmers 6-Cyl. 262 Diesel		
Belt - Fan & Alt.	4791039	▲9470HD
Belt - Fan & Gen.	4707727	▲9451HD
FSL20 Thru 120 Series		
Allis-Chalmers 4-Cyl. 153; Allis-Chalmers 4-Cyl. 175 Diesel		
Hose - Upper; Early(1 3/4" I.D.)		24228
Hose - Upper; Late(1 1/2" I.D.)		24224
Hose - Lower; Early(1 3/4" I.D.)		24228
Hose - Lower; Early		●26602
Allis-Chalmers 6-Cyl. 230; Allis-Chalmers 6-Cyl. 230 Diesel; Allis-Chalmers 6-Cyl. 262 Diesel		
Hose - Upper; (1 3/4" I.D.)		24228
Hose - Lower; Early(1 3/4" I.D.)		24228
Hose - Lower; Early		●26602
Waukesha FC		
Hose - Upper		≧21256
	or	●26503
FT		
Allis-Chalmers 4-Cyl. 153; Allis-Chalmers 4-Cyl. 175 Diesel		
Belt - Fan & Alt.	4791039	▲9470HD
Belt - Fan & Gen.; W/44 3/8" Belt O.C.	4707726	▲9440HD
Belt - Fan & Gen.; W/45 3/8" Belt O.C.	4707727	▲9451HD
Allis-Chalmers 4-Cyl. 182; Allis-Chalmers 4-Cyl. 182 Diesel		
Belt - Fan	4707729	▲9425HD
Belt - Fan & Gen.	4707727	▲9451HD
Allis-Chalmers 6-Cyl. 230; Allis-Chalmers 6-Cyl. 230 Diesel; Allis-Chalmers 6-Cyl. 262 Diesel		
Belt - Fan & Alt.	4791039	▲9470HD
Belt - Fan & Gen.	4707727	▲9451HD
Hose - Upper; (1 3/4" I.D.)		24228
Hose - Lower; (1 3/4" I.D.)		24228
Hose - Lower		●26602
Waukesha FC		
Belt - Fan & Alt.	4791039	▲9470HD
Belt - Fan & Gen.; W/44 3/8" Belt O.C.	4707726	▲9440HD
Belt - Fan & Gen.; W/45 3/8" Belt O.C.	4707727	▲9451HD
FT20; FT25		
Waukesha FC		
Hose - Upper		≧21256
	or	●26503
Hose - Lower; Early(1 1/4" I.D.)		24220
Hose - Lower; Late(2" I.D.)		24232

▲ Standard Belt Available. See Pages 630-631.
≧ Cut to Fit.

● Vulco-Flex® Coolant Hose.

Belts and Coolant Hose for Lift & Industrial Trucks

Application	Mfr. Part No.	Our No.
ALLIS-CHALMERS - Continued		
FT30-15		
Allis-Chalmers 4-Cyl. 153; Allis-Chalmers 4-Cyl. 153 Diesel		
Hose - Upper; W/L.S. Safety Equip.(1 1/2" I.D.)	24224	
Hose - Upper; W/O L.S. Safety Equip.(1 3/4" I.D.)	24228	
Hose - Lower; (1 3/4" I.D.)	24228	
Hose - Lower	●26602	
FT30-24; FT40		
Allis-Chalmers 4-Cyl. 153; Allis-Chalmers 4-Cyl. 153 Diesel		
Hose - Upper; W/L.S. Safety Equip.(1 1/2" I.D.)	24224	
Hose - Upper; W/O L.S. Safety Equip.(1 1/2" I.D.)	24224	
Hose - Lower; W/L.S. Safety Equip.(1 3/4" I.D.)	24228	
Hose - Lower; W/O L.S. Safety Equip.(1 3/4" I.D.)	24228	
Hose - Lower; W/O L.S. Safety Equip.	●26602	
FT50		
Allis-Chalmers 4-Cyl. 153; Allis-Chalmers 4-Cyl. 153 Diesel		
Hose - Upper; W/L.S. Safety Equip.(1 1/2" I.D.)	24224	
Hose - Upper; W/O L.S. Safety Equip.(1 3/4" I.D.)	24228	
Hose - Lower; (1 3/4" I.D.)	24228	
Hose - Lower	●26602	
FT100		
Allis-Chalmers 4-Cyl. 182; Allis-Chalmers 4-Cyl. 182 Diesel;		
Allis-Chalmers 6-Cyl. 230; Allis-Chalmers 6-Cyl. 230 Diesel		
Belt - Fan	4707729	▲9425HD
Belt - Fan & Gen.	4707727	▲9451HD
FT PL40		
Allis-Chalmers 4-Cyl. 153; Allis-Chalmers 4-Cyl. 153 Diesel		
Hose - Upper; W/L.S. Safety Equip.(1 1/2" I.D.)	24224	
Hose - Upper; W/O L.S. Safety Equip.(1 1/2" I.D.)	24224	
Hose - Lower; W/L.S. Safety Equip.(1 3/4" I.D.)	24228	
Hose - Lower; W/O L.S. Safety Equip.(1 3/4" I.D.)	24228	
Hose - Lower; W/O L.S. Safety Equip.	●26602	
FTB		
Allis-Chalmers 4-Cyl. 153		
Belt - Fan & Alt.	4791039	▲9470HD
Belt - Fan & Gen.	4707727	▲9451HD
Allis-Chalmers 4-Cyl. 153 Diesel		
Belt - Fan & Gen.	4707726	▲9440HD
Allis-Chalmers 4-Cyl. 175 Diesel; Waukesha FC		
Belt - Fan & Alt.	4791039	▲9470HD
Belt - Fan & Gen.	4707727	▲9451HD
FTB30		
Waukesha FC		
Hose - Upper	≈21256	
..... or	●26503	
Hose - Lower; Early(1 1/4" I.D.)	24220	
Hose - Lower; Late(2" I.D.)	24232	
FTB50		
Allis-Chalmers 4-Cyl. 153; Allis-Chalmers 4-Cyl. 153 Diesel		
Hose - Upper; W/L.S. Safety Equip.(1 1/2" I.D.)	24224	
Hose - Upper; W/O L.S. Safety Equip.(1 1/2" I.D.)	24224	
Hose - Lower; W/L.S. Safety Equip.(1 3/4" I.D.)	24228	
Hose - Lower; W/O L.S. Safety Equip.(1 3/4" I.D.)	24228	
Hose - Lower; W/O L.S. Safety Equip.	●26602	
FTBL		
Allis-Chalmers 4-Cyl. 153; Allis-Chalmers 4-Cyl. 175 Diesel;		
Waukesha FC		
Belt - Fan & Alt.	4791039	▲9470HD
Belt - Fan & Gen.	4707727	▲9451HD
FTBL30		
Waukesha FC		
Hose - Lower; Early(1 1/4" I.D.)	24220	

Application	Mfr. Part No.	Our No.
ALLIS-CHALMERS - Continued		
FTBL30 - Continued		
Waukesha FC - Continued		
Hose - Lower; Late(2" I.D.)		24232
FTBL50		
Allis-Chalmers 4-Cyl. 153; Allis-Chalmers 4-Cyl. 153 Diesel		
Hose - Upper; W/L.S. Safety Equip.(1 1/2" I.D.)		24224
Hose - Lower; W/L.S. Safety Equip.(1 3/4" I.D.)		24228
Hose - Lower; W/O L.S. Safety Equip.(1 3/4" I.D.)		24228
Hose - Lower; W/O L.S. Safety Equip.		●26602
FTD		
Allis-Chalmers 4-Cyl. 153; Allis-Chalmers 4-Cyl. 153 Diesel		
Belt - Fan & Gen.	4707726	▲9440HD
Allis-Chalmers 4-Cyl. 182; Allis-Chalmers 4-Cyl. 182 Diesel		
Belt - Fan	4707729	▲9425HD
Belt - Fan & Gen.	4707727	▲9451HD
Allis-Chalmers 6-Cyl. 230; Allis-Chalmers 6-Cyl. 230 Diesel;		
Allis-Chalmers 6-Cyl. 262 Diesel		
Belt - Fan & Alt.	4791039	▲9470HD
Belt - Fan & Gen.	4707727	▲9451HD
Hose - Upper; (1 3/4" I.D.)		24228
Hose - Lower; (1 3/4" I.D.)		24228
Hose - Lower		●26602
FTD30-15		
Allis-Chalmers 4-Cyl. 153; Allis-Chalmers 4-Cyl. 153 Diesel		
Hose - Upper; W/L.S. Safety Equip.(1 1/2" I.D.)		24224
Hose - Upper; W/O L.S. Safety Equip.(1 3/4" I.D.)		24228
Hose - Lower; (1 3/4" I.D.)		24228
Hose - Lower		●26602
FTD30-24; FTD40		
Allis-Chalmers 4-Cyl. 153; Allis-Chalmers 4-Cyl. 153 Diesel		
Hose - Upper; W/L.S. Safety Equip.(1 1/2" I.D.)		24224
Hose - Upper; W/O L.S. Safety Equip.(1 1/2" I.D.)		24224
Hose - Lower; W/L.S. Safety Equip.(1 3/4" I.D.)		24228
Hose - Lower; W/O L.S. Safety Equip.(1 3/4" I.D.)		24228
Hose - Lower; W/O L.S. Safety Equip.		●26602
FTD50		
Allis-Chalmers 4-Cyl. 153; Allis-Chalmers 4-Cyl. 153 Diesel		
Hose - Upper; W/L.S. Safety Equip.(1 1/2" I.D.)		24224
Hose - Upper; W/O L.S. Safety Equip.(1 3/4" I.D.)		24228
Hose - Lower; (1 3/4" I.D.)		24228
Hose - Lower		●26602
Allis-Chalmers 4-Cyl. 182; Allis-Chalmers 4-Cyl. 182 Diesel;		
Allis-Chalmers 6-Cyl. 230; Allis-Chalmers 6-Cyl. 230 Diesel		
Belt - Fan	4707729	▲9425HD
Belt - Fan & Gen.	4707727	▲9451HD
FTD70		
Allis-Chalmers 4-Cyl. 182; Allis-Chalmers 4-Cyl. 182 Diesel;		
Allis-Chalmers 6-Cyl. 230; Allis-Chalmers 6-Cyl. 230 Diesel		
Belt - Fan	4707729	▲9425HD
Belt - Fan & Gen.	4707727	▲9451HD
FTDB		
Allis-Chalmers 4-Cyl. 153; Allis-Chalmers 4-Cyl. 153 Diesel		
Belt - Fan & Gen.	4707726	▲9440HD
FTDB50		
Allis-Chalmers 4-Cyl. 153; Allis-Chalmers 4-Cyl. 153 Diesel		
Hose - Upper; W/L.S. Safety Equip.(1 1/2" I.D.)		24224
Hose - Lower; W/L.S. Safety Equip.(1 3/4" I.D.)		24228
Hose - Lower; W/O L.S. Safety Equip.(1 3/4" I.D.)		24228
Hose - Lower; W/O L.S. Safety Equip.		●26602

● Vulco-Flex® Coolant Hose.
≈ Cut to Fit.

▲ Standard Belt Available. See Pages 630-631.

Belts and Coolant Hose for Lift & Industrial Trucks

Application	Mfr. Part No.	Our No.
ALLIS-CHALMERS - Continued		
FTDOA		
Allis-Chalmers 6-Cyl. 230; Allis-Chalmers 6-Cyl. 230 Diesel; Allis-Chalmers 6-Cyl. 262 Diesel		
Belt - Fan & Alt.	4791039	▲9470HD
Belt - Fan & Gen.	4707727	▲9451HD
FTDOH		
Allis-Chalmers 4-Cyl. 182; Allis-Chalmers 4-Cyl. 182 Diesel; Allis-Chalmers 6-Cyl. 230; Allis-Chalmers 6-Cyl. 230 Diesel		
Belt - Fan	4707729	▲9425HD
Belt - Fan & Gen.	4707727	▲9451HD
FTDX		
Allis-Chalmers 4-Cyl. 153; Allis-Chalmers 4-Cyl. 153 Diesel		
Belt - Fan & Gen.	4707726	▲9440HD
Allis-Chalmers 6-Cyl. 230; Allis-Chalmers 6-Cyl. 230 Diesel; Allis-Chalmers 6-Cyl. 262 Diesel		
Belt - Fan & Alt.	4791039	▲9470HD
Belt - Fan & Gen.	4707727	▲9451HD
Hose - Upper; (1 3/4" I.D.)		24228
Hose - Lower; (1 3/4" I.D.)		24228
Hose - Lower		●26602
FTDX30-15		
Allis-Chalmers 4-Cyl. 153; Allis-Chalmers 4-Cyl. 153 Diesel		
Hose - Upper; W/L.S. Safety Equip.(1 1/2" I.D.)		24224
Hose - Upper; W/O L.S. Safety Equip.(1 3/4" I.D.)		24228
Hose - Lower; (1 3/4" I.D.)		24228
Hose - Lower		●26602
FTDX30-24; FTDX40		
Allis-Chalmers 4-Cyl. 153; Allis-Chalmers 4-Cyl. 153 Diesel		
Hose - Upper; W/L.S. Safety Equip.(1 1/2" I.D.)		24224
Hose - Upper; W/O L.S. Safety Equip.(1 1/2" I.D.)		24224
Hose - Lower; W/L.S. Safety Equip.(1 3/4" I.D.)		24228
Hose - Lower; W/O L.S. Safety Equip.(1 3/4" I.D.)		24228
Hose - Lower; W/O L.S. Safety Equip.		●26602
FTDXB		
Allis-Chalmers 4-Cyl. 153; Allis-Chalmers 4-Cyl. 153 Diesel		
Belt - Fan & Gen.	4707726	▲9440HD
FTDXB50		
Allis-Chalmers 4-Cyl. 153; Allis-Chalmers 4-Cyl. 153 Diesel		
Hose - Upper; W/L.S. Safety Equip.(1 1/2" I.D.)		24224
Hose - Lower; W/L.S. Safety Equip.(1 3/4" I.D.)		24228
Hose - Lower; W/O L.S. Safety Equip.(1 3/4" I.D.)		24228
Hose - Lower; W/O L.S. Safety Equip.		●26602
FTL		
Allis-Chalmers 4-Cyl. 153		
Belt - Fan & Alt.	4791039	▲9470HD
Belt - Fan & Gen.	4707727	▲9451HD
Allis-Chalmers 4-Cyl. 153 Diesel		
Belt - Fan & Gen.	4707726	▲9440HD
Allis-Chalmers 4-Cyl. 175 Diesel; Allis-Chalmers 6-Cyl. 230; Allis-Chalmers 6-Cyl. 230 Diesel; Allis-Chalmers 6-Cyl. 262 Diesel; Waukesha FC		
Belt - Fan & Alt.	4791039	▲9470HD
Belt - Fan & Gen.	4707727	▲9451HD
FTL20; FTL25		
Waukesha FC		
Hose - Lower; Early(1 1/4" I.D.)		24220
Hose - Lower; Late(2" I.D.)		24232
FTL30-15		
Allis-Chalmers 4-Cyl. 153; Allis-Chalmers 4-Cyl. 153 Diesel		
Hose - Upper; W/L.S. Safety Equip.(1 1/2" I.D.)		24224

Application	Mfr. Part No.	Our No.
ALLIS-CHALMERS - Continued		
FTL30-15 - Continued		
Allis-Chalmers 4-Cyl. 153; Allis-Chalmers 4-Cyl. 153 Diesel - Continued		
Hose - Upper; W/O L.S. Safety Equip.(1 3/4" I.D.)		24228
Hose - Lower; (1 3/4" I.D.)		24228
Hose - Lower		●26602
FTL30-24; FTL40		
Allis-Chalmers 4-Cyl. 153; Allis-Chalmers 4-Cyl. 153 Diesel		
Hose - Upper; W/L.S. Safety Equip.(1 1/2" I.D.)		24224
Hose - Upper; W/O L.S. Safety Equip.(1 1/2" I.D.)		24224
Hose - Lower; W/L.S. Safety Equip.(1 3/4" I.D.)		24228
Hose - Lower; W/O L.S. Safety Equip.(1 3/4" I.D.)		24228
Hose - Lower; W/O L.S. Safety Equip.		●26602
FTL50		
Allis-Chalmers 4-Cyl. 153; Allis-Chalmers 4-Cyl. 153 Diesel		
Hose - Upper; W/L.S. Safety Equip.(1 1/2" I.D.)		24224
Hose - Upper; W/O L.S. Safety Equip.(1 3/4" I.D.)		24228
Hose - Lower; (1 3/4" I.D.)		24228
Hose - Lower		●26602
FTL60 Thru 100		
Allis-Chalmers 6-Cyl. 230; Allis-Chalmers 6-Cyl. 230 Diesel; Allis-Chalmers 6-Cyl. 262 Diesel		
Hose - Upper; (1 3/4" I.D.)		24228
Hose - Lower; (1 3/4" I.D.)		24228
Hose - Lower		●26602
FTL70		
Allis-Chalmers 6-Cyl. 230; Allis-Chalmers 6-Cyl. 230 Diesel; Allis-Chalmers 6-Cyl. 262 Diesel		
Belt - Fan & Alt.	4791039	▲9470HD
Belt - Fan & Gen.	4707727	▲9451HD
FTL75		
Allis-Chalmers 4-Cyl. 182; Allis-Chalmers 4-Cyl. 182 Diesel; Allis-Chalmers 6-Cyl. 230; Allis-Chalmers 6-Cyl. 230 Diesel		
Belt - Fan	4707729	▲9425HD
Belt - Fan & Gen.	4707727	▲9451HD
FTL80; FTL100		
Allis-Chalmers 6-Cyl. 230; Allis-Chalmers 6-Cyl. 230 Diesel; Allis-Chalmers 6-Cyl. 262 Diesel		
Belt - Fan & Alt.	4791039	▲9470HD
Belt - Fan & Gen.	4707727	▲9451HD
FTLB50		
Allis-Chalmers 4-Cyl. 153; Allis-Chalmers 4-Cyl. 153 Diesel		
Belt - Fan & Gen.	4707726	▲9440HD
FTOH; FTOHL		
Allis-Chalmers 6-Cyl. 230; Allis-Chalmers 6-Cyl. 230 Diesel; Allis-Chalmers 6-Cyl. 262 Diesel		
Belt - Fan & Alt.	4791039	▲9470HD
Belt - Fan & Gen.	4707727	▲9451HD
Hose - Upper; (1 3/4" I.D.)		24228
Hose - Lower; (1 3/4" I.D.)		24228
Hose - Lower		●26602
FTP		
Allis-Chalmers 4-Cyl. 153		
Belt - Fan & Alt.	4791039	▲9470HD
Belt - Fan & Gen.	4707727	▲9451HD
Allis-Chalmers 4-Cyl. 153 Diesel		
Belt - Fan & Gen.	4707726	▲9440HD
Allis-Chalmers 4-Cyl. 175 Diesel		
Belt - Fan & Alt.	4791039	▲9470HD
Belt - Fan & Gen.	4707727	▲9451HD

▲ Standard Belt Available. See Pages 630-631.

● Vulco-Flex® Coolant Hose.

Belts and Coolant Hose for Lift & Industrial Trucks

Application	Mfr. Part No.	Our No.	Application	Mfr. Part No.	Our No.
ALLIS-CHALMERS - Continued			ALLIS-CHALMERS - Continued		
FTP - Continued			FTPL		
Allis-Chalmers 4-Cyl. 182; Allis-Chalmers 4-Cyl. 182 Diesel			Allis-Chalmers 6-Cyl. 230; Allis-Chalmers 6-Cyl. 230 Diesel;		
Belt - Fan 4707729	▲9425HD		Allis-Chalmers 6-Cyl. 262 Diesel		
Belt - Fan & Gen. 4707727	▲9451HD		Belt - Fan & Alt. 4791039	▲9470HD	
Allis-Chalmers 6-Cyl. 230; Allis-Chalmers 6-Cyl. 230 Diesel;			Belt - Fan & Gen. 4707727	▲9451HD	
Allis-Chalmers 6-Cyl. 262 Diesel			FTPL20		
Belt - Fan & Alt. 4791039	▲9470HD		Waukesha FC		
Belt - Fan & Gen. 4707727	▲9451HD		Hose - Lower; Early(1 1/4" I.D.)	24220	
Hose - Upper; (1 3/4" I.D.)	24228		Hose - Lower; Late(2" I.D.)	24232	
Hose - Lower; (1 3/4" I.D.)	24228		FTPL30		
Hose - Lower	●26602		Allis-Chalmers 4-Cyl. 153		
Waukesha FC			Belt - Fan & Alt. 4791039	▲9470HD	
Belt - Fan & Alt. 4791039	▲9470HD		Belt - Fan & Gen. 4707727	▲9451HD	
Belt - Fan & Gen. 4707727	▲9451HD		Hose - Upper; W/L.S. Safety Equip.(1 1/2" I.D.)	24224	
FTP20			Hose - Upper; W/O L.S. Safety Equip.(1 1/2" I.D.)	24224	
Waukesha FC			Hose - Lower; W/L.S. Safety Equip.(1 3/4" I.D.)	24228	
Hose - Lower; Early(1 1/4" I.D.)	24220		Hose - Lower; W/O L.S. Safety Equip.(1 3/4" I.D.)	24228	
Hose - Lower; Late(2" I.D.)	24232		Hose - Lower; W/O L.S. Safety Equip.	●26602	
FTP30; FTP40			Allis-Chalmers 4-Cyl. 153 Diesel		
Allis-Chalmers 4-Cyl. 153; Allis-Chalmers 4-Cyl. 153 Diesel			Belt - Fan & Gen. 4707726	▲9440HD	
Hose - Upper; W/L.S. Safety Equip.(1 1/2" I.D.)	24224		Hose - Upper; W/L.S. Safety Equip.(1 1/2" I.D.)	24224	
Hose - Upper; W/O L.S. Safety Equip.(1 1/2" I.D.)	24224		Hose - Upper; W/O L.S. Safety Equip.(1 1/2" I.D.)	24224	
Hose - Lower; W/L.S. Safety Equip.(1 3/4" I.D.)	24228		Hose - Lower; W/L.S. Safety Equip.(1 3/4" I.D.)	24228	
Hose - Lower; W/O L.S. Safety Equip.(1 3/4" I.D.)	24228		Hose - Lower; W/O L.S. Safety Equip.(1 3/4" I.D.)	24228	
Hose - Lower; W/O L.S. Safety Equip.	●26602		Hose - Lower; W/O L.S. Safety Equip.	●26602	
FTPD			Allis-Chalmers 4-Cyl. 175 Diesel		
Allis-Chalmers 4-Cyl. 153; Allis-Chalmers 4-Cyl. 153 Diesel			Belt - Fan & Alt. 4791039	▲9470HD	
Belt - Fan & Gen. 4707726	▲9440HD		Belt - Fan & Gen. 4707727	▲9451HD	
Allis-Chalmers 4-Cyl. 182; Allis-Chalmers 4-Cyl. 182 Diesel			Waukesha FC		
Belt - Fan 4707729	▲9425HD		Belt - Fan & Alt. 4791039	▲9470HD	
Belt - Fan & Gen. 4707727	▲9451HD		Belt - Fan & Gen. 4707727	▲9451HD	
Allis-Chalmers 6-Cyl. 230; Allis-Chalmers 6-Cyl. 230 Diesel;			Hose - Lower; Early(1 1/4" I.D.)	24220	
Allis-Chalmers 6-Cyl. 262 Diesel			Hose - Lower; Late(2" I.D.)	24232	
Belt - Fan & Alt. 4791039	▲9470HD		FTPL40		
Belt - Fan & Gen. 4707727	▲9451HD		Allis-Chalmers 4-Cyl. 153; Allis-Chalmers 4-Cyl. 153 Diesel		
Hose - Upper; (1 3/4" I.D.)	24228		Belt - Fan & Gen. 4707726	▲9440HD	
Hose - Lower; (1 3/4" I.D.)	24228		FTPL60		
Hose - Lower	●26602		Allis-Chalmers 4-Cyl. 182; Allis-Chalmers 4-Cyl. 182 Diesel		
FTPD30			Belt - Fan 4707729	▲9425HD	
Allis-Chalmers 4-Cyl. 153; Allis-Chalmers 4-Cyl. 153 Diesel			Belt - Fan & Gen. 4707727	▲9451HD	
Hose - Upper; W/L.S. Safety Equip.(1 1/2" I.D.)	24224		Allis-Chalmers 6-Cyl. 230; Allis-Chalmers 6-Cyl. 230 Diesel		
Hose - Upper; W/O L.S. Safety Equip.(1 1/2" I.D.)	24224		Belt - Fan 4707729	▲9425HD	
Hose - Lower; W/L.S. Safety Equip.(1 3/4" I.D.)	24228		Belt - Fan & Gen. 4707727	▲9451HD	
Hose - Lower; W/O L.S. Safety Equip.(1 3/4" I.D.)	24228		Hose - Upper; (1 3/4" I.D.)	24228	
Hose - Lower; W/O L.S. Safety Equip.	●26602		Hose - Lower; (1 3/4" I.D.)	24228	
Waukesha FC			Hose - Lower	●26602	
Hose - Lower; Early(1 1/4" I.D.)	24220		Allis-Chalmers 6-Cyl. 262 Diesel		
Hose - Lower; Late(2" I.D.)	24232		Hose - Upper; (1 3/4" I.D.)	24228	
FTPD40			Hose - Lower; (1 3/4" I.D.)	24228	
Allis-Chalmers 4-Cyl. 153; Allis-Chalmers 4-Cyl. 153 Diesel			Hose - Lower	●26602	
Hose - Upper; W/L.S. Safety Equip.(1 1/2" I.D.)	24224		FTS; FTSD; FTSL60		
Hose - Upper; W/O L.S. Safety Equip.(1 1/2" I.D.)	24224		Allis-Chalmers 6-Cyl. 230; Allis-Chalmers 6-Cyl. 230 Diesel;		
Hose - Lower; W/L.S. Safety Equip.(1 3/4" I.D.)	24228		Allis-Chalmers 6-Cyl. 262 Diesel		
Hose - Lower; W/O L.S. Safety Equip.(1 3/4" I.D.)	24228		Belt - Fan & Alt. 4791039	▲9470HD	
Hose - Lower; W/O L.S. Safety Equip.	●26602		Belt - Fan & Gen. 4707727	▲9451HD	
FTPDX			FTXB50		
Allis-Chalmers 6-Cyl. 230; Allis-Chalmers 6-Cyl. 230 Diesel;			Allis-Chalmers 4-Cyl. 153; Allis-Chalmers 4-Cyl. 153 Diesel		
Allis-Chalmers 6-Cyl. 262 Diesel			Hose - Upper; W/L.S. Safety Equip.(1 1/2" I.D.)	24224	
Belt - Fan & Alt. 4791039	▲9470HD		Hose - Upper; W/O L.S. Safety Equip.(1 1/2" I.D.)	24224	
Belt - Fan & Gen. 4707727	▲9451HD		Hose - Lower; W/L.S. Safety Equip.(1 3/4" I.D.)	24228	
Hose - Upper; (1 3/4" I.D.)	24228		Hose - Lower; W/O L.S. Safety Equip.(1 3/4" I.D.)	24228	
Hose - Lower; (1 3/4" I.D.)	24228		Hose - Lower; W/O L.S. Safety Equip.	●26602	
Hose - Lower	●26602				

▲ Standard Belt Available. See Pages 630-631.

● Vulco-Flex® Coolant Hose.

Belts and Coolant Hose for Lift & Industrial Trucks

Application	Mfr. Part No.	Our No.	Application	Mfr. Part No.	Our No.
ALLIS-CHALMERS - Continued			BAKER - Continued		
FU40			FGA050 - Continued		
Allis-Chalmers 4-Cyl. 153; Allis-Chalmers 4-Cyl. 175 Diesel; Waukesha FC			Continental F163 - Continued		
Belt - Fan & Alt.	4791039	▲9470HD	Hose - Lower		●25477
Belt - Fan & Gen.	4707727	▲9451HD	Continental F163 LPG		
P50			Hose - Upper		
Nissan H20 Diesel			Hose - Lower		
Belt - Fan	21067K7320	6723	Continental F227; Continental F245		
Belt - W.P. & Alt.		7410	Belt - Fan	717AT1	▲9350HD
Belt - Hyd. Pump		TR22588	Belt - Fan & Gen.		②7460
RT; RTD; RTL40			Belt - Alt.		7280
Allis-Chalmers 4-Cyl. 149; Allis-Chalmers 4-Cyl. 175 Diesel			Hercules IXLB3		
Belt - Fan & Gen.	233432	7380	Belt - Fan & Gen.	717C1	TR28423
Hose - Upper		≧20661	Hose - Upper		≧20416
		or			●25482
		●25251	Hercules QXD3		
AUTOMATIC TRANSPORTATION			Belt - Fan & Gen.		
GLF30; GLF40; GLF50; GLF60; GLF70; GLF80; GLF100; GLFP30; GLFP40; GLFP50; GLFP60; GLFP70; GLFP80; GMF150; GMF160; GMF180; GMF200			14Y9031		
Continental F162			Hose - Upper: (1 1/2" I.D.)		
Belt - Fan & Gen.; Early		▲9440HD	TR30428		
Belt - Fan & Gen.; Late		▲9490HD	24224		
BAKER			FGA070		
B80PD			Continental F162		
Deutz 4-Cyl. Diesel			Belt - Fan		
Belt - Fan & Alt.		7570	Belt - Fan & Gen.; W/43" Belt O.C.		
B140PC			7Y9031		
Volkswagen 4-Cyl.			Belt - Fan & Gen.; W/44 5/8" Belt O.C.		
Belt - Trans.		④TR22711	717AB1		
FD30; FD40; FD60; FG30			Belt - Alt.		
Hercules QXD3			717AD1		
Belt - Fan & Gen.	6Y9031	TR28423	Hose - Upper; 1860, 1883 Series		
FG60			Hose - Lower; 1849 Series		
Hercules QXD3			Hose - Lower; 1860, 1883 Series		
Belt - Fan & Gen.	14Y9031	TR30428	≧●25804		
FGA030			Hercules IXLB3		
Hercules IXA3			Belt - Fan & Gen.		
Belt - Fan; W/42 1/4" Belt O.C.	717AF1	▲9420HD	717C1		
Belt - Fan; W/43 1/4" Belt O.C.	717AP1	▲9430HD	TR28423		
Belt - Fan & Gen.	717D1	TR24414	Hercules QXD3		
Hose - Upper		●25474	Belt - Fan & Gen.		
FGA050			14Y9031		
Continental F162			Hose - Upper: (1 1/2" I.D.)		
Belt - Fan	717AE1	▲9319HD	24224		
Belt - Fan & Gen.; W/43" Belt O.C.	7Y9031	TR20426	FGD020; FGD025		
Belt - Fan & Gen.; W/44 5/8" Belt O.C.	717AB1	7445	Hercules IXA3		
Belt - Alt.	717AD1	7250	Belt - Fan; W/42 1/4" Belt O.C.		
Hose - Upper		≧20416	717AF1		
		or	Belt - Fan; W/43 1/4" Belt O.C.		
		●25474	717AP1		
Hose - Lower		●25477	Belt - Fan & Gen.		
Continental F162 LPG			717D1		
Hose - Upper		●25804	Hose - Upper		
Hose - Lower		●25477	●25474		
Continental F163			●25477		
Belt - Alt.		7280	Continental F162		
Hose - Upper		≧20416	Belt - Fan		
		or	Belt - Fan & Gen.; W/43" Belt O.C.		
		●25474	7Y9031		
		●25477	Belt - Fan & Gen.; W/44 5/8" Belt O.C.		
Continental F163 LPG			717AB1		
Hose - Upper		●25804	Belt - Alt.		
		●25477	717AD1		
Continental F163			Hose - Upper		
Belt - Alt.		7280	or		
Hose - Upper		≧20416	●25474		
		or	●25477		
		●25474	Continental F163 LPG		
		●25477	Hose - Upper		
		●25474	●25804		

▲ Standard Belt Available. See Pages 630-631.
 ● Vulco-Flex® Coolant Hose.
 ② Two Required.

≧ Cut to Fit.
 ④ Four Required.

Belts and Coolant Hose for Lift & Industrial Trucks

Application	Mfr. Part No.	Our No.	Application	Mfr. Part No.	Our No.
BAKER - Continued			BAKER - Continued		
FGD030; FGD040; FGD050 - Continued			FGU40; FGU60		
Continental F163 LPG - Continued		●25477	Continental F162		
Hose - Lower			Belt - Fan	717AE1	▲9319HD
Continental F227; Continental F245		▲9350HD	Belt - Fan & Gen.; W/43" Belt O.C.	7Y9031	TR20426
Belt - Fan	717AT1	②7460	Belt - Fan & Gen.; W/44 5/8" Belt O.C.	717AB1	7445
Belt - Fan & Gen.		7280	Belt - Alt.	717AD1	7250
Belt - Alt.			Continental F163		
Hercules IXLB3			Belt - Alt.		7280
Belt - Fan & Gen.	717C1	TR28423	Continental F227		
Hose - Upper		≧20416	Belt - Fan	717AT1	▲9350HD
or		●25482	Belt - Fan & Gen.		②7460
Hercules QXD3			Belt - Alt.		7280
Belt - Fan & Gen.	14Y9031	TR30428	Continental F245		
Hose - Upper; (1 1/2" I.D.)		24224	Belt - Fan	717AT1	▲9350HD
FGD060; FGD070; FGD080			Belt - Fan & Gen.		②7460
Continental F162			Belt - Alt.		7280
Belt - Fan	717AE1	▲9319HD	Hose - Upper		≧20046
Belt - Fan & Gen.; W/43" Belt O.C.	7Y9031	TR20426	or		●26501
Belt - Fan & Gen.; W/44 5/8" Belt O.C.	717AB1	7445	Hose - Lower		●25474
Belt - Alt.	717AD1	7250	Hercules IXLB3		
Continental F163			Belt - Fan & Gen.	717C1	TR28423
Belt - Alt.		7280	Hercules QXD3		
Continental F227			Belt - Fan & Gen.	14Y9031	TR30428
Belt - Fan	717AT1	▲9350HD	FIA030		
Belt - Fan & Gen.		②7460	Hercules IXA3		
Belt - Alt.		7280	Belt - Fan; W/42 1/4" Belt O.C.	717AF1	▲9420HD
Continental F245			Belt - Fan; W/43 1/4" Belt O.C.	717AP1	▲9430HD
Belt - Fan	717AT1	▲9350HD	Belt - Fan & Gen.	717D1	TR24414
Belt - Fan & Gen.		②7460	Hose - Upper		●25474
Belt - Alt.		7280	FIA050		
Hose - Upper; 1860, 1883 Series		●25804	Continental F162		
Hose - Lower; 1849 Series		●25477	Belt - Fan	717AE1	▲9319HD
Hose - Lower; 1860, 1883 Series		●25804	Belt - Fan & Gen.; W/43" Belt O.C.	7Y9031	TR20426
Hercules IXLB3			Belt - Fan & Gen.; W/44 5/8" Belt O.C.	717AB1	7445
Belt - Fan & Gen.	717C1	TR28423	Belt - Alt.	717AD1	7250
Hercules QXD3			Hose - Upper		≧20416
Belt - Fan & Gen.	14Y9031	TR30428	or		●25474
Hose - Upper; (1 1/2" I.D.)		24224	Hose - Lower		●25477
FGF020; FGF025			Continental F162 LPG		
Hercules IXA3			Hose - Upper		●25804
Belt - Fan; W/42 1/4" Belt O.C.	717AF1	▲9420HD	Hose - Lower		●25477
Belt - Fan; W/43 1/4" Belt O.C.	717AP1	▲9430HD	Continental F163		
Belt - Fan & Gen.	717D1	TR24414	Belt - Alt.		7280
Hose - Upper		●25474	Hose - Upper		≧20416
FGF030; FGF040; FGF050			or		●25474
Continental F162			Hose - Lower		●25477
Belt - Fan	717AE1	▲9319HD	Continental F163 LPG		
Belt - Fan & Gen.; W/43" Belt O.C.	7Y9031	TR20426	Hose - Upper		●25804
Belt - Fan & Gen.; W/44 5/8" Belt O.C.	717AB1	7445	Hose - Lower		●25477
Belt - Alt.	717AD1	7250	Continental F227; Continental F245		
Hose - Upper; W/Man. Trans.		≧20416	Belt - Fan	717AT1	▲9350HD
or		●25482	Belt - Fan & Gen.		②7460
Hose - Upper; W/Auto. Trans.; Early		≧20416	Belt - Alt.		7280
Hose - Upper; W/Auto. Trans.; Late		≧21794	Hercules IXLB3		
or		●25472	Belt - Fan & Gen.	717C1	TR28423
Hose - Lower		●25477	Hose - Upper		≧20416
Continental F163			or		●25482
Belt - Alt.		7280	Hercules QXD3		
Continental F227; Continental F245			Belt - Fan & Gen.	14Y9031	TR30428
Belt - Fan	717AT1	▲9350HD	Hose - Upper; (1 1/2" I.D.)		24224
Belt - Fan & Gen.		②7460	FIA070		
Belt - Alt.		7280	Continental F162		
Hercules IXLB3			Belt - Fan	717AE1	▲9319HD
Belt - Fan & Gen.	717C1	TR28423	Belt - Fan & Gen.; W/43" Belt O.C.	7Y9031	TR20426
Hercules QXD3			Belt - Fan & Gen.; W/44 5/8" Belt O.C.	717AB1	7445
Belt - Fan & Gen.	14Y9031	TR30428	Belt - Alt.	717AD1	7250

● Vulco-Flex® Coolant Hose.
② Two Required.

▲ Standard Belt Available. See Pages 630-631.
≧ Cut to Fit.

Belts and Coolant Hose for Lift & Industrial Trucks

Application	Mfr. Part No.	Our No.
BAKER - Continued		
FIA070 - Continued		
Continental F163		
Belt - Alt.		7280
Continental F227		
Belt - Fan 717AT1	▲9350HD	
Belt - Fan & Gen.	②7460	
Belt - Alt.		7280
Continental F245		
Belt - Fan 717AT1	▲9350HD	
Belt - Fan & Gen.	②7460	
Belt - Alt.		7280
Hose - Upper; 1860, 1883 Series	●25804	
Hose - Lower; 1849 Series	●25477	
Hose - Lower; 1860, 1883 Series	ⓧ●25804	
Hercules IXLB3		
Belt - Fan & Gen. 717C1		TR28423
Hercules QXD3		
Belt - Fan & Gen. 14Y9031		TR30428
Hose - Upper; (1 1/2" I.D.)		24224
FID020; FID025		
Hercules IXA3		
Belt - Fan; W/42 1/4" Belt O.C. 717AF1	▲9420HD	
Belt - Fan; W/43 1/4" Belt O.C. 717AP1	▲9430HD	
Belt - Fan & Gen. 717D1		TR24414
FID030; FID040; FID050		
Continental F162		
Belt - Fan 717AE1	▲9319HD	
Belt - Fan & Gen.; W/43" Belt O.C. 7Y9031	TR20426	
Belt - Fan & Gen.; W/44 5/8" Belt O.C. 717AB1	7445	
Belt - Alt. 717AD1	7250	
Hose - Upper	ⓧ<20416	
	or	●25474
Hose - Lower		●25477
Continental F162 LPG		
Hose - Upper	●25804	
Hose - Lower	●25477	
Continental F163		
Belt - Alt.	7280	
Hose - Upper	ⓧ<20416	
	or	●25474
Hose - Lower		●25477
Continental F163 LPG		
Hose - Upper	●25804	
Hose - Lower	●25477	
Continental F227; Continental F245		
Belt - Fan 717AT1	▲9350HD	
Belt - Fan & Gen.	②7460	
Belt - Alt.		7280
Hercules IXLB3		
Belt - Fan & Gen. 717C1		TR28423
Hose - Upper	ⓧ<20416	
	or	●25482
Hercules QXD3		
Belt - Fan & Gen. 14Y9031		TR30428
Hose - Upper; (1 1/2" I.D.)		24224
FID060; FID070; FID080		
Continental F162		
Belt - Fan 717AE1	▲9319HD	
Belt - Fan & Gen.; W/43" Belt O.C. 7Y9031	TR20426	
Belt - Fan & Gen.; W/44 5/8" Belt O.C. 717AB1	7445	
Belt - Alt. 717AD1	7250	
Continental F163		
Belt - Alt.		7280
Continental F227		
Belt - Fan 717AT1	▲9350HD	
Belt - Fan & Gen.	②7460	

Application	Mfr. Part No.	Our No.
BAKER - Continued		
FID060; FID070; FID080 - Continued		
Continental F227 - Continued		
Belt - Alt.		7280
Continental F245		
Belt - Fan 717AT1	▲9350HD	
Belt - Fan & Gen.	②7460	
Belt - Alt.		7280
Hose - Upper; 1860, 1883 Series	●25804	
Hose - Lower; 1849 Series	●25477	
Hose - Lower; 1860, 1883 Series	ⓧ●25804	
Hercules IXLB3		
Belt - Fan & Gen. 717C1		TR28423
Hercules QXD3		
Belt - Fan & Gen. 14Y9031		TR30428
Hose - Upper; (1 1/2" I.D.)		24224
FIF020; FIF025		
Hercules IXA3		
Belt - Fan; W/42 1/4" Belt O.C. 717AF1	▲9420HD	
Belt - Fan; W/43 1/4" Belt O.C. 717AP1	▲9430HD	
Belt - Fan & Gen. 717D1		TR24414
Hose - Upper		●25474
FIF030; FIF040; FIF050		
Continental F162		
Belt - Fan 717AE1	▲9319HD	
Belt - Fan & Gen.; W/43" Belt O.C. 7Y9031	TR20426	
Belt - Fan & Gen.; W/44 5/8" Belt O.C. 717AB1	7445	
Belt - Alt. 717AD1	7250	
Hose - Upper; W/Man. Trans.	ⓧ<20416	
	or	●25482
Hose - Upper; W/Auto. Trans.; Early		ⓧ<20416
Hose - Upper; W/Auto. Trans.; Late		ⓧ<21794
	or	●25472
Hose - Lower		●25477
Continental F163		
Belt - Alt.		7280
Continental F227; Continental F245		
Belt - Fan 717AT1	▲9350HD	
Belt - Fan & Gen.	②7460	
Belt - Alt.		7280
Hercules IXLB3		
Belt - Fan & Gen. 717C1		TR28423
Hercules QXD3		
Belt - Fan & Gen. 14Y9031		TR30428
FJA020; FJA025; FJA030		
Continental F226; Continental Y112		
Belt - Fan & Alt.		②7417
Hose - Upper		ⓧ<21660
	or	●25473
Hose - Lower		ⓧ<21794
	or	ⓧ<●25480
FJA050		
Continental F162		
Belt - Fan 717AE1	▲9319HD	
Belt - Fan & Gen.; W/43" Belt O.C. 7Y9031	TR20426	
Belt - Fan & Gen.; W/44 5/8" Belt O.C. 717AB1	7445	
Belt - Alt. 717AD1	7250	
Hose - Upper	ⓧ<20416	
	or	●25474
Hose - Lower		●25477
Continental F162 LPG		
Hose - Upper	●25804	
Hose - Lower	●25477	
Continental F163		
Belt - Alt.		7280
Continental F227		
Belt - Fan 717AT1	▲9350HD	
Belt - Fan & Gen.	②7460	

▲ Standard Belt Available. See Pages 630-631.
● Vulco-Flex® Coolant Hose.

② Two Required.
ⓧ< Cut to Fit.

Belts and Coolant Hose for Lift & Industrial Trucks

Application	Mfr. Part No.	Our No.
BAKER - Continued		
FJD060; FJD070; FJD080 - Continued		
Continental F227		
Belt - Fan	717AT1	▲9350HD
Belt - Fan & Gen.		②7460
Belt - Alt.		7280
Continental F245		
Belt - Fan	717AT1	▲9350HD
Belt - Fan & Gen.		②7460
Belt - Alt.		7280
Hose - Upper; 1860, 1883 Series		●25804
Hose - Lower; 1849 Series		●25477
Hose - Lower; 1860, 1883 Series		✕●25804
Hercules IXLB3		
Belt - Fan & Gen.	717C1	TR28423
Hercules QXD3		
Belt - Fan & Gen.	14Y9031	TR30428
Hose - Upper; (1 1/2" I.D.)		24224
FJF020; FJF025		
Continental F226; Continental Y112		
Belt - Fan & Alt.		②7417
Hose - Upper		✕21660
	or	●25473
Hose - Lower		✕21794
	or	✕●25480
FJF030; FJF040; FJF050		
Continental F162		
Belt - Fan	717AE1	▲9319HD
Belt - Fan & Gen.; W/43" Belt O.C.	7Y9031	TR20426
Belt - Fan & Gen.; W/44 5/8" Belt O.C.	717AB1	7445
Belt - Alt.	717AD1	7250
Hose - Upper; W/Man. Trans.		✕20416
	or	●25482
Hose - Upper; W/Auto. Trans.; Early		✕20416
Hose - Upper; W/Auto. Trans.; Late		✕21794
	or	●25472
Hose - Lower		●25477
Continental F163		
Belt - Alt.		7280
Continental F227		
Belt - Fan	717AT1	▲9350HD
Belt - Fan & Gen.		②7460
Belt - Alt.		7280
Continental F245		
Belt - Fan	717AT1	▲9350HD
Belt - Fan & Gen.		②7460
Belt - Alt.		7280
Hose - Upper; 1860, 1883 Series		●25804
Hose - Lower; 1849 Series		●25477
Hose - Lower; 1860, 1883 Series		✕●25804
Hercules IXLB3		
Belt - Fan & Gen.	717C1	TR28423
Hercules QXD3		
Belt - Fan & Gen.	14Y9031	TR30428
Hose - Upper; (1 1/2" I.D.)		24224
FMA030		
Continental F226; Continental Y112		
Belt - Fan & Alt.		②7417
Hose - Upper		✕21660
	or	●25473
Hose - Lower		✕21794
	or	✕●25480
FMA050		
Continental F162		
Belt - Fan	717AE1	▲9319HD
Belt - Fan & Gen.; W/43" Belt O.C.	7Y9031	TR20426
Belt - Fan & Gen.; W/44 5/8" Belt O.C.	717AB1	7445

Application	Mfr. Part No.	Our No.
BAKER - Continued		
FMA050 - Continued		
Continental F162 - Continued		
Belt - Alt.	717AD1	7250
Hose - Upper		✕20416
	or	●25474
Hose - Lower		●25477
Continental F162 LPG		
Hose - Upper		●25804
Hose - Lower		●25477
Continental F163		
Belt - Alt.		7280
Hose - Upper		✕20416
	or	●25474
Hose - Lower		●25477
Continental F163 LPG		
Hose - Upper		●25804
Hose - Lower		●25477
Continental F227; Continental F245		
Belt - Fan	717AT1	▲9350HD
Belt - Fan & Gen.		②7460
Belt - Alt.		7280
Hercules IXLB3		
Belt - Fan & Gen.	717C1	TR28423
Hose - Upper		✕20416
	or	●25482
Hercules QXD3		
Belt - Fan & Gen.	14Y9031	TR30428
Hose - Upper; (1 1/2" I.D.)		24224
FMA070		
Continental F162		
Belt - Fan	717AE1	▲9319HD
Belt - Fan & Gen.; W/43" Belt O.C.	7Y9031	TR20426
Belt - Fan & Gen.; W/44 5/8" Belt O.C.	717AB1	7445
Belt - Alt.	717AD1	7250
Continental F163		
Belt - Alt.		7280
Continental F227		
Belt - Fan	717AT1	▲9350HD
Belt - Fan & Gen.		②7460
Belt - Alt.		7280
Continental F245		
Belt - Fan	717AT1	▲9350HD
Belt - Fan & Gen.		②7460
Belt - Alt.		7280
Hose - Upper; 1860, 1883 Series		●25804
Hose - Lower; 1849 Series		●25477
Hose - Lower; 1860, 1883 Series		✕●25804
Hercules IXLB3		
Belt - Fan & Gen.	717C1	TR28423
Hercules QXD3		
Belt - Fan & Gen.	14Y9031	TR30428
Hose - Upper; (1 1/2" I.D.)		24224
FMC030; FMD020; FMD025		
Continental F226; Continental Y112		
Belt - Fan & Alt.		②7417
Hose - Upper		✕21660
	or	●25473
Hose - Lower		✕21794
	or	✕●25480
FMD030		
Continental F162		
Belt - Fan	717AE1	▲9319HD
Belt - Fan & Gen.; W/43" Belt O.C.	7Y9031	TR20426
Belt - Fan & Gen.; W/44 5/8" Belt O.C.	717AB1	7445
Belt - Alt.	717AD1	7250
Hose - Upper		✕20416

▲ Standard Belt Available. See Pages 630-631.
● Vulco-Flex® Coolant Hose.

② Two Required.
✕ Cut to Fit.

Belts and Coolant Hose for Lift & Industrial Trucks

Application	Mfr. Part No.	Our No.	Application	Mfr. Part No.	Our No.
BAKER - Continued			BAKER - Continued		
FMD030 - Continued			FMD040; FMD050 - Continued		
Continental F162 - Continued			Hercules QXD3 - Continued		
Hose - Upper		●25474	Hose - Upper; (1 1/2" I.D.)		24224
Hose - Lower		●25477	FMD060; FMD070; FMD080		
Continental F162 LPG			Continental F162		
Hose - Upper		●25804	Belt - Fan	717AE1	♣9319HD
Hose - Lower		●25477	Belt - Fan & Gen.; W/43" Belt O.C.	7Y9031	TR20426
Continental F163			Belt - Fan & Gen.; W/44 5/8" Belt O.C.	717AB1	7445
Belt - Alt.		7280	Belt - Alt.	717AD1	7250
Hose - Upper		⊗<20416	Continental F163		
	or	●25474	Belt - Alt.		7280
Hose - Lower		●25477	Continental F227		
Continental F163 LPG			Belt - Fan	717AT1	♣9350HD
Hose - Upper		●25804	Belt - Fan & Gen.		⊗7460
Hose - Lower		●25477	Belt - Alt.		7280
Continental F226			Continental F245		
Belt - Fan & Alt.		⊗7417	Belt - Fan	717AT1	♣9350HD
Hose - Upper		⊗<21660	Belt - Fan & Gen.		⊗7460
	or	●25473	Belt - Alt.		7280
Hose - Lower		⊗<21794	Hose - Upper; 1860, 1883 Series		●25804
	or	●25480	Hose - Lower; 1849 Series		●25477
Continental F227; Continental F245			Hose - Lower; 1860, 1883 Series		⊗<25804
Belt - Fan	717AT1	♣9350HD	Hercules IXLB3		
Belt - Fan & Gen.		⊗7460	Belt - Fan & Gen.	717C1	TR28423
Belt - Alt.		7280	Hercules QXD3		
Continental Y112			Belt - Fan & Gen.	14Y9031	TR30428
Belt - Fan & Alt.		⊗7417	Hose - Upper; (1 1/2" I.D.)		24224
Hose - Upper		⊗<21660	FMF020; FMF025		
	or	●25473	Continental F226; Continental Y112		
Hose - Lower		⊗<21794	Belt - Fan & Alt.		⊗7417
	or	●25480	Hose - Upper		⊗<21660
Hercules IXLB3			Hose - Lower		or ●25473
Belt - Fan & Gen.	717C1	TR28423			⊗<21794
Hose - Upper		⊗<20416			or ⊗<25480
	or	●25482	FMF030; FMF040; FMF050		
Hercules QXD3			Continental F162		
Belt - Fan & Gen.	14Y9031	TR30428	Belt - Fan	717AE1	♣9319HD
Hose - Upper; (1 1/2" I.D.)		24224	Belt - Fan & Gen.; W/43" Belt O.C.	7Y9031	TR20426
FMD040; FMD050			Belt - Fan & Gen.; W/44 5/8" Belt O.C.	717AB1	7445
Continental F162			Belt - Alt.	717AD1	7250
Belt - Fan	717AE1	♣9319HD	Hose - Upper; W/Man. Trans.		⊗<20416
Belt - Fan & Gen.; W/43" Belt O.C.	7Y9031	TR20426		or	●25482
Belt - Fan & Gen.; W/44 5/8" Belt O.C.	717AB1	7445	Hose - Upper; W/Auto. Trans.; Early		⊗<20416
Belt - Alt.	717AD1	7250	Hose - Upper; W/Auto. Trans.; Late		⊗<21794
Hose - Upper		⊗<20416		or	●25472
	or	●25474	Hose - Lower		●25477
Hose - Lower		●25477	Continental F163		
Continental F162 LPG			Belt - Alt.		7280
Hose - Upper		●25804	Continental F227		
Hose - Lower		●25477	Belt - Fan	717AT1	♣9350HD
Continental F163			Belt - Fan & Gen.		⊗7460
Belt - Alt.		7280	Belt - Alt.		7280
Hose - Upper		⊗<20416	Continental F245		
	or	●25474	Belt - Fan	717AT1	♣9350HD
Hose - Lower		●25477	Belt - Fan & Gen.		⊗7460
Continental F163 LPG			Belt - Alt.		7280
Hose - Upper		●25804	Hose - Upper; 1860, 1883 Series		●25804
Hose - Lower		●25477	Hose - Lower; 1849 Series		●25477
Continental F227; Continental F245			Hose - Lower; 1860, 1883 Series		⊗<25804
Belt - Fan	717AT1	♣9350HD	Hercules IXLB3		
Belt - Fan & Gen.		⊗7460	Belt - Fan & Gen.	717C1	TR28423
Belt - Alt.		7280	Hercules QXD3		
Hercules IXLB3			Belt - Fan & Gen.	14Y9031	TR30428
Belt - Fan & Gen.	717C1	TR28423	Hose - Upper; (1 1/2" I.D.)		24224
Hose - Upper		⊗<20416	FMF020; FMF025		
	or	●25482	Continental F226; Continental Y112		
Hercules QXD3			Belt - Fan & Alt.		⊗7417
Belt - Fan & Gen.	14Y9031	TR30428	Hose - Upper		⊗<21660

● Vulco-Flex® Coolant Hose.
⊗ Two Required.

⊗< Cut to Fit.
♣ Standard Belt Available. See Pages 630-631.

Belts and Coolant Hose for Lift & Industrial Trucks

Application	Mfr. Part No.	Our No.	Application	Mfr. Part No.	Our No.
BAKER - Continued			CASE - Continued		
FRH20			585E		
Hercules QXD3 Belt - Fan & Gen.	4Y9031	3340	Case 4-Cyl. 390 Diesel Belt - Fan & Alt.	J903099	▲K080620HD
FRT80			586		
Continental F245 Belt - Fan & Gen.		②7460	Case 4-Cyl. 188; Case 4-Cyl. 188 Diesel Belt - Fan & Alt.	A38824	▲9490HD
Hose - Upper		≧20046			
		or	586C		
Hose - Lower		●26501	Case 4-Cyl. 207 Diesel Belt - Fan & Alt.	D73446	▲9520HD
		●25474	Hose - Upper		20206
FTD020; FTD025			586D		
Hercules IXA3 Hose - Upper		●25474	Case 4-Cyl. 188 Diesel Belt - Fan & Alt.	D73446	▲9520HD
UT40			Hose - Upper		21379
Continental F245 Belt - Fan & Gen.		②7460	586E		
Hose - Upper		≧20046	Case 4-Cyl. 390 Diesel Belt - Fan & Alt.	J911559	▲K080620HD
		or	Belt - Fan, Alt. & W.P.	J911559	▲K080620HD
Hose - Lower		●26501	Hose - Upper		●26505
		●25474	Hose - Lower		●26519
CASE			M4K		
580B			Cummins 4-Cyl. 3.9 L Diesel; Cummins 6-Cyl. 5.9 L Diesel Belt - Fan & Alt.		
Case 4-Cyl. 188; Case 4-Cyl. 188 Diesel Belt - Fan & Alt.	A38824	▲9490HD		J911557	▲K080560HD
580CK Forklift			CATERPILLAR		
Case 4-Cyl. 159 Belt - Fan & Alt.	A38824	▲9490HD	HT4		
Hose - Upper; (2" I.D.)		24432	Caterpillar D311 Diesel Belt - Fan		
Hose - Lower		20957	Belt - Gov.	4F7956	TR34495
Case 4-Cyl. 188; Case 4-Cyl. 188 Diesel Belt - Fan & Alt.	A38824	▲9490HD	Belt - Starter	5B7168	▲9390HD
Hose - Upper - Eng. To W.P.; (2" I.D.)		24432		6B5653	TR24438
Hose - Upper - Eng. To Rad.; (2" I.D.)		24432	R40; R80; RC60		
Hose - Lower - Eng. To Rad.; (1 3/4" I.D.)		24428	Perkins 4-Cyl. 236 Diesel Belt - Fan & Alt.		
584					▲9500HD
Case 4-Cyl. 188; Case 4-Cyl. 188 Diesel Belt - Fan & Alt.	A38824	▲9490HD	T25		
584C			Continental F163 Belt - Fan & Alt.; W/36 1/4" Belt O.C.		
Case 4-Cyl. 207 Diesel Belt - Fan & Alt.	D73446	▲9520HD	Belt - Fan & Alt.; W/37 1/4" Belt O.C.	372448	▲9360HD
Hose - Upper		20206	Belt - Fan & Alt.; W/50 1/4" Belt O.C.	303291	▲9370HD
584D			Belt - P.S.	3P130	▲9500HD
Case 4-Cyl. 188 Diesel Belt - Fan & Alt.	D73446	▲9520HD	Hose - Lower	303288	9279
Hose - Upper		21379			≧21660
584E					or ●25473
Case 4-Cyl. 390 Diesel Belt - Fan & Alt.	J911559	▲K080620HD	T25D		
585			Peugeot XN1P Belt - W.P. & Alt.		
Case 4-Cyl. 188; Case 4-Cyl. 188 Diesel Belt - Fan & Alt.	A38824	▲9490HD		617117	7400
585C			T30		
Case 4-Cyl. 207 Diesel Belt - Fan & Alt.	D73446	▲9520HD	Continental F163 Belt - Fan & Alt.; W/36 1/4" Belt O.C.		
Hose - Upper		20206	Belt - Fan & Alt.; W/37 1/4" Belt O.C.	372448	▲9360HD
585D			Belt - Fan & Alt.; W/50 1/4" Belt O.C.	303291	▲9370HD
Case 4-Cyl. 188 Diesel Belt - Fan & Alt.	D73446	▲9520HD	Belt - P.S.	3P130	▲9500HD
Hose - Upper		21379	Hose - Lower	303288	9279
					≧21660
					or ●25473
			T30B		
			Continental F163 Belt - Fan & Alt.; W/36 1/4" Belt O.C.		
			Belt - Fan & Alt.; W/37 1/4" Belt O.C.	372448	▲9360HD
			Belt - Fan & Alt.; W/50 1/4" Belt O.C.	303291	▲9370HD
			Belt - P.S.	3P130	▲9500HD
			Hose - Upper	303288	9279
			Hose - Lower		●25474
					≧21660

② Two Required.
● Vulco-Flex® Coolant Hose.

≧ Cut to Fit.
▲ Standard Belt Available. See Pages 630-631.

Belts and Coolant Hose for Lift & Industrial Trucks

Application	Mfr. Part No.	Our No.	Application	Mfr. Part No.	Our No.
CATERPILLAR - Continued			CATERPILLAR - Continued		
T30B - Continued			T45B - Continued		
Continental F163 - Continued			Continental F163 - Continued		
Hose - Lower		●25473	Belt - Fan & Alt.; W/50 1/4" Belt O.C.	3P130	▲9500HD
T30C			Belt - P.S.	303288	9279
Caterpillar 1404			Hose - Upper		●25474
Belt - Fan & Alt.; W/47 5/8" Belt O.C.	57931	7475	Hose - Lower		≈<21660
Belt - Fan & Alt.; W/49 5/8" Belt O.C.		7495		or	●25473
Belt - Fan & Alt.; W/50 1/4" Belt O.C.	3P130	▲9500HD	T50		
Belt - W.P. & P.S.	7N510	7380	Continental F163		
T30D			Belt - Fan & Alt.; W/36 1/4" Belt O.C.	372448	▲9360HD
Peugeot XN1P			Belt - Fan & Alt.; W/37 1/4" Belt O.C.	303291	▲9370HD
Belt - W.P. & Alt.	617117	7400	Belt - P.S.	303288	9279
T35B			Hose - Lower		≈<21660
Continental F163				or	●25473
Belt - Fan & Alt.; W/36 1/4" Belt O.C.	372448	▲9360HD	Perkins 3-Cyl. 145		
Belt - Fan & Alt.; W/37 1/4" Belt O.C.	303291	▲9370HD	Belt - Fan & Alt.	314850	▲9550HD
Belt - Fan & Alt.; W/50 1/4" Belt O.C.	3P130	▲9500HD	T50B		
Belt - P.S.	303288	9279	Caterpillar 1404		
Hose - Upper		●25474	Belt - Fan & Alt.; W/47 5/8" Belt O.C.	57931	7475
Hose - Lower		≈<21660	Belt - Fan & Alt.; W/49 5/8" Belt O.C.		7495
	or	●25473	Belt - Fan & Alt.; W/50 1/4" Belt O.C.	3P130	▲9500HD
T35D			Continental F163		
Peugeot XN1P			Belt - Fan & Alt.; W/36 1/4" Belt O.C.	372448	▲9360HD
Belt - W.P. & Alt.	617117	7400	Belt - Fan & Alt.; W/37 1/4" Belt O.C.	303291	▲9370HD
T40			Belt - P.S.	303288	9279
Continental F163			Hose - Upper		●25474
Belt - Fan & Alt.; W/36 1/4" Belt O.C.	372448	▲9360HD	Hose - Lower		≈<21660
Belt - Fan & Alt.; W/37 1/4" Belt O.C.	303291	▲9370HD		or	●25473
Belt - P.S.	303288	9279	T50C		
Perkins 3-Cyl. 145		▲9550HD	Caterpillar 1404		
Belt - Fan & Alt.	314850	▲9550HD	Belt - Fan & Alt.; W/47 5/8" Belt O.C.	57931	7475
T40B			Belt - Fan & Alt.; W/49 5/8" Belt O.C.		7495
Continental F163			Belt - Fan & Alt.; W/50 1/4" Belt O.C.	3P130	▲9500HD
Belt - Fan & Alt.; W/36 1/4" Belt O.C.	372448	▲9360HD	Belt - W.P. & P.S.	7N510	7380
Belt - Fan & Alt.; W/37 1/4" Belt O.C.	303291	▲9370HD	T50D		
Belt - Fan & Alt.; W/50 1/4" Belt O.C.	3P130	▲9500HD	Peugeot XN1P		
Belt - P.S.	303288	9279	Belt - W.P. & Alt.; Ser. No. 2YB1 & After	2W2531	7440
Hose - Upper		●25474	Belt - W.P. & Alt.; Ser. No. 8EB1 & After	7W0717	7375
Hose - Lower		≈<21660	Hose - Upper; Ser. No. 2YB1 & After		●26611
	or	●25473	Hose - Lower; Ser. No. 8EB1 & After		●25476
T40C			T50DSA		
Caterpillar 1404			Peugeot XN1P		
Belt - Fan & Alt.; W/47 5/8" Belt O.C.	57931	7475	Belt - W.P. & Alt.	5M8137	▲9500HD
Belt - Fan & Alt.; W/49 5/8" Belt O.C.		7495	Hose - Upper		20573
Belt - Fan & Alt.; W/50 1/4" Belt O.C.	3P130	▲9500HD		or	●25527
Belt - W.P. & P.S.	7N510	7380	T55B		
T40D			Caterpillar 1404		
Peugeot XN1P			Belt - Fan & Alt.; W/47 5/8" Belt O.C.	57931	7475
Belt - W.P. & Alt.; Ser. No. 2YB1 & After	2W2531	7440	Belt - Fan & Alt.; W/49 5/8" Belt O.C.		7495
Belt - W.P. & Alt.; Ser. No. 8EB1 & After	7W0717	7375	Belt - Fan & Alt.; W/50 1/4" Belt O.C.	3P130	▲9500HD
Hose - Upper; Ser. No. 2YB1 & After		●26611	Continental F163		
Hose - Lower; Ser. No. 8EB1 & After		●25476	Belt - Fan & Alt.; W/36 1/4" Belt O.C.	372448	▲9360HD
T40DSA			Belt - Fan & Alt.; W/37 1/4" Belt O.C.	303291	▲9370HD
Peugeot XN1P			Belt - P.S.	303288	9279
Belt - W.P. & Alt.	5M8137	▲9500HD	Hose - Lower		≈<21660
Hose - Upper		20573		or	●25473
	or	●25527	T60		
T45B			Continental F163		
Continental F163			Belt - Fan & Alt.; W/36 1/4" Belt O.C.	372448	▲9360HD
Belt - Fan & Alt.; W/36 1/4" Belt O.C.	372448	▲9360HD	Belt - Fan & Alt.; W/37 1/4" Belt O.C.	303291	▲9370HD
Belt - Fan & Alt.; W/37 1/4" Belt O.C.	303291	▲9370HD	Belt - P.S.	303288	9279
T45B			Hose - Lower		≈<21660
Continental F163				or	●25473
Belt - Fan & Alt.; W/36 1/4" Belt O.C.	372448	▲9360HD	Perkins 3-Cyl. 145		
Belt - Fan & Alt.; W/37 1/4" Belt O.C.	303291	▲9370HD	Belt - Fan & Alt.	314850	▲9550HD

● Vulco-Flex® Coolant Hose.
≈< Cut to Fit.

▲ Standard Belt Available. See Pages 630-631.

Lift & Industrial Equipment

Belts and Coolant Hose for Lift & Industrial Trucks

Application	Mfr. Part No.	Our No.	Application	Mfr. Part No.	Our No.
CATERPILLAR - Continued			CATERPILLAR - Continued		
T60B			V25D		
Caterpillar 1404			Peugeot XN1P		
Belt - Fan & Alt.; W/47 5/8" Belt O.C.	57931	7475	Belt - Fan & Alt.	617117	7400
Belt - Fan & Alt.; W/49 5/8" Belt O.C.		7495	V30		
Belt - Fan & Alt.; W/50 1/4" Belt O.C.	3P130	▲9500HD	Continental F163		
Continental F163			Belt - Fan & Alt.	303291	▲9370HD
Belt - Fan & Alt.; W/36 1/4" Belt O.C.	372448	▲9360HD	Belt - P.S.	303291	▲9370HD
Belt - Fan & Alt.; W/37 1/4" Belt O.C.	303291	▲9370HD	Perkins 3-Cyl. 145		
Belt - P.S.	303288	9279	Belt - Fan & Alt.	314850	▲9550HD
Hose - Upper		●25474	V30B		
Hose - Lower		≧21660	Continental F163		
		or	Belt - Fan & Alt.	303291	▲9370HD
			Belt - P.S.	303291	▲9370HD
			Hose - Lower		≧21660
T60C; T80C; T100C; T110C; T120C			Perkins 3-Cyl. 145		
Caterpillar 1404			Belt - Fan & Alt.	314850	▲9550HD
Belt - Fan & Alt.; W/49 5/8" Belt O.C.		7495	V30C		
Belt - Fan & Alt.; W/50 1/4" Belt O.C.	3P130	▲9500HD	Caterpillar 1404		
Belt - W.P. & P.S.	7N510	7380	Belt - Fan & Alt.	62923	7495
Continental F227			Belt - W.P.	7N510	7380
Belt - Fan & Alt.; Ser. No. 33L1221 & Before ..	303291	▲9370HD	Hose - Lower - Eng. To Pipe		≧20661
Belt - Fan & Alt.; Ser. No. 33L1222 & After ...	8N3504	▲9395HD			or ≧●25251
Belt - Fan & P.S.; Ser. No. 33L1222 & After ..	303291	▲9370HD	Hose - Lower - Pipe To Rad.		≧20791
T165; T180; T200; T300; T400			Continental F163		
IH UV345; IH UV392			Belt - Fan & Alt.	62923	7495
Belt - Fan & Alt.	1N3010	7640	V30D		
Belt - Fan & Air Brake Compr.	1N9310	7500	Peugeot XN1P		
Hose - Lower		●26523	Belt - Fan & Alt.	617117	7400
TC30			V35B		
Continental F163			Continental F163		
Hose - Lower		≧21660	Belt - Fan & Alt.	303291	▲9370HD
		or	Belt - P.S.	303291	▲9370HD
			Hose - Lower		≧21660
TC30C; TC40C; TC50C			Perkins 3-Cyl. 145		
Continental F163			Belt - Fan & Alt.	314850	▲9550HD
Belt - Fan & Alt.; W/36 1/4" Belt O.C.	372448	▲9360HD	V35C		
Belt - Fan & Alt.; W/37 1/4" Belt O.C.	303291	▲9370HD	Caterpillar 1404		
Belt - Fan & Alt.; W/50 1/4" Belt O.C.	3P130	▲9500HD	Belt - Fan & Alt.	62923	7495
Belt - P.S.	303288	9279	Belt - W.P.	7N510	7380
Hose - Lower; (1 1/2" I.D.)		24224	Hose - Lower - Eng. To Pipe		≧20661
TC60C					or ≧●25251
Continental F163			Hose - Lower - Pipe To Rad.		≧20791
Belt - Fan & Alt.; W/36 1/4" Belt O.C.	372448	▲9360HD	Continental F163		
Belt - Fan & Alt.; W/37 1/4" Belt O.C.	303291	▲9370HD	Belt - Fan & Alt.	62923	7495
Belt - Fan & Alt.; W/50 1/4" Belt O.C.	3P130	▲9500HD	V35D		
Belt - P.S.	303288	9279	Peugeot XN1P		
Hose - Lower; (1 1/2" I.D.)		24224	Belt - Fan & Alt.	617117	7400
Continental F227			V40		
Hose - Upper; Ser. No. 33L1221 & Before		≧20416	Continental F163		
		or	Belt - Fan & Alt.	303291	▲9370HD
			Belt - P.S.	303291	▲9370HD
TC60D			Perkins 3-Cyl. 145		
Peugeot XN1P			Belt - Fan & Alt.	314850	▲9550HD
Belt - W.P. & Alt.; Ser. No. 2YB1 & After	2W2531	7440	V40B		
Belt - W.P. & Alt.; Ser. No. 8EB1 & After	7W0717	7375	Continental F163		
Hose - Upper; Ser. No. 2YB1 & After		●26611	Belt - Fan & Alt.	303291	▲9370HD
Hose - Lower; Ser. No. 8EB1 & After		●25476	Belt - P.S.	303291	▲9370HD
TC60DSA			Perkins 3-Cyl. 145		
Peugeot XN1P			Belt - Fan & Alt.	314850	▲9550HD
Belt - W.P. & Alt.	5M8137	▲9500HD	V40B		
Hose - Upper		20573	Continental F163		
		or	Belt - Fan & Alt.	303291	▲9370HD
			Belt - P.S.	303291	▲9370HD
			Hose - Lower		≧21660
TC80C; TC100C; TC110C; TC120C			Perkins 3-Cyl. 145		
Continental F227			Belt - Fan & Alt.	314850	▲9550HD
Hose - Upper; Ser. No. 33L1221 & Before		≧20416	V40B		
		or	Continental F163		
			Belt - Fan & Alt.	303291	▲9370HD
			Belt - P.S.	303291	▲9370HD
			Hose - Lower		≧21660
			Perkins 3-Cyl. 145		
			Belt - Fan & Alt.	314850	▲9550HD

▲ Standard Belt Available. See Pages 630-631.
 ≧ Cut to Fit.

● Vulco-Flex® Coolant Hose.

Belts and Coolant Hose for Lift & Industrial Trucks

Application	Mfr. Part No.	Our No.	Application	Mfr. Part No.	Our No.
CATERPILLAR - Continued			CATERPILLAR - Continued		
V40C			V50B		
Caterpillar 1404			Continental F163		
Belt - Fan & Alt.	62923	7495	Belt - Fan & Alt.	303291	♣9370HD
Belt - W.P.	7N510	7380	Belt - P.S.	303291	♣9370HD
Hose - Lower - Eng. To Pipe		♣<20661	Hose - Lower		♣<21660
		or ♣<25251	Perkins 3-Cyl. 145		
Hose - Lower - Pipe To Rad.		♣<20791	Belt - Fan & Alt.	314850	♣9550HD
Continental F163			V50C		
Belt - Fan & Alt.	62923	7495	Caterpillar 1404		
V40D			Belt - Fan & Alt.	62923	7495
Perkins			Belt - W.P.	7N510	7380
Belt - Fan & Alt.; W/44 1/8" Belt O.C.	2W2531	7440	Hose - Lower - Eng. To Pipe		♣<20661
Belt - Fan & Alt.; W/45 1/8" Belt O.C.	053536	7450			or ♣<25251
Peugeot XN1P			Hose - Lower - Pipe To Rad.		♣<20791
Belt - Fan & Alt.	7W0717	7375	Continental F163		
V40DSA			Belt - Fan & Alt.	62923	7495
Peugeot XN1P			V50D		
Belt - Fan & Alt.	5M8137	♣9500HD	Perkins		
Hose - Upper		♣25526	Belt - Fan & Alt.; W/44 1/8" Belt O.C.	2W2531	7440
Hose - Lower - Eng. To Pipe: (1 1/2" I.D.)		24224	Belt - Fan & Alt.; W/45 1/8" Belt O.C.	053536	7450
Hose - Lower - Pipe To Rad.		♣<20065	Peugeot XN1P		
V41			Belt - Fan & Alt.	7W0717	7375
Continental F163			V50DSA		
Belt - Fan & Alt.	6A3858	♣9500HD	Peugeot XN1P		
Hose - Upper		♣<20611	Belt - Fan & Alt.	5M8137	♣9500HD
Perkins 4-Cyl. 236			Hose - Upper		♣25526
Belt - Fan & Alt.	302191	♣9510HD	Hose - Lower - Eng. To Pipe: (1 1/2" I.D.)		24224
V41B			Hose - Lower - Pipe To Rad.		♣<20065
Continental F163			V51		
Belt - Fan & Alt.	6A3858	♣9500HD	Continental F163		
Hose - Upper		♣<20611	Belt - Fan & Alt.	6A3858	♣9500HD
Continental F227			Hose - Upper		♣<20611
Hose - Upper		♣<20814	Perkins 4-Cyl. 236		
Hose - Lower		20450	Belt - Fan & Alt.	302191	♣9510HD
		or ♣25474	V51B; V55B		
Perkins 4-Cyl. 236			Continental F227		
Belt - Fan & Alt.	302191	♣9510HD	Belt - Fan & Alt.	303291	♣9370HD
V45B			Hose - Upper		♣<20814
Continental F163			Hose - Lower		20450
Belt - Fan & Alt.	303291	♣9370HD			or ♣25474
Belt - P.S.	303291	♣9370HD	Perkins 4-Cyl. 236		
Hose - Lower		♣<21660	Belt - Fan & Alt.	302191	♣9510HD
Perkins 3-Cyl. 145			V60		
Belt - Fan & Alt.	314850	♣9550HD	Continental F163		
V45C			Belt - Fan & Alt.	6A3858	♣9500HD
Caterpillar 1404			Hose - Upper		♣<20611
Belt - Fan & Alt.	62923	7495	Perkins 4-Cyl. 236		
Belt - W.P.	7N510	7380	Belt - Fan & Alt.	302191	♣9510HD
Hose - Lower - Eng. To Pipe		♣<20661	V60B		
		or ♣<25251	Continental F163		
Hose - Lower - Pipe To Rad.		♣<20791	Belt - Fan & Alt.	6A3858	♣9500HD
Continental F163			Hose - Upper		♣<20611
Belt - Fan & Alt.	62923	7495	Continental F227		
V50			Hose - Upper		♣<20814
Continental F163			Hose - Lower		20450
Belt - Fan & Alt.	303291	♣9370HD			or ♣25474
Belt - P.S.	303291	♣9370HD	Perkins 4-Cyl. 236		
Perkins 3-Cyl. 145			Belt - Fan & Alt.	302191	♣9510HD
Belt - Fan & Alt.	314850	♣9550HD	V60C		
			Perkins 4-Cyl. 236		
			Belt - Fan & Alt.		♣9625HD

♣< Cut to Fit.

♣ Standard Belt Available. See Pages 630-631.

♣ Vulco-Flex® Coolant Hose.

Lift & Industrial
Equipment

Belts and Coolant Hose for Lift & Industrial Trucks

Application	Mfr. Part No.	Our No.
CATERPILLAR - Continued		
V60C - Continued		
Perkins 4-Cyl. 236 - Continued		
Belt - W.P.	2P6212	▲9505HD
Hose - Lower		●25477
V60D		
Perkins 4-Cyl. 236		
Belt - Fan & Alt.; W/61 1/4" Belt O.C.	3C4970	▲9610HD
Belt - Fan & Alt.; W/62 1/4" Belt O.C.	9L1183	▲9620HD
Belt - W.P.	2P6212	▲9505HD
Hose - Lower		●25477
V60DSA		
Peugeot XN1P		
Belt - Fan & Alt.	5M8137	▲9500HD
V60E		
Perkins 4-Cyl. 236		
Belt - Fan	8M8336	▲9620HD
Belt - W.P.	2P6212	▲9505HD
Belt - Alt.	9L1183	▲9620HD
Hose - Lower		●25477
V70C		
Perkins 4-Cyl. 236		
Belt - Fan & Alt.		▲9625HD
Belt - W.P.	2P6212	▲9505HD
Hose - Lower		●25477
V70D		
Perkins 4-Cyl. 236		
Belt - Fan & Alt.; W/61 1/4" Belt O.C.	3C4970	▲9610HD
Belt - Fan & Alt.; W/62 1/4" Belt O.C.	9L1183	▲9620HD
Belt - W.P.	2P6212	▲9505HD
Hose - Lower		●25477
V70E		
Perkins 4-Cyl. 236		
Belt - Fan	8M8336	▲9620HD
Belt - W.P.	2P6212	▲9505HD
Belt - Alt.	9L1183	▲9620HD
Hose - Lower		●25477
V80C		
Perkins 4-Cyl. 236		
Belt - Fan & Alt.		▲9625HD
Belt - W.P.	2P6212	▲9505HD
Hose - Lower		●25477
V80D		
Perkins 4-Cyl. 236		
Belt - Fan & Alt.; W/61 1/4" Belt O.C.	3C4970	▲9610HD
Belt - Fan & Alt.; W/62 1/4" Belt O.C.	9L1183	▲9620HD
Belt - W.P.	2P6212	▲9505HD
Hose - Lower		●25477
V80E		
Perkins 4-Cyl. 236		
Belt - Fan	8M8336	▲9620HD
Belt - W.P.	2P6212	▲9505HD
Belt - Alt.	9L1183	▲9620HD
Hose - Lower		●25477
V100		
Caterpillar 3208 Diesel		
Hose - Upper		≈21379
Hose - Lower		●26510
Ford 6-Cyl. 240		
Belt - Fan & Alt.	3P0130	▲9500HD
Perkins 4-Cyl. 236		
Belt - Fan & Alt.	7L5001	▲9580HD

Application	Mfr. Part No.	Our No.
CATERPILLAR - Continued		
V100 - Continued		
Perkins 4-Cyl. 236 - Continued		
Belt - P.S.; W/36 1/8" Belt O.C.	617108	7360
Belt - P.S.; W/53 1/4" Belt O.C.	680610	▲9530HD
Hose - Upper		●26611
Hose - Lower		●26506
V110		
Perkins 4-Cyl. 236 Diesel		
Belt - Fan & Alt.	680610	▲9530HD
V120		
Caterpillar 3208 Diesel		
Hose - Upper		≈21379
Hose - Lower		●26510
Ford 6-Cyl. 240		
Belt - Fan & Alt.	3P0130	▲9500HD
Perkins 4-Cyl. 236		
Belt - Fan & Alt.	7L5001	▲9580HD
Belt - P.S.; W/36 1/8" Belt O.C.	617108	7360
Belt - P.S.; W/53 1/4" Belt O.C.	680610	▲9530HD
Hose - Upper		●26611
Hose - Lower		●26506
V130		
Perkins 4-Cyl. 236 Diesel		
Belt - Fan & Alt.	680610	▲9530HD
V140		
Caterpillar 3208 Diesel		
Hose - Upper		≈21379
Hose - Lower		●26510
Ford 6-Cyl. 240		
Belt - Fan & Alt.	3P0130	▲9500HD
Perkins 4-Cyl. 236		
Belt - Fan & Alt.	7L5001	▲9580HD
Belt - P.S.; W/36 1/8" Belt O.C.	617108	7360
Belt - P.S.; W/53 1/4" Belt O.C.	680610	▲9530HD
Hose - Upper		●26611
Hose - Lower		●26506
Perkins 4-Cyl. 236 Diesel		
Belt - Fan & Alt.	680610	▲9530HD
V150		
Perkins 4-Cyl. 236 Diesel		
Belt - Fan & Alt.		▲9540HD
V160		
Caterpillar 3208 Diesel		
Belt - Fan & Alt.; W/Single Belt	4S6209	▲9650HD
Belt - Fan & Alt.; W/61 5/8" Belt O.C.		▲9610HD
Belt - Fan & Alt.; W/Dual Belts	8S5154	②▲9650HD
Belt - P.S.	5M8137	▲9500HD
Hose - Upper		≈21379
Hose - Lower		●26510
Continental 235; Perkins 6-Cyl. 354		
Belt - Fan & Alt.	6A9558	▲9610HD
Hose - Upper		●26509
Hose - Lower		●26511
V160B		
Caterpillar 3208 Diesel		
Belt - Fan & Alt.; W/Single Belt	4S6209	▲9650HD
Belt - Fan & Alt.; W/Dual Belts	8S5154	②▲9650HD
Belt - Fan & Alt.; W/61 5/8" Belt O.C.		▲9610HD
Belt - Belt; W/O Aux. Rad.		▲9500HD
Hose - Upper		≈21379
Hose - Lower		●26510
Continental 235; Perkins 6-Cyl. 354		
Hose - Upper		●26509

▲ Standard Belt Available. See Pages 630-631.
 ≈ Cut to Fit.

● Vulco-Flex® Coolant Hose.
 ② Two Required.

Belts and Coolant Hose for Lift & Industrial Trucks

Application	Mfr. Part No.	Our No.	Application	Mfr. Part No.	Our No.
CATERPILLAR - Continued			CATERPILLAR - Continued		
V160B - Continued			V200 - Continued		
Continental 235; Perkins 6-Cyl. 354 - Continued			Perkins 6-Cyl. 354		
Hose - Lower		●26511	Belt - Fan & Alt.	6A9558	▲9610HD
V160D			Hose - Upper		●26509
Ford V-8 351			Hose - Lower		●26511
Belt - Fan		7565	V200B		
Belt - Alt.		7430	Caterpillar 3208 Diesel		
V160E			Hose - Upper		≡<21379
Caterpillar 3208 Diesel			Hose - Lower		●26510
Belt - Fan & Alt.	8S5154	②▲9650HD	Continental 235; Perkins 6-Cyl. 354		
Belt - W.P.	5M8137	▲9500HD	Hose - Upper		●26509
Belt - P.S.	8N3504	▲9395HD	Hose - Lower		●26511
V160HF			V200ES		
Caterpillar 3145 Diesel			Caterpillar 3208 Diesel		
Belt - Fan & Alt.	688546	②▲9630HD	Belt - Fan & Alt.	8S5154	②▲9650HD
V180			Belt - W.P.	5M8137	▲9500HD
Caterpillar 3208 Diesel			Belt - P.S.	8N3504	▲9395HD
Belt - Fan & Alt.; W/Single Belt	4S6209	▲9650HD	V200HF		
Belt - Fan & Alt.; W/61 5/8" Belt O.C.		▲9610HD	Caterpillar 3145 Diesel		
Belt - Fan & Alt.; W/Dual Belts	8S5154	②▲9650HD	Belt - Fan & Alt.	688546	②▲9630HD
Belt - P.S.	5M8137	▲9500HD	V225		
Hose - Upper		≡<21379	Caterpillar 3145 Diesel		
Hose - Lower		●26510	Belt - Fan & Alt.	688546	②▲9630HD
Continental 235; Perkins 6-Cyl. 354			Ford V-8 351		
Belt - Fan & Alt.	6A9558	▲9610HD	Belt - Fan & Alt.	617140	②▲9540HD
Hose - Upper		●26509	V225B		
Hose - Lower		●26511	Caterpillar 3208 Diesel		
V180B			Hose - Upper		≡<21379
Caterpillar 3208 Diesel			Hose - Lower		●26510
Belt - Fan & Alt.; W/Single Belt	4S6209	▲9650HD	V225HF		
Belt - Fan & Alt.; W/Dual Belts	8S5154	②▲9650HD	Caterpillar 3145 Diesel		
Belt - Fan & Alt.; W/61 5/8" Belt O.C.		▲9610HD	Belt - Fan & Alt.	688546	②▲9630HD
Belt - Belt; W/O Aux. Rad.		▲9500HD	V250B		
Hose - Upper		≡<21379	Caterpillar 3208 Diesel		
Hose - Lower		●26510	Hose - Upper		≡<21379
Continental 235; Perkins 6-Cyl. 354			Hose - Lower		●26510
Hose - Upper		●26509	V300		
Hose - Lower		●26511	Caterpillar 3208 Diesel		
V180E			Belt - Fan & Alt.; W/Single Belt	4S6209	▲9650HD
Caterpillar 3208 Diesel			Belt - Fan & Alt.; W/61 5/8" Belt O.C.		▲9610HD
Belt - Fan & Alt.	8S5154	②▲9650HD	Belt - Fan & Alt.; W/Dual Belts	8S5154	②▲9650HD
Belt - W.P.	5M8137	▲9500HD	Belt - P.S.	5M8137	▲9500HD
Belt - P.S.	8N3504	▲9395HD	Hose - Upper		≡<21379
V180HF			Hose - Lower		●26510
Caterpillar 3145 Diesel			Continental 235; Perkins 6-Cyl. 354		
Belt - Fan & Alt.	688546	②▲9630HD	Belt - Fan & Alt.	6A9558	▲9610HD
V200			Hose - Upper		●26509
Caterpillar 3145 Diesel			Hose - Lower		●26511
Belt - Fan & Alt.	688546	②▲9630HD	V300B		
Caterpillar 3208 Diesel			Caterpillar 3208 Diesel		
Belt - Fan & Alt.; W/Single Belt	4S6209	▲9650HD	Hose - Upper		≡<21379
Belt - Fan & Alt.; W/61 5/8" Belt O.C.		▲9610HD	Hose - Lower		●26510
Belt - Fan & Alt.; W/Dual Belts	8S5154	②▲9650HD	Continental 235; Perkins 6-Cyl. 354		
Belt - P.S.	5M8137	▲9500HD	Hose - Upper		●26509
Hose - Upper		≡<21379	Hose - Lower		●26511
Hose - Lower		●26510	V330B		
Continental 235			Caterpillar 3208 Diesel		
Belt - Fan & Alt.	6A9558	▲9610HD	Hose - Upper		≡<21379
Hose - Upper		●26509	Hose - Lower		●26510
Hose - Lower		●26511	Ford V-8 351		
Ford V-8 351			Belt - Fan & Alt.	617140	②▲9540HD
Belt - Fan & Alt.	617140	②▲9540HD			

● Vulco-Flex® Coolant Hose.
 ▲ Standard Belt Available. See Pages 630-631.

② Two Required.
 ≡< Cut to Fit.

Belts and Coolant Hose for Lift & Industrial Trucks

Application	Mfr. Part No.	Our No.	Application	Mfr. Part No.	Our No.
CATERPILLAR - Continued			CHAMP - Continued		
VC40D			350 - Continued		
Peugeot XN1P			Chrysler 6-Cyl. 230 - Continued		
Belt - Fan & Alt.	617117	7400	Belt - P.S.; W/32 3/4" Belt O.C.		TR22322
VC60D			Belt - P.S.; W/38" Belt O.C.		TR22373
Perkins			600		
Belt - Fan & Alt.; W/44 1/8" Belt O.C.	2W2531	7440	Chrysler 6-Cyl. 230		
Belt - Fan & Alt.; W/45 1/8" Belt O.C.	053536	7450	Belt - Fan & Gen.	1092505	TR24476
Peugeot XN1P			Belt - C.S. & P.S.		7330
Belt - Fan & Alt.	7W0717	7375	700		
VC60DSA			IH BD269 Diesel		
Peugeot XN1P			Belt - Fan & Gen.		TR34467
Hose - Upper		●25526	C40		
Hose - Lower - Eng. To Pipe; (1 1/2" I.D.)		24224	Continental F163		
Hose - Lower - Pipe To Rad.		≡20065	Hose - Lower		●25478
CHAMP			CB40		
44HL			Continental F163		
Chrysler 6-Cyl. 230			Belt - Fan & Alt.		♣9463HD
Belt - Fan & Gen.	1092505	TR24476	Belt - P.S.		TR24515
Belt - P.S.; W/32 3/4" Belt O.C.		TR22322	Hose - Upper		●26501
Belt - P.S.; W/38" Belt O.C.		TR22373	Hose - Lower		●25478
Hose - Upper		●26601	CB50		
Hose - Lower		●25478	Chrysler 6-Cyl. 230		
100			Belt - P.S.		TR22322
Chrysler 6-Cyl. 230			Hose - Lower		●25478
Belt - Fan & Gen.	1092505	TR24476	Ford 4-Cyl. 256		
Belt - C.S. & P.S.		7330	Hose - Upper		●25478
135HLD			Challenger		
Chrysler 6-Cyl. 230			Chrysler 6-Cyl. 230		
Belt - Fan & Gen.	1092505	TR24476	Belt - Fan & Gen.	1092505	TR24476
Belt - P.S.; W/32 3/4" Belt O.C.		TR22322	Belt - P.S.		TR22322
Belt - P.S.; W/38" Belt O.C.		TR22373	SK60		
200			Chrysler 6-Cyl. 230		
Chrysler 6-Cyl. 230			Belt - Fan & Gen.	1092505	TR24476
Belt - Fan & Gen.	1092505	TR24476	Belt - P.S.		TR22322
Belt - C.S. & P.S.		7330	Continental F163		
Hose - Upper		●26601	Hose - Lower		●25478
Hose - Lower		●25478	SK70; SK80; SK100		
200HL			Chrysler 6-Cyl. 230		
Chrysler 6-Cyl. 230			Belt - Fan & Gen.	1092505	TR24476
Belt - Fan & Gen.	1092505	TR24476	Belt - P.S.		TR22322
Belt - P.S.; W/32 3/4" Belt O.C.		TR22322	Hose - Upper		●26601
Belt - P.S.; W/38" Belt O.C.		TR22373	Hose - Lower		●25478
Hose - Upper		●26601	TL40		
Hose - Lower		●25478	Chrysler 6-Cyl. 230		
200HLD			Belt - Fan & Gen.	1092505	TR24476
Chrysler 6-Cyl. 230			Belt - P.S.		TR22322
Belt - Fan & Gen.	1092505	TR24476	Continental F163		
Belt - P.S.; W/32 3/4" Belt O.C.		TR22322	Hose - Lower		●25478
Belt - P.S.; W/38" Belt O.C.		TR22373	TL40C		
Hose - Upper		●26602	Continental		
Hose - Lower		●25478	Belt - Fan		TR24476
300			Hose - Upper		●26603
Chrysler 6-Cyl. 230			Hose - Lower		●25478
Belt - Fan & Gen.	1092505	TR24476	TL50		
Belt - C.S. & P.S.		7330	Chrysler 6-Cyl. 230		
350			Belt - Fan & Gen.	1092505	TR24476
Chrysler 6-Cyl. 225			Belt - P.S.		TR22322
Hose - Upper		●25480	Continental F163		
Chrysler 6-Cyl. 230			Hose - Lower		●25478
Belt - Fan & Gen.	1092505	TR24476			

● Vulco-Flex® Coolant Hose.
♣ Standard Belt Available. See Pages 630-631.

≡ Cut to Fit.

Belts and Coolant Hose for Lift & Industrial Trucks

Application	Mfr. Part No.	Our No.	Application	Mfr. Part No.	Our No.
CLARK			CLARK - Continued		
235			H30; H50		
Clark D155G Diesel Belt - Fan & Gen.	1318618	②7440	Clark D155G Diesel; Continental F162 Belt - Fan & Gen.; W/55 5/8" Belt O.C.	1311815	②7555
355			Belt - Fan & Gen.; W/56 5/8" Belt O.C.	670199	②7565
Continental F162; Waukesha Diesel Belt - Fan & Gen.; W/56 1/8" Belt O.C.	1307965	②7560	H355		
Belt - Fan & Gen.; W/56 5/8" Belt O.C.	670199	②7565	Continental F162; Waukesha Diesel Belt - Fan & Gen.; W/56 1/8" Belt O.C.	1307965	②7560
355PD			Belt - Fan & Gen.; W/56 5/8" Belt O.C.	670199	②7565
Perkins; Perkins Diesel Belt - Fan	660056	▲9520HD	H355PD		
356			Perkins; Perkins Diesel Belt - Fan	660056	▲9520HD
Continental; Continental Diesel Belt - Fan	668774	②7480	H685		
Hose - Upper		20747	Perkins Belt - Fan & Alt./Gen.; W/55 1/8" Belt O.C.	742934	②7545
Hose - Lower		●25472	Belt - Fan & Alt./Gen.; W/56 5/8" Belt O.C.	670199	②7565
685			H915		
Perkins Belt - Fan & Alt./Gen.; W/55 1/8" Belt O.C.	742934	②7545	Perkins Belt - Fan & Alt./Gen.; W/63 1/8" Belt O.C.	1308322	②7630
Belt - Fan & Alt./Gen.; W/56 5/8" Belt O.C.	670199	②7565	Perkins Diesel		
Perkins Diesel Belt - Fan & Alt./Gen.; W/52 1/4" Belt O.C.	660056	▲9520HD	Belt - Fan & Alt./Gen.; W/52 1/4" Belt O.C.	660056	▲9520HD
Belt - Fan & Alt./Gen.; W/56 5/8" Belt O.C.	670199	②7565	Belt - Fan & Alt./Gen.; W/56 5/8" Belt O.C.	670199	②7565
Hose - Upper		≧20364	Hose - Upper		≧20364
Hose - Lower		≧21794	Hose - Lower		≧21794
		or ●25476			or ●25476
915			Perkins Diesel		
Perkins Belt - Fan & Alt./Gen.; W/63 1/8" Belt O.C.	1308322	②7630	Belt - Fan & Alt.	1316173	▲9600HD
Perkins Diesel Belt - Fan & Alt.	1316173	▲9600HD	HY40; HY50		
Clarklift C20B; Clarklift C25B			Continental; Continental Diesel Hose - Upper		≧20276
Continental Y112 Hose - Lower		≧20121	HY355PD		
		or ●25476	Perkins; Perkins Diesel Belt - Fan	660056	▲9520HD
Clarklift CFY20B; Clarklift CFY25B			HY685		
Continental F162 Hose - Lower		≧20900	Perkins Belt - Fan & Alt./Gen.; W/61 1/8" Belt O.C.	1320801	②7612
Continental F162 LPG Hose - Upper		≧20145	Belt - Fan & Alt./Gen.; W/63 1/8" Belt O.C.	1308322	②7630
Hose - Lower		≧20900	Hose - Lower		≧20230
F235					or ●25478
Clark D155G Diesel Belt - Fan & Gen.	1318618	②7440	Perkins Diesel		
FY235			Belt - Fan & Alt./Gen.	1316173	▲9600HD
Clark D155G Diesel Belt - Fan & Alt./Gen.	668774	②7480	Hose - Upper		≧20364
GCS20			Hose - Lower		≧21794
Mitsubishi 4G54; Waukesha D176 Diesel Belt - Fan & Alt.	2740163	7555			or ●25476
GPS15			HY1425		
Mitsubishi 4-Cyl. Diesel Belt - W.P. & Alt.	REMF6365	▲9375HD	Continental Belt - Fan	791338	②▲9500HD
Belt - Fan		7325	Belt - Gen.	791339	▲9530HD
GPS30			Hose - Upper		●26612
Mitsubishi 4G54; Waukesha D176 Diesel Belt - Fan & Alt.	2740163	7555	Hose - Lower		●26511
			Continental Diesel Belt - Fan	791338	②▲9500HD
			Belt - Gen.	791339	▲9530HD
			Hose - Upper		●26501
			Hose - Lower		●26507
			HY1625		
			GM Belt - Fan; W/59 1/4" Belt O.C.	1323090	②▲9590HD
			Belt - Fan; W/60 1/4" Belt O.C.	1318622	②▲9600HD
			Perkins Diesel		
			Belt - Fan & Gen.	1321653	▲9590HD

② Two Required.
● Vulco-Flex® Coolant Hose.

▲ Standard Belt Available. See Pages 630-631.
≧ Cut to Fit.

Belts and Coolant Hose for Lift & Industrial Trucks

Application	Mfr. Part No.	Our No.	Application	Mfr. Part No.	Our No.
CLARK - Continued			CLARK - Continued		
HY1830			Y1425		
Continental			Continental		
Belt - Fan	791338	②▲9500HD	Belt - Fan	791338	②▲9500HD
Belt - Gen.	791339	▲9530HD	Belt - Gen.	791339	▲9530HD
Hose - Upper		●26612	Hose - Upper		●26612
Hose - Lower		●26511	Hose - Lower		●26511
Continental Diesel			Continental Diesel		
Belt - Fan	791338	②▲9500HD	Belt - Fan	791338	②▲9500HD
Belt - Gen.	791339	▲9530HD	Belt - Gen.	791339	▲9530HD
Hose - Upper		●26501	Hose - Upper		●26501
Hose - Lower		●26507	Hose - Lower		●26507
HY2030			Y1625		
GM			Perkins		
Belt - Fan; W/59 1/4" Belt O.C.	1323090	②▲9590HD	Belt - Fan; W/49 1/4" Belt O.C.	666481	②▲9490HD
Belt - Fan; W/60 1/4" Belt O.C.	1318622	②▲9600HD	Belt - Fan; W/50 1/4" Belt O.C.	657250	②▲9500HD
Perkins Diesel			Perkins Diesel		
Belt - Fan & Gen.	1321653	▲9590HD	Belt - Fan & Gen.	666481	②▲9490HD
IT355			Perkins Diesel		
Continental; Continental Diesel			Belt - Fan & Gen.		
Belt - Fan	668774	②7480	Belt - Fan & Gen.	1321653	▲9590HD
Hose - Upper		20747	Y1830		
Hose - Lower		●25472	Continental		
IT581			Belt - Fan		
Perkins			Belt - Gen.		
Hose - Upper		≈20065	Hose - Upper		
Hose - Lower		●25476	Hose - Lower		
Perkins Diesel			Continental Diesel		
Belt - Fan	1317818	▲9540HD	Belt - Fan		
Hose - Upper		●25480	Belt - Gen.		
Hose - Lower		●25476	Hose - Upper		
Y30			Hose - Lower		
Continental; Continental Diesel			Y2030		
Belt - Fan & Gen.; W/55 3/4" Belt O.C.			Perkins		
Belt - Fan & Gen.; W/56 5/8" Belt O.C.		②7555	Belt - Fan; W/49 1/4" Belt O.C.		
		②7565	Belt - Fan; W/50 1/4" Belt O.C.		
Y40; Y50			Belt - Fan & Gen.		
Continental; Continental Diesel			Belt - Gen.		
Belt - Fan & Gen.; W/55 3/4" Belt O.C.			Perkins Diesel		
Belt - Fan & Gen.; W/56 5/8" Belt O.C.		②7555	Belt - Fan & Gen.		
Hose - Upper		②7565	Belt - Fan & Gen.		
		≈20276	Belt - Gen.		
Y235			Perkins Diesel		
Clark D155G Diesel			Belt - Fan & Gen.		
Belt - Fan & Alt./Gen.			Belt - Fan & Gen.		
Belt - Fan & Alt./Gen.	668774	②7480	Belt - Fan & Gen.		
Y355			CONDOR		
Waukesha; Waukesha Diesel			RT48A		
Belt - Fan & Gen.; W/56 1/8" Belt O.C.			Nissan 4-Cyl.		
Belt - Fan & Gen.; W/56 5/8" Belt O.C.		②7560	Belt - Fan & Alt.		
	670199	②7565	Belt - Fan & Alt.		
Y355PD			Belt - Fan & Alt.		
Perkins; Perkins Diesel			Belt - Fan & Alt.		
Belt - Fan			Hose - Upper		
Belt - Fan	660056	▲9520HD	Hose - Lower		
Y685			or		
Perkins			or		
Belt - Fan & Alt./Gen.; W/61 1/8" Belt O.C.			or		
Belt - Fan & Alt./Gen.; W/63 1/8" Belt O.C.		②7612	or		
Hose - Lower		②7630	or		
		≈20230	or		
		●25478	or		
Perkins Diesel			or		
Belt - Fan & Alt./Gen.			or		
Hose - Upper	1316173	▲9600HD	or		
Hose - Lower		≈20364	or		
		≈21794	or		
		●25476	or		

② Two Required.
● Vulco-Flex® Coolant Hose.

▲ Standard Belt Available. See Pages 630-631.
≈ Cut to Fit.

Belts and Coolant Hose for Lift & Industrial Trucks

Application	Mfr. Part No.	Our No.	Application	Mfr. Part No.	Our No.
ECONOMOBILE			GERLINGER - Continued		
620; 620B; 640			30R; 30RH; 30S; 30SH; 40R; 40RH; 40S; 40SH - Continued		
Continental F226 Belt - Fan & Gen. F140K215 TR28483			Ford V-8 - Continued		
IH BD220 Belt - Fan 150560R1 ▲9451HD			Belt - Gen.; W/43 7/8" Belt O.C.; W/L-Head Eng. C629027C5 7435		
Belt - W.P. & Gen. 150560R1 ▲9451HD			Belt - Gen.; W/45 1/8" Belt O.C.; W/L-Head Eng. C629027C6 7450		
IH UB220; IH UB240; IH UB264			Hercules DD298 Diesel; Hercules DD339 Diesel; Hercules GO298; Hercules GO339		
Belt - Fan; W/44 3/8" Belt O.C. TR28445			Belt - Fan & Gen.; W/46 1/2" Belt O.C. C629028C18 ▲9463HD		
Belt - Fan; W/45 1/8" Belt O.C. ▲9451HD			Belt - Fan & Gen.; W/48 1/4" Belt O.C. C629028C7 ▲9480HD		
Belt - W.P. & Alt. ▲9440HD			60AS		
Hose - Upper ●26511			Continental B427		
Hose - Lower ●26509			Belt - Fan & Alt./Gen. C629027C10 ②7550		
FABTEK			Belt - Fan & Gen. C629028C15 ②▲9570HD		
T40			60AV		
Wisconsin 4-Cyl.			Continental F244		
Belt - Gen. A51			Belt - Fan & Gen. ▲9360HD		
Belt - Hyd. Pump ②B50			Belt - Fan & Alt. C629027C17 7400		
GENIE			Belt - P.S. C629027C17 7400		
S40; S60; S65; S80; S85			Belt - Hyd. Pump ②▲9451HD		
Ford LRG423			A4D		
Belt - Fan & Alt. ▲K060415HD			Continental M330		
GERLINGER			Belt - Fan & Gen. C629027C10 ②7550		
4L			Belt - Fan & Alt.; W/Power Shift Trans. C629027C13 7550		
Ford V-8			Belt - Fan & Alt./Gen.; W/Man. Trans. C629028C22 ②▲9463HD		
Hose - Upper; (1 3/4" I.D.) ②24228			Belt - Alt./Gen.; W/Power Shift Trans. C629029C43 ▲9360HD		
4MH			Hercules D3000 Diesel		
Ford V-8			Belt - Fan & Alt./Gen. ▲9570HD		
Belt - Fan; W/39 3/4" Belt O.C. EAT8577A TR28400			Hercules D3400 Diesel		
Belt - Fan; W/41 3/8" Belt O.C. 8EQ8577A TR28406			Belt - Fan & Gen. C629028C27 ▲9550HD		
Belt - Fan; W/44 1/4" Belt O.C. C629029C14 TR28437			A10; A12		
Belt - Gen.; W/43 7/8" Belt O.C. C629027C5 7435			Continental F244		
Belt - Gen.; W/44 7/8" Belt O.C. C629028C4 ▲9447HD			Belt - Fan & Gen. A36902 ▲9360HD		
Belt - Gen.; W/50 1/4" Belt O.C. C629028C9 ▲9500HD			Belt - Fan & Alt. C629027C17 7400		
Belt - Gen.; W/56" Belt O.C. 8RT8620AA TR24562			Belt - Compr. C629028C30 ▲9520HD		
Hose - Upper; (1 3/4" I.D.) ②24228			Belt - P.S. C629027C17 7400		
Hercules DD298 Diesel; Hercules DD339 Diesel; Hercules GO298; Hercules GO339			Belt - Hyd. Pump C629028C6 ②▲9451HD		
Belt - Fan & Gen.; W/46 1/2" Belt O.C. C629028C18 ▲9463HD			Hose - Upper ●25480		
Belt - Fan & Gen.; W/48 1/4" Belt O.C. C629028C7 ▲9480HD			Hose - Lower ●25473		
4N			Hercules D2300 Diesel		
Ford V-8			Belt - Fan & Gen. C629028C30 ②▲9520HD		
Hose - Upper; (1 3/4" I.D.) ②24228			Belt - Fan & Alt. C629028C26 ▲9540HD		
12RH; 15RH			Belt - V.P. C629028C23 2420		
Continental F244			A15; A16; A18; A20; A22; A24		
Belt - Fan & Gen. ▲9360HD			Continental M330		
Belt - Fan & Alt. C629027C17 7400			Belt - Fan & Gen. C629027C10 ②7550		
Belt - P.S. C629027C17 7400			Belt - Fan & Alt.; W/Power Shift Trans. C629027C13 7550		
Belt - Hyd. Pump C629028C6 ②▲9451HD			Belt - Fan & Alt./Gen.; W/Man. Trans. C629027C22 ②▲9463HD		
Ford F223			Belt - Alt./Gen.; W/Power Shift Trans. C629029C43 ▲9360HD		
Belt - Fan & Gen.; W/36 1/4" Belt O.C. C629027C2 7360			Belt - Fan & Alt./Gen.; W/Clutch Pump C629028C18 ▲9463HD		
Belt - Fan & Gen.; W/37 1/8" Belt O.C. C629027C3 7370			Hose - Upper ●26611		
Belt - Fan & Alt. C629028C21 ▲9430HD			Hose - Lower ●26501		
Belt - Hyd. Pump C629028C6 ②▲9451HD			Hercules D3000 Diesel		
Hose - Upper ●25473			Belt - Fan & Alt./Gen. ▲9570HD		
30R; 30RH; 30S; 30SH; 40R; 40RH; 40S; 40SH			Hercules D3400 Diesel		
Ford V-8			Belt - Fan & Gen. C629028C27 ▲9550HD		
Belt - Fan; W/42 1/2" Belt O.C.; W/L-Head Eng. EAM8577A TR28423			AM		
Belt - Fan; W/44 1/4" Belt O.C.; W/L-Head Eng. C629029C14 TR28437			Continental B427		
			Belt - Fan & Alt./Gen. C629027C10 ②7550		
			Belt - Fan & Gen. C629028C15 ②▲9570HD		
			Belt - Compr. C629028C31 ▲9380HD		

▲ Standard Belt Available. See Pages 630-631.

② Two Required.

● Vulco-Flex® Coolant Hose.

Lift & Industrial
Equipment

Belts and Coolant Hose for Lift & Industrial Trucks

Application	Mfr. Part No.	Our No.
GERLINGER - Continued		
AMP		
Continental M363		
Belt - Fan	C629029C43	▲9360HD
Belt - W.P.	C629027C13	7550
B15; B16; B17; B18; B19; B20; B21; B22; B23; B24		
Continental M330		
Hose - Upper		●26611
Hose - Lower		●26603
Detroit Diesel 2-53 Diesel; Detroit Diesel 3-53 Diesel; Detroit Diesel 4-53 Diesel		
Belt - Gen. & W.P.	5114440	②7430
Belt - Fan; W/35 1/4" Belt O.C.	5126447	▲9350HD
Belt - Fan; W/39 1/4" Belt O.C.	5119186	②▲9425HD
Belt - Fan; W/40 1/4" Belt O.C.	5126763	②▲9400HD
Belt - Fan; W/42 3/4" Belt O.C.	5119186	②▲9425HD
Belt - Fan; W/44 1/4" Belt O.C.	5126761	▲9440HD
Belt - Fan; W/44 7/8" Belt O.C.	5126764	②▲9447HD
Belt - Fan; W/46 1/4" Belt O.C.	5123089	②7460
Belt - Fan; W/47 1/4" Belt O.C.		▲9470HD
Belt - Fan; W/48 1/4" Belt O.C.	5126765	▲9480HD
Belt - Fan; W/50 3/4" Belt O.C.	5126768	▲9505HD
Belt - Fan; W/52 1/4" Belt O.C.	5126253	▲9520HD
Belt - Fan & W.P.; W/Clutch Pump	C629029C50	▲9470HD
BT		
Continental M330		
Belt - Fan & Gen.	C629027C10	②7550
Belt - Fan & Alt.; W/Power Shift Trans.	C629027C13	7550
Belt - Fan & Alt./Gen.; W/Man. Trans.	C629028C22	②▲9463HD
Belt - Alt./Gen.; W/Power Shift Trans.	C629029C43	▲9360HD
G12; G15; G16; G18; G20; G22		
Continental M330		
Belt - Fan & Gen.	C629027C10	②7550
Belt - Fan & Alt.; W/Power Shift Trans.	C629027C13	7550
Belt - Fan & Alt./Gen.; W/Man. Trans.	C629028C22	②▲9463HD
Belt - Alt./Gen.; W/Power Shift Trans.	C629029C43	▲9360HD
Ford F223		
Belt - Fan & Gen.; W/36 1/4" Belt O.C.	C629027C2	7360
Belt - Fan & Gen.; W/37 1/8" Belt O.C.	C629027C3	7370
Belt - Fan & Alt.	C629028C21	▲9430HD
Belt - Hyd. Pump	C629028C6	②▲9451HD
Ford V-8		
Belt - Fan; W/39 3/4" Belt O.C.	EAT8577A	TR28400
Belt - Fan; W/44 1/4" Belt O.C.	C629029C14	TR28437
Belt - Gen.; W/43 7/8" Belt	C629027C5	7435
Belt - Gen.; W/45 3/8" Belt O.C.	C629028C5	▲9451HD
Belt - Gen.; W/50 1/4" Belt O.C.	C629028C9	▲9500HD
Belt - P.S.	C629028C2	▲9390HD
Hose - Lower		●26502
Hercules DD298 Diesel; Hercules DD339 Diesel; Hercules GO298; Hercules GO339		
Belt - Fan & Gen.; W/46 1/2" Belt O.C.	C629028C18	▲9463HD
Belt - Fan & Gen.; W/48 1/4" Belt O.C.	C629028C7	▲9480HD
H32; H36; H40		
Continental B427		
Belt - Fan & Alt./Gen.	C629027C10	②7550
Belt - Fan & Gen.	C629028C15	②▲9570HD
Hercules JXD; Hercules JXLD		
Belt - Fan & Gen.	22176	TR30408
HF		
Continental M330		
Belt - Fan & Gen.	C629027C10	②7550
Belt - Fan & Alt.; W/Power Shift Trans.	C629027C13	7550
Belt - Fan & Alt./Gen.; W/Man. Trans.	C629028C22	②▲9463HD
Belt - Alt./Gen.; W/Power Shift Trans.	C629029C43	▲9360HD

Application	Mfr. Part No.	Our No.
GERLINGER - Continued		
HF - Continued		
Hercules D3000 Diesel		
Belt - Fan & Alt./Gen.		▲9570HD
Hercules D3400 Diesel		
Belt - Fan & Gen.	C629028C27	▲9550HD
L12; L15; L16; L18; L20		
Ford V-8		
Belt - Fan; W/39 3/4" Belt O.C.	EAT8577A	TR28400
Belt - Fan; W/41 3/8" Belt O.C.	8EQ8577A	TR28412
Belt - Gen.; W/43 7/8" Belt O.C.	C629027C5	7435
Belt - Gen.; W/56" Belt O.C.	8RT8620AA	TR24562
Hose - Lower		●26602
L22		
Ford V-8		
Hose - Lower		●26602
M24; M26; M28; M30		
Continental M363		
Belt - Fan	C629029C43	▲9360HD
Belt - W.P.	C629027C13	7550
Ford V-8		
Belt - Fan; W/42 1/2" Belt O.C.	EAM8577A	TR28423
Belt - Fan; W/44 1/4" Belt O.C.	C629029C14	TR28437
Belt - Gen.; W/43 7/8" Belt O.C.	C629027C5	7435
Belt - Gen.; W/45 1/8" Belt O.C.	C629027C6	7450
Hercules DD298 Diesel; Hercules DD339 Diesel; Hercules GO298; Hercules GO339		
Belt - Fan & Gen.; W/46 1/2" Belt O.C.	C629028C18	▲9463HD
Belt - Fan & Gen.; W/48 1/4" Belt O.C.	C629028C7	▲9480HD
PC		
Ford V-8		
Belt - Fan; W/39 3/4" Belt O.C.	EAT8577A	TR28400
Belt - Fan; W/41 3/8" Belt O.C.	8EQ8577A	TR28406
Belt - Fan; W/44 1/4" Belt O.C.	C629029C14	TR28437
Belt - Gen.; W/43 7/8" Belt O.C.	C629027C5	7435
Belt - Gen.; W/44 7/8" Belt O.C.	C629028C4	▲9447HD
Belt - Gen.; W/50 1/4" Belt O.C.	C629028C9	▲9500HD
Belt - P.S.	C629028C2	▲9390HD
Hercules DD298 Diesel; Hercules DD339 Diesel; Hercules GO298; Hercules GO339		
Belt - Fan & Gen.; W/46 1/2" Belt O.C.	C629028C18	▲9463HD
Belt - Fan & Gen.; W/48 1/4" Belt O.C.	C629028C7	▲9480HD
PF30; PFH30		
Ford V-8		
Belt - Fan; W/42 1/2" Belt O.C.	EAM8577A	TR28423
Belt - Fan; W/44 1/4" Belt O.C.	C629029C14	TR28437
Belt - Gen.; W/43 7/8" Belt O.C.	C629027C5	7435
Belt - Gen.; W/45 1/8" Belt O.C.	C629027C6	7450
Hercules DD298 Diesel; Hercules DD339 Diesel; Hercules GO298; Hercules GO339		
Belt - Fan & Gen.; W/46 1/2" Belt O.C.	C629028C18	▲9463HD
Belt - Fan & Gen.; W/48 1/4" Belt O.C.	C629028C7	▲9480HD
PH462; PH562; PH662; PH862		
Ford V-8		
Belt - Fan; W/37" Belt O.C.	21A8577A	TR26366
Belt - Fan; W/39 3/4" Belt O.C.	EAT8577A	TR28400
Belt - Fan; W/41 3/8" Belt O.C.	8EQ8577A	TR28412
Belt - Gen.; W/43 7/8" Belt O.C.	C629027C5	7435
Belt - Gen.; W/53 1/2" Belt O.C.		TR24530
Belt - Gen.; W/56" Belt O.C.	8RT8620AA	TR24562
PH962		
Ford V-8		
Belt - Fan; W/37" Belt O.C.	21A8577A	TR26366
Belt - Fan; W/39 3/4" Belt O.C.	EAT8577A	TR28400

▲ Standard Belt Available. See Pages 630-631.

② Two Required.

● Vulco-Flex® Coolant Hose.

Belts and Coolant Hose for Lift & Industrial Trucks

Application	Mfr. Part No.	Our No.
GERLINGER - Continued		
PH962 - Continued		
Ford V-8 - Continued		
Belt - Fan; W/41 3/8" Belt O.C.	8EQ8577A	TR28412
Belt - Gen.; W/43 7/8" Belt O.C.	C629027C5	7435
Belt - Gen.; W/53 1/2" Belt O.C.		TR24530
Belt - Gen.; W/56" Belt O.C.	8RT8620AA	TR24562
Hose - Upper; (1 3/4" I.D.)		②24228
PW		
Continental M330		
Belt - Fan & Gen.	C629027C10	②7550
Belt - Fan & Alt.; W/Power Shift Trans.	C629027C13	7550
Belt - Fan & Alt./Gen.; W/Man. Trans.	C629028C2	②▲9463HD
Belt - Alt./Gen.; W/Power Shift Trans.	C629029C43	▲9360HD
Hercules D3000 Diesel		
Belt - Fan & Alt./Gen.		▲9570HD
Hercules D3400 Diesel		
Belt - Fan & Gen.	C629028C27	▲9550HD
RC60		
Continental B427		
Belt - Fan & Alt./Gen.	C629027C10	②7550
Belt - Fan & Gen.	C629028C15	②▲9570HD
S8; S8N; S10; S10N; S12; S15; S16; S18		
Continental F244		
Belt - Fan & Gen.		▲9360HD
Belt - Fan & Alt.	C629027C17	7400
Belt - P.S.	C629027C17	7400
Belt - Hyd. Pump	C629028C6	②▲9451HD
Continental M330		
Belt - Fan & Gen.	C629027C10	②7550
Belt - Fan & Alt.; W/Power Shift Trans.	C629027C13	7550
Belt - Fan & Alt./Gen.; W/Man. Trans.	C629028C22	②▲9463HD
Belt - Alt./Gen.; W/Power Shift Trans.	C629029C43	▲9360HD
Ford F223		
Belt - Fan & Gen.; W/36 1/4" Belt O.C.	C629027C2	7360
Belt - Fan & Gen.; W/37 1/8" Belt O.C.	C629027C3	7370
Belt - Fan & Alt.	C629028C21	▲9430HD
Belt - Hyd. Pump	C629028C6	②▲9451HD
Ford V-8		
Belt - Fan; W/39 3/4" Belt O.C.	EAT8577A	TR28400
Belt - Fan; W/41 3/8" Belt O.C.	8EQ8577A	TR28412
Belt - Fan; W/44 1/4" Belt O.C.	C629029C14	TR28437
Belt - Gen.; W/43 7/8" Belt O.C.	C629027C5	7435
Belt - Gen.; W/44 7/8" Belt O.C.	C629028C4	▲9447HD
Belt - Gen.; W/50 1/4" Belt O.C.	C629028C9	▲9500HD
Belt - Gen.; W/56" Belt O.C.	8RT8620A	TR24562
Belt - P.S.	C629028C2	▲9390HD
Hose - Lower		●26602
Hercules DD298 Diesel; Hercules DD339 Diesel; Hercules GO298; Hercules GO339		
Belt - Fan & Gen.; W/46 1/2" Belt O.C.	C629028C18	▲9463HD
Belt - Fan & Gen.; W/48 1/4" Belt O.C.	C629028C7	▲9480HD
Hercules JXD; Hercules JXLD		
Belt - Fan & Gen.	22176	TR30408
SC60		
Continental B427		
Belt - Fan & Alt./Gen.	C629027C10	②7550
Belt - Fan & Gen.	C629028C15	②▲9570HD
SM20; SM30		
Ford V-8		
Belt - Fan; W/39 3/4" Belt O.C.	EAT8577A	TR28400
Belt - Fan; W/41 3/8" Belt O.C.	8EQ8577A	TR28412
Belt - Fan; W/44 1/4" Belt O.C.	C629029C14	TR28437
Belt - Gen.; W/43 7/8" Belt O.C.	C629027C5	7435
Belt - Gen.; W/44 7/8" Belt O.C.	C629028C4	▲9447HD
Belt - Gen.; W/50 1/4" Belt O.C.	C629028C9	▲9500HD

Application	Mfr. Part No.	Our No.
GERLINGER - Continued		
SM20; SM30 - Continued		
Ford V-8 - Continued		
Belt - Gen.; W/56" Belt O.C.	8RT8620AA	TR24562
Hercules DD298 Diesel; Hercules DD339 Diesel; Hercules GO298; Hercules GO339		
Belt - Fan & Gen.; W/46 1/2" Belt O.C.	C629028C18	▲9463HD
Belt - Fan & Gen.; W/48 1/4" Belt O.C.	C629028C7	▲9480HD
SMH		
Ford V-8		
Belt - Fan; W/39 3/4" Belt O.C.	EAT8577A	TR28400
Belt - Fan; W/41 3/8" Belt O.C.	8EQ8577A	TR28412
Belt - Fan; W/44 1/4" Belt O.C.	C629029C14	TR28437
Belt - Gen.; W/43 7/8" Belt O.C.	C629027C5	7435
Belt - Gen.; W/44 7/8" Belt O.C.	C629028C4	▲9447HD
Belt - Gen.; W/50 1/4" Belt O.C.	C629028C9	▲9500HD
Belt - Gen.; W/56" Belt O.C.	8RT8620AA	TR24562
Hose - Upper; (1 3/4" I.D.)		②24228
Hercules DD298 Diesel; Hercules DD339 Diesel; Hercules GO298; Hercules GO339		
Belt - Fan & Gen.; W/46 1/2" Belt O.C.	C629028C18	▲9463HD
Belt - Fan & Gen.; W/48 1/4" Belt O.C.	C629028C7	▲9480HD
SRH (4H Series)		
Hercules JXLD		
Belt - Gen.		TR24400
U8		
Continental F244		
Hose - Upper		●25480
Hose - Lower		●25473
W12; W15; W16; W18; W20; W22		
Continental M330		
Belt - Fan & Gen.	C629027C10	②7550
Belt - Fan & Alt.; W/Power Shift Trans.	C629027C13	7550
Belt - Fan & Alt./Gen.; W/Man. Trans.	C629028C22	②▲9463HD
Belt - Alt./Gen.	C629029C43	▲9360HD
Ford F223		
Belt - Fan & Gen.; W/36 1/4" Belt O.C.	C629027C2	7360
Belt - Fan & Gen.; W/37 1/8" Belt O.C.	C629027C3	7370
Belt - Fan & Alt.	C629028C21	▲9430HD
Belt - Hyd. Pump	C629028C6	②▲9451HD
Ford V-8		
Belt - Fan; W/39 3/4" Belt O.C.	EAT8577A	TR28400
Belt - Fan; W/41 3/8" Belt O.C.	8EQ8577A	TR28412
Belt - Fan; W/44 1/4" Belt O.C.	C629029C14	TR28437
Belt - Gen.; W/43 7/8" Belt O.C.	C629027C5	7435
Belt - Gen.; W/44 7/8" Belt O.C.	C629028C4	▲9447HD
Belt - Gen.; W/50 1/4" Belt O.C.	C629028C9	▲9500HD
Belt - P.S.	C629028C2	▲9390HD
Hose - Lower		●26602
Hercules DD298 Diesel; Hercules DD339 Diesel; Hercules GO298; Hercules GO339		
Belt - Fan & Gen.; W/46 1/2" Belt O.C.	C629028C18	▲9463HD
Belt - Fan & Gen.; W/48 1/4" Belt O.C.	C629028C7	▲9480HD
Hercules JXD		
Belt - Fan & Gen.	22176	TR30408
GRADALL		
534B		
Perkins 4-Cyl. 236 Diesel; Waukesha 4-Cyl. 220 Diesel		
Belt - Fan & Alt.		▲9520HD
Hose - Upper		●26509
Hose - Lower - Eng. To Pipe; (1 1/2" I.D.)		24224
Hose - Lower - Pipe To Rad.		21660
Hose - By Pass		≅20065

② Two Required.
● Vulco-Flex® Coolant Hose.

▲ Standard Belt Available. See Pages 630-631.
≅ Cut to Fit.

Belts and Coolant Hose for Lift & Industrial Trucks

Application	Mfr. Part No.	Our No.	Application	Mfr. Part No.	Our No.
GRADALL-LOED			HYSTER - Continued		
534			80 - Continued		
Cummins V378 Diesel			Continental 6-Cyl. 245 - Continued		
Belt - Fan	178593	②TR22461	Hose - Upper		●25474
Belt - Fan & Alt.	178447	②7380	Hose - Lower		●25478
542			A66A		
Perkins 4-Cyl. 236 Diesel			GM V-6 4.3 L		
Belt - Fan & Alt.		②7450	Belt - Fan & Hyd. Pump	172883	②7525
Hose - Upper		③<21379	Belt - W.P. & Alt.		7375
		or ●26509	Hose - Upper		●25474
Hose - Lower		●26512	A150E Thru A225E		
Hose - By Pass		③<21942	GM V-6 305		
552; 554			Belt - Fan		
Chrysler V-8 318			Belt - Fan		
Belt - Fan & Alt.		▲9520HD	127034		
GROVE			▲9590HD		
AMZ40			H20E		
Kubota 3-Cyl.			Continental F112		
Belt - Fan & Alt.		7345	Belt - Fan, Alt. & W.P.		▲9490HD
Hose - Upper		③<21942	Hose - Upper		20433
AMZ50; AMZ56; AMZ66			or ●25526		
Nissan 4-Cyl.			Hose - Lower		
Belt - Fan & Alt.	1172077702	7385	●25474		
AMZ66XT			Continental Y112		
Ford 4-Cyl.			Belt - Fan & Gen.; W/45 3/8" Belt O.C.		
Belt - Fan & Alt.		▲K060415HD	118671		
MZ48B			Belt - Fan & Gen.; W/46 1/8" Belt O.C.		
Nissan 4-Cyl.			123577		
Belt - Fan & Alt.		7385	Belt - Fan & Gen.; W/48 1/8" Belt O.C.		
MZ66			97908		
Deutz 2-Cyl. 115 Diesel			Hose - Upper		
Belt - Alt.		AX33	●25472		
MZ116D			Hose - Lower		
Cummins 4-Cyl. 3.9 L Diesel			or ●25473		
Belt - Fan & Alt.		▲K080575HD	Hose - By Pass; Ser. No. BID2889 & After(1 1/2" I.D.)		
SM4688XT			24224		
Mitsubishi M20F			Hose - By Pass; Ser. No. BIE1911 & After(1 1/2" I.D.)		
Belt - Fan & Alt.		7345	24224		
HERCULIFT			Perkins 4-Cyl. 107 Diesel		
H4M32G			Hose - Upper - Eng. To Pipe		
Ford 4-Cyl. 172; Ford 4-Cyl. 192			●25472		
Belt - Fan; W/35A. Alt.		▲9420HD	Hose - Lower - Pipe To Rad.		
Belt - Hyd. Pump		TR20451	or ●20065		
Hose - Upper; (1 1/4" I.D.)		24220	●25473		
Hose - Lower		●25478	H25E		
HYSTER			Continental F112		
50			Belt - Fan, Alt. & W.P.		
Isuzu 4-Cyl. 207 Diesel			▲9490HD		
Belt - Fan & Alt.	5136710550	▲9476HD	20433		
Hose - Upper		●25252	or ●25526		
60			Hose - Lower		
Isuzu 4-Cyl. 92			●25474		
Belt - Fan & Alt.		▲9451HD	Continental Y112		
80			Belt - Fan & Gen.; W/45 3/8" Belt O.C.		
Continental 6-Cyl. 245			118671		
Belt - Fan & Alt.	111107	▲9470HD	Belt - Fan & Gen.; W/46 1/8" Belt O.C.		
			123577		
			Belt - Fan & Gen.; W/48 1/8" Belt O.C.		
			97908		
			Hose - Upper		
			●25473		
			Hose - Lower		
			20065		
			or ●25473		
			Hose - By Pass; Ser. No. BID2889 & After(1 1/2" I.D.)		
			24224		
			Hose - By Pass; Ser. No. BIE1911 & After(1 1/2" I.D.)		
			24224		
			Perkins 4-Cyl. 107 Diesel		
			Hose - Upper - Eng. To Pipe		
			●25473		
			Hose - Lower - Pipe To Rad.		
			or ●20065		
			●25473		
			H30E		
			Continental F112		
			Belt - Fan, Alt. & W.P.		
			▲9490HD		
			20433		
			or ●25526		
			Hose - Lower		
			●25474		
			Continental F135		
			Belt - Fan & Gen.; Ser. No. BID2888 & Before 118671		
			7450		
			Belt - Fan & Gen.; Ser. No. BIE1585 & Before 118671		
			7450		
			Belt - Fan & Gen.; Ser. No. BIE1586 Thru		
			BIE1910		
			97908		
			7440		
			Belt - Fan & Gen.; Ser. No. BID2889 & After . 981885		
			▲9510HD		
			Belt - Fan & Gen.; Ser. No. BIE1911 & After . 981885		
			▲9510HD		
			Hose - Upper - Eng. To Tank; Ser. No. BID2888 & Before		
			●25472		
			Hose - Upper - Eng. To Tank; Ser. No. BIE1910 & Before		
			●25472		
			Hose - Upper - Eng. To Tank; Ser. No. BID2889 & After		
			●25472		

② Two Required.
● Vulco-Flex® Coolant Hose.

③< Cut to Fit.
▲ Standard Belt Available. See Pages 630-631.

Belts and Coolant Hose for Lift & Industrial Trucks

Application	Mfr. Part No.	Our No.	Application	Mfr. Part No.	Our No.
HYSTER - Continued			HYSTER - Continued		
H30E - Continued			H40H - Continued		
Continental F135 - Continued			Perkins 4-Cyl. 203 Diesel - Continued		
Hose - Upper - Eng. To Tank; Ser. No. BID1911 & After		●25472	Hose - Lower		20355
Hose - Upper - Rad. To Tank; Ser. No. BID2889 & After		●25472		or	●25477
Hose - Upper - Rad. To Tank; Ser. No. BID1911 & After		●25472	H40XL		
Hose - Lower		≈20065	Continental F244		
	or	●25526	Belt - Fan, Gov. & Idler	502105903	▲9470HD
Hose - By Pass; Ser. No. BID2889 & After(1 1/2" I.D.)		24224	Belt - W.P. & Alt.	900293812	▲9412HD
Hose - By Pass; Ser. No. BIE1911 & After(1 1/2" I.D.)		24224	Hose - Upper		●25251
Continental Y112			H50F		
Belt - Fan & Gen.; W/45 3/8" Belt O.C.	118671	7450	Continental G193		
Belt - Fan & Gen.; W/46 1/8" Belt O.C.	123577	7460	Belt - Fan & Alt.	118135	▲9463HD
Belt - Fan & Gen.; W/48 1/8" Belt O.C.	97908	7440	Hose - Upper		●25473
Hose - Upper		●25473	Hose - Lower		≈20573
Hose - Lower		20065	Perkins 4-Cyl. 203 Diesel		
	or	●25473	Belt - Fan & Alt.	142526	▲9490HD
Hose - By Pass; Ser. No. BID2889 & After(1 1/2" I.D.)		24224	Hose - Upper		●25473
Hose - By Pass; Ser. No. BIE1911 & After(1 1/2" I.D.)		24224	Hose - Lower		20355
Perkins 4-Cyl. 107 Diesel				or	●25477
Belt - Fan & Gen.; W/32 3/4" Belt O.C.	148370	7325	H50H		
Belt - Fan & Gen.; W/48 1/8" Belt O.C.	100754	7480	Detroit Diesel 4-53 Diesel		
Hose - Upper - Eng. To Pipe		●25473	Hose - Lower		●26521
Hose - Lower - Pipe To Rad.		20065	Ford 4-Cyl.		
	or	●25473	Hose - Fan & Alt.		●25305
H30F			Hose - Lower; W/O.H.V. Eng.		≈21794
Continental G193			Hose - Lower; W/O.H.V. Eng.		or ●25473
Belt - Fan & Alt.	118135	▲9463HD	Ford 4-Cyl. 172		
Hose - Upper		●25473	Belt - Fan & Alt.	145313	▲9505HD
Hose - Lower		≈20573	Belt - W.P.		▲9313HD
Perkins 4-Cyl. 203 Diesel			Hose - Lower		≈21794
Belt - Fan & Alt.	142526	▲9490HD		or	●25480
Hose - Upper		●25473	Perkins 4-Cyl. 203 Diesel		
Hose - Lower		20355	Belt - Fan & Alt.	104728	▲9480HD
	or	●25477	Hose - Lower		20355
H30H				or	●25477
Ford 4-Cyl. 172			Perkins 6-Cyl. 354 Diesel		
Belt - Fan & Alt.	145313	▲9505HD	Hose - Lower		23562
Hose - Lower		≈21794	H50XL		
	or	●25480	GM 4-Cyl.		
Perkins 4-Cyl. 203 Diesel			Belt - Fan	324368	▲9470HD
Belt - Fan & Alt.	104728	▲9480HD	Belt - Alt.	326873	▲9420HD
Hose - Lower		20355	H60B		
	or	●25477	Continental F226		
H35XL			Belt - Fan & Gen.	111107	▲9470HD
GM 4-Cyl.			Belt - P.S.		▲9319HD
Hose - Upper		●25252	Hose - Upper		●25473
Mazda M4-121G			Hose - Lower		●25473
Belt - Alt.	326873	▲9420HD	H60C		
H40F			Continental F226		
Continental G193			Belt - Fan & Gen.	111107	▲9470HD
Belt - Fan & Alt.	118135	▲9463HD	Belt - P.S.	121185	▲9309HD
Hose - Upper		●25473	Hose - Upper		●25473
Hose - Lower		≈20573	Hose - Lower		●25473
Perkins 4-Cyl. 203 Diesel			Perkins 4-Cyl. 203 Diesel		
Belt - Fan & Alt.	142526	▲9490HD	Belt - Fan & Gen.; W/50 3/4" Belt O.C.	145313	▲9505HD
Hose - Upper		●25473	Belt - Fan & Gen.; W/52 1/4" Belt O.C.	79853	▲9520HD
Hose - Lower		20355	Belt - Fan & Gen.; W/53 1/4" Belt O.C.	985420	▲9530HD
	or	●25477	Hose - Upper		●25472
H40H			Hose - Lower		20230
Ford 4-Cyl. 172				or	●25478
Belt - Fan & Alt.	145313	▲9505HD	H60F		
Hose - Lower		≈21794	Continental G193		
	or	●25480	Belt - Fan & Alt.	118135	▲9463HD
Perkins 4-Cyl. 203 Diesel					
Belt - Fan & Alt.	104728	▲9480HD			

● Vulco-Flex® Coolant Hose.
 ▲ Standard Belt Available. See Pages 630-631.

≈ Cut to Fit.

Belts and Coolant Hose for Lift & Industrial Trucks

Application	Mfr. Part No.	Our No.	Application	Mfr. Part No.	Our No.
HYSTER - Continued			HYSTER - Continued		
H60F - Continued			H100B; H100C		
Continental G193 - Continued			Continental F244		
Hose - Upper		●25473	Belt - Fan & Gen.	111107	▲9470HD
Hose - Lower		✂20573	Hose - Upper		✂21794
Perkins 4-Cyl. 203 Diesel			or ●25473		
Belt - Fan & Alt.	142526	▲9490HD	Hose - Lower		●25478
Hose - Upper		●25473	Perkins 4-Cyl. 235 Diesel		
Hose - Lower		20355	Belt - Fan & Gen.	104728	▲9480HD
		or ✂●25477	Hose - Lower - Eng. To Pipe		✂20121
H60H			or ●25480		
Ford 4-Cyl. 172			Hose - Lower - Pipe To Rad.		
Belt - Fan & Alt.	145313	▲9505HD			✂20065
Hose - Lower		✂21794	Perkins 6-Cyl. 305 Diesel		
		or ✂●25480	Belt - Fan & Gen.	104728	▲9480HD
Perkins 4-Cyl. 203 Diesel			Hose - Upper		
Belt - Fan & Alt.	104728	▲9480HD			✂20957
Hose - Lower		20355	H100XL		
		or ✂●25477	GM V-6 4.3 L		
H70B			Belt - Fan & Alt.		
Continental F226			Belt - Fan & W.P.		
Belt - Fan & Gen.	111107	▲9470HD		374011	7500
Belt - P.S.		▲9319HD		374011	7500
Hose - Upper		●25473	H110F		
Hose - Lower		●25473	Chevrolet 6-Cyl. 250		
Continental F226			Belt - Fan & Gen.; W/37 5/8" Belt O.C.		
Belt - Fan & Gen.	111107	▲9470HD		172895	7375
Belt - P.S.	121185	▲9309HD	Belt - Fan & Gen.; W/52 7/8" Belt O.C.	172883	②7525
Hose - Upper		●25473	Belt - W.P.	155442	7380
Hose - Lower		●25473	Hose - Lower		●26502
Perkins 4-Cyl. 203 Diesel			Perkins 4-Cyl. 236 Diesel		
Belt - Fan & Gen.; W/50 3/4" Belt O.C.	145313	▲9505HD	Belt - Fan & Gen.	104728	▲9480HD
Belt - Fan & Gen.; W/52 1/4" Belt O.C.	79853	▲9520HD	Hose - Lower - Eng. To Pipe		✂20121
Belt - Fan & Gen.; W/53 1/4" Belt O.C.	985420	▲9530HD			or ●25480
Hose - Upper		●25472	Hose - Lower - Pipe To Rad.		✂20065
Hose - Lower		20230	H120B; H120C		
		or ●25478	Continental F244		
H80B			Belt - Fan & Gen.		
Continental F226			Hose - Upper		
Belt - Fan & Gen.	111107	▲9470HD		111107	▲9470HD
Belt - P.S.		▲9319HD	Hose - Lower		✂21794
Hose - Upper		●25473			or ●25473
Hose - Lower		●25473	Hose - Lower		●25478
Continental F226			Perkins 4-Cyl. 235 Diesel		
Belt - Fan & Gen.	111107	▲9470HD	Belt - Fan & Gen.	104728	▲9480HD
Belt - P.S.		▲9319HD	Hose - Lower - Eng. To Pipe		✂20121
Hose - Upper		●25473			or ●25480
Hose - Lower		●25473	Hose - Lower - Pipe To Rad.		✂20065
H80C			Perkins 6-Cyl. 305 Diesel		
Continental F226			Belt - Fan & Gen.		
Belt - Fan & Gen.	111107	▲9470HD		104728	▲9480HD
Belt - P.S.	121185	▲9309HD	Hose - Upper		
Hose - Upper		●25473			✂20957
Hose - Lower		●25473	H130F		
Continental F227			Chevrolet 6-Cyl. 250		
Hose - Upper		●25476	Belt - Fan & Gen.; W/37 5/8" Belt O.C.		
Hose - Lower		●25476		172895	7375
Perkins 4-Cyl. 203 Diesel			Belt - Fan & Gen.; W/52 7/8" Belt O.C.		
Belt - Fan & Gen.; W/50 3/4" Belt O.C.	145313	▲9505HD		172883	②7525
Belt - Fan & Gen.; W/52 1/4" Belt O.C.	79853	▲9520HD	Belt - W.P.	155442	7380
Belt - Fan & Gen.; W/53 1/4" Belt O.C.	985420	▲9530HD	Hose - Lower		●26502
Hose - Upper		●25472	Perkins 4-Cyl. 236 Diesel		
Hose - Lower		20230	Belt - Fan & Gen.	104728	▲9480HD
		or ●25478	Hose - Lower - Eng. To Pipe		✂20121
H80XL			or ●25480		
GM V-6 4.3 L			Hose - Lower - Pipe To Rad.		
Belt - Fan & Alt.	374011	7500			✂20065
Belt - Fan & W.P.	374011	7500	H140C; H150C		
Continental F244			Continental F244		
Belt - Fan & Gen.	111107	▲9470HD	Belt - Fan & Gen.	111107	▲9470HD
Hose - Upper		✂21794	Hose - Upper		✂21794
		or ●25473	Hose - Lower		●25478
Hose - Lower		●25478	Perkins 4-Cyl. 235 Diesel		
Perkins 4-Cyl. 235 Diesel			Belt - Fan & Gen.		
Belt - Fan & Gen.	104728	▲9480HD		104728	▲9480HD
Hose - Lower - Eng. To Pipe		✂20121	Hose - Lower - Eng. To Pipe		✂20121
		or ●25480			or ●25480
Hose - Lower - Pipe To Rad.		✂20065	Hose - Lower - Pipe To Rad.		✂20065

● Vulco-Flex® Coolant Hose.
 ▲ Standard Belt Available. See Pages 630-631.

✂ Cut to Fit.
 ② Two Required.

Belts and Coolant Hose for Lift & Industrial Trucks

Application	Mfr. Part No.	Our No.	Application	Mfr. Part No.	Our No.
HYSTER - Continued			HYSTER - Continued		
H140C; H150C - Continued			H225E - Continued		
Perkins 6-Cyl. 305 Diesel			Caterpillar 3204 Diesel - Continued		
Belt - Fan & Gen.	104728	▲9480HD	Belt - Fan & Alt.; Ser. No. B7P-2011 & After .	113221	▲9550HD
Hose - Upper		≧20957	Hose - Lower; (2 3/4" I.D.)		24244
H150E			GM V-6 305		
Caterpillar 3204 Diesel			Belt - Fan & Alt.; Ser. No. B7P-2010		
Belt - Fan; W/57 1/2" Belt O.C.	133323	TR28570	Belt - Fan & Alt.; Ser. No. B7P-2011	135417	▲9590HD
Belt - Fan & Alt.; Ser. No. B7P-2010 & Before	97897	▲9560HD			▲9580HD
Belt - Fan & Alt.; Ser. No. B7P-2011 & After .	113221	▲9550HD	Perkins 6-Cyl. 354 Diesel		
Hose - Lower; (2 3/4" I.D.)		24244	Belt - Fan; W/57 1/2" Belt O.C.	133323	TR28570
GM V-6 305			Belt - Fan & Alt.; Ser. No. B7P-2010 & Before	97897	▲9560HD
Belt - Fan & Alt.; Ser. No. B7P-2010	127034	▲9590HD	Belt - Fan & Alt.; Ser. No. B7P-2011 & After .	113221	▲9550HD
Belt - Fan & Alt.; Ser. No. B7P-2011	135417	▲9580HD	Hose - Upper		≧20611
Perkins 6-Cyl. 354 Diesel			Hose - Lower; Molded Hose		or
Belt - Fan; W/57 1/2" Belt O.C.	133323	TR28570			●26508
Belt - Fan & Alt.; Ser. No. B7P-2010 & Before	97897	▲9560HD	Hose - Lower; Strt. Hose(2 1/4" I.D.)		24236
Belt - Fan & Alt.; Ser. No. B7P-2011 & After .	113221	▲9550HD	H225ES		
Hose - Upper		≧20611	Caterpillar 3204 Diesel		
Hose - Lower; Molded Hose		or	Hose - Lower; (2 3/4" I.D.)		
		●26508			24244
Hose - Lower; Strt. Hose(2 1/4" I.D.)		24236	Perkins 6-Cyl. 354 Diesel		
H150F			Hose - Upper		
Chevrolet 6-Cyl. 250			Hose - Lower; Molded Hose		
Belt - Fan & Gen.; W/37 5/8" Belt O.C.	172895	7375			or
Belt - Fan & Gen.; W/52 7/8" Belt O.C.	172883	②7525			●26508
Belt - W.P.	155442	7380	Hose - Lower; Strt. Hose(2 1/4" I.D.)		
Hose - Lower		●26502			24236
Perkins 4-Cyl. 236 Diesel			H250A		
Belt - Fan & Gen.	104728	▲9480HD	GM V-6 305		
Hose - Lower - Eng. To Pipe		≧20121	Hose - Upper		
		or			●26512
Hose - Lower - Pipe To Rad.		●25480	Perkins 6-Cyl. 354 Diesel		
		≧20065	Hose - Upper		
H165E; H180E; H200E			Hose - Lower		
Caterpillar 3204 Diesel			or		
Belt - Fan; W/57 1/2" Belt O.C.	133323	TR28570	●26510		
Belt - Fan & Alt.; Ser. No. B7P-2010 & Before	97897	▲9560HD	H250E		
Belt - Fan & Alt.; Ser. No. B7P-2011 & After .	113221	▲9550HD	Caterpillar 3204 Diesel		
Hose - Lower; (2 3/4" I.D.)		24244	Belt - Fan; W/57 1/2" Belt O.C.		
GM V-6 305			133323		
Belt - Fan & Alt.; Ser. No. B7P-2010	127034	▲9590HD	Belt - Fan & Alt.; Ser. No. B7P-2010 & Before		
Belt - Fan & Alt.; Ser. No. B7P-2011	135417	▲9580HD	97897		
Perkins 6-Cyl. 354 Diesel			Belt - Fan & Alt.; Ser. No. B7P-2011 & After .		
Belt - Fan; W/57 1/2" Belt O.C.	133323	TR28570	113221		
Belt - Fan & Alt.; Ser. No. B7P-2010 & Before	97897	▲9560HD	Hose - Lower; (2 3/4" I.D.)		
Belt - Fan & Alt.; Ser. No. B7P-2011 & After .	113221	▲9550HD			
Hose - Upper		≧20611	GM V-6 305		
Hose - Lower; Molded Hose		or	Belt - Fan & Alt.; Ser. No. B7P-2010		
		●26508	127034		
Hose - Lower; Strt. Hose(2 1/4" I.D.)		24236	Belt - Fan & Alt.; Ser. No. B7P-2011		
			135417		
H200ES			Perkins 6-Cyl. 354 Diesel		
Caterpillar 3204 Diesel			Belt - Fan; W/57 1/2" Belt O.C.		
Belt - Fan; W/57 1/2" Belt O.C.	133323	TR28570	133323		
Belt - Fan & Alt.; Ser. No. B7P-2010 & Before	97897	▲9560HD	Belt - Fan & Alt.; Ser. No. B7P-2010 & Before		
Belt - Fan & Alt.; Ser. No. B7P-2011 & After .	113221	▲9550HD	97897		
GM V-6 305			Belt - Fan & Alt.; Ser. No. B7P-2011 & After .		
Belt - Fan & Alt.; Ser. No. B7P-2010	127034	▲9590HD	113221		
Belt - Fan & Alt.; Ser. No. B7P-2011	135417	▲9580HD	Hose - Upper		
Perkins 6-Cyl. 354 Diesel			Hose - Lower; Molded Hose		
Belt - Fan; W/57 1/2" Belt O.C.	133323	TR28570			
Belt - Fan & Alt.; Ser. No. B7P-2010 & Before	97897	▲9560HD	or		
Belt - Fan & Alt.; Ser. No. B7P-2011 & After .	113221	▲9550HD	●26508		
Hose - Upper		≧20611	Hose - Lower; Strt. Hose(2 1/4" I.D.)		
Hose - Lower; Molded Hose		or	24236		
		●26508	H275H		
Hose - Lower; Strt. Hose(2 1/4" I.D.)		24236	Detroit Diesel 4-53 Diesel		
H225E			Hose - Lower		
Caterpillar 3204 Diesel			●26521		
Belt - Fan; W/57 1/2" Belt O.C.	133323	TR28570	Ford 4-Cyl. 172		
Belt - Fan & Alt.; Ser. No. B7P-2010 & Before	97897	▲9560HD	Hose - Lower		
Belt - Fan & Alt.; Ser. No. B7P-2011 & After .	113221	▲9550HD	or		
GM V-6 305			●21794		
Belt - Fan & Alt.; Ser. No. B7P-2010	127034	▲9590HD	●25473		
Belt - Fan & Alt.; Ser. No. B7P-2011	135417	▲9580HD	Perkins 6-Cyl. 354 Diesel		
Perkins 6-Cyl. 354 Diesel			Hose - Lower		
Belt - Fan; W/57 1/2" Belt O.C.	133323	TR28570	23562		
Belt - Fan & Alt.; Ser. No. B7P-2010 & Before	97897	▲9560HD	H300		
Belt - Fan & Alt.; Ser. No. B7P-2011 & After .	113221	▲9550HD	Perkins 6-Cyl. 354 Diesel		
H225E			Hose - Upper		
Caterpillar 3204 Diesel			●26521		
Belt - Fan; W/57 1/2" Belt O.C.	133323	TR28570	H300A		
Belt - Fan & Alt.; Ser. No. B7P-2010 & Before	97897	▲9560HD	Detroit Diesel 4-53 Diesel		
Belt - Fan & Alt.; Ser. No. B7P-2011 & After .	113221	▲9550HD	Hose - Lower		
GM V-6 305			●26514		
Belt - Fan & Alt.; Ser. No. B7P-2010	127034	▲9590HD	GM V-6 305		
Belt - Fan & Alt.; Ser. No. B7P-2011	135417	▲9580HD	Hose - Upper		
Perkins 6-Cyl. 354 Diesel			●26512		
Belt - Fan; W/57 1/2" Belt O.C.	133323	TR28570	Perkins 6-Cyl. 354		
Belt - Fan & Alt.; Ser. No. B7P-2010 & Before	97897	▲9560HD	Hose - Upper		
Belt - Fan & Alt.; Ser. No. B7P-2011 & After .	113221	▲9550HD	●26510		

▲ Standard Belt Available. See Pages 630-631.
● Vulco-Flex® Coolant Hose.

≧ Cut to Fit.
② Two Required.

Lift & Industrial Equipment

Belts and Coolant Hose for Lift & Industrial Trucks

Application	Mfr. Part No.	Our No.	Application	Mfr. Part No.	Our No.
HYSTER - Continued			HYSTER - Continued		
H330; H350B			S60E; S70E; S80E; S100E - Continued		
Perkins 6-Cyl. 354 Diesel			Chevrolet 6-Cyl. 250 - Continued		
Hose - Upper		●26521	Hose - Upper - Pipe To Rad.		●26501
H360A; H400A; H460A			Perkins 4-Cyl. 236 Diesel		
Caterpillar D330 Diesel; Continental TD427 Diesel; Continental T427			Hose - Upper - Pipe To Rad.		20492
Hose - Upper		●26611	or ●25478		
Hose - Lower		●26502	Hose - Lower - Eng. To Pipe		●25532
HE50			S125A; S150A		
Continental F162			Continental F245		
Belt - Fan & Gen.; W/55 1/4" Belt O.C.	113221	▲9550HD	Belt - Fan & W.P.	111107	▲9470HD
Belt - Fan & Gen.; W/58 1/4" Belt O.C.	107195	▲9580HD	Perkins 4-Cyl. 236 Diesel		
Perkins 4-Cyl. 203 Diesel			Belt - Fan & W.P.	141319	▲9510HD
Belt - Fan	107195	▲9570HD	Z90A		
P40A; P50A			Continental 4-Cyl. Diesel		
Perkins 4-Cyl. 153 Diesel			Belt - Fan & Alt.; W/O.H.V. Eng.	104728	▲9480HD
Hose - Upper		●26611	Hose - Upper; W/O.H.V. Eng.		20357
Perkins 4-Cyl. 154 Diesel			or ●26602		
Hose - Upper		●26611	Hose - Lower - Eng. To Pipe; W/O.H.V. Eng.		≧20065
Hose - Lower		●25526	Hose - Lower - Pipe To Rad.; W/O.H.V. Eng.		≧20065
P60A; P80A			INGERSOLL-RAND		
Continental F226			VR642		
Hose - Upper		●25473	Cummins 4-Cyl. 3.9 L Diesel		
Hose - Lower		●25478	Belt - Fan & Alt.	3911587	▲K080537HD
Continental F227			INTERNATIONAL		
Hose - Upper		●25473	9000		
Perkins 4-Cyl. 236 Diesel			IH C291		
Hose - Upper		●25472	Belt - Fan	406097R1	▲9570HD
Hose - Lower - Pipe To Rad.; (1 1/2" I.D.)		24224	Belt - W.P. & Alt.	403617R1	▲9470HD
P125A; P150A			Hose - By Pass		20338
Caterpillar 3204 Diesel			IH D310 Diesel		
Hose - Lower; (2 3/4" I.D.)		24244	Belt - Fan	406097R1	▲9570HD
GM V-6 305			Hose - By Pass		20338
Hose - Upper		●26512	JLG		
Perkins 6-Cyl. 354 Diesel			30F		
Hose - Upper		≧20611	Wisconsin VH4D		
or ●26508			Belt - Alt.		1190
Hose - Lower; Molded Hose		≧20611	40-0		
or ●26508			Wisconsin VH4D		
Hose - Lower; Strt. Hose(2 1/4" I.D.)		24236	Belt - Alt.		1190
P150B			Belt - Gen.		▲9430HD
Detroit Diesel 4-53 Diesel			40-45		
Hose - Lower		●26521	Wisconsin V-4 4.0 L		
P165A; P180A			Belt - Alt.		2200
Caterpillar 3204 Diesel			Belt - Gen.		▲9415HD
Hose - Lower; (2 3/4" I.D.)		24244	40F		
GM V-6 305			Wisconsin VH4D		
Hose - Upper		●26512	Belt - Gen.		TR22425
Perkins 6-Cyl. 354 Diesel			60BR		
Hose - Upper		≧20611	Wisconsin VH4D		
or ●26508			Belt - Fan & Alt.		▲9435HD
Hose - Lower; Molded Hose		≧20611	Belt - Gen.		▲9490HD
or ●26508			JOHN DEERE		
Hose - Lower; Strt. Hose(2 1/4" I.D.)		24236	380		
P200B			John Deere 3-Cyl. 135		
Detroit Diesel 4-53 Diesel			Belt - Fan & Alt.	T20334	TR22474
Hose - Lower		●26521	Hose - Upper		20450
S60E; S70E; S80E; S100E			or ●25474		
Chevrolet 6-Cyl. 250			JOHN DEERE		
Hose - Upper - Eng. To Pipe		●25532	380		

● Vulco-Flex® Coolant Hose.
≧ Cut to Fit.

▲ Standard Belt Available. See Pages 630-631.

Belts and Coolant Hose for Lift & Industrial Trucks

Application	Mfr. Part No.	Our No.	Application	Mfr. Part No.	Our No.
JOHN DEERE - Continued			KALMAR		
380 - Continued			ACC20		
John Deere 3-Cyl. 152 Diesel			Allis-Chalmers 4-Cyl. 153		
Belt - Fan & Alt. T20334		TR22474	Hose - Upper		●25530
Hose - Upper		●25477	Allis-Chalmers 6-Cyl. 230; Allis-Chalmers 6-Cyl. 262 Diesel		
Hose - By Pass; (5/8" I.D.)		28441	Hose - Upper; (1 3/4" I.D.)		24228
480			Continental 4-Cyl. 135; Continental 4-Cyl. 163		
John Deere 4-Cyl. 180			Belt - Fan & Alt.		▲9451HD
Belt - Fan & Alt. T20334		TR22474	Hose - Upper		≅21794
Hose - Upper		●25474		or	●25476
Hose - Lower		●26603	Continental D262 Diesel		
John Deere 4039D Diesel			Hose - Upper		●26611
Hose - Upper		●25477	Hose - Lower; (1 3/4" I.D.)		24228
Hose - Lower		●26502	Continental F163		
480A; 480B			Continental F245		
John Deere 4-Cyl. 219			Hose - Upper		●25478
Belt - Fan & Alt. T24757		TR22508	Hose - Lower		●25476
Hose - Upper		≅20046	Continental F425		
		or	Hose - Upper		●25478
Hose - Lower		●26502	Waukesha FC133		
Hose - By Pass; (1/2" I.D.)		21182	Hose - Upper		≅20573
John Deere 4-Cyl. 219 Diesel				or	●25473
Belt - Fan & Alt. T24757		TR22508	Hose - Lower; (1 1/2" I.D.)		24224
Hose - Upper		20450	Waukesha FC173		
		or	Belt - Fan & Alt. 4822011		▲9430HD
Hose - Lower		●25477	ACC20L		
Hose - By Pass; (5/8" I.D.)		21182	Continental 4-Cyl. 135; Continental 4-Cyl. 163		
		28441	Belt - Fan & Alt.		
480G			Waukesha FC173		
John Deere 4-Cyl. 219; John Deere 4-Cyl. 219 Diesel			Belt - Fan & Alt. 4822011		
Belt - Fan & Alt. T24757		TR22508	ACC25		
482C			Allis-Chalmers 4-Cyl. 153		
John Deere 4039D Diesel			Hose - Upper		
Belt - Fan & Alt. R82602		TR22517	●25530		
K-D MANITOU			Allis-Chalmers 6-Cyl. 230; Allis-Chalmers 6-Cyl. 262 Diesel		
352; 355; 452			Hose - Upper; (1 3/4" I.D.)		
Ford 3-Cyl.			24228		
Belt - Fan & Alt./Gen.		▲9550HD	Continental 4-Cyl. 135; Continental 4-Cyl. 163		
Hose - Upper		●25480	Belt - Fan & Alt.		
Hose - Lower		●26502	▲9451HD		
Ford 3-Cyl. Diesel			Hose - Upper		
Belt - Fan & Alt./Gen.		▲9550HD	≅21794		
KALAMAZOO			or		
2500A			●25476		
Wisconsin TH; Wisconsin THD Diesel			Continental D262 Diesel		
Belt - Drive		▲9290HD	Hose - Upper		
2500B			●26611		
Wisconsin THD Diesel			Hose - Lower; (1 3/4" I.D.)		
Belt - Alt. Z2562		▲9370HD	24228		
3600A			Continental F163		
Wisconsin TH; Wisconsin THD Diesel			Hose - Upper		
Belt - Drive		▲9290HD	●25478		
K45A			Hose - Lower		
Continental F4162			●25476		
Belt - Fan & Gen. F140K239		TR24461	Continental F245		
Hose - Upper		●25473	Hose - Upper		
Hose - Lower		●25476	●25478		
			Waukesha FC133		
			Hose - Upper		
			≅20573		
			or		
			●25473		
			24224		
			Waukesha FC173		
			Belt - Fan & Alt. 4822011		
			▲9430HD		
			ACC25L		
			Continental 4-Cyl. 135; Continental 4-Cyl. 163		
			Belt - Fan & Alt.		
			▲9451HD		
			Waukesha FC173		
			Belt - Fan & Alt. 4822011		
			▲9430HD		
			ACC30		
			Allis-Chalmers 4-Cyl. 153		
			Hose - Upper		
			●25530		
			Allis-Chalmers 6-Cyl. 230; Allis-Chalmers 6-Cyl. 262 Diesel		
			Hose - Upper; (1 3/4" I.D.)		
			24228		
			Continental 4-Cyl. 135; Continental 4-Cyl. 163		
			Belt - Fan & Alt.		
			▲9451HD		

● Vulco-Flex® Coolant Hose.
 ▲ Standard Belt Available. See Pages 630-631.

≅ Cut to Fit.

Belts and Coolant Hose for Lift & Industrial Trucks

Application	Mfr. Part No.	Our No.
KALMAR - Continued		
ACC30 - Continued		
Continental 4-Cyl. 135; Continental 4-Cyl. 163 - Continued Hose - Upper	≈21794	●25476
	or	●25476
Continental D262 Diesel Hose - Upper	●26611	
Hose - Lower; (1 3/4" I.D.)	24228	
Continental F163 Hose - Upper	●25478	
Hose - Lower	●25476	
Continental F245 Hose - Upper	●25478	
Waukesha FC133 Hose - Upper	≈20573	
	or	●25473
Hose - Lower; (1 1/2" I.D.)	24224	
Waukesha FC173 Belt - Fan & Alt.	4822011	▲9430HD
ACC30L		
Continental 4-Cyl. 135; Continental 4-Cyl. 163 Belt - Fan & Alt.		▲9451HD
Waukesha FC173 Belt - Fan & Alt.	4822011	▲9430HD
ACC35; ACC40; ACC45; ACC50; ACC55; ACC60		
Allis-Chalmers 4-Cyl. 153 Belt - Fan & Alt.	4791039	▲9470HD
Hose - Upper		●25530
Allis-Chalmers 6-Cyl. 230; Allis-Chalmers 6-Cyl. 262 Diesel Belt - Fan & Alt.	4791039	▲9470HD
Hose - Upper; (1 3/4" I.D.)		24228
Continental 4-Cyl. 135 Hose - Upper	≈21794	
	or	●25476
Continental 4-Cyl. 153 Belt - Fan & Alt.	4856615	▲9360HD
Continental 4-Cyl. 163 Belt - Fan & Alt.	4856615	▲9360HD
Hose - Upper	≈21794	
	or	●25476
Continental D262 Diesel Hose - Upper	●26611	
Hose - Lower; (1 3/4" I.D.)	24228	
Continental F163 Belt - Fan & Alt.	4856615	▲9360HD
Hose - Upper		●25478
Hose - Lower		●25476
Continental F245 Belt - Fan & Alt.	4856615	▲9360HD
Hose - Upper		●25478
Hose - Lower		●25478
Perkins 4-Cyl. 203 Belt - Fan & Alt.	4848883	▲9451HD
Waukesha FC133 Hose - Upper	≈20573	
	or	●25473
Hose - Lower; (1 1/2" I.D.)		24224
ACC60C		
Allis-Chalmers 4-Cyl. 153 Hose - Upper		●25530
Allis-Chalmers 6-Cyl. 230; Allis-Chalmers 6-Cyl. 262 Diesel Hose - Upper; (1 3/4" I.D.)		24228
Continental 4-Cyl. 135; Continental 4-Cyl. 163 Hose - Upper	≈21794	
	or	●25476

Application	Mfr. Part No.	Our No.
KALMAR - Continued		
ACC60C - Continued		
Continental D262 Diesel Hose - Upper		●26611
Hose - Lower; (1 3/4" I.D.)		24228
Continental F163 Hose - Upper		●25478
Hose - Lower		●25476
Continental F245 Hose - Upper		●25478
Waukesha FC133 Hose - Upper		≈20573
	or	●25473
Hose - Lower; (1 1/2" I.D.)		24224
ACC70		
Allis-Chalmers 4-Cyl. 153 Belt - Fan & Alt.	4791039	▲9470HD
Hose - Upper		●25530
Allis-Chalmers 6-Cyl. 230; Allis-Chalmers 6-Cyl. 262 Diesel Belt - Fan & Alt.	4791039	▲9470HD
Hose - Upper; (1 3/4" I.D.)		24228
Continental 4-Cyl. 135 Hose - Upper		≈21794
	or	●25476
Continental 4-Cyl. 153 Belt - Fan & Alt.	4856615	▲9360HD
Continental 4-Cyl. 163 Belt - Fan & Alt.	4856615	▲9360HD
Hose - Upper		≈21794
	or	●25476
Continental D262 Diesel Hose - Upper		●26611
Hose - Lower; (1 3/4" I.D.)		24228
Continental F163 Belt - Fan & Alt.	4856615	▲9360HD
Hose - Upper		●25478
Hose - Lower		●25476
Continental F245 Belt - Fan & Alt.	4856615	▲9360HD
Hose - Upper		●25478
Hose - Lower		●25478
Perkins 4-Cyl. 203 Belt - Fan & Alt.	4848883	▲9451HD
Waukesha FC133 Hose - Upper		≈20573
	or	●25473
Hose - Lower; (1 1/2" I.D.)		24224
ACC80		
Allis-Chalmers 4-Cyl. 153 Belt - Fan & Alt.	4791039	▲9470HD
Hose - Upper		●25530
Allis-Chalmers 6-Cyl. 230; Allis-Chalmers 6-Cyl. 262 Diesel Belt - Fan & Alt.	4791039	▲9470HD
Hose - Upper; (1 3/4" I.D.)		24228
Continental 4-Cyl. 135 Hose - Upper		≈21794
	or	●25476
Continental 4-Cyl. 153 Belt - Fan & Alt.	4856615	▲9360HD
Continental 4-Cyl. 163 Belt - Fan & Alt.	4856615	▲9360HD
Hose - Upper		≈21794
	or	●25476
Continental D262 Diesel Hose - Upper		●26611
Hose - Lower; (1 3/4" I.D.)		24228

≈ Cut to Fit.

▲ Standard Belt Available. See Pages 630-631.

● Vulco-Flex® Coolant Hose.

Belts and Coolant Hose for Lift & Industrial Trucks

Application	Mfr. Part No.	Our No.	Application	Mfr. Part No.	Our No.
KALMAR - Continued			KALMAR - Continued		
ACC80 - Continued			ACP20 - Continued		
Continental F163			Waukesha FC133		
Belt - Fan & Alt.	4856615	▲9360HD	Hose - Upper		≧20573
Hose - Upper		●25478		or	●25473
Hose - Lower		●25476	Hose - Lower; (1 1/2" I.D.)		24224
Continental F245			Waukesha FC173		
Belt - Fan & Alt.	4856615	▲9360HD	Belt - Fan & Alt.	4822011	▲9430HD
Hose - Upper		●25478			
Perkins 4-Cyl. 203			ACP20L		
Belt - Fan & Alt.	4848883	▲9451HD	Continental 4-Cyl. 135; Continental 4-Cyl. 163		
Waukesha FC133			Belt - Fan & Alt.		▲9451HD
Hose - Upper		≧20573	Waukesha FC173		
		or	Belt - Fan & Alt.	4822011	▲9430HD
Hose - Lower; (1 1/2" I.D.)		24224			
			ACP25		
ACC100			Allis-Chalmers 4-Cyl. 153		
Allis-Chalmers 4-Cyl. 153			Hose - Upper		●25530
Belt - Fan & Alt.	4791039	▲9470HD	Allis-Chalmers 6-Cyl. 230; Allis-Chalmers 6-Cyl. 262 Diesel		
Hose - Upper		●25530	Hose - Upper; (1 3/4" I.D.)		24228
Allis-Chalmers 6-Cyl. 230; Allis-Chalmers 6-Cyl. 262 Diesel			Continental 4-Cyl. 135; Continental 4-Cyl. 163		
Belt - Fan & Alt.	4791039	▲9470HD	Belt - Fan & Alt.		▲9451HD
Hose - Upper; (1 3/4" I.D.)		24228	Hose - Upper		≧21794
Continental 4-Cyl. 135				or	●25476
Hose - Upper		≧21794	Continental D262 Diesel		
		or	Hose - Upper		●26611
			Hose - Lower; (1 3/4" I.D.)		24228
Continental 4-Cyl. 153			Continental F163		
Belt - Fan & Alt.	4856615	▲9360HD	Hose - Upper		●25478
Continental 4-Cyl. 163			Hose - Lower		●25476
Belt - Fan & Alt.	4856615	▲9360HD	Continental F245		
Hose - Upper		≧21794	Hose - Upper		●25478
		or	Waukesha FC133		
			Hose - Upper		≧20573
Continental D262 Diesel				or	●25473
Hose - Upper		●26611	Hose - Lower; (1 1/2" I.D.)		24224
Hose - Lower; (1 3/4" I.D.)		24228	Waukesha FC173		
Continental F163			Belt - Fan & Alt.	4822011	▲9430HD
Belt - Fan & Alt.	4856615	▲9360HD			
Hose - Upper		●25478	ACP25L		
Hose - Lower		●25476	Continental 4-Cyl. 135; Continental 4-Cyl. 163		
Continental F245			Belt - Fan & Alt.		▲9451HD
Belt - Fan & Alt.	4856615	▲9360HD	Waukesha FC173		
Hose - Upper		●25478	Belt - Fan & Alt.	4822011	▲9430HD
Hose - Lower		●25478			
Perkins 4-Cyl. 203			ACP30		
Belt - Fan & Alt.	4848883	▲9451HD	Allis-Chalmers 4-Cyl. 153		
Waukesha FC133			Hose - Upper		●25530
Hose - Upper		≧20573	Allis-Chalmers 6-Cyl. 230; Allis-Chalmers 6-Cyl. 262 Diesel		
		or	Hose - Upper; (1 3/4" I.D.)		24228
Hose - Lower; (1 1/2" I.D.)		24224	Continental 4-Cyl. 135; Continental 4-Cyl. 163		
			Belt - Fan & Alt.		▲9451HD
			Hose - Upper		≧21794
				or	●25476
			Continental D262 Diesel		
			Hose - Upper		●26611
			Hose - Lower; (1 3/4" I.D.)		24228
			Continental F163		
			Hose - Upper		●25478
			Hose - Lower		●25476
			Continental F245		
			Hose - Upper		●25478
			Waukesha FC133		
			Hose - Upper		≧20573
				or	●25473
			Hose - Lower; (1 1/2" I.D.)		24224
			Waukesha FC173		
			Belt - Fan & Alt.	4822011	▲9430HD

▲ Standard Belt Available. See Pages 630-631.
 ≧ Cut to Fit.

● Vulco-Flex® Coolant Hose.

Belts and Coolant Hose for Lift & Industrial Trucks

Application	Mfr. Part No.	Our No.
KALMAR - Continued		
ACP30L; ACP30PS		
Continental 4-Cyl. 135; Continental 4-Cyl. 163 Belt - Fan & Alt.		▲9451HD
Waukesha FC173 Belt - Fan & Alt.	4822011	▲9430HD
ACP35		
Allis-Chalmers 4-Cyl. 153 Belt - Fan & Alt.	4791039	▲9470HD
Hose - Upper		●25530
Allis-Chalmers 6-Cyl. 230; Allis-Chalmers 6-Cyl. 262 Diesel Belt - Fan & Alt.	4791039	▲9470HD
Hose - Upper; (1 3/4" I.D.)		24228
Continental 4-Cyl. 135 Hose - Upper		≈<21794
	or	●25476
Hose - Lower		●25476
Continental 4-Cyl. 153 Belt - Fan & Alt.	4856615	▲9360HD
Continental 4-Cyl. 163 Belt - Fan & Alt.	4856615	▲9360HD
Hose - Upper		≈<21794
	or	●25476
Hose - Lower		●25476
Continental D262 Diesel Hose - Upper		●26611
Hose - Lower; (1 3/4" I.D.)		24228
Continental F163 Belt - Fan & Alt.	4856615	▲9360HD
Hose - Upper		●25478
Hose - Lower		●25476
Continental F245 Belt - Fan & Alt.	4856615	▲9360HD
Hose - Upper		●25478
Perkins 4-Cyl. 203 Belt - Fan & Alt.	4848883	▲9451HD
Waukesha FC133 Hose - Upper		≈<20573
	or	●25473
Hose - Lower; (1 1/2" I.D.)		24224
ACP40		
Allis-Chalmers 4-Cyl. 153 Belt - Fan & Alt.	4791039	▲9470HD
Hose - Upper		●25530
Allis-Chalmers 6-Cyl. 230; Allis-Chalmers 6-Cyl. 262 Diesel Belt - Fan & Alt.	4791039	▲9470HD
Hose - Upper; (1 3/4" I.D.)		24228
Continental 4-Cyl. 135 Hose - Upper		≈<21794
	or	●25476
Continental 4-Cyl. 153 Belt - Fan & Alt.	4856615	▲9360HD
Continental 4-Cyl. 163 Belt - Fan & Alt.	4856615	▲9360HD
Hose - Upper		≈<21794
	or	●25476
Continental D262 Diesel Hose - Upper		●26611
Hose - Lower; (1 3/4" I.D.)		24228
Continental F163 Belt - Fan & Alt.	4856615	▲9360HD
Hose - Upper		●25478
Hose - Lower		●25476
Continental F245 Belt - Fan & Alt.	4856615	▲9360HD
Hose - Upper		●25478

Application	Mfr. Part No.	Our No.
KALMAR - Continued		
ACP40 - Continued		
Perkins 4-Cyl. 203 Belt - Fan & Alt.	4848883	▲9451HD
Waukesha FC133 Hose - Upper		≈<20573
	or	●25473
Hose - Lower; (1 1/2" I.D.)		24224
ACP45		
Allis-Chalmers 4-Cyl. 153 Belt - Fan & Alt.	4791039	▲9470HD
Hose - Upper		●25530
Allis-Chalmers 6-Cyl. 230; Allis-Chalmers 6-Cyl. 262 Diesel Belt - Fan & Alt.	4791039	▲9470HD
Hose - Upper; (1 3/4" I.D.)		24228
Continental 4-Cyl. 135 Hose - Upper		≈<21794
	or	●25476
Hose - Lower		●25476
Continental 4-Cyl. 153 Belt - Fan & Alt.	4856615	▲9360HD
Continental 4-Cyl. 163 Belt - Fan & Alt.	4856615	▲9360HD
Hose - Upper		≈<21794
	or	●25476
Hose - Lower		●25476
Continental D262 Diesel Hose - Upper		●26611
Hose - Lower; (1 3/4" I.D.)		24228
Continental F163 Belt - Fan & Alt.	4856615	▲9360HD
Hose - Upper		●25478
Hose - Lower		●25476
Continental F245 Belt - Fan & Alt.	4856615	▲9360HD
Hose - Upper		●25478
Perkins 4-Cyl. 203 Belt - Fan & Alt.	4848883	▲9451HD
Waukesha FC133 Hose - Upper		≈<20573
	or	●25473
Hose - Lower; (1 1/2" I.D.)		24224
ACP50		
Allis-Chalmers 4-Cyl. 153 Belt - Fan & Alt.	4791039	▲9470HD
Hose - Upper		●25530
Allis-Chalmers 6-Cyl. 230; Allis-Chalmers 6-Cyl. 262 Diesel Belt - Fan & Alt.	4791039	▲9470HD
Hose - Upper; (1 3/4" I.D.)		24228
Continental 4-Cyl. 135 Hose - Upper		≈<21794
	or	●25476
Continental 4-Cyl. 153 Belt - Fan & Alt.	4856615	▲9360HD
Continental 4-Cyl. 163 Belt - Fan & Alt.	4856615	▲9360HD
Hose - Upper		≈<21794
	or	●25476
Continental D262 Diesel Hose - Upper		●26611
Hose - Lower; (1 3/4" I.D.)		24228
Continental F163 Belt - Fan & Alt.	4856615	▲9360HD
Hose - Upper		●25478
Hose - Lower		●25476
Continental F245 Belt - Fan & Alt.	4856615	▲9360HD

▲ Standard Belt Available. See Pages 630-631.
≈< Cut to Fit.

● Vulco-Flex® Coolant Hose.

Belts and Coolant Hose for Lift & Industrial Trucks

Application	Mfr. Part No.	Our No.	Application	Mfr. Part No.	Our No.
KALMAR - Continued			KALMAR - Continued		
ACP50 - Continued			ACP60 - Continued		
Continental F245 - Continued		●25478	Perkins 4-Cyl. 203		▲9451HD
Hose - Upper			Belt - Fan & Alt.	4848883	
Perkins 4-Cyl. 203		▲9451HD	Waukesha FC133		≡<20573
Belt - Fan & Alt.	4848883		Hose - Upper		●25473
Waukesha FC133		≡<20573	Hose - Lower; (1 1/2" I.D.)		24224
Hose - Upper		or ●25473			
Hose - Lower; (1 1/2" I.D.)		24224	ACP60D; ACP60DX; ACP60L		
ACP55			Allis-Chalmers 4-Cyl. 153; Allis-Chalmers 6-Cyl. 230; Allis-Chalmers 6-Cyl. 262 Diesel		
Allis-Chalmers 4-Cyl. 153		▲9470HD	Belt - Fan & Alt.	4791039	▲9470HD
Belt - Fan & Alt.	4791039	●25530	Continental F163; Continental F245; Continental 4-Cyl. 153; Continental 4-Cyl. 163		▲9360HD
Hose - Upper			Belt - Fan & Alt.	4856615	
Allis-Chalmers 6-Cyl. 230; Allis-Chalmers 6-Cyl. 262 Diesel		▲9470HD	Perkins 4-Cyl. 203		▲9451HD
Belt - Fan & Alt.	4791039	24228	Belt - Fan & Alt.	4848883	
Hose - Upper; (1 3/4" I.D.)			ACP70		
Continental 4-Cyl. 135		≡<21794	Allis-Chalmers 4-Cyl. 153		▲9470HD
Hose - Upper		or ●25476	Belt - Fan & Alt.	4791039	▲9470HD
Hose - Lower		●25476	Hose - Upper		●25530
Continental 4-Cyl. 153		▲9360HD	Allis-Chalmers 6-Cyl. 230; Allis-Chalmers 6-Cyl. 262 Diesel		▲9470HD
Belt - Fan & Alt.	4856615		Belt - Fan & Alt.	4791039	24228
Continental 4-Cyl. 163		▲9360HD	Hose - Upper; (1 3/4" I.D.)		
Belt - Fan & Alt.	4856615	≡<21794	Continental 4-Cyl. 135		≡<21794
Hose - Upper		or ●25476	Hose - Upper		or ●25476
Hose - Lower		●25476	Continental 4-Cyl. 153		▲9360HD
Continental D262 Diesel		●26611	Belt - Fan & Alt.	4856615	
Hose - Upper		24228	Continental 4-Cyl. 163		▲9360HD
Hose - Lower; (1 3/4" I.D.)			Belt - Fan & Alt.	4856615	≡<21794
Continental F163		▲9360HD	Hose - Upper		or ●25476
Belt - Fan & Alt.	4856615	●25478	Continental D262 Diesel		●26611
Hose - Upper		●25476	Hose - Lower; (1 3/4" I.D.)		24228
Hose - Lower			Continental F163; Continental F245		▲9360HD
Continental F245		▲9360HD	Belt - Fan & Alt.	4856615	▲9360HD
Belt - Fan & Alt.	4856615	●25478	Hose - Upper		●25478
Hose - Upper			Hose - Lower		●25476
Hose - Lower			Perkins 4-Cyl. 203		▲9451HD
Perkins 4-Cyl. 203		▲9451HD	Belt - Fan & Alt.	4848883	
Belt - Fan & Alt.	4848883		Waukesha FC133		≡<20573
Waukesha FC133		≡<20573	Hose - Upper		or ●25473
Hose - Upper		or ●25473	Hose - Lower; (1 1/2" I.D.)		24224
Hose - Lower; (1 1/2" I.D.)		24224	ACP60		
ACP60			Allis-Chalmers 4-Cyl. 153		
Allis-Chalmers 4-Cyl. 153		▲9470HD	Belt - Fan & Alt.	4791039	▲9470HD
Belt - Fan & Alt.	4791039	●25530	Hose - Upper		●25530
Hose - Upper			Allis-Chalmers 6-Cyl. 230; Allis-Chalmers 6-Cyl. 262 Diesel		▲9470HD
Allis-Chalmers 6-Cyl. 230; Allis-Chalmers 6-Cyl. 262 Diesel		▲9470HD	Belt - Fan & Alt.	4791039	24228
Belt - Fan & Alt.	4791039	24228	Hose - Upper; (1 3/4" I.D.)		
Hose - Upper; (1 3/4" I.D.)			Continental 4-Cyl. 135		≡<21794
Continental 4-Cyl. 135		≡<21794	Hose - Upper		or ●25476
Hose - Upper		or ●25476	Continental 4-Cyl. 153		▲9360HD
Continental 4-Cyl. 153		▲9360HD	Belt - Fan & Alt.	4856615	
Belt - Fan & Alt.	4856615		Continental 4-Cyl. 163		▲9360HD
Continental 4-Cyl. 163		▲9360HD	Belt - Fan & Alt.	4856615	≡<21794
Belt - Fan & Alt.	4856615	≡<21794	Hose - Upper		or ●25476
Hose - Upper		or ●25476	Continental D262 Diesel		●26611
Continental D262 Diesel		●26611	Hose - Upper		24228
Hose - Upper		24228	Hose - Lower; (1 3/4" I.D.)		
Hose - Lower; (1 3/4" I.D.)			Continental F163; Continental F245		▲9360HD
Continental F163; Continental F245		▲9360HD	Belt - Fan & Alt.	4856615	●25478
Belt - Fan & Alt.	4856615	●25478	Hose - Upper		●25476
Hose - Upper			Hose - Lower		
Hose - Lower					

● Vulco-Flex® Coolant Hose.
≡< Cut to Fit.

▲ Standard Belt Available. See Pages 630-631.

Lift & Industrial Equipment

Belts and Coolant Hose for Lift & Industrial Trucks

Application	Mfr. Part No.	Our No.
KALMAR - Continued		
ACP80 - Continued		
Continental 4-Cyl. 135 - Continued		
Hose - Upper		●25476
Continental 4-Cyl. 153		
Belt - Fan & Alt. 4856615		▲9360HD
Continental 4-Cyl. 163		
Belt - Fan & Alt. 4856615		▲9360HD
Hose - Upper		≡21794
	or	●25476
Continental D262 Diesel		
Hose - Upper		●26611
Hose - Lower; (1 3/4" I.D.)		24228
Continental F163		
Belt - Fan & Alt. 4856615		▲9360HD
Hose - Upper		●25478
Hose - Lower		●25476
Continental F245		
Belt - Fan & Alt. 4856615		▲9360HD
Hose - Upper		●25478
Hose - Lower		●25482
Perkins 4-Cyl. 203		
Belt - Fan & Alt. 4848883		▲9451HD
Waukesha FC133		
Hose - Upper		≡20573
	or	●25473
Hose - Lower; (1 1/2" I.D.)		24224
ACP80D; ACP80DX		
Allis-Chalmers 4-Cyl. 153; Allis-Chalmers 6-Cyl. 230; Allis-Chalmers 6-Cyl. 262 Diesel		
Belt - Fan & Alt. 4791039		▲9470HD
Continental F163; Continental F245; Continental 4-Cyl. 153; Continental 4-Cyl. 163		
Belt - Fan & Alt. 4856615		▲9360HD
Perkins 4-Cyl. 203		
Belt - Fan & Alt. 4848883		▲9451HD
ACP100; ACP100C		
Allis-Chalmers 4-Cyl. 153		
Hose - Upper		●25530
Allis-Chalmers 6-Cyl. 230; Allis-Chalmers 6-Cyl. 262 Diesel		
Hose - Upper; (1 3/4" I.D.)		24228
Continental 4-Cyl. 135; Continental 4-Cyl. 163		
Hose - Upper		≡21794
	or	●25476
Continental D262 Diesel		
Hose - Upper		●26611
Hose - Lower; (1 3/4" I.D.)		24228
Continental F163		
Hose - Upper		●25478
Hose - Lower		●25476
Continental F245		
Hose - Upper		●25478
Waukesha FC133		
Hose - Upper		≡20573
	or	●25473
Hose - Lower; (1 1/2" I.D.)		24224
ACP110		
Allis-Chalmers 4-Cyl. 153		
Belt - Fan & Alt. 4791039		▲9470HD
Hose - Upper		●25530
Allis-Chalmers 6-Cyl. 230; Allis-Chalmers 6-Cyl. 262 Diesel		
Belt - Fan & Alt. 4791039		▲9470HD
Hose - Upper; (1 3/4" I.D.)		24228
Continental 4-Cyl. 135		
Hose - Upper		≡21794

Application	Mfr. Part No.	Our No.
KALMAR - Continued		
ACP110 - Continued		
Continental 4-Cyl. 135 - Continued		
Hose - Upper		●25476
Continental 4-Cyl. 153		
Belt - Fan & Alt. 4856615		▲9360HD
Continental 4-Cyl. 163		
Belt - Fan & Alt. 4856615		▲9360HD
Hose - Upper		≡21794
	or	●25476
Continental D262 Diesel		
Hose - Upper		●26611
Hose - Lower; (1 3/4" I.D.)		24228
Continental F163		
Belt - Fan & Alt. 4856615		▲9360HD
Hose - Upper		●25478
Hose - Lower		●25476
Continental F245		
Belt - Fan & Alt. 4856615		▲9360HD
Hose - Upper		●25478
Perkins 4-Cyl. 203		
Belt - Fan & Alt. 4848883		▲9451HD
Waukesha FC133		
Hose - Upper		≡20573
	or	●25473
Hose - Lower; (1 1/2" I.D.)		24224
C50		
Nissan H20 Diesel		
Belt - Fan	21067K7320	6723
Belt - W.P. & Alt.		7410
Belt - Hyd. Pump		TR22588
KOMATSU		
FG15		
Nissan 4P Diesel		
Belt - Fan & Alt. 9931201035		▲9400HD
Hose - Upper		●25253
FG20		
Nissan H20141DA Diesel		
Belt - Fan	19104K7206	▲9395HD
Belt - W.P. & Alt.	11720K7201	7370
Belt - P.S.	3046024860	B56
FG25		
Nissan H20141DA Diesel		
Belt - Fan	21067K7320	6723
Belt - W.P. & Alt.		7410
Belt - Hyd. Pump		TR22588
Hose - Upper		●25253
FG40		
Nissan 6-Cyl. Diesel		
Belt - Fan & Gov.		TR22588
Belt - W.P. & Alt.		TR24465
LIFT ALL		
80D		
John Deere 4276D Diesel		
Belt - Fan & Alt. T24473		TR22514
Hose - Upper		●26531
Hose - Lower		●26510
H80; H100; H120; H150; HT80; HT100; HT120; HT150		
IH UC263		
Belt - Fan & Alt.; W/47 7/8" Belt O.C.	358320C91	▲9476HD
Belt - Fan & Alt.; W/49 1/4" Belt O.C.	385674R1	▲9490HD
Belt - Oil Clutch Pump; W/33" Belt O.C.		▲9330HD

● Vulco-Flex® Coolant Hose.
≡ Cut to Fit.

▲ Standard Belt Available. See Pages 630-631.

Belts and Coolant Hose for Lift & Industrial Trucks

Application	Mfr. Part No.	Our No.	Application	Mfr. Part No.	Our No.
LIFT ALL - Continued			MERCURY - Continued		
H80; H100; H120; H150; HT80; HT100; HT120; HT150 - Continued			A452		
IH UC263 - Continued			Chrysler 8A-114		
Belt - Oil Clutch Pump; W/36 1/4" Belt O.C.		▲9360HD	Belt - Fan & Gen.		1263790 TR24500
Hose - Upper; 1972 & Older		≡<20427	A460		
Hose - Lower; 1972 & Newer		●26510	Waukesha FC98		
L40; L50; L60			Belt - Fan & Gen.		
IH UC153			Belt - Lower; (2" I.D.)		5315 TR20451 24232
Belt - Fan & Alt.		678200C1 7450	A930; A940		
Belt - Fan & Gen.		349175R1 7440	Chrysler Ind. 30-1027		
Belt - P.S.		▲9525HD	Belt - Fan & Gen.		1191449 TR24476
Hose - Lower		●25255	Hose - Upper		≡<20046
John Deere 4219D Diesel			Hose - Lower		≡<21794
Belt - Fan & Alt.		T20334T TR22474	Chrysler Ind. 30-128		
Hose - Upper		●25480	Belt - Fan & Gen.		1116202 TR24489
Hose - Lower		●26603	A950		
M60; M70; M80; M100; MT60; MT70; MT80; MT100			Chrysler Ind. 30-1027		
IH UC263			Belt - Fan & Gen.		1191449 TR24476
Belt - Fan & Alt.; W/47 7/8" Belt O.C.		358320C91 ▲9476HD	Chrysler Ind. 30-128		
Belt - Fan & Alt.; W/49 1/4" Belt O.C.		385674R1 ▲9490HD	Belt - Fan & Gen.		1116202 TR24489
Belt - Oil Clutch Pump; W/33" Belt O.C.		▲9330HD	A960		
Belt - Oil Clutch Pump; W/36 1/4" Belt O.C.		▲9360HD	Chrysler Ind. 30-1027		
Hose - Upper; 1972 & Older		≡<20427	Hose - Upper		≡<20046
Hose - Lower; 1972 & Newer		●26510	Hose - Lower		≡<21794
LULL			MITSUBISHI		
844 Highlander			FGC20; FGC25		
Chrysler V-8			Mitsubishi 4-Cyl. Diesel		
Belt - Fan & Alt.		②▲9476HD	Belt - W.P. & Alt.; W/36 1/4" Belt O.C.		MM15231 ▲9360HD
Hose - Upper		≡<21378	Belt - W.P. & Alt.; W/37 3/4" Belt O.C.		REMF6365 ▲9375HD
Hose - Lower		●25530	Belt - W.P. & Alt.; W/38 1/4" Belt O.C.		▲9380HD
Deutz F5L912 Diesel			MOBILIFT		
Belt - Alt.		7453	B; B224		
MASSEY FERGUSON			Continental		
MF202 Forklift; MF204 Forklift			Belt - Fan & Gen.		B715 TR22405
Continental Z134			Belt - Hyd. Pump		B716 TR24400
Belt - Fan & Gen.		181523M1 ▲9430HD	D		
Hose - Upper; (1 1/2" I.D.)		24224	Chrysler Ind. 30; Chrysler 6-Cyl. 230		
Hose - Lower		≡<20416	Belt - Fan & Gen.		D715 TR24489
or		●25473	Belt - Hyd. Pump		D716 TR22397
MF2500			D424		
Perkins 3-Cyl. 152 Diesel			Chrysler Ind. 30; Chrysler 6-Cyl. 230		
Belt - Fan & Gen.		671870M1 ▲9570HD	Belt - Fan & Gen.		D715 TR24489
Hose - Upper		●25473	Belt - Hyd. Pump		D716 TR22397
MF4500			Hose - Upper; (2 1/8" I.D.)		24234
Perkins 3-Cyl. 152			Hose - Lower; (1 1/2" I.D.)		24224
Belt - Fan & Gen.		509572M1 ▲9425HD	E; ER; EW		
MF6500			Minneapolis-Moline		
Perkins 4-Cyl. 236 Diesel			Belt - Gen. & Gov.		E715 ▲9290HD
Belt - Fan & Alt.		▲9525HD	F		
Hose - Upper		●26504	Minneapolis-Moline		
S4AG9A; S5H9A			Belt - Belt		2400
Perkins 4-Cyl. Diesel			H; HR; HW		
Belt - Fan & Alt.		▲9525HD	Minneapolis-Moline		
MERCURY			Belt - Gen. & Gov.		E715 ▲9290HD
A440			K; KW		
Waukesha FC98			Minneapolis-Moline		
Belt - Fan & Gen.		TR20426	Belt - Gen.		K715 2240
Hose - Upper; (2" I.D.)		24232			
Hose - Lower; (2" I.D.)		24232			

▲ Standard Belt Available. See Pages 630-631.
● Vulco-Flex® Coolant Hose.

≡< Cut to Fit.
② Two Required.

Belts and Coolant Hose for Lift & Industrial Trucks

Application	Mfr. Part No.	Our No.
MOBILIFT - Continued		
L		
Chrysler Ind. 30; Chrysler 6-Cyl. 230		
Belt - Fan & Gen.	D715	TR24489
Belt - Hyd. Pump	D716	TR22397
L524		
Chrysler Ind. 30; Chrysler 6-Cyl. 230		
Belt - Fan & Gen.	D715	TR24489
Belt - Hyd. Pump	D716	TR22397
Hose - Upper; (2 1/8" I.D.)		24234
Hose - Lower; (1 1/2" I.D.)		24224
M		
Hercules IXB3		
Belt - Fan & Gen.	M715	TR24449
Belt - Hyd. Pump; Early	M716A	TR24414
Belt - Hyd. Pump; Late	M716B	②▲9440HD
M40; M50		
Chrysler Ind. 30; Chrysler 6-Cyl. 230		
Belt - Fan & Gen.	D715	TR24489
Belt - Hyd. Pump	D716	TR22397
Hose - Upper; (2 1/8" I.D.)		24234
Hose - Lower; (1 1/2" I.D.)		24224
M324		
Hercules IXB		
Hose - Upper; (1 3/4" I.D.)		24228
Hose - Lower; (1 3/4" I.D.)		24228
Hercules IXB3		
Belt - Fan & Gen.	M715	TR24449
Belt - Hyd. Pump; Early	M716A	TR24414
Belt - Hyd. Pump; Late	M716B	②▲9440HD
MA20; MA25		
Waukesha FC		
Belt - Fan & Gen.	35A10020	▲9440HD
MA30; MA30 II		
Minneapolis-Moline		
Belt - Fan & Gen.	35A6148	▲9470HD
Belt - Alt.	35A8786	▲9480HD
MA30S		
Waukesha FC		
Belt - Fan & Gen.	35A10020	▲9440HD
MA35; MA40; MA40 II; MA45; MA50; MA50 II; MA55		
Minneapolis-Moline		
Belt - Fan & Gen.	35A6148	▲9470HD
Belt - Alt.	35A8786	▲9480HD
MA60; MA60 II		
Minneapolis-Moline		
Belt - Fan	10A12727	▲9490HD
Belt - Fan & Gen.	35A6148	▲9470HD
Belt - Alt.	35A8786	▲9480HD
MS20; MS25; MS30; MS35		
Minneapolis-Moline		
Belt - Gen. & Gov.		▲9290HD
MSB20; MSB25; MSB30; MSB35		
Ford V-4 104		
Belt - Fan & Alt.	35A9943	7590
MTS20; MTS25; MTS30; MTS35		
Minneapolis-Moline		
Belt - Gen. & Gov.		▲9290HD

Application	Mfr. Part No.	Our No.
MOBILIFT - Continued		
MY40		
Minneapolis-Moline		
Belt - Fan & Alt.	10A16423	7470
MY40B		
Chrysler 6-Cyl. 225; Chrysler 6-Cyl. 225 LPG		
Belt - Fan	203003566	7490
Belt - Alt.	203003565	7430
Belt - P.S.	203007009	②7400
Belt - Hyd. Pump	203007009	②7400
Perkins 4-Cyl. 236 Diesel		
Belt - Fan & Alt.	203005083	▲9520HD
Belt - P.S.	203007009	②7400
Hose - Upper - Eng. To Pipe		●25477
Hose - Upper - Pipe To Rad.; (1 1/2" I.D.)		24224
MY50		
Minneapolis-Moline		
Belt - Fan & Alt.	10A16423	7470
MY50B		
Chrysler 6-Cyl. 225; Chrysler 6-Cyl. 225 LPG		
Belt - Fan	203003566	7490
Belt - Alt.	203003565	7430
Belt - P.S.	203007009	②7400
Belt - Hyd. Pump	203007009	②7400
Perkins 4-Cyl. 236 Diesel		
Belt - Fan & Alt.	203005083	▲9520HD
Belt - P.S.	203007009	②7400
Hose - Upper - Eng. To Pipe		●25477
Hose - Upper - Pipe To Rad.; (1 1/2" I.D.)		24224
MY60		
Minneapolis-Moline		
Belt - Fan & Alt.	10A16423	7470
Hose - Lower		●25474
MY60B		
Chrysler 6-Cyl. 225; Chrysler 6-Cyl. 225 LPG		
Belt - Fan	203003566	7490
Belt - Alt.	203003565	7430
Belt - P.S.	203007009	②7400
Belt - Hyd. Pump	203007009	②7400
Perkins 4-Cyl. 236 Diesel		
Belt - Fan & Alt.	203005083	▲9520HD
Belt - P.S.	203007009	②7400
Hose - Upper - Eng. To Pipe		●25477
Hose - Upper - Pipe To Rad.; (1 1/2" I.D.)		24224
MY70		
Minneapolis-Moline		
Belt - Fan & Alt.	10A16423	7470
MY70B; MY80B		
Chrysler 6-Cyl. 225; Chrysler 6-Cyl. 225 LPG		
Belt - Fan	203003566	7490
Belt - Alt.	203003565	7430
Belt - P.S.	203007009	②7400
Belt - Hyd. Pump	203007009	②7400
Perkins 4-Cyl. 236 Diesel		
Belt - Fan & Alt.	203005083	▲9520HD
Belt - P.S.	203007009	②7400
Hose - Upper - Eng. To Pipe		●25477
Hose - Upper - Pipe To Rad.; (1 1/2" I.D.)		24224
WC20; WC25		
Waukesha FC		
Belt - Fan & Alt.	35A10020	▲9440HD

② Two Required.
● Vulco-Flex® Coolant Hose.

▲ Standard Belt Available. See Pages 630-631.

Belts and Coolant Hose for Lift & Industrial Trucks

Application	Mfr. Part No.	Our No.	Application	Mfr. Part No.	Our No.
MOBILIFT - Continued			NISSAN - Continued		
WC30			FG101; FG102; FG103 - Continued		
Continental F163			Nissan SD22 Diesel		
Belt - Fan	10A12727	♠9490HD	Hose - Upper; W/Pneumatic Tires		≈21103
Belt - Fan & Gen.; W/47 1/4" Belt O.C.	35A6148	♠9470HD	FG104; FG105		
Belt - Hyd. Pump	35A10015	♠9313HD	Nissan H20 Diesel		
Waukesha FC			Belt - Fan & Alt.; W/Cushion Tires		♠9370HD
Belt - Fan & Alt.	35A10020	♠9440HD	Belt - Fan; W/Pneumatic Tires	01904K7206	♠9375HD
WC35; WC40; WC45; WC50; WC55; WC60			Belt - W.P. & Alt.; W/Cushion Tires	2106766000	7360
Continental F163			Hose - Upper; W/Pneumatic Tires		≈21103
Belt - Fan	10A12727	♠9490HD	Nissan SD22 Diesel		
Belt - Fan & Gen.; W/47 1/4" Belt O.C.	35A6148	♠9470HD	Belt - Fan	0197810944	♠9375HD
Belt - Hyd. Pump	35A10015	♠9313HD	Belt - W.P. & Alt.	5835748571	♠9580HD
NAMCO			FG106; FG107		
15-15; 20-15			Nissan H30 Diesel		
Onan CCK Diesel			Belt - Fan & Alt.	2106749100	♠9370HD
Belt - Alt./Gen.; W/37 5/8" Belt O.C.		7375	Belt - Gov.	1914574200	♠9412HD
Belt - Gen.; W/38 1/8" Belt O.C.		7380	Nissan SD33 Diesel		
NISSAN			Belt - Fan & Alt.	2106786000	②♠9385HD
3.5; 3.25; 4.0			P3		
Nissan P40			Nissan D11 Diesel		
Belt - W.P. & Alt.	11720C6000	TR24465	Belt - Fan & Alt.	2106748300	♠9463HD
Belt - W.P. & Gov.	21067L6200	♠9375HD	Belt - Hyd. Pump	5833648600	②TR22474
Nissan SD33 Diesel			P5		
Belt - W.P. & Alt.	0197810984	♠9390HD	Nissan 6-Cyl.		
2700; 3000; 3500			Belt - Fan & Alt.	2106749100	♠9370HD
Nissan J15			Belt - Gov.	1914574200	♠9405HD
Belt - Fan & Alt.	11720U0105	7355	Nissan H20 Diesel		
Hose - Upper		≈20883	Belt - Fan & Alt.; W/36 1/8" Belt O.C.	2106766000	7360
Hose - Lower; W/Cushion Tires		≈20783	Belt - Fan & Alt.; W/39 1/4" Belt O.C.	1910448000	♠9360HD
4000; 5000; 6000			Belt - Hyd. Pump	2114048285	♠9550HD
Nissan H20 Diesel			Hose - Upper		≈21103
Belt - Fan & Alt.	11720L1102	7410	P8		
Hose - Upper		≈21201	Nissan 6-Cyl.		
Nissan SD22 Diesel			Belt - Fan & Alt.	2106749100	♠9370HD
Belt - Fan & Alt.; Dec. 31, 1979 & Older	0197811104	♠9435HD	Belt - Gov.	1914574200	♠9405HD
Belt - Fan & Alt.; Jan. 1, 1980 & Newer	0197811134	♠9430HD	Nissan H20 Diesel		
Hose - Lower - Eng. To Pipe		≈20776	Belt - Fan & Alt.; W/36 1/8" Belt O.C.	2106766000	7360
Hose - Lower - Pipe To Rad.; (1 3/8" I.D.)		24222	Belt - Fan & Alt.; W/39 1/4" Belt O.C.	1910448000	♠9360HD
F03			Belt - Hyd. Pump	2114048285	♠9550HD
Nissan TB42			OTTAWA		
Belt - Fan	1172052H05	TR24489	1-Step-30; Commando 30; Commando 30A; Commando 50		
Belt - Alt.	1172052H01	7480	Cummins V-8 210 Diesel		
Belt - Gov.	1172077702	7385	Belt - Fan	178685	②TR22485
FG005			Belt - Alt.	178473	♠9350HD
Nissan H20 Diesel			Commando 60T		
Belt - Fan & Alt.; W/Cushion Tires		♠9370HD	Caterpillar 1160 Diesel		
Belt - Fan; W/Pneumatic Tires	01904K7206	♠9375HD	Belt - Fan, Alt. & Air Brake Compr.		②♠9640HD
Belt - W.P. & Alt.; W/Cushion Tires	2106766000	7360	Belt - Fan & P.S.		②♠9540HD
Hose - Upper; W/Pneumatic Tires		≈21103	Hose - Upper		●26510
Nissan SD22 Diesel			Hose - Lower		●26511
Belt - Fan	0197810944	♠9375HD	Cummins V555 Diesel		
Belt - W.P. & Alt.	5835748571	♠9580HD	Belt - Fan	189917	②♠9490HD
FG101; FG102; FG103			Belt - Alt.		7430
Nissan D11 Diesel			YT30		
Belt - Fan & Alt.; W/Cushion Tires; Mar. 31, 1976 & Older	2106748300	♠9463HD	Cummins B Series 5.9 L Diesel		
Belt - Fan & Alt.; W/Pneumatic Tires; Mar. 31, 1976 & Older		♠9370HD	Belt - Fan & Alt.	3911562	♠K080575HD
Belt - Fan & Alt.; Apr. 1, 1976 & Newer	2106747605	♠9455HD	Hose - Upper		●26612
Belt - Fan, Alt. & Gov.; W/Cushion Tires	1172047600	♠9451HD	Hose - Lower		●26521
Belt - P.S.	48752L0410	TR22416			
Hose - Upper; W/Cushion Tires		20781			

♠ Standard Belt Available. See Pages 630-631.

② Two Required.

● Vulco-Flex® Coolant Hose.

≈ Cut to Fit.

◆ Green Stripe® PowerBand® Belt May Work, Use Template to Check.

Belts and Coolant Hose for Lift & Industrial Trucks

Application	Mfr. Part No.	Our No.	Application	Mfr. Part No.	Our No.
OTTAWA - Continued			PETTIBONE - Continued		
YT50			300		
Caterpillar 3208 Diesel			Aerojet		
Belt - Fan	②◆▲9430HD		Belt - Fan & Gen.	4132	TR22299
Belt - W.P., Alt. & Air Brake Compr.	②◆▲9640HD		300FLW		
Belt - P.S.	②◆▲9530HD		Waukesha ICK		
Hose - Upper	●26509		Belt - Fan & Gen.	4154	TR22336
Hose - Lower	●26510		300G; 300GT; 300P		
Detroit Diesel V-8 8.2 L Diesel			Continental F162		
Belt - Fan & Alt.	②◆▲9690HD		Hose - Upper		●26502
Belt - Fan & Air Brake Compr.	▲9710HD		Hose - Lower		●25478
Belt - P.S.	②◆▲9430HD		Continental F6226		
PETTIBONE			Belt - Fan & Gen.	F226K286	▲9480HD
6-33			300W		
Chrysler 6-Cyl. 225			Waukesha ICK		
Belt - Fan & Alt.		7525	Belt - Fan & Gen.	4154	TR22336
Belt - W.P.		7395	400		
Hose - Upper		●26512	Waukesha 4-Cyl.		
Hose - Lower - Eng. To Pipe		●26509	Belt - Fan & P.S.	4590	TR22461
Hose - Lower - Pipe To Rad.		●26512	Belt - Gen.	4625	9300
8-33			400G; 400GT; 400P		
Detroit Diesel 4-53 Diesel			Continental F162		
Belt - Fan	②7360		Hose - Upper		●26502
Belt - W.P. & Alt.	②7430		Hose - Lower		●25478
Hose - Upper	②21378		Continental F6226		
	or	●26602	Belt - Fan & Gen.	F226K286	▲9480HD
Hose - Lower - Eng. To Pipe; (2" I.D.)		24232	500		
Hose - Lower - Pipe To Rad.; (2" I.D.)		24232	Waukesha 4-Cyl.		
20GS4; 25GS4			Belt - Fan & P.S.	4590	TR22461
Continental Y112			Belt - Gen.	4625	9300
Belt - Fan & Alt.	Y91K00235	②7430	500G; 500GT; 500P		
30GA; 30GS			Continental F162		
Continental F162			Hose - Upper		●26502
Belt - Fan; 1966 & Newer		②7603	Hose - Lower		●25478
30GS4			Continental F6226		
Continental Y112			Belt - Fan & Gen.	F226K286	▲9480HD
Belt - Fan & Alt.	Y91K00235	②7430	600GTC		
40GA; 40GS; 50GA; 50GS			Continental F226		
Continental F162			Hose - Upper		●26502
Belt - Fan; 1966 & Newer		②7603	Hose - Lower		●25473
100			Continental F6226		
Aerojet			Belt - Fan & Gen.	F226K286	▲9480HD
Belt - Fan & Gen.	4132	TR22299	600GTF		
100FLW			Ford 4-Cyl. 172 Diesel		
Waukesha ICK			Hose - Upper		●25252
Belt - Fan & Gen.	4154	TR22336	Hose - Lower		●25476
200			700GTC		
Aerojet			Continental F226		
Belt - Fan & Gen.	4132	TR22299	Hose - Upper		●26502
200FLW; 200W			Hose - Lower		●25473
Waukesha ICK			Continental F6226		
Belt - Fan & Gen.	4154	TR22336	Belt - Fan & Gen.	F226K286	▲9480HD
250			Cary-All Super 8		
Aerojet			Continental F226; Continental F244		
Belt - Fan & Gen.	4132	TR22299	Belt - Fan & Gen.	F600K267	TR24465
250FLW; 250W			Cary-Lift 6		
Waukesha ICK			IH 6-Cyl.		
Belt - Fan & Gen.	4154	TR22336	Hose - Upper		●26508

② Two Required.

▲ Standard Belt Available. See Pages 630-631.

≠ Cut to Fit.

◆ Green Stripe® PowerBand® Belt May Work, Use Template to Check.

● Vulco-Flex® Coolant Hose.

Belts and Coolant Hose for Lift & Industrial Trucks

Application	Mfr. Part No.	Our No.	Application	Mfr. Part No.	Our No.
PETTIBONE - Continued			PETTIBONE - Continued		
Cary-Lift 6 - Continued			Cary-Lift Super 10; Cary-Lift Super 15 - Continued		
IH 6-Cyl. - Continued			Continental M363		
Hose - Lower - Eng. To Pipe; (2" I.D.)		24232	Belt - Fan		M330K342 7520
Hose - Lower - Pipe To Rad.; (2" I.D.)		24232	Detroit Diesel 3-71 Diesel		
Cary-Lift 8			Belt - Fan		
Continental F226			Belt - Gen.		5170972 ②TR22455
Belt - Fan & Gen.		F600K267 TR24465	Cary-Lift Super 20		
Continental F244			Cummins JN6BI Diesel		
Belt - Fan & Gen.		F600K267 TR24465	Belt - Fan		124466 ②TR24365
Hose - Upper		③<20416	Belt - W.P.		101427 TR22299
		or ●25474	Belt - Gen.		70885 TR22461
Cary-Lift 54H			Hose - Upper		●26509
Hercules GO339			Hose - Lower		●26508
Belt - Fan & Gen.		▲9490HD	Detroit Diesel 4-71 Diesel		
Hose - Upper		●26510	Belt - Fan		5170972 ②TR22455
Hose - Lower		②●26508	Belt - Gen.		3224367 TR28390
Cary-Lift 150			Cary-Lift Super 25		
Chrysler Ind. 32			Detroit Diesel 4055C Diesel		
Belt - Fan & Gen.		1116202 TR24489	Belt - Fan		3224368 TR34545
Cary-Lift 204D			Belt - Fan & Air Brake Compr.		3224451 TR34700
Detroit Diesel 6V-53 Diesel			Belt - Gen.		3224367 TR28390
Belt - Fan		②▲9350HD	Cary-Lift Super 30		
Belt - Alt.		②7390	Detroit Diesel 4-71 Diesel		
Belt - W.P.		②▲9375HD	Belt - Fan		5176420 ②TR22588
Hose - Upper - Left Side		●26502	Belt - Fan & Air Brake Compr.		5175105 ②BX71
Hose - Upper - Right Side		●26502	Belt - Gen.		3224367 TR28390
Hose - Lower		●26523	Detroit Diesel 6055C Diesel		
Cary-Lift Super 4			Belt - Fan		5170972 ②TR22455
Ford 6-Cyl. 240			Belt - Gen.		3224367 TR28390
Belt - Fan		▲9405HD	Cary-Lift Super 40; Cary-Lift Super 60		
Belt - W.P. & Alt.		7417	Cummins NH195 Diesel; Cummins NH220 Diesel		
Belt - Gov.		C7JZ8620P 7260	Belt - Fan & W.P.		134773 ②TR22405
Hose - Upper		●26502	Belt - Gen.		70350 TR22358
Hose - Lower		●26502	Cary-Lift Super 70		
Cary-Lift Super 5			Cummins NHRS6CI Diesel		
Ford 4-Cyl. 256 Diesel			Belt - Fan		134809 ②TR28492
Hose - Upper		③<20065	Belt - W.P.		178628 TR24438
		or ●25474	Cummins V-8 350		
Ford 6-Cyl. 256 Diesel			Belt - Fan		132237 ②TR28743
Belt - Fan & Alt.		▲9550HD	Belt - W.P.		132010 TR22363
Belt - Hyd. Pump		▲9395HD	Belt - Gen.		111724 TR22336
John Deere 4219D Diesel			Cummins V-8 430		
Belt - Fan & Alt.		T24473 TR22514	Belt - Fan		117230 ②TR30754
Belt - Hyd. Pump		▲9380HD	Belt - W.P.		129643 TR22363
Hose - Upper		③<21794	Belt - Gen.		111724 TR22336
		or ●25474	G15; G15B; G20; G20B; G25; G25B; G30; G30A		
Hose - Lower - Eng. To Pipe		③<20046	Waukesha ICK		
Hose - Lower - Pipe To Rad.		③<20974	Belt - Fan & Gen.		4154 TR22336
Cary-Lift Super 6			G30H; G40; G40H; G50		
IH 6-Cyl.			Willlys 4-Cyl.		
Belt - Fan & Alt.		274705R1 TR24438	Belt - Fan & P.S.		4590 TR22461
Cary-Lift Super 7			Belt - Gen.		4625 9300
Continental F226			Willlys GJ3A		
Belt - Fan		F226K286 ▲9480HD	Hose - Upper		●25476
Cary-Lift Super 8			Hose - Lower		●25477
Continental F226; Continental F244			G60		
Belt - Fan & Gen.		F600K267 TR24465	Willlys 6-Cyl.		
Cary-Lift Super 10; Cary-Lift Super 15			Belt - Fan & Gen.		647626 TR22363
Chrysler Ind. 32			Belt - P.S.		4705 TR22405
Belt - Fan & Gen.		1116202 TR24489	Hose - Upper		●25477
			Hose - Lower		●25477

Lift & Industrial Equipment

③ Cut to Fit.
▲ Standard Belt Available. See Pages 630-631.

● Vulco-Flex® Coolant Hose.
② Two Required.

Belts and Coolant Hose for Lift & Industrial Trucks

Application	Mfr. Part No.	Our No.	Application	Mfr. Part No.	Our No.
PETTIBONE - Continued			PETTIBONE - Continued		
GA30H; GA40			GSS15; GSS15B; GSS20A; GSS20B; GSS25; GSS25B; GSS30; GSS30A		
Continental F162			Waukesha ICK		
Belt - Fan & Gen.	F244K213	Ⓣ7480	Belt - Fan & Gen.	4154	TR22336
Belt - P.S.	70027	7360	HL644-22		
Hose - Upper		●25477	Ford 4-Cyl. 172		
Hose - Lower		●25476	Belt - Fan & Alt.	C6JZ8620B	▲9420HD
GA40H			Hose - Upper; (1 1/4" I.D.)		24220
Continental F162			Hose - Lower		●25474
Hose - Upper		●25477	SKYTRAK		
Hose - Lower		●25476	610 Super Skytrak		
GA50			Ford 3-Cyl.		
Continental F162			Belt - Fan & Alt.		▲9540HD
Belt - Fan & Gen.	F244K213	Ⓣ7480	Hose - Upper		●25480
Belt - P.S.	70027	7360	4030		
GA60; GA70; GA80			Ford 4-Cyl.		
Continental F6226			Belt - Fan & Gen.		▲9525HD
Belt - Fan & Gen.		Ⓣ7470	Hose - Upper		●26501
Hose - Upper		●25477	Hose - Lower		●26611
Ford 6-Cyl. 300			Ford 4-Cyl. Diesel		
Belt - Fan		▲9405HD	Belt - Fan & Gen.		▲9550HD
GS4-20; GS4-25			Hose - Upper		●25474
Continental Y112			5028; 5028HT; 6036; 10042		
Belt - Fan & Alt.	Y91K00235	Ⓣ7430	Cummins 4-Cyl. 3.9 L Diesel		
GS15; GS15B; GS20; GS20B; GS25; GS25B			Belt - Fan & Alt.	3911560	▲K080550HD
Waukesha ICK			SNORKEL LIFT		
Belt - Fan & Gen.	4154	TR22336	A42		
GS30			Ford 4-Cyl.		
Continental Y112			Belt - Fan & Alt.		7350
Belt - Fan & Alt.	Y91K00235	Ⓣ7430	A60		
Waukesha ICK			Ford 4-Cyl.		
Belt - Fan & Gen.	4154	TR22336	Belt - Fan & Alt.		▲K060415HD
GS30A			ATB46N		
Waukesha ICK			Ford LS9423		
Belt - Fan & Gen.	4154	TR22336	Belt - Fan & Alt.		7375
GS30H			PRO126		
Continental F162			Continental TM27		
Belt - Fan & Gen.	F244K213	Ⓣ7480	Belt - Fan & Alt.		▲K080560HD
Belt - P.S.	70027	7360	Hose - Upper		20046
GS40			Hose - Lower		21194
Continental F162			SLH3280HG		
Belt - Fan & Gen.	F244K213	Ⓣ7480	Kubota 3-Cyl.		
Belt - P.S.	70027	7360	Belt - Fan & Alt.		7375
Hose - Upper		●25477	SLH3284HD		
Hose - Lower		●25476	Kubota 3-Cyl.		
GS50			Belt - Fan & Alt.	REMF1345	7345
Continental F162			TB37		
Belt - Fan & Gen.	F244K213	Ⓣ7480	Ford 4-Cyl.		
Belt - P.S.	70027	7360	Belt - Fan & Alt.	11A0890	7350
Hose - Upper		●25477	TAYLOR		
Hose - Lower		●25476	Y20WO		
GS60			Detroit Diesel 4-53 Diesel		
Continental F6226			Belt - Fan		Ⓣ▲9412HD
Belt - Fan & Gen.		Ⓣ7470	Belt - W.P. & Alt.		7417
Hose - Upper		●25477	Hose - Upper		●26506
Ford 6-Cyl. 300					
Belt - Fan		▲9405HD			

Ⓣ Two Required.

▲ Standard Belt Available. See Pages 630-631.

● Vulco-Flex® Coolant Hose.

Belts and Coolant Hose for Lift & Industrial Trucks

Application	Mfr. Part No.	Our No.	Application	Mfr. Part No.	Our No.
TAYLOR - Continued			TCM-TOYO - Continued		
Y20WO - Continued			FG20 III; FG25N3		
Detroit Diesel 4-53 Diesel - Continued			Nissan H20 Diesel		
Hose - Upper - Eng. To Pipe; (2" I.D.)		24232	Belt - Fan		▲9390HD
Hose - Upper - Pipe To Rad.; (2" I.D.)		24232	Belt - W.P.	2106766000	7360
TCI			FG30M		
D4P60			Isuzu G201		
Detroit Diesel 4-53 Diesel			Belt - Fan & Alt.	13671302	▲9385HD
Belt - Fan		②▲9313HD	Belt - Hyd. Pump	13671201	▲9440HD
Belt - W.P. & Alt.		②▲9430HD	Hose - Upper		●25253
Hose - Upper; (1 1/2" I.D.)		24224	Hose - Lower		●25253
D4P80			FG30ZU		
John Deere 4239D Diesel			Isuzu G201		
Belt - Fan & Alt.		②▲9590HD	Belt - Gov.; Ser. No. 511295 & Before		▲9440HD
Hose - Upper - Eng. To Pipe		≈<21194	TECO-CRAB		
D4P100			8000-42		
John Deere 4239D Diesel			Detroit Diesel 3-53 Diesel		
Belt - Fan & Alt.		②▲9590HD	Belt - Fan	5119188	②▲9390HD
H4M50; H4M60; H4M80			Belt - W.P. & Alt.	5133601	②7410
Ford 4-Cyl. 172 Diesel			Hose - Upper; (2" I.D.)		24232
Belt - Fan & Alt.		▲9412HD	Hose - Upper		●25473
Belt - P.S.		TR22474	TOWMOTOR		
Hose - Upper - Eng. To Pipe; (1 1/4" I.D.)		24220	350		
Hose - Lower - Eng. To Pipe; (1 1/2" I.D.)		24224	Continental N62		
Waukesha VPD220A Diesel			Belt - Fan & Gen.	B19469	TR22373
Belt - Fan		7470	Hose - Upper		●26502
Belt - W.P. & Alt.	166226	7445	Hose - Lower		≈<21794
Hose - Lower - Eng. To Pipe		●26515		or	●25476
Herculift 40			351S		
Waukesha VRG155A			Continental Y112		
Belt - Fan & Alt.	166226	7445	Belt - Fan	B99481	7417
Hose - Upper		20355	390; 391; 391S; 392S; 400P		
Hose - Lower		20357	Continental F140; Continental Y112		
TCM-TOYO			Belt - Fan & Gen.; W/33 1/4" Belt O.C.		
FCG25			A40909		
Nissan H20 Diesel			Belt - Fan & Gen.; W/39 1/4" Belt O.C.		
Belt - Fan & Alt.	11720L1102	7410	A29001		
Hose - Upper		●25476	Belt - Fan & Gen.; W/40 3/4" Belt O.C.		
Hose - Lower		●25476	A15645		
FD35			410; 411		
Isuzu DA220 Diesel			Continental Y112		
Belt - Fan	13671198	②TR22545	Belt - Fan	A53536	7450
Hose - By Pass - W.P. To Pipe; (1" I.D.)		24216	Belt - Gen.	A53537	7350
Hose - By Pass - Pipe To Thermostat; (1" I.D.)		24216	420		
FG10 II; FG14 II			Continental F140; Continental Y112		
Nissan D11 Diesel			Belt - Fan & Gen.; W/33 1/4" Belt O.C.		
Belt - Fan	2106748300	▲9463HD	A40909		
FG15			Belt - Fan & Gen.; W/39 1/4" Belt O.C.		
Nissan J15			A29001		
Belt - Fan & Alt.	11720K7201	7370	Belt - Fan & Gen.; W/40 3/4" Belt O.C.		
Hose - Upper		●25253	A15645		
Hose - Lower		≈<20137	421		
	or	●25253	Continental F140; Continental F162		
FG20			Belt - Fan & Gen.		
Nissan			A40909		
Belt - Fan & Alt.	11720L1102	7410	Belt - Fan; W/P.S.		
Nissan H20 Diesel			66694C2		
Hose - Upper		●25253	422S		
Hose - Lower		●25477	Continental F140		
			Belt - Fan & Gen.		
			A40909		
			Belt - Fan; W/P.S.		
			66694C2		
			Continental F162		
			Belt - Fan & Gen.		
			A40909		
			Belt - Fan; W/P.S.		
			66694C2		
			Hose - Lower		
			≈<21794		
			or		
			●25473		

② Two Required.
≈< Cut to Fit.

▲ Standard Belt Available. See Pages 630-631.
● Vulco-Flex® Coolant Hose.

Belts and Coolant Hose for Lift & Industrial Trucks

Application	Mfr. Part No.	Our No.
TOWMOTOR - Continued		
440		
Continental Y112		
Belt - Fan	A53536	7450
Belt - Gen.	A53537	7350
441		
Continental F140		
Belt - Fan & Gen.	A40909	▲9330HD
Belt - Fan; W/P.S.	66694C2	▲9350HD
Continental Y112		
Belt - Fan	A53536	7450
Belt - Gen.	A53537	7350
460		
Continental F140; Continental Y112		
Belt - Fan & Gen.; W/33 1/4" Belt O.C.	A40909	▲9330HD
Belt - Fan & Gen.; W/39 1/4" Belt O.C.	A29001	▲9390HD
Belt - Fan & Gen.; W/40 3/4" Belt O.C.	A15645	▲9405HD
461		
Continental F140; Continental F162		
Belt - Fan & Gen.	A40909	▲9330HD
Belt - Fan; W/P.S.	66694C2	▲9350HD
Belt - P.S.	47563	▲9415HD
462S		
Continental F140		
Belt - Fan & Gen.	A40909	▲9330HD
Belt - Fan; W/P.S.	66694C2	▲9350HD
Belt - P.S.	47563	▲9415HD
Continental F162		
Belt - Fan & Gen.	A40909	▲9330HD
Belt - Fan; W/P.S.	66694C2	▲9350HD
Belt - P.S.	47563	▲9415HD
Hose - Lower	≈<21794	●25473
	or	
480P		
Continental F140; Continental Y112		
Belt - Fan & Gen.; W/33 1/4" Belt O.C.	A40909	▲9330HD
Belt - Fan & Gen.; W/39 1/4" Belt O.C.	A29001	▲9390HD
Belt - Fan & Gen.; W/40 3/4" Belt O.C.	A15645	▲9405HD
500; 500P; 501; 501P		
Continental F140; Continental F162		
Belt - Fan & Gen.	A40909	▲9330HD
Belt - Fan; W/P.S.	66694C2	▲9350HD
Belt - P.S.	47563	▲9415HD
502P; 502S		
Continental F140		
Belt - Fan & Gen.	A40909	▲9330HD
Belt - Fan; W/P.S.	66694C2	▲9350HD
Belt - P.S.	47563	▲9415HD
Continental F162		
Belt - Fan & Gen.	A40909	▲9330HD
Belt - Fan; W/P.S.	66694C2	▲9350HD
Belt - P.S.	47563	▲9415HD
Hose - Lower	≈<21794	●25473
	or	
510P		
Continental F140; Continental F162		
Belt - Fan & Gen.	A40909	▲9330HD
Belt - Fan; W/P.S.	66694C2	▲9350HD
Belt - P.S.	47563	▲9415HD
540		
Continental F209; Continental F226; Continental F244		
Belt - Fan & Gen.	A36902	▲9360HD

Application	Mfr. Part No.	Our No.
TOWMOTOR - Continued		
540 - Continued		
Continental F209; Continental F226; Continental F244 - Continued		
Belt - P.S.; W/28 1/4" Belt O.C.	66694C1	9279
Belt - P.S.; W/41 3/4" Belt O.C.	47563	▲9415HD
Hose - Upper		●25476
Hose - Lower		●25473
590		
Continental F209; Continental F226		
Belt - Fan & Gen.	A40909	▲9330HD
Belt - P.S.	47563	▲9415HD
Continental Y112		
Belt - Fan	57931	7480
Belt - Gen.	A57932	7417
590S		
Continental F209; Continental F226		
Belt - Fan & Gen.	A40909	▲9330HD
Belt - P.S.	47563	▲9415HD
600		
Continental F209; Continental F226; Continental F244		
Belt - Fan & Gen.	A36902	▲9360HD
Belt - P.S.; W/28 1/4" Belt O.C.	66694C1	9279
Belt - P.S.; W/41 3/4" Belt O.C.	47563	▲9415HD
Hose - Upper		●25476
Hose - Lower		●25473
601P		
Continental F140		
Belt - Fan & Gen.	A40909	▲9330HD
Belt - Fan; W/P.S.	66694C2	▲9350HD
Continental F162		
Belt - Fan & Gen.	A40909	▲9330HD
Belt - Fan; W/P.S.	66694C2	▲9350HD
Belt - P.S.	47563	▲9415HD
Hose - Lower	≈<21794	●25473
	or	
670; 680P		
Continental F209; Continental F226; Continental F244		
Belt - Fan & Gen.	A36902	▲9360HD
Belt - P.S.; W/28 1/4" Belt O.C.	66694C1	9279
Belt - P.S.; W/41 3/4" Belt O.C.	47563	▲9415HD
Hose - Upper		●25476
Hose - Lower		●25473
750S		
Continental F209; Continental F266		
Belt - Fan & Alt.	B66694C6	▲9350HD
Belt - Fan & Gen.	A36902	▲9360HD
900		
Continental F209; Continental F266		
Belt - Fan & Gen.	A40909	▲9330HD
Belt - P.S.	47563	▲9415HD
A10; A12		
Continental F244		
Belt - Fan & W.P.	36902	▲9360HD
Hose - Upper		●25480
Hose - Lower		●25473
A15; A16; A18; A20; A22; A24		
Continental M330		
Belt - Fan, W.P. & Gen.; Ser. No. 610040 & Before	629027C10	②7550
Belt - Fan, W.P. & Gen.; Ser. No. 610041 & Newer	629028C22	②▲9463HD
Hose - Upper		●26611
Hose - Lower		●26501

▲ Standard Belt Available. See Pages 630-631.
● Vulco-Flex® Coolant Hose.

≈< Cut to Fit.
② Two Required.

Belts and Coolant Hose for Lift & Industrial Trucks

Application	Mfr. Part No.	Our No.	Application	Mfr. Part No.	Our No.
TOWMOTOR - Continued			TOWMOTOR - Continued		
A15; A16; A18; A20; A22; A24 - Continued			T30B; T35B; T40B; T45B; T50B; T60B - Continued		
Detroit Diesel 4-53 Diesel			Continental F163; Continental F227 - Continued		
Belt - Fan	C629027C8	7490	Belt - Fan & P.S.	303291	▲9370HD
Belt - W.P. & Gen.; W/34 1/4" Belt O.C.	5121847	7340	Belt - P.S.	303288	9279
Belt - W.P. & Gen.; W/41 3/4" Belt O.C.	5120937	Ⓣ7417	Hose - Lower		●25472
Belt - W.P. & Gen.; W/43 1/8" Belt O.C.	5114440	Ⓣ7430	T60C; T70C; T80C; T90C; T100C; T120C		
Belt - W.P. & Gen.; W/44 1/4" Belt O.C.	5125514	Ⓣ7440	Continental F227		
Hose - Upper		●26507	Belt - Fan & Alt.	303291	▲9370HD
B10; B12			Hose - Upper		Ⓢ20416
Continental F244					or ●25476
Belt - Fan & W.P.	36902	▲9360HD	U6; U8		
Hose - Upper		●25480	Continental F244		
Hose - Lower		●25473	Belt - Fan & Alt.	C629027C17	7400
B15; B16; B18; B20; B22; B24			Belt - Fan & Gen.	A36902	▲9360HD
Continental M330			Belt - P.S.	C629027C17	7400
Belt - Fan, W.P. & Gen.	629029C50	Ⓣ▲9470HD	Belt - Air Brake Compr.	C629028C17	▲9520HD
Hose - Upper		●26611	Belt - Hyd. Pump	C629028C6	Ⓣ▲9451HD
Hose - Lower		●26603	Hose - Upper		●25480
Detroit Diesel 4-53 Diesel			Hose - Lower		●25473
Belt - Fan		7490	V30B; V35B; V40B; V45B; V50B; V55B; V60B		
Belt - W.P. & Gen.; W/34 1/4" Belt O.C.	5121847	7340	Continental F163		
Belt - W.P. & Gen.; W/41 3/4" Belt O.C.	5120937	Ⓣ7417	Belt - Fan & Alt.		▲9370HD
Belt - W.P. & Gen.; W/43 1/8" Belt O.C.	5114440	Ⓣ7430	Belt - P.S.		9279
Belt - W.P. & Gen.; W/44 1/4" Belt O.C.	5125514	Ⓣ7440	Hose - Lower		Ⓢ20450
Hose - Lower		●26507			or ●25472
Hercules Diesel			Continental F227		
Hose - Upper		●26511	Belt - Fan & Alt.		▲9370HD
Hose - Lower		●26612	Belt - P.S.		9279
B25			V60C; V70C; V80C		
Continental M330			Continental F227; Detroit Diesel 4-53 Diesel; Ford 6-Cyl. 240		
Belt - Fan, W.P. & Gen.	629029C50	Ⓣ▲9470HD	Belt - Fan & Alt.	2P6212	▲9505HD
Detroit Diesel 4-53 Diesel			Belt - W.P.	1P4313	▲9625HD
Belt - Fan		7490	V100; V120; V140		
Belt - W.P. & Gen.; W/34 1/4" Belt O.C.	5121847	7340	Ford 6-Cyl. 240		
Belt - W.P. & Gen.; W/41 3/4" Belt O.C.	5120937	Ⓣ7417	Belt - Fan & Alt.	3P130	▲9500HD
Belt - W.P. & Gen.; W/43 1/8" Belt O.C.	5114440	Ⓣ7430	Perkins 4-Cyl. 236 Diesel		
Belt - W.P. & Gen.; W/44 1/4" Belt O.C.	5125514	Ⓣ7440	Belt - Fan & Alt.	680610	▲9530HD
K5-30; K5-33			V160; V180; V200; V225		
Continental F162			Caterpillar 3145 Diesel		
Belt - Fan & Gen.; W/21/32" Belt T.W.; W/39 5/8" Belt O.C.	B11724	ⓉTR22392	Belt - Fan & Alt.	688546	▲9630HD
Belt - Fan & Gen.; W/1/2" Belt T.W.; W/39 1/4" Belt O.C.	A29001	▲9390HD	Ford V-8 351		
Hose - Upper; Ser. No. K5305336 & After		●25476	Belt - Fan & Alt.	617140	▲9540HD
Hose - Lower; Ser. No. K5305336 & After		●25473	TOYOTA		
K5-36			2FG15		
Continental F162			Toyota 5R		
Belt - Fan & Gen.; W/21/32" Belt T.W.; W/39 5/8" Belt O.C.	B11724	ⓉTR22392	Belt - Fan & Alt.	163722010071	▲9440HD
Belt - Fan & Gen.; W/1/2" Belt T.W.; W/39 1/4" Belt O.C.	A29001	▲9390HD	2FG20; 2FG25		
Hose - Upper; Ser. No. K536543 & After		●25476	Toyota 5R		
Hose - Lower; Ser. No. K536543 & After		●25473	Belt - Fan & Alt.; W/38 3/4" Belt O.C.	163711018071	▲9385HD
K5-40			Belt - Fan & Alt.; W/39 3/4" Belt O.C.	502FG1516371	▲9395HD
Continental F162			Belt - Fan & Alt.; W/40 1/4" Belt O.C.	163742010071	▲9400HD
Belt - Fan & Gen.; W/21/32" Belt T.W.; W/39 5/8" Belt O.C.	B11724	ⓉTR22392	Belt - Fan & Alt.; W/41 3/4" Belt O.C.		▲9415HD
Belt - Fan & Gen.; W/1/2" Belt T.W.; W/39 1/4" Belt O.C.	A29001	▲9390HD	Belt - Fan & Alt.; W/42 1/4" Belt O.C.	9951211068	▲9420HD
Hose - Upper; Ser. No. K5305311 & After		●25476	Belt - Fan & Alt.; W/42 3/4" Belt O.C.	163712010071	▲9425HD
Hose - Lower; Ser. No. K5405311 & After		●25473	3FG35		
T30B; T35B; T40B; T45B; T50B; T60B			Toyota 2F		
Continental F163; Continental F227			Belt - Fan & Alt.		TR22588
Belt - Fan & Alt.	303291	▲9370HD	Hose - Upper		Ⓢ20702
					or ●25478

Ⓣ Two Required.

▲ Standard Belt Available. See Pages 630-631.

● Vulco-Flex® Coolant Hose.

Ⓢ Cut to Fit.

Belts and Coolant Hose for Lift & Industrial Trucks

Application	Mfr. Part No.	Our No.	Application	Mfr. Part No.	Our No.
TOYOTA - Continued			UNITED TRACTOR - Continued		
3FGC20; 3FGC25			SM40 Shop Mule; SM50 Shop Mule		
Toyota 5R			Continental		
Belt - Fan & Alt.; W/38 3/4" Belt O.C.	163711018071	▲9385HD	Belt - Fan & Gen.	34799	TR24476
Belt - Fan & Alt.; W/39 3/4" Belt O.C.	502FG1516371	▲9395HD	Belt - Fan & Alt.	37399	TR24500
Belt - Fan & Alt.; W/40 1/4" Belt O.C.	163742010071	▲9400HD	Hose - Upper		●26603
Belt - Fan & Alt.; W/41 3/4" Belt O.C.		▲9415HD	Hose - Lower		●25477
Belt - Fan & Alt.; W/42 1/4" Belt O.C.	9951211068	▲9420HD	SM80 Shop Mule		
Belt - Fan & Alt.; W/42 3/4" Belt O.C.	163712010071	▲9425HD	Continental		
4FGC20			Belt - Fan & Gen.	36252	▲9480HD
Toyota 5P			Belt - Fan & Alt.	34294	▲9510HD
Hose - Upper		≈20661	Continental F244		
		or	Hose - Upper		●25474
		●25251	Hose - Lower		●25474
Toyota 5R			SM160 Shop Mule		
Belt - Fan & Alt.	9901121599	TR22416	Continental M363		
Hose - Upper		≈20661	Belt - Fan & P.S.	33231	②▲9463HD
		or	Belt - Gen. & W.P.	33230	7555
		●25251	Hose - Upper		≈20957
815T					or
Toyota 5R			Hose - Lower		●26502
Belt - Fan & Alt.	9934301215	TR22485			●26603
FG15; FG20; FG25			WALDEN		
Toyota 5R			4100		
Belt - Fan & Alt.; W/38 3/4" Belt O.C.	163711018071	▲9385HD	Continental 4-Cyl.		
Belt - Fan & Alt.; W/39 3/4" Belt O.C.	502FG1516371	▲9395HD	Belt - Fan & Alt.		▲9470HD
Belt - Fan & Alt.; W/40 1/4" Belt O.C.	163742010071	▲9400HD	Hose - Upper		●26501
Belt - Fan & Alt.; W/41 3/4" Belt O.C.		▲9415HD	5000		
Belt - Fan & Alt.; W/42 1/4" Belt O.C.	9951211068	▲9420HD	Ford 4-Cyl. 172; Ford 4-Cyl. 172 Diesel		
Belt - Fan & Alt.; W/42 3/4" Belt O.C.	163712010071	▲9425HD	Hose - Upper		●25251
FG28			Hose - Lower - Eng. To Pipe; (1 1/2" I.D.)		24224
Toyota 5P			Hose - Lower - Pipe To Rad.		≈20121
Belt - Fan & Alt.	9934301125	TR24489	Hose - By Pass		≈20338
Hose - Upper		≈20661	Ford 4-Cyl. Diesel		
		or	Belt - Fan & Alt.		▲9415HD
		●25251	5100		
Toyota 5R			Continental 4-Cyl.		
Hose - Upper		≈20661	Belt - Fan		▲9465HD
		or	Hose - Upper		●26501
		●25251	6000		
FG30; FG35; FG40			Ford 4-Cyl.		
Toyota 6-Cyl. 237			Belt - Fan & Alt.		▲9650HD
Belt - Fan & Alt.	9952311152	TR20451	Ford 4-Cyl. 172; Ford 4-Cyl. 172 Diesel		
FGC10; FGC15; FGC20; FGC25			Hose - Upper		●25251
Toyota 5R			Hose - Lower - Eng. To Pipe; (1 1/2" I.D.)		24224
Belt - Fan & Alt.; W/38 3/4" Belt O.C.	163711018071	▲9385HD	Hose - Lower - Pipe To Rad.		≈20121
Belt - Fan & Alt.; W/39 3/4" Belt O.C.	502FG1516371	▲9395HD	Hose - By Pass		≈20338
Belt - Fan & Alt.; W/40 1/4" Belt O.C.	163742010071	▲9400HD	WHITE		
Belt - Fan & Alt.; W/41 3/4" Belt O.C.		▲9415HD	2-78 Forklift; 4-78 Forklift		
Belt - Fan & Alt.; W/42 1/4" Belt O.C.	9951211068	▲9420HD	White 6-Cyl. 265		
Belt - Fan & Alt.; W/42 3/4" Belt O.C.	163712010071	▲9425HD	Belt - Fan & Alt.	158679A	7450
UNITED TRACTOR			Belt - P.S.	157176AA	7290
CB3 Chore Boy			Belt - A.C.	167897A	7480
Continental NA62			White 6-Cyl. 283 Diesel		
Belt - Fan & Gen.	33229	▲9330HD	Belt - Fan & Alt.	162071A	②7460
Hose - Upper		●25476	Belt - P.S.	157177AA	7375
Hose - Lower		●25472	Belt - A.C.	167897A	7480
CB50 Chore Boy			1680		
Wisconsin VG4D			Chrysler 6-Cyl. 225		
Belt - Gen.	30375	2240	Belt - Fan & Alt.		▲9540HD
SM26 Shop Mule; SM30 Shop Mule			Belt - W.P.		▲9390HD
Continental Y112			Belt - Hyd. Pump		▲9520HD
Belt - Fan & Gen.	35009	7405			
Belt - Fan & Alt.	37351	7400			
Hose - Upper; (1 3/4" I.D.)		24228			
Hose - Lower		●25476			

▲ Standard Belt Available. See Pages 630-631.
● Vulco-Flex® Coolant Hose.

≈ Cut to Fit.
② Two Required.

Belts and Coolant Hose for Lift & Industrial Trucks

Application	Mfr. Part No.	Our No.	Application	Mfr. Part No.	Our No.
WHITE - Continued			YALE - Continued		
1680 - Continued			G51CN Series		
Chrysler 6-Cyl. 225 - Continued			Continental F163		
Hose - Upper		●25530	Belt - Fan & Alt.	065019900	②7480
Hose - Lower		●26504	Belt - Aux. Pump	065014500	▲9341HD
YALE			G51NC		
AT20; AT30X			Continental F163		
IH U2A			Hose - Lower		
Belt - Fan	607K410	TR26341			●25476
Belt - Gen.	607K411	6826	G51P Series		
G3 Series			Chrysler Ind. 30		
Chrysler Ind. 52			Belt - Alt.		
Hose - Upper		≧<20957	570440	②7516
		or	Belt - P.S.	665606	▲9463HD
Hose - Lower		●26502	Belt - Hyd. Pump; W/40,000 To 50,000 Lb.		
		●25480	Hyd. Pump	568119	②▲9400HD
Chrysler Ind. 54			Belt - Hyd. Pump; W/60,000 To 80,000 Lb.		
Belt - Fan		②▲9463HD	Hyd. Pump	670481	③7400
Hose - Upper		≧<20957	Belt - Hyd. Pump; W/100,000 Lb. Hyd. Pump	583009	③▲9415HD
		or			
Hose - Lower		●26502	Continental F162		
		●25480	Belt - Fan & Alt.		
Ford V-8 272				
Belt - Fan; W/40 1/4" Belt O.C.	800908	TR28400	Belt - P.S.		
Belt - Fan; W/41" Belt O.C.	803740	TR28406		
Belt - W.P. & Gen.	800911	▲9451HD	Belt - F162		
Hose - Upper; Early		≧<20957		
		or	Belt - Fan & Alt.		
Hose - Upper; Late		●26502		
Hose - Lower; Early		●25530	Belt - P.S.		
Hose - Lower; Late		●25480		
		≧<20046	Belt - F162		
		or		
		●26602	Belt - Fan & Alt.		
G5 Series			G52 Series		
Ford V-8 272			Continental F124		
Belt - Fan	800908	TR28400	Belt - Fan		
Belt - W.P. & Gen.	800911	▲9451HD		
Hose - Upper		●25530	Belt - Fan & Gen.		
Hose - Lower		●26501		
Ford V-8 292			Belt - Gen.		
Belt - Fan		TR28437		
Belt - W.P. & Gen.	800911	▲9451HD	Belt - Gen.		
Hose - Upper		●25530		
Hose - Lower		●26501	Hose - Upper		
G10P				
Chrysler 6-Cyl. 225			Hose - Lower; (1 1/2" I.D.)		
Belt - Fan & Alt.		7417	or		
Hose - By Pass; (5/8" I.D.)		28441	≧<25480		
G51C			G54C Series		
Continental F163			Continental F162		
Hose - Upper		●26612	Belt - Fan		
Hose - Lower		●25476		
G51C Series			Belt - Hyd. Pump		
Chrysler Ind. 30				
Belt - Alt.	570440	②7516	Hose - Lower		
Belt - P.S.	665606	▲9463HD	or		
Belt - Hyd. Pump; W/40,000 To 50,000 Lb.			≧<25476		
Hyd. Pump	568119	②▲9400HD	●25473		
Belt - Hyd. Pump; W/60,000 To 80,000 Lb.			≧<21794		
Hyd. Pump	670481	③7400	24224		
Belt - Hyd. Pump; W/100,000 Lb. Hyd. Pump	583009	③▲9415HD			
Continental F162			G54P Series		
Belt - Fan & Alt.	650199	②7480	Continental F162		
Belt - P.S.	650145	▲9341HD	Belt - Fan		
Continental F163				
Belt - Fan & Alt.	065019900	②7480	Belt - Hyd. Pump		
Belt - Hyd. Pump		▲9451HD		
			Hose - Lower		
			or		
			≧<25476		
			●25476		
			●25473		
			≧<21660		
			●25476		
			G54P Series		
			Chrysler Ind. 31		
			Belt - Fan		
				
			Belt - Hyd. Pump		
				
			Hose - Upper		
				
			Hose - Lower; (1 1/2" I.D.)		
				
			24224		
			G81; G83C; G83P; G86		
			Chrysler 6-Cyl. 225		
			Hose - Upper		
				
			Hose - Lower		
				
			●25476		
			●25473		
			G357A		
			Mazda 4-Cyl.		
			Belt - Fan & Alt.		
				
			Hose - Upper		
				
			▲9451HD		
			●25476		
			GC100; GC150		
			Chrysler 6-Cyl. 225		
			Hose - Upper		
				
			●25480		
			GC Series		
			Continental F163		
			Belt - Fan & Alt.		
				
			065019900		
			②7480		

Lift & Industrial Equipment

● Vulco-Flex® Coolant Hose.
 ② Two Required.
 ③ Three Required.

≧< Cut to Fit.
 ▲ Standard Belt Available. See Pages 630-631.

Belts and Coolant Hose for Lift & Industrial Trucks

Application	Mfr. Part No.	Our No.	Application	Mfr. Part No.	Our No.
YALE - Continued			YALE - Continued		
GLC050			KG51 Series 10; KG51 Series 15 - Continued		
Mazda VA			IH U1 - Continued		
Belt - Fan & Alt.		▲9420HD	Belt - Gen.; W/H.O. Eng.		2230
Hose - Upper		20661	Belt - Gen.; W/O H.O. Eng.	607K411	9260
		or	IH U2A		
Hose - Lower		●25251	Belt - Fan	607K41	TR26341
		or	Belt - Gen.; W/26" Belt O.C.	607K411	9260
		✗21942	Belt - Gen.; W/28" Belt O.C.	6070G4018	9279
GLC Series			KG51 Series 20H		
Continental F163			IH U2A		
Belt - Fan & Alt.	065019900	②7480	Hose - Upper		23562
GP040; GP050R			Hose - Lower; (2" I.D.)		24232
Mazda VA			KG51 Series 30		
Belt - Fan & Alt.		▲9480HD	Chrysler 6-Cyl. 215		
Hose - Lower		●25476	Belt - Fan & Gen.	607K43	TR24489
GP52 Series			Chrysler 6-Cyl. 215 Diesel		
Continental F124			Hose - Upper		✗20046
Belt - Fan	607K410	TR26341	Chrysler Ind. 30-273; Chrysler Ind. 30-275		
Belt - Fan & Gen.		TR28437	Belt - Fan & Gen.	607K43	TR24489
Belt - Gen.	607K411	9260	Hose - Upper		✗20046
Hose - Upper		✗21794	KG51 Series 30X		
		or	IH U2A		
Hose - Lower; (1 1/2" I.D.)		●25472	Hose - Upper		23562
		24224	Hose - Lower; (2" I.D.)		24232
IH U2A			KG51 Series 40; KG51 Series 50; KG51 Series 60; KG51 Series 70; KG51 Series 80; KG51 Series 100		
Belt - Fan	251428R1	TR24315	Chrysler 6-Cyl. 215		
Belt - Gen.; W/21" Belt O.C.	351321R1	6821	Belt - Fan & Gen.	607K43	TR24489
Belt - Gen.; W/28" Belt O.C.	6070G4018	9279	Chrysler 6-Cyl. 215 Diesel		
Hose - Upper		●25473	Hose - Upper		✗20046
Hose - Lower		✗21794	Chrysler Ind. 30-273; Chrysler Ind. 30-275		
		or	Belt - Fan & Gen.	607K43	TR24489
		✗●25480	Hose - Upper		✗20046
GP060L; GP080L			KGA51 Series		
Ford 4-Cyl. 192; Ford 4-Cyl. 292 Diesel			Chrysler Ind. 30; Chrysler Ind. 30-273		
Belt - Fan & Alt.		▲9530HD	Belt - Fan & Gen.; W/P.S.	570440	②7516
Belt - W.P.		▲9313HD	Belt - Fan & Gen.; W/O P.S.	607K43	TR24489
GP100; GP150			Belt - P.S.	570165	7300
Chrysler 6-Cyl. 225			Belt - Hyd. Pump; W/P.S.	568119	②▲9400HD
Hose - Upper		●25480	Belt - Hyd. Pump; W/O P.S.	612006	②▲9425HD
GPR52 Series; GR52 Series			Hose - Upper		✗20046
Continental F124					or
Belt - Fan	607K410	TR26341	Hose - By Pass		●26501
Belt - Fan & Gen.		TR28437			✗20568
Belt - Gen.	607K411	9260	KGP51 Series		
Hose - Upper		✗21794	Chrysler Ind. 30; Chrysler Ind. 30-273		
		or	Hose - Upper		✗20046
Hose - Lower; (1 1/2" I.D.)		●25472			or
		24224	Hose - By Pass		●26501
IH U2A					✗20568
Belt - Fan	251428R1	TR24315	KGP Series		
Belt - Gen.; W/21" Belt O.C.	351321R1	6821	Chrysler Ind. 30; Chrysler Ind. 30-273		
Belt - Gen.; W/28" Belt O.C.	6070G4018	9279	Belt - Fan & Gen.; W/P.S.	570440	②7516
Hose - Upper		●25473	Belt - Fan & Gen.; W/O P.S.	607K43	TR24489
Hose - Lower		✗21794	Belt - P.S.	570165	7300
		or	Belt - Hyd. Pump; W/P.S.	568119	②▲9400HD
		✗●25480	Belt - Hyd. Pump; W/O P.S.	612006	②▲9425HD
GTC Series			KGPA51 Series		
Continental F163			Chrysler Ind. 30; Chrysler Ind. 30-273		
Belt - Fan & Alt.	065019900	②7480	Belt - Fan & Gen.; W/P.S.	570440	②7516
GTP50R			Belt - Fan & Gen.; W/O P.S.	607K43	TR24489
Mazda 4-Cyl.			Belt - P.S.	570165	7300
Belt - Fan, Gov. & Idler		▲9463HD	Belt - Hyd. Pump; W/P.S.	568119	②▲9400HD
Belt - W.P. & Alt.		▲9412HD	Belt - Hyd. Pump; W/O P.S.	612006	②▲9425HD
Hose - Upper		●25476	KG51 Series 10; KG51 Series 15		
KG51 Series 10; KG51 Series 15			IH U1		
Belt - Fan; W/Std. Fan	60712D	TR26353	Belt - Fan; W/Std. Fan	60712D	TR26353
Belt - Fan; W/High Speed Fan		TR28333	Belt - Fan; W/High Speed Fan		TR28333

▲ Standard Belt Available. See Pages 630-631.
● Vulco-Flex® Coolant Hose.

✗ Cut to Fit.
② Two Required.

Belts and Coolant Hose for Lift & Industrial Trucks

Application	Mfr. Part No.	Our No.	
YALE - Continued			
KGPA51 Series - Continued			
Chrysler Ind. 30; Chrysler Ind. 30-273 - Continued			
Hose - Upper		☞20046	
	or	●26501	
Hose - By Pass		☞20568	
L51 Series 30; L51 Series 40; L51 Series 50; L51 Series 60; L51 Series 70; L51 Series 80; L51 Series 100			
Chrysler 6-Cyl. 215			
Belt - Fan & Gen.	607K43		TR24489
Chrysler 6-Cyl. 215 Diesel			
Hose - Upper		☞20046	
Chrysler Ind. 30-273; Chrysler Ind. 30-275			
Belt - Fan & Gen.	607K43		TR24489
Hose - Upper		☞20046	
L52 Series			
Continental F124			
Belt - Fan	607K410		TR26341
Belt - Fan & Gen.			TR28437
Belt - Gen.	607K411		9260
IH U2A			
Belt - Fan	251428R1		TR24315
Belt - Gen.; W/21" Belt O.C.	351321R1		6821
Belt - Gen.; W/28" Belt O.C.	6070G4018		9279
L83C; L83P			
Chrysler 6-Cyl. 225			
Hose - Upper		●25476	
Hose - Lower		●25473	
ZETOR			
ND9031			
Zetor 4-Cyl.			
Belt - Fan & Alt.			TR22474

☞ Cut to Fit.

● Vulco-Flex® Coolant Hose.



Notes





Straight Hose Size List

Emission DEF Tank Fill, Heater & Coolant Hose Numbers

Diesel Emissions Fluid Tank Fill Hose						
I.D./Length	6	25	50	100	250	300
Diesel Emissions Fluid Tank Fill Hose						
3/4		DEF750025				DEF750300
1		DEF100025				DEF100300
Heater Hose						
I.D./Length	6	25	50	100	250	300
Charter® Heater Hose						
1/2			28400		28403	
5/8			28401		28404	
3/4			28402		28405	
Safety Stripe® Heater Hose						
1/4			28407			
5/16			28408			
3/8	28489		28409			
1/2	28490		28410			
5/8	28491		28411		28417	
3/4	28492		28412		28418	
1		28420	28413			
Premium Heater Hose						
1/2			28430			
5/8			28431		28433	
3/4			28432		28434	
Silicone Heater Hose						
3/8		26239				
1/2		26240				
5/8		26241				
3/4		26242				
1		26244				
Green Stripe® Heavy-Duty Heater Hose						
1/2			28439			
5/8			28441			28447
3/4			28442			28448
7/8			28443			
1			28444			28449
1 1/4			28445			

Size Lists





Straight Hose Size List

Coolant Hose					
I.D./Length	3	I.D./Length	3	I.D./Length	3
Severe Service Silicone Coolant Hose					
1	28225	1 3/4	28228	2 1/2	28231
1 1/4	28226	2	28229	2 3/4	28232
1 1/2	28227	2 1/4	28230	3	28233
Vulco® Coolant Hose					
1/2	24008	1 5/8	24026	2 5/8	24042
3/4	24012	1 3/4	24028	2 3/4	24044
7/8	24014	1 7/8	24030	2 7/8	24046
1	24016	2	24032	3	24048
1 1/8	24018	2 1/8	24034	3 1/4	24052
1 1/4	24020	2 1/4	24036	3 1/2	24056
1 3/8	24022	2 3/8	24038	4	24064
1 1/2	24024	2 1/2	24040		
Silicone Coolant Hose					
1/2	24808	1 1/2	24824	3	24848
5/8	24810	1 5/8	24826	3 1/8	24850
3/4	24812	1 3/4	24828	3 1/4	24852
7/8	24814	2	24832	3 1/2	24856
1	24816	2 1/4	24836	3 3/4	24860
1 1/8	24818	2 3/8	24838	4	24864
1 1/4	24820	2 1/2	24840	4 1/2	24872
1 3/8	24822	2 3/4	24844		
Green Stripe® Heavy-Duty 2-Ply Coolant Hose					
3/4	24212	1 7/8	24230	3	24248
7/8	24214	2	24232	3 1/8	24250
1	24216	2 1/8	24234	3 1/4	24252
1 1/8	24218	2 1/4	24236	3 1/2	24256
1 1/4	24220	2 3/8	24238	3 3/4	24260
1 3/8	24222	2 1/2	24240	4	24264
1 1/2	24224	2 5/8	24242	4 1/2	24272
1 5/8	24226	2 3/4	24244		
1 3/4	24228	2 7/8	24246		
Green Stripe® Heavy-Duty 4-Ply Coolant Hose					
1 3/4	24428	2 1/2	24440	3 1/4	24452
1 7/8	24430	2 5/8	24442	3 1/2	24456
2	24432	2 3/4	24444	3 5/8	24458
2 1/8	24434	2 7/8	24446	3 3/4	24460
2 1/4	24436	3	24448	4	24464
2 3/8	24438	3 1/8	24450	5	24480
Wire-Inserted Green Stripe® Coolant Hose					
I.D./Length	5	10	I.D./Length	5	10
1	24916	28316	2 3/8	24938	
1 1/8	24918		2 1/2	24940	28340
1 1/4	24920	28320	2 5/8	24942	
1 3/8	24922		2 3/4	24944	28344
1 1/2	24924	28324	2 7/8	24946	
1 5/8	24926	28326	3	24948	28348
1 3/4	24928	28328	3 1/2	24956	28356
1 7/8	24930	28330	4	24964	
2	24932	28332	5	24980	
2 1/8	24934		6	24996	
2 1/4	24936	28336			

Size Lists



Green Stripe® Truck and Bus V-Belts - Listed by Number

Showing Belt Numbers with Corresponding Nominal Outside Lengths, Top Widths and Angles

IMPORTANT: Lengths shown (O.C. is Outside Circumference) are obtained by measuring around the outside of the belt. These lengths will not agree exactly with the size significant belt numbering system which is based on the effective length of the belt. Effective length ("engineered" length) cannot be measured in the field because special tools are required.

Automotive Top Widths are the standard sizes defined by the automotive belt industry (SAE J636). Due to manufacturing processes that create "Vertical Flats", the top width of XL and Truck/Bus series V-Belts will not agree with the printed top width dimensions. Top width on this page and on the belt sleeve refers to the pulley groove width and not the actual top width of these belts. A picture of a V-Belt with "Vertical Flats" is shown below. Actual top width of like belt sizes will also vary slightly depending on the manufacturer and belt style.



Competitive V-Belt

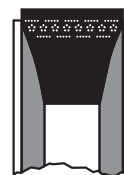

Our V-Belts with "Vertical Flats"

Belt No.	Length (in)	Length (mm)	Top Width (in)	Top Width (mm)	Angle	Belt No.	Length (in)	Length (mm)	Top Width (in)	Top Width (mm)	Angle
TR20412	41 1/2	1056	5/8	16	36°	TR22664	67	1703	11/16	17	36°
TR20426	43	1092	5/8	16	36°	TR22676	68	1728	11/16	17	36°
TR20451	45 1/2	1155	5/8	16	36°	TR22692	69 3/4	1773	11/16	17	36°
TR20544	54 3/4	1390	5/8	16	36°	TR22711	71 5/8	1819	11/16	17	36°
TR20619	62 3/8	1585	5/8	16	36°	TR22720	72 5/8	1844	11/16	17	36°
TR22299	30 1/2	774	11/16	17	36°	TR22752	75 3/4	1924	11/16	17	36°
TR22322	32 3/4	833	11/16	17	36°	TR22770	77 5/8	1971	11/16	17	36°
TR22329	33 1/2	850	11/16	17	36°	TR22792	79 5/8	2021	11/16	17	36°
TR22336	34 1/8	868	11/16	17	36°	TR24281	28 5/8	728	3/4	19	36°
TR22344	34 7/8	886	11/16	17	36°	TR24308	31 1/2	799	3/4	19	36°
TR22350	35 5/8	906	11/16	17	36°	TR24315	32	812	3/4	19	36°
TR22358	36 1/2	926	11/16	17	36°	TR24355	36 1/8	918	3/4	19	36°
TR22363	36 7/8	937	11/16	17	36°	TR24365	37 1/8	943	3/4	19	36°
TR22373	38	964	11/16	17	36°	TR24379	38 3/8	976	3/4	19	36°
TR22380	38 5/8	980	11/16	17	36°	TR24400	40 5/8	1032	3/4	19	36°
TR22386	39 1/8	993	11/16	17	36°	TR24403	40 3/4	1036	3/4	19	36°
TR22392	39 3/4	1010	11/16	17	36°	TR24407	41 1/4	1047	3/4	19	36°
TR22397	40 1/4	1022	11/16	17	36°	TR24414	41 7/8	1065	3/4	19	36°
TR22401	40 5/8	1031	11/16	17	36°	TR24424	42 7/8	1090	3/4	19	36°
TR22405	41 1/8	1045	11/16	17	36°	TR24438	44 3/8	1126	3/4	19	36°
TR22410	41 5/8	1056	11/16	17	36°	TR24449	45 5/8	1158	3/4	19	36°
TR22416	42 1/4	1073	11/16	17	36°	TR24457	46 1/4	1174	3/4	19	36°
TR22425	43 1/8	1095	11/16	17	36°	TR24461	46 5/8	1183	3/4	19	36°
TR22434	44	1117	11/16	17	36°	TR24465	47	1195	3/4	19	36°
TR22443	44 7/8	1139	11/16	17	36°	TR24476	48 1/4	1225	3/4	19	36°
TR22448	45 3/8	1151	11/16	17	36°	TR24489	49 3/8	1255	3/4	19	36°
TR22455	46 1/8	1171	11/16	17	36°	TR24500	50 5/8	1285	3/4	19	36°
TR22461	46 5/8	1184	11/16	17	36°	TR24515	51 7/8	1318	3/4	19	36°
TR22474	47 7/8	1218	11/16	17	36°	TR24530	53 5/8	1362	3/4	19	36°
TR22485	49 1/8	1247	11/16	17	36°	TR24538	54 1/4	1379	3/4	19	36°
TR22495	50 1/8	1273	11/16	17	36°	TR24562	56 5/8	1438	3/4	19	36°
TR22508	51 3/8	1306	11/16	17	36°	TR24578	58 1/4	1480	3/4	19	36°
TR22514	51 7/8	1319	11/16	17	36°	TR24597	60 1/4	1531	3/4	19	36°
TR22517	52 3/8	1332	11/16	17	36°	TR24607	61 1/4	1556	3/4	19	36°
TR22525	53 1/8	1349	11/16	17	36°	TR24619	62 1/2	1589	3/4	19	36°
TR22534	53 7/8	1369	11/16	17	36°	TR24638	64 1/4	1631	3/4	19	36°
TR22545	55 1/8	1399	11/16	17	36°	TR24647	65 1/4	1658	3/4	19	36°
TR22553	55 7/8	1420	11/16	17	36°	TR24664	67	1702	3/4	19	36°
TR22570	57 5/8	1462	11/16	17	36°	TR24688	69 1/4	1759	3/4	19	36°
TR22578	58 1/4	1479	11/16	17	36°	TR24709	71 1/4	1810	3/4	19	36°
TR22588	59 3/8	1509	11/16	17	36°	TR26341	34 5/8	879	13/16	21	36°
TR22607	61 1/4	1557	11/16	17	36°	TR26353	36	913	13/16	21	36°
TR22625	63 1/8	1602	11/16	17	36°	TR26366	37 1/4	947	13/16	21	36°
TR22635	64 1/8	1627	11/16	17	36°	TR28333	33 7/8	859	7/8	22	36°
TR22648	65 1/4	1658	11/16	17	36°	TR28346	35 1/8	892	7/8	22	36°
TR22657	66 1/4	1682	11/16	17	36°	TR28376	38 1/8	970	7/8	22	36°

All Green Stripe Truck and Bus V-Belts are Notched.

Size Lists



Green Stripe® Truck and Bus V-Belts - Listed by Number

Belt No.	Length (in)	Length (mm)	Top Width (in)	Top Width (mm)	Angle	Belt No.	Length (in)	Length (mm)	Top Width (in)	Top Width (mm)	Angle
TR28386	39 1/8	995	7/8	22	36°	TR28706	71 1/8	1808	7/8	22	36°
TR28390	39 5/8	1007	7/8	22	36°	TR28733	73 7/8	1875	7/8	22	36°
TR28400	40 5/8	1032	7/8	22	36°	TR28743	75	1904	7/8	22	36°
TR28406	41 1/8	1046	7/8	22	36°	TR28786	79 1/8	2009	7/8	22	36°
TR28412	41 7/8	1062	7/8	22	36°	TR30408	41 1/2	1054	15/16	24	36°
TR28423	42 7/8	1088	7/8	22	36°	TR30428	43 1/2	1104	15/16	24	36°
TR28429	43 1/2	1105	7/8	22	36°	TR30448	45 3/8	1152	15/16	24	36°
TR28437	44 1/4	1125	7/8	22	36°	TR30467	47 1/4	1201	15/16	24	36°
TR28445	45 1/8	1145	7/8	22	36°	TR30484	49	1244	15/16	24	36°
TR28454	45 7/8	1166	7/8	22	36°	TR30506	51 1/8	1299	15/16	24	36°
TR28463	46 7/8	1190	7/8	22	36°	TR30537	54 3/8	1381	15/16	24	36°
TR28473	47 7/8	1216	7/8	22	36°	TR30543	54 7/8	1393	15/16	24	36°
TR28480	48 5/8	1236	7/8	22	36°	TR30589	59 1/2	1510	15/16	24	36°
TR28483	48 7/8	1240	7/8	22	36°	TR30624	62 7/8	1599	15/16	24	36°
TR28492	49 3/4	1265	7/8	22	36°	TR30652	65 3/4	1671	15/16	24	36°
TR28498	50 1/4	1277	7/8	22	36°	TR30672	67 3/4	1722	15/16	24	36°
TR28501	50 7/8	1291	7/8	22	36°	TR30698	70 3/8	1788	15/16	24	36°
TR28510	51 5/8	1312	7/8	22	36°	TR30710	71 5/8	1818	15/16	24	36°
TR28514	52	1320	7/8	22	36°	TR30722	72 3/4	1849	15/16	24	36°
TR28522	52 7/8	1342	7/8	22	36°	TR30754	76	1929	15/16	24	36°
TR28545	55 1/8	1401	7/8	22	36°	TR30770	77 1/8	1960	15/16	24	36°
TR28550	55 5/8	1413	7/8	22	36°	TR30808	81 1/4	2065	15/16	24	36°
TR28557	56 1/4	1430	7/8	22	36°	TR32491	49 5/8	1262	1	25	36°
TR28565	57 1/8	1451	7/8	22	36°	TR32513	51 7/8	1317	1	25	36°
TR28570	57 5/8	1464	7/8	22	36°	TR32571	57 5/8	1464	1	25	36°
TR28575	58 1/8	1477	7/8	22	36°	TR34435	44 1/8	1120	1 1/16	27	36°
TR28583	58 7/8	1494	7/8	22	36°	TR34456	46 1/8	1172	1 1/16	27	36°
TR28596	60 1/4	1530	7/8	22	36°	TR34467	47 1/4	1199	1 1/16	27	36°
TR28616	62 1/8	1578	7/8	22	36°	TR34495	50 1/8	1273	1 1/16	27	36°
TR28628	63 3/8	1609	7/8	22	36°	TR34506	51 1/4	1303	1 1/16	27	36°
TR28649	65 1/2	1663	7/8	22	36°	TR34545	55	1395	1 1/16	27	36°
TR28657	66 1/4	1684	7/8	22	36°	TR34604	61 1/8	1553	1 1/16	27	36°
TR28666	67 1/4	1710	7/8	22	36°	TR34700	70 5/8	1793	1 1/16	27	36°
TR28680	68 5/8	1744	7/8	22	36°	TR34711	71 5/8	1820	1 1/16	27	36°
TR28693	69 7/8	1774	7/8	22	36°	TR34771	77 3/4	1975	1 1/16	27	36°

All Green Stripe Truck and Bus V-Belts are Notched.



Green Stripe® Truck and Bus V-Belts - Listed by Size

Showing Nominal Belt Top Widths, Outside Lengths and Angles with Our Corresponding Belt Numbers

IMPORTANT: Lengths shown (O.C. is Outside Circumference) are obtained by measuring around the outside of the belt. These lengths will not agree exactly with the size significant belt numbering system which is based on the effective length of the belt. Effective length ("engineered" length) cannot be measured in the field because special tools are required.

Automotive Top Widths are the standard sizes defined by the automotive belt industry (SAE J636). Due to manufacturing processes that create "Vertical Flats", the top width of XL and Truck/Bus series V-Belts will not agree with the printed top width dimensions. Top width on this page and on the belt sleeve refers to the pulley groove width and not the actual top width of these belts. A picture of a V-Belt with "Vertical Flats" is shown below. Actual top width of like belt sizes will also vary slightly depending on the manufacturer and belt style.



Competitive V-Belt

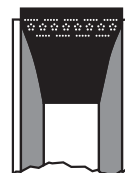

Our V-Belts with "Vertical Flats"

Length (in)	Length (mm)	Angle	Belt No.	Length (in)	Length (mm)	Angle	Belt No.	Length (in)	Length (mm)	Angle	Belt No.
5/8" (16mm) Top Width				11/16" (17mm) Top Width				13/16" (21mm) Top Width			
41 1/2	1056	36°	TR20412	- Continued				34 5/8	879	36°	TR26341
43	1092	36°	TR20426	66 1/4	1682	36°	TR22657	36	913	36°	TR26353
45 1/2	1155	36°	TR20451	67	1703	36°	TR22664	37 1/4	947	36°	TR26366
54 3/4	1390	36°	TR20544	68	1728	36°	TR22676	7/8" (22mm) Top Width			
62 3/8	1585	36°	TR20619	69 3/4	1773	36°	TR22692	33 7/8	859	36°	TR28333
11/16" (17mm) Top Width				71 5/8	1819	36°	TR22711	35 1/8	892	36°	TR28346
30 1/2	774	36°	TR22299	72 5/8	1844	36°	TR22720	38 1/8	970	36°	TR28376
32 3/4	833	36°	TR22322	75 3/4	1924	36°	TR22752	39 1/8	995	36°	TR28386
33 1/2	850	36°	TR22329	77 5/8	1971	36°	TR22770	39 5/8	1007	36°	TR28390
34 1/8	868	36°	TR22336	79 5/8	2021	36°	TR22792	40 5/8	1032	36°	TR28400
34 7/8	886	36°	TR22344	3/4" (19mm) Top Width				41 1/8	1046	36°	TR28406
35 5/8	906	36°	TR22350	28 5/8	728	36°	TR24281	41 7/8	1062	36°	TR28412
36 1/2	926	36°	TR22358	31 1/2	799	36°	TR24308	42 7/8	1088	36°	TR28423
36 7/8	937	36°	TR22363	32	812	36°	TR24315	43 1/2	1105	36°	TR28429
38	964	36°	TR22373	36 1/8	918	36°	TR24355	44 1/4	1125	36°	TR28437
38 5/8	980	36°	TR22380	37 1/8	943	36°	TR24365	45 1/8	1145	36°	TR28445
39 1/8	993	36°	TR22386	38 3/8	976	36°	TR24379	45 7/8	1166	36°	TR28454
39 3/4	1010	36°	TR22392	40 5/8	1032	36°	TR24400	46 7/8	1190	36°	TR28463
40 1/4	1022	36°	TR22397	40 3/4	1036	36°	TR24403	47 7/8	1216	36°	TR28473
40 5/8	1031	36°	TR22401	41 1/4	1047	36°	TR24407	48 5/8	1236	36°	TR28480
41 1/8	1045	36°	TR22405	41 7/8	1065	36°	TR24414	48 7/8	1240	36°	TR28483
41 5/8	1056	36°	TR22410	42 7/8	1090	36°	TR24424	49 3/4	1265	36°	TR28492
42 1/4	1073	36°	TR22416	44 3/8	1126	36°	TR24438	50 1/4	1277	36°	TR28498
43 1/8	1095	36°	TR22425	45 5/8	1158	36°	TR24449	50 7/8	1291	36°	TR28501
44	1117	36°	TR22434	46 1/4	1174	36°	TR24457	51 5/8	1312	36°	TR28510
44 7/8	1139	36°	TR22443	46 5/8	1183	36°	TR24461	52	1320	36°	TR28514
45 3/8	1151	36°	TR22448	47	1195	36°	TR24465	52 7/8	1342	36°	TR28522
46 1/8	1171	36°	TR22455	48 1/4	1225	36°	TR24476	55 1/8	1401	36°	TR28545
46 5/8	1184	36°	TR22461	49 3/8	1255	36°	TR24489	55 5/8	1413	36°	TR28550
47 7/8	1218	36°	TR22474	50 5/8	1285	36°	TR24500	56 1/4	1430	36°	TR28557
49 1/8	1247	36°	TR22485	51 7/8	1318	36°	TR24515	57 1/8	1451	36°	TR28565
50 1/8	1273	36°	TR22495	53 5/8	1362	36°	TR24530	57 5/8	1464	36°	TR28570
51 3/8	1306	36°	TR22508	54 1/4	1379	36°	TR24538	58 1/8	1477	36°	TR28575
51 7/8	1319	36°	TR22514	56 5/8	1438	36°	TR24562	58 7/8	1494	36°	TR28583
52 3/8	1332	36°	TR22517	58 1/4	1480	36°	TR24578	60 1/4	1530	36°	TR28596
53 1/8	1349	36°	TR22525	60 1/4	1531	36°	TR24597	62 1/8	1578	36°	TR28616
53 7/8	1369	36°	TR22534	61 1/4	1556	36°	TR24607	63 3/8	1609	36°	TR28628
55 1/8	1399	36°	TR22545	62 1/2	1589	36°	TR24619	65 1/2	1663	36°	TR28649
55 7/8	1420	36°	TR22553	64 1/4	1631	36°	TR24638	66 1/4	1684	36°	TR28657
57 5/8	1462	36°	TR22570	65 1/4	1658	36°	TR24647	67 1/4	1710	36°	TR28666
58 1/4	1479	36°	TR22578	67	1702	36°	TR24664	68 5/8	1744	36°	TR28680
59 3/8	1509	36°	TR22588	69 1/4	1759	36°	TR24688	69 7/8	1774	36°	TR28693
61 1/4	1557	36°	TR22607	71 1/4	1810	36°	TR24709	71 1/8	1808	36°	TR28706
63 1/8	1602	36°	TR22625					73 7/8	1875	36°	TR28733
64 1/8	1627	36°	TR22635					75	1904	36°	TR28743
65 1/4	1658	36°	TR22648					79 1/8	2009	36°	TR28786

All Green Stripe Truck and Bus V-Belts are Notched.

Size Lists



Green Stripe® Truck and Bus V-Belts - Listed by Size

Length (in)	Length (mm)	Angle	Belt No.	Length (in)	Length (mm)	Angle	Belt No.	Length (in)	Length (mm)	Angle	Belt No.
15/16" (24mm) Top Width				15/16" (24mm) Top Width				1" (25mm) Top Width			
- Continued				- Continued							
15/16" (24mm) Top Width								1 1/16" (27mm) Top Width			
41 1/2	1054	36°	TR30408	59 1/2	1510	36°	TR30589	49 5/8	1262	36°	TR32491
43 1/2	1104	36°	TR30428	62 7/8	1599	36°	TR30624	51 7/8	1317	36°	TR32513
45 3/8	1152	36°	TR30448	65 3/4	1671	36°	TR30652	57 5/8	1464	36°	TR32571
47 1/4	1201	36°	TR30467	67 3/4	1722	36°	TR30672				
49	1244	36°	TR30484	70 3/8	1788	36°	TR30698	44 1/8	1120	36°	TR34435
51 1/8	1299	36°	TR30506	71 5/8	1818	36°	TR30710	46 1/8	1172	36°	TR34456
54 3/8	1381	36°	TR30537	72 3/4	1849	36°	TR30722	47 1/4	1199	36°	TR34467
54 7/8	1393	36°	TR30543	76	1929	36°	TR30754	50 1/8	1273	36°	TR34495
				77 1/8	1960	36°	TR30770	51 1/4	1303	36°	TR34506
				81 1/4	2065	36°	TR30808	55	1395	36°	TR34545
								61 1/8	1553	36°	TR34604
								70 5/8	1793	36°	TR34700
								71 5/8	1820	36°	TR34711
								77 3/4	1975	36°	TR34771

All Green Stripe Truck and Bus V-Belts are Notched.

Size Lists



Green Stripe® Truck and Bus Powerband® Belts - Listed by Number

Showing Belt Numbers with Corresponding Nominal Outside Lengths, Top Widths per Strand and Angles

IMPORTANT: Lengths shown (O.C. is Outside Circumference) are obtained by measuring around the outside of the belt. These lengths will not agree exactly with the size significant belt numbering system which is based on the effective length of the belt. Effective length ("engineered" length) cannot be measured in the field because special tools are required.

Automotive Top Widths are the standard sizes defined by the automotive belt industry (SAE J636). Due to manufacturing processes that create "Vertical Flats", the top width of XL and Truck/Bus series V-Belts will not agree with the printed top width dimensions. Top width on this page and on the belt sleeve refers to the pulley groove width and not the actual top width of these belts. A picture of a V-Belt with "Vertical Flats" is shown below. Actual top width of like belt sizes will also vary slightly depending on the manufacturer and belt style.

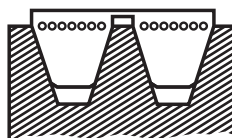

Belt No.	Length (in)	Length (mm)	Top Width Per Strand (in)	Top Width Per Strand (mm)	Template Color	Belt No.	Length (in)	Length (mm)	Top Width Per Strand (in)	Top Width Per Strand (mm)	Template Color
2/9305PB.....	31 1/2	799	1/2	13	Yellow	2/9660PB.....	66 7/8	1698	1/2	13	Yellow
2/9313PB.....	32 1/8	817	1/2	13	Yellow	2/9670PB.....	67 3/8	1710	1/2	13	Yellow
2/9325PB.....	33 1/2	852	1/2	13	Yellow	2/9690PB.....	70	1778	1/2	13	Yellow
2/9430PB.....	43 7/8	1116	1/2	13	Yellow	2/9700PB.....	70 7/8	1800	1/2	13	Yellow
2/9435PB.....	44 3/8	1128	1/2	13	Yellow	2/9710PB.....	71 7/8	1825	1/2	13	Yellow
2/9447PB.....	45 3/8	1154	1/2	13	Yellow	2/9720PB.....	72 7/8	1850	1/2	13	Yellow
2/9451PB.....	45 7/8	1164	1/2	13	Yellow	2/9730PB.....	74	1879	1/2	13	Yellow
2/9463PB.....	47	1195	1/2	13	Yellow	2/TR22517PB.....	52 1/2	1330	11/16	17	Green
2/9470PB.....	47 7/8	1217	1/2	13	Yellow	2/TR22553PB.....	56 1/4	1430	11/16	17	Green
2/9476PB.....	48 3/8	1230	1/2	13	Yellow	2/TR22570PB.....	58	1472	11/16	17	Green
2/9485FPB.....	49 5/8	1259	1/2	13	Pink	2/TR28400PB.....	41	1041	7/8	22	Red
2/9490PB.....	50	1270	1/2	13	Yellow	2/TR28411PB.....	41 3/4	1061	7/8	22	Red
2/9500PB.....	50 3/4	1290	1/2	13	Yellow	2/TR28429PB.....	44 1/8	1120	7/8	22	Red
2/9510PB.....	52	1321	1/2	13	Yellow	2/TR28437PB.....	44 1/4	1125	7/8	22	Red
2/9520PB.....	53	1346	1/2	13	Yellow	2/TR28466PB.....	47 1/8	1198	7/8	22	Red
2/9530PB.....	54	1373	1/2	13	Yellow	2/TR28473PB.....	48 1/4	1226	7/8	22	Red
2/9540PB.....	54 3/4	1390	1/2	13	Yellow	2/TR28480PB.....	49	1244	7/8	22	Red
2/9545PB.....	55 3/8	1405	1/2	13	Yellow	2/TR28483PB.....	49 1/8	1248	7/8	22	Red
2/9550PB.....	56	1424	1/2	13	Yellow	2/TR28492PB.....	50 3/8	1279	7/8	22	Red
2/9555PB.....	56 1/2	1435	1/2	13	Yellow	2/TR28501PB.....	51 1/8	1299	7/8	22	Red
2/9570PB.....	58	1474	1/2	13	Yellow	2/TR28510PB.....	51 5/8	1310	7/8	22	Red
2/9590PB.....	59 7/8	1521	1/2	13	Yellow	3/9470PB.....	47 7/8	1217	1/2	13	
2/9600PB.....	60 5/8	1540	1/2	13	Yellow	3/9500PB.....	50 5/8	1286	1/2	13	
2/9610PB.....	61 7/8	1571	1/2	13	Yellow	3/9525PB.....	53 1/4	1354	1/2	13	
2/9640PB.....	64 3/8	1635	1/2	13	Yellow	3/9530PB.....	54	1372	1/2	13	
2/9650PB.....	65 7/8	1673	1/2	13	Yellow						

Size Lists



Green Stripe® Truck and Bus Powerband® Belts - Listed by Size

Showing Nominal Belt Top Widths per Strand, Outside Lengths and Angles with Our Corresponding Belt Numbers

IMPORTANT: Lengths shown (O.C. is Outside Circumference) are obtained by measuring around the outside of the belt. These lengths will not agree exactly with the size significant belt numbering system which is based on the effective length of the belt. Effective length ("engineered" length) cannot be measured in the field because special tools are required.

Automotive Top Widths are the standard sizes defined by the automotive belt industry (SAE J636). Due to manufacturing processes that create "Vertical Flats", the top width of XL and Truck/Bus series V-Belts will not agree with the printed top width dimensions. Top width on this page and on the belt sleeve refers to the pulley groove width and not the actual top width of these belts. A picture of a V-Belt with "Vertical Flats" is shown below. Actual top width of like belt sizes will also vary slightly depending on the manufacturer and belt style.

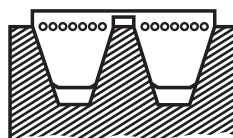

Length (in)	Length (mm)	Template Color	Belt No.	Length (in)	Length (mm)	Template Color	Belt No.	Length (in)	Length (mm)	Template Color	Belt No.
1/2" (13mm) Top Width				1/2" (13mm) Top Width (HC50)				11/16" (17mm) Top Width			
31 1/2	799	Yellow	2/9305PB					52 1/2	1330	Green	2/TR22517PB
32 1/8	817	Yellow	2/9313PB					56 1/4	1430	Green	2/TR22553PB
33 1/2	852	Yellow	2/9325PB	54	1372		3/9530PB	58	1472	Green	2/TR22570PB
43 7/8	1116	Yellow	2/9430PB	54 3/4	1390	Yellow	2/9540PB	7/8" (22mm) Top Width			
44 3/8	1128	Yellow	2/9435PB	55 3/8	1405	Yellow	2/9545PB				
45 3/8	1154	Yellow	2/9447PB	56	1424	Yellow	2/9550PB	41	1041	Red	2/TR28400PB
45 7/8	1164	Yellow	2/9451PB	56 1/2	1435	Yellow	2/9555PB	41 3/4	1061	Red	2/TR28411PB
47	1195	Yellow	2/9463PB	58	1474	Yellow	2/9570PB	44 1/8	1120	Red	2/TR28429PB
47 7/8	1217	Yellow	2/9470PB	59 7/8	1521	Yellow	2/9590PB	44 1/4	1125	Red	2/TR28437PB
47 7/8	1217		3/9470PB	60 5/8	1540	Yellow	2/9600PB	47 1/8	1198	Red	2/TR28466PB
48 3/8	1230	Yellow	2/9476PB	61 7/8	1571	Yellow	2/9610PB	48 1/4	1226	Red	2/TR28473PB
49 5/8	1259	Pink	2/9485FPB	64 3/8	1635	Yellow	2/9640PB	49	1244	Red	2/TR28480PB
50	1270	Yellow	2/9490PB	65 7/8	1673	Yellow	2/9650PB	49 1/8	1248	Red	2/TR28483PB
50 5/8	1286		3/9500PB	66 7/8	1698	Yellow	2/9660PB	50 3/8	1279	Red	2/TR28492PB
50 3/4	1290	Yellow	2/9500PB	67 3/8	1710	Yellow	2/9670PB	51 1/8	1299	Red	2/TR28501PB
52	1321	Yellow	2/9510PB	70	1778	Yellow	2/9690PB	51 5/8	1310	Red	2/TR28510PB
53	1346	Yellow	2/9520PB	70 7/8	1800	Yellow	2/9700PB				
53 1/4	1354		3/9525PB	71 7/8	1825	Yellow	2/9710PB				
54	1373	Yellow	2/9530PB	72 7/8	1850	Yellow	2/9720PB				
				74	1879	Yellow	2/9730PB				

Size Lists





FleetRunner® Heavy-Duty V-Belts - Listed by Number

Showing Belt Numbers with Corresponding Nominal Outside Lengths, Top Widths and Angles

Belt No.	Length (in)	Length (mm)	Top Width (in)	Top Width (mm)	Angle	Belt No.	Length (in)	Length (mm)	Top Width (in)	Top Width (mm)	Angle
9290HD	29 3/8	746	1/2	13	38°	9490HD	49 3/8	1254	1/2	13	38°
9305HD	30 7/8	784	1/2	13	38°	9495HD	49 29/32	1268	1/2	13	38°
9309HD	31 5/16	795	1/2	13	38°	9500HD	50 7/16	1281	1/2	13	38°
9313HD	31 7/8	810	1/2	13	38°	9505HD	50 7/8	1292	1/2	13	38°
9319HD	32 5/8	830	1/2	13	38°	9510HD	51 3/8	1305	1/2	13	38°
9325HD	32 7/8	835	1/2	13	38°	9520HD	52 7/16	1332	1/2	13	38°
9330HD	33 3/8	848	1/2	13	38°	9525HD	52 7/8	1343	1/2	13	38°
9335HD	33 29/32	862	1/2	13	38°	9530HD	53 7/16	1357	1/2	13	38°
9341HD	34 3/8	873	1/2	13	38°	9540HD	54 3/8	1382	1/2	13	38°
9345HD	34 7/8	886	1/2	13	38°	9545HD	54 27/32	1393	1/2	13	38°
9350HD	35 15/32	901	1/2	13	38°	9550HD	55 13/32	1408	1/2	13	38°
9355HD	35 31/32	914	1/2	13	38°	9555HD	55 27/32	1418	1/2	13	38°
9360HD	36 3/8	924	1/2	13	38°	9560HD	56 13/32	1433	1/2	13	38°
9365HD	36 7/8	936	1/2	13	38°	9565HD	56 27/32	1443	1/2	13	38°
9370HD	37 3/8	950	1/2	13	38°	9570HD	57 13/32	1458	1/2	13	38°
9375HD	37 15/16	963	1/2	13	38°	9580HD	58 3/8	1483	1/2	13	38°
9380HD	38 3/8	975	1/2	13	38°	9585HD	58 7/8	1496	1/2	13	38°
9385HD	38 29/32	989	1/2	13	38°	9590HD	59 13/32	1509	1/2	13	38°
9390HD	39 3/8	1000	1/2	13	38°	9600HD	60 13/32	1534	1/2	13	38°
9395HD	39 29/32	1013	1/2	13	38°	9605HD	60 31/32	1549	1/2	13	38°
9400HD	40 3/8	1026	1/2	13	38°	9610HD	61 7/16	1561	1/2	13	38°
9403HD	40 5/8	1032	1/2	13	38°	9620HD	62 3/8	1584	1/2	13	38°
9405HD	40 27/32	1038	1/2	13	38°	9625HD	62 7/8	1597	1/2	13	38°
9412HD	41 3/8	1051	1/2	13	38°	9630HD	63 13/32	1610	1/2	13	38°
9415HD	41 29/32	1065	1/2	13	38°	9635HD	63 29/32	1623	1/2	13	38°
9420HD	42 11/32	1075	1/2	13	38°	9640HD	64 3/8	1635	1/2	13	38°
9425HD	42 27/32	1088	1/2	13	38°	9650HD	65 3/8	1661	1/2	13	38°
9430HD	43 7/16	1103	1/2	13	38°	9660HD	66 3/8	1686	1/2	13	38°
9435HD	43 7/8	1115	1/2	13	38°	9670HD	67 3/8	1712	1/2	13	38°
9440HD	44 3/8	1127	1/2	13	38°	9680HD	68 3/8	1737	1/2	13	38°
9447HD	44 27/32	1139	1/2	13	38°	9690HD	69 3/8	1762	1/2	13	38°
9451HD	45 7/16	1154	1/2	13	38°	9700HD	70 3/8	1788	1/2	13	38°
9455HD	45 27/32	1165	1/2	13	38°	9710HD	71 3/8	1813	1/2	13	38°
9463HD	46 3/8	1178	1/2	13	38°	9720HD	72 3/8	1838	1/2	13	38°
9465HD	46 27/32	1190	1/2	13	38°	9730HD	73 11/32	1863	1/2	13	38°
9470HD	47 3/8	1203	1/2	13	38°	9740HD	74 7/8	1901	1/2	13	38°
9476HD	47 15/16	1218	1/2	13	38°	9745HD	74 7/8	1900	1/2	13	38°
9480HD	48 15/32	1231	1/2	13	38°	9755HD	75 15/16	1929	1/2	13	38°
9485HD	48 27/32	1240	1/2	13	38°						

All FleetRunner Heavy-Duty V-Belts are Notched.

Size Lists



FleetRunner® Heavy-Duty V-Belts - Listed by Size

Showing Nominal Belt Top Widths, Outside Lengths and Angles with Our Corresponding Belt Numbers

Length (in)	Length (mm)	Angle	Belt No.	Length (in)	Length (mm)	Angle	Belt No.	Length (in)	Length (mm)	Angle	Belt No.
1/2" (13mm) Top Width (HC50)				1/2" (13mm) Top Width (HC50)				1/2" (13mm) Top Width (HC50)			
29 3/8	746	38°	9290HD	- Continued				- Continued			
30 7/8	784	38°	9305HD	43 7/16	1103	38°	9430HD	56 27/32	1443	38°	9565HD
31 5/16	795	38°	9309HD	43 7/8	1115	38°	9435HD	57 13/32	1458	38°	9570HD
31 7/8	810	38°	9313HD	44 3/8	1127	38°	9440HD	58 3/8	1483	38°	9580HD
32 5/8	830	38°	9319HD	44 27/32	1139	38°	9447HD	58 7/8	1496	38°	9585HD
32 7/8	835	38°	9325HD	45 7/16	1154	38°	9451HD	59 13/32	1509	38°	9590HD
33 3/8	848	38°	9330HD	45 27/32	1165	38°	9455HD	60 13/32	1534	38°	9600HD
33 29/32	862	38°	9335HD	46 3/8	1178	38°	9463HD	60 31/32	1549	38°	9605HD
34 3/8	873	38°	9341HD	46 27/32	1190	38°	9465HD	61 7/16	1561	38°	9610HD
34 7/8	886	38°	9345HD	47 3/8	1203	38°	9470HD	62 3/8	1584	38°	9620HD
35 15/32	901	38°	9350HD	47 15/16	1218	38°	9476HD	62 7/8	1597	38°	9625HD
35 31/32	914	38°	9355HD	48 15/32	1231	38°	9480HD	63 13/32	1610	38°	9630HD
36 3/8	924	38°	9360HD	48 27/32	1240	38°	9485HD	63 29/32	1623	38°	9635HD
36 7/8	936	38°	9365HD	49 3/8	1254	38°	9490HD	64 3/8	1635	38°	9640HD
37 3/8	950	38°	9370HD	49 29/32	1268	38°	9495HD	65 3/8	1661	38°	9650HD
37 15/16	963	38°	9375HD	50 7/16	1281	38°	9500HD	66 3/8	1686	38°	9660HD
38 3/8	975	38°	9380HD	50 7/8	1292	38°	9505HD	67 3/8	1712	38°	9670HD
38 29/32	989	38°	9385HD	51 3/8	1305	38°	9510HD	68 3/8	1737	38°	9680HD
39 3/8	1000	38°	9390HD	52 7/16	1332	38°	9520HD	69 3/8	1762	38°	9690HD
39 29/32	1013	38°	9395HD	52 7/8	1343	38°	9525HD	70 3/8	1788	38°	9700HD
40 3/8	1026	38°	9400HD	53 7/16	1357	38°	9530HD	71 3/8	1813	38°	9710HD
40 5/8	1032	38°	9403HD	54 3/8	1382	38°	9540HD	72 3/8	1838	38°	9720HD
40 27/32	1038	38°	9405HD	54 27/32	1393	38°	9545HD	73 11/32	1863	38°	9730HD
41 3/8	1051	38°	9412HD	55 13/32	1408	38°	9550HD	74 7/8	1901	38°	9740HD
41 29/32	1065	38°	9415HD	55 27/32	1418	38°	9555HD	74 7/8	1900	38°	9745HD
42 11/32	1075	38°	9420HD	56 13/32	1433	38°	9560HD	75 15/16	1929	38°	9755HD
42 27/32	1088	38°	9425HD								

All FleetRunner Heavy-Duty V-Belts are Notched.

Size Lists



XL® Belts - Listed by Number

Showing Belt Numbers with Corresponding Nominal Outside Lengths, Top Widths and Angles

IMPORTANT: Lengths shown (O.C. is Outside Circumference) are obtained by measuring around the outside of the belt. These lengths will not agree exactly with the size significant belt numbering system which is based on the effective length of the belt. Effective length ("engineered" length) cannot be measured in the field because special tools are required.

Automotive Top Widths are the standard sizes defined by the automotive belt industry (SAE J636). Due to manufacturing processes that create "Vertical Flats", the top width of XL and Truck/Bus series V-Belts will not agree with the printed top width dimensions. Top width on this page and on the belt sleeve refers to the pulley groove width and not the actual top width of these belts. A picture of a V-Belt with "Vertical Flats" is shown below. Actual top width of like belt sizes will also vary slightly depending on the manufacturer and belt style.



Competitive V-Belt

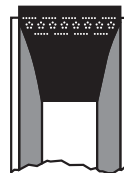

Our V-Belts with "Vertical Flats"

Belt No.	Length (in)	Length (mm)	Top Width (in)	Top Width (mm)	Angle	Belt No.	Length (in)	Length (mm)	Top Width (in)	Top Width (mm)	Angle
7208.....	▼ 21 1/4	540	13/32	10	36°	7374.....	37 3/4	960	5/16	8	38°
7215.....	▼ 22 1/8	561	13/32	10	36°	7375.....	▼ 38 1/8	967	13/32	10	36°
7228.....	23	585	5/16	8	36°	7379.....	38 1/4	970	5/16	8	38°
7234.....	23 3/4	605	5/16	8	38°	7380.....	▼ 38 5/8	980	13/32	10	36°
7240.....	▼ 24 5/8	624	13/32	10	36°	7381.....	38 1/4	970	1/4	6	38°
7250.....	▼ 25 5/8	650	13/32	10	36°	7384.....	38 3/4	985	5/16	8	38°
7255.....	▼ 26 1/8	663	13/32	10	36°	7385.....	▼ 39 1/8	993	13/32	10	36°
7260.....	▼ 26 5/8	675	13/32	10	36°	7388.....	39 1/4	995	1/4	6	38°
7261.....	26 1/4	665	1/4	6	36°	7389.....	39 1/4	995	5/16	8	38°
7265.....	▼ 27 1/8	688	13/32	10	36°	7390.....	▼ 39 5/8	1005	13/32	10	36°
7270.....	▼ 27 5/8	701	13/32	10	36°	7395.....	▼ 40 1/8	1018	13/32	10	36°
7274.....	27 1/4	690	5/16	8	38°	7400.....	▼ 40 5/8	1031	13/32	10	36°
7279.....	28 1/4	720	1/4	6	36°	7404.....	40 3/4	1035	5/16	8	38°
7280.....	▼ 28 5/8	726	13/32	10	36°	7405.....	▼ 41 1/8	1044	13/32	10	36°
7290.....	▼ 29 5/8	751	13/32	10	36°	7409.....	41 1/4	1050	1/4	6	38°
7292.....	▼ 29 7/8	758	13/32	10	36°	7410.....	▼ 41 5/8	1056	13/32	10	36°
7295.....	▼ 30 1/8	764	13/32	10	36°	7417.....	▼ 42 1/8	1069	13/32	10	36°
7298.....	30 1/4	770	1/4	6	38°	7419.....	42 1/4	1075	5/16	8	38°
7300.....	▼ 30 5/8	777	13/32	10	36°	7420.....	▼ 42 5/8	1082	13/32	10	36°
7304.....	30 3/4	780	5/16	8	36°	7425.....	▼ 43 1/8	1095	13/32	10	36°
7305.....	▼ 31 1/8	792	13/32	10	36°	7430.....	▼ 43 5/8	1107	13/32	10	36°
7309.....	31 1/4	795	1/4	6	38°	7435.....	▼ 44 1/8	1120	13/32	10	36°
7312.....	▼ 31 5/8	802	13/32	10	36°	7440.....	▼ 44 5/8	1132	13/32	10	36°
7315.....	▼ 32 1/8	815	13/32	10	36°	7444.....	44 3/4	1135	5/16	8	38°
7318.....	32 1/4	820	1/4	6	38°	7445.....	▼ 45 1/8	1145	13/32	10	36°
7320.....	▼ 32 5/8	828	13/32	10	36°	7447M.....	② 45 1/4	1149	13/32	10	37°
7324.....	32 3/4	830	5/16	8	38°	7448.....	▼ 45 3/8	1151	13/32	10	36°
7325.....	▼ 33 1/8	840	13/32	10	36°	7449.....	45 1/4	1150	5/16	8	38°
7328.....	▼ 33 3/8	847	13/32	10	36°	7450.....	▼ 45 5/8	1158	13/32	10	36°
7329.....	33 1/4	845	1/4	6	38°	7453.....	▼ 45 7/8	1164	13/32	10	36°
7330.....	▼ 33 5/8	853	13/32	10	36°	7455.....	▼ 46 1/8	1171	13/32	10	36°
7333.....	34 1/4	870	1/4	6	38°	7459.....	46 1/4	1175	5/16	8	38°
7334.....	33 3/4	855	5/16	8	38°	7460.....	▼ 46 5/8	1183	13/32	10	36°
7335.....	▼ 34 1/8	866	13/32	10	36°	7465.....	▼ 47 1/8	1196	13/32	10	36°
7340.....	▼ 34 5/8	878	13/32	10	36°	7470.....	▼ 47 5/8	1209	13/32	10	36°
7343.....	34 1/4	870	5/16	8	38°	7473.....	▼ 47 7/8	1215	13/32	10	36°
7345.....	▼ 35 1/8	891	13/32	10	36°	7475.....	▼ 48 1/8	1221	13/32	10	36°
7348.....	35 1/4	895	1/4	6	38°	7480.....	▼ 48 5/8	1234	13/32	10	36°
7350.....	▼ 35 5/8	904	13/32	10	36°	7483.....	▼ 48 7/8	1242	13/32	10	36°
7355.....	▼ 36 1/8	919	13/32	10	36°	7485.....	▼ 49 1/8	1247	13/32	10	36°
7359.....	36 1/4	920	1/4	6	38°	7490.....	▼ 49 5/8	1260	13/32	10	36°
7360.....	▼ 36 5/8	929	13/32	10	36°	7495.....	▼ 50 1/8	1272	13/32	10	36°
7362.....	36 1/2	925	5/16	8	38°	7496.....	49 5/8	1260	5/16	8	38°
7363.....	36 3/4	935	1/4	6	38°	7500.....	▼ 50 5/8	1285	13/32	10	36°
7365.....	▼ 37 1/8	942	13/32	10	36°	7508.....	▼ 51 1/8	1297	13/32	10	36°
7369.....	37 1/4	945	5/16	8	38°	7512.....	▼ 51 5/8	1310	13/32	10	36°
7370.....	▼ 37 5/8	954	13/32	10	36°	7516.....	▼ 52 1/8	1323	13/32	10	36°

▼ Indicates Notched Belt.

② Set of 2 Belts.

Size Lists



XL® Belts - Listed by Number

Belt No.	Length (in)	Length (mm)	Top Width (in)	Top Width (mm)	Angle	Belt No.	Length (in)	Length (mm)	Top Width (in)	Top Width (mm)	Angle
7520.....	▼ 52 5/8	1336	13/32	10	36°	9405.....	▼ 40 7/8	1038	15/32	12	36°
7525.....	▼ 53 1/8	1348	13/32	10	36°	9412.....	▼ 41 3/8	1051	15/32	12	36°
7530.....	▼ 53 5/8	1361	13/32	10	36°	9415.....	▼ 41 7/8	1064	15/32	12	36°
7535.....	▼ 54 1/8	1374	13/32	10	36°	9420.....	▼ 42 3/8	1076	15/32	12	36°
7541.....	▼ 54 5/8	1386	13/32	10	36°	9425.....	▼ 42 7/8	1089	15/32	12	36°
7545.....	▼ 55 1/8	1399	13/32	10	36°	9430.....	▼ 43 3/8	1102	15/32	12	36°
7550.....	▼ 55 5/8	1412	13/32	10	36°	9435.....	▼ 43 7/8	1114	15/32	12	36°
7555.....	▼ 56 1/8	1425	13/32	10	36°	9440.....	▼ 44 3/8	1127	15/32	12	36°
7560.....	▼ 56 5/8	1437	13/32	10	36°	9447.....	▼ 44 7/8	1140	15/32	12	36°
7565.....	▼ 57 1/8	1450	13/32	10	36°	9451.....	▼ 45 3/8	1153	15/32	12	36°
7570.....	▼ 57 5/8	1463	13/32	10	36°	9452M.....	▼ 45 5/8	1158	17/32	13	30°
7575.....	▼ 58 1/8	1475	13/32	10	36°	9453M.....	▼ 45 3/4	1161	17/32	13	30°
7580.....	▼ 58 5/8	1488	13/32	10	36°	9455.....	▼ 45 7/8	1165	15/32	12	36°
7585.....	▼ 59 1/8	1501	13/32	10	36°	9463.....	▼ 46 3/8	1178	15/32	12	36°
7590.....	▼ 59 5/8	1513	13/32	10	36°	9465.....	▼ 46 7/8	1191	15/32	12	36°
7597.....	▼ 60 1/8	1526	13/32	10	36°	9470.....	▼ 47 3/8	1203	15/32	12	36°
7603.....	▼ 60 5/8	1539	13/32	10	36°	9476.....	▼ 47 7/8	1216	15/32	12	36°
7612.....	▼ 61 5/8	1564	13/32	10	36°	9480.....	▼ 48 3/8	1229	15/32	12	36°
7619.....	▼ 62 5/8	1590	13/32	10	36°	9485.....	▼ 48 7/8	1241	15/32	12	36°
7625.....	▼ 63 1/8	1602	13/32	10	36°	9490.....	▼ 49 3/8	1254	15/32	12	36°
7630.....	▼ 63 5/8	1615	13/32	10	36°	9492M.....	▼ 49 5/8	1259	19/32	15	40°
7640.....	▼ 64 5/8	1640	13/32	10	36°	9495.....	▼ 49 7/8	1267	15/32	12	36°
7650.....	▼ 65 5/8	1666	13/32	10	36°	9500.....	▼ 50 3/8	1280	15/32	12	36°
7660.....	▼ 66 5/8	1691	13/32	10	36°	9505.....	▼ 50 7/8	1292	15/32	12	36°
7665.....	▼ 67 1/8	1704	13/32	10	36°	9510.....	▼ 51 3/8	1305	15/32	12	36°
7673.....	▼ 67 5/8	1717	13/32	10	36°	9520.....	▼ 52 3/8	1330	15/32	12	36°
7680.....	▼ 68 5/8	1742	13/32	10	36°	9525.....	▼ 52 7/8	1343	15/32	12	36°
7695.....	▼ 70 1/8	1780	13/32	10	36°	9530.....	▼ 53 3/8	1356	15/32	12	36°
7715.....	▼ 72 1/8	1831	13/32	10	36°	9540.....	▼ 54 3/8	1381	15/32	12	36°
7730.....	▼ 73 5/8	1869	13/32	10	36°	9545.....	▼ 54 7/8	1394	15/32	12	36°
7743.....	▼ 74 5/8	1894	13/32	10	36°	9550.....	▼ 55 3/8	1407	15/32	12	36°
7760.....	▼ 76 5/8	1945	13/32	10	36°	9551M.....	▼ 55 1/2	1411	17/32	13	40°
7775.....	▼ 78 1/8	1983	13/32	10	36°	9555.....	▼ 55 7/8	1418	15/32	12	36°
9245.....	▼ 24 7/8	632	15/32	12	36°	9560.....	▼ 56 3/8	1432	15/32	12	36°
9255.....	▼ 25 7/8	657	15/32	12	36°	9565.....	▼ 56 7/8	1445	15/32	12	36°
9260.....	▼ 26 3/8	670	15/32	12	36°	9570.....	▼ 57 3/8	1457	15/32	12	36°
9265.....	▼ 26 7/8	683	15/32	12	36°	9580.....	▼ 58 3/8	1483	15/32	12	36°
9270.....	▼ 27 3/8	695	15/32	12	36°	9585.....	▼ 58 7/8	1495	15/32	12	36°
9279.....	▼ 28 1/4	718	15/32	12	36°	9590.....	▼ 59 3/8	1508	15/32	12	36°
9290.....	▼ 29 3/8	746	15/32	12	36°	9600.....	▼ 60 3/8	1534	15/32	12	36°
9295.....	▼ 29 7/8	759	15/32	12	36°	9605.....	▼ 60 7/8	1546	15/32	12	36°
9300.....	▼ 30 3/8	772	15/32	12	36°	9610.....	▼ 61 3/8	1559	15/32	12	36°
9305.....	▼ 30 7/8	784	15/32	12	36°	9620.....	▼ 62 3/8	1584	15/32	12	36°
9309.....	▼ 31 3/8	797	15/32	12	36°	9625.....	▼ 62 7/8	1597	15/32	12	36°
9313.....	▼ 31 7/8	809	15/32	12	36°	9630.....	▼ 63 3/8	1610	15/32	12	36°
9319.....	▼ 32 3/8	822	15/32	12	36°	9635.....	▼ 63 7/8	1622	15/32	12	36°
9325.....	▼ 32 7/8	835	15/32	12	36°	9640.....	▼ 64 3/8	1635	15/32	12	36°
9330.....	▼ 33 3/8	848	15/32	12	36°	9650.....	▼ 65 3/8	1661	15/32	12	36°
9335.....	▼ 33 7/8	860	15/32	12	36°	9660.....	▼ 66 3/8	1686	15/32	12	36°
9341.....	▼ 34 3/8	873	15/32	12	36°	9670.....	▼ 67 3/8	1711	15/32	12	36°
9345.....	▼ 34 7/8	886	15/32	12	36°	9680.....	▼ 68 3/8	1737	15/32	12	36°
9348M.....	▼ 35 1/4	895	17/32	13	30°	9690.....	▼ 69 3/8	1762	15/32	12	36°
9350.....	▼ 35 3/8	899	15/32	12	36°	9700.....	▼ 70 3/8	1788	15/32	12	36°
9355.....	▼ 35 7/8	911	15/32	12	36°	9710.....	▼ 71 3/8	1813	15/32	12	36°
9360.....	▼ 36 3/8	924	15/32	12	36°	9720.....	▼ 72 3/8	1838	15/32	12	36°
9361M.....	▼ 36 1/2	928	19/32	15	40°	9730.....	▼ 73 3/8	1864	15/32	12	36°
9362M.....	▼ 36 5/8	930	17/32	13	30°	9740.....	▼ 74 3/8	1889	15/32	12	36°
9365.....	▼ 36 7/8	937	15/32	12	36°	9745.....	▼ 74 7/8	1902	15/32	12	36°
9370.....	▼ 37 3/8	949	15/32	12	36°	9755.....	▼ 75 7/8	1927	15/32	12	36°
9375.....	▼ 37 7/8	962	15/32	12	36°	9765.....	▼ 76 7/8	1953	15/32	12	36°
9378.....	▼ 38 1/8	968	15/32	12	36°	9770.....	▼ 77 3/8	1965	15/32	12	36°
9380.....	▼ 38 3/8	975	15/32	12	36°	9775.....	▼ 77 7/8	1978	15/32	12	36°
9385.....	▼ 38 7/8	987	15/32	12	36°	9810.....	▼ 81 3/8	2067	15/32	12	36°
9390.....	▼ 39 3/8	1000	15/32	12	36°	9820.....	▼ 82 3/8	2092	15/32	12	36°
9395.....	▼ 39 7/8	1013	15/32	12	36°	9830.....	▼ 83 3/8	2118	15/32	12	36°
9400.....	▼ 40 3/8	1026	15/32	12	36°	9840.....	▼ 84 3/8	2143	15/32	12	36°
9403.....	▼ 40 5/8	1032	15/32	12	36°	9850.....	▼ 85 3/8	2169	15/32	12	36°

▼ Indicates Notched Belt.

Size Lists



XL® Belts - Listed by Size

Showing Nominal Belt Top Widths, Outside Lengths and Angles with Our Corresponding Belt Numbers

IMPORTANT: Lengths shown (O.C. is Outside Circumference) are obtained by measuring around the outside of the belt. These lengths will not agree exactly with the size significant belt numbering system which is based on the effective length of the belt. Effective length ("engineered" length) cannot be measured in the field because special tools are required.

Automotive Top Widths are the standard sizes defined by the automotive belt industry (SAE J636). Due to manufacturing processes that create "Vertical Flats", the top width of XL and Truck/Bus series V-Belts will not agree with the printed top width dimensions. Top width on this page and on the belt sleeve refers to the pulley groove width and not the actual top width of these belts. A picture of a V-Belt with "Vertical Flats" is shown below. Actual top width of like belt sizes will also vary slightly depending on the manufacturer and belt style.



Competitive V-Belt

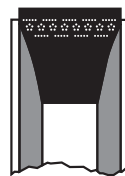

Our V-Belts with "Vertical Flats"

Length (in)	Length (mm)	Angle	Belt No.	Length (in)	Length (mm)	Angle	Belt No.	Length (in)	Length (mm)	Angle	Belt No.
1/4 (6mm) Top Width (HC25)				13/32" (10mm) Top Width (HC41)				13/32" (10mm) Top Width (HC41)			
26 1/4	665	36°	7261	- Continued				- Continued			
28 1/4	720	36°	7279	28 5/8	726	36°	7280	48 5/8	1234	36°	7480
30 1/4	770	38°	7298	29 5/8	751	36°	7290	48 7/8	1242	36°	7483
31 1/4	795	38°	7309	29 7/8	758	36°	7292	49 1/8	1247	36°	7485
32 1/4	820	38°	7318	30 1/8	764	36°	7295	49 5/8	1260	36°	7490
33 1/4	845	38°	7329	30 5/8	777	36°	7300	50 1/8	1272	36°	7495
34 1/4	870	38°	7333	31 1/8	792	36°	7305	50 5/8	1285	36°	7500
35 1/4	895	38°	7348	31 5/8	802	36°	7312	51 1/8	1297	36°	7508
36 1/4	920	38°	7359	32 1/8	815	36°	7315	51 5/8	1310	36°	7512
36 3/4	935	38°	7363	32 5/8	828	36°	7320	52 1/8	1323	36°	7516
38 1/4	970	38°	7381	33 1/8	840	36°	7325	52 5/8	1336	36°	7520
39 1/4	995	38°	7388	33 3/8	847	36°	7328	53 1/8	1348	36°	7525
41 1/4	1050	38°	7409	33 5/8	853	36°	7330	53 5/8	1361	36°	7530
5/16 (8mm) Top Width (HC31)				34 1/8	866	36°	7335	54 1/8	1374	36°	7535
23	585	36°	7228	34 5/8	878	36°	7340	54 5/8	1386	36°	7541
23 3/4	605	38°	7234	35 1/8	891	36°	7345	55 1/8	1399	36°	7545
27 1/4	690	38°	7274	35 5/8	904	36°	7350	55 5/8	1412	36°	7550
30 3/4	780	36°	7304	36 1/8	919	36°	7355	56 1/8	1425	36°	7555
32 3/4	830	38°	7324	36 5/8	929	36°	7360	56 5/8	1437	36°	7560
33 3/4	855	38°	7334	37 1/8	942	36°	7365	57 1/8	1450	36°	7565
34 1/4	870	38°	7343	37 5/8	954	36°	7370	57 5/8	1463	36°	7570
36 1/2	925	38°	7362	38 1/8	967	36°	7375	58 1/8	1475	36°	7575
37 1/4	945	38°	7369	38 5/8	980	36°	7380	58 5/8	1488	36°	7580
37 3/4	960	38°	7374	39 1/8	993	36°	7385	59 1/8	1501	36°	7585
38 1/4	970	38°	7379	39 5/8	1005	36°	7390	59 5/8	1513	36°	7590
38 3/4	985	38°	7384	40 1/8	1018	36°	7395	60 1/8	1526	36°	7597
39 1/4	995	38°	7389	40 5/8	1031	36°	7400	60 5/8	1539	36°	7603
40 3/4	1035	38°	7404	41 1/8	1044	36°	7405	61 5/8	1564	36°	7612
42 1/4	1075	38°	7419	41 5/8	1056	36°	7410	62 5/8	1590	36°	7619
44 3/4	1135	38°	7444	42 1/8	1069	36°	7417	63 1/8	1602	36°	7625
45 1/4	1150	38°	7449	42 5/8	1082	36°	7420	63 5/8	1615	36°	7630
46 1/4	1175	38°	7459	43 1/8	1095	36°	7425	64 5/8	1640	36°	7640
49 5/8	1260	38°	7496	43 5/8	1107	36°	7430	65 5/8	1666	36°	7650
13/32 (10mm) Top Width (HC41)				44 1/8	1120	36°	7435	66 5/8	1691	36°	7660
45 1/4	1149	36°	7447M	44 5/8	1132	36°	7440	67 1/8	1704	36°	7665
21 1/4	540	36°	7208	45 1/8	1145	36°	7445	67 5/8	1717	36°	7673
22 1/8	561	36°	7215	45 3/8	1151	36°	7448	68 5/8	1742	36°	7680
24 5/8	624	36°	7240	45 5/8	1158	36°	7450	70 1/8	1780	36°	7695
25 5/8	650	36°	7250	45 7/8	1164	36°	7453	72 1/8	1831	36°	7715
26 1/8	663	36°	7255	46 1/8	1171	36°	7455	73 5/8	1869	36°	7730
26 5/8	675	36°	7260	46 5/8	1183	36°	7460	74 5/8	1894	36°	7743
27 1/8	688	36°	7265	47 1/8	1196	36°	7465	76 5/8	1945	36°	7760
27 5/8	701	36°	7270	47 5/8	1209	36°	7470	78 1/8	1983	36°	7775
				47 7/8	1215	36°	7473				
				48 1/8	1221	36°	7475				

▼ Indicates Notched Belt. ② Set of 2 Belts.

Size Lists

XL® Belts - Listed by Size

Length (in)	Length (mm)	Angle	Belt No.	Length (in)	Length (mm)	Angle	Belt No.	Length (in)	Length (mm)	Angle	Belt No.
15/32 (12mm) Top Width (HC50)				15/32" (12mm) Top Width (HC50)				15/32" (12mm) Top Width (HC50)			
24 7/8	632	36°	▼ 9245	- Continued				- Continued			
25 7/8	657	36°	▼ 9255	43 7/8	1114	36°	▼ 9435	63 7/8	1622	36°	▼ 9635
26 3/8	670	36°	▼ 9260	44 3/8	1127	36°	▼ 9440	64 3/8	1635	36°	▼ 9640
26 7/8	683	36°	▼ 9265	44 7/8	1140	36°	▼ 9447	65 3/8	1661	36°	▼ 9650
27 3/8	695	36°	▼ 9270	45 3/8	1153	36°	▼ 9451	66 3/8	1686	36°	▼ 9660
28 1/4	718	36°	▼ 9279	45 7/8	1165	36°	▼ 9455	67 3/8	1711	36°	▼ 9670
29 3/8	746	36°	▼ 9290	46 3/8	1178	36°	▼ 9463	68 3/8	1737	36°	▼ 9680
29 7/8	759	36°	▼ 9295	46 7/8	1191	36°	▼ 9465	69 3/8	1762	36°	▼ 9690
30 3/8	772	36°	▼ 9300	47 3/8	1203	36°	▼ 9470	70 3/8	1788	36°	▼ 9700
30 7/8	784	36°	▼ 9305	47 7/8	1216	36°	▼ 9476	71 3/8	1813	36°	▼ 9710
31 3/8	797	36°	▼ 9309	48 3/8	1229	36°	▼ 9480	72 3/8	1838	36°	▼ 9720
31 7/8	809	36°	▼ 9313	48 7/8	1241	36°	▼ 9485	73 3/8	1864	36°	▼ 9730
32 3/8	822	36°	▼ 9319	49 3/8	1254	36°	▼ 9490	74 3/8	1889	36°	▼ 9740
32 7/8	835	36°	▼ 9325	49 7/8	1267	36°	▼ 9495	74 7/8	1902	36°	▼ 9745
33 3/8	848	36°	▼ 9330	50 3/8	1280	36°	▼ 9500	75 7/8	1927	36°	▼ 9755
33 7/8	860	36°	▼ 9335	50 7/8	1292	36°	▼ 9505	76 7/8	1953	36°	▼ 9765
34 3/8	873	36°	▼ 9341	51 3/8	1305	36°	▼ 9510	77 3/8	1965	36°	▼ 9770
34 7/8	886	36°	▼ 9345	52 3/8	1330	36°	▼ 9520	77 7/8	1978	36°	▼ 9775
35 3/8	899	36°	▼ 9350	52 7/8	1343	36°	▼ 9525	81 3/8	2067	36°	▼ 9810
35 7/8	911	36°	▼ 9355	53 3/8	1356	36°	▼ 9530	82 3/8	2092	36°	▼ 9820
36 3/8	924	36°	▼ 9360	54 3/8	1381	36°	▼ 9540	83 3/8	2118	36°	▼ 9830
36 7/8	937	36°	▼ 9365	54 7/8	1394	36°	▼ 9545	84 3/8	2143	36°	▼ 9840
37 3/8	949	36°	▼ 9370	55 3/8	1407	36°	▼ 9550	85 3/8	2169	36°	▼ 9850
37 7/8	962	36°	▼ 9375	55 7/8	1418	36°	▼ 9555	17/32 (14mm) Top Width			
38 1/8	968	36°	▼ 9378	56 3/8	1432	36°	▼ 9560	35 1/4	895	30°	▼ 9348M
38 3/8	975	36°	▼ 9380	56 7/8	1445	36°	▼ 9565	36 5/8	930	30°	▼ 9362M
38 7/8	987	36°	▼ 9385	57 3/8	1457	36°	▼ 9570	45 5/8	1158	30°	▼ 9452M
39 3/8	1000	36°	▼ 9390	58 3/8	1483	36°	▼ 9580	45 3/4	1161	30°	▼ 9453M
39 7/8	1013	36°	▼ 9395	58 7/8	1495	36°	▼ 9585	55 1/2	1411	40°	▼ 9551M
40 3/8	1026	36°	▼ 9400	59 3/8	1508	36°	▼ 9590	19/32 (15mm) Top Width			
40 5/8	1032	36°	▼ 9403	60 3/8	1534	36°	▼ 9600	36 1/2	928	40°	▼ 9361M
40 7/8	1038	36°	▼ 9405	60 7/8	1546	36°	▼ 9605	49 5/8	1259	40°	▼ 9492M
41 3/8	1051	36°	▼ 9412	61 3/8	1559	36°	▼ 9610				
41 7/8	1064	36°	▼ 9415	62 3/8	1584	36°	▼ 9620				
42 3/8	1076	36°	▼ 9420	62 7/8	1597	36°	▼ 9625				
42 7/8	1089	36°	▼ 9425	63 3/8	1610	36°	▼ 9630				
43 3/8	1102	36°	▼ 9430								

▼ Indicates Notched Belt

Size Lists



FleetRunner® Micro-V® Belts - Listed by Number

Showing Belt Numbers with Corresponding Nominal Outside Lengths, Top Widths and Angles

Belt No.	Length (in)	Length (mm)	Top Width (in)	Top Width (mm)	Angle	Belt No.	Length (in)	Length (mm)	Top Width (in)	Top Width (mm)	Angle
K040378HD	38 1/2	977	9/16	14	40°	K060806HD	81 1/8	2061	13/16	20	40°
K040388HD	39 3/8	999	9/16	14	40°	K060832HD	83 3/4	2127	13/16	20	40°
K040425HD	43 1/8	1095	9/16	14	40°	K060846HD	85 1/4	2164	13/16	20	40°
K040430HD	43 3/4	1111	9/16	14	40°	K060849HD	85 1/2	2171	13/16	20	40°
K040445HD	45 1/4	1150	9/16	14	40°	K060858HD	86 3/8	2193	13/16	20	40°
K040745HD	75 1/8	1905	9/16	14	40°	K060860HD	86 5/8	2201	13/16	20	40°
K040762HD	76 7/8	1952	9/16	14	40°	K060870HD	87 5/8	2225	13/16	20	40°
K050323HD	33	837	21/32	17	40°	K060875HD	88 1/8	2238	13/16	20	40°
K050336HD	34 3/8	872	21/32	17	40°	K060905HD	90 7/8	2308	13/16	20	40°
K050340HD	34 5/8	881	21/32	17	40°	K060908HD	91 1/4	2319	13/16	20	40°
K050345HD	35 1/4	894	21/32	17	40°	K060910HD	91 5/8	2329	13/16	20	40°
K050350HD	35 5/8	906	21/32	17	40°	K060923HD	92 7/8	2360	13/16	20	40°
K050360HD	36 3/4	932	21/32	17	40°	K060930HD	93 5/8	2377	13/16	20	40°
K050375HD	38 1/4	971	21/32	17	40°	K060935HD	94	2387	13/16	20	40°
K050380HD	38 3/4	983	21/32	17	40°	K060960HD	96 1/2	2453	13/16	20	40°
K050420HD	42 5/8	1084	21/32	17	40°	K060988HD	99 1/2	2526	13/16	20	40°
K060337HD	34 1/4	871	13/16	20	40°	K060990HD	99 5/8	2531	13/16	20	40°
K060340HD	34 3/4	881	13/16	20	40°	K060994HD	99 7/8	2537	13/16	20	40°
K060390HD	39 3/4	1008	13/16	20	40°	K060997HD	100 1/4	2546	13/16	20	40°
K060393HD	39 7/8	1012	13/16	20	40°	K061000HD	100 5/8	2555	13/16	20	40°
K060400HD	40 3/4	1034	13/16	20	40°	K061005HD	101 1/8	2568	13/16	20	40°
K060408HD	41 1/2	1054	13/16	20	40°	K061010HD	101 5/8	2581	13/16	20	40°
K060415HD	42 1/8	1069	13/16	20	40°	K061015HD	102 1/8	2593	13/16	20	40°
K060425HD	43 1/8	1095	13/16	20	40°	K061020HD	102 5/8	2605	13/16	20	40°
K060435HD	44 1/8	1122	13/16	20	40°	K061058HD	106 3/8	2701	13/16	20	40°
K060439HD	44 1/2	1129	13/16	20	40°	K061080HD	108 3/4	2761	13/16	20	40°
K060455HD	46	1170	13/16	20	40°	K061140HD	114 1/2	2910	13/16	20	40°
K060458HD	46 3/8	1179	13/16	20	40°	K061187HD	119 1/4	3030	13/16	20	40°
K060470HD	47 5/8	1211	13/16	20	40°	K061195HD	120 1/8	3051	13/16	20	40°
K060478HD	48 1/4	1227	13/16	20	40°	K061223HD	122 7/8	3121	13/16	20	40°
K060480HD	48 5/8	1237	13/16	20	40°	K061265HD	127 1/8	3229	13/16	20	40°
K060483HD	48 7/8	1241	13/16	20	40°	K061360HD	136 1/2	3467	13/16	20	40°
K060490HD	49 1/2	1258	13/16	20	40°	K070404HD	41	1042	15/16	24	40°
K060495HD	50 1/8	1274	13/16	20	40°	K070553HD	55 7/8	1418	15/16	24	40°
K060500HD	50 3/4	1288	13/16	20	40°	K070640HD	64 5/8	1642	15/16	24	40°
K060509HD	51 1/2	1309	13/16	20	40°	K070673HD	67 3/4	1722	15/16	24	40°
K060516HD	52 1/8	1325	13/16	20	40°	K070677HD	68 1/4	1734	15/16	24	40°
K060520HD	52 3/4	1339	13/16	20	40°	K070705HD	71 1/8	1807	15/16	24	40°
K060523HD	52 7/8	1342	13/16	20	40°	K070709HD	71 1/2	1816	15/16	24	40°
K060525HD	53 3/8	1355	13/16	20	40°	K070733HD	73 3/4	1874	15/16	24	40°
K060529HD	53 1/2	1359	13/16	20	40°	K070735HD	74 1/8	1883	15/16	24	40°
K060532HD	53 7/8	1367	13/16	20	40°	K070762HD	76 3/4	1949	15/16	24	40°
K060539HD	54 1/2	1385	13/16	20	40°	K070786HD	79 1/8	2011	15/16	24	40°
K060547HD	55 1/4	1404	13/16	20	40°	K070801HD	80 3/4	2051	15/16	24	40°
K060555HD	56	1423	13/16	20	40°	K070805HD	81 1/8	2061	15/16	24	40°
K060557HD	56 1/4	1429	13/16	20	40°	K070825HD	83 1/8	2112	15/16	24	40°
K060559HD	56 1/2	1436	13/16	20	40°	K070835HD	84	2134	15/16	24	40°
K060560HD	56 5/8	1439	13/16	20	40°	K071056HD	106 1/4	2699	15/16	24	40°
K060568HD	57 3/8	1459	13/16	20	40°	K071247HD	125 3/8	3183	15/16	24	40°
K060569HD	57 1/2	1462	13/16	20	40°	K080330HD	33 3/4	856	1 3/32	28	40°
K060575HD	58	1473	13/16	20	40°	K080375HD	38 1/8	968	1 3/32	28	40°
K060578HD	58 3/8	1483	13/16	20	40°	K080382HD	38 3/4	983	1 3/32	28	40°
K060586HD	59 1/4	1504	13/16	20	40°	K080384HD	39	990	1 3/32	28	40°
K060594HD	60	1523	13/16	20	40°	K080385HD	39 1/8	992	1 3/32	28	40°
K060598HD	60 3/8	1534	13/16	20	40°	K080400HD	40 3/4	1034	1 3/32	28	40°
K060605HD	61 1/8	1553	13/16	20	40°	K080415HD	42 1/8	1069	1 3/32	28	40°
K060615HD	62 1/8	1577	13/16	20	40°	K080427HD	43 1/2	1103	1 3/32	28	40°
K060625HD	63 1/8	1603	13/16	20	40°	K080433HD	43 7/8	1115	1 3/32	28	40°
K060635HD	64 1/8	1627	13/16	20	40°	K080435HD	44 1/8	1122	1 3/32	28	40°
K060637HD	64 3/8	1634	13/16	20	40°	K080450HD	45 5/8	1160	1 3/32	28	40°
K060653HD	65 7/8	1674	13/16	20	40°	K080465HD	47	1195	1 3/32	28	40°
K060658HD	66 3/8	1687	13/16	20	40°	K080468HD	47 3/8	1203	1 3/32	28	40°
K060660HD	66 3/4	1696	13/16	20	40°	K080471HD	47 3/4	1211	1 3/32	28	40°
K060670HD	67 1/2	1716	13/16	20	40°	K080485HD	49 1/8	1249	1 3/32	28	40°
K060672HD	67 3/4	1722	13/16	20	40°	K080496HD	50 1/8	1274	1 3/32	28	40°
K060675HD	68	1728	13/16	20	40°	K080505HD	51	1297	1 3/32	28	40°
K060680HD	68 5/8	1742	13/16	20	40°	K080510HD	51 1/2	1309	1 3/32	28	40°
K060685HD	69 1/8	1756	13/16	20	40°	K080514HD	52	1320	1 3/32	28	40°
K060690HD	69 5/8	1767	13/16	20	40°	K080525HD	53 1/8	1351	1 3/32	28	40°
K060696HD	70 1/8	1781	13/16	20	40°	K080530HD	53 1/2	1359	1 3/32	28	40°
K060716HD	72	1830	13/16	20	40°	K080537HD	54 1/4	1379	1 3/32	28	40°
K060723HD	72 7/8	1851	13/16	20	40°	K080539HD	54 1/2	1384	1 3/32	28	40°
K060735HD	74 1/8	1881	13/16	20	40°	K080545HD	55 1/8	1399	1 3/32	28	40°
K060736HD	74 1/8	1882	13/16	20	40°	K080550HD	55 3/4	1415	1 3/32	28	40°
K060739HD	74 1/2	1893	13/16	20	40°	K080553HD	55 7/8	1419	1 3/32	28	40°
K060747HD	75 3/8	1914	13/16	20	40°	K080560HD	56 5/8	1439	1 3/32	28	40°
K060795HD	80 1/8	2034	13/16	20	40°	K080565HD	57	1448	1 3/32	28	40°

Size Lists

FleetRunner® Micro-V® Belts - Listed by Number

Belt No.	Length (in)	Length (mm)	Top Width (in)	Top Width (mm)	Angle	Belt No.	Length (in)	Length (mm)	Top Width (in)	Top Width (mm)	Angle
K080566HD	57 1/8	1452	1 3/32	28	40°	K080915HD	92 1/8	2340	1 3/32	28	40°
K080570HD	57 1/2	1462	1 3/32	28	40°	K080922HD	92 3/4	2355	1 3/32	28	40°
K080575HD	58 1/8	1475	1 3/32	28	40°	K080926HD	93 1/8	2367	1 3/32	28	40°
K080580HD	58 5/8	1490	1 3/32	28	40°	K080931HD	93 5/8	2379	1 3/32	28	40°
K080585HD	59	1499	1 3/32	28	40°	K080934HD	93 7/8	2384	1 3/32	28	40°
K080590HD	59 1/2	1512	1 3/32	28	40°	K080939HD	94 1/2	2400	1 3/32	28	40°
K080594HD	60	1523	1 3/32	28	40°	K080944HD	95	2412	1 3/32	28	40°
K080600HD	60 5/8	1538	1 3/32	28	40°	K080952HD	95 3/4	2432	1 3/32	28	40°
K080605HD	61 1/8	1553	1 3/32	28	40°	K080956HD	96 1/4	2444	1 3/32	28	40°
K080610HD	61 3/4	1569	1 3/32	28	40°	K080962HD	96 3/4	2457	1 3/32	28	40°
K080615HD	62 1/8	1577	1 3/32	28	40°	K080964HD	97	2465	1 3/32	28	40°
K080620HD	62 5/8	1591	1 3/32	28	40°	K080968HD	97 1/2	2475	1 3/32	28	40°
K080623HD	62 7/8	1598	1 3/32	28	40°	K080986HD	99 1/8	2519	1 3/32	28	40°
K080626HD	63 1/8	1603	1 3/32	28	40°	K080991HD	99 5/8	2531	1 3/32	28	40°
K080630HD	63 5/8	1616	1 3/32	28	40°	K080994HD	100	2540	1 3/32	28	40°
K080638HD	64 3/8	1634	1 3/32	28	40°	K081000HD	100 5/8	2555	1 3/32	28	40°
K080645HD	65 1/4	1657	1 3/32	28	40°	K081005HD	101 1/8	2568	1 3/32	28	40°
K080649HD	65 1/2	1665	1 3/32	28	40°	K081020HD	102 5/8	2605	1 3/32	28	40°
K080653HD	65 7/8	1674	1 3/32	28	40°	K081023HD	102 7/8	2613	1 3/32	28	40°
K080660HD	66 1/2	1691	1 3/32	28	40°	K081035HD	104	2642	1 3/32	28	40°
K080670HD	67 1/2	1716	1 3/32	28	40°	K081044HD	105	2666	1 3/32	28	40°
K080672HD	67 3/4	1722	1 3/32	28	40°	K081055HD	106 1/8	2694	1 3/32	28	40°
K080675HD	68	1728	1 3/32	28	40°	K081065HD	107 1/8	2720	1 3/32	28	40°
K080677HD	68 1/4	1734	1 3/32	28	40°	K081074HD	108	2745	1 3/32	28	40°
K080680HD	68 5/8	1742	1 3/32	28	40°	K081079HD	108 1/2	2756	1 3/32	28	40°
K080683HD	68 7/8	1750	1 3/32	28	40°	K081088HD	109 3/8	2778	1 3/32	28	40°
K080685HD	69 1/8	1756	1 3/32	28	40°	K081092HD	109 3/4	2788	1 3/32	28	40°
K080690HD	69 5/8	1767	1 3/32	28	40°	K081099HD	110 1/2	2807	1 3/32	28	40°
K080694HD	70	1777	1 3/32	28	40°	K081102HD	110 3/4	2814	1 3/32	28	40°
K080700HD	70 1/2	1789	1 3/32	28	40°	K081124HD	113	2869	1 3/32	28	40°
K080702HD	70 3/4	1798	1 3/32	28	40°	K081153HD	116 1/4	2953	1 3/32	28	40°
K080708HD	71 1/4	1811	1 3/32	28	40°	K081177HD	118 1/4	3005	1 3/32	28	40°
K080710HD	71 1/2	1816	1 3/32	28	40°	K081189HD	119 1/2	3034	1 3/32	28	40°
K080716HD	72 1/8	1831	1 3/32	28	40°	K081196HD	120 1/8	3050	1 3/32	28	40°
K080718HD	72 3/8	1839	1 3/32	28	40°	K081207HD	121 3/8	3082	1 3/32	28	40°
K080720HD	72 5/8	1845	1 3/32	28	40°	K081213HD	121 7/8	3096	1 3/32	28	40°
K080723HD	72 7/8	1851	1 3/32	28	40°	K081223HD	122 3/4	3117	1 3/32	28	40°
K080726HD	73 1/4	1859	1 3/32	28	40°	K081264HD	127	3227	1 3/32	28	40°
K080730HD	73 1/2	1867	1 3/32	28	40°	K081265HD	127 1/8	3228	1 3/32	28	40°
K080733HD	73 3/4	1874	1 3/32	28	40°	K081298HD	130 3/8	3312	1 3/32	28	40°
K080734HD	74	1880	1 3/32	28	40°	K081325HD	133 1/8	3381	1 3/32	28	40°
K080738HD	74 3/8	1889	1 3/32	28	40°	K081331HD	133 3/4	3396	1 3/32	28	40°
K080740HD	74 5/8	1896	1 3/32	28	40°	K081359HD	136 1/2	3468	1 3/32	28	40°
K080745HD	75 1/8	1907	1 3/32	28	40°	K081362HD	136 3/4	3474	1 3/32	28	40°
K080751HD	75 5/8	1921	1 3/32	28	40°	K081369HD	137 1/2	3492	1 3/32	28	40°
K080755HD	76	1931	1 3/32	28	40°	K081377HD	138 1/4	3513	1 3/32	28	40°
K080760HD	76 1/2	1942	1 3/32	28	40°	K090500HD	50 1/2	1282	1 7/32	31	40°
K080765HD	77	1957	1 3/32	28	40°	K090609HD	61 1/2	1562	1 7/32	31	40°
K080774HD	77 3/4	1976	1 3/32	28	40°	K100381HD	38 3/4	983	1 3/8	35	40°
K080776HD	78 1/8	1985	1 3/32	28	40°	K100437HD	44 1/4	1124	1 3/8	35	40°
K080780HD	78 5/8	1996	1 3/32	28	40°	K100456HD	46 1/8	1173	1 3/8	35	40°
K080785HD	79	2007	1 3/32	28	40°	K100465HD	47	1195	1 3/8	35	40°
K080790HD	79 1/2	2019	1 3/32	28	40°	K100485HD	48 7/8	1241	1 3/8	35	40°
K080794HD	80	2032	1 3/32	28	40°	K100495HD	50 1/8	1274	1 3/8	35	40°
K080797HD	80 1/8	2037	1 3/32	28	40°	K100502HD	50 3/4	1288	1 3/8	35	40°
K080801HD	80 3/4	2050	1 3/32	28	40°	K100510HD	51 1/2	1309	1 3/8	35	40°
K080806HD	81 1/8	2061	1 3/32	28	40°	K100535HD	54	1373	1 3/8	35	40°
K080810HD	81 5/8	2073	1 3/32	28	40°	K100540HD	54 1/2	1385	1 3/8	35	40°
K080813HD	81 3/8	2067	1 3/32	28	40°	K100551HD	55 5/8	1414	1 3/8	35	40°
K080816HD	82 1/8	2086	1 3/32	28	40°	K100554HD	56	1423	1 3/8	35	40°
K080817HD	82 3/8	2091	1 3/32	28	40°	K100557HD	56 3/8	1432	1 3/8	35	40°
K080820HD	82 3/4	2101	1 3/32	28	40°	K100563HD	56 7/8	1444	1 3/8	35	40°
K080825HD	83 1/8	2112	1 3/32	28	40°	K100564HD	57	1448	1 3/8	35	40°
K080830HD	83 3/4	2127	1 3/32	28	40°	K100570HD	57 1/2	1462	1 3/8	35	40°
K080834HD	84	2134	1 3/32	28	40°	K100572HD	57 7/8	1469	1 3/8	35	40°
K080839HD	84 3/8	2144	1 3/32	28	40°	K100575HD	58 1/8	1475	1 3/8	35	40°
K080842HD	84 3/4	2154	1 3/32	28	40°	K100578HD	58 3/8	1482	1 3/8	35	40°
K080845HD	85 1/8	2161	1 3/32	28	40°	K100579HD	58 1/2	1487	1 3/8	35	40°
K080850HD	85 3/8	2175	1 3/32	28	40°	K100582HD	58 3/4	1492	1 3/8	35	40°
K080855HD	86 1/8	2187	1 3/32	28	40°	K100594HD	60	1523	1 3/8	35	40°
K080859HD	86 3/8	2195	1 3/32	28	40°	K100600HD	60 1/2	1538	1 3/8	35	40°
K080860HD	86 5/8	2200	1 3/32	28	40°	K100607HD	61 1/4	1557	1 3/8	35	40°
K080865HD	87 1/8	2212	1 3/32	28	40°	K100610HD	61 5/8	1564	1 3/8	35	40°
K080868HD	87 3/8	2219	1 3/32	28	40°	K100615HD	62	1576	1 3/8	35	40°
K080872HD	87 3/4	2230	1 3/32	28	40°	K100618HD	63 3/4	1619	1 3/8	35	40°
K080876HD	88 1/8	2240	1 3/32	28	40°	K100630HD	63 5/8	1616	1 3/8	35	40°
K080878HD	88 3/8	2245	1 3/32	28	40°	K100637HD	64 1/4	1633	1 3/8	35	40°
K080885HD	89 1/8	2263	1 3/32	28	40°	K100640HD	64 5/8	1642	1 3/8	35	40°
K080889HD	89 1/2	2272	1 3/32	28	40°	K100643HD	65	1651	1 3/8	35	40°
K080893HD	89 7/8	2282	1 3/32	28	40°	K100649HD	65 1/2	1664	1 3/8	35	40°
K080897HD	90 3/8	2295	1 3/32	28	40°	K100655HD	66	1678	1 3/8	35	40°
K080903HD	90 7/8	2308	1 3/32	28	40°	K100658HD	66 3/8	1687	1 3/8	35	40°
K080910HD	91 5/8	2326	1 3/32	28	40°	K100661HD	66 3/4	1694	1 3/8	35	40°

Size Lists



FleetRunner® Micro-V® Belts - Listed by Number

Belt No.	Length (in)	Length (mm)	Top Width (in)	Top Width (mm)	Angle	Belt No.	Length (in)	Length (mm)	Top Width (in)	Top Width (mm)	Angle
K100665HD	67 1/8	1704	1 3/8	35	40°	K120720HD	72 5/8	1845	1 21/32	42	40°
K100670HD	67 1/2	1716	1 3/8	35	40°	K120738HD	74 3/8	1889	1 21/32	42	40°
K100675HD	68	1728	1 3/8	35	40°	K120774HD	78	1982	1 21/32	42	40°
K100677HD	68 1/4	1734	1 3/8	35	40°	K120786HD	79 1/8	2010	1 21/32	42	40°
K100686HD	69 1/4	1758	1 3/8	35	40°	K120815HD	82	2083	1 21/32	42	40°
K100702HD	70 7/8	1800	1 3/8	35	40°	K120842HD	84 3/4	2154	1 21/32	42	40°
K100710HD	71 1/2	1816	1 3/8	35	40°	K120858HD	86 3/8	2194	1 21/32	42	40°
K100719HD	72 3/8	1840	1 3/8	35	40°	K120864HD	86 7/8	2208	1 21/32	42	40°
K100720HD	72 5/8	1845	1 3/8	35	40°	K120866HD	87 1/4	2215	1 21/32	42	40°
K100726HD	73 1/8	1859	1 3/8	35	40°	K120870HD	87 5/8	2225	1 21/32	42	40°
K100731HD	73 5/8	1871	1 3/8	35	40°	K120872HD	87 3/4	2230	1 21/32	42	40°
K100739HD	74 1/2	1893	1 3/8	35	40°	K120878HD	88 3/8	2245	1 21/32	42	40°
K100745HD	75 1/8	1907	1 3/8	35	40°	K120891HD	89 5/8	2278	1 21/32	42	40°
K100764HD	77	1957	1 3/8	35	40°	K120895HD	90 1/8	2289	1 21/32	42	40°
K100771HD	77 3/4	1976	1 3/8	35	40°	K120901HD	90 5/8	2301	1 21/32	42	40°
K100789HD	79 1/2	2019	1 3/8	35	40°	K120903HD	90 7/8	2308	1 21/32	42	40°
K100810HD	81 5/8	2073	1 3/8	35	40°	K120910HD	91 5/8	2326	1 21/32	42	40°
K100814HD	82	2083	1 3/8	35	40°	K120911HD	91 3/4	2329	1 21/32	42	40°
K100822HD	82 3/4	2102	1 3/8	35	40°	K120924HD	93 1/8	2364	1 21/32	42	40°
K100830HD	83 5/8	2124	1 3/8	35	40°	K120931HD	93 3/4	2381	1 21/32	42	40°
K100852HD	85 7/8	2182	1 3/8	35	40°	K120945HD	95	2415	1 21/32	42	40°
K100860HD	86 5/8	2200	1 3/8	35	40°	K120964HD	97	2463	1 21/32	42	40°
K100870HD	87 5/8	2226	1 3/8	35	40°	K120975HD	98 1/8	2492	1 21/32	42	40°
K100877HD	88 1/4	2242	1 3/8	35	40°	K120980HD	98 1/2	2503	1 21/32	42	40°
K100879HD	88 1/2	2247	1 3/8	35	40°	K120985HD	99 1/8	2516	1 21/32	42	40°
K100891HD	89 3/4	2278	1 3/8	35	40°	K120992HD	99 7/8	2537	1 21/32	42	40°
K100894HD	90	2285	1 3/8	35	40°	K121000HD	100 5/8	2556	1 21/32	42	40°
K100935HD	94	2388	1 3/8	35	40°	K121039HD	104 1/2	2654	1 21/32	42	40°
K100946HD	95 1/4	2419	1 3/8	35	40°	K121049HD	105 1/2	2680	1 21/32	42	40°
K100950HD	95 5/8	2428	1 3/8	35	40°	K121139HD	114 1/2	2909	1 21/32	42	40°
K100953HD	95 7/8	2436	1 3/8	35	40°	K140279HD	28 1/2	723	1 15/16	49	40°
K100983HD	98 7/8	2511	1 3/8	35	40°	K140345HD	35	890	1 15/16	49	40°
K100994HD	100	2539	1 3/8	35	40°	K140370HD	37 1/2	954	1 15/16	49	40°
K101010HD	101 1/2	2579	1 3/8	35	40°	K140429HD	43 1/2	1106	1 15/16	49	40°
K101015HD	102	2591	1 3/8	35	40°	K140433HD	43 7/8	1116	1 15/16	49	40°
K101091HD	109 5/8	2786	1 3/8	35	40°	K140451HD	45 5/8	1160	1 15/16	49	40°
K101115HD	112	2846	1 3/8	35	40°	K140496HD	50 1/8	1274	1 15/16	49	40°
K120281HD	28 3/4	730	1 21/32	42	40°	K140516HD	52 1/8	1325	1 15/16	49	40°
K120360HD	36 5/8	929	1 21/32	42	40°	K140524HD	53 1/8	1350	1 15/16	49	40°
K120390HD	39 3/4	1008	1 21/32	42	40°	K140555HD	56	1422	1 15/16	49	40°
K120400HD	40 3/4	1034	1 21/32	42	40°	K140580HD	58 5/8	1490	1 15/16	49	40°
K120410HD	41 1/2	1054	1 21/32	42	40°	K140594HD	60	1523	1 15/16	49	40°
K120525HD	53 1/8	1351	1 21/32	42	40°	K140597HD	60 3/8	1534	1 15/16	49	40°
K120559HD	56 1/2	1436	1 21/32	42	40°	K140603HD	60 7/8	1546	1 15/16	49	40°
K120594HD	60	1523	1 21/32	42	40°	K140618HD	62 3/8	1585	1 15/16	49	40°
K120606HD	61 1/8	1553	1 21/32	42	40°	K140627HD	63 3/8	1609	1 15/16	49	40°
K120610HD	61 3/4	1569	1 21/32	42	40°	K140662HD	66 3/4	1696	1 15/16	49	40°
K120640HD	64 5/8	1641	1 21/32	42	40°	K140682HD	68 3/4	1746	1 15/16	49	40°
K120645HD	65	1651	1 21/32	42	40°	K140700HD	70 1/2	1789	1 15/16	49	40°
K120702HD	70 3/4	1798	1 21/32	42	40°						

Size Lists



FleetRunner® Micro-V® Belts - Listed by Size

Showing Nominal Belt Top Widths, Outside Lengths and Angles
with Our Corresponding Belt Numbers

Length (in)	Length (mm)	Angle	Belt No.	Length (in)	Length (mm)	Angle	Belt No.	Length (in)	Length (mm)	Angle	Belt No.
9/16" (14mm) Top Width				13/16" (20mm) Top Width				1 3/32" (28mm) Top Width			
38 1/2	977	40°	K040378HD	- Continued				49 1/8	1249	40°	K080485HD
39 3/8	999	40°	K040388HD	72 7/8	1851	40°	K060723HD	50 1/8	1274	40°	K080496HD
43 1/8	1095	40°	K040425HD	74 1/8	1881	40°	K060735HD	51	1297	40°	K080505HD
43 3/4	1111	40°	K040430HD	74 1/8	1882	40°	K060736HD	51 1/2	1309	40°	K080510HD
45 1/4	1150	40°	K040445HD	74 1/2	1893	40°	K060739HD	52	1320	40°	K080514HD
75 1/8	1905	40°	K040745HD	75 3/8	1914	40°	K060747HD	53 1/8	1351	40°	K080525HD
76 7/8	1952	40°	K040762HD	80 1/8	2034	40°	K060795HD	53 1/2	1359	40°	K080530HD
21/32" (17mm) Top Width				81 1/8	2061	40°	K060806HD	54 1/4	1379	40°	K080537HD
33	837	40°	K050323HD	83 3/4	2127	40°	K060832HD	54 1/2	1384	40°	K080539HD
34 3/8	872	40°	K050336HD	85 1/4	2164	40°	K060846HD	55 1/8	1399	40°	K080545HD
34 5/8	881	40°	K050340HD	85 1/2	2171	40°	K060849HD	55 3/4	1415	40°	K080550HD
35 1/4	894	40°	K050345HD	86 3/8	2193	40°	K060858HD	55 7/8	1419	40°	K080553HD
35 5/8	906	40°	K050350HD	86 5/8	2201	40°	K060860HD	56 5/8	1439	40°	K080560HD
36 3/4	932	40°	K050360HD	87 5/8	2225	40°	K060870HD	57	1448	40°	K080565HD
38 1/4	971	40°	K050375HD	88 1/8	2238	40°	K060875HD	57 1/8	1452	40°	K080566HD
38 3/4	983	40°	K050380HD	90 7/8	2308	40°	K060905HD	57 1/2	1462	40°	K080570HD
42 5/8	1084	40°	K050420HD	91 1/4	2319	40°	K060908HD	58 1/8	1475	40°	K080575HD
13/16" (20mm) Top Width				91 5/8	2329	40°	K060910HD	58 5/8	1490	40°	K080580HD
34 1/4	871	40°	K060337HD	92 7/8	2360	40°	K060923HD	59	1499	40°	K080585HD
34 3/4	881	40°	K060340HD	93 5/8	2377	40°	K060930HD	59 1/2	1512	40°	K080590HD
39 3/4	1008	40°	K060390HD	94	2387	40°	K060935HD	60	1523	40°	K080594HD
39 7/8	1012	40°	K060393HD	96 1/2	2453	40°	K060960HD	60 5/8	1538	40°	K080600HD
40 3/4	1034	40°	K060400HD	99 1/2	2526	40°	K060988HD	61 1/8	1553	40°	K080605HD
41 1/2	1054	40°	K060408HD	99 5/8	2531	40°	K060990HD	61 3/4	1569	40°	K080610HD
42 1/8	1069	40°	K060415HD	99 7/8	2537	40°	K060994HD	62 1/8	1577	40°	K080615HD
43 1/8	1095	40°	K060425HD	100 1/4	2546	40°	K060997HD	62 5/8	1591	40°	K080620HD
44 1/8	1122	40°	K060435HD	100 5/8	2555	40°	K061000HD	62 7/8	1598	40°	K080623HD
44 1/2	1129	40°	K060439HD	101 1/8	2568	40°	K061005HD	63 1/8	1603	40°	K080626HD
46	1170	40°	K060455HD	101 5/8	2581	40°	K061010HD	63 5/8	1616	40°	K080630HD
46 3/8	1179	40°	K060458HD	102 1/8	2593	40°	K061015HD	64 3/8	1634	40°	K080638HD
47 5/8	1211	40°	K060470HD	102 5/8	2605	40°	K061020HD	65 1/4	1657	40°	K080645HD
48 1/4	1227	40°	K060478HD	106 3/8	2701	40°	K061058HD	65 1/2	1665	40°	K080649HD
48 5/8	1237	40°	K060480HD	108 3/4	2761	40°	K061080HD	65 7/8	1674	40°	K080653HD
48 7/8	1241	40°	K060483HD	114 1/2	2910	40°	K061140HD	66 1/2	1691	40°	K080660HD
49 1/2	1258	40°	K060490HD	119 1/4	3030	40°	K061187HD	67 1/2	1716	40°	K080670HD
50 1/8	1274	40°	K060495HD	120 1/8	3051	40°	K061195HD	67 3/4	1722	40°	K080672HD
50 3/4	1288	40°	K060500HD	122 7/8	3121	40°	K061223HD	68	1728	40°	K080675HD
51 1/2	1309	40°	K060509HD	127 1/8	3229	40°	K061265HD	68 1/4	1734	40°	K080677HD
52 1/8	1325	40°	K060516HD	136 1/2	3467	40°	K061360HD	68 5/8	1742	40°	K080680HD
52 3/4	1339	40°	K060520HD	15/16" (24mm) Top Width				68 7/8	1750	40°	K080683HD
52 7/8	1342	40°	K060523HD	41	1042	40°	K070404HD	69 1/8	1756	40°	K080685HD
53 3/8	1355	40°	K060525HD	55 7/8	1418	40°	K070553HD	69 5/8	1767	40°	K080690HD
53 1/2	1359	40°	K060529HD	64 5/8	1642	40°	K070640HD	70	1777	40°	K080694HD
53 7/8	1367	40°	K060532HD	67 3/4	1722	40°	K070673HD	70 1/2	1789	40°	K080700HD
54 1/2	1385	40°	K060539HD	68 1/4	1734	40°	K070677HD	70 3/4	1798	40°	K080702HD
55 1/4	1404	40°	K060547HD	71 1/8	1807	40°	K070705HD	71 1/4	1811	40°	K080708HD
56	1423	40°	K060555HD	71 1/2	1816	40°	K070709HD	71 1/2	1816	40°	K080710HD
56 1/4	1429	40°	K060557HD	73 3/4	1874	40°	K070733HD	72 1/8	1831	40°	K080716HD
56 1/2	1436	40°	K060559HD	74 1/8	1883	40°	K070735HD	72 3/8	1839	40°	K080718HD
56 5/8	1439	40°	K060560HD	76 3/4	1949	40°	K070762HD	72 5/8	1845	40°	K080720HD
57 3/8	1459	40°	K060568HD	79 1/8	2011	40°	K070786HD	72 7/8	1851	40°	K080723HD
57 1/2	1462	40°	K060569HD	80 3/4	2051	40°	K070801HD	73 1/4	1859	40°	K080726HD
58	1473	40°	K060575HD	81 1/8	2061	40°	K070805HD	73 1/2	1867	40°	K080730HD
58 3/8	1483	40°	K060578HD	83 1/8	2112	40°	K070825HD	73 3/4	1874	40°	K080733HD
59 1/4	1504	40°	K060586HD	84	2134	40°	K070835HD	74	1880	40°	K080734HD
60	1523	40°	K060594HD	106 1/4	2699	40°	K071056HD	74 3/8	1889	40°	K080738HD
60 3/8	1534	40°	K060598HD	125 3/8	3183	40°	K071247HD	74 5/8	1896	40°	K080740HD
61 1/8	1553	40°	K060605HD	1 3/32" (28mm) Top Width				75 1/8	1907	40°	K080745HD
62 1/8	1577	40°	K060615HD	33 3/4	856	40°	K080330HD	75 5/8	1921	40°	K080751HD
63 1/8	1603	40°	K060625HD	38 1/8	968	40°	K080375HD	76	1931	40°	K080755HD
64 1/8	1627	40°	K060635HD	38 1/8	968	40°	K080375HD	76 1/2	1942	40°	K080760HD
64 3/8	1634	40°	K060637HD	38 3/4	983	40°	K080382HD	77	1957	40°	K080765HD
65 7/8	1674	40°	K060653HD	39	990	40°	K080384HD	77 3/4	1976	40°	K080774HD
66 3/8	1687	40°	K060658HD	39 1/8	992	40°	K080385HD	78 1/8	1985	40°	K080776HD
66 3/4	1696	40°	K060660HD	40 3/4	1034	40°	K080400HD	78 5/8	1996	40°	K080780HD
67 1/2	1716	40°	K060670HD	42 1/8	1069	40°	K080415HD	79	2007	40°	K080785HD
67 3/4	1722	40°	K060672HD	43 1/2	1103	40°	K080427HD	79 1/2	2019	40°	K080790HD
68	1728	40°	K060675HD	43 7/8	1115	40°	K080433HD	80	2032	40°	K080794HD
68 5/8	1742	40°	K060680HD	44 1/8	1122	40°	K080435HD	80 1/8	2037	40°	K080797HD
69 1/8	1756	40°	K060685HD	45 5/8	1160	40°	K080450HD	80 3/4	2050	40°	K080801HD
69 5/8	1767	40°	K060690HD	47	1195	40°	K080465HD	81 1/8	2061	40°	K080806HD
70 1/8	1781	40°	K060696HD	47 3/8	1203	40°	K080468HD	81 5/8	2073	40°	K080810HD
72	1830	40°	K060716HD	47 3/4	1211	40°	K080471HD	81 3/8	2067	40°	K080813HD

Size Lists



FleetRunner® Micro-V® Belts - Listed by Size

Length (in)	Length (mm)	Angle	Belt No.	Length (in)	Length (mm)	Angle	Belt No.	Length (in)	Length (mm)	Angle	Belt No.
1 3/32" (28mm) Top Width				1 7/32" (31mm) Top Width				1 21/32" (42mm) Top Width			
- Continued											
82 1/8	2086	40°	K080816HD	50 1/2	1282	40°	K090500HD	28 3/4	730	40°	K120281HD
82 3/8	2091	40°	K080817HD	61 1/2	1562	40°	K090609HD	36 5/8	929	40°	K120360HD
82 3/4	2101	40°	K080820HD	1 3/8" (35mm) Top Width				39 3/4	1008	40°	K120390HD
83 1/8	2112	40°	K080825HD	38 3/4	983	40°	K100381HD	40 3/4	1034	40°	K120400HD
83 3/4	2127	40°	K080830HD	44 1/4	1124	40°	K100437HD	41 1/2	1054	40°	K120410HD
84	2134	40°	K080834HD	46 1/8	1173	40°	K100456HD	53 1/8	1351	40°	K120525HD
84 3/8	2144	40°	K080839HD	47	1195	40°	K100465HD	56 1/2	1436	40°	K120559HD
84 3/4	2154	40°	K080842HD	48 7/8	1241	40°	K100485HD	60	1523	40°	K120594HD
85 1/8	2161	40°	K080845HD	50 1/8	1274	40°	K100495HD	61 1/8	1553	40°	K120606HD
85 3/8	2175	40°	K080850HD	50 3/4	1288	40°	K100502HD	61 3/4	1569	40°	K120610HD
86 1/8	2187	40°	K080855HD	51 1/2	1309	40°	K100510HD	64 5/8	1641	40°	K120640HD
86 3/8	2195	40°	K080859HD	54	1373	40°	K100535HD	65	1651	40°	K120645HD
86 5/8	2200	40°	K080860HD	54 1/2	1385	40°	K100540HD	70 3/4	1798	40°	K120702HD
87 1/8	2212	40°	K080865HD	55 5/8	1414	40°	K100551HD	72 5/8	1845	40°	K120720HD
87 3/8	2219	40°	K080868HD	56	1423	40°	K100554HD	74 3/8	1889	40°	K120738HD
87 3/4	2230	40°	K080872HD	56 3/8	1432	40°	K100557HD	78	1982	40°	K120774HD
88 1/8	2240	40°	K080876HD	56 7/8	1444	40°	K100563HD	79 1/8	2010	40°	K120786HD
88 3/8	2245	40°	K080878HD	57	1448	40°	K100564HD	82	2083	40°	K120815HD
89 1/8	2263	40°	K080885HD	57 1/2	1462	40°	K100570HD	84 3/4	2154	40°	K120842HD
89 1/2	2272	40°	K080889HD	57 7/8	1469	40°	K100572HD	86 3/8	2194	40°	K120858HD
89 7/8	2282	40°	K080893HD	58 1/8	1475	40°	K100575HD	86 7/8	2208	40°	K120864HD
90 3/8	2295	40°	K080897HD	58 3/8	1482	40°	K100578HD	87 1/4	2215	40°	K120866HD
90 7/8	2308	40°	K080903HD	58 1/2	1487	40°	K100579HD	87 5/8	2225	40°	K120870HD
91 5/8	2326	40°	K080910HD	58 3/4	1492	40°	K100582HD	87 3/4	2230	40°	K120872HD
92 1/8	2340	40°	K080915HD	60	1523	40°	K100594HD	88 3/8	2245	40°	K120878HD
92 3/4	2355	40°	K080922HD	60 1/2	1538	40°	K100600HD	89 5/8	2278	40°	K120891HD
93 1/8	2367	40°	K080926HD	61 1/4	1557	40°	K100607HD	90 1/8	2289	40°	K120895HD
93 5/8	2379	40°	K080931HD	61 5/8	1564	40°	K100610HD	90 5/8	2301	40°	K120901HD
93 7/8	2384	40°	K080934HD	62	1576	40°	K100615HD	90 7/8	2308	40°	K120903HD
94 1/2	2400	40°	K080939HD	63 3/4	1619	40°	K100618HD	91 5/8	2326	40°	K120910HD
95	2412	40°	K080944HD	63 5/8	1616	40°	K100630HD	91 3/4	2329	40°	K120911HD
95 3/4	2432	40°	K080952HD	64 1/4	1633	40°	K100637HD	93 1/8	2364	40°	K120924HD
96 1/4	2444	40°	K080956HD	64 5/8	1642	40°	K100640HD	93 3/4	2381	40°	K120931HD
96 3/4	2457	40°	K080962HD	65	1651	40°	K100643HD	95	2415	40°	K120945HD
97	2465	40°	K080964HD	65 1/2	1664	40°	K100649HD	97	2463	40°	K120964HD
97 1/2	2475	40°	K080968HD	66	1678	40°	K100655HD	98 1/8	2492	40°	K120975HD
99 1/8	2519	40°	K080986HD	66 3/8	1687	40°	K100658HD	98 1/2	2503	40°	K120980HD
99 5/8	2531	40°	K080991HD	66 3/4	1694	40°	K100661HD	99 1/8	2516	40°	K120985HD
100	2540	40°	K080994HD	67 1/8	1704	40°	K100665HD	99 7/8	2537	40°	K120992HD
100 5/8	2555	40°	K081000HD	67 1/2	1716	40°	K100670HD	100 5/8	2556	40°	K121000HD
101 1/8	2568	40°	K081005HD	68	1728	40°	K100675HD	104 1/2	2654	40°	K121039HD
102 5/8	2605	40°	K081020HD	68 1/4	1734	40°	K100677HD	105 1/2	2680	40°	K121049HD
102 7/8	2613	40°	K081023HD	69 1/4	1758	40°	K100686HD	114 1/2	2909	40°	K121139HD
104	2642	40°	K081035HD	70 7/8	1800	40°	K100702HD	1 15/16" (49mm) Top Width			
105	2666	40°	K081044HD	71 1/2	1816	40°	K100710HD	28 1/2	723	40°	K140279HD
106 1/8	2694	40°	K081055HD	72 3/8	1840	40°	K100719HD	35	890	40°	K140345HD
107 1/8	2720	40°	K081065HD	72 5/8	1845	40°	K100720HD	37 1/2	954	40°	K140370HD
108	2745	40°	K081074HD	73 1/8	1859	40°	K100726HD	43 1/2	1106	40°	K140429HD
108 1/2	2756	40°	K081079HD	73 5/8	1871	40°	K100731HD	43 7/8	1116	40°	K140433HD
109 3/8	2778	40°	K081088HD	74 1/2	1893	40°	K100739HD	45 5/8	1160	40°	K140451HD
109 3/4	2788	40°	K081092HD	75 1/8	1907	40°	K100745HD	50 1/8	1274	40°	K140496HD
110 1/2	2807	40°	K081099HD	77	1957	40°	K100764HD	52 1/8	1325	40°	K140516HD
110 3/4	2814	40°	K081102HD	77 3/4	1976	40°	K100771HD	53 1/8	1350	40°	K140524HD
113	2869	40°	K081124HD	79 1/2	2019	40°	K100789HD	56	1422	40°	K140555HD
116 1/4	2953	40°	K081153HD	81 5/8	2073	40°	K100810HD	58 5/8	1490	40°	K140580HD
118 1/4	3005	40°	K081177HD	82	2083	40°	K100814HD	60	1523	40°	K140594HD
119 1/2	3034	40°	K081189HD	82 3/4	2102	40°	K100822HD	60 3/8	1534	40°	K140597HD
120 1/8	3050	40°	K081196HD	83 5/8	2124	40°	K100830HD	60 7/8	1546	40°	K140603HD
121 3/8	3082	40°	K081207HD	85 7/8	2182	40°	K100852HD	62 3/8	1585	40°	K140618HD
121 7/8	3096	40°	K081213HD	86 5/8	2200	40°	K100860HD	63 3/8	1609	40°	K140627HD
122 3/4	3117	40°	K081223HD	87 5/8	2226	40°	K100870HD	66 3/4	1696	40°	K140662HD
127	3227	40°	K081264HD	88 1/4	2242	40°	K100877HD	68 3/4	1746	40°	K140682HD
127 1/8	3228	40°	K081265HD	88 1/2	2247	40°	K100879HD	70 1/2	1789	40°	K140700HD
130 3/8	3312	40°	K081298HD	89 3/4	2278	40°	K100891HD				
133 1/8	3381	40°	K081325HD	90	2285	40°	K100894HD				
133 3/4	3396	40°	K081331HD	94	2388	40°	K100935HD				
136 1/2	3468	40°	K081359HD	95 1/4	2419	40°	K100946HD				
136 3/4	3474	40°	K081362HD	95 5/8	2428	40°	K100950HD				
137 1/2	3492	40°	K081369HD	95 7/8	2436	40°	K100953HD				
138 1/4	3513	40°	K081377HD	98 7/8	2511	40°	K100983HD				
				100	2539	40°	K100994HD				
				101 1/2	2579	40°	K101010HD				
				102	2591	40°	K101015HD				
				109 5/8	2786	40°	K101091HD				
				112	2846	40°	K101115HD				

Size Lists



Micro-V AT® Belts - Listed by Number

Showing Belt Numbers with Corresponding Nominal Outside Lengths, Top Widths and Angles

Belt No.	Length (in)	Length (mm)	Top Width (in)	Top Width (mm)	Angle	Belt No.	Length (in)	Length (mm)	Top Width (in)	Top Width (mm)	Angle
2PJ800	31 7/8	810	3/16	4.7	40°	K040315	32 1/4	818	9/16	14	40°
2PJ836	33 1/4	846	3/16	4.7	40°	K040319	32 1/2	824	9/16	14	40°
2PJ845	33 5/8	855	3/16	4.7	40°	K040320	32 3/4	831	9/16	14	40°
2PJ860	34 1/4	870	3/16	4.7	40°	K040322	32 7/8	836	9/16	14	40°
2PJ905	36	915	3/16	4.7	40°	K040325	33 1/4	844	9/16	14	40°
6PK1190	46 27/32	1190	13/16	21	40°	K040329	33 3/8	849	9/16	14	40°
6PK1660	65 1/2	1660	13/16	21	40°	K040330	33 3/4	856	9/16	14	40°
6PK1856	73	1856	13/16	21	40°	K040332	33 3/4	858	9/16	14	40°
6PK1880	74 7/16	1877	13/16	21	40°	K040335	34	864	9/16	14	40°
6PK1882	73 7/8	1882	13/16	21	40°	K040336	34 1/8	867	9/16	14	40°
6PK1890	74 13/32	1890	13/16	21	40°	K040337	34 1/4	871	9/16	14	40°
6PK2090	82 1/4	2090	13/16	21	40°	K040338	34 3/8	874	9/16	14	40°
7PK1930	76	1930	15/16	24	40°	K040340	34 5/8	881	9/16	14	40°
7PK2164	85 1/8	2164	15/16	24	40°	K040343	34 7/8	885	9/16	14	40°
7PK2217	87 9/32	2217	15/16	24	40°	K040345	35	889	9/16	14	40°
DK050565	* 57 3/4	1468	21/32	17	40°	K040346	35 1/4	894	9/16	14	40°
DK050610	* 62 1/8	1579	21/32	17	40°	K040347	35 3/8	897	9/16	14	40°
DK060472	* 48 1/2	1232	13/16	20	40°	K040350	35 5/8	906	9/16	14	40°
DK060519	* 53	1348	13/16	20	40°	K040353	35 7/8	912	9/16	14	40°
DK060674	* 68 1/2	1741	13/16	20	40°	K040355	36 1/8	918	9/16	14	40°
DK060702	* 71 1/4	1811	13/16	20	40°	K040358	36 3/8	924	9/16	14	40°
DK060718	* 73	1853	13/16	20	40°	K040360	36 3/4	932	9/16	14	40°
DK060725	* 73 3/4	1872	13/16	20	40°	K040365	37 1/8	943	9/16	14	40°
DK060729	* 74 1/4	1885	13/16	20	40°	K040370	37 1/2	954	9/16	14	40°
DK060791	* 80 3/8	2043	13/16	20	40°	K040372	38	964	9/16	14	40°
DK060867	* 87 7/8	2232	13/16	24	40°	K040378	38 1/2	977	9/16	14	40°
DK060956	* 95 3/4	2432	13/16	20	40°	K040382	38 3/4	983	9/16	14	40°
DK060973	* 98 5/8	2504	13/16	20	40°	K040384	39	990	9/16	14	40°
DK070536	* 54 7/8	1394	15/16	24	40°	K040385	39 1/8	993	9/16	14	40°
DK070551	* 56 3/8	1432	15/16	24	40°	K040388	39 3/8	999	9/16	14	40°
DK070817	* 82 7/8	2105	15/16	24	40°	K040390	39 3/4	1008	9/16	14	40°
DK071135	* 114 1/8	2899	15/16	24	40°	K040395	40 1/4	1020	9/16	14	40°
DK080534	* 54	1370	1 3/32	28	40°	K040398	40 3/8	1027	9/16	14	40°
DK081254	* 126	3200	1 3/32	28	40°	K040399	40 5/8	1030	9/16	14	40°
DK081403	* 140 7/8	3579	1 3/32	28	40°	K040400	40 3/4	1035	9/16	14	40°
DK100709	* 71 1/2	1817	1 3/8	35	40°	K040405	41 1/4	1050	9/16	14	40°
J060293	29 3/4	755	9/16	14	40°	K040410	41 5/8	1060	9/16	14	40°
J060328	33 1/2	850	9/16	14	40°	K040413	42 1/8	1068	9/16	14	40°
K030195	20	509	13/32	11	40°	K040415	42	1068	9/16	14	40°
K030220	22 5/8	576	13/32	11	40°	K040418	42 3/8	1075	9/16	14	40°
K030236	24 1/4	615	13/32	11	40°	K040420	42 5/8	1085	9/16	14	40°
K030240	24 3/4	629	13/32	11	40°	K040425	43 1/8	1095	9/16	14	40°
K030243	24 7/8	632	13/32	11	40°	K040430	43 3/4	1110	9/16	14	40°
K030245	25 1/4	640	13/32	11	40°	K040438	44 3/8	1125	9/16	14	40°
K030250	25 3/4	654	13/32	11	40°	K040440	44 3/4	1135	9/16	14	40°
K030265	27 1/8	689	13/32	11	40°	K040445	45 1/4	1150	9/16	14	40°
K030267	27 3/8	695	13/32	11	40°	K040450	45 3/4	1160	9/16	14	40°
K030280	28 3/4	730	13/32	11	40°	K040457	46 1/4	1175	9/16	11	40°
K030290	29 3/4	755	13/32	11	40°	K040460	46 5/8	1185	9/16	14	40°
K030295	30 1/8	765	13/32	11	40°	K040465	47	1195	9/16	14	40°
K030299	30 1/2	775	13/32	11	40°	K040470	47 3/4	1215	9/16	14	40°
K030300	30 3/4	781	13/32	11	40°	K040476	48 1/8	1223	9/16	14	40°
K030310	31 5/8	805	13/32	11	40°	K040488	49 3/8	1254	9/16	14	40°
K030323	32 7/8	836	13/32	11	40°	K040490	49 1/2	1255	9/16	14	40°
K030328	33 1/2	850	13/32	11	40°	K040500	50 5/8	1285	9/16	14	40°
K030334	34	864	13/32	11	40°	K040506	51 1/8	1300	9/16	14	40°
K030338	34 3/8	874	13/32	11	40°	K040510	51 1/2	1310	9/16	14	40°
K030340	34 5/8	881	13/32	11	40°	K040512	51 3/4	1315	9/16	14	40°
K030350	35 5/8	906	13/32	11	40°	K040514	52	1320	9/16	14	40°
K030365	37 1/8	943	13/32	11	40°	K040517	52 1/8	1325	9/16	14	40°
K030384	39 1/8	993	13/32	11	40°	K040520	52 5/8	1335	9/16	14	40°
K030390	39 3/4	1008	13/32	11	40°	K040525	53 1/8	1349	9/16	14	40°
K030395	40 1/4	1021	13/32	11	40°	K040529	53 1/2	1359	9/16	14	40°
K030415	42 1/8	1068	13/32	11	40°	K040535	54	1370	9/16	14	40°
K030425	43 1/8	1095	13/32	11	40°	K040545	55	1395	9/16	14	40°
K030441	44 3/4	1135	13/32	11	40°	K040551	55 5/8	1414	9/16	14	40°
K030455	46	1170	13/32	11	40°	K040560	56 1/2	1435	9/16	14	40°
K030471	47 3/4	1212	13/32	11	40°	K040575	58 1/8	1475	9/16	14	40°
K040220	22 5/8	575	9/16	14	40°	K040595	60	1525	9/16	14	40°
K040233	24 1/2	622	9/16	14	40°	K040620	62 5/8	1591	9/16	14	40°
K040245	25 1/4	640	9/16	14	40°	K040630	63 5/8	1615	9/16	14	40°
K040250	25 3/4	654	9/16	14	40°	K040635	64	1627	9/16	14	40°
K040270	27 3/4	704	9/16	14	40°	K040685	69 1/8	1755	9/16	14	40°
K040274	28	710	9/16	14	40°	K040745	75 1/8	1905	9/16	14	40°
K040275	28 1/4	717	9/16	14	40°	K040762	76 7/8	1952	9/16	14	40°
K040285	29 1/4	742	9/16	14	40°	K040882	88 3/4	2255	9/16	14	40°
K040292	29 3/4	755	9/16	14	40°	K040940	94 5/8	2405	9/16	14	40°
K040300	30 3/4	781	9/16	14	40°	K050200	20 3/4	527	21/32	17	40°
K040305	31 1/4	793	9/16	14	40°	K050271	27 3/4	704	21/32	17	40°
K040310	31 3/4	805	9/16	14	40°	K050275	28 1/4	717	21/32	17	40°

* Dual Sided Belt



Micro-V AT® Belts - Listed by Number

Belt No.	Length (in)	Length (mm)	Top Width (in)	Top Width (mm)	Angle	Belt No.	Length (in)	Length (mm)	Top Width (in)	Top Width (mm)	Angle
K050280	28 3/4	730	21/32	17	40°	K050755	76	1932	21/32	17	40°
K050290	29 3/4	755	21/32	17	40°	K050757	76 1/4	1937	21/32	17	40°
K050316	32 1/4	818	21/32	17	40°	K050778	78 3/8	1989	21/32	17	40°
K050317	32 1/2	824	21/32	17	40°	K050817	82 1/2	2096	21/32	17	40°
K050321	32 3/4	831	21/32	17	40°	K050825	83 1/8	2112	21/32	17	40°
K050323	33	837	21/32	17	40°	K050835	84	2134	21/32	17	40°
K050326	33 1/4	843	21/32	17	40°	K050836	84 1/8	2138	21/32	17	40°
K050330	33 3/4	856	21/32	17	40°	K050845	85 1/8	2164	21/32	17	40°
K050335	34	864	21/32	17	40°	K050855	86 1/8	2187	21/32	17	40°
K050336	34 3/8	872	21/32	17	40°	K050887	89 1/8	2265	21/32	17	40°
K050340	34 5/8	881	21/32	17	40°	K060288	29 1/2	748	13/16	20	40°
K050344	35	889	21/32	17	40°	K060295	30 1/8	765	13/16	20	40°
K050345	35 1/4	894	21/32	17	40°	K060305	31 1/4	793	13/16	20	40°
K050350	35 5/8	906	21/32	17	40°	K060325	33 1/4	844	13/16	20	40°
K050355	36 1/8	918	21/32	17	40°	K060331	33 3/4	856	13/16	20	40°
K050360	36 3/4	932	21/32	17	40°	K060338	34 3/8	873	13/16	20	40°
K050364	37	939	21/32	17	40°	K060340	34 3/4	881	13/16	20	40°
K050365	37 1/8	943	21/32	17	40°	K060345	35 1/4	894	13/16	20	40°
K050368	37 3/8	949	21/32	17	40°	K060355	36 1/8	918	13/16	20	40°
K050370	37 3/4	957	21/32	17	40°	K060365	37 1/8	943	13/16	20	40°
K050375	38 1/4	970	21/32	17	40°	K060370	37 3/4	957	13/16	20	40°
K050380	38 3/4	983	21/32	17	40°	K060374	38	964	13/16	20	40°
K050385	39 1/4	996	21/32	17	40°	K060380	38 3/4	983	13/16	20	40°
K050390	39 3/4	1008	21/32	17	40°	K060385	39 1/8	993	13/16	20	40°
K050396	40 1/4	1021	21/32	17	40°	K060388	39 3/8	999	13/16	20	40°
K050398	40 3/8	1027	21/32	17	40°	K060390	39 3/4	1008	13/16	20	40°
K050400	40 5/8	1031	21/32	17	40°	K060393	39 7/8	1012	13/16	20	40°
K050402	40 3/4	1035	21/32	17	40°	K060400	40 3/4	1034	13/16	20	40°
K050405	41 1/4	1047	21/32	17	40°	K060405	41	1043	13/16	20	40°
K050407	41 3/8	1050	21/32	17	40°	K060406	41 1/4	1050	13/16	20	40°
K050410	41 3/4	1059	21/32	17	40°	K060407	41 3/8	1052	13/16	20	40°
K050415	42 1/8	1068	21/32	17	40°	K060408	41 1/2	1054	13/16	20	40°
K050418	42 3/8	1076	21/32	17	40°	K060409	41 5/8	1056	13/16	20	40°
K050420	42 5/8	1084	21/32	17	40°	K060410	41 3/4	1059	13/16	20	40°
K050425	43 1/8	1095	21/32	17	40°	K060415	42 1/8	1069	13/16	20	40°
K050429	43 1/2	1103	21/32	17	40°	K060418	42 3/8	1076	13/16	20	40°
K050433	43 3/4	1113	21/32	17	40°	K060420	42 1/2	1081	13/16	20	40°
K050435	44 1/8	1122	21/32	17	40°	K060423	42 7/8	1089	13/16	20	40°
K050438	44 1/2	1129	21/32	17	40°	K060425	43 1/8	1095	13/16	20	40°
K050440	44 3/4	1135	21/32	17	40°	K060426	43 1/8	1096	13/16	20	40°
K050446	45 1/8	1148	21/32	17	40°	K060427	43 1/2	1103	13/16	20	40°
K050448	45 3/8	1152	21/32	17	40°	K060431	43 3/4	1111	13/16	20	40°
K050450	45 5/8	1160	21/32	17	40°	K060434	43 7/8	1116	13/16	20	40°
K050455	46	1170	21/32	17	40°	K060435	44 1/8	1122	13/16	20	40°
K050459	46 3/8	1179	21/32	17	40°	K060439	44 1/2	1129	13/16	20	40°
K050460	46 5/8	1186	21/32	17	40°	K060441	44 3/4	1135	13/16	20	40°
K050470	47 5/8	1211	21/32	17	40°	K060445	45 1/8	1148	13/16	20	40°
K050474	47 7/8	1218	21/32	17	40°	K060448	45 3/8	1153	13/16	20	40°
K050478	48 3/8	1228	21/32	17	40°	K060450	45 5/8	1160	13/16	20	40°
K050480	48 5/8	1237	21/32	17	40°	K060455	46	1170	13/16	20	40°
K050486	49 1/8	1249	21/32	17	40°	K060458	46 3/8	1179	13/16	20	40°
K050490	49 1/2	1258	21/32	17	40°	K060461	46 5/8	1186	13/16	20	40°
K050500	50 5/8	1286	21/32	17	40°	K060465	47	1195	13/16	20	40°
K050505	51	1297	21/32	17	40°	K060468	47 3/8	1204	13/16	20	40°
K050507	51 1/8	1300	21/32	17	40°	K060470	47 5/8	1211	13/16	20	40°
K050510	51 3/4	1315	21/32	17	40°	K060473	47 7/8	1216	13/16	20	40°
K050516	52 1/4	1327	21/32	17	40°	K060474	47 7/8	1217	13/16	20	40°
K050520	52 5/8	1338	21/32	17	40°	K060478	48 1/4	1227	13/16	20	40°
K050523	52 7/8	1343	21/32	17	40°	K060480	48 5/8	1237	13/16	20	40°
K050530	53 1/2	1359	21/32	17	40°	K060483	48 7/8	1241	13/16	20	40°
K050532	53 7/8	1367	21/32	17	40°	K060486	49 1/8	1248	13/16	20	40°
K050538	54 3/8	1380	21/32	17	40°	K060490	49 1/2	1258	13/16	20	40°
K050545	55 1/4	1404	21/32	17	40°	K060492	49 3/4	1265	13/16	20	40°
K050551	55 3/4	1415	21/32	17	40°	K060494	50	1270	13/16	20	40°
K050565	57	1448	21/32	17	40°	K060495	50 1/8	1274	13/16	20	40°
K050570	57 1/2	1462	21/32	17	40°	K060500	50 3/4	1288	13/16	20	40°
K050586	59 1/4	1504	21/32	17	40°	K060505	51	1297	13/16	20	40°
K050609	61 1/2	1563	21/32	17	40°	K060507	51 1/8	1300	13/16	20	40°
K050612	61 3/4	1568	21/32	17	40°	K060509	51 1/2	1309	13/16	20	40°
K050618	62 3/8	1584	21/32	17	40°	K060512	51 3/4	1315	13/16	20	40°
K050625	63 1/8	1603	21/32	17	40°	K060514	52	1321	13/16	20	40°
K050630	63 5/8	1616	21/32	17	40°	K060516	52 1/8	1325	13/16	20	40°
K050635	64 1/8	1627	21/32	17	40°	K060520	52 3/4	1339	13/16	20	40°
K050640	64 5/8	1642	21/32	17	40°	K060523	52 7/8	1342	13/16	20	40°
K050644	65	1651	21/32	17	40°	K060525	53 3/8	1355	13/16	20	40°
K050647	65 1/4	1657	21/32	17	40°	K060529	53 1/2	1359	13/16	20	40°
K050650	65 5/8	1667	21/32	17	40°	K060532	53 7/8	1367	13/16	20	40°
K050653	65 7/8	1675	21/32	17	40°	K060535	54 1/4	1379	13/16	20	40°
K050658	66 3/8	1687	21/32	17	40°	K060539	54 1/2	1385	13/16	20	40°
K050660	66 3/4	1696	21/32	17	40°	K060547	55 1/4	1404	13/16	20	40°
K050665	67 1/8	1704	21/32	17	40°	K060551	55 3/4	1415	13/16	20	40°
K050690	69 3/4	1772	21/32	17	40°	K060555	56	1423	13/16	20	40°
K050705	71 1/8	1807	21/32	17	40°	K060557	56 1/4	1429	13/16	20	40°
K050715	72 1/8	1831	21/32	17	40°	K060559	56 1/2	1436	13/16	20	40°
K050720	72 5/8	1845	21/32	17	40°	K060560	56 5/8	1439	13/16	20	40°
K050750	75 3/8	1914	21/32	17	40°	K060563	56 7/8	1445	13/16	20	40°

Size Lists



Micro-V AT® Belts - Listed by Number

Belt No.	Length (in)	Length (mm)	Top Width (in)	Top Width (mm)	Angle	Belt No.	Length (in)	Length (mm)	Top Width (in)	Top Width (mm)	Angle
K060569	57 1/2	1462	13/16	20	40°	K060849	85 1/2	2171	13/16	20	40°
K060573	57 7/8	1471	13/16	20	40°	K060850	85 5/8	2175	13/16	20	40°
K060575	58	1473	13/16	20	40°	K060854	85 7/8	2182	13/16	20	40°
K060578	58 3/8	1483	13/16	20	40°	K060858	86 3/8	2193	13/16	20	40°
K060586	59 1/4	1504	13/16	20	40°	K060860	86 5/8	2201	13/16	20	40°
K060588	59 3/8	1508	13/16	20	40°	K060863	86 7/8	2206	13/16	20	40°
K060594	60	1523	13/16	20	40°	K060864	86 7/8	2208	13/16	20	40°
K060598	60 3/8	1534	13/16	20	40°	K060866	87 1/4	2216	13/16	20	40°
K060602	60 3/4	1542	13/16	20	40°	K060868	87 3/8	2219	13/16	20	40°
K060604	60 7/8	1547	13/16	20	40°	K060870	87 5/8	2225	13/16	20	40°
K060605	61 1/8	1553	13/16	20	40°	K060874	87 7/8	2233	13/16	20	40°
K060609	61 1/2	1563	13/16	20	40°	K060875	88 1/8	2238	13/16	20	40°
K060612	61 3/4	1569	13/16	20	40°	K060876	88 1/8	2239	13/16	20	40°
K060615	62 1/8	1577	13/16	20	40°	K060878	88 3/8	2245	13/16	20	40°
K060620	62 5/8	1591	13/16	20	40°	K060882	88 7/8	2257	13/16	20	40°
K060623	62 7/8	1598	13/16	20	40°	K060883	89	2261	13/16	20	40°
K060625	63 1/8	1603	13/16	20	40°	K060885	89 1/8	2263	13/16	20	40°
K060630	63 5/8	1616	13/16	20	40°	K060886	89 1/8	2265	13/16	20	40°
K060635	64 1/8	1627	13/16	20	40°	K060888	89 1/2	2273	13/16	20	40°
K060637	64 3/8	1634	13/16	20	40°	K060891	89 3/4	2278	13/16	20	40°
K060640	64 5/8	1642	13/16	20	40°	K060895	90 1/8	2289	13/16	20	40°
K060642	64 3/4	1646	13/16	20	40°	K060900	90 5/8	2301	13/16	20	40°
K060645	65	1651	13/16	20	40°	K060905	90 7/8	2308	13/16	20	40°
K060650	65 1/2	1665	13/16	20	40°	K060908	91 1/4	2318	13/16	20	40°
K060651	65 3/4	1669	13/16	21	40°	K060910	91 5/8	2329	13/16	20	40°
K060653	65 7/8	1674	13/16	20	40°	K060915	92 1/8	2340	13/16	20	40°
K060658	66 3/8	1687	13/16	20	40°	K060919	92 3/8	2347	13/16	20	40°
K060660	66 3/4	1696	13/16	20	40°	K060923	92 7/8	2360	13/16	20	40°
K060663	66 7/8	1699	13/16	20	40°	K060926	93 1/8	2364	13/16	20	40°
K060667	67 1/4	1708	13/16	20	40°	K060930	93 5/8	2377	13/16	20	40°
K060670	67 1/2	1716	13/16	20	40°	K060935	94	2387	13/16	20	40°
K060672	67 3/4	1722	13/16	20	40°	K060938	94 1/2	2400	13/16	20	40°
K060675	68	1728	13/16	20	40°	K060942	94 3/4	2407	13/16	20	40°
K060680	68 5/8	1742	13/16	20	40°	K060945	95 1/8	2415	13/16	20	40°
K060682	68 7/8	1750	13/16	20	40°	K060947	95 1/4	2419	13/16	20	40°
K060685	69 1/8	1756	13/16	20	40°	K060950	95 5/8	2428	13/16	20	40°
K060690	69 5/8	1767	13/16	20	40°	K060956	96 1/8	2440	13/16	20	40°
K060695	70	1777	13/16	20	40°	K060960	96 5/8	2452	13/16	20	40°
K060696	70 1/4	1783	13/16	20	40°	K060962	96 7/8	2460	13/16	20	40°
K060703	70 7/8	1799	13/16	20	40°	K060966	97 1/8	2468	13/16	20	40°
K060705	71 1/8	1807	13/16	20	40°	K060970	97 5/8	2479	13/16	20	40°
K060710	71 1/2	1816	13/16	20	40°	K060975	98 1/8	2492	13/16	20	40°
K060711	71 5/8	1820	13/16	20	40°	K060980	98 5/8	2505	13/16	20	40°
K060716	72	1830	13/16	20	40°	K060984	99	2513	13/16	20	40°
K060721	72 5/8	1845	13/16	20	40°	K060988	99 1/2	2526	13/16	20	40°
K060722	72 3/4	1848	13/16	20	40°	K060990	99 5/8	2531	13/16	20	40°
K060725	73 1/4	1859	13/16	20	40°	K060994	99 7/8	2537	13/16	20	40°
K060730	73 1/2	1867	13/16	20	40°	K060995	100	2539	13/16	20	40°
K060733	73 7/8	1876	13/16	20	40°	K060997	100 1/4	2546	13/16	20	40°
K060735	74 1/8	1881	13/16	20	40°	K061000	100 5/8	2555	13/16	20	40°
K060739	74 1/2	1893	13/16	20	40°	K061005	101 1/8	2568	13/16	20	40°
K060744	75	1904	13/16	20	40°	K061010	101 5/8	2581	13/16	20	40°
K060747	75 3/8	1914	13/16	20	40°	K061015	102 1/8	2593	13/16	20	40°
K060750	75 5/8	1921	13/16	20	40°	K061016	102 1/4	2596	13/16	20	40°
K060755	76	1932	13/16	20	40°	K061020	102 5/8	2605	13/16	20	40°
K060760	76 1/2	1942	13/16	20	40°	K061025	103	2615	13/16	20	40°
K060763	76 7/8	1951	13/16	20	40°	K061031	103 5/8	2633	13/16	20	40°
K060764	77	1957	13/16	20	40°	K061033	103 7/8	2639	13/16	20	40°
K060770	77 3/8	1967	13/16	20	40°	K061037	104 1/4	2649	13/16	20	40°
K060771	77 5/8	1971	13/16	20	40°	K061045	105	2666	13/16	20	40°
K060772	77 7/8	1977	13/16	20	40°	K061049	105 1/2	2680	13/16	20	40°
K060775	78	1982	13/16	20	40°	K061054	106	2692	13/16	20	40°
K060780	78 5/8	1996	13/16	20	40°	K061058	106 3/8	2701	13/16	20	40°
K060785	79	2007	13/16	20	40°	K061066	107 1/8	2722	13/16	20	40°
K060787	79 1/8	2010	13/16	20	40°	K061073	107 7/8	2741	13/16	20	40°
K060790	79 1/2	2018	13/16	20	40°	K061075	108 1/8	2746	13/16	20	40°
K060795	80 1/8	2034	13/16	20	40°	K061080	108 3/4	2761	13/16	20	40°
K060798	80 3/8	2040	13/16	20	40°	K061093	109 3/4	2788	13/16	20	40°
K060802	80 3/4	2051	13/16	20	40°	K061098	109 3/8	2780	13/16	20	40°
K060804	81	2057	13/16	20	40°	K061099	110 1/2	2807	13/16	20	40°
K060806	81 1/8	2061	13/16	20	40°	K061105	111 1/8	2824	13/16	20	40°
K060810	81 5/8	2073	13/16	20	40°	K061110	111 5/8	2835	13/16	20	40°
K060815	82 1/8	2085	13/16	20	40°	K061115	111 7/8	2841	13/16	20	40°
K060819	82 1/2	2093	13/16	20	40°	K061120	112 1/2	2859	13/16	20	40°
K060820	82 1/2	2096	13/16	20	40°	K061123	112 7/8	2869	13/16	20	40°
K060822	82 3/4	2102	13/16	20	40°	K061130	113 5/8	2886	13/16	20	40°
K060825	83 1/8	2112	13/16	20	40°	K061140	114 1/2	2910	13/16	20	40°
K060827	83 1/4	2116	13/16	20	40°	K061141	114 5/8	2911	13/16	20	40°
K060828	83 3/8	2119	13/16	20	40°	K061145	115 1/4	2927	13/16	20	40°
K060832	83 3/4	2127	13/16	20	40°	K061177	118 1/4	3005	13/16	20	40°
K060834	84	2134	13/16	20	40°	K061187	119 1/4	3030	13/16	20	40°
K060837	84 1/4	2140	13/16	20	40°	K061195	120 1/8	3051	13/16	20	40°
K060840	84 1/2	2147	13/16	20	40°	K061203	120 7/8	3069	13/16	20	40°
K060841	84 5/8	2149	13/16	20	40°	K061230	123 5/8	3138	13/16	20	40°
K060842	84 3/4	2153	13/16	20	40°	K061247	125 1/4	3183	13/16	20	40°
K060845	85 1/4	2165	13/16	20	40°	K061251	125 5/8	3192	13/16	20	40°

Size Lists



Micro-V AT® Belts - Listed by Number

Belt No.	Length (in)	Length (mm)	Top Width (in)	Top Width (mm)	Angle	Belt No.	Length (in)	Length (mm)	Top Width (in)	Top Width (mm)	Angle
K061360	136 1/2	3467	13/16	20	40°	K071141	114 5/8	2912	15/16	24	40°
K061369	137 1/2	3492	13/16	20	40°	K071150	115 5/8	2936	15/16	24	40°
K061373	137 7/8	3502	13/16	20	40°	K071157	116 1/4	2953	15/16	24	40°
K061380	138 5/8	3519	13/16	20	40°	K071194	119 7/8	3046	15/16	24	40°
K061420	142 1/2	3621	13/16	20	40°	K071247	125 3/8	3183	15/16	24	40°
K061490	149 1/2	3799	13/16	20	40°	K080300	30 3/4	781	1 3/32	28	40°
K070319	32 1/2	824	15/16	24	40°	K080330	33 3/4	856	1 3/32	28	40°
K070362	36 7/8	936	15/16	24	40°	K080360	36 3/4	932	1 3/32	28	40°
K070370	37 3/4	957	15/16	24	40°	K080365	37 1/8	943	1 3/32	28	40°
K070390	39 3/4	1008	15/16	24	40°	K080370	37 3/4	957	1 3/32	28	40°
K070415	42	1068	15/16	24	40°	K080375	38 1/8	968	1 3/32	28	40°
K070425	43 1/8	1095	15/16	24	40°	K080382	38 3/4	983	1 3/32	28	40°
K070448	45 3/8	1153	15/16	24	40°	K080384	39	990	1 3/32	28	40°
K070491EMD	49 5/8	1261	15/16	24	40°	K080390	39 3/4	1008	1 3/32	28	40°
K070500	50 5/8	1286	15/16	24	40°	K080392	39 7/8	1014	1 3/32	28	40°
K070505	51 1/8	1300	15/16	24	40°	K080400	40 3/4	1034	1 3/32	28	40°
K070539	54 1/2	1385	15/16	24	40°	K080408	41 3/8	1051	1 3/32	28	40°
K070553	55 7/8	1418	15/16	24	40°	K080415	42 1/8	1069	1 3/32	28	40°
K070610	61 5/8	1564	15/16	24	40°	K080424	43	1091	1 3/32	28	40°
K070622	62 3/4	1594	15/16	24	40°	K080427	43 1/2	1103	1 3/32	28	40°
K070628	63 3/8	1609	15/16	24	40°	K080435	44 1/8	1122	1 3/32	28	40°
K070630	63 5/8	1616	15/16	24	40°	K080450	45 5/8	1160	1 3/32	28	40°
K070640	64 5/8	1642	15/16	24	40°	K080455	46	1170	1 3/32	28	40°
K070644	65	1651	15/16	24	40°	K080458	46 3/8	1179	1 3/32	28	40°
K070649	66 1/2	1688	15/16	24	40°	K080465	47	1195	1 3/32	28	40°
K070653	65 7/8	1675	15/16	24	40°	K080471	47 3/4	1211	1 3/32	28	40°
K070655	66	1678	15/16	24	40°	K080485	49 1/8	1249	1 3/32	28	40°
K070669	67 1/2	1714	15/16	24	40°	K080491	49 5/8	1260	1 3/32	28	40°
K070673	67 3/4	1722	15/16	24	40°	K080496	50 1/8	1274	1 3/32	28	40°
K070677	68 1/4	1734	15/16	24	40°	K080505	51	1297	1 3/32	28	40°
K070680	68 5/8	1743	15/16	24	40°	K080510	51 1/2	1309	1 3/32	28	40°
K070683	68 7/8	1750	15/16	24	40°	K080514	52	1320	1 3/32	28	40°
K070685	69 1/8	1756	15/16	24	40°	K080525	53 1/8	1351	1 3/32	28	40°
K070690	69 1/2	1767	15/16	24	40°	K080530	53 1/2	1359	1 3/32	28	40°
K070694	70	1779	15/16	24	40°	K080537	54 1/4	1379	1 3/32	28	40°
K070701	70 3/4	1796	15/16	24	40°	K080545	55 1/8	1399	1 3/32	28	40°
K070705	71 1/8	1807	15/16	24	40°	K080550	55 3/4	1415	1 3/32	28	40°
K070709	71 1/2	1816	15/16	24	40°	K080558	56 1/4	1429	1 3/32	28	40°
K070721	72 3/4	1847	15/16	24	40°	K080560	56 5/8	1439	1 3/32	28	40°
K070730	73 5/8	1870	15/16	24	40°	K080565	57	1448	1 3/32	28	40°
K070733	73 3/4	1874	15/16	24	40°	K080566	57 1/8	1452	1 3/32	28	40°
K070735	74 1/8	1883	15/16	24	40°	K080570	57 1/2	1462	1 3/32	28	40°
K070750	75 5/8	1920	15/16	24	40°	K080575	58 1/8	1475	1 3/32	28	40°
K070755	76 1/8	1933	15/16	24	40°	K080580	58 5/8	1490	1 3/32	28	40°
K070763	76 7/8	1951	15/16	24	40°	K080585	59	1499	1 3/32	28	40°
K070776	78	1982	15/16	24	40°	K080590	59 1/2	1512	1 3/32	28	40°
K070786	79 1/8	2011	15/16	24	40°	K080594	60	1523	1 3/32	28	40°
K070795	80	2033	15/16	24	40°	K080600	60 5/8	1538	1 3/32	28	40°
K070801	80 3/4	2051	15/16	24	40°	K080605	61 1/8	1553	1 3/32	28	40°
K070810	81 5/8	2073	15/16	24	40°	K080610	61 3/4	1569	1 3/32	28	40°
K070822	82 3/4	2102	15/16	24	40°	K080615	62 1/8	1577	1 3/32	28	40°
K070825	83 1/8	2112	15/16	24	40°	K080620	62 5/8	1591	1 3/32	28	40°
K070834	84	2133	15/16	24	40°	K080623	62 7/8	1598	1 3/32	28	40°
K070835	84	2134	15/16	24	40°	K080626	63 1/8	1603	1 3/32	28	40°
K070846	85 1/4	2164	15/16	24	40°	K080630	63 5/8	1616	1 3/32	28	40°
K070852	85 3/4	2178	15/16	24	40°	K080635	64 1/4	1633	1 3/32	28	40°
K070855	86 1/8	2187	15/16	24	40°	K080644	65	1651	1 3/32	28	40°
K070873	87 7/8	2232	15/16	24	40°	K080645	65 1/4	1657	1 3/32	28	40°
K070880	88 1/2	2249	15/16	24	40°	K080649	65 1/2	1665	1 3/32	28	40°
K070882	88 3/4	2255	15/16	24	40°	K080653	65 7/8	1674	1 3/32	28	40°
K070885	89 1/8	2263	15/16	24	40°	K080655	66 1/4	1683	1 3/32	28	40°
K070886	89 1/8	2265	15/16	24	40°	K080660	66 1/2	1691	1 3/32	28	40°
K070890	89 3/4	2278	15/16	24	40°	K080670	67 1/2	1716	1 3/32	28	40°
K070896	90 1/8	2289	15/16	24	40°	K080672	67 3/4	1722	1 3/32	28	40°
K070901	90 5/8	2301	15/16	24	40°	K080675	68	1728	1 3/32	28	40°
K070903	90 7/8	2308	15/16	24	40°	K080677	68 1/4	1734	1 3/32	28	40°
K070905	91 1/8	2314	15/16	24	40°	K080680	68 5/8	1742	1 3/32	28	40°
K070916	92 1/4	2343	15/16	24	40°	K080685	69 1/8	1756	1 3/32	28	40°
K070922	92 3/4	2357	15/16	24	40°	K080690	69 5/8	1767	1 3/32	28	40°
K070924	93	2362	15/16	24	40°	K080694	70	1777	1 3/32	28	40°
K070931	93 5/8	2378	15/16	24	40°	K080700	70 1/2	1789	1 3/32	28	40°
K070951	95 3/4	2431	15/16	24	40°	K080702	70 3/4	1798	1 3/32	28	40°
K070971	97 3/4	2481	15/16	24	40°	K080708	71 1/4	1811	1 3/32	28	40°
K070975	97 3/4	2484	15/16	24	40°	K080710	71 1/2	1816	1 3/32	28	40°
K070976	98 1/8	2492	15/16	24	40°	K080716	72 1/8	1831	1 3/32	28	40°
K071005	101 1/8	2568	15/16	24	40°	K080720	72 5/8	1845	1 3/32	28	40°
K071009	101 3/8	2576	15/16	24	40°	K080726	73 1/4	1859	1 3/32	28	40°
K071013	101 7/8	2586	15/16	24	40°	K080730	73 1/2	1867	1 3/32	28	40°
K071031	103 5/8	2633	15/16	24	40°	K080733	73 3/4	1874	1 3/32	28	40°
K071037	104 1/4	2649	15/16	24	40°	K080734	74	1880	1 3/32	28	40°
K071040	104 5/8	2656	15/16	24	40°	K080738	74 3/8	1889	1 3/32	28	40°
K071045	105 1/8	2671	15/16	24	40°	K080740	74 5/8	1896	1 3/32	28	40°
K071056	106 1/4	2699	15/16	24	40°	K080745	75 1/8	1907	1 3/32	28	40°
K071065	107 1/8	2720	15/16	24	40°	K080751	75 5/8	1921	1 3/32	28	40°
K071130	113 5/8	2886	15/16	24	40°	K080755	76	1931	1 3/32	28	40°
K071134	114	2897	15/16	24	40°	K080760	76 1/2	1942	1 3/32	28	40°

Size Lists



Micro-V AT® Belts - Listed by Number

Belt No.	Length (in)	Length (mm)	Top Width (in)	Top Width (mm)	Angle	Belt No.	Length (in)	Length (mm)	Top Width (in)	Top Width (mm)	Angle
K080765	77	1957	1 3/32	28	40°	K100535	54	1373	1 3/8	35	40°
K080774	77 3/4	1976	1 3/32	28	40°	K100540	54 1/2	1385	1 3/8	35	40°
K080776	78 1/8	1985	1 3/32	28	40°	K100554	56	1423	1 3/8	35	40°
K080780	78 5/8	1996	1 3/32	28	40°	K100563	56 7/8	1444	1 3/8	35	40°
K080785	79	2007	1 3/32	28	40°	K100570	57 1/2	1462	1 3/8	35	40°
K080790	79 1/2	2019	1 3/32	28	40°	K100572	57 7/8	1469	1 3/8	35	40°
K080797	80 1/8	2037	1 3/32	28	40°	K100575	58 1/8	1475	1 3/8	35	40°
K080806	81 1/8	2061	1 3/32	28	40°	K100579	58 1/2	1487	1 3/8	35	40°
K080810	81 5/8	2073	1 3/32	28	40°	K100594	60	1523	1 3/8	35	40°
K080816	82 1/8	2086	1 3/32	28	40°	K100607	61 1/4	1557	1 3/8	35	40°
K080817	82 3/8	2091	1 3/32	28	40°	K100610	61 5/8	1564	1 3/8	35	40°
K080820	82 3/4	2101	1 3/32	28	40°	K100618	62 3/8	1585	1 3/8	35	40°
K080825	83 1/8	2112	1 3/32	28	40°	K100630	63 5/8	1616	1 3/8	35	40°
K080830	83 3/4	2127	1 3/32	28	40°	K100637	64 1/4	1633	1 3/8	35	40°
K080839	84 3/8	2144	1 3/32	28	40°	K100640	64 5/8	1642	1 3/8	35	40°
K080842	84 3/4	2154	1 3/32	28	40°	K100655	66	1678	1 3/8	35	40°
K080855	86 1/8	2187	1 3/32	28	40°	K100658	66 3/8	1687	1 3/8	35	40°
K080859	86 3/8	2195	1 3/32	28	40°	K100665	67 1/8	1704	1 3/8	35	40°
K080865	87 1/8	2212	1 3/32	28	40°	K100670	67 1/2	1716	1 3/8	35	40°
K080872	87 3/4	2230	1 3/32	28	40°	K100675	68	1728	1 3/8	35	40°
K080876	88 1/8	2240	1 3/32	28	40°	K100677	68 1/4	1734	1 3/8	35	40°
K080878	88 3/8	2245	1 3/32	28	40°	K100710	71 1/2	1816	1 3/8	35	40°
K080893	89 7/8	2282	1 3/32	28	40°	K100719	72 3/8	1840	1 3/8	35	40°
K080897	90 3/8	2295	1 3/32	28	40°	K100731	73 5/8	1871	1 3/8	35	40°
K080903	90 7/8	2308	1 3/32	28	40°	K100739	74 1/2	1893	1 3/8	35	40°
K080910	91 5/8	2326	1 3/32	28	40°	K100771	77 3/4	1976	1 3/8	35	40°
K080915	92 1/8	2340	1 3/32	28	40°	K100789	79 1/2	2019	1 3/8	35	40°
K080922	92 3/4	2355	1 3/32	28	40°	K100810	81 5/8	2073	1 3/8	35	40°
K080926	93 1/8	2367	1 3/32	28	40°	K100840	84 5/8	2149	1 3/8	35	40°
K080934	93 7/8	2384	1 3/32	28	40°	K100852	85 7/8	2182	1 3/8	35	40°
K080939	94 1/2	2400	1 3/32	28	40°	K100891	89 3/4	2278	1 3/8	35	40°
K080944	95	2412	1 3/32	28	40°	K120281	28 3/4	730	1 21/32	42	40°
K080948	95 3/8	2424	1 3/32	28	40°	K120360	36 5/8	929	1 21/32	42	40°
K080952	95 3/4	2432	1 3/32	28	40°	K120390	39 3/4	1008	1 21/32	42	40°
K080956	96 1/4	2444	1 3/32	28	40°	K120400	40 3/4	1034	1 21/32	42	40°
K080968	97 1/2	2475	1 3/32	28	40°	K120410	41 1/2	1054	1 21/32	42	40°
K080981	98 5/8	2505	1 3/32	28	40°	K120525	53 1/8	1351	1 21/32	42	40°
K080986	99 1/8	2519	1 3/32	28	40°	K120559	56 1/2	1436	1 21/32	42	40°
K080991	99 5/8	2531	1 3/32	28	40°	K120594	60	1523	1 21/32	42	40°
K081000	100 5/8	2555	1 3/32	28	40°	K120606	61 1/8	1553	1 21/32	42	40°
K081005	101 1/8	2568	1 3/32	28	40°	K120610	61 3/4	1569	1 21/32	42	40°
K081020	102 5/8	2605	1 3/32	28	40°	K120702	70 3/4	1798	1 21/32	42	40°
K081023	102 7/8	2613	1 3/32	28	40°	K120720	72 5/8	1845	1 21/32	42	40°
K081035	104	2642	1 3/32	28	40°	K120738	74 3/8	1889	1 21/32	42	40°
K081074	108	2745	1 3/32	28	40°	K120815	82	2083	1 21/32	42	40°
K081079	108 1/2	2756	1 3/32	28	40°	K120842	84 3/4	2154	1 21/32	42	40°
K081088	109 3/8	2778	1 3/32	28	40°	K120864	86 7/8	2208	1 21/32	42	40°
K081092	109 3/4	2788	1 3/32	28	40°	K120872	87 3/4	2230	1 21/32	42	40°
K081102	110 3/4	2814	1 3/32	28	40°	K120878	88 3/8	2245	1 21/32	42	40°
K081124	113	2869	1 3/32	28	40°	K120891	89 5/8	2278	1 21/32	42	40°
K081145	115 1/8	2924	1 3/32	28	40°	K120901	90 5/8	2301	1 21/32	42	40°
K081153	116 1/4	2953	1 3/32	28	40°	K120903	90 7/8	2308	1 21/32	42	40°
K081177	118 1/4	3005	1 3/32	28	40°	K120911	91 3/4	2329	1 21/32	42	40°
K081189	119 1/2	3035	1 3/32	28	40°	K120924	93 1/8	2364	1 21/32	42	40°
K081196	120 1/8	3050	1 3/32	28	40°	K120931	93 3/4	2381	1 21/32	42	40°
K081207	121 3/8	3082	1 3/32	28	40°	K120964	97	2463	1 21/32	42	40°
K081213	121 7/8	3096	1 3/32	28	40°	K120979	98 1/8	2492	1 21/32	42	40°
K081223	122 3/4	3117	1 3/32	28	40°	K121039	104 1/2	2654	1 21/32	42	40°
K081253	125 7/8	3198	1 3/32	28	40°	K140345	35	890	1 15/16	49	40°
K081264	127	3227	1 3/32	28	40°	K140352	35 7/8	910	1 15/16	49	40°
K081265	127 1/8	3228	1 3/32	28	40°	K140370	37 1/2	954	1 15/16	49	40°
K081298	130 3/8	3312	1 3/32	28	40°	K140429	43 1/2	1106	1 15/16	49	40°
K081325	133 1/8	3381	1 3/32	28	40°	K140433	43 7/8	1116	1 15/16	49	40°
K081331	133 3/4	3396	1 3/32	28	40°	K140451	45 5/8	1160	1 15/16	49	40°
K081359	136 1/2	3468	1 3/32	28	40°	K140496	50 1/8	1274	1 15/16	49	40°
K081362	136 3/4	3499	1 3/32	28	40°	K140516	52 1/8	1325	1 15/16	49	40°
K081377	138 1/4	3513	1 3/32	28	40°	K140524	53 1/8	1350	1 15/16	49	40°
K081490	149 1/2	3799	1 3/32	28	40°	K140555	56	1422	1 15/16	49	40°
K090500	50 1/2	1282	1 7/32	31	40°	K140580	58 5/8	1490	1 15/16	49	40°
K090609	61 1/2	1562	1 7/32	31	40°	K140594	60	1523	1 15/16	49	40°
K100381	38 3/4	983	1 3/8	35	40°	K140597	60 3/8	1534	1 15/16	49	40°
K100437	44 1/4	1124	1 3/8	35	40°	K140603	60 7/8	1546	1 15/16	49	40°
K100445	45 1/8	1148	1 3/8	35	40°	K140618	62 3/8	1585	1 15/16	49	40°
K100456	46 1/8	1173	1 3/8	35	40°	K140627	63 3/8	1609	1 15/16	49	40°
K100465	47	1195	1 3/8	35	40°	K140662	66 3/4	1696	1 15/16	49	40°
K100485	48 7/8	1241	1 3/8	35	40°	K140682	68 3/4	1746	1 15/16	49	40°
K100495	50 1/8	1274	1 3/8	35	40°	K140700	70 1/2	1789	1 15/16	49	40°
K100502	50 3/4	1288	1 3/8	35	40°	K150759	76 3/8	1942	2 1/16	53	40°
K100510	51 1/2	1309	1 3/8	35	40°						

Size Lists



Micro-V AT® Belts - Listed by Size

Showing Nominal Belt Top Widths, Outside Lengths and Angles
with Our Corresponding Belt Numbers

Length (in)	Length (mm)	Angle	Belt No.	Length (in)	Length (mm)	Angle	Belt No.	Length (in)	Length (mm)	Angle	Belt No.
3/16 (4.7mm) Top Width				9/16" (14mm) Top Width				21/32" (17mm) Top Width			
31 7/8	810	40°	2PJ800	- Continued				- Continued			
33 1/4	846	40°	2PJ836	36 1/8	918	40°	K040355	34	864	40°	K050335
33 5/8	855	40°	2PJ845	36 3/8	924	40°	K040358	34 3/8	872	40°	K050336
34 1/4	870	40°	2PJ860	36 3/4	932	40°	K040360	34 5/8	881	40°	K050340
36	915	40°	2PJ905	37 1/8	943	40°	K040365	35	889	40°	K050344
13/32" (11mm) Top Width				37 1/2	954	40°	K040370	35 1/4	894	40°	K050345
20	509	40°	K030195	38	964	40°	K040372	35 5/8	906	40°	K050350
22 5/8	576	40°	K030220	38 1/2	977	40°	K040378	36 1/8	918	40°	K050355
24 1/4	615	40°	K030236	38 3/4	983	40°	K040382	36 3/4	932	40°	K050360
24 3/4	629	40°	K030240	39	990	40°	K040384	37	939	40°	K050364
24 7/8	632	40°	K030243	39 1/8	993	40°	K040385	37 1/8	943	40°	K050365
25 1/4	640	40°	K030245	39 3/8	999	40°	K040388	37 3/8	949	40°	K050368
25 3/4	654	40°	K030250	39 3/4	1008	40°	K040390	37 3/4	957	40°	K050370
27 1/8	689	40°	K030265	40 1/4	1020	40°	K040395	38 1/4	970	40°	K050375
27 3/8	695	40°	K030267	40 3/8	1027	40°	K040398	38 3/4	983	40°	K050380
28 3/4	730	40°	K030280	40 5/8	1030	40°	K040399	39 1/4	996	40°	K050385
29 3/4	755	40°	K030290	40 3/4	1035	40°	K040400	39 3/4	1008	40°	K050390
30 1/8	765	40°	K030295	41 1/4	1050	40°	K040405	40 1/4	1021	40°	K050396
30 1/2	775	40°	K030299	41 5/8	1060	40°	K040410	40 3/8	1027	40°	K050398
30 3/4	781	40°	K030300	42 1/8	1068	40°	K040413	40 5/8	1031	40°	K050400
31 5/8	805	40°	K030310	42	1068	40°	K040415	40 3/4	1035	40°	K050402
32 7/8	836	40°	K030323	42 3/8	1075	40°	K040418	41 1/4	1047	40°	K050405
33 1/2	850	40°	K030328	42 5/8	1085	40°	K040420	41 3/8	1050	40°	K050407
34	864	40°	K030334	43 1/8	1095	40°	K040425	41 3/4	1059	40°	K050410
34 3/8	874	40°	K030338	43 3/4	1110	40°	K040430	42 1/8	1068	40°	K050415
34 5/8	881	40°	K030340	44 3/8	1125	40°	K040438	42 3/8	1076	40°	K050418
35 5/8	906	40°	K030350	44 3/4	1135	40°	K040440	42 5/8	1084	40°	K050420
37 1/8	943	40°	K030365	45 1/4	1150	40°	K040445	43 1/8	1095	40°	K050425
39 1/8	993	40°	K030384	45 3/4	1160	40°	K040450	43 1/2	1103	40°	K050429
39 3/4	1008	40°	K030390	46 1/4	1175	40°	K040457	43 3/4	1113	40°	K050433
40 1/4	1021	40°	K030395	46 5/8	1185	40°	K040460	44 1/8	1122	40°	K050435
42 1/8	1068	40°	K030415	47	1195	40°	K040465	44 1/2	1129	40°	K050438
43 1/8	1095	40°	K030425	47 3/4	1215	40°	K040470	44 3/4	1135	40°	K050440
44 3/4	1135	40°	K030441	48 1/8	1223	40°	K040476	45 1/8	1148	40°	K050446
46	1170	40°	K030455	49 3/8	1254	40°	K040488	45 3/8	1152	40°	K050448
46 1/4	1175	40°	K040457	49 1/2	1255	40°	K040490	45 5/8	1160	40°	K050450
47 3/4	1212	40°	K030471	50 5/8	1285	40°	K040500	46	1170	40°	K050455
9/16" (14mm) Top Width				51 1/8	1300	40°	K040506	46 3/8	1179	40°	K050459
22 5/8	575	40°	K040220	51 1/2	1310	40°	K040510	46 5/8	1186	40°	K050460
24 1/2	622	40°	K040233	51 3/4	1315	40°	K040512	47 5/8	1211	40°	K050470
25 1/4	640	40°	K040245	52	1320	40°	K040514	47 7/8	1218	40°	K050474
25 3/4	654	40°	K040250	52 1/8	1325	40°	K040517	48 3/8	1228	40°	K050478
27 3/4	704	40°	K040270	52 5/8	1335	40°	K040520	48 5/8	1237	40°	K050480
28	710	40°	K040274	53 1/8	1349	40°	K040525	49 1/8	1249	40°	K050486
28 1/4	717	40°	K040275	53 1/2	1359	40°	K040529	49 1/2	1258	40°	K050490
29 1/4	742	40°	K040285	54	1370	40°	K040535	50 5/8	1286	40°	K050500
29 3/4	755	40°	J060293	55	1395	40°	K040545	51	1297	40°	K050505
29 3/4	755	40°	K040292	55 5/8	1414	40°	K040551	51 1/8	1300	40°	K050507
30 3/4	781	40°	K040300	56 1/2	1435	40°	K040560	51 3/4	1315	40°	K050510
31 1/4	793	40°	K040305	58 1/8	1475	40°	K040575	52 1/4	1327	40°	K050516
31 3/4	805	40°	K040310	60	1525	40°	K040595	52 5/8	1338	40°	K050520
32 1/4	818	40°	K040315	62 5/8	1591	40°	K040620	52 7/8	1343	40°	K050523
32 1/2	824	40°	K040319	63 5/8	1615	40°	K040630	53 1/2	1359	40°	K050530
32 3/4	831	40°	K040320	64	1627	40°	K040635	53 7/8	1367	40°	K050532
32 7/8	836	40°	K040322	69 1/8	1755	40°	K040685	54 3/8	1380	40°	K050538
33 1/4	844	40°	K040325	75 1/8	1905	40°	K040745	55 1/4	1404	40°	K050545
33 3/8	849	40°	K040329	76 7/8	1952	40°	K040762	55 3/4	1415	40°	K050551
33 1/2	850	40°	J060328	88 3/4	2255	40°	K040882	57	1448	40°	K050565
33 3/4	856	40°	K040330	94 5/8	2405	40°	K040940	57 1/2	1462	40°	K050570
33 3/4	858	40°	K040332	21/32" (17mm) Top Width				57 3/4	1468	40°	*DK050565
34	864	40°	K040335	20 3/4	527	40°	K050200	59 1/4	1504	40°	K050586
34 1/8	867	40°	K040336	27 3/4	704	40°	K050271	61 1/2	1563	40°	K050609
34 1/4	871	40°	K040337	28 1/4	717	40°	K050275	61 3/4	1568	40°	K050612
34 3/8	874	40°	K040338	28 3/4	730	40°	K050280	62 1/8	1579	40°	*DK050610
34 5/8	881	40°	K040340	29 3/4	755	40°	K050290	62 3/8	1584	40°	K050618
34 7/8	885	40°	K040343	32 1/4	818	40°	K050316	63 1/8	1603	40°	K050625
35	889	40°	K040345	32 1/2	824	40°	K050317	63 5/8	1616	40°	K050630
35 1/4	894	40°	K040346	32 3/4	831	40°	K050321	64 1/8	1627	40°	K050635
35 3/8	897	40°	K040347	33	837	40°	K050323	64 5/8	1642	40°	K050640
35 5/8	906	40°	K040350	33 1/4	843	40°	K050326	65	1651	40°	K050644
35 7/8	912	40°	K040353	33 3/4	856	40°	K050330	65 1/4	1657	40°	K050647
								65 5/8	1667	40°	K050650
								65 7/8	1675	40°	K050653

* Dual Sided Belt

Size Lists



Micro-V AT® Belts - Listed by Size

Length (in)	Length (mm)	Angle	Belt No.	Length (in)	Length (mm)	Angle	Belt No.	Length (in)	Length (mm)	Angle	Belt No.
21/32" (17mm) Top Width				13/16" (20mm) Top Width				13/16" (20mm) Top Width			
- Continued				- Continued				- Continued			
66 3/8	1687	40°	K050658	51 1/2	1309	40°	K060509	77	1957	40°	K060764
66 3/4	1696	40°	K050660	51 3/4	1315	40°	K060512	77 3/8	1967	40°	K060770
67 1/8	1704	40°	K050665	52	1321	40°	K060514	77 5/8	1971	40°	K060771
69 3/4	1772	40°	K050690	52 1/8	1325	40°	K060516	77 7/8	1977	40°	K060772
71 1/8	1807	40°	K050705	52 3/4	1339	40°	K060520	78	1982	40°	K060775
72 1/8	1831	40°	K050715	52 7/8	1342	40°	K060523	78 5/8	1996	40°	K060780
72 5/8	1845	40°	K050720	53	1348	40°	*DK060519	79	2007	40°	K060785
75 3/8	1914	40°	K050750	53 3/8	1355	40°	K060525	79 1/8	2010	40°	K060787
76	1932	40°	K050755	53 1/2	1359	40°	K060529	79 1/2	2018	40°	K060790
76 1/4	1937	40°	K050757	53 7/8	1367	40°	K060532	80 1/8	2034	40°	K060795
78 3/8	1989	40°	K050778	54 1/4	1379	40°	K060535	80 3/8	2040	40°	K060798
82 1/2	2096	40°	K050817	54 1/2	1385	40°	K060539	80 3/8	2043	40°	*DK060791
83 1/8	2112	40°	K050825	55 1/4	1404	40°	K060547	80 3/4	2051	40°	K060802
84	2134	40°	K050835	55 3/4	1415	40°	K060551	81	2057	40°	K060804
84 1/8	2138	40°	K050836	56	1423	40°	K060555	81 1/8	2061	40°	K060806
85 1/8	2164	40°	K050845	56 1/4	1429	40°	K060557	81 5/8	2073	40°	K060810
86 1/8	2187	40°	K050855	56 1/2	1436	40°	K060559	82 1/8	2085	40°	K060815
89 1/8	2265	40°	K050887	56 5/8	1439	40°	K060560	82 1/2	2093	40°	K060819
13/16" (20mm) Top Width				56 7/8	1445	40°	K060563	82 1/2	2096	40°	K060820
29 1/2	748	40°	K060288	57 1/2	1462	40°	K060569	82 3/4	2102	40°	K060822
30 1/8	765	40°	K060295	57 7/8	1471	40°	K060573	83 1/8	2112	40°	K060825
31 1/4	793	40°	K060305	58	1473	40°	K060575	83 1/4	2116	40°	K060827
33 1/4	844	40°	K060325	58 3/8	1483	40°	K060578	83 3/8	2119	40°	K060828
33 3/4	856	40°	K060331	59 1/4	1504	40°	K060586	83 3/4	2127	40°	K060832
34 3/8	873	40°	K060338	59 3/8	1508	40°	K060588	84	2134	40°	K060834
34 3/4	881	40°	K060340	60	1523	40°	K060594	84 1/4	2140	40°	K060837
35 1/4	894	40°	K060345	60 3/8	1534	40°	K060598	84 1/2	2147	40°	K060840
36 1/8	918	40°	K060355	60 3/4	1542	40°	K060602	84 5/8	2149	40°	K060841
37 1/8	943	40°	K060365	60 7/8	1547	40°	K060604	84 3/4	2153	40°	K060842
37 3/4	957	40°	K060370	61 1/8	1553	40°	K060605	85 1/4	2165	40°	K060845
38	964	40°	K060374	61 1/2	1563	40°	K060609	85 1/2	2171	40°	K060849
38 3/4	983	40°	K060380	61 3/4	1569	40°	K060612	85 5/8	2175	40°	K060850
39 1/8	993	40°	K060385	62 1/8	1577	40°	K060615	85 7/8	2182	40°	K060854
39 3/8	999	40°	K060388	62 5/8	1591	40°	K060620	86 3/8	2193	40°	K060858
39 3/4	1008	40°	K060390	62 7/8	1598	40°	K060623	86 5/8	2201	40°	K060860
39 7/8	1012	40°	K060393	63 1/8	1603	40°	K060625	86 7/8	2206	40°	K060863
40 3/4	1034	40°	K060400	63 5/8	1616	40°	K060630	86 7/8	2208	40°	K060864
41	1043	40°	K060405	64 1/8	1627	40°	K060635	87 1/4	2216	40°	K060866
41 1/4	1050	40°	K060406	64 3/8	1634	40°	K060637	87 3/8	2219	40°	K060868
41 3/8	1052	40°	K060407	64 5/8	1642	40°	K060640	87 5/8	2225	40°	K060870
41 1/2	1054	40°	K060408	64 3/4	1646	40°	K060642	87 7/8	2233	40°	K060874
41 5/8	1056	40°	K060409	65	1651	40°	K060645	88 1/8	2238	40°	K060875
41 3/4	1059	40°	K060410	65 1/2	1665	40°	K060650	88 1/8	2239	40°	K060876
42 1/8	1069	40°	K060415	65 7/8	1674	40°	K060653	88 3/8	2245	40°	K060878
42 3/8	1076	40°	K060418	66 3/8	1687	40°	K060658	88 7/8	2257	40°	K060882
42 1/2	1081	40°	K060420	66 3/4	1696	40°	K060660	89	2261	40°	K060883
42 7/8	1089	40°	K060423	66 7/8	1699	40°	K060663	89 1/8	2263	40°	K060885
43 1/8	1095	40°	K060425	67 1/4	1708	40°	K060667	89 1/8	2265	40°	K060886
43 1/8	1096	40°	K060426	67 1/2	1716	40°	K060670	89 1/2	2273	40°	K060888
43 1/2	1103	40°	K060427	67 3/4	1722	40°	K060672	89 3/4	2278	40°	K060891
43 3/4	1111	40°	K060431	68	1728	40°	K060675	90 1/8	2289	40°	K060895
43 7/8	1116	40°	K060434	68 1/2	1741	40°	*DK060674	90 5/8	2301	40°	K060900
44 1/8	1122	40°	K060435	68 5/8	1742	40°	K060680	90 7/8	2308	40°	K060905
44 1/2	1129	40°	K060439	68 7/8	1750	40°	K060682	91 1/4	2318	40°	K060908
44 3/4	1135	40°	K060441	69 1/8	1756	40°	K060685	91 5/8	2329	40°	K060910
45 1/8	1148	40°	K060445	69 5/8	1767	40°	K060690	92 1/8	2340	40°	K060915
45 3/8	1153	40°	K060448	70	1777	40°	K060695	92 3/8	2347	40°	K060919
45 5/8	1160	40°	K060450	70 1/4	1783	40°	K060696	92 7/8	2360	40°	K060923
46	1170	40°	K060455	70 7/8	1799	40°	K060703	93 1/8	2364	40°	K060926
46 3/8	1179	40°	K060458	71 1/8	1807	40°	K060705	93 5/8	2377	40°	K060930
46 5/8	1186	40°	K060461	71 1/4	1811	40°	*DK060702	94	2387	40°	K060935
47	1195	40°	K060465	71 1/2	1816	40°	K060710	94 1/2	2400	40°	K060938
47 3/8	1204	40°	K060468	71 5/8	1820	40°	K060711	94 3/4	2407	40°	K060942
47 5/8	1211	40°	K060470	72	1830	40°	K060716	95 1/8	2415	40°	K060945
47 7/8	1216	40°	K060473	72 5/8	1845	40°	K060721	95 1/4	2419	40°	K060947
47 7/8	1217	40°	K060474	72 3/4	1848	40°	K060722	95 5/8	2428	40°	K060950
48 1/4	1227	40°	K060478	73	1853	40°	*DK060718	95 3/4	2432	40°	*DK060956
48 1/2	1232	40°	*DK060472	73 1/4	1859	40°	K060725	96 1/8	2440	40°	K060956
48 5/8	1237	40°	K060480	73 1/2	1867	40°	K060730	96 5/8	2452	40°	K060960
48 7/8	1241	40°	K060483	73 3/4	1872	40°	*DK060725	96 7/8	2460	40°	K060962
49 1/8	1248	40°	K060486	73 7/8	1876	40°	K060733	97 1/8	2468	40°	K060966
49 1/2	1258	40°	K060490	74 1/8	1881	40°	K060735	97 5/8	2479	40°	K060970
49 3/4	1265	40°	K060492	74 1/4	1885	40°	*DK060729	98 1/8	2492	40°	K060975
50	1270	40°	K060494	74 1/2	1893	40°	K060739	98 5/8	2504	40°	*DK060973
50 1/8	1274	40°	K060495	75	1904	40°	K060744	98 5/8	2505	40°	K060980
50 3/4	1288	40°	K060500	75 3/8	1914	40°	K060747	99	2513	40°	K060984
51	1297	40°	K060505	75 5/8	1921	40°	K060750	99 1/2	2526	40°	K060988
51 1/8	1300	40°	K060507	76	1932	40°	K060755	99 5/8	2531	40°	K060990
				76 1/2	1942	40°	K060760	99 7/8	2537	40°	K060994
				76 7/8	1951	40°	K060763	100	2539	40°	K060995

* Dual Sided Belt

Size Lists



Micro-V AT® Belts - Listed by Size

Length (in)	Length (mm)	Angle	Belt No.	Length (in)	Length (mm)	Angle	Belt No.	Length (in)	Length (mm)	Angle	Belt No.
13/16" (20mm) Top Width				15/16" (24mm) Top Width				1 3/32" (28mm) Top Width			
- Continued				- Continued				- Continued			
100 1/4	2546	40°	K060997	67 1/2	1714	40°	K070669	39	990	40°	K080384
100 5/8	2555	40°	K061000	67 3/4	1722	40°	K070673	39 3/4	1008	40°	K080390
101 1/8	2568	40°	K061005	68 1/4	1734	40°	K070677	39 7/8	1014	40°	K080392
101 5/8	2581	40°	K061010	68 5/8	1743	40°	K070680	40 3/4	1034	40°	K080400
102 1/8	2593	40°	K061015	68 7/8	1750	40°	K070683	41 3/8	1051	40°	K080408
102 1/4	2596	40°	K061016	69 1/8	1756	40°	K070685	42 1/8	1069	40°	K080415
102 5/8	2605	40°	K061020	69 1/2	1767	40°	K070690	43	1091	40°	K080424
103	2615	40°	K061025	70	1779	40°	K070694	43 1/2	1103	40°	K080427
103 5/8	2633	40°	K061031	70 3/4	1796	40°	K070701	44 1/8	1122	40°	K080435
103 7/8	2639	40°	K061033	71 1/8	1807	40°	K070705	45 5/8	1160	40°	K080450
104 1/4	2649	40°	K061037	71 1/2	1816	40°	K070709	46	1170	40°	K080455
105	2666	40°	K061045	72 3/4	1847	40°	K070721	46 3/8	1179	40°	K080458
105 1/2	2680	40°	K061049	73 5/8	1870	40°	K070730	47	1195	40°	K080465
106	2692	40°	K061054	73 3/4	1874	40°	K070733	47 3/4	1211	40°	K080471
106 3/8	2701	40°	K061058	74 1/8	1883	40°	K070735	49 1/8	1249	40°	K080485
107 1/8	2722	40°	K061066	75 5/8	1920	40°	K070750	49 5/8	1260	40°	K080491
107 7/8	2741	40°	K061073	76	1930	40°	7PK1930	50 1/8	1274	40°	K080496
108 1/8	2746	40°	K061075	76 1/8	1933	40°	K070755	51	1297	40°	K080505
108 3/4	2761	40°	K061080	76 7/8	1951	40°	K070763	51 1/2	1309	40°	K080510
109 3/8	2780	40°	K061098	78	1982	40°	K070776	52	1320	40°	K080514
109 3/4	2788	40°	K061093	79 1/8	2011	40°	K070786	53 1/8	1351	40°	K080525
110 1/2	2807	40°	K061099	80	2033	40°	K070795	53 1/2	1359	40°	K080530
111 1/8	2824	40°	K061105	80 3/4	2051	40°	K070801	54	1370	40°	*DK080534
111 5/8	2835	40°	K061110	81 5/8	2073	40°	K070810	54 1/4	1379	40°	K080537
111 7/8	2841	40°	K061115	82 3/4	2102	40°	K070822	55 1/8	1399	40°	K080545
112 1/2	2859	40°	K061120	82 7/8	2105	40°	*DK070817	55 3/4	1415	40°	K080550
112 7/8	2869	40°	K061123	83 1/8	2112	40°	K070825	56 1/4	1429	40°	K080558
113 5/8	2886	40°	K061130	84	2133	40°	K070834	56 5/8	1439	40°	K080560
114 1/2	2910	40°	K061140	84	2134	40°	K070835	57	1448	40°	K080565
114 5/8	2911	40°	K061141	85 1/8	2164	40°	7PK2164	57 1/8	1452	40°	K080566
115 1/4	2927	40°	K061145	85 1/4	2164	40°	K070846	57 1/2	1462	40°	K080570
118 1/4	3005	40°	K061177	85 3/4	2178	40°	K070852	58 1/8	1475	40°	K080575
119 1/4	3030	40°	K061187	86 1/8	2187	40°	K070855	58 5/8	1490	40°	K080580
120 1/8	3051	40°	K061195	87 9/32	2217	40°	7PK2217	59	1499	40°	K080585
120 7/8	3069	40°	K061203	87 7/8	2232	40°	*DK060867	59 1/2	1512	40°	K080590
123 5/8	3138	40°	K061230	87 7/8	2232	40°	K070873	60	1523	40°	K080594
125 1/4	3183	40°	K061247	88 1/2	2249	40°	K070880	60 5/8	1538	40°	K080600
125 5/8	3192	40°	K061251	88 3/4	2255	40°	K070882	61 1/8	1553	40°	K080605
136 1/2	3467	40°	K061360	89 1/8	2263	40°	K070885	61 3/4	1569	40°	K080610
137 1/2	3492	40°	K061369	89 1/8	2265	40°	K070886	62 1/8	1577	40°	K080615
137 7/8	3502	40°	K061373	89 3/4	2278	40°	K070890	62 5/8	1591	40°	K080620
138 5/8	3519	40°	K061380	90 1/8	2289	40°	K070896	62 7/8	1598	40°	K080623
142 1/2	3621	40°	K061420	90 5/8	2301	40°	K070901	63 1/8	1603	40°	K080626
149 1/2	3799	40°	K061490	90 7/8	2308	40°	K070903	63 5/8	1616	40°	K080630
13/16" (21mm) Top Width				15/16" (24mm) Top Width				1 3/32" (28mm) Top Width			
46 27/32	1190	40°	6PK1190	91 1/8	2314	40°	K070905	64 1/4	1633	40°	K080635
65 1/2	1660	40°	6PK1660	92 1/4	2343	40°	K070916	65	1651	40°	K080644
65 3/4	1669	40°	K060651	92 3/4	2357	40°	K070922	65 1/4	1657	40°	K080645
73	1856	40°	6PK1856	93	2362	40°	K070924	65 1/2	1665	40°	K080649
74 7/16	1877	40°	6PK1880	93 5/8	2378	40°	K070931	65 7/8	1674	40°	K080653
73 7/8	1882	40°	6PK1882	95 3/4	2431	40°	K070951	66 1/4	1683	40°	K080655
74 13/32	1890	40°	6PK1890	97 3/4	2481	40°	K070971	66 1/2	1691	40°	K080660
82 1/4	2090	40°	6PK2090	97 3/4	2484	40°	K070975	67 1/2	1716	40°	K080670
15/16" (24mm) Top Width				1 3/32" (28mm) Top Width				1 3/32" (28mm) Top Width			
32 1/2	824	40°	K070319	98 1/8	2492	40°	K070976	67 3/4	1722	40°	K080672
36 7/8	936	40°	K070362	101 1/8	2568	40°	K071005	68	1728	40°	K080675
37 3/4	957	40°	K070370	101 3/8	2576	40°	K071009	68 1/4	1734	40°	K080677
39 3/4	1008	40°	K070390	101 7/8	2586	40°	K071013	68 5/8	1742	40°	K080680
42	1068	40°	K070415	103 5/8	2633	40°	K071031	69 1/8	1756	40°	K080685
43 1/8	1095	40°	K070425	104 1/4	2649	40°	K071037	69 5/8	1767	40°	K080690
45 3/8	1153	40°	K070448	104 5/8	2656	40°	K071040	70	1777	40°	K080694
49 5/8	1261	40°	K070491EMD	105 1/8	2671	40°	K071045	70 1/2	1789	40°	K080700
50 5/8	1286	40°	K070500	106 1/4	2699	40°	K071056	70 3/4	1798	40°	K080702
51 1/8	1300	40°	K070505	107 1/8	2720	40°	K071065	71 1/4	1811	40°	K080708
54 1/2	1385	40°	K070539	113 5/8	2886	40°	K071130	71 1/2	1816	40°	K080710
54 7/8	1394	40°	*DK070536	114	2897	40°	K071134	72 1/8	1831	40°	K080716
55 7/8	1418	40°	K070553	114 1/8	2899	40°	*DK071135	72 5/8	1845	40°	K080720
56 3/8	1432	40°	*DK070551	114 5/8	2912	40°	K071141	73 1/4	1859	40°	K080726
61 5/8	1564	40°	K070610	115 5/8	2936	40°	K071150	73 1/2	1867	40°	K080730
62 3/4	1594	40°	K070622	116 1/4	2953	40°	K071157	73 3/4	1874	40°	K080733
63 3/8	1609	40°	K070628	119 7/8	3046	40°	K071194	74	1880	40°	K080734
63 5/8	1616	40°	K070630	125 3/8	3183	40°	K071247	74 3/8	1889	40°	K080738
64 5/8	1642	40°	K070640	1 3/32" (28mm) Top Width				74 5/8	1896	40°	K080740
65	1651	40°	K070644	30 3/4	781	40°	K080300	75 1/8	1907	40°	K080745
65 7/8	1675	40°	K070653	33 3/4	856	40°	K080330	75 5/8	1921	40°	K080751
66	1678	40°	K070655	36 3/4	932	40°	K080360	76	1931	40°	K080755
66 1/2	1688	40°	K070649	37 1/8	943	40°	K080365	76 1/2	1942	40°	K080760
				37 3/4	957	40°	K080370	77	1957	40°	K080765
				38 1/8	968	40°	K080375	77 3/4	1976	40°	K080774
				38 3/4	983	40°	K080382	78 1/8	1985	40°	K080776
								78 5/8	1996	40°	K080780
								79	2007	40°	K080785

* Dual Sided Belt

Size Lists

Micro-V AT® Belts - Listed by Size

Length (in)	Length (mm)	Angle	Belt No.	Length (in)	Length (mm)	Angle	Belt No.	Length (in)	Length (mm)	Angle	Belt No.
1 3/32" (28mm) Top Width				1 3/32" (28mm) Top Width				1 21/32" (42mm) Top Width			
- Continued				- Continued							
79 1/2	2019	40°	K080790	130 3/8	3312	40°	K081298	28 3/4	730	40°	K120281
80 1/8	2037	40°	K080797	133 1/8	3381	40°	K081325	36 5/8	929	40°	K120360
81 1/8	2061	40°	K080806	133 3/4	3396	40°	K081331	39 3/4	1008	40°	K120390
81 5/8	2073	40°	K080810	136 1/2	3468	40°	K081359	40 3/4	1034	40°	K120400
82 1/8	2086	40°	K080816	136 3/4	3499	40°	K081362	41 1/2	1054	40°	K120410
82 3/8	2091	40°	K080817	138 1/4	3513	40°	K081377	53 1/8	1351	40°	K120525
82 3/4	2101	40°	K080820	140 7/8	3579	40°	*DK081403	56 1/2	1436	40°	K120559
83 1/8	2112	40°	K080825	149 1/2	3799	40°	K081490	60	1523	40°	K120594
83 3/4	2127	40°	K080830	1 7/32" (31mm) Top Width				61 1/8	1553	40°	K120606
84 3/8	2144	40°	K080839	50 1/2	1282	40°	K090500	61 3/4	1569	40°	K120610
84 3/4	2154	40°	K080842	61 1/2	1562	40°	K090609	70 3/4	1798	40°	K120702
86 1/8	2187	40°	K080855	1 3/8" (35mm) Top Width				72 5/8	1845	40°	K120720
86 3/8	2195	40°	K080859	38 3/4	983	40°	K100381	74 3/8	1889	40°	K120738
87 1/8	2212	40°	K080865	44 1/4	1124	40°	K100437	82	2083	40°	K120815
87 3/4	2230	40°	K080872	45 1/8	1148	40°	K100445	84 3/4	2154	40°	K120842
88 1/8	2240	40°	K080876	46 1/8	1173	40°	K100456	86 7/8	2208	40°	K120864
88 3/8	2245	40°	K080878	47	1195	40°	K100465	87 3/4	2230	40°	K120872
89 7/8	2282	40°	K080893	48 7/8	1241	40°	K100485	88 3/8	2245	40°	K120878
90 3/8	2295	40°	K080897	50 1/8	1274	40°	K100495	89 5/8	2278	40°	K120891
90 7/8	2308	40°	K080903	50 3/4	1288	40°	K100502	90 5/8	2301	40°	K120901
91 5/8	2326	40°	K080910	51 1/2	1309	40°	K100510	90 7/8	2308	40°	K120903
92 1/8	2340	40°	K080915	54	1373	40°	K100535	91 3/4	2329	40°	K120911
92 3/4	2355	40°	K080922	54 1/2	1385	40°	K100540	93 1/8	2364	40°	K120924
93 1/8	2367	40°	K080926	56	1423	40°	K100554	93 3/4	2381	40°	K120931
93 7/8	2384	40°	K080934	56 7/8	1444	40°	K100563	97	2463	40°	K120964
94 1/2	2400	40°	K080939	57 1/2	1462	40°	K100570	98 1/8	2492	40°	K120979
95	2412	40°	K080944	57 7/8	1469	40°	K100572	104 1/2	2654	40°	K121039
95 3/8	2424	40°	K080948	58 1/8	1475	40°	K100575	1 15/16" (49mm) Top Width			
95 3/4	2432	40°	K080952	58 1/2	1487	40°	K100579	43 1/2	1106	40°	K140429
96 1/4	2444	40°	K080956	60	1523	40°	K100594	43 7/8	1116	40°	K140433
97 1/2	2475	40°	K080968	61 1/4	1557	40°	K100607	45 5/8	1160	40°	K140451
98 5/8	2505	40°	K080981	61 5/8	1564	40°	K100610	50 1/8	1274	40°	K140496
99 1/8	2519	40°	K080986	62 3/8	1585	40°	K100618	52 1/8	1325	40°	K140516
99 5/8	2531	40°	K080991	63 5/8	1616	40°	K100630	53 1/8	1350	40°	K140524
100 5/8	2555	40°	K081000	64 1/4	1633	40°	K100637	56	1422	40°	K140555
101 1/8	2568	40°	K081005	64 5/8	1642	40°	K100640	58 5/8	1490	40°	K140580
102 5/8	2605	40°	K081020	66	1678	40°	K100655	60	1523	40°	K140594
102 7/8	2613	40°	K081023	66 3/8	1687	40°	K100658	60 3/8	1534	40°	K140597
104	2642	40°	K081035	67 1/8	1704	40°	K100665	60 7/8	1546	40°	K140603
108	2745	40°	K081074	67 1/2	1716	40°	K100670	62 3/8	1585	40°	K140618
108 1/2	2756	40°	K081079	68	1728	40°	K100675	63 3/8	1609	40°	K140627
109 3/8	2778	40°	K081088	68 1/4	1734	40°	K100677	66 3/4	1696	40°	K140662
109 3/4	2788	40°	K081092	71 1/2	1816	40°	K100710	68 3/4	1746	40°	K140682
110 3/4	2814	40°	K081102	71 1/2	1817	40°	*DK100709	70 1/2	1789	40°	K140700
113	2869	40°	K081124	72 3/8	1840	40°	K100719	35	890	40°	K140345
115 1/8	2924	40°	K081145	73 5/8	1871	40°	K100731	35 7/8	910	40°	K140352
116 1/4	2953	40°	K081153	74 1/2	1893	40°	K100739	37 1/2	954	40°	K140370
118 1/4	3005	40°	K081177	77 3/4	1976	40°	K100771	2 1/16" (53mm) Top Width			
119 1/2	3035	40°	K081189	79 1/2	2019	40°	K100789	76 3/8	1942	40°	K150759
120 1/8	3050	40°	K081196	81 5/8	2073	40°	K100810				
121 3/8	3082	40°	K081207	84 5/8	2149	40°	K100840				
121 7/8	3096	40°	K081213	85 7/8	2182	40°	K100852				
122 3/4	3117	40°	K081223	89 3/4	2278	40°	K100891				
125 7/8	3198	40°	K081253								
126	3200	40°	*DK081254								
127	3227	40°	K081264								
127 1/8	3228	40°	K081265								

* Dual Sided Belt

Size Lists



Special Belts - Listed by Number

Showing Belt Numbers with Corresponding Nominal Outside Lengths, Top Widths and Angles

Belt No.	Length (in)	Length (mm)	Top Width (in)	Top Width (mm)	Angle	Belt No.	Length (in)	Length (mm)	Top Width (in)	Top Width (mm)	Angle
811.....	★ 22 1/2	572	1 1/8	29		5744.....	53 3/8	1355	1/2	12.5	36°
813.....	★ 26 3/4	679	1 1/8	29		6007.....	▼ 52	1320	1 3/16	30	28°
814.....	★ 31 1/2	800	1 1/8	29		6012.....	▼ 33 3/8	848	29/32	23	32°
822.....	★ 36	914	1	25		6013.....	▼ 36 3/4	933	29/32	23	30°
5500.....	▼ 56 1/4	1430	13/16	20	38°	6021.....	▼ 41 3/4	1059	1 3/16	30	32°
5501.....	71	1805	13/16	20	38°	6044.....	▼ 44 1/8	1120	1 3/16	30	32°
5502.....	64 3/4	1645	13/16	20	38°	6061.....	▼ 27 1/4	691	5/8	16	33°
5503.....	52	1320	13/16	20	38°	6069.....	▼ 43 1/8	1087	1 7/32	30	24°
5504.....	65	1650	13/16	20	38°	6083.....	▼ 43 1/2	1105	1 3/16	30	32°
5506.....	132	3355	21/32	16	40°	6092.....	▼ 45 1/2	1156	1 1/4	32	30°
5508.....	59	1500	3/8	10	39°	6096.....	▼ 46 5/8	1186	1 1/4	32	28°
5509.....	81	2055	3/8	10	40°	6098.....	▼ 40 3/8	1026	1 3/16	30	32°
5510.....	▼ 35 1/8	890	1/2	12	38°	6183.....	★ 15 1/2	395	5/16	8	
5511.....	54	1370	13/16	20	38°	6224.....	▼ 48 3/8	1229	1/2	13	42°
5512.....	67 1/8	1705	13/16	20	38°	6234.....	◇ 71 1/2	1815	1/2	12.5	36°
5513.....	55	1395	13/16	20	38°	6304.....	▼ 47	1194	1 1/4	32	28°
5516.....	◇ 58 1/2	1485	1/2	12/13	36°	6312.....	▼ 36 7/8	937	1 1/4	32	34°
5517.....	93 5/8	2378	1/2	12/13	40°	6314.....	▼ 45	1143	1 3/16	30	32°
5518.....	▼ 93 1/8	2365	1/2	12	38°	6316.....	▼ 56 1/8	1425	1 3/16	30	30°
5519.....	▼ 31 5/8	805	1/2	12.5	38°	6354 (180 Teeth)	56 3/4	1440	25/32	20	
5520.....	53	1346	13/16	20	38°	6370.....	31 7/8	810	1/2	12.5	37°
5521.....	50	1270	13/16	20	38°	6372.....	38 3/4	974	1/2	12.5	40°
5522.....	60 1/2	1535	13/16	20	40°	6375.....	◇ 74 3/8	1890	1/2	12.5	36°
5523.....	164	4165	21/32	16	40°	6376.....	36 3/4	933	1/2	12.5	40°
5524.....	115 1/2	2935	21/32	16	40°	6377.....	79 3/4	2025	1/2	12/13	40°
5525.....	118	3075	21/32	16	40°	6378.....	103 1/4	2625	1/2	12/13	40°
5526.....	142	3605	21/32	16	40°	6379.....	108 1/8	2745	1/2	12/13	40°
5527.....	◇ 53 3/4	1363	1/2	13	36°	6380.....	25 3/8	645	3/8	9.5	37°
5528.....	58	1475	1/2	13	38°	6384 (153 Teeth)	48 1/4	1225	1	25	
5529.....	▼ 42 7/8	1090	21/32	16	38°	6385 (140 Teeth)	44 1/8	1120	1	25	
5530.....	▼ 67 1/8	1705	1/2	12	38°	6386 (130 Teeth)	41	1040	1	25	
5533.....	51 7/8	1320	21/32	16	38°	6387.....	127 1/8	3230	1/2	13	40°
5534.....	69	1753	21/32	16	38°	6389.....	49 1/8	1245	1/4	6	42°
5535.....	155	3935	21/32	16	40°	6390.....	34 3/8	873	3/8	10	38°
5536.....	34 1/8	865	1/2	12	37°	6391.....	32 1/2	825	1/4	6	42°
5537.....	86 7/8	2205	21/32	16	40°	6392.....	32	815	1/4	6	42°
5538.....	113 1/2	2880	21/32	16	40°	6398.....	117 1/8	2975	1/2	12/13	40°
5539.....	▼ 76 7/8	1955	1 1/4	32	39°	6413 (65 Teeth)	◇ 24 3/8	619	3/8	9.5	
5700.....	68 1/4	1735	1/2	12.5	38°	6414 (61 Teeth)	◇ 22 7/8	581	3/8	9/10	
5701.....	110 1/2	2805	1/2	12.5	40°	6421 (68 Teeth)	25 1/2	650	5/16	8	
5707 (167 Teeth)	19 3/4	501	19/32	15		6548.....	83 1/8	2110	1/2	12/13	39°
5710.....	▼ 35 3/8	900	1 3/16	30	28°	6550.....	120 1/4	3055	1/2	12/13	40°
5716 (220 Teeth)	69 9/32	1760	25/32	20		6560.....	126 1/8	3205	1/2	13	40°
5718.....	44 5/8	1135	1 1/4	32	40°	6565.....	107 1/4	2725	1/2	13	39°
5724.....	54 7/8	1395	1/2	12.5	36°	6572.....	▼ 62 7/8	1590	1 1/8	31	38°
5725.....	48 7/8	1230	7/16	11	36°	6574.....	64 1/4	1630	1/2	13	40°
5726.....	57 3/8	1455	1/2	12.5	36°	6575.....	54 1/4	1377	1/2	13	38°
5731.....	35 1/2	900	3/8	9.5	36°	6582.....	90 5/8	2350	1/2	13	40°
5732.....	35 3/4	910	3/8	9.5	36°	6583.....	34 1/2	875	1/2	12.5	40°
5734.....	45 1/4	1150	1/2	12.5	36°	6589.....	29 3/4	755	3/8	9.5	37°
5735.....	37 7/8	960	1/2	12.5	36°	6596.....	44	1120	7/16	11	38°
5736.....	39	990	1/2	12.5	36°	6597.....	57	1450	7/16	11	38°
5737.....	48	1220	1/2	12.5	36°	6599.....	▼ 86 5/8	2200	1 15/32	37	38°
5738.....	49 3/8	1255	1/2	12.5	36°	6601.....	▼ 53	1346	1 1/8	29	38°
5740.....	54	1370	1/2	12.5	36°	6604.....	157	3988	7/8	22	40°
5741.....	36 1/2	925	1/2	12.5	36°	6697.....	35 1/2	900	3/16	5	60°
5742.....	44 3/4	1135	1/2	12.5	36°	6698.....	48 1/32	1220	9/32	7	60°
5743.....	43 7/8	1115	1/2	12.5	36°						

◇ Double-V Belt.
★ Flat Belt. Length Given Is Inside Circumference.

▼ Indicates Notched Belt.
◇ Timing Belt. Length Given is Pitch Length.

Size Lists





Special Belts - Listed by Size

Showing Nominal Belt Top Widths, Outside Lengths and Angles
with Our Corresponding Belt Numbers

Length (in)	Length (mm)	Angle	Belt No.	Length (in)	Length (mm)	Angle	Belt No.	Length (in)	Length (mm)	Angle	Belt No.
3/16" (5mm) Top Width				1/2" (12.5mm) Top Width				13/16" (20mm) Top Width			
35 1/2	900	60°	6697	- Continued				- Continued			
1/4" (6mm) Top Width				54	1370	36°	5740	54	1370	38°	5511
32 1/2	825	42°	6391	57 3/8	1455	36°	5726	55	1395	38°	5513
32	815	42°	6392	58 1/2	1485	36°	◇ 5516	56 1/4	1430	38°	▼ 5500
49 1/8	1245	42°	6389	68 1/4	1735	38°	5700	60 1/2	1535	40°	5522
9/32" (7mm) Top Width				71 1/2	1815	36°	◇ 6234	64 3/4	1645	38°	5502
48 1/32	1220	60°	6698	74 3/8	1890	36°	◇ 6375	65	1650	38°	5504
5/16" (8mm) Top Width				79 3/4	2025	40°	6377	67 1/8	1705	38°	5512
15 1/2	395		★ 6183	83 1/8	2110	39°	6548	71	1805	38°	5501
25 1/2	650		6421 (68 Teeth)	93 5/8	2378	40°	5517	7/8" (22mm) Top Width			
3/8" (9.5mm) Top Width				103 1/4	2625	40°	6378	157	3988	40°	6604
22 7/8	581		◇ 6414 (61 Teeth)	108 1/8	2745	40°	6379	29/32" (23mm) Top Width			
24 3/8	619		◇ 6413 (65 Teeth)	110 1/2	2805	40°	5701	33 3/8	848	32°	▼ 6012
25 3/8	645	37°	6380	117 1/8	2975	40°	6398	36 3/4	933	30°	▼ 6013
29 3/4	755	37°	6589	120 1/4	3055	40°	6550	1" (25mm) Top Width			
35 1/2	900	36°	5731	1/2" (13mm) Top Width				36	914		★ 822
35 3/4	910	36°	5732	48 3/8	1229	42°	▼ 6224	41	1040		6386 (130 Teeth)
3/8" (10mm) Top Width				53 3/4	1363	36°	◇ 5527	44 1/8	1120		6385 (140 Teeth)
34 3/8	873	38°	6390	54 1/4	1377	38°	6575	48 1/4	1225		6384 (153 Teeth)
59	1500	39°	5508	58	1475	38°	5528	1 1/8" (29mm) Top Width			
81	2055	40°	5509	64 1/4	1630	40°	6574	22 1/2	572		★ 811
7/16" (11mm) Top Width				90 5/8	2350	40°	6582	26 3/4	679		★ 813
44	1120	38°	6596	107 1/4	2725	39°	6565	31 1/2	800		★ 814
48 7/8	1230	36°	5725	126 1/8	3205	40°	6560	53	1346	38°	▼ 6601
57	1450	38°	6597	127 1/8	3230	40°	6387	1 13/16" (30mm) Top Width			
1/2" (12mm) Top Width				19/32" (15mm) Top Width				22 1/2	572		★ 811
34 1/8	865	37°	5536	19 3/4	501		5707 (167 Teeth)	26 3/4	679		★ 813
35 1/8	890	38°	▼ 5510	5/8" (16mm) Top Width				31 1/2	800		★ 814
67 1/8	1705	38°	▼ 5530	27 1/4	691	33°	▼ 6061	53	1346	38°	▼ 6601
93 1/8	2365	38°	▼ 5518	21/32" (16mm) Top Width				1 1/8" (31mm) Top Width			
1/2" (12.5mm) Top Width				42 7/8	1090	38°	▼ 5529	35 3/8	900	28°	▼ 5710
31 5/8	805	38°	▼ 5519	51 7/8	1320	38°	5533	40 3/8	1026	32°	▼ 6098
31 7/8	810	37°	6370	69	1753	38°	5534	41 3/4	1059	32°	▼ 6021
34 1/2	875	40°	6583	86 7/8	2205	40°	5537	43 1/2	1105	32°	▼ 6083
36 1/2	925	36°	5741	113 1/2	2880	40°	5538	43 1/8	1087	24°	▼ 6069
36 3/4	933	40°	6376	115 1/2	2935	40°	5524	44 1/8	1120	32°	▼ 6044
37 7/8	960	36°	5735	118	3075	40°	5525	45	1143	32°	▼ 6314
38 3/4	974	40°	6372	132	3355	40°	5506	52	1320	28°	▼ 6007
39	990	36°	5736	142	3605	40°	5526	56 1/8	1425	30°	▼ 6316
43 7/8	1115	36°	5743	155	3935	40°	5535	1 1/8" (32mm) Top Width			
44 3/4	1135	36°	5742	164	4165	40°	5523	62 7/8	1590	38°	▼ 6572
45 1/4	1150	36°	5734	25/32" (20mm) Top Width				1 1/4" (32mm) Top Width			
48	1220	36°	5737	56 3/4	1440		6354 (180 Teeth)	36 7/8	937	34°	▼ 6312
49 3/8	1255	36°	5738	69 9/32	1760		5716 (220 Teeth)	44 5/8	1135	40°	5718
53 3/8	1355	36°	5744	13/16" (20mm) Top Width				45 1/2	1156	30°	▼ 6092
54 7/8	1395	36°	5724	50	1270	38°	5521	46 5/8	1186	28°	▼ 6096
				52	1320	38°	5503	47	1194	28°	▼ 6304
				53	1346	38°	5520	76 7/8	1955	39°	▼ 5539
								1 15/32" (37mm) Top Width			
								86 5/8	2200	38°	▼ 6599

◇ Double-V Belt.
★ Flat Belt. Length Given Is Inside Circumference.

▼ Indicates Notched Belt.
✱ Timing Belt. Length Given is Pitch Length.

Size Lists



Hi-Power® II V-Belts - Listed by Number

Showing Hi-Power® II Belts with Corresponding Top Widths and Nominal Outside Lengths

PLEASE NOTE: V-Belt drives which use the belt as a clutch requires special consideration because the heat generated by belt slip (during engagement and disengagement) on some clutching applications can cause the V-Belt tensile materials in the belts listed below to shrink in length. The shrinkage may cause a belt, which is already engaged and driving, to not de-clutch, or a de-clutched belt may engage itself and start driving the machine unexpectedly. Depending on the machine and circumstances, either situation could prove dangerous to the machine operator or bystanders.

Belts especially designed to minimize or eliminate heat shrinkage may be required.

IMPORTANT: The outside length is determined by placing a steel tape around the outside of the belt. This method should be used because it is the one most commonly used by Dealers and Jobbers when measuring a belt.

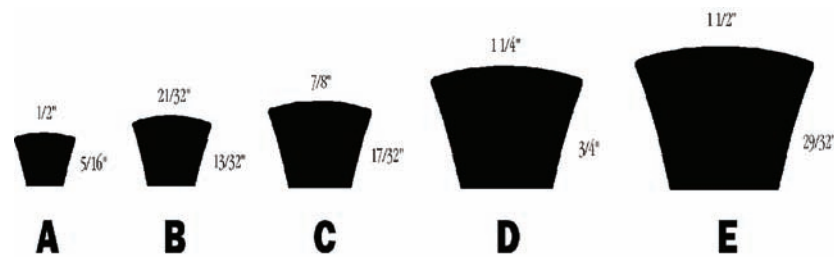

Belt No.	Length (in)	Belt No.	Length (in)	Belt No.	Length (in)	Belt No.	Length (in)	Belt No.	Length (in)
A24.....	26	A Section - Cont.		A Section - Cont.		B Section - Cont.		B Section - Cont.	
A25.....	27	A69.....	71	A117.....	119	B55.....	58	B99.....	102
A26.....	28	A70.....	72	A118.....	120	B56.....	59	B100.....	103
A27.....	29	A71.....	73	A120.....	122	B57.....	60	BP100 (Aramid).....	103
A28.....	30	A72.....	74	A124.....	126	B58.....	61	B101.....	104
A29.....	31	A73.....	75	A128.....	130	B59.....	62	B102.....	105
A29.8.....	31 13/16	A74.....	76	A130.....	132	B60.....	63	B103.....	106
A30.....	32	A75.....	77	A132.....	134	B61.....	64	B104.....	107
A31.....	33	A76.....	78	A133.....	135	B62.....	65	B105.....	108
A32.....	34	A77.....	79	A134.....	136	B63.....	66	B106.....	109
A33.....	35	A78.....	80	A136.....	138	B64.....	67	B107.....	110
A34.....	36	A79.....	81	A140.....	142	B65.....	68	B108.....	111
A35.....	37	A80.....	82	A144.....	146	B66.....	69	BP108 (Aramid).....	111
A36.....	38	A81.....	83	A148.....	150	B67.....	70	B109.....	112
A37.....	39	A82.....	84	A158.....	160	B68.....	71	B110.....	113
A38.....	40	A83.....	85	A173.....	175	B69.....	72	B111.....	114
A39.....	41	A84.....	86	A180.....	182	B70.....	73	B112.....	115
A40.....	42	A85.....	87	B Section		B71.....	74	B113.....	116
A41.....	43	A86.....	88	B28.....	31	B72.....	75	B114.....	117
A42.....	44	A87.....	89	B29.....	32	B73.....	76	B115.....	118
A43.....	45	A88.....	90	B30.....	33	B74.....	77	B116.....	119
A44.....	46	A89.....	91	B31.....	34	B75.....	78	B117.....	120
A45.....	47	A90.....	92	B32.....	35	B76.....	79	B118.....	121
A46.....	48	A91.....	93	B33.....	36°	B77.....	80	B120.....	123
A47.....	49	A92.....	94	B34.....	37	B78.....	81	B122.....	125
A48.....	50	A93.....	95	B35.....	38°	B79.....	82	B123.....	126
A49.....	51	A94.....	96	B36.....	39	B80.....	83	B124.....	127
A50.....	52	A95.....	97	B37.....	40°	B81.....	84	B126.....	129
A51.....	53	A96.....	98	B38.....	41	B82.....	85	B127.....	130
A52.....	54	A97.....	99	B39.....	42	B83.....	86	B128.....	131
A53.....	55	A98.....	100	B40.....	43	B84.....	87	B130.....	133
A54.....	56	A99.....	101	B41.....	44	B85.....	88	B131.....	134
A55.....	57	A100.....	102	B42.....	45	B86.....	89	B132.....	135
A56.....	58	A101.....	103	B43.....	46	B87.....	90	B133.....	136
A57.....	59	A102.....	104	B44.....	47	B88.....	91	B134.....	137
A58.....	60	A103.....	105	B45.....	48	B89.....	92	B135.....	138
A59.....	61	A105.....	107	B46.....	49	B90.....	93	B136.....	139
A60.....	62	A106.....	108	B47 (Aramid).....	50	B91.....	94	B138.....	141
A61.....	63	A107.....	109	B48.....	51	B92.....	95	B139.....	142
A62.....	64	A108.....	110	B49.....	52	B93.....	96	B140.....	143
A63.....	65	A110.....	112	B50.....	53	B94.....	97	B142.....	145
A64.....	66	A112.....	114	B51.....	54	B95.....	98	B143.....	146
AP64 (Aramid).....	66	A113.....	115	B52.....	55	BP95 (Aramid).....	98	B144.....	147
A65.....	67	A114.....	116	B53.....	56	B96.....	99	B146.....	149
A66.....	68	A115.....	117	B54.....	57	B97.....	100	B147.....	150
A67.....	69	A116.....	118			B98.....	101	B148.....	151
A68.....	70								

Size Lists



Hi-Power® II V-Belts - Listed by Number

Belt No.	Length (in)	Belt No.	Length (in)	Belt No.	Length (in)	Belt No.	Length (in)	Belt No.	Length (in)
B Section - Cont.		C Section - Cont.		C Section - Cont.		C Section - Cont.		D Section - Cont.	
B150.....	153	C55.....	59	C105.....	109	C225.....	227	D300.....	303
B152.....	155	C57.....	61	CP105 (Aramid).....	109	C240.....	242	D315.....	318
B154.....	157	C60.....	64	C106.....	110	C255.....	257	D330.....	333
B156.....	159	C62.....	66	C107.....	111	C270.....	272	D345.....	348
B158.....	161	C63.....	67	C108.....	112	C285.....	287	D360.....	363
B162.....	165	C65.....	69	C109.....	113	C300.....	302	D390.....	393
B166.....	169	C67.....	71	C110.....	114	C315.....	317	D420.....	423
B168.....	171	C68.....	72	C111.....	115	C330.....	332	D450.....	453
B173.....	176	C70.....	74	C112.....	116	C345.....	347	D480.....	483
B180.....	183	C71.....	75	C115.....	119	C360.....	362	D540.....	543
B188.....	191	C72.....	76	C116.....	120	C390.....	392	D600.....	603
B190.....	193	C73.....	77	C120.....	124	C420.....	422	D660.....	663
B192.....	195	C75.....	79	C122.....	126	D Section			
B195.....	198	C78.....	82	C124.....	128				
B199.....	202	C79.....	83	C126.....	130	E Section			
B205.....	208	C80.....	84	C128.....	132				
B210.....	213	C81.....	85	C130.....	134	E180.....	187		
B225.....	226	C83.....	87	C136.....	140	E195.....	202		
B230.....	231	C84.....	88	C140.....	144	E210.....	217		
B240.....	241	C85.....	89	C144.....	148	E240.....	244		
B255.....	256	C86.....	90	C148.....	152	E270.....	274		
B270.....	271	C87.....	91	C150.....	154	E300.....	304		
B285.....	286	C90.....	94	C151.....	155	E330.....	334		
B300.....	301	C92.....	96	C152.....	156 3/4	E360.....	364		
B315.....	316	C93.....	97	C156.....	160	E390.....	394		
C Section		C95.....	99	C158.....	162	E420.....	424		
		C96.....	100	C162.....	166	E480.....	484		
C48.....	52	C97.....	101	C170.....	174	E540.....	544		
C50.....	54	C98.....	102	C173.....	177	E600.....	604		
C51.....	55	C99.....	103	C180.....	184	E660.....	664		
C53.....	57	C100.....	104	C190.....	194				
C54.....	58	C101.....	105	C195.....	199				
		C103.....	107	C210.....	214				

Size Lists



Hi-Power® II PowerBand® Belts - Listed by Number and Size

Key to Size Numbering System

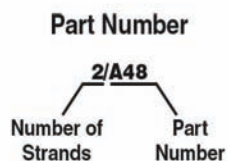

The part number is constructed by placing the number of strands required followed by a slash in front of the size.

In the example above 2/ is the number of strands, A48 is the belt size.

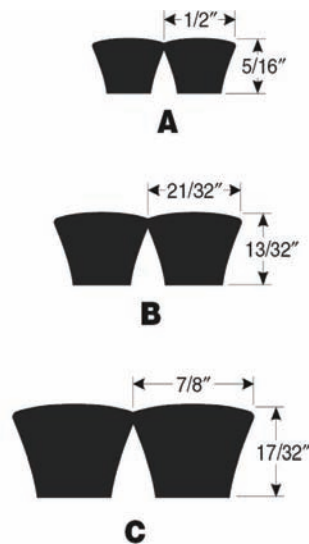

Belt No.	Nominal Outside Length (in)	Belt No.	Nominal Outside Length (in)	Belt No.	Nominal Outside Length (in)
A Section		B Section - Continued		B Section - Continued	
2/A36.....	38	2/B64.....	67	2/B95.....	98
2/A48.....	50	2/B68.....	71	2/B99.....	102
2/A74.....	76	2/B75.....	78	2/B148.....	151
3/A55.....	57	2/B80.....	83	2/B162.....	165
3/A85.....	87	2/B85.....	88	3/B81.....	84
B Section		2/B86.....	89	C Section	
2/B48.....	51	2/B90.....	93	2/C90.....	94
2/B61.....	64	2/B92.....	95		
		2/B93.....	96		

Size Lists





Super HC® PowerBand® Belts - Listed by Number and Size

Key to Size Numbering System

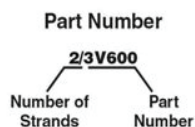

The part number is constructed by placing the number of strands required followed by a slash in front of the size.

In the example above **2/** is the number of strands, **3V600** is the belt size.

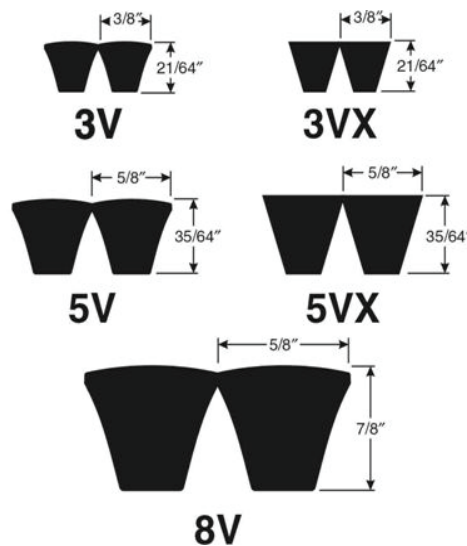

Belt No.	Nominal Outside Length (in)	Belt No.	Nominal Outside Length (in)	Belt No.	Nominal Outside Length (in)
3V / 3VX Section		5V / 5VX / 5VP Section		5V / 5VX / 5VP Section - Cont.	
2/3V600.....	60	2/5V950.....	95	2/5VX917.....	91 3/4
2/3VX375.....	37 1/2	2/5V975.....	97 1/2	2/5VX930.....	93
2/3VX475.....	47 1/2	2/5V1020.....	102	2/5VX950.....	95
2/3VX500.....	50	2/5VX560.....	56	2/5VX1000.....	100
2/3VX630.....	63	2/5VX600.....	60	2/5VX1042.....	105 1/4
3/3V875.....	87 1/2	2/5VX670.....	67	2/5VX1075.....	108 1/8
3/3V879.....	87 27/32	2/5VX686.....	69 1/4	2/5VX1400.....	140
3/3V910.....	91	2/5VX710.....	71	3/5VP213.68.....	213 11/16
3/3VX500.....	50	2/5VX800.....	80	3/5VP2000.....	200
3/3VX560.....	56	2/5VX830.....	83	5/5VX800.....	80
4/3VX425.....	42 1/2	2/5VX850.....	85		

Size Lists



Truflex® and PoweRated® - Belt Dimensions

Length (in)	Truflex® Belt No.	PoweRated® Belt No.	Length (in)	Truflex® Belt No.	PoweRated® Belt No.	Length (in)	Truflex® Belt No.	PoweRated® Belt No.
1/2" (13mm) Top Width - Cont.			21/32" (17mm) Top Width - Cont.			21/32" (17mm) Top Width - Cont.		
82	2820	6882	35	3350	6935	68	3680	6968
83	2830	6883	35 1/2	3355		69	3690	6969
84	2840	6884	36	3360	6936	70	3700	6970
85	2850	6885	37	3370	6937	71	3710	6971
86	2860	6886	38	3380	6938	72	3720	6972
87	2870	6887	39	3390	6939	73	3730	6973
88	2880	6888	40	3400	6940	74	3740	6974
89	2890	6889	41	3410	6941	75	3750	6975
90	2900	6890	42	3420	6942	76	3760	6976
91	2910	6891	43	3430	6943	77	3770	6977
92	2920	6892	44	3440	6944	78	3780	6978
93	2930	6893	45	3450	6945	79	3790	6979
94	2940	6894	46	3460	6946	80	3800	6980
95	2950	6895	47	3470	6947	81	3810	6981
96	2960	6896	48	3480	6948	82	3820	6982
97	2970	6897	49	3490	6949	83	3830	6983
98	2980	6898	50	3500	6950	84	3840	6984
99	2990	6899	51	3510	6951	85	3850	6985
100	2999	68100	52	3520	6952	86	3860	6986
21/32 (17mm) Top Width			53	3530	6953	87	3870	6987
23	3230	6923	54	3540	6954	88	3880	6988
24	3240	6924	55	3550	6955	89	3890	6989
25	3250	6925	56	3560	6956	90	3900	6990
26	3260	6926	57	3570	6957	91	3910	6991
26 1/2	3265		58	3580	6958	92	3920	6992
27	3270	6927	59	3590	6959	93	3930	6993
28	3280	6928	60	3600	6960	94	3940	6994
29	3290	6929	61	3610	6961	95	3950	6995
30	3300	6930	62	3620	6962	96	3960	6996
31	3310	6931	63	3630	6963	97	3970	6997
32	3320	6932	64	3640	6964	98	3980	6998
33	3330	6933	65	3650	6965	99	3990	6999
34	3340	6934	66	3660	6966	100	3999	69100
			67	3670	6967			

Size Lists



Green Stripe® Vulco-Flex® Coolant Hose - Listed by Number

**Showing Vulco-Flex® Coolant Hose Numbers
with Corresponding Hose Inside Diameters and Lengths**

Hose No.	I.D. (in)	I.D. (mm)	Length (in)	Length (mm)	Hose No.	I.D. (in)	I.D. (mm)	Length (in)	Length (mm)
26501.....	1 3/4	44	13 1/2	343	26523.....	2 1/4	57	19	483
26502.....	1 3/4	44	16 1/2	419	26524.....	2 1/4	57	24	610
26503.....	1 3/4, 2	44,51	10	254	26525.....	2 1/4	57	27	686
26504.....	1 3/4, 2	44, 51	16 1/2	419	26526.....	2 1/4, 2 1/2	57, 64	18	457
26505.....	1 3/4, 2	44, 51	19	483	26527.....	2 1/4, 2 1/2	57, 64	21	533
26506.....	1 3/4, 2	44, 51	23 1/2	597	26528.....	2 1/4, 2 1/2	57, 64	25	635
26507.....	2	51	9 1/2	241	26529.....	2 1/2	64	11	279
26508.....	2	51	12 1/5	310	26530.....	2 1/2	64	14	356
26509.....	2	51	14 1/2	368	26531.....	2 1/2	64	16	406
26510.....	2	51	17	432	26532.....	2 1/2	64	24	610
26511.....	2	51	20	508	26533.....	2 1/2	64	28	711
26512.....	2	51	24	610	26534.....	2 3/4	70	7	178
26513.....	2	51	33	838	26535.....	2 3/4	70	14	356
26514.....	2, 2 1/4	51, 57	8 1/2	216	26536.....	2 3/4	70	18	457
26515.....	2, 2 1/4	51, 57	15	381	26537.....	2 3/4	70	32	813
26516.....	2, 2 1/4	51, 57	17 1/2	445	26538.....	3	76	37	940
26517.....	2, 2 1/4	51, 57	25	635	26601.....	1 3/4	44	6	152
26518.....	2, 2 1/2	51, 64	20	508	26602.....	1 3/4	44	8 1/2	216
26519.....	2 1/4	57	9	229	26603.....	1 3/4	44	11	279
26520.....	2 1/4	57	11	279	26611.....	1 3/4	44	19	483
26521.....	2 1/4	57	14	356	26612.....	1 3/4	44	23 1/2	597
26522.....	2 1/4	57	17	432					

Length is Centerline Length

Size Lists



Green Stripe® Vulco-Flex® Coolant Hose - Listed by Size

**Showing Inside Diameters and Lengths
with Corresponding Vulco-Flex® Coolant Hose Numbers**

Length (in)	Length (mm)	Hose No.	Length (in)	Length (mm)	Hose No.	Length (in)	Length (mm)	Hose No.
1 3/4" (44mm) I.D.			2" (51mm), 2 1/4" (57mm) I.D.			2 1/2" (64mm) I.D.		
6.....	152	26601	8 1/2.....	216	26514	11.....	279	26529
8 1/2.....	216	26602	15.....	381	26515	14.....	356	26530
11.....	279	26603	17 1/2.....	445	26516	16.....	406	26531
13 1/2.....	343	26501	25.....	635	26517	24.....	610	26532
16 1/2.....	419	26502	2" (51mm), 2 1/2" (64mm) I.D.			28.....	711	26533
19.....	483	26611	20.....	508	26518	2 3/4" (70mm) I.D.		
23 1/2.....	597	26612	2 1/4" (57mm) I.D.			7.....	178	26534
1 3/4" (44mm), 2" (51mm) I.D.			9.....	229	26519	14.....	356	26535
10.....	254	26503	11.....	279	26520	18.....	457	26536
16 1/2.....	419	26504	14.....	356	26521	32.....	813	26537
19.....	483	26505	17.....	432	26522	3" (76mm) I.D.		
23 1/2.....	597	26506	19.....	483	26523	37.....	940	26538
2" (51mm) I.D.			24.....	610	26524			
9 1/2.....	241	26507	27.....	686	26525			
12 1/5.....	310	26508	2 1/4" (57mm), 2 1/2" (64mm) I.D.					
14 1/2.....	368	26509	18.....	457	26526			
17.....	432	26510	21.....	533	26527			
20.....	508	26511	25.....	635	26528			
24.....	610	26512						
33.....	838	26513						

Size Lists





Vulco-Flex® II Coolant Hose - Listed by Number

Showing Vulco-Flex® II Coolant Hose Numbers with Corresponding Hose Inside Diameters and Lengths

Hose No.	I.D. (in)	I.D. (mm)	Length (in)	Length (mm)	Hose No.	I.D. (in)	I.D. (mm)	Length (in)	Length (mm)
25150.....	1 1/8	28	12	305	25384.....	1 3/8	35	25	635
25152.....	1 1/8	28	15	381	25409.....	1 3/8, 1 1/2	35, 38	26	660
25154.....	1 1/8	28	18	457	25428.....	1 3/8, 1 5/8	35, 41	17	432
25157.....	1 1/8	28	23	584	25472.....	1 1/2	38	8	203
25180.....	1 1/8, 1 1/4	28, 32	19	483	25473.....	1 1/2	38	10.5	267
25249.....	1 1/4	32	7 1/2	191	25474.....	1 1/2	38	12	305
25250.....	1 1/4	32	9 1/2	241	25476.....	1 1/2	38	14	356
25251.....	1 1/4	32	13	330	25477.....	1 1/2	38	15.5	394
25252.....	1 1/4	32	15	381	25478.....	1 1/2	38	17	432
25253.....	1 1/4	32	17	432	25480.....	1 1/2	38	20	508
25254.....	1 1/4	32	18 1/2	470	25482.....	1 1/2	38	22	559
25255.....	1 1/4	32	20	508	25484.....	1 1/2	38	25	635
25257.....	1 1/4	32	23	584	25487.....	1 1/2	38	30	762
25260.....	1 1/4	32	26 1/2	673	25490.....	1 1/2	38	35	889
25262.....	1 1/4	32	30	762	25499.....	1 1/2	38	48	1219
25265.....	1 1/4	32	35	889	25526.....	1 1/2, 1 3/4	38, 44	13 1/5	335
25269.....	1 1/4	32	41	1041	25527.....	1 1/2, 1 3/4	38, 44	15	381
25284.....	1 1/4, 1 3/8	32, 35	26	660	25528.....	1 1/2, 1 3/4	38, 44	16 1/2	419
25300.....	1 1/4, 1 1/2	32, 38	12	305	25530.....	1 1/2, 1 3/4	38, 44	20	508
25302.....	1 1/4, 1 1/2	32, 38	15 1/2	394	25532.....	1 1/2, 1 3/4	38, 44	22	559
25305.....	1 1/4, 1 1/2	32, 38	19 1/2	495	25535.....	1 1/2, 1 3/4	38, 44	27	686
25307.....	1 1/4, 1 1/2	32, 38	23	584	25582.....	1 1/2, 2	38, 51	22	559
25309.....	1 1/4, 1 1/2	32, 38	26	660	25804.....	▲ 1 1/2	38	20	508
25311.....	1 1/4, 1 1/2	32, 38	29	737	25806.....	▲ 1 1/2	38	23 1/5	589
25321.....	1 1/4, 1 1/2	32, 38	44	1118	25808.....	▲ 1 1/2	38	25 3/4	653

▲ 90° Molded Elbow on One End.

Length is Centerline Length

Size Lists



Vulco-Flex® II Coolant Hose - Listed by Size

**Showing Inside Diameters and Lengths
with Corresponding Vulco-Flex® II Coolant Hose Numbers**

Length (in)	Length (mm)	Hose No.	Length (in)	Length (mm)	Hose No.	Length (in)	Length (mm)	Hose No.
1 1/8" (29mm) I.D.			1 1/4" (32mm), 1 1/2" (38mm) I.D.			1 1/2" (38mm) I.D. - Cont.		
12	305	25150	12	305	25300	15.5	394	25477
15	381	25152	15 1/2	394	25302	17	432	25478
18	457	25154	19 1/2	495	25305	20	508	25480
23	584	25157	23	584	25307	20	508	▲ 25804
1 1/8" (29mm), 1 1/4" (32mm) I.D.			26	660	25309	22	559	25482
19	483	25180	29	737	25311	23 1/5	589	▲ 25806
1 1/4" (32mm) I.D.			44	1118	25321	25	635	25484
7 1/2	191	25249	1 3/8" (35mm) I.D.			25 3/4	653	▲ 25808
9 1/2	241	25250	25	635	25384	30	762	25487
13	330	25251	1 3/8" (35mm), 1 1/2" (38mm) I.D.			35	889	25490
15	381	25252	26	660	25409	48	1219	25499
17	432	25253	1 3/8" (35mm), 1 5/8" (41mm) I.D.			1 1/2" (38mm), 1 3/4" (44mm) I.D.		
18 1/2	470	25254	17	432	25428	13 1/5	335	25526
20	508	25255	1 1/2" (38mm) I.D.			15	381	25527
23	584	25257	8	203	25472	16 1/2	419	25528
26 1/2	673	25260	10.5	267	25473	20	508	25530
30	762	25262	12	305	25474	22	559	25532
35	889	25265	14	356	25476	27	686	25535
41	1041	25269	1 1/4" (32mm), 1 3/8" (35mm) I.D.			1 1/2" (38mm), 2" (51mm) I.D.		
26	660	25284				22	559	25582

▲ 90° Molded Elbow on One End.

Length is Centerline Length

Size Lists



Manufacturers' Part Numbers

Showing Manufacturers' Part Numbers for Air Vent Hose With Our Corresponding Replacement Numbers

Mfr. Part No.	Hose No.	Mfr. Part No.	Hose No.	Mfr. Part No.	Hose No.	Mfr. Part No.	Hose No.
0172332	23648	2339H21	23005	3827885	23764	66RU213	23002
0172340	23764	2364673	23764	3829421	23648	66RU226P12	23002
027015631	23218	2389H2	23002	3834561	23764	66RU226P2	23006
027015792	23005	2434355	23005	3839436	23640	66RU226P22	23107
027016847	23106	2489039	23788	3839761	23640	66RU27P1	23005
027105709	23215	2489075	23788	3839762	23640	66RU27P4	23101
027115989	23300	2494361	23788	3845511	23648	66RU27P7	23106
03117220	23218	2505990	23005	3845512	23648	672313	23216
039177	23005	255162C2	23005	3853336	23634	672889	23005
0391772	23002	2694361	23788	3856649	23632	686775C1	23201
0505639BA	23218	2788H216	23218	3856988	23764	688261	23215
0508332RA	23221	2825685	23005	3858411	23644	699884	23005
0510199	23218	288343C1	23005	3858412	23644	6CA01222	23005
055637	23215	301467R1	23005	3858649	23648	6CD01222	23002
055639	23218	30146R1	23005	3858650	23648	6CM01222	23106
055641	23005	302699	23218	3861379	23644	6CS01221	23218
055646	23106	3030788	23002	3861442	23644	70590906	23201
055649	23006	304056	23002	3861680	23644	713069	23300
056332	23004	304058	23005	3862819	23764	722964	23221
056540	23216	304874R1	23005	3864640	23644	724301	23002
058332	23221	3132144R1	23780	3867080	23636	724477	23005
1030227	23221	314902R1	23006	3867081	23636	764713C1	23218
103807	23002	319119C1	23005	3870215	23648	792925	23107
103808	23005	319119CC1	23005	3870283	23764	7S7755	23004
105314	23221	321891R1	23106	3875861	23644	8713132	23002
105315	23202	329060R1	23005	3885138	23632	88163R1	23002
109181	23005	3295H2	23005	3895470	23632	9002889	23106
10A19587	23201	345467C1	23006	3895482	23644	9036168	23221
124159	23005	362943C1	23006	3895939	23644	985203R1	23005
14017	23002	362946C7	23215	3897882	23640	986634R1	23002
140171	23002	3745593	23764	3897722	23644	C3TZ 9B613 A	23002
142483	23202	3746662	23764	3902109	23648	C6TZ 9B613 C	23218
151614	23106	3747133	23632	3904060	23101	C6TZ 9B613 D	23209
1522449	23100	3747134	23632	3905094	23648	C6TZ 9C681 E	23006
1522454	23106	3747316	23632	3906412	23780	C8HA 9B699 C	23209
1522457	23005	3747347	23648	3906480	23764	DOHA 9B699 H	23215
1529295	23215	3747348	23648	3924539	23624	DOHA 9C681 E	23218
1529315	23218	3747475	23780	3937902	23636	DOHA 9C682 B	23004
1531808	23209	3747476	23640	3946963	23628	DOHZ 9B613 H	23004
15MD1254	23221	3751123	23764	3946964	23628	DOHZ 9B613 K	23215
162206	23005	3752275	23764	396313C1	23218	DOHZ 9C681 E	23218
1701570	23005	3756896	23640	407026C1	23218	GBK11272	23402
1712171	23002	3758482	23648	407524	23002	K123143	23300
1718522	23005	3758483	23648	414974C1	23300	K12350	23218
174608	23005	3765549	23632	425309R1	23006	K12351	23215
176034	23002	3766764	23648	427305R1	23221	K12381	23216
177174	23106	3766765	23764	431714R1	23203	K12384	23209
177174H1	23106	3766816	23648	439682C1	23006	K12385	23208
198811R1	23005	3768178	23632	44Z867D5	23218	K123A51	23215
1AAA04	23209	3771019	23764	481374C1	23004	K123B140	23221
1AAA06	23218	3773811	23648	508694	23002	K123B150	23218
1AAA13	23208	3777947	23632	513864	23005	K123B50	23218
1AAA15	23215	3777948	23632	515424	23002	K123B51	23218
1AAA23	23002	3785921	23640	536798	23006	K123B65	23215
1AAA25	23004	3785923	23640	538459	23002	K123B78	23400
1AAA26	23005	3786410	23764	542060	23005	K123B81	23216
1AAA27	23006	3789169	23636	590906	23201	K123B84	23209
1AAA36	23106	3791182	23640	5MD1224	23218	K123B85	23208
1AAA51	23216	3791183	23640	5MD2528	23201	K123C104	23218
2014372	23208	3791184	23640	5MD2589	23216	K34211	23005
2039929	23006	3792425	23640	603961C1	23005	K34212	23002
2041705	23006	3794411	23632	638459	23002	K34225	23106
2070456	23218	3796657	23632	638967A	23400	K34227	23006
2084361	23221	3812768	23764	643348C1	23218	K34260	23004
20MD19311	23106	3818479	23764	657996	23006	N50204C	23002
20MD29306P2	23218	3821940	23636	657997	23218	N50204E	23005
20MD29306P3	23215	3827026	23640	658162	23106	NA005906	23218
20MD29320P1	23300	3827027	23640	66RU180	23215	R29405R	23005
221229	23218	3827550	23636	66RU188	23006	S87805	23005
223150002	23006	3827552	23636	66RU198	23006	SR35222	23005

Size Lists



Changeover Listing - Air Vent Hose

Showing Competitive Numbers With Our Corresponding Air Vent Hose Numbers

Competitive No.	Hose No.	Competitive No.	Hose No.	Competitive No.	Hose No.	Competitive No.	Hose No.
ACDelco		23400	23400	78927GL	23216	Huntington Rubber	
33600	23002	23401	23401	78976GL	23106	3H4	23002
33601	23004	23402	23402	78980GL	23107	3H5	23004
33602	23005	23610	23610	79063	23610	3H6	23006
33603	23006	23612	23612	79075	23612	35R30	23100
33604	23100	23614	23614	79088	23614	45HL5	23208
33605	23101	23616	23616	79100	23616	45HL6	23215
33606	23106	23620	23620	79125	23620	45HL35	23202
33607	23107	23622	23622	79138	23622	54HL6	23216
33608	23201	23624	23624	79150	23624	70R60	23107
33609	23202	23626	23626	79163	23626	90HL3	23201
33610	23203	23628	23628	79175	23628	90HL5	23209
33612	23208	23630	23630	79188	23630	90HL6	23218
33613	23209	23632	23632	79200	23632	90HL7	23221
33614	23215	23634	23634	79213	23634	90HL35	23203
33615	23216	23636	23636	79225	23636	NAPA (U.S.) Belts & Hose	
33616	23218	23638	23638	79238	23638	682	23002
33618	23221	23640	23640	79250	23640	696	23004
33619	23300	23642	23642	79263	23642	825	23764
33620	23400	23644	23644	79275	23644	827	23780
33621	23401	23648	23648	79300	23648	828	23788
33622	23402	23656	23656	79350	23656	830	23610
33700	23610	23658	23658	79363	23658	831	23612
33701	23612	23664	23664	79400	23764	832	23614
33702	23614	23672	23672	79450	23772	833	23616
33703	23616	23680	23680	79500	23780	834	23620
33704	23620	23688	23688	79550	23788	835	23622
33705	23622	23764	23764	Donaldson		836	23624
33706	23624	23772	23772	P101290	23100	837	23626
33707	23626	23780	23780	P101294	23106	838	23628
33708	23628	23788	23788	P105532	23201	839	23630
33709	23630	Dayco		P105535	23218	840	23632
33710	23632	78607	23002	P105536	23221	841	23634
33711	23634	78607GL	23002	P105547	23215	842	23636
33712	23636	78613	23004	P105609	23002	843	23638
33713	23638	78613GL	23004	P105610	23004	844	23640
33714	23640	78616	23005	P105611	23005	845	23642
33715	23642	78616GL	23005	P105612	23006	846	23644
33716	23644	78619	23006	P107844	23209	847	23648
33717	23648	78619GL	23006	P109021	23208	848	23656
33718	23656	78651	23100	P109331	23202	849	23658
33719	23658	78651GL	23100	P112610	23107	850	23664
33720	23664	78655	23101	P114318	23203	851	23672
33721	23672	78655GL	23101	P117724	23300	852	23680
33722	23680	78675	23106	Griffith Rubber		853	23688
33723	23688	78675GL	23106	4HH	23002	870	23201
CARQUEST Belts & Hose		78683	23107	5HH	23004	873	23202
23002	23002	78683GL	23107	6HH	23006	875	23203
23004	23004	78715	23202	6 5 1/2 HHR	23106	883	23209
23005	23005	78715GL	23202	43HHR	23101	891	23218
23006	23006	78727	23208	55HH	23005	892	23402
23100	23100	78727GL	23208	76HHR	23107	894	23107
23101	23101	78735	23215	353HHR	23100	Stratoflex	
23106	23106	78735GL	23215	655HHR	23106	45E50	23208
23107	23107	78802	23201	RL390	23201	45E60	23215
23201	23201	78802GL	23201	RL545	23208	60J55	23106
23202	23202	78805	23203	RL590	23209	70J60	23107
23203	23203	78805GL	23203	RL645	23215	90E50	23209
23208	23208	78814	23209	RL654	23216	90E60	23218
23209	23209	78814GL	23209	RL690	23218	90E70	23221
23215	23215	78820	23218	RL790	23221	S40	23002
23216	23216	78820GL	23218	RL3545	23202	S50	23004
23218	23218	78826	23221	RL3590	23203	S55Y	23005
23221	23221	78826GL	23221	RL65590	23300	S60	23006
23300	23300	78875	23300				
		78875GL	23300				
		78927	23216				

Size Lists



Air Vent Hose Dimensions

Use the chart below to locate the part number or hose type required. The column heading titled Row No. refers to the row an illustration and dimensions appear in the following pages.

Part No.	Hose Type	Row No.
23002	Hump	2
23004	Hump	2
23005	Hump	2
23006	Hump	2
23100	Reducer Hump	3
23101	Reducer Hump	3
23106	Reducer Hump	3
23107	Reducer Hump	3
23201	90° Elbow	7
23202	45° Elbow	5
23203	90° Elbow	7
23208	45° Elbow	5
23209	90° Elbow	7
23215	45° Elbow (Ribbed)	4
23216	54° Elbow (Ribbed)	6
23218	90° Elbow (Ribbed)	8
23221	90° Elbow (Ribbed)	8
23300	90° Reducing Elbow	9
23400	Straight Flexible	1
23401	Straight Flexible	1
23402	Straight Flexible	1





Air Vent Hose Dimensions - continued

1. Straight Flexible

A I.D. (In.)	B Lgth. (In.)	Part No.	Wt. Per Piece (Lbs.)
4	22	23400	.96
6	19	23401	1.46
6-1/8	19	23402	1.47

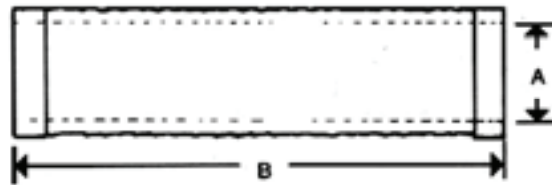

2. Hump

A I.D. (In.)	B Lgth. (In.)	Part No.	Wt. Per Piece (Lbs.)
4	5	23002	.63
5	6	23004	1.21
5-1/2	6	23005	1.32
6	5	23006	1.22

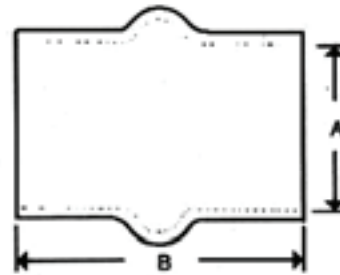

3. Reducer Hump

I.D. (In.)		B Lgth. (In.)	Part No.	Wt. Per Piece (Lbs.)
From A	To C			
3-1/2	3	5-1/4	23100	1.38
4	3	5-1/4	23101	1.06
6	5-1/2	6	23106	1.69
7	6	6	23107	1.92

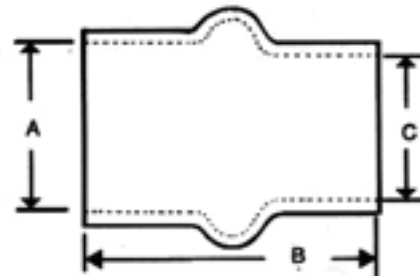

4. 45° Elbow (Ribbed Construction)

A I.D. (In.)	Part No.	Wt. Per Piece (Lbs.)
6	23215	2.48

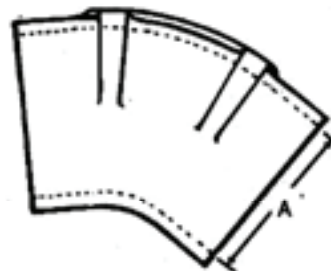

5. 45° Elbow

A I.D. (In.)	Part No.	Wt. Per Piece (Lbs.)
3-1/2	23202	.85
5	23208	1.27

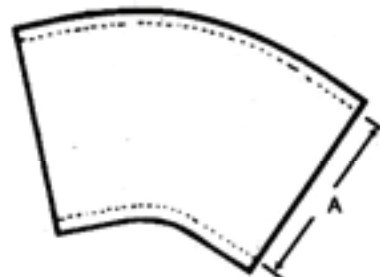



Air Vent Hose Dimensions - continued

6. 54° Elbow (Ribbed Construction)

A I.D. (In.)	Part No.	Wt. Per Piece (Lbs.)
6	23216	3.10

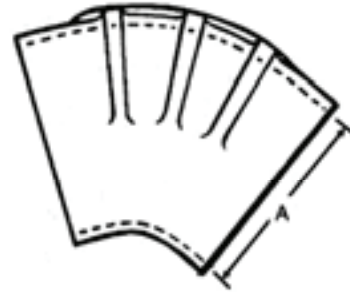

7. 90° Elbow

A I.D. (In.)	Part No.	Wt. Per Piece (Lbs.)
3	23201	1.23
3-1/2	23203	1.31
5	23209	2.51

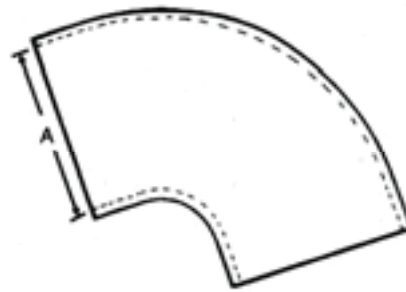

8. 90° Elbow (Ribbed Construction)

A I.D. (In.)	Part No.	Wt. Per Piece (Lbs.)
6	23218	4.08
7	23221	6.55

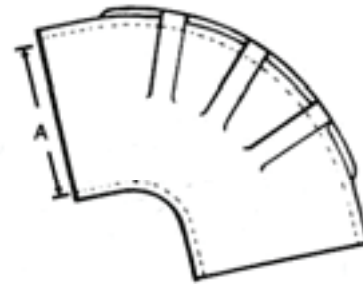

9. 90° Reducing Elbow (Ribbed Construction)

A I.D. (In.)	B Lgth. (In.)	Part No.	Wt. Per Piece (Lbs.)
5-1/2	6	23300	3.50

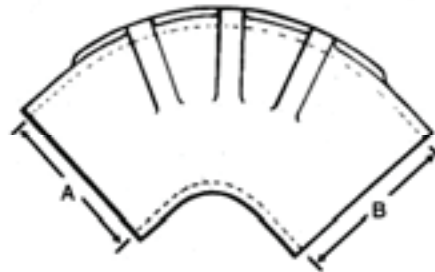

Size Lists





Changeover Listing - FleetRunner®

FleetRunner® V-Belt Numbers

FleetRunner® HD V-Belt Part No.	XL® V-Belt Part No.	FleetRunner® HD V-Belt Part No.	XL® V-Belt Part No.	FleetRunner® HD V-Belt Part No.	XL® V-Belt Part No.	FleetRunner® HD V-Belt Part No.	XL® V-Belt Part No.
9290HD	9290	9400HD	9400	9495HD	9495	9620HD	9620
9305HD	9305	9403HD	9403	9500HD	9500	9625HD	9625
9309HD	9309	9405HD	9405	9505HD	9505	9630HD	9630
9313HD	9313	9412HD	9412	9510HD	9510	9635HD	9635
9319HD	9319	9415HD	9415	9520HD	9520	9640HD	9640
9325HD	9325	9420HD	9420	9525HD	9525	9650HD	9650
9330HD	9330	9425HD	9425	9530HD	9530	9660HD	9660
9335HD	9335	9430HD	9430	9540HD	9540	9670HD	9670
9341HD	9341	9435HD	9435	9545HD	9545	9680HD	9680
9345HD	9345	9440HD	9440	9550HD	9550	9690HD	9690
9350HD	9350	9447HD	9447	9555HD	9555	9700HD	9700
9355HD	9355	9451HD	9451	9560HD	9560	9710HD	9710
9360HD	9360	9455HD	9455	9565HD	9565	9720HD	9720
9365HD	9365	9463HD	9463	9570HD	9570	9730HD	9730
9370HD	9370	9465HD	9465	9580HD	9580	9740HD	9740
9375HD	9375	9470HD	9470	9585HD	9585	9745HD	9745
9380HD	9380	9476HD	9476	9590HD	9590	9755HD	9755
9385HD	9385	9480HD	9480	9600HD	9600		
9390HD	9390	9485HD	9485	9605HD	9605		
9395HD	9395	9490HD	9490	9610HD	9610		

FleetRunner® Micro-V® Belt Numbers

FleetRunner® Micro-V® Part No.	Micro-V® Belt Part No.	FleetRunner® Micro-V® Part No.	Micro-V® Belt Part No.	FleetRunner® Micro-V® Part No.	Micro-V® Belt Part No.	FleetRunner® Micro-V® Part No.	Micro-V® Belt Part No.
K040378HD	K040378	K060495HD	K060495	K060680HD	K060680	K061058HD	K061058
K040388HD	K040388	K060500HD	K060500	K060685HD	K060685	K061080HD	K061080
K040425HD	K040425	K060509HD	K060509	K060690HD	K060690	K061140HD	K061140
K040430HD	K040430	K060516HD	K060516	K060696HD	K060696	K061187HD	K061187
K040445HD	K040445	K060520HD	K060520	K060716HD	K060716	K061195HD	K061195
K040745HD	K040745	K060523HD	K060523	K060735HD	K060735	K061360HD	K061360
K040762HD	K040762	K060525HD	K060525	K060739HD	K060739	K070553HD	K070553
K050323HD	K050323	K060529HD	K060529	K060747HD	K060747	K070640HD	K070640
K050336HD	K050336	K060532HD	K060532	K060795HD	K060795	K070673HD	K070673
K050340HD	K050340	K060539HD	K060539	K060806HD	K060806	K070677HD	K070677
K050345HD	K050345	K060547HD	K060547	K060832HD	K060832	K070705HD	K070705
K050350HD	K050350	K060555HD	K060555	K060849HD	K060849	K070709HD	K070709
K050360HD	K050360	K060557HD	K060557	K060858HD	K060858	K070733HD	K070733
K050375HD	K050375	K060559HD	K060559	K060860HD	K060860	K070735HD	K070735
K050380HD	K050380	K060560HD	K060560	K060870HD	K060870	K070786HD	K070786
K050420HD	K050420	K060569HD	K060569	K060875HD	K060875	K070801HD	K070801
K060340HD	K060340	K060575HD	K060575	K060905HD	K060905	K070825HD	K070825
K060390HD	K060390	K060578HD	K060578	K060908HD	K060908	K070835HD	K070835
K060393HD	K060393	K060586HD	K060586	K060910HD	K060910	K071056HD	K071056
K060400HD	K060400	K060594HD	K060594	K060923HD	K060923	K071247HD	K071247
K060408HD	K060408	K060598HD	K060598	K060930HD	K060930	K080330HD	K080330
K060415HD	K060415	K060605HD	K060605	K060935HD	K060935	K080375HD	K080375
K060425HD	K060425	K060615HD	K060615	K060960HD	K060960	K080382HD	K080382
K060435HD	K060435	K060625HD	K060625	K060988HD	K060988	K080384HD	K080384
K060439HD	K060439	K060635HD	K060635	K060990HD	K060990	K080400HD	K080400
K060455HD	K060455	K060637HD	K060637	K060994HD	K060994	K080415HD	K080415
K060458HD	K060458	K060653HD	K060653	K060997HD	K060997	K080427HD	K080427
K060470HD	K060470	K060658HD	K060658	K061000HD	K061000	K080435HD	K080435
K060478HD	K060478	K060660HD	K060660	K061005HD	K061005	K080450HD	K080450
K060480HD	K060480	K060670HD	K060670	K061010HD	K061010	K080465HD	K080465
K060483HD	K060483	K060672HD	K060672	K061015HD	K061015	K080471HD	K080471
K060490HD	K060490	K060675HD	K060675	K061020HD	K061020	K080485HD	K080485

FleetRunner
Interchange



Changeover Listing - FleetRunner®

FleetRunner® Micro-V® Belt Numbers

FleetRunner® Micro-V® Part No.	Micro-V® Belt Part No.	FleetRunner® Micro-V® Part No.	Micro-V® Belt Part No.	FleetRunner® Micro-V® Part No.	Micro-V® Belt Part No.	FleetRunner® Micro-V® Part No.	Micro-V® Belt Part No.
K080496HD	K080496	K080745HD	K080745	K081124HD	K081124	K100771HD	K100771
K080505HD	K080505	K080751HD	K080751	K081153HD	K081153	K100789HD	K100789
K080510HD	K080510	K080755HD	K080755	K081177HD	K081177	K100810HD	K100810
K080514HD	K080514	K080760HD	K080760	K081189HD	K081189	K100852HD	K100852
K080525HD	K080525	K080765HD	K080765	K081196HD	K081196	K100891HD	K100891
K080530HD	K080530	K080774HD	K080774	K081207HD	K081207	K120281HD	K120281
K080537HD	K080537	K080776HD	K080776	K081213HD	K081213	K120360HD	K120360
K080545HD	K080545	K080780HD	K080780	K081223HD	K081223	K120390HD	K120390
K080550HD	K080550	K080785HD	K080785	K081264HD	K081264	K120400HD	K120400
K080560HD	K080560	K080790HD	K080790	K081265HD	K081265	K120410HD	K120410
K080565HD	K080565	K080797HD	K080797	K081298HD	K081298	K120525HD	K120525
K080566HD	K080566	K080806HD	K080806	K081325HD	K081325	K120559HD	K120559
K080570HD	K080570	K080810HD	K080810	K081331HD	K081331	K120594HD	K120594
K080575HD	K080575	K080816HD	K080816	K081359HD	K081359	K120606HD	K120606
K080580HD	K080580	K080817HD	K080817	K081362HD	K081362	K120610HD	K120610
K080585HD	K080585	K080820HD	K080820	K081377HD	K081377	K120702HD	K120702
K080590HD	K080590	K080825HD	K080825	K090500HD	K090500	K120720HD	K120720
K080594HD	K080594	K080830HD	K080830	K090609HD	K090609	K120738HD	K120738
K080600HD	K080600	K080839HD	K080839	K100381HD	K100381	K120815HD	K120815
K080605HD	K080605	K080842HD	K080842	K100437HD	K100437	K120842HD	K120842
K080610HD	K080610	K080855HD	K080855	K100456HD	K100456	K120864HD	K120864
K080615HD	K080615	K080859HD	K080859	K100465HD	K100465	K120872HD	K120872
K080620HD	K080620	K080865HD	K080865	K100485HD	K100485	K120878HD	K120878
K080623HD	K080623	K080872HD	K080872	K100495HD	K100495	K120891HD	K120891
K080626HD	K080626	K080876HD	K080876	K100502HD	K100502	K120901HD	K120901
K080630HD	K080630	K080878HD	K080878	K100510HD	K100510	K120903HD	K120903
K080638HD	K080635	K080893HD	K080893	K100535HD	K100535	K120911HD	K120911
K080645HD	K080645	K080897HD	K080897	K100540HD	K100540	K120924HD	K120924
K080649HD	K080649	K080903HD	K080903	K100554HD	K100554	K120931HD	K120931
K080653HD	K080653	K080910HD	K080910	K100563HD	K100563	K120964HD	K120964
K080660HD	K080660	K080915HD	K080915	K100570HD	K100570	K120975HD	K120979
K080670HD	K080670	K080922HD	K080922	K100572HD	K100572	K121039HD	K121039
K080672HD	K080672	K080926HD	K080926	K100575HD	K100575	K140345HD	K140345
K080675HD	K080675	K080934HD	K080934	K100579HD	K100579	K140370HD	K140370
K080677HD	K080677	K080939HD	K080939	K100594HD	K100594	K140429HD	K140429
K080680HD	K080680	K080944HD	K080944	K100607HD	K100607	K140433HD	K140433
K080685HD	K080685	K080952HD	K080952	K100610HD	K100610	K140451HD	K140451
K080690HD	K080690	K080956HD	K080956	K100618HD	K100618	K140496HD	K140496
K080694HD	K080694	K080968HD	K080968	K100630HD	K100630	K140516HD	K140516
K080700HD	K080700	K080986HD	K080986	K100637HD	K100637	K140524HD	K140524
K080702HD	K080702	K080991HD	K080991	K100640HD	K100640	K140555HD	K140555
K080708HD	K080708	K081000HD	K081000	K100655HD	K100655	K140580HD	K140580
K080710HD	K080710	K081005HD	K081005	K100658HD	K100658	K140594HD	K140594
K080716HD	K080716	K081020HD	K081020	K100665HD	K100665	K140597HD	K140597
K080720HD	K080720	K081023HD	K081023	K100670HD	K100670	K140603HD	K140603
K080726HD	K080726	K081035HD	K081035	K100675HD	K100675	K140618HD	K140618
K080730HD	K080730	K081074HD	K081074	K100677HD	K100677	K140627HD	K140627
K080733HD	K080733	K081079HD	K081079	K100710HD	K100710	K140662HD	K140662
K080734HD	K080734	K081088HD	K081088	K100719HD	K100719	K140682HD	K140682
K080738HD	K080738	K081092HD	K081092	K100731HD	K100731	K140700HD	K140700
K080740HD	K080740	K081102HD	K081102	K100739HD	K100739		

FleetRunner
Interchange



Notes



Distributed by / Distribué par / Distribuido por
CQ Sourcing, Inc., 4721 Hargrove Road, Raleigh, NC 27616



Please recycle this catalog!