



Specializing in precision high pressure valves, fittings, and fluid control devices



Specializing in
precision high
pressure valves,
fittings, and fluid
control devices

i n n o v a t i o n

Superior Products and Service

Innovative Pressure Technologies specializes in the design and manufacture of precision high pressure valves, fittings, and other fluid control devices and related components and accessories. With over 35 years of manufacturing experience and millions of completed valves, assemblies, and individual components delivered, IPT is recognized as a leading provider of high pressure valves and fittings technologies. Our commitment to quality, customer service and product innovation has enabled us to manufacture world-class products for a wide variety of applications. Our integrated manufacturing process enables us to provide product solutions to the most challenging requirements. From design to delivery, short to long run production, standard products to custom solutions, IPT can provide a timely and cost effective product that will meet or exceed your expectations. At IPT, we excel in providing extraordinary customer service, attention to detail, and superior products.









MARKETS WE SERVE INCLUDE:



- | Aerospace/Defense | Automotive | Compressed Natural Gas | General Industry |
- | Oil/Chemical/Gas Production & Research | Liquid Nitrogen | Polyethylene Low Density |
- | Research Laboratories | Universities | Pharmaceutical | Power Generation | Water/Wastewater |

www.inpressure.com

CONTENTS

Ball Valves — 10,000 - 20,000 PSI	2 - 5	
Coned & Threaded Valves, Fittings & Tubing — 20,000 to 60,000 PSI	6 - 17	
Pipe Valves & Fittings — To 15,000 PSI	18 - 29	
Hose Fittings	30 - 31	
Custom Manifolds	32	
Double Block & Bleed Valves	33	
Relief Valves	34	
Manifold Valves — To 10,000 PSI	35	
Subsea Valves	36	

Floating Ball Style Ball Valves

BALL VALVES — 10,000 to 20,000 PSI

For applications
up to 10,000 PSI



FEATURES & BENEFITS

- Economical 2-way floating ball design for most on-off process applications to 10,000 psi
- Adjustable packing provides high cycle life and low operating torque
- Blow out resistant stem with stem bearing for high cycle life and low torque operation
- 3 standard mounting options: Panel mount design using panel nut, or 2 bolts through panel into valve body, and bolted through body mounting holes with dual bolt pattern for other OEM valve replacement
- Large selection of tube and pipe fittings available
- Optional valve lockout
- Complete material traceability on all components
- Equipment can be manufactured to meet NACE MR-01-75 and American Petroleum Institute standards. Consult your nearest authorized distributor for more information
- Optional packing, seal, and seat materials available
- Available with electric, pneumatic or hydraulic actuators and accessories for remote operation

SPECIFICATIONS

Working Pressure: Up to 10,000 PSI
Port Sizes: 3/16", 1/4", 3/8" or 1/2"
Standard Connections: Male or Female NPT
M/P Cone & Thread
H/P Cone & Thread

TYPICAL APPLICATIONS

- Critical service process isolation
- Sour Gas
- Hydraulic process fluids
- Automated service with actuator

TYPICAL MATERIALS

- 316 cold-worked stainless steel
- Glass-filled Teflon packing
- Fiber-reinforced PEEK seats
- Viton seals
- Nitronic 60 bearings



ORDERING

BVH 2 - 9 MF - 9 MF

PORT & PRESSURE	
BVF	3/16" – 10,000 PSI
BVG	1/4" – 10,000 PSI
BVH	3/8" – 10,000 PSI
BVJ	1/2" – 10,000 PSI

FLOW CONFIGURATION	
2	2-way

CONNECTION SIZE	
2	1/8" size
4	1/4" size
6	3/8" size
8	1/2" size
9	9/16" size
12	3/4" size
16	1" size

CONNECTION TYPE	
NF	Female NPT
NM	Male NPT
MF	M/P Cone/Thread Female
MM	M/P Cone/Thread Male
MT	M/P Cone/Thread Tube Nipple
HF	H/P Cone/Thread Female
HM	H/P Cone/Thread Male
HT	H/P Cone/Thread Tube Nipple

Other connections, such as socket weld, butt weld, and British threads are available on request.

EXAMPLES:

BVH2-9MF-9MF
3/8" port, 10,000 PSI, 2-way valve with 9/16" M/P Female connections

BVG2-4NF-4NF
1/4" port, 10,000 PSI, 2-way valve with 1/4" NPT Female connections

MEDIUM PRESSURE CONNECTIONS

CONNECTION SIZE	PORT
1/4" MP	0.109
3/8" MP	0.203
9/16" MP	0.312
3/4" MP	0.437
1" MP	0.562

FEMALE AND MALE PIPE CONNECTIONS

CONNECTION SIZE	PIPE ID
1/8" NPT	Customer defined.
1/4" NPT	
3/8" NPT	
1/2" NPT	
3/4" NPT	
1" NPT	

HIGH PRESSURE CONNECTIONS

CONNECTION SIZE	PORT
1/4" HP	0.093
3/8" HP	0.125
9/16" HP	0.187

NOTES:

1. For a cost-effective solution, select a Ball Valve with a port size equal to or slightly larger than the connection port size. See examples above.
2. All Maximum Allowable Working Pressures (MAWP) are based on usage @ 72° F.

Trunnion Style Ball Valves

BALL VALVES — 10,000 to 20,000 PSI

For applications
up to 20,000 PSI



SPECIFICATIONS

Working Pressure: Up to 20,000 PSI
Port Sizes: 3/16", 1/4" or 3/8"
Standard Connections: Male or Female NPT
M/P Cone & Thread
H/P Cone & Thread

TYPICAL APPLICATIONS

- Critical service process isolation
- Sour Gas
- Hydraulic process fluids
- Automated service with actuator

TYPICAL MATERIALS

- 316 cold-worked stainless steel
- Fiber-reinforced PEEK seats
- Viton seals

FEATURES & BENEFITS

- Bi-directional trunnion style closure, ideal for severe duty applications
- Blow out proof stem
- 3 standard mounting options: Panel mount design using panel nut, or 2 bolts through panel into valve body, and bolted through body mounting holes with dual bolt pattern for other OEM valve replacement
- Large selection of tube and pipe fittings available
- 2- to 5-way valve configurations for process control optimization
- 3-way valve available in either Switching or Diverting style
- Optional valve lockout
- Complete material traceability on all components
- Equipment can be manufactured to meet NACE MR-01-75 and American Petroleum Institute standards. Consult your nearest authorized distributor for more information
- Optional packing, seal, spring, and seat materials available
- Available with electric, pneumatic or hydraulic actuators and accessories for remote operation

ORDERING

BVL S - 4 MF - 4 MF - 4 NM

PORT & PRESSURE*

BVF	3/16" – 10,000 PSI
BVG	1/4" – 10,000 PSI
BVH	3/8" – 10,000 PSI
BVJ	1/2" – 10,000 PSI
BVL	3/16" – 20,000 PSI
BVM	1/4" – 20,000 PSI
BVN	3/8" – 20,000 PSI

*Final working pressure of the complete valve is determined by the MAWP of the chosen end connections

FLOW CONFIGURATION

T	2-way Trunion
S	3-way Switching
D	3-way Diverting
4	4-way
5	5-way

CONNECTION SIZE

2	1/8" size
4	1/4" size
6	3/8" size
8	1/2" size
9	9/16" size
12	3/4" size
16	1" size

CONNECTIONTYPE & MAWP
(The bottom port should be listed last if configuring a 3-way or 5-way valve)

NF	Female NPT	1/8" thru 1/2" – 15,000 PSI
NM	Male NPT	3/4" thru 1" – 10,000 PSI
MF	M/P Cone/Thread Female	
MM	M/P Cone/Thread Male	20,000 PSI
MT	M/P Cone/Thread Tube Nipple	
HF	H/P Cone/Thread Female	
HM	H/P Cone/Thread Male	60,000 PSI
HT	H/P Cone/Thread Tube Nipple	

Other connections, such as socket weld, butt weld, and British threads are available on request.

EXAMPLES:

BVLS-4MF-4MF-4NM
3/16" port, 15,000 PSI, 3-way switching valve with 1/4" M/P Female connections in the sides, 1/4" NPT Male connection in the bottom
(Note: Although the L-series valve is rated for 20,000 PSI, the working pressure of this configuration is only 15,000 because of the NPT connection.)

BVH4-6MF-6MF-6MF-6MF
3/8" port, 10,000 PSI, 4-way valve with 3/8" M/P Female connections

BALL VALVES — 10,000 to 20,000 PSI

MEDIUM PRESSURE CONNECTIONS

CONNECTION SIZE	PORT	MAWP
1/4" MP	0.109	20,000 PSI
3/8" MP	0.203	
9/16" MP	0.312	
3/4" MP	0.437	
1" MP	0.562	

FEMALE AND MALE PIPE CONNECTIONS

CONNECTION SIZE	MAWP	PIPE ID
1/8" NPT	15,000 PSI	Customer defined. See notes below.
1/4" NPT	15,000 PSI	
3/8" NPT	15,000 PSI	
1/2" NPT	15,000 PSI	
3/4" NPT	10,000 PSI	
1" NPT	10,000 PSI	

HIGH PRESSURE CONNECTIONS

CONNECTION SIZE	PORT	MAWP
1/4" HP	0.093	20,000 PSI
3/8" HP	0.125	
9/16" HP	0.187	

- NOTES:**
- For a cost-effective solution, select a Ball Valve with a port size equal to or slightly larger than the connection port size. See examples above.
 - All Maximum Allowable Working Pressures (MAWP) are based on usage @ 72° F.
 - MAWP listed for pipe connections is based on the Ball Valve Connection. Customer is responsible for suitable piping connection and pressure rating.

Needle Valves

CONED & THREADED VALVES, FITTINGS & TUBING — 20,000 to 60,000 PSI



SPECIFICATIONS

Max. Working Pressure:
Up to 60,000 PSI (4140 bar)

Temperature Ratings:
-100° to 450° F (-73° to 232°C)
Grafoil packing available for high temperature service

TYPICAL APPLICATIONS

- General plant service
- Instrument isolation
- Hydraulic applications
- Pneumatic applications
- Pressure measurement devices
- Venting

TYPICAL MATERIALS

- 316 Stainless Steel body and trim with 17-4 PH stem and glass-filled Teflon packing
- Other materials available upon request

FEATURES & BENEFITS

- Non-rotating stem prevents galling and scoring
- Vee or Regulating tip stem
- Six body styles for a wide variety of applications
- Integral through-holes for bracket mounting
Panel mounting option is also available
- Gland locking device prevents loosening of the packing gland, reducing leak potential
- Equipment can be manufactured to meet NACE MR-01-75 and American Petroleum Institute standards. Consult your nearest authorized distributor for more information
- Optional soft seat available in a wide variety of materials
- Complete material traceability on all components

ACTUATOR OPTIONS

All needle valves are available with a variety of pneumatic, hydraulic or electric actuators. Consult your nearest authorized distributor for proper selection of valve and actuator combination.

ORDERING

ACTUATOR STYLE	FUNCTION	MEDIUM DUTY	HEAVY DUTY
Pneumatic	Air-to-Open, Normally-Closed	A019	A050
	Air-to-Close, Normally-Open	AC19	AC50
	Double-Acting	DA19	DA50
Hydraulic	Double-Acting	HD2	HD4

Other Options: -SS Stainless Steel Handle -PM Panel Mount -GR Grafoil packing for temperatures to 1200°F (649°C)

ORDERING

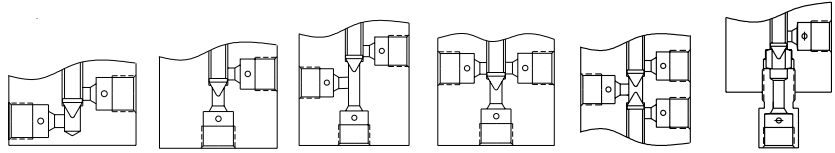

PRESSURE	CONNECTION		STEM TIP	2-WAY STRAIGHT		2-WAY ANGLE		3-WAY 2 INLET PORTS		3-WAY 2 OUTLET PORTS		2-STEM MANIFOLD		REPLACEABLE SEAT	
	SIZE	PORT		CV*											
20,000 PSI (1380 bar)	1/4"	0.109"	0.31	Vee	NV4M1VA20	NV4M2VA20	NV4M3VA20	NV4M4VA20	NV4M5VA20	NV4M6VA20					
				Reg	NV4M1RA20	NV4M2RA20	NV4M3RA20	NV4M4RA20	NV4M5RA20	NV4M6RA20					
	3/8"	0.203"	0.75	Vee	NV6M1VA20	NV6M2VA20	NV6M3VA20	NV6M4VA20	NV6M5VA20	NV6M6VA20					
				Reg	NV6M1RA20	NV6M2RA20	NV6M3RA20	NV6M4RA20	NV6M5RA20	NV6M6RA20					
	9/16"	0.312"	1.75	Vee	NV9M1VB20	NV9M2VB20	NV9M3VB20	NV9M4VB20	NV9M5VB20	NV9M6VB20					
				Reg	NV9M1RB20	NV9M2RB20	NV9M3RB20	NV9M4RB20	NV9M5RB20	NV9M6RB20					
	3/4"	0.438"	2.80	Vee	NV12M1VC20	NV12M2VC20	NV12M3VC20	NV12M4VC20	NV12M5VC20	NV12M6VC20					
				Reg	NV12M1RC20	NV12M2RC20	NV12M3RC20	NV12M4RC20	NV12M5RC20	NV12M6RC20					
	1"	0.562"	5.20	Vee	NV16M1VD20	NV16M2VD20	NV16M3VD20	NV16M4VD20	NV16M5VD20	NV16M6VD20					
				Reg	NV16M1RD20	NV16M2RD20	NV16M3RD20	NV16M4RD20	NV16M5RD20	NV16M6RD20					
30,000 PSI (2070 bar)	1/4"	0.093"	0.12	Vee	NV4H1VY30	NV4H2VY30	NV4H3VY30	NV4H4VY30	NV4H5VY30	NV4H6VY30					
				Reg	NV4H1RY30	NV4H2RY30	NV4H3RY30	NV4H4RY30	NV4H5RY30	NV4H6RY30					
	3/8"	0.125"	0.23	Vee	NV6H1VY30	NV6H2VY30	NV6H3VY30	NV6H4VY30	NV6H5VY30	NV6H6VY30					
				Reg	NV6H1RY30	NV6H2RY30	NV6H3RY30	NV6H4RY30	NV6H5RY30	NV6H6RY30					
	9/16"	0.187"	0.33	Vee	NV9H1VY30	NV9H2VY30	NV9H3VY30	NV9H4VY30	NV9H5VY30	NV9H6VY30					
				Reg	NV9H1RY30	NV9H2RY30	NV9H3RY30	NV9H4RY30	NV9H5RY30	NV9H6RY30					
60,000 PSI (4140 bar)	1/4"	0.093"	0.08	Vee	NV4H1VM60	NV4H2VM60	NV4H3VM60	NV4H4VM60	NV4H5VM60	NV4H6VM60					
				Reg	NV4H1RM60	NV4H2RM60	NV4H3RM60	NV4H4RM60	NV4H5RM60	NV4H6RM60					
	3/8"	0.125"	0.09	Vee	NV6H1VM60	NV6H2VM60	NV6H3VM60	NV6H4VM60	NV6H5VM60	NV6H6VM60					
				Reg	NV6H1RM60	NV6H2RM60	NV6H3RM60	NV6H4RM60	NV6H5RM60	NV6H6RM60					
	9/16"	0.125"	0.14	Vee	NV9H1VM60	NV9H2VM60	NV9H3VM60	NV9H4VM60	NV9H5VM60	NV9H6VM60					
				Reg	NV9H1RM60	NV9H2RM60	NV9H3RM60	NV9H4RM60	NV9H5RM60	NV9H6RM60					

*Cv values listed are for 2-way straight valves. For other styles, increase Cv value by 50%.

Check Valves

CONED & THREADED VALVES, FITTINGS & TUBING — 20,000 to 60,000 PSI



FEATURES & BENEFITS

- Prevents reverse flow where leak-tight shutoff is required
- Two styles to fit most applications:
 - Ball Seat Poppet — Metal-to-metal seat for rapid cycling or severe environments
 - Soft Seat Poppet — O-ring seat for fast shut-off and reliable seal; standard material is Nitrile. A variety of seal materials are available for even the harshest media
- Complete material traceability on all components
- Equipment can be manufactured to meet NACE MR-01-75 and American Petroleum Institute standards. Consult your nearest authorized distributor for more information

SPECIFICATIONS

Max. Working Pressure:
Up to 60,000 PSI (4140 bar)

Temperature Ratings:
Ball Seat Poppet – -420° to 1200°F
(-251° to 648°C)

Soft Seat Poppet – -65° to 250°F
(-54° to 121°C) (with standard Nitrile seal)

Nominal Cracking Pressure:
15 PSI (1 bar)
Optional cracking pressures up to 100 PSI
(7 bar)

TYPICAL APPLICATIONS

- Gas
- Liquid
- Fluid handling for the chemical/ petrochemical, research, and oil and gas industries

TYPICAL MATERIALS

- 316 Stainless Steel
- Other materials available on request

ORDERING

PRESSURE	CONNECTION SIZE	BALL POPPET	O-RING POPPET
20,000 PSI (1380 bar)	1/4"	CV4MFB20	CV4MFS20
	3/8"	CV6MFB20	CV6MFS20
	9/16"	CV9MFB20	CV9MFS20
	3/4"	CV12MFB20	CV12MFS20
	1"	CV16MFB20	CV16MFS20
60,000 PSI (4140 bar)	1/4"	CV4HFB60	CV4HFS60
	3/8"	CV6HFB60	CV6HFS60
	9/16"	CV9HFB60	CV9HFS60

Coned & Threaded Fittings & Adapters

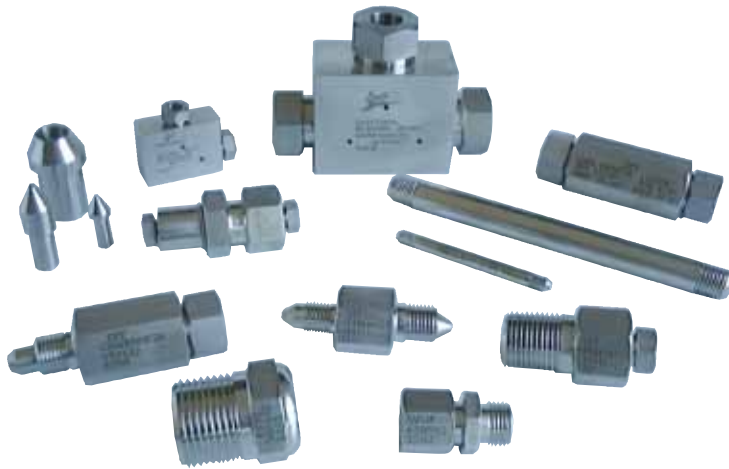

SPECIFICATIONS

Max. Working Pressure:

Up to 60,000 PSI (4140 bar)

Temperature Ratings:

-100° to 600°F (-73° to 315°C)

TYPICAL MATERIALS

- 316 Cold Worked Stainless Steel
- Other materials available on request

FEATURES & BENEFITS

- Coned and threaded connection provides dependable performance in gas or liquid service
- Safety weep holes standard on all pressure connections
- All medium and high pressure fittings, adapters, and couplings complete with glands and collars when required
- Anti-vibration connection components available
- Adapters available in one or two piece designs
- Prototype and design assistance available for special applications
- Complete material traceability on all components
- 100% manufactured in the USA for the highest reliability
- Equipment can be manufactured to meet NACE MR-01-75. Consult your nearest authorized distributor for more information

CONED & THREADED FITTINGS

CONED & THREADED VALVES, FITTINGS & TUBING — 20,000 to 60,000 PSI

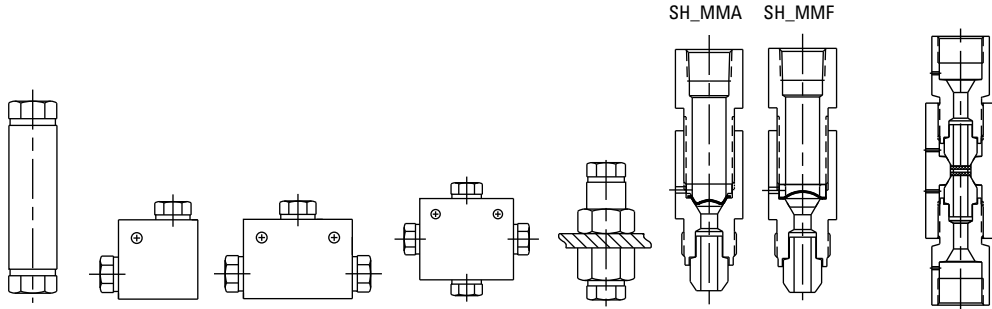

CONNECTION	COUPLING	ELBOW	TEE	CROSS	BULKHEAD	SAFETY HEAD	LINE FILTER	MAWP
1/4" M/P	CN4MF20	L4MF20	T4MF20	X4MF20	BH4MF20	SH4MM*20	LF4MF20-*/*	20,000 PSI
3/8" M/P	CN6MF20	L6MF20	T6MF20	X6MF20	BH6MF20	SH6MM*20	LF6MF20-*/*	20,000 PSI
9/16" M/P	CN9MF20	L9MF20	T9MF20	X9MF20	BH9MF20	SH9MM*20	LF9MF20-*/*	20,000 PSI
3/4" M/P	CN12MF20	L12MF20	T12MF20	X12MF20	BH12MF20	SH12MM*20	LF12MF20-*/*	20,000 PSI
1" M/P	CN16MF20	L16MF20	T16MF20	X16MF20	BH16MF20	SH16MM*20	LF16MF20-*/*	20,000 PSI
1/4" H/P	CN4HF60	L4HF60	T4HF60	X4HF60	BH4HF60	SH4HM*60	LF4HF60-*/*	60,000 PSI
3/8" H/P	CN6HF60	L6HF60	T6HF60	X6HF60	BH6HF60	SH6HM*60	LF6HF60-*/*	60,000 PSI
9/16" H/P	CN9HF60	L9HF60	T9HF60	X9HF60	BH9HF60	SH9HM*60	LF9HF60-*/*	60,000 PSI

*Insert A for 1/4" Angled style; Insert F for 1/2" Flat style

Replace */* with the desired micron ratings
Example: L4MF20-40/20 would have 40 micron and 20 micron elements

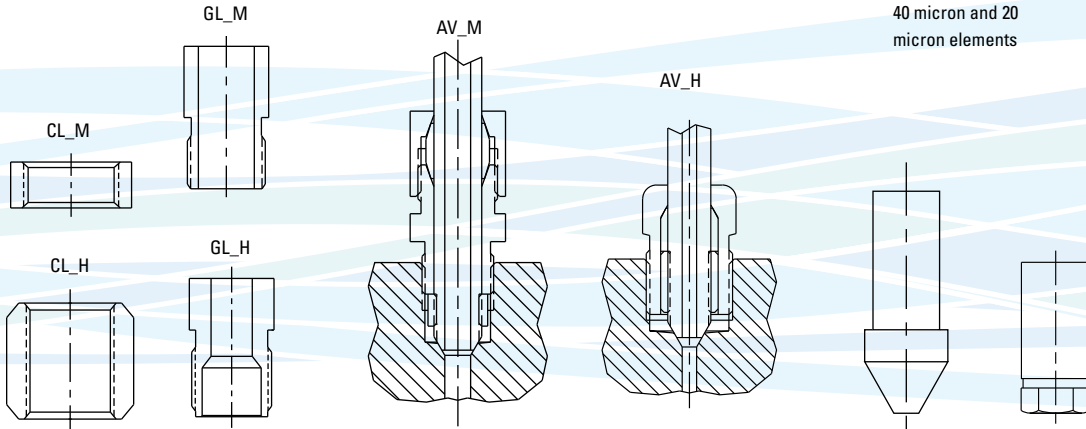

CONNECTION	COLLAR	GLAND	ANTI-VIBRATION GLAND	PLUG	CAP
1/4" M/P	CL4M	GL4M	AV4M	PL4M	CA4M20
3/8" M/P	CL6M	GL6M	AV6M	PL6M	CA6M20
9/16" M/P	CL9M	GL9M	AV9M	PL9M	CA9M20
3/4" M/P	CL12M	GL12M	AV12M	PL12M	CA12M20
1" M/P	CL16M	GL16M	AV16M	PL16M	CA16M20
1/4" H/P	CL4H	GL4H	AV4H	PL4H	CA4H60
3/8" H/P	CL6H	GL6H	AV6H	PL6H	CA6H60
9/16" H/P	CL9H	GL9H	AV9H	PL9H	CA9H60

MALE X FEMALE ADAPTERS*

MALE END		FEMALE END				
		HP CONE & THREAD				
		1/4"	3/8"	9/16"		
HP Cone & Thread	1/4"	CN4HM4HF20	CN4HM6HF20	CN4HM9HF20		
	3/8"	CN6HM4HF20	CN6HM6HF20	CN6HM9HF20		
	9/16"	CN9HM4HF20	CN9HM6HF20	CN9HM9HF20		
		HP CONE & THREAD				
		1/4"	3/8"	9/16"		
MP Cone & Thread	1/4"	CN4MM4HF20	CN4MM6HF20	CN4MM9HF20		
	3/8"	CN6MM4HF20	CN6MM6HF20	CN6MM9HF20		
	9/16"	CN9MM4HF20	CN9MM6HF20	CN9MM9HF20		
	3/4"	CN12MM4HF20	CN12MM6HF20	CN12MM9HF20		
	1"	CN16MM4HF20	CN16MM6HF20	CN16MM9HF20		
		HP CONE & THREAD				
		1/4"	3/8"	9/16"		
NPT	1/8"	CN2NM4HF15	CN2NM6HF15	CN2NM9HF15		
	1/4"	CN4NM4HF15	CN4NM6HF15	CN4NM9HF15		
	3/8"	CN6NM4HF15	CN6NM6HF15	CN6NM9HF15		
	1/2"	CN8NM4HF15	CN8NM6HF15	CN8NM9HF15		
	3/4"	CN12NM4HF10	CN12NM6HF10	CN12NM9HF10		
	1"	CN16NM4HF10	CN16NM6HF10	CN16NM9HF10		
		MP CONE & THREAD				
		1/4"	3/8"	9/16"	3/4"	1"
HP Cone & Thread	1/4"	CN4HM4MF20	CN4HM6MF20	CN4HM9MF20	CN4HM12MF20	CN4HM16MF20
	3/8"	CN6HM4MF20	CN6HM6MF20	CN6HM9MF20	CN6HM12MF20	CN6HM16MF20
	9/16"	CN9HM4MF20	CN9HM6MF20	CN9HM9MF20	CN9HM12MF20	CN9HM16MF20
		MP CONE & THREAD				
		1/4"	3/8"	9/16"	3/4"	1"
MP Cone & Thread	1/4"	CN4MM4MF20	CN4MM6MF20	CN4MM9MF20	CN4MM12MF20	CN4MM16MF20
	3/8"	CN6MM4MF20	CN6MM6MF20	CN6MM9MF20	CN6MM12MF20	CN6MM16MF20
	9/16"	CN9MM4MF20	CN9MM6MF20	CN9MM9MF20	CN9MM12MF20	CN9MM16MF20
	3/4"	CN12MM4MF20	CN12MM6MF20	CN12MM9MF20	CN12MM12MF20	CN12MM16MF20
	1"	CN16MM4MF20	CN16MM6MF20	CN16MM9MF20	CN16MM12MF20	CN16MM16MF20
		MP CONE & THREAD				
		1/4"	3/8"	9/16"	3/4"	1"
NPT	1/8"	CN2NM4MF15	CN2NM6MF15	CN2NM9MF15	CN2NM12MF15	CN2NM16MF15
	1/4"	CN4NM4MF15	CN4NM6MF15	CN4NM9MF15	CN4NM12MF15	CN4NM16MF15
	3/8"	CN6NM4MF15	CN6NM6MF15	CN6NM9MF15	CN6NM12MF15	CN6NM16MF15
	1/2"	CN8NM4MF15	CN8NM6MF15	CN8NM9MF15	CN8NM12MF15	CN8NM16MF15
	3/4"	CN12NM4MF10	CN12NM6MF10	CN12NM9MF10	CN12NM12MF10	CN12NM16MF10
	1"	CN16NM4MF10	CN16NM6MF10	CN16NM9MF10	CN16NM12MF10	CN16NM16MF10

* Last two digits of part number designates pressure x 1000 psi (e.g. CN4HM4HF20 is rated for 20,000 psi)

Continued on next page....

CONED & THREADED VALVES, FITTINGS & TUBING — 20,000 to 60,000 PSI

MALE X FEMALE ADAPTERS (CONTINUED)*

MALE END		FEMALE END					
		NPT					
		1/8"	1/4"	3/8"	1/2"	3/4"	1"
HP Cone & Thread	1/4"	CN4HM2NF15	CN4HM4NF15	CN4HM6NF15	CN4HM8NF15	CN4HM12NF10	CN4HM16NF10
	3/8"	CN6HM2NF15	CN6HM4NF15	CN6HM6NF15	CN6HM8NF15	CN6HM12NF10	CN6HM16NF10
	9/16"	CN9HM2NF15	CN9HM4NF15	CN9HM6NF15	CN9HM8NF15	CN9HM12NF10	CN9HM16NF10
MP Cone & Thread		NPT					
		1/8"	1/4"	3/8"	1/2"	3/4"	1"
		1/4"	CN4MM2NF15	CN4MM4NF15	CN4MM6NF15	CN4MM8NF15	CN4MM12NF10
3/8"	CN6MM2NF15	CN6MM4NF15	CN6MM6NF15	CN6MM8NF15	CN6MM12NF10	CN6MM16NF10	
9/16"	CN9MM2NF15	CN9MM4NF15	CN9MM6NF15	CN9MM8NF15	CN9MM12NF10	CN9MM16NF10	
3/4"	CN12MM2NF15	CN12MM4NF15	CN12MM6NF15	CN12MM8NF15	CN12MM12NF10	CN12MM16NF10	
1"	CN16MM2NF15	CN16MM4NF15	CN16MM6NF15	CN16MM8NF15	CN16MM12NF10	CN16MM16NF10	

* Last two digits of part number designates pressure x 1000 psi (e.g. CN4HM2NF15 is rated for 15,000 psi)

MALE X MALE ADAPTERS*

MALE END		MALE END		
		HP CONE & THREAD		
		1/4"	3/8"	9/16"
HP Cone & Thread	1/4"	CN4HM60	CN4HM6HM60	CN4HM9HM60
	3/8"	CN4HM6HM60	CN6HM60	CN6HM9HM60
	9/16"	CN4HM9HM60	CN6HM9HM60	CN9HM60
MP Cone & Thread		HP CONE & THREAD		
		1/4"	3/8"	9/16"
		1/4"	CN4MM4HM20	CN4MM6HM20
3/8"	CN6MM4HM20	CN6MM6HM20	CN6MM9HM20	
9/16"	CN9MM4HM20	CN9MM6HM20	CN9MM9HM20	
3/4"	CN12MM4HM20	CN12MM6HM20	CN12MM9HM20	
1"	CN16MM4HM20	CN16MM6HM20	CN16MM9HM20	
NPT		HP CONE & THREAD		
		1/4"	3/8"	9/16"
		1/8"	CN2NM4HM15	CN2NM6HM15
1/4"	CN4NM4HM15	CN4NM6HM15	CN4NM9HM15	
3/8"	CN6NM4HM15	CN6NM6HM15	CN6NM9HM15	
1/2"	CN8NM4HM15	CN8NM6HM15	CN8NM9HM15	
3/4"	CN12NM4HM10	CN12NM6HM10	CN12NM9HM10	
1"	CN16NM4HM10	CN16NM6HM10	CN16NM9HM10	
Type M Hose		HP CONE & THREAD		
		1/4"	3/8"	9/16"
		9/16"-18	CN9RM4HM50	CN9RM6HM50
3/4"-16	CN12RM4HM30	CN12RM6HM30	CN12RM9HM30	
7/8"-14	—	CN14RM6HM50	CN14RM9HM50	
1"-12	—	CN16RM6HM30	CN16RM9HM30	
1-1/8"-12	—	—	CN18RM9HM50	
1-5/16"-12	—	—	CN21RM9HM50	

* Last two digits of part number designates pressure x 1000 psi (e.g. CN4HM20 is rated for 20,000 psi)

Continued on next page...

CONED & THREADED VALVES, FITTINGS & TUBING — 20,000 to 60,000 PSI

MALE X MALE ADAPTERS (CONTINUED)*

MALE END		MALE END				
		HP CONE & THREAD				
		1/4"	3/8"	9/16"	3/4"	1"
JIC 37° Flare	1/4"	CN4JM4HM10	CN4JM6HM10	CN4JM9HM10		
	3/8"	CN6JM4HM10	CN6JM6HM10	CN6JM9HM10		
	1/2"	CN8JM4HM10	CN8JM6HM10	CN8JM9HM10		
	3/4"	CN12JM4HM10	CN12JM6HM10	CN12JM9HM10		
	1"	CN16JM4HM10	CN16JM6HM10	CN16JM9HM10		
		MP CONE & THREAD				
		1/4"	3/8"	9/16"	3/4"	1"
JIC 37° Flare	1/4"	CN4JM4MM10	CN4JM6MM10	CN4JM9MM10	CN4JM12MM10	CN4JM16MM10
	3/8"	CN6JM4MM10	CN6JM6MM10	CN6JM9MM10	CN6JM12MM10	CN6JM16MM10
	1/2"	CN8JM4MM10	CN8JM6MM10	CN8JM9MM10	CN8JM12MM10	CN8JM16MM10
	3/4"	CN12JM4MM10	CN12JM6MM10	CN12JM9MM10	CN12JM12MM10	CN12JM16MM10
	1"	CN16JM4MM10	CN16JM6MM10	CN16JM9MM10	CN16JM12MM10	CN16JM16MM10
		MP CONE & THREAD				
		1/4"	3/8"	9/16"	3/4"	1"
MP Cone & Thread	1/4"	CN4MM20	CN4MM6MM20	CN4MM9MM20	CN4MM12MM20	CN4MM16MM20
	3/8"	CN4MM6MM20	CN6MM20	CN6MM9MM20	CN6MM12MM20	CN6MM16MM20
	9/16"	CN4MM9MM20	CN6MM9MM20	CN9MM20	CN9MM12MM20	CN9MM16MM20
	3/4"	CN4MM12MM20	CN6MM12MM20	CN9MM12MM20	CN12MM20	CN12MM16MM20
	1"	CN4MM16MM20	CN6MM16MM20	CN9MM16MM20	CN12MM16MM20	CN16MM20
		MP CONE & THREAD				
		1/4"	3/8"	9/16"	3/4"	1"
NPT	1/8"	CN2NM4MM15	CN2NM6MM15	CN2NM9MM15	CN2NM12MM15	CN2NM16MM15
	1/4"	CN4NM4MM15	CN4NM6MM15	CN4NM9MM15	CN4NM12MM15	CN4NM16MM15
	3/8"	CN6NM4MM15	CN6NM6MM15	CN6NM9MM15	CN6NM12MM15	CN6NM16MM15
	1/2"	CN8NM4MM15	CN8NM6MM15	CN8NM9MM15	CN8NM12MM15	CN8NM16MM15
	3/4"	CN12NM4MM10	CN12NM6MM10	CN12NM9MM10	CN12NM12MM10	CN12NM16MM10
	1"	CN16NM4MM10	CN16NM6MM10	CN16NM9MM10	CN16NM12MM10	CN16NM16MM10
		MP CONE & THREAD				
		1/4"	3/8"	9/16"	3/4"	1"
Type M Hose	9/16"-18	CN4MM9RM20	CN6MM9RM20	CN9MM9RM20	CN12MM9RM20	CN16MM9RM20
	3/4"-16	CN4MM12RM20	CN6MM12RM20	CN9MM12RM20	CN12MM12RM20	CN16MM12RM20
	7/8"-14	CN4MM14RM20	CN6MM14RM20	CN9MM14RM20	CN12MM14RM20	CN16MM14RM20
	1"-12	CN4MM16RM20	CN6MM16RM20	CN9MM16RM20	CN12MM16RM20	CN16MM16RM20
	1-5/16"-12	—	—	CN9MM21RM20	CN12MM21RM20	CN16MM21RM20

* Last two digits of part number designates pressure x 1000 psi (e.g. CN4JM4HM10 is rated for 10,000 psi)

CONED & THREADED VALVES, FITTINGS & TUBING — 20,000 to 60,000 PSI

FEMALE X FEMALE ADAPTER COUPLINGS*

FEMALE END		FEMALE END				
		HP CONE & THREAD				
		1/4"	3/8"	9/16"		
HP Cone & Thread	1/4"	CN4HF60	CN4HF6HF60	CN4HF9HF60		
	3/8"	CN4HF6HF60	CN6HF60	CN6HF9HF60		
	9/16"	CN4HF9HF60	CN6HF9HF60	CN9HF60		
		HP CONE & THREAD				
		1/4"	3/8"	9/16"		
MP Cone & Thread	1/4"	CN4MF4HF20	CN4MF6HF20	CN4MF9HF20		
	3/8"	CN6MF4HF20	CN6MF6HF20	CN6MF9HF20		
	9/16"	CN9MF4HF20	CN9MF6HF20	CN9MF9HF20		
	3/4"	CN12MF4HF20	CN12MF6HF20	CN12MF9HF20		
	1"	CN16MF4HF20	CN16MF6HF20	CN16MF9HF20		
		HP CONE & THREAD				
		1/4"	3/8"	9/16"		
NPT	1/8"	CN2NF4HF15	CN2NF6HF15	CN2NF9HF15		
	1/4"	CN4NF4HF15	CN4NF6HF15	CN4NF9HF15		
	3/8"	CN6NF4HF15	CN6NF6HF15	CN6NF9HF15		
	1/2"	CN8NF4HF15	CN8NF6HF15	CN8NF9HF15		
	3/4"	CN12NF4HF10	CN12NF6HF10	CN12NF9HF10		
	1"	CN16NF4HF10	CN16NF6HF10	CN16NF9HF10		
		MP CONE & THREAD				
		1/4"	3/8"	9/16"	3/4"	1"
MP Cone & Thread	1/4"	CN4MF20	CN4MF6MF20	CN4MF9MF20	CN4MF12MF20	CN4MF16MF20
	3/8"	CN4MF6MF20	CN6MF20	CN6MF9MF20	CN6MF12MF20	CN6MF16MF20
	9/16"	CN4MF9MF20	CN6MF9MF20	CN9MF20	CN9MF12MF20	CN9MF16MF20
	3/4"	CN4MF12MF20	CN6MF12MF20	CN9MF12MF20	CN12MF20	CN12MF16MF20
	1"	CN4MF16MF20	CN6MF16MF20	CN9MF16MF20	CN12MF16MF20	CN16MF20
		MP CONE & THREAD				
		1/4"	3/8"	9/16"	3/4"	1"
NPT	1/8"	CN2NF4MF15	CN2NF6MF15	CN2NF9MF15	CN2NF12MF15	CN2NF16MF15
	1/4"	CN4NF4MF15	CN4NF6MF15	CN4NF9MF15	CN4NF12MF15	CN4NF16MF15
	3/8"	CN6NF4MF15	CN6NF6MF15	CN6NF9MF15	CN6NF12MF15	CN6NF16MF15
	1/2"	CN8NF4MF15	CN8NF6MF15	CN8NF9MF15	CN8NF12MF15	CN8NF16MF15
	3/4"	CN12NF4MF10	CN12NF6MF10	CN12NF9MF10	CN12NF12MF10	CN12NF16MF10
	1"	CN16NF4MF10	CN16NF6MF10	CN16NF9MF10	CN16NF12MF10	CN16NF16MF10

* Last two digits of part number designates pressure x 1000 psi (e.g. CN4HF20 is rated for 20,000 psi)

NIPPLES

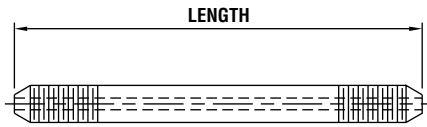

PRESSURE	CONNECTION SIZE	MIN LENGTH	STANDARD LENGTHS							
			2.75"	3.00"	4.00"	4.50"	6.00"	8.00"	10.00"	12.00"
20,000 PSI (1380 bar)	1/4"	2.00	N4M20-2.75	N4M20-3.00	N4M20-4.00	—	N4M20-6.00	N4M20-8.00	N4M20-10.00	N4M20-12.00
	3/8"	2.50	—	N6M20-3.00	N6M20-4.00	—	N6M20-6.00	N6M20-8.00	N6M20-10.00	N6M20-12.00
	9/16"	3.00	—	N9M20-3.00	N9M20-4.00	—	N9M20-6.00	N9M20-8.00	N9M20-10.00	N9M20-12.00
	3/4"	3.25	—	—	N12M20-4.00	—	N12M20-6.00	N12M20-8.00	N12M20-10.00	N12M20-12.00
	1"	4.50	—	—	—	N16M20-4.50	N16M20-6.00	N16M20-8.00	N16M20-10.00	N16M20-12.00
60,000 PSI (4140 bar)	1/4"	2.75	N4H60-2.75	N4H60-3.00	N4H60-4.00	—	N4H60-6.00	N4H60-8.00	N4H60-10.00	N4H60-12.00
	3/8"	3.00	—	—	N6H60-4.00	—	N6H60-6.00	N6H60-8.00	N6H60-10.00	N6H60-12.00
	9/16"	4.00	—	—	N9H60-4.00	—	N9H60-6.00	N9H60-8.00	N9H60-10.00	N9H60-12.00

*To order a custom length, replace the last segment of the catalog number above to the desired length in inches.
Example: To order a 9/16" MP nipple 5.25" long, specify part number N9M20-5.25

High Pressure Tubing

CONED & THREADED VALVES, FITTINGS & TUBING — 20,000 to 60,000 PSI



FEATURES & BENEFITS

- High resistance to corrosion. IPT 316L is also supplied with high molybdenum, minimum 2.5%.
- Good weldability
- Good resistance to organic acids at high concentrations and moderate temperatures
- Good resistance to inorganic acids, e.g. phosphoric and sulfuric acids, at moderate concentrations and temperatures. IPT 316L can also be used in sulfuric acid of concentrations above 90% at low temperature.
- Good resistance to salt solutions, e.g. sulfates, sulfides and sulfites
- Good resistance in caustic environments
- High quality, consistent from delivery to delivery.
- A wide variety of sizes and grades available

SPECIFICATIONS

Max. Working Pressure:
20,000 PSI (1030 bar) or
60,000 PSI (4140 bar)

Temperature Rating:
-100° to 600°F (-73° to 315°C)

TYPICAL APPLICATIONS

- Industrial applications where types AISI 304 and 304L have insufficient corrosion resistance
- Heat exchangers
- Condensers
- Pipelines
- Cooling and heating coils
- Offshore oil & gas, chemical, petrochemical, pulp & paper, and food industries

TYPICAL MATERIALS

- 316L Stainless Steel

ORDERING

PART NUMBER	O.D.	I.D.	MAWP @ 72°F
TU4M20	1/4"	0.109"	20,000 PSI
TU6M20	3/8"	0.203"	
TU9M20	9/16"	0.312"	
TU12M20	3/4"	0.438"	
TU16M20	1"	0.562"	60,000 PSI
TU4H60	1/4"	0.083"	
TU6H60	3/8"	0.125"	
TU9H60	9/16"	0.188"	

Tubing is supplied in 18-22 ft. random lengths.
Custom lengths are available on request.

Coning & Threading Tools



FEATURES & BENEFITS

- Innovative Pressure Technologies manufactures precision quality coning and threading tools for tubing sizes through 9/16" OD
- Tools are manufactured from stainless steel for long life
- All tools are designed with interchangeable blades, bushings and dies. The convenient kit includes everything needed to prepare both medium and high pressure tubing in 1/4", 3/8" & 9/16" sizes
- Tools are easily adaptable for use with a power hand drill
- Tools guide on the outside diameter of the tubing, eliminating misalignment issues that adversely affect quality
- Lightweight tube vise securely holds the tubing during both coning and threading operations, preventing marring and collapse of the tubing
- Tube vise eliminates the need for soft jaws in vise
- Custom coning tool gauge allows for fast setup
- Power coning and threading machine is available. Consult your nearest authorized distributor

CONING AND THREADING KIT

CTK469: Complete Kit for coning and threading both medium and high pressure tubing in 1/4", 3/8" & 9/16" sizes

REPLACEMENT BLADES AND DIES

TUBING SIZE	MP BLADE	HP BLADE	DIE
1/4"	BL4M	BL4H	DT4
3/8"	BL6M	BL6H	DT6
9/16"	BL9M	BL9H	DT9



CONED & THREADED VALVES, FITTINGS & TUBING — 20,000 to 60,000 PSI

Pipe Needle Valves

PIPE VALVES & FITTINGS — To 15,000 PSI



SPECIFICATIONS

Max. Working Pressure:
Up to 15,000 PSI (1030 bar)

Temperature Ratings:
-100° to 450°F (-73° to 232°C)
Grafoil packing available for high temperature service

TYPICAL APPLICATIONS

- General plant service
- Instrument isolation
- Hydraulic applications
- Pneumatic applications
- Pressure measurement devices
- Venting

TYPICAL MATERIALS

- 316 Stainless Steel body and trim with 17-4 PH stem and glass-filled Teflon packing
- Other materials available upon request

FEATURES & BENEFITS

- Non-rotating stem prevents galling and scoring
- Vee or Regulating tip stem
- Nine body styles for a wide variety of applications
- Integral through-holes for bracket mounting
Panel mounting option is also available
- Gland locking device prevents loosening of the packing gland, reducing leak potential
- Optional soft seat available in a wide variety of materials
- Complete material traceability on all components
- Equipment can be manufactured to meet NACE MR-01-75 and American Petroleum Institute standards. Consult your nearest authorized distributor for more information

ACTUATOR OPTIONS

All needle valves are available with a variety of pneumatic, hydraulic or electric actuators. Consult factory for proper selection of valve and actuator combination.

ORDERING

ACTUATOR STYLE	FUNCTION	MEDIUM DUTY	HEAVY DUTY
Pneumatic	Air-to-Open, Normally-Closed	A019	A050
	Air-to-Close, Normally-Open	AC19	AC50
	Double-Acting	DA19	DA50
Hydraulic	Double-Acting	HD2	HD4

Other Options: -SS Stainless Steel Handle -PM Panel Mount -GR Grafoil packing for temperatures to 1200°F (649°C)

ORDERING

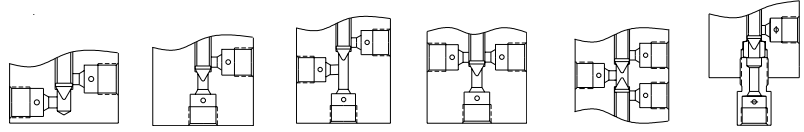

PRESSURE	CONNECTION		PORT	CV*	STEM TIP	2-WAY		3-WAY 2 INLET		3-WAY 2 OUTLET		2-STEM MANIFOLD	REPLACEABLE SEAT
	SIZE	PORT				STRAIGHT	2-WAY ANGLE	PORTS	PORTS				
15,000 PSI (1035 bar)	1/8"	0.187"	0.65	Vee	NV2N1VA15	NV2N2VA15	NV2N3VA15	NV2N4VA15	NV2N5VA15	NV2N6VA15			
		0.187"	0.65	Reg	NV2N1RA15	NV2N2RA15	NV2N3RA15	NV2N4RA15	NV2N5RA15	NV2N6RA15			
	1/4"	0.250"	0.75	Vee	NV4N1VA15	NV4N2VA15	NV4N3VA15	NV4N4VA15	NV4N5VA15	NV4N6VA15			
		0.250"	0.75	Reg	NV4N1RA15	NV4N2RA15	NV4N3RA15	NV4N4RA15	NV4N5RA15	NV4N6RA15			
	3/8"	0.312"	1.75	Vee	NV6N1VB15	NV6N2VB15	NV6N3VB15	NV6N4VB15	NV6N5VB15	NV6N6VB15			
		0.312"	1.75	Reg	NV6N1RB15	NV6N2RB15	NV6N3RB15	NV6N4RB15	NV6N5RB15	NV6N6RB15			
1/2"	0.312"	1.75	Vee	NV8N1VB15	NV8N2VB15	NV8N3VB15	NV8N4VB15	NV8N5VB15	NV8N6VB15				
	0.312"	1.75	Reg	NV8N1RB15	NV8N2RB15	NV8N3RB15	NV8N4RB15	NV8N5RB15	NV8N6RB15				
10,000 PSI (690 bar)	3/4"	0.562"	3.40	Vee	NV12N1VD10	NV12N2VD10	NV12N3VD10	NV12N4VD10	NV12N5VD10	NV12N6VD10			
		0.562"	3.40	Reg	NV12N1RD10	NV12N2RD10	NV12N3RD10	NV12N4RD10	NV12N5RD10	NV12N6RD10			
	1"	0.562"	3.40	Vee	NV16N1VD10	NV16N2VD10	NV16N3VD10	NV16N4VD10	NV16N5VD10	NV16N6VD10			
		0.562"	3.40	Reg	NV16N1RD10	NV16N2RD10	NV16N3RD10	NV16N4RD10	NV16N5RD10	NV16N6RD10			

*Cv values listed are for 2-way straight valves. For other styles, increase Cv value by 50%.

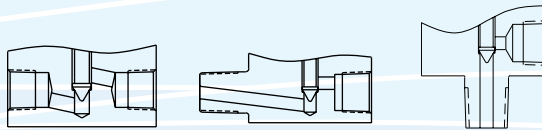

PRESSURE	CONNECTION		PORT	CV*	STEM TIP	2-WAY STRAIGHT		2-WAY ANGLE	
	SIZE	PORT				2-WAY STRAIGHT	MALE X FEMALE	MALE X FEMALE	
15,000 PSI (1035 bar)	1/8"	0.187"	0.60	Vee	NV2N1VE15	NV2N7VE15	NV2N8VE15		
		0.187"	0.60	Reg	NV2N1RE15	NV2N7RE15	NV2N8RE15		
	1/4"	0.250"	0.73	Vee	NV4N1VE15	NV4N7VE15	NV4N8VE15		
		0.250"	0.73	Reg	NV4N1RE15	NV4N7RE15	NV4N8RE15		
	3/8"	0.250"	0.73	Vee	NV6N1VE15	NV6N7VE15	NV6N8VE15		
		0.250"	0.73	Reg	NV6N1RE15	NV6N7RE15	NV6N8RE15		
1/2"	0.250"	1.75	Vee	NV8N1VE15	NV8N7VE15	NV8N8VE15			
	0.250"	1.75	Reg	NV8N1RE15	NV8N7RE15	NV8N8RE15			
10,000 PSI (690 bar)	3/4"	0.687"	5.20	Vee	NV12N1VF10	NV12N7VF10	NV12N8VF10		
		0.687"	5.20	Reg	NV12N1RF10	NV12N7RF10	NV12N8RF10		
	1"	0.687"	5.20	Vee	NV16N1VF10	NV16N7VF10	NV16N8VF10		
		0.687"	5.20	Reg	NV16N1RF10	NV16N7RF10	NV16N8RF10		

*Cv values listed are for 2-way straight valves. For other styles, increase Cv value by 50%.

Pipe Check Valves

PIPE VALVES & FITTINGS — To 15,000 PSI



FEATURES & BENEFITS

- Prevents reverse flow where leak-tight shutoff is required
- Three styles to fit most applications:
 - Ball Seat Poppet — Metal-to-metal seat for rapid cycling or severe environments
 - Soft Seat Poppet — O-ring seat for fast shut-off and reliable seal; standard material is Nitrile. A variety of seal materials are available for even the harshest media.
 - Dual Seal Ball Style — Rapid, reliable sealing on the Glass-filled Teflon seat, backed by metal-to-metal sealing for durability
- Complete material traceability on all components
- Equipment can be manufactured to meet NACE MR-01-75 and American Petroleum Institute standards. Consult your nearest authorized distributor for more information

SPECIFICATIONS

- Max. Working Pressure:
 - Up to 15,000 PSI (1030 bar)
- Temperature Ratings:
 - Ball Seat Poppet – -420° to 1200°F (-251° to 648°C)
 - Soft Seat Poppet – -65° to 250°F (-54° to 121°C) (with standard Nitrile seal)
 - Dual Seal Ball – -320° to 400°F (-195° to 204°C)
- Nominal Cracking Pressure:
 - 15 PSI (1 bar)
 - Optional cracking pressures up to 100 PSI (7 bar)
- End Connections:
 - Female NPT

TYPICAL APPLICATIONS

- Gas
- Liquid
- Fluid handling for the chemical/ petrochemical, research, and oil and gas industries

TYPICAL MATERIALS

- 316 Stainless Steel
- Other materials available on request

ORDERING

PRESSURE	CONNECTION SIZE	BALL POPPET	O-RING POPPET	DUAL SEAL
15,000 PSI (1035 bar)	1/8"	CV2NFB15	CV2NFS15	CV2NFD15
	1/4"	CV4NFB15	CV4NFS15	CV4NFD15
	3/8"	CV6NFB15	CV6NFS15	CV6NFD15
	1/2"	CV8NFB15	CV8NFS15	CV8NFD15
10,000 PSI (690 bar)	3/4"	CV12NFB10	CV12NFS10	CV12NFD10
	1"	CV16NFB10	CV16NFS10	CV16NFD10

Pipe Fittings & Adapters



SPECIFICATIONS

Max. Working Pressure:

Up to 15,000 PSI (1030 bar)

Temperature Ratings:

-100° to 600°F (-73° to 315°C)

TYPICAL MATERIALS

- 316 Cold Worked Stainless Steel
- Other materials available on request

FEATURES & BENEFITS

- Non-standard design and prototype assistance
- Complete material traceability on all components
- 100% manufactured in the USA for the highest reliability
- Equipment can be manufactured to meet NACE MR-01-75 and American Petroleum Institute standards. Consult your nearest authorized distributor for more information

PIPE FITTINGS

PIPE VALVES & FITTINGS — To 15,000 PSI

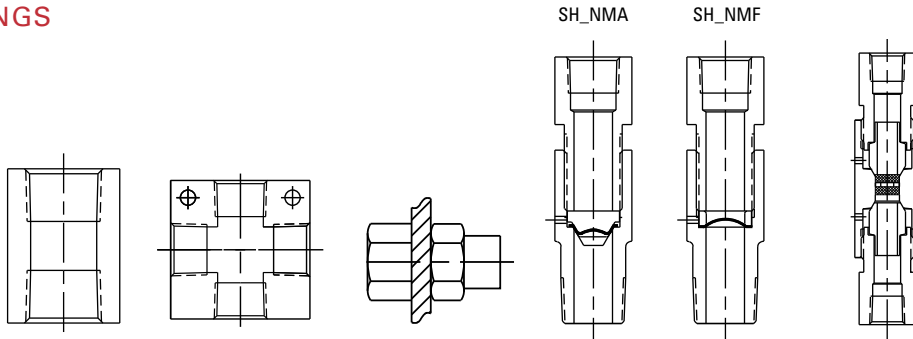

CONNECTION	COUPLING	CROSS	BULKHEAD	SAFETY HEAD	LINE FILTER	MAWP
1/8" NPT	CN2NF15	X2NF15	BH2NF15	SH2NM*15	LF2NF15-*/*	15,000 PSI
1/4" NPT	CN4NF15	X4NF15	BH4NF15	SH4NM*15	LF4NF15-*/*	15,000 PSI
3/8" NPT	CN6NF15	X6NF15	BH6NF15	SH6NM*15	LF6NF15-*/*	15,000 PSI
1/2" NPT	CN8NF15	X8NF15	BH8NF15	SH8NM*15	LF8NF15-*/*	15,000 PSI
3/4" NPT	CN12NF10	X12NF10	BH12NF10	SH12NM*10	LF12NF10-*/*	10,000 PSI
1" NPT	CN16NF10	X16NF10	BH16NF10	SH16NM*10	LF16NF10-*/*	10,000 PSI

*Insert A for 1/4" Angled style; Insert F for 1/2" Flat style
 Replace */* with the desired micron ratings
 Example: L4MF20-40/20 would have 40 micron and 20 micron elements

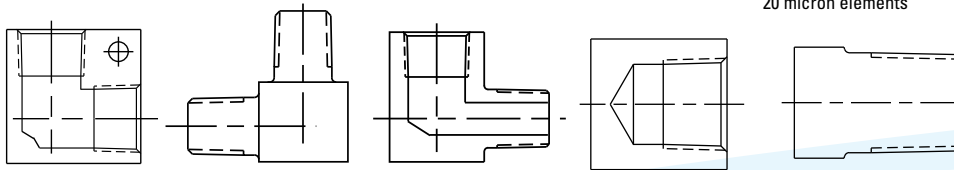

CONNECTION	FEMALE ELBOW	MALE ELBOW	STREET ELBOW	CAP	PLUG	MAWP
1/8" NPT	L2NF15	L2NM15	L2NM2NF15	CA2N15	PL2N15	15,000 PSI
1/4" NPT	L4NF15	L4NM15	L4NM4NF15	CA4N15	PL4N15	15,000 PSI
3/8" NPT	L6NF15	L6NM15	L6NM6NF15	CA6N15	PL6N15	15,000 PSI
1/2" NPT	L8NF15	L8NM15	L8NM8NF15	CA8N15	PL8N15	15,000 PSI
3/4" NPT	L12NF10	L12NM10	L12NM12NF10	CA12N10	PL12N10	10,000 PSI
1" NPT	L16NF10	L16NM10	L16NM16NF10	CA16N10	PL16N10	10,000 PSI

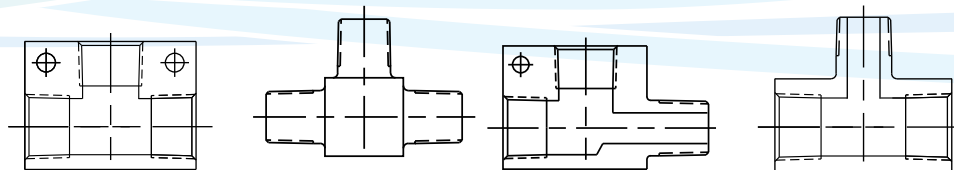

CONNECTION	FEMALE TEE	MALE TEE	MALE RUN TEE	MALE BRANCH TEE	MAWP
1/8" NPT	T2NF15	T2NM15	T2NF2NM2NF15	T2NF2NF2NM15	15,000 PSI
1/4" NPT	T4NF15	T4NM15	T4NF4NM4NF15	T4NF4NF4NM15	15,000 PSI
3/8" NPT	T6NF15	T6NM15	T6NF6NM6NF15	T6NF6NF6NM15	15,000 PSI
1/2" NPT	T8NF15	T8NM15	T8NF8NM8NF15	T8NF8NF8NM15	15,000 PSI
3/4" NPT	T12NF10	T12NM10	T12NF12NM12NF10	T12NF12NF12NM10	10,000 PSI
1" NPT	T16NF10	T16NM10	T16NF16NM16NF10	T16NF16NF16NM10	10,000 PSI

MALE X FEMALE ADAPTERS*

MALE END		FEMALE END					
		HP CONE & THREAD					
		1/4"	3/8"	9/16"			
NPT	1/8"	CN2NM4HF15	CN2NM6HF15	CN2NM9HF15			
	1/4"	CN4NM4HF15	CN4NM6HF15	CN4NM9HF15			
	3/8"	CN6NM4HF15	CN6NM6HF15	CN6NM9HF15			
	1/2"	CN8NM4HF15	CN8NM6HF15	CN8NM9HF15			
	3/4"	CN12NM4HF10	CN12NM6HF10	CN12NM9HF10			
	1"	CN16NM4HF10	CN16NM6HF10	CN16NM9HF10			
		MP CONE & THREAD					
		1/4"	3/8"	9/16"	3/4"	1"	
NPT	1/8"	CN2NM4MF15	CN2NM6MF15	CN2NM9MF15	CN2NM12MF15	CN2NM16MF15	
	1/4"	CN4NM4MF15	CN4NM6MF15	CN4NM9MF15	CN4NM12MF15	CN4NM16MF15	
	3/8"	CN6NM4MF15	CN6NM6MF15	CN6NM9MF15	CN6NM12MF15	CN6NM16MF15	
	1/2"	CN8NM4MF15	CN8NM6MF15	CN8NM9MF15	CN8NM12MF15	CN8NM16MF15	
	3/4"	CN12NM4MF10	CN12NM6MF10	CN12NM9MF10	CN12NM12MF10	CN12NM16MF10	
	1"	CN16NM4MF10	CN16NM6MF10	CN16NM9MF10	CN16NM12MF10	CN16NM16MF10	
		NPT					
		1/8"	1/4"	3/8"	1/2"	3/4"	1"
HP Cone & Thread	1/4"	CN4HM2NF15	CN4HM4NF15	CN4HM6NF15	CN4HM8NF15	CN4HM12NF10	CN4HM16NF10
	3/8"	CN6HM2NF15	CN6HM4NF15	CN6HM6NF15	CN6HM8NF15	CN6HM12NF10	CN6HM16NF10
	9/16"	CN9HM2NF15	CN9HM4NF15	CN9HM6NF15	CN9HM8NF15	CN9HM12NF10	CN9HM16NF10
		NPT					
		1/8"	1/4"	3/8"	1/2"	3/4"	1"
MP Cone & Thread	1/4"	CN4MM2NF15	CN4MM4NF15	CN4MM6NF15	CN4MM8NF15	CN4MM12NF10	CN4MM16NF10
	3/8"	CN6MM2NF15	CN6MM4NF15	CN6MM6NF15	CN6MM8NF15	CN6MM12NF10	CN6MM16NF10
	9/16"	CN9MM2NF15	CN9MM4NF15	CN9MM6NF15	CN9MM8NF15	CN9MM12NF10	CN9MM16NF10
	3/4"	CN12MM2NF15	CN12MM4NF15	CN12MM6NF15	CN12MM8NF15	CN12MM12NF10	CN12MM16NF10
	1"	CN16MM2NF15	CN16MM4NF15	CN16MM6NF15	CN16MM8NF15	CN16MM12NF10	CN16MM16NF10
		NPT					
		1/8"	1/4"	3/8"	1/2"	3/4"	1"
NPT	1/8"	CN2NM2NF15	CN2NM4NF15	CN2NM6NF15	CN2NM8NF15	CN2NM12NF10	CN2NM16NF10
	1/4"	CN4NM2NF15	CN4NM4NF15	CN4NM6NF15	CN4NM8NF15	CN4NM12NF10	CN4NM16NF10
	3/8"	CN6NM2NF15	CN6NM4NF15	CN6NM6NF15	CN6NM8NF15	CN6NM12NF10	CN6NM16NF10
	1/2"	CN8NM2NF15	CN8NM4NF15	CN8NM6NF15	CN8NM8NF15	CN8NM12NF10	CN8NM16NF10
	3/4"	CN12NM2NF10	CN12NM4NF10	CN12NM6NF10	CN12NM8NF10	CN12NM12NF10	CN12NM16NF10
	1"	CN16NM2NF10	CN16NM4NF10	CN16NM6NF10	CN16NM8NF10	CN16NM12NF10	CN16NM16NF10

* Last two digits of part number designates pressure x 1000 psi (e.g. CN2NM4HF15 is rated for 15,000 psi)

PIPE VALVES & FITTINGS — TO 15,000 PSI

MALE X MALE ADAPTERS*

PIPE VALVES & FITTINGS — To 15,000 PSI

MALE END		MALE END					
		HP CONE & THREAD					
		1/4"	3/8"	9/16"			
NPT	1/8"	CN2NM4HM15	CN2NM6HM15	CN2NM9HM15			
	1/4"	CN4NM4HM15	CN4NM6HM15	CN4NM9HM15			
	3/8"	CN6NM4HM15	CN6NM6HM15	CN6NM9HM15			
	1/2"	CN8NM4HM15	CN8NM6HM15	CN8NM9HM15			
	3/4"	CN12NM4HM10	CN12NM6HM10	CN12NM9HM10			
	1"	CN16NM4HM10	CN16NM6HM10	CN16NM9HM10			
		JIC 37° FLARE					
		1/4"	3/8"	1/2"	1"		
NPT	1/4"	CN4JM4NM10	CN4JM6NM10	CN4JM8NM10	—		
	3/8"	CN6JM4NM10	CN6JM6NM10	CN6JM8NM10	—		
	1/2"	CN8JM4NM10	CN8JM6NM10	CN8JM8NM10	—		
	3/4"	CN12JM4NM10	CN12JM6NM10	CN12JM8NM10	—		
	1"	CN16JM4NM10	CN16JM6NM10	CN16JM8NM10	CN16JM16NM10		
		MP CONE & THREAD					
		1/4"	3/8"	9/16"	3/4"	1"	
NPT	1/8"	CN2NM4MM15	CN2NM6MM15	CN2NM9MM15	CN2NM12MM15	CN2NM16MM15	
	1/4"	CN4NM4MM15	CN4NM6MM15	CN4NM9MM15	CN4NM12MM15	CN4NM16MM15	
	3/8"	CN6NM4MM15	CN6NM6MM15	CN6NM9MM15	CN6NM12MM15	CN6NM16MM15	
	1/2"	CN8NM4MM15	CN8NM6MM15	CN8NM9MM15	CN8NM12MM15	CN8NM16MM15	
	3/4"	CN12NM4MM10	CN12NM6MM10	CN12NM9MM10	CN12NM12MM10	CN12NM16MM10	
	1"	CN16NM4MM10	CN16NM6MM10	CN16NM9MM10	CN16NM12MM10	CN16NM16MM10	
		NPT					
		1/8"	1/4"	3/8"	1/2"	3/4"	1"
NPT	1/8"	CN2NM15	CN2NM4NM15	CN2NM6NM15	CN2NM8NM15	CN2NM12NM10	CN2NM16NM10
	1/4"	CN2NM4NM15	CN4NM15	CN4NM6NM15	CN4NM8NM15	CN4NM12NM10	CN4NM16NM10
	3/8"	CN2NM6NM15	CN4NM6NM15	CN6NM15	CN6NM8NM15	CN6NM12NM10	CN6NM16NM10
	1/2"	CN2NM8NM15	CN4NM8NM15	CN6NM8NM15	CN8NM15	CN8NM12NM10	CN8NM16NM10
	3/4"	CN2NM12NM10	CN4NM12NM10	CN6NM12NM10	CN8NM12NM10	CN12NM10	CN12NM16NM10
	1"	CN2NM16NM10	CN4NM16NM10	CN6NM16NM10	CN8NM16NM10	CN12NM16NM10	CN16NM10
			TYPE M HOSE				
		9/16"-18	3/4"-16	1"-12	1-5/16"-12		
NPT	1/4"	CN4NM9RM15	CN4NM12RM15	CN4NM16RM15	—		
	3/8"	CN6NM9RM15	CN6NM12RM15	CN6NM16RM15	—		
	1/2"	CN8NM9RM15	CN8NM12RM15	CN8NM16RM15	CN8NM21RM15		
	3/4"	CN12NM9RM10	CN12NM12RM10	CN12NM16RM10	CN12NM21RM10		
	1"	CN16NM9RM10	CN16NM12RM10	CN16NM16RM10	CN16NM21RM10		

* Last two digits of part number designates pressure x 1000 psi (e.g. CN2NM4HM15 is rated for 15,000 psi)

FEMALE X FEMALE ADAPTER COUPLINGS*

FEMALE END		HP CONE & THREAD		
		1/4"	3/8"	9/16"
NPT	1/8"	CN2NF4HF15	CN2NF6HF15	CN2NF9HF15
	1/4"	CN4NF4HF15	CN4NF6HF15	CN4NF9HF15
	3/8"	CN6NF4HF15	CN6NF6HF15	CN6NF9HF15
	1/2"	CN8NF4HF15	CN8NF6HF15	CN8NF9HF15
	3/4"	CN12NF4HF10	CN12NF6HF10	CN12NF9HF10
	1"	CN16NF4HF10	CN16NF6HF10	CN16NF9HF10

FEMALE END		MP CONE & THREAD				
		1/4"	3/8"	9/16"	3/4"	1"
NPT	1/8"	CN2NF4MF15	CN2NF6MF15	CN2NF9MF15	CN2NF12MF15	CN2NF16MF15
	1/4"	CN4NF4MF15	CN4NF6MF15	CN4NF9MF15	CN4NF12MF15	CN4NF16MF15
	3/8"	CN6NF4MF15	CN6NF6MF15	CN6NF9MF15	CN6NF12MF15	CN6NF16MF15
	1/2"	CN8NF4MF15	CN8NF6MF15	CN8NF9MF15	CN8NF12MF15	CN8NF16MF15
	3/4"	CN12NF4MF10	CN12NF6MF10	CN12NF9MF10	CN12NF12MF10	CN12NF16MF10
	1"	CN16NF4MF10	CN16NF6MF10	CN16NF9MF10	CN16NF12MF10	CN16NF16MF10

FEMALE END		NPT					
		1/8"	1/4"	3/8"	1/2"	3/4"	1"
NPT	1/8"	CN2NF15	CN2NF4NF15	CN2NF6NF15	CN2NF8NF15	CN2NF12NF10	CN2NF16NF10
	1/4"	CN2NF4NF15	CN4NF15	CN4NF6NF15	CN4NF8NF15	CN4NF12NF10	CN4NF16NF10
	3/8"	CN2NF6NF15	CN4NF6NF15	CN6NF15	CN6NF8NF15	CN6NF12NF10	CN6NF16NF10
	1/2"	CN2NF8NF15	CN4NF8NF15	CN6NF8NF15	CN8NF15	CN8NF12NF10	CN8NF16NF10
	3/4"	CN2NF12NF10	CN4NF12NF10	CN6NF12NF10	CN8NF12NF10	CN12NF10	CN12NF16NF10
	1"	CN2NF16NF10	CN4NF16NF10	CN6NF16NF10	CN8NF16NF10	CN12NF16NF10	CN16NF10

* Last two digits of part number designates pressure x 1000 psi (e.g. CN2NF4HF15 is rated for 15,000 psi)

Low Pressure Needle Valves

PIPE VALVES & FITTINGS — To 15,000 PSI

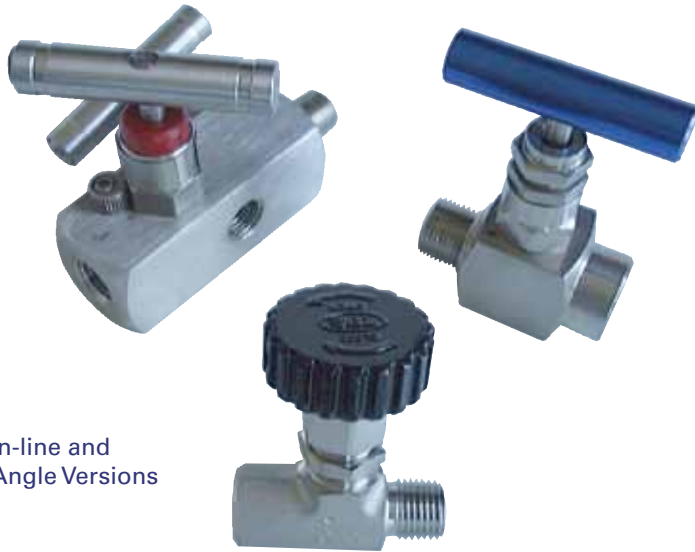

In-line and
Angle Versions

FEATURES & BENEFITS

- Bonnet anti-rotation device prevents accidental loosening
- Adjustable packing reduces the possibility of bonnet/body leaks
- Rotating tip design assures valve closure without seat galling
- Bonnet design prevents accidental stem removal
- Soft seat design with O-ring seals available
- Integral bonnet design panel nut allows panel installation without disrupting the packing
- Gauge valves combine the function of a tee, calibration valve, isolation valve and all tubing and fittings in a single valve

SPECIFICATIONS

- Max. Pressure Rating (metal seated):
Up to 6,000 PSI @ 200°F (414 bar @ 93°C)
- Pressure Rating at Max. Temperature:
PTFE – 4130 PSI @ 450°F
(284 bar @ 232°C)
Grafoil – 1500 PSI @ 1000°F
(103 bar @ 538°C)

TYPICAL APPLICATIONS

- General plant service
- Instrument isolation
- General hydraulic and pneumatic service
- Pressure measurement devices
- Venting

TYPICAL MATERIALS

- 316 Stainless Steel



UNION BONNET NEEDLE VALVE ORDERING

PRESSURE	CONNECTION SIZE	IN-LINE	ANGLE	IN-LINE	ANGLE
		FEMALE X FEMALE	FEMALE X FEMALE	MALE X FEMALE	MALE X FEMALE
6000 PSI (414 bar)	1/8"	GNV2N1V6	GNV2N2V6	GNV2N7V6	GNV2N8V6
	1/4"	GNV4N1V6	GNV4N2V6	GNV4N7V6	GNV4N8V6
	3/8"	GNV6N1V6	GNV6N2V6	GNV6N7V6	GNV6N8V6
	1/2"	GNV8N1V6	GNV8N2V6	GNV8N7V6	GNV8N8V6
	3/4"	GNV12N1V6	GNV12N2V6	GNV12N7V6	GNV12N8V6
	1"	GNV16N1V6	GNV16N2V6	GNV16N7V6	GNV16N8V6

INTEGRAL BONNET NEEDLE VALVE ORDERING

PRESSURE	CONNECTION SIZE	IN-LINE	ANGLE	IN-LINE	ANGLE	IN-LINE
		FEMALE X FEMALE	FEMALE X FEMALE	MALE X FEMALE	MALE X FEMALE	MALE X FEMALE
3000 PSI (207 bar)	1/8"	JNV2N1V3	—	JNV2N7V3	—	—
	1/4"	JNV4N1V3	—	JNV4N7V3	—	—
	1/2"	JNV8N1V3	—	JNV8N7V3	—	—
	3/4"	JNV12N1V3	—	JNV12N7V3	—	—
	1"	JNV13N1V3	—	JNV13N7V3	—	—
6000 PSI (414 bar)	1/8"	HN2N1V6	HN2N2V6	HN2N7V6	HN2N8V6	HN2N9V6
	1/4"	HN4N1V6	HN4N2V6	HN4N7V6	HN4N8V6	HN4N9V6
	1/2"	HN8N1V6	HN8N2V6	HN8N7V6	HN8N8V6	HN8N9V6
	3/4"	HN12N1V6	HN12N2V6	HN12N7V6	HN12N8V6	HN12N9V6
	1"	HN16N1V6	HN16N2V6	HN16N7V6	HN16N8V6	HN16N9V6

GAUGE AND GAUGE ROOT NEEDLE VALVE ORDERING

PRESSURE	CONNECTION SIZE	SHORT BODY	LONG BODY
		6000 PSI (414 bar)	1/2" Female x 1/2" Female
	1/2" Male x 1/2" Female	KNV8N7V6	LNV8N7V6
	3/4" Female x 3/4" Female	KN12N1V6	LNV12N1V6
	3/4" Male x 1/2" Female	KN12N7V6	LNV12N7V6

Low Pressure Check Valves

PIPE VALVES & FITTINGS — To 15,000 PSI



SPECIFICATIONS

Max. Working Pressure:
3,000 PSI (207 bar)

Temperature Ratings:
Viton – -10° to 375°F (-23° to 191°C)
Buna – -10° to 250°F (-23° to 121°C)

Nominal Cracking Pressure:
1, 10, 25 PSI (0.07, 0.69, 1.72 bar)
Optional cracking pressures up to 100 PSI

TYPICAL APPLICATIONS

- Gas
- Liquid
- Fluid handling for the chemical/ petrochemical, research, and oil and gas industries

TYPICAL MATERIALS

- 316 Stainless Steel

FEATURES & BENEFITS

- Instant shutoff in upstream condition
- Stops reverse flow in order to protect instrumentation
- 100% factory tested for both crack & reseal

ORDERING

PRESSURE	CONNECTION SIZE	FEMALE X FEMALE	MALE X MALE
3000 PSI (207 bar)	1/4"	CV4NFP3	CV4NMP3
	3/8"	CV6NFP3	CV6NMP3
	1/2"	CV8NFP3	CV8NMP3
	3/4"	CV12NFP3	CV12NMP3
	1"	CV16NFP3	CV16NMP3

Low Pressure Ball Valves



FEATURES & BENEFITS

- On/off service ball valve in both 2- and 3-way patterns
- Floating ball design provides seat wear compensation and ensures leak proof shut off on pressure
- Bi-directional flow
- Micro-finished ball provides a positive seal
- Handle indicates flow direction
- Panel mountable
- 100% factory tested

ORDERING

PRESSURE	CONNECTION		2-WAY		3-WAY	
	SIZE	PORT	FEMALE X FEMALE	MALE X MALE	FEMALE X FEMALE	MALE X MALE
3000 PSI (207 bar)	1/8"	3/16" (5 mm)	CBV2-2NF-2NF	CBV2-2NM-2NM	CBVS-2NF-2NF-2NF	CBVS-2NM-2NM-2NM
	1/4"		CBV2-4NF-4NF	CBV2-4NM-4NM	CBVS-4NF-4NF-4NF	CBVS-4NM-4NM-4NM
	3/8"		CBV2-6NF-6NF	CBV2-6NM-6NM	CBVS-6NF-6NF-6NF	CBVS-6NM-6NM-6NM
	1/2"		CBV2-8NF-8NF	CBV2-8NM-8NM	CBVS-8NF-8NF-8NF	CBVS-8NM-8NM-8NM
	3/4"	3/8" (10 mm)	DBV2-12NF-12NF	DBV2-12NM-12NM	DBVS-12NF-12NF-12NF	DBVS-12NM-12NM-12NM
	1"		DBV2-16NF-16NF	DBV2-16NM-16NM	DBVS-16NF-16NF-16NF	DBVS-16NM-16NM-16NM
6000 PSI (414 bar)	1/8"	3/16" (5 mm)	RBV2-2NF-2NF	RBV2-2NM-2NM	RBVS-2NF-2NF-2NF	RBVS-2NM-2NM-2NM
	1/4"		RBV2-4NF-4NF	RBV2-4NM-4NM	RBVS-4NF-4NF-4NF	RBVS-4NM-4NM-4NM
	3/8"		RBV2-6NF-6NF	RBV2-6NM-6NM	RBVS-6NF-6NF-6NF	RBVS-6NM-6NM-6NM
	1/2"		RBV2-8NF-8NF	RBV2-8NM-8NM	RBVS-8NF-8NF-8NF	RBVS-8NM-8NM-8NM
	3/4"	3/8" (10 mm)	SBV2-12NF-12NF	SBV2-12NM-12NM	SBVS-12NF-12NF-12NF	SBVS-12NM-12NM-12NM
	1"		SBV2-16NF-16NF	SBV2-16NM-16NM	SBVS-16NF-16NF-16NF	SBVS-16NM-16NM-16NM

SPECIFICATIONS

Max. Working Pressure:

Up to 6,000 PSI (414 bar)

End Connections:

Tube

NPT taper thread in male and female

BSP/ISO taper thread in male and female

TYPICAL APPLICATIONS

- Instrument air lines
- General plant service
- Automated service with actuator

TYPICAL MATERIALS

- 316 Stainless Steel
- Brass

Hose Fittings

HOSE FITTINGS



FEATURES & BENEFITS

- Complete material traceability on all components
- 100% manufactured in the USA for the highest reliability

SPECIFICATIONS

Max. Working Pressure:
Up to 50,000 PSI (3450 bar)

Temperature Ratings:
-100° to 600°F (-73° to 315°C)

TYPICAL MATERIALS

- 316 Cold Worked Stainless Steel
- Other materials available on request

Plugs

Type M Hose	9/16"-18	PL9R
	3/4"-16	PL12R
	1"-12	PL16R
	1-5/16"-12	PL21R

Caps

Type M Hose	9/16"-18	CA9R50
	3/4"-16	CA12R30
	1"-12	CA16R30
	1-5/16"-12	CA21R20

MALE X MALE ADAPTERS*

		MALE END					
		TYPE M HOSE					
		9/16"-18	3/4"-16	1"-12	1-5/16"-12		
NPT	1/4"	CN4NM9RM15	CN4NM12RM15	CN4NM16RM15	—		
	3/8"	CN6NM9RM15	CN6NM12RM15	CN6NM16RM15	—		
	1/2"	CN8NM9RM15	CN8NM12RM15	CN8NM16RM15	CN8NM21RM15		
	3/4"	CN12NM9RM10	CN12NM12RM10	CN12NM16RM10	CN12NM21RM10		
	1"	CN16NM9RM10	CN16NM12RM10	CN16NM16RM10	CN16NM21RM10		
		TYPE M HOSE					
		9/16"-18	3/4"-16	7/8"-14	1"-12	1-1/8"-12	1-5/16"-12
Type M Hose	9/16"-18	CN9RM50	CN9RM12RM30	CN9RM14RM50	CN9RM16RM30	CN9RM18RM50	—
	3/4"-16	CN9RM12RM30	CN12RM30	—	CN12RM16RM30	—	—
	7/8"-14	CN9RM14RM50	—	CN14RM50	—	CN14RM18RM50	—
	1"-12	CN9RM16RM30	CN12RM16RM30	—	CN16RM30	—	CN16RM21RM20
	1-1/8"-12	CN9RM18RM50	—	CN14RM18RM50	—	CN18RM50	—
	1-5/16"-12	—	—	—	CN16RM21RM20	—	CN21RM20

* Last two digits of part number designates pressure x 1000 psi (e.g. CN4NM9RM15 is rated for 15,000 psi)

Continued on next page...



MALE X MALE ADAPTERS* (CONTINUED FROM PREVIOUS PAGE)

MALE END		MALE END				
		HP CONE & THREAD				
		1/4"	3/8"	9/16"		
JIC 37° Flare	1/4"	CN4JM4HM10	CN4JM6HM10	CN4JM9HM10		
	3/8"	CN6JM4HM10	CN6JM6HM10	CN6JM9HM10		
	1/2"	CN8JM4HM10	CN8JM6HM10	CN8JM9HM10		
		HP CONE & THREAD				
		1/4"	3/8"	9/16"		
Type M Hose	9/16"-18	CN9RM4HM50	CN9RM6HM50	CN9RM9HM50		
	3/4"-16	CN12RM4HM30	CN12RM6HM30	CN12RM9HM30		
	7/8"-14	—	CN14RM6HM50	CN14RM9HM50		
	1"-12	—	CN16RM6HM30	CN16RM9HM30		
	1-1/8"-12	—	—	CN18RM9HM50		
	1-5/16"-12	—	—	CN21RM9HM50		
		JIC 37° FLARE				
		1/4"	3/8"	1/2"	1"	
JIC 37° Flare	1/4"	CN4JM10	CN4JM6JM10	CN4JM8JM10	—	
	3/8"	CN4JM6JM10	CN6JM10	CN6JM8JM10	—	
	1/2"	CN4JM8JM10	CN6JM8JM10	CN8JM10	—	
	1"	—	—	—	CN16JM10	
		JIC 37° FLARE				
		1/4"	3/8"	1/2"	1"	
NPT	1/4"	CN4JM4NM10	CN4JM6NM10	CN4JM8NM10	—	
	3/8"	CN6JM4NM10	CN6JM6NM10	CN6JM8NM10	—	
	1/2"	CN8JM4NM10	CN8JM6NM10	CN8JM8NM10	—	
	3/4"	CN12JM4NM10	CN12JM6NM10	CN12JM8NM10	—	
	1"	CN16JM4NM10	CN16JM6NM10	CN16JM8NM10	CN16JM16NM10	
		MP CONE & THREAD				
		1/4"	3/8"	9/16"	3/4"	1"
JIC 37° Flare	1/4"	CN4JM4MM10	CN4JM6MM10	CN4JM9MM10	—	—
	3/8"	CN6JM4MM10	CN6JM6MM10	CN6JM9MM10	CN6JM12MM10	
	1/2"	CN8JM4MM10	CN8JM6MM10	CN8JM9MM10	CN8JM12MM10	CN8JM16MM10
	1"	—	—	CN16JM9MM10	CN16JM12MM10	CN16JM16MM10
		MP CONE & THREAD				
		1/4"	3/8"	9/16"	3/4"	1"
Type M Hose	9/16"-18	CN4MM9RM20	CN6MM9RM20	CN9MM9RM20	CN12MM9RM20	CN16MM9RM20
	3/4"-16	CN4MM12RM20	CN6MM12RM20	CN9MM12RM20	CN12MM12RM20	CN16MM12RM20
	7/8"-14	CN4MM14RM20	CN6MM14RM20	CN9MM14RM20	CN12MM14RM20	CN16MM14RM20
	1"-12	CN4MM16RM20	CN6MM16RM20	CN9MM16RM20	CN12MM16RM20	CN16MM16RM20
	1-5/16"-12			CN9MM21RM20	CN12MM21RM20	CN16MM21RM20

* Last two digits of part number designates pressure x 1000 psi (e.g. CN4JM4HM10 is rated for 10,000 psi)

Custom Manifolds

MANIFOLD VALVES



FEATURES & BENEFITS

Pressure manifolds minimize space requirements and reduce installation time necessary to plumb a pressure system. In addition, the number of potential leak points is minimized by reducing the number of components used in a system.

IPT will design and manufacture pressure manifolds to meet specific installation, layout and pressure requirements. These manifolds can withstand pressures up to 60,000 PSI (4140 bar) and are available in a variety of materials.

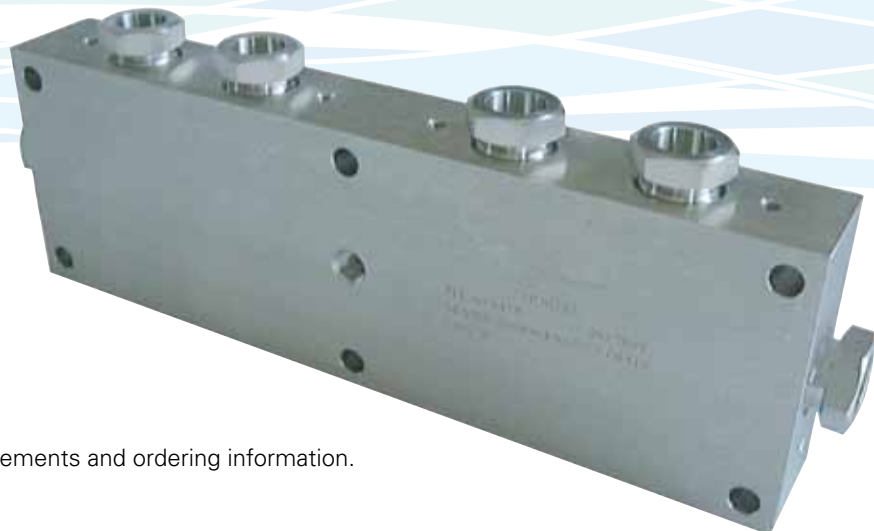

Consult factory to discuss your requirements and ordering information.

Double Block & Bleed Valves

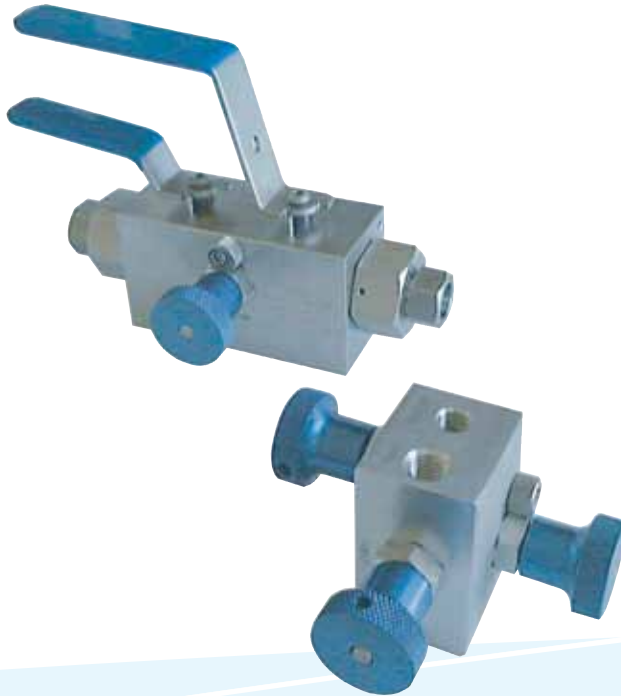

SPECIFICATIONS

Max Working Pressure:

Up to 20,000 PSI (1380 bar)

Temperature Rating:

-100° to 450°F (-73°C to 232°C)

Grafoil packing available for temperatures to 1200°F (649°C)

End Connections:

Male or Female NPT

MP Cone & Thread

HP Cone & Thread

TYPICAL APPLICATIONS

- Pressure monitoring & test
- Chemical injection
- Drain line isolation

TYPICAL MATERIALS

- 316 cold-worked stainless steel
- Fiber reinforced PEEK seats
- Glass-filled Teflon packing
- Viton seals

FEATURES & BENEFITS

- One-piece, trunnion mounted stem design eliminates shear failure and reduces the effects of side loading found in two-piece designs
- Vee stem vent valve
- Full-port flow path minimizes pressure drop
- Quarter turn from open to close with positive stop

IPT Double Block and Bleed valves are custom-designed to meet each individual requirement.

Contact your nearest authorized distributor for assistance in the design of a valve to meet your specific needs.

Relief Valves

RELIEF VALVES



SPECIFICATIONS

- Max. Working Pressure:
Up to 20,000 PSI (1380 bar)
- Temperature Rating:
-100° to 450°F (-73° to 232°C)
- End Connections:
MP Cone & Thread

TYPICAL APPLICATIONS

- Pressure gas systems
- Cryogenic systems
- Petrochemical applications

TYPICAL MATERIALS

- 316 Stainless Steel

Note: Although IPT relief valves are capable of handling air, gases, steam, vapor and liquids, they are not recommended for steam boiler applications and are not ASME code stampable.

Relief valves are designed to open proportionally to increasing back pressure and, therefore, are not recommended for applications requiring immediate full valve flow at set pressure (such as polymerizations, decompositions, etc.). Full flow of relief valve is defined at 10% over set pressure.

ORDERING

CATALOG NUMBER*		INLET CONNECTION	OUTLET CONNECTION	ORIFICE IN. (MM)	PRESSURE RATING PSIG @ 100°F (BAR @ 38° C)		
SET PRESSURE	ADJUSTABLE				MIN SET	MAX SET	MAX BACK
RV6MF12NF*	RVA6MF12NF10-15	3/8" MP	3/4" FNPT	0.188 (4.78)	10,000 (689)	15,000 (1034)	
RV6MF12NF*	RVA6MF12NF15-20			0.156 (4.02)	15,000 (1034)	20,000 (1380)	
RV9MF12NF*	RVA9MF12NF1.5-5	9/16" MP	3/4" FNPT	0.312 (7.92)	1,500 (103)	5,000 (345)	500 (34.5)
RV9MF12NF*	RVA9MF12NF5-10			0.250(6.35)	5,000 (345)	10,000 (689)	
RV9MF12NF*	RVA9MF12NF10-15			0.188 (4.78)	10,000 (689)	15,000 (1034)	
RV9MF12NF*	RVA9MF12NF15-20			0.156 (4.02)	15,000 (1034)	20,000 (1380)	

*Complete catalog number by specifying the required set pressure.

Examples:

RV9MF12NF2 would be a relief valve with 9/16" MP inlet, factory set for 2,000 PSI

RV6MF12NF12 would be a relief valve with 3/8" MP inlet, factory set for 12,000 PSI

2-, 3- and 5-Stem Manifold Valves



SPECIFICATIONS

Max. Pressure Rating (metal seated):
6,000 PSI @ 200°F (414 bar @ 93°C)

Pressure Rating at Max. Temperature:
PTFE – 4130 PSI @ 450°F
(284 bar @ 232°C)

Grafoil – 1500 PSI @ 1000°F
(103 bar @ 538°C)

Orifice Size: 0.156 inch (4.0 mm)

TYPICAL APPLICATIONS

- General plant service
- Pressure instrumentation devices
- Differential pressure instrumentation devices
- Pressure equalization
- Block and bleed applications
- Venting

FEATURES & BENEFITS

- Convenient method of blocking, bleeding, and calibrating pressure instruments
- Designed for connecting system impulse line & transmitter
- Combine the function of a tee, calibration valve, isolation valve, all tubing and fittings in a single valve configuration
- Bonnet lock pins prevent accidental loosening
- Rotating tip design assures valve closure without seat galling
- Special hardened ball seat is ideal for both gas and liquid service
- All stem packing is located below the stem threads preventing galling, corrosion and contamination
- Adjustable packing reduces the possibility of bonnet/body leaks
- Full back-sealed bonnets prevent accidental stem removal and blowout

ORDERING

	FLANGE-TO-FLANGE H-TYPE	PIPE-TO-PIPE R-TYPE	PIPE-TO-FLANGE T-TYPE	PIPE-TO-PIPE OBLIQUE D-TYPE
2-Valve	2VMFF-S6-8-4-NF	2VMPP-S6-8-4-NF	2VMPF-S6-8-4-NF	—
3-Valve	3VMFF-S6-8-4-NF	3VMPP-S6-8-4-NF	3VMPF-S6-8-4-NF	3VMD-S6-8-4-NF
5-Valve	5VMFF-S6-8-4-NF	5VMPP-S6-8-4-NF	5VMPF-S6-8-4-NF	—

Valves for Subsea Service

SUBSEA VALVES



SPECIFICATIONS

Working Pressure:
3,000 PSI to 15,000 PSI
(20,684 to 103,420 kPa)
(207 to 1035 bar)

Port Sizes: 1/4" through 2"

TYPICAL MATERIALS

Body & End Flanges:
Stainless steel
Duplex steel

Seals:
PEEK seats for excellent chemical, heat and wear resistance
NBR Buna-N o-rings for operation from -35°F to 250°F (-37°C to 121°C)

Other seal materials available for extreme service

FEATURES & BENEFITS

- Floating Ball design on valves rated up to 6,000 PSI for low cost and high performance
- Trunnion Ball design on valves rated 10,000 PSI and above for improved performance
- Full and reduced port designs available
- Smooth, low-torque operation
- T-handle for manual operation, Paddle handle for ROV operation, or Hydraulic actuator for remote operation
- Wide selection of tube, pipe and flanged end connections
- Blow-out proof stem for increased safety
- 100% testing to API-598 or contract requirements assures quick start-up and operational performance
- Needle valve designs available, consult factory
- Complete material traceability on all components
- Equipment can be manufactured to meet NACE MR-01-75 and American Petroleum Institute standards. Consult factory for more information.

STANDARD TERMS AND CONDITIONS

Prices: All prices are FOB, the plant of manufacture of Innovative Pressure Technologies, LLC. (Hereinafter referred to as "IPT"), unless otherwise stated. Prices also do not include any federal, state, or local taxes or other governmental charges upon or with respect to the sale, purchase, manufacture, delivery, storage, processing, use or consumption of any of the goods or services provided hereby. Consequently, in addition to the price specified, the amount of such taxes or other governmental charges that IPT may be required to pay or collect under present or existing future law shall be paid by the purchaser and added to the invoice.

Cancellation or Changes: An accepted order is not subject to cancellation or change except on terms acceptable and satisfactory to IPT, including reasonable cancellation charges in the event of cancellation or an equitable price adjustment in the event of changes in an accepted order. Direction from purchaser to cancel may be treated as a repudiation making the purchaser immediately liable for loss, expense and other damages sustained. If this order is cancelled or delayed prior to the completion of the contract, purchaser shall indemnify IPT for costs incurred by IPT up to the date of cancellation or delay and for all damages sustained by IPT due to cancellation or delay of this order.

Failure to Deliver: IPT shall not be responsible for delays in delivery, or failure to deliver due to causes beyond its reasonable control, including without limitation, acts of God, acts of purchaser, government action (civil or military), taking or preempting IPT's production facilities, legal interferences or prohibitions, fires, strikes or other labor difficulties, or hostilities, insurrections or riots, embargoes, equipment breakdown, wrecks or delays in transportation, unusually severe weather, inability to obtain necessary labor, material or manufacturing facilities due to causes beyond its reasonable control or any like dissimilar cause beyond its reasonable control. In the event of such delay, the date of delivery shall be extended for a period equal to the time lost by reason of the delay. IPT shall have the right to furnish suitable substitutes for materials which cannot be obtained because of above causes and to portion its shipment among its customers in such a manner as it shall be equitable. If the material, apparatus or equipment is or thereafter become subject to government control, allocation, regulation or restriction, the necessary and proper rating certificate shall be supplied by the purchaser. Delivery dates are from receipt of order, prints, models or materials, whichever is later, which are to be furnished by the purchaser. Due to the nature of IPT's custom work, delivery dates are estimates and not guarantees, and purchaser understands and agrees to reasonable delays in delivery. Overtime and other direct costs incurred to hasten delivery of purchaser's request shall be added to the stated prices and paid by purchaser. Shipment of goods ready for delivery can be deferred beyond date for delivery only with IPT's consent and upon full payment of IPT's invoice for same plus storage costs. There shall be no penalties for late shipments unless arranged prior to production and confirmed by IPT in writing.

Risk of Loss: IPT assumes no responsibility for delays, breakage or damage after having made delivery to a common carrier, at which time, all risk of loss for any cause passes to purchaser. Unless otherwise specified, packing will be for domestic shipping and meet the requirements of United States common carriers.

Claims: No claim for variances from purchaser's specifications or shortages in orders will be considered by IPT unless presented to it in writing within thirty (30) days after receipt of goods.

Payment: If the financial condition of the purchaser at any time does not, in the judgment of IPT, justify continuance of the work to be performed by IPT on the terms of payment as agreed upon, IPT may require full or partial payment in advance or shall be entitled to cancel any order then outstanding and receive reimbursements for its reasonable cancellation charges, and in the event of bankruptcy insolvency of the purchaser or in the event any proceeding is brought against the purchaser, voluntary or involuntary, under the bankruptcy or any insolvency laws, IPT shall be entitled to cancel any order then outstanding, and shall receive reimbursement for its reasonable cancellation charges. Title to tools and fixtures shall remain in IPT until all terms of payment have been satisfied.

Default: IPT may make partial shipments and each shipment shall be treated as a separate transaction, but in the event of any default by the purchaser, IPT, without prejudice to any other remedy provided herein or by law, may treat such default as breach of the entire contract or may defer further deliveries until such default is cured, in which latter event, if IPT so elects, the dates of all subsequent deliveries shall be extended for a period equal to the length of time of such deferral. If, despite any default by the purchaser, IPT elects to continue to make deliveries, its actions shall not constitute a waiver of any default by the purchaser or in any way effect IPT's remedies provided herein or by law for any such default.

Quality Systems: Although IPT is registered for specific products with respect to ISO9000, not all IPT products fall within the scope of registration. IPT's intention is to manufacturer all of its products within a ISO9000 system whenever possible. For all Standard Products, IPT will maintain a copy of all controlling documentation at IPT. Customers are free to review this documentation upon request at IPT's facilities. All changes with respect to IPT Standard Products will be controlled by the applicable IPT Quality Management Team.

LIMITED WARRANTY: All IPT products are warranted against defective materials and workmanship for a period of one (1) year from the date of delivery to the original purchaser. Any product that is found to be defective within the one year period will be replaced at the discretion of IPT. **THIS WARRANTY IS IN LIEU OF ALL OTHER WARRANTIES, EXPRESS OR IMPLIED, OF MERCHANTABILITY, FITNESS FOR PARTICULAR PURPOSE, PERFORMANCE, OR OTHERWISE.** IPT is not an expert in the customer's technical field and therefore does not warrant the suitability of its products for the applications selected by the customer. IPT accepts no responsibility for misuse, misapplication or unauthorized modification of its products.

LIMITATION OF LIABILITY: IPT's obligation under this limited warranty is strictly and exclusively limited to the repair or replacement free of charge of such articles as are found to be defective in material or workmanship on the condition that the purchaser gives prompt written notice to IPT of any claim to breach of warranty within the warranty period, and, if requested, returns the defective articles to IPT. IPT will not assume any expenses or liability for repairs made to its articles outside of its plant, without its prior written consent. IPT reserves the right to satisfy its warranty obligation in full, with respect to defective articles, by the payment to the purchaser of all sums paid by the purchaser to IPT for such articles. **IN NO EVENT SHALL IPT BE LIABLE FOR CLAIMS (BASED UPON BREACH OF EXPRESS OR IMPLIED WARRANTY, NEGLIGENCE OR OTHERWISE) FOR ANY DAMAGES, WHETHER DIRECT, IMMEDIATE, INCIDENTAL, FORESEEABLE, CONSEQUENTIAL, OR SPECIAL.**

Return of Goods: Goods may not be returned to IPT for repair or replacement or credit, or otherwise, without IPT's prior written authorization and IPT will not accept any responsibility for goods returned without such authorization. All transportation costs incident to the shipment of any material to or from IPT under this or the foregoing paragraph shall be charged to the purchaser.

Waiver: No provision hereof and no breach of any provision shall be deemed waived by reason of any previous waiver of such provision of any breach thereof. There are no understandings, conditions or agreements relative to this quotation that are not fully expressed herein.

Terms, Interest and Collection Costs: Terms are Net 30 Days. Terms of payment for this quotation are set forth therein. In the event it is necessary to place any contract based on this proposal in the hands of an attorney for collection, purchaser shall pay IPT's reasonable costs of collection of money due and unpaid, including reasonable attorneys' fees.

Design Modifications: Purchaser will allow extra charges for authorized or requested changes to purchaser's design or specifications. IPT is not responsible for dimensional or other errors on purchaser's drawings, and purchaser shall reimburse IPT for additional costs resulting from such errors.

Intellectual Property Rights: IPT shall retain all rights in all intellectual property, including any rights under any patents as well as any un-patented information, such as trade secrets, confidential information, trademarks, trade dress, or copyrights possessed by IPT which may be protected by state, federal and/or common law, and nothing in this Quotation or Acknowledgement shall be deemed or construed to be a transfer or license of any of IPT's intellectual property. Buyer shall obtain rights to such intellectual property only to the extent that IPT may grant such rights (whether by license or otherwise) in writing.

Liabilities: Purchaser agrees to defend, and protect, and save harmless IPT against all suits from all damages, claims and demands for actual or alleged infringement of any patent or for manufacture of goods by reason of IPT's execution of the designs, prints, drawings, requirements, or specifications of purchaser.

Purchaser's Property: IPT shall have the right to scrap, without liability, prints submitted for quotation, as well as models, patterns, tools, fixtures or other property belonging to purchaser unless written directions for shipment of such property are given to IPT within thirty (30) days of notification by IPT.

Tooling Modifications: Any modifications made to the tooling in order to manufacture an acceptable part will be at the discretion of IPT.

Choice of Forum: The rights and obligations of purchaser and IPT shall be governed by the laws of the Commonwealth of Pennsylvania, without giving affect to principles of conflicts of law. Any lawsuit between purchaser and IPT shall be filed exclusively in a court either located in or having jurisdiction over, Erie County, Pennsylvania.

Orders: The above terms and conditions shall be deemed included as part of any order or orders placed with IPT in accordance with or as a result of this Quotation or Acknowledgement. All orders by purchaser require a written purchase order and are subject to acknowledgment by IPT. The terms of this Quotation or Acknowledgement supersede the terms of purchaser's purchase order. Any additional or different terms on purchaser's purchase order form are deemed material alterations to any contract between IPT and purchaser, and IPT hereby gives notice of its objection to them. The terms and conditions set forth by this Quotation or Acknowledgement are limited to orders placed with IPT or resulting from this Quotation or Acknowledgement. Any subsequent orders placed by buyer not resulting from this Quotation or Acknowledgement, such as orders for service parts, may be subject to terms and conditions differing from the terms and conditions.



4922 Pittsburgh Avenue
Erie, PA 16509-6207
Phone: 814-833-5200
Fax: 814-836-1824
sales@inpressure.com

www.inpressure.com

 **WARNING!**

Property damage, personal injury, or death can result due to the failure, improper selection, and/or improper use of the products or systems described herein.