

S

- Zone 1, 2, 21, 22
- Group IIC
- Aluminium junction boxes
- Wide selection of models
- IP66 / 67

S.1 series



SSC series



*Temperature sensor box
SWS series*



SF series



ED.2018

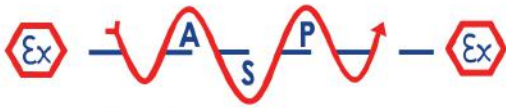

S... series Junction boxes gas group IIC

The S series junction boxes are made from aluminium alloy or AISI316L stainless steel and are used to accommodate cables connected both with multi-pole terminal strips and modular terminals. The extensive range offered caters to specific customer requirements and can be installed in areas classified as Zone 1, 2, 21, 22. The design features of the S series junction boxes make them suitable for operating temperatures in the -40°C to +160°C range depending on their size, the type of gasket used and the terminals used (see table for relevant electrical features).

Cortem Group labels its products with a non-removable adhesive label featuring a hologram and an alphanumerical univocal code, as a safety measure against the illegal sale of fakes so that all the products are guaranteed as original. Non-compliance with the International standards entails serious risks for the environment, especially for those working daily on the plants.



Application sectors:



CERTIFICATION DATA FOR EMPTY ENCLOSURES

Classification:	Group II	Category 2GD		
Installation: EN 60079.14	zone 1 - zone 2 (Gas)	zone 21 - zone 22 (Dust)		
Marking:	CE 0722 Ex II 2 GD - Ex d IIC Gb - Ex tb IIC Db - IP66/67			
Certification:	ATEX	CESI 03 ATEX 059U		
	IECEX	IECEX CES 15.0012U		
Standards:	CENELEC EN 60079-0: 2012, EN 60079-1: 2007, EN 60079-31, EN 60529: 1991 and EUROPEAN DIRECTIVE 2014/34/UE			
Ambient Temp.:	-40°C (-20°C) +160°C			
Degree of protection:	IP66/67			

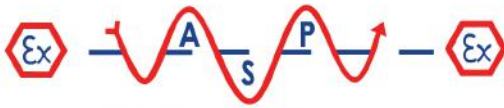

S... series Junction boxes gas group IIC

CERTIFICATION DATA FOR ENCLOSURES WITH TERMINALS

Classification:	Group II	Category 2GD		
Installation: EN 60079.14	zone 1 - zone 2 (Gas)	zone 21 - zone 22 (Dust)		
Marking:	<p>CE 0722 II 2 GD - Ex d IIC T... Gb - Ex tb IIIC T... Db - IP66/67</p> <p>CE 0722 II 2 GD - Ex e IIC T... Gb - Ex tb IIIC T... Db - IP66/67</p> <p>CE 0722 II 2 GD - Ex i IIC T... Gb - Ex tb IIIC T... Db - IP66/67</p>			
Certification:	ATEX CESI 02 ATEX 091			
	IEC Ex CES 14.0018X	All IEC Ex certification data can be downloaded from www.cortemgroup.com		
	TR CU AVAILABLE	All TR CU certification data can be downloaded from www.cortemgroup.com		
	INMETRO DNV 14.0108	All INMETRO certification data can be downloaded from www.cortemgroup.com		
Standards:	CENELEC EN 60079-0: 2012, EN 60079-1: 2007, EN 60079-7: 2007, EN 60079-11: 2012, EN60079-31: 2009, EN 60529: 1991 and EUROPEAN DIRECTIVE 2014/34/UE			
Ambient Temp.:	<p> -40°C (-20°C) +40°C </p> <p>The boxes can be installed in other ambient temperature ranges. In this case, the terminal strips used must be made from the materials indicated in chart 1 and 2.</p>			
Degree of protection:	IP66/67			

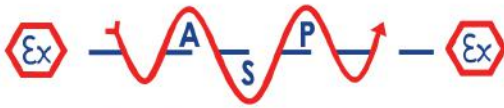

S... series Junction boxes gas group IIC



MECHANICAL FEATURES

Body and lid:	Low copper content aluminium alloy. Screw-on lid with safety fastening grub screw
Gasket:	Acid/hydrocarbon-resistant silicone, located between body and lid
Entries:	GAS UNI ISO 7/1 thread
Certification label:	Adhesive label located on lid for size 6 and 9 boxes; on body for size 4
Bolts and screws:	Stainless steel
Earth screws:	Stainless steel. On inside and outside of body complete with anti-rotation brackets
Corrosion Resistance:	The STANDARD of the aluminium alloy used by Cortem has passed the tests required by standards EN 60068-2-30 (hot/humid cycles) and EN 60068-2-11 (salt mist tests)

ELECTRICAL FEATURES

Rated voltage:	750 V
Rated frequency:	50 / 60 Hz

TERMINALS

Terminal cross-sectional area:	1.5; 2.5; 4; 6; 10; 16; 25; 35; 70 [mm ²]
Rated current:	8 - 175 [A]
Max. current density:	2.5 - 6.6 [A/mm ²]

ACCESSORIES AVAILABLE ON REQUEST/ SPECIAL REQUESTS

- AISI 316 L stainless steel boxes (Ex. SC-16.1S)
- Electropolished AISI 316 L stainless steel boxes (Ex. SC-16.1SE)
- Boxes coated with RAL 7035 paint (Ex. SC-16.1V)
- Boxes with different entry diameter
- Cast iron boxes
- Other threads:
 - NPT threads ANSI B1.20.1 (Ex. SC-26.1N)
 - GAS UNI ISO 228 thread (Ex. SC-26.1C)
 - Metric threads ISO 261/965 (Ex. SC-26.1I)



AISI 316 L stainless steel box code SX-36.1SE with electropolished finish

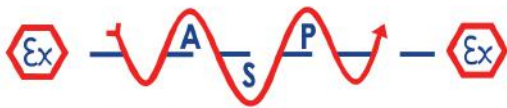

S... series Junction boxes gas group IIC

S SERIES ENCLOSURE SELECTION CHART

Code	Position of entries	GAS UNI ISO 7/1	Model	Outside dimensions mm					Inside dimensions mm			Weight kg
				A	D1	H	C	B1	Ød1	S	S1	
SC-14.1		2 x 1/2"	A	72	65	61	34	17	54x2	3,5	3,5	
SC-24.1		2 x 3/4"	A	72	65	61	34	17	54x2	3,5	3,5	
SC-16.1		2 x 1/2"	A	100	89	67	34	17	80x2	3,5	3,5	
SC-26.1		2 x 3/4"	A	100	89	67	34	17	80x2	3,5	3,5	
SC-36.1		2 x 1"	A	107	89	75	42	21	80x2	3,5	3,5	
SC-29.1		2 x 3/4"	B	190	146	105	60	30	130x2	4	7	
SC-39.1		2 x 1"	B	190	146	105	60	30	130x2	4	7	
SC-59.1		2 x 1 1/2"	B	190	146	105	60	30	130x2	4	7	
SC-69.1		2 x 2"	B	190	146	110	70	35	130x2	4	7	
SL-14.1			2 x 1/2"	A	72	65	61	34	17	54x2	3,5	3,5
SL-24.1	2 x 3/4"		A	72	65	61	34	17	54x2	3,5	3,5	
SL-16.1	2 x 1/2"		A	100	89	67	34	17	80x2	3,5	3,5	
SL-26.1	2 x 3/4"		A	100	89	67	34	17	80x2	3,5	3,5	
SL-36.1	2 x 1"		A	107	89	75	42	21	80x2	3,5	3,5	
SL-29.1	2 x 3/4"		B	166	146	105	60	30	130x2	4	7	
SL-39.1	2 x 1"		B	166	146	105	60	30	130x2	4	7	
SL-59.1	2 x 1 1/2"		B	166	146	105	60	30	130x2	4	7	
SL-69.1	2 x 2"		B	166	146	110	70	35	130x2	4	7	
ST-14.1			3 x 1/2"	A	72	65	61	34	17	54x2	3,5	3,5
ST-24.1		3 x 3/4"	A	72	65	61	34	17	54x2	3,5	3,5	
ST-16.1		3 x 1/2"	A	100	89	67	34	17	80x2	3,5	3,5	
ST-26.1		3 x 3/4"	A	100	89	67	34	17	80x2	3,5	3,5	
ST-36.1		3 x 1"	A	107	89	75	42	21	80x2	3,5	3,5	
ST-29.1		3 x 3/4"	B	190	146	105	60	30	130x2	4	7	
ST-39.1		3 x 1"	B	190	146	105	60	30	130x2	4	7	
ST-59.1		3 x 1 1/2"	B	190	146	105	60	30	130x2	4	7	
ST-69.1		3 x 2"	B	190	146	110	70	35	130x2	4	7	
SX-14.1			4 x 1/2"	A	72	65	61	34	17	54x2	3,5	3,5
SX-24.1	4 x 3/4"		A	72	65	61	34	17	54x2	3,5	3,5	
SX-16.1	4 x 1/2"		A	100	89	67	34	17	80x2	3,5	3,5	
SX-26.1	4 x 3/4"		A	100	89	67	34	17	80x2	3,5	3,5	
SX-36.1	4 x 1"		A	107	89	75	42	21	80x2	3,5	3,5	
SX-29.1	4 x 3/4"		B	190	146	105	60	30	130x2	4	7	
SX-39.1	4 x 1"		B	190	146	105	60	30	130x2	4	7	
SX-59.1	4 x 1 1/2"		B	190	146	105	60	30	130x2	4	7	
SX-69.1	4 x 2"		B	190	146	110	70	35	130x2	4	7	

S... series Junction boxes gas group IIC

DIMENSIONAL DRAWING

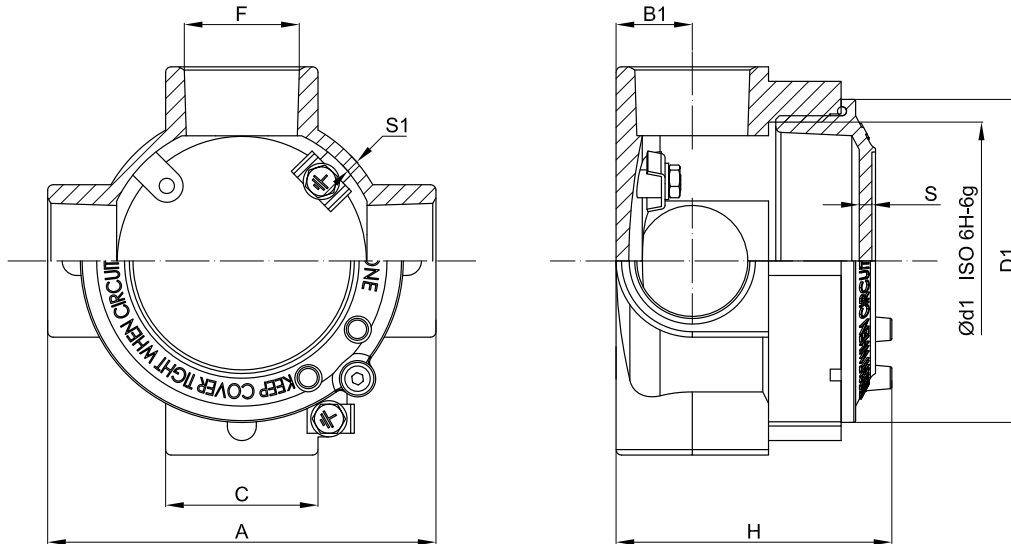

MODEL A

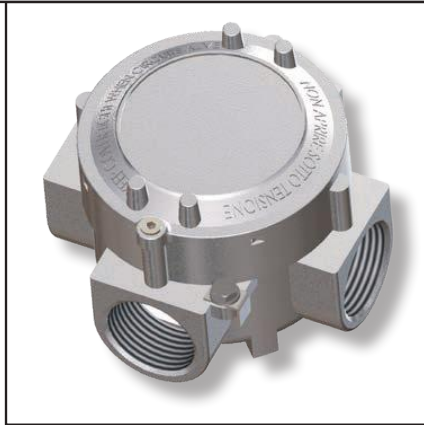

MODEL B

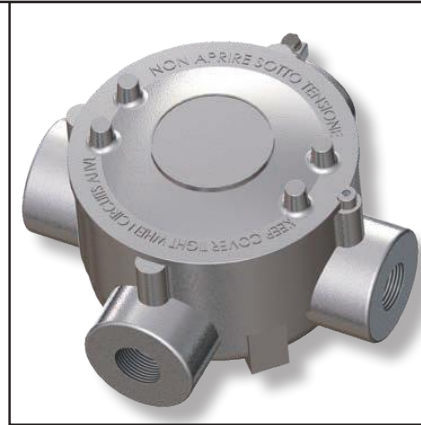

Code	MODEL	F GAS UNI ISO 7/1	Outside dimensions mm				Inside dimensions mm			Weight kg	
			A	D1	H	C	B1	Ød1	S	S1	
SB-14		2 x 1/2"	90	65	90	39	43	54x2	3,5	3,5	
SB-24		2 x 3/4"	90	65	90	39	43	54x2	3,5	3,5	
SB-16		2 x 1/2"	110	90	90	45	43	80x2	3,5	5	
SB-26		2 x 3/4"	110	90	90	45	43	80x2	3,5	5	
SB-36		2 x 1"	114	90	96	45	52	80x2	3,5	5	
SB-49		2 x 1 1/4"	180	150	114	60	59	130x2	4	5	
SB-59		2 x 1 1/2"	180	150	114	60	59	130x2	4	5	
SB-69		2 x 2"	180	150	114	74	71	130x2	4	5	

SF... SSC... series Junction boxes gas group IIC



MODEL SF



MODEL SSC

SF series enclosures from the (with wall-mounting bracket) and SSC series (with ceiling-mounting bracket) are installed on ducting paths as junction boxes for connecting and branching conductors.

Various different models are available and they can be supplied with multi-pole terminal strips or modular terminals.

MECHANICAL AND ELECTRICAL FEATURES

MOUNTING BRACKETS: Galvanized steel for SSC. Aluminium for SF.

Other features are identical to S series boxes

ACCESSORIES AVAILABLE ON REQUEST/ SPECIAL REQUESTS

See S series boxes

SF... SSC... SERIES ENCLOSURE SELECTION CHART

Code	Position of entries	GAS UNI ISO 7/1	Outside dimensions mm			Weight kg
		F	D1	A	B	
SFC-14.1		2 x 1/2"	65	75	90	
SFC-24.1		2 x 3/4"	65	75	90	
SFC-16.1		2 x 1/2"	89	110	130	
SFC-26.1		2 x 3/4"	89	110	130	
SFC-36.1		2 x 1"	89	110	130	
SFC-29.1		2 x 3/4"	146	160	180	
SFC-39.1		2 x 1"	146	160	180	
SFC-59.1		2 x 1 1/2"	146	160	180	
SFC-69.1		2 x 2"	146	160	180	
SFL-14.1		2 x 1/2"	65	75	90	
SFL-24.1		2 x 3/4"	65	75	90	
SFL-16.1		2 x 1/2"	89	110	130	
SFL-26.1		2 x 3/4"	89	110	130	
SFL-36.1		2 x 1"	89	110	130	
SFL-29.1		2 x 3/4"	146	160	180	
SFL-39.1		2 x 1"	146	160	180	
SFL-59.1		2 x 1 1/2"	146	160	180	

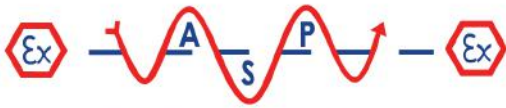

SF... SSC... series Junction boxes gas group IIC

Code	Position of entries	GAS UNI ISO 7/1 F	Outside dimensions mm			Weight kg
			D1	A	B	
SFT-14.1		3 x 1/2"	65	75	90	
SFT-24.1		3 x 3/4"	65	75	90	
SFT-16.1		3 x 1/2"	89	110	130	
SFT-26.1		3 x 3/4"	89	110	130	
SFT-36.1		3 x 1"	89	110	130	
SFT-29.1		3 x 3/4"	146	160	180	
SFT-39.1		3 x 1"	146	160	180	
SFT-59.1		3 x 1 1/2"	146	160	180	
SFT-69.1		3 x 2"	146	160	180	
SFX-14.1		4 x 1/2"	65	75	90	
SFX-24.1		4 x 3/4"	65	75	90	
SFX-16.1		4 x 1/2"	89	110	130	
SFX-26.1		4 x 3/4"	89	110	130	
SFX-36.1		4 x 1"	89	110	130	
SFX-29.1		4 x 3/4"	146	160	180	
SFX-39.1		4 x 1"	146	160	180	
SFX-59.1		4 x 1 1/2"	146	160	180	
SFX-69.1		4 x 2"	146	160	180	
SSC-14.1		3 x 1/2"	65	65	80	
SSC-24.1		3 x 3/4"	65	65	80	
SSC-16.1		3 x 1/2"	89	110	125	
SSC-26.1		3 x 3/4"	89	110	125	
SSC-36.1		3 x 1"	89	110	125	
SSC-29.1		3 x 3/4"	146	130	150	
SSC-39.1		3 x 1"	146	130	150	
SSC-59.1		3 x 1 1/2"	146	130	150	
SSC-69.1		3 x 2"	146	130	150	

The encoding in the marking on the nameplates remains unchanged with respect to the one indicated on the S series junction boxes.

DIMENSIONAL DRAWING

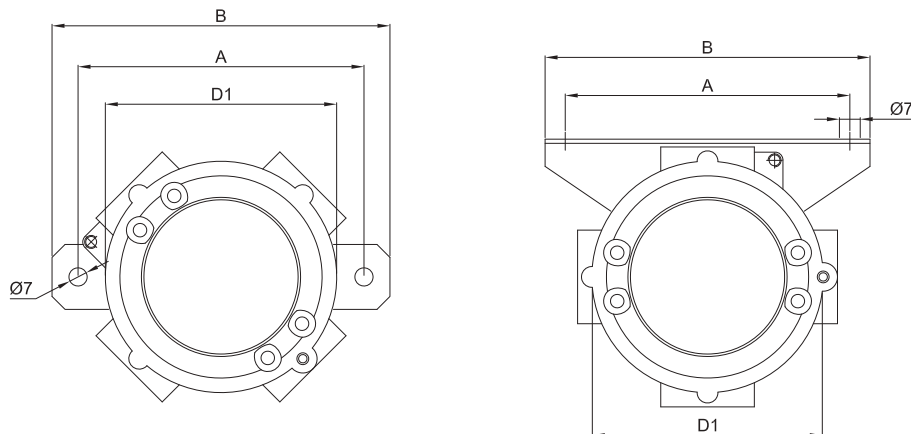

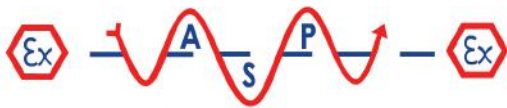

S... series Junction boxes - Terminal tables

CHART 1

Ex d IIC rated terminal strips			
Ambient temperature	Terminal material	Temperature class	Maximum surface temperature
-20°C +40°C -40°C +40°C	Polyamide (PA)	T6	T85°C
-20°C +65°C -40°C +65°C	Melamine (KrG) Wemid Stamin (KrS)	T5	T100°C
-20°C +150°C -40°C +150°C	Ceramic (Steatite)	T3	T200°C

CHART 2

Ex e II or Ex i IIC rated terminal strips (ATEX-certified terminals)			
Ambient temperature	Terminal material	Temperature class	Maximum surface temperature
-20°C +40°C -40°C +40°C	Polyamide (PA)	T6	T85°C
-20°C +65°C -40°C +65°C	Melamine (KrG) Wemid Stamin (KrS)	T5	T100°C
-20°C +80°C -40°C +80°C	Melamine (KrG) Stamin (KrS) Ceramic (Steatite)	T4	T135°C

MOUNTING RAILS (as per standard IEC 60715)

Terminal manufacturer	Terminal code	ENCLOSURE TYPE		
		S.1 - SB 14-24	S.1 - SB 16-26-36	S.1 - SB 29-39-49-59-69
		PROFILE TYPE		
CABUR	CBD	-	-	Top hat PR/3/AC
	SV	-	-	DIN PR/DIN/AC
	RN	-	Top hat PR/2/AC	Top hat PR/2/AC
WEIDMULLER	WDU	-	Top hat PR/3/AC	Top hat PR/3/AC
	SAK	-	-	DIN PR/DIN/AC
	BK	Bracket	Bracket	Bracket
	AKZ	-	Top hat PR/2/AC	Top hat PR/2/AC

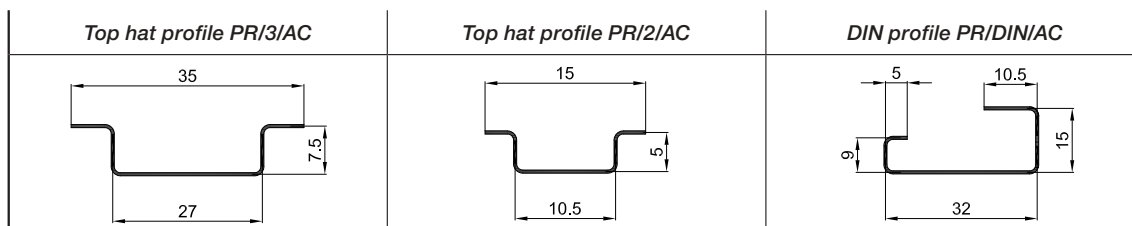

S... series Junction boxes - Terminal tables

Ex d IIC rated enclosures		CROSS-SECTIONAL AREA AND MAXIMUM NUMBER OF TERMINALS								
Enclosure type	Size	1.5	2.5	4	6	10	16	25	35	70
S.1 - SB	14-24	-	-	3	-	-	-	-	-	-
S.1 - SB	16-26-36	8	8	6	-	-	-	-	-	-
S.1	29-39-59-69	16	16	16	9	7	6	4	4	3
SB	49-59-69	16	16	16	10	8	7	5	5	4
Maximum current (A)	at 40°C	10	12.5	20	24	30	48	75	105	175
	at 65°C at 150°C	8	10.5	17	20	24	40	65	88	150
Maximum current density (A/mm ²) for terminals and cables		6.6	5	5	4	3	3	3	3	2.5
Maximum current (A) referring to 35% of the max. number of terminals as given in the table	at 40°C	13	19.5	24	30	50	64	100	140	210
	at 65°C at 150°C	10	12.5	20	24	30	48	75	105	175
Maximum current density (A/mm ²) for terminals and cables referring to 35% of the max. number of terminals as given in the table		8.5	7	6	5	5	4	4	4	3
Min.-max. rated voltage (V)		420 - 750								

Minimum distances for Ex d IIC rated enclosures with terminals

Enclosure type	Size	Minimum surface distance		S.1	SB
		a min.	b+b min.		
S.1 - SB	14-24	6	20	x	x
S.1 - SB	16-26-36			40	40
S.1	29-39-59-69			58.5	50
SB	49-59-69			100	85

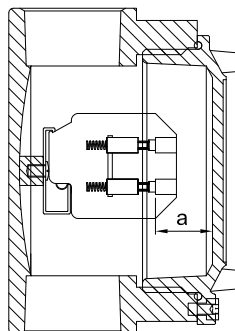
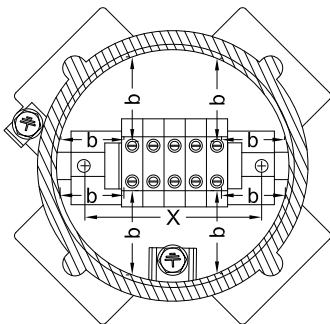

Enclosure code SFL-36.1 with 3 x AKZ-2.5 terminals and 1 x AKE2.5 earth terminal

S... series Junction boxes - Terminal tables

Ex e IIC rated enclosures		CROSS-SECTIONAL AREA AND MAXIMUM NUMBER OF TERMINALS														
Enclosure type	Size	1.5			2.5			4			6			10		
		Tab 1	Tab 2	Tab 3	Tab 1	Tab 2	Tab 3	Tab 1	Tab 2	Tab 3	Tab 1	Tab 2	Tab 3	Tab 1	Tab 2	Tab 3
S.1 - SB	14-24	-	-	-	-	-	-	3	-	-	-	-	-	-	-	-
S.1 - SB	16-26-36	8	8	8	8	8	8	6	6	6	-	-	-	-	-	-
S.1	29-39-59-69	16	16	16	16	16	16	16	14	14	9	9	9	7	7	7
SB	49-59-69	16	16	16	16	16	16	16	14	14	10	10	9	8	7	7
Maximum current (A)	at 40°C	8			10.5			17			20			24		
	at 65°C	5.5			7.5			12			14			17		
	at 150°C															
Maximum current density (A/mm ²) for terminals and cables		6.6			5			5			4			3		
Min.-max. rated voltage (V)		275 - 630														

Ex e IIC rated enclosures		CROSS-SECTIONAL AREA AND MAXIMUM NUMBER OF TERMINALS						
Enclosure type	Size	16			25			
		Tab 1	Tab 2	Tab 3	Tab 1	Tab 2	Tab 3	
S.1 - SB	14-24	-	-	-	-	-	-	-
S.1 - SB	16-26-36	-	-	-	-	-	-	-
S.1	29-39-59-69	6	6	6	4	4	4	4
SB	49-59-69	7	6	6	5	4	4	4
Maximum current (A)	at 40°C	40			65			
	at 65°C	29			47			
	at 150°C							
Maximum current density (A/mm ²) for terminals and cables		3			3			
Min.-max. rated voltage (V)		275 - 630						



Enclosure code SFL-26.1 with 3 x RP-4 terminals and 1 x TR-2 earth terminal

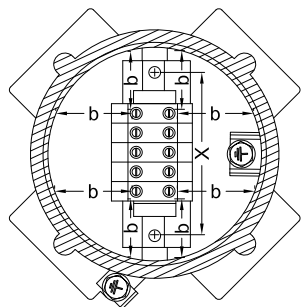
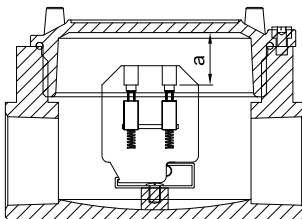

Minimum distances for Ex e IIC rated enclosures with terminals

Tab 1	Enclosure type	Size	Minimum surface distance		S.1	SB
			a min.	b+b min.		
	S.1 - SB	14-24	6	20	x	x
S.1 - SB	16-26-36	40			40	
S.1	29-39-59-69	58.5			50	
SB	49-59-69	100			85	

Tab 2	Enclosure type	Size	Minimum surface distance		S.1	SB
			a min.	b+b min.		
	S.1 - SB	14-24	8	25	x	x
S.1 - SB	16-26-36	40			40	
S.1	29-39-59-69	58.5			50	
SB	49-59-69	100			85	

Tab 3	Enclosure type	Size	Minimum surface distance		S.1	SB
			a min.	b+b min.		
	S.1 - SB	14-24	10	32	x	x
S.1 - SB	16-26-36	40			40	
S.1	29-39-59-69	58.5			50	
SB	49-59-69	100			85	

NOTES:
 Tab 1 for operating voltage U ≤ 400
 Tab 2 for operating voltage U ≤ 500
 Tab 3 for operating voltage U ≤ 630

S... series Junction boxes - Terminal tables

Ex i IIC rated enclosures		CROSS-SECTIONAL AREA AND MAXIMUM NUMBER OF TERMINALS														
Enclosure type	Size	1.5			2.5			4			6			10		
		Tab 4	Tab 5	Tab 6	Tab 4	Tab 5	Tab 6	Tab 4	Tab 5	Tab 6	Tab 4	Tab 5	Tab 6	Tab 4	Tab 5	Tab 6
S.1 - SB	14-24	-	-	-	-	-	-	3	-	-	-	-	-	-	-	-
S.1 - SB	16-26-36	8	8	8	8	8	8	6	6	6	-	-	-	-	-	-
S.1	29-39-59-69	16	16	16	16	16	16	16	14	14	9	9	9	7	7	7
SB	49-59-69	16	16	16	16	16	16	16	14	14	10	10	9	8	7	7
Maximum current (A) at 40°C		8			10.5			17			20			24		
Maximum current (A) at 65°C at 150°C		5.5			7.5			12			14			17		
Maximum current density (A/mm ²) for terminals and cables		6.6			5			5			4			3		
Max. rated voltage (V)		630														

Ex i IIC rated enclosures		CROSS-SECTIONAL AREA AND MAXIMUM NUMBER OF TERMINALS					
Enclosure type	Size	16			25		
		Tab 4	Tab 5	Tab 6	Tab 4	Tab 5	Tab 6
S.1 - SB	14-24	-	-	-	-	-	-
S.1 - SB	16-26-36	-	-	-	-	-	-
S.1	29-39-59-69	6	6	6	4	4	4
SB	49-59-69	7	6	6	5	4	4
Maximum current (A) at 40°C		40			65		
Maximum current (A) at 65°C at 150°C		29			47		
Maximum current density (A/mm ²) for terminals and cables		3			3		
Max. rated voltage (V)		630					



Enclosure code SFL-36.1 with 3 x RP-4EXI terminals and 1 x TR-2 earth terminal

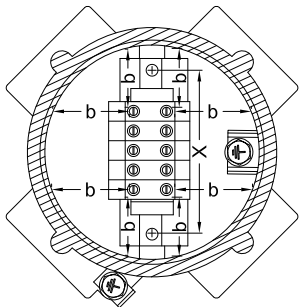
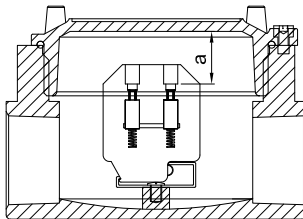

NOTES:
 Tab 1 for operating voltage U ≤ 400
 Tab 2 for operating voltage U ≤ 500
 Tab 3 for operating voltage U ≤ 630

Minimum distances for Ex i IIC rated enclosures with terminals

Tab 4	Enclosure type	Size	Minimum surface distance		S.1	SB
			a min.	b+b min.		
	S.1 - SB	14-24	6	20	x	x
S.1 - SB	16-26-36	40			40	
S.1	29-39-59-69	58.5			50	
SB	49-59-69	100			85	

Tab 5	Enclosure type	Size	Minimum surface distance		S.1	SB
			a min.	b+b min.		
	S.1 - SB	14-24	7	30	x	x
S.1 - SB	16-26-36	40			40	
S.1	29-39-59-69	58.5			50	
SB	49-59-69	100			85	

Tab 6	Enclosure type	Size	Minimum surface distance		S.1	SB
			a min.	b+b min.		
	S.1 - SB	14-24	8	36	x	x
S.1 - SB	16-26-36	40			40	
S.1	29-39-59-69	58.5			50	
SB	49-59-69	100			85	

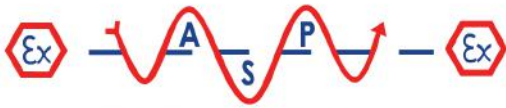

S... series Junction boxes - Terminal tables

TERMINAL MANUFACTURER	TERMINAL CODE	ENCLOSURE TYPE				CONDUCTOR CROSS-SECTIONAL AREA sq mm
		SB - S.1 14 - 24	SB - S.1 16 - 26 - 36	S.1 29 - 39 59 - 69	SB 49 - 59 - 69	
		MAXIMUM NUMBER OF TERMINALS				
CABUR	CBD 2			12	15	2.5
	CBD 4			10	12	4
	CBD 6			8	10	6
	CBD 10			7	8	10
	CBD 16			6	7	16
	CBD 25			4	5	25
	CBD 35			3	4	35
	CBD 70			3	4	70
	SV 2			12	10	2.5
	SV 4			10	8	4
	SV 6			8	7	6
	SV 10			6	5	10
	RP 4		6	14	14	4
	WEIDMULLER	WDU 1.5/R 3.5/E		10	22	22
WDU 2.5N/E			5	14	16	2.5
WDU 2.5				14	16	2.5
WDU 4				12	14	4
WDU 6				9	10	6
WDU 10				7	8	10
WDU 16				6	7	16
WDU 35				4	5	35
SAK 2.5				12	9	2.5
SAK 4				12	9	4
SAK 6				8	7	6
SAK 10				7	5	10
SAK 16				5	4	16
SAK 35				4	3	35
AKZ 1.5			8	14	14	1.5
AKZ 2.5			8	14	14	2.5
AKZ 4			6	14	14	4
BK 2 (2 poles)		1	2	4	3	4
BK 3 (3 poles)		1	1	2	2	4
BK 4 (4 poles)			1	2	2	4
BK 6 (6 poles)				1	1	4
BK 12 (12 poles)					4	

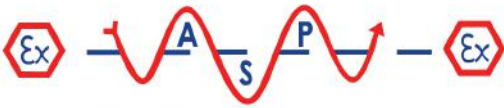

A.S.P. Electro-Technology Ltd

Tel: +44 (0) 1455 635796
Fax: +44 (0) 1455 610851

sales@asp-electro-tech.com
www.asp-electro-tech.com

S... series junction boxes



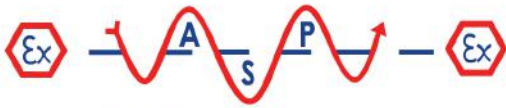

SWS... series Junction boxes



ORIGINAL PRODUCT

'Ex d' SWS series enclosures are normally used to house temperature sensors, such as thermocouples, level gauges, flow transmitters and pressure sensors.

MECHANICAL FEATURES

Body and lid:	Low copper content aluminium alloy. Screw-on lid with safety fastening grub screw and steel chain so the lid cannot be misplaced
Gasket:	Acid/hydrocarbon-resistant silicone, located between body and lid
Entries:	Standard NPT thread
Certification label:	Adhesive label located on inside of lid
Bolts and screws:	Stainless steel
Earth screws:	Stainless steel. On inside and outside of body complete with anti-rotation brackets
Coating:	Polyester coating RAL 7035 (Light grey)
Corrosion Resistance:	The STANDARD of the aluminium alloy used by Cortem has passed the tests required by standards EN 60068-2-30 (hot/humid cycles) and EN 60068-2-11 (salt mist tests)

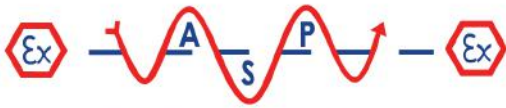

SWS... series Junction boxes

DIMENSIONAL DRAWING

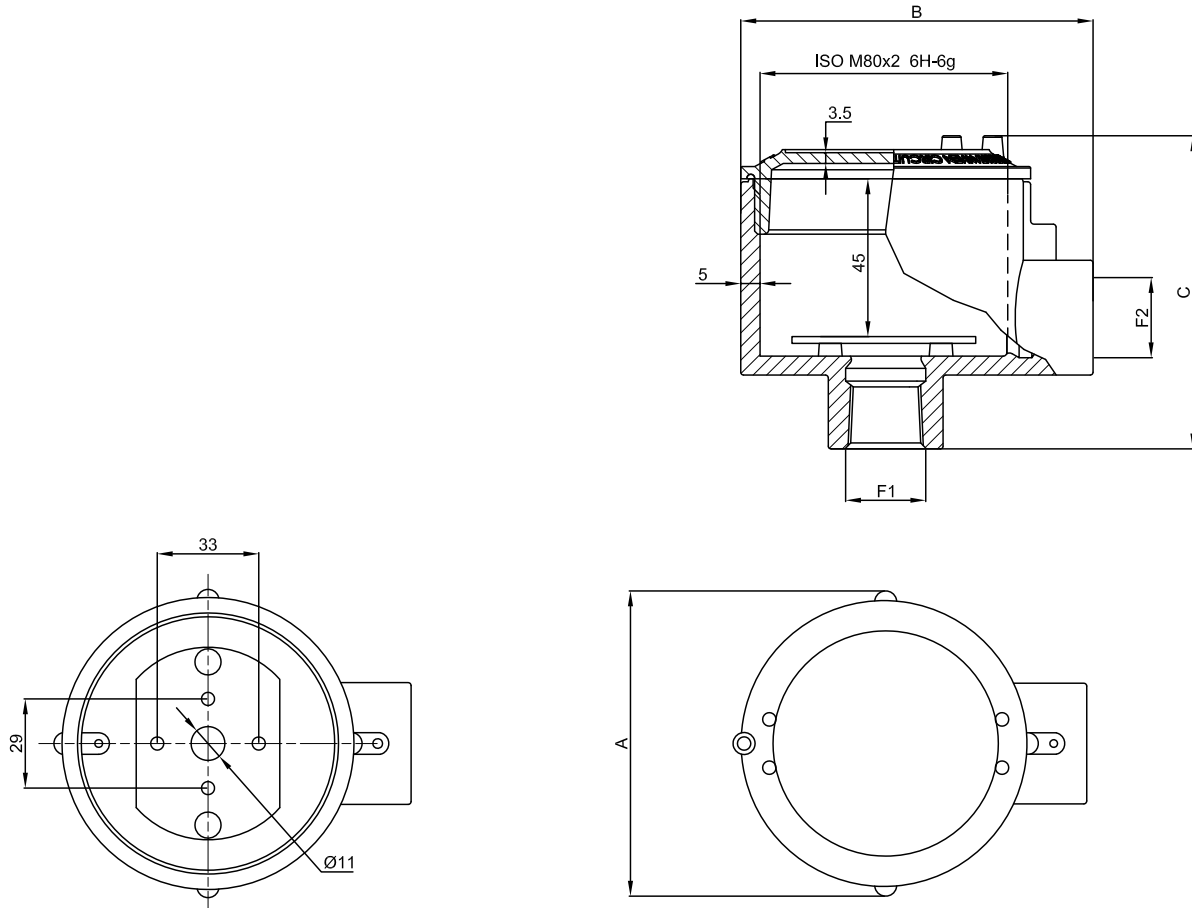

Code	Outside dimensions mm			Entry Ø		Weight kg
	A	B	C	F1	F2	
SWS-16	100	115	100	1/2" NPT	1/2" NPT	
SWS-26	100	115	100	3/4" NPT	3/4" NPT	
SWS-26/21	100	115	100	1/2" NPT	3/4" NPT	