

CATALOG





ALL PRICES ARE SUBJECT TO
CHANGE WITHOUT NOTICE.
PLEASE VERIFY.

PLACING AN ORDER WITH ALBERTA IRRIGATION SUPPLY LTD.

- To provide same day shipping to our customers, all orders must be placed by 1:00 P.M. Orders can be placed by either phone or fax.

Phone: (780) 453-5950
Fax: (780) 452-3470
Toll Free: (888) 453-0101

MINIMUM ORDER

- Minimum order for charge accounts is \$25.00. Orders below minimum can be paid by cash, cheque, or credit card, or be subject to the \$25.00 minimum charge.
- There is no minimum charge for cash accounts.

PRICING

- All prices and terms quoted in this catalog are subject to change without notice.
- GST is not included in all prices in this price list.
- Invoicing discrepancies are to be directed to our Accounting Department within 10 days from date of invoice.

TERMS OF PAYMENT

- Alberta Irrigation Supply Ltd. terms of payment are 30 days, with interest @ 2% per month on overdue accounts.
- When making your payments, please indicate which invoices are being paid. To avoid incurring penalties, all payments must be received by the due date.
- New Customer's first order is subject to cash terms; an additional 2% discount will apply.

SHIPPING

- Orders will be shipped F.O.B. Edmonton warehouse.
- Claims against transport companies are the Customer's responsibility.

BACK ORDERS

- All back orders will be shipped on separate waybills and sent Prepaid; freight will be prepaid by Alberta Irrigation Supply Ltd. on back orders only.
- Back ordered items do not include items listed as "Special Order".

RETURNS

- Merchandise returns will be accepted up to 30 days from date of invoice.
- A 25% restocking fee will be assessed on new goods returned for credit. Prior approval in the form of a "Returned Goods Authorization" must be obtained.
- Credit will not be given for **Obsolete**, **Shopworn**, or "**Special order**" items.
- All return merchandise is to be shipped prepaid to Alberta Irrigation Supply Ltd. Goods returned "collect" shall not be accepted.

LOW VOLUME IRRIGATION

<u>ADAPTERS</u>	PG 8	<u>MICRO FITTINGS</u>	PG 8
<u>DRIPLINE</u>	PG 10	<u>MICRO MANIFOLDS</u>	PG 9
<u>DRIPLINE FITTINGS</u>	PG 11	<u>MICRO SPRAYS</u>	PG 6
<u>DRIPPERS</u>	PG 9	<u>RISERS</u>	PG 7
<u>EMITTERS</u>	PG 9	<u>STAKES</u>	PG 7
<u>HOLE PUNCHES</u>	PG 10	<u>TIE DOWNS</u>	PG 10

LANDSCAPE IRRIGATION

<u>BALL VALVES</u>	PG 22	<u>PVC PIPE</u>	PG 34
<u>BIG 'O' PIPE</u>	PG 42	<u>QUICK COUPLERS & KEYS</u>	PG 28
<u>BRASS HOSE FITTING</u>	PG 22	<u>RAIN SENSORS</u>	PG 32-33
<u>BRASS IMPACTS SPRINKLERS</u> ..	PG 27	<u>REGULATORS</u>	PG 20
<u>BRASS VALVES</u>	PG 28	<u>RISERS</u>	PG 18
<u>CEMENT</u>	PG 34	<u>ROLLER SPRINKLERS</u>	PG 27
<u>CHECK VALVES</u>	PG 22	<u>ROTOR TOOLS</u>	PG 26
<u>CLAMPS & SADDLES</u>	PG 23	<u>ROTORS</u>	PG 24-25
<u>COMPRESSION FITTINGS</u>	PG 35	<u>SADDLE TEES</u>	PG 39
<u>CONTROLLERS</u>	PG 32-33	<u>SAWS</u>	PG 39
<u>DRAINAGE</u>	PG 31	<u>SCH 40 FITTINGS</u>	PG 35-37
<u>FILTERS</u>	PG 20	<u>SOLENOIDS</u>	PG 22
<u>FILTERS (IN-LINE)</u>	PG 13	<u>SPRAY BODIES</u>	PG 14
<u>FLAGS</u>	PG 39	<u>SWING JOINTS</u>	PG 14
<u>GLUE</u>	PG 34	<u>SWING JOINTS PVC</u>	PG 29
<u>INSERT FITTINGS</u>	PG 16-17	<u>TAPE</u>	PG 39
<u>LEEMCO FITTINGS</u>	PG 42-43	<u>TOOLS</u>	PG 39-41
<u>MANIFOLD FTG</u>	PG 13	<u>TOTES</u>	PG 39
<u>NIPPLES</u>	PG 18	<u>TURNSEALS</u>	PG 19
<u>NOZZLES (FOR SPRAY HEADS)</u>	PG 15	<u>VALVE BOXES</u>	PG 30
<u>NOZZLES (FOR ROTORS)</u>	PG 24-25	<u>VALVES</u>	PG 21
<u>POLY CUTTERS</u>	PG 12	<u>WIRE</u>	PG 38
<u>POLY PIPE FITTINGS</u>	PG 13	<u>WIRE CONNECTORS</u>	PG 38
<u>POLY PIPE FLEX PIPE</u>	PG 12		

OTHER IRRIGATION & LANDSCAPE PRODUCTS

<u>Water Reels & Big Guns</u>	PG 48-49	<u>Chemicals & Landscape Decor</u> .	PG 47
<u>Plad Pumping Systems</u>	PG 50-51	<u>Fountains & Pumps</u>	PG 45
<u>Ponds, Kits, Liners</u>	PG 46	<u>Landscape Lighting</u>	PG 44

LANDSCAPE DRIP IRRIGATION OVERVIEW

Rain Bird Xerigation/Landscape drip products are made especially for low-volume irrigation systems. By delivering water at or near the plants' root zones, Rain Bird Xerigation products offer targeted watering with advantages...

*Designed Flexibility
(simple construction, easily expandable)*

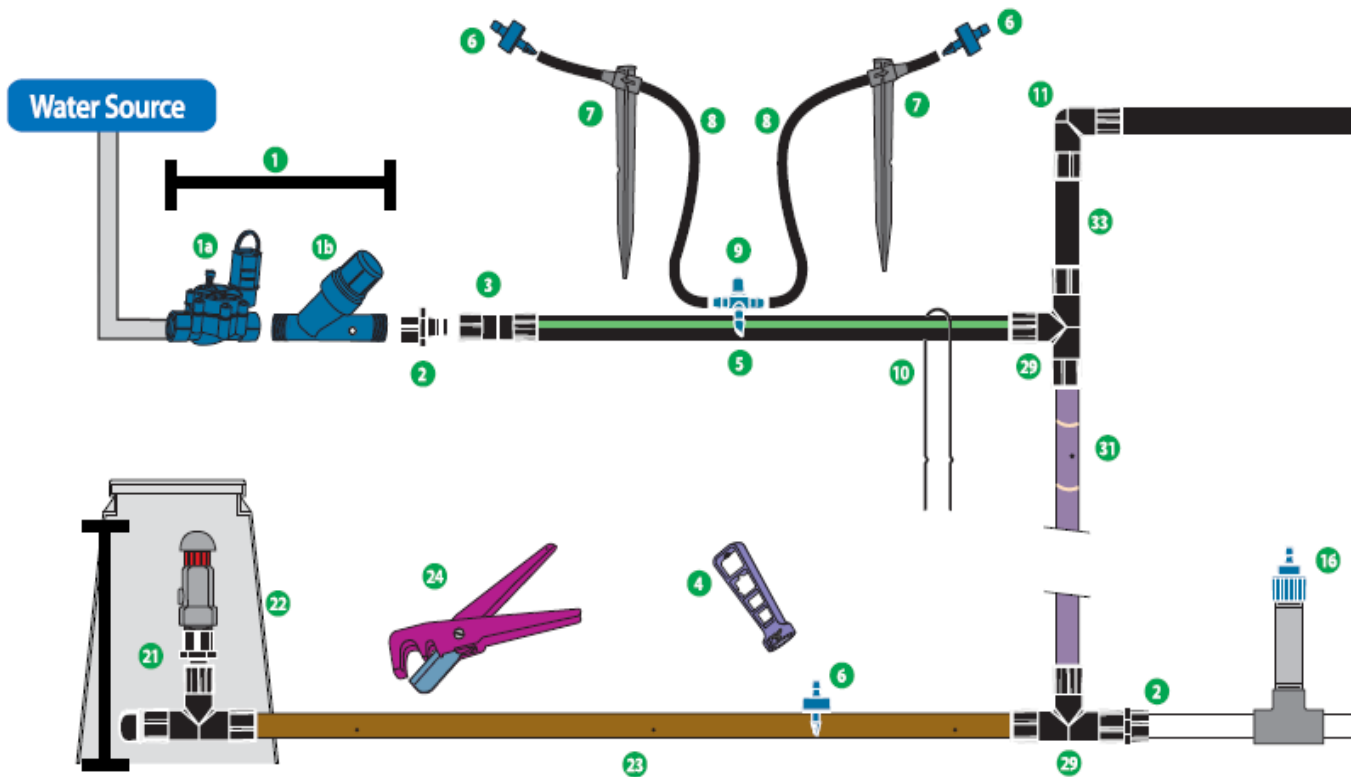

- | | |
|---|---|
| 1) Control Zone Kit (1a + 1b) | 9) 1/4" Barb tee (pg. 8) |
| 1a) Low Flow Valve (pg. 21) | 10) Tie-Down Stake (pg. 10) |
| 1b) Pressure Regulating Filter (pg. 20) | 11) Easy Fit Elbow (pg. 11,13,16,19) |
| 2) Easy Fit Female Adapter (pg. 11,13) | 12) Diffuser Bug Cap (pg. 6,8) |
| 3) Easy Fit Coupling (pg. 11,13) | 13) PC Emitter Diffuser Cap (pg. 8) |
| 4) Emitter Tool (pg. 10) | 14) PC Module-1032 (pg. 8) |
| 5) Black Stripe Tubing (pg. 10) | 15) Poly Flex Riser Assembly (pg. 7) |
| 6) Bug Emitter (pg. 9) | 16) Bug Emitter (pg. 9) |
| 7) 1/4" Tubing Stake (pg.7) | 17) 1/4" Self-Pierce barb connect (pg. 9) |
| 8) XQ 1/4" Distribution Tubing (pg. 10) | 18) SQ Square Nozzle (pg. 15) |

Maximization of weed growth

Reduced Liability
(No over-spray, No run-offs)

Greater Efficiency

Water Conversion





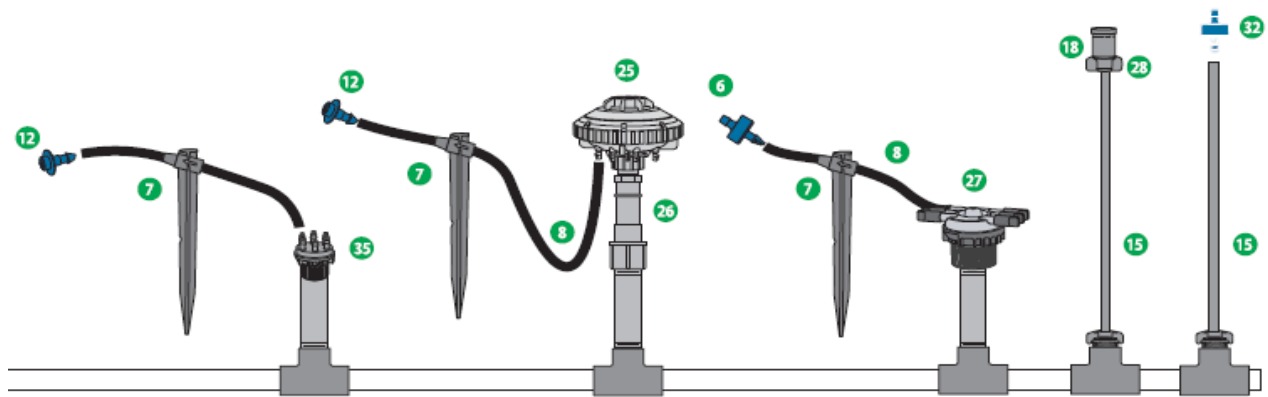
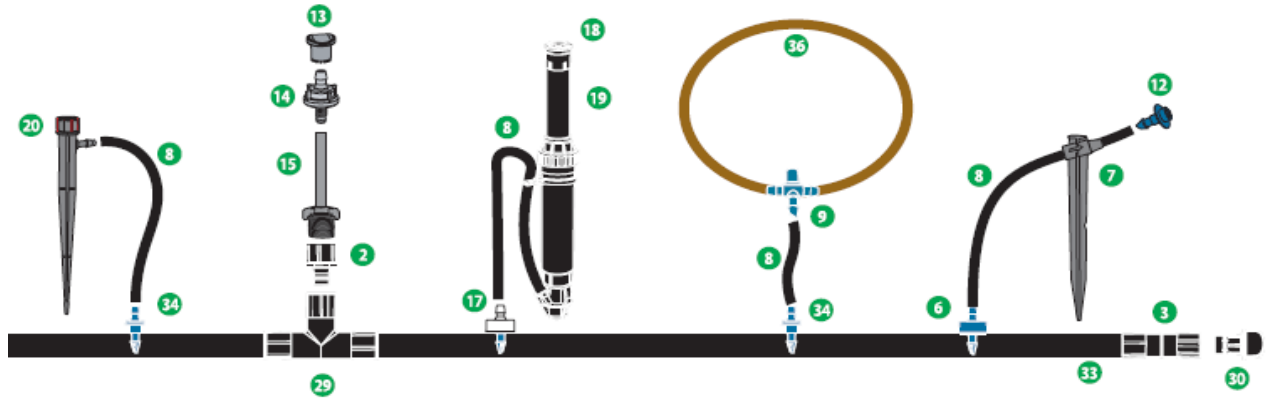







Healthier Plants

Cost Savings



- 19) Pop-Up (pg. 14)
- 20) Bubbler Spike (pg. 7)
- 21) Air Relief Valve Kit (pg. 20-22)
- 22) Valve Box (pg. 30)
- 23) Dripline (pg. 12)
- 24) Tubing Cutter (pg. 12)
- 25) Multi-Outlet Bird (pg. 9)
- 26) Inline Pressure Regulator (pg. 20)
- 27) 6 Outlet manifold (pg. 9)

- 28) SQ Nozzle Adapter (pg. 15)
- 29) Easy Fit Tee (pg. 11,13,16,19)
- 30) Easy Fit Flush Cap (pg. 13,16)
- 31) Dripline (pg. 12)
- 32) Bug Emitter (pg. 9)
- 33) Distribution Tubing (pg. 12)
- 34) 1/4" Barb Connector (pg. 8)
- 35) Multi-Outlet Bug (pg. 9)
- 36) 1/4" Landscape Dripline (pg. 10)

	PART NO.	DESCRIPTION	LIST PRICE	UNIT
 <p>Vari & Xeri Sprays 90° 180° 360°</p> 	D2-X66001	XS-090 XERI-SPRAY QUARTER W/1032 THREAD	2.15	each
	D2-X66010	XS-180 XERI-SPRAY HALF W/1032 THREAD	2.15	each
	D2-X66020	XS-360 XERI-SPRAY FULL W/1032 THREAD	2.15	each
 <p>Spectrum 360° Adapters & Spike</p> 	D2-X66030	XS-360TS XERI TRUE-SPRAY W/1032 THREAD	2.15	each
	D2-X66036	XS-360TS-025 XERI TRUE-SPRAY 1/4" BARB	1.94	each
	D2-X66039	XS-360TS-SPYK XERI TRUE-SPRAY 5" SPIKE	1.78	each
<p>Xeri Micro Valves</p>  <p>D2-X66500 D2-X66310 D2-X66510</p>	D2-X66310	X360ADJMST XERI 360 ADJ. MISTER (13195)	2.15	each
	D2-X66500	XMV-1032 XERI MICRO VLV 1/4" 10-32 THR.	2.15	each
	D2-X66510	XMV-025 XERI MICRO VLV 1/4" BxB	2.05	each
<p>Xeri Bubblers & Stakes</p>  <p>180° / 360°</p> 	D2-X64001	SXB-360 XERI-BUBBLER W/10-32 THREAD	2.15	each
	D2-X64010	SXB-180 XERI-BUBBLER W/10-32 THREAD	2.15	each
	D2-X64036	SXB-360-025 XERI-BUBBLER W/1/4" BARB	2.05	each
	D2-X64040	SXB-360-SPYK XERI-BUBBLER W/5" SPIKE	1.74	each
	D2-X64049	SXB-180-SPYK XERI-BUBBLER W/5" SPIKE	1.74	each
	D2-X65000	UXB-360 XERI-BUBBLER W/10-32 THREAD	2.15	each
	D2-X65039	UXB-360-SPYK XERI-BUBBLER W/5" SPIKE	1.74	each
<p>Jet Caps & Base</p>  <p>90° 180° 360°</p> 	D2-A10815	JET CAP 90deg. - BLACK	0.42	each
	D2-A10825	JET CAP 180deg. - BLACK	0.42	each
	D2-A10845	JET CAP 360deg. - BLACK	0.42	each
	D2-A10935	JET BASE - GREEN	0.45	each
<p>Blue Single Jet</p>  <p>360° 180° 90°</p> 	D2-A15415	JET SPRAY 90deg - BLUE	0.42	each
	D2-A15425	JET SPRAY 180deg - BLUE	0.42	each
	D2-A15445	JET SPRAY 360deg - BLUE	0.42	each
<p>Rotors & Downspray</p>   <p>D2-A20205 D2-A20135 D2-A19005</p>	D2-A19005	CFd DOWNSPRAY (NO STAKE)	0.80	each
	D2-A54305	CFd DOWNSPRAY STAKE ASSY - BLACK	5.70	each
	D2-A20135	INVERTED ROTOR SPRAY	2.30	each
	D2-A20205	VARI-ROTOR SPRAY	3.10	each



STAKES & RISERS



PART NO.	DESCRIPTION	LIST PRICE	UNIT
D2-X56000	PFR-12 POLYFLEX RISER 12"	0.49	each
D2-A50145	PFR-18 POLYFLEX RISER 18"	1.08	each
D2-X55050	RS-025T RISER STAKE 1/4" BARB	1.29	each
D2-X54000	TS-025 1/4" TUBING STAKE (original)	0.87	each
D2-X54001	TS025WCAP 1/4" TUBING STAKE W/BUG CAP	0.87	each
D2-X64040	SXB-360-SPYK XERI-BUBBLER W/5" SPIKE	1.78	each
D2-X64049	SXB-180-SPYK XERI-BUBBLER W/5" SPIKE	1.78	each
D2-X65039	UXB-360-SPYK XERI-BUBBLER W/5" SPIKE	1.78	each
D2-X66039	XS-360TS-SPYK XERI TRUE-SPRAY 5" SPIKE	1.84	each
D2-A40875	ASTA STAKE 12"	1.58	each
D2-A40885	ASTA STAKE 8"	1.30	each
D2-A40905	21" ASTA-STAKES	3.84	each
D2-A50305	VARI-JET 90 WITH 12" ASTA STAKE ASSY	5.65	each
D2-A50315	VARI-JET 180 WITH 12" ASTA STAKE ASSY	5.65	each
D2-A50325	VARI-JET 360 WITH 12" ASTA STAKE ASSY	5.65	each
D2-A30995	SHRUBBLER 360 IN-LINE SPIKE	2.05	each
D2-NDAFSBUB	AGRIFIM DAFS UMBRELLA BUBBLER W/6" STAKE	1.69	each

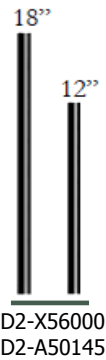

COMBINE NOZZLES WITH STAKES, RISERS, OR SPIKES





Adapter Female
D2-X59000



1800-XBA ADAPT
D2-X51000



L1-A16501
PA-8S ADAPTER



Goof Plugs
D2-X42050



PART	NO & DESCRIPTION	LIST PRICE	UNIT
L1-A16501	PA-8S PLASTIC SHRUB HEAD ADAPTER	2.20	each
L1-A46500	PA-8S-PRS PLASTIC SHRUB ADAPTER W/PRS	6.50	each
D2-X51000	1800-XBA XERI-BUBBLER ADAPT. F/1032 THR	2.15	each
D2-X59000	10-32A 1/2" FNPT x 10-32 THREAD ADAPTER	1.43	each
D2-X42050	EMA-GPX XERI TUBING GOOF PLUGS	0.20	each
D2-A40195	ANTELCO BF JOINER 1/4" (0.18") BARBxBARB	0.27	each
D2-A40295	ANTELCO BF 1/4"(0.18) ELBOW BARBxBARB	0.58	each
D2-A40395	ANTELCO BF 1/4" (0.18") TEE BxBxB	0.58	each
D2-A40495	ANTELCO CROSS 0.18" BARB	0.67	each
D2-A40915	ANTELCO BF ADAPTER 10-32UNF thrxthr	0.26	each
D2-A40995	ADAPTER 0.18" BARB X 10-32thread	0.26	each
D2-X42000	RAINBIRD XBF-3 1/4" BxBxB TEE	0.32	each
D2-X42010	RAINBIRD XBF-2 1/4" BARB x BARB ELL	0.27	each
D2-X42020	RAINBIRD XBF-1CONN 1/4" BARB CONNECTOR	0.22	each
D2-X52000	FRA-050 RISER ADAPTER FOR 1/2" RISER	0.99	each



Adapter barb x Thd
D2-A40995



Adapter 1/4" Thd
D2-A40915



Cross-Barbed
D2-A40495



Elbow
D2-X42010



Connector
D2-X42020



Joiner
D2-A40195



Elbow
D2-A40295



Tee
D2-A40395



D2-X42000

Essential components in low pressure micro irrigation systems. Used in conjunction with low pressure tubing. These fittings are practical and durable.





D2-X60000
\$27.95 ea

8 Multi-Outlet Manifold

XBD-80, 8 multi-outlet emission device, with 8 configurable ports and 10 flow options for each port for maximum flexibility.



Photo courtesy Rain Bird



D2-A51305
\$17.00 ea

9 Multi-Outlet Manifold

9 Multi-outlet low water volume drip manifold, connect to 1/2" thread; equipped with 1/4" fittings & plugs.



EMITTERS & DRIPPERS & MANIFOLDS

PART	NO & DESCRIPTION	LIST PRICE	UNIT
 SPB-025 CONNECTOR	D2-X42030 1/4" Self-Piercing Barb Connector (SBP). RANGE: *Flow: Unrestricted *Pressure: 15 to 50 PSI	\$ 0.96	EACH
 XB XERI-BUG EMITTER	D2-X685.. 1/4" Xeri Bug Emitters (XB). For watering root zones of plants trees and container plants. RANGE: *Flow: 0.5 to 2.0 GPH *Pressure: 15 to 50 PSI	\$ 0.96	EACH
 PC MODULE EMITTER	D2-X710.. 1/4" Pressure Compensating Emitters (PC) For watering large shrubs & trees RANGE: *Flow: 5 to 24 GPH *Pressure: 10 to 50 PSI	\$ 2.15	EACH
 EMT - 6XERI	D2-X57000 1/2" FPT inlet, threads into; 1/2" MPT riser and provides a manifold with 6 free-flowing barb outlets 1/4"	\$ 7.65	EACH

DRIPPERS



D2-A30625 / 55

D2-A30745
ASTA DRIP SPIKE - PC 1 GPH → \$ 1.75 EACH

← CETA SPIKE & IN-LINE SPIKE - PC 1 GPH → \$ 2.15 EACH

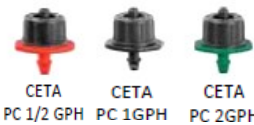
 **D2-A30555/45/65**
→ \$ 1.30 EACH
CETA PC 1/2 GPH CETA PC 1GPH CETA PC 2GPH

 **D2-A30545/55/65**
→ \$ 1.30 EACH
CETA PC 1/2 GPH CETA PC 1GPH CETA PC 2GPH



TO ORDER EMAIL: sales@albertairrigation.com

CALL: 1-780-453-5950 FAX: 1-780-452-3470



LD-09-12 DRIPLINE

100 or 250 or 500 rolls

Operating Range: 0 to 60 psi

Pressure: 8.5 to 60 psi

Flow rates: 0.6 and 0.9 gph

Required Filtration: 120 mesh

The strongest and most flexible 1/4" Distribution Tubing available to extend emitter outlets to desirable discharge locations.

PART NO.	DESCRIPTION	LIST PRICE	UNIT
D2-X36240	LD16STK 1/2" DRIPLINE TUBING STAKE	0.98	each
D2-X58001	TDS050 W/BEND GALV TIE DOWN STAKE	0.57	each
D2-A42315	ANTELCO KEY PUNCH TOOL	1.70	each
D2-X80100	XMTOOL XERIMAN TOOL	13.78	each
D2-A50048	POCKET PUNCH - GREEN	12.95	each
D2-A51098	PUNCH N CUT TOOL	29.99	each
D2-NA220V100	1/4" VINYL TUBING - 100ft rolls	0.17	per ft
D2-NA220V1000	1/4" VINYL TUBING - 1000 feet	148.00	each
D2-X33101	1/4" XQ1000B TUBING IN A BUCKET 1000FT	148.00	each
D2-N0180050SH	1/4" SOAKER HOSE (50' - 6" SPACING)	22.50	each
D2-X35790	LD-09-12-100 LANDSCAPE DRIPLINE 100'	86.00	each
D2-X35791	LD-09-12-250 LANDSCAPE DRIPLINE 250'	215.00	each
D2-X35795	LD-09-12-500 LANDSCAPE DRIPLINE 500'	430.00	each
D2-A16615	eZyvalve 4-STATION MINI MANIFOLD BOX	124.95	each



TIE DOWNS
D2-X58001



KEY PUNCH
D2-A42315



PUNCH N CUT
D2-A51098



XMTOOL
D2-X80100



POCKET PUNCH
D2-A50048



1/4" VINYL FLEXIBLE TUBING



**eZyvalve - 24v
(4 Drip Zones)**





DRIPLINE INSERT FITTINGS

FEATURES & BENEFITS

INSERT FITTINGS ARE MADE OF ROBUST MATERIAL TO MAKE CONNECTING PIPE FAST AND EASY.

EASY TWIST-IN INSERTION, NO GLUE OR CLAMPS NEEDED FOR INSTALLATION.

AGGRESSIVE BARB LIP MAKES A SECURE CONNECTION THAT IS LESS LIKELY TO LEAK.

Operating: Up to 80 psi

PART NO.	DESCRIPTION	LIST PRICE	UNIT
D2-X36200	LD16ELB 16mm BARB ELBOW	0.91	each
D2-X36210	LD16CPLG 16mm BARB COUPLING	0.80	each
D2-X36220	LD16TEE 16mm BARB TEE	1.00	each
D2-X36240	LD16STK 1/2" DRIPLINE TUBING STAKE	0.98	each
D2-X36250	LD16THRDXY 1/2" DUAL BARB "Y" X 3/4" MPT	2.08	each
D2-X36311	LOC1675MPT LOC 16MM 075 MPT ADAPTER	2.57	each
D2-X40099	600CF X 700CF REDUCING COUPLER	1.49	each
L1-A46003	SBA-050 1/2" MALE NPTx1/2" BARB ADAPTER	0.44	each
L1-A46004	SB-TEE 1/2" SPIRAL BARB TEE	0.60	each
L1-A46005	SBA-075 3/4" MALE NPTx1/2" BARB ADAPTER	0.49	each
L1-A46006	SB-CPLG 1/2" SPIRAL BARB COUPLING	0.47	each
L1-A46010	SBE-050 1/2" MALE x 1/2" BARB ELBOW	0.43	each
L1-A46011	SBE-075 3/4" MALE x 1/2" BARB ELBOW	0.49	each



SB INSERT FITTINGS



LD16 INSERT FITTINGS



TO ORDER EMAIL: sales@albertairrigation.com

CALL: 1-780-453-5950 FAX: 1-780-452-3470

Pipe Cutters

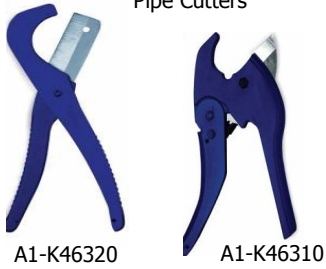

Polytubes



SPX FLEX PIPE L1-A82030



PART	NO & DESCRIPTION	LIST PRICE	UNIT
PP-030050	1/2" POLY-DRIP TUBING	.24 / ft	
PP-030075	3/4" POLY-DRIP TUBING	.28 / ft	
PP-060050	1/2" POLYPIPE PRIME 100	P.O.A.	
PP-060075	3/4" POLYPIPE PRIME 100	.48 / ft	
PP-060100	1" POLYPIPE PRIME 100	.76 / ft	
PP-060125	1 1/4" POLYPIPE PRIME 100	1.37 / ft	
PP-060150	1 1/2" POLYPIPE PRIME 100	1.79 / ft	
PP-060200	2" POLYPIPE PRIME 100	2.97 / ft	
L1-A82030	SPX100 FLEX SWING PIPE	.77 / ft	
A1-K46310	KING RATCHET POLY/PVC PIPE CUTTER	32.15	
A1-K46320	KING POLY PIPE CUTTERS - BLUE	16.99	

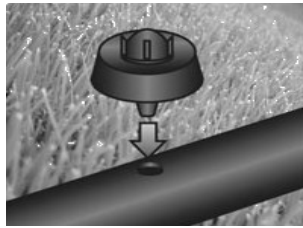

Poly tubing is perfect for irrigation, hydroponic; pond and waterfall applications. Available in a variety of sizes: 1", 3/4", 1/2", 1/4"; and can be installed above or below ground. The 1/2" and the 3/4" vinyl tubing serves as the main line or a branch line, into which the, spray bodies & swing joints, drippers, stakes or 1/4" connectors with micro tubing are linked.

Be sure not to pull poly tubing too tight; allow for expansion and contraction due to changing weather conditions.

Maximum working pressure for the poly tubing is 100 PSI and maximum flow rate is 220 GPH (3.6 GPM).



RAIN BIRD



D2-A44355 D2-A44415

Filtration device designed to trap foreign particles in the water and reduce clogging of emitters.



PART NO.	DESCRIPTION	LIST PRICE	UNIT
D2-X43000	MDCFCOUP Multi-Fit Comp. CPLG	2.30	each
D2-X43001	MDCFEL Multi-Fit Comp ELL	2.70	each
D2-X43002	MDCFTEE Multi-Fit Comp.Tee	3.38	each
D2-X43007	MDCF75FHT 3/4" COMP x FHT ADAPTER	1.48	each
D2-X43008	MDCFCAP Multi-Fit Flush Cap	1.27	each
D2-A44355	ANTELCO IN-LINE FILTER 1/2" (13mm)	8.20	each
D2-A44365	ANTELCO 5/8" IN-LINE FILTER (16mm)	8.28	each
D2-A44415	ANTELCO 5/8" SNAP-ON FILTER (16mm)	9.68	each
D2-A45505	ANTELCO GREEN BACK VALVE 1/2"	5.32	each
D2-A45515	ANTELCO 5/8" GREEN BACK VALVE	5.60	each
D2-A45535	ANTELCO GREENBACK VALVE 3/4" (20mm)	7.95	each



Multi-Fit Coupling



Multi-Fit Adapter



Multi-Fit Elbow



Multi-Fit Cap



Multi-Fit Tee



MDCF COMPRESSION FITTINGS ARE QUICK AND EASY TO INSTALL ONTO 1/2" TUBING



CONTROL VALVE



GREENBACK VALVE TO CONTROL THE WATER FLOW IN LOW PRESSURE IRRIGATION SYSTEMS.

DURA Plastic Products Inc.



DURA MANIFOLD FITTINGS

PART NO.	DESCRIPTION	LIST PRICE	UNIT
DU-08303	1" x 1" NIPPLE FOR PLASTIC THREADS(GRAY)	1.95	each
DU-08303131	1"x3/4"NIPPLE FOR PLASTIC THREADS (GRAY)	2.20	each
DU-301010	1" SWIVEL x 1" MIPT x 1" SWIVEL TEE	8.35	each
DU-306009	1" MIPT x 1" SWL ELL	7.15	each
DU-306010	1" SWIVEL x 1" SWIVEL ELL	7.90	each
DU-320010	1"SWIVELx1"MIPTx1"SWIVELx1"SWIVEL CROSS	11.10	each
DU-329010	1" SWIVEL x 1" SWIVEL COUPLING	5.95	each
DU-348010	1" FIPT CAP	1.85	each

Alberta Irrigation Supply

TO ORDER EMAIL: sales@albertairrigation.com

CALL: 1-780-453-5950 FAX: 1-780-452-3470

SPRAY BODIES

Irritrol



RAIN BIRD



PART NO.	DESCRIPTION	LIST PRICE	UNIT
TR-430R	IRRITROL 430R 1/2" ROTOR	24.71	each
TR-550R	IRRITROL 550R 3/4" ROTOR	22.89	each
TS-IPRO300	IRRITROL I-PRO 3" POP-UP SPRINKLER	6.43	each
TS-IPRO400	IRRITROL I-PRO 4" POP-UP SPRINKLER	4.50	each
TS-SL412	IRRITROL SL412 POP UP W/12VAN	5.30	each
L1-A44020	1802 2" HI-POP BODY ASSEMBLY ONLY	6.90	each
L1-A44120	1804 4" HI-POP BODY ASSEMBLY ONLY	4.85	each
L1-A43905	1804-SAM 4" HI-POP BODY ONLY	5.95	each
L1-A50205	1804-PRS 4" BODY ASSEMBLY ONLY	9.60	each
L1-A44915	1804-SAM-PRS 4" BODY ONLY	14.10	each
L1-A44205	1806 6" HI-POP BODY ASSEMBLY ONLY	14.50	each
L1-A43715	1806-SAM-PRS 6" BODY ONLY	25.32	each
L1-A44305	1812 12" HI-POP BODY ASSEMBLY ONLY	25.59	each
L1-A44500	1800-EXT 6" EXTENSION	6.23	each
D2-X20000	1800-XC RAIN BIRD XERI-CAP	3.40	each
D2-X21000	1800RETRO 1800 XERI RETROFIT KIT	29.19	each

OPTIONS FOR 1800 SPRAY HEADS

SAM: Built-in Seal-a-Matic check valve, for changing elevations.

PRS: Pressure regulator built into stem, for high areas or widely fluctuating water pressures.

**Nozzles Sold Separately (see page 10)

SWING JOINTS



Swing Joint

Installation of a swing joint:

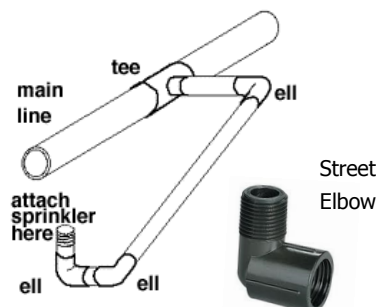

PART NO.	DESCRIPTION	LIST PRICE	UNIT
A1-A46035	SA125050 12"x1/2"x1/2" SWING JOINT	3.20	each
A1-A46045	SA125075 12"x1/2"x3/4" SWING JOINT	3.50	each
A1-A46050	SA127575 12" SWING ASSY 3/4MPT X 3/4 MPT	3.27	each
A1-A53200	MSE050 1/2" MARLEX STREET ELL - BLACK	0.92	each
A1-A53205	MSE-075 RAINBIRD 3/4" MARLEX STREET ELL	1.04	each

Swing joints easily adjusts sprinklers to proper height and position.

Alberta Irrigation Supply

TO ORDER EMAIL: sales@albertairrigation.com

CALL: 1-780-453-5950 FAX: 1-780-452-3470



VAN Series
Adjustable Spray Nozzles



EASY TO ADJUST

Operating Range →

- For trajectory see specs
- Optimum pressure: 30 psi (2.1 bar)

VAN NOZZLES \$3.15 EACH

<u>DESCRIPTION</u>				<u>SPRAY ARC</u>			
4-VAN:	YELLOW	Arc Nozzle	3 - 4 Feet				
6-VAN:	ORANGE	Arc Nozzle	4 - 6 Feet				
8-VAN:	GREEN	Arc Nozzle	6 - 8 Feet				
10-VAN:	BLUE	Arc Nozzle	8 - 10 Feet				
12-VAN:	BROWN	Arc Nozzle	10 - 12 Feet				
15-VAN:	BLACK	Arc Nozzle	12 - 15 Feet				
18-VAN:	TAN	Arc Nozzle	15 - 18 Feet				

Easy arc adjustment from 0° to 330° for 4, 6, 8 Van nozzles
 Easy arc adjustment from 0° to 360° for 10,12,15,18 Van nozzles
 Blue filter screen insert to maintain precise radius and to prevent clogging



MPR Series
Plastic Spray Nozzles



STAINLESS STEEL ADJUSTMENT

SCREW TO ADJUST FLOW AND RADIUS

Operating Range →

- Spacing: 3 to 20 feet (0.9 to 4.6 m)
- Optimum pressure: 30 psi (2.1 bar)

MPR NOZZLES \$3.15 EACH

<u>DESCRIPTION</u>		<u>SPRAY ARC</u>				
5-MPR Series:	3 - 5 Feet					
8-MPR Series:	5 - 8 Feet					
10-MPR Series	7 - 10 Feet					
12-MPR Series	9 - 12 Feet					
15-MPR Series:	11 - 15 Feet					
15-MPR SideStrip:	15est 15cst 15rcs 15Lcs 15sst					
9-MPR SideStrip:	9sst					

MPR side strip spray nozzles vary in length & width according to psi; distance can be anywhere from 3' to 4' in width and up to 15' in length on either side of nozzle
 White filter screen insert to maintain precise radius and to prevent clogging



TO ORDER EMAIL: sales@albertairrigation.com

CALL: 1-780-453-5950 FAX: 1-780-452-3470

INSERT FITTINGS

MALE ADAPTER P8-1436005 TO P8-1436211



Red. Insert x Male



Male x Insert

TEES P8-1401005 TO P8-1403005



Red Tee IxI



C&R Tee IxF



Tee Insert



Bullhead Tee IxI



Com. Tee IxM

P8-1449005 TO P8-1449020



Plug Insert

P8-1435005 TO P8-1435015



Female Adapter

P8-1420007



Cross Insert

90° ELBOW P8-1406005 TO P8-1413015



Insert x Ins



Comb. Ins x Mipt



RED. Ins x Ins



RED. Ins x Fipt

COUPLING P8-1429005 TO P8-1429212



Red. Insert x Insert



Insert x Insert

LASCO
Fittings, Inc.

Alberta
Irrigation
Supply

TO ORDER EMAIL: sales@albertairrigation.com
CALL: 1-780-453-5950 FAX: 1-780-452-3470

INSERT FITTINGS

PART NO.	DESCRIPTION	LIST PRICE	PART NO.	DESCRIPTION	LIST PRICE
P8-1401005	TEE 1/2" (INSERT)	1.60	P8-1406101	RED. 90 ELBOW 3/4x1/2" IxRI	1.70
P8-1401007	TEE 3/4" (INSERT)	1.74	P8-1407005	C&R 90 ELBOW 1/2x1/2" IxFPT	1.65
P8-1401010	TEE 1" (INSERT)	2.26	P8-1407007	C&R 90 ELBOW 3/4x3/4" IxFPT	1.79
P8-1401012	TEE 1 1/4" (INSERT)	3.53	P8-1407010	C&R 90ELB. 1x1" IxFPT	2.30
P8-1401015	TEE 1 1/2" (INSERT)	4.00	P8-1407101	C&R 90 ELBOW 3/4x1/2" IxFPT	1.70
P8-1401020	TEE 2" (INSERT)	7.90	P8-1407130	C&R 90 ELBOW 1x1/2" IxFPT	1.79
P8-1401074	Bullhead TEE 1/2x1/2x3/4" IxIxBI	4.33	P8-1407131	C&R 90 ELBOW 1x3/4" IxFPT	2.08
P8-1401094	REDUCING TEE 3/4x1/2x1/2" IxRIxRI	2.16	P8-1407211	C&R 90 ELBOW 1 1/2x1" IxFPT	3.50
P8-1401101	REDUCING TEE 3/4x3/4x1/2 IxIxIR	1.97	P8-1413005	C&R 90 ELBOW 1/2" IxMPT	1.84
P8-1401102	BULLHEAD TEE 3/4x3/4x1" IxIxBI	4.98	P8-1413007	C&R 90 ELBOW 3/4" IxMPT	2.54
P8-1401125	REDUCING TEE 1x3/4x3/4" IxRIxRI	3.74	P8-1413010	COMBINATION 90 ELBOW 1" IxMPT	3.34
P8-1401130	REDUCING TEE 1x1x1/2" IxIxRI	2.30	P8-1413015	COMBINATION 90 ELL 1 1/2" IxMPT	5.90
P8-1401131	REDUCING TEE 1x1x3/4" IxIxRI	2.32	P8-1420007	CROSS 3/4" (INSERT)	4.19
P8-1401132	BULLHEAD TEE 1x1x1 1/4" IxIxBI	6.96	P8-1420010	CROSS 1" (INSERT)	5.22
P8-1401167	REDUCING TEE 1 1/4x1 1/4x3/4 IxIxRI	3.02	P8-1429005	COUPLING 1/2" IxI	0.75
P8-1401168	REDUCING TEE 1-1/4x1-1/4x1"	3.02	P8-1429007	COUPLING 3/4" IxI	0.90
P8-1401203	REDUCING TEE 1 1/2x1 1/4x1 1/4" IRR	5.41	P8-1429010	COUPLING 1" IxI	0.94
P8-1401210	REDUCING TEE 1 1/2x1 1/2x3/4 IxIxRI	5.27	P8-1429015	COUPLING 1 1/2" IxI	1.64
P8-1401211	REDUCING TEE 1 1/2x1 1/2x1" IxIxRI	5.27	P8-1429020	COUPLING 2" IxI	3.13
P8-1401247	REDUCING TEE 2x2x1 1/2" IxIxRI	7.50	P8-1429101	RED. COUPLING 3/4x1/2" IxI	1.22
P8-1401248	REDUCING TEE 2x2x3/4" IxIxRI	7.50	P8-1429130	RED. COUPLING 1x1/2" IxI	1.66
P8-1401249	REDUCING TEE 2x2x1" IxIxRI	7.50	P8-1429131	RED. COUPLING 1x3/4" IxI	1.26
P8-1401250	REDUCING TEE 2x2x1 1/4" IxIxRI	7.86	P8-1429211	RED. COUPLING 1 1/2x1 IxI	2.98
P8-1401251	REDUCING TEE 2x2x1 1/2" IxIxRI	8.10	P8-1429212	RED. COUPLING 1 1/2x1 1/4" IxI	2.32
P8-1402005	C&R TEE 1/2x1/2x1/2" IxIxFPT	1.74	P8-1435007	FEMALE ADAPT/ 3/4" IxFPT	3.54
P8-1402007	C&R TEE 3/4x3/4x3/4" IxIxFPT	2.62	P8-1435010	FEMALE ADAPT. 1" IxFPT	3.93
P8-1402010	C&R TEE 1x1x1" IxIxFPT	3.08	P8-1435015	FEMALE ADAPT. 1 1/2" IxFPT	6.13
P8-1402101	C&R TEE 3/4x3/4x1/2" IxIxFPT	2.16	P8-1436005	MALE ADAPT 1/2" IxMPT	0.74
P8-1402124	C&R TEE 1x3/4x1/2" IxRIxRFPT	3.54	P8-1436007	MALE ADAPT. 3/4" IxMPT	0.90
P8-1402130	C&R TEE 1x1x1/2" IxIxFPT	2.84	P8-1436010	MALE ADAPT. 1" IxMPT	0.94
P8-1402131	C&R TEE 1x1x3/4" IxIxFPT	2.84	P8-1436012	MALE ADAPTER 1 1/4" IxMPT	1.47
P8-1402210	C&R TEE 1 1/2x1 1/2x3/4" IIFPT	7.07	P8-1436015	MALE ADAPT. 1 1/2" IxMPT	1.64
P8-1402211	C&R TEE 1 1/2x1 1/2x1" IIFPT	7.07	P8-1436020	MALE ADAPT. 2" IxMPT	3.15
P8-1402248	C&R TEE 2x2x3/4" IxIxFPT	8.45	P8-1436074	RED. MALE ADAPT. 1 1/2x3/4" RMPTxI	2.32
P8-1402249	C&R TEE 2x2x1" IxIxFPT	9.31	P8-1436101	RED. MALE AD. 3/4x1/2" MPTxRI	2.10
P8-1402251	C&R TEE 2x2x1 1/2" IxIxFPT	9.74	P8-1436102	RED. MALE AD 3/4x1" RMPTxI	2.41
P8-1403005	COMBINATION TEE 1/2" IxIxMPT	2.22	P8-1436131	RED. MALE AD. 1x3/4" MPTxRI	2.16
P8-1406005	90 ELBOW 1/2" IxI	1.46	P8-1436211	RED. MALE AD. 1 1/2x1" MPTxRI	3.34
P8-1406007	90 ELBOW 3/4" IxI	1.79	P8-1449005	INSERT PLUG 1/2"	1.33
P8-1406010	90 ELBOW 1" IxI	1.98	P8-1449007	INSERT PLUG 3/4"	1.38
P8-1406012	90 ELBOW 1 1/4" IxI	2.22	P8-1449010	INSERT PLUG 1"	1.86
P8-1406015	90 ELBOW 1 1/2" IxI	2.62	P8-1449015	INSERT PLUG 1 1/2"	2.58
P8-1406020	90 ELBOW 2" IxI	3.66	P8-1449020	INSERT PLUG 2"	4.55

LASCO
Fittings, Inc.



TO ORDER EMAIL: sales@albertairrigation.com

CALL: 1-780-453-5950 FAX: 1-780-452-3470

NIPPLES & SCH80 RISERS

CUT-OFF NIPPLES



THREAD NIPPLES



RISER NIPPLES



PART	NO & DESCRIPTION	LIST PRICE	UNIT
P8-K050012	1/2" X 12" BLACK CUT-OFF NIPPLE (KBI)	1.15	each
P8-K05003	1/2" x 3" CUTOFF RISER EXTENSION (KBI)	1.09	each
P8-M461007	3/4 X 6 BLACK CUTOFF NIPPLES	0.56	each
P8-M481005	CUT-OFF NIPPLE 1/2x6"MTxMT	1.44	each
P8-M481007	CUT-OFF NIPPLE 3/4x6"MTxMT	2.10	each
P8-M481101	3/4 X 1/2 X 6 CUT-OFF NIPPLE	1.61	each
P3-115060	1-1/2 X 6 TOE NIPPLE S80	6.40	each
P3-120060	2 X 6 TOE NIPPLE SCH80	8.07	each
P3-120120	2x12 TOE NIPPLE	13.37	each
P3-205011	SCH80 NIPPLE 1/2"X CLOSE	0.76	each
P3-205020	SCH80 NIPPLE 1/2"X 2	0.81	each
P3-205050	SCH80 NIPPLE 1/2"X 5"	1.20	each
P3-205060	SCH80 NIPPLE 1/2"X 6	1.35	each
P3-205100	SCH80 NIPPLE 1/2 X 10"	1.88	each
P3-205120	SCH80 NIPPLE 1/2 X 12"	2.13	each
P3-205180	SCH80 NIPPLE 1/2 X 18"	2.90	each
P3-205240	SCH80 NIPPLE 1/2 X 24"	3.50	each
P3-205360	SCH 80 NIPPLE 1/2"X 36"	11.51	each
P3-207013	SCH80 NIPPLE 3/4"X CLOSE	0.81	each
P3-207020	SCH80 NIPPLE 3/4"X 2	0.84	each
P3-207030	SCH80 NIPPLE 3/4"X 3	0.99	each
P3-207060	SCH80 NIPPLE 3/4 X 6"	1.61	each
P3-207120	SCH80 NIPPLE 3/4"X 12	2.56	each
P3-207180	SCH80 NIPPLE 3/4"X 18	3.44	each
P3-207240	SCH80 NIPPLE 3/4"X 24	4.38	each
P3-207360	SCH80 NIPPLE 3/4 X 36	10.07	each
P3-210015	SCH80 NIPPLE 1 X CLOSE	1.18	each
P3-210020	SCH80 NIPPLE 1 X 2"	1.24	each
P3-210060	SCH80 NIPPLE 1 X 6"	2.33	each
P3-210080	SCH80 NIPPLE 1"X 8	2.73	each
P3-210120	SCH80 NIPPLE 1 X 12"	3.69	each
P3-210240	SCH80 NIPPLE 1 X 24"	6.32	each
P3-212030	SCH80 NIPPLE 1 1/4X3	1.90	each
P3-215017	SCH80 NIPPLE 1 1/2X1 3/4 CLOSE	1.88	each
P3-215020	SCH80 NIPPLE 1 1/2X2 SHORT	2.00	each
P3-215025	SCH80 NIPPLE 1 1/2X2 1/2	2.13	each
P3-215030	SCH80 NIPPLE 1 1/2X3	2.33	each
P3-215060	SCH80 NIPPLE 1 1/2X6	3.50	each
P3-215100	SCH80 NIPPLE 1 1/2X10	4.84	each
P3-215120	SCH80 NIPPLE 1 1/2X12	5.54	each
P3-220020	SCH80 NIPPLE 2X2	2.45	each
P3-220025	SCH80 NIPPLE 2X2 1/2 SHORT	2.73	each
P3-220030	SCH80 NIPPLE 2X3	2.91	each
P3-220040	SCH80 NIPPLE 2X4	3.37	each
P3-220060	SCH80 NIPPLE 2X6	4.45	each
P3-220080	SCH80 NIPPLE 2X8	5.43	each
P3-220120	SCH80 NIPPLE 2X12	7.34	each
P3-225060	SCH80 NIPPLE 2 1/2X6	11.05	each
P3-230026	SCH80 NIPPLE 3X2 5/8 CLOSE	8.00	each
P3-230040	SCH80 NIPPLE 3X4	10.12	each
P3-230060	SCH80 NIPPLE 3X6	13.11	each
P3-230120	SCH80 NIPPLE 3X12	21.98	each
P3-240060	SCH80 NIPPLE 4X6	15.62	each
P3-240120	SCH80 NIPPLE 4X12	28.67	each



PART NO.	DESCRIPTION	LIST PRICE	
P9-T5001	INSERT ELB 3/4X3/4	3.35	Ea
P9-T5002	INSERT ELB 1x1"	3.60	Ea
P9-T5003	INSERT ELB 3/4X1	3.80	Ea
P9-T5005	ELBOW 1/2 X 1/2	2.35	Ea
P9-T5101	ELBOW 3/4x3/4" SxMPT	2.85	Ea
P9-T5102	ELBOW 3/4x1" SxMPT	3.65	Ea
P9-T5103	ELBOW 1x3/4" SxMPT	4.15	Ea
P9-T5104	ELBOW 1x1 SxMPT	3.55	Ea
P9-T5201	ELBOW 3/4X1/2" SXFIPT	2.65	Ea
P9-T5202	ELBOW 3/4x3/4" SxFPT	2.70	Ea
P9-T5203	ELBOW 1x1/2" SxFPT	2.75	Ea
P9-T5204	ELBOW 1x3/4" SxFPT	3.00	Ea
P9-T5205	ELBOW 11/4x 1/2" SxFPT	4.20	Ea
P9-T5301	ELBOW 3/4x3/4x1/2"SxSxFPT	4.55	Ea
P9-T5302	ELBOW 1x1x1/2" SxSxFPT	4.80	Ea
P9-T5303	ELBOW 1x1x3/4" SxSxFPT	5.10	Ea
P9-T5401	M.ADAP. 3/4x1/2" SxMPT	2.60	Ea
P9-T5402	M. ADAP. 3/4x3/4" SxMPT	2.35	Ea
P9-T5403	M.ADAP. 1x3/4" SxMPT	2.75	Ea
P9-T5403SP	MALE ADAPT 3/4 INSERT X 1 MPT	2.75	Ea
P9-T5404	M. ADAP. 1x1" SxMPT	2.45	Ea
P9-T5404SP	1" X 1-1/4" MALE ADAPTER	2.45	Ea
P9-T5405	M. ADAP. 11/4x1" SxMPT	4.10	Ea
P9-T5407	M. ADAPTER 1/2 X 1/2	1.75	Ea
P9-T5408	MALE ADAPTER 1/2 X 3/4 MPT	1.80	Ea
P9-T5501	IN.COUP. 3/4x3/4"	3.35	Ea
P9-T5502	IN.COUP. 3/4x1"	3.35	Ea

PART NO.	DESCRIPTION	LIST PRICE	
P9-T5503	INSERT COUP. 1x1"	3.55	Ea
P9-T5504	INSERT. COUP. 11/4x1"	5.20	Ea
P9-T5506	COUPLING 1/2 X 1/2	2.35	Ea
P9-T5601	INS.TEE 3/4x3/4x3/4"	4.20	Ea
P9-T5602	INSERT TEE 1x1x1"	4.55	Ea
P9-T5603	INSERT TEE 3/4x1x1"	5.25	Ea
P9-T5604	INSERT TEE 3/4x3/4x1"	5.25	Ea
P9-T5605	INSERT TEE 1x1x3/4"	5.25	Ea
P9-T5606	INSERT TEE 1x3/4x3/4	5.25	Ea
P9-T5608	INS. TEE 11/4x11/4x11/4"	8.15	Ea
P9-T5609	TEE 1/2 X 1/2 X 1/2	3.00	Ea
P9-T5701	C.TEE 3/4x3/4x1/2 SxSxFPT	3.60	Ea
P9-T5702	C.TEE 3/4x3/4x3/4"SxSxFPT	3.85	Ea
P9-T5703	C. TEE 1x1x1/2"SxSxFPT	4.20	Ea
P9-T5704	C. TEE 1x1x3/4" SxSxFPT	4.35	Ea
P9-T5705	C.TEE 3/4x1x1/2 SxSxFPT	4.35	Ea
P9-T5706	C.TEE 11/4x11/4x1/2SxSxFPT	6.50	Ea
P9-T5707	C.TEE 11/4x11/4x3/4"SSFPT	6.85	Ea
P9-T5708	C.TEE 11/4x11/4x1" SSFPT	6.90	Ea
P9-T5709	TEE COMB 1/2 X 1/2 X 1/2	3.00	Ea
P9-T5710	COMB. TEE 1/2x1/2x3/4 FPT	3.25	Ea
P9-T5801	S.O.TEE 3/4x3/4x3/4x1/2"	7.15	Ea
P9-T5802	SOTEE 1x1x1x1/2"	7.55	Ea
P9-T5803	SOTEE 3/4x3/4x1x1/2"	7.75	Ea
P9-T5900	END CAP 1/2	2.15	Ea
P9-T5901	3/4" ENDCAPS	2.25	Ea



P9-T5200



P9-T5300



P9-T5700



P9-T5000



P9-T5600



P9-T5901



P9-T5400



P9-T5500



P9-T5100



P9-T5800

COMPRESSION FITTINGS... THE 5-SECOND CONNECTION FOR POLYETHYLENE PIPES



TO ORDER EMAIL: sales@albertairrigation.com

CALL: 1-780-453-5950 FAX: 1-780-452-3470



REGULATORS & FILTERS

PART NO.	DESCRIPTION	LIST PRICE	UNIT
D2-X14005	RBV-075 MPTB 3/4" IN-LINE FILTER - BULK	28.05	each
D2-X14010	RBV-200MX MESH XERI REPLACEMENT FILTERS	11.94	each
D2-X14011	RBV-150-MESH XERI FILTER	15.63	each
D2-X14012	RBV-100MX MESH XERI REPLACEMENT FILTERS	14.05	each
D2-X14053	RBV-100 MPTB 1" INLINE FILTER - BULK	26.92	each
D2-X14131	QKCHK100 1" BASKET FILTER W/200 MESH SCR	132.39	each
D2-X14134	QKCHK100M REPLACEMENT FILTER - 100 MESH	49.79	each
D2-X14135	QKCHK150M 150M MESH REPLACEMENT FILTER	48.35	each
D2-X15000	PSI-L30X-075 XERI LOW PRESS. REG. 30PSI	33.33	each
D2-X15050	PSI-M30X-075 XERI MED. PRESS REG 30 PSI	33.33	each
D2-X15060	PSI-M40X-075 XERI MED. PRESS REG 40 PSI	33.33	each
D2-X15140	PSI-M40X-100 1" XERI MED PRESS REGUL.	33.33	each



RBV PRESSURE REGULATING FILTER
 REGULATES PRESSURE TO 30 OR 40PSI
 STATIC FILTER HELPS PREVENT PLUGGING IN A DRIP IRRIGATION SYSTEM—LOW VOLUME.



RBV REPLACEMENT FILTERS



QKCHK FILTER

QUICK CHECK BASKET FILTER WITH BUILT-IN PRESSURE REGULATOR WITH A CLEAN/DIRTY INDICATOR FOR LOW VOLUME IRRIGATION ZONES.

40 PSI PRESSURE REGULATOR BUILT-IN.



QKCHK REPLACEMENT FILTERS

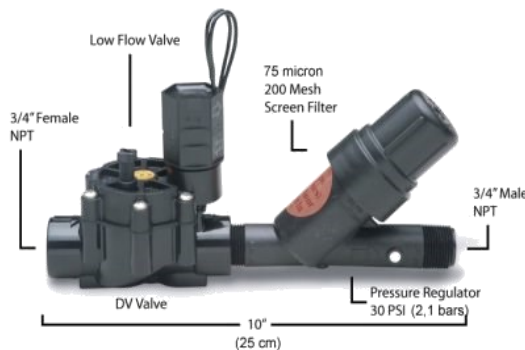

PSI IN-LINE PRESSURE REGULATOR
 LOW FLOW CONTROL ZONE KITS
 WITH PR FILTER

REGULATES OUTLET PRESSURE TO 30 PSI, 40 PSI, OR 50 PSI



TO ORDER EMAIL: sales@albertairrigation.com
 CALL: 1-780-453-5950 FAX: 1-780-452-3470

OPERATES IN LOW-FLOW AND XERIGATION



Diaphragm Kit
R1-21074603

V6-B DV Electric Valves

Use on separate pressure vacuum breaker (PVB) or a double-check valve where required by city codes to protect against back flow. Check your local city codes to determine what type of valves are required. Pressure: 15—150 psi



V6-B72700

D2-X12100 / D2-X12110

Valves designed exclusively for the low flow rates of a drip irrigation system. Can effectively handle particles at low flow rate.



TV-2400T

OPERATES IN LOW-FLOW

Flow control feature
Reliable and convenient for residential operation.
Flow range: 25—30 GPM
Pressure range: 10—150 PSI

PART	DESCRIPTION	LIST PRICE	UNIT
D2-X12100	LFV075 3/4" XERI CONTROL VALVE	39.40	each
D2-X12110	LFV100 1" LOW FLOW XERI CONTROL VALVE	41.50	each
V6-B72110	75-DV 3/4" NPT ELECTRIC VALVE 24VAC FxF	45.50	each
V6-B72231	100-DV 1" NPT ELECTRIC VALVE 24VAC FxF	45.50	each
V6-B72421	100-DVF 1" VALVE 24VAC W/FLOW CONTROL	41.75	each
V6-B72700	100-ASVF 1" ANTI-SIPHON VALVE	45.94	each
R1-21074603	RPK DIAPH RETND FLTR-DV/DVF	22.50	each
TV-205T	205T 1" ELECTRIC PGA VALVE	42	each
TV-240045	WRENCH - REMOVAL OF VLV BONNET	9.82	each
TV-2400T	2400T 1" JAR TOP VLV NPT	42	each
TV-70015	700-1.5 1-1/2" ELEC. GLOBE VLV	199.08	each
TV-7002	700-2 2" ELEC. GLOBE VLV	273.75	each
TV-700B75	700B.75 3/4" ULTRA FLOW VLV	56.32	each
V5-B30310	100-PGA 1" GLOBE/ANGLE VALVE 24VAC	52.60	each
V5-B30410	150-PGA 1-1/2" GLOBE/ANGLE VALVE 24VAC	169.06	each
V5-B30510	200-PGA 2" GLOBE/ANGLE VALVE 24VAC	235.44	each
V5-B34183	100-PEB 1" ELEC. VLV 24VAC W/E-Z BLEED	140.70	each
V5-B34383	150-PEB 1-1/2" ELEC VLV 24VAC-E-Z BLEED	144.89	each
V5-B34583	200-PEB 2" ELEC VALVE 24VAC W/E-Z BLEED	150.00	each
V5-B35113	150-PES-B 1-1/2" ELEC VALVE (SCRUBBER)	269.19	each
V5-B35213	200-PES-B 2" ELECTRIC VALVE (SCRUBBER)	348.27	each



V5-B34 / V5-B35

Heavy-duty performance
Pressure: up to 200 psi

PESB only: Scrubber scrapes its stainless steel screen clean to break down grit and plant material.



TV-205T

These heavy-duty high flow valves are dependable operation in potable and dirty water applications; debris tolerant.
Pressure range of 10-150 psi
With or without adjustable flow

PGA Globe/Angle Valve 24VA

Withstand constant 150 psi

Double-filtered pilot flow to resist debris and clogging of solenoid ports.

Manual internal bleed operates the valve without allowing water into the valve box.

Allows pressure regulator to be adjusted without turning the valve on at the controller.



V5-B303/304/305



TV-700B

TV-70015

TV-7002

Heavy duty electric globe valves
Precise flow, minimum pressure loss
Superior regulation, stainless steel filter

SOLENOIDS



Includes diaphragm, metering rod, bleed, and o-ring

R1-20858801
RainBird



TP-DCL
Irritrol



C3-K80910
RainBird



TP-R81124VACG
Irritrol

PART NO.	DESCRIPTION	LIST PRICE
C3-K80910	TBOSSOL POTTED LATCHING SOLENOID	67.48
R1-20858801	RPK SOLENOID DV W/FILTER 15	20.16
TP-DCL	DCL LATCHING SOLENOID	44.85
TP-R81124VACG	60HZ REPLACEMENT SOLENOID	22.20
TP-RSCAP	CAP & PISTON ASSY FOR RS1000	7.27
TP-SPKHR1	SPK-HR1 DIAPHRAGM REPAIR KIT	37.75

PCV BALL/CHECK VALVES



BV PVC Ball Valve



CV — CHECK VALVE



PART NO.	DESCRIPTION	LIST PRICE
D2-X16011	CV100 1" CHECK VALVE	29.91
D2-X16012	CV075 3/4" CHECK VALVE	25.23
V2-A12010	BV150SS PVC BALL VLV 1-1/2" SxS	21.95
V2-A12012	BV200SS 2" PVC BALL VALVE SLIP	26.65
V2-A12022	BV050FF 1/2" FTPxFPT PVC BALL VALVE	6.32
V2-A12024	BV075FF 3/4" FPTxFPT PVC BALL VALVE	9.90
V2-A12026	BV100FF 1" FPTxFPT PVC BALL VALVE	11.62
V2-A12030	BV150FF 1-1/2" FPTxFPT PVC BALL VALVE	18.95
V2-A12032	BV200FF 2" FPTxFPT PVC BALL VALVE	21.95

BRASS HOSE FITTINGS

Sediment Faucet



Brass Blow-Off Assembly



HO-100001
HO-100002
Female Pipe Swivel



Brass Hose Y



HO-100004
Female Hose Adapter



HO-100003
Male Hose Adapter



PART NO.	DESCRIPTION	LIST PRICE
SA-G10000	BRASS BLOW-OFF ASSEMBLY	17.99
HO-100001	1" F. HOSE TO 1" FEMALE PIPE SWL 199 S-F	12.80
HO-100002	3/4 F.HOSE X 3/4 F. PIPE SWIVEL 199S-E	4.85
HO-100003	3/4 MPT X MALE GARDEN HOSE ADAP 196-E	2.55
HO-100004	3/4 MPT X F.GARDEN HOSE ADAPTER 199-E	5.30
HO-100103E	BRASS COUPLING 3/4" FIPTxFIPT	4.15
HO-100103F	CAST COUPLING 1" FIPTxFIPT	5.30
HO-100103G	1-1/4" CAST COUPLING FIPTxFIPT	8.85
HO-100200W	BRASS 3/4" CAP - F.HOSE THREAD	1.36
HO-100202W	BRASS 3/4" HOSE Y	8.99
V5-10740	1/2" SEDIMENT FAUCET BD-1c	7.69
V5-10741	3/4" SEDIMENT VALVE	8.59



KWIKSEAL



Saddle tee is for use with poly pipe only. It provides a 1/2" female connection to connect a sprinkler head.

FLO-CONTROL - SADDLE TEE



Easy to use tees form a water-tight seal with the Included O-ring and the wedge-style tightening system.

PART NO.	DESCRIPTION	LIST PRICE	UNIT
A1-D75C	DAWN 75C KWIKSEAL 3/4PPx1/2 FIPT" SADDLE	2.20	each
A1-D100C	DAWN 100C KWIKSEAL 1"PPx1/2"FIPT SADDLE	2.30	each
A1-D100D	DAWN 100D KWIKSEAL 1"PPx3/4"FIPT SADDLE	2.50	each
A1-DKT007C	DAWN 3/4x1/2 KWIKTAP TEE	2.35	each
A1-DKT007D	DAWN 3/4x3/4 FPT KWIKTAP TEE	2.35	each
A1-DKT010C	DAWN 1x1/2 FPT KWIKTAP TEE	2.35	each
A1-DKT010D	DAWN 1x3/4 FPT KWIKTAP TEE	2.35	each
SM-421507	FLO-CONTROL 1-1/2"x 3/4" CLAMP-IT SADDLE	19.60	each
SM-422015	FLO-CONTROL 2x1-1/2 CLAMP-IT SADDLE FIPT	23.44	each
SM-443015	FLO CONTROL 3x1-1/2" IPS PVC SADDLE	37.50	each
SM-443020	FLO-CONTROL 3x2 IPS CLAMP-IT SADDLE		
F1-D00103BRASS	3/4 X 1/2 SADDLE TEE - BRASS	P.O.A.	
F1-D00106BRASS	3/4 X 3/4 SADDLE TEE - BRASS	P.O.A.	
F1-D00108BRASS	1 X 1/2 SADDLE TEE - BRASS	P.O.A.	
F1-D00111BRASS	1 X 3/4 SADDLE TEE - BRASS	P.O.A.	
F1-D00116BRASS	1 1/4 X 1 SADDLE TEE - BRASS	P.O.A.	
F1-D00120BRASS	2 X 1/2 SADDLE TEE - BRASS	P.O.A.	



SADDLE TEE - BRASS

Poly pipe only. Provides a 1/2" fpt connection to connect a sprinkler head.



KWIKTAP SADDLE TEE

A superior saddle tee for Polyethylene, no tools required.

TRIDON OETIKER

POLY PIPE CLAMPS

O2-R1098 Clamp Pincers



Stainless Steel Clamps



HAS Clamps



PART NO.	DESCRIPTION	LIST PRICE	UNIT
T1-G01010	5/8" HF-SS SERIES CLAMPS (HAS10)		1.70
T1-G01012	3/4" HF-SS SERIES CLAMPS (HAS12)		1.75
T1-G01016	1" HF-SS SERIES CLAMPS (HAS16)		1.80
T1-G01020	1 1/4" HF-SS SERIES CLAMPS (HAS20)		1.85
T1-G01024	1 1/2" HF-SS SERIES CLAMPS (HAS24)		1.90
T1-G01028	1 3/4" HF-SS SERIES CLAMPS (HAS28)		1.95
T1-G01032	2" HF-SS SERIES CLAMPS (HAS32)		1.95
T1-G01036	2 1/4" HF-SS SERIES CLAMPS (HAS36)		1.98
O2-R198RSTAINLES	198R 3/4" STAINLESS STEEL CLAMP		0.29
O2-R210RSTAINLES	210R 1 3/16" SS STEEL CLAMP FOR 1/2"		0.29
O2-R256RSTAINLES	256R 3/4" STAINLESS STEEL CLAMP		
O2-R271RSTAINLES	271R 1-1/16" SS STEEL CLAMP FOR 3/4"		0.31
O2-R331RSTAINLES	331R 1-5/16" STAINLESS STEEL CLAMP		
O2-R346RSTAINLES	346R 1-3/8" SS STEEL CLAMP FOR 1"		0.33
O2-R1098	1098 STANDARD STRAIGHT JAW PINCERS		39.85

3500 Series
Full & Part circle



Nozzles

Residential application.
Adjust spray arc with screwdriver; 40° to 360°
Interchangeable nozzles

SAM: Built-in Seal-a-Matic check valve, for changing elevations.

5000 Series
Full & Part circle



Residential or commercial application.
Adjust spray arc with screwdriver 40° to 360°
Interchangeable nozzles

SAM: Built-in Seal-a-Matic check valve, for changing elevations.

Tool
S1-Y05100 Tool



TREE NOZZLES
S1-Y04500



MAXI-PAW ROTOR
2045A-08



Residential application.
Powerful throw for better water coverage with no brown spots.
Seal-o-matic check valve.
Water saver guide arm.
Simple pattern change adjustment



PART NO.	DESCRIPTION	LIST PRICE	UNIT
S1-Y34000	3504PC 4" PART/REVERSE FULL CIRCLE ROTOR	31.38	each
S1-Y34500	3504PC SAM 3500 SERIES 4" POP UP	33.50	each
S1-Y34900	3500SPCSAM 3500 SHRUB ROTOR W/SAM	36.00	each
S1-Y52000	5012PC 12" TOP LOADING ROTOR	59.30	each
S1-Y54000	5004PC 4" TOP LOADING PC ROTOR	26.70	each
S1-Y54010	5004FC 4" TOP LOADING FC ROTOR	26.70	each
S1-Y54400	5000S PC SHRUB ROTOR	24.99	each
S1-Y55000	5004PCSAM 4" PART/REVERSE FC ROTOR SAM	27.05	each
S1-Y05100	ROTORTOOL FOR 5000 SERIES HEADS	4.25	each
S1-Y04...	NOZZLES FOR 5000 SERIES ROTOR - EXTRA NOZZLE	1.99	each
L1-A47...	GALLONAGE NOZZLES - VARIOUS SIZES & ARCS	1.75	each
L1-A845...	ROTARY NOZZLES - VARIOUS SIZES & ARCS	8.05	each
S1-B0690008	2045A-08 MAXI-PAW ROTOR P/F CIRCLE	49.62	each
I1-B4600008	2045-PJ-08 MAXI-BIRD SPRINKLER	31.70	each
R1-208001	2045 - PAW COVER & CAP ASSY	7.99	each
M1-B41866	42064 MINI-PAW AND MAXI-PAW WRENCH	12.59	each

Radius Adjustment slot

Pull-up slot

Flow Shut-off slot



5000 PLUS

5000 PLUS

Nozzle Identification plug

Arc Adjustment slot

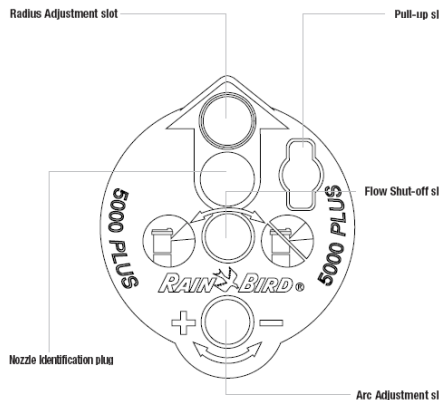
L1-A845... Rotary nozzles
Can be zones with 5000 series
20-55 PSI, 13' to 24' radius

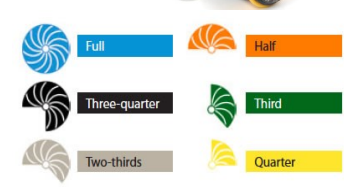
- Full
- Half
- Three-quarter
- Third
- Two-thirds
- Quarter

M1-B41866
Maxi Wrench



Maxi-Bird Sprinkler



Number 06 Number 07 Number 08
Number 10 Number 12 Number 07LA Number 10LA

2045-PJ-08 Nozzles

Used for slope and large-area, above-grade applications
Easy to adjust, easy to service



COMMERCIAL ROTORS



6500 Falcon Series
Full & Part circle

Commercial Applications
Spacing up to 65' with
interchangeable nozzles
High speed; 0° to 360°

Built-in Seal-a-Matic check valve, for
changing elevations.



7000SS Series
Full & Part circle

Rugged commercial
applications
Interchangeable nozzles

50° to 330° part circle, 360° non
reversing full circle. Memory Arc
returns the rotor to its original arc
setting. Seal-a-Matic check valve



7000SS Series
Full & Part circle

Tough commercial
applications, long radius
Interchangeable nozzles

50° to 330° part circle, 360° non
reversing full circle.

PART NO.	DESCRIPTION	LIST PRICE	UNIT
S4-B00400	6504OPT OPERATING PRESSURE TEST TOOL	39.00	each
S4-B65001	6504PC F-4PC 4" FALCON ROTOR LESS NOZ	59.81	each
S4-B65011	6504FC F-4FC 4" FALCON ROTOR LESS NOZ	59.81	each
S4-B65501	6504PC F-4PC STAINLESS FALCON LESS NOZ	87.42	each
S4-B65511	6504FC F-4FC STAINLESS FALCON LESS NOZ	87.42	each
S4-232693S	ROTOR HOLDUP TOOL W/LEVEL (FOR FALCON)	9.51	each
S4-B81300	8005SS STAINLESS STEEL ROTOR	111.96	each
S4-B82100	7005SS PART/FULL ROTOR STAINLESS STEEL	119.62	each
S4-G25000	TA-85-PC TALON 85 PC ROTOR	186.74	each



S4-232693S
Hold-Up Tool for Falcon Series

Works with Rainbird series
5000, 5500, 6504, 7005, 8005



FALCON NOZZLES



8005
57' to 81'
(17,4 m to 24,7 m)



7005
39' to 71'
(11,9 m to 21,7 m)



5500
17' to 55'
(5,2 m to 16,8 m)



6504
39' to 65'
(11,9 m to 19,0 m)



5000
25' to 50'
(7,6 m to 15,2 m)



3500
15' to 35'
(4,6 m to 10,7 m)



TO ORDER EMAIL: sales@albertairrigation.com

CALL: 1-780-453-5950 FAX: 1-780-452-3470



RECREATION TURF ROTORS & TOOLS



900 / 950 Series
Eagle Rotor



900 Arc: 360°
Radius: 63 - 97 feet
Pressure: 60 - 100 psi
Flow: 21.4 - 57.1 gpm
Stream Height: 20 feet

950 Arc: 40° - 345°
Radius: 70 - 92 feet
Pressure: 60 - 100 psi
Flow: 19.5 - 59.4 gpm
Stream Height: 20 feet



700 / 750 Series
Eagle Rotor



700 Arc: 360°
Radius: 56 - 79 feet
Pressure: 60 - 100 psi
Flow: 16.3 - 43.9 gpm
Stream Height: 17 feet

751 Arc: 30° - 345°
Radius: 65 - 75 feet
Pressure: 60 - 100 psi
Flow: 7.0 - 37.7 gpm
Stream Height: 17 feet



500 / 550 Series
Eagle Rotor



500 Arc: 360°
Radius: 27 - 47 feet
Pressure: 40 - 80 psi
Flow: 6.0 - 13.2 gpm
Stream Height: 13 feet

550 Arc: 30° - 345°
Radius: 27 - 49 feet
Pressure: 40 - 80 psi
Flow: 6.0 - 13.6 gpm
Stream Height: 13 feet

EAGLE ROTORS

The closed case construction of the Eagle rotors dramatically extends the life of the rotor by protecting the motor from debris, sand or silt, along with outside elements and environmental changes due to hot or cold weather conditions.

PART NO.	DESCRIPTION	LIST PRICE	UNIT
S3-G1104054	500-E ELECTRIC FC (LESS NOZZLE)		P.O.A.
S3-G14040	550-E EAGLE PC ROTOR		P.O.A.
S3-G03500	700-B EAGLE ROTOR		P.O.A.
S3-GRC101848	751-E Eagle PC Golf Rotor - 80 PSI		P.O.A.
S3-G60400	EAGLE NEST WITH 700 INTERNAL ASSY		P.O.A.
S3-G00100	900-E FC ELECTRIC ROTOR ACME/80PSI/#56		P.O.A.
S3-G00400950E	950-E PC ELECTRIC ROTOR ACME/80PSI 26-12		P.O.A.
S3-B41700	VT-900 VALVE INSERTION TOOL		P.O.A each
S3-B41710	VT-500/700 VALVE INSERTION TOOL		P.O.A each
S3-B41720	EGL-SVK SELECTOR VALVE KEY - ORANGE	21.99	each
S3-D02203	SRP-900 SNAP-RING PLIERS	59.00	each
S3-D02215	DR-SVK 7" SELECTOR VALVE KEY	53.54	each
S3-D02221	DR-SVK 18" SELECTOR VALVE KEY	98.13	each
S3-D02236	SRP-700 SNAP-RING PLIER	119.27	each
S3-D05205	UHA UNIVERSAL HOSE ADAPTER	98.00	each



Snap-Ring Pliers
500 & 700 Series



Snap-Ring Pliers
900 Series



EGL Orange
Selector Valve key
500 & 700 Series



DR-SVK Selector Valve Key
900 Series

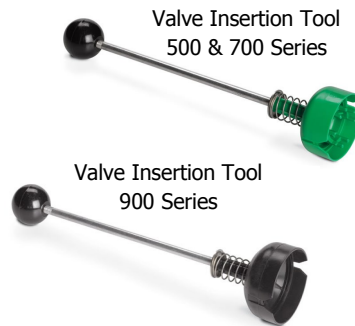

Valve Insertion Tool
500 & 700 Series

Valve Insertion Tool
900 Series



Universal Hose
Adapter

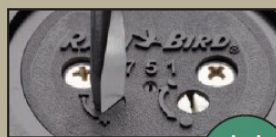

Set primary rotor arc.

Arc A

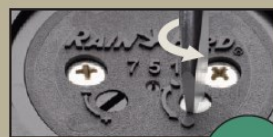

Turn the Full/Part Adjustment
Screw for full-circle operation.

Full Circle

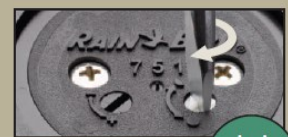

Turn to part circle again for
either Arc A or Arc B setting.

No need to adjust arc when going
between full- and part-circle settings.

Arc A

or

Arc B

Versatility with a twist. Easily shift between three arc settings to
selectively water fairways, roughs—or both.



Sprinkler Base

Metal Roller
Base 15" or 22"



GS10
Green Spray
Nozzle

PART NO.	DESCRIPTION	LIST PRICE	UNIT
BU-15S	BUCKNER 15S 1/2" BRASS IMPACT F/C	37.95	each
BU-2000S	BUCKNER #2000S 3/4" F/C BRASS IMPACT	56.55	each
BU-261SDX1206	BUCKNER 261SDX 3/4" F/P BRASS IMPACT **	102.17	each
BU-300SAX	BUCKNER 300SAX 1" FC BRASS IMPACT OPPOS	143.62	each
BU-350SA	BUCKNER #350SA 1" FC BRASS IMPACT - SAME	149.95	each
BU-360SA	BUCKNER 360SA 1" F/P BRASS IMPACT	189.58	each
BU-400S	BUCKNER 400S 1-1/4" F/C BRASS IMPACT DN	279.90	each
BU-90DZ10	BUCKNER 1/2" PLASTIC/ZINC F/P IMPACT	29.30	each
BU-90SD	BUCKNER 90SD 1/2" P/F BRASS IMPACT	72.63	each
BU-AI123	BUCKNER AI123 1-1/4" F/P BRASS IMPACT	315.96	each
BU-WB07	BUCKNER SPRINKLER BASE - 3/4" FPT OUTLET	27.74	each
I2-1210493	BUCKNER 15" METAL ROLLER BASE 3/4" FHT	215	each
I2-1000282	BUCKNER 22" METAL ROLLER BASE 1" FIP	273.13	each
I2-1000263	BUCKNER GS 1" FEMALE GREEN SPRAY NOZZLE	21.95	each



BU-90DZ
1/2" F/P

Pressure: 25 - 55 psi
Flow: 2.11 - 5.64 gpm
Spacing: 34 - 47 feet
Trajectory: 25 degrees



BU-90SD
1/2" F/P

Pressure: 25 - 55 psi
Flow: 3.54 - 5.44 gpm
Spacing: 35 - 48 feet
Trajectory: 25 degrees



BU-261SDX
3/4" F/P

Pressure: 30 - 60 psi
Flow: 3.94 - 13.73 gpm
Spacing: 41 - 50 feet
Trajectory: 25 degrees



BU-2000S
3/4" FC

Pressure: 35 - 80 psi
Flow: 2.5 - 15.7 gpm
Spacing: 40 - 60 feet
Trajectory: 25 degree



BU-AI123
1-1/4" F/P

Pressure: 55 - 95 psi
Flow: 24.9 - 121 gpm
Spacing: 75 - 113 feet
Trajectory: 23 degrees



BU-360SA
1" F/P

Pressure: 35 - 100 psi
Flow: 7.75 - 44.01 gpm
Spacing: 49 - 77 feet
Trajectory: 23 degrees



BU-15S
1/2" FC

Pressure: 25 - 55 psi
Flow: 3.54 - 5.44 gpm
Spacing: 35 - 48 feet
Trajectory: 7°, 15°, 25°



BU-350SA
1" FC

Pressure: 40 - 80 psi
Flow: 14.6 - 46.6 gpm
Spacing: 47 - 80 feet
Trajectory: 23 degree



BU-300SAX
1" FC

Pressure: 40 - 80 psi
Flow: 14.6 - 46.6 gpm
Spacing: 47 - 80 feet
Trajectory: 23 degree



BU-400S
1-1/4" FC

Pressure: 65 - 100 psi
Flow: 34.62 - 132.18 gpm
Spacing: 85 - 117 feet
Trajectory: 23 degrees



BRASS VALVES



RED & WHITE GATE VALVE

VBM Manual Valve Brass

Easy service & cleaning

Designed to provide low friction-loss performance



Dual Check Valve

DVC 7U-2 Back Flow Preventer



VACUUM BREAKER

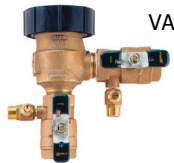

MAS Brass Ball Valve

PART NO.	DESCRIPTION	LIST PRICE	UNIT
V5-D23012	1-1/4" RED & WHITE GATE VALVE	85.27	each
V5-D23001	1-1/2" RED & WHITE GATE VALVE 206A	114.55	each
V5-D23002	1" RED & WHITE GATE VALVE 206A	45.36	each
V5-D23003	2" RED & WHITE GATE VALVE 206A	182.00	each
V5-D230025	2-1/2" RED & WHITE GATE VLV 206A		P.O.A.
V5-D23004	3" RED & WHITE GATE VALVE 206A		P.O.A.
V5-D23005	4" RED & WHITE GATE VALVE 206A		P.O.A.
BU-VBM20	VBM20 BUCKNER 2" BRASS MANUAL VALVE		P.O.A.
V5-D0345150SCRD	1/2" BRASS BALL VALVE	9.45	each
V5-D0348375SCRD	MAS 3/4" BRASS BALL VALVE B1-F	13.45	each
V5-D03484100SCRD	MAS 1" BRASS BALL VALVE B1-F	18.83	each
V5-D03485150SCRD	MAS 1 1/2" BRASS BALL VALVE B1-F	38.65	each
V5-D03487200SCRD	MAS 2" BRASS BALL VALVE B-1F	59.95	each
B1-62099	3/4" DUAL CHECK VALVE ASSY- 007-QT	178.85	each
B1-D02875DVC075	DCV 75 3/4" DUAL CHECK VALVE - 7U2-2	35.95	each
B1-D02900DCV100	DCV 100 1" DUAL CHECK VALVE - 7U2-2	38.65	each
B1-D03001AVB075	ATMOSPHERIC VACUUM BREAKER 3/4"	26.75	each
B1-D03002AVB100	ATMOSPHERIC VACUUM BREAKER 1"	42.80	each

BRASS QUICK COUPLERS & KEYS



Quick Coupler



TLK Key



Quick Coupler with key
Ideal for reclaimed water
Available in new Acme threads

Acme Thread

PART NO.	DESCRIPTION	LIST PRICE	UNIT
BU-QB33K07	BUCKNER QB33K07 3/4" KEY FOR QUICK COUP.	43.59	each
BU-QB5RK10	Buckner Key for 1" Quick Coupler (2011)	89.00	each
BU-QC101	QC101 BUCKNER KEY 1" MALE & 3/4" FEMALE	87.95	each
BU-QCS101	QCS101 BUCKNER KEY 1-1/4" MALEx 1" FEMALE	101.75	each
BU-QCV075R	BUCKNER 3/4" BRASS QC VLV 1SLOT YELLOW	57.99	each
BU-QCV101R	QCV101R BUCKNER 1" BRASS QC W/YEL RUB COV	84.99	each
BU-SPIKEB	BUCKNER 1/2" FNPTx3/4" FHT&MHT METAL STEP	17.95	each
V3-B10603	3RC QUICK COUPLE VALVE W/YELLOW R.COV	57.99	each
V3-B11801	33DK Rainbird 3/4" Quick Coupling Key 3/4"	34.99	each
V3-B12401	44K - 44 SERIES VALVE KEY	84.99	each
V3-B12703	5RC QUICK COUPLING VALVE W/YEL R.COV.	84.99	each
V3-B13301	55K-1 SERIES 55 KEY - 1"	87.99	each
BU-HS075	HS075 BUCKNER 3/4" HOSE SWIVEL FPTxMHT	52.45	each
BU-HS100	HS100 BUCKNER 1" FPTx3/4" MHT HOSE SWIVEL	57.99	each
BU-HS101	HS101 BUCKNER 1" FPT HOSE SWIVEL	62.99	each

SWING JOINTS - PVC

PART NO.	DESCRIPTION	LIST PRICE
P7-302251	2x1-1/2" SERVICE TEE - HEAVY TURF	4.65
P7-305015	1-1/2" DOUBLE SWING TEE - HEAVY TURF	4.65
P7-307251	2x1-1/2" SERVICE ELBOW - HEAVY TURF	3.72
P7-364251	2x1-1/2" TAP'T SADDLE	13.17
P7-G001004	1-1/2" ACMExACME INLET	9.22
P7-G001016	1-1/2x1-1/4 CONNECTOR m.acmeXm.acme	6.96
P7-G002132	1" FIPT TO 1-1/4" ACME SJ ADAPTER	8.14
P7-G002212	1-1/2 FIPT to 1-1/4 ACME SJ ADAPTER	8.14
P7-G100218	1" REPLACEMENT SWING ARM - 18" LAY	23.84
P7-G102132	1 X 1-1/4 ACMExMIPT SPECIAL SJ ELBOW	14.16
P7-G132212	1" UNITIZED SWING JOINT MIPxMIP	41.48
P7-G13S212	1" SWING JOINT MIPTx SNAP LOK	84.58
P7-G13S218	1" SWING JOINT MIPTxSNAP LOK - 18" LAY	90.10
P7-G1M0212	1" SWINGJOINT - 1-1/2" MAINLINE X 1"ACME	41.48
P7-G1M0218	1"ACM SW JT W/1-1/2" MAINL. ACME-18"LONG	45.98
P7-G1MS212	1" SNAPLOK x 1-1/2" MAINL. ACME SWING JT	84.58
P7-G200002	1-1/4" STREET ELBOW ACMExACME	17.04
P7-G200218	1-1/4" REPLACEMENT SWING ARM - 18" LAY	28.47
P7-G202000	1-1/4" ST. EII ACMExMIPT SJ OUTLET	9.97
P7-G202012	1-1/4" ADAPTER FIPT SPR. HEAD TO ACME	7.27
P7-G202212	1 1/4x1 1/2 INCREASE MIPT OUTLET	18.18
P7-G208212	1-1/4"x1-1/2" ACMExACME S.J. OUTLET	18.18
P7-G210000	1-1/4" INLET MIPTxACME	6.96
P7-G220000	1-1/4" SHORT SPG x ACME INLET	6.96

PART NO.	DESCRIPTION	LIST PRICE
P7-G230000	1-1/4" SJ MIPT INLET	6.96
P7-G232212	1 1/4" UNITIZED SWING JOINT MIPTxMIPT	55.05
P7-G270212	1-1/4" SWING JOINT - L.SPIGOTxMALE ACME	55.05
P7-G2M0212	1-1/4 ACME SW JT x 1-1/2" MAINLINE ACME	55.05
P7-G300002	1 1/2" STR. ELL ASS'Y (M.ACMExF.ACME)	20.30
P7-G300218	1-1/2" REPLACEMENT SWING ARM - 18" LAY	35.98
P7-G302000	1-1/2" STR. ELL ACMExMIPT SJ OUTLET	11.07
P7-G302015	1-1/2" ADAPTER FIPT SPR.HEAD TO ACME	8.67
P7-G308212	1-1/2x1-1/4 MALE ACME ELL - SPECIAL	18.18
P7-G320000	1-1/2 SPG x ACME SJ INLET (NIPPLE)	9.22
P7-G330000	1-1/2" INLET MIPTxACME	9.22
P7-G330212	1-1/2" Swing Joint MIP x ACME - 12" Lay	66.93
P7-G332212	1-1/2" UNITIZED SWING JOINT MPTxMPT	66.93
P7-G370000	1-1/2" IINLET SPG x ACME	9.22
P7-G370212	1-1/2" SWING JOINT - L. SPIGOTxMALE ACME	66.93
P7-G372212	1-1/2" SWING JOINT - LONG SPGxMIPT	66.93
P7-G3M0212	1-1/2" x 12" SWING JOINT - M.ACMExM.ACME	66.93
P7-G587001	1-1/2" x 7" ACME RISER (pre-glued)	14.75
P7-G587002	1" x 7" ACME RISER (pre-glued)	9.07
P7-G587003	1-1/4" x 7" ACME RISER (pre-glued)	11.15
P7-G590001	1-1/2" ACME RISER KIT	14.75
P7-G590002	1" ACME RISER KIT	9.07
P7-G590003	1-1/4" ACME RISER KIT	11.15

LASCO

Fittings, Inc.

Adapter - Head to Acme
G202012 & G302015



Snap Lok - with Swing Joint



P7-364251 - TAP'T SADDLE



Inlet Style



Outlet Style

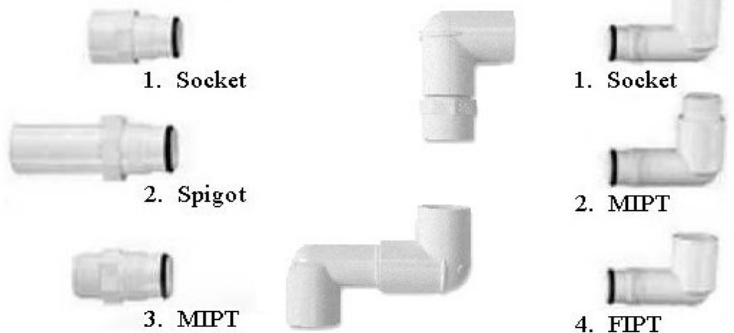

TO ORDER EMAIL: sales@albertairrigation.com

CALL: 1-780-453-5950 FAX: 1-780-452-3470



A well-designed valve box can make installation faster and easier while reducing the need for future maintenance. Residential & commercial grades available



VB-6RND

TOP: 5.7" x 9" H

BOTTOM: 7.5" x 9"



VB-10RND

TOP: 8.9" x 10" H

BOTTOM: 11.9" x 10"

PART NO.	DESCRIPTION	LIST PRICE	UNIT
----------	-------------	------------	------

CARSON VALVE BOXES

910 LID	#910 LID ONLY (Electrical / Irrigation / Potable)		P.O.A.
910 BOX	#910 10" ROUND VALVE BOX - NO LID		P.O.A.
1220 LID	1220 - LID ONLY		P.O.A.
1220 - 6"	6" HIGH VALVE BOX - NO LID		P.O.A.
1220 - 12"	12" HIGH VALVE BOX - NO LID		P.O.A.
1419 LID	1419 - LID ONLY		P.O.A.
1419 - 6"	6" HIGH VALVE BOX - NO LID		P.O.A.
1419 - 12"	12" HIGH VALVE BOX - NO LID		P.O.A.
1324 - 15"	15" HIGH LARGE VALVE BOX w/LID		P.O.A.
1730 - 18"	18" LARGE VALVE BOX w/LID		P.O.A.

RAINBIRD VALVE BOXES

VB6RND	6" ROUND VALVE BOX w/LID		P.O.A.
VB10RND	10" ROUND VALVE BOX w/LID		P.O.A.
VB-STD	6" or 12" STANDARD SHORT VALVE BOX		P.O.A.
VB-JMB	6" or 12" JUMBO LONG VALVE BOX		P.O.A.
VB-SPR	15" SUPER VALVE BOX		P.O.A.
VB-MAX	18" MAXI VALVE BOX		P.O.A.



VB-STD-6EXT

TOP: 20" x 14.75" x 6.75" H

BOTTOM: 20" x 14.5"



VB-JMB-6EXT

TOP: 24.5" x 17.9" x 6.75" H

BOTTOM: 24.5" x 17.9"



VB-STD-STANDARD

TOP: 14.5" x 9.4" x 12.1" H

BOTTOM: 18.7" x 14.1"



VB-JMB-JUMBO

TOP: 18.7" x 12.2" x 12.1" H

BOTTOM: 24" x 17.5"



VB-SPR-H SUPER JUMBO

TOP: 22.5" x 13" x 15" H

BOTTOM: 28.8" x 19.5"



VB-MAX-H MAXI JUMBO

TOP: 29.4" x 16.4 x 18" H

BOTTOM: 35.1" x 21.9"



1730

40" x 27" x 18" H

1324

32" x 22" x 15" H



1419-6 18.5" x 13.5" x 6.75" H

1220-6 24.5" x 17.5" x 6.75" H



1419-12 20.5" x 15.5" x 12" H

1220-12 25.5" x 19" x 12" H



910 ROUND

9.5" x 13" x 10" H

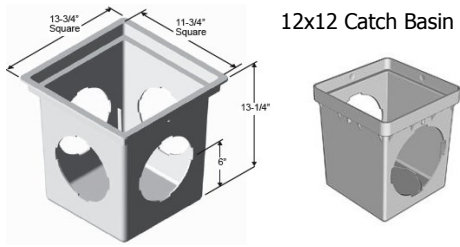

12x12 Catch Basin

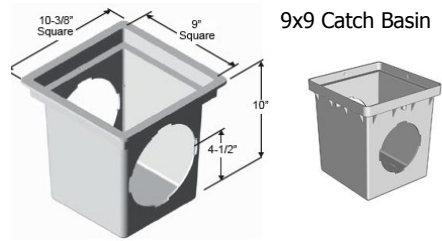

9x9 Catch Basin

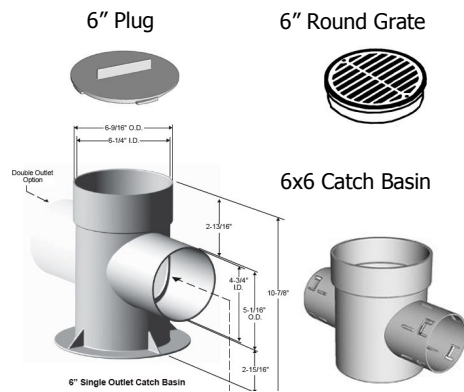

6" Plug

6" Round Grate

6x6 Catch Basin

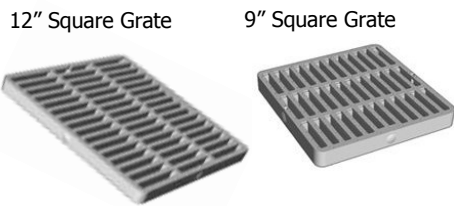

12" Square Grate

9" Square Grate

PART NO.	DESCRIPTION	LIST PRICE	UNIT
GC-TT155	TURF TEK 3" - 4" POPUP DRAINAGE EMITTER	48.05	each
GC-TT244	TURF TEK 3x4" UNIVERSAL ADAPTER	10.99	each
GC-TT101	TURF TEK 6" SINGLE OUTLET CATCH BASIN	23.75	each
GC-TT119	TURF TEK 6" ROUND GRATE - GREEN	13.85	each
GC-TT201	TURF TEK 6" DOUBLE OUTLET CATCH BASIN	24.40	each
GC-TT247	TURF TEK 6" UNIVERSAL OFFSET OUTLET	10.20	each
GC-TT250	TURF TEK 6" PLUG	6.80	each
GC-TT910	TURF TEK 9x9" SQUARE GRATE - GREEN	50.79	each
GC-TT911	TURF TEK 9x9" SQUARE GRATE - BLACK	43.25	each
GC-TT920	TURF TEK 9x9" CATCH BASIN - 2 WAY	49.33	each
GC-TT921	TURF TEK 9" CATCH BASIN - 4 WAY	54.70	each
GC-TT1220	TURF TEK 12x12" SQUARE GRATE - GREEN	61.25	each
GC-TT1250	TURF TEK 12x12" CATCH BASIN - 2 WAY	56.95	each
GC-TT1252	TURF TEK 12" CATCH BASIN - 4 WAY	72.51	each
GC-TT1253	TURF TEK 12x12x6 CATCH BASIN - BLACK	33.45	each



The basins act as sump areas to collect debris and help keep pipe lines unclogged.



Pop-Up Drain Emitter

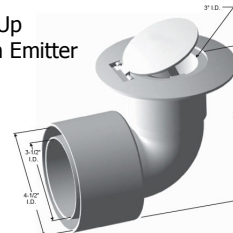

3x4 Universal Adapter
Offset allows for adjusting inlet height.



Specially designed 12" and 9" Catch Basins are offered with many features and accessories:

Versatile & Strong— Use with our atrium or square grates. The basins are strong enough to also support our cast iron or steel grates.

6" Universal Outlet— Fits 6" S/D, 6" corrugated and 6" SDR35 pipe

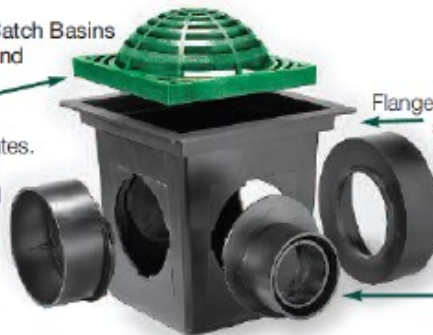

Unique Patented Design— Flanged top design prevents catch basin from settling below grade level, and provides more support for concrete applications

8" Universal Outlet— Fits 8" S/D & 8" corrugated pipe

3"x 4" Universal Offset Outlet— Fits 3" & 4" corrugated and S/D pipe, plus 4" SDR35 Offset allows for adjustment of the inlet height



TC-JRDC4

1 - 4 Stations Residential
Outdoor/Indoor

3 Start Times per program
Rain sensor compatibility



TC-JRMAX

4, 6, 8 Stations
Residential
Outdoor/Indoor

Input: 120 V
Output: 24 V

Three independent programs
Self-guided programming
Multiple watering day options
Program review feature



TC-RD Rain Dial

6, 8, 12 Stations
Residential
Outdoor/Indoor

Input: 120 V
Output: 24 V

Remote control ready
RainSensor™ ready
Three independent programs
Water budgeting
Odd/even date watering
Water well recovery (delay btwn stns)
Master valve/pump start circuit
assignable per station
Clear/erase memory by program
Program stack or overlap option
Manual station advance



TC-KD Kwik Dial

6, 9, 12 Stations
Residential
Outdoor/Indoor

Input: 120 V
Output: 24 V

Specifications

Station run times: 1-240 minutes (4 hrs)
in 1-minute increments.
Start times: 3 per program, up to 9 daily

PART NO.	DESCRIPTION	LIST PRICE	UNIT
TC-JRDC4	IRRITROL JRDC-4 BAT. OP. CONTROLLER 4STN	185.60	each
TC-JRMAX6120	IRRITROL JRMAX 6STN INDOOR CONTROLLER	131.38	each
TC-JRMAX8120	IRRITROL JRMAX8-120 8STN INDOOR CONTROL.	156.94	each
TC-JRMAX8120EXT	IRRITROL JRMAX8-120 8 STN OUTDOOR CONTR.	232.60	each
TC-KD12EXT	IRRITROL KD12-EXT KWIK DIAL CONTROLLER	336.63	each
TC-KD12INT	IRRITROL KD12-INT KWIK DIAL 12stn INDOOR	393.87	each
TC-KD6EXT	IRRITROL KD6-EXT 6STN KWIKDIAL CONTROLL.	269.29	each
TC-KD6INT	IRRITROL KD6-INT KWIK DIAL CONTROLLER	173.03	each
TC-KD9EXT	IRRITROL KD9-EXT KWIK DIAL CONTROLLER	313.87	each
TC-KD9INT	IRRITROL KD9-INT KWIK DIAL CONTROLLER	239.53	each
TC-KSRKIT	IRRITROL KSR-KIT REMOTE KIT FOR RAINDIAL	316.97	each
TC-KSRKITK	IRRITROL KSR REMOTE CONTR.KIT >KWIK-DIAL	268.50	each
TC-PC12ADDEXT	IRRITROL PC- 12stn ADD-ON MODULE - EXT	452.60	each
TC-PC12INTPAK	IRRITROL PC CONTROLLER PKG (W/REMOTE)	618.90	each
TC-RD1200EXT	IRRITROL RD1200-EXT RAIN DIAL CONTROLLER	565.84	each
TC-RD1200INT	IRRITROL RD1200-INT RAIN DIAL CONTROLLER	516.09	each
TC-RD600EXT	IRRITROL RD600-EXT RAIN DIAL CONTROLLER	309.12	each
TC-RD900EXT	IRRITROL RD900-EXT RAIN DIAL CONTROLLER	429.64	each
TC-TC24EXB	IRRITROL TOTAL CONTROL - 24stn OUTDOOR	1054.41	each
TC-RS1000	IRRITROL RS1000 WIRELESS RAIN SENSOR	137.52	each
TP-RSBATTTX	BATTERY PAK (2) FOR RS1000	7.97	each



TC-TC24EXB

18 to 24 Stations
Residential / Commercial
Outdoor / Indoor
4 Independent programs

PC Controller - 12-station Indoor/outdoor
2-way remote



SYSTEM REQUIREMENTS

Windows-compatible PC
Windows 2000, XP Home Edition,
XP Professional or 2003
Available USB 1.0 (or greater) port
900 MHz CPU
64 MB RAM and CD-ROM drive
20MB free hard disk space
Keyboard and pointing device (mouse)
Internet connectivity (high speed)

EASY SYSTEM EXPANSION UP TO 48 STATIONS



TC-KSRKITK

For: Kwik Dial
Input: 120 V
Output: 24 V

Capacity: One station valve
plus a master valve



RS1000 - Wireless Rain Sensor
Residential / Commercial

Suspends irrigation during rainfall
Allows for setting the ideal dry-out time



ESP TM2 Series

Easiest controllers
For indoor and outdoor

Available in 4, 6, 8, 12 stations
3 Programs (A,B,C) and 4 start times
Wifi adaptable & rain sensor compatible.



ESP Modular Series

Stations: 4 to 22 stations
Indoor/outdoor

The modular design makes it easy to expand the controller's capabilities to 22 stations should the watering needs of your landscape change in the future.



ESP LXM Series

Stations: 4, 8, 12

Configure up to 48 stations
Automatic Seasonal Adjust

Quickly diagnose field wiring and solenoid problems.

Removable Battery-Programmable Panel for easy programming prior to installation

C2-F39000 ESP-SMT Smart controller

Stations: 4 Indoor/outdoor



Prevent over-watering and under-watering
Automatically adjusts watering times for each zone based on temperature, effective rainfall and plant/soil type to reduce water use by 30-70%.

PART NO.	DESCRIPTION	LIST PRICE	UNIT
C2-ESPTM2-4	4 STATION CONTROLLER WIFI - 120V	224.28	each
C2-ESPTM2-8	8 STATION CONTROLLER WIFI - 120V	299.00	each
C2-ESPTM2-12	12 STATION CONTROLLER WIFI - 120V	399.95	each
C2-F38200	ESPSM3 3stn MODULE FOR ESP-4MI CONTROL	84.79	each
C2-F38260	ESPSM3 6stn MODULE FOR ESP-4MI CONTROL	185.74	each
C2-F39000	ESPSMT4i INDOOR SMART CONTROLLER	415.95	each
C2-F39010	ESPSMTUPG UPGRADE KIT - ESP4M TO ESPSMT	321.34	each
C2-F42210	ESPLXME 8stn OUTDOOR CONTROLLER	524.00	each
C2-F42200	ESPLXMSM4 4stn MODULE FOR LXM CONTROLLER	119.25	each
C2-F42210	ESPLXMSM8 8stn MODULE FOR LXM CONTROLLER	230.92	each
C2-WIFI	WIFI LINK - ESP & TM CONTROLLER	215.88	each
A1-A66450	PW2000 ELECTRONIC TROUBLESHOOTING TOOL	131.10	each
C3-K80010	TBOSFT FIELD TRANSMITTER	P.O.A	
C3-K80410	TBOS4CMUS 4 STN CONTROL MODULE	P.O.A	
A1-A553000	WR2RC RAINBIRD WIRELESS RAINSENSOR	185.42	each
A1-A46775	PIGTAIL 6' APPLIANCE PIGTAIL	12.56	each



WR2RC WIRELESS RAINSENSOR

Programming is accomplished using only four buttons.
Saves time & improves system performance.
Easy to install, manage, and understand. Superior response to rainfall and cold temperatures.

A1-A46775

PIGTAIL 6' PIGTAIL



WIFI LINK (for controllers)



WIFI LINK

For all ESP controllers.
Fully accessible and programmable from iOS or Android compatible devices



PAR-ES CONTROLLER

Easy Programming
72 Station Compatibility
Greater Water Precision
Multiple Schedule Operation
16 Solenoid Simultaneous Op
Program Stacking & Expansion



MODULES:

Add more zones: 3 or 6
For all ESP controllers.
Increase the zones when you add a module to the ESP controller



TBOS4CMUS 4 STN CONTROL MODULE

TBOSFT FIELD TRANSMITTER

Commercial applications
Convenient temporary option for providing uninterrupted irrigation while making repairs.

The TBOS battery-operated line of buriable controllers allows the use of automatic irrigation in the absence of AC power.

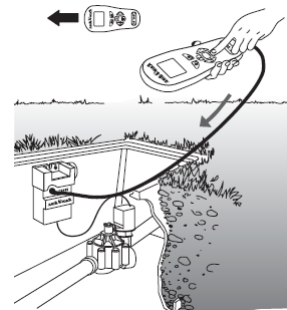



IPEX



PVC PIPE

PART NO.	DESCRIPTION	LIST PRICE	UNIT
P1-211075	3/4" DR21 - Ser 200 PVC BE		P.O.A.
P1-211100	1" DR21 - SER 200 PVC BE		P.O.A.
P1-211150	1-1/2" DR21 - Ser 200 PVC BE		P.O.A.
P1-211200	2" DR21 - Ser 200 PVC BE		P.O.A.
P1-211250	2-1/2" DR21 - Ser 200 PVC BE		P.O.A.
P1-211300	3" DR21 - SER 200 PVC BE		P.O.A.
P1-211400	4" DR21 - SER 200 PVC BE		P.O.A.
P1-260300	3" DR26 - Ser 160 PVC GT		P.O.A.
P1-260400	4" DR26 - Ser 160 PVC GT		P.O.A.
P1-260600	6" DR26 - Ser 160 PVC GT		P.O.A.
P1-261150	11/2" DR26 - SER 160 PVC BE		P.O.A.
P1-261200	2" DR26 - SER 160 PVC BE		P.O.A.
P1-261250	21/2" DR26 - SER 160 PVC BE		P.O.A.
P1-261300	3" DR26 - Ser 160 PVC BE		P.O.A.
P1-261400	4" DR26 - SER 160 PVC BE		P.O.A.

PVC PIPE - SPIGOT & BELL END



Light weight, high strength, and low reactivity; well-suited for commercial irrigation and sewage.

PVC pipes can be fused together using various solvent cements, or heat-fused (butt-fusion process, similar to joining HDPE pipe), creating permanent joints that are virtually impervious to leakage. It's superior durability has proven strength and flexibility, combined with outstanding resistance to corrosion and chemical attack .

GLUE & PRIMER



PART NO.	DESCRIPTION	LIST PRICE	UNIT
P5-074335	XIRTEC 7 PVC PRIMER PURPLE - 1/2 PINT	10.50	each
P5-074336	XIRTEC 7 PVC PRIMER PURPLE - PINT 473	16.33	each
P5-074337	XIRTEC 7 PVC PRIMER PURPLE - QUART 946	29.45	each
P5-074338	XIRTEC 7 PVC PRIMER PURPLE - GALLON 3.7	83.55	each
P5-074362	XIRTEC 11 HEAVY GREY PVC CEMENT - 1/2 PT	10.85	each
P5-074363	XIRTEC 11 HEAVY GREY PVC CEMENT - PINT	19.80	each
P5-074364	XIRTEC 11 HEAVY GREY PVC CEMENT - QUART	32.05	each
P5-074365	XIRTEC 11 HEAVY GREY PVC CEMENT - GALLON	112.10	each
P5-074393	IPEX 25 WET/DRY MED. CEMENT - PINT (473)	18.25	each
P5-074397	IPEX 5 WET/DRY PRIMER - PINT (473)	18.55	each
P5-074422	DQ-150 CAP DAUBER FOR QUART CAN (946ml)	1.50	each
P5-074424	MT-651 CAN W/ 1-3/4" NECK (quart can)	8.15	each
P5-074454	BCP-1 1" BRUSH CAP APPLICATOR BCP-1	14.50	each



TO ORDER EMAIL: sales@albertairrigation.com

CALL: 1-780-453-5950 FAX: 1-780-452-3470

COMPRESSION & COUPLING FITTINGS

PART NO.	DESCRIPTION	LIST PRICE
P4-21125	1" COMPRESSION COUPLING	3.25
P4-21126	1-1/4" COMPRESSION COUPLING	5.60
P4-21127	1-1/2" COMPRESSION COUPLING	6.95
P4-21128	2" COMPRESSION COUPLING	9.95
P4-21129	2-1/2" COMPRESSION COUPLING	15.50
P4-21130	3" COMPRESSION COUPLING	19.85
P4-21131	4" COMPRESSION COUPLING	32.25
P4-21133	6" COMPRESSION COUPLING	67.95

PART NO.	DESCRIPTION	LIST PRICE
P4-22312	1-1/4" TELESCOPIC EASY FIX COUPLING	7.25
P4-22315	1-1/2" TELESCOPIC EASY FIX COUPLING	7.95
P4-22320	2" TELESCOPIC EASY-FIX COUPLING	12.25
P4-22325	2-1/2" TELESCOPIC EASY FIX COUPLING	18.50
P4-22330	3" TELESCOPIC EASY FIX COUPLING	23.10
P4-22340	4" TELESCOPIC EASY FIX COUPLING	40.45
P4-22360	6" TELESCOPIC EASY-FIX COUPLING	99.95



SCH 40: CAPS/PLUGS/BUSHING/UNIONS

PART NO.	DESCRIPTION	LIST PRICE
P2-439072	THRD. BUSH 1/2x1/4" MPTxFPT	2.31
P2-439098	THRD BUSHING 3/4x1/4" MPTxFPT	1.44
P2-439099	THRD BUSHING 3/4x3/8" MPTxFPT	1.44
P2-439101	THRD BUSHING 3/4x1/2" MPTxFPT	1.44
P2-439130	THRD BUSHING 1x1/2" MPTxFPT	2.01
P2-439131	THRD BUSHING 1x3/4" MPTxFPT	2.01
P2-439166	THRD BUSHING 1 1/4x1/2" MPTxFPT	2.98
P2-439167	THRD BUSHING 1 1/4x3/4" MPTxFPT	2.98
P2-439168	THRD BUSHING 1 1/4x1" MPTxFPT	2.98
P2-439210	THRD BUSHING 1 1/2x3/4" MPTxFPT	3.61
P2-439211	THRD BUSHING 1 1/2x1" MPTxFPT	3.61
P2-439212	THRD BUSHING 1-1/2 x 1-1/4" MPTxFPT	3.61
P2-439249	THRD BUSHING 2x1" MPTxFPT	3.86
P2-439250	THRD BUSHING 2x1 1/4" MPTxFPT	3.86
P2-439251	THRD BUSHING 2x1 1/2" MPTxFPT	3.86
P2-439292	THRD BUSHING 2 1/2x2" MPTxFPT	13.50
P2-447007	CAP 3/4" SLIP	0.51
P2-447010	CAP 1" SLIP	0.81
P2-447015	CAP 1 1/2" SLIP	1.26
P2-447020	CAP 2" SLIP	1.50
P2-447030	CAP 3" SLIP	5.24
P2-447040	CAP 4" SLIP	11.91

PART NO.	DESCRIPTION	LIST PRICE
P2-447060	CAP 6" SLIP	28.55
P2-448005	CAP 1/2" FPT	0.94
P2-448007	CAP 3/4" FPT	1.07
P2-448010	CAP 1" FPT	1.62
P2-448015	CAP 1 1/2" FPT	2.01
P2-448020	CAP 2" FPT	3.55
P2-448025	CAP 2 1/2" FPT	5.24
P2-448060	6" CAP FPT	0.00
P2-449005	PLUG 1/2" SP	1.07
P2-449007	PLUG 3/4" SP	1.26
P2-449015	PLUG 1 1/2" SP	2.55
P2-450005	PLUG 1/2" MPT	1.32
P2-450007	PLUG 3/4" MPT	1.42
P2-450010	PLUG 1" MPT	2.31
P2-450015	PLUG 1 1/2" MPT	2.62
P2-450020	PLUG 2" MPT	3.37
P2-450025	PLUG 2 1/2" MPT	4.69
P2-450030	PLUG 3" MPT	7.10
P2-457015	1 1/2" PVC-UNION O-RING SLIPxSLIP	18.85
P2-457020	2" PVC-UNION O-RING SLIPxSLIP	25.42
P2-458015	1 1/2" PVC-UNION O-RING FPTxFPT	21.48
P2-458020	2" PVC-UNION O-RING FPTxFPT	26.40
P2-465025	2-1/2" ELBOW 22-1/2 DEGREE BEND	12.75



THRD BUSHING



PLUG



CAP



UNION

TO ORDER EMAIL: sales@albertairrigation.com

CALL: 1-780-453-5950 FAX: 1-780-452-3470

SCH 40 TEES & ELBOWS

PART NO.	DESCRIPTION	LIST PRICE
P2-401005	TEE 1/2" SSS	0.61
P2-401007	TEE 3/4" SSS	0.70
P2-401010	TEE 1" SSS	1.30
P2-401015	TEE 1 1/2" SSS	2.48
P2-401020	TEE 2" SSS	3.61
P2-401025	TEE 2 1/2" SSS	11.91
P2-401030	TEE 3" SSS	15.65
P2-401040	TEE 4" SSS	28.31
P2-401060	TEE 6" SSS	95.28
P2-401080	TEE 8" SSS	220.98
P2-401210	RED.TEE 11/2x11/2x3/4"SSS	3.93
P2-401211	RED.TEE 11/2x11/2x1" SSS	3.93
P2-401249	RED.TEE 2x2x1" SSS	3.86
P2-401250	RED. TEE 2x2x11/4" SSS	3.86
P2-401251	RED.TEE 2x2x11/2" SSS	3.86
P2-401289	RED.TEE 21/2x21/2x1" SSS	11.89
P2-401291	RED.TEE 21/2x21/2x11/2SSS	11.89
P2-401292	RED.TEE 21/2x21/2x2" SSS	11.89
P2-401337	RED.TEE 3x3x11/2" SSS	17.02
P2-401338	RED.TEE 3x3x2" SSS	16.99
P2-401420	RED.TEE 4x4x2" SSS	28.31
P2-401422	RED.TEE 4x4x3" SSS	28.31
P2-402005	TEE 1/2" SxSxFPT	0.81
P2-402007	TEE 3/4" SxSxFPT	1.26
P2-402010	TEE 1" SxSxFPT	2.31
P2-402015	TEE 1 1/2" SxSxFPT	4.79
P2-402020	TEE 2" SxSxFPT	6.08
P2-402101	RED.TEE 3/4x3/4x1/2"SSFPT	1.07
P2-402130	RED.TEE 1x1x1/2" SSFPT	1.62
P2-402131	RED.TEE 1x1x3/4" SSFPT	2.31
P2-402210	RED.TEE 11/2x11/2x3/4"SSF	4.79
P2-402211	RED.TEE 11/2x11/2x1 SSFPT	4.79
P2-402248	RED.TEE 2x2x3/4" SSFPT	6.03
P2-402249	RED.TEE 2x2x1" SSFPT	6.03
P2-402250	RED.TEE 2x2x11/4" SSFPT	6.03
P2-402251	RED.TEE 2x2x11/2" SSFPT	6.03
P2-402291	RED.TEE 21/2x21/2x11/2SSF	13.06
P2-402422	RED.TEE 4x4x3" SSFPT	31.17
P2-405005	TEE 1/2" FPTxFPTxFPT	2.23
P2-405007	TEE 3/4" FPTxFPTxFPT	3.50
P2-405010	TEE 1" FPTxFPTxFPT	4.86

PART NO.	DESCRIPTION	LIST PRICE
P2-406005	90 ELL 1/2" SxS	0.49
P2-406007	90 ELL 3/4" SxS	0.55
P2-406010	90 ELL 1" SxS	0.98
P2-406015	90 ELL 1 1/2" SxS	1.86
P2-406020	90 ELL 2" SxS	2.93
P2-406025	90 ELL 2 1/2" SxS	8.91
P2-406030	90 ELL 3" SxS	10.66
P2-406040	90 ELL 4" SxS	19.07
P2-406060	90 ELL 6" SxS	60.63
P2-406131	RED. 90 ELL 1x3/4" SxS	1.75
P2-407005	ELL 90 1/2" SxFPT	0.61
P2-407007	ELL 90 3/4" SxFPT	0.70
P2-407010	ELL 90 1" SxFPT	1.30
P2-407015	ELL 90 1 1/2" SxFPT	2.42
P2-407020	ELL 90 2" SxFPT	6.26
P2-407131	RED.90 ELL 1x3/4" SxFPT	2.01
P2-407211	11/2"x1" 90 ELL SxF	4.87
P2-408005	90 ELL 1/2" FPTxFPT	1.18
P2-408007	90 ELL 3/4" FPTxFPT	1.75
P2-408010	90 ELL 1" FPTxFPT	3.73
P2-408015	90 ELL 1 1/2" FPTxFPT	5.06
P2-408020	90 ELL 2" FPTxFPT	7.66
P2-409010	90 STREET ELL 1" SPxS	2.93
P2-409012	90 STREET ELL 1 1/4" SPxS	3.50
P2-410005	90 STREET ELL 1/2" MPTxS	1.07
P2-410007	90 STREET ELL 3/4" MPT x S	1.26
P2-410010	90 STREET ELL 1" MPTxS	2.10
P2-411010	90 STREET ELL 1" SPxFPT	2.81
P2-411015	90 STREET ELL 1 1/2" SPxFPT	3.81
P2-412005	90 STREET ELL 1/2"PVC MPTxFP	1.44
P2-412007	90 STREET ELL 3/4" PVC MPTxFPT	1.75
P2-412010	90 STREET ELL 1 PVC MPTxFPT	2.99
P2-412015	90 STREET ELL 1 1/2 PVC MPTXFPT	4.05
P2-417010	45 ELL 1" SxS	1.50
P2-417012	45 ELL 1 1/4" SxS	2.10
P2-417015	45 ELL 1 1/2" SxS	2.63
P2-417020	45 ELL 2" SxS	3.42
P2-417025	45 ELL 2 1/2" SxS	8.93
P2-417030	45 ELL 3" SxS	13.86
P2-417040	45 ELL 4" SxS	24.84
P2-417060	45 ELL 6" SxS	61.38
P2-418020	2" 22-1/2 DEG. ELBOW	4.89
P2-418030	3" 22-1/2 DEG. ELL SS	19.76
P2-418040	4" 22-1/2 DEG ELL SS	35.50



TEES - THREADED OR SLIP



TEES - REDUCING



90° THREADED OR SLIP



90° Street Elbow



90° REDUCING ELBOW



45° ELBOW



LASCO
Fittings, Inc.

Alberta
Irrigation
Supply

TO ORDER EMAIL: sales@albertairrigation.com

CALL: 1-780-453-5950 FAX: 1-780-452-3470

SCH 40: ADAPTER/BUSHING/COUPLERS

PART NO.	DESCRIPTION	LIST PRICE
P2-420010	CROSS 1" SLIP	3.86
P2-420015	CROSS 1 1/2" SLIP	5.78
P2-420020	CROSS 2" SLIP	8.54
P2-429005	COUPLING 1/2" SLIP	0.32
P2-429007	COUPLING 3/4" S X S	0.44
P2-429010	COUPLING 1" SLIP	0.78
P2-429012	COUPLING 1 1/4" SLIP	1.07
P2-429015	COUPLING 1 1/2" SLIP	1.14
P2-429020	COUPLING 2" SLIP	1.75
P2-429025	COUPLING 2 1/2" SLIP	3.86
P2-429030	COUPLING 3" SLIP	6.05
P2-429040	COUPLING 4" SLIP	8.75
P2-429060	COUPLING 6" SLIP	27.67
P2-429080	COUPLING 8" SLIP	51.67
P2-43000545	COUPLING 1/2" GRAY FPTxFPT	0.70
P2-43000745	COUPLING 3/4" GRAY FPTxFPT	1.29
P2-430010	THREADED COUPLING 1"	1.50
P2-430020	2" THREADED COUPLING FxF	4.36
P2-430101	COUPLING 3/4x1/2" FPTxFPT	2.32
P2-435010	FEMALE ADAPTER 1" FPTxS	0.81
P2-435015	FEMALE ADAPTER 1 1/2" FPTxS	1.44
P2-435020	FEMALE ADAPTER 2" FPTxS	1.92
P2-435025	FEMALE ADAPTER 2 1/2" FPTxS	4.87
P2-435030	FEMALE ADAPTER 3" FPTxS	6.54
P2-435040	FEMALE ADAPTER 4" FPTxS	10.83
P2-436005	MALE ADAPTER 1/2" MPTxS	0.44
P2-436007	MALE ADAPTER 3/4" MPTxS	0.49
P2-436010	MALE ADAPTER 1" MPTxS	0.88
P2-436015	MALE ADAPTER 1 1/2" MPTxS	1.44
P2-436020	MALE ADAPTER 2" MPTxS	1.88
P2-436025	MALE ADAPTER 2 1/2" MPTxS	5.55
P2-436030	MALE ADAPTER 3" MPTxS	8.11
P2-436040	MALE ADAPTER 4" MPTxS	10.34
P2-436060	MALE ADAPTER 6" MPTxS	26.97
P2-436080	8" MALE ADAPTER MPTxS	122.57
P2-436101	MALE ADAPTER RED. 3/4x1/2" MPTxS	0.81
P2-436213	MALE ADAPTER RED. 1 1/2x2" MPTxS	3.98
P2-436251	MALE ADAPTER RED. 2x1 1/2" MPTxS	4.54
P2-436252	MALE ADAPTER RED. 2x2 1/2" MPTxS	7.08

PART NO.	DESCRIPTION	LIST PRICE
P2-437101	RED. BUSHING 3/4x1/2" SPxS	0.51
P2-437130	RED. BUSHING 1x1/2" SPxS	0.94
P2-437131	RED. BUSHING 1x3/4" SPxS	0.94
P2-437168	RED. BUSHING 1 1/4x1" SPxS	1.26
P2-437209	RED. BUSHING 1 1/2x1 1/2" SPxS	1.32
P2-437210	RED. BUSHING 1 1/2x3/4" SPxS	1.32
P2-437211	RED. BUSHING 1 1/2x1" SPxS	1.32
P2-437212	RED. BUSHING 1 1/2x1 1/4" SPxS	1.32
P2-437247	RED. BUSHING 2x1 1/2" SPxS	2.18
P2-437248	RED. BUSHING 2x3/4" SPxS	2.18
P2-437249	RED. BUSHING 2x1" SPxS	2.18
P2-437250	RED. BUSHING 2x1 1/4" SPxS	2.18
P2-437251	RED. BUSHING 2x1 1/2" SPxS	2.18
P2-437291	RED. BUSHING 2 1/2x1 1/2" SPxS	3.51
P2-437292	RED. BUSHING 2 1/2x2" SPxS	3.51
P2-437336	RED. BUSHING 3x1 1/4" SPxS	5.18
P2-437337	RED. BUSHING 3x1 1/2" SPxS	5.18
P2-437338	RED. BUSHING 3x2" SPxS	5.18
P2-437339	RED. BUSHING 3x2 1/2" SPxS	5.18
P2-437420	RED. BUSHING 4x2" SPxS	11.58
P2-437421	RED. BUSHING 4x2 1/2" SPxS	11.58
P2-437422	RED. BUSHING 4x3" SPxS	11.58
P2-437532	RED. BUSHING 6x4" SPxS	28.65
P2-437585	RED. BUSHING 8x6" SPxS	99.94
P2-438101	RED. BUSHING 3/4x1/2" SPxFPT	0.81
P2-438130	RED. BUSHING 1x1/2" SPxFPT	1.30
P2-438131	RED. BUSHING 1x3/4" SPxFPT	1.30
P2-438166	RED. BUSHING 1 1/4x1 1/2" SPxFPT	2.01
P2-438167	RED. BUSHING 1 1/4x3/4" SPxFPT	2.01
P2-438168	RED. BUSHING 1 1/4x1" SPxFPT	2.01
P2-438209	RED. BUSHING 1 1/2x1 1/2" SPxFPT	2.31
P2-438210	RED. BUSHING 1 1/2x3/4" SPxFPT	2.31
P2-438211	RED. BUSHING 1 1/2x1" SPxFPT	2.31
P2-438212	RED. BUSHING 1 1/2x1 1/4" SPxFPT	2.31
P2-438248	RED. BUSHING 2x3/4" SPxFPT	3.10
P2-438249	RED. BUSHING 2x1" SPxFPT	3.10
P2-438250	RED. BUSHING 2x1 1/4" SPxFPT	3.10
P2-438251	RED. BUSHING 2x1 1/2" SPxFPT	3.10
P2-438289	RED. BUSHING 2 1/2x1" SPxFPT	4.50
P2-438291	RED. BUSHING 2 1/2x1 1/2" SPxFPT	4.50
P2-438292	RED. BUSHING 2 1/2x2" SPxFPT	4.50
P2-438337	RED. BUSHING 3x1 1/2" SPxFPT	5.18
P2-438338	RED. BUSHING 3x2" SPxFPT	5.18
P2-438420	RED. BUSHING 4x2" SPxFPT	11.55
P2-438422	RED. BUSHING 4x3" SPxFPT	11.55

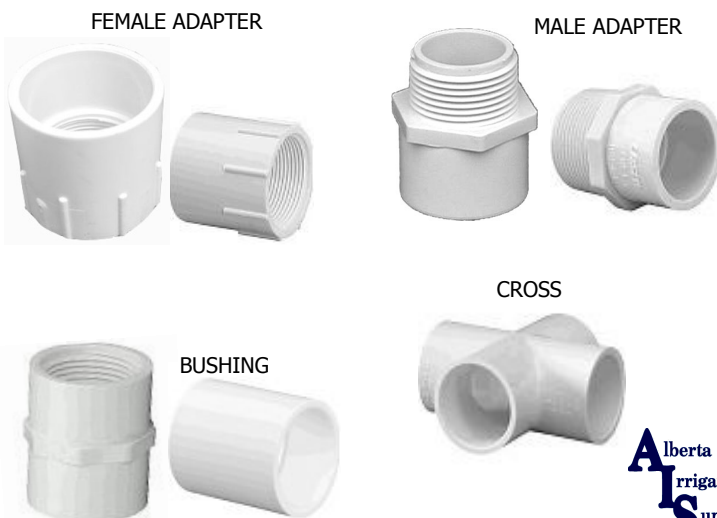

TO ORDER EMAIL: sales@albertairrigation.com
 CALL: 1-780-453-5950 FAX: 1-780-452-3470

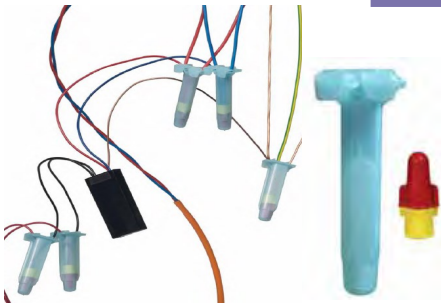

WATER PROOF CONNECTORS

DBR/Y This new wire connector from 3M incorporates the great features of a "Performance Plus" wire nut with the proven reliability of the DBY/DBR series that was the backbone of the irrigation industry for over 20 years. This connector can be used with confidence on any irrigation system, especially 2-Wire/2-Core.

LOW VOLT WATERPROOF CONNECTORS



WIRE STRIPPER

#316IR To connect two or three low volt wire ends, insulate the connection and provide a moisture resistant seal.

PART NO.	DESCRIPTION	LIST PRICE	UNIT
W1-021954BLACK	TWU# 14 DIR Burial Wire BLACK		P.O.A
W1-021954BLUE300	TWU# 14 DIR Burial Wire BLUE		P.O.A
W1-021954GREEN300	TWU# 14 DIR Burial Wire GREEN		P.O.A
W1-021954ORAN300	TWU# 14 DIR Burial Wire ORANGE		P.O.A
W1-021954PURPLE	TWU #14 DIR Burial Wire PURPLE		P.O.A
W1-021954RED	TWU #14 DIR Burial Wire RED		P.O.A
W1-021954WHITE	TWU #14 DIR Burial Wire WHITE		P.O.A
W1-025944	3/C 18 SOL 60 Irrigation Wire		P.O.A
W1-025946	5/C 18 SOL 60 Irrigation Wire		P.O.A
W1-025948	7/C 18 SOL 60 Irrigation Wire		P.O.A
W1-025950	9/C 18 SOL 60* Irrigation Wire		P.O.A
W1-025951	10/C 18 SOL Irrigation Wire		P.O.A
W1-025952	12/C 18 SOL Irrigation Wire		P.O.A
W1-180150	12/2 Low Voltage Lighting Wire UL-D		P.O.A
W1-10222	BLUE 300V KING CONNECTOR	1.88	
W1-270228R	#316IR LOW VOLT CONNECTOR (22-16AWG)	1.99	
W1-270670	DBY/R WATERPROOF CONNECTOR BY 3M	2.95	
W1-61145	KING DRYCONN BLACK/WHITE CONNECTOR	0.86	
A1-K46501	KING COMFORT SQUEEZE WIRE STRIPPER	21.85	

14 Gauge Direct Burial Wire



Single conductor, type UF is typically used for control valves; a general purpose, direct burial wire that is widely used on all kinds of irrigation systems. Available from 14 AWG



Typically, each single strand of white and red wire is ran from the irrigation controller to the first valve in the system and then consecutively to each additional valve in the system.

18 Gauge Wire Conductor: 3,5,7,9,10,12



Multi-conductor cable used primarily in residential and small commercial irrigation projects. The irrigation cable shall incorporate enough wires to accommodate all the valves it is designed to control, plus some spares for future expansion.

12/2 Low voltage cable wire 20AMP rated, 240W, 12V for landscape lighting

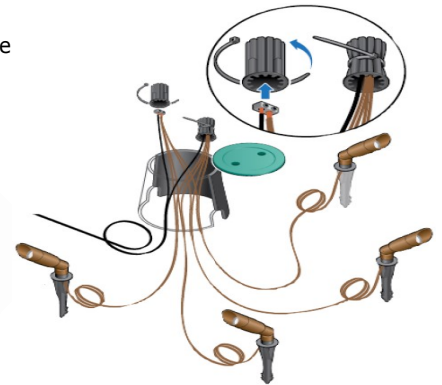



MARKER FLAGS



KING 7mil
ELECTRICAL TAPE



TEFLON TAPE



KP1 KNEE PAD



PART NO.	DESCRIPTION	LIST PRICE	UNIT
A1-K86001	KING 7mil ELECTRICAL TAPE	0.99	each
A1-A50130	TEFLON050 1/2" TEFLON TAPE	0.89	each
A1-A50135	TEFLON075 3/4" X 480" TEFLON TAPE	.97	each
A1-A50140	TEFLON100 1" X 480" TEFLON TAPE	1.39	each
A1-A56110	KP1 HARD PLASTIC SHELL KNEE PAD	41.71	each
A1-K47026	KING BLACK TOTE 10" X 15"	6.47	each
Flags	Flags	0.25	each
A1-K46340	KING INNOVATION 12" HACKSAW	16.99	each
A1-K46341	KING - HACKSAW REPLACEMENT BLADE - 2pk	2.99	each
A1-K48036	SIPHON KING 36" PUMP X 36" HOSE	45.89	each
A1-K48272	SIPHON KING 72" REPLACEMENT HOSE	14.92	each

Siphon King; Pump & Hose



King Innovation's Siphon King pump is perfect for removing water from valve boxes, meter pits, pipe trenches... virtually anywhere water accumulates!

Available in 24" pump with 36" hose, 36" pump with 36" or 72" hose, and 60" pump with 72" hose.



BLACK TOTE 10" X 15"



12" HACKSAW



CORING TOOL



KWIKCUT TOOL POUCH



32" WIRE ROPE SAW



9" PVC/ABS HANDSAW



NUT DRIVER



PART NO.	DESCRIPTION	LIST PRICE	UNIT
A1-DBT135	DAWN KWIKCUT REPL. BLADES - MEDIUM T135	8.00	each
A1-DCP10	DAWN CP10 KWIKCUT LEATHER TOOL POUCH	10.10	each
A1-DGS09	DAWN 9" PVC/ABS HANDSAW	23.80	each
A1-DHCT	DAWN KWIKSEAL CORING TOOL FOR 1/2 & 3/4	16.25	each
A1-DND375	DAWN ND375 KWIKSEAL NUT DRIVER (BLACK)	3.55	each
A1-DRS32	DAWN 32" WIRE ROPE SAW	8.45	each

CORONA TOOLS



MC-UT66004 (4")
MC-UT66006 (6")
Head Trimmer
Grip, twist, & turn
No bending



MC-UT65001
MC-UT65002
For extraction of broken
nipples and risers in
irrigation systems

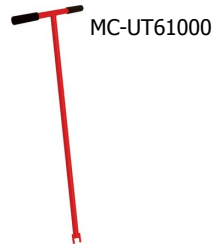

MC-UT61000
Sprinkler & Valve Key
Grip, twist, & turn
No bending



MC-SH60061 (6")
MC-SH6001 (5")
Oscillating Hoe



MC-UT71000
Scrapper Chopper (4")



MC-GT3080
Trowel



MC-GT3070
Cultivator



MC-CT3730
Cultivator



MC-SH63000
Weeding Hoe



MC-SG2950
Bulb Planter



MC-GT3050
Rake



MC-RK61061
Landscape Rake



MC-RK62000
Shrub Rake



MC-BM61002
24" Broom



MC-SF72030
Drain Spade



MC-SS62030
Drain Spade



MC-SS64106 (6")
Trench Shovel



MC-SS64224 (4")
Trench Shovel



MC-SS65500
Shovel - Back Hollow



MC-SS47000
Floral Shovel



MC-SS61020



MC-SS28010



MC-SS31030

Square Point Shovels



MC-SS64002
Trench Cleanout Shovel



TO ORDER EMAIL: sales@albertairrigation.com
CALL: 1-780-453-5950 FAX: 1-780-452-3470

CORONA TOOLS

PART NO.	DESCRIPTION	LIST PRICE	PART NO.	DESCRIPTION	LIST PRICE
MC-BM61002	24" PUSH BROOM - 2 BRISTLES	46.00	MC-SS31030	SQUARE POINT SHOVEL 14ga	21.50
MC-CT3730	ERGONOMIC HANDLE CULTIVATOR	9.95	MC-SS47000	FLORAL SHOVEL W/42" HDL	18.95
MC-GT3050	EXTENDABLE HANDLE RAKE	12.95	MC-SS61020	SQUARE POINT CLOSED-BACK SHOVEL	47.50
MC-GT3070	EXTENDABLE HANDLE CULTIVATOR	12.95	MC-SS62030	CLOSED BACK DRAIN SPADE - SCFD30	42.75
MC-GT3080	EXTENDABLE HANDLE TROWEL	12.95	MC-SS64022	TRENCH CLEAN OUT - 2"	36.75
MC-RK61061	ALUMINUM LANDSCAPE RAKE 24"	44.95	MC-SS64106	6" TRENCH SHOVEL	18.50
MC-RK62000	FIXED TINE SHRUB RAKE 8"	9.95	MC-SS64224	4" TRENCH SHOVEL W/FG HDL	33.50
MC-SF72030	DRAIN SPADE FORGED PRO	72.50	MC-SS65500	IRRIGATION SHOVEL	26.25
MC-SG2950	BULB PLANTER	5.95	MC-UT61000	4' SPRINKLER & VLV KEY	27.50
MC-SH60001	OSCILLATING HOE	24.00	MC-UT65001	EZ-OUT EXTRACTOR TOOL - 1"&1.25"	12.00
MC-SH60061	OSCILLATING HOE W/ALUM. HDLE	29.00	MC-UT65002	1/2"& 3/4" EZ OUT RISER EXTRACTOR	6.50
MC-SH63000	HEAVY DUTY WEEDING HOE	29.50	MC-UT66004	4" SPRINKLER HEAD TRIMMER	36.75
MC-SS28010	DRAIN SPADE 16ga W/D HANDLE	21.95	MC-UT66006	6" HEAD TRIMMER	46.00
			MC-UT71000	HEAVY DUTY FORGED SCRAPER	24.95

MIDWEST TOOLS

PART NO.	DESCRIPTION	LIST PRICE	PART NO.	DESCRIPTION	LIST PRICE
MZ-12525	24" DUAL PURPOSE RAKE 66" RED AH	39.45	MZ-49400	ROUND SHOVEL P40-47" FIBRE HDLE	41.55
MZ-41004	SPADE/CULTIVATOR COMBO UGLY TOOL	21.70	MZ-49401	ROUND SHOVEL W/27" FIBRG HDL	39.80
MZ-42103	GARDENPRO CULTIVATOR/LOOP HOE	28.15	MZ-70936	ROLLER SQUEEGEE 36" NON-ABSORBENT	92.00
MZ-42203	3-PRONG CULTIVATOR W/60"	22.45	MZ-85050	10"X10"TAMP-1/4"STEEL Plt 60"HNDL	47.05
MZ-42630	3 IN 1 HOE/CULTIVATOR/WEEDER	26.10	MZ-85428	8"DIAMETER SPRINKLER HEAD TRIMMER	51.30
MZ-49151	ROUND POINT SHOVEL 30" DW	19.85	MZ-87028	AQUATIC WEED ERADICATOR	107.65
			MZ-89006	TRENCHING SHOVEL 6" GREEN	34.40



MZ-42203



MZ-12525



MZ-49151



MZ-42103



MZ-85428



MZ-85050



MZ-70936



MZ-87028



TO ORDER EMAIL: sales@albertairrigation.com

CALL: 1-780-453-5950 FAX: 1-780-452-3470

BIG 'O' TUBING & FITTINGS

"Y" Tubing	Part No.	Description	List Price
	P0-010400	4" PERFORATED BIG "O" PIPE	0.57 ft
	P0-010401	4" SOLID (NON-PERF) BIG "O" PIPE	0.57 ft
	P0-010601	6" SOLID (NON-PERF) BIG "O" PIPE	2.62 ft
	P0-030400	4" FILTER BIG "O" PIPE (w/sock)	0.86 ft
	P0-210400	4" BIG 'O' END CAP INSERT PLUG	1.49 ea
	P0-210402	4" BIG 'O' TUBING "Y"	8.99 ea
	P0-210403	4" BIG "O" COUPLING	8.99 ea
	P0-210404	4" BIG 'O' TEE	3.39 ea
	P0-210603	6" BIG 'O' COUPLING INSERT	3.45 ea
	P0-216400	6" BIG 'O' TUBING REDUCER 6 x 4	6.79 ea
	P0-218803	8" BIG 'O' COUPLING - SNAP	10.19 ea

The industry standard in agricultural drainage, lightweight Big O plastic tubing is perfect for drainage and water management around the home and yard.



Solid Big 'O' Tubing



Perforated Big 'O' Tubing



With sock Big 'O' Tubing



MECHANICAL TEES



Mechanical branch connections for reducing branch outlets without welding. The MT-2 is a bolted saddle type fitting with

grooved outlets. Design assures superior sealing, full pipe support, excellent stability and easy installation

Part No.	Description	List Price
SM-292010	2 X 1 MECHANICAL TEE	P.O.A.
SM-292012	2 x 1-1/4 MECHANICAL TEE	P.O.A.
SM-292015	2 X 1-1/2 MECHANICAL TEE	P.O.A.
SM-293010	3 X 1 MECHANICAL TEE	P.O.A.
SM-293020	3 X 2 MECHANICAL TEE	P.O.A.
SM-294010	4 X 1 MECHANICAL TEE	P.O.A.
SM-294030	4 x 3 MECHANICAL TEE	P.O.A.
SM-296020	6 X 2 MECHANICAL TEE	P.O.A.
SM-296040	6 X 4 MECHANICAL TEE	P.O.A.

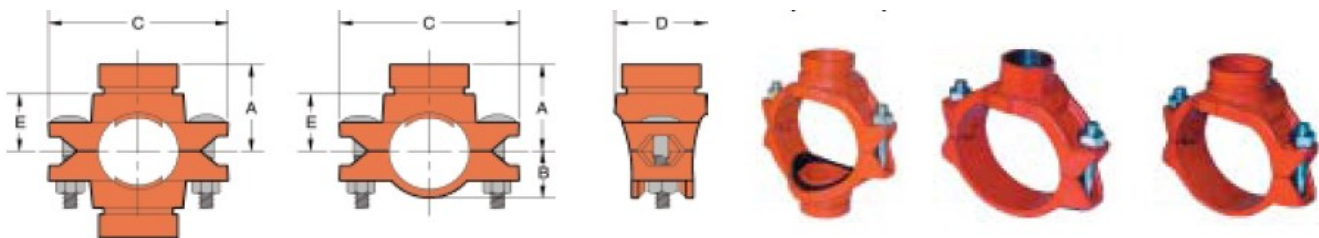

TO ORDER EMAIL: sales@albertairrigation.com
 CALL: 1-780-453-5950 FAX: 1-780-452-3470

LEEMCO FITTINGS

P.O.A. PRICED ON APPLICATION

PIPE-TO-FITTING RESTRAINT



JOINT RESTRAINT



DEEP SLANT BELL FITTINGS



RESTRAINT FITTINGS



FITTINGS



GATE VALVE TIE BAR



LATERAL ANGLE VALVE



THREADED SADDLE TEE



LATERAL BELL SADDLE



VALVE EXTENSION



MAIN LINE GATE VALVE



QC STABILIZER



TO ORDER EMAIL: sales@albertairrigation.com
 CALL: 1-780-453-5950 FAX: 1-780-452-3470

LANDSCAPE LIGHTING

LED SAVES UP TO 75% OVER ALL OTHER TRADITIONAL INCANDESCENT/HALOGEN LOW VOLTAGE LIGHTING



TRADITIONAL INCANDESCENT/
HALOGEN LOW VOLTAGE LIGHTING

PATH - LED 12V



15826BKT
Path Light



15871TZZ
Path Light



15833AZT
Path Light

PATH 12V



15310BKT
Path Light



15392OZ
Path Light



15322AGZ
Path Light

DECK - LED 12V



15765BBR
Post light

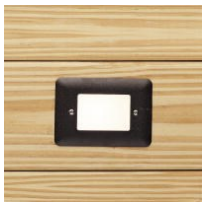

15780AZT
Step light



15773AZT
Brick wall light

DECK 12V

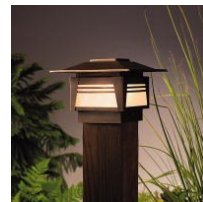

15071OZ
Post Light

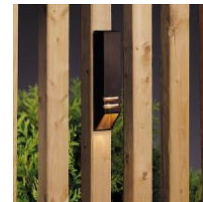

15066AZ
Rail Light

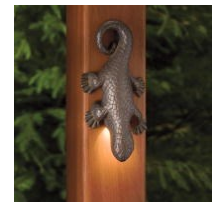

15047OZ
Post Light

ACCENT - LED 12V



15728BKT
Well light



15861AZT
Wall wash



15733BKT
Angle light

ACCENT 12V

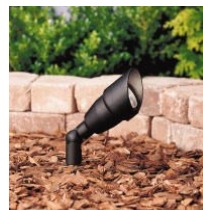

15374BKT
Spot Light

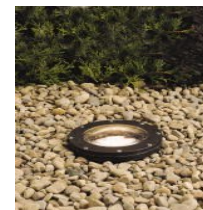

15194AZ
Well Light

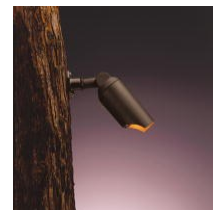

15087AZT
Down Light

TRANSFORMERS



AVAILABLE IN 300W, 600W, 900W STAINLESS OR REGULAR COAT FINISH

Plus Series Transformers: feature a 6' cord, pluggable options with a powder coated steel case. **NOT** approved for use with fixtures placed in ponds or landscape water features.



Pro Series Transformers: provide the best options and flexibility needed for most installations. Output voltage range will suit most jobs. Features include a commercial grade toroid core and coil submersible rating, pluggable timer and photocell outlets, plus a lifetime warranty.

WATER LIGHT 12V

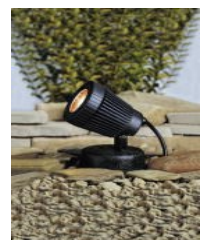

15191BK
Under Water

**ASK FOR A COMPLETE LIST
OF OUR KICHLER PRODUCTS**



TO ORDER EMAIL: sales@albertairrigation.com

CALL: 1-780-453-5950 FAX: 1-780-452-3470



FOUNTAINS & AERATORS

AERATING FOUNTAINS



SMALL POND FOUNTAINS

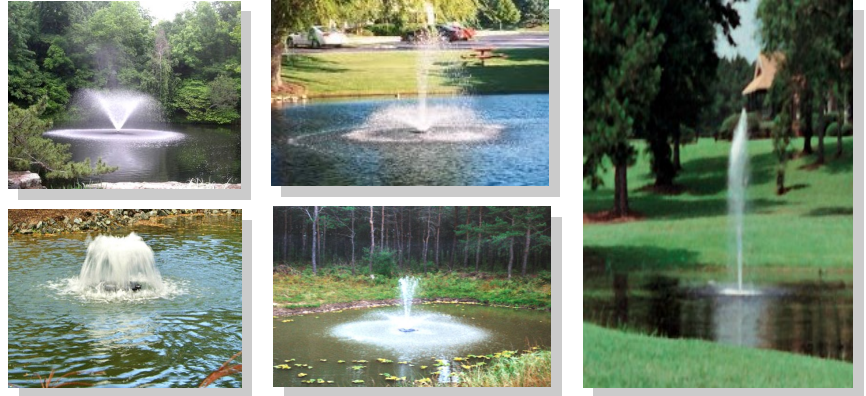

GIANT POND FOUNTAINS

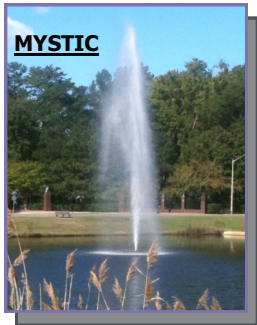

MYSTIC

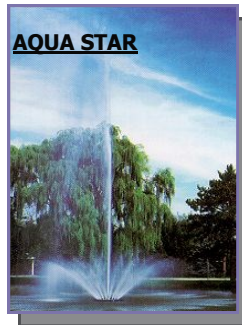

AQUA STAR

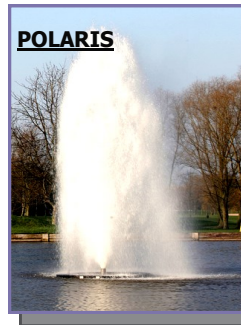

POLARIS

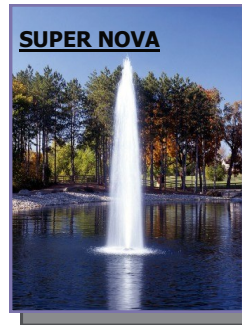

SUPER NOVA



TRIAD

MR-16 LOW VOLT LIGHTING

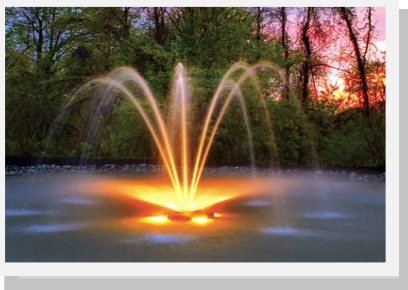

HIGH VOLT LIGHTING

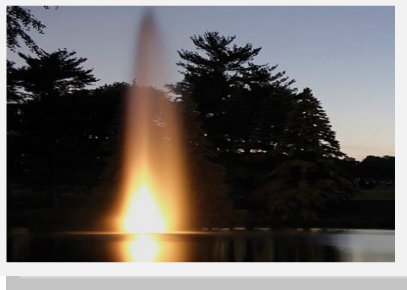

PAR-64 HIGH VOLT LIGHTING



Otterbine Aerators improve your water quality; reducing algae and foul odors, and are backed by a 5-year warranty to insure that they get the job done. Whether it's the pond in your backyard, irrigation pond on a golf course or farm, detention pond in your community - anywhere you are looking to improve your water quality and perhaps create some aesthetic appeal we have a solution for you!



LAKE DYE

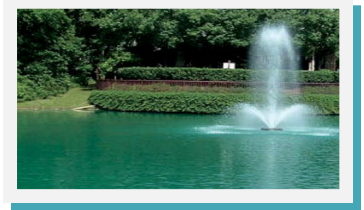

CALL FOR PRICING



TO ORDER EMAIL: sales@albertairrigation.com
CALL: 1-780-453-5950 FAX: 1-780-452-3470



PART NO.	DESCRIPTION	LIST PRICE
NP-12100	SUBMERSIBLE ULTRA PUMP - 200 GPH	P.O.A
NP-15100	SUBMERSIBLE ULTRA PUMP - 500 GPH	P.O.A
NP-17500	SUBMERSIBLE ULTRA PUMP - 750 GPH	P.O.A
NP-19013	AQUASCAPE ULTRAPOND PUMP 2500 GPH	P.O.A
NP-99443	AQUAFORCE 1000 SOLIDS HANDLING PUMP	P.O.A
NP-98136	AQUABASIN PUMP KIT 350	P.O.A
NP-98138	AQUABASIN PUMP KIT 750	P.O.A
NP-99738	AQUAJET 600 ALL-IN-ONE FOUNTAIN PUMP KIT	P.O.A
NP-99739	AQUAJET 1000 ALL-IN-ONE FOUNTAIN KIT	P.O.A
NP-02403	AQUASCAPE BIO BALLS 144 PCS.	P.O.A
NP-60027	ULTRAKLEEN FILTER 1000 GAL W/UV CLARIFY	P.O.A
NP-99218	REPLACEMENT FILTER BRUSH SET MICROSKM	P.O.A

POND FOUNTAIN HEADS

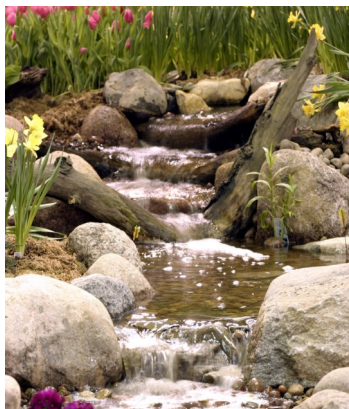

PART NO.	DESCRIPTION	LIST PRICE
NP-99388	3-TIER CASCADE FOUNTAIN (WOOD)	P.O.A
NP-21000	MAXI WATERBELL FOUNTAIN HEAD	P.O.A
NP-22000	MAXI WATERLILY FOUNTAIN HEAD	P.O.A
NP-20000	DIVERT VALVE(FOR MAXI FTN HEADS)	P.O.A
NP-23000	MAXI FOAM JET FOUNTAIN HEAD	P.O.A
NP-24000	MAXI DAISY FOUNTAIN HEAD	P.O.A
NP-99765	AQUASCAPE 8'x11' MICROPOND KIT	P.O.A
NP-99769	AQUASCAPE MICROPONDLESS WATERFALL KIT	P.O.A



POND LINERS & MATS



PART NO.	DESCRIPTION	LIST PRICE
NP-EPDM1050	AQUASCAPE EPDM 45mil LINER - 10' WIDTH	P.O.A
NP-EPDM2050	AQUASCAPE EPDM 45mil LINER - 20' WIDTH	P.O.A
NP-99272	AQUASCAPE AQUAMAT MINI	P.O.A
NP-99221	AQUASCAPE COVER TAPE 6"x25' ROLL	P.O.A



NP-99221 Liner Tape

The grass-like AquaMats are precision-engineered to provide habitat for your fish while simultaneously improving water quality and health.

Pond liners are specially formulated to be safe for exposure to fish and plant life in decorative ponds.
HIGHLY FLEXIBLE:



TO ORDER EMAIL: sales@albertairrigation.com
CALL: 1-780-453-5950 FAX: 1-780-452-3470



Eco Floc
Formulated to
Gathers together
fine particles for
easy filtration

Aqua Clearer
Reduces sludge

Pond Shade
Safely colors
pond water

Eco Starter
Dechlorinates &
ages water to
help relieve
stress from fish
& plants

S.A.B. Extreme
Algae Buster

Eco Barley
(extract & pellets)
Clean & clear water
Breaks down pond sludge
Keeps filters clean.

NP-21053—Foam
Adhere rocks together.
Fill voids to eliminate
water seepage

PART NO.	DESCRIPTION	LIST PRICE
NP-98903	ECO-BARLEY STRAW EXTRACT - 8.5oz	21.98
NP-99402	AQUASCAPE ECOFLOC 8oz.	14.98
NP-99403	AQUASCAPE ECOFLOC 23oz.	29.98
NP-99404	ECOSTARTER LIQUID - 8oz. BOTTLE	19.98
NP-99410	AQUASCAPE ECOSHADER POND SHADE 8oz.	14.98
NP-99420	AQUASCAPE FEATURE FOAM FREE - 8oz.	6.98
NP-99425	AQUASCAPE ECOFOAM AWAY 8 OZ.	14.98
NP-99427	ECOSTARTER DISSOLVABLE PACKETS	6.98
NP-99431	AQUASCAPE ECO BARLEY PELLETS 2LBS.	19.98
NP-99432	AQUASCAPE ECO BARLEY PELLETS 5 LBS.	44.98
NP-21053	AQUASCAPE BLACK WATERFALL FOAM	21.98
NP-29298	AQUACLEARER EXTREME DRY 4.6 OZ.	19.98
NP-29299	AQUACLEARER EXTREME DRY 1.2 LBS.	49.98
NP-29302	AQUACLEARER EXTREME LIQUID 71 OZ	69.98
NP-29304	AQUACLEARER 1GAL EXTREME WETLA	199.98
NP-29308	AQUASCAPE SAB EXTREME DRY 8oz.	29.98
NP-29309	AQUASCAPE SAB EXTREME DRY 38.4oz.	79.98

ORNAMENTS

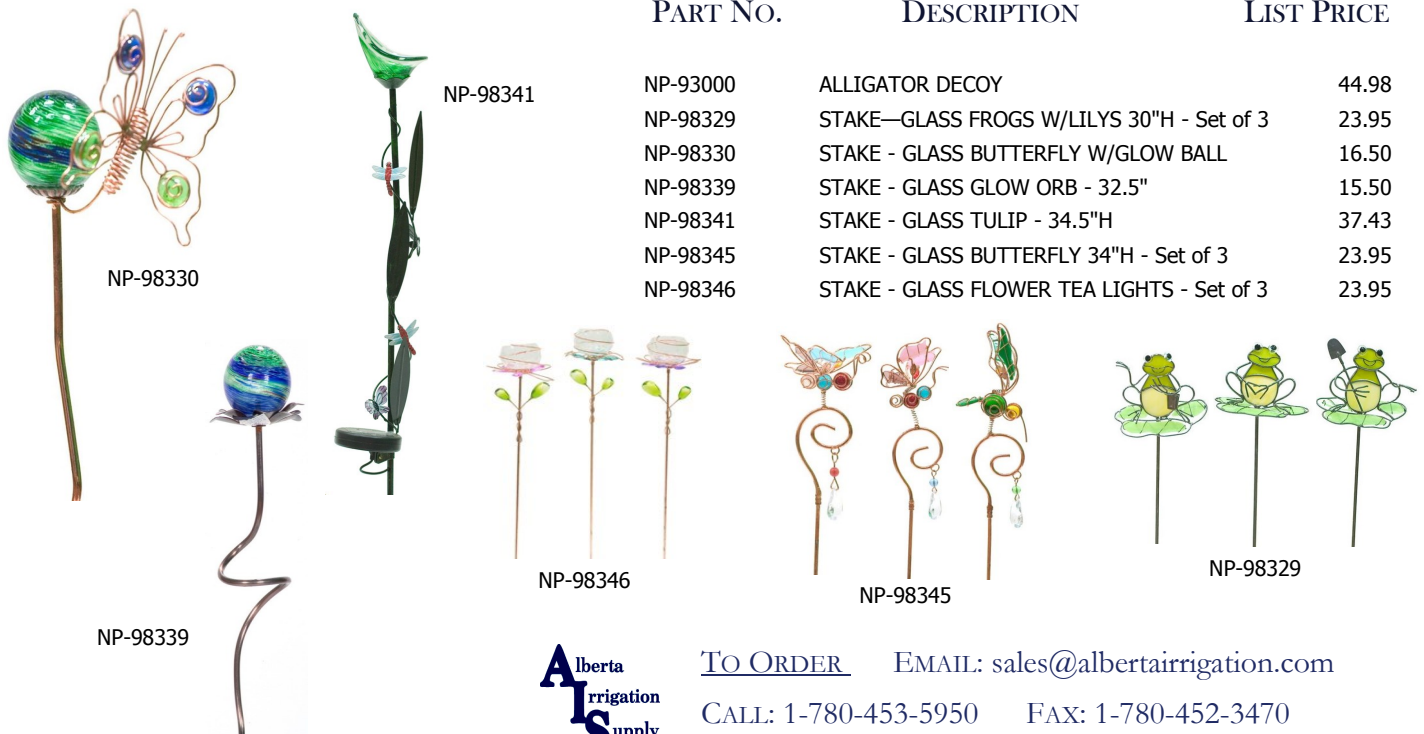

NP-98330

NP-98339

NP-98341

NP-98346

NP-98345

NP-98329

PART NO.	DESCRIPTION	LIST PRICE
NP-93000	ALLIGATOR DECOY	44.98
NP-98329	STAKE—GLASS FROGS W/LILYS 30"H - Set of 3	23.95
NP-98330	STAKE - GLASS BUTTERFLY W/GLOW BALL	16.50
NP-98339	STAKE - GLASS GLOW ORB - 32.5"	15.50
NP-98341	STAKE - GLASS TULIP - 34.5"H	37.43
NP-98345	STAKE - GLASS BUTTERFLY 34"H - Set of 3	23.95
NP-98346	STAKE - GLASS FLOWER TEA LIGHTS - Set of 3	23.95

WATER REELS - BIG OR SMALL

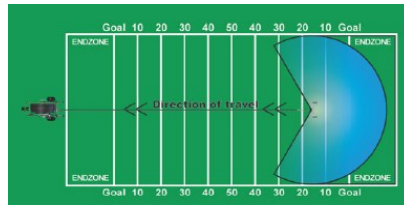

IRRIGATE IN (1) PASS

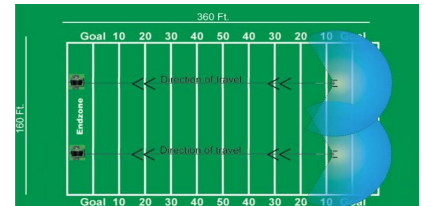

IRRIGATE IN (2) PASSES

Automation for unattended operation
Simple, uncomplicated operation
Portable & reliable irrigation
Extremely efficient water use

Turbine Drive: Operate at 10psi or less, 1.8" tube

Bellows Drive: Balance between retraction and output

Electric Drive: 12v rechargeable battery, no booster pump

Gas Drive: High speeds & solid wastes without psi loss



HORSE ARENA & DUST



ACREAGE & GARDEN



PASTURE & LOTS



SPORTS & REC. FIELD



**Gas drives are available special order

AGRICULTURE & LARGE PRODUCTION

Turbine powered water reels operate with booster pump at 9/ 21/23 HP

Depending on model, the production can:

Irrigated width:	154' – 320'
Irrigated Length:	797' – 1410'
Irrigated Acre per run:	2.8 – 10.4



agriculture & turf

EFFECTIVELY IRRIGATE:

Multiple locations
Irregular shapes
Sod farms & hay



corn & cash crops

FLEXIBILITY FOR:

Crop depth needs
Insurance against dry weather & draught



vegetables & produce

INCREASED YIELDS:

Water on demand
Directional coverage
beyond center pivots



wastewater disposal

MANEUVERABILITY:

Engine drive allows for higher retraction at lower application

NELSON BIG GUNS

PATENTED PRESSURE AND FLOW COMPENSATING DRIVE

Engineered and precision manufactured for heavy-duty reliability and long life. Excellent drive action & full range of nozzle sizes. Reliable adjustment allows for setting the arc to within 1 degree, without overriding the stops.



APPLICATIONS

- Turf Irrigation
- Synthetic Turf Cooling
- Sports Field, Arenas, Pastures
- Agriculture Production
- Dust & Mining Suppression
- Wastewater Applications

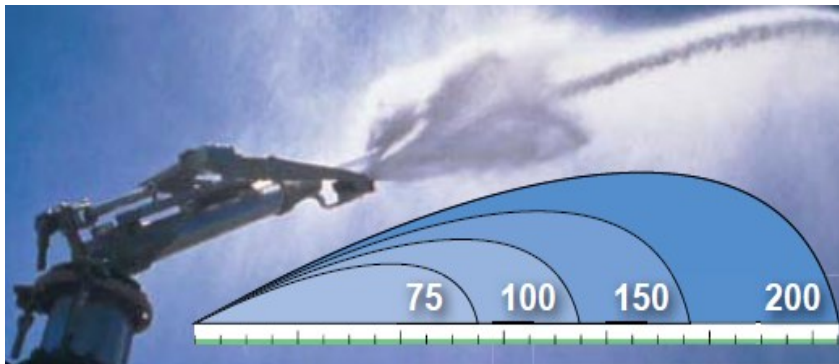

TO ORDER BIG GUNS® SPECIFY THE FOLLOWING:

Model No., Trajectory, Connection Size & Type, Nozzle Size & Type, Optional Coatings (Anodized or Anodized and Powder Coated) NOTE: Extended lead time may be necessary for large quantities of anodized or anodized and powder coated products.

Specification Example:
SR100 (24°), 2" FNPT, 100T-0.8"

	75 SERIES		100 SERIES			150 SERIES			200 SERIES	
PERFORMANCE	30-160 GPM (6.8-36.3 M ³ /H)		50-300 GPM (10-70 M ³ /H)			100-630 GPM (23-150 M ³ /H)			250-1200 GPM (55-275 M ³ /H)	
	 25-80 PSI (1.75-6 Kg/cm ²)		 40-110 PSI (3.5-8 Kg/cm ²)			 50-120 PSI (3.5-9 Kg/cm ²)			 60-130 PSI (4-9 Kg/cm ²)	
MODEL & TRAJECTORY	Full Circle F75	Part Circle SR75	Full Circle F100	Part Circle SR100	Part Circle SRA100	Full Circle F150	Part Circle SR150	Part Circle SRA150	Full Circle F200	Part Circle SR200
	21°, 24°		18°, 21°, 24°, 43°			15-45° Adjustable		21°, 24°, 27°, 43°		15-45° Adjustable
									21°, 24°, 27°	

PRESSURE BOOSTING SYSTEMS



PUMPING SYSTEMS

**FOR ALL YOUR FLUID MOVEMENT NEEDS
RELIABLE SYSTEMS THAT ENSURE SUFFICIENT
SUPPLY & PRESSURE AT ALL LEVELS**

**OUR STRATEGIC PARTNER COMPANY,
AP IRRIGATION SYSTEMS LTD.**

OFFERS MANY SERVICES:

**INSTALLATION OF PUMPING UNITS
COMPLETE TURNKEY SERVICE, SUPPLY & INSTALL OF
WET WELL AND INTAKE STRUCTURES
DIRECTIONAL DRILLING FOR DRAINAGE**

****CALL FOR CUSTOM DESIGN & PRICING****

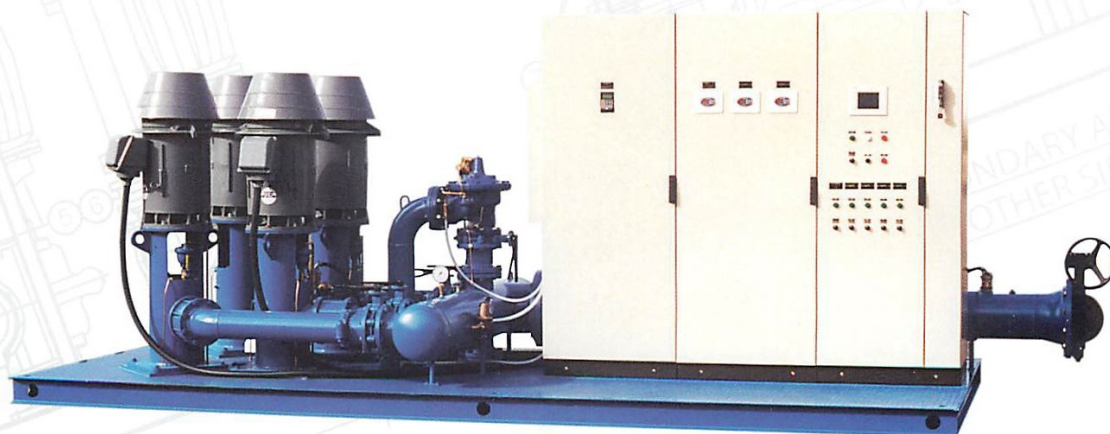

TO ORDER EMAIL: sales@albertairrigation.com
CALL: 1-780-453-5950 FAX: 1-780-452-3470



Alberta
Arrigation
Supply

CALL: 1-780-453-5950
 FAX: 1-780-452-3470

EMAIL: sales@albertairrigation.com

PARTS & SERVICE FOR ALL YOUR WATER & LANDSCAPE APPLICATIONS

**IRRIGATION - LANDSCAPE - LIGHTING
DRAINAGE - PONDS - FOUNTAINS**



Alberta
Irrigation
Supply

16030 - 118 Ave Edmonton, AB T5V 1C6

Toll Free (888) 453-0101

Phone (780) 453-5950 Fax (780) 452-3470

Email: sales@albertairrigation.com

PROFESSIONAL EQUIPMENT & EXPERT ADVICE SINCE 1973