

### FEATURES

- Trimmed 0.25% Reference
- Wide Operating Current Range 250µA to 150mA
- Low Dynamic Output Impedance
- Low Output Noise
- Nominal Temperature Range to 85°C
- Temperature-Compensated: 60ppm/°C
- Internal Amplifier with 150mA Capability

### APPLICATIONS

- Battery Powered Systems
- Switching Power Supplies
- Adjustable Power Supplies
- Linear Regulators
- Error Amplifiers
- Notebook/Personal Computer
- Monitors/ VCR/ TV
- Pagers

### GENERAL DESCRIPTION

The AMS3431 is a three-terminal adjustable shunt regulator with guaranteed temperature stability over the entire range of operation. The output voltage can be set to any value between 2.5V (VREF) and 36V by adding two external resistors. Due to the sharp turn-on characteristics this device is an excellent replacement for zener diodes in many applications.

AMS3431 is available in the space saving SOT-23 package and in the TO-92 package.

### ORDERING INFORMATION:

TOL.	PACKAGE TYPE		OPERATING TEMPERATURE RANGE
	TO-92	3 LEAD SOT-23	
±0.25%	AMS3431AN	AMS3431AM	-40 to +85° C
±0.5%	AMS3431BN	AMS3431BM	-40 to +85° C
±1.0%	AMS3431CN	AMS3431CM	-40 to +85° C

### PIN CONNECTIONS

**TO-92**  
Plastic Package (N)

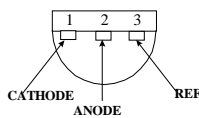

**Bottom View**

**3L SOT-23**  
(M)

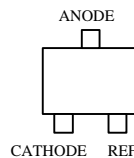

**Top View**

## ABSOLUTE MAXIMUM RATINGS (Note 1)

Cathode Voltage ( $V_Z$ )	37V	Internal Power Dissipation ( $P_D$ )	
Continuous Cathode Current ( $I_Z$ )	-10mA to +150mA	TO-92 Package	0.78W
Reference Input Current ( $I_{REF}$ )	10mA	SOT-23 Package	0.28W
Junction Temperature ( $T_J$ )	-40°C to +125°C	Thermal Resistance ( $\phi_{JA}$ )	
Storage Temperature	-65°C to +150°C	TO-92 Package	160°C/W
Lead Temperature (Soldering, 25sec.)	265°C	SOT-23 Package	410°C/W

**Note 1:** Absolute Maximum Ratings indicate limits beyond which damage to the device may occur. Operating Ratings indicate conditions for which the device is intended to be functional, but do not guarantee specific performance limits. For guaranteed specifications and test conditions, see the Electrical Characteristics. The guaranteed specifications apply only for the test conditions listed.

## ELECTRICAL CHARACTERISTICS

Electrical Characteristics at  $I_Z=10$  mA and  $T_A = +25^\circ\text{C}$  unless otherwise specified.

Parameter	Conditions	AMS3431A			AMS3431B			AMS3431C			Units
		Min	Typ	Max	Min	Typ	Max	Min	Typ	Max	
Reference Voltage		2.489	2.495	2.501	2.483	2.495	2.507	2.470	2.495	2.520	V
Deviation of Reference Input Voltage over Temperature	$V_Z = V_{REF}$ (circuit 1)		8.0	15		8.0	15		8.0	15	mV
	$T_A = +25^\circ\text{C}$ to $+85^\circ\text{C}$ $T_A = -40^\circ\text{C}$ to $+25^\circ\text{C}$		8.0	15		8.0	15		8.0	15	mV
Ratio of Change in Reference Voltage to Cathode Voltage	$V_Z$ from $V_{REF}$ to 10V		-0.5	-2.7		-0.5	-2.7		-0.5	-2.7	mV/V
	$V_Z$ from $V_{REF}$ to 36V		-1.0	-2.0		-1.0	-2.0		-1.0	-2.0	mV/V
Reference Input Current	$R1 = 10\text{k}\Omega$ , $R2 = \infty\Omega$ (test circuit 2)		0.5	4.0		0.5	4.0		0.5	4.0	$\mu\text{A}$
Reference Input Current Deviation over Temperature	$R1 = 10\text{k}\Omega$ , $R2 = \infty\Omega$ $T_A = \text{Full Range}$ (test circuit 2)		0.4	1.2		0.4	1.2		0.4	1.2	$\mu\text{A}$
Off State Cathode Current	$V_Z = 36\text{V}$ , $V_{REF} = 0\text{V}$ ( test circuit 3)		0.04	0.5		0.04	0.5		0.04	0.5	$\mu\text{A}$
Dynamic Output Impedance	$f < 1\text{KHz}$ , $V_Z = V_{REF}$ $I_Z = 100\mu\text{A}$ to $100\text{mA}$ (test circuit 1)		0.25	0.5		0.25	0.5		0.25	0.5	$\Omega$
Minimum Operating Current	$V_Z = V_{REF}$ (test circuit 1)		100	250		100	250		100	250	$\mu\text{A}$

## RECOMMENDED OPERATING CONDITIONS:

	Min	Max
Cathode Voltage, ( $V_Z$ )	$V_{REF}$	36 V
Cathode Current, ( $I_Z$ )	0.25mA	120mA

## TEST CIRCUITS

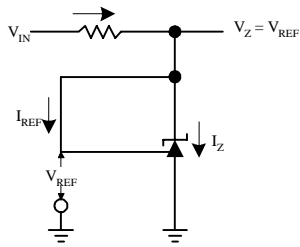

**Figure 1.** Test Circuit for  $V_Z = V_{REF}$

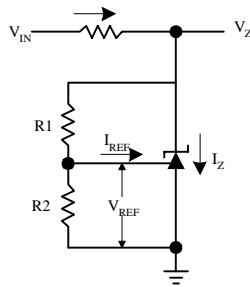

**Figure 2.** Test Circuit for  $V_{REF}$  vs  $I_Z$   
Test circuit for  $I_{REF}$ .

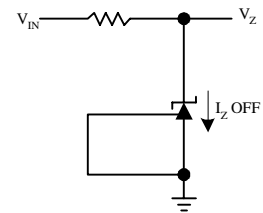

**Figure 3.** Test Circuit for Off-State Current

## TYPICAL APPLICATIONS

### Shunt Regulator

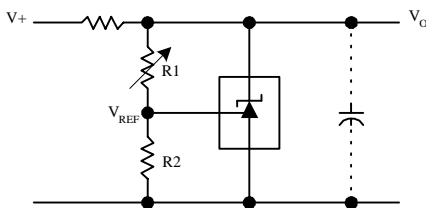

$$V_O \approx (1 + R1/R2)V_{REF}$$

### Single Supply Comparator with Temperature Compensated Threshold

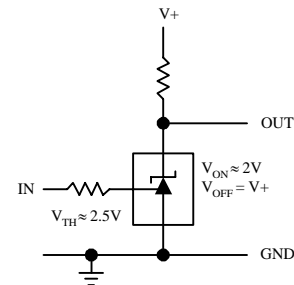

### Series Regulator

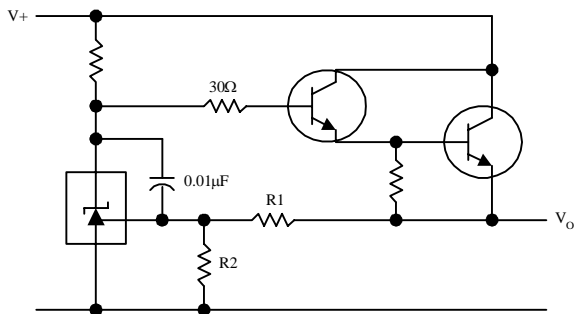

$$V_O \approx (1 + R1/R2)V_{REF}$$

### Higher Current Shunt Regulator

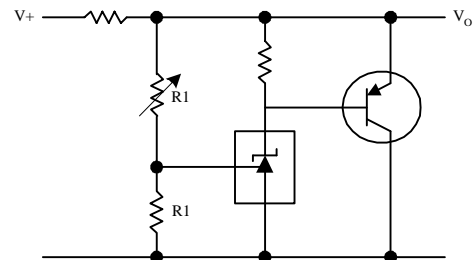

$$V_O \approx (1 + R1/R2)V_{REF}$$

## TYPICAL APPLICATIONS (Continued)

### Over Voltage/Under Voltage Protection Circuit

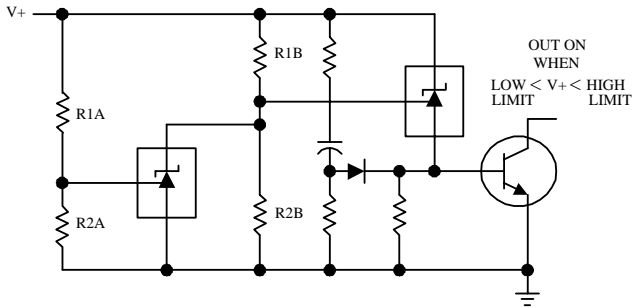

$$\text{LOW LIMIT} \approx V_{\text{REF}}(1 + R1B/R2B) + V_{\text{BE}}$$

$$\text{LOW LIMIT} \approx V_{\text{REF}}(1 + R1A/R2A)$$

### Voltage Monitor

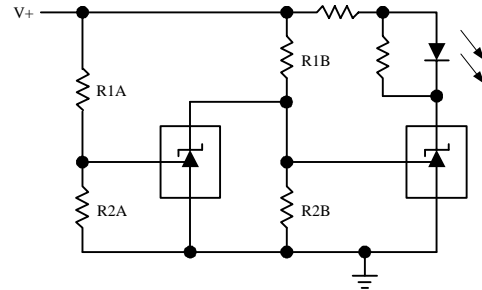

$$\text{LOW LIMIT} \approx V_{\text{REF}}(1 + R1B/R2B) + V_{\text{BE}}$$

$$\text{LOW LIMIT} \approx V_{\text{REF}}(1 + R1A/R2A)$$

LED ON WHEN LOW LIMIT < V+ < HIGH LIMIT

### Delay Timer

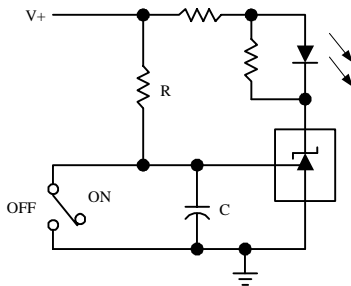

$$\text{DELAY} = R * C * \ln * V+ / (V+ - V_{\text{REF}})$$

### Current Limiter or Current Source

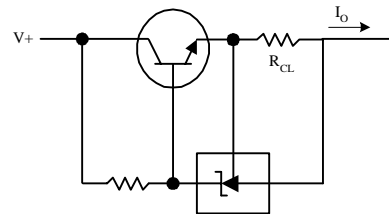

$$I_O = V_{\text{REF}} / R_{\text{CL}}$$

### Constant Current Sink

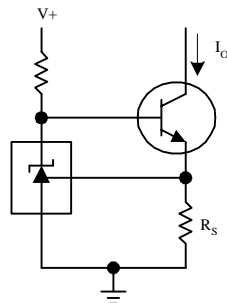

$$I_O = V_{\text{REF}} / R_S$$

## TYPICAL PERFORMANCE CHARACTERISTICS

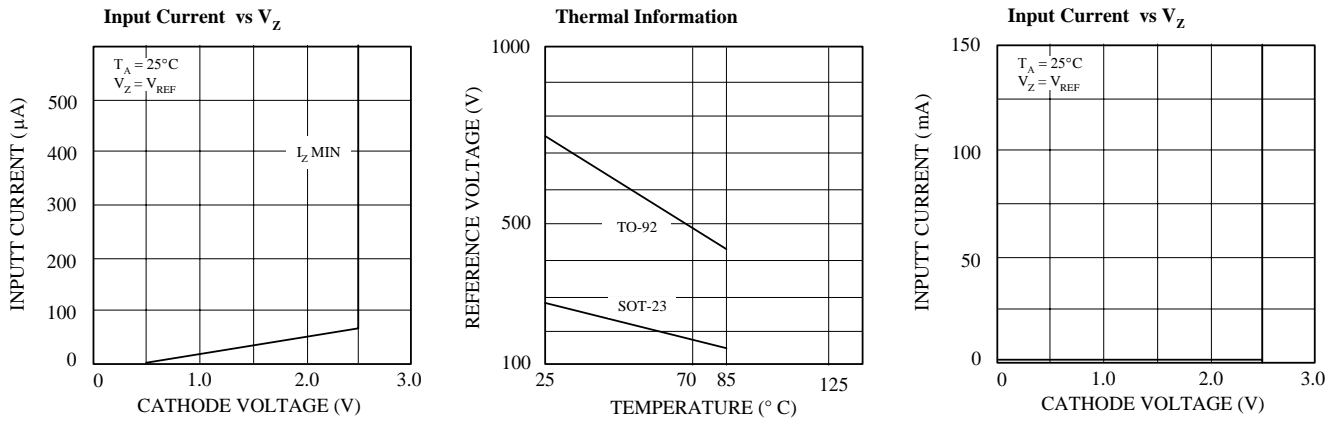

**PACKAGE DIMENSIONS** inches (millimeters) unless otherwise noted.

### 3L TO-92 PLASTIC PACKAGE (N)

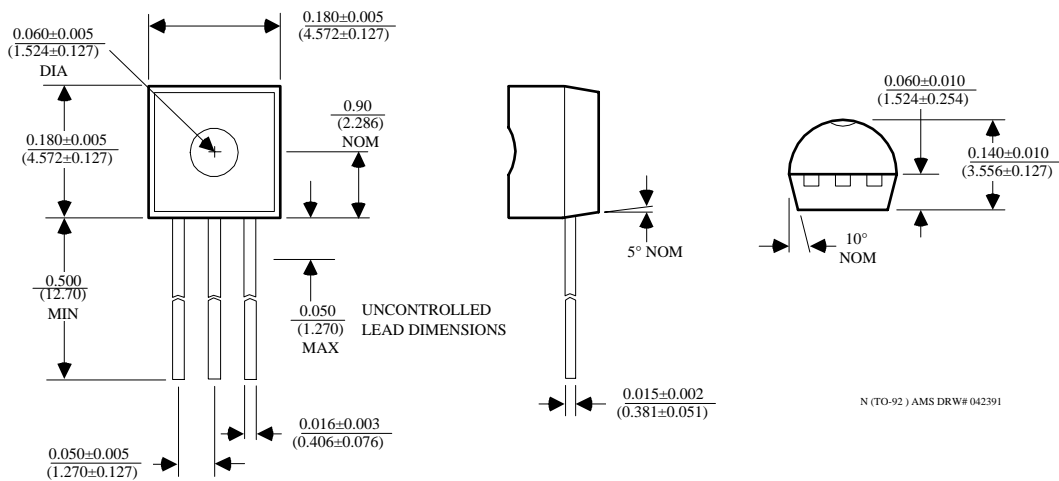

PACKAGE DIMENSIONS inches (millimeters) unless otherwise noted (Continued).

## 3 LEAD SOT-23 PLASTIC PACKAGE (M)

