



**2010 / 2011**

**THE ENGINE BUILDER'S SOLUTION.**

**ANYTIME.**

**ONLINE.**

**ENGINEQUEST.COM**



## Your Search for Cylinder Heads and Engine Parts is Complete!

### **AAEQ Manufacturers and Recyclers** is a

comprehensive resource that provides leadership in the automotive manufacturing, remanufacturing and recycling industries. Family-owned and operated since 1949, AAEQ has a well-deserved reputation for outstanding customer service and integrity. The company tailors its services to the needs of each customer while serving a diversified audience under its AA Midwest and EngineQuest (EQ) divisions.

**If you're a performance or production engine builder or rebuilder, your search for cylinder heads and specialty or hard-to-find engine parts begins and ends at EngineQuest® (EQ®).**

**At EQ we are 100% committed to getting you the right parts at the right time, at the right price. Looking for a cast iron or aluminum cylinder head casting? We have thousands in stock. A timing cover? We offer the largest single line available anywhere.**

**From complete head bolt sets to exhaust manifolds, EQ puts the best selection of new, remanufactured and reclaimed engine parts at your fingertips, so you can keep your project on track and get it done right the first time.**

**AA Midwest** is the industry's top supplier of engine and transmission cores. The division also has a growing automotive salvage business at its facilities in Blue Island, IL and Las Vegas, NV, where it processes vehicles for the export market, shipping body parts and clips, engines, transmissions, and other components to bulk buyers throughout the world.

**EngineQuest (EQ)** is a leading supplier of new, remanufactured and reclaimed engine parts – including hard-to-find items – to performance and stock engine builders, machine shops and race teams. EQ offers a select line of specialty stock replacement and high-performance cylinder heads, all manufactured to exacting standards and specifications.

### **Warehouse Locations:**

LAS VEGAS, NV • CHICAGO, IL • DALLAS, TX

#### **LAS VEGAS**

EQ Headquarters  
2580 N. Commerce Street  
N. Las Vegas, NV 89030-3876

#### **CHICAGO**

4050 S. Wentworth Avenue  
Chicago, IL 60609-2841

#### **DALLAS**

8930 Govenors Row  
Dallas, TX 75247



[www.aaeq.net](http://www.aaeq.net)



#### **CUSTOMER SERVICE**

Monday – Friday 7am - 5pm Pacific Time

**toll free 800.426.8771**

**local 702.649.7776 fax 702.649.6777**

**[www.enginequest.com](http://www.enginequest.com)**

# INDEX

PRODUCT	PAGE	PRODUCT	PAGE	PRODUCT	PAGE
Adaptors, Carburetor	21	Exhaust Manifolds—Toyota	44	Pipe Plugs, Metric Thread	30
Adaptors, Dipstick Tube	36	Flow Numbers	8	Pipe Plugs, Standard Thread	30
Adaptors, Oil Filter	34	Flywheels	45,46,47	Piston Pin Bushings	34
AMC Timing Covers	16	Ford Cylinder Heads	5	Plugs, Smog	30
Balance Shaft Elimination Kits	38	Ford Exhaust Manifolds	43,44	Plymouth Exhaust Manifolds	44
Balancers	23	Ford Oil Pans	28	Pontiac Oil Pans	28
Bare Blocks	21	Ford Timing Covers	17,18,19	Pontiac Timing Covers	19
Breather Grommets	29	Fuel Pump Block Off Plates	21	PCV Grommets	29
Buick Oil Pans	27	Galley Plug, Solid	30	Rocker Arm Guide	9
Buick Timing Covers	16	GEO Exhaust Manifolds	44	Rear Main Seal Conversions	35
Cadillac Oil Pans	27	Grommets, Breather	29	Rear Main Seals	36
Cam Eccentrics	32,33	Grommets, PCV	29	Retainer, Valve Springs	9
Cam Gear Bolts	33	Harmonic Balancers	23	Rocker Arm Baffles	9
Cam Gear Washers	33	Head Bolts	10,11	Rocker Arm Oil Shield	9
Cam Plugs	33	Head to Block Dowels	31	Rocker Arm Studs	7
Cam Thrust Plates	32	Hollander Interchanges	48	Rocker Shaft Buttons	31
Camshaft Button Spring	20	Images, Exhaust Manifolds	39,40,41	Roller Lifter Clips	9
Camshaft Button	20	Images, Oil Pans	24,25,26	Roller Lifter Retainers	9
Carburetor Adaptors	21	Images, Timing Covers	12,13,14,15	Seal Retainers	35
Chevrolet Cylinder Heads	4,6	Inner Belt Cover	20	Seals, Rear Main	36
Chevrolet Exhaust Manifolds	42	Interchanges, Hollander	48	Seals, Timing Cover	36
Chevrolet Oil Pans	27	Interchanges, OEM	49	Smog Plugs	30
Chevrolet Timing Covers	16,17	International Exhaust Manifolds	44	Solid Oil Galley Plugs	30
Chrysler Cylinder Heads	4,7	Isuzu Cylinder Heads	5	Standard Flywheels	45,46,47
Chrysler Exhaust Manifolds	42,43	Isuzu Exhaust Manifolds	44	Step Drills	37
Chrysler Oil Pans	28	Isuzu Timing Covers	19	Thrust Plates	32
Chrysler Timing Covers	17	Jaguar Timing Covers	19	Timing Chain Dampner	20
Conversion Jigs	37	Jet Valve Eliminations	38	Timing Chain Tensioner Spring	20
Crankshafts	22	Jeep Exhaust Manifolds	44	Timing Chain Tensioner Stop	20
Cylinder Head Adaptor	8	Jeep Oil Pans	28	Timing Chain Tensioner	20
Cylinder Head Bolts	10,11	Jeep Timing Covers	19	Timing Cover Mounting Dowels	31
Cylinder Heads—Mazda	5	Lash Cap	31	Timing Cover Seals	36
Cylinder Heads—Chevrolet	4,6	Lincoln Timing Covers	19	Timing Cover Images	12,13,14,15
Cylinder Heads—Chrysler	4,7	Marine Bare Blocks	21	Timing Covers—AMC	16
Cylinder Heads—Ford	5	Mazda Cylinder Heads	5	Timing Covers—Buick	16
Cylinder Heads—Isuzu	5	Mazda Exhaust Manifolds	44	Timing Covers—Chevrolet	16,17
Cylinder Heads—Nissan	5	Mazda Timing Cover	19	Timing Covers—Chrysler	17
Cylinder Heads—Performance	6,7	Mercury Timing Cover	19	Timing Covers—Ford	17,18,19
Cylinder Heads—Toyota	5	Nissan Cylinder Heads	5	Timing Covers—Isuzu	19
Dipsticks	29	Nissan Exhaust Manifolds	44	Timing Covers—Jaguar	19
Dipstick Tube Adaptors	36	Nissan Timing Covers	19	Timing Covers—Jeep	19
Dowel Pins	31	OEM Interchanges	49	Timing Covers—Lincoln	19
Dowels, Head to Block	31	Oil Filler Cap	29	Timing Covers—Mazda	19
Dowels, Timing Cover	31	Oil Filter Adaptors	34	Timing Covers—Mercury	19
Elimination Kits	38	Oil Pan Bolts	29	Timing Covers—Nissan	19
Engine Pre-Luber	36	Oil Pan Images	24,25,26	Timing Covers—Pontiac	19
Exhaust Manifold Images	39,40,41	Oil Pans—Buick	27	Timing Covers—Saturn	19
Exhaust Manifolds—Chevrolet	42	Oil Pans—Cadillac	27	Timing Covers—Toyota	19
Exhaust Manifolds—Chrysler	42,43	Oil Pans—Chevrolet	27	Timing Sets	22
Exhaust Manifolds—Ford	43,44	Oil Pans—Chrysler	28	Tinware Sets	29
Exhaust Manifolds—GEO	44	Oil Pans—Ford	28	Toyota Cylinder Heads	5
Exhaust Manifolds—International	44	Oil Pans—Jeep	28	Toyota Exhaust Manifolds	44
Exhaust Manifolds—Isuzu	44	Oil Pans—Pontiac	28	Toyota Timing Covers	19
Exhaust Manifolds—Jeep	44	Oiler	36	Valve Spring Retainers	9
Exhaust Manifolds—Mazda	44	Performance Cylinder Heads	6,7	Valve Covers	29
Exhaust Manifolds—Nissan	44	Pin Bushings	34	Warranty	50
Exhaust Manifolds—Plymouth	44	Pipe Plugs, Japanese Thread	30		

# NEW CYLINDER HEADS

## NEW! EQ now offers bare and fully loaded cylinder heads!

All EQ cylinder heads outperform their competitors—whether you need stock or performance heads.

- EQ Bare heads are ready to install to the drive train... no porting or polishing needed!
- EQ Loaded heads include OE-quality stainless steel valves, seals, valve springs and retainers.



Contact your EQ cylinder head specialist for latest listings, or visit [www.eqcylinderheads.com](http://www.eqcylinderheads.com)

- THE HIGHEST GRADE CAST IRON AND ALUMINUM
- THICKER DECK FOR GREATER STRENGTH
- IMPROVED DESIGN TO RESIST CRACKING
- REDESIGNED WATER FLOW FOR GREATER THERMAL CONDUCTIVITY
- 25 POINT QUALITY CHECK ON EVERY HEAD
- BACKED BY OUR REPUTATION
- SUPERIOR PORT FINISH FOR INCREASED FLOW
- RACING TECHNOLOGY USED FOR DEVELOPMENT
- HARDENED EXHAUST SEATS
- CNC MACHINED GUIDES AND SEATS
- COMPETITIVE PRICES!
- 3 ANGLE VALVE FINISH

## CHEVROLET

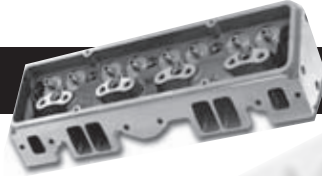

PART #	LITERS	CID	YEARS	CASTING/NOTES	VALVE SIZE INTAKE	VALVE SIZE EXHAUST	INSTALLED VALVE HEIGHT INTAKE	INSTALLED VALVE HEIGHT EXHAUST
CH134N	2.2	134	90-97	391, 391S 7MM VALVE GUIDE ID	1.732"	1.457"	1.9110-1.9400"	1.9350-1.9650"
CH305A	5.0	305	96-00	12552520, 12557113, 12558059 (170CC /58CC)	1.94"	1.500"	1.970-2.000"	1.970-2.000"
CH305B	5.0	305	96-00	12552520, 12557113, 12558059 (170CC /58CC)	1.84"	1.500"	1.970-2.000"	1.970-2.000"
CH350A	5.7	350	55-86	167CC INTAKE RUNNER / 76CC COMBUSTION CHAMBER UNIVERSAL	1.94"	1.500"	1.990-2.000"	1.990-2.000"
CH350AA	5.7	350	55-86	167CC INTAKE RUNNER / 76CC COMBUSTION CHAMBER <b>UNIVERSAL (ASSEMBLED)</b>	1.94"	1.500"	1.990-2.000"	1.990-2.000"
CH350C	5.7	350	96-02	12558062, 10239906 170CC INTAKE RUNNER / 64CC COMBUSTION CHAMBER	1.940"	1.500"	1.975-2.005"	2.015-2.045"
CH350CA	5.7	350	96-02	12558062, 10239906 <b>170CC INTAKE RUNNER / 64CC COMBUSTION CHAMBER (ASSEMBLED)</b>	1.940"	1.500"	1.975-2.005"	2.015-2.045"
CH350E	5.7	350	-	12558062, 10239906 (SAME AS CC170BA) VORTEC COMBUSTION CHAMBER / 69-86 INTAKE BOLT PATTERNS	1.940"	1.500"	1.975-2.005"	2.015-2.045"
CH350F	5.7	350	-	12558062, 10239906 (SAME AS CC170BA2) VORTEC COMBUSTION CHAMBER / 69-86 INTAKE BOLT PATTERNS OUTER PERIMETER VALVE COVER MOUNTING HOLE	1.940"	1.500"	1.975-2.005"	2.015-2.045"
CH350G	5.7	350	-	083, 191, 193, 217, 810 VORTEC HEAD WITH HEAT RISER / 87-95 INTAKE BOLT PATTERNS UNIVERSAL MARINE/AUTO CAN BE USED AS REPLACEMENT (IN PAIRS ONLY)	1.940"	1.500"	1.975-2.005"	2.015-2.045"
CH350H	5.7	350	-	083, 191, 193, 217, 810 VORTEC HEAD WITH HEAT RISER / 69-86 INTAKE BOLT PATTERNS UNIVERSAL MARINE/AUTO CAN BE USED AS REPLACEMENT (IN PAIRS ONLY) OUTER PERIMETER VALVE COVER MOUNTING HOLE	1.940"	1.500"	1.975-2.005"	2.015-2.045"
CH350I	5.7	350	55-86	IMCA SPORTMOD AND HOBBY STOCK SPEC HEAD 167CC INTAKE RUNNER / 76CC COMBUSTION CHAMBER	1.940"	1.500"	1.970-2.000"	1.970-2.000"
CH395N	6.2	381	90-95	10137567-90" INTAKE BOLTS	1.811"	1.535"	2.1570-2.1870"	2.2300-2.200"
CH395N	6.5	395	92-99	10137567-90" INTAKE BOLTS	1.811"	1.535"	2.1570-2.1870"	2.2300-2.2600"
CH395B	6.5	395	92-99	10137567-60" INTAKE BOLTS	1.811"	1.535"	2.1570-2.1870"	2.2300-2.2600"

## CHRYSLER/MITSUBISHI

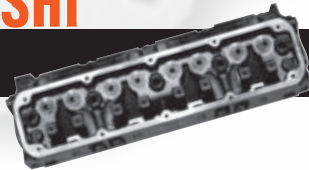

PART #	LITERS	CID	YEARS	CASTING/NOTES	VALVE SIZE INTAKE	VALVE SIZE EXHAUST	INSTALLED VALVE HEIGHT INTAKE	INSTALLED VALVE HEIGHT EXHAUST
CH123N	2.0	1997	83-91	12 VALVE 4G63				
CH124N	2.0			8 VALVE 4G63				
CH143A	2.4	2350	93-99	8 VALVE 4G64 SOHC	1.299"	1.142"	1.950"-1.960"	1.950"-1.960"
CH153N	2.5	153	87-95	782	1.598"	1.394"	1.9600-2.0090"	1.9600-2.0090"
CH154N	2.6	2555	81-90	8 VALVE SOHC G54B	1.81"	1.493"	1.690-1.710"	1.680-1.700"
CH155N	2.6	156	81-88	3 VALVE	1.810"	1.493"	1.690-1.710"	1.680-1.700"
CH318A	5.2	318	92-04	53005714, 53006671, 53020466, 53020468 INTAKE PORT 172CC / COMBUSTION CHAMBER 62CC	1.920"	1.624"	1.7830-1.85"	1.7830-1.85"
CH318A	5.9	360	92-02	53005714, 53006671, 53020466, 53020468 INTAKE PORT 172CC / COMBUSTION CHAMBER 62CC	1.920"	1.624"	1.7830-1.85"	1.7830-1.85"
CH318AA	5.9	360	92-02	53005714, 53006671, 53020466, 53020468 <b>INTAKE PORT 172CC / COMBUSTION CHAMBER 62CC (ASSEMBLED)</b>	1.920"	1.624"	1.7830-1.85"	1.7830-1.85"
CH318B	5.2	318		53005714, 53006671, 53020466, 53020468 WITH LA STYLE INTAKE BOLT PATTERN	1.920"	1.624"	1.7830-1.85"	1.7830-1.85"
CH318BA	5.2	318		53005714, 53006671, 53020466, 53020468 <b>WITH LA STYLE INTAKE BOLT PATTERN (ASSEMBLED)</b>	1.920"	1.624"	1.7830-1.85"	1.7830-1.85"
	5.9	360						

ORANGE LISTINGS ARE ALSO FOR INDUSTRIAL FORKLIFT APPLICATIONS:  
CH122A, CH124N, CH143A, CH154N, CH136N



# NEW CYLINDER HEADS



CALL FOR A QUOTE ON QUANTITY BUYS ON ASSEMBLED HEADS!

## FORD

PART #	LITER	CID	YEARS	CASTING/NOTES	VALVE SIZE INTAKE	VALVE SIZE EXHAUST	INSTALLED VALVE HEIGHT INTAKE	INSTALLED VALVE HEIGHT EXHAUST
CH244A	4.0	244	90-94	90TM, 93TM	1.713"	1.358"	1.7350-1.7450"	1.7350-1.7450"
<b>CH244AA</b>	<b>4.0</b>	<b>244</b>	<b>90-94</b>	<b>90TM, 93TM</b>	<b>1.713"</b>	<b>1.358"</b>	<b>1.7350-1.7450"</b>	<b>1.7350-1.7450"</b>
CH244B	4.0	244	95-97	95TM	1.713"	1.358"	1.7350-1.7450"	1.7350-1.7450"
<b>CH244BA</b>	<b>4.0</b>	<b>244</b>	<b>95-97</b>	<b>95TM</b>	<b>1.713"</b>	<b>1.358"</b>	<b>1.7350-1.7450"</b>	<b>1.7350-1.7450"</b>
CH244C	4.0	244	98-00	98TM	1.713"	1.358"	1.7350-1.7450"	1.7350-1.7450"
<b>CH244CA</b>	<b>4.0</b>	<b>244</b>	<b>98-00</b>	<b>98TM</b>	<b>1.713"</b>	<b>1.358"</b>	<b>1.7350-1.7450"</b>	<b>1.7350-1.7450"</b>
CH300A	4.9	300	87-96	E7TE WITH A.I.R. HOLES	1.718"	1.560"	2.1200-2.1500"	2.2000-2.2300"
CH300B	4.9	300	87-96	E7TE NON SMOG (MADE W/70,000 SERIES DURABOND EXHAUST SEATS FOR FLEX FUEL ENGINES)	1.718"	1.560"	2.1200-2.1500"	2.2000-2.2300"
<b>CH300BA</b>	<b>4.9</b>	<b>300</b>	<b>87-96</b>	<b>E7TE NON SMOG</b> (MADE W/70,000 SERIES DURABOND EXHAUST SEATS FOR FLEX FUEL ENGINES)	<b>1.718"</b>	<b>1.560"</b>	<b>2.1200-2.1500"</b>	<b>2.2000-2.2300"</b>
CH300C	4.9	300	87-96	E7TE NON SMOG	1.718"	1.560"	2.1200-2.1500"	2.2000-2.2300"

## ISUZU

PART #	LITER	CID	YEARS	CASTING/NOTES	VALVE SIZE INTAKE	VALVE SIZE EXHAUST	INSTALLED VALVE HEIGHT INTAKE	INSTALLED VALVE HEIGHT EXHAUST
CH138N	2.3	4ZD1	86-95	4ZD1	1.736"	1.453"	1.7200-1.7500"	1.7200-1.7500"
CH156N	2.6	4ZE1	88-97	4ZE1	1.736"	1.453"	1.7200-1.7500"	1.7200-1.7500"

## MAZDA

PART #	LITER	CID	YEARS	CASTING/NOTES	VALVE SIZE INTAKE	VALVE SIZE EXHAUST	INSTALLED VALVE HEIGHT INTAKE	INSTALLED VALVE HEIGHT EXHAUST
<b>CH122A</b>	<b>2.0</b>	<b>1998</b>	<b>84-87</b>	<b>FE</b>	<b>1.732"</b>	<b>1.417"</b>	<b>1.831-1.850"</b>	<b>1.831-1.850"</b>
<b>CH122A</b>	<b>2.2</b>	<b>2184</b>	<b>87-93</b>	<b>F2 / 8 VALVE</b>	<b>1.732"</b>	<b>1.417"</b>	<b>1.831-1.850"</b>	<b>1.831-1.850"</b>
CH157N	2.6	2606	89-94	G6 / 12 VALVE	1.312"	1.417"	1.9290-1.9490" 48.997-49.505MM	1.9290-1.9490" 48.997-49.505MM

## NISSAN

PART #	LITER	CID	YEARS	CASTING/NOTES	VALVE SIZE INTAKE	VALVE SIZE EXHAUST	INSTALLED VALVE HEIGHT INTAKE	INSTALLED VALVE HEIGHT EXHAUST
CH146N	2.4	Z24	83-89		1.658"	1.500"	1.840-1.860"	1.840-1.860"

## TOYOTA

PART #	LITER	CID	YEARS	CASTING/NOTES	VALVE SIZE INTAKE	VALVE SIZE EXHAUST	INSTALLED VALVE HEIGHT INTAKE	INSTALLED VALVE HEIGHT EXHAUST
CH132N	2.2		97-01	3SFE/5SFE, DOHC, W/O DISTRIBUTOR HOLE, W/CAM SENSOR	1.260"	1.063"	1.510"-1.520"	1.510"-1.520"
<b>CH136N</b>	<b>2.0</b>	<b>1998</b>	<b>84-85</b>	<b>3YEC 8 VALVE OHV</b>	<b>1.580"</b>	<b>1.425"</b>	<b>1.890"-1.910"</b>	<b>1.890"-1.900"</b>
CH136N	2.2	2237	86-89	4YEC 8 VALVE OHV	1.580"	1.425"	1.890"-1.910"	1.890"-1.900"
CH144N	2.4	144	5-95	22R, 22REC	1.770"	1.457"	44.55MM-44.92MM	44.55MM-44.92MM
<b>CH144NA</b>	<b>2.4</b>	<b>144</b>	<b>5-95</b>	<b>22R, 22REC</b>	<b>1.770"</b>	<b>1.457"</b>	<b>44.55MM-44.92MM</b>	<b>44.55MM-44.92MM</b>
CH274N	4.5	4476	93-97	1FZFE DOHC	1.496"	1.260"	1.590"	1.590"

ORANGE LISTINGS ARE ALSO FOR INDUSTRIAL FORKLIFT APPLICATIONS:  
CH122A, CH124N, CH143A, CH154N, CH136N

24/7 ONLINE ORDERING! VISIT US ON THE WEB AT [WWW.ENGINEQUEST.COM](http://WWW.ENGINEQUEST.COM)



# PERFORMANCE CYLINDER HEADS

*EQ Cylinder Heads, using the latest in technology, have been redesigned to give you more power and better efficiency, at competitive prices!*

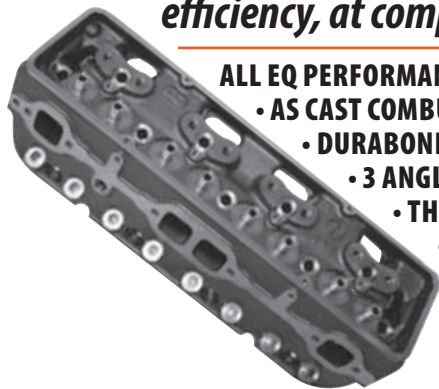

**ALL EQ PERFORMANCE CYLINDER HEADS FEATURE:**

- AS CAST COMBUSTION CHAMBERS AND PORTS
- DURABOND EXHAUST SEATS
- 3 ANGLE VALVE JOB
- THICK DECK FACES FOR ANGLE MILLING
- PHOSPHOR BRONZE INTAKE AND EXHAUST GUIDE(23° HEADS ONLY)
- MACHINED FOR GUIDE PLATE USE
- RAISED INTAKE RUNNER PORTS FOR INCREASED PERFORMANCE
- ORDER ONE SIS350 (SCREW IN STUDS) FOR EACH CYLINDER HEAD
- NEWLY DESIGNED COMBUSTION CHAMBERS

PART #	INTAKE RUNNER VOLUME	COMBUSTION CHAMBER VOLUME	DIRECTION OF SPARK PLUG	INTAKE VALVE	EXHAUST VALVE	GUIDE ID	GUIDE OD	INTAKE PORT WIDTH	INTAKE PORT HEIGHT	EXHAUST PORT WIDTH	EXHAUST PORT HEIGHT
--------	----------------------	---------------------------	-------------------------	--------------	---------------	----------	----------	-------------------	--------------------	--------------------	---------------------

## VORTEC BOLT ON PERFORMANCE FOR 305 CID –A TRUE POWER IMPROVED HEAD

CH305A	170CC	58CC	STRAIGHT	1.94	1.50	11/32"	.530"/.531"				
CH305B	170CC	58CC	STRAIGHT	1.84	1.50	11/32"	.530"/.531"				

## VORTEC BOLT ON PERFORMANCE FOR 350 CID –A TRUE POWER IMPROVED HEAD

CH350C	170CC	64CC	STRAIGHT	1.94	1.50	11/32"	.530"/.531"				
CC170BA	170CC	64CC (CH350E)	STRAIGHT	1.94	1.50	11/32"	.530"/.531"				
CC170BA2	170CC	64CC (CH350F)	STRAIGHT	1.94	1.50	11/32"	.530"/.531"				

69-86 INTAKE BOLT PATTERN  
CENTER BOLT VALVE COVER MOUNTING HOLES  
69-86 INTAKE BOLT PATTERN & PERIMETER VALVE COVER MOUNTING HOLES

## BOLT ON PERFORMANCE FOR 327 / 350 CID

CH350I	167CC	76CC	STRAIGHT	1.94	1.50	11/32"	.530"/.531"	1.19"	2.00"	1.35"	1.35"
CC167CS2	167CC	67CC	STRAIGHT	2.02	1.60	11/32"	.530"/.531"	1.19"	2.00"	1.35"	1.35"
CC167CS	167CC	67CC	STRAIGHT	1.94	1.50	11/32"	.530"/.531"	1.19"	2.00"	1.35"	1.35"
CC167ES2	167CC	76CC	STRAIGHT	2.02	1.60	11/32"	.530"/.531"	1.19"	2.00"	1.35"	1.35"
CC167ES	167CC	76CC (CH350A)	STRAIGHT	1.94	1.50	11/32"	.530"/.531"	1.19"	2.00"	1.35"	1.35"

## BEST SUITED FOR 327 / 350 CID

–GREAT FOR IMCA STOCK CARS–GOOD CHOICE FOR STREET PERFORMANCE

CC180AA	180CC	50CC	ANGLED	2.02	1.60	11/32"	.530"/.531"	1.19"	2.00"	1.35"	1.35"
CC180BA	180CC	64CC	ANGLED	2.02	1.60	11/32"	.530"/.531"	1.19"	2.00"	1.35"	1.35"
CC180BS	180CC	64CC	STRAIGHT	2.02	1.60	11/32"	.530"/.531"	1.19"	2.00"	1.35"	1.35"

## BEST SUITED FOR 350/383 CID

–GREAT FOR IMCA MODIFIED CARS–FOR MAX STREET PERFORMANCE OVAL TRACK AND DRAG

CC200AA	200CC	50CC	ANGLED	2.02	1.60	11/32"	.530"/.531"	1.23"	2.12"	1.35"	1.35"
CC200BA	200CC	64CC	ANGLED	2.02	1.60	11/32"	.530"/.531"	1.23"	2.12"	1.35"	1.35"
CC200BS	200CC	64CC	STRAIGHT	2.02	1.60	11/32"	.530"/.531"	1.23"	2.12"	1.35"	1.35"

## ALUMINUM BOLT ON PERFORMANCE FOR 350/383 CID

–FOR MAX STREET PERFORMANCE OVAL TRACK AND DRAG

AC200BS	197CC	65CC	STRAIGHT	2.02	1.60	11/32"	.530"/.531"	1.23"	2.12"	1.35"	1.35"
---------	-------	------	----------	------	------	--------	-------------	-------	-------	-------	-------

RECOMMEND THE USE OF OFFSET ROCKERS OR 5/16 PUSHRODS

## BEST SUITED FOR 383 / 400 CID

–GREAT FOR IMCA MODIFIED CARS–FOR MAX STREET PERFORMANCE OVAL TRACK AND DRAG

CC220AA	220CC	50CC	ANGLED	2.02	1.60	11/32"	.530"/.531"	1.23"	2.23"	1.35"	1.35"
CC220BA	220CC	64CC	ANGLED	2.02	1.60	11/32"	.530"/.531"	1.23"	2.23"	1.35"	1.35"
CC220BS	220CC	64CC	STRAIGHT	2.02	1.60	11/32"	.530"/.531"	1.23"	2.23"	1.35"	1.35"

## BEST SUITED FOR 400 CID AND LARGER

–GREAT FOR IMCA MODIFIED CARS

CC235AA	235CC	50CC	ANGLED	2.08	1.60	11/32"	.530"/.531"	1.25"	2.24"	1.35"	1.35"
CC235BA	235CC	64CC	ANGLED	2.08	1.60	11/32"	.530"/.531"	1.25"	2.24"	1.35"	1.35"
CC235BS	235CC	64CC	STRAIGHT	2.08	1.60	11/32"	.530"/.531"	1.25"	2.24"	1.35"	1.35"



# PERFORMANCE CYLINDER HEADS

## CHRYSLER 318 & 360 CID

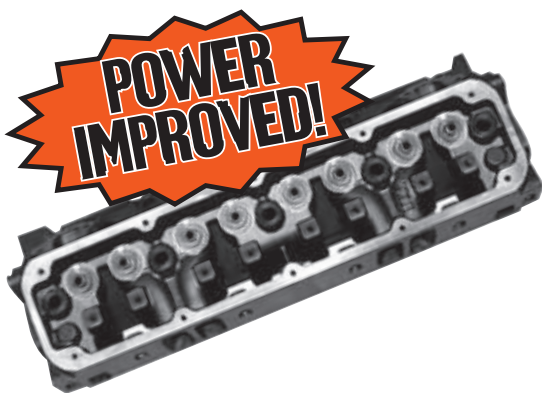

PART #	INTAKE RUNNER VOLUME	COMBUSTION CHAMBER VOLUME	INTAKE VALVE	EXHAUST VALVE
<b>1992-2004 V8 MAGNUM</b>				
CH318A	172CC	62CC	1.920"	1.624"
CH318AA (ASSEMBLED)	172CC	62CC	1.920"	1.624"
<b>WITH LA TYPE BOLT PATTERN</b>				
<b>USES ALL MAGNUM ROCKER PARTS WITH LA STYLE INTAKE</b>				
CH318B	172CC	62CC	1.920"	1.624"
CH318BA (ASSEMBLED)	172CC	62CC	1.920"	1.624"

## SCREW-IN STUDS, SMALL BLOCK CHEVY

### EACH CYLINDER HEAD REQUIRES THE USE OF A SCREW-IN ROCKER ARM STUD.

ORDER #SIS350 (8 PIECES PER SET, ENOUGH FOR 1 CYLINDER HEAD)

- STUDS MEASURE 7/16-14 X 3/8-24 X 2.375" OVERALL
- HEAT TREATED TO RC 33-39 AND ARE OXIDE



## CYLINDER HEAD TECH NOTES

**SUGGESTED SPARK PLUG: V57C = COLD / V59C = HOT**

**USE PLUS .100" LONGER VALVES IN ALL CC180'S, CC200'S, CC220'S AND CC235'S TO ENABLE PROPER INSTALLED SPRING HEIGHT. WATER JACKETS REQUIRES FLUSHING BEFORE ASSEMBLY.**

**VALVE TO GUIDE CLEARANCES FOR STAINLESS VALVES IS: INTAKE 0.0015" - 0.002" / EXHAUST 0.002" - 0.0025"**

**VALVE SPRING POCKET WIDTH 1.575" ON ALL CC180, CC200, CC220 AND CC235 SERIES PART NUMBERS**

**VALVE SPRING POCKET WIDTH 1.320" ON ALL CC167, CH350A AND CH350I SERIES PART NUMBERS**

**ROCKER BOLT TORQUE: 50 - 55 FT/LB**

**HEAD BOLT TORQUE SETTINGS: 65 - 70 FT LBS SHORT (7/16) / 70-75FT LBS LONG (7/16)**

### EQ Cylinder Heads are:

- All cast iron heads are manufactured in Queensland, Australia by Toowoomba Metal Technologies (except for 6.5 GM Diesel).
- Newly designed to be much more efficient than previous versions, and are not allowed to be cast until flow numbers and Dyno numbers exceed previously PUBLISHED numbers, averaging 10 - 15 CFM greater than the old Pro Head.
- Cast at an ISO 9001 facility where one head from the beginning of each run is digitally checked for all tolerances, and each head is checked prior to being shipped to ensure maximum quality.
- Manufactured with a .4375 thick head deck, enabling better heat transfer, and allowing for a better machining platform for decking. EQ Cylinder Heads is the only company to manufacture a LOW RAIL valve cover. Our early GM head has a machined valve cover rail that enables the installer to run the head in an early GM vehicle where valve cover clearance is an issue.
- Currently using ONLY phosphorous bronze guides in the performance head line.
- Machined with DURABOND 30000 series exhaust seats in both the stock replacement and the performance cylinder heads.
- A TRUE Vortec cylinder head! Unlike the competition's cylinder head, where a late model bolt pattern is applied to an early head.
- Priced competitively to all other cast iron cylinder heads.

EngineQuest is the only head maker in the business offering a full 1 yr. limited parts and labor warranty on stock replacement applications. (See page 50 for warranty details).



# FLOW NUMBERS

ALL TESTING WAS DONE ON A SUPER FLOW SF-1020 - TEST DATA @ 28 INCHES OF WATER

CH350C

170 CC INTAKE RUNNER/  
64 CC COMBUSTION CHAMBER  
Chevrolet V8 5.7L Vortec

CC180BA

180 CC INTAKE RUNNER/  
64 CC COMBUSTION CHAMBER

CC200BA

200 CC INTAKE RUNNER/  
64 CC COMBUSTION CHAMBER

CC220BA

220 CC INTAKE RUNNER/  
64 CC COMBUSTION CHAMBER

INTAKE		EXHAUST*		INTAKE		EXHAUST*		INTAKE		EXHAUST*		INTAKE		EXHAUST*	
LEFT	CFM	LEFT	CFM	LEFT	CFM	LEFT	CFM	LEFT	CFM	LEFT	CFM	LEFT	CFM	LEFT	CFM
.100	54.00	.100	49.30	.100	65.40	.100	55.30	.100	74.80	.100	65.50	.100	71.50	.100	64.10
.200	103.90	.200	87.60	.200	130.00	.200	106.60	.200	137.20	.200	113.30	.200	141.30	.200	115.40
.300	147.60	.300	118.80	.300	177.90	.300	133.20	.300	185.70	.300	146.90	.300	196.10	.300	145.10
.400	194.40	.400	139.70	.400	212.80	.400	156.60	.400	225.00	.400	170.20	.400	238.10	.400	169.80
.500	224.30	.500	148.50	.500	234.90	.500	174.50	.500	252.50	.500	181.70	.500	265.10	.500	189.30
.600	226.20	.600	152.00	.600	242.30	.600	182.80	.600	264.40	.600	187.80	.600	280.50	.600	201.70
.700	228.40	.700	152.70	.700	244.30	.700	188.30	.700	272.20	.700	189.50	.700	284.20	.700	207.60

CC235BA

235 CC INTAKE RUNNER/  
64 CC COMBUSTION CHAMBER

CH318A/B

172 CC INTAKE RUNNER/  
62 CC COMBUSTION CHAMBER

CH350I

167 CC INTAKE RUNNER/  
76 CC COMBUSTION CHAMBER

INTAKE		EXHAUST*		INTAKE		EXHAUST*		INTAKE		EXHAUST*	
LEFT	CFM	LEFT	CFM	LEFT	CFM	LEFT	CFM	LEFT	CFM	LEFT	CFM
.100	72.42	.100	55.70	.100	63	.100	56	.100	65.37	.100	61.64
.200	141.07	.200	107.50	.200	128	.200	101	.200	114.37	.200	100.99
.300	198.43	.300	138.10	.300	183	.300	141	.300	170.59	.300	132.76
.400	246.95	.400	168.10	.400	225	.400	169	.400	214.02	.400	140.34
.500	279.31	.500	186.60	.500	235	.500	176	.500	239.09	.500	139.87
.600	296.38	.600	195.30	.600	240	.600	176	.600	221.18	.600	143.19
.700	304.14	.700	200.10								

\*WITHOUT PIPE

“EQ Heads have the cleanest runners,  
they flow better than any other cast iron head.”

– Chad Lenker, Engine Builder, Ultimate Machine

“More power at a lower price.

EQ Cylinder Heads are one of the best kept secrets in racing.”

– Brian Blessington, IMCA Racer

# CYLINDER HEAD ADAPTORS

One of the first items we designed  
to help the rebuilder solve  
their problem!

## AH034 - Add a 7th Hole

Use early small block Chevrolet heads with  
6 exhaust bolt holes in place of 7 bolt hole  
heads. No need to sell your customer a  
different head or manifold.



AH034

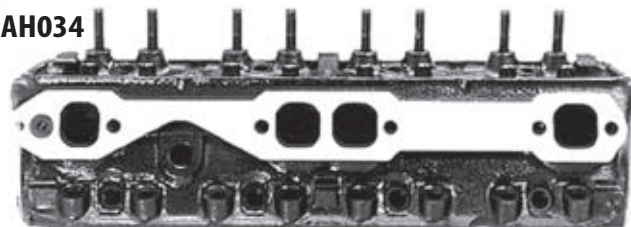



# ROLLER LIFTER RETAINERS



DESCRIPTION	YEARS	PART #
FORD 302 CID	86-97	EQ # RLR302* EQ # RLC302*
CHEVROLET SMALL BLOCK	86-97	EQ # RLR350* EQ # RLC350*
CHEVROLET 4.3L	87-92 #10046165 92-93 #10105916 94-UP #12551431	EQ # RLC350* EQ # RLR262* EQ # RLR263* EQ # RLR264*

\*RECLAIMED ITEM



# ROCKER ARM PRODUCTS



RAB351

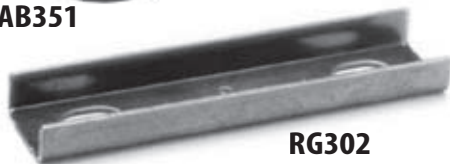

RG302



RS390R



RS171R

PART #	ITEM	DESCRIPTION
RAB351*	ROCKER ARM BAFFLE	FORD V8 302, 351C, M, W, 400, 429 & 460
RG302	ROCKER ARM GUIDE	FORD L6 300 1985-UP/302, 351W 1978 & UP
RS390R*	ROCKER ARM OIL SHIELD	FORD 330, 352, 360, 361, 390, 391 CID
RS171R*	ROCKER ARM OIL SHIELD	FORD 171 CID

\*RECLAIMED ITEM

# VALVE SPRING RETAINERS

MAKE	DESCRIPTION	PART #	PIECES/PACK
FORD	1986 - 1992 2.9L 177 CID	VSR244	6
FORD	1990 - 2000 4.0L 244 CID	VSR244	6
CHRYSLER	1992 - 2004 5.2L 318 CID	VSR318	8
CHRYSLER	1992 - 2002 5.9L 360 CID	VSR318	8



VSR244



VSR318

24/7 ONLINE ORDERING! VISIT US ON THE WEB AT [WWW.ENGINEQUEST.COM](http://WWW.ENGINEQUEST.COM)



# CYLINDER HEAD BOLT SETS

If you need new head bolt sets, you've come to the right place! We carry one of the most complete lines in the industry. Remember, all of ours are per engine!



PART #	MFG	LITERS	CID	NOTES	YEARS	CLEVITE	CORTECO	FELPRO	PIONEER	ROL	SBI	TOPLINE	VICTOR
HB150N	AMC	2.5	150	1/2" HEAD BOLTS	83-96								
HB259N	AMC	4.0	242		86-96						220-1090		
HB231N	BUICK	3.3	204		89-93	216-7057 (2)		ES74031		MM23193 (2)	220-1024		GS33233 (2)
HB231N	BUICK	3.8	231	VIN "L"- "C"- "W"	86-95	216-7057 (2)		ES74031		MM23193 (2)	220-1024		GS33233 (2)
HB181N	BUICK	3.0	181		85-88	216-7044 (2)	66563	ES72726		MM22751 (2)	220-1012		GS33255 (2)
HB233N	BUICK	3.8	231	VIN "3"	86-88	216-7058 (2)	67314	ES74022		MM23190			GS33237 (2)
HB123N	CHEVROLET	2.0	121	OHV ALUM HEAD	87-89			ES72158	S-121				GS33284
HB133N	CHEVROLET	2.2	134	OHV ALUM HEAD	90-99		67318	ES74016		MM23303	220-1025		GS33294
							67397						GS33267
HB173N	CHEVROLET	2.8	173		80-86	216-7054 (2)	67170	ES72857 (2)	S-173	MM23022	220-1019		GS33223 (2)
HB189N	CHEVROLET	2.8	173	VIN "W"	86-94		67311	ES74018	S-173-A	MM23188	220-1019		GS33224
													GS33225
HB189N	CHEVROLET	3.1	189	VIN "T"- "W" EXCEPT CAVALIER	86-94		67311	ES74018	S-173-A	MM23188	220-1019		GS33224
													GS33225
HB190N	CHEVROLET	3.1	189	VIN "M"	94-96	216-7034 (2)	67312	ES74019		MM23236	220-1031		
HB207N	CHEVROLET	3.1	189	VIN "J"	96-01			ES72892					
HB207N	CHEVROLET	3.4	207	VIN "E"	00-01			ES72892					
HB262N	CHEVROLET	4.3	262	V6, W/O SHOULDER	85-97	216-7027 (2)		ES74034 (2)					GS33286 (2)
HB263N	CHEVROLET	4.3	262	V6, W/SOULDER	97-06	216-7027 (2)		ES74034 (2)					
HB349N	CHEVROLET	4.8	294	TRUCK	99-03			ES72173 (2)					
HB350N	CHEVROLET	5.0	305	SMALL BLOCK V8	66-97	216-7026 (2)	67315 (2)	ES72856 (2)	S-327 (2)	MM23184 (2)	220-1018 (2)		GS33285 (2)
HB305N	CHEVROLET	5.0	305	SMALL BLOCK V8	96-01								
HB349N	CHEVROLET	5.3	325		99-03								
HB350N	CHEVROLET	5.7	350	SMALL BLOCK V8	66-97	216-7026 (2)	67315 (2)	ES72856 (2)	S-327 (2)	MM23184 (2)	220-1018 (2)		GS33285 (2)
HB305N	CHEVROLET	5.7	350	SMALL BLOCK V8	96-01								
HB349N	CHEVROLET	5.7	346		97-03								
HB454N	CHEVROLET	6.0	366	BIG BLOCK V8	66-94	216-7032 (2)			S-454 (2)				GS33287 (2)
HB349N	CHEVROLET	6.0	364		99-03								
HB381N	CHEVROLET	6.2	381	DIESEL	82-93	216-7014 (2)	67319 (2)	ES72724 (2)		MM23025 (2)	220-1010 (2)		GS33193 (2)
HB454N	CHEVROLET	6.5	396	BIG BLOCK V8	70-72	216-7032 (2)			S-454 (2)				GS33287 (2)
HB381N	CHEVROLET	6.5	395	DIESEL	92-01	216-7014 (2)	67319 (2)	ES72724 (2)		MM23025 (2)	220-1010 (2)		GS33193 (2)
HB350N	CHEVROLET	6.6	400	SMALL BLOCK V8	66-97	216-7026 (2)	67315 (2)	ES72856 (2)	S-327 (2)	MM23184 (2)	220-1018 (2)		GS33285 (2)
HB454N	CHEVROLET	7.0	427	BIG BLOCK V8	66-94	216-7032 (2)			S-454 (2)				GS33287 (2)
HB454N	CHEVROLET	7.4	454	BIG BLOCK V8	70-98	216-7032 (2)			S-454 (2)				GS33287 (2)
HB143N	CHRYSLER	2.0	2000CC	SOHC VIN "C"	95-00		67606	ES72157			220-1074	HBC27	
HB145N	CHRYSLER	2.0	2000CC	DOHC VIN "Y"	95-00			ES72166			220-1072/79	HBC26	
HB134N	CHRYSLER	2.2	135	10 MM	81-85	216-7104	66566	ES72118	S-135	MM23013	220-1000		GS33250
HBW134	CHRYSLER	2.2	135	10 MM WASHER SET	81-85								
HB135N	CHRYSLER	2.2	135	11 MM	86-94	216-7015	66565	ES72723	S-153	MM22675	220-1009	HBC25	GS33184
HBW135	CHRYSLER	2.2	135	11 MM WASHER SET	81-85								
HB135N	CHRYSLER	2.5	153	11MM	86-95	216-7015	66565	ES72723	S-153	MM22675	220-1009	HBC25	GS33184
HBW135	CHRYSLER	2.2	135	11 MM WASHER SET	81-85								
HB156N	CHRYSLER	2.6	2600CC		81-90			ES72860	S-156	MM23187	220-1022	HBC23	GS33325
HBW180	CHRYSLER	2.6	2600CC	HEAD BOLT WASHER SET	81-90								
HB166N	CHRYSLER	2.7	166	DOHC VIN "R", VIN "U"	98-04			ES72894 (2)			220-1077 (2)	HBC31	
HB180N	CHRYSLER	3.0	181		87-96		67320	ES72859	S-181 (2)	MM23014	220-1021	HBM19	GS33327
HBW180	CHRYSLER	3.0	181	HEAD BOLT WASHER SET	87-96								
HB197N	CHRYSLER	3.2	197	CONCORD SOHC VIN "J"	98-01			ES72895 (2)					
HB202N	CHRYSLER	3.3	201		90-01		67153	ES72849		MM23012	220-1017		GS33251 (2)
								ES72163					
HB197N	CHRYSLER	3.5	215	CONCORD SOHC VIN "G"	98-04			ES72895 (2)			220-1086 (2)		
HB202N	CHRYSLER	3.8	231		90-01		67153	ES72849		MM23012	220-1017		GS33251 (2)
								ES72163					
HB239N	CHRYSLER	3.9	239	VIN "X" MAGNUM	92-03			ES71038					
HB318N	CHRYSLER	5.2	318		92-04			ES71308-1					
HB318N	CHRYSLER	5.9	360		92-03			ES71308-1					
HB149N	DODGE	2.5	150	DAKOTA	98-02			ES72896					

ALL ORANGE LISTINGS ARE TORQUE-TO-YIELD



CUSTOMER SERVICE • MONDAY - FRIDAY 7 AM - 5 PM PACIFIC TIME • TOLL FREE 800.426.8771 • LOCAL 702.649.7776 • FAX 702.649.6777

# CYLINDER HEAD BOLT SETS



**If you need new head bolt sets, you've come to the right place! We carry one of the most complete lines in the industry. Remember, all of ours are per engine!**

PART #	MFG	LITERS	CID	NOTES	YEARS	CLEVITE	CORTECO	FELPRO	PIONEER	ROL	SBI	TOPLINE	VICTOR
HB098N	FORD	1.6	98	4 CYL	81-85	216-7017	76996	ES72672	S-116	MM22538	220-1008		GS33163
HB098N	FORD	1.9	116		85-96	216-7017	76996	ES72672	S-116	MM22538	220-1008		GS33163
HB098N	FORD	2.0	122	SOHC/TRACE/ESCORT VIN "P"	97-01	216-7017	76996	ES72672	S-116	MM22538	220-1008	HBFD7	GS33163
HB140N	FORD	2.3	140	OHC	74-97		67324	ES72137		MM23016	220-1006		GS33328
HB141N	FORD	2.3	140	HSC	84-92								GS33292
HB141N	FORD	2.5	153	HSC	84-92								GS33292
HB171N	FORD	2.8	171	CAR & TRUCK	76-87								
HB177N	FORD	2.9	177		86-90	216-7054 (2)	66568	ES72794	S-177	MM23017	220-1016		GS33221
HB183N	FORD	3.0	183	VIN "U"	86-98	216-7021 (2)	67325	ES72136	S-182 (2)	MM23019	220-1005		GS33220 (2)
HB184N	FORD	3.0	183	S.H.O. VIN "Y"	89-95		67326	ES74030	PF-423	MM23251	220-1029		
HB185N	FORD	3.0	183	VIN "2"	98-04			ES72174 (2)					
HB230N	FORD	3.8	232		82-88	216-7043 (2)	67329 (2)	ES72129 (2)	S-230 (1)	MM23182 (2)	220-1002 (2)		GS33194 (2)
HB184N	FORD	3.2	195	DOHC VIN "P"	93-95		67326	ES74030	PF-423	MM23251	220-1029		
HB232N	FORD	3.8	232		89-95	216-7036 (2)	67328 (2)	ES72131 (2)	S-232	MM23020 (2)	220-1004 (2)		GS33219 (2)
HB256N	FORD	3.8	232		96-99		67327 (2)	ES72160 (2)		MM23213 (2)	220-1034 (2)		GS33317
HB256N	FORD	3.9	238	OHV, VIN "4"	04			ES72160 (2)					
HB177N	FORD	4.0	244		90-01	216-7054 (2)	66568	ES72794	S-177	MM23017	220-1016		GS33221
HB256N	FORD	4.2	256	VIN "2"	96-04		67327 (2)	ES72160 (2)		MM23213 (2)	220-1034 (2)		
HB280N	FORD	4.6	250	SOHC / DOHC	91-04	216-7099 (2)	67330 (2)	ES72798 (2)	S-280 (2)	MM23021 (2)	220-1023 (2)		GS33269
HB302N	FORD	5.0	302		70-01	216-7038 (2)	67331 (2)	ES72155 (2)	S-302 (2)		220-1033 (2)		
HB280N	FORD	5.4	330	SOHC	97-04	216-7099 (2)	67330 (2)	ES72798 (2)	S-280 (2)	MM23021 (2)	220-1023 (2)		GS33269
HB370N	FORD	6.1	370	TRUCK VIN "H"	79-91								
HB413N	FORD	6.8	413	V10 VIN "S"	97-03						220-1071 (2)		
HB370N	FORD	7.0	429	TRUCK	79-91								
HB370N	FORD	7.5	460	VIN "L"- "G"	68-99								
HB061N	GEO	1.0	61	SPRINT 3 CYL	85-92	216-7024	67317	ES74015		MM23302			GS33242
HB097N	GEO	1.6	98	4 CYL G16KC (SUZUKI ENGINE)	89-95							HBS24	GS33244
HB150N	JEEP	2.5	150	1/2" HEAD BOLT"	83-96								
HB149N	JEEP	2.5	150	CHEROKEE, WRANGLER	97-02			ES72896					
HB259N	JEEP	4.0	242		86-96						220-1090		
HB244N	JEEP	4.0	244	GRAND CHEROKEE, WRANGLER	96-04			ES71102			220-1091		
HB177N	MAZDA	4.0	4015CC	VIN "X", "8X", "ZL" (O.H.C.)	91-00	216-7054 (2)	66568	ES72794	S-177	MM23017	220-1016		GS33221
HB156N	MAZDA	2.6	2600CC		81-90			ES72860	S-156	MM23187	220-1022	HBC23	GS33325
HBW180	MITSUBISHI	2.6	2600CC	HEAD BOLT WASHER SET	81-90								
HB180N	MITSUBISHI	3.0	181		87-96		67320	ES72859	S-181 (2)	MM23014	220-1021	HBM19	GS33327
HBW180	MITSUBISHI	3.0	181	HEAD BOLT WASHER SET	87-96								
HB143N	NEON	2.0	2000CC	SOHC	95-00		67606	ES72157			220-1074	HBC27	
HB145N	NEON	2.0	2000CC	DOHC	95-00			ES72166			220-1072/79	HBC26	
HB142N	OLDSMOBILE	2.3	138	QUAD 4 DOHC VIN "A", "D"	88-96	216-7123	66561	ES72727	S-138	MM23023	220-1013		GS33239
HB142N	OLDSMOBILE	2.3	138	QUAD OHC VIN "3"	92-94			ES72727					
HB122N	PONTIAC	1.8	112	VIN "O", "J"	82-86	216-7020	66560	ES72728	S-112B	MM22750	220-1014		GS33189 GS33222
HB122N	PONTIAC	2.0	122	VIN "H", "K", "M"	87-94	216-7020	66560	ES72728	S-112B	MM22750	220-1014		GS33189 GS33222
HB151N	PONTIAC	2.5	151		80-83								
HB152N	PONTIAC	2.5	151	VIN "R"	84-91	216-7019	66562	ES72733	S-151	MM22752	220-1015		GS33190
HB153N	PONTIAC	2.5	151	VIN "U"	85-91	216-7122	67310	ES72858	S-151-U	MM23186	220-1020		GS33266
HB199N	TOYOTA	2.0	1988CC	CAMRY 3SFE	87-89		67338	ES74032		MM23308	220-1060		
HB216N	TOYOTA	2.2	2164CC	CAMRY 5SFE	90-01		67337	ES72154		MM23309			
							67494						
HB144N	TOYOTA	2.4	2366CC	22REC	85-96							HBT08	
HB179N	TOYOTA	3.0	2959CC	3VZE SOHC / TRUCK	88-95						220-1052	HBT031	
HBW180	TOYOTA	3.0	2959CC	3VZE SOHC / TRUCK	88-95								
				HEAD BOLT WASHER SET									
HB206N	TOYOTA	3.4	3377CC	5VZFE TRUCK	95-01			ES72168 (2)			220-1048	HBT033	

ALL ORANGE LISTINGS ARE TORQUE-TO-YIELD

24/7 ONLINE ORDERING! VISIT US ON THE WEB AT [WWW.ENGINEQUEST.COM](http://WWW.ENGINEQUEST.COM)



# TIMING COVER APPLICATIONS

**N** = NEW **RM** = REMANUFACTURED **R** = RECLAIMED (SPECIAL ORDER ONLY)

**WE CARRY THE LARGEST TIMING COVER SELECTION IN THE INDUSTRY!**

**REMANUFACTURING INCLUDES:**

- ALL NEW INTERNAL PARTS (GEARS, SHAFTS, SPRINGS & PLUNGERS)
- FULL IDLE BENCH TESTING (200 DEGREE, 10 WEIGHT OIL)
- OIL PRESSURE MEETS OR EXCEEDS OEM
- RELIEF VALVE OPERATION CHECKED
- ALL CASTINGS THOROUGHLY CLEANED AND INSPECTED
- ALL GASKET SURFACES CHECKED FOR FLATNESS
- OIL FLOW (GPM) MEETS OR EXCEEDS OEM
- FULLY WARRANTED

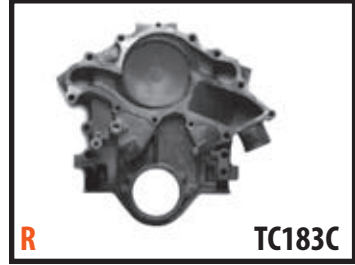
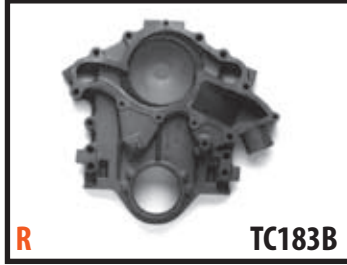
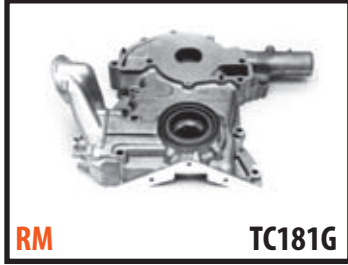
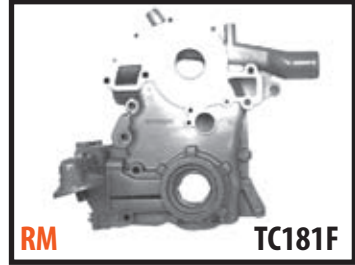
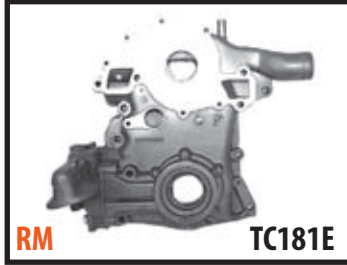
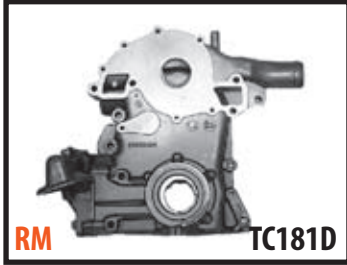
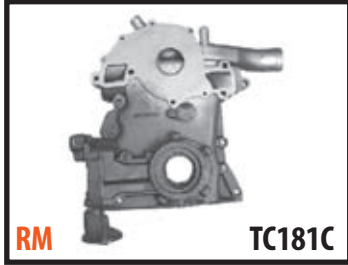
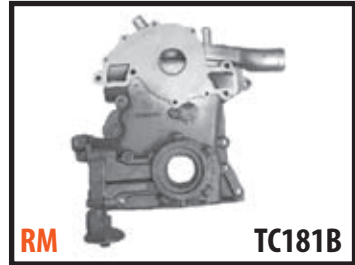
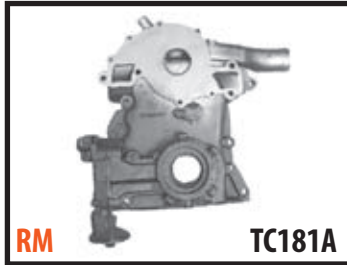
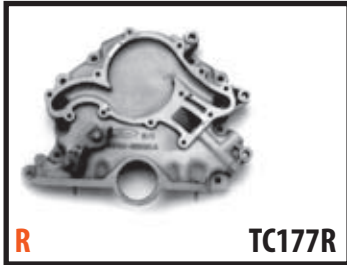
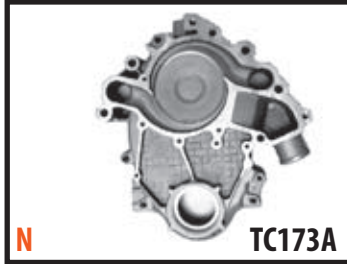
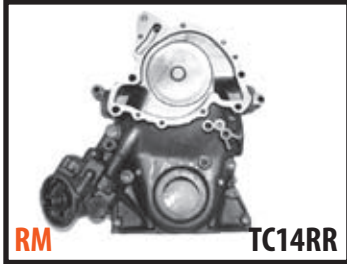

**RECLAIMED INCLUDES:**

- HAVE BEEN CLEANED
- GASKET SURFACES REFACED
- ALL OPENINGS CHECKED



# TIMING COVER APPLICATIONS

N = NEW RM = REMANUFACTURED R = RECLAIMED (SPECIAL ORDER ONLY)

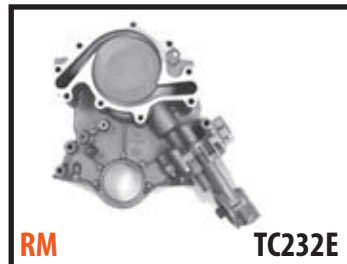
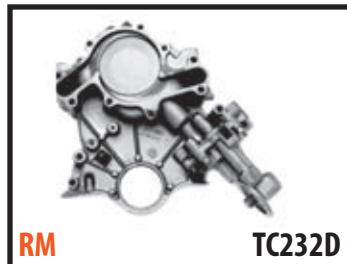
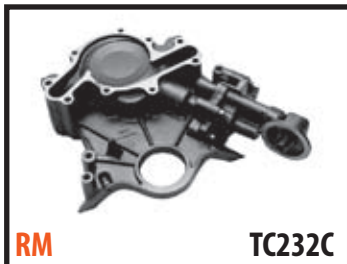
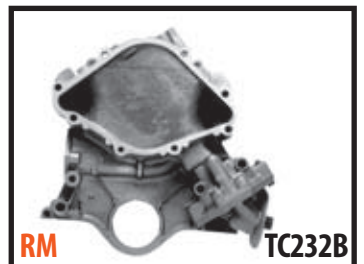
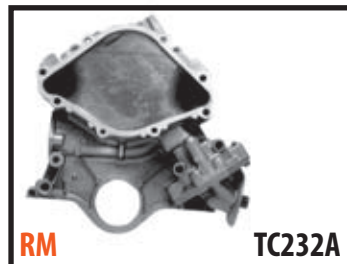
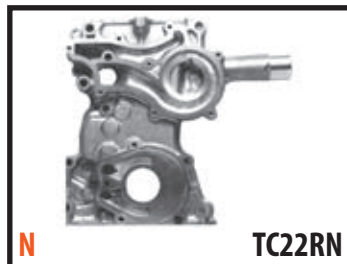
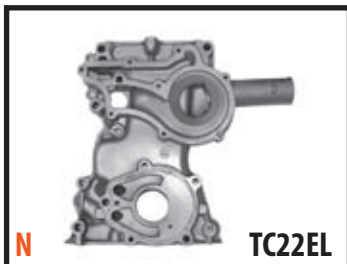
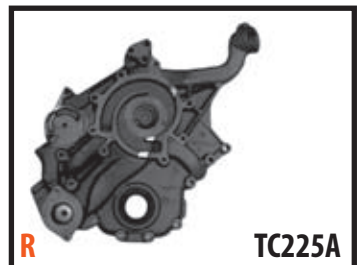
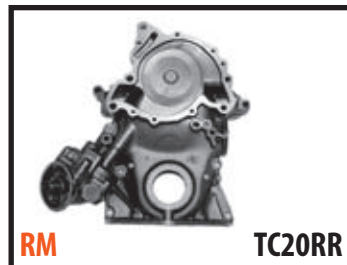
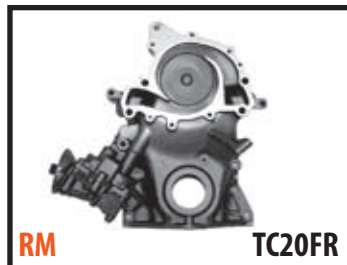
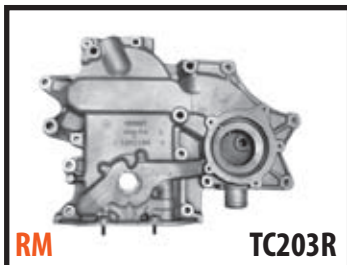
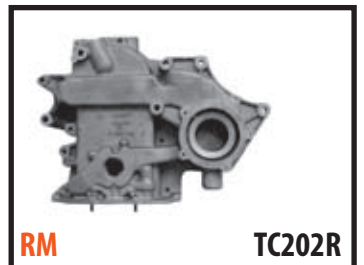
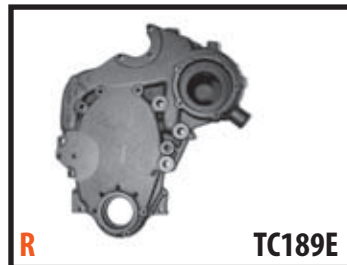
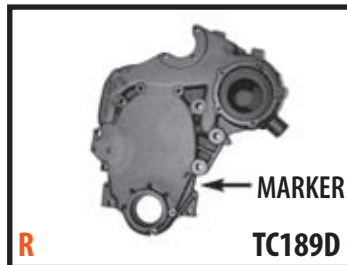
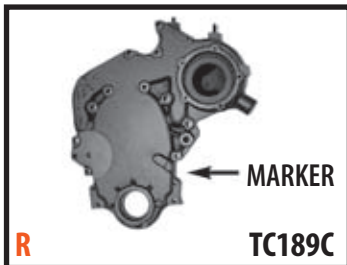
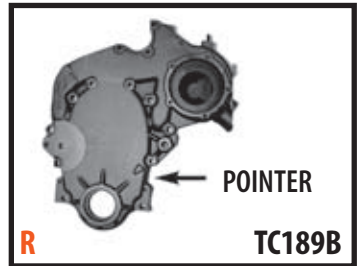
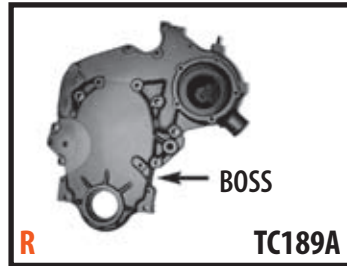
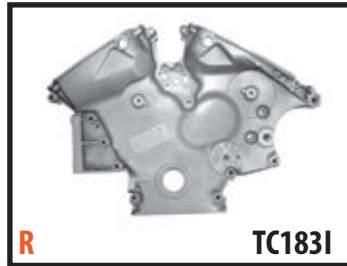
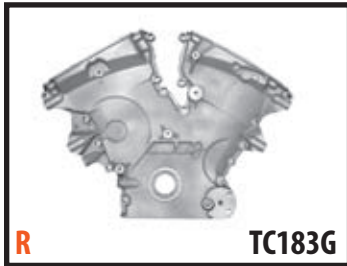
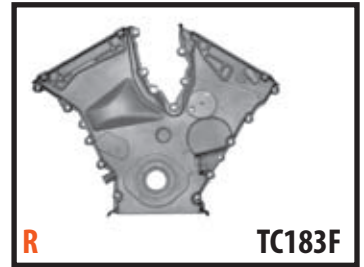
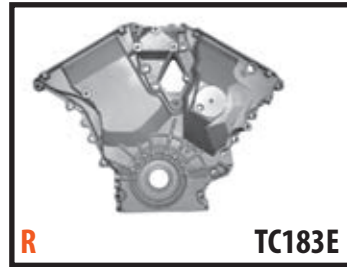
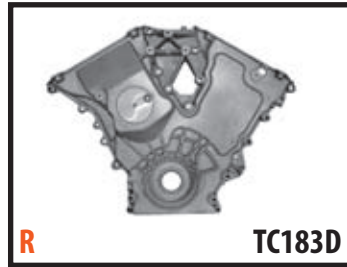

**RECLAIMED INCLUDES:**

- HAVE BEEN CLEANED
- GASKET SURFACES REFACED
- ALL OPENINGS CHECKED

# TIMING COVER APPLICATIONS

N = NEW RM = REMANUFACTURED R = RECLAIMED (SPECIAL ORDER ONLY)

VISIT  
[WWW.ENGINEQUEST.COM](http://WWW.ENGINEQUEST.COM)  
 FOR LARGER IMAGES

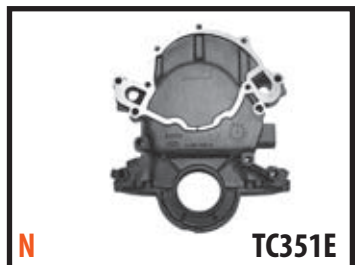
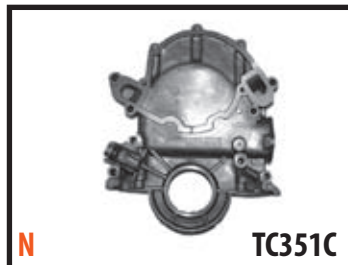
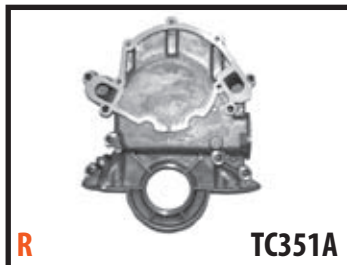
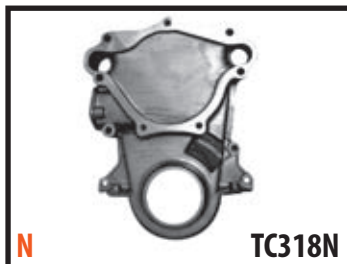
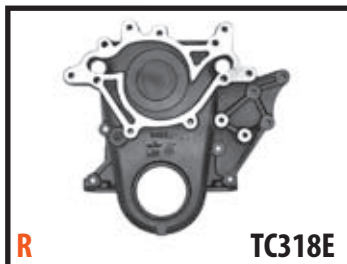
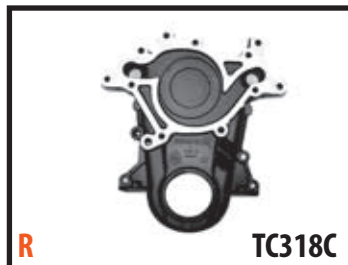
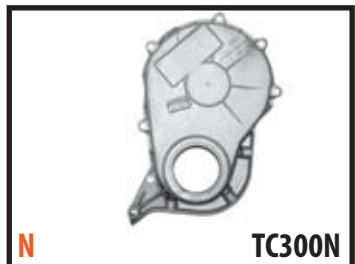
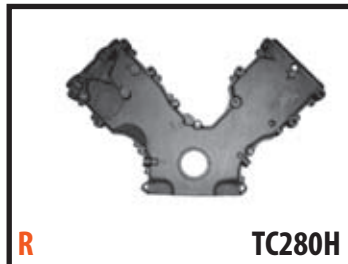
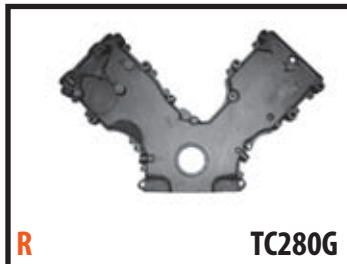
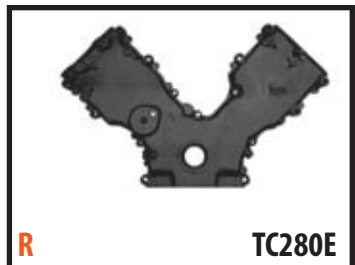
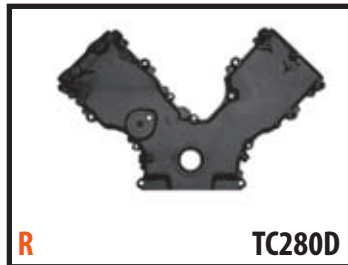
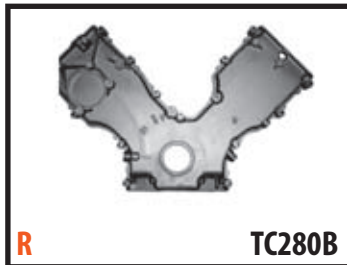
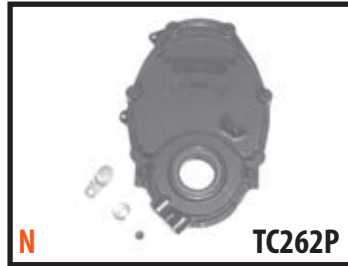
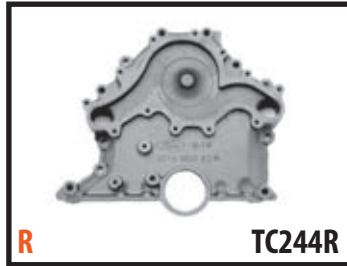

### RECLAIMED INCLUDES:

- HAVE BEEN CLEANED
- GASKET SURFACES REFACED
- ALL OPENINGS CHECKED











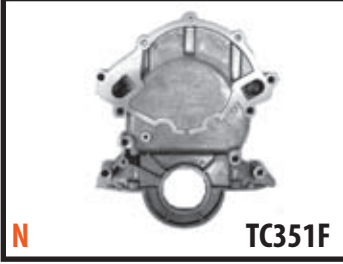
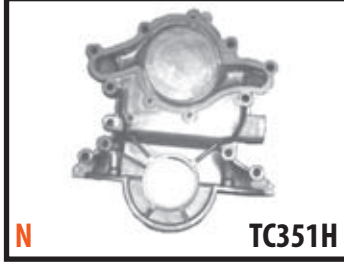

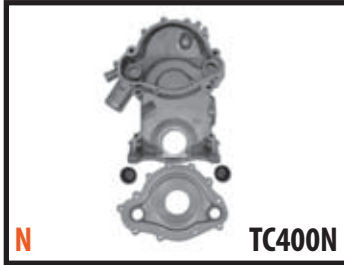
# TIMING COVER APPLICATIONS

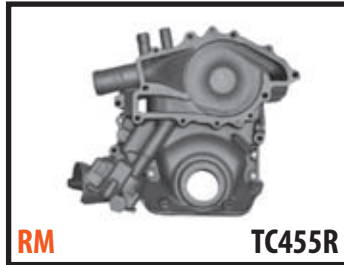
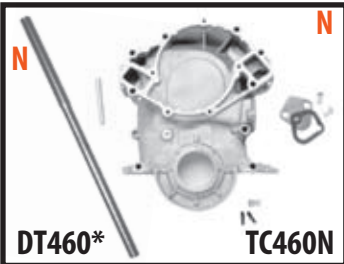
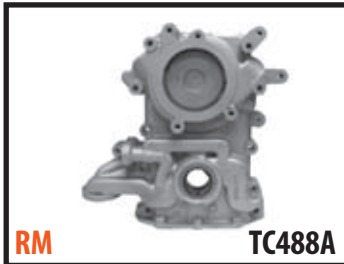
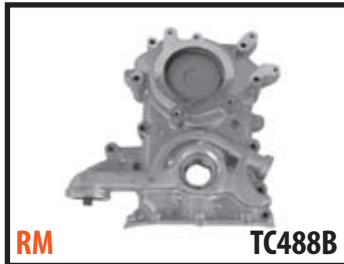

VISIT  
**WWW.ENGINEQUEST.COM**  
 FOR LARGER IMAGES

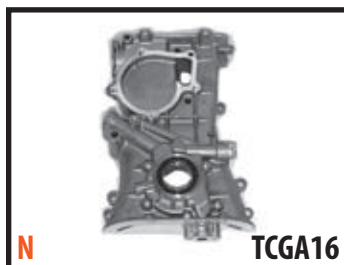
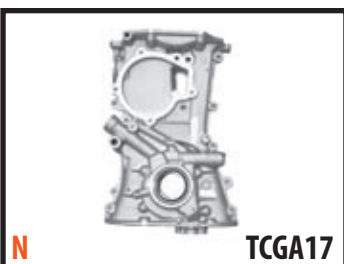
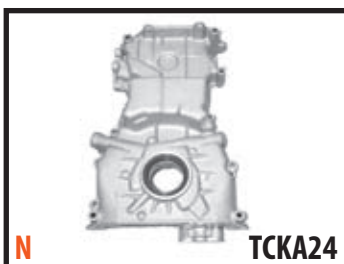
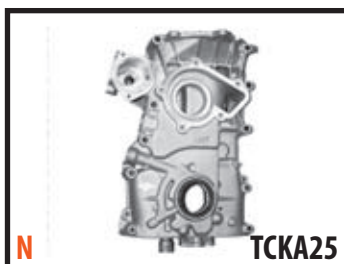
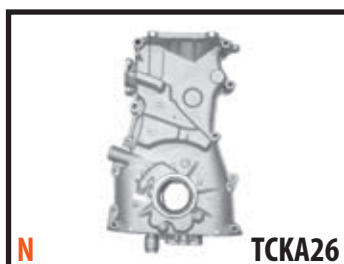
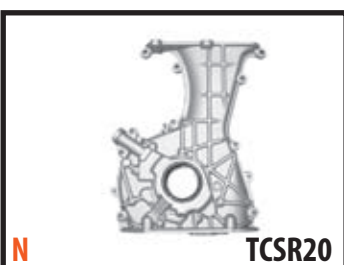
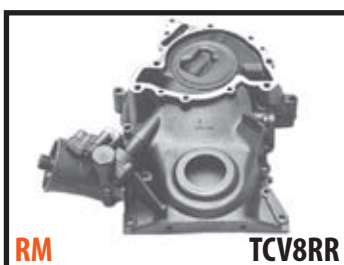
**N = NEW**   **RM = REMANUFACTURED**   **R = RECLAIMED (SPECIAL ORDER ONLY)**

 <b>N</b> TC351F	 <b>N</b> TC351H
 <b>N</b> TC361N	 <b>N</b> TC400N
 <b>N</b> TC454C	 <b>RM</b> TC455R
 <b>N</b> TC460N DT460*	 <b>RM</b> TC488A
 <b>RM</b> TC488B	 <b>N</b> TCC305
 <b>N</b> TCC349	 <b>N</b> TCC350
 <b>N</b> TCC454	 <b>N</b> TCGA16
 <b>N</b> TCGA17	 <b>N</b> TCKA24
 <b>N</b> TCKA25	 <b>N</b> TCKA26
 <b>N</b> TCSR20	 <b>RM</b> TCV8RR
 <b>N</b> TM350C	 <b>N</b> TM454C

\*ORDER SEPARATELY

**RECLAIMED INCLUDES:**  
 • HAVE BEEN CLEANED • GASKET SURFACES REFACED • ALL OPENINGS CHECKED

24/7 ONLINE ORDERING! VISIT US ON THE WEB AT [WWW.ENGINEQUEST.COM](http://WWW.ENGINEQUEST.COM)



# TIMING COVER APPLICATIONS

PART #	MFG	VEHICLE	ENG	LITERS	YEARS	CASTING # / OEM #	NOTES	TYPE	HOLLANDER #
TC242R	AMC		150	2.5	83-02	53005768, 53020221, J3225186, 53020233		N	308-219A, 219B, 382
TC242R	AMC		232	3.8	75-79	53005768, 53020221, J3225186, 53020233		N	308-219A, 219B, 382
TC242R	AMC		242	4.0	93-01	53005768, 53020221, J3225186, 53020233		N	308-219A, 219B, 382
TC242R	AMC		258	4.2	75-86	53005768, 53020221, J3225186, 53020233		N	308-219A, 219B, 382
TC361N	AMC		290	4.7	66-69	J8129373, 3226242 (OIL FILTER HOUSING)		N	308-218A, B, C, D
TC361N	AMC		304	5.0	70-81	J8129373, 3226242 (OIL FILTER HOUSING)		N	308-218A, B, C, D
TC361N	AMC		343	5.6	67-69	J8129373, 3226242 (OIL FILTER HOUSING)		N	308-218A, B, C, D
TC361N	AMC		360	5.9	70-91	J8129373, 3226242 (OIL FILTER HOUSING)		N	308-218A, B, C, D
TC361N	AMC		390	6.4	68-70	J8129373, 3226242 (OIL FILTER HOUSING)		N	308-218A, B, C, D
TC361N	AMC		401	6.6	70-78	J8129373, 3226242 (OIL FILTER HOUSING)		N	308-218A, B, C, D
TS042	BUICK		V6		78-85		NEOPRENE TIMING COVER SEAL	N	
TC14FR	BUICK	FWD CAR	181	3.0	82-85		14 BOLT OIL PAN	RM	308-211
TC181A	BUICK	CAR	181	3.0	85	25523276	SPLINED PUMP, 1 BYPASS NIPPLE	RM	
TC181B	BUICK	CAR	181	3.0	86-86	25524607	SPLINED PUMP, 2 BYPASS NIPPLES	RM	
TC181C	BUICK	CAR	181	3.0	86-88	25524607, 25530946, 25531877, 25526382	2 FLATS ON DRIVE, 2 BYPASS NIPPLES, REAR FACING OFA	RM	308-154A
TC181D	BUICK	CAR	181	3.0	86-88	25526382, 25531877, 25529279, 25530946	2 FLATS ON DRIVE, 2 BYPASS NIPPLES, FRONT FACING OFA, WITH CAM SENSOR HOLE	RM	308-154B
TC20FR	BUICK	CAR FWD	181	3.0	85-85	25522652	20 BOLT OIL PAN	RM	308-210
TC14RR	BUICK	RWD CAR	196	3.2	78-79		14 BOLT OIL PAN	RM	308-208
TC181E	BUICK	CAR	204	3.3	89-90	25532382, 25533496	2 FLATS ON DRIVE, 2 BYPASS NIPPLES, FRONT FACING OFA, WITH CAM SENSOR HOLE	RM	308-267
TC14FR	BUICK	FWD CAR	231	3.8	84-85		14 BOLT OIL PAN	RM	308-211
TC14RR	BUICK	RWD CAR	231	3.8	78-84		14 BOLT OIL PAN	RM	308-208
TC20FR	BUICK	CAR FWD	231	3.8	85-85	25522652	20 BOLT OIL PAN	RM	308-210
TC20RR	BUICK	CAR RWD	231	3.8	85-89	25522651	20 BOLT OIL PAN	RM	308-209
TC181C	BUICK	CAR	231	3.8	86-87	25524607, 25530946, 25531877, 25526382	2 FLATS ON DRIVE, 2 BYPASS NIPPLES, REAR FACING OFA	RM	308-154A
TC181D	BUICK	CAR	231	3.8	86-88	25526382, 25531877, 25529279, 25530946	2 FLATS ON DRIVE, 2 BYPASS NIPPLES, FRONT FACING OFA, WITH CAM SENSOR HOLE	RM	308-154B
TC181E	BUICK	CAR	231	3.8	89-90	25532382, 25533496	2 FLATS ON DRIVE, 2 BYPASS NIPPLES, FRONT FACING OFA, WITH CAM SENSOR HOLE	RM	308-267
TC181F	BUICK	CAR	231	3.8	89-90	25532382, 25533496	2 FLATS ON DRIVE, 2 BYPASS NIPPLES, FRONT FACING OFA, WITHOUT CAM SENSOR HOLE	RM	308-212
TC181G	BUICK	CAR	231	3.8	93-95	24502348, 24503274		RM	308-392
TC14RR	BUICK	RWD CAR	252	4.1	80-84		14 BOLT OIL PAN	RM	308-208
TCV8RR	BUICK		300	4.9	65-66	1254992		RM	308-116
TCV8RR	BUICK		340	5.6	66-67	1254992		RM	308-116
TCV8RR	BUICK		350	5.7	68-76	1254992		RM	308-116
TC455R	BUICK	CAR	400	6.6	67-69			RM	
TC455R	BUICK	CAR	430	7.0	67-69			RM	
TC455R	BUICK	CENTURY, REGAL, RIVIERA	455	7.5	67-76			RM	
TC173A	CHEVROLET	S10	173	2.8	82-86	14100617, 12509037	FOR GOODWRENCH ENGINE	N	
TC173B	CHEVROLET	BLAZER, CAMARO, FIREBIRD, S10	173	2.8	87-92	14090537, 10049009		N	308-137
TC173C	CHEVROLET	BLAZER, CAMARO, FIREBIRD, S10	173	2.8	82-86	14024263, 14033526, 14048323		N	308-136
TC173B	CHEVROLET	CAMARO, FIREBIRD	189	3.1	90-92	14090537, 10049009		N	308-137
TC189A	CHEVROLET		189	3.1	-	10070144	BOSS @ 2 O'CLOCK	R	
TC189B	CHEVROLET		189	3.1	-	10071044	POINTER @ 2 O'CLOCK	R	
TC189C	CHEVROLET		189	3.1	-	10226111	MARKER @ 2 O'CLOCK	R	
TC189D	CHEVROLET		189	3.1	-	24505739, 34505740	MARKER @ 2 O'CLOCK	R	
TC189E	CHEVROLET		189	3.1	-	24505739, 34505740		R	
TC262P	CHEVROLET	CAR & TRUCK	262	4.3	96-03	12554555, 12554557	WITH OPEN SENSOR HOLE AND PLUG	N	308-434
TCC350	CHEVROLET	CAR & TRUCK	305	5.0	79-79	10243963	METAL 8" BALANCER	N	308-128
TCC305	CHEVROLET	CAR & TRUCK	305	5.0	80-95	12531283, 12523974	METAL 6-3/4" BALANCER	N	308-130, 131

**N = NEW RM = REMANUFACTURED R = RECLAIMED (SPECIAL ORDER ONLY)**



CUSTOMER SERVICE • MONDAY - FRIDAY 7 AM - 5 PM PACIFIC TIME • TOLL FREE 800.426.8771 • LOCAL 702.649.7776 • FAX 702.649.6777



# TIMING COVER APPLICATIONS

**N = NEW RM = REMANUFACTURED R = RECLAIMED (SPECIAL ORDER ONLY)**

PART #	MFG	VEHICLE	ENG	LITERS	YEARS	CASTING # / OEM #	NOTES	TYPE	HOLLANDER #
TC350M	CHEVROLET	MARINE	305	5.0	86-95		METAL 6-3/4" BALANCER, UNCHROMED TIMING MARKER	N	NEW
TM350M	CHEVROLET	MARINE	305	5.0	86-95		UNCHROMED TIMING MARKER	N	NEW
TC350C	CHEVROLET	CAR & TRUCK	305	5.0	79-95		CHROME	N	NEW
TM350C	CHEVROLET	CAR & TRUCK	305	5.0	79-95		CHROME TIMING MARKER	N	NEW
TC350P	CHEVROLET	CAR & TRUCK	305	5.0	96-02	12558343, 12562818	WITH OPEN SENSOR HOLE AND PLUG	N	308-436
TCC350	CHEVROLET	CAR & TRUCK	350	5.7	67-79	10243963	METAL 8" BALANCER	N	308-128
TCC305	CHEVROLET	CAR & TRUCK	350	5.7	80-95	12531283, 12523974	METAL 6-3/4" BALANCER	N	308-130, 131
TC350C	CHEVROLET	CAR & TRUCK	350	5.7	67-95		CHROME	N	
TM350C	CHEVROLET	CAR & TRUCK	350	5.7	67-95		CHROME TIMING MARKER	N	
TM350	CHEVROLET	CAR & TRUCK	350	5.7	67-95		UNCHROMED TIMING MARKER	N	
TCC349	CHEVROLET	CAR & TRUCK	350	5.7	UP TO 85		UNCHROMED TIMING COVER	N	
TC350M	CHEVROLET	MARINE	350	5.7	86-95		METAL 6-3/4" BALANCER, UNCHROMED TIMING MARKER	N	NEW
TM350M	CHEVROLET	MARINE	350	5.7	86-95		UNCHROMED TIMING MARKER	N	NEW
TC350P	CHEVROLET	CAR & TRUCK	350	5.7	96-02	12558343, 12562818	WITH OPEN SENSOR HOLE AND PLUG	N	308-436
TCC350	CHEVROLET	CAR & TRUCK	400	6.6	70-80	10243963	METAL 8" BALANCER	N	308-128
TC350C	CHEVROLET	CAR & TRUCK	400	6.6	70-80		CHROME	N	
TCC454	CHEVROLET	CAR & TRUCK	396	6.5	65-70	3885048, 330850	BLACK PAINTED	N	308-158A, B
TC454C	CHEVROLET	CAR & TRUCK	396	6.5	65-70	3885048, 330850	CHROME	N	308-158A, B
TM454C	CHEVROLET	CAR & TRUCK	396	6.5	65-70		CHROME TIMING MARKER	N	
TCC454	CHEVROLET	CAR & TRUCK	427	7.0	68-90	3885048, 330850	BLACK PAINTED	N	308-158A, B
TC454C	CHEVROLET	CAR & TRUCK	427	7.0	68-90	3885048, 330850	CHROME	N	308-158A, B
TM454C	CHEVROLET	CAR & TRUCK	427	7.0	68-90		CHROME TIMING MARKER	N	
TCC454	CHEVROLET	CAR & TRUCK	454	7.4	68-90	3885048, 330850	BLACK PAINTED	N	308-158A, B
TC454C	CHEVROLET	CAR & TRUCK	454	7.4	68-90	3885048, 330850	CHROME	N	308-158A, B
TM454C	CHEVROLET	CAR & TRUCK	454	7.4	68-90		CHROME TIMING MARKER	N	
TC202R	CHRYSLER	CARAVAN, DYNASTY IMPERIAL, NEW YORKER, TOWN & COUNTRY, VOYAGER	201	3.3	90-97	4448877		RM	308-316
TC203R	CHRYSLER	LH CAR ONLY	201	3.3	90-96	5211164		RM	
TC225A	CHRYSLER	DAKOTA	225	3.7	04-05	53020793			308-569
TC225A	CHRYSLER	DURANGO	225	3.7	04-05	53020793			308-569
TC225A	CHRYSLER	PICKUP	225	3.7	02-05	53020793			308-569
TC202R	CHRYSLER	CARAVAN, DYNASTY, IMPERIAL, NEW YORKER, TOWN & COUNTRY, VOYAGER	231	3.8	94-00	4448877		RM	308-316
TC318B	CHRYSLER	CAR, TRUCK & VAN	239	3.9	79-91	2951698, 3769966	2-1/4" SEAL HOLE	R	308-245B
TC318C	CHRYSLER	CAR, TRUCK & VAN	239	3.9	92-96	53006705		R	308-345
TC318D	CHRYSLER	CAR, TRUCK & VAN	239	3.9	97-02	53020196		R	308-491
TC318N	CHRYSLER	CAR, TRUCK & VAN	318	5.2	70-78	2951698, 3769966	3-3/16" SEAL HOLE	N	308-245A
TC318B	CHRYSLER	CAR, TRUCK & VAN	318	5.2	79-91	2951698, 3769966	2-1/4" SEAL HOLE	R	308-245B
TC318C	CHRYSLER	CAR, TRUCK & VAN	318	5.2	92-96	53006705		R	308-345
TC318D	CHRYSLER	CAR, TRUCK & VAN	318	5.2	97-02	53020196		R	308-491
TC318N	CHRYSLER	CAR, TRUCK & VAN	340	5.6	70-73	2951698, 3769966	3-3/16" SEAL HOLE	N	308-245A
TC318B	CHRYSLER	CAR, TRUCK & VAN	360	5.9	79-91	2951698, 3769966	2-1/4" SEAL HOLE	R	308-245B
TC318E	CHRYSLER	PICKUP, VAN, RAMCHARGER	360	5.9	90-93	4483753		R	308-346
TC318C	CHRYSLER	CAR, TRUCK & VAN	360	5.9	92-96	53006705		R	308-345
TC318D	CHRYSLER	CAR, TRUCK & VAN	360	5.9	97-02	53020196		R	308-491
TC318N	CHRYSLER	CAR, TRUCK & VAN	360	5.9	70-78	2951698, 3769966	3-3/16" SEAL HOLE	N	308-245A
TC488A	CHRYSLER	TRUCK	488	8.0	94-97	53005820, 53020971	PRESSURE RELIEF VALVE IS ON LEFT SIDE OF COVER	R	308-374
TC488B	CHRYSLER	TRUCK	488	8.0	98-03	53006826	CAN BE USED IN PLACE OF TC488A (PRESSURE RELIEF IS ON RIGHT SIDE OF COVER)	R	308-374
TC116I	FORD	CAR	116	1.9	85-90	E6FZ9019B	INNER, PLASTIC	N	308-283 & 284
TC141I	FORD	CAR & TRUCK	140	2.3	74-88	D4FZ6019C, E3ZZ6019B	INNER, PLASTIC	N	308-274
TC142I	FORD	CAR & TRUCK	140	2.3	89-94	F3ZZ6019B	INNER, PLASTIC	N	308-327
TC143I	FORD	CAR & TRUCK	140	2.3	95-99	F5Z76019C	INNER, PLASTIC	N	308-455
TC177R	FORD	BRONCO II, RANGER	177	2.9	87-92	86TM6059		R	308-295
TC183A	FORD	AEROSTAR, SABLE, TAURUS	183	3.0	86-90	E6AE6059AE, E9DE		R	308-299
TC183B	FORD	AEROSTAR, RANGER, SABLE, TAURUS	183	3.0	90-92	F1DE6059HA		R	308-300
TC183C	FORD	RANGER, SABLE, TAURUS	183	3.0	93-94	F5DE6059AB		R	308-409A
TC183D	FORD	SABLE, TAURUS	183	3.0	96-00	F6DE6D080BJ, F8DE6D080AB, F8DZ6019AA	CAM POSITION SENSOR UPPER RIGHT, CRANK POSITION SENSOR LOWER LEFT, BELT TENSIONER LEFT	R	308-450A, 450B
TC183E	FORD	SABLE, TAURUS	183	3.0	00-04	1F1E6D080AB, 2F1Z6019AA	CAM POSITION SENSOR UPPER RIGHT, CRANK POSITION SENSOR LOWER LEFT, BELT TENSIONER RIGHT	R	308-540A, 540B

# TIMING COVER APPLICATIONS

PART #	MFG	VEHICLE	ENG	LITERS	YEARS	CASTING # / OEM #	NOTES	TYPE	HOLLANDER #
TC183F	FORD	ESCAPE	183	3.0	01-04	1S7E6D080AD, 1S7Z6019BA	CAM POSITION SENSOR UPPER RIGHT, CRANK POSITION SENSOR LOWER RIGHT, BELT TENSIONER RIGHT	R	308-542
TC232A	FORD	CAR & TRUCK	232	3.8	82-85	E2AE6059DC	WITH MECHANICAL FUEL PUMP	RM	308-296
TC232B	FORD	CAR & TRUCK	232	3.8	86-87	E4AE6059B	WITH ELECTRIC FUEL PUMP	RM	308-297
TC232C	FORD	CAR & TRUCK	232	3.8	88-93	E7DE6059FA, D9DE6059BB		RM	308-350A
TC232D	FORD	CAR & TRUCK	232	3.8	94-95	F46E6059BA	WITH ECC MOUNT	RM	308-350B
TC232E	FORD	CAR & TRUCK	232	3.8	96-99	F65E6059AE, F65E6F008AD, F65EAD, F75E6F008AA, F75EAD		RM	308-451
TC300N	FORD	TRUCK & VAN	240	3.9	65-97	E5TE6019H		N	308-293
TC244R	FORD	AEROSTAR, EXPLORER, MOUNTAINEER, RANGER (OHV & SOHC.)	244	4.0	90-03	90TM6059, 95TM, 97JM		R	308-306, 470, 471A, 471B
TC232E	FORD	CAR & TRUCK	256	4.2	97-00	F65E6059AE, F65E6F008AD, F65EAD, F75E6F008AA, F75EAD		RM	308-451
TC280A	FORD	CROWN VICTORIA, GRAND MARQUEE, TOWN CAR	280	4.6	91-92	F1AE, F2AE, F1AZ6019A	DOES NOT HAVE ANY CAST AND DRILLED BOSSES FOR TENSIONER. HAS 15 SMALL 8.0MM MOUNTING BOLT HOLES.	R	308-326
TC280B	FORD	COUGAR, CROWN VICTORIA, MARQUEE, TOWN CAR, THUNDERBIRD	280	4.6	92-95	F3AW, F5AE, F5AZ9019A	HAS SIX CAST AND DRILLED BOSSES FOR TENSIONER. HAS 15 SMALL 8.0MM MOUNTING BOLT HOLES.	R	308-379A, 379B, 379C
TC280C	FORD	COUGAR, CROWN VICTORIA, GRAND MARQUEE, TOWN CAR, MUSTANG	280	4.6	96-00	F65AE, F7AE, F7ZE, F8ZE, F8ZZ6019CA	HAS SIX CAST AND DRILLED BOSSES FOR TENSIONER, 10 (LARGE) 10.0MM BOLT WHEN USED AND 5 (SMALL) 8.0MM MOUNTING BOLT. MOUNTING BOLT LOCATION BY WATER PUMP IS .250" HIGHER THAN PRIOR YEARS.	R	308-453
TC280D	FORD	CROWN VICTORIA, GRAND MARQUEE, TOWN CAR, MUSTANG	280	4.6	99-00	XR3R-BB, XR3Z6019BA	HAS REVISED FOUR BOLT BOSS MOUNT FOR 2000 TENSIONER, 10 (LARGE) 10.0MM BOLT MUSTANG AND 5 (SMALL) 8.0MM MOUNTING BOLT HOLES.	R	308-531A
TC280E	FORD	CROWN VICTORIA, GRAND MARQUEE, TOWN CAR, MUSTANG	280	4.6	01-03	2W7E, 2W7Z6019AA	HAS REVISED FOUR BOLT BOSS MOUNT FOR TENSIONER, 10 (LARGE) 10.0MM BOLT AND 5 (SMALL) 8.0MM MOUNTING BOLT HOLES.	R	308-531B
TC280F	FORD	EXPEDITION, F150, F250, VAN	280	4.6	97-01	F65E, F65Z6019AB	HAS SIX CAST AND DRILLED BOSSES FOR 2001 WINDSOR TENSIONER IN A DIFFERENT PATTERN. HAS WHEN USED 10 (LARGE) 10.0MM BOLT AND 5 (SMALL) 8.0MM MOUNTING BOLT HOLES	R	308-473A
TC280G	FORD	F150, VAN	280	4.6	99-03	2L3E, 2L3Z6019AA	HAS SIX CAST AND DRILLED BOSSES FOR 2003 WINDSOR TENSIONER IN A DIFFERENT PATTERN. HAS WHEN USED 10 (LARGE) 10.0MM BOLT AND 5 (SMALL) 8.0MM MOUNTING BOLT HOLES, MOM BUT DOES NOT USE ADVANCE POINTER CAN BE USED FOR FF4608/CN 2L3E	R	308-552
TC280H	FORD	TRUCK	280	4.6	02-04	2L3E, 2L3Z6019AA	HAS SIX CAST AND DRILLED BOSSES FOR WINDSOR TENSIONER IN A DIFFERENT PATTERN. HAS WHEN USED 10 (LARGE) 10.0MM BOLT AND 5 (SMALL) 8.0MM MOUNTING BOLT HOLES, MOM HAVE BUT DOES USE THE 30° ADVANCE POINTER CAN BE USED FOR FF4607/CN2L3E	R	
TC280I	FORD	EXPLORER, EXPEDITION, TRUCK	280	4.6	02-05	1L2E, 2L1E, 2L2E, 3L3E, 2L1Z6019BA, 2L2Z9019AA, 2L2Z9019AA, 3L3Z6019AA	HAS HIGH MOUNT POWER STEERING PUMP ON DRIVERS SIDE WITH BOSS CHANGES FOR MOUNTING, BELT IDLER MOUNTING LOCATION ADDED.	R	
TC300N	FORD	TRUCK & VAN	300	4.9	65-97	E5TE6019H		N	308-293
TC351A	FORD	CAR, TRUCK & VAN	302	5.0	69-84	D40E, D7AE, D9TE		N	308-302A, B
TC351C	FORD	TRUCK & VAN	302	5.0	83-86	E0AE, E3AE6059CA	WITH ECC MOUNT	N	308-460A
TC351C	FORD	CAR	302	5.0	83-89	E0AE, E3AE6059CA	WITH ECC MOUNT	N	308-460A
TC351E	FORD	COUGAR, THUNDERBIRD	302	5.0	91-93	E5AE, E8AE	WITH ELECTRIC FUEL PUMP MOUNT	N	308-323
TC351F	FORD	TRUCK & VAN	302	5.0	87-97	E7TE6059BA, F6TE6059NA		N	308-313A, 313B
TC351H	FORD	EXPLORER, MOUNTAINEER	302	5.0	96-01	F67Z6019AA, F15E6059BC, F87E6059AA		N	308-457
TC351H	FORD	MUSTANG	302	5.0	94-95	F67Z6019AA, F15E6059BC, F87E6059AA		N	308-457
TC351A	FORD	CAR, TRUCK & VAN	351W	5.8	69-84	D40E, D7AE, D9TE		N	308-302A, B
TC351C	FORD	TRUCK & VAN	351W	5.8	83-86	E0AE, E3AE6059CA	WITH ECC MOUNT	N	308-460A
TC351C	FORD	CAR	351W	5.8	83-89	E0AE, E3AE6059CA	WITH ECC MOUNT	N	308-460A
TC351F	FORD	TRUCK & VAN	351W	5.8	87-97	E7TE6059BA, F6TE6059NA		N	308-313A, 313B

**N = NEW RM = REMANUFACTURED R = RECLAIMED (SPECIAL ORDER ONLY)**

18

CUSTOMER SERVICE • MONDAY - FRIDAY 7 AM - 5 PM PACIFIC TIME • TOLL FREE 800.426.8771 • LOCAL 702.649.7776 • FAX 702.649.6777

# TIMING COVER APPLICATIONS

**N = NEW RM = REMANUFACTURED R = RECLAIMED (SPECIAL ORDER ONLY)**

PART #	MFG	VEHICLE	ENG	LITERS	YEARS	CASTING # / OEM #	NOTES	TYPE	HOLLANDER #
TC460N	FORD	CAR, TRUCK & VAN	429	7.0	69-78	E8TE6059AA		N	308-309, 312, 410
DT460	FORD	CAR, TRUCK & VAN	429	7.0	69-78	C8SZ6754A	DIP STICK TUBE	N	
TC460N	FORD	CAR, TRUCK & VAN	460	7.5	69-97	E8TE6059AA		N	308-309, 312, 410
DT460	FORD	CAR, TRUCK & VAN	460	7.5	69-97	C8SZ6754A	DIP STICK TUBE	N	
TC173B	ISUZU	TROOPER	173	2.8	89-91	14090537, 10049009		N	308-137
TC173B	ISUZU	RODEO	189	3.1	91-92	14090537, 10049009		N	308-137
TC173B	ISUZU	PICKUP	189	3.1	91-94	14090537, 10049009		N	308-137
TC183G	JAGUAR		183	3.0	00-03	XW4E6D080AD, XW4Z6019AA, 1W4Z6019AA	CAM POSITION SENSOR UPPER RIGHT, CRANK POSITION SENSOR LOWER LEFT	R	308-532, 579, 590
TC183I	JAGUAR		183	3.0	03-04	1X4E6D080AD	2 CAM POSITION SENSOR UPPER, CRANK POSITION SENSOR LOWER LEFT	R	
TC242R	JEEP		150	2.5	83-02	53005768, 53020221, J3225186, 53020233		N	308-219A, 219B, 382
TC225A	JEEP	CHEROKEE	225	3.7	05-05	53020793		R	308-569
TC225A	JEEP	LIBERTY	225	3.7	02-05	53020793		R	308-569
TC242R	JEEP		232	3.8	75-79	53005768, 53020221, J3225186, 53020233		N	308-219A, 219B, 382
TC242R	JEEP		242	4.0	93-01	53005768, 53020221, J3225186, 53020233		N	308-219A, 219B, 382
TC242R	JEEP		258	4.2	75-86	53005768, 53020221, J3225186, 53020233		N	308-219A, 219B, 382
TC361N	JEEP		290	4.7	66-69	J8129373, 3226242 (OIL FILTER HOUSING)		N	308-218A, B, C, D
TC361N	JEEP		304	5.0	70-81	J8129373, 3226242 (OIL FILTER HOUSING)		N	308-218A, B, C, D
TC361N	JEEP		343	5.6	67-69	J8129373, 3226242 (OIL FILTER HOUSING)		N	308-218A, B, C, D
TC361N	JEEP		360	5.9	70-91	J8129373, 3226242 (OIL FILTER HOUSING)		N	308-218A, B, C, D
TC361N	JEEP		390	6.4	68-70	J8129373, 3226242 (OIL FILTER HOUSING)		N	308-218A, B, C, D
TC361N	JEEP		401	6.6	70-78	J8129373, 3226242 (OIL FILTER HOUSING)		N	308-218A, B, C, D
TC183G	LINCOLN	LS	183	3.0	00-03	XW4E6D080AD, XW4Z6019AA, 1W4Z6019AA	CAM POSITION SENSOR UPPER RIGHT, CRANK POSITION SENSOR LOWER LEFT	R	308-532, 579, 590
TC183H	LINCOLN	LS	183	3.0	03-06	3W4E6D080AD, 3W4Z6019AA	2 CAM POSITION SENSOR UPPER, CRANK POSITION SENSOR LOWER LEFT	R	
TC183F	MAZDA	TRIBUTE	183	3.0	01-04	157E6D080AD, 157Z6019BA	CAM POSITION SENSOR UPPER RIGHT, CRANK POSITION SENSOR LOWER RIGHT, BELT TENSIONER RIGHT	R	
TC244R	MAZDA	B-4000, NAVAJO	244	4.0	91-03	90TM6059, 95TM, 97JM		R	308-306, 470, 471A, 471B
TC183F	MERCURY	COUGAR	155	2.5	01-02	157E6D080AD, 157Z6019BA	CAM POSITION SENSOR UPPER RIGHT, CRANK POSITION SENSOR LOWER RIGHT, BELT TENSIONER RIGHT	R	308-542
TCGA17	NISSAN	SENTRA, 200SX	GA16DE	1.6	91-00	13500-0M301 13500-53Y02 13500-F4300		N	308-58573
TCGA16	NISSAN	SENTRA	GA16I	1.6	89-90	13500-77A01		N	308-58232
TCSR20	NISSAN	SENTRA	SR20DE	2.0	91-00	13500-53J00		N	308-58375
TCKA24	NISSAN	STANZA, AXCESS	KA24	2.4	90-92	13500-30R00		N	308-58215
TCKA25	NISSAN	240SX	KA24DE	2.4	91-94	13500-53F00		N	308-58373
TCKA26	NISSAN	ALTIMA	KA24DE	2.4	93-00	13500-1E402	TCKA27 SUPERCEDES INTO THIS NUMBER	N	308-58507
TC173B	ISUZU	TROOPER	173	2.8	89-91	14090537, 10049009		N	308-137
TC173B	ISUZU	RODEO	189	3.1	91-92	14090537, 10049009		N	308-137
TC173B	ISUZU	PICKUP	189	3.1	91-94	14090537, 10049009		N	308-137
TC301R	PONTIAC	CAR	265	4.3	80-81		WITHOUT TIMING MARK	R	308-140
TC301R	PONTIAC	CAR	301	4.9	77-81		WITHOUT TIMING MARK	R	308-140
TC400N	PONTIAC	CAR	301	4.9	69-77		WITH WATER PUMP BACKING PLATE & 2 WATER TUBE INSERTS	N	308-141
TC400N	PONTIAC	CAR	350	5.7	69-77		WITH WATER PUMP BACKING PLATE & 2 WATER TUBE INSERTS	N	308-141
TC400N	PONTIAC	CAR	400	6.6	69-77		WITH WATER PUMP BACKING PLATE & 2 WATER TUBE INSERTS	N	308-141
TC301R	PONTIAC	CAR	400	6.6	77-81		WITHOUT TIMING MARK	R	308-140
TC400N	PONTIAC	CAR	455	7.5	70-76		WITH WATER PUMP BACKING PLATE & 2 WATER TUBE INSERTS	N	308-141
TC22EL	TOYOTA	CAR & TRUCK	20R, 22R	2.0	78-84	11302-38010	11-1/4" TALL 3-1/2" WATER NECK	N	308-54354A, B
TC22RN	TOYOTA	TRUCK	22REC	2.4	85-96	11302-35010	11-1/8" TALL	N	308-58033

## RECLAIMED INCLUDES:

- HAVE BEEN CLEANED
- GASKET SURFACES REFACED
- ALL OPENINGS CHECKED

24/7 ONLINE ORDERING! VISIT US ON THE WEB AT [WWW.ENGINEQUEST.COM](http://WWW.ENGINEQUEST.COM)



# TIMING TENSIONERS & COMPONENTS



TB181



TS047



TT059



TT060



TC116I



TC141I



TC142I



TC143I



TT049/TT055



TT046



TT061



TB141N



TB140N



TT140



TD173/TD174



TT232

PART #	MFG	ENGINE	DESCRIPTION	OEM #	YEARS
TS047	BUICK	V6 3.0L, 3.2L, 3.8L, 4.1L	CAMSHAFT THRUST BUTTON SPRING	1254199	82-88
TT061	BUICK	V6 231 CID	TIMING CHAIN TENSIONER	25535668	85-94
TB181	BUICK	V6 3.8L 231 CID	CAMSHAFT ROLLER TYPE THRUST BUTTON	25532588	85-88
TT059	BUICK	V6	TIMING CHAIN DAMPNER LEFT SIDE	1354138	
TT060	BUICK	V6	TIMING CHAIN DAMPNER RIGHT SIDE	1356634	64-87
TT046	CHEVROLET	2.0L 121 CID 2.2L 134 CID	TIMING CHAIN TENSIONER	14081712	82-89 89-95
TD173	CHEVROLET	V6 2.8L 173 CID	TIMING CHAIN DAMPNER	477264	UP TO 88
TD174	CHEVROLET	V6 2.8L, 3.1L 173, 189 CID	TIMING CHAIN DAMPNER	14078822	89-95
TC116I	FORD	1.9L	NEW INNER BELT COVER	E6FZ6019B	85-90
TC141I	FORD	2.3L 140 CID OHC	INNER TIMING BELT COVER (PLASTIC)	D4FZ6019C, E3ZZ6019B	74-88
TC142I	FORD	2.3L 140 CID OHC	INNER TIMING BELT COVER (PLASTIC)	F3ZZ6019B	89-94
TC143I	FORD	2.3L 140 CID OHC	INNER TIMING BELT COVER (PLASTIC)	F57Z6019C	95-99
TT140	FORD	2.3L 140 CID OHC	TIMING BELT TENSIONER SPRING	D4FZ6L273A, F47Z6L273A	74-99
TB140N	FORD	2.3L 140 CID OHC	TENSIONER SPRING STUD	E9TZ6K282A	74-99
TB141N	FORD	2.3L 140 CID OHC	TENSIONER SPRING STOP	E7ZZ6E008A	74-99
TT049	FORD	2.9L 177 CID, 4.0L 244 CID	TIMING CHAIN TENSIONER	E6TZ6K254A	86-96
TT055	FORD	2.9L 177 CID	TIMING CHAIN GUIDE	E6TZ6K297A	86-90
TT232	FORD	3.8L 232 CID, 4.2L 256 CID	TIMING CHAIN TENSIONER	F0DZ6K254A	89-99

**EQ Branded Items**  
Please call for  
availability and pricing



## BARE BLOCKS

**BL262U**



**BL350U**



**BL395NA/NB**

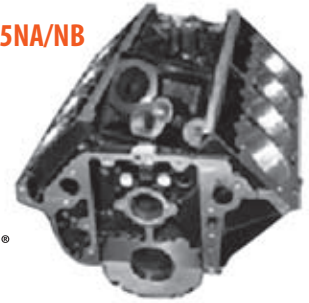

**BL262U** - General Motors 4.3L Roller Cam V6 Bare Block Core. Ready for remanufacturing. Block has been baked, blasted, magnafluxed and drilled for mechanical fuel pump. Cylinder bores, main saddles and lifter galley have been inspected. Ready for remanufacturing. Block may need to be line honed.

**BL350U** - General Motors 5.7L 350 CID Bare Block Core. 1 piece rear seal, roller cam, 2 bolt main. This is a core. Block has been baked, blasted, magnafluxed and drilled for mechanical fuel pump. Cylinder bores, main saddles and lifter galley have been inspected. Ready for remanufacturing. Block will have to be bored. Block may need to be line honed.

**BL395NA** - *NEW* GM 6.5L Diesel Bare Block Core. Regular and exhaust mounted turbo.

**BL395NB** - *NEW* GM 6.5L Diesel Bare Block Core. Center mounted turbo.

## CARBURETOR ADAPTOR

**CA200**

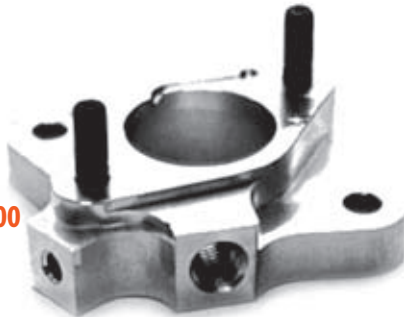

**CA200** - Converts 1970-79 200/250 CID Ford Engines with 1-3/4" carburetor mount to fit in pre-1969 engines with 1-1/2" carburetor mount. Looks factory original.

**A MUST FOR FORD  
AUTO RESTORERS!**

## FUEL PUMP BLOCK OFF PLATES

**BOP076** - Universal Style Plate

**GOP076** - Universal Style Gasket

Fits:

- Fords - all except 2.8L, 351C, 351M, 400
- Dodge - all domestic
- Pontiac - all V8
- Chevrolet - Big Block, 250, 292
- AMC - 6 CYL, V8
- Buick - V6, V8



**BOP076**

**BOP087** - Small Block Chevrolet

**GOP087** - Small Block Chevrolet Gasket

Gasket Fits Chevrolet - all small block (4 hole)



**BOP087**

# CRANKSHAFTS



**MAJOR TIME AND MONEY SAVER. NO NEED TO WORRY ABOUT BENT,  
BROKEN OR EVEN DAMAGED SNOOTS!**



**NEW  
STD/STD CRANKS  
NO WELDS,  
NO GRINDING,  
JUST DROP IN  
AND GO!**

PART #	MFG	DESCRIPTION	YEARS	HOLLANDER #
CS122S*	CHRYSLER/ MITSUBISHI	2.0L 4G63 7 BOLT, STEEL	92.5-97	303-58330A&B
CS381	CHEVROLET	6.5L 381 CID 1 PC. REAR SEAL, CAST	92-01	303-752
CS022	CHEVROLET	7.0L 427 CID 1 PC. REAR SEAL, CAST	90-UP	
CS454	CHEVROLET	7.4L 454 CID, 2 PC. REAR SEAL, CAST	70-90	303-479
CS454A	CHEVROLET	7.4L 454 CID, 1 PIECE REAR SEAL, CAST	91+	303-738
CS256	FORD	4.2L 256 CID, CAST	97-02	303-807
CS351	FORD	5.8L 351W 1 PIECE REAR SEAL, CAST	69-90	303-631
CS015	FORD	5.9L 361HD, CAST		
CS428	FORD	7.0L 428 CID, CAST	66-70	303-355
CS179	TOYOTA	3.0L 3VZE SOHC, CAST	88-95	303-58180
CS179	TOYOTA	3.4L 5VZ DOHC, CAST	95-02	303-58180

\*ALSO FOR INDUSTRIAL FORKLIFT APPLICATIONS  
WARRANTY VOID UNLESS A NEW HARMONIC BALANCER IS INSTALLED  
AT THE SAME TIME.

# IMPORT TIMING SETS

**ALL SETS INCLUDE REQUIRED GASKETS AND SEALS**



**TCS068  
MITSUBISHI 2.6L, 1986 - 89**



**TCS070  
TOYOTA 22REC, 1985 - 95**



# NEW HARMONIC BALANCERS



PART #	MFG	LITERS	CID	YEARS	NOTES	HOLLANDER #
BA242N	AMC	4.0	242	87-02	Jeep	309-402
BA204A	Buick	3.3	204	89-90	Full Size	309-457
BA204B	Buick	3.3	204	91-92	Full Size	309-458
BA204C	Buick	3.3	204	93	Full Size	309-484
BA231A	Buick	3.8	231	86-88	Full Size	309-406B
BA231B	Buick	3.8	231	89-90	Full Size	309-430
BA231C	Buick	3.8	231	91-92	Full Size	309-436
BA231D	Buick	3.8	231	93-94	Full Size	309-489
BA250N	Chevrolet	4.1	250	67-75	Double Groove	309-119
BA251N	Chevrolet	4.1	250	75-76	Double Groove	309-163
BA252N	Chevrolet	4.1	250	77-84	Double Groove	309-168
BA292N	Chevrolet	4.8	292	75-89	Truck, Double Groove	309-178
BA349N	Chevrolet	5.0, 5.7	305, 350	69-93	Car & Truck 8" Solid	309-148
BA350N	Chevrolet	5.0, 5.7	305, 350	69-95	Car & Truck 6-3/4" Solid	309-152
BA304N	Chevrolet	5.0, 5.7	305, 350	77-86	Car & Truck 8" Hollow	309-169
BA305N	Chevrolet	5.0, 5.7	305, 350	79-93	Car & Truck 6-3/4" Hollow	309-172
BA396N	Chevrolet	6.5	396	65-72	Big Block	309-116
BA400N	Chevrolet	6.6	400	69-80	Small Block	309-157
BA454N	Chevrolet	7.4	454	70-90	Big Block	309-162
BA140N	Ford	2.3	140	90-94	Tempo, Topaz	309-541
BA232B	Ford	3.8	232	88-95	Taurus, Sable, Continental	309-448
BA232A	Ford	3.8	232	94-95	T-Bird, Mustang, Windstar	309-477
BA289N	Ford	4.7	289	65-69	3 bolt	309-260
BA302N	Ford	5.0	302	84-95	Car & Truck E4TE, E4TZ	309-381
BA351N	Ford	5.8	351W	88-97	Truck E8TZ, E8TE	309-427
BA390N	Ford	5.9, 6.4, 7.0	360, 390, 427, 428	66-76	Car & Truck	309-284
BA460N	Ford	7.0, 7.5	429, 460	68-97	Truck D9TE	309-279/293/599

**WE HAVE SEARCHED THE WORLD OVER TO BRING YOU THE FINEST QUALITY!**



**BA140NA**



**BA204A**



**BA204B**



**BA204C**



**BA231A**



**BA231B**



**BA231C**



**BA231D**



**BA232A**



**BA232B**



**BA242N**



**BA250N**



**BA251N**



**BA252N**



**BA289N**



**BA292N**



**BA302N**



**BA304N**



**BA305N**



**BA349N**



**BA350N**



**BA351N**



**BA390N**



**BA396N**



**BA400N**



**BA454N**



**BA460N**

24/7 ONLINE ORDERING! VISIT US ON THE WEB AT [WWW.ENGINEQUEST.COM](http://WWW.ENGINEQUEST.COM)



# OIL PANS

## RECLAIMED INCLUDES:

- THERMALLY CLEANED • PAINTED • INSPECTED FOR HOLES



 R OP098A	 R OP098B	 R OP116A	 R OP120A
 R OP121A	 R OP135A	 R OP135B	 R OP138A
 R OP138B	 R OP138C	 R OP140A	 R OP153A
 R OP153B	 R OP155A	 R OP156A	 R OP166A
 R OP173A	 R OP173B	 R OP173C	 R OP173D
 R OP173E	 R OP173F	 R OP181A	 R OP183A
 R OP183B	 R OP183C	 R OP183D	 R OP183E

**R = RECLAIMED N = NEW**  
(SPECIAL ORDER ONLY)



CUSTOMER SERVICE • MONDAY - FRIDAY 7 AM - 5 PM PACIFIC TIME • TOLL FREE 800.426.8771 • LOCAL 702.649.7776 • FAX 702.649.6777





## RECLAIMED INCLUDES:

- THERMALLY CLEANED
- PAINTED
- INSPECTED FOR HOLES

 <b>R</b> OP189E	 <b>R</b> OP202A	 <b>R</b> OP225A	 <b>R</b> OP231A
 <b>R</b> OP232A	 <b>R</b> OP232B	 <b>R</b> OP232C	 <b>R</b> OP232D
 <b>R</b> OP232E	 <b>R</b> OP232F	 <b>R</b> OP232G	 <b>R</b> OP232H
 <b>R</b> OP239A	 <b>R</b> OP239B	 <b>R</b> OP242A	 <b>R</b> OP244A
 <b>R</b> OP252A	 <b>R</b> OP258A	 <b>R</b> OP262A	 <b>R</b> OP262B
 <b>R</b> OP262C	 <b>N</b> OP262M	 <b>R</b> OP300A	 <b>R</b> OP300B
 <b>N</b> OP302A	 <b>R</b> OP302B	 <b>N</b> OP304C	 <b>N</b> OP305C

**R = RECLAIMED N = NEW**  
(SPECIAL ORDER ONLY)

# OIL PANS

## RECLAIMED INCLUDES:

- THERMALLY CLEANED • PAINTED
- INSPECTED FOR HOLES

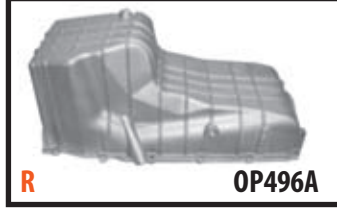
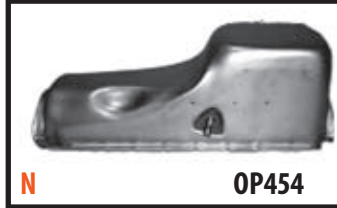
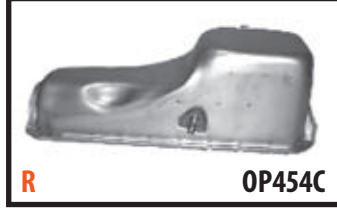
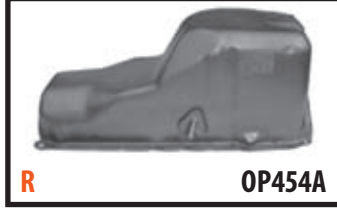
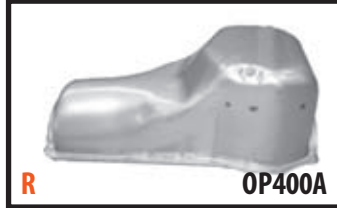
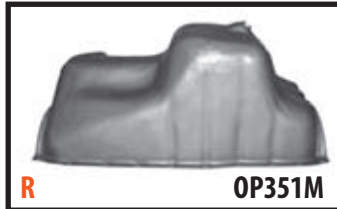
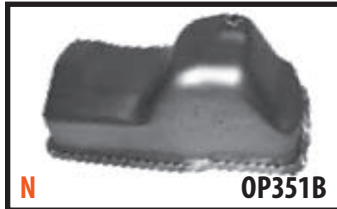
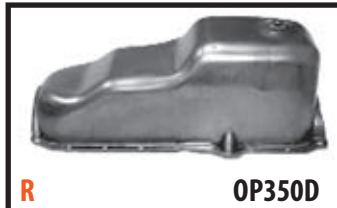
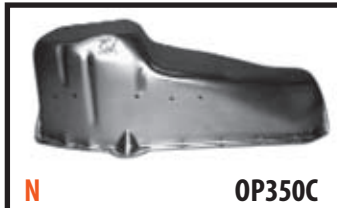
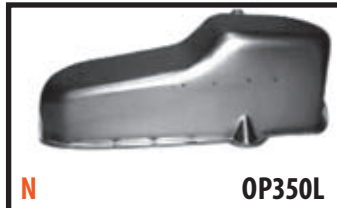
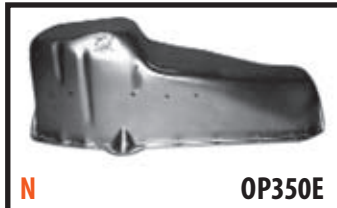
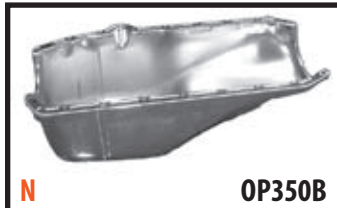
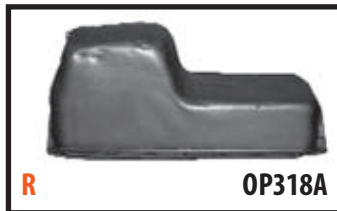

**R = RECLAIMED N = NEW**  
(SPECIAL ORDER ONLY)



PART #	MFG	APPLICATION	ENG	LITERS	YEARS	NOTES	TYPE	HOLLANDER #
OP231A	BUICK	RWD	231	2.8	81-84	14 BOLT OIL PAN	RECLAIMED	311-484
OP252A	CADILLAC	FWD	252	4.2	81-85		RECLAIMED	
OP098A	CHEVROLET	NOVA	98	1.6	85-88	SOHC	RECLAIMED	311-578
OP098B	CHEVROLET	NOVA, PRIZM	98	1.6	88-92	DOHC	RECLAIMED	311-632
OP173A	CHEVROLET	S10 (4X2), RWD CAR	173	2.8	82-86		RECLAIMED	311-523
OP173E	CHEVROLET	FWD	173	2.8	82-86		RECLAIMED	311-522
OP173D	CHEVROLET	BLAZER (4X4), S10 (4X4)	173	2.8	86-93		RECLAIMED	311-644
OP173C	CHEVROLET	FWD	173	2.8	87-94		RECLAIMED	311-592
OP173D	CHEVROLET	BLAZER (4X4), S10 (4X4)	189	3.1	86-93		RECLAIMED	311-644
OP173C	CHEVROLET	FWD	189	3.1	87-94		RECLAIMED	311-592
OP173F	CHEVROLET	FWD	189	3.1	88-94		RECLAIMED	311-592B
OP173F	CHEVROLET	FWD	207	3.4	88-94		RECLAIMED	311-592B
OP262A	CHEVROLET	PICKUP TRUCK	262	4.3	85-85	2 PIECE SEAL DESIGN	RECLAIMED	311-569
OP262B	CHEVROLET	PICKUP TRUCK & VAN	262	4.3	86-96	1 PIECE SEAL DESIGN	RECLAIMED	311-576
OP262C	CHEVROLET	4 X 4	262	4.3	90-95		RECLAIMED	311-621
OP262M	CHEVROLET	MARINE	262	4.3	95-99	1 PIECE SEAL DESIGN	NEW	
OP350C	CHEVROLET	CAR, PICKUP & VAN	305	5.0	70-79	CHROME / LEFT DIP	NEW	311-358
OP350E	CHEVROLET	CAR, PICKUP & VAN	305	5.0	70-79	LEFT DIP	NEW	311-358
OP350C	CHEVROLET	CAR, PICKUP & VAN	305	5.0	70-79	CHROME / LEFT DIP	NEW	311-358
OP350E	CHEVROLET	CAR, PICKUP & VAN	305	5.0	70-79	LEFT DIP	NEW	311-358
OP350A	CHEVROLET	CAR, PICKUP & VAN	305	5.0	70-79	LEFT DIP 6 QUART WITH BAFFLE	NEW	
OP350AC	CHEVROLET	CAR, PICKUP & VAN	305	5.0	70-79	LEFT DIP 6 QUART WITH BAFFLE	NEW	
OP350B	CHEVROLET	CAR, PICKUP & VAN	305	5.0	70-79	LEFT DIP 6 QUART WITHOUT BAFFLE	NEW	
OP350BC	CHEVROLET	CAR, PICKUP & VAN	305	5.0	70-79	LEFT DIP 6 QUART WITHOUT BAFFLE	NEW	
OP305C	CHEVROLET	CAR, PICKUP & VAN	305	5.0	80-85	CHROME / RIGHT DIP	NEW	311-483
OP305L	CHEVROLET	CAR, PICKUP & VAN	305	5.0	80-85	RIGHT DIP	NEW	311-483
OP304C	CHEVROLET	CAR, PICKUP & VAN	305	5.0	86-00	CHROME	NEW	311-572A
OP350L	CHEVROLET	CAR, PICKUP & VAN	305	5.0	86-00	4 QUART PAN	NEW	311-572A
OP350M	CHEVROLET	MARINE	305	5.0	86-96	5 QUART	NEW	
OP350D	CHEVROLET	PICKUP TRUCK	305	5.0	87-02	5 QUART	RECLAIMED	311-647
OP349A	CHEVROLET	PICKUP TRUCK	325	5.3	99-04		RECLAIMED	311-859
OP350C	CHEVROLET	CAR, PICKUP & VAN	350	5.7	70-79	CHROME / LEFT DIP	NEW	311-358
OP350E	CHEVROLET	CAR, PICKUP & VAN	350	5.7	70-79	LEFT DIP	NEW	311-358
OP350A	CHEVROLET	CAR, PICKUP & VAN	350	5.7	70-79	LEFT DIP 6 QUART WITH BAFFLE	NEW	
OP350AC	CHEVROLET	CAR, PICKUP & VAN	350	5.7	70-79	LEFT DIP 6 QUART WITH BAFFLE	NEW	
OP350B	CHEVROLET	CAR, PICKUP & VAN	350	5.7	70-79	LEFT DIP 6 QUART WITHOUT BAFFLE	NEW	
OP350BC	CHEVROLET	CAR, PICKUP & VAN	350	5.7	70-79	LEFT DIP 6 QUART WITHOUT BAFFLE	NEW	
OP305C	CHEVROLET	CAR, PICKUP & VAN	350	5.7	80-85	CHROME / RIGHT DIP	NEW	311-483
OP305L	CHEVROLET	CAR, PICKUP & VAN	350	5.7	80-85	RIGHT DIP	NEW	311-483
OP304C	CHEVROLET	CAR, PICKUP & VAN	350	5.7	86-00	CHROME	NEW	311-572A
OP350L	CHEVROLET	CAR, PICKUP & VAN	350	5.7	86-00	4 QUART PAN	NEW	311-572A
OP350M	CHEVROLET	MARINE	350	5.7	86-96	5 QUART	NEW	
OP350D	CHEVROLET	PICKUP TRUCK	350	5.7	87-02	5 QUART	RECLAIMED	311-647
OP349A	CHEVROLET	PICKUP TRUCK	364	6.0	99-04		RECLAIMED	311-859
OP366A	CHEVROLET	PICKUP TRUCK	366	6.0	91-98	1 PIECE SEAL DESIGN	RECLAIMED	
OP381A	CHEVROLET	PICKUP TRUCK	381	6.2	82-91		RECLAIMED	311-623A & B
OP381B	CHEVROLET	PICKUP TRUCK	381	6.2	92-95		RECLAIMED	311-712
OP454	CHEVROLET	CAR & TRUCK	396	6.5	65-90	2 PIECE REAR SEAL DESIGN	NEW	311-365
OP454C	CHEVROLET	CAR & TRUCK	396	6.5	65-90	CHROME 2 PIECE REAR SEAL DESIGN	NEW	311-365
OP350C	CHEVROLET	CAR, PICKUP & VAN	400	6.6	70-79	CHROME / LEFT DIP	NEW	311-358
OP350E	CHEVROLET	CAR, PICKUP & VAN	400	6.6	70-79	LEFT DIP	NEW	311-358
OP350A	CHEVROLET	CAR, PICKUP & VAN	400	6.6	70-79	LEFT DIP 6 QUART WITH BAFFLE	NEW	
OP350AC	CHEVROLET	CAR, PICKUP & VAN	400	6.6	70-79	CHROME / LEFT DIP 6 QUART WITH BAFFLE	NEW	
OP350B	CHEVROLET	CAR, PICKUP & VAN	400	6.6	70-79	LEFT DIP 6 QUART WITHOUT BAFFLE	NEW	
OP350BC	CHEVROLET	CAR, PICKUP & VAN	400	6.6	70-79	CHROME / LEFT DIP 6 QUART W/OUT BAFFLE	NEW	
OP454	CHEVROLET	CAR & TRUCK	454	7.4	65-90	2 PIECE REAR SEAL DESIGN	NEW	311-365
OP454C	CHEVROLET	CAR & TRUCK	454	7.4	65-90	CHROME 2 PIECE REAR SEAL DESIGN	NEW	311-365
OP454A	CHEVROLET	1500 PICKUP, 2500 PICKUP, 3500 PICKUP, VAN & SUBURBAN	454	7.4	91-00	1 PIECE SEAL DESIGN	RECLAIMED	311-692



# OIL PANS

PART #	MFG	APPLICATION	ENG	LITERS	YEARS	NOTES	TYPE	HOLLANDER #
OP135A	CHRYSLER	FWD	135	2.2	81-87		RECLAIMED	311-493
OP135B	CHRYSLER	FWD	135	2.2	89-94		RECLAIMED	311-655
OP153B	CHRYSLER	CAR & MINI VAN	135	2.2	89-95		RECLAIMED	311-654
OP153A	CHRYSLER	CAR & MINI VAN	153	2.5	86-88		RECLAIMED	311-579
OP153B	CHRYSLER	CAR & MINI VAN	153	2.5	89-95		RECLAIMED	311-654
OP156A	CHRYSLER	CAR & MINI VAN	156	2.6	81-85		RECLAIMED	311-494
OP181A	CHRYSLER	CAR & MINI VAN	181	3.0	87-96		RECLAIMED	311-605
OP202A	CHRYSLER	FWD	202	3.3	90-94		RECLAIMED	311-658
OP225A	CHRYSLER	PICKUP TRUCK	225	3.7	71-83		RECLAIMED	311-383
OP202A	CHRYSLER	FWD	230	3.8	90-94		RECLAIMED	311-658
OP239A	CHRYSLER	PICKUP TRUCK	239	3.9	87-88		RECLAIMED	311-604
OP239B	CHRYSLER	PICKUP TRUCK & VAN	239	3.9	89-91		RECLAIMED	311-660
OP239C	CHRYSLER	PICKUP, SUV & VAN	239	3.9	92-99		RECLAIMED	311-694
OP318A	CHRYSLER	PICKUP TRUCK	318	5.2	71-91		RECLAIMED	311-384
OP360B	CHRYSLER	150 PICKUP, 250 PICKUP, VAN, RAMCHARGER	318	5.2	92-93		RECLAIMED	311-696
OP318B	CHRYSLER	1500 PICKUP, 2500 PICKUP	318	5.2	94-01		RECLAIMED	311-735
OP360A	CHRYSLER	PICKUP & VAN	360	5.9	71-91		RECLAIMED	311-385
OP360B	CHRYSLER	150 PICKUP, 250 PICKUP, 350 PICKUP, VAN, RAMCHARGER	360	5.9	92-93		RECLAIMED	311-696
OP360B	CHRYSLER	1500 PICKUP, 2500 PICKUP, 3500 PICKUP	360	5.9	94-02		RECLAIMED	311-696
OP116A	FORD	ESCORT	116	1.9	91-96	SOHC	RECLAIMED	311-726
OP140A	FORD	RANGER	140	2.3	83-85	SMOOTH CAP	RECLAIMED	311-537
OP183A	FORD	CAR	183	3.0	90-91	WITHOUT LOW OIL SENSOR	RECLAIMED	311-667
OP183B	FORD	AEROSTAR, RANGER	183	3.0	90-92		RECLAIMED	311-683
OP183C	FORD	CAR	183	3.0	90-92		RECLAIMED	311-702
OP183D	FORD	PICKUP TRUCK	183	3.0	93-96		RECLAIMED	311-721
OP183E	FORD	SABLE & TAURUS	183	3.0	95-99	OHV	RECLAIMED	311-765
OP232A	FORD	RWD	232	3.8	83-87	WITHOUT LOW OIL SENSOR	RECLAIMED	311-506A
OP232B	FORD	RWD	232	3.8	83-87	WITH LOW OIL SENSOR	RECLAIMED	311-506B
OP232C	FORD	RWD	232	3.8	88-	WITHOUT LOW OIL SENSOR	RECLAIMED	311-642A
OP232D	FORD	RWD	232	3.8	88-	WITH LOW OIL SENSOR	RECLAIMED	311-642B
OP232G	FORD	FWD	232	3.8	88-95	WITH LOW OIL SENSOR	RECLAIMED	311-705A-G
OP232H	FORD	FWD	232	3.8	88-98	WITHOUT LOW OIL SENSOR	RECLAIMED	311-763A-D
OP232E	FORD	RWD	232	3.8	89-97	WITH LOW OIL SENSOR	RECLAIMED	311-724
OP232F	FORD	RWD	232	3.8	89-97	WITHOUT LOW OIL SENSOR	RECLAIMED	311-725
OP300A	FORD	PICKUP & VAN	300	4.9	70-82	DIPTUBE IN PAN	RECLAIMED	311-479
OP300B	FORD	PICKUP & VAN	300	4.9	83-96		RECLAIMED	311-611
OP302A	FORD	BRONCO, PICKUP & VAN	302	5.0	80-96		NEW	311-613A & B
OP302B	FORD	CAR	302	5.0	89-90	DIPTUBE IN BLOCK	RECLAIMED	311-612A
OP351C	FORD	CAR	351W	5.8	69-79		RECLAIMED	311-330
OP351M	FORD	BRONCO, PICKUP TRUCK	351M	5.8	77-79	4 X 4	RECLAIMED	311-450
OP400A	FORD	BRONCO, PICKUP TRUCK	351M	5.8	77-79	4 X 2	NEW	311-449
OP351A	FORD	PICKUP & VAN	351W	5.8	81-87		RECLAIMED	311-497
OP351D	FORD	CAR	351W	5.8	83-89		RECLAIMED	311-821
OP351B	FORD	PICKUP & VAN	351W	5.8	88-96		NEW	311-643
OP351M	FORD	BRONCO, PICKUP TRUCK	400	6.6	77-79	4 X 4	RECLAIMED	311-450
OP400A	FORD	BRONCO, PICKUP TRUCK	400	6.6	77-79	4 X 2	NEW	311-449
OP420A	FORD	PICKUP TRUCK	420	6.9	83-94		RECLAIMED	311-536
OP420A	FORD	PICKUP TRUCK	444	7.3	83-94		RECLAIMED	311-536
OP460A	FORD	PICKUP & VAN	460	7.5	93-97	FOR SCREW-IN TYPE DIPSTICK TUBE	RECLAIMED	311-766, 767, 768
OP173B	JEEP		173	2.8	84-86		RECLAIMED	311-552
OP258A	JEEP		232	3.8	71-90		RECLAIMED	311-395
OP242A	JEEP		242	4.0	87-00		RECLAIMED	311-601
OP258A	JEEP		258	4.2	71-90		RECLAIMED	311-395
OP318B	JEEP	GRAND CHEROKEE, GRAND WAGONEER	318	5.2	93-98		RECLAIMED	311-735
OP121A	PONTIAC	FWD	121	2.0	87-92	OHC	RECLAIMED	311-600
OP138A	PONTIAC	CAST # 22538921	138	2.4	87-91	QUAD FOUR	RECLAIMED	311-646
OP138B	PONTIAC	CAST # 24570333 & 24571250	138	2.4	90-94	QUAD FOUR	RECLAIMED	311-707
OP138C	PONTIAC	CAST # 24574397	138	2.4	96-96	QUAD FOUR	RECLAIMED	311-790



# NEW OEM TYPE TINWARE



**ALL VALVE COVER SETS HAVE OIL BAFFLES.  
TIN SET INCLUDES: OIL PAN, VALVE COVERS,  
TIMING COVER, TIMING MARKER,  
DIPSTICK & TUBE.**

CHEVROLET V6 262, V8 305/350 1986 AND UP.  
REPLACES OEM #S 12561389 / 14091675

**SBM183**

FORD 3.0L MAIN BOLT OEM# E9DZ-6345-D



PART #	DESCRIPTION	COATING	APPLICATION	YEARS
VC262	VALVE COVER SET	UNCHROMED	CHEVROLET 4.3L 262 V6	86 & UP METAL
VC350	VALVE COVER SET	UNCHROMED	CHEVROLET SMALL BLOCK	UP TO 85
VC350C	VALVE COVER SET	CHROMED	CHEVROLET SMALL BLOCK	UP TO 85
VC350M	VALVE COVER SET	UNCHROMED	CHEVROLET SMALL BLOCK (1 BREATHER & 1 FILLER PER SIDE)	UP TO 85
VC302N	VALVE COVER	UNCHROMED	FORD 302, 351W	68-98
VC350L	VALVE COVER SET	UNCHROMED	CHEVROLET SMALL BLOCK (1 PUSH-IN, 2 PUSH-IN)	86 & UP
VC351L	VALVE COVER SET	UNCHROMED	CHEVROLET SMALL BLOCK (1 PUSH-IN & 1 SCREW-IN, 1 PUSH-IN)	86 & UP
VC352L	VALVE COVER SET	UNCHROMED	CHEVROLET SMALL BLOCK (1 PUSH-IN & 1 SCREW-IN PER SIDE)	86 & UP
VC305C	VALVE COVER SET	CHROMED	CHEVROLET SMALL BLOCK	86 & UP
VC350H	TALL STYLE VALVE COVER SET	CHROMED	CHEVROLET SMALL BLOCK	UP TO 85
VC454	VALVE COVER SET	UNCHROMED	CHEVROLET BIG BLOCK	68-90
VC454C	VALVE COVER SET	CHROMED	CHEVROLET BIG BLOCK	68-90
VC454H	TALL STYLE VALVE COVER SET	CHROMED	CHEVROLET BIG BLOCK	68-90
TS350	TIN SET	UNCHROMED	CHEVROLET SMALL BLOCK	UP TO 79
TS350C	TIN SET	CHROMED	CHEVROLET SMALL BLOCK	UP TO 79
TS305	TIN SET	UNCHROMED	CHEVROLET SMALL BLOCK	80-85
TS305C	TIN SET	CHROMED	CHEVROLET SMALL BLOCK	80-85
TCC305	TIMING COVER	UNCHROMED	CHEVROLET SMALL BLOCK WITH 6-3/4" BALANCER	80-UP WITH WELDED TAB
TC262P	TIMING COVER	PLASTIC	CHEVROLET 4.3L	96-00
TCC349	TIMING COVER	UNCHROMED	CHEVROLET SMALL BLOCK, NO TIMING MARKER	UP TO 85
TCC350	TIMING COVER	UNCHROMED	CHEVROLET SMALL BLOCK WITH 8" BALANCER	UP TO 79
TC350P	TIMING COVER	PLASTIC	CHEVROLET SMALL BLOCK	96-00
TC350C	TIMING COVER	CHROMED	CHEVROLET SMALL BLOCK	FOR BOLT-ON MARKER
TC350M	TIMING COVER	UNCHROMED	CHEVROLET SMALL BLOCK (MARINE)	86 & UP
TC454C	TIMING COVER	CHROMED	CHEVROLET BIG BLOCK	2 PIECE SEAL / 68-90
TCC454	TIMING COVER	UNCHROMED	CHEVROLET BIG BLOCK	68-90
TM350C	TIMING COVER MARKER	CHROMED	CHEVROLET SMALL BLOCK	
TM454C	TIMING COVER MARKER	CHROMED	CHEVROLET BIG BLOCK	
DT350C	DIPSTICK & TUBE	CHROMED	CHEVROLET SMALL BLOCK	UP TO 79
DT454C	DIPSTICK & TUBE	CHROMED	CHEVROLET BIG BLOCK	2 PIECE SEAL
AB350	BREATHER GROMMET	RUBBER	UNIVERSAL	UP TO 85
PCV350	PCV GROMMET	RUBBER	UNIVERSAL	UP TO 85
OC350N	OIL FILLER CAP	PLASTIC	SCREW IN	86 & UP
OPB305	OIL PAN BOLT		262, 305, 350	86 & UP

# REPLACEMENT PIPE PLUGS

PART #	MFG	OEM #	SIZE	QTY
JPP001	TOYOTA	90345-51066	1/8" - 28	25
JPP002	TOYOTA	90344-52003	1/4" - 19	25
JPP003	TOYOTA	90344-53008	3/8" - 19	25
	TOYOTA	90344-53011		
	MITSUBISHI	MS661162	25	
	MITSUBISHI	MD145018	25	
JPP004	MITSUBISHI/TOYOTA		1/2" - 14	25
JPP005	MITSUBISHI/TOYOTA		3/4" - 14	25

## JAPANESE THREADS FOR TOYOTA & MITSUBISHI PIPE PLUGS HAVE SEALANT ON THREADS



### JPP05A - ASSORTMENT PACK

CONTAINS: 5 OF EACH SIZE



# METRIC PIPE PLUGS

## WITH VIBRA-SEAL COATING ON THREADS

### MPP05A - ASSORTMENT PACK

CONTAINS: 5 OF EACH SIZE



PART #	THREAD SIZE	HEIGHT	SOCKET DRIVE	SOCKET DEPTH	QTY
MPP001	8MM - 1.0	8MM	4MM	4MM	25
MPP002	10MM - 1.0	8MM	5MM	4MM	25
MPP003	12MM - 1.5	10MM	6MM	5MM	25
MPP004	14MM - 1.5	10MM	7MM	5MM	25
MPP005	16MM - 1.5	10MM	8MM	5MM	25
MPP006	18MM - 1.5	10MM	8MM	5MM	25
MPP007	20MM - 1.5	10MM	10MM	5MM	25
MPP008	22MM - 1.5	10MM	10MM	5MM	25
MPP009	24MM - 1.5	12MM	12MM	6MM	25

# SOLID OIL GALLEY PLUGS

PART #	OD	LENGTH	QTY
OGP001	.234	.640	25
OGP002	.250	.510	25
OGP003	.444	.265	25
OGP004	.471	.310	25
OGP005	.508	.310	25
OGP007	.518	.310	25
OGP008	.579	.310	25
OGP009	.581	.310	25
OGP010	.629	.310	25

PART #	OD	LENGTH	QTY
OGP24A	.205 OR 5.21MM	.264 OR 6.24MM	25
OGP24B	.284 OR 7.22MM	.325 OR 8.27MM	25
OGP24C	.242 OR 6.16MM	.241 OR 6.12MM	25
OGP24D	.512 OR 13.01MM	.488 OR 12.39MM	25

## NO NEED TO THREAD SMALL PASSAGES

- EASY TO INSTALL
- HELP STOP LEAKS
- FILL VOIDS

### OGP10A - ASSORTMENT PACK

CONTAINS: 10 OF EACH SIZE



# STANDARD PIPE & SMOG PLUGS

## SMOG PLUGS

PART #	DESCRIPTION	QTY
SP151	CHEVROLET 250, 292CID, PONTIAC 151CID SMOG PLUG-3/4"x18"	10
SP300E	FORD 300 CID SMOG PLUG PRE '84-V8, 330, 360, 361HD, 390, 391HD-1/2"x20"x.55"	10
SP300L	FORD 300 CID SMOG PLUG '84 AND UP-9/16"x 18"x.55"	10
FTP034	FORD V8 255, 302, 351C, 351M, 351W, 400 THERMALACTOR PLUG 5/8" - 11"ODx7/16"-14ID	25

FTPBLK ALSO AVAILABLE - 500 PACK



SP300L



SP151/FTP034

## STANDARD PIPE PLUGS

WITH VIBRA-SEAL COATING

PART #	SIZE	QTY
SPP062	1/16" X .300"	50
SPP125	1/8" X .300"	50
SPP250	1/4" X .375"	50
SPP251	1/4" X .460"	50
SPP375	3/8" X .375"	50
SPP376	3/8" X .460"	50
SPP500	1/2" X .550"	25
SPP750	3/4" X .540"	25

### SPP25A - ASSORTMENT PACK

CONTAINS: 25 OF EACH SIZE



ALL SPP#s AVAILABLE IN 1000 PACK



# DOWEL PINS, MISC. PARTS



DP302/DP390/TCD302



DP350



LC302

EQ #	DESCRIPTION
PC155N	2.6L MITSUBISHI PRECUP 4PK
PC395T	6.2/6.5L GM DIESEL PRECUP EACH
CHI01	CYLINDER HEAD INSERT 1/2"-13 THREADED OD X 3/8"-16 ID STEEL INSERT
RR231	BUICK V6/V8 ROCKER ARM SHAFT RETAINER BUTTON
HD173	CHEVROLET V6 173 CID HEAD TO BLOCK DOWEL
DP350	CHEVROLET V8 TRANSMISSION TO BLOCK DOWEL PIN OEM #12338119
HD350	CHEVROLET SMALL BLOCK CYLINDER HEAD TO BLOCK DOWEL
HD454	CHEVROLET BIG BLOCK CYLINDER HEAD DOWEL
GOPG54	CHRYSLER/MITSUBISHI 2.6L (G54) OIL PUMP GASKET
ST052	CHRYSLER/MITSUBISHI 2.6L (G54) EXHAUST MANIFOLD STUD (8 X 1.25 X 55)
ST054	CHRYSLER/MITSUBISHI 2.6L (G54) INTAKE MANIFOLD STUD (8 X 1.25 X 40)
BDV8F	FORD V8 BLOCK TO TRANS DOWEL EAD6397AB
HS171N	FORD V6 2.8L 171CID OEM # D4ZZ6B070A
DP171N	MOUNTING DOWEL OEM # D2RY6178B FOR HS171N
TCD302	FORD 255, 302, 351W V8 1979-UP TIMING COVER TO BLOCK DOWEL
LC302	FORD 302/351W V8 VALVE CAP
DP302	FORD SMALL BLOCK V8 HEAD TO BLOCK DOWEL OEM #C20Z6A008A
DP390	FORD BIG BLOCK V8 HEAD TO BLOCK DOWEL OEM #B9AE6A008A
OP22RN	TOYOTA 85-95, 22REC NEW OIL PUMP



Point-of-Sale  
Counter Card  
and Poster

Sell Sheets



**Request your  
counter card,  
poster & sell sheets.**

**Let us help you sell more parts!**

# NEW & RECLAIMED CAM ECCENTRICS

ALL RECLAIMED ITEMS ARE SUBJECT TO AVAILABILITY



PART #	DESCRIPTION
CE120I	FORD V8 255, 302, 351W, 400, 460 INNER CAM ECCENTRIC (UP TO 85)
CE1200	FORD V8 255, 302, 351W, 400, 460 OUTER CAM ECCENTRIC (UP TO 85)
CE124N	AMC V8 (INCL. DIST. GEAR, SPACER, WASHER & BOLT)
CE125R	CHRYSLER 318/360
CE126R	FORD 360/390 CID - SOLID 1 PIECE DESIGN
CE127R	FORD 302 CID - SOLID 1 PIECE DESIGN
CE128R	OLDS V8 307/350
CE129N	TOYOTA 22REC (INCLUDES DRIVE GEAR, BOLT & WASHER)
CE390N	FORD 360/390 2 PIECE CAM ECCENTRIC

EACH RECLAIMED ECCENTRIC HAS BEEN THOROUGHLY CLEANED AND INSPECTED TO ENSURE SERVICEABLE FOR REMANUFACTURING

# RECLAIMED CAM THRUST PLATES

ALL RECLAIMED ITEMS ARE SUBJECT TO AVAILABILITY

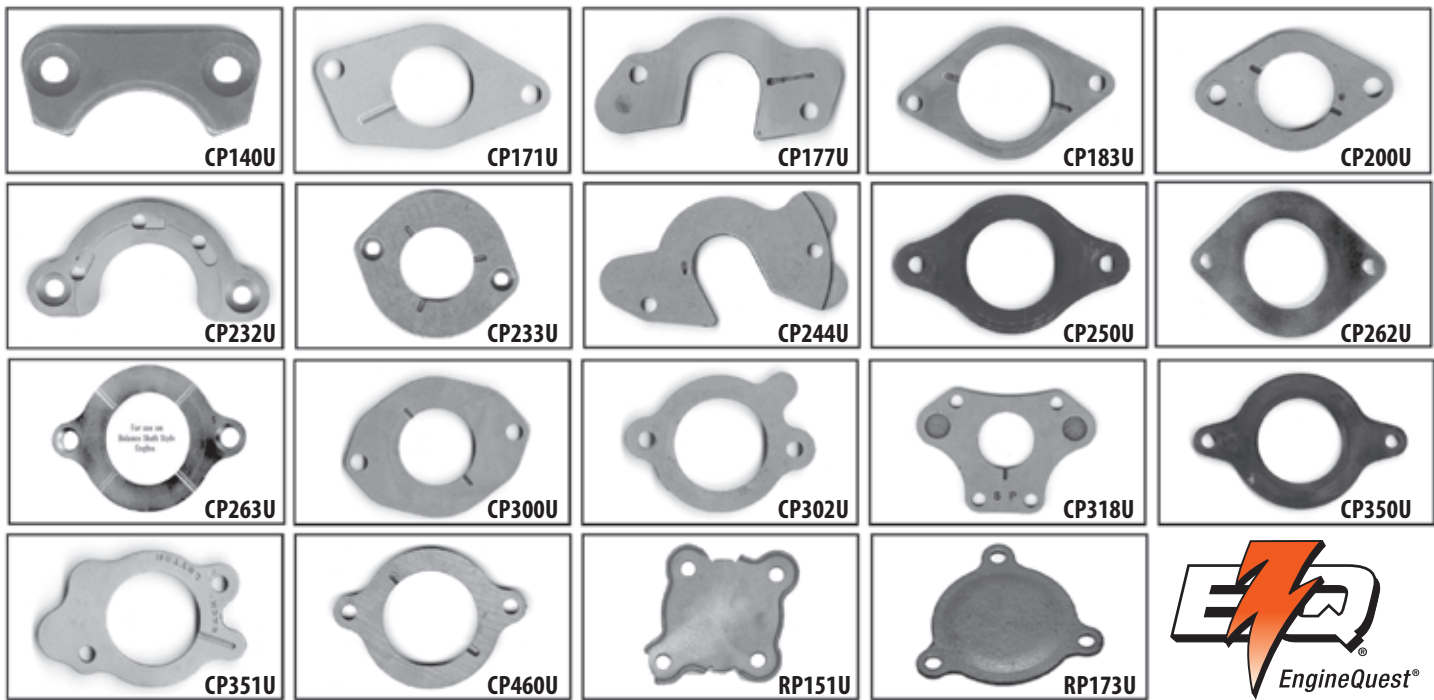

PART #	APPLICATION	OEM #
CP140U	FORD 140 OHC CAM & LAY SHAFT RETAINER	D4FZ6613A
CP153U	FORD 2.3L (84-88), 2.5L (86-88)	E43Z6269A
CP171U	FORD 171 (2.8L)	D2RY6269A
CP177U	FORD 177 (2.9L)	
CP183U	FORD 183 (3.0L) 82-92	E6DZ6269A
CP200U	FORD 144, 170, 200, 250	CODE6269A
CP232U	FORD 232 (3.8L)	
CP233U	FORD 232 (3.8L) BALANCE SHAFT	
CP244U	FORD 244 (4.0L)	
CP250U	CHEVROLET 230, 250, 292 (63-93), PONTIAC 151 (R CODE)	10000568
CP262U	CHEVROLET 262 (4.3L)	

PART #	APPLICATION	OEM #
CP263U	CHEVROLET 4.3L BALANCE SHAFT	
CP300U	FORD 240, 300 (65-91)	C5AZ6269A
CP301U	PONTIAC 301, 400, 455	
CP302U	FORD 289, 302 (67-86)	C90Z6269A
CP318U	CHRYSLER 318, 360 (66-91)	
CP349U	CHEVROLET 305, 350 3.90" TIP TO TIP	
CP350U	CHEVROLET 305, 350 4.23" TIP TO TIP ROLLER CAM	10168501
CP351U	FORD 351W	
CP460U	FORD 351C, 351M, 400, 429, 460 (68-91)	C8SZ6269A
RP151U	PONTIAC 151 (U CODE) REAR CAM PLATE	12508079
RP173U	CHEVROLET 173 (2.8L) REAR CAM PLATE	476544





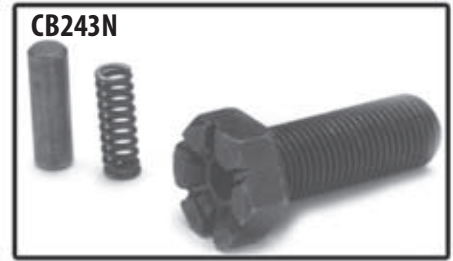
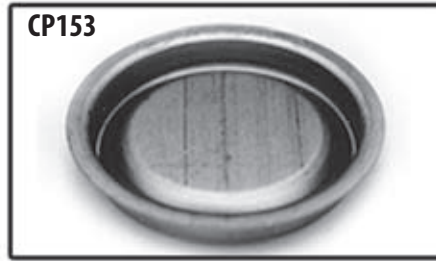
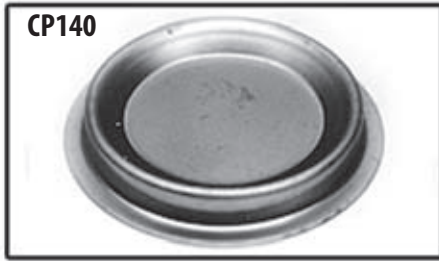
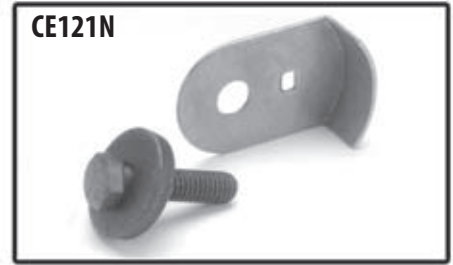
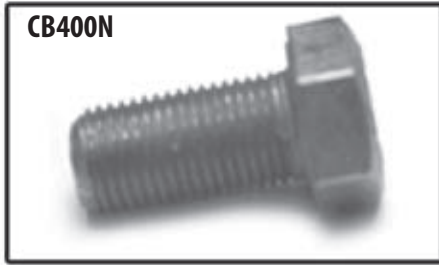

PART #	MFG	APPLICATION	DESCRIPTION	OEM #
CB243N	AMC/JEEP	LATE MODEL 4.0 & 4.2L	NEW CAM GEAR BOLT	83502890
CB258N	AMC/JEEP	258 CID	NEW CAM GEAR BOLT	
CW258N	AMC/JEEP	258 CID	NEW CAM GEAR WASHER	J3173284
CW225N	CHRYSLER	225 CID	NEW CAM GEAR BOLT WASHER	
CP202	CHRYSLER	3.3 & 3.8L	NEW CAM PLUG	4483620
CB318N	CHRYSLER	V8 318 & 360 CID UP TO 1991	NEW CAM GEAR BOLT	
CW318N	CHRYSLER	V8 318 & 360 CID UP TO 1991	NEW CAM GEAR WASHER	1618732
CB302N	FORD	V8 255, 302, 351W, 400	NEW CAM GEAR BOLT	
CW302N	FORD	V8 255, 302, 351W, 400	NEW CAM GEAR WASHER	C1TE6278A
CE121N	FORD	V8 255, 302, 351W, 400	CAM ECCENTRIC (85 & UP) W/BOLT & WASHER	D5AZ6287A
CP140	FORD	140 CID HSC (1987)	CAM PLUG - 2.210" OD	E43E6266A
CP153	FORD	2.3 & 2.5L HSC (88-UP) 3.0L V6	CAM PLUG - 2.230" OD	E6AE6266BA

# PISTON BIN BUSHINGS

**We Want you to Compare Our Quality...**  
*on our large selection of boreable and honeable bushings.*

MFG	ENGINE	YEARS	HONEABLE	OD	ID	LENGTH	QTY	BOREABLE	OD	ID	LENGTH	QTY
CHRYSLER	2.7L	98-03						PB167B	.9432	.9451	.8750	6
CHRYSLER	318/340	57-73	PB318H	1.039	.976	1.185	8	PB318B	1.039	.964	1.185	8
GM	6.2L DIESEL	82-93						PB381B	1.304	1.192	1.00	8
NISSAN	VG30	87-96	PBVG3H	.948	.817	.811	6	PBVG3B	.948	.791	.811	6
NISSAN	SR20DE	91-94	PBSR2H	.987	.856	.886	4	PBSR2B	.987	.830	.886	4
NISSAN	KA24E	89-99	PBKA2H	.948	.817	.968	4	PBKA2B	.948	.791	.968	4
TOYOTA	20R, 22RE, 22REC	85-95	PB22RH	.949	.870	1.087	4	PB22R	.949	.837	1.087	4



# OIL FILTER ADAPTORS

PART #	MFG	APPLICATION	YEARS	OEM#	QTY
OFA150	AMC/JEEP	2.5L 150 CID	87 - 93	3241335	5
OFA258	AMC/JEEP	4.0L 244 CID	81 - 86	J3173226	5
OFA258	AMC/JEEP	4.2L 258 CID	81 - 86	J3173226	5
OFA304	AMC/JEEP	5.0L 304 CID	70 - 81		5
OFA304	AMC/JEEP	5.9L 360 CID	70 - 91		5
OFA304	AMC/JEEP	6.6L 401 CID	70 - 78		5
OFA173	CHEVROLET	1.8L	82 - UP	466383	5
OFA173	CHEVROLET	2.0L	82 - UP	466383	5
OFA173	CHEVROLET	2.8L 173 CID	82 - UP	466383	5
OFA262	CHEVROLET	4.3L 262 CID	86 - UP	14081300	10
OFA305	CHEVROLET	SMALL BLOCK		3952301	EACH
OFA454	CHEVROLET	BIG BLOCK		3853870	5
OFA345	CHRYSLER	5.7L HEMI		4104511A	10
OFA098	FORD	1.6L 98 CID	81 - 85	F4FZ6890A	5
OFA140	FORD	2.3L 140 CID	75 - 85	D4FZ6890A	5
OFA183	FORD	3.0L 183 CID	86 - 91	E6DZ6890A	5
OFA244	FORD	4.0L 244 CID	92 - 98	F0TZ6890A	5
OFA302	FORD	3.8L 232 CID	86 - 96	D7AZ6890A	10
OFA302	FORD	4.9L 300 CID	86 - 96	D7AZ6890A	10
OFA302	FORD	5.0L 302 CID	86 - 96	D7AZ6890A	10
OFA302	FORD	5.8L 351W CID	86 - 96	D7AZ6890A	10
OFA460	FORD	7.5L 460 CID		C9AE6890A	5
OFA142	OLDSMOBILE	2.3L QUAD 4	87 - UP	22538711	5
OFA151	PONTIAC	2.5L 151 CID	76 - 86	100489	5

**Why send your customer looking for filter adaptors, when EngineQuest has them available!**



### ASSORTMENT PACK

OFA17A - ASSORTMENT PACK CONTAINS:  
 • (1) OFA098 • (2) OFA151 • (2) OFA173 • (2) OFA183  
 • (2) OFA244 • (4) OFA262 • (4) OFA302  
 ALL IN BOX, EASY TO USE AND CLEARLY MARKED.



# CONVERSION REAR MAIN SEAL HOLDERS

## CHEVROLET 1986 - UP, V6 262 CID & V8 SMALL BLOCK

THE CHOICE IS YOURS - USE EARLY OR LATE STYLE OIL PAN

ENABLES A REBUILDER TO INSTALL A 2-PC. DESIGN CRANKSHAFT IN A 1-PC. SEAL DESIGN APPLICATION. MANUFACTURED FROM BILLET ALUMINUM.

**BEST ADAPTORS  
AVAILABLE!  
PERIOD!**

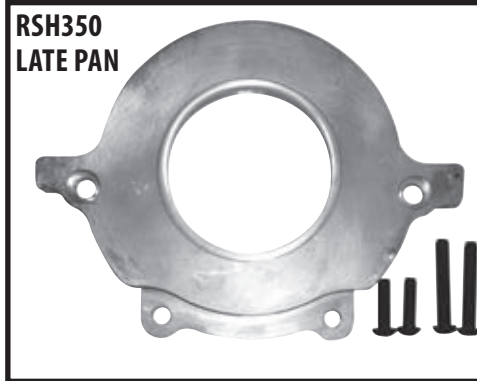
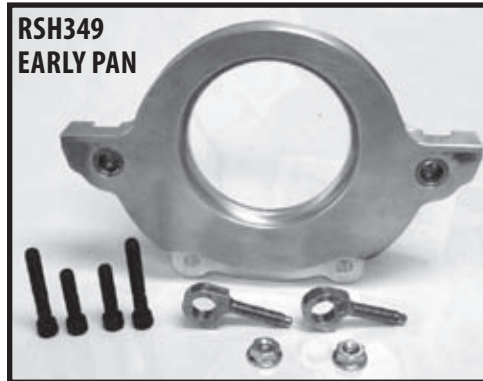

**AT350  
ALIGNMENT TOOL**  
FOR USE WITH RSH349 & RSH350  
CONVERSION SEAL HOLDERS



# SEAL RETAINERS



PART #	MFG	DESCRIPTION & ENGINE	OEM #
SH262	CHEVROLET	SEAL HOLDER STUD V6 262 CID 1996-02	10218027
SH350R	CHEVROLET	REAR SEAL HOUSING V6 262 CID/V8 305 & 350 CID	10108477
SHS350	CHEVROLET	SEAL RETAINER & OIL PAN STUD V6 262 CID, V8 305 & 350 CID	14080362
SHD350	CHEVROLET	REAR SEAL RETAINER DOWEL V6 262 CID, V8 305 & 350 CID	14024244, 9441003
SH134R	CHRYSLER	FRONT SEAL HOUSING L4 2.2L 135 CID	5214788
SH135N	CHRYSLER	REAR SEAL HOUSING L4 2.2L 135 CID, 2.5L 153 CID	5214784
SH153R	CHRYSLER	FRONT SEAL HOUSING L4 2.5L 153 CID	4387580
SH156R	CHRYSLER/MITSUBISHI	REAR SEAL HOUSING L4 2.6L 156 CID	
SH181R	CHRYSLER/MITSUBISHI	REAR SEAL HOUSING V6 3.0L 181 CID	MD125544
SH202R	CHRYSLER/MITSUBISHI	REAR SEAL HOUSING V6 3.3L 202 CID	4654389
SH098R	FORD	REAR SEAL HOUSING L4 1.6L W/GROOVED CAP	E4EE6K318AA
SH116R	FORD	REAR SEAL HOUSING L4 1.9L	E5FZ6K301A, FOCZ6K301A, F0EE6K318A
SH140R	FORD	REAR SEAL HOUSING L4 2.3L 140 CID HSC	E53E6335A
SH141R	FORD	FRONT SEAL HOUSING W/GROOVED CAP L4 2.3L 140 CID OHC	D42E6059AB, E37E6059AA
SH142R	FORD	FRONT SEAL HOUSING W/FLAT CAP L4 2.3L 140 CID OHC	E59E6059AA, E69E6059A
SH143R	FORD	FRONT SEAL HOUSING W/FLAT CAP L4 2.3L 140 CID OHC	E89E6059AC
SH144R	FORD	FRONT SEAL HOUSING W/FLAT CAP L4 2.3L 140 CID OHC	F17E6059AB
SH145R	FORD	FRONT SEAL HOUSING W/FLAT CAP L4 2.3L 140 CID OHC	F57E6059AD

# REAR MAIN SEALS

**RMS400**



**RMS400** - Chevrolet Rear Main Seal  
For blocks that have been align honed.

**TS042**



**TS042** - Timing Cover Seal  
Buick V6

**TS058**



**TS058** - Rear Main Seal  
Buick V6 1978-85 and V8 and Oldsmobile 350.  
2 piece rubber design. Replaces OEM rope style.

# DIPSTICK TUBE ADAPTORS

**CHEVROLET & FORD ADAPTORS MAKE YOUR EARLY BLOCKS LATE!**

**OPPOSITE SIDE DIPSTICK ADAPTORS CONVERT PRE-1980 CHEVROLET SMALL BLOCKS TO 1980 THRU 1985**

PART #	DESCRIPTION
DA025	WELD-ON - BLANK (DRILL YOUR OWN DIPSTICK TUBE HOLE.)
DA026P	BOLT-ON PAN RAIL (HAS ANGLED BOLT HOLES)
DA026W	BOLT-ON WATER JACKET (HAS STRAIGHT BOLT HOLES)
DA027	WELD-ON (WITH DIPSTICK TUBE HOLE DRILLED)

**FORD 300 REAR SCREW-IN DIPSTICK ADAPTOR**

PART #	DESCRIPTION
DA028	BOLT-ON

**DA028**



**DA026P**



# ENGINE PRE-LUBER

- ✓ PRESSURIZED PRE-LUBING AN ENGINE IS RECOMMENDED BY THE PRODUCTION ENGINE REMANUFACTURERS ASSOCIATION (PERA)
- ✓ INCLUDES MOUNTING ADAPTORS AND HOSE
- ✓ THE BEST FOR CRANK & CHAIN DRIVEN OIL PUMPS
- ✓ ELIMINATES DRY ENGINE STARTS
- ✓ MOUNTS TO OIL SENDING UNIT
- ✓ HOLDS UP TO 5 QUARTS OF OIL
- ✓ SIMPLE AND EASY TO USE, REUSABLE
- ✓ PRESSURIZES OILING SYSTEM (IMPORTANT ON WAREHOUSED MOTORS)



**PL40**



# BLOCK & HEAD CONVERSION JIGS



**CK361**

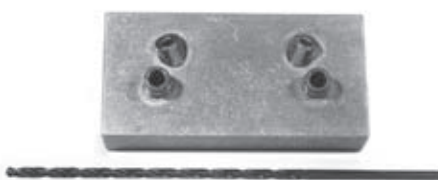

**DJ302**



**CJ262**

**DJ029P / DD129**



**DJ029P / DD129**

## STEP DRILLS



**CJ305**



PART #	DESCRIPTION
<b>CJ262</b>	CONVERT CHEVROLET 4.3L 262 CID BLOCKS W/ELECTRIC FUEL PUMPS TO ACCEPT MECHANICAL FUEL PUMP (INCL. DRILL BITS AND REAMERS).
<b>CJ305</b>	CONVERT CHEVROLET SMALL BLOCKS W/ELECTRIC FUEL PUMPS TO ACCEPT MECHANICAL FUEL PUMP (INCL. DRILL BITS AND REAMERS).
<b>CK361</b>	CONVERSION JIG TO TURN FORD 330MD, 352, 360, 390 BLOCKS INTO 330HD, 361, 391 BLOCK (INCL. DRILL BITS).
<b>DD129</b>	DRILL BIT FOR USE WITH DA026P AND DA026W JIGS.
<b>DJ029P</b>	MOUNTING AND DRILLING JIG FOR CHEVROLET PAN RAIL STYLE DIPSTICK ADAPTOR (100% ACCURATE EACH AND EVERY TIME).
<b>DJ029W</b>	MOUNTING AND DRILLING JIG FOR CHEVROLET WATER JACKET STYLE DIPSTICK ADAPTOR (100% ACCURATE EACH AND EVERY TIME).
<b>DJ030</b>	MOUNTING AND DRILLING JIG FOR FORD 300 CID BOLT ON DIPSTICK ADAPTOR.
<b>DJ031</b>	DRILLING JIG TO RELOCATE DIPSTICK TUBE TO REAR OF BLOCK. CONVERTS FORD 302 V8 1975-78 TO 79-UP & FORD 351W 75-86 TO 87-UP. USE STEP DRILL BIT SD041.
<b>DJ036</b>	NEW PRODUCTION STYLE TOOLING INCLUDES STEP DRILL THAT BORES HOLE AND CUTS RELIEF ALL IN ONE STEP. CONVERTS FORD 302 V8 75-78 INTO 79-UP & FORD 351W 75-86 INTO 87 AND UP. JIG MOUNTS TO CYLINDER HEAD DECK.
<b>DJ032</b>	ENABLES REBUILDER TO DRILL EXTRA PLUG COOLING HOLES IN 440 CHRYSLER HEADS. USE CASTING # "452". A MUST FOR ALL MOTOR HOMES.
<b>DJ033</b>	DRILLING JIG FOR CHEVROLET 305, 350 1978-79 THAT HAD RIGHT SIDE DIPSTICK PADS. USE STEP DRILL BIT SD043.
<b>DJ035</b>	CONVERT CHEVROLET 6 CYLINDER AND SMALL BLOCKS WITH 2 BOLT HOLE STARTER PAD TO A UNIVERSAL 3 BOLT HOLE. ALSO CAN BE USED FOR BROKEN STARTER BOLT HOLE REPAIR. USE STEP DRILL BIT SD044.
<b>DT129</b>	TAP USED WITH DA026P AND DA026W.
<b>SD041</b>	"U" DRILL BIT FOR USE WITH DJ031 JIG.
<b>SD042</b>	STEP DRILL USED TO CONVERT FORD 302 CYLINDER HEADS INTO FORD 351W HEADS.
<b>SD043</b>	STEP DRILL BIT FOR USE WITH DJ033 JIG.
<b>SD044</b>	STEP DRILL BIT FOR USE WITH DJ035 JIG.

**ALL TOOLING NON-RETURNABLE**

# ELIMINATION KITS

## BALANCE SHAFT – BEK122

Chrysler/Mitsubishi 1.8L, 2.0L, 2.4L, G62B, G63B, 4G63B, G64B, 4G64B (belt drive applications)

**KIT INCLUDES:** Upper & lower bushings, balance shaft replacement pin, oil galley block-off plug.



## BALANCE SHAFT – BEK156

Chrysler/Mitsubishi 2.6L  
**KIT INCLUDES:** Replacement bushing, balance shaft replacement pin, oil pump drive chain.



## BALANCE SHAFT – BEK157

Chrysler/Mitsubishi 2.6L

**KIT INCLUDES:** Replacement bushing, balance shaft replacement pin, oil pump drive chain, chain guide, crank guide, crank gear, oil pump gear.

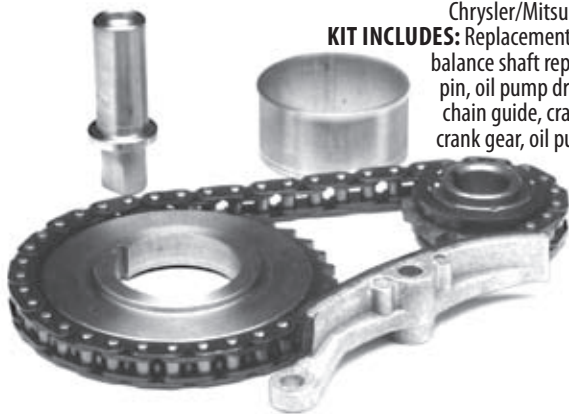

## BALANCE SHAFT – JVE156

Chrysler/Mitsubishi 2.6L

Replaces jet valves in cylinder heads for use in non jet valve applications. Fits many other applications where OEM Jet Valve #MD009440 is used.



ANYTIME. ONLINE. ENGINEQUEST.COM

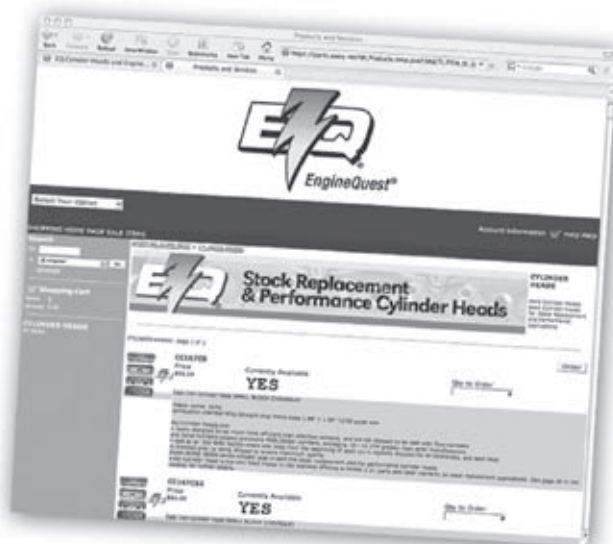

Easy downloadable EQ Webstore desktop icon for one-step order access every time!



With just one click you can shop, buy and ship!

•Real-time Inventory





## RECLAIMED INCLUDES:

- LOW TEMPERATURE BAKED
- GASKET SURFACES REFACED
- SHOT BLASTED FOR CLEANLINESS
- MAGNETIC PARTICLE INSPECTION FOR CRACKS

EN = NEW CASTING  
EX = RECLAIMED (SUBJECT TO AVAILABILITY)

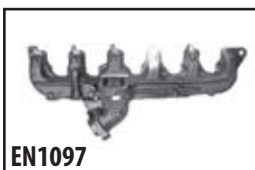
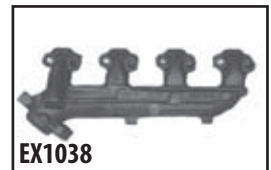
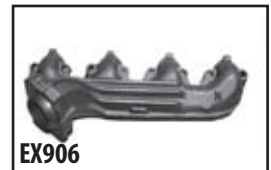
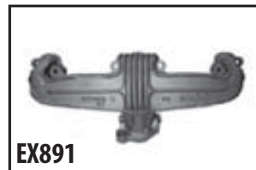
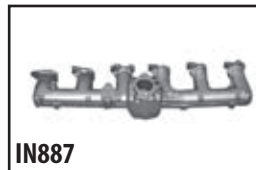
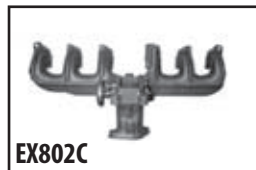
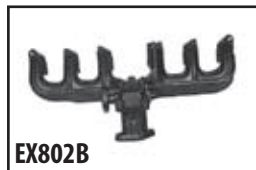
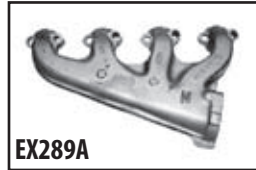
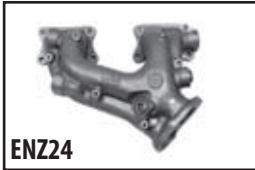

EXHAUST MANIFOLDS CONTINUED ON NEXT PAGE















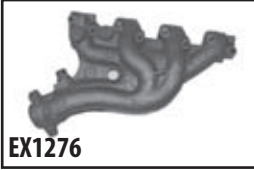





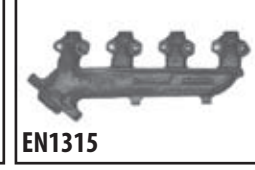











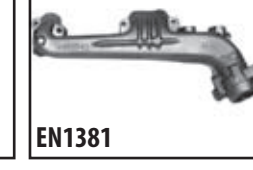





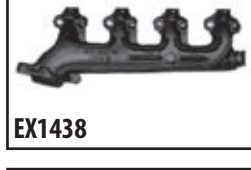

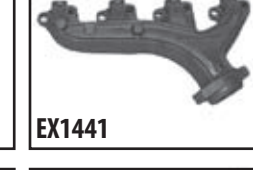
# EXHAUST MANIFOLDS

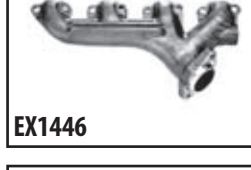
EN = NEW CASTING  
EX = RECLAIMED (SUBJECT TO AVAILABILITY)

## RECLAIMED INCLUDES:

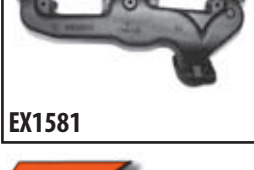
- LOW TEMPERATURE BAKED
- GASKET SURFACES REFACED
- SHOT BLASTED FOR CLEANLINESS
- MAGNETIC PARTICLE INSPECTION FOR CRACKS



 EX1159	 EN1198	 EX1239	 EN1267	
 EX1276	 EX1278	 EN1283	 EX1284	 EX1285
 EN1287	 EN1314	 EN1315	 EN1316	 EN1318
 EX1325	 EX1332	 EX1350	 EX1351	 EX1356
 EX1358	 EX1365	 EX1367	 EN1377	 EN1381
 EN1386	 EN1387	 EN1408	 EN1409	 EX1421
 EX1422	 EX1438	 EN1439	 EX1440	 EX1441
 EX1445	 EX1446	 EX1455	 EX1466	 EN1533
 EX1581	 EX1607	 EX1609	 EX1625	

VISIT  
[WWW.ENGINEQUEST.COM](http://WWW.ENGINEQUEST.COM)  
FOR LARGER IMAGES

EXHAUST MANIFOLDS CONTINUED ON NEXT PAGE





# EXHAUST MANIFOLDS

EN = NEW CASTING

EX = RECLAIMED (SUBJECT TO AVAILABILITY)

## RECLAIMED INCLUDES:

- LOW TEMPERATURE BAKED
- GASKET SURFACES REFACED
- SHOT BLASTED FOR CLEANLINESS
- MAGNETIC PARTICLE INSPECTION FOR CRACKS

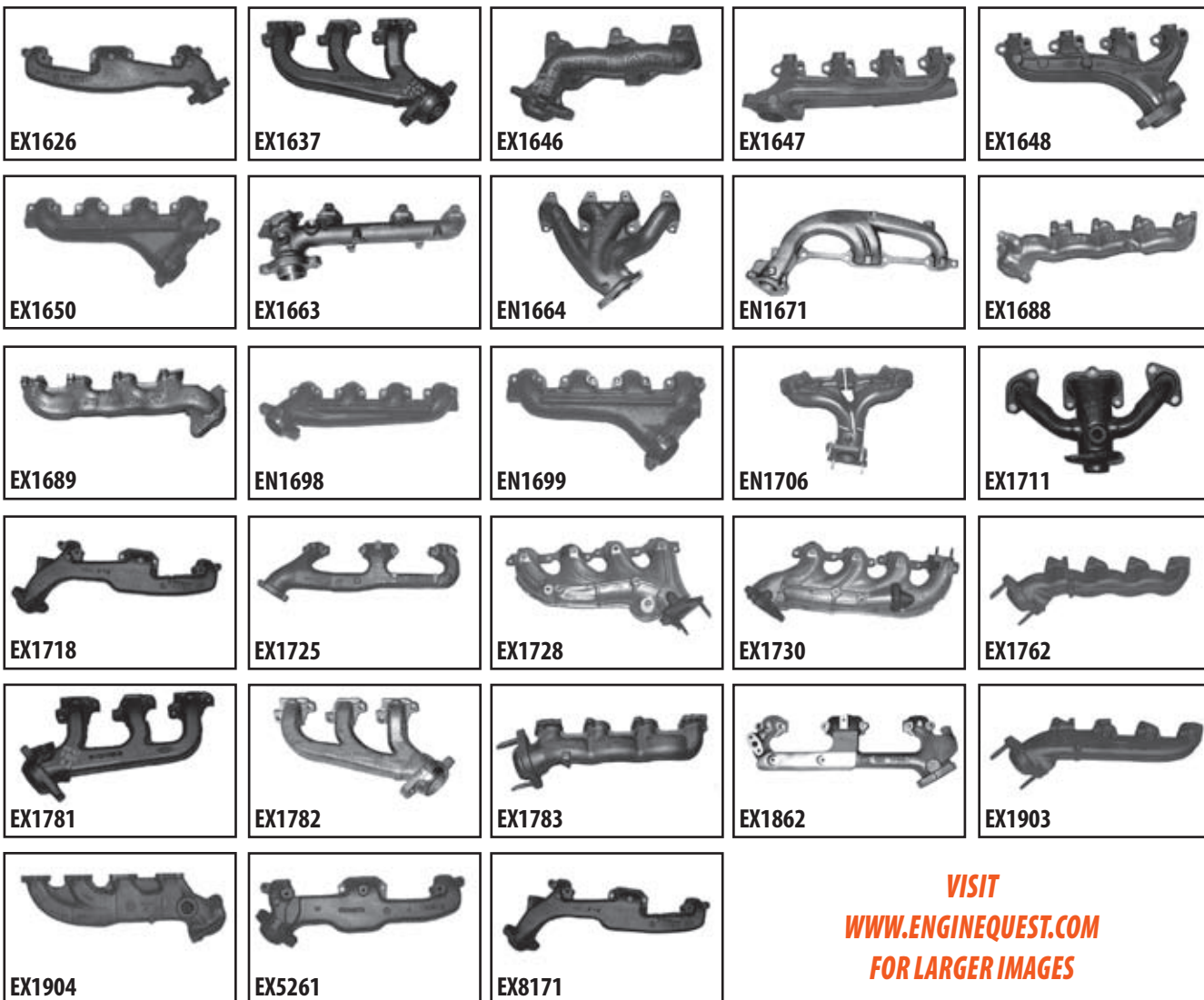

EXHAUST MANIFOLDS CONTINUED ON NEXT PAGE

VISIT  
[WWW.ENGINEQUEST.COM](http://WWW.ENGINEQUEST.COM)  
FOR LARGER IMAGES

## RECLAIMED PARTS POLICY

All reclaimed parts are special order only and are no longer stocked in our warehouses.

Call or fax the reclaimed part(s) needed to our sales department and we will give availability of the part(s) in a 24-48 hour window.

Please allow 24 hours to bake, blast and clean all reclaimed parts.

# EXHAUST MANIFOLDS

## RECLAIMED INCLUDES:

- LOW TEMPERATURE BAKED
- GASKET SURFACES REFACED
- SHOT BLASTED FOR CLEANLINESS
- MAGNETIC PARTICLE INSPECTION FOR CRACKS

EN = NEW CASTING

EX = RECLAIMED (SUBJECT TO AVAILABILITY)

PART #	MFG	VEHICLE	ENG	LITERS	YEARS	SIDE	NOTES	HOLLANDER #	CASTINGS	CASTINGS #2
EN1664	CHEVROLET	S10 TRUCK	134	2.2	94-97			327-1664		
EX1711	CHEVROLET	FWD CAR	151	2.5	82-90			327-1711A-F		
EN1267	CHEVROLET	S10	151	2.5	85-93			327-1267	10034543	10037597, 10044282
EX1127	CHEVROLET	S10	173	2.8	82-86	RIGHT		327-1127	14033087	
EX1663	CHEVROLET	FWD CAR	191	3.1	93-96	REAR		327-1663	10244605	
EN324	CHEVROLET	CAR & TRUCK	305, 350	5.7	67-72	BOTH	WITH A.I.R. HOLES, 2" FLANGE DIA	327-324	336711	372243
EN743	CHEVROLET	CAR & TRUCK	305, 350	5.7	67-72	RIGHT	WITH A.I.R. HOLES	327-743	3896956	3905364
EN695	CHEVROLET	CAR & TRUCK	305, 350	5.7	67-72	LEFT	WITH A.I.R. HOLES	327-695		
EN942	CHEVROLET	CAR & TRUCK	305, 350	5.7	77-86	LEFT	WITH A.I.R. HOLES	327-942	364753	1406436
EX1358	CHEVROLET	CAR	305, 350	5.7	80-85	RIGHT		327-1358		
EN1073	CHEVROLET	CAR	305, 350	5.7	80-86	LEFT	WITH A.I.R. HOLES	327-1073	14007400	
EN1103	CHEVROLET	TRUCK	305, 350	5.7	83-86	RIGHT	CAST IRON (3 HOLE MOUNTING FLANGE)	327-1103	14031376	14034069
EN1198	CHEVROLET	TRUCK	305, 350	5.7	83-86	LEFT	CAST IRON	327-1198	14050233	
EX1200	CHEVROLET	TRUCK	305, 350	5.7	83-86	RIGHT		327-1200	14050282	
EX1350	CHEVROLET	TRUCK	305, 350	5.7	87-90	RIGHT	WITH A.I.R. HOLES	327-1350	14093660	
EX1351	CHEVROLET	TRUCK	305, 350	5.7	87-90	LEFT		327-1351	14093653	
EX1356	CHEVROLET	CAMARO/FIREBIRD	305, 350	5.7	87-92	LEFT		327-1356	14094063	
EX1367	CHEVROLET	TRUCK	305, 350	5.7	87-90	RIGHT	WITH A.I.R. HOLES	327-1367	14093654	14093682
EN1408	CHEVROLET	TRUCK	305, 350	5.7	88-94	RIGHT	WITH A.I.R. HOLES	327-1408	14093658	14093652
EN1409	CHEVROLET	TRUCK	305, 350	5.7	88-94	LEFT	WITH A.I.R. HOLES	327-1409	10045315	14093651
EX1466	CHEVROLET	TRUCK	305, 350	5.7	89-94	RIGHT	WITHOUT A.I.R. HOLES	327-1466	10166158	14093654, 14102018
EX1455	CHEVROLET	CAR	305, 350	5.7	91-92	RIGHT		327-1455	10108437	10128448
EN1671	CHEVROLET	CAR & TRUCK	305, 350	5.7	94-96	RIGHT		327-1671	12524289	12550622
EX1725	CHEVROLET	TRUCK	305, 350	5.7	96	RIGHT		327-1725	12554973	
EX1726	CHEVROLET	TRUCK	305, 350	5.7	96	LEFT		327-1726	12554974	
EX1862	CHEVROLET	TRUCK	350	5.7	98-00	LEFT	WITH A.I.R. HOLES	327-1862	12556041	
EX1861	CHEVROLET	TRUCK	350	5.7	98-00	RIGHT	WITH A.I.R. HOLES	327-1861	12556040	
EN366R	CHEVROLET	TRUCK	366, 427	6.0, 7.0	69-89	RIGHT	WITH A.I.R. HOLES		3964244	
EN366L	CHEVROLET	TRUCK	366, 427	6.0, 7.0	69-89	LEFT	WITH A.I.R. HOLES		10085605	
EX870	CHEVROLET	CAR	396, 454	7.4	67-76	LEFT	WITH A.I.R. HOLES	327-870	3292225	
EN774B	CHEVROLET	TRUCK	454	7.4	71-81	LEFT	WITH A.I.R. HOLES	327-774B	343787	3994045, 6272279
EN602B	CHEVROLET	CAR & TRUCK	396, 454	7.4	67-87	RIGHT	WITH A.I.R. HOLES	327-602B	14045176	353030, 3868874
EX1364	CHEVROLET	TRUCK	454	7.4	83-91	LEFT	WITH A.I.R. HOLES	327-1364	14057190	14103191
EX1365	CHEVROLET	TRUCK	454	7.4	87-91	RIGHT	WITH A.I.R. HOLES		10045730	10045732
EX1728	CHEVROLET	TRUCK	454	7.4	96-00	LEFT	WITHOUT A.I.R. HOLES	327-1728	12571680	12564154
EX1820	CHEVROLET	TRUCK	454	7.4	96-00	LEFT	WITH A.I.R. HOLES	327-1820	12564158	12559572, 12571681
EX1730	CHEVROLET	TRUCK	454	7.4	96-00	RIGHT	WITH A.I.R. HOLES	327-1730	12556337	
EN1706	CHRYSLER	CIRRUS	148	2.4	95-00			327-1706		
EN1706	CHRYSLER	SEBRING	148	2.4	96-98			327-1706		
EN1706	CHRYSLER	STRATUS	148	2.4	95-00			327-1706		
EX1100	CHRYSLER	MINIVAN	156	2.6	81-86		HAS 2 HOLE FLANGE, NO PRE CAT	327-1100		
EX1239	CHRYSLER	MINIVAN	156	2.6	84-85		FEDERAL EMISSIONS	327-1239		
EX802B	CHRYSLER	CAR & TRUCK	225	3.7	73-80		WITHOUT O2 SENSOR HOLE	327-802B	4100448	

EXHAUST MANIFOLDS CONTINUED ON NEXT PAGE



# EXHAUST MANIFOLDS

EN = NEW CASTING EX = RECLAIMED (SUBJECT TO AVAILABILITY)

PART #	MFG	VEHICLE	ENG	LITERS	YEARS	SIDE	NOTES	HOLLANDER #	CASTINGS	CASTINGS #2
EX802C	CHRYSLER	CAR & TRUCK	225	3.7	81-87		WITH O2 SENSOR HOLE	327-802C	4105375	4267233
EX1421	CHRYSLER	TRUCK	239	3.9	88-91	RIGHT		327-1421	4323777	4327778
EX1422	CHRYSLER	TRUCK	239	3.9	88-91	LEFT		327-1422	4323780	4327781
EN1381	CHRYSLER	DAKOTA	239	3.9	87-89	LEFT	WITH O2 SENSOR HOLE	327-1381	4343742	
EX880	CHRYSLER	CAR & TRUCK	318, 360	5.2, 5.9	75-89	RIGHT	WITHOUT HEAT RISER	327-880	3830493	3870323, 3879721
EX882	CHRYSLER	CAR & TRUCK	318, 360	5.2, 5.9	75-87	BOTH	WITHOUT A.I.R. HOLES, HAS HEAT RISER	327-882	3870059	4041425
EX891	CHRYSLER	CAR & TRUCK	318, 360	5.2, 5.9	75-87	BOTH	WITHOUT HEAT RISER	327-891	3870057, 4071606	4227650, 5214669
EX1625	CHRYSLER	SUV, PICKUP	318, 360	5.2, 5.9	94-98	RIGHT	WITH EGR HOLE	327-1625	53009376	
EX1626	CHRYSLER	SUV, PICKUP	318, 360	5.2, 5.9	94-98	LEFT		327-1626	53010187	
EX5261	CHRYSLER	SUV, PICKUP	318, 360	5.2, 5.9	94-98	RIGHT	WITHOUT EGR HOLE	327-1625		
EX1718	CHRYSLER	SUV, PICKUP	318, 360	5.2, 5.9	96-99	RIGHT	WITH EGR HOLE	327-1718	53010186	53006618
EX8171	CHRYSLER	SUV, PICKUP	318, 360	5.2, 5.9	96-99	RIGHT	WITHOUT EGR HOLE	327-1718	53010186	53006618
EX413	CHRYSLER	TRUCK	413	6.8		BOTH				
EX855	CHRYSLER	TRUCK	400, 440	6.6, 7.2	72-78	LEFT		327-855	3769109	
EN1276	FORD	RANGER	140	2.3	85-92			327-1276, 327-1500	E6ZE9430AA	
EX1614	FORD	RANGER	140	2.4	93-94			327-1614	F37Z9430D	
EN1287	FORD	TEMPO, TOPAZ	140	2.3	85-94			327-1287	E53E9430AC/AD/AE	
EX1316	FORD	RANGER/BRONCO	177	2.9	86-90	RIGHT		327-1316	E67E9430AD	F0TE9430BE
EX1332	FORD	AEROSTAR/RANGER	183	3.0	86-96	RIGHT		327-1332	E69E9430BA	E89E9430CA
EX1646	FORD	TRUCK	183	3.0	93-97	RIGHT		327-1646	F47Z9430A	F47E9430AA
EX1607	FORD	RANGER/BRONCO	244	4.0	90-95	RIGHT		327-1607A/B	F07E9430AB/AC	F37E9430LA
EX1609	FORD	RANGER/BRONCO	244	4.0	90-95	LEFT		327-1609A	F07E9431AC/AD	F37E9431KA
EX1637	FORD	CAR	256	4.2	94	LEFT		327-1637	F4AZ9431B	F4AE9431BA
EX1781	FORD	CAR	256	4.2	97-98	RIGHT		327-1781	F65E9430AC/AD	F65E9430AF/BB
EX1782	FORD	TRUCK AND VAN	256	4.2	97-98	LEFT		327-1782	F65Z9431A	F65E9431AC
EX1903	FORD	F150 AND VAN	256	4.2	99-03	RIGHT		327-1903	XL3Z9430AA	XL3E9430AC
EX1904	FORD	F150 AND VAN	256	4.2	99-03	LEFT		327-1904	XL3Z9431AA	XL3E9431AC
EX1688	FORD	FULL SIZE	280	4.6	95-99	RIGHT		327-1688	F5AE9430AE	
EX1689	FORD	FULL SIZE	280	4.6	95-99	LEFT		327-1689	F5AE9431AE	
EX1762	FORD	MUSTANG	280	4.6	96-98	LEFT	SOHC	327-1762	F6ZZ9431FA	F6ZE94731FB
EX1783	FORD	EXPEDITION/ PICKUP	280	4.6	97-98	RIGHT		327-1783	F65Z9430B, F65E9430BD	F65E9430BE, F65E9430BF
EN452	FORD	TRUCK	300	4.9	70-80			327-452	D7TE9430DC	E4TE9428UA
EN1097	FORD	TRUCK	300	4.9	81-86		WITH O2 SENSOR HOLE	327-1097	E3TE9430RC	E4TE9428CB
IN887	FORD	TRUCK	300	4.9	77-86	INTAKE		329-887	D7TE9425JA	ESTE9425FA
EN1386	FORD	TRUCK	300	4.9	87-96	FRONT		327-1386	E7TE9430GA/ GB/GC/GD	
EN1387	FORD	TRUCK	300	4.9	87-96	REAR		327-1387	E7TE9431HD	F5TE9431FA
EX1048	FORD	CAR	255, 302	4.2, 5.0	80-83	LEFT		327-1048	E0AE9431KB	E0AE9431KC
EX1095	FORD	CAR	255, 302	4.2, 5.0	81-85	LEFT		327-1095	E1SE9431BA	
EX289A	FORD	MUSTANG	289, 302	4.7, 5.0	65-67	LEFT				
EX289B	FORD	MUSTANG	289, 302	4.7, 5.5	65-66	LEFT				
EX1038	FORD	CAR	302	5.0	80-85	RIGHT	WITH CHOKE TUBE HOLE	327-1038A	E0AE9430FC	
EN1318	FORD	TRUCK	302	5.0	80-95	RIGHT	WITH O2 SENSOR HOLE	327-1318A,B,C	E0AE9430FC	E6AE9430GB, F3TE9430LA
EN1049	FORD	TRUCK	302	5.0	80-95	LEFT		327-1866A,B,C	E0TE9431CA	F3TE9431JA, F3TE9431NA
EX1325	FORD	MUSTANG	302	5.0	86-93	LEFT		327-1325	E6SE9431AA	
EX992	FORD	CAR & TRUCK	351W	5.8	79-82	RIGHT		327-992	D9AE9430FC	

EXHAUST MANIFOLDS CONTINUED ON NEXT PAGE



# EXHAUST MANIFOLDS

EN = NEW CASTING EX = RECLAIMED (SUBJECT TO AVAILABILITY)

PART #	MFG	VEHICLE	ENG	LITERS	YEARS	SIDE	NOTES	HOLLANDER #	CASTINGS	CASTINGS #2
EX1096	FORD	TRUCK	351W	5.8	81-87	RIGHT	WITHOUT A.I.R. HOLES	327-1096	E5TE9430BA	E5TE9430CA
EX1159	FORD	TRUCK	351W	5.8	83-87	LEFT	WITHOUT A.I.R. HOLES	327-1159	E3TE9431AA	E5TE9431BA
EX1278	FORD	TRUCK	351W	5.8	85-87	LEFT	WITH A.I.R. HOLES	327-1278	E5TE9431BA	
EX1315	FORD	TRUCK	351W	5.8	85-87	RIGHT	WITH A.I.R. HOLES	327-1315	E5TE9430BA	
EN1438	FORD	TRUCK	351W	5.8	88-93	RIGHT	WITH A.I.R. HOLES (PLUGS TO BLOCKOFF SUPPLIED)	327-1438	E8TE9430AB	F4YE9430EB
EN1439	FORD	TRUCK	351W	5.8	88-93	LEFT	WITH A.I.R. HOLES (PLUGS TO BLOCKOFF SUPPLIED), W/O2 HOLE	327-1439	E8TE9431AB	
EX1647	FORD	TRUCK	351W	5.8	88-93	RIGHT	WITHOUT A.I.R. HOLES, W/O2 HOLE	327-1647	F4TE9430DB, DC	
EX1648	FORD	TRUCK	351W	5.8	94-97	LEFT	WITHOUT A.I.R. HOLES, W/O2 HOLE	327-1648	F4TE9431DB, DC	
EX1650	FORD	TRUCK	351W	5.8	94-97	LEFT	WITH A.I.R. HOLES, W/O2 HOLE	327-1650	F4TE9431EB	F4TE EA, EB
EX906	FORD	CAR	460	7.5	75-78	RIGHT		327-906	D5VE9430BA	
EX907	FORD	CAR	460	7.5	75-78	LEFT		327-907	D5VE9431AB	
EX936	FORD	TRUCK	460	7.5	75-84	RIGHT	WITHOUT A.I.R. HOLES	327-936	E9JL9430BA	
EX937	FORD	TRUCK	460	7.5	75-84	LEFT		327-937	F2TZ9431C	
EX1283	FORD	TRUCK	460	7.5	85-90	RIGHT	WITH A.I.R. HOLES	327-1283	E5HE9430AA, AC	E9JL9430AA
EX1284	FORD	TRUCK	460	7.5	85-89	RIGHT	WITHOUT A.I.R. HOLES	327-1284	E5HE9430CA, E9HL9430BA, E9HL9430BA	E9HL9430BA, F2PE9430AA
EX1285	FORD	TRUCK	460	7.5	85-90	LEFT	WITH A.I.R. HOLES	327-1285	E5HE9431AA, E5HE9431AC	
EX1445	FORD	TRUCK	460	7.5	88-92	RIGHT		327-1445A	E8TE9430CB	
EX1446	FORD	TRUCK	460	7.5	88-92	LEFT	WITHOUT A.I.R. HOLES	327-1446A	E9TE9431CA	F6TE9429LA
EN1698	FORD	TRUCK	460	7.5	88-97	RIGHT		327-1698A,B	E7TE9428EA, E7TE9428EB	E7TE9428EC, F4TE9430AA
EN1699	FORD	TRUCK	460	7.5	88-97	LEFT		327-1699A,B	E7TE9431EA, E7TE9431EB	E7TE9431EC, F4TE9431AA
EN4AF	GEO	PRISM	4AFE, 7FE	1.6	89-97		WITH O2 SENSOR HOLE (SUPPLIED WITH PLUG)	327-58263, 58362		
EX404	INTERNATIONAL	TRUCK	404			BOTH			446843	
EN1664	ISUZU	HOMBRE	134	2.2	96-97			327-1664		
EX1581	JEEP	GRAND CHEROKEE	318, 360	5.2	93-98	LEFT		327-1581	53009377	
EN1314	JEEP		150	2.5	83-90		WITH O2 SENSOR HOLE	327-1314	2511, 0032	3241170, 3442625
EN1377	JEEP		242	4.0	87-90			327-1377		
EN1533	JEEP		242	4.0	91-99			327-1533	33007075	
EX1158	JEEP		258	4.2	83-90			327-1158	3237096	3237426
EX779	JEEP		304	5.0	70-81	RIGHT	WITH A.I.R. HOLES	327-779	6210160	8121274, 8130211
EX801	JEEP		304	5.0	70-81	LEFT	WITH A.I.R. HOLES	327-801	3210159	
EX779	JEEP		360	5.9	70-91	RIGHT	WITH A.I.R. HOLES	327-779	6210160	8121274, 8130211
EX801	JEEP		360	5.9	70-91	LEFT	WITH A.I.R. HOLES	327-801	3210159	
EX779	JEEP		401	6.6	70-78	RIGHT	WITH A.I.R. HOLES	327-779	6210160	8121274, 8130211
EX801	JEEP		401	6.6	70-78	LEFT	WITH A.I.R. HOLES	327-801	3210159	
ENZ5DE	MAZDA	PROTÉGÉ	Z5DE	1.5	95-98			327-58756		
ENKA24	NISSAN	PICKUP	KA24	2.4	90-97			327-58326A,B	14004-F4003	
ENZ24	NISSAN	TRUCK	Z24	2.4	83-89			327-58091, 58092, 58142		
EN1706	PLYMOUTH	BREEZE	148	2.4	96-00			327-1706		
EN4AF	TOYOTA	CELICA, COROLLA	4AFE, 7FE	1.6	88-97		WITH O2 SENSOR HOLE (SUPPLIED WITH PLUG)	327-58263, 58362		
EN22RE	TOYOTA	PICKUP	22RE	2.7	86-95			327-58129, 58134A, B		
EN165	TOYOTA	PICKUP	2RZFE/3RZFE	2.4/2.7	94-00			327-58679		

## RECLAIMED INCLUDES:

• LOW TEMPERATURE BAKED • GASKET SURFACES REFAED • SHOT BLASTED FOR CLEANLINESS • MAGNETIC PARTICLE INSPECTION FOR CRACKS

CUSTOMER SERVICE • MONDAY - FRIDAY 7 AM - 5 PM PACIFIC TIME • TOLL FREE 800.426.8771 • LOCAL 702.649.7776 • FAX 702.649.6777



# STANDARD TRANSMISSION FLYWHEELS

MODEL	ENG	YEAR	NOTES	PART #
<b>BUICK</b>				
SKYHAWK	1.8	82		FW6500
		83-86		FW6551
	2.0	83-86		FW6500
		87-89	VIN 8TH DIGIT "1" VIN 8TH DIGIT "M" VIN 8TH DIGIT "K"	FW6500 FW6552 FW6552
SKYLARK	2.3	88-89		FW6524
	2.5	80-88		FW6514
	2.8	80-85		FW6505
<b>CADILLAC</b>				
CIMMARON	4 CYL	82-86		FW6500
	2.8	85-86 87-88		FW6505 FW6500
<b>CHEVROLET</b>				
ASTRO	2.5	85-90		FW6517
	4.3	85		FW6504
		86-90		FW6525
BERETTA	2.0	87-89		FW6500
	2.2	90-96		FW6500
	2.3	90-94		FW6524
	2.8	87-89		FW6500
	3.1	90-93		FW6500
BLAZER MIDSIZE & FULL SIZE	1.9	83-84		FW1202
	2.0	83-84		FW6510
	2.5	85-88		FW6510
	2.8	82-84		FW6511
		85-86		FW6512
		87-89		FW6513
	4.3	90-92		FW6529
		93		FW6565
		94	FW CAST #14103283, VIN "W", CENTRAL PORT INJ FW CAST #10218655 VIN "Z", THROTTLE BODY INJ	FW6529
		95-98		FW6529
	99-05		FW6569	
	ALL 6 CYL	69-82	11" & 12" DISC	FW6504
	305 & 350	69-85		FW6504
	400	86-94		FW6525
	454	75-79		FW6567
		73-87		FW6531
CAMARO	3.8	67-69		FW6516
		80-81		FW6516
		96-02		FW6533
		67-82	10.4" DISC 153 TOOTH GEAR 11" DISC	FW6516
			168 TOOTH GEAR	FW6504
		83-85	VIN 8TH DIGIT "H", "7" OR "G"	FW6516*
				FW6515*
		86	VIN 8TH DIGIT "G" OR "H"	FW6526**
				FW6527**
		87	CARB	FW6526**
			EFI	FW6527**
	350	88-92	THROTTLE BODY INJ MULTI-PORT INJ	FW6526**
		93-97		FW6527**
	98-02		FW6503	
	400	70-71		FW6536 FW6567
CAVALIER	2.0 & 2.2	83-00		FW6500
		02	VIN "4"	FW6500
	2.8	87-89		FW6500
	3.1	90-94		FW6500
CELEBRITY	2.8	87-88		FW6500
CORSICA	2.0 & 2.2	87-96		FW6500
	2.8	87-89		FW6500
	3.1	90-96		FW6500
CORVETTE	ALL V-8	78-85	10.4" DISC 11" DISC	FW6516 FW6504
		86-88		FW6526

\*FW6515 AND FW6516 ARE INTER-CHANGEABLE.  
\*\*FW6526 AND FW6527 ARE INTER-CHANGEABLE.

MODEL	ENG	YEAR	NOTES	PART #
<b>CHEVROLET (CONTINUED)</b>				
LUV	1.8	80-82	4WD	FW1202
S10 & S15	1.9	82-85		FW1202
	2.0	83-84		FW6510
	2.2	94-03		FW6528
	2.5	85-93		FW6510
	2.8	82-84		FW6511
		85-86		FW6512
		87-93		FW6513
	4.3	90-92		FW6529
		93		FW6565
		94-95	FW CAST #14103283 VIN "W" PORT INJ	FW6529
		FW CAST #10218655 VIN "Z" THROTTLE BODY INJ	FW6565	
		96-97	FW6529	
	98	ZN4 NOT ZN4	FW6569	
		99-03	FW6529	
CHEVROLET TRUCKS C,K,G,P,R, V,10,20,30	250	70-84		FW6504
	262 (4.3)	85		FW6504
		86-87		FW6525
		88-89	VAN TRUCK	FW6525
				FW6529
		90-93		FW6529
		94		FW6565
		95	FW CAST #14103283	FW6529
			FW CAST #10218655 THROTTLE BODY INJ	FW6565
		96-98		FW6529
	292	67-88		FW6550
	305 (5.0)	67-85		FW6504
		86-99		FW6525
350 (5.7)	67-85	10.4" CLUTCH 11" & 12" CLUTCH	FW6535 FW6504	
	86-95		FW6525	
	96-99	CASTING #14091599	FW6525	
	82-93	CASTING #14050525	FW6568	
	380 (6.2) DIESEL			
	400	70-80	FW6567	
	454 (7.4)	73-90	FW6531	
		91-95	FW6561	
		97-00	FW6574	
<b>CHRYSLER</b>				
ACCLAIM	2.5	89-93		FW3402
LASER	2.2	86-87	TURBO	FW3402
	2.5	86		FW3402
LEBARON	2.2	86-90	TURBO	FW3402
		91-93		FW3402
	2.5	86-93		FW3402
	3.0	90-95		FW3402
<b>DODGE</b>				
ARIES	2.2	86-89	TURBO	FW3402
	2.5	86-89		FW3402
CARAVAN	ALL	86-94		FW3402
CHARGER	2.2	86-87	TURBO	FW3402
DAKOTA	2.5	87-95		FW3402
		96-99		FW3418
	240 (3.9)	87-91		FW3409
DAYTONA, SHELBY, IROC	2.5	86-93		FW3402
LANCER	3.0	90-93		FW3402
NEON	2.5	86-89		FW3402
OMNI 024	2.0	02		FW3402
RAM VAN MINI	2.2	86-90	TURBO	FW3402
SHADOW	ALL	86-92		FW3402
	2.2	87-91	TURBO	FW3402
		92-94		FW3402

FLYWHEELS CONTINUED ON NEXT PAGE



# STANDARD TRANSMISSION FLYWHEELS

MODEL	ENG	YEAR	NOTES	PART #
<b>DODGE (CONTINUED)</b>				
SHADOW	2.5 & 3.0	88-94		FW3402
SPIRIT	ALL	89-95		FW3402
TRUCKS	240 (3.9)	88-91		FW3409
VANS AND RAMCHARGER 100-300 SERIES	318 (5.2)	70-87	10.5" DISC 11" DISC	FW3409 FW3411 FW3411 FW3430 FW3431
	5.9 CUMMINS TURBO DIESEL	88-91 89-93 94-97		
	360 (5.9)	70-93 94-02		FW3413 FW3419
	383	66-71		FW3411
	400	71-81		FW3411
	440	74-81		FW3411
400 & 600	ALL	86-88	TURBO	FW3402
	2.5	86-88		FW3402
<b>FORD</b>				
AEROSTAR	2.3	86-87		FW703
	2.8	85-86		FW701
	3.0	86-94		FW723
	4.0	90		FW724
BRONCO & BRONCO II	2.0	84-88		FW703
	2.3	84-88		FW703
	2.8	84		FW702
		85		FW701
	2.9	86-91		FW701
	4.0	90-91		FW724
	4.9 (300)	80-93		FW714
	5.0 (302)	65-80		FW720
		81-96		FW710
	5.8 (351W)	68-81		FW720
		82-93		FW735
	400M	78-82		FW718
E SERIES VAN	4.9 (300)	78-96		FW714
	5.0 (302)	68-80		FW720
		81-90		FW710
	5.8 (351W)	68-80		FW720
		81-89		FW735
	400 M	80-83		FW718
ESCORT & EXP	1.6	81-86		FW706
EXPLORER	4.0	91-97		FW724
F150	3.8 (230)	81-83		FW735
F250	4.9 (300)	80-96		FW714
F350	5.0 (302)	68-76		FW720
F450 SERIES TRUCKS		77-80		FW735
		81-96		FW710
	351W	68-81		FW720
		82-93		FW735
	360	65-76		FW746
	390	67-76		FW747
	400	77-82		FW718
MUSTANG	2.3	83	9" DISC	FW703
	2.3	84-86		FW703
	289	65-69	157 TEETH	FW789
			28 OZ. WEIGHT	
	5.0	79-85	157 TEETH	FW712
			50 OZ. WEIGHT	
		86-95	157 TEETH	FW711
			50 OZ. WEIGHT	
RANGER	2.0	83-89		FW703
	2.3	83-94		FW703
	2.8	83-85		FW702
	2.9	85-92		FW701
	3.0	90-94		FW723
	4.0	90-96		FW724
TAURUS	3.0	89-90	9.5" DISC	FW723
TEMPO	3.0	92-94		FW723
THUNDERBIRD	2.3	83-88		FW703

MODEL	ENG	YEAR	NOTES	PART #
<b>GMC</b>				
S15 & T15	1.9	82-85		FW1202
JIMMY AND SONOMA	2.0	83-84		FW6510
	2.5	85-93		FW6510
PICKUP	2.8	82-84		FW6511
		85-86		FW6512
		87-93		FW6513
	4.3	90-92		FW6529
		94-95	CASTING #14103283 VIN "W" CENTRAL PORT INJ	FW6529
		96-97		FW6529
		98	ZN4 NOT ZN4	FW6569
		99-03		FW6529
SAFARI	4.3	85		FW6504
		86-90		FW6529
TRUCKS C,K,G,P,R, V,10,20,30 SIERRA AND VANS	250	67-84		FW6504
	262 (4.3)	85		FW6504
		86-87		FW6525
		88-89	VAN TRUCK	FW6525
		90-93		FW6529
		95	ENGINE CODE "AA_" FW CASTING #14103283	FW6529
		96-98		FW6529
	305 (5.0)	68-85		FW6504
		86-99		FW6525
	350 (5.7)	68-85		FW6504
		86-96		FW6525
		97-99	FW CASTING #12550526	FW6525
	400	70-80		FW6567
	454 (7.4)	73-90		FW6531
		91-95		FW6561
		96		FW6562
<b>ISUZU</b>				
AMIGO	2.6	89-94		FW1204
HOMBRE	4.3	97-98	CASTING #14103283	FW6529
I-MARK	1.8	81-84		FW1202
IMPULSE	1.9	83-5/87		FW1202
PICKUP P'UP	1.8	81-82	4WD	FW1202
	2.6	88-95		FW1204
	3.1	91-94		FW6500
RODEO	2.6	91-98		FW1204
	3.1	91-92	CASTING #14018712 CASTING #14046567	FW6500 FW6513
TROOPER II	1.9	84-85		FW1202
	2.6	88-91		FW1204
<b>JEEP</b>				
CHEROKEE, GRAND CHEROKEE, SPORTWAGON & WAGONEER (MIDSIZE)	2.8 (173)	83-84		FW6511
		85-86		FW6512
		91-01		FW1002
	304	71-81		FW1005
	360	71-83		FW1005
CJ	4.2 (258)	82-86		FW1001
WRANGLER	4.0	91-04		FW1002
J10 & J20	2.8 (173)	86		FW6512
COMANCHE & GLADIATOR	5.0 (304)	91-94		FW1002
		71-81		FW1005
<b>MAZDA</b>				
B2000	2.3	94		FW703
B2200	2.6	87-88		FW519
B2300		89	CARB	FW519
B2500	3.0	94		FW723
B2600	4.0	94-96		FW724
B3000				
B4000				
NAVAJO	4.0	91-94		FW724
<b>MERCURY</b>				
CAPRI	5.0	79-85		FW712
		86		FW711

FLYWHEELS CONTINUED ON NEXT PAGE



# STANDARD TRANSMISSION FLYWHEELS

MODEL	ENG	YEAR	NOTES	PART #
<b>MERCURY (CONTINUED)</b>				
COUGAR	2.3	83-86	9" DISC	FW703
	5.0	79-85		FW712
		86-93		FW711
LN7 & LINX	1.6	81-85		FW706
MERKUR XR4TI	2.3	85-89		FW703
TOPAZ	3.0	92-94	723	
<b>NISSAN</b>				
AXCESS	2.4	89-95	4WD	FW304
FRONTIER - NON-SUPERCHARGED	4 CYL	98-04		FW304
NX COUPE	1.6	91-94		FW303
PATHFINDER	4 CYL	87-89		FW304
PULSAR SOHC	1.6	82-8/86		FW300
		9/86-6/88		FW301
		7/88-90		FW303
SENTRA	1.6	82-12/85		FW300
		1/86-6/88		FW301
		7/88-99		FW303
TRUCKS	4 CYL	11/82-96		FW304
XTERRA	4 CYL	00-04		FW304
200SX	1.6	95-98		FW303
280Z	ALL 6 CYL	75-83	TURBO & 2+2	FW304
ZX, TURBO & 2+2				
<b>OLDSMOBILE</b>				
CIERA	2.8	87-90		FW6500
	3.1	89-90		FW6500
CUTLASS	2.8	88-89		FW6500
	1.8	82		FW6500
FIRENZA	2.0	83-87		FW6500
		87-89	VIN 8TH DIGIT "1"	FW6500
		87		FW6500
<b>PLYMOUTH</b>				
ACCLAIM	ALL	89-93		FW3402
HORIZON	2.2	86-90	TURBO	FW3402
NEON	ALL	03-05	TURBO	FW3402
RELIANT	2.5	86-89		FW3402
SUNDANCE	2.2	87-90	TURBO	FW3402
		88-94		FW3402
		93-94		FW3402
TURISMO	2.2	86-90	TURBO	FW3402
VOYAGER	ALL 4 CYL	86-93		FW3402
<b>PONTIAC</b>				
FIERO	2.8	88		FW6500
FIREBIRD	229	80-81		FW6516
TRANS AM	ALL V8	77-82	10.4" DISC	FW6516
			11" DISC	FW6504
		83-85	VIN 8TH DIGIT "H", "7" or "G"	FW6516*
		86	VIN 8TH DIGIT "G" or "H"	FW6515**
		87	CARB	FW6527**
	EFI	FW6526**		
	88-92	THROTTLE BODY INJ	FW6527**	
		MULTI-PORT INJ	FW6527**	
GRAND PRIX	2.8	88-89		FW6500
J2000	4 CYL	85-90		FW6500
SUNBIRD	1.8	82		FW6500
		83-86		FW6500
		92-94		FW6500
SUNFIRE	2.2	95-01		FW6500
		02	VIN "4"	FW6500
6000	2.8	86-89		FW6500
<b>TOYOTA</b>				
CAMRY - 2WD	4-CYL	83-86		FW109
		87-5/89		FW107
		6/89-01		FW108
CELICA - 2WD NON TURBO	4-CYL	8/83-7/85		FW100
		8/85-86	2SELC ENG.	FW109
				6 CRANK BOLTS

\*FW6515 AND FW6516 ARE INTER-CHANGEABLE.

\*\*FW6526 AND FW6527 ARE INTER-CHANGEABLE.

MODEL	ENG	YEAR	NOTES	PART #
<b>TOYOTA (CONTINUED)</b>				
CELICA - 2WD NON TURBO		87-88	3SFE ENG.	FW107
		89-5/89	3SFE ENG.	6 CRANK BOLTS FW107
		6/89-7/89	3SGELC ENG.	6 CRANK BOLTS FW108
		90-93	4AFE ENG.(ST)	8 CRANK BOLTS FW116
		94-97	5SFE ENG.(GT)	6 CRANK BOLTS FW108
		98-99	5SFE ENG.(GT)	8 CRANK BOLTS FW108
COROLLA	1.6	83		FW116
MR-2	2.2	1/90-95		FW108
SOLARA	4-CYL	99-01		FW108
TRUCKS 2WD & 4WD	2.4	8/83-85	N/TURBO	FW100
		86-88		FW100
		89-7/92		FW100
		8/92-95		2WD FW100
				4WD FW123
	3.0	88-95		FW103
T 100	3.0	93-94	2WD	FW103
4 RUNNER NON-TURBO	4 CYL	84-7/92		FW100
		8/92-10/95		FW123
4 RUNNER TURBO	4 CYL	88-10/95		FW103
		86-87		FW123
<b>VOLKSWAGEN</b>				
CORRADO	1.8	89-92		FW8210
JETTA DIESEL	4 CYL	97	TDI	FW8210
		98		FW8210
		99	VIN 8TH DIGIT "H"	FW8210
PASSAT GAS	1.8	90-97		FW8210
PASSAT DIESEL	4 CYL	96-97	TDI	FW8210

## GM CAUTION

### VERY IMPORTANT!!!

#### ALWAYS MATCH GM 2.8L & 4.3L CASTING NUMBERS!

PART #	CASTING #	LOOK FOR:	WEIGHT ON BACK
FW6500	14018712	NO WEIGHT ON BACK	
FW6505	476505	LARGE WEIGHT ON BACK	
PART #	CASTING #	BOLT CIRCLE:	WEIGHT ON BACK
FW6501	14033181	10-7/8"	YES
FW6502	14100560		NO
FW6511	14033092	10-7/8"	YES
FW6512	14033092	10-1/5"	YES
FW6513	14046567	10-1/5"	NO
FW6521	14033181	10-1/5"	YES
FW6529	14013282	N/A	YES
FW6565	10218653	N/A	YES

PART #	TEETH	NOTES	FACE
FW3411	143		
FW3413	168	14"	
FW6504	153		13-1/4"
FW6516	153		
FW6525	168		
FW6526	153		
FW6527	153	12-3/4"	
FW6529	168		
FW6569	168		
FW6574			
FW711	157	13-1/4	12-1/4"
FW712	157		500Z
FW715		4 SETS OF 2 MOUNTING	
FW716		3 SETS OF 2 MOUNTING	
FW720			11"
FW735	164	14"	280Z
FW747	184		11-1/2"
FW789	157		280Z



# HOLLANDER INTERCHANGES

PART #	HOLLANDER #	PART #	HOLLANDER #	PART #	HOLLANDER #	PART #	HOLLANDER #	PART #	HOLLANDER #	PART #	HOLLANDER #
CS428	303-355	TC232A	308-296	BA302N	309-381	OP202A	311-658	EX1356	327-1356	ENZ5DE	327-58756
CS454	303-479	TC183A	308-299	BA242N	309-402	OP239B	311-660	EX1358	327-1358	EN602B	327-602B
CS454A	303-479	TC183B	308-300	BA231A	309-406B	OP183A	311-667	EX1365	327-1365	EN695	327-695
CS454S	303-479	TC351A	308-302A	TC460N	309-410	OP183B	311-683	EX1367	327-1367	EN743	327-743
CS179	303-58180	TC351A	308-302B	BA351N	309-427	OP280A	311-684B	EN1377	327-1377	EN774B	327-774A
CS122S	303-58330A	TC244R	308-306	BA231B	309-430	OP454A	311-692	EN1381	327-1381	EN774B	327-774B
CS122S	303-58330B	TC460N	308-309	BA231C	309-436	OP239C	311-694	EN1386	327-1386	EX779	327-779
CS351	303-631	TC351F	308-313A	BA232B	309-448	OP360B	311-696	EN1387	327-1387	EX802B	327-802B
CS381	303-752	TC351F	308-313B	BA204A	309-457	OP183C	311-702	EN1408	327-1408A	EX802C	327-802C
CS256	303-807	TC202R	308-316	BA204B	309-458	OP232G	311-705A	EN1408	327-1408B	EN815	327-815
TC183E	305-540B	TC351E	308-323	BA232A	309-477	OP138B	311-707	EN1408	327-1408C	EX855	327-855
CH155N	306-1231	TC142I	308-327A	BA204C	309-484	OP381B	311-712	EN1409	327-1409A	EX870	327-870
CH155N	306-1361	TC142I	308-327B	BA231D	309-489	OP166A	311-719	EN1409	327-1409B	EX880	327-880
CH153N	306-1382	TC142I	308-327C	BA140N	309-541	OP183D	311-721	EN1409	327-1409C	EX882	327-882
CH350D	306-1408	TC116B	308-333	BA460N	309-599	OP140B	311-722	EX1421	327-1421	EX891	327-891
CH350B	306-1411	TC318C	308-345	OP351C	311-330	OP232E	311-724	EX1422	327-1422	EX906	327-906
CH300A	306-1418A	TC318E	308-346	OP350C	311-358	OP232F	311-725	EN1438	327-1438	EX907	327-907
CH300A	306-1418B	TC232C	308-350A	OP350E	311-358	OP116A	311-726	EN1439	327-1439	EN936	327-936
CH244A	306-1467	TC232D	308-350B	OP454	311-365	OP318B	311-735	EX1445	327-1445	EX936	327-936
CH318A	306-1512	TC488A	308-374	OP454C	311-365	OP189A	311-744	EX1446	327-1446	EX937	327-937
CH395N	306-1527	TC488B	308-374	OP225A	311-383	OP133A	311-749	EX1455	327-1455	EN942	327-942
CH134N	306-1553A	TC242R	308-382	OP318A	311-384	OP120A	311-759	EX1466	327-1466	EN966	327-966
CH134N	306-1553B	TC181G	308-392	OP360A	311-385	OP232H	311-762A	EN1533	327-1533	EX992	327-992
CH244B	306-1606	TC232B	308-397	OP258A	311-395	OP232H	311-762B	EX1581	327-1581	FW6574	409-1025
CH305A	306-1628	TC183C	308-409A	OP400A	311-449	OP232H	311-762C	EX1607	327-1607	FW3409	409-236
CH350C	306-1629	TC262P	308-434	OP351M	311-450	OP232H	311-762D	EX1609	327-1609	FW746	409-262C
CH244C	306-1706	TC350P	308-436	OP300A	311-479	OP183E	311-765	EX1614	327-1614	FW789	409-290
CH144N	306-58131A	TC183D	308-450A	OP305C	311-483	OP460A	311-766	EX1625	327-1625	FW6515	409-329
CH144N	306-58131B	TC183D	308-450B	OP305L	311-483	OP460A	311-767	EX1626	327-1626	FW747	409-343
CH146N	306-58140	TC232E	308-451	OP231A	311-484	OP460A	311-768	EX1637	327-1637	FW6504	409-347B
CH122A	306-58173B	TC143I	308-455	OP135A	311-493	OP244A	311-771C	EX1646	327-1646	FW3411	409-396
CH138N	306-58203A	TC351H	308-457	OP156A	311-494	OP138C	311-790	EX1647	327-1647	FW6531	409-440
CH138N	306-58203B	TC351C	308-460A	OP351A	311-497	OP351D	311-821	EX1648	327-1648	FW6567	409-477
CH156N	306-58305A	TC318D	308-491	OP232A	311-506A	OP349A	311-859	EX1650	327-1650	FW519	409-50508
CH156N	306-58305B	TC116A	308-506	OP232B	311-506B	OP155A	311-932	EX1663	327-1663	FW3413	409-521
CH157N	306-58401	TC116C	308-518	OP173E	311-522	EN1006	327-1006	EN1664	327-1664	FW100	409-52256
CH350A	306-982A	TC183G	308-532	OP173A	311-523	EX1038	327-1038	EN1671	327-1671	FW123	409-52256
CH350A	306-982B	TC183E	308-540A	OP420A	311-536	EX1048	327-1048	EN1698	327-1698	FW300	409-53634
CH350A	306-982C	TC183F	308-542	OP140A	311-537	EN1073	327-1073	EN1699	327-1699	FW301	409-58282
TCV8RR	308-116	TC22EL	308-54354A	OP173B	311-552	EX1095	327-1095	EN1706	327-1706	FW107	409-58294
TC455R	308-118	TC22EL	308-54354B	OP262A	311-569	EX1096	327-1096	EX1711	327-1711	FW103	409-58308A
TCC350	308-128	TC225A	308-569	OP304C	311-572A	EN1097	327-1097	EX1718	327-1718	FW1202	409-58342
TCC305	308-130	TC183G	308-579	OP350L	311-572A	EX1100	327-1100	EX1725	327-1725	FW1204	409-58356
TCC305	308-131	TC22RN	308-58033	OP273A	311-574	EN1103	327-1103	EX1726	327-1726	FW304	409-58393A
TC173C	308-136	TC22A	308-58038	OP262B	311-576	EX1127	327-1127	EX1730	327-1730	FW303	409-58397
TC173B	308-137	TCKA24	308-58215	OP098A	311-578	EX1158	327-1158	EX1762	327-1762	FW108	409-58423
TC301R	308-140	TCGA16	308-58232	OP153A	311-579	EX1159	327-1159	EX1781	327-1781	FW718	409-600
TC400R	308-141	TCKA25	308-58373	OP173C	311-592A	EN1198	327-1198	EX1782	327-1782	FW714	409-655
TC181C	308-154A	TCRSR20	308-58375	OP173C	311-592B	EX1200	327-1200	EX1783	327-1783	FW710	409-682
TC181D	308-154B	TCKA26	308-58507	OP173F	311-592B	EN1314	327-1209	EX1820	327-1820	FW712	409-692
TC454C	308-158A	TCGA17	308-58573	OP121A	311-600	EX1239	327-1239	EX1728	327-1827	FW6500	409-695
TC454C	308-158B	TCKA27	308-58741	OP242A	311-601	EN1267	327-1267	EX1862	327-1862	FW6511	409-700
TC14RR	308-208	TC183G	308-590	OP239A	311-604	EN1276	327-1276	EN1049	327-1866A	FW1001	409-713
TC20RR	308-209	BA396N	309-116	OP181A	311-605	EX1276	327-1276	EN1049	327-1866B	FW703	409-724
TC20FR	308-210	BA250N	309-119	OP300B	311-611	EX1278	327-1278	EN1049	327-1866C	FW716	409-725
TC14FR	308-211	BA349N	309-148	OP302B	311-612A	EX1283	327-1283	EX1903	327-1903	FW702	409-729
TC181F	308-212	BA350N	309-152	OP302A	311-613	EX1284	327-1284	EX1904	327-1904	FW6512	409-772
TC361N	308-218A	BA400N	309-157	OP262C	311-621	EN1285	327-1285	EN324	327-324F	FW6510	409-773A
TC361N	308-218B	BA454N	309-162	OP381A	311-623A	EN1287	327-1287	EX452	327-452	FW6510	409-773B
TC361N	308-218C	BA251N	309-163	OP381A	311-623B	EN1315	327-1314	ENZ24	327-58091	FW6525	409-781
TC242R	308-222	BA252N	309-168	OP098B	311-632	EX1315	327-1315	ENZ24	327-58092	FW711	409-794
TC318N	308-245A	BA304N	309-169	OP232C	311-642A	EX1316	327-1316	EN22RE	327-58134A	FW701	409-795
TC318B	308-245B	BA305N	309-172	OP232D	311-642B	EN1318	327-1318A	EN22RE	327-58134B	FW723	409-796
TC181E	308-267	BA292N	309-178	OP351B	311-643	EN1319	327-1318B	ENZ24	327-58142	FW724	409-796
TC141I	308-274	BA289N	309-260	OP173D	311-644	EN1320	327-1318C	EN4AF	327-58263	FW6529	409-812
TC116I	308-283	BA460N	309-297	OP138A	311-646	EX1325	327-1325	ENKA24	327-58326A	FW6513	409-816
TC116I	308-284	BA390N	309-284	OP350D	311-647	EX1332	327-1332	ENKA24	327-58326B	FW3402	409-828
TC300N	308-293	BA460N	309-293	OP153B	311-654	EX1350	327-1350	EN4AF	327-58362	FW735	409-841
TC177R	308-295	TC460N	309-312	OP135B	311-655	EX1351	327-1351	EN165	327-58679	FW715	409-845
										FW743	409-845
										FW3430	409-856





# OEM INTERCHANGES

PART #	OEM CASTING#	PART #	OEM CASTING#	PART #	OEM CASTING#	PART #	OEM CASTING#	PART #	OEM CASTING#	PART #	OEM CASTING#
HB149N	6035514	RLR264	12551431	HB142A	24573309	CH318A	53006671	CP171U	D2RY6269A	HB183A	E7DZ6965A
HB149N	6035516	BA350N	12551537	HB142B	24573310	TC318C	53006705	RAW177	D2RY6A528A	TC351C	E7PA6019A
BA231A	25527381	OC350N	12551757	HB133C	2475886	TC488B	53006826	RB302N	D3AZ6A527A	TC351F	E7TE6059AA
CH350C	...062	TC262P	12554555	TC181A	25523276	TC318D	53020196	RB400N	D3AZ6A527A	TC351F	E7TZ6019A
CH350D	...083	TC262P	12554557	TS042	25523327	TC242R	53020221	SH141R	D4ZE6059AB	FW1715	E7TZ6375A
CH350B	...191	VC3502	12555269	TC181B	25524607	CH318A	5302044	HB140N	D4ZF6065A	TB141N	E7ZZ6E008A
CH350B	...193	VC352L	12555269	HB231B	25525953	TC488A	53020971	CP140U	D4ZF6613A	CE120I	E80Z6287A
CH318A	...466	EX1862	12556041	HB231A	25527831	HB135A	5601433	OFA140	D4ZF6890A	SH143R	E89E6059AC
CH395N	...567	EX1730	12556337	TB181	25532588	ST055	6031867	TT140	D4ZF6L273A	TC351E	E8AE6059
CH350A	...624	TC350P	12558343	BA231B	25535485	HB318A	6034691	TC351A	D40E6059	TC460N	E8TE6059
CH350C	...906	HB349N	12558840	TT061	25535668	RB135N	6034915	RS171R	D4ZZ6524A	BA351N	E8TZ6316B
CP250U	10000568	OP350M	12559020	HB231C	25539869	HB318B	6034960	HS171N	D4ZZ6B070A	FW710	E8TZ6375C
OFA151	10004891	EX1820	12559572	CE125R	2843661	HB244N	6035514	CE121N	D5AZ6287A	HB184N	E9DZ6065A
HB122A	10031210	HB349N	12560744	TC318B	2951698	HB244N	6035516	BA390N	D5TE6316	HB141B	E9DZ6065D
HB122B	10031213	HB349N	12560745	TC318N	2951698	HB202A	6101631	HB177A	D6TZ6065A	SBM183	E9DZ6345D
HB122C	10031214	SBM350	12561389	OFA258	3173226	BA349N	6272222	HB177N	D6TZ6065A	TB140N	E9TZ6K282A
HB153A	10044565	TC350P	12562818	CW258N	3173284	BA400N	6272225	TC351A	D7AE6059	BDV8F	EAD6397A / B
HB153C	10044567	EX1728	12564154	OFA150	3241335	HB134A	6500754	OFA302	D7AZ6890A	RLR302	FOAZ6C515A
HB153B	10044569	EX1820	12564158	BA242N	33002920	HB145A	6503559	EX452	D7TE9430DC	TT232	F0DZ6K254A
RLR262	10046165	EX1728	12571680	EN1533	33007072	HB145B	6503560	TC232C	D9D6059BB	OFA244	F0TZ6890A
BA305N	10066046	EX1820	12571681	EN1533	33007075	HB143B	6503561	TC351A	D9TE6059	FW703	F0ZZ6375A
TC189A	10070144	TCGA17	13500-0M301	TC454C	330850	HB143A	6503562	BA460N	D9TE6313FA	SH144R	F17E6059AB
TC189B	10071044	TCKA26	13500-1E402	TC189E	34505740	HB166A	6504087	BA460N	D9TZ6316C	HB280A	F1AZ6065A
HB189B	10100033	TCKA27	13500-1E404	FTP034	3514185	HB197N	6504329	TC351C	E0AE6059	TC351H	F1SE6059BC
HB189A	10100034	TCKA24	13500-30R00	BA251N	352153	CS021	817	FW714	E0TZ6375A	TC351C	F1SZ6019A
HB133A	10101245	TCKA25	13500-53F00	TM454C	354407	CB243N	83502890	TC232A	E2AE6059DC	TC232D	F2AE6059BA
HB151B	10101702	TCSR20	13500-53J00	TC318B	3769966	TC177R	86TM6059	HB230B	E2DZ6065D	TC183B	F2DE6059HA
FW6525	10105832	TCGA17	13500-53Y02	TC318N	3769966	HB144A	90105-12092	FW712	E2ZZ6375A	HB280A	F3AZ6065A
SH350R	10108477	TCGA16	13500-77A01	OFA454	3853870	HB216N	90109-10132	SH141R	E4ZE6059AA	HB183A	F3DZ6065A
CS022	10114189	TCGA17	13500-F4300	BA292N	38577352	HB199N	90110-10006	TC351C	E3AE6059	RG302	F3TZ6A588A
HB454A	10141204	TT059	1354138	BA396N	3860008	HB199N	90201-10344	TC141I	E3ZZ6019B	TC142I	F3ZZ6019B
HB454B	10141205	TT060	1356634	HB454A	3877668	JPP002	90344-52003	CP140	E43E6266A	HB302A	F3ZZ6065B
BA454N	10141212	TT073A	140100617	HB454B	3877669	JPP003	90344-53008	CP153U	E4ZE6269A	HB302B	F3ZZ6065C
RLR263	1015916	FW6529	14013282	TC454C	3885048	JPP003	90344-53011	TC232B	E4AE6059BB	HB302C	F3ZZ6065D
CP350U	10168501	FW6500	14018712	HD454	3894327	JPP001	90345-51006	BA302N	E4DT6316A	OFA098	F4FZ6890A
HB305C	10168525	HD173	14024244	BA250N	3896590	HB179A	90910-02075	HB098A	E4FZ6065A	HB232A	F4SZ6065A
HB305B	10168526	HD350	14024244	TCD302	3899675	HB179N	90910-02075	EN1097	E5ZE628CB	HB232B	F4SZ6065B
HB305A	10168527	SHD350	14024244	GP454U	3904378	HB206A	90910-02077	EX452	E4TE9428UA	BA232B	F4SZ6B321A
VC352L	10211648	TC173C	14024263	WK460	3911715	HB206N	90910-02077	EN1097	E4TZ9426D	BA232A	F4SZ6B321B
RF454N	10213466	FW6511	14033092	OFA305	3952301	PB22RH	90999-73072	SH140R	E53E6335A	TT140	F4TZ6L273A
SH5262	10218027	FW6512	14033092	FW6567	3986394	CH244A	90910-73072	EN1287	E53E9430AC	EN1698	F4TZ9430A
TC189C	10226111	FW6513	14046567	FW6504	3991469	TC244R	90YM6059	EN1287	E53E9430AD	EN1699	F4TZ9431A
HB189A	10227593	HB381A	14077193	FW6531	3993827	CH244A	93TM	SH142R	E59E6059AA	FTP034	F4ZZ6E086A
HB189B	10227594	TD174	14078822	CS013	3Y	SHD350	9441003	TC351E	E5AE6059FA	SH145R	F57E6059AD
HB133C	10234934	ST173	14079567	CS013	3Y AB	HB061A	96059992	EX1283	E5HE9430AA	TC143I	F57Z6019C
OP350M	10242245	SHS350	14080362	HB150A	40073011	HB061N	96059992	EX1283	E5HE9430AC	HB280A	F5AZ6065A
TCC350	10243963	OFA262	14081300	HB150C	4007307	HB097A	96061591	EX1285	E5HE9431AC	HB413N	F5AZ6065A
TC350M	10243967	TT046	14081712	HB150B	4007308	HB097N	96061591	FW716	E5TA6375J	TC183C	F5DE6059AB
EX1663	10244605	HB350B	14082315	HB150A	4007310	CH244C	981TM	TC300N	E5TE6019H	TC232E	F65E6059AE
CH144N	11101-35060	HB350C	14082316	EN1381	4323470	DP390	B9AE6A008A	EX1096	E5TE9430BA	EX1783	F65E9430BD
CO144N	11181-35050	HB350A	14082317	EN1381	4343742	CW302N	C1TE6278A	EX1096	E5TE9430CA	EX1783	F65E9430BE
TC22RN	11302-35010	OP305L	14082348	SH153R	4387580	DP302	C20Z6AA008A	EX1159	E5TE9431BA	EX1783	F65E9430BF
TC22EL	11302-38010	HB123A	14086098	FW3411	4431100	CE126R	C3AZ6287A	EX1278	E5TE9431BA	CS256	F65E-AC
TC22ES	11302-38010	HB123B	14086099	FW3413	4431100	CE127R	C3AZ6287B	TC460N	E5TZ6019K	EX1783	F65Z9430B
HB151A	12337818	WK173	14089209	CP202	4483620	FW789	C30E6380B	EX1315	E5TZ9430BA	EX1782	F65Z9431A
HB153B	12337925	TC173B	14090537	TC318E	4483753	FW747	C4AZ6375L	EX1315	E5TZ9430C	TC351F	F67Z6019AA
HB153A	12338006	SBM350	14091675	BA252N	458149	CP300U	C5AZ6269A	EX1316	E67E9430AD	TC351H	F67Z6019AA
HB152A	12338010	IS173	14094802	BA304N	458652	BA289N	C5AZ6312A	SH142R	E69E6059A	OP183E	F68Z6675BA
HB152B	12338012	VC350M	14095094	OP350E	465221	FW746	C5AZ6375K	EX1332	E69E9430BA	BA140N	F6PZ6312AA
HB153C	12338022	RLR350	14101116	SH202R	4654389	BA390N	C8AZ6316B	TC183A	E6AE6059AE	TC351F	F6TE6059
DP350	12338119	OP22RN	15100-35020	OFA173	466383	HB370A	C8SZ6065A	CP153	E6AE6266BA	TC351F	F6TZ6019NA
BA204A	12339997	CW318N	1618732	GP173U	476531	HB370B	C8SZ6065B	EN1318	E6AE9430GB	EX1762	F6ZZ9431FA
TC455R	1238864	EN4AF	17141-19016	HB173A	476543	CP460U	C8SZ6269A	CP183U	E6DZ6269A	HB256A	F7ZZ6065AA
RP151U	12508079	OFA142	22538711	RP173U	476544	DT460	C8SZ-6754-A	OFA183	E6DZ6890A	HB256B	F7ZZ6065BA
TB046	1250948	BA231C	24501201	HB173B	476573	OFA460	C9AE6890A	RB183N	E6DZ6A527A	TC351H	F8TE6059AA
TCC305	12523974	BA204B	24501985	TD173	477264	CP302U	C90Z6269A	TC116I	E6FZ6019B	TC351E	FOAZ6019A
OP350L	12528916	TC181G	24502348	BA232A	4FCZ6B321C	LC302	C90Z6500C	TC351C	E6SZ6019B	HB156A	MD020730
OP350M	12529174	BA231D	24503066	SH135N	5214784	CP200U	CODE6269A	TT049	E6TZ6K254A	HB180A	MD065959
TCC305	12531283	BA204C	24503067	SH144R	5214788	CE1200	D0AE6287A	TT055	E6TZ6K297A	ST180	MD108396
RB231N	1254198	HB189C	24505015	TC242R	53005768	RAB351	D1AZ6524A	FW711	E6ZZ6375A	SH181R	MD125544
TS047	1254199	TC189D	24505739	TC488A	53005820	HB171A	D1FZ6435A	TC351A	E7AZ6019A	EX1903	XL3Z9430AA
RR231	1254371	BA231C	24534911	EN1377	53006244	DP171N	D2RY6178B	TC232C	E7DE6059FA	EX1904	XL3Z9431AA



# WARRANTY

**ENGINEQUEST** warrants to the original purchaser that each product sold by us shall be free of defects in material and workmanship under normal use and with periodic maintenance as recommended by the original equipment manufacturer subject to the following terms and conditions:

**TERMS:** 12 months from date of purchase or term of engine warranty whichever comes first.

**STANDARDS:** Subject to limitations listed herein, ENGINEQUEST, at its option, shall repair or replace a product within the warranty term after determination by ENGINEQUEST that the product is defective.

All repairs and/or replacements covered by this warranty must be authorized in advance by ENGINEQUEST. Unauthorized repairs will not be paid.

Remanufactured oil pump and timing cover warranty is void if pump cover has been removed or altered in any way. We assume no liability unless we are contacted before any work is done.

ENGINEQUEST will not pay towing or consequential damages. Contact our Sales Dept. for more information.

Crankshaft warranty requires installation of new harmonic balancer at time of crankshaft installation.

**LIMITATIONS:** This warranty applies to products originally supplied by ENGINEQUEST. This warranty does not apply to or include any of the following:

- A. Damage as a result of OVERHEATING, LACK OF LUBRICATION or CONTAMINATION.
- B. Repair or replacement required as a result of any accident or misuse.
- C. Repair or replacement of any accessory or service item, including specifically but not limited to:
  - all components of the cooling, fuel, electrical and ignition systems in
  - all belts, hoses, and filters.

D. Any product used for competition racing or related purposes.

E. Any product to which a device or accessory not conforming to original manufacturer's specifications has been installed.

F. Any product on which periodic maintenance services required by the original manufacturer have not been performed.

**LIMITED LIABILITY:** ENGINEQUEST's liability under this warranty is limited solely to the repair or replacement of defective product. ENGINEQUEST shall not be liable for any incidental, special, consequential or exemplary damages, including but not limited to rental cars, towing fees or for any service not expressly provided for herein, related to or arising from our product.

**STANDARD REIMBURSEMENT FOR LABOR:** The amount of Labor credit for repairs will be determined by multiplying the standard labor rate per hour (based on your area, not to exceed \$40.00 USD) by the factory time shown in Chilton's and Motor's manuals. Not to exceed \$250.00.

**LIMITED WARRANTY:** This warranty is given in lieu of all other warranties, expressed or implied, including any implied warranty of fitness for any particular purpose. No dealer nor any agent or employee thereof, is authorized to extend or modify this warranty. This warranty may be distributed in a state(s) which may not allow the limitation or exclusion of some warranties or of incidental or consequential damages. In the event that any provision of this warranty should be or become invalid or unenforceable, the remaining terms and conditions hereof shall remain in full force and effect.

All returns must be accompanied by a Return Goods Authorization (RGA) issued by Customer Service.

# TESTIMONIALS

## Mike "The Pirate" Pruitt Wins IMCA's Northern SportMods at Super Nationals With EQ® Cylinder Heads!



*Our first experience with EQ cylinder heads was on our IMCA Stock Car. We dyno tested a 383 with Iron Eagle 200 runner heads, then dyno tested the same engine with 200 runner EQ heads. We ended up picking up 10HP at 5500 RPM, and Torque by 30lbs at the same RPM! Last year we raced IMCA Sport Mods and used OEM heads and didn't win any races, this year we switched over to the IMCA legal EQ heads and not only won Boone Super Nationals but also picked up multiple wins. We noticed a huge gain in both drivability and total HP!! None of this would have been possible without using EngineQuest Cylinder Heads!!*

*Thanks to everyone at EngineQuest for building some great cylinder heads.*

*Mike Pruitt, IMCA Racer, Penetrator Chassis Inc.*

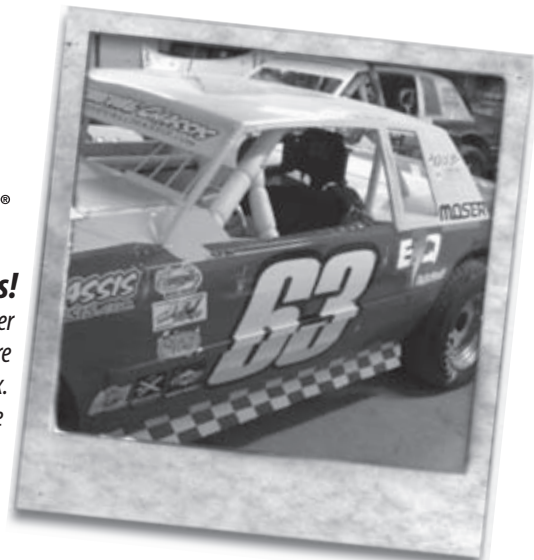

## EQ® Cylinder Heads Helps Power the Way to Multiple Wins!

*We race weekly each year with a goal of an IMCA National Championship at year's end. EQ Cylinder Heads have helped power me to 16 top 4's (including 10 wins) in my first 18 starts. Other heads require porting and polishing to obtain maximum power but the EQ's are ready to bolt on right out of the box. We especially like the 200cc/50cc heads. Other cylinder heads also require 36-38 degrees of timing in the engine but we only need 30-32 degrees of timing with the EQ heads because they are much more efficient. Thanks for all your help and support.*

*Best Regards,  
Mike Nichols, Nichols Racing #63*



# EQ Gives You the Support You Need to Succeed!

Our engine builder solution doesn't end when we ship your parts. EQ backs its resellers with a comprehensive marketing program, including a dealer locator on our website to help drive business directly to your door. Advertising and extensive public relations keep our products top-of-mind, while helpful, high-quality sell sheets, point-of-sale and other materials help educate, inform and close sales.

When media editors want to build an engine, who do they call for performance cylinder heads? EngineQuest. As unbiased automotive pros, they know that EQ provides better flow numbers, better quality, and more performance for the price. In build after build, they rave about the performance and fit of EQ products. To see more, go to our website and click on the link to Engine Builds [www.enginequest.com/enginebuilds](http://www.enginequest.com/enginebuilds)

## Advertising

Creative and professional ad design featured in leading publications.



## Promotions



## Public Relations



## Sell Sheets



## 24/7 ONLINE ORDERING!



## Point-of-Sale



## eNewsletter



## Website



**WITH JUST ONE CLICK YOU CAN SHOP, BUY, & SHIP!**  
•Real-time Inventory



## IMCA Racers are Winning with EQ Cylinder Heads!

As the title sponsor of the IMCA EQ Cylinder Heads Wild West Modified Tour, and exclusive supplier of Spec Chevy Cylinder Head for IMCA Northern and Southern Sport Mods and Hobby Stock Class. EQ proudly supports motorsports and has a long-term winning record.



2580 N. Commerce St.  
N. Las Vegas, NV 89030



The parts you need,  
when you need them, fast!

Cylinder heads

Head bolts

Exhaust manifolds

Timing covers

Oil pans

Standard flywheels

Harmonic balancers

And much more!



Official Series  
Title Sponsor  
**MCA**  
RACING



© 2009 AAEQ Manufacturers and Recyclers

800•426•8771 enginequest.com