



CONTENTS

PETERBILT	1-7
INTERNATIONAL	8
FREIGHTLINER	9-14
KENWORTH	15-18
VOLVO	19-20
EXHAUST STACKS 21-22	
LED LIGHTS 23-48	
LED LIGHT STRIP & BRACKETS 49-58	
HEADLIGHTS 59-63	
BEZELS 64	
EXTERIOR 65-66	
INTERIOR 67-70	
CONCHO KNOBS 71-72	
STEERING WHEELS 73	
TRAIN HORNS 74	
SPECIALTY TRIM 75-76	
HUB CABS 77	
LUG NUT COVERS 78	
INDEX	79-84
COMPANY POLICY	85
ORDER FORM	86

TIMER KNOBS

Item No.	Description
W41680	AMBER JEWEL CHROME PLASTIC
W41681	BLUE JEWEL CHROME PLASTIC
W41682	CLEAR JEWEL CHROME PLASTIC
W41684	PURPLE JEWEL CHROME PLASTIC
W41685	RED JEWEL CHROME PLASTIC
W41687	NO JEWEL CHROME PLASTIC
W4222	2006 + RECTANGULAR DOME LIGHT COVER CHROME PLASTIC



CHROME WINDOW CRANKS FOR 2006 +

W44922	CHROME WINDOW CRANK NO JEWEL
W44923	AMBER JEWEL
W44924	BLUE JEWEL
W44925	CLEAR JEWEL
W44926	GREEN JEWEL
W44927	PURPLE JEWEL



DIAGNOSTIC PORT SOCKET COVERS FOR 2006 +

W44932	AMBER JEWEL CHROME PLASTIC
W44933	BLUE JEWEL CHROME PLASTIC
W44934	CLEAR JEWEL CHROME PLASTIC
W44935	GREEN JEWEL CHROME PLASTIC
W44936	PURPLE JEWEL CHROME PLASTIC
W44937	RED JEWEL CHROME PLASTIC
W44938	SMOKE JEWEL CHROME PLASTIC
W44939	CHROME PLASTIC NO JEWEL



DOMES LENS COVERS FOR 2006 +

Item No.	Description
W45640	AMBER DOME LIGHT LENS
W45641	BLUE DOME LIGHT LENS
W45642	CLEAR DOME LIGHT LENS
W45643	GREEN DOME LIGHT LENS
W45644	PURPLE DOME LIGHT LENS
W45645	RED DOME LIGHT LENS



W45646	(18) LED AMBER DOME LIGHT BASE FOR PB 2006 + REPLACES 211-2 BULBS
W45647	(18) LED BLUE DOME LIGHT BASE FOR PB 2006 + REPLACES 211-2 BULBS
W45648	(18) LED RED DOME LIGHT BASE FOR PB 2006 + REPLACES 211-2 BULBS
W45649	(18) LED WHITE DOME LIGHT BASE FOR PB 2006 + REPLACES 211-2 BULBS



W47534	S.S. CIGARETTE LIGHTER TRIM, PLAIN
W47535	S.S. CIGARETTE LIGHTER TRIM, ENGRAVED SCRIPT
W4770	2006 + CB ENCLOSURE CHROME PLASTIC



KNOB COVERS FOR 2006 +

- | Item No. | Description |
|----------|---|
| W48090 | AMBER JEWEL CHROME PLASTIC |
| W48091 | BLUE JEWEL CHROME PLASTIC |
| W48092 | CLEAR JEWEL CHROME PLASTIC |
| W48093 | GREEN JEWEL CHROME PLASTIC |
| W48094 | PURPLE JEWEL CHROME PLASTIC |
| W48095 | RED JEWEL CHROME PLASTIC |
| W48096 | SMOKE JEWEL CHROME PLASTIC |
| W48200 | 2006 + A/C TRIANGLE VENT |
| W4829 | 2006 + FUSE DOOR COVER, CHROME PLASTIC |
| W4830 | 2006 + CENTER DASH INSTRUMENT BEZEL W/ VISOR, CHROME PLASTIC (EACH) |

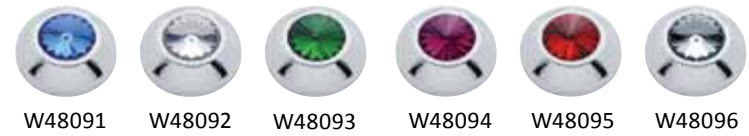

SWITCH TRIMS

- | | |
|---------|---|
| W48917 | ROCKER SWITCH COVER, NO JEWEL (3-PK) |
| W48930 | AMBER JEWEL ACCENT, CHROME PLASTIC (3-PK) |
| W48931 | BLUE JEWEL ACCENT, CHROME PLASTIC (3-PK) |
| W48932 | CLEAR JEWEL ACCENT, CHROME PLASTIC (3-PK) |
| W48933 | GREEN JEWEL ACCENT, CHROME PLASTIC (3-PK) |
| W48934 | PURPLE JEWEL ACCENT, CHROME PLASTIC (3-PK) |
| W48935 | RED JEWEL ACCENT, CHROME PLASTIC (3-PK) |
| W50950 | SLEEPER VENT TRIM INTERIOR CHROME PLASTIC |
| W50960 | WOOD CB RADIO BOX TRIM |
| W51009B | ALUMINUM SHELL CASING TOGGLE SWITCH (2 PCS) |



SWITCH TRIMS (continued)

- | | |
|--------|--|
| W51715 | PB 387 WINDOW SWITCH COVER 4 HOLES CHROME PLASTIC - DRIVER SIDE |
| W51716 | PB 387 WINDOW SWITCH COVER 2 HOLES CHROME PLASTIC - PASSENGER SIDE |
| W51734 | 2006 + MID STEERING COLUMN COVER CHROME PLASTIC |
| W5176 | 2006 + LOWER STEERING COLUMN COVER CHROME PLASTIC |
| W5177 | LOWER STEERING COLUMN COVER CHROME PLASTIC (OLDER MODEL) |
| W51767 | S.S. DIGITAL MESSAGE CENTER COVER, W/ CURSIVE SCRIPT |
| W5178 | 2006 + CENTER DASH WARNING LIGHT PANEL COVER CHROME PLASTIC |
| W51995 | 2006 + EMBLEM PANEL TRIM CHROME PLASTIC |
| W51996 | 2006 + S.S. PASSENGER DOOR POCKET COVER |



GAUGE COVERS FOR 2006 +

Item No.	Description
W58580	2 GAUGE COVER CHROME PLASTIC
W58593	3 GAUGE CLUSTER COVER CHROME PLASTIC - LEFT SIDE
W58594	3 GAUGE CLUSTER COVER CHROME PLASTIC - RIGHT SIDE
W58789	3 GAUGE COVER VERTICAL W/VISOR CHROME PLASTIC
W58790	2 GAUGE COVER VERTICAL W/VISOR CHROME PLASTIC
W58791	2 GAUGE COVER HORIZONTAL W/VISOR CHROME PLASTIC
W58792	3 GAUGE CLUSTER COVER HORIZONTAL CHROME PLASTIC
W58793	4 GAUGE CLUSTER COVER HORIZONTAL CHROME PLASTIC



W5097PA	(10) LED AMBER WOOD ARMREST
W5097PC	(10) LED CLEAR/AMBER WOOD ARMREST
W5097PR	(10) LED RED WOOD ARMREST
W5097PRC	(10) LED CLEAR/RED WOOD ARMREST



W5097PC

W48918	S.S. "A" PANEL POCKET COVER
W48919	S.S. "A" PANEL POCKET COVER W/ DESIGN & HARDWARE INCLUDED



W5097PRC

W40041	2006 + SUN VISOR HOOK CHROME PLASTIC (2 PCS)
--------	--

W5166	S.S. SLEEPER SHOCK COVER
W51671	S.S. UPPER WINDOW SILL COVER (PAIR)
W51672	CHROME UPPER WINDOW SILL COVER (PAIR)
W51673	CHROME S.S. HARDWARE FOR WINDOW SILL COVER (12 PK)



W48918

W48919



W40041

W5166

W51673

W51672 & W5097D

AIR TANK STRAPS

Item No.	Description
W52770	15" S.S. AIR TANK STRAP
W52773	15" S.S. AIR TANK STRAP 2 1/2" WIDE
W54546	(32) LED LIGHT BASE W/ S.S. 359 LOGO
W51780	S.S. WINDOW SHADE FOR 359 & 379 (PAIR)
W51946	S.S. GRILL 16 LOUVERED BARS EXTENDED HOOD, FITS 2007 & EARLIER PB 379
W51947	(14) LED AMBER S.S. SIDE GRILL DEFLECTOR
W51948	(14) LED CLEAR/AMBER S.S. SIDE GRILL DEFLECTOR
W51950	S.S. SIDE GRILL W/LIGHT CUTOUT



W52770



W54546



W51780

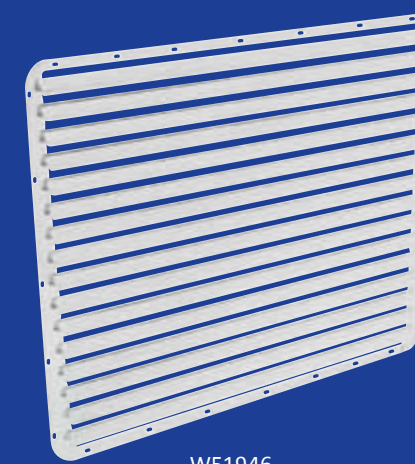

W51946



W51947



W51948

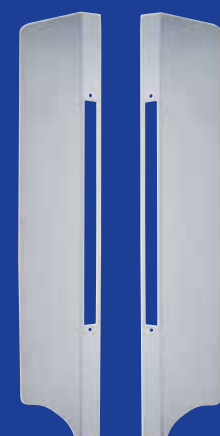

W51950

AIR CLEANER LIGHT KITS STAINLESS STEEL

Item No.	Description
HOUSING BRACKET LED	
W53858	(14) AMBER ON EACH OF EIGHT LIGHT STRIPS - PAIR
W53859	(14) CLEAR/AMBER ON EACH OF EIGHT LIGHT STRIPS - PAIR
W53860	(14) CHROME/AMBER ON EACH OF EIGHT LIGHT STRIPS - PAIR
W53862	(14) CLEAR/AMBER ON EACH OF EIGHT REFLECTOR LIGHT STRIPS - PAIR
W53861	(19) AMBER ON EACH OF EIGHT REFLECTOR LIGHT STRIPS - PAIR
W53863	AIR CLEANER BRACKET W/ 8 HOLE LIGHT STRIP CUTOUT - PAIR
W52764	5" CHROME STACK CLAMP
W52765	5" S.S. STACK MOUNT CLAMP
W52766	5" CHROME STACK CLAMP



INTERIOR

W40220	2005 + TURN SIGNAL HANDLE, CHROME PLASTIC
W40223	2006 + "NOT FOR PARKING" LEVER COVER, CHROME PLASTIC
W40268	DIMMER SWITCH TRIM RIM, CHROME PLASTIC
W40270	387 CONTROL A/C BEZEL CHROME PLASTIC



Item No.	Description
W47576	SPEAKER COVER, CHROME PLASTIC - 2 PACK
W48217	"I" MIRROR ARM HOUSING COVER SET, CHROME PLASTIC - DRIVER & PASSENGER SIDE
W48218	"I" MIRROR ARM HOUSING COVER, CHROME PLASTIC - DRIVER SIDE
W48219	"I" MIRROR ARM HOUSING COVER, CHROME PLASTIC - PASSENGER SIDE



W50451	FRONT SIDE FENDER TRIM CHROME FOR INTERNATIONAL 9000
W54959	13" DROP 2002-2006 (16) LED CLEAR/AMBER DIAMOND LIGHT STYLE W/ HARDWARE FITS 4000 SERIES
W58794	SPEED/TACHOMETER GAUGE COVER CHROME PLASTIC W/ VISOR FITS 2007 +
W58800	SPEED/TACHOMETER CHROME GAUGE BEZEL W/ VISOR FITS 900 SERIES
W58795	GAUGE COVER CHROME PLASTIC W/VISOR



W58796	DASH TRIM RECTANGULAR CHROME PLASTIC
W47574	A/C CONTROL BUTTON CHROME PLASTIC
W48207	INSIDE DOOR HANDLE CHROME - DRIVER SIDE
W48208	INSIDE DOOR HANDLE CHROME - PASSENGER SIDE



FREIGHTLINER

BRAKE COVERS

Item No.	Description
	TRAILER BRAKE
W40233	BASE COVER ONLY
W40234	COVER W/ AMBER JEWEL
W40235	COVER W/ BLUE JEWEL
W40236	COVER W/ CLEAR JEWEL
W40237	COVER W/ GREEN JEWEL
W40238	COVER W/PURPLE JEWEL
W40239	COVER W/ RED JEWEL
W4023P	COVER CHROME PLASTIC NO JEWEL



W40233



W40236



W40234

W40235

W40237

W40238

W40239

W4023P

DOME LENS

W4565A	AMBER DOME LENS
W4565B	BLUE DOME LENS
W4565C	CLEAR DOME LENS
W4565G	GREEN DOME LENS
W4565P	PURPLE DOME LENS
W4565R	RED DOME LENS



W4565A



W4565B



W4565C



W4565G



W4565P



W4565R



INTERIOR FOR CASCADIA 2007 +

Item No.	Description
W47580	DOOR SPEAKER COVER FOR FL CASCADIA 2007 + DRIVER SIDE
W47581	DOOR SPEAKER COVER FOR FL CASCADIA 2007 + PASSENGER SIDE
W48264	A/C VENT CHROME CHROME - DRIVER SIDE
W48265	A/C VENT CHROME CHROME - PASSENGER SIDE



W48264



W48265



W47580



W47581

W48266	SWITCH COVER WINDOW 5 OPENING CHROME PLASTIC - DRIVER SIDE
W48267	SWITCH COVER WINDOW 2 OPENING CHROME PLASTIC - PASSENGER SIDE
W47582	DOOR HANDLE COVER CHROME PLASTIC FOR CASCADIA - DRIVER SIDE
W47583	DOOR HANDLE COVER CHROME PLASTIC FOR CASCADIA - PASSENGER SIDE



W48266



W48267

SWITCH COVER FOR WINDOW

W48260	3 OPENING CHROME PLASTIC, FITS CENTURY, CORONADO & COLUMBIA - DRIVER SIDE
W48261	2 OPENING CHROME PLASTIC, FITS CENTURY, CORONADO & COLUMBIA - DRIVER SIDE
W48262	1 OPENING CHROME PLASTIC, FITS CENTURY, CORONADO & COLUMBIA - DRIVER SIDE
W48263	1 OPENING CHROME PLASTIC, FITS CENTURY, CORONADO & COLUMBIA - PASSENGER SIDE



W48260



W48261



W48262



W48263

SWITCH TRIMS

- | Item No. | Description |
|----------|---------------------------|
| | ROCKER SWITCH TRIM |
| W48947 | W/ AMBER JEWEL (3-PK) |
| W48948 | W/ BLUE JEWEL (3-PK) |
| W48949 | W/ CLEAR JEWEL (3-PK) |
| W48950 | W/ GREEN JEWEL (3-PK) |
| W48951 | W/ PURPLE JEWEL (3-PK) |
| W48952 | W/ RED JEWEL (3-PK) |
| W48953 | W/ SMOKE JEWEL (3-PK) |
| W48954 | NO JEWEL (3-PK) |



ROCKER SWITCH TRIM 3 OPENINGS

- | | |
|--------|------------------------|
| W48955 | W/ AMBER JEWEL (3-PK) |
| W48956 | W/ BLUE JEWEL (3-PK) |
| W48957 | W/ CLEAR JEWEL (3-PK) |
| W48958 | W/ GREEN JEWEL (3-PK) |
| W48959 | W/ PURPLE JEWEL (3-PK) |
| W48960 | W/ RED JEWEL (3-PK) |
| W48961 | W/ SMOKE JEWEL (3-PK) |
| W48962 | NO JEWEL (3-PK) |



INTERIOR

- | | |
|--------|--|
| W50951 | SLEEPER VENT COVER INTERIOR CHROME PLASTIC |
| W50952 | CHROME HANDLE FOR UPPER BUNK |
| W50953 | TURN SIGNAL CONTROL COVER CHROME PLASTIC |
| W51718 | DOOR HANDLE EXTERIOR COVER CHROME PLASTIC - DRIVER SIDE |
| W51719 | DOOR HANDLE EXTERIOR COVER CHROME PLASTIC - PASSENGER SIDE |
| W48247 | PANEL TRIM BUTTON CHROME PLASTIC |
| W48268 | GAUGE CLUSTER COVER W/ VISOR CHROME PLASTIC, FITS COLUMBIA |

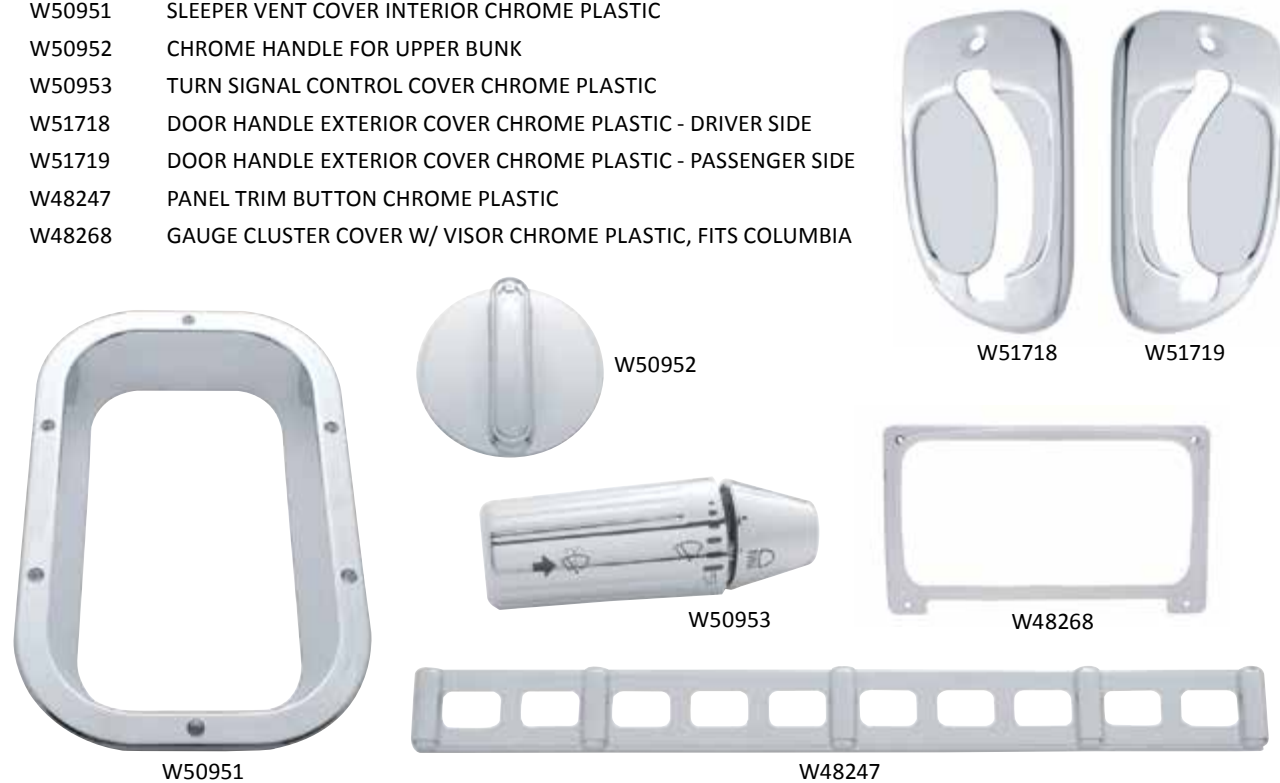

INTERIOR (continued) & EXTERIOR

- | Item No. | Description |
|----------|--|
| W5175 | 2007 + LOWER STEERING COLUMN COVER CHROME PLASTIC, FITS FLD CENTURY, COLUMBIA & CORONADO |
| W51850 | CLASSIC FLD 120/112 WINDOW DOOR DEFLECTOR |
| W5495 | CONDO S.S. 12" DROP VISOR W/ 10-2" LIGHT HOLE - NO LIGHT |
| W5496 | CONDO S.S. 12" DROP VISOR W/ 10-2" AMBER FLAT LIGHTS |
| W54958 | 12.5" DROP VISOR NO LIGHTS FLAT TOP, FITS CONDO, CLASSIC'S |



MIRROR COVERS FOR 2005 +

Item No. Description

- MIRROR COVER CHROME PLASTIC**
 W40185 MIRROR COVER CHROME PLASTIC- DRIVER SIDE
 W40186 MIRROR COVER CHROME PLASTIC- PASSENGER SIDE
 W40182 MIRROR COVERS CHROME PLASTIC - PAIR

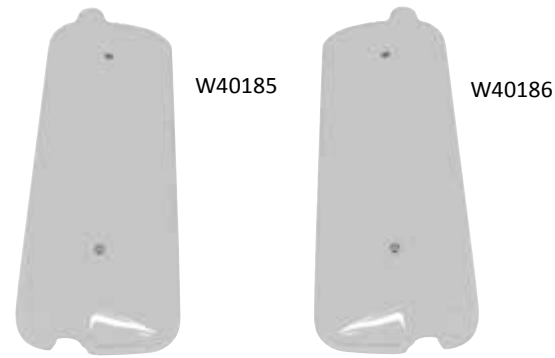

- W40199 (14) LED AMBER 12" LIGHT STRIP - DRIVER SIDE
 W40200 (14) LED AMBER 12" LIGHT STRIP - PASSENGER SIDE
 W40202 (14) LED CLEAR/AMBER 12" LIGHT STRIP - DRIVER SIDE
 W40203 (14) LED CLEAR/AMBER 12" LIGHT STRIP - PASSENGER SIDE
 W40204 (14) LED CHROME/AMBER 12" LIGHT STRIP -DRIVER...
 W40205 (14) LED CHROME/AMBER 12" LIGHT STRIP - PASSENGER SIDE
 W40206 (19) LED AMBER REFLECTOR 19" LIGHT STRIP - DRIVER SIDE
 W40207 (19) LED AMBER REFLECTOR 12" LIGHT STRIP - PASSENGER SIDE
 W40208 (19) LED CLEAR/AMBER REFLECTOR 12" LIGHT STRIP - DRIVER SIDE
 W40209 (19) LED CLEAR/AMBER REFLECTOR 12" LIGHT STRIP - PASSENGER SIDE
 W40183 (16) LED MIRROR LIGHT, FITS FLD CENTURY
 W40184 (16) LED WEST COAST STYLE MIRROR - PAIR



W40207

EXTERIOR

Item No. Description

- W48233 MIRROR POST COVER - DRIVER SIDE
 W48234 MIRROR POST COVER - PASSENGER SIDE
 W48235 MIRROR POST COVER SET - DRIVER & PASSENGER SIDE



W48233



W48234

- W4572 CENTURY 2005+ HEADLIGHT HOUSING ONLY CHROME PLASTIC - DRIVER SIDE
 W4573 CENTURY 2005+ HEADLIGHT HOUSING ONLY CHROME PLASTIC - PASSENGER SIDE
 W54606 INNER HEADLIGHT BEZEL CHROME PLASTIC - DRIVER SIDE
 W54607 INNER HEADLIGHT BEZEL CHROME PLASTIC - PASSENGER SIDE



W4572



W54606



W40183

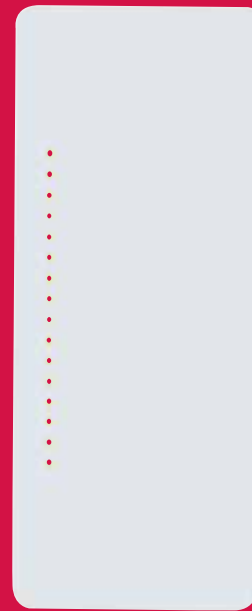

W40184



2006 +

- | Item No. | Description |
|----------|--|
| W40040 | SUNVISOR HOOK/CLIP PAIR, CHROME PLASTIC |
| W40221 | PB & KW LEVER COVER TURN SIGNAL CHROME PLASTIC - 1 SET |
| W40222 | TURN SIGNAL CONTROL TRIM CHROME PLASTIC |
| W40293 | COMPARTMENT TRAY CHROME PLASTIC |



W40221



W40222



W40040



W40293

- | | |
|--------|---|
| W40294 | MIRROR CONTROL TRIM COVER CHROME PLASTIC |
| W40295 | WINDOW CONTROL TRIM COVER CHROME PLASTIC |
| W40296 | BLANK GAUGE COVER CHROME PLASTIC |
| W58797 | PUSH ON CHROME PLASTIC GAUGE BEZEL W/ VISOR |
| W58798 | PUSH ON CHROME PLASTIC GAUGE BEZEL |



W40294



W40295



W40296



W58797



W58798



INTERIOR

- | Item No. | Description |
|----------|---|
| W40297 | UPPER SPEAKER GRILL COVER - DRIVER SIDE |
| W40298 | UPPER SPEAKER GRILL COVER - PASSENGER SIDE |
| W48130 | A/C HEATER OUTER CONTROL KNOB, CHROME PLASTIC (3 PKG) |
| W48139 | A/C HEATER CONTROL PLATE S.S. (2002 W/ 3 LARGE & 2 SMALL KNOB CUT OUTS) |



W40297



W48130



W48139

- | | |
|--------|--|
| W48173 | CENTER DOME LIGHT BEZEL CHROME PLASTIC |
| W4831 | CUP HOLDER CHROME PLASTIC 2006 + |



W4831

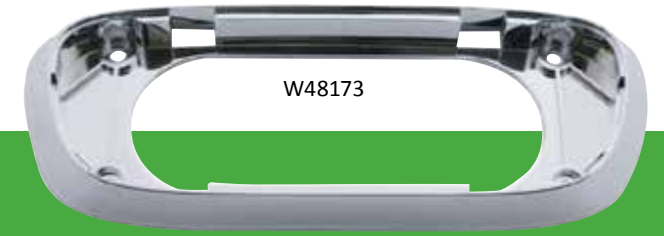

W48173

- | | |
|----------|--|
| W4834H | HOOD LATCH TRIM FOR T660 CHROME PLASTIC - PAIR |
| W51698-B | SUNROOF WINDOW INTERIOR OUTER TRIM, 1-PC OEM REPLACEMENT, CHROME PLASTIC |
| W51707 | DOOR HANDLE COVER |
| W51717 | STEERING COLUMN CHROME PLASTIC |
| W51953 | CENTER STEERING COLUMN COVER, CHROME PLASTIC |



W4834H



W51698-B



W51707



W51717



W51953

A/C VENTS FIT 2002-2005

Item No. Description

PASSENGER VENT

- W48162 AMBER JEWEL CHROME PLASTIC
- W48163 BLUE JEWEL CHROME PLASTIC
- W48164 CLEAR JEWEL CHROME PLASTIC
- W48165 GREEN JEWEL CHROME PLASTIC
- W48166 PURPLE JEWEL CHROME PLASTIC
- W48167 RED JEWEL CHROME PLASTIC



W48162



W48169



W48177

DRIVER VENT

- W48168 AMBER JEWEL CHROME PLASTIC
- W48169 BLUE JEWEL CHROME PLASTIC
- W48170 CLEAR JEWEL CHROME PLASTIC
- W48170G GREEN JEWEL CHROME PLASTIC
- W48170P PURPLE JEWEL CHROME PLASTIC
- W48170R RED JEWEL CHROME PLASTIC

CENTER VENT

- W48174 AMBER/JEWEL CHROME PLASTIC
- W48175 BLUE JEWEL CHROME PLASTIC
- W48176 CLEAR JEWEL CHROME PLASTIC
- W48177 GREEN JEWEL CHROME PLASTIC
- W48178 PURPLE JEWEL CHROME PLASTIC
- W48179 RED JEWEL CHROME PLASTIC
- W4832 SLEEPER VENT CHROME PLASTIC



W4832

SWITCH TRIMS 2006 +

- W48963 ROCKER SWITCH TRIM W/ AMBER JEWEL (3 PKG)
- W48964 ROCKER SWITCH TRIM W/ BLUE JEWEL (3 PKG)
- W48965 ROCKER SWITCH TRIM W/ CLEAR JEWEL (3 PKG)
- W48966 ROCKER SWITCH TRIM W/ GREEN JEWEL (3 PKG)
- W48967 ROCKER SWITCH TRIM W/ PURPLE JEWEL (3 PKG)
- W48968 ROCKER SWITCH TRIM W/ RED JEWEL (3 PKG)
- W48969 ROCKER SWITCH TRIM W/ SMOKE JEWEL (3 PKG)
- W48970 ROCKER SWITCH TRIM NO JEWEL (3 PKG)



W48963 W48964 W48965 W48966 W48967 W48968 W48969 W48970

EXTERIOR TRIMS

- Item No. Description
- W51823 15" S.S. AIR CLEANER MOUNTING BRACKET
- W51842 FRONT HOOD TRIM FOR T300 1995 - 2007
- W51708 DAYLITE DOOR BOTTOM WINDOW TRIM (PAIR)
- W51845 WINDOW DOOR DEFLECTOR
- W51702 LONG CENTER WINDSHIELD POST COVER 21-7/8" (EACH)



W51823



W51842

W51845



W51708



W51702

- W51956 2006 + WINDSHIELD POST CHROME PLASTIC - DRIVER SIDE
- W51957 2006 + WINDSHIELD POST CHROME PLASTIC - PASSENGER SIDE
- W54602 2007 + FRONT BUMPER LIGHT BEZEL CHROME PLASTIC, FITS T660 - DRIVER SIDE
- W54603 2007 + FRONT BUMPER LIGHT BEZEL CHROME PLASTIC, FITS T660 - PASSENGER SIDE
- W51570 BLUE FLOOR MATS 4-PC SET, FITS T600, T800, W900



W51956



W51957



W54602



W54603



W51570

DROP VISORS

- W5494 12" S.S. CURVED WINDSHIELD DROP VISOR FOR W900
- W51967 16" S.S. GANGSTER DROP VISOR



W5494



W51967

A/C VENTS

- | Item No. | Description |
|----------|-----------------------------|
| W47556 | AMBER JEWEL CHROME PLASTIC |
| W47557 | BLUE JEWEL CHROME PLASTIC |
| W47558 | CLEAR JEWEL CHROME PLASTIC |
| W47559 | GREEN JEWEL CHROME PLASTIC |
| W47560 | PURPLE JEWEL CHROME PLASTIC |
| W47561 | RED JEWEL CHROME PLASTIC |



- | | |
|--------|---|
| W47563 | CHROME PLASTIC NO JEWEL FITS MODELS VN & VT |
| W47548 | CHROME PLASTIC A/C KNOB - 3 PIECE SET |



INTERIOR TRIM

- | | |
|--------|--|
| W47543 | DOOR HANDLE COVER CHROME |
| W47544 | S.S. CENTER SWITCH COVER W/ VENT TRIM |
| W47545 | S.S. AIR VALVE PANEL TRIM |
| W47546 | S.S. RIGHT SIDE SWITCH PANEL COVER W/ GAUGE CUTOUT |
| W47547 | S.S. RIGHT SIDE SWITCH PANEL COVER |
| W47549 | S.S. LIGHT SWITCH PANEL |

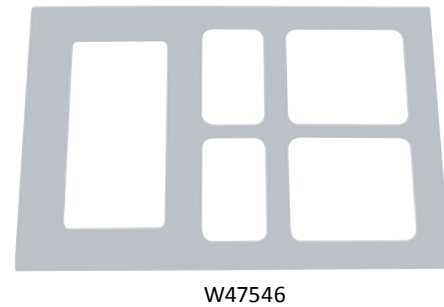
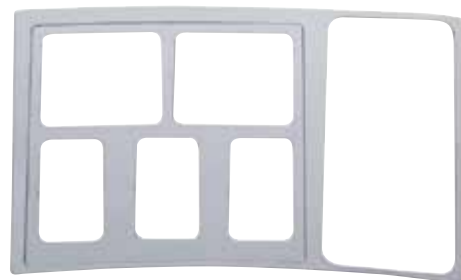

INTERIOR TRIM

- | Item No. | Description |
|---------------------------------|-------------|
| SWITCH BUTTON WITH JEWEL | |

- | | |
|---------|-----------------------------|
| W47564 | AMBER JEWEL CHROME PLASTIC |
| W47565 | BLUE JEWEL CHROME PLASTIC |
| W47566 | CLEAR JEWEL CHROME PLASTIC |
| W47567 | GREEN JEWEL CHROME PLASTIC |
| W47568 | PURPLE JEWEL CHROME PLASTIC |
| W47569 | RED JEWEL CHROME PLASTIC |
| W47570 | SMOKE JEWEL CHROME PLASTIC |
| W4757-1 | NO JEWEL CHROME PLASTIC |



W47564 W47565 W47566 W47567

- | | |
|--------|--|
| W47584 | TRAILER BRAKE HANDLE COVER
CHROME PLASTIC |
|--------|--|



W47568 W47569 W47570 W4757-1

- | | |
|--------|------------------------------|
| W47585 | A/C S.S. CONTROL COVER |
| W47586 | S.S. BOTTOM LEFT DASH COVER |
| W47587 | S.S. BOTTOM RIGHT DASH COVER |
| W47550 | SLEEPER SIGNAL LIGHT BEZEL |



EXTERIOR TRIM

- | | |
|--------|--|
| W47588 | S.S. HOOD TRIM 2003 + VOLVO VN - DRIVER SIDE |
| W47589 | S.S. HOOD TRIM 2003 + VOLVO VN - 1 PC PASSENGER SIDE |



Exhaust Stacks

STACKS

Item No.	Description
EXHAUST STACK, BULL HORN	
W55619	6" O.D. 96" (H) STRAIGHT BOTTOM
W55620	6" O.D. 108" (H) STRAIGHT BOTTOM
W55621	6" O.D. 120" (H) STRAIGHT BOTTOM
W55622	7" O.D. 96" (H) STRAIGHT BOTTOM
W55623	7" O.D. 108" (H) STRAIGHT BOTTOM
W55624	7" O.D. 120" (H) STRAIGHT BOTTOM
W55641	REDUCING 7" - 5" O.D. x 36"

EXHAUST STACK, CURVED	
W55625	6" O.D. 96" (H) STRAIGHT BOTTOM
W55626	6" O.D. 108" (H) STRAIGHT BOTTOM
W55627	6" O.D. 120" (H) STRAIGHT BOTTOM
W55628	7" O.D. 96" (H) STRAIGHT BOTTOM
W55629	7" O.D. 108" (H) STRAIGHT BOTTOM
W55630	7" O.D. 120" (H) STRAIGHT BOTTOM
W55617	REDUCING 8" - 5" O.D. x 96" (H)

EXHAUST STACK, MITRE	
W55631	6" O.D. 96" (H) STRAIGHT BOTTOM
W55632	6" O.D. 108" (H) STRAIGHT BOTTOM
W55633	6" O.D. 120" (H) STRAIGHT BOTTOM
W55634	7" O.D. 96" (H) STRAIGHT BOTTOM
W55635	7" O.D. 108" (H) STRAIGHT BOTTOM
W55636	7" O.D. 120" (H) STRAIGHT BOTTOM
W55618	REDUCING 8" - 5" O.D. x 108" (H)

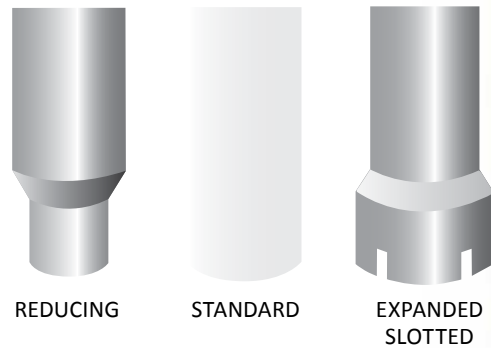

CLAMPS

Item No.	Description
W52781	5" S.S. EXHAUST CLAMP
W52791	6" S.S. EXHAUST CLAMP
W55637	6" S.S. STRAIGHT EXHAUST CLAMP W/BACKET
W55638	7" S.S. STRAIGHT EXHAUST CLAMP W/BACKET
PETERBILT	
W52764	5" CHROME STACK BRACKET
W52765	5" S.S. STACK MOUNT CLAMP
W52766	5" CHROME STACK CLAMP

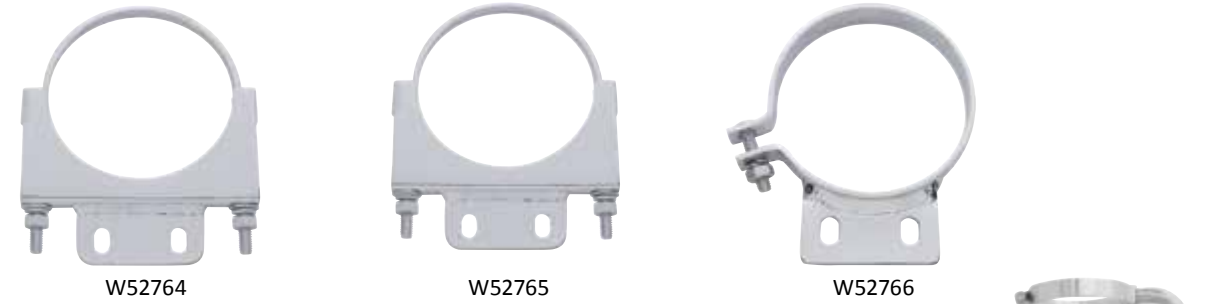

EXHAUST HANDLES

W52821	5" S.S. GRAB HANDLE EXHAUST SET
W52822	6" S.S. GRAB HANDLE EXHAUST SET



ELBOWS

W55642	PB 379 CHROME ELBOW 58° ANGLE
W55643	PB 379 CHROME ELBOW 58° ANGLE 5" O.D.



LED Lights

MIRROR LIGHTS & BEZELS

Item No.	Description
AUXILIARY LIGHTS	
W40389	(12) AMBER/CHROME RECTANGULAR
W40390	(12) RED/CHROME RECTANGULAR
W40585	(9) 2" AMBER/CHROME FLAT
W40586	(9) 2" BLUE/CHROME FLAT
W40587	(9) 2" GREEN/CHROME FLAT
W40588	(9) 2" RED/CHROME FLAT
W40599	(13) 2 1/2" RED/CHROME



W40389



W40390



W40585



W40586



W40587



W40588



W40599

W41671	(39) AMBER/CHROME TEARDROP
W41672	(39) RED/CHROME TEARDROP
W41675	(39) AMBER/CHROME TEARDROP W/CHROME BEZEL
W45814	(39) AMBER/CHROME P/T/C TEARDROP LIGHT W/ CHROME BEZEL SINGLE BAR
W45815	(39) RED/CHROME S/T/T TEARDROP LIGHT W/ CHROME BEZEL SINGLE BAR



W45814



W41672



W41675

W41673	(39) AMBER/CHROME BLAZE LIGHT
W41674	(39) RED/CHROME BLAZE LIGHT
W45788	FLAME, OVAL LIGHT BEZEL (EACH)



W41673

W4314AC	(10) AMBER/CHROME OVAL LIGHT
W4314RC	(10) RED/CHROME OVAL LIGHT



W45788



W4314AC



W4314RC

MIRROR LIGHTS & BEZELS

Item No.	Description
AUXILIARY LIGHTS (continued)	
W43150	(10) RED/CHROME 4" ROUND LIGHT
W43151	(10) AMBER/CHROME 4" ROUND LIGHT



W43150



W43151

W45727	(14) AMBER/CHROME LENS FLUSH MOUNT LIGHT BAR
W45728	(14) RED/CHROME LENS FLUSH MOUNT LIGHT BAR



W45728

W45735	(14/14) AMBER-RED CHROME LENS DOUBLE FACE 12" LIGHT BAR W/ CHROME PLASTIC HOUSING
W51949	(14) AMBER/CHROME S.S SIDE GRILL DEFLECTOR FOR PB



W45735



W51949



LED Lights

MARKER LIGHTS

Item No.	Description
2" ROUND	
W40596	(9) 2" AMBER/SMOKE FLAT STYLE LENS CLEARANCE LIGHT
W40612	(9) 2" MARKER LIGHT AMBER/AMBER W/ REFLECTOR
W40613	(9) 2" MARKER LIGHT RED/RED W/ REFLECTOR
W40614	(9) 2" MARKER LIGHT CLEAR/AMBER W/ REFLECTOR
W40615	(9) 2" MARKER LIGHT CLEAR/RED W/ REFLECTOR



W40596



W40612



W40613



W40614



W40615

W40616	(7) 2" AMBER CLEARANCE MARKER LIGHT W/REFLECTOR
W40617	(7) 2" RED CLEARANCE MARKER LIGHT W/ REFLECTOR
W40618	(7) 2" CLEAR/AMBER CLEARANCE MARKER LIGHT W/ REFLECTOR
W40619	(7) 2" CLEAR/RED CLEARANCE MARKER LIGHT W/ REFLECTOR
W41011E	(1) 2" CLEAR/RED LIGHT



W40617



W41011E

2 1/2" ROUND

W40604	(9) 2 1/2" AMBER/AMBER CLEARANCE MARKER REFLECTOR LIGHT
W40605	(9) 2 1/2" RED/RED CLEARANCE MARKER REFLECTOR LIGHT
W40606	(9) 2 1/2" CLEAR/AMBER CLEARANCE MARKER REFLECTOR LIGHT
W40607	(9) 2 1/2" CLEAR/RED CLEARANCE MARKER REFLECTOR LIGHT



W40604



W40605



W40606



W40607

MARKER LIGHTS (continued)

Item No.	Description
2 1/2" ROUND	
W41012E	(1) 2 1/2" AMBER LIGHT
W41013E	(1) 2 1/2" RED LIGHT
W41014E	(1) 2 1/2" CLEAR/AMBER LIGHT
W41015E	(1) 2 1/2" CLEAR/RED LIGHT
W40355	(4) 2 1/2" RED/RED CLEARANCE - MARKER REFLECTOR LIGHT
W40356	(4) 2 1/2" CLEAR/AMBER CLEARANCE - MARKER REFLECTOR LIGHT
W40357	(4) 2 1/2" CLEAR/RED CLEARANCE - MARKER REFLECTOR LIGHT



W41015E



W40355



W40356

THIN STYLE

W40350	(3) AMBER/AMBER REFLECTOR
W40352	(3) CLEAR/AMBER REFLECTOR
W40353	(3) CLEAR/RED REFLECTOR



W40350



W40352

OVAL

W40409	(2) AMBER MARKER LIGHT W/ CHROME BASE
W40410	(2) RED MARKER LIGHT W/ CHROME BASE
W40411	(2) CLEAR/AMBER MARKER LIGHT W/ CHROME BASE
W40412	(2) CLEAR/RED MARKER LIGHT W/ CHROME BASE



W40409



W40411

LED Lights

ROUND LIGHTS

- | Item No. | Description |
|-------------------|---|
| SEQUENTIAL | |
| W40518 | (35) AMBER 4" SEQUENTIAL ARROW |
| W40519 | (35) RED 4" SEQUENTIAL ARROW |
| S/T/T | |
| W43135 | (10) RED/RED 4" S/T/T LIGHT W/REFLEX FLANGE |
| W43136 | (36) RED/RED 4" S/T/T ECONOMY LIGHT |
| W43137 | (36) CLEAR/RED 4" S/T/T ECONOMY LIGHT |
| W43145 | (19) RED/RED 4" S/T/T W/REFLECTOR LIGHT |
| W43147 | (19) CLEAR/RED 4" S/T/T W/REFLECTOR LIGHT |
| W43148 | (7) ROUND 4" RED/RED S/T/T ECONOMY LIGHT |
| W43149 | (7) ROUND 4" CLEAR/RED S/T/T ECONOMY LIGHT |



W40518



W43135



W43136



W43137



W43145



W43147



W43148



W43149

- | | |
|--------|---|
| W46303 | (12) CLEAR/RED 4" S/T/T RAISED LENS |
| W46305 | (30) RED/RED 4" S/T/T ECONOMY LIGHT W/3 FEMALE TERMINAL |
| W46306 | (30) CLEAR/RED 4" S/T/T ECONOMY LIGHT W/3 FEMALE TERMINAL |
| W4637 | (12) CLEAR/RED 4" S/T/T REFLECTOR LIGHT |
| W4638 | (12) RED/RED 4" S/T/T REFLECTOR LIGHT |
| W4639 | (7) RED/RED 4" S/T/T LIGHT W/REFLECTOR |
| W4640 | (7) CLEAR/RED 4" S/T/T LIGHT W/REFLECTOR |



W46303



W46305



W46306



W4637



W4638



W4639



W4640

ROUND LIGHTS

- | Item No. | Description |
|----------|---|
| W46301 | (13) 4" RED SPECIAL REFLECTIVE SERIES LIGHT W/PIGTAIL & GROMMET |
| W46302 | (13) 4" CLEAR/RED SPECIAL REFLECTIVE SERIES LIGHT W/ PIGTAIL & GROMMET |
| W4643 | (44) RED 4" LIGHT W/ CHROME PLASTIC BEZEL & GROMMET INCLUDED (HARD WIRE W/2 CONTACT FEMALE PLUG) |
| W4644 | (24) RED / (20) AMBER 4" LIGHT W/ CHROME PLASTIC BEZEL & GROMMET INCLUDED (HARD WIRE W/2 CONTACT FEMALE PLUG) |
| W4645 | (20) RED / (18) WHITE 4" LIGHT W/ CHROME PLASTIC BEZEL & GROMMET INCLUDED (HARD WIRE W/2 CONTACT FEMALE PLUG) |

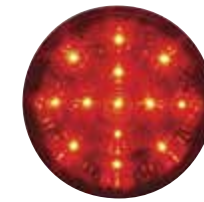

W46301



W46302



W4643



W4644



W4645

P/T/C

- | | |
|--------|--|
| W43144 | (19) AMBER/AMBER 4" P/T/C W/ REFLECTOR LIGHT |
| W43146 | (19) CLEAR/AMBER 4" P/T/C W/ REFLECTOR LIGHT |
| W4641 | (7) AMBER 4" P/T/C LIGHT W/ REFLECTOR |
| W4642 | (7) CLEAR/AMBER 4" P/T/C LIGHT W/ REFLECTOR |



W43144



W4641

WORK LIGHTS

- | | |
|--------|---|
| W54164 | (6) WHITE SUPER BRIGHT SINGLE MOUNTING STUD 1 WATT |
| W54213 | (6) WORK LIGHT W/ RUBBER HOUSING SUPER BRIGHT |
| W54835 | (12) BRIGHT WHITE RECTANGULAR SPOT WORK LIGHT 3 WATTS |



W54164



W54213



W54835

BACK UP

- | | |
|--------|--|
| W44534 | (20) SUPER WHITE 4" BACK-UP-LIGHT W/ 3 CONTACT FEMALE PLUG |
|--------|--|

BUS LIGHTS

- | | |
|--------|--|
| W43890 | (17) AMBER 7" LAMP, TURN / TAIL P/T/C |
| W43891 | (17) RED 7" LAMP, STOP / TURN / TAIL S/T/T |

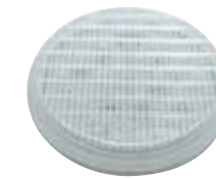

W44534



W43890

LED Lights

OVAL LIGHTS

Item No. Description
EMERGENCY
 W44561 (27) AMBER EMERGENCY QUAD LIGHT



W44561

SEQUENTIAL
 W43127 (35) AMBER/AMBER SEQUENTIAL REFLECTOR LIGHT
 W43128 (35) RED/RED SEQUENTIAL REFLECTOR LIGHT
 W43129 (35) CLEAR/AMBER SEQUENTIAL REFLECTOR LIGHT



W43127



W43128



W43129

TURN SIGNAL ONLY
 W42423 (28) AMBER TURN SIGNAL LAMP ONLY
 W4260LC (18) CLEAR/AMBER MID TRAILER, TURN SIGNAL LAMP ONLY



W42423

S/T/T
 W43133 (6) RED/RED ECONOMY S/T/T LIGHT
 W43134 (6) CLEAR/RED ECONOMY S/T/T LIGHT



W43133



W4260LC

W43141 (19) RED/RED 6" REFLECTOR S/T/T LIGHT
 W43143 (19) CLEAR/RED 6" REFLECTOR S/T/T LIGHT



W43141



W43143

W4647 (7) RED S/T/T W/ REFLECTOR LIGHT
 W4649 (7) CLEAR/RED S/T/T W/ REFLECTOR LIGHT
 W44570 (10) RED S/T/T LIGHT W/ CHROME BEZEL (3 WIRE PLUG)



W4647



W44570

OVAL LIGHTS (continued)

Item No. Description
P/T/C
 W43131 (25) AMBER/AMBER P/T/C W/ REFLECTOR LIGHT
 W43142 (19) CLEAR/AMBER 6" REFLECTOR P/T/C LIGHT



W43131

W4646 (7) AMBER P/T/C W/ REFLECTOR LIGHT
 W4648 (7) CLEAR/AMBER P/T/C W/ REFLECTOR LIGHT



W4648



W43142

SLIM STYLE SINGLE
 W5402 (10) RED SLIM S/T/T W/ S.S. MOUNTING BRACKET (EACH)
 W54020 (10) CLEAR/RED SLIM S/T/T W/ S.S. MOUNTING BRACKET (EACH)
 W54021 (10) AMBER SLIM P/T/C W/ S.S. MOUNTING BRACKET (EACH)
 W54022 (10) CLEAR/AMBER SLIM P/T/C W/ S.S. MOUNTING BRACKET (EACH)



W5402

SLIM STYLE DOUBLE
 W54023 (10/10) RED DOUBLE SLIM S/T/T W/ S.S. MOUNTING BRACKET (EACH)
 W54024 (10/10) CLEAR/RED DOUBLE SLIM S/T/T W/ S.S. MOUNTING BRACKET (EACH)
 W54025 (10/10) AMBER DOUBLE SLIM P/T/C W/ S.S. MOUNTING BRACKET (EACH)
 W54026 (10/10) CLEAR/AMBER DOUBLE SLIM P/T/C W/ S.S. MOUNTING BRACKET (EACH)



W54026

SLIM STYLE TRIPLE
 W54027 (10/10/10) RED TRIPLE SLIM S/T/T W/ S.S. MOUNTING BRACKET (EACH)
 W54028 (10/10/10) CLEAR/RED TRIPLE SLIM S/T/T W/ S.S. MOUNTING BRACKET (EACH)
 W54029 (10/10/10) AMBER TRIPLE SLIM P/T/C W/ S.S. MOUNTING BRACKET (EACH)
 W54030 (10/10/10) CLEAR/AMBER TRIPLE SLIM P/T/C W/ S.S. MOUNTING BRACKET (EACH)



W54030

LED Lights

RECTANGULAR LIGHTS

Item No.	Description
	WORK LIGHT
W54215	(6) WORK LIGHT W/ RUBBER HOUSING SUPER BRIGHT
W54835	(12) BRIGHT WHITE RECTANGULAR SPOT WORK LIGHT 3 WATTS
W5923	BEZEL W/ VISOR CHROME PLASTIC
W43154	(16) CLEAR/RED MARKER LIGHT REFLECTOR W/ CHROME BEZEL



W54215



W54835



W5923



W43154

SINGLE & DOUBLE FACE LED LIGHTS

SQUARE DOUBLE FACE

W40460	(18/3/18) W/ REFLECTOR AMBER/RED LIGHTS & AMBER SIDE MARKER - DRIVER SIDE 2 STUDS
W40461	(18/3/18) W/ REFLECTOR AMBER/RED LIGHTS & AMBER SIDE MARKER - PASSENGER SIDE 2 STUDS
W40462	(18/3/18) W/ REFLECTOR CLEAR LENS W/ AMBER/RED LIGHTS & AMBER SIDE MARKER - DRIVER SIDE 2 STUDS
W40463	(18/3/18) W/ REFLECTOR CLEAR LENS W/ AMBER/RED LIGHTS & AMBER SIDE MARKER - PASSENGER SIDE 2 STUDS



W40460



W40462

W40464	BEZEL W/ VISOR FOR SQUARE DOUBLE FACE REFLECTOR LIGHTS CHROME PLASTIC (EACH)
W40465	BEZEL W/OUT VISOR FOR SQUARE DOUBLE FACE REFLECTOR LIGHTS CHROME PLASTIC (EACH)
W40466	SQUARE BEZEL MIRROR W/ VISOR FOR DOUBLE FACE, FITS W4044LL-W4044LR & W40445-W40446 (EACH)



W40464



W40465



W40466

SINGLE & DOUBLE FACE LED LIGHTS (continued)

Item No.	Description
	ROUND DOUBLE FACE
W42235	(21/21) AMBER/RED DOUBLE FACE TURN SIGNAL W/ LIGHT REFLECTOR
W42236	(21/21) AMBER/RED CLEAR LENS DOUBLE FACE TURN SIGNAL W/LIGHT REFLECTOR
W42237	BEZEL W/ VISOR CHROME PLASTIC, FITS W42235 & W42236 ONLY
W42238	BEZEL W/ UP SIDE DOWN VISOR CHROME PLASTIC, FITS W42235 & W42236
W42239	BEZEL W/OUT VISOR CHROME PLASTIC, FITS W42235 & W42239



W42235



W42237



W42238



W42239

OVAL DOUBLE FACE

W44253	(10/10) RED/RED S.S. HOUSING CHROME PLASTIC BEZEL, FITS W4425R
W44257	(10/10) AMBER/RED S.S. HOUSING CHROME PLASTIC BEZEL
W44258	(10/10) AMBER/AMBER S.S. HOUSING CHROME PLASTIC BEZEL
W44259	(10/10) RED/RED S.S. HOUSING CHROME PLASTIC BEZEL, FITS W44570
W46026	(13/13) RED/AMBER OVAL DOUBLE FACE "T" MOUNT 3 WIRE
W46027	(13/13) CLEAR LENS RED/AMBER OVAL DOUBLE FACE "T" MOUNT 3 WIRE



W44257



W46026



W46027



W46041



W46041

W46041	(6/6) RED/AMBER RECTANGULAR DOUBLE FACE "T" MOUNT
W46042	(6/6) CLEAR LENS RED/AMBER RECTANGULAR DOUBLE FACE "T" MOUNT
W46043	(6/6) RED/AMBER RECTANGULAR DOUBLE FACE "STRAIGHT" MOUNT
W46044	(6/6) CLEAR LENS RED/AMBER RECTANGULAR DOUBLE FACE "STRAIGHT" MOUNT
W46400	HOUSING ONLY FOR SINGLE FACE LARGE AUXILIARY LIGHT, CHROME CAST



W46400

LED Lights

LED UTILITY LIGHT LICENSE PLATES

- | Item No. | Description |
|----------|---|
| W59443 | (14) AMBER/AMBER LICENSE PLATE FRAME W/ 12" LIGHT BAR |
| W59444 | (14) RED/RED LICENSE PLATE FRAME W/ 12" LIGHT BAR |
| W59445 | (14) CLEAR/AMBER LICENSE PLATE FRAME W/ 12" LIGHT BAR |
| W59446 | (14) CLEAR/RED LICENSE PLATE FRAME W/ 12" LIGHT BAR |
| W5944R | (14) CLEAR/RED CHROME PLASTIC LICENSE PLATE FRAME |
| W5944W | (14) CLEAR/WHITE CHROME PLASTIC LICENSE PLATE FRAME |



W59443



W5944R



W5944W

- | | |
|--------|--|
| W5945 | (10) CLEAR/AMBER LICENSE PLATE FRAME W/ 9" LIGHT BAR |
| W5946 | (10) CLEAR/RED LICENSE PLATE FRAME W/ 9" LIGHT BAR |
| W59466 | (6) CLEAR/WHITE CYLINDER LICENSE PLATE FRAME LIGHT |



W59466



W5945

- | | |
|--------|---|
| W59601 | (10) AMBER OVAL LIGHT, CHROME LICENSE PLATE FRAME |
| W59602 | (10) RED OVAL LIGHT, CHROME LICENSE PLATE FRAME |
| W59603 | (10) CLEAR/AMBER OVAL LIGHT, CHROME LICENSE PLATE FRAME |
| W59604 | (10) CLEAR/RED OVAL LIGHT, CHROME LICENSE PLATE FRAME |



W59601



W59602



W59603

- | | |
|--------|---|
| W54163 | (5) WHITE HIGH POWERED RECTANGULAR AUXILIARY/UTILITY LIGHT 12V TO 24V |
| W59605 | LICENSE PLATE W/ PROTECTOR COVER CHROME |
| W5947 | LICENSE PLATE FRAME CHROME W/ LIGHT BAR CUT OUT |



W54163



W59605



W5947

LED BACK UP & AUXILIARY LIGHTS

- | Item No. | Description |
|----------|--|
| W44533 | (32) CLEAR/WHITE RECTANGULAR BACK UP LIGHT |
| W4569AA | (5) AMBER AUXILIARY LIGHT (2-3/4" x 1/2" FOR 12V SYSTEM) |
| W4569BA | (5) BLUE AUXILIARY LIGHT (2-3/4" x 1/2" FOR 12V SYSTEM) |
| W4569GA | (5) GREEN AUXILIARY LIGHT (2-3/4" x 1/2" FOR 12V SYSTEM) |
| W4569PA | (5) PURPLE AUXILIARY LIGHT (2-3/4" x 1/2" FOR 12V SYSTEM) |
| W4569RA | (5) RED AUXILIARY LIGHT (2-3/4" x 1/2" FOR 12V SYSTEM) |
| W4569WA | (5) WHITE AUXILIARY LIGHT (2-3/4" x 1/2" FOR 12V SYSTEM) |
| W45795 | (37/14) CLEAR/AMBER, RED AUXILIARY LIGHT W/ ZEPHYR BEZEL |
| W45796 | (37/14) CLEAR/AMBER, RED AUXILIARY LIGHT W/ TEARDROP BEZEL |
| W45797 | (37/14) CLEAR/AMBER, RED AUXILIARY LIGHT W/ FLAME BEZEL |
| W45798 | (37/14) CLEAR/AMBER, RED AUXILIARY LIGHT ONLY |



W44533



W4569AA



W45795



W45796



W45797

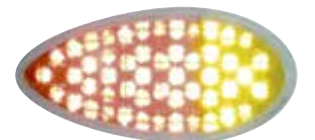

W45798

- | | |
|--------|---|
| W45817 | (6) AMBER PYRAMID AUXILIARY LIGHT W/ CHROME PLASTIC HOUSING |
| W45818 | (6) BLUE PYRAMID AUXILIARY LIGHT W/ CHROME PLASTIC HOUSING |
| W45819 | (6) RED PYRAMID AUXILIARY LIGHT W/ CHROME PLASTIC HOUSING |
| W45820 | (6) WHITE PYRAMID AUXILIARY LIGHT W/ CHROME PLASTIC HOUSING |
| W45821 | (28) AMBER AUXILIARY LIGHT W/ CHROME PLASTIC HOUSING |
| W45822 | (28) BLUE AUXILIARY LIGHT W/ CHROME PLASTIC HOUSING |
| W45823 | (28) RED AUXILIARY LIGHT W/ CHROME PLASTIC HOUSING |
| W45824 | (28) WHITE AUXILIARY LIGHT W/ CHROME PLASTIC HOUSING |



W45817



W45818



W45819



W45820



W45821



W45822



W45823



W45824

LED Lights

LED CAB LIGHTS

- | Item No. | Description |
|------------------------------|----------------------------------|
| RECTANGULAR REFLECTOR | |
| W4570-A | (8) AMBER FOR FREIGHTLINER |
| W4570-AC | (8) AMBER/CLEAR FOR FREIGHTLINER |



W4570-A

W4570-AC

- | | |
|--------|--|
| W53793 | (17) AMBER KIT, INCLUDES CHROME PLASTIC HOUSING |
| W53794 | (17) CLEAR/AMBER LIGHT KIT, INCLUDES CHROME PLASTIC HOUSING |
| W53795 | (17) AMBER/AMBER LIGHT LAMP REPLACEMENT (HOUSING NOT INCLUDED) |
| W53796 | (17) CLEAR/AMBER LIGHT LAMP REPLACEMENT (HOUSING NOT INCLUDED) |
| W53797 | (19) AMBER/AMBER W/CHROME PLASTIC HOUSING |
| W53798 | (19) CLEAR/AMBER W/CHROME PLASTIC HOUSING |
| W53799 | (19) AMBER/AMBER (HOUSING NOT INCLUDED) |
| W53800 | (19) CLEAR/AMBER (HOUSING NOT INCLUDED) |



W53793

W53794

W53795

W53796



W53797

W53799

W53800

LED CAB LIGHTS (continued)

- | Item No. | Description |
|--|-------------|
| CHROME PLASTIC HOUSING ASSEMBLY | |

- | | |
|--------|---|
| W53804 | (19) AMBER 2 WIRE GRAKON STYLE |
| W53805 | (19) CLEAR/AMBER 2 WIRE GRAKON STYLE (WATERMELON LENS) |
| W53806 | (19) AMBER 2 WIRE GRAKON STYLE (BEEHIVE STYLE) |
| W53807 | (19) CLEAR/AMBER 2 WIRE GRAKON STYLE (BEEHIVE STYLE) |
| W53808 | (19) AMBER BEEHIVE W/REFLECTOR LENS 2 WIRE GRAKON STYLE |
| W53809 | (19) CLEAR/AMBER W/REFLECTOR LENS 2 WIRE GRAKON STYLE |



W53804

W53806

W53808

- | | |
|--------|---|
| W53837 | (17) RED BEEHIVE STYLE "REPLACEMENT LAMP" |
| W53838 | (17) CLEAR/RED BEEHIVE STYLE "REPLACEMENT LAMP" |
| W53839 | CHROME HOUSING ONLY W/OUT VISOR, FITS ONLY GRAKON STYLE LIGHT |
| W53803 | CHROME HOUSING ONLY W/ VISOR, FITS ONLY GRAKON STYLE LIGHT |



W53837

W53838

W53839

W53803

WATERMELON STYLE

- | | |
|--------|--|
| W53844 | (17) AMBER W/ CLEAR REFLECTOR - DUAL FUNCTION (3-WIRE) |
| W53845 | (17) RED W/ CLEAR REFLECTOR (3-WIRE) |
| W53846 | (17) CLEAR/AMBER W/ CLEAR REFLECTOR (3-WIRE) |
| W53847 | (17) CLEAR/RED W/ CLEAR REFLECTOR (3-WIRE) |
| W53842 | (19) AMBER W/ CHROME PLASTIC HOUSING & VISOR |
| W53843 | (19) AMBER/CLEAR W/ CHROME PLASTIC HOUSING & VISOR |
| W53785 | (19) AMBER GRAKON 1000 STYLE REFLECTOR REPLACEMENT LENS ASSEMBLY - USE OEM GASKET & SCREWS |
| W53786 | (19) CLEAR/AMBER GRAKON 1000 STYLE REFLECTOR REPLACEMENT LENS ASSEMBLY - USE OEM GASKET & SCREWS |



W53844

W53845

W53846



W53842

W53785

W53786

LED Lights

MIRROR LIGHTS & BEZELS

Item No. Description AUXILIARY LIGHTS (continued)

W52060 (14) AMBER/CHROME 12" S/T/T STRIP LIGHT
W/ S.S. MOUNTING BRACKET 12-3/4" x 1-3/8" EACH

W52061 (14) RED/CHROME 12" S/T/T STRIP LIGHT
W/ S.S. MOUNTING BRACKET 12-3/4" x 1-3/8" EACH



W52060



W52061

W52072 (14/14) AMBER/CHROME 12" S/T/T DOUBLE STACK STRIP LIGHT
W/ S.S. MOUNTING BRACKET 12-3/4" x 1-3/8" EACH

W52073 (14/14) RED/CHROME 12" S/T/T DOUBLE STACK STRIP LIGHT
W/ S.S. MOUNTING BRACKET 12-3/4" x 1-3/8" EACH



W52072 & W52073

W52084 (14/14) AMBER/CHROME 25-5/16" S/T/T DOUBLE STRIP LIGHT
W/ S.S. MOUNTING BRACKET 25-5/16" x 2-5/8" EACH

W52085 (14/14) RED/CHROME 25-5/16" S/T/T DOUBLE STRIP LIGHT
W/ S.S. MOUNTING BRACKET 25-5/16" x 2-5/8" EACH



W52085

W52096 (14/14) AMBER/CHROME 25-5/16" S/T/T FOUR STRIP LIGHT
W/ S.S. MOUNTING BRACKET 25-5/16" x 2-5/8" EACH



W52096

W52097 (14/14) RED/CHROME 25-5/16" S/T/T FOUR STRIP LIGHT
W/ S.S. MOUNTING BRACKET 25-5/16" x 2-5/8" EACH



W52097

MIRROR LIGHTS & BEZELS (continued)

Item No. Description

W52131 (28) AMBER/CHROME DOUBLE STACK 12" LIGHT BAR W/ CHROME HOUSING

W52132 (28) RED/CHROME DOUBLE STACK 12" LIGHT BAR W/ CHROME HOUSING

W52133 (28) AMBER/RED CHROME LENS DOUBLE STACK 12" LIGHT BAR W/ CHROME HOUSING



W52131

MIRROR BEZELS

W5405M 2" MIRROR BEZEL CHROME PLASTIC

W5405MV 2" MIRROR BEZEL W/ VISOR CHROME PLASTIC

W54065 2 1/2" MIRROR BEZEL CHROME PLASTIC

W5406M 4" MIRROR BEZEL CHROME PLASTIC

W5406MV 4" MIRROR BEZEL W/ VISOR CHROME PLASTIC

W5407M OVAL MIRROR BEZEL CHROME PLASTIC



W5405M

W5405MV

W54065



W5406M



W5406MV



W5407M

W59447 (14) AMBER/CHROME LICENSE PLATE FRAME W/ 12" LIGHT BAR

W59448 (14) RED/CHROME LICENSE PLATE FRAME W/ 12" LIGHT BAR



W59447



W59448

LED Lights

MARKER LIGHTS

Item No. Description

RECTANGULAR

- W40543A (20) AMBER REFLECTIVE TURTLE BACK
- W40544A (20) RED REFLECTIVE TURTLE BACK
- W40545A (20) CLEAR/AMBER REFLECTIVE TURTLE BACK
- W40546A (20) CLEAR/RED REFLECTIVE TURTLE BACK



W40394

- W40394 (4) AMBER/AMBER CLEARANCE MARKER LIGHT W/ REFLECTOR
- W40395 (4) RED/RED CLEARANCE MARKER LIGHT W/ REFLECTOR
- W40396 (4) CLEAR/AMBER CLEARANCE MARKER LIGHT W/ REFLECTOR
- W40397 (4) CLEAR/RED CLEARANCE MARKER LIGHT W/ REFLECTOR



W40395

- W40471 (3) AMBER/AMBER MARKER LIGHT W/ REFLECTOR
- W40472 (3) RED/RED MARKER LIGHT W/ REFLECTOR
- W40473 (3) CLEAR/AMBER MARKER LIGHT W/ REFLECTOR
- W40474 (3) CLEAR/RED MARKER LIGHT W/ REFLECTOR



W40471

- W40398 (4) AMBER/AMBER MARKER LIGHT W/ REFLECTOR
- W40399 (4) CLEAR/AMBER MARKER LIGHT W/ REFLECTOR
- W40479 (4) RED/RED MARKER LIGHT W/ REFLECTOR
- W40480 (4) CLEAR/RED MARKER LIGHT W/ REFLECTOR



W40399

- W40549 (13) AMBER/AMBER CLEARANCE MARKER LIGHT REFLECTOR
- W40550 (13) RED/RED CLEARANCE MARKER LIGHT REFLECTOR
- W40551 (13) CLEAR/AMBER CLEARANCE MARKER LIGHT REFLECTOR



W40550

- W43152 (16) AMBER/AMBER MARKER LIGHT REFLECTOR W/ CHROME BEZEL
- W43153 (16) CLEAR/AMBER MARKER LIGHT REFLECTOR W/ CHROME BEZEL



W43152



W43153

- W44153 (14) AMBER MARKER LIGHT
- W44154 (14) RED MARKER LIGHT
- W44155 (14) CLEAR/AMBER MARKER LIGHT
- W44156 (14) CLEAR/RED MARKER LIGHT



W44153



W44154



W44155

MARKER LIGHTS (continued)

Item No. Description

RECTANGULAR (continued)

- W44160 (3) AMBER/AMBER MARKER LIGHT REFLECTOR
- W44163 (3) CLEAR/RED MARKER LIGHT REFLECTOR
- W44164 (3) RED/RED MARKER LIGHT REFLECTOR
- W44165 (3) CLEAR/AMBER MARKER LIGHT REFLECTOR



W44160



W44164



W44165

PETERBILT STYLE CLEARANCE, MARKER LIGHTS

- W54135 (13) CLEAR/AMBER W/ CHROME BEZEL 2-3/16" x 6-11/16" x 3/4"
- W54136 (13) CLEAR/RED W/ CHROME BEZEL 2-3/16" x 6-11/16" x 3/4"
- W40401 (12) AMBER W/ REFLECTOR LIGHT & REBEL CHROME BEZEL
- W40402 (12) RED W/ REFLECTOR LIGHT & REBEL CHROME BEZEL
- W40403 (12) CLEAR/AMBER W/ REFLECTOR LIGHT & REBEL CHROME BEZEL
- W40404 (12) CLEAR/RED W/ REFLECTOR LIGHT & REBEL CHROME BEZEL



W40401



W54135



W40403

- W54031 BEZEL RENEGADE W/ SIDE GUARDS FOR PB AERO STYLE MARKER LIGHT
- W54032 (3) LED AMBER AERO STYLE MARKER LIGHT CHROME PLASTIC BEZEL W/ SIDE GUARDS



W54031



W54032

- W54131 (13) AMBER W/ CHROME BEZEL 2-3/16" x 6-11/16" x 3/4"
- W54132 (13) RED W/ CHROME BEZEL 2-3/16" x 6-11/16" x 3/4"



W54131

LED Lights

MARKER LIGHTS (continued)

- | Item No. | Description |
|--|---|
| MARKER LIGHTS W/ CHROME PLATED S.S. RIM FOR PETERBILT | |
| W40475 | (10) AMBER/AMBER MARKER REFLECTOR LIGHT |
| W40476 | (10) RED/RED MARKER REFLECTOR LIGHT |
| W40477 | (10) CLEAR/AMBER MARKER REFLECTOR LIGHT |
| W40478 | (10) CLEAR/RED MARKER REFLECTOR LIGHT |



W40475



W40476



W40477

"SPECIAL STYLE I"

- | | |
|----------|--|
| W54158 | (16/16) DOUBLE FACE AMBER/RED LIGHT W/S.S. HSG. / CHR. PLST. BEZEL |
| W5415RA | (16) AMBER/AMBER MARKER LIGHT W/ REFLECTOR |
| W5415RC | (16) CLEAR/AMBER MARKER LIGHT W/ REFLECTOR |
| W5415RCR | (16) CLEAR/RED MARKER LIGHT W/ REFLECTOR |
| W5415RR | (16) RED/RED MARKER LIGHT W/ REFLECTOR |



W54158



W5415RA



W5415RC



W5415RR

MINI CLEARANCE

- | | |
|--------|---|
| W59670 | (3) AMBER MARKER LIGHT W/ S.S. BEZEL & RUBBER GROMMET |
| W59671 | (3) RED MARKER LIGHT W/ S.S. BEZEL & RUBBER GROMMET |
| W59672 | (3) CLEAR/AMBER MARKER LIGHT W/ S.S. BEZEL & RUBBER GROMMET |
| W59673 | (3) CLEAR/RED MARKER LIGHT W/ S.S. BEZEL & RUBBER GROMMET |
| W59674 | (3) CLEAR/BLUE MARKER LIGHT W/ S.S. BEZEL & RUBBER GROMMET |
| W59675 | (3) CLEAR/WHITE MARKER LIGHT W/ S.S. BEZEL & RUBBER GROMMET |



W59670



W59671



W59672



W59673



W59674



W59675

- | | |
|--------|--------------------|
| W54520 | LED STROBE FLASHER |
|--------|--------------------|



W54520

MARKER LIGHTS (continued)

- | Item No. | Description |
|---------------------|---|
| SIDE MARKERS | |
| W54133 | (6) AMBER SMALL SIDE M/C LIGHT W/CHROME BEZEL
1-1/16" x 3 -15/16" x 3/4" |
| W54134 | (6) RED SMALL SIDE M/C LIGHTW/CHROME BEZEL
1-1/16" x 3 -15/16" x 3/4" |



W54133

- | | |
|--------|--|
| W40405 | (3) AMBER MARKER REFLECTOR LIGHT W/ CHROME BEZEL |
| W40406 | (3) RED MARKER REFLECTOR LIGHT W/ CHROME BEZEL |
| W40407 | (3) CLEAR/AMBER MARKER REFLECTOR LIGHT W/ CHROME BEZEL |
| W40408 | (3) CLEAR/RED MARKER REFLECTOR LIGHT W/ CHROME BEZEL |



W40405



LED Lights

OVAL LIGHTS

- | Item No. | Description |
|---------------------------------------|---|
| "OLD SCHOOL" & RETRO STYLE | |
| W54872 | (40) RED/RED S/T/T "OLD SCHOOL" LIGHT FLUSH MOUNT W/ CHROME BEZEL |
| W54874 | (40) RED/RED S/T/T "OLD SCHOOL" LIGHT |
| W54875 | (40) CLEAR/RED S/T/T "OLD SCHOOL" LIGHT |



W54872



W54874



W54875

- | | |
|--------|--|
| W54876 | OVAL CHROME BEZEL FOR "OLD SCHOOL" LIGHT FLUSH MOUNT |
| W54877 | (39) RED/RED S/T/T RETRO LIGHT W/ CHROME BEZEL FLUSH MOUNT |
| W54878 | (16) AMBER/AMBER S/T/T RETRO LIGHT W/ CHROME BEZEL FLUSH MOUNT |
| W54879 | (16) RED/RED S/T/T RETRO LIGHT W/ CHROME BEZEL FLUSH MOUNT |
| W54880 | RECTANGULAR CHROME BEZEL FOR RETRO LIGHT FLUSH MOUNT |
| W54881 | (39) RED/RED S/T/T RETRO LIGHT |
| W54882 | (16) AMBER/AMBER S/T/T RETRO LIGHT |
| W54883 | (16) RED/RED S/T/T RETRO LIGHT |



W54876



W54877



W54880



W54881



W54878



W54882



W54883

- | | |
|--------|---|
| W44535 | (16) OVAL SUPER BRIGHT BACK-UP WHITE LIGHT-CLEAR LENS |
|--------|---|



W44535

TEARDROP LIGHTS

- | Item No. | Description |
|-----------------|--|
| TEARDROP | |
| W45789 | (39) AMBER/AMBER TEAR DROP LIGHT |
| W45790 | (39) AMBER/CLEAR TEAR DROP LIGHT |
| W45811 | (39) RED/RED S/T/T TEARDROP LIGHT W/ CHROME BEZEL SINGLE BAR |
| W45813 | (39) CLEAR/RED S/T/T TEARDROP LIGHT W/ CHROME BEZEL SINGLE BAR |
| W45810 | (39) AMBER/AMBER P/T/C TEARDROP LIGHT W/ CHROME BEZEL SINGLE BAR |
| W45812 | (39) CLEAR/AMBER P/T/C TEARDROP LIGHT W/ CHROME BEZEL SINGLE BAR |
| W45816 | BEZEL CHROME FLUSH MOUNT FOR TEARDROP LIGHT |



W45790



W45810



W45816



W45811

RECTANGULAR LIGHTS

- | | |
|--------------------|--|
| SINGLE STUD | |
| W45825 | (4) AMBER/AMBER SINGLE STUD LIGHT W/ CHROME HOUSING |
| W45826 | (4) RED/RED SINGLE STUD LIGHT W/ CHROME HOUSING |
| W45827 | (4) CLEAR/AMBER SINGLE STUD LIGHT W/ CHROME HOUSING |
| W45828 | (4) CLEAR/RED SINGLE STUD LIGHT W/ CHROME HOUSING |
| W52103 | LIGHT BEZEL CHROME PLASTIC, FITS W52104, W52105 ONLY |



W45825

W45826

W45827



W52103

- | | |
|--------------|--|
| S/T/T | |
| W52104 | (40) RED/RED S/T/T, FITS W52103 |
| W52105 | (40) CLEAR/RED S/T/T LIGHT, FITS W52103 |
| W52106 | (40) RED/RED S/T/T LIGHT W/ CHROME PLASTIC BEZEL |
| W52107 | (40) CLEAR/RED S/T/T LIGHT W/ CHROME PLASTIC BEZEL |



W52104



W52105



W52106



W52107

LED Lights

SINGLE & DOUBLE FACE LED LIGHTS

Item No.	Description
AUXILIARY LIGHT W/CHROME CAST HOUSING (EACH)	
W46401	(17) RED, SINGLE FACE BEEHIVE STYLE
W46402	(17) CLEAR/RED, SINGLE FACE BEEHIVE STYLE
W46403	(17) AMBER, SINGLE FACE BEEHIVE STYLE
W46404	(17) CLEAR/AMBER, SINGLE FACE BEEHIVE STYLE
W46405	(17) RED, SINGLE FACE WATERMELON STYLE
W46406	(17) CLEAR/RED, SINGLE FACE WATERMELON STYLE
W46407	(17) AMBER, SINGLE FACE WATERMELON STYLE
W46408	(17) CLEAR/AMBER, SINGLE FACE WATERMELON STYLE
W46410	(17/17) AMBER/RED, CHROME DOUBLE FACE REFLECTOR



W46401



W46407



W46408



W46410



W54233

W54233	(15) AMBER/AMBER 3" SINGLE FACE, SINGLE STUD 2 WIRE
W54234	(15) RED/RED 3" SINGLE FACE, SINGLE STUD 2 WIRE
W54235	(15) CLEAR/AMBER 3" SINGLE FACE, SINGLE STUD 2 WIRE
W54236	(15) CLEAR/RED 3" SINGLE FACE, SINGLE STUD 2 WIRE



W46104



W4610H

W46104	(12) CLEAR/RED 4" SINGLE FACE, S.S. HOUSING W/ CHROME PLASTIC BEZEL W/VISOR
W4610H	4" SINGLE SIDE S.S. LIGHT HOUSING ONLY W/REINFORCED STUD

W40467	(15/15) RED-AMBER 3" ROUND DOUBLE FACE REFLECTOR LIGHTS 2 WIRE
W40468	(15/15) RED-AMBER CLEAR LENS 3" ROUND DOUBLE FACE REFLECTOR LIGHTS 2 WIRE

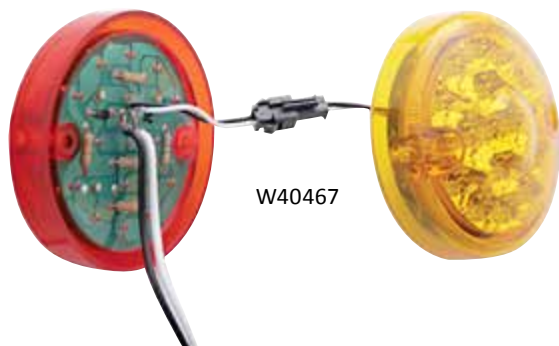

W40467



W40468

LED UTILITY & LICENSE PLATES LIGHT

Item No.	Description
W40400	(4) CLEAR/WHITE RECTANGULAR AUXILIARY/UTILITY W/LIGHT REFLECTOR
W4043W	(12) CLEAR/WHITE RECTANGULAR AUXILIARY/UTILITY W/LIGHT REFLECTOR

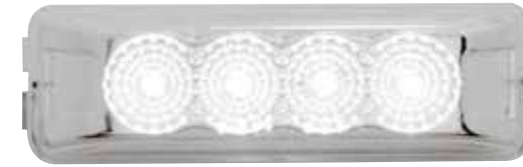

W40400



W4043W

W4045ES	(3) AMBER ASSEMBLY W/OUT VISIBLE SCREWS
W4046ES	(3) BLUE ASSEMBLY W/OUT VISIBLE SCREWS
W4047ES	(3) GREEN ASSEMBLY W/OUT VISIBLE SCREWS
W4048ES	(3) WHITE ASSEMBLY W/OUT VISIBLE SCREWS
W4049ES	(3) PURPLE ASSEMBLY W/OUT VISIBLE SCREWS
W4050ES	(3) RED ASSEMBLY W/OUT VISIBLE SCREWS



W4046ES



W40481

W40481	(4) WHITE ROUND AUXILIARY LIGHT FOR LICENSE PLATE
W44532	(12) UTILITY 4" WHITE LIGHT W/REFLECTOR 3 FEMALE PLUG
W44532K	(12) UTILITY 4" WHITE LIGHT W/REFLECTOR KIT INCLUDES BLACK GROMMET & 3 FEMALE PLUG
W4455U	(10) OVAL UTILITY REFLECTIVE LENS SUPER BRIGHT 2 CONTACT FEMALE PLUG
W4632U	(10) CLEAR 4" SUPER THIN ECONOMY UTILITY LIGHT 3 CONTACT FEMALE PLUG



W44532



W44532K



W4455U



W4632U

W59434	(14) CLEAR/BLUE LICENSE PLATE FRAME W/ 12" UTILITY LIGHT BAR
W59435	(14) CLEAR/GREEN LICENSE PLATE FRAME W/ 12" UTILITY LIGHT BAR
W59436	(14) CLEAR/WHITE LICENSE PLATE FRAME W/ 12" UTILITY LIGHT BAR
W59437	(14) CLEAR/BLUE UTILITY LIGHT BAR W/ CHROME BEZEL
W59438	(14) CLEAR/GREEN UTILITY LIGHT BAR W/ CHROME BEZEL
W59439	(14) CLEAR/WHITE UTILITY LIGHT BAR W/ CHROME BEZEL
W5944	(10) RED/RED LICENSE PLATE FRAME W/ 9" LIGHT BAR
W59449	(10) AMBER/AMBER LICENSE PLATE FRAME W/ 9" LIGHT BAR



W59434



W59437



W59438



W59439



W5944

LED Lights

LED CAB LIGHTS

Item No.	Description
W53787	(19) AMBER FOR GRAKON 2000 MODEL W/OUT HOUSING, FITS PB 387
W5382H	CAB LIGHT CHROME PLASTIC HOUSING ONLY, W/OUT HARDWARE



LED, BULBS ACCENT

194 BULB W/WEDGE BASE

W41021	(5) LED WHITE - PROJECTS A WIDE ILLUMINATING GLOW 2/PKG
W41022	(5) AMBER HIGH POWERED LED 2/PKG
W41023	(5) BLUE HIGH POWERED LED 2/PKG
W41024	(5) RED HIGH POWERED LED 2/PKG
W41025	(5) WHITE HIGH POWERED LED 2/PKG



W41022 W41023 W41024 W41025

HEADLIGHT ACCENT LIGHT FOR EXISTING H4 HEADLIGHT SYSTEMS

W41591	(4) AMBER
W41592	(4) BLUE
W41593	(4) GREEN
W41594	(4) PURPLE
W41595	(4) RED
W41596	(4) WHITE



W41594

3157 WEDGE BASE

W43324	(12) WHITE, 2-1/8" HEIGHT (EACH)
--------	----------------------------------



W43324

1156 RIGHT ANGLE

W43376	(24) WHITE SINGLE CONTACT STRAIGHT PINS (EACH)
--------	--



W43376

1157 DOUBLE CONTACT OFFSET PINS

W43416	(13) WHITE
W43417	(13) AMBER
W43418	(13) RED



W43416



W43417

LED, BULBS ACCENT (continued)

Item No.	Description
W41107	(6) 36 MM WHITE BULBS 2/PKG
W41108	(6) 36 MM AMBER BULBS 2/PKG
W41109	(6) 36 MM BLUE BULBS 2/PKG
W41110	(6) 36 MM GREEN BULBS 2/PKG
W41111	(6) 36 MM PURPLE BULBS 2/PKG
W41112	(6) 36 MM RED BULBS 2/PKG



W41108



W41109



W41112

W4650	(39) BRIGHT WHITE W/CHROME BEZEL
W4651	(21) BRIGHT WHITE W/CHROME BEZEL



W4650



W4651

W45747	CLEAR LENS, ON-OFF SWITCH 2 WIRE, 6-1/2" x 3-3/8"
W45748	PURPLE LENS, ON-OFF SWITCH 2 WIRE, 6-1/2" x 3-3/8"
W45749	CLEAR LENS W/BLACK LITE BULBS, ON-OFF SWITCH 2 WIRE, 6-1/2" x 3-3/8"



W45747



W45748



W45749











LED Light Strip & Brackets

STAINLESS STEEL MIRROR BRACKETS

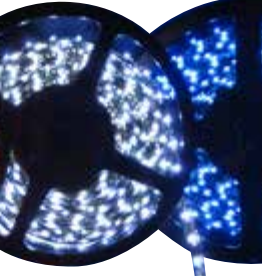

Item No.	Description	
W40187	(23) AMBER 17 1/4" LIGHT BAR	 W40187
W40188	(23) CLEAR/AMBER 17 1/4" LIGHT BAR	
W40189	(11) AMBER 17" LIGHT BAR	 W40189
W40190	(11) CLEAR/AMBER 17" LIGHT BAR	
W40191	(11) AMBER 17" LIGHT BAR W/BEZEL	 W40191
W40192	(11) CLEAR/AMBER 17" LIGHT BAR W/BEZEL	
W40193	S.S W/LIGHT BAR CUT OUT BRACKET ONLY	 W40193

FLEXIBLE PEEL & STICK LIGHT STRIP











19 1/2" LIGHT STRIP		
W41328	(30) BLUE	 W41329
W41329	(30) GREEN	 W41330
W41330	(30) WHITE	 W41331
W41331	(30) AMBER	 W41332
W41332	(30) RED	 W41333

STRIP ROLL (16 FEET) 12V		
W41333	(60) WHITE	 W41337
W41334	(60) BLUE	 W41333
W41335	(60) AMBER	 W41334
W41336	(60) GREEN	
W41337	(60) RED	

LED AUXILIARY LIGHTS

W45671	(14) AMBER AUXILIARY/MIRROR LIGHT 6" x 1-1/8" x 1/4" CHROME PLASTIC HOUSING 2-HARD WIRED	 W45671
W45672	(14) BLUE AUXILIARY/MIRROR LIGHT 6" x 1-1/8" x 1/4" CHROME PLASTIC HOUSING 2-HARD WIRED	
W45673	(14) GREEN AUXILIARY/MIRROR LIGHT 6" x 1 1/8" x 1/4" CHROME PLASTIC HOUSING 2-HARD WIRED	
W45675	(14) RED AUXILIARY/MIRROR LIGHT 6" x 1- 1/8" x 1/4" CHROME PLASTIC HOUSING 2-HARD WIRED	
W45676	(14) WHITE AUXILIARY/MIRROR LIGHT 6" x 1-1/8" x 1/4" CHROME PLASTIC HOUSING 2-HARD WIRED	
W45689	(60) AMBER STRIP LIGHT 17" x 1-3/8" x 7/8" INTERIOR USE	 W45690
W45690	(60) RED STRIP LIGHT 17" x 1-3/8" x 7/8" INTERIOR USE	

DOUBLE FACE AUXILIARY

Item No.	Description	
W45757	(10/10) AMBER/RED 9" LIGHT BAR W/ CHROME PLASTIC HOUSING	 W45757
W45758	(10/10) CLEAR/AMBER-RED LENS 9" LIGHT BAR W/ CHROME PLASTIC HOUSING	 W45758
W45770	(10/10) CLEAR/RED 9" LIGHT BAR ONLY	
W4578	9" LIGHT BAR HOUSING ONLY CHROME PLASTIC	 W4578
W45729	(14/14) AMBER/RED 12" LIGHT BAR W/ CHROME PLASTIC HOUSING	 W45729
W45730	(14/14) CLEAR/AMBER-RED LENS 12" LIGHT BAR W/ CHROME PLASTIC HOUSING	 W45730
W45736	(14/14) AMBER/AMBER 12" LIGHT BAR ONLY	
W45737	(14/14) RED/RED 12" LIGHT BAR ONLY	
W45738	(14/14) CLEAR/AMBER 12" LIGHT BAR ONLY	
W45739	(14/14) CLEAR/RED 12" LIGHT BAR ONLY	
W4579	12" LIGHT BAR HOUSING ONLY CHROME PLASTIC	 W4579
W45791	(8) AMBER ACCESSORY STRIP LIGHT (2-PC)	 W45791
W45792	(8) BLUE ACCESSORY STRIP LIGHT (2-PC)	 W45792
W45793	(8) RED ACCESSORY STRIP LIGHT (2-PC)	 W45793
W45794	(8) WHITE ACCESSORY STRIP LIGHT (2-PC)	 W45794
W52018	(16) RED/RED LIGHT BAR (15-3/8")	 W52018
W52019	(16) CLEAR/RED LIGHT BAR (15-3/8")	 W52019
W52032	(10) AMBER/AMBER STRIP LIGHT (6-1/2")	 W52032
W52033	(10) RED/RED STRIP LIGHT (6-1/2")	
W52034	(10) CLEAR/AMBER STRIP LIGHT (6-1/2")	 W52035
W52035	(10) CLEAR/RED STRIP LIGHT (6-1/2")	
W52036	(10) RED 9" LIGHT STRIP W/ CHROME PLASTIC BEZEL	
W52037	(10) AMBER 9" LIGHT STRIP W/ CHROME PLASTIC BEZEL	
W52038	(10) CLEAR/AMBER 9" LIGHT STRIP W/ CHROME PLASTIC BEZEL	
W52039	(10) CLEAR/RED 9" LIGHT STRIP W/ CHROME PLASTIC BEZEL	 W52038

LED Light Strip & Brackets

Item No. Description

- W52044 9" S.S. SINGLE STRIP LIGHT MOUNTING BRACKET (EACH)
- W52045 9" S.S. DOUBLE STRIP LIGHT MOUNTING BRACKET (EACH)



- W52046 (14) LED BLUE UTILITY LIGHT BAR 12" W/ MOUNTING HOLES
- W52047 (14) LED GREEN UTILITY LIGHT BAR 12" W/ MOUNTING HOLES
- W52048 (14) LED WHITE UTILITY LIGHT BAR 12" W/ MOUNTING HOLES



W52046

- W52054 12" S.S. SINGLE STRIP LIGHT MOUNTING BRACKET (EACH)
- W52055 12" S.S. DOUBLE STRIP LIGHT MOUNTING BRACKET (EACH)



W52054

W52055

- W52056 (11) LED AMBER/AMBER P/T/C LIGHT BAR W/ BEZEL DOTS CHROME PLASTIC
- W52057 (11) LED RED/RED S/T/T LIGHT BAR W/ BEZEL DOTS CHROME PLASTIC
- W52058 (11) LED CLEAR/AMBER P/T/C LIGHT BAR W/ BEZEL DOTS CHROME PLASTIC
- W52059 (11) LED CLEAR/RED S/T/T LIGHT BAR W/ BEZEL DOTS CHROME PLASTIC



W52056

W52057

- W5211 CHROME PLASTIC SINGLE DOT BEZEL, ONLY
- W52062 S.S. LIGHT BAR BEZEL ONLY, FITS 12" LED LIGHT



W5211

W52062

LED DOUBLE STACK

- W52068 (11/11) AMBER/AMBER P/T/C STRIP LIGHT W/ BEZEL DOTS CHROME PLASTIC
- W52069 (11/11) RED/RED S/T/T STRIP LIGHT W/ BEZEL DOTS CHROME PLASTIC
- W52070 (11/11) CLEAR/AMBER P/T/C STRIP LIGHT W/ BEZEL DOTS CHROME PLASTIC
- W52071 (11/11) CLEAR/RED S/T/T STRIP LIGHT W/ BEZEL DOTS CHROME PLASTIC



W52068

W52071

LED DOUBLE STACK - Continued

Item No. Description

**25 5/16" S/T/T STRIP LIGHT
W/ S.S. MOUNTING BRACKET (25 5/16" x 2-5/8")**

- W52080 (14/14) AMBER/AMBER (EACH)
- W52081 (14/14) RED/RED (EACH)
- W52082 (14/14) CLEAR/AMBER (EACH)
- W52083 (14/14) CLEAR/RED (EACH)



W52080

**25 5/16" S/T/T FOUR STRIP LIGHT
W/ S.S. MOUNTING BRACKET (25 5/16" x 2-5/8")**

- W52092 (14/14) AMBER/AMBER (EACH)
- W52093 (14/14) RED/RED (EACH)
- W52094 (14/14) CLEAR/AMBER (EACH)
- W52095 (14/14) CLEAR/RED (EACH)



W52093

- W52101 S.S. 25-5/16" DOUBLE LIGHT BRACKET ONLY
- W52102 S.S. 25-5/16" FOUR LIGHT BRACKET ONLY



W52101

W52102

- W59339 S.S. DOUBLE SIDED LIGHT BRACKET W/ CUT OUT 17-5/16"
- W59340 S.S. LIGHT BRACKET W/CUT OUT 17-5/16"
- W52098 S.S. 12-3/4" SINGLE LIGHT BRACKET ONLY
- W52099 S.S. 12-3/4" DOUBLE LIGHT BRACKET ONLY



W59339

W59340

W52098

W52099

LED Light Strip & Brackets

LIGHT BRACKETS WITH MINI LED'S

Item No. Description S.S. LIGHT BRACKET W/ 1 MINI LED

- W5937 (3) AMBER LIGHT & BEZEL
- W5938 (3) RED LIGHT & BEZEL
- W5939 (3) CLEAR/AMBER LIGHT & BEZEL
- W5940 (3) CLEAR/RED LIGHT & BEZEL
- W5941 (3) CLEAR/BLUE LIGHT & BEZEL
- W5942 (3) CLEAR/WHITE LIGHT & BEZEL



S.S. LIGHT BRACKET W/ 1 MINI LED

- W5943 (4) AMBER LIGHT & BEZEL
- W59631 (4) BLUE LIGHT & BEZEL
- W59632 (4) GREEN LIGHT & BEZEL
- W59633 (4) RED LIGHT & BEZEL
- W59634 (4) WHITE LIGHT & BEZEL



S.S. LIGHT BRACKET W/ 2 MINI LED

- W59635 (3) AMBER LIGHT & BEZEL
- W59636 (3) RED LIGHT & BEZEL
- W59637 (3) CLEAR/AMBER LIGHT & BEZEL
- W56938 (3) CLEAR/RED LIGHT & BEZEL
- W59639 (3) CLEAR/BLUE LIGHT & BEZEL
- W59642 (3) CLEAR/WHITE LIGHT & BEZEL



S.S. LIGHT BRACKET W/ 2 MINI LED

- W59643 (4) AMBER LIGHT & BEZEL
- W59644 (4) BLUE LIGHT & BEZEL
- W59645 (4) GREEN LIGHT & BEZEL
- W59646 (4) RED LIGHT & BEZEL
- W59647 (4) WHITE LIGHT & BEZEL



LIGHT BRACKETS WITH MINI LED'S - Continued

Item No. Description S.S. LIGHT BRACKET W/ 3 MINI LED

- W59648 (3) AMBER LIGHT & BEZEL
- W59649 (3) RED LIGHT & BEZEL
- W59650 (3) CLEAR/AMBER LIGHT & BEZEL
- W59651 (3) CLEAR/RED LIGHT & BEZEL
- W59652 (3) CLEAR/BLUE LIGHT & BEZEL
- W59653 (3) CLEAR/WHITE LIGHT & BEZEL



S.S. LIGHT BRACKET W/ 3 MINI LED

- W59654 (4) AMBER LIGHT & BEZEL
- W59655 (4) BLUE LIGHT & BEZEL
- W59656 (4) GREEN LIGHT & BEZEL
- W59657 (4) RED LIGHT & BEZEL
- W59658 (4) WHITE LIGHT & BEZEL



S.S. LIGHT BRACKET W/ 4 MINI LED

- W59659 (3) AMBER LIGHT & BEZEL
- W59660 (3) RED LIGHT & BEZEL
- W59661 (3) CLEAR/AMBER LIGHT & BEZEL
- W59662 (3) CLEAR/RED LIGHT & BEZEL
- W59663 (3) CLEAR/BLUE LIGHT & BEZEL
- W59664 (3) CLEAR/WHITE LIGHT & BEZEL



S.S. LIGHT BRACKET W/ 4 MINI LED

- W59665 (4) AMBER LIGHT & BEZEL
- W59666 (4) BLUE LIGHT & BEZEL
- W59667 (4) GREEN LIGHT & BEZEL
- W59668 (4) RED LIGHT & BEZEL
- W59669 (4) WHITE LIGHT & BEZEL



S.S. LIGHT BRACKET W/ 5 MINI LED

- W5924 (3) AMBER LIGHT & BEZEL
- W5925 (3) RED LIGHT & BEZEL
- W5926 (3) CLEAR/AMBER LIGHT & BEZEL
- W5928 (3) CLEAR/RED LIGHT & BEZEL
- W5929 (3) CLEAR/BLUE LIGHT & BEZEL
- W5931 (3) CLEAR/WHITE LIGHT & BEZEL



S.S. LIGHT BRACKET W/ 5 MINI LED

- W5932 (4) AMBER LIGHT & BEZEL
- W5933 (4) BLUE LIGHT & BEZEL
- W5934 (4) GREEN LIGHT & BEZEL
- W5935 (4) RED LIGHT & BEZEL
- W5936 (4) WHITE LIGHT & BEZEL



LED Light Strip & Brackets

LIGHT BRACKETS WITH LIGHT BAR

Item No.	Description
S.S. BRACKET W/ 17" LIGHT BAR	
W5948	(11) LED AMBER P/T/C LIGHT BAR
W5949	(11) LED RED S/T/T LIGHT BAR
W5951	(11) LED CLEAR/RED S/T/T LIGHT BAR
W5952	(11) LED AMBER P/T/C LIGHT BAR W/ BEZEL
W5953	(11) LED RED S/T/T LIGHT BAR W/ BEZEL
W5954	(11) LED CLEAR/AMBER P/T/C LIGHT BAR W/ BEZEL
W5955	(11) LED CLEAR/RED S/T/T LIGHT BAR W/ BEZEL



W5948



W5952

S.S. DOUBLE LIGHT BRACKET W/ (11) LED LIGHT BAR

W5956	(11) LED AMBER, RED
W5957	(11) LED CLEAR/AMBER, CLEAR/RED
W5958	(11) LED AMBER, AMBER
W5959	(11) LED RED, RED
W5960	(11) LED CLEAR/AMBER, CLEAR/AMBER
W5961	(11) LED CLEAR/RED, CLEAR/RED



W5957



W5960

S.S. DOUBLE LIGHT BRACKET W/ (11) LED LIGHT BARS & BEZEL

W5963	(11) LED AMBER, RED
W5966	(11) LED CLEAR/AMBER, CLEAR/RED
W5967	(11) LED AMBER, AMBER
W5968	(11) LED RED, RED
W5969	(11) LED CLEAR/AMBER, CLEAR/AMBER
W5969-2	(11) LED CLEAR/RED, CLEAR/RED



W5963

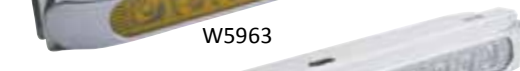

W5966

SEQUENTIAL LED LIGHTS WITH STAINLESS STEEL HOUSING

W52014LR	(14) RED 12" LEFT TO RIGHT STRIP LIGHT
W52014RL	(14) RED 12" RIGHT TO LEFT STRIP LIGHT
W52015LR	(14) CLEAR/RED 12" LEFT TO RIGHT STRIP LIGHT
W52015RL	(14) CLEAR/RED 12" RIGHT TO LEFT STRIP LIGHT
W52016LR	(14) AMBER 12" LEFT TO RIGHT STRIP LIGHT
W52016RL	(14) AMBER 12" RIGHT TO LEFT STRIP LIGHT
W52017LR	(14) CLEAR/AMBER 12" LEFT TO RIGHT STRIP LIGHT
W52017RL	(14) CLEAR/AMBER 12" RIGHT TO LEFT STRIP LIGHT
W52063	(14) AMBER STRIP LIGHT W/ MOUNTING HOLE
W52064	(14) RED STRIP LIGHT W/ MOUNTING HOLE
W52065	(14) CLEAR/AMBER STRIP LIGHT W/ MOUNTING HOLE
W52066	(14) CLEAR/RED STRIP LIGHT W/ MOUNTING HOLE



W52014RL



W52015RL



W52063

Item No.	Description
W40196	(23) RED S/T/T LIGHT STRIP W/ REFLECTOR
W40197	(23) CLEAR/RED S/T/T LIGHT STRIP W/ REFLECTOR
W40198	(23) AMBER S/T/T LIGHT STRIP W/ REFLECTOR



W40196



W40197

FLEXIBLE PEEL & STICK LIGHT STRIP

10 3/4" LIGHT STRIP

W41328S	(12) BLUE
W41330S	(12) WHITE
W41331S	(12) AMBER
W41332S	(12) RED



W41328S

STRIP ROLL (16 FEET) 12V

W41333	(60) WHITE
W41334	(60) BLUE
W41335	(60) AMBER
W41336	(60) GREEN
W41337	(60) RED



W41337

W41333

W41334

CONNECTABLE LIGHT STRIP

W41328C	(12) BLUE 12" FLEXIBLE CONNECTABLE LIGHT STRIP PEEL & STICK
W41329C	(12) GREEN 12" FLEXIBLE CONNECTABLE LIGHT STRIP PEEL & STICK
W41330C	(12) WHITE 12" FLEXIBLE CONNECTABLE LIGHT STRIP PEEL & STICK
W41331C	(12) AMBER 12" FLEXIBLE CONNECTABLE LIGHT STRIP PEEL & STICK
W41332C	(12) RED 12" FLEXIBLE CONNECTABLE LIGHT STRIP PEEL & STICK



W41328C

W52001T	(11) RED S/T/T 15" LIGHT STRIP SUPER THIN
W52002T	(11) CLEAR/RED S/T/T 15" LIGHT STRIP SUPER THIN



W52001T



W52002T

W40194	S.S. MIRROR W/ (18) LED AMBER RECTANGULAR LIGHT
W40195	S.S. MIRROR W/ (18) LED AMBER RECTANGULAR LIGHT HEATED



W40195

LED Light Strip & Brackets

LED DOUBLE STACK

Item No. Description DOUBLE STACK 12" LIGHT BAR W/ CHROME HOUSING

- W52121 (28) AMBER
- W52122 (28) RED
- W52123 (28) CLEAR/AMBER
- W52124 (28) CLEAR/AMBER
- W52125 (28) AMBER/RED
- W52126 (28) AMBER/RED CLEAR LENS
- W52127 (28) AMBER/AMBER, WHITE/CLEAR
- W52128 (28) RED/RED, CLEAR/WHITE
- W52129 (28) CLEAR/AMBER, CLEAR/WHITE
- W52130 (28) CLEAR/RED, CLEAR/WHITE
- W52131 (28) CHROME/AMBER



W52127



W52128



W52129



W52131



W52130

DOUBLE STACK 12" LIGHT BAR W/ CHROME HOUSING

- W52134 (38) AMBER
- W52135 (38) RED
- W52136 (38) CLEAR/AMBER
- W52137 (38) CLEAR/RED
- W52138 (38) AMBER/RED
- W52139 (38) CLEAR/AMBER, CLEAR/RED



W52134



W52135



W52138



W52139



W52140

- W52140 12"CHROME PLASTIC LIGHT BAR HOUSING

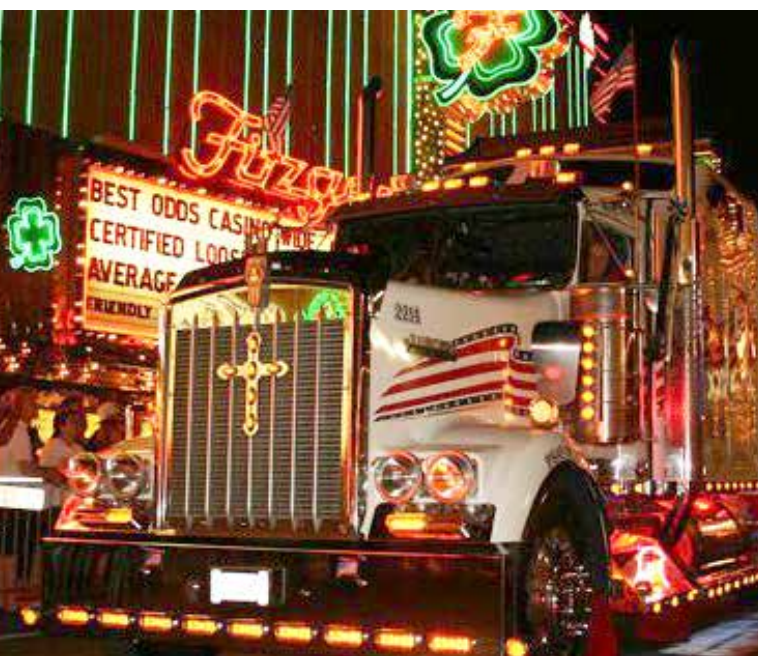

STAINLESS STEEL BUMPERS BRACKET WITH LED LIGHTS

Item No. Description W/ 6 LIGHT BARS (79-1/2")

- W52108 (19) AMBER
- W52109 (19) RED
- W52110 (19) CLEAR/AMBER
- W52111 (19) CLEAR/RED



W52108



W52109



W52110

REFLECTOR LIGHT BAR (12" x 5/8")

- W52112 (19) AMBER P/T/C
- W52113 (19) RED S/T/T
- W52114 (19) CLEAR/AMBER P/T/C
- W52115 (19) RED S/T/T



W52112



W52113



W52114

6-1/2" LIGHT BAR W/ BEZEL

- W52116 (10) AMBER P/T/C
- W52117 (10) RED S/T/T
- W52118 (10) CLEAR/AMBER P/T/C
- W52119 (10) CLEAR/RED S/T/T



W52116



W52120

- W52120 CHROME PLASTIC BEZEL 6-1/2"

KENWORTH HOOD EMBLEM

CHROME PLASTIC W/ 12" LIGHT BAR

- W54560 (14) AMBER
- W54561 (14) CLEAR/AMBER
- W54562 (14) AMBER/CHROME LENS
- W54565 (14) RED
- W54566 (14) CLEAR/RED
- W54567 (14) RED/CHROME
- W54570 (14) CLEAR/BLUE
- W54571 (14) CLEAR/GREEN
- W54572 (14) CLEAR/WHITE



W54561

- W54563 (19) AMBER
- W54564 (19) CLEAR/AMBER REFLECTOR
- W54568 (19) RED REFLECTOR
- W54569 (19) CLEAR/RED REFLECTOR



W54563

- W54573 KW HOOD EMBLEM HOUSING W/ LIGHT BAR CUT OUT CHROME PLASTIC



W54573

Headlights

PETERBILT

TURN SIGNAL COVERS

Item No.	Description
W41563	TURN SIGNAL HEADLIGHT COVER TEAR DROP CUT CHROME PLASTIC
W41564	TURN SIGNAL HEADLIGHT COVER RECTANGULAR LIGHT CUT OUT
W41599V	TURN SIGNAL COVER W/ VISOR LOW PROFILE CHROME PLASTIC



W41563



W41564



W41599V

LED TURN SIGNAL COVERS

W41570	(39) AMBER/AMBER TEARDROP STYLE
W41571	(39) CLEAR/AMBER TEARDROP STYLE
W41670	(39) AMBER/CHROME CHROME TEARDROP



W41570



W41670

W41572	(15) AMBER/AMBER CHROME PLASTIC RECTANGULAR STYLE
W41573	(15) CLEAR/AMBER CHROME PLASTIC RECTANGULAR STYLE
W41574	(12) AMBER/AMBER CHROME PLASTIC RECTANGULAR STYLE
W41575	(12) CLEAR/AMBER CHROME PLASTIC RECTANGULAR STYLE
W41576	(12) AMBER/AMBER CHROME PLASTIC RECTANGULAR REFLECTOR LIGHT
W41577	(12) CLEAR/AMBER CHROME PLASTIC RECTANGULAR REFLECTOR LIGHT
W41578	(10) AMBER/AMBER CHROME PLASTIC RECTANGULAR REFLECTOR LIGHT
W41579	(12) CLEAR/AMBER CHROME PLASTIC RECTANGULAR REFLECTOR LIGHT



W41572



W41575



W41576



W41578

PETERBILT – Continued

LED TURN SIGNAL COVERS

Item No.	Description
W41597	(37) AMBER TURN SIGNAL LIGHT W/ CHROME BASE FOR DUAL SQUARE HEADLIGHT ASSEMBLY (EACH)
W41598	(37) CLEAR/AMBER TURN SIGNAL LIGHT W/ CHROME BASE FOR DUAL SQUARE HEADLIGHT ASSEMBLY (EACH)



W41597



W41598

LED HEADLIGHTS

W41632	(5) CLEAR/AMBER LENS BLACK "GUIDE"
W41634	(5) AMBER/AMBER LENS W/ LIGHT & BULB CHROME RIM BLACK "GUIDE"
W41635	(5) CLEAR/AMBER LENS W/ CHROME RIM BLACK "GUIDE"
W41637	(5) AMBER/AMBER LENS W/ CHROME RIM LED H6024 HALOGEN BLACK "GUIDE"
W41638	(5) CLEAR/AMBER LENS W/ CHROME RIM LED H6024 HALOGEN BLACK "GUIDE"
W41639	H4 HALOGEN (W4302) NO MOUNT LIGHT BLACK "GUIDE"
W41640	(5) AMBER/AMBER LENS W/ CHROME RIM LED H4 HALOGEN
W41641	(5) CLEAR/AMBER LENS W/ CHROME RIM LED H4 HALOGEN BLACK "GUIDE"
W41643	(5) AMBER/AMBER LENS W/ CHROME RIM LED CRYSTAL H4 HALOGEN BLACK "GUIDE"
W41644	(5) CLEAR/AMBER LENS W/ CHROME RIM LED CRYSTAL H4 HALOGEN BLACK "GUIDE"
W41630	(5) AMBER/AMBER LENS BLACK "GUIDE"
W41642	CRYSTAL H4 HALOGEN (W43015) NO TOP MOUNT LIGHT BLACK "GUIDE"
W41636	H6024 HALOGEN (W4303A) NO MOUNT LIGHT BLACK "GUIDE"
W41631	BLACK "GUIDE" HOUSING ONLY NO LIGHT
W41645	CHROME "GUIDE" HOUSING ONLY NO LIGHT
W41646	(5) AMBER/AMBER LENS CHROME "GUIDE"
W41647	S.S. VINTAGE STYLE W/ CRYSTAL H4 HALOGEN BULB
W41633	BLACK "GUIDE" W/ 6014 BULB (W4302A) NO MOUNT LIGHT
W41852	WIRE HARNESS FOR 359 DUAL
W41853	WIRE FOR A VINTAGE STYLE W/ 3 CONTACT PIGTAIL & S.S. WIRE LOOM



W41632



W41635



W41631



W41645



W41646



W41647



W41633

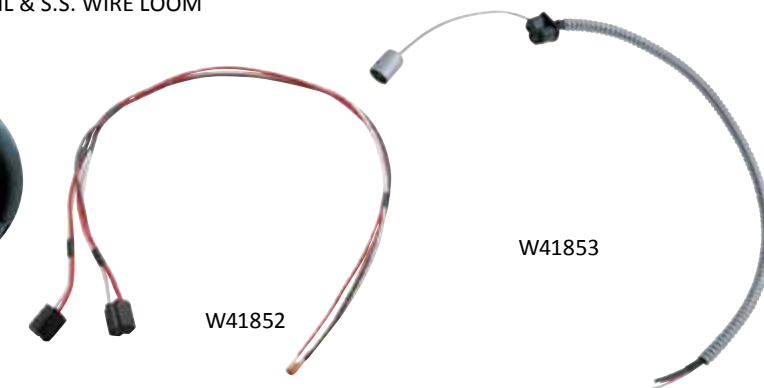

W41852

W41853

Headlights

KENWORTH

P/T/C FRONT LIGHT

Item No.	Description
W41565	(29) LED KW AMBER/AMBER - DRIVER SIDE
W41566	(29) LED KW AMBER/AMBER - PASSENGER SIDE
W41567	(29) LED KW CLEAR/AMBER - DRIVER SIDE
W41568	(29) LED KW CLEAR/AMBER - PASSENGER SIDE

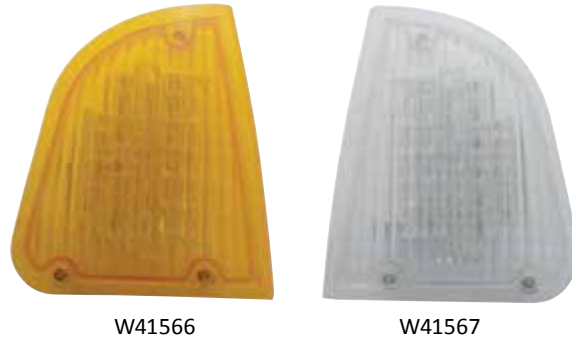

TURN SIGNAL COVER

W41580	CHROME PLASTIC HEADLIGHT TURN SIGNAL COVER W/ VISOR
W41588	CHROME PLASTIC HEADLIGHT TURN SIGNAL COVER



FREIGHTLINER

W41589CA	(19) LED TURN SIGNAL W/ CLEAR/AMBER LENS
W41589	(19) LED TURN SIGNAL W/ AMBER LENS
W45705	(61) LED CLEAR/AMBER DAYTIME RUNNING LIGHT, FITS ONLY FLD CENTURY 2005 & OLDER - DRIVER SIDE
W45706	(61) LED CLEAR/AMBER DAYTIME RUNNING LIGHT, FITS ONLY FLD CENTURY 2005 & OLDER - PASSENGER SIDE
W45707	(61) LED AMBER/AMBER DAYTIME RUNNING LIGHT, FITS FLD CENTURY 2005 & OLDER - DRIVER SIDE
W45708	(61) LED AMBER/AMBER DAYTIME RUNNING LIGHT, FITS FLD CENTURY 2005 & OLDER - PASSENGER SIDE
W45845	FL DAYTIME RUNNING LIGHT ADAPTOR CHROME PLASTIC - DRIVER SIDE
W45846	FL DAYTIME RUNNING LIGHT ADAPTOR CHROME PLASTIC - PASSENGER SIDE
W54604	HEADLIGHT CHROME BEZEL FOR FL COLUMBIA - DRIVER SIDE
W54605	HEADLIGHT CHROME BEZEL FOR FL COLUMBIA - PASSENGER SIDE



UNIVERSAL HEADLIGHTS & BEZELS

Item No.	Description
W41599	LOW PROFILE HEADLIGHT TURN SIGNAL COVER CHROME PLASTIC
W41648	(34) LED CLASSIC "GUIDE" S.S. HOUSING WHITE CRYSTAL HALOGEN
W41649	(34) LED CLASSIC "GUIDE" CHROME HOUSING WHITE CRYSTAL HALOGEN
W41660	(34) LED CLASSIC "GUIDE" S.S. HOUSING AMBER CRYSTAL HALOGEN
W41661	(34) LED CLASSIC "GUIDE" CHROME HOUSING AMBER CRYSTAL HALOGEN



W4307	(34) LED AMBER/CLEAR HEADLIGHT 7" ROUND CRYSTAL STYLE
W4307A	(34) LED CLEAR/WHITE HEADLIGHT 7" ROUND CRYSTAL STYLE
W4308A	(10) LED AMBER/AMBER HEADLIGHT 7" ROUND CRYSTAL STYLE

W52030	S.S. VISOR W/ LIP FOR 5-3/4" ROUND HEADLIGHT (EACH)
W54587	6" X 8" LED STRIP LIGHT CUT OUT CHROME PLASTIC LED HEADLIGHT BEZEL W/ VISOR
W54588	(10) LED AMBER 6" X 8" RECTANGULAR HEADLIGHT BEZEL W/ VISOR
W54589	(10) LED CLEAR/AMBER 6" X 8" RECTANGULAR HEADLIGHT BEZEL W/ VISOR



W54513	(34) LED TOP & BOTTOM AMBER UNIVERSAL HEADLIGHT BEZEL
W54592	BEZEL FOR DUAL RECTANGULAR HEADLIGHT LIGHT W/ VISOR, LIGHT BAR CUT OUT CHROME PLASTIC



Headlights

UNIVERSAL HEADLIGHTS & BEZELS

- | Item No. | Description |
|----------|---|
| W54593 | CHROME PLASTIC HEADLIGHT BEZEL - DRIVER SIDE |
| W54594 | CHROME PLASTIC HEADLIGHT BEZEL - PASSENGER SIDE |
| W54595 | BLACK PLASTIC HEADLIGHT BEZEL - DRIVER SIDE |
| W54596 | BLACK PLASTIC HEADLIGHT BEZEL - PASSENGER SIDE |
| W54598 | BEZEL FOR DUAL RECTANGULAR HEADLIGHT LIGHT, CHROME PLASTIC - DRIVER SIDE |
| W54599 | BEZEL FOR DUAL RECTANGULAR HEADLIGHT LIGHT, CHROME PLASTIC - PASSENGER SIDE |



- | | |
|---------|---|
| W5459CH | BEZEL W/ VISOR FOR DUAL RECTANGULAR HEADLIGHTS, CHROME PLASTIC W/ (14) LED AMBER/CHROME 12" P/T/C STRIP LIGHT |
| W5459W | BEZEL W/ VISOR FOR DUAL RECTANGULAR HEADLIGHTS, CHROME PLASTIC W/ (14) LED WHITE 12" STRIP LIGHT |
| W54601 | PIGTAIL FOR HEADLIGHT BULB, 3-CONTACT FEMALE |

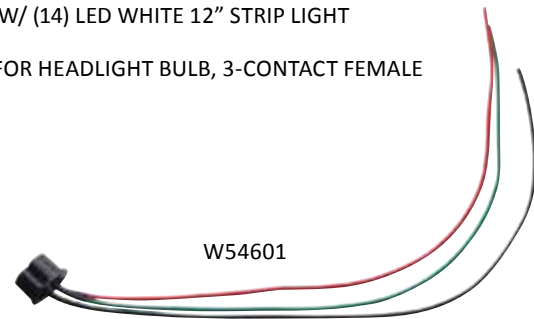

RECTANGULAR HEADLIGHTS WITH LED

- | | |
|--------|--|
| W43024 | (9) WHITE LED 6 X 4 (LOW BEAM) |
| W43025 | (9) WHITE LED 6 X 4 (HIGH BEAM) |
| W43022 | (9) AMBER LED 6 X 4 (LOW BEAM) |
| W43023 | (9) AMBER LED 6 X 4 (HIGH BEAM) |
| W43020 | CRYSTAL PROJECTION W/ (6) LED WHITE (LOW BEAM ONLY) |
| W43021 | CRYSTAL PROJECTION W/ (6) LED WHITE (HIGH BEAM ONLY) |



W43022



W43020



W43021

Bezels

BEZELS

- | Item No. | Description |
|----------|---|
| W5405AT | 2" CHROME PLASTIC TWIST ON |
| W5405T | 2" CHROME PLASTIC TWIST ON W/ VISOR |
| W5404AT | 2-1/2" CHROME PLASTIC TWIST ON |
| W5404T | 2-1/2" CHROME PLASTIC TWIST ON W/ VISOR |
| W5406AT | 4" CHROME PLASTIC TWIST ON W/ VISOR |
| W5406T | 4" CHROME PLASTIC TWIST ON |
| W54583 | 4" S.S. 3 SCREW MOUNTING |
| W5407AT | OVAL, CHROME PLASTIC TWIST ON |
| W5407T | OVAL CHROME PLASTIC TWIST ON W/ VISOR |
| W4425 | OVAL FOR W4425, W4424R, W44253 |
| W5211-2 | CHROME PLASTIC DOUBLE STACK DOT BEZEL, ONLY |



W5405AT

W5405T

W5404AT

W5404T



W5406AT

W5406T



W54583



W5407AT



W5407AT



W4425



W5211-2

Exterior

TOOL BOXES

Item No.	Description
W51574	DIAMOND PLATE ALUMINUM TOOL BOX 24" L X 18" W X 18" H
W51575	DIAMOND PLATE ALUMINUM TOOL BOX 36" L X 18" W X 18" H
W51576	DIAMOND PLATE ALUMINUM TOOL BOX 48" L X 18" W X 18" H
W51577	BLACK SMOOTH TOOL BOX 24" L X 18" W X 18" H
W51578	BLACK SMOOTH TOOL BOX 36" L X 18" W X 18" H
W51579	BLACK SMOOTH TOOL BOX 48" L X 18" W X 18" H



W51574



W51577

LED TOP FLAP PLATES

W59615	2" X 24" LED (11) AMBER/AMBER LIGHT BAR BEZEL CHROME W/ 4-WELDED STUDS
W59616	2" X 24" LED (11) RED/RED LIGHT BAR BEZEL CHROME W/ 4-WELDED STUDS
W59617	2" X 24" LED (11) CLEAR/AMBER LIGHT BAR BEZEL CHROME W/ 4-WELDED STUDS
W59618	2" X 24" LED (11) CLEAR/RED LIGHT BAR BEZEL CHROME W/ 4-WELDED STUDS



W59617

W59623	2" X 24" W/ LIGHT BAR CUT OUT CHROME
W59627	2" X 24" LED (11) AMBER/AMBER LIGHT BAR W/ 4-WELDED STUDS
W59628	2" X 24" LED (11) RED/RED LIGHT BAR W/ 4-WELDED STUDS
W59629	2" X 24" LED (11) CLEAR/AMBER LIGHT BAR W/ 4-WELDED STUDS
W59630	2" X 24" LED (11) CLEAR/RED LIGHT BAR W/ 4-WELDED STUDS



W59623



W59627

RUBBER MUD FLAPS

Item No.	Description
W40125	24" X 24" BLACK RUBBER MUD FLAP
W40126	24" X 30" BLACK RUBBER MUD FLAP
W40127	24" X 36" BLACK RUBBER MUD FLAP



W40125



W40126



W40127

ALUMINUM STEPS

W42722	STEP FRAME ALUMINUM 12" L X 13" W X 24" H - 1 PC
W42723	STEP FRAME ALUMINUM 18" L X 13" W X 24" H - 1 PC
W42724	STEP FRAME ALUMINUM 24" L X 13" W X 24" H - 1 PC
W4661F	FACE SKULL ACCENT DIE CAST CHROME W/ MOUNTING SCREWS - 1 PC



W4661F

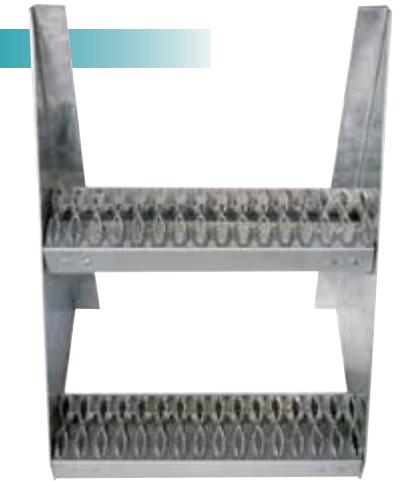

W42722

W4287D	18" RED FLAG MESH NYLON FABRIC WATER RESISTANT W/ HOOK
W50802CH	8" CHROME BULL BALLS
W54512	MERMAID HOOD ORNAMENT CHROME



W4287D



W54512



W50802CH

Interior

AIR VALVE KNOBS

- Item No. Description**
 W41119 GRENADE KNOB CHROME ALUMINUM TRACTOR
 W41120 GRENADE KNOB CHROME ALUMINUM TRAILER
 W43920 KNIFE KNOB CHROME
 W41132 BRASS KNUCKLE KNOB CHROME ALUMINUM TRACTOR
 W41133 BRASS KNUCKLE KNOB CHROME ALUMINUM TRAILER

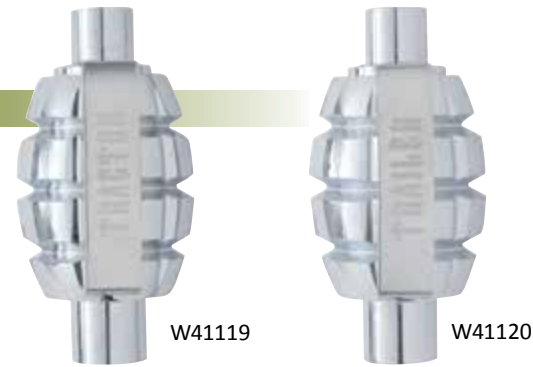

- W43608 CROSS STYLE 3" AIR VALVE SCREW-MOUNT CHROME KNOB W/GLOSSY BLACK-TRACTOR STICKER
 W43609 CROSS STYLE 3" AIR VALVE SCREW-MOUNT CHROME KNOB W/GLOSSY BLUE-TRACTOR STICKER
 W43711 CROSS STYLE 3" AIR VALVE SCREW-MOUNT CHROME KNOB W/GLOSSY RED-TRAILER STICKER
 W43614 NEW STYLE 3" AIR VALVE SCREW-MOUNT KNOB W/GLOSSY BLACK-TRACTOR- STICKER CHROME ALUMINUM



- W43950 GREEN JEWEL CHROME DELUXE AIR VALVE KNOB, S.S. "TRACTOR"
 W43951 PURPLE JEWEL CHROME DELUXE AIR VALVE KNOB, S.S. "TRACTOR"
 W43952 RED JEWEL CHROME DELUXE AIR VALVE KNOB, S.S. "TRACTOR"
 W43953 AMBER JEWEL CHROME DELUXE AIR VALVE KNOB, S.S. "TRAILER"
 W43954 BLUE JEWEL CHROME DELUXE AIR VALVE, S.S. "TRAILER"
 W43955 CLEAR JEWEL CHROME DELUXE AIR VALVE, S.S. "TRAILER"



GEARSHIFT KNOBS

- Item No. Description**
 W4703 SKULL W/ AMBER LIGHT UP HEAD & RED LED EYES LIGHT UP RED LEDS 13/18 SPEED

- W4704 RED DICE HEAD
 W4705 WHITE DICE HEAD
 W4706 BLACK DICE HEAD
 W4707 BLUE DICE HEAD
 W4708 PURPLE DICE HEAD



- W4709 BASEBALL HEAD
 W4710 GEARSHIFT MOUNTING ADAPTOR CHROME

- W4692 CHROME SPIKE STYLE HORIZONTAL EATON FULLER TRANS. 13/18 SPEED
 W4693 CHROME SPIKE STYLE VERTICAL EATON FULLER TRANS. 13/18 SPEED
 W4698 GEARSHIFT MOUNTING ADAPTOR DIE CAST CHROME FOR "SPIKE" SHIFTER
 W4699 GEARSHIFT MOUNTING ADAPTOR DIE CAST CHROME FOR "WAVEY" SHIFTER

- W4694 CHROME WAVEY STYLE EATON FULLER TRANS. 13/18 SPEED
 W4695 CHROME WAVEY STYLE VERTICAL EATON FULLER TRANS. 13/18 SPEED
 W4696 CHROME SPIKE GRIP HANDLE
 W4697 CHROME WAVEY GRIP HANDLE



- W4700 GEARSHIFT KNOB W/ SKULL HEAD CHROME EATON FULLER TRANS. 13/18 SPEED
 W4701 GEARSHIFT KNOB W/ BALL HEAD CHROME EATON FULLER TRANS. 13/18 SPEED
 W4702 GEARSHIFT KNOB W/ PISTON CHROME EATON FULLER TRANS. 13/18 SPEED
 W42478 GEAR SHIFT KNOB FITS EATON FULLER TRANS. STYLE 13/18 SPEED CHROME ALUMINUM



Interior

STICKERS

Item No.	Description
W43706-A	BLACK STICKER ONLY-GLOSSY "TRAILER" CROSS STYLE
W43706-B	BLUE STICKER ONLY-GLOSSY "TRAILER" CROSS STYLE
W43706-C	GREEN SITCKER ONLY-GLOSSY "TRAILER" CROSS STYLE
W43923	STICKER "TRAILER", S.S. CURSIVE ENGRAVED SCRIPT - ON AIR VALVE SCREW-MOUNT KNOB
W43924	STICKER "EMERGENCY", S.S. CURSIVE ENGRAVED SCRIPT - ON AIR VALVE SCREW-MOUNT KNOB



W43706-A



W43706-B



W43706-C



W43923



W43924

PLAQUES

W43948	S.S. FOR DELUXE AIR VALVE KNOB TRACTOR
W43949	S.S. FOR DELUXE AIR VALVE KNOB TRAILER



W43948



W43949

DELPHI RADIO KNOBS

W4806	PLAIN CHROME PLASTIC DELPHI RADIO KNOB
W4806-A	AMBER JEWEL CHROME PLASTIC
W4806-B	BLUE JEWEL CHROME PLASTIC
W4806-C	CLEAR JEWEL CHROME PLASTIC
W4806-G	GREEN JEWEL CHROME PLASTIC
W4806-P	PURPLE JEWEL CHROME PLASTIC
W4806-R	RED JEWEL CHROME PLASTIC
W4806-S	SMOKE JEWEL CHROME PLASTIC



W4806



AMBER



BLUE



CLEAR



GREEN



PURPLE



RED



SMOKE

W41680	PB TIMER KNOB W/AMBER JEWEL CHROME PLASTIC
W41681	PB TIMER KNOB W/BLUE JEWEL CHROME PLASTIC
W41971	AC/HEATER SLIDER-CONTROL KNOB, NOTCHED TOP CHROME PLASTIC (3-PKG)



W41680



W41681



W41971

ROCKER SWITCH TRIM FOR KENWORTH, PETERBILT & FREIGHTLINER

Item No.	Description
----------	-------------

W48971	AMBER JEWEL CHROME PLASTIC
W48972	BLUE JEWEL CHROME PLASTIC
W48973	CLEAR JEWEL CHROME PLASTIC
W48974	GREEN JEWEL CHROME PLASTIC
W48975	PURPLE JEWEL CHROME PLASTIC
W48976	RED JEWEL CHROME PLASTIC
W48977	NO JEWEL CHROME PLASTIC



W48971

W48978	AMBER JEWEL CHROME PLASTIC
W48979	BLUE JEWEL CHROME PLASTIC
W48980	CLEAR JEWEL CHROME PLASTIC
W48981	GREEN JEWEL CHROME PLASTIC
W48982	PURPLE JEWEL CHROME PLASTIC
W48983	RED JEWEL CHROME PLASTIC
W48984	NO JEWEL CHROME PLASTIC



W48979

W48985	AMBER JEWEL CHROME PLASTIC
W48986	BLUE JEWEL CHROME PLASTIC
W48987	CLEAR JEWEL CHROME PLASTIC
W48988	GREEN JEWEL CHROME PLASTIC
W48989	PURPLE JEWEL CHROME PLASTIC
W48990	RED JEWEL CHROME PLASTIC
W48991	NO JEWEL CHROME PLASTIC



W48987

W48992	AMBER JEWEL CHROME PLASTIC
W48993	BLUE JEWEL CHROME PLASTIC
W48994	CLEAR JEWEL CHROME PLASTIC
W48995	GREEN JEWEL CHROME PLASTIC
W48996	PURPLE JEWEL CHROME PLASTIC
W48997	RED JEWEL CHROME PLASTIC
W48998	NO JEWEL CHROME PLASTIC



W48995



AMBER

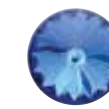

BLUE

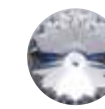

CLEAR



GREEN



PURPLE

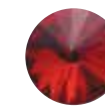

RED



Concho Style Knobs

LARGE AIR VALVE KNOBS - SCREW ON

Item No.	Description
CHROME KNOB	
W43501	SHINY SILVER PLATE CONCHO W/ SILVER PLATE ROPE BORDER
W43502	POLISHED SILVER PLATE CONCHO W/ GOLD PLATE ROPE BORDER
W43505	BLACK CANYON ROSE CONCHO W/ YELLOW & ROSE GOLD PLATE, FAUX RUBY ACCENT SILVER ROPE BORDER
W43510	GOLD PLATED 3-D TEXAS STAR W/ ENGRAVED ANTIQUE SILVER PLATED RING CONCHO



REDWOOD KNOB

W43503	BLACK CANYON ROSE CONCHO W/ YELLOW & ROSE GOLD PLATE, FAUX RUBY ACCENT SILVER ROPE BORDER
W43504	RAISED TEXAS STAR
W43507	SHINY SILVER PLATE CONCHO W/ SILVER PLATE ROPE BORDER
W43508	POLISHED SILVER PLATE CONCHO W/ GOLD PLATE ROPE BORDER
W43511	GOLD PLATED 3-D TEXAS STAR W/ ENGRAVED ANTIQUE SILVER PLATED RING CONCHO



SMALL DASH KNOBS - PIN MOUNT

Item No.	Description
FOR PANEL LIGHTS, WIPER, WASHER, FAN-AIR	
• CHROME KNOB	
W45481	SHINY SILVER PLATE CONCHO W/ SILVER PLATE ROPE BORDER
W45482	POLISHED SILVER PLATE CONCHO W/ GOLD PLATE ROPE BORDER
W45483	RANGER STAR ENGRAVED SILVER PLATED CONCHO
W45485	BLACK CANYON ROSE CONCHO W/ YELLOW & ROSE GOLD PLATE, FAUX RUBY ACCENT SILVER ROPE BORDER
W45498	GOLD PLATED 3-D TEXAS STAR W/ ENGRAVED ANTIQUE SILVER PLATED RING CONCHO



FOR PANEL LIGHTS, WIPER, WASHER, FAN-AIR

• REDWOOD KNOB

W45491	SHINY SILVER PLATE CONCHO W/ SILVER PLATE ROPE BORDER
W45492	POLISHED SILVER PLATE CONCHO W/ GOLD PLATE ROPE BORDER
W45493	RANGER STAR ENGRAVED SILVER PLATED CONCHO
W45495	BLACK CANYON ROSE CONCHO W/ YELLOW & ROSE GOLD PLATE, FAUX RUBY ACCENT SILVER ROPE BORDER
W45497	GOLD PLATED 3-D TEXAS STAR W/ ENGRAVED ANTIQUE SILVER PLATED RING CONCHO



POP OUT CIGARETTE LIGHTER

MATCH WITH ALL CONCHO STYLE

W45510	SILVER CONCHO & GOLD TEXAS STAR
W45521	SHINY SILVER PLATE CONCHO W/ SILVER PLATE ROPE BORDER
W45522	POLISHED SILVER PLATE CONCHO W/ GOLD PLATE ROPE BORDER
W45523	BLACK CANYON ROSE CONCHO (RUBY COLOR JEWEL)
W45527	BLACK CANYON ROSE CONCHO (AMBER COLOR JEWEL)
W45525	RANGER STAR ENGRAVED SILVER PLATED CONCHO
W45526	GOLD PLATED 3-D TEXAS STAR



Steering Wheels

18"

Item No.	Description
WW043E	W/ 4 CHROME SPOKES & HORN BUTTON FITS FLD 1989 +
WW051E	W/ 4 CHROME SPOKES CUT OUT & HORN BUTTON FITS FLD 1989 +
WW052E	W/ 4 CHROME SPOKES CUT OUT & HORN BUTTON FITS PB-1998 ON & KW-2001 +
WW103	GUITAR STYLE W/ 3 S.S. SPOKES & CHROME HORN BUTTON FITS PB 1998 +
WW056	WOOD 4 CHROME SPOKES W/ SKULLS FITS FLD 1989 +
WW057	WOOD 4 CHROME SPOKES W/ SKULLS FITS PB 1998 + & KW 2001 +



WW043E



WW051E



WW103



WW056

Train Horns

HEAVY DUTY & SUPER LOUD

Item No.	Description
W41743	DELUXE 4 TRUMPET HEAVY DUTY TRAIN HORN CHROME
W41763	(24) LED AMBER TRUMPET SINGLE TRAIN HORN CHROME
W41766	(24) LED AMBER RECTANGULAR REPLACEMENT LIGHT
W41764	LIGHT BASE W/ HORN
W41767	3 TRUMPET TRAIN HORN, HEAVY DUTY SUPER LOUD, CHROME (DOWN-LEFT)
W41768	3 TRUMPET TRAIN HORN, HEAVY DUTY SUPER LOUD, CHROME (DOWN-RIGHT)



W41743



W41763



W41766



W41764



W41767



W41768

ECONOMY

W4175E3	TRAIN HORN 3 TRUMPET ECONOMY
W4175E4	TRAIN HORN 4 TRUMPET ECONOMY



W4175E3



W4175E4

HORN COVER

W41765	(1) LED HORN COVER
--------	--------------------



W41765

Specialty Trim



SEXY GIRL CUT OUT



CURVY GIRL CUT OUT

Please contact your sales representative for more information on any parts made to order in this section.



BUG DEFLECTOR



DROP VISOR



BILLET ALUMINUM STEP



BUG DEFLECTOR



RAIN DEFLECTOR

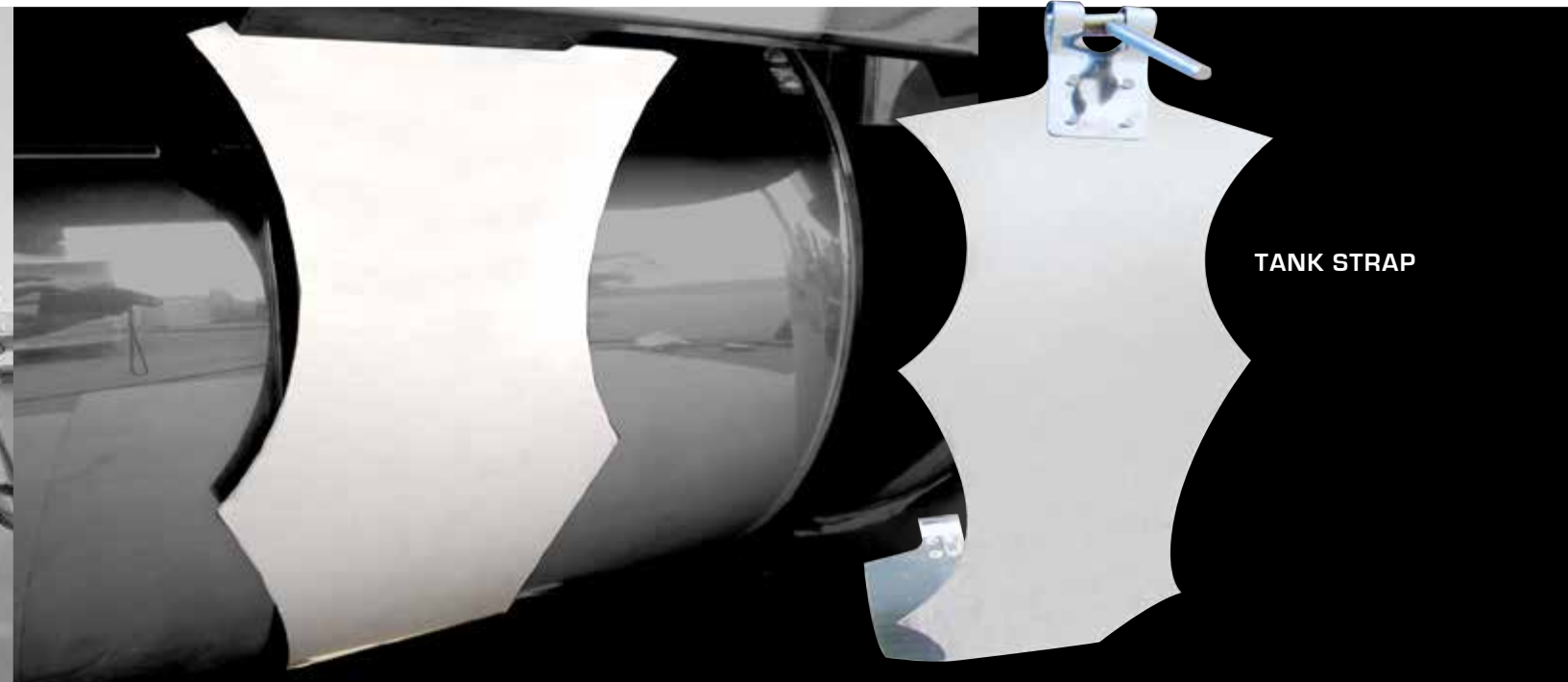

TANK STRAP

Hub Caps

Lug Nut Covers

FRONT & REAR

Item No.	Description
W5014F	FRONT CHROME UNIMOUNT HUB CAP, ALUMINUM WHEELS 6 NOTCH & 3/4" LIP EXTENDED HEIGHT 8 23/32"
W50150	FRONT CHROME HUB CAP 4 EVEN NOTCHES 1" POINTED LIP
W50151	FRONT CHROME HUB CAP 5 EVEN NOTCHES 1" POINTED LIP
W50082	REAR CHROME HUB CAP 7 1/2" I.D.



W5045PT	FRONT CHROME PLASTIC AXLE COVER W/ POP OFF TOP
W5046PT	REAR CHROME PLASTIC AXLE COVER W/ POP OFF TOP



33 MM

Item No.	Description
W53429	33 MM x 3-1/8" CHROME PLASTIC SPIKE FOR HEX NUTS & BOLTS W/OUT FLANGE
W53445	33 MM x 4-1/4" CHROME PLASTIC TALL FLAT TOP CYLINDER SCREW-ON TYPE
W53430-2	33 MM x 4-3/8" CHROME PLASTIC SPIKE THREAD ON



SPIKE STYLE

W53422	1/2" x 1-7/16" CHROME PLASTIC SPIKE FOR HEX NUTS & BOLTS W/OUT FLANGE
W53421	7/16" x 1-1/4" CHROME PLASTIC FOR HEX NUTS & BOLTS W/OUT FLANGE
W53423	9/16" x 1-1/2" CHROME PLASTIC FOR HEX NUTS & BOLTS W/OUT FLANGE
W53424	5/8" x 2" CHROME PLASTIC FOR HEX NUTS & BOLTS W/OUT FLANGE
W53426	3/4" x 1-7/8" CHROME PLASTIC FOR HEX NUTS & BOLTS W/OUT FLANGE
W53427	15/16" x 2-1/2" CHROME PLASTIC FOR HEX NUTS & BOLTS W/OUT FLANGE
W53425	1/16" x 2-1/16" CHROME PLASTIC FOR HEX NUTS & BOLTS W/OUT FLANGE
W53428	1 1/8" x 2-13/16" CHROME PLASTIC FOR HEX NUTS & BOLTS W/OUT FLANGE
W53430	1-1/2" CHROME PLASTIC PUSH ON STYLE
W5026	15/16" x 1-1/4" PUSH ON FOR HEX NUTS & BOLTS



PRODUCT INDEX

PRODUCT INDEX

Item No.	Page No.	Item No.	Page No.	Item No.	Page No.	Item No.	Page No.	Item No.	Page No.	Item No.	Page No.	Item No.	Page No.	Item No.	Page No.	Item No.	Page No.		
W40040	15	W40293	15	W40472	39	W41021	47	W41571	59	W41671	23	W4308A	62	W43711	67	W44937	1	W4569PA	34
W40041	5	W40294	15	W40473	39	W41022	47	W41572	59	W41672	23	W43127	29	W43890	28	W44938	1	W4569RA	34
W40125	66	W40295	15	W40474	39	W41023	47	W41573	59	W41673	23	W43128	29	W43891	28	W44939	1	W4569WA	34
W40126	66	W40296	15	W40475	41	W41024	47	W41574	59	W41674	23	W43129	29	W43920	67	W45481	72	W45705	61
W40127	66	W40297	16	W40476	41	W41025	47	W41575	59	W41675	23	W43131	30	W43923	69	W45482	72	W45706	61
W40182	13	W40298	16	W40477	41	W41107	48	W41576	59	W41680	1	W43133	29	W43924	69	W45483	72	W45707	61
W40183	13	W40350	26	W40478	41	W41108	48	W41577	59	W41680	69	W43134	29	W43948	69	W45485	72	W45708	61
W40184	13	W40352	26	W40479	39	W41109	48	W41578	59	W41681	1	W43135	27	W43949	69	W45491	72	W4570-A	35
W40185	13	W40353	26	W4047ES	46	W41110	48	W41579	59	W41681	69	W43136	27	W43950	67	W45492	72	W4570-AC	35
W40186	13	W40355	26	W40480	39	W41111	48	W41580	61	W41682	1	W43137	27	W43951	67	W45493	72	W4572	14
W40187	49	W40356	26	W40481	46	W41112	48	W41588	61	W41684	1	W43141	29	W43952	67	W45495	72	W45727	24
W40188	49	W40357	26	W4048ES	46	W41119	67	W41589	61	W41685	1	W43142	30	W43953	67	W45497	72	W45728	24
W40189	49	W40389	23	W4049ES	46	W41120	67	W41589CA	61	W41687	1	W43143	29	W43954	67	W45498	72	W45729	50
W40190	49	W40390	23	W4050ES	46	W41132	67	W41591	47	W41743	74	W43144	28	W43955	67	W45510	72	W4573	14
W40191	49	W40394	39	W40518	27	W41133	67	W41592	47	W4175E3	74	W43145	27	W44153	39	W45521	72	W45730	50
W40192	49	W40395	39	W40519	27	W41328	49	W41593	47	W4175E4	74	W43146	28	W44154	39	W45522	72	W45735	24
W40193	49	W40396	39	W40543A	39	W41328C	56	W41594	47	W41763	74	W43147	27	W44155	39	W45523	72	W45736	50
W40194	56	W40397	39	W40544A	39	W41328S	56	W41595	47	W41764	74	W43148	27	W44156	39	W45525	72	W45737	50
W40195	56	W40398	39	W40545A	39	W41329	49	W41596	47	W41765	74	W43149	27	W44160	40	W45526	72	W45738	50
W40196	56	W40399	39	W40546A	39	W41329C	56	W41597	60	W41766	74	W4314AC	23	W44163	40	W45527	72	W45739	50
W40197	56	W40400	46	W40549	39	W41330	49	W41598	60	W41767	74	W4314RC	23	W44164	40	W45640	2	W45747	48
W40198	56	W40401	40	W40550	39	W41330C	56	W41599	62	W41768	74	W43150	24	W44165	40	W45641	2	W45748	48
W40199	13	W40402	40	W40551	39	W41330S	56	W41599V	59	W41852	60	W43151	24	W4425	64	W45642	2	W45749	48
W40200	13	W40403	40	W40585	23	W41331	49	W41630	60	W41853	60	W43152	39	W44253	32	W45643	2	W45757	50
W40202	13	W40404	40	W40586	23	W41331C	56	W41631	60	W41971	69	W43153	39	W44257	32	W45644	2	W45758	50
W40203	13	W40405	42	W40587	23	W41331S	56	W41632	60	W4222	1	W43154	31	W44258	32	W45645	2	W45770	50
W40204	13	W40406	42	W40588	23	W41332	49	W41633	60	W42235	32	W43324	47	W44259	32	W45646	2	W4578	50
W40205	13	W40407	42	W40596	25	W41332C	56	W41634	60	W42236	32	W43376	47	W44532	46	W45647	2	W45788	23
W40206	13	W40408	42	W40599	23	W41332S	56	W41635	60	W42237	32	W43416	47	W44532K	46	W45648	2	W45789	44
W40207	13	W40409	26	W40604	25	W41333	49	W41636	60	W42238	32	W43417	47	W44533	34	W45649	2	W4579	50
W40208	13	W40410	26	W40605	25	W41333	56	W41637	60	W42239	32	W43418	47	W44534	28	W4565A	9	W45790	44
W40209	13	W40411	26	W40606	25	W41334	49	W41638	60	W42423	29	W43501	71	W44535	43	W4565B	9	W45791	50
W40220	7	W40412	26	W40607	25	W41334	56	W41639	60	W42478	68	W43502	71	W4455U	46	W4565C	9	W45792	50
W40221	15	W4043W	46	W40612	25	W41335	49	W41640	60	W4260LC	29	W43503	71	W44561	29	W4565G	9	W45793	50
W40222	15	W4045ES	46	W40613	25	W41335	56	W41641	60	W42722	66	W43504	71	W44570	29	W4565P	9	W45794	50
W40223	7	W40460	31	W40614	25	W41336	49	W41642	60	W42723	66	W43505	71	W44922	1	W4565R	9	W45795	34
W40233	9	W40461	31	W40615	25	W41336	56	W41643	60	W42724	66	W43507	71	W44923	1	W45671	49	W45796	34
W40234	9	W40462	31	W40616	25	W41337	49	W41644	60	W4287D	66	W43508	71	W44924	1	W45672	49	W45797	34
W40235	9	W40463	31	W40617	25	W41337	56	W41645	60	W43020	63	W43510	71	W44925	1	W45673	49	W45798	34
W40236	9	W40464	31	W40618	25	W41563	59	W41646	60	W43021	63	W43511	71	W44926	1	W45675	49	W45810	44
W40237	9	W40465	31	W40619	25	W41564	59	W41647	60	W43022	63	W43608	67	W44927	1	W45676	49	W45811	44
W40238	9	W40466	31	W41011E	25	W41565	61	W41648	62	W43023	63	W43609	67	W44932	1	W45689	49	W45812	44
W40239	9	W40467	45	W41012E	26	W41566	61	W41649	62	W43024	63	W43614	67	W44933	1	W45690	49	W45813	44
W4023P	9	W40468	45	W41013E	26	W41567	61	W41660	62	W43025	63	W43706-A	69	W44934	1	W4569AA	34	W45814	23
W40268	7	W4046ES	46	W41014E	26	W41568	61	W41661	62	W4307	62	W43706-B	69	W44935	1	W4569BA	34	W45815	23
W40270	7	W40471	39	W41015E	26	W41570	59	W41670	59	W4307A	62	W43706-C	69	W44936	1	W4569GA	34	W45816	44

PRODUCT INDEX

Item No.	Page No.	Item No.	Page No.	Item No.	Page No.	Item No.	Page No.	Item No.	Page No.	Item No.	Page No.	Item No.	Page No.	Item No.	Page No.
W45817	34	W4645	28	W47566	20	W48170P	17	W48951	11	W48997	70	W5178	4	W52057	51
W45818	34	W4646	30	W47567	20	W48170R	17	W48952	11	W48998	70	W51780	6	W52058	51
W45819	34	W4647	29	W47568	20	W48173	16	W48953	11	W50082	77	W51823	18	W52059	51
W45820	34	W4648	30	W47569	20	W48174	17	W48954	11	W5014F	77	W51842	18	W52060	37
W45821	34	W4649	29	W47570	20	W48175	17	W48955	11	W50150	77	W51845	18	W52061	37
W45822	34	W4650	48	W4757-1	20	W48176	17	W48956	11	W50151	77	W51850	12	W52062	51
W45823	34	W4651	48	W47574	8	W48177	17	W48957	11	W5026	78	W51946	6	W52063	55
W45824	34	W4661F	66	W47576	8	W48178	17	W48958	11	W50451	8	W51947	6	W52064	55
W45825	44	W4692	68	W47580	10	W48179	17	W48959	11	W5045PT	77	W51948	6	W52065	55
W45826	44	W4693	68	W47581	10	W48200	3	W48960	11	W5046PT	77	W51949	24	W52066	55
W45827	44	W4694	68	W47582	10	W48207	8	W48961	11	W50802CH	66	W51950	6	W52068	51
W45828	44	W4695	68	W47583	10	W48208	8	W48962	11	W50950	3	W51953	16	W52069	51
W45845	61	W4696	68	W47584	20	W48217	8	W48963	17	W50951	11	W51956	18	W52070	51
W45846	61	W4697	68	W47585	20	W48218	8	W48964	17	W50952	11	W51957	18	W52071	51
W46026	32	W4698	68	W47586	20	W48219	8	W48965	17	W50953	11	W51967	18	W52072	37
W46027	32	W4699	68	W47587	20	W48233	14	W48966	17	W50960	3	W51995	4	W52073	37
W46041	32	W4700	68	W47588	20	W48234	14	W48967	17	W5097PA	5	W51996	4	W52080	52
W46042	32	W4701	68	W47589	20	W48235	14	W48968	17	W5097PC	5	W52001T	56	W52081	52
W46043	32	W4702	68	W4770	2	W48247	11	W48969	17	W5097PR	5	W52002T	56	W52082	52
W46044	32	W4703	68	W4806	69	W48260	10	W48970	17	W5097PRC	5	W52014LR	55	W52083	52
W46104	45	W4704	68	W4806-A	69	W48261	10	W48971	70	W51009B	3	W52014RL	55	W52084	37
W4610H	45	W4705	68	W4806-B	69	W48262	10	W48972	70	W51570	18	W52015LR	55	W52085	37
W46301	28	W4706	68	W4806-C	69	W48263	10	W48973	70	W51574	65	W52015RL	55	W52092	52
W46302	28	W4707	68	W4806-G	69	W48264	10	W48974	70	W51575	65	W52016LR	55	W52093	52
W46303	27	W4708	68	W4806-P	69	W48265	10	W48975	70	W51576	65	W52016RL	55	W52094	52
W46305	27	W4709	68	W4806-R	69	W48266	10	W48976	70	W51577	65	W52017LR	55	W52095	52
W46306	27	W4710	68	W4806-S	69	W48267	10	W48977	70	W51578	65	W52017RL	55	W52096	37
W4632U	46	W47534	2	W48090	3	W48268	11	W48978	70	W51579	65	W52018	50	W52097	37
W4637	27	W47535	2	W48091	3	W4829	3	W48979	70	W5166	5	W52019	50	W52098	52
W4638	27	W47543	19	W48092	3	W4830	3	W48980	70	W51671	5	W52030	62	W52099	52
W4639	27	W47544	19	W48093	3	W4831	16	W48981	70	W51672	5	W52032	50	W52101	52
W4640	27	W47545	19	W48094	3	W4832	17	W48982	70	W51673	5	W52033	50	W52102	52
W46400	32	W47546	19	W48095	3	W4834H	16	W48983	70	W51698-B	16	W52034	50	W52103	44
W46401	45	W47547	19	W48096	3	W48917	3	W48984	70	W51702	18	W52035	50	W52104	44
W46402	45	W47548	19	W48130	16	W48918	5	W48985	70	W51707	16	W52036	50	W52105	44
W46403	45	W47549	19	W48139	16	W48919	5	W48986	70	W51708	18	W52037	50	W52106	44
W46404	45	W47550	20	W48162	17	W48930	3	W48987	70	W51715	4	W52038	50	W52107	44
W46405	45	W47556	19	W48163	17	W48931	3	W48988	70	W51716	4	W52039	50	W52108	58
W46406	45	W47557	19	W48164	17	W48932	3	W48989	70	W51717	16	W52044	51	W52109	58
W46407	45	W47558	19	W48165	17	W48933	3	W48990	70	W51718	11	W52045	51	W5211	51
W46408	45	W47559	19	W48166	17	W48934	3	W48991	70	W51719	11	W52046	51	W52110	58
W4641	28	W47560	19	W48167	17	W48935	3	W48992	70	W51734	4	W52047	51	W52111	58
W46410	45	W47561	19	W48168	17	W48947	11	W48993	70	W5175	12	W52048	51	W52112	58
W4642	28	W47563	19	W48169	17	W48948	11	W48994	70	W5176	4	W52054	51	W5211-2	64
W4643	28	W47564	20	W48170	17	W48949	11	W48995	70	W51767	4	W52055	51	W52113	58
W4644	28	W47565	20	W48170G	17	W48950	11	W48996	70	W5177	4	W52056	51	W52114	58

PRODUCT INDEX



Item No.	Page No.	Item No.	Page No.	Item No.	Page No.	Item No.	Page No.	Item No.	Page No.
W54026	30	W54562	58	W5495	12	W5926	54	W5957	55
W54027	30	W54563	58	W54958	12	W5928	54	W5958	55
W54028	30	W54564	58	W54959	8	W5929	54	W5959	55
W54029	30	W54565	58	W5496	12	W5931	54	W5960	55
W54030	30	W54566	58	W55617	21	W5932	54	W59601	33
W54031	40	W54567	58	W55618	21	W5933	54	W59602	33
W54032	40	W54568	58	W55619	21	W59339	52	W59603	33
W5404AT	64	W54569	58	W55620	21	W5934	54	W59604	33
W5404T	64	W54570	58	W55621	21	W59340	52	W59605	33
W5405AT	64	W54571	58	W55622	21	W5935	54	W5961	55
W5405M	38	W54572	58	W55623	21	W5936	54	W59615	65
W5405MV	38	W54573	58	W55624	21	W5937	53	W59616	65
W5405T	64	W54583	64	W55625	21	W5938	53	W59617	65
W54065	38	W54587	62	W55626	21	W5939	53	W59618	65
W5406AT	64	W54588	62	W55627	21	W5940	53	W59623	65
W5406M	38	W54589	62	W55628	21	W5941	53	W59627	65
W5406MV	38	W54592	62	W55629	21	W5942	53	W59628	65
W5406T	64	W54593	63	W55630	21	W5943	53	W59629	65
W5407AT	64	W54594	63	W55631	21	W59434	46	W5963	55
W5407M	38	W54595	63	W55632	21	W59435	46	W59630	65
W5407T	64	W54596	63	W55633	21	W59436	46	W59631	53
W54131	40	W54598	63	W55634	21	W59437	46	W59632	53
W54132	40	W54599	63	W55635	21	W59438	46	W59633	53
W54133	42	W5459CH	63	W55636	21	W59439	46	W59634	53
W54134	42	W5459W	63	W55637	22	W5944	46	W59635	53
W54135	40	W54601	63	W55638	22	W59443	33	W59636	53
W54136	40	W54602	18	W55641	21	W59444	33	W59637	53
W54158	41	W54603	18	W55642	22	W59445	33	W59638	53
W5415RA	41	W54604	61	W55643	22	W59446	33	W59639	53
W5415RC	41	W54605	61	W58580	5	W59447	38	W59642	53
W5415RCR	41	W54606	14	W58593	5	W59448	38	W59643	53
W5415RR	41	W54607	14	W58594	5	W59449	46	W59644	53
W54163	33	W54835	28	W58789	5	W5944R	33	W59645	53
W54164	28	W54835	31	W58790	5	W5944W	33	W59646	53
W54213	28	W54872	43	W58791	5	W5945	33	W59647	53
W54215	31	W54874	43	W58792	5	W5946	33	W59648	54
W54233	45	W54875	43	W58793	5	W59466	33	W59649	54
W54234	45	W54876	43	W58794	8	W5947	33	W59650	54
W54235	45	W54877	43	W58795	8	W5948	55	W59651	54
W54236	45	W54878	43	W58796	8	W5949	55	W59652	54
W54512	66	W54879	43	W58797	15	W5951	55	W59653	54
W54513	62	W54880	43	W58798	15	W5952	55	W59654	54
W54520	41	W54881	43	W58800	8	W5953	55	W59655	54
W54546	6	W54882	43	W5923	31	W5954	55	W59656	54
W54560	58	W54883	43	W5924	54	W5955	55	W59657	54
W54561	58	W5494	18	W5925	54	W5956	55	W59658	54

Item No.	Page No.
W59659	54
W5966	55
W59660	54
W59661	54
W59662	54
W59663	54
W59664	54
W59665	54
W59666	54
W59667	54
W59668	54
W59669	54
W5967	55
W59670	41
W59671	41
W59672	41
W59673	41
W59674	41
W59675	41
W5968	55
W5969	55
W5969-2	55
WW043E	73
WW051E	73
WW052E	73
WW056	73
WW057	73
WW103	73

Copyright © 2012 West Inc., Temecula, CA. All Rights Reserved. No part of this work may be reproduced or copied in any form or by any means - graphic, electronic, or mechanical including photocopying, taping, or information storage and retrieval systems - without the prior written permission of West, Inc.



COMPANY POLICY

MINIMUM ORDER

Minimum order is \$50.00 or a \$10.00 handling fee will be added automatically to the invoice without further notice. Drop Shipment fee is an additional \$10.00.

PRICES

Wholesale Distributor (WD) pricing is available to all “case quantity” orders and a Minimum order amount of \$500.00 may be required. Any orders that do not meet requirement for WD pricing will be subject to additional charges. ALL PRICES AND INVENTORY ARE SUBJECT TO CHANGE WITHOUT PRIOR NOTICE.

PAYMENT TERMS

All new accounts are shipped COD, cashiers’ check only, until credit is established. Telephone verification of credit references may be accepted for company check approval. Written credit information must be submitted and approved by our credit department before orders can be shipped on a NET 30 basis. Open accounts are due 30 days from date of invoice. A late charge of 1 ½% per month will apply to all past due amounts. Past due accounts will be placed on COD at the discretion of WEST, Inc. credit department. A \$35.00 fee will apply to all returned checks.

AMERICAN EXPRESS, VISA AND MASTER CARD ARE ACCEPTED



WARRANTY

All West, Inc. products sold are warranted to be free from defects in workmanship or material for a period of six months (180 days) from date of purchase. All LED lights and STACKS are warranted for a period of one year (365 days) from date of purchase. Any defective merchandise returned according to West, Inc’ return policy will be exchanged. Warranty is null and void on merchandise that has been negligently damaged, misused, modified or improperly installed. West, Inc. accepts no responsibility for incidental or consequential damages. Cut wire on lighting voids warranty. No other warranty is made. ALL PRICES, TERMS, CONDITIONS & PRODUCTS ARE SUBJECT TO CHANGE WITHOUT FURTHER NOTICE.

LIGHTING NOTICE

All lights other than Legal Clearance / Marker Lights are for decorative use only. Blue, Green, and Purple Lights are NOT to be used as Legal Clearance / Marker Lights. WEST, Inc. and/or its’ distributors are not responsible for any use or applications on colored lights.

RETURNS

All returns are subject to approval and will not be accepted without an authorization number from WEST, Inc. All items must be returned in original packaging. Return freight must be prepaid. Returns are inspected prior to approval and are subject to 20% restocking fee. All returns must be made within 30 days. Sorry, no exceptions. No Returns for “Special Order” Items.

SPECIAL ORDERS

All special order items must be prepaid and no returns are accepted. Completed (Signed) special order form must accompany prepayment. Special order items are noted with an asterisk *.

BACK ORDERS

All back orders are kept on file and will be shipped as soon as the merchandise is available. Upon request we may notify you when merchandise is ready to ship.

FREIGHT

WEST, Inc. will pay freight charges on WD orders over \$1,000.00 provided customer remits payment timely and according to established credit terms (does not include stacks, bumpers, mud flaps or other noted items). Freight charges will be applied to all delinquent accounts. WEST, Inc. reserves the right to choose the most economical carrier. Customer is responsible for excess fees for any orders requested as “Special Delivery, Drop Shipments, Over Night, Second Day, etc.” Discounts do not apply to “Special Delivery” orders.

FREIGHT DAMAGE

Orders lost or damaged in transit must be reported in writing immediately to the Carrier & WEST, Inc. to assist in the handling of your claim. Freight credit will be applied to your account when/if the Carrier reimburses WEST, Inc. We do not accept any liability for the carrier’s responsibility. Shortages must be reported in writing upon receipt. Any damage to the exterior of any box upon delivery must be noted to the carrier “accepted subject to inspection” on the delivery receipt to assist in a claim. Any damaged boxes must be retained for carrier’s inspection.



ORDER FORM

FROM _____ Customer No. _____
 _____ Terms _____
 _____ Purchase Order No. _____
 SHIP TO _____ Authorized Purchaser _____
 _____ Signature _____
 _____ Date _____

DROP SHIP

ITEM NO.	QTY.	DESCRIPTION	UNIT PRICE	EXTENDED PRICE
TOTAL				

Notes/Comments _____

P.O. Box 890351 Temecula, CA 92589 • Tel. 888.400.9378 • Fax. 800.821.1785 • Email. sales@westchrome.com

www.westchrome.com