

MTS 6 Pole Test Switches	
Part Number	Arrangement
206-A	1/1/1/1/1/1
206-B	13/13/13
206-C	10/10/10
206-D	2/2/2
206-E	16/16
206-F	1/1/1/10/1
206-G	1/10/10/1
206-H	1/13/13/1
206-J	1/1/10/10
206-K	11/11/11
206-L	2/2/13
206-N	90X3 (6-BP-6-BP-6-BP)
206-O	2K/2K/2K
206-P	1/1/1/1/11
206-Q	2K/2K/2K
206-R	9/9/9/9/9/9
206-S	1/1/13/13
206-T	#1/1/1/1/1/1#
206-V	1K/1K/1K/1K/1/1
206-X	90/90/90
206-Z	11/11/1/1
206-AA	#13/13/13#
206-AB	#6-6-6-6-6#24
206-AC	20-24/13
206-AD	16/17
206-AE	24-19/13
206-AF	#6-6-6-6-6-5#
206-AG	24-5-5-5-5-5
206-AH	16/6-6-5
206-AJ	6R-BPX3 all ganged
206-AK	11GB/11GR/11GK
206-AL	#2/2/13R#
206-AM	#1/#6-6-6-5#/1# 1st & 6th element locking bar
206-AN	#1/13/13/1#
206-AO	10B/10E/10Y
206-AP	1/1/1/1/10
206-AQ	24#5-5-5-5-5#
206-AR	2/2/13R
206-AS	1B/1B/1G/1/13YK
206-AT	1B/1B/1G/1G/1/1
206-AU	1/1/1/1/1/1K
206-AV	1B/1E/1Y/1W/1G/1W
206-AW	1/1/9/9/9/9
206-AX	1/2/2/1
206-AY	17/1/1/1
206-AZ	1/1/1/1/10Y
206-BA	1/1/10Y/10Y
206-BB	20-24/6-24
206-BC	10R/10G/10W
206-BD	2/20-24
206-BE	1K/1K/1K/1K/1K/1K
206-BF	1/1/17/1

MTS 6 Pole Test Switches	
Part Number	Arrangement
206-BG	10EG/10BG/10YG
206-BH	10/10/1/1
206-BJ	/2/2/2/
206-BK	1Y/1B/1G/1E/1N/1KW
206-BL	10/2/25A/25A
206-BM	90/26/1/1/26/25/24
206-BN	2#91-90#
206-BO	13/2K/2K
206-BP	1/1W/1B/1/1W/1B
206-BQ	1/17/1/1
206-BR	#1/6-6-6-6-5#
206-BS	10/1/1/1/1
206-BT	#11/11/11#
206-BU	1/1/1K/1K/10E
206-BV	10/10/25/25
206-BW	+6-6-6-6-6-5+
206-BX	1K/1W/1Y/1Y/1/1
206-BY	1/1/#13/13#
206-BZ	1/25A/X3
206-CA	+9/9/9/19+
206-CB	#1/+6-6-6-6-6-1+# Pos. 1 & 6 only ganged
206-CC	2/10/2
206-CD	25/25/25/25/25/25
206-CE	1/1/1/26X6-1/1/1
206-CF	9/9/9/17
206-CG	1/1/1/17
206-CH	24/1K/1K/1K/10R
206-CI	10R/10R/10R
206-CJ	+9W-5-9W-5Y-9W-5R+
206-CK	11R/11/X2
206-CL	#6E-6E-6E-5E#/13E
206-CM	13E/13E/13E
206-CN	11/11/1K/1K
206-CO	1/24/1/24/1/24
206-CP	25/24/25/24/25/24
206-CQ	1/25/10/25/1
206-CR	2RG/2RG/2RG
206-CS	1B/1B/2Y/2Y
206-CT	+6-1+/X3
206-CU	13/13/2
206-CV	1/1/24/1/1/24
206-CW	13/2/2
206-CX	1E/1E/1E/1E/1E/1E
206-CY	1/1/#20-5#
206-CZ	13R/13R/13R
206-DA	2B/2B/2B
206-DB	1K/1K/10/10
206-DC	1/1/10R/10R
206-DD	1B/1B/10B/10B
206-DE	1KW/1KW/10/KW/10KW
206-DF	#1/X4/13#
206-DG	2E/2E/2E

MTS 6 Pole Test Switches	
Part Number	Arrangement
206-DH	2B/1W/1W/1W/1W
206-DI	24/10/24/10
206-DJ	16/1/1/1
206-DK	10/24/X2 WITH MTS 11 ON HINGED SIDE
206-DL	#1/1/1/1#/2
206-DM	10R/10G/10
206-DN	16RYB/26/16RYB
206-DO	24/1K/1K/1K/10R
206-DP	#6-6-6-5/1#/1
206-DQ	1/13/1/13
206-DR	#1Y/1Y/1Y/1Y#/2B
206-DS	2Y/2Y/2Y
206-DT	2Y/2Y/2B
206-DU	1Y/1Y/1Y/1Y/1Y/1Y
206-DV	10R/10B/10Y
206-DX	1Y/1Y/1Y/91Y/1Y
206-DY	1K/1/1B/1G/1Y/1W
206-DZ	10R/10W/10B
206-EA	91Y/91Y/91Y
206-EB	11R/11R/11R
206-EC	/13/13/13/
206-ED	/10/10/10/
206-EF	1B/1B/1B/1B/1B/1B
206-EG	1/24/24/1/24/24
206-EH	#/1Y/1Y/1Y/24/1Y/24/#
206-EI	#1K/1K/1K/1K/1K/1K#
206-EJ	16K/16K
206-EK	#13R/13R/13R#
206-EL	1/1B/1K/1/1B/1K
206-EM	#/13/13/#24-24/
206-EN	10/10R/10B
206-EP	6-6-6-6-6-24
206-EQ	9/13/9/13
206-ER	91/91/91
206-ES	9W/9W#5-5R-5G/1B#
206-EU	1B/1B/1/1/1/1
206-EV	1K/1/10Y/10B
206-EW	9W/#9W-19KRG#/1B
206-EX	24/1/24/1/24/1
206-EZ	13KE/13GE/13RE
206-FA	1B/1B/1/1/1Y/1Y
206-FC	13/#6-6-6-5#
206-FD	10/10E/10Y
206-FE	24W-5 / 24W-5Y / 24W-5R ^(24w/Blade-Shorted by pairs)
206-FG	1/25/1W/25/1B/25
206-FH	1/1W/1B/25/25/25
206-FI	1K/1K/1/1/1K/1K
206-FK	1K/1K/10R/1/1B
206-FL	1K/1K/1/1Y/1G/1
206-FM	1K/1/1K/24/1/25A
206-FN	1K/1E/1K/24/1/25A
206-FP	1/25A/1W/25A/1B/25A

MTS 6 Pole Test Switches	
Part Number	Arrangement
206-FQ	1/1/11/11
206-FR	13/13B/13G

Type MTS Miniature Test Switches



- **Compact and versatile**
- **Front- and back-connected styles**
- **Safe, durable, rugged and reliable**
- **Recognized by CUL & UL**
- **Class 1E qualified per IEEE Standard 323-1974**

DESCRIPTION

In many panelboard, switchgear, metering, control circuit and instrumentation applications, space is at a premium. Yet provisions must be made to facilitate troubleshooting, testing, calibration and checkout of relays, meters, transducers, instruments and control systems. STATES Type MTS Miniature Test Switches are the compact, versatile solution for disconnecting and testing these devices and circuits.

They are the result of over 60 years of experience in the design and manufacture of test switches, and make use of the latest improvements in material composition and construction techniques.

Many features are incorporated for increased safety, durability, ruggedness and reliability. All the features you need, including potential elements, current elements and make-before-break short-circuiting elements for current transformer circuits and test jacks, are available in test switches ranging from 1 to 52 poles on one base, and in a miniature size.

Each switch blade can be operated independently or, where required, adjacent handles can be ganged for simultaneous operation.

All Type MTS Test Switches are available in both front- and back-connected styles. Protective covers (available in clear or opaque) are automatically included with all back-connected styles and may be ordered as an optional item with front-connected switches.

CLASS 1E QUALIFIED PER IEEE STANDARD 323-1974

Type MTS Test Switches have successfully completed a generic test program that meets the requirements of most nuclear power plants for Class 1E applications outside containment.

Extensive accelerated-life testing was conducted by an outside, independent firm using thermal aging, mechanical aging, environmental extremes, radiation exposure and seismic simulation to conduct tests.

The service conditions and parameters of the test program included:

- 41-year life at 131° F (55° C), 600 operations, 95% humidity, 2.2 x 10⁸ rads of radiation and 10g maximum acceleration seismic level.
- Recognized by UL and CUL.
- Underwriters Laboratories Inc. recognizes STATES Type MTS Miniature Test Switches under its component program, File No. E75355, with a rating of 600 volts, 30 amperes.



Space-saving miniaturization means full test capability; yet, a Type MTS 10-pole switch requires just 7 inches of mounting space. Unit-pole construction permits virtually any pole arrangement from 1 to 52 poles mounted on a single base.

STATES

FEATURES AND BENEFITS

- **Self-extinguishing materials:** All non-metallic components are made of self-extinguishing, flame-retardant materials with Underwriters Laboratories' best rating for self-extinguishing materials (V-O).
- **Nonferrous material:** All current-carrying metallic components, including hardware, are made of highest quality nonferrous materials such as copper, bronze, brass or phosphor bronze. This ensures excellent conductivity and minimizes galvanic action between dissimilar metals.
- **Nickel plating:** All current-carrying metallic components, including hardware, have a corrosion-resistant nickel finish that ensures good electrical contact and smooth operation of moving parts even after years of inactivity.
- **Safety-grip handle:** A molded handle covers the terminal and includes a lower lip that projects over the metal parts of the switch, thus protecting the operator from contact with live components.
- **One-piece jaw and hinge:** One-piece construction of hinge and jaw eliminates unnecessary, multiple connection points.
- **Special blade shape:** All blades are shaped so that the edge of the blade enters at a right angle to the jaw; thus, the blade enters and exits the full width of the jaw simultaneously.
- **Switch jaws:** All STATES Test Switches have uniform contact pressure over the full width of the blade. The "ping" heard when opening the blade is due to the special, spring-grade phosphor bronze used in the jaw. This design ensures an excellent low-resistance contact that will not overheat.
- **High barriers:** Maximum circuit isolation is obtained by extra-high barriers that provide uncompromised protection. Barriers are permanently mounted and cannot fall out or be knocked out, as in some "snap-in" designs.
- **Short-circuit jaw:** A rugged, make-before-break element is used to short the secondary of a current transformer.
- **Fixed terminal studs:** The screw terminals on which wiring connections are made are a part of a rigid, immovable assembly and cannot be turned or backed out.
- **Test jack:** The test jack eliminates the possibility of opening current transformer secondaries and permits safe, easy measurements to be made in current circuits without disturbing permanent wiring. A dual-circuit test plug, such as the STATES Part No. 15000, inserted into the test jack puts the measuring instrument in series with the current circuit. The test jack does not carry current except when making a test because it is shunted by a standard switch blade that is opened only when the test jack is used.
- **Color-coded handles:** Unless otherwise specified, potential elements have red handles and current elements have black; however, the following other colors are available at additional cost: blue, orange, white, yellow, green.
- **Identification card holder:** Each safety grip handle is slotted for insertion of an identification card for marking or coding. Cards are available under Part No. MTS28.

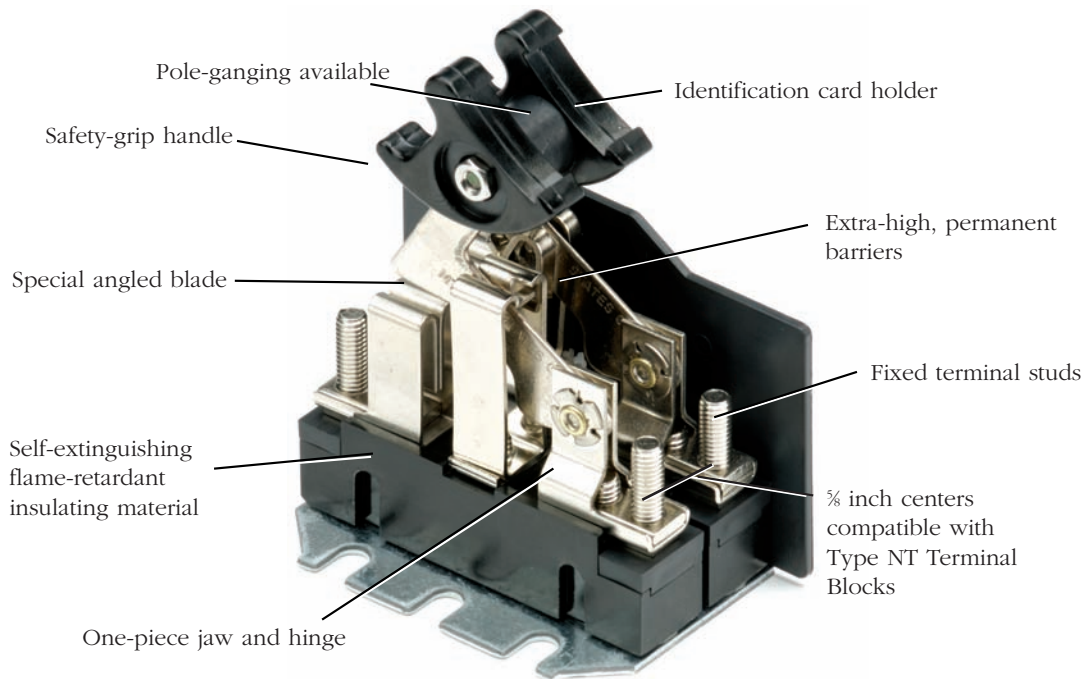

STATES Type MTS Test Switch

STATES

All configurations are available in either a front- or back-connected style.

FRONT-CONNECTED SWITCHES

The front-connected test switch usually is used where wiring entering and leaving the test switch is located on the same side of the panel that the test switch is mounted.

To order front-connected switches, refer to **Ordering Information**.



Front-connected type

BACK-CONNECTED SWITCHES

All switches can be provided in a back-connected version so that the switch is mounted on one side of a panel and the wiring connections are made on the opposite side.

Back-connected switches have factory-installed insulated barriers that project from the rear of the switch. They include either clear or opaque covers.

To order back-connected switches, refer to **Ordering Information**.



Bottom of Back-connected switch

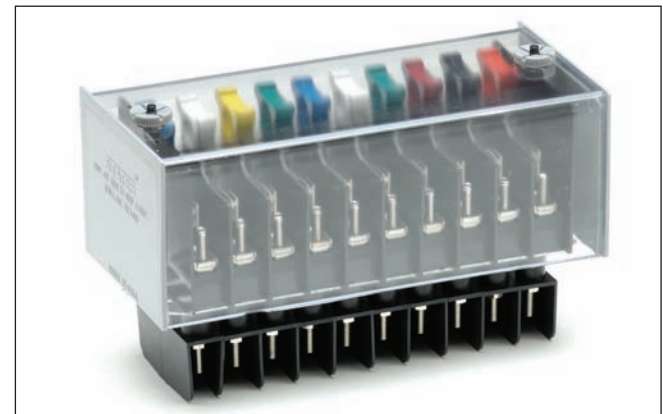

Back-connected type

STATES

COVERS

STATES Type MTS Test Switches feature rugged, virtually unbreakable covers available in clear or opaque styles. These covers are manufactured from tough, self-extinguishing, flame-retardant polycarbonate. The covers are constructed so

that all switch blades must be closed when the cover is properly sealed. Switches provided with covers include two insulated studs that have holes for wire seals. To add a cover, refer to **Ordering Information**.

COVERS FOR FRONT-CONNECTED SWITCHES

Covers for front-connected switches are open or slotted at the bottom of each side to permit wiring to enter and exit between the cover and the panel.



Slotted, front-connected clear cover

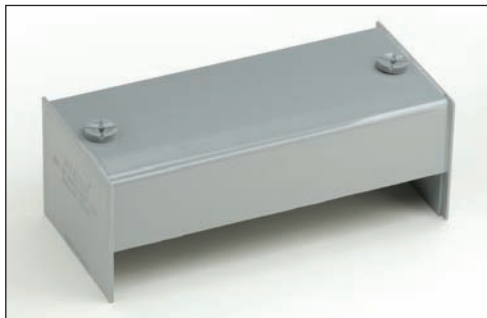

Front-connected opaque (C1) cover



Front-connected clear (C3) cover

COVERS FOR BACK-CONNECTED SWITCHES

A cover is automatically included with a back-connected test switch. However, you must select either a clear or opaque style.



Nonslotted, back-connected clear cover – The nonslotted covers for back-connected switches fit flush with the panel because all wiring exits at the rear of the test switch.



Back-connected opaque (C2) cover



Back-connected clear (C4) cover

Cover style must be specified at order placement

STATES

TYPICAL INSTALLATIONS FOR STATES TYPE MTS TEST SWITCHES

1 ϕ Watt Transducer

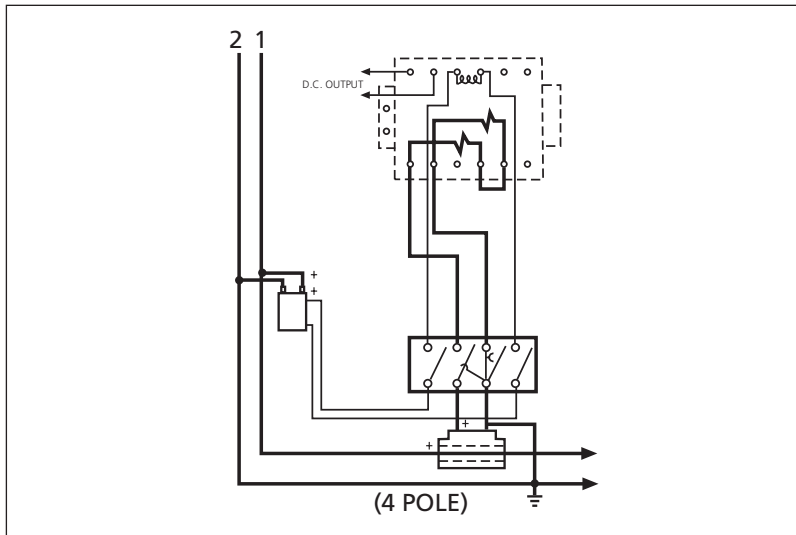

4-Pole Test Switch - Part No. 204-N



3 ϕ Watthour Meter

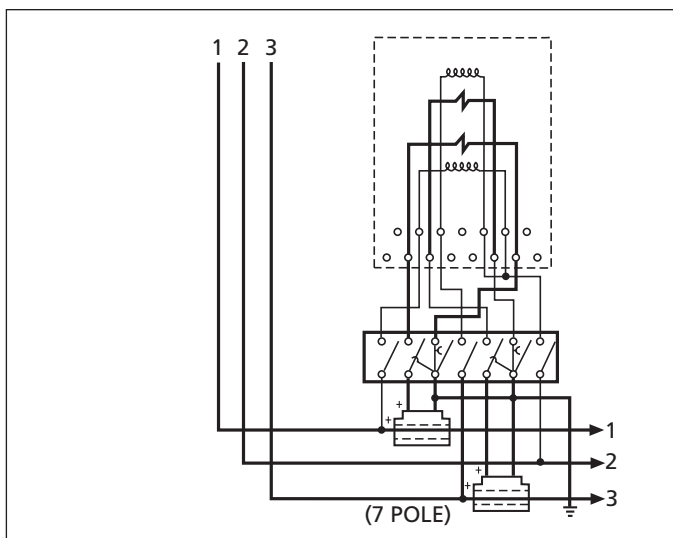

7-Pole Test Switch - Part No. 207-K



Overcurrent Relays

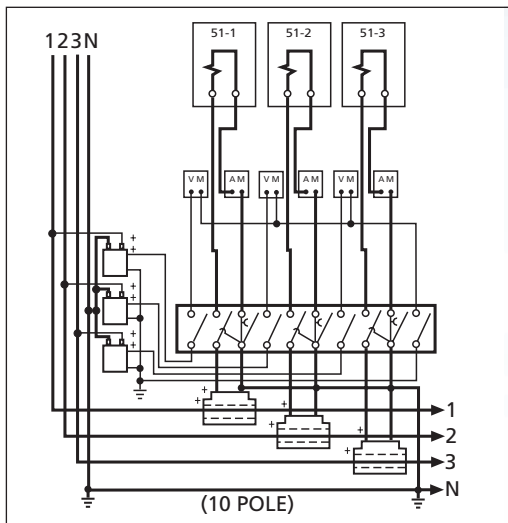

10-Pole Test Switch - Part No. 210-E



ORDERING INFORMATION

The part numbers under the arrangements on the following pages are for front-connected switches without covers. These same numbers are also used as the basis for ordering back-connected.

The part numbers are three digits followed by a letter or letter and number combination.

Example: 203-A

1/1/1



203-A

The slashes “/” in the arrangements represent barriers that are installed standard between any adjoining elements of opposite polarity.

To order front-connected switches

Specify the part numbers shown under the arrangements on the following pages.

Example: 210-A

For covers, add the appropriate prefix:

Cover	Prefix
Front-connected, slotted, opaque	C1
Front-connected, slotted, clear	C3

Example: C3-210-A

To order back-connected switches

Specify the desired arrangement and add the suffix -B. All back-connected switches are provided with either a clear or opaque cover. For covers, add the appropriate prefix:

Cover	Prefix
Back-connected, solid, opaque	C2
Back-connected, solid, clear	C4

Example: C4-210-A-B

Special Orders

Special Arrangements: In addition to the typical arrangements shown on the following pages, special arrangements are available. These can be made of any combination of potential or current elements, with a maximum of 52 poles. For more information, refer to the following example and illustrations on Page 40.

To order a customized, 10-pole, back-connected switch with a clear, back-connected cover, specify:

Switch Type: STATES Type MTS

No. of poles: 10-pole test switch

***Arrangement:** 10/2/11/1/16

Style: Back-connected

Cover: Clear, back-connected

Handle Colors: The standard colors for handles are red for potential and black for current. Handles are also available in other colors.

***Arrangements should be given as front view of switch, left to right.**

To specify non-standard colors, add to the element number the appropriate color code:

Color	Color Code	Color	Color Code
Black	k	Red	r
Blue	b	White	w
Green	g	Yellow	y
Orange	e		

To order a switch with handles in non-standard colors, you must specify the arrangement with colors indicated. For example, to order a 10-pole switch with special handle colors, specify: **Arrangement:** 10/10r/10g/10w/1k/1k

Ganged handles: You may specify a yoking bar to gang adjacent handles.

For example, to order a switch with the adjacent potentials ganged, you must specify: **Gang all potentials**

Hinge position: The “U” in an arrangement (next to an element) indicates the hinge is positioned upside down from the typical arrangement.

OPTIONAL ACCESSORIES



Socket Wrench and Insert

To speed installation of the terminal nuts on STATES Test Switches, the socket wrench (Part No. 16028) and 3/8 inch insert (Part No. 16027) are available.

Also available are the 5/16 inch insert (Part No. 16025) for use in installing the terminal nuts on STATES Type Terminal Blocks and STATES Type MTS Test Switches.

The screwdriver attachment (Part No. 16022) makes this wrench your complete meter installation tool.

Dual Circuit Plug

By inserting the STATES Dual Circuit Plug (Part No. 15000) into the test jack, safe measurement can be made of current transformer secondary current.



Jumper Strips

Part No. TBT167 2 Pole Strap

Part No. TBT168 58 Pole Strap

(The TBT168 can be cut to the required length)

This nickel-plated jumper strip is made specially for the STATES Type NT & ZWM Terminal Blocks and the STATES Type MTS Test Switches.



See Accessories on page 67.

STATES

FRONT VIEW 1-POLE



201-A

Color Options: **1k**
201-C
1y
201-D



201-B

2-POLE 1/1



202-A

Color Options: **1k/1k**
202-H
1y/1y
202-D



202-B

2k
202-J



202-C



202-F

Color Option: **11r**
202-L



202-E

Other 2-Pole
Standard Arrangement:

6-24
202-G

3-POLE

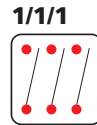

203-A

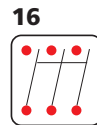

203-D



203-B

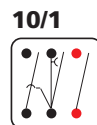

203-C

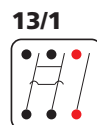

203-H



203-J

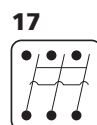

203-E

Other 3-Pole
Standard Arrangements:

6-6-5
203-K

6-6-24
203-L

9/9/9
203-F

9/24-5
203-G

4-POLE

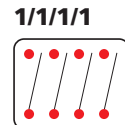

204-A

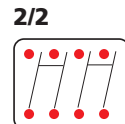

204-D

Color Option: **2k/2k**
204-A2

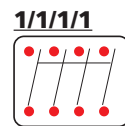

204-E

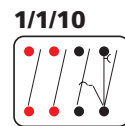

204-F



204-J

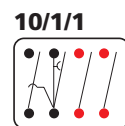

204-K

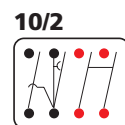

204-G

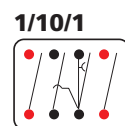

204-N

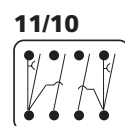

204-Q

4-POLE (CONT.)

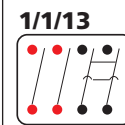

204-B

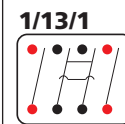

204-L

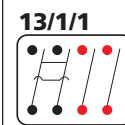

204-M

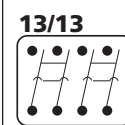

204-H

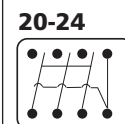

204-C

Other 4-Pole
Standard Arrangements:

1/10/24
204-A3

1/16
204-A5

9/9/9/9
204-R

9/24-14
204-S

11/11
204-W

11b/11e
204-Z

20-9
204-A4

20r-24
204-U

24-19r
204-T

STATES

FRONT VIEW

5-POLE

1/1/1/1/1

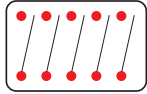

205-A

1/1/16

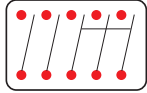

205-H

1/1/1/10



205-B

1/1/10/1



205-C

1/10/1/1

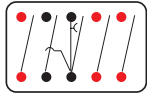

205-D

10/1/10

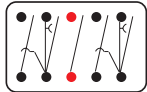

205-F

11/1/10

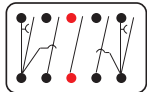

205-G

9/9/9/9/24

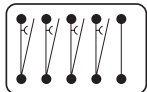

205-J

1/1/1/13

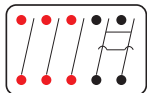

205-E

6-POLE

1/1/1/1/1/1

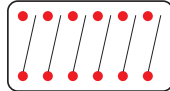

206-A

2/2/2

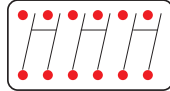

206-D

16/16

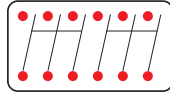

206-E

1/1/1/10/1

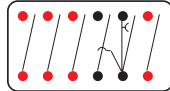

206-F

1/10/10/1

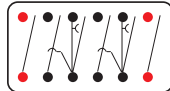

206-G

1/1/10/10

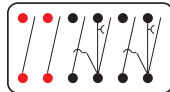

206-J

11/11/11

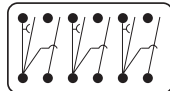

206-K

10/10/10

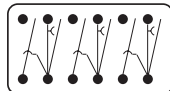

206-C

1/13/13/1

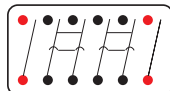

206-H

6-Pole (CONT.)

1/1/13/13



206-S

13/13/13

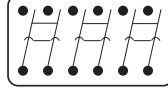

206-B

Other 6-Pole
Standard Arrangements:

1/1/1/1/1/1

206-P

2/2/13

206-L

7-POLE

1/1/1/1/1/1/1

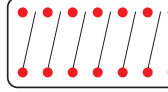

207-A

1/10/1/1/1/1

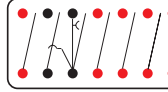

207-G

1/1/10/1/1/1

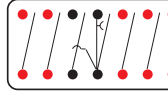

207-F

1/1/1/1/10/1

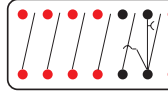

207-H

16/10/10

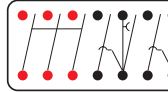

207-J

7-Pole (CONT.)

1/10/1/10/1

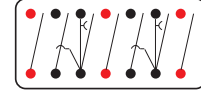

207-K

1/10/1/11/1

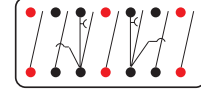

207-B

1/1/1/10/10



207-C

Color Option:

1k/1k/1k/10/10

207-P

1/1/1/10/11

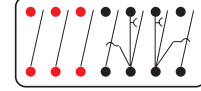

207-E

1/13/1/13/1

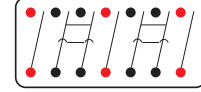

207-D

13/13/13/9

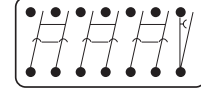

207-L

Other 7-Pole
Standard Arrangements:

#1/1/1/1/1/1/1#

207-M

1/1/1/1/11/11

207-Q

1/6-1-6-9-9/1

207-N

6-6-6-6-6-6-24

207-S

9/9/9/24-19

207-R

STATES

FRONT VIEW

8-POLE

1/1/1/1/1/1/1/1

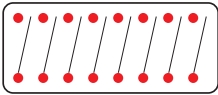

208-D

1/1/1/10/1/1/1

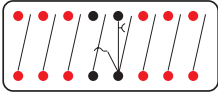

208-E

1/10/1/1/11/1

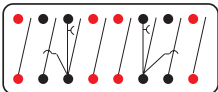

208-A

10/10/1/1/1/1

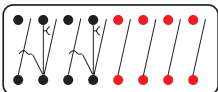

208-B

1/1/1/1/10/10

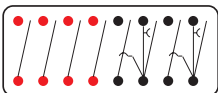

208-G

1/10/10/10/1

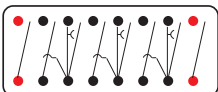

208-K

10/10/10/1/1

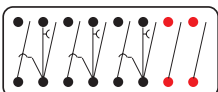

208-L

10/10/10/10

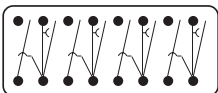

208-P

1/1/1/13/1/1/1

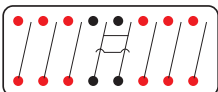

208-Q

8-Pole (CONT.)

1/1/1/1/1/1/1/3

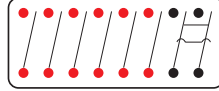

208-C

1/13/1/1/13/1

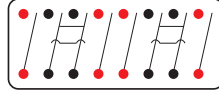

208-H

1/1/1/1/13/13



208-J

16/24/13/13

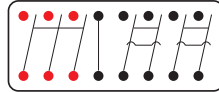

208-F

1/13/13/13/1

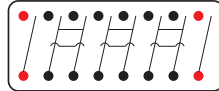

208-M

13/13/13/1/1

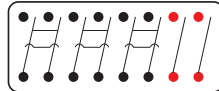

208-N

13/13/13/13

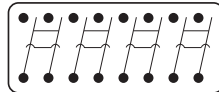

208-W

Other 8-Pole
Standard Arrangements:

#1/1/1/1/1/1/1/1#
208-T

1/6-1-6-9-1-9/1
208-R

2/2/2/2
208-S

9-POLE

1/1/1/1/1/1/1/1/1

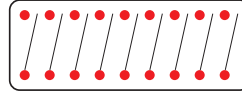

209-A

16/16/16

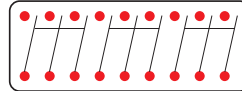

209-B

1/1/1/10/10/10

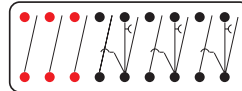

209-U

16/10/10/10



209-E

1/10/1/10/1/10



209-K

1/13/1/13/1/13

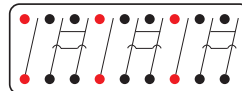

209-H

1/1/1/13/13/13

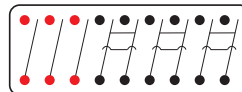

209-D

6-6-6-6-6-6-6-24

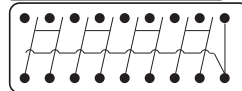

209-C

Other 9-Pole
Standard Arrangements:

1/1/24/10/10/10
209-F

9/9/9/9/9/9/9/1
209-G

11/9/11/9/11/9
209-J

10-POLE

1/1/1/1/1/1/1/1/1/1

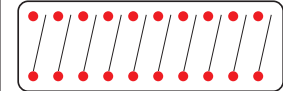

210-A

1/1/1/1/1/1/1/10/1

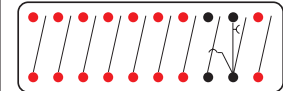

210-B

1/1/1/1/1/10/10/1

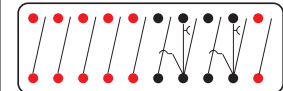

210-C

1/1/1/10/1/1/10/1

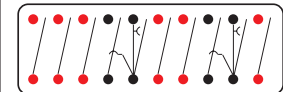

210-D

1/10/1/1/1/1/10/1

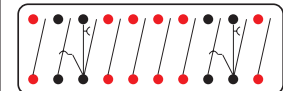

210-F

1/10/1/10/1/10/1

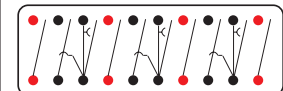

210-E

1/1/1/1/10/10/10

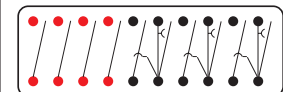

210-H

1/1/1/10/10/10/1

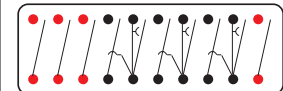

210-J

1/10/10/10/10/1

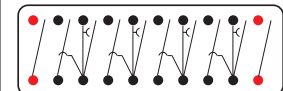

210-K

10/10/10/10/1/1



210-L

Color Key: k: Black b: Blue g: Green e: Orange r: Red w: White y: Yellow

STATES

FRONT VIEW

10-Pole (CONT.)

10/10/10/10/10

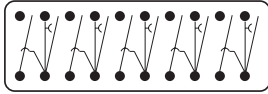

210-M

1/13/1/13/1/13/1



210-G

13/13/13/13/13

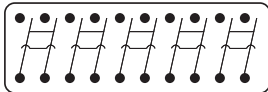

210-N

13/13/13/1/1/1/24

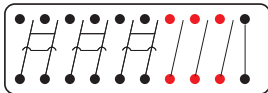

210-P

Other 10-Pole
Standard Arrangements:

1/1/1/24/10/10/10
210-T

1/1/1/24/13/13/13
210-AA

1/10/1/10/1/10/24
210-R

2/2/2/2/2
210-Y

9/9/9/9/9/9/9/9/9/9
210-Q

9/9/9/9/24-5-5-5-5-5
210-V

9/9/9/24#-19-19#
210-U

10/10/10/1/1/1/1
210-W

13/13/13/13/13
210-X

1/1/1/1/9-5-9-5-9-5
210-S

11-POLE

1/1/1/1/1/1/1/1/1/1/1
211-A

10/10/9/10/9/9/2
211-C

13/13/1/1/1/1/1/1/1
211-B

12-POLE

1/1/1/1/1/1/1/1/1/1/1/1

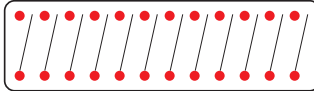

212-A

2/2/2/2/2/2

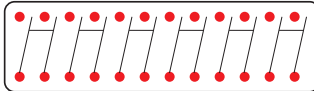

212-B

1/1/1/1/1/1/1/1/1/1/1/1

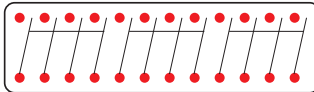

212-C

10/10/10/10/10/10

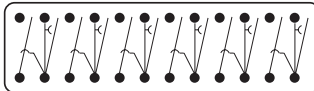

212-D

Other 12-Pole
Standard Arrangements:

1/1/10/1/10/1/10/1/1
212-F

1/10/1/10/1/10/1/10
212-E

9/9/9/9/9/9/9/9/9/16
212-H

13/13/13/13/13/13
212-G

16-POLE

16 - #1 elements

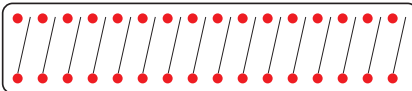

216-A

8 - #2 elements

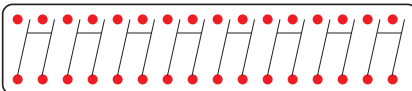

216-B

Other 16-Pole
Standard Arrangements:

1/1/1/1/13/13/1/1/1/1/1/1/1
216-D

1/1/1/24/10/10/10/10/10/10
216-C

21-POLE

21 - #1 elements
221-A

13/13/13/24/13/13/13/24/13/13/13/24
221-B

24/13w/13g/13k/24/13w/13g/13k/24/13w/13g/13k
221-C

13k/13g/13w/24/13k/13g/13w/24/13k/13g/13w/24
221-D

22-POLE

22 - #1 elements
222-A

2/2/2/2/2/2/2/2/2/2/2/2
222-B

24-POLE

24 - #1 elements
224-A

12 - #2 elements
224-B

12 - #13 elements
224-E

26-POLE

26 - #1 elements
226-A

26 - #1k elements
226-K

40-POLE

40 - #1 elements
240-A

20 - #13 elements
240-B













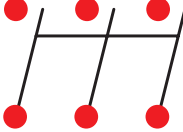

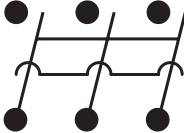

52-POLE

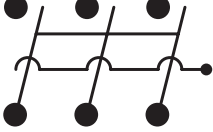
52 - #1 elements
252-A

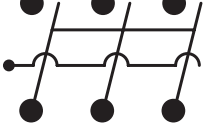
26 - #13 elements
252-B

STATES

ELEMENTS FOR CUSTOMIZED SWITCHES NOT LISTED UNDER TYPICAL ARRANGEMENTS

<p>1</p>  <p>Single-Pole Potential</p>	<p>2</p>  <p>Ganged Double-Pole Potential</p>	<p>16</p>  <p>Ganged Three-Pole Potential</p>
<p>13</p>  <p>Ganged Two-Pole Short-Circuiting Current Assembly</p>	<p>17</p>  <p>Ganged Three-Pole Short-Circuiting Current Assembly</p>	<p>9</p>  <p>Current Test Jack</p>
<p>6</p>  <p>Short-Circuiting Assembly With Right-Hand Common Bar</p>	<p>10</p>  <p>Right-Hand Current Assembly Consists of Test Jack and Short-Circuiting Current Assemblies</p>	<p>20</p>  <p>Ganged Three-Pole Short-Circuiting Current Assembly, Right Extension</p>
<p>5</p>  <p>Short-Circuiting Assembly With Left-Hand Common Bar</p>	<p>11</p>  <p>Left-Hand Current Assembly Consists of Test Jack and Short-Circuiting Current Assemblies</p>	<p>19</p>  <p>Ganged Three-Pole Short-Circuiting Current Assembly, Left Extension</p>
<p>90</p>  <p>Right-Hand Short-Circuiting Assembly Ending at a Terminal</p>	<p>91</p>  <p>Left-Hand Short-Circuiting Assembly Ending at a Terminal</p>	<p>24</p>  <p>Through Bar</p>
<p>25</p>  <p>600-Volt Fuse Holder</p>	<p>25A</p>  <p>250-Volt Fuse Holder</p>	<p>26</p>  <p>Blank Space</p>

NOTES:

- Barriers are provided between poles of opposite polarity.
- Potential handles are red and current handles are black unless otherwise specified.
- Specify adjacent handles to be ganged (yoked) if desired.
- Arrange elements left to right, front view.
- Element No. 25A accepts standard cartridge fuses rated 250 VAC 30 AMP. **Fuse not included.** Fuse dimensions must be 1/4" diameter and 1 1/4" in length.
- Element No. 25 accepts standard cartridge fuses rated 600 VAC 30 AMP. **Fuse not included.** Fuse dimensions must be 9/32" diameter and 1 1/2" in length.

Color Key: k: Black b: Blue g: Green e: Orange r: Red w: White y: Yellow

STATES

Dimensions (in inches)

NUMBER OF POLES	A	B	C	D	E
1	1 3/8	1 1/8	9/16	1 13/16	43/64
2	2	1 3/4	1 3/16	2 1/2	1 19/64
3	2 5/8	2 7/32	1 13/16	3 1/8	1 59/64
4	3 1/4	3	2 7/16	3 3/4	2 35/64
5	3 7/8	3 5/8	3 1/16	4 3/8	3 11/64
6	4 1/2	4 1/4	3 11/16	5	3 51/64
7	5 1/8	4 7/8	4 5/16	5 5/8	4 27/64
8	5 3/4	5 1/2	4 15/16	6 1/4	5 3/64
9	6 3/8	6 1/8	5 9/16	6 7/8	5 43/64
10	7	6 3/4	6 3/16	7 1/2	6 19/64
11	7 5/8	7 3/8	6 13/16	8 1/8	6 59/64
12	8 1/4	8	7 7/16	8 3/4	7 35/64
13	8 7/8	8 5/8	8 1/16	9 3/8	8 11/64
14	9 1/2	9 1/4	8 11/16	10	8 51/64
15	10 1/8	9 7/8	9 5/16	10 5/8	9 27/64
16	10 3/4	10 1/2	9 15/16	11 1/4	10 3/64
17	11 3/8	11 1/8	10 9/16	11 7/8	10 43/64
18	12	11 3/4	11 3/16	12 1/2	11 19/64
19	12 5/8	12 3/8	11 13/16	13 1/8	11 59/64
20	13 1/4	13	12 7/16	13 3/4	12 35/64
21	13 7/8	13 5/8	13 1/16	14 3/8	13 11/64
22	14 1/2	14 1/4	13 11/16	15	13 51/64
23	15 1/8	14 7/8	14 5/16	15 5/8	14 27/64
24	15 3/4	15 1/2	14 15/16	16 1/4	15 3/64
25	16 3/8	16 1/8	15 9/16	16 7/8	15 43/64
26	17 5/8	17 3/8	16 13/16	18 1/8	*

NUMBER OF POLES	A	B	C	D	E
27	18 1/4	18	17 7/16	18 3/4	*
28	18 7/8	18 5/8	18 1/16	19 3/8	*
29	19 1/2	19 1/4	18 11/16	20	*
30	20 1/8	19 7/8	19 5/16	20 5/8	*
31	20 3/4	20 1/2	19 15/16	21 1/4	*
32	21 3/8	21 1/8	20 9/16	21 7/8	*
33	22	21 3/4	21 3/16	22 1/2	*
34	22 5/8	22 3/8	21 13/16	23 1/8	*
35	23 1/4	23	22 7/16	23 3/4	*
36	23 7/8	23 5/8	23 1/16	24 3/8	*
37	24 1/2	24 1/4	23 11/16	25	*
38	25 1/8	24 7/8	24 5/16	25 5/8	*
39	25 3/4	25 1/2	24 15/16	26 1/4	*
40	26 3/8	26 1/8	25 9/16	26 7/8	*
41	27	26 3/4	26 3/16	27 1/2	*
42	27 5/8	27 3/8	26 13/16	28 1/8	*
43	28 1/4	28	27 7/16	28 3/4	*
44	28 7/8	28 5/8	28 1/16	29 3/8	*
45	29 1/2	29 1/4	28 11/16	30	*
46	30 1/8	29 7/8	29 5/16	30 5/8	*
47	30 3/4	30 1/2	29 15/16	31 1/4	*
48	31 3/8	31 1/8	30 9/16	31 7/8	*
49	32	31 3/4	31 3/16	32 1/2	*
50	32 5/8	32 3/8	31 13/16	33 1/8	*
51	33 7/8	33 5/8	33 1/16	33 3/4	*
52	34 1/2	34 1/4	33 11/16	34 3/8	*

Note: To provide extra mounting support, at 26 poles one blank space is added; at 51 poles two blank spaces are added.

* Panel cutout mounting not recommended

STATES Type MTS Front-Connected Switches

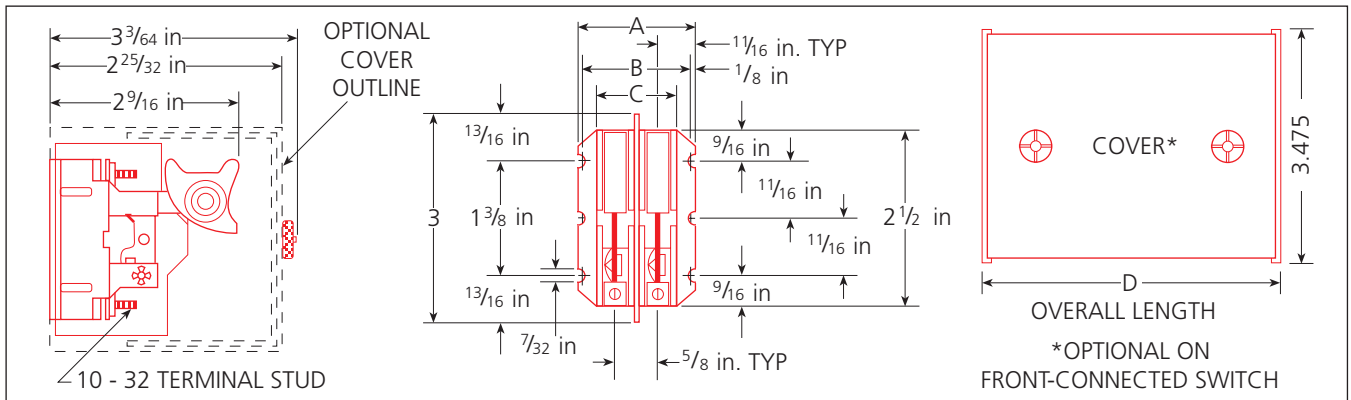

STATES Type MTS Back-Connected Switches

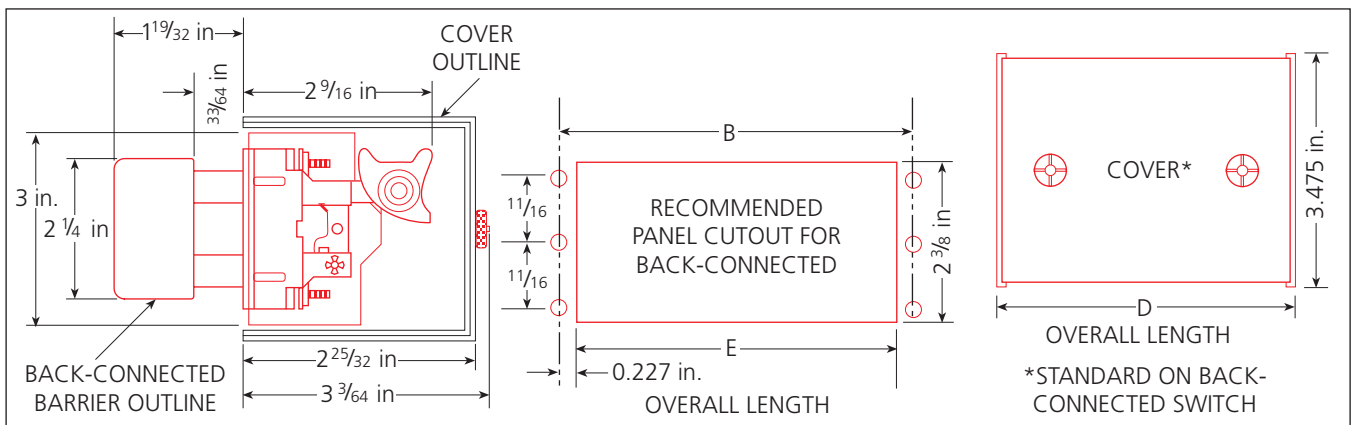

Color Key: k: Black b: Blue g: Green e: Orange r: Red w: White y: Yellow

STATES FMS Test Switch Part Numbers Cross Referenced to ABB FT-1 Part Numbers

Number of Poles	STATES Part Number	STATES Element Arrangement	ABB Part Number	ABB Rack Code
10	FMS-10A1	1K-1K-1K-1K-1K-1K-1K-1K-1K	129A501G01	001
10	FMS-10N	1K-10-1K-1K-1K-1K-10-1K	129A513G01	013
10	FMS-10E1	1K-1K-1K-10-10-10-1K	129A514G01	014
10	FMS-10E4	1K-10-10-10-10-1K	129A518G01	018
10	FMS-10S	1K-9-9-9-9-9-9-9-1K	129A519G01	019
10	FMS-10M	1K-1K-1K-10-1K-1K-10-1K	129A520G01	020
10	FMS-10C1	1K-10-1K-10-1K-10-1K	129A528G01	026
10	FMS-10B	9-9-9-9-9-9-9-9-9	129A529G01	027
10	FMS-10L	1K-1K-1K-1K-1K-10-10-1K	129A532G01	030
10	FMS-10R	1K-1K-9-10-10-10-1K	129A535G01	033
10	FMS-10A	1-1-1-1-1-1-1-1-1	129A539G01	036
10	FMS-10T	9-9-9-9-9-9-9-9-1K	129A541G01	037
10	FMS-10J	1K-1K-1K-1K-1K-1K-1K-10-1K	129A542G01	038
10	FMS-10K	1K-1K-1K-1K-1K-1K-9-10-1K	129A553G01	048
10	FMS-10PD	1K-1K-1K-10R-10R-10R-1K	1586C42G03	288
10	FMS-10GK	1K-1K-1K-1K-10-10-10	1586C42G05 670B197G18	119
10	FMS-10GZ	1K-10-10-10-10-1	1586C42G08	340
10	FMS-10SP	6-6-6-9-6-6-6-9-1K-1	1586C42G09	188
10	FMS-10FP	1-1-10-10-10-10	1586C42G16	204
10	FMS-10HD	1K-1K-1K-10-10-10-9	1586C42G19	208
10	FMS-10A3	10-1-1-1-1-1-1-1-1	1586C42G20	209
10	FMS-10FC	1K-1K-1K-1K-1K-1K-1K-1K-1	1586C42G23	212
10	FMS-10KA	1K-1K-1K-1K-1K-1K-1K-1K-2	1586C42G23	212
10	FMS-10FA	1-1K-1K-1K-1K-1K-1K-1K-1K	1586C42G31	247
10	FMS-10AD	10-10-10-1K-1K-1K-1	1586C42G36	252
10	FMS-10FH	1K-1K-1K-1K-1K-1K-1K-10-1	1586C42G38	254
10	FMS-10MW	1-1-1-1-1-1-1-1-1K-1K	1586C42G44	261
10	FMS-10GM	1-1-1K-1K-1K-1K-1K-1K-1K-1K	1586C42G45	262
10	FMS-10FG	1-1-1-1-1-1-1-10-1	1586C42G47	264
10	FMS-10PK	9-9-9-9-9-9-9-9-1	188A286G01	280
10	FMS-10C	1-10-1-10-1-10-1	188A523G01	056
10	FMS-10D	1-1-1-1-10-10-10	498A010G01	065
10	FMS-10I	9-1K-1K-1K-1K-1K-1K-1K-1K	498A011G01	066
10	FMS-10P	10-10-1K-1K-1K-1K-1K-1K	498A015G01	070
10	FMS-10F	10-10-10-10-10	498A020G01	073
10	FMS-10KC	2K-1K-1K-1K-1K-1K-1K-1K	571B878G13	
10	FMS-10KD	10-10-10-9-1-1-1	571B878G15	
10	FMS-10LE	1K-1K-1K-1K-1K-1K-10-10	670B197G23	122
10	FMS-10Z	1K-1K-1-1-1-1-1-1-1	670B197G24	123
10	FMS-10KU	10R-10R-1-1-1-1-1-1	670B197G25	124

Number of Poles	STATES		ABB	
	Part Number	STATES Element Arrangement	Part Number	ABB Rack Code
10	FMS-10GL	1K-1K-1K-1K-1-1-1-1-1-1	670B197G26	185
10	FMS-10JJ	1-1-1-1-1K-1K-1K-1K-1K-1K	670B197G31	127
10	FMS-10FK	1K-1K-1K-10-10-10-1	670B197G32	128
10	FMS-10FJ	1K-1K-10-1K-1K-1K-1K-1K-1K	670B197G33	178
10	FMS-10KB	1-1-1-10-1-1-1-1-1	670B197G33	178
10	FMS-10PM	1-1-9-10-10-10-1	670B197G35	180
10	FMS-10FY	1-1K-1K-1K-1K-1K-1K-1K-1K-1	670B197G36	181
10	FMS-10FI	1-10-10-10-10-1K	670B197G38	200
10	FMS-10E	1-1-1-10-10-10-1	714B325G32	137
10	FMS-10GA	1-1-1-1-1-1-1K-1K-1K-1K	716B562G10	140
10	FMS-10NC	9-10-10-10-10-9	716B562G13	398
10	FMS-10GS	1K-1K-10-10-10-10	716B562G25	184
10	FMS-10GB	1K-1K-1K-1K-1K-1K-1K-1K-10	716B562G26	145
10	FMS-10NX	1K-1K-1K-1K-1-1-1K-10-1K	716B562G35	152
10	FMS-10QG	6-6-6-9-6-6-6-9-1K-1K	744B430G11	163
10	FMS-10FX	1K-1K-1K-1K-1K-1K-1K-1K-1K - 1	774B430G19	170
10	FMS-10FF	10-10-10-1K-1K-1K-1K	774B430G20	171
10	FMS-10E3	10-10-10-10-1-1	774B430G22	173
10	FMS-10E2	10-10-10-1-1-1-1	774B430G24	183
10	FMS-10G	10-10-10-10-1K-1K	837A407G01	083
10	FMS-10JK	10-1K-1K-1K-1K-1K-1K-1K-1K	837A665G01	202
10	FMS-10AB	1-10-10-10-10-1	849A513G01	084
10	FMS-10PH	1K-1K-1K-1K-10R-10R-10R	9660A85G01	267
10	FMS-10FL	1-1K-1K-10-1K-1K-10-1K	9660A91G01	268
10	FMS-10HI	10-10-1-1-1-1-1-1	9663A31G01	275
10	FMS-10PG	10R-10R-10R-10R-10R	9663A33G01	276
10	FMS-10FR	1K-1K-1K-1K-1K-1K-10-1K-1K	9663A60G01	282
10	FMS-10PJ	1-1-1K-10-10-10-1K	9667A80G01	298
10	FMS-10GJ	1K-1-1K-1K-1-1K-1K-1-1K-1K	9668A27G01	301
10	FMS-10JG	1-1K-1-1K-1-1K-1-1K-1-1K	9668A54G01	304
10	FMS-10GN	1K-1K-1K-1K-1K-1K-1K-1K-1B-1B	9671A94G01	323
10	FMS-10V	1B-1B-1B-10-10-10-1B	9672A01G01	325
10	FMS-10GP	1-1-1-1-1-1-1B-1B-1B-1B	9672A02G01	326
10	FMS-10HZ	1K-1K-1K-1K-1K-1K-1-1-1-1	9672A71G01	330
10	FMS-10PV	1-1-1-1-1-1-1-1-10	9672A89G01	436
10	FMS-10AH	1E-1E-1E-1E-1E-1E-1E-1E-1E	9672A97G01	440
10	FMS-10PA	1K-1K-1K-1K-1K-1K-1K-10R-1K	9676A15G01	453
10	FMS-10PE	1K-10R-1K-10R-1K-10R-1K	9676A17G01	454
10	FMS-10Y	9-9-9-10-10-10-9	9676A18G01	455
10	FMS-10LR	1-1-1-10-10-10-1W	9676A35G01	464
10	FMS-10QV	1W-1W-1W-1W-10-10-10	9688A02G01	571
<hr/>				
9	FMS-09K	1K-1K-26-10-10-10-1K	129A515G01	015
9	FMS-09I	1K-1K-1K-1K-1K-10-10-26	129A545G01	041
9	FMS-09G	1K-1K-26-1K-1K-1K-1K-1K-1K	129A548G01	044

Number of Poles	STATES		ABB Part Number	ABB Rack Code
	Part Number	STATES Element Arrangement		
9	FMS-09F	1K-1K-1K-1K-26-1K-1K-1K-1K-1K	129A551G01	047
9	FMS-09J	1K-1K-1K-1K-26-10-10-1K	188A633G01	059
9	FMS-09L	9-10-10-10-10-26	498A021G01	074
9	FMS-09H	1K-1K-1K-1K-1K-26-10-9-1K	629A483G01	081
9	FMS-09D	26-1-10-1-10-1-10	9663A34G01	277
8	FMS-08I	1K-1K-1K-1K-26-26-1K-1K-1K-1K	129A502G01	002
8	FMS-08Q	1K-10-1K-26-26-1K-10-1K	129A512G01	012
8	FMS-08G	26-10-10-10-10-26	129A517G01	017
8	FMS-08T	26-10-10-10-26-1K-1K	129A521G01	021
8	FMS-08S	26-10-10-10-1K-1K-26	129A525G01	024
8	FMS-08P	1K-1K-26-10-10-26-1K-1K	129A530G01	028
8	FMS-08AX	1K-1K-1K-1K-26-26-1K-1K-1K-1	129A536G01	331
8	FMS-08M	1K-1K-1K-1K-26-10-10-26	129A544G01	040
8	FMS-08H	1K-1K-1K-1K-1K-26-26-1K-1K-1K	129A546G01	042
8	FMS-08J	1K-26-26-1K-1K-1K-1K-1K-1K-1K	129A549G01	045
8	FMS-08V	9-9-9-9-26-26-9-9-9-9	188A229G01	050
8	FMS-08K	1K-1K-1K-1K-1K-26-26-10-1K	188A632G01	058
8	FMS-08L	1K-1K-1K-26-26-10-1K-1K-1K	291B960G26	110
8	FMS-08W	26-9-9-9-9-9-9-9-26	498A004G01	062
8	FMS-08N	1K-1K-26-9-9-9-9-26-1K-1K	498A016G01	071
8	FMS-08U	1K-26-9-10-10-10-26	498A019G01	072
8	FMS-08R	26-26-1K-1K-1K-10-10-1K	629A315G01	080
8	FMS-08BT	10-10-10-26-26-1-1	991A938G01	938
7	FMS-07J	1K-26-26-1K-1K-1K-26-1K-1K-1K	129A503G01	003
7	FMS-07L	1K-1K-26-26-26-10-1K-1K-1K	129A510G01	010
7	FMS-07Q	1K-1K-26-26-26-10-10-1K	129A511G01	011
7	FMS-07H	26-1K-1K-1K-1K-1K-1K-26-26	129A526G01	025
7	FMS-07M	1K-10-1K-26-26-26-1K-1K-1K	188A261G01	051
7	FMS-07N	1K-1K-9-26-9-26-9-26-1K-1K	188A477G01	055
7	FMS-07R	1K-9-9-26-9-26-9-26-1K-1K	188A618G01	057
7	FMS-07K	1K-1K-1K-1K-1K-26-26-10-26	291B959G18	103
7	FMS-07W	1K-1K-1K-1K-1K-1K-1K-26X3	291B959G28	357
7	FMS-07P	1K-1K-1K-26-26-10-10-26	498A008G01	063
7	FMS-07F	1K-1K-1K-1K-26-26-1K-1K-1K-26	498A013G01	068
6	FMS-06H	1K-1K-1K-26-26-26-26-1K-1K-1K	129A504G01	004
6	FMS-06J	1K-26-26-26-26-1K-1K-10-1K	129A509G01	009
6	FMS-06Q	26-26-26-10-10-10-26	129A516G01	016
6	FMS-06P	26-26-9-9-9-9-9-9-26-26	129A523G01	022
6	FMS-06L	1K-26-26-26-26-10-10-1K	129A537G01	034
6	FMS-06K	1K-1K-26-26-26-26-9-10-1K	129A543G01	039
6	FMS-06G	1K-1K-1K-1K-26-26-26-26-1K-1K	129A550G01	046
6	FMS-06M	9-26-9-26-9-26-26-9-9-9	188A304G01	052
6	FMS-06I	26-26-26-1K-1K-1K-1K-1K-1K-26	188A416G01	053
6	FMS-06R	26-26-26-9-9-9-9-9-26	188A454G01	054

Number of Poles	STATES		ABB	
	Part Number	STATES Element Arrangement	Part Number	ABB Rack Code
6	FMS-06Y	1K-1K-1K-1K-1K-1K-26-26-26-26	291B958G25	216
6	FMS-06T	26-26-26-10R-10R-10R-26	291B958G28	270
6	FMS-06N	26-10-26-10-26-10-26	498A014G01	069
6	FMS-06AF	10-10-10-26-26-26-26	9660A97G01	273
6	FMS-06F	26-26-26-26-10-10-10	9672A72G01	426
5	FMS-05G	1K-1K-26-26-26-26-26-1K-1K-1K	129A505G01	005
5	FMS-05I	1K-10-1K-26-26-26-26-26-1K	129A508G01	008
5	FMS-05H	1K-1K-26-26-26-26-26-10-1K	129A533G01	031
5	FMS-05K	9-26-9-26-9-26-9-26-9-26	129A555G01	049
4	FMS-04I	1K-26-26-26-26-26-26-1K-1K-1K	129A506G01	006
4	FMS-04L	1K-26-26-26-26-26-26-10-1K	129A507G01	007
4	FMS-04J	26-26-1K-1K-1K-1K-26-26-26-26	129A524G01	023
4	FMS-04T	1K-1K-26-26-26-26-26-26-1K-1K	129A538G01	035
4	FMS-04V	26-26-1-1-1-1-26-26-26-26	1586C39G01	336
4	FMS-04N	26-26-26-26-26-10-10-26	291B956G13	091
4	FMS-04K	1K-1K-26-26-26-26-26-10-26	291B956G18	092
4	FMS-04P	26-9-9-9-9-26-26-26-26-26	291B956G23	093
4	FMS-04X	9-9-9-9-26-26-26-26-26-26	291B956G27	195
4	FMS-04H	1K-1K-1K-26-26-26-26-26-26-1K	498A022G01	075
4	FMS-04M	26-10-10-26-26-26-26-26	498A027G01	077
4	FMS-04U	1K-1K-1K-1K-26-26-26-26-26-26	9672A73G01	427
3	FMS-03E	26-26-26-26-26-26-26-1K-1K-1K	716B871G11	156
2	FMS-02H	26-26-26-26-26-10-26-26-26	129A531G01	029
2	FMS-02F	26-26-26-1K-26-26-1K-26-26-26	129A534G01	032
2	FMS-02I	26-26-26-26-26-26-26-10-26	291B954G12	088
2	FMS-02E	1K-1K-26-26-26-26-26-26-26-26	291B954G13	089
2	FMS-02G	26-10-26-26-26-26-26-26-26	498A026G01	076
30	194RG-330P		FR4G014014014C	

Number of Poles	STATES Part Number	STATES Element Arrangement	ABB Part Number	ABB Rack Code

Please refer to the STATES Terminal Block and Test Switches Catalog or the FMS Bulletin for switch options and element definitions.

*Not all ABB part numbers have been cross referenced to STATES. If you have one you would like crossed, please call 800-325-4574, and we will be happy to assist you.

Switch Handle Colors Available:
R = Red, K = Black, B = Blue, Y = Yellow, N = Brown, G = Green, W = White, E = Orange
 Potentials are standard Red Handles, unless otherwise specified
 Currents are standard Black Handles, unless otherwise specified

P=1K C-C = 10 T=1

P=1K C-C = 10 T=1

P=1K C-C = 10 T=1

P=1K C-C = 10 T=1

P=1K C-C = 10 T=1