

# Hard-to-Find Connectivity and Technology Parts

## Product Guide & Catalog



Computer Parts  
KVM - Server Management  
A/V - Digital Signage  
Cables & Accessories



Fast, friendly customer service  
**1-800-265-1844**  
[www.startech.com](http://www.startech.com)



**Making hard-to-find easy!®**

StarTech.com  
**Advantage #1**  
**Your One Stop Source for Hard-to-find Parts**

With over 2000 products in 43 product lines, you'll save time and money by sourcing all your connectivity and technology parts from one convenient vendor.

StarTech.com  
**Advantage #2**  
**Free Phone, Email and Online Chat Support**

Free and fast support from our North American-based team of technology specialists takes the worry out of completing your solutions. Email responses in two hours-guaranteed!

StarTech.com  
**Advantage #3**  
**Informative, User-Friendly Web Site**

Our award-winning web site offers features, specifications, photos and exclusive tools and resources that make it easy to find and source products quickly.

*Excite customers. Succeed. Have fun!*

Exceeding your expectations is top priority at StarTech.com. That's why we developed our winning statement: "Excite customers. Succeed. Have fun!" We know we are winning as a business when we are making our winning statement happen.

We firmly believe that going the extra mile to provide you with exceptional service and ensuring we always have the hard-to-find parts you need, translates into success for both you and us.

From our award-winning web site that allows you to easily find and source the products you need to our world class service and support that provides you with free, immediate access to our technology specialists by phone, email or online chat, we're always working to make your job easier.

One of our knowledgeable representatives is looking forward to help you complete your next solution. So give us a call at 1-800-265-1844 or visit us online at [www.startech.com](http://www.startech.com) today and you'll see how StarTech.com truly makes hard-to-find easy.

**Paul Seed**  
Owner & President

**Ken Kalopsis**  
Owner & Vice President

**We're here to help!**

Contact the StarTech.com team for immediate answers to your questions.



**Three Convenient Support Options**



**Phone Support**

Speak with one of our friendly customer service or technical support representatives.  
**1-800-265-1844**



**Email Support**

Get an answer from our expert staff within 2 hours, Monday to Friday.

**[sales@startech.com](mailto:sales@startech.com)**



**Chat Online**

Get real-time support from one of our knowledgeable technical or customer support professionals via chat!

**[www.startech.com](http://www.startech.com)**

**Looking for more detailed product information, such as specifications, certifications and photos?**

**Visit our website for:**

- Detailed product information including features, applications, certifications, etc.
- Technical specifications, such as product dimensions, weights and much more...
- Quality photographs of every product
- Exclusive online tools and downloadable reference material
- Check inventory levels, find distributors and place orders online



All the information you need is available 24/7 at **[www.startech.com](http://www.startech.com)**

**Distributed by:**



**Testimonial**

“ I appreciate you getting back to me so quickly... you guys have the best customer service of anyone I've worked with. Always a pleasure dealing with you!

**Eric Schultz**  
OnSite Professional Computer Services

**Table of Contents**

**Computer Parts**

Hard-to-find Parts	Page 2
Mobility Products	Page 3
Industrial I/O Cards	Page 4-5
Consumer I/O Cards	Page 6-7
Fans and Cooling	Page 8
Power Supplies	Page 9
Drive Enclosures	Page 10-11
USB Products	Page 12-13
Networking	Page 14

**Cables & Accessories**

Custom Cables	Page 15
USB & FireWire	Page 16
Patch Cables	Page 17
Internal Cables	Page 18
Fiber Optic	Page 19
DisplayPort / AV Cables	Page 20

**A/V Solutions**

Extenders	Page 22
Converters	Page 23
Spitters	Page 24
Switches	Page 25

**Server Management**

Desktop KVM Switches	Page 26
Enterprise KVM Switches	Page 27
Server Racks	Page 28-29



Many of our products are RoHS compliant. See our website or contact us for details.

**In The News**

“ If you ever need any cable, device, or something you can't find StarTech.com is your best bet to find it. 

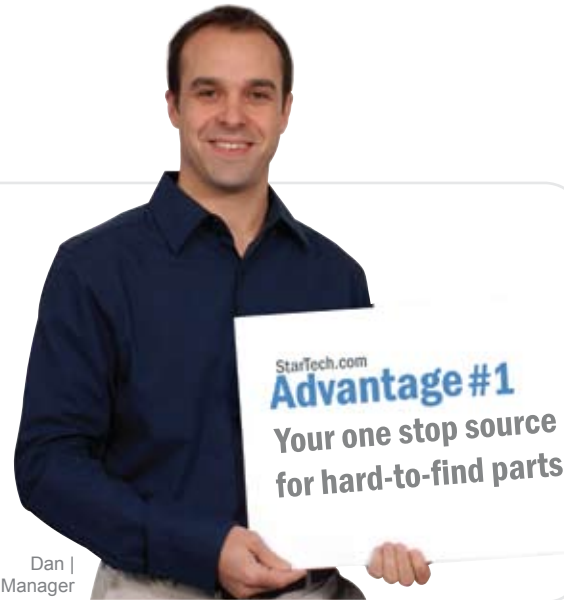

**DisplayPort to VGA Video Adapter Converter**

DP2VGA  
Connect a VGA computer monitor to a DisplayPort video card or other DisplayPort source.



**CardBus to ExpressCard Adapter**

CB2EC  
You can use this adapter to connect all of your existing CardBus cards without the hassle or expense of having to replace them.



**SATA 15 Pin Power Adapter to LP4 M/F**

LP4SATAFM  
Compatible with all IDE hard drives and easy to install.



**PCI Express to 2 PCI & 2 PCIe Expansion Enclosure System**

PEX2PCIE4L  
Expands available expansion slots by providing additional external PCI and PCIe slots.



**Slimline SATA Cable with Power**

SLSATAF20  
Allows easy connection of Slimline optical drives to standard SATA motherboards.



**DVI 1 to 2 Splitter Cable**

DVISPL1DD  
This DVI-D splitter cable makes things easy with being able to instantly connect 2 DVI-D displays to a single digital DVI source.



**2.5in SATA or USB to Dual Compact Flash SSD Adapter with RAID**

2CF2SATAR  
Allows the CF hard drive adapter to be connected directly to a Desktop or Notebook PC.



**8 Port PCI Express Low Profile Serial Adapter Card**

PEX8S950LP  
Designed to fit in small/micro form factor computer cases, making it the perfect choice when space is at a premium.

**Popular Hard-to-Find Parts**

Description	Part Number
Screws for Case Fan Mounting (Pkg. of 50)	FANSCREW
1-1/4" Dia. Self-Adhesive Rubber Feet for PC Cases (4/pkg)	RUBBERFEET
7 Pc. Precision Screwdriver Kit	CTK100P
PCI POST PC System Diagnostics Test Card with 2 x 7 Segment LED	PCIPOST
PCI Express x16 Left Slot Riser Adapter Card for 1U/2U Servers	PEX16RISER
Screws #6-32 x 1/4" long (Pkg. of 50)	SCREW6_32
P.C. Tool Kit	CTK200
ATX Case Front Bezel Wire Kit	BEZELWRKIT
Assortment of screws, nuts and standoffs	PCSCREWKIT
2.54mm Standard Jumper Caps (Pkg. of 100)	JUMPER254

**On-the-Go Solutions**

StarTech.com offers a broad selection of high quality mobility products, making it easy for you to find what you need quickly.



**In The News**

“ StarTech.com's USB to VGA Docking Station does exactly what it promises 



**USB VGA Multi Monitor External Video Adapter**

USB2VGAE2  
Can be used with up to four additional USB2VGAE2 USB video adapters, creating multiple VGA connections.



**DisplayPort to DVI Video Adapter Converter**

DP2DVI  
Lets you connect a DVI-D display to a DisplayPort video source.



**4-in-1 USB VGA Adapter and Docking Station**

USBVGADOCK  
Acts as a USB 2.0 hub allowing you to connect a keyboard, mouse, printer, audio devices, and more.



**2.5" Black eSATA/USB External Hard Drive Enclosure for SATA HDD**

SAT2510BU2E  
Archive valuable data from notebook and desktop computers, using fast 3Gb/s transfer speed.



**USB Powered Laptop Cooler with 2 Built in Fans**

NBCOOLERSE  
Ultralight size and weight for maximum portability and easy transportation.



**Professional USB to RS-232 Serial Adapter with COM Port Retention**

ICUSB2321X  
The fast and easy way to add a reliable RS232 serial port to USB enabled computers.



**CardBus to ExpressCard Laptop Adapter Card - USB Based**

EC2CBU  
Quickly and easily adapts USB based ExpressCard/34 devices to work through your laptop CardBus slot.



**USB DVI External Dual or Multi Monitor Video Adapter**

USB2DVI  
The perfect solution for turning an available USB 2.0 port into a DVI port.



**1 Port eSATA Slim ExpressCard Drive Controller Card**

ECESATA1  
1 Port Slimline eSATA ExpressCard recesses flush into slot for optimal mobility.

**Popular Mobility Products**

Description	Part Number
USB to PS2 Keyboard and Mouse Adapter	USBPS2PC
USB Stereo Audio Adapter External Sound Card	ICUSBAUDIOB
2 Port ExpressCard 1394a Firewire Card	EC13942
Compact Black USB 2.0 to 10/100 Mbps Ethernet Network Adapter	USB2106S
InfoSafe 2.5in eSATA USB 2.0 External Hard Drive Enclosure	SAT2510U2E
14-in-1 USB 2.0 High Capacity Silver Multi Media Memory Card Reader	FCREADHC
ExpressCard 12-in-1 Multi Media Memory Card Reader/Writer	ECREAD
4 ft Retractable USB 2.0 Cable A to B - M/M	USBRETAB4
2 Port CardBus Laptop USB 2.0 PC Card Adapter	CB2S950

**Parallel**

# of Ports	Bus	Type	Data Rate	Features	Part Number
1 Port	CardBus	Parallel	1.5 Mbps	Laptops	CB1PECP
1 Port	ExpressCard	Parallel	1.5 Mbps	Laptops; USB-Based EC	EC1UP
1 Port	ExpressCard	Parallel	1.5 Mbps	Laptops	EC1PECPSP
1 Port	PCI	EPP/ECP Parallel	1.5 Mbps	Incl LP Bracket	PCI1PECP
2 Port	PCI	EPP/ECP Parallel	1.5 Mbps	Incl LP Bracket	PCI2PECP
1 Port	PCI Low Profile	EPP/ECP Parallel	1.5 Mbps	-	PCI1P_LP
1 Port	PCI	EPP/ECP Parallel	1.5 Mbps	-	PCI1P
1 Port	PCI	EPP/ECP Parallel	1.5 Mbps	3.3/5.0V; Incl LP Bracket	PCI1PECPDV
1 Port	PCI Express	EPP/ECP Parallel	1.5 Mbps	Single Chip; Incl LP Bracket	PEX1P
2 Port	PCI Express	EPP/ECP Parallel	1.5 Mbps	Incl LP Bracket	PEX2PECP



1 Port PCI Express Dual Profile Parallel Adapter Card - SPP/EPP/ECP PEX1P

**Serial Cards**

# of Ports	Bus	Chipset	Type	Data Rate	Features	Part Number
1 Port	ISA	16C550	RS-232	460.8 Kbits/sec	-	ISA1S550
1 Port	PCI	16C550	RS-232	921 Kbits/sec	-	PCI1S550
1 Port	PCI	16C550	RS-232	921 Kbits/sec	Low Profile	PCI1S550_LP
1 Port	PCI	16C650	RS-232	921 Kbits/sec	Dual Voltage	PCI1S650PW
2 Port	ISA	16C550	RS-232	460.8 Kbits/sec	-	ISA2S550
2 Port	PCI	16C550	RS-232	921 Kbits/sec	-	PCI2S550
2 Port	PCI	16C550	RS-232	921 Kbits/sec	Low Profile	PCI2S550_LP
2 Port	PCI	16C950	RS-422/485	921 Kbits/sec	-	PCI2S485
2 Port	PCI	16C950	RS-422/485	921 Kbits/sec	Low Profile	PCI2S485LP
2 Port	PCI	16C554	RS-422/485	115.2 Kbits/sec	Optically Isolated	PCI2S422ISO
2 Port	PCI	16C650	RS-232	921 Kbits/sec	Dual Voltage	PCI2S650PW
2 Port	PCI	16C950	RS-232	460.8 Kbits/sec	-	PCI2S950
2 Port	PCI	16C950	RS-232	460.8 Kbits/sec	Dual Voltage	PCI2S950DV
2 Port	PCI Express	16C950	RS-232	460.8 Kbits/sec	-	PEX2S950
4 Port	PCI	16C550	RS-232	921 Kbits/sec	1 slot with breakout cable	PCI4S550
4 Port	PCI	16C550	RS-232	921 Kbits/sec	2 slots	PCI4S550N
4 Port	PCI	16C554	RS-422/485	230.4 Kbits/sec	-	PCI4S422DB9
4 Port	PCI	16C554	RS-422/485	230.4 Kbits/sec	Optically Isolated	PCI4S422ISO
4 Port	PCI	16C650	RS-232	921 Kbits/sec	Dual Voltage	PCI4S650PW
4 Port	PCI	16C950	RS-232	115.2 Kbits/sec	-	PCI4S950
4 Port	PCI	16C950	RS-232	921 Kbits/sec	-	PCI4S9503V
4 Port	PCI Express	16C950	RS-232	115.2 Kbits/sec	-	PEX4S950
8 Port	PCI	16C950	RS-232	921 Kbits/sec	-	PCI8S9503V
8 Port	PCI Express	16C950	RS-232	921 Kbits/sec	Low Profile	PEX8S950LP



2 Port ISA RS232 Serial Adapter Card with 16550 UART ISA2S550



8 Port Buffered High-Speed 16950 Serial PCI Card PCI8S9503V

**Single Chip PCIe Serial Cards - NEW (48% Less load on CPU)**

# of Ports	Bus	Chipset	Type	Data Rate	Features	Part Number
1 Port	PCI Express	16C550	RS-232	460.8 Kbits/sec	Dual Profile	PEX1S552
1 Port	PCI Express	16C950	RS-232	460.8 Kbits/sec	Oxford Chip, Dual Profile	PEX1S952
2 Port	PCI Express	16C550	RS-232	460.8 Kbits/sec	Dual Profile	PEX2S552
2 Port	PCI Express	16C950	RS-232	460.8 Kbits/sec	Oxford Chip, Dual Profile	PEX2S952
4 Port	PCI Express	16C550	RS-232	460.8 Kbits/sec	Dual Profile	PEX4S552
4 Port	PCI Express	16C550	RS-232	250 Kbits/sec	Low Profile, Breakout cable	PEX4S552B
1 Port	PCI Express	8161B/88E1111	Multi-Mode	1000 Mbts/sec	Gigabit Fiber SC	PEX1000MMS
4 Port	PCI Express	16C950	RS-232	460.8 Kbits/sec	Oxford Chip, Dual Profile	PEX4S952
8 Port	PCI Express	16C950	RS-232	460.8 Kbits/sec	Oxford Chip, Dual Profile	PEX8S952



4 Port PCI Express RS232 Serial Adapter Card with Breakout Cable PEX4S552B

**Combo Cards / Multi-Packs**

# of Ports	Bus	Chipset	Type	Data Rate	Features	Part Number
2 Serial, 1 Parallel	PCI	16C550	RS-232 + EPP/ECP	460.8 Kbits/sec & 1.5 Mbts/sec	-	PCI2S1P
2 Serial, 1 Parallel	PCI Express	16C550	RS-232 + EPP/ECP	460.8 Kbits/sec & 1.5 Mbts/sec	Single Chip, Dual Profile	PEX2S5521P
2 Serial, 1 Parallel	PCI Express	16C550	RS-232 + EPP/ECP	250 Kbits/sec & 1.5 Mbts/sec	Low Profile, Breakout cable	PEX2S1P552B
1 Port	PCI	16C550	RS-232	921 Kbits/sec	10 Pack	10PKPCI1S550
2 Port	PCI	16C550	RS-232	921 Kbits/sec	10 Pack	10PKPCI2S550



2S1P Native PCI Express Parallel Serial Combo Card with 16550 UART PEX2S5521P

For more products & detailed information visit [www.startech.com/iocards](http://www.startech.com/iocards)

**USB to Serial**

# of Ports	Type	Features	Part Number
1 Port	RS-232	Lowest Price	ICUSB232
1 Port	RS-232	Com Port Retention	ICUSB232PRO
1 Port	RS-232	Com Port Retention and Renaming	ICUSB2321X
2 Port	RS-232	-	ICUSB232C2
2 Port	RS-232	-	ICUSB232HUB2
4 Port	RS-232	-	ICUSB2324
2 Port	RS-232	Com Port Retention and Renaming	ICUSB2322X
4 Port	RS-232	Com Port Retention and Renaming	ICUSB2324X
8 Port	RS-232	-	ICUSB2328
1 Port	RS-422/485	Isolated Circuits	ICUSB422IS



Professional USB to RS-232 Serial Adapter ICUSB2321X

**Expresscard/Cardbus to Serial**

# of Ports	Bus	Chipset	Type	Features	Part Number
1 Port	Expresscard	16C950	RS-232	USB Based	EC1S232U
1 Port	Cardbus	16C950	RS-422/485	-	CB1S485
2 Port	Cardbus	16C950	RS-232	-	CB2S950
4 Port	Cardbus	16C950	RS-232	-	CB4S950
1 Port	Expresscard	16C950	RS-232	-	EC1S950
2 Port	Expresscard	16C950	RS-232	-	EC2S950
4 Port	Expresscard	16C950	RS-232	-	EC4S950
1 Port	Expresscard	16C950	RS-232	Single Chip Architecture	EC1S952
2 Port	Expresscard	16C950	RS-232	Single Chip Architecture	EC2S952



4 Port Native PCI Express RS232 Serial Adapter Card with 16550 UART PEX4S552

**Powered USB/USB PlusPower**

# of Ports	Bus	Port Voltages	Features	Part Number
3 Port	PCI	3 x 12V	-	PCI312PUSB
3 Port	PCI	3 x 12V	Low Profile Bracket	PCI312PUSBLP
3 Port	PCI Express	3 x 12V	-	PEX312PUSB
3 Port	PCI Express	3 x 12V	Low Profile Bracket	PEX312PUSBLP
2 Port	Motherboard	1 x 24V, 1 x 12V	Requires No PCI or PCIE Connection from a PC	PUSBADAP
2 Port	Motherboard	1 x 24V, 1 x 12V	Low Profile Bracket, Requires No PCI or PCIE Connection from a PC	PUSBADAPLP
3 Port	PCI	1 x 24V, 2 x 12V	Low Profile, highest total voltage	PCI1224PUSB



3 Port LP PCI Express 12V Powered USB Adapter Card - USB PlusPower PEX312PUSBLP

For more products & detailed information visit [www.startech.com/iocards](http://www.startech.com/iocards)

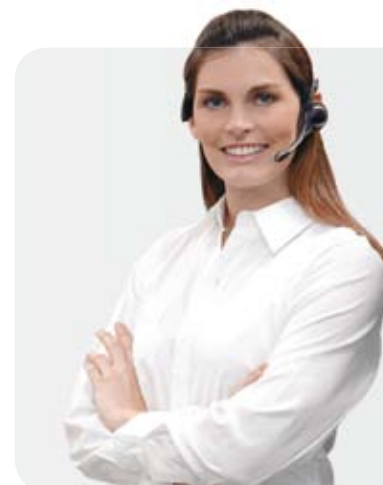

StarTech.com's new ConXit Connection Wizard helps you find the right converter, extender, splitter, interface card or cable in two easy steps!

Visit: [www.startech.com/conxit](http://www.startech.com/conxit)



## Added Functionality, Increased Productivity

## Wide Selection

Quickly find the right card for any application to optimize system performance.

## Functionality

StarTech.com I/O cards can help you add new capabilities to your systems, helping to maximize productivity.

**USB**

# of Ports	Bus	Type	Data Rate	Features	Part Number
2 Ports	Cardbus	USB 2.0	480Mbps	Laptops	CBUSB22
4 Ports	Cardbus	USB 2.0	480Mbps	Laptops	CB420USB
2 Ports	Express Card	USB 2.0	480Mbps	Laptops	EC230USB
4 Port	Express Card	USB	480 Mbps	Laptops	EC400USB
3 Ports	PCI	USB 2.0	480Mbps	2 Ext / 1 Int	PCI220USB
3 Ports	PCI Low Profile	USB 2.0	480Mbps	2 Ext / 1 Int	PCI220USBLP
4 Ports	PCI	USB 2.0	480Mbps	3 Ext / 1 Int	PCI330USB2
5 Ports	PCI	USB 2.0	480Mbps	4 Ext / 1 Int	PCI420USB
6 Ports	PCI	USB 2.0	480Mbps	4 Ext / 2 Int	PCI625USB2I
5 Ports	PCI Express	USB 2.0	480Mbps	4 Ext / 1 Int	PEX400USB2

**FireWire**

# of Ports	Bus	Type	Data Rate	Features	Part Number
2 Ports	Cardbus	FireWire	400Mbps	Laptops; Digital Video Kit Included	CB1394_2
3 Ports	Cardbus	FireWire	400Mbps	Laptops; Digital Video Kit Included	CB1394
3 Ports	Cardbus	FireWire 800	800Mbps	Laptops	CB1394B3
2 Ports	Express Card	FireWire	400Mbps	Laptops	EC13942
2 Ports	Express Card	FireWire	400 / 800Mbps	Laptops; 1 x 1394a / 1 x 1394b	EC13941A1B
2 Ports	Express Card	FireWire 800	800Mbps	Laptops	EC1394B2
3 Ports	PCI	FireWire	400Mbps	2 Ext / 1 Int; DV Kit	PCH1394_2
3 Ports	PCI Low Profile	FireWire	400Mbps	2 Ext / 1 Int; DV Kit	PCI1394_2LP
3 Ports	PCI	FireWire 800/400	800 / 400Mbps	2x1394b / 1x1394a; DV Kit	PCH1394B_3
4 Ports	PCI	FireWire	400Mbps	3 Ext / 1 Int; DV Kit	PCH1394_4
4 Ports	PCI	FireWire	400Mbps	DV Kit; PC/Mac; Incl LP Bracket	PCI1394MP
2 Ports	PCI Express	FireWire	400Mbps	Single Chip; LP Bkt	PEX1394A2
2 Ports	PCI Express	FireWire	400Mbps	Single Chip; DV Kit; LP Bkt	PEX1394A2DV
4 Ports	PCI Express	FireWire	400Mbps	3 Ext / 1 Int; LP Bkt	PEX13943
3 Ports	PCI Express	FireWire 800/400	800 / 400Mbps	2x1394b / 1x1394a; Single Chip, LP	PEX1394B3

**Combo**

# of Ports	Bus	Type	Data Rate	Features	Part Number
3 Ports	PCI	Combo	115Kbps, 1.5Mbps	2 Serial, 1 ECP/EPP Parallel	PCI2S1P
3 Ports	ExpressCard	Combo	400Mbps; 480Mbps	Laptops; 2 Firewire; 1 USB	EC1U2F
5 Ports	PCI	Combo	480Mbps, 400Mbps	3 USB, 2 FireWire	PCI3UV22F
3 Ports	PCI Express	Combo	230.4Kbps, 1.5Mbps	2 Serial, 1 Parallel	PEX2S1P
2 Ports	PCI 3.3/5.0V	Combo	920Kbps, 1.5Mbps	1 Serial, 1 Parallel	PCI2S1PDV
3 Ports	PCI 3.3/5.0V	Combo	920Kbps, 1.5Mbps	2 Serial, 1 Parallel	PCI2S1PDVLP

**eSATA / SATA**

# of Ports	Bus	Type	Data Rate	Features	Part Number
2 Port	Cardbus	eSATA	150 Mbps	Laptop; 2 Ext. 32 bit CardBus	CBESAT2
1 Port	Express Card	eSATA	300 Mbps	Slimline, PM Support, 34 mm	ECESATA1
1 Port	Express Card	Power eSATA	300 Mbps	1 Ext. 5V Power; PM Support	ECESATUSB1
2 Port	Express Card	eSATA	300 Mbps	2 Ext, Port Multiplier, Single Chip	ECESATA22
2 Port	Express Card	eSATA	300 Mbps	2 Ext, Port Multiplier, Single Chip	ECESATA254
2 Port	PCI	eSATA/SATA	150 Mbps	1 Internal AND 1 External	PCIESATA2I
4 Port	PCI	SATA	150 Mbps	RAID 0,1; LP Bracket	PCISATA4R1
2 Port	PCI Express	eSATA/SATA	300 Mbps	1 Int OR 1 Ext, PM, Single Chip; LP Bkt	PEXESATA1
2 Port	PCI Express	eSATA/SATA	300 Mbps	1 Int AND 1 Ext, PM, Single Chip; LP Bkt	PEXESATA2I
2 Port	PCI Express	eSATA	300 Mbps	2 Ext, PM, Single Chip; LP Bkt	PEXESATA2
2 Port	PCI Express	SATA	300 Mbps	2 Port SATA, PM, Single Chip	PEXSATA22I
6 Port	PCI Express	SATA/eSATA	300 Mbps	4 Int / 2 Ext, Port Multiplier	PEXSATA24E

For more products & detailed information visit [www.startech.com/iocards](http://www.startech.com/iocards)**IDE / SATA**

# of Ports	Bus	Type	Data Rate	Features	Part Number
2 IDE	PCI	ATA/IDE	133 Mbps	Dual Channel - Support 4 Drives	PCIIDE2
1 IDE	PCI Express LP	IDE/133	133 Mbps	1 Channel (2 Drives); Dual Profile	PEX2IDE
2 SATA, 1 IDE	PCI	SATA/IDE	150 Mbps	Combo, Dual Profile; LP Bracket	PCISAT2IDE1
1 eSATA/SATA, 2 IDE	PCI Express	SATA/IDE	300 Mbps	Combo, Dual Channel IDE, RAID 0,1	PEXSAT2IDE2

1 Port PCI Express IDE Controller Adapter Card PEX2IDE

**Bridging Adapters / Converters**

Host to Peripheral	Host System	Bus/Connector	Features	Part Number
EC to PCMCIA/CardBus	Laptop	ExpressCard	Laptops; Wireless, Industrial, Legacy	CB2EC
PCMCIA/CardBus to EC	Laptop	CardBus	Laptops; USB-Based ExpressCard/34	EC2CBU
PCI to PCMCIA/CardBus	Desktop	PCI 3.3/5.0 V	Single Card Port; PCI or PCI-X	PCI2PCMCIA1E
PCI to PCMCIA/CardBus	Desktop	PCI 3.3/5.0 V	Dual Card Ports; PCI or PCI-X; LP Bkt	PCI2PCMCIA2
PCI to Mini PCI	Desktop	PCI 3.3/5.0 V	Mini PCI Wireless; PCI or PCI-X	PCI2MPCIB
PCI Express to ExpressCard	Desktop	PCI Express	Supports 34 and 54mm EC	PEX2EC
PCI Express to ExpressCard	Desktop	PCI Express	34 and 54mm; Std & Low Profile Bkt	PEX2ECDP
PCI Express to ExpressCard	Desktop	PCI Express	34 and 54mm; 3.5" or 5.25" Bay	PEX2EC35
PCI Express to PCI/PCIe	Desktop/Laptop	PCI Express	Expansion box with 2 PCI + PCIe	PEX2PCIE4L
PCI Express to PCI	Desktop/Laptop	PCI-Express	4 Slot PCI Expansion Bay	PEX2PC14
ExpressCard to PCI	Laptop	ExpressCard	Connect PEX2PC14 to Laptop	EC2PCI
SATA to IDE	Desktop/Server	IDE HD to Adapter; SATA to Mb	Connect IDE HD to SATA System	SATA2ATA133
IDE to SATA	Desktop/Server	Keyed IDE Connection to Mb	Connect 2 SATA HD to IDE System	PATA2SATA2
IDE to SATA	Desktop/Server	Adapter to HD; IDE 40pin Cable from Mb	Connect SATA HD to IDE System	IDE2SAT
IDE to SATA	Desktop/Server	Adapter to IDE Mb; SATA to HD	Connect 2.5 or 3.5" SATA to IDE	IDE2SAT25

ExpressCard to CardBus Laptop Adapter PC Card CB2EC

Dual Profile PCI Express to ExpressCard Adapter PEX2ECDP

**Compact Flash Adapters**

Host to Peripheral	Host System	Connector	Features	Part Number
IDE to CF	Desktop	IDE 40 or 44 pin	Fits in 3.5" Bay; CF & Micro-Drive	35BAYCF2IDE
SATA to CF	Desktop	SATA Data; SP4	Fits in 3.5" Bay; CF & Micro-Drive	35BAYCF2SAT
1.8" IDE to CF	Laptop; iPod	ZIF/LIF 40 pin	Bootable Solid State Drive; CF or M-D	ZIF2CF
1.8" or 2.5" IDE to CF	Laptop	IDE 44 pin	Bootable Solid State Drive; CF or M-D	CF2IDE18
1.8" IDE to CF	Laptop	IDE 50 pin	SSD Enclosure Size, Bootable	IDE502CFE
IDE 2.5" to CF	Laptop/Desktop	IDE 44 pin	Bootable SSD; Dual CF or Micro-Drives	CF2X2IDE25
1.8" Micro SATA to CF	Laptop	MicroSATA	SSD Enclosure Size, Bootable	CF2USAT18E
SATA to CF	Laptop/Desktop	SATA 22pin (Data/Power)	Bootable Solid State Drive; CF or M-D	SAT2CF
IDE to CF	Desktop	IDE 40 or 44 pin	Bootable SSD; CF or M-D; Rear PCI	PLATEIDE2CF
IDE 3.5" to CF	Desktop	IDE 40 pin	Bootable Solid State Drive; CF or M-D	IDE2CFINT
2.5"/3.5" IDE to CF	Laptop/Desktop	IDE 44 or 40 pin	Bootable Solid State Drive; CF or M-D	IDE2CF
SATA to Dual CF	Laptop	SATA 22 Pin	RAID 0,1, BIG; Bootable SSP	2CF2SATAR

Dual Profile PCI Express to ExpressCard Adapter IDE2SAT25

SATA to Compact Flash SSD Adapter SAT2CF

**Media Card Readers**

Type	Host System	Bus	Features	Part Number
Single Slot; 12-in-1	Laptop	ExpressCard 34/54	SD/MMC/MS/MS PRO/XD	ECREAD
Single Slot	Laptop	ExpressCard 34mm	Compact Flash & Micro-Drives	CF2EC

ExpressCard 12-in-1 Multi Media Memory Card ECREAD

**Video Cards**

# of Ports	Bus	Resolution	Features	Part Number
Single VGA	PCI	1280 x 1024 (32Bit)	Server, Thin Client, Industrial	PCIVGAV7

**Sound Cards**

Ports	Bus	Type	Features	Part Number
Audio Out, Line in, Mic, MIDI	PCI	4 Channel	Legacy Audio SBPro	PCISOUND4CH
Audio Out, Line in, Mic	PCI Low Profile	4 Channel	AC97 3D Audio, Incl LP Bracket	PCISOUND4LP
Audio Out, Line in, Mic, MIDI	PCI	5.1 Channel	Legacy Audio SBPro; 3D Audio; Game Port	PCISOUND5CH
Audio Out, Line in, Mic, MIDI	PCI Low Profile	5.1 Channel	Dolby Digital EX; 96 Kbs / 24 bit Audio	PCISOUND5LP
Audio Out, Line in, Mic, MIDI	PCI	7.1 Channel	Dolby Digital EX; DirectSound™, 2 Audio Inputs	PCISOUND7

4 Channel Low Profile PCI Sound Adapter Card AC97 3D Audio Effects PCISOUND4LP

**SCSI Cards**

# of Ports	Bus	Type	Data Rate	Features	Part Number
1 Port	PCI	Ultra Wide 68 pin	40 Mbyte/sec.	Up to 15 Wide SCSI devices supported	PCISC5IUW

**Other Cards & IO**

Description	Part Number
PCI Express 1x Riser Card	PCIE1RIS
PCI Express 1x to 4x, 8x, 16x Low Profile Adapter	PEX1TO16
Black 3.5" Drive Bay Multi-Port Panel w/ eSATA	35BAYPANELBK

PCI Express x1 Left Slot Riser Adapter Card for Low Profile System PCIE1RIS

5 Port PCI Express USB 2.0 Adapter Card PEX400USB2

2 Port 1b 1a ExpressCard 34mm Laptop 1394 FireWire Adapter Card EC13941A1B

2 Port 1b 1a ExpressCard 34mm Laptop 1394 FireWire Adapter Card PEX1394B3

2 Port ExpressCard 54mm eSATA Controller Adapter Card ECESATA254

4 Port PCI Express x4 SATA II Card PEXSATA24E

# Cooling Solutions

## Reliable

We provide a reliable foundation for any replacement, upgrade or system build.

## Versatile

Our cooling solutions are designed to suit virtually any system configuration.



### CPU Coolers

Types	Suited For	Fan Type	Material	Part Number
Socket T/775	Core 2 Duo Quad Processor	95mm/BB	Aluminum	FAN775E
AMD/Intel/Socket T/ 775	1U Dual Core & High Speed P4	70mm/DBB	Copper	FAN7751U
AMD/Universal	K8 family, Socket AM2/939/940/754	92mm/BB	Aluminum	FANK8AM2
AMD/Universal	K8 family, Socket AM2/939/940/754 - Athlon, Opteron, Sempron	92mm/BB	Aluminum	FANK8AM21U
Universal Intel P4/AMD	P3 (370), P4 (478) to 3.2 GHz, K7/K8 (A/939/940/754)	70mm/BB	Aluminum	UNIVERSALHSF
Universal/Socket AM2	3 HP, P3, P4, Dual Core, (478/775) K7/K8 (754,939,940,AM2)	92mm/BB	Aluminum	FAN939775HP
Socket 478	P4 up to 2.8 GHz	60mm/BB	Aluminum	FAN478
Socket 423	P4 up to 2GHz	60mm/BB	Aluminum	FANP4
Socket 7/370	K-6 to 500 MHz (socket 7) and P3/Celeron (socket 370)	50mm/BB	Aluminum	FANP1003LD
Socket 7/370	P3, Celeron up to 1.4GHz, AMD K6	60mm/BB	Aluminum	FAN370PRO
Socket 7/370	1U Server Design, P3/Celeron & Athlon/Duron to 1GHZ	60mm/BB	Copper	FAN3701U
Socket A, Socket 370	Athlon XP	60mm/BB	Aluminum	FANATHLON
Socket A, Socket 370	Duron, Thunderbird, to 1300 MHz & XP to 2000 MHz	60mm/BB	Aluminum	FANDURONTB
VGA Card	Chipsets, Video Cards - nVIDIA and ATI	40mm/BB	Copper	FANUNIVGA

Retail-Ready

### Notebook Cooler

Types	Suited For	Fan Type	Color	Part Number
Two Fans	Portable, Ergonomic	Plastic	Black	NBCOOLERSE
Two 80mm Fans	Ultra light, quiet 19 dBA noise level, up to 15"	Plastic	Black	NBCOOLERLE
Four 60mm Fans	Portable, lightweight design variable speed, up to 15"	Plastic	Black	NBCOOLER
Two 70mm Fans	Combined cooler, plus card reader and USB hub, up to 15"	Aluminum	Silver	NBCOOLERPRO
Fan	Air extracting notebook fan with 2 speed control, 180° rotatable	Plastic	Black	NBFAN

Retail-Ready

### Case / CPU / Other Fans

Types	Suited For	Fan Type	Connector	Part Number
Case	40 x 40 x 10mm	Dual Ball Bearing	LP4	FAN4X1LP4
Case	50x50x10mm	Dual Ball Bearing	LP4/TX3	FAN5X1TX3
Case	50x50x15mm	Dual Ball Bearing	TX3	FAN5X15TX3
Case	60x60x10mm	Dual Ball Bearing	TX3	FAN6X1TX3
Case/CPU Cooler	70x70x15mm	Dual Ball Bearing	TX3	FAN7X15TX3
Case/CPU Cooler	70x70x15mm	Dual Ball Bearing	TX3	FAN7X25TX3
Case	80x80x25mm	Dual Ball Bearing	TX3	FAN8X25TX3L
Case	80x80x25mm	Ever Lubricate Bearing	LP4	FANBOXSL
Case	92x92x25mm	Ball Bearing	LP4	FANBOX92
Case	120x120x25mm	Ball Bearing	LP4	FANBOX12
Exhaust Video Card	110x90x20mm	Ball Bearing	LP4	FANCASE
Hard Drive, Triple Fans	40x40x20mm	Ball Bearing	LP4	FANDRIVEBK
Hard Drive, Dual Fans	40x40x20mm	Ball Bearing	LP4	FANDRIVE2BK
DDR/SDRAM	126x27x7mm	Aluminum	N/A	RAMCOOLERBL

Retail-Ready

# Powerful Performance, Lasting Reliability

## Wide Selection

A broad range of styles and outputs to suit the requirements of most Intel and AMD based systems.

## High Quality

The high quality design of our power supplies ensures a dependable and reliable performance, suitable for a wide range of environments.



550 Watt Professional ATX12V 2.01 Power Supply with PCI Express and SATA ATX2PW550PRO



Reliable 400 Watt ATX12V 2.01 Power Supply with 20 and 24-pin Connectors ATX2POWER400



400 Watt ATX12V 2.01 Dell PC Replacement Power Supply ATXPW400DELL



400 Watt Silent ATX12V 2.01 P4 Power Supply with 12cm Fan ATX2POW400HS



400 Watt Silent ATX12V 2.01 P4 Power Supply with 12cm Fan MICATXPOW255



4U Black Rackmount PC Case with 450 Watt P4 Power Supply RMC4450

### Professional Series

Wattage	MTBF	Fan	ATX 12V	Mb Support	Other	Part Number
250	100,000	80 mm Dual Ball Bearing	1.3	20 pin	Aux 6 Pin	ATXPOW250PRO
300	100,000	80 mm Dual Ball Bearing	1.3	20 pin	Aux 6 Pin	ATXPOW300PRO
350	100,000	80 mm Dual Ball Bearing	1.3	20 pin	-	ATXPOW350PRO
400	100,000	80 mm Dual Ball Bearing	2.01	24/20 pin	Dual 12V / PCI-E / SATA	ATX2PW400PRO
450	100,000	80 mm Dual Ball Bearing	2.01	24/20 pin	Dual 12V / PCI-E / SATA	ATX2PW450PRO
500	100,000	80 mm Dual Ball Bearing	2.01	24/20 pin	Dual 12V / PCI-E / SATA	ATX2PW500PRO
550	100,000	120 mm Dual Ball Bearing	2.01	24/20 pin	Dual 12V / PCI-E / SATA	ATX2PW550PRO

Retail-Ready

### Reliable Series

Wattage	MTBF	Fan	ATX 12V	Mb Support	Other	Part Number
250	100,000	80 mm Sleeve Bearing	1.3	20 pin	Aux 6 Pin	ATXPOWER250
300	100,000	80 mm Sleeve Bearing	1.3	20 pin	Aux 6 Pin	ATXPOWER300
350	100,000	80 mm Sleeve Bearing	2.01	24/20 pin	Dual 12V / PCI-E / SATA	ATX2POWER350
400	100,000	80 mm Sleeve Bearing	2.01	24/20 pin	Dual 12V / PCI-E / SATA	ATX2POWER400
450	100,000	80 mm Sleeve Bearing	2.01	24/20 pin	Dual 12V / PCI-E / SATA	ATX2POWER450

Retail-Ready

### Dell Replacements

Wattage	MTBF	Fan	ATX 12V	Mb Support	Other	Part Number
350	100,000	80 mm Sleeve Bearing	2.01	20/24 pin	For a complete list of compatible models please visit our website	ATXPW350DELL
400	100,000	80 mm Sleeve Bearing	2.01	20/24 pin		ATXPW400DELL

Retail-Ready

### Silent

Wattage	MTBF	Fan	ATX 12V	Mb Support	Other	Part Number
400	100,000	120 mm Dual Ball Bearing	2.01	24/20 pin	Dual 12V/PCI-E/SATA	ATX2POW400HS
450	100,000	120 mm Dual Ball Bearing	2.01	24/20 pin	Dual 12V / PCI-E / SATA	ATX2POW450HS
500	100,000	120 mm Dual Ball Bearing	2.01	24/20 pin	Dual 12V / PCI-E / SATA	ATX2POW500HS

Retail-Ready

### Specialized

Wattage	MTBF	Fan	ATX 12V	Mb Support	Other	Part Number
350	100,000	80 mm Ball Bearing	1.3	20 pin	Dual Fans	ATXPOW350DF
400	100,000	80 mm Ball Bearing	1.3	20 pin	Dual Fans	ATXPOW400DF
145	100,000	80 mm Sleeve Bearing	1.3	20 pin	MicroATX	MICATXPOW145
255	100,000	80 mm Sleeve Bearing	1.3	20 pin	MicroATX	MICATXPOW255

Retail-Ready

### PS/2

Wattage	MTBF	Fan	Other	Part Number
230	40,000	Sleeve Bearing	PS/2 - Style	PS2POWER230

Retail-Ready

### Rackmount Cases

Types	Color	Height	Power Supply	Part Number
Rackmount	Black	4U	450 W	RMC4450
Rackmount	Black	4U	None	RMC40001

For more products & detailed information visit [www.startech.com/fans](http://www.startech.com/fans)

For more products & detailed information visit [www.startech.com/powersupply](http://www.startech.com/powersupply)

# Versatile Drive Enclosures

## Innovative

Turn hard drives into dynamic storage options while adding innovative capabilities.

## Sturdy

Designed and built to last, our external hard drive enclosures are able to withstand virtually any environment.

## Dependable

Constructed from high quality materials and designed to offer a durable, secure way to store valuable data.



### In The News

“StarTech.com makes it easy to build custom portable hard drives that are perfect for transporting and safekeeping large files”



### Portable/Laptop

Drive Type	Drive Size	Connection	Construction	Color	Features	Part Number
IDE	1.8"	USB 2.0	Aluminum	Silver	Low / Zero Insertion Force	IDE1810U2Z
IDE	2.5"	USB 2.0	Aluminum	Silver	Portability	IDE2510U2
Serial ATA	2.5"	USB 2.0	Aluminum	Silver	Portability	SAT2510U2
Serial ATA	2.5"	USB 2.0	Aluminum	Black	Portability	SAT2510BU2
Serial ATA	2.5"	USB 2.0	Aluminum	Black	Portability; OTB	SAT2510BU2B
Serial ATA	2.5"	eSATA / USB 2.0	Aluminum	Silver	eSATA 3 Gb/s	SAT2510U2E
Serial ATA	2.5"	eSATA / USB 2.0	Aluminum	Black	eSATA 3 Gb/s	SAT2510BU2E
Serial ATA	Dual 2.5"	eSATA/USB 2.0	Aluminum	Black	Two 2.5" HD; RAID	SAT2520U2ER

Retail-Ready

### IDE/ATA

Drive Type	Drive Size	Connection	Construction	Color	Features	Part Number
IDE	3.5"	USB 2.0	Aluminum	Silver	One-Button Backup	IDECASE35U2B
IDE	5.25"	USB 2.0	Aluminum	Silver	HDD / CD / DVD	IDECASE525U2

Retail-Ready

### Desktop

Drive Type	Drive Size	Connection	Construction	Color	Features	Part Number
Serial ATA	3.5"	USB 2.0	Aluminum	Silver	SATA HD	SAT3510U2V
Serial ATA	3.5"	USB 2.0	Aluminum	Black	SATA HD	SAT3510BU2V
Serial ATA	3.5"	USB 2.0	Aluminum	Silver	SATA HD, Fan, OTB	SAT3510U2B
Serial ATA	3.5"	eSATA/USB 2.0	Aluminum	Black	SATA, Fan, Removable Trayless HD	SAT3510BU2E
Serial ATA / IDE	3.5"	USB 2.0	Aluminum	Black	SATA / IDE HD	UNI3510U2
Serial ATA/IDE	3.5"	eSATA/ USB 2.0	Aluminum	Silver	Screwless, Fan, OTB	UNI3510U2E
Serial ATA / IDE	3.5"	eSATA/USB 2.0	Aluminum	Black	Screwless, Fan, OTB	UNI3510U2EB
Serial ATA	5.25"	eSATA / USB 2.0	Aluminum	Silver	SATA DVD / CD / HD/ Blu - Ray	SAT5210U2E

Retail-Ready

### Multi Drive / RAID

Drive Type	Drive Size	Connection	Construction	Color	Features	Part Number
Serial ATA	Dual 3.5"	USB 2.0	Aluminum	Silver	JBOD	SAT3520U2
Serial ATA	Dual 3.5"	USB 2.0	Aluminum	Char / Black	Dual HD / RAID 0/1	SAT3520U2R
Serial ATA	Dual 3.5"	eSATA/USB 2.0	Aluminum	Silver	Dual HD / RAID 0/1	SAT3520U2ER
Serial ATA	Dual 3.5"	eSATA/USB 2.0	Aluminum	Silver	Removable Trays; RAID 0,1	S352U2RER
Serial ATA	4 x3.5"	eSATA	Aluminum	Black	4 Drives, RAID, 0,1,1+0	SAT3540ER

Retail-Ready

### HD Docking Storage

Drive Type	Drive Size	Connection	Construction	Color	Features	Part Number
Serial ATA	2.5" / 3.5"	USB 2.0	Aluminum	Black	Easy connect, No enclosure	SATADOCKU2
Serial ATA	2.5" / 3.5"	eSATA / USB 2.0	Aluminum	Black	Easy connect, No enclosure	SATADOCKU2E
Serial ATA	Dual 2.5" / 3.5"	eSATA / USB 2.0	Aluminum	Black	Dual Hard Drives 2.5 or 3.5"	SATADOCK22UE
Serial ATA	Dual 2.5" / 3.5"	USB 2.0	Plastic	Black/Silver	Dual Hard Drive Duplicator	SATDOCK22R

Retail-Ready

# Removable Storage Solutions

## Versatile

We offer a wide range of removable hard drive enclosures to help you find the perfect fit for your mobile storage solutions.

## Convenient

Our removable hard drive enclosures provide the compatibility and ease of use required for easy integration into any solution.



### Internal/External Combo

Drive Type	Style	Construction	Color	Features	Part Number
Serial ATA	3.5" & 5.25" Bays	Aluminum	Silver	Internal Removable 2.5"/ External (USB) Storage	SAT2510U2REM
Serial ATA	2.5" Enclosure	Aluminum	Silver	Ext. 2.5" USB 2.0 Enclosure for SAT2510U2REM	SAT2510U2S
Serial ATA	5.25" Bay	Aluminum	Silver	Internal Removable 3.5"/ External (USB) Storage	SAT3510U2REM

Retail-Ready

### Trayless

Drive Type	Style	Construction	Color	Features	Part Number
Serial ATA	Single 5.25" Bay	Aluminum	Black	Internal Mount; Fast Swap 3.5" HD; Keylock; LED	HSB100SATBK
Serial ATA	PCI Slot	Aluminum	Black	Internal PCI Slot, Single 2.5" Trayless Bay	S25SLOTR
Serial ATA	Single 5.25" Bay	Aluminum	Black	Internal Mount; Fast Swap Dual 2.5" HD	HSB220SAT25B
Serial ATA	Two 5.25" Bays	Aluminum	Black	Internal Mount; 3 x 3.5" HD Backplane	HSB320SATBK
Serial ATA	Three 5.25" Bays	Aluminum	Black	Internal Mount; 4 x 3.5" HD Backplane	HSB430SATBK
Serial ATA	Single 5.25" Bay	Plastic	Black	Internal Mount, 1 x each 2.5" x 3.5" or 2" x 2.5" HD	SATADOCK525

Retail-Ready

### SATA Drive Drawer / Mobile Rack

Drive Type	Style	Construction	Color	Features	Extras Available	Part Number
Serial ATA	Value	Plastic	Black	3Gb/s Transfer	Caddy (DRW110CADSBK)	DRW110SATBK
Serial ATA	Rugged	Plastic, Aluminum	Black	Two Fans	Caddy (DRW113CADSBK)	DRW113SATBK
Serial ATA	Durable	Aluminum	Black	3Gb/s Transfer	Caddy (150CADSBK)	DRW150SATBK
Serial ATA	Professional	Aluminum	Black	Shock Absorbers	Caddy (DRW115CADSBK)	DRW115SATBK

Retail-Ready

### SATA Backplanes

Drive Type	Style	Construction	Color	Features	Extras Available	Part Number
Serial ATA	2 Bay	Aluminum	Black	3 Hard Drives	Tray (SATATRAYBK)	SATABAY3BK
Serial ATA	3 Bay	Aluminum	Black	4 Hard Drives	Tray (SATATRAYBK)	SATABAY4BK
Serial ATA	3 Bay	Aluminum	Black	5 Hard Drives	Tray (SATATRAYBK)	SATABAY5BK

### IDE Drive Drawer / Mobile Rack

Drive Type	Style	Construction	Color	Features	Extras Available	Part Number
IDE ATA 133	Value	Plastic	Black	3 K Insertion Cycle	Caddy	DRW110ATABK
IDE ATA 133	Rugged	Plastic, Aluminum	Black	Hot Swap Software	Caddy	DRW113ATABK
IDE ATA 133	Durable	Aluminum	Black	Cableless Connector	-	DRW150ATABK
IDE ATA 133	Professional	Aluminum	Black	Max. Durability	Bay, Caddy	DRW115ATABK

Retail-Ready

### Serial Attached SCSI (SAS)

Drive Type	Style	Construction	Color	Features	Extras Available	Part Number
SAS / SATA	Durable	Aluminum	Black	3 Gb/s Transfer	-	DRW150SASBK
SAS / SATA	Durable	Aluminum	Black	4 x 2.5" HD	-	SATABAY425BK

### SCSI

Drive Type	Style	Construction	Color	Features	Extras Available	Part Number
U320 68 Pin	Durable	Aluminum	Black	2 DBB Fans	Caddy (150SCSIBKCAD)	DRW150SCSIBK
80 Pin SCA	Durable	Aluminum	Black	2 DBB Fans	-	DRW150SCABK

Retail-Ready

### Drive Mounting Brackets

Drive Type	Part Number
Metal 3.5" to 5.25" Drive Adapter Bracket	BRACKET
2.5" SATA HD to 3.5" Drive Bay Mounting Kit (IDE version also - BRACKET25)	BRACKET25SAT
Bracket for 3.5" Floppy with Bezel (also Available in Beige)	BRACKETFDBK
3.5" Bay to Dual 2.5" SATA HDD Adapter	SATA35252X
3.5" Bay to Dual 2.5" IDE HDD Adapter	IDE35252X
3.5" IDE to 1.8" ZIF/LIF HDD Adapter	ZIF2IDE35

Retail-Ready

For more products & detailed information visit [www.startech.com/drivedrawers](http://www.startech.com/drivedrawers)

For more products & detailed information visit [www.startech.com/drivedrawers](http://www.startech.com/drivedrawers)

# USB Connectivity Solutions

## Selection

Our broad selection of USB and FireWire products allows you to harness the abilities of cutting edge technology, giving you access to more functions and faster data transfers.

## Quality

As with any StarTech.com product, we offer only the highest quality of USB device design and construction.

## Reliability

StarTech.com USB devices and components are built to provide consistency excellent performance.



### USB Devices - Hubs

Ports	Interface	Data Rate	Type	Color	Desktop/ Laptop	Part Number
2 Ports	USB 2.0	480 Mbps	Docking Station	Black	Laptop	USB6N1DOCK
3 Ports	USB 2.0	480 Mbps	Hub / Card Reader	Black / Silver	Desktop/ Laptop	ST4205READ
4 Ports	USB 2.0	480 Mbps	Hub	Black / Silver	Desktop/ Laptop	ST4205USB
4 Ports	USB 2.0	480 Mbps	Hub	Black	Desktop/ Laptop	ST4202USB
4 Ports	USB 2.0	480 Mbps	Hub	Silver	Desktop/ Laptop	ST4200MINI
7 Ports	USB 2.0	480 Mbps	Hub	Black / White	Desktop/ Laptop	ST7200USB
7 Ports	USB 2.0	480 Mbps	Hub	Black	Desktop/ Laptop	ST7202USB



4 Port Compact Black USB 2.0 Hub  
ST4202USB

Retail-Ready

### USB Devices - Card Readers

Interface	Data Rate	Bay or Standalone	Color	SDHC Compatible	Desktop/ Laptop	Part Number
USB 2.0	480 Mbps	Standalone	Silver	Yes	Desktop / Laptop	FCREADHC
USB 2.0	480 Mbps	Standalone	Black	Yes	Desktop / Laptop	FCREADMICRO
USB 2.0	480 Mbps	Standalone	Silver	No	Desktop / Laptop	FCREADMINI
USB 2.0	480 Mbps	Bay	Beige	No	Desktop	35FCREAD
USB 2.0	480 Mbps	Bay	Black	Yes	Desktop	35FCREADBK
USB 2.0	480 Mbps	Standalone or Bay	Beige	No	Desktop	35FCREAD20
USB 2.0	480 Mbps	Standalone or Bay	Black	No	Desktop	35FCREAD20BK
USB 2.0	480 Mbps	Ejectable or Bay	Silver	No	Desktop	35FCREADREM



14-in-1 USB 2.0 High Capacity Silver Multi Media Memory Card Reader  
FCREADHC

Retail-Ready



### External 56K USB Modem

- Converts a USB port into an external 56k dialup modem
- Supports data receive rates up to 56Kbps



### USB 2.0 to SATA IDE Adapter

- Connect 2.5" or 3.5" SATA/IDE drives to a USB 2.0 port
- Quickly transfer files from one drive to another



### USB to Stereo Audio Adapter Converter

ICUSBAUDIO and ICUSBAUDIOB

- Add headsets and microphones to your computer without the need to unplug other devices
- Available in black or white



### 7.1 Channel USB Audio Adapter External Sound Card

ICUSBAUDIO7

- Analog and digital audio output for seven channels of sound
- Easy volume control with volume and mute buttons on device

For more products & detailed information visit [www.startech.com/usb](http://www.startech.com/usb)

# USB Graphic Adapters

## Easy

An easy, simple to use solution for connecting multiple displays through a USB 2.0 port.

## Convenient

Plugs into the host computer system or docking bay in a matter of seconds, quickly helping you get the most out of your PC operating environment.



## In The News

“If it's your desktop that's hampering you, consider expanding your virtual real estate by adding a monitor or two using a USB display adapter from StarTech.com”



### USB VGA Multi Monitor External Video Adapter

USB2VGAE2

- A compact, lightweight, cost effective, USB to VGA adapter

Max Displays	Max Resolution
1	1680x1050 @ 32 bits

### USB VGA External Multi Monitor Video Adapter - High Resolution

USB2VGA2

- Our highest performance, USB to VGA adapter with support for up to 5 displays

Max Displays	Max Resolution
5	1600 x 1200 @ 32 bits

### USB DVI VGA External Dual or Multi Monitor Video Adapter

USB2DVIE

- Acts as an external video card for any USB 2.0 computer

Max Displays	Max Resolution
5	1600 x 1200 @ 32 bits

### USB DVI External Multi Monitor Video Adapter

USB2DVI

- Acts as an external video card connected through USB 2.0 with Mac® support

Max Displays	Max Resolution
5	1600 x 1200 @ 32 bits

### 4-in-1 USB VGA Adapter and Docking Station

USBVGA DOCK

- Acts as a USB 2.0 hub allowing you to connect a keyboard, mouse, printer, audio devices, and more

Max Displays	Max Resolution
1	1280x1024 @ 32 bits

## Connect one or up to five adapters to one PC.

### Why are they convenient?

- Works well with any VGA connected display, and on any PC running Windows 2000, Windows XP, Windows Vista
- Plugs into the host computer system or docking bay in a matter of seconds, quickly helping you get the most out of your PC operating environment
- Eliminates the hassle of installing a second video card

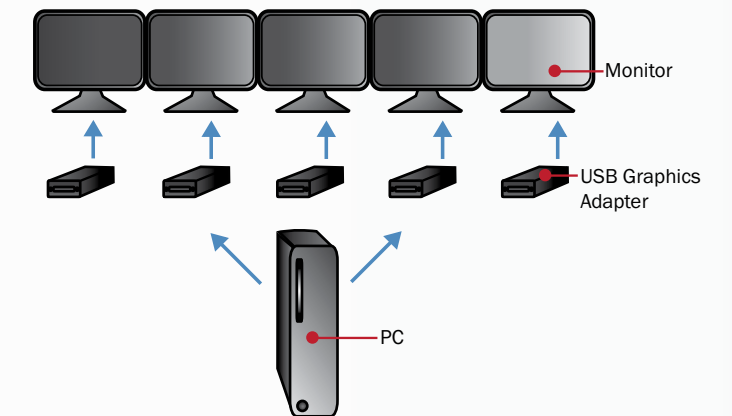

For more products & detailed information visit [www.startech.com/usb](http://www.startech.com/usb)



# Build Rock Solid Networks

## Simple Installation

StarTech.com networking products are designed for simple set-up and fast deployment, saving valuable time and expense.

## Reliability

Our networking products are designed to withstand challenging environments, while operating at peak performance.



Atif | Key Account Manager

### Ethernet Network Cards

Description	Host System	Part Number
1 Port PCI and LP PCI 10/100 Ethernet Card	Desktop	ST100S/ ST100SLP
1 Port PCI Express 10/100 Ethernet Card w/ LP Bracket	Desktop	PEX100S
1 Port Dongle-less 10/100 PCMCIA CardBus Ethernet Card	Laptop	UE1205CB
1 Port USB 2.0 to 10/100 Ethernet Adapter	Desktop / Laptop	USB2106S
1 Port Gigabit ExpressCard (10/100/1000 Mbps/sec.)	Laptop	EC1000BT
1 Port 10/100/1000 Mbps 32 bit PCI Gigabit Card w/LP Bracket	Desktop	ST1000BT32
1 Port PCI Express 10/100/1000 Mbps Gigabit Ethernet Card	Desktop	ST1000SPEX
2 Port PCI Express 10/100/1000 Mbps Gigabit Ethernet Card	Desktop	ST1000SPEXDP

Retail-Ready

### Wireless

Description	Host System	Part Number
802.11g Wireless PCI NIC Adapter (Incl LP Bracket)	Desktop	PCI555WG
54 Mbps USB 802.11g Wireless Mini NIC Adapter	Desktop / Laptop	USB555WG
802.11g Wireless Cardbus NIC Adapter	Laptop	CB555WG

### Print Servers

Description	Part Number
1 Port Parallel or 1 Port USB 10/100 Mbps Print Server	PM1115P / PM1115U
Multi-function Printer and USB Device Server (10/100 MBPS)	PM1115UMF

Retail-Ready

### Network Hubs & Switches

Description	Part Number
16, 8 and 5 Port Desktop 10/100 Fast Ethernet Switch	DS16105, DS8107, DS5107

### Extenders

Input Connector	Ports	Maximum Distance	Features	Part Number
RS-232	1 Port	3300ft.	Serial RS-232 over Cat5/6	RS232EXTC5
RJ-45	1 Port	3300ft.	Ethernet over Single Pair (telephone wire)	110VDSLEX (kit)
USB	1/1/2 Port	330ft. / 165ft. / 165 ft.	USB over Cat5/6	USB100EXT /110EXT/120EXT
USB 2.0	4 Port	330ft.	USB over Cat5/6	USB204EXT
USB 2.0 + VGA	1 Port	500ft.	KVM Console extender	SV565UTPU
USB 2.0 + VGA + Serial + Audio	1 Port	1000ft.	Long Distance KVM Console extender	SV56UTPUSA

### Converters/Switches

Input Connector	Ports	Output Connector	Features	Part Number
RS-232	1 Port	RS-422/485	RS-232 to RS422/485 serial converter	IC485S
RJ45	1 Port	RS-232/422/485	Serial over IP Ethernet Device Server	NETRS2321E
RJ45	1, 2, or 4 Port	RS-232	Serial over IP Ethernet Device Server	NETRS232_1, 2, 4
RJ45 Powered	1 Port	RS-232	Power Over Ethernet (POE) to Serial RS-232	NETRS2321POE

### Fiber Media Converters

Speed	Max. Distance	Type	Connector	Features	Part Number
10/100Mbps	2 km	Multi-Mode	SC or ST	-	MCM110SC2/ST2
10/100Mbps	2 km	Multi-Mode	SC or ST	Steel Case	ET90110SC/ST
10/100Mbps	20 km	WDM (Single fiber for TX/RX)	SC	Kit, includes both end units	ET90110WDM
10/100Mbps	30 km	Single Mode	SC	Longest Distance	ET90110SM30
1000Mbps	550 m	Multi-Mode	SC or LC	Steel Case	ET91000SC/LC
1000Mbps	550 m / 15 km	Multi-Mode/Single Mode	SC	-	MCMGBSC055/15
1000Mbps	10 km	Multi-Mode to Single Mode	SC	Multi-Mode to Single Mode Converter	ET91000MMSM
1000Mbps	40 km	Single Mode	SC or LC	Longest Distance	ET91000SM40/LC

For more products & detailed information visit [www.startech.com/networking](http://www.startech.com/networking)

# Custom Cables

You can rely on our technical expertise to help build the technology solutions you need to win more business. With over 20 years of experience providing high quality IT and AV products, we offer robust manufacturing and custom product design capabilities that can help you complete solutions while eliminating hassle and wasted time.

1. Provide us with the basic requirements of your project. Our expert technical staff will review the project quickly, provide a free consultation and cost quotation within 24 hours.

2. We can produce quantities as high as 100,000 pieces with rapid lead times.

StarTech.com's custom manufacturing capabilities include:

- Assembled and Injection Molded Data Cables
- Fiber Optic Cable Assemblies
- Video and Monitor Cables
- Internal Power and Data Cables
- Custom Wiring Harnesses
- Custom Labeling and Barcoding

For more information visit [www.startech.com/custom](http://www.startech.com/custom)

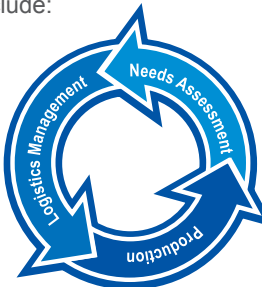

### The StarTech.com Advantage:

- A complete range of IT hardware including hard-to-find and custom solutions
- Access to engineers who can develop custom solutions and provide post sales support
- Industry certifications including UL, CSA, TUV and ETL
- Industry leading warranties
- ISO 9001:2000 Registered
- Over 20 years experience in the IT industry

# Consistent performance for better connections

StarTech.com's broad selection of cables helps add value to any project, by saving the time needed to find the right solution. Not only do our cables provide maximum quality and reliability, but the breadth of our product selection helps to ensure all customer needs are met in one place.

Backed by a lifetime warranty, all of our cables ensure top level performance for any application.



### Power Cables

Lengths	Type	Color	Connectors	Part Number
1 ft, 6 ft, 10 ft	Standard Computer Power Cord Extension	Black	C14, C13	PXT100x
10 ft	10ft Power Extension Y Cable	Black	C14, C13x2	PXT100Y
1 ft, 3 ft, 6 ft, 10 ft	Standard Computer Power Cord	Black	5-15P, C13	PXT101x
6ft	2 Prong European PC Power Cord	Black	Euro Plug, C13	PXT101EUR
6ft	6 ft NEMA 5-15 to C13 Right Angle Power Cable	Black	5-15P, C13 Right Angle	PXT101L
6ft	Laptop Computer Power Cable	Black	1-15P, C7	PXT101NB
6ft	3-Slot Laptop Power Cable	Black	5-15P, 3 C5	PXT101NB3S
6ft	6ft Universal Computer Power Cord (NEMA 5-15P to C13)	Black	5-15P, C13x2	PXT101Y
1ft, 3ft, 6ft, 10ft	1ft Computer Power Cord ( C19 to C20)	Black	C19, C20	PXTC19C20x
8ft	Server Power Cord 12 AWG	Black	L5-20P, C13	PXTL520C198
6ft	Server Power Cord 14 AWG	Black	L6-20P, C13	PXTL620C136
1ft	Computer Monitor Power Cable	Black	C14, 5-15R	PAC100
1ft, 10ft	Power Cord Extension Cable	Black	5-15P, 5-15R	PAC101x
1.5ft	Power Cord Extension Splitter Cable	Black	5-15P, 5-15Rx2	PAC101Y

xx = Length

For more products & detailed information visit [www.startech.com/cables](http://www.startech.com/cables)

## Fast and Reliable USB and FireWire cables

### Selection

Our broad selection of USB and FireWire products allow you to harness the abilities of cutting edge technology, giving you access to more functions and faster data transfers.

### Quality

As with any StarTech.com product, we offer only the highest quality of USB and FireWire design and construction.

### Reliability

StarTech.com USB and FireWire cables are designed and built to exceed the highest quality standards.



1 ft High Speed USB 2.0 Cable  
USB2HAB1



10 Ft IEEE-1394 Firewire Cable 6-6 M/M  
1394\_10



Gender Changer USB A Female to USB A Female  
GCUSBAAFF

### USB Cables

Lengths	Type	Color	Connectors	Part Number
1 ft, 3 ft, 6 ft, 10 ft	USB 2.0 Certified	Black	A Male, B Male	USB2HABxx
15 ft	USB 2.0	Black	A Male, B Male	USB2HAB15
6 ft, 10 ft, 15 ft	USB 2.0	Transparent	A Male, B Male	USB2HABxxT
3 ft, 6 ft, 10 ft, 15 ft	USB 2.0	Beige	A Male, B Male	USBFAB_xx
3 ft, 6 ft, 10 ft, 15 ft	USB 2.0	Transparent	A Male, B Male	USBFAB_xxT
3 ft, 6 ft, 10 ft	USB 2.0	Gray	A Male, Mini B Male 5 Pin	USB2HABMxx
3 ft, 6 ft, 10 ft	USB 2.0	Black	A Male, Mini B Male 4 Pin	USBFA4Sxx
6 in, 6 ft	USB 2.0 Extension	Beige	A Male, A Male	USBEXTAA_xx
6 ft	USB 2.0 Extension	Beige	A Male, A Male	USBFAA_6
15 ft	USB 2.0 Active Extension	Beige	A Male, A Male	USB2FAAEXT15
3 ft, 6ft	Micro USB Cable - A to Right Angle Micro B	Black	A Male, Micro B Right Angle	UUSBHAUBxRA
1 ft, 3 ft, 6 ft, 10 ft	USB A to MicroUSB B Cable	Black	A Male, Micro B	UUSBHAUBxx

xx = Length

### FireWire Cables

Lengths	Type	Color	Connectors	Part Number
6 ft, 10 ft, 15 ft	IEEE-1394 FireWire A	Black	6 Pin, 6 Pin	1394_xx
10 ft, 15 ft	IEEE-1394 FireWire A	Transparent	6 Pin, 6 Pin	1394_xxT
6 ft, 10 ft, 15 ft	IEEE-1394 FireWire A	Black	4 Pin, 4 Pin	1394_44_xx
6 ft, 10 ft, 15 ft	IEEE-1394 FireWire A	Black	4 Pin, 6 Pin	1394_46_xx
15 ft	IEEE-1394 FireWire A	Transparent	4 Pin, 6 Pin	1394_46_15T
6 ft, 10 ft	IEEE-1394 FireWire B	Black	9 Pin, 4 Pin	1394_94_xx
6 ft, 10 ft	IEEE-1394 FireWire B	Black	9 pin, 6 Pin	1394_96_xx
6 ft, 10 ft	IEEE-1394 FireWire B	Black	9 Pin, 9 Pin	1394_99_xx

xx = Length

### Adapters

Type	Color	Connectors	Part Number
Replacement USB to PS/2 Keyboard Adapter F/M	Purple	PS/2 Male, USB A Female	GC46FMKEY
Replacement PS/2 to USB Keyboard Adapter M/F	Purple	USB A Male, PS/2 Female	GC46MFKEY
Replacement PS/2 Mouse to USB Adapter - F/M	Beige	USB A Male, PS/2 Female	GC46MF
Replacement USB to PS2 Mouse Adapter	Green	PS/2 Male, USB A Female	GC46FM
Gender Changer USB A Male to USB A Male	White	USB A Female, USB A Female	GCUSBAAFF
Gender Changer USB A Female to USB B Female	White	USB A Male, USB A Male	GCUSBAAMM
Adapter USB B Male to USB A Female	White	USB A Female, USB B Female	GCUSBABFF
Adapter USB A Male to USB B Female	Beige	USB B Male, USB A Female	GCUSBABFM
Gender Changer USB B Male to USB B Male	White	USB A Male, USB B Female	GCUSBABMF
USB to Micro USB Adapter	Black	USB A Male, Micro USB B Male	GCUSBAMBM
IEEE-1394 Firewire 4-6 Adapter F/M	Black	USB B Male, USB B Male	GCUSBBBMM
IEEE-1394 Firewire 4-6 Adapter F/M	Black	Firewire 6 pin Male, Firewire 4 pin Female	FIRE46FM
IEEE-1394 Firewire 4-6 Adapter M/F	Black	Firewire 4 pin Male, Firewire 6 pin Female	FIRE46MF
4 Port USB Connector Backplate	Gray	USB Female x 4, USB Header x 2	USBPLATE4
2 Port Low Profile Connector Backplate	Gray	USB Female x2, USB Header x2	USBPLATELP

For more products & detailed information visit [www.startech.com/cables](http://www.startech.com/cables)

## Great Selection, Reliable Performance

### Lasting Value

To ensure long-term, peak performance, StarTech.com patch cables carry a comprehensive, lifetime warranty.

### Best Selection

We offer a complete line of patch cables to suit virtually any project requirement.

### Durability

All StarTech.com patch cables are designed to exceed the highest standards, while enduring even the harshest environments.



### Cat 5e Patch Cables



Molded Cat 5e Patch Cables  
M45PATCHxx

#### Available lengths:

1 ft. 2 ft. 3 ft. 5 ft. 6 ft. 7 ft.  
10 ft. 15 ft. 20 ft. 25 ft. 35 ft.  
50 ft. 75 ft. 100 ft.

#### Available colors:

- Red
- Orange
- Yellow
- Blue
- Purple
- Green
- Gray
- Black
- White



Snagless Cat 5e Patch Cables  
RJ45PATCHxx

#### Available lengths:

1 ft. 2 ft. 3 ft. 5 ft. 6 ft. 7 ft.  
10 ft. 15 ft. 20 ft. 25 ft. 35 ft.  
50 ft. 75 ft. 100 ft.

#### Available colors:

- Red
- Orange
- Yellow
- Blue
- Purple
- Gray
- Black
- White

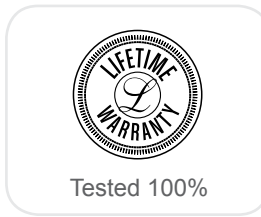

### Cat 6 Patch Cables



Molded Cat 6 Patch Cables  
C6PATCHxx

#### Available lengths:

1 ft. 2 ft. 3 ft. 5 ft. 6 ft. 7 ft. 8 ft.  
10 ft. 12 ft. 15 ft. 20 ft. 25 ft.  
35 ft. 50 ft. 100 ft

#### Available colors:

- Red
- Orange
- Yellow
- Blue
- Green
- Gray
- Black
- White



Snagless Cat 6 Patch Cables  
N6PATCHxx

#### Available lengths:

3 ft. 7 ft. 10 ft. 15 ft. 25 ft. 50 ft.

#### Available colors:

- Black
- Blue

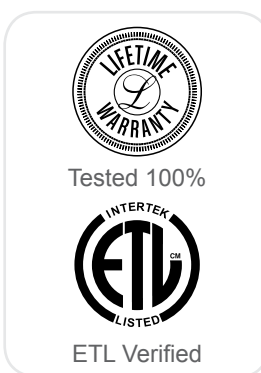

Cat 5e and Cat 6 wire is also available in Solid and Stranded bulk 1000ft Rolls in all colors

### Patch Cables Made Easy!

Use our "Cables at a Glance" tool to quickly find the right patch cable for the job.

Visit: [www.startech.com/cables](http://www.startech.com/cables)



## Quality Internal Cables

### Rugged Construction

Built to withstand almost any environment, our cables offer the ultimate in durability.

### Top Quality

High quality materials and exceptional workmanship combined for top quality cables.

### Incredible Selection

Our offering of internal computer cables allows you to source all of your cable needs from one place, saving valuable time.



### SATA Cables

Lengths	Type	Connectors	Part Number
20 in	Micro SATA to SATA with Power	Micro SATA Female, LP4	MCSATAF20
12 in	Micro SATA to SATA with Power	Micro SATA Male, LP4	MCSATAM12
12 in	Micro SATA Extension Cables	Micro SATA Male, Micro SATA Female	MCSATA12EXT
20 in	Slimline SATA with Power	Slimline SATA Male, LP4	SLSATAM20
20 in	Slimline SATA with Power	Slimline SATA Female, LP4	SLSATAF20
20 in	Slimline SATA Extension Cable	Slimline SATA Male, Slimline SATA Female	SLSATA20EXT
-	Slimline SATA Adapter with Power	Slimline SATA Female, SATA Data, Power	SLSATAADAP
-	Slimline SATA Adapter with Screwmount	Slimline SATA Female, SATA Data, SP4 Power	SLSATACDADAP
18 in, 24 in	SATA Data and Power	Sata Data/Power, Sata DATA, LP4	SATAxxPOW
5 in	SATA Power Cable with Floppy	Sata Power Female, LP4, Floppy Power	LP4SATAFMD
-	SATA Power to LP4 Adapter	Sata Power Female, LP4	LP4SATAFM
5 in	SATA Power Splitter Cable	SATA Power Female, SATA Power Female x 2	PYO3SATA
12 in	LP4 to SATA Power Splitter Cable	LP4, SATA Power Female x 2	PYO2LP4SATA
6 in	LP4 to SATA Power Cable	LP4, SATA Power female	SATAPOWADAP
18 in, 24 in	SATA to Left Angle SATA Cable	Sata Data, SATA Data Left Angle	SATAxxLA1
18 in, 24 in, 36 in	SATA to Right Angle SATA Cable	Sata Data, SATA Data Right Angle	SATAxxRA1
18 in	Right Angle SATA Cable	Sata Data Right Angle, SATA Data Right Angle	SATARA18
18 in, 24 in, 36 in	SATA Cable	SATA Data, Sata DATA	SATA24
-	SATA Power Gender Changer	SATA Power Female, SATA Power Female	GCSATAFF
12 in, 18 in, 24 in	Latching SATA cable	Latching SATA data, Latching SATA data	LSATA12
12 in, 18 in, 24 in	Latching SATA Cable, 1 Right Angle	Latching SATA data, Latching SATA data Right Angle	LSATA12RA1
12 in, 18 in, 24 in	Latching SATA Cable, 2 Right Angle	Latching SATA data Right Angle, Latching SATA data Right Angle	LSATA12RA2
12 in	SATA Data and Power Slot Plate Cable	SATA Data/Power Slot plate, SATA Data/Power motherboard	SATAPOWPLAT1
12 in	SATA Data Slot Plate Cable	SATA Data Slot plate, SATA Data	SATAPLATE1



12" latching SATA cable  
2 Right Angle  
LSATA12RA2



6 in 20 pin ATX Power  
Supply to 24 pin  
Motherboard Adapter  
ATX2024MF

### Internal Power Cables

Lengths	Type	Connectors	Part Number
6 in	PCI Express	PCI Express Power 6 pin, LP4 x 2	LP4PCIEXADAP
6 in	PCI Express	PCI Express Power 6 pin, PCI Express Power 8 pin	PCIEX68ADAP
8 in	EPS Power Extension Cable	EPS Power Male 8 pin Male, EPS Power 8 pin Female	EPS8EXT
8 in	P4 Power Extension Cable	P4 Power 4 pin Male, P4 Power 4 pin female	ATXP4EXT
8 in	ATX Power Extension Cable	ATX Power 24 pin Male, ATX Power 24 pin Female	ATX24POWEXT
6 in	LP4 to P4 Power Cable	LP4, P4 Power	LP4P4ADAP
6 in	ATX Power 20 pin to 24 pin Adapter	ATX Power 24 pin Male, ATX Power 20 pin Female	ATX2024FM
6 in	ATX Power 24 pin to 20 pin Adapter	ATX Power 20 pin Male, ATX Power 24 pin Female	ATX2024MF
9 in	LP4 Power Splitter Cable	LP4 Male, LP4 Female x 2	PYO2L
8 in	LP4 to LP4 / SP4 Splitter Cable	LP4, LP4 and SP4	PYO2SL
12 in	TX3 Fan Power Extension Cable	TX3 Male, TX3 Female	TX3EXT12
12 in	TXS Fan Power Splitter Cable	TX3 Male x 2, TX3 Female	TX3SPLIT12
6 in	TXS Fan Power Splitter Cable	TX3 Male x 2, TX3 Female	TX3SPLITTER
6 in	TX3 Fan Power Extension Cable	TX3 Male, TX3 Female	TX3EXT6



8in ATX12V 4 Pin P4 CPU  
Power Extension Cable  
ATXP4EXT

xx = Length

xx = Length

## Fiber Speeds, StarTech.com Quality

### Durability

StarTech.com fiber optic cables are designed and constructed to provide impressive performance in any environment.

### Quality

Our selection of Fiber Optic cables are constructed of the highest quality materials, ensuring optimum performance.



Custom lengths available!  
Call for details

SKU Type	50FIB-Conn-Length (e.g. 50FIBLCLC1) 50/125 Duplex Multimode	FIB-Conn-Length (e.g. FIBLCLC1) 62/125 Duplex Multimode	SMFIB-Conn-Length (e.g. SMFIBLCS1) 9/125 Duplex Singlemode
LC-LC	1m, 2m, 3m, 5m, 10m, 15m, 20m, 25m, 30m, 35m, 40m, 45m, 50m, 55m, 60m, 65m, 70m, 80m, 85m, 90m, 95m, 100m, 110m, 120m, 130m, 140m, 150m	1m, 2m, 3m, 4m, 5m, 7m, 8m, 10m, 15m, 20m, 100m, 130m, 160m, 200m	
LC-MT	1m, 2m, 3m, 5m, 10m, 15m, 20m, 25m, 30m, 35m, 40m, 45m, 50m, 55m, 60m, 65m, 70m, 80m, 85m, 90m, 95m, 100m, 110m, 120m, 130m, 140m, 150m	1m, 2m, 3m, 5m, 7m, 10m, 15m	
LC-SC	1m, 2m, 3m, 5m, 10m, 15m, 20m, 25m, 30m, 35m, 40m, 45m, 50m, 55m, 60m, 65m, 70m, 80m, 85m, 90m, 95m, 100m, 110m, 120m, 130m, 140m, 150m	1m, 2m, 3m, 5m, 7m, 10m, 15m	1m, 5m
LC-ST		1m, 2m, 3m, 5m, 7m, 10m, 15m	
MT-MT	1m, 2m, 3m, 5m, 10m, 15m, 20m, 25m, 30m, 35m, 40m, 45m, 50m, 55m, 60m, 65m, 70m, 80m, 85m, 90m, 95m, 100m, 110m, 120m, 130m, 140m, 150m	1m, 2m, 3m, 5m, 7m, 10m, 15m	
SC-MT	1m, 2m, 3m, 5m, 10m, 15m, 20m, 25m, 30m, 35m, 40m, 45m, 50m, 55m, 60m, 65m, 70m, 80m, 85m, 90m, 95m, 100m, 110m, 120m, 130m, 140m, 150m	1m, 2m, 3m, 5m, 7m, 10m	
MT-ST		1m, 2m, 3m, 5m, 7m, 1m	
SC-SC	1m, 2m, 3m, 5m, 10m, 15m, 20m, 25m, 30m, 35m, 40m, 45m, 50m, 55m, 60m, 65m, 70m, 80m, 85m, 90m, 95m, 100m, 110m, 120m, 130m, 140m, 150m	1m, 2m, 3m, 5m, 7m, 10m, 15m, 20m, 30m, 40m, 50m, 100m, 200m	1m, 2m, 3m, 5m, 10m, 15m, 20m, 30m
ST-SC		1m, 2m, 3m, 5m, 7m, 10m, 15m, 20m, 60m	1m, 2m, 3m, 5m, 10m, 15m, 20m, 30m
ST-ST		1m, 2m, 3m, 5m, 7m, 10m, 15m, 20m, 50m	1m, 2m, 3m, 5m, 10m, 15m, 20m, 30m

For more products & detailed information visit [www.startech.com/cables](http://www.startech.com/cables)

For more information visit [www.startech.com/cables](http://www.startech.com/cables)

## A/V Cables For Your Viewing Pleasure...

### Quality

Our cables are built from the highest quality materials to provide the best possible image.

### Reliability

All of our video cables are backed by lifetime warranty, to ensure long-lasting enjoyment.



### DisplayPort / DVI

Lengths	Type	Connectors	Part Number
6 ft, 10 ft, 15 ft, 25 ft, 35 ft, 50 ft	DisplayPort Cable	DisplayPort Male, DisplayPort Male	DISPLPORTxL
6 ft, 10 ft, 15 ft, 20 ft	DVI-D Dual Link male	DVI-D Male, DVI-D Male	DVIDDMx
6 ft, 10 ft	DVI_D Dual Link Extension	DVI-D Male, DVI-D Female	DVIDDMFxx
6 ft, 10 ft, 15 ft, 20 ft	DVI-I Dual Link Male	DVI-I Male, DVI-I Male	DVIIDMMx
6 ft, 10 ft, 15 ft	DVI-I Dual Link Extension	DVI-I Male, DVI-I Female	DVIIDMFxx
3 ft, 6 ft, 10 ft	DVI to Coax High Resolution VGA Monitor Cable	DVI-I Male, HD15 Male	DVIIVGAMMxx
12 in	DVI Splitter Cable	DVI-D Male, DVI-D Female x 2	DVISPL1DD

xx = Length



15 ft DisplayPort Cable with Latches  
DISPLPORT15L

### HDMI

Lengths	Type	Connectors	Part Number
6 ft	HDMI Male to Mini HDMI male	HDMI Male, Mini-HDMI Male	HDMIACMM6
10 ft, 15 ft, 20 ft, 25 ft	HDMI Male to DVI-D Male	HDMI Male, DVI-D Male	HDMIDVIMMxx
3 ft, 6 ft, 10 ft, 15 ft, 20 ft, 25 ft, 30 ft, 45 ft, 45 ft, 50 ft	HDMI Male to HDMI male	HDMI Male, HDMI Male	HDMIMMx

xx = Length



6 ft HDMI to Mini HDMI Digital Video Cable  
HDMIACMM6

### Adapters

Type	Connectors	Part Number
DVI to VGA Adapter M/F	DVI-I Male, HD15 Female	DVIIVGAMF
DVI to VGA Display Adapter F/M	DVI-I Female, HD15 Male	DVIIVGAFM
DVI-I Female to DVI-I Female Adapter	DVI-I Female, DVI-I Female	GCDVIIF
HDMI to DVI Adapter F/M	HDMI Female, DVI-D Male	HDMIDVIFM
HDMI to DVI Adapter M/F	HDMI Male, DVI-D Female	HDMIDVIMF
HDMI to Mini HDMI Cable Adapter	Mini HDMI Male, HDMI Female	HDMIACFM
Mini DVI to DVI Video Cable Adapter for Macs	Mini DVI Male, DVI-D Female	MDVIDVIMF
Mini DVI to HDMI Video Cable Adapter for Macs	Mini DVI Male, HDMI Female	MDVIHDMIMF
Mini DVI to VGA Video Cable Adapter for Macs	Mini DVI Male, HD15 Female	MDVIIVGAMF



DVI-I Female to DVI-I Female Adapter  
GCDVIIF

### SVGA Cables

Lengths	Type	Connectors	Part Number	
3ft, 6ft, 10ft, 15ft, 25ft, 50ft, 75ft, 100ft	SVGA Monitor	SVGA Male, SVGA Male	HD15 Male, HD15 Male	MXT101MMHQxx
3ft, 6ft, 10ft, 15ft, 25ft, 50ft, 75ft, 100ft, 150ft, 200ft	Monitor Extension	SVGA Male, SVGA Female	HD15 Male, HD15 Female	MXT101HQxx
6ft, 10ft, 15ft	Super Thin Profile SVGA Monitor	HD15 Male, HD15 Male		MXT101MMLPxx
6ft, 10ft, 15ft	Super Thin Profile SVGA Monitor Extension	HD15 Male, HD15 Female		MXT101LPxx

xx = Length



6 ft Coax High Resolution VGA Monitor Cable  
MXT101MMHQ

For more products & detailed information visit [www.startech.com/cables](http://www.startech.com/cables)



Find the right converter, extender, splitter, card or cable in 2 easy steps!

### Hard-to-Find Just Got Easier!

Do you ever have trouble finding the right product to connect IT or A/V peripherals?

StarTech.com's new ConXit Connection Wizard helps you find the right converter, extender, splitter, interface card or cable in two easy steps!

Take the worry out of finding the right interconnect product and try ConXit today!

Visit: [www.startech.com/conxit](http://www.startech.com/conxit)



#### STEP 1

Select connection device



#### STEP 2

Select connection on PC or host device



#### Result

The best products are recommended

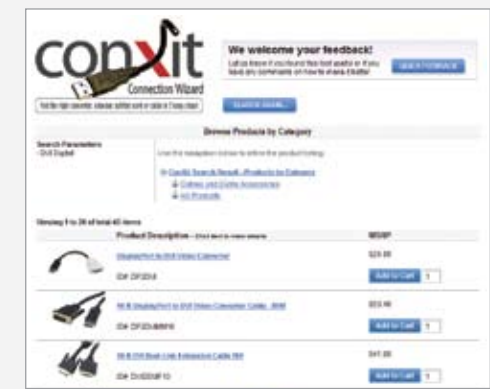

For more information visit [www.startech.com/conxit](http://www.startech.com/conxit)

# CONVERGEAV

## VGA Video Converters

Description	Input Signal	Output Signal	SKU
VGA to HDMI Video Converter with Audio	VGA / Component	HDMI	VGAHD2HDMI
VGA to HDMI Professional Video Converter with Scaler	VGA	HDMI	VGA2HDMIPRO
VGA to S-Video or Composite High Resolution Video Converter	VGA	S-Video / Composite	VGA2VID
VGA to S-Video or Composite Video Converter with Remote Control	VGA	S-Video / Composite	VGA2NTSCPRO
VGA to DVI-I Video Converter with Scaler	VGA	DVI-I	VGA2DVII
2 Way VGA to Component HDTV Video Converter with Scaler	VGA	Component	VGA2TV2WAY

## DVI Video Converters

Description	Input Signal	Output Signal	SKU
DVI to VGA Video Converter with Scaler	DVI-D	VGA	DVI2VGA
DVI-D to HDMI Video Converter with Audio	DVI-D	HDMI	DVI2HDMI

## Component Video Converters

Description	Input Signal	Output Signal	SKU
Component to HDMI Video Converter with Audio	Component	HDMI	CPNTA2HDMI
Component to HDMI Video Converter with Digital Audio	Component	HDMI	CPNTTOS2HDMI
Component to DVI Video Converter	Component	DVI-I	CPNT2DVI
Component to VGA Video Converter with Audio	Component	VGA	CPNT2VGAA

## S-Video and Composite Video Converters

Description	Input Signal	Output Signal	SKU
S-Video and Composite to VGA Video Converter	S-Video / Composite	VGA	COMP2VGA
S-Video and Composite to VGA Video Converter with Scaler	S-Video / Composite	VGA / Component	VID2VGATV
S-Video and Composite to HDMI Video Converter with Scaler	S-Video / Composite	HDMI	VID2HDMITV
S-Video and Composite to DVI Video Converter with Scaler	S-Video / Composite	DVI-D	VID2DVIDTV
S-Video and Composite to USB Video Capture Cable with Audio	S-Video / Composite	N/A	SVID2USB2

## Other Converters

Description	Input Signal	Output Signal	SKU
Two Way Digital Coaxial to TosLink Audio Converter	TosLink, Digital Coaxial	TosLink, Digital Coaxial	SPDIFCOAXTOS
HDMI to HDMI Video Converter with Scaler and Audio Separation	HDMI / DVI	HDMI / DVI	HDMI2HDMI



Professional VGA to HDMI Audio Video Converter  
VGA2HDMIPRO



DVI and Digital Audio to HDMI Converter  
DVI2HDMI



Component to VGA Video Converter with Audio  
CPNT2VGAA



S-Video and Composite to HDMI Video Converter with Scaler  
VID2HDMITV



HDMI to HDMI Video Converter with Scaler and Audio Separation  
HDMI2HDMI

Accessories  
DVI/HDMI  
Cables  
P.20

### DisplayPort to HDMI

#### Specifications

- Maximum Resolution: 1920x1200
- DP2HDMIADAP: Requires HDMI cable for Display
- DP2HDMI: Requires HDMI cable for Display
- DP2HDMIMM10: All-in-one converter and cable

Description	Part #
Compact DisplayPort to HDMI Video Converter	DP2HDMIADAP
DisplayPort to HDMI Video Converter	DP2HDMI
10ft DisplayPort to HDMI Video Converter	DP2HDMIMM10
6 ft DisplayPort to HDMI Video Converter Cable - M/M	DP2HDMIMM6

Accessories  
DVI/HDMI  
Cables  
P.20

### DisplayPort to DVI

#### Specifications

- Maximum Resolution: 1920x1200
- DP2DVI: Requires DVI cable for Display
- DP2DVIIMM10: All-in-one converter and cable

Description	Part #
DisplayPort to DVI Video Converter	DP2DVI
10ft DisplayPort to DVI Video Converter	DP2DVIIMM10
6 ft DisplayPort to DVI Video Converter Cable - M/M	DP2DVIIMM6

Accessories  
VGA  
Cables  
P.20

### DisplayPort to VGA

#### Specifications

- Maximum Resolution: 1920x1200
- Requires VGA cable

Description	Part #
DisplayPort to VGA Video Converter	DP2VGA

# Save Yourself Time and Money with Our Wide Range of Extenders

Our line of VGA extenders use Cat 5e cabling to allow for longer distances and simple installation. StarTech.com offers signal management hardware and cabling for video extension and digital signage applications.



## UTPE / UTPEA series



The UTPEA Series offers point to multi-point 4 and 8 port extenders with the option of using a repeater / line splitter (STUTPEA4X) to run up to 32 displays (see solution diagram).

### Specifications

Max Resolution and Distance	
1024x768	300m / 950ft
1280x1024	200m / 600ft
1600x1200	100m / 300ft
1920x1200	50m / 150ft

Accessories  
VGA Cables  
P.20  
Cat5 Patch Cables  
P.17

Description - With Audio	Part #
4 Port VGA Video Extender over Cat5 - with Audio	ST124UTPEA
8 Port VGA Video Extender over Cat5 - with Audio	ST128UTPEA
VGA Video Receiver over Cat5 - with Audio	STUTPEALR
4 Port VGA Video Line Splitter over Cat5 - with Audio	STUTPEA4X

Description - No Audio	Part #
4 Port VGA Video Extender over Cat5	ST124UTPE
8 Port VGA Video Extender over Cat5	ST128UTPE
VGA Video Receiver over Cat5 - Long Range Receiver	STUTPRXL

## In The News

StarTech.com's Converge A/V VGA Video and Audio over Cat 5 Systems Offers a Convenient, Cost-effective Digital Signage Solution



## How the UTPEA Series Works

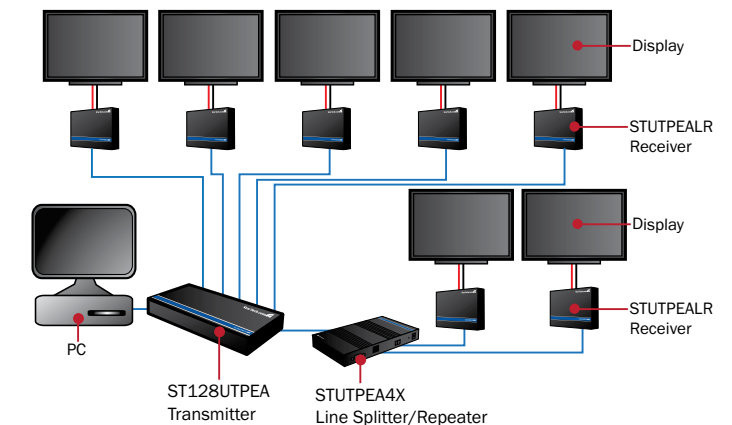

## Now Available Wall Plates for UTPE Series

**VGA Wall Plate Video Extender Transmitter and Receiver over Cat 5**  
STUTPWAL  
This is a point-to-point kit ideal for 1 display

**VGA Wall Plate Video Extender Receiver over Cat 5**  
STUTPRXWAL  
Compatible with:  
ST124UTPE and ST128UTPE

**VGA Wall Plate Video Extender Transmitter over Cat 5**  
STUTPTXWAL  
Compatible with: STUTPRXL

## ST121 series

The ST121 Series offers point to point (one Cat 5 cable) or point to multi-point for larger installations. Use a repeater (ST121EXT) to drop signals up to 32 displays along your path.

### Specifications

Max Resolution and Distance	
1280x1024	150m / 600ft
1440x900	100m / 300ft
1600x1200	50m / 150ft

Accessories  
VGA Cables  
P.20  
Cat5 Patch Cables  
P.17

Point-to-Point	Part #
VGA Video Extender over Cat5 - w/with Receiver	ST121UTP
VGA Video Extender over Cat5 with Audio - with Receiver	ST122UTPA
Point-to-Multi Point	
4 Port VGA Video Extender over Cat5	ST1214T
8 Port VGA Video Extender over Cat5	ST1218T
VGA Video Receiver over Cat5	ST121R
VGA Video Repeater / Extender over Cat5	ST121EXT

## The Right Splitter to Meet the Demanding Needs of any Application



Description	Part #
2 Port VGA Video Splitter	ST122W
4 Port VGA Video Splitter	ST124W
8 Port VGA Video Splitter	ST128W

(All Wall Mountable)

### Wall Mountable VGA Splitters - W Series

- Front panel access to ports allows for easier access and wall mount capability

#### Specifications

- Maximum Resolution: 1600x1200
- Maximum Distance: 200ft / 60m
- Bandwidth: 250MHz

Accessories  
VGA Cables  
P.20



Description	Part #
2 Port VGA Video Splitter	ST122L
4 Port VGA Video Splitter	ST124L
8 Port VGA Video Splitter	ST128L

### Performance VGA Splitters - L Series

- Our best selling series offers reliability, durability and high performance resolution and bandwidth

#### Specifications

- Maximum Resolution: 1920x1440
- Maximum Distance: 200ft / 60m
- Bandwidth: 250MHz

Accessories  
VGA Cables  
P.20



Description	Part #
2 Port VGA Video Splitter	ST122PRO
4 Port VGA Video Splitter	ST124PRO
8 Port VGA Video Splitter	ST128PRO

### Professional VGA Splitters

- Professional grade splitters for the most demanding requirements

#### Specifications

- Maximum Resolution: 2048x1536
- Maximum Distance: 200ft / 60m
- Bandwidth: 350MHz

Accessories  
VGA Cables  
P.20



Description	Part #
2 Port DVI Video Splitter	ST122DVI
4 Port DVI Video Splitter	ST124DVI

### DVI Video Splitters

- Our 2 and 4 port DVI splitters offer Digital or Analog support

#### Specifications

- Maximum Resolution: 1600x1200
- Maximum Distance: 10m / 30ft

Accessories  
DVI Cables  
P.20

## CONVERGEAV

### 2 Port VGA Video Splitter - USB Powered



Hot Product

#### No power adapter required means a simple and clean installation for any application

- Power the ST122LE with the included USB power cable for boosting distance requirements

#### Specifications

- Maximum Resolution: 2048x1536
- Maximum Distance: 200ft / 60m
- Bandwidth: 300MHz

Accessories  
VGA Cables  
P.20

Description	Part #
2 Port VGA Video Splitter - 300 MHz	ST122LE

### 2 Port VGA Video Splitter - with Audio



#### Split video and audio from one computer between two sets of VGA displays

- The ST122PROA is a high quality VGA video and audio splitter offering high resolution, high bandwidth, and audio support

#### Specifications

- Maximum Resolution: 2048x1536
- Maximum Distance: 200ft / 60m
- Bandwidth: 400MHz

Accessories  
VGA Cables  
P.20

Description	Part #
2 Port VGA Splitter	ST122PROA

## Home Theater and Professional Rack-mountable Switches for Component, VGA, and HDMI Connectivity



Description	Part #
4 Port VGA Video Switch	VS415RVGA
8 Port VGA Video Switch	VS815RVGA

### VGA Switches

- Connect to your display at a maximum distance of 65 meters
- Solid construction in a metal enclosure

#### Specifications

- Maximum Resolution: 2048x1536
- Maximum Distance: 200ft / 60m
- Bandwidth: 450MHz

Accessories  
VGA Cables  
P.20



Description	Part #
4 Port VGA Video Switch	VS410RVGAA

### Professional VGA Switch with Audio and RS-232

- Connect up to 4 PC's/HDTV with audio devices to one monitor, TV, or projector

#### Specifications

- Maximum Resolution: 1920x1200 / 1080p
- Maximum Distance: 200ft / 60m
- Bandwidth: 650MHz
- Control: IR Remote or RS-232

Accessories  
VGA Cables  
P.20

- Desktop or Rack-Mount (Mounts Included)

See application diagram below



Description	Part #
2x2 VGA Video Matrix Switch	ST222MX
2x4 VGA Video Matrix Switch	ST224MX
2x8 VGA Video Matrix Switch	ST228MX
4x4 VGA Video Matrix Switch	*ST424MX

### VGA Matrix Switches

- Allows you to connect 2 computers to 8 monitors and switch video signals to any desired display

#### Specifications

- Maximum Resolution: 1920x1440
- Maximum Distance: 200ft / 60m

Accessories  
VGA Cables  
P.20

- \*ST424MX (4x4 Matrix): Includes Rack-Mounts and supports audio.

### Digital Signage Solutions

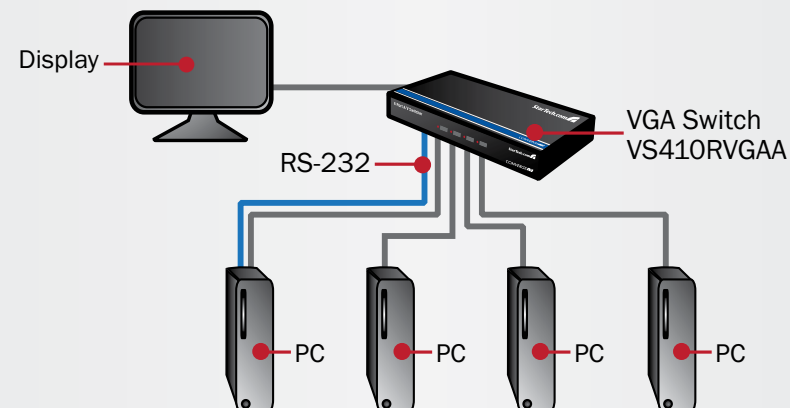

## CONVERGEAV

### Professional DVI Video Matrix Switch - with Audio



#### Select between two DVI-I sources for display on up to four monitors

- Allows two DVI computers to provide video input to display on four different monitors with audio

#### Specifications

- Maximum Resolution: 1600x1200
- Maximum Distance: 15ft / 5m
- Signal: DVI-I (Analog and Digital)
- Control: IR Remote or RS-232
- Installation Use: Desktop or Rack-Mount (Mounts Included)
- Audio Support: Yes, 3.5mm Audio Jacks

Description	Part #
2x4 DVI Video Matrix Switch with Remote	VS420RDVIA

### High Definition Switches

Select from HDMI, Component, S-Video, or composite video switches



VS410HDMIE



CPNT410IR

Description	Part #
4 Port HDMI Switch with Remote	VS410HDMIE
4 Port Component Video Switch	CPNT410IR

# A KVM to Fit Any Configuration

## Complete lineup

StarTech.com Desktop KVM Switches offers to fit any situation. Our breadth of product offerings ensures you will find the exact KVM you need for any types of connections you may have.

## Reliable

Our Desktop KVM Switches can help eliminate unnecessary downtime by providing a consistently reliable operating experience.



2 Port USB VGA Cable KVM Switch with Audio SV215MICUSBA



4 Port USB KVM Switch with Ethernet Switch Audio & USB 2.0 Hub SV431USBAN



4 Port StarView USB Console KVM switch with OSD SV431DUSB



2 Port Dual DVI USB KVM Switch with Audio SV231DVIDDU

### USB

Ports	Input Interface	Video Type	Audio	Accessory Cables	Features	Part Number
2 Port	USB	VGA	Yes	Built-In	KVM on a cable, Hot key + push button	SV215MICUSBA
2 Port	USB	VGA	Yes	Included	Kit	SV211KUSB
2 Port	USB	VGA	-	Included	Professional Series	SV231USB
2 Port	USB	VGA	Yes	Included	Built in ethernet network switch	SV231USBAN
2 Port	USB	VGA	Yes	USBVGA4N1Ax(6, 10)	Hot key, 2 port, 2.0 USB Hub	SV231USBA
2 Port	USB	DVI	Yes	Built-In	KVM on a cable, Hot key + push button	SV215MICDVIA
2 Port	USB	DVI	Yes	Included	Kit	SV211KDVI
2 Port	USB	DVI	Yes	USBVGA4N1Ax(6, 10,15)	Hot key, 2 port, 2.0 USB Hub	SV231UADVIA
4 Port	USB	VGA	Yes	Included	Built in ethernet network switch	SV431USBAN
4 Port	USB	DVI Dual-Link	Yes	USBVGA4N1Ax(6, 10,15)	Ultra High resolution	SV431DVIAUHR
4 Port	USB	VGA	Yes	Included	Kit	SV411KUSB
4 Port	USB	VGA	Yes	USBVGA4N1Ax(6, 10)	Hot key, 2 port, 2.0 USB Hub	SV431USBA
4 Port	USB	DVI	Yes	USBVGA4N1Ax(6, 10,15)	4 port USB 2.0 USB Hub	SV431DVIUA
4 Port	USB	DVI	Yes	USBVGA4N1Ax(6, 10,15)	Independent audio switching	SV431UADVIA
4 Port	USB	VGA	-	SVUSB2N1_x(6,10,15)	Professional Series, Rackmount	SV431USB
4 Port	USB	VGA	Yes	SVUSB2N1_x(6,10,15)	Professional Series, Rackmount	SV431USBAE
2 Port	USB	DisplayPort	-	DISLPORT6L	First DisplayPort KVM in the world	SV231DPU

### PS/2

Ports	Input Interface	Video Type	Audio	Accessory Cables	Features	Part Number
2 Port	PS/2	VGA	-	Included	Kit	SV211K
2 Port	PS/2	VGA	-	Built-In	KVM on a cable	SV221MICRO
2 Port	PS/2	DVI	-	DVIISMM6 + KXT102MM	Hot key + push button	SV221DVI
2 Port	PS/2	VGA	-	SVPS23N1_x(6,10,15)	Professional Series	SV231
4 Port	PS/2	VGA	-	Included	Kit	SV411K
4 Port	PS/2	VGA	Yes	Included	Kit	SV411KA
4 Port	PS/2	DVI	-	DVIISMM6 + KXT102MM	Professional Series, Rackmount	SV421DVI
4 Port	PS/2	VGA	-	SVPS23N1_x(6,10,15)	Professional Series, Rackmount	SV431

### USB & PS/2 Hybrids

Ports	Input Interface	Video Type	Accessory Cables	Features	Part Number
4 Port	PS/2	VGA	SVPS23N1_x(6,10,15) or SVUSB2N1_x(6,10,15)	Professional Series	SV431H
4 Port	USB	VGA	SVECONUSx(6, 10, 15) or SVECONx(6, 10, 15)	Professional Series	SV431DUSB

### Dual Display KVMs

Ports	Input Interface	Video Type	Audio	Accessory Cables	Part Number
2 Port	PS/2	Dual Displays VGA + VGA	-	SVPS23N1_x(6,10,15) + MXT101MMHQ	SV221DD
2 Port	PS/2	Dual Displays DVI + DVI	-	DVIISMM6 + KXT102MM	SV221DVIDD
2 Port	USB	Dual Displays VGA + DVI	Yes	USBVGA4N1Ax(6, 10,15) + MXT101MMHQ	SV231DDUSB
2 Port	USB	Dual Displays DVI + DVI	Yes	USBVGA4N1Ax(6, 10,15) + DVIDSMx(10,15)	SV231DVIDDU
4 Port	PS/2	Dual Displays VGA + VGA	-	SVPS23N1_x(6,10,15) + MXT101MMHQ	SV421DD
4 Port	PS/2	Dual Displays DVI + DVI	-	DVIISMM6 + KXT102MM	SV421DVIDD
4 Port	USB	Dual Displays VGA + DVI	Yes	USBVGA4N1Ax(6, 10,15) + MXT101MMHQ	SV431DDUSB
4 Port	USB	Dual Displays DVI + DVI	Yes	USBVGA4N1Ax(6, 10,15) + DVIDSMx(10,15)	SV431DVIDDU

For more products & detailed information visit [www.startech.com/KVM](http://www.startech.com/KVM)

# Broad Compatibility, Maximum Reliability



## Reliable and Affordable

Built for durability and longevity, StarTech.com Enterprise KVM Switches provide a consistently reliable user experience, and are backed by warranty, and free technical support.

## Complete Solutions

StarTech.com KVM switches include unique, all-in-one devices, for control of your entire server room.



KVM Console to USB 2.0 Portable Laptop Crash Cart Adapter NOTECONS01



8 Port StarView USB Console KVM switch with OSD SV831DUSB



16 Port Enhanced RS232 Serial Console Server ECS0016



1U 17in Rackmount LCD Console with Integrated 16 Port IP KVM Switch CABCONS1716I



6 ft 4-in-1 USB DVI KVM Cable with Audio and Microphone USBV4N1A6

### Portable KVM Adapter

Output Plug	Input Plug	Ports	Video	Features	Part Number
USB 2.0	USB + PS/2	1 Port	VGA	Turns your laptop into a portable KVM console	NOTECONS01

### Enterprise KVM (Rackmount)

Output Plug	Input Plug	Ports	Video	Accessory Cables*	Details	Part Number
USB + PS/2	PS/2	8 Port	VGA	SVECONUSx(6, 10, 15) or SVECONx(6, 10, 15)	-	SV831HD
USB + PS/2	USB + PS/2	8 Port	VGA	SVECONUSx(6, 10, 15) or SVECONx(6, 10, 15)	-	SV831DUSB
USB + PS/2	USB + PS/2	8 Port	VGA	SVECONUSx(6, 10, 15) or SVECONx(6, 10, 15)	With Audio	SV831DUSBA
PS/2	PS/2	8 Port	VGA	SVPS23N1_x(6,10,15, 25, 35, 50)	-	SV831
USB + PS/2	PS/2	16 Port	VGA	SVECONUSx(6, 10, 15) or SVECONx(6, 10, 15)	-	SV1631HD
USB + PS/2	USB + PS/2	16 Port	VGA	SVECONUSx(6, 10, 15) or SVECONx(6, 10, 15)	-	SV1631DUSB
USB + PS/2	PS/2	8 Port	VGA	SV5PS2S or SV5USBS (available in 4 & 8 packs)	CAT5	SV831DUTP
USB + PS/2	PS/2	16 Port	VGA	SV5PS2S or SV5USBS (available in 4 & 8 packs)	CAT5	SV1631DUTP
PS/2	PS/2	8 Port	VGA	SVPS23N1_x(6,10,15)	Dual User	SV832DS

### KVM over IP / Remote Server Management (Rackmount)

Output Plug	Input Plug	Ports	Video	Accessory Cables*	Details	Part Number
USB	USB	1 Port	VGA	Included	USB 2.0 Virtual Media	SV1107IPEXT
USB + PS/2	USB + PS/2	1 Port	VGA	Included + USB2HAB6	USB 2.0 Virtual Media	SV1115IPEXT
USB + PS/2	PS/2	4 Port	VGA	SVECONUSx(6, 10, 15) or SVECONx(6, 10, 15)	-	SV441HDIE
USB	USB	4 Port	VGA	Included (optional SVUSBVGAx(6,10))	USB 2.0 Virtual Media	SV441DUSBI
USB + PS/2	PS/2	8 Port	VGA	SVECONUSx(6, 10, 15) or SVECONx(6, 10, 15)	-	SV841HDIE
USB + PS/2	PS/2	16 Port	VGA	SVECONUSx(6, 10, 15) or SVECONx(6, 10, 15)	-	SV1641HDIE
USB + PS/2	USB + PS/2	16 Port	VGA	SV5PS2M or SV5USBM	USB 2.0 Virtual Media	SV1653DXI
USB + PS/2	USB + PS/2	16 Port	VGA	SV5PS2M or SV5USBM	USB 2.0 Virtual Media	SV1654DX4I
USB + PS/2	USB + PS/2	32 Port	VGA	SV5PS2M or SV5USBM	USB 2.0 Virtual Media**	SV3254DX4I
Serial RJ45	RJ45	16 Port	-	GC98FF + M45PATCHxBL (3,6,10,15)	Serial Console Server	ECS0016
N/A	Serial DB9	8 Outlet	-	PXT101	Serial Controlled	PCM815SHNA

### Rackmount LCD Console

KVM Ports	Video Size	Accessory Cables*	Details	Part Number
1 Port	15"	SVPS23N1_x(6,10,15,25) or USBEXTAA_x(6,10)	Lockable LCD	RACKCONS1501
1 Port	17"	SVPS23N1_x(6,10,15,25) or USBEXTAA_x(6,10)	Lockable LCD	RACKCONS1701
8 Port	17"	SVECONUSx(6, 10, 15) or SVECONx(6, 10, 15)	Lockable LCD	RACKCONS1708
16 Port	17"	SVECONUSx(6, 10, 15) or SVECONx(6, 10, 15)	Lockable LCD	RACKCONS1716
1 Port	19"	SVPS23N1_x(6,10,15,25) or USBEXTAA_x(6,10)	Lockable LCD	RACKCONS1901
16 Port	19"	SVECONUSx(6, 10, 15) or SVECONx(6, 10, 15)	Lockable LCD	RACKCONS1916
1 Port	19"	SVPS23N1_x(6,10,15,25)	Professional Series - Modular	1UCABCONS19
16 Port	17"	SVECONUSx(6, 10, 15) or SVECONx(6, 10, 15)	Over IP, Professional Series - Modular	CABCONS1716I

### Universal KVM Cables

KVM Connectors	PC Connectors	Length	Part Number
USB+VGA	USB+VGA	6, 10, 15 ft.	SVUSB2N1_x(6,10,15)
USB+DVI+SPKR+MIC	USB+DVI+SPKR+MIC	6, 15 ft.	USBV4N1Ax(6,15)
DB15	USB+VGA	6, 10, 15 ft.	SVECONUSx(6,10,15)
DB15	PS/2+VGA	6, 10, 15, 25, 50 ft.	SVECONx(6,10,15,25,50)
PS/2+VGA	PS/2+VGA	6, 10, 15, 25, 35, 50 ft.	SVPS23N1_x(6,10,15,25,35,50)
PS/2+VGA	PS/2+VGA	6, 10, 15, 25, 50 ft.	PS23N1THINx(6,10,15,25,50)

For more products & detailed information visit [www.startech.com/KVM](http://www.startech.com/KVM)

## Robust Server Racks

- Form factors to suit any application or environment.
- Choice of superior passive or active cooling designed to keep your equipment cool based on your application.
- Lockable side panels and doors increase security.
- Casters and cable management are included on full-size models.
- Flat pack versions available to ship unassembled for handling and staging at a low cost.
- Lifetime warranties give you peace of mind.

## DuraRak Open Racks

- Most cost-effective rack for situations where security is not a strict requirement.
- Open rack design optimizes airflow through and around installed equipment.
- Lowest price – this no frills DuraRak design ships unassembled to minimize manufacturing and transportation costs.
- Available in 4 post and 2 post (“telco”) versions.
- New! Heavy duty open rack, great for high density equipment like UPSs, Blade Servers, etc. (4POSTRACKHD)



**DuraRak Wallmount Cabinets**

- Solid construction in an easy-to-handle package.
- Pre-built cabinets perfect for rapid deployment and installation.

### Vertical Wallmount - NEW (mount on a wall or under a desk)

Part #	RK119WALLV	RK219WALLV	RK319WALLV	RK419WALLV
Mounting Depth	Open	Open	Open	Open
Capacity	1U	2U	3U	4U
Details	Vertical / Horizontal	Vertical / Horizontal	Vertical / Horizontal	Vertical / Horizontal

### Wallmount

Part #	WALLMOUNTH2	WALLMOUNTH4	WALLMOUNT6	RK812WALLO	CAB1019WALL	RK1219WALH	RK1219WALL	RK1219WALHM
Mounting Depth	4"	4"	12"	12"	18"	15"	18"	16.25"
Capacity	2U	4U	6U	8U	10U	12U	12U	12U
Details	Hinged	Hinged	Open	Open	Lockable Door	Lockable Door	Lockable Door	Lockable Door

### Open rack/relay rack (flat packs)

Part #	RK12OD	2POSTRACK	4POSTRACK12	4POSTRACK25	4POSTRACK36	4POSTRACKBK	4POSTRACKHD
Mounting Depth	Open	Open	31.5"	31.5"	31.5"	31.5"	36"
Capacity	12U	42U	12U	25U	36U	42U	45U
Details	Desktop Rack	-	Adjustable Depth	Adjustable Depth	Adjustable Depth	Adjustable Depth	1800lb. Capacity



### Full Rack Solutions

Part #	2636CABINET	RK2236BKF	7236CABINET	RK4236BK	RK4242BK	*RK4236BKNS	*RK4242BKNS
Rack Mounting	36"	36"	36"	36"	42"	36"	42"
Capacity	15U	22U	41U	42U	42U	42U	42U
Details	Lockable	Vented, Lockable	Vented, Lockable	Vented, Lockable	Vented, Lockable	Sides Available	Sides Available

*\*No sides versions are perfect when setting up rows of racks; save money and space*

### Rack Shelves

Part #	CABSHELF	CABSHELFD	RK36SLF	RK36SLFS	RK42SLF	RK42SLFS
Rack Mounting	16"	33"	36"	36"	42"	42"
Capacity	1U	1U	1U	1U	1U	1U
Details	Universal Rack Shelf	Fixed Shelf	Fixed Vented Shelf	Sliding Vented Shelf	Fixed Vented Shelf	Sliding Vented Shelf

### Rack Shelves / LCD Mount

Part #	RKLCDBK	SLIDESHELF	ADJSHELF	SH39LK	4UDRAWER
Rack Mounting	Open	22"	19-38"	9"	14"
Capacity	VESA LCD	1U	1U	3U	4U
Details	LCD Mount	Sliding shelf	Adjustable shelf	Locking Storage Box	Sliding Drawer



## ConXit Connection Wizard

StarTech.com's new ConXit Connection Wizard helps you find the right converter, extender, splitter, interface card or cable in two easy steps!

Visit: [www.startech.com/conxit](http://www.startech.com/conxit)



Tia | Customer Service Representative





# www.startech.com

Complete product information and exclusive resources online whenever you need it

### Loaded with Features

Tools and guides help you find the products you need

Downloads such as drivers, catalogs and handouts

Earn a diploma at StarTech University

### The Most Product Information

Product photo galleries show you exactly what you're getting

Detailed technical specifications for every product

Applications and solutions

### Availability Made Easy

Direct hotlinks to your preferred distributor

Secure online ordering provides peace of mind

Quick buy tools makes ordering simple

