



Cembre



Certified Quality Management System



Certified Environmental Management System



Certified Occupational Health & Safety Management System



GENERAL CATALOGUE



QUALITY POLICY AND OBJECTIVES



This catalogue illustrates the range of our standard products. For each product family we indicate the principal features, and sometimes the most frequent applications and the necessary guidelines for a correct application. Our sales personnel are at your disposal to supply more detailed information and our design and development engineers are available to study new solutions to particular applications.



All Cembre products comply with Directive 2011/65/EU of the European Parliament and Council dated 8 June 2011 (and subsequent amendment).

On 14th December 1990 Cembre SpA Quality Management System was certified by Lloyd's Register of Quality Assurance (LRQA) according to ISO 9002-1987 EN 29002 - 1987 BS 5750: Part 2: 1987 for the manufacture of insulated and uninsulated copper crimping connectors. Then on 22nd December 1992 Cembre SpA was certified ISO 9001 for the design and manufacture of cable accessories, electrical connectors and associated tools. The activities of the main premises in Brescia, the Italian regional offices and the subsidiary companies in Great Britain, France, Spain, Germany and USA are governed by a single Quality System, assessed by Lloyd's Register of Quality as conforming to the ISO 9001:2008 norm, for the design, manufacture and sales of electrical connectors and associated tools, cable accessories, marking systems, tooling and products for railway applications. In house repair, refurbishment and calibration of tooling. This guarantees a homogeneous and high quality level of the products and services that Cembre offers to its customers.

Cembre S.p.A. has recently recognised the need to align its Environmental Management System with the spirit and content of UNI EN ISO 14001: 2004 as fundamental to future development. To this end the company undertook a wide-ranging review of all functions including development and design stages, material selection, usage and manufacturing processes. The resulting definition of operational procedures in line with these aims and provisions has enabled Cembre S.p.A. to achieve Environmental Certification, further highlighting the company's sensitive and careful approach to environmental protection.

Cembre S.p.A. has recently enhanced its business processes with the certification by Lloyd's Register of Quality Assurance, of its Management System for the Health and Safety of Workers,

in accordance with the standard OHSAS18001:2007 (Occupational Health and Safety Management System). The project, launched in early 2011, was strategically designed to facilitate the active participation of all employees at every level in the application of systems management, in order to optimise compliance of risk management capability with regard to laws and regulations concerning the health and safety of workers. All employees have received exhaustive training and are involved, by exercising their individual responsibility and competence, as key players in the identification of residual risk situations and the proposal of corrective solutions. For Cembre then, this certification is not only the proper recognition of the quality of work performed, but also an incentive to maintain a determined competitive advantage in increasingly difficult and aggressive international markets.

Cembre S.p.A. factory in Brescia (ITALY) covers an area of approximately 121.000 sqm

*Cembre Ltd.
factory in Curdworth (Birmingham)*



Production Units



CONNECTORS FOR CONTROL, POWER AND DISTRIBUTION

Halogen free insulated terminals type VP, RP, BP, GP	4-5
Insulated chain terminals type CRP, CBP, CGP	6-7
PVC insulated crimp terminals type RF, BF, GF	8-9
Reinforced PA 6.6 insulated terminals type RKY, BKY, GKY	10-11
Female disconnect terminals type RF-F, BF-F, GF-F	12
Male disconnect terminals type RF-M, BF-M, GF-M	12
Partially insulated male/female connectors type RF-FM, BF-FM	12
Insulated bullet and socket connectors type RF-B, BF-B	12
Butt and parallel connectors type PL-M, PL-P	13
Butt connectors type NL-M	13
PE HD insulated, heat shrinkable type WL-M	13
Close end connectors type NL-P	13
Reinforced disconnect terminals type RKF, BKF, GKF	14
Female connectors, open barrel type RN-FA, BN-FA	14
Male connectors, open barrel type RN-MA, BN-MA	15
Male tabs, for board mounting type MP, MPD	15
Connector sleeves type CFA, CMA	15
Insulated end sleeves type PKE, PKC, PKD	16
"Twin" insulated end sleeves type PKET, PKCT	17
Uninsulated end sleeves type KE	17
Uninsulated terminals type S	18-19
Uninsulated terminals type RN, BN, GN	20-21
Copper tube crimping lugs type A-M	22-23
Ring tongue terminals with contained palm for L.V. circuit breakers type A-M	24
Copper tube crimping lugs type A-L angled 90°	25
Heavy duty Copper tube terminals type 2A-M	26
Through connectors type L-M	27
Parallel connectors type L-P	27
PA6.6 insulated Copper tube lugs type ANE-M	28
PA6.6 insulated fork terminals type ANE-U	29
Flexible braids type FL	29
PA6.6 insulated pin terminals type ANE-P	30
Uninsulated pin connectors type A-P	30
PA6.6 insulated Copper tube lugs type ANE-M, for extra flexible Copper conductor	31
Copper tube crimping lugs type A-M, for extra flexible Copper conductor	32
Copper tube lugs 4ESI fixing	33
Insulated covers type ES	33
Copper tube crimping lugs according to DIN 46235 type DR	34-35
Crimping through connectors according to DIN 46267 T.1 type DSV	35
Colour coded Copper crimping lugs type C	36-37
Colour coded Copper crimping lugs type CL	38
Colour coded Copper crimping lugs type C-D	39
Colour coded splices type BSCL	40

CONNECTORS FOR DERIVATIONS AND EARTHING

Sleeve connectors type C-C	41
Mechanical fixing lugs	42
Cable clamps	43

HIGH VOLTAGE COPPER TERMINALS

High voltage Copper terminals type CA-M, 2A-M	44
High voltage terminals type CA-2M, 2A-2M, 2A-2M/55°	45
High voltage stalk connectors type MTC	46
High voltage Copper through connectors type MT-TD, MT-GC	47

CONNECTORS FOR ALUMINIUM CONDUCTORS

Aluminium terminals type AA-M	48
Through connectors type MTMA-GC, MTMA/1	49
Reducer through connectors type MTMA-GC	49
Bimetallic connectors, Copper palm fixing type CAA-M	50
Bimetallic connectors, Copper pin type MTA-C	50

TERMINAL BLOCKS

ZETA <i>più</i> single pole terminal blocks	52-55
ZETA <i>block</i> power distribution blocks	56-57
ZETA <i>mini</i> one way terminal blocks	58

PHOTOVOLTAIC INSTALLATIONS

Connectors type CS4	59-60
---------------------	-------

CABLE GLANDS AND ACCESSORIES

MAXI <i>block</i> cable glands, Polyamide, IP68	62-64
<i>spiral</i> block cable glands, Polyamide, IP68	65
MAXI <i>block</i> ATEX cable glands, Polyamide, IP65	66
Compression cable glands, Polyamide PA6, IP54	67-68
Compression cable glands & hole plugs, Polystyrene, IP54	69
MAXI <i>brass</i> cable glands, Nickel plated Brass, IP68	70-73
MAXI <i>brass</i> ATEX cable glands, Nickel plated Brass, IP65	74
EMC cable glands & locknuts, Nickel plated Brass, IP68	74
Compression cable glands, Nickel plated & plain Brass, IP54	75
MAXI <i>inox</i> cable glands, Stainless Steel, IP68	76-77
Locknuts with & without collar, Polyamide	78-79
Locknuts, Nickel plated & plain Brass	80
EMC locknuts, Nickel plated Brass	81
MAXI <i>inox</i> locknuts, Stainless Steel	81
Internal plugs & multi-entry seals for cable glands	82-83
Thread enlargers, reducers and converters, Nickel plated Brass	84-85
Accessories	86
O-rings, sealing rings and compression washers	87-89
Entry plugs, Polyamide PA6, Polystyrene, IP54	90-91
Entry bushes, Polyamide PA6	92
Entry plugs & bushes, Nickel plated & plain Brass, IP54	93
RUTASEAL grommets, EPDM, IP67	94

CABLE & CONDUIT ACCESSORIES

SECUR <i>clips</i> retaining clips for cable & conduit, ABS	94
--	----

MECHANICAL TOOLS

Mechanical tools	96-113
Pneumatic press and bench tools	115-118

HYDRAULIC TOOLS

Hydraulic crimping tools	120-131
Hydraulic cable cutters	132-140
Special tools	141-143
Accessories	143
Crimping force gauges & pressure test devices	144

CORDLESS HYDRAULIC TOOLS

	146-166
--	---------

HYDRAULIC PUMPS

	168-172
--	---------

HYDRAULIC UNITS

	173-174
--	---------

DIE SELECTOR CHART

	176-185
--	---------

APPENDIX

Reference/Code cross-chart	186-195
Comparison of AWG, MCM and Metric conductor cross sections	196
IEC 60228 : 2004 - 11 Conductor Tables	197-199
System of denomination of harmonised cables according to CENELEC HD 361	200
UL & VDE approvals	201
IP ratings, flammability tests, torque settings	202-204

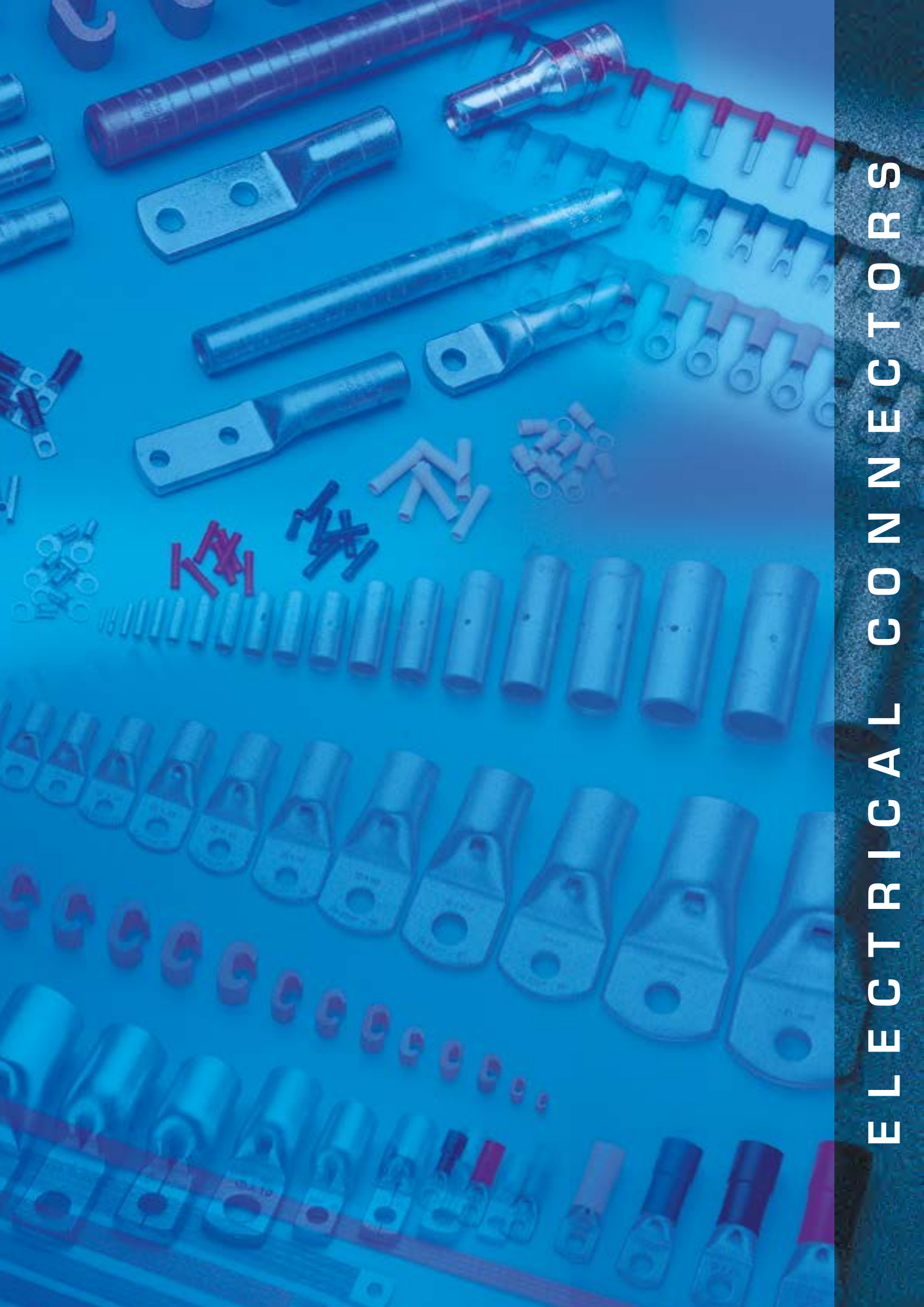

ELECTRICAL CONNECTORS

HALOGEN FREE INSULATED TERMINALS



File no. E125401

VP RP
BP GP

P range funnel entry

OPERATING
TEMPERATURE
UP TO 115°C



The "P" range of terminals has been designed, to meet the increasing demands for improved safety and reliability of electrical connectors. The Polycarbonate insula-





tion, is a Halogen free, self extinguishing thermoplastic material class VO (UL 94). The unique funnel shaped entry of the insulation sleeve, guarantees total

insertion of the conductor strands into the terminal barrel, creating a secure and reliable, electrical and mechanical connection.

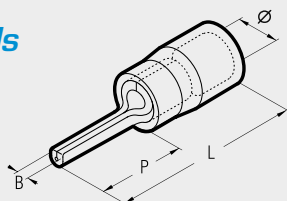
The operating temperature range is - 20 to + 115°C (Surge + 130°C). Recommended crimping tools are shown on pages 96 to 115, 150.





pin terminals

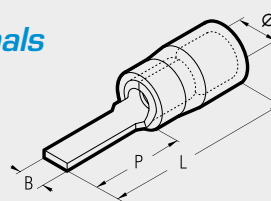

Cond. Size sqmm (AWG)	Ref.	Dimensions mm				Quantity Box/Bag
		Ø	B	P	L	
 0,2÷0,5 (24÷20)	VP-P 10	3,0	1,0	9,8	20,2	4.000/100
 0,25÷1,5 (22÷16)	RP-P 8	4,0	1,6	7,8	17,9	3.000/100
	RP-P 10	4,0	1,6	9,8	19,9	3.000/100
	RP-P 12	4,0	1,6	12,0	22,1	3.000/100
 1,5÷2,5 (16÷14)	BP-P 8	4,9	1,7	7,8	17,9	3.000/100
	BP-P 10	4,9	1,8	9,8	19,9	3.000/100
	BP-P 12	4,9	1,8	11,8	21,9	3.000/100
 4÷6 (12÷10)	GP-P 10	6,6	2,2	10,4	24,5	1.000/100
	GP-P 12	6,6	2,2	12,6	26,7	1.000/100
	GP-P 14	6,6	2,2	14,6	28,7	1.000/100



blade terminals

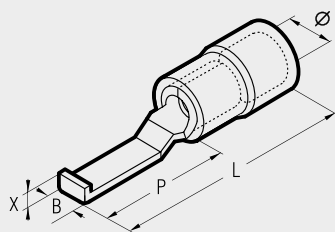

Cond. Size sqmm (AWG)	Ref.	Dimensions mm				Quantity Box/Bag
		Ø	B	P	L	
 0,2÷0,5 (24÷20)	VP-PP 12/19	3,0	1,9	12,4	22,4	4.000/100
 0,25÷1,5 (22÷16)	RP-PP 12	4,0	3,0	12,8	22,9	3.000/100
	RP-PP 12/1	4,0	3,0	11,3	21,4	3.000/100
	RP-PP 12/19	4,0	1,9	13,2	23,3	3.500/100
	RP-PP 12/23	4,0	2,3	13,2	23,3	2.500/100
	RP-PP 14	4,0	3,0	14,8	24,9	2.500/100
	RP-PP 16/23	4,0	2,3	17,2	27,3	2.500/100
 1,5÷2,5 (16÷14)	BP-PP 12	4,9	3,5	12,8	22,9	2.500/100
	BP-PP 12/25	4,9	2,5	13,3	23,4	2.000/100
	BP-PP 12/29	4,9	2,9	13,3	23,4	2.500/100
	BP-PP 16/25	4,9	2,5	17,2	27,3	2.500/100
 4÷6 (12÷10)	GP-PP 12	6,6	4,0	13,3	27,4	1.000/100
	GP-PP 17	6,6	2,9	19,1	33,2	1.000/100

hooked blade terminals



Cond. Size sqmm (AWG)	Ref.	Dimensions mm					Quantity Box/Bag
		Ø	B	P	L	X	
 0,25÷1,5 (22÷16)	RP-PPL 30*	4,0	3,0	17,5	28,3	1,7	3.000/100
	RP-PPL 46*	4,0	4,6	17,5	28,3	1,7	3.000/100
 1,5÷2,5 (16÷14)	BP-PPL 30*	4,9	3,0	17,5	28,3	1,7	2.500/100
	BP-PPL 46*	4,9	4,6	17,5	28,8	1,7	2.500/100
 4÷6 (12÷10)	GP-PPL 46*	6,6	4,6	17,5	32,6	1,9	1.000/100

*Not UL approved

HALOGEN FREE INSULATED TERMINALS



File no. E125401

P range funnel entry

VP RP
BP GP

ring terminals

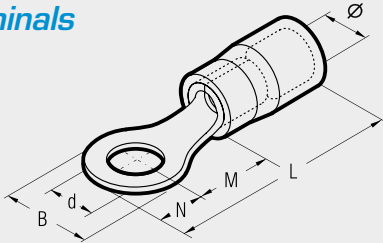

fork/spade terminals

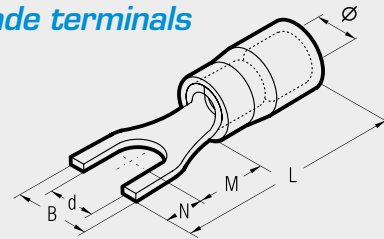

Cond. Size sqmm (AWG)	Ø Stud mm	Ref.	Dimensions mm						Quantity Box/Bag
			Ø	B	M	N	L	d	
0,2÷0,5 (24÷20)		2 *VP-M 2	3,0	5,6	4,5	2,8	17,5	2,2	4.000/100
		3 VP-M 3	3,0	5,6	4,5	2,8	17,5	3,2	4.000/100
		3,5 VP-M 3.5	3,0	5,6	4,5	2,8	17,5	3,7	4.000/100
		4 VP-M 4	3,0	7,0	6,5	3,5	20,2	4,3	4.000/100
		5 VP-M 5	3,0	7,8	7,1	3,9	21,2	5,3	4.000/100
		6 *VP-M 6	3,0	9,4	8,1	4,7	23,0	6,4	4.000/100
0,25÷1,5 (22÷16)		2 *RP-M 2	4,0	5,6	4,5	2,8	17,4	2,2	3.000/100
		3 RP-M 3	4,0	5,6	4,5	2,8	17,4	3,2	3.000/100
		3,5 RP-M 3.5	4,0	5,6	4,5	2,8	17,4	3,7	3.000/100
		3,5 RP-M 3.5/1	4,0	6,2	7,1	3,1	20,2	3,7	3.000/100
		4 RP-M 4	4,0	7,0	6,5	3,5	20,1	4,3	3.000/100
		4 RP-M 4/3	4,0	7,8	7,1	3,9	21,1	4,3	3.000/100
		5 RP-M 5	4,0	7,8	7,1	3,9	21,1	5,3	3.000/100
		6 RP-M 6	4,0	9,4	8,1	4,7	22,9	6,4	2.500/100
1,5÷2,5 (16÷14)		6 RP-M 6/1	4,0	12,0	10,3	6,0	26,4	6,4	2.000/100
		7 RP-M 7	4,0	9,4	8,1	4,7	22,9	7,2	2.500/100
		8 RP-M 8	4,0	12,0	10,3	6,0	26,4	8,4	2.500/100
		10 RP-M 10	4,0	15,5	13,0	7,7	30,9	10,5	2.000/100
		12 RP-M 12	4,0	18,0	15,5	9,0	34,6	13,0	2.000/100
		2 *BP-M 2	4,9	5,6	5,0	2,8	17,9	2,2	2.500/100
		3 BP-M 3	4,9	5,6	5,0	2,8	17,9	3,2	2.500/100
		3,5 BP-M 3.5	4,9	5,6	5,0	2,8	17,9	3,7	3.000/100
4÷6 (12÷10)		3,5 BP-M 3.5/1	4,9	6,2	6,5	3,1	19,7	3,7	2.500/100
		4 BP-M 4	4,9	8,0	6,5	4,0	20,6	4,3	2.500/100
		5 BP-M 5	4,9	8,0	7,5	4,0	21,6	5,3	2.500/100
		6 BP-M 6	4,9	9,4	8,6	4,7	23,4	6,4	2.500/100
		6 BP-M 6/1	4,9	12,0	10,3	6,0	26,4	6,4	2.500/100
		6 *BP-M 6/2	4,9	8,4	5,4	4,2	19,7	6,4	2.500/100
		7 BP-M 7	4,9	10,0	7,8	5,0	22,9	7,2	2.500/100
		8 BP-M 8	4,9	12,0	10,3	6,0	26,4	8,4	1.500/100
		10 BP-M 10	4,9	15,5	13,0	7,7	30,9	10,5	1.500/100
		12 BP-M 12	4,9	18,0	15,5	9,0	34,6	13,0	1.500/100
4÷6 (12÷10)		3 GP-M 3	6,6	8,0	8,1	4,0	26,2	3,2	1.000/100
		3,5 GP-M 3.5	6,6	8,0	8,1	4,0	26,2	3,7	1.500/100
		4 GP-M 4	6,6	9,0	8,1	4,5	26,7	4,3	1.000/100
		5 GP-M 5	6,6	9,0	8,1	4,5	26,7	5,3	1.000/100
		6 GP-M 6	6,6	11,0	11,1	5,5	30,7	6,4	1.000/100
		6 GP-M 6/1	6,6	11,0	8,1	5,5	27,7	6,4	1.000/100
		7 GP-M 7	6,6	11,0	11,1	5,5	30,7	7,2	1.000/100
		8 GP-M 8	6,6	13,6	12,1	6,8	33,0	8,4	1.000/100
		8 *GP-M 8/1	6,6	11,0	8,1	5,5	27,7	8,4	1.000/100
		10 GP-M 10	6,6	13,6	12,1	6,8	33,0	10,5	1.000/100
4÷6 (12÷10)		10 GP-M 10/1	6,6	15,5	13,8	7,7	35,7	10,5	1.000/100
		12 GP-M 12	6,6	19,0	15,1	9,5	38,7	13,0	500/100
		14 GP-M 14	6,6	21,0	16,1	10,5	40,7	15,0	500/100
		16 GP-M 16	6,6	24,0	17,1	12,0	43,2	17,0	500/100

Cond. Size sqmm (AWG)	Ø Stud mm	Ref.	Dimensions mm						Quantity Box/Bag
			Ø	B	M	N	L	d	
0,2÷0,5 (24÷20)		3 VP-U 3	3,0	5,5	5,5	4,0	18,7	3,2	4.000/100
		3,5 VP-U 3.5	3,0	6,0	6,5	3,8	19,5	3,7	4.000/100
0,25÷1,5 (22÷16)		4 VP-U 4	3,0	6,5	7,5	3,7	20,4	4,3	4.000/100
		3 RP-U 3	4,0	5,5	5,5	4,0	19,6	3,2	3.000/100
		3,5 RP-U 3.5	4,0	6,0	6,5	3,8	20,4	3,7	3.000/100
		3,5 RP-U 3.5/2	4,0	6,4	6,5	3,8	20,4	3,7	3.000/100
		4 RP-U 4	4,0	6,5	7,5	3,7	21,3	4,3	3.000/100
		4 RP-U 4/1	4,0	8,5	7,5	3,7	21,3	4,3	3.500/100
		4 RP-U 4/2	4,0	7,5	7,5	3,7	21,3	4,3	3.500/100
		5 RP-U 5	4,0	8,5	7,5	3,7	21,3	5,3	3.000/100
		5 *RP-U 5/1	4,0	9,4	7,5	3,7	21,3	5,3	3.000/100
		6 RP-U 6	4,0	9,4	8,1	4,7	22,9	6,4	2.000/100
1,5÷2,5 (16÷14)		6 RP-U 6/1	4,0	12,0	9,2	7,1	26,4	6,4	2.000/100
		8 RP-U 8	4,0	14,0	10,0	6,3	26,4	8,4	2.500/100
		10 RP-U 10	4,0	17,5	13,0	7,7	30,9	10,5	1.500/100
		12 RP-U 12	4,0	20,0	15,5	9,0	34,6	13,0	1.500/100
		3 BP-U 3	4,9	5,5	5,5	4,0	19,6	3,2	2.500/100
		3,5 BP-U 3.5	4,9	6,4	6,5	3,8	20,4	3,7	2.500/100
		3,5 *BP-U 3.5/1	4,9	7,2	6,5	3,8	20,4	3,7	2.500/100
		4 BP-U 4	4,9	6,5	7,5	3,7	21,3	4,3	2.500/100
		4 BP-U 4/1	4,9	8,5	7,5	3,7	21,3	4,3	3.000/100
		4 BP-U 4/2	4,9	7,5	7,5	3,7	21,3	4,3	2.000/100
4÷6 (12÷10)		5 BP-U 5	4,9	8,5	7,5	3,7	21,3	5,3	2.000/100
		6 BP-U 6	4,9	9,4	8,1	4,7	22,9	6,4	2.000/100
		6 BP-U 6/1	4,9	12,0	9,2	7,1	26,4	6,4	2.000/100
		8 BP-U 8	4,9	14,0	10,0	6,3	26,4	8,4	1.500/100
		10 BP-U 10	4,9	17,5	13,0	7,7	30,9	10,5	2.000/100
		12 BP-U 12	4,9	20	15,5	9,0	34,6	13,0	1.500/100
		3,5 GP-U 3.5	6,6	7,5	8,5	3,9	26,5	3,7	1.500/100
		4 GP-U 4	6,6	7,5	8,0	4,4	26,5	4,3	1.000/100
		5 GP-U 5	6,6	9,5	8,0	4,4	26,5	5,3	1.000/100
		6 GP-U 6	6,6	10,0	11,0	5,5	30,6	6,4	1.000/100
4÷6 (12÷10)		8 GP-U 8	6,6	13,5	12,0	8,0	34,1	8,4	1.000/100
		10 GP-U 10	6,6	15,5	13,0	8,0	35,1	10,5	1.000/100
		10 GP-U 10/1	6,6	17,5	13,8	7,7	35,7	10,5	1.000/100
		12 GP-U 12	6,6	21,0	15,1	9,5	38,7	13,0	500/100
		14 GP-U 14	6,6	23,0	16,1	10,5	40,7	15,0	500/100
		16 GP-U 16	6,6	26,0	17,1	11,5	42,7	17,0	500/100

*Made to order

INSULATED CHAIN TERMINALS

CP range with easy entry



CRP
CBP
CGP



HALOGEN FREE
OPERATING TEMPERATURE UP TO 115°C

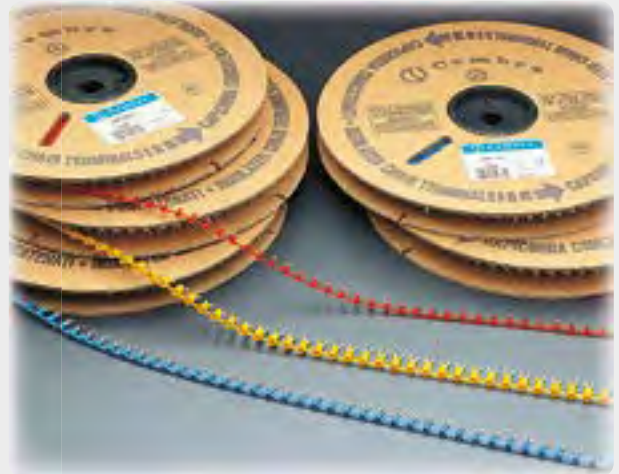

The "CP" range of terminals has been designed to meet the increasing demands for improved safety and reliability of electrical connectors.

Developed for use with production equipment, to give a quick and reliable crimped joint, the Polycarbonate insulation is a Halogen free, self extinguishing thermoplastic material class

VO (UL 94). The unique funnel shaped entry of the insulation sleeve guarantees total insertion of the conductor strands into the terminal barrel, creating a se-

cure and reliable, electrical and mechanical connection. The operating temperature range is - 20 to + 115°C (Surge + 130°C).

pin terminals

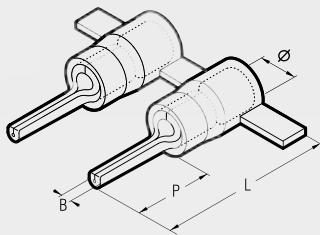

blade terminals

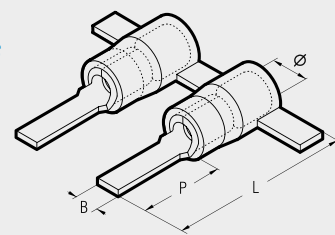

Conductor Size sqmm (AWG)	Ref.	Dimensions mm				Quantity
		Ø	B	P	L	
0,25÷1,5 (22÷16)	CRP-P 8	4,0	1,6	8,0	17,9	2.000
	CRP-P 10	4,0	1,6	10,0	19,9	2.000
	CRP-P 12	4,0	1,6	12,0	22,1	2.000
1,5÷2,5 (16÷14)	CBP-P 8	4,9	1,8	8,0	17,9	1.750
	CBP-P 10	4,9	1,8	10,0	19,9	1.750
	CBP-P 12	4,9	1,8	12,0	21,9	1.750
4÷6 (12÷10)	CGP-P 10	6,6	2,2	10,0	24,5	1.250
	CGP-P 12	6,6	2,2	12,0	26,7	1.250
	CGP-P 14	6,6	2,2	14,0	28,7	1.250

Conductor Size sqmm (AWG)	Ref.	Dimensions mm				Quantity
		Ø	B	P	L	
0,25÷1,5 (22÷16)	CRP-PP 12	4,0	3,0	12,8	22,9	2.000
	*CRP-PP 12/1	4,0	3,0	11,3	21,4	2.000
	*CRP-PP 12/23	4,0	2,3	13,2	23,3	2.000
	CRP-PP 14	4,0	3,0	14,8	24,9	2.000
1,5÷2,5 (16÷14)	CBP-PP 12	4,9	3,5	12,8	22,9	1.750
	*CBP-PP 12/25	4,9	2,5	13,3	23,4	1.750
4÷6 (12÷10)	CGP-PP 12	6,6	4,0	13,3	27,4	1.250
	*CGP-PP 17	6,6	2,9	19,1	33,2	1.250

male disconnect terminals

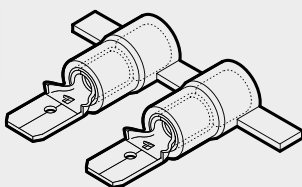

female disconnect terminals

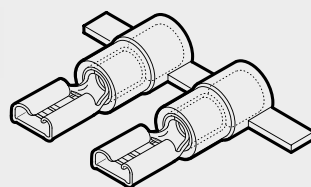

female disconnect terminals fully insulated

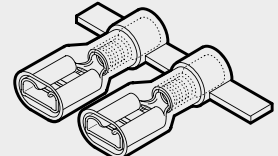

Conductor Size sqmm (AWG)	Ref.	Tab mm	Quantity
0,25÷1,5 (22÷16)	CRP-M 608	6,35 x 0,8	2.000
1,5÷2,5 (16÷14)	CBP-M 608	6,35 x 0,8	1.750
4÷6 (12÷10)	CGP-M 608	6,35 x 0,8	1.250

Conductor Size sqmm (AWG)	Ref.	Tab mm	Quantity
0,25÷1,5 (22÷16)	CRP-F 305	2,8 x 0,5	2.000
	CRP-F 308	2,8 x 0,8	2.000
	CRP-F 405	4,8 x 0,5	2.000
	CRP-F 408	4,8 x 0,8	2.000
	CRP-F 608	6,35 x 0,8	2.000
	1,5÷2,5 (16÷14)	CBP-F 405	4,8 x 0,5
CBP-F 408		4,8 x 0,8	1.750
CBP-F 608		6,35 x 0,8	1.750
4÷6 (12÷10)	CGP-F 608	6,35 x 0,8	1.250

Conductor Size sqmm (AWG)	Ref.	Tab mm	Quantity
0,25÷1,5 (22÷16)	CRP-F 405P*	4,8 x 0,5	2.000
	CRP-F 408P*	4,8 x 0,8	2.000
	CRP-F 608P	6,35 x 0,8	1.500
1,5÷2,5 (16÷14)	CBP-F 408P*	4,8 x 0,8	1.500
	CBP-F 608P	6,35 x 0,8	1.500
4÷6 (12÷10)	CGP-F 608P	6,35 x 0,8	1.250

*Not UL approved

*Made to order

INSULATED CHAIN TERMINALS



fork/spade terminals

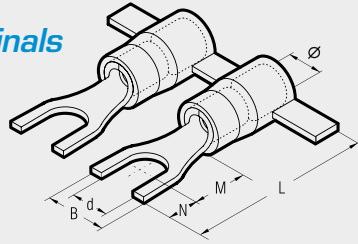

CP range with easy entry

CRP
CBP
CGP

Cond. Size sqmm (AWG)	Ø Stud mm	Ref.	Dimensions mm					Quantity	
			Ø	B	M	N	L		d
0,25÷1,5 (22÷16)	3	CRP-U 3	4,0	5,5	5,5	4,0	19,6	3,2	2.000
	3,5	CRP-U 3.5	4,0	6,0	6,5	3,8	20,4	3,7	2.000
	3,5	*CRP-U 3.5/2	4,0	6,4	6,5	3,8	20,4	3,7	2.000
	4	CRP-U 4	4,0	6,5	7,5	3,7	21,3	4,3	2.000
	4	*CRP-U 4/1	4,0	8,5	7,5	3,7	21,3	4,3	2.000
	4	*CRP-U 4/2	4,0	7,5	7,5	3,7	21,3	4,3	2.000
	5	CRP-U 5	4,0	8,5	7,5	3,7	21,3	5,3	2.000
	6	CRP-U 6	4,0	9,4	8,1	4,7	22,9	6,4	2.000
1,5÷2,5 (16÷14)	6	*CRP-U 6/1	4,0	12,0	9,2	7,1	26,4	6,4	2.000
	8	*CRP-U 8	4,0	14,0	10,0	6,3	26,4	8,4	2.000
	3	CBP-U 3	4,9	5,5	5,5	4,0	19,6	3,2	1.750
	3,5	CBP-U 3.5	4,9	6,4	6,5	3,8	20,4	3,7	1.750
	4	CBP-U 4	4,9	6,5	7,5	3,7	21,3	4,3	1.750
	4	*CBP-U 4/1	4,9	8,5	7,5	3,7	21,3	4,3	1.750
	4	*CBP-U 4/2	4,9	7,5	7,5	3,7	21,3	4,3	1.750
	5	CBP-U 5	4,9	8,5	7,5	3,7	21,3	5,3	1.750
4÷6 (12÷10)	6	CBP-U 6	4,9	9,4	8,1	4,7	22,9	6,4	1.750
	3,5	*CGP-U 3.5	6,6	7,5	8,5	3,9	26,5	3,7	1.250
	4	*CGP-U 4	6,6	7,5	8,0	4,4	26,5	4,3	1.250
	5	CGP-U 5	6,6	9,5	8,0	4,4	26,5	5,3	1.250
6	CGP-U 6	6,6	10,0	11,0	5,5	30,6	6,4	1.250	

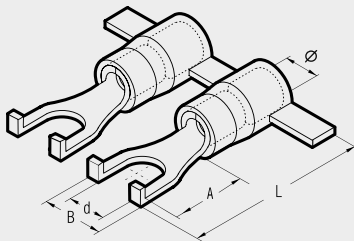

Cond. Size sqmm (AWG)	Ø Stud mm	Ref.	Dimensions mm					Quantity
			Ø	B	A	L	d	
1,5÷2,5 (16÷14)	4	CBP-U 4/3L*	4,9	6,5	9,5	14,5	4,3	1.750

hooked blade terminals

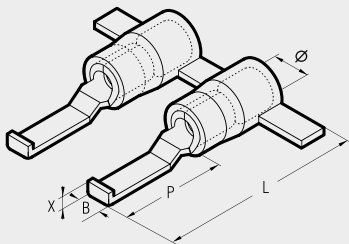

Cond. Size sqmm (AWG)	Ref.	Dimensions mm					Quantity
		Ø	B	P	L	X	
0,25÷1,5 (22÷16)	CRP-PPL30*	4,0	3,0	17,5	28,8	1,7	2.000
1,5÷2,5 (16÷14)	CBP-PPL30*	4,9	3,0	17,5	28,8	1,7	1.750

*Not UL approved

*Made to order

ring terminals

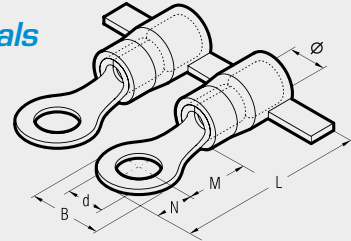

Cond. Size sqmm (AWG)	Ø Stud mm	Ref.	Dimensions mm					Quantity	
			Ø	B	M	N	L		d
0,25÷1,5 (22÷16)	3	CRP-M 3	4,0	5,6	4,5	2,8	17,4	3,2	2.000
	3,5	CRP-M 3.5	4,0	5,6	4,5	2,8	17,4	3,7	2.000
	3,5	*CRP-M 3.5/1	4,0	6,2	7,1	3,1	20,2	3,7	2.000
	4	CRP-M 4	4,0	7,0	6,5	3,5	20,1	4,3	2.000
	4	*CRP-M 4/3	4,0	7,8	7,1	3,9	21,1	4,3	2.000
	5	CRP-M 5	4,0	7,8	7,1	3,9	21,1	5,3	2.000
	6	CRP-M 6	4,0	9,4	8,1	4,7	22,9	6,4	2.000
	6	*CRP-M 6/1	4,0	12,0	10,3	6,0	26,4	6,4	2.000
1,5÷2,5 (16÷14)	7	CRP-M 7	4,0	9,4	8,1	4,7	22,9	7,2	2.000
	8	CRP-M 8	4,0	12,0	10,3	6,0	26,4	8,4	2.000
	3	CBP-M 3	4,9	5,6	5,0	2,8	17,9	3,2	1.750
	3,5	CBP-M 3.5	4,9	5,6	5,0	2,8	17,9	3,7	1.750
	3,5	*CBP-M 3.5/1	4,9	6,2	6,5	3,1	19,6	3,7	1.750
	4	CBP-M 4	4,9	8,0	6,5	4,0	20,6	4,3	1.750
	5	CBP-M 5	4,9	8,0	7,5	4,0	21,6	5,3	1.750
	6	CBP-M 6	4,9	9,4	8,6	4,7	23,4	6,4	1.750
4÷6 (12÷10)	6	*CBP-M 6/1	4,9	12,0	10,3	6,0	26,4	6,4	1.750
	7	CBP-M 7	4,9	10,0	7,8	5,0	22,9	7,2	1.750
	8	CBP-M 8	4,9	12,0	10,3	6,0	26,4	8,4	1.750
	3	CGP-M 3	6,6	8,0	8,1	4,0	26,2	3,2	1.250
	3,5	CGP-M 3.5	6,6	8,0	8,1	4,0	26,2	3,7	1.250
	4	CGP-M 4	6,6	9,0	8,1	4,5	26,7	4,3	1.250
	5	CGP-M 5	6,6	9,0	8,1	4,5	26,7	5,3	1.250
	6	CGP-M 6	6,6	11,0	11,1	5,5	30,7	6,4	1.250
6	*CGP-M 6/1	6,6	11,0	8,1	5,5	27,7	6,4	1.250	
7	CGP-M 7	6,6	11,0	11,1	5,5	30,7	7,2	1.000	
8	CGP-M 8	6,6	13,6	12,1	6,8	33,0	8,4	1.250	
8	*CGP-M 8/1	6,6	11,0	8,1	5,5	27,7	8,4	1.250	



Interchangeable application heads are available for crimping these terminals with the bench press ELB-3 (see page 118).

PVC INSULATED CRIMP TERMINALS

F range funnel entry



File no. E125401

RF BF
GF



The unique funnel shaped PVC sleeve guarantees total insertion of the conductor strands into the terminal barrel, creating a secure and reliable, electrical and mechanical connection. The internal surface of the

barrel is rifled to improve contact with conductor strands when crimped and to increase tensile strength. The "F" range of terminals offers a wide selection of rings, forks, pins and blades, designed to meet the ever

changing end user requirements.

The operating temperature range is - 20 to + 80°C (Surge + 90°C).

Recommended crimping tools are shown on pages 96 to 115, 150.

pin terminals

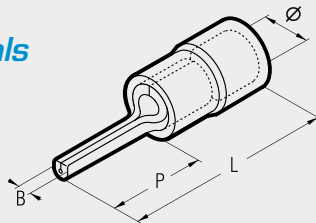

blade terminals

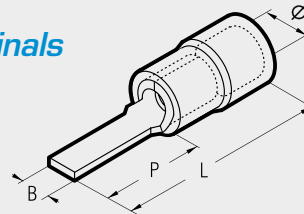

Conductor Size sqmm (AWG)	Ref.	Dimensions mm				Quantity Box/Bag
		Ø	B	P	L	
0,25÷1,5 (22÷16)	RF-P 8	3,9	1,6	8,0	17,9	3.000/100
	RF-P 10	3,9	1,6	10,0	19,9	3.000/100
	RF-P 12	3,9	1,6	12,0	22,1	3.000/100
1,5÷2,5 (16÷14)	BF-P 8	4,9	1,7	8,0	17,9	3.000/100
	BF-P 10	4,9	1,8	10,0	19,9	2.500/100
	BF-P 12	4,9	1,8	12,0	21,9	2.500/100
4÷6 (12÷10)	GF-P 10	6,7	2,2	10,0	24,6	1.000/100
	GF-P 12	6,7	2,2	12,0	26,8	1.000/100
	GF-P 14	6,7	2,2	14,0	28,8	1.000/100

Conductor Size sqmm (AWG)	Ref.	Dimensions mm				Quantity Box/Bag
		Ø	B	P	L	
0,25÷1,5 (22÷16)	RF-PP 12	3,9	3,0	12,8	22,9	3.000/100
	RF-PP 12/1	3,9	3,0	11,3	21,4	3.000/100
	RF-PP 12/19	3,9	1,9	13,2	23,3	3.000/100
	RF-PP 12/23	3,9	2,3	13,2	23,3	2.500/100
	RF-PP 14	3,9	3,0	14,8	24,9	2.500/100
1,5÷2,5 (16÷14)	RF-PP 16/23	3,9	2,3	17,2	27,3	2.500/100
	BF-PP 12	4,9	3,5	12,8	22,9	2.500/100
	BF-PP 12/25	4,9	2,5	13,3	23,4	2.000/100
	BF-PP 12/29*	4,9	2,9	13,3	23,4	2.500/100
	BF-PP 16/25	4,9	2,5	17,2	27,3	2.500/100
4÷6 (12÷10)	GF-PP 12	6,7	4,0	13,3	27,5	1.000/100
	GF-PP 17	6,7	2,9	19,2	33,4	1.000/100

hooked blade terminals

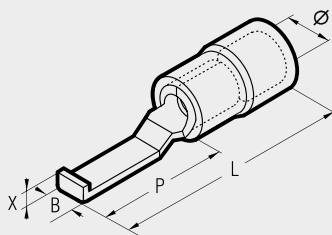

Conductor Size sqmm (AWG)	Ref.	Dimensions mm					Quantity Box/Bag
		Ø	B	P	L	X	
0,25÷1,5 (22÷16)	RF-PPL 30*	3,9	3,0	17,5	28,4	1,7	2.500/100
	RF-PPL 46*	3,9	4,6	17,5	28,4	1,7	2.500/100
1,5÷2,5 (16÷14)	BF-PPL 30*	4,9	3,0	17,5	28,4	1,7	2.000/100
	BF-PPL 46*	4,9	4,6	17,5	28,4	1,7	2.000/100
4÷6 (12÷10)	GF-PPL 46*	6,7	4,6	17,5	32,7	1,9	1.000/100

*Not UL approved

PVC INSULATED CRIMP TERMINALS

F range funnel entry

RF BF
GF



File no. E125401

VALSTAR V3-F

Robust plastic case with compartments, containing:

- An assortment of PVC insulated crimp terminals for conductor sizes 0,25 to 6 mm² (22÷10 AWG).
- Tool Crimpstar® HP 3.



Connectors included:

- Qty 50 terminals RF-U4
- Qty 50 terminals RF-U5
- Qty 50 terminals RF-P10
- Qty 50 terminals BF-U4
- Qty 50 terminals BF-U5
- Qty 50 terminals BF-P10
- Qty 25 terminals GF-U5
- Qty 25 terminals GF-U6
- Qty 25 terminals GF-P12
- Qty 25 connectors PLO6-M
- Qty 25 connectors PL1-M

ring terminals

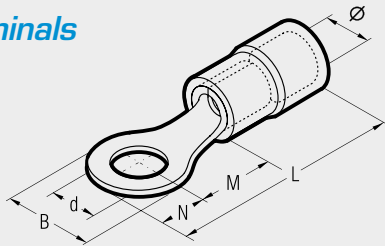

fork/spade terminals

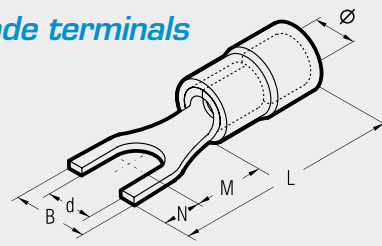

Cond. Size sqmm (AWG)	Ø Stud mm	Ref.	Dimensions mm						Quantity Box/Bag
			Ø	B	M	N	L	d	
2		*RF-M 2*	3,9	5,6	4,5	2,8	17,4	2,2	3.000/100
3		RF-M 3	3,9	5,6	4,5	2,8	17,4	3,2	3.000/100
3,5		RF-M 3.5	3,9	5,6	4,5	2,8	17,4	3,7	3.000/100
3,5		RF-M 3.5/1	3,9	6,2	7,1	3,1	20,3	3,7	3.000/100
4		RF-M 4	3,9	7,0	6,5	3,5	20,1	4,3	3.000/100
4		RF-M 4/3*	3,9	7,8	7,1	3,9	21,1	4,3	3.000/100
5		RF-M 5	3,9	7,8	7,1	3,9	21,1	5,3	2.500/100
6		RF-M 6	3,9	9,4	8,1	4,7	22,9	6,4	2.500/100
6		RF-M 6/1	3,9	12,0	10,3	6,0	26,4	6,4	2.000/100
7		RF-M 7	3,9	9,4	8,1	4,7	22,9	7,2	2.500/100
8		RF-M 8	3,9	12,0	10,3	6,0	26,4	8,4	2.000/100
0,25÷1,5 (22÷16)		10 RF-M 10	3,9	15,5	13,0	7,7	30,9	10,5	1.500/100
		12 RF-M 12	3,9	18,0	15,5	9,0	34,6	13,0	1.500/100
		2 *BF-M 2*	4,9	5,6	5,0	2,8	17,9	2,2	3.000/100
		3 BF-M 3	4,9	5,6	5,0	2,8	17,9	3,2	2.500/100
		3,5 BF-M 3.5	4,9	5,6	5,0	2,8	17,9	3,7	2.500/100
		3,5 BF-M 3.5/1	4,9	6,2	6,5	3,1	19,7	3,7	2.500/100
		4 BF-M 4	4,9	8,0	6,5	4,0	20,6	4,3	2.500/100
		5 BF-M 5	4,9	8,0	7,5	4,0	21,6	5,3	2.500/100
		6 BF-M 6	4,9	9,4	8,6	4,7	23,4	6,4	2.000/100
		6 BF-M 6/1	4,9	12,0	10,3	6,0	26,4	6,4	2.000/100
		6 BF-M 6/2	4,9	8,4	5,4	4,2	19,7	6,4	2.500/100
		7 BF-M 7	4,9	10,0	7,8	5,0	22,9	7,2	2.000/100
		8 BF-M 8	4,9	12,0	10,3	6,0	26,4	8,4	1.500/100
1,5÷2,5 (16÷14)		10 BF-M 10	4,9	15,5	13,0	7,7	30,9	10,5	1.500/100
		12 BF-M 12	4,9	18	15,5	9,0	34,6	13,0	1.000/100
		3 GF-M 3	6,7	8,0	8,1	4,0	26,3	3,2	1.000/100
		3,5 GF-M 3.5	6,7	8,0	8,1	4,0	26,3	3,7	1.000/100
		4 GF-M 4	6,7	9,0	8,1	4,5	26,8	4,3	1.000/100
		5 GF-M 5	6,7	9,0	8,1	4,5	26,8	5,3	1.000/100
		6 GF-M 6	6,7	11,0	11,1	5,5	30,8	6,4	1.000/100
		6 GF-M 6/1	6,7	11,0	8,1	5,5	27,8	6,4	1.000/100
		7 GF-M 7	6,7	11,0	11,1	5,5	30,8	7,2	1.000/100
		8 GF-M 8	6,7	13,6	12,1	6,8	33,1	8,4	1.000/100
		8 GF-M 8/1	6,7	11,0	8,1	5,5	27,8	8,4	1.000/100
		10 GF-M 10	6,7	13,6	12,1	6,8	33,1	10,5	1.000/100
		10 GF-M 10/1	6,7	15,5	13,8	7,7	35,8	10,5	1.000/100
		12 GF-M 12	6,7	19,0	15,1	9,5	38,8	13,0	500/100
4÷6 (12÷10)		14 GF-M 14	6,7	21,0	16,1	10,5	40,8	15,0	500/100
		16 GF-M 16	6,7	24,0	17,1	12,0	43,3	17,0	500/100

Cond. Size sqmm (AWG)	Ø Stud mm	Ref.	Dimensions mm						Quantity Box/Bag
			Ø	B	M	N	L	d	
3		RF-U 3	3,9	5,5	5,5	4,0	19,6	3,2	3.000/100
3,5		RF-U 3.5	3,9	6,0	6,5	3,8	20,4	3,7	3.000/100
3,5		RF-U 3.5/1	3,9	7,2	6,5	3,8	20,4	3,7	3.000/100
3,5		RF-U 3.5/2*	3,9	6,4	6,5	3,8	20,4	3,7	3.000/100
4		RF-U 4	3,9	6,5	7,5	3,7	21,3	4,3	3.000/100
4		RF-U 4/1	3,9	8,5	7,5	3,7	21,3	4,3	3.000/100
4		RF-U 4/2	3,9	7,5	7,5	3,7	21,3	4,3	3.000/100
5		RF-U 5	3,9	8,5	7,5	3,7	21,3	5,3	3.000/100
5		*RF-U 5/1*	3,9	9,4	7,5	3,7	21,3	5,3	3.000/100
6		RF-U 6	3,9	9,4	8,1	4,7	22,9	6,4	2.000/100
6		RF-U 6/1	3,9	12,0	9,2	7,1	26,4	6,4	2.500/100
8		RF-U 8	3,9	14,0	10,0	6,3	26,4	8,4	2.000/100
0,25÷1,5 (22÷16)		10 RF-U 10	3,9	17,5	13,0	7,7	30,9	10,5	1.500/100
		12 RF-U 12	3,9	20,0	15,5	9,0	34,6	13,0	1.500/100
		3 BF-U 3	4,9	5,5	5,5	4,0	19,6	3,2	2.500/100
		3,5 BF-U 3.5	4,9	6,4	6,5	3,8	20,4	3,7	2.500/100
		*3,5 BF-U 3.5/1	4,9	7,2	6,5	3,8	20,4	3,7	3.000/100
		4 BF-U 4	4,9	6,5	7,5	3,7	21,3	4,3	2.500/100
		4 BF-U 4/1	4,9	8,5	7,5	3,7	21,3	4,3	2.000/100
		4 BF-U 4/2	4,9	7,5	7,5	3,7	21,3	4,3	2.000/100
		5 BF-U 5	4,9	8,5	7,5	3,7	21,3	5,3	2.000/100
		5 BF-U 5/2*	4,9	12,0	11,3	5,0	26,3	5,3	1.500/100
		6 BF-U 6	4,9	9,4	8,1	4,7	22,9	6,4	2.000/100
		6 BF-U 6/1	4,9	12,0	9,2	7,1	26,4	6,4	2.000/100
		8 BF-U 8	4,9	14,0	10,0	6,3	26,4	8,4	1.500/100
1,5÷2,5 (16÷14)		10 BF-U 10	4,9	17,5	13,0	7,7	30,9	10,5	1.000/100
		12 BF-U 12	4,9	20,0	15,5	9,0	34,6	13,0	1.500/100
		3,5 GF-U 3.5	6,7	7,5	8,5	3,9	26,6	3,7	1.000/100
		4 GF-U 4	6,7	7,5	8,0	4,4	26,6	4,3	1.000/100
		5 GF-U 5	6,7	9,5	8,0	4,4	26,6	5,3	1.000/100
		6 GF-U 6	6,7	10,0	11,0	5,5	30,7	6,4	1.000/100
		8 GF-U 8	6,7	13,5	12,0	8,0	34,2	8,4	1.000/100
		10 GF-U 10	6,7	15,5	13,0	8,0	35,2	10,5	1.000/100
		10 GF-U 10/1	6,7	17,5	13,8	7,7	35,8	10,5	1.000/100
		12 GF-U 12	6,7	21,0	15,1	9,5	38,8	13,0	500/100
4÷6 (12÷10)		14 GF-U 14	6,7	23,0	16,1	10,5	40,8	15,0	500/100
		16 GF-U 16	6,7	26,0	17,1	11,5	42,8	17,0	500/100

*Not UL approved

*Made to order

REINFORCED PA 6.6 INSULATED TERMINALS

RKY
BKY
GKY

KY range

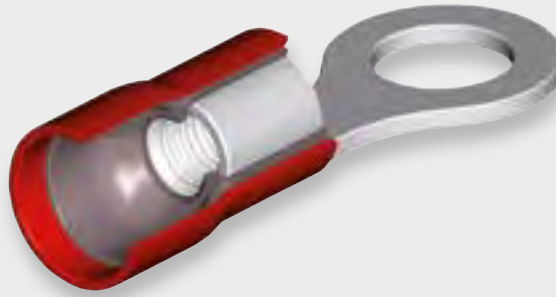

'KY' type terminals are designed to offer improved mechanical and electrical integrity under heavy-duty application.

This is achieved via a Copper sleeve located between

the Copper barrel and Polyamide insulation of the terminal. Then, during crimping, the insulation of the conductor is integrated into the crimp due to the Copper sleeve being deformed

around it to maintain the level of 'grip' required in applications subject to continuous mechanical vibrations (e.g: mobile plant, vehicles, moving components).

The operating temperature range is - 20 to + 105°C (Surge + 110°C).

Recommended crimping tools are shown on pages 96 to 115, 150.

pin terminals

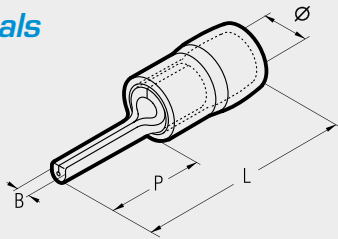

blade terminals

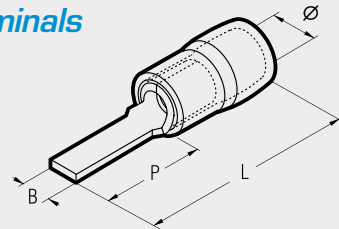

Conductor Size sqmm (AWG)	Ref.	Dimensions mm				Quantity Box/Bag
		Ø	B	P	L	
0,25÷1,5 (22÷16)	RKY-P 8	4,5	1,9	9,0	19,8	3.000/100
	RKY-P 10	4,5	1,9	10,0	20,8	3.500/100
	RKY-P 12	4,5	1,9	12,0	22,8	3.000/100
1,5÷2,5 (16÷14)	BKY-P 8	5,2	1,9	9,0	19,8	3.000/100
	BKY-P 10	5,2	1,9	10,0	20,8	3.000/100
	BKY-P 12	5,2	1,9	12,0	22,8	3.000/100
4÷6 (12÷10)	GKY-P 14	7,0	2,8	14,0	27,0	1.000/100

Conductor Size sqmm (AWG)	Ref.	Dimensions mm				Quantity Box/Bag
		Ø	B	P	L	
0,25÷1,5 (22÷16)	RKY-PP 12	4,5	3,0	13,0	23,8	3.000/100
	RKY-PP 12/19	4,5	2,0	18,0	28,8	3.000/100
	RKY-PP 16/23	4,5	2,2	18,0	28,8	2.500/100
1,5÷2,5 (16÷14)	BKY-PP 12	5,2	3,0	13,0	23,8	2.500/100
	BKY-PP 12/25	5,2	2,4	13,0	23,8	2.000/100
	BKY-PP 16/23	5,2	2,2	18,0	28,8	2.500/100
4÷6 (12÷10)	GKY-PP 12	7,0	4,0	14,0	27,0	1.000/100
	GKY-PP 17	7,0	2,0	18,0	31,0	1.000/100

Consult Cembre for a wider range of pin and blade dimensions.

hooked blade terminals

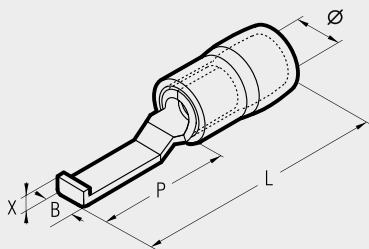

Conductor Size sqmm (AWG)	Ref.	Dimensions mm					Quantity Box/Bag
		Ø	B	P	L	X	
0,25÷1,5 (22÷16)	RKY-PPL 30	4,5	3,0	16,8	28,2	2,1	3.000/100
	RKY-PPL 46	4,5	4,6	16,8	28,2	2,1	3.000/100
1,5÷2,5 (16÷14)	BKY-PPL 30	5,2	3,0	16,8	28,2	2,1	2.500/100
	BKY-PPL 46	5,2	4,6	16,8	28,2	2,1	2.500/100
4÷6 (12÷10)	GKY-PPL 46	7,0	4,6	17,2	30,2	2,4	1.000/100

REINFORCED PA 6.6 INSULATED TERMINALS



KY range

RKY
BKY
GKY

ring terminals

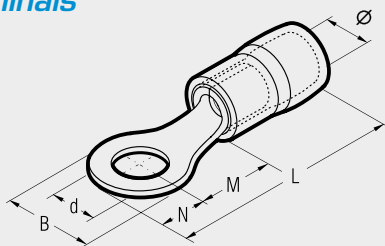

fork/spade terminals

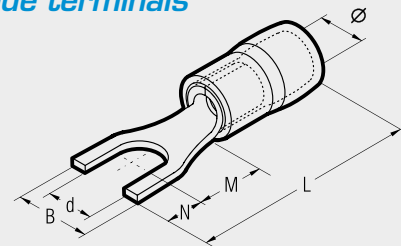

Cond. Size sqmm (AWG)	Ø Stud mm	Ref.	Dimensions mm						Quantity Box/Bag
			Ø	B	M	N	L	d	
0,25÷1,5 (22÷16)	3	RKY-M 3	4,5	5,5	5,0	2,5	18,5	3,2	3.000/100
	3,5	RKY-M 3.5	4,5	5,5	5,0	2,5	18,5	3,7	3.000/100
	3,5	RKY-M 3.5/1	4,5	6,6	6,3	3,1	20,4	3,7	3.000/100
	4	RKY-M 4	4,5	6,6	6,3	3,1	20,4	4,3	3.000/100
	5	RKY-M 5	4,5	8,0	7,0	3,8	21,8	5,3	3.000/100
	6	RKY-M 6/1	4,5	11,6	11,0	5,8	27,8	6,4	2.000/100
	8	RKY-M 8	4,5	11,6	11,0	5,8	27,8	8,4	2.500/100
	10	RKY-M 10	4,5	13,6	13,9	6,6	31,5	10,5	1.500/100
1,5÷2,5 (16÷14)	12	RKY-M 12	4,5	19,6	16,0	9,4	36,4	13,0	1.500/100
	3	BKY-M 3	5,2	6,6	4,8	3,0	18,8	3,2	2.500/100
	3,5	BKY-M 3.5	5,2	6,6	4,8	3,0	18,8	3,7	2.500/100
	3,5	BKY-M 3.5/1	5,2	6,6	6,3	3,1	20,4	3,7	2.500/100
	4	BKY-M 4	5,2	8,5	7,8	4,0	22,8	4,3	2.500/100
	5	BKY-M 5	5,2	8,5	7,8	4,0	22,8	5,3	2.500/100
	6	BKY-M 6/1	5,2	12,0	11,0	5,8	27,8	6,4	2.500/100
	8	BKY-M 8	5,2	12,0	11,0	5,8	27,8	8,4	1.500/100
4÷6 (12÷10)	10	BKY-M 10	5,2	13,6	13,9	6,6	31,5	10,5	1.500/100
	12	BKY-M 12	5,2	19,2	16,0	9,4	36,4	13,0	1.000/100
	3,5	GKY-M 3.5	7,0	7,2	6,1	3,6	22,7	3,7	1.000/100
	4	GKY-M 4	7,0	9,5	9,1	4,5	26,6	4,3	1.000/100
	5	GKY-M 5	7,0	9,5	9,1	4,5	26,6	5,3	1.000/100
	6	GKY-M 6	7,0	12,0	10,5	6,0	29,5	6,4	1.000/100
	8	GKY-M 8	7,0	15,0	13,5	7,5	34,0	8,4	1.000/100
	10	GKY-M 10	7,0	15,0	13,5	7,5	34,0	10,5	1.000/100
4÷6 (12÷10)	12	GKY-M 12	7,0	19,2	16,0	9,6	38,6	13,0	1.000/100
	14	GKY-M 14	7,0	32,0	25,2	16,0	54,2	15,0	500/100
	16	GKY-M 16	7,0	32,0	25,2	16,0	54,2	17,0	500/100

Cond. Size sqmm (AWG)	Ø Stud mm	Ref.	Dimensions mm						Quantity Box/Bag
			Ø	B	M	N	L	d	
0,25÷1,5 (22÷16)	3	RKY-U 3	4,5	5,7	6,5	4,5	22,0	3,2	2.500/100
	3,5	RKY-U 3.5	4,5	5,7	6,5	4,5	22,0	3,7	2.500/100
	4	RKY-U 4	4,5	6,4	6,5	4,5	22,0	4,3	3.000/100
	5	RKY-U 5	4,5	8,1	6,5	4,5	22,0	5,3	3.000/100
	6	RKY-U 6	4,5	9,5	6,5	4,5	22,0	6,4	2.000/100
	6	RKY-U 6/1	4,5	12,0	11,0	6,0	28,0	6,4	2.000/100
1,5÷2,5 (16÷14)	3	BKY-U 3	5,2	5,7	6,5	4,5	22,0	3,2	2.500/100
	3,5	BKY-U 3.5	5,2	6,0	6,5	4,5	22,0	3,7	2.500/100
	4	BKY-U 4	5,2	6,4	6,5	4,5	22,0	4,3	2.500/100
	5	BKY-U 5	5,2	7,9	6,5	4,5	22,0	5,3	2.500/100
	6	BKY-U 6	5,2	9,3	6,5	4,5	22,0	6,4	2.000/100
	6	BKY-U 6/1	5,2	12,0	11,0	6,0	28,0	6,4	2.000/100
4÷6 (12÷10)	3,5	GKY-U 3.5	7,0	7,2	7,5	3,9	24,4	3,7	1.500/100
	4	GKY-U 4	7,0	7,2	7,5	3,9	24,4	4,3	1.000/100
	5	GKY-U 5	7,0	9,0	7,0	5,5	25,5	5,3	1.000/100
	6	GKY-U 6	7,0	12,0	12,0	6,5	31,5	6,4	1.000/100
	8	GKY-U 8	7,0	14,0	10,5	7,0	30,5	8,4	1.000/100

Consult Cembre for a wider range of pin and blade dimensions.

RF-F BF-F GF-F



Manufactured from Brass strip
- Electrolytically Tin plated
- The operating temperature range is -20 to +115°C (Surge +130°C).
- Recommended crimping tools are shown on pages 96 to 115, 150.









FEMALE DISCONNECT TERMINALS











File no. E212000



Polycarbonate insulated terminals - partially reinforced with Copper sleeve

Cond. Size sqmm (AWG)	Ref.	Tab Size	Quantity Box/Bag
0,25÷1,5 (22÷16)	 RF-F 305	2,8 x 0,5	3.000/100
	 RF-F 308*	2,8 x 0,8	3.000/100
	 RF-F 405	4,8 x 0,5	2.500/100
1,5÷2,5 (16÷14)	 RF-F 408	4,8 x 0,8	2.500/100
	 BF-F 608	6,35 x 0,8	2.000/100
	 BF-F 405	4,8 x 0,5	2.500/100
4÷6 (12÷10)	 BF-F 408	4,8 x 0,8	2.500/100
	 GF-F 608	6,35 x 0,8	1.000/100

Polycarbonate fully insulated terminals - partially reinforced with Copper sleeve

Cond. Size sqmm (AWG)	Ref.	Tab Size	Quantity Box/Bag
0,25÷1,5 (22÷16)	 RF-F 305P	2,8 x 0,5	2.000/100
	 RF-F 308P*	2,8 x 0,8	2.000/100
	 RF-F 405P	4,8 x 0,5	1.500/100
1,5÷2,5 (16÷14)	 RF-F 408P	4,8 x 0,8	1.500/100
	 BF-F 608P	6,35 x 0,8	1.000/100
	 BF-F 405P	4,8 x 0,5	1.500/100
4÷6 (12÷10)	 BF-F 408P	4,8 x 0,8	2.000/100
	 GF-F 608P	6,35 x 0,8	800/100

*Not UL approved

RF-M BF-M GF-M



Manufactured from Brass strip
- Electrolytically Tin plated
- The operating temperature range is -20 to +115°C (Surge +130°C).
- Recommended crimping tools are shown on pages 96 to 115, 150.



MALE DISCONNECT TERMINALS





File no. E212000



Polycarbonate insulated terminals - partially reinforced with Copper sleeve

Cond. Size sqmm (AWG)	Ref.	Tab Size	Quantity Box/Bag
0,25÷1,5 (22÷16)	 RF-M 608	6,35 x 0,8	3.000/100
1,5÷2,5 (16÷14)	 BF-M 608	6,35 x 0,8	2.500/100
4÷6 (12÷10)	 GF-M 608	6,35 x 0,8	1.000/100

Polycarbonate fully insulated terminals - partially reinforced with Copper sleeve

Cond. Size sqmm (AWG)	Ref.	Tab Size	Quantity Box/Bag
0,25÷1,5 (22÷16)	 RF-M 608P*	6,35 x 0,8	1.000/100
1,5÷2,5 (16÷14)	 BF-M 608P*	6,35 x 0,8	1.000/100

*Not UL approved

RF-FM BF-FM RF-B BF-B





Manufactured from Brass strip
- Electrolytically Tin plated
- The operating temperature range is -20 to +115°C (Surge +130°C).
- Recommended crimping tools are shown on pages 96 to 115, 150.

MALE/FEMALE CONNECTORS







File no. E212000

Polycarbonate insulated terminals - partially reinforced with Copper sleeve

Cond. Size sqmm (AWG)	Ref.	Tab Size	Quantity Box/Bag
0,25÷1,5 (22÷16)	 RF-FM 608	6,35 x 0,8	1.000/100
1,5÷2,5 (16÷14)	 BF-FM 608	6,35 x 0,8	1.500/100

BULLET AND SOCKET CONNECTORS

Polycarbonate insulated terminals - partially reinforced with Copper sleeve

Cond. Size sqmm (AWG)	Ref.	Ø mm	Quantity Box/Bag
0,25÷1,5 (22÷16)	 RF-BM 4*	4	2.500/100
	 RF-BF 4*	4	1.000/100
1,5÷2,5 (16÷14)	 BF-BM 5*	5	2.000/100
	 BF-BF 5*	5	800/100

*Not UL approved



BUTT AND PARALLEL CONNECTORS



File no. E125401

butt connectors

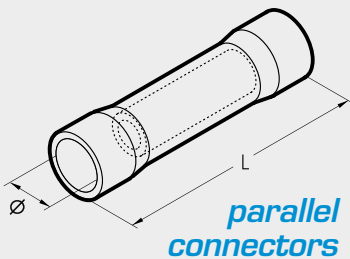

parallel connectors

PVC insulated

Cond. Size sqmm (AWG)	Ref.	Ø mm	L mm	Quantity Box/Bag
0,25÷0,5 (24÷20)	PL 01-M*	3,0	25	3.000/100
0,25÷1,5 (22÷16)	PL 03-M	4,0	25	1.000/100
1,5÷2,5 (16÷14)	PL 06-M	5,0	25	1.500/100
4÷6 (12÷10)	PL 1-M	6,5	32	500/100
0,25÷1,5 (22÷16)	PL 03-P*	4,0	20	3.000/100
1,5÷2,5 (16÷14)	PL 06-P*	5,0	16	2.000/100

*Not UL approved

PL



- Manufactured from Copper tube
- Electrolytically Tin plated
 - The operating temperature range is - 20 to + 80°C (Surge + 90°C).
 - Recommended crimping tools are shown on pages 96 to 115, 150.

BUTT CONNECTORS



Polyamide PA6.6 insulated

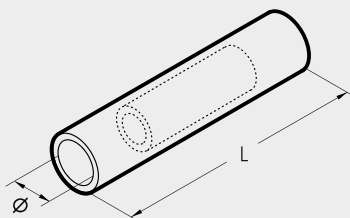

Cond. Size sqmm (AWG)	Ref.	Øi mm	L mm	Quantity Box/Bag
0,25÷1,5 (22÷16)	NL 03-M	4,0	25,0	1.000/100
1,5÷2,5 (16÷14)	NL 06-M	5,4	25,5	1.500/100
4÷6 (12÷10)	NL 1-M	5,4	32,0	1.000/100
10 (8÷7)	NL 2-M	6,8	43,0	500/100
16 (6÷5)	NL 3-M	7,9	44,0	500/100

NL-M



- Manufactured from Copper tube
- Electrolytically Tin plated
 - The operating temperature range is - 20 to + 115°C (Surge + 130°C).
 - Recommended crimping tools are shown on pages 96 to 115, 150.



PE HD insulated, heat shrinkable

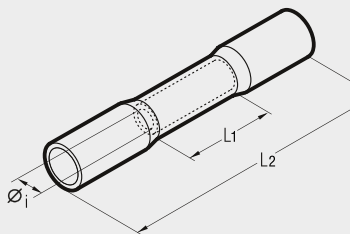

Cond. Size sqmm (AWG)	Ref.	Ø i mm	L1 mm	L2 mm	Quantity Box/Bag
0,5÷1 (20÷17)	WL 03-M	1,7	15,0	36,0	1.500/100
1,5÷2,5 (16÷14)	WL 06-M	2,3	15,0	36,0	1.000/100
4÷6 (12÷10)	WL 1-M	3,4	15,0	41,0	500/100

WL-M



Max operating voltage: 600 V
Shrink temperature: 150 °C
Temperature range: -40 °C to + 105 °C
Protection: IP68

- Manufactured from Copper tube
- Electrolytically Tin plated
 - Heat shrink sleeve with sealant
 - Recommended crimping tools are shown on pages 98.



CLOSE END CONNECTORS

Polyamide PA6.6 insulated

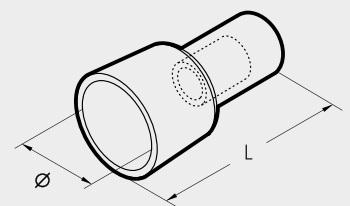

Cond. Size sqmm (AWG)	Ref.	Ø mm	L mm	Quantity Box/Bag
0,25÷1,5 (22÷16)	NL 03-P	9,8	21,0	1.000/100
1,5÷2,5 (16÷14)	NL 06-P	7,9	19,9	1.000/100
1,5÷2,5 (16÷14)	NL 06-PB	6,5	13,6	1.500/100
4÷6 (12÷10)	NL 1-P	10,5	21,5	800/100
4÷6 (12÷10)	NL 1-PG	9,0	17,8	1.000/100

NL-P



- Manufactured from Copper tube
- Electrolytically Tin plated
 - The operating temperature range is - 20 to + 115°C (Surge + 130°C).
 - Recommended crimping tools are shown on pages 96 to 115, 150.

RKF-F BKF-F GK-F



- Manufactured from Brass strip
- Electrolytically Tin plated
- fully reinforced with Copper sleeve, funnel entry
- The operating temperature range is -20°C to $+105^{\circ}\text{C}$ (Surge $+110^{\circ}\text{C}$)
- Recommended crimping tools are shown on pages 96 to 115, 150.

REINFORCED DISCONNECT TERMINALS

for Copper cables



female connectors, fully reinforced with Copper sleeve

PA6.6 insulated terminals

Cond. Size sqmm (AWG)	Ref.	Tab Size	Quantity Box/Bag
0,25÷1,5 (22÷16)	RKF-F 305	2,8 x 0,5	3.000/100
	RKF-F 308	2,8 x 0,8	3.500/100
	RKF-F 405	4,8 x 0,5	3.000/100
	RKF-F 408	4,8 x 0,8	2.500/100
	RKF-F 608	6,35 x 0,8	2.500/100
1,5÷2,5 (16÷14)	BKF-F 405	4,8 x 0,5	3.000/100
	BKF-F 408	4,8 x 0,8	3.000/100
4-6 (12÷10)	BKF-F 608	6,35 x 0,8	2.000/100
	GK-F 608	6,35 x 0,8	1.500/100

PA6.6 fully insulated terminals

Cond. Size sqmm (AWG)	Ref.	Tab Size	Quantity Box/Bag
0,25÷1,5 (22÷16)	RKF-F 405P	4,8 x 0,5	1.500/100
	RKF-F 408P	4,8 x 0,8	2.000/100
	RKF-F 608P	6,35 x 0,8	1.000/100
	BKF-F 405P	4,8 x 0,5	2.000/100
1,5÷2,5 (16÷14)	BKF-F 408P	4,8 x 0,8	2.000/100
	BKF-F 608P	6,35 x 0,8	1.000/100
4-6 (12÷10)	GK-F 608P	6,35 x 0,8	1.000/100

RKF BKF GKF



- Manufactured from Brass strip
- Electrolytically Tin plated
- fully reinforced with Copper sleeve, funnel entry
- The operating temperature range is -20°C to $+105^{\circ}\text{C}$ (Surge $+110^{\circ}\text{C}$)
- Recommended crimping tools are shown on pages 96 to 115, 150.

male connectors, fully reinforced with Copper sleeve - PA6.6 insulated terminals

Cond. Size sqmm (AWG)	Ref.	Tab Size	Quantity Box/Bag
0,25÷1,5 (22÷16)	RKF-M 608	6,35 x 0,8	3.000/100
1,5÷2,5 (16÷14)	BKF-M 608	6,35 x 0,8	2.500/100
4-6 (12÷10)	GKF-M 608	6,35 x 0,8	1.000/100

male/female connectors, fully reinforced with Copper sleeve - PA6.6 insulated terminals

Cond. Size sqmm (AWG)	Ref.	Tab Size	Quantity Box/Bag
0,25÷1,5 (22÷16)	RKF-FM 608	6,35 x 0,8	1.500/100
1,5÷2,5 (16÷14)	BKF-FM 608	6,35 x 0,8	1.500/100

bullet and socket connectors fully reinforced with Copper sleeve PA6.6 insulated terminals

Cond. Size sqmm (AWG)	Ref.	Ø mm	Quantity Box/Bag
0,25÷1,5 (22÷16)	RKF-BM 4	4	2.500/100
	RKF-BF 4	4	1.000/100
1,5÷2,5 (16÷14)	BKF-BM 4	4	2.000/100
	BKF-BF 4	4	800/100

RN-FA BN-FA



- Manufactured from Brass strip
- The operating temperature range is -40 to $+125^{\circ}\text{C}$.
- Recommended crimping tools are shown on page 102.

FEMALE CONNECTORS

open barrel

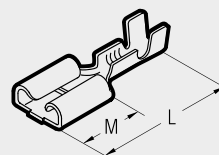

Conductor Size sqmm (AWG)	Ref.	Tab mm	M mm	L mm	Quantity Box/Bag
0,5÷1 (20÷17)	RN-FA 305	2,8 x 0,5	6,3	15,0	6.000/100
	RN-FA 405	4,8 x 0,5	6,3	15,0	5.000/100
	RN-FA 608	6,3 x 0,8	7,7	19,0	3.000/100
1÷2,5 (17÷14)	BN-FA 608	6,3 x 0,8	7,7	19,0	3.000/100
	* BN-FAB 608	6,3 x 0,8	7,7	15,5	1.000/100
	** BN-FAR 608	6,3 x 0,8	7,7	19,0	3.000/100

*flag type **with retainer



MALE CONNECTORS

open barrel

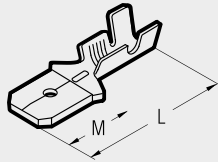

Conductor Size sqmm (AWG)	Ref.	Tab mm	M mm	L mm	Quantity Box/Bag
0,5÷1 (20÷17)	RN-MA 305	2,8 x 0,5	5,8	13,0	6.000/100
	RN-MA 405	4,8 x 0,5	6,3	17,3	5.000/100
	RN-MA 608	6,3 x 0,8	7,9	19,7	4.000/100
1÷2,5 (17÷14)	BN-MA 608	6,3 x 0,8	7,9	20,0	4.000/100

RN-MA BN-MA



- Manufactured from Brass strip
- The operating temperature range is - 40 to + 125°C.
- Recommended crimping tool is shown on page 102



MALE TABS

for board mounting

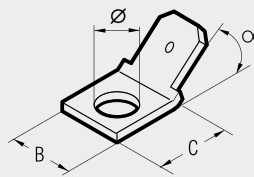

Ref.	Tab mm	Ø Stud mm	B mm	C mm	α	Quantity Box/Bag
MP 608	6,3 x 0,8	4	8	8,5	0°	5.000/100
MP 608/45	6,3 x 0,8	4	8	8,5	45°	6.000/100
MP 608/90	6,3 x 0,8	4	8	8,5	90°	5.000/100
* MP 608D	6,3 x 0,8	5	8	14	0°	5.000/100

*double tab

MP MPD



- Manufactured from Brass strip
- The operating temperature range is - 40 to + 125°C.

CONNECTOR SLEEVES

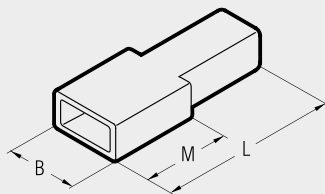

Ref.	Connector	B mm	M mm	L mm	Material	Quantity Box/Bag
CFA 300	Female 2,8	5,5	7	18	Polyethylene	3.000/100
*CFA 400	Female 4,8	7,5	9	20	Polyethylene	2.000/100
*CFA 600	Female 6,3	9,0	11	24	Polyethylene	1.500/100
**CFA2 600	Female 6,3	9,0	9	22	Polyethylene	1.500/100
CFAR 600	Female 6,3 frontal insertion with retainer	9,0	12	25	Polyamide 6.6	1.000/100
CFAB 600	Female 6,3 flag	10,0	-	18	Polyamide 6.6	1.000/100
*CMA 600	Male 6,3	12,0	11	22	Polyethylene	1.000/100

CFA CMA



- * For a single cable.
Colours available:
Transparent: no suffix
Red: add suffix R
Black: add suffix N

- ** For twin cables.
Colours available:
Transparent: no suffix
Red: add suffix R
Black: add suffix N
Green: add suffix V
Blue: add suffix B
Yellow: add suffix G

POLYPROPYLENE INSULATED END SLEEVES

for flexible Copper cables



**PKE
PKC
CPKD**



The PKE, PKC, CPKD range of end sleeves is manufactured from Tin plated electrolytic Copper. Designed and developed to reinforce fine wire strands when terminating a cable into a connector block.

The operating temperature range is - 20 to + 105°C (Surge + 110°C).

Recommended crimping tools are shown on pages 96 to 118, 121, 150, 152, 154.

VALSTAR ND#2/PKE
Comprising:
- a selection of PKE end sleeves conductor size 1÷6 sqmm
- tool ND#2

VALSTAR ND#2/PKC
Comprising:
- a selection of PKC end sleeves conductor size 1÷6 sqmm
- tool ND#2

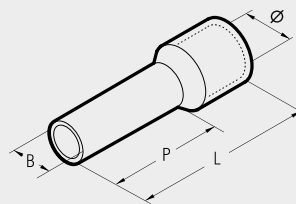

Conductor Size sqmm	Ref.	Dimensions mm				Insulation Colour	Quantity Box/Bag
		Ø	B	P	L		
0,1÷0,3	PKE 308	1,9	1,3	8,0	12,4	● yellow	25.000/500
0,3÷0,5	PKE 508	2,6	1,3	8,0	14,0	○ white	10.000/500
0,75	PKE 7508	3,4	1,6	8,2	14,6	● blue	10.000/500
1,0	PKE 108	3,4	1,8	8,2	14,6	● red	10.000/500
1,5	PKE 1508	3,8	2,1	8,2	14,6	● black	10.000/500
	PKE 1518	3,8	2,1	18,0	24,4		5.000/500
2,5	PKE 2508	4,4	2,6	8,2	15,2	○ grey	7.500/500
	PKE 2518	4,4	2,6	18,0	25,0		5.000/500
4,0	PKE 409	4,8	3,2	9,0	16,0	● orange	5.000/200
	PKE 418	4,8	3,2	18,0	25,0		3.000/200
6,0	PKE 612	5,8	3,9	12,0	20,0	● green	2.500/100
	PKE 618	5,8	3,9	18,0	26,0		2.000/100
10,0	PKE 1012	7,4	4,8	12,0	21,5	● brown	1.500/100
	PKE 1018	7,4	4,8	18,0	27,5		1.500/100
16,0	PKE 1612	9,3	5,9	12,0	22,7	○ white	1.000/100
	PKE 1618	9,3	5,9	18,0	28,6		1.000/100
25,0	PKE 25016	10,0	7,9	16,0	29,0	● black	500/50
	PKE 25022	10,0	7,9	22,0	35,0		500/50

Conductor Size sqmm	Ref.	Dimensions mm				Insulation Colour	Quantity Box/Bag
		Ø	B	P	L		
0,1÷0,3	PKC 306	1,9	1,3	6,0	10,4	● light blue	25.000/500
	PKC 308	1,9	1,3	8,0	12,4		25.000/500
0,3÷0,5	PKC 508	2,6	1,3	8,0	14,0	● orange	10.000/500
	PKC 510	2,6	1,3	10,0	16,0		10.000/500
0,75	PKC 7508	3,4	1,6	8,2	14,6	○ white	10.000/500
	PKC 7512	3,4	1,6	12,0	18,4		10.000/500
1,0	PKC 108	3,4	1,8	8,2	14,6	● yellow	10.000/500
	PKC 112	3,4	1,8	12,0	18,4		10.000/500
1,5	PKC 1508	3,8	2,1	8,2	14,6	● red	10.000/500
	PKC 1518	3,8	2,1	18,0	24,4		5.000/500
2,5	PKC 2508	3,9	2,6	8,2	15,2	● blue	7.500/500
	PKC 2518	3,9	2,6	18,0	25,0		5.000/500
4,0	PKC 409	4,8	3,2	9,0	16,0	○ grey	5.000/200
	PKC 418	4,8	3,2	18,0	25,0		3.000/200
6,0	PKC 612	5,8	3,9	12,0	20,0	● black	2.500/100
	PKC 618	5,8	3,9	18,0	26,0		2.000/100
10,0	PKC 1012	7,4	4,8	12,0	21,5	○ ivory	1.500/100
	PKC 1018	7,4	4,8	18,0	27,5		1.500/100
16,0	PKC 1612	9,3	5,9	12,0	22,7	● green	1.000/100
	PKC 1618	9,3	5,9	18,0	28,6		1.000/100
25,0	PKC 25016	10,0	7,9	16,0	29,0	● brown	500/50
	PKC 25022	10,0	7,9	22,0	35,0		500/50
35,0	PKC 35016	12,0	8,9	16,0	30,0	● beige	500/50
	PKC 35025	12,0	8,9	25,0	39,0		400/50
50,0	PKC 50020	13,8	11,0	20,0	36,0	● olive	300/50
	PKC 50030	13,8	11,0	30,0	46,0		250/50
70	PKC 70022	16,0	14,3	22,0	38,0	● yellow	100/25
95	PKC 95025	18,0	15,7	25,0	44,0	● red	100/25
120	PKC 120027	21,0	17,5	27,0	48,0	● blue	100/25

Insulated chain end sleeves

Developed for use with production equipment to give a quick and reliable crimped joint. Conforms to DIN standard 46 228/4.

Conductor Size sqmm	Ref.	Dimensions mm				Insulation Colour	Quantity Reel
		Ø	B	P	L		
0,3÷0,5	CPKD 508	2,6	1,3	8,0	14,0	○ white	5.000
0,75	CPKD 7508	2,8	1,5	8,0	14,0	○ grey	5.000
1	CPKD 108	3,0	1,7	8,0	14,0	● red	5.000
1,5	CPKD 1508	3,5	2,0	8,0	14,0	● black	5.000
2,5	CPKD 2508	4,2	2,5	8,0	14,0	● blue	3.000



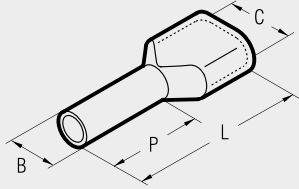

“TWIN” POLYPROPYLENE INSULATED END SLEEVES

for fine stranded cables

Conductor Size sqmm	Ref.	Dimensions mm				Insulation Colour	nd#4, HNKE16 and HNKE 50	Quantity Bag
		C	B	P	L			
2 x 0,5	PKET 508	4,6x2,6	1,5	8,0	15,0	○ white	1	500
2 x 0,75	PKET 7508	5,2x2,6	2,1	8,0	15,0	● blue	1,5	500
	PKET 7512	5,2x2,6	2,1	12,0	19,0			500
2 x 1	PKET 108	5,8x3,2	2,6	8,0	16,0	● red	2,5	500
	PKET 112	5,8x3,2	2,6	12,0	20,0			500
2 x 1,5	PKET 1508	6,5x3,6	2,6	8,0	16,0	● black	2,5	500
	PKET 1512	6,5x3,6	2,6	12,0	20,0		2,4	500
2 x 2,5	PKET 2510	7,5x4,3	3,2	10,0	18,0	○ grey	4	250
	PKET 2512	7,5x4,3	3,2	12,0	21,0			250
2 x 4	PKET 412	9,0x5,2	4,2	12,0	23,0	● orange	6	100
2 x 6	PKET 614	10,0x7,2	5,3	14,0	26,0	● green	10	100
2 x 10	PKET 1014	13,0x7,2	7,0	14,0	26,0	● brown	16	100
2 x 16	PKET 1616	18,0x9,5	8,8	16,0	30,0	○ white	35	100

Conductor Size sqmm	Ref.	Dimensions mm				Insulation Colour	nd#4, HNKE16 and HNKE 50	Quantity Bag
		C	B	P	L			
2 x 0,5	PKCT 508	4,6x2,6	1,5	8,0	15,0	● orange	1	500
2 x 0,75	PKCT 7508	5,2x2,6	2,1	8,0	15,0	○ white	1,5	500
	PKCT 7512	5,2x2,6	2,1	12,0	19,0			500
2 x 1	PKCT 108	5,8x3,2	2,6	8,0	16,0	● yellow	2,5	500
	PKCT 112	5,8x3,2	2,6	12,0	20,0			500
2 x 1,5	PKCT 1508	6,5x3,6	2,6	8,0	16,0	● red	2,5	500
	PKCT 1512	6,5x3,6	2,6	12,0	20,0		2,4	500
2 x 2,5	PKCT 2510	7,5x4,3	3,2	10,0	18,0	● blue	4	250
	PKCT 2512	7,5x4,3	3,2	12,0	21,0			250
2 x 4	PKCT 412	9,0x5,2	4,2	12,0	23,0	○ grey	6	100
2 x 6	PKCT 614	10,0x7,2	5,3	14,0	26,0	● black	10	100
2 x 10	PKCT 1014	13,0x7,2	7,0	14,0	26,0	○ ivory	16	100
2 x 16	PKCT 1616	18,0x9,5	8,8	16,0	30,0	● green	35	100



Type PKET, PKCT ranges of twin end sleeves are manufactured from Tin plated electrolytic Copper. Designed to accommodate two cables terminating in the same sleeve they are ideal for looping conductors. The operating temperature range is - 20 to + 105°C (Surge + 110°C).

Recommended crimping tools are shown on pages 96 to 117, 121, 150, 152, 154.

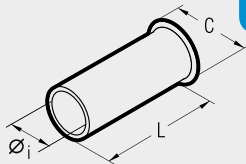

UNINSULATED END SLEEVES

for flexible Copper cables

Conductor Size sqmm	Ref.	Dimensions mm			Quantity Box/Bag
		Ø	L	C	
0,5	*KE 506 ST	1,0	6,0	2,1	50.000/500
	KE 508 ST	1,0	8,0	2,1	50.000/500
0,75	*KE 7506 ST	1,2	6,0	2,3	50.000/500
	KE 7508 ST	1,2	8,0	2,3	50.000/500
1	*KE 106 ST	1,4	6,0	2,5	25.000/500
	*KE 110 ST	1,4	10,0	2,5	25.000/500
1,5	*KE 1508 ST	1,8	7,0	2,8	25.000/500
	*KE 1510 ST	1,8	10,0	2,8	25.000/500
2,5	*KE 2508 ST	2,3	7,0	3,4	25.000/500
	*KE 2510 ST	2,3	10,0	3,4	20.000/500
4	*KE 410 ST	2,8	9,0	4,0	12.500/500
	*KE 412 ST	2,8	12,0	4,0	12.500/500
6	*KE 610 ST	3,5	10,0	4,7	10.000/500
	*KE 612 ST	3,5	12,0	4,7	7.500/500
10	*KE 616 ST	3,5	15,0	4,7	5.000/500
	*KE 1016 ST	4,5	15,0	5,8	4.000/250
16	*KE 1616 ST	5,8	15,0	7,5	3.000/250
	KE 25015 ST	7,3	15,0	9,5	1.500/100
25	*KE 25018 ST	7,3	18,0	9,5	1.500/100
	KE 35012 ST	8,3	12,0	11,0	1.500/100
35	KE 35015 ST	8,3	15,0	11,0	1.500/100
	*KE 35018 ST	8,3	18,0	11,0	1.000/100

*To DIN standard 46 228/1



KE series end sleeves are manufactured from Tin plated electrolytic Copper. Designed and developed for use with flexible cables.

Recommended crimping tools are shown on pages 96 to 117, 121, 150, 152, 154.

S

UNINSULATED TERMINALS

S range - brazed seam



S range terminals are manufactured from electrolytic Copper strip and Tin plated. The seam is brazed to

provide uniform mechanical strength. The terminal barrel is rifled to enhance electrical con-

tact and to improve mechanical strength.

Recommended crimping tools are shown on pages 96 to 115, 150.

pin terminals

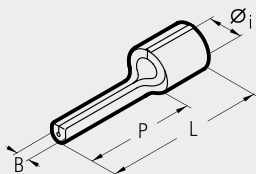

blade terminals

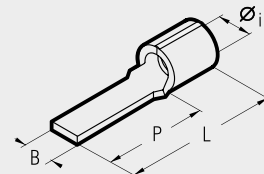

Conductor Size sqmm (AWG)	Ref.	Dimensions mm				Quantity Box/Bag
		Øi	B	P	L	
0,25÷1,25 (22÷16)	S 1.5-P 8	1,8	1,6	8,0	12,0	8.000/100
	S 1.5-P 10	1,8	1,6	10,0	14,0	8.000/100
	S 1.5-P 12	1,8	1,6	12,0	16,2	8.000/100
1,5÷2,5 (16÷14)	S 2.5-P 8	2,4	1,7	8,0	12,0	7.000/100
	S 2.5-P 10	2,4	1,8	10,0	14,0	7.000/100
	S 2.5-P 12	2,4	1,8	12,0	16,0	7.000/100
4÷6 (12÷10)	S 6-P 10	3,6	2,2	10,0	16,8	4.000/100
	S 6-P 12	3,6	2,2	12,0	19,4	4.000/100
	S 6-P 14	3,6	2,2	14,0	21,0	3.500/100

Conductor Size sqmm (AWG)	Ref.	Dimensions mm				Quantity Box/Bag
		Øi	B	P	L	
0,25÷1,25 (22÷16)	S 1.5-PP 12	1,8	3,0	12,8	17,0	8.000/100
	*S 1.5-PP 12/1	1,8	3,0	11,3	15,5	8.000/100
	S 1.5-PP 12/19	1,8	1,9	13,2	17,4	8.000/100
	S 1.5-PP 14	1,8	3,0	14,8	19,0	8.000/100
	S 2.5-PP 12	2,4	3,5	12,8	17,0	7.000/100
1,5÷2,5 (16÷14)	S 2.5-PP 12/25	2,4	2,5	13,3	17,5	7.000/100
	S 2.5-PP 16/25	2,4	2,5	17,2	21,4	7.000/100
	S 6-PP 12	3,6	4,0	13,3	19,7	4.000/100
4÷6 (12÷10)	S 6-PP 17	3,6	2,9	19,1	25,5	4.000/100

*Made to order



UNINSULATED TERMINALS

S range - brazed seam

S

ring terminals

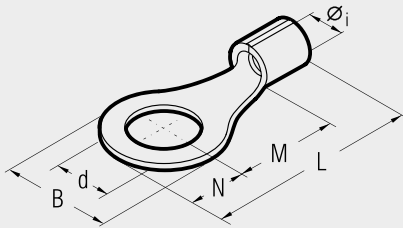

fork/spade terminals

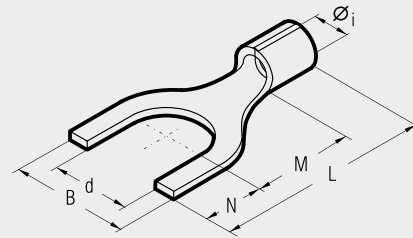

Cond. Size sqmm (AWG)	Ø Stud mm	Ref.	Dimensions mm						Quantity Box/Bag
			Øi	B	M	N	L	d	
0,25÷1,25 (22÷16)	2	*S 1.5-M 2	1,8	5,6	4,5	2,8	11,5	2,2	7.000/100
	3	S 1.5-M 3	1,8	5,6	4,5	2,8	11,5	3,2	7.000/100
	3,5	S 1.5-M 3,5	1,8	5,6	4,5	2,8	11,5	3,7	7.000/100
	3,5*	S 1.5-M 3,5/1	1,8	6,2	7,1	3,1	14,4	3,7	7.000/100
	4	S 1.5-M 4	1,8	7,0	6,5	3,5	14,2	4,3	7.000/100
	4*	S 1.5-M 4/3	1,8	7,8	7,1	3,9	15,2	4,3	7.000/100
	5	S 1.5-M 5	1,8	7,8	7,1	3,9	15,2	5,3	7.000/100
	6	S 1.5-M 6	1,8	9,4	8,1	4,7	17,0	6,4	6.000/100
	6	S 1.5-M 6/1	1,8	12,0	10,3	6,0	20,5	6,4	5.000/100
	7	S 1.5-M 7	1,8	9,4	8,1	4,7	17,0	7,2	6.000/100
	8	S 1.5-M 8	1,8	12,0	10,3	6,0	20,5	8,4	4.000/100
	10	S 1.5-M 10	1,8	15,5	13,0	7,7	25,0	10,5	3.000/100
12	S 1.5-M 12	1,8	18,0	15,5	9,0	28,7	13,0	2.000/100	
1,5÷2,5 (16÷14)	3	S 2.5-M 3	2,4	5,6	5,0	2,8	12,0	3,2	6.000/100
	3,5	S 2.5-M 3,5	2,4	5,6	5,0	2,8	12,0	3,7	6.000/100
	3,5*	S 2.5-M 3,5/1	2,4	6,2	6,5	3,1	13,8	3,7	5.000/100
	4	S 2.5-M 4	2,4	8,0	6,5	4,0	14,7	4,3	5.000/100
	5	S 2.5-M 5	2,4	8,0	7,5	4,0	15,7	5,3	5.000/100
	6	S 2.5-M 6	2,4	9,4	8,6	4,7	17,5	6,4	5.000/100
	6	S 2.5-M 6/1	2,4	12,0	10,3	6,0	20,5	6,4	5.000/100
	7	S 2.5-M 7	2,4	10,0	7,8	5,0	17,0	7,2	5.000/100
	8	S 2.5-M 8	2,4	12,0	10,3	6,0	20,5	8,4	4.000/100
	10	S 2.5-M 10	2,4	15,5	13,0	7,7	25,0	10,5	2.500/100
	12	S 2.5-M 12	2,4	18,0	15,5	9,0	28,7	13,0	2.000/100
	4÷6 (12÷10)	3	S 6-M 3	3,6	8,0	8,1	4,0	18,5	3,2
3,5		S 6-M 3,5	3,6	8,0	8,1	4,0	18,5	3,7	3.000/100
4		S 6-M 4	3,6	9,0	8,1	4,5	19,0	4,3	3.000/100
5		S 6-M 5	3,6	9,0	8,1	4,5	19,0	5,3	2.500/100
6		S 6-M 6	3,6	11,0	11,1	5,5	23,0	6,4	2.500/100
6*		S 6-M 6/1	3,6	11,0	8,1	5,5	20,0	6,4	2.500/100
7		S 6-M 7	3,6	11,0	11,1	5,5	23,0	7,2	2.500/100
8		S 6-M 8	3,6	13,6	12,1	6,8	25,3	8,4	2.000/100
8*		S 6-M 8/1	3,6	11,0	8,1	5,5	20,0	8,4	2.500/100
10		S 6-M 10	3,6	13,6	12,1	6,8	25,3	10,5	2.000/100
10		S 6-M 10/1	3,6	15,5	13,8	7,7	28,0	10,5	2.000/100
12		S 6-M 12	3,6	19,0	15,1	9,5	31,0	13,0	1.000/100
14	S 6-M 14	3,6	21,0	16,1	10,5	33,0	15,0	1.000/100	
16	S 6-M 16	3,6	24,0	17,1	12,0	35,5	17,0	1.000/100	
10 (8)	4	S 10-M 4	4,8	11,5	9,0	5,8	23,8	4,3	2.000/100
	5	S 10-M 5	4,8	11,5	9,0	5,8	23,8	5,3	2.000/100
	6	S 10-M 6	4,8	11,5	9,0	5,8	23,8	6,4	2.000/100
	7	S 10-M 7	4,8	11,5	9,0	5,8	23,8	7,2	1.500/100

Cond. Size sqmm (AWG)	Ø Stud mm	Ref.	Dimensions mm						Quantity Box/Bag
			Øi	B	M	N	L	d	
0,25÷1,25 (22÷16)	3	S 1.5-U 3	1,8	5,5	5,5	4,0	13,7	3,2	7.000/100
	3,5	S 1.5-U 3,5	1,8	6,0	6,5	3,8	14,5	3,7	7.000/100
	3,5*	S 1.5-U 3,5/2	1,8	6,4	6,5	3,8	14,5	3,7	7.000/100
	4	S 1.5-U 4	1,8	6,5	7,5	3,7	15,4	4,3	7.000/100
	4*	S 1.5-U 4/1	1,8	8,5	7,5	3,7	15,4	4,3	7.000/100
	4	S 1.5-U 4/2	1,8	7,5	7,5	3,7	15,4	4,3	7.000/100
	5	S 1.5-U 5	1,8	8,5	7,5	3,7	15,4	5,3	7.000/100
	5*	S 1.5-U 5/1	1,8	9,4	7,5	3,7	15,4	5,3	7.000/100
	6	S 1.5-U 6	1,8	9,4	8,1	4,7	17,0	6,4	6.000/100
	6*	S 1.5-U 6/1	1,8	12,0	9,2	7,1	20,5	6,4	6.000/100
	8	S 1.5-U 8	1,8	14,0	10,0	6,3	20,5	8,4	3.000/100
	10	S 1.5-U 10	1,8	17,5	13,0	7,7	25,0	10,5	2.500/100
12	S 1.5-U 12	1,8	20,0	15,5	9,0	28,7	13,0	2.000/100	
1,5÷2,5 (16÷14)	3	S 2.5-U 3	2,4	5,5	5,5	4,0	13,7	3,2	6.000/100
	3,5	S 2.5-U 3,5	2,4	6,4	6,5	3,8	14,5	3,7	6.000/100
	3,5*	S 2.5-U 3,5/12,4	2,4	7,2	6,5	3,8	14,5	3,7	6.000/100
	4	S 2.5-U 4	2,4	6,5	7,5	3,7	15,4	4,3	5.000/100
	4*	S 2.5-U 4/1	2,4	8,5	7,5	3,7	15,4	4,3	6.000/100
	4	S 2.5-U 4/2	2,4	7,5	7,5	3,7	15,4	4,3	6.000/100
	5	S 2.5-U 5	2,4	8,5	7,5	3,7	15,4	5,3	6.000/100
	6	S 2.5-U 6	2,4	9,4	8,1	4,7	17,0	6,4	5.000/100
	6*	S 2.5-U 6/1	2,4	12,0	9,2	7,1	20,5	6,4	4.000/100
	8	S 2.5-U 8	2,4	14,0	10,0	6,3	20,5	8,4	2.500/100
	10	S 2.5-U 10	2,4	17,5	13,0	7,7	25,0	10,5	2.000/100
	12	S 2.5-U 12	2,4	20,0	15,5	9,0	28,7	13,0	2.000/100
4÷6 (12÷10)	3,5	S 6-U 3,5	3,6	7,5	8,5	3,9	18,8	3,7	3.000/100
	4	S 6-U 4	3,6	7,5	8,0	4,4	18,8	4,3	3.000/100
	5	S 6-U 5	3,6	9,5	8,0	4,4	18,8	5,3	2.500/100
	6	S 6-U 6	3,6	10,0	11,0	5,5	22,9	6,4	2.500/100
	8	S 6-U 8	3,6	13,5	12,0	8,0	26,4	8,4	2.000/100
	10	S 6-U 10	3,6	15,5	13,0	8,0	27,4	10,5	2.000/100
	10*	S 6-U 10/1	3,6	17,5	13,8	7,7	28,0	10,5	2.000/100
	12	S 6-U 12	3,6	21,0	15,1	9,5	31,0	13,0	1.000/100
	14	*S 6-U 14	3,6	23,0	16,1	10,5	33,0	15,0	1.000/100
	16	*S 6-U 16	3,6	26,0	17,1	11,5	35,0	17,0	1.000/100

*Made to order

UNINSULATED TERMINALS

RN, BN, GN range - unbrazed



RN
BN
GN



RN, BN, GN range terminals are manufactured from electrolytic Copper strip and

Tin plated. The seam is unbrazed. The terminal barrel is rifled

to enhance electrical contact and to improve mechanical strength.

Recommended crimping tools are shown on pages 96 to 115, 150.

pin terminals

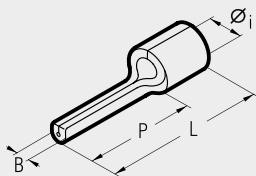

blade terminals

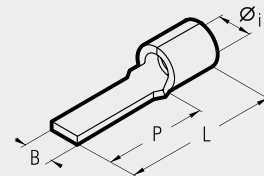

Conductor Size sqmm (AWG)	Ref.	Dimensions mm				Quantity Box/Bag
		Øi	B	P	L	
0,25÷1,5 (22÷16)	RN-P 8	1,8	1,6	8,0	12,0	8.000/100
	RN-P 10	1,8	1,6	10,0	14,0	8.000/100
	RN-P 12	1,8	1,6	12,0	16,2	8.000/100
1,5÷2,5 (16÷14)	BN-P 8	2,4	1,7	8,0	12,0	7.000/100
	BN-P 10	2,4	1,8	10,0	14,0	7.000/100
	BN-P 12	2,4	1,8	12,0	16,0	7.000/100
4÷6 (12÷10)	GN-P 10	3,6	2,2	10,0	16,8	4.000/100
	GN-P 12	3,6	2,2	12,0	19,0	4.000/100
	GN-P 14	3,6	2,2	14,0	21,0	3.500/100

Conductor Size sqmm (AWG)	Ref.	Dimensions mm				Quantity Box/Bag
		Øi	B	P	L	
0,25÷1,5 (22÷16)	RN-PP 12	1,8	3,0	12,8	17,0	8.000/100
	RN-PP 12/1	1,8	3,0	11,3	15,5	8.000/100
	RN-PP 12/19	1,8	1,9	13,2	17,4	8.000/100
	RN-PP 14	1,8	3,0	14,8	19,0	8.000/100
	RN-PP 16/23	1,8	2,3	17,2	21,4	8.000/100
1,5÷2,5 (16÷14)	BN-PP 12	2,4	3,5	12,8	17,0	7.000/100
	BN-PP 12/25	2,4	2,5	13,3	17,5	7.000/100
	BN-PP 16/25	2,4	2,5	17,2	21,4	7.000/100
4÷6 (12÷10)	GN-PP 12	3,6	4,0	13,3	19,7	4.000/100
	GN-PP 17	3,6	2,9	19,1	25,5	4.000/100



UNINSULATED TERMINALS

RN, BN, GN range - unbrazed

RN
BN
GN

ring terminals

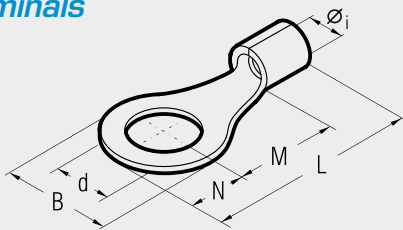

fork/spade terminals



Cond. Size sqmm (AWG)	Ø Stud mm	Ref.	Dimensions mm					Quantity Box/Bag	
			Øi	B	M	N	L		d
0,25÷1,5 (22÷16)	2	*RN-M 2	1,8	5,6	4,5	2,8	11,5	2,2	7.000/100
	3	RN-M 3	1,8	5,6	4,5	2,8	11,5	3,2	7.000/100
	3,5	RN-M 3.5	1,8	5,6	4,5	2,8	11,5	3,7	7.000/100
	3,5	RN-M 3.5/1	1,8	6,2	7,1	3,1	14,4	3,7	7.000/100
	4	RN-M 4	1,8	7,0	6,5	3,5	14,2	4,3	7.000/100
	4	RN-M 4/3	1,8	7,8	7,1	3,9	15,2	4,3	7.000/100
	5	RN-M 5	1,8	7,8	7,1	3,9	15,2	5,3	7.000/100
	6	RN-M 6	1,8	9,4	8,1	4,7	17,0	6,4	6.000/100
	6	RN-M 6/1	1,8	12,0	10,3	6,0	20,5	6,4	4.000/100
	7	RN-M 7	1,8	9,4	8,1	4,7	17,0	7,2	6.000/100
	8	RN-M 8	1,8	12,0	10,3	6,0	20,5	8,4	4.000/100
	10	RN-M 10	1,8	15,5	13,0	7,7	25,0	10,5	3.000/100
12	RN-M 12	1,8	18,0	15,5	9,0	28,7	13,0	2.000/100	
1,5÷2,5 (16÷14)	2	*BN-M 2	2,4	5,6	5,0	2,8	12,0	2,2	6.000/100
	3	BN-M 3	2,4	5,6	5,0	2,8	12,0	3,2	6.000/100
	3,5	BN-M 3.5	2,4	5,6	5,0	2,8	12,0	3,7	6.000/100
	3,5	BN-M 3.5/1	2,4	6,2	6,5	3,1	13,8	3,7	6.000/100
	4	BN-M 4	2,4	8,0	6,5	4,0	14,7	4,3	5.000/100
	5	BN-M 5	2,4	8,0	7,5	4,0	15,7	5,3	5.000/100
	6	BN-M 6	2,4	9,4	8,6	4,7	17,5	6,4	5.000/100
	6	BN-M 6/1	2,4	12,0	10,3	6,0	20,5	6,4	5.000/100
	7	BN-M 7	2,4	10,0	7,8	5,0	17,0	7,2	5.000/100
	8	BN-M 8	2,4	12,0	10,3	6,0	20,5	8,4	4.000/100
	10	BN-M 10	2,4	15,5	13,0	7,7	25,0	10,5	2.500/100
	12	BN-M 12	2,4	18,0	15,5	9,0	28,7	13,0	2.000/100
4÷6 (12÷10)	3	GN-M 3	3,6	8,0	8,1	4,0	18,5	3,2	3.000/100
	3,5	GN-M 3.5	3,6	8,0	8,1	4,0	18,5	3,7	3.000/100
	4	GN-M 4	3,6	9,0	8,1	4,5	19,0	4,3	3.000/100
	5	GN-M 5	3,6	9,0	8,1	4,5	19,0	5,3	2.500/100
	6	GN-M 6	3,6	11,0	11,1	5,5	23,0	6,4	2.500/100
	6	GN-M 6/1	3,6	11,0	8,1	5,5	20,0	6,4	2.500/100
	7	GN-M 7	3,6	11,0	11,1	5,5	23,0	7,2	2.500/100
	8	GN-M 8	3,6	13,6	12,1	6,8	25,3	8,4	2.000/100
	8	*GN-M 8/1	3,6	11,0	8,1	5,5	20,0	8,4	2.500/100
	10	GN-M 10	3,6	13,6	12,1	6,8	25,3	10,5	2.000/100
	10	GN-M 10/1	3,6	15,5	13,8	7,7	28,0	10,5	2.000/100
	12	GN-M 12	3,6	19,0	15,1	9,5	31,0	13,0	1.000/100
	14	GN-M 14	3,6	21,0	16,1	10,5	33,0	15,0	1.000/100
	16	GN-M 16	3,6	24,0	17,1	12,0	35,5	17,0	1.000/100

Cond. Size sqmm (AWG)	Ø Stud mm	Ref.	Dimensions mm					Quantity Box/Bag	
			Øi	B	M	N	L		d
0,25÷1,5 (22÷16)	3	RN-U 3	1,8	5,5	5,5	4,0	13,7	3,2	7.000/100
	3,5	RN-U 3.5	1,8	6,0	6,5	3,8	14,5	3,7	7.000/100
	3,5	RN-U 3.5/2	1,8	6,4	6,5	3,8	14,5	3,7	7.000/100
	4	RN-U 4	1,8	6,5	7,5	3,7	15,4	4,3	7.000/100
	4	RN-U 4/1	1,8	8,5	7,5	3,7	15,4	4,3	7.000/100
	4	RN-U 4/2	1,8	7,5	7,5	3,7	15,4	4,3	7.000/100
	5	RN-U 5	1,8	8,5	7,5	3,7	15,4	5,3	5.000/100
	5	*RN-U 5/1	1,8	9,4	7,5	3,7	15,4	5,3	5.000/100
	6	RN-U 6	1,8	9,4	8,1	4,7	17,0	6,4	6.000/100
	6	RN-U 6/1	1,8	12,0	9,2	7,1	20,5	6,4	3.000/100
	8	RN-U 8	1,8	14,0	10,0	6,3	20,5	8,4	5.000/100
	10	RN-U 10	1,8	17,5	13,0	7,7	25,0	10,5	3.000/100
12	RN-U 12	1,8	20,0	15,5	9,0	28,7	13,0	2.000/100	
1,5÷2,5 (16÷14)	3	BN-U 3	2,4	5,5	5,5	4,0	13,7	3,2	6.000/100
	3,5	BN-U 3.5	2,4	6,4	6,5	3,8	14,5	3,7	6.000/100
	3,5	BN-U 3.5/1	2,4	7,2	6,5	3,8	14,5	3,7	6.000/100
	4	BN-U 4	2,4	6,5	7,5	3,7	15,4	4,3	6.000/100
	4	BN-U 4/1	2,4	8,5	7,5	3,7	15,4	4,3	6.000/100
	4	BN-U 4/2	2,4	7,5	7,5	3,7	15,4	4,3	6.000/100
	5	BN-U 5	2,4	8,5	7,5	3,7	15,4	5,3	5.000/100
	6	BN-U 6	2,4	9,4	8,1	4,7	17,0	6,4	5.000/100
	6	BN-U 6/1	2,4	12,0	9,2	7,1	20,5	6,4	4.000/100
	8	BN-U 8	2,4	14,0	10,0	6,3	20,5	8,4	4.000/100
	10	BN-U 10	2,4	17,5	13,0	7,7	25,0	10,5	3.500/100
	12	BN-U 12	2,4	20,0	15,5	9,0	28,7	13,0	2.000/100
4÷6 (12÷10)	3,5	GN-U 3.5	3,6	7,5	8,5	3,9	18,8	3,7	3.000/100
	4	GN-U 4	3,6	7,5	8,0	4,4	18,8	4,3	3.000/100
	5	GN-U 5	3,6	9,5	8,0	4,4	18,8	5,3	2.500/100
	6	GN-U 6	3,6	10,0	11,0	5,5	22,9	6,4	2.500/100
	8	GN-U 8	3,6	13,5	12,0	8,0	26,4	8,4	2.000/100
	10	GN-U 10	3,6	15,5	13,0	8,0	27,4	10,5	2.000/100
	10	GN-U 10/1	3,6	17,5	13,8	7,7	28,0	10,5	2.000/100
	12	GN-U 12	3,6	21,0	15,1	9,5	31,0	13,0	1.000/100
	14	GN-U 14	3,6	23,0	16,1	10,5	33,0	15,0	1.000/100
	16	GN-U 16	3,6	26,0	17,1	11,5	35,0	17,0	1.000/100

*Made to order

A-M



COPPER TUBE CRIMPING LUGS

for Copper conductors

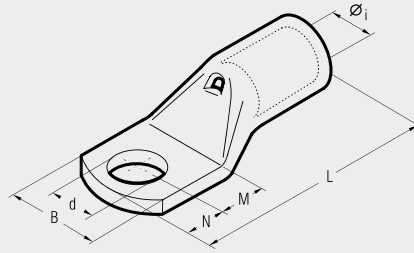

File no. E125401



File no. E125401

A-M series lugs are manufactured from electrolytic Copper tube.

The dimensions of the tube are designed to obtain the most efficient electrical conductivity and mechanical strength to resist vibration and pull out.

Cembre lugs are annealed to guarantee optimum ductility which is an absolute necessity for connectors which will have to withstand the severe deformation arising when compressed and any bending of the palm during installation.

In applications subject to vibration, lugs still have to provide a reliable connection and annealing plays a vital role in avoiding cracking or breaks between the barrel and palm.

The presence of an inspection hole facilitates full insertion of the conductor, whilst the barrel length has been designed to allow easy and accurate positioning of the dies during the crimping operation.

Lugs are electrolytically plated to avoid oxidation. A-M series lugs form an important part of Cembre crimping systems for power carrying conductors, details of the appropriate crimping tools and dies are shown opposite and in detail on pages 176 to 177.

Our technicians are always available to provide any technical advice which may be required.

The enclosed table is only indicative of the range and many variations in stud fixing and palm lengths are also available.

Cond. Size sqmm	Ø Stud mm	Ref.	Dimensions mm						Quantity Box/Bag	Mechanical Tools	Hydraulic Tools
			Øi	B	M	N	L	d			
0,25÷1,5	3	A 03-M 3*	1,8	6,0	4,5	3,5	16,0	3,2	5.000/100	HNT	B 150
		A 03-M 3.5*	1,8	6,5	4,5	3,5	16,0	3,7	5.000/100		
		A 03-M 4*	1,8	6,5	5,0	4,0	17,0	4,3	5.000/100		
		A 03-M 5*	1,8	7,5	5,5	4,5	18,0	5,3	5.000/100		
		A 03-M 6*	1,8	9,0	6,0	5,0	19,0	6,4	5.000/100		
1,5÷2,5	3,5	A 06-M 3*	2,4	6,0	4,5	3,5	17,0	3,2	4.000/100	HNT	B 150
		A 06-M 3.5*	2,4	6,5	4,5	3,5	17,0	3,7	4.000/100		
		A 06-M 4*	2,4	7,5	5,0	4,0	18,0	4,3	4.000/100		
		A 06-M 5*	2,4	8,5	5,5	4,5	19,0	5,3	4.000/100		
		A 06-M 6*	2,4	9,0	6,0	5,0	20,0	6,4	4.000/100		
4÷6	4	A 06-M 8*	2,4	12,0	9,0	8,0	26,0	8,4	2.500/100	HNT	B 150
		A 1-M 3	3,6	7,5	4,5	3,5	20,5	3,2	2.000/100		
		A 1-M 3.5	3,6	7,5	4,5	3,5	20,5	3,7	2.000/100		
		A 1-M 4	3,6	8,0	5,0	4,0	21,5	4,3	2.000/100		
		A 1-M 5	3,6	9,0	6,5	6,0	25,0	5,3	2.000/100		
10	5	A 1-M 6	3,6	11,0	7,0	6,0	25,5	6,4	2.000/100	HNT	B 150
		A 1-M 8	3,6	14,0	9,0	8,0	29,5	8,4	1.500/100		
		A 1-M 10	3,6	16,5	11,0	10,0	33,5	10,5	1.000/100		
		A 2-M 4	4,6	10,0	5,0	4,0	22,5	4,3	1.500/100		
		A 2-M 5	4,6	10,0	6,5	6,0	26,0	5,3	1.500/100		
16	6	A 2-M 6	4,6	11,0	7,0	6,0	26,5	6,4	1.500/100	HNT	B 150
		A 2-M 8	4,6	15,0	9,0	8,0	30,5	8,4	1.000/100		
		A 2-M 10	4,6	18,0	11,0	10,0	34,5	10,5	1.000/100		
		A 2-M 12	4,6	19,0	14,0	12,0	39,5	13,2	500/100		
		A 3-M 4	5,8	11,5	5,0	4,0	25,5	4,3	1.000/100		
25	8	A 3-M 5	5,8	11,5	6,5	6,0	29,0	5,3	1.000/100	HNT	B 150
		A 3-M 6	5,8	11,5	7,0	6,0	29,5	6,4	1.000/100		
		A 3-M 8	5,8	15,0	9,0	8,0	33,5	8,4	500/100		
		A 3-M 10	5,8	18,0	11,0	10,0	37,5	10,5	500/100		
		A 3-M 12	5,8	20,0	14,0	12,0	42,5	13,2	500/100		
35	10	A 5-M 4	7,0	14,0	5,0	4,0	28,0	4,3	1.000/100	HNT	B 150
		A 5-M 5	7,0	14,0	6,5	6,0	31,5	5,3	500/100		
		A 5-M 6	7,0	14,0	7,0	6,0	32,0	6,4	500/100		
		A 5-M 8	7,0	15,0	9,0	8,0	36,0	8,4	500/100		
		A 5-M 10	7,0	18,0	11,0	10,0	40,0	10,5	500/100		
50	12	A 5-M 12	7,0	21,0	14,0	12,0	45,0	13,2	500/100	HNT	B 150
		A 7-M 5	8,9	17,0	6,5	6,0	34,0	5,3	500/100		
		A 7-M 6	8,9	17,0	7,0	6,0	34,5	6,4	500/100		
		A 7-M 8	8,9	17,0	9,0	8,0	38,5	8,4	400/100		
		A 7-M 10	8,9	19,0	11,0	10,0	42,5	10,5	400/100		
70	14	A 7-M 12	8,9	21,0	14,0	12,0	47,5	13,2	300/50	HNT	B 150
		A 10-M 6	10,0	19,0	8,0	7,0	38,5	6,4	200/50		
		A 10-M 8	10,0	19,0	9,0	8,0	40,5	8,4	200/50		
		A 10-M 10	10,0	20,0	11,5	9,5	44,5	10,5	200/50		
		A 10-M 12	10,0	21,0	12,0	12,0	47,5	13,2	200/50		
70	16	A 10-M 14	10,0	25,0	16,0	14,0	55,5	15,0	200/50	HNT	B 150
		A 10-M 16	10,0	26,0	18,0	16,0	59,5	17,0	200/50		
		A 14-M 6	11,3	21,0	8,0	7,0	44,0	6,4	200/50		
		A 14-M 8	11,3	21,0	9,0	8,0	46,0	8,4	200/50		
		A 14-M 10	11,3	21,0	11,0	10,0	50,0	10,5	200/50		
70	12	A 14-M 12	11,3	22,0	14,0	12,0	55,0	13,2	150/50	HNT	B 150
		A 14-M 14	11,3	25,0	16,0	14,0	59,0	15,0	100/50		
		A 14-M 16	11,3	26,0	18,0	16,0	63,0	17,0	100/50		

*Not UL approved

COPPER TUBE CRIMPING LUGS

for Copper conductors

A-M



File no. E125401



File no. E125401

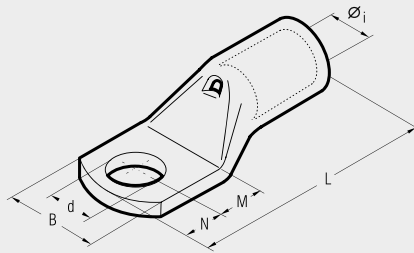

Cond. Size sqmm	Ø Stud mm	Ref.	Dimensions mm						Quantity Box/Bag	Mechanical Tools	Hydraulic Tools
			Øi	B	M	N	L	d			
95	95	6 A 19-M 6	13,5	25,0	8,0	7,0	50,5	6,4	100/25	TN 120 SE** B 35-45D B 35-50D HT 45E HT 51 RH 50 B 500E B 55 HT 81-U RHU 81 HT 120 and tools and heads with 130 kN crimping force ECW-H3D RHU 520	
		8 A 19-M 8	13,5	25,0	9,0	8,0	52,5	8,4	100/25		
		10 A 19-M 10	13,5	25,0	11,0	10,0	56,5	10,5	100/25		
		12 A 19-M 12	13,5	25,0	14,0	12,0	61,5	13,2	100/25		
		14 A 19-M 14	13,5	25,0	16,0	14,0	65,5	15,0	100/25		
		16 A 19-M 16	13,5	27,0	18,0	16,0	69,5	17,0	100/25		
120	95	20 A 19-M 20	13,5	29,5	22,0	20,0	77,5	21,0	50/25		
		8 A 24-M 8	15,2	28,5	9,0	8,0	54,0	8,4	100/25		
		10 A 24-M 10	15,2	28,5	11,0	10,0	58,0	10,5	100/25		
		12 A 24-M 12	15,2	28,5	14,0	12,0	63,0	13,2	100/25		
		14 A 24-M 14	15,2	28,5	16,0	14,0	67,0	15,0	50/25		
150	120	16 A 24-M 16	15,2	28,5	18,0	16,0	71,0	17,0	50/25		
		20 A 24-M 20	15,2	30,0	22,0	20,0	79,0	21,0	50/25		
		8 A 30-M 8	16,7	31,5	13,0	11,0	69,0	8,4	50/25		
		10 A 30-M 10	16,7	31,5	13,0	11,0	69,0	10,5	50/25		
		12 A 30-M 12	16,7	31,5	16,0	14,0	75,0	13,2	50/25		
185	150	14 A 30-M 14	16,7	31,5	18,0	16,0	79,0	15,0	50/25		
		16 A 30-M 16	16,7	31,5	19,0	17,0	81,0	17,0	50/25		
		20 A 30-M 20	16,7	31,5	22,0	20,0	87,0	21,0	50/25		
		8 A 37-M 8	19,2	35,5	13,0	11,0	76,0	8,4	50/25		
		10 A 37-M 10	19,2	35,5	13,0	11,0	76,0	10,5	40/20		
240	185	12 A 37-M 12	19,2	35,5	16,0	14,0	82,0	13,2	40/20		
		14 A 37-M 14	19,2	35,5	18,0	16,0	86,0	15,0	30/15		
		16 A 37-M 16	19,2	35,5	19,0	17,0	88,0	17,0	30/15		
		20 A 37-M 20	19,2	35,5	22,0	20,0	94,0	21,0	30/15		
		8 A 48-M 8	21,1	39,0	13,0	11,0	77,5	8,4	30/15		
300	240	10 A 48-M 10	21,1	39,0	13,0	11,0	77,5	10,5	30/15		
		12 A 48-M 12	21,1	39,0	14,0	12,0	79,5	13,2	30/15		
		14 A 48-M 14	21,1	39,0	18,0	16,0	92,0	15,0	30/15		
		16 A 48-M 16	21,1	39,0	19,0	17,0	94,0	17,0	30/15		
		20 A 48-M 20	21,1	39,0	22,0	20,0	100,0	21,0	30/15		
400	300	10 A 60-M 10	23,7	44,0	20,0	11,0	96,0	10,5	20/10		
		12 A 60-M 12	23,7	44,0	20,0	14,0	99,0	13,2	20/10		
		14 A 60-M 14	23,7	44,0	22,0	16,0	103,0	15,0	20/10		
		16 A 60-M 16	23,7	44,0	22,0	19,0	106,0	17,0	20/10		
		20 A 60-M 20	23,7	44,0	24,0	23,0	112,0	21,0	20/10		
500	300	12 A 80-M 12	27,0	51,0	22,0	19,0	113,0	13,2	20/5		
		14 A 80-M 14	27,0	51,0	22,0	19,0	113,0	15,0	20/5		
		16 A 80-M 16	27,0	51,0	22,0	19,0	113,0	17,0	20/5		
		20 A 80-M 20	27,0	51,0	24,0	23,0	119,0	21,0	20/5		
630	500	16 A 100-M 16	30,3	56,5	22,0	19,0	117,0	17,0	15/1		
		20 A 100-M 20	30,3	56,5	24,0	23,0	123,0	21,0	15/1		
800	630	16 A 120-M 16♦	33,4	61,6	22,0	19,0	128,0	17,0	12/1		
		20 A 120-M 20♦	33,4	61,6	24,0	23,0	134,0	21,0	10/1		
1000	800	16 A 160-M 16♦	38,0	72,0	24,0	19,0	141,0	17,0	6/1		
		20 A 160-M 20♦	38,0	72,0	24,0	23,0	145,0	21,0	6/3		
		16 A 200-M 16♦	44,0	80,0	24,0	19,0	158,0	17,0	6/1		
		20 A 200-M 20♦	44,0	80,0	24,0	23,0	162,0	21,0	6/1		

*Actual conductor section may require a larger lug eg for 120mm² size use A30-... lug.

**See page 109



Isolated covers made of PVC for subsequent isolation of the uninsulated connectors, see page 33.



♦Not UL approved

A-M



RING TONGUE TERMINALS WITH CONTAINED PALM

for L.V. circuit breakers
for Copper conductors

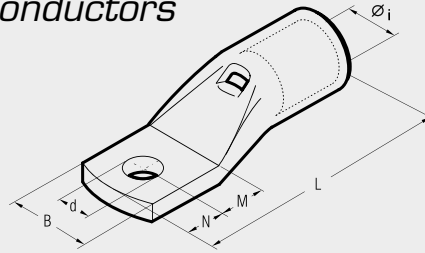

File no. E125401



File no. E125401

This range of terminals features contained palm width and has been specifically developed for application on L.V. circuit breakers with reduced space terminal blocks. The contained palm width allows an immediate and easier installation. Cembre terminals are manufactured from electrolytic Copper tube.

The specifically designed section of the barrel and the choice of principal dimensions are optimising the best combination of mechanical strength and electrical conductivity. These terminals are annealed to guarantee optimum ductility and are electrolytically Tin plated to avoid oxidation. The barrel is provided with an internal taper to ease the introduction of the conductor; furthermore, its length grants a comfortable and correct positioning between dies, during crimping operations. Each palm is marked with the Cembre logo and part number.

Cond. Size Flexible sqmm	Ø Stud mm	Ref.	Dimensions mm						Quantity Box/Bag	Mechanical Tools	Hydraulic Tools							
			Øi	B	M	N	L	d										
10	5	A 2-M 5/9	4,6	9,0	6,5	6,0	26,0	5,3	1000/100	HN5 HN-A25	TN 70 SE	B 150	B 35-45D	B 35-50D	HT 45-E	HT 51 RH 50 B 50OE B 55	HT 81-U RHU 81	ECWH3D
16	5	A 3-M 5/9	5,8	9,0	6,5	6,0	29,0	5,3	1000/100									
25	5	A 5-M 5/9	7,0	9,0	6,5	6,0	31,5	5,3	500/100	TN 120 SE	B 35-45D	B 35-50D	HT 45-E	HT 51 RH 50 B 50OE B 55	HT 81-U RHU 81	ECWH3D		
35	6	A 7 B-M 6/11.5	8,9	11,5	8,0	7,0	36,5	6,4	400/100									
50	6	A 10 B-M 6/11.5	10,0	11,5	8,0	7,0	40,5	6,4	200/50	TN 120 SE	B 35-45D	B 35-50D	HT 45-E	HT 51 RH 50 B 50OE B 55	HT 81-U RHU 81	ECWH3D		
70	6	A 14 B-M 6/11.5	11,3	11,5	8,0	7,0	44,0	6,4	200/50									
95	8	A 19 B-M 8/15.5	13,5	15,5	9,0	8,0	52,5	8,4	100/25	TN 120 SE	B 35-45D	B 35-50D	HT 45-E	HT 51 RH 50 B 50OE B 55	HT 81-U RHU 81	ECWH3D		
120	8	A 24 B-M 8/19	15,2	19,0	14,0	9,0	60,0	8,4	100/25									
	10	A 24 B-M 10/19	15,2	19,0	14,0	9,0	60,0	10,5	100/25	TN 120 SE	B 35-45D	B 35-50D	HT 45-E	HT 51 RH 50 B 50OE B 55	HT 81-U RHU 81	ECWH3D		
150	8	A 30 B-M 8/19	16,7	19,0	18,0	9,0	70,0	8,4	50/25									
	10	A 30 B-M 10/19	16,7	19,0	18,0	9,0	70,0	10,5	50/25	TN 120 SE	B 35-45D	B 35-50D	HT 45-E	HT 51 RH 50 B 50OE B 55	HT 81-U RHU 81	ECWH3D		
185	10	A 37 B-M 10/24.5	19,2	24,5	18,0	9,0	77,0	10,5	50/25									
	10	A 48-M 10/31	21,1	31,0	13,0	9,0	80,0	10,5	30/15	TN 120 SE	B 35-45D	B 35-50D	HT 45-E	HT 51 RH 50 B 50OE B 55	HT 81-U RHU 81	ECWH3D		
240	12	A 48-M 12/31	21,1	31,0	16,0	12,0	86,0	13,2	30/15									
	16	A 48-M 16/31	21,1	31,0	19,0	17,0	94,0	17,0	30/15	TN 120 SE	B 35-45D	B 35-50D	HT 45-E	HT 51 RH 50 B 50OE B 55	HT 81-U RHU 81	ECWH3D		
300	10	A 60 B-M 10/31	23,7	31,0	16,0	12,0	95,0	10,5	20/10									
	12	A 60 B-M 12/31	23,7	31,0	16,0	12,0	95,0	13,2	20/10	TN 120 SE	B 35-45D	B 35-50D	HT 45-E	HT 51 RH 50 B 50OE B 55	HT 81-U RHU 81	ECWH3D		

Details of the appropriate crimping tools and dies are shown on pages 176 to 177.



COPPER TUBE CRIMPING LUGS ANGLED 90°

for Copper conductors



File no. E125401



File no. E125401

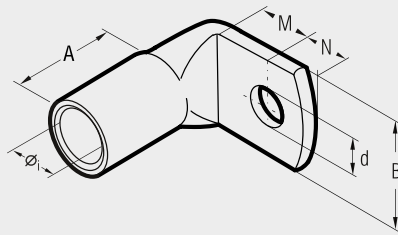

A-L



Cond. Size sqmm	Ø Stud mm	Ref.	Dimensions mm						Quantity Box/Bag	Mechanical Tools	Hydraulic Tools
			Øi	B	M	N	A	d			
6	6	A 1-L 6	3,6	11,0	7,0	6,0	9,5	6,4	2.000/100	HN1	B 150
	5	A 2-L 5	4,6	10,0	6,5	6,0	10,5	5,3	1.500/100		
10	6	A 2-L 6	4,6	11,0	7,0	6,0	10,5	6,4	1.500/100	HN5	B 150
	8	A 2-L 8	4,6	15,0	9,0	8,0	10,5	8,4	500/100		
16	5	A 3-L 5	5,8	11,5	6,5	6,0	12,0	5,3	1.000/100	HN425	B 150
	6	A 3-L 6	5,8	11,5	7,0	6,0	12,0	6,4	1.000/100		
	8	A 3-L 8	5,8	15,0	9,0	8,0	12,0	8,4	1.000/100		
	10	A 3-L 10	5,8	18,0	11,0	10,0	12,0	10,5	500/100		
25	6	A 5-L 6	7,0	14,0	7,0	6,0	13,0	6,4	500/100	TN 70 SE	B 150
	8	A 5-L 8	7,0	15,0	9,0	8,0	13,0	8,4	500/100		
	10	A 5-L 10	7,0	18,0	11,0	10,0	13,0	10,5	500/100		
35	25	A 7-L 6	8,9	17,0	7,0	6,0	15,5	6,4	500/100	TN 120 SE**	B 35-45D B 35-50D HT 45-E
	8	A 7-L 8	8,9	17,0	9,0	8,0	15,5	8,4	300/100		
	10	A 7-L 10	8,9	19,0	11,0	10,0	15,5	10,5	400/100		
	12	A 7-L 12	8,9	21,0	14,0	12,0	15,5	13,2	300/100		
50	6	A 10-L 6	10,0	19,0	8,0	7,0	16,5	6,4	300/100	HT 51 RH 50 RHU 81 HT 81-J RHU 81 ECW-H3D RHU 520	B 150
	8	A 10-L 8	10,0	19,0	9,0	8,0	16,5	8,4	300/100		
	10	A 10-L 10	10,0	20,0	11,5	9,5	16,5	10,5	200/50		
	12	A 10-L 12	10,0	21,0	12,0	12,0	16,5	13,2	200/50		
70	8	A 14-L 8	11,3	21,0	9,0	8,0	20,0	8,4	200/50	HT 120 and tools and heads with 130 kN crimping force	B 150
	10	A 14-L 10	11,3	21,0	11,0	10,0	20,0	10,5	200/50		
	12	A 14-L 12	11,3	22,0	14,0	12,0	20,0	13,2	150/50		
95	16	A 14-L 16	11,3	26,0	18,0	16,0	20,0	17,0	150/50	HT 120 and tools and heads with 130 kN crimping force	B 150
	8	A 19-L 8	13,5	25,0	9,0	8,0	24,5	8,4	100/25		
	10	A 19-L 10	13,5	25,0	11,0	10,0	24,5	10,5	100/25		
120	12	A 19-L 12	13,5	25,0	14,0	12,0	24,5	13,2	100/25	HT 120 and tools and heads with 130 kN crimping force	B 150
	10	A 24-L 10	15,2	28,5	11,0	10,0	25,5	10,5	50/25		
150	12	A 24-L 12	15,2	28,5	14,1	12,0	25,5	13,2	50/25	HT 120 and tools and heads with 130 kN crimping force	B 150
	10	A 30-L 10	16,7	31,5	13,0	11,0	28,5	10,5	50/25		
185	12	A 30-L 12	16,7	31,5	16,0	14,0	28,5	13,2	50/25	HT 120 and tools and heads with 130 kN crimping force	B 150
	10	A 37-L 10	19,2	31,5	13,0	11,0	31,5	10,5	50/25		
240	12	A 37-L 12	19,2	31,5	16,0	14,0	31,5	13,2	50/25	HT 120 and tools and heads with 130 kN crimping force	B 150
	185	A 48-L 12	21,1	39,0	16,0	14,0	33,0	13,2	30/15		
300	240	A 60-L 12	23,7	39,0	20,0	14,0	42,0	13,2	20/10	HT 120 and tools and heads with 130 kN crimping force	B 150
	300	A 60-L 12	23,7	39,0	20,0	14,0	42,0	13,2	20/10		

*Actual conductor section may require a larger lug eg for 120mm² size use A30-... lug.

**See page 109

A-L series lugs angled 90° are manufactured from electrolytic Copper tube. The dimensions of the tube are designed to obtain the most efficient electrical conductivity and mechanical strength to resist vibration and pull out.

Cembre lugs are annealed to guarantee optimum ductility which is an absolute necessity for connectors which will have to withstand the severe deformation arising when compressed and any bending of the palm during installation.

In applications subject to vibration, terminals still have to perform a reliable connection, annealing plays a vital role in avoiding cracking or breaks between the barrel and palm.

The presence of an inspection hole facilitates full insertion of the conductor, whilst the barrel length has been designed to allow easy and accurate positioning of the dies during the crimping operation.

Lugs are electrolytically Tin plated to avoid oxidation. Details of the appropriate crimping tools and dies are shown on pages 196 to 197.

HEAVY DUTY COPPER TUBE TERMINALS

2A-M

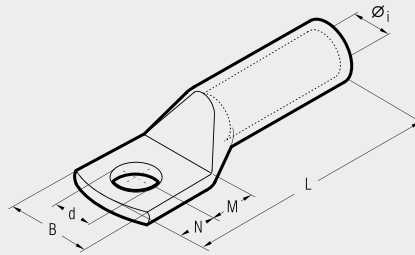

2A-M series terminals are made from high purity Copper tube, and are annealed.

They feature a double length barrel for enhanced electrical and mechanical performance in heavy duty applications.

The absence of an inspection hole prevents the entry of water or moisture into the crimped joint making these terminals suitable for outdoor applications.

The terminals are electrolytically Tin plated to prevent atmospheric corrosion.

Details of the appropriate crimping tools and dies are shown on pages 176 to 177.

2A-2M series terminals with double stud hole palm are also available, please consult us.



Conductor Size sqmm	Ø Stud mm	Ref.	Dimensions mm						Quantity Box/Bag	Mechanical Tools	Hydraulic Tools	
			Øi	B	M	N	L	d				
16	8	2 A 3-M 8	5,8	15,0	9,0	8,0	43,5	8,4	600/100	HN5	B 150	
	10	2 A 3-M 10	5,8	18,0	11,0	10,0	47,5	10,5	500/100			
25	8	2 A 5-M 8	7,0	15,0	9,0	8,0	51,0	8,4	400/100	HN425		
	10	2 A 5-M 10	7,0	18,0	11,0	10,0	55,0	10,5	300/50			
35	12	2 A 5-M 12	7,0	21,0	14,0	12,0	60,0	13,2	300/50	TN 70 SE		
	8	2 A 7-M 8	8,9	17,0	9,0	8,0	53,0	8,4	250/50			
50	10	2 A 7-M 10	8,9	19,0	11,0	10,0	57,0	10,5	250/50	TN 70 SE		
	12	2 A 7-M 12	8,9	21,0	14,0	12,0	62,0	13,2	200/50			
63	10	2 A 10-M 10	10,0	20,0	11,0	10,0	63,0	10,5	200/50	TN 120 SE*		
	12	2 A 10-M 12	10,0	21,0	14,0	12,0	68,0	13,2	150/50			
70	14	2 A 10-M 14	10,0	25,0	16,0	14,0	72,0	15,0	150/50	TN 120 SE*	B 35-45D	
	16	2 A 10-M 16	10,0	26,0	18,0	16,0	76,0	17,0	150/50			B 35-50O
95	10	2 A 14-M 10	11,3	21,0	11,0	10,0	70,0	10,5	100/50	TN 120 SE*	HT 45-E	
	12	2 A 14-M 12	11,3	22,0	14,0	12,0	75,0	13,2	100/50			B 55
120	14	2 A 14-M 14	11,3	25,0	16,0	14,0	79,0	15,0	100/50	TN 120 SE*	HT 51	
	16	2 A 14-M 16	11,3	26,0	18,0	16,0	83,0	17,0	100/50			RH 50
125	10	2 A 19-M 10	13,5	25,0	11,0	10,0	76,5	10,5	75/25	TN 120 SE*	HT 81-J	
	12	2 A 19-M 12	13,5	25,0	14,0	12,0	81,5	13,2	75/25			RH 50
150	14	2 A 19-M 14	13,5	25,0	16,0	14,0	85,5	15,0	75/25	TN 120 SE*	HT 81-J	
	16	2 A 19-M 16	13,5	27,0	18,0	16,0	90,5	17,0	75/25			B 50OE
185	20	2 A 19-M 20	13,5	29,5	22,0	20,0	97,5	21,0	75/25	TN 120 SE*	HT 81-J	
	10	2 A 24-M 10	15,2	28,5	11,0	10,0	82,0	10,5	50/25			RH 50
240	12	2 A 24-M 12	15,2	28,5	14,0	12,0	87,0	13,2	50/25	TN 120 SE*	HT 81-J	
	14	2 A 24-M 14	15,2	28,5	16,0	14,0	91,0	15,0	50/25			RH 50
300	16	2 A 24-M 16	15,2	28,5	18,0	16,0	95,0	17,0	50/25	TN 120 SE*	HT 81-J	
	20	2 A 24-M 20	15,2	30,0	22,0	20,0	103,0	21,0	50/25			RH 50
350	10	2 A 30-M 10	16,7	31,5	13,0	11,0	92,0	10,5	50/25	TN 120 SE*	HT 81-J	
	12	2 A 30-M 12	16,7	31,5	16,0	14,0	98,0	13,2	30/15			RH 50
400	14	2 A 30-M 14	16,7	31,5	18,0	16,0	102,0	15,0	30/15	TN 120 SE*	HT 81-J	
	16	2 A 30-M 16	16,7	31,5	19,0	17,0	104,0	17,0	30/15			RH 50
450	20	2 A 30-M 20	16,7	31,5	22,0	20,0	110,0	21,0	30/15	TN 120 SE*	HT 81-J	
	12	2 A 37-M 12	19,2	35,5	16,0	14,0	108,0	13,2	30/15			RH 50
500	14	2 A 37-M 14	19,2	35,5	18,0	16,0	112,0	15,0	30/15	TN 120 SE*	HT 81-J	
	16	2 A 37-M 16	19,2	35,5	19,0	17,0	114,0	17,0	30/15			RH 50
550	20	2 A 37-M 20	19,2	35,5	22,0	20,0	120,0	21,0	30/15	TN 120 SE*	HT 81-J	
	12	2 A 48-M 12	21,1	39,0	16,0	14,0	109,0	13,2	20/5			RH 50
600	14	2 A 48-M 14	21,1	39,0	18,0	16,0	113,0	15,0	20/5	TN 120 SE*	HT 81-J	
	16	2 A 48-M 16	21,1	39,0	19,0	17,0	115,0	17,0	20/5			RH 50
650	20	2 A 48-M 20	21,1	39,0	22,0	20,0	121,0	21,0	25/5	TN 120 SE*	HT 81-J	
	12	2 A 60-M 12	23,7	44,0	20,0	14,0	129,5	13,2	20/5			RH 50
700	14	2 A 60-M 14	23,7	44,0	22,0	16,0	133,5	15,0	20/5	TN 120 SE*	HT 81-J	
	16	2 A 60-M 16	23,7	44,0	22,0	19,0	136,5	17,0	20/5			RH 50
750	20	2 A 60-M 20	23,7	44,0	24,0	23,0	142,5	21,0	20/5	TN 120 SE*	HT 81-J	
	12	2 A 80-M 12	27,0	51,0	22,0	19,0	140,0	13,2	15/5			RH 50
800	14	2 A 80-M 14	27,0	51,0	22,0	19,0	140,0	15,0	10/5	TN 120 SE*	HT 81-J	
	16	2 A 80-M 16	27,0	51,0	22,0	19,0	140,0	17,0	10/5			RH 50
850	20	2 A 80-M 20	27,0	51,0	24,0	23,0	146,0	21,0	15/5	TN 120 SE*	HT 81-J	
	16	2 A 100-M 16	30,3	56,5	22,0	19,0	147,0	17,0	10/1			RH 50
900	20	2 A 100-M 20	30,3	56,5	24,0	23,0	153,0	21,0	10/1	TN 120 SE*	HT 81-J	
	16	2 A 120-M 16	33,4	61,5	22,0	19,0	159,0	17,0	20/1			RH 50
950	20	2 A 120-M 20	33,4	61,5	24,0	23,0	165,0	21,0	20/1	TN 120 SE*	HT 81-J	
	800	20	2 A 160-M 20	38,0	72,0	24,0	23,0	187,0	21,0		12/1	
1000	20	2 A 200-M 20	44,0	80,0	24,0	23,0	202,0	21,0	6/1	TN 120 SE*	HT 120 and tools and heads with 130 kN crimping force ECW-H30 RHU 520	

*See page 109

THROUGH CONNECTORS



File no. E125401



File no. E125401

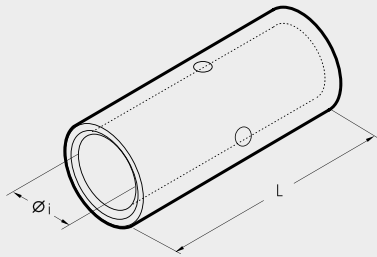

Conductor Size sqmm		Ref.	Dimensions mm		Quantity Box/Bag	Mechanical Tools	Hydraulic Tools
low stranded	Flexible		Øi	L			
0,25÷1,5	0,25÷1,5	L 03-M	1,8	15	6.000/100	HN 1	B 15D
1,5÷2,5	1,5÷2,5	L 06-M	2,4	15	4.000/100		
4÷6	4÷6	L 1-M	3,6	22	2.000/100	HN 5	B 35-45D B 35-50D HT 45-E
10	10	L 2-M	4,6	25	1.000/100		
16	16	L 3-M	5,8	27	1.000/100	HN A25	B 55 HT 51 RH 50 B 500E B 55 HT 81-U RHU 81
25	25	L 5-M	7,0	29	500/100		
35	25÷35	L 7-M	8,9	33	400/100	TN 70 SE	ECW-H3D RHU 520
50	35÷50	L 10-M	10,0	37	200/50		
70	50÷70	L 14-M	11,3	39	200/50	TN 120 SE*	HT 120 and tools and heads with 130 kN crimping force
95	70÷95	L 19-M	13,5	43	100/25		
120	95÷120	L 24-M	15,2	47	100/25	B 35-45D B 35-50D HT 45-E	RHU 520
150	120÷150	L 30-M	16,7	58	50/25		
185	150÷185	L 37-M	19,2	64	50/25	HT 51 RH 50 B 500E B 55 HT 81-U RHU 81	ECW-H3D RHU 520
240	185÷240	L 48-M	21,1	75	30/15		
300	240÷300	L 60-M	23,7	90	20/10	HT 120 and tools and heads with 130 kN crimping force	RHU 520
400	300÷400	L 80-M	27,0	94	20/5		
500	400÷500	L 100-M	30,3	98	12/1	HT 120 and tools and heads with 130 kN crimping force	RHU 520
630	500÷630	L 120-M*	33,4	105	12/1		
800	600	L 160-M*	38,0	112	9/1	HT 120 and tools and heads with 130 kN crimping force	RHU 520
1000	800	L 200-M*	44,0	120	6/1		

*See page 109

*Not UL approved

L-M



L-M range of connectors are designed for jointing low voltage conductors. Made of electrolytic Copper tube having the same dimension as A-M series lugs: L-M connectors are annealed and electrolytically Tin plated. They feature an internal taper at both ends to ease the introduction of the conductor and a central stop to ensure correct positioning. Details of the appropriate crimping tools and dies are shown on pages 176 to 177.

PARALLEL CONNECTORS

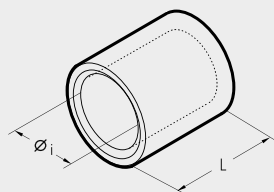

Total Conductor Size sqmm		Ref.	Dimensions mm		Quantity Box/Bag	Mechanical Tools	Hydraulic Tools
low stranded	Flexible		Øi	L			
0,25÷1,5	0,25÷1,5	L 03-P	1,8	6,0	10.000/100	HN 1	B 15D
1,5÷2,5	1,5÷2,5	L 06-P	2,4	6,0	5.000/100		
4÷6	4÷6	L 1-P	3,6	9,0	3.000/100	HN 5	B 35-45D B 35-50D HT 45-E
10	10	L 2-P	4,6	10,5	3.000/100		
16	16	L 3-P	5,8	11,5	2.000/100	HN A25	B 55 HT 51 RH 50 B 500E B 55 HT 81-U RHU 81
25	25	L 5-P	7,0	13,0	1.500/100		
35	25÷35	L 7-P	8,9	14,0	500/100	TN 70 SE	ECW-H3D RHU 520
50	35÷50	L 10-P	10,0	16,0	500/100		
70	50÷70	L 14-P	11,3	18,0	500/100	TN 120 SE*	HT 120 and tools and heads with 130 kN crimping force
95	70÷95	L 19-P	13,5	19,0	300/50		
120	95÷120	L 24-P	15,2	22,0	200/50	B 35-45D B 35-50D HT 45-E	RHU 520
150	120÷150	L 30-P	16,7	26,5	100/50		
185	150÷185	L 37-P	19,2	26,5	100/50	HT 51 RH 50 B 500E B 55 HT 81-U RHU 81	ECW-H3D RHU 520
240	185÷240	L 48-P	21,1	34,0	60/15		
300	240÷300	L 60-P	23,7	43,0	50/25	HT 120 and tools and heads with 130 kN crimping force	RHU 520

*See page 109

L-P



Made of electrolytic Copper tube, having the same dimensions as A-M series lugs, L-P connectors are annealed and electrolytically Tin plated. They feature an internal taper to ease the introduction of the conductor. Details of the appropriate crimping tools and dies are shown on pages 176 to 177.

POLYAMIDE PA6.6 INSULATED COPPER TUBE LUGS

ANE-M

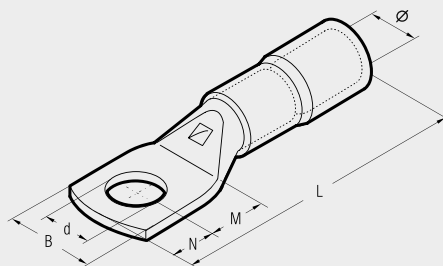

ANE-M series lugs are manufactured from electrolytic Copper tube annealed and Tin plated.

The interior of the PA6.6 insulated sleeve is funnel shaped so as to ensure complete and easy introduction of the conductor strands.

It also eliminates the need to insulate the terminal using either tape or heat shrinkable tubing.

Furthermore the PA6.6 sleeve avoids the possibility of conductor breakage at the barrel entrance.

The operating temperature range is - 20 to + 115°C (Surge + 130°C).

In order to achieve the best electrical and mechanical performance it is suggested that they are crimped using dies and tools specifically developed for this purpose by Cembre.

Details of the appropriate crimping tools and dies are shown on pages 178 to 179.

Cond. Size Flexible sqmm	Ø Stud mm	Ref.	Dimensions mm						Quantity Box/Bag	Mechanical Tools	Hydraulic Tools	
			Ø	B	M	N	L	d				
10	4	ANE 2-M 4	8,0	10,0	5,0	4,0	34,1	4,3	500/100	HMN3	B 15D	
	5	ANE 2-M 5	8,0	10,0	6,5	6,0	37,6	5,3	500/100			
	6	ANE 2-M 6	8,0	11,0	7,0	6,0	38,1	6,4	500/100			
	8	ANE 2-M 8	8,0	15,0	9,0	8,0	42,1	8,4	500/100			
	10	ANE 2-M 10	8,0	18,0	11,0	10,0	46,1	10,5	500/100			
	12	ANE 2-M 12	8,0	19,0	14,0	12,0	51,1	13,2	500/100			
16	4	ANE 3-M 4	9,2	11,5	5,0	4,0	38,6	4,3	500/100	HMN4	B 15D	
	5	ANE 3-M 5	9,2	11,5	6,5	6,0	42,1	5,3	500/100			
	6	ANE 3-M 6	9,2	11,5	7,0	6,0	42,6	6,4	500/100			
	8	ANE 3-M 8	9,2	15,0	9,0	8,0	46,6	8,4	500/100			
	10	ANE 3-M 10	9,2	18,0	11,0	10,0	50,6	10,5	400/100			
	12	ANE 3-M 12	9,2	20,0	14,0	12,0	55,6	13,2	300/100			
25	4	ANE 5-M 4	11,1	14,0	5,0	4,0	41,0	4,3	300/100	TMN 70	B 35-50D	
	5	ANE 5-M 5	11,1	14,0	6,5	6,0	44,5	5,3	300/100			
	6	ANE 5-M 6	11,1	14,0	7,0	6,0	45,0	6,4	300/100			
	8	ANE 5-M 8	11,1	15,0	9,0	8,0	49,0	8,4	300/100			
	10	ANE 5-M 10	11,1	18,0	11,0	10,0	53,0	10,5	300/100			
	12	ANE 5-M 12	11,1	21,0	14,0	12,0	58,0	13,2	250/50			
35	6	ANE 7-M 6	13,6	17,0	7,0	6,0	50,0	6,4	200/50	TMN 120	B 55	
	8	ANE 7-M 8	13,6	17,0	9,0	8,0	54,0	8,4	200/50			
	10	ANE 7-M 10	13,6	19,0	11,0	10,0	58,0	10,5	200/50			
	12	ANE 7-M 12	13,6	21,0	14,0	12,0	63,0	13,2	200/50			
	6	ANE 10-M 6	13,8	19,0	8,0	7,0	53,0	6,4	200/50			
	8	ANE 10-M 8	13,8	19,0	9,0	8,0	55,0	8,4	150/50			
50	10	ANE 10-M 10	13,8	20,0	11,5	9,5	59,0	10,5	150/50	TMN 120	B 500E	
	12	ANE 10-M 12	13,8	21,0	12,0	12,0	62,0	13,2	150/50			
	6	ANE 14-M 6	15,8	21,0	8,0	7,0	61,0	6,4	100/25			
	8	ANE 14-M 8	15,8	21,0	9,0	8,0	63,0	8,0	100/25			
	10	ANE 14-M 10	15,8	21,0	11,0	10,0	67,0	10,5	100/25			
	12	ANE 14-M 12	15,8	22,0	14,0	12,0	72,0	13,2	100/25			
70	14	ANE 14-M 14	15,8	25,0	16,0	14,0	76,0	15,0	100/25	TMN 120	B 55	
	8	ANE 19-M 8	18,0	25,0	9,0	8,0	73,0	8,4	50/25			
	10	ANE 19-M 10	18,0	25,0	11,0	10,0	77,0	10,5	50/25			
	12	ANE 19-M 12	18,0	25,0	14,0	12,0	82,0	13,2	50/25			
	14	ANE 19-M 14	18,0	25,0	16,0	14,0	86,0	15,0	50/25			
	16	ANE 19-M 16	18,0	27,0	18,0	16,0	80,0	17,0	50/25			
120	10	ANE 24-M 10	20,0	28,5	11,0	10,0	77,7	10,5	50/25	TMN 120	B 55	
	12	ANE 24-M 12	20,0	28,5	14,0	12,0	86,5	13,2	50/25			
	14	ANE 24-M 14	20,0	28,5	16,0	14,0	88,5	15,0	50/25			
	16	ANE 24-M 16	20,0	28,5	18,0	16,0	90,5	17,0	50/25			
	12	ANE 30-M 12	23,0	31,5	16,0	14,0	101,0	13,2	30/15			
	14	ANE 30-M 14	23,0	31,5	18,0	16,0	105,0	15,0	30/15			
150	16	ANE 30-M 16	23,0	31,5	19,0	17,0	107,0	17,0	30/15	TMN 120	B 55	
	20	ANE 30-M 20	23,0	31,5	22,0	20,0	113,0	21,0	30/15			



ECW-H3D

HT 120 and tools and heads with 130 kN crimping force

HT 51 RH 50 B 500E

HT 51 RH 50 B 55

HT 120 and tools and heads with 130 kN crimping force

HT 51 RH 50 B 500E

HT 51 RH 50 B 55

POLYAMIDE PA6.6 INSULATED FORK TERMINALS



File no. E125401

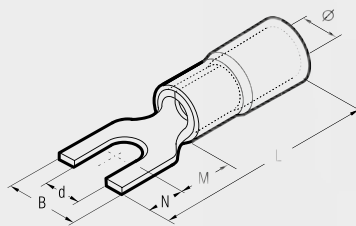

ANE-U



Conductor Size Flexible sqmm	Ø Stud mm	Ref.	Dimensions mm						Quantity Box/Bag	Mechanical Tools				Hydraulic Tools					
			Ø	B	M	N	L	d		HNN 3	HNN 4	TNN70	TNN 120	B 150	B 35-500	HT 51 RH 50	B 500E B 55	HT 120 and tools and heads with 130 kN crimping force	ECW-H3D
10	4	ANE 2-U 4	8,0	9,8	7,5	7,0	35,1	4,3	500/100										
	5	ANE 2-U 5	8,0	11,5	7,5	7,0	35,1	5,3	500/100										
16	4	ANE 3-U 4	9,2	10,0	10,0	8,0	41,1	4,3	500/100										
	5	ANE 3-U 5	9,2	11,5	10,0	8,0	41,1	5,3	500/100										

The operating temperature range is - 20 to + 115°C (Surge + 130°C).

In order to achieve the best electrical and mechanical performance it is suggested that they are crimped using dies and tools specifically developed for this purpose by Cembre.

Details of the appropriate crimping tools and dies are shown on pages 178 to 179.

ANE-U series terminals are made from electrolytic Copper, rolled, Tin plated and brazed.

The interior of the PA6.6 insulated sleeve is funnel shaped so as to ensure complete and easy introduction of the conductor strands.

FLEXIBLE BRAIDS

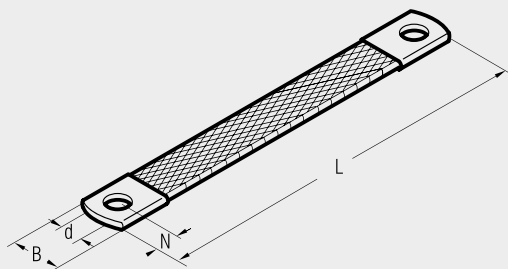

FL



Size sqmm	Ø Stud mm	Ref.	Dimensions mm				Quantity
			B	N	L	d	
10	8	FL 10-150	17	10	150	8,5	50
	8	FL 10-200	17	10	200	8,5	50
	8	FL 10-250	17	10	250	8,5	50
	8	FL 16-150	17	10	150	8,5	50
	8	FL 16-200	17	10	200	8,5	50
16	8	FL 16-250	17	10	250	8,5	50
	8	FL 16-320	17	10	320	8,5	50
	8	FL 16-350	17	10	350	8,5	50
	8	FL 16-420	17	10	420	8,5	25
	8	FL 16-570	17	10	570	8,5	25
	8	FL 16-660	17	10	660	8,5	25
	8	FL 25-150	21	10	150	8,5	50
25	8	FL 25-200	21	10	200	8,5	50
	8	FL 25-250	21	10	250	8,5	50
	8	FL 25-300	21	10	300	8,5	50

Flexible braids are manufactured from electrolytic Copper wire.

Braids of different conductor sizes or lengths are available on request. Standard finish - bright Copper.

Flexible braids can be supplied Tin plated, in this case add the suffix "ST" to reference.

E.g.:
- FL 10-150 (Bright Copper)
- FL 10-150-ST (Tin plated)

ANE-P



POLYAMIDE PA6.6 INSULATED PIN TERMINALS



File no. E125401

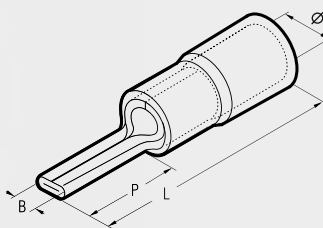

ANE-P series terminals are made from electrolytic Copper, rolled, Tin plated and brazed. The interior of the PA6.6 insulated sleeve is funnel shaped so as to ensure complete and easy introduction of the conductor strands.

The operating temperature range is - 20 to + 115°C (Surge + 130°C).

In order to achieve the best electrical and mechanical performance it is suggested that they are crimped using dies and tools specifically developed for this purpose by Cembre.

Conductor Size Flexible sqmm	Ref.	Dimensions mm				Quantity Box/Bag	Mechanical Tools			Hydraulic Tools					
		Ø	B	P	L		HNN 3	HNN 4	TNW 70	TNW 120	B 15D	B 35-50D	HT 51, PH 50 B 50DE B 55	HT 120 and tools and heads with 130 kN crimping force	ECW-H3D
10	ANE 2-P 12	8,0	4,3	14,5	35,1	500/100									
16	ANE 3-P 14	9,2	5,5	18,0	41,1	500/100									
25	ANE 5-P 16	11,1	7,0	20,3	45,0	300/100									
35	ANE 7-P 20	13,6	8,0	24,5	55,0	200/50									

Details of the appropriate crimping tools and dies are shown on pages 178 to 179.

A-P



UNINSULATED PIN CONNECTORS

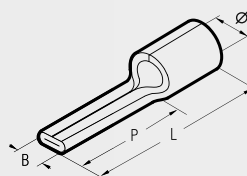

A-P series pin connectors are designed to terminate conductors into contact blocks.

They are manufactured from Copper strip, rolled, brazed and Tin plated.

Details of the appropriate crimping tools and dies are shown on pages 176 to 177.

Cond. Size sqmm	Ref.	Dimensions mm				Quantity Box/Bag	Mechanical Tools			Hydraulic Tools										
		low stranded	flexible*	Ø1	B		P	L	HN 1	HN 5	HN-A25	TN 70 SE	TN 120 SE	B 15D	B 35-45D	HT 45-E	HT 45	HT 51, PH 50 B 50DE B 55	HT 120 and tools and heads with 130 kN crimping force	ECW-H3D
10	10 A 2-P 12			4,8	4,3	14,5	23,5	1.000/100												
16	16 A 3-P 14			5,9	5,5	18,0	28,0	1.500/100												
25	25 A 5-P 16			7,0	7,0	20,3	32,0	1.000/100												
35	25÷35 A 7-P 20			8,9	8,0	24,5	39,0	500/100												
50	35÷50 A 10-P 25			10,0	9,5	26,0	45,0	250/50												
70	50÷70 A 14-P 30			11,5	11,0	31,0	55,0	200/50												

POLYAMIDE PA6.6 INSULATED COPPER TUBE LUGS



for extra flexible Copper conductors

ANE-M

for fine stranded
SPECIAL
flexible conductors

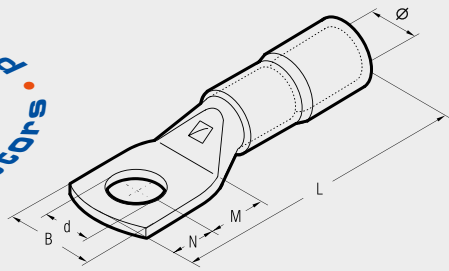

Conductor Size Extra Flexible sqmm	Ø Stud mm	Ref.	Dimensions mm						Quantity Box/Bag	Mechanical Tools	Hydraulic Tools		
			Ø	B	M	N	L	d					
35	6	ANE 9-M 6/15	13,6	15,0	8,0	7,0	54,0	6,4	200/50	TMM 70	B 35-500		
	8	ANE 9-M 8	13,6	17,0	9,0	8,0	56,0	8,4	200/50				
	10	ANE 9-M 10	13,6	18,5	11,0	10,0	60,0	10,5	150/50				
	12	ANE 9-M 12	13,6	21,0	14,0	12,0	65,0	13,2	150/50				
50	6	ANE 12-M 6/15	15,7	15,0	8,0	7,0	59,5	6,4	100/25			TMM 120	B 55 B 500E RH 50 HT 51 ECW-H3D
	8	ANE 12-M 8	15,7	19,8	9,0	8,0	61,5	8,4	100/25				
	10	ANE 12-M 10	15,7	19,8	11,0	10,0	65,5	10,5	100/25				
	10	ANE 12-M 10/19	15,7	19,0	11,0	10,0	65,5	10,5	100/25				
70	12	ANE 12-M 12	15,7	22,0	14,0	12,0	70,5	13,2	100/25				
	6	ANE 17-M 6	17,9	23,0	8,0	7,0	63,8	6,4	100/25				
	8	ANE 17-M 8	17,9	23,0	9,0	8,0	65,8	8,4	100/25				
	10	ANE 17-M 10	17,9	23,0	11,0	10,0	69,8	10,5	50/25				
	10	ANE 17-M 10/19	17,9	19,0	11,0	10,0	69,8	10,5	100/25				
	12	ANE 17-M 12	17,9	23,0	14,0	12,0	74,8	13,2	50/25				
95	14	ANE 17-M 14	17,9	25,0	15,5	12,0	76,3	15,0	50/25				
	16	ANE 17-M 16	17,9	27,0	16,5	13,5	78,8	17,0	50/25				
	8	ANE 20-M 8	20,0	27,0	9,0	8,0	70,6	8,4	50/25				
	10	ANE 20-M 10	20,0	27,0	11,0	10,0	74,6	10,5	50/25				
	12	ANE 20-M 12	20,0	27,0	14,0	12,0	79,6	13,2	50/25				
120	14	ANE 20-M 14	20,0	27,0	15,5	12,0	81,1	15,0	50/25				
	16	ANE 20-M 16	20,0	27,0	16,5	13,5	83,6	17,0	50/25				
	10	ANE 29-M 10	22,4	30,0	11,0	10,0	81,5	10,5	50/25				
	12	ANE 29-M 12	22,4	30,0	14,0	12,0	86,5	13,2	50/25				
	14	ANE 29-M 14	22,4	30,0	15,5	12,0	88,5	15,0	50/25				
150	16	ANE 29-M 16	22,4	30,0	16,5	13,5	90,5	17,0	50/25				
	20	ANE 29-M 20	22,4	30,0	22,0	20,0	102,5	21,0	50/25				
	12	ANE 35-M 12	25,0	34,2	16,0	14,0	95,0	13,2	30/15				
	14	ANE 35-M 14	25,0	34,2	18,0	16,0	99,0	15,0	30/15				
	16	ANE 35-M 16	25,0	34,2	19,0	17,0	101,0	17,0	30/15				
	20	ANE 35-M 20	25,0	34,2	22,0	20,0	107,0	21,0	30/15				

These lugs are particularly recommended for use with extra flexible conductors on for instance, welding machines.

ANE-M series lugs are manufactured from electrolytic Copper tube annealed and Tin plated.

The interior of the PA6.6 insulated sleeve is funnel shaped so as to ensure complete and easy introduction of the conductor strands.

It also eliminates the need to insulate the terminal using either tape or heat shrinkable tubing.

Furthermore the PA6.6 sleeve avoids the possibility of conductor breakage at the barrel entrance.

The operating temperature range is - 20 to + 115°C (Surge + 130°C).

In order to achieve the best electrical and mechanical performance it is suggested that they are crimped using dies and tools specifically developed for this purpose by Cembre.

Details of the appropriate crimping tools and dies are shown on pages 178 to 179.

A-M

COPPER TUBE CRIMPING LUGS

for extra flexible Copper conductors

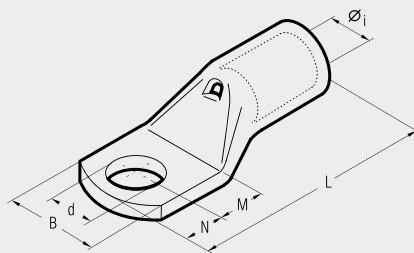

for fine stranded
SPECIAL
flexible conductors

These lugs are particularly recommended for use with extra flexible conductors on for instance, welding machines.

A-M series lugs are designed to suit panel applications.

The dimensions of the tube are designed to obtain the most efficient electrical conductivity and mechanical strength to resist vibration and pull out.

Cembre lugs are annealed to guarantee optimum ductility and electrolytically Tin plated to avoid oxidation.

The presence of an inspection hole facilitates full insertion of the conductor.

Details of the appropriate crimping tools and dies are shown on pages 176 to 177.

Conductor Size Extra Flexible sqmm	Ø Stud mm	Ref.	Dimensions mm						Quantity Box/Bag	Mechanical Tools	Hydraulic Tools			
			Øi	B	M	N	L	d						
35	6	A 9-M 6/15	9,3	15,0	8,0	7,0	38,5	6,4	400/100	TN 70 SE				
	8	A 9-M 8	9,3	17,0	9,0	8,0	40,5	8,4	400/100					
	10	A 9-M 10	9,3	18,5	11,0	10,0	44,5	10,5	400/100					
	12	A 9-M 12	9,3	21,0	14,0	12,0	49,5	13,2	300/50					
50	6	A 12-M 6/15	11,0	15,0	8,0	7,0	40,5	6,4	200/50			TN 120 SE	B 35-45D B 35-50D HT 45-E	
	8	A 12-M 8	11,0	19,3	9,0	8,0	42,5	8,4	200/50					
	10	A 12-M 10	11,0	19,3	11,0	10,0	46,5	10,5	200/50					
	10	A 12-M 10/19	11,0	19,0	11,0	10,0	46,5	10,5	200/50					
70	12	A 12-M 12	11,0	22,0	14,0	12,0	51,5	13,2	200/50					B 55 HT 51 RH 50 B 500E B 55 HT 81-J RHU 81 HT 120 and tools and heads with 130 kN crimping force ECW-H3D RHU 520
	6	A 17-M 6	13,0	23,0	8,0	7,0	45,0	6,4	200/50					
	8	A 17-M 8	13,0	23,0	9,0	8,0	47,0	8,4	150/50					
	10	A 17-M 10	13,0	23,0	11,0	10,0	51,0	10,5	150/50					
95	10	A 17-M 10/19	13,0	19,0	11,0	10,0	51,0	10,5	200/50	B 55 HT 51 RH 50 B 500E B 55 HT 81-J RHU 81 HT 120 and tools and heads with 130 kN crimping force ECW-H3D RHU 520				
	12	A 17-M 12	13,0	23,0	14,0	12,0	56,0	13,2	150/50					
	14	A 17-M 14	13,0	25,0	15,5	12,0	57,5	15,0	150/25					
	16	A 17-M 16	13,0	27,0	16,5	13,5	60,0	17,0	150/25					
120	8	A 20-M 8	15,0	27,0	9,0	8,0	50,0	8,4	100/25		B 55 HT 51 RH 50 B 500E B 55 HT 81-J RHU 81 HT 120 and tools and heads with 130 kN crimping force ECW-H3D RHU 520			
	10	A 20-M 10	15,0	27,0	11,0	10,0	54,0	10,5	100/25					
	12	A 20-M 12	15,0	27,0	14,0	12,0	59,0	13,2	100/25					
	14	A 20-M 14	15,0	27,0	15,5	12,0	60,5	15,0	100/25					
	16	A 20-M 16	15,0	27,0	16,5	13,5	63,0	17,0	100/25					
	8	A 29-M 8	16,5	30,0	9,0	8,0	53,5	8,4	100/25					
150	10	A 29-M 10	16,5	30,0	11,0	10,0	57,5	10,5	100/25			B 55 HT 51 RH 50 B 500E B 55 HT 81-J RHU 81 HT 120 and tools and heads with 130 kN crimping force ECW-H3D RHU 520		
	12	A 29-M 12	16,5	30,0	14,0	12,0	62,5	13,2	100/25					
	14	A 29-M 14	16,5	30,0	15,5	12,0	64,0	15,0	100/25					
	16	A 29-M 16	16,5	30,0	16,5	13,5	66,5	17,0	100/25					
185	20	A 29-M 20	16,5	30,0	22,0	20,0	78,5	21,0	75/25	B 55 HT 51 RH 50 B 500E B 55 HT 81-J RHU 81 HT 120 and tools and heads with 130 kN crimping force ECW-H3D RHU 520				
	10	A 35-M 10	19,2	34,2	13,0	11,0	65,5	10,5	50/25					
	12	A 35-M 12	19,2	34,2	16,0	14,0	71,5	13,2	50/25					
	14	A 35-M 14	19,2	34,2	18,0	16,0	75,5	15,0	50/25					
185	16	A 35-M 16	19,2	34,2	19,0	17,0	77,5	17,0	50/25		B 55 HT 51 RH 50 B 500E B 55 HT 81-J RHU 81 HT 120 and tools and heads with 130 kN crimping force ECW-H3D RHU 520			
	20	A 35-M 20	19,2	34,2	22,0	20,0	83,5	21,0	50/25					
	10	A 40-M 10	21,0	37,5	13,0	11,0	73,0	10,5	30/15					
	12	A 40-M 12	21,0	37,5	16,0	14,0	79,0	13,2	30/15					
185	14	A 40-M 14	21,0	37,5	18,0	16,0	83,0	15,0	30/15			B 55 HT 51 RH 50 B 500E B 55 HT 81-J RHU 81 HT 120 and tools and heads with 130 kN crimping force ECW-H3D RHU 520		
	16	A 40-M 16	21,0	37,5	19,0	17,0	85,0	17,0	30/15					
	20	A 40-M 20	21,0	37,5	22,0	20,0	91,0	21,0	30/15					



Isolated covers made of PVC for subsequent isolation of the uninsulated connectors, see page 33.



COPPER TUBE LUGS 4-ESI FIXING

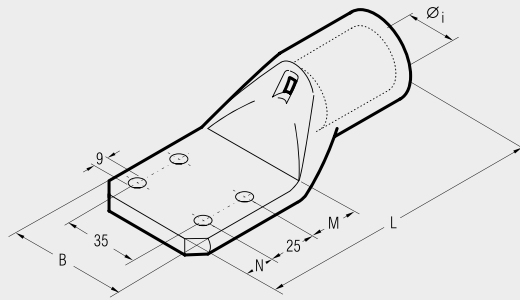

Conductor Size sqmm	Ref.	Dimensions mm					Quantity Box/Bag	Hydraulic Tools		
		Øi	B	M	N	L		HT 51 RH 50 B 500E B 55	HT 81JU RHU 81	HT 120 and tools and heads with 130 kN crimping force
185	A 37-4ESI	19,2	61	20	15	124	20/10	ECW-H3D RHU 520		
240	A 48-4ESI	21,1	61	20	15	128	20/10			
300	A 60-4ESI	23,7	61	20	15	133	20/10			
400	A 80-4ESI	27,0	61	20	15	134	15/5			
500	A 100-4ESI	30,3	61	20	15	139	10/5			
630	A 120-4ESI	33,4	61	20	15	144	10/5			
800	A 160-4ESI	38,0	61	20	15	158	8/4			

A-4ESI



A-4ESI series lugs are made from high purity electrolytic Copper tube, annealed and Tin plated. The four hole stud fixing in accordance with E.A. specifications ensures compatibility with most transformer fixing arrangements. Details of the appropriate crimping tools and dies are shown on pages 176 to 177.

INSULATED COVERS

For uninsulated connectors

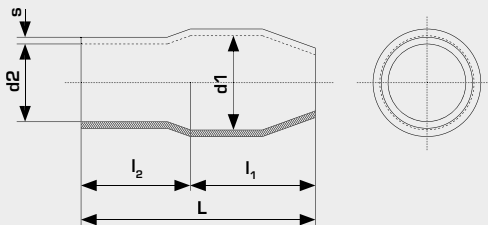

ES

Ref.	Connectors A-M*	d1 Ø	d2 Ø	l ₁ ±1	l ₂ ±1	L ± 2	s ± 0.2	Quantity	Minimum Order Qty
ES03-..	A03	3.3	3.1	7.0	8.0	15.0	0.6	100	3.000
ES06-..	A06	4.5	3.7	8.0	8.0	16.0	0.7	100	
ES1-..	A1	5.7	4.1	9.0	9.0	18.0	0.8	100	
ES2-..	A2	7.2	6.2	11.0	10.0	21.0	1.0	100	1.000
ES3-..	A3	10.0	8.0	15.0	13.0	28.0	1.1	100	
ES5-..	A5	12.0	9.5	15.0	14.0	29.0	1.2	100	
ES10-..	A7, A9, A10	14.0	11.8	17.0	17.0	34.0	1.4	100	500
ES14-..	A12, A14	17.0	13.9	22.0	20.0	42.0	1.5	100	
ES19-..	A17, A19	19.0	16.0	25.0	21.0	46.0	1.5	50	
ES24-..	A20, A24	22.0	18.0	31.0	24.0	55.0	1.7	50	200
ES30-..	A29, A30	24.0	20.0	32.0	28.0	60.0	1.8	50	
ES37-..	A35, A37	26.0	22.0	34.0	31.0	65.0	1.8	50	
ES40-..	A40, A48**	32.2	24.0	38.0	31.0	69.0	2.0	50	100
ES48-..	A48**	36.5	27.2	42.0	33.0	75.0	2.0	50	
ES80-..	A60, A80	36.7	30.0	42.0	33.0	75.0	2.0	25	

Dimensions are in mm

Add the suffix corresponding to the selected colour to the reference:

-BU blue, **-GY** grey, **-BR** brown, **-BK** black, **-WH** white, **-RE** red, **-GN** green, **-YE** yellow, **-PK** pink

* See A-M type copper tube lugs on pages 22-23, 32

** Depending on the diameter of the insulated cable

Insulated covers in PVC for general use with Cembre A-M copper tube lugs characterised by environmental tolerance, flexibility, not inflammability & stable performance. Widely used for the insulation and protection of connections and electrical terminations.

General features:

- Material: PVC
- Self extinguishing (UL94): VO
- Working temperature: 85 °C
- Colours: red, yellow, blue, green, black, grey, white, brown, pink.

COPPER TUBE CRIMPING LUGS ACCORDING TO DIN 46235

for Copper conductors



DR

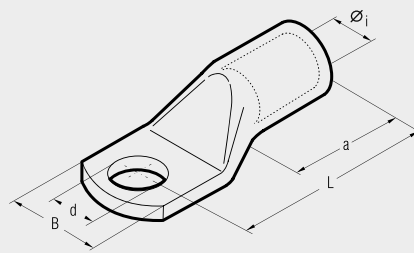

DR series lugs are manufactured from electrolytic Copper tube and designed to obtain high electrical conductivity combined with the mechanical strength required to resist vibration and pull out.

Cembre lugs are annealed and Tin plated for improved surface protection.

The annealing process optimises the structural features of the material allowing easier crimping and greater resistance to mechanical stresses.

Dimensions are according to DIN 46235.

The barrel entrance of the lug is chamfered to allow easy conductor insertion, while its length facilitates precise positioning in the crimping die.

Each lug is marked with:

- Cembre logo and part code.
- conductor type and csa (mm²).
- Stud Ø (mm).
- crimping die code

Details of the appropriate crimping tools and dies are shown on page 185.

Consult us for special requirements

Conductor Size sqmm	Ø Stud mm	Ref.	Code	Dimensions mm					Quantity Box/Bag	Mechanical Tools	Hydraulic Tools						
				Øi	d	L	B	a									
6	5	DR6-5	5	3,7	5,3	24,0	8,5	10,0	800/100	HND25	B 15D						
	6	DR6-6	5	3,7	6,4	24,0	9,0	10,0	800/100								
	8	DR6-8*	5	3,7	8,4	26,0	13,0	10,0	800/100								
10	5	DR10-5	6	4,4	5,3	27,5	10,0	10,0	800/100	HND25	B 15D						
	6	DR10-6	6	4,4	6,4	27,0	10,0	10,0	800/100								
	8	DR10-8*	6	4,4	8,4	28,0	13,0	10,0	800/100								
16	10	DR10-10*	6	4,4	10,5	28,5	15,0	10,0	800/100	HND25	B 15D						
	5	DR16-5*	8	5,5	5,3	36,0	13,0	20,0	400/100								
	6	DR16-6	8	5,5	6,4	36,0	13,0	20,0	400/100								
25	8	DR16-8	8	5,5	8,4	37,0	13,0	20,0	400/100	HND25	B 15D						
	10	DR16-10	8	5,5	10,5	40,0	16,5	20,0	400/100								
	12	DR16-12*	8	5,5	13,0	41,0	19,0	20,0	400/100								
35	6	DR25-6	10	7,0	6,4	39,0	14,6	20,0	400/100	TND 6-70	B 15D						
	8	DR25-8	10	7,0	8,4	39,5	16,0	20,0	400/100								
	10	DR25-10	10	7,0	10,5	40,0	16,0	20,0	200/100								
50	12	DR25-12	10	7,0	13,0	40,5	18,0	20,0	200/100	TND 6-70	B 15D						
	6	DR35-6*	12	8,2	6,4	42,5	17,5	20,0	200/100			TND 10-120	B 35-45D B 35-500 HT 45-E				
	8	DR35-8	12	8,2	8,4	42,0	17,0	20,0	200/100								
10	DR35-10	12	8,2	10,5	43,0	19,0	20,0	200/100									
70	12	DR35-12	12	8,2	13,0	43,0	21,0	20,0	200/100	TND 10-120	B 35-45D B 35-500 HT 45-E						
	16	DR35-16*	12	8,2	17,0	44,0	28,0	20,0	200/100								
	6	DR50-6*	14	10,0	6,4	52,0	20,0	28,0	100/25								
95	8	DR50-8	14	10,0	8,4	52,0	20,0	28,0	100/25	TND 10-120	B 35-45D B 35-500 HT 45-E						
	10	DR50-10	14	10,0	10,5	53,0	22,0	28,0	100/25								
	12	DR50-12	14	10,0	13,0	53,0	24,0	28,0	100/25								
120	16	DR50-16	14	10,0	17,0	57,0	28,0	28,0	100/25	TND 10-120	B 35-45D B 35-500 HT 45-E						
	8	DR70-8	16	11,5	8,4	56,0	24,0	28,0	50/25								
	10	DR70-10	16	11,5	10,5	56,0	24,0	28,0	50/25								
150	12	DR70-12	16	11,5	13,0	56,0	24,0	28,0	50/25	TND 10-120	B 35-45D B 35-500 HT 45-E						
	16	DR70-16	16	11,5	17,0	60,0	30,0	28,0	50/25								
	20	DR70-20*	16	11,5	21,0	84,5	30,0	28,0	50/25								
185	8	DR95-8*	18	13,5	8,4	65,0	28,0	35,0	50/25	TND 10-120	B 35-45D B 35-500 HT 45-E						
	10	DR95-10	18	13,5	10,5	66,0	28,0	35,0	50/25								
	12	DR95-12	18	13,5	13,0	66,0	28,0	35,0	50/25								
240	16	DR95-16	18	13,5	17,0	65,5	32,0	35,0	50/25	TND 10-120	B 35-45D B 35-500 HT 45-E						
	20	DR95-20*	18	13,5	21,0	71,0	33,0	35,0	50/25								
	8	DR120-8*	20	15,5	8,4	70,0	31,0	35,0	50/25								
300	10	DR120-10	20	15,5	10,5	70,0	31,0	35,0	50/25	TND 10-120	B 35-45D B 35-500 HT 45-E						
	12	DR120-12	20	15,5	13,0	70,5	31,0	35,0	50/25								
	16	DR120-16	20	15,5	17,0	70,0	31,5	35,0	50/25								
400	20	DR120-20	20	15,5	21,0	72,0	36,0	35,0	50/25	TND 10-120	B 35-45D B 35-500 HT 45-E						
	10	DR150-10	22	17,0	10,5	79,0	34,0	35,0	50/25								
	12	DR150-12	22	17,0	13,0	78,5	34,0	35,0	50/25								
500	16	DR150-16	22	17,0	17,0	78,0	34,0	35,0	50/25	TND 10-120	B 35-45D B 35-500 HT 45-E						
	20	DR150-20	22	17,0	21,0	78,0	38,0	35,0	50/25								
	10	DR185-10	25	19,0	10,5	83,0	37,0	40,0	25/25								
600	12	DR185-12	25	19,0	13,0	82,5	37,0	40,0	25/25	TND 10-120	B 35-45D B 35-500 HT 45-E						
	16	DR185-16	25	19,0	17,0	82,0	37,0	40,0	25/25								
	20	DR185-20	25	19,0	21,0	83,0	40,0	40,0	25/25								
800	10	DR240-10*	28	21,5	10,5	92,0	42,0	40,0	20/10	TND 10-120	B 35-45D B 35-500 HT 45-E						
	12	DR240-12	28	21,5	13,0	92,0	42,5	40,0	20/10								
	16	DR240-16	28	21,5	17,0	92,0	42,5	40,0	20/10								
1000	20	DR240-20	28	21,5	21,0	92,0	45,0	40,0	20/10	TND 10-120	B 35-45D B 35-500 HT 45-E						

* Non-standard; dimensions of the tube according to DIN 46.235

HT 51 RH 50 B 500E
HT 81-U RHU 81
HT 120 and tools with 130 kN crimping force
ECW43D
RHU 520

COPPER TUBE CRIMPING LUGS ACCORDING TO DIN 46235



for Copper conductors

DR

Conductor Size sqmm	Ø Stud mm	Ref.	Code	Dimensions mm					Quantity Box/Bag	Hydraulic Tools	
				Øi	d	L	B	a			
300	12	DR300-12*	32	24,5	13,0	104,0	47,0	50,0	10/5	HT 120 and tools and heads with 130 kN crimping force	ECW-H3D RHU 520
	16	DR300-16	32	24,5	17,0	100,0	48,0	50,0	10/5		
	20	DR300-20	32	24,5	21,0	100,0	47,0	50,0	10/5		
400	12	DR400-12*	38	27,5	13,0	117,0	55,0	70,0	5/5		
	16	DR400-16	38	27,5	17,0	117,0	55,0	70,0	5/5		
	20	DR400-20	38	27,5	21,0	117,0	55,0	70,0	5/5		
500	12	DR500-12*	42	31,0	13,0	130,0	60,0	70,0	5/5		
	16	DR500-16*	42	31,0	17,0	130,0	60,0	70,0	5/5		
	20	DR500-20	42	31,0	21,0	130,0	60,0	70,0	5/5		
625	20	DR625-20	44	34,5	21,0	135,0	63,0	80,0	5/5		

* Non-standard; dimensions of the tube according to DIN 46235

Consult us for special requirements

CRIMPING THROUGH CONNECTORS ACCORDING TO DIN 46267 T.1



for Copper cables

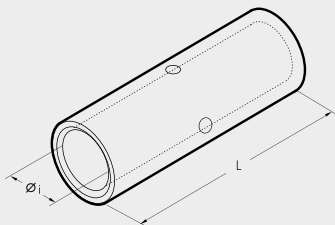

DSV



Conductor Size sqmm	Ref.	Code	Dimensions mm		Quantity Box/Bag	Mechanical Tools	Hydraulic Tools	
			Øi	L				
6	DSV 6	5	3,7	30	1.200/100	HND25 TND 6-70 TND 10-120 B 15D B 35-45D B 35-50D HT 45-E HT 51 RH 50 B500E HT 81-J RHU 81 HT 120 and tools and heads with 130 kN crimping force ECW-H3D RHU 520		
10	DSV 10	6	4,4	30	1.200/100			
16	DSV 16	8	5,5	50	400/100			
25	DSV 25	10	7,0	50	200/100			
35	DSV 35	12	8,2	50	200/100			
50	DSV 50	14	10,0	56	200/50			
70	DSV 70	16	11,5	56	100/50			
95	DSV 95	18	13,5	70	100/50			
120	DSV 120	20	15,5	70	50/25			
150	DSV 150	22	17,0	80	50/25			
185	DSV 185	25	19,0	85	25/25			
240	DSV 240	28	21,5	90	15/15			
300	DSV 300	32	24,5	100	10/5			
400	DSV 400	38	27,5	150	10/5			
500	DSV 500	42	31,0	160	5/5			
625	DSV 625	44	34,5	160	5/5			

DSV series through connectors are manufactured from electrolytic Copper tube, annealed and surface protected by tin plating. Internal and external dimensions match those of DR series lugs.

Chamfered ends and a central stop provide easy and correct insertion of the conductor.

Details of the appropriate crimping tools and dies are shown on page 185.

Consult us for special requirements

C



COLOUR CODED COPPER CRIMPING LUGS

for Copper conductors



File no. E125401

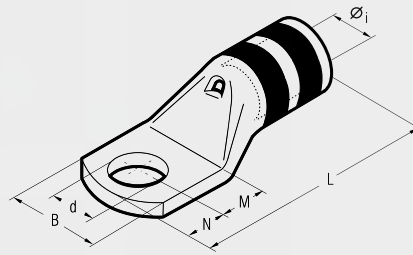

C series lugs are manufactured from electrolytic Copper tube.

The dimensions of the tube are designed to obtain the most efficient electrical conductivity and mechanical strength to resist vibration and pull out.

Cembre lugs are annealed to guarantee optimum ductility, an absolute necessity for connectors which will have to withstand the severe deformation arising when compressed and any bending of the palm during installation.

In applications subject to vibration, terminals have to perform a reliable connection, the annealing process plays a vital role in avoiding cracking or breaks between the barrel and palm.

The presence of an inspection hole facilitates full insertion of the conductor. The barrel length has been designed to allow easy and accurate positioning of the dies during the crimping operation.

Lugs are electrolytically tinned to avoid oxidation.

The tongue is clearly marked with wire size and die index for Cembre tools.

UL listed for US and Canada per UL486A up to 35 KV.

C series lugs are an important part of Cembre crimping systems for power carrying conductors.

Details of the appropriate crimping tools and dies are shown on page 184.

Cembre technicians are available to provide technical advice as required.

Please consult Cembre for products not listed.

Cond. Size sqmm	Conductor AWG		Ø Stud mm	Ref.	Dimensions mm						Colour Code	Quantity Box/Bag	Mechanical Tools	Hydraulic Tools
	Size	Navy			Øi	B	M	N	L	d				
10	8	23	4	C8-8	4,6	10,0	5,0	4,0	22,5	4,3	RED	600/50	TN 70 SE	B15
			5	C8-10	4,6	10,0	6,5	6,0	26,0	5,3		600/50		
			6	C8-14	4,6	11,0	7,0	6,0	26,5	6,4		600/50		
			8	C8-516	4,6	15,0	9,0	8,0	30,5	8,4		600/50		
			10	C8-38	4,6	18,0	11,0	10,0	34,5	10,5		600/50		
			12	C8-12	4,6	19,0	14,0	12,0	39,5	13,2		600/50		
16	6	40	4	C6-8	5,8	11,5	5,0	4,0	25,5	4,3	BLUE	600/50		
			5	C6-10	5,8	11,5	6,5	6,0	29,0	5,3		600/50		
			6	C6-14	5,8	11,5	7,0	6,0	29,5	6,4		600/50		
			8	C6-516	5,8	15,0	9,0	8,0	33,5	8,4		600/50		
			10	C6-38	5,8	18,0	11,0	10,0	37,5	10,5		600/50		
			12	C6-12	5,8	20,0	14,0	12,0	42,5	13,2		600/50		
25	4	40	4	C4-8	6,2	12,5	5,0	4,0	25,5	4,3	GREY	600/50		
			5	C4-10	6,2	12,5	6,5	6,0	29,0	5,3		600/50		
			6	C4-14	6,2	12,5	7,0	6,0	29,5	6,4		600/50		
			8	C4-516	6,2	15,0	9,0	8,0	33,5	8,4		600/50		
			10	C4-38	6,2	18,0	11,0	10,0	37,5	10,5		400/50		
			12	C4-12	6,2	20,0	14,0	12,0	42,5	13,2		400/50		
35	2	60	4	C3-8	7,0	14,0	5,0	4,0	28,0	4,3	WHITE	600/50		
			5	C3-10	7,0	14,0	6,5	6,0	31,5	5,3		600/50		
			6	C3-14	7,0	14,0	7,0	6,0	32,0	6,4		600/50		
			8	C3-516	7,0	15,0	9,0	8,0	36,0	8,4		600/50		
			10	C3-38	7,0	18,0	11,0	10,0	40,0	10,5		400/50		
			12	C3-12	7,0	21,0	14,0	12,0	45,0	13,2		400/50		
50	1/0	100	5	C2-10	7,6	17,0	6,5	6,0	33,0	5,3	BROWN	400/50		
			6	C2-14	7,6	17,0	7,0	6,0	33,5	6,4		400/50		
			8	C2-516	7,6	17,0	9,0	8,0	37,5	8,4		400/50		
			10	C2-38	7,6	19,0	11,0	10,0	41,5	10,5		400/50		
			12	C2-12	7,6	21,0	14,0	12,0	46,5	13,2		200/50		
			16	C2-0-58	10,0	26,0	18,0	16,0	59,5	17,0		200/25		
70	2/0	125	6	C1-14	8,9	17,0	7,0	6,0	34,5	6,4	GREEN	400/50		
			8	C1-516	8,9	17,0	9,0	8,0	38,5	8,4		400/50		
			10	C1-38	8,9	19,0	11,0	10,0	42,5	10,5		400/50		
			12	C1-12	8,9	21,0	14,0	12,0	47,5	13,2		200/50		
			6	C1/0-14	10,0	19,0	8,0	7,0	40,5	6,4		200/25		
			8	C1/0-516	10,0	19,0	9,0	8,0	42,5	8,4		200/25		
95	3/0	150	10	C1/0-38	10,0	20,0	11,0	10,0	46,5	10,5	PINK	200/25		
			12	C1/0-12	10,0	21,0	14,0	12,0	51,5	13,2		200/25		
			14	C1/0-916	10,0	25,0	16,0	14,0	55,5	15,0		200/25		
			16	C1/0-58	10,0	26,0	18,0	16,0	59,5	17,0		200/25		
			6	C2/0-14	11,3	21,0	8,0	7,0	44,0	6,4		200/25		
			8	C2/0-516	11,3	21,0	9,0	8,0	46,0	8,4		200/25		
			10	C2/0-38	11,3	21,0	11,0	10,0	50,0	10,5	BLACK	200/25		
			12	C2/0-12	11,3	22,0	14,0	12,0	55,0	13,2		200/25		
			14	C2/0-916	11,3	25,0	16,0	14,0	59,0	15,0		100/25		
			16	C2/0-58	11,3	26,0	18,0	16,0	63,0	17,0		100/25		
			20	C2/0-34	11,3	29,5	22,0	20,0	75,0	21,0		100/25		
			6	C3/0-14	12,4	23,0	8,0	7,0	45,0	6,4		200/25		
			8	C3/0-516	12,4	23,0	9,0	8,0	47,0	8,4	ORANGE	200/25		
			10	C3/0-38	12,4	23,0	11,0	10,0	51,0	10,5		100/25		
			12	C3/0-12	12,4	24,0	14,0	12,0	56,0	13,2		100/25		
			14	C3/0-916	12,4	27,0	16,0	14,0	60,0	15,0		100/25		
			16	C3/0-58	12,4	28,0	18,0	16,0	64,0	17,0		100/25		
			20	C3/0-34	12,4	31,5	22,0	20,0	72,0	21,0		100/25		

HT 120 and tools and heads with 130 kN crimping force
ECWH3D
RHU 520

COLOUR CODED COPPER CRIMPING LUGS

for Copper conductors



File no. E125401

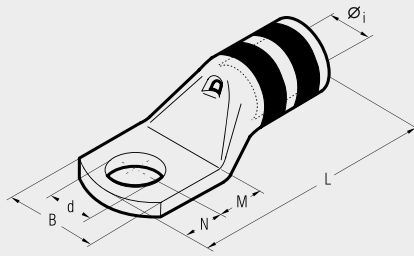

C

Cond. Size sqmm	Conductor AWG		Ref.	Dimensions mm						Colour Code	Quantity Box/Bag	Mechanical Tools	Hydraulic Tools	
	Size	Navy		Ø Stud mm	Øi	B	M	N	L					d
4/0	200	6	C4/0-14	13,5	25,0	8,0	7,0	50,5	6,4	PURPLE	100/25	TN 120 SE B35-50	HT 120 and tools and heads with 130 kN crimping force ECW-H3D RHU 520	
		8	C4/0-516	13,5	25,0	9,0	8,0	52,5	8,4		100/25			
		10	C4/0-38	13,5	25,0	11,0	10,0	56,5	10,5		100/25			
		12	C4/0-12	13,5	25,0	14,0	12,0	61,5	13,2		100/25			
		14	C4/0-916	13,5	25,0	16,0	14,0	65,5	15,0		100/25			
		16	C4/0-58	13,5	27,0	18,0	16,0	69,5	17,0		50/25			
		20	C4/0-34	13,5	29,5	22,0	20,0	77,5	21,0		50/25			
120	250 MCM	6	C250-14	15,2	28,5	8,0	7,0	52,0	6,4	YELLOW	100/25			
		8	C250-516	15,2	28,5	9,0	8,0	54,0	8,4		100/25			
		10	C250-38	15,2	28,5	11,0	10,0	58,0	10,5		100/25			
		12	C250-12	15,2	28,5	14,0	12,0	63,0	13,2		50/25			
		14	C250-916	15,2	28,5	16,0	14,0	67,0	15,0		50/25			
		16	C250-58	15,2	28,5	18,0	16,0	71,0	17,0		50/25			
		20	C250-34	15,2	30,0	22,0	20,0	79,0	21,0		50/25			
150	300 MCM	8	C300-516	16,7	31,5	13,0	11,0	69,0	8,4	WHITE	40/10			
		10	C300-38	16,7	31,5	13,0	11,0	69,0	10,5		40/10			
		12	C300-12	16,7	31,5	16,0	14,0	75,0	13,2		40/10			
		14	C300-916	16,7	31,5	18,0	16,0	79,0	15,0		40/10			
		16	C300-58	16,7	31,5	19,0	17,0	81,0	17,0		40/10			
		20	C300-34	16,7	31,5	22,0	20,0	87,0	21,0		40/10			
		22	C300-78	16,7	31,5	24,0	23,0	92,0	23,0		40/10			
185	350 MCM	10	C350-38	17,6	33,0	13,0	11,0	70,5	10,5	RED	40/20			
		12	C350-12	17,6	33,0	16,0	14,0	76,5	13,2		40/20			
		14	C350-916	17,6	33,0	18,0	16,0	80,5	15,0		40/20			
		16	C350-58	17,6	33,0	19,0	17,0	82,5	17,0		40/20			
		20	C350-34	17,6	33,0	22,0	20,0	88,5	21,0		40/20			
		22	C350-78	17,6	37,0	24,0	23,0	93,5	23,0		30/15			
		400	400 MCM	10	C400-38	19,2	35,5	13,0	11,0		76,0			10,5
12	C400-12			19,2	35,5	16,0	14,0	82,0	13,2	40/20				
14	C400-916			19,2	35,5	18,0	16,0	86,0	15,0	40/20				
16	C400-58			19,2	35,5	19,0	17,0	88,0	17,0	40/20				
20	C400-34			19,2	35,5	22,0	20,0	94,0	21,0	40/20				
22	C400-78			19,2	35,5	24,0	23,0	99,0	23,0	40/20				
240	500 MCM			10	C500-38	21,1	39,0	13,0	11,0	82,0	10,5	BROWN	30/15	
		12	C500-12	21,1	39,0	16,0	14,0	88,0	13,2	30/15				
		14	C500-916	21,1	39,0	18,0	16,0	92,0	15,0	30/15				
		16	C500-58	21,1	39,0	19,0	17,0	94,0	17,0	30/15				
		20	C500-34	21,1	39,0	22,0	20,0	100,0	21,0	20/10				
		22	C500-78	21,1	39,0	24,0	23,0	105,0	23,0	20/10				
		300	600 MCM	12	C600-12	23,7	44,0	20,0	14,0	99,0	13,2		GREEN	20/10
14	C600-916			23,7	44,0	22,0	16,0	103,0	15,0	20/10				
16	C600-58			23,7	44,0	22,0	19,0	106,0	17,0	20/10				
20	C600-34			23,7	44,0	24,0	23,0	112	21,0	10/5				
22	C600-78			23,7	44,0	24,0	23,0	112,0	23,0	10/5				
750	MCM			12	C750-12	26,0	48,0	22,0	19,0	113,0	13,2	BLACK		10/5
				16	C750-58	26,0	48,0	22,0	19,0	113,0	17,0			10/5
		20	C750-34	26,0	48,0	24,0	23,0	119,0	21,0	10/5				
		22	C750-78	26,0	48,0	24,0	23,0	119,0	23,0	10/5				

CL

COLOUR CODED COPPER CRIMPING LUGS

one hole long barrel for Copper conductors

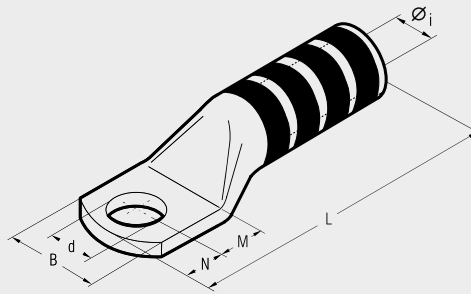

File no. E125401

CL series lugs are manufactured from electrolytic Copper tube for use in heavy duty applications.

The dimensions of the tube are designed to obtain the most efficient electrical conductivity and mechanical strength to resist vibration and pull out.

Cembre lugs are annealed to guarantee optimum ductility which is an absolute necessity for connectors which will have to withstand the severe deformation arising when compressed and any bending of the palm during installation.

In applications subject to vibration, terminals have to perform a reliable connection, the annealing process plays a vital role in avoiding cracking or breaks between the barrel and palm.

The long barrel provides better mechanical pull-out strength.

Lugs are electrolytically plated to avoid oxidation.

The tongue is clearly marked with wire size and die index for Cembre tools.

UL listed for US and Canada per UL486A up to 35 KV.

CL series lugs are an important part of Cembre crimping systems for power carrying conductors. Details of the appropriate crimping tools and dies are shown on page 184.

Cembre technicians are available to provide technical advice as required.

Please consult Cembre for products not listed.

Cond. Size sqmm	Conductor		Ø Stud mm	Ref.	Dimensions mm						Colour Code	Quantity Box/Bag	Mechanical Tools	Hydraulic Tools		
	Size	Navy			Øi	B	M	N	L	d						
10	8	23	5	CL8-10	4,6	10,0	6,5	6,0	37,5	5,3	RED	400/50	TN 70 SE	B15		
			6	CL8-14	4,6	11,0	7,0	6,0	38,0	6,4		400/50				
			10	CL8-38	4,6	18,0	11,0	10,0	46,0	10,5		400/50				
16	6		5	CL6-10	5,8	11,5	6,5	6,0	40,0	5,3	BLUE	400/50				
			6	CL6-14	5,8	11,5	7,0	6,0	40,5	6,4		400/50				
			12	CL6-12	5,8	20,0	14,0	12,0	53,5	13,2		400/50				
25	4	40	5	CL4-10	6,2	12,5	6,5	6,0	47,0	5,3	GREY	400/50				
			6	CL4-14	6,2	12,5	7,0	6,0	47,5	6,4		400/50				
			10	CL4-38	6,2	18,0	11,0	10,0	55,5	10,5		400/50				
			12	CL4-12	6,2	20,0	14,0	12,0	60,5	13,2		400/50				
35	2	60	6	CL3-14	7,0	14,0	7,0	6,0	47,5	6,4	WHITE	200/100				
			8	CL3-516	7,0	15,0	9,0	8,0	51,5	8,4		200/100				
			10	CL3-38	7,0	18,0	11,0	10,0	55,5	10,5		200/100				
			12	CL3-12	7,0	21,0	14,0	12,0	60,5	13,2		200/100				
35	2	60	5	CL2-10	7,6	17,0	6,5	6,0	46,0	5,3	BROWN	200/50				
			8	CL2-14	7,6	17,0	7,0	6,0	46,5	6,4		200/50				
			8	CL2-516	7,6	17,0	9,0	8,0	50,5	8,4		200/50				
			12	CL2-12	7,6	21,0	14,0	12,0	59,5	13,2		200/50				
50	1/0	100	5	CL1-10	8,9	17,0	6,5	6,0	48,0	5,3	GREEN	200/50				
			8	CL1-516	8,9	17,0	9,0	8,0	52,5	8,4		200/50				
			12	CL1-12	8,9	21,0	14,0	12,0	61,5	13,2		200/50				
			5	CL1/0-10	10,0	19,0	8,0	7,0	53,5	5,3		100/50				
70	2/0	125	8	CL1/0-516	10,0	19,0	9,0	8,0	55,5	8,4	PINK	100/50				
			10	CL1/0-38	10,0	20,0	11,0	10,0	59,5	10,5		100/50				
			12	CL1/0-12	10,0	21,0	14,0	12,0	64,5	13,2		100/50				
			10	CL2/0-38	11,3	21,0	11,0	10,0	67,5	10,5		100/50				
95	3/0	150	12	CL2/0-12	11,3	22,0	14,0	12,0	72,5	13,2	BLACK	100/50				
			12	CL3/0-12	12,4	24,0	14,0	12,0	71,5	13,2		100/50				
			10	CL4/0-38	13,5	25,0	11,0	10,0	73,5	10,5		60/30				
			12	CL4/0-12	13,5	25,0	14,0	12,0	78,5	13,2		60/30				
120	250 MCM	250	12	CL250-12	15,2	28,5	14,0	12,0	84,0	13,2	YELLOW	50/25				
			150	300 MCM	300	12	CL300-12	16,7	31,5	16,0		14,0	98,0	13,2	30/15	
185	350 MCM	350	12	CL350-12	17,6	33,0	16,0	14,0	98,0	13,2	RED	30/15				
			400	12	CL400-12	19,2	35,5	16,0	14,0	107,0		13,2	BLUE	20/10		
				16	CL400-58	19,2	35,5	19,0	17,0	113,0		17,0		20/10		
			240	500 MCM	500	12	CL500-12	21,1	39,0	16,0		14,0	108,0	13,2	BROWN	20/10
16	CL500-58	21,1				39,0	19,0	17,0	114,0	17,0	20/10					
300	600 MCM	600	12	CL600-12	23,7	44,0	20,0	14,0	128,5	13,2	GREEN	10/5				
			16	CL600-58	23,7	44,0	22,0	19,0	135,5	17,0		10/5				
			750	MCM	750	12	CL750-12	26,0	48,0	22,0		19,0	140,5	13,2	BLACK	10/5
						16	CL750-58	26,0	48,0	22,0		19,0	140,5	17,0		10/5

Also available with inspection hole.

In case of order, add suffix IH to the part number.

E.g.: CL250IH-12

COLOUR CODED COPPER CRIMPING LUGS



double hole long barrel for Copper conductors



File no. E125401

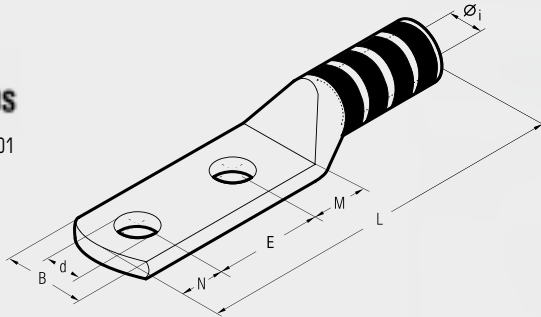

CL-D

Cond. Size sqmm	Conductor AWG	Ø Stud mm	Ref.	Dimensions mm							Colour Code	Quantity Box/Bag	Mechanical Tools	Hydraulic Tools
				Øi	B	M	E	N	L	d				
10	8	23	6 CL8-D14	4,6	11,0	7,0	16,0	6,0	53,0	6,4	RED	400/50	B15	
			6 CL8-D141	4,6	11,0	7,0	19,0	6,0	56,0	6,4	RED	400/50		
			10 CL8-D38	4,6	18,0	11,0	25,5	10,0	70,5	10,5	RED	400/50		
16	6	23	6 CL6-D14	5,8	11,5	7,0	16,0	6,0	54,5	6,4	BLUE	400/50	B15	
			6 CL6-D141	5,8	11,5	7,0	19,0	6,0	57,5	6,4	BLUE	400/50		
			10 CL6-D38	5,8	18,0	11,0	25,5	10,0	72,0	10,5	BLUE	400/50		
25	4	40	12 CL6-DN	5,8	20,0	14,0	44,5	12,0	96,0	13,2	BLUE	400/50	B15	
			6 CL4-D14	6,2	12,5	7,0	16,0	6,0	62,0	6,4	GREY	200/50		
			6 CL4-D141	6,2	12,5	7,0	19,0	6,0	65,0	6,4	GREY	200/50		
25	4	40	10 CL4-D38	6,2	18,0	11,0	25,5	10,0	79,5	10,5	GREY	200/50	B15	
			12 CL4-DN	6,2	20,0	14,0	44,5	12,0	103,5	13,2	GREY	200/50		
			10 CL3-D38	7,0	18,0	11,0	25,5	10,0	79,5	10,5	WHITE	200/50		
35	2	60	12 CL3-DN	7,0	21,0	14,0	44,5	12,0	103,5	13,2	WHITE	200/50	B15	
			6 CL2-D14	7,6	17,0	7,0	16,0	6,0	61,0	6,4	BROWN	200/50		
			6 CL2-D141	7,6	17,0	7,0	19,0	6,0	64,0	6,4	BROWN	200/50		
35	2	60	10 CL2-D38	7,6	19,0	11,0	25,5	10,0	78,5	10,5	BROWN	100/50	TN 70 SE	
			12 CL2-DN38	7,6	19,0	11,0	44,5	10,0	97,5	10,5	BROWN	100/50		
			12 CL2-DN	7,6	21,0	14,0	44,5	12,0	102,5	13,2	BROWN	100/50		
50	1	75	6 CL1-D14	8,9	17,0	7,0	16,0	6,0	63,0	6,4	GREEN	200/50	TN 120 SE	
			6 CL1-D141	8,9	17,0	7,0	19,0	6,0	66,0	6,4	GREEN	200/50		
			10 CL1-D38	8,9	19,0	11,0	25,5	10,0	80,5	10,5	GREEN	100/25		
50	1/0	100	12 CL1-DN	8,9	21,0	14,0	44,5	12,0	104,5	13,2	GREEN	100/25	TN 120 SE	
			6 CL1/O-D14	10,0	19,0	7,9	16,0	7,0	68,0	6,4	PINK	100/25		
			6 CL1/O-D141	10,0	19,0	7,9	19,0	7,0	71,0	6,4	PINK	100/25		
70	2/0	125	10 CL1/O-D38	10,0	20,0	10,9	25,5	10,0	83,5	10,5	PINK	100/25	TN 120 SE	
			12 CL1/O-DN	10,0	21,0	14,0	44,5	12,0	107,5	13,2	PINK	100/25		
			6 CL2/O-D14	11,3	21,0	7,8	16,0	7,0	76,0	6,4	BLACK	60/30		
70	2/0	125	6 CL2/O-D141	11,3	21,0	7,8	19,0	7,0	79,0	6,4	BLACK	60/30	TN 120 SE	
			10 CL2/O-D38	11,3	21,0	11,0	25,5	10,0	91,5	10,5	BLACK	60/30		
			12 CL2/O-DN	11,3	22,0	14,0	44,5	12,0	115,5	13,2	BLACK	60/30		
95	3/0	150	6 CL3/O-D141	12,4	23,3	8,0	19,0	7,0	82,0	6,4	ORANGE	60/30	TN 120 SE	
			10 CL3/O-D38	12,4	23,3	11,0	25,5	10,0	94,5	10,5	ORANGE	60/30		
			12 CL3/O-DN	12,4	24,0	14,0	44,5	12,0	118,5	13,2	ORANGE	60/30		
120	250	250	6 CL4/O-D141	13,5	25,0	13,0	19,0	11,0	94,0	6,4	PURPLE	50/25	TN 120 SE	
			10 CL4/O-D38	13,5	25,0	11,0	25,5	10,0	97,5	10,5	PURPLE	50/25		
			10 CL4/O-DN38	13,5	25,0	11,0	44,5	10,0	116,5	10,5	PURPLE	50/25		
120	MCM	250	12 CL4/O-DN	13,5	25,0	14,0	44,5	12,0	121,5	13,2	PURPLE	50/25	TN 120 SE	
			10 CL250-D38	15,2	28,5	11,0	25,5	10,0	103,0	10,5	YELLOW	40/20		
			12 CL250-DN	15,2	28,5	14,0	44,5	12,0	127,0	13,2	YELLOW	40/20		
150	300	300	10 CL300-D38	16,7	31,5	13,0	25,5	11,0	116,0	10,5	WHITE	30/15	TN 120 SE	
			12 CL300-DN	16,7	31,5	16,0	44,5	14,0	141,0	13,2	WHITE	30/15		
			6 CL350-D141	17,6	33,0	13,0	19,0	11,0	109,5	6,4	RED	30/15		
185	350	350	10 CL350-D38	17,6	33,0	13,0	25,5	11,0	116,0	10,5	RED	30/15	TN 120 SE	
			12 CL350-DN	17,6	33,0	16,0	44,5	14,0	141,0	13,2	RED	30/15		
			6 CL400-D141	19,2	35,5	13,0	19,0	11,0	118,5	6,4	BLUE	20/10		
240	400	400	10 CL400-D38	19,2	35,5	13,0	25,5	11,0	125,0	10,5	BLUE	20/10	TN 120 SE	
			12 CL400-DN	19,2	35,5	16,0	44,5	14,0	150,0	13,2	BLUE	20/10		
			6 CL500-D141	21,1	39,0	13,0	19,0	11,0	119,5	6,4	BROWN	20/10		
240	500	MCM	10 CL500-D38	21,1	39,0	13,0	25,5	11,0	126,0	10,5	BROWN	10/5	TN 120 SE	
			12 CL500-DN	21,1	39,0	16,0	44,5	14,0	151,0	13,2	BROWN	10/5		
			10 CL600-D38	23,7	44,0	20,0	25,5	11,0	149,5	10,5	GREEN	20/5		
300	600	MCM	12 CL600-DN	23,7	44,0	20,0	44,5	14,0	171,5	13,2	GREEN	20/5	TN 120 SE	
			10 CL750-DN38	26,0	48,0	20,0	44,5	11,0	173,5	10,5	BLACK	15/5		
			10 CL750-D38	26,0	48,0	20,0	25,5	11,0	154,5	10,5	BLACK	15/5		
300	750	MCM	12 CL750-DN	26,0	48,0	20,0	44,5	14,0	176,5	13,2	BLACK	15/5	TN 120 SE	

CL series lugs are manufactured from electrolytic Copper tube.

The dimensions of the tube are designed to obtain the most efficient electrical conductivity and mechanical strength to resist vibration and pull out.

Cembre lugs are annealed to guarantee optimum ductility, an absolute necessity for connectors which will have to withstand the severe deformation arising when compressed and any bending of the palm during installation.

In applications subject to vibration, terminals have to perform a reliable connection, the annealing process plays a vital role in avoiding cracking or breaks between the barrel and palm.

The barrel length has been designed to allow easy and accurate positioning of the dies during the crimping operation.

Lugs are electrolytically tin-plated to avoid oxidation.

The tongue is clearly marked with wire size and die index for Cembre tools.

UL listed for US and Canada per UL486A up to 35 KV.

CL series lugs are an important part of Cembre crimping systems for power carrying conductors. Details of the appropriate crimping tools and dies are shown on page 184.

Cembre technicians are available to provide technical advice as required.

Please consult Cembre for products not listed.

BSCL



COLOUR CODED SPLICES

long barrel

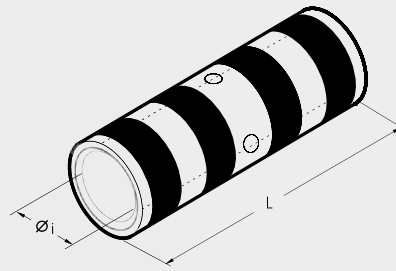

File no. E125401

BSCL range of connectors are designed for jointing low voltage conductors in heavy duty applications. Made of electrolytic Copper tube having the same dimension as C and CL series lugs, BSCL connectors are annealed and electrolytically Tin plated. They feature an internal taper at both ends to ease the introduction of the conductor and a central stop to ensure correct positioning. **UL listed for US and Canada per UL486A up to 35 KV.**

Appropriate crimping tools and dies are shown in details on page 184.

Conductor Size sqmm	Conductor Size AWG	Ref.	Dimensions mm		Colour Code	Quantity Box/Bag	Mechanical Tools		Hydraulic Tools						
			Øi	L											
10	8	BSCL8	4,6	50,5	RED	600/150	HM1	HM5	B15	HT 51 RH 50 B500E ECW/H3D RHU 520					
16	6	BSCL6	5,8	50,5	BLUE	400/100									
25	4	BSCL4	6,2	60,5	GREY	200/100	TN 70 SE	B3550							
	3	BSCL3	7,0	60,5	WHITE	200/50									
35	2	BSCL2	7,6	60,5	BROWN	200/50	TN 120 SE		HT 120 and tools and heads with 130 kN crimping force						
	1	BSCL1	8,9	65,5	GREEN	200/50									
50	1/0	BSCL1/0	10,0	73,0	PINK	200/50	RHU 520								
70	2/0	BSCL2/0	11,3	79,0	BLACK	100/50									
95	3/0	BSCL3/0	12,4	79,0	ORANGE	80/40					RHU 520				
	4/0	BSCL4/0	13,5	85,5	PURPLE	50/25									
120	250 MCM	BSCL250	15,2	85,5	YELLOW	50/25						RHU 520			
150	300 MCM	BSCL300	16,7	104,5	WHITE	40/20									
185	350 MCM	BSCL350	17,6	104,5	RED	40/20							RHU 520		
	400 MCM	BSCL400	19,2	111,0	BLUE	20/10									
240	500 MCM	BSCL500	21,1	117,0	BROWN	20/10								RHU 520	
300	600 MCM	BSCL600	23,7	139,5	GREEN	20/10									
	750 MCM	BSCL750	26,0	149,0	BLACK	10/10									RHU 520



SLEEVE CONNECTORS

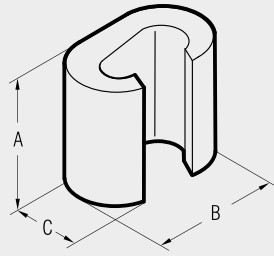

C-C



Tin plated version

Conductor Size sqmm		Ref.	Dimensions mm			Quantity Box/Bag	Mechanical Tools	Hydraulic Tools					
Run	Tap		A	B	C								
6÷2,5	6÷1,5	C 6-C 6 ST	9,0	9,8	6,4	1.000/100	HP4-C10						
10	10÷1,5	C 10-C 10 ST	12,0	12,6	8,4	500/100							
16	16÷1,5	C 16-C 16 ST	17,0	19,4	12,0	500/100		B 35-45D	B 35-50D	HT 45-E	B 55		
25÷16	10÷1,5	C 25-C 10 ST	17,0	19,8	13,0	400/50							
25	25÷16	C 25-C 25 ST	17,0	21,4	13,0	300/50				HT 51	RH 50	B 500E	RHU 81
40÷35	16÷1,5	C 35-C 16 ST	21,0	24,6	15,4	200/25							
40÷35	40÷25	C 35-C35 ST	21,0	26,6	15,6	200/25							
50	25÷10												
70÷63	25÷1,5	C 70-C 25 N ST	21,0	26,4	17,5	200/25							
50	25÷4	C 50-C 25 ST	25,0	32,9	21,0	100/25							
50	50÷35	C 50-C 50 ST	26,0	33,0	21,0	100/25							
70÷50	40÷4	C 70-C 35 ST	28,0	33,0	21,0	100/25							
70÷50	70÷35	C 70-C 70 ST	28,0	34,0	21,0	100/25							
100÷95	40÷4	C 95-C 35 ST	29,0	40,6	26,0	50/25							
100÷95	70÷40	C 95-C 70 ST	29,0	41,0	26,0	50/25							
100÷95	100÷63	C 95-C 95 ST	29,0	41,0	26,0	50/25							
125÷110	125÷25	C 120-C 120 ST	30,0	45,0	28,0	50/25							
160÷150	125÷25	C 150-C 120 ST	31,0	45,0	28,0	50/25							
150	150÷63	C 150-C 150 ST	30,0	45,0	28,0	50/25							
185	100÷16	C 185-C 95 ST	31,0	45,0	28,0	50/25							
185÷120	185÷120	C 185-C 185 ST	22,6	68,0	34,0	30/15							
240÷150	120÷95	C 240-C 120 ST	22,6	68,0	34,0	30/15							

"C" connectors are manufactured from high purity Copper profiles and are suitable for a variety of uses either to create an earthing network or tapping off from overhead distribution lines. Each connector is marked as follows:

- Cembre trade mark
- Reference number
- Conductor size-Run
- Conductor size-Tap
- Number of crimps
- Die reference.

Details of the appropriate crimping tools and dies are shown on page 180.

bright surface version

Conductor Size sqmm		Ref.	Dimensions mm			Quantity Box/Bag	Mechanical Tools	Hydraulic Tools					
Run	Tap		A	B	C								
6÷2,5	6÷1,5	C 6-C 6	9,0	9,8	6,4	1.000/100	HP4-C10						
10	10÷1,5	C 10-C 10	12,0	12,6	8,4	500/100							
16	16÷1,5	C 16-C 16	17,0	19,4	12,0	500/100		B 35-45D	B 35-50D	HT 45-E	B 55		
25÷16	10÷1,5	C 25-C 10	17,0	19,8	13,0	400/50							
25	25÷16	C 25-C 25	17,0	21,4	13,0	300/50				HT 51	RH 50	B 500E	RHU 81
40÷35	16÷1,5	C 35-C 16	21,0	24,6	15,4	200/25							
40÷35	40÷25	C 35-C35	21,0	26,6	15,6	200/25							
50	25÷10												
70÷63	25÷1,5	C 70-C 25 N	21,0	26,4	17,5	200/25							
50	25÷4	C 50-C 25	25,0	32,9	21,0	100/25							
50	50÷35	C 50-C 50	26,0	33,0	21,0	100/25							
70÷50	40÷4	C 70-C 35	28,0	33,0	21,0	100/25							
70÷50	70÷35	C 70-C 70	28,0	34,0	21,0	100/25							
100÷95	40÷4	C 95-C 35	29,0	40,6	26,0	50/25							
100÷95	70÷40	C 95-C 70	29,0	41,0	26,0	50/25							
100÷95	100÷63	C 95-C 95	29,0	41,0	26,0	50/25							
125÷110	125÷25	C 120-C 120	30,0	45,0	28,0	50/25							
160÷150	125÷25	C 150-C 120	31,0	45,0	28,0	50/25							
150	150÷63	C 150-C 150	30,0	45,0	28,0	50/25							
185	100÷16	C 185-C 95	31,0	45,0	28,0	50/25							
185÷120	185÷120	C 185-C 185	22,6	68,0	34,0	30/15							
240÷150	120÷95	C 240-C 120	22,6	68,0	34,0	30/15							

Example of tap connection

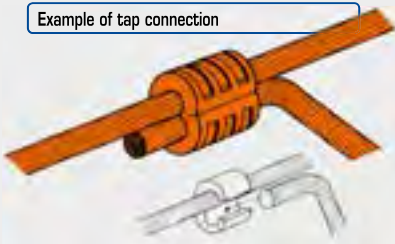

Example of joint connection

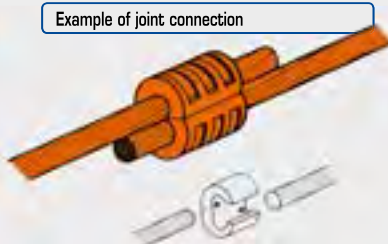

Example of joining two running conductors

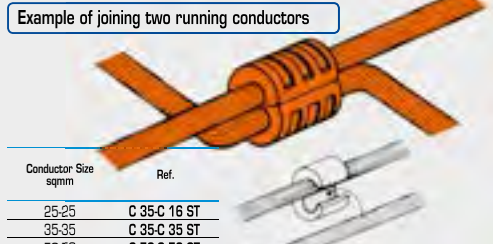

Conductor Size sqmm	Ref.
25-25	C 35-C 16 ST
35-35	C 35-C 35 ST
50-50	C 70-C 70 ST
63-63	C 95-C 70 ST
70-70	
95-95	C 150-C 120 ST
120-120	C 150-C 150
125-125	C 185-C 95 ST

MECHANICAL FIXING LUGS

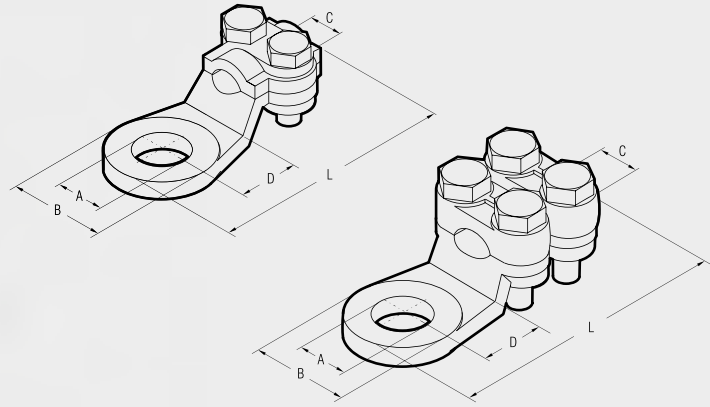

Material:
Brass CB754S EN 1982
Nickel plated.
Zinc plated Steel bolts.

2 bolt fixing lugs

Conductor Size sqmm	Ref.	A bolt	Dimensions mm				Quantity
			B	C	D	L	
16	2155	M8	18,0	4,5	12,5	39	100
16	2171	M10	18,0	4,5	12,5	39	100
25	2156	M8	19,5	6,0	13,0	43	100
25	2172	M10	19,5	6,0	13,0	43	100
35	2157	M12	23,0	7,0	15,0	49	50
35	2173	M14	23,0	7,0	15,0	49	50
50	2174	M14	25,0	8,0	17,0	56	50

4 bolt fixing lugs

Conductor Size sqmm	Ref.	A bolt	Dimensions mm				Quantity
			B	C	D	L	
50	2158	M12	23,5	8	16,0	57	50
75	2160	M12	28,0	10	20,0	65	25
75	2176	M16	28,0	10	20,0	65	25
100	2161	M12	31,0	13	17,0	66	25
125	2162	M15	33,0	14	18,0	71	25
150	2163	M14	34,0	16	19,5	75	25
175	2164	M15	36,0	16	21,0	78	25

CABLE CLAMPS

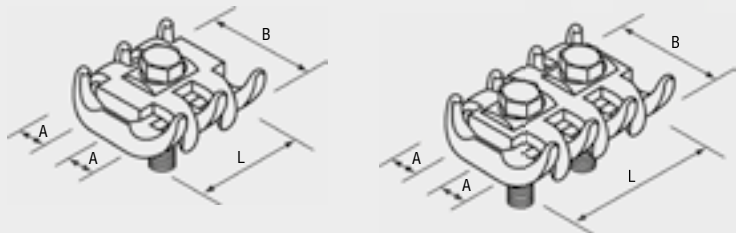

Single bolt fixing

Conductor Size sqmm	Ref.	Ø A for cable mm	Dimensions mm		Quantity
			B	L	
6÷16	2323	3÷ 5	24	20	50
16÷50	2326	5÷ 8	30	25	50
35÷70	2329	7÷12	40	30	25

Material:
Brass CB754S EN 1982
Zinc plated Steel bolts.
Zinc plated Steel nut.

2 bolt fixing

Conductor Size sqmm	Ref.	Ø A for cable mm	Dimensions mm		Quantity
			B	L	
6÷16	2333	3÷ 5	27	32	50
16÷50	2336	5÷ 8	32	40	50
35÷70	2339	7÷12	40	44	25
50÷95	2342	8÷14	48	48	10
70÷150	2344	12÷16	51	53	10
150÷300	2346*	16÷22	66	66	5

* Stainless Steel bolts

HIGH VOLTAGE COPPER TERMINALS

CA-M 2A-M

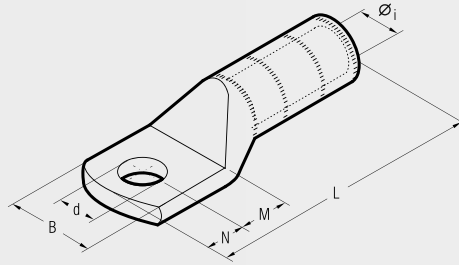
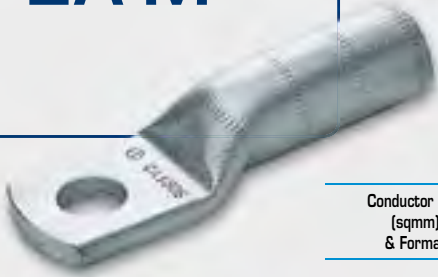

Series CA-M and 2A-M terminals are designed for high voltage applications up to 33 kV.

They are manufactured from high purity Copper tube, annealed and Tin plated.

The extended barrel enhances both electrical and mechanical performance. The absence of an inspection hole prevents moisture entry into the crimped joint and makes these terminals suitable for outdoor applications.

Details of the appropriate crimping tools and dies are shown on page 180.

Conductor Size (sqmm) & Format	Ø Stud mm	Ref.	Dimensions mm						Quantity Box/Bag	Hydraulic Tools
			Øi	B	M	N	L	d		
25 R/BR/BS*	8	CA 25-M 8	6,8	14,0	9	8	65,0	8,4	300/50	BS5500
	10	CA 25-M 10	6,8	18,0	13	11	72,0	10,5	200/50	
	12	CA 25-M 12	6,8	21,0	16	14	78,0	13,2	200/50	
30 RC/S ÷ 40 S	12	CA 40 S-M 12	8,2	21,0	16	14	79,0	13,2	150/50	
	16	CA 40 S-M 16	8,2	26,0	19	17	85,0	17,0	100/50	
35 BR/BS*	10	CA 35-M 10	8,25	21,0	13	11	73,0	10,5	150/50	
	12	CA 35-M 12	8,25	21,0	16	14	79,0	13,2	150/50	
	16	CA 35-M 16	8,25	26,0	19	17	85,0	17,0	150/50	
50 RC	12	CA 50 R-M 12	8,7	20,5	16	14	79,0	13,2	150/50	
	16	CA 50 S-M 16	9,5	26,0	19	17	85,0	17,0	100/50	
50 S	10	CA 50-M 10	9,5	21,0	13	11	73,0	10,5	150/50	
	12	CA 50-M 12	9,5	21,0	16	14	79,0	13,2	150/50	
50 BR/BS*	14	CA 50-M 14	9,5	25,0	18	16	83,0	15,0	100/50	
	16	CA 50-M 16	9,5	26,0	19	17	85,0	17,0	100/50	
	10	CA 70 S-M 10	11,0	26,0	13	11	75,2	10,5	50/25	
63 S ÷ 70 S	12	CA 70 S-M 12	11,0	28,0	16	14	81,2	13,2	50/25	
	16	CA 70 S-M 16	11,0	30,0	19	17	87,2	17,0	50/25	
70 BR/BS*	12	CA 70 S-M 12	11,0	28,0	16	14	81,2	13,2	50/25	
	14	CA 70 S-M 14	11,0	28,0	18	16	85,2	15,0	50/25	
	16	CA 70 S-M 16	11,0	30,0	19	17	87,2	17,0	50/25	
80 S ÷ 95 RC	12	CA 95 R-M 12	12,0	28,0	16	14	91,0	13,2	50/25	
	14	CA 95 R-M 14	12,0	29,0	18	16	95,0	15,0	50/25	
95 S ÷ 100 S	12	CA 95 S-M 12	13,5	28,0	16	14	91,0	13,2	50/25	
	14	CA 95 S-M 14	13,5	29,0	18	16	94,5	15,0	50/25	
	16	CA 95 S-M 16	13,5	30,0	20	17	97,0	17,0	50/25	
95 BR/BS*	10	CA 95-M 10	13,5	28,0	13	11	85,0	10,5	50/25	
	12	CA 95-M 12	13,5	28,0	16	14	91,0	13,2	50/25	
	16	CA 95-M 16	13,5	30,0	20	17	97,0	17,0	50/25	
120 RC/S ÷ 150 RC	12	CA 150 R-M 12	15,0	31,0	16	14	97,0	13,2	30/15	
	14	CA 150 R-M 14	15,0	31,0	18	16	101,0	15,0	30/15	
120 BR/BS*	12	CA 120-M 12	15,0	31,0	16	14	97,0	13,2	30/15	
	16	CA 120-M 16	15,0	31,0	19	17	103,0	17,0	30/15	
	12	CA 150 S-M 12	16,5	32,0	16	14	97,0	13,2	30/15	
150 S ÷ 160 RC	14	CA 150 S-M 14	16,5	32,0	18	16	101,0	15,0	30/15	
	12	CA 150-M 12	16,5	32,0	16	14	97,0	13,2	30/15	
150 BR/BS*	16	CA 150-M 16	16,5	32,0	19	17	103,0	17,0	30/15	
	12	CA 200 R-M 14	17,0	32,5	18	16	101,0	15,0	30/15	
160 S ÷ 200 RC	12	CA 185-M 12	18,0	33,5	16	14	97,0	13,2	30/15	
	16	CA 185-M 16	18,0	33,5	19	17	103,0	17,0	30/15	
200 S ÷ 240 RC	14	CA 240 R-M 14	19,2	43,0	18	16	107,0	15,0	15/5	
	12	CA 240-M 12	20,5	42,0	16	14	103,0	13,2	15/5	
240 S ÷ 315 RC	16	CA 240-M 16	20,5	42,0	19	17	109,0	17,0	15/5	
	20	CA 240-M 20	20,5	42,0	22	20	115,0	21,0	15/5	
240 BR/BS*	12	CA 300-M 12	23,0	43,5	16	14	109,5	13,2	15/5	
	16	CA 300-M 16	23,0	43,5	19	17	115,5	17,0	15/5	
	20	CA 300-M 20	23,0	43,5	22	20	121,5	21,0	15/5	
300 BR/BS*	14	CA 315 S-M 14	23,7	44,0	18	16	105,0	15,0	15/5	
	12	2 A 80-M 12	27,0	51,0	22	19	140,0	15,0	15/5	
315 S	16	2 A 80-M 16	27,0	51,0	22	19	140,0	17,0	15/5	
	20	2 A 80-M 20	27,0	51,0	24	23	146,0	21,0	15/5	
400 R	16	2 A 100-M 16	30,3	56,5	22	19	147,0	17,0	10/1	
	20	2 A 100-M 20	30,3	56,5	24	23	153,0	21,0	10/1	
500 R	16	2 A 120-M 16	33,4	61,5	22	19	159,0	17,0	20/1	
	20	2 A 120-M 20	33,4	61,5	24	23	165,0	21,0	20/1	
600 R ÷ 630 R	16	2 A 120-M 16	33,4	61,5	22	19	159,0	17,0	20/1	
	20	2 A 120-M 20	33,4	61,5	24	23	165,0	21,0	20/1	

Conductor Format: R = Round, RC = Round Compact, S = Sector; BR = IEC228 (BS6360) Round, BS* = IEC228 (BS6360) Sector
* = Pre-rounding required, consult Cembre for appropriate die set

HIGH VOLTAGE TERMINALS

two hole fixing

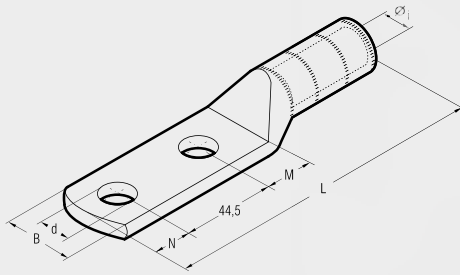

CA-2M 2A-2M

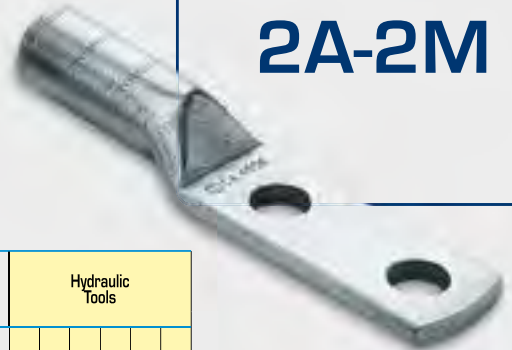

Conductor Size (sqmm) & Format	Ø Stud mm	Ref.	Dimensions mm					Quantity Box/Bag	Hydraulic Tools	
			Øi	B	M	N	L			d
25 R	8	CA 25-2 M 8	6,8	14,0	10	11	113,5	8,4	200/50	B35-500 B 55 RHU 50 B 500E B 55 RHU 81 RHU 81-U HT 120 and tools and heads with 130 kN crimping force ECW-H3D RHU 520
	12	CA 25-2 M 12	6,8	21,0	16	14	122,5	13,2	150/50	
25 BR/BS*	8	CA 25-2 M 8	6,8	14,0	10	11	113,5	8,4	200/50	
	10	CA 25-2 M 10	6,8	18,0	13	11	116,5	10,5	150/50	
	12	CA 25-2 M 12	6,8	21,0	16	14	122,5	13,2	150/50	
30 RC/S ÷ 40 S	12	CA 40 S-2 M 12	8,2	21,5	16	14	123,5	13,2	100/50	
35 BR/BS*	12	CA 35-2 M 12	8,25	21,5	16	14	123,5	13,2	100/50	
50 RC	12	CA 50 R-2 M 12	8,7	20,5	16	14	123,5	13,2	100/50	
50 S	12	CA 50 S-2 M 12	9,5	21,0	16	14	123,5	13,2	100/50	
50 BR/BS*	12	CA 50-2 M 12	9,5	21,0	16	14	123,5	13,2	100/50	
63 S ÷ 70 S	12	CA 70 S-2 M 12	11,0	27,0	16	14	127,7	13,2	50/25	
70 BR/BS*	12	CA 70 S-2 M 12	11,0	27,0	16	14	127,7	13,2	50/25	
80 S ÷ 95 RC	14	CA 95 R-2 M 14	12,0	28,0	18	16	139,5	15,0	30/15	
95 S ÷ 100 S	14	CA 95 S-2 M 14	13,5	29,0	18	16	139,5	15,0	30/15	
95 BR/BS*	12	CA 95-2 M 12	13,5	28,0	16	14	135,5	13,2	30/15	
120 RC/S ÷ 150 RC	14	CA 150 R-2 M 14	15,0	31,0	18	16	145,5	15,0	30/15	
120 BR/BS*	12	CA 120-2 M 12	15,0	31,0	16	14	141,5	13,2	30/15	
150 S ÷ 160 RC	14	CA 150 S-2 M 14	16,5	32,0	18	16	145,5	15,0	30/15	
150 BR/BS*	12	CA 150-2 M 12	16,5	32,0	16	14	141,5	13,2	30/15	
160 S ÷ 200 RC	14	CA 200 R-2 M 14	17,0	32,5	18	16	145,0	15,0	30/15	
185 BR/BS*	12	CA 185-2 M 12	18,0	32,5	16	14	141,5	13,2	30/15	
200 S ÷ 240 RC	14	CA 240 R-2 M 14	19,2	43,0	18	16	151,5	15,0	15/5	
240 S ÷ 315 RC	14	CA 315 R-2 M 14	21,5	43,0	18	16	149,5	15,0	20/5	
240 BR/BS*	12	CA 240-2 M 12	20,5	43,0	16	14	147,5	13,2	15/5	
300 BR/BS*	12	CA 300-2 M 12	23,0	43,0	16	14	145,5	13,2	20/5	
315 S	14	CA 315 S-2 M 14	23,7	44,0	18	16	149,5	15,0	20/5	
	12	2 A 80-2 M 12	27,0	51,0	20	14	177,5	13,2	15/5	
400 R	14	2 A 80-2 M 14	27,0	51,0	22	16	181,5	15,0	15/5	
	16	2 A 80-2 M 16	27,0	51,0	22	19	184,5	17,0	15/5	
500 R	14	2 A 100-2 M 14	30,3	56,5	22	16	182,5	15,0	10/5	
	16	2 A 100-2 M 16	30,3	56,5	22	19	185,5	17,0	10/5	
600 R ÷ 630 R	14	2 A 120-2 M 14	33,4	61,5	22	16	200,5	15,0	15/5	
	16	2 A 120-2 M 16	33,4	61,5	22	19	202,5	17,0	15/5	

Conductor Format: R = Round, RC = Round Compact, S = Sector, BR = IEC228 (BS6360) Round, BS* = IEC228 (BS6360) Sector
* = Pre-rounding required, consult Cembre for appropriate die set

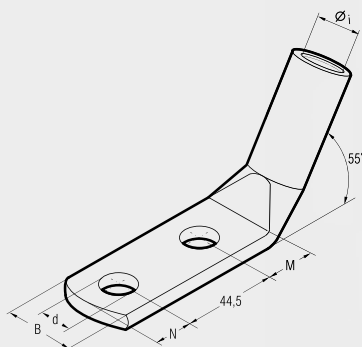

2A-2M/55°



Conductor Size (sqmm) & Format	Ø Stud mm	Ref.	Dimensions mm					Quantity Box/Bag	Hydraulic Tools
			Øi	B	M	N	d		
400 R	14	2 A 80 - 2 M 14/55°	27,0	51,0	22	16	15	10/5	HT 120 and tools and heads with 130 kN crimping force ECW-H3D RHU 520
600 R ÷ 630 R	14	2 A 120 - 2 M 14/55°	33,4	61,5	22	16	15	15/3	

Conductor Format: R = Round

The 2A-2M/55° Copper Tube Terminal Lugs have the same characteristics as the CA-2M and 2A-2M ranges, with the additional feature of the palm bent at 55°.

HIGH VOLTAGE STALK CONNECTORS

MT-C

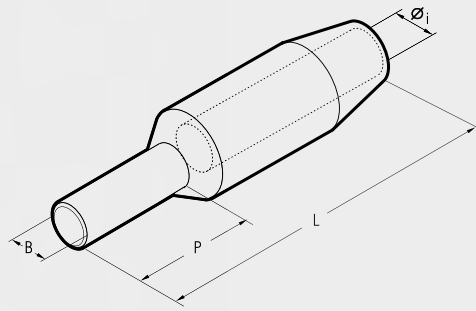

MT-C series connectors are designed for high voltage applications up to 33 kV. They are manufactured from high purity Copper, annealed and Tin plated. The extended barrel enhances both electrical and mechanical performance. The stalk or pin makes these connectors ideal for terminating conductors into contact blocks. Details of the appropriate crimping tools and dies are shown on page 180.

Conductor Size (sqmm) & Format	Ref.	Dimensions mm				Quantity Box/Bag	Hydraulic Tools				
		Øi	B	P	L						
25 R	MT 25-C 8	6,8	8	35	80	90/3	B35-50D				
30 RC/S ÷ 40 S	MT 40 S-C 8	8,2	8	35	80	90/3					
	MT 40 S-C 10	8,2	10	35	80	90/3					
	MT 40 S-C 14-80	8,2	14	80	123	30/3					
35 BR/BS*	MT 35-C 8	8,2	8	35	80	90/3					
	MT 35-C 10	8,2	10	35	80	90/3					
	MT 35-C 14-80	8,2	14	80	123	30/3					
50 RC	MT 50 R-C 8	8,8	8	35	80	90/3					
	MT 50 R-C 10	8,8	10	35	80	90/3					
50 S	MT 50 S-C 8	9,5	8	35	80	90/3					
	MT 50 S-C 10	9,5	10	35	80	90/3					
	MT 50 S-C 14-80	9,5	14	80	123	30/3					
	MT 50-C 8	9,5	8	35	80	90/3					
50 BR/BS*	MT 50-C 10	9,2	10	35	80	90/3					
	MT 50-C 14-80	9,5	14	80	123	90/3					
63 S ÷ 70 S	MT 70 S-C 10	11,2	10	35	90	30/3	HT 51 RH-50 B 500E B 55				
70 BR/BS*	MT 70-C 10	11,2	10	35	90	30/3					
	MT 95 R-C 10	12,0	10	45	110	60/3					
80 S ÷ 95 RC	MT 95 R-C 12	12,0	12	45	110	60/3					
	MT 95 S-C 10	13,5	10	45	110	60/3					
95 S ÷ 100 S	MT 95 S-C 12	13,5	12	45	110	60/3					
	MT 95 S-C 14-80	13,5	14	80	145	60/3					
95 BR/BS*	MT 95-C 10	13,5	10	45	110	60/3					
	MT 95-C 12	13,5	12	45	110	60/3					
	MT 95-C 14-80	13,5	14	80	145	60/3					
120 RC/S ÷ 150 RC	MT 150 R-C 12	15,0	12	45	110	60/3					
	MT 150 R-C 16	15,0	16	45	110	30/3					
120 BR/BS*	MT 120-C 12	15,0	12	45	110	60/3					
	MT 120-C 16	15,0	16	45	110	60/3					
150 S ÷ 160 RC	MT 150 S-C 12	16,5	12	45	110	60/3					
	MT 150 S-C 14-80	16,5	14	80	145	45/3					
	MT 150 S-C 16	16,5	16	45	110	60/3					
150 BR/BS*	MT 150-C 10	16,5	10	45	110	60/3					
	MT 150-C 12	16,5	12	45	110	60/3					
	MT 150-C 14-80	16,5	14	80	145	45/3					
	MT 150-C 16	16,5	16	45	110	60/3					
160 S ÷ 200 RC	MT 200 R-C 10	17,0	10	45	110	30/3					
	MT 200 R-C 16	17,0	16	45	110	30/3					
185 BR/BS*	MT 185-C 10	18,0	10	45	110	30/3					
	MT 185-C 16	18,0	16	45	110	30/3					
200 S ÷ 240 RC	MT 240 R-C 12	19,5	12	50	115	30/3					
	MT 240 R-C 16	19,5	16	50	115	30/3					
240 S ÷ 315 RC	MT 315 R-C 16	21,5	16	50	115	30/3					
	MT 240-C 12	20,5	12	45	110	30/3					
240 BR/BS*	MT 240-C 16	20,5	16	50	115	30/3					
	MT 300-C 16	23,0	16	50	115	30/3					
300 BR/BS*	MT 300-C 16	23,0	16	50	115	30/3					
315 S	MT 315 S-C 16	24,0	16	60	130	30/3					

Conductor Format: R = Round, RC = Round Compact, S = Sector, BR = IEC228 (BS6360) Round, BS* = IEC228 (BS6360) Sector
 * = Pre-rounding required, consult Cembre for appropriate die set

HIGH VOLTAGE COPPER THROUGH CONNECTORS

MT-TD MT-GC

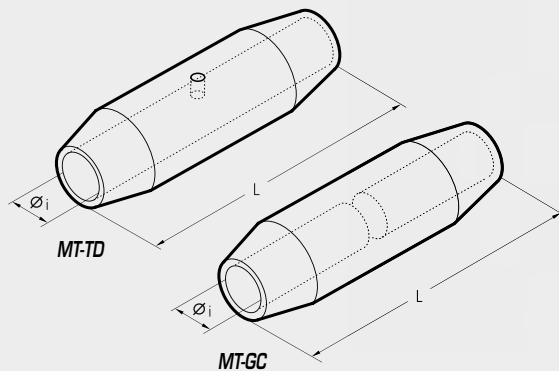

Conductor Size (sqmm) & Format	Ref.	Ref.	Dimensions mm		Quantity Box/Bag	Hydraulic Tools			
			Øi	L		B35-50D	B55	B500E	B81
25 R/BR/BS*	MT 25-TD	MT 25-GC	6,8	60	90/3	B35-50D	B55	B500E	B81
30 RC/S ÷ 40 S	MT 40 S-TD	MT 40 S-GC	8,2	60	90/3				
30 BR/BS*	MT 35-TD	MT 35-GC	8,2	60	90/3				
50 RC	MT 50 R-TD	MT 50 R-GC	8,7	60	90/3				
50 S	MT 50 S-TD	MT 50 S-GC	9,5	60	90/3				
50 BR/BS*	MT 50-TD	MT 50-GC	9,5	60	90/3				
63 S ÷ 70 S	MT 70 S-TD	MT 70 S-GC	11,0	70	30/3				
70 BR/BS*	MT 70-TD	MT 70-GC	11,0	70	30/3				
80 S ÷ 95 RC	MT 95 R-TD	MT 95 R-GC	12,0	80	30/3				
95 S ÷ 100 S	MT 95 S-TD	MT 95 S-GC	13,5	80	30/3				
95 BR/BS*	MT 95-TD	MT 95-GC	13,5	80	30/3				
120 RC/S ÷ 150 RC	MT 150 R-TD	MT 150 R-GC	15,0	80	30/3				
120 BR/BS*	MT 120-TD	MT 120-GC	15,0	80	30/3				
150 S ÷ 160 RC	MT 150 S-TD	MT 150 S-GC	16,5	80	30/3				
150 BR/BS*	MT 150-TD	MT 150-GC	16,5	80	30/3				
160 S ÷ 200 RC	MT 200 R-TD	MT 200 R-GC	17,0	100	30/3				
185 BR/BS*	MT 185-TD	MT 185-GC	18,0	100	30/3				
200 S ÷ 240 RC	MT 240 R-TD	MT 240 R-GC	19,2	100	30/3				
240 S ÷ 315 RC	MT 315 R-TD	MT 315 R-GC	21,5	100	30/3				
240 BR/BS*	MT 240-TD	MT 240-GC	20,5	100	30/3				
300 BR/BS*	MT 300-TD	MT 300-GC	23,0	100	30/3				
315 S	MT 315 S-TD	MT 315 S-GC	23,7	100	30/3				
400 BR/BS*	MT 400-TD	MT 400-GC	27,0	120	15/3				
500 R	MT 500-TD		30,3	118	15/3				
600 R ÷ 630 R	MT 630-TD		33,4	130	9/3				

Conductor Format: R = Round, RC = Round Compact, S = Sector, BR = IEC228 (BS6360) Round, BS* = IEC228 (BS6360) Sector
* = Pre-rounding required, consult Cembre for appropriate die set

MT-TD and MT-GC series connectors are designed to join conductors in high voltage applications up to 33 kV.

They are manufactured from high purity Copper, annealed and Tin plated.

MT-GC series feature a solid stop which forms a barrier between the two conductors being joined, this prevents the migration of oils or greases, which may be present, in one cable contaminating the other cable.

MT-TD connectors are unblocked and are suitable for joining cables of the same type.

Details of the appropriate crimping tools and dies are shown on page 180.

ALUMINIUM TERMINALS

AA-M

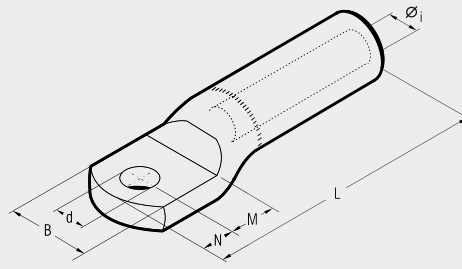

AA-M series terminals are made from Aluminium of a purity equal to or greater than 99,5%.

They are designed to accept a variety of conductor forms especially low stranded compacted conductors.

Non circular conductors may require pre-rounding prior to introduction to the terminal.

Barrels are capped and filled with grease so as to avoid oxidation of the Aluminium.

Details of the appropriate crimping tools and dies are shown on page 181.

Conductor Size sqmm	Ø Stud mm	Ref.	Dimensions mm						Quantity Box/Bag	Hydraulic Tools	
			Øi	B	M	N	L	d			
16	8	AA 16-M 8	5,5	21	13	11	77,0	8,4	60/3	HT 131-JUC RHU 131-C B 131-JUC	
25	8	AA 25-M 8	6,5	21	13	11	77,0	8,4	60/3		
35	8	AA 35-M 8	8,0	23	13	11	77,5	8,4	60/3		
	10	AA 35-M 10	8,0	23	13	11	77,5	10,5	60/3		
50	12	AA 50-M 12	9,0	26	16	14	91,0	13,2	60/3		
	14	AA 50-M 14	9,0	26	18	16	95,0	15,0	60/3		
70	12	AA 70-M 12	11,0	27	16	14	91,0	13,2	45/3		
	14	AA 70-M 14	11,0	27	18	16	95,0	15,0	45/3		
95	12	AA 95-M 12	12,5	27	16	14	91,0	13,2	45/3		
	14	AA 95-M 14	12,5	27	18	16	95,0	15,0	45/3		
120	12	AA 120-M 12	13,7	35	16	14	115,0	13,2	30/3		
	14	AA 120-M 14	13,7	35	18	16	119,0	15,0	30/3		
150	12	AA 150-M 12	15,5	34	16	14	115,0	13,2	30/3		
	14	AA 150-M 14	15,5	34	18	16	119,0	15,0	30/3		
185	12	AA 185-M 12	17,0	42	20	14	122,0	13,2	18/3		
	14	AA 185-M 14	17,0	42	22	16	126,0	15,0	18/3		
240	12	AA 240-M 12	19,5	44	20	14	122,0	13,2	15/3		
	14	AA 240-M 14	19,5	44	22	16	126,0	15,0	15/3		
300	12	AA 300-34 M 12	22,5	47	22	14	130,0	13,2	15/3	HT120 HT131-C RHC 131	ECW-H3D
	14	AA 300-34 M 14	22,5	47	22	16	132,0	15,0	15/3		
	16	AA 300-34 M 16	22,5	47	22	17	133,0	17,0	15/3		
400	16	AA 300-M 16	23,3	54	19	17	172,0	17,0	12/3	RHU 230-630	
400	16	AA 400-M 16	26,0	56	19	17	172,0	17,0	12/3		
500	16	AA 500-40 M 16	29,1	57	22	19	177,0	17,0	12/3		
630	16	AA 630-M 16	32,5	70	22	19	177,0	17,0	9/3		



THROUGH CONNECTORS

for Aluminium conductors

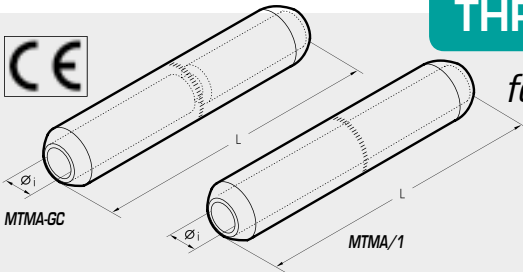

MTMA-GC MTMA/1



Conductor Size sqmm	Ref.	Ref.	Dimensions mm		Quantity Box/Bag	Hydraulic Tools	
			Øi	L			
10	MTMA 10-GC		4,3	90,5	60/3	HT 131-UC RHU 131-C B 131-UC	
16	MTMA 16-GC	MTMA 16/1	5,5	90,5	60/3		
25	MTMA 25-GC	MTMA 25/1	6,5	90,5	60/3		
35	MTMA 35-GC	MTMA 35/1	8,0	90,5	60/3		
	MTMA 35-20-GC		8,0	106,5	30/3		
50	MTMA 50-GC	MTMA 50/1	9,0	106,5	30/3		
70	MTMA 70-GC	MTMA 70/1	11,0	106,5	30/3		
95	MTMA 95-GC		12,5	110,0	30/3		
		MTMA 95/1	12,5	106,5	30/3		
120	MTMA 120-GC	MTMA 120/1	13,7	133,0	30/3		
150	MTMA 150-GC		15,5	135,0	30/3		
		MTMA 150/1	15,5	133,5	30/3		
185	MTMA 185-GC	MTMA 185/1	17,0	143,5	15/3		
240	MTMA 240-GC	MTMA 240/1	19,5	143,5	15/3		
300	MTMAD 300-GC		22,5	144,5	15/3		HT120 HT131-C RHC 131
	MTMA 300-GC	MTMAD 300/1	22,5	135,0	15/3		
400		MTMA 400/1	26,0	218,0	15/3		RHU 230-630
500	MTMA 500-GC		29,1	218,5	15/3		
500		MTMA 500-40/1	29,1	218,0	12/3		
630		MTMA 630/1	32,5	218,5	12/3		

MTMA-GC series through connectors are made from Aluminium of a purity equal to or greater than 99,5%. They feature a solid stop which creates a barrier between the two sides of conductors to be joined. Barrels are capped and filled with grease so as to avoid oxidation of the connector. MTMA/1 series through connectors are unblocked and are suitable for joining cables of the same type. Details of the appropriate crimping tools and dies are shown on pages 182-183.

REDUCER THROUGH CONNECTORS

for Aluminium or Copper conductors

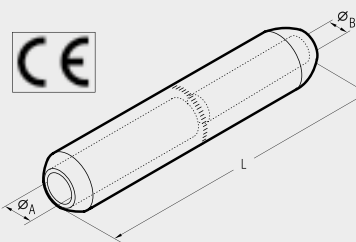

MTMA-GC



Conductor Size sqmm		Ref.	Dimensions mm			Quantity Box/Bag	Hydraulic Tools	
Side A Al	Side B Al/Cu		ØA	ØB	L			
16	10	MTMA 16-10-GC	5,5	4,3	90,5	60/3	HT 131-UC RHU 131-C B 131-UC	
25	10	MTMA 25-10-GC	6,5	4,3	90,5	60/3		
	16	MTMA 25-16-GC	6,5	5,5	90,5	60/3		
50	25	MTMA 50-25-GC	9,0	6,5	106,5	30/3		
	35	MTMA 50-35-GC	9,0	8,0	106,5	30/3		
70	35	MTMA 70-35-GC	11,0	8,0	106,5	30/3		
	50	MTMA 70-50-GC	11,0	9,0	106,5	30/3		
95	50	MTMA 95-50-GC	12,5	9,0	109,4	30/3		
	70	MTMA 95-70-GC	12,5	11,0	106,5	30/3		
120	70	MTMA 120-70-GC	13,7	11,0	133,0	30/3		
	95	MTMA 120-95-GC	13,7	12,5	133,0	30/3		
150	70	MTMA 150-70-GC	15,5	11,0	133,0	30/3		
	95	MTMA 150-95-GC	15,5	12,5	134,4	30/3		
185	120	MTMA 150-120-GC	15,5	13,7	133,0	30/3		
	120	MTMA 185-120-GC	17,0	13,7	143,5	15/3		
240	150	MTMA 185-150-GC	17,0	15,5	143,5	15/3		
	150	MTMA 240-150-GC	19,5	15,5	143,5	15/3		
300	185	MTMA 240-185-GC	19,5	17,0	143,5	15/3		
	95	MTMAD 300-95-GC	22,5	12,5	144,5	15/3	HT120 HT131-C RHC 131	ECW-H3D
150	MTMAD 300-150-GC	22,5	15,5	144,5	15/3			
185	MTMAD 300-185-GC	22,5	17,0	144,5	15/3			
240	MTMAD 300-240-GC	22,5	19,5	144,5	15/3			
400	240	MTMA 400-240-GC	26,0	19,5	218,0	15/3		RHU 230-630
	300	MTMA 400-300-GC	26,0	23,3	218,0	15/3		
500	300	MTMA 500-300-GC	29,1	23,3	218,5	12/3		
	400	MTMA 500-400-GC	29,1	26,0	218,5	12/3		

MTMA-GC series reducer through connectors are manufactured to the same specification as MTMA-GC series through connectors. Details of the appropriate crimping tools and dies are shown on pages 182-183.

CAA-M



BIMETALLIC CONNECTORS

Copper palm fixing Aluminium barrels

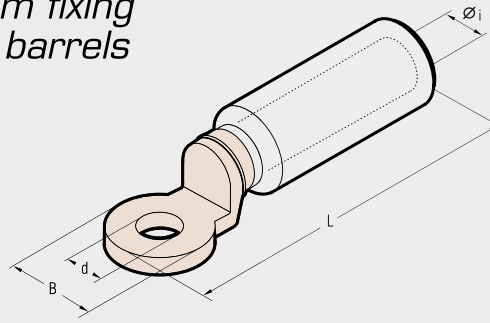

The barrels of series CAA-M connectors are made from Aluminium of a purity equal to or greater than 99,5%. The barrel is friction welded to the palm thus achieving the best possible transition between the Copper palm and Aluminium barrel. Barrels are capped and filled with grease so as to avoid oxidation of the Aluminium.

Details of the appropriate crimping tools and dies are shown on pages 181, 183.

Conductor Size sqmm	Ø Stud mm	Ref.	Dimensions mm				Quantity Box/Bag	Hydraulic Tools	
			Øi	B	L	d			
10	12	CAA 10-M 12	4,3	24	87,0	13,0	90/3	HT 131-UC RHU 131-C B 131-UC	
16	12	CAA 16-M 12	5,5	24	87,0	13,0	90/3		
25	12	CAA 25-M 12	6,5	24	87,0	13,0	90/3		
35	12	CAA 35-M 12	8,0	24	87,0	13,0	90/3		
	12	CAA 35-20-M 12	8,0	24	87,0	13,0	60/3		
50	12	CAA 50-M 12	9,0	24	87,0	13,0	60/3		
70	12	CAA 70-M 12	11,0	24	87,0	13,0	60/3		
95	12	CAA 95-M 12	12,5	24	87,0	13,0	60/3		
120	12	CAA 120-M 12	13,7	31	111,0	13,0	30/3		
150	12	CAA 150-M 12	15,5	31	111,0	13,0	30/3		
185	12	CAA 185-M 12	17,0	35	116,0	13,0	24/3		
240	12	CAA 240-M 12	19,5	35	116,0	13,0	18/3		
300	12	CAA 300-34 M 12	22,5	35	120,0	13,0	15/3		
	16	CAA 300-34 M 16	22,5	35	120,0	17,0	15/3		
400	16	CAA 300-M 16	23,3	35	152,5	16,5	12/3		
	16	CAA 400-M 16	26,0	35	152,5	16,5	12/3		
500	16	CAA 500-M 16 TNBD	29,1	35	152,5	16,5	12/3		
630	8	CAA 630-4 M 8	32,5	60	192,0	4 x 9,0*	9/3		

* 4 holes with 30 mm between axes

MTA-C



BIMETALLIC CONNECTORS

Copper pin Aluminium barrels

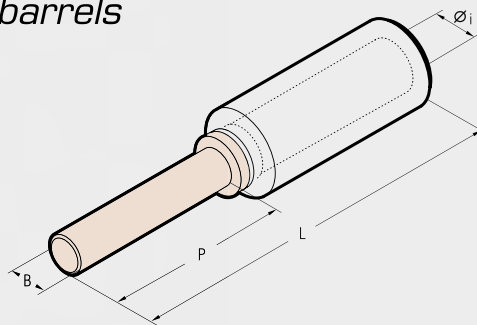

The barrels of series MTA-C connectors are made from Aluminium of a purity equal to or greater than 99,5%. The barrel is friction welded to the pin thus achieving the best possible transition between the Copper pin and Aluminium barrel. Barrels are capped and filled with grease so as to avoid oxidation of the Aluminium.

Details of the appropriate crimping tools and dies are shown on pages 181, 183.

Conductor Size sqmm	Ref.	Dimensions mm				Quantity Box/Bag	Hydraulic Tools	
		Øi	B	P	L			
16	MTA 16-C	5,5	8	30	82	90/3	HT 131-UC RHU 131-C B 131-UC	
25	MTA 25-C	6,5	8	30	82	90/3		
35	MTA 35-C	8,0	8	30	82	90/3		
50	MTA 50-C	9,0	12	45	97	60/3		
70	MTA 70-C	11,0	12	45	97	60/3		
95	MTA 95-C	12,5	12	45	97	60/3		
120	MTA 120-C	13,7	14	55	125	30/3		
150	MTA 150-C	15,5	14	55	125	30/3		
185	MTA 185-C	17,0	14	55	125	24/3		
240	MTA 240-C	19,5	14	55	125	24/3		

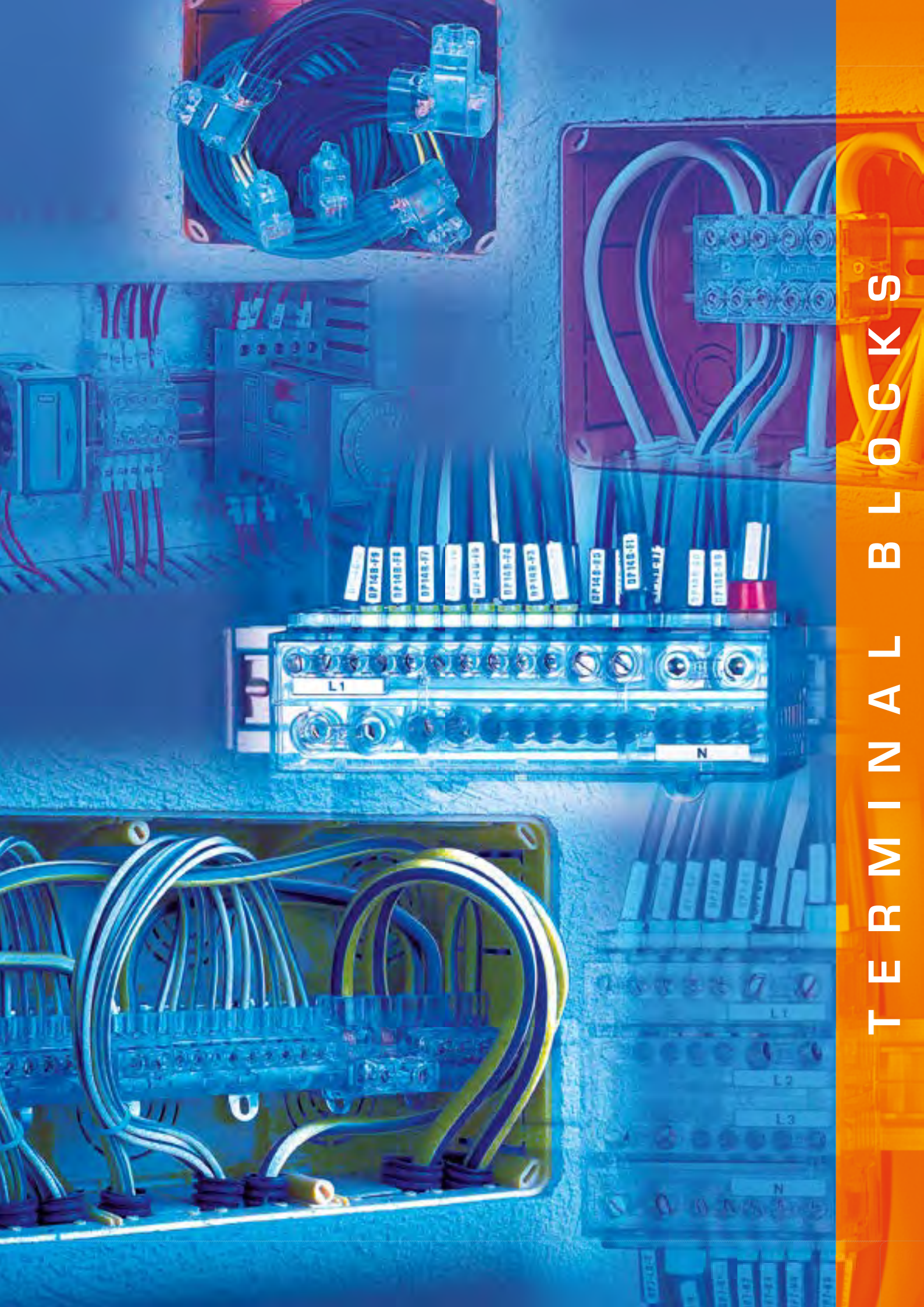

TERMINAL BLOCKS

Z6

SINGLE POLE TERMINAL BLOCKS

indirect clamping
nominal section 6 sqmm



Z6-3

Z6-5



Z6-6

Z6-10

The "Z...D" version has been designed for mounting on DIN rails



3, 5, 6 and 10 way, single pole terminal blocks for conductor section 1 to 6 sqmm.

Self contained and robust, they are quick and easy to install for both industrial and domestic use.

The indirect clamping of the "ZETA più" terminal blocks guarantees a low and stable contact resistance.

Indirect clamping eliminates damage to the conductor strands.

The easy-entry receptacles also grant a fast and reliable insertion of the cable.

Ref.	No. of Ways	Connecting Capacity sqmm	Nominal Voltage V	Maximum Operating Temperature °C	Insulation Specification	Self Extinguishing Specification	Dimensions mm	Weight g	Quantity
Z6-3	3	(3 way) 1÷6	450	85	IP 20	V-0 (UL 94)	23x23xh27,5	15	30
Z6-3D							23x40xh36,5	18,5	10
Z6-5	5	(5 way) 1÷6	450	85	IP 20	V-0 (UL 94)	35x23xh27,5	23	20
Z6-5D							35x40xh36,5	26,5	10
Z6-6	6	(6 way) 1÷6	450	85	IP 20	V-0 (UL 94)	23x43xh28,5	26	15
Z6-6D							23x53xh33	31	10
Z6-10	10	(10 way) 1÷6	450	85	IP 20	V-0 (UL 94)	35x43xh28,5	41	10
Z6-10D							35x53xh33	46	15

D= Version with clamp for DIN rail

Technical features:

- Self-extinguishing Polycarbonate body
- Tempered Steel clamps
- Electrolytically Tin plated Copper interconnections

Z16

SINGLE POLE TERMINAL BLOCKS

indirect clamping
nominal section 16 sqmm



Z16-3

Z16-4



Z16-5N



Z16-8



Z16-12

3, 4, 5, 8 and 12 way, single pole terminal blocks.

Ideal for use as an equipotential bonding connector for both industrial and domestic use.

Ref.	No. of Ways	Connecting Capacity sqmm	Nominal Voltage V	Maximum Operating Temperature °C	Insulation Specification	Self Extinguishing Specification	Dimensions mm	Weight g	Quantity
Z16-3	3	16	450	85	IP 20	V-0 (UL 94)	38x31,3xh38	52	20
Z16-3D							38x50xh44	55,5	15
Z16-4	4	16	450	85	IP 20	V-0 (UL 94)	27x54xh37	50	15
Z16-4D							27x58xh43	54	10
Z16-5N	5	16	450	85	IP 20	V-0 (UL 94)	61x31,5xh38	64,5	10
Z16-5ND							61x50xh44	68	4
Z16-8	8	(2 way) 16 + (6 way) 6	450	85	IP 20	V-0 (UL 94)	35,5x50xh36,5	50	15
Z16-8D							35,5x57xh42	56	10
Z16-12	12	(2 way) 16 + (10 way) 6	450	85	IP 20	V-0 (UL 94)	104,5x32,5xh36,5	115	8
Z16-12D							104,5x50xh42	125	5

D= Version with clamp for DIN rail



SINGLE POLE TERMINAL BLOCKS

indirect clamping
nominal section 35 sqmm

Z35



Z35-3



Z35-4



Z35-6

Ref.	No. of Ways	Connecting Capacity sqmm	Nominal Voltage V	Maximum Operating Temperature °C	Insulation Specification	Self Extinguishing Specification	Dimensions mm	Weight g	Quantity
Z35-3	3	35	450	85	IP 20	V-0 (UL 94)	53x48,5xh42	110	10
Z35-3D							53x50xh48	114	5
Z35-4	4	35	450	85	IP 20	V-0 (UL 94)	37x85xh42	129	5
Z35-4D							37x85xh48	133	5
Z35-6	6	(2 way) 35 + (4 way) 16	450	85	IP 20	V-0 (UL 94)	83x41xh43	130	8
Z35-6D	(2+4)						83x49xh52	140	5

D= Version with clamp for DIN rail

3, 4 and 6 way, single pole terminal blocks. Ideal for use as an equipotential bonding connector for both industrial and domestic use.



SINGLE POLE TERMINAL BLOCKS

indirect clamping
for earthing applications 

Z35 Z50



Z50-10D



Z35T-11
Z35T-11D



Z35-26D











Ref.	No. of Ways	Connecting Capacity sqmm	Maximum Operating Temperature °C	Self Extinguishing Specification	Dimensions mm	Weight g	Quantity
Z35T-11	11	(1 way) 35 +	85	V-0 (UL 94)	58x43xh42	70	10
Z35T-11D	(1+10)	(10 way) 6			58x53xh47	75	
Z35-26D	26 (2+24)	(2 way) 35 + (24 way) 10	85	V-0 (UL 94)	151x52xh48	379	4
Z50-10D	10 (2+8)	(2 way) 50 + (8 way) 25	85	V-0 (UL 94)	77,5x55xh49	320	6

D= Version with clamp for DIN rail

10, 11 and 26 way, single pole terminal blocks. Ideal for use as an equipotential bonding connector for both industrial and domestic use.

CONNECTING CAPACITY OF TERMINAL BLOCKS

TERMINAL BLOCKS TYPE "ZETA più"







TYPE		NOMINAL SECTION	No. OF WAYS X NOMINAL SECTION	CONNECTING CAPACITY OF EACH WAY* No. of Conductors x Section	MARKINGS
Z6-3	Z6-3D	6 ²	3 x 6 ²	1 x 6 ² R/F	   
Z6-5	Z6-5D	6 ²	5 x 6 ²	1 x 4 ² R/F	
Z6-6	Z6-6D	6 ²	6 x 6 ²	1÷2 x 2,5 ² R/F	
Z6-10	Z6-10D	6 ²	10 x 6 ²	1÷2 x 1,5 ² R/F 1÷4 x 1 ² R/F	
Z16-3	Z16-3D	16 ²	3 x 16 ²	1 x 16 ² R/F 1 x 10 ² R/F 1÷2 x 6 ² R/F 1÷3 x 4 ² R/F 1÷4 x 2,5 ² R/F 1÷8 x 1,5 ² R/F	   
Z16-4	Z16-4D	16 ²	4 x 16 ²	1 x 16 ² F 1 x 10 ² F 1÷2 x 6 ² F 1÷3 x 4 ² F 1÷4 x 2,5 ² F 1÷8 x 1,5 ² F	
Z16-5N	Z16-5ND	16 ²	5 x 16 ²	1 x 16 ² R/F 1 x 10 ² R/F 1÷2 x 6 ² R/F 1÷3 x 4 ² R/F 1÷4 x 2,5 ² R/F 1÷8 x 1,5 ² R/F	 
Z16-8	Z16-8D	16 ² /6 ²	2 x 16 ²	1 x 16 ² R/F 1 x 10 ² R/F 1÷2 x 6 ² R/F 1÷3 x 4 ² R/F 1÷4 x 2,5 ² R/F 1÷8 x 1,5 ² R/F	
Z16-12	Z16-12D	16 ² /6 ²	2 x 16 ²	1 x 16 ² F 1 x 10 ² F 1÷2 x 6 ² F 1÷3 x 4 ² F 1÷4 x 2,5 ² F	 
			10 x 6 ²	1 x 6 ² F 1 x 4 ² F 1÷2 x 2,5 ² F 1÷2 x 1,5 ² F 1÷4 x 1 ² F	

*A mixture of conductor sizes may be connected to the terminal block provided that the sum of their sections is less than the nominal section.

R = Rigid conductor F = Flexible conductor

CONNECTING CAPACITY OF TERMINAL BLOCKS

TERMINAL BLOCKS TYPE "ZETA più"

TYPE	NOMINAL SECTION	No. OF WAYS X NOMINAL SECTION	CONNECTING CAPACITY OF EACH WAY* No. of Conductors x Section	MARKINGS
Z35-3 Z35-3D	35 ²	3 x 35 ²	1 x 35 ² R/F 1 x 25 ² R/F 1÷2 x 16 ² R/F 1÷3 x 10 ² R/F 1÷5 x 6 ² R/F	CE 
Z35-4 Z35-4D	35 ²	4 x 35 ²	1 x 35 ² F 1 x 25 ² F 1÷2 x 16 ² F 1÷3 x 10 ² F 1÷6 x 6 ² F	CE 
Z35-6 Z35-6D	35 ² /16 ²	2 x 35 ²	1 x 35 ² R/F 1 x 25 ² R/F 1÷2 x 16 ² R/F 1÷3 x 10 ² R/F 1÷6 x 6 ² F	CE   
		4 x 16 ²	1 x 16 ² R/F 1 x 10 ² R/F 1÷2 x 6 ² R/F 1÷3 x 4 ² R/F 1÷5 x 2,5 ² F	
Z35T-11 Z35T-11D	35 ² /6 ²	1 x 35 ²	1 x 35 ² R/F 1 x 25 ² R/F 1 x 16 ² R/F 1 x 10 ² R/F	CE 
		10 x 6 ²	1 x 6 ² R/F 1 x 4 ² R/F 1÷2 x 2,5 ² R/F 1÷2 x 1,5 ² R/F 1÷4 x 1 ² R/F	
Z35-26D	35 ² /10 ²	2 x 35 ²	1 x 35 ² R/F 1 x 25 ² R/F 1÷2 x 16 ² R/F 1÷3 x 10 ² R/F 1÷6 x 6 ² R/F	CE   
		24 x 10 ²	1 x 10 ² R/F 1 x 6 ² R/F 1÷2 x 4 ² R/F 1÷4 x 2,5 ² R/F	
Z50-10D	50 ² /25 ²	2 x 50 ²	1 x 50 ² R/F 1 x 35 ² R/F 1÷2 x 25 ² R/F 1÷4 x 16 ² R/F	CE ** 
		8 x 25 ²	1 x 25 ² R/F 1÷2 x 16 ² R/F 1÷3 x 10 ² R/F 1÷6 x 6 ² R/F 1÷9 x 4 ² R/F	

*A mixture of conductor sizes may be connected to the terminal block provided that the sum of their sections is less than the nominal section.

R = Rigid conductor F = Flexible conductor

MARKINGS:



Istituto italiano del Marchio di Qualità type approval



Lloyd's Register of Shipping type approval



Registro Italiano Navale type approval



** EN 60947-7-1: 2002

CONFORM TO:

Directives 2006/95/CE

EN 60998-1: 2004 and
EN 60998-2-1: 2004 Norms

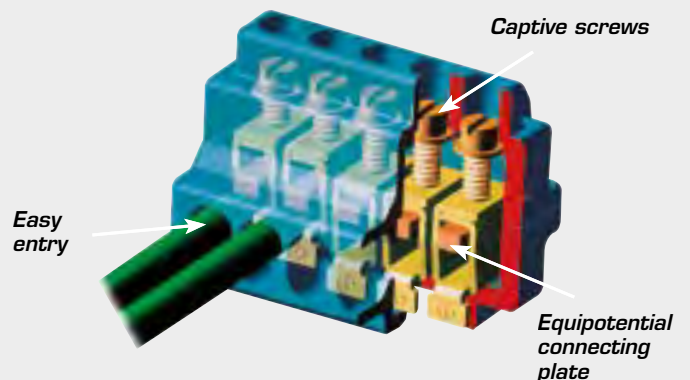

Z-DP

POWER DISTRIBUTION BLOCK

indirect clamping

type
ZETAblock®

FOUR POLE
100 A

TWO POLE
125 A

FOUR POLE
125 A

FOUR POLE
160 A

Z 25-DP7-100

Z 35-DP14B-125

Z 50-DP12-160

Z 35-DP14-125

100, 125 and 160A, 2-4 pole distribution blocks with 7, 14 and 12 ways per pole respectively.

Accepting a wide cable CSA range (1 - 50 sqmm) and of compact size, ZETA blocks are ideal for control cabinets and distribution panels.

The lateral arrangement of terminals on upper and lower faces (Z35-DP14B one face only), simplifies connection and promotes tidy, homogeneous cable routing to assist subsequent wiring operations.

Easy entry apertures provide quick, effective cable insertion while the indirect clamping feature eliminates damage to cable strands and assures a low, stable contact resistance.

Ref.	No. of poles	No. of Ways per pole	Nominal CSA for each pole sqmm	Maximum operating voltage Ui	Impulse voltage Uimp	Maximum operating current In	Allowable short duration fault current Icw	Maximum allowed peak fault current Ipk	Self Extinguishing Specification	Dimensions mm	Weight g	Qty
Z 25-DP7-100	4	7 (2+5)	(2 way) 25 + (5 way) 6	800 V	8 kV	100 A	3 kA	18 kA	V-0 (UL 94)	70x84xh45	290	2
Z 35-DP14-125	4	14 (2+2+10)	(2 way) 35 + (2 way) 16 + (10 way) 6	800 V	8 kV	125 A	4,2 kA	18 kA	V-0 (UL 94)	137x83xh46	700	1
Z 35-DP14B-125	2	14 (2+2+10)	(2 way) 35 + (2 way) 16 + (10 way) 6	800 V	8 kV	125 A	4,2 kA	18 kA	V-0 (UL 94)	137x44xh46	360	2
Z 50-DP12-160	4	12 (2+4+6)	(2 way) 50 + (4 way) 25 + (6 way) 16	800 V	8 kV	160 A	6 kA	18 kA	V-0 (UL 94)	150x84xh48	780	1

Technical features:

- Self extinguishing antishock Polycarbonate body
- Tempered Steel captive clamping screws and plates
- Electrolytically Tin plated Copper interconnectors

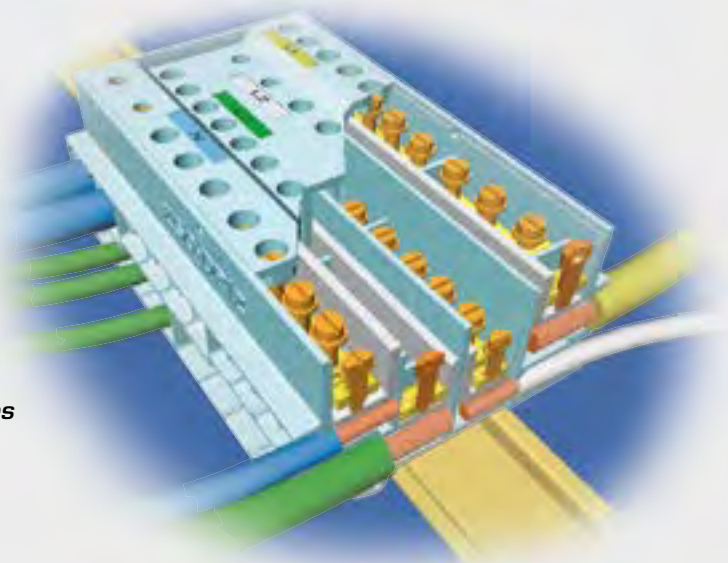

type
ZETAblock®

POWER DISTRIBUTION BLOCK







indirect clamping

Z-DP



CONNECTING CAPACITY OF POWER DISTRIBUTION BLOCK

POWER DISTRIBUTION BLOCK TYPE "ZETAblock"

TYPE	NOMINAL SECTION	No. OF WAYS x NOMINAL SECTION	CONNECTING CAPACITY OF EACH WAY No. of Conductors x Section	MARKINGS
Z25-DP7-100	25 ² /6 ²	2 x 25 ²	1 x 25 ² F 1 x 16 ² F 1÷2 x 10 ² F	  25-6 apmm
		5 x 6 ²	1 x 6 ² F 1 x 4 ² F 1÷2 x 2,5 ² F 1÷2 x 1,5 ² F 1÷4 x 1 ² F	
Z35-DP14-125 Z35-DP14B-125	35 ² /16 ² /6 ²	2 x 35 ²	1 x 35 ² F 1 x 25 ² F 1÷2 x 16 ² F 1÷3 x 10 ² F	  25-16-6 apmm
		2 x 16 ²	1 x 16 ² F 1 x 10 ² F 1÷2 x 6 ² F 1÷3 x 4 ² F 1÷4 x 2,5 ² F	
		10 x 6 ²	1 x 6 ² F 1 x 4 ² F 1÷2 x 2,5 ² F 1÷2 x 1,5 ² F 1÷4 x 1 ² F	
Z50-DP12-160	50 ² /25 ² /16 ²	2 x 50 ²	1 x 50 ² F 1 x 35 ² F 1÷2 x 25 ² F	  50-25-16 apmm
		4 x 25 ²	1 x 25 ² F 1 x 16 ² F 1÷2 x 10 ² F	
		6 x 16 ²	1 x 16 ² F 1 x 10 ² F 1÷2 x 6 ² F	

F = Flexible conductor

MARKINGS:



Istituto italiano del Marchio di Qualità type approval

CONFORM TO:

Directives 2006/95/CE

EN 60947-7-1: 2002 Norms

ONE WAY TERMINAL BLOCKS



Z-1

indirect clamping



Ref.	Connecting Capacity sqmm	Nominal Voltage V	Maximum Operating Temperature °C	Insulation Specification	Self Extinguishing Specification	Dimensions mm	Weight g	Quantity Box/Bag
Z2.5-1	2,5	450	85	IP 20	V-0 (UL 94)	7,6x20xh23,5	3	500/25
Z6-1	6					11,5x28xh29	6	250/25
Z10-1	10					15,6x32xh32,5	11	100/10
Z16-1	16					18x34xh38	15	100/10
Z25-1	25					20,8x42,5xh43,5	29	50/10
Z35-1	35					25x45xh51,5	37	40/10

One way, single pole terminal blocks for conductors sections from 0.5 to 35 sqmm. Self contained and robust, they are ideal for the fast and safe installation for industrial and domestic applications.

The indirect clamping of the "ZETAmini" terminal blocks guarantees a low and stable contact resistance.

The easy-entry receptacle also grants a fast and reliable insertion of the cable.

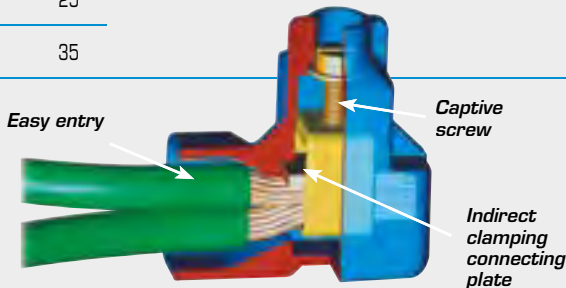

Technical features:

- Self-extinguishing Polycarbonate body
- Electrolytically Zinc plated, tempered Steel clamp and screw

- Electrolytically Tin plated Steel connection plate

CONNECTING CAPACITY OF TERMINAL BLOCKS

TYPE	NOMINAL SECTION	CONNECTING CAPACITY *		MARKINGS
		No. of Conductors x Section		
Z2.5-1	2,5 ²	2 x 2,5 ² R/F 2÷3 x 1,5 ² R/F 2÷5 x 1,0 ² R/F	2÷6 x 0,75 ² R/F 2÷10 x 0,5 ² R/F 2÷18 x Ø0,4÷0,6 mm communication type wire	CE, Lloyd's Register, Registro Italiano Navale, IEC, UL, T 85°C P 20
Z6-1	6 ²	2 x 6 ² R/F 2÷3 x 4 ² R/F 2÷4 x 2,5 ² R/F 2÷6 x 1,5 ² R/F 2÷6 x 1 ² R/F	2÷10 x 0,75 ² R/F 2÷12 x 0,5 ² R/F (1 x 6 ²) + (4 x 1,5 ²) (1 x 6 ²) + (2 x 2,5 ²)	CE, Lloyd's Register, Registro Italiano Navale, IEC, UL, T 85°C P 20
Z10-1	10 ²	2 x 10 ² R/F 2÷3 x 6 ² R/F 2÷5 x 4 ² R/F 2÷8 x 2,5 ² R/F (1 x 6 ²) + (1 x 4 ²) + (2 x 2,5 ²) + (3 x 1,5 ²)	2÷12 x 1,5 ² R/F 2÷20 x 1 ² R/F 2÷25 x 0,75 ² R/F	CE, Lloyd's Register, Registro Italiano Navale, IEC, UL, T 85°C P 20
Z16-1	16 ²	2 x 16 ² R/F 2÷3 x 10 ² R/F 2÷5 x 6 ² R/F	2÷8 x 4 ² R/F 2÷12 x 2,5 ² R/F 2÷18 x 1,5 ² R/F	CE, Lloyd's Register, Registro Italiano Navale, IEC, UL, T 85°C P 20
Z25-1	25 ²	2 x 25 ² R/F 2÷3 x 16 ² R/F 2÷4 x 10 ² R/F	2÷8 x 6 ² R/F 2÷11 x 4 ² R/F 4÷16 x 2,5 ² R/F	CE, Lloyd's Register, Registro Italiano Navale, IEC, UL, T 85°C P 20
Z35-1	35 ²	2 x 35 ² R/F 2÷3 x 25 ² R/F 2÷4 x 16 ² R/F 2÷7 x 10 ² R/F	2÷11 x 6 ² R/F 4÷17 x 4 ² R/F 5÷28 x 2,5 ² R/F	CE, Lloyd's Register, Registro Italiano Navale, IEC, UL, T 85°C P 20

*A mixture of conductor sizes may be connected to the terminal block provided that the sum of their sections is less than twice the nominal section.

R = Rigid conductor

F = Flexible conductor

MARKINGS:

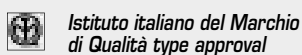

CONFORM TO:

Directives 2006/95/CE

EN 60998-1: 2004 and EN 60998-2-1: 2004 Norms

CS4 CONNECTORS

for PV conductors

CS4



New



Certificate No R60040256



CS411 - CS412
FREE version



CS420
FIXED version



CS4 range

Ref.	Description	Flexible Conductor Size sqmm	Cable External Ø mm	Quantity Box/Bag
CS411	free connector set	2,5 - 4 - 6	4,4 ÷ 5,8	100/10
CS412	free connector set	2,5 - 4 - 6	5,8 ÷ 7,2	100/10
CS420	fixed connector set	2,5 - 4 - 6	4,4 ÷ 7,2	100/10

CS4 connectors are ideal for the connection of Copper conductors in photovoltaic installations. Recommended crimping tools are shown on pages 103, 105, 150.

accessories

Ref.	Description	Quantity Box/Bag
CS4 KEY	Disconnection tool - for easy working on inverters and string boxes	100/10
CS4 MFC	Sealing cap for male and female connector	1.000/100
CS4 GR	Rear gasket for fixed connectors	1.000/100

Technical features:

rated voltage	1000 VDC
rated impulse voltage	8 kV
rated insulation voltage	4 kV
rated input current	30 A
reference standard	EN 50521:2008
application class	Class A
protection class	Class II
pollution class	3
over voltage category	III
lower ambient temperature	-40 °C
upper ambient temperature	+85 °C
upper temperature limit	105 °C
type of conductor	Flexible
termination type	Crimped
cable clamp type	Ø min. 4,4 ± 0,2 mm Ø max. 7,2 ± 0,2 mm
number of poles	1
conductor size	2,5 - 4,0 and 6,0 mm ²
degree of protection	IP 67
rewirable	no
cable nut tightening torque	1,5 Nm

CS4 MFC



CS4 GR



CS4 KEY



CS4



CS4 CONNECTORS

for PV conductors

free connector male



Ref.	Flexible Cond. Size sqmm	Cable External Ø mm
CS411M	2,5 - 4 - 6	4,4 ÷ 5,8
CS412M		5,8 ÷ 7,2

Part	Description
1	Threaded locking ring (PPO)
2	Strain relief (Acetal Resin)
3	Grommet (EPDM)
4	Body connector male (PPO)
5	Male terminal (Cu alloy)

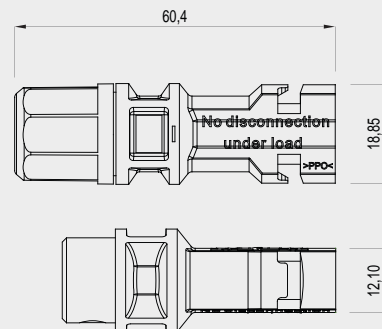

free connector female

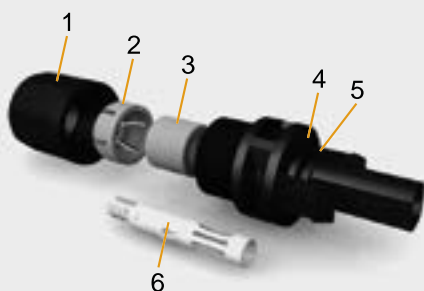

Ref.	Flexible Cond. Size sqmm	Cable External Ø mm
CS411F	2,5 - 4 - 6	4,4 ÷ 5,8
CS412F		5,8 ÷ 7,2

Part	Description
1	Threaded locking ring (PPO)
2	Strain relief (Acetal Resin)
3	Grommet (EPDM)
4	Body connector female (PPO)
5	O-ring (EPDM)
6	Female terminal (Cu alloy)

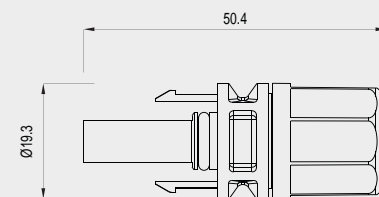

fixed connector male



Ref.	Flexible Cond. Size sqmm	Cable External Ø mm
CS420M	2,5 - 4 - 6	4,4 ÷ 7,2

Part	Description
1	Nut (PPO)
2	Gasket (NBR)
3	Body connector male (PPO)
4	Male terminal (Cu alloy)

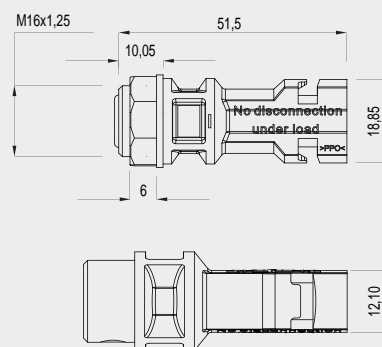

fixed connector female



Ref.	Flexible Cond. Size sqmm	Cable External Ø mm
CS420F	2,5 - 4 - 6	4,4 ÷ 7,2

Part	Description
1	Nut (PPO)
2	Gasket (NBR)
3	O-ring (EPDM)
4	Body connector female (PPO)
5	Female terminal (Cu alloy)

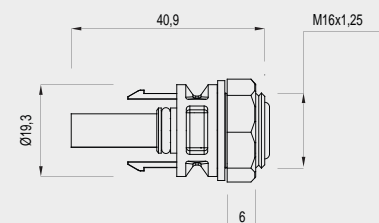



CABLE GLANDS AND ACCESSORIES

MAXIblock® CABLE GLANDS

Polyamide PA6.6

1900



Material: POLYAMIDE PA6.6
self-extinguishing class V2 (UL 94)
Temperature range:
-20°C to +90°C (continuous)
Sealing ring: NEOPRENE® 50 sh A
Protection: IP 68
Colour: RAL 7035 light grey,
RAL 9005 black, RAL 7001 dark
grey

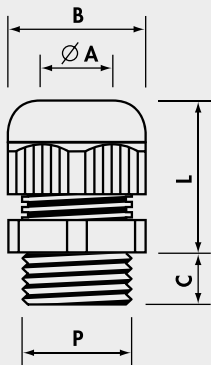

MAXIblock® standard

Metric thread M 1.5 pitch CEI EN 60423 CEI EN 50262

Ref. Light Grey	P	Fixing Hole Ø (mm)	Ø A mini-max (mm)	B Spanner (mm)	C (mm)	L min-max (mm)	Quantity
1900.M12	M12x1,5	12,2	3,5- 7	15	8	18-22	100
1900.M16	M16x1,5	16,2	5 -10	19	8	22-27	100
1900.M20	M20x1,5	20,5	7 -13	25	9	24-30	100
1900.M25	M25x1,5	25,4	10 -17	30	10	28-39	50
1900.M32	M32x1,5	32,5	13 -21	36	10	33-44	25
1900.M40	M40x1,5	40,5	19 -28	46	10	36-45	15
1900.M50	M50x1,5	50,5	27 -35	55	12	43-52	10
1900.M63	M63x1,5	64,0	34 -45	66	12	45-55	5

Add to Ref: N for Black, G for Dark Grey

MAXIblock® reduced cable entry

Metric thread M 1.5 pitch CEI EN 60423 CEI EN 50262

Ref. Light Grey	P	Fixing Hole Ø (mm)	Ø A mini-max (mm)	B Spanner (mm)	C (mm)	L min-max (mm)	Quantity
1910.M12	M12x1,5	12,2	2- 5	15	8	18-22	100
1910.M16	M16x1,5	16,2	3- 7	19	8	22-27	100
1910.M20	M20x1,5	20,5	5-10	25	9	24-30	100
1910.M25	M25x1,5	25,4	7-13	30	10	28-39	50
1910.M32	M32x1,5	32,5	8-14	36	10	33-44	25
1910.M40	M40x1,5	40,5	15-23	46	10	36-45	15
1910.M50	M50x1,5	50,5	21-29	55	12	43-52	10
1910.M63	M63x1,5	64,0	27-39	66	12	45-55	5

Add to Ref: N for Black, G for Dark Grey

MAXIblock® extended thread

Metric thread M 1.5 pitch CEI EN 60423 CEI EN 50262

Ref. Light Grey	P	Fixing Hole Ø (mm)	Ø A mini-max (mm)	B Spanner (mm)	C (mm)	L min-max (mm)	Quantity
1901.M12	M12x1,5	12,2	3,5- 7	15	15	18-22	100
1901.M16	M16x1,5	16,2	5 -10	19	15	22-27	100
1901.M20	M20x1,5	20,5	7 -13	25	15	24-30	50
1901.M25	M25x1,5	25,4	10 -17	30	15	30-41	50
1901.M32	M32x1,5	32,5	13 -21	36	15	33-44	25
1901.M40	M40x1,5	40,5	19 -28	46	18	36-45	15
1901.M50	M50x1,5	50,5	27 -35	55	18	43-52	10
1901.M63	M63x1,5	64,0	34 -45	66	18	45-55	5

Add to Ref: N for Black, G for Dark Grey

MAXIblock® CABLE GLANDS

Polyamide PA6.6

1900

MAXIblock® standard

Pg thread DIN 40 430

Ref. Light Grey	P	Fixing Hole Ø (mm)	Ø A mini-max (mm)	B Spanner (mm)	C (mm)	L min-max (mm)	Quantity
1900.07	Pg 7	12,7	3,5- 7	15	8	18-22	100
1900.09	Pg 9	15,5	5 - 8	19	8	22-26	100
1900.11	Pg11	18,8	5 -10	22	8	23-28	100
1900.13	Pg13,5	20,5	7 -12	24	9	24-29	100
1900.16	Pg16	22,6	10 -14	27	10	26-31	50
1900.21	Pg21	28,5	13 -18	33	12	30-35	50
1900.29	Pg29	37,2	18 -25	42	12	33-39	25
1900.36	Pg36	47,2	20 -32	53	14	42-49	10
1900.42	Pg42	54,2	28 -38	60	14	42-50	5
1900.48	Pg48	60,0	37 -45	66	15	45-55	5

Add to Ref: N for Black, G for Dark Grey



Material: POLYAMIDE PA6.6
self-extinguishing class V2 (UL 94)
Temperature range:
-20°C to +90°C (continuous)
Sealing ring: NEOPRENE® 50 sh A
Protection: IP 68
Colour: RAL 7035 light grey,
RAL 9005 black, RAL 7001 dark
grey

MAXIblock® reduced cable entry

Pg thread DIN 40 430

Ref. Light Grey	P	Fixing Hole Ø (mm)	Ø A mini-max (mm)	B Spanner (mm)	C (mm)	L min-max (mm)	Quantity
1910.07	Pg 7	12,7	2- 5	15	8	18-22	100
1910.09♦	Pg 9	15,5	2- 6	19	8	22-26	100
1910.11	Pg11	18,8	4- 7	22	8	23-28	100
1910.13	Pg13,5	20,5	5-10	24	9	24-29	100
1910.16♦	Pg16	22,6	6-12	27	10	26-31	50
1910.21	Pg21	28,5	9-15	33	12	30-35	50
1910.29♦	Pg29	37,2	12-20	42	12	33-39	25
1910.36	Pg36	47,2	18-26	53	14	42-49	10
1910.42	Pg42	54,2	25-31	60	14	42-50	5
1910.48♦	Pg48	60,0	27-39	66	15	45-55	5

Add to Ref: N for Black

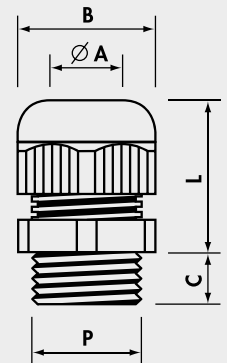

MAXIblock® extended thread

Pg thread DIN 40 430

Ref. Light Grey	P	Fixing Hole Ø (mm)	Ø A mini-max (mm)	B Spanner (mm)	C (mm)	L min-max (mm)	Quantity
1901.07	Pg 7	12,7	3,5- 7	15	15	18-22	100
1901.09	Pg 9	15,5	5 - 8	19	15	22-26	100
1901.11	Pg11	18,8	5 -10	22	15	23-28	100
1901.13	Pg13,5	20,5	7 -12	24	15	24-29	100
1901.16	Pg16	22,6	10 -14	27	15	26-31	50
1901.21	Pg21	28,5	13 -18	33	15	30-35	50
1901.29	Pg29	37,2	18 -25	42	15	33-39	25
1901.36	Pg36	47,2	20 -32	53	18	42-49	10
1901.42	Pg42	54,2	28 -38	60	18	42-50	5
1901.48	Pg48	60,0	37 -45	66	18	45-55	5

Add to Ref: N for Black

♦Not UL approved

MAXIblock® CABLE GLANDS

Polyamide PA6.6

MAXIblock® standard factory fitted with locknuts with collar

Metric thread M 1.5 pitch CEI EN 60423 CEI EN 50262

1900/X



Material: POLYAMIDE PA6.6
self-extinguishing class V2 (UL 94)
Temperature range:
-20°C to +90°C (continuous)
Sealing ring: NEOPRENE® 50 sh A
Protection: IP 68
Colour: RAL 7035 light grey,



Ref.	P	Fixing Hole Ø (mm)	Ø A mini-max (mm)	B Spanner (mm)	C (mm)	L min-max (mm)	Quantity Box/Bag
1900.M12/X	M12x1,5	12,2	3,5- 7	15	8	18-22	100/10
1900.M16/X	M16x1,5	16,2	5 -10	19	8	22-27	100/10
1900.M20/X	M20x1,5	20,5	7 -13	25	9	24-30	50/10
1900.M25/X	M25x1,5	25,4	10 -17	30	10	28-39	30/10
1900.M32/X	M32x1,5	32,5	13 -21	36	10	33-44	20/10
1900.M40/X	M40x1,5	40,5	19 -28	46	10	36-45	10/5
1900.M50/X	M50x1,5	50,5	27 -35	55	12	43-52	10/5
1900.M63/X	M63x1,5	64,0	34 -45	66	12	45-55	5/5

Pg thread DIN 40 430

Ref.	P	Fixing Hole Ø (mm)	Ø A mini-max (mm)	B Spanner (mm)	C (mm)	L min-max (mm)	Quantity Box/Bag
1900.07/X	Pg 7	12,7	3,5- 7	15	8	18-22	100/10
1900.09/X	Pg 9	15,5	5 - 8	19	8	22-26	100/10
1900.11/X	Pg11	18,8	5 -10	22	8	23-28	100/10
1900.13/X	Pg13,5	20,5	7 -12	24	9	24-29	50/10
1900.16/X	Pg16	22,6	10 -14	27	10	26-31	30/10
1900.21/X	Pg21	28,5	13 -18	33	12	30-35	20/10
1900.29/X	Pg29	37,2	18 -25	42	12	33-39	20/10
1900.36/X	Pg36	47,2	20 -32	53	14	42-49	10/5
1900.42/X	Pg42	54,2	28 -38	60	14	42-50	5/5
1900.48/X	Pg48	60,0	37 -45	66	15	45-55	5/5

1900



Material: POLYAMIDE PA6.6
self-extinguishing class V2 (UL 94)
Temperature range:
-20°C to +90°C (continuous)
Sealing ring: NEOPRENE® 50 sh A
Protection: IP 68
Colour: RAL 7035 light grey,
RAL 9005 black



MAXIblock® standard

BSP thread ISO 228/1

Ref. Grey	P Light	Fixing Hole Ø (mm)	Ø A mini-max (mm)	B Spanner (mm)	C (mm)	L min-max (mm)	Quantity
1900.14	G1/4"	13,5	3- 6,5	15	8	18-22	100
1900.38	G3/8"	17,0	4- 8	19	8	22-26	100
1900.12	G1/2"	21,5	7-12	24	10	24-29	100
1900.34	G3/4"	27,0	13-18	33	12	30-35	50

Add to Ref: N for Black

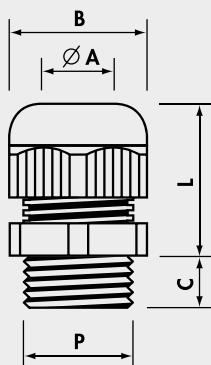

spiralblock® CABLE GLANDS

Polyamide PA6.6



spiralblock® standard

Metric thread M 1.5 pitch CEI EN 60423 CEI EN 50262

Ref. Light Grey	P	Fixing Hole Ø (mm)	Ø A mini-max (mm)	B Spanner (mm)	C (mm)	L min-max (mm)	Quantity
1500.M12	M12x1,5	12,2	3,5- 7	15	8	57	100
1500.M16	M16x1,5	16,2	5 -10	19	8	79	50
1500.M20	M20x1,5	20,5	7 -13	25	9	90	25
1500.M25	M25x1,5	25,4	10 -17	30	10	120	20
1500.M32	M32x1,5	32,5	13 -21	36	10	140	10

Add to Ref: N for Black

spiralblock® standard

Pg thread DIN 40 430

Ref. Light Grey	P	Fixing Hole Ø (mm)	Ø A mini-max (mm)	B Spanner (mm)	C (mm)	L min-max (mm)	Quantity
1500.07	Pg 7	12,7	3,5- 7	15	8	57	100
1500.09	Pg 9	15,5	5 - 8	19	8	68	100
1500.11	Pg11	18,8	5 -10	22	8	80	50
1500.13	Pg13,5	20,5	7 -12	24	10	90	50
1500.16	Pg16	22,6	10 -14	27	10	100	25
1500.21	Pg21	28,5	13 -18	33	12	112	20

Add to Ref: N for Black

spiralblock® standard

BSP thread ISO 228/1

Ref. Light Grey	P	Fixing Hole Ø (mm)	Ø A mini-max (mm)	B Spanner (mm)	C (mm)	L min-max (mm)	Quantity
1500.14	G1/4"	13,5	3- 6,5	15	8	57	100
1500.38	G3/8"	17,0	4- 8	19	9	68	100
1500.12	G1/2"	21,5	7-12	24	10	90	50
1500.34	G3/4"	27,0	13-18	33	12	112	20

Add to Ref: N for Black

1500



Material: POLYAMIDE PA6.6 self-extinguishing class V2 (UL 94)
 Temperature range: -20°C to +90°C (continuous)
 Sealing ring: NEOPRENE® 50 sh A
 Protection: IP 68
 Colour: RAL 7035 light grey, RAL 9005 black

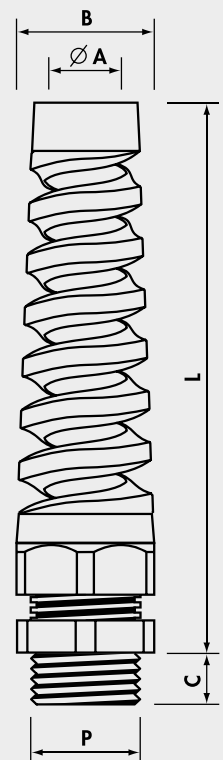

4900



Material: POLYAMIDE PA6.6
 self-extinguishing class V2 (UL 94)
 Safety level: Ex e IIC/Ex tb IIIC
 according to
 EN 60079-0 : 2009
 EN 60079-7 : 2007
 EN 60079-31 : 2009
 Areas of utilisation: 1 & 2, 21 & 22
 Temperature range:
 -20°C to +75°C (continuous)
 Sealing ring: NEOPRENE®
 Protection: IP 65
 Colour: RAL 7035 light grey

MAXIblock® ATEX CABLE GLANDS

Polyamide PA6.6



II 2 GD

Certificate No IMQ ATEX 028X

Metric thread M 1.5 pitch CEI EN 60423 CEI EN 50262

Ref. Light Grey	P	Fixing Hole Ø (mm)	Ø A mini-max (mm)	B Spanner (mm)	C (mm)	L min-max (mm)	Quantity
4900.M12	M12x1,5	12,2	3,5- 6,5	15	8	18-22	100
4900.M16	M16x1,5	16,2	6,5-10	19	8	22-27	100
4900.M20	M20x1,5	20,5	9 -13	25	9	24-30	100
4900.M25	M25x1,5	25,4	11 -17	30	10	28-39	50
4900.M32	M32x1,5	32,5	16 -21	36	10	33-44	25
4900.M40	M40x1,5	40,5	21 -28	46	10	36-45	15
4900.M50	M50x1,5	50,5	27 -35	55	12	43-52	10
4900.M63	M63x1,5	64,0	35 -42	66	12	45-55	5

extended thread

Ref. Light Grey	P	Fixing Hole Ø (mm)	Ø A mini-max (mm)	B Spanner (mm)	C (mm)	L min-max (mm)	Quantity
4901.M12	M12x1,5	12,2	3,5- 6,5	15	15	18-22	100
4901.M16	M16x1,5	16,2	6,5-10	19	15	22-27	100
4901.M20	M20x1,5	20,5	9 -13	25	15	24-30	50
4901.M25	M25x1,5	25,4	11 -17	30	15	30-41	50
4901.M32	M32x1,5	32,5	16 -21	36	15	33-44	25
4901.M40	M40x1,5	40,5	21 -28	46	18	36-45	15
4901.M50	M50x1,5	50,5	27 -35	55	18	43-52	10
4901.M63	M63x1,5	64,0	35 -42	66	18	45-55	5

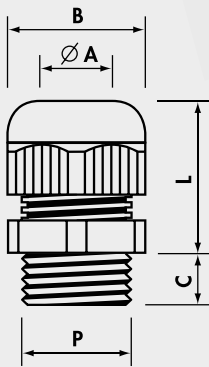

Pg thread DIN 40 430

Ref. Light Grey	P	Fixing Hole Ø (mm)	Ø A mini-max (mm)	B Spanner (mm)	C (mm)	L min-max (mm)	Quantity
4900.07	Pg 7	12,7	3,5- 6,5	15	8	18-22	100
4900.09	Pg 9	15,5	6,5- 8	19	8	22-26	100
4900.11	Pg11	18,8	8 -10	22	8	23-28	100
4900.13	Pg13,5	20,5	9 -12	24	9	24-29	100
4900.16	Pg16	22,6	10 -14	27	10	26-31	50
4900.21	Pg21	28,5	14 -18	33	12	30-35	50
4900.29	Pg29	37,2	18 -22	42	12	33-39	25
4900.36	Pg36	47,2	22 -32	53	14	42-49	10
4900.42	Pg42	54,2	28 -38	60	14	42-50	5
4900.48	Pg48	60,0	38 -45	66	15	45-55	5

extended thread

Ref. Light Grey	P	Fixing Hole Ø (mm)	Ø A mini-max (mm)	B Spanner (mm)	C (mm)	L min-max (mm)	Quantity
4901.07	Pg 7	12,7	3,5- 6,5	15	15	18-22	100
4901.09	Pg 9	15,5	6,5- 8	19	15	22-26	100
4901.11	Pg11	18,8	8 -10	22	15	23-28	100
4901.13	Pg13,5	20,5	9 -12	24	15	24-29	100
4901.16	Pg16	22,6	10 -14	27	15	26-31	50
4901.21	Pg21	28,5	14 -18	33	15	30-35	50
4901.29	Pg29	37,2	18 -22	42	15	33-39	25
4901.36	Pg36	47,2	22 -32	53	18	42-49	10
4901.42	Pg42	54,2	28 -38	60	18	42-50	5
4901.48	Pg48	60,0	38 -45	66	18	45-55	5

COMPRESSION CABLE GLANDS

Polyamide PA6

1700
1400



Pg thread DIN 40 430 - Dimensions DIN 46 320

Ref. Light Grey	P	Fixing Hole Ø (mm)	Ø A min-max (mm)	B1 Spanner (mm)	B2 Spanner (mm)	C (mm)	L min-max (mm)	Quantity Box/Bag
1709	Pg 7	12,7	5,5- 7	15	16	8	16-20	300/100
*1700	Pg 9	15,5	6,5- 8,5	17	20	8	19-22	200/100
*1701	Pg11	18,8	8 -10	19	22	8	21-25	100/100
*1702	Pg13,5	20,5	8 -11	21	24	9	22-26	100/100
1703	Pg16	22,6	11 -14	23	27	10	24-33	50/50
1704	Pg21	28,5	14,5-18	30	33	11	25-32	50/25
1705	Pg29	37,2	19 -26	40	42	11	27-32	20/10
1706	Pg36	47,2	30 -34	50	53	14	33-42	10/10
1707	Pg42	54,2	30 -38	55	60	13	37-48	5/5
1708	Pg48	60,0	38 -44	60	65	14,5	37-48	5/5

*Add to Ref: N for Black

Material: POLYAMIDE PA6 self-extinguishing class VO (UL 94)
Temperature range: -20°C to +90°C (continuous)
Sealing ring: PVC 50 sh A
Protection: IP 54
Colour: RAL 7035 light grey, RAL 9005 black

BSP thread ISO 228/1

Ref. Light Grey	P	Fixing Hole Ø (mm)	Ø A min-max (mm)	B1 Spanner (mm)	B2 Spanner (mm)	C (mm)	L min-max (mm)	Quantity Box/Bag
1400	G1/4"	13,5	5,5- 7	15	16	8	16-20	300/100
*1401	G3/8"	17,0	6,5- 8,5	17	20	8	19-22	200/100
*1401B	G3/8"	17,0	8 -10	19	22	8	18-24	100/100
*1401C	G3/8"	17,0	10 -12	22	24	9	22-26	100/100
*1402	G1/2"	21,5	8 -11	21	24	9	22-26	100/100
1403	G5/8"	23,5	11 -14	23	27	10	24-33	50/50
1404	G3/4"	27,0	14,5-18	30	33	11	25-32	50/25
1405	G1"	34,0	17 -22	34	38	11,5	27-35	20/10
1407	G1"1/2	48,0	30 -34	50	53	14	33-42	10/10
1408	G2"	60,0	38 -44	60	65	14,5	37-48	5/5

*Add to Ref: N for Black

Metric thread M 1.5 pitch CEI EN 60423

Ref. Light Grey	P	Fixing Hole Ø (mm)	Ø A min-max (mm)	B1 Spanner (mm)	B2 Spanner (mm)	C (mm)	L min-max (mm)	Quantity Box/Bag
1730M20	M20x1,5	20,5	8-11	21	24	9	22-26	100

*Add to Ref: N for Black

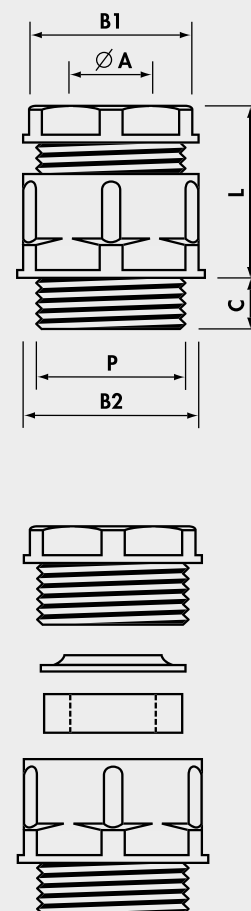

1700T



Material: POLYAMIDE PA6
 self-extinguishing class VO (UL 94)
 Temperature range:
 -20°C to +90°C (continuous)
 Protection: IP 54
 Colour: RAL 7035 light grey,
 RAL 9005 black

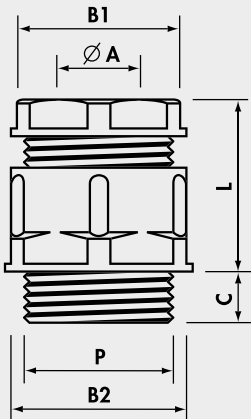

COMPRESSION CABLE GLANDS

Polyamide PA6

Compression cable glands

special Internal blanking disc: PVC 50 sh

Pg thread DIN 40 430 - Dimensions DIN 46 320

Ref. Light Grey	P	Fixing Hole Ø (mm)	Ø A min-max (mm)	B1 Spanner (mm)	B2 Spanner (mm)	C (mm)	L min-max (mm)	Quantity Box/Bag
* 1700T	Pg 9	15,5	6,5- 8,5	17	20	8	19-22	200/100
* 1701T	Pg11	18,8	8 -10	19	22	8	21-25	100/100
* 1702T	Pg13,5	20,5	8 -11	21	24	9	22-26	100/100

*Add to Ref: N for Black

Compression cable gland - reduced cable entry

Sealing ring: CHLOROPRENE, concentric, multi-sector

Pg thread DIN 40 430 - Dimensions DIN 46 320

Ref Light Grey	P	Fixing Hole Ø (mm)	Ø A min-max (mm)	B1 Spanner (mm)	B2 Spanner (mm)	C (mm)	L min-max (mm)	Quantity
1702CONC	Pg13,5	20,5	5,5-13	21	24	9	22-26	100

Add to Ref: N for Black

POLYSTYRENE CABLE GLANDS

Polystyrene PS

1700P



Cable Glands

Sealing ring: PVC 50 sh A - Protection: IP 54

Pg thread DIN 40 430 - Dimensions DIN 46 320

Ref. Light Grey	P	Fixing Hole Ø (mm)	Ø A min-max (mm)	B1 Spanner (mm)	B2 Spanner (mm)	C (mm)	L min-max (mm)	Quantity Box/Bag
1700P	Pg9	15,5	7 - 8,5	17	20	8	19-22	200/100
* 1701P	Pg11	18,8	8 -10	19	22	8	21-25	100/100
* 1702P	Pg13,5	20,5	8 -11	21	24	9	22-26	100/100
1703P	Pg16	22,6	11 -14	24	27	10	24-33	50/50
1704P	Pg21	28,5	14,5-18	30	33	11	25-32	50/25

*Add to Ref: N for Black

Material: POLYSTYRENE PS
 Temperature range:
 -20°C to +60°C (continuous)
 Colour: RAL 7035 light grey,
 RAL 9005 black

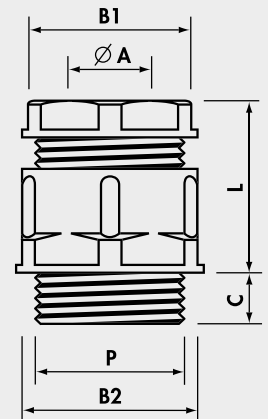

MAXIbrass® CABLE GLANDS

Nickel Plated Brass



2900



Material:
NICKEL PLATED BRASS
(CuZn 39 Pb 3)
Sealing-ring: NEOPRENE®
Cable grip insert:
POLYAMIDE PA6.6
O-Ring: NITRILE 70 sh A
(factory fitted)
Protection: IP 68
Temperature range:
-25°C to +100°C (continuous)

MAXIbrass® standard

Metric thread M 1.5 pitch CEI EN 60423 CEI EN 50262

Ref. Nickel Plated Brass	P	Fixing Hole Ø (mm)	Ø A min-max (mm)	B Spanner (mm)	E (mm)	C (mm)	L min-max (mm)	Quantity
2900.M12N	M12x1,5	12,2	3 - 7	16	18	6,5	16-20	100
2900.M16N	M16x1,5	16,2	4,5-10	20	23	7,0	20-25	100
2900.M20N	M20x1,5	20,5	7 -13	24	27	8,0	20-27	50
2900.M25N	M25x1,5	25,4	10 -17	29	32	8,0	24-30	50
2900.M32N	M32x1,5	32,5	11 -21	36	40	9,0	27-34	25
2900.M40N	M40x1,5	40,5	19 -28	45	50	9,0	34-42	10
2900.M50N	M50x1,5	50,5	26 -35	54	60	10,0	35-43	8
2900.M63N	M63x1,5	64,0	34 -45	67	74	15,0	40-52	5

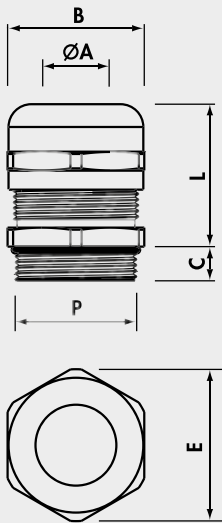

MAXIbrass® reduced cable entry

Metric thread M 1.5 pitch CEI EN 60423 CEI EN 50262

Ref. Nickel Plated Brass	P	Fixing Hole Ø (mm)	Ø A min-max (mm)	B Spanner (mm)	E (mm)	C (mm)	L min-max (mm)	Quantity
2910.M12N	M12x1,5	12,2	1 - 5	16	18	6,5	16-20	100
2910.M16N	M16x1,5	16,2	2,5- 7	20	23	7,0	20-25	100
2910.M20N	M20x1,5	20,5	5 -10	24	27	8,0	20-27	50
2910.M25N	M25x1,5	25,4	6 -13	29	32	8,0	24-30	50
2910.M32N	M32x1,5	32,5	7 -14	36	40	9,0	27-34	25
2910.M40N	M40x1,5	40,5	13 -23	45	50	9,0	34-42	10
2910.M50N	M50x1,5	50,5	20 -29	54	60	10,0	35-43	8
2910.M63N	M63x1,5	64,0	27 -39	67	74	15,0	40-52	5

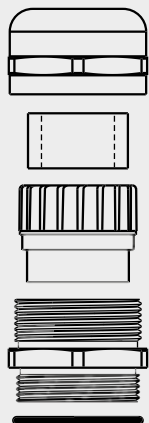

MAXIbrass® CABLE GLANDS

Nickel Plated Brass

2900



MAXIbrass® extended thread

Metric thread M 1.5 pitch CEI EN 60423 CEI EN 50262

Ref. Nickel Plated Brass	P	Fixing Hole Ø (mm)	Ø A min-max (mm)	B Spanner (mm)	E (mm)	C (mm)	L min-max (mm)	Quantity
2901.M12N	M12x1,5	12,2	3 - 7	16	18	12	16-20	100
2901.M16N	M16x1,5	16,2	4,5-10	20	23	12	20-25	100
2901.M20N	M20x1,5	20,5	7 -13	24	27	12	20-27	50
2901.M25N	M25x1,5	25,4	10 -17	29	32	12	24-30	50
2901.M32N	M32x1,5	32,5	11 -21	36	40	15	27-34	25
2901.M40N	M40x1,5	40,5	19 -28	45	50	15	34-42	10
2901.M50N	M50x1,5	50,5	26 -35	54	60	15	35-43	8

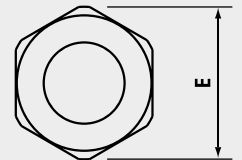
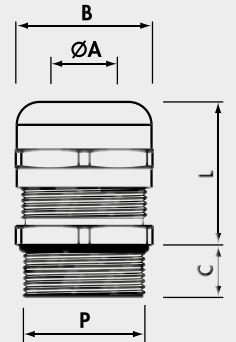

MAXIbrass® extended thread and reduced cable entry

Metric thread M 1.5 pitch CEI EN 60423 CEI EN 50262

Ref. Nickel Plated Brass	P	Fixing Hole Ø (mm)	Ø A min-max (mm)	B Spanner (mm)	E (mm)	C (mm)	L min-max (mm)	Quantity
2911.M12N	M12x1,5	12,2	1 - 5	16	18	12	16-20	100
2911.M16N	M16x1,5	16,2	2,5- 7	20	23	12	20-25	100
2911.M20N	M20x1,5	20,5	5 -10	24	27	12	20-27	50
2911.M25N	M25x1,5	25,4	6 -13	29	32	12	24-30	50
2911.M32N	M32x1,5	32,5	7 -14	36	40	15	27-34	25
2911.M40N	M40x1,5	40,5	13 -23	45	50	15	34-42	10
2911.M50N	M50x1,5	50,5	20 -29	54	60	15	35-43	8

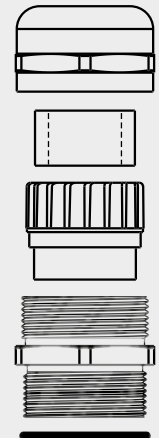

MAXIbrass® CABLE GLANDS

Nickel Plated Brass



2900



Material:
NICKEL PLATED BRASS
(CuZn 39 Pb 3)
Sealing-ring: NEOPRENE®
Cable grip insert:
POLYAMIDE PA6.6
O-Ring: NITRILE 70 sh A
(factory fitted)
Protection: IP 68
Temperature range:
-25°C to +100°C (continuous)

MAXIbrass® standard

Pg thread DIN 40 430

Ref. Nickel Plated Brass	P	Fixing Hole Ø (mm)	Ø A min-max (mm)	B Spanner (mm)	E (mm)	C (mm)	L min-max (mm)	Quantity
2900.07N	Pg 7	12,7	3 - 7	16	18	5,0	16-20	100
2900.09N	Pg 9	15,5	4 - 8	17	19	6,0	17-23	100
2900.11N	Pg11	18,8	4,5-10	20	23	6,0	20-25	100
2900.13N	Pg13,5	20,5	5 -12	22	25	6,5	20-26	50
2900.16N	Pg16	22,6	7 -13	24	27	6,5	20-27	50
2900.21N	Pg21	28,5	10 -17	30	33	7,0	24-30	50
2900.29N	Pg29	37,2	17 -25	40	45	8,0	30-37	25
2900.36N	Pg36	47,2	20 -32	50	55	8,0	38-48	10
2900.42N	Pg42	54,2	28 -38	57	63	10,0	39-48	5
2900.48N	Pg48	60,0	34 -45	67	74	15,0	40-52	5

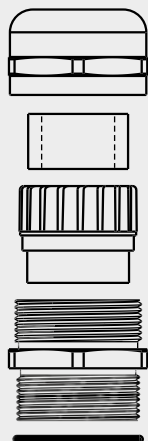
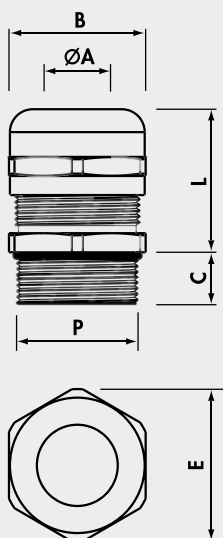

MAXIbrass® reduced cable entry

Pg thread DIN 40 430

Ref. Nickel Plated Brass	P	Fixing Hole Ø (mm)	Ø A min-max (mm)	B Spanner (mm)	E (mm)	C (mm)	L min-max (mm)	Quantity
2910.07N	Pg 7	12,7	1 - 5	16	18	5,0	16-20	100
2910.09N	Pg 9	15,5	2 - 6	17	19	6,0	17-23	100
2910.11N	Pg11	18,8	2,5- 7	20	23	6,0	20-25	100
2910.13N	Pg13,5	20,5	4 -10	22	25	6,5	20-26	50
2910.16N	Pg16	22,6	5 -10	24	27	6,5	20-27	50
2910.21N	Pg21	28,5	6 -13	30	33	7,0	24-30	50
2910.29N	Pg29	37,2	11 -20	40	45	8,0	30-37	25
2910.36N	Pg36	47,2	18 -26	50	55	8,0	38-48	10
2910.42N	Pg42	54,2	24 -31	57	63	10,0	39-48	5
2910.48N	Pg48	60,0	27 -39	67	74	15,0	40-52	5

MAXIbrass® CABLE GLANDS

Nickel Plated Brass

2900

MAXIbrass® extended thread

Pg thread DIN 40 430

Ref. Nickel Plated Brass	P	Fixing Hole Ø (mm)	Ø A min-max (mm)	B Spanner (mm)	E (mm)	C (mm)	L min-max (mm)	Quantity
2901.07N	Pg 7	12,7	3 - 7	16	18	12	16-20	100
2901.09N	Pg 9	15,5	4 - 8	17	19	12	17-23	100
2901.11N	Pg11	18,8	4,5-10	20	23	12	20-25	100
2901.13N	Pg13,5	20,5	5 -12	22	25	12	20-26	50
2901.16N	Pg16	22,6	7 -13	24	27	12	20-27	50
2901.21N	Pg21	28,5	10 -17	30	33	12	24-30	50
2901.29N	Pg29	37,2	17 -25	40	45	15	30-37	25
2901.36N	Pg36	47,2	20 -32	50	55	15	38-48	10
2901.42N	Pg42	54,2	28 -38	57	63	15	39-48	5

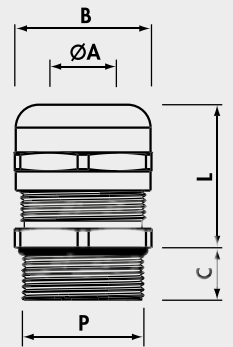

MAXIbrass® extended thread and reduced cable entry

Pg thread DIN 40 430

Ref. Nickel Plated Brass	P	Fixing Hole Ø (mm)	Ø A min-max (mm)	B Spanner (mm)	E (mm)	C (mm)	L min-max (mm)	Quantity
2911.07N	Pg 7	12,7	1 - 5	16	18	12	16-20	100
2911.09N	Pg 9	15,5	2 - 6	17	19	12	17-23	100
2911.11N	Pg11	18,8	2,5- 7	20	23	12	20-25	100
2911.13N	Pg13,5	20,5	4 -10	22	25	12	20-26	50
2911.16N	Pg16	22,6	5 -10	24	27	12	20-27	50
2911.21N	Pg21	28,5	6 -13	30	33	12	24-30	50
2911.29N	Pg29	37,2	11 -20	40	45	15	30-37	25
2911.36N	Pg36	47,2	18 -26	50	55	15	38-48	10
2911.42N	Pg42	54,2	24 -31	57	63	15	39-48	5

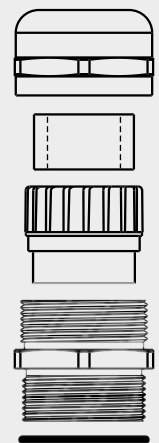
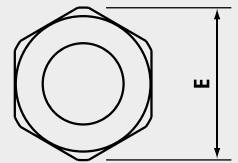

MAXIbrass® ATEX CABLE GLANDS

5900



Nickel Plated Brass



Temperature range: -25°C to +75°C (continuous)
Protection: IP 65

Certificate No IMQ ATEX 028X

Metric thread M 1.5 pitch CEI EN 60423 CEI EN 50262

Material: NICKEL PLATED BRASS
(CuZn 39 Pb 3)
Sealing-ring: NEOPRENE®
Cable grip insert: POLYAMIDE PA6.6
O-Ring: NITRILE 70 sh A (factory fitted)
Safety level: Ex e IIC/Ex tb IIIC
according to
EN 60079-0 : 2009
EN 60079-7 : 2007
EN 60079-31 : 2009
Areas of utilisation: 1 & 2, 21 & 22

Ref. Nickel Plated Brass	P	Fixing Hole Ø (mm)	Ø A min-max (mm)	B Spanner (mm)	E (mm)	C (mm)	L min-max (mm)	Quantity
5900.M12N	M12x1,5	12,2	3 - 6,5	16	18	6,5	16-20	100
5900.M16N	M16x1,5	16,2	6,5-10	20	23	7,0	20-25	100
5900.M20N	M20x1,5	20,5	10 -13	24	27	8,0	20-27	50
5900.M25N	M25x1,5	25,4	11 -17	29	32	8,0	24-30	50
5900.M32N	M32x1,5	32,5	14 -21	36	40	9,0	27-34	25
5900.M40N	M40x1,5	40,5	21 -27	45	50	9,0	34-42	10
5900.M50N	M50x1,5	50,5	26 -35	54	60	10,0	35-43	8
5900.M63N	M63x1,5	64,0	35 -42	67	74	15,0	40-52	5

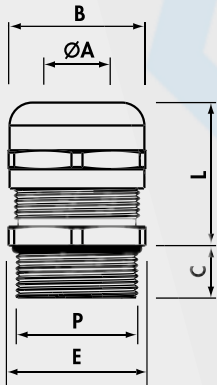

extended thread

Ref. Nickel Plated Brass	P	Fixing Hole Ø (mm)	Ø A min-max (mm)	B Spanner (mm)	E (mm)	C (mm)	L min-max (mm)	Quantity
5901.M12N	M12x1,5	12,2	3 - 6,5	16	18	12	16-20	100
5901.M16N	M16x1,5	16,2	6,5-10	20	23	12	20-25	100
5901.M20N	M20x1,5	20,5	10 -13	24	27	12	20-27	50
5901.M25N	M25x1,5	25,4	11 -17	29	32	12	24-30	50
5901.M32N	M32x1,5	32,5	14 -21	36	40	12	27-34	25
5901.M40N	M40x1,5	40,5	21 -27	45	50	12	34-42	10
5901.M50N	M50x1,5	50,5	26 -35	54	60	12	35-43	8

20M3



EMC CABLE GLANDS

Nickel Plated Brass

Protection: IP 68, 5 bar
Temperature range: -30°C to +120°C (continuous)



Metric thread M 1.5 pitch CEI EN 60423 CEI EN 50262

Material: NICKEL PLATED BRASS
(CuZn 39 Pb 3)
Sealing-ring: CLOROPRENE (CR)
Cable grip insert: PA 6.6
O-Ring: (NBR) (factory fitted)

Ref. Nickel Plated Brass	P	Fixing Hole Ø (mm)	Ø A min-max (mm)	B Spanner (mm)	C (mm)	L max (mm)	Quantity Box/Bag
20M3M1261N	M12x1,5	12,2	3 - 6,5	14	5	22	300/100
20M3M1661N	M16x1,5	16,2	5,5-10	17	5,5	24,5	200/100
20M3M2061N	M20x1,5	20,5	8 -13	22	6	27	100/50
20M3M2561N	M25x1,5	25,4	11 -18	30	7	31	50/25
20M3M3261N	M32x1,5	32,5	15 -21	34	8	33	30/10
20M3M4061N	M40x1,5	40,5	19 -27	44	8	40	20/10
20M3M5061N	M50x1,5	50,5	26 -35	55	9	48	10/5
20M3M6361N	M63x1,5	64,0	39 -48	66	10	50	5/5

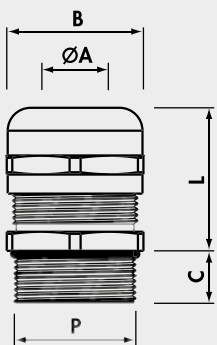

EMC Cable glands and locknuts are designed to work together in electrical or electronic applications where a metallic cable shielding must be equipotential with a metallic enclosure, in accordance with the EMC directive.

Offering IP68 ingress protection at 5 bar pressure, EMC Cable glands will maintain shielding from electromagnetic disturbance in underground applications.

EMC locknuts have serrated teeth to maintain electrical contact through paint or surface coatings, a feature which also enhances vibration resistance.

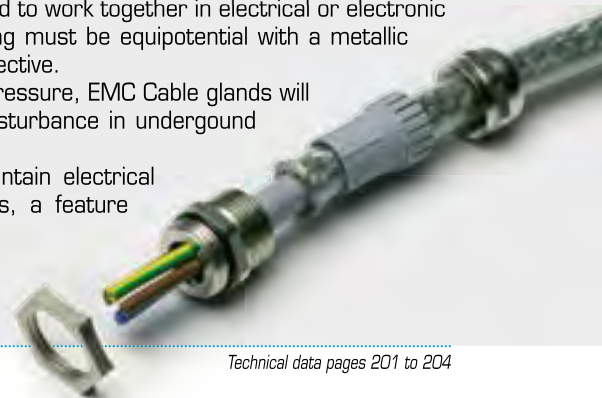



COMPRESSION CABLE GLANDS

Brass

2003
2002
2001

Metric thread M 1.5 pitch CEI EN 60423 CEI EN 50262

Ref. Nickel Plated Brass	P	Fixing Hole Ø (mm)	Ø A min-max (mm)	B1 Spanner Head (mm)	B2 Spanner Body (mm)	C (mm)	L min-max (mm)	Quantity Box/Bag
2003M1221N	M12x1,5	12,2	4 - 6	13	14	5	13-16	500/100
2003M1621N	M16x1,5	16,2	8 -10	15	17	5	14-17	200/100
2003M2021N	M20x1,5	20,5	10 -12	20	22	6	16-19	150/50
2003M2521N	M25x1,5	25,4	17 -19	28	30	7	19-23	50/50
2003M3221N	M32x1,5	32,5	26 -28	37	39	8	21-25	100/50
2003M4021N	M40x1,5	40,5	33 -35	47	50	8	24-30	20/20
2003M5021N	M50x1,5	50,5	39 -41	54	57	9	28-34	10/5
2003M6321N	M63x1,5	64,0	43 -45	60	66/68	10	30-36	10/5



Material: Metric & Pg threads
NICKEL PLATED BRASS
(CuZn 39 Pb 3)
BSP thread - PLAIN BRASS
Protection: IP 54
Sealing ring:
Metric thread - RUBBER 55sh A
Pg thread - RUBBER 55 sh A
BSP thread - PVC 50 sh A

Pg thread DIN 40 430 - Dimensions DIN 46 320

Ref. Nickel Plated Brass	P	Fixing Hole Ø (mm)	Ø A min-max (mm)	B1 Spanner Head (mm)	B2 Spanner Body (mm)	C (mm)	L min-max (mm)	Quantity Box/Bag
200200721N	Pg 7	12,7	5 - 7	13	14	5	13-16	400/100
200200921N	Pg 9	15,5	8 -10	15	17	6	14-17	300/100
200201121N	Pg11	18,8	8 -10	18	20	6	14-18	200/50
200201321N	Pg13,5	20,5	10 -12	20	22	6,5	16-19	100/50
200201621N	Pg16	22,6	12 -14	22	24	6,5	17-20	50/50
200202121N	Pg21	28,5	17 -19	28	30	7	19-23	50/50
200202921N	Pg29	37,2	26 -28	37	40	8	21-25	15/15
200203621N*	Pg36	47,2	33 -35	47	50	9	24-30	10/10
200204221N	Pg42	54,2	39 -41	54	57	10	28-34	10/10
200204821N*	Pg48	60,0	43 -45	60	64	10	36-45	10/10

* Double sealing ring

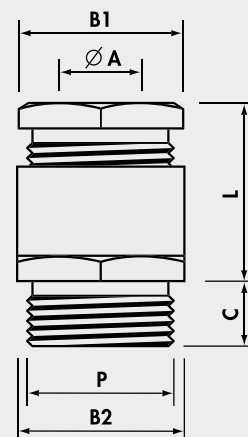

BSP thread ISO 228/1

Ref. Nickel Plated Brass	P	Fixing Hole Ø (mm)	Ø A min-max (mm)	B1 Spanner Head (mm)	B2 Spanner Body (mm)	C (mm)	L min-max (mm)	Quantity Box/Bag
200101441	G1/4"	13,5	5,5 - 7	13	15	6,5	14-17	400/100
207101441	G1/4"	13,5	5,5 - 7	13	∅15	6,5	14-17	400/100
200103841	G3/8"	17,0	6,5 - 8,5	17	19	7,5	15-19	200/100
200101241	G1/2"	21,5	8 -11	21	23	8	17-23	100/100
200105841	G5/8"	23,5	11 -14	23	25	8,5	20-24	100/50
200103441	G3/4"	27,0	14,5-17,5	27	29	9	20-26	50/50
200110041	G1"	34,0	18 -22	34	36	10	23-28	25/25
200111841	G1"1/8	38,0	21 -26	38	40	10,5	23-28	25/25
200111441	G1"1/4	42,0	28 -32	42	45	11,5	25-31	20/20
200111241	G1"1/2	48,0	32 -36	48	50	11,5	28-35	20/20
200120041	G2"	60,0	38 -42	60	64	13,5	31-37	10/10
• 200121221*	G2"1/2	76,0	44 -57	80	80	20	32-37	5/5
• 200130021	G3"	89,0	67 -69	95	95	20	42-52	5/5

Add to Ref: N for NICKEL PLATED BRASS

• Sealing ring: CLOROPRENE

* Concentric sealing ring

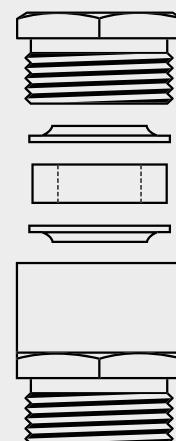

MAXIinox CABLE GLANDS



7900
7900A



Stainless Steel 303 (X8 CrNiS 18-9)

Stainless Steel 316L (X2 CrNiMo 17-12-2)

Material:
STAINLESS STEEL 303/316L
Sealing-ring: NEOPRENE®
Cable grip insert:
POLYAMIDE PA6.6
O-Ring: NITRILE 70 sh A
(factory fitted)
Protection: IP 68
Temperature range:
-25°C to +100°C (continuous)

MAXIinox Stainless Steel AISI 303

Metric thread M 1.5 pitch CEI EN 60423 CEI EN 50262

Stainless Steel AISI 303	P	Fixing Hole Ø (mm)	Ø A min-max (mm)	B Spanner (mm)	E (mm)	C (mm)	L min-max (mm)	Quantity Box/Bag
7900.M12	M12x1,5	12,2	3 - 7	16	18	6,5	16-20	90/30
7900.M16	M16x1,5	16,2	4,5-10	20	23	7,0	20-25	120/30
7900.M20	M20x1,5	20,5	7 -13	24	27	8,0	20-27	75/25
7900.M25	M25x1,5	25,4	10 -17	29	32	8,0	24-30	40/20
7900.M32	M32x1,5	32,5	11 -21	36	40	9,0	27-34	15
7900.M40	M40x1,5	40,5	19 -28	45	50	9,0	34-42	15
7900.M50	M50x1,5	50,5	26 -35	54	60	10,0	35-43	10
7900.M63	M63x1,5	64,0	34 -45	67	74	15,0	40-52	5

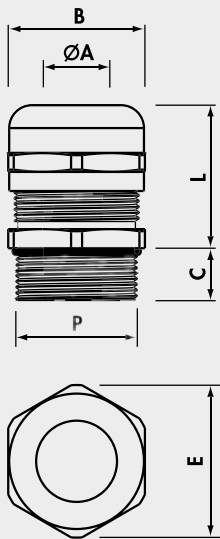

MAXIinox Stainless Steel AISI 316L

Metric thread M 1.5 pitch CEI EN 60423 CEI EN 50262

Stainless Steel AISI 316L	P	Fixing Hole Ø (mm)	Ø A min-max (mm)	B Spanner (mm)	E (mm)	C (mm)	L min-max (mm)	Quantity Box/Bag
7900A.M12	M12x1,5	12,2	3 - 7	16	18	6,5	16-20	60/20
7900A.M16	M16x1,5	16,2	4,5-10	20	23	7,0	20-25	80/20
7900A.M20	M20x1,5	20,5	7 -13	24	27	8,0	20-27	60/20
7900A.M25	M25x1,5	25,4	10 -17	29	32	8,0	24-30	30/15
7900A.M32	M32x1,5	32,5	11 -21	36	40	9,0	27-34	12
7900A.M40	M40x1,5	40,5	19 -28	45	50	9,0	34-42	10
7900A.M50	M50x1,5	50,5	26 -35	54	60	10,0	35-43	7
7900A.M63	M63x1,5	64,0	34 -45	67	74	15,0	40-52	5



MAXIinox CABLE GLANDS

Stainless Steel 303 (X8 CrNiS 18-9)

Stainless Steel 316L (X2 CrNiMo 17-12-2)

7900 7900A



MAXIinox Stainless Steel AISI 303

Pg thread DIN 40 430

Stainless Steel AISI 303	P	Fixing Hole Ø (mm)	Ø A min-max (mm)	B Spanner (mm)	E (mm)	C (mm)	L min-max (mm)	Quantity Box/Bag
7900.07	Pg 7	12,7	3 - 7	16	18	5,0	16-20	90/30
7900.09	Pg 9	15,5	4 - 8	17	19	6,0	17-23	90/30
7900.11	Pg11	18,8	4,5-10	20	23	6,0	20-25	60/30
7900.13	Pg13,5	20,5	5 -12	22	25	6,5	20-26	90/30
7900.16	Pg16	22,6	7 -13	24	27	6,5	20-27	60/30
7900.21	Pg21	28,5	10 -17	30	33	7,0	24-30	40/20
7900.29	Pg29	37,2	17 -25	40	45	8,0	30-37	30/15
7900.36	Pg36	47,2	20 -32	50	55	8,0	38-48	10
7900.42	Pg42	54,2	28 -38	57	63	10,0	36-46	5
7900.48	Pg48	60,0	34 -45	67	74	15,0	40-52	5

Material: STAINLESS STEEL 303/316L
 Sealing-ring: NEOPRENE®
 Cable grip insert: POLYAMIDE PA6.6
 O-Ring: NITRILE 70 sh A (factory fitted)
 Protection: IP 68
 Temperature range: -25°C to +100°C (continuous)

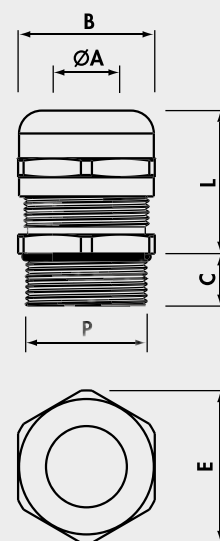

MAXIinox Stainless Steel AISI 316L

Pg thread DIN 40 430

Stainless Steel AISI 316L	P	Fixing Hole Ø (mm)	Ø A min-max (mm)	B Spanner (mm)	E (mm)	C (mm)	L min-max (mm)	Quantity Box/Bag
7900A.07	Pg 7	12,7	3 - 7	16	18	5,0	16-20	60/20
7900A.09	Pg 9	15,5	4 - 8	17	19	6,0	17-23	60/20
7900A.11	Pg11	18,8	4,5-10	20	23	6,0	20-25	100/20
7900A.13	Pg13,5	20,5	5 -12	22	25	6,5	20-26	100/20
7900A.16	Pg16	22,6	7 -13	24	27	6,5	20-27	40/20
7900A.21	Pg21	28,5	10 -17	30	33	7,0	24-30	60/15
7900A.29	Pg29	37,2	17 -25	40	45	8,0	30-37	20/10
7900A.36	Pg36	47,2	20 -32	50	55	8,0	38-48	7
7900A.42	Pg42	54,2	28 -38	57	63	10,0	36-46	5
7900A.48	Pg48	60,0	34 -45	67	74	15,0	40-52	5

LOCKNUTS WITH COLLAR

Polyamide PA6 or PA6.6

1143
1142
1141

Material: POLYAMIDE PA6 or 6.6
self-extinguishing class V2 (UL 94)
Temperature range:
-20°C to +90°C (continuous)
Colour: RAL 7035 light grey,
RAL 9005 black,
RAL 7001 dark grey

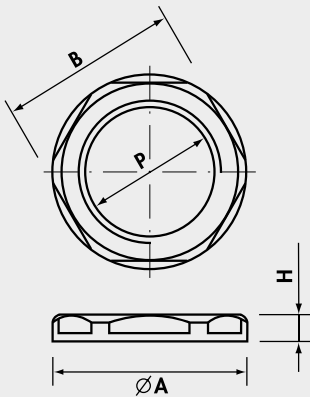

Metric thread M 1.5 pitch CEI EN 60423

Ref. Light Grey	P	Ø A (mm)	B Spanner (mm)	H (mm)	Quantity Box/Bag
1143M12	M12X1,5	18,5	17	5	1.000/100
1143M16	M16X1,5	24	22	5	600/100
1143M20	M20X1,5	29	27	6	400/100
1143M25	M25X1,5	35,5	32	6	100
1143M32	M32X1,5	45	41	7	50
1143M40	M40X1,5	55	50	7	30
1143M50	M50X1,5	65	60	8	30
1143M63	M63X1,5	82	75	8	15

Add to Ref: N for Black, G for Dark Grey

Pg thread DIN 40 430 - Dimensions DIN 46 320

Ref. Light Grey	P	Ø A (mm)	B Spanner (mm)	H (mm)	Quantity Box/Bag
1142007	Pg 7	21	19	5	100
1142009	Pg 9	24	22	5	700/100
1142011	Pg11	26	24	5	500/100
1142013	Pg13,5	29	27	6	400/100
1142016	Pg16	33	30	6	100
1142021	Pg21	39	36	7	200/50
1142029	Pg29	50	46	7	50
1142036	Pg36	66	60	8	30
1142042	Pg42	73	65	8	25
1142048	Pg48	78	70	8	20

Add to Ref: N for Black, G for Dark Grey

BSP thread ISO 228/1

Ref. Light Grey	P	Ø A (mm)	B Spanner (mm)	H (mm)	Quantity Box/Bag
1141012	G1/2"	29	27	6	400/100
1141112	G1"1/2	66	60	8	30
1141200	G2"	78	70	8	20

Add to Ref: N for Black

LOCKNUTS WITHOUT COLLAR

Polyamide PA6 or PA6.6

1112
1710
1410



Metric thread M 1.5 pitch CEI EN 60423

Ref. Light Grey	P	B Spanner (mm)	H (mm)	Quantity Box/Bag
1112	M12X1,5	17	5	1.000/100
1116	M16X1,5	22	5	700/100
1120	M20X1,5	27	6	400/100
1125	M25X1,5	32	6	100
1132	M32X1,5	41	7	50
1140	M40X1,5	50	7	30
1150	M50X1,5	60	8	30
1163	M63X1,5	75	8	15

Add to Ref: N for Black

Pg thread DIN 40 430 - Dimensions DIN 46 320

Ref. Light Grey	P	B Spanner (mm)	H (mm)	Quantity Box/Bag
* 1719E17	Pg 7	17	5	1.000/100
1719	Pg 7	19	5	100
1710	Pg 9	22	5	700/100
1711	Pg11	24	5	500/100
1712	Pg13,5	27	6	400/100
1713	Pg16	30	6	100
△*1714E34	Pg21	34	7	200/100
1714	Pg21	36	7	200/100
1715	Pg29	46	7,5	100/50

Add to Ref: N for Black

△ Light Grey only

* Not DIN 46 320

BSP thread ISO 228/1

Ref. Light Grey	P	B Spanner (mm)	H (mm)	Quantity Box/Bag
1410	G1/4"	19	5	800/100
1411	G3/8"	23	6	600/100
1412	G1/2"	27	6	400/100
1413	G5/8"	30	6	100
1414	G3/4"	34	7	200/100
1415	G1"	40	7	50

Add to Ref: N for Black

Material:
POLYAMIDE PA6 or 6.6
self-extinguishing class V2 (UL 94)
Temperature range:
-20°C to +90°C (continuous)
Colour: RAL 7035 light grey,
RAL 9005 black

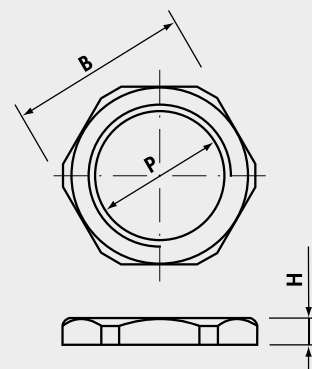

2033
2032
2031

LOCKNUTS

Brass



Metric thread M 1.5 pitch CEI EN 60423

Ref. Nickel Plated Brass	P	B Spanner (mm)	H (mm)	Quantity Box/Bag
2033M12N	M12X1,5	16	2,8	2.000/100
2033M16N	M16X1,5	19	2,8	1.000/100
2033M20N	M20X1,5	24	3	600/100
2033M25N	M25X1,5	30	4,0	400/50
2033M32N	M32X1,5	36	4	250/25
2033M40N	M40X1,5	45	5,0	150/10
2033M50N	M50X1,5	60	5	100/10
2033M63N	M63X1,5	70	5,5	50/5

Pg thread DIN 40 430 - Dimensions DIN 46 320

Ref. Nickel Plated Brass	P	B Spanner (mm)	H (mm)	Quantity Box/Bag
2032007N	Pg 7	16*	2,8	1.500/100
2032009N	Pg 9	18	2,8	1.500/100
2032011N	Pg11	21	3	1.000/100
2032013N	Pg13,5	23	3	1.000/100
2032016N	Pg16	26	3	600/100
2032021N	Pg21	32	3,5	500/100
2032029N	Pg29	41	4	300/100
2032036N	Pg36	51	5	100/10
2032042N	Pg42	60	5	50/10
2032048N	Pg48	64	5,5	50/10

*Different dimension to DIN 46320

BSP thread ISO 228/1

Ref. Plain Brass	P	B Spanner (mm)	H (mm)	Quantity Box/Bag
2031014	G1/4"	16	3	2.400/100
2031038	G3/8"	19	3	2.000/100
2031012	G1/2"	24	3,5	1.000/100
2031058	G5/8"	26	4	500/50
2031034	G3/4"	30	4	500/50
2031100	G1"	37	4	250/25
2031118	G1"1/8	41	4,5	100/25
2031114	G1"1/4	45	4,5	200/20
2031112	G1"1/2	52	5,5	100/20
2031200	G2"	64	7	50/10
2031212	G2"1/2	80	7	20/5
2031300	G3"	95	8	20/5

Add to Ref: N for NICKEL PLATED BRASS

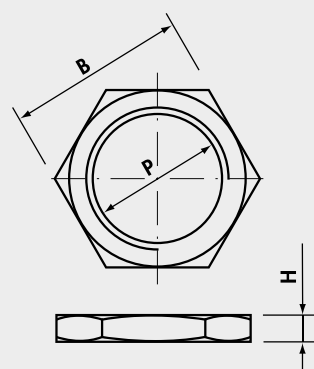
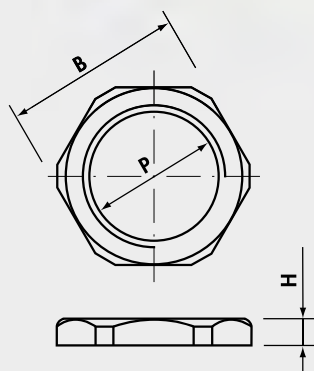

EMC LOCKNUTS

Nickel Plated Brass

20N3



EMC Locknuts

Material: NICKEL PLATED BRASS (CuZn 40 Pb 3)

Metric thread M 1.5 pitch CEI EN 60423

Ref. Nickel Plated Brass	P	B Spanner (mm)	H (mm)	Quantity Box/Bag
20N3M12N	M12X1,5	15	4,1	1000/100
20N3M16N	M16X1,5	19	4,2	1000/100
20N3M20N	M20X1,5	24	4,2	500/100
20N3M25N	M25X1,5	30	4,8	400/100
20N3M32N	M32X1,5	36	5,4	200/100
20N3M40N	M40X1,5	46	6,2	100/50
20N3M50N	M50X1,5	60	7	50/50
20N3M63N	M63X1,5	70	7	50/25

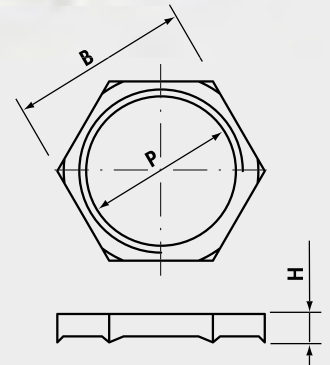

MAXInox LOCKNUTS

Stainless Steel 303 (X8 CrNiS 18-9)

Stainless Steel 316L (X2 CrNiMo 17-12-2)

7032 7033



Metric thread M 1.5 pitch CEI EN 60423

Stainless Steel AISI 303	Stainless Steel AISI 316L	P	B Spanner (mm)	H (mm)	AISI 303 Quantity Box/Bag	AISI 316L Quantity Box/Bag
7033M12	7033AM12	M12X1,5	16	2,8	450/30	300/20
7033M16	7033AM16	M16X1,5	20	2,8	450/30	300/20
7033M20	7033AM20	M20X1,5	24	3,5	250/25	200/20
7033M25	7033AM25	M25X1,5	29	4	160/20	120/15
7033M32	7033AM32	M32X1,5	36	4	105/15	84/12
7033M40	7033AM40	M40X1,5	45	5	60/15	40/10
7033M50	7033AM50	M50X1,5	57	5	40/10	28/7
7033M63	7033AM63	M63X1,5	70	5,5	32/8	20/5

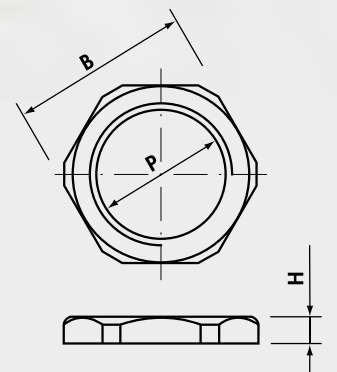

Pg thread DIN 40 430

Stainless Steel AISI 303	Stainless Steel AISI 316L	P	B Spanner (mm)	H (mm)	AISI 303 Quantity Box/Bag	AISI 316L Quantity Box/Bag
7032007	7032A007	Pg 7	16	2,8	450/30	300/20
7032009	7032A009	Pg 9	20	2,8	450/30	300/20
7032011	7032A011	Pg11	22	3	300/30	200/20
7032013	7032A013	Pg13,5	22	3	300/30	200/20
7032016	7032A016	Pg16	27	3	240/30	160/20
7032021	7032A021	Pg21	32	3,5	160/20	150/15
7032029	7032A029	Pg29	41	4	60/15	40/10
7032036	7032A036	Pg36	50	5	40/10	28/7
7032042	7032A042	Pg42	60	5	40/10	20/5
7032048	7032A048	Pg48	64	5,5	32/8	20/5

TCP

INTERNAL PLUGS FOR CABLE GLANDS

Polyamide PA6.6



Material: POLYAMIDE PA6.6
 self-extinguishing class V2 (UL 94)
 Temperature range:
 -20°C to +90°C (continuous)
 Colour: RAL 9005 black
 Application:
 Blanking the cable entry of
MAXIblock[®], **MAXIbrass**[®] and
MAXIinox cable glands and
 maintaining IP 68.

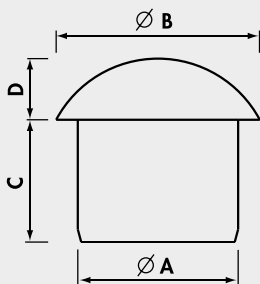

Plugs

Ref.	Suitable for		Ø A (mm)	Ø B (mm)	C (mm)	D (mm)	Quantity Box/Bag
	MAXIblock [®]	MAXIbrass [®] MAXIinox					
TCP5	M12R + Pg7R	M12R	4,5	8,5	10,8	4,5	3.000/100
TCP10	Pg9R	Pg9R	6	12	12	4,5	2.000/100
TCP12	M12 + Pg7	M12 + Pg7	6,8	12	12	4,5	1.000/100
	M16R + Pg11R	M16R + Pg11R					
TCP15	Pg9	Pg9	8	11	11,5	5	1.500/100
TCP18	M16 + Pg11	M16 + Pg11	9,5	12,5	13	5	1.500/100
TCP20	M20R	M20R	10	15	14	6	800/100
	Pg13,5 + Pg13,5R Pg16R	Pg13 + Pg13,5R Pg16R					
TCP25	M20 + Pg16	M20 + Pg16	12,5	17	15	8	400/100
TCP30	M25R + M32R	M25R + M32R	12,5	22,5	18	9	300/100
	Pg21R	Pg21R					
TCP35	M25 + Pg21	M25 + Pg21	16	19,5	18	8	300/100
TCP40	M32	M32	19	22,5	19	9	150/50
TCP45	M40R + Pg29 + Pg36R	M40R + Pg29	22	30	20	10	100/50
TCP50	M40 + M50R + Pg42R	M40 + M50R	27,5	38	25	12	50/25
TCP55	Pg36	Pg36	31,5	36,5	23,5	12	50/25
TCP60	M50	M50	34,5	40	23,5	12	50/25
TCP65	M63R + Pg42 + Pg48R	M63R + Pg42	37,5	48	26,5	12	30/15
TCP70	M63 + Pg48	M63 + Pg48	43	48	26,5	12	30/15

R: reduced cable entry

MULTI-ENTRY SEALS & PLUGS FOR CABLE GLANDS

36 TGM

Material: NEOPRENE® 70 sh A
 Temperature range:
 -40°C to +130°C
 Protection: IP 68
 Colour: RAL 9005 black
 Application:
 IP68 sealing of multiple cables entering
MAXIblock®, **MAXIbrass**® or
MAXIinox cable glands.



Multi-entry seals

Ref.	Suitable for		n° entries	Ø Dia entry (mm)	Quantity Box/Bag
	MAXIblock ®	MAXIbrass ® MAXIinox			
36A3M1623	M16 + Pg11	M16 + Pg11	2	3	1.500/100
36A3M1624	M16 + Pg11	M16 + Pg11	2	4	1.000/100
36A3M16322	M16 + Pg11	M16 + Pg11	3	2,2	1.500/100
36A3M2025	M20 + Pg13,5	M20 + Pg13,5 + Pg16	2	5	500/100
36A3M2034	M20 + Pg13,5	M20 + Pg13,5 + Pg16	3	4	500/100
36A3M20356	M20 + Pg13,5	M20 + Pg13,5 + Pg16	3	5,6	500/100
36A3M2526	M25	M25 + Pg21	2	6	300/50
36A3M2536	M25	M25 + Pg21	3	6	300/50
36A3M2537	M25	M25 + Pg21	3	7	300/50
36A3M2545	M25	M25 + Pg21	4	5	300/50
36A3M2546	M25	M25 + Pg21	4	6	300/50
36A3M2554	M25	M25 + Pg21	5	4	300/50
36A3M3228	M32	M32	2	8	150/50
36A3M3239	M32	M32	3	9	150/50
36A3M32465	M32	M32	4	6,5	150/50
36A3M3248	M32	M32	4	8	150/50
36A3M4078	M40	M40	7	8	100/100
36A3M40106	M40	M40	10	6	100/100
36A3M5088	M50	M50	8	8	50/50
36C201629	Pg16	-	2	3+9	400/50

2 ENTRIES

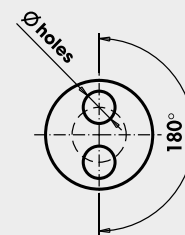

3 ENTRIES

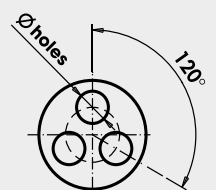

4 ENTRIES

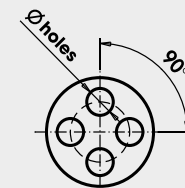

5 ENTRIES

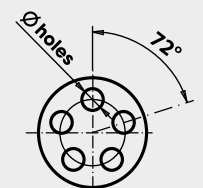

Material: POLYAMIDE PA6.6
 Temperature range:
 -20°C to +90°C (continuous)
 Colour: RAL 7035 light grey

Application:
 Plugging unused entries
 in multi-entry seals and
 maintaining IP68.

Multi-entry seal plugs

Ref.	Suitable for Seal	Ø A	L	Quantity Box/Bag
		(mm)	(mm)	
TGM38	36A3M1623	3	10	5.000/100
TGM48	36A3M1624 + 36A3M2034 + 36A3M2554	4	8	5.000/100
TGM58	36A3M2025	5	8	5.000/100
TGM513	36A3M2545	5	13	2.500/50
TGM613	36A3M2526 + 36A3M2536 + 36A3M40106	6	13	2.000/50
TGM713	36A3M2537	7	13	2.000/50
TGM817	36A3M3248 + 36A3M5088 + 36A3M4078	8	17	100

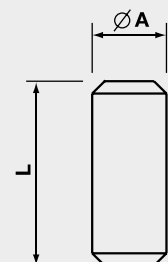

ENTRY THREAD ADAPTERS

Nickel Plated Brass

Entry thread enlargers

Metric thread M 1.5 pitch CEI EN 60423

Ref.	P EXT	P INT	Ø A (mm)	C (mm)	H (mm)	Quantity Box/Bag
20931216N	M12X1,5	M16X1,5	18	5	15,5	500/100
20931620N	M16X1,5	M20X1,5	22	5	17,5	300/100
20932025N	M20X1,5	M25X1,5	27	6	20	150/50
20932532N	M25X1,5	M32X1,5	34	7	22,5	100/50
20932540N	M25X1,5	M40X1,5	42	7	23,5	50/50
20933240N	M32X1,5	M40X1,5	42	8	24,5	50/50
20933250N	M32X1,5	M50X1,5	52	8	27,5	25/25
20934050N	M40X1,5	M50X1,5	52	8	27,5	25/25
20935063N	M50X1,5	M63X1,5	66	9	31	20/10

Entry thread reducers

Metric thread M 1.5 pitch CEI EN 60423

Ref.	P EXT	P INT	Ø A (mm)	C (mm)	H (mm)	Quantity Box/Bag
20431612N	M16X1,5	M12X1,5	18	5	7,5	1.000/100
20432012N	M20X1,5	M12X1,5	22	6	9	600/100
20432016N	M20X1,5	M16X1,5	22	6	9	500/100
20432512N	M25X1,5	M12X1,5	27	7	10	300/50
20432516N	M25X1,5	M16X1,5	27	7	10	300/50
20432520N	M25X1,5	M20X1,5	27	7	10	300/100
20433220N	M32X1,5	M20X1,5	34	8	11	100/25
20433225N	M32X1,5	M25X1,5	34	8	11	200/50
20434025N	M40X1,5	M25X1,5	43	8	11,5	100/25
20434032N	M40X1,5	M32X1,5	43	8	11,5	100/25
20435032N	M50X1,5	M32X1,5	53	9	12,5	50/10
20435040N	M50X1,5	M40X1,5	53	9	12,5	50/25
20436340N	M63X1,5	M40X1,5	66	10	14	30/10
20436350N	M63X1,5	M50X1,5	66	10	14	30/10

Entry thread converters - Metric to Pg

Ref.	P EXT	P INT	Fig.	Ø A (mm)	C (mm)	H (mm)	Quantity Box/Bag
20A42011N	M20X1,5	Pg11	1	22	6,5	17,5	300/100
20A42016N	M20X1,5	Pg16	1	24	6,5	20	200/50
20A42513N	M25X1,5	Pg13,5	2	27	7	10	300/50
20A42516N	M25X1,5	Pg16	2	27	7	10	300/50
20A43216N	M32X1,5	Pg16	2	36	8	11,5	100/25
20A43221N	M32X1,5	Pg21	2	36	8	11,5	100/25

Entry thread converters - Pg to Metric

Ref.	P EXT	P INT	Fig.	Ø A (mm)	C (mm)	H (mm)	Quantity Box/Bag
20A40916N	Pg 9	M16X1,5	1	20	6	15	400/100
20A41120N	Pg11	M20X1,5	1	22	6	16	300/100
20A41320N	Pg13,5	M20X1,5	1	24	6,5	16,5	200/50
20A41620N	Pg16	M20X1,5	2	24	6,5	9,5	50/50
20A42120N	Pg21	M20X1,5	2	30	7	10	100/100
20A42125N	Pg21	M25X1,5	2	30	7	10	100/100
20A42925N	Pg29	M25X1,5	2	39	8	11,5	50/50

2093
2043
20A4



Material: NICKEL PLATED BRASS
(CuZn 40 Pb 3)

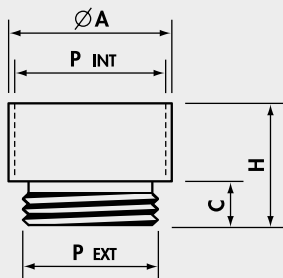

Fig. 1

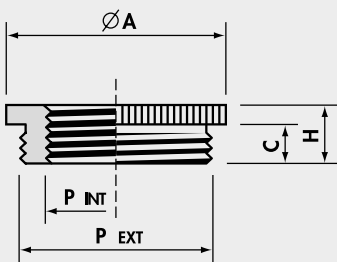

Fig. 2

ENTRY THREAD ADAPTERS

Nickel Plated Brass

1800
2042



Entry thread enlargers

Pg thread DIN 40 430 - Dimensions DIN 46 320-K

Ref.	P EXT	P INT	Ø A (mm)	C (mm)	H (mm)	Quantity Box/Bag
180709	Pg 7	Pg 9	17	5	15	600/100
180911	Pg 9	Pg11	20	6	16,5	500/100
180913	Pg 9	Pg13,5	22	6	17,5	300/100
181113	Pg11	Pg13,5	22	6	17,5	300/100
181116	Pg11	Pg16	24	6	18,5	100/50
181316	Pg13,5	Pg16	24	6,5	19	200/50
181321	Pg13,5	Pg21	30	6,5	21	150/50
181621	Pg16	Pg21	30	6,5	21	100/25
182129	Pg21	Pg29	39	7	23	75/25
182936	Pg29	Pg36	50	8	27,5	30/10
183642	Pg36	Pg42	57	9	31	20/10
184248	Pg42	Pg48	64	10	33	20/10

Material: NICKEL PLATED BRASS
(CuZn 40 Pb 3)

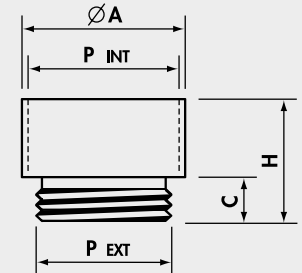

Entry thread reducers

Pg thread DIN 40 430 - Dimensions DIN 46 320-H

Ref.	P EXT	P INT	Ø A (mm)	C (mm)	H (mm)	Quantity Box/Bag
20420907N	Pg 9	Pg 7	17	6	8,5	800/100
20421107N	Pg11	Pg 7	20	6	8,5	600/100
20421109N	Pg11	Pg 9	20	6	8,5	600/100
20421307N	Pg13,5	Pg 7	22	6,5	9	600/100
20421309N	Pg13,5	Pg 9	22	6,5	9	600/100
20421311N	Pg13,5	Pg11	22	6,5	9	600/100
20421607N	Pg16	Pg 7	24	6,5	9,5	300/50
20421609N	Pg16	Pg 9	24	6,5	9,5	400/100
20421611N	Pg16	Pg11	24	6,5	9,5	400/100
20421613N	Pg16	Pg13,5	24	6,5	9,5	400/100
20422111N	Pg21	Pg11	30	7	10	200/50
20422113N	Pg21	Pg13,5	30	7	10	200/50
20422116N	Pg21	Pg16	30	7	10	200/50
20422916N	Pg29	Pg16	39	8	11,5	100/25
20422921N	Pg29	Pg21	39	8	11,5	100/25
20423621N	Pg36	Pg21	50	9	12,5	50/25
20423629N	Pg36	Pg29	50	9	12,5	50/25
20424229N	Pg42	Pg29	57	10	14	50/25
20424236N	Pg42	Pg36	57	10	14	50/25
20424836N	Pg48	Pg36	64	10	14	50/25
20424842N	Pg48	Pg42	64	10	14	50/25

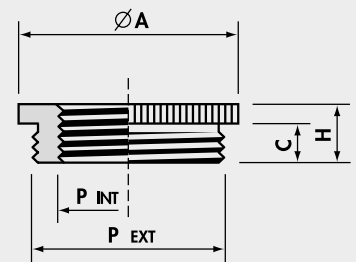

ACCESSORIES

6010

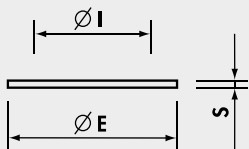
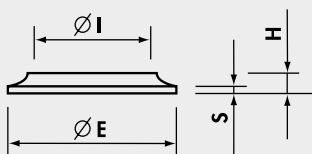

Compression washers

Material: Zinc plated STEEL UNI 5961/84

Ref.	Fits thread	Ø E (mm)	Ø I (mm)	H (mm)	S (mm)	Quantity Box/Bag
6010.14	G1/4"	11	8	1,1	0,5	15.000/1.000
6010.38	G3/8"	14,5	10	1,8	0,5	5.000/1.000
6010.12	Pg13,5 + G1/2"	18	14	1,5	0,5	4.000/1.000
6010.58	Pg16 + G5/8"	20	15,5	2	0,5	3.000/1.000
6010.34	G3/4"	24	18,5	2	0,5	2.500/500
6010.01	G1"	30	24,5	2	0,5	1.500/500
6010.114	G1"1/4	38	33,5	2	0,5	1.000/500
6010.11	Pg11	17	12	1,9	0,5	5.000/1.000
6010.21	Pg21	26,5	20	2,3	0,5	2.000/500
6010.29	Pg29 + G1"1/8	35	26,5	2	0,5	1.000/500
6010.36	Pg36 + G1"1/2	45	38	-	0,8	750/250
6010.42	Pg42	51	42,5	2,3	0,5	500/250
6010.48	Pg48 + G2"	56	47,5	3	0,5	400/100

SEALING RINGS

1880 1890



Concentric sealing rings Material: BUTADIENE-NITRILE NBR with concentric perforations

Ref.	Suitable only for Cable Glands IP54 (1700... 2002...)	Ø E (mm)	Ø 3 (mm)	Ø 2 (mm)	Ø 1 (mm)	Ø I (mm)	H (mm)	Quantity Box/Bag		
1880	Pg9 + M16	13,3	-	-	-	10	7,5	5,5	1.500/100	
1881	Pg11	16,5	-	-	-	12,5	10	7,5	6	1.000/100
1882	Pg13,5 + M20 + G1/2"	18,3	-	-	-	12,5	10	7,5	6	800/100
1883	Pg16 + G5/8"	20,4	-	-	15	12,5	10	7,5	7	600/100
1884	Pg21 + M25	26,0	-	-	19	16	13	10	8	300/100
1884A	Pg21 + M25	26,0	-	-	20,5	18	15	10,5	8	300/100
*1885	Pg29 + M32 + G1 1/8"	34,7	-	-	27	24	21	18	9,5	150/50
1886	Pg36 + G1 1/2" + M40	44,7	-	-	33	30	27	24	12	100/50
*1887	Pg42 + M50	51,7	-	-	39	36	33	30	14	50/25
1888/5	Pg48 + G2" + M63	57,0	45	41	37	33	29	24	14	75/25
*1888	Pg48 + G2" + M63	57,0	-	-	45	42	39	36	14	75/25

*material: RUBBER NR

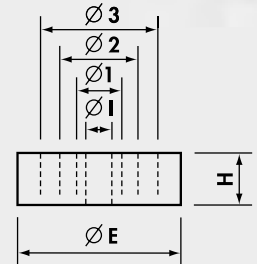

O-rings

Material: BUTADIENE-NITRILE 70 sh

Ref.	Fits thread	Ø E (mm)	Ø I (mm)	H (mm)	Quantity Box/Bag
1889	M12	12,81	9,25	1,78	1.000
1890	Pg7 + G1/4"	14,38	10,82	1,78	5.000/1.000
1890A	M16 + Pg9 + G3/8"	15,98	12,42	1,78	5.000/1.000
1891	Pg11	19,16	15,60	1,78	5.000/1.000
1891A	M20	20,73	17,17	1,78	5.000/1.000
1892	Pg13,5 + G1/2"	22,33	18,77	1,78	5.000/1.000
1892A	Pg16 + G5/8"	23,91	20,35	1,78	5.000/1.000
1892B	M25	25,51	21,95	1,78	5.000/1.000
1893	Pg21	28,68	25,12	1,78	3.000/500
1893A	M32	30,00	26,00	2,00	500
1925,3	G3/4"	30,31	25,07	2,62	1.000/500
1894	G1"	35,06	29,82	2,62	1.000/500
1895	M40 + Pg29 + G1 1/8"	39,84	34,60	2,62	1.000/500
1896	G1 1/4"	43,01	37,77	2,62	500
1897	Pg36 + G1 1/2"	49,36	44,12	2,62	800/100
1898	Pg42 + G1 3/4"	55,71	50,47	2,62	800/100
1899	Pg48 + G2"	62,06	56,82	2,62	100
1899A	G2 1/2"	76,50	69,44	3,53	100/1
1899B	G3"	92,60	81,92	5,34	100/1

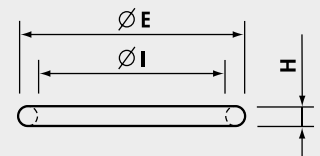

SEALING RINGS

PVC 50 sh A

341
342
343
344



Material: PVC 50 sh A

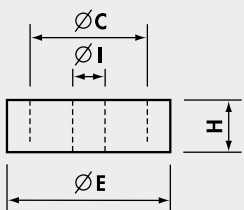
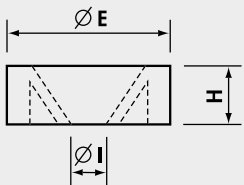
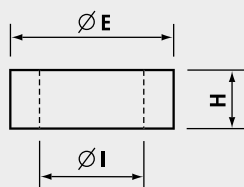

Cylindrical sealing rings

Ref.	Fits thread	C (mm)	Ø E (mm)	Ø I (mm)	H (mm)	Quantity Box/Bag
3411014	G1/4"	-	10,9	6,7	6	1.500/100
3411038	G3/8" + M16	-	14,5	8,5	6	1.000/100
3411012	Pg13,5 + G1/2" + M20	-	18	11	7,5	500/100
3412016	Pg16 + G5/8"	-	20	14	7,5	300/100
3422016	Pg16 + G5/8"	-	20	10	7,5	300/100
3411034	G3/4"	-	23,5	17,5	8	300/100
3411100	G1"	-	29	22	10	200/100
3412011	Pg11	-	16,5	10	7	1.000/100
3412021	Pg21 + M25	-	26	18	8,5	300/100
3422021	Pg21 + M25	-	26	13	8,5	250/50
3412029	Pg29 + G1"1/8 + M32	-	35	26	10	200/100

Membrane sealing rings

Ref.	Fits thread	C (mm)	Ø E (mm)	Ø I (mm)	H (mm)	Quantity Box/Bag
3431100	G1"	-	29	15	9,5	200/100

Double sealing rings

Ref.	Fits thread	C (mm)	Ø E (mm)	Ø I (mm)	H (mm)	Quantity Box/Bag
3441012	G1/2" + Pg13,5 + M20	13	18,5	8	6,5	500/100
3441034	G3/4"	17	23	12,5	8,5	300/100

SEALING RINGS

357 FD



Material: BUTADIENE-NITRILE NBR 70 sh A

Temperature range: -20°C to +70°C

Colour: RAL 7035 light grey

Ref.	Fits thread	Ø E (mm)	Ø I (mm)	H (mm)	Quantity Box/Bag
3572007	Pg7	16,5	11,5	1	4.000/100
3572011	Pg11	23	17,5	1	2.500/100
35720131	Pg13,5 + M20X1,5 + G1/2"	27,5	20,5	1,4	1.000/100
3572013	Pg13,5	30	20,5	2,2	1.000/100
3572016	Pg16	29	23	2	1.000/100
3572021	Pg21	33,5	27	3	500/100
3573M16	M16X1,5	20,5	16,3	1	3.000/100
3573M20	M20X1,5 + Pg13,5 + G1/2"	25,5	20,5	1	4.000/100
3573M25	M25X1,5	30,5	25,5	1	2.000/100
3573M32	M32X1,5	40,5	32,5	1	1.500/100

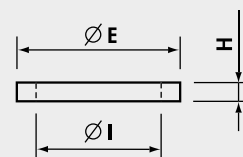

Material: NEOPRENE® 80 sh A

Temperature range: -25°C to +100°C

Colour: RAL 9005 black

Ref.	Fits thread	Ø E (mm)	Ø I (mm)	H (mm)	Quantity Box/Bag
FD M12	M12	16	10	1,2	2.500/50
FD 7	Pg7 + G1/4"	17	11,3	1,2	3.000/50
FD 9	Pg9	20	13,9	1,2	2.000/50
FD M16	M16 + G3/8"	20	15,5	1,2	2.000/50
FD 11	Pg11	23	17,1	1,2	2.000/50
FD M20	M20	24	18	1,2	2.000/50
FD 13,5	Pg13,5 + G1/2"	25	19	1,2	2.500/50
FD 16	Pg16 + G5/8"	27	21	1,2	1.500/50
FD M25	M25	31	23	1,2	1.000/20
FD 21	Pg21 + G3/4"	34,5	27	1,5	1.000/25
FD M32	M32 + G1"	40	30	1,5	600/20
FD 29	Pg29 + G1"1/8"	45	35,2	1,5	500/25
FD M40	M40 + G1"1/4"	48	38	1,5	500/20
FD 36	Pg36 + G1"1/2"	56	45,2	1,5	250/25
FD M50	M50	55	47,5	1,0	10
FD 42	Pg42 + G1"3/4"	62	52	1,0	10
FD 48	Pg48 + G2"	68	58	1,0	10
FD M63	M63	68	60,5	1,0	500/5

ENTRY PLUGS

Polyamide PA6

1053
1052



Material: POLYAMIDE PA6
reinforced with fibreglass
self-extinguishing class VO (UL 94)
Temperature range:
-20°C to +90°C (continuous)
Protection: IP 54
Colour: RAL 7035 light grey,
RAL 9005 black

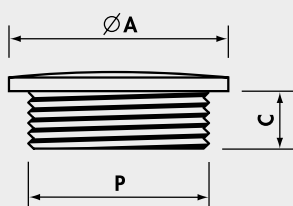

Metric thread M 1.5 pitch CEI EN 60423

Ref. Light Grey	P	Ø A (mm)	C (mm)	Quantity
1053M12	M12X1,5	15	6	100
1053M16	M16X1,5	20	6	100
1053M20	M20X1,5	25	7	100
1053M25	M25X1,5	30	7	100
1053M32	M32X1,5	37	9	50
1053M40	M40X1,5	47	9	30
1053M50	M50X1,5	58	10	20
1053M63	M63X1,5	72	12	10

Add to Ref: N for Black

Pg thread DIN 40 430 - Dimensions DIN 46 320

Ref. Light Grey	P	Ø A (mm)	C (mm)	Quantity Box/Bag
1052007	Pg 7	15	6	100
1052009	Pg 9	19	6	100
1052011	Pg11	22	7	100
1052013	Pg13,5	25	7	100
1052016	Pg16	27	7	100
1052021	Pg21	33	9	50
1052029	Pg29	44	9	100/50
1052036	Pg36	55	10	20
1052042	Pg42	62	10	10
1052048	Pg48	69	12	10

Add to Ref: N for Black

ENTRY PLUGS

Polystyrene PS

1253
1840



Protection: IP 54

Metric thread M 1.5 pitch CEI EN 60423

Ref. Light Grey	P	Ø A (mm)	C (mm)	Quantity
1253M12	M12X1,5	15	6	100
1253M16	M16X1,5	20	6	100
1253M20	M20X1,5	25	7	100
1253M25	M25X1,5	30	7	100
1253M32	M32X1,5	37	9	50
1253M40	M40X1,5	47	9	30
1253M50	M50X1,5	58	10	20
1253M63	M63X1,5	72	12	10

Add to Ref: N for Black

Material: POLYSTYRENE PS
Temperature range:
-20°C to +60°C (continuous)
Colour: RAL 7035 light grey,
RAL 9005 black

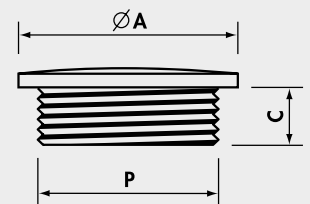

Pg thread DIN 40 430 - Dimensions DIN 46 320

Ref. Light Grey	P	Ø A (mm)	C (mm)	Quantity Box/Bag
1840	Pg 7	15	6	100
1841	Pg 9	19	6	100
1842	Pg11	22	7	100
1843	Pg13,5	25	7	100
1844	Pg16	27	7	100
1845	Pg21	33	9	50
1846	Pg29	44	9	100/50
1847	Pg36	55	10	20
1848	Pg42	62	10	10
1849	Pg48	69	12	10

Add to Ref: N for Black

1700

ENTRY BUSHES

Polyamide PA6



Material: POLYAMIDE PA6
 self-extinguishing class VO (UL 94)
 Temperature range:
 -20°C to +90°C (continuous)
 Colour: RAL 7035 light grey,
 RAL 9005 black

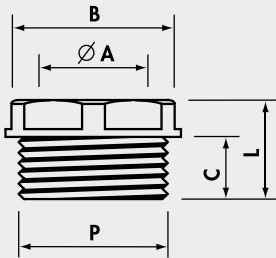

Entry bushes

Pg thread DIN 40 430 - Dimensions DIN 46 320

Ref. Light Grey	P	ØA (mm)	B Spanner (mm)	C (mm)	L (mm)	Quantity Box/Bag
* 1700.2	Pg 9	10	16	9	14	600/100
* 1701.2	Pg11	11,5	19	10	15	300/100
* 1702.2	Pg13,5	13,5	21	11	16,5	300/100
1703.2	Pg16	16	23	12,5	18,5	200/100
1704.2	Pg21	22	30	12	17,5	100/50
1705.2	Pg29	27	40	15	22	50/50

BSP thread ISO 228/1

* 1830	G1/4"	8,5	15	8,5	13,5	800/100
* 1831	G3/8"	11,5	17	9	14	300/100
* 1832	G1/2"	13	21	11	16,5	300/100

Metric thread M 1.5 pitch CEI EN 60423

△1835G	M16X1,5	11,5	17	9	14	100/100
* 1836	M20X1,5	13,5	21	11	16,5	300/100

* Add to Ref: N for Black

△ Dark Grey only

Blind entry bushes

Pg thread DIN 40 430 - Dimensions DIN 46 320

Ref. Light Grey	P	ØA (mm)	B Spanner (mm)	C (mm)	L (mm)	Quantity Box/Bag
* 1702.5	Pg13,5	-	21	11	17	300/100
1703.5	Pg16	-	23	12,5	18,5	200/100

BSP thread ISO 228/1

* 1861	G3/8"	-	17	9	14	600/100
* 1862	G1/2"	-	21	11	16,5	200/100

Metric thread M 1.5 pitch CEI EN 60423

* 1866	M20X1,5	-	21	11	17	100
--------	---------	---	----	----	----	-----

*Add to Ref: N for Black

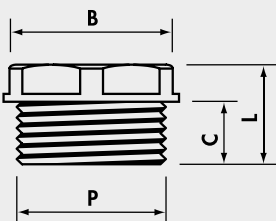

ENTRY PLUGS AND BUSHES

Brass

2053
2052
2021

Entry plugs

Metric thread M 1.5 pitch CEI EN 60423

Ref. Nickel Plated Brass	P	Ø A (mm)	C (mm)	Quantity Box/Bag
2053M12N	M12X1,5	14	5	1,500/100
2053M16N	M16X1,5	18	5	1,000/100
2053M20N	M20X1,5	22	6,5	500/100
2053M25N	M25X1,5	28	7	200/100
2053M32N	M32X1,5	35	8	150/25
2053M40N	M40X1,5	44	8,5	100/25
2053M50N	M50X1,5	54	9	50/25
2053M63N	M63X1,5	67	10	25/25

Pg thread DIN 40 430 - Dimensions DIN 46 320

Ref. Nickel Plated Brass	P	Ø A (mm)	C (mm)	Quantity Box/Bag
2052007N	Pg 7	14	5	1,500/100
2052009N	Pg 9	17	6	1,000/100
2052011N	Pg11	20	6	500/100
2052013N	Pg13,5	22	6,5	500/100
2052016N	Pg16	24	6,5	500/100
2052021N	Pg21	30	7	200/50
2052029N	Pg29	39	8	100/25
2052036N	Pg36	50	9	50/25
2052042N	Pg42	57	10	25/25
2052048N	Pg48	64	10	25/25



Material: Entry plugs - NICKEL PLATED BRASS (CuZn 40 Pb 3)
Entry bushes - PLAIN BRASS
Protection: Entry plugs - IP 54

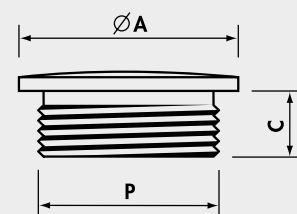

Entry bushes

BSP thread ISO 228/1

Ref. Brass	P	Ø A (mm)	B Spanner (mm)	C (mm)	L (mm)	Quantity Box/Bag
2021014	G1/4"	10	13	6	8,5	1,000/100
2021038	G3/8"	12	17	7,5	10,5	800/100
2021012	G1/2"	16	21	9,5	13	400/100
2021058	G5/8"	18	23	10	13,5	250/50
2021034	G3/4"	21	27	10	14	200/50
2021100	G1"	26,5	34	11	15,5	100/50
2021118	G1"1/8	31	38	12	16,5	100/25
2021114	G1"1/4	35	42	13	18	50/25
2021112	G1"1/2	41,5	48	13	18,5	50/25
2021200	G2"	51,5	60	13,5	19,5	25/25

Add to Ref: N for NICKEL PLATED BRASS

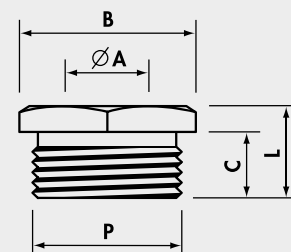

RUTASEAL GROMMETS



RS



Material: EPDM
 Halogen-free and chemical resistant
 Temperature range: -40°C to +110°C
 Protection: IP 67
 Colour: RAL 7001 light grey
 Application:
 IP67 sealing of cables and conduits
 in Metric and Pg threaded entries
 through material thickness 0,5-4 mm

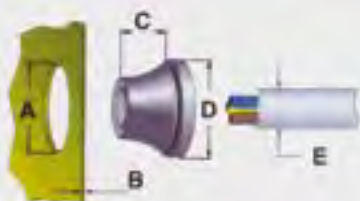

Fits Metric thread

Ref.	Fits Threaded Entry	Dimensions					Quantity Box/Bag
		A (mm)	B (mm)	C (mm)	D (mm)	E (mm)	
RS0407.M12	M12	12,5	0,5 - 2	5,6	20,0	4 - 7	2,000/50
RS0509.M16	M16	16,5	1 - 4	11,0	21,0	5 - 9	2,000/50
RS0813.M20	M20/Pg13,5	20,5	1 - 4	13,4	25,5	8 - 13	3,000/50
RS1117.M25	M25	25,5	1 - 4	15,3	30,5	11 - 17	2,000/50
RS1520.M32	M32	32,5	1 - 4	18,6	38,5	15 - 20	1,000/25
RS1928.M40	M40	40,5	1 - 4	21,7	48,5	19 - 28	600/25
RS2735.M50	M50	50,5	1 - 4	25,0	60,5	27 - 35	250/10

Fits Pg thread

Ref.	Fits Threaded Entry	Dimensions					Quantity Box/Bag
		A (mm)	B (mm)	C (mm)	D (mm)	E (mm)	
RS0305.07	Pg 7	12,5	0,5 - 2	5,4	20,0	3 - 5	2,000/50
RS0507.09	Pg 9	16,0	1 - 4	10,3	21,0	5 - 7	2,000/50
RS0710.11	Pg11	19,0	1 - 4	12,7	24,0	7 - 10	3,000/50
RS1014.16	Pg16	23,0	1 - 4	14,7	28,0	10 - 14	2,000/50
RS1420.21	Pg21	29,0	1 - 4	17,6	35,0	14 - 20	1,000/25
RS2026.29	Pg29	38,0	1 - 4	20,0	46,0	20 - 26	600/25
RS2635.36	Pg36	48,0	1 - 4	23,9	58,0	26 - 35	250/10



MECHANICAL AND PNEUMATIC TOOLS

HP 1



Manual tool, compact and easy to use, equipped with:

- treated Steel crimp jaws with high mechanical properties.
- factory-set ratchet for crimping control (automatic handle opening upon completion of crimping operation).
- Emergency release lever which, if necessary, opens the crimp jaws before their complete closure.
- Ergonomically designed non-slip moulded plastic grips.

Technical features:



Crimpstar[®] HP 1

Crimp style:



Crimping range:	PVC, PC and PA6.6 insulated terminals and connectors for conductor sizes 0,2 to 2,5 sqmm
Dimensions:	
Length (closed handles)	234,5 mm
Width (closed handles)	73,0 mm
Height	18,3 mm
Weight:	512 g
Package dimensions:	240 x 81 x 25 mm



HP 3



Manual tool, compact and easy to use, equipped with:

- treated Steel crimp jaws with high mechanical properties.
- factory-set ratchet for crimping control (automatic handle opening upon completion of crimping operation).
- Emergency release lever which, if necessary, opens the crimp jaws before their complete closure.
- Ergonomically designed non-slip moulded plastic grips.

Technical features:

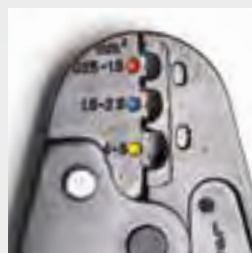

Crimpstar[®] HP 3

Crimp style:



Crimping range:	PVC, PC and PA6.6 insulated terminals and connectors for conductor sizes 0,25 to 6 sqmm
Dimensions:	
Length (closed handles)	234,5 mm
Width (closed handles)	73,0 mm
Height	18,3 mm
Weight:	498 g
Package dimensions:	240 x 81 x 25 mm



MECHANICAL TOOLS *Crimpstar*[®] RANGE

HNN 3



Technical features:



Crimpstar[®] HNN 3

Crimping range:

Dimensions:

Length (closed handles)

Width (closed handles)

Height

Weight:

Package dimensions:

Crimp style:



PA6.6 insulated terminals and connectors for conductor sizes 1,5 to 10 sqmm

234,5 mm

73,0 mm

18,3 mm

491 g

240 x 81 x 25 mm

Manual tool, compact and easy to use, equipped with:

- treated Steel crimp jaws with high mechanical properties.
- factory-set ratchet for crimping control (automatic handle opening upon completion of crimping operation).
- Emergency release lever which, if necessary, opens the crimp jaws before their complete closure.
- Ergonomically designed non-slip moulded plastic grips.



HNN 4



Technical features:



Crimpstar[®] HNN 4

Crimping range:

Dimensions:

Length (closed handles)

Width (closed handles)

Height

Weight:

Package dimensions:

Crimp style:



PA6.6 insulated terminals and connectors for conductor sizes 10 and 16 sqmm

234,5 mm

73,0 mm

18,3 mm

492 g

240 x 81 x 25 mm

Manual tool, compact and easy to use, equipped with:

- treated Steel crimp jaws with high mechanical properties.
- factory-set ratchet for crimping control (automatic handle opening upon completion of crimping operation).
- Emergency release lever which, if necessary, opens the crimp jaws before their complete closure.
- Ergonomically designed non-slip moulded plastic grips.



HPH 1



Manual tool, compact and easy to use, equipped with:

- treated Steel crimp jaws with high mechanical properties.
- factory-set ratchet for crimping control (automatic handle opening upon completion of crimping operation).
- Emergency release lever which, if necessary, opens the crimp jaws before their complete closure.
- Ergonomically designed non-slip moulded plastic grips.

Technical features:

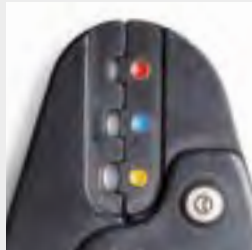

Crimpstar[®] HPH 1

Crimp style:



Through connectors
PE HD insulated, heat shrinkable.
for conductor sizes 0,5 to 6 sqmm
and PA6.6 connectors NL-M, NL-P
for conductor sizes 0,25 to 6 mm²

Crimping range:

Dimensions:

Length (closed handles) 234,5 mm

Width (closed handles) 73,0 mm

Height 18,3 mm

Weight: 512 g

Package dimensions: 240 x 81 x 25 mm



HNKE 4



Manual tool, compact and easy to use, equipped with:

- treated Steel crimp jaws with high mechanical properties.
- factory-set ratchet for crimping control (automatic handle opening upon completion of crimping operation).
- Emergency release lever which, if necessary, opens the crimp jaws before their complete closure.
- Ergonomically designed non-slip moulded plastic grips.

Technical features:



Crimpstar[®] HNKE 4

Crimp style:



End sleeves
for conductor sizes 0,5 to 4 sqmm

Crimping range:

Dimensions:

Length (closed handles) 236 mm

Width (closed handles) 73,0 mm

Height 18,3 mm

Weight: 516 g

Package dimensions: 240 x 81 x 25 mm



MECHANICAL TOOLS *Crimpstar*[®] RANGE

HNKE 16



Technical features:

Crimpstar[®] HNKE 16

Crimp style:



Crimping range:

End sleeves
for conductor sizes 4 to 16 mm²

Dimensions:

Length (closed handles)

236 mm

Width (closed handles)

73,0 mm

Height

18,3 mm

Weight:

491 g

Package dimensions:

240 x 81 x 25 mm

Manual tool, compact and easy to use, equipped with:

- treated Steel crimp jaws with high mechanical properties.
- factory-set ratchet for crimping control (automatic handle opening upon completion of crimping operation).
- Emergency release lever which, if necessary, opens the crimp jaws before their complete closure.
- Ergonomically designed non-slip moulded plastic grips.



HNKE 50



Technical features:

Crimpstar[®] HNKE 50

Crimp style:



Crimping range:

End sleeves
for conductor sizes 25 - 35 - 50 mm²

Dimensions:

Length (closed handles)

234,5 mm

Width (closed handles)

73,0 mm

Height

18,3 mm

Weight:

590 g

Package dimensions:

240 x 81 x 25 mm

Manual tool, compact and easy to use, equipped with:

- treated Steel crimp jaws with high mechanical properties.
- factory-set ratchet for crimping control (automatic handle opening upon completion of crimping operation).
- Emergency release lever which, if necessary, opens the crimp jaws before their complete closure.
- Ergonomically designed non-slip moulded plastic grips.



MECHANICAL TOOLS *Crimpstar*[®] RANGE

HN 1



Manual tool, compact and easy to use, equipped with:

- treated Steel crimp jaws with high mechanical properties.
- factory-set ratchet for crimping control (automatic handle opening upon completion of crimping operation).
- Emergency release lever which, if necessary, opens the crimp jaws before their complete closure.
- Ergonomically designed non-slip moulded plastic grips.

Technical features:



Crimpstar[®] HN 1

Crimp style:



Uninsulated terminals and connectors for conductor sizes 0,25 to 10 sqmm

Crimping range:

Dimensions:

Length (closed handles) 234,5 mm

Width (closed handles) 73,0 mm

Height 18,3 mm

Weight: 480 g

Package dimensions:

240 x 81 x 25 mm



HN 5



Manual tool, compact and easy to use, equipped with:

- treated Steel crimp jaws with high mechanical properties.
- factory-set ratchet for crimping control (automatic handle opening upon completion of crimping operation).
- Emergency release lever which, if necessary, opens the crimp jaws before their complete closure.
- Ergonomically designed non-slip moulded plastic grips.

Technical features:



Crimpstar[®] HN 5

Crimp style:



Uninsulated terminals and connectors for conductor sizes 10 and 16 sqmm

Crimping range:

Dimensions:

Length (closed handles) 234,5 mm

Width (closed handles) 73,0 mm

Height 18,3 mm

Weight: 489 g

Package dimensions:

240 x 81 x 25 mm



HN-A25



Manual tool, compact and easy to use, equipped with:

- treated Steel crimp jaws with high mechanical properties.
- factory-set ratchet for crimping control (automatic handle opening upon completion of crimping operation).
- Emergency release lever which, if necessary, opens the crimp jaws before their complete closure.
- Ergonomically designed non-slip moulded plastic grips.

Technical features:



Crimpstar[®] HN-A25

Crimping range:	Uninsulated terminals and connectors A-M, L-M and L-P series for conductor sizes 10 to 25 mm ²
Dimensions:	
Length (closed handles)	229 mm
Width (closed handles)	78,6 mm
Height	18,3 mm
Weight:	500 g
Package dimensions:	240 x 81 x 25 mm



HN-D25



Manual tool, compact and easy to use, equipped with:

- treated Steel crimp jaws with high mechanical properties.
- factory-set ratchet for crimping control (automatic handle opening upon completion of crimping operation).
- Emergency release lever which, if necessary, opens the crimp jaws before their complete closure.
- Ergonomically designed non-slip moulded plastic grips.

Technical features:



Crimpstar[®] HN-D25

Crimping range:	Cu tube lugs DR (DIN 46235) and through connectors DSV (DIN 46267) for conductor sizes 10 to 25 sqmm
Dimensions:	
Length (closed handles)	229 mm
Width (closed handles)	78,6 mm
Height	18,3 mm
Weight:	500 g
Package dimensions:	240 x 81 x 25 mm



MECHANICAL TOOLS *Crimpstar*[®] RANGE

HF 1



Manual tool, compact and easy to use, equipped with:

- treated Steel crimp jaws with high mechanical properties.
- factory-set ratchet for crimping control (automatic handle opening upon completion of crimping operation).
- Emergency release lever which, if necessary, opens the crimp jaws before their complete closure.
- Ergonomically designed non-slip moulded plastic grips.

Technical features:



Crimpstar[®] HF 1

Crimping range:

Dimensions:

Length (closed handles)

Width (closed handles)

Height

Weight:

Package dimensions:

Crimp style:



Open barrel Brass terminals for conductors sizes 0,5 to 4 sqmm (not BN-FAB/FAR type)

234,5 mm

73,0 mm

18,3 mm

509 g

240 x 81 x 25 mm



HF 2



Manual tool, compact and easy to use, equipped with:

- treated Steel crimp jaws with high mechanical properties.
- factory-set ratchet for crimping control (automatic handle opening upon completion of crimping operation).
- Emergency release lever which, if necessary, opens the crimp jaws before their complete closure.
- Ergonomically designed non-slip moulded plastic grips.

Technical features:



Crimpstar[®] HF 2

Crimping range:

Dimensions:

Length (closed handles)

Width (closed handles)

Height

Weight:

Package dimensions:

Crimp style:



Open barrel Brass terminals for conductors sizes 0,08 to 1,3 sqmm (28 to 16 AWG)

234,5 mm

73,0 mm

18,3 mm

497 g

240 x 81 x 25 mm



MECHANICAL TOOLS *Crimpstar*® RANGE

HX 1



Manual tool, compact and easy to use, equipped with:

- treated Steel crimp jaws with high mechanical properties.
- factory-set ratchet for crimping control (automatic handle opening upon completion of crimping operation).
- Emergency release lever which, if necessary, opens the crimp jaws before their complete closure.
- Ergonomically designed non-slip moulded plastic grips.

Technical features:

Crimpstar® HX 1

Crimp style:



Crimping range:

Coaxial connectors type
RG58, RG59, RG62 and RG 71

Dimensions:

Length (closed handles)

234,5 mm

Width (closed handles)

73,0 mm

Height

18,3 mm

Weight:

481 g

Package dimensions:

240 x 81 x 25 mm



Specific positioner
for Cembre CS4
connectors

HN-CS4



Technical features:

Crimpstar® HN-CS4

Crimp style:

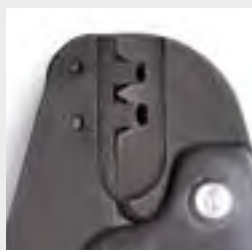

Crimping range:

Cembre CS4 connectors
for conductors sizes 2,5 - 4 - 6 sqmm

Dimensions:

Length (closed handles)

231 mm

Width (closed handles)

78,6 mm

Height

46 mm

Weight:

650 g

Package dimensions:

230 x 85 x 50 mm

Manual tool, compact and easy to use, equipped with:

- treated Steel crimp jaws with high mechanical properties.
- factory-set ratchet for crimping control (automatic handle opening upon completion of crimping operation).
- Emergency release lever which, if necessary, opens the crimp jaws before their complete closure.
- Ergonomically designed non-slip moulded plastic grips.

MECHANICAL TOOLS *nd*[®] RANGE

ND#1



A generation of tools, with a unique mechanism to reduce operator effort. Small and compact, with ergonomically designed handles for ease of operation.

High quality materials combined with advanced design and manufacturing technology, produce a reliable tool with a guaranteed consistent, crimping operation.

Technical features:

ND#1	Crimp style:	
Crimping range:	Insulated and uninsulated end sleeves for conductors sizes 0,3 to 1,5 sqmm	
Dimensions:		
Length (closed handles)	190 mm	
Width (closed handles)	72 mm	
Height	21 mm	
Weight:	470 g	

ND#2



Technical features:

ND#2	Crimp style:	
Crimping range:	Insulated and uninsulated end sleeves for conductors sizes 1 to 6 sqmm	
Dimensions:		
Length (closed handles)	190 mm	
Width (closed handles)	72 mm	
Height	21 mm	
Weight:	470 g	

ND#3



Technical features:

ND#3	Crimp style:	
Crimping range:	Insulated and uninsulated end sleeves for conductors sizes 6 to 16 sqmm	
Dimensions:		
Length (closed handles)	190 mm	
Width (closed handles)	72 mm	
Height	21 mm	
Weight:	470 g	

ND#4



Technical features:

ND#4	Crimp style:	
Crimping range:	Insulated and uninsulated end sleeves for conductors sizes 0,5 to 4 sqmm	
Dimensions:		
Length (closed handles)	190 mm	
Width (closed handles)	72 mm	
Height	21 mm	
Weight:	470 g	

Package dimensions: 195 x 76 x 20 mm



MECHANICAL TOOLS ZKE RANGE

Crimp style:



ZKE 6-F

Tool for crimping end sleeves
0,5 to 6 sqmm
front insertion

Crimp style:



ZKE 610

Single aperture, ratchet controlled tool
for crimping end sleeves,
0,08 to 10 sqmm
side insertion

Crimp style:



ZKE 2

For end sleeves
0,5 to 16 sqmm

MECHANICAL TOOL HWE1

with interchangeable dies

HWE1



Rapid insertion/extraction of
dies without using other tools



A robust and reliable tool designed to
optimise the installers time and
effort. A single tool body with
a range of interchangeable
dies allows a quick and simple
transfer from one cable/connector
combination to another, across a range
of applications.

Technical features

- Length: 240 mm
- Weight: 590 g
- Automatic opening of handles following completion of the crimping operation
- Dull Nickel finish
- Anti-slip handle grips

INTERCHANGEABLE DIES TO ORDER SEPARATELY

INSULATED AND UNINSULATED END SLEEVES

WF16

Size 0,5 ÷ 16 mm²

INSULATED CONNECTORS RED, BLUE AND YELLOW

IT6

Size 0,5 ÷ 6 mm²

PHOTOVOLTAIC CONNECTORS (MULTI-CONTACT)

MC3

Size 4 ÷ 6 mm²

MC4

Size 4 ÷ 6 mm²

INSULATED AND UNINSULATED END SLEEVES

WF6

Size 0,5 ÷ 6 mm²

WF35

Size 16 ÷ 35 mm²



UNINSULATED CABLE LUGS

NIT10

Size 0,5 ÷ 10 mm²

OPEN BARREL BRASS CONNECTORS

OB2.5P

Size 0,5 and 2,5 mm²

SUB-D 075

Size 0,05 and 0,75 mm²

SUB-D 050

Size 0,08 and 0,5 mm²

COAXIAL CONNECTORS

C59

RG58, RG59, RG62

See page 111 for **HB 11** cable stripper



Also available:

HWE1 KIT

comprising:

- HWE1 Manual mechanical tool
- WF16 die
- IT6 die
- all contained in a sturdy plastic case with extra compartments for interchangeable dies

MECHANICAL TOOLS HP4 RANGE

HP4-R

Professional manual mechanical tool with ratchet mechanism that prevents the handles from opening again before reaching the ratchet.

Equipped with a positioning device to reduce the operator's effort and facilitate proper crimping of the conductor. According to the different thicknesses of the conductor insulation, the crimping on the insulation can be carried out by adjusting the jaws through three different settings:

1) strong, 2) medium, 3) light.

The tool is particularly easy to use thanks to its shape and handle coating.

At the end of the crimping the outer surface of the conductor is automatically stamped with the following crimping code:

one point for red conductor sizes from 0.25 to 1.5 mm²



Construction features:

- Special treated and externally protected Steel body, ratchet and handles.
- Handle coating in soft red PVC plastic.

Technical features:



HP4-R

Crimping range:

Dimensions:

Length (closed handles)

Width (closed handles)

Weight:

Package dimensions:

Crimp style:



PVC, PC and PA6.6 insulated terminals and connectors for conductor sizes 0,25 to 1,5 sqmm

265 mm

80 mm

500 g

330 x 110 x 50 mm



HP4-B

Professional manual mechanical tool with ratchet mechanism that prevents the handles from opening again before reaching the ratchet.

Equipped with a positioning device to reduce the operator's effort and facilitate proper crimping of the conductor. According to the different thicknesses of the conductor insulation, the crimping on the insulation can be carried out by adjusting the jaws through three different settings:

1) strong, 2) medium, 3) light.

The tool is particularly easy to use thanks to its shape and handle coating.

At the end of the crimping the outer surface of the conductor is automatically stamped with the following crimping code:

two points for blue conductor sizes from 1.5 to 2.5 mm²



Construction features:

- Special treated and externally protected Steel body, ratchet and handles.
- Handle coating in soft blue PVC plastic.

Technical features:



HP4-B

Crimping range:

Dimensions:

Length (closed handles)

Width (closed handles)

Weight:

Package dimensions:

Crimp style:



PVC, PC and PA6.6 insulated terminals and connectors for conductor sizes 1,5 to 2,5 sqmm

265 mm

80 mm

500 g

330 x 110 x 50 mm



MECHANICAL TOOLS HP4 RANGE

HP4-G



Construction features:

- Special treated and externally protected Steel body, ratchet and handles.
- Handle coating in soft yellow PVC plastic.



Professional manual mechanical tool with ratchet mechanism that prevents the handles from opening again before reaching the ratchet.

Equipped with a positioning device to reduce the operator's effort and facilitate proper crimping of the conductor. According to the different thicknesses of the conductor insulation, the crimping on the insulation can be carried out by adjusting the jaws through three different settings:

1) strong, 2) medium, 3) light.

The tool is particularly easy to use thanks to its shape and handle coating.

At the end of the crimping the outer surface of the conductor is automatically stamped with the following crimping code: three points for yellow conductor from 4 to 6 sqmm

Technical features:

HP4-G

Crimp style:



Crimping range:

PVC, PC and PA6.6 insulated terminals and connectors for conductor sizes 4 to 6 sqmm

Dimensions:

Length (closed handles)

320 mm

Width (closed handles)

105 mm

Weight:

810 g

Package dimensions:

330 x 110 x 50 mm



HP4-C10



Professional manual mechanical tool with ratchet mechanism that prevents the handles from opening again before reaching the ratchet.

The tool is particularly easy to use thanks to its shape and handle coating.

Construction features:

- Specially treated and externally protected Steel body, ratchet and handles.
- Handle coating in soft yellow PVC.

Technical features:

HP4-C10

Crimp style:



Crimping range:

For sleeve connectors type C6-C6 and C10-C10

Dimensions:

Length (closed handles)

325 mm

Width (closed handles)

105 mm

Weight:

730 g

Package dimensions:

330 x 110 x 50 mm



MECHANICAL TOOLS TN RANGE

TN 70SE

Professional manual mechanical tool suitable for crimping A-M Cu lugs and non-insulated L-M and L-P connectors.
Heat treated Steel crimp jaws.
Easily adjustable die positioning by knurled screw and reference vernier scale.
Handles made from anti-slip plastic with hilt.



Technical features:



TN 70SE

Crimp style:



Crimping range:

*Uninsulated terminals and connectors for conductor sizes 6 R/F to 70 R/F mm²

Dimensions:

Length (closed handles)

450 mm

Width (closed handles)

127 mm

Weight:

2 kg

*R= Rigid conductor F= Flexible conductor

TNN 70

Professional manual mechanical tool suitable for the crimping of wire terminals and PA 6.6 insulated connectors.
Heat treated Steel crimp jaws.
Easily adjustable die positioning by knurled screw and reference vernier scale.
Handles made from anti-slip plastic with hilt.



Technical features:



TNN 70

Crimp style:



Crimping range:

*Polyamide PA6.6 insulated terminals and connectors for conductor sizes 10 F to 70 F mm²

Dimensions:

Length (closed handles)

450 mm

Width (closed handles)

127 mm

Weight:

2 kg

*F= Flexible conductor

MECHANICAL TOOLS TN RANGE

TN 120SE



Professional manual mechanical tool suitable for crimping A-M Cu lugs and non-insulated L-M and L-P connectors. Heat treated Steel crimp jaws. Easily adjustable die positioning by knurled screw and reference vernier scale. Handles made from anti-slip plastic with hilt.

Technical features:

TN 120SE

Crimp style:



Crimping range:

*Uninsulated terminals and connectors for conductor sizes 10 R/F to 120 R/150 F mm²

Dimensions:

Length (closed handles)

700 mm

Width (closed handles)

170 mm

Weight:

3 kg

*R= Rigid conductor F= Flexible conductor

TNN 120



Professional manual mechanical tool suitable for the crimping of wire terminals and PA 6.6 insulated connectors. Heat treated Steel crimp jaws. Easily adjustable die positioning by knurled screw and reference vernier scale. Handles made from anti-slip plastic with hilt.

Technical features:

TNN 120

Crimp style:



Crimping range:

*Polyamide PA6.6 insulated terminals and connectors for conductor sizes 10 F to 120 F mm²

Dimensions:

Length (closed handles)

700 mm

Width (closed handles)

170 mm

Weight:

3 kg

*F= Flexible conductor

MECHANICAL TOOLS TND RANGE

TND 6-70

Mechanical tools equipped with rotating dies with hexagonal imprint compliant with **DIN 480863** suitable to crimp Copper lugs according to **DIN 46235** and through connectors according to **DIN 46267 T.1** (refer to page 34-35), Particularly sturdy and easy to handle.



Technical features:



TND 6-70

Crimp style:



Crimping range:

Uninsulated terminals and connectors according to **DIN 46235** and **DIN 46267 T.1** for conductor sizes 6 to 70 mm²

Dimensions:

Length (closed handles)

515 mm

Width (closed handles)

132 mm

Weight:

2 kg

TND 10-120

Mechanical tools equipped with rotating dies with hexagonal imprint compliant with **DIN 480863** suitable to crimp Copper lugs according to **DIN 46235** and through connectors according to **DIN 46267 T.1** (refer to page 34-35), Particularly sturdy and easy to handle.



Technical features:



TND 10-120

Crimp style:



Crimping range:

Uninsulated terminals and connectors according to **DIN 46235** and **DIN 46267 T.1** for conductor sizes 10 to 120 mm²

Dimensions:

Length (closed handles)

665 mm

Width (closed handles)

162 mm

Weight:

3,7 kg

CABLE CUTTERS

KT



KT 1

Cutting Capacity - Section Cond. sqmm

Rigid	Multi-Cond.	Flexible
Cu 16 Al 35	Cu 50 Al 50	Cu 70



KT 2

Cutting Capacity - Section Cond. sqmm

Rigido	Multi-Cond.	Flexible
Cu 16 Al 50	Cu 70 Al 70	Cu 95



KT 5

Hand operated tool for cutting cables up to max section 25 sqmm



KT 3

For cutting cables Ø max 32 mm
Weight: 0,59 kg
Length: 255 mm



KT 4

For cutting cables Ø max 52 mm
Weight: 0,89 kg
Length: 310 mm

511



5116660250

For cutting cables Ø max 18 mm
Weight: 1,5 kg
Length: 600 mm

5116660500

For cutting cables Ø max 25.4 mm
Weight: 3 kg
Length: 800 mm

WIRE STRIPPERS

HB 1-U



Wire stripper for PVC insulated cables 0,1 to 6 sqmm



HB 11



For photovoltaics insulated cables 2,5 to 6 sqmm stripping length 8,5 mm

SCISSORS

SC 1



Electricians scissors with high carbon Steel blades and satin finished Nylon handles.

SC 3X



Multi-purpose scissors with high hardness blades (56 HRC) and anti slide serrations. The moulded plastic handles combine a rigid structure with a softer material for finger comfort. Cutting of flexible conductors up to 35 mm²

SC 4X

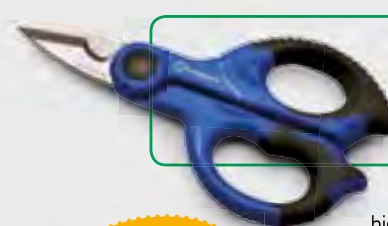

New

Multi-purpose scissors with high hardness blades (56 HRC) and anti slide serrations. The moulded plastic handles combine a rigid structure with a softer material for finger comfort. Cutting of flexible conductors up to 50 mm²

CABLE STRIPPING TOOLS

HB 13UE

Universal cable stripping tool for external sleeves of Low/Medium Voltage cables Ø 12,7 to 63,5 mm and primary insulator in XLPE max Ø 38,1 mm



HB 12N

For vulcanised extruded semiconductor

HB12N cable stripping tool removes the semiconductor layer by being manually rotated around the cable while lateral advancement is achieved automatically. Safe and convenient, it can be used on cables with a semi-con diameter between 18 - 60 mm.

- Sturdy frame in anodised Aluminium alloy and Steel.
- Special Steel blade with precise cutting depth regulation.
- Stripping operation can start at any point along the conductor.
- Bearing mounted rollers provide smooth cutting action.



- With "REVERSE" function, which allows the removal of semiconductor up to 7 mm thick from the sheath of the cable.
- Double speed for each direction.



The **HB 12N** kit includes:

- HB 12N cable stripping tool
- sturdy plastic case

HB 29-U HB 40-U

Wire stripper, for circular cables.



- Three types of cut:
 - Circumferential
 - Linear
 - Spiral
- Blade height adjustable to suit insulation thickness
- Blade profile suits difficult insulation
- PTFE blade housing reduces friction
- Spare blade HBSJ29/40

- **HB 29-U:** Ø 4,5 - 29 mm
- **HB 40-U:** Ø 19 - 40 mm

Dimensions:	HB 29-U	HB 40-U
Length mm:	138	153
Width mm:	38	54
Depth mm:	38	28
Weight g:	100	110

HAND TOOL FOR CUTTING AND SEALING FLEXIBLE CONDUIT

KTS 1632



Cuts and seals flexible plastic conduit in a single operation. Lightweight and easy to operate. Suitable for flexible conduits from Ø16 to Ø32 mm.

Length: 230 mm
Width: 58 mm
Thickness: 32 mm.
Weight: 0,32 kg.

PC 1



Plastic pipe cutting tool
 Cutting capacity: Ø 6 to Ø 42 mm.

Body:
 die-cast Aluminium alloy
Blade material:
 hardened Carbon Steel

FRAME-TYPE HOLE PUNCHING TOOL FOR CABLE TRUNKING

MT-FC48N

Table denotes the punch/die set reference, for each hole size. Suitable for punching holes in mild Steel, fibreglass or plastic material, up to 2 mm thick.

Hole dimensions					Maximum thickness of mild Steel (mm)	Code
Nominal	Ø (inch)	Pg	ISO	Inch		
15,5	.610	Pg9	-	-	2	RD 15.5 SS-FC
16,2	.638	-	ISO-16	-		RD 16.2 SS-FC
17,5	.689	-	-	-		RD 17.5 SS-FC
18,8	.740	Pg11	-	-		RD 18.8 SS-FC
19,1	.752	-	-	-		RD 19.1 SS
20,5	.807	Pg 13,5	ISO-20	-		RD 20.5 SS
22,6	.890	Pg16	-	-		RD 22.6 SS
23,8	.937	-	-	5/8"		RD 23.8 SS
25,4	1.000	-	ISO-25	-		RD 25.4 SS
27,0	1.063	-	-	3/4"		RD 27.0 SS
28,5	1.122	Pg21	-	-		RD 28.5 SS
30,5	1.201	-	-	7/8"		RD 30.5 SS
31,8	1.252	-	-	-		RD 31.8 SS
32,5	1.279	-	ISO-32	-		RD 32.5 SS
34,6	1.362	-	-	-		RD 34.6 SS
37,2	1.464	Pg29	-	-		RD 37.2 SS
38,1	1.500	-	-	-		RD 38.1 SS
40,5	1.594	-	ISO-40	-		RD 40.5 SS-FC
41,3	1.626	-	-	-		RD 41.3 SS-FC
42,5	1.673	-	-	1 1/4"		RD 42.5 SS-FC
43,2	1.701	-	-	-	RD 43.2 SS-FC	
44,5	1.752	-	-	-	RD 44.5 SS-FC	
47,2	1.858	Pg36	-	-	RD 47.2 SS-FC	



New

VAL P30
 Supplied in a robust plastic case.

Lightweight and easy to operate, designed for punching holes up to 47,2 mm diameter in the side wall of trunking without the need for pre drilling.

Max centre of hole to edge of trunking: 53,5 mm

Length : 251,5 mm
Width: 224 mm
Thickness : 66 mm
Weight: 3,28 kg



BENCH PRESS TOOLS

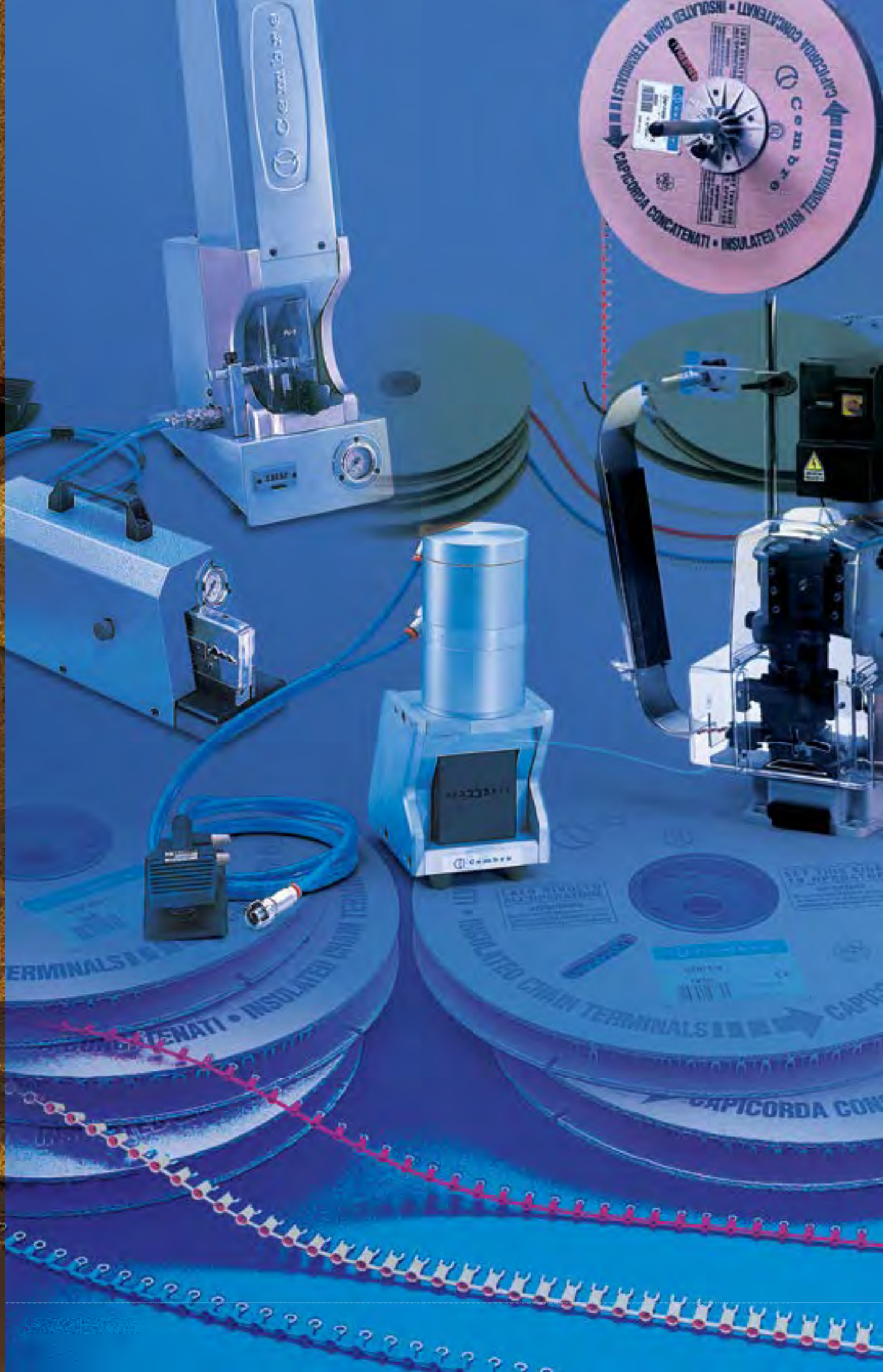

BENCH PRESS TOOLS



PNB-1

INTERCHANGEABLE DIES (to be ordered separately)

Die Set	Guard*	Connector Type	Nominal Conductor Size sqmm
PV-1	PU-1	Insulated connectors	green 0,2÷0,5
PR-1			red 0,25÷1,5
PB-1			blue 1,5÷2,5
PG-1			yellow 4÷6
KE 0.75-1	PK-1	End Sleeves	0,3 - 0,5 - 0,75
KE 2.5-1			1 - 1,5 - 2,5
KE 10-1			4 - 6 - 10
MTT 16-50			16
MTT 25-50	ME-1		25
N1-1	PU-1	A 03-M.. S 1.5..	0,25 - 1,5
		A 06-M.. S 2.5..	1,5 - 2,5
		A 1-M.. S 6..	4 - 6
ME 1-50	PU-1		A1-M.. 4 - 6
ME 2-50			A2-M.. S10-M.. 10
ME 3-50	ME-1	Uninsulated Copper lugs	A3-M.. 16
ME 5-50			A5-M.. 25
ME 7-50			A7-M.. 35
ME 9-50			A9-M.. 50
ME 10-50			A10-M.. 50
ME 12-50			A12-M.. 50
MN 2RF-50			MN RF-1
MN 3RF-50	ANE3-M.. 16		
MN 5RF-50	ANE5-M.. 25		
MN 7RF-50	ANE7-M.. 35		
			ANE9-M.. 35

* Supplied as standard with the machine

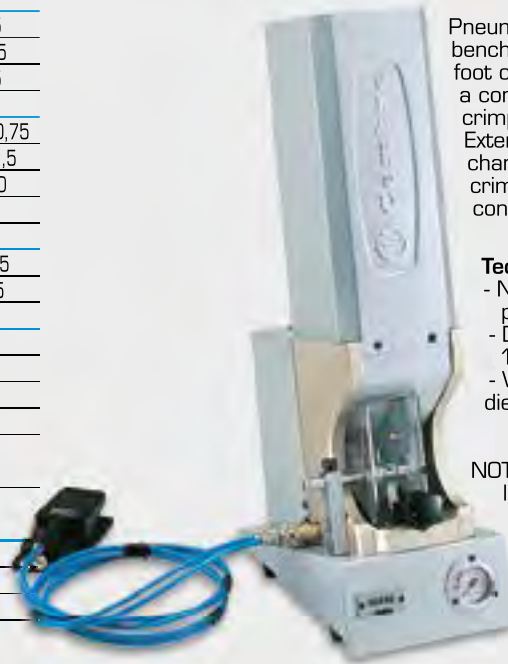

Pneumo-hydraulic, production bench press, controlled by a foot operated pedal, provides a consistent and reliable crimped connection. Extensive range of interchangeable dies available for crimping a wide variety of connectors.

Technical details:

- Nominal operating pressure: 6 bar
- Dimensions LxDxH: 180x320x700 mm
- Weight: 23 kg (without dies)

NOTE: for applications not listed, please contact Cembre.



PNB-3

Tool	Connector Type	Conductor Size sqmm
PNB-3P*	Insulated connectors red, blue and yellow	0,25÷6
PNB-3PD	Insulated terminals and butt connectors - frontal insertion	0,25÷6
PNB-3N1	Uninsulated terminals	0,25÷10
PNB-3N5	Uninsulated terminals	10÷16
PNB-3NN3	Polyamide insulated terminals	1,5÷10
PNB-3NN4	Polyamide insulated terminals	10÷16
PNB-3F/M	Bullet connectors	0,5÷2,5

* Will also crimp Polycarbonate fully-insulated terminals if fitted with PNB3F/M positioner; available as an optional accessory.



Technical details:

- Normal operating pressure: 6±7 bar
- Dimensions LxDxH: 130x370x195 mm
- Weight: 10,3 kg

Pneumatic bench press operated by foot pedal for crimping terminals and connectors 0,25 to 16 sqmm.



PNB-4KE

Tool	Connector Type	Conductor Size sqmm
PNB-4KE	End Sleeves type PK. and type KE	0,3÷10

Technical details:

- Nominal operating pressure: 6 bar
- Dimensions LxDxH: 120x160x300mm
- Weight: 6 kg



Pneumatic bench press, controlled by a foot operated pedal. Supplied with a multi-aperture die suitable for crimping insulated and uninsulated end sleeves from 0,3 to 10 sqmm. Compact and efficient. Easy to operate, producing a secure and reliable crimped connection.

ELECTRICAL CRIMPING TOOL

ECT-KE2.5

Portable



Portable electrical crimping tool for end sleeves 0,14 to 2,5 sqmm with 13 mm crimp length. Crimping occurs automatically when the end sleeve activates an internal pressure switch.

Technical details:

- Supply voltage: 220/230V 50Hz
- Maximum operating temperature: 40 °C
- Crimp length: 13 mm

Tool	Connector Type	Conductor Size sqmm
ECT-KE2.5	End Sleeves type PK.. and type KE	0.14÷2.5



PNEUMATIC CRIMPING TOOLS

Hand held - PNB series



PNB-6KE PNB-7KE

Technical details:

PNB-6KE

Crimping range	0,25 ÷ 2,5 sqmm / 24 ÷ 14 AWG
Weight	400 g
Dimensions	Ø 44 x 200 mm
Spiral hose length	2 m

PNB-7KE

Crimping Range	4 ÷ 10 sqmm / 12 ÷ 8 AWG
Weight	400 g
Dimensions	Ø 44 x 200 mm
Spiral hose length	2 m

PNB-6KE and PNB-7KE hand tools facilitate the rapid crimping of insulated end sleeves while avoiding the operator discomfort associated with ordinary manual tools.

Lightweight and easy to use, these tools are ideal for panel building applications and component assembly.

Both tools are designed to be maintenance-free and need no routine calibration. A 4-6 bar air supply is required for connection via the quick coupler fitted to the hose supplied with the tool.



PNEUMATIC CRIMPING TOOLS

Bench mounted tools with foot pedal - PNB series

PNB-6KE-T PNB-7KE-T



PNB-6KE-T

Crimping range	0,25 ÷ 2,5 sqmm / 24 ÷ 14 AWG
Weight	1000 g
Dimensions	Ø 140 x 200 x 70 mm
Inclusive of spiral hose, foot pedal and bench mount with storage	

Technical details:

PNB-7KE-T

Crimping Range	4 ÷ 10 sqmm / 12 ÷ 8 AWG
Weight	1000 g
Dimensions	Ø 140 x 200 x 70 mm
Inclusive of spiral hose, foot pedal and bench mount with storage	



PNB-6KE-T and **PNB-7KE-T** have bench mounts with storage and are foot pedal operated to allow operators to have both hands free when assembling cable harnesses.

Both tools are designed to be maintenance-free and need no routine calibration. A 4-6 bar air supply is required for connection via the quick coupler fitted to the hose supplied with the tool.

BENCH PRESS

ELB-3

for Polycarbonate insulated chain connectors



Electro-pneumatic, production bench press, controlled by a foot operated pedal. Producing a consistent and reliable crimped connection. Interchangeable application heads available to suit the complete range of Polycarbonate insulated connectors.

Technical details:

- Air supply: 6 bar (90 psi)
- Dimensions LxDxH: 180x250x620mm
- Weight: 41 kg (without application heads)
- Motor:
 - Power 0,55 kW / 0,75 HP
 - Supply Voltage 220 V / 50 Hz
 - Speed 2.800 r.p.m

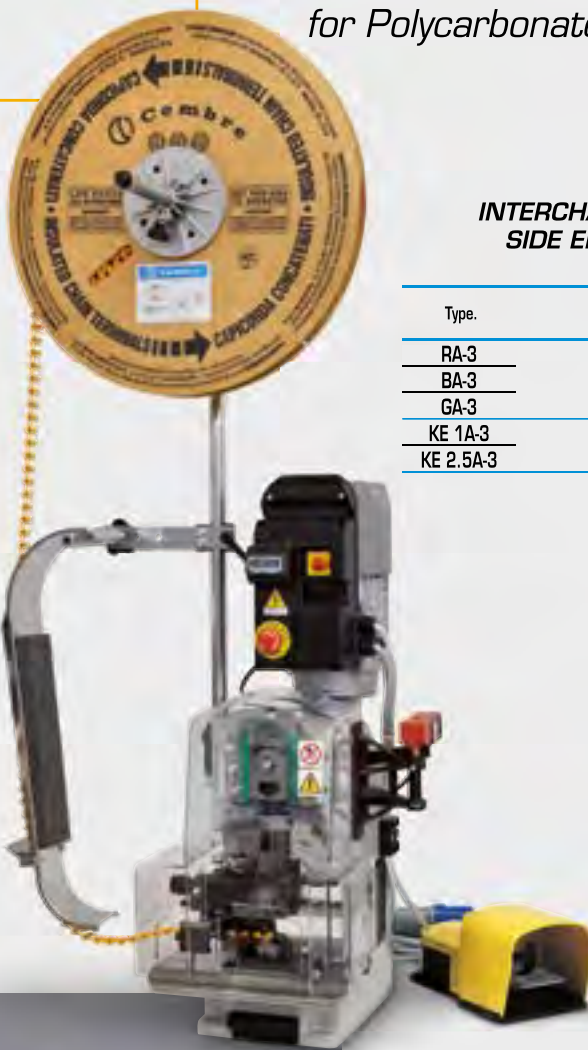

INTERCHANGEABLE APPLICATOR HEADS, SIDE ENTRY WITH PNEUMATIC FEED (ORDER AS REQUIRED)

Type.	Connectors	Conductor Size sqmm
RA-3	Polycarbonate insulated chain terminals	red
BA-3		blue
GA-3		yellow
KE 1A-3	Insulated chain end sleeves	0,5÷1
KE 2.5A-3		1÷2,5



OPERATING TEMPERATURE UP TO 115°C

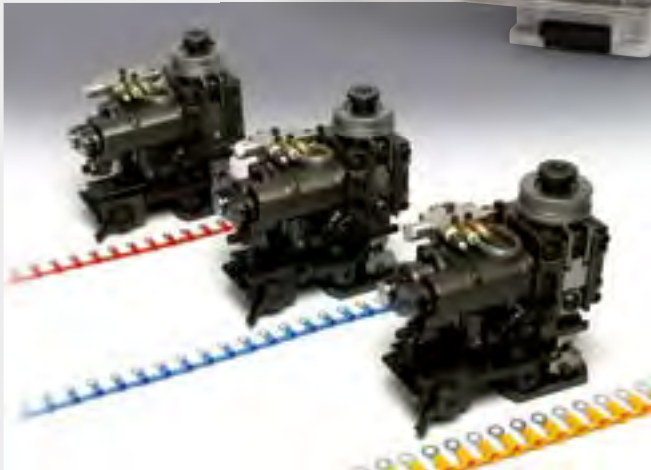

See pages 6-7 and 16 for types and features of the insulated chain connectors and end sleeves.



HYDRAULIC CRIMPING TOOLS AND CUTTERS

HYDRAULIC CRIMPING TOOL

HT 45-E

general features

Crimping force kN	Dimensions mm		Weight kg
	length	width	
50	346	130	2,0

MAIN APPLICATIONS - max section mm²

L.V. lugs and splices	"C" sleeve connectors	H.V. lugs and splices
150	35	70

STORAGE

Type	Dimensions mm	Weight kg	Supplied with the tool	Purchase separately
VAL P1*	445x290xh95	1,2	✳	—

*Suitable for storage of the tool and 20 sets of dies.

Lightweight and compact, this tool is ideal for the compression of connectors on overhead lines and other general applications.

Having the benefit of spring loaded handles, the dies can be advanced using only one hand; therefore leaving the other hand free to position the connector.

For ease of operation and comfort of the operator, the tool head can be fully rotated through 180 degrees.

The built-in safety valve will by-pass the oil supply when the maximum pressure is reached, and a pressure releasing system can easily be operated at any stage of the compression.



The operator can advance the dies using only one hand, leaving the other hand free to position the connector.

Openable head, ideal for derivations from running conductors

180° rotatable head, to work in the most comfortable position

Safety valve bypassing the oil supply when the maximum pressure is reached

Pressure releasing system, that can be operated at any stage.

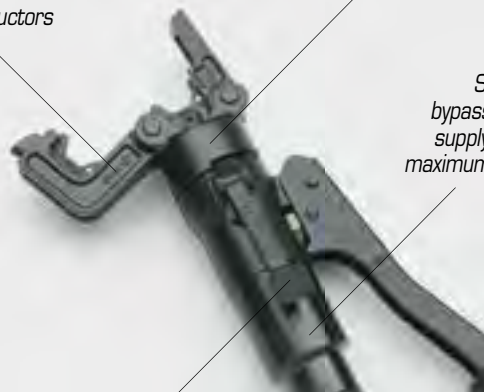

HYDRAULIC CRIMPING TOOL

general features

Crimping force kN	Dimensions mm		Weight kg
	length	width	
50	380	130	2,7

MAIN APPLICATIONS - max section mm²

L.V. lugs and splices	Insulated terminals	End sleeves	"C" sleeve Connectors
240	120	120	70

STORAGE

Type	Dimensions mm	Weight kg	Supplied with the tool	Purchase separately
VAL P1*	445x290xh95	1,2	✳	—

* Suitable for storage of the tool and 20 sets of dies.

HT 51-KV version also available for Power Supply Companies



HT 51

New design two speed hydraulic tool, lightweight and compact, this tool is ideal for working in confined spaces. Having the benefit of spring loaded handles, the dies can be advanced using only one hand; therefore leaving the other hand free to position the connector.

For ease of operation and comfort of the operator, the tool head can be fully rotated through 180 degrees. The built-in safety valve will by-pass the oil supply when the maximum pressure is reached, and a pressure release system can easily be operated at any stage of the compression.

HYDRAULIC PRESSHEAD

general features



Crimping force kN	Max operating pressure bar	Dimensions mm		Weight kg
		length	width	
50	700	196	75	1,6

MAIN APPLICATIONS - max section mm²

L.V. lugs and splices	Insulated terminals	End sleeves	"C" sleeve Connectors
240	120	120	70

STORAGE

Type	Dimensions mm	Weight kg	Supplied with the tool	Purchase separately
VAL P1*	445x290xh95	1,2	✳	—
Canvas bag 007	350x105	0,13	—	✳

* Suitable for storage of the tool and 20 sets of dies.



Hydraulic presshead complete with quick automatic coupler for connection to a hydraulic pump with a working pressure of 700 bar max, (see page 168-172) RH 50 is suitable for installing the same range of connectors as HT 51.

HYDRAULIC PRESSHEAD

general features



Crimping force kN	Max operating pressure bar	Dimensions mm		Weight kg
		length	width	
50	700	210	70	1,6

MAIN APPLICATIONS - max section mm²

L.V. lugs and splices	Insulated terminals	End sleeves
240	120	120

STORAGE

Type	Dimensions mm	Weight kg	Supplied with the tool	Purchase separately
VAL P1*	445x290xh95	1,2	✳	—
Canvas bag 007	350x105	0,13	—	✳

* Suitable for storage of the tool and 20 sets of dies.



Particularly suitable for high volume bench crimping.

RHM 50

Hydraulic press-head complete with quick automatic coupler for connection to hydraulic pump with working pressure of 700 bar max, (see page 168-172). RHM50 is suitable for installing the same range of connectors as RH50.

These tools are supplied without dies. For die selection, please refer to chart on pages 176 to 185

HT 81-U

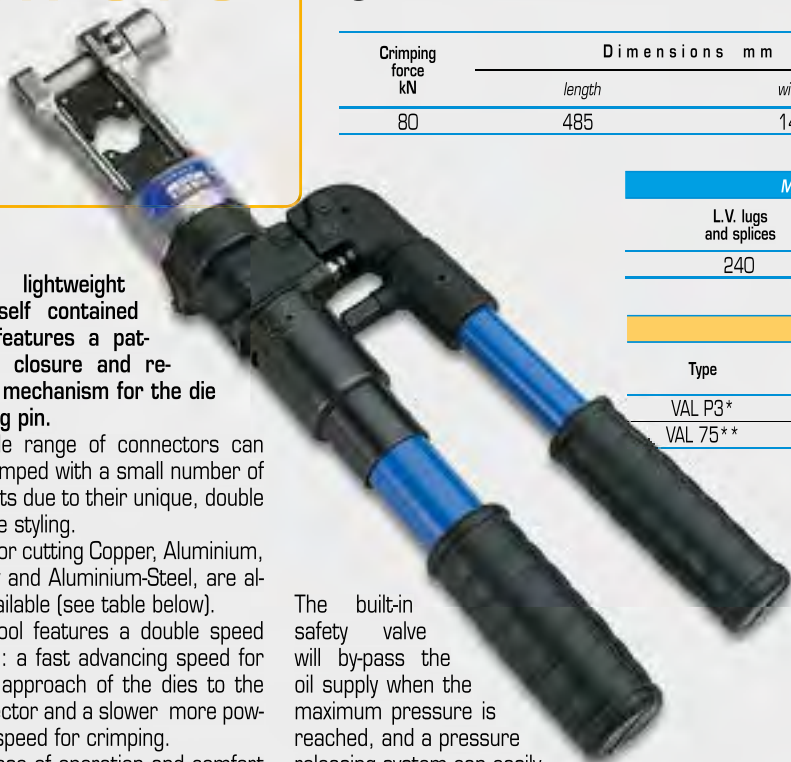

This lightweight and self contained tool features a patented closure and release mechanism for the die locking pin.

A wide range of connectors can be crimped with a small number of die sets due to their unique, double groove styling.

Dies for cutting Copper, Aluminium, Aldrey and Aluminium-Steel, are also available (see table below).

The tool features a double speed action: a fast advancing speed for rapid approach of the dies to the connector and a slower more powerful speed for crimping.

For ease of operation and comfort of the operator the tool head can be fully rotated through 180 degrees.

The built-in safety valve will by-pass the oil supply when the maximum pressure is reached, and a pressure releasing system can easily be operated at any stage of the compression.

HYDRAULIC CRIMPING TOOL

general features

Crimping force kN	Dimensions mm		Weight Kg
	length	width	
80	485	141	3,4

MAIN APPLICATIONS - max section mm²

L.V. lugs and splices	"C" sleeve connectors	H.V. lugs and splices
240	100	200

STORAGE

Type	Dimensions mm	Weight kg	Supplied with the tool	Purchase separately
VAL P3*	620x380xh135	2,5	✳	—
VAL 75**	270x80xh30	0,15	—	✳

* Suitable for storage of the tool and three VAL 75.

** Suitable for storing five sets of dies.



HYDRAULIC PRESSHEAD

general features



Crimping force kN	Max operating pressure bar	Dimensions mm		Weight kg
		length	width	
80	700	235	91	1,9

MAIN APPLICATIONS - max section mm²

L.V. lugs and splices	"C" sleeve connectors	H.V. lugs and splices
240	100	200

STORAGE

Type	Dimensions mm	Weight kg	Supplied with the tool	Purchase separately
Canvas bag 007	350x105	0,13	—	✳

HT 81-U and RHU 81 ACCESSORIES FOR CUTTING CONDUCTORS

Die Type	Cutting Capacity	Conductor Type
	Ø 16 mm	Cu, Alu, Aldrey and Alu-Steel
MB2-80U	This die is suitable to cut Steel conductors (R ≤ 160 daN/mm ²) having the most common strandings, i.e.: 19 x 1,2 = Ø est. 6,0 mm 7 x 3,0 = Ø est. 9,0 mm 19 x 2,1 = Ø est. 10,5 mm 19 x 2,3 = Ø est. 11,5 mm	
MB3-80U	Suitable to cut Aluminium strands of 150 mm ² Aluminium-Steel conductors, without damage to the Steel core	

RHU 81



Hydraulic presshead complete with quick automatic coupler for connection to a hydraulic pump with a working pressure of 700 bar max, (see page 168-172).

This lightweight and self contained head features a patented closure and release mechanism for the die locking pin.

The head is easy to use and is ideally suited for crimping in confined spaces.

RHU81 is suitable for installing the same range of connectors as HT 81-U.



These tools are supplied without dies. For die selection, please refer to chart on pages 176 to 185

HYDRAULIC CRIMPING TOOL

general features

HT 120

Crimping force kN	Dimensions mm		Weight kg
	length	width	
120	488	138	5,7

MAIN APPLICATIONS - max section mm ²					
L.V. lugs	L.V. splices	Insulated terminals	"C" sleeve connectors	H.V. lugs	H.V. splices
400	240	240	185	400	240

STORAGE				
Type	Dimensions mm	Weight kg	Supplied with the tool	Purchase separately
VAL P3*	620x380x135	2,5	✳	—

*Suitable for storage of the tool and 14 sets of dies.



The built-in safety valve will by-pass the oil supply when the maximum pressure is reached, and a pressure release system can easily be operated at any stage of the compression.



This light-weight and self contained tool will accept the semi-circular slotted dies, common to most 130 kN tools.

It is particularly suitable for installing crimp type electrical connectors for overhead line applications.

The tool features a double speed action: a fast advancing speed for rapid approach of the dies to the connector and a slower more powerful speed for crimping.

For ease of operation and comfort of the operator the tool head can be fully rotated through 180 degrees.

HT 120-KV
version also available for
Power Supply Companies



Die release system, protected from accidental operation

HT 120 features a double speed action: a fast advancing speed for rapid approach of the dies to the connector and a slower more powerful speed for crimping.



Pressure release trigger, which can be operated at any stage of the compression.

HYDRAULIC CRIMPING TOOL

HT 131-C

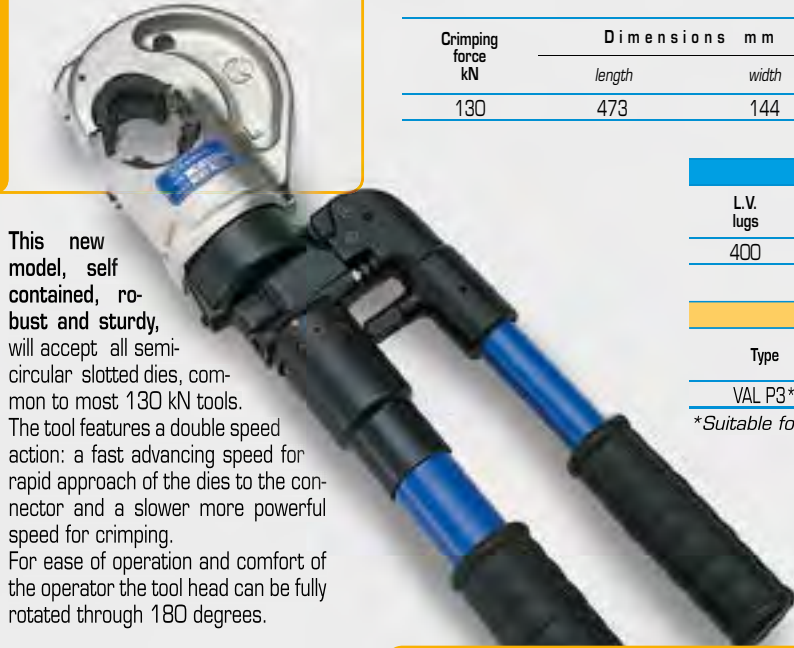

This new model, self contained, robust and sturdy, will accept all semi-circular slotted dies, common to most 130 kN tools. The tool features a double speed action: a fast advancing speed for rapid approach of the dies to the connector and a slower more powerful speed for crimping. For ease of operation and comfort of the operator the tool head can be fully rotated through 180 degrees.

general features

Crimping force kN	Dimensions mm		Jaw Opening mm	Weight kg
	length	width		
130	473	144	25	5,5

MAIN APPLICATIONS - max section mm²

L.V. lugs	L.V. splices	Insulated terminals	"C" sleeve connectors	H.V. lugs	H.V. splices
400	240	240	185	400	240

STORAGE

Type	Dimensions mm	Weight kg	Supplied with the tool	Purchase separately
VAL P3*	620x380xh135	2,5	✳	—

*Suitable for storage of the tool and 14 sets of dies

The built-in safety valve will by-pass the oil supply when the maximum pressure is reached, and the pressure release system can easily be operated at any stage of compression.



HYDRAULIC PRESSHEADS

RHC 131



Hydraulic presshead complete with quick automatic coupler for connection to a hydraulic pump with a working pressure of 700 bar max, (see page 168-172) This new design with improved mechanical features,

general features

Crimping force kN	Max operating pressure bar	Dimensions mm		Jaw Opening mm	Weight kg
		length	width		
130	700	232	124	25	3,8



MAIN APPLICATIONS - max section mm²

L.V. lugs	L.V. splices	Insulated terminals	"C" sleeve connectors	H.V. lugs	H.V. splices
400	240	240	185	400	240

STORAGE

Type	Dimensions mm	Weight kg	Supplied with the tool	Purchase separately
VAL P26*	445x290xh115	1,2	—	✳

*Suitable for storage of the head and 14 sets of dies

is suitable for installing the same range of connectors as HT 131-C.



RHM 132

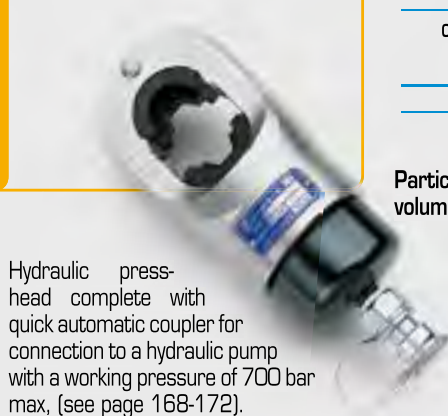

Hydraulic press-head complete with quick automatic coupler for connection to a hydraulic pump with a working pressure of 700 bar max, (see page 168-172).

general features

Crimping force kN	Max operating pressure bar	Dimensions mm		Weight kg
		length	width	
130	700	216	80	3,1



MAIN APPLICATIONS - max section mm²

L.V. lugs	Insulated terminals	H.V. lugs
400	240	400

STORAGE

Type	Dimensions mm	Weight kg	Supplied with the tool	Purchase separately
VAL P26*	445x290xh115	1,2	—	✳

*Suitable for storage of the head and 14 sets of dies



Particularly suitable for high volume bench crimping.

These tools are supplied without dies. For die selection, please refer to chart on pages 176 to 185

HYDRAULIC CRIMPING TOOL

general features

Crimping force kN	Dimensions mm		Jaw Opening mm	Weight kg
	length	width		
130	538	144	42	7,0

MAIN APPLICATIONS - max section mm²

L.V. lugs and splices	Insulated terminals	"C" sleeve connectors	H.V. lugs and splices
400	240	185	400

STORAGE

Type	Dimensions mm	Weight kg	Supplied with the tool	Purchase separately
VAL P3*	620x380xh135	2,5	⌘	—

*Suitable for storage of the tool and 12 sets of dies

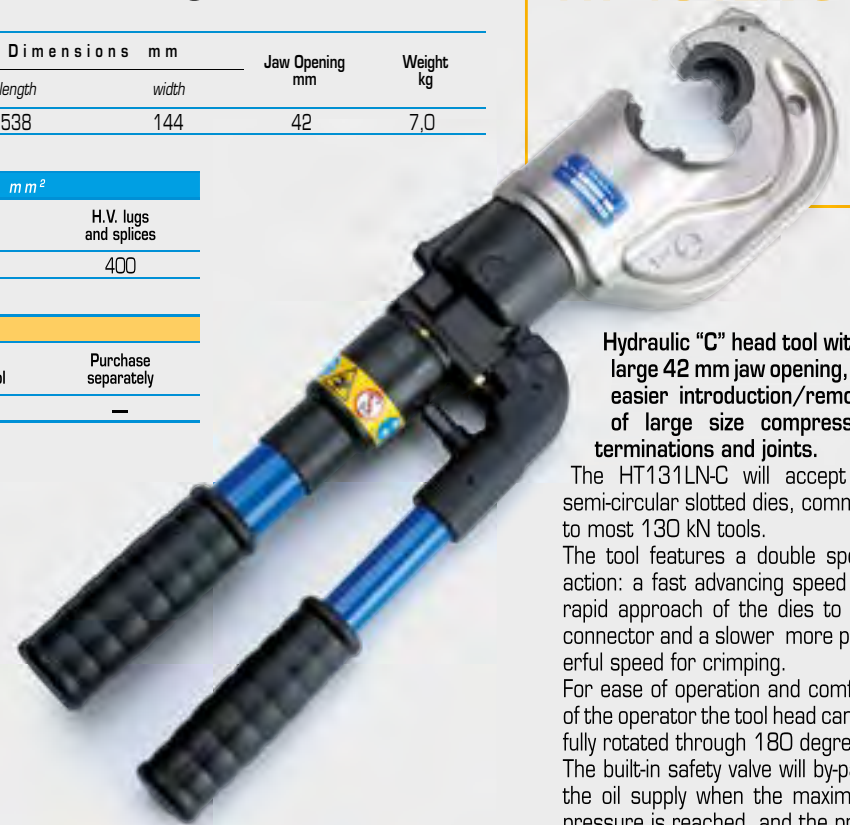

HT 131LN-C

Hydraulic "C" head tool with a large 42 mm jaw opening, for easier introduction/removal of large size compression terminations and joints.

The HT131LN-C will accept all semi-circular slotted dies, common to most 130 kN tools.

The tool features a double speed action: a fast advancing speed for rapid approach of the dies to the connector and a slower more powerful speed for crimping.

For ease of operation and comfort of the operator the tool head can be fully rotated through 180 degrees. The built-in safety valve will by-pass the oil supply when the maximum pressure is reached, and the pressure release system can easily be operated at any stage of compression.

HYDRAULIC PRESSHEAD

general features

Crimping force kN	Max operating pressure bar	Dimensions mm		Jaw Opening mm	Weight kg
		length	width		
130	700	298	122	42	5,4

MAIN APPLICATIONS - max section mm²

L.V. lugs and splices	Insulated terminals	"C" sleeve connectors	H.V. lugs and splices
400	240	185	400

STORAGE

Type	Dimensions mm	Weight kg	Supplied with the tool	Purchase separately
VAL P26*	445x290xh115	1,2	—	⌘

*Suitable for storage of the head and 14 sets of dies



RHC 131LN



Hydraulic head featuring a large 42 mm jaw opening; complete with quick automatic coupler for connection to a hydraulic pump with a working pressure of 700 bar max, (see page 168-172). Is suitable for installing the same range of connectors as HT 131LN-C.

These tools are supplied without dies. For die selection, please refer to chart on pages 176 to 185

HT 131-UC

HYDRAULIC CRIMPING TOOL

general features

Crimping force kN	Dimensions mm		Weight kg
	length	width	
130	488	149	5,4

This robust and self contained tool will accept the accessories for performing the "Deep Stepped Indent" system of crimping on Aluminium cables.

This tool will also accept the semi-circular slotted dies, common to most 130 kN tools. HT 131-UC performance features are the same as those of HT 131-C.

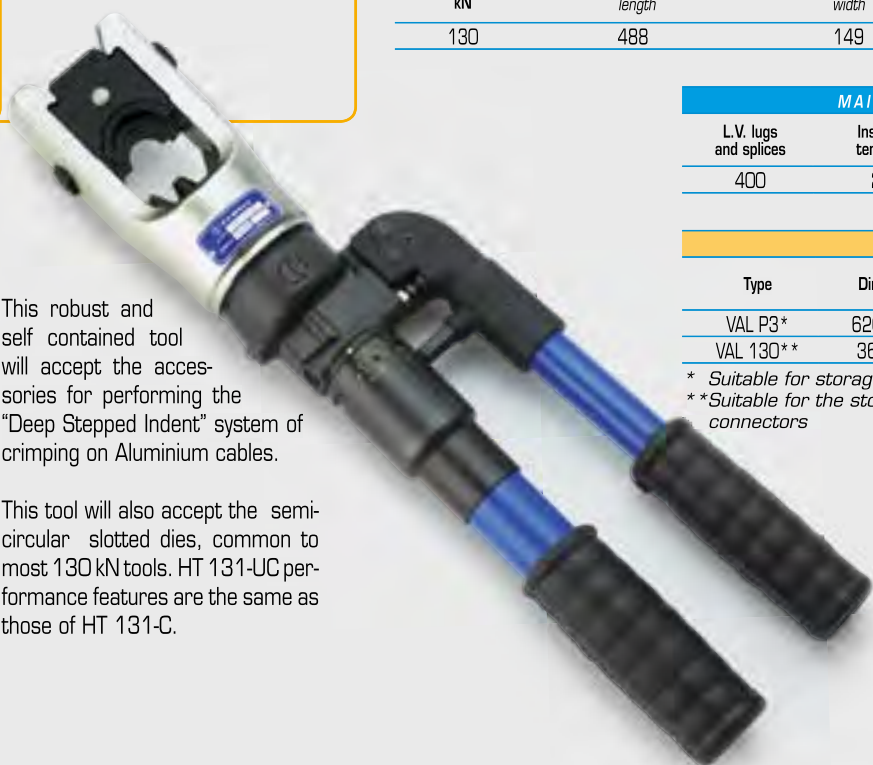

MAIN APPLICATIONS - max section mm²

L.V. lugs and splices	Insulated terminals	"C" sleeve connectors	H.V. lugs and splices	Alu lugs and splices
400	240	185	400	300

STORAGE

Type	Dimensions mm	Weight kg	Supplied with the tool	Purchase separately
VAL P3*	620x380xh135	2,5	✳	—
VAL 130**	360x280xh48	3,0	—	✳

* Suitable for storage of the tool and 14 sets of semi-circular slotted dies
 ** Suitable for the storage of accessories for crimping Aluminium connectors



HYDRAULIC PRESSHEAD

general features



Crimping force kN	Max operating pressure bar	Dimensions mm		Weight kg
		length	width	
130	700	245	89	3,7

Hydraulic presshead complete with quick automatic coupler for connection to a hydraulic pump with a working pressure of 700 bar max, (see page 168-172).

RHU 131-C is suitable for installing the same range of connectors as HT 131-UC.

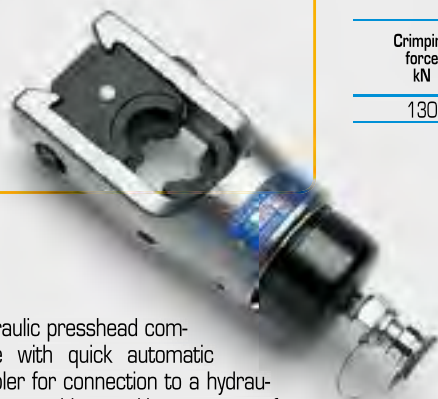

MAIN APPLICATIONS - max section mm²

L.V. lugs and splices	Insulated terminals	"C" sleeve connectors	H.V. lugs and splices	Alu lugs and splices
400	240	185	400	300

STORAGE

Type	Dimensions mm	Weight kg	Supplied with the tool	Purchase separately
VAL P26*	445x290xh115	1,2	—	✳
VAL 130**	360x280xh48	3,0	—	✳
VAL 130-U***	450x305xh80	5,0	—	✳

* Suitable for storage of the head and 14 sets of dies
 ** Suitable for the storage of accessories for crimping Aluminium connectors
 *** Suitable for storage of the head, semi-circular slotted dies and dies for crimping Aluminium connectors



VAL 130

VAL 130-U

VAL P26

These tools are supplied without dies. For die selection, please refer to chart on pages 176 to 185

HYDRAULIC PRESSHEAD



general features

Crimping force kN	Max operating pressure bar	Dimensions mm		Weight kg
		length	width	
230	700	290	120	5,5

MAIN APPLICATIONS - max section mm²

L.V. lugs and splices	Insulated terminals	"C" sleeve connectors	H.V. lugs and splices
630	300	240	630

STORAGE

Type	Dimensions mm	Weight kg	Supplied with the tool	Purchase separately
VAL ECW-H3D*	345x305xh90	4,2	—	*

* Suitable for storage of the head and 10 sets of dies

ECW-H3D ACCESSORIES FOR CUTTING CONDUCTORS

Die Type	Cutting Capacity	Conductor Type
WT2-3D	Ø 20 mm	Cu, Alu, Aldrey and Alu-Steel
	Ø 20 mm	Extra flexible Steel with ≥ 200 strands
	This die is suitable to cut Steel conductors (R ≤ 160 daN/mm ²) having the most common strandings, i.e.:	
	19 x 1,2 = Ø est. 6,0 mm	
	7 x 3,0 = Ø est. 9,0 mm	
	19 x 2,1 = Ø est. 10,5 mm	
	19 x 2,3 = Ø est. 11,5 mm	



Hydraulic presshead complete with quick automatic coupler for connection to a hydraulic pump with a working pressure of 700 bar max, (see page 168-172).

Adaptor type **AU230-130D** is available as an optional extra enabling the head to utilise the semi-circular slotted dies which are common to most 130 kN tools. Also available is a series of dies for the compression of DIN electrical connectors, and a die for cutting Copper, Aluminium, aldreyl, Aluminium-Steel and Steel conductors.



HYDRAULIC PRESSHEAD



general features

Crimping force kN	Max operating pressure bar	Dimensions mm		Weight kg
		length	width	
230	700	320	110	6,4

MAIN APPLICATIONS - max section mm²

Alu lugs and splices	Cu lugs and splices
500	630

STORAGE

Type	Dimensions mm	Weight kg	Supplied with the tool	Purchase separately
VAL 231*	470x273xh96	7,2	*	—

* Suitable for storage of the head and dies for Aluminium compression

RHU 231

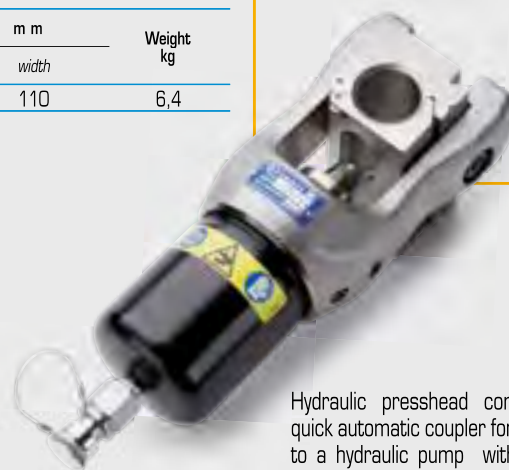

Hydraulic presshead complete with quick automatic coupler for connection to a hydraulic pump with a working pressure of 700 bar max, (see page 168-172).

For crimping up to 500 sqmm Aluminium.

Dies are available also for crimping Copper connectors.



These tools are supplied without dies. For die selection, please refer to chart on pages 176 to 185

RHU 230-630



Hydraulic presshead complete with quick automatic coupler for connection to a hydraulic pump with a working pressure of 700 bar max, (see page 168-172).

It allows for crimping up to 630 sqmm Aluminium (according to HN 68 S90).

Adapters **AU 230-130-C/N**, and **AU 230-PS/E**, are available as an optional extra enabling the head to utilise the semicircular slotted dies which are common to most 130 kN tools.

HYDRAULIC PRESSHEAD

general features



Crimping force kN	Max operating pressure bar	Dimensions mm		Weight kg
		length	width	
230	700	365	193	9,0

MAIN APPLICATIONS - max section mm²

CU lugs and splices	Alu lugs and splices	"C" sleeve connectors	H.V. lugs and splices
400	630	185	400

STORAGE

Type	Dimensions mm	Weight kg	Supplied with the tool	Purchase separately
VAL 230-630*	405x230xh145	3,5	✳	—
VAL MAT 230-630*	290x260xh70	3,1	—	✳

* Suitable for storage of the head

** Suitable for storage of the accessories



VAL MAT 230-630



VAL 230-630

RHU 450



Hydraulic presshead complete with quick automatic coupler for connection to a hydraulic pump with a working pressure of 700 bar max, (see page 168-172).

HYDRAULIC PRESSHEAD

general features



Crimping force kN	Max operating pressure bar	Dimensions mm		Weight kg
		length	width	
450	700	260	120	10,3

MAIN APPLICATIONS - Hexagonal crimp according to DIN 48083 max section mm²

Cu	Al	Al/St
1000	1000	680/85

STORAGE

Type	Dimensions mm	Weight kg	Supplied with the tool	Purchase separately
VAL 450*	285x212xh124	2,8	✳	—

* Suitable for storage of the head



Adaptor type **AU 450-130 D** is available as an optional extra enabling the head to utilise the semi-circular slotted dies which are common to most 130 kN tools.

These tools are supplied without dies. For die selection, please refer to chart on pages 176 to 185

HYDRAULIC PRESSHEAD

general features



Crimping force kN	Max operating pressure bar	Dimensions mm		Weight kg
		length	width	
520	700	306	200	18,0

MAIN APPLICATIONS - max section mm²

Lugs and splices	H.V. overhead lines
1200	630

STORAGE

Type	Dimensions mm	Weight kg	Supplied with the tool	Purchase separately
VAL 520*	384x231xh145	3,2	—	✳
VAL MAT 520**	500x310xh68	5,1	—	✳

* Suitable for storage of the head

** Suitable for storage of 10 sets of dies



VAL MAT 520



VAL 520

RHU 520



Hydraulic presshead complete with quick automatic coupler for connection to a hydraulic pump with a working pressure of 700 bar max, (see page 168-172).

Adaptor type **AU520-130C** is available as an optional extra enabling the head to utilise the semi-circular slotted dies which are common to most 130 kN tools.

RHU 600

HYDRAULIC PRESSHEAD

general features



Crimping force kN	Max operating pressure bar	Dimensions with support mm		Weight with support kg
		length	width	
600	700	447	241	22.4

MAIN APPLICATIONS

- "U" Alcoa series die and "L" Burndy series die, etc.
- Aluminium and Copper max size 2156 MCM

STORAGE

Type	Dimensions mm	Weight kg	Supplied with the tool	Purchase separately
VAL 600*	480x235xh260	8,6	✳	—

* Suitable for storage of the head



VAL 600

Hydraulic presshead complete with quick automatic coupler for connection to a hydraulic pump with a working pressure of 700 bar max, (see page 168-172).

HYDRAULIC PRESSHEAD



general features

RHU 1000

Crimping force kN	Max operating pressure bar	Dimensions mm		Weight kg
		length	width	
1.100	700	414	278	50,6

STORAGE

Type	Dimensions mm	Weight kg	Supplied with the tool	Purchase separately
VAL 1000*	334x244xh435	12	✳	—

*Suitable for storage of the head



VAL 1000

New

Operable from single or double acting hydraulic power source



Lifting eye; screwed into the base of the cylinder; allows easy transportation of the head in aerial operation.

RHU 1000 is a 1.100 kN hydraulic presshead for full tension, transmission and substation connections, complete with quick automatic coupler for connection to hydraulic pumps with a working pressure of 700 bar max, (see pages 168-172).

The standard version must be operated by a single acting pump; possibility to convert from single to double acting by substitution of the breather valve with a female quick coupling.

RHU1000 will accept all semi-circular slotted dies common to most

100 ton heads as the Alcoa ones. The die cap is removable for an easy connector positioning; the upper part of the cap automatically rotates during the die changing process to present the correct positioning of the die. Lifting eye included.

Insertion of the upper die:



After substitution of the dies, insert the die into the head.



Pull the pin.



The upper part of the cap automatically rotates...



...to the correct position.

INDUSTRIAL APPLICATION
HT-TC051



Hand operated hydraulic tool specifically designed to cut Copper, Aluminium and Telecommunications cable having a max overall diameter of 50 mm. The tool features a double speed action: a fast advancing speed for rapid approach of the blades to the cable and a slower more powerful speed for cutting. The blades are manufactured from high strength special Steel, heat treated to ensure a long service life. The head can be easily opened to allow the cutting of run-

ning cables. The head can rotate through 90 degrees, to enable the operator to work in the most comfortable position. HT-TC051 features an automatic

HYDRAULIC CUTTING TOOL

general features

Max cutting Ø mm	Dimensions mm		Weight kg
	length	width	
50	497	129	4,38

STORAGE

Type	Dimensions mm	Weight kg	Supplied with the tool	Purchase separately
Canvas Bag 010	545x160	0,15	✳	—

safety valve to bypass oil when reaching maximum pressure; a pressure release device can also be operated at any stage of operation.



INDUSTRIAL APPLICATION
TC 050



Hydraulic cutting head complete with quick automatic coupler for connection to a hydraulic pump with a working pressure of 700 bar max, (see page 168-172) TC050 features the same cutting capability as HT-TC051.

HYDRAULIC CUTTING HEAD

general features



Max cutting Ø mm	Max operating pressure bar	Dimensions mm		Weight kg
		length	width	
50	700	325	112	3,2

STORAGE

Type	Dimensions mm	Weight kg	Supplied with the tool	Purchase separately
Canvas bag 011	360x137	0,13	✳	—



INDUSTRIAL APPLICATION
HT-TC065

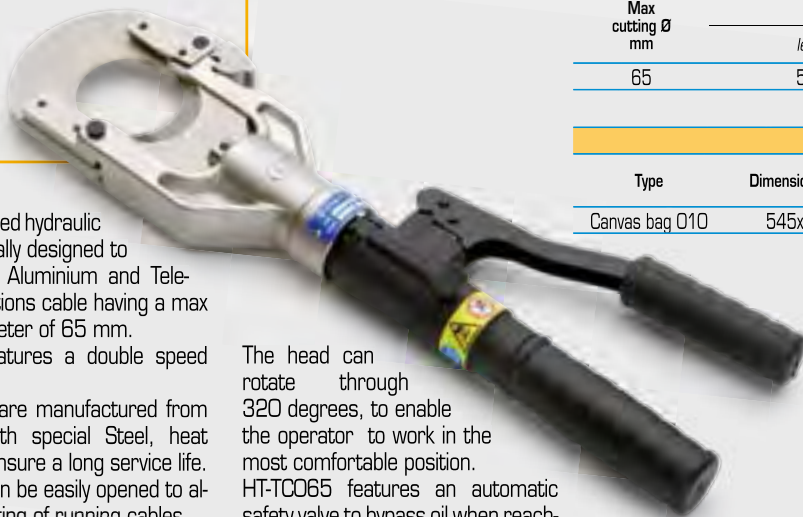

Hand operated hydraulic tool specifically designed to cut Copper, Aluminium and Telecommunications cable having a max overall diameter of 65 mm. The tool features a double speed action. The blades are manufactured from high strength special Steel, heat treated to ensure a long service life. The head can be easily opened to allow the cutting of running cables.

The head can rotate through 320 degrees, to enable the operator to work in the most comfortable position. HT-TC065 features an automatic safety valve to bypass oil when reach-

HYDRAULIC CUTTING TOOL

general features

Max cutting Ø mm	Dimensions mm		Weight kg
	length	width	
65	523	129	5

STORAGE

Type	Dimensions mm	Weight kg	Supplied with the tool	Purchase separately
Canvas bag 010	545x160	0,15	✳	—

ing maximum pressure; a pressure release device can also be operated at any stage of operation.



HYDRAULIC CUTTING TOOL

general features

Max cutting Ø mm	Dimensions mm		Weight kg
	length	width	
85	652,5	175	6,6

STORAGE

Type	Dimensions mm	Weight kg	Supplied with the tool	Purchase separately
VAL P7	727x202xh115	1,3	✳	—

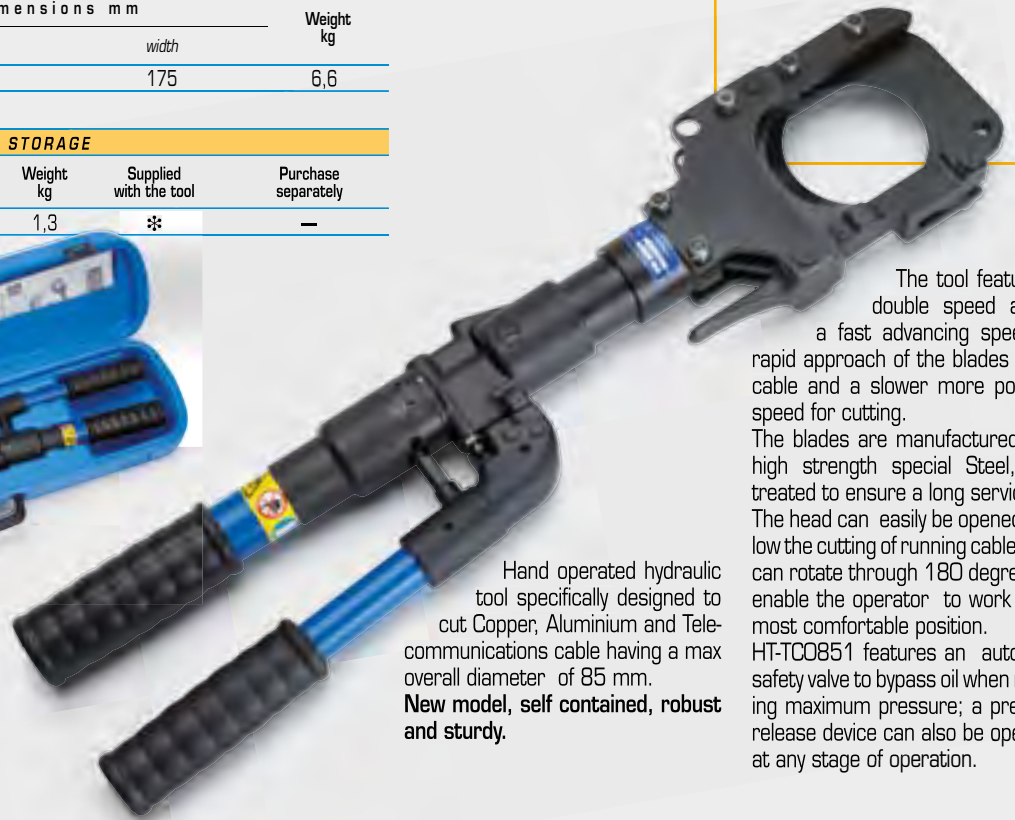

Hand operated hydraulic tool specifically designed to cut Copper, Aluminium and Telecommunications cable having a max overall diameter of 85 mm.
New model, self contained, robust and sturdy.

INDUSTRIAL APPLICATION HT-TC0851

The tool features a double speed action: a fast advancing speed for rapid approach of the blades to the cable and a slower more powerful speed for cutting. The blades are manufactured from high strength special Steel, heat treated to ensure a long service life. The head can easily be opened to allow the cutting of running cables, and can rotate through 180 degrees, to enable the operator to work in the most comfortable position. HT-TC0851 features an automatic safety valve to bypass oil when reaching maximum pressure; a pressure release device can also be operated at any stage of operation.

HYDRAULIC CUTTING HEAD

general features



Max cutting Ø mm	Max operating pressure bar	Dimensions mm		Weight Kg
		length	width	
85	700	409	135	4,9

STORAGE

Type	Dimensions mm	Weight kg	Supplied with the tool	Purchase separately
VAL TC 085	465x155xh65	2,4	✳	—



INDUSTRIAL APPLICATION TC 085

Hydraulic cutting head complete with quick automatic coupler for connection to a hydraulic pump with a working pressure of 700 bar max, (see page 168-172)

TC085 features the same cutting capability as HT-TC0851.

INDUSTRIAL APPLICATION
TC 096

HYDRAULIC CUTTING HEAD



general features

Max cutting Ø mm	Max operating pressure bar	Dimensions mm		Weight kg
		length	width	
95	700	397	249	7,9

STORAGE

Type	Dimensions mm	Weight kg	Supplied with the tool	Purchase separately
VAL 096	450x265xh145	6,8	✳	—



Hydraulic cutting head specifically designed to cut Copper and Aluminium cable having a max overall diameter of 95 mm.

The head is complete with a quick automatic coupler for connection to a hydraulic pump with a working pressure of 700 bar max, (see page 168-172).



Handle designed for ease of operation



HYDRAULIC CUTTING HEAD

general features

INDUSTRIAL APPLICATION
TC 120

Max cutting Ø mm	Max operating pressure bar	Dimensions mm		Weight kg
		length	width	
120	700	536	175	9,5

STORAGE

Type	Dimensions mm	Weight kg	Supplied with the tool	Purchase separately
VAL TC 120	590x209xh84	4,9	✳	—



Hydraulic cutting head specifically designed to cut Copper, Aluminium and Telecommunications cable having a max overall diameter of 120 mm.

The head can easily be opened to cut running cables, and the handle allows the most comfortable positioning of the head onto the cable to be cut.

The head is complete with a quick automatic coupler for connection to a hydraulic pump with a working pressure of 700 bar max, (see page 168-172).

TC 120 cutting capacity - a few examples:

Cable type	Capacity
3x150 mm ² Steel armoured	Ø80 mm
1000 mm ² Cu - EPR rubber insulated	Ø85 mm
1000 mm ² Cu - EPR rubber insulated + lead sheath	Ø92 mm
1000 mm ² Cu - EPR rubber insulated + lead sheath + PE sheath	Ø100 mm
240 mm ² EPR rubber insulated	



Handle designed for ease of operation



Opening head, to allow cutting of running cables

OVERHEAD LINE APPLICATION
HT-TC026



Hand operated hydraulic tool specifically designed to cut Copper, Alu, Aluminium, Aluminium-Steel cables and Steel ropes, Aluminium and Steel rods having a max overall diameter of 25 mm. The tool features a double speed action: a fast advancing speed for rapid approach of the blades to the cable and a slower more powerful speed for cutting. The blades are manufactured from high strength special Steel, heat treated to ensure a long service life. The head can rotate through 180 degrees, to enable the operator to work in the most comfortable position, and can easily be opened to allow the cutting of running cables. HT-TC026 features an automatic safety valve to bypass oil when reaching maximum pressure; a pressure release device can also be operated at any stage of operation.

HYDRAULIC CUTTING TOOL

general features

Max cutting Ø mm	Dimensions mm		Weight kg
	length	width	
25	382	129	3,2

STORAGE

Type	Dimensions mm	Weight kg	Supplied with the tool	Purchase separately
Canvas bag 001	430x155	0,15	✳	—



CUTTING CAPACITY

	MATERIAL	TENSILE STRENGTH (daN/mm²)	MAX CUTTING DIAMETER (mm)	
			HT-TC026 TC 025	HT-TC026Y B-TC250E
ROPE & CONDUCTORS	COPPER	≤ 41	25	
	ALUMINIUM	≤ 20	25	
	ALMELEC	≤ 34	25	
	STEEL	≤ 180	INDICATIVE EXAMPLES: 7 x 3,0 : Ø est. = 9,0 mm 19 x 2,1 : Ø est. = 10,5 mm 19 x 2,2 : Ø est. = 11,0 mm 19 x 2,3 : Ø est. = 11,5 mm	
	MULTI STRANDS STEEL (STRANDS Qty ≥ 200)	≤ 180	18	
RODS	ACSR	≤ 180	25 INDICATIVE EXAMPLES: 26 x 2,50 + 7 x 1,95 : Ø est. = 15,85 26 x 3,06 + 7 x 2,38 : Ø est. = 19,38 26 x 3,60 + 7 x 2,80 : Ø est. = 22,80	
	STEEL	≤ 60	13	
		≤ 42	16	
	COPPER	≤ 30	20	
	≤ 25	23		
ALUMINIUM	≤ 16	25		

OVERHEAD LINE APPLICATION
TC 025



Hydraulic cutting head complete with quick automatic coupler for connection to a hydraulic pump with a working pressure of 700 bar max, (see page 168-172)

TC025 has the same cutting capability as HT-TC026.

HYDRAULIC CUTTING HEAD

general features



Max cutting Ø mm	Max operating pressure bar	Dimensions mm		Weight kg
		length	width	
25	700	213	82	2,0

STORAGE

Type	Dimensions mm	Weight kg	Supplied with the tool	Purchase separately
Canvas bag 007	350x105	0,13	✳	—



HYDRAULIC CUTTING TOOL

general features

OVERHEAD LINE APPLICATION HT-TC026Y

Max cutting Ø mm	Dimensions mm		Weight kg
	length	width	
25	394,5	129	3,35

STORAGE

Type	Dimensions mm	Weight kg	Supplied with the tool	Purchase separately
Canvas Bag 001	430x155	0,15	✳	—

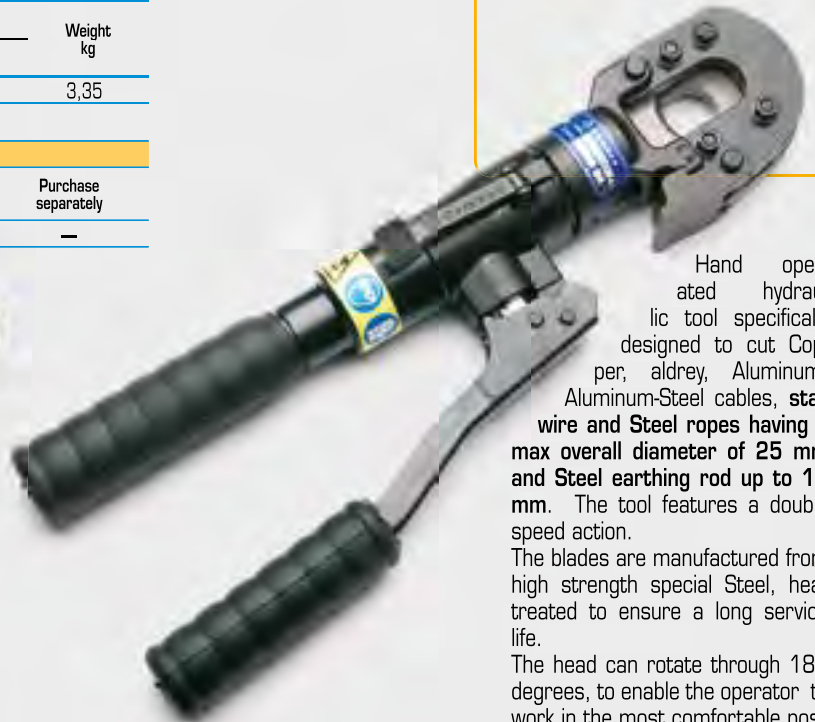

Hand operated hydraulic tool specifically designed to cut Copper, aldreyl, Aluminum, Aluminum-Steel cables, **stay wire and Steel ropes having a max overall diameter of 25 mm and Steel earthing rod up to 16 mm.** The tool features a double speed action.

The blades are manufactured from high strength special Steel, heat treated to ensure a long service life.

The head can rotate through 180 degrees, to enable the operator to work in the most comfortable position, and can easily be opened to allow the cutting of running cables. HT-TC026Y features an automatic safety valve to bypass oil when reaching maximum pressure; a pressure release device can also be operated at any stage of operation.

Ideal for earthing rod and stay wire

HT-TC026Y cutting capacity - a few examples:

Ø		EARTHING RODS AND STAY WIRES
mm	in.	
12,7	1/2"	STEEL EARTHING ROD, COPPER PLATED; Tensile strength = 79 daN/mm ²
14,2	/	STEEL EARTHING ROD, COPPER PLATED; Tensile strength = 69 daN/mm ²
15,6	/	STEEL EARTHING ROD; Tensile strength = 69 daN/mm ²
15,9	5/8"	STEEL EARTHING ROD, COPPER PLATED (CON ED - ILLINOIS); Tensile strength = 57 daN/mm ²
15,9	5/8"	STEEL EARTHING ROD, COPPER PLATED (CON ED - STATEN ISLAND); Tensile strength = 78 daN/mm ²
19	3/4"	STEEL EARTHING ROD, COPPER PLATED; Tensile strength = 74 daN/mm ²
9,15 (3,05x7)	/	STAY WIRE
10,8 (3,6x7)	/	STAY WIRE (PORTLAND GENERAL ELECTRIC)
11,1 (3,7x7)	/	STAY WIRE (PORTLAND GENERAL ELECTRIC)
12,3 (4,1x7)	/	STAY WIRE (PORTLAND GENERAL ELECTRIC)
12,6 (4,2x7)	/	STAY WIRE (PORTLAND GENERAL ELECTRIC)

HYDRAULIC CUTTING TOOL

general features

OVERHEAD LINE APPLICATION HT-TC041



Hand operated hydraulic tool specifically designed to cut Copper, Alu, Aluminium, Aluminium-Steel cables and Steel ropes, Aluminium and Steel rods having a max overall diameter of 40 mm.

New model, even more self contained, robust and sturdy.

The blades are manufactured from high strength special Steel, heat treated to ensure a long service life. The head can rotate through 180 degrees, to enable the operator to work in the most comfortable position, and can easily be opened to allow cutting of running cables.

HT-TC041 features an automatic safety valve to bypass oil when reaching maximum pressure; a pressure release device can also be operated at any stage of operation.



Max cutting Ø mm	Dimensions mm		Weight kg
	length	width	
40	550	144	5,8

STORAGE

Type	Dimensions mm	Weight kg	Supplied with the tool	Purchase separately
VAL P7	727x202xh115	1,3	✳	—

CUTTING CAPACITY

MATERIAL	TENSILE STRENGTH (daN/mm ²)	MAX CUTTING DIAMETER (mm)	
		HT-TC 041 B-TC450E	TC 04 B-TC04
COPPER	≤ 41	40	
ALUMINIUM	≤ 20	40	
ALMELEC	≤ 34	40	
ROPE & CONDUCTORS	STEEL	INDICATIVE EXAMPLES: 7 x 3,0 : Ø est. = 9,0 mm 19 x 2,1 : Ø est. = 10,5 mm 19 x 2,3 : Ø est. = 11,5 mm	
	MULTI STRANDS STEEL (STRANDS Q.TY ≥ 200)	18	
	ACSR	40 INDICATIVE EXAMPLES: 26 x 2,50 + 7 x 1,95 : Ø est. = 15,85 26 x 3,06 + 7 x 2,38 : Ø est. = 19,38 26 x 3,60 + 7 x 2,80 : Ø est. = 22,80 54 x 3,50 + 19 x 2,10 : Ø est. = 31,50 54 x 4,36 + 19 x 2,62 : Ø est. = 39,20	
RODS	STEEL	≤ 60	18
		≤ 42	20
	COPPER	≤ 30	30
	ALUMINIUM	≤ 16	40

HYDRAULIC CUTTING HEAD

general features

OVERHEAD LINE APPLICATION TC 04



Hydraulic cutting head complete with quick automatic coupler for connection to a hydraulic pump with a working pressure of 700 bar max, (see page 168-172)
TC04 has the same cutting capability as HT-TC041.

Max cutting Ø mm	Max operating pressure bar	Dimensions mm		Weight kg
		length	width	
40	700	311	100	4,0

STORAGE

Type	Dimensions mm	Weight kg	Supplied with the tool	Purchase separately
VAL 04	350x125xh68	2,0	✳	—



HYDRAULIC CUTTING TOOL

general features

Max cutting Ø mm	Dimensions mm		Weight kg
	length	width	
50	503	129	4,7

STORAGE

Type	Dimensions mm	Weight kg	Supplied with the tool	Purchase separately
Canvas Bag 010	545x160	0,15	✳	—



OVERHEAD LINE APPLICATION HT-TC051Y

Hand operated hydraulic tool specifically designed to cut Copper, Aluminum, Aluminum-Steel cables (ACSR) having a max overall diameter of 50 mm.

The HT-TC051Y is provided with a two stage hydraulic system, which advances the blades quickly to the cable. This proven system saves operator time and effort.

The HT-TC051Y is provided with an automatic safety valve to bypass oil when reaching max pressure. This means safety to the operator and protection to the blades.

The blades are manufactured from high strength special Steel, heat treated to ensure a long service life. The shape of the blades provides a "clean" cut.

The head can be opened to allow cutting of running cables and ropes. The head rotates 90 degrees allowing the operator to perform the cut in the most comfortable position.

The tool is supplied complete with canvas bag 010 for protection and storage when not in use.

Not suitable for cutting stay wire, Steel rope or earthing rod.

HYDRAULIC CUTTING HEAD

general features

Max cutting Ø mm	Max operating pressure bar	Dimensions mm		Weight kg
		length	width	
50	700	331	112	3,3

STORAGE

Type	Dimensions mm	Weight kg	Supplied with the tool	Purchase separately
Canvas bag 011	360x137	0,13	✳	—



OVERHEAD LINE APPLICATION TC 050Y

Hydraulic cutting head complete with quick automatic coupler for connection to a hydraulic pump with a working pressure of 700 bar max, (see page 168-172).

TC 050Y features the same cutting capability as HT-TC051Y.

Not suitable for cutting stay wire, Steel rope or earthing rod.



OVERHEAD LINE APPLICATION
HT-TC055

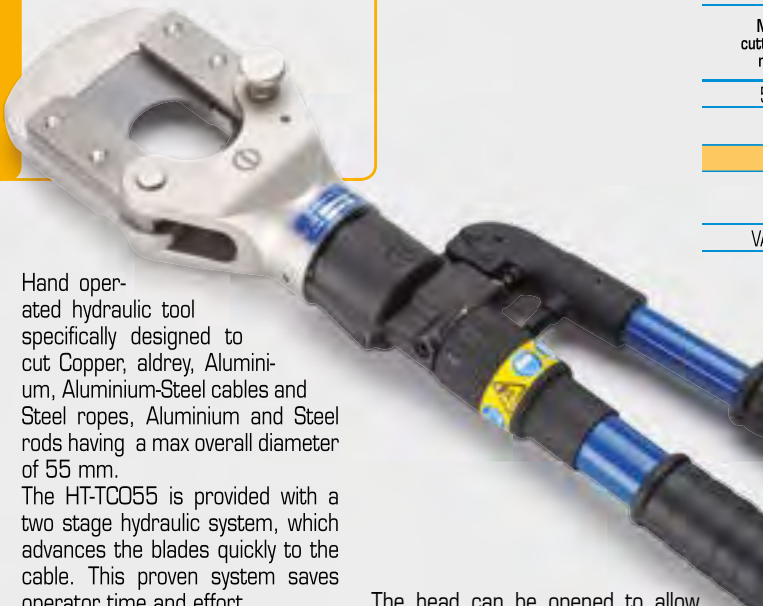

Hand operated hydraulic tool specifically designed to cut Copper, Al, Aluminium, Aluminium-Steel cables and Steel ropes, Aluminium and Steel rods having a max overall diameter of 55 mm.

The HT-TC055 is provided with a two stage hydraulic system, which advances the blades quickly to the cable. This proven system saves operator time and effort.

The HT-TC055 is provided with an automatic safety valve to bypass oil when reaching max pressure.

This means safety to the operator and protection to the blades.

The blades are manufactured from high strength special Steel, heat treated to ensure a long service life. The shape of the blades provides a "clean" cut.

The head can be opened to allow cutting of running cables and ropes. The head rotates 330 degrees allowing the operator to perform the cut in the most comfortable position. The tool is supplied complete with plastic case VAL P7 for protection and storage when not in use.



HYDRAULIC CUTTING TOOL

general features

Max cutting Ø mm	Dimensions mm		Weight kg
	length	width	
55	595	144	8,3

STORAGE				
Type	Dimensions mm	Weight kg	Supplied with the tool	Purchase separately
VAL P7	727x202x115	1,3	*	—

CUTTING CAPACITY				
MATERIAL	TENSILE STRENGTH (daN/mm ²)	MAX CUTTING DIAMETER (mm)		
		HT-TC055 TC 055 B-TC055		
COPPER	≤ 41	55		
ALUMINIUM	≤ 20	55		
ALMELEC	≤ 34	55		
STEEL	≤ 180	INDICATIVE EXAMPLES: 7 x 3,0 : Ø est. = 9,0 mm 19 x 2,1 : Ø est. = 10,5 mm 19 x 2,3 : Ø est. = 11,5 mm		
		MULTI STRANDS STEEL (STRANDS Q.TY ≥ 200)	≤ 180	22
		ACSR	≤ 180	50 INDICATIVE EXAMPLES: 26 x 2,50 + 7 x 1,95 : Ø est. = 15,85 26 x 3,06 + 7 x 2,38 : Ø est. = 19,38 26 x 3,60 + 7 x 2,80 : Ø est. = 22,80 26 x 4,44 + 7 x 3,45 : Ø est. = 28,14 54 x 3,50 + 19 x 2,10 : Ø est. = 31,50 54 x 4,36 + 19 x 2,62 : Ø est. = 39,20 83 x 4,60 + 16 x 2,80 : Ø est. = 50,00
GUY WIRE (GW15-9/16-188)	Extra high strength grade	7 x 4,77 : Ø est. = 14,30 mm		
RODS	STEEL	≤ 60	20	
	STEEL	≤ 42	22	
	COPPER	≤ 30	34	
	COPPER	≤ 25	38,5	
ALUMINIUM	≤ 16	50		

OVERHEAD LINE APPLICATION
TC 055



Hydraulic cutting head complete with quick automatic coupler for connection to a hydraulic pump with a working pressure of 700 bar max, (see page 168-172)

TC055 has the same cutting capability as HT-TC055.

HYDRAULIC CUTTING HEAD

general features



Max cutting Ø mm	Max operating pressure bar	Dimensions mm		Weight kg
		length	width	
55	700	357	134	6,6

STORAGE				
Type	Dimensions mm	Weight kg	Supplied with the tool	Purchase separately
VAL TC055	384x231x145	3,7	*	—



SPECIAL TOOLS



general features

Frame-type hole punching head RH-FC48N

Type	Max piercing Ø mm	Max centre of hole to edge of trunking (mm)	Max operating pressure bar	Dimensions mm		Weight kg
				length	width	
RH-FC 48N	47,2	53,5	700	259,5	147,5	3,7

Storage type	Dimensions mm	Weight kg
VAL P30*	315x300x95	0,93

*Supplied with the head

Hole Dimensions					Maximum thickness of mild Steel (mm)	Code
Nominal Ø (mm)	Ø (inch)	Pg	ISO	Inch		
15,5	.610	Pg9	-	-	2	RD 15.5 SS-FC
16,2	.638	-	ISO-16	-		RD 16.2 SS-FC
17,5	.689	-	-	-		RD 17.5 SS-FC
18,8	.740	Pg11	-	-		RD 18.8 SS-FC
19,1	.752	-	-	-		RD 19.1 SS
20,5	.807	Pg 13,5	ISO-20	-		RD 20.5 SS
22,6	.890	Pg16	-	-		RD 22.6 SS
23,8	.937	-	-	5/8"		RD 23.8 SS
25,4	1.000	-	ISO-25	-		RD 25.4 SS
27,0	1.063	-	-	3/4"		RD 27.0 SS
28,5	1.122	Pg21	-	-		RD 28.5 SS
30,5	1.201	-	-	7/8"		RD 30.5 SS
31,8	1.252	-	-	-		RD 31.8 SS
32,5	1.279	-	ISO-32	-		RD 32.5 SS
34,6	1.362	-	-	-		RD 34.6 SS
37,2	1.464	Pg29	-	-		RD 37.2 SS
38,1	1.500	-	-	-		RD 38.1 SS
40,5	1.594	-	ISO-40	-		RD 40.5 SS-FC
41,3	1.626	-	-	-		RD 41.3 SS-FC
42,5	1.673	-	-	1 1/4"		RD 42.5 SS-FC
43,2	1.701	-	-	-		RD 43.2 SS-FC
44,5	1.752	-	-	-		RD 44.5 SS-FC
47,2	1.858	Pg36	-	-		RD 47.2 SS-FC



Table denotes the punch/die set reference, for each hole size. Suitable for punching holes in mild Steel, fibreglass or plastic material, up to 2 mm thick.

VAL P30

Supplied in a robust plastic case.



Hydraulic head complete with automatic quick coupler, designed for punching holes from 15,5 up to 47,2 mm diameter in the side wall of trunking without the need for pre drilling. For operation, the head must be joined to a hydraulic pump developing a pressure of 700 bar (see page 168-172).

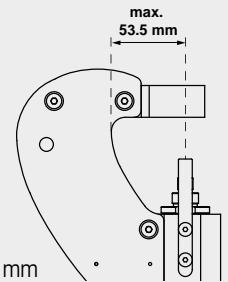

Max centre of hole to edge of trunking: 53,5 mm



Piercing heads RHT

Type	Max piercing Ø mm	Max hole distance from bar edge (mm)	Max operating pressure bar	Dimensions mm		Weight kg
				length	width	
RHT 160	21	30	700	240	153	6,5
RHT 160-60N	21	60	700	240	181	9,2

Storage type	Dimensions mm	Weight kg
VAL 160*	283x180x100	2,3

*Supplied with the head



Hydraulic head complete with automatic quick coupler, for piercing holes of various diameters in Copper, Aluminium and Steel bars with max. thickness of 10 mm.

This compact and handy tool is widely used for transformer room connections, control switch boards and power plants.

For operation the head must be joined to a hydraulic pump developing a pressure of 700 bar (see page 168-172).

Available accessories (to be ordered separately):

Piercing Ø mm	6,5	8,5	9	10,5	11	13	13,5	14	15	17	19	21
Set die - indenter	RT 6,5	RT 8,5	RT 9	RT 10,5	RT 11	RT 13	RT 13,5	RT 14	RT 15	RT 17	RT 19	RT 21

MAX. THICKNESS

Hole diameter (mm)	6,5	8,5	9	10,5	11	13	13,5	14	15	17	19	21
Max thickness strep in Copper	10	10	10	10	10	10	10	10	10	10	8	8
Max thickness strep in Steel	10	10	10	10	10	9	9	9	8	7	6	4
Punch die/set	RT 6,5	RT 8,5	RT 9	RT 10,5	RT 11	RT 13	RT 13,5	RT 14	RT 15	RT 17	RT 19	RT 21

SPECIAL TOOLS



Puller-type hole punching tool HT-FL75

general features

New

Max punching Ø mm	Dimensions mm		Weight kg
	length	width	
140	452	129	3,67

STORAGE				
Type	Dimensions mm	Weight kg	Supplied with the tool	Purchase separately
VAL P28	620x360xh138	2,4	✳	—



Hand operated hydraulic tool specifically designed for hole punching stainless Steel, mild Steel, fibreglass and plastic sheet materials up to 3,5 mm thickness. Compact, lightweight and easy to handle.

The balanced punching head pivots 180deg through a full 360deg rotation for ease of use in confined spaces.

The tool is supplied complete with plastic case VAL P28 for protection and storage when not in use.

Supplied with Pullers TD-11, TD-19 and spiral bit Ø 11,5 mm.

For the punch-die selection chart see page 166.



Universal joint allows punching head to pivot 180deg over a full 360deg rotation.



Puller-type hole punching head RH-FL75



Max punching Ø mm	Max operating pressure bar	Dimensions mm		Weight kg
		length	width	
140	700	163	106	1,9

STORAGE				
Type	Dimensions mm	Weight kg	Supplied with the tool	Purchase separately
VAL P29	448x288xh105	1,4	✳	—



Hydraulic head, for hole punching stainless Steel, mild Steel, fibreglass and plastic sheet materials up to 3,5 mm thickness.

Compact and lightweight, easy to handle in confined spaces due to a rotating 90deg quick automatic coupler for connection to a hydraulic pump with a working pressure of 700 bar max (see page 168-172).

Supplied with Pullers TD-11, TD-19 and spiral bit Ø 11,5 mm.

For the punch-die selection chart see page 166.





SPECIAL TOOLS

general features

Nut splitting heads RHTD

RHTD 1724

Suitable for splitting nuts mm	Max operating pressure bar	Weight kg
16 (M10) ÷ 27 (M18)	700	1,76

RHTD 3241

Suitable for splitting nuts mm	Max operating pressure bar	Weight kg
27 (M18) ÷ 41 (M27)	700	4,6

RHTD 3241-T

Suitable for splitting square and hexagonal nuts or fastening bushes mm	Max operating pressure bar	Weight kg
27 (M18) ÷ 41 (M27)	700	4,9

STORAGE

Type	Dimensions mm	Weight kg
VAL P4*	315x300x95	0,93

*Supplied with the head



VAL P4

Supplied in a robust plastic case.



Hydraulic nut splitting head complete with automatic quick coupler. For operating the head must be joined to a hydraulic pump developing a pressure of 700 bar (see page 168-172).

DIMENSIONS mm:

	RHTD 3241	RHTD 1724	RHTD 3241T
A	66	40,5	77
B	36	25	41
C	208	150,5	222
D	75,5	54	75,5
E	16	7,5	21,5

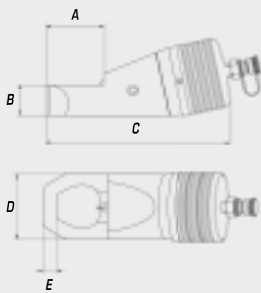

TOOL SETTING FOR RHTD

DOUBLE BLADE					SINGLE BLADE										
Moving blade and fixed blade marked "B"					Moving blade marked "B" - Blind plated marked "C"										
Hexagonal Nuts		Square Nuts		Fastening Bushes*		Hexagonal Nuts		Square Nuts							
	mm		Ø		mm		Ø _A		mm		Ø		mm		Ø
27	M 18	27	M18	1/2"	.807"	32	M 22	32	M 22	32	M 22	36	M 24	41	M 27
30	M 20	30	M 20	5/8"	1.010"	34	M 22	34	M 22	36	M 24	41	M 27		
32	M 22	32	M 22	3/4"	1.200"	36	M 24								
34	M 22	36	M 24	7/8"	1.375"										
36	M 24	41	M 27	1"	1.575"										
41	M 27			1 1/8"	1.770"										

*Blades for cutting FASTENING BUSHES are specially shaped.

ACCESSORIES

Flexible hoses

TF 300-Q 38 FM

3 m length flexible hose fitted with an automatic female quick coupler and a male quick coupler.

TF 600-Q 38 FM

6 m length flexible hose fitted with an automatic female quick coupler and a 3/8" NPT male threaded bush.

TF 300-Q 38 F

3 m length flexible hose equipped with automatic female quick coupler at one end and male threading at the other end.



High pressure flexible hoses for joining hydraulic heads to pumps. In addition to the standard versions listed below alternative hose lengths are available, please consult us:

Quick couplers



Q 38-M

Q 38-M

Male automatic coupler for hydraulic heads.



Q 38-F

Q 38-F

Female automatic coupler for hydraulic pumps and flexible hoses.

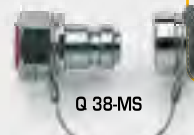

Q 38-MS

Q 38-MS

Male automatic coupler for flexible hoses.

STANDARD VERSIONS



I 38-M

I 38-M

Male automatic coupler for insulated hydraulic heads.



I 38-F

I 38-F

Female automatic coupler for insulated hydraulic pumps and flexible hoses.



I 38-MS

I 38-MS

Male automatic coupler for insulated flexible hoses.

INSULATED VERSIONS

MPC 1



Pressure checking device MPC 1

The MPC1 device, complete with test adapter set, is used to measure the maximum oil pressure on all Cembre tools.

MPC 2



Crimping force gauge MPC 2

The MPC2 device, complete with test die set, to measure the maximum force developed by Cembre tools:

HT 131-C, HT 131LN-C, HT 120, HT 120-KV, RHC 131, RHC 131-KV, RHC 131LN, B 131-C, B 131-C-KV, B 131LN-C, B 131LN-C-KV, B 135-C, B 135-C-KV, B 135LN-C, B 135LN-C-KV.

MPC 4



Crimping force gauge MPC 4

The MPC4 device, complete with test die set, to measure the maximum force developed by Cembre tools:

ECW-H3D, RHU240-3D-850, RHU 300-3D

MPC 7



Crimping force gauge MPC 7

The MPC7 device, complete with test die set, to measure the maximum force developed by Cembre tools:

HT45, HT 51, HT 51-KV, HT 51L, HT 51L-KV, RH 50, HT 61, RH 61, B15D (use adaptor available separately), B 35-45D, B 35-50D, B 46, B 51, B 51-KV, B 51L, B 51L-KV, B 54D, B 55, B 55-KV, B 62.



CORDLESS HYDRAULIC TOOLS

18.0 V CORDLESS TOOL FEATURES

- 1 Head rotates through 180°.
- 2 Switch protected against accidental operation.
- 3 Pressure release button.
- 4 Slot-in battery with release button.
- 5 LED lighting of the working area.
- 6 Motor ventilation.
- 7 Bi-component body for increased impact resistance.
- 8 Multifunction OLED display with touch button.
- 9 Improved balance for better handling.
- 10 Anatomically shaped grip for greater comfort.
- 11 18.0 V - 4.0 Ah Li-Ion high power batteries.

New

18.0V
4.0Ah
Li-Ion

NEW
18V Li-Ion
BATTERY

DOUBLE
ACTION
SPEED



LED lighting of the working area



Anatomical shape for improved comfort grip



Automatic slot-in battery with release button



Multifunction OLED display with touch button



18.0 V CORDLESS TOOL FEATURES

Multifunction OLED display:

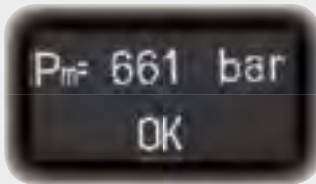

Crimping pressure and force being generated for confirmation of adherence to norms and best practice



Battery power availability



Tool service required to maintain optimum condition

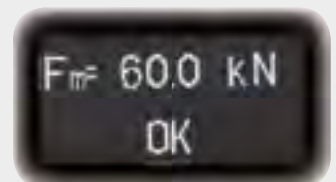

General operating information

SUPPLIED WITH

- 1 CB 1840L, 18.0 V - 4.0 Ah Li-Ion high power battery (2 pcs.)
- 2 ASC 30-36 GB 27045000 Battery charger. (INPUT 220-240 V / 50-60 Hz; OUTPUT 12-42 V DC / 3.0 A max.)
- 3 Shoulder strap.
- 4 Plastic carrying case.



B 500 Acoustic Noise

(Directive 2006/42/EC, annexe 1, point 1.7.4.2 letter u)

- The weighted continuous acoustic pressure level equivalent A at the workplace L_{pA} is equal to **73 dB (A)**
- The maximum value of the weighted acoustic displacement pressure C at the workplace L_{pCpeak} is less than **< 94,5 dB (C)**
- The acoustic power level emitted by the machine L_{WA} is equal to **79 dB (A)**

Risks due to vibration

(Directive 2006/42/EC, annexe 1, point 2.2.1.1)

Tests performed in accordance with specifications UNI ENV 25349 and UNI EN 28662 pt. 1, in operating conditions more severe than normal, certify that the weighed root mean square, in frequency of the acceleration the upper limbs are exposed to, for each biodynamic reference axis, does not exceed **0,575 m/sec²**.

14.4 V CORDLESS TOOL FEATURES

- Cordless tooling can be operated with one hand.
- Balanced tool for greater control.
- Head rotates for ease of operation in confined spaces.
- Battery condition displayed after every crimping operation and battery insertion to show the residual battery power.
- The tools are fitted with a maximum pressure valve to indicate a correct crimping operation or the full extent of the blade travel.
- Extremely quiet in operation with very little vibration.
- Durable moulded body offering high resistance to wear and damage in all operating conditions.

- The plastic or Steel carrying case can accommodate the tool and all the accessories.

Common features:



double speed action:
a rapid approach speed
and a slower more powerful
speed for crimping or cutting.



14.4V
3.0Ah
Li-Ion

new more powerful Li-Ion battery
14.4V - 3.0Ah; reduced memory
effect, better environmental
compatibility, lighter.



SUPPLIED WITH

- 1 CB 1430L 14.4 V 3.0 Ah Li-Ion high power battery (2 pcs.).
- 2 CFC 230N Battery charger.
(INPUT 230 V/50-60 Hz; OUTPUT 7.2-18 V DC)
- 3 Shoulder strap.

- Plastic/Metal carrying case suitable for storage of the tool, accessories and dies (depending on tool type).



OPTIONAL ACCESSORIES

- 4 BPS 230.14 mains power supply.
Main features: INPUT 230V~ 50-60Hz; OUTPUT 14,4V~ thermal and short circuit protection.
Current supply: up to 5A extended use; 23A for 50 s; 30A for 8 s.
- 5 ESC 600 cable for connection to a 12V DC external power supply/vehicle battery length 6 m (suitable only for tools with 12V DC socket).
- 6 CFC 12-24ICN car battery charger.
(INPUT 12-24 V DC; OUTPUT 7.2-18 V DC)



B-55 Acoustic Noise

(Directive 2006/42/EC, annexe 1, point 1.7.4.2 letter u)

- The weighted continuous acoustic pressure level equivalent A at the workplace L_{pA} is equal to **75 dB (A)**
- The maximum value of the weighted acoustic displacement pressure C at the workplace L_{pCpeak} is less than **< 130 dB (C)**
- The acoustic power level emitted by the machine L_{WA} is equal to **85.3 dB (A)**

Risks due to vibration

(Directive 2006/42/EC, annexe 1, point 2.2.1.1)

Tests performed in accordance with specifications UNI ENV 25349 and UNI EN 28662 pt. 1, in operating conditions more severe than normal, certify that the weighed root mean square, in frequency of the acceleration the upper limbs are exposed to, for each biodynamic reference axis, does not exceed **2.5 m/sec²**.

B-TC041 Acoustic Noise

(Directive 2006/42/EC, annexe 1, point 1.7.4.2 letter u)

- The weighted continuous acoustic pressure level equivalent A at the workplace L_{pA} is equal to **72.4 dB (A)**
- The maximum value of the weighted acoustic displacement pressure C at the workplace L_{pCpeak} is less than **< 130 dB (C)**
- The acoustic power level emitted by the machine L_{WA} is equal to **83.1 dB (A)**

9.6 V CORDLESS TOOL FEATURES

- Cordless tooling can be operated with one hand.
- Balanced tool for greater control.
- Head rotates for ease of operation in confined spaces.
- Battery condition displayed after every crimping operation and battery insertion to show the residual battery power.
- The tools are fitted with a maximum pressure valve to indicate a correct crimping operation or the full extent of the ram travel.
- Extremely quiet in operation with very little vibration.
- Durable moulded body offering high resistance to wear and damage in all operating conditions.
- The plastic carrying case can accommodate the tool and all the accessories.



SUPPLIED WITH

- 1 **CB 9620H** 9.6 V 2.0 Ah Ni-MH high power battery (2 pcs.) or **CB 9630H** 9.6 V 3.0 Ah Ni-MH high power battery, only for B54D-D6 (2 pcs.).
 - 2 **CFC 230N** Battery charger. (INPUT 230 V/50-60 Hz; OUTPUT 7.2-18 V DC)
 - 3 **Adaptor CBA 96-144.**
- **VAL P22** Plastic carrying case suitable for storing the tool and accessories.



OPTIONAL ACCESSORIES

- 4 **CFC 12-241CN** car battery charger. (INPUT 12-24 V DC; OUTPUT 7.2-18 V DC)
- 5 **Adaptor CBA 96-144.**
- 6 **BPS 230.96**, mains power supply. **Main features:** INPUT 230V $\overline{\sim}$ 50-60Hz; OUTPUT 9,6V $\overline{\sim}$ thermal and short circuit protection. **Current supply:** up to 8A extended use; 25A for 50 s; 30A for 8 s



B 15D Acoustic Noise

(Directive 2006/42/EC, annexe 1, point 1.7.4.2 letter u)

- The weighted continuous acoustic pressure level equivalent A at the workplace L_{pA} is equal to **66.8 dB (A)**
- The maximum value of the weighted acoustic displacement pressure C at the workplace L_{pCpeak} is less than **< 130 dB (C)**
- The acoustic power level emitted by the machine L_{WA} is equal to **75 dB (A)**

Risks due to vibration

(Directive 2006/42/EC, annexe 1, point 2.2.1.1)

Tests performed in accordance with specifications UNI ENV 25349 and UNI EN 28662 pt. 1, in operating conditions more severe than normal, certify that the weighed root mean square, in frequency of the acceleration the upper limbs are exposed to, for each biodynamic reference axis, does not exceed 2.5 m/sec².

9.6 V CORDLESS HYDRAULIC CRIMPING TOOL

B 15D

general features



Crimping force kN	Dimensions mm			Battery Ni-MH	Weight kg (with battery)
	length	height	width		
15	320	117	66	9.6 V 2.0 Ah	1,68

**9.6V
2.0Ah
Ni-MH**

MAIN APPLICATIONS - max section mm²

Copper lugs and splices	Insulated terminals	End sleeves
0,25 - 16	0,25 - 16	0,3 - 35

STORAGE

Type	Dimensions mm	Weight kg	Supplied with the tool	Purchase separately
VAL P22	465x315xh116	1,5	✳	—

The tool is supplied as:

- Basic tool with battery and wrist strap
- Spare battery
- Battery charger
- Battery adapter

- Plastic carrying case suitable for storing the tool and accessories

Can be operated with one hand. Balanced for greater control. Head rotates 340° for ease of operation in confined spaces. Fitted with a maximum pressure valve. Extremely quiet, minimal vibration. Durable moulded body offering high resistance to wear and damage in all operating conditions. Ni-MH battery; powerful, better environmental compatibility. Complete with a display which, after every operation and battery insertion, indicates the residual battery power.

Supplied in a robust plastic case to accommodate the tool and all the accessories. Two batteries and charger included. Many different interchangeable crimping dies available.

Many different interchangeable crimping dies available

CRIMPING DIES AVAILABLE

Conductor size mm ²	Conductor size (AWG)	Connector type	DIE SET	
0,25 ÷ 16	22 ÷ 6	A... ; L...-M ; L...-P ; S... ; RN... ; BN... ; GN...	MA03/3-15	☺
1,5 ÷ 10	16 ÷ 8	A... ; L...-M ; L...-P	ME03/2-15	☺
10 ÷ 16	8 ÷ 6	A... ; 2A... ; L...-M ; L...-P	ME2/3-15	
4 ÷ 10	12 ÷ 8	T... (NF C 20130 style) ; L...-T	MS4/10-15	☺
10 ÷ 16	8 ÷ 6	T... (NF C 20130 style) ; L...-T	MS10/16-15	
10 ÷ 16	8 ÷ 6	HR... ; HSV...	MH10/16-15	☺
6 ÷ 16	10 ÷ 6	DR... (DIN 46235 style) ; DSV... (DIN 46267 T1 style)	MK5/8-15	
10 ÷ 16	8 ÷ 6	ANE... ; AN... ; IN... ; EN...	NN4-15	☺
0,25 ÷ 6	22 ÷ 10	R... ; B... ; G... (not suffix P) ; PL... ; NL...	RBG-15	☺
0,25 ÷ 6	22 ÷ 10	R... ; B... ; G... (not suffix P, RF/BF-BF)	RBV-15 with positioner	☺
0,3 ÷ 4	22 ÷ 12	PKE ; PKC ; PKD ; PKT ; KE	KE4-15	☺
4 ÷ 16	12 ÷ 6	PKE ; PKC ; PKD ; PKT ; KE	KE16-15	☺
16 ÷ 35	6 ÷ 2	PKE ; PKC ; PKD ; PKT ; KE	KE35-15	☺
2,5 - 4 - 6	14 - 12 - 10	CS4 (per impianti fotovoltaici) ☼	MCS4-15	☺

Head rotates 340° for ease of operation

Durable moulded body offering high resistance to wear and damage in all operating conditions

Sculptured body for optimum comfort



Battery condition display



Interchangeable die sets



Ergonomically designed operating switch



Automatic slot-in battery

9.6 V CORDLESS HYDRAULIC CRIMPING TOOL



general features

B 35-45D

**9.6V
2.0Ah
Ni-MH**

Crimping force kN	Dimensions mm			Battery Ni-MH	Weight kg (with battery)
	length	height	width		
35	342	108	66	9.6 V 2.0 Ah	2,1

MAIN APPLICATIONS - max section mm²

L.V. lugs and splices	"C" sleeve Connectors	H.V. lugs and splices
150	35	70

STORAGE

Type	Dimensions mm	Weight kg	Supplied with the tool	Purchase separately
VAL P22	465x315x116	1,5	✳	—

The tool is supplied as:

- Basic tool with battery and wrist strap
- Spare battery
- Battery charger
- Battery adapter
- Plastic carrying case suitable for storing the tool and accessories



Can be operated with one hand. Balanced for greater control. Head rotates 180° for ease of operation in confined spaces. Fitted with a maximum pressure valve. Extremely quiet, minimal vibration. Durable moulded body offering high resistance to wear and damage in all operating conditions. Ni-MH battery; powerful, better environmental compatibility. Complete with a display which, after every operation and battery insertion, indicates the residual battery power. Supplied in a robust plastic case to accommodate the tool and all the accessories. Two batteries and charger included. B35-45D accepts many of the dies common to 45 kN Cembre crimping tools. B35-45D specific dies available for crimping 120 mm² and 150 mm². Application field as shown in the table above. For further details please refer to tables of page 176-185.

Wide-opening head, ideal for derivations from running conductors



Motor ventilation



Head rotates 180° for ease of operation

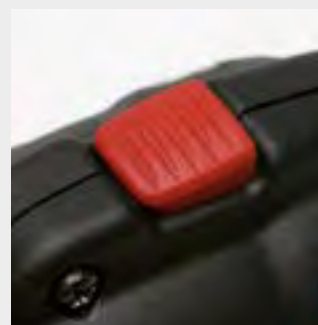

Pressure release button



Sculptured body for optimum comfort

These tools are supplied without dies. For die selection, please refer to chart on pages 176 to 185

9.6 V CORDLESS HYDRAULIC CRIMPING TOOL

B 35-50D

general features



Crimping force kN	Dimensions mm			Battery Ni-MH	Weight kg (with battery)
	length	height	width		
35	372	108	66	9.6 V 2.0 Ah	2,4

**9.6V
2.0Ah
Ni-MH**

MAIN APPLICATIONS - max section mm²

L.V. lugs and splices	Insulated terminals	End sleeves	"C" sleeve Connectors
150	50	95	35

STORAGE

Type	Dimensions mm	Weight kg	Supplied with the tool	Purchase separately
VAL P22	465x315x116	1,5	✳	—

Can be operated with one hand.
Balanced for greater control.
Head rotates 180° for ease of operation in confined spaces.
Fitted with a maximum pressure valve.
Extremely quiet, minimal vibration.
Durable moulded body offering high resistance to wear and damage in all operating conditions.
Ni-MH battery; powerful, better environmental compatibility.
Complete with a display which, after every operation and battery insertion, indicates the residual battery power.
Supplied in a robust plastic case to accommodate the tool and all the accessories.
Two batteries and charger included.
B35-50D accepts many of the dies common to 50 kN Cembre crimping tools.

B35-50D specific dies available for crimping 120 mm² and 150 mm². Application field as shown in the table above. For further details please refer to tables of page 176-185.

The tool is supplied as:

- Basic tool with battery and wrist strap
- Spare battery
- Battery charger
- Battery adapter
- Plastic carrying case suitable for storing the tool and accessories

Head rotates by 180° for ease of operation

Sculptured body for optimum comfort

Durable moulded body offering high resistance to wear and damage in all operating conditions



Wide-opening head, ideal for derivations from running conductors



Switch ergonomically designed



Battery condition display



Automatic slot-in battery

These tools are supplied without dies. For die selection, please refer to chart on pages 176 to 185

9.6 V CORDLESS HYDRAULIC CRIMPING TOOL



general features

B 54D-D6

**9.6V
3.0Ah
Ni-MH**

Crimping force kN	Dimensions mm			Battery Ni-MH	Weight kg (with battery)
	length	height	width		
54	450	119	66	9.6 V 3.0 Ah	2,9

MAIN APPLICATIONS - max section AWG

Copper lugs and splices	Aluminum lugs and splices	Aluminum H taps
300 MCM	4/0	4/0 - 4/0

STORAGE

Type	Dimensions mm	Weight kg	Supplied with the tool	Purchase separately
VAL P25	497x370x137	2,3	✳	—
VAL MAT-W	175x96x45	0,93	—	✳

The tool is supplied as:

- Basic tool with battery and wrist strap
- Spare battery
- Battery charger
- Battery adapter
- Plastic carrying case suitable for storing the tool and accessories



VAL P25

VAL MAT-W

Available as optional accessories:
VAL MAT-W metal case for storing 12 Index die sets, fits into VAL-P25.

The professional tool ideal for OH lines and residential service applications.

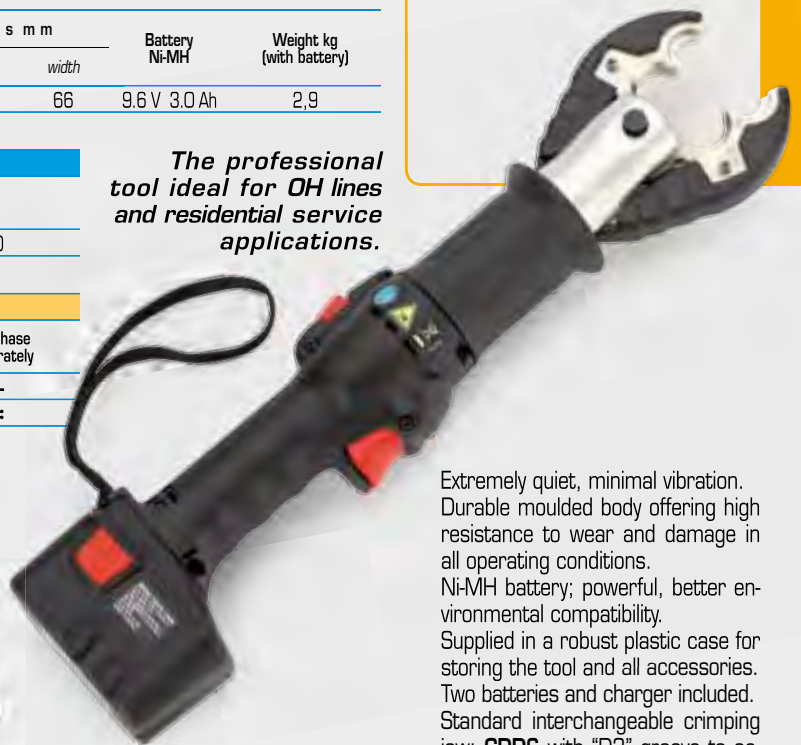

Extremely quiet, minimal vibration. Durable moulded body offering high resistance to wear and damage in all operating conditions. Ni-MH battery; powerful, better environmental compatibility. Supplied in a robust plastic case for storing the tool and all accessories. Two batteries and charger included. Standard interchangeable crimping jaw: CDD6 with "D3" groove to accept all "W" style crimping dies + "BG" fixed groove. Complete with a display which, after every operation and battery insertion, indicates the residual battery power.

Can be operated with one hand. Balanced for greater control. Jaws rotate 180° for ease of operation in confined spaces. Fitted with a maximum pressure valve.

INTERCHANGEABLE CRIMPING JAWS

CAT. No	GROOVES	CRIMPING DIE COMPATIBILITY
CDD6	"D3" TO ACCEPT ALL "W" STYLE CRIMPING DIES + "BG" FIXED GROOVE	FCI Burndy Green lee IlSCO
CDD6-8	"D3" TO ACCEPT ALL "W" STYLE CRIMPING DIES + "O" FIXED GROOVE	Huskie Panduit
CMB1	Cutting jaws for: one-time disposable lock hasps; 4AWG Alumoweld; ACSR 4/0	
CMB2	Cutting jaws for: # 8 Copperweld; 4/0 Cu.; 336 MCM Aluminium; 477 MCM ACSR (Str. 26/7)	
CMB3	Cutting jaws for: 1/4" Guy Wire ; 5/16" Guy Wire	



CDD6 jaws

With "D3" groove to accept all "W" style crimping dies + "BG" fixed groove.



CDD6-8 jaws

With "D3" groove to accept all "W" style crimping dies + "O" fixed groove.

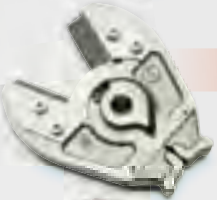

CMB1 jaws

Cutting jaws for: one-time disposable lock hasps, 4AWG Alumoweld; ACSR 4/0



CMB2 jaws

Cutting jaws for:
- # 8 Copperweld
- 4/0 Cu.
- 336 MCM Aluminium
- 477 MCM ACSR (Str. 26/7)



CMB3 jaws

Cutting jaws for:
- 1/4" Guy Wire
- 5/16" Guy Wire

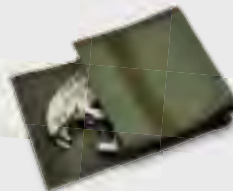

Canvas Bag 013

Sturdy canvas bag, suitable for storing the cutting jaws



Jaws rotate 180°



Detail of the quick jaw change device.

18.0 V CORDLESS HYDRAULIC CRIMPING TOOL

B 500E

New



**NEW
18V Li-Ion
BATTERY**

general features



Nominal Compression Force kN	Dimensions mm			Battery	Weight kg (with battery)
	length	height	width		
63	300	343	83	18 V 4.0 Ah	4,2



**18.0V
4.0Ah
LI-ION**

MAIN APPLICATIONS - max section mm²

L.V. lugs and splices	Insulated terminals	End sleeves	"C" sleeve Connectors
240	120	120	70

STORAGE

Type	Dimensions mm	Weight kg	Supplied with the tool	Purchase separately
VALP35	500x480x128	3,1	*	—

The tool is supplied as:

- Basic tool with battery and shoulder strap
- Spare battery
- Battery charger
- Plastic carrying case suitable for storing the tool and 20 die sets



The next generation of Cembre cordless hydraulic tools represents a significantly advantageous evolution from current models.

Born of the renowned B51 type crimping tool, the 63 kN B500E is suitable for a wide range of connectors up to 240 sqmm using die sets common to the Cembre 50 kN tooling range.

New Li-Ion 18 V 4 Ah batteries offer a higher capacity than 14.4 V 3 Ah, while greater crimping speed and crimping force result from a revitalised hydraulic system with double speed action: a rapid approach of the dies to the connector then a slower, more powerful speed for crimping.

A maximum pressure sensor and pressure relief valve assure greater precision and repeatability of the pressure cycle and double the provision for operator safety.

The OLED display provides essential real time tool operating information data including:

- Crimping pressure and force being generated, for confirmation of adherence to norms and best practice
- Battery power availability
- Tool identification, LED work light state, reset, no. of operational and service crimping cycles
- Tool service required to maintain optimum condition.

Designed with improved balance, B500E is easily manageable during the crimping process and, by the use of bi-component plastics, has a shell with high resistance to wear and damage.

Rubber grip inserts, low noise and minimal vibration aid operator comfort while additional convenience and safety are provided by LED lighting of the working area. Crimping cycle data (up to 200,000 events) is automatically stored on a memory card for transfer to PC by USB interface.

Operating temperature:
-15 to +50 ° C

New



B 500E-KV
version also available for
Power Supply Companies

LED lighting of the working area



Anatomically shaped grip for improved comfort



Multifunction OLED display with touch button



Slot-in battery with release button



These tools are supplied without dies. For die selection, please refer to chart on pages 176 to 185

14.4 V CORDLESS HYDRAULIC CRIMPING TOOL



general features

B 55



**14.4V
3.0Ah
Li-Ion**

Crimping force kN	Dimensions mm			Battery	Weight kg (with battery)
	length	height	width		
55	358	302	94	14.4 V 3.0 Ah	4,7

MAIN APPLICATIONS - max section mm²

Copper lugs and splices	Insulated terminals	End sleeves	"C" sleeve Connectors
240	120	120	70

STORAGE

Type	Dimensions mm	Weight kg	Supplied with the tool	Purchase separately
VAL P9	543x412x130	2,2	✳	—

The tool is supplied as:

- Basic tool with battery, wrist strap and shoulder strap
- Spare battery
- Battery charger
- Plastic carrying case suitable for storing the tool and accessories



14.4 V cordless hydraulic crimping tool, lightweight and balanced for single hand operation. The tool features a double speed action: a fast advancing speed for rapid approach of the dies to the connector and a slower more powerful speed for crimping. The crimping head can rotate through 180° for ease of operation.



**Li-Ion
BATTERY**

The B 55, with adapter AU55-50, will accept all Cembre 50 kN dies; with adapter AU55-W it will accept "W" dies.

Fitted with a maximum hydraulic pressure valve. Complete with a display which, after every operation and battery insertion, indicates the residual battery power. Extremely quiet in operation, with very little vibration. Ergonomically designed with a sculptured body for operator comfort.

With adapter AU55-50 for accepting Cembre dies.



Cembre die

AU55-50 adapter

With adapter AU55-W for accepting "W" dies.

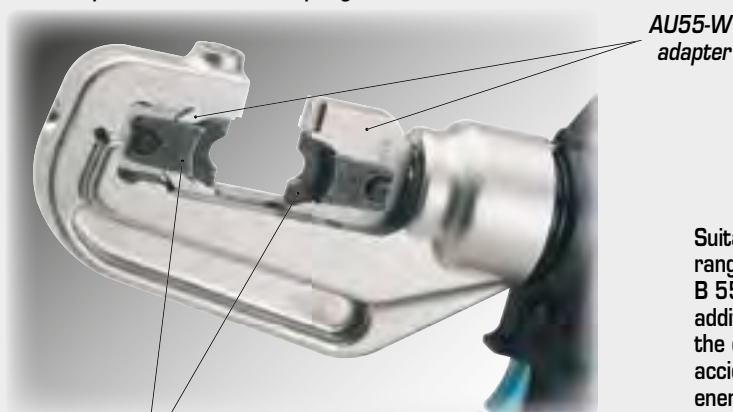

"W" die

AU55-W adapter

Suitable for installing the same range of connectors of B 55, B 55-KV tool is provided with additional coatings to protect the operator and tool against accidental brush contact with energised conductors.

Particularly suitable for Power Supply Companies.



B 55-KV

These tools are supplied without dies. For die selection, please refer to chart on pages 176 to 185

18.0 V CORDLESS HYDRAULIC CRIMPING TOOL

B 1350-CE

New

general features



Nominal Compression Force kN	Dimensions mm			Jaw Opening mm	Battery	Weight kg (with battery)
	length	height	width			
132	338	344	83	25	18,0 V 4.0 Ah	6,4



**18.0V
4.0Ah
Li-Ion**

The next generation of Cembre cordless hydraulic tools represents a significantly advantageous evolution from current models. Born of the renowned B135-C type crimping tool, B1350-CE is suitable for a wide range of connectors up to 400 sqmm using die sets common to the Cembre 130 kN tooling range. New Li-Ion 18 V 4 Ah batteries offer a higher capacity than 14.4 V 3 Ah, while greater crimping speed and crimping force result from a revitalised hydraulic system with double speed action: a rapid approach of the dies to the connector then a slower, more powerful speed for crimping. A maximum pressure sensor and pressure relief valve assure greater precision and repeatability of the



**NEW
18V Li-Ion
BATTERY**

pressure cycle and double the provision for operator safety. The OLED display provides essential real time tool operating information data including:

- Crimping pressure and force being generated, for confirmation of adherence to norms and best practice
- Battery power availability
- Tool identification, LED work light state, reset, no. of operational

MAIN APPLICATIONS - max section mm²

L.V. lugs	L.V. splices	Insulated terminals	"C" sleeve connectors	H.V. lugs	H.V. splices
400	240	240	185	400	240

STORAGE

Type	Dimensions mm	Weight kg	Supplied with the tool	Purchase separately
VALP36	500x480x128	3,1	*	—

The tool is supplied as:

- Basic tool with battery and shoulder strap
- Spare battery
- Battery charger
- Plastic carrying case suitable for storing the tool and 7 die sets



and service crimping cycles - Tool service required to maintain optimum condition. Designed with improved balance, B1350-CE is easily manageable during the crimping process and, by the use of bi-component plastics, has a shell with high resistance to wear and damage. Rubber grip inserts, low noise and minimal vibration aid operator comfort while additional convenience and safety are provided by LED light-

ing of the working area. Crimping cycle data (up to 200,000 events) is automatically stored on a memory card for transfer to PC by USB interface.

Operating temperature: -15 to +50 ° C

18.0 V CORDLESS HYDRAULIC CRIMPING TOOL

B 1350L-CE

New

general features



Crimping force kN	Dimensions mm			Jaw Opening mm	Battery	Weight kg (with battery)
	length	height	width			
132	395	372	83	42	18,0 V 4.0 Ah	8,2



**18.0V
4.0Ah
Li-Ion**

B1350L-CE version, featuring a large 42 mm jaw opening, for an easier introduction/removal of large size compression terminations and joints.



**NEW
18V Li-Ion
BATTERY**

MAIN APPLICATIONS - max section mm²

L.V. lugs and splices	Insulated terminals	"C" sleeve Connectors	H.V. lugs and splices
400	240	185	400

STORAGE

Type	Dimensions mm	Weight kg	Supplied with the tool	Purchase separately
VALP36	500x480x128	3,1	*	—

The tool is supplied as:

- Basic tool with battery and shoulder strap
- Spare battery
- Battery charger
- Plastic carrying case suitable for storing the tool and 7 die sets



These tools are supplied without dies. For die selection, please refer to chart on pages 176 to 185

18.0 V CORDLESS HYDRAULIC CRIMPING TOOL



general features

B 1350-UCE

New



**18.0V
4.0Ah
Li-Ion**

Crimping force kN	Dimensions mm			Battery	Weight kg (with battery)
	length	height	width		
132	351	369	83	18,0 V 4.0 Ah	5,9

MAIN APPLICATIONS - max section mm²

L.V. lugs and splices	Insulated terminals	"C" sleeve Connectors	H.V. lugs and splices	Alu lugs and splices
400	240	185	400	300

STORAGE

Type	Dimensions mm	Weight kg	Supplied with the tool	Purchase separately
VALP36	500x480x128	3,1	✳	—

The tool is supplied as:

- Basic tool with battery and shoulder strap
- Spare battery
- Battery charger
- Plastic carrying case suitable for storing the tool and 7 die sets



**NEW
18V Li-Ion
BATTERY**

The next generation of Cembre cordless hydraulic tools represents a significantly advantageous evolution from current models. Born of the renowned B135-UC type crimping tool, B1350-UCE will accept the accessories for performing the "Deep Stepped Indent" system of crimping on Aluminium cables. The B1350-UCE will accept all semi-circular slotted dies, common to most 12 tons tools (U dies). New Li-Ion 18 V 4 Ah batteries offer a higher capacity than 14.4 V 3 Ah, while greater crimping

speed and crimping force result from a revitalised hydraulic system with double speed action: a rapid approach of the dies to the connector then a slower, more powerful speed for crimping. A maximum pressure sensor and pressure relief valve assure greater precision and repeatability of the pressure cycle and double the provision for operator safety. The OLED display provides essential real time tool operating information

data including:

- Crimping pressure and force being generated, for confirmation of adherence to norms and best practice
- Battery power availability
- Tool identification, LED work light state, reset, no. of operational and service crimping cycles
- Tool service required to maintain optimum condition.

Designed with improved balance, B1350-UCE is easily manageable

during the crimping process and, by the use of bi-component plastics, has a shell with high resistance to wear and damage. Rubber grip inserts, low noise and minimal vibration aid operator comfort while additional convenience and safety are provided by LED lighting of the working area. Crimping cycle data (up to 200,000 events) is automatically stored on a memory card for transfer to PC by USB interface.

Operating temperature:
-15 to +50 ° C



LED lighting of the working area



Multifunction OLED display with touch button



Anatomically shaped grip for improved comfort



Slot-in battery with release button

These tools are supplied without dies. For die selection, please refer to chart on pages 176 to 185

18.0 V CORDLESS HYDRAULIC CRIMPING TOOL

B 1300-CE

New

general features



Crimping force kN	Dimensions mm			Jaw Opening mm	Battery	Weight kg (with battery)
	length	height	width			
132	406	239	102,5	25	18.0 V - 4.0 Ah	6,5



**18.0V
4.0Ah
Li-Ion**



**NEW
18V Li-Ion
BATTERY**

MAIN APPLICATIONS - max section mm²

L.V. lugs	L.V. splices	Insulated terminals	"C" sleeve connectors	H.V. lugs	H.V. splices
400	240	240	185	400	240

STORAGE

Type	Dimensions mm	Weight kg	Supplied with the tool	Purchase separately
VAL P41	691x456x176	4,0	✳	—

The tool is supplied as:

- Basic tool with battery and shoulder strap
- Spare battery
- Battery charger
- Plastic carrying case suitable for storing the tool and 12 die sets



The next generation of Cembre cordless hydraulic tools represents a significantly advantageous evolution from current models.

Born of the renowned B131-C type crimping tool, B1300-CE is suitable for a wide range of connectors up to 400 sqmm using die sets common to the Cembre 130 kN tooling range.

New Li-Ion 18 V 4 Ah batteries offer a higher capacity than 14.4 V 3 Ah, while greater crimping speed and crimping force result from a revitalised hydraulic system with double speed action: a rapid approach of the dies to the connector then a slower, more powerful speed for crimping.

A maximum pressure sensor and pressure relief valve assure greater precision and repeatability of the pressure cycle and double the provision for operator safety.

The OLED display provides essential real time tool operating information data including:

- Crimping pressure and force being generated, for confirmation of adherence to norms and best practice
- Battery power availability
- Tool identification, LED work light state, reset, no. of operational and service crimping cycles
- Tool service required to maintain optimum condition.

Designed with improved balance, B1300-CE is easily manageable during the crimping process and, by the use of bi-component plastics, has a shell with high resistance to wear and damage.

Rubber grip inserts, low noise and minimal vibration aid operator comfort while additional convenience and safety are provided by LED lighting of the working area.

Crimping cycle data (up to 200,000 events) is automatically stored on a memory card for transfer to PC by USB interface.

Operating temperature:
-15 to +50 ° C

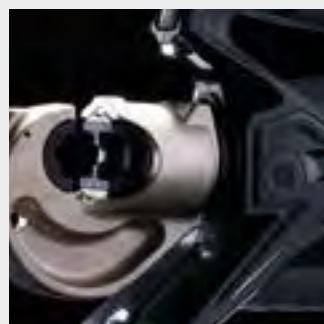

LED lighting of the working area



Anatomically shaped grip for improved comfort



B 1300-CE-KV
version also available for
Power Supply Companies



Slot-in battery with release button



Multifunction OLED display with touch button

These tools are supplied without dies. For die selection, please refer to chart on pages 176 to 185

18.0 V CORDLESS HYDRAULIC CRIMPING TOOL



general features



18.0V
4.0Ah
Li-Ion

Crimping force kN	Dimensions mm			Jaw Opening mm	Battery	Weight kg (with battery)
	length	height	width			
132	471	239	102,5	42	18.0 V - 4.0 Ah	8,0

MAIN APPLICATIONS - max section mm²

L.V. lugs and splices	Insulated terminals	"C" sleeve Connectors	H.V. lugs and splices
400	240	185	400

STORAGE

Type	Dimensions mm	Weight kg	Supplied with the tool	Purchase separately
VAL P41	691x456x176	4,0	✳	—

The tool is supplied as:

- Basic tool with battery and shoulder strap
- Spare battery
- Battery charger
- Plastic carrying case suitable for storing the tool and 12 die sets

Also available in the B1300L-CE version, featuring a large 42 mm jaw opening, for an easier introduction/removal of large size compression terminations and joints.



New

NEW
18V Li-Ion
BATTERY

18.0 V CORDLESS HYDRAULIC CRIMPING TOOL



general features



18.0V
4.0Ah
Li-Ion

Crimping force kN	Dimensions mm			Battery	Weight kg (with battery)
	length	height	width		
132	423	239	102,5	18.0 V - 4.0 Ah	6,5

MAIN APPLICATIONS - max section mm²

L.V. lugs and splices	Insulated terminals	"C" sleeve Connectors	H.V. lugs and splices	Alu lugs and splices
400	240	185	400	300

STORAGE

Type	Dimensions mm	Weight kg	Supplied with the tool	Purchase separately
VAL P41	691x456x176	4,0	✳	—

The tool is supplied as:

- Basic tool with battery and shoulder strap
- Spare battery
- Battery charger
- Plastic carrying case suitable for storing the tool and 12 die sets



New

NEW
18V Li-Ion
BATTERY

The next generation of Cembre cordless hydraulic tools represents a significantly advantageous evolution from current models. Born of the renowned B131-UC type crimping tool, B1300-UCE will accept the accessories for performing the "Deep Stepped Indent" system of crimping on Aluminium cables. The B1300-UCE will accept all semi-circular slotted dies, common to most 12 tons tools (U dies).

New Li-Ion 18 V 4 Ah batteries offer a higher capacity than 14.4 V 3 Ah, while greater crimping speed and crimping force result from a revitalised hydraulic system with double speed action: a rapid approach of the dies to the connector then a slower, more powerful speed for crimping. A maximum pressure sensor and pressure relief valve assure greater precision and repeatability of the pressure cycle and double the provision for operator safety.

The OLED display provides essential real time tool operating information data including:

- Crimping pressure and force being generated, for confirmation of adherence to norms and best practice
- Battery power availability
- Tool identification, LED work light state, reset, no. of operational and service crimping cycles
- Tool service required to maintain optimum condition.

Designed with improved balance, B1300-UCE is easily manageable during the crimping process and, by the use of bi-component plastics, has a shell with high resistance to wear and damage.

Rubber grip inserts, low noise and minimal vibration aid operator comfort while additional convenience and safety are provided by LED lighting of the working area.

Crimping cycle data (up to 200,000 events) is automatically stored on a memory card for transfer to PC by USB interface.

Operating temperature:
-15 to +50 ° C

These tools are supplied without dies. For die selection, please refer to chart on pages 176 to 185

OVERHEAD LINE APPLICATION
B35-TC025



Can be operated with one hand. Balanced for greater control. Head rotates 180° for ease of operation in confined spaces. Fitted with a maximum pressure valve. Extremely quiet, minimal vibration. Durable moulded body offering high resistance to wear and damage in all operating conditions. Ni-MH battery; powerful, better environmental compatibility. Complete with a display which, after every operation and battery insertion, indicates the residual battery power. Supplied in a robust plastic case to accommodate the tool and all the accessories. Two batteries and charger included.

The tool is supplied as:

- Basic tool with battery and wrist strap
- Spare battery
- Battery charger • Battery adapter
- Plastic carrying case suitable for storing the tool and accessories

9.6 V CORDLESS HYDRAULIC CUTTING TOOL

general features



**9.6V
2.0Ah
Ni-MH**

Max cutting Ø mm	Dimensions mm			Battery	Weight kg (with battery)
	length	height	width		
25	377	114	66	9.6 V 2.0 Ah	3,0

STORAGE				
Type	Dimensions mm	Weight kg	Supplied with the tool	Purchase separately
VAL P22	465x315x116	1,5	✳	—

CUTTING CAPACITY			
MATERIAL	TENSILE STRENGTH (daN/mm ²)	MAX CUTTING DIAMETER (mm)	
		B35-TC025	
ROPE & CONDUCTORS	COPPER	≤ 41	25
	ALUMINIUM	≤ 20	25
	ALMELEC	≤ 34	25
	STEEL	≤ 180	INDICATIVE EXAMPLES: 19 x 2,1 : Ø est. = 10,5 mm 19 x 2,2 : Ø est. = 11,0 mm
	MULTI STRANDS STEEL (STRANDS Qty ≥ 200)	≤ 180	-
RODS	ACSR	≤ 180	25
	STEEL	≤ 60	10
		≤ 42	-
		≤ 30	-
	COPPER	≤ 25	16
ALUMINIUM	≤ 16	25	

18.0 V CORDLESS HYDRAULIC CUTTING TOOL

general features



**18.0V
4.0Ah
Li-Ion**

OVERHEAD LINE APPLICATION
B-TC250E

New



**NEW
18V Li-Ion
BATTERY**

Next generation of 18.0 V cordless hydraulic cutting tool specifically designed to cut Copper, Aldey, Aluminium, Aluminium-Steel cables and Steel ropes, Aluminium and Steel rods having a max overall diameter of 25 mm. The blades are manufactured from high strength special Steel, heat treated to ensure a long service life. New Li-Ion 18 V 4 Ah batteries offer a higher capacity than 14.4 V 3 Ah,

while greater cutting speed and cutting force result from a revitalised hydraulic system with double speed action. The battery is equipped with led indicators that indicate the remaining battery life at any time by pressing the adjacent button. The head can rotate through 180 degrees,

STORAGE				
Type	Dimensions mm	Weight kg	Supplied with the tool	Purchase separately
VALP37	500x480x128	3,1	✳	—

The tool is supplied as:

- Basic tool with battery and shoulder strap
- Spare battery
- Battery charger
- Plastic carrying case suitable for storing the tool and accessories

to enable the operator to work in the most comfortable position, and can easily be opened to allow cutting of running cables. Fitted with a maximum hydraulic pressure valve. Designed with improved balance, B-TC250E is easily manageable during the cutting process and, by the use of bi-component plastics, has a



shell with high resistance to wear and damage. Rubber grip inserts, low noise and minimal vibration aid operator comfort while additional convenience and safety are provided by LED lighting of the working area. For cutting capacity data see page 136. Operating temperature: -15 to +50 °C

18.0 V CORDLESS HYDRAULIC CUTTING TOOL



general features



**18.0V
4.0Ah
Li-Ion**

Max cutting Ø mm	Dimensions mm			Battery	Weight kg (with battery)
	length	height	width		
45	407	401	88	18,0 V 4.0 Ah	6,7

STORAGE

Type	Dimensions mm	Weight kg	Supplied with the tool	Purchase separately
VALP37	500x480x128	3,1	✳	—

The tool is supplied as:

- Basic tool with battery and shoulder strap
- Spare battery
- Battery charger
- Plastic carrying case suitable for storing the tool and accessories



Next generation of 18.0V cordless hydraulic cutting tool specifically designed cut Copper, aldrej, Aluminium, Aluminium-Steel cables and Steel ropes, Aluminium and Steel rods having a max overall diameter of 45 mm. The blades are manufactured from high strength special Steel, heat treated to ensure a long service life.

New Li-Ion 18 V 4 Ah batteries offer a higher capacity than 14.4 V 3 Ah, while greater cutting speed and cutting force result from a revitalised hydraulic system with double speed action. The battery is equipped with led indicators that indicate the remaining battery life at any time by pressing the adjacent button. The head can rotate through 180 degrees, to

enable the operator to work in the most comfortable position, and can easily be opened to allow cutting of running cables. Fitted with a maximum hydraulic pressure valve. Designed with improved balance, B-TC450E is easily manageable during the cutting process and, by the use of bi-component plastics, has a shell with high resistance to wear and damage. Rubber grip inserts, low noise and minimal vibration aid operator comfort while additional convenience and safety are provided by LED lighting of the working area. For cutting capacity data see page 138.



Operating temperature:
-15 to +50 ° C

OVERHEAD LINE APPLICATION
B-TC450E

New

**NEW
18V Li-Ion
BATTERY**

14.4 V CORDLESS HYDRAULIC CUTTING TOOL



general features



**14.4V
3.0Ah
Li-Ion**

Max cutting Ø mm	Dimensions mm			Battery	Weight kg (with battery)
	length	height	width		
40	492	250	100	14,4 V 3.0 Ah	7,3

STORAGE

Type	Dimensions mm	Weight kg	Supplied with the tool	Purchase separately
VAL BTC04	566x410x130	6,7	✳	—

The tool is supplied as:

- Basic tool with battery and shoulder strap
- Spare battery
- Battery charger
- Metal carrying case suitable for storing the tool and accessories



- 14.4 V cordless hydraulic cutting tool specifically designed cut Copper, aldrej, Aluminium, Aluminium-Steel cables and Steel ropes, Aluminium and Steel rods having a max overall diameter of 40 mm.
- Lightweight and balanced for single hand operation.
- The tool features a double speed action: a fast advancing speed for rapid approach of the blades to the cable and a slower more powerful speed for cutting.
- For ease of operation and comfort of the operator the tool head can be rotated through 180 degrees.
- The tool is powered by 14.4 V dc Li-Ion battery.
- A balanced tool for optimum control.

- Quiet in operation with very little vibration.
- Lightweight construction enables the operator to hold the tool in one hand and to position the cable with the other hand.
- The operating buttons, cut/release, are mechanically interlocked, to prevent accidental operation of the tool.
- A microprocessor controls the tool operation and automatically cuts out the motor, on completion

- of the cutting operation, saving energy and extending battery life.
- The residual battery capacity is automatically displayed after every operation and battery insertion.
- Fitted with an integral socket, for connection to a 12 V dc external power supply/vehicle battery.
- The tool is provided with a maximum pressure valve. For cutting capacity data see page 138.



**Li-Ion
BATTERY**

OVERHEAD LINE APPLICATION
B-TC04

18.0 V CORDLESS HYDRAULIC CUTTING TOOL

OVERHEAD LINE APPLICATION
B-TC500YE

New



Next generation of 18.0 V cordless hydraulic cutting tool specifically designed to cut Copper, Aluminium, Aluminium-Steel cables (ACSR) having a max overall diameter of 50 mm. The blades are manufactured from high strength special Steel, heat treated to ensure a long service life. New Li-Ion 18 V 4 Ah batteries offer a higher capacity than 14.4 V 3 Ah, while greater cutting speed and cutting force result from a revitalised hydraulic system with double speed action.

**NEW
18V Li-Ion
BATTERY**

The battery is equipped with led indicators that indicate the remaining battery life at any time by pressing the adjacent button. The head can rotate through 90 degrees, to enable the operator to work in the most comfortable position, and can easily be opened to allow cutting of running cables.

general features

Max cutting Ø mm	Dimensions mm			Battery	Weight kg (with battery)
	length	height	width		
50	405	398	83	18.0 V 4.0 Ah	5,8



**18.0V
4.0Ah
Li-Ion**

STORAGE

Type	Dimensions mm	Weight kg	Supplied with the tool	Purchase separately
VALP37	500x480x128	3,1	✳	—

The tool is supplied as:

- Basic tool with battery and shoulder strap
- Spare battery
- Battery charger
- Plastic carrying case suitable for storing the tool and accessories



Fitted with a maximum hydraulic pressure valve. Designed with improved balance, B-TC500YE is easily manageable during the cutting process and, by the use of bi-component plastics, has a shell with high resistance to wear and damage.

Rubber grip inserts, low noise and minimal vibration aid operator comfort while additional convenience and safety are provided by LED lighting of the working area. Operating temperature: -15 to +50 °C

Not suitable for cutting stay wire, Steel rope or earthing rod.

14.4 V CORDLESS HYDRAULIC CUTTING TOOL

OVERHEAD LINE APPLICATION
B-TC055

general features

Max cutting Ø mm	Dimensions mm			Battery	Weight kg (with battery)
	length	height	width		
55	483	298	94	14.4 V 3.0 Ah	9,1



**14.4V
3.0Ah
Li-Ion**



**Li-Ion
BATTERY**

14.4 V cordless hydraulic cutting tool, lightweight and balanced for single hand operation. Specifically designed cut Copper, Aldrey, Aluminium, Aluminium-Steel cables and Steel ropes, Aluminium and Steel rods having a max overall diameter of 55 mm. The tool features a double speed action: a fast advancing speed for rapid approach of the blades to the cable and a slower more powerful speed for cutting. The blades are manufactured from high strength special Steel, heat treated to ensure a long service life.

The head can be easily opened to allow the cutting of running cables. The head can rotate through 320 degrees, to enable the operator to work in the most comfortable position.

The tool is supplied as:

- Basic tool with battery and shoulder strap
- Spare battery • Battery charger

- Metal carrying case suitable for storing the tool and accessories

Fitted with a maximum hydraulic pressure valve. Complete with a display which, after every operation and battery insertion, indicates the residual battery power. Extremely quiet in operation, with very little vibration. Ergonomically designed with a sculptured body for operator comfort. For cutting capacity data see page 140.



STORAGE

Type	Dimensions mm	Weight kg	Supplied with the tool	Purchase separately
VAL B-TC095	565x410x132	6,7	✳	—

18.0 V CORDLESS HYDRAULIC CUTTING TOOL



general features



18.0V
4.0Ah
Li-Ion

Max cutting Ø mm	Dimensions mm			Battery	Weight kg (with battery)
	length	height	width		
50	405	398	83	18.0 V 4.0 Ah	5,8

STORAGE

Type	Dimensions mm	Weight kg	Supplied with the tool	Purchase separately
VALP37	500x480x128	3,1	✳	—

The tool is supplied as:

- Basic tool with battery and shoulder strap
- Spare battery
- Battery charger
- Plastic carrying case suitable for storing the tool and accessories

Next generation of 18.0 V cordless hydraulic cutting tool specifically designed to cut Copper, Aluminium and telecommunication cable having a max overall diameter of 50 mm. The blades are manufactured from high strength special Steel, heat treated to ensure a long service life. New Li-Ion 18 V 4 Ah batteries offer a higher capacity than 14.4 V 3 Ah, while greater cutting speed and cutting force result from a revitalised hydraulic system with double speed



action. The battery is equipped with led indicators that indicate the remaining battery life at any time by pressing the adjacent button. The head can rotate through 90 degrees, to enable the operator to work in the most comfortable position, and can easily be opened to allow cutting of running cables.

Fitted with a maximum hydraulic pressure valve. Designed with improved balance, B-TC500E is easily manageable during the cutting process and, by the use of bi-component plastics, has a shell with high resistance to wear and damage. Rubber grip inserts, low noise and minimal vibration aid operator comfort while additional convenience and safety are provided by LED lighting of the working area. Operating temperature: -15 to +50 ° C



INDUSTRIAL APPLICATION
B-TC500E

New

NEW
18V Li-Ion
BATTERY

18.0 V CORDLESS HYDRAULIC CUTTING TOOL



general features



18.0V
4.0Ah
Li-Ion

Max cutting Ø mm	Dimensions mm			Battery	Weight kg (with battery)
	length	height	width		
65	429	415	83	18.0 V 4.0 Ah	6,4

STORAGE

Type	Dimensions mm	Weight kg	Supplied with the tool	Purchase separately
VALP37	500x480x128	3,1	✳	—

The tool is supplied as:

- Basic tool with battery and shoulder strap
- Spare battery
- Battery charger
- Plastic carrying case suitable for storing the tool and accessories

Next generation of 18.0 V cordless hydraulic cutting tool specifically designed to cut Copper, Aluminium and telecommunication cable having a max overall diameter of 65 mm. The blades are manufactured from high strength special Steel, heat treated to ensure a long service life. New Li-Ion 18 V 4 Ah batteries offer a higher capacity than 14.4 V 3 Ah, while greater cutting speed and cutting force result from a revitalised hydraulic system with double speed



action. The battery is equipped with led indicators that indicate the remaining battery life at any time by pressing the adjacent button. The head can rotate through 335 degrees, to enable the operator to work in the most comfortable position, and can easily be opened to allow cutting of running cables.

Fitted with a maximum hydraulic pressure valve. Designed with improved balance, B-TC650E is easily manageable during the cutting process and, by the use of bi-component plastics, has a shell with high resistance to wear and damage. Rubber grip inserts, low noise and minimal vibration aid operator comfort while additional convenience and safety are provided by LED lighting of the working area. Operating temperature: -15 to +50 ° C



INDUSTRIAL APPLICATION
B-TC650E

New

NEW
18V Li-Ion
BATTERY

INDUSTRIAL APPLICATION
B-TC650-SCE

18.0 V CORDLESS HYDRAULIC CUTTING TOOL

general features



Max cutting Ø mm	Dimensions mm			Battery	Weight kg (with battery)
	length	height	width		
65	503	464	105	18.0V 4.0Ah	7,7



18.0V
4.0Ah
Li-Ion

New



Next generation of 18.0 V cordless hydraulic cutting tool specifically designed to cut Copper, Aluminium and telecommunication cable having a max overall diameter of 65 mm. The blades are manufactured from high strength special Steel, heat treated to ensure a long service life. The open head and the "scissor" movement of the blades facilitate the cutting of running cables. New Li-Ion 18 V 4 Ah batteries offer a higher capacity than 14.4 V 3 Ah, while greater cutting speed and cutting force result from a revitalised hydraulic system with double speed action. The battery is equipped with led indicators that indicate the re-

maintaining battery life at any time by pressing the adjacent button. The head can rotate through 180 degrees, to enable the operator to

NEW
18V Li-Ion
BATTERY

The tool is supplied as:

- Basic tool with battery and shoulder strap
- Spare battery
- Battery charger
- Metal carrying case suitable for storing the tool and accessories

work in the most comfortable position, and can easily be opened to allow cutting of running cables. Fitted with a maximum hydraulic pressure valve. Designed with improved balance, B-TC650-SCE is easily manageable during the cutting process and, by the use of bi-component plastics, has a shell with high resistance to wear and damage. Rubber grip inserts, low noise and minimal vibration aid operator comfort while



additional convenience and safety are provided by LED lighting of the working area. For cutting capacity data see page 142. Operating temperature: -15 to +50 ° C

STORAGE

Type	Dimensions in.	Weight kg	Supplied with the tool	Purchase separately
VAL B-TC950	565x410x132	6,7	✳	—

INDUSTRIAL APPLICATION
B-TC095

14.4 V CORDLESS HYDRAULIC CUTTING TOOL

general features



Max cutting Ø mm	Dimensions mm			Battery	Weight kg (with battery)
	length	height	width		
95	527	305	94	14.4V 3.0Ah	7,06



14.4V
3.0Ah
Li-Ion



14.4 V cordless hydraulic cutting tool specifically designed to cut Copper, Aluminium and telecommunication cable having a max overall diameter of 95 mm. The tool features a double speed action: a fast advancing speed for rapid approach of the blades to the cable and a slower more powerful speed for cutting.

The blades are manufactured from high strength special Steel, heat treated to ensure a long service life. The head can be easily opened to allow the cutting of running cables.

Li-Ion
BATTERY

The tool is supplied as:

- Basic tool with battery and shoulder strap
- Spare battery
- Battery charger
- Metal carrying case suitable for storing the tool and accessories

The head can rotate through 335 degrees, to enable the operator to work in the most comfortable position. Fitted with a maximum hydraulic pressure valve. Complete with a display which, after every operation and battery insertion, indicates the residual battery power.



Extremely quiet in operation, with very little vibration. Ergonomically designed with a sculptured body for operator comfort.

STORAGE

Type	Dimensions mm	Weight kg	Supplied with the tool	Purchase separately
VAL B-TC095	565x410x132	6,7	✳	—

14.4 V CORDLESS HYDRAULIC FRAME-TYPE HOLE PUNCHING TOOL



general features

B-FC48N

New



**14.4V
3.0Ah
Li-Ion**

Max hole punch Ø mm	Dimensions mm			Battery	Weight kg (with battery)
	length	height	width		
47,2	354	302	94	14,4 V 3.0 Ah	5,6

STORAGE

Type	Dimensions mm	Weight kg	Supplied with the tool	Purchase separately
VAL P9	543x412x130	2,2	✳	—

The tool is supplied as:

- Basic tool with battery, wrist strap and shoulder strap
- Spare battery
- Battery charger
- Plastic carrying case suitable for storing the tool and accessories



14.4 V cordless hydraulic tool for punching holes from 15,5 up to 47,2 mm diameter in the side wall of trunking without the need for pre drilling. Lightweight and balanced for single-hand operation.

The tool features a double speed action: a fast advancing speed for rapid approach of the dies to the material and a slower, more powerful speed for punching.



Li-Ion BATTERY

The punching head can rotate through 180° for ease of operation.

Complete with a display which, after every operation and battery insertion, indicates the residual battery power.

Extremely quiet in operation, with very little vibration.

Ergonomically designed with a sculptured body for operator comfort.

Also available in the hand operated mechanical version MT-FC48N.

For the punch/die set reference see table.

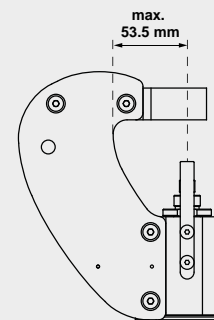

Max centre of hole to edge of trunking: 53,5 mm

Table denotes the punch/die set reference, for each hole size. Suitable for punching holes in mild Steel, fibreglass or plastic material, up to 2 mm thick.

Hole Dimensions				Maximum thickness of mild Steel (mm)	Code
Nominal	Ø (mm)	Ø (inch)	Pg		
	15,5	.610	Pg9	-	RD 15.5 SS-FC
	16,2	.638	-	ISO-16	RD 16.2 SS-FC
	17,5	.689	-	-	RD 17.5 SS-FC
	18,8	.740	Pg11	-	RD 18.8 SS-FC
	19,1	.752	-	-	RD 19.1 SS
	20,5	.807	Pg 13,5	ISO-20	RD 20.5 SS
	22,6	.890	Pg16	-	RD 22.6 SS
	23,8	.937	-	-	RD 23.8 SS
	25,4	1.000	-	ISO-25	RD 25.4 SS
	27,0	1.063	-	-	RD 27.0 SS
	28,5	1.122	Pg21	-	RD 28.5 SS
	30,5	1.201	-	-	RD 30.5 SS
	31,8	1.252	-	-	RD 31.8 SS
	32,5	1.279	-	ISO-32	RD 32.5 SS
	34,6	1.362	-	-	RD 34.6 SS
	37,2	1.464	Pg29	-	RD 37.2 SS
	38,1	1.500	-	-	RD 38.1 SS
	40,5	1.594	-	ISO-40	RD 40.5 SS-FC
	41,3	1.626	-	-	RD 41.3 SS-FC
	42,5	1.673	-	-	RD 42.5 SS-FC
	43,2	1.701	-	-	RD 43.2 SS-FC
	44,5	1.752	-	-	RD 44.5 SS-FC
	47,2	1.858	Pg36	-	RD 47.2 SS-FC

14.4 V CORDLESS HYDRAULIC PULLER-TYPE HOLE PUNCHING TOOL

B-FL750E

general features



New

NEW 18V Li-Ion BATTERY

New Li-Ion 18 V 4 Ah batteries offer a higher capacity than 14.4 V 3 Ah, while greater punch speed and punching force result from a revitalised hydraulic system with double speed action. The battery is equipped with led indicators that indicate the remaining battery life at any time by pressing the adjacent button. The balanced punching head pivots 180deg through a full 360deg rotation for ease of use in confined spaces. Fitted with a maximum hydraulic pressure valve.

Next generation of 18.0 V cordless hydraulic tool specifically designed for hole punching stainless Steel, mild Steel, fibreglass and plastic sheet materials up to 3,5 mm thickness.



**18.0V
4.0Ah
Li-Ion**

Max punching Ø mm	Dimensions mm			Battery	Weight kg (with battery)
	length	height	width		
Ø 140	363	366	83	18.0 V 4.0 Ah	5,1

STORAGE

Type	Dimensions mm	Weight kg	Supplied with the tool	Purchase separately
VAL FCL	565x410x132	6,7	✳	—

The tool is supplied as:

- Basic tool with battery, wrist strap and shoulder strap
- Spare battery
- Battery charger
- Puller TD-11
- Puller TD-19
- Spiral bit Ø 11,5 mm

- Metal carrying case suitable for storing the tool and accessories



Designed with improved balance, B-FL750E is easily manageable during the punching process and, by the use of bi-component plastics, has a shell with high resistance to wear and damage. Rubber grip inserts, low noise and minimal vibration aid operator comfort while additional convenience and safety are provided by LED lighting of the working area.

Operating temperature: -15 to +50 °C

PUNCHING ACCESSORIES AVAILABLE

ROUND PUNCH						Material max thickness	Pilot hole Ø	Code				
Hole diameter			Stainless Steel	Mild Steel	Punch			Die	Puller			
Nominal	Pg	ISO										
Ø (mm)	Ø (inch)	Pg	ISO	Steel	Steel	Die	Puller	Code				
15,5	.610	Pg9	-									
16,2	.638	-	ISO-16									
17,5	.689	-	-									
18,8	.740	Pg11	-									
19,1	.752	-	-									
20,5	.807	Pg 13,5	ISO-20									
22,6	.890	Pg16	-									
23,8	.937	-	-									
25,4	1.000	-	ISO-25									
27,0	1.063	-	-									
28,5	1.122	Pg21	-									
30,5	1.201	-	-									
28,5	1.122	Pg 21	-									
30,5	1.201	-	-									
31,8	1.252	-	-									
32,5	1.279	-	ISO-32									
34,6	1.362	-	-									
37,2	1.464	Pg29	-									
38,1	1.500	-	-									
40,5	1.594	-	ISO-40									
41,3	1.626	-	-									
42,5	1.673	-	-									
43,2	1.701	-	-									
44,5	1.752	-	-									
47,2	1.858	Pg36	-									
50,5	1.988	-	ISO-50									
54,2	2.134	Pg42	-									
60,0	2.362	Pg48	-									
64,0	2.520	-	ISO-63									
65,0	2.559	-	-									
76,0	2.992	-	-									
80,5	3.169	-	-									
100,0	3.937	-	-									
120,0	4.724	-	-									

* Puller included in the kit

SQUARE PUNCH						Material max thickness	Pilot hole Ø	Code				
Hole size			Stainless Steel	Mild Steel	Punch			Die	Puller			
Nominal	Pg	ISO										
Ø (mm)	Ø (inch)	Pg <td>ISO <td>Steel <td>Steel <td>Die <td>Puller <td>Code</td> <td></td> <td></td> <td></td> <td></td> </td></td></td></td></td>	ISO <td>Steel <td>Steel <td>Die <td>Puller <td>Code</td> <td></td> <td></td> <td></td> <td></td> </td></td></td></td>	Steel <td>Steel <td>Die <td>Puller <td>Code</td> <td></td> <td></td> <td></td> <td></td> </td></td></td>	Steel <td>Die <td>Puller <td>Code</td> <td></td> <td></td> <td></td> <td></td> </td></td>	Die <td>Puller <td>Code</td> <td></td> <td></td> <td></td> <td></td> </td>	Puller <td>Code</td> <td></td> <td></td> <td></td> <td></td>	Code				
21,0 x 21,0	.827 x .827	-	-									
46,0 x 46,0	1.811 x 1.811	-	-									
68,0 x 68,0	2.677 x 2.677	-	-									
92,0 x 92,0	3.622 x 3.622	-	-									
126,0 x 126,0	4.960 x 4.960	-	-									
138,0 x 138,0	5.433 x 5.433	-	-									

Stainless Steel = Rm= 700 N/mm² - Mild Steel = Rm= 500 N/mm²

RECTANGULAR PUNCH			
Hole size		Material max thickness	Pilot hole Ø
Nominal	Pg		
Ø (mm)	Ø (inch)	Steel	Steel
18,0 x 46,0	.709 x 1.811		
22,0 x 46,0	.866 x 1.811		
35,0 x 86,0	1.377 x 3.385		
35,0 x 112,0	1.377 x 4.409		
36,0 x 46,0	1.417 x 1.811		
37,0 x 54,0	1.456 x 2.125		
37,0 x 67,0	1.456 x 2.637		
37,0 x 88,0	1.456 x 3.464		
37,0 x 104,0	1.456 x 4.094		
46,0 x 54,0	1.811 x 2.126		
46,0 x 72,0	1.811 x 2.835		
46,0 x 107,0	1.811 x 4.212		

(*) The washer supplied with the KIT must be threaded onto the draw stud and positioned between the head and the die to allow the die to rest correctly.

Universal joint allows punching head to pivot 180deg over a full 360deg rotation.

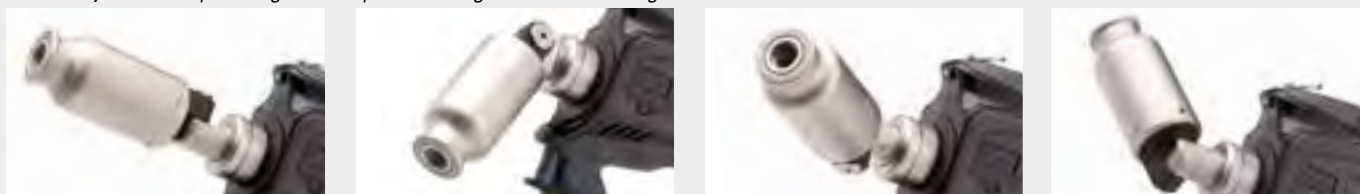



HYDRAULIC PUMPS AND UNITS

HYDRAULIC PUMPS

PO 7000

Foot operated double speed pump, developing a maximum pressure of 700 bar.

The pump is supplied with 3 m long high pressure flexible hose complete with female self-lock quick coupler.

Pressure can be withdrawn at any time during operation by depressing the release lever.

A solid shaped stand gives the pump stability during operation.



Operating pressure bar	Dimensions mm			Weight kg
	length	width	height	
700	680	200	163	9,8

Storage type	Dimensions mm	Weight kg
VAL P21*	820x430xh290	6,74

*Supplied with the pump



CPP-0

The CPP-0 air hydraulic power unit intensifies an air supply of 6-8 bar (87-115 psi) to a power crimping or cutting force of up to 700 bar (10.000 psi) depending upon the input pressure.

The control pedal allows for advancing and pressure release at any stage of the operation.

The unit is provided with a 2 m high pressure flexible hose, including a 3/8" NPT female self-lock quick coupler.



Operating pressure bar	Dimensions mm			Weight kg
	length	width	height	
700	320	150	200	6,8

HYDRAULIC PUMPS

CPE-1

CPE-1-110



Operating pressure bar	Dimensions mm			Weight kg
	length	width	height	
700	372	223	482	21

The pump is supplied with:

- high pressure flexible hose with male and female automatic quick coupler
- remote hand controller
- external supply connection cable

Available as optional accessories:

- Remote foot controller **RCP-B70**.
- Transportation trolley **CS-CPE-1**
- Control handle integrated with 3 m length flex hoses **ERCH-WH**



Electrically driven hydraulic pump, powered by a 230V / 50-60Hz single-phase electric motor. The remote hand controller allows advancement and pressure release on completion of the crimping operation. The mechanically actuated emergency button located on the pump body allows the pressure release at any time in case of power shortage.

Also available **CPE-1-110** version for 110-115V / 50-60Hz. Both models are IP 55 rated.



PORTABLE ELECTRO-HYDRAULIC PUMPS B70M-P24 RANGE

BATTERY OPERATED

Easily accessible oil top-up inlet



Remote electrical hand or foot controller connection (not KV version)



Remote pneumatic hand controller connection (KV version only)



**24V
3.1Ah
Ni-MH**



Powerful 24V Ni-MH rechargeable battery

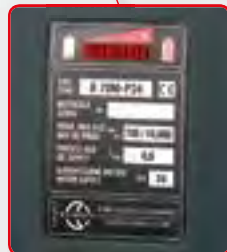

Battery residual power level display



Manual pressure release button



24V dc external power supply socket with protective cap



High pressure hose connects to automatic self-lock quick coupling with protective cap

Variously supplied with different versions:



HYDRAULIC PUMPS

B70M-P24



Operating pressure bar	Dimensions mm			Weight kg
	length	width	height	
700	390	163	323	9,2*

*without accessories



B70M-P24

- 1 Portable electro-hydraulic pump, 24V dc battery for independent use, developing 700 bar pressure; equipped with an integral socket for connection to an external 24 V dc supply
- 2 **BH2433** Battery 24V dc 3.1Ah
- 3 **DC24** External battery charger
- 4 Shoulder strap
- 5 Canvas holdall for carrying accessories
- 6 3 m flexible hose complete with male + female 3/8" NPT self-lock quick couplers
- 7 **ERCH** Remote control



Operating pressure bar	Dimensions mm			Weight kg
	length	width	height	
700	390	163	323	9,2*

*without accessories



B70M-P24-CH

B70M-P24-CH

- 1 Portable electro-hydraulic pump, 24V dc battery for independent use, developing 700 bar pressure; equipped with an integral socket for connection to an external 24 V dc supply
- 2 **BH2433** Battery 24V dc 3.1Ah
- 3 **DC24** External battery charger
- 4 Shoulder strap
- 5 Canvas holdall for carrying accessories
- 6 **ERCH-WH** Remote hand controller integrated with 3 m length flexible hose complete with male + female 3/8" NPT self-lock quick couplers



Operating pressure bar	Dimensions mm			Weight kg
	length	width	height	
700	390	163	323	9,2*

*without accessories



B70M-P24-KV

B70M-P24-KV

- 1 Portable electro-hydraulic pump, 24V dc battery for independent use. Equipped with high dielectric insulated oil and automatic "insulated" lock quick coupler to allow connection only with insulated hoses.
- 2 **BH2433** Battery 24V dc 3.1Ah.
- 3 **DC24** External battery charger.
- 4 Shoulder strap
- 5 Canvas holdall for carrying accessories.
- 6 **PRCH** Remote pneumatic hand controller

Insulated heads suitable for use with this pump are generally supplied complete with high pressure insulated hoses; if necessary the hose can be purchased separately.

ACCESSORIES FOR B70M-P24

ESC 300CEE
CONNECTING CABLE WITH 24V dc CEE TYPE PLUG
(for power from an external source, length 3 meters)



ESC 600
CONNECTING CABLE WITH CROCODILE CLIPS
(for power from an external source, length 6 meters)



BPS 230.24
network power supply
INPUT 230V ac 50-60Hz; OUTPUT 24V dc
thermal and short circuit protection.
Current supply: up to 4A extended use;
18A for 50 s; 25A for 8 s.



EPS 115-230.24
network power supply
SUPPLY IN: 110/240V
ac autorange
50-60Hz; 700W
SUPPLY OUT: 24V dc; 30A max



ERCH-WH
Remote hand controller
integrated with 3 m
length flexible hose



Operating
push-button



Pressure release button

TRS-B70
CANVAS RUCKSACK
(for carrying the pump)



SH-B70
HOOK
(for hanging the pump
from a ladder)



VAL-P18
Durable transport
case for pump and
accessories.



RCP-B70
PORTABLE REMOTE
FOOT CONTROL



HYDRAULIC UNITS

(pump PO 7000 + head RHC 131)

Crimping force kN	Dimensions pump mm	Dimensions head mm	Weight kg
130	680x200xh163	232x124	13,6

MAIN APPLICATIONS - max section mm²

L.V. lugs and splices	Insulated terminals	"C" sleeve connectors	H.V. lugs and splices
400	240	185	400

Storage type	Dimensions mm	Weight kg
VAL P21*	820x430xh290	6,74

*Supplied with the unit, suitable for storage of 24 semi-circular slotted dies



Hydraulic units are obtained by combining the double stage hydraulic foot pump with the various hydraulic press heads featured on previous

pages. The use of the double speed pump considerably reduces operating time.

CP 1131



(pump PO 7000 + head RHU 131-C)

Crimping force kN	Dimensions pump mm	Dimensions head mm	Weight kg
130	680x200xh163	245x89	13,5

MAIN APPLICATIONS - max section mm²

L.V. lugs and splices	Insulated terminals	"C" sleeve connectors	H.V. lugs and splices	Alu lugs and splices
400	240	185	400	300

Storage type	Dimensions mm	Weight kg
VAL P21*	820x430xh290	6,74

*Supplied with the unit, suitable for storage of 24 semi-circular slotted dies and accessories for crimping Aluminium connectors



CPU 1131-C



CPU 1230-3D

(pump PO 7000 + head ECW-H3D)

Crimping force kN	Dimensions pump mm	Dimensions head mm	Weight kg
230	680x200xh163	290x120	15,3

MAIN APPLICATIONS - max section mm²

L.V. lugs and splices	Insulated terminals	"C" sleeve connectors	H.V. lugs and splices
630	300	240	630

Storage type	Dimensions mm	Weight kg
VAL P21*	820x430xh290	6,74

*Supplied with the unit, suitable for storage of 24 semi-circular slotted dies and adaptors and dies specific for head ECW-H3D



HYDRAULIC CUTTING UNITS

CP 1096



(pump **PO 7000** + head **TC 096**)

Max cutting Ø mm	Dimensions pump mm	Dimensions head mm	Weight kg
95	680x200x163	397x249	17,7
Storage type	Dimensions mm	Weight kg	
VAL CP 096*	785x430x175	14,0	

*Supplied with the unit

Units CP-W-KV



GS approval
n. ET 13045



Hydraulic units provide protection against short circuit when cutting accidentally live L.V. / M.V. cables with nominal voltage up to 60 kV.

Unit Type	Max cutting Ø mm	Dimensions pump	Dimensions head	Weight kg
CP 1086-W-1000-KV	85	680x200x163	405x143	16,6
CP 1096-W-1000-KV	95	680x200x163	407x245	19,0
CP 1120-W-1000-KV	120	680x200x163	556x185	20,2

Storage case type	Dimensions mm	Weight kg
VAL CPO96-W*	785x430x175	12,6

*Supplied with the unit



Available as optional accessories:

- EK100 earth cable for the pump (1 m length)
- EK500P earth cable for the head (5 m length) with earth rod and canvas bag





DIE SELECTOR CHART

APPLICATION	CONDUCTOR		CONNECTOR		HYDRAULIC TOOLS													HYDRAULIC TOOLS																		
					B 15D			B 35-45D			B 35-50D			HT 45-E			HT 51 B 500E			RH 50 B 55			HT 81-U RHU 81			HT 120 and tools and heads with 130 kN crimping force			ECW-H3D			RHU 520				
					TERMINAL	SPLICE	DIE SET	NEST	INDENTOR	DIE SET	NEST	INDENTOR	DIE SET	NEST	INDENTOR	DIE SET	NEST	INDENTOR	DIE SET	NEST	INDENTOR	DIE SET	NEST	INDENTOR	DIE SET	NEST	INDENTOR	DIE SET	NEST	INDENTOR	DIE SET	NEST	INDENTOR	DIE SET	NEST	INDENTOR
COPPER CONDUCTORS	0,25 ÷ 2,5	A 03-M. A 06-M.		L 03M / L 03P L 06M / L 06P	ME03/2-15 MA03/3-15																															
	4 ÷ 6	A 1-M. A 1-L.		L 1-M L 1-P	ME03/2-15 MA03/3-15	MA 1	PA 1	ME 1	MA 1-50	PA 1-50	ME 1-50	MA 1	PA 1	ME 1																						
	10	A 2-M. A 2-L. A 2-P12		L 2-M L 2-P	ME03/2-15 ME2/3-15 MA03/3-15	MA 2.3		ME 2	MA 2.3-50		ME 2-50	MA 2.3		ME 2																						
	16	A 3-M. A 3-L. A 3-P14	2A 3-M.	L 3-M L 3-P	ME2/3-15 MA03/3-15		PA 5	ME 3		PA 5-50	ME 3-50		PA 5	ME 3																						
	25	A 5-M. A 5-L. A 5-P16	2A 5-M.	L 5-M L 5-P		MA 5		ME 5	MA 5-50		ME 5-50	MA 5		ME 5																						
	35	25* 35	A 7-M. A 7-L. A 7-P20	2A 7-M.	L 7-M L 7-P		MA 7	PA 10	ME 7	MA 7-50	PA 10-50	ME 7-50	MA 7	PA 10	ME 7																					
	50	35* 50	A 10-M. A 10-L. A 10-P25	2A 10-M.	L 10-M L 10-P		MA 10		ME 10	MA 10-50		ME 10-50	MA 10		ME 10																					
	70	50* 70	A 14-M. A 14-L. A 14-P30	2A 14-M.	L 14-M L 14-P				ME 14	MA 14-50	PA 19-50	ME 14-50			ME 14																					
	95	70* 95	A 19-M. A 19-L.	2A 19-M.	L 19-M L 19-P				ME 19	MA 19-50		ME 19-50			ME 19																					
	120	95* 120	A 24-M. A 24-L.	2A 24-M.	L 24-M L 24-P				ME 24	MA 24-50	PA 24-50	ME 24-50			ME 24																					
	150	120* 150	A 30-M. A 30-L.	2A 30-M.	L 30-M L 30-P				ME 30L			ME 30L-50			ME 30																					
	185	150* 185	A 37-M. A 37-L. A 37-4ESI	2A 37-M.	L 37-M L 37-P																															
	240	185* 240	A 48-M. A 48-L. A 48-4ESI	2A 48-M.	L 48-M L 48-P																															
	300	240 300	A 60-M. A 60-L. A 60-4ESI	2A 60-M.	L 60-M L 60-P																															
	400	300 400	A 80-M. A 80-4ESI	2A 80-M.	L 80-M																															
	500	400 500	A 100-M. A 100-4ESI	2A 100-M.	L 100-M																															
	630	500 630	A 120-M. A 120-4ESI	2A 120-M.	L 120-M																															
800	630	A 160-M. A 160-4ESI	2A 160-M.	L 160-M																																
1000	800	A 200-M.	2A 200-M.	L 200-M																																
EXTRA FLEXIBLE COPPER CONDUCTORS	35	A 9-M.				MA 9	PA 10	ME 9	MA 9-50	PA 10-50	ME 9-50	MA 9	PA 10	ME 9																						
	50	A 12-M.						ME 12	MA 12-50		ME 12-50			ME 12																						
	70	A 17-M.						ME 17	MA 17-50	PA 19-50	ME 17-50			ME 17																						
	95	A 20-M.						ME 20	MA 20-50		ME 20-50			ME 20																						
	120	A 29-M.						ME 29			ME 29-50			ME 29																						
	150	A 35-M.																																		
	185	A 40-M.																																		

Hexagonal crimp (use one size up with fine stranded conductors, E.G.: 95² fine stranded use A19-.. + ME 19 or A 20-.. + ME 20)







Indent crimp

* Contact Cembre for appropriate die set

N.B.: Number inside symbol indicates the number of crimps on A-M barrel



DIE SELECTOR CHART

DIE SELECTOR CHART

APPLICATION	CONDUCTOR	CONNECTOR					HYDRAULIC TOOLS										
							B 15D	B 35-45D	B 35-50D	HT 45-E	HT 51 B 500E	RH 50 B 55	HT 81-U RHU 81	HT 120 and tools and heads with 130 kN crimping force			ECW-H3D
	Conductor Size Flex sqmm	TERMINAL					DIE SET		DIE SET		DIE SET		NEST	INDENTOR	DIE SET	NEST	INDENTOR
 ANE..M..  ANE..P..  ANE..U..	10	ANE 2-M..	ANE 2-P12	ANE 2-U..			NN4-15 ☺		MN 2 RF-50 ☺		MN 2 RF-50 ☺		MN 2-C ☺	PN 7-C	MN 2 RF-C ☺	Adaptor AU 230-130 D with die set MN..C and indentor PN..C or with die set MN..RF-C and die set MN..FC	
	16	ANE 3-M..	ANE 3-P14	ANE 3-U..				MN 3 RF-50 ☺	MN 3 RF-50 ☺	MN 3-C ☺	MN 3 RF-C ☺						
	25	ANE 5-M..	ANE 5-P16					MN 5 RF-50 ☺	MN 5 RF-50 ☺	MN 5-C ☺	MN 5 RF-C ☺						
	35	ANE 7-M..	ANE 7-P20					MN 7 RF-50 ☺	MN 7 RF-50 ☺	MN 7-C ☺	MN 7 RF-C ☺						
	50	ANE 10-M..						MN 10 RF-50 ☺	MN 10 RF-50 ☺	MN 10-C ☺	MN 10 RF-C ☺						
	70	ANE 14-M..							MN 14 RF-50 ☺	MN 14-C ☺	MN 14 RF-C ☺						
	95	ANE 19-M..							MN 19 RF-50 ☺	MN 19-C ☺	MN 19 RF-C ☺						
	120	ANE 24-M..							MN 24 RF-50 ☺	MN 24-C ☺	MN 24 RF-C ☺						
	150	ANE 30-M..								MN 30-C ☺	MN 30 RF-C ☺						
 ANE..M..	35	ANE 9-M..						MN 7 RF-50 ☺	MN 7 RF-50 ☺	MN 9-C ☺	PN 14-C	MN 7 RF-C ☺	Adaptor AU 230-130 D with die set MN..C and indentor PN..C or with die set MN..RF-C and die set MN..FC				
	50	ANE 12-M..					MN 12 F-50 ☺	MN 12 F-50 ☺	MN 12-C ☺	MN 12 F-C ☺							
	70	ANE 17-M..						MN 17 F-50 ☺	MN 17-C ☺	MN 17 F-C ☺							
	95	ANE 20-M..						MN 20 F-50 ☺	MN 20-C ☺	MN 20 F-C ☺							
	120	ANE 29-M..							MN 29-C ☺	MN 29 F-C ☺							
	150	ANE 35-M..							MN 35-C ☺	MN 35 F-C ☺							
 PK ...  KE ...	Conductor Size Flex sqmm	TERMINAL					DIE SET		DIE SET		DIE SET						
	0,3 ÷ 4	PKD 506 ÷ PKD 418	PKE 508 ÷ PKE 418	PKC 508 ÷ PKC 418	KE 506 ÷ KE 412		KE 4-15 ▽										
	4 ÷ 16	PKD 410 ÷ PKD 1618	PKE 410 ÷ PKE 1618	PKC 410 ÷ PKC 1618	KE 410 ÷ KE 1616		KE 16-15 ▽										
	16	PKD 16..	PKE 16..	PKC 16..	KE 16..		KE 35-15 ▽		MTT 16-50 ▽	MTT 16-50 ▽							
	25	PKD 25..	PKE 25..	PKC 25..	KE 25..			MTT 25-50 ▽	MTT 25-50 ▽								
	35	PKD 35..		PKC 35..	KE 35..			MTT 35-50 ▽	MTT 35-50 ▽								
	50	PKD 50..		PKC 50..				MTT 50-50 ▽	MTT 50-50 ▽								
	70			PKC 70..				MTT 70-50 ▽	MTT 70-50 ▽								
	95			PKC 95..				MTT 95-50 ▽	MTT 95-50 ▽								
120			PKC 120..					MTT 120-50 ▽									
 PKT ...	Conductor Size Flex sqmm	TERMINAL					DIE SET	COMP. APERTURE	DIE SET	DIE SET							
	2 x 0,5	PKT 508 PKT 510					KE 4-15 ▽	1									
	2 x 0,75	PKT 7508 PKT 7512				1,5											
	2 x 1	PKT 108 PKT 112				2,5											
	2 x 1,5	PKT 1508 PKT 1512				2,5											
	2 x 2,5	PKT 2510 PKT 2512					KE 4-15 ▽ KE 16-15 ▽	4									
	2 x 4	PKT 412					KE 16-15 ▽	6									
	2 x 6	PKT 614						10									
	2 x 10	PKT 1014					KE 16-15 ▽ KE 35-15 ▽	16	MTT 16-50 ▽	MTT 16-50 ▽							
2 x 16	PKT 1614					KE 35-15 ▽	35	MTT 35-50 ▽	MTT 35-50 ▽								

☺ Indent crimp ☺ Radial crimp ▽ Trapezium crimp

DIE SELECTOR CHART

APPLICATION	CONDUCTOR		CONNECTORS			HYDRAULIC TOOLS										
						B 35-45D	B 35-50D	HT 45-E	HT 51 B 500E	RH 50 B 55	HT 81-U RHU 81	HT 120 and tools and heads with 130 kN crimping force	ECW-H3D	RHU 520		
 c..c..ST  c..c..	Conductor Size sqmm		CONNECTOR	CONNECTOR		DIE SET	DIE SET	DIE SET	DIE SET	DIE SET	DIE SET	DIE SET	DIE SET	DIE SET	DIE SET	
	Run	Tap														
	6 ÷ 2,5	6 ÷ 1,5	C 6 - C 6 ST	C 6 - C 6		MC 6 (1)	MC 6-50 (1)	MC 6 (1)	MC 6-50 (1)	MC 6.25-U (1)						
	10	10 ÷ 1,5	C 10 - C 10 ST	C 10 - C 10		MC 10 (1)	MC 10-50 (1)	MC 10 (1)	MC 10-50 (1)	MC 10-U (1)	MC 10-C (1)	Adaptor AU 230-130 D with die set MC..C	Adaptor AU 520-130 C with die set MC..C			
	16	16 ÷ 1,5	C 16 - C 16 ST	C 16 - C 16												
	25 ÷ 16	10 ÷ 1,5	C 25 - C 10 ST	C 25 - C 10		MC 25 (2)	MC 25-50 (2)	MC 25 (2)	MC 25-50 (2)	MC 6.25-U MC 25-U (1)	MC 25-C (1)					
	25	25 ÷ 16	C 25 - C 25 ST	C 25 - C 25												
	40 ÷ 35	16 ÷ 1,5	C 35 - C 16 ST	C 35 - C 16												
	40 ÷ 35	40 ÷ 25	C 35 - C 35 ST	C 35 - C 35		MC 35 (2)	MC 35-50 (2)	MC 35 (2)								
	50	25 ÷ 10														
	70 ÷ 63	25 ÷ 1,5	C 70 - C 25N ST	C 70 - C 25N												
	50	25 ÷ 4	C 50 - C 25 ST	C 50 - C 25												
	*50	50 ÷ 35	C 50 - C 50 ST	C 50 - C 50												
	*70 ÷ 50	40 ÷ 4	C 70 - C 35 ST	C 70 - C 35					*MC 70-50 (3)	MC 70-80-U (3)	MC 70-C (3)	MC 70-3D (1)				
	*70 ÷ 50	70 ÷ 35	C 70 - C 70 ST	C 70 - C 70												
	100 ÷ 95	40 ÷ 4	C 95 - C 35 ST	C 95 - C 35												
	100 ÷ 95	70 ÷ 40	C 95 - C 70 ST	C 95 - C 70						MC 95-80-U (3)	MC 95-C (3)	MC 95-3D (1)				
	100 ÷ 95	100 ÷ 63	C 95 - C 95 ST	C 95 - C 95												
	125 ÷ 110	125 ÷ 25	C 120 - C 120 ST	C 120 - C 120												
	160 ÷ 150	125 ÷ 25	C 150 - C 120 ST	C 150 - C 120							MC 185-C (3)	MC 185-3D (1)				
150	150 ÷ 63	C 150 - C 150 ST	C 150 - C 150													
185	100 ÷ 16	C 185 - C 95 ST	C 185 - C 95													
185 ÷ 120	185 ÷ 120	C 185 - C 185 ST	C 185 - C 185													
240 ÷ 150	120 ÷ 95	C 240 - C 120 ST	C 240 - C 120								MC 240-3D (1)					
 MT..TD MT..GC CA..M.. CA..2M.. MT..C..	Conductor Size sqmm		TERMINALS		TERMINALS			DIE SET		DIE SET	DIE SET	DIE SET	DIE SET	DIE SET	DIE SET	
	25 R		MT 25 - TD	MT 25 - GC	CA 25 - M..	CA 25 - 2M..	MT 25 - C..		MMT 25-50 (1)		MMT 25-50 (1)	MMT 25-U (1)	MMT 25-C (1)	Adaptor AU 230-130 D with die set MMT..C	Adaptor AU 520-130 C with die set MMT..C	
	35 RC/S ÷ 40 S		MT 40 S - TD	MT 40 S - GC	CA 40 S - M..	CA 40 S - 2M..	MT 40 S - C..									
	50 RC		MT 50 R - TD	MT 50 R - GC	CA 50 R - M..	CA 50 R - 2M..	MT 50 R - C..		MMT 50-50 (1)		MMT 50-50 (1)	MMT 50-U (1)	MMT 50-C (1)			
	50 S		MT 50 S - TD	MT 50 S - GC	CA 50 S - M..	CA 50 S - 2M..	MT 50 S - C..									
	63 S ÷ 70 S		MT 70 S - TD	MT 70 S - GC	CA 70 S - M..	CA 70 S - 2M..	MT 70 S - C..									
	80 S ÷ 95 RC		MT 95 R - TD	MT 95 R - GC	CA 95 R - M..	CA 95 R - 2M..	MT 95 R - C..				MMT 95-50 (1)	MMT 95-U (1)	MMT 95-C (1)			
	95 S ÷ 100 S		MT 95 S - TD	MT 95 S - GC	CA 95 S - M..	CA 95 S - 2M..	MT 95 S - C..									
	120 RC/S ÷ 150 RC		MT 150 R - TD	MT 150 R - GC	CA 150 R - M..	CA 150 R - 2M..	MT 150 R - C..									
	150 S ÷ 160 RC		MT 150 S - TD	MT 150 S - GC	CA 150 S - M..	CA 150 S - 2M..	MT 150 S - C..									
	160 S ÷ 200 RC		MT 200 R - TD	MT 200 R - GC	CA 200 R - M..	CA 200 R - 2M..	MT 200 R - C..				MMT 200-50 (1)	MMT 200-U (1)	MMT 200-C (1)			
	185 BR/BS		MT 185 - TD	MT 185 - GC	CA 185 - M..	CA 185 - 2M..	MT 185 - C..									
	200 S ÷ 240 RC		MT 240 R - TD	MT 240 R - GC	CA 240 R - M..	CA 240 R - 2M..	MT 240 R - C..									
	240 S ÷ 315 RC		MT 315 R - TD	MT 315 R - GC	CA 315 R - M..	CA 315 R - 2M..	MT 315 R - C..						MMT 315-C (1)			
	315 S		MT 315 S - TD	MT 315 S - GC	CA 315 S - M..	CA 315 S - 2M..	MT 315 S - C..									
	400 R		MT 400 - TD		2A 80 - M..	2A 80 - 2M..							ME 80-C (1)			ME 80-3D (1)
500 R		MT 500 - TD		2A 100 - M..	2A 100 - 2M..								ME 100-3D (1)	ME 100-520 (1)		
600 R ÷ 630 R		MT 630 - TD		2A 120 - M..	2A 120 - 2M..								ME 120-3D (1)	ME 120-520 (1)		







 = Hexagonal crimp

 = Oval crimp

 = circular crimp





* When using die set type MC70-50, the conductors marked with a star must be annealed.

DIE SELECTOR CHART FOR DEEP STEPPED INDENTING WITH CONTAINING DIES

APPLICATIONS	CONDUCTOR	CONNECTORS			HYDRAULIC TOOLS			
					HYDRAULIC TOOLS	HT 131-UC	RHU 131-C	B 1350-UCE
 	Conductor Size sqmm	LUGS			DIE HOLDER	DIE		INDENTOR
	10	CAA 10 - M..			AU 130-150	MV 35 	MUA 35 	PS 130-35/E
	16	CAA 16 - M..	MTA 16 - C					
	25	CAA 25 - M..	MTA 25 - C					
	35	CAA 35 - M..	MTA 35 - C					
	50	CAA 50 - M..	MTA 50 - C					
	70	CAA 70 - M..	MTA 70 - C..					
	95	CAA 95 - M..	MTA 95 - C..		AU 130-240	MV 95 	MUA 95 	PS 130-95/E
	120	CAA 120 - M..	MTA 120 - C..					
	150	CAA 150 - M..	MTA 150 - C..					
	185	CAA 185 - M..	MTA 185 - C..					
	240	CAA 240 - M..	MTA 240 - C..					
300	CAA 300 - 34 - M..							
	Conductor Size sqmm	LUGS			DIE HOLDER	DIE		INDENTOR
	16	AA 16 - M..			AU 130-150	MUA 35 	PS 130-35/E	
	25	AA 25 - M..						
	35	AA 35 - M..						
	50	AA 50 - M..						
	70	AA 70 - M..						
	95	AA 95 - M..						
	120	AA 120 - M..			AU 130-240	MUA 95 	PS 130-95/E	
	150	AA 150 - M..						
	185	AA 185 - M..						
	240	AA 240 - M..						
	300	AA 300 - 34 - M..						
300	AA 300 - 34 - M..							

 Indent crimp

DIE SELECTOR CHART FOR DEEP STEPPED INDENTING WITH CONTAINING DIES

Conductor Size sqmm	SPLICES		Conductor Size sqmm		SPLICES	HYDRAULIC TOOLS			
			Al	Al/Cu		HT 131-UC	RHU 131-C	B 1350-UC	B 1300-UC
						DIE HOLDER	DIE	INDENTOR	
10	MTMA 10-GC					AU 130-150	MVM 35 	MUA 35 	PS 130-35/E
16	MTMA 16-GC	MTMA 16/1	16	10	MTMA 16-10 GC				
25	MTMA 25-GC	MTMA 25/1	25	10	MTMA 25-10 GC				
			25	16	MTMA 25-16 GC				
35	MTMA 35-GC	MTMA 35/1							
50	MTMA 50-GC	MTMA 50/1	50	25	MTMA 50-25 GC				
			50	35	MTMA 50-35 GC				
70	MTMA 70-GC	MTMA 70/1	70	35	MTMA 70-35 GC				
			70	50	MTMA 70-50 GC				
95	MTMA 95-GC	MTMA 95/1	95	50	MTMA 95-50 GC				
			95	70	MTMA 95-70 GC				
120	MTMA 120-GC	MTMA 120/1	120	70	MTMA 120-70 GC				
			120	95	MTMA 120-95 GC				
150	MTMA 150-GC	MTMA 150/1	150	70	MTMA 150-70 GC				
			150	95	MTMA 150-95 GC				
185	MTMA 185-GC	MTMA 185/1	185	120	MTMA 185-120 GC				
			185	150	MTMA 185-150 GC				
240	MTMA 240-GC	MTMA 240/1	240	150	MTMA 240-150 GC				
			240	185	MTMA 240-185 GC				
300	MTMAD 300-GC	MTMAD 300/1	300	185	MTMAD 300-185 GC				
			300	240	MTMAD 300-240 GC				
						AU 130-240	MVM 240 	MUA 240 	PS 130-240/E

MTMA...GC

PRE-ROUNDERS SELECTION

DIES DESCRIPTION

DIES SEQUENCE

ALUMINIUM CONDUCTOR SIZE sqmm

PRE-ROUNDER

DIE-SUPPORT

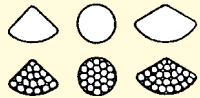

1) AU 130-.. DIE-HOLDER

Used to house dies and pre-rounders.

2) UP 130-.. PRE-ROUNDERS

Used to round Aluminium sectoral conductors in order to introduce them into circular connectors.

Each pre-rounder is made of two parts: the upper part is housed in die-holder **AU 130-..** and the lower part is locked onto **AC 130-P..** die support.

3) AC 130-P.. DIE SUPPORT

Houses lower part of pre-rounder **UP 130-..**

4) MUA... DIES

Containing dies.

5) PS 130-../E INDENTORS

Such indentors are specifically engineered for deep indentation of Aluminium conductors of any stranding configuration.

CONDUCTOR ROUNDING

CRIMPING

1



1



2



4



























3

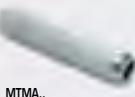

5



DIE SELECTOR CHART

APPLICATIONS	CONDUCTOR	CONNECTORS		HYDRAULIC TOOLS										
				HT 120 and tools and heads with 130 kN crimping force	HT 131-UC B 1350-UCE		RHU 131-C B 1300-UCE		ECW-H3D	RHU 230-630				
					HEXAGONAL CRIMP	INDENT CRIMP			HEXAGONAL CRIMP	INDENT CRIMP				
	Conductor Size sqmm	LUGS		DIE SET	DIE HOLDER	DIE	INDENTOR	DIE SET	ADAPTOR	DIE	INDENTOR			
CAA..M. 	300	CAA 300-34 - M..		MK34L-C 	AU 130-240	MUA 300-34 	PS 130-240/E	MK34-3D 						
	300	CAA 300 - M16						MK38-3D 	AU 230-630	MV 230-400 MC5E 	PS 230-400 5E			
	400	CAA 400 - M16												
	500	CAA 500 - M16 TNBD												
	630	CAA 630 - 4M8							MK46-3D 		MV 230-630 MC6E 	PS 230-630 6E		
AA..M. 	300	AA 300 - 34 - M..		MK34L-C 	AU 130-240	MUA 300-34 	PS 130-240/E	MK34-3D 						
	300	AA 300 - M16						MK38-3D 	AU 230-630	MUA 230-630-400 	PS 230-400 5E			
	400	AA 400 - M16												
	500	AA 500 - 40 - M16												
	630	AA 630 - M16							MK46-3D 		MUA 230-630-630 	PS 230-630 6E		
MTMA.. 	300	MTMAD 300/1	300	95	MTMAD 300-95-GC	MK34L-C 	AU 130-240	MUA 300-34 	PS 130-240/E	MK34-3D 				
				150	MTMAD 300-150-GC									
	185	MTMAD 300-185-GC												
	240	MTMAD 300-240-GC												
	300	MTMA 300-GC								MK38-3D 	AU 230-630	MVM 230-400 MJ5E 	PS 230-400 5E	
	400	MTMA 400/1	400	240	MTMA 400-240-GC									
	500	MTMA 500-40/1												
	500	MTMA 500-GC	500	300	MTMA 500-300-GC									
	630	MTMA 630/1			400	MTMA 500-400-GC					MK46-3D 	MVM 230-630 MJ6E 	PS 230-630 6E	



































 Indent crimp



 Hexagonal crimp

ALUMINIUM CONDUCTORS

DIE SELECTOR CHART

HYDRAULIC TOOLS

APPLICATIONS	CONDUCTOR			CONNECTOR			HYDRAULIC TOOLS					
	Conductor Size sqmm	Conductor Size AWG	Conductor Size Navy	LUGS	SPLICES	B 15D	B35-50D	HT 51 RH 50 B 500E	HT 120 and tools and heads with 130 kN crimping force	ECW-H3D	RHU 520	
						DIE SET	DIE SET	DIE SET	DIE SET	DIE SET	DIE SET	
C...	10	8	23	C8..	CL8..	BSCL8	ME03/2-15  ME2/3-15  MA03/3-15 		MY 2-50 		MY 2-C 	
	16	6		C6..	CL6..	BSCL6	ME2/3-15  MA03/3-15 		MY 3-50 		MY 3-C 	
	25	4	40	C4..	CL4..	BSCL4			MY 4-50 		MY 4-C 	
CL...		3	50	C3..	CL3..	BSCL3			MY 5-50 		MY 5-C 	
	35	2	60	C2..	CL2..	BSCL2			MY 6-50 		MY 6-C 	
		1	75	C1..	CL1..	BSCL1			MY 7-50 		MY 7-C 	
	50	1/0	100	C1/0..	CL1/0..	BSCL1/0			MY 10-50 		MY 10-C 	
	70	2/0	125	C2/0..	CL2/0..	BSCL2/0			MY 14-50 		MY 14-C 	
	95	3/0	150	C3/0..	CL3/0..	BSCL3/0			MY 16-50 		MY 16-C 	
		4/0	200	C4/0..	CL4/0..	BSCL4/0			MY 19-50 		MY 19-C 	
	120	250 MCM	250	C250..	CL250..	BSCL250			MY 24-50 		MY 24-C 	
		300 MCM	300	C300..	CL300..	BSCL300			MY 30L-50 		MY 30-C 	
		350 MCM	350	C350..	CL350..	BSCL350					MY 36-C 	
BSCL..		400 MCM	400	C400..	CL400..	BSCL400					MY 37-C 	
	240	500- MCM		C500..	CL500..	BSCL500			MY 48-50 		MY 48-C 	
		600 MCM		C600..	CL600..	BSCL600					MY 60-C 	
		750 MCM		C750..	CL750..	BSCL750					MY 76-C 	

 Circular crimp Hexagonal crimp Indent crimp

N.B.: Number inside symbol indicates the number of crimps for C short barrel lugs only

REFERENCE/CODE CROSS-REFERENCE CHART

Ref.	Code	Ref.	Code	Ref.	Code	Ref.	Code	Ref.	Code
1052007	3005900	1142042	3005050	1500.09	3002015	1714N	3005536	1895	3016490
1052007N	3005901	1142042G	3005052	1500.09N	3002016	1715	3005540	1896	3016500
1052009	3005903	1142042N	3005051	1500.11	3002020	1715N	3005541	1897	3016510
1052009N	3005904	1142048	3005055	1500.11N	3002021	1719	3005510	1898	3016520
1052011	3005906	1142048G	3005057	1500.12	3002120	1719E17	3005581	1899	3016530
1052011N	3005907	1142048N	3005056	1500.12N	3002121	1719E17N	3005580	1899A	3016535
1052013	3005909	1143M12	3005215	1500.13	3002025	1719N	3005511	1899B	3016540
1052013N	3005910	1143M12G	3005217	1500.13N	3002026	1730M20	3003225	1900.07	3001010
1052016	3005912	1143M12N	3005216	1500.14	3002110	1730M20N	3003226	1900.07G	3001012
1052016N	3005913	1143M16	3005220	1500.14N	3002111	180709	3017610	1900.07N	3001011
1052021	3005915	1143M16G	3005222	1500.16	3002030	180911	3017620	1900.07/X	3001077
1052021N	3005916	1143M16N	3005221	1500.16N	3002031	180913	3017625	1900.09	3001015
1052029	3005918	1143M20	3005225	1500.21	3002035	181113	3017630	1900.09G	3001017
1052029N	3005919	1143M20G	3005227	1500.21N	3002036	181116	3017640	1900.09N	3001016
1052036	3005921	1143M20N	3005226	1500.34	3002130	181316	3017650	1900.09/X	3001080
1052036N	3005922	1143M25	3005230	1500.34N	3002131	181321	3017655	1900.11	3001020
1052042	3005924	1143M25G	3005232	1500.38	3002115	181621	3017660	1900.11G	3001022
1052042N	3005925	1143M25N	3005231	1500.38N	3002116	182129	3017670	1900.11N	3001021
1052048	3005927	1143M32	3005235	1500.M12	3002205	182936	3017680	1900.11/X	3001083
1052048N	3005928	1143M32G	3005237	1500.M12N	3002206	1830	3004110	1900.12	3001120
1053M12	3005958	1143M32N	3005236	1500.M16	3002210	1830N	3004111	1900.12N	3001121
1053M12N	3005959	1143M40	3005240	1500.M16N	3002211	1831	3004115	1900.13	3001025
1053M16	3005961	1143M40G	3005242	1500.M20	3002215	1831N	3004116	1900.13G	3001027
1053M16N	3005962	1143M40N	3005241	1500.M20N	3002216	1832	3004120	1900.13N	3001026
1053M20	3005964	1143M50	3005245	1500.M25	3002220	1832N	3004121	1900.13/X	3001086
1053M20N	3005965	1143M50G	3005247	1500.M25N	3002221	1835G	3004222	1900.14	3001110
1053M25	3005967	1143M50N	3005246	1500.M32	3002225	1836	3004225	1900.14N	3001111
1053M25N	3005968	1143M63	3005250	1500.M32N	3002226	183642	3017690	1900.16	3001030
1053M32	3005970	1143M63G	3005252	1700	3003015	1836N	3004226	1900.16G	3001032
1053M32N	3005971	1143M63N	3005251	1700.2	3004015	1840	3006610	1900.16N	3001031
1053M40	3005973	1150	3005745	1700.2N	3004016	1840N	3006611	1900.16/X	3001089
1053M40N	3005974	1150N	3005746	1700N	3003016	1841	3006615	1900.21	3001035
1053M50	3005976	1163	3005750	1700P	3006015	1841N	3006616	1900.21G	3001037
1053M50N	3005977	1163N	3005751	1700T	3003515	1842	3006620	1900.21N	3001036
1053M63	3005979	1253M12	3006750	1700TN	3003516	184248	3017700	1900.21/X	3001092
1053M63N	3005980	1253M12N	3006751	1701	3003020	1842N	3006621	1900.29	3001040
1112	3005715	1253M16	3006755	1701.2	3004020	1843	3006625	1900.29G	3001042
1112N	3005716	1253M16N	3006756	1701.2N	3004021	1843N	3006626	1900.29N	3001041
1116	3005720	1253M20	3006760	1701N	3003021	1844	3006630	1900.29/X	3001095
1116N	3005721	1253M20N	3006761	1701P	3006020	1844N	3006631	1900.34	3001130
1120	3005725	1253M25	3006765	1701PN	3006021	1845	3006635	1900.34N	3001131
1120N	3005726	1253M25N	3006766	1701T	3003517	1845N	3006636	1900.36	3001045
1125	3005730	1253M32	3006770	1701TN	3003518	1846	3006640	1900.36G	3001047
1125N	3005731	1253M32N	3006771	1702	3003025	1846N	3006641	1900.36N	3001046
1132	3005735	1253M40	3006775	1702.2	3004025	1847	3006645	1900.36/X	3001098
1132N	3005736	1253M40N	3006776	1702.2N	3004026	1847N	3006646	1900.38	3001115
1140	3005740	1253M50	3006780	1702.5	3004425	1848	3006650	1900.38N	3001116
1140N	3005741	1253M50N	3006781	1702.5N	3004426	1848N	3006651	1900.42	3001050
1141012	3005120	1253M63	3006785	1702CONC	3003523	1849	3006655	1900.42G	3001052
1141012N	3005121	1253M63N	3006786	1702CONCN	3003524	1849N	3006656	1900.42N	3001051
1141112	3005155	1400	3003110	1702N	3003026	1861	3004515	1900.42/X	3001101
1141112N	3005156	1401	3003114	1702P	3006025	1861N	3004516	1900.48	3001055
1141200	3005170	1401B	3003116	1702PN	3006026	1862	3004520	1900.48G	3001057
1141200N	3005171	1401BN	3003117	1702T	3003519	1862N	3004521	1900.48N	3001056
1142007	3005010	1401C	3003118	1702TN	3003520	1866	3004615	1900.48/X	3001104
1142007G	3005012	1401CN	3003119	1703	3003030	1866N	3004616	1900.M12	3001215
1142007N	3005011	1401N	3003115	1703.2	3004030	1880	3016215	1900.M12G	3001217
1142009	3005015	1402	3003120	1703.5	3004430	1881	3016220	1900.M12N	3001216
1142009G	3005017	1402N	3003121	1703P	3006030	1882	3016225	1900.M12/X	3001310
1142009N	3005016	1403	3003125	1704	3003035	1883	3016230	1900.M16	3001220
1142011	3005020	1404	3003130	1704.2	3004035	1884	3016235	1900.M16G	3001222
1142011G	3005022	1405	3003135	1704P	3006035	1884A	3016236	1900.M16N	3001221
1142011N	3005021	1407	3003155	1705	3003040	1885	3016240	1900.M16/X	3001313
1142013	3005025	1408	3003170	1705.2	3004040	1886	3016245	1900.M20	3001225
1142013G	3005027	1410	3005610	1706	3003045	1887	3016250	1900.M20G	3001227
1142013N	3005026	1410N	3005611	1707	3003050	1888	3016255	1900.M20N	3001226
1142016	3005030	1411	3005615	1708	3003055	1888/5	3016256	1900.M20/X	3001316
1142016G	3005032	1411N	3005616	1709	3003010	1889	3016405	1900.M25	3001230
1142016N	3005031	1412	3005620	1710	3005515	1890	3016410	1900.M25G	3001232
1142021	3005035	1412N	3005621	1710N	3005516	1890A	3016420	1900.M25N	3001231
1142021G	3005037	1413	3005625	1711	3005520	1891	3016430	1900.M25/X	3001319
1142021N	3005036	1413N	3005626	1711N	3005521	1891A	3016431	1900.M32	3001235
1142029	3005040	1414	3005630	1712	3005525	1892	3016440	1900.M32G	3001237
1142029G	3005042	1414N	3005631	1712N	3005526	1892A	3016450	1900.M32N	3001236
1142029N	3005041	1415	3005635	1713	3005530	1892B	3016451	1900.M32/X	3001322
1142036	3005045	1415N	3005636	1713N	3005531	1893	3016460	1900.M40	3001240
1142036G	3005047	1500.07	3002010	1714	3005535	1893A	3016461	1900.M40G	3001242
1142036N	3005046	1500.07N	3002011	1714E34	3005572	1894	3016480	1900.M40N	3001241

REFERENCE/CODE CROSS-REFERENCE CHART

Ref.	Code	Ref.	Code	Ref.	Code	Ref.	Code	Ref.	Code
1900.M40/X	3001325	1910.M16N	3001711	2021118	3014140	20435040N	3017971	20N3M40N	3015820
1900.M50	3001245	1910.M20	3001715	2021118N	3014141	20436340N	3017973	20N3M50N	3015822
1900.M50G	3001247	1910.M20G	3001717	2021200	3014170	20436350N	3017975	20N3M63N	3015824
1900.M50N	3001246	1910.M20N	3001716	2021200N	3014171	2052007N	3011810	2155	3051010
1900.M50/X	3001328	1910.M25	3001720	2031012	3015620	2052009N	3011815	2156	3051015
1900.M63	3001250	1910.M25G	3001722	2031012N	3015621	2052011N	3011820	2157	3051020
1900.M63G	3001252	1910.M25N	3001721	2031014	3015610	2052013N	3011825	2158	3051125
1900.M63N	3001251	1910.M32	3001725	2031014N	3015611	2052016N	3011830	2160	3051130
1900.M63/X	3001331	1910.M32G	3001727	2031034	3015630	2052021N	3011835	2161	3051135
1901.07	3001503	1910.M32N	3001726	2031034N	3015631	2052029N	3011840	2162	3051140
1901.07N	3001504	1910.M40	3001730	2031038	3015615	2052036N	3011845	2163	3051145
1901.09	3001515	1910.M40G	3001732	2031038N	3015616	2052042N	3011850	2164	3051150
1901.09N	3001516	1910.M40N	3001731	2031058	3015625	2052048N	3011855	2165	3051155
1901.11	3001520	1910.M50	3001735	2031058N	3015626	2053M12N	3011910	2167	3051165
1901.11N	3001521	1910.M50G	3001737	2031100	3015635	2053M16N	3011915	2171	3051131
1901.13	3001535	1910.M50N	3001736	2031100N	3015636	2053M20N	3011920	2172	3051315
1901.13N	3001536	1910.M63	3001740	2031112	3015655	2053M25N	3011925	2173	3051320
1901.16	3001550	1910.M63G	3001742	2031112N	3015656	2053M32N	3011930	2174	3051325
1901.16N	3001551	1910.M63N	3001741	2031114	3015645	2053M40N	3011935	2176	3051430
1901.21	3001568	1925.3	3016470	2031114N	3015646	2053M50N	3011940	2323	3052010
1901.21N	3001569	200101241	3013120	2031118	3015640	2053M63N	3011945	2326	3052020
1901.29	3001575	200101241N	3013121	2031118N	3015641	207101441	3013607	2329	3052030
1901.29N	3001576	200101441	3013110	2031200	3015670	207101441N	3013608	2333	3052110
1901.36	3001582	200101441N	3013111	2031200N	3015671	208200711N	3011010	2336	3052120
1901.36N	3001583	200103441	3013130	2031212	3015685	208200911N	3011015	2339	3052130
1901.42	3001590	200103441N	3013131	2031212N	3015686	208201111N	3011020	2342	3052140
1901.42N	3001591	200103841	3013115	2031300	3015695	208201311N	3011025	2344	3052150
1901.48	3001596	200103841N	3013116	2031300N	3015696	208201611N	3011030	2346	3052160
1901.48N	3001597	200105841	3013125	2032007N	3015511	208202111N	3011035	2900.07N	3012010
1901.M12	3001650	200105841N	3013126	2032009N	3015516	208202911N	3011040	2900.09N	3012015
1901.M12G	3001652	200110041	3013135	2032011N	3015521	208203611N	3011045	2900.11N	3012020
1901.M12N	3001651	200110041N	3013136	2032013N	3015526	208204211N	3011050	2900.13N	3012025
1901.M16	3001655	200111241	3013155	2032016N	3015531	208204811N	3011055	2900.16N	3012030
1901.M16G	3001657	200111241N	3013156	2032021N	3015536	20931216N	3017705	2900.21N	3012035
1901.M16N	3001656	200111441	3013145	2032029N	3015541	20931620N	3017707	2900.29N	3012040
1901.M20	3001660	200111441N	3013146	2032036N	3015546	20932025N	3017709	2900.36N	3012045
1901.M20G	3001662	200111841	3013140	2032042N	3015551	20932532N	3017711	2900.42N	3012050
1901.M20N	3001661	200111841N	3013141	2032048N	3015556	20932540N	3017713	2900.48N	3012055
1901.M25	3001665	200120041	3013170	2033M12N	3015751	20933240N	3017715	2900.M12N	3012215
1901.M25G	3001667	200120041N	3013171	2033M16N	3015756	20933250N	3017717	2900.M16N	3012220
1901.M25N	3001666	200121221	3013185	2033M20N	3015761	20934050N	3017719	2900.M20N	3012225
1901.M32	3001670	200121221N	3013186	2033M25N	3015766	20935063N	3017721	2900.M25N	3012230
1901.M32G	3001672	200130021	3013195	2033M32N	3015771	20A40916N	3018650	2900.M32N	3012235
1901.M32N	3001671	200130021N	3013196	2033M40N	3015776	20A41120N	3018655	2900.M40N	3012240
1901.M40	3001675	200200721N	3013011	2033M50N	3015781	20A41320N	3018657	2900.M50N	3012245
1901.M40G	3001677	200200921N	3013016	2033M63N	3015786	20A41620N	3018659	2900.M63N	3012250
1901.M40N	3001676	200201121N	3013021	20420907N	3017810	20A42011N	3018610	2901.07N	3012590
1901.M50	3001680	200201321N	3013026	20421107N	3017820	20A42016N	3018612	2901.09N	3012593
1901.M50G	3001682	200201621N	3013031	20421109N	3017822	20A42120N	3018661	2901.11N	3012596
1901.M50N	3001681	200202121N	3013036	20421307N	3017830	20A42125N	3018665	2901.13N	3012599
1901.M63	3001685	200202921N	3013041	20421309N	3017832	20A42513N	3018615	2901.16N	3012602
1901.M63G	3001687	200203621N	3013046	20421311N	3017835	20A42516N	3018617	2901.21N	3012605
1901.M63N	3001686	200204221N	3013051	20421607N	3017840	20A42925N	3018667	2901.29N	3012608
1910.07	3001501	200204821N	3013056	20421609N	3017842	20A43216N	3018620	2901.36N	3012611
1910.07N	3001502	2003M1221N	3013215	20421611N	3017845	20A43221N	3018621	2901.42N	3012614
1910.09	3001509	2003M1621N	3013220	20421613N	3017847	20E200711N	3011102	2901.M12N	3012650
1910.09N	3001510	2003M2021N	3013225	20422111N	3017850	20E200911N	3011104	2901.M16N	3012652
1910.11	3001526	2003M2521N	3013230	20422113N	3017855	20E201111N	3011106	2901.M20N	3012654
1910.11N	3001527	2003M3221N	3013235	20422116N	3017858	20E201311N	3011108	2901.M25N	3012656
1910.13	3001539	2003M4021N	3013240	20422916N	3017860	20E201611N	3011110	2901.M32N	3012658
1910.13N	3001540	2003M5021N	3013245	20422921N	3017865	20E202111N	3011112	2901.M40N	3012660
1910.16	3001552	2003M6321N	3013250	20423621N	3017870	20E202911N	3011114	2901.M50N	3012662
1910.16N	3001553	2021012	3014120	20423629N	3017875	20E203611N	3011116	2901.07N	3012501
1910.21	3001565	2021012N	3014121	20424229N	3017880	20E204211N	3011118	2901.09N	3012511
1910.21N	3001566	2021014	3014110	20424236N	3017885	20E204811N	3011120	2901.11N	3012521
1910.29	3001578	2021014N	3014111	20424836N	3017890	20M3M1261N	3011410	2901.13N	3012531
1910.29N	3001579	2021034	3014130	20424842N	3017895	20M3M1661N	3011412	2901.16N	3012541
1910.36	3001588	2021034N	3014131	20431612N	3017949	20M3M2061N	3011414	2901.21N	3012551
1910.36N	3001589	2021038	3014115	20432012N	3017951	20M3M2561N	3011416	2901.29N	3012555
1910.42	3001592	2021038N	3014116	20432016N	3017953	20M3M3261N	3011418	2901.36N	3012560
1910.42N	3001593	2021058	3014125	20432512N	3017955	20M3M4061N	3011420	2901.42N	3012565
1910.48	3001598	2021058N	3014126	20432516N	3017957	20M3M5061N	3011422	2901.48N	3012570
1910.48N	3001599	2021100	3014135	20432520N	3017959	20M3M6361N	3011424	2901.M12N	3012710
1910.M12	3001705	2021100N	3014136	20433220N	3017961	20N3M12N	3015810	2901.M16N	3012712
1910.M12G	3001707	2021112	3014155	20433225N	3017963	20N3M16N	3015812	2901.M20N	3012714
1910.M12N	3001706	2021112N	3014156	20434025N	3017965	20N3M20N	3015814	2901.M25N	3012716
1910.M16	3001710	2021114	3014145	20434032N	3017967	20N3M25N	3015816	2901.M32N	3012718
1910.M16G	3001712	2021114N	3014146	20435032N	3017969	20N3M32N	3015818	2901.M40N	3012720

REFERENCE/CODE CROSS-REFERENCE CHART

Ref.	Code	Ref.	Code	Ref.	Code	Ref.	Code	Ref.	Code
2910.M50N	3012722	2A80-M16	2509150	4901.M32	3002962	7900.42	3010040	A10-P25	2221990
2910.M63N	3012724	2A80-M20	2509230	4901.M40	3002965	7900.48	3010045	A100-M16	2370030
2911.07N	3012110	3411012	3016645	4901.M50	3002968	7900A.07	3010060	A100-M20	2370110
2911.09N	3012113	3411014	3016615	4901.M63	3002971	7900A.09	3010062	A10B-M6/11,5	2220078
2911.11N	3012116	3411034	3016665	5900.M12N	3012810	7900A.11	3010064	A12-M10	2230270
2911.13N	3012119	3411038	3016625	5900.M16N	3012812	7900A.13	3010066	A12-M10/19	2230280
2911.16N	3012122	3411100	3016695	5900.M20N	3012814	7900A.16	3010068	A12-M12	2230310
2911.21N	3012125	3412011	3016635	5900.M25N	3012816	7900A.21	3010070	A12-M6/15	2230210
2911.29N	3012128	3412016	3016657	5900.M32N	3012818	7900A.29	3010072	A12-M8	2230230
2911.36N	3012131	3412021	3016685	5900.M40N	3012820	7900A.36	3010074	A120-M16	2372070
2911.42N	3012134	3412029	3016705	5900.M50N	3012822	7900A.42	3010076	A120-M20	2372150
2911.M12N	3012750	3422016	3016658	5900.M63N	3012824	7900A.48	3010078	A14-M10	2240230
2911.M16N	3012752	3422021	3016686	5901.M12N	3012850	7900.M12	3010110	A14-M12	2240270
2911.M20N	3012754	3431100	3016895	5901.M16N	3012852	7900.M16	3010113	A14-M14	2240310
2911.M25N	3012756	3441012	3017045	5901.M20N	3012854	7900.M20	3010116	A14-M16	2240350
2911.M32N	3012758	3441034	3017065	5901.M25N	3012856	7900.M25	3010119	A14-M6	2240110
2911.M40N	3012760	3572007	3017410	5901.M32N	3012858	7900.M32	3010122	A14-M8	2240150
2911.M50N	3012762	3572011	3017430	5901.M40N	3012860	7900.M40	3010125	A14-P30	2241730
2A10-M10	2502070	3572013	3017445	5901.M50N	3012862	7900.M50	3010128	A14B-M6/11,5	2240118
2A10-M12	2502150	35720131	3017446	5116660250	3061210	7900.M63	3010131	A160-M16	2374150
2A10-M14	2502190	3572016	3017455	5116660500	3061215	7900A.M12	3010150	A160-M20	2374170
2A10-M16	2502230	3572021	3017480	6010.01	3016090	7900A.M16	3010152	A17-M10	2250270
2A100-2M14	2509760	3573M16	3017520	6010.11	3016030	7900A.M20	3010154	A17-M10/19	2250280
2A100-2M16	2509780	3573M20	3017530	6010.12	3016040	7900A.M25	3010156	A17-M12	2250310
2A100-M16	2509630	3573M25	3017540	6010.14	3016010	7900A.M32	3010158	A17-M14	2250350
2A100-M20	2509670	3573M32	3017550	6010.21	3016080	7900A.M40	3010160	A17-M16	2250860
2A120-2M14	2509930	36A3M1623	3016910	6010.29	3016100	7900A.M50	3010162	A17-M6	2250210
2A120-2M14/55°	2509952	36A3M1624	3016912	6010.34	3016060	7900A.M63	3010164	A17-M8	2250230
2A120-2M16	2509970	36A3M16322	3016913	6010.36	3016110	A1-L6	2103200	A19-M10	2260190
2A120-M16	2509870	36A3M2025	3016920	6010.38	3016020	A2-L5	2170820	A19-M12	2260230
2A120-M20	2509890	36A3M2034	3016922	6010.42	3016120	A2-L6	2170830	A19-M14	2260270
2A14-M10	2503030	36A3M20356	3016923	6010.48	3016130	A2-L8	2170850	A19-M16	2260310
2A14-M12	2503110	36A3M2526	3016930	6010.58	3016050	A3-L5	2180620	A19-M20	2260390
2A14-M14	2503150	36A3M2536	3016932	6010.114	3016070	A3-L6	2180630	A19-M6	2260110
2A14-M16	2503190	36A3M2537	3016934	7032007	3010604	A3-L8	2180640	A19-M8	2260150
2A160-M20	2509980	36A3M2545	3016936	7032009	3010606	A3-L10	2180659	A19B-M8/15,5	2260163
2A19-M10	2504030	36A3M2546	3016937	7032011	3010608	A5-L6	2190670	A1-M10	2103270
2A19-M12	2504110	36A3M2554	3016938	7032013	3010610	A5-L8	2190710	A1-M3	2103030
2A19-M14	2504190	36A3M3228	3016944	7032016	3010614	A5-L10	2190750	A1-M3,5	2103070
2A19-M16	2504270	36A3M3239	3016946	7032021	3010616	A7-L6	2200710	A1-M4	2103110
2A19-M20	2504350	36A3M32465	3016945	7032029	3010618	A7-L8	2200750	A1-M5	2103150
2A200-M20	2509989	36A3M3248	3016943	7032036	3010620	A7-L10	2200790	A1-M6	2103190
2A24-M10	2505030	36A3M4078	3016952	7032042	3010622	A7-L12	2200830	A1-M8	2103230
2A24-M12	2505150	36A3M40106	3016954	7032048	3010624	A10-L6	2220605	A20-M10	2270270
2A24-M14	2505230	36A3M5088	3016968	7032A007	3010628	A10-L8	2220610	A20-M12	2270310
2A24-M16	2505310	36C201629	3016982	7032A009	3010630	A10-L10	2220650	A20-M14	2270350
2A24-M20	2505390	4900.07	3002710	7032A011	3010632	A10-L12	2220690	A20-M16	2270390
2A3-M10	2500070	4900.09	3002713	7032A013	3010634	A14-L8	2241245	A20-M8	2270230
2A3-M8	2500030	4900.11	3002716	7032A016	3010636	A14-L10	2241250	A200-M16	2376090
2A30-M10	2506020	4900.13	3002719	7032A021	3010638	A14-L12	2241290	A200-M20	2376100
2A30-M12	2506030	4900.16	3002722	7032A029	3010640	A19-L8	2260560	A24-M10	2280150
2A30-M14	2506110	4900.21	3002725	7032A036	3010642	A19-L10	2260570	A24-M12	2280190
2A30-M16	2506190	4900.29	3002728	7032A042	3010644	A19-L12	2260610	A24-M14	2280230
2A30-M20	2506270	4900.36	3002731	7032A048	3010646	A24-L10	2281010	A24-M16	2280270
2A37-M12	2507070	4900.42	3002734	7033M12	3010652	A24-L12	2281050	A24-M20	2280310
2A37-M14	2507110	4900.48	3002737	7033M16	3010654	A30-L10	2300870	A24-M8	2280110
2A37-M16	2507190	4900.M12	3002750	7033M20	3010656	A30-L12	2300910	A24B-M10/19	2280155
2A37-M20	2507270	4900.M16	3002753	7033M25	3010658	A37-L10	2320510	A24B-M8/19	2280115
2A48-M12	2508030	4900.M20	3002756	7033M32	3010660	A37-L12	2320550	A29-M10	2290270
2A48-M14	2508070	4900.M25	3002759	7033M40	3010662	A48-L12	2341295	A29-M12	2290310
2A48-M16	2508110	4900.M32	3002762	7033M50	3010664	A60-L12	2351010	A29-M14	2290350
2A48-M20	2508190	4900.M40	3002765	7033M63	3010666	A03-M3	2100030	A29-M16	2290390
2A5-M10	2500570	4900.M50	3002768	7033AM12	3010670	A03-M3,5	2100070	A29-M20	2290430
2A5-M12	2500650	4900.M63	3002771	7033AM16	3010672	A03-M4	2100110	A29-M8	2290230
2A5-M8	2500530	4901.07	3002910	7033AM20	3010674	A03-M5	2100150	A2-M10	2170270
2A60-M12	2508480	4901.09	3002913	7033AM25	3010676	A03-M6	2100190	A2-M12	2170310
2A60-M14	2508500	4901.11	3002916	7033AM32	3010678	A06-M3	2101030	A2-M4	2170070
2A60-M16	2508530	4901.13	3002919	7033AM40	3010680	A06-M3,5	2101070	A2-M5	2170150
2A60-M20	2508610	4901.16	3002922	7033AM50	3010682	A06-M4	2101110	A2-M5/9	2170155
2A7-M10	2501110	4901.21	3002925	7033AM63	3010684	A06-M5	2101150	A2-M6	2170190
2A7-M12	2501150	4901.29	3002928	7900.07	3010000	A06-M6	2101190	A2-M8	2170230
2A7-M8	2501030	4901.36	3002931	7900.09	3010005	A06-M8	2101230	A2-P12	2170650
2A80-2M12	2509310	4901.42	3002934	7900.11	3010010	A10-M10	2220150	A30-M10	2300110
2A80-2M14	2509350	4901.48	3002937	7900.13	3010015	A10-M12	2220190	A30-M12	2300150
2A80-2M14/55°	2509346	4901.M12	3002950	7900.16	3010020	A10-M14	2220230	A30-M14	2300230
2A80-2M16	2509390	4901.M16	3002953	7900.21	3010025	A10-M16	2220270	A30-M16	2300270
2A80-M12	2509030	4901.M20	3002956	7900.29	3010030	A10-M6	2220070	A30-M20	2300350
2A80-M14	2509070	4901.M25	3002959	7900.36	3010035	A10-M8	2220110	A30-M8	2300070

REFERENCE/CODE CROSS-REFERENCE CHART

Ref.	Code	Ref.	Code	Ref.	Code	Ref.	Code	Ref.	Code
A30B-M10/19	2300120	AA120-M12	2741510	ANE3-U4	2415870	BF-M4	2052150	BN-M7	2152310
A30B-M8/19	2300080	AA120-M14	2741550	ANE3-U5	2415875	BF-M5	2052190	BN-M8	2152350
A35-M10	2310265	AA150-M12	2742030	ANE30-M12	2458320	BF-M6	2052230	BN-MA608	3031740
A35-M12	2310270	AA150-M14	2742070	ANE30-M14	2458350	BF-M6/1	2052270	BN-P10	2153190
A35-M14	2310310	AA185-M12	2742510	ANE30-M16	2458370	BF-M6/2	2052280	BN-P12	2153230
A35-M16	2310350	AA185-M14	2742550	ANE30-M20	2458390	BF-M608	2053650	BN-P8	2153150
A35-M20	2310390	AA240-M12	2743030	ANE35-M12	2460010	BF-M608P	2053655	BN-PP12	2153270
A37-M10	2320110	AA240-M14	2743070	ANE35-M14	2460030	BF-M7	2052310	BN-PP12/25	2153310
A37-M12	2320150	AA300-M16	2743150	ANE35-M16	2460050	BF-M8	2052350	BN-PP16/25	2153350
A37-M14	2320190	AA300-34-M12	2743205	ANE35-M20	2460070	BF-P10	2053250	BN-U10	2152910
A37-M16	2320230	AA300-34-M14	2743210	ANE5-M10	2418540	BF-P12	2053290	BN-U12	2152950
A37-M20	2320270	AA300-34-M16	2743215	ANE5-M12	2418550	BF-P8	2053210	BN-U3	2152630
A37-M8	2320070	AA400-M16	2743310	ANE5-M4	2418500	BF-PP12	2053330	BN-U3.5	2152670
A37B-M10/24,5	2320120	AA50-M12	2740110	ANE5-M5	2418510	BF-PP12/25	2053370	BN-U3.5/1	2152680
A3-M10	2180270	AA50-M14	2740150	ANE5-M6	2418520	BF-PP12/29	2053380	BN-U4	2152710
A3-M12	2180310	AA500-40-M16	2743330	ANE5-M8	2418530	BF-PP16/25	2053410	BN-U4/1	2152730
A3-M4	2180030	AA630-M16	2743370	ANE5-M16	2418560	BF-PPL30	2053460	BN-U4/2	2152732
A3-M5	2180110	AA70-M12	2740510	ANE7-M6	2422300	BF-PPL46	2053465	BN-U5	2152750
A3-M5/9	2180120	AA70-M14	2740550	ANE7-M8	2422310	BF-U10	2052910	BN-U6	2152790
A3-M6	2180150	AA95-M12	2741030	ANE7-M10	2422320	BF-U12	2052950	BN-U6/1	2152830
A3-M8	2180190	AA95-M14	2741070	ANE7-M12	2422330	BF-U3	2052630	BN-U8	2152870
A3-P14	2180830	AC130-P	2615531	ANE7-P20	2422360	BF-U3,5	2052670	BP-M10	2046345
A40-M10	2330230	ANE10-M6	2439350	ANE9-M10	2430170	BF-U3,5/1	2052671	BP-M12	2046350
A40-M12	2330270	ANE10-M8	2439360	ANE9-M12	2430180	BF-U4	2052710	BP-M2	2046305
A40-M14	2330310	ANE10-M10	2439370	ANE9-M6/15	2430150	BF-U4/1	2052720	BP-M3	2046310
A40-M16	2330350	ANE10-M12	2439380	ANE9-M8	2430160	BF-U4/2	2052730	BP-M3,5	2046315
A40-M20	2330390	ANE12-M10	2442220	ASC30-36 GB	2598486	BF-U5	2052750	BP-M3,5/1	2046316
A48-M10	2340110	ANE12-M10/19	2442225	AU130-150	2615560	BF-U5/2	2052765	BP-M4	2046320
A48-M10/31	2340120	ANE12-M12	2442230	AU130-240	2615590	BF-U6	2052790	BP-M5	2046325
A48-M12	2340150	ANE12-M6/15	2442200	AU230-130D	2636960	BF-U6/1	2052830	BP-M6	2046330
A48-M12/31	2340158	ANE12-M8	2442210	AU230-630	2680300	BF-U8	2052870	BP-M6/1	2046331
A48-M14	2340190	ANE14-M6	2446410	AU520-130C	2648230	BH2433	2596105	BP-M6/2	2046332
A48-M16	2340230	ANE14-M8	2446420	B-FC48N	2598870	BKF-BF4	2053632	BP-M7	2046335
A48-M16/31	2340238	ANE14-M10	2446430	B-FL750E	2598867	BKF-BM4	2053662	BP-M8	2046340
A48-M20	2340310	ANE14-M12	2446440	B-TC250E	2596268	BKF-F405	2053562	BP-P10	2046415
A48-M8	2340070	ANE14-M14	2446450	B-TC04	2599410	BKF-F405P	2053567	BP-P12	2046420
A5-M10	2190190	ANE17-M10	2447260	B-TC450E	2599407	BKF-F408	2053572	BP-P8	2046410
A5-M12	2190230	ANE17-M10/19	2447265	B-TC500E	2598829	BKF-F408P	2053577	BP-PP12	2046440
A5-M4	2190030	ANE17-M12	2447270	B-TC500YE	2598823	BKF-F608	2053612	BP-PP12/25	2046445
A5-M5	2190070	ANE17-M14	2447280	B-TC055	2598830	BKF-F608P	2053622	BP-PP12/29	2046450
A5-M5/9	2190075	ANE17-M16	2447290	B-TC650E	2599442	BKF-FM608	2053692	BP-PP16/25	2046455
A5-M6	2190110	ANE17-M6	2447240	B-TC650-SCE	2599432	BKF-M608	2053652	BP-PPL30	2046470
A5-M8	2190150	ANE17-M8	2447250	B-TC095	2598845	BKY-M3	2145842	BP-PPL46	2046475
A5-P16	2191510	ANE19-M8	2449510	B15D	2599833	BKY-M3.5	2145845	BP-U10	2046565
A60-M10	2350030	ANE19-M10	2449520	B1300-CE	2599352	BKY-M3.5/1	2145847	BP-U12	2046570
A60-M12	2350070	ANE19-M12	2449530	B1300-CE-KV	2599390	BKY-M4	2145853	BP-U3	2046510
A60-M14	2350150	ANE19-M14	2449540	B1300-UCE	2599367	BKY-M5	2145856	BP-U3,5	2046515
A60-M16	2350190	ANE19-M16	2449550	B1300L-CE	2599360	BKY-M6/1	2145862	BP-U3,5/1	2046516
A60-M20	2350230	ANE2-M10	2408840	B1350-CE	2599323	BKY-M8	2145871	BP-U4	2046530
A60B-M10/31	2350033	ANE2-M12	2408845	B1350L-CE	2599329	BKY-M10	2145874	BP-U4/1	2046531
A60B-M12/31	2350072	ANE2-M4	2408820	B1350-UCE	2599337	BKY-M12	2145878	BP-U4/2	2046540
A7-M10	2200190	ANE2-M5	2408825	B35-45D	2599894	BKY-P8	2145930	BP-U5	2046545
A7-M12	2200230	ANE2-M6	2408830	B35-50D	2599904	BKY-P10	2145932	BP-U6	2046555
A7-M5	2200070	ANE2-M8	2408835	B35-TC025	2599510	BKY-P12	2145934	BP-U6/1	2046556
A7-M6	2200110	ANE2-P12	2408850	B500E	2596212	BKY-PP12	2145940	BP-U8	2046560
A7-M8	2200150	ANE2-U4	2408860	B500E-KV	2596208	BKY-PP12/25	2145942	BPS230.14	2598500
A7-P20	2201750	ANE2-U5	2408865	B54D-D6	2599923	BKY-PP16/23	2145944	BPS230.24	2596093
A7B-M6/11,5	2200120	ANE20-M10	2451320	B55	2598990	BKY-PPL30	2145950	BPS230.96	2598497
A80-M12	2360030	ANE20-M12	2451330	B55-KV	2598984	BKY-PPL46	2145952	BSCL1	2489535
A80-M14	2360070	ANE20-M14	2451340	B70M-P24	2596120	BKY-U3	2145900	BSCL1/0	2489540
A80-M16	2360110	ANE20-M16	2451350	B70M-P24-CH	2596136	BKY-U3.5	2145903	BSCL2	2489530
A80-M20	2360150	ANE20-M8	2451310	B70M-P24-KV	2596127	BKY-U4	2145906	BSCL2/0	2489545
A9-M10	2210270	ANE24-M10	2453530	BA-3	2598424	BKY-U5	2145909	BSCL250	2489560
A9-M12	2210310	ANE24-M12	2453550	BF-BF5	2053630	BKY-U6	2145912	BSCL3	2489525
A9-M6/15	2210210	ANE24-M14	2453570	BF-BM5	2053660	BKY-U6/1	2145914	BSCL3/0	2489550
A9-M8	2210230	ANE24-M16	2453590	BF-F405	2053560	BN-FA608	3031640	BSCL300	2489565
A100-4ESI	2370990	ANE29-M10	2456010	BF-F405P	2053565	BN-FAB608	3031660	BSCL350	2489570
A120-4ESI	2372850	ANE29-M12	2456030	BF-F408	2053570	BN-FAR608	3031680	BSCL4	2489520
A160-4ESI	2374350	ANE29-M14	2456050	BF-F408P	2053575	BN-M10	2152390	BSCL4/0	2489555
A200-4ESI	2376165	ANE29-M16	2456070	BF-F608	2053610	BN-M12	2152430	BSCL400	2489575
A37-4ESI	2321510	ANE29-M20	2456090	BF-F608P	2053620	BN-M2	2152010	BSCL500	2489580
A48-4ESI	2340950	ANE3-M10	2415840	BF-FM608	2053690	BN-M3	2152030	BSCL6	2489515
A60-4ESI	2350850	ANE3-M12	2415850	BF-M10	2052390	BN-M3,5	2152070	BSCL600	2489585
A80-4ESI	2360850	ANE3-M4	2415800	BF-M12	2052430	BN-M3,5/1	2152110	BSCL750	2489590
AA16-M8	2740020	ANE3-M5	2415810	BF-M2	2052010	BN-M4	2152150	BSCL8	2489510
AA25-M8	2740050	ANE3-M6	2415820	BF-M3	2052030	BN-M5	2152190	C1/0-12	2396280
AA35-M8	2740070	ANE3-M8	2415830	BF-M3,5	2052070	BN-M6	2152230	C1/0-14	2396220
AA35-M10	2740075	ANE3-P14	2415860	BF-M3,5/1	2052110	BN-M6/1	2152270	C1/0-38	2396260

REFERENCE/CODE CROSS-REFERENCE CHART

Ref.	Code	Ref.	Code	Ref.	Code	Ref.	Code	Ref.	Code
C1/0-516	2396240	C600-12	2398120	CA150R-M14	2532850	CAA95-M12	2760190	CL1/OIH-58	2396417
C1/0-58	2396320	C600-34	2398180	CA150S-2M14	2533330	CB1430L	2598494	CL1/OIH-916	2396415
C1/0-916	2396300	C600-58	2398160	CA150S-M12	2533210	CB1840L	2598493	CL1-10	2396183
C1-12	2396080	C600-78	2398200	CA150S-M14	2533250	CB9620H	2598503	CL1-12	2396191
C1-14	2396020	C600-916	2398140	CA185M12	8005586	CBA96-144	2598508	CL1-516	2396187
C1-38	2396060	C6-10	2395240	CA185M16	8005590	CBP-F405	2076535	CL1-D14	2396160
C1-516	2396404	C6-12	2395320	CA240M12	8005594	CBP-F408	2076540	CL1-D141	2396161
C2/0-12	2396480	C6-14	2395260	CA240M16	8005596	CBP-F408P	2076543	CL1-D38	2396170
C2/0-14	2396420	C6-38	2395300	CA240M20	8005600	CBP-F608	2076545	CL1-DN	2396175
C2/0-34	2396540	C6-516	2395280	CA200R-2M14	2533570	CBP-F608P	2076550	CL1IH-10	2396205
C2/0-38	2396460	C6-8	2395220	CA200R-M14	2533530	CBP-M3	2076310	CL1IH-12	2396217
C2/0-516	2396440	C750-12	2398320	CA240R-2M14	2533850	CBP-M3,5	2076315	CL1IH-14	2396208
C2/0-58	2396520	C750-34	2398380	CA240R-M14	2533770	CBP-M3,5/1	2076320	CL1IH-38	2396214
C2/0-916	2396500	C750-58	2398360	CA300M12	8005604	CBP-M4	2076325	CL1IH-516	2396211
C2-10	2395820	C750-78	2398400	CA300M16	8005608	CBP-M5	2076335	CL2/0-12	2396594
C2-12	2395900	C8-10	2395040	CA300M20	8005610	CBP-M6	2076340	CL2/0-38	2396591
C2-14	2395840	C8-12	2395120	CA25-2M12	2530210	CBP-M6/1	2076345	CL2/0-D14	2396560
C2-38	2395880	C8-14	2395060	CA25-2M8	2530130	CBP-M608	2076560	CL2/0-D141	2396561
C250-12	2397080	C8-38	2395100	CA25-M10	2530050	CBP-M7	2076350	CL2/0-D38	2396570
C250-14	2397020	C8-516	2395080	CA25-M12	2530090	CBP-M8	2076355	CL2/0-DN	2396575
C250-34	2397140	C8-8	2395020	CA25-M8	2530010	CBP-P10	2076455	CL2/OIH-12	2396611
C250-38	2397060	C10-C10	2490070	CA35M10	8005524	CBP-P12	2076460	CL2/OIH-14	2396605
C250-516	2397040	C120-C120	2490630	CA35M12	8005526	CBP-P8	2076450	CL2/OIH-34	2396617
C250-58	2397120	C150-C120	2490670	CA35M16	8005530	CBP-PP12	2076480	CL2/OIH-38	2396609
C250-78	2397160	C150-C150	2490690	CA315R-2M14	2534430	CBP-PP12/25	2076490	CL2/OIH-516	2396607
C250-916	2397100	C16-C16	2490110	CA315R-M14	2534330	CBP-PPL30	2076498	CL2/OIH-58	2396615
C2-516	2395860	C185-C185	2490745	CA315S-2M14	2534610	CBP-U3	2076380	CL2/OIH-916	2396613
C3/0-12	2396680	C185-C95	2490710	CA315S-M14	2534530	CBP-U3,5	2076385	CL2-10	2395985
C3/0-14	2396620	C240-C120	2490760	CA40S-2M12	2530510	CBP-U4	2076395	CL2-12	2395997
C3/0-34	2396740	C25-C10	2490150	CA40S-M12	2530450	CBP-U4/1	2076400	CL2-14	2395988
C3/0-38	2396660	C25-C25	2490190	CA40S-M16	2530490	CBP-U4/2	2076405	CL250-12	2397204
C3/0-516	2396640	C35-C16	2490230	CA50RM12	2530790	CBP-U4/3L	2076408	CL250-D38	2397180
C3/0-58	2396720	C35-C35	2490270	CA50SM12	2531110	CBP-U5	2076410	CL250-DN	2397185
C3/0-916	2396700	C50-C25	2490350	CA50SM16	2531150	CBP-U6	2076415	CL250IH-12	2397229
C300-12	2397360	C50-C50	2490390	CA50R-2M12	2530870	CDD6	2599940	CL250IH-14	2397220
C300-34	2397420	C59	8420035	CA50R-M12	2530790	CDD6-8	2599941	CL250IH-34	2397238
C300-38	2397340	C6-C6	2490030	CA50S-2M12	2531190	CFA2600	3031942	CL250IH-38	2397226
C300-516	2397320	C70-C25N	2490310	CA50S-M12	2531110	CFA300	3031900	CL250IH-516	2397223
C300-58	2397400	C70-C35	2490430	CA50S-M16	2531150	CFA400	3031914	CL250IH-58	2397235
C300-78	2397440	C70-C70	2490470	CA70-M12	2531870	CFA600	3031928	CL250IH-916	2397232
C300-916	2397380	C95-C35	2490510	CA70SM10	2531420	CFAB600	3031970	CL2-516	2395991
C3-10	2395640	C95-C70	2490550	CA70SM12	2531430	CFAR600	3031956	CL2-D14	2395960
C3-12	2395720	C95-C95	2490590	CA70SM14	2531450	CFC230N	2598490	CL2-D141	2395961
C3-14	2395660	C10-C10ST	2492070	CA70S-2M12	2531510	CFC12-24ICN	2598492	CL2-D38	2395970
C3-38	2395700	C120-C120ST	2492630	CA70S-M12	2531430	CGP-F608	2076845	CL2-DN	2395975
C350-12	2397540	C150-C120ST	2492670	CA70S-M16	2531470	CGP-F608P	2076850	CL2-DN38	2395971
C350-34	2397600	C150-C150ST	2492690	CA95R-2M14	2532230	CGP-M3	2076610	CL2IH-10	2396005
C350-38	2397520	C16-C16ST	2492110	CA95R-M12	2532150	CGP-M3,5	2076615	CL2IH-12	2396017
C350-58	2397580	C185-C185ST	2492745	CA95R-M14	2532190	CGP-M4	2076625	CL2IH-14	2396008
C350-78	2397620	C185-C95ST	2492710	CA95M10	8005554	CGP-M5	2076635	CL2IH-38	2396014
C350-916	2397560	C240-C120ST	2492760	CA95M12	8005556	CGP-M6	2076640	CL2IH-516	2396011
C3-516	2395680	C25-C10ST	2492150	CA95M16	8005560	CGP-M6/1	2076645	CL3/0-12	2396794
C3-8	2395620	C25-C25ST	2492190	CA95S-2M14	2532610	CGP-M608	2076860	CL3/0-D141	2396761
C4/0-12	2396880	C35-C16ST	2492230	CA95S-M12	2532450	CGP-M7	2076850	CL3/0-D38	2396770
C4/0-14	2396820	C35-C35ST	2492270	CA95S-M14	2532490	CGP-M8	2076860	CL3/0-DN	2396775
C4/0-34	2396940	C50-C25ST	2492350	CA95S-M16	2532500	CGP-M8/1	2076865	CL3/OIH-12	2396811
C4/0-38	2396860	C50-C50ST	2492390	Canvas Bag 001	2593300	CGP-P10	2076755	CL3/OIH-14	2396805
C4/0-516	2396840	C6-C6ST	2492030	Canvas Bag 007	2593295	CGP-P12	2076760	CL3/OIH-34	2396817
C4/0-58	2396920	C70-C25NST	2492310	Canvas Bag 010	2593298	CGP-P14	2076765	CL3/OIH-38	2396809
C4/0-916	2396900	C70-C35ST	2492430	Canvas Bag 011	2593299	CGP-PP12	2076780	CL3/OIH-516	2396807
C400-12	2397740	C70-C70ST	2492470	Canvas Bag 013	2593294	CGP-PP17	2076790	CL3/OIH-58	2396815
C400-34	2397800	C95-C35ST	2492510	CAA10-M12	2760005	CGP-U3,5	2076685	CL3/OIH-916	2396813
C400-38	2397720	C95-C70ST	2492550	CAA120-M12	2760310	CGP-U4	2076695	CL300-12	2397491
C400-58	2397780	C95-C95ST	2492590	CAA150-M12	2760350	CGP-U5	2076710	CL300-D38	2397470
C400-78	2397820	CA1202M12	8005766	CAA16-M12	2760012	CGP-U6	2076715	CL300-DN	2397475
C400-916	2397760	CA1502M12	8005776	CAA185-M12	2760430	CL1/0-10	2396385	CL300IH-12	2397509
C4-10	2395440	CA1852M12	8005786	CAA240-M12	2760590	CL1/0-12	2396397	CL300IH-34	2397515
C4-12	2395520	CA252M10	2530170	CAA25-M12	2760030	CL1/0-38	2396394	CL300IH-38	2397507
C4-14	2395460	CA3002M12	8005806	CAA300-M16	2760710	CL1/0-516	2396391	CL300IH-516	2397505
C4-38	2395500	CA352M12	8005726	CAA300-34-M12	2760680	CL1/0-D14	2396360	CL300IH-58	2397513
C4-516	2395480	CA502M12	8005736	CAA300-34-M16	2760715	CL1/0-D141	2396361	CL300IH-916	2397511
C4-8	2395420	CA952M12	8005756	CAA35-M12	2760070	CL1/0-D38	2396370	CL3-12	2395797
C500-12	2397940	CA120M12	8005566	CAA35ADN	2762260	CL1/0-DN	2396375	CL3-14	2395788
C500-34	2398000	CA120M16	8005570	CAA400-M16	2760750	CL1/OIH-10	2396405	CL3-38	2395794
C500-38	2397920	CA150M12	8005576	CAA50-M12	2760110	CL1/OIH-12	2396413	CL350-12	2397688
C500-58	2397980	CA150M16	8005580	CAA500-M16-TNBD	2760852	CL1/OIH-14	2396407	CL350-D141	2397661
C500-78	2398020	CA150R-2M14	2533010	CAA630-4M8	2760950	CL1/OIH-38	2396411	CL350-D38	2397670
C500-916	2397960	CA150R-M12	2532810	CAA70-M12	2760150	CL1/OIH-516	2396409	CL350-DN	2397675

REFERENCE/CODE CROSS-REFERENCE CHART

Ref.	Code	Ref.	Code	Ref.	Code	Ref.	Code	Ref.	Code
CL350IH-12	2397708	CL6IH-516	2395411	CS412	3032115	DR625-12	2389030	ES24-BK	2470479
CL350IH-34	2397717	CL750-12	2398485	CS412-F	3032160	DR625-16	2389050	ES30-BK	2470480
CL350IH-38	2397705	CL750-58	2398488	CS412-M	3032161	DR625-20	2389060	ES37-BK	2470481
CL350IH-58	2397714	CL750-D38	2398470	CS420	3032130	DSV6	2489010	ES40-BK	2470482
CL350IH-916	2397711	CL750-DN	2398475	CS420-F	3032180	DSV10	2489015	ES48-BK	2470483
CL3-516	2395791	CL750-DN38	2398471	CS420-M	3032181	DSV16	2489020	ES80-BK	2470484
CL3-D38	2395770	CL750IH-12	2398505	CS4-GR	3032070	DSV25	2489025	ES03-WH	2470490
CL3-DN	2395775	CL750IH-34	2398511	CS4-KEY	3032010	DSV35	2489030	ES06-WH	2470491
CL3IH-10	2395805	CL750IH-58	2398508	CS4-MFC	3032058	DSV50	2489035	ES1-WH	2470492
CL3IH-12	2395817	CL8-10	2395183	CS-CPE-1	2592748	DSV70	2489040	ES2-WH	2470493
CL3IH-14	2395808	CL8-14	2395186	CS4-GR	2596100	DSV95	2489045	ES3-WH	2470494
CL3IH-38	2395814	CL8-38	2395192	DR6-5	2387910	DSV120	2489050	ES5-WH	2470495
CL3IH-516	2395811	CL8-D14	2395160	DR6-6	2387920	DSV150	2489055	ES10-WH	2470496
CL4/0-12	2396994	CL8-D141	2395161	DR6-8	2387930	DSV185	2489060	ES14-WH	2470497
CL4/0-38	2396991	CL8-D38	2395170	DR10-5	2388000	DSV240	2489065	ES19-WH	2470498
CL4/0-D141	2396961	CL8IH-10	2395203	DR10-6	2388005	DSV300	2489070	ES24-WH	2470499
CL4/0-D38	2396970	CL8IH-12	2395215	DR10-8	2388010	DSV400	2489075	ES30-WH	2470500
CL4/0-DN	2396975	CL8IH-14	2395206	DR10-10	2388015	DSV500	2489080	ES37-WH	2470501
CL4/0-DN38	2396971	CL8IH-38	2395212	DR16-5	2388025	DSV625	2489085	ES40-WH	2470502
CL4/0IH-12	2397011	CL8IH-516	2395209	DR16-6	2388030	ECT-KE2.5	8030200	ES48-WH	2470503
CL4/0IH-14	2397005	CMA600	3031984	DR16-8	2388040	ECW-H3D	2630073	ES80-WH	2470504
CL4/0IH-34	2397017	CMB1	2599943	DR16-10	2388050	ELB-3	2598422	ES03-RE	2470510
CL4/0IH-38	2397009	CMB2	2599945	DR16-12	2388060	ERCH	2596112	ES06-RE	2470511
CL4/0IH-516	2397007	CP1086-W-1000-KV	2597905	DR25-6	2388110	ERCH-WH	2596114	ES1-RE	2470512
CL4/0IH-58	2397015	CP1096	2597700	DR25-8	2388120	ES03-BU	2470410	ES2-RE	2470513
CL4/0IH-916	2397013	CP1096-W-1000-KV	2597695	DR25-10	2388130	ES06-BU	2470411	ES3-RE	2470514
CL400-12	2397888	CP1120-W-1000-KV	2597958	DR25-12	2388140	ES1-BU	2470412	ES5-RE	2470515
CL400-58	2397894	CP1131	2610120	DR25-16	2388160	ES2-BU	2470413	ES10-RE	2470516
CL400-D141	2397861	CPE-1	2592751	DR35-6	2388210	ES3-BU	2470414	ES14-RE	2470517
CL400-D38	2397870	CPE-1-110	2592752	DR35-8	2388220	ES5-BU	2470415	ES19-RE	2470518
CL400-DN	2397875	CPKD108	2808582	DR35-10	2388230	ES10-BU	2470416	ES24-RE	2470519
CL400IH-12	2397908	CPKD1508	2808587	DR35-12	2388240	ES14-BU	2470417	ES30-RE	2470520
CL400IH-34	2397917	CPKD2508	2808592	DR35-16	2388246	ES19-BU	2470418	ES37-RE	2470521
CL400IH-38	2397905	CPKD508	2808573	DR50-6	2388250	ES24-BU	2470419	ES40-RE	2470522
CL400IH-58	2397914	CPKD7508	2808578	DR50-8	2388255	ES30-BU	2470420	ES48-RE	2470523
CL400IH-916	2397911	CPP-0	2592671	DR50-10	2388260	ES37-BU	2470421	ES80-RE	2470524
CL4-10	2395585	CPU1131-C	2610150	DR50-12	2388270	ES40-BU	2470422	ES03-GN	2470530
CL4-12	2395597	CPU1230-3D	2630200	DR50-14	2388280	ES48-BU	2470423	ES06-GN	2470531
CL4-14	2395588	CRP-F305	2076225	DR50-16	2388290	ES80-BU	2470424	ES1-GN	2470532
CL4-38	2395594	CRP-F308	2076230	DR70-8	2388320	ES03-GY	2470430	ES2-GN	2470533
CL4-D14	2395560	CRP-F405	2076235	DR70-10	2388330	ES06-GY	2470431	ES3-GN	2470534
CL4-D141	2395561	CRP-F405P	2076237	DR70-12	2388340	ES1-GY	2470432	ES5-GN	2470535
CL4-D38	2395570	CRP-F408	2076240	DR70-14	2388350	ES2-GY	2470433	ES10-GN	2470536
CL4-DN	2395575	CRP-F408P	2076242	DR70-16	2388360	ES3-GY	2470434	ES14-GN	2470537
CL4IH-10	2395605	CRP-F608	2076245	DR70-20	2388380	ES5-GY	2470435	ES19-GN	2470538
CL4IH-12	2395617	CRP-F608P	2076250	DR95-8	2388390	ES10-GY	2470436	ES24-GN	2470539
CL4IH-14	2395608	CRP-M3	2076010	DR95-10	2388395	ES14-GY	2470437	ES30-GN	2470540
CL4IH-38	2395614	CRP-M3.5	2076015	DR95-12	2388400	ES19-GY	2470438	ES37-GN	2470541
CL4IH-516	2395611	CRP-M3.5/1	2076020	DR95-14	2388410	ES24-GY	2470439	ES40-GN	2470542
CL500-12	2398088	CRP-M4	2076025	DR95-16	2388420	ES30-GY	2470440	ES48-GN	2470543
CL500-58	2398094	CRP-M4/3	2076030	DR95-20	2388430	ES37-GY	2470441	ES80-GN	2470544
CL500-D141	2398061	CRP-M5	2076035	DR120-8	2388450	ES40-GY	2470442	ES03-YE	2470550
CL500-D38	2398070	CRP-M6	2076040	DR120-10	2388460	ES48-GY	2470443	ES06-YE	2470551
CL500-DN	2398075	CRP-M6/1	2076045	DR120-12	2388470	ES80-GY	2470444	ES1-YE	2470552
CL500IH-12	2398108	CRP-M608	2076260	DR120-16	2388490	ES03-BR	2470450	ES2-YE	2470553
CL500IH-34	2398117	CRP-M7	2076050	DR120-20	2388500	ES06-BR	2470451	ES3-YE	2470554
CL500IH-38	2398105	CRP-M8	2076055	DR150-10	2388530	ES1-BR	2470452	ES5-YE	2470555
CL500IH-58	2398114	CRP-P10	2076155	DR150-12	2388540	ES2-BR	2470453	ES10-YE	2470556
CL500IH-916	2398111	CRP-P12	2076160	DR150-16	2388560	ES3-BR	2470454	ES14-YE	2470557
CL600-12	2398285	CRP-P8	2076150	DR150-20	2388570	ES5-BR	2470455	ES19-YE	2470558
CL600-58	2398291	CRP-PP12	2076180	DR185-10	2388600	ES10-BR	2470456	ES24-YE	2470559
CL600-D38	2398270	CRP-PP12/1	2076185	DR185-12	2388610	ES14-BR	2470457	ES30-YE	2470560
CL600-DN	2398275	CRP-PP12/23	2076190	DR185-16	2388620	ES19-BR	2470458	ES37-YE	2470561
CL600IH-12	2398305	CRP-PP14	2076195	DR185-20	2388630	ES24-BR	2470459	ES40-YE	2470562
CL600IH-34	2398314	CRP-PPL30	2076205	DR240-10	2388710	ES30-BR	2470460	ES48-YE	2470563
CL600IH-58	2398311	CRP-U3	2076080	DR240-12	2388720	ES37-BR	2470461	ES80-YE	2470564
CL600IH-916	2398308	CRP-U3.5	2076085	DR240-16	2388730	ES40-BR	2470462	ES03-PK	2470570
CL6-10	2395385	CRP-U3.5/2	2076090	DR240-20	2388740	ES48-BR	2470463	ES06-PK	2470571
CL6-12	2395397	CRP-U4	2076095	DR300-10	2388780	ES80-BR	2470464	ES1-PK	2470572
CL6-14	2395388	CRP-U4/1	2076100	DR300-12	2388790	ES03-BK	2470470	ES2-PK	2470573
CL6-D14	2395360	CRP-U4/2	2076105	DR300-16	2388810	ES06-BK	2470471	ES3-PK	2470574
CL6-D141	2395361	CRP-U5	2076110	DR300-20	2388820	ES1-BK	2470472	ES5-PK	2470575
CL6-D38	2395370	CRP-U6	2076115	DR400-12	2388870	ES2-BK	2470473	ES10-PK	2470576
CL6-DN	2395375	CRP-U6/1	2076120	DR400-16	2388890	ES3-BK	2470474	ES14-PK	2470577
CL6IH-10	2395405	CRP-U8	2076125	DR400-20	2388900	ES5-BK	2470475	ES19-PK	2470578
CL6IH-12	2395417	CS411	3032100	DR500-12	2388950	ES10-BK	2470476	ES24-PK	2470579
CL6IH-14	2395408	CS411-F	3032150	DR500-16	2388970	ES14-BK	2470477	ES30-PK	2470580
CL6IH-38	2395414	CS411-M	3032151	DR500-20	2388980	ES19-BK	2470478	ES37-PK	2470581

REFERENCE/CODE CROSS-REFERENCE CHART

Ref.	Code	Ref.	Code	Ref.	Code	Ref.	Code	Ref.	Code
ES40-PK	2470582	GKY-M5	2145988	HB11	2591343	KITTRD-9.4C	2685015	M255-520	2648776
ES48-PK	2470583	GKY-M6	2145991	HB12N	2591345	KITTRD-M11C	2685016	M295-520	2648780
ES80-PK	2470584	GKY-M8	2145994	HB13UE	2591347	KT1	2591319	M340-520	2648784
ESC300CEE	2596110	GKY-M10	2145997	HF1	2590900	KT2	2591320	M440-520	2648840
ESC600	2599001	GKY-M12	2146000	HF2	2590905	KT3	2591330	M540-520	2648910
F1-15	2599865	GKY-M14	2146003	HN1	2590300	KT4	2598060	M70	2651090
FD11	3017354	GKY-M16	2146006	HN5	2590291	KT5	2591279	M70-50	2675800
FD13,5	3017356	GKY-P14	2146040	HNA25	2590401	KTS1632	2590700	M70-C	2611590
FD16	3017358	GKY-PP12	2146045	HNCS4	2590024	L03-M	2480020	M70.140-U	2603710
FD21	3017360	GKY-PP17	2146047	HND25	2590403	L03-P	2485010	M75	2651100
FD29	3017362	GKY-PPL46	2146055	HNKE4	2590299	L06-M	2480050	M75-50	2675805
FD36	3017364	GKY-U3.5	2146020	HNKE16	2590329	L06-P	2485040	M75-C	2611650
FD42	3017366	GKY-U4	2146023	HNKE50	2590342	L10-M	2480330	M75.96-U	2603715
FD48	3017368	GKY-U5	2146026	HNN3	2590296	L10-P	2485270	M96	2651110
FD7	3017350	GKY-U6	2146029	HNN4	2590292	L100-M	2480930	M96-50	2675850
FD9	3017352	GKY-U8	2146032	HP1	2590500	L120-M	2481010	M96-C	2611800
FDM12	3017375	GN-M10	2154250	HP1-1	2590502	L14-M	2480410	MA03/3-15	2599870
FDM16	3017374	GN-M10/1	2154290	HP3	2590531	L14-P	2485350	MA1	2650110
FDM20	3017377	GN-M12	2154330	HP3-1	2590532	L160-M	2481050	MA10	2650190
FDM25	3017379	GN-M14	2154370	HP4-B	2590032	L19-M	2480490	MA10-50	2675666
FDM32	3017381	GN-M16	2154410	HP4-C10	2590040	L19-P	2485430	MA10-C	2610860
FDM40	3017383	GN-M3	2154010	HP4-G	2590033	L1-M	2480090	MA10.19-U	2600290
FDM50	3017385	GN-M3.5	2154030	HP4-R	2590031	L1-P	2485070	MA100-3D	2601790
FDM63	3017387	GN-M4	2154070	HPH-1	2590029	L200-M	2481090	MA100-520	2645690
FL10-150	2510070	GN-M5	2154110	HT-FL75	2665030	L24-M	2480570	MA12-C	2610870
FL10-200	2510150	GN-M6	2154150	HT-TC026	2591406	L24-P	2485510	MA12.20-U	2600310
FL10-250	2510190	GN-M6/1	2154160	HT-TC026Y	2591408	L2-M	2480130	MA120-3D	2631810
FL16-150	2510470	GN-M7	2154170	HT-TC041	2591426	L2-P	2485100	MA120-520	2645711
FL16-200	2510550	GN-M8	2154210	HT-TC051	2591472	L30-M	2480650	MA14-50	2675670
FL16-250	2510590	GN-M8/1	2154220	HT-TC051Y	2591475	L30-P	2485590	MA14-C	2610880
FL16-320	2510670	GN-P10	2155250	HT-TC055	2591445	L37-M	2480730	MA160-520	2645731
FL16-350	2510690	GN-P12	2155290	HT-TC065	2591477	L37-P	2485670	MA17-50	2675672
FL16-420	2510710	GN-P14	2155310	HT-TC0851	2591496	L3-M	2480170	MA17-C	2610890
FL16-570	2510750	GN-PP12	2155330	HT120	2610420	L3-P	2485130	MA19-50	2675674
FL16-660	2510790	GN-PP17	2155370	HT120-KV	2610430	L48-M	2480810	MA19-C	2610900
FL25-150	2510950	GN-U10	2154850	HT131-C	2610416	L48-P	2485680	MA19-U	2600320
FL25-200	2511070	GN-U10/1	2154890	HT131-UC	2610436	L5-M	2480210	MA2-C	2610810
FL25-250	2511110	GN-U12	2154930	HT131LN-C	2610419	L5-P	2485160	MA2.3	2650130
FL25-300	2511190	GN-U14	2154970	HT45-E	2650040	L60-M	2480850	MA2.3-50	2675660
GA-3	2598429	GN-U16	2155010	HT51	2670610	L60-P	2485690	MA20-50	2675675
GF-F608	2055630	GN-U3.5	2154650	HT51-KV	2670611	L7-M	2480250	MA20-C	2610910
GF-F608P	2055650	GN-U4	2154690	HT81-U	2600036	L7-P	2485190	MA200-520	2645750
GF-M10	2054250	GN-U5	2154730	HWE-1	8420010	L80-M	2480890	MA24-50	2675676
GF-M10/1	2054290	GN-U6	2154770	I38-F	2593863	M108-520	2648752	MA24-C	2610920
GF-M12	2054330	GN-U8	2154810	I38-M	2593858	M108-C	2611860	MA24-U	2600330
GF-M14	2054370	GP-M10	2046645	I38-MS	2593862	M108.215-U	2603723	MA29-C	2610930
GF-M16	2054410	GP-M10/1	2046646	IT6	8420016	M110-520	2648754	MA29.80-U	2600360
GF-M3	2054010	GP-M12	2046650	KE0,75-1	2591050	M113	2651130	MA3-C	2610820
GF-M3,5	2054030	GP-M14	2046655	KE10-1	2591049	M113-50	2675855	MA3.5-U	2600210
GF-M4	2054070	GP-M16	2046660	KE1016ST	2803150	M113-C	2611870	MA30-80-U	2600380
GF-M5	2054110	GP-M3	2046610	KE106ST	2802310	M113.173-U	2603730	MA30-C	2610940
GF-M6	2054150	GP-M3,5	2046615	KE110ST	2802390	M118	2651150	MA35-C	2610950
GF-M6/1	2054160	GP-M4	2046620	KE1508ST	2802510	M118-50	2675860	MA35-U	2600390
GF-M608	2055670	GP-M5	2046625	KE1510ST	2802550	M118-C	2611910	MA37-C	2610960
GF-M7	2054170	GP-M6	2046630	KE16-15	2599861	M118.158-U	2603725	MA37-U	2600410
GF-M8	2054210	GP-M6/1	2046631	KE1616ST	2803190	M140	2651170	MA40-C	2610970
GF-M8/1	2054220	GP-M7	2046635	KE1A-3	2598430	M140-50	2675870	MA40-U	2600430
GF-P10	2055310	GP-M8	2046640	KE2,5-1	2598459	M140-C	2612010	MA48-C	2610980
GF-P12	2055350	GP-M8/1	2046641	KE2,5A-3	2598432	M140.190-U	2603800	MA48-U	2600450
GF-P14	2055370	GP-P10	2046715	KE25015ST	2803455	M145-520	2648770	MA5	2650150
GF-PP12	2055390	GP-P12	2046720	KE25018ST	2803460	M158	2651200	MA5-50	2675662
GF-PP17	2055430	GP-P14	2046725	KE2508ST	2802670	M158-50	2675880	MA5-C	2610830
GF-PPL46	2055465	GP-PP12	2046740	KE2510ST	2802710	M158-C	2612130	MA60-C	2610990
GF-U10	2054810	GP-PP17	2046750	KE35-15	2599862	M160-520	2648771	MA7	2650170
GF-U10/1	2054850	GP-PPL46	2046755	KE35012ST	2803470	M173	2651210	MA7-50	2675664
GF-U12	2054890	GP-U10	2046865	KE35015ST	2803475	M173-50	2675890	MA7-C	2610840
GF-U14	2054930	GP-U10/1	2046866	KE35018ST	2803480	M173-C	2612230	MA7.14-U	2600250
GF-U16	2054970	GP-U12	2046870	KE4-15	2599860	M173L-C	2612240	MA80-3D	26501770
GF-U3,5	2054610	GP-U14	2046875	KE410ST	2802870	M190-50	2675900	MA80-520	2645671
GF-U4	2054650	GP-U16	2046880	KE412ST	2802910	M190-520	2648772	MA9	2650180
GF-U5	2054690	GP-U3,5	2046825	KE506ST	2802030	M190-C	2612330	MA9-50	2675665
GF-U6	2054730	GP-U4	2046830	KE508ST	2802070	M208-C	2612420	MA9-C	2610850
GF-U8	2054770	GP-U5	2046845	KE610ST	2802990	M208-U	2603780	MA9.17-U	2600270
GK-F608	2145500	GP-U6	2046855	KE612ST	2803030	M215-50	2675910	MB2-80U	2604350
GK-F608P	2145502	GP-U8	2046860	KE616ST	2803070	M215-520	2648773	MB3-80U	2604400
GKF-M608	2055672	HB1-J	2598062	KE7506ST	2802110	M215-C	2612490	MCO	2650490
GKY-M3.5	2145982	HB29-U	8060030	KE7508ST	2802150	M220-520	2648774	MCO-U	2603510
GKY-M4	2145985	HB40-U	8060035	KITHWE1	8420012	M232-C	2612590	MCO2-U	2603550

REFERENCE/CODE CROSS-REFERENCE CHART

Ref.	Code	Ref.	Code	Ref.	Code	Ref.	Code	Ref.	Code
MC10	2650530	ME30-C	2614227	MK18-C	2614310	MQ35-50	2675019	MT240R-TD	2540710
MC10-50	2675610	ME30-U	2604890	MK20-C	2614320	MQ50-50	2675021	MT25-C8	2543030
MC10-C	2611100	ME35-50	2676150	MK22-C	2614330	MQ70-50	2675024	MT25-GC	2541150
MC10-U	2600610	ME35-C	2614229	MK25-C	2614340	MQM10-C	2610661	MT25-TD	2540150
MC185-3D	2632030	ME35-U	2604910	MK28-C	2614350	MQM16-C	2610662	MT315R-C16	2545950
MC185-C	2611150	ME37-50	2676160	MK32-C	2614360	MQM25-C	2610663	MT315R-GC	2542150
MC2	2650500	ME37-C	2614231	MK34L-C	2614371	MQM35-C	2610664	MT315R-TD	2540750
MC240-3D	2632035	ME37-U	2604930	MMT200-50	2676388	MQM50-C	2610665	MT315S-C16	2545990
MC25	2650550	ME40-50	2676165	MMT200-C	2611190	MQM70-C	2610666	MT315S-GC	2542290
MC25-50	2675620	ME40-C	2614233	MMT200-U	2601170	MQM95-C	2610667	MT315S-TD	2540790
MC25-C	2611110	ME40-U	2604950	MMT25-50	2676380	MQM120-C	2610668	MT400-TD	2540830
MC25-U	2600650	ME48-50	2676170	MMT25-C	2611160	MQM150-C	2610669	MT40S-C10	2543410
MC3	8420018	ME48-C	2614235	MMT25-U	2601050	MQM185-C	2610670	MT40S-C14-80	2546070
MC35	2650570	ME48-U	2604970	MMT315-C	2611200	MQM240-C	2610671	MT40S-C8	2543400
MC35-50	2675630	ME5	2652070	MMT50-50	2676382	MGS16-C	2610752	MT40S-GC	2541610
MC35-C	2611120	ME5-50	2676030	MMT50-C	2611170	MGS35-C	2610753	MT40S-TD	2540190
MC35-U	2600690	ME5-C	2614205	MMT50-U	2601090	MGS70-C	2610754	MT500-TD	2540870
MC4	8420019	ME5.7-U	2604790	MMT95-50	2676384	MGS150-C	2610755	MT50R-C10	2543650
MC6	2650510	ME60-C	2614237	MMT95-C	2611180	MGS240-C	2610756	MT50R-C8	2543610
MC6-50	2675605	ME7	2652090	MMT95-U	2601130	MS4/10-15	2599880	MT50R-GC	2541690
MC6.25-U	2600630	ME7-50	2676040	MN10-C	2610560	MS10/16-15	2599881	MT50R-TD	2540270
MC70-3D	2632010	ME7-C	2614207	MN10RF-50	2676250	MT-FC48N	2685903	MT50S-C10	2543850
MC70-50	2675640	ME80-3D	2634930	MN10RF-C	2610768	MT120C12	8006254	MT50S-C14-80	2546110
MC70-80U	2600720	ME80-520	2648550	MN12-C	2610570	MT120C16	8006258	MT50S-C8	2543810
MC70-C	2611130	ME80-C	2614239	MN12F-50	2676260	MT150C10	8006252	MT50S-GC	2541650
MC95-3D	2632020	ME9	2652110	MN12F-C	2610770	MT150C12	8006264	MT50S-TD	2540230
MC95-80U	2600730	ME9-50	2676050	MN14-C	2610580	MT150C1480	8006266	MT630-TD	2540890
MC95-C	2611140	ME9-C	2614209	MN14RF-50	2676270	MT150C16	8006268	MT70S-C10	2544050
MCCC16-C	2617050	ME9.20-U	2604810	MN14RF-C	2610772	MT185C10	8006262	MT70S-GC	2541730
MCCC25-C	2617070	MFB13-40	2598040	MN17-C	2610591	MT185C16	8006278	MT70S-TD	2540350
MCCC35-C	2617090	MFB50-63	2598045	MN17F-50	2676280	MT240C12	8006284	MT95R-C10	2544290
MCCC50-C	2617110	MH10/16-15	2599886	MN17F-C	2610774	MT240C16	8006288	MT95R-C12	2544330
MCS4-15	2599868	MK17S-C	2614307	MN19-C	2610600	MT300C16	8006298	MT95R-GC	2541770
ME03/2-15	2599875	MK17S-C	2614307	MN19RF-50	2676285	MT35C8	8006210	MT95R-TD	2540390
ME1	2652010	MK14-3D	2634781	MN19RF-C	2610776	MT35C10	8006212	MT95S-C10	2544530
ME1-50	2676005	MK16-3D	2634783	MN2-C	2610511	MT35C1480	8006216	MT95S-C12	2544570
ME10	2652130	MK18-3D	2634785	MN20-C	2610610	MT50C8	8006220	MT95S-C14-80	2546230
ME10-50	2676060	MK20-3D	2634786	MN20F-50	2676290	MT50C10	8006222	MT95S-GC	2541850
ME10-C	2614211	MK22-3D	2634787	MN20F-C	2610778	MT50C1480	8006226	MT95S-TD	2540470
ME10.24-U	2604830	MK25-3D	2634788	MN24-C	2610620	MT70C10	8006232	MTA16-C	2770001
ME100-3D	2634940	MK28-3D	2634790	MN24RF-50	2676295	MT95C10	8006242	MTA25-C	2770020
ME100-520	2648552	MK32-3D	2634800	MN24RF-C	2610780	MT95C12	8006244	MTA35-C	2770030
ME12	2652150	MK34-3D	2634810	MN29-C	2610625	MT95C1480	8006246	MTA50-C	2770310
ME12-50	2676070	MK38-3D	2634830	MN29F-C	2610782	MT120GC	8006150	MTA70-C	2770550
ME12-C	2614213	MK42-3D	2634850	MN2RF-50	2676210	MT150GC	8006160	MTA95-C	2770830
ME12.17-U	2604850	MK44-3D	2634870	MN2RF-C	2610760	MT185GC	8006170	MTA120-C	2771510
ME120-3D	2634950	MK46-3D	2634880	MN3-C	2610520	MT240GC	8006180	MTA150-C	2771710
ME120-520	2648554	MK5/8-15	2599890	MN30-C	2610630	MT300GC	8006190	MTA185-C	2772150
ME14	2652170	MK5	2651575	MN30RF-C	2610784	MT35GC	8006110	MTA240-C	2773010
ME14-50	2676080	MK6	2651580	MN35-C	2610635	MT400GC	8006195	MTMA10-GC	2720025
ME14-C	2614215	MK8	2651610	MN35F-C	2610786	MT50GC	8006120	MTMA120-70-GC	2721410
ME160-520	2648556	MK10	2651640	MN37-C	2610640	MT70GC	8006130	MTMA120-95-GC	2721450
ME17	2652190	MK12	2651670	MN37RF-C	2610788	MT95GC	8006140	MTMA120-GC	2720272
ME17-50	2676090	MK14	2651700	MN3RF-50	2676220	MT120TD	8006050	MTMA150-120-GC	2721630
ME17-C	2614217	MK16	2651730	MN3RF-C	2610762	MT150TD	8006060	MTMA150-70-GC	2721550
ME19	2652210	MK18	2651750	MN48-C	2610650	MT185TD	8006070	MTMA150-95-GC	2721590
ME19-50	2676100	MK20	2651770	MN48RF-C	2610790	MT240TD	8006080	MTMA150-GC	2720330
ME19-C	2614219	MK5-50	2675360	MN5-C	2610530	MT300TD	8006090	MTMA16-10-GC	2720560
ME2	2652030	MK6-50	2675370	MN5RF-50	2676230	MT35TD	8006010	MTMA16-GC	2720035
ME2/3-15	2599876	MK8-50	2675390	MN5RF-C	2610764	MT50TD	8006020	MTMA185-120-GC	2721900
ME2-50	2676010	MK10-50	2675410	MN60-C	2610660	MT70TD	8006030	MTMA185-150-GC	2721910
ME2-C	2614201	MK12-50	2675430	MN7-C	2610540	MT95TD	8006040	MTMA185-GC	2720360
ME2.19-U	2604750	MK14-50	2675450	MN7RF-50	2676240	MT150R-C12	2545010	MTMA240-GC	2720410
ME20	2652230	MK16-50	2675470	MN7RF-C	2610766	MT150R-C16	2545090	MTMA240-150-GC	2722050
ME20-50	2676110	MK18-50	2675490	MN80-3D	2631450	MT150R-GC	2541870	MTMA240-185-GC	2722090
ME200-520	2648558	MK20-50	2675510	MN9-C	2610551	MT150R-TD	2540550	MTMA25-10-GC	2720575
ME20-C	2614221	MK22-50	2675530	MP608	3031810	MT150S-C12	2545310	MTMA25-16-GC	2720580
ME24	2652250	MK22L	2651791	MP608/45	3031815	MT150S-C14-80	2546270	MTMA25-GC	2720090
ME24-50	2676120	MK22L-50	2675534	MP608/90	3031820	MT150S-C16	2545350	MTMA300-GC	2720430
ME24-C	2614223	MK25-50	2675550	MP608D	3031830	MT150S-GC	2541910	MTMA35-20-GC	2720135
ME29-50	2676130	MK28-50	2675560	MPC1	2595201	MT150S-TD	2540630	MTMA35-GC	2720130
ME29-C	2614225	MK28-60	2671460	MPC2	2595203	MT200R-C10	2545540	MTMA400-240-GC	2722245
ME29-U	2604870	MK6-C	2614250	MPC4	2595208	MT200R-C16	2545550	MTMA400-300-GC	2722250
ME3	2652050	MK8-C	2614260	MPC5	8460004	MT200R-GC	2542030	MTMA50-25-GC	2720650
ME3-50	2676020	MK10-C	2614270	MPC7	2595221	MT200R-TD	2540670	MTMA50-35-GC	2720660
ME3-C	2614203	MK12-C	2614280	MQ10-50	2675010	MT240R-C12	2545710	MTMA50-GC	2720152
ME3.14-U	2604770	MK14-C	2614290	MQ16-50	2675013	MT240R-C16	2545750	MTMA500-GC	2720515
ME30-50	2676140	MK16-C	2614300	MQ25-50	2675016	MT240R-GC	2542110	MTMA500-300-GC	2722260

REFERENCE / CODE CROSS-REFERENCE CHART

Ref.	Code	Ref.	Code	Ref.	Code	Ref.	Code	Ref.	Code
MTMA500-400-GC	2722270	MY5-C	2613365	PKE2508	8020050	RBV-15	2599852	RF-M12	2050430
MTMA70-35-GC	2720940	MY60-C	2613425	PKE25016	8020130	RCP-B70	2596116	RF-M2	2050010
MTMA70-50-GC	2720980	MY6-50	2677390	PKE25022	8020140	RD100SS	2685623	RF-M3	2050030
MTMA70-GC	2720195	MY6-C	2613370	PKE2518	8020060	RD120SS	2685624	RF-M3,5	2050070
MTMA95-50-GC	2721030	MY7-50	2677335	PKE308	8010197	RD126X126	2685669	RF-M3,5/1	2050110
MTMA95-70-GC	2721070	MY76-C	2613430	PKE409	8020070	RD138X138	2685670	RF-M4	2050150
MTMA95-GC	2720232	MY7-C	2613375	PKE418	8020080	RD15.5SS	2685560	RF-M4/3	2050170
MTMA16/1	2720031	ND1	2590080	PKE508	8020000	RD15.5SS-FC	2685550	RF-M5	2050190
MTMA25/1	2720071	ND2	2590082	PKE612	8020090	RD16.2SS	2685562	RF-M6	2050230
MTMA35/1	2720111	ND3	2590084	PKE618	8020100	RD16.2SS-FC	2685552	RF-M6/1	2050270
MTMA50/1	2720160	ND4	2590086	PKE7508	8020010	RD17.5SS	2685564	RF-M608	2051650
MTMA70/1	2720191	NIT10	8420017	PKCT108	8020220	RD17.5SS-FC	2685554	RF-M608P	2051655
MTMA95/1	2720250	NLO3-M	2469328	PKCT112	8020225	RD18.8SS	2685566	RF-M7	2050310
MTMA120/1	2720280	NLO3-P	2110870	PKCT1014	8020260	RD18.8SS-FC	2685556	RF-M8	2050350
MTMA150/1	2720320	NLO6-M	2469330	PKCT1508	8020230	RD18X46	2685654	RF-P10	2051250
MTMA185/1	2720370	NLO6-P	2111950	PKCT1512	8020235	RD19.1SS	2685568	RF-P12	2051290
MTMA240/1	2720400	NLO6-PB	2111960	PKCT2510	8020240	RD20.5SS	2685570	RF-P8	2051210
MTMAD300/1	2720460	NL1-M	2469350	PKCT2512	8020245	RD21X21	2685650	RF-PP12	2051330
MTMA400/1	2720475	NL1-P	2113970	PKCT412	8020250	RD22.6SS	2685572	RF-PP12/1	2051340
MTMA500-40/1	2720509	NL1-PG	2113990	PKCT508	8020200	RD22X46	2685656	RF-PP12/19	2051370
MTMA630/1	2720530	NL2-M	2469390	PKCT614	8020255	RD23.8SS	2685574	RF-PP12/23	2051380
MTMAD300-GC	2720440	NL3-M	2469430	PKCT1616	8020265	RD25.4SS	2685576	RF-PP14	2051410
MTMAD300-95-GC	2722121	NN4-15	2599867	PKCT7508	8020210	RD27SS	2685578	RF-PP16/23	2051450
MTMAD300-150-GC	2722140	OB2.5P	8420034	PKCT7512	8020215	RD28.5SS	2685580	RF-PPL30	2051460
MTMAD300-185-GC	2722160	PA1	2650230	PKET108	8020320	RD30.5SS	2685582	RF-PPL46	2051465
MTMAD300-240-GC	2722220	PA10	2650290	PKET112	8020327	RD28.5SS-19	2685584	RF-U10	2050950
MTT16-50	2677220	PA10-50	2675686	PKET1014	8020360	RD30.5SS-19	2685586	RF-U12	2050990
MTT25-50	2677230	PA10-C	2611010	PKET1508	8020330	RD31.8SS	2685588	RF-U3	2050630
MTT35-50	2677240	PA100-3D	2631930	PKET1512	8020335	RD32.5SS	2685590	RF-U3,5	2050670
MTT50-50	2677250	PA120-3D	2631950	PKET1616	8020365	RD34.6SS	2685592	RF-U3,5/1	2050680
MTT70-50	2677260	PA120-520	2645600	PKET2510	8020340	RD35X86	2685657	RF-U3,5/2	2050681
MTT95-50	2677270	PA19-50	2675694	PKET2512	8020345	RD35X112	2685659	RF-U4	2050710
MTT120-50	2677275	PA200-520	2645610	PKET412	8020350	RD36X46	2685658	RF-U4/1	2050730
MJA150	2616050	PA24-50	2675696	PKET508	8020300	RD37.2SS	2685594	RF-U4/2	2050750
MJA230-630-400	2680129	PA24-C	2611020	PKET614	8020355	RD37X104	2685674	RF-U5	2050790
MJA230-630-630	2680130	PA48-C	2611030	PKET7508	8020310	RD37X54	2685671	RF-U5/1	2050791
MJA240	2616070	PA5	2650250	PKET7512	8020315	RD37X67	2685672	RF-U6	2050830
MJA300-34	2616090	PA5-50	2675682	PL01-M	2049510	RD37X88	2685673	RF-U6/1	2050870
MJA95	2616030	PA60-C	2611040	PL03-M	2051850	RD38.1SS	2685596	RF-U8	2050910
MV150	2616170	PB-1	2591046	PL03-P	2051860	RD40.5SS	2685598	RH50	2670050
MV230-400 MC5E	2680860	PC-1	2590705	PL06-M	2053850	RD40.5SS-FC	2685627	RHC131	2619010
MV230-630 MC6E	2680870	PG-1	2591047	PL06-P	2053860	RD41.3SS	2685600	RHC131LN	2619021
MV240	2616180	PKC108	8010070	PL1-M	2055870	RD41.3SS-FC	2685628	RH-FC48N	2592596
MV35	2616150	PKC112	8010075	PN14-C	2610710	RD42.5SS	2685602	RH-FL75	2592597
MV95	2616160	PKC1012	8010120	PN24-C	2610720	RD42.5SS-FC	2685629	RHM132	2619410
MVM150	2616310	PKC1018	8010125	PN37-C	2610730	RD43.2SS	2685604	RHM50	2670035
MVM230-400 MJ5E	2680910	PKC1508	8010080	PN48-C	2610740	RD43.2SS-FC	2685630	RHT160	2592422
MVM230-630 MJ6E	2680920	PKC1518	8010085	PN60-C	2610750	RD44.5SS	2685606	RHT160-60N	2592584
MVM240	2616320	PKC1612	8010130	PN7-C	2610700	RD44.5SS-FC	2685632	RHTD1724	2682482
MVM35	2616290	PKC1618	8010135	PN80-3D	2631460	RD46X107	2685652	RHTD3241	2682502
MVM95	2616300	PKC2508	8010090	PNB-1	2591040	RD46X46	2685660	RHTD3241T	2682517
MY10-50	2677340	PKC2518	8010095	PNB-3F/M	2591088	RD46X54	2685662	RHU131-C	2619210
MY10-C	2613380	PKC25016	8010140	PNB-3N1	2591092	RD46X72	2685664	RHU230-630	2680075
MY14-50	2677345	PKC25022	8010145	PNB-3N5	2591096	RD47.2SS	2685608	RHU450	2640011
MY14-C	2613385	PKC306	8010040	PNB-3NN3	2591094	RD47.2SS-FC	2685634	RHU520	2640151
MY16-50	2677350	PKC308	8010045	PNB-3NN4	2591095	RD50.5SS	2685610	RHU600	2640250
MY16-C	2613390	PKC35016	8010150	PNB-3P	2591090	RD54.2SS	2685612	RHU1000	2640810
MY19-50	2677355	PKC35025	8010155	PNB-3P1	2591084	RD60SS	2685614	RHU81	2600045
MY19-C	2613395	PKC409	8010100	PNB-3PD	2591091	RD64SS	2685616	RKF-BF4	2051632
MY24-50	2677360	PKC418	8010105	PNB-4KE	2591251	RD65SS	2685618	RKF-BM4	2051662
MY24L-50	2677362	PKC508	8010050	PNB-6KE	2591260	RD68X68	2685666	RKF-F305	2051562
MY24-C	2613400	PKC510	8010055	PNB-6KE-T	2591262	RD76SS	2685620	RKF-F308	2051582
MY2-50	2677310	PKC50020	8010160	PNB-7KE	2591268	RD80.5SS	2685622	RKF-F405	2051602
MY2-C	2613350	PKC50030	8010165	PNB-7KE-T	2591270	RD92X92	2685668	RKF-F405P	2051607
MY30-50	2677365	PKC612	8010110	PO7000	2595904	RF-BF4	2051630	RKF-F408	2051592
MY30L-50	2677366	PKC618	8010115	PR-1	2591045	RF-BM4	2051660	RKF-F408P	2051597
MY30-C	2613405	PKC70022	2809595	PRCH	2596113	RF-F305	2051560	RKF-F608	2051612
MY3-50	2677315	PKC7508	8010060	PS130-150/E	2616371	RF-F305P	2051565	RKF-F608P	2051622
MY36-50	2677370	PKC7512	8010065	PS130-240/E	2616381	RF-F308	2051580	RKF-FM608	2051692
MY36-C	2613410	PKC95025	2809600	PS130-35/E	2616351	RF-F308P	2051585	RKF-M608	2051652
MY37-50	2677375	PKC120027	2809605	PS130-95/E	2616361	RF-F405	2051600	RKY-M3	2145684
MY37-C	2613415	PKE108	8020020	PS230-400 5E	2680186	RF-F405P	2051605	RKY-M3,5	2145685
MY3-C	2613355	PKE1012	8020110	PS230-630 6E	2680189	RF-F408	2051590	RKY-M3,5/1	2145687
MY4-50	2677320	PKE1018	8020120	Q38-F	2593861	RF-F408P	2051595	RKY-M4	2145690
MY48-50	2677380	PKE1508	8020030	Q38-M	2593859	RF-F608	2051610	RKY-M5	2145699
MY48-C	2613420	PKE1518	8020040	Q38-MS	2593860	RF-F608P	2051620	RKY-M6/1	2145705
MY4-C	2613360	PKE1612	8020126	RA-3	2598428	RF-FM608	2051690	RKY-M8	2145711
MY5-50	2677325	PKE1618	8020128	RBG-15	2599850	RF-M10	2050390	RKY-M10	2145715

REFERENCE/CODE CROSS-REFERENCE CHART

Ref.	Code	Ref.	Code	Ref.	Code	Ref.	Code	Ref.	Code
RKY-M12	2145718	RP-PP14	2151400	S2,5-M2	2161800	TCP35	3019270	VP-P10	2049210
RKY-P8	2145782	RP-PP12/19	2151390	S2,5-M3	2161810	TCP40	3019280	VP-PP12/19	2049370
RKY-P10	2145783	RP-PP16/23	2151410	S2,5-M3,5	2161850	TCP45	3019290	VP-U3	2048630
RKY-P12	2145784	RN-U10	2150990	S2,5-M3,5/1	2161890	TCP5	3019210	VP-U3,5	2048670
RKY-PP12	2145790	RN-U12	2151030	S2,5-M4	2161930	TCP50	3019300	VP-U4	2048710
RKY-PP12/19	2145792	RN-U3	2150670	S2,5-M4	2161930	TCP55	3019305	WF6	8420030
RKY-PP16/23	2145793	RN-U3,5	2150710	S2,5-M5	2161970	TCP60	3019310	WF16	8420015
RKY-PPL30	2145795	RN-U3,5/2	2150720	S2,5-M6	2162010	TCP65	3019315	WF35	8420031
RKY-PPL46	2145798	RN-U4	2150750	S2,5-M6/1	2162050	TCP70	3019320	WL03-M	8440100
RKY-U3	2145730	RN-U4/1	2150760	S2,5-M7	2162090	TD-M16C	2685010	WL06-M	8440101
RKY-U3,5	2145733	RN-U4/2	2150790	S2,5-M8	2162130	TF300-Q38F	2592862	WL1-M	8440102
RKY-U4	2145736	RN-U5	2150830	S2,5-M8	2162130	TF300-Q38FM	2592863	WT2-3D	2636970
RKY-U5	2145739	RN-U5/1	2150840	S2,5-P10	2163050	TF600-Q38FM	2592981	Z10-1	2845030
RKY-U6	2145742	RP-M2	2046005	S2,5-P8	2163010	TGM38	3016155	Z16-1	2845040
RKY-U6/1	2145743	RP-M3	2046015	S2,5-PP12	2163170	TGM48	3016157	Z16-12	2844156
RN-FA305	3031610	RP-M3,5	2046016	S2,5-PP12/25	2163210	TGM513	3016165	Z16-12D	2844157
RN-FA405	3031615	RP-M4	2046020	S2,5-PP16/25	2163250	TGM58	3016159	Z16-3	2844115
RN-FA608	3031620	RP-M4/3	2046023	S2,5-U10	2162730	TGM613	3016167	Z16-3D	2844116
RN-M10	2150430	RP-M6	2150230	S2,5-U12	2162770	TGM713	3016169	Z16-4	2844130
RN-M12	2150470	RP-M6/1	2150270	S2,5-U3	2162410	TGM817	3016171	Z16-4D	2844131
RN-M2	2150010	RP-M7	2150350	S2,5-U3,5	2162450	TN120S	2590270	Z16-5N	2844122
RN-M3	2150030	RP-M8	2150390	S2,5-U3,5/1	2162460	TN70	2590230	Z16-5ND	2844123
RN-M3,5	2150070	RP-MA305	3031710	S2,5-U4	2162490	TNN120	2590290	Z2,5-1	2845010
RN-M3,5/1	2150110	RP-MA405	3031715	S2,5-U4/1	2162510	TNN70	2590240	Z35-1	2845060
RN-M4	2150150	RP-MA608	3031720	S2,5-U4/2	2162530	TNN71	2590241	Z35-26D	2844216
RN-M4/3	2150170	RN-P10	2151270	S2,5-U5	2162570	TRS-B70	2593280	Z35-3	2844205
RN-M5	2150190	RN-P12	2151310	S2,5-U6	2162610	UP130-120	2616520	Z35-3D	2844206
RN-M6	2150230	RN-P8	2151230	S2,5-U6/1	2162650	UP130-150	2616530	Z35-4	2844201
RN-M6/1	2150270	RN-PP12	2151350	S2,5-U8	2162690	UP130-185	2616550	Z35-4D	2844202
RN-M7	2150350	RN-PP12/1	2151370	S6-M10	2163830	UP130-240	2616560	Z35-6D	2844211
RN-M8	2150390	RN-PP12/19	2151390	S6-M10/1	2163850	UP130-50	2616470	Z35-DP14-125	2845210
RN-MA305	3031710	RN-PP14	2151400	S6-M12	2163890	UP130-70	2616490	Z35-DP14B-125	2845212
RN-MA405	3031715	RN-PP16/23	2151410	S6-M14	2163930	VAL04	2593310	Z35T-11	2844220
RN-MA608	3031720	RN-U10	2150990	S6-M16	2163970	VAL096	2593669	Z35T-11D	2844221
RN-P10	2151270	RN-U12	2151030	S6-M3	2163510	VAL1000	2593426	Z50-10D	2844230
RN-P12	2151310	RN-U3	2150670	S6-M3,5	2163550	VAL130	2610450	Z50-DP12-160	2845220
RN-U3,5	2150710	RN-U3,5	2150710	S6-M4	2163590	VAL130-U	2610451	Z6-1	2845020
RN-U3,5/2	2150720	RN-U4	2150750	S6-M5	2163630	VAL160	2593405	Z6-10	2844106
RN-U4	2150750	RN-U4/1	2150760	S6-M6	2163670	VAL22	2593370	Z6-10D	2844107
RN-U4/1	2150760	RN-U4/2	2150790	S6-M6/1	2163710	VAL22-3	2593406	Z6-3	2844080
RN-U4/2	2150790	RN-U5	2150830	S6-M7	2163750	VAL22-C	2593402	Z6-3D	2844081
RN-U5	2150830	RN-U5/1	2150840	S6-M8	2163790	VAL450	2593424	Z6-5D	2844101
RN-U6	2150870	RP-M10	2046045	S6-M8/1	2163800	VAL520	2593410	Z6-6	2844108
RN-U6/1	2150910	RP-M12	2046050	S6-P10	2164710	VAL600	2593425	Z6-6D	2844109
RN-U8	2150950	RP-M2	2046005	S6-P12	2164750	VAL75	2600110	ZKE2	2590710
RP-M10	2046045	RP-M3	2046015	S6-PP12	2164870	VALB-TC04	2593705	ZKE610	2590718
RP-M12	2046050	RP-M3,5	2046016	S6-U10	2164370	VALB-TC095	2593703	ZKE6-F	2590716
RP-M2	2046005	RP-M4	2046020	S6-U10/1	2164390	VALB-TC950	2593704	ZS-B16	2842185
RP-M3	2046015	RP-M4/3	2046023	S6-U12	2164430	VALECW-H3D	2593421	ZS-B4	2842115
RP-M3,5/1	2046016	RP-M6	2150230	S6-U14	2164470	VALFCL	2593709	ZS-B6	2842155
RP-M4	2046020	RP-M6/1	2150270	S6-U16	2164510	VALMAT520	2593411	ZS-T16	2842190
RP-M4/3	2046023	RP-M7	2150350	S6-U3,5	2164170	VALP1	2590595	ZS-T4	2842120
RP-M5	2046025	RP-M8	2150390	S6-U4	2164210	VALP3	2590610	ZS-T6	2842160
RP-M6	2046030	RP-M8	2150390	S6-U5	2164250	VALP4	2590612	ZS-U16	2842180
RP-M6/1	2046031	RP-P10	2046115	S6-U6	2164290	VALP7	2590616	ZS-U4	2842110
RP-M7	2046035	RP-P12	2046120	S6-U8	2164330	VALP9	2590619	ZS-U6	2842150
RP-M8	2046040	RP-P8	2046110	SC1	2591261	VALP19	2590629		
RP-P10	2046115	RP-PP12	2046140	SC3X	2591264	VALP21	2874156		
RP-P12	2046120	RP-PP12/1	2046145	SC4X	2591265	VALP22	2874157		
RP-P8	2046110	RP-PP12/19	2151390	SH-B70	2596080	VALP26	2590635		
RP-PP12	2046140	RP-PP14	2161360	SUB-DO50	8420033	VALP27	2590638		
RP-PP12/1	2046145	RP-PP16/23	2046155	SUB-DO75	8420032	VALP28	2590639		
RP-PP12/19	2046150	RP-PP16/23	2046155	S1,5-U10	2160950	VALP30	2590642		
RP-PP12/23	2046155	RP-PP16/23	2046155	S1,5-U12	2160990	VALP35	2590647		
RP-PP14	2046160	RP-PP16/23	2046155	S1,5-U3	2160630	VALP36	2590648		
RP-PP16/23	2046165	RP-PP16/23	2046155	S1,5-U3,5	2160670	VALP37	2590646		
RP-PPL30	2046180	RP-PP16/23	2046155	S1,5-U3,5/2	2160682	VALP41	2590645		
		RP-PP16/23	2046155	S1,5-U4	2160710	VALSTAR V3-F	2590577		
		RP-PP16/23	2046155	S1,5-U4/1	2160730	VALTC085	2593323		
		RP-PP16/23	2046155	S1,5-U4/2	2160750	VALTC120	2593322		
		RP-PP16/23	2046155	S1,5-U5	2160790	VP-M2	2048010		
		RP-PP16/23	2046155	S1,5-U5/1	2160800	VP-M3	2048030		
		RP-PP16/23	2046155	S1,5-U6	2160830	VP-M3,5	2048070		
		RP-PP16/23	2046155	S1,5-U6/1	2160870	VP-M4	2048150		
		RP-PP16/23	2046155	S1,5-U8	2160910	VP-M5	2048190		
		RP-PP16/23	2046155	S2,5-M10	2162170	VP-M6	2048210		
		RP-PP16/23	2046155	S2,5-M12	2162210				

COMPARISON OF AWG, MCM AND METRIC CONDUCTOR CROSS SECTIONS

AWG comparison to Metric

AWG	Actual conductor csa mm ²	Comparable metric csa mm ²
27	0,10	
26	0,13	0,14
25	0,16	-
24	0,21	0,2
23	0,26	0,25
22	0,33	0,34
21	0,41	-
20	0,52	0,5
19	0,65	-
18	0,82	0,75
17	1,04	1
16	1,31	-
15	1,65	1,5
14	2,08	-
13	2,63	2,5
12	3,31	-
11	4,15	4
10	5,27	6
9	6,62	-
8	8,35	-
7	10,6	10
6	13,3	-
5	16,8	16
4	21,2	-
3	26,7	25
2	33,6	35
1	42,4	-
1/0	53,4	50
2/0	67,5	70
3/0	85,0	95
4/0	107,2	120

MCM comparison to Metric

MCM	Actual conductor csa mm ²	Comparable metric csa mm ²
250	127	120
300	152	150
350	177	185
400	203	-
500	253	240
600	304	300
700	355	-
800	405	400
900	456	-
1000	507	500
1250	633	625
1500	760	800
1750	887	-
2000	1010	1000

MAXIMUM DIAMETERS OF CIRCULAR COPPER CONDUCTORS: SOLID, NON COMPACTED STRANDED AND FLEXIBLE

Cross sectional area [mm ²]	Conductors in cables for fixed installations		Flexible conductors (Classes 5 and 6) Maximum diameter [mm]
	Solid (Class 1) Maximum diameter [mm]	Stranded (Class 2) Maximum diameter [mm]	
0,5	0,9	1,1	1,1
0,75	1,0	1,2	1,3
1	1,2	1,4	1,5
1,5	1,5	1,7	1,8
2,5	1,9	2,2	2,4
4	2,4	2,7	3,0
6	2,9	3,3	3,9
10	3,7	4,2	5,1
16	4,6	5,3	6,3
25 ^a	5,7	6,6	7,8
35 ^a	6,7	7,9	9,2
50 ^a	7,8	9,1	11,0
70 ^a	9,4	11,0	13,1
95 ^a	11,0	12,9	15,1
120 ^a	12,4	14,5	17,0
150 ^a	13,8	16,2	19,0
185	15,4	18,0	21,0
240	17,6	20,6	24,0
300	19,8	23,1	27,0
400	22,2	26,1	31,0
500	-	29,2	35,0
630	-	33,2	39,0
800	-	37,6	-
1000	-	42,2	-

NOTE: The values given for flexible conductors represent both class 5 and class 6 conductors.

^a Solid Copper conductor shaving cross-sectional areas of 25 mm² and above are for particular types of cable, e.g. mineral insulated, and not for general purposes.

MINIMUM AND MAXIMUM DIAMETERS OF STRANDED COMPACTED CIRCULAR COPPER, ALUMINIUM AND ALUMINIUM ALLOY CONDUCTORS

Cross-sectional area [mm ²]	Stranded compacted circular conductors (Class 2)	
	Minimum diameter [mm]	Maximum diameter [mm]
10	3,6	4,0
16	4,6	5,2
25	5,6	6,5
35	6,6	7,5
50	7,7	8,6
70	9,3	10,2
95	11,0	12,0
120	12,3	13,5
150	13,7	15,0
185	15,3	16,8
240	17,6	19,2
300	19,7	21,6
400	22,3	24,6
500	25,3	27,6
630	28,7	32,5

NOTES: - The dimensional limits of Aluminium conductors with cross-sectional areas above 630 mm² are not given as the compaction technology is not generally established.

- The values are given for compacted Copper conductors in the size range 1,5 mm² to 6 mm².

MINIMUM AND MAXIMUM DIAMETERS OF CIRCULAR ALUMINIUM CONDUCTORS

Cross-sectional area [mm ²]	Solid conductors (Class 1)	
	Minimum diameter [mm]	Maximum diameter [mm]
10	3,4	3,7
16	4,1	4,6
25	5,2	5,7
35	6,1	6,7
50	7,2	7,8
70	8,7	9,4
95	10,3	11,0
120	11,6	12,4
150	12,9	13,8
185	14,5	15,4
240	16,7	17,6
300	18,8	19,8
400	21,2	22,2
500	24,0	25,1
630	27,3	28,4
800	30,9	32,1
1000	34,8	36,0
1200	37,8	39,0

CLASS 1:

SOLID CONDUCTORS FOR SINGLE-CORE AND MULTI-CORE CABLES

Nominal cross-sectional area [mm ²]	Maximum resistance of conductor at 20 °C		
	Circular, annealed Copper conductors		Aluminium and Aluminium alloy conductors, circular or shaped ^c [ohm/km]
	Plain [ohm/km]	Metal [ohm/km]	
0,5	36	36,7	-
0,75	24,5	24,8	-
1	18,1	18,2	-
1,5	12,1	12,2	-
2,5	7,41	7,56	-
4	4,61	4,70	-
6	3,08	3,11	-
10	1,83	1,84	3,08 ^a
16	1,15	1,16	1,91 ^a
25	0,727 ^b	-	1,20 ^a
35	0,524 ^b	-	0,868 ^a
50	0,387 ^b	-	0,641
70	0,268 ^b	-	0,443
95	0,193 ^b	-	0,320 ^d
120	0,153 ^b	-	0,253 ^d
150	0,124 ^b	-	0,206 ^d
185	0,101 ^b	-	0,164 ^d
240	0,0775 ^b	-	0,125 ^d
300	0,0620 ^b	-	0,100 ^d
400	0,0465 ^b	-	0,0778
500	-	-	0,0605
630	-	-	0,0469
800	-	-	0,0367
1000	-	-	0,0291
1200	-	-	0,0247

^a Aluminium conductors 10 mm² to 35 mm² circular only

^b Solid Copper conductors having nominal cross-sectional area of 25 mm² and above are for particular types of cable, e.g. mineral insulated, and not for general purposes.

^c For solid Aluminium alloy conductors, having the same nominal cross-sectional area as an Aluminium conductor, the resistance value given in the table should be multiplied by a factor of 1,162 unless otherwise agreed between the manufacturer and the purchaser.

^d For single core cables, four sectoral shaped conductors may be assembled into a single circular conductor. The maximum resistance of the assembled conductor shall be 25% of that of the individual component conductors.

CLASS 2:

STRANDED CONDUCTORS FOR SINGLE-CORE AND MULTI-CORE CABLES

Nominal cross-sectional area [mm ²]	Minimum number of wires in the conductor						Maximum resistance of conductor at 20 °C		
	Circular		Circular compacted		Shaped		Annealed Copper conductor		Aluminium or Aluminium alloy conductor ^c [ohm/km]
	Cu	Al	Cu	Al	Cu	Al	Plain wires [ohm/km]	Metal-coated wires [ohm/km]	
0,5	7	-	-	-	-	-	36,0	36,7	-
0,75	7	-	-	-	-	-	24,5	24,8	-
1,0	7	-	-	-	-	-	18,1	18,2	-
1,5	7	-	6	-	-	-	12,1	12,2	-
2,5	7	-	6	-	-	-	7,41	7,56	-
4	7	-	6	-	-	-	4,61	4,70	-
6	7	-	6	-	-	-	3,08	3,11	-
10	7	7	6	6	-	-	1,83	1,84	3,08
16	7	7	6	6	-	-	1,15	1,16	1,91
25	7	7	6	6	6	6	0,727	0,734	1,20
35	7	7	6	6	6	6	0,524	0,529	0,868
50	19	19	6	6	6	6	0,387	0,391	0,641
70	19	19	12	12	12	12	0,268	0,270	0,443
95	19	19	15	15	15	15	0,193	0,195	0,320
120	37	37	18	15	18	15	0,153	0,154	0,253
150	37	37	18	15	18	15	0,124	0,126	0,206
185	37	37	30	30	30	30	0,0991	0,100	0,164
240	61	61	34	30	34	30	0,0754	0,0762	0,125
300	61	61	34	30	34	30	0,0601	0,0607	0,100
400	61	61	53	53	53	53	0,0470	0,0475	0,0778
500	61	61	53	53	53	53	0,0366	0,0369	0,0605
630	91	91	53	53	53	53	0,0283	0,0286	0,0469
800	91	91	53	53	-	-	0,0221	0,0224	0,0367
1000	91	91	53	53	-	-	0,0176	0,0177	0,0291
1200			<i>b</i>				0,0151	0,0151	0,0247
1400 ^a			<i>b</i>				0,0129	0,0129	0,0212
1600			<i>b</i>				0,0113	0,0113	0,0186
1800 ^a			<i>b</i>				0,0101	0,0101	0,0165
2000			<i>b</i>				0,0090	0,0090	0,0149
2500			<i>b</i>				0,0072	0,0072	0,0127

^a Non-preferred sizes. Other non-preferred sizes are recognized for some specialized applications but are not within the scope of this standard.

^b The minimum number of wires for these sizes is not specified. These sizes may be constructed from 4, 5 or 6 equal segments (Milliken).

^c For stranded Aluminium alloy conductors having the same nominal cross-sectional area as an Aluminium conductor the resistance value should be agreed between the manufacturer and the purchaser.

CLASS 5:

FLEXIBLE COPPER CONDUCTORS FOR SINGLE-CORE AND MULTI-CORE CABLES

Nominal cross-sectional [mm ²]	Maximum diameter of wires in conductor [mm]	Maximum resistance of conductor at 20 °C	
		Plain wires [ohm/km]	Metal-coated wires [ohm/km]
0,5	0,21	39,0	40,1
0,75	0,21	26,0	26,7
1,0	0,21	19,5	20,0
1,5	0,26	13,3	13,7
2,5	0,26	7,98	8,21
4	0,31	4,95	5,09
6	0,31	3,30	3,39
10	0,41	1,91	1,95
16	0,41	1,21	1,24
25	0,41	0,780	0,795
35	0,41	0,554	0,565
50	0,41	0,386	0,393
70	0,51	0,272	0,277
95	0,51	0,206	0,210
120	0,51	0,161	0,164
150	0,51	0,129	0,132
185	0,51	0,106	0,108
240	0,51	0,0801	0,0817
300	0,51	0,0641	0,0654
400	0,51	0,0486	0,0495
500	0,61	0,0384	0,0391
630	0,61	0,0287	0,0292

CLASS 6:

FLEXIBLE COPPER CONDUCTORS FOR SINGLE-CORE AND MULTI-CORE CABLES

Nominal cross-sectional [mm ²]	Maximum diameter of wires in conductor [mm]	Maximum resistance of conductor at 20 °C	
		Plain wires [ohm/km]	Metal-coated wires [ohm/km]
0,5	0,16	39,0	40,1
0,75	0,16	26,0	26,7
1,0	0,16	19,5	20,0
1,5	0,16	13,3	13,7
2,5	0,16	7,98	8,21
4	0,16	4,95	5,09
6	0,21	3,30	3,39
10	0,21	1,91	1,95
16	0,21	1,21	1,24
25	0,21	0,780	0,795
35	0,21	0,554	0,565
50	0,31	0,386	0,393
70	0,31	0,272	0,277
95	0,31	0,206	0,210
120	0,31	0,161	0,164
150	0,31	0,129	0,132
185	0,41	0,106	0,108
240	0,41	0,0801	0,0817
300	0,41	0,0641	0,0654

- H Cable conforming to harmonised standards
- A Recognised national type of cable
- N Other type of national cable

- 00 Less than 100 / 100 V
- 01 Above 100 / 100 V and less than 300 / 300 V
- 03 300 / 300 V
- 05 300 / 500 V
- 07 450 / 750 V
- 1 0,6 / 1 kV

- B Ethylenpropylene rubber for working temperature of 60° C
- N Polychloroprene
- N2 Polychloroprene for welding cables
- Q Polyurethane
- R Rubber
- V Common-quality PVC
- V2 PVC for working temperatures of 90° C
- V3 PVC for low temperature cables
- V4 Reticulate PVC
- V5 Oil-resistant PVC
- Z Polyolefin mixture

- C Concentric Copper core
- C4 Copper braid screen on multiple cores
- C5 Copper braid screen on single cores
- C7 Screen made of Copper straps or ribbons

- Z2 Round Steel strand armour
- Z3 Steel strap armour
- Z4 Steel ribbon armour
- Z5 Steel strand braid

- H Flat divisible cable with or without sheath
- H2 Flat indivisible cable
- H3 Flat cable with cores separated by a slot
- H6 Flat cable with three or more cores
- H7 Cable with double-layered insulation
- H8 Extendable cord

- D Flexible core for weldings cables
- E Very flexible core for welding cables
- F Flexible core for moving connections
- H Very flexible core for moving connections
- K Flexible core for fixed laying
- R Rigid round cord
- U Round rigid single strand

REFERENCE TO THE STANDARDS

RATED VOLTAGE

INSULATION AND SHEATH MATERIAL

SCREENS

ARMOURS

CONSTRUCTIVE FORM OF THE CABLE

CONDUCTOR FLEXIBILITY DEGREE

UL AND VDE MARKING OF CABLE GLANDS

MAXIblock® - spiralblock®

Ref. Light Grey	Thread	COMPRESSION RANGE Ø min-max			IMPACT CATEGORY (*)	MARKING	
		Nominal [mm]	UL 514B				
			[mm]	[inches]			
1900.M12	M12x1.5	3.5-7	3.5	0.14	3.5-7	1	USR-CNR / VDE
1900.M16	M16x1.5	5-10	7	0.28	7-10	1	USR-CNR / VDE
1900.M20	M20x1.5	7-13	13	0.51	7-13	3	USL-CNL / VDE
1900.M25	M25x1.5	10-17	17	0.67	10-17	3	USL-CNL / VDE
1900.M32	M32x1.5	13-21	15-21	0.60-0.83	13-21	3	USL-CNL / VDE
1900.M40	M40x1.5	19-28	21-28	0.83-1.10	19-28	3	USL-CNL / VDE
1900.M50	M50x1.5	27-35	27-34	1.06-1.34	27-35	3	USL-CNL / VDE
1900.M63	M63x1.5	34-45	35-45	1.38-1.77	34-45	3	USL-CNL / VDE
1910.M12	M12x1.5	2-5	2-5	0.08-0.20	2-5	1	USR-CNR / VDE
1910.M16	M16x1.5	3-7	4-7	0.16-0.28	4-7	1	USR-CNR / VDE
1910.M20	M20x1.5	5-10	5-10	0.20-0.40	5-10	3	USR-CNR / VDE
1910.M25	M25x1.5	7-13	7-13	0.28-0.51	7-13	3	USR-CNR / VDE
1910.M32	M32x1.5	8-14	8-14	0.31-0.55	8-14	3	USR-CNR / VDE
1910.M40	M40x1.5	15-23	15-23	0.59-0.91	15-23	3	USL-CNL / VDE
1910.M50	M50x1.5	21-29	21-29	0.83-1.14	21-29	3	USL-CNL / VDE
1910.M63	M63x1.5	27-39	28-39	1.1-1.54	27-39	3	USL-CNL / VDE
1901.M12	M12x1.5	3.5-7	3.5	0.14	3.5-7	1	USR-CNR / VDE
1901.M16	M16x1.5	5-10	7	0.28	7-10	1	USR-CNR / VDE
1901.M20	M20x1.5	7-13	13	0.51	7-13	3	USL-CNL / VDE
1901.M25	M25x1.5	10-17	17	0.67	10-17	3	USL-CNL / VDE
1901.M32	M32x1.5	13-21	15-21	0.60-0.83	13-21	3	USL-CNL / VDE
1901.M40	M40x1.5	19-28	21-28	0.83-1.10	19-28	3	USL-CNL / VDE
1901.M50	M50x1.5	27-35	27-34	1.06-1.34	27-35	3	USL-CNL / VDE
1901.M63	M63x1.5	34-45	35-45	1.38-1.77	34-45	3	USL-CNL / VDE
1500.M12	M12x1.5	3.5-7	3.5	0.14	3.5-7	1	USR-CNR / VDE
1500.M16	M16x1.5	5-10	7	0.28	7-10	1	USR-CNR / VDE
1500.M20	M20x1.5	7-13	13	0.51	7-13	3	USL-CNL / VDE
1500.M25	M25x1.5	10-17	17	0.67	10-17	3	USL-CNL / VDE
1500.M32	M32x1.5	13-21	15-21	0.60-0.83	13-21	3	USL-CNL / VDE
1940.M25	M25x1.5	13-18	13-18	0.51-0.71	-	-	USL-CNL
1540.M25	M25x1.5	13-18	13-18	0.51-0.71	-	-	USL-CNL

Add to Ref: **N** for Black, **G** for Dark Grey

MAXIblock® - spiralblock®

Ref. Light Grey	Thread	COMPRESSION RANGE Ø min-max			MARKING
		Nominal [mm]	UL 514B		
			[mm]	[inches]	
1900.07	Pg 7	3.5-7	4.5-6.5	0.18-0.25	USR-CNR
1900.09	Pg 9	5-8	5.5-8	0.22-0.31	USR-CNR
1900.11	Pg 11	5-10	6.5-9.5	0.26-0.37	USR-CNR
1900.13	Pg 13.5	7-12	8-11.5	0.31-0.45	USL-CNL
1900.16	Pg 16	10-14	10.5-14	0.41-0.55	USL-CNL
1900.21	Pg 21	13-18	13-18	0.51-0.71	USL-CNL
1900.29	Pg 29	18-25	18.5-25	0.73-0.98	USL-CNL
1900.36	Pg 36	20-32	21.5-32	0.85-1.26	USL-CNL
1900.42	Pg 42	28-38	28-38	1.10-1.49	USL-CNL
1900.48	Pg 48	37-45	40-44	1.57-1.73	USL-CNL
1910.07	Pg 7	2-5	2-5	0.08-0.20	USR-CNR
1910.11	Pg 11	4-7	4-7	0.16-0.28	USR-CNR
1910.13	Pg 13	5-10	10	0.39	USR-CNR
1910.21	Pg 21	9-15	10-14	0.39-0.55	USR-CNR
1910.36	Pg 36	18-26	18-26	0.71-1.02	USR-CNR
1910.42	Pg 42	25-31	25-31	0.98-1.22	USL-CNL
1901.07	Pg 7	3.5-7	6.5	0.26	USR-CNR
1901.09	Pg 9	5-8	5.5-8	0.22-0.31	USR-CNR
1901.11	Pg 11	5-10	6.5-9.5	0.26-0.37	USR-CNR
1901.13	Pg 13.5	7-12	8-11.5	0.31-0.45	USL-CNL
1901.16	Pg 16	10-14	10.5-14	0.41-0.55	USL-CNL
1901.21	Pg 21	13-18	13-18	0.51-0.71	USL-CNL
1901.29	Pg 29	18-25	18.5-25	0.73-0.98	USL-CNL
1901.36	Pg 36	20-32	21.5-32	0.85-1.26	USL-CNL
1901.42	Pg 42	28-38	28	1.10	USL-CNL
1901.48	Pg 48	37-45	40-44	1.57-1.73	USL-CNL
1500.07	Pg 7	3.5-7	4.5-6.5	0.18-0.25	USR-CNR
1500.09	Pg 9	5-8	5.5-8	0.22-0.31	USR-CNR
1500.11	Pg 11	5-10	6.5-9.5	0.26-0.37	USR-CNR
1500.13	Pg 13.5	7-12	8-11.5	0.31-0.45	USL-CNL
1500.16	Pg 16	10-14	10.5-14	0.41-0.55	USL-CNL
1500.21	Pg 21	13-18	13-18	0.51-0.71	USL-CNL
1900.14	G1/4"	3-6.5	4.5-6.5	0.18-0.25	USR-CNR
1900.38	G3/8"	4-8	5.5-8	0.22-0.31	USR-CNR
1900.12	G1/2"	7-12	8-11.5	0.31-0.45	USL-CNL
1900.34	G3/4"	13-18	13-18	0.51-0.71	USL-CNL
1901.12	G1/2"	7-12	8-11.5	0.31-0.45	USL-CNL
1500.14	G1/4"	3-6.5	4.5-6.5	0.18-0.25	USR-CNR
1500.38	G3/8"	4-8	5.5-8	0.22-0.31	USR-CNR
1500.12	G1/2"	7-12	8-11.5	0.31-0.45	USL-CNL
1500.34	G3/4"	13-18	13-18	0.51-0.71	USL-CNL

Add to Ref: **N** for Black, **G** for Dark Grey

MAXIbrass®

Tipo	Thread	COMPRESSION RANGE Ø min-max			MARKING
		Nominal [mm]	UL 514B		
			[mm]	[inches]	
2900.07N	Pg 7	3-7	3-7	0.12-0.28	USR-CNR
2900.09N	Pg 9	4-8	4-8	0.16-0.31	USR-CNR
2900.11N	Pg 11	4.5-10	4.5-10	0.18-0.39	USR-CNR
2900.13N	Pg 13.5	5-12	9-12	0.35-0.47	USL-CNL
2900.16N	Pg 16	7-13	10-13	0.39-0.51	USL-CNL
2900.21N	Pg 21	10-17	12-17	0.47-0.67	USL-CNL
2900.29N	Pg 29	17-25	18-25	0.71-0.98	USL-CNL
2900.36N	Pg 36	20-32	22-32	0.86-1.26	USL-CNL
2900.42N	Pg 42	28-38	28-35	1.10-1.38	USL-CNL
2900.48N	Pg 48	34-45	34-45	1.33-1.77	USL-CNL
2910.07N	Pg 7	1-5	1-5	0.04-0.20	USR-CNR
2910.09N	Pg 9	2-6	3-6	0.12-0.24	USR-CNR
2910.11N	Pg 11	2.5-7	3.5-7	0.14-0.28	USR-CNR
2910.13N	Pg13.5	4-10	5.5-10	0.22-0.39	USR-CNR
2910.16N	Pg 16	5-10	6-10	0.24-0.39	USR-CNR
2910.21N	Pg 21	6-13	7-13	0.28-0.51	USR-CNR
2910.29N	Pg 29	11-20	12-20	0.47-0.79	USR-CNR
2910.36N	Pg 36	18-26	19-26	0.75-1.02	USL-CNL
2910.42N	Pg 42	24-31	24-31	0.94-1.22	USL-CNL
2910.48N	Pg 48	27-39	31-39	1.22-1.54	USL-CNL
2901.07N	Pg 7	3-7	3-7	0.12-0.28	USR-CNR
2901.09N	Pg 9	4-8	4-8	0.16-0.31	USR-CNR
2901.11N	Pg 11	4.5-10	4.5-10	0.18-0.39	USR-CNR
2901.13N	Pg13.5	5-12	9-12	0.35-0.47	USL-CNL
2901.16N	Pg 16	7-13	10-13	0.39-0.51	USL-CNL
2901.21N	Pg 21	10-17	12-17	0.47-0.67	USL-CNL
2901.29N	Pg 29	17-25	18-25	0.71-0.98	USL-CNL
2901.36N	Pg 36	20-32	22-32	0.86-1.26	USL-CNL
2901.42N	Pg 42	28-38	28-35	1.10-1.38	USL-CNL
2911.07N	Pg 7	1-5	1-5	0.04-0.20	USR-CNR
2911.09N	Pg 9	2-6	3-8	0.12-0.31	USR-CNR
2911.11N	Pg 11	2.5-7	3.5-7	0.14-0.28	USR-CNR
2911.13N	Pg13.5	4-10	5.5-10	0.22-0.39	USR-CNR
2911.16N	Pg 16	5-10	6-10	0.24-0.39	USR-CNR
2911.21N	Pg 21	6-13	7-13	0.28-0.51	USR-CNR
2911.29N	Pg29	11-20	12-20	0.47-0.79	USR-CNR
2911.36N	Pg36	18-26	19-26	0.75-1.02	USL-CNL
2911.42N	Pg42	24-31	24-31	0.94-1.22	USL-CNL

VDE: Licence nos 40008472, 40008474, 40008475 and 40008476

USL-CNL: UL LISTING file no E220310; control no 48SB valid in USA & Canada

USR-CNR: UL RECOGNITION file no E220310 valid in USA & Canada (with reduced tightening force)

(*) EN 50262 § 9.4

MAXIbrass®

Tipo	Thread	COMPRESSION RANGE Ø min-max			IMPACT CATEGORY (*)	MARKING	
		Nominal [mm]	UL 514B				
			[mm]	[inches]			
2900.M12N	M12x1.5	3-7	3-7	0.12-0.28	3-7	5	USR-CNR / VDE
2900.M16N	M16x1.5	4.5-10	4.5-10	0.18-0.39	4.5-10	6	USL-CNL / VDE
2900.M20N	M20x1.5	7-13	8-13	0.31-0.51	7-13	6	USL-CNL / VDE
2900.M25N	M25x1.5	10-17	10-17	0.39-0.67	10-17	6	USL-CNL / VDE
2900.M32N	M32x1.5	11-21	11-21	0.43-0.83	11-21	6	USL-CNL / VDE
2900.M40N	M40x1.5	19-28	19-28	0.75-1.10	19-28	6	USL-CNL / VDE
2900.M50N	M50x1.5	26-35	27-35	1.06-1.38	26-35	6	USL-CNL / VDE
2900.M63N	M63x1.5	34-45	34-45	1.33-1.77	34-45	6	USL-CNL / VDE
2910.M12N	M12x1.5	1-5	2-5	0.08-0.20	1-5	5	USR-CNR / VDE
2910.M16N	M16x1.5	2.5-7	3.5-7	0.14-0.28	2.5-7	6	USR-CNR / VDE
2910.M20N	M20x1.5	5-10	5-10	0.20-0.39	5-10	6	USR-CNR / VDE
2910.M25N	M25x1.5	6-13	6-13	0.24-0.51	6-13	6	USR-CNR / VDE
2910.M32N	M32x1.5	7-14	7-14	0.28-0.55	7-14	6	USR-CNR / VDE
2910.M40N	M40x1.5	13-23	15-23	0.59-0.90	17-23	6	USL-CNL / VDE
2910.M50N	M50x1.5	20-29	20-29	0.79-1.14	22-29	6	USL-CNL / VDE
2910.M63N	M63x1.5	27-39	28-39	1.10-1.54	31-39	6	USL-CNL / VDE
2901.M12N	M12x1.5	3-7	3-7	0.12-0.28	3-7	5	USR-CNR/VDE
2901.M16N	M16x1.5	4.5-10	4.5-10	0.18-0.39	4.5-10	6	USL-CNL / VDE
2901.M20N	M20x1.5	7-13	8-13	0.31-0.51	7-13	6	USL-CNL / VDE
2901.M25N	M25x1.5	10-17	10-17	0.39-0.67	10-17	6	USL-CNL / VDE
2901.M32N	M32x1.5	11-21	11-21	0.43-0.83	11-21	6	USL-CNL / VDE
2901.M40N	M40x1.5	19-28	19-28	0.75-1.10	19-28	6	USL-CNL / VDE
2901.M50N	M50x1.5	26-35	27-35	1.06-1.38	26-35	6	USL-CNL / VDE
2911.M12N	M12x1.5	1-5	2-5	0.08-0.20	1-5	5	USR-CNR/VDE
2911.M16N	M16x1.5	2.5-7	3.5-7	0.14-0.28	2.5-7	6	USR-CNR / VDE
2911.M20N	M20x1.5	5-10	5-10	0.20-0.39	5-10	6	USR-CNR / VDE
2911.M25N	M25x1.5	6-13	6-13	0.24-0.51	6-13	6	USR-CNR / VDE
2911.M32N	M32x1.5	7-14	7-14	0.28-0.55	7-14	6	USR-CNR/VDE
2911.M40N	M40x1.5	13-23	15-23	0.59-0.90	13-23	6	USL-CNL / VDE
2911.M50N	M50x1.5	20-29	20-29	0.79-1.14	22-29	6	USL-CNL / VDE

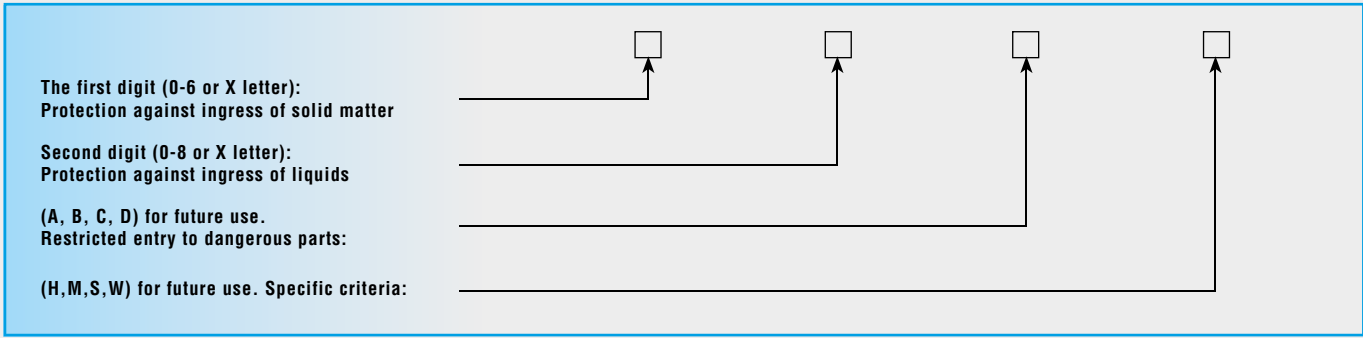

**1st CHARACTERISTIC NUMBER:
PROTECTION AGAINST INGRESS OF SOLID MATTER**

PROTECTION	0	1	2	3	4	5	6
Protection against ingress of solid matter caused by		solid bodies measuring over 50 mm	solid bodies measuring over 12,5 mm	solid bodies measuring over 2,5 mm	solid bodies measuring over 1 mm	powder in harmful quantities	Powder (completely protected)
Test method		Accessibility gauge \varnothing 50 mm	Accessibility gauge \varnothing 12,5 mm	Accessibility gauge \varnothing 2,5 mm	Accessibility gauge \varnothing 1 mm	talcum powder	talcum powder

**2nd CHARACTERISTIC NUMBER:
PROTECTION AGAINST INGRESS OF LIQUIDS**



PROTECTION	0	1	2	3	4	5	6	7	8
Protection against ingress of liquids caused by		Drops of water falling vertically	Vertical drops of water with inclination of casing up to 15°	Rain	Sprays of water	Jets of water	Powerful jets of water	Temporary Immersion	Permanent Immersion
Test method		Agreement between manufacturer and user but more severe than 7	Agreement between manufacturer and user but more severe than 7	Agreement between manufacturer and user but more severe than 7	Agreement between manufacturer and user but more severe than 7	Agreement between manufacturer and user but more severe than 7	Agreement between manufacturer and user but more severe than 7	Agreement between manufacturer and user but more severe than 7	Agreement between manufacturer and user but more severe than 7

**1st ADDITIONAL LETTER
RESTRICTED ENTRY TO DANGEROUS PARTS**

RESTRICTED ENTRY	A	B	C	D
Restricted entry to dangerous parts caused by	back of hand	finger	tool	wire
Test method	accessibility gauge \varnothing 50 mm	articulated test finger	accessibility gauge \varnothing 2,5 mm	accessibility gauge \varnothing 1 mm

**2nd ADDITIONAL LETTER
MEANING OF THE SECOND ADDITIONAL LETTER**

SPECIFIC CRITERIA	H	M	S	W
Specific criteria	High voltage equipment	Tested against negative effects of water penetration, when the moveable parts of the equipment (e.g. wheels of a revolving machine) are moving	Tested against the negative effects of water penetration, when the moveable parts of the equipment (e.g. wheels of a revolving machine) are stationary	Suitable for use in environmental conditions as specified and equipped with additional measures of protection

TYPE OF TEST	TEST EQUIPMENT	COMPLIANCE WITH STANDARDS	OBJECTIVE OF TEST	TEST RESULTS	TEST CONDITIONS		
					heat source	length of test	characteristic features
CHARACTERISTIC FEATURES		IEC 695-2-1 CEI 50-11 DIN VDE 0471-2-1	Check that abnormal heating produced by overcurrent and bad contacts does not compromise the safety of the insulating material. Lighting test. The wire is pressed against the sample using force and penetrates up to 7 mm.	Any sign of flame starting must stop within 30 sec. of removing the glowing wire TEST TEMPERATURE <ul style="list-style-type: none"> • 650° for materials which do not support parts under tension • 750° for materials which support parts under tension of moving sockets and plugs • 850° for materials which support parts under tension of fixed sockets and switches 	Glow-wire 4 mm in diameter	Wire applied for 30 seconds	Flame extinction time
NEEDLE FLAME		IEC 695-2-1 CEI 50-11	Simulates the effect small flames have which may occur due to internal faults of products in order to judge the fire risk.	<ul style="list-style-type: none"> • the sample does not catch fire • the flame and incandescent particles do not spread the fire • combustion lasts less than 30 seconds 	Bunsen burner flame	Flame applied for (Ta) 5, 10, 20, 30, 60, 120 sec. According to particular standards	The degree of severity: flame application time (Ta)
UL (UNDERWRITER LABORATORIES)		UL 94	Measuring of time the sample continues to burn after the direct flame has been removed	<ul style="list-style-type: none"> • V0 if the sample burns for less than 5 sec. before going out. • V1 if it burns for less than 25 sec. • V2 if it burns for less than 25 sec. With incandescent drops • HB if it burns for more than 25 sec. (horizontal sample and burning speed less than 38 mm per minute) Comparable to ASTM D-635 	Bunsen burner flame	Flame applied for 10 seconds twice following	Length of combustion

MAXIblock[®], spiralblock[®], MAXIbrass[®], MAXIinox

to obtain IP68 ingress protection in accordance with EN 50262

Torque ratio values apply to mounting in a threaded entry and to use with a locknut

THREAD CABLE GLAND	CABLE GLAND torque ratio Nm	
	metallic	non-metallic
M12 x 1,5	6	2,7
M16 x 1,5	6	5,0
M20 x 1,5	8	7,0
M25 x 1,5	8	7,5
M32 x 1,5	12	8,0
M40 x 1,5	18	8,0
M50 x 1,5	18	10,0
M63 x 1,5	18	10,0

MAXIblock[®], spiralblock[®], MAXIbrass[®], MAXIinox

to obtain IP68 ingress protection in accordance with DIN VDE for Pg threads

Torque ratio values apply to mounting in a threaded entry and to use with a locknut

THREAD CABLE GLAND	CABLE GLAND torque ratio Nm		
	metallic	non-metallic series	
		1900	1910
Pg 7	6.25	2.5	2.5
Pg 9	6.25	3.75	3.75
Pg 11	6.25	3.75	3.75
Pg 13,5	6.25	3.75	3.75
Pg 16	7.5	5.0	5.0
Pg 21	10.0	7.5	7.5
Pg 29	10.0	7.5	7.5
Pg 36	18.0	7.5	7.5
Pg 42	18.0	7.5	10.0
Pg 48	18.0	7.5	10.0

MAXIblock[®], spiralblock[®]

to obtain IP68 with reduced tightening force for GAS threads

Torque ratio values apply to mounting in a threaded entry and to use with a locknut

THREAD CABLE GLAND	CABLE GLAND non-metallic torque ratio Nm
	G1/4"
G3/8"	5
G1/2"	6
G3/4"	10

Also available in the Cembre product range

"Industrial Marking Systems"

ROLLY
THERMAL TRANSFER SYSTEM
FOR REEL MEDIA PRINTING



mg3
MARKINGENIUS 3

PC-DRIVEN THERMAL
TRANSFER MARKER
PRINTING SYSTEM



NEW MARKERS FOR THE IDENTIFICATION OF
TERMINAL BLOCKS AND CABLES

RING
cablesys
MANUAL CABLE
MARKING SYSTEMS



SIGN
stick-onsys
WARNING, PROHIBITION
AND MANDATORY SIGNS



ASK FOR THE CATALOGUES

Cembre

Crimpstar

ZETAmini

MAXIblock

oelma

nd

ZETApiù

spiralblock

**MARKIN
Genius**

ZETAblock

MAXIbrass

**GENERAL
MARKING**

**SICUR
clips**

are registered trademarks of Cembre S.p.A.

The information contained in this catalogue is to aid the commercial selection of products. It is not intended for use as an instruction manual. Information concerning application and the correct operational use is provided by the specific manual delivered with the products.

This catalogue is the property of Cembre. Any reproduction (in full or in part) is forbidden without the prior written permission of Cembre.

Cembre reserve the right to modify the specifications in this catalogue without prior notice.



Dunton Park
Kingsbury Road, Curdworth
Sutton Coldfield - West Midlands B76 9EB
Tel.: 01675 470440
Fax: 01675 470220
E-mail: sales@cembre.co.uk



Design, manufacture and sales of electrical connectors and associated tools, cable accessories, marking systems, toolings and products for railway applications. In house repair, refurbishment and calibration of toolings.



www.cembre.co.uk



Cod. 6260567