

### INDEX

PART NAME	GROUP NUMBER	PART NAME	GROUP NUMBER
<b>A</b>		<b>B - cont'd.</b>	
Absorber (body bolt)	00154-5	Base (rear seat back center arm rest)	67204
Absorber (dash panel sound center)	015A22	Base (roof luggage carrier front)	550A30-1
Absorber (dash panel sound outer)	01590	Base (roof luggage carrier rear)	550A30-1
Absorber (quarter outside panel rear sound)	280A44	Bearing (front door vent window lower pivot)	22330, 223A30
Absorber (roof panel sound)	54330	Bearing (rear seat back latch handle)	61346
Absorber & retainer assy. (body bolt upper)	00396	Bellcrank (front door latch)	26448-9
Actuator (back window regulator)	44085	Bellcrank (front door latch control)	21900
Actuator (front door vacuum latch)	218A42-3	Bellcrank (rear door latch)	26448-9
Actuator (luggage compt. door vacuum latch)	43232	Belt (rear seat shoulder strap)	60126
Actuator (rear door vacuum latch)	26594-5	Belt assy. (center passenger)	611B60
Actuator (tailgate latch)	431A38	Belt assy. (front seat complete)	611A72-3
Actuator assy. (front seat back adjusting)	610A02	Belt assy. (rear seat complete)	613B84-5
Adjuster (front door latch actuating rod)	21816	Belt kit (front seat shoulder strap)	60232
Adjuster (passenger reclining seat head rest guide rod)	612A24	Bezel (console panel glove compt. door lock)	060A12
Adjuster (tailgate latch actuating rod)	21816	Bezel (front seat back latch handle)	62672-3
Airfoil (front spoiler)	001A06, 001A74	Bezel (instrument panel A/C grille)	044B16
Air scoop (quarter panel brake)	29076-7, 290A76-7	Bezel (instrument panel ash receptacle)	04815
Air scoop (roof)	280B62-3	Bezel (instrument panel cluster opening)	04606
Anti-rattle (console panel finish rear floor)	044E16	Bezel (instrument panel glove compt. door lock)	060A12
Anti-rattle (front door handle outside)	22408	Bezel (luggage compt. vacuum door latch release switch)	43662
Anti-rattle (front door window glass)	23314	Bezel (quarter vent air door knob)	278C52-3
Anti-rattle (front door window lower guide)	223A58	Bezel (rear seat back latch)	624A08
Anti-rattle (liftgate belt)	404A76	Bezel (rear seat belt opening)	611B90
Anti-rattle (luggage compt. torsion bar)	45028	Bezel (shoulder strap opening)	60220
Anti-rattle (quarter window)	29610	Bezel (vacuum door latch control switch)	218A82
Anti-rattle (rear door handle outside)	22408	Bezel assy. (quarter vent air grille screen)	278C00-9
Anti-rattle (tailgate)	44454	Body (folding top hold down clamp)	50532
Anti-rattle (tailgate counterbalance torsion bar)	431D82	Body assy.	00000-1
Anti-rattle (tailgate torsion bar)	45028	Bolt (body mounting)	00394
Anti-squeak (cowl top vent grille)	02204	Bolt (folding top bow adjusting)	51514
Anti-squeak (tailgate counterbalance spring)	430A12	Bolt (front seat back pivot arm)	60392
Arm (visor)	04110-1	Bolt (front seat track attaching)	60056
Arm & bracket assy. (visor)	04144-5	Bolt (front seat track link)	625A12
Arm & plate assy. (front door window regulator)	23234-5	Bolt (liftgate latch)	404A54, 40480
Attaching kit (instrument panel pad)	04200	Bolt (seat belt anchor eye)	61212
<b>B</b>		Bolt (tailgate check cable)	44486
Baffle (cowl side panel water)	021A58	Bolt (tailgate latch release lever)	431D72
Bar (engine compartment support)	29432	Boot (front seat shoulder strap)	60234-5
Bar (front door vent window division)	22296-7	Boot (fuel filler opening collar to wheelhouse)	280B24
Bar (front seat torsion)	604K22, 604K36	Bow (folding top no. 2)	51274
Bar (instrument panel passenger assist)	045B22	Bow (folding top no. 3)	51269
Bar (luggage compt. door hinge torsion)	44890-1	Bow (folding top rear no. 4)	51278
Bar (tailgate hinge torsion)	44890-1	Box & snuffer (instrument panel ash receptacle)	04821
Bar assy. (front seat adjuster torsion)	61832	Box & snuffer (console panel ash receptacle)	04821
Bar & link assy. (front seat adjuster front torsion)	618C30	Brace (body rear corner panel)	28442-3
Bar & link assy. (front seat adjuster rear torsion)	618C32	Brace (body side lower panel)	278A42
Base (aux. seat cushion)	607A60	Brace (body side window opening rear reinforcement)	279C72-3
Base (folding top main pivot support)	50140-1, 506A44-5	Brace (brake pedal support)	01524
Base (front seat adjuster regulator)	617C80-1	Brace (brake pedal support center)	015A18
Base (quarter panel outside ornament)	290C82-3	Brace (brake pedal support instrument panel)	015A08
		Brace (dash panel to frame)	01714-5
		Brace (folding top main pivot bracket support)	53152-3

## INDEX

PART NAME	GROUP NUMBER	PART NAME	GROUP NUMBER
<b>B - cont'd.</b>		<b>B - cont'd.</b>	
Brace (instrument panel)	04488 , 04510	Bracket (front door arm rest finger tip plate)	240A10
Brace (instrument panel center)	045D56	Bracket (front door arm rest mounting)	24116
Brace (instrument panel lower flange to cowl inner panel)	04672	Bracket (front door inside pull handle mounting)	22606
Brace (instrument panel to cowl)	045D56	Bracket (front door latch actuator)	220A14
Brace (instrument panel to floor)	04598	Bracket (front door trim panel upper)	23834
Brace (instrument panel upper)	044E00	Bracket (front door vent window lower pivot)	22954-5
Brace (lower back panel floor inner)	40396-7	Bracket (front door vent window upper pivot)	21464-5
Brace (package tray strainer to floor)	46674-5	Bracket (front door window channel)	23288
Brace (quarter latch pillar to floor)	28198-9	Bracket (front door window glass channel rear)	23296
Brace (quarter latch pillar to quarter side member)	29388-9	Bracket (front door window glass rear)	21430-1
Brace (quarter latch pillar to wheelhouse)	28258-9	Bracket (front door window glass rear inner)	234A56-7
Brace (quarter panel latch side lower rear reinforcement)	28268-9	Bracket (front door window lower stop)	21790
Brace (quarter panel to rear floor)	27726-7	Bracket (front door window rear guide adjusting lower)	23136
Brace (quarter panel to wheelhouse)	27800-1	Bracket (front door window regulator drive arm)	21504
Brace (rear seat back support to strainer)	62446	Bracket (front door window regulator equalizer arm)	23230-1
Brace (spare wheel)	47040	Bracket (front door window regulator motor mounting)	23312-3
Brace (steering column bracket)	03052-3	Bracket (front door window stop)	21760-1
Brace (upper back panel)	40378-9	Bracket (front door window stop upper)	21764
Bracket (aux. seat back floor pivot)	607A04-5	Bracket (front door window stop upper rear)	21772
Bracket (aux. seat back support)	600A74-5	Bracket (front floor pan seat track reinforcement)	107A70
Bracket (aux. seat cushion floor pivot)	606A78	Bracket (front seat adjusting tube)	618A88-9
Bracket (aux. seat cushion floor support)	60786	Bracket (front seat back hinge)	61066
Bracket (aux. seat support to rear floor)	60774	Bracket (front seat back latch)	62614 , 62634
Bracket (back window glass)	422B18-9	Bracket (front seat back latch solenoid)	625A56-7
Bracket (back window lower stop)	44062	Bracket (front seat back pivot)	618C46
Bracket (back window regulator arm)	44074-5	Bracket (front seat back side shield upper support)	621A10-1
Bracket (back window upper stop)	42202-3	Bracket (front seat belt boot extension)	612B12
Bracket (body bolt)	11278	Bracket (front seat cushion side shield)	62256
Bracket (brake pedal support)	01530	Bracket (front seat head rest mounting)	610B10-1
Bracket (center body pillar to roof)	24574-5	Bracket (front seat head rest mounting rear)	611B12
Bracket (center body pillar upper hinge)	24450-1	Bracket (front seat horizontal regulator)	60436
Bracket (center floor pan to quarter wheelhouse)	113A70-1	Bracket (front seat mounting)	61918
Bracket (coat hook)	29019 , 292A32	Bracket (front seat track front)	619A94-8
Bracket (console panel mounting front)	045B32	Bracket (front seat track motor mounting)	617B48
Bracket (console panel mounting rear)	045B34	Bracket (front seat track mounting rear)	618B42
Bracket (console panel opening pad front)	045E30	Bracket (front wheelhouse dash support lower)	021A64
Bracket (console panel opening pad rear)	045E32	Bracket (fuel filler door hinge on body)	40586
Bracket (cowl top inner panel to instrument panel)	023A02	Bracket (instrument panel air control mounting)	01870
Bracket (cowl top panel to front fender apron)	02294-5	Bracket (instrument panel glove compt. door catch striker)	06158
Bracket (cowl top panel to pillar)	022A24-5	Bracket (instrument panel glove compt. door latch mounting)	06136
Bracket (cowl top vent grille)	02224-5	Bracket (instrument panel locator)	045F94
Bracket (dash panel to accelerator mounting)	016B84	Bracket (instrument panel lower flange reinforcement)	045D54-5
Bracket (dash panel to cowl top panel)	016B86	Bracket (instrument panel pad retaining upper)	045B66
Bracket (door trim panel reflector)	237A96	Bracket (instrument panel to cowl side)	04366-7
Bracket (floor pan to rear seat back strainer)	11456	Bracket (instrument panel vent air control lever mounting)	01816
Bracket (folding top lift solenoid)	50644-5	Bracket (liftgate latch)	404A56
Bracket (folding top main pivot)	53118-9	Bracket (liftgate latch release lever)	404A50
Bracket (folding top main pivot bracket extension to wheelhouse)	50660-1	Bracket (lower back finish panel)	403C10
Bracket (folding top main pivot support to wheelhouse outer)	501A28-31	Bracket (luggage compt. door)	44588-9
Bracket (folding top no. 2 bow)	514A30-1		
Bracket (folding top no. 3 bow)	53144-5		

### INDEX

PART NAME	GROUP NUMBER	PART NAME	GROUP NUMBER
<b>B - cont'd.</b>		<b>B - cont'd.</b>	
Bracket (luggage compt. door check)	42790-1	Bracket (rear door window rear guide adjusting lower)	23136
Bracket (luggage compt. door hinge mounting)	45036-7	Bracket (rear door window regulator drive arm)	270A42
Bracket (luggage compt. door hinge support)	42810-1	Bracket (rear door window regulator equalizer arm)	23230-1
Bracket (luggage compt. door hinge to floor pan)	427A24-5	Bracket (rear door window regulator equalizer arm)	27166
Bracket (luggage compt. door hinge to hinge support)	41966-7	Bracket (rear door window regulator motor)	270A02-3
Bracket (luggage compt. door hinge to wheelhouse)	42704-5, 42738-9, 42744-5	Bracket (rear door window regulator motor mounting)	23312-3
Bracket (luggage compt. door latch mounting)	432A48	Bracket (rear door window stop)	21760-1
Bracket (luggage compt. door latch striker)	43235, 43275	Bracket (rear door window stop upper)	21764
Bracket (luggage compt. door latch vacuum actuator mounting)	432A36	Bracket (rear floor pan)	112B36-7
Bracket (luggage compt. door lift on body)	427A48	Bracket (rear floor pan to rear cross member)	11344-5
Bracket (luggage compt. door lift on door)	41836	Bracket (rear seat back filler)	62424-5
Bracket (luggage compt. front access door prop on body)	45732	Bracket (rear seat back latch)	613B18-20
Bracket (package tray strainer to wheelhouse)	46608-9	Bracket (rear seat back spring hanger outer)	667A02-3
Bracket (quarter panel inside to floor pan)	278C72-3	Bracket (rear seat back stop to wheelhouse)	631A02-3
Bracket (quarter panel to wheelhouse brace)	291B74-5	Bracket (rear seat back support bumper)	613B76-7
Bracket (quarter regulator extension support)	303B07-8	Bracket (rear seat back support to side)	62444
Bracket (quarter trim panel)	311A24	Bracket (rear seat belt mounting)	612B00-1
Bracket (quarter trim panel lower)	310A84-5	Bracket (rear seat cushion torsion bar outer to floor)	606A42
Bracket (quarter trim panel retainer rear)	311A22-3	Bracket (rear seat frame front to floor)	617C88
Bracket (quarter trim panel support)	30308	Bracket (rear seat frame rear to floor)	617C90-1
Bracket (quarter trim panel to floor)	311A98	Bracket (rear seat support)	605A38
Bracket (quarter trim panel to wheelhouse)	31424-5	Bracket (rear seat support to floor)	62442-3
Bracket (quarter trim panel upper center)	311A78	Bracket (roof bow mounting)	508A16
Bracket (quarter trim panel upper retainer)	31284	Bracket (roof side outer front rail extension)	51262-3
Bracket (quarter window front guide lower)	298A36	Bracket (roof side outer rail)	513B56-7
Bracket (quarter window glass)	305A02-3	Bracket (roof side outer rear rail to rail extension)	513A84-5
Bracket (quarter window glass channel)	30550	Bracket (roof side rear trim)	519B96
Bracket (quarter window glass channel rear)	30510	Bracket (sliding roof motor mounting)	502L04
Bracket (quarter window glass run retainer)	30046	Bracket (spare wheel cover hold down at belt)	47250
Bracket (quarter window guide lower)	29778-9, 298A56	Bracket (spare wheel cover support front)	47178
Bracket (quarter window guide rear)	297A20	Bracket (spare wheel cover support rear)	47180
Bracket (quarter window guide roller mounting)	29854	Bracket (spare wheel mounting)	47076
Bracket (quarter window lower pivot)	30272-3	Bracket (spare wheel well lower panel)	47182
Bracket (quarter window lower stop)	29982	Bracket (tailgate counterbalance torsion bar center)	430A30
Bracket (quarter window panel to wheelhouse)	28054-5	Bracket (tailgate latch)	431A26, 431D76
Bracket (quarter window regulator drive arm)	30014-5	Bracket (tailgate latch)	431D76
Bracket (quarter window regulator equalizer arm)	23230-1, 303A06-7	Bracket (tailgate outside handle)	430A66
Bracket (quarter window stop)	21760-1, 29998	Bracket (upper back panel brace)	403C66-7
Bracket (quarter window stop upper rear)	21772	Bracket (upper back panel brace lower)	403D90-1
Bracket (rear door glass front)	263A52-3	Bracket (upper back panel brace to roof rail)	403E18-9
Bracket (rear door glass rear)	257A18-9	Bracket (visor arm)	04122-3
Bracket (rear door inside handle)	266A22	Bracket (visor clip mounting)	04131
Bracket (rear door pull handle)	26642	Bracket (windshield hold down)	03048
Bracket (rear door stationary window division bar lower)	263A24	Bracket & pivot (visor upper corner)	04090
Bracket (rear door trim panel upper)	23834	Bracket & screw kit (luggage compt. luggage carrier)	55078
Bracket (rear door window equalizer arm upper)	26348	Bracket & screw kit (roof luggage carrier)	55078
Bracket (rear door window glass channel)	26384	Bumper (aux. floor panel)	115A72-3
		Bumper (aux. seat back floor panel)	605A18
		Bumper (aux. seat back floor pivot arm)	61506
		Bumper (back window stop lower)	440A06
		Bumper (front door)	265A28
		Bumper (front door at belt)	23036-7

## INDEX

PART NAME	GROUP NUMBER	PART NAME	GROUP NUMBER
<b>B - cont'd.</b>		<b>B - cont'd.</b>	
Bumper (front door hinge)	23567	Bushing (front door latch bellcrank)	21932
Bumper (front door upper)	23030	Bushing (front door latch pawl)	21801
Bumper (front door vent window upper)	21774-5	Bushing (front door vent window upper pivot)	229A00
Bumper (front door window stop)	21762	Bushing (front door window glass bracket)	23258
Bumper (fuel filler door)	405A22	Bushing (front door window guide)	21496
Bumper (instrument panel glove compt. door)	06066 , 06162	Bushing (front door window regulator arm)	234A28
Bumper (instrument panel glove compt. door arm)	06115	Bushing (front seat adjusting)	618A67
Bumper (liftgate)	40452	Bushing (front seat adjusting trans.)	618C24-5 618A55
Bumper (luggage compt. door inside)	43634	Bushing (front seat back center arm rest pad)	654A28
Bumper (quarter window stop)	21762 , 29994	Bushing (front seat back latch)	62608
Bumper (rear corner pillar)	40426	Bushing (front seat back pivot shaft)	610B82
Bumper (rear door)	265A28	Bushing (front seat track link)	61781
Bumper (rear door at belt)	23036-7	Bushing (luggage compt. door latch mounting bolt)	53916
Bumper (rear door upper)	23030	Bushing (luggage compt. door torsion bar outer)	448A06
Bumper (rear door upper hinge)	268A98	Bushing (quarter window upper pivot)	29848
Bumper (rear door window stop)	21762 , 26066 , 29994	Bushing (rear door hinge)	22841
Bumper (rear seat back)	62430	Bushing (rear door window glass bracket)	23258
Bumper (rear seat back floor)	613A12	Bushing (rear door window guide)	21496
Bumper (rear seat back latch)	613B30-1	Bushing (rear door window regulator arm)	234A28
Bumper (rear seat back latch handle stop pin)	61339	Bushing (roof hold down clamp control)	54800
Bumper (rear seat back stop)	61082	Bushing (spare wheel cover hold down handle)	47112
Bumper (rear seat cushion panel)	60578	Bushing (tailgate counterbalance torsion bar lower)	407A32
Bumper (tailgate)	23030	Bushing (tailgate counterbalance torsion bar on body)	43074
Bumper (tailgate latch)	431B62-3	Bushing (tailgate hinge)	22841
Bumper (tailgate on pillar)	40224 , 439A00-1	Bushing (tailgate window guide)	21496
Bumper (tailgate support)	44482	Button (back window regulator)	44084
Bumper (tailgate upper hinge on gate)	43082	Button (front door access hole plug)	22285-6
Bumper (tailgate window stop)	29994	Button (rear door window stabilizer)	25754
Bushing (back window glass)	42138	Button (rear seat back latch release)	62432
Bushing (back window guide)	42126	Button & pin kit (front door outside handle)	22454-5
Bushing (folding top balance link)	54054	Button & pin kit (rear door outside handle)	22454-5 , 26602
Bushing (folding top balance link to base extension)	50614		
Bushing (folding top balance link to center side rail)	50636	<b>C</b>	
Bushing (folding top balance link to main pivot bracket)	50664	Cable (front seat adjusting front vertical actuating)	617B10-1
Bushing (folding top center rail)	50471	Cable (front seat adjusting horizontal actuating)	617B14-5
Bushing (folding top center side rail rear)	503A04	Cable (front seat adjusting rear vertical actuating)	617B12-3
Bushing (folding top hinge)	22841	Cable (front seat back adjusting actuator)	610A84
Bushing (folding top hydraulic lift)	50678	Cable (instrument panel glove compt. door check)	060A08
Bushing (folding top lower link)	507A74	Cable (tailgate check)	43052
Bushing (folding top lower power link)	50453	Cable & slide assy. (sliding roof)	502B20
Bushing (folding top main center link)	506A88	Cable assy. (game table)	280C40
Bushing (folding top main control center)	50486-7	Cap (center body pillar finish)	24452-3
Bushing (folding top main control rear)	50486-7	Cap (front seat back side shield moulding)	61482-3
Bushing (folding top main pivot bracket)	50473	Cap (luggage compt. carrier rail finish)	55182-3
Bushing (folding top no. 2 bow pivot)	506A84	Cap (quarter trim panel upper)	31490-1
Bushing (folding top rear side rail to power cylinder)	50412	Cap (roof luggage carrier rail finish)	55182-3
Bushing (folding top side front link)	506A78	Cap (roof luggage carrier side rail end)	550A52-3
Bushing (folding top side rail hinge)	53072	Cap (roof side inner rear moulding)	517B26-7
Bushing (front door hinge)	22841	Cap (roof trim panel support)	52126
		Cap (sliding roof drive housing shaft)	502L52
		Carriage (rear door window roller front)	263A16
		Carriage (rear door window roller rear)	262A62
		Carrier (quarter window slide)	296A06-7

### INDEX

PART NAME	GROUP NUMBER	PART NAME	GROUP NUMBER
<b>C - cont'd.</b>		<b>C - cont'd.</b>	
Case (quarter window regulator cable lower)	303A98	Collar (fuel filler)	405A62
Catch (console panel glove compt. door latch)	060A96	Collar (quarter panel fuel filler)	405A98
Catch (console panel glove compt. door latch striker plate)	06064	Compartment (console panel glove)	06010
Catch (instrument panel glove compt. door latch striker plate)	06064	Compartment (instrument panel glove)	06010
Catch (rear seat back)	60575 , 613B28	Compartment (storage)	31500
Channel (back window glass)	422A08	Connector (cowl vent air duct)	01878
Channel (quarter window glass)	29900-1	Connector (vacuum door latch hose)	22035
Channel (quarter window lower)	29958-9	Connector (vent air register damper motor hose)	019A86
Channel (quarter window upper)	29962-3	Console (roof)	519A58
Channel (rear door window glass lower)	26228-9	Console panel	045B55
Channel & retainer assy. (front door glass)	21458-9	Control (instrument panel vent air outlet duct)	01890-1
Check (console panel glove compt. door hinge)	06222	Control (tailgate latch remote)	43170
Clamp (back window housing drain tube)	423B12	Control (vent air register damper)	02006
Clamp (folding top hold down front)	50508	Control & link assy. (front door latch remote)	21818-9 , 26404-5
Clamp (folding top hold down side)	50500-1	Control & link assy. (rear door latch remote)	21818-9 , 26404-5
Clamp (luggage compt. ski carrier hold down)	55008	Counterbalance (folding top)	506A98
Clamp (quarter window)	29846-7	Coupling (front seat adjuster trans. drive)	618A59
Clamp (roof ski carrier hold down)	55008	Coupling (package tray lift assy. to motor)	46593
Clamp (sliding roof drain hose)	502L63	Coupling (sliding roof motor to gear box)	502A20
Clip (back window glass)	422B34	Coupling (tailgate window regulator drive)	23440
Clip (back window outside lower moulding)	42309	Coupling assy. (front door vent window driveshaft)	23624
Clip (console panel upper moulding)	044B26	Cover (aux. seat back latch)	605A16-7
Clip (front door arm rest)	24146	Cover (back belt moulding joint)	403A22
Clip (front door vent window weatherstrip)	214A18	Cover (back window garnish moulding joint)	42458
Clip (front door weatherstrip retainer)	20479	Cover (back window garnish upper moulding joint)	42353
Clip (front door window front)	222A04	Cover (back window moulding joint)	424A04
Clip (front door window top)	222A44-5	Cover (back window outside center mounting joint)	42426
Clip (front door window top outer)	222B08	Cover (back window outside lower corner mounting joint)	42426
Clip (instrument panel ash receptacle)	048B52	Cover (back window outside moulding joint upper)	42450
Clip (instrument panel finish panel)	045A30-1	Cover (back window outside side moulding joint)	42460
Clip (instrument panel lower moulding)	044B26	Cover (body bolt)	001A86
Clip (instrument panel moulding)	04878	Cover (coat hook)	29024
Clip (instrument panel pad retainer)	04278	Cover (console panel clock opening)	04428
Clip (instrument panel pad retaining upper)	044B96	Cover (console panel front)	044D38
Clip (instrument panel pad retaining upper moulding)	04561	Cover (console panel moulding joint)	04796
Clip (luggage compt. carrier retainer)	46004	Cover (cowl top inner panel)	022A88
Clip (package tray trim panel front)	46705	Cover (cowl top panel moulding)	022A62
Clip (quarter arm rest)	24146	Cover (cowl top panel opening inner)	02085
Clip (quarter trim panel retainer)	31168	Cover (cowl vent air opening)	02109
Clip (quarter window moulding outer frame set)	42450	Cover (dash panel wiring)	017A99
Clip (rear door arm rest)	24146	Cover (front door ash receptacle)	238A02
Clip (rear door weatherstrip retainer)	20479	Cover (front door inside handle)	22642
Clip (rear door window top)	263A80	Cover (front door outside top moulding joint)	208A12
Clip (roof headlining retainer)	51026	Cover (front door pull handle)	22678
Clip (roof headlining side retaining strip)	51054	Cover (front door pull handle retainer)	22670
Clip (roof side rail weatherstrip support)	514B02	Cover (front door window rear stop)	234A30
Clip (roof ski carrier hold down clamp retaining)	55020	Cover (front door window regulator handle screw)	23362
Clip (spare wheel well cover panel front)	47154	Cover (front door wiring shield)	20798
Clip (spare wheel well cover panel rear)	47154	Cover (front floor pan wire)	112B88-9
Clip (spare wheel well cover panel upper)	47154	Cover (front floor panel wire front)	112A19
Clip (tailgate latch release lever knob retaining)	431B72	Cover (front seat adjusting vertical regulator)	618A20
Clip (visor arm)	04131-2	Cover (front seat adjusting horizontal actuator)	618A45
Collar (cowl panel vent air duct)	02880		

## INDEX

PART NAME	GROUP NUMBER	PART NAME	GROUP NUMBER
<b>C - cont'd.</b>		<b>C - cont'd.</b>	
Cover (front seat back hinge pin)	63174	Cover (sliding roof cable drive housing)	502L14
Cover (front seat back pivot side inner)	61692-3	Cover (sliding roof panel opening side reinforcement tab)	518A38
Cover (front seat back pivot side outer)	61694-5	Cover (spare wheel well)	47042
Cover (front seat back side shield)	66456-7	Cover (tailgate at belt)	40212-3
Cover (front seat belt anchor bolt boot)	61140	Cover (tailgate panel inside)	40704, 40726
Cover (front seat belt retractor boot)	61140	Cover (tailgate window regulator access hole)	40790
Cover (front seat retractor shoulder strap)	20235	Cover (trans. band adjusting access)	12128
Cover (front seat shoulder strap opening)	60230	Cover (windshield header flange)	03496
Cover (front seat shoulder strap reel)	20235	Cover (windshield outside top)	03152-3
Cover (instrument panel access hole)	044D82	Cover kit (console panel front)	044E34
Cover (instrument panel A/C opening)	04371	Cover set (cargo floor complete)	60925
Cover (instrument panel cigar lighter opening)	04648	Crank handle (sliding roof emergency)	502A50
Cover (instrument panel clock opening)	04428	Cup (front door inside handle)	22634-5
Cover (instrument panel glove compt. fuse panel opening)	06156	Cup (rear door inside handle)	22634-5
Cover (instrument panel heater control opening)	04371	Cup (sliding roof handle)	502A96
Cover (instrument panel power back lite control opening)	044F58	Cup assy. (rear door inside handle)	266A24-5
Cover (instrument panel radio opening)	04360, 04371	Cup & moulding assy. (front door inside handle)	226A34-5
Cover (instrument panel radio speaker opening)	04374	Cup & moulding assy. (rear door inside handle)	226A34-5
Cover (instrument panel rear window defogger control opening)	044F58	Cylinder (luggage compt. door lock with keys)	43279
Cover (instrument panel steering column opening)	04459	Cylinder (tailgate lock with keys)	431C50, 43279
Cover (instrument panel to floor brace)	044G00		
Cover (instrument panel utility shelf)	13598	<b>D</b>	
Cover (instrument panel vent air control register opening)	04514	Dampener (front door latch spring vibration)	219A37
Cover (liftgate hinge)	42946	Dampener (rear door latch spring vibration)	219A37
Cover (luggage compt. door access hole)	45792	Dampener (sliding roof motor mounting bracket vibration)	502L02
Cover (luggage compt. door hinge access hole)	427A88	Damper (cowl vent air valve)	01862-3
Cover (luggage compt. door lock key hole)	43514	Damper (front seat back latch vibration)	610B62
Cover (package tray defogger)	46884	Deadener (center floor pan front sound)	111B74
Cover (package tray vent)	466A04	Deadener (quarter panel to wheelhouse sound)	292B02
Cover (quarter ash receptacle)	238A02	Deflector (cowl side vent air)	01415
Cover (quarter panel name plate stud)	290B76	Deflector (instrument panel vent air outlet)	01968
Cover (quarter trim at luggage compt. door prop)	31226	Door (console panel ash receptacle)	04786
Cover (quarter wheelhouse opening)	27754	Door (console panel glove compt.)	06024
Cover (quarter window latch bracket retainer)	30584	Door (fuel filler opening)	405A26
Cover (quarter window lower pivot)	30246	Door (lower back panel fuel filler)	40628
Cover (quarter window regulator panel access hole)	27930-1	Door (luggage compt.)	40110
Cover (quarter window stop)	30068	Door (luggage compt. front access)	45728
Cover (rear door ash receptacle)	238A02	Door (storage compt.)	31560
Cover (rear door pull handle)	22678	Door assy. (front)	20124-5
Cover (rear door window front stop)	25775	Door assy. (rear)	24630-1
Cover (rear door window regulator handle screw)	23362	Door & plate assy. (console panel rear ash receptacle)	048A60
Cover (rear floor access hole)	111B24	Door & retainer assy. (console panel ash receptacle)	048A14
Cover (rear seat access hole)	606A54	Dowel (folding top no. 1 bow)	514A38
Cover (rear seat back latch bracket)	613B24	Drain (aux. floor)	112B48
Cover (rear seat back stop to wheelhouse)	631A05	Drive assy. (front door window regulator electric)	23394-5
Cover (roof drip moulding joint)	51762	Drive assy. (front seat track)	617C94-5
Cover (roof drip side finish moulding joint)	51828-9	Drive assy. (quarter window regulator electric)	23394-5, 30304-5
Cover (roof luggage carrier retainer)	550A68	Drive assy. (rear door window regulator electric)	23394-5
Cover (roof side inner moulding joint)	51744-5	Drive assy. (tailgate window regulator electric)	23394-5
Cover (shoulder strap reel)	60235	Duct (cowl vent air outlet)	01934-5
Cover (shoulder strap storage hook)	29024		

### INDEX

PART NAME	GROUP NUMBER	PART NAME	GROUP NUMBER
<b>E</b>		<b>E - cont'd.</b>	
Escutcheon (front door inside handle)	22620-1	Extension (quarter trim panel to package tray)	310A62-3
Escutcheon (front seat back latch)	62624-5	Extension (quarter wheelhouse front)	27950-1
Escutcheon (front seat back latch handle)	62680	Extension (quarter wheelhouse inner panel)	27926
Escutcheon (instrument panel glove compt. door lock)	06095	Extension (quarter wheelhouse inner panel rear)	279A51
Escutcheon (quarter window regulator handle)	303A20	Extension (quarter wheelhouse rear)	27896-7
Escutcheon (rear door inside handle)	303A20	Extension (quarter wheelhouse to roof outer pillar)	28230-1
Escutcheon (rear seat back latch handle)	613B26-7	Extension (quarter window guide)	30056-7
Extension (aux. floor side)	11772-3	Extension (quarter window regulator)	303A04
Extension (back belt side moulding)	41740-1	Extension (quarter window regulator panel)	30484-5
Extension (back window lower frame)	422A64-5	Extension (rear corner inner front lower pillar)	278C80-1
Extension (back window upper inner frame)	422A38-9	Extension (rear corner inner pillar rear)	410A37
Extension (brake pedal support)	015A36	Extension (rear floor cross sill to inner quarter panel)	10796-7
Extension (cowl side panel)	02062-3	Extension (rear floor pan rear corner)	11252-3
Extension (cowl top to front fender bracket)	023A18-9	Extension (rear floor pan side front)	112A48-9
Extension (dash panel to cowl side outer panel)	017A70-1	Extension (rear floor pan to quarter panel)	11239, 11250-1
Extension (floor pan side)	11142-3	Extension (rear floor rear cross member)	106A18-9
Extension (floor side inner member)	105A62-3	Extension (rear floor rear sill panel)	10838-9
Extension (floor side inner member front)	10066-7	Extension (rear roof outer rail to wheelhouse)	52562-3
Extension (floor side member rear)	105A68-9	Extension (rear side member to floor side member)	10784-5
Extension (floor side member to front side member front)	103A28-9	Extension (rear side member to floor side member upper)	104A34-5
Extension (floor side outer member)	10492-3	Extension (roof drip finish moulding)	517A10-1
Extension (folding rear seat back strainer finish panel)	62494	Extension (roof drip side moulding)	517A12
Extension (folding top main pivot bracket)	531A18-9	Extension (roof luggage carrier side rail)	55134-5
Extension (folding top main pivot bracket support)	531A16-7	Extension (roof luggage carrier side rail front)	550A56-7
Extension (folding top main pivot bracket to wheelhouse support)	53142-3	Extension (roof luggage carrier side rail rear)	55058-9
Extension (front body pillar reinforcement)	026A08-9	Extension (roof outer rear rail to wheelhouse)	513A44-5
Extension (front body upper inner pillar)	025A80-1	Extension (roof panel rear)	50847
Extension (front door vent window regulator shaft)	23442	Extension (roof side inner rear rail)	51220-1, 513A34-5
Extension (front floor pan rear)	112B42-3	Extension (roof side outer rear rail)	51206-7
Extension (front lower bracket to inner rear rail)	42246-7	Extension (roof side rear rail)	513A86-7
Extension (front side inner member upper)	100A01	Extension (spare wheel well side lower front)	47122
Extension (front side member)	10062-3	Extension (spare wheel well side lower rear)	47120
Extension (front side quarter member rear)	10644-5	Extension (tailgate lock cylinder)	431A66
Extension (lower back panel)	40544	Extension assy. (quarter panel upper rear)	27702-3
Extension (luggage compt. door latch)	43283	Extension assy. (rear seat back floor panel)	613A82
Extension (package tray to quarter panel)	46534-5	Extension assy. (seat belt)	611C22
Extension (package tray to roof)	46820-1		
Extension (quarter belt rail)	28786-7	<b>F</b>	
Extension (quarter latch pillar reinforcement to wheelhouse)	28290-1	Fastener (body outside finish panel)	290B32
Extension (quarter panel)	28072-3	Fastener (front door inner panel bottom drain seal)	20807
Extension (quarter panel inside front)	27998-9	Fastener (rear door inner panel bottom drain seal)	20807
Extension (quarter panel inside rear)	278C82-3	Fastener (roof luggage carrier support)	55180
Extension (quarter panel inside to floor pan)	28750-1	Fastener (roof side rail weatherstrip)	20807
Extension (quarter panel lower rear)	279C90-1, 28058-9	Filler (aux. floor to quarter wheelhouse inner)	111A82-3
Extension (quarter panel outer rear)	28518-9	Filler (center floor pan corner)	112B72-3
Extension (quarter panel rear)	28010-1	Filler (console panel front)	044F98
Extension (quarter panel upper rear)	28072-3	Filler (floor side outer member front end)	10170-1
Extension (quarter panel window regulator)	303A06	Filler (front body pillar to cowl side lower)	025A90-1
Extension (quarter trim panel)	311A96-7	Filler (front body pillar to front fender center)	025A42-3
		Filler (front body to front fender lower)	02670-1

## INDEX

PART NAME	GROUP NUMBER	PART NAME	GROUP NUMBER
<b>F - cont'd.</b>		<b>G - cont'd.</b>	
Filler (front seat lower corner)	611A42-3	Gear (front seat adjusting horizontal)	618A42-3
Filler (instrument panel cluster finish panel)	045F58	Gear (front seat adjusting regulator)	617A15
Filler (instrument panel end)	04500-1	Gear (front seat vertical regulator)	60406-7
Filler (instrument panel pad at speaker)	045D38	Gear (sliding roof drive pinion)	502L87
Filler (quarter latch pillar to reinforcement)	28438-9	Gear assy. (front seat horizontal regulator)	60471-2
Filler (quarter panel lower rear)	28034-5	Gear assy. (front seat vertical regulator)	60465-6
Filler (quarter panel outer rear extension)	279C80-1	Gear box & drive assy. (sliding roof)	502C19
Filler (quarter panel upper front)	28060-1	Gear kit (front door window regulator drive)	234A24
Filler (quarter trim panel to quarter regulator panel rear)	31210-1	Gear kit (quarter window regulator drive)	234A24
Filler (quarter wheelhouse outer)	278B50-1	Gear kit (rear door window regulator drive)	234A24
Filler (quarter window opening front corner lower)	29436-7	Gear kit (tailgate window regulator drive)	234A24
Filler (quarter window opening rear corner)	29458-9	Glass (back window)	42006
Filler (rear door upper extension trim panel)	274A48-9	Glass (front door vent window)	21412-3
Filler (rear floor pan)	11103	Glass (front door window)	21410-1
Filler (rear floor to quarter panel)	11228-9	Glass (quarter window)	29710-1
Filler (spare wheel well side lower)	47276	Glass (quarter window rear stationary)	29726, 29736, 29740-1
Filler (tailgate at belt)	43896-7	Glass (rear door window)	25712-3
Filler (tailgate outer to inner panel)	407A40-1	Glass (rear door window stationary)	26870-1
Filler (upper back panel to upper outer panel)	40328-9	Glass (windshield)	03100
Filler (windshield frame weatherstrip)	03082	Glass & channel assy. (back window)	42030
Frame (back window lower)	42232	Glass & channel assy. (front door window)	21400-1
Frame (back window lower side)	41974-5	Glass, channel & frame assy. (rear door window)	25700-1
Frame (back window side)	42248-9	Grille (cowl top vent)	02228
Frame (back window upper)	42220	Grille (quarter panel scoop)	290C60-1
Frame (front door glass)	22220-1	Grille (upper back panel vent air)	403C28
Frame (front door vent window less handle & glass)	21608-9	Grille assy. (front door vent air inner)	202A24
Frame (quarter window)	30218-9, 30504-5,	Grille assy. (quarter pillar vent air)	280B62-3
Frame (rear seat)	613A10	Grommet (dash panel overdrive cable)	01694
Frame (rear seat back upper)	613A04	Grommet (folding top lift hydraulic pump mounting)	50763
Frame (sliding roof headlining less headlining)	502A42	Grommet (front door latch knob)	21999
Frame (windshield)	03014	Grommet (front seat shoulder strap pin)	60116
Frame & division bar assy. (front door vent window)	22204-5	Grommet (instrument panel glove compt. door check arm)	06122
Frame set (quarter window inner)	29962-3	Grommet (quarter window guide)	297A22
Frame set (quarter window outer)	29958-9	Grommet (rear door latch knob)	21999
<b>G</b>		Grommet (rear floor pan opening)	111A88
Game and table kit	279B76	Grommet (tailgate latch knob)	431A34
Game kit	280C36	Grommet (vacuum door latch control)	22192
Game table	279B04	Grommet (vacuum door latch hose)	22194
Gasket (cowl vent air duct drain)	018B32	Guide (back window glass)	41960-1
Gasket (cowl vent air inlet duct to cowl top inner panel)	01999	Guide (front door window front)	223A00-1
Gasket (cowl vent air register)	01408	Guide (front door window latch side)	222A56-7
Gasket (cowl vent duct)	018B24	Guide (front door window lower)	222A92
Gasket (quarter wheelhouse opening cover)	27766	Guide (front door window upper)	22362
Gasket (quarter window regulator drive)	422B22	Guide (quarter window)	29764-5
Gasket (rear spoiler support)	44228-9	Guide (quarter window actuator)	303A30-1
Gasket (tailgate window regulator drive)	422B22	Guide (quarter window front)	29752-3
Gasket kit (folding top motor & reservoir)	50745	Guide (quarter window latch side)	222A56-7
Gear (front door vent window regulator drive)	23626-7	Guide (rear door window front)	26216-7
Gear (front seat adjuster trans.)	617B80	Guide (rear door window latch side)	222A56-7
Gear (front seat adjuster vertical)	618A78-9	Guide (rear door window lower)	222A92
		Guide (rear door window rear)	26222-3
		Guide (rear door window upper)	22362
		Guide (sliding roof cable)	502L16-7



### INDEX

PART NAME	GROUP NUMBER	PART NAME	GROUP NUMBER
<b>G - cont'd.</b>		<b>H - cont'd.</b>	
Guide (sliding roof front)	502L08-9	Hinge (liftgate)	42900-1
Guide (sliding roof lower front)	502L30	Hinge (luggage compt. door)	42700-1
Gusset (cowl side to front pillar lower)	02426-7	Hinge (luggage compt. front access door)	45702
Gusset (dash panel lower reinforcement to front side member)	017A24-5	Hinge (quarter window inner)	302A14
Gusset (floor side member to front side member)	10194-5	Hinge (rear seat back center arm rest flap upper)	67277
Gusset (floor side member to rear side member)	10196-7	Hinge (rear seat back floor extension)	60675
Gusset (floor side member to wheelhouse)	103A18-23	Hinge (rear seat back floor panel)	60615-6
Gusset (front cross member to side member)	10948-9	Hinge (rear seat back floor support anchor)	607A86
Gusset (front side member front)	100A14-5	Hinge (storage compt. door)	31518
Gusset (lower back panel side)	403C08-9	Hinge (storage compt. door front)	11640-1
		Hinge (storage compt. door rear)	116A00-1
		Hinge (tailgate)	43000-1
		Hinge (tailgate lower)	43056
		Hinge (tailgate lower on body)	430B06
		Hinge (tailgate lower on gate)	430B08
		Hinge (tailgate upper on body)	43086
		Hinge (tailgate upper on gate)	43090
		Hinge (upper back finish panel)	40582-3
		Hinge assy. (front door upper)	22800-1
		Hinge assy. (rear door upper)	26800-1
		Hinge & check assy. (front door lower)	22810-1
		Hinge & check assy. (rear door lower)	26802-3
		Hold down assy. (load restrainer)	64384
		Hook (coat)	29024-5
		Hook (front seat track release cable)	619A02
		Hook (seat belt to floor)	61280
		Hose (folding top hydraulic lift)	53456
		Hose (folding top hydraulic lift lower)	53390-2
		Hose (folding top hydraulic lift upper)	53390-2
		Hose (instrument panel vent air register damper motor)	019A88
		Hose (luggage compt. door latch vacuum control)	43240
		Hose (luggage compt. door vacuum latch)	406A06-8
		Hose (sliding roof frame drain front)	502C52-3
		Hose (sliding roof frame drain rear)	502C52-3
		Hose (tailgate vacuum latch)	406A06-8
		Hose (vacuum door latch)	21927
		Housing (back window regulator handle manual)	44044
		Housing (front door arm rest window regulator switch plate)	24038-9
		Housing (front door ash receptacle)	238A06-7
		Housing (front seat adjuster trans. pinion)	618C36
		Housing (front seat horizontal regulator gear)	603A46-7
		Housing (front seat vertical regulator gear)	603A48-9
		Housing (fuel filler pipe outer)	40354
		Housing (fuel filler pipe)	27936
		Housing (fuel filler pipe center)	405B12
		Housing (fuel filler pipe inner)	11310
		Housing (quarter window at rear roof)	525A12-3
		Housing (quarter window at rear roof rail)	52564-5
		Housing (quarter window regulator)	303A46-7
		Housing (rear door ash receptacle)	27470-1
		Housing (sliding roof cable drive)	502L10
		Housing (sliding roof panel)	502C22
		Housing (tailgate outside latch release handle)	431E76
		Housing (vacuum door latch control)	219A61
<b>H</b>			
Handle (back window regulator)	44009		
Handle (console panel ash receptacle)	04830		
Handle (console panel glove compt. door)	061A44		
Handle (front door inside)	22600-1		
Handle (front door vent window)	22916-7		
Handle (front door window regulator)	23342 , 30322		
Handle (front seat back adjusting)	61198		
Handle (front seat back latch)	62622		
Handle (front seat track adjusting)	61753		
Handle (instrument panel ash receptacle)	04830		
Handle (liftgate)	43400		
Handle (luggage compt. vacuum door latch release control valve)	43385		
Handle (quarter window)	30252		
Handle (quarter window regulator)	23342 , 30322		
Handle (rear door inside)	22600-1		
Handle (rear door inside assist)	24648		
Handle (rear door outside)	26604-5		
Handle (rear door window regulator)	23342 , 30322		
Handle (rear seat back latch)	62418-9		
Handle (sliding roof emergency crank)	502A50		
Handle (spare wheel cover hold down)	45849		
Handle (tailgate latch)	431B82		
Handle (tailgate latch release)	431C62		
Handle (tailgate regulator)	44009		
Handle assy. (front door outside)	22404-5		
Handle assy. (rear door outside)	22404-5		
Handle & housing assy. (tailgate outside latch release)	430A70		
Handle & knob assy. (back window regulator manual)	44008		
Header (folding top)	53038		
Hinge (aux. floor front panel)	11770		
Hinge (aux. seat back floor)	60928		
Hinge (back window louver)	44272-3		
Hinge (console panel arm rest)	04604		
Hinge (console panel glove compt. door)	06050		
Hinge (front door vent window upper pivot)	21490-1		
Hinge (instrument panel glove compt. door)	06050		

## INDEX

PART NAME	GROUP NUMBER	PART NAME	GROUP NUMBER
<b>I</b>		<b>L - cont'd.</b>	
Insert (back window louver latch)	44288	Latch (storage compt. door)	11598 , 31700
Insert (console finish panel center)	04722	Latch (tailgate)	43150-1
Insert (front door inside handle)	22644	Latch (tailgate lower)	431D88
Insert (front door latch striker plate)	22040	Latch (tailgate on body)	431B54
Insert (quarter panel outside lower ornament)	290C38-9	Latch assy. (aux. seat back floor)	61142-3
Insert (quarter panel outside ornament)	291C80-3	Latch assy. (front door)	21812-3
Insert (quarter panel outside upper ornament)	290C60-1	Latch assy. (front seat back)	62648-9
Insert (rear door inside handle)	22644	Latch assy. (rear door)	26412-3
Insert (rear door latch striker plate)	22040	Latch assy. (rear seat back release)	61382-3
Insert (roof side rail weatherstrip)	51266	Latch kit (back window louver)	442A08
Insert (sliding roof guide rail)	502L31	Latch kit (luggage compt. door remote control)	432A00
Insulation (front door latch actuator)	21938-9	Latch kit (rear door safety)	21850
Insulator (dash panel)	01670-1	Latch kit (storage compt. door)	47026
Insulator (front seat belt anchor bolt)	612A12	Latch or lever (folding top hold down clamp)	50536-7
<b>K</b>		Letter (console)	044F42
Key (front door & ignition lock blank)	22053	Letter (lower back panel)	40282
Key (glove compt. door cylinder lock blank)	43562	Letter (luggage compt. door)	40282
Key (luggage compt. door cylinder lock blank)	43562	Letter (quarter panel outside)	29210-1
		Letter (tailgate)	40282
KIT - refer to appropriate noun name For example:		Lever (front door latch actuating rod)	22384-5
Gear kit (quarter window regulator drive)	234A24	Lever (front door latch operating)	21970
		Lever (front seat back latch)	62720
		Lever (front seat back pivot shaft)	610B70, 610B90
		Lever (liftgate latch release)	43119
Knob (front door latch control rod)	21850	Lever (luggage compt. door latch operating)	43358
Knob (front door vent window regulator handle)	23352	Lever (rear door latch actuating rod)	22384-5
Knob (front door window regulator handle)	23352	Lever (tailgate latch release)	431A75
Knob (instrument panel glove compt. door)	06164	Lever (tailgate lock cylinder)	431F60
Knob (quarter window regulator handle)	23352	Lid assy. (fuel filler opening)	405A26
Knob (rear door latch control rod)	21850	Lift (folding top)	50600-1
Knob (rear door window regulator handle)	23352	Lift (luggage compt. door hydraulic)	406A10
Knob (sliding roof panel handle)	518A06	Lift (luggage compt. door less bracket)	40654-5
Knob (tailgate latch control rod)	431A36	Liftgate	40010
Knob (tailgate latch release lever)	431A76	Link (folding top balance)	50454-5
Knob (windshield hold down)	03848	Link (folding top control)	50316-7
Knob (windshield latch)	03818	Link (folding top no. 4 bow control)	507A66-7
Knob & insert assy. (instrument panel ash receptacle)	048B38	Link (folding top power)	50352
		Link (folding top power upper)	506A52
		Link (folding top side front)	506A90-1
		Link (front door latch control rod lever)	219A84 , 22164-5
<b>L</b>		Link (front door latch remote control)	21940-1
Label (front door scuff plate)	10130	Link (front seat track front)	62520-1
Label (shoulder strap instructions)	60234	Link (front seat track rear)	62512-3
Latch (aux. floor panel rear)	116A14	Link (luggage compt. door latch actuating)	43226
Latch (back window louver)	44274	Link (rear door latch control rod)	26420-1
Latch (console panel glove compt. door)	061A34	Link (rear door latch remote control)	26442-3
Latch (console panel glove compt. door non-locking)	06072	Link (tailgate latch release)	431A50-1 , 431A78-9
Latch (folding top hold down clamp)	506A48	Link (tailgate upper hinge release)	431E58
Latch (front seat)	619A86	Link (tailgate upper latch release)	431B74
Latch (instrument panel glove compt. door non-locking)	06072	Link (tailgate upper latch to lower latch actuator)	431A24
Latch (luggage compt. door)	43200	Link assy. (front seat back latch)	62650-1
Latch (luggage compt. front access door)	45704	Link & support assy. (front seat back center arm rest)	65406
Latch (quarter window)	303A24		
Latch (spare wheel cover hold down)	45848		
Latch (spare wheel well cover)	47256		

## INDEX

PART NAME	GROUP NUMBER	PART NAME	GROUP NUMBER
<b>L - cont'd.</b>		<b>M - cont'd.</b>	
Link & vertical strainer assy. (rear seat back center arm rest)	67210	Moulding (back window garnish side)	42416-7
Lock cylinder & keys (front door)	21984-5	Moulding (back window garnish upper)	42410
Lock cylinder & keys (front door & ignition lock)	22050	Moulding (back window outside lower)	42404-5
Lock cylinder & keys (glove compt. door)	06081	Moulding (back window outside side)	42492-3
Lock cylinder & keys (luggage compt.)	43505	Moulding (back window outside top)	42430-1
Lock cylinder & keys (storage compt.)	115A32	Moulding (back window outside upper)	423A00-1
Lock set	22050	Moulding (back window outside upper corner)	42376-7 , 42452-3
Lock set (glove compt. & luggage compt.)	43507	Moulding (back window outside upper outer)	424A90-1
Lock set (glove compt. & tailgate)	43507	Moulding (body rocker panel)	101A04-5 , 10176-7
Lock set (luggage compt. & glove compt.)	43507	Moulding (center body pillar outside upper)	24458-9
Lock set (tailgate & glove compt.)	43507	Moulding (console panel front)	045B24-5
Loop (front seat belt retaining)	61222	Moulding (console panel lower edge)	04578-9
Loop (tie down)	60213	Moulding (console panel rear)	04736
Louver (back window)	44270	Moulding (console panel rear lower edge)	044E12-3
Louver (instrument panel vent air regulator)	018B08	Moulding (console panel side)	045C26-7
Louver kit (back window)	44268	Moulding (console panel side rear)	045B70-1
Luggage carrier (luggage compt.)	55100	Moulding (console panel upper)	045A20-1
Luggage carrier (roof)	55100	Moulding (cowl side trim panel)	020A46-7
		Moulding (cowl top panel)	022A64-5
		Moulding (cowl top panel end)	02396-7
		Moulding (front body pillar drip finish)	02512-3 , 026A16-7
		Moulding (front body pillar outside belt)	026A24-5
		Moulding (front body pillar upper)	025A84-5
		Moulding (front door outside)	20938-9
		Moulding (front door outside at belt)	20934-5
		Moulding (front door outside front)	20916-7
		Moulding (front door outside lower)	20878-9
		Moulding (front door outside rear edge)	20940-1 , 21000-1
		Moulding (front door outside upper)	20932-3
		Moulding (front door outside upper rear)	20944-5
		Moulding (front door trim panel)	20942-3 , 21110-1
		Moulding (front door trim panel center)	20970-1
		Moulding (front door trim panel center lower)	21004
		Moulding (front door trim panel front)	20968-9
		Moulding (front door trim panel lower)	20956-7 , 25578-9
		Moulding (front door trim panel lower edge)	23886
		Moulding (front door trim panel lower rear)	21222-3
		Moulding (front door trim panel rear)	20920-1
		Moulding (front door trim panel upper)	20914-5
		Moulding (front door trim panel upper center front)	208A48
		Moulding (front door window frame rear)	20982-3
		Moulding (front door window frame top)	20492-3 , 20846-7
		Moulding (front door window garnish)	20904-5
		Moulding (front door window garnish finish)	20986
		Moulding (front pillar drip)	025A20-1
		Moulding (front seat back)	65206
		Moulding (front seat back center arm rest)	644A36
		Moulding (front seat back side shield)	61402-3 , 61424-5
		Moulding (front seat back side shield top)	61404-5
<b>M</b>			
Member (aux. floor cross at cab)	10920-1		
Member (aux. floor cross front)	11361		
Member (floor side inner)	10116-7		
Member (floor side outer)	10120-1		
Member (floor side rear)	10124-5		
Member (front floor cross)	10852		
Member (front floor cross lower)	10812-3		
Member (front floor cross no. 1)	10692-3 , 10776		
Member (front floor cross no. 1A)	107A62-3		
Member (front floor cross no. 2)	10728		
Member (front floor cross no. 2 outer)	10662-3		
Member (front floor cross upper)	10672-3		
Member (front seat back front side lower)	612A22-3		
Member (front side)	10462-3		
Member (front side inner)	10008-9		
Member (front side outer)	10218-9		
Member (front suspension no. 1 cross)	10018		
Member (front suspension no. 2 cross)	10010		
Member (luggage compt. front access door hinge mounting)	45782		
Member (rear floor cross front)	10786		
Member (rear floor cross rear)	10780		
Member (roof luggage carrier front)	55109		
Member (roof luggage carrier rear)	55109		
Motor & bracket assy. (cowl vent air register damper)	019A84		
Motor & cover assy. (front door vent window regulator gear electric)	23406-7		
Motor & drive (tailgate window regulator)	40964		
Motor & plate assy. (folding top hydraulic lift pump)	53357		
Motor & plate kit (folding top hydraulic lift)	533A00		
Moulding (back belt outside center)	423A20-1		
Moulding (back belt outside side)	423A18-9		
Moulding (back window garnish lower)	42456-7		

## INDEX

PART NAME	GROUP NUMBER	PART NAME	GROUP NUMBER
<b>M - cont'd.</b>		<b>M - cont'd.</b>	
Moulding (front seat cushion side shield)	61400-1 , 61410-1	Moulding (quarter window garnish upper)	29008-9
Moulding (fuel filler door)	29140-1 , 405A48	Moulding (quarter window garnish upper front)	29014-5
Moulding (instrument panel center)	04472-3	Moulding (quarter window outside front)	290A66-7, 29622
Moulding (instrument panel lower)	04388-9	Moulding (quarter window outside lower)	291C02-3
Moulding (instrument panel lower end)	04718-9	Moulding (quarter window outside lower rear corner)	290D54
Moulding (instrument panel lower finish panel outer)	044C10	Moulding (quarter window outside rear)	290E52-3, 29396-7, 29536-7
Moulding (instrument panel pad)	04460	Moulding (quarter window outside upper)	290A60-1, 29796-7
Moulding (instrument panel pad retaining lower)	044A36-7	Moulding (rear corner pillar outside)	40720-1
Moulding (instrument panel pad retainer upper)	04522-3	Moulding (rear corner pillar venturi panel)	412A08-9
Moulding (instrument panel upper pad retaining)	04296-7	Moulding (rear corner pillar venturi panel lower)	412A24-5
Moulding (lower back panel extension)	403A96-7	Moulding (rear door outside)	25532-3
Moulding (lower back panel)	423A58	Moulding (rear door outside belt)	25554-5
Moulding (lower back panel center)	423A14	Moulding (rear door outside belt rear)	254A92-3
Moulding (lower back panel lower)	423A84	Moulding (rear door outside front)	25440-1
Moulding (lower back panel upper)	423A82	Moulding (rear door outside lower)	25556-7
Moulding (luggage compt. door)	40104 , 42512-3	Moulding (rear door outside rear edge)	255A00-1, 25510-1
Moulding (luggage compt. door upper)	42510	Moulding (rear door outside upper)	25540-1
Moulding (luggage compt. front access door trim)	45770	Moulding (rear door outside upper rear)	26090-1
Moulding (package tray finish end)	465A04-5	Moulding (rear door trim panel center)	25502-3
Moulding (package tray finish intermediate)	465A00-1	Moulding (rear door trim panel center upper)	254A84-5
Moulding (package tray on body side)	46530-1	Moulding (rear door trim panel lower)	25578-9
Moulding (quarter arm rest)	31796-7	Moulding (rear door trim panel rear)	25546-7
Moulding (quarter belt inside)	29250-1	Moulding (rear door trim panel rear outer)	255A14-5
Moulding (quarter latch pillar finish)	291A58-9	Moulding (rear door trim panel upper front)	25504-5
Moulding (quarter outside)	29038-9	Moulding (rear door window frame front)	254A12-3
Moulding (quarter outside belt center)	290A88-9	Moulding (rear door window frame rear)	20982-3, 25522-3
Moulding (quarter outside lower)	291E20-1	Moulding (rear door window frame top)	25542-3
Moulding (quarter outside lower front)	29076-7	Moulding (rear floor pan side)	111A08-9
Moulding (quarter outside lower rear)	29066-7	Moulding (rear floor pan side rear)	112B04
Moulding (quarter outside ornament)	290D14-5	Moulding (rear quarter window garnish upper)	290A14-5
Moulding (quarter outside rear belt)	29138-9	Moulding (rear seat back outer)	61144-5
Moulding (quarter outside to lower back panel)	29098-9	Moulding (rear seat back top)	61138
Moulding (quarter outside upper)	29076-7	Moulding (rear seat back upper)	61040-1
Moulding (quarter panel & pillar)	291C96-7	Moulding (roof drip finish front)	51718-9
Moulding (quarter panel extension)	29078-9	Moulding (roof drip rear)	51704
Moulding (quarter panel lower rear edge)	290E10-1	Moulding (roof drip rear finish)	51834-5
Moulding (quarter panel outside belt)	29034-5	Moulding (roof drip side finish)	51728-9
Moulding (quarter panel outside rear end)	291A50-1	Moulding (roof drip side finish front)	51726-7
Moulding (quarter panel outside rear end lower)	291C84-5	Moulding (roof drip side finish rear)	51726-7
Moulding (quarter panel outside upper)	29140-1	Moulding (roof outside center rear)	517B58-9
Moulding (quarter panel outside upper rear end)	291A24-5	Moulding (roof outside rear)	517A36-7
Moulding (quarter panel rear extension)	29312-3	Moulding (roof outside rear center)	50044
Moulding (quarter trim panel)	31140-1	Moulding (roof outside rear side)	517A02-3
Moulding (quarter trim panel belt)	31322-3	Moulding (roof outside side center)	517B56-7
Moulding (quarter trim panel lower)	31214-5	Moulding (roof outside side rear)	517A62-3
Moulding (quarter wheel opening)	29164-5	Moulding (roof side)	51628-9
Moulding (quarter wheel opening cover)	29050-1	Moulding (roof side inner front)	51752-3
Moulding (quarter wheelhouse trim panel front)	290E40-1	Moulding (roof side inner rear)	51754-5
Moulding (quarter wheelhouse trim panel rear)	290E40-1	Moulding (roof side outside upper)	29140-1
Moulding (quarter window frame)	292A08-9	Moulding (tailgate outside)	41018
Moulding (quarter window garnish finish)	29086-7		
Moulding (quarter window garnish lower)	29002-3		
Moulding (quarter window garnish rear)	291A84-5		

### INDEX

PART NAME	GROUP NUMBER	PART NAME	GROUP NUMBER
<b>M - cont'd.</b>		<b>O - cont'd.</b>	
Moulding (tailgate outside belt)	403A70	Ornament (roof side outside)	517A18, 517A20-1, 517A56-7
Moulding (upper back panel vent air)	423B14-5	Ornament (seat belt buckle)	611C02
Moulding (windshield garnish lower)	03626	Ornament (tailgate)	43500-4
Moulding (windshield garnish lower corner)	03662-3	Ornament (tailgate lock cylinder hole)	43830
Moulding (windshield garnish side)	03512-3, 03598-9	Ornament (tailgate lower)	517A58
Moulding (windshield garnish upper)	03606-7	Ornament (tailgate outside)	517A20-1
Moulding (windshield header inside)	03542		
Moulding (windshield outside belt)	03148-9	<b>P</b>	
Moulding (windshield outside side)	03136-7	Pad (aux. seat cushion)	66856
Moulding (windshield outside top)	03144-5	Pad (back window louver hinge)	44280
Moulding (windshield outside upper corner)	03220-1	Pad (back window regulator handle manual)	44011
Moulding assy. (quarter trim panel front)	290A42-3	Pad (back window regulator handle power)	44011
Moulding kit (body side)	21048	Pad (body side rail end support)	32242
Moulding kit (front door outside rear edge)	20910	Pad (console panel)	04620
Moulding kit (rear door outside rear edge)	20910	Pad (front door outside handle large)	22428-9
		Pad (front door outside handle small)	22448-9
<b>N</b>		Pad (front seat back)	64810-1
Nozzle (back window housing drain)	42312	Pad (front seat back head rest)	610A60
Numeral (front fender)	291B30-1	Pad (front seat cushion)	632A22
Numeral (quarter panel)	291B30-1	Pad (front seat back center arm rest)	65478-9
Numeral (tailgate)	291B30-1	Pad (front seat back side shield)	66488
Nut (back belt moulding retaining)	423A66	Pad (luggage compt. door hinge on body)	42840-1
Nut (folding top balance link)	506A94	Pad (luggage compt. door hinge on door)	42842-3
Nut (instrument panel air control mounting)	018A10	Pad (luggage compt. door lock cylinder sleeve)	43625
Nut (luggage compt. door latch)	53510	Pad (rear door inside assist handle)	24650
Nut (luggage compt. vacuum door latch release control)	43387	Pad (rear door outside handle large)	22428-9
Nut (roof luggage carrier lock)	55026	Pad (rear door outside handle small)	22448-9
Nut (sliding roof panel front adjusting)	502B66	Pad (rear seat back center arm rest)	67273
Nut (sliding roof panel rear guide adjusting)	518A16	Pad (rear seat back center arm rest filler)	668A14
Nut (vacuum door latch control mounting)	22158	Pad (roof air deflector panel support)	50870
Nut & housing assy. (luggage compt. door latch)	40610	Pad (roof luggage carrier slat)	55147
		Pad (roof luggage carrier support)	55170-7
<b>O</b>		Pad (roof luggage carrier support front)	55156-7
Ornament (console panel)	045D84	Pad (roof luggage carrier support rear)	55156-7
Ornament (front door trim panel)	20802-3	Pad (roof outside side front)	537A02, 53740
Ornament (front seat back)	64824	Pad (sliding roof console header)	519B66
Ornament (fuel filler door)	405A86	Pad (sliding roof front)	502L40
Ornament (lower back panel)	40316	Pad (sliding roof side rail)	519B94
Ornament (luggage compt. door)	43500-4	Pad (tailgate bumper)	404B40
Ornament (quarter panel)	291A52-3	Pad (tailgate handle)	43539
Ornament (quarter panel outside)	28032-3, 517A20-1	Pan (aux. floor)	11580
Ornament (quarter panel outside rear)	290A76-7	Pan (aux. floor rear)	114A24
Ornament (quarter trim panel)	20802-3	Pan (center floor)	11160
Ornament (rear corner pillar venturi panel)	412A22-3	Pan (front floor)	11135
Ornament (rear door trim panel)	20802-3	Pan (rear floor)	11215-9
Ornament (rear seat back)	64824	Pan (rear floor rear)	11360
Ornament (roof side)	43500-4	Pan (rear floor side rear)	112A22-3
Ornament (roof side center)	517A28-9	Panel (aux. floor)	11564, 11578
Ornament (roof side inner)	50266-7, 517A00-1	Panel (aux. floor center)	115A70
Ornament (roof side lower)	517A58	Panel (aux. floor front finish)	115A50
		Panel (aux. floor rear)	115A42

## INDEX

PART NAME	GROUP NUMBER	PART NAME	GROUP NUMBER
<b>P - cont'd.</b>		<b>P - cont'd.</b>	
Panel (aux. floor side)	115A44-5	Panel (instrument panel finish end)	04334-5, 04392-3
Panel (aux. floor support side)	115A20-1	Panel (instrument panel finish end lower)	045C41
Panel (aux. seat back)	607A26	Panel (instrument panel finish intermediate)	044B56-7
Panel (aux. seat back floor front)	60940	Panel (instrument panel finish lower)	044A10-1
Panel (aux. seat back floor rear)	60942	Panel (instrument panel finish lower outer)	044A85
Panel (back)	40300	Panel (instrument panel finish upper)	044A90
Panel (back center)	40262	Panel (instrument panel glove compt. door finish)	06036
Panel (back window lower frame trim)	424A68	Panel (instrument panel upper)	04634
Panel (body front)	00124	Panel (lower back)	40320, 40324
Panel (body front corner)	00350-1	Panel (lower back applique)	40584-5
Panel (body rear)	40304-5	Panel (lower back finish)	423A42
Panel (body rear corner)	280A58-9	Panel (lower back inside)	40492
Panel (body rocker)	10128-9	Panel (lower back panel to bumper)	403B26-7
Panel (body side inner)	27864-5	Panel (lower back side)	40380-1
Panel (body side outer)	278A98-9	Panel (luggage compt. door outside finish)	425A02-3
Panel (body side window opening)	278E26-7	Panel (package tray)	46506, 46510
Panel (center floor finish)	115A58	Panel (package tray end)	46514-5
Panel (console)	045A36-7	Panel (package tray lower)	46519
Panel (console glove compt. )	06021	Panel (package tray trim)	46668
Panel (console glove compt. door finish)	060A84	Panel (package tray trim end front)	46918-9
Panel (console panel arm rest finish)	04610	Panel (package tray upper)	46512
Panel (console panel center)	045A76		
Panel (console panel finish rear)	045B72	Panel (quarter)	27846-7
Panel (console panel front)	045A76	Panel (quarter arm rest finish)	316A02-3
Panel (console panel less instruments)	045B55	Panel (quarter arm rest finish lower)	31644
Panel (console panel radio access)	044C50-1	Panel (quarter inside center)	278C58-9
Panel (console panel side)	044C72-3	Panel (quarter inside front)	27790-1
Panel (console panel top)	044D90 , 045A12	Panel (quarter lower rear extension finish)	29158-9
Panel (cowl side)	02038-9	Panel (quarter outside finish)	290B12-3
Panel (cowl side outer)	02044-5	Panel (quarter outside finish front)	291E22-3
Panel (cowl top)	02010	Panel (quarter outside finish rear)	27866-7
Panel (cowl top inner)	02018	Panel (quarter panel inside front)	278A08-9
Panel (cowl top outer)	02012	Panel (quarter panel inside rear)	278A10-1
Panel (dash)	01605 , 01610-1	Panel (quarter panel inside to floor pan)	27858-9
		Panel (quarter trim panel finish)	310A02-3
Panel (front body pillar outside finish)	025A56-7	Panel (quarter wheel opening cover)	27974-5
Panel (front door arm rest finish)	24168-9	Panel (quarter wheelhouse inner)	27886-7
Panel (front door arm rest finish lower)	24058-9	Panel (quarter wheelhouse outer)	27894-5
Panel (front door opening)	202A60-1	Panel (quarter window regulator)	27870-1
Panel (front door opening inside front)	202A66-7	Panel (quarter window regulator housing inner)	280A10-1
Panel (front door opening inside rear)	206A62-3	Panel (quarter window regulator housing outer)	280A26-7
Panel (front door outer repair)	20200-1	Panel (rear corner inner finish upper)	40454-5
Panel (front door outside finish)	20206-7	Panel (rear corner outer)	41230-1
Panel (front door trim panel finish)	21216-7 , 237A22-3	Panel (rear corner pillar venturi front)	41096-7
Panel (front seat back rear trim)	61632	Panel (rear corner pillar venturi inner)	412A20-1
Panel (front seat head rest trim)	610B40	Panel (rear corner pillar venturi outer)	41090-1
Panel (front wheelhouse inner)	02048-9	Panel (rear door arm rest finish)	27542-3
Panel (front wheelhouse upper)	02046-7	Panel (rear door arm rest finish lower)	27594-5
Panel (fuel filler door applique)	405A50	Panel (rear door outer finish)	24730-1
Panel (instrument)	04320	Panel (rear door outer repair)	24700-1
Panel (instrument panel ash receptacle door trim)	04817	Panel (rear floor sill rear)	11318 , 11323
Panel (instrument panel center)	04774		
Panel (instrument panel cluster opening finish)	044D70-1	Panel (rear seat back center arm rest)	67248
Panel (instrument panel finish center)	04338	Panel (rear seat back spring support)	60700

### INDEX

PART NAME	GROUP NUMBER	PART NAME	GROUP NUMBER
<b>P - cont'd.</b>		<b>P - cont'd.</b>	
Panel (roof)	50202	Pin (folding top main pivot bracket to rear side rail)	506A96
Panel (roof air deflector)	50822, 50860	Pin (folding top no. 8 bow)	53008
Panel (roof side)	50284-5	Pin (folding top rear side rail)	503A10
Panel (roof side inner rear)	513C06-7, 51982-3	Pin (folding top side front link)	506A82
Panel (sliding roof)	502B98	Pin (folding top side rail hinge)	54052
Panel (spare wheel well)	47043	Pin (front door hinge)	22840, 43030
Panel (spare wheel well side inner)	47028	Pin (front seat back pivot)	611B24
Panel (spare wheel well side lower)	47030	Pin (front seat track)	61880
Panel (storage compt. door)	11698-9	Pin (luggage compt. door hinge spring guide)	427A06
Panel (tailgate inside belt finish)	425A20	Pin (luggage compt. hinge)	43030
Panel (tailgate inside cover)	40705	Pin (quarter window latch)	30330
Panel (tailgate outside)	40710	Pin (rear door hinge)	22840, 26832, 43030
Panel (tailgate outside finish)	42507	Pin (rear door upper hinge assist spring)	268A90
Panel (upper back)	40310, 40314	Pin (rear seat back floor panel)	613B02
Panel (upper back finish)	403A78	Pin (tailgate hinge)	22840, 43030
Panel (windshield header)	03408	Pin (visor anchor)	04114
Panel assy. (aux. seat back floor)	605A10-1	Pinion (front seat adjusting trans.)	618A54
Panel assy. (body side)	27700-1	Pivot (front door window regulator arm to glass channel)	23274
Panel assy. (body side upper)	278A92-3	Pivot (front door window regulator to inner panel)	23242
Panel assy. (front pillar)	02042-3	Pivot (front seat back)	618C04
Panel assy. (quarter)	27840-1	Pivot (front seat back adjuster actuator)	618C56
Panel assy. (rear seat back)	60508	Pivot (quarter window upper)	30264-5
Panel assy. (rear seat back floor)	61390	Pivot (rear door window regulator arm to glass channel)	23274
Panel & pillar assy. (cowl side front body)	02500-1	Pivot (rear door window regulator to inner panel)	23242
Panel & reinforcement assy. (cowl top)	02896	Pivot (tailgate lower hinge)	430A20
Partition (console panel glove compt.)	061A84	Pivot kit (tailgate upper hinge on body)	43096
Pawl (front seat back latch)	62606-7	Plate (aux. seat back floor pivot)	60780-1
Pillar (center body outer upper)	24316-7	Plate (back window regulator handle anchor manual)	44048
Pillar (front body lower)	02500-1	Plate (belt side rail to wheelhouse reinforcement mounting)	28702-3
Pillar (front body upper)	02504-5	Plate (body rear corner panel reinforcement)	28038-9
Pillar (front body upper inner)	02508-9, 02522-3	Plate (body side upper panel access hole cover)	278C74-5
Pillar (front body upper inner corner)	02622-3	Plate (console panel glove compt. door latch)	061A36
Pillar (front body upper outer)	02516-7, 02536-7	Plate (console panel finish insert)	044F44
Pillar (front body upper outer corner)	02616-7	Plate (console panel finish insert center)	044F24
Pillar (quarter latch upper outer)	28324-5	Plate (console panel gearshift lever opening cover)	045B78
Pillar (quarter wheelhouse to roof inner)	278A36-7	Plate (console panel glove compt. door latch catch anchor)	06150
Pillar (quarter wheelhouse to roof inner lower)	280A36-7	Plate (cowl top panel access hole cover)	02256-7
Pillar (quarter wheelhouse to roof inner upper)	28106-7	Plate (dash panel speedo. cable cover)	016B56
Pillar (quarter wheelhouse to roof outer)	278A38-9	Plate (floor outer member end)	103A94-5
Pillar (rear corner)	41038-9	Plate (floor pan seat track reinforcement)	113A28
Pillar (rear corner inner)	412A02-3	Plate (floor side member to floor)	104A36
Pillar (rear corner inner front center)	412A32-3	Plate (folding top hold down clamp latch front)	50530-1
Pillar (rear corner inner front lower)	41228-9	Plate (folding top no. 1 bow scuff)	50153
Pillar (rear corner inner front upper)	41210-1	Plate (front body pillar hinge anchor)	02638-9
Pillar assy. (center body)	24300-1	Plate (front body pillar hinge anchor upper)	02666-7
Pillar assy. (quarter latch)	28160-1	Plate (front body pillar lower hinge reinforcement)	02576-7
Pin (folding top balance link to center side rail)	506A76	Plate (front body pillar upper hinge reinforcement)	02570-1
Pin (folding top bracket no. 3 bow)	53150	Plate (front door arm rest)	24148-9
Pin (folding top center side rail front)	50492		
Pin (folding top hold down clamp control link)	503A02		
Pin (folding top hydraulic lift)	50698		

PART NAME

GROUP  
NUMBER

PART NAME

GROUP  
NUMBER

## INDEX

## P - cont'd.

Plate (front door inside handle)	23370
Plate (front door inside panel cover)	21122-3
Plate (front door latch striker)	22008
Plate (front door latch striker tapping)	22024
Plate (front door name)	04460
Plate (front door outside name)	04460, 20978
Plate (front door scuff)	13200-9
Plate (front door trim panel name)	20816
Plate (front door vent window handle division bar scuff)	22980
Plate (front door window glass run retainer)	214A26
Plate (front door window regulator handle)	23370
Plate (front door wire opening cover)	21202
Plate (front fender name)	25622-3
Plate (front floor lower cross member)	10962
Plate (front floor pan access hole cover)	111A74
Plate (front floor pan drain hole cover)	11117
Plate (front seat adjusting regulator)	618C38
Plate (front seat back ornament mounting)	64825
Plate (front seat back scuff)	60060, 61642-3
Plate (front seat head rest stabilizer upper)	610A80
Plate (front seat shoulder strap anchor)	60226
Plate (front side inner member)	104A02
Plate (instrument panel glove compt. door latch catch anchor)	06150
Plate (instrument panel name)	04460
Plate (instrument panel pad retainer)	044C78
Plate (instrument panel steering column finish)	04475
Plate (liftgate latch)	43108
Plate (liftgate lock access hole cover)	40466
Plate (liftgate name)	42528
Plate (liftgate prop arm anchor)	404A44
Plate (lower back panel name)	403A72
Plate (luggage compt. door hinge anchor on door)	42752
Plate (luggage compt. door latch striker)	432A06, 43252
Plate (luggage compt. door name)	42495, 42528
Plate (luggage compt. door ornament)	425A82
Plate (package tray end)	46652-3
Plate (parking brake cable skid)	112B62
Plate (quarter panel name)	25622-3, 50399-400
Plate (quarter window regulator handle)	23370, 29191
Plate (rear corner outer panel end)	41098-9
Plate (rear door inside handle)	23370
Plate (rear door latch remote control)	265A66-7
Plate (rear door latch striker)	22008
Plate (rear door latch striker tapping)	22024
Plate (rear door scuff)	13228-9
Plate (rear door window glass run retainer)	214A26
Plate (rear door window regulator handle)	23370
Plate (rear floor pan drain hole cover)	113A36
Plate (rear seat back catch striker)	601A68

## P - cont'd.

Plate (rear seat back latch striker anchor)	61340
Plate (rear seat back ornament mounting)	64825
Plate (rear seat back stop anchor)	61328
Plate (rear seat cushion torsion bar inner bracket anchor)	606A44
Plate (rear seat front anchor)	605A40
Plate (rear seat rear anchor)	605A44
Plate (roof luggage carrier front rail)	550A22
Plate (roof luggage carrier support cover)	550A54-5
Plate (roof side outer name)	50399-400
Plate (sliding roof panel rear guide)	51812
Plate (sliding roof retaining)	502L26
Plate (steering column opening cover)	01698-9
Plate (tailgate counterbalance torsion bar mounting)	430A28
Plate (tailgate hinge on body anchor)	43480-1
Plate (tailgate latch release handle mounting)	431C78
Plate (tailgate latch striker)	43146, 431A72
Plate (tailgate name)	25622-3, 42528
Plate (tailgate scuff)	42624
Plate (vent window regulator handle)	23370
Plug (floor pan seat belt anchor opening)	10034
Plug (front door vent window mounting access)	22304
Plug (seat belt retractor cover bolt access)	611B32
Prop (liftgate)	404A10
Prop (luggage compt. door)	44206-7
Prop (luggage compt. front access door)	45734
Pump repair kit (folding top hydraulic lift)	53337

## R

Rack (front seat adjusting regulator base)	619A88-9
Rail (back window header)	41302
Rail (body side)	32222
Rail (folding top center side)	51154-5
Rail (folding top front side)	53104-5
Rail (folding top rear side)	53138-9
Rail (folding top rear side inner)	531A08-9
Rail (front door opening upper)	211A10-1
Rail (front door outside finish lower)	20402-3, 20868-9
Rail (front door outside finish upper)	20960-1
Rail (quarter belt inside)	28714-5
Rail (quarter belt rear)	28716
Rail (quarter belt side)	41732-3, 41736-7
Rail (quarter belt side front)	41708-9
Rail (quarter outside finish)	28712-3
Rail (quarter panel outside finish)	290A41
Rail (rear door outside finish lower)	25300-1
Rail (rear door outside finish upper)	25320-1
Rail (roof front)	513B76
Rail (roof luggage carrier front)	55106
Rail (roof luggage carrier rear)	55106, 55138



## INDEX

PART NAME	GROUP NUMBER	PART NAME	GROUP NUMBER
<b>R - cont'd.</b>		<b>R - cont'd.</b>	
Rail (roof luggage carrier side)	55114-5	Reinforcement (center body pillar upper inner center)	243A60
Rail (roof rear)	513B06, 513A58	Reinforcement (center body pillar upper inner top)	243A62
Rail (roof side)	513A52-3	Reinforcement (center floor pan at pinion bumper)	112A06-7
Rail (roof side drip center)	51700-1	Reinforcement (center floor pan body bolt hole)	11393-4
Rail (roof side drip front)	51700-1	Reinforcement (center floor pan muffler mounting bracket)	113A12-3
Rail (roof side drip rear)	51700-1	Reinforcement (center floor pan no. 6 body bolt)	11376
Rail (roof side front inner)	51180-1	Reinforcement (center floor pan to seat back strainer)	11192
Rail (roof side front outer)	51186-7	Reinforcement (console panel rear)	04300
Rail (roof side inner rear)	51212-3	Reinforcement (cowl side inner panel to body rocker panel)	020A84-5
Rail (roof side inner rear upper)	51618-9	Reinforcement (cowl side panel)	02884-5
Rail (roof side outer rear)	51216-7	Reinforcement (cowl top inner panel)	022A06-7
Rail (sliding roof panel headlining retainer)	502L19	Reinforcement (cowl top inner panel center)	023A20
Rail (tailgate outside finish upper)	423A70	Reinforcement (cowl top panel)	02000-1, 02034
Rail assy. (quarter panel fuel filler door finish)	28600	Reinforcement (dash panel at circuit breaker)	016B44
Rail & guide (sliding roof)	502C06-7	Reinforcement (dash panel at steering column support)	01697
Rail & moulding assy. (roof side outer)	513A54-5	Reinforcement (dash panel outer)	017A00-1
Rail & reinforcement assy. (folding top rear side)	53192-3	Reinforcement (dash panel to frame brace inner)	016B50
Rail & support assy. (roof luggage carrier)	55104-5	Reinforcement (dash panel to frame brace to floor side member)	016A12-3
Receptacle (console panel ash)	30702-3	Reinforcement (dash panel to front floor pan)	016A22-3
Receptacle (console panel rear ash)	048A42	Reinforcement (floor pan center)	113A30
Receptacle (front door ash)	30702-3	Reinforcement (floor plate trans. cover)	12110
Receptacle (front seat back ash)	62876	Reinforcement (floor side inner member)	10418-9
Receptacle (instrument panel ash)	04810-1	Reinforcement (floor side member at center body pillar)	10164
Receptacle (quarter ash)	30702-3	Reinforcement (floor side member rear extension)	105A70
Receptacle (rear door ash)	30702-3	Reinforcement (floor side member to dash mounting)	101A68-9
Recreation kit (table)	279B76	Reinforcement (floor side member to front side member front)	10262-3
Reflector (front door trim panel)	23820	Reinforcement (floor side member to front side member rear)	10156-7
Register (instrument panel vent air)	01814-5,	Reinforcement (floor side outer member)	10132-3
Regulator (back window)	44000	Reinforcement (floor side rear member inner)	10144-5
Regulator assy. (front door vent window)	23402-3	Reinforcement (floor trans. cover plate)	12118-9
Regulator assy. (front door window electric less motor and drive)	23208-9	Reinforcement (folding top side quarter stay)	54212
Regulator assy. (front door window manual)	23200-1	Reinforcement (front body pillar)	02526-7
Regulator assy. (front door window manual less arms)	23202-3	Reinforcement (front body pillar lower)	02542-3
Regulator assy. (front seat adjusting)	617A01	Reinforcement (front body upper outer pillar)	02524-5
Regulator assy. (front seat power adjusting)	618A36	Reinforcement (front body upper pillar to roof rail)	02574-5
Regulator assy. (quarter window electric)	30380-1	Reinforcement (front door outside)	20225
Regulator assy. (quarter window manual)	30306-7	Reinforcement (front door outside handle)	22486
Regulator assy. (rear door window electric less motor, drive & spring)	27008-9	Reinforcement (front door outside panel at belt)	21124-5
Regulator assy. (rear door window manual)	27000-1	Reinforcement (front door window lower)	214A48
Reinforcement (aux. seat cushion support)	607A64	Reinforcement (front floor no. 2 cross member)	10648
Reinforcement (back lower trim panel)	403B32	Reinforcement (front floor pan)	111A44-5
Reinforcement (belt side rail)	28708-9	Reinforcement (front floor pan inner)	111B12-3
Reinforcement (body side inner panel)	28126	Reinforcement (front floor pan rear)	11144-5
Reinforcement (body side panel lower)	27814-5	Reinforcement (front floor pan seat track)	11634-5, 11246-9
Reinforcement (body side window opening rear)	279C18-9, 279C20-1	Reinforcement (front seat back frame)	61046-7
Reinforcement (brake pedal support dash panel)	01552-3		
Reinforcement (center body pillar)	24320-1		
Reinforcement (center body pillar at belt)	243A18-9		
Reinforcement (center body pillar lower)	24426-7		
Reinforcement (center body pillar to roof rail)	24312		

## INDEX

PART NAME	GROUP NUMBER	PART NAME	GROUP NUMBER
<b>R - cont'd.</b>		<b>R - cont'd.</b>	
Reinforcement (front seat belt anchor to side member)	61216	Reinforcement (rear floor side member to bumper mounting)	103A06-7
Reinforcement (front seat shoulder strap mounting)	601A80-1	Reinforcement (rear floor side member to floor side inner member)	10158-9
Reinforcement (front seat track)	617A46	Reinforcement (rear seat back center arm rest flap)	67254
Reinforcement (front seat track to floor)	617B70-1	Reinforcement (rear side member to floor quarter)	104A70-1
Reinforcement (front suspension no. 2 cross member outer)	10104-5	Reinforcement (roof luggage carrier slat)	55124
Reinforcement (front suspension no. 2 cross member outer front)	10542-3	Reinforcement (roof panel center)	50244 , 50290
Reinforcement (front wheelhouse panel)	02464-5	Reinforcement (roof panel front)	50222 , 50263
Reinforcement (fuel filler pipe housing)	405B64	Reinforcement (roof panel rear)	50217 , 50291
Reinforcement (instrument panel brace to cowl side panel)	045F38	Reinforcement (roof panel rear side)	50844-5
Reinforcement (instrument panel cluster opening)	04462	Reinforcement (roof rear rail)	513A24-5
Reinforcement (instrument panel finish panel)	045B86	Reinforcement (roof side outer rear rail)	513B34-5
Reinforcement (instrument panel glove compt. door latch)	06172	Reinforcement (roof side rail)	513A06-7
Reinforcement (instrument panel lower flange center)	04674	Reinforcement (roof side rail lower)	513B96-7
Reinforcement (liftgate hinge on body)	42942	Reinforcement (seat belt anchor to floor pan)	61216
Reinforcement (liftgate latch striker)	431F62	Reinforcement (shoulder strap mounting)	60246
Reinforcement (lower back center panel)	40338-9	Reinforcement (storage compt. door latch)	11688
Reinforcement (lower back panel center)	40440	Reinforcement (tail lamp opening)	27970-1
Reinforcement (luggage compt. door opening side)	279A62-3	Reinforcement (tailgate panel hinge)	40718
Reinforcement (luggage compt. door upper corner)	44822-3	Reinforcement (tailgate upper hinge on gate)	43061
Reinforcement (package tray to floor pan)	46516	Reinforcement assy. (body rear corner panel)	278A68-9
Reinforcement (quarter latch pillar)	28364-5	Reservoir (vacuum door latch control)	219A02
Reinforcement (quarter latch pillar to wheelhouse)	28330-1	Reservoir repair kit (folding top hydraulic lift)	53376
Reinforcement (quarter panel at belt)	28700-1	Retainer (aux. floor front carpet front)	130A14
Reinforcement (quarter panel latch side)	28200-1	Retainer (aux. floor front carpet side)	130A08-9
Reinforcement (quarter panel latch side lower)	28216-7	Retainer (aux. floor rear carpet rear)	130A26
Reinforcement (quarter panel latch side upper)	28208-9	Retainer (aux. floor rear carpet side)	130A24-5
Reinforcement (quarter panel to wheelhouse)	29200-1	Retainer (aux. floor rear inner panel)	115A60
Reinforcement (quarter trim panel)	31218	Retainer (aux. seat cushion frame outer)	607A48
Reinforcement (quarter trim panel lower)	31296-7	Retainer (back belt moulding)	40248 , 423A04
Reinforcement (quarter trim panel upper edge)	31462	Retainer (back belt moulding joint cover)	424B02
Reinforcement (quarter trim panel upper edge rear)	31464	Retainer (back belt side moulding)	423B06
Reinforcement (quarter wheelhouse at seat back bracket)	28022-3	Retainer (back trim panel center)	403D26
Reinforcement (quarter wheelhouse inner panel)	27798-9	Retainer (back trim panel side)	40471
Reinforcement (quarter window regulator panel upper)	27874-5	Retainer (back trim panel upper)	403D26
Reinforcement (rear corner inner rear pillar lower)	410A42-3	Retainer (back window garnish side moulding)	423B18-9
Reinforcement (rear corner lower pillar)	41058-9	Retainer (back window glass run upper)	42372
Reinforcement (rear door latch striker anchor plate)	26482	Retainer (back window glass seal)	420A58
Reinforcement (rear door outside handle)	22486	Retainer (back window lower frame trim panel)	424A80
Reinforcement (rear door outside panel at belt)	26086-7	Retainer (back window lower frame trim panel center)	424A78
Reinforcement (rear floor cross member to floor pan)	10950-1	Retainer (back window lower garnish moulding)	423A06
Reinforcement (rear floor cross member upper)	10790-1	Retainer (back window outside lower center moulding)	423A26
Reinforcement (rear floor pan)	111A64	Retainer (back window outside lower moulding center)	424A86
Reinforcement (rear floor rear cross member)	10760	Retainer (back window outside moulding)	03178 , 42413
Reinforcement (rear floor rear sill panel)	10816	Retainer (back window outside side moulding)	42318 , 423A26
Reinforcement (rear floor rear sill panel extension)	10974-5	Retainer (back window outside top moulding)	423A26
Reinforcement (rear floor side member rear spring mounting)	10326		

## INDEX

PART NAME	GROUP NUMBER	PART NAME	GROUP NUMBER
<b>R - cont'd.</b>		<b>R - cont'd.</b>	
Retainer (back window outside upper moulding)	42435	Retainer (front door vent window division bar glass run)	222A88-9
Retainer (back window outside upper outer moulding)	423B10	Retainer (front door vent window handle)	30212
Retainer (back window regulator button)	44088	Retainer (front door vent window weatherstrip)	21408-9
Retainer (back window upper garnish moulding)	42468	Retainer (front door weatherstrip)	20586
Retainer (body bolt absorber lower)	00157	Retainer (front door window glass channel bracket)	234A46
Retainer (body bolt absorber upper)	00163	Retainer (front door window guide)	23222
Retainer (body bolt anchor plate)	113A66	Retainer (front fender outside front edge moulding)	208A38
Retainer (body bolt insulator lower)	00151	Retainer (front fender outside moulding)	20842
Retainer (body bolt no. 6 anchor plate)	111B88	Retainer (front floor carpet edge center)	130A42
Retainer (body outside moulding)	425A16	Retainer (front floor carpet side)	130A44-5
Retainer (body side inner panel)	278C96	Retainer (front seat adjusting spring)	618C28
Retainer (body side moulding)	29318	Retainer (front seat adjusting trans. pinion)	618C26
Retainer (body side outside moulding)	42413	Retainer (front seat back ash receptacle)	62868
Retainer (center body pillar upper front weatherstrip)	243A38-9	Retainer (front seat back button & strap)	63520
Retainer (center body pillar upper rear weatherstrip)	243A56-7	Retainer (front seat back center arm rest cover)	654A54
Retainer (center floor finish panel)	115A64	Retainer (front seat back latch spring)	610B66
Retainer (coat hook)	29232	Retainer (front seat back ornament)	64462
Retainer (console panel)	04684-5	Retainer (front seat back side shield)	62178
Retainer (console panel ash receptacle)	04780, 04826-7, 30714	Retainer (front seat shoulder strap)	60236-7
Retainer (console panel finish panel)	045A28	Retainer (front seat track adjusting handle)	618B58, 62060
Retainer (console panel glove compt. door latch)	044E62	Retainer (front seat track assist spring)	618C64
Retainer (console panel rear moulding)	045A96	Retainer (front seat track rack)	618C10
Retainer (cowl top panel moulding)	022A44	Retainer (fuel filler door bumper)	405B72
Retainer (cowl top vent grille)	02316	Retainer (hood latch rod)	21952-4
Retainer (dash panel front sound absorber)	01691		
		Retainer (instrument panel ash receptacle)	04826-7
Retainer (folding top bow listing)	50156	Retainer (instrument panel ash receptacle door trim panel)	048B08
Retainer (folding top center side rail weatherstrip)	51560-1	Retainer (instrument panel ash receptacle retainer)	04837
Retainer (folding top dust hood front)	54676	Retainer (instrument panel center finish panel)	04784
Retainer (folding top no. 1 bow rear weatherstrip)	51352-3, 514A26-7	Retainer (instrument panel finish lower center)	04619
Retainer (folding top no. 4 bow zipper)	52542	Retainer (instrument panel finish panel)	045A28
Retainer (folding top rear side rail weatherstrip)	51554-5	Retainer (instrument panel glove compt. door latch catch)	06125
Retainer (front body pillar upper weatherstrip)	02594-5	Retainer (instrument panel moulding)	04439
Retainer (front door arm rest finish panel)	240A16	Retainer (instrument panel steering column opening cover)	045E94
Retainer (front door ash receptacle)	30714		
Retainer (front door glass rear weatherstrip)	214A24-5	Retainer (liftgate door latch rod)	21952-4
Retainer (front door glass run front)	21572	Retainer (liftgate latch spring)	404A48
Retainer (front door glass run latch side)	222A00-1	Retainer (liftgate outside upper moulding)	42531
Retainer (front door latch rod)	21952-4	Retainer (liftgate weatherstrip)	43738
Retainer (front door latch striker anchor plate)	22021	Retainer (load restrainer inner panel body side)	642A98
Retainer (front door lock cylinder)	22023	Retainer (lower back panel finish)	423A64
Retainer (front door moulding)	42533	Retainer (lower back panel lining board)	40433
Retainer (front door opening windlace)	02614	Retainer (lower back panel moulding)	40368, 42331, 42527
Retainer (front door outside finish panel)	208A70	Retainer (luggage compt. door lock cylinder)	22023, 43629
Retainer (front door outside moulding)	20842		
Retainer (front door outside rear edge moulding)	208A40	Retainer (luggage compt. door moulding)	42533
Retainer (front door pull handle)	22676	Retainer (luggage compt. door outside finish panel)	42592
Retainer (front door trim panel)	237A24-7, 25576-7, 23760-3	Retainer (luggage compt. front access door cover lower)	45786







## INDEX

PART NAME	GROUP NUMBER	PART NAME	GROUP NUMBER
<b>S - cont'd.</b>		<b>S - cont'd.</b>	
Seal (cowl top vent grille)	021A32	Seal (tailgate latch cover)	43154
Seal (cowl vent air duct outer)	01970	Seal (tailgate upper hinge on gate)	430A84
Seal (cowl vent air inlet duct)	01988	Seal (tailgate window regulator drive)	422B12
Seal (dash panel at windshield wiper hose opening)	016B04, 016B30	Seal (windshield garnish side moulding)	03266
Seal (folding top center side rail)	54790-1	Seal (windshield glass)	03804
Seal (folding top header windshield)	03045	Seal (windshield hinge)	03828
Seal (folding top rear side rail)	54784-5	Shaft (front door vent window handle)	30238
Seal (front body pillar at belt)	02730-1	Shaft (front seat adjusting regulator)	60480
Seal (front door front at belt)	20264-5	Shaft (front seat adjusting trans.)	618A60
Seal (front door inner panel bottom drain)	20700	Shaft (front seat back pivot)	610B68
Seal (front door inside panel lower)	20272	Shaft (quarter window handle)	30238
Seal (front door latch remote control)	219A59	Shaft (spare wheel cover hold down handle)	47108
Seal (front door rear at belt)	20266-7, 20558-9	Shelf (instrument panel utility)	13504
Seal (front door trim panel)	237A48	Shield (ash receptacle)	30716
Seal (front door vacuum latch actuator shaft)	21842	Shield (back window wiring)	424B04
Seal (front door vent window frame)	222A80-1	Shield (cowl side inner panel water)	02266
Seal (front door vent window lower front)	223A32-3	Shield (folding top compt.)	546A06
Seal (front door window rear upper)	20588-9	Shield (front body upper pillar wire)	026A75
Seal (front door window regulator drive)	422B12	Shield (front door latch remote control opening)	20334-5
Seal (fuel filler pipe opening)	28630	Shield (front door scuff plate wiring)	13218
Seal (luggage compt. door lock cylinder shaft)	432A44	Shield (front door trim panel water)	20318
Seal (package tray)	46640-1	Shield (front door wiring)	20770
Seal (quarter latch pillar to window frame)	28182-3	Shield (front seat adjuster)	617C20-1, 62116
Seal (quarter panel outer rear extension)	27802	Shield (front seat back)	60762
Seal (quarter wheel opening cover)	27986-7	Shield (front seat back inside)	610A68-9
Seal (quarter window latch retainer)	297A30	Shield (front seat back latch)	62730
Seal (quarter window regulator drive)	422B12	Shield (front seat back latch actuator)	62718-9
Seal (quarter window regulator panel rear)	303A80	Shield (front seat back side)	61616-7
Seal (rear door inner panel bottom drain)	20700	Shield (front seat belt)	611A70
Seal (rear door latch remote control)	219A59	Shield (front seat center arm rest)	654A82
Seal (rear door rear at belt)	253A02-3	Shield (front seat cushion rear)	63218-9
Seal (rear door vacuum latch actuator shaft)	21842	Shield (front seat cushion side)	62186-7
Seal (rear door window front upper)	247A10-1	Shield (liftgate latch)	404A68-9
Seal (rear floor pan extension drain)	11202	Shield (lower back panel to bumper)	403B22
Seal (sliding roof panel opening rear)	50928	Shield (luggage compt. door latch striker)	432A70
Seal (spare wheel well cover rear)	47262	Shield (luggage compt. door to filler)	403C50
Seal (spare wheel well cover upper)	47264	Shield (quarter panel to bumper end splash)	280A94
Seal (steering column opening cover plate)	01738	Shield (quarter trim panel water)	20318, 31090-1
Seal (tailgate inner panel)	40371	Shield (rear door scuff plate wiring)	13218-20
Seal (tailgate inner panel bottom drain)	20700, 407A46	Shield (rear door trim panel water)	20318
		Shield (rear door trim water)	27458
		Shield (rear license plate lamp)	40427
		Shim (body bolt)	00145
		Shim (cowl top vent grille extension)	02249

## INDEX

PART NAME	GROUP NUMBER	PART NAME	GROUP NUMBER
<b>S - cont'd.</b>		<b>S - cont'd.</b>	
Shim (front door latch striker plate)	22058, 265A06	Spacer (front door window regulator handle)	23227
Shim (rear door latch striker plate)	265A06	Spacer (front door window regulator motor bracket)	234A18
Shim (tailgate latch striker plate)	265A06, 431A61	Spacer (front seat adjuster regulator solenoid retainer)	618C34
Shim (tailgate lower latch striker plate)	43152	Spacer (front seat back center arm rest support)	654A76
Shim (tailgate upper latch striker plate)	43152	Spacer (front seat back latch pawl)	62704
Sill (rear floor cross rear)	10608	Spacer (front seat back pivot arm)	60394
Slat (folding top no. 4 bow)	50340	Spacer (front seat back pivot outer cover)	61610
Slat (roof luggage carrier)	55150	Spacer (front seat back to cushion)	64752
Slat kit (roof luggage carrier)	550A60	Spacer (front seat back to cushion outer)	617K79
Sleeve (front seat back adjusting actuator)	611A98	Spacer (front seat belt)	612A56
Sleeve (front seat back assist spring)	64730	Spacer (front seat belt retractor)	612A16
Sleeve (front seat back hinge pivot)	61696-7	Spacer (front seat head rest guide rod sleeve)	610B64
Sleeve (front seat head rest guide rod)	610A16	Spacer (front seat regulator gear)	618C42
Sleeve (luggage compt. door latch mounting bolt bushing)	53917	Spacer (front seat shoulder strap)	612A56
Sleeve (luggage compt. door lock cylinder)	43603	Spacer (front seat shoulder strap anchor plate)	60228
Sleeve (visor anchor pin)	04115	Spacer (front seat track to floor)	62016
Slide (front door window stabilizer arm inner)	21528	Spacer (instrument panel glove compt. door latch catch)	061A42
Slide (front seat track)	619A34	Spacer (liftgate latch release lever)	431A06
Slide (instrument panel ash receptacle)	044E26-7	Spacer (luggage compt. door lock cylinder sleeve)	43565
Slide (quarter window guide)	298A64	Spacer (quarter outside center belt moulding)	290B16
Socket (back window regulator stem manual)	44017	Spacer (quarter trim panel)	31392
Solenoid assy. (front seat back latch)	62690	Spacer (quarter wheelhouse inner to fuel tank)	280B26
Solenoid & valve assy. (vacuum door latch control)	220A00	Spacer (quarter window garnish front)	29072
Spacer (aux. floor rear)	115A62	Spacer (quarter window garnish moulding rear)	30153
Spacer (back belt moulding)	40249	Spacer (quarter window glass roller)	263A86
Spacer (back window glass lower)	420A22	Spacer (quarter window handle)	302A00
Spacer (back window louver)	442A14, 44284	Spacer (quarter window latch retainer)	302A06
Spacer (back window outside moulding)	42554	Spacer (rear door trim panel upper edge)	274A28
Spacer (back window outside side moulding)	42552	Spacer (rear door window garnish moulding)	20922
Spacer (door trim panel edge reinforcement)	237A82	Spacer (rear door window glass roller)	263A86
Spacer (floor side member moulding)	102A78	Spacer (rear door window regulator motor bracket)	234A18, 270A50
Spacer (floor side outer member)	10510	Spacer (rear seat shoulder strap anchor plate)	60228
Spacer (folding top main pivot bracket)	53082	Spacer (roof side inner front moulding)	517C30
Spacer (folding top rear side rail to upper reinforcement)	531A10	Spacer (sliding roof friction clutch)	502L46
Spacer (front body pillar moulding)	026A14	Spacer (tailgate upper hinge on body)	43098
Spacer (front door hinge bushing)	22822	Spacer (windshield glass)	030A12
Spacer (front door vent window handle)	302A00	Spacer (windshield header)	03456
Spacer (front door window garnish moulding)	20922	Spacer (windshield outside belt moulding)	03150, 03200
Spacer (front door window glass roller)	263A86	Spoiler kit (rear)	44210
Spacer (front door window regulator handle manual)	44036	Spring (back window regulator handle manual)	44036
Spacer (front door window regulator handle pawl manual)	44016	Spring (back window regulator handle pawl manual)	44016
Spacer (front door window regulator socket retaining manual)	44050	Spring (back window regulator socket retaining manual)	44050



## INDEX

PART NAME	GROUP NUMBER	PART NAME	GROUP NUMBER
<b>S - cont'd.</b>		<b>S - cont'd.</b>	
Spring (console panel glove compt. door)	06069	Spring (tailgate latch)	431B50
Spring (folding top hold down clamp latch)	50527	Spring (tailgate latch ratchet pawl)	26514
Spring (folding top hold down clamp lever)	50572	Spring (tailgate outside handle)	430A82
		Spring (tailgate window regulator counterbalance)	23318 , 40867
Spring (front door hinge lower)	21232	Spring (visor arm clip)	04134
Spring (front door inside handle)	22624	Spring (windshield hold down)	03652
Spring (front door latch remote control)	21910		
Spring (front door latch toggle)	21872-3	Spring assy. (front seat back)	64700-1
Spring (front door vent window pivot)	22926	Spring assy. (front seat cushion)	63100
Spring (front door window regulator counterbalance)	23318	Spring assy. (passenger reclining seat head rest)	612A34
Spring (front door window regulator handle)	22624	Spring assy. (rear seat back)	66700
		Spring assy. (rear seat cushion)	63120
Spring (front seat back adjusting handle)	610A14		
Spring (front seat back assist)	64748-9	Stabilizer (back window at belt weatherstrip outside)	422B26
Spring (front seat back latch)	61097-8	Stabilizer (front door window glass inner)	22380
Spring (front seat back latch catch retracting)	617K74	Stabilizer (front door window glass rear)	214A30-1
Spring (front seat cushion helper)	63084 , 63186	Stabilizer (quarter window glass frame)	30470
		Stabilizer (rear door window)	263A32
Spring (front seat track assist)	61828	Stabilizer (rear door window glass inner)	22380
Spring (front seat track latch)	61883	Stabilizer (rear door window rear)	263A54
Spring (front seat track vertical assist)	617A44 , 617A64	Stabilizer (tailgate window inner)	41910
Spring (fuel filler opening door hinge)	405A24	Stem (front seat back adjusting)	610B22
Spring (instrument panel glove compt. door)	06069	Stem assy. (front seat back latch)	62634
		Step kit (pickup box side)	20092
Spring (luggage compt. door counterbalance)	42858		
Spring (luggage compt. door hinge)	42760	Stop (back window lower)	42308
Spring (luggage compt. door lift retainer)	45592	Stop (back window upper)	41958
		Stop (door latch actuator rear)	220A22
Spring (passenger reclining seat back hinge check)	62466-7		
		Stop (front door vent window pivot)	22992
Spring (quarter ash receptacle retainer cover tension)	30728	Stop (front door window front guide)	29814-5
Spring (quarter window regulator counterbalance)	23318 , 27048 , 30351	Stop (front door window lower)	21758-9
		Stop (front door window upper)	21768-9
Spring (quarter window regulator handle)	22624	Stop (front door window upper)	21770-1
		Stop (front door window upper rear)	222A54-5
Spring (rear door hinge lower)	21232	Stop (front seat back)	61064
Spring (rear door inside handle)	22624	Stop (front seat back pivot)	64754
Spring (rear door latch remote control)	21910	Stop (front seat back to cushion)	60310
Spring (rear door latch toggle)	21872-3		
Spring (rear door upper hinge assist)	268A86	Stop (quarter window)	29968-9
Spring (rear door window regulator counterbalance)	23318 , 27048	Stop (quarter window front guide)	29814-5
		Stop (quarter window lower)	21758-9 , 29805 , 30698
Spring (rear door window regulator handle)	22624	Stop (quarter window rear upper)	262A84
		Stop (quarter window upper)	21768-9 25780-1
Spring (rear seat back bumper)	62434	Stop (rear door window lower)	21758-9 , 26058
Spring (rear seat back latch handle)	61097-8	Stop (rear door window rear upper)	262A84
Spring (rear seat cushion)	63150	Stop (rear door window upper)	21768-9
Spring (sliding roof panel rear)	518A36	Stop (rear door window upper front)	262A20-1
Spring (tailgate check cable)	444A12-3		
Spring (tailgate counterbalance)	430A00		

## INDEX

PART NAME	GROUP NUMBER	PART NAME	GROUP NUMBER
<b>S - cont'd.</b>		<b>S - cont'd.</b>	
Stop (rear seat back)	62426	Strip (roof headlining side retaining rear lower)	50900-1
Stop (rear seat back floor)	60596-7	Strip (roof headlining side tacking upper)	519B12-3
Stop (storage compt. door)	11712	Strip (tailgate inside cover panel)	407A16-7
Stop (tailgate check cable spring)	444A16	Strip (windshield)	03243
Stop (tailgate lower hinge)	430A48		
Stop (tailgate window lower)	21758-9	Stripe kit (body side)	20000-1
		Stripe kit (cowl)	20000-1
Strainer (luggage compt. front access door opening)	45780-1	Stripe kit (front fender name)	20000-1
Strainer (package tray to floor)	46610-1	Stripe kit (hood)	20000-1
Strainer (package tray to wheelhouse)	46774-5		
Strainer (quarter panel belt to floor)	28788	Stripe kit (luggage compt. door)	20000-1
Strainer (quarter panel to rear floor)	28772-3	Stripe kit (luggage compt. name)	20000-1
Strainer (rear seat back support to belt rail)	46840-1	Stripe kit (quarter panel extensions)	20000-1
Strainer (roof side rear rail to floor)	513C10-1	Stripe kit (quarter panel name)	20000-1
Strainer (upper back panel to wheelhouse lower)	403D54-5		
		Stud (roof luggage carrier front rail)	550A20
Strap (luggage compt. carrier hold down front)	46018-20	Stud (windshield hold down)	03854
Strap (luggage compt. carrier hold down rear)	46018-20		
Strap (tailgate counterbalance spring)	430A14	Support (aux. floor)	11500-1
Strap assy. (shoulder)	60232	Support (aux. floor pan rear)	11450-1
Strap & bracket assy. (front door check)	23574	Support (aux. floor side panel)	115A46-7
Strap kit (roof luggage carrier hold down)	55196	Support (aux. floor side rear)	11738-9
		Support (aux. seat cushion)	607A62
Striker (console panel glove compt. door)	06157		
Striker (folding top hold down side clamp)	503A08	Support (body side rail end)	32240-1
Striker (front door latch)	265A04	Support (body side rail top)	32224
Striker (front seat back latch)	62638-9	Support (body side window opening panel rear)	279C44-5
Striker (liftgate latch)	404A42	Support (brake pedal)	01500, 01508
Striker (luggage compt. front access door latch)	45746	Support (clutch pedal)	01500
Striker (rear door latch)	265A04	Support (console panel)	045B56
Striker (rear seat back latch)	62440-1	Support (console panel front)	045B28-9
Striker (storage compt. door latch)	105A90, 31710	Support (console panel glove compt. door catch)	06152
		Support (console panel side)	045B26-7
Striker (tailgate door latch)	265A04		
Striker (tailgate lower latch)	431E72	Support (folding top lift)	506A58
Striker & cable (quarter window)	302A08-9	Support (folding top main pivot bracket)	53156-9
		Support (folding top main pivot support base)	53004-5
Strip (back belt rail tacking center)	41745	Support (front door arm rest)	24160-1
Strip (belt side center tacking)	41878	Support (front seat back pivot)	617C04-5, 64744
Strip (belt side front tacking)	41772-3	Support (front seat back side shield)	62298
Strip (console panel to radio bezel filler)	045B06	Support (front seat back side shield lower)	62296-7
Strip (front door opening panel skid)	202A70	Support (front seat back trim panel)	61606
Strip (glass retainer)	21478	Support (front seat cushion side shield front)	62168-9
Strip (quarter window glass retaining)	29724	Support (front seat cushion side shield rear)	62194-5
		Support (front seat shoulder strap loop)	60242
Strip (roof headlining at quarter window rear tacking)	50986	Support (front seat track rear)	61796
Strip (roof headlining back window tacking upper)	519A06	Support (front seat track to floor)	60422
Strip (roof headlining header tacking)	51016		
Strip (roof headlining retaining)	50956-7	Support (instrument panel at steering column opening)	045F52
Strip (roof headlining side center tacking)	50996	Support (instrument panel brace)	045F40
Strip (roof headlining side rear tacking)	50998-9	Support (instrument panel pad)	04746
Strip (roof headlining side retaining)	50842-3	Support (instrument panel pad top moulding)	045C72
Strip (roof headlining side retaining front)	50936-7		
Strip (roof headlining side retaining rear corner)	52114-5		



## INDEX

PART NAME	GROUP NUMBER	PART NAME	GROUP NUMBER
<b>W</b>		<b>W - cont'd.</b>	
Washer (back window glass bracket)	422B50	Weatherstrip (luggage compt. door)	43720-1
Washer (folding top bow adjusting bolt)	51548	Weatherstrip (quarter window)	30248-9
Washer (front door vent window handle)	22982	Weatherstrip (quarter window at belt inner)	29744-5
Washer (front door vent window pivot friction)	22963	Weatherstrip (quarter window at belt outer)	29732-3
Washer (front door window regulator roller)	270A58	Weatherstrip (quarter window front)	30146-7
Washer (front seat track link)	618C40	Weatherstrip (quarter window glass channel)	21510
Washer (quarter window regulator roller)	270A58	Weatherstrip (quarter window glass inner)	29742-3
Washer (rear door window regulator roller)	270A58	Weatherstrip (quarter window inner rear)	30254-5
Washer (roof luggage carrier rail nut)	550A64	Weatherstrip (quarter window rear stationary glass)	29904-5
Washer (sliding roof handle)	502B50	Weatherstrip (rear door)	25324-5
Washer (tailgate window regulator roller)	270A58	Weatherstrip (rear door glass at belt inside)	25860-1
Weatherstrip (back window glass)	42084	Weatherstrip (rear door glass at belt outside)	25596-7
Weatherstrip (back window glass at belt)	420A00	Weatherstrip (rear door glass channel)	21510 , 26258
Weatherstrip (back window glass inner)	42072	Weatherstrip (rear door glass front)	25824-5 , 25854-5
Weatherstrip (back window glass lower side run)	420A20-1	Weatherstrip (rear door stationary window)	26894-5 , 26928
Weatherstrip (body side upper panel)	279C30	Weatherstrip (roof rear)	54732
Weatherstrip (body side window)	305A26-7	Weatherstrip (roof side rail)	51222-3
Weatherstrip (body side window opening panel lower)	278C94-5	Weatherstrip (roof side rail rear)	513A68-9 , 513B68-9
Weatherstrip (folding top front sides rail)	53986-7	Weatherstrip (sliding roof panel front)	502C12 , 502C50
Weatherstrip (folding top header rail)	53986-7	Weatherstrip (sliding roof panel intermediate)	502C50
Weatherstrip (folding top no. 1 bow)	51325 , 514A28	Weatherstrip (sliding roof panel rear)	502C12
Weatherstrip (folding top no. 1 bow front)	51338	Weatherstrip (sliding roof panel sides)	502C50
Weatherstrip (folding top side front rail intermediate)	53928-9	Weatherstrip (tailgate)	41608
Weatherstrip (folding top side intermediate rear rail)	53900-1	Weatherstrip (tailgate lower)	43730
Weatherstrip (folding top side rail center)	51564-5	Weatherstrip (tailgate outer panel to belt)	41610
Weatherstrip (folding top side rail front)	51562-3	Weatherstrip (tailgate side)	41626
Weatherstrip (folding top side rail rear)	51566-7	Weatherstrip (tailgate side on body)	43964-5
Weatherstrip (front body pillar upper)	02626-7	Weatherstrip (windshield)	03110
Weatherstrip (front door)	20530-1	Weatherstrip (windshield frame)	03114
Weatherstrip (front door at belt inside)	21456-7	Weatherstrip (windshield outside side moulding)	03154
Weatherstrip (front door at belt outside)	21452-3	Weatherstrip & retainer assy. (rear door upper rear extension)	255A38-9
Weatherstrip (front door glass channel)	21510	Weatherstrip & seal assy. (rear door window rear)	25388-9
Weatherstrip (front door glass rear)	214A14-5	Wedge (liftgate)	404B04-5
Weatherstrip (front door opening lower)	20708-9	Wheelhouse assy. (rear quarter)	27882-3
Weatherstrip (front door vent window division bar)	21450-1	Window (quarter less handle)	29706-7
Weatherstrip (front door vent window front)	21448-9	Window assy. (quarter)	29700-1
Weatherstrip (liftgate lower)	422B32 , 42289	Wiring (folding top side tension)	52806
Weatherstrip (liftgate upper)	404A06	Worm (front seat adjusting horizontal)	618A42-3

# FORD CAR PARTS

## BODY SECTION 000

1

GROUP NUMBER	YEAR	BODY TYPE	DESCRIPTION	PART NUMBER		QTY.
				BODY PAINTED and TRIMMED	BODY LESS PAINT and TRIM	
<b>00000-1 BODY ASSEMBLY</b>						
<b>- U -</b>						
		ORDER BRONCO BODIES BY DESCRIPTION				
GROUP NUMBER	YEAR	BODY TYPE	DESCRIPTION	PART NUMBER		QTY.
<b>00052 RETAINER - VEHICLE IDENTIFICATION CONTAINER</b>						
	70/	P	Under front seat	D0DZ	6200052-A	1
<b>001A06 AIRFOIL - FRONT - SPOILER - Refer to Group 001A74</b>						
<b>00124 PANEL - BODY FRONT</b>						
	66/	U		C6TZ	9600124-A	1
<b>00145 SHIM - BODY MOUNT - Also refer to Body Bolt Chart at end of Section 020</b>						
	65/66	▲A		C3AA	6200145-A	AR
	68/72	A(except 76)	7/16" thick	C8AZ	6200145-A	AR
	72	B				AR
	69	S				AR
			3/32" thick-split	C8AZ	6200145-B	AR
			3/32" thick-solid	C8AZ	6200145-C	AR
	69/72	A(except 71) ,S	1/16" thick-2 1/4" O.D. x 3/4" I.D.	C9AZ	6200145-C	AR
	68/72	A(76)	1/16" thick	C8AZ	7600145-A	AR
	69/72	A(71, 76)	1/16" thick-2 9/32" O.D.	C9AZ	6200145-A	AR
			1/16" thick-2 1/4" O.D.	C9AZ	6200145-B	AR
			1/8" thick-2 1/8" O.D. x 13/32" I.D.	C9AZ	7600145-C	AR
			1/16" thick-2 1/8" O.D. x 13/32" I.D.	C9AZ	7600145-D	AR
	72	B,S	1/16" thick-1 3/4" O.D.	D2OZ	6500145-A	AR
	67/68	S	1/8" thick	C7MY	6200145-A	AR
			1/16" thick	C7MY	6200145-B	AR
<b>00151 RETAINER - BODY BOLT INSULATOR - LOWER - Also refer to Body Bolt Chart at end of Section 020</b>						
	69/	A(71)		C9AZ	7100151-A	2
	68/	U		C8TZ	9600151-A	4
<b>00154-5 ABSORBER - BODY BOLT - Also refer to Body Bolt Chart at end of Section 020</b>						
<b>- A -</b>						
	65	A(except 76)	Upper-2 1/2" O. D. -rubber	D0VY	6500154-C	10to16
			Lower-rubber	C3AZ	6200155-A	10to16
			Lower-1 7/8" O. D. - rubber	C5AZ	6200155-B	2
	65/66	A(71)	Upper-1 1/2" O. D. -rubber	C5AZ	7600154-A	6
			Lower-2 1/4" O. D. -rubber	C5AZ	7100155-A	6
	65/68	A(76)	Upper-2" O. D. - rubber	C5AZ	7600154-C	2
			Upper-1 1/2" O. D. - rubber	C5AZ	7600154-A	6
			Lower-2 1/4" O. D. -rubber	C5AZ	7600155-A	6
	65/70	A(except 76)	Lower-2 1/4" O. D. -rubber	C7AZ	6200155-A	4
	68/70	A	Lower-2" x 1 1/4"-steel	C8AZ	6200155-A	2
	69/71	A(except 76)	Lower-2 1/4" O.D.	D0SZ	6500155-A	4 \$
	71	A(except 71, 76)	1 7/8" dia. x 5/8" thick	D1AZ	6500155-A	4
	68/71	A(except 71)	Upper -2 9/32" O.D.	D3AZ	6500154-A	2
	69/	A(71, 76)	Upper-1 1/2" O.D.-rubber	C5AZ	7600154-A	2 or 4
			Lower-2 1/4" O. D. - rubber	C5AZ	7600155-A	6
			Lower-2 1/8" O.D.	C9AZ	7600155-C	2 or 4
			Lower-2" O. D.	C9AZ	7600155-B	2
	69/	A	Lower-1 1/2" O.D.	C9AZ	6200155-B	2
	70/	A(except 71, 76)	1 7/8" O.D.-rubber	D0VY	6500154-B	AR
	72	A(except 76)	Lower-8 3/8" x 2 1/4"-rubber	D0SZ	6500155-A	2
<b>- B -</b>						
	72	B	Lower-1" O.D. x 1 7/8" long	D2OZ	6500155-B	2
			Lower - 2" O.D. - yellow	D2OZ	6500155-C	AR

♦ Canada only

May, 1975

COPYRIGHT © 1975 -

FORD MOTOR COMPANY

- DEARBORN, MICHIGAN

**FINAL ISSUE**

GROUP NUMBER	YEAR	BODY TYPE	DESCRIPTION	PART NUMBER	QTY.	
<b>00154-5 ABSORBER - BODY BOLT - continued - Also refer to Body Bolt Chart at end of Section 020</b>						
- S -						
	67/	S	Upper-2 1/4" O.D. -rubber	D0VY 6500154-B	AR	
			Lower-2 1/4" O.D. - rubber	C7SZ 6500155-B	2 or 4	
			Lower-2" x 1 3/8"	C7SZ 6500155-C	2	
	67/71	S	Lower-2" x 1 1/4"-steel	C8AZ 6200155-A	2	
			Lower-2 1/4" O. D. -rubber	C7AZ 6200155-A	4	
	67/70	S	"Before 9/2/69"	Lower-approx. 7" long x 2 1/4" wide x 1 3/4" thick	C8SZ 6500155-A	2
	70	S	Upper-2 9/32" O. D.	D3AZ 6500154-A	2	
	70/	S	"From 9/2/69"	Lower-8 5/16" long x 2 1/4" wide x 2" thick	D0SZ 6500155-A	2
	72	S	Lower-1 1/2" O.D.	D2SZ 6500155-A	AR	
			Lower-2" long x 1 1/2" O.D.	C9AZ 6200155-B	2	
- U -						
	66/	U	Upper-2 1/2" O.D. -rubber -Ident. Code 3 & 4	C6TZ 8100154-A	4	
			Upper-2 1/2" O.D. -rubber-Ident. Code 1 & 2	C6TZ 8100154-B	4	
			Lower-2 1/4" O.D. -rubber	C6TZ 8100155-A	4	
<b>00157 RETAINER - BODY BOLT ABSORBER - LOWER - Also refer to Body Bolt Chart at end of Section 020</b>						
	65/67	A	Lower-2" long x 1" wide	C5AZ 6200157-A	2	
	65/	A	1 7/8" O. D.	C5AZ 6200157-B	2 or 4	
	67/68	S	Lower-2" long x 1" wide	C5AZ 6200157-A	2	
	65/71	S	1 7/8" O. D.	C5AZ 6200157-B	4	
	66/	U	2 7/32" O.D. -steel	C6TZ 8100157-A	4	
			2 1/2" wide-hook type-steel	C6TZ 8100157-B	2	
<b>00163 RETAINER - BODY BOLT ABSORBER - LOWER - UPPER - Also refer to Body Bolt Chart at end of Section 020</b>						
	65/67	A(except 76)	1 3/4" O.D.	C7AZ 6200163-A	2	
	68/	A(except 71)	2 1/4" O.D.	C8AZ 6200163-A	2	
	70/71	A(except 71)	2 13/32" x 1 51/64"	D0AZ 6200163-A	2	
	68/	A(except 76)	2 1/4" x 1 3/8"	C8AZ 6200163-B	2	
	72	B	1 27/32" O.D.	D2OZ 6500163-A	2	
	67/69	S	1 3/4" O. D.	C7AZ 6200163-A	2	
	68/71	S	2 1/4" O. D.	C8AZ 6200163-A	2	
	68/	S	2 1/4" x 1 3/8"	C8AZ 6200163-B	2	
	66/	U	2 1/2" O.D.	C3AZ 6200163-A	4	
			2 1/2" O.D. -4 grooves	C6TZ 8100163-A	4	
<b>001A74 AIRFOIL - FRONT SPOILER</b>						
	69	F(63)	Kit-includes attaching parts	C9ZZ 63001A74-A	1	
	70	F(63) Boss	Black plastic	D0ZZ 65001A06-A	1	
	70	F(Shelby 350/500)		D0ZZ 65001A74-A	1	
	71/	F(63D) Boss (302,351 engine)		D1ZZ 63001A06-A	1	
			Screw & washer assv.-hex.head-1/4"-20 x 3/4"	40953-S8(U263)	14	
<b>001A86 COVER - BODY BOLT</b>						
	72	B(97)		D2OZ 97001A86-A	1	
			Screw-hex.-No. 8-18 x 3/4"	376389-S101(UU82D)	2	
<b>00350-1 PANEL - BODY FRONT CORNER</b>						
	66/	U	R. H.	C6TZ 9600350-A	1	
			L. H.	C6TZ 9600351-A	1	
<b>00366 SEAL - BODY FRONT PANEL</b>						
	66/	U	Lower-56 3/4" long x 1 7/16" wide x 3/16" thick	C6TZ 9600366-B	1	
<b>00394 BOLT - BODY MOUNTING - Also refer to Body Bolt Chart at end of Section 020</b>						
- A -						
	68	A(except 76)	7/16"-14 x 3 1/2" hex.hd.tapping stud- steel	C8AZ 6500394-A	4	
	68	A(76)	7/16"-14 x 2" hex.hd.	C8AZ 7600394-A	2	
	68	A(71)	7/16"-14 x 2" hex.hd.	C8AZ 7100394-B	4	
	68	A	7/16"-14 x 4 1/4" hex.hd.	C8AZ 6200394-A	2	
	69/	A	7/16"-14 x 3" hex.head	C9AZ 7100394-A	2	
			7/16"-14 x 4 7/8" hex.head	C9AZ 6200394-B	2	
	69/	A(except 76)	7/16"-14 x 3.16" self tapping	C9AZ 6200394-D	4	
	69/	A(71, 76)	7/16"-14 x 2 1/2" hex.head	C9AZ 7100394-B	2 or 4	
	68/	A(76)	1/2"-13 x 2 3/4" hex.head	C8AZ 7600394-B	1	

# FORD CAR PARTS

## BODY SECTION 000

3

GROUP NUMBER	YEAR	BODY TYPE	DESCRIPTION	PART NUMBER	QTY.
<b>00394 BOLT - BODY MOUNTING - continued - Also refer to Body Bolt Chart at end of Section 020</b>					
- B -					
	72	B		D0VY 6500394-A	AR
- S -					
	68	S	7/16"-14 x 3 1/8" hex. hd.	C8AZ 6200394-A	2
	68/69	S	7/16"-14 x 3 1/2" hex. hd. tapping stud-steel	C8AZ 6500394-A	6
	69/71	S	7/16"-14 x 3 5/32" self tapping	C9AZ 6200394-D	6
	70/71	S	7/16"-14 x 3" hex. head	C9AZ 7100394-A	2
			7/16"-14 x 4 7/8" hex. head	C9AZ 6200394-B	2
	72	S		D0VY 6500394-A	AR
<b>00396 ABSORBER and RETAINER ASSY. - BODY BOLT - UPPER - Also refer to Body Bolt Chart at end of Section 020</b>					
	67	A, S	1 29/64" thick x 2 1/4" long	C7AZ 6200396-C	4
	67/68	A, S	1 1/4" O.D.	C9AZ 6200396-A	AR
	69	A(76)	3" O.D.	C9AY 7600396-A	1
	68	A, S	1 7/8" O.D.-lower	C8AZ 6200396-D	2
	69/	A(except 71), S			2
	68/69	A(except 76)	4 1/4" long -includes stud	D2OZ 6500396-C	2
	72	B			2
	69/72	S			2
	69/	A	2 1/4" O.D.	C9AZ 6200396-A	AR
	70	S			4
	69/71	A(except 76) "Before 1/15/71"	4 5/8" long -includes stud	C9AZ 6200396-B	2
	72	A(except 71, 76)			2
	71	A(except 76) "From 1/15/71"	4 1/2" long -includes stud	D1AZ 6500396-A	2
	68/	A(76)	1 3/4" O. D. -includes stud	C8AZ 6200396-C	2
	69/	A(76)	2" O. D. -includes stud	C9AZ 7600396-B	2
	72	A(except 76)	Upper - 4 1/2" long	D1MY 6500396-A	2
	72	B	2" O.D. x 1 5/8" long	D2SZ 6500396-A	2
			2" O.D. x 1 5/8" long	D2SZ 6500396-A	2
			4 1/2" long -stud	D2SZ 6500396-D	2
	72	B	Upper-2 1/2" O.D.	D2OZ 6500396-D	AR
	72	B (63, 65, 71, 97)	Upper-2 1/2" O.D.	D2OZ 6500396-E	2
<b>01408 GASKET - COWL VENT AIR REGISTER</b>					
	65/66	A(57)	Uniflow system	C4SZ 6301408-B	2
	65/66	S(63)			2
	67/68	S			1
	69	S			1
	70	S(57)		D0SZ 5701408-A	1
<b>014A08 VALVE - FRONT DOOR VENT AIR OUTER - LOCK SIDE</b>					
	69/	A		C9AZ 62014A08-A	1
<b>01415 DEFLECTOR - COWL SIDE VENT AIR</b>					
	67/71	S	L. H. -with heater-without A/C	C7SZ 6501415-A	1
<b>01500 SUPPORT - BRAKE AND CLUTCH PEDAL - Also refer to Group 01508</b>					
	66/	U		C6TZ 9601500-A	1
<b>01508 SUPPORT - BRAKE PEDAL</b>					
- A -					
	65/66	A	Without movable steering column	C5AZ 6201508-C	1
	67	A		C7AZ 6201508-B	1
	68	A		C8AZ 6201508-A	1
	69	A		C9AZ 6201508-A	1
	70	A	With manual transmission		1
	71/	A	With manual transmission	D1AZ 6501508-A	1
	70/	A	With automatic transmission	D0AZ 6201508-A	1
			Nut & washer assy.-1/4"-20	33795-S7(M49)	2
	72	A	Clip	372172-S100(GG228)	2
			Nut(spring)-flat type-1/4"	45054-S(M120)	2

GROUP NUMBER	YEAR	BODY TYPE	DESCRIPTION	PART NUMBER	QTY.
<b>01508</b>	<b>SUPPORT - BRAKE PEDAL - continued</b>				
- B -					
65	B			*C5OZ 6201508-A	1
65	B		With power brakes	♣CC5OB 6201508-B	1
			Without power brakes	CC5OB 6201508-A	1
66	B			C6OZ 6201508-A	1
67	B			C6OZ 6201508-B	1
68/69	B			C9OZ 5401508-A	1
70/71	B			D0OZ 6501508-A	1
72	B		With manual transmission	D3OZ 6501508-A	1
			With automatic transmission	D2OZ 6501508-B	1
			Nut-3/8"-16	33799-S7(M52)	2
			Nut-U wing panel-5/16"-18	37914-S(MM192AD)	AR
			Retainer-3/8"-16	384989-S2(MM206C)	2
- F -					
65/66	F			C5ZZ 6501508-C	1
67/68	F		Without power brakes	C7ZZ 6501508-C	1
			With power brakes	C7ZZ 6501508-D	1
69	F		Without power brakes	C9ZZ 6501508-A	1
			With power brakes	C9ZZ 6501508-B	1
70	F(exc. 63 Boss)		Without power brakes	D0ZZ 6501508-A	1
			With power brakes	D0ZZ 6501508-B	1
70	F(63) Boss			D0ZZ 6301508-A	1
71/72	F	"Before 6/25/72"	With manual brakes-manual transmission	D1ZZ 6501508-A	1
			With power brakes-manual transmission	D1ZZ 6501508-B	1
			With manual brakes-automatic transmission	D1ZZ 6501508-C	1
			With power brakes-automatic transmission	D1ZZ 6501508-D	1
			Screw-self-tapping-1/4"-14 x 3/4"	55914-S2(U254F)	2
			Stud-3/8"-16 x 1 3/4"	384463-S(WW12A)	2
71/72	F	"From 6/25/72"	With manual brakes-manual transmission	D3ZZ 6501508-A	1
			With power brakes-manual transmission	D3ZZ 6501508-B	1
			With manual brakes-automatic transmission	D3ZZ 6501508-C	1
			With power brakes-automatic transmission	D3ZZ 6501508-D	1
- L -					
71/72	L			D2FZ 6201508-B	1
71/	L		Screw-self-tapping-1/4"-14 x 3/4"	55914-S36(U254F)	2
72	L		Screw & washer-hex.head-3/8"-16 x 2"	350879-S(3B566X)	2
- P -					
70	P		Without locking steering column	D0DZ 6201508-B	1
70/	P		With locking steering column	D0DZ 6201508-A	1
- S -					
70/71	S			D0SZ 6501508-A	1
72	S			D2OZ 6501508-B	1
70/	S		Screw & washer-5/16"-18 x 1"	57140-S2(B340H)	1
72	S		Nut-U-5/16"-18	379114-S2(MM192AD)	AR
			Retainer-3/8"-16	384989-S2(MM206C)	2
- U -					
66/	U		Refer to Group 01500		
- X -					
65	X			C5DZ 6201508-A	1
66	X			C6OZ 6201508-A	1
67	X			C6OZ 6201508-B	2
68/70	X			C9OZ 5401508-A	1
65/66	A, B, F, S, X		Screw & washer-hex.head-5/16"-28 x 3/4"	359662-S7-8(BB575A)	2
			Nut-hex.-5/16"-18	34392-S7-8(M93)	2
			Screw & washer-hex.head-5/16"-18 x 1 5/8"	359530-S8(BB576)	1

\* U. S. only

♣ Canada only



# FORD CAR PARTS

**BODY  
SECTION 000**

5

GROUP NUMBER	YEAR	BODY TYPE	DESCRIPTION	PART NUMBER	QTY.
<b>01508 SUPPORT - BRAKE PEDAL - continued</b>					
	67	A, F	Nut-hex.-5/16"-18	34392-S7(M93)	2
	67/	A, B	Screw & washer-hex.head-5/16"-18 x 1"	378178-S2(BB412B)	2
			Nut & washer-1/4"-20	33795-S7(M49)	2
	70/	B, L	Screw-hex.head-3/8"-16 x 1"	20388-S8(B80)	2
	65/	F	Screw & washer-hex.head-No.14-10 x 5/8"	31498-S8(U253B)	2
	65/70	X			2
	67/70	X	Screw & washer-hex.head-5/16"-18 x 13/16"	359662-S7-8(BB575A)	2
<b>015A08 BRACE - BRAKE PEDAL SUPPORT INSTRUMENT PANEL - Refer to Group 01524</b>					
<b>015A18 BRACE - BRAKE PEDAL SUPPORT - CENTER</b>					
	69	F		C9ZZ 65015A18-A	1
	70	F		D0ZZ 65015A18-A	1
	70	P	W/locking steering column-refer to Group 04510		1
	70	P	Without locking steering column	D0DZ 62015A18-B	1
<b>015A22 ABSORBER - DASH PANEL SOUND - CENTER</b>					
	69/70	F	"Before 8/11/69"	C9WY 65015A22-A	1
	70	F	"From 8/11/69"	D0ZZ 65015A22-A	1
<b>01524 BRACE - BRAKE PEDAL SUPPORT</b>					
	66/67	B		C6OZ 6201524-A	1
	68/69	B		C8OZ 5401524-A	1
	70/71	B	Refer to Group 04488		
	72	B		D2GZ 6501524-A	1
	69/70	F		D0ZZ 6501524-A	1
	71/	L		D1FZ 6201524-A	1
	70	P	W/locking steering column-refer to Group 04510	D0DZ 6201524-A	1
	70	P	Without locking steering column	D0DZ 6201524-B	1
			Nut & retainer-5/16"-18	379114-S2(MM192AD)	1
	72	S		D2SZ 6501524-A	1
			Nut-U-5/16"-18	45264-S101(M141H)	1
			Nut & washer assy.-5/16"-18	45338-S2(M89P)	2
			Screw & washer assy.-hex. hd.-5/16"-18 x 1"	57041-S2(B340D)	2
			Screw & washer assy.-hex.hd.-5/16"-18 x 15/16"	57039-S(B340B)	2
	66/67	X		C6OZ 6201524-A	1
	68/70	X		C8OZ 5401524-A	1
	66/67	B, X	Screw & washer-5/16"-18 5/8"	*378735-S2	2
	68/69	B, X	Screw & washer-5/16"-18 x 1"	378178-S2(BB412B)	3
<b>01530 BRACKET - BRAKE PEDAL SUPPORT</b>					
	71/	L		D1FZ 6201530-A	1
<b>015A36 EXTENSION - BRAKE PEDAL SUPPORT</b>					
	69	A		C9AZ 62015A36-A	1
	70	A		D0AZ 62015A36-A	1
	71/	A		D1AZ 65015A36-A	1
<b>01552-3 REINFORCEMENT - BRAKE PEDAL SUPPORT DASH PANEL</b>					
	72	S	R.H.	D2SZ 6501552-A	1
			L.H.	D2SZ 6501553-A	1
			Nut & washer-hex.head-5/16"-18	376838-S2(MM296AF)	2or4
			Clip-5/16"-18 x 7/8"	378685-S2(BB644)	2
<b>01590 ABSORBER - DASH PANEL SOUND - OUTER</b>					
	69/70	F	"Before 8/11/69"	C9WY 6501590-A	1
	70	F	"From 8/11/69"	D0ZZ 6501590-A	1
	70/72	P		D0DZ 6201590-A	1
<b>016B04 SEAL - DASH PANEL AT WINDSHIELD WIPER HOSE OPENING</b>					
	67/69	S		C7SZ 65016B04-A	1
	70/71	S	Add (2) holes for windshield wipers	D0SZ 65016B30-A	1
<b>01605 PANEL - DASH - Refer to Group 01610</b>					

GROUP NUMBER	YEAR	BODY TYPE	DESCRIPTION	PART NUMBER	QTY.
<b>01610-1 PANEL - DASH</b>					
- A -					
69/70		A(except 76)		C9AZ 6201610-A	1
69/70		A(76)		C9AZ 7601610-A	1
71/		A(except 76)		D1AZ 6501610-A	1
71/		A(76)		D1AZ 7601610-A	1
71		A	Bolt-hex.head-1/4"-20 x 5/8"	354476-S2(BB570)	2
72		A	Plug (button)-1/2" dia.	377935-S(PP2D)	1
- B -					
68/69		B(except 76)		C8OZ 5401610-B	1
70		B(except 76)		D0OZ 6501610-A	1
70		B(76)		D0OZ 7601610-A	1
71		B(except 76)		D1OZ 6501610-A	1
71		B(76)		D1OZ 7601610-A	1
72		B	Without A/C	D2OZ 6501610-A	1
			With A/C	D2OZ 6501610-B	1
68/72		B	Plug (button)-1 1/8" dia. - use w/out heater	378444-S(PP3H)	2
72		B	Plug (button)-7/8" dia.	377949-S(PP3F)	1
- F -					
65/66		F		C5ZZ 6501605-A	1
65		F	Plug(button)-13/16" diameter	377949-S (PP3F)	1
66		F	Plug (button)-3/16" x 13/16" hole size	376012-S(PP13C)	1
70		F		D0ZZ 6501610-A	1
71/		F	Cut to fit	D1ZZ 6501610-A	1
			Grommet-1 5/8" dia.	383945-S(KK90)	1
- L -					
71/		L		D1FZ 6201610-A	1
- P -					
70/		P		D0DZ 6201610-A	1
- S -					
68/69		S		C8SZ 6501610-B	1
			Plug (button)-13/16" dia.	377949-S(PP3F)	1
70/71		S		D0SZ 6501610-A	1
72		S	Includes reinforcement	D2SZ 6501610-A	1
- U -					
66/		U	R. H.	C6TZ 9601610-B	1
66/68		U	L.H.-not replaced (3-74)	★C6TZ 9601611-A	1
69/72		U	" Before Ser. P40,001"	C9TZ 9601611-A	1
72		U	" From Ser. P40,001"	D3BZ 1001611-A	1
- X -					
68		X	"Before 2/1/68"	C8OZ 5401610-A	1
68/70		X	"From 2/1/68"	C8OZ 5401610-B	1
			Plug (button)-1 1/8" dia. -use without heater	378444-S(PP3H)	2
<b>016A12-3 REINFORCEMENT - DASH PANEL TO FRAME BRACE TO FLOOR SIDE MEMBER</b>					
69/		A(76)	R. H.	C9AZ 76016A12-A	1
			L. H.	C9AZ 76016A13-A	1
<b>016A22-3 REINFORCEMENT - DASH PANEL TO FRONT FLOOR PAN</b>					
67/70		F(63, 65)	R. H.	C7ZZ 65016A22-C	1
			L. H.	C7ZZ 65016A23-B	1
65/70		F(76)	R. H.	C5ZZ 76016A22-A	1
67/70		F(76)	L. H.	C5ZZ 76016A23-B	1
71/		F(63, 65)	R.H.	D1ZZ 65016A22-A	1
			L.H.	D1ZZ 65016A23-A	1
71/		F(76)	R.H.	D1ZZ 76016A22-A	1
			L.H.	D1ZZ 76016A23-A	1
70/		P	R. H.	D0DZ 62016A22-A	1
			L. H.	D0DZ 62016A23-A	1

# FORD CAR PARTS

**BODY  
SECTION 000**

7

GROUP NUMBER	YEAR	BODY TYPE	DESCRIPTION	PART NUMBER	QTY.
<b>016B30</b>			<b>SEAL - DASH PANEL AT WINDSHIELD WIPER HOSE OPENING - Refer to Group 016B04</b>		
<b>016B44</b>			<b>REINFORCEMENT - DASH PANEL AT CIRCUIT BREAKER</b>		
	70/	S		D0SZ 65016B44-A	1
<b>016B50</b>			<b>REINFORCEMENT - DASH PANEL TO FRAME BRACE INNER</b>		
	68/	S		C8SZ 65016B50-B	1
<b>016B56</b>			<b>PLATE - DASH PANEL SPEEDOMETER CABLE COVER</b>		
	66/70	B, X		C6OZ 62016B56-A	1
	71	B			1
	72	B		D2OZ 65016B56-A	1
	66/68	B, X	Screw-cross recess washer head-No.8-15 x 3/4"	350075-S13(UU88)	2
	69	B, X	Screw-cross recess washer head-No.8-18 x 1/2"	381969-S2(UU89A)	7
	70/71	B	Screw-cross recess-tapping-No.8-18 x 1/2"	381944-S9(UU89B)	2
<b>01670-1</b>			<b>INSULATOR - DASH PANEL - Also refer to group 01708</b>		
			- A -		
	69/70	A		C9AZ 6201670-B	1
	71/	A		D1AZ 6501670-A	1
			- B -		
	70/71	B		D0OZ 6501670-A	1
	72	B	R.H.-without A/C	D2OZ 6501670-A	1
	72	B(53B, 65B, 71B, 97D, R)	R.H.-with A/C	D2OZ 6501670-B	1
			L.H.-w/ or w/o A/C and w/automatic trans.	D2OZ 6501671-C	1
	72	B(53D, 63R, 65D, R, 71D, K, 97K)	L.H. -with or without A/C, auto. trans.	D2OZ 6501671-A	1
	70/	B	Screw-oval trim head drive-No.8-18 x 3/4"	380911-S9(UU66E)	1
			- F -		
	67	F	With heater	C6OZ 6201670-B	1
	69	F	With heater	C9WY 6501670-B	1
	70	F	With heater	D0WY 6501670-B	1
	71/	F		D1ZZ 6501670-B	1
	69/	F	Screw-oval trim head drive-No.8-18 x 3/4"	380911-S9(UU66E)	2
			- L -		
	71	L	" Before 2/13/71"	D1FZ 6201670-A	1
	71/72	L	"From 2/13/71 to 8/18/72"	D1FZ 6201670-C	1
	72	L	" From 8/18/72"	D3FZ 6201970-A	1
			- P -		
	70/72	P	" Before 5/29/72"	D0DZ 6201670-A	1
	72	P	P-except LTD - "From 5/29/72"	D3DZ 621670-A	1
	72	P(54, 62A)	-LTD	D2DZ 5401670-A	1
			- S -		
	70/71	S		D0SZ 6501670-A	1
	72	S	R.H.	D2SZ 6501670-A	1
			L.H.	D2SZ 6501671-A	1
	67/	A, B, F, S	Clip	377347-S2(HH8H)	4to8
	68/	A, B, F, U	For retainer refer to Group 01691		
			- U -		
	69/	U(97, 98)		C9TZ 9701670-A	1
			- X -		
	67	X	With heater	C6OZ 6201670-B	1
	67/70	X	Clip	377347-S2(HH8H)	4to8
			Screw-oval trim head drive-No.8-18 x 3/4"	380911-S9(UU66E)	1
	68/70	X	For retainer refer to Group 01691		
<b>016B84</b>			<b>BRACKET - DASH PANEL TO ACCELERATOR MOUNTING</b>		
	72	B		D2OZ 65016B84-B	1
	72	S		D2OZ 65016B84-A	1

GROUP NUMBER	YEAR	BODY TYPE	DESCRIPTION	PART NUMBER	QTY.	
<b>016B86</b>	<b>BRACKET - DASH PANEL TO COWL TOP PANEL</b>					
	72	S		D2SZ 65016B86-A	1	
<b>01691</b>	<b>RETAINER - DASH PANEL FRONT SOUND ABSORBER</b>					
	68/	A	Use with A/C	C8ZZ 6501691-A	AR	
	68/	B, F			AR	
	70/	P, S			AR	
	69/	U			AR	
	68/70	X			AR	
	71/	L	With heater and A/C	D1FZ 6201691-A	3or4	
<b>01694</b>	<b>GROMMET - DASH PANEL OVERDRIVE CABLE</b>					
	65	S	With automatic transmission	B7S 4001694-A	1	
<b>01697</b>	<b>REINFORCEMENT - DASH PANEL AT STEERING COLUMN SUPPORT</b>					
	70/71	S		D0SZ 6501697-A	1	
<b>01698-9</b>	<b>PLATE - STEERING COLUMN OPENING COVER</b>					
	<b>- A -</b>					
	69/	A	Upper	C9AZ 6201698-A	1	
			Lower	C9AZ 6201699-A	1	
			Stud-5/16"-18 x 1 1/2"	382974-S(WW129Y)	1	
	<b>- B -</b>					
	66	B	R. H.	C6OZ 6201698-A	1	
			L. H.	C6OZ 6201699-A	1	
			Screw & washer-hex, head-No.14-10 x 1"	42154-S7-8(U256)	5	
	68/69	B	Plastic-upper - Paint to match	C8OZ 5401698-A	1	
			Plastic-lower - Paint to match	C8OZ 5401698-B	1	
	70/71	B	Upper	D0OZ 6201698-A	1	
			Lower	D0OZ 6201699-A	1	
	<b>- P -</b>					
	70/	P	Lower	D0DZ 6201698-A	1	
	<b>- U -</b>					
	68/	U	Lower	C8TZ 9601698-A	1	
			Upper	C8TZ 9601698-B	1	
			Clip	381637-S2(GG290)	2	
			Screw	★55934-S	4	
	<b>- X -</b>					
	67	X	"Before 1/16/67"	R. H.	C7OZ 6201698-A	1
				L. H.	C7OZ 6201699-A	1
	67	X	"From 1/16/67"	R. H.	C7OZ 6201698-B	1
				L. H.	C7OZ 6201699-B	1
	68/69	X	Plastic-upper-Paint to match	C8OZ 5401698-A	1	
			Plastic-lower-Paint to match	C8OZ 5401698-B	1	
<b>01714-5</b>	<b>BRACE - DASH PANEL TO FRAME</b>					
	69/71	A(except 76)	R. H.	C9AZ 6201714-A	1	
			L. H.	C9AZ 6201715-A	1	
	72	A(except 76)	R.H.	C9MY 5401714-C	1	
			L.H.	C9AZ 6201715-A	1	
	72	B	R.H.	D2OZ 6501714-A	1	
			L.H.	D2OZ 6501715-A	1	
	68/71	S	R.H.	C8SZ 6501714-A	1	
			L.H.	C8SZ 6501715-A	1	
	72	S	R.H.	D2SZ 6501714-A	1	
			L.H.	D2SZ 6501715-A	1	
<b>017A24-5</b>	<b>GUSSET - DASH PANEL LOWER REINFORCEMENT TO FRONT SIDE MEMBER</b>					
	65/66	S	R. H. - not replaced (3-74)	★C2SZ 63017A24-A	1	
	64	S	L. H.	C2SZ 63017A25-A	1	

# FORD CAR PARTS

**BODY  
SECTION 000**

9

GROUP NUMBER	YEAR	BODY TYPE	DESCRIPTION	PART NUMBER	QTY.
<b>01738</b>	<b>SEAL - STEERING COLUMN OPENING COVER PLATE - Also Refer to Group 3513 in Chassis Section</b>				
	70/	A		DOAZ 6501738-A	1
	65/68	B, X	"Before 3/3/69" Refer to Chassis Group 3513		
	69	B, X	"From 3/3/69"	C9OZ 6501738-A	1
	70/	P		D0DZ 6201738-A	1
<b>017A50-1</b>	<b>RETAINER - STEERING COLUMN OPENING COVER</b>				
	67	B, X	R. H. - with power steering L. H.	C7OZ 62017A50-B C7OZ 62017A51-B	1 1
	68/69	B		C9OZ 54017A50-B	2
	68/69	X			2
	69/70	F	Lower-at floor-with fixed column Upper-at instrument panel-with tilt column Lower-at floor-with tilt column	C9ZZ 65017A50-A C9ZZ 65017A50-D C9ZZ 65017A50-C	1 1 1
	71/	F	Lower Upper-refer to Group 04459	D1ZZ 65017A50-A	1
	69/	F	Screw & washer-hex. hd. -5/16" -18 x 7/8"	383295-S100(BB863HX)	4
<b>017A70-1</b>	<b>EXTENSION - DASH PANEL TO COWL SIDE OUTER PANEL</b>				
	69/	A(except 76)	R. H. L. H.	C9AZ 62017A70-A C9AZ 62017A71-A	1 1
	69/	A(76)	R. H. L. H.	C9AZ 76017A70-A C9AZ 76017A71-A	1 1
	68/69	S	R. H.	C8SZ 65017A70-A	1
	67/69	S	L. H.	C7SZ 65017A71-A	1
	70/71	S	R. H. L. H.	D0SZ 65017A70-A D0SZ 65017A71-A	1 1
<b>017A99</b>	<b>COVER - DASH PANEL WIRING</b>				
	69/	A		C9AZ 62017A99-A	1
	72	B, S		D2OZ 65017A99-A	1
			Screw-pan hd.drive point-No.8-18 x 1/2"	380934-S101(UU67F)	1
	65	A(57)	Refer to Group 10852 in Chassis Section		
<b>018B08</b>	<b>LOUVER - INSTRUMENT PANEL VENT AIR REGULATOR</b>				
	72	B	R.H. L.H. - Refer to Group 19893 in Chassis Section	D2OZ 65018B08-A	1
<b>018A10</b>	<b>NUT - INSTRUMENT PANEL AIR CONTROL MOUNTING</b>				
	71/	A	Without A/C	D1AZ 62018A10-A	2
<b>01814-5</b>	<b>REGISTER - VENT AIR</b>				
	71/	F	R.H. -also used with integral A/C L.H.	D1ZZ 6501814-A D1ZZ 6501815-A	1 1
	67/71	S	Screw-hex.washer head-No.8-12 x 1/4" Includes motor Screw-flat head-No.8-18 x 1/2" Gasket - refer to Group 01408	383938-S2(UU52V) C7SZ 6501815-B 377948-S2(UU48G)	2 1 8
<b>01816</b>	<b>BRACKET - VENT AIR CONTROL LEVER MOUNTING</b>				
	68/69	B	Used with Forced Ventilation & without A/C	C8OZ 5401816-B	1
<b>018A16-7</b>	<b>SCREEN - COWL TOP VENT</b>				
	71/	A	R.H. or L.H.	D1AZ 65018A16-A	2
	70/71	B	R. H. L. H.	D0OZ 65018A16-A D0OZ 65018A17-A	1 1
	72	B	R.H. L.H.	D2OZ 65018A16-A D2OZ 65018A17-A	1 1
	71/	F	R.H. L.H.	D1ZZ 65018A16-A D1ZZ 65018A17-A	1 1
	70/71	S	R. H. L. H.	D0SZ 65018A16-A D0SZ 65018A17-A	1 1
	72	S	R.H. L.H.	D2SZ 65018A16-A D2SZ 65018A17-A	1 1
	70/	B, S	Pin (drive)-1/4" x 9/16"	382570-S(HH8T)	8
	72	B	Screw-pan head-No. 8-18 x 3/4"	376328-S(UU67G)	1

**BODY  
SECTION 000**
**FORD CAR PARTS**

GROUP NUMBER	YEAR	BODY TYPE	DESCRIPTION	PART NUMBER	QTY.
<b>018B24 GASKET - COWL VENT AIR CONDITIONER DUCT</b>					
	66/69	B, X	At engine	C6OZ 62018B24-B	1
	66/70	B	At air duct	C6OZ 62018B24-C	1
	66/70	X			1
<b>018B32 GASKET - COWL VENT AIR DUCT DRAIN</b>					
	66/	U		C6TZ 96018B32-A	1
<b>01862-3 DAMPER - VENT AIR VALVE</b>					
- A -					
	69	A	"Before 1/29/69"	R. H. C9AZ 6201862-A	1
				L. H. C9AZ 6201863-B	1
	69/	A	"From 1/29/69"	R. H. C9AZ 6201862-B	1
				L. H. C9AZ 6201863-B	1
- B -					
	65	B		C3AZ 6201862-B	2
	66/69	B	R. H.	C6OZ 6201862-A	1
			L. H.	C6OZ 6201863-A	1
	70/71	B	R. H.	C6OZ 6201862-A	1
			L. H. -w/o forced ventilation	C6OZ 6201863-A	1
			L. H. -w/forced ventilation	D0OZ 6201863-A	1
	72	B	R. H. -without A/C	D2OZ 6501862-A	1
			L. H.	D2OZ 6501863-A	1
- F -					
	65/66	F		C3AZ 6201862-B	1
	67/68	F	R. H.	C6OZ 6201862-A	1
			L. H.	C6OZ 6201863-A	1
	69/70	F	R. H.	C9ZZ 6501862-A	1
			L. H.	C9ZZ 6501863-A	1
	71/	F	R. H. -without A/C	D1ZZ 6501862-A	2
- L -					
	72	L	R. H.	D2FZ 6201862-A	1
			L. H.	D2FZ 6201863-A	1
- S -					
	67/71	S	R. H. -without A/C	C7SZ 6501862-A	1
			L. H.	C7SZ 6501863-A	1
- X -					
	65/70	X	R. H.	C6OZ 6201862-A	1
			L. H.	C6OZ 6201863-A	1
<b>01870 BRACKET - INSTRUMENT PANEL AIR CONTROL MOUNTING</b>					
	68/69	B, X	R. H. -without A/C	C8OZ 5401870-B	1
			L. H. -with or without A/C		1
	70/71	B		D0OZ 6501870-A	1
	65/66	F		C5ZZ 6501870-A	1
	67/69	F		C7ZZ 6501870-A	1
	71/	F	R. H. -without A/C	D1ZZ 6501870-A	1
<b>01878 CONNECTOR - COWL VENT AIR DUCT</b>					
	72	B	R. H. -without A/C	D2OZ 6501878-A	1
	71/	F	L. H. -without A/C	D1ZZ 6501878-A	1
	71	L	R. H.	D1FZ 6201878-A	1
			L. H.	D1FZ 6201878-B	1
	72	L	R. H.	D2FZ 6201878-A	1
			L. H.	D2FZ 6201878-B	1

# FORD CAR PARTS

**BODY  
SECTION 000**

11

GROUP NUMBER	YEAR	BODY TYPE	DESCRIPTION	PART NUMBER	QTY.
<b>01890-1 CONTROL - INSTRUMENT PANEL VENT AIR OUTLET DUCT</b>					
<b>- A -</b>					
65/66	A		R. H.	C5AZ 6201890-A	1
			L. H.	C5AZ 6201891-A	1
67	A		Clip	380829-S2(GG249)	1
			R.H.-without Forced Ventilation	C7AZ 6201890-A	1
65/67	A		L. H.	C7AZ 6201891-A	1
			Also refer to Group 18552 in Chassis Section		
68	A		R. H.	C8AZ 6201890-A	1
			L. H.-also used with Forced Ventilation	C8AZ 6201891-A	1
			Also refer to Group 18552 in Chassis Section		
69	A		R. H.-without A/C	C9AZ 6201890-B	1
			L. H. - with or without A/C	C9AZ 6201891-B	1
70	A		R. H.	D0AZ 6201890-A	1
			L. H.	D0AZ 6201891-A	1
			Clip	381672-S2(GG139H)	1
71/	A		R.H.-without A/C	D1AZ 6201890-A	1
			L. H.	D1AZ 6201891-A	1
66/71	A		Nut-spring-3/16"	383358-S(MM260)	2
<b>- B -</b>					
65	B		L. H.-with or without fresh air heater or automatic choke & cut to length	C5DZ 6201891-A	1
			Screw-cross recess pan hd.-No.10-32 x 5/8"	50525-S8 (U159)	1
			Clip-improvise	*374081-S100	1
			Washer-flat-No.10	44716-S8(X15)	1
			Lockwasher-No.10	34803-S7(X60)	1
66/67	B		Nut-hex.-No.10-32	34079-S7(M163)	1
			R. H.	C6OZ 6201890-A	1
68/69	B		L. H.	C6OZ 6201891-B	1
			R.H.-without A/C or Forced Ventilation	C8OZ 5401890-A	1
			R.H.-with A/C and Forced Ventilation	C8OZ 5401890-B	1
70/71	B		L. H.	C8OZ 5401891-A	1
			R. H. -without A/C	D0OZ 5401890-A	1
70/71	B		L. H. -with ram air vent-8 1/2" long	D0OZ 5401891-A	1
70/71	B(54, 57, 62, 71)		L. H.-without ram air vent-10 3/4" long	D0OZ 5401891-B	1
66/71	B		Nut-spring-3/16"	383358-S(MM260)	2
72	B		R. H.-without A/C	D2OZ 6501890-A	1
			L. H.	D2OZ 6501891-A	1
<b>- F -</b>					
65/66	F		L. H.-with or without fresh air heater or automatic choke & cut to length	C5DZ 6201891-A	1
67	F	"Before 4/3/67"	L. H.	C7ZZ 6501891-A	1
67/68	F	"From 4/3/67"	L. H.	C7ZZ 6501891-C	1
69/70	F		R. H.	C9ZZ 6501890-A	1
			L. H.	C9ZZ 6501891-A	1
71/	F		R.H.-without A/C	D1ZZ 6501890-A	1
			L. H.-with or without A/C	D1ZZ 6501891-A	1
			Nut-hex.lock-7/16"-14	34988-S4(M89D)	1
<b>- L -</b>					
71	L		R. H.-without A/C	D1FZ 6201890-A	1
			L. H.	D1FZ 6201891-A	1
72	L		R. H.	D2FZ 6201890-A	1
			L. H.	D2FZ 6201891-A	1
<b>- P -</b>					
70/	P		L. H.	D1DZ 6201891-A	1

**BODY  
SECTION 000**
**FORD CAR PARTS**

GROUP NUMBER	YEAR	BODY TYPE	DESCRIPTION	PART NUMBER	QTY.
<b>01890-1 CONTROL - INSTRUMENT PANEL VENT AIR OUTLET DUCT - continued</b>					
- S -					
	65/66	S	R. H.	C4SZ 6301890-C	1
			L. H.	C4SZ 6301891-C	1
	67	S	R. H. -Used without A/C	C7SZ 6501890-A	1
			L. H.	C7SZ 6501891-A	1
	68/70	S-includes knob	With A/C and without speed control-single cable	C8SZ 6501890-B	1
			Without A/C or speed control-dual cable	C8SZ 6501890-D	1
			Screw-hex.washer lead top-No.10-12 x 1/2"	42127-S8(U248C)	2
	68/71	S-includes knob	With A/C & ATC-single cable	C8SZ 6501890-C	1
			Without A/C -with speed control and defogger-triple cable	C8SZ 6501890-E	1
	70/	S	Back window vent control-refer to Group 02006		
	66/71	S	Nut-spring-3/16"	383358-S(MM260)	2
- X -					
	65	X	L. H. -With or without fresh air heater or automatic choke & cut to length	C5DZ 6201891-A	1
			Screw-cross recess pan hd.-No.10-32 x 5/8"	50525-S8(U159)	1
			Clip -improvise	★374081-S100	1
			Washer-flat-No.10	44716-S8(X15)	1
			Lockwasher-No.10	34803-S7(X60)	1
			Nut-hex.-No.10-32	34079-S7(M163)	1
			Nut-spring-3/16"	383358-S(MM260)	1
	66/67	X	R. H.	C6OZ 6201890-A	1
			L. H.	C6OZ 6201891-B	1
	68/70	X	R.H.-Use without A/C	C8DZ 6201890-A	1
			L. H.	C8OZ 5401891-A	1
	66/	A, B, S	Nut-spring-1/8"	383358-S(MM260)	1
	66/70	X	Nut-spring cap-3/16"	376912-S2(MM263F)	1
			Screw-hex.hd.tap.washer-No.10-12 x 1/2"	42127-S8(U248C)	1
			Washer-flat-No.10	44713-S8(X13)	1
	68	B, X	Bolt-hex.hd.-1/4"-20 x 1/2"	376562-S(BB541)	2
	67/68	F	Clip	381965-S2(GG278)	1
	65/66	S	Clip	378897-S7-8(GG162A)	2
<b>01934-5 DUCT - COWL VENT AIR - OUTLET</b>					
- A -					
	65/68	A	R. H.	C5AZ 6201934-A	1
			L. H.	C5AZ 6201935-A	1
			Screw-hex.washer hd.-No.10-12 x 5/8"	42134-S8(U249)	6or12
	69	A	"Before 1/29/69" R. H. -without A/C -r/b C9AZ 6201934-C(7/74)	★C9AZ 6201934-A	1
			R. H. -with A/C	C9AZ 6201934-B	1
			L. H. -with or without A/C-r/b C9AZ 6201935-B (8/74)	★C9AZ 6201935-A	1
	69/	A	"From 1/29/69" R. H. -without A/C	C9AZ 6201934-C	1
			R. H. -with A/C	C9AZ 6201934-D	1
			L. H. -with or without A/C	C9AZ 6201935-B	1
- B -					
	66/67	B	R.H.-without heater or defroster-not repl.(3-74)	★C6OZ 6201934-A	1
			L. H.	C6OZ 6201935-C	1
	68	B	R. H. -with forced ventilation	C8OZ 5401934-B	1
	66/69	B	R. H. -without integral A/C	C8OZ 5401934-A	1
	67/69	B	R. H. -with integral A/C	C9OZ 5401934-A	1
	68/69	B	L. H.	C8OZ 5401935-A	1
			No. 10-16 x 1/2" Pan head tapping screw	52787-S13(U367A)	1



# FORD CAR PARTS

**BODY  
SECTION 000**

13

GROUP NUMBER	YEAR	BODY TYPE	DESCRIPTION	PART NUMBER	QTY.
<b>01934-5 DUCT - COWL VENT AIR - OUTLET -continued</b>					
<b>- B -</b>					
	70/71	B	R.H.-with A/C and without forced air ventilation L.H.	D0OZ 5401934-B D0OZ 5401935-A	1 1
	70/71	B	R.H.-without A/C and with forced air ventilation L.H.	D0OZ 5401934-A D0OZ 6501935-A	1 1
			R.H.-without A/C or forced air ventilation L.H.	D0OZ 5401934-C D0OZ 5401935-A	1 1
	72	B	R.H.-without A/C L.H. - connects to cowl panel L.H. - connects to Group 19893 Screw-washer head-1/4"-14 x 3/4" Clip-1/4"-20 x 1"	D2OZ 6501934-A D2OZ 6501935-A D2OZ 6501935-B 55914-S36(U254F) 382764-S2(BB643CB)	1 1 1 1 3
<b>- F -</b>					
	67/68	F	R.H.-without heater or defroster L.H. -not replaced(3-74)	C7ZZ 6501934-A ★C7ZZ 6501935-A	1 1
	69/70	F	R.H. L.H.	C9ZZ 6501934-A C9ZZ 6501935-A	1 1
	71/	F	R.H.-without A/C L.H. -with or without A/C Nut (spring)-3/16" Nut & washer-hex.flange-No.10-24 Screw-hex.washer head-1/4"-14	D1ZZ 6501934-A D1ZZ 6501935-A 383358-S(MM260) 376792-S(MM191D) 55914-S2(U254F)	1 1 2 4 1
<b>- L -</b>					
	71	L	R.H.-Refer to Illustration Section 184 in Chassis Section		
	71	L	L.H.	D1FZ 6201935-A	1
	72	L	R.H. L.H.	D4FZ 6201934-A D4FZ 6201935-A	1 1
<b>- P -</b>					
	70/	P	L.H. Nut-hex.stamped-1/4"-24	D0DZ 6201935-A 45243-S7-8(M178)	1 3
<b>- S -</b>					
	67/71	S	R.H. -With heater and without defroster or A/C L.H. -With heater, defroster, with or without A/C	C7SZ 6501934-A C7SZ 6501935-A	1 1
	65/	S	Screw-hex.washer head-No.10-12 x 5/8"	42134-S8 (U249)	8 or 12
<b>- U -</b>					
	66/	U	L.H. Screw-round head-No.10-12 x 5/8"	C6TZ 9601934-B 373086-S101(BB630A)	1 8
<b>- X -</b>					
	66	X	"Before 1/3/66"	L.H.	
	66	X	"From 1/3/66"	L.H.	
	66/67	X	R.H. -Without integral A/C	C6OZ 6201935-A C8OZ 6201935-B	1 1
	67	X	L.H.	C8OZ 5401934-A C8OZ 6201935-C	1 1
	67/70	X	R.H. -With integral A/C	C9OZ 5401934-A	1
	68/70	X	R.H. -Without integral A/C-not replaced(5/74) L.H. -Without integral A/C Screw-pan head tapping-No.10-16 x 1/2"	★C8DZ 5401934-A C8OZ 5401935-A 52787-S13(U367A)	1 1 1
	66/67	B, F	Nut-hex. -No.10-24 Nut-hex. -1/4"-20 Lockwasher-1/4"	359606-S8(MM291A) 33795-S7(M49) 34940-S7-8(X88)	3 3 3
<b>01968 DEFLECTOR - INSTRUMENT PANEL AIR OUTLET</b>					
	67/71	S	R.H. -Without A/C & with heater	C7SZ 6501968-A	1
	68/71	S	R.H. -With A/C & manual temperature control R.H. -With A/C & automatic temperature control	C8SZ 6501968-A C8SZ 6501968-B	1 1
	67/71	S	L.H. -Refer to basic Group 01415		

GROUP NUMBER	YEAR	BODY TYPE	DESCRIPTION	PART NUMBER	QTY.
<b>01970</b>	<b>SEAL - VENT AIR DUCT - OUTER</b>				
	65	A,S	R.H. or L.H. -Improvise from caulking sealer	★	
<b>019A84</b>	<b>MOTOR and BRACKET ASSY. - COWL VENT AIR REGISTER DAMPER</b>				
	65/66	A(57)		C4SZ 63019A84-B	2
	65/66	S(63)			2
	67/71	S		C7SZ 65019A84-A	2
			No. 8-32 x 1/2" Hex.washer head screw	40917-S8(U257)	4
<b>019A86</b>	<b>CONNECTOR - VENT AIR REGISTER DAMPER MOTOR HOSE</b>				
	65/71	S		C4SZ 63019A86-A	1
	65/66	A(57)			1
<b>01988</b>	<b>SEAL - VENT AIR INLET DUCT</b>				
	66/72	U	L.H.	C6TZ 9601988-B	1
			Center-approx. 9 7/16" x 8 9/16"	C6TZ 9601988-C	1
<b>019A88</b>	<b>HOSE - VENT AIR REGISTER DAMPER MOTOR - Refer to Group 17543 in Chassis Section</b>				
	65	A(57)	1/16" I.D. x 1/8" O.D. & .110" I.D. x .240" O.D. - cut from C4SZ 17543-C		
			.25" I.D. - cut from 17543 - Refer to Chassis Section		
			Clip	377987-S(GG256)	4
			Connector-T-3/16" x 3/16" x 3/16"	378830-S(II-106H)	1
			1/4"-20 Hex. nut	34055-S8(M158)	1
			No. 8-15 x 1/2" Flat head tapping screw	52012-S8(U202)	26
	66/67	A(57)	Cut 106" long from 17543-Refer to Chassis Group		
	66/67	S	Cut 106" long from 17543-Refer to Chassis Section		
	68	S	Cut 143" long from 17543-Refer to Chassis Section		
	69	S	Cut 17" long from 17543-Refer to Chassis Section		
<b>01999</b>	<b>GASKET - VENT AIR INLET DUCT TO COWL TOP INNER PANEL</b>				
	66/69	B, X	With heater - at vent air inlet duct	C6OZ 6201999-A	2
	70/71	B	R.H.	D0OZ 5401999-A	1
			L.H.	D0OZ 6201999-A	1
	72	B	R.H.	D2OZ 6501999-B	1
			L.H.	D2OZ 6501999-A	1
	65/66	F		C2OZ 6201999-A	1
	67/68	F	L.H.	C7ZZ 6501999-A	1
	71/	F	R.H.-without A/C	D1ZZ 6501999-B	1
	71/	L	L.H.	D1FZ 6201999-B	1
	72	L	R.H.	D2FZ 6201999-A	1
	70/	P		D0DZ 6201999-A	1
	66/	U		C6TZ 9601999-A	1

# FORD CAR PARTS

## BODY SECTION 020

1

GROUP NUMBER	YEAR	BODY TYPE	DESCRIPTION	PART NUMBER	QTY.
<b>02006 CONTROL - VENT AIR REGISTER DAMPER</b>					
	65/66	A(57)		C5AZ 5702006-B	1
	65/66	S(63)		C4SZ 6302006-A	1
			1/2"-28 Hex. nut	356098-S2(MM122A)	1
	67/69	S		C7SZ 6502006-A	1
	70/71	S	Rear window vent with knob	D1SZ 6502006-A	1
	70/	S	Cowl vent control-refer to Group 01890-1		
<b>02010 PANEL - COWL TOP</b>					
	70/71	B		D0OZ 6502010-A	1
	72	B	Without A/C	D2OZ 6502010-A	1
			With A/C	D2OZ 6502010-B	1
	69/70	F		C9ZZ 6502010-A	1
	71/	F		D1ZZ 6502010-A	1
	71/72	L	Includes wiper motor bracket	D2FZ 6202010-A	1
	70	P	Without locking steering column	D0DZ 6202010-A	1
	70/	P	With locking steering column	D0DZ 6202010-B	1
	72	S		D2SZ 6502010-A	1
	66/	U		C6TZ 9602010-B	1
	66/67	X		C6OZ 6202010-E	1
	68/70	X		C8OZ 5402010-B	1
<b>02012 PANEL - COWL TOP - OUTER</b>					
	68	A		C8AZ 6202012-A	1
	69	A		C9AZ 6202012-A	1
	70	A		D0AZ 6202012-A	1
	71/	A		D1AZ 6502012-A	1
	68/69	S		C8SZ 6502012-A	1
	70/71	S		D0SZ 6502012-A	1
<b>02018 PANEL - COWL TOP - INNER</b>					
	69/70	A		C9AZ 7602018-A	1
	71	A		D1AZ 7602018-A	1
	72	A		D2AZ 7602018-A	1
	68/69	S		C8SZ 6502018-A	1
	70/71	S		D0SZ 6502018-B	1
<b>02034 REINFORCEMENT - COWL TOP PANEL</b>					
	70	F(63)-Boss 302		D0ZZ 6302034-A	1
<b>02038-9 PANEL - COWL SIDE</b>					
	69/70	A	R. H.	C9AZ 7602038-A	1
	70	A(except 76)	L. H.	D0AZ 6202039-A	1
	69/70	A(76)	L. H.	C9AZ 7602039-A	1
	71/	A(except 76)	R. H. -inner	D1AZ 6502038-A	1
			L. H.	D1AZ 6502039-A	1
	71/	A(76)	R. H. -inner	D1AZ 7602038-A	1
			L. H.	D1AZ 7602039-A	1
	72	B	R. H.	D2OZ 6502038-A	1
			L. H.	D2OZ 6502039-A	1
	69	F	R. H.	C9ZZ 6502038-A	1
	70	F	R. H.	D0ZZ 6502038-A	1
	69/70	F	L. H.	C9ZZ 6502039-A	1
	71/	F	R. H. -inner	D1ZZ 6502038-A	1
			L. H.	D1ZZ 6502039-A	1
	71/72	L	"Before 10/25/71" R. H. -inner	D1FZ 6202038-A	1
			L. H.	D1FZ 6202039-A	1
	72	L	"From 10/25/71" R. H. -inner	D3FZ 6202038-A	1
			L. H.	D1FZ 6202039-A	1
	67/69	S	R. H.	C7SZ 6502038-B	1
	70/71	S	R. H.	D0SZ 6502038-A	1
	68/71	S	L. H.	C8SZ 6502039-A	1
	72	S	R. H.	D2SZ 6502038-A	1
			L. H.	D2SZ 6502039-A	1
	69/	U	R. H.	C9TZ 9602038-A	1
			L. H.	C9TZ 9602039-A	1
			Plug (button)-1" dia. hole	377678-S(PP3E)	1

**BODY  
SECTION 020**
**FORD CAR PARTS**

GROUP NUMBER	YEAR	BODY TYPE	DESCRIPTION	PART NUMBER	QTY.
<b>02042-3</b>	<b>PANEL ASSY. - FRONT PILLAR - Also refer to groups 02500-1 &amp; 02504-5</b>				
	<b>- B -</b>				
	68/69	B(54, 71)	R. H.	C8OZ 5402042-B	1
			L. H.	C8OZ 5402043-B	1
	70/71	B(except 63, 71)	R. H.	D0OZ 6502042-A	1
			L. H.	D0OZ 6502043-A	1
	70/71	B(63)	R. H.	D0OZ 6302042-A	1
			L. H.	D0OZ 6302043-A	1
	70/71	B(71)	R. H.	D0OZ 7102042-A	1
			L. H.	D0OZ 7102043-A	1
	<b>- P -</b>				
	70	P	"Before 9/15/69"	R. H.	D0DZ 6202042-A
				L. H.	D0DZ 6202043-A
	70/72	P	"From 9/15/69 to 7/3/72"	R. H.	D0DZ 6202042-B
				L. H.	D0DZ 6202043-B
	72	P	"From 7/3/72"	R. H.	D2DZ 6202042-A
				L. H.	D2DZ 6202043-A
	<b>- X -</b>				
	68/70	X	R. H.	C8DZ 6202042-B	1
			L. H. - not replaced (5-75)	★C8DZ 6202043-B	1
<b>02044-5</b>	<b>PANEL - COWL SIDE OUTER</b>				
	66/68	A	R. H.	C5AZ 6202044-B	1
			L. H. -not replaced (3-74)	★C5AZ 6202045-B	1
	69/70	A(except 76)	R. H.	C9AZ 6202044-A	1
			L. H.	C9AZ 6202045-A	1
	69/70	A(76)	R. H.	C9AZ 7602044-A	1
	71/	A			1
			L. H.	C9AZ 7602045-A	1
	69/70	F	R. H.	C9ZZ 6502044-A	1
			L. H.	C9ZZ 6502045-A	1
	67/71	S	R. H.	C7SZ 6502044-A	1
			L. H.	C7SZ 6502045-A	1
<b>02046-7</b>	<b>PANEL - FRONT WHEELHOUSE - UPPER</b>				
	66/	U	R. H.	C6TZ 9602046-A	1
			L. H.	C6TZ 9602047-A	1
<b>02048-9</b>	<b>PANEL - FRONT WHEELHOUSE - INNER</b>				
	66/	U	R. H.	C6TZ 9602048-A	1
			L. H.	C6TZ 9602049-A	1
<b>02062-3</b>	<b>EXTENSION - COWL SIDE PANEL</b>				
	72	B	Refer to Group 02038-9		
	71/	L	R. H.	D1FZ 6202062-A	1
			L. H.	D1FZ 6202063-A	1
<b>020A84-5</b>	<b>REINFORCEMENT - COWL SIDE INNER PANEL TO BODY ROCKER PANEL</b>				
	69/	A	Refer to Group 02884-5		
	67/71	S	R. H.	C7SZ 65020A84-A	1
			L. H.	C7SZ 65020A85-A	1
<b>02085</b>	<b>COVER - COWL TOP PANEL OPENING INNER</b>				
	71/	L	With A/C		D1FZ 6202085-A
<b>02104</b>	<b>VENT - COWL SIDE</b>				
	66/	U	L. H.	C5TZ 8102104-A	1
<b>02109</b>	<b>COVER - COWL VENT AIR OPENING</b>				
	71/	A	L. H. -with A/C		D1AZ 6502109-A
	68/	S	L. H. -with A.T.C.		C8SZ 6502109-A
			No. 10-12 x 5/8" hex. head washer tapscrew		42134-S2(U249)
<b>021A22</b>	<b>SEAL - COWL SIDE PANEL</b>				
	67/68	A		C7AZ 62021A22-A	2
			Clip	381672-S2(GG139H)	14
	69/70	A		C9AZ 62021A22-A	2
	67/71	S		C7SZ 65021A22-A	2
<b>021A32</b>	<b>SEAL - COWL TOP VENT GRILLE</b>				
	69	B, X	Cut from rubber 7" long x 1" x 1/2"		★
	67/69	S		C7SZ 65021A32-B	2
<b>021A46</b>	<b>SEAL - COWL TOP PANEL</b>				
	66	B	55" long-cut from AB 19560-A		★

# FORD CAR PARTS

## BODY SECTION 020

3

GROUP NUMBER	YEAR	BODY TYPE	DESCRIPTION	PART NUMBER	QTY.	
<b>02158</b>	<b>SEAL - COWL SIDE VENT AIR DUCT</b>					
	66/68	A	30" long-cut to fit	C6AZ 6202158-B	2	
	69/	A			2	
	67/68	S			2	
	71	S			2	
	69/70	S			C9SZ 6502158-A	2
<b>021A58</b>	<b>BAFFLE - COWL SIDE PANEL WATER</b>					
	68/69	S	Use with R. H. air duct	C8SZ 65021A58-A	1	
	70/71	S		D0SZ 65021A58-A	1	
<b>021A64</b>	<b>BRACKET - FRONT WHEELHOUSE DASH SUPPORT - LOWER</b>					
	66/	U		C6TZ 96021A64-A	2	
<b>02204</b>	<b>ANTI-SQUEAK - COWL TOP VENT GRILLE</b>					
	65	S	Cut off 1 3/4"	B7C 8102204-A	AR	
<b>022A06-7</b>	<b>REINFORCEMENT - COWL TOP INNER PANEL</b>					
	72	B	R.H.	D2OZ 65022A06-A	1	
			L.H.	D2OZ 65022A07-A	1	
	71/	L	R. H.	D1FZ 62022A06-A	1	
			L. H.	D1FZ 62022A07-A	1	
	72	S	R.H.	D2SZ 65022A06-A	1	
			L.H.	D2SZ 65022A07-A	1	
<b>02207</b>	<b>TUBE - COWL TOP INNER PANEL DRAIN</b>					
	72	B,S		D2OZ 6502207-A	1	
	65/66	S	Clamp	C1SZ 6302207-A	2	
				B7AZ 8287-D	2	
<b>02207</b>	<b>TUBE - VENT AIR DUCT</b>					
	66/	U		C6TZ 9602207-B	1	
<b>02224-5</b>	<b>BRACKET - COWL TOP VENT GRILLE</b>					
	69/70	A	R. H.	C9AZ 6202224-A	1	
			L. H.	C9AZ 6202225-A	1	
<b>022A24-5</b>	<b>BRACKET - COWL TOP PANEL TO PILLAR</b>					
	68/70	B, X	R. H.	C8OZ 54022A24-A	1	
	71	B(except 63)	L. H.		1	
				C8OZ 54022A25-A	1	
<b>02228</b>	<b>GRILLE - COWL TOP VENT</b>					
	65/66	A		C5AZ 6202228-B	1	
	67/68	A		C7AZ 6202228-B	1	
	69/70	A		D0AZ 6202228-A	1	
			Button (plug)-3/4" x 1"-without radio	378770-S(PP13B)	1	
	66/67	B		C6OZ 6202228-B	1	
	68/69	B		C8OZ 5402228-A	1	
	69/70	F		C9Z 6502228-A	1	
	68/69	S		C8SZ 6502228-A	1	
	66/67	X		C6OZ 6202228-B	1	
	68/70	X		C8OZ 5402228-A	1	
	65/70	A, B, S, X	No. 8-15 x 5/8" Hex. washer head screw	*42133-S8	8to12	
			No. 8-15 x 1/2" Cross recess pan head screw	52726-S13(U381)	2	
<b>022A44</b>	<b>RETAINER - COWL TOP PANEL MOULDING</b>					
	69/70	A		C9AZ 62022A44-A	5	
				C9AZ 62022A44-B	2	
<b>02249</b>	<b>SHIM - COWL TOP VENT GRILLE EXTENSION</b>					
	68/70	X	37 1/2" long	C8DZ 6202249-A	1	
<b>02256-7</b>	<b>PLATE - COWL TOP PANEL ACCESS HOLE COVER</b>					
	70/71	S	R. H.	D0SZ 6502256-A	1	
			L. H.	D0SZ 6502257-A	1	
<b>022A58</b>	<b>SCREEN - COWL TOP VENT - CENTER</b>					
	71/	A		D1AZ 65022A58-A	1	
	70/	S		D0SZ 65022A58-A	1	
<b>022A62</b>	<b>COVER - COWL TOP PANEL MOULDING</b>					
	69	A	"Before 5/1/69"	Used as center cap for group 022A64-5 - r/b C9AZ 62022A62-C (7-74)	*C9AZ 62022A62-B	1
	69/70	A	"From 5/1/69"	Used as center cap for group 022A64-5	C9AZ 62022A62-C	1
<b>022A64-5</b>	<b>MOULDING - COWL TOP PANEL - Includes Attaching Parts</b>					
	69/70	A	R. H.	C9AZ 62022A64-C	1	
			L. H.	C9AZ 62022A65-C	1	
			For center cap refer to Group 022A62			
<b>022A88</b>	<b>COVER - COWL TOP INNER PANEL</b>					
	71	B		D1OZ 65022A88-A	1	

GROUP NUMBER	YEAR	BODY TYPE	DESCRIPTION	PART NUMBER	QTY.	
<b>02294-5 BRACKET - COWL TOP PANEL TO FRONT FENDER APRON</b>						
70/71	B		R. H.	D00Z 6502294-A	1	
			L. H.	D00Z 6502295-A	1	
			Bumper (round) rubber	380624-S(CC18A)	2	
69/70	F		R. H.	C9ZZ 6502294-A	1	
			L. H.	C9ZZ 6502295-A	1	
71/	L		R. H.	D1FZ 6202294-A	1	
			L. H.	D1FZ 6202295-A	1	
70	P(62)	"Before 12/31/69"	R. H.	D0DZ 6202294-A	1	
			L. H.	D0DZ 6202295-A	1	
70/	P(62)	"From 12/31/69"	R. H.	D0DZ 6202294-B	1	
			L. H.	D0DZ 6202295-B	1	
			Bumper (round) rubber	380624-S(CC18A)	2	
66/67	X		R. H.	C6OZ 6202294-B	1	
			L. H., -not replaced (3-74)	*C6OZ 6202295-B	1	
<b>023A02 BRACKET - COWL TOP INNER PANEL TO INSTRUMENT PANEL</b>						
72	A			D2AZ 65023A02-A	1	
<b>02316 RETAINER - COWL TOP VENT GRILLE</b>						
67	S			C7SZ 6502316-A	9	
<b>023A18-9 EXTENSION - COWL TOP TO FRONT FENDER BRACKET</b>						
72	S		R.H.	D2SZ 65023A18-A	1	
			L.H.	D2SZ 65023A19-A	1	
<b>023A20 REINFORCEMENT - COWL TOP INNER PANEL - CENTER</b>						
72	S			D2SZ 65023A20-A	1	
<b>023A30-1 VALVE - COWL TOP WITH DRAIN</b>						
72	B	"Before 8/16/71"	R.H.	D2OZ 65023A30-A	1	
			L.H.	D2OZ 65023A31-A	1	
72	B	"From 8/16/71"	R. H.	D2OZ 65023A30-B	1	
			L. H.	D2OZ 65023A31-B	1	
<b>02396-7 MOULDING - COWL TOP PANEL END - Includes Attaching Parts</b>						
69/70	A(except 76)		R. H.	C9AZ 6202396-B	1	
			L. H.	C9AZ 6202397-B	1	
GROUP NUMBER	YEAR	BODY TYPE	DESCRIPTION	PART NUMBER		QTY.
				RIGHT HAND	LEFT HAND	
<b>02464-5 REINFORCEMENT - FRONT WHEELHOUSE PANEL</b>						
66/	U			C6TZ 9602464-B	C6TZ 9602465-B	1
<b>02500-1 PILLAR - FRONT BODY - LOWER</b>						
69/	A			C9AZ 6202500-A	C9AZ 6202501-A	1
72	B			D2OZ 6502500-A	D2OZ 6502501-A	1
69/70	F			C9ZZ 6502500-A	C9ZZ 6502501-A	1
71/	F			D1ZZ 6502500-A	D1ZZ 6502501-A	1
71	L			D1FZ 6202500-A	D1FZ 6202501-A	1
72	L			D2FZ 6202500-A	D2FZ 6202501-A	1
67/69	S			C7SZ 6502500-B	C8SZ 6502501-B	1
70/71	S(57, 65B, D)			D0SZ 5702500-A	D0SZ 5702501-A	1
70/71	S(65A, C)			D0SZ 6502500-A	D0SZ 6502501-A	1
72	S			D2SZ 6502500-A	D2SZ 6502501-A	1
68/	U		Side front	C8TZ 9602500-B	C8TZ 9602501-B	1
69/	A, F, S		Plug (button)-1" dia. hole	377678-S(PP3E)	377678-S(PP3E)	2
<b>02500-1 PANEL AND PILLAR ASSY. - COWL SIDE FRONT BODY</b>						
66/67	U			C8TZ 9602500-B	C6TZ 9602501-A	1
<b>02504-5 PILLAR - FRONT BODY - UPPER</b>						
70	A(57, 63, 65)		Inner	D0AZ 6302504-A	D0AZ 6302505-A	1
70	A(76)		Inner	D0AZ 7602504-A	D0AZ 7602505-A	1
71	A(53, 57)		Inner and outer	D1AZ 5702504-A	D1AZ 5702505-A	1
70/	A(54, 62, 71)		Inner and outer	D1AZ 5402504-A	D1AZ 5402505-A	1
71/	A(65)		Inner and outer	D1AZ 6502504-A	D1AZ 6502505-A	1
71/	A(76)		Inner and outer	D1AZ 7602504-A	D1AZ 7602505-A	1
			Screw-pan head- No. 8-18 x 1/2"	380934-S101(UU67F)	380934-S101(UU67F)	2
70/71	B(54, 62)			D0OZ 5402504-A	D0OZ 5402505-A	1
70/71	B(63)			D0OZ 6302504-A	D0OZ 6302505-A	1
72	B		Inner	D2OZ 6502504-A	D4OZ 6502505-A	1
69/70	F(63)		Inner	C9ZZ 6302504-A	C9ZZ 6302505-A	1
69/70	F(65)		Inner	C9ZZ 6502504-A	C9ZZ 6502505-A	1
69/70	F(76)		Inner	C9ZZ 7602504-A	C9ZZ 7602505-A	1

# FORD CAR PARTS

**BODY  
SECTION 020**

5

GROUP NUMBER	YEAR	BODY TYPE	DESCRIPTION	PART NUMBER		QTY.
				RIGHT HAND	LEFT HAND	
<b>02504-5 PILLAR - FRONT BODY - UPPER - continued</b>						
	71/	F(63)		D1ZZ 6302504-A	D1ZZ 6302505-A	1
	71/	F(65)		D1ZZ 6502504-A	D1ZZ 6502505-A	1
	71/	F(76)		D1ZZ 7602504-A	D1ZZ 7602505-A	1
			Screw-pan head- No. 6-20 x 3/8"	376389-S101(UU82D)	376389-S101(UU82D)	2
	70/71	S(57)	Refer to Group 02522-3			
	70	S(65)		D0SZ 6502504-A	D0SZ 6502505-A	1
	71	S(65A, C)		D1SZ 6502504-A	D1SZ 6502505-A	1
	72	S		D2SZ 6502504-A	D2SZ 6502505-A	1
<b>02508-9 PILLAR - FRONT BODY - UPPER INNER -Refer to Group 02522-3</b>						
<b>025A10-1 TROUGH - FRONT BODY PILLAR - UPPER</b>						
	65	X		C0DB 64025A10-B	C0DB 64025A11-B	1
			No. 8 x 1/2" Cross recess pan head screw	52726-S13(U381)	52726-S13(U381)	4
<b>02512-3 MOULDING - FRONT BODY PILLAR DRIP FINISH - INCLUDES ATTACHING PARTS</b>						
	70	A(57, 63, 65)		D0AZ 5702512-A	D0AZ 5702513-A	1
	71/	A(53, 57, 65)	Refer to Group 026A16-7			
	70	B(54, 62)		D0OZ 5402512-C	D0OZ 5402513-C	1
	71	B(54)				1
	70/71	B(57, 65)		D0OZ 5402512-A	D0OZ 5402513-A	1
	70/71	B(66)		D0OZ 6602512-A	D0OZ 6602513-A	1
	70	B(71B)		D0OZ 7102512-A	D0OZ 7102513-A	1
	70/71	B(71C, D, E)		D0OZ 7102512-B	D0OZ 7102513-B	1
	72	B(97)		D2OZ 9702512-A	D2OZ 9702513-A	1
	70/	B(54, 62)	No. 8-18 x 3/8" Round head screw	381671-S45X(UU89C)	381671-S45X(UU89C)	2
	70/	S(65)	Refer to Group 026A16-7			
<b>02516-7 PILLAR - FRONT BODY - UPPER OUTER -Also Refer to Groups 02504-5 and 02536-7</b>						
	70/	A	Refer to Group 02504-5			
	66/67	B(54, 62, 66, 71)		C6OZ 6202516-B	C6OZ 6202517-B	1
	70	B(54, 57, 62, 65, 66)		D0OZ 6502516-A	D0OZ 6502517-A	1
	71	B(54, 57, 65, 66)				1
	66/71	B(63, 76)	Refer to Group 02536-7			
	68/71	B(71)		C8OZ 5402516-B	C8OZ 5402517-B	1
	71/	L		D1FZ 6202516-A	D1FZ 6202517-A	1
	70/	P		D0DZ 6202516-A	D0DZ 6202517-A	1
	68/70	S		D0SZ 5702516-A	D0SZ 5702517-A	1
	67	S		C7SZ 6502516-A	C7SZ 6502517-A	1
	71	S(57, 65B, D)				1
	71/	S(65A, C)	Refer to Group 02504-5			
	66/70	X		C6OZ 6202516-B	C6OZ 6202517-B	1
<b>025A20-1 MOULDING - FRONT PILLAR DRIP - Includes Attaching Parts</b>						
	65/66	S(76)	Refer to Group 517A54			
<b>02522-3 PILLAR - FRONT BODY - UPPER INNER</b>						
	69	A(54, 62, 71)	Assy. -inner & outer	C9AZ 6202508-A	★C9AZ 6202509-A Not replaced (5-75)	1
	69	A(76)	Assy. -inner & outer	★C9AZ 7602508-A Not replaced (5-75)	C9AZ 7602509-A	1
	70/	A(54, 62, 71, 76)	Refer to Group 02504-5			
	65	B(except 65)		★C2OZ 6202522-B Not replaced (1-73)	C2OZ 6202523-B	1
	65	B(65)		C3OZ 6502522-B	★C3OZ 6502523-B Not replaced (1-73)	1
	68	B(54, 71) "Before 1/1/68"		C8OZ 5402522-A	C8OZ 5402523-C	1
	68/69	B(54, 71) "From 1/1/68"		C8OZ 5402522-C	C8OZ 5402523-C	1
	68/69	B(76)		C8OZ 7602522-C	C8OZ 7602523-C	1
	68/69	B(63, 65, 66)		C8OZ 6302522-C	C8OZ 6302523-C	1
	70	B(54, 57, 62, 65, 66) - "Before 11/3/69"		D0OZ 6502522-A	D0OZ 6502523-A	1
	70	B(54, 57, 62, 65, 66) -		D0OZ 6502522-B	D0OZ 6502523-B	1
	71	B(54, 57, 65, 66) "From 11/3/69"				1
	70/71	B(71)		D0OZ 7102522-B	D0OZ 7102523-B	1
	70/71	B(76)		D0OZ 7602522-A	D0OZ 7602523-A	1
	70/	P		D0DZ 6202508-A	D0DZ 6202509-A	1

GROUP NUMBER	YEAR	BODY TYPE	DESCRIPTION	PART NUMBER				QTY.
				RIGHT HAND		LEFT HAND		
<b>02522-3</b>	<b>PILLAR - FRONT BODY - UPPER INNER - continued</b>							
	67/69	S		C7SZ	6502508-A	C7SZ	6502509-A	1
	70/71	S(57)		D0SZ	5702508-A	D0SZ	5702509-A	1
	71	S(65B, D)						1
	70	S(65)	Refer to Group 02504-5					
	71	S(65A, C)						
	68/70	X		C8OZ	5402522-C	C8OZ	5402523-C	1
<b>02524-5</b>	<b>REINFORCEMENT - FRONT BODY UPPER OUTER PILLAR</b>							
	70/71	B(except 63, 71)		D0OZ	6502524-A	D0OZ	6502525-A	1
<b>02526-7</b>	<b>REINFORCEMENT - FRONT BODY PILLAR</b>							
	66/	U		C6TZ	9602526-A	C6TZ	9602527-A	1
<b>02536-7</b>	<b>PILLAR - FRONT BODY - UPPER OUTER - Also refer to Group 02516-7 and 02522-3</b>							
	68/69	B(63, 65, 66)		C8OZ	6302536-B	C8OZ	6302537-B	1
	68/69	B(76)		C8OZ	7602536-B	C8OZ	7602537-B	1
	70/71	B(76)		D0OZ	7602536-B	D0OZ	7602537-B	1
<b>02542-3</b>	<b>REINFORCEMENT - FRONT BODY PILLAR - LOWER</b>							
	67/69	S		C7SZ	6502542-A	C7SZ	6502543-A	1
	70/71	S		D0SZ	6502542-A	D0SZ	6502543-A	1
<b>025A42-3</b>	<b>FILLER - FRONT BODY PILLAR TO FRONT FENDER - CENTER</b>							
	67/68	S		C7SZ	65025A42-A	C7SZ	65025A43-A	1
	70	S		D0SZ	65025A42-A	D0SZ	65025A43-A	1
<b>025A56-7</b>	<b>PANEL - FRONT BODY PILLAR OUTSIDE FINISH - INCLUDES ATTACHING PARTS</b>							
	70	B(54, 57, 62, 65)	W/o vinyl roof cover - paint to match-smooth finish	D0OZ	65025A56-A	D0OZ	65025A57-A	1
	71	B(54, 57, 65)						1
	70	B(54, 57, 62, 65)	W/vinyl roof cover - paint to match -textured steel	D0OZ	65025A56-B	D0OZ	65025A57-B	1
	71	B(54, 57, 65)						1
	70/71	B(66)		D0OZ	66025A56-A	D0OZ	66025A57-A	1
	70/71	B(71)		D0OZ	71025A56-A	D0OZ	71025A57-A	1
	67/69	S		C7SZ	65025A56-B	★C7SZ	65025A57-B	1
	70/	S(57)	Paint to match				Not replaced (5-75)	
	71	S(65B, D)		D0SZ	57025A56-A	D0SZ	57025A57-A	1
								1
<b>02570-1</b>	<b>PLATE - FRONT BODY PILLAR UPPER HINGE REINFORCEMENT</b>							
	67/71	S		C7SZ	6502570-A	C7SZ	6502571-A	1
<b>02574-5</b>	<b>REINFORCEMENT - FRONT BODY UPPER PILLAR TO ROOF RAIL</b>							
	66/67	B(54, 62, 66, 71)		C8OZ	6202574-A	C6OZ	6202575-A	1
	68/70	B(54, 62, 63, 71)						1
	71	B(71)						1
	66/70	X						1
<b>02576-7</b>	<b>PLATE - FRONT BODY PILLAR LOWER HINGE REINFORCEMENT</b>							
	67/71	S		C7SZ	6502576-A	C7SZ	6502577-A	1
<b>025A80-1</b>	<b>EXTENSION - FRONT BODY UPPER INNER PILLAR</b>							
	70/71	B(63)		D0OZ	63025A80-A	D0OZ	63025A81-A	1
<b>025A84-5</b>	<b>MOULDING - FRONT BODY PILLAR - UPPER</b>							
	67/69	S		C7SZ	65025A84-C	C7SZ	65025A85-C	1
	70/71	S(57)		D0SZ	57025A84-A	D0SZ	57025A85-A	1
	71	S(65B, D)						1
			Screw-flat head- No.6-20 x 1/2"		373541-S(UU98)		373541-S(UU98)	2
			Clip		353675-S2(GG325)		353675-S2(GG325)	6
<b>025A90-1</b>	<b>FILLER - FRONT BODY PILLAR TO COWL SIDE LOWER</b>							
	68/71	S		C8SZ	65025A90-A	C8SZ	65025A91-A	1
<b>02594-5</b>	<b>RETAINER - FRONT BODY PILLAR UPPER WEATHERSTRIP</b>							
	71/	A(76)		D1AZ	7602594-A	D1AZ	7602595-A	1
	68/69	B(76)		C8OZ	7602594-A	C8OZ	7602595-A	1
	70	B(57, 63, 65, 66)		D1OZ	6502594-A	D0OZ	6502595-A	1
	70	B(76)		D0OZ	7602594-A	D0OZ	7602595-A	1
	71	B(57, 63, 65, 66)		D1OZ	6502594-A	D1OZ	6502595-A	1
	71	B(76)		D1OZ	7602594-A	D1OZ	7602595-A	1
	71/	F(except 76)		D1ZZ	6502594-A	D1ZZ	6502595-A	1
	71/	F(76)		D1ZZ	7602594-A	D1ZZ	7602595-A	1



# FORD CAR PARTS

## BODY SECTION 020

7

GROUP NUMBER	YEAR	BODY TYPE	DESCRIPTION	PART NUMBER		QTY.
				RIGHT HAND	LEFT HAND	
<b>02594-5 RETAINER - FRONT BODY PILLAR UPPER WEATHERSTRIP - continued</b>						
	65/66	F(76)	Screw-flat head self tapping-No.8-18x 1/2"	377948-S2(UU48G)	377948-S2(UU48G)	6or16
	67	A(76),B(76)				6or8
	71/	A,B,F	Screw-washer head-No.8-18 x 1/2"	380660S2(UU141)	380660-S2(UU141)	6
<b>026A08-9 EXTENSION - FRONT BODY PILLAR REINFORCEMENT</b>						
	69/	U		C9TZ 96026A08-A	C9TZ 96026A09-A	1
GROUP NUMBER	YEAR	BODY TYPE	DESCRIPTION	PART NUMBER		QTY.
<b>02614 RETAINER - FRONT DOOR OPENING WINDLACE</b>						
	65	A,B,S,X		B7A 7002614-A		AR
<b>026A14 SPACER - FRONT BODY PILLAR MOULDING</b>						
	69	S		C9SZ 65026A14-A		2
	70	S(57)				2
	71	S(65B, D)				2
GROUP NUMBER	YEAR	BODY TYPE	DESCRIPTION	PART NUMBER		QTY.
<b>02616-7 PILLAR - FRONT BODY UPPER OUTER CORNER</b>						
	70	B(54, 57, 62, 65, 66)		D0OZ 6502616-A	D0OZ 6502617-A	1
	71	B(54, 57, 65, 66)				1
	70/71	B(63)		D0OZ 6302616-A	D0OZ 6302616-A	1
	69/	F	Refer to Group02504-5			
	66	S(63C, 63D)		C6SZ 6302616-A	C6SZ 6302617-A	1
	67/69	S		C7SZ 6502616-A	C7SZ 6502617-A	1
	70/71	S(57)				1
<b>026A16-7 MOULDING - FRONT BODY PILLAR DRIP FINISH - INCLUDES ATTACHING PARTS</b>						
	71/	A(53, 57)		D1AZ 57026A16-A	D1AZ 57026A17-A	1
	71/	A(65)		D1AZ 65026A16-A	D1AZ 65026A17-A	1
	70	S(65)		D0SZ 65026A16-A	D0SZ 65026A17-A	1
	71	S(65A, C)		D1SZ 65026A16-A	D1SZ 65026A17-A	1
<b>02622-3 PILLAR - FRONT BODY UPPER INNER CORNER</b>						
- A -						
	69	A(57, 63, 65)		C9AZ 6302622-A	C9AZ 6302623-A	1
	70	A(57, 63, 65)		D0AZ 6302622-A	D0AZ 6302623-A	1
	71/	A(53, 57, 65)				1
	69/70	A(54, 62, 71)		C9AZ 6202622-A	C9AZ 6202623-A	1
	71/	A(54, 71)				1
- B -						
	70	B(54, 57, 62, 65, 66)		D0OZ 6502622-A	D0OZ 6502623-A	1
	71	B(54, 57, 65, 66)				1
	70/	B(63)		D0OZ 6302622-A	D0OZ 6302623-A	1
- F -						
	69/70	F(63)		C9ZZ 6302622-A	C9ZZ 6302623-A	1
	69/70	F(65)		C9ZZ 6502622-A	C9ZZ 6502623-A	1
- P -						
	70/	P		D0DZ 6202622-A	D0DZ 6202623-A	1
- S -						
	67/69	S		C7SZ 6502622-A	C7SZ 6502623-A	1
	70/71	S(57)				1
	71	S(65B, D)				1
<b>026A24-5 MOULDING - FRONT BODY PILLAR - OUTSIDE BELT - INCLUDES ATTACHING PARTS</b>						
	70/	P	With vinyl roof cover-textured steel-paint to match	D0DZ 62026A24-A	D0DZ 62026A25-A	1
<b>02626-7 WEATHERSTRIP - FRONT BODY PILLAR - UPPER - Also refer to Group 03198-9</b>						
- A -						
	65/66	A(76)		C5AZ 7602626-A	C5AZ 7602627-A	1
	67/68	A(76)		★C7AZ 7602626-B	C7AZ 7601627-B	1
	69/70	A(76)	With metal strip	C9AZ 7602626-A	C9AZ 7602627-A	1
	70/	A(76)	Without metal strip	D0AZ 7602626-A	D0AZ 7602627-A	1
			Screw-round head-No.8-18 x 1/2"	381801-S2(UU148)	381801-S2(UU148)	2

**BODY  
SECTION 020**
**FORD CAR PARTS**

GROUP NUMBER	YEAR	BODY TYPE	DESCRIPTION	PART NUMBER		QTY.
				RIGHT HAND	LEFT HAND	
<b>02626-7 WEATHERSTRIP - FRONT BODY PILLAR - UPPER-</b> Also refer to Group 03198-9 - <b>continued</b>						
<b>- B -</b>						
	66/67	B(76)		★C6OZ 7602626-A Not replaced(3-74)	C6OZ 7602627-A	1
	67	B(76)	Screw-pan head tapping No.8-32 x 7/16"	★353656-S100	★353656-S100	2
	68/69	B(76)		C8OZ 7602626-A	C8OZ 7602627-A	1
	70/71	B(76)		D0OZ 7602626-A	D0OZ 7602627-A	1
	68/71	B(76)	Screw & washer assy.- hex.hd.-No.8-18 x 3/4"	375389-S101(UU82D)	376389-S101(UU82D)	2
<b>- F -</b>						
	65/68	F(76)		C5ZZ 7602626-D	C5ZZ 7602627-D	1
	69/70	F(76)		C9ZZ 7602626-A	C9ZZ 7602627-A	1
	71/	F(76)		D1ZZ 7602626-A	D1ZZ 7602627-A	1
			Screw-pan head- No.8-15 x 3/4"	371828-S100(UU81)	371828-S100(UU81)	2
	69/	F(76)	Screw & washer assy.- hex.hd.-No.8-18 x 3/4"	376389-S101(UU82D)	376389-S10(UU82D)	2
<b>- S -</b>						
	65/66	S(76)	Screw-cross recess flat hd.-No.8-15 x 1/2"	377948-S2(UU48G)	377948-S2(UU48G)	10
<b>- U -</b>						
	66/	U	Refer to Group 51222-3			
GROUP NUMBER	YEAR	BODY TYPE	DESCRIPTION	PART NUMBER		QTY.
<b>02638-9 PLATE - FRONT BODY PILLAR HINGE ANCHOR-LOWER</b>						
	69/	A		D9DZ 6202638-A		4
	66/70	B, X	R. H.	C6OZ 6202638-B		1
			L. H.	C6OZ 6202639-A		1
	72	B, S		D1FZ 6202638-A		4
	71/	F	R. H.	C6OZ 6202638-B		1
			L. H.	C6OZ 6202639-A		1
	71/	L	Upper and lower	D1FZ 6202638-A		4
	70/	P		D0DZ 6202638-A		4
<b>02666-7 PLATE - FRONT BODY PILLAR HINGE ANCHOR - UPPER</b>						
	69/70	A		C9ZZ 6502666-A		4
	66	B, X		C6OZ 6202666-A		2
	71	B	R. H.	D1ZZ 6502666-A		1
			L. H.	D1ZZ 6502667-A		1
	69/70	F		C9ZZ 6502666-A		4
	71/	F	R. H.	D1ZZ 6502666-A		1
			L. H.	D1ZZ 6502667-A		1
<b>02670-1 FILLER - FRONT BODY TO FRONT FENDER LOWER</b>						
	67/68	S	R. H.	C7SZ 6502670-A		1
			L. H. -not replaced (3-74)	★C7SZ 6502671-A		1
<b>026A75 SHIELD - FRONT BODY UPPER PILLAR WIRE</b>						
	66/69	B(54, 71)		C6OZ 62026A75-B		1
	68/70	X		C6OZ 62026A75-B		1
<b>02730-1 SEAL - FRONT BODY PILLAR AT BELT</b>						
	72	A(53, 65, 76)	R. H.	D2AZ 6502730-A		1
			L. H.	D2AZ 6502731-A		1
	72	A(57)	R. H.	D2AZ 5702730-A		1
			L. H.	D2AZ 5702731-A		1
<b>02880 COLLAR - COWL PANEL VENT AIR DUCT</b>						
	66/	U	Use with heater	C6TZ 9602880-A		1
<b>02884-5 REINFORCEMENT - COWL SIDE PANEL</b>						
	69/70	A	R. H.	C9AZ 6202884-A		1
	71	A	"Before 6/14/71"	R. H.	D1AZ 6502884-A	1
	69/71	A	"Before 6/14/71"	L. H.	C9AZ 6202885-A	1
	71/	A	"From 6/14/71"	R. H.	D2AZ 6502884-A	1
			L. H.	D2AZ 6502885-A		1
<b>02896 PANEL and REINFORCEMENT ASSY. - COWL TOP</b>						
	66	A(76)		★CC6AB 7602896-B		1

**BODY BOLT CHART**

**HOW TO FIND BODY BOLTS and RELATED PARTS**

- 1) To determine Body Bolts and Related Parts you must know:
  - a) YEAR
  - b) CAR LINE
  - c) BODY TYPE
  - d) BODY BOLT LOCATION
  - e) NAME OF PART
  
- 2) Using this information and the typical illustration shown on page 12, refer to the listing beginning on page 13.
  
- 3) Locate the appropriate Code Number for Bolts, Nuts, Retainers etc.
  
- 4) Translate the Code Number into a Service Part Number by referring to the Cross Reference listing on page 21.

Read down to locate Code Number.

Read across to locate Service Part Number.

**EXAMPLE:**

a) Year	1967
b) Car Line	FORD
c) Body Type	71
d) Body Bolt Location	Number 9
e) Name of Part	Absorber, Bolt, Flat washer, Lockwasher, Retainer, Shim and Spacer

**Code Numbers listed are:**

**Part numbers shown for these Codes are:**

Absorber ---62	C5AZ 5B098-B
Bolt ---52	★379515-S2
Flat washer---44	★375301-S
Lockwasher---13	34848-S8(X75)
Retainer ---96	C5AZ 6200157-B
Shim ---97	C3AZ 6200163-A
Spacer ---★	Not serviced

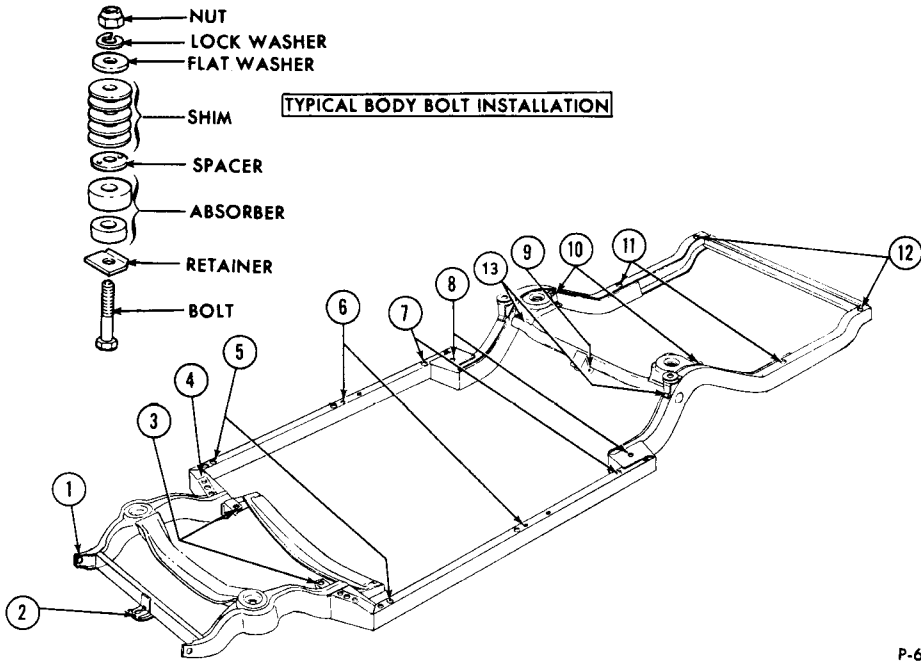

P-6301

1965/ FORD and 1967/ THUNDERBIRD  
1972 TORINO

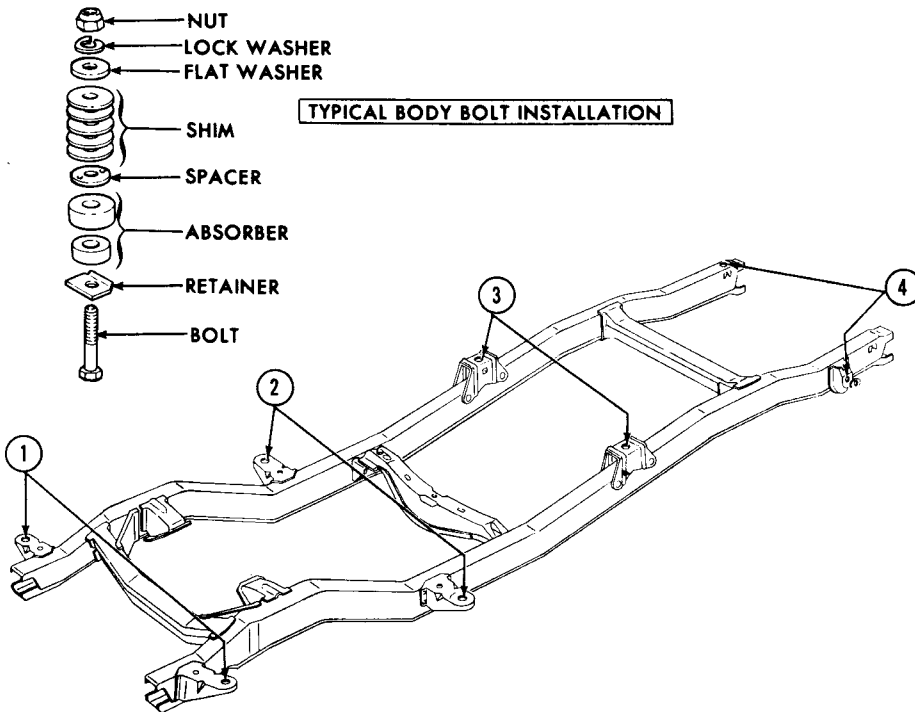

P-6302

1966/ BRONCO

### BODY BOLT CHART - continued

BODY TYPE	PART NAME	BODY BOLT LOCATION													
		1	2	3	4	5	6	7	8	9	10	11	12	13	14
		PART CODE NUMBER													
<b>1965 FORD</b>															
All	Absorber														62
	Absorber														144
Except 71	Absorber														62
	Absorber														144 148
Except 71, 76	Absorber	143													
	Absorber	82													
	Absorber				73	73									
	Absorber				82	82									
71	Absorber		62	73	79				79	79					144
	Absorber		82	82	89				89	89					62
76	Absorber		62				81	81	81	81					
	Absorber		90					90	90	90					
Except 71	Bolt											51		51	
Except 71, 76	Bolt	35													
71	Bolt		35										47	47	
76	Bolt	53				47									
All	Clip														*
Except 71	Clip												*		
71	Absorber														147
Except 71, 76	Absorber									63					
76	Absorber	65													
Except 71	Absorber														148
Except 71	Lockwasher												13		43
Except 71, 76	Lockwasher	9													
71	Lockwasher		9											13	
76	Lockwasher	11					13								
Except 71, 76	Nut	2													
Except 76	Nut			5	5										
71	Nut		2				3				3				
76	Nut		4				7	57	57						
All	Retainer														96
All	Retainer														100
Except 71	Retainer												96		
Except 71	Retainer												99	61	
Except 71, 76	Retainer	95									61				
Except 71, 76	Retainer	100													
Except 76	Retainer				49	49									
71	Retainer														96
71	Retainer		100			48				48					100
71, 76	Retainer		95								48				
76	Retainer					48	102			48					
76	Retainer						96								
Except 71	Shim	*									*		*	*	
Except 76	Shim	*		*	*					*			*	*	
71	Shim		*		*				*				*	*	
76	Shim	67				*	*	*	*	*			*	*	
71, 76	Spacer										*				
Except 76	Stud			54	54										
71	Stud				56				56	56					
76	Stud							55	55	56					
Except 71, 76	Washer	27													
Except 76	Washer			29	29										
71	Washer		27		28					28				15	
76	Washer	22	30			29	21	21	21						

**BODY BOLT CHART - continued**

BODY TYPE	PART NAME	BODY BOLT LOCATION													
		1	2	3	4	5	6	7	8	9	10	11	12	13	14
		PART CODE NUMBER													
<b>1966 FORD</b>															
All	Absorber		62												62
All	Absorber		90												144
Except 71	Absorber										62				
Except 76	Absorber			73	73										
Except 76	Absorber			82	82										
71	Absorber									62		62			
76	Absorber					81	81	81	81						
76	Absorber					90	90	90	90						
Except 71	Absorber											144			
71	Absorber												144		
Except 71	Bolt										51			51	
Except 76	Bolt		35												
71	Bolt									1					
71	Bolt									52				47	
76	Bolt	53				47									
All	Clip														*
Except 71	Clip											*			
Except 76	Absorber										63				
76	Absorber	65								*					
Except 71	Absorber													148	
Except 71	Lockwasher											13			
Except 76	Lockwasher		9												
71	Lockwasher										13				
76	Lockwasher	11				13									
Except 76	Nut		2	5	5										
76	Nut					7	57	57	57						
All	Retainer														100
All	Retainer		95												96
Except 71	Retainer											96	61		
Except 71	Retainer											99	99		
Except 76	Retainer		100	49	49					61					
71	Retainer										96		96		
71	Retainer										100				
76	Retainer					96									
76	Retainer					102	48	48	48						
All	Shim									*			*	*	
Except 71	Shim										*				
Except 76	Shim		*	*	*										
76	Shim	67				*	*	*							
Except 76	Spacer		*												
76	Spacer									*					
Except 76	Stud			54	54										
76	Stud						56	56	56						
Except 76	Washer		27	29	29										
71	Washer										44			15	
76	Washer	22	30			29	21	21	21						

## BODY BOLT CHART - continued

BODY TYPE	PART NAME	BODY BOLT LOCATION													
		1	2	3	4	5	6	7	8	9	10	11	12	13	14
		PART CODE NUMBER													
<b>1967 FORD</b>															
All	Absorber		62											62	
All	Absorber		90												
Except 71	Absorber												105		
Except 71	Absorber												62		
Except 76	Absorber			73	73										
Except 76	Absorber			82	82										
71	Absorber										62		62		
76	Absorber					81	81	81	81						
76	Absorber						90	90	90						
Except 71	Bolt											51		51	
Except 76	Bolt		58												
71	Bolt										52		47	47	
76	Bolt	53				47									
All	Clip											*		*	
Except 71, 76	Absorber								145						
76	Absorber	65					*	*	*						
Except 71	Absorber													149	
Except 71	Lockwasher											13		43	
Except 76	Lockwasher		9												
71	Lockwasher										13		13		
76	Lockwasher	11			13										
Except 76	Nut		2	5	5										
76	Nut		4			7	57	57							
All	Retainer														96
All	Retainer														100
Except 71	Retainer											96			
Except 76	Retainer		100	49	49										
71	Retainer											96		95	
71	Retainer											97		100	
76	Retainer		95			96									
76	Retainer					102	48	48	48						
Except 71	Shim											*			
71	Shim											*		*	
76	Shim	67				*	*	*	*						
Except 76	Spacer		152												
71	Spacer											*			
76	Spacer											*			
Except 76	Stud			54	54										
76	Stud						56	56	56						
Except 76	Washer			29	29										
71	Washer											44			
76	Washer	27	30			29	21	21	21						
<b>1968 FORD</b>															
Exc. 71, 76	Absorber	191			87								174		87
Exc. 71, 76	Absorber	172			109								175		112
71	Absorber	191			87								174	87	112
71	Absorber	172			109								175	112	172
76	Absorber	172		142		81	81	81					174		112
76	Absorber	182		184		90	90	90					175		172
54, 57, 62, 63, 65	Clip														*
71	Clip														*
Exc. 71, 76	Lockwasher												60		60
71	Lockwasher												60	60	60
76	Lockwasher		11	186									60		60
Exc. 71, 76	Absorber								146						150
71	Absorber								146						
76	Absorber		65												150
Exc. 76	Nut	116			49										
Exc. 76	Nut				14										
76	Nut	116		116		48	48	48							
76	Nut					57	57	57							

**BODY BOLT CHART - continued**

BODY TYPE	PART NAME	BODY BOLT LOCATION													
		1	2	3	4	5	6	7	8	9	10	11	12	13	14
		PART CODE NUMBER													
<b>1968 FORD - continued</b>															
Exc. 71, 76	Retainer	192												176	96
71	Retainer	192												176	96 193
76	Retainer													176	96
Exc. 71	Bolt													59	178
71	Bolt													104	104 104
Exc. 76	Shim	188												187	
Exc. 76	Shim	189												*	
Exc. 76	Shim	190												*	
76	Shim		67	185		187	187	187						187	
76	Shim					*	*	*						*	
Exc. 76	Stud	181			103										
76	Stud		181	181		56	56	56							
76	Spacer							152							
Exc. 76	Washer			29											
76	Washer		22			21	21	21							
<b>1969 FORD</b>															
Exc. 71, 76	Absorber & stud	213													
71	Absorber & stud									121					
76	Absorber & stud	121		123											
	Absorber & stud			161		162		163	210		175			112	
Exc. 71, 76	Absorber		209		109						174			86	
	Absorber	158			157						175			112	
71	Absorber	191			109				109		78	86	86		
	Absorber	158			157						159	112	112		
76	Absorber					80	200	80	157		174			86	
Exc. 71, 76	Bolt										166			168	
71	Bolt										166			168	
76	Bolt	208									169	168	168	169	
54, 57, 62, 63, 65	Clip										169			166	
71, 76	Clip														*
Exc. 71, 76	Absorber							194	*				*		
71	Absorber				195								195		
76	Absorber		202										145		
Exc. 71, 76	Lockwasher										60			60	
71	Lockwasher										60	60	60	60	
76	Lockwasher		11	207							60	60	60	60	
Exc. 76	Nut	116			14										
76	Nut	206		116		48	116	57							
76	Nut					57	203								
Exc. 71, 76	Retainer	192									176			96	
71	Retainer	192									176	96		154	
76	Retainer						164				176				
Exc. 71	Shim										156				
Exc. 71, 76	Shim	188									*			196	
Exc. 71, 76	Shim	189									*			197	
Exc. 71, 76	Shim	190												*	
71	Shim	188												196	
71	Shim	189									196			197	
71	Shim	190												*	
76	Shim		*	185		198		198	198		*			196	
76	Shim					199		199	199		*			197	
76	Spacer							*							
Exc. 76	Stud	181			167										
76	Stud		181	181		204	181	170							
71	Stud & absorber									121					
76	Stud & absorber	121		123											
76	Stud & absorber			161		162		163	210		175			112	
Exc. 76	Washer			29											
76	Washer		22	22		21	205	21							



### BODY BOLT CHART - continued

BODY TYPE	PART NAME	BODY BOLT LOCATION													
		1	2	3	4	5	6	7	8	9	10	11	12	13	14
		PART CODE NUMBER													
<b>1970/ FORD</b>															
Exc. 71, 76	Absorber				130						160		109		
	Absorber	158									175		175		
71	Absorber				217			162	109			109	175		
	Absorber	158			*			80	175		175	109	109		
	Absorber											175			
Exc. 71, 76	Absorber & stud	213													
	Absorber & stud	218													
76	Absorber	158				80		80	175		160		175		
	Absorber	182		161							175	109	109		
	Absorber & stud			123											
Exc. 71, 76	Bolt				165						166		168		
71	Bolt	166			165				169			168	169		
76	Bolt	208							169		166				
71	Clip								*						
Exc. 71, 76	Absorber							194				195			
76	Absorber		202												
Exc. 71, 76	Lockwasher										60		60		
71	Lockwasher							60	60		60	60	60		
76	Lockwasher		11	207					60		60		60		
Exc. 76	Nut	116			14			57							
76	Nut	116		116		57		57						168	
Exc. 71, 76	Retainer	192									176		96		
71	Retainer	192						*	96			96	154		
76	Retainer								96		176		96		
Exc. 71, 76	Shim	188													
	Shim	189													
	Shim	190													
71	Shim	188						198	196						
	Shim	189						199	197						
	Shim	190						*							
76	Shim		*	185		198		198	196		156				
	Shim		*			199		199	197						
	Shim		*												
	Spacer								*						
Exc. 76	Stud	181							56						
76	Stud		181	181		56			56						
	Stud & absorber			123											
	Stud & absorber	158				80		80	175		160		175		
Exc. 76	Washer				29										
76	Washer	23	22	22											
<b>1972 TORINO</b>															
Exc. 71,97	Absorber				225			227				225	225	225	
53, 64, 65	Absorber & ret.				226			226				226	224	224	
All	Absorber & stud			191											
	Absorber	172						225							
	Absorber						223								
	Bolt				216			216				216	216	216	
	Clip														
	Lockwasher														
	Nut														
	Retainer	219													
	Shim	190			163			163				163	163	163	
	Shim	188													
	Shim	189													
71,97	Absorber & ret.				224			226				226	224		
	Absorber				228			227					225		

**BODY BOLT CHART - continued**

BODY TYPE	PART NAME	BODY BOLT LOCATION													
		1	2	3	4	5	6	7	8	9	10	11	12	13	14
		PART CODE NUMBER													
<b>1967 THUNDERBIRD</b>															
All	Absorber		62	109	109					109		105	*	105	
	Absorber		110	111	173					111		87		62	
	Bolt		58									51		47	
	Clip											*		*	
	Insulator												151		
	Lockwasher		9									13		13	
	Nut		2	115	115					115					
	Retainer		95									96	61	96	
	Retainer		100												
	Shim		*	*	*					*		*	*	*	
	Spacer		152												
	Stud			103	103					103					
Washer		27	117	117					27						
<b>1968 THUNDERBIRD</b>															
All	Absorber	172			109			87			174	112	112		
	Absorber	180			173			109			175	172	86		
	Bolt										177	178	179		
	Clip											*	*		
	Lockwasher										60	60	60		
	Nut	116			14			14							
	Retainer	100									176	96	96		
	Shim	171						187			187				
	Shim	188						*			*				
	Stud	181			103			103							
	Washer				29			23							
	<b>1969 THUNDERBIRD</b>														
All	Absorber	172			109			87			174	86	86		
	Absorber				173			109			175	112	112		
	Absorber & stud	191													
	Bolt										177	178	179		
	Clip											*			
	Lockwasher										60	60	60		
	Nut	116			14			14							
	Retainer	192									176	96	96		
	Shlm	188						*			*				
	Shlm	189						*			*				
	Shlm	190													
	Stud	181			103			103							
Washer				29			23								
<b>1970/71 THUNDERBIRD</b>															
All	Absorber	172	86		109			87			174	109	109		
	Absorber	189			*173			109				112	112		
	Absorber				#212										
	Absorber & stud	191													
	Bolt				165						166	168	165		
	Clip											*			
	Lockwasher										60	60	60		
	Nut	116			14			14							
	Retainer	192									176	96	96		
	Shlm	188						*			*	*			
	Shlm	189						*			*	*			
	Shlm	190													
Stud	181						103								
Washer				29			23								

\* Before 9/2/69

# From 9/2/69

### BODY BOLT CHART - continued

BODY TYPE	PART NAME	BODY BOLT LOCATION														
		1	2	3	4	5	6	7	8	9	10	11	12	13	14	
		PART CODE NUMBER														
<b>1972 THUNDERBIRD</b>																
All	Absorber	172			220			220			220	220	220			
	Absorber & ret.				221			221			221	221	221			
	Absorber & stud	191														
	Bolt	★						★			★	★	★			
	Clip															
	Absorber						80									
	Lockwasher															
	Nut	116							★			★	★	★		
	Retainer	219														
	Shim	188			163				163			163	163	163		
Shim	189															
Shim	190															

<b>1966/67 BRONCO</b>															
All	Absorber	118	118	118	118										
	Absorber	119	119	119	119										
	Bolt	37	37	25	123										
	Lockwasher	12	124	124	124										
	Retainer	97	97	121	121										
	Retainer	120	120	121	121										
	Retainer			122	122										
	Shim	★	★	★	★										

<b>1968/72 BRONCO</b>															
All	Absorber	119	119	119	118										
	Absorber	129	129												
All - 1968/69	Bolt	125	125	126	127										
All - 1970	Bolt	214	214	215	216										
All	Lockwasher	12	124	124	124										
	Retainer	97	97	121	121										
	Retainer	120	120	128	128										
	Retainer			128	128										
	Shim	★													

#### CODE NUMBER TO PART NUMBER LISTING - Quantity as required

CODE NO.	PART NUMBER	DESCRIPTION	CODE NO.	PART NUMBER	DESCRIPTION
1	20348-S2(B77)	Bolt-hex, head-3/8"-16 x 3/4"	39	372337-S(BB390)	Bolt-hex, head-1/2"-20 x 1 5/8"
2	33799-S8(M52)	Nut-hex, -3/8"-16	43	375266-S2/XX326A)	Lockwasher
3	33925-S2(M33)	Nut-hex, -3/8"-24	46	376095-S7-8(BB178A)	Bolt-hex, head-7/16"-14 x 1 7/8"
4	34394-S7-8(M93A)	Nut-hex, -3/8"-16	47	376275-S7-8(BB181A)	Bolt-hex, head-7/16"-14 x 2 9/16"
5	34396-S7(M95)	Nut-hex, -7/16"-14	48	377317-S(MM192X)	Nut & retainer assy. -3/8"-16
7	34670-S8(M54)	Nut-hex, -7/16"-14	49	377318-S2(MM192Y)	Nut & retainer assy. -7/16"-14
9	34807-S8(X66)	Lockwasher-spring-3/8"	50	377957-S7-8(BB169A)	Bolt-hex, head-3/8"-16 x 3 3/4"
11	34809-S2(X68)	Lockwasher-spring-1/2"	51	★379143-S8	Bolt-hex, head-7/16"-14 x 3 3/4"
12	34847-S8(X74)	Lockwasher-spring-3/8"	52	★379515-S2	Bolt-hex, head-7/16"-14 x 2 1/8"
13	34848-S8(X75)	Lockwasher-spring-7/16"	53	★379647-S2	Bolt-hex, head-1/2"-13 x 2 3/4"
14	34988-S4(M89D)	Nut-hex, -7/16"-14	54	379966-S2(WW98H)	Stud
15	44730-S8(X26)	Washer-flat-7/16"	55	★380612-S2	Stud
17	★304903-S8	Bolt-hex, head	56	380616-S2(WW127)	Stud-3/8" -16 x 2 5/16"
20	351092-S32(MM262)	Nut-spring-1/2"	57	380618-S(MM173T)	Nut-3/8" -16
21	351321-S8(XX197)	Washer-flat-9/16"	58	381843-S2(BB404E)	Bolt-hex, head-3/8"-16 x 3 3/16"
22	★351470-S2	Washer-flat-17/32"	59	C8AZ 7100394-B	Bolt-hex, head-7/16"-14 x 4 1/4"
23	375266-S2(XX326A)	Washer-flat-7/16"	60	★352433-S2	Lockwasher
24	351988-S8(BB187)	Bolt-hex, head-7/16"-14 x 3 3/4"	61	C5AZ 5B078-B	Retainer
25	353677-S8(BB405)	Bolt-hex, head-3/8"-16 x 3 13/32"	62	C5AZ 5B098-B	Absorber
27	★356379-S8	Washer-flat	63	C5AZ 5A103-E	Absorber
28	★356442-S2	Washer-flat-1/2"	65	C4AZ 8125-B	Insulator
29	356583-S100(XX170)	Washer-flat-7/16"	66	C4AZ 8125-C	Insulator
30	356606-S8(XX184)	Washer-flat-1/2"	67	C3AZ 8126-A	Shim
35	C1VE 6A527-A	Bolt-hex, head-3/8"-16 x 2 29/32"	69	★B8E 8126-A	Shim
37	371741-S(BB160)	Bolt-hex, head-3/8"-16 x 2 1/2"	72	★B7A 7000151-B	Retainer

## BODY BOLT CHART - continued

## CODE NUMBER TO PART NUMBER LISTING - Quantity as required

CODE NO.	PART NUMBER	DESCRIPTION	CODE NO.	PART NUMBER	DESCRIPTION
73	D0VY 6500154-C	Absorber	162	C9AZ 7600155-C	Absorber & stud
74	C4AZ 6200154-A	Absorber	163	D2OZ 6500145-A	Shim-1 3/4" O.D.
78	C9AZ 6200396-A	Absorber & retainer-lower	164	C9AZ 7600163-A	Retainer
79	C5AZ 7600154-A	Absorber-upper	165	C9AZ 6200394-D	Bolt-hex. hd.
80	D2SZ 5A103-A	Absorber	166	C9AZ 6200394-B	Bolt-hex. hd. -7/16"-14 x 1 7/8"
81	C5AZ 7600154-C	Absorber	167	C9AZ 6200394-D	Stud-7/16"-14 x 3 5/32"
82	C3AZ 6200155-A	Absorber	168	C9AZ 7100394-A	Bolt-hex. hd. -7/16"-14 x 3"
83	C3AZ 6200155-E	Absorber	169	C9AZ 7100394-B	Bolt-hex. hd. -7/16"-14 x 2 1/2"
84	C4AZ 6200155-A	Absorber	170	*C9AZ 7600394-A	Stud-7/16"-14
85	C4AZ 6200155-B	Absorber	171	C7MY 6200145-A	Shim
86	C5AZ 7600154-A	Absorber - upper	172	D2OZ 6500155-B	Absorber-lower
87	C7AZ 6200155-A	Absorber	173	C8SZ 6500155-A	Absorber-lower
89	C5AZ 7100155-A	Absorber	174	D0VY 6500154-B	Absorber - upper
90	C5AZ 7600155-A	Absorber	175	C8AZ 6200396-D	Absorber & retainer - lower
95	C5AZ 6200157-A	Retainer	176	C8AZ 6200163-A	Retainer-upper
96	C5AZ 6200157-B	Retainer	177	C8AZ 6200394-A	Bolt
97	C3AZ 6200163-A	Retainer	178	C8AZ 6200394-B	Bolt
99	C5AZ 6200163-B	Retainer	179	*C8AZ 7600394-A	Bolt
100	C7AZ 6200163-A	Retainer	180	C7AZ 6200396-C	Retainer-upper
102	C5AZ 7600163-A	Retainer	181	C8AZ 7600394-B	Stud-hex. hd. -1/2"-13 x 2 3/4"
103	C8AZ 6500394-A	Stud	182	C8AZ 6200396-C	Absorber-upper
104	C8AZ 7100394-B	Bolt-hex. head-7/16"-14 x 2"	184	*C8AZ 7600396-A	Absorber & retainer-upper
105	C7AZ 6200396-C	Stud-3/8"-16 x 2"	185	C8AZ 7600145-A	Shim
106	380311-S2(WW80G)	Stud-3/8"-16 x 2"	186	376515-S2(XX326)	Lockwasher-1/2"
107	39885-S7-8(U263E)	Screw	187	C7MY 6200145-B	Shim
108	373403-S8(MM173J)	Nut	188	C8AZ 6200145-A	Shim
109	D0VY 6500154-B	Absorber - upper	189	C8AZ 6200145-B	Shim
110	C7SZ 6500155-C	Absorber - 2" x 1 3/8"	190	C8AZ 6200145-C	Shim
111	C7SZ 6500155-B	Absorber-2 1/4" O.D. -rubber	191	D2OZ 6500396-C	Absorber & stud
112	C9AZ 6200396-A	Absorber and retainer	192	C8AZ 6200163-B	Retainer
114	*40954-S2	Screw	193	C8AZ 7100151-A	Absorber & retainer-lower
115	*55713-S7	Nut-hex. -3/8"-16	194	C9AZ 5A103-A	Absorber
116	34979-S4(B69FA)	Nut-hex. -1/2"-13	195	C9AZ 5A103-B	Absorber
117	*373290-S2	Washer	196	C9AZ 6200145-A	Shim
118	C6TZ 8100154-A	Absorber-upper	197	C9AZ 6200145-B	Shim
119	C6TZ 8100155-A	Absorber-lower	198	C9AZ 7600145-C	Shim
120	C6TZ 8100157-A	Retainer	199	C9AZ 7600145-D	Shim
121	C9AZ 7600396-A	Absorber & retainer - upper	200	*C9AZ 5B098-A	Absorber
122	C6TZ 8100157-B	Retainer	202	8C 8124-A	Absorber
123	C9AZ 7600396-B	Absorber & stud-upper	203	*382760-S	Nut-hex. -1/2"-13
124	351487-S(XX291)	Lockwasher-external tooth-3/8"	204	*382761-S	Stud-3/8"-16 x 2 1/8"
125	383271-S2(BB552AC)	Bolt-hex. head-3/8"-16 x 3 1/2"	205	*382763-S	Washer-flat-11/16"
126	383272-S2(BB552BC)	Bolt-hex. head-3/8"-16 x 4 1/4"	206	33773-S(M89M)	Nut-hex. -1/2" x 13
127	382322-S2(BB552C)	Bolt-hex. head-3/8"-16 x 4 1/8"	207	376515-S(XX326)	Lockwasher-internal tooth-1/2"
128	*C6TZ 9600151-A	Retainer	208	C9AZ 16152-A	Bolt
129	C6TZ 8100154-B	Absorber	209	C9AZ 5B098-B	Absorber
140	C8AZ 7600394-B	Bolt-hex. head-1/2"-13 x 2 3/4"	210	C9AY 7600396-A	Absorber & retainer - upper
141	C8AZ 7600396-A	Absorber	211	D0AZ 6200163-A	Retainer
142	*C8AZ 7600155-A	Absorber-lower	212	D0SZ 6500155-A	Absorber
143	*C5AZ 5B098-A	Absorber	213	C9AZ 6200396-B	Absorber & stud - upper-4 5/8" long
144	C5AZ 5B098-C	Absorber	214	383271-S2(BB552AC)	Bolt-hex. hd. -3/8"-16 x 3 1/2"
145	C7AZ 5A103-B	Absorber	215	383272-S2(BB552BC)	Bolt-hex. hd. -3/8"-16 x 4 1/4"
146	C8AZ 5A103-A	Absorber	216	383273-S2(BB552CC)	Bolt-hex. hd. -3/8"-16 x 5"
147	*C5AZ 5A103-D	Absorber	217	D1AZ 6500155-A	Absorber
148	C5AZ 5A103-A	Absorber	218	D1AZ 6500396-A	Absorber & stud upper-4 1/2" long
149	C7AZ 5A103-A	Absorber	219	D2OZ 6500163-A	Retainer
150	C8AZ 5A103-B	Absorber	220	D2SZ 6500155-A	Absorber-lower
151	C7SZ 5A103-A	Absorber	221	D2SZ 6500396-A	Absorber & retainer-upper
152	C7AZ 5A076-A	Spacer	222	D2OZ 5A103-A	Absorber
153	C3AZ 5A076-A	Spacer	223	D2OZ 5A103-B	Absorber
154	C9AZ 7100151-A	Retainer	224	D2OZ 6500396-D	Absorber & retainer-upper
156	C9AZ 6200145-C	Shim	225	D2OZ 6500155-C	Absorber-lower
157	C9AZ 6200155-A	Absorber	226	D2OZ 6500396-E	Absorber & retainer-upper
158	C9AZ 6200155-B	Absorber - lower	227	D2OZ 5A103-C	Absorber
159	C5AZ 7600154-A	Absorber	228	D2OZ 6500155-D	Absorber-lower
160	C9AZ 6200154-B	Absorber			
161	C9AZ 7600155-B	Absorber & stud			

# FORD CAR PARTS

## BODY SECTION 030

1

GROUP NUMBER	YEAR	BODY TYPE	DESCRIPTION	PART NUMBER		QTY.	
				CLEAR	TINTED		
<b>030A12 SPACER - WINDSHIELD GLASS</b>							
67/68 69	A	"Before 4/15/68"	Lower -5/8" x 2"	C5AZ	62030A12-C	2	
	S		Lower			2	
65/70 70/71 68/70	A, B, S-	"From 4/15/68"	Lower- 7/8" x 1 3/16"	C8AZ	62030A12-A	2	
	F					2	
	X					2	
69 70	A, B, F, S, X		Lower-1 1/8" wide	C9AZ	62030A12-A	2	
	A					2	
71/	A, F		Lower-attaches to cowl top outer panel	D2AZ	65030A12-A	2	
72	A, F		Lower	D0DZ	62030A12-A	2	
68	B, X	"Before 4/15/68"	Lower	C8OZ	54030A12-A	2	
70/71	B, S		Lower	D0OZ	65030A12-A	2	
71	A, F					2	
72	B, S		Lower	D2OZ	65030A12-A	2	
70/	P		Lower	D0DZ	62030A12-A	4	
			Screw-self tap rd.washer hd.-No.8-18 x 3/8"	379560-S101(UU89CA)		8	
<b>03014 FRAME - WINDSHIELD</b>							
66/	U		1/4-20 x 1/2" Hex. head bolt	C9TZ	9603014-B	1	
					20308-S8(B40)	10	
<b>03045 SEAL - FOLDING TOP HEADER WINDSHIELD - Refer to Group 51338</b>							
<b>03048 BRACKET - WINDSHIELD HOLD DOWN</b>							
67/	U(97,98)			C8TZ	9603048-A	1	
<b>03052-3 BRACE - STEERING COLUMN BRACKET</b>							
70/71	B		R. H.	D0OZ	6503052-A	1	
			L. H.	D0CZ	6503053-A	1	
<b>03082 FILLER - WINDSHIELD FRAME WEATHERSTRIP</b>							
66/	U(97,98)		Rubber	C6TZ	9703082-A	2	
GROUP NUMBER	YEAR	BODY TYPE	DESCRIPTION	PART NUMBER		QTY.	
				CLEAR	TINTED		
<b>03100 %GLASS - WINDSHIELD</b>							
NAGS NUMBER							
- A -							
65/67	A(54, 62, 71)		Δ	W665	C6AZ 6203100-A	C6AZ 6203100-B	1
			▲	W664	★C6AZ 6303100-A	C6AZ 6303100-D	1
Not replaced (5-75)							
68	A(54, 62, 71)		Δ	W697	C8AZ 6203100-A	C8AZ 6203100-B	1
68	A(57, 63, 65, 76)		Δ	W696	C6AZ 6303100-C	C6AZ 6303100-D	1
69	A(54, 62, 71)		●	W719	C9AZ 6203100-A	C9AZ 6203100-B	1
69	A(57, 63, 65, 76)		Δ	W718	C9AZ 6303100-A	C9AZ 6303100-B	1
70	A(54, 62, 71)		#	W734	C9AZ 6203100-C	C9AZ 6203100-D	1
70	A(57, 63, 65, 76)		#	W733	D0AZ 6303100-A	D0AZ 6303100-B	1
71/	A(53, 57, 76)		Δ	W769	D1AZ 5703100-A	D1AZ 5703100-B	1
71/	A(54, 71)		Δ	W770	D1AZ 5403100-A	D1AZ 5403100-B	1
71/72	A(65)		Δ	W799	D3AZ 6503100-A	D3AZ 6503100-B	1
- B -							
65	B(except 65)			W619	C2OZ 6203100-A	C2OZ 6203100-B	1
65	B(65)		Δ	W634	C3OZ 6503100-C	C3OZ 6503100-D	1
66/67	B(54, 62, 66, 71)			W666	C6OZ 6203100-A	C6OZ 6203100-B	1
66/67	B(63, 76)		Δ	W667	C6OZ 6303100-A	C6OZ 6303100-B	1
68/69	B(54, 71)		●	W701	C8OZ 5403100-A	C8OZ 5403100-B	1
68/69	B(63, 65, 66, 76)		Δ	W700	C8OZ 6303100-A	C8OZ 6303100-B	1
70/71	B(54, 57, 62, 65, 66, 76)		Δ	W736	D0OZ 6503100-A	D0OZ 6503100-B	1
70/71	B(63)		Δ	W735	D0OZ 6303100-A	D0OZ 6303100-B	1
70/71	B(71)		Δ	W737	D0OZ 7103100-A	D0OZ 7103100-B	1
72	B		Δ	W791	D2OZ 6503100-A	D2OZ 6503100-B	1

# Includes flat type mirror bracket   ● Ball type mirror bracket   Δ Includes mirror bracket   ▲ Includes button & pad

% To convert ball type to flat type mirror bracket use basic Group 17698 in Chassis Section

May, 1975

COPYRIGHT © 1975 -

FORD MOTOR  
COMPANY

- DEARBORN, MICHIGAN

**FINAL ISSUE**

GROUP NUMBER	YEAR	BODY TYPE	DESCRIPTION	PART NUMBER		QTY.	
				CLEAR	TINTED		
<b>03100 % GLASS - WINDSHIELD - continued</b>							
				NAGS NUMBER			
- F -							
65/67	F			W654	C6ZZ 6503100-A	C6ZZ 6503100-C	1
68	F		Δ	W703	C8ZZ 6503100-A	C8ZZ 6503100-B	1
69	F(63)		●	W720	C9ZZ 6303100-A	C9ZZ 6303100-B	1
69	F(65, 76)		●	W721	C9ZZ 6503100-A	C9ZZ 6503100-B	1
70	F(63)		#	W738	D0ZZ 6303100-A	D0ZZ 6303100-B	1
70	F(65, 76)		#	W739	D0ZZ 6503100-A	D0ZZ 6503100-B	1
71/72	F(63)		Δ	W800	D3ZZ 6303100-A	D3ZZ 6303100-B	1
71/72	F(65, 76)		Δ	W801	D3ZZ 6503100-A	D3ZZ 6503100-B	1
- L -							
71/	L		Δ	W774	D1FZ 6203100-A	D1FZ 6203100-B	1
- P -							
70/71	P		Δ	W727	D0DZ 6203100-A	D0DZ 6203100-B	1
72	P		Δ	W797	D2DZ 6203100-A	D2DZ 6203100-B	1
- S -							
65/66	S		Δ	W651	C4SZ 6303100-A	C4SZ 6303100-B	1
67	S		Δ	W686	C7SZ 6503100-A	C7SZ 6503100-B	1
68/69	S		Δ	W702	C7SZ 6503100-C	C7SZ 6503100-D	1
70	S(57)		Δ-incl.antenna	W741	D0SZ 5703100-C	D0SZ 5703100-D	1
70	S(65)		Δ-incl.antenna	W740	D0SZ 6503100-A	D0SZ 6503100-B	1
71	S(57, 65B, D)		Δ-less antenna	W742	D0SZ 5703100-A	D0SZ 5703100-B	1
71	S(65A, C)		Δ-less antenna	W771	D1SZ 6503100-A	D1SZ 6503100-B	1
72	S		Δ	W792	D2SZ 6503100-B	D2SZ 6503100-A	1
- U -							
66	U	"Before Ser. 844, 001"		1084T	C6TZ 9603100-A		1
66/67	U	"From Ser. 844, 001"		1084K	C6TZ 9603100-B		1
68/69	U		Δ	1084K1	C6TZ 9603100-C		1
70/	U		#	1084KI-A	DOBZ 9703100-A		1
- X -							
65	X(except 63, 76)			W584	C0DB 6403100-E	C0DB 6403100-F	1
65	X(63, 76)		Δ	W635	C3DZ 7603100-C	C3DZ 7603100-D	1
66/67	X			W666	C6OZ 6203100-A	C6OZ 6203100-B	1
68/69	X		●	W701	C8OZ 5403100-A	C8OZ 5403100-B	1
70	X		#	W744	C9DZ 5403100-B	C9DZ 5403100-A	1
GROUP NUMBER	YEAR	BODY TYPE	DESCRIPTION	PART NUMBER		QTY.	
<b>03110 WEATHERSTRIP - WINDSHIELD - Also refer to group 19562</b>							
- B -							
65	B(except 65)				C2OZ 6203110-A	1	
- F -							
65/68	F				C5ZZ 6503110-A	1	
- L -							
71/	L				D1FZ 6203110-A	1	
- P -							
70/71	P		Use w/1/4" thick glass		D0DZ 6203110-A	1	
72	P		Use w/7/32" thick glass		D2DZ 6203110-A	1	
- S -							
65/66	S(63)				C4SZ 6303110-A	1	
- U -							
66/	U		Without mouldings		C6TZ 9603110-B	1	
67/	U		With mouldings		C7TZ 9603110-A	1	
- X -							
65	X(except 63, 76)				C0DB 6403110-C	1	
65	X(63)				C3DZ 6303110-A	1	
65	X(76)				C3DZ 7603110-A	1	
<b>03114 WEATHERSTRIP - WINDSHIELD FRAME</b>							
66/	U (97, 98)		56" long		C6TZ 9703114-A	1	

Δ Includes mirror bracket

● Ball type mirror bracket

# Includes flat type mirror bracket

% To convert ball type to flat type mirror bracket use basic Group 17698 in Chassis Section

# FORD CAR PARTS

## BODY SECTION 030

3

GROUP NUMBER	YEAR	BODY TYPE	DESCRIPTION	PART NUMBER		QTY.
				RIGHT HAND	LEFT HAND	
<b>03136-7 MOULDING - WINDSHIELD OUTSIDE - SIDE - Includes Attaching Parts</b>						
<b>- A -</b>						
	65/68	A(54, 62, 71)		C5AZ 6203136-C	C5AZ 6203137-C	1
	65/68	A(57, 63, 65)		C5AZ 6303136-C	C5AZ 6303137-C	1
	65/68	A(76)		C5AZ 7603136-D	C5AZ 7603137-D	1
	65/68	A(54, 57, 62, 63, 71)	Retainer	C6AZ 6203782-A	C6AZ 6203782-A	2
	65/67	A(57, 63)	Rivet (blind)	379229-S(SS44A)	379229-S(SS44A)	AR
	69/70	A(54, 62, 71)		C9AZ 6203136-A	C9AZ 6203137-A	1
	69/70	A(57, 63, 65)		C9AZ 6303136-A	C9AZ 6303137-A	1
	69/70	A(76)		C9AZ 7603136-B	C9AZ 7603137-B	1
	71/	A(53, 54, 57, 71)		D1AZ 5403136-A	D1AZ 5403137-A	1
	71/	A(65)		D1AZ 6503136-A	D1AZ 6503137-A	1
	71/	A(76)		D1AZ 7603136-A	D1AZ 7603137-A	1
<b>- B -</b>						
	65	B(except 65)		C2OZ 6203136-A	★C2OZ 6203137-A Not replaced(3-74)	1
	66/67	B(63)		C8OZ 6503136-A	★C6OZ 6303137-A r/b C8OZ 6503137-A (7-72)	1
	66	B(54, 62, 71)		C6OZ 6203136-A	C6OZ 6203137-A	1
	67	B(54, 62, 66, 71)				1
	68/69	B(54, 71)				1
	68/69	B(63, 65, 66)		C8OZ 6503136-A	C8OZ 6503137-A	1
	68/69	B(76)		C8OZ 7603136-A	C8OZ 7603137-A	1
	68/69	B(54, 71)	No.8-18 x 3/4" round hd. screw	379560-S101 (UU89CA)	379560-S101 (UU89CA)	6
	70/71	B(54, 57, 62, 65, 66)		D0OZ 6503136-A	D0OZ 6503137-A	1
	70/71	B(63)	Includes upper moulding	D0OZ 6303136-A	D0OZ 6303137-A	1
	70/71	B(71)		D0OZ 7103136-A	D0OZ 7103137-A	1
	70/71	B(76)		D0OZ 7603136-A	D0OZ 7603137-A	1
	72	B		D2OZ 6503136-A	D2OZ 6503137-A	1
<b>- F -</b>						
	65/68	F(63, 65)		C5ZZ 6503136-B	C5ZZ 6503137-B	1
	65/68	F(76)		C5ZZ 7603136-D	C5ZZ 7603137-D	1
	69/70	F(63)		C9ZZ 6303136-A	C9ZZ 6303137-A	1
	69/70	F(65)		C9ZZ 6503136-A	C9ZZ 6503137-A	1
	69/70	F(76)		C9ZZ 7603136-B	C9ZZ 7603137-B	1
	71/	F(63)		D1ZZ 6303136-A	D1ZZ 6303137-A	1
	71/	F(65)	Refer to Group 03144-5			
	71/	F(76)		D1ZZ 7603136-A	D1ZZ 7603137-A	1
<b>- L -</b>						
	71/	L		D1FZ 6203136-A	D1FZ 6203137-A	1
<b>- P -</b>						
	70/72	P		D0DZ 6203136-A	D0DZ 6203137-A	1
<b>- S -</b>						
	65	S(63)		C4SZ 6303136-A	★C4SZ 6303137-A Not replaced(3-74)	1
	66	S(63A)				1
	66	S(63C, D)		C6SZ 6303136-A	C6SZ 6303137-A	1
	67/69	S		C7SZ 6503136-A	C7SZ 6503137-A	1
	70/71	S(67)		D0SZ 5703136-A	D0SZ 5703137-A	1
	71	S(65B, D)				1
	70	S(65)		D0SZ 6503136-A	D0SZ 6503137-A	1
	71	S(65A, C)				1
	72	S		D2SZ 6503136-A	D2SZ 6503137-A	1
<b>- U -</b>						
	67/72	U(97, 98)		C7TZ 9603136-B	C7TZ 9603137-B	1
<b>- X -</b>						
	65	X(except 63, 76)	Less attaching parts	C1DB 6403136-A	C1DB 6403137-A	1
			No. 8-15 x 3/4" Cross recess oval head screw	359872-S100(UU54B)	359872-S100(UU54B)	2
	66	X(54, 62, 66, 71)		C6OZ 6203136-A	C6OZ 6203137-A	1
	67/70	X(54, 62, 71)				1
	67/70	X	No.8-18 x 3/8" Round hd. screw	379560-S101 (UU89CA)	379560-S101 (UU89CA)	6

**BODY  
SECTION 030**
**FORD CAR PARTS**

GROUP NUMBER	YEAR	BODY TYPE	DESCRIPTION	PART NUMBER	QTY.
<b>03144-5 MOULDING - WINDSHIELD OUTSIDE - TOP - INCLUDES ATTACHING PARTS</b>					
- A -					
	65/66	A(54, 62, 71) "Before 9/1/65"		C5AZ 6203144-B	1
			Retainer	C5AZ 6203178-B	8
	66/68	A(54, 62, 71) "From 9/1/65"		C6AZ 6203144-A	1
	65/66	A(57, 63) "Before 2/1/66"	Without weld on stud-less attaching parts	C5AZ 6303144-B	1
			Retainer	C5AZ 6303178-A	8
	66/67	A(57, 63) "From 2/1/66"	With weld on stud	C6AZ 6303144-A	1
	68	A(57, 63, 65)			1
	65/66	A(76)	R. H.	C5AZ 7603144-B	1
			L. H. -not replaced (3-74)	★C5AZ 7603145-B	1
	67/68	A(76)	R. H. -not replaced (3-74)	★C7AZ 7603144-A	1
			L. H.	C7AZ 7603145-A	1
	69/70	A(54, 62, 71)		C9AZ 6203144-A	1
	69/70	A(57, 63, 65)		C9AZ 6303144-A	1
	71/	A(53, 57)		D1AZ 5703144-A	1
	71/	A(54)		D1AZ 5403144-A	1
	71/	A(65)		D1AZ 6503144-A	1
	71/	A(71)		D1AZ 7103144-A	1
	69/	A(76)	R. H.	C9AZ 7603144-A	1
			L. H.	C9AZ 7603145-A	1
- B -					
	65	B(65)		C3OZ 6503144-A	1
	66	B(54, 62, 71)		C6OZ 6203144-A	1
	67	B(54, 62, 66, 71)			1
	68	B(54, 66, 71)			1
	69	B(54, 71)			1
	66/67	B(63)		C6OZ 6303144-A	1
	68	B(63, 65)			1
	69	B(63, 65, 66)			1
	70	B(54, 57, 62, 65, 66, 76)		D0OZ 6503144-A	1
	71	B(54, 57, 65, 66)			1
	70/71	B(63)	Refer to Group 03136-7		
	70/71	B(71)		D0OZ 7103144-A	1
	66/71	B(76)	R. H.	C8OZ 7603144-A	1
			L. H.	C8OZ 7603145-A	1
	72	B		D2OZ 6503144-A	1
- F -					
	65/68	F(63, 65)	R. H.	C5ZZ 6503144-B	1
			L. H.	C5ZZ 6503145-B	1
	65/68	F(76)	R. H.	C5ZZ 7603144-A	1
			L. H.	C5ZZ 7603145-A	1
	69/70	F(63)		C9ZZ 6303144-A	1
	69/70	F(65)		C9ZZ 6503144-A	1
	69	F(76) "Before 4/29/69"	R. H.	C9ZZ 7603144-A	1
			L. H.	C9ZZ 7603145-A	1
	69/70	F(76) "From 4/29/69"	R. H.	C9ZZ 7603144-B	1
			L. H.	C9ZZ 7603145-B	1
	71/	F(63)		D1ZZ 6303144-A	1
	71/	F(65)	R. H.	D1ZZ 6503144-A	1
			L. H.	D1ZZ 6503145-A	1
	71/	F(76)	R. H.	D1ZZ 7603144-A	1
			L. H.	D1ZZ 7603145-A	1
- L -					
	71/	L	R. H.	D1FZ 6203144-A	1
			L. H.	D1FZ 6203145-A	1
- P -					
	70/72	P	R. H.	D0DZ 6203144-A	1
			L. H.	D0DZ 6203145-A	1



# FORD CAR PARTS

**BODY  
SECTION 030**

5

GROUP NUMBER	YEAR	BODY TYPE	DESCRIPTION	PART NUMBER	QTY.
<b>03144-5 MOULDING - WINDSHIELD OUTSIDE-TOP - Includes Attaching Parts - continued</b>					
- S -					
	67/71	S (57)	R. H.	C7SZ 6503144-A	1
	67/69	S (65)			1
	71	S (65B, D)	L. H.	C7SZ 6503145-A	1
	70	S (65)		D0SZ 6503144-A	1
	71	S (65A, C)			1
	72	S		D2SZ 6503144-A	1
- U -					
	67/72	U(97,98)	R. H.	C7TZ 9603144-B	1
			L. H.	C7TZ 9603145-B	1
- X -					
	65	X(except 63, 76)		C0DB 6403144-A	1
	65	X(63)		C3DZ 6303144-A	1
	66/70	X(54, 62, 66, 71)		C6OZ 6203144-A	1
<b>03148-9 MOULDING - WINDSHIELD OUTSIDE - BELT - Includes Attaching Parts</b>					
- A -					
	65/68	A	R. H.	C5AZ 6203148-B	1
			L. H.	C5AZ 6203149-B	1
	69/70	A		C9AZ 6203148-A	1
	65	A	No. 6 x 1/2" Cross recess flat head screw	52010-S8(U200)	2
- B -					
	66/69	B	R. H.	C6OZ 6203148-A	1
			L. H.	C6OZ 6203149-A	1
	65	B	No. 6 x 1/2" Cross recess flat head screw	52010-S8(U200)	2
- F -					
	65/68	F		C5ZZ 6503148-B	1
	69/70	F(63, 65)	R. H.	D0ZZ 6503148-B	1
			L. H.	D0ZZ 6503149-B	1
	69/70	F(76)	R. H.	C9ZZ 7603148-A	1
			L. H.	C9ZZ 7603149-A	1
- L -					
	71/	L	R. H.	D1FZ 6203148-A	1
			L. H.	D1FZ 6203149-A	1
- P -					
	70/72	P	R. H.	D0DZ 6203148-A	1
			L. H.	D0DZ 6203149-A	1
- S -					
	67/69	S	R. H.	C7SZ 6503148-A	1
			L. H.	C7SZ 6503149-A	1
- U -					
	67/	U(97,98)		C7TZ 9603148-B	1
- X -					
	65	X		C0DB 6403148-A	1
			No. 6 x 1/2" Cross recess flat head screw	52010-S8(U200)	2
	66/70	X	R. H.	C6OZ 6203148-A	1
			L. H.	C6OZ 6203149-A	1
<b>03150 SPACER - WINDSHIELD OUTSIDE BELT MOULDING - Also refer to Group 03200</b>					
	66/68	B, X	1" long	C6OZ 6203150-D	3
	67/68	B, X	1 1/4" long	C7OZ 6203150-A	8
	66/	B	3/4" long -at front fender	C6OZ 6203150-B	8
	66/70	X			8
	69/	B	1" long	C9OZ 5403150-A	3
	69/70	X			3
	67/68	F		C7ZZ 6503150-A	4
	69/70	F	2" long-at cowl top	C9ZZ 6503150-A	1
			3/4" long-at front fender	C9ZZ 6503150-B	1
			3/4" long-at cowl top	C9ZZ 6503150-C	1
	70/	P		D0DZ 6203150-A	2
	67/69	S	"Before 4/1/69"	C7SZ 6503150-A	4
			Lower center	C7SZ 6503150-B	2
	69/	S	"From 4/1/69"	C9SZ 6503150-A	4
			Lower center	C9SZ 6503150-B	2
			Side		

GROUP NUMBER	YEAR	BODY TYPE	DESCRIPTION	PART NUMBER	QTY.	
<b>03152-3</b>	<b>COVER - WINDSHIELD OUTSIDE TOP</b> - Refer to group 03220-1					
<b>03154</b>	<b>WEATHERSTRIP - WINDSHIELD - OUTSIDE - SIDE MOULDING</b> - Refer to Group 19562 in Paint Section					
<b>03174</b>	<b>RETAINER - WINDSHIELD OUTSIDE SIDE MOULDING</b>					
	70	P	"Before 10/29/69"	Refer to Group 03406		
	70/ 71/	P L	"From 10/29/69"	D0DZ 6203174-A	AR 5	
<b>03178</b>	<b>RETAINER - WINDSHIELD OUTSIDE MOULDING</b> - Also refer to group 42413					
	65/67	A(57, 63)	"Before 2/1/66"	Side and top	C5AZ 6303178-A 8	
	66 65/67	A(76) A(57, 63)	"From 2/1/66"	Side Also used on back window	C6AZ 7603178-A 4 9or14	
	65/67	A(54, 62, 71)		C5AZ 6203178-B	8	
	67/68	A(76)		Side C5AZ 6303178-A	4	
	65	F		Refer to Group 42413		
	69/70	S		C9SZ 6503178-A	2	
	71	S(57, 65B, D)			2	
	65	X(63)		C3DZ 6303178-A	5	
			No. 8-18 x .38" Cross recess truss head screw	376378-S101(UU97)	8 or 22	
<b>03200</b>	<b>SPACER - WINDSHIELD OUTSIDE BELT MOULDING</b> - Also refer to Group 03150					
	66	B(except 76), X - "Before 12/27/65"	3/4" wide	C6OZ 6203200-A	5	
	66/70 71	B, X B "From 12/27/65"	3/4" wide	C6OZ 6203200-B	5 5	
	67/69 71	S S(57, 65B, D)	3/4" wide	C7SZ 6503200-A	AR 14	
GROUP NUMBER	YEAR	BODY TYPE	DESCRIPTION	PART NUMBER		QTY.
				RIGHT HAND	LEFT HAND	
<b>03220-1</b>	<b>MOULDING - WINDSHIELD OUTSIDE UPPER CORNER</b> - Includes Attaching Parts					
	65	B(except 65)	Less attaching parts	C2OZ 6203220-B	★C2OZ 6203221-B Not replaced (3-74)	1
	65	X(except 63, 76)		C0DB 6403152-C	★C0DB 6403153-C Not replaced	1
GROUP NUMBER	YEAR	BODY TYPE	DESCRIPTION	PART NUMBER	QTY.	
<b>03243</b>	<b>STRIP - WINDSHIELD</b>					
	70/72	A, B, F, S	61" long-cut to fit	D3AZ 6503243-A	1	
<b>03266</b>	<b>SEAL - WINDSHIELD GARNISH SIDE MOULDING</b>					
	65	S(76)	Cut to 23" from C4SZ 63517B30-A		2	
	66	S(63C, D)	Cut to 24" from C4SZ 63517B30-A		2	
	66	S(76)	Cut to 22" from C4SZ 63517B30-A		2	
<b>03406-7</b>	<b>RETAINER - WINDSHIELD OUTSIDE BELT MOULDING</b>					
	65/68	A	Also included with 03148-9 moulding	C5AZ 6203407-A	2	
	67/68	A		C7AZ 6203407-A	6	
	65/68	A	No. 8-15 x 5/8" Hex. washer head screw	★42133-S2	2or8	
	66/67	B, X		C6OZ 6203407-A	7	
	68/69	B, X		C9OZ 5403407-A	7	
	69/70	F		C9ZZ 6503406-A	7	
	70	P	"Before 10/29/69"			
	70	P	"From 10/29/69"	D0DZ 62Q3406-A	8	
	67/69	S	Refer to Group 03174			
			R.H.	C7SZ 6503406-B	1	
			L.H.	C7SZ 6503407-B	1	
<b>03408</b>	<b>PANEL - WINDSHIELD HEADER</b>					
			- A -			
	65/66	A(57, 63)	"Before 2/7/66"	C5AZ 6303408-A	1	
	65/66	A(76)	"Before 2/7/66"	C5AZ 7603408-A	1	
	69/70	A(57, 63, 65)		D1AZ 5703408-A	1	
	71/	A(53, 57)			1	
	69/	A(54, 62, 71)		D1AZ 5403408-A	1	
	71/	A(65)		D1AZ 6503408-A	1	
	69/	A(76)		C9AZ 7603408-A	1	

# FORD CAR PARTS

**BODY  
SECTION 030**

7

GROUP NUMBER	YEAR	BODY TYPE	DESCRIPTION	PART NUMBER	QTY.	
<b>03408 PANEL - WINDSHIELD HEADER - continued</b>						
- B -						
	68/69	B(54, 71)		C8OZ 5403408-A	1	
	68/71	B(76)		C8OZ 7603408-A	1	
	70/71	B(except 71, 76)		D0OZ 6503408-A	1	
	70/71	B(71)		C8OZ 5403408-A	1	
	72	B		D2OZ 6503408-A	1	
- F -						
	65/66	F(63, 65)		C5ZZ 6503408-A	1	
	69/70	F(63)		C9ZZ 6303408-A	1	
	69/70	F(65)		C9ZZ 6503408-A	1	
	69	F(76) "Before 4/29/69"		C9ZZ 7603408-A	1	
	69/70	F(76) "From 4/29/69"		C9ZZ 7603408-B	1	
	71/	F(63, 65)		D1ZZ 6503408-A	1	
	71/	F(76)		D1ZZ 7603408-A	1	
- P -						
	70/	P		D0DZ 6203408-A	1	
- S -						
	68/69	S		C8SZ 6503408-A	1	
	70/71	S(57)			1	
	71	S(65B, D)			1	
	70	S(65)		D0SZ 6503408-A	1	
	71	S(65A, C)		D1SZ 6503408-A	1	
	72	S		D2SZ 6503408-A	1	
- X -						
	68/70	X		C8OZ 5403408-A	1	
<b>03496 COVER - WINDSHIELD HEADER FLANGE</b>						
	68	A(63),S(65)		C8SZ 6503496-A	2	
	68	F(63, 65)	17 1/2" long	C8ZZ 6503496-A	2	
	68	S(57)		C8SZ 5703496-A	1	
<b>03542 MOULDING - WINDSHIELD HEADER - INSIDE</b>						
	66	B(63)	Red	C6OZ 6303542-AAC	1	
			Clip	376330-S2(GG121)	1	
	67/68	B(except 76), X	Black	C9OZ 5403542-C1A	1	
	69	B(except 76), X	Aqua	C9OZ 5403542-C1K	1	
			Black	C9OZ 5403542-C1A	1	
			Blue(light)	C9OZ 5403542-C1B	1	
			Nugget gold	C9OZ 5403542-C1Y	1	
			White	C9OZ 5403542-C1W	1	
	70	B(except 76)	Black	C9OZ 5403542-C1A	1	
			Blue	D0OZ 5403542-C	1	
			Ginger	D0OZ 5403542-A	1	
			Green	D0OZ 5403542-B	1	
			Red	D0OZ 5403542-D	1	
			White	C9OZ 5403542-C1W	1	
	71	B(except 76)	Black	C9OZ 5403542-C1A	1	
			Blue	D0OZ 5403542-C	1	
			Ginger	D0OZ 5403542-A	1	
			Gray gold	D1OZ 5403542-C	1	
			Green	D1OZ 5403542-B	1	
			Vermillion	D1OZ 5403542-A	1	
			White	C9OZ 5403542-C1W	1	
	66/71	B(76)	Refer to Group 03606-7			
GROUP NUMBER	YEAR	BODY TYPE	DESCRIPTION	PART NUMBER		QTY.
				RIGHT HAND	LEFT HAND	
<b>03598-9 MOULDING - WINDSHIELD GARNISH - SIDE - Includes Attaching Parts</b>						
- A -						
	65	A(57, 63)		C5AZ 6303598-B	★C5AZ 6303599-A Not replaced (3-74)	1
	66	A(57, 63)		C5AZ 6303598-B	★C5AZ 6303599-B Not replaced (3-74)	1
	67	A, B, S	Refer to Group 03598-9 in Soft Trim Section			

GROUP NUMBER	YEAR	BODY TYPE	DESCRIPTION	PART NUMBER		QTY.
				RIGHT HAND	LEFT HAND	
<b>03598-9 MOULDING - WINDSHIELD GARNISH - SIDE - Incl. attaching parts - continued</b>						
- A -						
	68	A(54, 62, 71)	Paint to match	C8AZ 6203598-A	★C8AZ 6203599-A Not replaced (5-75)	1
	69	A(57, 63, 65)	Paint to match	C9AZ 6303598-A	C9AZ 6303599-A	1
	69/70	A(54, 62, 71)	Paint to match	C9AZ 6203598-A	C9AZ 6203599-A	1
	71/71	A(54, 71)				1
	70	A(57, 63, 65)	Paint to match	D0AZ 6303598-A	D0AZ 6303599-A	1
	71/71	A(53, 57)				1
	71/71	A(65)	Paint to match	D1AZ 6503598-A	D1AZ 6503599-A	1
	69/71	A(76)	Paint to match	C9AZ 7603598-A	C9AZ 7603599-A	1
	69/71	A	No. 8-18 x 1 1/2" oval head self tapping screw	376290-S100(UU56D)	376290-S100(UU56D)	2
- B -						
	66/68	B	Refer to Group 03598-9 in Soft Trim Section			
	69	B	Serviced in Assembly - refer to Group 02522-3			
	70/71	B(63)	Paint to match	D0OZ 6303598-A	D0OZ 6303599-A	1
	72	B "Before 3/6/72"	Paint to match	D2OZ 6503598-A	★D2OZ 6503599-A r/b D3OZ 6503599-A (5-75)	1
	72	B "From 3/6/72"	Black	D3OZ 6503598-A	D3OZ 6503599-A	1
			Ginger	D3OZ 6503598-F	D3OZ 6503599-F	1
			Green	D3OZ 6503598-D	D3OZ 6503599-D	1
			Tobacco	D3OZ 6503598-C	D3OZ 6503599-C	1
- F -						
	65/66	F	Serviced in assy. - Refer to Group 02522-3			
	69/70	F(63)	Paint to match	C9ZZ 6303598-A	C9ZZ 6303599-A	1
	69/70	F(65)	Paint to match	C9ZZ 6503598-A	C9ZZ 6503599-A	1
	69	F(76) "Before 4/15/70"	Paint to match	C9ZZ 7603598-A	C9ZZ 7603599-A	1
	69/70	F(76) "From 4/15/70"	Paint to match	★C9ZZ 7603598-B Not replaced	C9ZZ 7603599-B	1
	71/72	F(63)	Black	D3ZZ 6303598-G	D3ZZ 6303599-G	1
			Blue	D3ZZ 6303598-B	D3ZZ 6303599-B	1
			Ginger	D3ZZ 6303598-L	D3ZZ 6303599-L	1
			Green	D3ZZ 6303598-K	D3ZZ 6303599-K	1
			Vermillion	D3ZZ 6303598-H	D3ZZ 6303599-H	1
			White	D3ZZ 6303598-J	D3ZZ 6303599-J	1
	71/72	F(65) "Before 7/15/72"	Paint to match	D1ZZ 6503598-A	D1ZZ 6503599-A	1
	72	F(65) "From 7/15/72"	Black	D3ZZ 6503598-J	D3ZZ 6503599-J	1
			Blue	D3ZZ 6503598-B	D3ZZ 6503599-B	1
			Ginger	D3ZZ 6503598-M	D3ZZ 6503599-M	1
			Green	D3ZZ 6503598-E	D3ZZ 6503599-E	1
			Red	D3ZZ 6503598-H	D3ZZ 6503599-H	1
			Vermillion	D3ZZ 6503598-K	D3ZZ 6503599-K	1
			White	D3ZZ 6503598-L	D3ZZ 6503599-L	1
	71/72	F(76) "Before 7/15/72"	Paint to match	★D1ZZ 7603598-A r/b Colors (3-74)	D1ZZ 7603599-A	1
	72	F(76) "From 7/15/72"	Black	D3ZZ 7603598-G	D3ZZ 6503599-G	1
			Blue	D3ZZ 7603598-B	D3ZZ 6503599-B	1
			Ginger	D3ZZ 7603598-F	D3ZZ 6503599-F	1
			Green	D3ZZ 7603598-H	D3ZZ 6503599-H	1
			Red	D3ZZ 7603598-E	D3ZZ 6503599-E	1
- S -						
	65	S(63)		C4SZ 6303598-B	★C4SZ 6303599-C Not replaced (3-74)	1
	68/69	S "From 4/15/68"	Paint to match	C8SZ 6503598-A	C8SZ 6503599-A	1
	70/71	S(57)	"Before 4/15/68" - refer to basic Group 03598-9 in Soft Trim Section			1
	71	S(65B, D)				1

# FORD CAR PARTS

**BODY  
SECTION 030**

9

GROUP NUMBER	YEAR	BODY TYPE	DESCRIPTION	PART NUMBER		QTY.
				RIGHT HAND	LEFT HAND	
<b>03598-9 MOULDING - WINDSHIELD GARNISH - SIDE - Incl. attaching parts - continued</b>						
<b>- S -</b>						
	70	S(65)	Paint to match	D0SZ 6503598-A	D0SZ 6503599-A	1
	71	S(65A,C)				1
	72	S	Black	D3SZ 6503598-M	D3SZ 6503598-M	1
			Blue	★D3SZ 6503598-B r/b D4SZ 6503598-A	D3SZ 6503599-B	1
			Ginger	D3SZ 6503598-R	D3SZ 6503599-R	1
			Gold	D3SZ 6503598-P	D3SZ 6503599-P	1
			Green	D3SZ 6503598-G	D3SZ 6503599-G	1
			Red	D3SZ 6503598-D	D3SZ 6503599-D	1
			Tobacco	D3SZ 6503598-L	D3SZ 6503599-L	1
			White	D3SZ 6503598-N	D3SZ 6503599-N	1
<b>03606 MOULDING - WINDSHIELD GARNISH - UPPER- Includes attaching parts</b>						
<b>- A -</b>						
	69/70	A(except 76)	Paint to match		C9AZ 6203606-A	1
	69/	A(76)			C9AZ 7603606-A	1
	69/	A	No. 8-18 x 1 1/2" oval head self tapping screw		376290-S100(UU56D)	4
	71/	A(except 65, 76)	Paint to match		D1AZ 5403606-A	1
	71/	A(65)	Paint to match		D1AZ 6503606-A	1
<b>- B -</b>						
	66/71	B(76)			C6OZ 7603606-C	1
	72	B	Paint to match		D2OZ 6503606-A	1
<b>- F -</b>						
	65/67	F(76)			C5ZZ 7603606-A	1
	69/70	F(63)	Paint to match		C9ZZ 6303606-A	1
	69/70	F(65)	Paint to match		C9ZZ 6503606-A	1
	69/70	F(76)			C9ZZ 7603606-B	1
	71/	F(63, 65)	Paint to match		D1ZZ 6503606-A	1
	71/	F(76)			D1ZZ 7603606-A	1
<b>- S -</b>						
	67/68	S "Before 3/15/68"	Paint to match		C7SZ 6503606-A	1
	68/69	S "From 3/15/68"	Paint to match		C8SZ 6503606-A	1
	71	S(57, 65B, D)"Before 8/17/70"				1
	71	S(57, 65B, D)"From 8/17/70"	Paint to match		D1SZ 6503606-A	1
	70	S	Paint to match		D0SZ 6503606-A	1
	71	S(65A, C)				1
	72	S	Paint to match		D2SZ 6503606-A	1
	71	S(65)	Screw-oval head self tap.-No.8-18 x 1 1/2"		376290-S100(UU56D)	2
<b>03662-3 MOULDING - WINDSHIELD GARNISH LOWER CORNER</b>						
	68/69	B, X	R. H. -Paint to match L. H.		C8OZ 5403662-A C8OZ 5403663-A	1 1
	70/71	B, X	Refer to Group 04500-1			
	70	P(62)	R. H. -Blue L. H.		D0DZ 6203662-E D0DZ 6203663-E	1 1
			R. H. -Nugget Gold L. H.		D0DZ 6203662-D D0DZ 6203663-D	1 1
			R. H. -Red L. H.		D0DZ 6203662-B D0DZ 6203663-B	1 1
	70/	P(62)	R. H. - Paint to match L. H.		D0DZ 6203662-A D0DZ 6203663-A	1 1
<b>03782-3 RETAINER - WINDSHIELD OUTSIDE BELT MOULDING END</b>						
	71/	L	R. H. -lower L. H.		D1FZ 6203782-A D1FZ 6203783-A	1 1
<b>03800 SUPPORT - WINDSHIELD OUTSIDE TOP MOULDING</b>						
	69/	A(76), F(76)			C9AZ 7603800-A	5
	66/71	B(76)			C6OZ 7603800-A	5
<b>03804 SEAL - WINDSHIELD GLASS - Refer to Group 19562 in Paint Section</b>						
<b>03818 KNOB - WINDSHIELD LATCH</b>						
	66/	U			C6TZ 9603818-B	2
<b>03826 RETAINER - WINDSHIELD GARNISH MOULDING LOWER</b>						
	65/66	A	Slotted		C5AZ 6203826-A	4or5

May, 1975

COPYRIGHT © 1975 -

FORD MOTOR  
COMPANY

- DEARBORN, MICHIGAN

**FINAL ISSUE**

GROUP NUMBER	YEAR	BODY TYPE	DESCRIPTION	PART NUMBER	QTY.	
<b>03828 SEAL - WINDSHIELD HINGE</b>						
	66/	U	60" long	C6TZ 9603828-A	1	
			1/4"-20 x 1/2" Hex. head bolt	20308-S8(B40)	2	
<b>03830 RETAINER - WINDSHIELD OUTSIDE TOP MOULDING OUTER</b>						
	69/70	A(76)		C9AZ 7603830-A	1	
<b>03848 KNOB - WINDSHIELD HOLD DOWN</b>						
	66/	U		C6TZ 9603848-A	1	
<b>03850 RETAINER - WINDSHIELD HOLD DOWN - INCLUDES ATTACHING PARTS</b>						
	66/	U		C6TZ 9603850-A	1	
			1/4"-20 Hex. lock nut	34390-S7(M92)	2	
<b>03852 SPRING - WINDSHIELD HOLD DOWN</b>						
	66/	U		C6TZ 9603852-A	1	
<b>03854 STUD - WINDSHIELD HOLD DOWN</b>						
	66/	U	Includes extension	C6TZ 9603854-A	1	
			Refer to Group 03848 for knob			
GROUP NUMBER	YEAR	BODY TYPE	DESCRIPTION	PART NUMBER		QTY.
				RIGHT HAND	LEFT HAND	
<b>04000-1 SUPPORT - VISOR ARM BRACKET</b>						
	67/69	S(57, 65)		C7SZ 6504000-A	C7SZ 6504001-A	1
	70/71	S(57)				1
	71	S(65B, D)				1
GROUP NUMBER	YEAR	BODY TYPE	DESCRIPTION	PART NUMBER	QTY.	
<b>04002 SUPPORT - VISOR ARM CLIP</b>						
	67/69	S		C7SZ 6504002-A	1	
	70/71	S(57)			1	
	71	S(65B, D)			1	
<b>04090 BRACKET and PIVOT - VISOR</b>						
	70/71	S(57)	Refer to Group 04144-5			
	70	S(65)		D0SZ 6504090-A	2	
	71	S(65A, C)			2	
<b>04110-1 ARM - VISOR - Also refer to Group 04144-5</b>						
	65/66	A(76), F(76)		C5ZZ 7604110-A	2	
	66/70	B(76)		C6OZ 7604110-A	2	
	67/69	S		C7SZ 6504110-A	2	
	70/71	S(57)			2	
	70/	S(65)		D0SZ 6504110-A	2	
	66/69	U	"Before Ser. E24,001" R. H.	C6TZ 9604110-A	1	
			L. H.	C6TZ 9604111-A	1	
	69/	U	"From Ser. E24,001"	C9TZ 9704110-A	2	
			No. 10-12 x 1/2" Cross recess pan head screw	52727-S8(U382)	2	
<b>04114 PIN - VISOR ANCHOR</b>						
	65/69	A	Includes rubber tip-refer to Group 04115	C3DZ 7604114-B	2	
	65/69	B			2	
	66/69	F			2	
	65/67	X(63, 76)			2	
	69	S, X			1	
	70	A, B, F, S, X	Includes rubber tip	D0DZ 6204114-B	2	
	71	A, B, F, L, P, S			2	
		"Before 5/3/71"				
	71/	A, B, F, L, P, S		D3AZ 6504114-A	2	
		"From 5/3/71"				
	65	S		C4SZ 6304114-A	2	
	66	S(63A, 76)			2	
	65	F			2	
	70	P			2	
	69/	U		C9TZ 9704114-A	1	
<b>04115 SLEEVE - VISOR ANCHOR PIN</b>						
	65/69	All	Rubber tip - Used with Group 04114	★C5AZ 6204115-A	2	
				r/b DIDZ 6204115-A		
	70/	A, B, F, L, P, S, U-	Rubber tip	D1DZ 6204115-A	2	
		"From 2/2/70"				









**BODY  
SECTION 030**
**FORD CAR PARTS**

GROUP NUMBER	YEAR	BODY TYPE	DESCRIPTION	PART NUMBER		QTY.
				RIGHT HAND	LEFT HAND	
<b>04144-5 ARM and BRACKET ASSY. - VISOR - continued</b>						
- F -						
	65/66	F(63, 65)	Includes arm	C5ZZ 6504144-A	C5ZZ 6504144-A	2
	65/66	F(76)	Less arm	C5ZZ 7604144-B	C5ZZ 7604145-B	1
	65/66 67	F(76) B(except 76), X	No. 8-15 x 5/8" Cross recess oval head screw	53027-S13(U278)	53027-S13(U278)	4
			No. 8-15 x 1 1/4" Cross recess oval head screw	53066-S13(U284)	53066-S13(U284)	2
	65/66	F(76)	No. 10-12 x 1 1/4" Cross recess screw	52383-S6(U305A)	52383-S6(U305A)	2
	67	F(except 76)	Chrome	C7AZ 6204144-A	C7AZ 6204144-A	2
	68/70	F(63, 65)		C7AZ 6204144-A	C7AZ 6204144-A	2
	69	F(76)	Includes attaching parts	C9ZZ 7604144-B	C9ZZ 7604145-A	1
	70	F(76)	Includes attaching parts	C9ZZ 7604144-B	C9ZZ 7604145-B	1
	71/	F(63, 65)		C9AZ 6204144-A	C9AZ 6204144-A	1
	71/72	F(76)	Includes attaching parts	D2ZZ 7604144-A	D2ZZ 7604145-A	1
- L -						
	71/	L		D1FZ 6204144-A	D1FZ 6204144-A	2
- P -						
	70/	P	Includes attaching parts	C9AZ 6204144-A	C9AZ 6204144-A	2
- S -						
	65/66	S(63)		C4SZ 6304144-B	C4SZ 6304145-B	1
	65/66	S(76)	Chrome bracket	C4SZ 7604144-A	C4SZ 7604145-A	1
	65/66	S(76)	No. 8-15 x 5/8" Cross recess oval head screw	53027-S13(U278)	53027-S13(U278)	4
	65/66	S(63)	No. 8-32 x 3/8" cross recess oval head screw and washer assy.	382617-S7-8 (EE600CC)	382617-S7-8 (EE600CC)	2
	65/66	S	No. 8-15 x 1 1/4" Cross recess oval head screw	53066-S13(U284)	53066-S13(U284)	4
	67/69 70/71 71	S S(57) S(65B, D)	Bright finish	C7SZ 6504144-A	C7SZ 6504144-A	2 2 2
			No. 10-24 x 1/4" Socket set lock screw	*377533-S9	*377533-S9	2
	70/71 72	S(65A, C) S	Refer to Group 04090			
			Also refer to Group 04122-3	C9AZ 6204144-A	C9AZ 6204144-A	2
- U -						
	66/	U	Refer to Group 04110-1			
- X -						
	65	X(except 63, 76)	Paint to match	C0DZ 6404144-A	C0DZ 6404145-A	1
	65	X(except 63, 76), B(except 65)	No. 8-15 x 3/4" Cross recess oval head screw	52360-S13(U294)	52360-S13(U294)	6
	65	X(63, 76)	No. 8-15 x 1 1/2" Cross recess oval head screw	52388-S13(U298)	52388-S13(U298)	4
	66	X		C6OZ 5404144-A	C6OZ 5404144-A	2
	67	X		C7OZ 6204144-A	C7OZ 6204144-A	2
	68	X				2
	69/70	X	Includes attaching parts	C9AZ 6204144-A	C9AZ 6204144-A	2

# FORD CAR PARTS

## BODY SECTION 042

1

GROUP NUMBER	YEAR	BODY TYPE	DESCRIPTION	PART NUMBER	QTY.
<b>04278 CLIP - INSTRUMENT PANEL PAD RETAINER - Also refer to Group 044C78</b>					
	65/66	A		C5AZ 6204278-A	AR
			Nut-stamped-No. 10-24	45243-S8(M178)	AR
	68/70	B, X		C8OZ 5404278-A	AR
	69/70	F			AR
	70	A			AR
	71/	A, B, F, S		D1AZ 6504278-A	AR
<b>04300 REINFORCEMENT - CONSOLE PANEL - REAR</b>					
	69/70	A		C9AZ 6504300-A	1
	72	B	With full length console & bucket seats	D2OZ 6504300-A	1
	71	F	Refer to Group 045A36		1
	68/69	S		C8SZ 6504300-A	1
	70/71	S		D0SZ 6504300-B	1
	72	S	Center	D2SZ 6504300-B	1
<b>04320 PANEL - INSTRUMENT</b>					
<b>- A -</b>					
	69	A		C9AZ 6204320-A	1
	70	A		D0AZ 6204320-A	1
	71	A	Lower	D1AZ 6504320-A	1
			Upper-refer to Group 044A90		
	72	A		D2AZ 6504320-A	1
			Stud-5/16"-18 x 1 5/8"	379054-S2 (WW78VE)	1
	71/	A	Nut & washer assy.-5/16"-18	376838-S(MM296A)	1
<b>- B -</b>					
	68/69	B	Without forced ventilation	C8OZ 5404320-C	1
			With forced ventilation	C8OZ 5404320-D	1
	70	B(54A, B, 62A, 63H, 65A, B, E, 66A, B, 71B, D)	Lower-paint to match	D0OZ 5404320-A	1
	71	B(54A, 63H, 65A, E, 66A, B, 71D)			1
	70/71	B(54C, 57C, 63C, F, 65C, 66C, 71)	Lower-textured steel-includes instruction sheet for A/C	D0OZ 5404320-C	1
	71	B(54A, 71D) "From 6/18/71"			1
	70/71	B(57E, 65E, 66E, 71, 76)	Lower-vinyl clad steel-wood grain finish-includes instruction sheet for A/C	D0OZ 5404320-B	1
	70/71	B	Upper-refer to Group 04634		
	72	B "Before 7/15/72"	Gold	D2GZ 6504320-E	1
			Tobacco	D2GZ 6504320-B	1
	72	B "From 7/15/72"	Paint to match	D3OZ 6504320-A	1
<b>- F -</b>					
	69	F	Without A/C	C9ZZ 6504320-C	1
			With A/C	C9ZZ 6504320-D	1
	70	F	With or without A/C	D0ZZ 6504320-A	1
	71/	F	Includes openings for gauges	D1ZZ 6304320-A	1
			Less openings for gauges	D1ZZ 6504320-A	1
<b>- L -</b>					
	71/	L	Without seat belt warning lamp opening	D1FZ 6204320-A	1
	72	L "Before 12/1/71"	With seat belt warning lamp opening	D2FZ 6204320-A	1
	72	L "From 12/1/71"	With seat belt warning lamp opening	D2FZ 6204320-B	1
<b>- P -</b>					
	70	P	Without locking steering column or A/C	D0DZ 6204320-C	1
	70	P	Without locking steering column and with A/C	D0DZ 6204320-D	1
	70/72	P "Before 12/1/71"	With locking steering column, w/o A/C, and w/o lamp opening	D0DZ 6204320-A	1
	70/72	P "Before 12/1/71"	With locking steering column, A/C, and w/o lamp opening	D0DZ 6204320-B	1
			5/16"-18 x 3/4" Screw & washer assy.	57140-S2(B340H)	6
	72	P "From 12/1/71"	W/o A/C and with seat belt lamp opening	D2DZ 6204320-A	1
			With A/C and with seat belt opening	D2DZ 6204320-B	1
<b>- S -</b>					
	68/69	S		C8SZ 6504320-A	1
	70/71	S		D1SZ 6504320-A	1
	72	S "Before 6/15/72"	Paint to match	D2SZ 6504320-A	1
	72	S "From 6/15/72"	Paint to match	D3SZ 6504320-A	1

GROUP NUMBER	YEAR	BODY TYPE	DESCRIPTION	PART NUMBER	QTY.
<b>04320 PANEL - INSTRUMENT - continued</b>					
- U -					
68/	U		Paint to match-includes instruction sheet	C8TZ 9604320-B	1
			No.8-18 Nut (U type) spring	381863-S2(MM275J)	1
- X -					
68/70	X		Without ornament or A/C holes	C8DZ 6204320-D	1
<b>04334-5 PANEL - INSTRUMENT PANEL FINISH END - Refer to Group 04392-3</b>					
<b>04338 PANEL - INSTRUMENT PANEL FINISH - @ INCLUDES ATTACHING PARTS</b>					
- A -					
67	A		Without A/C or Forced Ventilation-not replaced@	★C7AZ 6204338-A	1
			With A/C-not replaced (3-73)	@ ★C7AZ 6204338-B	1
			With Forced Ventilation-not replaced	@ ★C7AZ 6304338-A	1
68	A		Refer to Basic Groups 04392-3 or 04774		1
69/70	A		Refer to Basic Group 04392		
71/72	A(53H, 57H, 65H, 71H, 76)		"LTD" - w/o lamp opening	@ D1AZ 6504338-C	1
71/	A(53K, 57K, 65K)		"Brougham"-w/o seat belt lamp opening	@ D1AZ 6504338-B	1
72	A(53K, 57K, 65K)		With seat belt lamp opening	@ D2AZ 6504338-B	1
71/	A(54B, 71B)		"Custom"- w/o seat belt lamp opening	D1AZ 5404338-A	1
72	A(54B, 71B)		"Custom"-with seat belt lamp opening	@ D2AZ 5404338-A	1
71/	A(54D, 65D, 71D)		"Custom 500"-w/o seat belt lamp opening	D1AZ 5404338-B	1
72	A(54D, 71D)		"Custom 500"-with seat belt lamp opening	@ D2AZ 5404338-B	1
72	A(54D, F, 57F, 65F)		W/o seat belt lamp opening	@ D2AZ 6504338-C	1
			Wood grain-with seat belt lamp opening	D2AZ 6504338-E	1
71/	A(54F, 57F, 65F, 71F)		"Galaxie 500" -w/o seat belt lamp opening	D1AZ 6504338-A	1
72	A(54F, 57F, 65F, 71F)		With seat belt lamp opening	@ D2AZ 6504338-A	1
72	A(53H, 57H, 65H, 71H, 76)- "From 12/1/71"		"LTD" - w/lamp opening	D2AZ 6504338-D	1
- B -					
65	B(54B, 62B, 65, 71B)		With radio	C5OZ 6204338-D	1
68	B(54C, 65C, 71E)		Center-without Forced Ventilation and with radio -22, 69" long	C8OZ 5404338-D	1
			Refer to basic Group 19893 Chassis section for - with radio and A/C		
68/69	B(except 54C, 65C, E, 71E)		L.H. & center-without Forced Ventilation - approx. 48" long	C8OZ 5404338-A	1
			L.H. & center-with Forced Ventilation- -approx. 48" long	C8OZ 6304338-B	
69	B(54C, 65C, E, 71E)		Center-w/o Forced Ventilation and w/radio	@ C9OZ 5404338-A	1
			Center-without Forced Ventilation and w/o radio	C9OZ 5404338-B	1
			Center-with Forced Ventilation and w/o radio	C9OZ 5404338-C	1
72	B(53B, 65B, 71B)		R.H.-w/o A/C or lamp opening -black	@ D2OZ 6504338-A	1
			R.H.-w/o A/C and with lamp opening -black	@ D2OZ 6504338-G	1
			R.H.-with A/C and w/o lamp opening -black	@ D2OZ 6504338-D	1
			R.H.-with A/C and lamp opening -black	@ D2OZ 6504338-K	1
72	B(53D, 63R, 65D, R, 71D)		R.H.-w/o A/C or lamp opening -black	@ D2OZ 6504338-B	1
			R.H.-w/o A/C and with lamp opening -black	@ D2OZ 6504338-H	1
			R.H.-with A/C and w/o lamp opening -black	@ D2OZ 6504338-E	1
			R.H.-with A/C and lamp opening -black	@ D2OZ 6504338-L	1
72	B(53D, 65D, 71K)		R.H.-w/o A/C or lamp opening -wood grain	@ D2OZ 6504338-C	1
			R.H.-w/o A/C and w/lamp opening-wood grain	@ D2OZ 6504338-J	1
			R.H.-with A/C and w/o lamp opening-wood grain	@ D2OZ 6504338-F	1
			R.H.-with A/C and lamp opening -wood grain	@ D2OZ 6504338-M	1
72	B(97D)		R.H.-w/o A/C or lamp opening	@ D2OZ 6504338-B	1
			R.H.-w/o A/C and with lamp opening	@ D2OZ 9704338-H	1
			R.H.-with A/C and w/o lamp opening	@ D2OZ 9704338-A	1
			R.H.-with A/C and lamp opening	@ D2OZ 9704338-G	1
72	B(97K)		R.H.-w/o A/C or lamp opening	@ D2OZ 9704338-D	1
			R.H.-with A/C and w/o lamp opening	@ D2OZ 9704338-C	1
			R.H.-with A/C and lamp opening	@ D2OZ 9704338-J	1
			R.H.-w/o A/C and with lamp opening	@ D2OZ 9704338-K	1
72	B(97R)		R.H.-w/o A/C and with lamp opening	@ D2OZ 9704338-N	1
			R.H.-with A/C and lamp opening	@ D2OZ 9704338-P	1
			R.H.-w/o A/C or lamp opening	D2OZ 9704338-L	1
			R.H.-with A/C and w/o lamp opening	D2OZ 9704338-M	1

# FORD CAR PARTS

**BODY  
SECTION 042**

3

GROUP NUMBER	YEAR	BODY TYPE	DESCRIPTION	PART NUMBER	QTY.
<b>04338 PANEL - INSTRUMENT PANEL FINISH - @INCLUDES ATTACHING PARTS - continued</b>					
- F -					
	69	F(63, 65E, 76A, B)- "Before 1/6/69"	With clock opening-Light teak wood finish- includes attaching parts	C9ZZ 6504338-C	1
	69/70	F(63, 65E, 76A, B)- "From 1/6/69"	With clock opening-Dark teak wood finish- includes attaching parts	C9ZZ 6504338-D	1
	69/70	F	Without clock opening-Black camera case finish- includes attaching parts	C9ZZ 6504338-A	1
	69/70	F	With clock opening-Black camera case finish- includes attaching parts	C9ZZ 6504338-B	1
	70	F(63A, 65A, 76A)	Without clock opening-wood grain finish- includes attaching parts	D0ZZ 6504338-A	1
	71/	F-w/o decor group	Black	D1ZZ 6504338-A	1
	71/72	F-w/dec group- "Before 12/1/71"	Argent - w/o warning lamp opening	D1ZZ 6504338-B	1
	72	F-w/dec group- "From 12/1/71"	Black- w/warning lamp opening	D2ZZ 6504338-A	1
			Nut(spring)-No. 8-18	45174-S8(M136)	1
			Nut-self thread stamping-3/8"-24	376642-S35(MM292A)	4
			Screw-hex. washer hd. -tap. -No. 8-12 x 1/2"	383938-S2(UU52Y)	4
- L -					
	71/	L	Without seat belt warning lamp opening	D1FZ 6204338-A	1
	72	L	With seat belt warning lamp opening and wood grain insert	D2FZ 6204338-A	1
- P -					
	72	P(54A, 62A)	W/o A/C-wood grain	D2DZ 6204338-A	1
			W/A/C-wood grain	D2DZ 6204338-B	1
- S -					
	72	S "Before 6/15/72"		D2SZ 6504338-B	1
	72	S "From 6/15/72"		D3SZ 6504338-A	1
- X -					
	68/70	X(54B, 62B, C, 71B)	Includes attaching parts	C8DZ 6204338-A	1
<b>04360 COVER - INSTRUMENT PANEL RADIO OPENING</b>					
	65	F	Paint to match	C5ZZ 6504360-A	1
	66/	F	Refer to Group 04371		
<b>04366-7 BRACKET - INSTRUMENT PANEL TO COWL SIDE</b>					
	69/70	A	1 11/16" x 3/4" slot	C8OZ 5404366-A	1
	70	A	3/8" x 3/4" slot	C9AZ 6204366-A	1
	71/72	A		D1AZ 6504366-A	2
	68/69	B		C8OZ 5404366-A	2
	70/71	B		D0OZ 6504366-A	2
	69/70	F		C9ZZ 6504366-A	2
	71/	F	R. H.	D1ZZ 6504366-A	1
			L. H.	D1ZZ 6504367-A	1
			5/16"-18 Hex. lock nut	376838-S(MM296AF)	2
	71/	L	R. H.	D1FZ 6204366-A	1
	70/	P	R. H.	D0DZ 6204366-A	1
			L. H.	D0DZ 6204367-A	1
			5/16"-18 x 3/4" Screw & washer assy.	57140-S2(B340H)	4
	66/67	X	R. H.	C6OZ 6204366-A	1
			L. H.	C6OZ 6204367-A	1
	68/70	X		C8OZ 5404366-A	2
<b>04371 COVER - INSTRUMENT PANEL RADIO, HEATER OR AIR CONDITIONING OPENING -</b>					
Includes attaching parts (When radio is not used)					
- A -					
	69/70	A	Wood grain finish-approx.3" long knob opening	C9AZ 6204371-B	1
	69/	A	Black-plastic-approx.3" long knob opening	C9AZ 6204371-C	1
	71/	A(53, 54F, 57F, 65F, H, K, 71F, H, 76)	Cherry wood grain finish	D1AZ 6504371-B	1
	71	A(54B, D, 71B, D)	Gray camera case finish	D1AZ 6504371-A	1



# FORD CAR PARTS

**BODY  
SECTION 042**

5

GROUP NUMBER	YEAR	BODY TYPE	DESCRIPTION	PART NUMBER	QTY.
<b>04392-3 PANEL - INSTRUMENT PANEL - FINISH END - continued</b>					
	68/71	S	R. H. -Paint to match L. H.	C8SZ 6504392-B C8SZ 6504393-B	1 1
	70/71	S	L.H.-lower- Teakwood	D0SZ 6504393-A	1
			Screw-oval truss hd.-No.8-18 x 1/2"	375452-S100(BB630D)	1
			Nut (spring)-No.8-18	381765-S2(MM275E)	2
	72	S	R.H. L.H.	D2SZ 6504334-A D2SZ 6504335-A	1 1
	65	X(54B, 62B, 63B, 66B, 71B, C, 76A)	R. H.	C5DZ 6204392-B	1
	66/67	X(71)	L. H. - with power lift gate window	C6DZ 7104393-A	1
	68/70	X(54B, 62B, C, 71B)	R. H. -without A/C or Forced Ventilation- includes attaching parts	C8OZ 5404392-A	1
<b>044E00 BRACE - INSTRUMENT PANEL - UPPER</b>					
	66/67	B, X	Use with A/C	C6DZ 62044E00-A	1
<b>044G00-2 COVER - INSTRUMENT PANEL TO FLOOR BRACE</b>					
	72	L(slot type)	Avocado	D2FZ 62044G00-AEG	1
			Beige	D2FZ 62044G00-AAT	1
			Black	D2FZ 62044G00-AAA	1
			Blue	D2FZ 62044G00-AAB	1
			Ginger	D2FZ 62044G00-AAF	1
			Green	D2FZ 62044G00-AAR	1
			Orange	D2FZ 62044G00-AEC	1
	72	L (bin type)	Avocado - plastic	D2FZ 62044G02-B	1
			Beige	D2FZ 62044G02-C	1
			Black	D2FZ 62044G02-A	1
			Blue	D2FZ 62044G02-G	1
			Ginger	D2FZ 62044G02-E	1
			Green	D2FZ 62044G02-D	1
			Orange	D2FZ 62044G02-F	1
			Brace - refer to group 04598		
<b>044A10-1 PANEL - INSTRUMENT PANEL FINISH - LOWER - INCLUDES ATTACHING PARTS</b>					
	69/70	A(54A, C, 57, 63, 65, 71B, C, 76)	R.H.-approx. 2 1/2" wide L. H.	C9AZ 54044A10-B C9AZ 54044A11-B	1 1
	69/70	A(54C, 57F, 65A, 71A, E)	R.H.-approx. 4 1/2" wide L. H.	C9AZ 54044A10-A C9AZ 54044A11-A	1 1
	71	A	Without A/C - paint to match -includes I. S. - prime with D1AZ 19000-A(adhesive sealer)	D1AZ 65044A10-A	1
			With A/C - paint to match -includes I. S. - prime with D1AZ 19000-A (adhesive sealer)	*D1AZ 65044A10-B r/b D2AZ 65044A10-D	φ 1
			Screw-tapping washer head-No.8-18 x 3/4"	384157-S2(UU89FB)	3
	72	A	W/o A/C or lamp opening-paint to match - prime with D1AZ 19000-A (adhesive sealer)	*D2AZ 65044A10-A r/b D2AZ 65044A10-C	φ 1
			W/o A/C and w/lamp opening-paint to match prime with D1AZ 19000-A (adhesive sealer)- incl. I. S.	D2AZ 65044A10-C	1
			W/ A/C and lamp opening-paint to match prime with D1AZ 19000-A (adhesive sealer)- incl. I. S.	D2AZ 65044A10-D	1
	67	F(63B, 65B, 76B)		C7ZZ 65044A10-C	1
	67	F(63A, 65A, C, 76A, C)	Camera case finish	C7ZZ 65044A10-D	1
	68	F(63A, 65A, C, 76A)	With decor group		1
	68	F(63, 65, 76)	Wood grain finish	C8ZZ 65044A10-A	1
	67/69	S		C8SZ 65044A10-B	1
	70/71	S	R. H. -paint to match	D0LY 65044A10-A	1
			Bumper (RH) 51/64" long	377781-S(CC34)	1
			Bumper (LH) 19/32" long	380239-S(CC42)	1
<b>044C10 MOULDING - INSTRUMENT PANEL LOWER FINISH PANEL - OUTER - INCLUDES ATTACHING PARTS</b>					
	68/71	S	R. H.	C8SZ 65044C10-B	1

GROUP NUMBER	YEAR	BODY TYPE	DESCRIPTION	PART NUMBER	QTY.
<b>044E12-3 MOULDING - CONSOLE PANEL REAR LOWER EDGE -INCLUDES ATTACHING PARTS</b>					
	68/69		R. H.	C8SZ 65044E12-B	1
			L. H.	C8SZ 65044E13-B	1
<b>044B16 BEZEL - INSTRUMENT PANEL AIR CONDITIONING GRILLE</b>					
	71/	F-w/o decor group	Black	D1ZZ 65044B16-A	1
			Screw-hex.hd. self tapping-No.8-12 x 1/2"	383938-S2(UU52V)	4
	71/	F-w/ decor group	Argent-part of group 04338		
<b>044E16 ANTI-RATTLE CONSOLE FINISH PANEL - REAR FLOOR</b>					
	67/68	F	"Before 2/1/68"	C7ZZ 65044E16-A	2
	68	F	"From 2/1/68"	C7ZZ 65044E16-B	2
<b>044A20 SUPPORT - INSTRUMENT PANEL TO COWL TOP</b>					
	72	S		D2SZ 65044A20-A	1
			Screw-hex. head self tapping-No. 8-18 x 1/2"	55907-S2(U254B)	3
<b>044F24 PLATE - CONSOLE FINISH INSERT - CENTER</b>					
	69/70	A		C9YZ 65044F24-A	1
<b>044B26 CLIP - PANEL UPPER MOULDING</b>					
	65/66	S	Console	C1SB 63044B26-A	AR
			Instrument panel extension lower moulding		AR
	68/69	S	Console	C8SZ 65044B26-A	AR
	70	S	Console	D0SZ 65044B26-A	14
	71	S	Console	D1SZ 65044B26-A	4or14
<b>044E26-7 SLIDE - INSTRUMENT PANEL ASH RECEPTACLE</b>					
	65	A	Serviced in assy. -refer to Group 04810		
	66/68	A	R. H. -Includes spring	C6AZ 62044E26-B	1
			L. H.	C6AZ 62044E27-B	1
<b>04428 COVER - INSTRUMENT PANEL OR CONSOLE - CLOCK OPENING - When Clock is not installed</b>					
	69/70	A		C9AZ 6204428-A	1
	71/	A		D1AZ 6504428-A	1
	69	B		C9OZ 5404428-A	1
	70/71	B		D0OZ 6504428-A	1
	72	B		D2GY 6504428-A	1
	68	F(63A,65A,C,76A,C)	Use to cover stem opening	C6GY 6204428-B	1
	69/70	F		C9ZZ 6504428-A	1
	71/	F(63R)	Console-"Mach 1"	D1ZZ 6304428-A	1
			Console-"Mustang"	D1ZZ 6304428-B	1
	70/	P	Console - Paint to match	D0DZ 6204428-A	1
			Nut-spring-1/4"	45054-S8(MI20)	2
<b>044A36 MOULDING - INSTRUMENT PANEL PAD RETAINING-LOWER - INCLUDES ATTACHING PARTS</b>					
	67/68	A	R. H. -Paint to match	C7AZ 62044A36-A	1
			For clip refer to Group 04878		
	65/66	S		C4SZ 63044A36-B	1
			Clip	C4SZ 6304561-A	10
<b>044A38-9 EXTENSION - INSTRUMENT PANEL - LOWER - Paint to match</b>					
	67	A	Refer to Group 04320		
<b>044D38 COVER - CONSOLE PANEL FRONT</b>					
	71/	L	With consolette	D1FZ 62044D38-A	1
	70/	P	Consolette-incl. attaching parts-paint to match	D0DZ 62044D38-A	1
<b>04439 RETAINER - INSTRUMENT PANEL MOULDING</b>					
	65	B		C2OZ 6204439-A	5 to9
	65/66	S			16
	67/	U(97,98)	Clip-R.H.-also included in Group 04338	C7TZ 9604439-A	ø 7
			Clip-L.H.-also included in Group 04388	C7TZ 9604439-B	ø 7
			No. 8-15 x 1/2" Cross recess pan head screw	52726-S13(U381)	7
	65/66	X	Also refer to Group 044B96		
<b>044F42 LETTER - CONSOLE</b>					
	69/70	A	"X"	C9AZ 63044F42-A	1
			"L"	C9AZ 63044F42-B	1
<b>044F44 PLATE - CONSOLE FINISH PANEL INSERT</b>					
	69/71	A		C9YZ 65044F44-A	1



# FORD CAR PARTS

**BODY  
SECTION 042**

7

GROUP NUMBER	YEAR	BODY TYPE	DESCRIPTION	PART NUMBER		QTY.
				RIGHT HAND	LEFT HAND	
<b>044C50-1 PANEL - CONSOLE PANEL RADIO ACCESS</b>						
	66	S	Aqua	*C6SZ 63044C50-BBE Not replaced	C6SZ 63044C51-D3E	1
<b>044B56-7 PANEL - INSTRUMENT PANEL FINISH - INTERMEDIATE</b>						
	67	B	L. H.-Use with A/C		C7OZ 62044B57-A	1
	67	S	Includes attaching parts		C7SZ 65044B56-A	1
<b>044F58 COVER - INSTRUMENT PANEL CONTROL OPENING</b>						
	72	B(53, 63, 65)	Without rear window defogger		D2OZ 65044F58-A	1
	72	B(71)	Without power back lite			1
<b>04459 COVER - INSTRUMENT PANEL STEERING COLUMN</b>						
	70	A	Paint to match		D0AZ 6204459-A	1
	71/	A	Paint to match-includes instruction sheet- prime with D1AZ 19000-A (adhesive sealer)		D1AZ 6504459-A	1
			No.8-18 x 3/4" round washer head screw		384157-S2(UU89FB)	2
	70	B(54, 62A, 63H, 65B, 66A, B, 71B, D)	Steel-paint to match		D0OZ 6504459-D	1
	71	B(54, 63H, 65A, 66A, B, 71D)				1
	70	B(57E, 65E, 66E)	Vinyl clad finish		D0OZ 6504459-B	1
		"Before 9/22/69"				
	70/71	B(57E, 65E, 66E, 71E)	Vinyl clad finish		D0OZ 6504459-E	1
		"From 9/22/69"				
	70/71	B(54C, 57C, 63C, F, 65C, 66C, 71C, 76)	Steel-paint to match		D0OZ 6504459-F	1
	71	B(54A, 63H, 65A, 66A, B, 71D)- "From 6/18/71"				1
	70/	B	Nut (spring)-No.8-18		45174-S8(M138)	2
	69	F(63)			C9ZZ 6304459-A	1
	69	F(65, 76)			C9ZZ 6504459-A	1
	70	F	Paint to match		D0ZZ 6504459-A	1
			No.8-18 x 3/4" rd.washer head screw		384157-S2(UU89FB)	2
	71/	F	Paint to match-includes instruction sheet - prime with D1AZ 19000-A (adhesive sealer)		D1ZZ 6504459-A	1
	71/	L			D1FZ 6204459-A	1
	68	S	"Before 10/9/67" Ivy gold		C8SZ 6504459-BIG	1
			Nugget gold.		C8SZ 6504459-BIY	1
	68	S	"From 10/9/67" Black		C8SZ 6504459-B1A	1
			Blue		C8SZ 6504459-B1B	1
	69	S	Paint to match		C9SZ 6504459-A	1
	70/71	S	Paint to match		D0SZ 6504459-A	1
			Bolt-hex. head-1/2"-20 x 1 5/8"		376889-S7-8(BB376C)	2
	72	S			D2SZ 6504459-A	1
<b>04460 MOULDING - INSTRUMENT PANEL PAD</b>						
	68/69	B	Bright finish-plastic-21 3/4" long		C9OZ 5404460-A	1
<b>04460 PLATE - INSTRUMENT PANEL NAME - INCLUDES ATTACHING PARTS - Also refer to Group 04338</b>						
- A -						
	70	A(54A, 57B, 63B, 65C, 71B, C, 76A)	"Galaxie 500"		D0AZ 5404460-A	1
	70	A(54B, 62B, 71H, J)	"Custom 500"		D0AZ 6204460-A	1
	70	A(54C, 57F, 65A, 71A, E)	"LTD"		D0AZ 5404460-B	1
	70	A(54E, 62E, 71D)	"Custom "		D0AZ 6204460-B	1
	70	A(63C, 76B)	"XL"		D0AZ 6304460-A	1
	71/	A(53K, 57K, 65K)	"Brougham"		D1AZ 6504460-A	1
	71	A(53H, 57H, 65H, 71H, 76)	"LTD"		D1AZ 6504460-B	1

GROUP NUMBER	YEAR	BODY TYPE	DESCRIPTION	PART NUMBER	QTY.
<b>04460</b>	<b>PLATE - INSTRUMENT PANEL NAME - INCLUDES ATTACHING PARTS - Also refer to Group 04338-</b>				
<b>continued</b>					
<b>- B -</b>					
	68	B(63D, 65D, 66D, 76D)	"GT"-on instrument panel pad	C8OZ 6304460-A	1
	70	B(54A, 62A, 71D)	"Falcon"	D0OZ 6204460-A	1
	70	B(54B, 65B, 71B)	"Fairlane 500"	D0OZ 6504460-A	1
	71	B(54A, 65A, 71D)	"Torino"	D1OZ 6504460-A	1
	70	B(54C, 57C, E, 63C, 65C, E, 71C, E, 76C)	"Torino"	D0OZ 6504460-B	1
	71	B(54E, 65E, 71E)	"Torino"		1
	71	B(54C, 57C, 63C, 65C, 71C)	"Torino 500"	D1OZ 6504460-B	1
	70	B(63F, 65F, 76F)	"Torino GT"	D0OZ 6504460-D	1
	71	B(63F, 76F)			1
	70	B(63H, 65H)	"Cobra"	D0OZ 6504460-C	1
	71	B(63H)			1
	70/71	B(66)	"Ranchero"	D0OZ 6604460-A	1
<b>- F -</b>					
	66/68	F(except GT 350/500)	Refer to Group 06024		
	68	F(GT 350)	"GT 350"	S8MS 6304460-D	1
	68	F(GT 500)	"GT 500"	S8MS 6304460-C	1
	69	F(63A, B, 76A, B)	"Mustang"	C9ZZ 6304460-B	1
	70	F(except 63C)			1
	69/70	F(63C)	"Mach I"	C9ZZ 6304460-A	1
	69/70	F(GT 350)	"Cobra GT 350"	C9ZZ 6304460-C	1
	69/70	F(GT500)	"Cobra GT 500"	C9ZZ 6304460-D	1
	69/71	F(65E, F)	"Grande"	C9ZZ 6504460-A	1
<b>- L -</b>					
	71/	L	"Pinto"	D1FZ 6204460-A	1
<b>- P -</b>					
	70/	P	"Maverick"	D0DZ 6204460-C	1
			1/8" self thread spring nut	373888-S7(MM290)	2
<b>- S -</b>					
	67	S	"Thunderbird"	C7SZ 6504460-A	1
	70	S(65)	Front door		2
	72	S	"Thunderbird" medallion	D2SZ 6504460-B	1
<b>- U -</b>					
	72	U(98)	"Explorer"	C9TZ 8104460-A	1
<b>- X -</b>					
	66	X(66)	Refer to Group 06036		
	68/70	X(54B, 62B, C, 71B)	"Futura"	C8DZ 6204460-A	1
<b>04462</b>	<b>REINFORCEMENT - INSTRUMENT PANEL CLUSTER</b>				
	69/71	A		C9AZ 6204462-A	1
<b>04462</b>	<b>RETAINER - CONSOLE PANEL GLOVE COMPARTMENT DOOR LATCH</b>				
	68	B		C8OZ 63044E62-A	1
<b>044D70-1</b>	<b>PANEL - INSTRUMENT PANEL CLUSTER FINISH-includes Attaching Parts-Paint to Match</b>				
	69	A	R. H.	C9AZ 62044D70-A	1
			R. H. - with vacuum door latch opening	C9AZ 62044D70-B	1
			L. H.	C9AZ 62044D71-A	1
	69	A(71, 76)	L. H.-includes opening for power back window switch or folding top switch	C9AZ 62044D71-B	1
	70	A	R. H. -without vacuum door latch	D0AZ 62044D70-A	1
			R. H. -with vacuum door latch	D0AZ 62044D70-B	1
	70	A(54, 57, 62, 63, 65, 71B, D, H)	L. H.	D0AZ 62044D71-A	1
	70	A(71, 76)	L. H. -includes opening for power back window switch or folding top switch	D0AZ 76044D71-A	1
	71	A	R.H.-refer to Group 04282 in Soft Trim Section		
	71/	A	L.H. - Black - includes I.S. -prime with D1AZ 19000-A (adhesive sealer)	D1AZ 65044D70-A	1
	72	S	"Before 5/3/72"	D2SZ 65044D70-B	1
	72	S	"From 5/3/72"	D3SZ 65044D70-A	1
<b>04472-3</b>	<b>MOULDING - INSTRUMENT PANEL - CENTER - INCLUDES ATTACHING PARTS</b>				
	69/70	F	R. H. -paint to match	C9ZZ 6504472-A	1
			L. H.	C9ZZ 6504473-A	1

# FORD CAR PARTS

**BODY  
SECTION 042**

9

GROUP NUMBER	YEAR	BODY TYPE	DESCRIPTION	PART NUMBER	QTY.	
<b>044C72-3 PANEL - CONSOLE PANEL SIDE - INCLUDES ATTACHING PARTS</b>						
	68/69	S	"Before 4/1/69"	R. H.	C8SZ 65044C72-C	1
				L. H.	C8SZ 65044C73-C	1
				No. 8-18 x 3/4" oval head tapping screw	52445-S(U317)	2
	69/	S	"From 4/1/69"	Refer to Group 045A36		
<b>04475 PLATE - INSTRUMENT PANEL STEERING COLUMN FINISH</b>						
	68	S		Lower-Paint to match	C8SZ 6504475-B	1
	69	S			C9SZ 6504475-A	1
<b>044C78 PLATE - INSTRUMENT PANEL PAD RETAINER</b>						
	68/69	B, X			C8OZ 54044C78-A	AR
	70	A, B			D0AZ 62044C78-A	AR
	71/	A, B, S	Attach with clip 04278		D1AZ 65044C78-A	AR
<b>044D82 COVER - INSTRUMENT PANEL ACCESS HOLE</b>						
	68	A			C8AZ 62044D82-A	2
<b>044A85 PANEL - INSTRUMENT PANEL FINISH LOWER - OUTER - INCLUDES ATTACHING PARTS</b>						
	68/69	S	With A/C		C8SZ 65044A85-B	1
	68/69	S	Without A/C -paint to match		C8SZ 65044A85-A	1
	70/71	S(57, 65C, D)				1
	70/71	S(65A, B)			D0SZ 65044A85-A	1
	70/71	S(57)	No. 8-18 nut (spring)		381765-S2(MM275E)	7
<b>04488 BRACE - INSTRUMENT PANEL</b>						
	69/70	A			C9AZ 6204488-A	1
	70/71	B			D0OZ 6504488-A	1
	70/	P			D0DZ 6204488-A	1
			5/16"-18 nut (U)		379114-S2(MM192AD)	1
<b>044A90 PANEL - INSTRUMENT PANEL FINISH - UPPER - INCLUDES ATTACHING PARTS</b>						
	67/68	A	Refer to Group 044A90 in Soft Trim Section			
	69	A(54A, C, 57B, F, 63B, C, 65A, C, 71A, B, C, E, 76)	R. H. -paint to match-with Forced Ventilation and moulding		C9AZ 54044A90-B	1
	69	A(54B, E, 62, 71D, H, J)	R. H. -paint to match-with Forced Ventilation-without moulding		C9AZ 62044A90-B	1
	69/70	A(54A, C, 57B, F, 63B, C, 65A, C, 71A, B, C, E, 76)	R. H. -paint to match-without A/C or Forced Ventilation		C9AZ 54044A90-A	1
	69/70	A(54A, C, 57, 63, 65, 71A, B, C, E, 76)	R. H. -paint to match-with A/C		C9AZ 54044A90-C	1
	69/70	A(54B, E, 62, 71D, H, J)	R. H. -paint to match-without A/C or Forced Ventilation		C9AZ 62044A90-A	1
			R. H. -paint to match-with A/C		C9AZ 62044A90-C	1
	71/72	A	"Before 9/13/71"	Paint to match	D1AZ 65044A90-A	1
				Lower-refer to Group 04320		
	72	A	"From 9/13/71"	Paint to match	D2AZ 65044A90-C	1
	72	B		Paint to match	D2OZ 65044A90-A	1
	67/68	F(63A, 65A, C, 76A, C)	Camera case finish (black)-includes ornament		C7ZZ 65044A90-B	1
	67	F	3/8"-24 Nut (stamped)		376642-S35(MM292A)	8
	71/	F	Paint to match		D1ZZ 65044A90-A	1
			No. 8-18 x 3/4" oval trim head screw		384154-S9(UU66G)	2
	67/69	S	Paint to match		C7SZ 65044A90-A	1
			Refer to Group 045A30 for clip			
	70/71	S	Paint to match		D0SZ 65044A90-A	1
			No. 8-18 x 1/2" oval trim head screw		375452-S100(BB630D)	2
	72	S	Paint to match		D2SZ 65044A90-A	1
<b>044B90 REINFORCEMENT - CONSOLE PANEL - FRONT</b>						
	72	B, S			D2OZ 65044B90-A	2
<b>044D90 PANEL - CONSOLE PANEL TOP</b>						
	68	F	Refer to Group 044D90 in Soft Trim Section			
	69	F (except GT350/500)	Black-front		C9ZZ 63044D90-A1A	1
			Blue		C9ZZ 63044D90-A2B	1
			Ivy gold		C9ZZ 63044D90-A1G	1
			Nugget gold		C9ZZ 63044D90-A1Y	1
			Red		C9ZZ 63044D90-A1D	1

**BODY  
SECTION 042**
**FORD CAR PARTS**

GROUP NUMBER	YEAR	BODY TYPE	DESCRIPTION	PART NUMBER	QTY.
<b>044D90 PANEL - CONSOLE PANEL TOP - continued</b>					
	69/70	F(GT350/500)	Chrome ribbed }	C9ZZ 63044D90-C	1
	70	F(except GT 350/500)	Black-front	D0ZZ 63044D90-C	1
			Blue	D0ZZ 63044D90-B	1
			Ginger	D0ZZ 63044D90-D	1
			Green	D0ZZ 63044D90-A	1
	71/	F	Paint to match	D1ZZ 65044D90-A	1
	68	S	Aqua	C8SZ 65044D90-A2K	1
			No. 8-15 x 1/2" Flat hd. screw	52012-S8(U202)	8
	69	S	Paint to match	C9SZ 65044D90-A	1
	70/71	S	Paint to match	D0SZ 65044D90-A	1
	72	S	Front	D2SZ 65044D90-A	1
<b>044B96 CLIP - INSTRUMENT PANEL PAD RETAINING-UPPER</b>					
	65/66	X		C4GY 54044B96-C	10
<b>044F98 FILLER - CONSOLE PANEL - FRONT</b>					
	70/71	S		D0SZ 65044F98-A	1
	70/	S(65A, B)	No. 8-18 x 3/4" Pan head cross recess screw	376389-S101(UU82D)	2
<b>04500-1 FILLER - INSTRUMENT PANEL END - Paint to Match</b>					
	70/71	B(except 63, 71)	R. H.	D0OZ 6504500-A	1
			L. H.	D0OZ 6504501-A	1
	70/71	B(63)	R. H.	D0OZ 6304500-A	1
			L. H.	D0OZ 6304501-A	1
	70/71	B(71)	R. H.	D0OZ 7104500-A	1
			L. H.	D0OZ 7104501-A	1
<b>04510 BRACE - INSTRUMENT PANEL -Also refer to Group 04488</b>					
	70	A		D0AZ 6204510-A	1
	71/	A		D1AZ 6504510-A	1
			Nut & washer assy.-5/16"-18	376838-S2(MM296AF)	2
	69/70	F		C9ZZ 6504510-A	1
	71/	F		D1ZZ 6504510-B	1
			Screw & washer assy.-hex. head-5/16"-18 x 1"	57140-S2(B340H)	2
	71/	L		D1FZ 6204510-A	1
	70/	P		D0DZ 6204510-A	1
<b>045A12 PANEL - CONSOLE PANEL TOP</b>					
	65	B	Used with manual 4/S/T	C3AZ 65045A12-A	1
	68/69	S	" Before 4/1/69"	C8SZ 65045A12-A	1
	69	S	"From 4/1/69"	Refer to Group 045B70	
	72	S		D2SZ 65045A12-A	1
<b>04514 COVER - INSTRUMENT PANEL VENT AIR CONTROL REGISTER</b>					
	71/	F	Without A/C	D1ZZ 6504514-A	1
<b>045E18 SEAL - CONSOLE PANEL FRONT</b>					
	68	F	Black	C8ZZ 65045E18-A1A	2
<b>04522 MOULDING - INSTRUMENT PANEL PAD RETAINER UPPER</b>					
	71	F	Black	D1ZZ 6504522-C	1
			Blue	D1ZZ 6504522-B	1
			Ginger	D1ZZ 6504522-D	1
			Green	D1ZZ 6504522-A	1
<b>045B22 BAR - PASSENGER ASSIST</b>					
	71/	F	Includes pad and retainer	D1ZZ 65045B22-A	1
<b>045B24-5 MOULDING - CONSOLE PANEL - FRONT</b>					
	65	B	R. H. -Includes attaching parts	C2AZ 76045B24-A	1
			L. H.	C2AZ 76045B25-A	1
			No. 8-15 x 1/2" Cross recess oval head screw	52344-S13(U292)	2or4
<b>045C26-7 MOULDING - CONSOLE PANEL SIDE - INCLUDES ATTACHING PARTS</b>					
	69/70	A	R. H. - snap on	C9AZ 63045C26-A	1
			L. H.	C9AZ 63045C27-A	1
	68/69	S	R.H. -on upper front	C8SZ 65045C26-A	1
	70/71	S	R. H.	D0SZ 65045C26-A	1
	68/71	S	L. H.	C8SZ 65045C27-A	1
	72	S	R. H.	D2SZ 65045C26-A	1
			L. H.	D2SZ 65045C27-A	1
	66	X	L. H.	C6OZ 63045C26-A	1
<b>045A28 RETAINER - FINISH PANEL</b>					
	72	B	Instrument panel	D2GZ 65045A28-A	1
	72	B,S	Console panel	D2SZ 65045A28-A	1

# FORD CAR PARTS

## BODY SECTION 042

GROUP NUMBER	YEAR	BODY TYPE	DESCRIPTION	PART NUMBER	QTY.
<b>045B28-9 SUPPORT - CONSOLE PANEL FRONT - Also refer to Group 045A36</b>					
	72	B	W/full length console & bucket seats	D2OZ 65045B28-A	1
	68/71	S	R.H.	C8SZ 65045B28-A	1
	70/71	S	L.H.	D0SZ 65045B29-A	1
	72	S		D2OZ 65045B28-A	1
<b>045A30-1 CLIP - INSTRUMENT PANEL FINISH PANEL</b>					
	71/	A	R.H.-lower	D1AZ 65045A30-B	1
			L.H.	D1AZ 65045A31-A	1
	67/71	S		C7SZ 65045A30-A	4or6
<b>045B32 BRACKET - CONSOLE PANEL MOUNTING - FRONT</b>					
	72	B,S	W/full length console & bucket seats	D2OZ 65045B32-A	1
<b>045B34 BRACKET - CONSOLE PANEL MOUNTING - REAR</b>					
	72	B	W/full length console & bucket seats	D2OZ 65045B34-A	1
	72	S	W/full length console	D2SZ 65045B34-A	1

045A36 PANEL - CONSOLE		PART NUMBER LESS SUFFIX	COLORS and APPLICABLE PART NUMBER SUFFIXES													QTY.
BODY TYPE	R/L		AQUA	BLACK	BLUE	EMBER-GLO	GINGER	IVY GOLD	NUGGET GOLD	PALO-MINO	PARCH-MENT	RED	SADDLE	WHITE	OTHER	

1965

B		C5OZ 65045A36									CAE							1
F(65,76)-w/o A/C-		C5ZZ 65045A36											CAF					1
"Before 12/1/64"														CAF				1
F(65,76)-w/ A/C-		C5ZZ 65045A36												CAF				1
"Before 8/20/64"															CAF			1
F(63,65,76)-w/A/C-		C5ZZ 65045A36		CAB														1
"From 12/1/64"																		1
X(62,63,66)		C5DZ 63045A36		BFA	†BFC				BFE	BFF		BFB				*BFD		1

1966

F		C5ZZ 65045A36		CAB														1
---	--	---------------	--	-----	--	--	--	--	--	--	--	--	--	--	--	--	--	---

1967

F		C7ZZ 65045A36		A1A	A1B													1
---	--	---------------	--	-----	-----	--	--	--	--	--	--	--	--	--	--	--	--	---

1968

B-w/notch for 04620 pad		C8OZ 63045A36		B1A	B1B			•B1G			B1U	B1D		*A1W				1
		C9OZ 63045A36						•A1G										1
F		C8ZZ 65045A36		A1A	A1B													1
S- w/sides		C8SZ 65045A36												⊕B				1
S			Refer to Group 044D90 for Top Panel															

1969

A		C9AZ 63045A36		B1A	•B1B			B1G	B1Y			B1D						1
				†B2B														1
B-w/notch		C8OZ 63045A36		B1K	B1A	B1B		†B1G	B1Y		B1U	B1D		*A1W				1
		C9OZ 63045A36						•A1G										1
F		C9ZZ 65045A36		C1K	C1A			C1G	C1Y			C1D						1
S		C8SZ 65045A36												⊕B				1

1970

A-"Before 12/1/69"		D0AZ 65045A36			A													1
A-"From 12/1/69"		D0AZ 65045A36			B													1
B- paint to match		D0OZ 65045A36			G													1
B		52445-S13(U317)	No.8-18 x 1" -oval head screw															
F		D0ZZ 65045A36			G			H										1
P		D0DZ 62045A36			B													1
S		D0SZ 65045A36			A													1

† Light      \* Turquoise      • Dark      ⊕ Aluminum  
 May, 1975      COPYRIGHT © 1975 - FORD MOTOR COMPANY - DEARBORN, MICHIGAN



# FORD CAR PARTS

## BODY SECTION 042

13

GROUP NUMBER	YEAR	BODY TYPE	DESCRIPTION	PART NUMBER	QTY.
<b>04567 PANEL - CONSOLE PANEL TOP FINISH - continued</b>					
- B -					
	66/67	B	Use with manual 4 speed transmission	C6OZ 6304567-B	1
			Use with automatic transmission	C6OZ 6304567-C	1
	68/71	B	Front-to retain ash receptacle assy. -with column shift	@ C8OZ 6304567-A	1
			Rear-with manual trans. floor shift	@ C8OZ 6304567-C	1
	68/70	B(except Super GT)	Rear-with column shift	@ C8OZ 6304567-B	1
			Rear-with automatic trans. floor shift	@ C8OZ 6304567-D	1
	70	B	Rear-with manual trans. floor shift-black camera case & bright finish	@ D0OZ 6504567-A	1
	70	B(63F, 76F)-Super GT	Rear-with automatic trans. floor shift - wood grain	@ D0OZ 6504567-C	1
	70	B(Super GT)	Rear-with manual floor shift-wood grain	@ D0OZ 6504567-B	1
			Rear-with column shift-wood grain	@ D0OZ 6504567-D	1
	70/71	B(except Super GT)	Rear-with manual trans. -floor shift-black paint	@ D0OZ 6504567-E	1
			Rear-with automatic trans. floor shift-black paint	@ D0OZ 6504567-F	1
			Rear-with column shift-black paint	@ D0OZ 6504567-G	1
	72	B	Front-with column shift & bucket seats	D2OZ 6504567-A	1
			Front-with floor shift & bucket seats	D2OZ 6504567-B	1
- F -					
	65/66	F	Used without A/C-Camera Case finish	@ C5ZZ 6504567-A	1
			Used without A/C-Wood Grain finish	@ C5ZZ 6504567-C	1
	67	F	With glove compartment door & w/ø warning lamps	C7ZZ 6504567-A	1
	68	F	With glove compartment door	@ C8ZZ 6504567-A	1
	69	F(63C, 65E)	Front-with auto. trans.	@ C9ZZ 6504567-A	1
			Front-with manual trans.	@ ★C9ZZ 6504567-B	ø 1
				not replaced	
	69	F(63A, B, 65A, B, 76A, B)	Front-with auto. trans.	@ C9ZZ 6504567-D	1
			Front-with manual trans.	@ C9ZZ 6504567-C	1
	70	F(except 63C, 65E)	Front-with auto. trans. -Black	@ D0ZZ 6304567-D	1
			Front-with manual trans. -Black	@ D0ZZ 6304567-C	1
	70	F(63C, 65E)	Front-with auto. trans. -Teakwood finish	@ D0ZZ 6304567-A	1
			Front-with manual trans. -Teakwood finish	@ D0ZZ 6304567-B	1
<b>045B70-1 MOULDING - CONSOLE PANEL SIDE - REAR - INCLUDES ATTACHING PARTS</b>					
	67	S(65)	R. H.	C7SZ 65045B70-A	1
			L. H. - not replaced (3-74)	★ C7SZ 65045B71-A	1
	68/69	S	R.H. and L.H. side	C8SZ 65045B70-B	2
	70/71	S			2
	68/69	S	L. H.	C8SZ 65045B71-B	1
	69	S "From 4/1/69"	Rear	C9SZ 65045B70-A	1
	70/71	S			1
<b>045B72 PANEL - CONSOLE PANEL FINISH - REAR - Includes Attaching Parts</b>					
	68	F	Use with automatic transmission-Paint to match	C8ZZ 65045B72-B	1
	69	F	Refer to group 06010		1
<b>045C72 SUPPORT - INSTRUMENT PANEL PAD RETAINER TOP MOULDING</b>					
	67/68	F		C7ZZ 65045C72-A	1
<b>045A76 PANEL - CONSOLE</b>					
	69	A-w/o auto. trans.	Center-Black	C9AZ 63045A76-B1A	1
			Blue (dark)	C9AZ 63045A76-B1B	1
			Blue (light)	C9AZ 63045A76-B2B	1
			Ivy Gold	C9AZ 63045A76-B1G	1
			Red	C9AZ 63045A76-B1D	1
	69	A-w/auto. trans.	Center-Black	C9AZ 63045A76-C1A	1
			Blue (dark)	C9AZ 63045A76-C1B	1
			Blue (light)	C9AZ 63045A76-C2B	1
			Ivy gold	C9AZ 63045A76-C1G	1
			Nugget gold	C9AZ 63045A76-C1Y	1
			Red	C9AZ 63045A76-C1D	1

@ - Includes attaching parts  
May, 1975

COPYRIGHT © 1975 -

FORD MOTOR  
COMPANY

- DEARBORN, MICHIGAN

**FINAL ISSUE**

**BODY  
SECTION 042**
**FORD CAR PARTS**

GROUP NUMBER	YEAR	BODY TYPE	DESCRIPTION	PART NUMBER	QTY.
<b>045A76 PANEL - CONSOLE - continued</b>					
	70	A-w/o auto. trans.	Center-paint to match	D0AZ 63045A76-A	1
	70/71	A-w/auto. trans.	Center-paint to match	D0AZ 63045A76-B	1
	71	A-w/auto. trans.	Center-paint to match	D1AZ 65045A76-A	1
	71	A	No.8-18 x 1/2" oval trim head screw	52413-S13(U316)	2
<b>04578-9 MOULDING - CONSOLE PANEL LOWER EDGE</b>					
	68/69	S	" Before 4/1/69" R.H. -Includes attaching parts L.H. - not replaced (3-74)	C8SZ 6504578-A ★ C8SZ 6504579-A	1 1
<b>045B78 PLATE - CONSOLE PANEL GEAR SHIFT LEVER OPENING COVER</b>					
	69/71	A		C9AZ 63045B78-A	1
<b>045D84 ORNAMENT - CONSOLE PANEL - Includes Attaching Parts</b>					
	67	S	"Thunderbird" emblem-includes insert	C7SZ 65045D84-A	1
<b>045B86 REINFORCEMENT - INSTRUMENT PANEL FINISH PANEL</b>					
	70/71	S		D0SZ 65045B86-A	1
<b>045E94 RETAINER - INSTRUMENT PANEL STEERING COLUMN OPENING COVER</b>					
	71/	L		D1FZ 62045E94-A	1
<b>045A96 RETAINER - CONSOLE PANEL REAR MOULDING</b>					
	65	B		C2AZ 76045A96-A	6
			No. 8-15 x 3/8" Cross recess pan head screw	52720-S8 (U380)	6
<b>04598 BRACE - INSTRUMENT PANEL TO FLOOR</b>					
	72	L	To attach basic 044G00 Screw & washer assy.	D2FZ 6204598-A ★57039-S2	1 2
<b>04604 HINGE - CONSOLE PANEL ARM REST</b>					
	68/71	S		C8SZ 6504604-A	1
			No. 8-15 x 3/4" Cross recess pan head screw	52742-S8(U385)	3
<b>04606 BEZEL - INSTRUMENT PANEL CLUSTER OPENING</b>					
	70/71	B		D0OZ 6504606-A	1
<b>04610 PANEL - CONSOLE PANEL ARM REST FINISH</b>					
	68/71	S	Paint to match	C8SZ 6504610-B	1
			No. 8-18 x 3/8" Cross recess oval head screw	53008-S13(U275)	3
<b>04619 RETAINER - INSTRUMENT PANEL FINISH LOWER - CENTER - INCLUDES ATTACHING PARTS</b>					
	67	S		C7SZ 6504619-A	1
	68/69	S(57C, D, 65C, D)	Paint to match	C9SZ 6504619-A	1
	70/71	S(57, 65C, D)	Paint to match	D0SZ 6504619-B	1
<b>04620 PAD - CONSOLE PANEL - Refer to Group in Soft Trim Section</b>					
<b>04634 PANEL - INSTRUMENT PANEL - UPPER</b>					
	70/71	B	Paint to match	D0OZ 6504634-A	1
<b>04648 COVER - INSTRUMENT PANEL CIGAR LIGHTER OPENING - When Cigar Lighter is not used</b>					
	70	B		C8DZ 6204648-A	1
	68/70	X(54A, 62A, 71A)		C8DZ 6204648-A	1
<b>04672 BRACE - INSTRUMENT PANEL LOWER FLANGE TO COWL INNER PANEL</b>					
	68/70	B, X		C8OZ 5404672-A	1
	71	B			1
	72	B	Attaches to cowl-7 3/4" long	D2GZ 6504672-A	1
	69/70	F		C9ZZ 6504672-A	1
	71/	F		D1ZZ 6504672-A	1
	70/	P		D0DZ 6204672-A	1
	72	S		D2SZ 6504672-A	1
<b>04674 REINFORCEMENT - INSTRUMENT PANEL LOWER FLANGE - CENTER</b>					
	70/71	S		D0SZ 6504674-A	1
<b>04684 RETAINER - CONSOLE PANEL</b>					
	68/	B		C8OZ 6304684-A	1
	68/	S		C8SZ 6504684-A	1
			No.8-18 Nut (spring)	383054-S2(MM276AD)	4



# FORD CAR PARTS

**BODY  
SECTION 047**

1

GROUP NUMBER	YEAR	BODY TYPE	DESCRIPTION	PART NUMBER	QTY.
<b>04718-9 Moulding - Instrument Panel Lower End - Includes Attaching Parts</b>					
	69/70	F	R. H. -Paint to match	C9ZZ 6504718-A	1
			L. H.	C9ZZ 6504719-A	1
<b>04722 INSERT - Console Finish Panel - Center</b>					
	69/70	A		C9YZ 6504722-A	1
<b>04736 Moulding - Console Panel - Rear - Includes Attaching Parts</b>					
	69/70	A		C9AZ 6304736-A	1
	72	S		D2SZ 6504736-A	1
<b>04746 SUPPORT - Instrument Panel Pad</b>					
	71/	F		D1ZZ 6504746-A	1
			Screw-pan head-No.8-18 x 3/4"	376389-S100(UU82D)	4
<b>04774 PANEL - Instrument Panel - Center</b>					
- A -					
	68	A(54C,57F,63C,65A,71A,E,76B)	Wood grain finish-includes attaching parts-1 37/64" wide	C8AZ 5404774-A	1
- B -					
	66/67	B(63C,D,71E,76C,D)		C6OZ 6304774-B	1
	67	B(66B,D)	With radio	C7DZ 6204774-A	1
	67	B(66B,D)	Without radio	C6DZ 6204774-A	1
	68	B(54C,65C,71E)	Refer to Group 04338		
- F -					
	67/68	F(63A,65A,C,76A,C)	Camera case finish	C7ZZ 6504774-B	1
	68	F(63,65,76)	Wood grain finish	C8ZZ 6504774-A	1
	69	F(63C,65E)- "Before 1/6/69"	Light teak wood finish-without radio-includes attaching parts	C9ZZ 6504774-C	1
			Light teak wood finish-with radio-includes attaching parts	C9ZZ 6504774-D	1
	69/70	F(63C,65E)- "From 1/6/69"	Dark teak wood finish-without radio-includes attaching parts	C9ZZ 6504774-E	1
			Dark teak wood finish-with radio-includes attaching parts	C9ZZ 6504774-F	1
	69/70	F(except 63C,65E)	Black-camera case finish-without radio-includes attaching parts	C9ZZ 6504774-A	1
	69/70	F(except 63C,65E)	Black-corinthian grain finish-with radio	C9ZZ 6504774-B	1
	71/	F(63D,R,65D,76D)	Black-camera case finish-without instrument gauge openings-with Mustang name plate	D1ZZ 6504774-C	1
			Blue	D1ZZ 6504774-B	1
			Ginger	D1ZZ 6504774-A	1
			Green	D1ZZ 6504774-D	1
	71/	F(63D,65D,76D)	Black-camera case finish-with instrument gauge openings	D1ZZ 6504774-J	1
			Blue	D1ZZ 6504774-K	1
			Ginger	D1ZZ 6504774-L	1
			Green	D1ZZ 6504774-M	1
	71/	F(63D,R,65F)	Black-wood grain finish-with instrument gauge openings	D1ZZ 6304774-A	1
			Blue	D1ZZ 6304774-B	1
			Ginger	D1ZZ 6304774-C	1
			Green	D1ZZ 6304774-D	1
	71/	F(65F)	Black-wood grain finish-without instrument gauge openings-with Grande name plate	D1ZZ 6504774-E	1
			Blue	D1ZZ 6504774-F	1
			Ginger	D1ZZ 6504774-G	1
			Green	D1ZZ 6504774-H	1
	72	F(63D,65D)		D2ZZ 6504774-A	1
	71/	F(63,65,76)	Screw-pan head-No. 8-18 x 3/4"	376389-S100(UU82D)	2
- S -					
	67	S(65)	Refer to Chassis Group 19893		

GROUP NUMBER	YEAR	BODY TYPE	DESCRIPTION	PART NUMBER	QTY.
<b>04774</b>	<b>PANEL - INSTRUMENT PANEL - CENTER - continued</b>				
	- X -				
	65	X(54B, 62B, 63B, 66B, 71B, C, 76A)	With radio	C5DZ 6204774-A	1
	66	X(54B, 62B, C, 66B, D, 71B)	With radio	C6DZ 6204774-B	1
	67	X(54B, 62B, C, 71B)	With radio	C7DZ 6204774-A	1
	65/66	X	Without radio	★	
<b>04780</b>	<b>RETAINER - CONSOLE PANEL ASH RECEPTACLE</b>				
	68/	B		D0OZ 6504780-A	1
	71/72	F	W/consolette	D1ZZ 6304780-A	1
			W/full length console	D1ZZ 6504780-A	1
<b>04784</b>	<b>RETAINER - INSTRUMENT PANEL CENTER FINISH PANEL</b>				
	69/70	F		C9ZZ 6504784-A	2
<b>04786</b>	<b>DOOR - CONSOLE PANEL ASH RECEPTACLE - Paint to match - Also refer to Group 04788</b>				
	71/	F	W/full length console	D1ZZ 6504786-A	1
<b>04788</b>	<b>RECEPTACLE - CONSOLE PANEL ASH</b>				
	68/69	B		C8OZ 6304788-B	1
	70	B	Camera case finish	D0OZ 6304788-A	1
			Wood grain	D0OZ 6504788-A	1
	71	B	Black	D0OZ 6304788-B	1
	69/70	F(except GT350/500)		C9ZZ 6504788-A	1
	69/70	F(GT 350/500)		C9ZZ 6304788-B	1
	71/	F	W/consolette-paint to match	D1ZZ 6504788-A	1
	65/66	S	Bumper	C4SZ 6304788-B	1
			No. 8-32 x 1/2" Cross recess pan head screw	375838-S(CC32)	2
			No. 8 Flat washer	51764-S8(U366)	4
				44710-S8(X10)	4
	69	S	Black-paint to match	D0SZ 6504788-A	1
			Blue	C9SZ 6504788-F	1
			Ivy gold	C9SZ 6504788-E	1
			Nugget gold	C9SZ 6504788-D	1
			Red	C9SZ 6504788-A	1
			No. 6-32 x 1/4"-pan head tap. screw	41540-S(U353)	2
	70	S	Black	D0SZ 6504788-A	1
			Blue	D0SZ 6504788-C	1
			Ginger	D0SZ 6504788-B	1
			Green	D0SZ 6504788-F	1
			Nugget Gold	D0SZ 6504788-E	1
			Red	D0SZ 6504788-D	1
	71	S	Black	D0SZ 6504788-A	1
			Blue	D0SZ 6504788-C	1
			Green	D1SZ 6504788-A	1
			Red	D0SZ 6504788-D	1
<b>04796</b>	<b>COVER - CONSOLE PANEL MOULDING JOINT</b>				
	68	S		C8SZ 6504796-B	1
	69/71	S		C9SZ 6504796-A	1
<b>04803</b>	<b>RECEPTACLE KIT - REAR FLOOR ASH</b>				
	67/71	F		C8WY 6504803-A	1
<b>04810-1</b>	<b>RECEPTACLE - INSTRUMENT PANEL ASH - Paint to match - Also refer to Groups 04821 and 04826</b>				
	- A -				
	65/66	A	Bumper-1/4" dia. hole	C5AZ 6204810-A	1
			Bumper	380239-S(CC42)	2
				377880-S(CC39)	2
	67	A	Refer to Group 04821		
	68	A(54C, 57F, 63C, 65A, 71A-E, 76B)		C8AZ 5404810-B	1
	71/	A	R.H. - includes instruction sheet	D1AZ 6504810-A	1
			L.H. - includes instruction sheet	D1AZ 6504811-A	1
			11/32" ball bearing	354872-S(AA10B)	AR
	70	A	Refer to Groups 04821 and 04826-7		

# FORD CAR PARTS

## BODY SECTION 047

3

GROUP NUMBER	YEAR	BODY TYPE	DESCRIPTION	PART NUMBER	QTY.
<b>04810-1 RECEPTACLE - INSTRUMENT PANEL ASH - Paint to match - Also refer to Groups 04821 and 04826 - continued</b>					
- B -					
	68/69	B	Includes retainer	C8OZ 5404810-A	1
	70	B(54A, B, 62A, 63H, 65B, H, 66A, B, 71B, D)			1
	71	B(54A, 63H, 65A, 66A, B, 71D) - "Before 6/18/71"			1
	70/71	B(54C, 57C, 63C, F, 65C, 66C, 71C, 76C)		D0OZ 6504810-A	1
	71	B(54A, 63H, 65A, 66A, B, 71D) "From 6/18/71"			1
	70/71	B(57E, 63F, 65E, 66E, 71E, 76F)		D0OZ 6504810-B	1
			Bumper	379919-S(CC36A)	2
	72	B "Before 10/15/71"		D2GY 6504810-A	1
	72	B "From 10/15/71"	r/b D3OZ 6504810-A (7/74)	★D2GY 6504810-B	ø 1
- F -					
	65/66	F	3 3/4" wide	C4DZ 6204810-A	1
	68	F	For knob and insert refer to Group 048E38		
- L -					
	71	L "Before 8/21/70"	Less handle	D1FZ 6204810-A	1
	71/	L "From 8/21/70"	Includes handle	D1FZ 6204810-B	1
- P -					
	70/	P		D0DZ 6204810-B	1
- S -					
	68/71	S(57B, C, 65C, D)	Includes nylon slides	D0SZ 6504810-A	1
	68/69	S	11/32" ball bearing	354872-S(AA10B)	AR
	72	S	Black	D2SZ 6504810-A	1
- U -					
	66/67	U		C1UZ 8904810-A	1
	68/	U		C7TZ 9604810-A	1
- X -					
	65	X	3 3/4" wide	C4DZ 6204810-A	1
	68/70	X	Includes retainer	C8OZ 5404810-A	1
	65/66	B, F, X	Bumper	380369-S(CC44)	2
<b>048A14 DOOR and RETAINER ASSY. - CONSOLE PANEL ASH RECEPTACLE</b>					
	69/70	F	Paint to match	C9ZZ 65048A14-A	1
<b>04815 BEZEL - INSTRUMENT PANEL ASH RECEPTACLE</b>					
	69/70	F		C9ZZ 6504815-A	1
<b>04817 PANEL - INSTRUMENT PANEL ASH RECEPTACLE DOOR TRIM - INCLUDES ATTACHING PARTS</b>					
	68	A(54C, 57F, 63C, 65A, 71A, E, 76B)	Wood grain	C8AZ 5404817-A	1
<b>04821 BOX and SNUFFER - ASH RECEPTACLE</b>					
- A -					
	65/66	A	Instrument panel	C5AZ 6204821-A	1
	67	A	Instrument panel	C7AZ 6204821-A	1
			Also refer to Group 044E26-7 (slide assy.)		
	68	A	Refer to Group 04810		
	69/70	A	"Before 9/15/69" Instrument panel-paint to match	C9AZ 6204821-A	1
	70	A	"From 9/15/69" Instrument panel-paint to match-ball bearing type	D0AZ 6204821-A	1
- B -					
	66/67	B	Instrument panel-with A/C-paint to match	C6OZ 6204821-B	ø 1
	68/	B	Refer to Group 04810		
- F -					
	65/66	F	Console - Refer to Group 048A42		
	67	F	Instrument panel-paint to match	C7ZZ 6504821-A	1
	68	F	Instrument panel-paint to match	C8ZZ 6504821-A	1
	68	F	Console-Refer to Groups 30702 and 30714		
	67/68	F	Bumper	380369-S(CC44)	1
	69	F	Instrument panel-paint to match	C9ZZ 6504821-A	1
	70	F	Instrument panel-paint to match	D0ZZ 6504821-A	1
	71/	F	W/full length console	D1ZZ 6504821-A	1

**BODY  
SECTION 047**
**FORD CAR PARTS**

GROUP NUMBER	YEAR	BODY TYPE	DESCRIPTION	PART NUMBER	QTY.
<b>04821</b>	<b>BOX and SNUFFER - ASH RECEPTACLE - continued</b>				
	- S -				
	65/66	S	Console - Front - Also refer to Group 04788	C4SZ 6304821-A	1
	67/71	S	Console-Front	C7SZ 6504821-A	1
	68/71	S(57B,C,65C,D)	Instrument panel	C8SZ 6504821-A	1
	- X -				
	66/67	X	Instrument panel-without A/C-paint to match	C6OZ 6204821-A	1
			Instrument panel-with A/C- paint to match	C6OZ 6204821-B	1
<b>04826-7</b>	<b>RETAINER - ASH RECEPTACLE</b>				
	- A -				
	65/67	A		C5AZ 6204826-D	1
	68	A	Refer to Group 04810		
	69/70	A	"Before 9/15/69" Instrument panel	C9AZ 6204826-A	1
	70	A	"From 9/15/69" Instrument panel - ball bearing type	D0AZ 6204826-A	1
	71/	A	Instrument panel	D1AZ 6504827-A	1
	- B -				
	66/67	B	Without A/C	C6OZ 6204826-A	1
			With A/C	C6OZ 6204826-B	1
	- F -				
	67	F		C7ZZ 6504826-B	1
	68	F		C8ZZ 6504826-A	1
	69	F	Paint to match	C9ZZ 6504826-A	1
	70	F		D0ZZ 6504826-A	1
	- S -				
	67	S	Console panel-Rear-Paint to match	C7SZ 6504826-A	1
	- U -				
	66/67	U		C1UZ 8904826-A	1
	68/	U		C7TZ 9604826-A	1
	66/	U	No. 8-18 x 3/8" Cross recess washer head screw	376378-S101(UU97)	3
	- X -				
	65	X		C4DZ 6204826-A	1
	66/67	X	Without A/C	C6OZ 6204826-A	1
			With A/C	C6OZ 6204826-B	1
	65/67	A, B, F, X	No. 8 x 3/8" Cross recess binding head screw	52720-S8(U380)	3or4
			No. 10 External tooth lockwasher	34903-S8(X96)	3or4
			No. 8-15 x 1/2" Cross recess pan head screw	52726-S13(U381)	4
<b>04830</b>	<b>HANDLE - CONSOLE PANEL ASH RECEPTACLE</b>				
	67	A	Instrument panel-Includes attaching parts	C7AZ 6204830-A	1
	67	A	No. 6-20 x 1/4" Pan head screw	52533-S(U226)	2
			5/16" Rivet	*64130-S	2
<b>04830</b>	<b>HANDLE - INSTRUMENT PANEL ASH RECEPTACLE</b>				
	68	A	Part of 04810 assy.		
<b>04837</b>	<b>RETAINER - INSTRUMENT PANEL ASH RECEPTACLE RETAINER - Also refer to Group 04810</b>				
	67	A	Paint to match	C7AZ 6204837-A	1
<b>048B38</b>	<b>KNOB and INSERT ASSY. - INSTRUMENT PANEL ASH RECEPTACLE</b>				
	69	F		C9ZZ 65048B38-A	1
<b>048A42</b>	<b>RECEPTACLE - CONSOLE PANEL REAR ASH</b>				
	69/71	A, F	Receptacle-refer to Group 62876	C9YZ 65048A42-A	1
	70/71	B		D0OZ 65048A42-A	1
	65/66	F	No. 8-15 x 1/2" Cross recess pan head screw	52726-S13(U381)	3
	67	F	Includes chrome door and spring	C7ZZ 65048A42-A	1
	67	S(65)	Includes door-Black	C7SZ 65048A42-A1A	1
			-Blue	C7SZ 65048A42-A1B	1
			-Gold	C7SZ 65048A42-A1G	1
			-Parchment	C7SZ 65048A42-A1U	1
			-Red	C7SZ 65048A42-A1D	1
			-Saddle	C7SZ 65048A42-A1F	1
<b>048B52</b>	<b>CLIP - INSTRUMENT PANEL ASH RECEPTACLE - INCLUDES ATTACHING PARTS</b>				
	69/71	S		C9SZ 65048B52-A	1

# FORD CAR PARTS

**BODY  
SECTION 047**

GROUP NUMBER	YEAR	BODY TYPE	DESCRIPTION	PART NUMBER	QTY.
<b>04878 CLIP - INSTRUMENT PANEL MOULDING</b>					
	67/68	A		C8AZ 6204878-B	4
	70/	P	With A/C	D0DZ 6204878-A	11
<b>060A08 CABLE - INSTRUMENT PANEL GLOVE COMPARTMENT DOOR CHECK</b>					
	69/70	F		C9ZZ 65060A08-A	1
	65	X		C4DZ 62060A08-A	2
	65/66	F			1
	65/66	F, X	No. 8-18 x 1/2" Pan head shoulder screw	379203-S2(UU81M)	2
	65/66	S		C4SZ 63060A08-A	1
	72	S		D2SZ 65060A08-A	1
	66/	U		C6TZ 96060A08-A	1
			No. 8-15 x 5/8" Self tapping fillister head screw	52554-S8(U230)	2
			No. 8-15 Nut (spring)	45133-S2(M126)	2
			No. 8-12 Nut (spring)	45174-S8(M131)	1
			No. 8-18 x 9/16" Pan head shield screw	382249-S2(UU81W)	1
<b>06010 COMPARTMENT - INSTRUMENT PANEL GLOVE</b>					
<b>- A -</b>					
	65/66	A	Without A/C	C5AZ 6206010-A	1
	67	A	Without A/C	C7AZ 6206010-C	1
			With A/C	C7AZ 6206010-D	1
	68	A	Without A/C	C8AZ 6206010-A	1
	69/70	A		C9AZ 6206010-A	1
	71	A	"Before 3/15/71" Without A/C or A.T.C.	D1AZ 6506010-A	1
			With A/C or A.T.C.	D1AZ 6506010-B	1
	71	A	"From 3/15/71" Without A.T.C.	D1AZ 6506010-C	1
			With A.T.C.	D1AZ 6506010-D	1
	72	A	Without A/C	D2AZ 6506010-A	1
			With A/C	D2AZ 6506010-B	1
	71/	A	Nut (spring)-U shape	45174-S8(M138)	5
<b>- B -</b>					
	65	B		C2OZ 6206010-A	1
	66/67	B		C6OZ 6206010-B	1
			No. 8-15 x 3/8" Cross recess washer screw	376378-S101(UU97)	6
	67	B	With hang-on A/C	C7OZ 5406010-A	1
	67	B(63, 76)	No. 8-15 x 5/8" Oval head screw	52352-S8(U293)	2
	68/69	B	Without A/C	C9DZ 6206010-A	1
			With A/C	C8OZ 5406010-B	1
	70/71	B	Without A/C	D0OZ 6506010-A	1
			With A/C - plastic	D0OZ 5406010-A	1
			No. 8-18 x 3/8"-pan head self tap screw	52720-S8(U380)	8
	72	B(without A/C)		D2GZ 6506010-A	1
	72	B (with A/C)		D0OZ 5406010-A	1
<b>- F -</b>					
	65/66	F		C5ZZ 6506010-A	1
	67/68	F	Without hang-on A/C	C7ZZ 6506010-A	1
	69/70	F	Without A/C	C9ZZ 6506010-A	1
			With A/C	C9ZZ 6506010-B	1
	71/	F	Without A/C	D1ZZ 6506010-A	1
			With A/C	D1WY 6505010-A	1
			No. 8-18 x 1/2" Round washer head screw	382086-S9(UU89F)	5
<b>- L -</b>					
	71/72	L	"Before 4/1/72"	D1FZ 6206010-A	1
	72	L	"From 4/1/72"	D2FZ 6206010-A	1
			No. 8-18 x 3/8"-self tap fill.hd.screw	52540-S13(U227)	4
<b>- S -</b>					
	67	S	With identification plate retainer	C7SZ 6506010-C	1
	68/69	S		C8SZ 6506010-A	1
	70/71	S		D0SZ 6506010-A	1
	72	S		D2SZ 6506010-A	1
<b>- U -</b>					
	66/70	U		C6TZ 9606010-A	1
	71/	U		D1BZ 1006010-A	1

GROUP NUMBER	YEAR	BODY TYPE	DESCRIPTION	PART NUMBER	QTY.
<b>06010</b>	<b>COMPARTMENT - INSTRUMENT PANEL GLOVE - continued</b>				
	- X -				
	65	X			
	66/67	X	Without A/C	C4DZ 6206010-A	1
	67	X	With A/C	C6OZ 6206010-B	1
	68	X	With A/C	C7OZ 5406010-A	1
	70	X	Without A/C	C8OZ 5406010-B	1
	65/66	A, B, F, S, X		C9DZ 6206010-A	1
	66	F	No. 8 x 1" Cross recess oval head screw	52376-S13(U296)	6or7
	66/	U	No. 8-15 x 3/4" Cross recess washer head screw	350075-S13(UU88)	5
					5
<b>06010</b>	<b>COMPARTMENT - CONSOLE PANEL GLOVE</b>				
	- A -				
	69/70	A	"Before 10/1/69"	Black	
	70	A	"From 9/2/69 to 12/1/69"	Black	
	70/71	A	"From 12/1/69"	Black-with 1/2" dia. hole on left side	
				C9AZ 6306010-B1A	1
				D0AZ 6306010-A	1
				D0AZ 6306010-B	1
	- B -				
	68/70	B	"Before 9/2/69"		
	70	B	"From 9/2/69 to 12/1/69"		
	70/71	B	"From 12/1/69"		
	72	B			
				C8OZ 6306010-A	1
				D0GY 6506010-A	1
				D0GY 6506010-B	1
				D2OZ 6506010-A	1
	- F -				
	69	F	Includes retainer, spacer, socket and rivet		
			Rear-Aqua		
			-Blue	C9ZZ 6506010-A2K	1
			-Ivy gold	C9ZZ 6506010-A2B	1
			-Nugget gold	C9ZZ 6506010-A1G	1
			-Red	C9ZZ 6506010-A1Y	1
			-Red	C9ZZ 6506010-A1D	1
	70	F	"Before 9/2/69"	Rear-Black	
			-Blue	D0ZZ 6306010-D	1
			-Ginger	D0ZZ 6306010-B	1
			-Green	D0ZZ 6306010-F	1
			-Red	D0ZZ 6306010-A	1
			-Tobacco	D0ZZ 6306010-E	1
			-Tobacco	D0ZZ 6306010-C	1
	70	F	"From 9/2/69 to 12/1/69"	Rear-Black	
			-Blue	D0OZ 6306010-K	1
			-Ginger	D0OZ 6306010-H	1
			-Green	D0OZ 6306010-M	1
			-Red	D0OZ 6306010-G	1
			-Red	D0OZ 6306010-L	1
			-Tobacco	D0OZ 6306010-J	1
	70	F	"From 12/1/69"	Rear-Black	
			-Blue	D0ZZ 6306010-R	1
			-Ginger	D0ZZ 6306010-P	1
			-Green	D0ZZ 6306010-T	1
			-Red	D0ZZ 6306010-N	1
			-Red	D0ZZ 6306010-S	1
			-Tobacco	D0ZZ 6306010-Q	1
	71/	F	Use with full length console	D1ZZ 6506010-B	1
	- S -				
	65/66	S	Drill 1/2" hole for L/compt. door latch remote control release	C4SZ 6306010-C	1
			No. 8-15 x 1" Cross recess oval head screw	52376-S13(U296)	4
	68/70	S	"Before 11/3/69"	C8SZ 6506010-B	1
	70/71	S	"From 11/3/69"	D0SZ 6506010-B	1
	72	S		D2OZ 6506010-A	1
	- X -				
	66	X		C6OZ 6306010-A	1

# FORD CAR PARTS

**BODY  
SECTION 047**

7

GROUP NUMBER	YEAR	BODY TYPE	DESCRIPTION	PART NUMBER	QTY.
<b>060A12 BEZEL - INSTRUMENT PANEL of CONSOLE GLOVE COMPARTMENT DOOR LOCK - Includes Attaching Parts</b>					
	65/66	A	"Before 12/1/65"	C5AZ 62060A12-A	1
	66/68	A	"From 12/1/65"	C5AZ 62060A12-B	1
	71/	A	Instrument panel	D1AZ 65060A12-A	1
	66	B(54A,62A,63C,D, 71, 76C,D), X(54, 62A, 66A, 71A)	Instrument panel	C6OZ 62060A12-A	1
	67	B, F, S, X(54, 62A, 71A)			1
	68	B, F, S, X			1
	69/70	A, F			1
	72	F			1
	69/71	B, S			1
	69	X(54A,62A,71A)			1
	68/71	S	Console panel	C8SZ 65060A12-A	1
	71	S			1
<b>06021 PANEL - CONSOLE GLOVE COMPARTMENT</b>					
	65	F	"Before 8/20/64"	C5ZZ 6506021-AFA	1
			Blue	C5ZZ 6506021-AFA	1
			Palomino	C5ZZ 6506021-AFA	1
<b>06024 DOOR - INSTRUMENT PANEL GLOVE COMPARTMENT</b>					
- A -					
	67/68	A		C7AZ 6206024-A	1
	69/70	A		C9AZ 6206024-A	1
	71/	A	Includes hinge-paint to match -incl. I. S.	D1AZ 6506024-A	1
- B -					
	66/67	B		C6OZ 6206024-A	1
	68/69	B		C8OZ 5406024-A	1
	70	B(54,62A,63H,65B,66A,B,71B)	Paint to match	D0OZ 6506024-A	1
	71	B(54, 63H, 66A, B, 71D)			1
	70/71	B(54C,57C,63C,F,65C,F, 66C,71C,76)	Textured steel	D0OZ 6506024-B	1
	70/71	B(57E,65E,66E,71E,76F)	Vinyl clad steel -wood grain finish	D0OZ 6506024-C	1
	72	B	Black	D2GY 6506024-B	1
			Blue	D2GY 6506024-E	1
			Green	D2GY 6506024-C	1
			Tobacco	D2GY 6506024-A	1
			Paint to match	D3OZ 6506024-A	1
- F -					
	65/66	F(63B, 65B, 76B)	Wood grain finish	C5ZZ 6506024-D	1
	67/68	F		C7ZZ 6506024-A	1
	69/70	F		C9ZZ 6506024-A	1
	71/	F		D1ZZ 6506024-A	1
- L -					
	71/	L		D1FZ 6206024-A	1
- S -					
	67/69	S		C7SZ 6506024-A	1
	70/71	S	Bumper	D0SZ 6506024-A	1
				379162-S(CC34A)	1
	72	S	Paint to match	D2SZ 6506024-A	1
- U -					
	66/	U	Paint to match	C3UZ 8906024-A	1
			No. 8-32 x 1/2" Hex. head screw and washer assy.	382240-S2 (BB551BM)	2
- X -					
	66/67	X		C6OZ 6206024-A	1
	68/69	X		C8OZ 5406024-A	1
<b>06024 DOOR - CONSOLE PANEL GLOVE COMPARTMENT</b>					
- A -					
	69	A	Black-Padded	C9AZ 6306024-A1A	1
			Blue (dark)	C9AZ 6306024-A1B	1
			Blue (light)	C9AZ 6306024-A2B	1
			Ivy gold	C9AZ 6306024-A1G	1
			Nugget gold	C9AZ 6306024-A1Y	1
			Red	C9AZ 6306024-A1D	1

GROUP NUMBER	YEAR	BODY TYPE	DESCRIPTION	PART NUMBER	QTY.
<b>06024</b>	<b>DOOR - CONSOLE PANEL GLOVE COMPARTMENT - continued</b>				
<b>- A - continued</b>					
70	A	"Before 12/1/69"	Black	D0AZ 6306024-J	1
			Blue	D0AZ 6306024-G	1
			Ginger	D0AZ 6306024-H	1
			Green	D0AZ 6306024-F	1
			Red	D0AZ 6306024-K	1
70	A	"From 12/1/69"	Black	D0AZ 6306024-P	1
			Blue	D0AZ 6306024-M	1
			Ginger	D0AZ 6306024-N	1
			Green	D0AZ 6306024-L	1
			Red	D0AZ 6306024-R	1
71/72	A		Black	D1AZ 6306024-A	1
			Red	D1AZ 6306024-B	1
<b>- B -</b>					
68	B		Blue	C9OZ 6306024-DDB	1
68/69	B		Aqua	C9OZ 6306024-DDK	1
			Black	C9OZ 6306024-DDA	1
			Nugget gold	C9OZ 6306024-DDY	1
			Red	C9OZ 6306024-DDD	1
			Ivy Gold	C9OZ 6306024-DDG	1
69	B		White	C9OZ 6306024-DBW	1
69/70	B	"Before 9/2/69"	Paint to match	C9OZ 6306024-DDB	1
70	B	"From 9/2/69 to 12/1/69"	Paint to match	D0OZ 6506024-D	1
70/71	B	"From 12/1/69"	Paint to match	D0OZ 6506024-E	1
			Screw self tap. fill. head-No. 8-18 x 3/8"	52540-S13(U227)	4
72	B		Paint to match	D2OZ 6506024-A	1
<b>- F -</b>					
65/66	F		With Camera Case finish	C5ZZ 6506024-B	1
65/66	F	"From 3/8/65"	With wood grain finish	C5ZZ 6506024-C	1
67/68	F	(except GT 350/500)		C8ZZ 6506024-A	1
			Bumper	379162-S(CC34A)	1
69	F		Nugget gold-less hinge-no catch-plain	C9ZZ 6506024-B1Y	1
69/70	F	"Before 9/2/69"	Red	C9ZZ 6506024-B1D	1
			Black-less hinge-no catch-plain	C9ZZ 6506024-B1A	1
			Blue	C9ZZ 6506024-B2B	1
70	F	"Before 9/2/69"	Red	D0ZZ 6506024-C	1
70	F	"From 9/2/69 to 12/1/69"	Black-less hinge-magnetic catch-plain	D0ZZ 6306024-K	1
			Blue	D0ZZ 6306024-B	1
			Ginger	D0ZZ 6306024-F	1
			Green	D0ZZ 6306024-A	1
			Red	D0ZZ 6306024-E	1
			Tobacco	D0ZZ 6306024-C	1
			Black-less hinge-positive catch-plain	D0ZZ 6306024-K	1
Blue	D0ZZ 6306024-H	1			
70	F	"From 12/1/69"	Ginger	D0ZZ 6306024-M	1
			Green	D0ZZ 6306024-G	1
			Red	D0ZZ 6306024-L	1
71/	F		Paint to match	D1ZZ 6506024-B	1
69/	F		No. 8-18 x 3/8"-pan head screw	52720-S8(U380)	4
<b>- L -</b>					
71/	L			D1FZ 6206024-B	1
<b>- P -</b>					
70/	P		Consolette - includes hinge and attaching parts-paint to match	D0DZ 6206024-A	1
<b>- S -</b>					
65	S		Mink	C5SZ 6306024-EBD	1
66	S		Black	C5SZ 6306024-EBB	1
			Mink (light)	C5SZ 6306024-EBD	1
			Black	D0SZ 6506024-BA	1
68/69	S		Blue	D0SZ 6506024-CA	1
			Ivy gold	C8SZ 6506024-AIG	1
			Red	C8SZ 6506024-A1D	1



# FORD CAR PARTS

**BODY  
SECTION 047**

9

GROUP NUMBER	YEAR	BODY TYPE	DESCRIPTION	PART NUMBER	QTY.
<b>06024 DOOR - CONSOLE PANEL GLOVE COMPARTMENT - continued</b>					
- S -					
	70	S	Black-positive catch	D0SZ 6506024-B	1
			Blue	D0SZ 6506024-G	1
			Ginger	D0SZ 6506024-D	1
			Green	D0SZ 6506024-E	1
	70	S	Red	D0SZ 6506024-C	1
			Black-magnetic catch	D0SZ 6506024-BA	1
			Blue	D0SZ 6506024-GA	1
			Ginger	D0SZ 6506024-DA	1
	71	S	Green	D0SZ 6506024-EA	1
			Red	D0SZ 6506024-CA	1
			Black-positive catch	D0SZ 6506024-B	1
			Blue	D0SZ 6506024-G	1
	72	S	Ginger	D0SZ 6506024-D	1
			Green	D1SZ 6506024-A	1
			Red	D0SZ 6506024-C	1
			Paint to match-also use D1ZZ 6506050-B hinge	D2OZ 6506024-A	1
<b>06036 PANEL - INSTRUMENT PANEL GLOVE COMPARTMENT DOOR FINISH - INCLUDES ATTACHING PARTS</b>					
- A -					
67		A(54A, C, 57, 63, 71A, E, 76)	Wood grain finish-2" wide-lower	C7AZ 5406036-A	1
67		A(54B, E, 62, 71B, C, D)	With A/C		1
67		A(54C, 57F, 63J)	Wood grain finish-5" wide-upper	C7AZ 6306036-A	1
68		A(54A, 57, 63, 65, 71A, B, C, E, 76)	Bright finish and wood grain finish - lower - without name plate	C8AZ 5706036-A	1
68		A(54C, 57F, 63C, 65A, 71A, E, 76B)	Wood grain finish - upper	C8AZ 5406036-A	1
68		A(54C, 57F, 65A)	Wood grain finish - lower - "Brougham"	C8AZ 5406036-B	1
69/70		A(54A, B, C, 57, 63, 65, 71B, C, 76)	Wood grain finish (2 1/4" wide) - with glove compartment lock opening	C9AZ 6206036-A	1
69/70		A(54C, 57F, 65A, 71A, E)	Wood grain finish (3 1/2" wide) - with glove compartment lock opening	C9AZ 5406036-A	1
69/70		A(54C, 57F, 65A)	Wood grain finish (3 1/2" wide) - "Brougham"	C9AZ 5406036-B	1
- B -					
68		B	With A/C	C8OZ 5406036-C	1
68		B(54C, 65C, 71E)	Wood grain finish-15.21" long - without A/C	C8OZ 5406036-A	1
68		B(54B, 63B, E, 65B, E, 71B, 76B, E)	Without A/C	C8OZ 5406036-B	1
69		B(63D, F, 65D, F, 66C, D, 76D, F)			
69		B(54C, 65C, 71E)	Wood grain (dark teak)-without A/C	C9OZ 5406036-B	1
69		B	Upper & lower-wood grain(rosewood)-with A/C	C9OZ 5406036-A	1
70		B	Refer to Group 06024		
- F -					
71/		F-w/decor group	Argent	D1ZZ 6506036-A	1
- S -					
67/69		S		C7SZ 6506036-A	1
70/71		S	Paint to match	D0LY 6506036-A	1
- X -					
68/69		X(54B, 62B, C, 71B)	Without A/C	C8OZ 5406036-B	1
69		X	Upper & lower-wood grain(rosewood)-with A/C	C9OZ 5406036-A	1
<b>06050 HINGE - INSTRUMENT PANEL GLOVE COMPARTMENT DOOR</b>					
69/70		A		C9AZ 6206050-A	1
71/		A		D1AZ 6506050-A	1
68/71		B		C8OZ 5406050-A	1
72		B		D2GY 6506050-A	1
67/68		F		C7ZZ 6506050-B	1
69/70		F	Includes reinforcement	C9ZZ 6506050-A	1
71/		F		D1ZZ 6506050-A	1
71/		L		D1FZ 6206050-A	1
67/71		S		C7SZ 6506050-A	1
72		S		D2SZ 6506050-A	1
66/		U		C3UZ 8906050-AP	1
68/70		X		C8OZ 5406050-A	1

GROUP NUMBER	YEAR	BODY TYPE	DESCRIPTION	PART NUMBER	QTY.
<b>06050-1</b>	<b>HINGE - CONSOLE PANEL GLOVE COMPARTMENT DOOR</b>				
	69/71	A	Plastic	C9AZ 6306050-A	1
	68/71	B		C8OZ 6306050-A	1
	72	B		D1ZZ 6506050-B	1
	65/66	F	R. H.	C5ZZ 6506050-A	1
			L. H.	C5ZZ 6506051-A	1
	69/70	F		C9ZZ 6306050-A	1
	71/	F	W/full length console	D1ZZ 6506050-B	1
	71/	L		D1FZ 6206050-B	1
	68/71	S	Paint to match	C8SZ 6506050-A	1
	72	S		D1ZZ 6506050-B	1
	66	X		C6OZ 6306050-A	1
<b>06064</b>	<b>CATCH - INSTRUMENT PANEL GLOVE COMPARTMENT DOOR LATCH STRIKER PLATE</b>				
	- A -				
	65	A		★C4VY 5306064-A r/b C6OZ 6206064-A	φ 1
	69/	A	Also used on stowage compartment	C9AZ 6206064-A	1
	- B -				
	65	B(except 65B)		C2OZ 6206064-A	1
	65	B(65B)		C2AZ 7606064-A	1
	66	B	"Before 3/22/66"	C4VY 5306064-A	1
	66,69	B	"From 3/22/66"	C6OZ 6206064-A	1
	70/	B		C9AZ 6206064-A	1
	- F -				
	65	F(63B, 65B, 76B)		C5ZZ 6506064-A	1
	66	F			1
	67/68	F		C6OZ 6206064-A	1
	69/	F		C9AZ 6206064-A	1
	- L -				
	71/	L		C9AZ 6206064-A	1
	- S -				
	67/69	S		C7SZ 6506064-A	1
	70/	S		C9AZ 6206064-A	1
	- U -				
	66/	U		C2SZ 6306064-A	1
			No. 8-32 x 1/2" Pan head screw	31061-S8(U50)	2
	- X -				
	65	X		C4DZ 6206064-C	1
	66	X	"Before 3/22/66"	C4VY 5306064-A	1
	66/70	X	"From 3/22/66"	C6OZ 6206064-A	1
	65/67	A, B, S, X	No. 8 x 3/8" Cross recess pan head screw	52720-S8(U380)	2
			No. 8 External tooth lockwasher	34938-S8(X85)	2
	65/67	A	No. 8-32 x 5/16" Fill. hd screw & lockwasher	355067-S7(BB53)	2
	69/	A	No. 8-18 x 1/2"-pan head tap.screw & washer assy.	376389-S101(UU82D)	2
	67/69	S			2
<b>06064</b>	<b>CATCH-CONSOLE PANEL GLOVE COMPARTMENT DOOR LATCH STRIKER PLATE - Also refer to Group 060A96 , 061A34, 061A36</b>				
	65/67	A		C4DZ 6206064-C	1
	65	F		C4DZ 6206064-C	1
	70/	P		D0DZ 6206064-A	1
	65/66	S		C4SZ 6306064-B	1
	68	S	Refer to groups 061A34 & 061A36		
	70/71	S		D0SZ 6506064-A	φ 1
	65/66	X(62C, 63C, 64D, 66H, 76B, D)		C4DZ 6306064-A	1
<b>06066</b>	<b>BUMPER - INSTRUMENT PANEL GLOVE COMPARTMENT DOOR</b>				
	66/69	A, B, X		C6AZ 6206066-A	2
	70/71	S(65A, B)			2

# FORD CAR PARTS

**BODY  
SECTION 047**

11

GROUP NUMBER	YEAR	BODY TYPE	DESCRIPTION	PART NUMBER	QTY.
<b>06069 SPRING - GLOVE COMPARTMENT DOOR</b>					
	66/69	A	Instrument panel	C6AZ 6206069-A	1
	67/69	B, X			1
	70	X			1
	70/71	S	On console		1
<b>06072 LATCH - GLOVE COMPARTMENT DOOR - NON LOCKING</b>					
- A -					
	65/66	A	Console door-Includes attaching parts	C5AZ 6306072-A	1
- B -					
	67	B(66,71)	Instrument panel	C6DZ 6206072-B	1
- F -					
	65	F	Instrument panel- Includes attaching parts	C5ZZ 6506072-A	1
	65/66	F	Console door-Includes attaching parts	C5AZ 6306072-A	1
	67/68	F	Instrument panel	C6DZ 6206072-B	1
	69/70	F	Instrument panel	C9ZZ 6506072-A	1
			No. 8-18 x 1/2" -pan head screw & washer assy.	376389-S101(UU82D)	2
	71/	F	Instrument panel	D1ZZ 6506072-A	1
			Screw & washer assy.-pan head tap- No.8-18 x 3/4"	376389-S101(UU82D)	2
- L -					
	71/	L	Instrument panel	D1ZZ 6506072-A	1
- X -					
	65	X(54B,62B,63B,66B,71C,76A)	Instrument panel-Includes attaching parts	C4DZ 6206072-B	1
	65	X(54A, D, 59A, 62D, 66, 71A, 71B, 78)	Instrument panel-Includes attaching parts	C5AZ 6306072-A	1
	66/70	X(54, 62, 66, 71)	Instrument panel	C6DZ 6206072-B	1
<b>06081 LOCK CYLINDER and KEYS - GLOVE COMPARTMENT DOOR - Refer to Group 22050</b>					
<b>060A84 PANEL - CONSOLE GLOVE COMPARTMENT DOOR FINISH</b>					
	68/70	S	"Before 11/3/69" Paint to match	C8SZ 65060A84-A	1
	70/71	S	"From 11/3/69" Paint to match	D0SZ 65060A84-A	1
<b>06095 ESCUTCHEON - INSTRUMENT PANEL GLOVE COMPARTMENT DOOR LOCK</b>					
	65	A,B		C0AB 6406095-A	1
	66/	U			1
<b>060A96 CATCH - CONSOLE GLOVE COMPARTMENT DOOR LATCH</b>					
	70	A, B, F	"Before 12/1/69"	D0AZ 63060A96-A	1
	70/71	A	"From 12/1/69"	D0ZZ 63060A96-B	1
	70/	B, F			1
	72	S			1
	68/71	S	Refer to Group 06064		
<b>061A14 ORNAMENT - CONSOLE PANEL</b>					
	72	B		D2OZ 65061A14-A	1
<b>06115 BUMPER - INSTRUMENT PANEL GLOVE COMPARTMENT DOOR ARM</b>					
	65/68	A		B6A 7006115-A	1
	65	F			1
<b>06122 GROMMET - INSTRUMENT PANEL GLOVE COMPARTMENT DOOR CHECK ARM</b>					
	65/68	A		C3AZ 6206122-A	1
	65	B			1
<b>06125 RETAINER - INSTRUMENT PANEL GLOVE COMPARTMENT DOOR LATCH CATCH</b>					
	69/71	A		C9AZ 6206125-A	1
	69/	B, F, L, S			1

GROUP NUMBER	YEAR	BODY TYPE	DESCRIPTION	PART NUMBER	QTY.
<b>061A34</b>	<b>LATCH - CONSOLE PANEL GLOVE COMPARTMENT DOOR</b>				
	66	B, X	Magnet type	C6OZ 63061A34-A	1
	67/68	A, B			1
	68/70	S			1
	70	A, B, F	"Before 12/1/69"	D0AZ 63061A34-A	1
	70/71	A	"From 12/1/69"	D0AZ 63061A34-B	1
	70	B, F	"From 12/1/69"	D0ZZ 63061A34-A	1
	72	B, S	Paint to match	D2OZ 65061A34-A	1
	71/	F	Full length console	D1ZZ 63061A34-A	1
	71/	L		D1FZ 62061A34-A	1
<b>06136</b>	<b>BRACKET - INSTRUMENT PANEL GLOVE COMPARTMENT DOOR LATCH MOUNTING</b>				
	72	S		D2SZ 6506136-A	1
<b>061A36</b>	<b>PLATE - CONSOLE PANEL GLOVE COMPARTMENT DOOR LATCH</b>				
	68/70	S		C8SZ 65061A36-A	1
<b>061A44</b>	<b>HANDLE - CONSOLE PANEL GLOVE COMPARTMENT DOOR</b>				
	70/71	S	Paint to match	D0SZ 65061A44-A	1
<b>06150</b>	<b>PLATE - GLOVE COMPARTMENT DOOR LATCH CATCH ANCHOR</b>				
	65/66	X		C4DZ 6206150-A	1
	65/66	A	Console		1
	65	F(63A, 65A, C, 76A, C)	Instrument panel		1
	66	F			1
<b>06152</b>	<b>SUPPORT - CONSOLE PANEL GLOVE COMPARTMENT DOOR CATCH</b>				
	70/71	B		D0GY 6506152-A	1
<b>06156</b>	<b>COVER - INSTRUMENT PANEL GLOVE COMPARTMENT FUSE PANEL OPENING</b>				
	68/69	S	With skid control	C8SZ 6506156-A	1
	70	S		D0SZ 6506156-A	1
	71	S		D1SZ 6506156-A	1
<b>06157</b>	<b>STRIKER - CONSOLE PANEL GLOVE COMPARTMENT DOOR</b>				
	65	A, B, X	Steel	C2AZ 7606157-B	1
			No. 8 x 3/8" Cross recess pan head screw	52720-S8(U380)	2
<b>06158</b>	<b>BRACKET - INSTRUMENT PANEL GLOVE COMPARTMENT DOOR CATCH STRIKER</b>				
	69/70	F		C9ZZ 6506158-A	1
	65/66	S		C4SZ 6306158-B	1
			No. 8-32 x 1/2" Screw & lockwasher assy.	40917-S8(U257)	2
			No. 8 Flat washer	44710-S8(X10)	2
<b>06162</b>	<b>BUMPER - INSTRUMENT PANEL GLOVE COMPARTMENT DOOR</b>				
	66/	U		C3UZ 8906162-A	2
			No. 8-15 x 3/4" Cross recess washer head screw	350075-S13(UU88)	2
<b>06164</b>	<b>KNOB - INSTRUMENT PANEL GLOVE COMPARTMENT DOOR</b>				
	72	B, S		D2OZ 6506164-A	1
<b>06172</b>	<b>REINFORCEMENT - INSTRUMENT PANEL GLOVE COMPARTMENT DOOR LATCH</b>				
	72	B		D2GY 6506172-A	1
<b>061A84</b>	<b>PARTITION - CONSOLE PANEL GLOVE COMPARTMENT</b>				
	68/71	B	Plastic	C8OZ 63061A84-A	1
<b>06222</b>	<b>CHECK - CONSOLE PANEL GLOVE COMPARTMENT DOOR HINGE</b>				
	70/	P		D0DZ 6206222-A	1

# FORD CAR PARTS

## BODY SECTION 100

1

GROUP NUMBER	YEAR	BODY TYPE	DESCRIPTION	PART NUMBER	QTY.	
<b>100A01 EXTENSION - FRONT SIDE INNER MEMBER UPPER</b>						
	70/71	B	L.H.	D00Z 65100A01-A	1	
	70/	P	L.H.	D0DZ 62100A01-A	1	
<b>10008-9 MEMBER - FRONT SIDE INNER - Also refer to Group 10462</b>						
	71/	L	R.H.	D1FZ 6210008-A	1	
			L.H.	D1FZ 6210009-A	1	
<b>10010 MEMBER - FRONT SUSPENSION NO. 2 CROSS</b>						
	66/68	B	With 8 cyl. (390 engine)	C6OZ 6210010-D	1	
	67/68	B	With 6 cyl. or 8 cyl. (289 engine)		1	
	69	B	With 6 cyl. or 8 cyl. engines		1	
	66	B	With 6 cyl. , 8 cyl. (289 engine)	C6OZ 6210010-C	1	
	66/70	X	With 6 cyl. , 8 cyl. (302 engine)		1	
	70/71	B		D0OZ 6510010-B	1	
	70/	F			1	
	71/72	L		D1FZ 6210010-A	1	
<b>100A14-5 GUSSET - FRONT SIDE MEMBER FRONT</b>						
	68/70	F(63, 65)	R.H.	C8ZZ 65100A14-A	1	
			L.H.	C8ZZ 65100A15-A	1	
	71/	F(63, 65)	R.H.	D1ZZ 65100A14-A	1	
			L.H.	D1ZZ 65100A15-A	1	
	70/	P	R.H.	D0DZ 62100A14-A	1	
			L.H.	D0DZ 62100A15-A	1	
<b>10018 MEMBER - FRONT SUSPENSION NO. 1 CROSS - Also Refer to Group 10852</b>						
	65/66	F		C5ZZ 6510018-A	1	
	65	X		C3DZ 6210018-B	1	
<b>10034 PLUG - FLOOR PAN SEAT BELT ANCHOR OPENING</b>						
	65	A, B, F, S, U, X	When seat belts are not installed	C2AZ 6210034-A	4	
	69/	B(71)	When rear facing seat belts are not installed		4	
	70/71	S(57)			4	
<b>10062-3 EXTENSION - FRONT SIDE MEMBER</b>						
- B -						
	68/69	B(76)	R.H.	C6OZ 7610062-B	1	
			L.H.	C6OZ 7610063-B	1	
	68/	B(except 76)	Refer to Group 105A62			
	70/71	B(76)	R.H.	D0OZ 7610062-A	1	
			L.H.	D0OZ 7610063-A	1	
- F -						
	65/68	F(63, 65)		C5ZZ 6510062-B	2	
	69/70	F(63, 65)	R.H.	C5ZZ 6510062-C	1	
			L.H.	C5ZZ 6510063-A	1	
	65/70	F(76)	R.H.	C5ZZ 7610062-B	1	
			L.H.	C5ZZ 7610063-A	1	
	71/	F(63, 65)	R.H.	D1ZZ 6510062-A	1	
			L.H.	D1ZZ 6510063-A	1	
	71/	F(76)	R.H.	D1ZZ 7610062-A	1	
			L.H.	D1ZZ 7610063-A	1	
- L -						
	71/72	L	"Before 12/23/71" R.H.	D1FZ 6210062-A	1	
			L.H.	D1FZ 6210063-A	1	
	72	L	"From 12/23/71" R.H.	D2FZ 6210062-A	1	
			L.H.	D2FZ 6210063-A	1	
- P -						
	70/	P	Refer to Group 101A22			
GROUP NUMBER	YEAR	BODY TYPE	DESCRIPTION	PART NUMBER		QTY.
				RIGHT HAND	LEFT HAND	
<b>10066-7 EXTENSION - FLOOR SIDE INNER MEMBER FRONT</b>						
	66	B(except 76), X		C6OZ 6210066-A	C6OZ 6210067-A	1
	67/69	B(54, 63, 65, 66, 71), except Talladega		C8OZ 5410066-A	C8OZ 5410067-A	1
	68/70	X				1
	70/71	B(except 76)		D0OZ 6510066-A	D0OZ 6510067-A	1

GROUP NUMBER	YEAR	BODY TYPE	DESCRIPTION	PART NUMBER		QTY.
				RIGHT HAND	LEFT HAND	
<b>10104-5 REINFORCEMENT - FRONT SUSPENSION NO. 2 CROSS MEMBER OUTER</b>						
	66/69	B, X		★C6OZ 6210104-A	C6OZ 6210105-A	1
	70/71	B		D0OZ 6510104-A	D0OZ 6510105-A	1
<b>10104-5 Moulding - BODY ROCKER PANEL - INCLUDES ATTACHING PARTS</b>						
	65	A(54A, 57B, 63B, 71B, C, 76A) "Before 9/21/64"	Rear	C5AZ 62101A04-A	C5AZ 62101A05-A	1
	65	A(54A, 57, 63, 71B, C, 76)- "From 9/21/64"		C5AZ 63101A04-B	C5AZ 63101A05-B	1
			No. 8-18 x 1/2" Rd. hd. screw	379557-S101(UU89CB)	379557-S101(UU89CB)	AR
<b>10116-7 MEMBER - FLOOR SIDE INNER</b>						
	66	B(54, 62, 63)- "Before 10/1/65"		C6OZ 6310116-A	C6OZ 6310117-E	1
	66	B(71) "Before 10/1/65"		C6OZ 6310116-B	C6OZ 7110117-A	1
	66	B(exc. 76)- "From 10/1/65 to 2/14/66"		C6OZ 6310116-B	C6OZ 6310117-D	1
	66/69	B(except 76)- "From 2/14/66"	Cut to length	C6OZ 6310116-E	C6OZ 6310117-E	1
	70/71	B		D0OZ 7610116-A	D0OZ 7610117-A	1
	72	B(53) "Before 2/22/72"		D2OZ 5310116-A	D2OZ 5310117-A	1
	72	B(53) "From 2/22/72"		D2OZ 5310116-B	D2OZ 5310117-B	1
	72	B(63, 65) "Before 2/22/72"		D2OZ 6510116-A	D2OZ 6510117-A	1
	72	B(63, 65) "From 2/22/72"		D2OZ 6510116-B	D2OZ 6510117-B	1
	72	B(71) "Before 12/1/71"		D2OZ 7110116-A	D2OZ 7110117-A	1
	72	B(71)- "From 12/1/71 to 2/22/72"		D2OZ 7110116-B	D2OZ 7110117-B	1
	72	B(71) "From 2/22/72"		D2OZ 7110116-C	D2OZ 7110117-C	1
	72	B(97) "Before 2/22/72"		D2OZ 9710116-A	D2OZ 9710117-A	1
	72	B(97) "From 2/22/72"		D2OZ 9710116-B	D2OZ 9710117-B	1
	65/69	F(63, 65)		★C5ZZ 6510116-D Not Repl. (2-74)	D0WY 7610117-A	1
	65/67	F(76)		★C5ZZ 7610116-A Not Repl. (1-73)	C5ZZ 7610117-B	1
	68/69	F(76)		★C5ZZ 7610116-B Not Repl. (1-73)	C5ZZ 7610117-B	1
	70	F(65)		D0WY 6510116-A	D0WY 6510117-A	1
	70	F(76)		D0WY 7610116-A	D0WY 7610117-A	1
	71/72	F "Before 12/1/71"		D1ZZ 7610116-A	D1ZZ 7610117-A	1
	72	F(65) "From 12/1/71"		D2ZZ 6510116-A	D2ZZ 6510117-A	1
	72	F(76) "From 12/1/71"		D2ZZ 7610116-A	D2ZZ 7610117-A	1
	71	L		D1FZ 6210116-A	D1FZ 6210117-A	1
	72	L "Before 12/1/71"		D2FZ 6210116-A	D2FZ 6210117-A	1
	72	L "From 12/1/71"		D2FZ 6210116-B	D2FZ 6210117-B	1
	71	P(54)		D1DZ 5410116-A	D1DZ 5410117-A	1
	72	P(54) "Before 12/1/71"		D2DZ 5410116-A	D2DZ 5410117-A	1
	72	P(54) "From 12/1/71"		D2DZ 5410116-B	D2DZ 5410117-B	1
	70	P(62)		D0DZ 6210116-A	D0DZ 6210117-A	1
	72	P(62) "Before 12/1/71"		D2DZ 6210116-A	D2DZ 6210117-A	1
	72	P(62) "From 12/1/71"		D2DZ 6210116-B	D2DZ 6210117-B	1
	70/	P	Plug (button)-1/2" dia. hole	377935-S(PP2D)	377935-S(PP2D)	2
	72	S		D2SZ 6510116-A	D2SZ 6510117-A	1
	66/69	X(54, 62)	Cut to length	C6OZ 6310116-E	C6OZ 6310117-E	1
	66	X(66, 71) "Before 10/1/65"		C6OZ 6310116-B	C6OZ 7110117-A	1
	66	X(66, 71) "From 10/1/65"	Cut to length	C6OZ 6310116-B	C6OZ 6310117-D	1
<b>10120-1 MEMBER - FLOOR SIDE OUTER - Also refer to group 10128-9</b>						
	69	A		C9AZ 7110120-A	C9AZ 7110121-A	1
	70/71	A		D0AZ 7110120-A	D0AZ 7110121-A	1
	68/70	S(57)		C8SZ 5710120-A	C8SZ 5710121-A	1
	68/70	S(65)		C8SZ 6510120-A	C8SZ 6510121-A	1
	71	S(57)		D1SZ 5710120-A	D1SZ 5710121-A	1
	71	S(65)		D1SZ 6510120-A	D1SZ 6510121-A	1

# FORD CAR PARTS

## BODY SECTION 100

3

GROUP NUMBER	YEAR	BODY TYPE	DESCRIPTION	PART NUMBER		QTY.
				RIGHT HAND	LEFT HAND	
<b>101A22-3 EXTENSION - FLOOR SIDE MEMBER - FRONT - Also refer to Group 10062-3</b>						
68/69	B, X			C8OZ 54101A22-A	C8OZ 54101A23-A	1
70/	P			D0DZ 62101A22-A	D0DZ 62101A22-A	2
<b>10124-5 MEMBER - FLOOR SIDE REAR</b>						
68/69	B(54, 63, 65)			C8OZ 5410124-A	C8OZ 5410125-A	1
67/71	B(66, 71)			C9OZ 6610124-A	C8OZ 7110125-B	1
68/69	B(76)			★C8OZ 7610124-A	C8OZ 7610125-A	1
70	B(54, 57, 62, 63, 65)			D0OZ 6510124-A	D0OZ 6510125-A	1
71	B(54, 57, 63, 65)					1
70/	B(76)			D0OZ 7610124-A	D0OZ 7610125-A	1
68	F(63, 65)			C9ZZ 6510124-A	C8ZZ 6510125-A	1
69/70	F(63, 65)			C9ZZ 6510124-A	C8ZZ 7610125-A	§ 1
68/70	F(76)			C8ZZ 7610124-A	C8ZZ 7610125-A	1
71/72	F(63, 65)-with dual exhaust - "Before 12/1/71"			D1ZZ 6510124-A	D1ZZ 6510125-A	1
72	F(63, 65) "From 12/1/71"			D2ZZ 6510124-A	D2ZZ 6510125-A	1
71/72	F(76) "Before 12/1/71"			D1ZZ 7610124-A	D1ZZ 7610125-A	1
72	F(76) "From 12/1/71"			D2ZZ 7610124-A	D2ZZ 7610125-A	1
72	L(73)			D2FZ 7310124-A	D2FZ 7310125-A	1
70	P			D0DZ 6210124-A	D0DZ 6210125-A	1
71/	P			D1DZ 6210124-A	D1DZ 6210125-A	1
66/67	X(66, 71)			★C6DZ 7110124-A	C6OZ 7110125-B	1
68/69	X(54, 62) "Before 7/28/69"			C8DZ 6210124-A	C8DZ 6210125-A	1
69/70	X(except 71)- "From 7/28/69"			C9DZ 6210124-A	C9DZ 6210125-A	1
68	X(71)			C6OZ 7110124-A	C6OZ 7110125-B	1
69	X(71)			C9OZ 6610124-A	C6OZ 7110125-B	1
<b>10128-9 PANEL - BODY ROCKER</b>						
- A -						
65/68	A(54, 57)			C5AZ 5710128-A	C5AZ 5710129-A	1
65/68	A(62, 63, 65, 76)			C5AZ 6310128-B	C5AZ 6310129-B	1
65/68	A(71)			C5AZ 7110128-A	C5AZ 7110129-A	1
69/70	A(54, 57, 71)			C9AZ 5710128-A	C9AZ 5710129-A	1
69/70	A(62, 63, 65, 76)			C9MY 7610128-A	C9MY 7610129-A	1
71/	A(53, 54, 57, 71)			D1AZ 5710128-A	D1AZ 5710129-A	1
71/	A(65, 76)			D1AZ 7610128-A	D1AZ 7610129-A	1
- B -						
66/67	B(except 66, 71)			C6OZ 7610128-B	C6OZ 7610129-B	1
66	B(71)			C6OZ 7110128-A	C6OZ 7110129-A	1
67	B(66, 71)					1
68/69	B(66, 71)			C8OZ 7110128-A	C8OZ 7110129-A	1
68/69	B(except 63, 66, 71)			C8OZ 7610128-A	C8OZ 7610129-A	1
68/69	B(63)-except Talladega					1
69	B(63) Talladega			C9OZ 6310128-A	C9OZ 6310129-A	1
70/71	B(54, 57, 62, 63, 65, 76)			D0OZ 7610128-A	D0OZ 7610129-A	1
70/71	B(66)			D0OZ 6610128-A	D0OZ 6610129-A	1
70/71	B(71)			D0OZ 7110128-A	D0OZ 7110129-A	1
72	B(53, 71)			D2OZ 5310128-A	D2OZ 5310129-A	1
72	B(63, 65)			D2OZ 6510128-A	D2OZ 6510129-A	1
72	B(97)			D2OZ 9710128-A	D2OZ 9710129-A	1
- F -						
65/66	F			C5ZZ 6510128-A	C5ZZ 6510129-A	1
			Valve (drain)	C4AZ 62103A58-C	C4AZ 62103A58-C	2
67/68	F			C7ZZ 7610128-B	C7ZZ 7610129-B	1
69/70	F			C9ZZ 7610128-B	C9ZZ 7610129-B	1
71/	F			D1ZZ 7610128-A	D1ZZ 7610129-A	1
- L -						
71	L			D2FZ 6210128-A	D1FZ 6210129-A	§ 1
72	L(62, 64) "Before 12/1/71"			D2FZ 6210128-A	D2FZ 6210129-A	1
72	L(62, 64) "From 12/1/71"			D2FZ 6210128-B	D2FZ 6210129-B	1
72	L(73)			D2FZ 7310128-B	D2FZ 7310129-B	1

**BODY  
SECTION 100**
**FORD CAR PARTS**

GROUP NUMBER	YEAR	BODY TYPE	DESCRIPTION	PART NUMBER		QTY.
				RIGHT HAND	LEFT HAND	
<b>10128-9 PANEL - BODY ROCKER - continued</b>						
- P -						
	71/	P(54)		D1DZ 5410128-A	D1DZ 5410129-A	1
	70/	P(62)		D0DZ 6210128-A	D0DZ 6210129-A	1
- S -						
	67	S(57)		C9SZ 5710128-B	★C7SZ 5710129-A Not Repl. (3-74)	1
	68/69	S(57)		C9SZ 5710128-B	C9SZ 5710129-B	1
	67/69	S(65)		C9SZ 6510128-B	D1SZ 6510129-A	1
	70	S(57)		D0SZ 5710128-B	D0SZ 5710129-A	1
	70	S(65)		D0SZ 6510128-B	D0SZ 6510129-A	1
	71	S(57)		D1SZ 5710128-A	D1SZ 5710129-A	1
	71	S(65)		D1SZ 6510128-A	D1SZ 6510129-A	1
	72	S		D2SZ 6510128-A	D2SZ 6510129-A	1
- U -						
	66	U	"Before Ser.886,001"	C6TZ 9610128-A	C6TZ 9610128-A	2
	66/	U	"From Ser.886,001"	C6TZ 9610128-B	C6TZ 9610128-B	2
- X -						
	66/70	X(54,62)		C6DZ 5410128-A	C6DZ 5410129-A	1
	66	X(66,71)		C6OZ 7110128-A	C6OZ 7110129-A	1
	67/70	X(71)				1
<b>10130 LABEL - SILL PLATE</b>						
	65/70	F(GT 350/500)		S7MS 6310130-A	S7MS 6310130-A	2
<b>10132-3 REINFORCEMENT - FLOOR SIDE OUTER MEMBER</b>						
	65/66	F		C5ZZ 6510132-B	C5ZZ 6510132-A	2
	67/70	F		C5ZZ 6510132-B	C5ZZ 6510132-B	2
	72	L(73)		D2FZ 7310132-A	D2FZ 7310133-A	1
	72	S		D2SZ 6510132-A	D2SZ 6510133-A	1
<b>10144-5 REINFORCEMENT - FLOOR SIDE REAR MEMBER INNER</b>						
	66/71	B(76)		C6OZ 7610144-A	C6OZ 7610145-A	1
GROUP NUMBER	YEAR	BODY TYPE	DESCRIPTION	PART NUMBER		QTY.
<b>10146 MOULDING KIT - ROCKER PANEL</b>						
	71/	L			D1FZ 6210146-A	1
GROUP NUMBER	YEAR	BODY TYPE	DESCRIPTION	PART NUMBER		QTY.
<b>10156-7 REINFORCEMENT - FLOOR SIDE MEMBER TO FRONT SIDE MEMBER REAR</b>						
	66/69	B(54, 62, 63, 65, 66, 71), X		C6OZ 6210156-B	C6OZ 6210157-B	1
	70/71	B(except 76)		D0OZ 6510156-A	D0OZ 6510157-A	1
	70/71	B(76)		D0OZ 7610156-A	D0OZ 7610157-A	1
<b>10158-9 REINFORCEMENT - REAR FLOOR SIDE MEMBER TO FLOOR SIDE INNER MEMBER</b>						
	66/69	B(76)		C6OZ 7610158-A	C6OZ 7610159-A	1
	70	B(54, 62, 63, 76)				1
	71	B(54, 57, 63, 65, 76)				1
	66/70	X(54, 62)		C6DZ 6210158-A	C6DZ 6210159-A	1
<b>10164 REINFORCEMENT - FLOOR SIDE MEMBER AT CENTER BODY PILLAR</b>						
	70/71	B(57)		D0OZ 5710164-A	D0OZ 5710164-A	2
<b>101A68-9 REINFORCEMENT - FLOOR SIDE MEMBER TO DASH MOUNTING</b>						
	66	B(76)		C6OZ 76101A68-A	C6OZ 76101A69-A	1
	67	B(76)-427 C. I. D.- "Before 1/16/67"		C7OZ 76101A68-A	★C6OZ 76101A69-B Not Repl'd. (1-73)	1
	67	B(76) "Before 1/16/67"		C6OZ 76101A68-A	★C6OZ 76101A69-B Not Repl'd. (1-73)	1
	67/69	B(76)-200, 289, 390- "From 1/16/67"		C6OZ 76101A68-A	★C6OZ 76101A69-A Not Repl'd. (3-74)	1
	67/69	B(76) "From 1/16/67"		C7OZ 76101A68-A	★C6OZ 76101A69-C Not Repl'd. (1-73)	1
	68/69	B(76)		C6OZ 76101A68-A	★C6OZ 76101A69-C Not Repl'd. (1-73)	1
	70/71	B(76)		C6OZ 76101A68-A	D0OZ 76101A69-A	1



# FORD CAR PARTS

## BODY SECTION 100

5

GROUP NUMBER	YEAR	BODY TYPE	DESCRIPTION	PART NUMBER		QTY.
				RIGHT HAND	LEFT HAND	
<b>10170-1 FILLER - FLOOR SIDE OUTER MEMBER FRONT END</b>						
66/69		B(54, 65, 66, 71), X		C8OZ 5410170-A	C8OZ 5410171-A	1
68/69		B(63)-except Talladega				1
70/71		B		D0OZ 6510170-A	D0OZ 6510171-A	1
72		B		D2OZ 6510170-A	D2OZ 6510171-A	1
71/		F		D1ZZ 6510170-A	D1ZZ 6510171-A	1
70/		P		D0DZ 6210170-A	D0DZ 6210171-A	1
72		S		D2SZ 6510170-A	D2SZ 6510171-A	1
<b>10176-7 MOULDING - BODY ROCKER PANEL - INCLUDES ATTACHING PARTS</b>						
<b>- A -</b>						
65		A(54A, 57B, 63B, 71B, C, 76A)- "Before 9/21/64"	1 3/4" wide	C5AZ 6210176-B	C5AZ 6210177-B	1
65		A(57F, 63C, F, 76B)- "Before 9/21/64"	3 1/8" wide	C5AZ 6310176-A	C5AZ 6310177-A	1
65		A(54A, 57, 63, 71, 76)- "From 9/21/64"				1
65		A(54B, E, 62, 71A, D, E) 71D, 71E)	3 1/8" wide	C5AZ 6210176-C	C5AZ 6210177-C	1
66		A(54A, 57, 63, 71B, C, 76)		C6AZ 5410176-A	C6AZ 5410177-A	1
66		A(54B, E, 62, 71A, D, E)		C6AZ 6210176-B	C6AZ 6210177-B	1
68		A(54A, C, 57, 63, 65, 71B, C, 76)		C8AZ 5410176-A	C8AZ 5410177-A	1
70		A(54B, C, E, 57F, 62, 63, 65A, C, 71B, C, D, H, J, 76)		D0AZ 5410176-A	D0AZ 5410176-A	2
72		A(54F, 57F, 65F, 71F)		D2AZ 6510176-A	D2AZ 6510177-A	1
65/66		A	Rivet (blind)	378527-S(SS44B)	378527-S(SS44B)	AR
66		A	Clip assy. -No.10- 24 x 1 1/4"	380872-S100(BB643B)	380872-S100(BB643B)	2
<b>- B -</b>						
65		B		C5OZ 6210176-A	C5OZ 6210177-A	1
66		B(54B, 62B, 63B, C, 76B, C) 76C)		C6OZ 6210176-B	C6OZ 6210177-B	1
66		B(71B)		C6OZ 7110176-E	C6OZ 7110177-B	1
69		B(54C, 65C)		C9OZ 5410176-A	C9OZ 5410177-A	1
70		B(57E, 63F, 65E, 76F)		D0OZ 6510176-A	D0OZ 6510177-A	1
71		B(54C, 57C, 63C, 65C)		D1OZ 6510176-A	D1OZ 6510177-A	1
71		B(63F, 76)	Includes "GT" letters	D1OZ 6310176-A	D1OZ 6310177-A	1
71		B(66B, 71C)		D1OZ 7110176-A	D1OZ 7110177-A	1
71		B(66C)	Includes "GT" letters	D1OZ 6610176-A	D1OZ 6610177-A	1
71		B	Clip	381955-S100(GG333)	381955-S100(GG333)	2
<b>- F -</b>						
65/66		F(63, 65, 76)		C5ZZ 6510176-A	C5ZZ 6510177-A	1
67/68		F		C7ZZ 6510176-A	C7ZZ 6510177-A	1
69		F		C9ZZ 6510176-A	C9ZZ 6510177-A	1
70		F(63A, B, 65A, B, 76)		D0ZZ 6510176-B	D0ZZ 6510177-B	1
70		F(63C)		D0ZZ 6310176-A	D0ZZ 6310177-A	1
70		F(65E)	Black insert	D0ZZ 6510176-A	D0ZZ 6510177-A	1
71/		F		D1ZZ 6510176-A	D1ZZ 6510177-A	1
<b>- L -</b>						
71/72		L		D1FZ 6210176-A	D1FZ 6210176-A	2
<b>- P -</b>						
71/		P(54)		D1DZ 5410176-A	D1DZ 5410176-A	2
70/		P(62)	1 3/4" wide-without moulding holes	D0DZ 6210176-A	D0DZ 6210176-A	2
			Screw-round washer hd.- No.8-18 x 1/4"	381671-S45X(UU89C)	381671-S45X(UU89C)	AR
			Washer nut and sealer- hex. No. 8-32	377523-S100(MM291C)	377523-S100(MM291C)	2

**BODY  
SECTION 100**
**FORD CAR PARTS**

GROUP NUMBER	YEAR	BODY TYPE	DESCRIPTION	PART NUMBER		QTY.
				RIGHT HAND	LEFT HAND	
<b>10176-7 MOULDING - BODY ROCKER PANEL - INCLUDES ATTACHING PARTS - continued</b>						
- S -						
	67	S(57)		C7SZ 5710176-A	C7SZ 5710177-A	1
	67	S(65)		C7SZ 6510176-A	C7SZ 6510177-A	1
	68	S(57)		★C8SZ 5710176-A	C8SZ 5710176-A	φ 2
					r/b DOSZ 5710176-A (6/74)	
	68	S(65)		C8SZ 6510176-A	C8SZ 6510176-A	2
	69	S(57)		C9SZ 5710176-A	C9SZ 5710177-A	1
	69	S(65)		C9SZ 6510176-A	C9SZ 6510177-A	1
	70/71	S(57)		D0SZ 5710176-A	D0SZ 5710176-A	2
	70/71	S(65)		D0SZ 6510176-A	D0SZ 6510176-A	2
	72	S		D2SZ 6510176-A	D2SZ 6510177-A	1
			Clip-No. 8-32 x 1 1/4"	382121-S100(GG333A)	382121-S100(GG333A)	2
	68/71	S	Screw-pan head-No.6- 20 x 3/8"	382371-S(UU81L)	382371-S(UU81L)	2
- X -						
	65	X		C3DZ 6210176-B	C3DZ 6210177-B	1
	66	X(54, 62)		C9DZ 6210176-A	C9DZ 6210177-A	1
	69/70	X(54, 62)				1
	66	X(66, 71)		C9DZ 7110176-A	C9DZ 7110177-A	1
	69/70	X(71)				1
- U -						
	66/	U		C6TZ 9610176-A	C6TZ 9610177-A	1

**10182 RETAINER - ROCKER PANEL MOULDING**

REFER TO APPROPRIATE EXTERIOR MOULDING ILLUSTRATION  
FOR COMPLETE RETAINER PART NUMBER

**10194-5 GUSSET - FLOOR SIDE MEMBER TO FRONT SIDE MEMBER**

	67/69	B(except 76), X		C7OZ 6210194-B	C7OZ 6210195-B	1
	70	B(except 76), X		D0OZ 6510194-B	D0OZ 6510195-B	1
	71	B(except 76)				1
	70/71	B(76)		D0OZ 6510194-A	D0OZ 6510195-A	1

**10196-7 GUSSET - FLOOR SIDE MEMBER TO REAR SIDE MEMBER**

	66/71	B(76)		C6OZ 7610196-A	C6OZ 7610197-A	1
--	-------	-------	--	----------------	----------------	---

**10198 RETAINER - ROCKER PANEL MOULDING**

REFER TO APPROPRIATE EXTERIOR MOULDING ILLUSTRATION  
FOR COMPLETE RETAINER PART NUMBER

**10218-9 MEMBER - FRONT SIDE OUTER - Also refer to Group 10462**

	66/69	B(except 76)		C6OZ 6210218-A	C6OZ 6210219-B	1
	66/69	B(76)		C6OZ 7610218-A	C6OZ 7610219-B	1
	70/71	B		D0OZ 6510218-A	D0OZ 6510219-A	1
	67/70	F		C7ZZ 6510218-B	C7ZZ 6510219-B	1
	71/	F		D1ZZ 6510218-A	D1ZZ 6510219-A	1
	71/	L		D1FZ 6210218-A	D1FZ 6210219-A	1
	70/72	P		D0DZ 6210218-A	D0DZ 6210219-A	1
	66/70	X		C6OZ 6210218-A	C6OZ 6210219-B	1

**10262-3 REINFORCEMENT - FLOOR SIDE MEMBER TO FRONT SIDE MEMBER FRONT**

	66	B(54, 62, 63, 66, 71)		★C6OZ 6210262-A Not Repl'd. (3-74)	C6OZ 6210263-A	1
	67	B(except 76)- "Before 4/3/67"		★C6OZ 6210262-A Not Repl'd. (3-74)	C6OZ 6210263-C	1
	67	B(except 76) - "From 4/3/67"		★C6OZ 6210262-B Not Repl'd. (1-73)	C6OZ 6210263-C	1
	68/69	B(except 76)		C8OZ 5410262-A	C6OZ 6210263-C	1
	66/69	B(76)		C6OZ 7610262-B	★C6OZ 7610263-B Not repl'd. (1-73)	1
	70/71	B(except 76)		D0OZ 6510262-A	D0OZ 6510263-A	1
	70/71	B(76)		D0OZ 7610262-A	D0OZ 7610263-A	1

# FORD CAR PARTS

**BODY  
SECTION 100**

7

GROUP NUMBER	YEAR	BODY TYPE	DESCRIPTION	PART NUMBER		QTY.
				RIGHT HAND	LEFT HAND	
<b>10262-3 REINFORCEMENT - FLOOR SIDE MEMBER TO FRONT SIDE MEMBER FRONT - continued</b>						
	66	X		★C6OZ 6210262-A Not Repl'd. (3-74)	C6OZ 6210263-A	1
	67	X	"Before 4/3/67"	★C6OZ 6210262-A Not Repl'd. (3-74)	C6OZ 6210263-B	1
	67	X	"From 4/3/67"	★C6OZ 6210262-B Not Repl'd. (1-73)	C6OZ 6210263-C	1
	68/70	X		C8OZ 5410262-A	C6OZ 6210263-C	1
<b>102A78 SPACER - FLOOR SIDE MEMBER MOULDING</b>						
	66	A		C6AZ 54102A78-C	C6AZ 54102A78-C	6
	65	B		C5OZ 62102A78-A	C5OZ 62102A78-A	2
<b>103A06-7 REINFORCEMENT - REAR FLOOR SIDE MEMBER TO BUMPER MOUNTING</b>						
	66/67	B(54, 62, 63, 76)		C6OZ 62103A06-A	DOOZ 65103A07-A	1
	68/69	B(54, 63, 76)				1
	70/71	B(except 66, 71)		DOOZ 65103A06-A	DOOZ 65103A07-A	1
<b>103A22-3 GUSSET - FLOOR SIDE MEMBER TO WHEELHOUSE</b>						
	65/66	F(76) "Before 2/14/66"	Front-Steel	C5ZZ 76103A22-A	C5ZZ 76103A23-B	1
	66	F(76)- "From 2/14/66 to 5/23/66"	Front-Steel	C5ZZ 76103A22-B	C5ZZ 76103A23-B	1
	68/72	F(76) "Before 12/1/71"	Inner	D1ZZ 76103A22-A	D1ZZ 76103A23-A	1
	72	F(76) "From 12/1/71"	Inner	D2ZZ 76103A22-A	D2ZZ 76103A23-A	1
<b>10326 REINFORCEMENT-REAR FLOOR SIDE MEMBER REAR SPRING MOUNTING</b>						
	66	X(54, 62)		C6DZ 6210326-A	C6DZ 6210326-A	1
	67/	B	Serviced in basic			
	67/70	X	Group 10124-5			
<b>103A28-9 EXTENSION - FLOOR SIDE MEMBER TO FRONT SIDE MEMBER FRONT</b>						
	69	B(63) Talladega		C9OZ 63103A28-A	C9OZ 63103A29-A	1
	67/70	F(63, 65)		C8ZZ 65103A28-A	C7ZZ 65103A29-C	1
	65/70	F(76)		C5ZZ 76103A28-A		1
	65/70	F(76)			C5ZZ 76103A29-C	1
	71/	F		D1ZZ 65103A28-A	D1ZZ 65103A29-A	1
	70/	P		D0DZ 62103A28-A	D0DZ 62103A29-A	1
GROUP NUMBER	YEAR	BODY TYPE	DESCRIPTION	PART NUMBER	QTY.	
<b>103A58 VALVE - BODY ROCKER PANEL DRAIN</b>						
	65/69	A		C4AZ 62103A58-C	4or6	
	71/	A(71)				2
	65/	B				2
	65/66	F				2
	65/70	X				2
	67	F, S	Refer to Group 11202			
<b>103A94-5 PLATE - FLOOR OUTER MEMBER END</b>						
	71/72	L(62, 64) "Before 12/1/71"	R.H.	D1FZ 62103A94-A		1
			L.H.	D1FZ 62103A95-A		1
	72	L(62, 64) "From 12/1/71"	R.H.	D2FZ 62103A94-A		1
			L.H.	D2FZ 62103A95-A		1
<b>104A02 PLATE - FRONT SIDE INNER MEMBER</b>						
	70/	P		D0DZ 62104A02-A		2
GROUP NUMBER	YEAR	BODY TYPE	DESCRIPTION	PART NUMBER		QTY.
<b>10418-9 REINFORCEMENT - FLOOR SIDE INNER MEMBER</b>						
	66	B(76) "Before 11/15/65"		C6OZ 7610418-A	C6OZ 7610419-A	1
	66	B(76) "From 11/15/65"		C6OZ 7610418-B	C6OZ 7610419-B	1
	67/71	B(76)		C6OZ 7610418-E	DOOZ 7610419-A	1
	69/70	F(76)		C9ZZ 7610418-A	C9ZZ 7610419-A	1
	71	F(76)		D1ZZ 7610418-A	D1ZZ 7610419-A	1
	72	F(76)		D2ZZ 7610418-B	D2ZZ 7610419-B	1
	65/66	S(76)		★C4SZ 7610418-A	C4SZ 7610418-A	2
				Not replaced (3-74)		

May, 1975

COPYRIGHT © 1975 —

FORD MOTOR  
COMPANY

—DEARBORN, MICHIGAN

**FINAL ISSUE**

GROUP NUMBER	YEAR	BODY TYPE	DESCRIPTION	PART NUMBER	QTY.
<b>104A34-5 EXTENSION - REAR SIDE MEMBER TO FLOOR SIDE MEMBER UPPER</b>					
	66	B(71), X(66, 71)	R. H.	C6OZ 71104A34-A	1
	67/71	B(66, 71)			1
	67/70	X(71)			1
			L. H.	C6OZ 71104A35-A	1
	66/69	B(54, 62, 63)	R. H.	C6OZ 62104A34-A	1
			L. H.	C6OZ 62104A35-A	1
	66/71	B(76)	R. H.	C6OZ 76104A34-A	1
	70/71	B(54, 57, 62, 63, 65)	R. H.		1
			L. H.	C6OZ 76104A35-A	1
	67	B(54, 62, 63, 76)	Plug (button) 13/16" dia. hole	377678-S(PP3E)	2
	65/	F(63, 65)	R. H.	C5ZZ 65104A34-A	1
			L. H.	C5ZZ 65104A35-A	1
	65/	F(76)	R. H.	C5ZZ 76104A34-A	1
			L. H.	C5ZZ 76104A35-A	1
	66/70	X(54, 62)	R. H.	C6DZ 62104A34-A	1
			L. H.	C6DZ 62104A35-A	1
<b>10462-3 MEMBER - FRONT SIDE</b>					
	67/70	F	R. H. -includes inner	C7ZZ 6510462-B	1
			L. H.	C7ZZ 6510463-B	1
	70/71	P	R. H.	D0DZ 6210462-A	1
			L. H.	D0DZ 6210463-A	1
<b>104A70-1 REINFORCEMENT - REAR SIDE MEMBER TO FLOOR QUARTER</b>					
	66/71	B(76)	R. H.	C6OZ 76104A70-A	1
			L. H.	C6OZ 76104A71-A	1
<b>10492-3 EXTENSION - FLOOR SIDE OUTER MEMBER</b>					
	69/70	A(54, 57, 62, 71)	R. H. -rear- 6 1/4" long	C9AZ 5410492-B	1
	71/	A(53, 54, 57, 71)			1
			L. H.	C9AZ 5410493-B	1
	71/	F	R. H.	D1ZZ 6510492-A	1
			L. H.	D1ZZ 6510493-A	1
<b>10510 SPACER - FLOOR SIDE OUTER MEMBER</b>					
	66/69	B(except 63 Talladega)		C6OZ 6210510-B	4
	66/70	X			4
<b>10542-3 REINFORCEMENT - FRONT SUSPENSION NO. 2 CROSS MEMBER OUTER FRONT</b>					
	66/71	B	R. H.	C6OZ 6210542-A	1
	66/70	X			1
			L. H.	C6OZ 6210543-A	1
<b>105A62-3 EXTENSION - FLOOR SIDE INNER MEMBER</b>					
	68/69	B(except 76), X		C8OZ 54105A62-A	2
	70/71	B(except 76)	R. H.	D0OZ 65105A62-A	1
			L. H.	D0OZ 65105A63-A	1
<b>105A68-9 EXTENSION - FLOOR SIDE MEMBER REAR</b>					
	67/71	S(57)	R. H.	C7SZ 57105A68-A	1
			L. H.	C7SZ 57105A69-A	1
	70	S(65)	R. H.	D0SZ 65105A68-A	1
	71	S(65A, C)			1
			L. H.	D0SZ 65105A69-A	1
<b>105A70 REINFORCEMENT - FLOOR SIDE MEMBER REAR EXTENSION</b>					
	66/69	B(76)		C6OZ 76105A70-B	2
	70/71	P			2
	70/71	B(76)		D0OZ 76105A70-A	2
<b>105A90 STRIKER - STORAGE COMPARTMENT DOOR LATCH</b>					
	67/71	A(71), B(71)		C7AZ 71105A90-A	1
	72	A(71)			1
	72	B(71)	Refer to group 31710		
<b>10608 SILL - REAR FLOOR CROSS REAR</b>					
	66/	U		C6TZ 9610608-A	1

# FORD CAR PARTS

## BODY SECTION 100

9

GROUP NUMBER	YEAR	BODY TYPE	DESCRIPTION	PART NUMBER				QTY.
				RIGHT HAND		LEFT HAND		
<b>106A18-9 EXTENSION - REAR FLOOR REAR CROSS MEMBER</b>								
	72	B(97)		D2OZ	97106A18-A	D2OZ	97106A19-A	1
	67/71	S		C7SZ	65106A18-A	C7SZ	65106A19-A	1
<b>10644-5 EXTENSION - FRONT SIDE QUARTER MEMBER REAR</b>								
	66/71	B(76)		C6OZ	7610644-B	C6OZ	7610645-B	1
<b>10648 REINFORCEMENT - FRONT FLOOR NO. 2 CROSS MEMBER</b>								
	72	S		D2SZ	6510648-A	D2SZ	6510648-A	1
<b>10662-3 MEMBER - FRONT FLOOR CROSS NO. 2 OUTER</b>								
	70/71	S(65)		D0SZ	6510662-A	D0SZ	6510663-A	1
<b>10672-3 MEMBER - FRONT FLOOR CROSS UPPER</b>								
	66/71	B(76)		C6OZ	7610672-A	C6OZ	7610672-A	1
	72	B		D2OZ	6510672-A	D2OZ	6510673-A	1
	69/70	F(63)		C9ZZ	6310672-A	C9ZZ	6310673-A	1
	69/70	F(65)		C9ZZ	6510672-A	C9ZZ	6510673-A	1
	69/70	F(76)		C9ZZ	7610672-A	C9ZZ	7610673-A	1
	71/	F(63)		D1ZZ	6310672-A	D1ZZ	6310673-A	1
	71/	F(65)		D1ZZ	6510672-A	D1ZZ	6510673-A	1
	71/	F(76)		D1ZZ	7610672-A	D1ZZ	7610673-A	1
	72	S		D2OZ	6510672-A	D2OZ	6510673-A	1
<b>10692-3 MEMBER - FRONT FLOOR CROSS NO. 1</b>								
	66/67	B(except 76)		C6OZ	6210692-B	C6OZ	6210693-A	1
	68/71	B(except 76)		C6OZ	6210692-B	C6OZ	6210693-B	1
	72	B		D2OZ	6510692-A	D2OZ	6510692-A	1
	65/70	F		C5ZZ	6510692-C	C5ZZ	6510692-C	1
	71/	F	Remove emergency brake cable brkt. from engine support (6A023) and re-weld brkt. to new engine support (C7ZZ 6A023-D) as required	D1ZZ	6510692-A	D1ZZ	6510692-A	1
	70	P		D0DZ	6210692-C	D0DZ	6210692-C	1
	71/	P		D1DZ	6210692-A	D1DZ	6210692-A	1
	66	S		★C6SZ	6310692-A	C6SZ	6310692-A	1
				Not replaced (3-74)				
	68/69	S		C8SZ	6510692-B	C8SZ	6510693-B	1
	70/71	S(57)						1
	71	S(65B, D)						1
	70	S(65)		D0SZ	6510692-A	D0SZ	6510693-A	1
	71	S(65A, C)						1
	72	S		D2OZ	6510692-A	D2OZ	6510692-A	1
	66/67	X		C6OZ	6210692-A	C6OZ	6210693-A	1
	68/70	X		C6OZ	6210692-B	C6OZ	6210693-B	1
GROUP NUMBER	YEAR	BODY TYPE	DESCRIPTION	PART NUMBER				QTY.
<b>10728 MEMBER - FRONT FLOOR CROSS NO. 2</b>								
	70/	P	Without non-reclining bucket seats	D0DZ	6210728-A			2
	71/	P(62)	With non-reclining bucket seats	D1DZ	6210728-A			2
	68/69	S	R. H.	C8SZ	6510728-A			1
	70/71	S(57)						1
	71	S(65B, D)						1
			L. H.	C8SZ	6510728-B			1
	65	X(except 76)		C3DZ	6210728-A			2
<b>10760 REINFORCEMENT - REAR FLOOR REAR CROSS MEMBER</b>								
	66/69	B(76)		C8OZ	7610760-A			1
	70	B(76)		D0OZ	7610760-A			2
	71	B(76)		D1OZ	7610760-A			1
	65/71	F(76)		C5ZZ	7610760-B			1
<b>107A70 BRACKET - FRONT FLOOR PAN SEAT TRACK REINFORCEMENT</b>								
	67/69	S		C7SZ	65107A70-A			2
<b>10776 MEMBER - FRONT FLOOR CROSS NO. 1</b>								
	72	L		D2FZ	6210776-A			1

**BODY  
SECTION 100**
**FORD CAR PARTS**

GROUP NUMBER	YEAR	BODY TYPE	DESCRIPTION	PART NUMBER		QTY.
				RIGHT HAND	LEFT HAND	
<b>10780 MEMBER - REAR FLOOR CROSS - REAR</b>						
	66/67	B(54, 62, 63, 76)		C6OZ	6210780-A	1
	68/69	B(54, 63, 65, 76)		C8OZ	5410780-A	1
	66/70	B(66), X(71)- B(66)		C6DZ	7110780-D	1
	70	B(54, 57, 62, 63, 65, 76)		D0OZ	7610780-A	1
	71	B(except 71)		D1OZ	7610780-A	1
	72	B(except 71, 97)		D2OZ	6510780-A	1
	65/70	F		C5ZZ	7610780-B	1
			Plug (button)-3/8" diameter hole	379286-S	(PP2C)	1
	71/	F		D1ZZ	6510780-A	1
	72	L(73)		D2FZ	7310780-A	1
	70	P		D0DZ	6210780-A	1
	71/	P	Notches for fuel tank straps	D1DZ	6210780-A	1
	67/71	S		C7SZ	6510780-A	1
	72	S	Refer to Group 11215			
	65	X(59, 66, 71, 78)		C4DZ	5910780-A	1
	66	X(66, 71) "Before 12/28/65"		C6DZ	7110780-A	1
	66/70	X(54, 62)		C6DZ	6210780-A	1
<b>10784-5 EXTENSION - REAR SIDE MEMBER TO FLOOR SIDE MEMBER - Also refer to Group 10124-5</b>						
	65/69	F(63, 65)	R. H.	C5ZZ	6510784-A	1
	70/	P	L. H. Refer to Group 10124-5	★C5ZZ	6510785-A	1
	65/68	F	Plug (button)-1 1/2" diameter hole		377901-S(PP14N)	4
<b>10786 MEMBER - REAR FLOOR CROSS - FRONT</b>						
	67/70	B(66), X(71)		C6DZ	7110786-D	1
	71	B(66)				1
	66	X(66, 71) "Before 12/28/65"		C6DZ	7110786-A	1
	66	X(66, 71) "From 12/28/65"		C6DZ	7110786-D	1
	67	X(71) "Before 3/1/67"				1
<b>10790 REINFORCEMENT - REAR FLOOR CROSSMEMBER UPPER</b>						
	67/71	B(66)		C7OZ	6610790-A	2
	67/70	X(71)				2
GROUP NUMBER	YEAR	BODY TYPE	DESCRIPTION	PART NUMBER		QTY.
				RIGHT HAND	LEFT HAND	
<b>10796-7 EXTENSION - REAR FLOOR CROSS SILL TO INNER QUARTER PANEL - Also Refer to Group 10838-9</b>						
	72	B(71)		D2OZ	7110796-A	
				D2OZ	7110797-A	1
<b>10812-3 MEMBER - FRONT FLOOR CROSS LOWER</b>						
	67/70	F(76)		C5ZZ	7610812-B	1
	68/70	F(76)		C5ZZ	7610813-C	1
	71/	F(76)		D1ZZ	7610812-A	1
				D1ZZ	7610813-A	1
<b>10816 REINFORCEMENT - REAR FLOOR REAR SILL PANEL</b>						
	72	B(71)		D2OZ	7110816-A	1
<b>10838-9 EXTENSION - REAR FLOOR REAR SILL PANEL - Also refer to Group 10796-7</b>						
	66/68	A(71)		C6AZ	7110838-A	
	69/70	A(71)		C6AZ	7110839-A	1
	71/	A(71)		C9AZ	7110838-A	
	66	B(71), X(66, 71)		C9AZ	7110839-A	1
	67/70	B(66, 71), X(71)		D1AZ	7110838-A	
	71	B(66, 71)		D1AZ	7110839-A	1
				C6OZ	7110838-A	
				C6OZ	7110839-A	1
						1
						1
GROUP NUMBER	YEAR	BODY TYPE	DESCRIPTION	PART NUMBER		QTY.
<b>10852 MEMBER - FRONT FLOOR CROSS - Also Refer to Group 10018</b>						
	66/69	B		C8OZ	5410852-A	1
	70	B	Use w/250, 302 or 351 C. I. D. engines	★COOZ	6510852-A	1
				r/b D0OZ	6510852-B	
					(8-73)	
	70	B	Use with 429 C. I. D. engines	D0OZ	6510852-B	1
	71	B	Use with all engines			1
	71/	F				1

GROUP NUMBER	YEAR	BODY TYPE	DESCRIPTION	PART NUMBER	QTY.
<b>10852</b>	<b>MEMBER - FRONT FLOOR CROSS - Also refer to Group 10018 - continued</b>				
	67/70	F		C7ZZ 6510852-B	1
	70	P	"Before 9/15/69"	D0DZ 6210852-A	1
	70/	P	"From 9/15/69"	D0DZ 6210852-B	1
	66/69	X		C8OZ 5410852-A	1
<b>10920-1</b>	<b>MEMBER - AUXILIARY FLOOR CROSS AT CAB</b>				
	72	B(97)	L.H.	D2OZ 9710921-A	1
	66	X(66)		C6DZ 6610920-B	1
	67/71	B(66)			1
<b>10948-9</b>	<b>GUSSET - FRONT CROSS MEMBER TO SIDE MEMBER</b>				
	70/72	P	"Before 5/10/72"	R.H. D0DZ 6210948-A	1
				L.H. D0DZ 6210949-A	1
	72	P	"From 5/10/72"	R.H. D3DZ 6210948-A	1
				L.H. D3DZ 6210949-A	1
<b>10950-1</b>	<b>REINFORCEMENT - REAR FLOOR CROSS MEMBER TO FLOOR PAN</b>				
	65/71	F(76)	R.H. L.H.	C5ZZ 7610950-A C5ZZ 7610951-A	1 1
<b>10962</b>	<b>PLATE - FRONT FLOOR LOWER CROSS MEMBER</b>				
	66/70	B(76B, C)		C6OZ 7610962-A	1
	69/70	B(76D, F)	With 390 engine		1
	71	B(76)	With 429 engine		1
	65/	F(76)		C5ZZ 7610962-A	1
			3/8"-16 x 1 1/8" Hex. head bolt & washer assy.	373162-S(BB563A)	6
<b>10974-5</b>	<b>REINFORCEMENT - REAR FLOOR REAR SILL PANEL EXTENSION</b>				
	66	B(71), X(66, 71)	R.H.	C6OZ 7110974-A	1
	67/70	B(66, 71), X(71)			1
	71	B(66, 71)			1
			L.H.	C6OZ 7110975-A	1
	72	B(71)	R.H. L.H.	D2OZ 7110974-A D2OZ 7110975-A	1 1
<b>111A08-9</b>	<b>MOULDING - REAR FLOOR PAN SIDE</b>				
	66/71	B(71)	R.H. -Paint to match L.H.	C6OZ 71111A08-A C6OZ 71111A09-A	1 1
			No. 8-18 x 1/2" Pan head screw	380934-S101(UU67F)	2
<b>111B12-3</b>	<b>REINFORCEMENT - FRONT FLOOR PAN INNER</b>				
	68/71	S	R.H. L.H.	C7SZ 65111B12-B C7SZ 65111B13-B	1 1
<b>11117</b>	<b>PLATE - FRONT FLOOR PAN DRAIN HOLE COVER</b>				
	65/70	A, X	Drill holes as required	C7AZ 6211117-A	AR
	65/71	B, S			AR
	65/66	F			AR
	71/	A, L, S		C7ZZ 6511117-A	AR
	69	B(54, 63, 76)	With 4 speed trans. -428 engine		AR
	71	B(62, 63, 65, 76)	With 429 engine		AR
	72	B			AR
	67/	F			AR
	70/	P			AR
	70/	P	Screw-hex. hd. - No. 8-18 x 3/4"	376389-S101(UU82D)	2
<b>111B24</b>	<b>COVER - REAR FLOOR ACCESS HOLE</b>				
	66	X(66)		C6DZ 66111B24-A	3
	67/71	B(66)			3
	70	B(except 66, 71), P	Improvise	★	
<b>11135</b>	<b>PAN - FRONT FLOOR</b>				
	- A -				
	69/70	A(54)		C9AZ 5411135-A	1
	69/70	A(57)		C9MY 5711135-A	1
	69/70	A(63, 65)		C9AZ 6311135-A	1
	69/70	A(71)		C9AZ 7111135-A	1
	69/70	A(76)		C9AZ 7611135-A	1

**BODY  
SECTION 100**
**FORD CAR PARTS**

GROUP NUMBER	YEAR	BODY TYPE	DESCRIPTION	PART NUMBER	QTY.
<b>11135</b>	<b>PAN - FRONT FLOOR - continued</b>				
	71/72	A(53, 54, 57, 71)- "Before 12/1/71"		D1AZ 5711135-A	1
	72	A(53, 54, 57, 71)- "From 12/1/71"		D2AZ 5711135-A	1
	71/72	A(65) "Before 12/1/71"		D1AZ 6511135-A	1
	72	A(65) "From 12/1/71"		D2AZ 6511135-A	1
	71/72	A(76) "Before 12/1/71"		D1AZ 7611135-A	1
	72	A(76) "From 12/1/71"		D2AZ 7611135-A	1
	<b>- B -</b>				
	70	B(54, 57, 62, 63, 65)		D0OZ 6511135-A	1
	70	B(66, 71)		D0OZ 7111135-A	1
	70	B(76)		D0OZ 7611135-A	1
	71	B			1
	72	B(53, 71, 97)- "Before 1/3/72"		D2OZ 5311135-A	1
	72	B(53, 71, 97)- "From 1/3/72"		D2OZ 5311135-B	1
	72	B(63, 65) "Before 1/3/72"		D2OZ 6511135-A	1
	72	B(63, 65) "From 1/3/72"		D2OZ 6511135-B	1
	<b>- F -</b>				
	65/66	F		C5ZZ 6511135-A	1
	67/68	F		C5ZZ 6511135-C	1
	69/70	F		C9ZZ 6511135-A	1
	71/72	F "Before 12/1/71"		D1ZZ 6511135-A	1
	72	F(63, 65) "From 12/1/71"		D2ZZ 6511135-A	1
	72	F(76) "From 12/1/71"		D2ZZ 7611135-A	1
	<b>- L -</b>				
	71/72	L "Before 12/1/71"		D2FZ 6211135-A	1
	72	L "From 12/1/71"		D3FZ 6211135-B	1
	<b>- P -</b>				
	70	P(62)		D0DZ 6211135-A	1
	71/72	P "Before 12/1/71"		D1DZ 5411135-A	1
	72	P "From 12/1/71"		D2DZ 5411135-A	1
	<b>- S -</b>				
	68/71	S(57)		D0SZ 5711135-A	1
	68/70	S(65)		D0SZ 6511135-A	1
	71	S(65)		D1SZ 6511135-A	1
	72	S		D2SZ 6511135-A	1
	<b>- U -</b>				
	66/	U		C6TZ 9611135-A	1
	<b>- X -</b>				
	66	X(66, 71)		C6OZ 7111135-A	1
	67	X(71)			1
	66/70	X(54, 62)		C6DZ 6211135-B	1
	68/70	X(71)		C6OZ 7111135-B	1
	69/	A	Plug (button)-1 1/2" diameter hole	352285-S (PP5)	4
			Plug (button)-3 1/16" diameter hole	372443-S (PP12)	2
	69/	A	Plug (button)-1" x 2"	379305-S (PP13D)	10
	65	X	Plug (button)-5/8" diameter hole-body bolt hole	357042-S (PP2)	2or4
	69/	A			4
	69/	A	Plug (button)-1 1/4" diameter hole	352284-S (PP4)	4
	69/	A, S	Plug (button)-2 7/16" diameter hole-transmission	374732-S (PP14)	1
	65/70	X	band adjustment access hole		1
	65/70	A, B, S, X	Plug (button)-7/8" diameter hole	377949-S (PP3F)	2
	65/70	A, B, F, S	Plug (button)-1 1/2" diameter hole - flat	377901-S (PP14N)	6or8
	65/70	B(66, 71)	Plug (button)-1 1/2" diameter hole	377678-S (PP3E)	2
	72	B, S			2
	67	F(76)	Plug (button)-3" diameter hole	377865-S7-8 (PP14Q)	2
	66	X(66)	Plug (button)-1/2" diameter hole	377935-S (PP2D)	4
<b>11142-3</b>	<b>EXTENSION - FLOOR PAN SIDE</b>				
	66/	U	R. H.	C6TZ 9611142-A	1
			L. H.	C6TZ 9611143-A	1



# FORD CAR PARTS

## BODY SECTION 100

13

GROUP NUMBER	YEAR	BODY TYPE	DESCRIPTION	PART NUMBER		QTY.
				RIGHT HAND	LEFT HAND	
<b>11144-5 REINFORCEMENT - FRONT FLOOR PAN REAR</b>						
	72	B(71)		D2OZ 7211144-A	D2OZ 7111145-A	1
	72	L	Side	D2FZ 6211144-A	D2FZ 6211144-A	2
<b>111A44-5 REINFORCEMENT - FRONT FLOOR PAN</b>						
	68/71	S		C8SZ 65111A44-B	C8SZ 65111A45-B	1
GROUP NUMBER	YEAR	BODY TYPE	DESCRIPTION	PART NUMBER		QTY.
<b>11160 PAN - CENTER FLOOR</b>						
- A -						
	69	A(except 71)		C9AZ 6211160-A		1
	70/71	A(except 71)		D1AZ 6511160-A		1
	69/71	A(71)		C9AZ 7111160-A		1
	72	A(except 71, 76)		D2AZ 6511160-A		1
	72	A(71)	"Before 12/1/71"	D2AZ 7111160-A		1
	72	A(71)	"From 12/1/71"	D2AZ 7111160-B		1
	72	A(76)		D2AZ 7611160-A		1
- B -						
	66/71	B(66)		C6DZ 6611160-B		1
	66/71	B(except 66, 71)		C6OZ 6211160-C		1
	66/70	B(71), X(71)		C6OZ 7111160-B		1
	71	B(71)				1
	72	B(71)	"Before 12/1/71"	D2OZ 7111160-A		1
	72	B(71)	"From 12/1/71"	D2OZ 7111160-B		1
- F -						
	65/70	F		C5ZZ 6511160-D		1
	71	F		D1ZZ 6511160-A		1
	72	F		D2ZZ 6511160-A		1
- P -						
	70	P(62)		D0DZ 6211160-A		1
	71	P		D1DZ 6211160-A		1
	72	P		D2DZ 6211160-A		1
- S -						
	67/70	S		D0SZ 6511160-A		1
	71	S		D1SZ 6511160-A		1
- U -						
	66/71	U		C6TZ 9611160-A		1
	72	U	"Before Ser. P40,001"	D2TZ 1011160-A		1
	72	U	"From Ser. P40,001"	D3BZ 1011160-A		1
	66/	U	Plug (button)-1/4" diameter hole	380864-S(PP2A)		1
	72	U	Bolt-hex.washer hd.-3/8"-16 x 4 17/64"	383272-S2(BB552BC)		2
<b>111A64 REINFORCEMENT - REAR FLOOR PAN</b>						
	66/71	B(except 66, 71)		C6OZ 62111A64-A		2
	66/70	X(except 71)				2
	70	P	Improvise from pressed board	★		
<b>111A74 PLATE - FRONT FLOOR PAN ACCESS HOLE COVER</b>						
	71/	A(P/C)	With 8 cyl. 429 engine	D1AZ 54111A74-A		1
<b>111B74 DEADENER - CENTER FLOOR PAN FRONT SOUND</b>						
	67/68	A(71)		C7AZ 71111B74-A		1
<b>111A88 GROMMET - REAR FLOOR PAN OPENING</b>						
	71	B	California units only	D0DZ 62111A88-A		1
	70	P	With evaporative emission control			1
<b>11192 REINFORCEMENT - CENTER FLOOR PAN TO SEAT BACK STRAINER</b>						
	65/67	F(76)		C5ZZ 7611192-A		1
	69/70	F(76)				1
	71/	F(76)		D1ZZ 7611192-A		1
<b>11202 SEAL - REAR FLOOR PAN EXTENSION DRAIN</b>						
	65	A, B, S, X(59, 71, 78)		C3AZ 6211202-A		1or2
	66/67	A, B, S, X				1or2
	68/70	A, B(71), S, X(54, 62, 71)				1or2
	69/71	A(except 71)		C7ZZ 6511202-A		2
	68/	B(except 71, 97)				2
	67/	F				2
	72	L				2
	70/	P	Use with 11/32" square hole			2
	67/71	S				2
	72	A(except 71)	Plug (button)-hole size 7/8"	377949-S(PP3F)		2

**BODY  
SECTION 100**
**FORD CAR PARTS**

GROUP NUMBER	YEAR	BODY TYPE	DESCRIPTION	PART NUMBER	QTY.
<b>112B04 Moulding - Rear Floor Pan Side Rear</b>					
66/	B(71)		Paint to match	C6OZ 71112B04-A	1
66/70	X(71)		Refer to Group 47176		
<b>112A06-7 REINFORCEMENT - CENTER FLOOR PAN AT PINION BUMPER</b>					
72	P		R.H. for seat belt attachment	D2DZ 62112A06-A	1
			L.H.	D2DZ 62112A07-A	1
<b>11215-9 PAN - REAR FLOOR</b>					
- A -					
69/70	A(except 71)			C9AZ 6211215-A	1
69/71	A(71)			C9AZ 7111215-A	1
71	A(except 71)			D1AZ 6511215-A	1
72	A(except 71)			D2AZ 6511215-A	1
72	A(71)			D2AZ 7111215-A	1
69/	A		Plug - 5/8" diameter hole	357042-S(PP2)	2
- B -					
66/71	B(71)		Plug (button) -15/16" diameter hole	C6OZ 7111218-B	1
67/69	B(66)			377678-S(PP3E)	2
70/71	B(66)			C6DZ 6611218-B	1
72	B(53, 63, 65)			D0OZ 6611218-A	1
72	B(71)			D2OZ 6511215-A	1
72	B(97)			D2OZ 7111215-A	1
72	B(97)		End extension	D2OZ 9711215-A	1
				D2OZ 9711218-A	§ 1
- F -					
65/70	F		R. H.	C9ZZ 6511218-A	1
			L. H.	C9ZZ 6511219-A	1
			Grommet-1 1/2" diameter hole	352285-S(PP5)	1
67/68	F(except Cobra Jet)		R. H.	★C7ZZ 6511218-A	∅ 1
			L. H.	Not replaced	
			Plug (button)-7/8" diameter hole	C7ZZ 6511219-A	1
71/	F			377949-S(PP3F)	2
				D1ZZ 6511218-A	1
- L -					
71/72	L(62, 64)	"Before 12/1/71"		D2FZ 6211218-B	1
			Plug (button)-1" diameter hole	383796-S(PP3FA)	2
72	L(62, 64)	"From 12/1/71"		D2FZ 6211218-C	1
72	L(73)			D3FZ 7311215-A	1
- P -					
70	P(62)		R. H.	D0DZ 6211218-A	1
			L. H.	D0DZ 6211219-A	1
71/	P		Plug(button)-7/8" diameter hole	D1DZ 6211218-A	1
				377949-S(PP3F)	2
- S -					
67/71	S		Plug (button)-1 5/8" diameter hole	C7SZ 6511218-C	1
72	S			★379536-S	2
			Plug (button)-15/16" dia. hole	D2SZ 6511215-A	1
				377678-S(PP3E)	2
- U -					
66/	U		Bolt-hex. washer hd.-3/8"-16 x 5"	C6TZ 9611215-A	1
				383273-S2(BB552CC)	2
- X -					
66/70	X(71)			C6DZ 7111218-A	1
66	X(66)		Plug(button)-1/2" diameter hole	D0OZ 6611218-A	1
				377935-S (PP2D)	6
<b>112A19 COVER - FRONT FLOOR PANEL WIRE FRONT</b>					
69/	A		L.H.	C9AZ 62112A19-A	1

# FORD CAR PARTS

## BODY SECTION 100

15

GROUP NUMBER	YEAR	BODY TYPE	DESCRIPTION	PART NUMBER		QTY.
				RIGHT HAND	LEFT HAND	
<b>112A22-3 PAN - REAR FLOOR SIDE REAR</b>						
	66	B(54, 62, 63)			C6OZ 62112A23-A	1
	68/69	B(54, 63, 65)		C8OZ 54112A22-A	C8OZ 54112A23-A	1
	70/71	B(54, 57, 62, 63, 65, 76)		D0OZ 65112A22-A	D0OZ 65112A23-A	1
	66/70	X(54, 62)		C6DZ 62112A22-A	C6DZ 62112A23-A	1
	66/71	B	Plug (button)-13/16" diameter hole	377949-S(PP3F)	377949-S(PP3F)	1
	66/70	X	Plug (button)-3/8" diameter hole	379286-S(PP2C)	379286-S(PP2C)	1
<b>11228-9 FILLER - REAR FLOOR TO QUARTER PANEL</b>						
	69/70	A(54, 57, 63, 65, 76)			C9AZ 5411228-A	1or2
	71	A(53, 54F, 57, 65, 76)				2
	72	A(53H, K, 57H, K, 65H, K, 76)				1or2
	68/69	B(54, 63, 65, 76)			C8OZ 5411228-A	2
	70/71	B(except 66, 71)	R. H. L. H.		D0OZ 6511228-A	1or2
	65/66	F			C5ZZ 6511228-A	1
	67/68	F	Panel board		C7ZZ 6511229-A	1
	69/70	F			C9ZZ 6511228-A	1
	71	F			D1ZZ 6511228-A	1
	68/70	X(54, 62)			C8DZ 6211228-A	2
	65/67	B, X	No. 14-10 x 1" Truss head screw		32951-S7-8(U352A)	3or6
<b>112B36-7 BRACKET - REAR FLOOR PAN-Also refer to Body Bolt Chart at end of Section 020</b>						
	67/	S	R. H. - at front body bolt hole L. H.		C7SZ 65112B36-A	1
					C7SZ 65112B37-A	1
<b>112B42-3 EXTENSION - FRONT FLOOR PAN REAR</b>						
	68/71	S	R. H. L. H.		C8SZ 65112B42-B	1
					C8SZ 65112B43-B	1
<b>11246-9 REINFORCEMENT - FRONT FLOOR PAN SEAT TRACK</b>						
	71	A(except 76)			D1AZ 6511248-A	1
	71	A(76)			D1AZ 7611248-A	1
	66/71	B (except 76)			★C6OZ 6211246-B	1
	72	B			D2OZ 6511248-A	1
	71/	F			D1ZZ 6511246-A	2
	70/	P			D0DZ 6211248-A	2
	68/71	S(57)			C8SZ 6511248-B	1
	70/71	S(65)			D0SZ 6511248-A	1
	72	S			D2OZ 6511248-A	1
	66/	U	Front seat-5/16"-18 Weld nut Rear seat		C6TZ 9611246-A	2
	66/	U	Front seat-5/16"-18 Weld bolt-Used with auxiliary fuel tank Rear seat		C6TZ 9611246-B	2
	66/70	X			★C6OZ 6211246-B Not replaced (3-74)	1
<b>112A48-9 EXTENSION - REAR FLOOR PAN SIDE FRONT</b>						
	66/	U			C6TZ 96112A48-A	1
<b>112B48 DRAIN - AUXILIARY FLOOR</b>						
	67/71	B(66)	Includes 2.06" wide drain plate		C6DZ 66112B48-B	4
	66/70	X(66)	"From 4/18/66"		C6DZ 66112B48-E	2or4
	66	X(66)	"Before 4/18/66"		C6DZ 66112B48-A	4

GROUP NUMBER	YEAR	BODY TYPE	DESCRIPTION	PART NUMBER		QTY.
				RIGHT HAND	LEFT HAND	
<b>11250-1</b>	<b>EXTENSION - REAR FLOOR PAN TO QUARTER PANEL</b>					
	65/66	A(except 71)		C5AZ 6211250-A	C5AZ 6211251-A	1
	67	A(except 71)		C7AZ 6211250-A	C7AZ 6211251-A	1
	68	A(except 71)		C8AZ 6211250-A	C8AZ 6211251-A	1
	69/70	A(except 71)		C9AZ 6211250-A	C9AZ 6211251-A	1
	71	A(except 71)		D1AZ 6511250-A	D1AZ 6511251-A	1
	72	A(except 71)		D2AZ 6511250-A	D2AZ 6511251-A	1
	72	B(except 71,97)		D2OZ 6511250-A	D2OZ 6511251-A	1
	67/71	S		C7SZ 6511250-B	C7SZ 6511251-A	1
	72	S		D2SZ 6511250-A	D2SZ 6511251-A	1
	65/66	A,B,S	Plug(button)-1 1/2" dia. hole	377678-S(PP3E)	377678-S(PP3E)	2
	72	A	Plug(button)7/8" dia.hole	377949-S(PP3F)	377949-S(PP3F)	2
<b>11252-3</b>	<b>EXTENSION - REAR FLOOR PAN REAR CORNER</b>					
	68/71	B(71)		C8OZ 7111252-A	C8OZ 7111253-A	1
	67/71	S		C7SZ 6511252-A	C7SZ 6511252-A	1
<b>112B62</b>	<b>PLATE - PARKING BRAKE CABLE SKID</b>					
	67/68	S		C7SZ 65112B62-A	C7SZ 65112B62-A	1
	69/71	S		C9SZ 65112B62-A	C9SZ 65112B62-A	1
<b>112B72-3</b>	<b>FILLER - CENTER FLOOR PAN CORNER</b>					
	67/68	A(except 71)		C7AZ 62112B72-A	C7AZ 62112B73-A	1
	68/71	S				1
<b>11278</b>	<b>BRACKET - BODY BOLT</b>					
	68/71	S		C8SZ 6511278-B	C8SZ 6511278-B	2
<b>112B88-9</b>	<b>COVER - FRONT FLOOR PAN WIRE</b>					
	69/	A		C9AZ 62112B88-A		1
	69/70	A(except 63, 65, 76)			C9AZ 62112B89-A	1
	71/	A(except 65, 76)				1
	69/70	A(63, 65, 76)		C9AZ 63112B89-A	C9AZ 63112B89-A	1
	71/	A(65, 76)				1
	72	B,S			D2OZ 65112B88-B	1
	72	B,S			D2OZ 65112B88-A	1
	72	B(53, 71),S		D2OZ 53112B88-A	D2OZ 53112B88-A	1
	72	B(63, 65)			D2OZ 65112B88-C	1
	72	B(97)		D2OZ 97112B88-A	D2OZ 97112B88-A	1
	71/	A	Pin-drive-plastic-5/16"	377163-S(NN165)	377163-S(NN165)	2
GROUP NUMBER	YEAR	BODY TYPE	DESCRIPTION	PART NUMBER		QTY.
<b>11310</b>	<b>HOUSING - FUEL TANK FILLER PIPE INNER</b>					
	65/66	A(except 71)		C5AZ 6211310-B		1
	67/69	B(except 71)	Refer to Group 27936			
<b>113A12-3</b>	<b>REINFORCEMENT - CENTER FLOOR PAN MUFFLER MOUNTING BRACKET</b>					
	65/66	F	R. H. -Use with dual muffler-not replaced (3-74) L. H.	★C5ZZ 65113A12-A		1
				C5ZZ 65113A13-A		1
	67/71	F	R. H. -Use with dual muffler L. H.	C5ZZ 65113A12-B		1
				C5ZZ 65113A13-B		1
<b>11318</b>	<b>PANEL - REAR FLOOR SILL REAR</b>					
	66/68	A(71)		C6AZ 7111323-A		1
	69/71	A(71)		C9AZ 7111323-A		1
	66	B(71)	"Before 12/10/65"	C6OZ 7111323-A		1
	67/71	B(66)		C6DZ 7111323-B		1
	67/71	B(71)		C7OZ 7111323-A		1
	72	B(71)		D2OZ 7111318-A		1
	72	B(97)		D2OZ 9711318-A		1
	72	L(73)		D2FZ 7311318-A		1
			Screw-oval head-cross recess-No. 8-18 x 1/2"	52413-S13(U316)		8
	65	X(59, 66, 71, 78)	Refer to Group 11318			1
	66/70	X(66, 71)		C6DZ 7111323-B		1
<b>11323</b>	<b>PANEL - REAR FLOOR SILL REAR - Refer to group 11318</b>					
<b>113A28</b>	<b>PLATE - FLOOR PAN SEAT TRACK REINFORCEMENT</b>					
	66/71	B(except 76)		C6OZ 62113A28-A		1
	66/70	X				1

# FORD CAR PARTS

## BODY SECTION 100

17

GROUP NUMBER	YEAR	BODY TYPE	DESCRIPTION	PART NUMBER		QTY.
				RIGHT HAND	LEFT HAND	
<b>113A30 REINFORCEMENT - FLOOR PAN CENTER</b>						
	66/70	B(62, 63, 65, 66, 76), X(62)		C6OZ	63113A30-B	1
	71	B(63, 65, 66, 76)				1
<b>113A36 PLATE - REAR FLOOR PAN DRAIN HOLE COVER</b>						
	68/	A, S		C7AZ	62113A36-A	1
	68/	A	Screw-hex. washer hd. -No. 8-18 x 3/4"	376389-S101(UU82D)		2
<b>11344-5 BRACKET - REAR FLOOR PAN TO REAR CROSS MEMBER</b>						
	66/70	X(54, 62)	R. H.	C6DZ	6211344-A	1
			L. H.	C6DZ	6211345-A	1
<b>11360 PAN - REAR FLOOR REAR</b>						
	72	A(71)		D2AZ	7111360-A	1
<b>11361 MEMBER - AUXILIARY FLOOR CROSS FRONT</b>						
	67/71	B(66)		C6DZ	6611361-B	1
	66	X(66)				1
	72	B(97)		D2OZ	9711361-A	1
<b>113A66 RETAINER - BODY BOLT ANCHOR PLATE</b>						
	72	B(except 71)		D2OZ	65113A66-A	2or4
	72	B(71)		D2OZ	71113A66-A	2
<b>113A70-1 BRACKET - CENTER FLOOR PAN TO QUARTER WHEEL HOUSE</b>						
	71/72	A(71)	R. H.	D1AZ	71113A70-A	1
			L. H.	D1AZ	71113A71-A	1
	72	B(71)	R. H.	D2OZ	71113A70-A	1
			L. H.	D2OZ	71113A71-A	1
<b>11376 REINFORCEMENT - CENTER FLOOR PAN NO. 12 BODY BOLT</b>						
	72	B(97)		D2OZ	9711376-A	2
<b>11393-4 REINFORCEMENT - CENTER FLOOR PAN BODY BOLT HOLE</b>						
	66/71	B(76)	R. H.	C6OZ	7611393-B	1
			L. H.	C6OZ	7611394-A	1
	70/71	P(62)	With evaporative emission control	D0DZ	6211393-A	1
	67	S		C7SZ	6511393-A	2
	68/69	S		C7SZ	6511393-C	2
	70	S		D0SZ	6511393-A	1
	71	S		D1SZ	6511393-A	2
<b>114A24 PAN - AUXILIARY FLOOR REAR</b>						
	67/71	B(66)		C6DZ	66114A24-A	1
	66	X(66)				1
	67/71	B(66)	5/16"-18 x 1 1/4" Hex. hd. screw & washer assy.	381746-S2(BB630P)		7
GROUP NUMBER	YEAR	BODY TYPE	DESCRIPTION	PART NUMBER		QTY.
<b>11450-1 SUPPORT - AUXILIARY FLOOR PAN REAR</b>						
	67/68	F(63)		C7ZZ	6311450-B	1
	69/70	F(63)		C9ZZ	6311450-A	1
GROUP NUMBER	YEAR	BODY TYPE	DESCRIPTION	PART NUMBER		QTY.
<b>11456 BRACKET - FLOOR PAN TO REAR SEAT BACK STRAINER</b>						
	69/70	A(54, 57, 62)		C9AZ	6211456-A	1
	71/	A(53, 54, 57)				2
	69/	A(63, 65)		C9AZ	6311456-A	1
	69/72	A(76)				1
	66/67	B(62, 63, 76)		C6OZ	6211456-A	2
	68/71	B(76)				1 or 2
	68/	B(65)		C8OZ	6511456-A	2
	70/	P		D0DZ	6211456-A	2
	66/70	X(54, 62)		C6OZ	6211456-A	2
<b>11500-1 SUPPORT - AUXILIARY FLOOR</b>						
	68/	B(71)	R. H. - w/o aux. seat	C8OZ	7111500-A	1
			L. H.	C8OZ	7111501-A	1
			W/aux. seat-refer to Group 61142-3			
			Screw & lockwasher assy. -pan hd. - 5/16"-18 x 5/8"	382589-S9(BB630GH)		6

**BODY  
SECTION 100**
**FORD CAR PARTS**

GROUP NUMBER	YEAR	BODY TYPE	DESCRIPTION	PART NUMBER	QTY.	
<b>11510</b>	<b>SUPPORT - STORAGE COMPARTMENT LATCH STRIKER</b>					
	72	B(71)		D2OZ 7111510-A	1	
<b>115A20-1</b>	<b>PANEL - AUXILIARY FLOOR SUPPORT SIDE</b>					
	70/71	B(66)	R. H. L. H.	D0OZ 66115A20-A D0OZ 66115A21-A	1 1	
<b>115A32</b>	<b>LOCK CYLINDER and KEYS - STORAGE COMPARTMENT - Refer to Group 22050</b>					
<b>115A42</b>	<b>PANEL - AUXILIARY FLOOR REAR - PAINT TO MATCH</b>					
	69/	A(71)		C9AZ 71115A42-A	1	
	72	B(71)		D2OZ 71115A42-A	1	
	65	F(63)	W/folding rear seat	C5ZZ 63115A42-A	1	
	66/70	F(63)	W/folding rear seat	C6ZZ 63115A42-A	1	
	71/	F(63)	W/folding rear seat	D1ZZ 63115A42-A	1	
GROUP NUMBER	YEAR	BODY TYPE	DESCRIPTION	PART NUMBER		QTY.
				RIGHT HAND	LEFT HAND	
<b>115A44-5</b>	<b>PANEL - AUXILIARY FLOOR SIDE - PAINT TO MATCH AS REQUIRED</b>					
	65/66	A(71A, C)- "Before 9/3/65"	Black	C5AZ 71115A44-H	C5AZ 71115A45-P	1
			Palomino	C5AZ 71115A44-J	C5AZ 71115A45-P	1
			Red	C5AZ 71115A44-K	C5AZ 71115A45-P	1
			Light Blue	C5AZ 71115A44-L	C5AZ 71115A45-P	1
			Gold	C5AZ 71115A44-M	C5AZ 71115A45-P	1
			Turquoise	C5AZ 71115A44-N	C5AZ 71115A45-P	1
	65/66	A(71B, E) "Before 9/3/65"	Black	C5AZ 71115A44-B	C5AZ 71115A45-R	1
			Gold	C5AZ 71115A44-F	C5AZ 71115A45-R	1
			Turquoise	C5AZ 71115A44-G	C5AZ 71115A45-R	1
	65/66	A(71B, D, E)- "Before 9/3/65"	Palomino	C5AZ 71115A44-C	C5AZ 71115A45-R	1
			Red	C5AZ 71115A44-D	C5AZ 71115A45-R	1
			Light Blue	C5AZ 71115A44-E	C5AZ 71115A45-R	1
	67	A(71B, D, E)- "From 4/17/67"		C5AZ 71115A44-R	C5AZ 71115A45-R	1
	68	A(71B, D, E, H)				1
	69/	A(71)				
			Screw-oval head drive point-No.8-18 x 1/2"	C9AZ 71115A44-A 375452-S100(BB630D)	C9AZ 71115A45-A 375452-S100(BB630D)	1 4
	68/	A(71)	Screw-cross recess oval head tap-No.8-32 x 3/8"	52012-S8(U202)	52012-S8(U202)	4
	66/71	B(71)		C6OZ 71115A44-A	C6OZ 71115A45-A	1
	72	B(71)		D2OZ 71115A44-A	D2OZ 71115A45-A	1
			Screw-pan hd. tap-No.8-18 x 1/2"	380934-S101(UU67F)	380934-S101(UU67F)	8
<b>115A46-7</b>	<b>SUPPORT - AUXILIARY FLOOR SIDE PANEL</b>					
	69/	A(71)		C9AZ 71115A46-A	C9AZ 71115A47-A	1
GROUP NUMBER	YEAR	BODY TYPE	DESCRIPTION	PART NUMBER	QTY.	
<b>115A50</b>	<b>PANEL - AUXILIARY FLOOR FRONT FINISH</b>					
	65/	F(63)-w/folding rear seat		C6ZZ 63115A50-A	1	
<b>115A58</b>	<b>PANEL - CENTER FLOOR FINISH - PAINT TO MATCH</b>					
	69/	A(71)		C9AZ 71115A58-A	1	
	69/	A(71)	Bumper -7/16" dia.	377798-S(CC40M)	2	
	69/	A(71), B(71)	Screw-oval head drive point-No.8-18 x 1/2"	375452-S100(BB630D)	AR	
	66/71	B(71)		C6OZ 71115A58-A	1	
	72	B(71)		D2OZ 71115A58-A	1	
<b>115A60</b>	<b>RETAINER - AUXILIARY FLOOR REAR INNER PANEL</b>					
	65/70	F(63)	Also used with folding rear seat	C5ZZ 63115A60-A	2	
	71/	F(63)	Also used with folding rear seat	D1ZZ 63115A60-A	1	
<b>115A62</b>	<b>SPACER - AUXILIARY FLOOR REAR</b>					
	71/	F(63)	With folding rear seat	D1ZZ 63115A62-A	2	
<b>11564</b>	<b>PANEL - AUXILIARY FLOOR - Refer to Group 11578-9</b>					
<b>115A64</b>	<b>RETAINER - CENTER FLOOR FINISH PANEL</b>					
	66/71	B(71)		C6OZ 71115A64-A	1	
	72	B(71)		D2OZ 71115A64-A	1	

# FORD CAR PARTS

## BODY SECTION 100

19

GROUP NUMBER	YEAR	BODY TYPE	DESCRIPTION	PART NUMBER	QTY.
<b>115A72-3 BUMPER - AUXILIARY FLOOR PANEL</b>					
	65/66 67/	A(71A, C) A(71)	R. H. L. H. -Half round-Also used as seat stop located on wheel house panel or with side facing rear seat	C5AZ 71115A72-A	1 1or2
			Screw-pan head tapping-No.10-18 x 3/8"	52720-S8(U380)	2
	65/66	A(71A, C)	L. H. -Half round-Also used as seat stop located on wheel house panel or with side facing rear seat	C5AZ 71115A73-A	1
	67	A(71A, C)	L. H.		1
	68	A(71A, C, J)	L. H.		1
	66/68	A(71)	Rectangular-without side facing rear seat	C6AZ 71115A72-A	2
	69/	A(71)		C9AZ 71115A72-A	2
	72	B(71)		D2OZ 71115A72-A	2
<b>11578 PANEL - AUXILIARY FLOOR</b>					
	65	F(63)		C5ZZ 6311564-A	1
	66	F(63)		C6ZZ 6311564-A	1
	67/70	F(63)	With folding rear seat-Paint to match	C6ZZ 6311564-B	1
	71/	F(63)	Front-with folding rear seat-paint to match	D1ZZ 6311578-A	1
<b>11580 PAN - AUXILIARY FLOOR</b>					
	67/71	B(66)		C6DZ 6611580-B	1
	66	X(66)			1
	65/66	X(66)	5/16"-18 x 5/8" Hex. head bolt	20326-S7(B49)	AR
			5/16" Lockwasher	34806-S7(X64)	AR
			5/16"-18 Nut & retainer assy.	379484-S2(MM207A)	AR
<b>11598 LATCH - STORAGE COMPARTMENT DOOR</b>					
	65/66	A(71)	Includes link	C5AZ 7111598-C	1
	66	B(71)			1
	67/	A(71)	Includes link	C7AZ 7111598-B	1
	67/71	B(71)	Includes link		1
	72	B(71)	Refer to group 31700		
<b>116A00-1 HINGE - STORAGE COMPARTMENT DOOR REAR</b>					
	69/	A(71)	R. H.	C9AZ 71116A00-A	1
			L. H.	C9AZ 71116A01-A	1
			Front - refer to Basic Group 11640-1		
<b>116A14 LATCH - AUXILIARY FLOOR PANEL REAR</b>					
	71/	F(63)	With folding rear seat	D1ZZ 63116A14-A	2
<b>11634-5 REINFORCEMENT - FRONT FLOOR PAN SEAT TRACK</b>					
	71/	P(54, 62)	R. H. -Inner-non-reclining bucket seats	D1DZ 6211634-A	1
			L. H.	D1DZ 6211635-A	1
	68/71	S	Lower	C8SZ 6511634-A	AR
<b>11640-1 HINGE - STORAGE COMPARTMENT DOOR - FRONT</b>					
	69/	A(71)	R. H.	C9AZ 7111640-A	1
			L. H.	C9AZ 7111641-A	1
<b>11688 REINFORCEMENT - STORAGE COMPARTMENT DOOR LATCH</b>					
	67/68	A(71)		C7AZ 7111688-A	1
	67/71	B(71)		C7OZ 7111688-A	1
<b>11698-9 PANEL - STORAGE COMPARTMENT DOOR</b>					
	69/	A(71)	R. H. -Paint to match	C9AZ 7111698-A	1
			L. H.	C9AZ 7111699-A	1
<b>11712 STOP - STORAGE COMPARTMENT DOOR</b>					
	71	A(71)		D1AZ 7111712-A	2
<b>11738-9 SUPPORT - AUXILIARY FLOOR SIDE REAR</b>					
	67/71	B(66)	R. H.	C6DZ 6611738-B	1
	66	X(66)	L. H. -not replaced (9/74)	*C6DZ 6611739-B	1 ø 1
<b>11770 HINGE - AUXILIARY FLOOR FRONT PANEL</b>					
	65/	F(63)	Includes attaching parts	C5ZZ 6311770-B	1
<b>11772-3 EXTENSION - AUXILIARY FLOOR SIDE</b>					
	72	B(71)	R. H. -Paint to match	D2OZ 7111772-A	1
			L. H.	D2OZ 7111773-A	1
			Screw-pan hd. drill point-No, 8-18 x 1/2"	380934-S101(UU67F)	2

GROUP NUMBER	YEAR	BODY TYPE	DESCRIPTION	PART NUMBER	QTY.
<b>12110</b>	<b>REINFORCEMENT - FLOOR PLATE TRANSMISSION COVER</b>				
71/	P		With manual transmission	D1DZ 6212110-A	1
<b>12118-9</b>	<b>REINFORCEMENT - FLOOR TRANSMISSION COVER PLATE</b>				
69/71	A(except 71)		With manual transmission	C9AZ 6212118-A	1
69/71	A		R.H.with auto.trans. & console L.H.	C9AZ 6312118-A	1
72	B(63,65)		With auto. trans. & console	C9AZ 6312119-A	1
65/68	F			D2OZ 6512118-A	1
69/70	F			C5ZZ 6512118-A	1
71/	F			C9ZZ 6512118-A	1
71/	L,P		With auto. trans. (floor shift)	D1ZZ 6512118-A	1
				D1DZ 6212118-A	1
<b>12128</b>	<b>COVER - TRANSMISSION BAND ADJUSTING ACCESS</b>				
65	A, S		Plug (button)-2.41" diameter hole	374732-S(PP14)	1
<b>130A08-9</b>	<b>RETAINER - AUXILIARY FLOOR FRONT CARPET SIDE - INCLUDES ATTACHING PARTS</b>				
67/70	F(63)		R. H. -With folding rear seat L. H.	C7ZZ 63130A08-A	1
71/	F(63)		R. H. - With folding rear seat L. H.	C7ZZ 63130A09-A	1
				D1ZZ 63130A08-A	1
71/	L		With folding rear seats	D1ZZ 63130A09-A	1
				D1FZ 62130A08-A	2
<b>130A10</b>	<b>RETAINER - AUXILIARY FLOOR REAR CARPET FRONT</b>				
71/72	F(63)		With folding rear seat	D1ZZ 63130A10-A	1
<b>130A14</b>	<b>RETAINER - AUXILIARY FLOOR FRONT CARPET FRONT - INCLUDES ATTACHING PARTS</b>				
66/	F(63)		With folding rear seat	C6ZZ 63130A14-A	1
71/	L		With rear seat sport deck	D1FZ 62130A14-AA	1
<b>130A16-7</b>	<b>RETAINER - REAR SEAT BACK FLOOR CARPET SIDE - INCLUDES ATTACHING PARTS</b>				
65/	F(63)		R. H. -with fixed or folding rear seat-Paint to match. L. H.	C5ZZ 63130A16-B	2
			Bumper (rubber)	C5ZZ 63130A17-B	2
				380369-S (CC44)	2
<b>130A18</b>	<b>RETAINER - REAR SEAT BACK FLOOR CARPET FRONT - INCLUDES ATTACHING PARTS</b>				
65/	F(63)		With folding rear seat-attaches carpet to basic number 115A42	C5ZZ 63130A18-A	1
			With folding rear seat-attaches carpet to basic numbers 11564 & 61390	C5ZZ 63130A18-B	1
			Also used with fixed rear seat-Paint to match		1
71	L(64)	"Before 9/15/71"		D1FZ 64130A18-A	1
71/	L(64)	"From 9/15/71"		D1FZ 64130A18-B	1
72	L(73)				1
<b>130A20</b>	<b>RETAINER - REAR SEAT BACK FLOOR CARPET REAR</b>				
65/	F(63)		Includes attaching parts	C5ZZ 63130A20-A	2
71/	L(64)			D1FZ 64130A20-A	1
<b>130A24-5</b>	<b>RETAINER - AUXILIARY FLOOR REAR CARPET SIDE - INCLUDES ATTACHING PARTS</b>				
65/70	F(63)		R. H. - With folding rear seat L. H.	C5ZZ 63130A24-A	1
			No. 8-15 x 5/8" Cross recess oval head screw	C5ZZ 63130A25-A	1
				52352-S8(U293)	3
71/	F(63)		With folding rear seat	D1ZZ 63130A24-A	2
<b>130A26</b>	<b>RETAINER - AUXILIARY FLOOR REAR CARPET REAR - INCLUDES ATTACHING PARTS</b>				
65/69	F(63)		With folding rear seat	C5ZZ 63130A26-A	1
			No. 8-15 x 5/8" Cross recess oval head screw	52352-S8(U293)	6
<b>130A30</b>	<b>RETAINER - REAR FLOOR - REAR - INCLUDES ATTACHING PARTS</b>				
67/	U(98)			C7TZ 98130A30-B	1
<b>130A44-5</b>	<b>RETAINER - FRONT FLOOR CARPET - SIDE - INCLUDES ATTACHING PARTS</b>				
67	U	"Before A42, 001"	R. H. L. H.	C7TZ 96130A44-A	1
				C7TZ 96130A45-A	1
67/	U(97, 98)	"From A42, 001"	R. H. -Use with vinyl mat L. H.	C7TZ 96130A44-B	1
				C7TZ 96130A45-B	1
<b>13144</b>	<b>RETAINER - REAR FLOOR MAT - INCLUDES ATTACHING PARTS</b>				
67/	B, P, X		Refer to Group 13144-5 in Soft Trim Section		
67/	U(98)		Front-One piece design	C7TZ 9813144-D	3



# FORD CAR PARTS

## BODY SECTION 100

21

GROUP NUMBER	YEAR	BODY TYPE	DESCRIPTION	PART NUMBER		QTY.
				RIGHT HAND	LEFT HAND	
<b>13200-9 PLATE - FRONT DOOR SCUFF</b>						
<b>- A -</b>						
65/68	A(62, 63, 65, 76)			C7AZ 6213208-B	C7AZ 6213209-B	1
67	A		Retainer -front	C6AZ 14A163-A	C6AZ 14A163-A	4
65/68	A(54, 57, 71)			C7AZ 5413208-B	C7AZ 5413209-B	1
65/68	A(54, 57, 62, 63, 65, 76)		No.8-18 x 1" Oval head tapping screw	52445-S(U317)	52445-S(U317)	4or6
69/	A(53, 54, 57, 71)			C9AZ 5413208-A	C9AZ 5413208-A	2
69/70	A(62, 63, 65, 76)			C9AZ 6213208-A	C9AZ 6213208-A	2
71/	A(65, 76)					2
<b>- B -</b>						
65	B(54, 71)			★CC50B5413200-B Not replaced (3-74)	★CC50B 5413201-B	1
66/67	B(54, 71)			☆C7OZ 5413208-A	☆C7OZ 5413208-A	2
66	B(54, 71)			★CC60B 5413200-A	★CC60B 5413200-A	2
66/67	B(62, 63, 66, 76)			C7OZ 6213208-A	C7OZ 6213208-A	2
68/69	B(54, 71)			C8OZ 5413208-A	C8OZ 5413208-A	2
70/71	B(71)					2
68/69	B(63, 65, 66, 76)			C8OZ 6313208-A	C8OZ 6313208-A	2
70/71	B(54, 57)			D0OZ 5413208-A	D0OZ 5413208-A	2
72	B(63, 65, 97)			D2OZ 6513208-A	D2OZ 6513208-A	2
70	B(62, 63, 65, 66, 76)			D0OZ 6513208-A	D0OZ 6513208-A	2
71	B(63, 65, 66, 76)					2
72	B(53, 71)			D2OZ 5313208-A	D2OZ 5313208-A	2
<b>- F -</b>						
65/67	F		Includes attaching parts- outer or lower	*C5ZZ 6513208-B	*C5ZZ 6513208-B	2*
65/68	F(63, 65)		Inner or upper	C5ZZ 6513208-D	C5ZZ 6513208-D	2
65/68	F(76)		Inner or upper	C5ZZ 7613208-C	C5ZZ 7613208-C	2
69/70	F		Transfer-refer to Group 10130	C9ZZ 6513208-A	C9ZZ 6513208-A	2
71/	F			D1ZZ 6513208-A	D1ZZ 6513208-A	2
65/	F		No. 8-18 x 3/4" Oval head tapping screw	55974-S45(U316D)	55974-S45(U316D)	18
<b>- L -</b>						
71/	L			D1FZ 6213208-A	D1FZ 6213208-A	2
<b>- P -</b>						
70	P(62)		Includes attaching parts	D0DZ 6213208-A	D0DZ 6213208-A	2
71/	P(54)			D1DZ 5413208-A	D1DZ 5413208-A	2
71/	P(62)			D1ZZ 6513208-A	D1ZZ 6513208-A	2
<b>- S -</b>						
65/66	S		Inner or upper	C4SZ 6313208-D	C4SZ 6313209-D	1
65/66	S		Outer or lower	C4SZ 6313208-C	C4SZ 6313208-C	2
			Screw-oval head tapping- No.10-24 x 5/8"	376490-S101(UU56B)	376490-S101(UU56B)	4
			Screw-oval head tapping- No.10-24 x 1"	★376359-S101	★376359-S101	8
68/71	S(57)			C8SZ 5713208-A	C8SZ 5713209-A	1
67/71	S(65)			C8SZ 6513208-A	C8SZ 6513208-A	2
72	S			D2SZ 6513208-A	D2SZ 6513208-A	2
<b>- X -</b>						
65	X(54, 71)			★CC5DB 5413200-A	★C3DZ 6213209-A	1
65	X(59, 62, 63, 78)			★CC5DB 6213200-A	★CC5DB 6213201-A	1
66/67	X(54, 71)			☆C7OZ 5413208-A	☆C7OZ 5413208-A	2
66	X(54, 71)			★CC60B 5413200-A	★CC60B 5413200-A	2
66/67	X(62, 63, 76)			☆C7OZ 6213208-A	☆C7OZ 6213208-A	2
68/70	X(54, 71)			C8DZ 5413208-A	C8DZ 5413208-A	2
68/70	X(62)			C8OZ 6313208-A	C8OZ 6313208-A	2
65/	A		Screw and washer assy.- No.8-18 x 3/4"	★379083-S101	★379083-S101	8 or 14
65/	A, B		Screw-cross recess pan head-No.8-18 x 3/4"	376389-S101(UU82D)	376389-S101(UU82D)	8 or 12
65/70	X					12

\* Component of Accessory Kit C5ZZ 6513242-A

☆ U. S. only

★ Canada only

May, 1975

COPYRIGHT © 1975 -

FORD MOTOR  
COMPANY

- DEARBORN, MICHIGAN

**FINAL ISSUE**



20000-1 STRIPE KIT - BODY SIDE

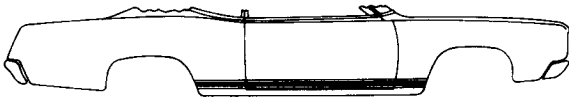

TYPE 1

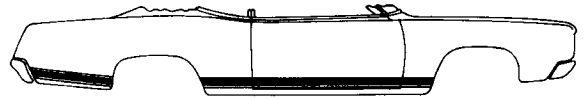

TYPE 2

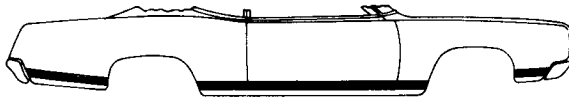

TYPE 3

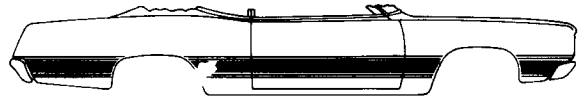

TYPE 4

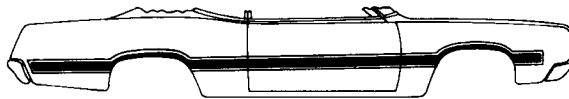

TYPE 5

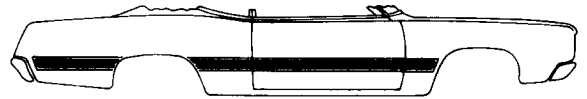

TYPE 6

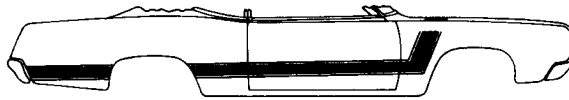

TYPE 7



TYPE 8

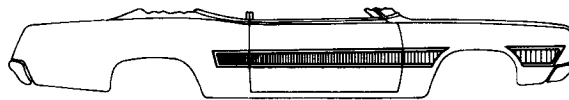

TYPE 9

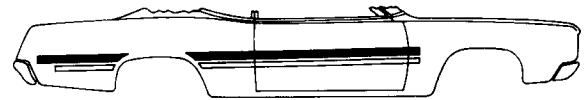

TYPE 10



TYPE 11

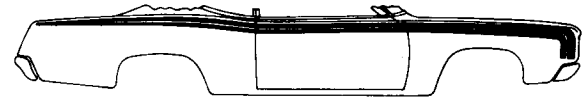

TYPE 12



TYPE 13



TYPE 14

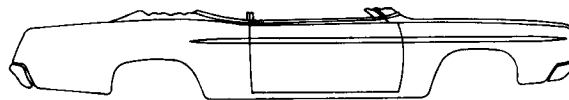

TYPE 15

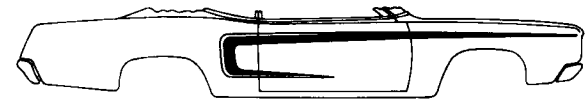

TYPE 16

P-7849

20000-1 STRIPE KIT - BODY SIDE - continued

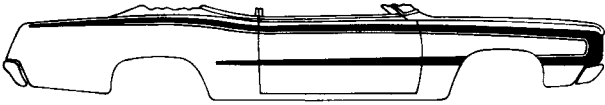

TYPE 17

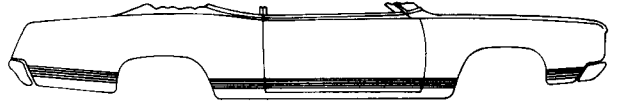

TYPE 18

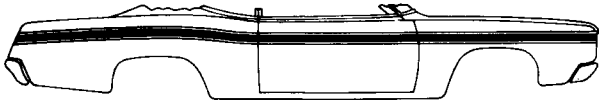

TYPE 19

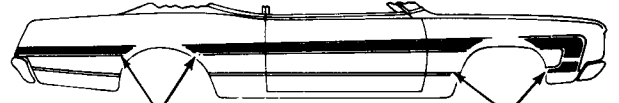

CENTER BODY KIT

LOWER BODY KIT

TYPE 20

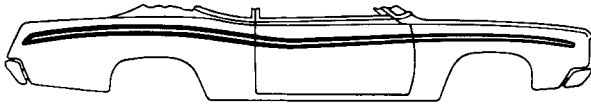

TYPE 21

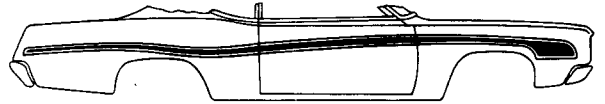

TYPE 22

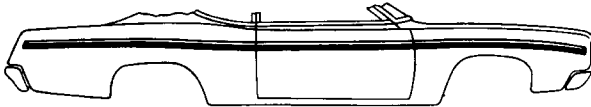

TYPE 23

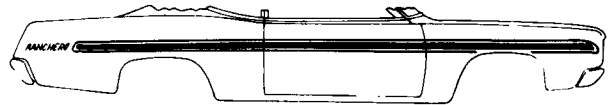

TYPE 24

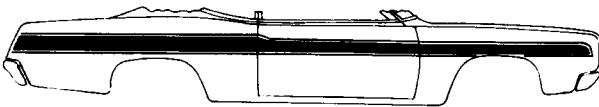

TYPE 25

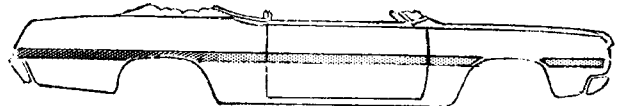

TYPE 26

# FORD CAR PARTS

**BODY  
SECTION 200**

3

YEAR	MODEL	TYPE	COLOR	DESCRIPTION	PART NUMBER	QTY.
<b>20000-1 STRIPE KIT - BODY SIDE - continued</b>						
<b>- A -</b>						
68	A(63C, 76B)	3	Black	R.H.-non-reflective	C8AZ 6320000-A	1
				L.H.	C8AZ 6320001-A	1
			Red	R.H.-non-reflective	C8AZ 6320000-B	1
				L.H.	C8AZ 6320001-B	1
68	A(63C, 76B)	3	White	R.H.-non-reflective	C8AZ 6320000-C	1
				L.H.	C8AZ 6320001-C	1
			Black	R.H.-reflective	C8AZ 6320000-E	1
				L.H.	C8AZ 6320001-E	1
68	A(63C, 76B)	11	White	R.H.-reflective	C8AZ 6320000-G	1
				L.H.	C8AZ 6320001-G	1
			Black w/red center	R.H.	C8AZ 6320000-J	1
				L.H.	C8AZ 6320001-J	1
68	A(63C, 76B)	11	Gold w/red center	R.H.	C8AZ 6320000-K	1
				L.H.	C8AZ 6320001-K	1
			Gold w/black center	R.H.	C8AZ 6320000-L	1
				L.H.	C8AZ 6320001-L	1
69	A(63C, 76B)	17	Black		C9AZ 6320000-F	1
			Gold		C9AZ 6320000-H	1
			Red		C9AZ 6320000-G	1
			Silver		C9AZ 6320000-J	1
			White		C9AZ 6320000-K	1

## PIN STRIPES

TRANSFERS NOT AVAILABLE FOR REPAIR OR REPLACEMENT.  
REFER TO "STRIPING LACQUER" IN PAINT SECTION.

<b>- B -</b>						
66	B(63D, 76D)	1	Black		C6OZ 6320000-D	2
			White		C6OZ 6320000-E	2
67	B(63D, 76D)	1	Black	Non-reflective	C6OZ 6320000-D	2
			Red	Non-reflective	C6OZ 6320000-F	2
			White	Non-reflective	C6OZ 6320000-E	2
67	B(63D, 76D)	1	White	Reflective	C7OZ 6320000-G	2
68	B(63D)	17	Black	R.H.-non-reflective	C8OZ 6320000-A	1
				L.H.	C8OZ 6320001-A	1
			Blue	R.H.-non-reflective	C8OZ 6320000-B	1
				L.H.	C8OZ 6320001-B	1
			Gold	R.H.-non-reflective	C8OZ 6320000-E	1
				L.H.	C8OZ 6320001-E	1
			Red	R.H.-non-reflective	C8OZ 6320000-C	1
				L.H.	C8OZ 6320001-C	1
			White	R.H.-non-reflective	C8OZ 6320000-D	1
				L.H.	C8OZ 6320001-D	1
68	B(63D)	17	Black	R.H.-reflective	C8OZ 6320000-F	1
				L.H.	C8OZ 6320001-F	1
			Blue	R.H.-reflective	C8OZ 6320000-G	1
				L.H.	C8OZ 6320001-G	1
			Red	R.H.-reflective	C8OZ 6320000-H	1
				L.H.	C8OZ 6320001-H	1
			White	R.H.-reflective	C8OZ 6320000-J	1
				L.H.	C8OZ 6320001-J	1
68	B(63D, 65D, 76D)	2	Black	Non-reflective	C8OZ 6520000-A	2
			Blue	Non-reflective	C8OZ 6520000-B	2
			Gold	Non-reflective	C8OZ 6520000-E	2
			Red	Non-reflective	C8OZ 6520000-C	2
			White	Non-reflective	C8OZ 6520000-D	2
68	B(63D, 65D, 76D)	2	Black	Reflective	C8OZ 6520000-F	2
			Blue	Reflective	C8OZ 6520000-G	2
			Red	Reflective	C8OZ 6520000-H	2
			White	Reflective	C8OZ 6520000-J	2

YEAR	MODEL	TYPE	COLOR	DESCRIPTION	PART NUMBER	QTY.
<b>20000-1 STRIPE KIT - BODY SIDE - continued</b>						
- B -						
68	B(66D)	17	Black	R.H.	C8OZ 6620000-A	1
				L.H.	C8OZ 6620001-A	1
			Blue	R.H. - not replaced(3-74)	★C8OZ 6620000-B	1
				L.H.	C8OZ 6620001-B	1
			Gold	R.H.	C8OZ 6620000-E	1
				L.H.	C8OZ 6620001-E	1
69	B(63D, F, 65D, 76D)	17	Black		C8OZ 6620000-C	1
				L.H.	C8OZ 6620001-C	1
			White	R.H.	C8OZ 6620000-D	1
				L.H.	C8OZ 6620001-D	1
			Blue		C9OZ 6320000-F	1
					★	
69	B(65D, F, 76D, F)	2	Gold		C9OZ 6320000-H	1
			Red		C9OZ 6320000-G	1
			White		C9OZ 6320000-J	1
			Black		C8OZ 6520000-A	2
69	B(65A)	15	Gold		C8OZ 6520000-E	2
			Red		C9OZ 6520000-A	2
			White		C8OZ 6520000-D	2
			Black w/red center		C9OZ 6520000-C	1
69	B(63- Talladega)	11	White w/gold center		C9OZ 6520000-D	1
			White w/red center		C9OZ 6520000-B	1
			Black		C9OZ 6320000-K	1
69	B(66A, B)	2	White		C9OZ 6320000-L	1
			Black		C9OZ 6620000-K	1
69	B(66C, D)	17	Black		C9OZ 6620000-F	1
			Gold		C9OZ 6620000-H	1
			Red		C9OZ 6620000-G	1
			White		C9OZ 6620000-J	1
70	B(63F, 76F)	9	Blue	Incl. Black border	D0OZ 6320000-A	1
			Brown/Gold	Incl. Black border	D0OZ 6320000-D	1
			Green/Yellow	Incl. Black border	D0OZ 6320000-C	1
			Red/Orange	Incl. Black border	D0OZ 6320000-B	1
70	B(66C)	9	Blue	Incl. Black border	D0OZ 6620000-A	1
			Brown/Gold	Incl. Black border	D0OZ 6620000-D	1
			Green/Yellow	Incl. Black border	D0OZ 6620000-C	1
			Red/Orange	Incl. Black border	D0OZ 6620000-B	1
71	B(63C, F, H, 66C, 76F)	9	Blue	Incl. Black border	D1OZ 6320000-A	1
			Brown/Gold	Incl. Black border	D1OZ 6320000-D	1
			Green/Yellow	Incl. Black border	D1OZ 6320000-C	1
			Red/Orange	Incl. Black border	D1OZ 6320000-B	1
71	B(66A, B, C)	24	Gold and Black	Incl. "Ranchero"	D1OZ 6620000-B	1
			Orange and Black	Incl. "Ranchero"	D1OZ 6620000-D	1
			Silver and Black	Incl. "Ranchero"	D1OZ 6620000-A	1
			Yellow and Black	Incl. "Ranchero"	D1OZ 6620000-C	1
72	B(63R, 65R)	26	Blue		D2OZ 6320000-E	1
			Green	R/b D2OZ 6320000-M and D2OZ 6320001-D (5-73)	★D2OZ 6320000-H	1
72	B(63R, 65R)	26	Blue	R.H.	D2OZ 6320000-J	1
				L.H.	D2OZ 6320001-A	1
			Brown	R.H.	D2OZ 6320000-K	1
				L.H.	D2OZ 6320001-B	1
			Green	R.H.	D2OZ 6320000-M	1
				L.H.	D2OZ 6320001-D	1
			Red	R.H.	D2OZ 6320000-L	1
				L.H.	D2OZ 6320001-C	1
72	B(65D)	26	Blue	R.H.	D2OZ 6520000-E	1
				L.H.	D2OZ 6520001-A	1
			Brown	R.H.	D2OZ 6520000-F	1
				L.H.	D2OZ 6520001-B	1
			Green	R.H.	D2OZ 6520000-H	1
				L.H.	D2OZ 6520001-D	1
			Red	R.H.	D2OZ 6520000-G	1
				L.H.	D2OZ 6520001-C	1

# FORD CAR PARTS

## BODY SECTION 200

5

YEAR	MODEL	TYPE	COLOR	DESCRIPTION	PART NUMBER	QTY.
<b>20000-1 STRIPE KIT - BODY SIDE - continued</b>						
- B -						
72	B(97D)		Argent	Lower body-25 ft. roll	D1ZZ 6320000-M	1
			Black	Lower body-25 ft. roll	D1ZZ 6320000-L	1
				Tailgate-refer to group 42602		
72	B(97R)	25	Yellow		D2OZ 9720000-B	1
72	B(97R)	25	Blue	R.H.	D2OZ 9720000-F	1
				L.H.-tailgate-refer to group 42602	D2OZ 9720001-A	1
			Orange	R.H.	D2OZ 9720000-H	1
				L.H.	D2OZ 9720001-C	1
			Silver	R.H.	D2OZ 9720000-J	1
				L.H.	D2OZ 9720001-D	1
			Yellow	R.H.	D2OZ 9720000-G	1
				L.H.	D2OZ 9720001-B	1

### PIN STRIPES

TRANSFERS NOT AVAILABLE FOR REPAIR OR REPLACEMENT.  
REFER TO "STRIPING LACQUER" IN PAINT SECTION.

- F -						
65/66	F	1	Black		C5ZZ 6520000-A	2
			Blue		C5ZZ 6520000-D	2
			Red		C5ZZ 6520000-C	2
			White		C5ZZ 6520000-B	2
65/66	F			Racing stripes refer to Group 19E504 in Accessories Section		
65/66	F(GT350/500)			Rocker panel-refer to Group 16224 in Chassis Section		
67	F	1	Black	Non-reflective	C7ZZ 6520000-A	2
			Blue	Non-reflective	C7ZZ 6520000-D	2
			Red	Non-reflective	C7ZZ 6520000-C	2
			White	Non-reflective	C7ZZ 6520000-B	2
67	F	1	White	Reflective	C7ZZ 6520000-E	2
67/68	F(GT350/500)			Rocker panel - refer to Group 16224 in Chassis Section		
68	F	16	Black	R.H.-non-reflective	C8ZZ 6520000-A	1
				L.H.	C8ZZ 6520001-A	1
			Blue	R.H.-non-reflective	C8ZZ 6520000-B	1
				L.H.	C8ZZ 6520001-B	1
			Gold	R.H.-non-reflective	C8ZZ 6520000-E	1
				L.H.	C8ZZ 6520001-E	1
			Red	R.H.-non-reflective	C8ZZ 6520000-C	1
				L.H.	C8ZZ 6520001-C	1
			White	R.H.-non-reflective	C8ZZ 6520000-D	1
				L.H.	C8ZZ 6520001-D	1
68	F	16	Black	R.H.-reflective	C8ZZ 6520000-F	1
				L.H.	C8ZZ 6520001-F	1
			Blue	R.H.-reflective	C8ZZ 6520000-G	1
				L.H.-not replaced (3-74)	★C8ZZ 6520001-G	1
			Red	R.H.-reflective	C8ZZ 6520000-H	1
				L.H.	C8ZZ 6520001-H	1
			White	R.H.-reflective	C8ZZ 6520000-J	1
				L.H.	C8ZZ 6520001-J	1
68	F	1	Black	Non-reflective	C8ZZ 6520000-L	2
			Gold	Non-reflective	C8ZZ 6520000-R	2
			White	Non-reflective	C8ZZ 6520000-P	2
68	F	1	Black	Reflective	C8ZZ 6520000-S	2
			White	Reflective	C8ZZ 6520000-V	2
68	F(GT/CS)	*	Black	Body side-incl."GT/CS"	C8ZZ 6520000-A1A	1
			White	Body side-incl."GT/CS"	C8ZZ 6520000-A1H	1
68	F(GT/CS)	*	Black	L/compt.	C8ZZ 6520000-B1A	1
			White	L/compt.	C8ZZ 6520000-B1H	1

\* Refer to appropriate Exterior Moulding Illustration Section

May, 1975

Copyright © 1975 -

FORD MOTOR  
COMPANY

- DEARBORN, MICHIGAN

**FINAL ISSUE**

YEAR	MODEL	TYPE	COLOR	DESCRIPTION	PART NUMBER	QTY.
<b>20000-1 STRIPE KIT - BODY SIDE - continued</b>						
- F -						
69	F(63C)	6	Black w/gold center Red w/gold center Gold w/white center	Incl."Mach I" Incl."Mach I" Incl."Mach I"	C9ZZ 6320000-D C9ZZ 6320000-E C9ZZ 6320000-F	1 1 1
69	F	1	Black Gold Red White		C9ZZ 6520000-M C9ZZ 6520000-P C9ZZ 6520000-N C9ZZ 6520000-R	1 1 1 1
69	F(65E)	21	Black w/gold center Gold w/white center		C9ZZ 6520000-S C9ZZ 6520000-U	1 1
69/70	F(63-GT350)	4	Black Blue Gold White	Incl."GT350" Incl."GT350" Incl."GT350" Incl."GT350"	C9ZZ 6320000-R C9ZZ 6320000-G C9ZZ 6320000-H C9ZZ 6320000-J	1 1 1 1
69/70	F(63-GT500)	4	Black Blue Gold White	Incl."GT500" Incl."GT500" Incl."GT500" Incl."GT500"	C9ZZ 6320000-N C9ZZ 6320000-K C9ZZ 6320000-L C9ZZ 6320000-M	1 1 1 1
69/70	F(76-GT350)	4	Black Blue Gold White	Incl."GT350" Incl."GT350" Incl."GT350" Incl."GT350"	C9ZZ 7620000-G C9ZZ 7620000-A C9ZZ 7620000-B C9ZZ 7620000-C	1 1 1 1
69/70	F(76-GT500)	4	Black Blue Gold White	Incl."GT500" Incl."GT500" Incl."GT500" Incl."GT500"	C9ZZ 7620000-H C9ZZ 7620000-D C9ZZ 7620000-E C9ZZ 7620000-F	1 1 1 1
69	F(63A)	15	Black w/red center White w/gold center White w/red center		C9ZZ 6320000-T C9ZZ 6320000-U C9ZZ 6320000-S	1 1 1
69	F(63A,B)	8	Black	Incl."Boss 302"	C9ZZ 6320000-V	1
69	F(65A,C)	15	Black w/red center White w/gold center White w/red center		C9ZZ 6520000-W C9ZZ 6520000-X C9ZZ 6520000-V	1 1 1
70	F(63A,B)	7	Black	Incl."Boss 302"	D0ZZ 6320000-C	1
70	F(63A)	8	Black		D0ZZ 6320000-D	1
70	F(63C)	*	Black White	L/compt. door & quarter panel extensions L/compt.door & quarter panel extensions	D0ZZ 6320000-A D0ZZ 6320000-B	1 1
71/	F(63,65)	20	Argent Black	Center body only ⊕ Center body only ⊕	D1ZZ 6320000-B D1ZZ 6320000-A	1 1
71/	F(63,65)	20	Argent Black	Lower body-25 ft.roll Lower body-25 ft.roll	D1ZZ 6320000-M D1ZZ 6320000-L	1 1
71/	F(63R)	*	Argent Black	Incl. "Mach I" (l/compt.) and "Mach I/Mustang" (fenders) Incl. "Mach I" (l/compt.) and "Mach I/Mustang" (fenders)	D1ZZ 6320000-D D1ZZ 6320000-C	1 1
71	F(63D)-Boss 302	*	Argent Black	Incl. "Boss 302" (l/compt.) and "Boss 302/Mustang" (fenders) Incl. "Boss 302" (l/compt.) and "Boss 302/Mustang" (fenders)	D1ZZ 6320000-F D1ZZ 6320000-E	1 1
71/	F(63D)-Boss 351	*	Argent Black	Incl. "Boss 351" (l/compt.) and "Boss 351/Mustang" (fenders) Incl. "Boss 351" (l/compt.) and "Boss 351/Mustang" (fenders)	D1ZZ 6320000-J D1ZZ 6320000-K	1 1
71	F(63D)-exc.Boss 302, 351	*	Argent Black	L/compt. L/compt.	D1ZZ 6320000-H D1ZZ 6320000-G	1 1
72	F(65F)	21	Black w/orange center Gold w/lime center Gold w/white center		D2ZZ 6520000-B D2ZZ 6520000-C D2ZZ 6520000-A	1 1 1
72	F(63D)	*	Blue and Red	Hood and quarter extensions only	D2ZZ 6320000-A	1
72	F(65D)	*	Blue and Red	Hood and quarter extensions only	D2ZZ 6520000-D	1
72	F(63D,65D)	*	Blue and red	Lower body-25 ft. roll-1 1/4" wide	D2ZZ 6320000-B	1

\* Refer to appropriate Exterior Moulding Illustration Section

⊕ Lower body stripe kit may also be required



# FORD CAR PARTS

## BODY SECTION 200

7

YEAR	MODEL	TYPE	COLOR	DESCRIPTION	PART NUMBER	QTY.
<b>20000-1 STRIPE KIT - BODY SIDE - continued</b>						
- L -						
72	L(64)	*	Blue and Red	Hood and quarter extensions only	D2FZ 6420000-A	1
72	L(64)	*	Blue and red	Front fender rear, door, quarter panel-25 ft.roll-1 1/4" wide	D2FZ 6420000-B	1
72	L(64)	*	Red	Front fender front, l/compt. and cowl	D2FZ 6420000-C	1
72	L(62, 64)	*	Black	Front fender, rear door and quarter panel-1 1/2" wide-25 ft. roll	D2FZ 6220000-A	AR
			Blue (bright)		D2FZ 6220000-B	AR
			Blue (light)		D2FZ 6220000-G	AR
			Green (dark)		D2FZ 6220000-D	AR
			Green (medium)		D2FZ 6220000-C	AR
			Ginger		D2FZ 6220000-E	AR
			Tan		D2FZ 6220000-H	AR
			White		D2FZ 6220000-F	AR
72	L(62, 64)	*	Avocado	1 1/2" wide-25 ft.roll	D2FZ 6220000-J	1
			Orange		D2FZ 6220000-K	1
- P -						
70	P	5	Black	R/b D0DZ 6220000-C and D0DZ 6220001-A (10/74)	*D0DZ 6220000-A	1
70	P	5	Black	R. H.	D0DZ 6220000-C	1
				L. H.	D0DZ 6220001-A	1
			White	R. H.	D0DZ 6220000-D	1
				L. H.	D0DZ 6220001-B	1
71	P(62)	5	Orange w/black center	R. H. - incl. " Grabber"	D1DZ 6220000-D	1
				L. H. - incl. " Grabber"	D1DZ 6220001-A	1
			White w/silver center	R. H. - incl. " Grabber"	D1DZ 6220000-F	1
				L. H. - incl. " Grabber"	D1DZ 6220001-C	1
			Yellow w/black center	R. H. - incl. " Grabber"	D1DZ 6220000-E	1
				L. H. - incl. " Grabber"	D1DZ 6220001-B	1
72	P(62D)	5	Black w/black border	R. H. - incl. " Grabber"	D2DZ 6220000-H	1
				L. H. - incl. " Grabber"	D2DZ 6220001-D	1
			Gold w/white border	R. H. - incl. " Grabber"	D2DZ 6220000-F	1
				L. H. - incl. " Grabber"	D2DZ 6220001-B	1
			Lime w/lime border	R. H. - incl. " Grabber"	D2DZ 6220000-G	1
				L. H. - incl. " Grabber"	D2DZ 6220001-C	1
			Orange w/orange border	R. H. - incl. " Grabber"	D2DZ 6220000-E	1
				L. H. - incl. " Grabber"	D2DZ 6220001-A	1
72	P(62D)	*	Black	L/compt. door & quarter panel extensions	D2DZ 6220000-M	1
		*	Lime	L/compt. door & quarter panel extensions	D2DZ 6220000-L	1
		*	Orange	L/compt. door & quarter panel extensions	D2DZ 6220000-J	1
		*	White	L/compt. door & quarter panel extensions	D2DZ 6220000-K	1
72	P(62A)	*	Red	Cowl and deck lid-25 ft. roll	D2FZ 6420000-C	1
72	P(62A)	*	Blue and red	Lower body-25 ft. roll	D2ZZ 6320000-B	1
72	P(62A)	*	Blue and red	Hood and quarter extensions only	D2DZ 6220000-N	1
- U -						
66/	U	1	Red		C6TZ 9620000-B	2
			White		C6TZ 9620000-A	2
72	U(Ranger)		Orange and white		D2BZ 1020000-A	1
- X -						
65/66	X			Racing stripes-refer to Group 19E504 in Accessories Section		
69/70	X(54)	15	Black w/red center		C9DZ 5420000-A	1
			White w/gold center		C9DZ 5420000-C	1
			White w/red center		C9DZ 5420000-B	1
69/70	X(62)	15	Black w/red center		C9DZ 6220000-A	1
			White w/gold center		C9DZ 6220000-C	1
			White w/red center		C9DZ 6220000-B	1

\* Refer to appropriate Exterior Moulding Illustration Section

May, 1975

COPYRIGHT © 1975 -

FORD MOTOR  
COMPANY

- DEARBORN, MICHIGAN

**FINAL ISSUE**

## PIN STRIPES

TRANSFERS NOT AVAILABLE FOR REPAIR OR REPLACEMENT.  
REFER TO "STRIPING LACQUER" IN PAINT SECTION.

GROUP NUMBER	YEAR	BODY TYPE	DESCRIPTION	PART NUMBER	QTY.
<b>20092</b>	<b>STEP KIT - PICKUP BOX SIDE</b>				
	66/71	U		C3UZ 8720092-A	1

Consists of

1-C3UB 8720002-A	Strip	1-B8A 19562-A	Sealer
1-C3UB 8720044-A	Step	4-52432-S8	Screw
1-C3UB 8720086-A	Seal	1-Instruction sheet No. 2029	

GROUP NUMBER	YEAR	BODY TYPE	DESCRIPTION	PART NUMBER		QTY.
				RIGHT HAND	LEFT HAND	
<b>20124-5</b>	<b>DOOR ASSY. - FRONT - Less Hinges, Paint, Trim, Window Regulator, Latch and Remote Control, Drill Holes as required</b>					

- A -

67	A(54, 71)		C7AZ 5420124-A	C7AZ 5420125-A	1
67	A(57)		C7AZ 5720124-A	★C7AZ 5720125-A Not replaced (11-73)	1
67	A(63, 76)		★C7AZ 6320124-A Not replaced (3-74)	★C7AZ 6320125-A Not replaced (11-73)	1
68	A(54, 71)		C8AZ 5420124-A	C8AZ 5420125-A	1
68	A(57)		C8AZ 5720124-A	C8AZ 5720125-A	1
68	A(63, 65, 76)		C8AZ 6320124-A	C8AZ 6320125-A	1
69	A(54, 71)		C9AZ 5420124-A	C9AZ 5420125-A	1
69	A(57)		C9AZ 5720124-A	C9AZ 5720125-A	1
69	A(62)		★C9AZ 6220124-A Not replaced (3/75)	C9AZ 6220125-A	1
69	A(63, 65, 76)		C9AZ 6320124-A	C9AZ 6320125-A	1
70	A(54, 71)		D0AZ 5420124-A	D0AZ 5420125-A	1
70	A(63, 65, 76)		D0AZ 6320124-A	D0AZ 6320125-A	1
70	A(57)		D0AZ 5720124-A	D0AZ 5720125-A	1
71/	A(53)		D2AZ 5320124-A	D2AZ 5320125-A	1
71/	A(54, 71)		D2AZ 5420124-A	D2AZ 5420125-A	1
71/	A(57)		D2AZ 5720124-A	D2AZ 5720125-A	1
71/	A(65, 76)		D2AZ 6520124-A	D2AZ 6520125-A	1

- B -

66	B(63, 76)		C6OZ 6320124-A	C6OZ 6320125-A	1
66/67	B(54, 71)		★C6OZ 5420124-A Not replaced (3-74)	C6OZ 5420125-A	1
66/67	B(62)		C6OZ 6220124-A	C6OZ 6220125-A	1
67	B(66)		C7DZ 6620124-A	★C6DZ 6620125-B Not replaced (3/75)	1
68/69	B(54, 71)		C8OZ 5420124-A	C8OZ 5420125-A	1
68/69	B(63, 65, 66, 76)		C8OZ 6320124-A	C8OZ 6320125-A	1
70	B(62)		D0OZ 6220124-A	D0OZ 6220125-A	1
70	B(63, 65, 76)		D1OZ 6520124-A	D0OZ 6520125-A	1
70	B(66)		D1OZ 6520124-A	D1OZ 6520125-A	1
70/71	B(54)		D0OZ 5420124-A	D0OZ 5420125-A	1
70/71	B(57)		D0OZ 5720124-A	D0OZ 5720125-A	1
71	B(63, 65, 66, 76)		D1OZ 6520124-A	D1OZ 6520125-A	1
70/71	B(71)		D0OZ 7120124-A	D0OZ 7120125-A	1
72	B(53, 71)		★D2OZ 5320124-A r/b D3OZ 5320124-B (11-73)	D2OZ 5320125-A	1
72	B(63, 65, 97)		D2OZ 6520124-A	★D2OZ 6520125-A r/b D3OZ 6520125-A	1

- F -

65/66	F		C5ZZ 6520124-B	C5ZZ 6520125-B	1
67/68	F	Includes arm rest retainers	C7ZZ 6520124-C	C7ZZ 6520125-C	1
69/70	F		D0ZZ 6520124-A	D0ZZ 6520125-A	1
71/72	F		D3ZZ 6520124-A	D3ZZ 6520125-A	1

# FORD CAR PARTS

## BODY SECTION 200

GROUP NUMBER	YEAR	BODY TYPE	DESCRIPTION	PART NUMBER		QTY.
				RIGHT HAND	LEFT HAND	
<b>20124-5 DOOR ASSY. - FRONT - continued</b> - Less Hinges, Paint, Trim, Window Regulator, Latch and Remote Control, Drill Holes as required						
- L -						
	71	L(62, 64)		D2FZ 6220124-A	★D1FZ 6220125-A r/b D3FZ 6220125-B (11-73)	1
	72	L(62, 64) "Before 3/1/72"		D2FZ 6220124-A	★D2FZ 6220125-A r/b D2FZ 6220125-B (1-73)	1
	72	L(62, 64) "From 3/1/72"		D2FZ 6220124-B	★D2FZ 6220125-B r/b D3FZ 6220125-B (12-73)	1
	72	L(73)		★D2FZ 7320124-B r/b D3FZ 7320124-B (3-74)	D2FZ 7320125-B	1
- P -						
	70	P(62)-w/o racing mirror		D0DZ 6220124-A	★D0DZ 6220125-A r/b D1DZ 6220125-B(12/74)	1
	70	P(62)-w/ racing mirror		D0DZ 6220124-A	★D0DZ 6220125-B r/b D1DZ 6220125-B (11-73)	1
	71/72	P(54) "Before 3/1/72"		D2DZ 5420124-A	D2DZ 5420125-A	1
	71/72	P(62) "Before 3/1/72"		D0DZ 6220124-A	D1DZ 6220125-B	1
	72	P(54) "From 3/1/72"		D2DZ 5420124-B	D2DZ 5420125-B	1
	72	P(62) "From 3/1/72"		D2DZ 6220124-B	D2DZ 6220125-B	1
- S -						
	65/66	S		★C5SZ 6320124-B Not replaced (3/75)	C5SZ 6320125-B	1
	67	S(65)		★C7SZ 6520124-A Not replaced (3-74)	C7SZ 6520125-A	1
	68/69	S(65)		C9SZ 6520124-A	C9SZ 6520125-A	1
	69	S(57)		C9SZ 5720124-A	C9SZ 5720125-A	1
	70	S(57)		★D0SZ 5720124-A r/b D1SZ 5720124-A (11-73)	D0SZ 5720125-A	1
	70	S(65)		★D0SZ 6520124-A r/b D1SZ 6520124-A(10/74)	★D0SZ 6520125-A r/b D1SZ 6520125-A(12/74)	1
	71	S(57)		D1SZ 5720124-A	D1SZ 5720125-A	1
	71	S(65)		D1SZ 6520124-A	D1SZ 6520125-A	1
	72	S "Before 3/1/72"		D2SZ 6520124-A	D2SZ 6520125-A	1
	72	S "From 3/1/72"		D2SZ 6520124-B	★D2SZ 6520125-B r/b D3SZ 6520125-B	1
- U -						
	66/69	U	Vinyl door-no longer available	★	★	
	66/67	U		C6TZ 9720124-B	C6TZ 9720125-B	1
	68	U	Less frame	C8TZ 9720124-A	C9TZ 9720125-A	1
	69/	U	Includes frame	C9TZ 9720124-A	C9TZ 9720125-A	1
- X -						
	66/67	X(54, 71)		★C6OZ 5420124-A Not replaced (3-74)	C6OZ 5420125-A	1
	66/67	X(62)		C6OZ 6220124-A	C6OZ 6220125-A	1
	66	X(66)		C7DZ 6620124-A	★C6DZ 6620125-B Not replaced (3/75)	1
	68/70	X(54, 71)		C8DZ 5420124-A	C8DZ 5420125-A	1
	68/70	X(62)		C8DZ 6220124-A	C8DZ 6220125-A	1
	65/	A, F	Bumper-on door	C2AZ 6223030-A	C2AZ 6223030-A	4
	65/69	B(62, 65)	Bumper-at door lock	C2OZ 6223030-A	C2OZ 6223030-A	2
	65/66	F	Plug (button)-1 1/2"diam. hole-lockside	C5ZZ 6522286-A	C5ZZ 6522286-A	4
	65/66	S	Bumper on lower rear corner	372617-S(CC24A)	372617-S(CC24A)	2
	67	S	Bumper	C7SZ 6523030-A	C7SZ 6523030-A	2

GROUP NUMBER	YEAR	BODY TYPE	DESCRIPTION	PART NUMBER		QTY.
				RIGHT HAND	LEFT HAND	
<b>20200-1</b>	<b>PANEL - FRONT DOOR OUTER - REPAIR - Drill Holes as required</b>					
- A -						
	65/66	A(54, 57, 71)		C6AZ 5420200-A	C6AZ 5420201-A	1
	65/66	A(62, 63, 76)		C5AZ 6220200-A	C5AZ 6220201-A	1
	67/68	A(54, 57, 71)		C7AZ 5420200-A	C7AZ 5420201-A	1
	67/68	A(62, 63, 76)		C7AZ 6220200-A	C7AZ 6220201-A	1
	68	A(65)				1
	69/70	A(54, 71)		C9AZ 5420200-A	C9AZ 5420201-A	1
	69/70	A(57)		D0AZ 5720200-A	D0AZ 5720201-A	1
	69	A(62)		C9AZ 6220200-A	C9AZ 6220201-A	1
	69/70	A(63, 65, 76)		D0AZ 6320200-A	D0AZ 6320201-A	1
	71/	A(53, 54, 57, 71)		D1AZ 5420200-A	D1AZ 5420201-A	1
	71/	A(65, 76)		D1AZ 6520200-A	D1AZ 6520201-A	1
- B -						
	66/67	B(54, 71)		C6OZ 5420200-A	C6OZ 5420201-A	1
	66	B(62, 63, 76)		C6OZ 6220200-A	C6OZ 6220201-A	1
	67	B(62, 63, 66, 76)				1
	68/69	B(54, 71)		C8OZ 5420200-A	C8OZ 5420201-A	1
	68/69	B(63, 65, 66, 76)		C8OZ 6320200-A	C8OZ 6320201-A	1
	70/71	B(63, 65, 66, 76)		D0OZ 6520200-A	D0OZ 6520201-B	1
	70	B(62)				1
	70/71	B(54)		D0OZ 5420200-A	D0OZ 5420201-A	1
	70/71	B(57)		D0OZ 5720200-A	D0OZ 5720201-A	1
	70/71	B(71)		D0OZ 7120200-A	D0OZ 7120201-A	1
	72	B(53, 71)		D2OZ 5320200-A	D2OZ 5320201-A	1
	72	B(63, 65, 97)		D2OZ 6520200-A	D2OZ 6520201-A	1
- F -						
	65/66	F		★C5ZZ 6520200-A Not replaced (5/75)	C5ZZ 6520201-A	1
	67/68	F		C7ZZ 6520200-A	C7ZZ 6520201-A	1
	69/70	F		C9ZZ 6520200-A	C9ZZ 6520201-A	1
	71/72	F	"Before 9/15/71"	★D1ZZ 6520200-A r/b D3ZZ 6520200-A(10/74)	D1ZZ 6520201-A	1
	72	F	"From 9/15/71"	★D1ZZ 6520200-A r/b D3ZZ 6520200-A(10/74)	D2ZZ 6520201-A	1
- L -						
	71/72	L		D2FZ 6220200-A	D2FZ 6220201-A	1
- P -						
	70/	P(62)		D0DZ 6220200-A	D0DZ 6220201-B	1
	71/	P(54)		D1DZ 5420200-A	D1DZ 5420201-A	1
- S -						
	67/71	S(57)		C9SZ 5720200-A	C9SZ 5720201-A	1
	67/71	S(65)		C9SZ 6520200-A	C9SZ 6520201-A	1
	72	S		D3SZ 6520200-B	D3SZ 6520201-B	1
- X -						
	65	X(54, 71)		★C4DZ 5420200-B Not replaced (3/75)	C4DZ 5420201-B	1
	65	X(except 54, 71)		C4DZ 6220200-A	C4DZ 6220201-A	1
	66/70	X(54, 71)		C6OZ 5420200-A	C6OZ 5420201-A	1
	66	X(62, 66)		C6OZ 6220200-A	C6OZ 6220201-A	1
	67/70	X(62)				1
<b>20206-7</b>	<b>PANEL - FRONT DOOR OUTSIDE FINISH</b>					
	71/	A(53H, K, 57H, K)		D1AZ 5720206-A	D1AZ 5720207-A	1
	71/	A(65H, K, 76H)		D1AZ 6520206-A	D1AZ 6520207-A	1

# FORD CAR PARTS

**BODY  
SECTION 200**

11

GROUP NUMBER	YEAR	BODY TYPE	DESCRIPTION	PART NUMBER	QTY.
<b>202A24 GRILLE ASSY. - FRONT DOOR VENT AIR - INNER</b>					
	67	A-with pressure relief vent system	Black	C7AZ 63202A24-A1A	2
<b>20225 REINFORCEMENT - FRONT DOOR OUTSIDE</b>					
	72	S-w/R.H. - remote control mirror		D3SZ 6520225-A	1
<b>20235 COVER - FRONT SEAT SHOULDER STRAP REEL - Refer to group 60235</b>					
<b>20235 COVER - FRONT SEAT RETRACTOR SAFETY HARNESS</b>					
	69/70	F(63-GT 350/500)		C9ZZ 6320235-A	2
<b>202A60-1 PANEL - FRONT DOOR OPENING - Paint to match</b>					
	66/69	U(96)	R. H. -Fiberglass	C6TZ 96202A60-A	1
			L. H.	C6TZ 96202A61-A	1
			No. 10-12 x 2" Cross recess oval head screw	*370696-S101	4
			No. 10-12 x 1 5/8" Cross recess oval head self tapping screw	375706-S101(UU56E)	20
			No. 10-16 x 1/2" Pan head self tapping screw	376383-S100(UU82J)	30
			No. 10-16 x 2" Cross recess pan head screw	381557-S101(UU56AA)	4
<b>202A62-3 PANEL - FRONT DOOR OPENING INSIDE - REAR - Paint to match</b>					
	66/69	U(96)	R. H. -Steel	C6TZ 96202A62-A	1
			L. H.	C6TZ 96202A63-A	1
			No. 10-12 x 1/2" Pan head self tapping screw	376383-S100(UU82J)	16
<b>20264-5 SEAL - FRONT DOOR FRONT AT BELT</b>					
	69/70	A(57, 63, 65, 76)	R. H. -r/b D1AZ 6520264-A	*D0AZ 6320264-A	1
			L. H.	D0AZ 6320265-A	1
	71/	A(53, 57, 65, 76)	R.H.	D1AZ 6520264-A	1
			L.H.	D1AZ 6520265-A	1
	71/	A(53, 57, 65, 76)	Screw, pan head-No.8-15 x 3/4"	371828-S100 (UU81)	8
	69/70	F	R. H.	C9ZZ 6520264-A	1
			L. H.	C9ZZ 6520265-A	1
	71/	F	R.H.	D1ZZ 6520264-A	1
			L.H.	D1ZZ 6520265-A	1
	71	F	Screw, pan head-No.8-15 x 3/4"	371828-S100(UU81)	16
<b>20266-7 SEAL - FRONT DOOR REAR AT BELT</b>					
	72	A(57)	R.H.	D2AZ 5720266-B	1
			L.H.	D2AZ 5720267-B	1
<b>202A66-7 PANEL - FRONT DOOR OPENING INSIDE - FRONT - Paint to match</b>					
	66/69	U(96)	R. H. -Steel	C6TZ 96202A66-A	1
			L. H.	C6TZ 96202A67-A	1
			No. 10-12 x 1/2" Pan head self tapping screw	376383-S100(UU82J)	14
<b>202A70 STRIP - FRONT DOOR OPENING PANEL SKID</b>					
	66/69	U(96)		C6TZ 96202A70-A	2
<b>20272 SEAL - FRONT DOOR INSIDE PANEL - LOWER</b>					
	67/68	F		C7WY 6520272-A	2
	69/71	F		C9ZZ 6520272-A	2
	71	F	Screw, pan head-No.8-15 x 3/4"	371828-S100(UU81)	16
	72	S		D2SZ 6520272-A	2
<b>20318 SHIELD - DOOR TRIM WATER</b>					
	65/70	A, B, F, S, U, X	28" x 54"-cut to fit	COAB 6420318-C	AR
<b>20334-5 SHIELD - FRONT DOOR LATCH REMOTE CONTROL OPENING</b>					
	70/	U(97, 98)	R. H.	D0TZ 9620334-A	1
			L. H.	D0TZ 9620335-A	1
	72	S		D4SZ 6520334-A	2
<b>20402-3 RAIL - FRONT DOOR OUTSIDE FINISH - LOWER - Refer to Group 20868-9</b>					
<b>20479 CLIP - DOOR WEATHERSTRIP RETAINER - Includes Attaching Parts</b>					
	70	A(57)	Front or rear door	D0AZ 5720479-A	AR

GROUP NUMBER	YEAR	BODY TYPE	DESCRIPTION	PART NUMBER		QTY.
				RIGHT HAND	LEFT HAND	
<b>20492-3 MOULDING - FRONT DOOR WINDOW FRAME TOP</b>						
- A -						
	65/68	A(54, 71)		C5AZ 5420492-B	C5AZ 5420493-B	1
	69/	A(54, 71)	Rustless steel-less insert	C9AZ 5420492-A	C9AZ 5420493-A	1
	69/71	A(54, 71)	Rustless steel-with insert	C9AZ 5420492-C	C9AZ 5420493-C	1
	70/71	A(54, 71)	Aluminum	D0AZ 5420492-A	D0AZ 5420493-A	1
- B -						
	66/67	B(54B, 71B, E)		C6OZ 5420492-A	C6OZ 5420493-A	1
	66/67	B(62B)		C6OZ 6220492-A	C6OZ 6220493-A	1
	67	B(66B, D)		C6DZ 6620492-A	C6DZ 6620493-A	1
	68/69	B(54) with vinyl roof cover	Black	C8OZ 5420492-B1A	C8OZ 5420493-B1A	1
	68/69	B(54B, C, 71B, E) w/out vinyl roof cover	Bright finish	C8OZ 5420492-A	C8OZ 5420493-A	1
	70/71	B(71C, E)				1
	69	B(54) with vinyl roof cover	White	C9OZ 5420492-BBW	C9OZ 5420493-BBW	1
	70/71	B(54C)		D0OZ 5420492-A	D0OZ 5420493-A	1
- L -						
	71/72	L(62, 64)		D1FZ 6220492-A	D1FZ 6220493-A	1
	72	L(73)		D2FZ 7320492-B	D2FZ 7320493-B	1
- U -						
	67/	U(97, 98)		C7TZ 9720492-A	C7TZ 9720493-A	1
- X -						
	66/70	X(54, 71)		C6OZ 5420492-A	C6OZ 5420493-A	1
	66/70	X(62)		C6OZ 6220492-A	C6OZ 6220493-A	1
	66	X(66)		*C6DZ 6620492-A	C6DZ 6620493-A	1
				Not replaced (3-74)		
<b>20530-1 WEATHERSTRIP - FRONT DOOR</b>						
- A -						
	65/66	A(63, 76)		C5AZ 6320530-B	C5AZ 6320531-B	1
	65/68	A(54, 71)		C5AZ 5420530-B	C5AZ 5420531-B	1
	65/68	A(57)		C5AZ 5720530-B	C5AZ 5720531-B	1
	65/68	A(62)		C5AZ 6220530-B	C5AZ 6220531-B	1
	66/67	A	Also refer to Group 20758			
	67/68	A(63, 76)		C5AZ 6320530-B	C5AZ 6320531-B	1
	68	A(65)				1
	65/68	A(63, 76)	Screw-No. 8-18 x 3/8" - pan head	52720-S8 (U380)	52720-S8 (U380)	2
	69	A(62)		C9AZ 6220530-B	C9AZ 6220531-A	1
	69/71	A(54, 71)		*C9AZ 5420530-B r/b D2AZ 5420530-A (1/75)	*C9AZ 5420531-A r/b D2AZ 5420531-A (1/75)	1
	69/72	A(57) "Before 10/11/71"		*C9AZ 5720530-A r/b D2AZ 5720530-B (10/74)	C9AZ 5720531-A	1
	69/	A(63, 65, 76)		C9AZ 6320530-A	C9AZ 6320531-A	1
	71/	A(53)		D2AZ 5320530-A	D2AZ 5320531-A	1
	69/	A(54, 71)		D2AZ 5420530-A	D2AZ 5420531-A	1
	69/72	A(57) "From 10/11/71"		D2AZ 5720530-B	D2AZ 5720531-B	1
	71	A	Screw-No. 8-15 x 3/4" - pan head	371828-S100 (UU81)	371828-S100 (UU81)	AR
- B -						
	65	B(54, 71)		C5OZ 5420530-A	C5OZ 5420531-A	1
	65	B	Screw No. 6-18 1/2" - pan head	32921-S7 (U334)	32921-S7 (U334)	2
	65	B	Screw No. 6-32 x 1/2" - self tap pan head	51763-S8(U362)	51763-S8(U362)	AR
	65	B	5/16" Plug	375547-S(PP14E)	375547-S(PP14E)	20or24
	66/67	B(54, 71)		C6OZ 5420530-C	C6OZ 5420531-C	1
	66/67	B(62)		C6OZ 6220530-C	C6OZ 6220531-C	1
	66/67	B(63, 76)		C6OZ 6320530-A	C6OZ 6320531-A	1
	67	B(66)		C6DZ 6620530-C	C6DZ 6620531-C	1
	66/67	B	Pin (drive)-Nylon	377163-S(NN165)	377163-S(NN165)	2

# FORD CAR PARTS

## BODY SECTION 200

GROUP NUMBER	YEAR	BODY TYPE	DESCRIPTION	PART NUMBER		QTY.
				RIGHT HAND	LEFT HAND	
<b>20530-1 WEATHERSTRIP - FRONT DOOR - continued</b>						
<b>- B -</b>						
	66/67	B	Screw No. 6-18 x 3/8" - pan head	52718-S8(U377A)	52718-S8(U377A)	2
	68/69	B(63, 65, 66, 76)		C8OZ 6320530-A	C8OZ 6320531-A	1
	68/69	B(54, 71)		C8OZ 5420530-A	C8OZ 5420531-A	1
	70/71	B(71)				1
	70/71	B(54)	Lower-on door	D0OZ 5420530-A	D0OZ 5420531-A	1
	70/71	B(54)	Upper-on body-refer to Group 51222-3			
	70/71	B(57)		D0OZ 5720530-A	D0OZ 5720531-A	1
	70	B(62)	Lower-on door	D0OZ 6220530-A	D0OZ 6220531-A	1
	70	B(62)	Upper-on body-refer to Group 51222-3			
	70/71	B(63, 65, 76)		D0OZ 6520530-A	D0OZ 6520531-A	1
	70	B(66) "Before 4/10/70"		D0OZ 6520530-A	D0OZ 6620531-A	1
	70/71	B(66) "From 4/10/70"		D0OZ 6620530-B	D0OZ 6620531-B	1
	70	B	Pin (drive)-1/4"	382570-S (HH8T)	382570-S (HH8T)	2 or 4
	71	B(54)				4
	71	B(57, 63, 65, 66, 76)	Screw-No.6-20 x 3/8"-	★383850-S100	★383850-S100	8
	72	B(53, 71)		D2OZ 5320530-A	D2OZ 5320531-A	1
	72	B(63, 65, 97)		D2OZ 6520530-A	D2OZ 6520531-A	1
<b>- F -</b>						
	65/66	F		C5ZZ 6520530-A	C5ZZ 6520531-A	1
	67/68	F		C7ZZ 6520530-A	C7ZZ 6520531-A	1
			No. 6-18 x 3/8" Cross recess pan head screw	★374842-S101	★374842-S101	10
			Pin (drive)-Nylon	377163-S (NN165)	377163-S (NN165)	2
	69/70	F		C9ZZ 6520530-A	C9ZZ 6520531-A	1
	71/	F		D1ZZ 6520530-A	D1ZZ 6520531-A	1
	71/	F	Screw-No.8-15 x 3/4"-	371828-S100 (UU81)	371828-S100 (UU81)	12
<b>- L -</b>						
	71/72	L(62, 64) "Before 10/1/71"		★D1FZ 6220530-A r/b D2FZ 6220530-B (10/74)	D1FZ 6220531-A	1
	72	L"From 10/1/71 to 12/13/71"		D2FZ 6220530-A	★D2FZ 6220531-A r/b D2FZ 6220531-B (5-73)	1
	72	L "From 12/13/71"		★D2FZ 6220530-B r/b D4FZ 6220530-A	D2FZ 6220531-B	1
<b>- P -</b>						
	70/	P(62)		D0DZ 6220530-A	D0DZ 6220531-A	1
	70/	P(62)	Pin-1/4" x 19/32"-drive	382570-S(HH8T)	382570-S(HH8T)	4
	71/	P(54)		D1DZ 5420530-A	D1DZ 5420531-A	1
<b>- S -</b>						
	65	S		C4SZ 6320530-C	C4SZ 6320531-C	1
			5/16" Plug	375547-S(PP14E)	375547-S(PP14E)	44
	66	S		C6SZ 6320530-A	C6SZ 6320531-A	1
	67	S(65)		C7SZ 6520530-A	C7SZ 6520531-A	1
			No. 6-18 x 3/8" Cross recess pan head screw	★52718-S2	★52718-S2	10or12
	67/71	S(57)		D0SZ 5720530-A	D0SZ 5720531-A	1
	68/69	S(65)		D0SZ 6520530-A	★C8SZ 6520531-A r/b D0SZ 6520531-A (1-73)	1
	70/71	S(65)		D0SZ 6520530-A	D0SZ 6520531-A	1
	72	S "Before 10/15/71"		D2SZ 6520530-A	★D2SZ 6520531-A r/b D2SZ 6520531-B (5-73)	1
	72	S "From 10/15/71"		D2SZ 6520530-B	D2SZ 6520531-B	1
	71	S	Screw, pan head, cross recess tapping- No.6-20 x 3/8"	★383850-S100	★383850-S100	2
	71	S	Screw, hex.washer head- No.10-12 x 5/8"	42134-S8 (U249)	42134-S8 (U249)	1

**BODY  
SECTION 200**
**FORD CAR PARTS**

GROUP NUMBER	YEAR	BODY TYPE	DESCRIPTION	PART NUMBER		QTY.
				RIGHT HAND	LEFT HAND	
<b>20530-1 WEATHERSTRIP - FRONT DOOR - continued</b>						
- X -						
	65	X(54, 71)		+C4DZ 5420530-B	+C4DZ 5420531-B	1
	65	X(59, 62, 66, 78)		+C4DZ 6220530-B	+C4DZ 6220531-B	1
	65	X(63, 76)		+C4DZ 6320530-B	★+C4DZ 6320531-B	1
	65	X	5/16" Plug	375547-S(PP14E)	375547-S(PP14E)	20or26
	66/70	X(54, 71)		C6OZ 5420530-C	C6OZ 5420531-C	1
	66/70	X(62)		C6OZ 6220530-C	C6OZ 6220531-C	1
	66	X(66)		C6DZ 6620530-C	C6DZ 6620531-C	1
	65/71	A	Retainer	C5AZ 6220586-A	C5AZ 6220586-A	AR
	67/71	F, S		AR		
	66/71	B		AR		
	66/70	X		AR		
	72	S		AR		
<b>20558-9 SEAL - FRONT DOOR REAR AT BELT</b>						
	68/69	B(63, 65, 66, 76)		C8OZ 6320558-A	C8OZ 6320559-A	1
	70/71	B(57)		D0OZ 5720558-A	D0OZ 5720559-A	1
	70/71	B(63, 65, 66)		D0OZ 6520558-A	D0OZ 6520559-A	1
	70/71	B	Screw-pan head- No.6-20 x 3/8"	★383850-S100	★383850-S100	8
	67/69	F	No.6-18 x 3/8" Pan head screw	C7ZZ 6520558-B ★374842-S101	C7ZZ 6520559-B ★374842-S101	1 10
<b>20586 RETAINER - WEATHERSTRIP</b>						
	65/71	A		C5AZ 6220586-A	C5AZ 6220586-A	AR
	66/71	B, F, S				AR
	66/	U				AR
	66/70	X				AR
	71	P				AR
	72	S				AR
			Screw No. 6-18 x 3/8" - pan head	52718-S8 (U377A)	52718-S8(U377A)	AR
<b>20588-9 SEAL - FRONT DOOR WINDOW - REAR UPPER</b>						
	65/66	F		★C5ZZ 6520588-A	C5ZZ 6520589-A	1
	67/69	F	Refer to Group 20558-9			
<b>20700 SEAL - INNER PANEL BOTTOM DRAIN</b>						
	65/71	A, B, S, X	Front door, rear door or tail gate	C3AZ 6220700-B		AR
	72	A(71)	Tail gate			2
<b>20708-9 WEATHERSTRIP FRONT - DOOR OPENING - LOWER</b>						
	66/	U	R. H.	C6TZ 9720708-A		1
			L. H.	C6TZ 9720709-A		1
	66/71	U	Screw-No. 8-15 x 1/2"-cross recess, pan head Retainer	52726-S13(U381) C5AZ 6220586-A		4 18
	72	U	Screw-No.8-15 x 5/8"-fillister head, cross recess, tapping	52554-S8 (U230)		4
<b>20748 TRANSFER - WOOD GRAIN</b>						
- A -						
	65	A(71A, E)	"From 12/27/63" Dark Walnut grain-cut as required-sheet 64 3/8" x 12"	C4AZ 7120748-B		AR
	65/67	A(71A, E)	Walnut grain with Black planking lines-cut as required-sheet 67" x 21" - Adhesive type - use for total repair only	C5AZ 7120748-A		AR

† Used on Units with Retainer welded to Door Bottom



# FORD CAR PARTS

## BODY SECTION 200

15

GROUP NUMBER	YEAR	BODY TYPE	DESCRIPTION	PART NUMBER	QTY.
<b>20748 TRANSFER - WOOD GRAIN - continued</b>					
<b>- A -</b>					
	66	A(71A, E)	Dark Walnut Grain with Black planking lines-cut as required-sheet 63 7/8" x 13 1/2"	C6AZ 7120748-A	AR
	67	A(71A, E)	Walnut grain with Black planking lines-cut as required-sheet 61 1/2" x 13 5/8"	C7AZ 7120748-A	AR
	68	A(71A, E)-for units built at Dallas	Walnut grain with Black planking lines-cut as required-sheet 66 3/8" x 17 13/64" (Di Noc)	C8AZ 7120748-A	AR
	68	A(71A, E)-except units built at Dallas	Walnut grain with Black planking line-cut as required-sheet 66 3/8" x 17 13/64" Adhesive type	C8AZ 7120748-B	AR
	69/70	A(71A, E)-for units built at Dallas only	Cherry grain with Black planking lines-cut as required-sheet 62 11/16" x 18 5/64" (Di Noc)	C9AZ 7120748-B	AR
	71/	A(71H)	Cherry grain w/planking lines-66" x 20"- adhesive type-non reflective	D1AZ 7120748-A	AR
	69/70	A(71A, E)-except units built at Dallas			AR
	71/	A(71H)	Tailgate only-reflective-Refer to Group 40722		
<b>- B -</b>					
	66	B(71E)	Walnut Grain with Black planking lines-cut as required-sheet 59.75" x 13.65"	C6OZ 7120748-A	AR
	66	B(71E)	Walnut Grain without Black planking lines - cut as required-sheet 8" x 1"	C6OZ 7120748-B	2
	66/67	B(71E)	Walnut grain with Black planking lines-cut as required-sheet 67" x 21"-adhesive type-use for total repair only	C5AZ 7120748-A	AR
	67	B(71E)	Walnut grain with Black planking lines-cut as required-sheet 59 3/4" x 13 5/8"	C7OZ 7120748-A	AR
	67	B(71E)	Walnut grain with Black planking lines-sheet 8"x1"	C7OZ 7120748-B	2
	68	B(71E)	Walnut grain with Black planking lines-cut as required-sheet 59 7/8" x 15 13/16" -adhesive type	C8OZ 7120748-B	AR
	69	B(71E)	Non-reflective-Walnut grain with black planking line-cut as required-59 7/8" x 15 13/16" - adhesive type	C9OZ 7120748-A	AR
	70/71	B(66E, 71E)	Cherry woodgrain- with planking lines-cut as required-18 3/4" x 84" -adhesive type	D0OZ 6620748-A	AR
	70/71	B(66E, 71E)	Reflective-tail gate only-Refer to Group 40722		
	72	B(71K, 97K)			
	72	B(71K, 97K)	Non-reflective-Cherry woodgrain-without planking lines-cut as required-19" x 83 1/2" - adhesive type	D2OZ 7120748-A	AR
<b>- L -</b>					
	72	L(73)	Cherry woodgrain-w/o planking lines-cut as required-17" x 60"- adhesive type	D2FZ 7320748-A	AR
<b>- X -</b>					
	65	X(71C)	Light Walnut grain-cut as required-sheet 64 3/8" x 12"	C4AZ 7120748-A	AR
	65	X(71C)	Walnut grain with Black planking lines-cut as required-sheet 67" x 21"-adhesive type-use for total repair only	C5AZ 7120748-A	AR
	65/		Water soluble transfer solution	M 5412-A	AR
			Bonding coat	M 4584	AR
<b>20770 SHIELD - FRONT DOOR WIRING - Also Refer to Group 14A099 in Chassis Section</b>					
	67/71	S		D0LZ 6520770-A	2
	72	S		D2SZ 6520770-A	2
<b>20798 COVER - FRONT DOOR WIRING SHIELD</b>					
	67/	S		C6VY 5320798-A	2

GROUP NUMBER	YEAR	BODY TYPE	DESCRIPTION	PART NUMBER	QTY.
<b>20802-3</b>	<b>ORNAMENT - DOOR TRIM PANEL</b>				
	- A -				
	65	A	"500"	•C5AB 6220802-A	1
	69	A(54A, 57B, 63B, 65C, 71B, C, 76A)	"Galaxie 500" -Includes attaching parts *	C9AZ 5420802-A	2
	69	A(63C, 76B)	"XL" -With bend over tabs	C9AZ 6320802-A	2
	69	A(54C, 57F, 65A, 71A, E)	"LTD" -Includes attaching parts	C9AZ 5720802-A	2
	70	A(54C, 57F, 65A)			1
	70	A(54C, 57F, 65A)	"Brougham" - inside	D0AZ 5420802-B	2
	70	A(54C, 57F, 65A, 71A, E)	"Luxury" - inside	D0AZ 5420802-A	2
	71	A(57K, 65K, 71H)			2
	71	A(54F, 57F, 65F, 71F)	Crown emblem	D1AZ 6520802-B	2
	72	A(53H, K, 57H, K, 65H, K, 71H, 76)	Crown emblem-refer to group 23942-3 in Soft Trim Section	★D1AZ 6520802-A Not replaced (10/74)	2
	70	A	Nut-self threading 5/32"	382110-S100(MM284X)	4
	- B -				
	69	B(63)-Talladega	"Talladega"	C9OZ 6320816-A	2
	70	B(54B, 65B, 71B)	"Fairlane 500"	D0OZ 6520802-B	2
	70/71	B(63H)	Cobra emblem-includes attaching parts	D0OZ 6520802-A	2
	72	B(71K)	"Squire"	D2OZ 7120802-A	2
	- F -				
	69/70	F(63A, B, 65A, B, C, D, 76)	R. H. -Includes attaching parts L. H.	C9ZZ 6520802-A C9ZZ 6520803-A	1 1
	69/70	F(Shelby GT350/500)	"Shelby Cobra" -adhesive backed	C9ZZ 6320802-B	2
	- P -				
	71/	P	Steer's head-adhesive backed	D1DZ 6220802-A	2
	- S -				
	68	S		C8SZ 6520802-A	2
	69	S(57C, 65)			2
	70/71	S(57C, 65)		D0SZ 6520802-A	2 or 4
	70	S(65)	Also refer to Group 04460		
<b>20807</b>	<b>FASTENER - DOOR INNER PANEL BOTTOM DRAIN SEAL</b>				
	65/66	S		C1AB 6220807-A	4 to 12
	65	B(54, 62, 65, 71)			2 or 4
	65/67	A(57, 63, 76)			6 to 14
	68/69	A	Front and rear doors		AR
	65/69	F	Door-upper front		4
	67/69	F(65)	Roof side rail weatherstrip		AR
	65	X(59, 71, 78)			4
<b>208A12</b>	<b>COVER - FRONT DOOR OUTSIDE TOP MOULDING JOINT</b>				
	66	X(66B, D)		C6DZ 66208A12-A	2
	67	B(66B, D)			2
<b>20816</b>	<b>PLATE - DOOR TRIM PANEL NAME - Refer to group 20802</b>				
<b>20818</b>	<b>RETAINER - OUTSIDE MOULDING</b>				
	REFER TO APPROPRIATE EXTERIOR MOULDING ILLUSTRATION FOR COMPLETE RETAINER PART NUMBER				
<b>208A40</b>	<b>RETAINER - DOOR OUTSIDE REAR EDGE MOULDING</b>				
	66	A(54, 57B, 62, 63B, 71B, C, D, 76A)		C6AZ 62208A40-A	2 or 4
<b>20842</b>	<b>RETAINER - OUTSIDE MOULDING</b>				
	65	S	Front fender	C2DZ 6420842-A	8
	65	S	Door		12
	65	S	Quarter		15
	72	L(exc. Squire)	Front door	D2FZ 6220842-A	2

# FORD CAR PARTS

**BODY  
SECTION 200**

17

GROUP NUMBER	YEAR	BODY TYPE	DESCRIPTION	PART NUMBER	QTY.
<b>20846-7 MOULDING - FRONT DOOR WINDOW FRAME TOP</b>					
	70/	P(62)	R. H. -snap on-dull finish	D0DZ 6220846-A	1
			L. H.	D0DZ 6220847-A	1
	72	P(62A)	R.H.-snap on-bright finish	D2DZ 6220846-A	1
			L.H.	D2DZ 6220847-A	1
	71/	P(54)	R.H.-snap on -dull finish	D1DZ 5420846-A	1
			L.H.	D1DZ 5420847-A	1
	72	P(54)	R.H.-snap on-bright finish	D2DZ 5420846-A	1
			L.H.	D2DZ 5420847-A	1
	65	X(62B, 66B, 78B)	R. H.	C0DB 6420846-D	1
			L. H.	C0DB 6420847-D	1
<b>208448 MOULDING - FRONT DOOR TRIM PANEL UPPER CENTER FRONT</b>					
	70/71	S		D0SZ 65208A48-A	2
GROUP NUMBER	YEAR	BODY TYPE	DESCRIPTION	PART NUMBER	QTY.
				RIGHT HAND	LEFT HAND
<b>20868-9 RAIL - FRONT DOOR OUTSIDE FINISH - LOWER - INCLUDES ATTACHING PARTS</b>					
- A -					
	65	A(71A, E)		C5AZ 7120868-A	★C5AZ 7120869-A Not replaced (3-74)
	66	A(71A, E)		C6AZ 7120868-A	C6AZ 7120869-A
	67	A(71A, E)		C7AZ 7120868-A	C7AZ 7120869-A
	68	A(71A, E)		C8AZ 7120868-A	C8AZ 7120869-A
	69/70	A(71A, E)		C9AZ 7120868-A	C9AZ 7120869-A
	71	A(71H)		D1AZ 7120868-A	D1AZ 7120869-A
	72	A(71H)		D2AZ 7120868-A	D2AZ 7120869-A
- B -					
	66/67	B(71E)		C6OZ 7120868-A	C6OZ 7120869-A
	68/69	B(71E)		C8OZ 7120868-A	C8OZ 7120869-A
	70/71	B(66E)		D0OZ 6620868-A	D0OZ 6620869-A
	70/71	B(71E)		D0OZ 7120868-A	D0OZ 7120869-A
	72	B(71K)		D2OZ 7120868-A	D2OZ 7120869-A
	72	B(97K)		D2OZ 9720868-A	D2OZ 9720869-A
- L -					
	72	L(73)		D2FZ 7320868-A	D2FZ 7320869-A
<b>208A70 RETAINER - FRONT DOOR OUTSIDE FINISH PANEL</b>					
	71/	A(53,57)		D1AZ 57208A70-A	D1AZ 57208A70-A
	71/	A(65,76)		D1AZ 65208A70-A	D1AZ 65208A70-A
<b>20878-9 MOULDING - FRONT DOOR OUTSIDE - LOWER - INCLUDES ATTACHING PARTS</b>					
- A -					
	67	A(54A, 57B, 71B, C)		C7AZ 5420878-A	C7AZ 5420879-A
	67	A(54C, 57F) "Before 1/16/67"	With Vinyl tape insert	C7AZ 5720878-A	C7AZ 5720879-A
	67	A(54C, 57F) "From 1/16/67"	With painted insert	C7AZ 5420878-B	C7AZ 5420879-B
	67	A(63B, 76A)	With 1 stripe Vinyl tape insert	C7AZ 6320878-B	C7AZ 6320878-B
	67	A(63C, J, 76B)- "Before 1/16/67"	With 6 stripes Vinyl tape insert	C7AZ 6320878-A	C7AZ 6320878-A
	67	A(63C, J, 76B)- "From 1/16/67"	With 2 painted inserts	C7AZ 6320878-C	C7AZ 6320878-C
	69	A(54A, 57B, 71B, C)		C9AZ 5420878-A	C9AZ 5420879-A
	69	A(54C, 57F)		C9AZ 5420878-B	C9AZ 5420879-B
	69	A(63B, 65C, 76A)		C9AZ 6320878-A	C9AZ 6320879-A
	69	A(65A)		C9AZ 6520878-A	C9AZ 6520879-A
	71/	A(54F, 57F, 71F)		D1AZ 5420878-A	D1AZ 5420879-A
	71/	A(53, 57H, K)		D1AZ 5720878-A	D1AZ 5720879-A
	71/	A(65F)		D1AZ 6520878-A	D1AZ 6520879-A
	71/	A(65H, K, 76)		D1AZ 6520878-B	D1AZ 6520879-B

**BODY  
SECTION 200**
**FORD CAR PARTS**

GROUP NUMBER	YEAR	BODY TYPE	DESCRIPTION	PART NUMBER		QTY.
				RIGHT HAND	LEFT HAND	
<b>20878-9 MOULDING - FRONT DOOR OUTSIDE - LOWER - INCLUDES ATTACHING PARTS - continued</b>						
- B -						
	67	B(54B, 71B)		C7OZ 5420878-A	C7OZ 5420879-A	1
	67	B(62B, 63B, C, 66B, 66D, 76B, C)		C7OZ 6220878-A	C7OZ 6220879-A	1
	68	B(54C)		C8OZ 5420878-A	C8OZ 5420879-A	1
	68	B(65C)		C8OZ 6520878-A	C8OZ 6520879-A	1
	69	B(54B, 71B)		C9OZ 5420878-A	C9OZ 5420879-A	1
	69	B(63B, E, 65B, E, 66B, 76B, E)		C9OZ 6320878-A	C9OZ 6320879-A	1
	72	B(53D, 71D)		D2OZ 5320878-A	D2OZ 5320879-A	1
	72	B(63R, 65D, R)		D2OZ 6520878-A	D2OZ 6520879-A	1

- F -

	71/	F-w/o racing stripes		D1ZZ 6320878-A	D1ZZ 6320879-A	1
--	-----	----------------------	--	----------------	----------------	---

- S -

	69	S(57)		C9SZ 5720878-A	C9SZ 5720878-A	2
	69	S(65)		C9SZ 6520878-A	C9SZ 6520878-A	2

- X -

	65	X(54B)		C5DZ 5420878-A	C5DZ 5420879-A	1
	65	X(71B) "From 10/6/64"				1
	65	X(62B, 63, 76)		C5DZ 6220878-A	C5DZ 6220879-A	1
	65	X(66)		★C4DZ 6220878-A Not replaced (3-74)	C4DZ 6220879-A	1

GROUP NUMBER	YEAR	BODY TYPE	DESCRIPTION	PART NUMBER	QTY.
--------------	------	-----------	-------------	-------------	------

**20880-4 RETAINER - OUTSIDE MOULDING**

REFER TO APPROPRIATE EXTERIOR MOULDING ILLUSTRATION  
FOR COMPLETE RETAINER PART NUMBER

**208A80 RETAINER - FRONT DOOR WINDOW FRAME**

	72	L(73)		D2FZ 73208A80-A	2
--	----	-------	--	-----------------	---

GROUP NUMBER	YEAR	BODY TYPE	DESCRIPTION	PART NUMBER		QTY.
				RIGHT HAND	LEFT HAND	

**20904-5 MOULDING - FRONT DOOR WINDOW GARNISH - Paint to match. Drill holes as required**

	68/69	B(63B, E, 65A, B, E, 66A, B, 76B, E)		C8OZ 6320904-A	C8OZ 6320905-A	1
	69/70	F(63A, 65A, 76A)		C9ZZ 6520904-A	C9ZZ 6520905-A	1
	71/	F(63D, R, 65D)		D1ZZ 6520904-A	D1ZZ 6520905-A	1

GROUP NUMBER	YEAR	BODY TYPE	DESCRIPTION	PART NUMBER	QTY.
--------------	------	-----------	-------------	-------------	------

**20910 MOULDING KIT - DOOR OUTSIDE REAR EDGE**

- A -

	66	A(54, 57, 71)	Not replaced (11-73)	★C6AZ 5420910-A	1
	67	A(54, 57, 71)	Not replaced (11-73)	★C7AZ 5720910-A	1
	68	A(54, 57, 71)	Not replaced (11-73)	★C8AZ 5420910-A	1
	69/70	A(54, 57, 71)		C9AZ 5420910-A	1
	71/	A(53, 54, 57, 71)	Service details ⊕ (7-73)	★D1AZ 5320910-A	1
	71/	A(65, 76)		D1AZ 6520910-A	1

- B -

	66	B(62, 63, 76)		C6OZ 6220910-A	1
	67	B(62, 63, 66, 76)			1
	68/69	B(63, 65, 66, 76)		C8OZ 6320910-A	1
	70/71	B(54, 57)		★D0OZ 5420910-A Not replaced (10/74)	1
	70/71	B(71)		D0OZ 7120910-A	1
	72	B(63, 65, 97)		D2OZ 6520910-A	1
	72	B(53, 71)		D2OZ 5320910-A	1

- F -

	67/68	F	Not replaced (3-74)	★C7ZZ 6520910-A	1
	71/	F	Not replaced (5/75)	★D1ZZ 6520910-A	1

- L -

	71/	L (exc. Squire)		D1FZ 6220910-A	1
	72	L (Squire)	Woodgrain	D2FZ 7320910-A	1

# FORD CAR PARTS

## BODY SECTION 200

19

GROUP NUMBER	YEAR	BODY TYPE	DESCRIPTION	PART NUMBER	QTY.
<b>20910 MOULDING KIT - DOOR OUTSIDE REAR EDGE - continued</b>					
- P -					
	70/	P(62)		D0DZ 6220910-A	1
	71/	P(54)		D1DZ 5420910-A	1
- S -					
	65/66	S	Not replaced (11-73)	★C4SZ 6320910-A	1
	67/71	S(57)	Service details ⊕ (4-73)	★C7SZ 5720910-A	1
	72	S		D2SZ 6520910-A	1
- U -					
	66/	U		D5TZ 9720910-A	1
- X -					
	66/67	X(62, 66)	Not replaced (11-73)	★C6OZ 6220910-A	1
GROUP NUMBER	YEAR	BODY TYPE	DESCRIPTION	PART NUMBER	QTY.
<b>20914-5 MOULDING - FRONT DOOR TRIM PANEL - UPPER - INCLUDES ATTACHING PARTS</b>					
	66	A(57F, 63F)		♣C6MY 5020914-A	1
				♣C6MY 5020915-A	1
<b>20916-7 MOULDING - FRONT DOOR OUTSIDE - FRONT</b>					
	67/	U(97, 98)		C7TZ 9720916-A	1
				C7TZ 9720917-A	1
<b>20920-1 MOULDING - FRONT DOOR TRIM PANEL - REAR</b>					
	66	A(57F)		♣C6MY 5020920-A	1
	69	A(54C, 57F)		C9AZ 5720920-A	1
	70	A(54C, 57F, 71H, J)		Not replaced (10/74)	1
	69/70	A(65A)		C9AZ 6520920-A	1
				C9AZ 6520921-A	1
<b>20922 SPACER - DOOR WINDOW GARNISH MOULDING</b>					
	69/70	F(63A, 65A, 76A)		C9ZZ 6520922-A	2 or 4
	71/	F(63D, 65D, 76D)		D1ZZ 6520922-A	4
				D1ZZ 6520922-A	4
<b>20932-3 MOULDING - FRONT DOOR OUTSIDE UPPER - INCLUDES ATTACHING PARTS</b>					
	70	A(54C, 57F)	Upper	D0AZ 5420932-A	4
	70	A(63C, 65A, 76)	Upper	D0AZ 6320932-A	4
	68	B(54C)		C8OZ 5420932-A	1
	68	B(65C)		C8OZ 6520932-A	1
	65	X(62B, 63, 76)		C5DZ 6220932-A	1
				★C5DZ 6220933-A	1
	65	X(66)		Not replaced (5/75)	1
				C4DZ 6220932-A	1
				C4DZ 6220933-A	1
<b>20934-5 MOULDING - FRONT DOOR OUTSIDE - AT BELT - INCLUDES WEATHERSTRIP and ATTACHING PARTS</b>					
- A -					
	65/66	A(57)		C5AZ 5720934-A	1
	65	A(63, 76)		C5AZ 6320934-A	1
	66	A(76)		C5AZ 6320935-A	1
	66	A(63)		C6AZ 6320934-A	1
	67	A(54C)		C7AZ 5420934-A	1
	67/68	A(57)		C7AZ 5720934-A	1
	67	A(63, 76)		C7AZ 6320934-A	1
	68	A(63, 65, 76)		C7AZ 6320935-A	1
	69/70	A(53, 57, 71)	Refer to group 21452-3		
	69/70	A(63, 65, 76)		C9AZ 6320934-A	1
	71/	A(53, 57)		C9AZ 6320935-A	1
	71/	A(65, 76)	54" long - 3/4" wide	D1MY 5720934-A	1
	71/	A	5" long - 3/4" wide	D1AZ 6520934-A	1
	71/	A		D1AZ 6520934-B	1
	67/	A	No. 6-20 x 3/8" screw-truss head	353803-S8(UU95)	AR
				353803-S8(UU95)	AR
- B -					
	68/69	B(63, 65C, 66)		C8OZ 6320934-A	1
	70	B(65C, 66)		C8OZ 6320935-A	1
	70/	B(63)		D0OZ 6320934-A	1
				D0OZ 6320935-A	1
- L -					
	72	L(62, 64)	W/o R.H. mirror	D4FZ 6220934-A	1
	72	L(73)	"Before 5/1/72"	D2FZ 7320934-A	1
	72	L(73)	W/o R.H. racing mirror	D2FZ 7320935-A	1
	72	L(73)	W/R.H. racing mirror	D2FZ 7320934-B	1
	72	L(73)	"From 5/1/72"	D2FZ 7320935-A	1
	72	L(73)	W/o R.H. racing mirror	D2FZ 7329034-C	1
	72	L(73)	W/R.H. racing mirror	D2FZ 7320935-B	1
				D2FZ 7320934-D	1
				D2FZ 7320935-B	1

♣ Canada only  
May, 1975

⊕ Refer to appropriate Exterior Moulding Illustration Section

COPYRIGHT © 1975 -

FORD MOTOR COMPANY

- DEARBORN, MICHIGAN

**FINAL ISSUE**

GROUP NUMBER	YEAR	BODY TYPE	DESCRIPTION	PART NUMBER				QTY.
				RIGHT HAND		LEFT HAND		
<b>20934-5 MOULDING - FRONT DOOR OUTSIDE - AT BELT - INCLUDES WEATHERSTRIP and ATTACHING PARTS - continued</b>								
- P -								
	72	P(54)		D3DZ	5420934-A	D3DZ	5420935-A	1
	72	P(62A)		D3DZ	6220934-A	D3DZ	6220935-A	1
- S -								
	67/71	S(57)		C7SZ	5720934-B	C7SZ	5720935-B	1
	67/71	S(65)		C7SZ	6520934-B	C7SZ	6520935-B	1
	67/71	S	Screw No. 8-18 x 3/8" - pan head	52720-S8(U380)		52720-S8(U380)		AR
	72	S		D2SZ	6520934-A	D2SZ	6520935-A	1
<b>20938-9 MOULDING - FRONT DOOR OUTSIDE - INCLUDES ATTACHING PARTS</b>								
- A -								
	65	A(54A, E, 57B, 71B, C)	37.80" long	C5AZ	5420938-A	C5AZ	5420938-A	2
	65	A(54B)	14.78" long - Rear	C5AZ	5420938-B	C5AZ	5420938-B	2
	65	A(54B, 62B)	23.15" long - Front	C5AZ	6220938-A	C5AZ	6220938-A	2
	65	A(62E, 63B, 76A)	49.46" long	C5AZ	6220938-B	C5AZ	6220938-B	2
	66	A(54, 57B, 71B, C, D)		C6AZ	5420938-A	C6AZ	5420938-A	2
	66	A(62, 63B, 76A)		C6AZ	6220938-A	C6AZ	6220938-A	2
	67	A(54, 57, 71B, C, D)		C7AZ	5420938-A	C7AZ	5420938-A	2
	67	A(62, 63, 76)		C7AZ	6220938-A	C7AZ	6220938-A	2
	68	A(54, 57, 71)		C8AZ	5420938-B	C8AZ	5420938-B	2
	68	A(62B, E, 63, 65, 76)		C8AZ	6220938-B	C8AZ	6220938-B	2
	69	A(54, 57, 71)	Less insert	C9AZ	5420938-A	C9AZ	5420939-A	1
	70	A(54B, 71D, H, J)						1
	69	A(62, 63B, 65, 76A)	Less insert	C9AZ	6220938-A	C9AZ	6220939-A	1
	70	A(65M)						1
	70	A(54, 57, 71)	Black insert	D0AZ	5420938-C	D0AZ	5420939-C	1
			Blue insert	D0AZ	5420938-D	D0AZ	5420939-D	1
			Brown insert	D0AZ	5420938-A	D0AZ	5420939-A	1
			Green insert	D0AZ	5420938-B	D0AZ	5420939-B	1
	70	A(63, 65, 76)	Black insert	D0AZ	6520938-C	D0AZ	6520939-C	1
			Blue insert	D0AZ	6520938-D	D0AZ	6520939-D	1
			Brown insert	D0AZ	6520938-A	D0AZ	6520939-A	1
			Green insert	D0AZ	6520938-B	D0AZ	6520939-B	1
	71	A(53, 54, 57, 71B, D, F)	Less insert	D1AZ	5420938-A	D1AZ	5420938-A	2
	71	A(65, 76)	Less insert	D1AZ	6520938-A	D1AZ	6520938-A	2
	71	A(53, 54, 57, 65, 71B, D, F, 76)	Cut to fit	D1OZ	6520938-B	D1OZ	6520939-B	2
	72	A(53, 54, 57, 71B, D, F)		D2AZ	5420938-A	D2AZ	5420939-A	1
	72	A(65, 76)		D2AZ	6520938-A	D2AZ	6520939-A	1
- B -								
	65	B(54B, 71B)		C5OZ	5420938-A	C5OZ	5420939-A	1
	65	B(62B, 65)		C5OZ	6220938-A	C5OZ	6220939-A	1
	66	B(54, 71B, 71D)		C6OZ	5420938-A	C6OZ	5420939-A	1
	66	B(62, 63B, C, 76B, C)		C6OZ	6220938-A	C6OZ	6220939-A	1
	67	B(54A, 71D)		C7OZ	5420938-A	C7OZ	5420939-A	1
	67	B(54B)		C6OZ	5420938-A	C6OZ	5420939-A	1
	67	B(62A, 66A)		C7OZ	6220938-A	C7OZ	6220939-A	1
	67	B(62B, 63B, 76B)		C6OZ	6220938-A	C6OZ	6220939-A	1
	68	B(54A, B, 71B, D)		C8OZ	5420938-A	C8OZ	5420939-A	1
	68	B(63B, E, 65A, B, E, 66A, B, 76B, E)		C8OZ	6320938-A	C8OZ	6320939-A	1
	69	B(54A, B, C, 71B)		C9OZ	5420938-A	C9OZ	5420939-A	1
	69	B(63B, E, 65A, B, C, E, 66A, B, 76B, E)		C9OZ	6520938-A	C9OZ	6520939-A	1
	70	B(54, 57, 71B, C, D)	Black insert	D0OZ	5420938-C	D0OZ	5420939-C	1
			Blue insert	D0OZ	5420938-D	D0OZ	5420939-D	1
			Brown insert	D0OZ	5420938-A	D0OZ	5420939-A	1
			Green insert	D0OZ	5420938-B	D0OZ	5420939-B	1
	70	B(62, 63, 65, 66A, B, 76)	Black insert	D0OZ	6620938-C	D0OZ	6620939-C	1
			Blue insert	D0OZ	6620938-D	D0OZ	6620939-D	1
			Brown insert	D0OZ	6620938-A	D0OZ	6620939-A	1
			Green insert	D0OZ	6620938-B	D0OZ	6620939-B	1
	71	B(57E)	Less insert	D1OZ	5720938-A	D1OZ	5720939-A	1

# FORD CAR PARTS

## BODY SECTION 200

21

GROUP NUMBER	YEAR	BODY TYPE	DESCRIPTION	PART NUMBER		QTY.
				RIGHT HAND	LEFT HAND	
<b>20938-9 MOULDING - FRONT DOOR OUTSIDE - INCLUDES ATTACHING PARTS - continued</b>						
<b>- B -</b>						
71		B(65E)	Less insert	D1OZ 6520938-A	D1OZ 6520939-A	1
71		B(63, 65B, C, 66, 76)	Less insert	D1OZ 6520938-B	D1OZ 6520939-B	1
71		B(54, 57, 71)	Black insert	D0OZ 5420938-C	D0OZ 5420939-C	1
71		B(63, 65, 66, 76)	Black insert	D0OZ 6620938-C	D0OZ 6620939-C	1
72		B(53, 71D)	Black insert	D3OZ 5320938-A	D3OZ 5320939-A	1
72		B(63, 65, 97D)	Black insert	D3OZ 6520938-A	D3OZ 6520939-A	1
72		B(71K)	Wood grain insert	D3OZ 7120938-A	D3OZ 7120939-A	1
72		B(97K)	Wood grain insert	D3OZ 9720938-A	D3OZ 9720939-A	1
<b>- F -</b>						
69/70	F		52" long-adhesive backed -Black vinyl insert Front door-cut to 51" Quarter-cut to 11 3/8" Frt. fender-cut to 26 5/8" Rear end cap-Refer to Group 29076	†C9SZ 6520938-A	†C9SZ 6520938-A	AR
70	F(63C)			D0ZZ 6320938-A	D0ZZ 6320939-A	1
71/	F		Black insert	D1ZZ 6520938-C	D1ZZ 6520939-C	1
71	F		Blue insert	D1ZZ 6520938-D	D1ZZ 6520939-D	1
			Brown insert	D1ZZ 6520938-A	D1ZZ 6520939-A	1
			Green insert	D1ZZ 6520938-B	D1ZZ 6520939-B	1
<b>- L -</b>						
71/72	L(62, 64)	"Before 3/1/72"	Black insert	D1FZ 6220938-A	D1FZ 6220938-A	1
72	L(exc. Squire)-	"From 3/1/72"	Black insert	D2FZ 6220938-B	D2FZ 6220938-B	1
72	L(73 Squire)		Wood grain insert	D2FZ 7320938-A	D2FZ 7320938-A	1
<b>- P -</b>						
70/	P		Cut to fit	†D1WZ 6520938-A	†D1WZ 6520938-A	AR
	P(54)		Front door-41" long			
	P(54)		Rear door-27" long			
	P(62)		Front door-53" long			
70/	P(62)		Quarter-cut to 8" long	†D1WZ 16003-A	†D1WZ 16003-A	1
71	P(54)		Black insert	★D1DZ 5420938-A	★D1DZ 5420939-A	1
				r/b D2DZ 5420938-A	r/b D2DZ 5420939-A	
72	P(54)		Black insert	D2DZ 5420938-A	D2DZ 5420939-A	1
70/	P(62)		Black insert	D2DZ 6220938-A	D2DZ 6220939-A	1
72	P(54)		Blue insert	D2DZ 5420938-BB	D2DZ 5420939-BB	1
			Brown insert	D2DZ 5420938-BT	D2DZ 5420939-BT	1
			Copper insert	D2DZ 5420938-BC	D2DZ 5420939-BC	1
			Green insert	D2DZ 5420938-BR	D2DZ 5420939-BR	1
			White insert	D2DZ 5420938-BJ	D2DZ 5420939-BJ	1
72	P(62A)		Blue insert	D2DZ 6220938-BB	D2DZ 6220939-BB	1
			Brown insert	D2DZ 6220938-BT	D2DZ 6220939-BT	1
			Copper insert	D2DZ 6220938-BC	D2DZ 6220939-BC	1
			Green insert	D2DZ 6220938-BR	D2DZ 6220939-BR	1
			White insert	D2DZ 6220938-BJ	D2DZ 6220939-BJ	1
<b>- S -</b>						
65/66	S			C4SZ 6320938-A	C4SZ 6320938-A	1
67	S(57)		Refer to Group 20956			
69/71	S		52" long-adhesive backed -Black vinyl insert	†C9SZ 6520938-A	†C9SZ 6520938-A	AR
	S(57)		Frt. door-cut to 37 1/4"			
	S(57)		Rear door-cut to 27 1/2"			
	S(57)		Qtr. -front-cut to 3 1/2"			
	S(65)		Qtr. front-cut to 14" long			
	S		Qtr. rear-cut to 25" long			
			Rear end cap-Refer to Group 29076			

† For Dealer installed Adhesive backed Body Side Moulding Kit

May, 1975

COPYRIGHT © 1975 -

FORD MOTOR  
COMPANY

- DEARBORN, MICHIGAN

**FINAL ISSUE**

**BODY  
SECTION 200**
**FORD CAR PARTS**

GROUP NUMBER	YEAR	BODY TYPE	DESCRIPTION	PART NUMBER		QTY.
				RIGHT HAND	LEFT HAND	
<b>20938-9 MOULDING - FRONT DOOR OUTSIDE - INCLUDES ATTACHING PARTS - continued</b>						
- S -						
70	S(57)		Black-insert-lower	D0SZ 5720938-C	D0SZ 5720939-C	1
			Blue	D0SZ 5720938-D	D0SZ 5720939-D	1
			Brown	D0SZ 5720938-A	D0SZ 5720939-A	1
			Green	D0SZ 5720938-B	D0SZ 5720939-B	1
70	S(65)		Black-insert-lower	D0SZ 6520938-C	D0SZ 6520939-C	1
			Blue	D0SZ 6520938-D	D0SZ 6520939-D	1
			Brown	D0SZ 6520938-A	D0SZ 6520939-A	1
			Green	D0SZ 6520938-B	D0SZ 6520939-B	1
71	S(57)		Black insert	D0SZ 5720938-C	D0SZ 5720939-C	1
			Blue insert	D0SZ 5720938-D	D0SZ 5720939-D	1
			Brown insert	D0SZ 5720938-A	D0SZ 5720939-A	1
			Green insert	D1SZ 5720938-A	D1SZ 5720939-A	1
71	S(65)		Black insert	D0SZ 6520938-C	D0SZ 6520939-C	1
			Blue insert	D0SZ 6520938-D	D0SZ 6520939-D	1
			Brown insert	D0SZ 6520938-A	D0SZ 6520939-A	1
			Green insert	D1SZ 6520938-A	D1SZ 6520939-A	1
72	S		Black insert	D2SZ 6520938-AA	D2SZ 6520939-AA	1
- U -						
67/	U(97, 98)			C7TZ 9720938-A	C7TZ 9720938-A	2
- X -						
65	X(54D, 62D, 71B)-			C5DZ 6220938-A	C5DZ 6220939-A	1
	"Before 10/6/64"					
65	X(54D, 62D, 71A)-					1
	"From 10/6/64"					
65	X(66B)			C4DZ 6220938-A	C4DZ 6220938-A	2
67	X(54B, 71B)			C7DZ 5420938-A	C7DZ 5420939-A	1
67	X(62B, C)			C7DZ 6220938-A	C7DZ 6220939-A	1
68	X(54, 71)			C8DZ 5420938-A	C8DZ 5420939-A	1
68	X(62)			C8DZ 6220938-A	C8DZ 6220939-A	1
<b>20940-1 MOULDING - FRONT DOOR OUTSIDE REAR EDGE</b>						
- A -						
67	A(62, 63, 76)			★ C7AZ 6220940-A	C7AZ 6220941-A	1
68	A(62, 63, 65, 76)			Not replaced (12/74)		1
67/69	A(54, 57, 71)			C7AZ 5420940-A	C7AZ 5420941-A	1
70	A(54, 57, 71)			D0AZ 5420940-A	D0AZ 5420941-A	1
70	A(65)			D0AZ 6520940-A	D0AZ 6520941-A	1
71/	A(53, 54, 57, 71B, D, F)			D1AZ 5420940-A	D1AZ 5420941-A	1
71/	A(65, 76)			D1AZ 6520940-A	D1AZ 6520941-A	1
- B -						
67	B(54, 71)			C7OZ 5420940-A	C7OZ 5420941-A	1
67	B(62, 63, 66, 76)			C7OZ 6320940-A	C7OZ 6320941-A	1
68/69	B(54, 71)			C8OZ 5420940-A	C8OZ 5420941-A	1
68/69	B(63, 65, 66, 76)			C8OZ 6320940-A	C8OZ 6320941-A	1
72	B(53, 71B, D)			D2OZ 5320940-A	D2OZ 5320941-A	1
72	B(63, 65, 97)			D2OZ 6520940-A	D2OZ 6520941-A	1
- F -						
67/68	F			C7ZZ 6520940-A	C7ZZ 6520941-A	1
72	F			D2ZZ 6520940-A	D2ZZ 6520941-A	1
- L -						
72	L			D2FZ 6220940-A	D2FZ 6220941-A	1
- P -						
72	P(54)			D2DZ 5420940-A	D2DZ 5420941-A	1
72	P(62)			D2DZ 6220940-A	D2DZ 6220941-A	1
- S -						
61/71	S		Refer to Group 21000-1			1
72	S			D2SZ 6520940-A	D2SZ 6520941-A	1
- X -						
67/68	X(54, 71)			C7OZ 5420940-A	C7OZ 5420941-A	1
67/68	X(62)			C7OZ 6320940-A	C7OZ 6320941-A	1



# FORD CAR PARTS

**BODY  
SECTION 200**

23

GROUP NUMBER	YEAR	BODY TYPE	DESCRIPTION	PART NUMBER		QTY.
				RIGHT HAND	LEFT HAND	
<b>20942-3 MOULDING - FRONT DOOR TRIM PANEL</b>						
	72	B(53)		D2OZ 5320942-A	D2OZ 5320942-A	2
	72	B(63R, 97R)		D2OZ 6320942-A	D2OZ 6320943-A	1
	72	B(65)		D2OZ 6520942-A	D2OZ 6520942-A	2
	69	F(63B, 65B, D, 76B)		C9ZZ 6520942-A	C9ZZ 6520943-A	1
	72	S		D2SZ 6520942-A	D2SZ 6520943-A	1
<b>20944-5 MOULDING - FRONT DOOR OUTSIDE UPPER REAR - INCLUDES ATTACHING PARTS</b>						
	65	X(54B, 62B, 63, 76)		★C5DZ 6220944-A	C5DZ 6220945-A	1
	65	X(71B) "From 10/6/64"		Not replaced (3/75)		1
<b>20956-7 MOULDING - FRONT DOOR TRIM PANEL LOWER</b>						
- A -						
	65/66	A(57F)		★C5MY 5020956-C Not replaced (3-74)	★C5MY 5020957-C	1
	66	A(63F)		★C5MY 6320956-C Not replaced (3-74)	★C5MY 6320957-C	1
	69	A(54C, 57F, 65A)		C9AZ 6520956-A	C9AZ 6520957-A	1
	70	A(54C, 57F, 65A)		D0AZ 5420956-A	D0AZ 5420957-A	2
	71/	A(57K, 65K)				2
- B -						
	68/69	B(54C)		C8OZ 5420956-A	C8OZ 5420956-A	2
- F -						
	67/69	F	Includes attaching parts	C7ZZ 6520956-A	C7ZZ 6520957-A	1
- S -						
	70/71	S(65A, B)		D0SZ 6520956-A	D0SZ 6520956-A	2
<b>20960-1 RAIL - FRONT DOOR OUTSIDE FINISH - UPPER</b>						
- A -						
	66	A(71A, E)	Includes attaching parts	C6AZ 7120960-A	C6AZ 7120961-A	1
	67	A(71A, E)	Includes attaching parts	C7AZ 7120960-A	C7AZ 7120961-A	1
	68	A(71A, E)	Includes attaching parts	C8AZ 7120960-A	C8AZ 7120961-A	1
	69/70	A(71A, E)	Includes attaching parts	C9AZ 7120960-A	C9AZ 7120961-A	1
	71	A(71H)		D1AZ 7120960-A	D1AZ 7120961-A	1
	72	A(71H)		D2AZ 7120960-A	D2AZ 7120961-A	1
- B -						
	66/67	B(71E)	Includes attaching parts	C6OZ 7120960-A	★C6OZ 7120961-A Not replaced (3/75)	1
	68/69	B(71E)	Includes attaching parts	C8OZ 7120960-A	C8OZ 7120961-A	1
	70/71	B(66E)		D0OZ 6620960-A	D0OZ 6620961-A	1
	70/71	B(71E)		D0OZ 7120960-A	D0OZ 7120961-A	1
	72	B(71K)		D2OZ 7120960-A	D2OZ 7120961-A	1
	72	B(97K)		D2OZ 9720960-A	D2OZ 9720961-A	1
- L -						
	72	L(73)		D2FZ 7320960-A	D2FZ 7320961-A	1
<b>20968-9 MOULDING - FRONT DOOR TRIM PANEL FRONT</b>						
	69	A(54C, 57F, 65A)		C9AZ 6520968-A	C9AZ 6520968-A	2
GROUP NUMBER	YEAR	BODY TYPE	DESCRIPTION	PART NUMBER		QTY.
<b>20970-1 MOULDING - FRONT DOOR TRIM PANEL CENTER</b>						
	68/69	S(57)	R. H. -not replaced (3-74) L. H.	★C8SZ 5720970-A		1
	68/69	S(65)	R. H. -not replaced (3-74) L. H.	C8SZ 5720971-A		1
				★C8SZ 6520970-A		1
				C8SZ 6520971-A		1
<b>20978 PLATE - FRONT DOOR OUTSIDE NAME - Also refer to group 20802</b>						
	69	B(63)-Talladega	Ford "T"-adhesive backed	C9OZ 6320978-A		2

★ Canada only

May, 1975

COPYRIGHT © 1975 —

FORD MOTOR  
COMPANY

— DEARBORN, MICHIGAN

**FINAL ISSUE**

GROUP NUMBER	YEAR	BODY TYPE	DESCRIPTION	PART NUMBER		QTY.
				RIGHT HAND	LEFT HAND	
<b>20982-3 MOULDING - DOOR WINDOW FRAME REAR</b>						
- A -						
	65/68	A(54, 71)		C5AZ 5420982-A	C5AZ 5420983-A	1
	69/71	A(54, 71)	Rustless steel-with insert	C9AZ 5420982-A	C9AZ 5420983-A	1
	69/	A(54, 71)	Rustless steel-less insert	C9AZ 5420982-B	C9AZ 5420983-B	1
	70/71	A(54, 71)	Aluminum	D0AZ 5420982-A	D0AZ 5420983-A	1
- B -						
	66/67	B(54B, 71B, E)		C6OZ 5420982-A	C6OZ 5420983-A	1
	66/67	B(62B)		C6OZ 6220982-A	C6OZ 6220983-A	1
	67	B(66B, D)		★C6DZ 6620982-A Not replaced (3-74)	C6DZ 6620983-A	1
	68/69	B(54)	With vinyl roof cover-Black-camera case	C8OZ 5420982-B2A	C8OZ 5420983-B2A	1
	68/69	B(54)	With vinyl roof cover-Black-Levant grain	C8OZ 5420982-B1A	C8OZ 5420983-B1A	1
	68/69	B(54B, C, 71B, E)	Without vinyl roof cover	C8OZ 5420982-A	C8OZ 5420983-A	1
	70/71	B(71C, E)				1
	69	B(54)	With vinyl roof cover-White	C9OZ 5420982-BBW	C9OZ 5420983-BBW	1
	70/	B(54)		D0OZ 5420982-A	D0OZ 5420983-A	1
- L -						
	71/	L	Bright finish	D2FZ 6220982-A	D2FZ 6220983-A	1
- P -						
	70/	P(62)	Dull finish	D0DZ 6220982-A	D0DZ 6220983-A	1
	71/	P(54)	Dull finish	D1DZ 5420982-A	D1DZ 5420983-A	1
	72	P(54)	Bright finish	D2DZ 5420982-A	D2DZ 5420983-A	1
	72	P(62A)	Bright finish	D2DZ 6220982-A	D2DZ 6220983-A	1
- U -						
	67/	U(97, 98)		C7TZ 9720982-A	C7TZ 9720983-A	1
- X -						
	65	X(62B, 66B, 78B)		C0DB 6420982-B	C0DB 6420983-B	1
	66	X(54A, 62B, C)		C6OZ 6220982-A	C6OZ 6220983-A	1
	67/70	X(62)				1
	66	X(54B)		C6OZ 5420982-A	C6OZ 5420983-A	1
	67/70	X(54, 71)				1
	66	X(62A, 66)		★C6DZ 6620982-A Not replaced (3-74)	C6DZ 6620983-A	1
<b>20986 MOULDING - FRONT DOOR WINDOW GARNISH FINISH</b>						
	68/69	B(63B, E, 65A, B, E, 66A, B, 76B, E)		C8OZ 6320986-A	C8OZ 6320986-A	2

# FORD CAR PARTS

## BODY SECTION 210

1

GROUP NUMBER	YEAR	BODY TYPE	DESCRIPTION	PART NUMBER		QTY.	
				RIGHT HAND	LEFT HAND		
<b>21000-1 MOULDING - FRONT DOOR OUTSIDE REAR EDGE - INCLUDES ATTACHING PARTS</b>							
	67/71	S(57)		C7SZ	5721000-C	C7SZ 5721001-C	1
	67/71	S(65)		C7SZ	6521000-C	C7SZ 6521001-C	1
<b>21004 MOULDING - FRONT DOOR TRIM PANEL CENTER LOWER</b>							
	66	A(57F)		♣C6MY	5021004-A	♣C6MY 5021004-A	2
GROUP NUMBER	YEAR	BODY TYPE	DESCRIPTION	PART NUMBER		QTY.	
<b>21048 MOULDING KIT - BODY SIDE</b>							
<b>- A -</b>							
	65	A(54A, E, 57B)	Service details	★C5AZ 5421048-A		1 ♂	
Consists of							
1-C5AZ	16003-B	* Moulding-fender-R. H.	1-C5AZ 5425532-A	*Moulding-rear door-R. H.			
1-C5AZ	16004-B	* Moulding-fender-L. H.	1-C5AZ 5425533-A	*Moulding-rear door-L. H.			
2-C5AZ	5420938-A	* Moulding-front door	2-C5AZ 5429038-A	*Moulding-quarter			
1-Installation sheet-No. 1472							
	65	A(54B)	Service details	★C5AZ 5421048-B		1	
Consists of							
2-C5AZ	5420938-B	*Moulding-front door	1-C5AZ 5425533-A	*Moulding-rear door-L. H.			
1-C5AZ	5425532-A	*Moulding-rear door-R. H.	2-C5AZ 5429038-A	*Moulding-quarter			
1-Installation Sheet-No. 1473							
	65	A(62B)	Service details	★C5AZ 6221048-B		1 ♂	
Consists of							
2-C5AZ	6220938-C	* Moulding-door	2-C5AZ 6229038-A	*Moulding-quarter			
1-Installation Sheet-No. 1473							
	65	A(62E, 63B, 76A)	Service Details	★C5AZ 6221048-A		1	
Consists of							
1-C5AZ	16003-B	* Moulding-fender-R. H.	2-C5AZ 6220938-B	*Moulding-door			
1-C5AZ	16004-B	* Moulding-fender-L. H.	2-C5AZ 6229038-A	*Moulding-quarter			
1-Installation Sheet-No. 1472							
	65	A(71B, C, D)	Service details	★C5AZ 7121048-A		1 ♂	
Consists of							
1-C5AZ	16003-B	* Moulding-fender-R. H.	1-C5AZ 5425532-A	*Moulding-rear door-R. H.			
1-C5AZ	16004-B	* Moulding-fender-L. H.	1-C5AZ 5425533-A	*Moulding-rear door-L. H.			
2-C5AZ	5420938-A	* Moulding-front door	2-C5AZ 7129038-A	*Moulding-quarter			
1-Installation Sheet-No. 1472							
	66	A(54A, E, 57B, 71B, C, D)	Service details	★C6AZ 5421048-A		1	
Consists of							
2-C6AZ	16003-A	Moulding assy.-front fender side	22-C6AZ 16A076-A	Retainer-front fender moulding			
2-C6AZ	5420938-A	Moulding-front door outside	2-C6AZ 6229144-A	Retainer-quarter rear moulding			
2-C6AZ	5425532-A	Moulding-rear door outside	1-Sk-C6AA 5421048-A	Installation sketch			
6-C6AZ	62208A38-A	Retainer assy.-front edge mldg.	8-376792-S	Nut			
2-C6AZ	62208A40-A	Retainer assy.-rear edge mldg.	22-★52839-S8	Screw			
2-C6AZ	16228-A	Medallion-front fender side-Not	Included in Kit - Order Separately				
	66	A(54A, E, 57B, 71B, C, D)	Service details	★C6AZ 5421048-B		1 ♂	
Consists of							
2-C6AZ	16003-A	Moulding assy.-front fender side	22-C6AZ 16A076-A	Retainer-front fender moulding			
2-C6AZ	16228-A	Medallion-front fender side	2-C6AZ 6229144-A	Retainer-quarter rear moulding			
2-C6AZ	5420938-A	Moulding-front door outside	1-Sk-C6AA 5421048-A	Installation sketch			
2-C6AZ	5425532-A	Moulding-rear door outside	1-Instruction Sheet No. 2209				
6-C6AZ	62208A38-A	Retainer assy.-front edge mldg.	8-376792-S	Nut			
2-C6AZ	62208A40-A	Retainer assy.-rear edge mldg.	22-★52839-S8	Screw			
	66	A(62E, 63B, 76A)		C6AZ 6221048-B		1 ♂	
Consists of							
2-C6AZ	16003-A	Moulding assy.-front fender side	26-C6AZ 16A076-A	Retainer-front fender moulding			
2-C6AZ	16228-A	Medallion-front fender side	2-C6AZ 6229144-A	Retainer-quarter rear			
2-C6AZ	6220938-A	Moulding-door outside	1-SK-C6AA 6221048-A	Installation sketch			
2-C6AZ	6229038-B	Moulding-quarter outside	6-376792-S	Nut			
4-C6AZ	62208A38-A	Retainer assy.-front edge mldg.	24-★52839-S8	Screw			
2-C6AZ	62208A40-A	Retainer assy.-rear edge mldg.	1-Instruction Sheet No. 2208				

\* Includes Attaching Parts

⊗ Refer to appropriate Exterior Moulding Illustration Section

♣ Canada only

May, 1975

COPYRIGHT © 1975 —

FORD MOTOR  
COMPANY

— DEARBORN, MICHIGAN

**FINAL ISSUE**

GROUP NUMBER	YEAR	BODY TYPE	DESCRIPTION	PART NUMBER	QTY.
<b>21048</b>	<b>MOULDING KIT - BODY SIDE - continued</b>				
- A -					
	68	A(54, 57)	Service details ⊕	*★C8AZ 5421048-A	1
	68	A(62, 63, 65, 76)	Service details ⊕	*★C8AZ 6221048-A	1
	68	A(71)	Service details ⊕	*★C8AZ 7121048-A	1
	69	A(54, 57)	Service details ⊕	*★C9AZ 5421048-A	1
	69	A(62, 63, 65, 76)	Service details ⊕	*★C9AZ 6221048-A	1
	70	A(54B, C, E, 57F)	Black vinyl insert -service details ⊕ (6-72)	*★D0AZ 5421048-A	1
	70	A(63C, 65A, 76)	Black vinyl insert -service details ⊕ (10/74)	*★D0AZ 6221048-A	1
	70	A(71)	Black vinyl insert -service details ⊕ (10/74)	*★D0AZ 7121048-A	1
	71	A(53, 54, 57, 71B, D, F)	Service details ⊕ (6-72)	*★D1AZ 5421048-A	1
	71	A(65, 76)	Service details ⊕ (6-72)	*★D1AZ 6521048-A	1
	72	A(53, 54, 57)	Black vinyl insert -service details ⊕ (10/74)	*★D2AZ 5421048-A	1
	72	A(65, 76)	Black vinyl insert -service details ⊕ (10/74)	*★D2AZ 6521048-A	1
	72	A(71B, D, F)	Black vinyl insert -service details ⊕ (10/74)	*★D2AZ 7121048-A	1
- B -					
	68	B(54A, 54C)	Service details ⊕ (6-72)	*★C8OZ 5421048-A	1
	69	B(71B)	Service details ⊕ (6-72)	*★C9OZ 7121048-A	1
	68	B(63D, 65A, C, D, 76D)	Service details ⊕ (6-72)	*★C8OZ 6321048-A	1
	69	B(63, 65, 66, 76)	Service details ⊕ (6-72)	*★C9OZ 6521048-A	1
	70/71	B(62, 63, 65, 66, 76)	With Black vinyl insert -includes I. S. 3532 - service details ⊕ (6-73)	*★D0OZ 6521048-A	1
	72	B(63, 65)	Black vinyl insert-r/b D3OZ 6521048-A (3/74)	*★D2OZ6521048-A	1
- F -					
	69/70	F	With vinyl insert - not replaced (3-74)	*★C9ZZ 6521048-A	1
- L -					
	71/	L		D1FZ 6221048-A	1
- P -					
	71/	P(54)	Adhesive backed	D1DZ 5421048-A	1
	71/	P(62)	Adhesive backed	D1DZ 6221048-A	1
- S -					
	65	S	Service details ⊕ (6-72)	*★C5SZ 6321048-A	1
Consists of					
	2-C5SZ	16003-B	*Moulding-fender	1-C4SZ 6329039-A	*Moulding-quarter-L. H. -rear
	2-C4SZ	6320938-A	*Moulding assy. -door	1-C4SZ 6329077-A	*Moulding-quarter-L. H. -front
	1-C4SZ	6329038-A	*Moulding-quarter-R. H.	1-C4SZ 63405A48-A	*Moulding-fuel filler door
1-Installation Sketch-No. 1323					
	69/71	S(65)	Vinyl insert-Aluminum -service details ⊕	*★C9SZ 6521048-B	1
	69/71	S(57)	Not replaced (10/74)	*★C9SZ 5721048-B	1
- X -					
	68/70	X(54)	Service details ⊕ (6-72)	*★C8DZ 5421048-A	1
	68/70	X(62)	Service details ⊕ (10-72)	*★C8DZ 6221048-A	1
	68/70	X(71)	Service details ⊕ (6-72)	*★C8DZ 7121048-A	1
<b>21048</b>	<b>MOULDING KIT - BODY SIDE - VINYL TAPE</b>				
	69	A, B, F, S, X	Tape-38 foot roll	C9AZ 6221048-B	AR
	65/	A, B, F, S, X	Bright edge w/black center (38 foot roll) - not replaced (10/74)	*★D0AZ 6221048-B	AR
<b>21060-6</b>	<b>RETAINER - OUTSIDE MOULDING</b>				
REFER TO APPROPRIATE EXTERIOR MOULDING ILLUSTRATION FOR COMPLETE RETAINER PART NUMBER					
<b>21094-7</b>	<b>RETAINER - OUTSIDE MOULDING</b>				
REFER TO APPROPRIATE EXTERIOR MOULDING ILLUSTRATION FOR COMPLETE RETAINER PART NUMBER					
<b>21094</b>	<b>RETAINER - MOULDING UNIVERSAL</b>				
			Use with mouldings 1/2" thru 1" wide	C1AZ 6421094-C	AR
			Use with mouldings 1" thru 1 3/4" wide	C1AZ 6421094-B	AR

\* Includes attaching parts

⊕ Refer to appropriate Exterior Moulding Illustration Section

# FORD CAR PARTS

## BODY SECTION 210

GROUP NUMBER	YEAR	BODY TYPE	DESCRIPTION	PART NUMBER	QTY.		
<b>21110-1 MOULDING - FRONT DOOR TRIM PANEL</b>							
	69/70	A(54C, 57F)		C9AZ 5721110-A	2		
	71/	A(57K)			2		
	69/70	A(65A)		C9AZ 6521110-A	2		
	71/	A(65K)			2		
	70/71	S(65A, B)	Paint to match	D0SZ 6521110-A	2		
	70/71	S(65A, B)	Front-paint to match	D0SZ 6521110-B	2		
<b>211A10-1 RAIL - FRONT DOOR OPENING UPPER</b>							
	66/	U(98)	R. H. -75 1/8" long	C6TZ 98211A10-B	1		
	66/	U(97)	Cut to 31 7/8" long from round end		1		
			L. H.	C6TZ 98211A11-B	1		
<b>21122-3 PLATE - FRONT DOOR INSIDE PANEL COVER</b>							
	66/67	U	R. H.	C7TZ 9721122-A	1		
			L. H.	C7TZ 9721123-A	1		
	68/	U	R. H.	C8TZ 9721122-A	1		
			L. H.	C8TZ 9721123-A	1		
	66/67	U	No. 10-12 x 1/2" Cross recess pan head screw	52727-S8(U382)	20		
<b>21124-5 REINFORCEMENT - FRONT DOOR OUTSIDE PANEL AT BELT</b>							
	71/72	A(53, 57)	R. H.	D1AZ 5721124-A	1		
			L. H.	D1AZ 5721125-A	1		
	71/72	A(65, 76)	R. H.	D1MY 6521124-A	1		
			L. H.	D1MY 6521125-A	1		
<b>21202 PLATE - FRONT DOOR WIRE OPENING COVER</b>							
	68/71	S		C8SZ 6521202-A	2		
<b>21216-7 PANEL - FRONT DOOR TRIM PANEL FINISH</b>							
	66	A(57F)	R. H.	♣C6MY 5021216-A	1		
			L. H.	♣C6MY 5021217-A	1		
	66	A(63F)	R. H.	♣C6MY 6321216-A	1		
			L. H. - not replaced	♣C6MY 6321217-A	1		
<b>21222-3 MOULDING - FRONT DOOR TRIM PANEL LOWER REAR</b>							
	69	A(65A)	R. H.	C9AZ 6521222-A	1		
			L. H.	C9AZ 6521223-A	1		
	70	A(65A)	R. H.	D0AZ 6521222-A	1		
	71	A(65K)	R. H.		1		
			L. H.	D0AZ 6521223-A	1		
<b>21232 SPRING - DOOR HINGE LOWER</b>							
	65/70	B, X	11 coils-Front & rear doors-lower	C0DZ 6421232-B	2or4		
	65/68	A(54, 57, 71)	Rear door		2		
	65/68	F	Front door		2		
	65/68	A	5 1/4" retracting spring-front door-lower	C5AZ 6221232-B	2		
GROUP NUMBER	YEAR	BODY TYPE	DESCRIPTION	PART NUMBER		QTY.	
				CLEAR	TINTED		
<b>21400-1 GLASS and CHANNEL ASSY. - FRONT DOOR WINDOW - Tempered, unless otherwise indicated</b>							
- A -							
NAGS							
NUMBER							
	69	A(57)	R. H.	D4087	C9AZ 5721400-A	C9AZ 5721400-B	1
			L. H.	D4088	C9AZ 5721401-A	C9AZ 5721401-B	1
	69	A(63, 65, 76)"Before 5/29/69"	R. H.	D4080	C9AZ 6321400-A	C9AZ 6321400-B	1
			L. H.	D4081	C9AZ 6321401-A	C9AZ 6321401-B	1
	69	A(63, 65, 76)"From 5/29/69"	R. H.	D4080	C9AZ 6321400-C	C9AZ 6321400-D	1
			L. H.	D4081	C9AZ 6321401-C	C9AZ 6321401-D	1
	70	A(57)	R. H.	D4315	D0AZ 5721400-A	D0AZ 5721400-B	1
			L. H.	D4316	D0AZ 5721401-A	D0AZ 5721401-B	1
	70	A(63, 76)	R. H.	D4380	D0AZ 6321400-A	D0AZ 6321400-B	1
			L. H.	D4381	D0AZ 6321401-A	D0AZ 6321401-B	1
	70	A(65)	R. H.	D4382	D0AZ 6521400-A	D0AZ 6521400-B	1
			L. H.	D4383	D0AZ 6521401-A	D0AZ 6521401-B	1
	71/	A	Refer to Group 21410-1				

♣ Canada only



# FORD CAR PARTS

## BODY SECTION 210

GROUP NUMBER	YEAR	BODY TYPE	DESCRIPTION	PART NUMBER		QTY.
				RIGHT HAND	LEFT HAND	
<b>21408-9 RETAINER - FRONT DOOR VENT WINDOW WEATHERSTRIP</b>						
	65/68	A(54, 62, 71)		C5AZ 6221408-B	C5AZ 6221409-B	1
	69/ 70	A(54, 71)		C9AZ 5421408-A	C9AZ 5421409-A	1
	69	A(62)		C9AZ 6221408-A	C9AZ 6221409-A	1
	66/69	B(54, 62, 71), X	Upper	C6OZ 6221408-A	C6OZ 6221409-A	1
	70/71	B(71)				1
	70/71	B(54, 62)		D0OZ 5421408-A	D0OZ 5421409-A	1
	65/68	A	Bolt-No. 10-24 x 3/8"- hex. head	371698-S(BB122)	371698-S(BB122)	2
	65/68	A	Screw-No. 8-18 x 3/8"- pan head	52720-S8(U230)	52720-S8(U230)	2
	69	A(54, 62, 71)	Screw-No. 8-18 x 3/8"- fillister head	52540-S19(U327)	52540-S19(U327)	1
	71	B(54)	Screw & lockwasher- No. 8-32 x 1/2"-hex. head	57075-S2(B330A)	57075-S2(B330A)	2
	71	B(57)	Screw & washer-1/4"- 20 x 1"	★57132-S2	★57132-S2	4
	71	B(71)	Screw-No. 8-18 x 3/8"- pan hd., cross recess- tapping	★55926-S40	★55926-S40	6
	67/71	B, X	Nut lock-5/16"-18	34392-S7(M93)	34392-S7(M93)	2
	68/71	B, X	Washer flat-5/16"	375897-S(XX118A)	375897-S(XX118A)	2
GROUP NUMBER	YEAR	BODY TYPE	DESCRIPTION	PART NUMBER		QTY.
				CLEAR	TINTED	

**21410-1 GLASS - FRONT DOOR WINDOW - Tempered, unless otherwise indicated-Also refer to Group 21400-1**

- A -

NAGS

NUMBER

	65/68	A(54, 71)	R. H.	D3321	C5AZ 5421410-A	C5AZ 5421410-B	1
			L. H.	D3322	C5AZ 5421411-A	C5AZ 5421411-B	1
	65/68	A(57)	R. H.	D3307	C5AZ 5721410-A	C5AZ 5721410-B	1
			L. H.	D3308	C5AZ 5721411-A	C5AZ 5721411-B	1
	65/68	A(62)	R. H.	D3316	C5AZ 6221410-A	C5AZ 6221410-B	1
			L. H.	D3317	C5AZ 6221411-A	C5AZ 6221411-B	1
	65/66	A(63, 76)	R. H.	D3302	C5AZ 6321410-A	C5AZ 6321410-B	1
	67/68	A(76)					1
			L. H.	D3303	C5AZ 6321411-A	C5AZ 6321411-B	1
	67	A(63)	R. H.	D3711	C7AZ 6321410-A	C7AZ 6321410-B	1
			L. H.	D3712	C7AZ 6321411-A	C7AZ 6321411-B	1
	68	A(63)	R. H.	D3891	C8AZ 6321410-A	C8AZ 6321410-B	1
			L. H.	D3892	C8AZ 6321411-A	C8AZ 6321411-B	1
	68	A(65)	R. H.	D3896	C8AZ 6521410-A	C8AZ 6521410-B	1
			L. H.	D3897	C8AZ 6521411-A	C8AZ 6521411-B	1
	69/70	A(54, 71)	R. H.	D4103	C9AZ 5421410-A	C9AZ 5421410-B	1
			L. H.	D4104	C9AZ 5421411-A	C9AZ 5421411-B	1
	69	A(62)	R. H.	D4096	C9AZ 6221410-A	C9AZ 6221410-B	1
			L. H.	D4097	C9AZ 6221411-A	C9AZ 6221411-B	1
	70	A(63, 76) "Before 5/4/70"	R. H. -use with bolt-on design	D4305	D0AZ 6321410-A	D0AZ 6321410-B	1
			L. H.	D4306	D0AZ 6321411-A	D0AZ 6321411-B	1
	70	A(65)	R. H. -use with bolt-on design	D4310	D0AZ 6521410-A	D0AZ 6521410-B	1
	70	A(63, 76) "From 5/4/70"					1
			L. H.	D4311	D0AZ 6521411-A	D0AZ 6521411-B	1
	71/	A(53)	R. H.	D4512	D1AZ 5321410-A	D1AZ 5321410-B	1
			L. H.	D4513	D1AZ 5321411-A	D1AZ 5321411-B	1
	71/	A(54, 71)	R. H.	D4516	D1AZ 5421410-A	D1AZ 5421410-B	1
			L. H.	D4517	D1AZ 5421411-A	D1AZ 5421411-B	1
	71/	A(57)	R. H.	D4506	D1AZ 5721410-A	D1AZ 5721410-B	1
			L. H.	D4507	D1AZ 5721411-A	D1AZ 5721411-B	1
	71/	A(65)	R. H.	D4500	D1AZ 6521410-A	D1AZ 6521410-B	1
			L. H.	D4501	D1AZ 6521411-A	D1AZ 6521411-B	1
	71/	A(76)	R. H.	D4310	D0AZ 6521410-A	D0AZ 6521410-B	1
			L. H.	D4311	D0AZ 6521411-A	D0AZ 6521411-B	1

GROUP NUMBER	YEAR	BODY TYPE	DESCRIPTION	PART NUMBER				QTY.
				CLEAR		TINTED		
21410-1		GLASS - FRONT DOOR WINDOW - continued - Tempered, unless otherwise indicated						
- B -				- Also refer to Group 21400-1				
				NAGS NUMBER				
65	B(54, 71)		4359T	C2OZ	5421410-A			2
65	B(62)		4357T	C2OZ	6221410-A	C2OZ	6221410-B	2
65	B(65)		2421T	C3OZ	6521410-A	C3OZ	6521410-B	2
66/69	B(54, 71)	R. H.	D3523	C6OZ	5421410-A	C6OZ	5421410-B	1
		L. H.	D3524	C6OZ	5421411-A	C6OZ	5421411-B	1
66/67	B(62)	R. H.	D3518	C6OZ	6221410-A	C6OZ	6221410-B	1
		L. H.	D3519	C6OZ	6221411-A	C6OZ	6221411-B	1
66/67	B(63)	R. H.	D3541	C6OZ	6321410-A	C6OZ	6321410-B	1
		L. H.	D3542	C6OZ	6321411-A	C6OZ	6321411-B	1
66/67	B(76)	R. H.	D3546	C6OZ	7621410-A	C6OZ	7621410-B	1
		L. H.	D3547	C6OZ	7621411-A	C6OZ	7621411-B	1
67	B(66)	R. H.	D3537	C6DZ	6621410-A	C6DZ	6621410-B	1
		L. H.	D3538	C6DZ	6621411-A	C6DZ	6621411-B	1
68/69	B(63, 65, 66, 76)	Refer to Group 21400-1						
70/71	B(54)	R. H.	D4350	D0OZ	5421410-A	D0OZ	5421410-B	1
		L. H.	D4351	D0OZ	5421411-A	D0OZ	5421411-B	1
70/71	B(57)	R. H.	D4335	D0OZ	5721410-A	D0OZ	5721410-B	1
		L. H.	D4336	D0OZ	5721411-A	D0OZ	5721411-B	1
70	B(62)	R. H.	D4346	D0OZ	6221410-A	D0OZ	6221410-B	1
		L. H.	D4347	D0OZ	6221411-A	D0OZ	6221411-B	1
70/71	B(63)	R. H.	D4323	D0OZ	6321410-A	D0OZ	6321410-B	1
		L. H.	D4324	D0OZ	6321411-A	D0OZ	6321411-B	1
70/71	B(65)	R. H.	D4328	D0OZ	6521410-A	D0OZ	6521410-B	1
		L. H.	D4329	D0OZ	6521411-A	D0OZ	6521411-B	1
70/71	B(66)	R. H.	D4373	D0OZ	6621410-A	D0OZ	6621410-B	1
		L. H.	D4379	D0OZ	6621411-A	D0OZ	6621411-B	1
70/71	B(71)	R. H.	D3523	C6OZ	5421410-A	C6OZ	5421410-B	1
		L. H.	D3524	C6OZ	5421411-A	C6OZ	5421411-B	1
70/71	B(76)	R. H.	D4340	D0OZ	7621410-A	D0OZ	7621410-B	1
		L. H.	D4341	D0OZ	7621411-A	D0OZ	7621411-B	1
72	B(53, 71)	R. H.	D4725	D2OZ	5321410-A	D2OZ	5321410-B	1
		L. H.	D4726	D2OZ	5321411-A	D2OZ	5321411-B	1
72	B(63)	R. H.	D4713	D2OZ	6321410-A	D2OZ	6321410-B	1
		L. H.	D4714	D2OZ	6321411-A	D2OZ	6321411-B	1
72	B(65)	R. H.	D4719	D2OZ	6521410-A	D2OZ	6521410-B	1
		L. H.	D4720	D2OZ	6521411-A	D2OZ	6521411-B	1
72	B(97)	R. H.	D4753	D2OZ	9721410-A	D2OZ	9721410-B	1
		L. H.	D4754	D2OZ	9721411-A	D2OZ	9721411-B	1
- F -								
65/66	F(63)	R. H.	D3330	C5ZZ	6321410-A	C5ZZ	6321410-B	1
		L. H.	D3331	C5ZZ	6321411-A	C5ZZ	6321411-B	1
65/66	F(65)	R. H.	D3295	C5ZZ	6521410-A	C5ZZ	6521410-B	1
		L. H.	D3296	C5ZZ	6521411-A	C5ZZ	6521411-B	1
65/66	F(76)	R. H.	D3291	C5ZZ	7621410-A	C5ZZ	7621410-B	1
		L. H.	D3292	C5ZZ	7621411-A	C5ZZ	7621411-B	1
67/68	F(63)	R. H.	D3752	C7ZZ	6321410-A	C7ZZ	6321410-B	1
		L. H.	D3753	C7ZZ	6321411-A	C7ZZ	6321411-B	1
67/68	F(65)	R. H.	D3755	C7ZZ	6521410-C	C7ZZ	6521410-D	1
		L. H.	D3756	C7ZZ	6521411-C	C7ZZ	6521411-D	1
67/68	F(76)	R. H.	D3759	C7ZZ	7621410-A	C7ZZ	7621410-B	1
		L. H.	D3760	C7ZZ	7621411-A	C7ZZ	7621411-B	1
69/70	F	†	Refer to Group 21400-1					

† With bonded design



# FORD CAR PARTS

## BODY SECTION 210

7

GROUP NUMBER	YEAR	BODY TYPE	DESCRIPTION	PART NUMBER		QTY.	
				CLEAR	TINTED		
<b>21410-1 GLASS - FRONT DOOR WINDOW - continued</b> - Tempered, unless otherwise indicated - Also refer to Group 21400-1							
- F -							
NAGS NUMBER							
70	F(65, 76)	†	R.H. L.H.	D4282 D4283	D0ZZ 6521410-A D0ZZ 6521411-A	D0ZZ 6521410-B D0ZZ 6521411-B	1 1
70	F(63)	†	R.H. -use with press on weatherstrip retainer L.H.	D4280 D4281	D0ZZ 6321410-A D0ZZ 6321411-A	D0ZZ 6321410-B D0ZZ 6321411-B	1 1
70	F(63)		With bonded weather- strip retainer-refer to Group 21400-1				
71/	F(63)		R.H. L.H.	D4531 D4532	D1ZZ 6321410-A D1ZZ 6321411-A	D1ZZ 6321410-B D1ZZ 6321411-B	1 1
71/	F(65, 76)		R.H. L.H.	D4537 D4538	D1ZZ 6521410-A D1ZZ 6521411-A	D1ZZ 6521410-B D1ZZ 6521411-B	1 1
- L -							
71	L (62, 64) "Before 1/11/71"		R.H. L.H.	#D4544 #D4545	#D1FZ 6221410-A #D1FZ 6221411-A	#D1FZ 6221410-B #D1FZ 6221411-B	1 1
71/	L (62, 64) "From 1/11/71"		R.H. L.H.	D4544A D4545A	D1FZ 6221410-C D1FZ 6221411-C	D1FZ 6221410-D D1FZ 6221411-D	1 1
72	L(73)		R.H. L.H.	D4744 D4745	D2FZ 7321410-A D2FZ 7321411-A	D2FZ 7321410-B D2FZ 7321411-B	1 1
- P -							
70/	P(62)		R.H. L.H.	D4275 D4276	D2DZ 6221410-A D2DZ 6221411-A	D2DZ 6221410-B D2DZ 6221411-B	1 1
71/	P(54)		R.H. L.H.	D4551 D4552	D2DZ 5421410-A D2DZ 5421411-A	D2DZ 5421410-B D2DZ 5421411-B	1 1
- S -							
65	S			4432T	C4SZ 6321410-A	C4SZ 6321410-B	2
66	S(63A, 76)						2
66	S(63C, D)			4476T	C6SZ 6321410-A	C6SZ 6321410-B	2
67/71	S		Refer to Group 21400-1				
72	S		R.H. L.H.	D4734 D4735	D2SZ 6521410-A D2SZ 6521411-A	D2SZ 6521410-B D2SZ 6521411-B	1 1
- U -							
66/	U			4477T	C6TZ 9721410-A		2
- X -							
65	X(54, 71)			4273T	C0DZ 5821410-J	C0DZ 5821410-K	2
65	X(59, 62, 66, 78)			4271T	C0DZ 6421410-J	C0DZ 6421410-K	2
65	X(63)			2486T	C4DZ 6321410-C	C4DZ 6321410-D	2
65	X(76)			2431T	C4DZ 7621410-C	C4DZ 7621410-D	2
66/70	X(54, 71)		R.H. L.H.	D3523 D3524	C6OZ 5421410-A C6OZ 5421411-A	C6OZ 5421410-B C6OZ 5421411-B	1 1
66	X(66)		R.H. L.H.	D3537 D3538	C6DZ 6621410-A C6DZ 6621411-A	C6DZ 6621410-B C6DZ 6621411-B	1 1
68/70	X(62)		R.H. L.H.	D3518 D3519	C6OZ 6221410-A C6OZ 6221411-A	C6OZ 6221410-B C6OZ 6221411-B	1 1
<b>21412-3 GLASS - FRONT DOOR VENT WINDOW</b> - Tempered unless otherwise indicated							
- A -							
65/68	A(54, 62, 71)		R.H. L.H.	D3314 D3315	C5AZ 6221412-C C5AZ 6221413-C	C5AZ 6221412-D C5AZ 6221413-D	1 1
65/67 68	A(57, 63, 76) A(57, 63, 65, 76)		R.H. R.H. L.H.	V3300 V3301	C5AZ 6321412-C C5AZ 6321413-C	C5AZ 6321412-D C5AZ 6321413-D	1 1

† With bonded design

‡ With bolt on design

# Reinforcement required - refer to Group 214A48

GROUP NUMBER	YEAR	BODY TYPE	DESCRIPTION	PART NUMBER		QTY.	
				CLEAR	TINTED		
<b>21412-3</b>	<b>GLASS - FRONT DOOR VENT WINDOW - Tempered unless otherwise indicated - continued</b>						
<b>- A -</b>							
NAGS NUMBER							
	69/70	A(54, 71)	R. H. L. H.	V4101 V4102	C9AZ 5421412-A C9AZ 5421413-A	C9AZ 5421412-B C9AZ 5421413-B	1 1
	69	A(62)	R. H. L. H.	V4094 V4095	C9AZ 6221412-A C9AZ 6221413-A	C9AZ 6221412-B C9AZ 6221413-B	1 1
<b>- B -</b>							
	65	B(exc. 65)		2393T	C2OZ 6221412-A	C2OZ 6221412-B	2
	65	B(65)		2427T	C3OZ 6521412-A	C3OZ 6521412-B	2
	66/67	B(63, 76)	R. H. L. H.	V3539 V3540	C6OZ 6321412-C C6OZ 6321413-C	C6OZ 6321412-D C6OZ 6321413-D	1 1
	66/67 68/69 70/71	B(54, 62, 66, 71) B(54, 71) B(71)	R. H.  L. H.	V3516  V3517	C6OZ 6221412-C  C6OZ 6221413-C	C6OZ 6221412-D  C6OZ 6221413-D	1 1 1
	70/71	B(54, 62)	R. H. L. H.	V4344 V4345	D00Z 5421412-A D00Z 5421413-A	D00Z 5421412-B D00Z 5421413-B	1 1
	70/71	B(57)	R. H. L. H.	V4333 V4334	D00Z 5721412-A D00Z 5721413-A	D00Z 5721412-B D00Z 5721413-B	1 1
<b>- F -</b>							
	65/68	F	R. H. L. H.	V3289 V3290	C5ZZ 6521412-C C5ZZ 6521413-C	C5ZZ 6521412-D C5ZZ 6521413-D	1 1
<b>- S -</b>							
	65/66	S		2490T	C4SZ 6321412-A	C4SZ 6321412-B	2
<b>- U -</b>							
	66/	U		2527T	C6TZ 9721412-A		2
<b>- X -</b>							
	65	X (except 63, 76)		2312T	C2DZ 6421412-A		2
	65	X(63, 76)		2430T	C3DZ 7621412-A	C3DZ 7621412-B	2
	66/70	X	R. H. L. H.	V3516 V3517	C6OZ 6221412-C C6OZ 6221413-C	C6OZ 6221412-D C6OZ 6221413-D	1 1
GROUP NUMBER	YEAR	BODY TYPE	DESCRIPTION	PART NUMBER		QTY.	
<b>214A14-5</b>	<b>WEATHERSTRIP - FRONT DOOR GLASS - REAR</b>						
	69	A(57)			C9AZ 57214A14-C	C9AZ 57214A15-C	1
	69	A(63, 65, 76)			C9AZ 63214A14-C	C9AZ 63214A15-C	1
	68/69	B(63, 65)			C8OZ 63214A14-B	C8OZ 63214A15-B	1
	68/69	B(76)			C8OZ 76214A14-B	C8OZ 76214A15-B	1
	69	F(65, 76)			C9ZZ 65214A14-A	C9ZZ 65214A15-A	1
	69/70	F(63)			D0ZZ 63214A14-A	D0ZZ 63214A15-A	1
	67/70	S(65)			D0LY 65214A14-A	D0LY 65214A15-A	1
			No. 6-18 x 3/8" Cross recess pan head screw	★52718-S2		★52718-S2	2
<b>214A18</b>	<b>CLIP - FRONT DOOR VENT WINDOW WEATHERSTRIP</b>						
	65/70	A(54, 62, 71)			C5AZ 62214A18-A	C5AZ 62214A18-A	2
<b>214A24-5</b>	<b>RETAINER - FRONT DOOR GLASS REAR - WEATHERSTRIP - Refer to Group 22220-1</b>						
<b>214A26</b>	<b>PLATE - DOOR WINDOW GLASS RUN RETAINER</b>						
	67/71	S	Front door		C7SZ 65214A26-B	C7SZ 65214A26-B	4
	67/71	S(57)	Rear door				2
	71	S(57)	Screw & washer-1/4"- 20 x 3/4"	★382682-S100		★382682-S100	2
	67/71	S	No. 8-15 x 1/2" Flat head cross screw	52012-S8(U202)		52012-S8(U202)	2
	67/71	S	1/4"-20 x 3/4" Hex. washer head screw	371492-S2(BB569)		371492-S2(BB569)	8or12

# FORD CAR PARTS

## BODY SECTION 210

9

GROUP NUMBER	YEAR	BODY TYPE	DESCRIPTION	PART NUMBER		QTY.
				RIGHT HAND	LEFT HAND	
<b>21430-1 BRACKET - FRONT DOOR WINDOW GLASS - REAR</b>						
70/		A(63, 65, 76)	Use with bolt on channel	D0AZ 6321430-C	D0AZ 6321431-C	1
71/		A(53, 57)		D1AZ 5721430-A	D1AZ 5721431-A	1
71/		A(54, 71)		D1AZ 5421430-A	D1AZ 5421430-A	2
70		B(57) "Before 12/1/69"		D0OZ 5721430-A	D0OZ 5721431-A	1
70/71		B(57) "From 12/1/69"		D0OZ 5721430-B	D0OZ 5721431-B	1
70		B(63, 65, 66, 76) - "Before 12/1/69"		D0OZ 6521430-A	D0OZ 6521431-A	1
70/71		B(63, 65, 66, 76) - "From 12/1/69"		D0OZ 6521430-B	D0OZ 6521431-B	1
69/70		F	Use with bolt on channel	D0ZZ 6521430-A	D0ZZ 6521431-A	1
70		A(63, 65, 76), B(57, 63, 65, 66, 76), F, D(65)	Screw & washer assy. - hex. head 1/4"-20 x 49/64"	57472-S40(B339V)	57472-S40(B339V)	2
71		A	Nut-tee-1/4"-20	384289-S2(MM131GE)	384289-S2(MM131GE)	4
<b>214A30-1 STABILIZER - FRONT DOOR WINDOW GLASS - REAR</b>						
69/70		A(57, 63, 65, 76)		C9AZ 57214A30-A	C9AZ 57214A31-A	1
71/		A(53, 57, 65, 76)				1
69/		A	1/4"-20 x 5/8" Hex. hd. screw & washer	57472-S40(B339V)	57472-S40(B339V)	AR
<b>21448-9 WEATHERSTRIP - FRONT DOOR VENT WINDOW FRONT</b>						
- A -						
65/68		A(54, 62, 71)	Clip	C5AZ 6221448-B	C5AZ 6221449-B	1
65/67		A(57, 63, 76)		C5AZ 62214A18-A	C5AZ 62214A18-A	2
68		A(57, 63, 65, 76)		C5AZ 6321448-A	C5AZ 6321449-A	1
69/70		A(54, 71)		C9AZ 5421448-A	C9AZ 5421449-A	1
69		A(62)		C9AZ 6221448-A	C9AZ 6221449-A	1
- B -						
65		B(65)		C3OZ 6521448-C	★C3OZ 6521449-C Not replaced (3-74)	1
66/67		B(63, 76)		C6OZ 6321448-A	C6OZ 6321449-A	1
66		B(54, 62, 71)		C6OZ 6221448-B	C6OZ 6221449-B	1
67		B(54, 62, 66, 71)				1
68/69		B(54, 71)				1
70/71		B(71)				1
70/71		B(54, 62)		D0OZ 5421448-A	D0OZ 5421449-A	1
70/71		B(57)		D0OZ 5721448-A	D0OZ 5721449-A	1
- F -						
65/66		F		C5ZZ 6521448-B	C5ZZ 6521449-B	1
67/68		F		C7ZZ 6521448-A	C7ZZ 6521449-A	1
- S -						
65/66		S	Drill drain holes as required	C4SZ 6321448-A	C4SZ 6321449-A	1
65/66		S	Screw-fillister head- No. 6-32 x 1/4"	31031-S8(U44)	31031-S8(U44)	2
- U -						
66/		U		C6TZ 9721448-A	C6TZ 9721449-A	1
- X -						
65		X(except 63, 76)		C1DZ 6421448-A	★C1DZ 6421449-A Not replaced (10/74)	1
66/70		X		C6OZ 6221448-B	C6OZ 6221449-B	1
<b>214A48 REINFORCEMENT - FRONT DOOR WINDOW LOWER</b>						
71		L		D1FZ 62214A48-A	D1FZ 62214A48-A	2

GROUP NUMBER	YEAR	BODY TYPE	DESCRIPTION	PART NUMBER				QTY.
				RIGHT HAND		LEFT HAND		
<b>21450-1 WEATHERSTRIP - FRONT DOOR VENT WINDOW DIVISION BAR</b>								
	65/66	F		C5ZZ	6521450-A	C5ZZ	6521450-A	2
	65/66	S		C4SZ	6321450-A	C4SZ	6321451-A	1
	66/	U		C6TZ	9721450-A	C6TZ	9721450-A	2
	65	X(except 63, 76)		C0DB	6421450-A	C0DB	6421450-A	2
	65	A, B(except 65), S, X	3/16" x 5/32" Rivet	0A	7021524	0A	7021524	8 to 16
<b>21452-3 WEATHERSTRIP - FRONT DOOR AT BELT - OUTSIDE - INCLUDES CLIPS</b>								
- A -								
	65/68	A(54, 71)		C5AZ	5421452-A	C5AZ	5421453-A	1
	65/68	A(62)		C5AZ	6221452-A	C5AZ	6221453-A	1
	69	A(54, 71)		C9AZ	5421452-A	C9AZ	5421453-A	1
	69	A(57)		C9AZ	5721452-A	C9AZ	5721453-A	1
	69	A(62)		C9AZ	6221452-A	C9AZ	6221453-A	1
	69	A(63, 65, 76)	Refer to Group 20934-5					
	70	A(54, 71)	"Before 2/2/70"	D0AZ	5421452-A	D0AZ	5421453-B	1
	70	A(54, 71)	"From 2/2/70"	D0AZ	5421452-B	D0AZ	5421453-B	1
	70	A(57)		D0AZ	5721452-B	D0AZ	5721453-B	1
	70	A(65, 76)	"Before 2/2/70"	D0AZ	6521452-A	D0AZ	6521453-A	1
	70	A(65, 76)	"From 2/2/70"	D0AZ	6521452-B	D0AZ	6521453-B	1
	71/	A(53)	Incl. 1/4" moulding	D1AZ	5321452-A	D1AZ	5321453-A	1
	71/	A(57)	Incl. 1/4" moulding	D1AZ	5721452-A	D1AZ	5721453-A	1
	71/	A(54, 71)	Incl. 1/4" moulding	D1AZ	5421452-A	D1AZ	5421453-A	1
	71/	A(65, 76)	Incl. 1/4" moulding	D1AZ	6521452-A	D1AZ	6521453-A	1
- B -								
	65	B(54, 71)		C2OZ	5421452-A	C2OZ	5421453-A	1
	65	B(54, 71)	Inside	C2OZ	5421453-A	C2OZ	5421452-A	1
	65	B(62)		C3OZ	6221452-A	C3OZ	6221453-A	1
	65	B(65)		C3OZ	6521452-A	C3OZ	6521452-A	2
	66/67	B(54, 71)		C6OZ	5421452-A	C6OZ	5421453-A	1
	66	B(62)		C6OZ	6221452-A	C6OZ	6221453-A	1
	67	B(62, 66)						1
	66/67	B(63, 76)		C6OZ	6321452-A	C6OZ	6321453-A	1
			No. 6-20 x 9/16" Flat head screw	373541-S(UU98)		373541-S(UU98)		2
	68/69	B(54A, B, 71B, D)	Less bright bead	C8OZ	5421452-A	C8OZ	5421453-A	1
	68/69	B(54C, 71E)	With bright bead	C8OZ	5421452-B	C8OZ	5421453-B	1
	68/69	B(63, 65C, 66)	Refer to Group 20934-5					
	68/69	B(65, 66A, B, 76)	Less bright bead	C8OZ	6521452-A	C8OZ	6521453-A	1
	70/71	B(54)	Less bright bead	D0OZ	5421452-B	D0OZ	5421453-B	1
			With bright bead	D0OZ	5421452-A	D0OZ	5421453-A	1
	70/71	B(57)	With bright bead	D0OZ	5721452-A	D0OZ	5721453-A	1
			Less bright bead	D0OZ	5721452-B	D0OZ	5721453-B	1
	70	B(62)		D0OZ	6221452-A	D0OZ	6221453-A	1
	70/71	B(63)	Refer to Group 20934-5					
	70/71	B(65, 66, 76)	With bright bead	D0OZ	6521452-A	D0OZ	6521453-A	1
	70/71	B(65, 66)	Less bright bead	D0OZ	6521452-B	D0OZ	6521453-B	1
	70/71	B(71)	With bright bead	D0OZ	7121452-A	D0OZ	7121453-A	1
			Less bright bead	C8OZ	5421452-A	C8OZ	5421453-A	1
	72	B(53, 71)		D2OZ	5321452-A	D2OZ	5321453-A	1
	72	B(63, 65, 97)		D2OZ	6521452-A	★D2OZ 6521453-A r/b D3OZ 6521453-A (3-74)		1
- F -								
	65/66	F		C5ZZ	6521452-B	C5ZZ	6521453-B	1
			No. 4-24 x 3/8" Cross recess flat head screw	52003-S13(U194)		52003-S13(U194)		2
	67/68	F	Without clips	C7ZZ	6521452-A	C7ZZ	6521453-A	1
			No. 6-20 x 1/2" Flat head drill point screw	★380922-S2		★380922-S2		2

# FORD CAR PARTS

## BODY SECTION 210

11

GROUP NUMBER	YEAR	BODY TYPE	DESCRIPTION	PART NUMBER		QTY.
				RIGHT HAND	LEFT HAND	
<b>21452-3 WEATHERSTRIP - FRONT DOOR AT BELT OUTSIDE - INCLUDES CLIPS - continued</b>						
- F -						
	69/70	F(63)	"Before 10/1/69"	★C9ZZ 6321452-B r/b D0ZZ 6321452-A (12/74)	C9ZZ 6321453-B	1
	69/70	F(65, 76)		C9ZZ 6521452-A	C9ZZ 6521453-A	1
	70	F(63)	"From 10/1/69"	D0ZZ 6321452-A	D0ZZ 6321453-A	1
	71/	F(exc.65F)		D1ZZ 6521452-A	D1ZZ 6521453-A	1
	71/	F(65F)		D1ZZ 6521452-B	D1ZZ 6521453-B	1
- L -						
	71/	L		D1FZ 6221452-A	D1FZ 6221453-A	1
- P -						
	70	P(62)		D0DZ 6221452-B	D0DZ 6221453-B	1
	71/	P(54)		D1DZ 5421452-A	D1DZ 5421452-A	2
	71/	P(62)		D1DZ 6221452-A	D1DZ 6221453-A	1
- S -						
	65/66	S		C4SZ 6321452-A	C4SZ 6321453-A	1
	67/	S	Refer to Group 20934-5			
- U -						
	66/	U		C6TZ 9721452-A	C6TZ 9721453-A	1
			Inside	C6TZ 9721453-A	C6TZ 9721452-A	1
- X -						
	65	X(54, 71)	Cut to fit	C0DZ 6421452-E	C0DZ 6421453-E	2
	65	X(59, 62, 66, 78)				2
	65	X(63, 76)		C3DZ 7621452-A	C3DZ 7621453-A	1
	66/70	X(54, 71)		C6OZ 5421452-A	C6OZ 5421453-A	1
	66/70	X(62, 66)		C6OZ 6221452-A	C6OZ 6221453-A	1
	65/	A, B	No.4 x 3/8" Cross recess flat head screw	52003-S13(U194)	52003-S13(U194)	4
<b>21456-7 WEATHERSTRIP - FRONT DOOR AT BELT INSIDE</b>						
- A -						
	65/68	A(54, 71)	Less clips	C5AZ 5421456-B	C5AZ 5421457-B	1
	65/68	A(57)	Less clips	C5AZ 5721456-B	C5AZ 5721457-B	1
	65/68	A(62)	Less clips	C5AZ 6221456-B	★C5AZ 6221457-B Not replaced (3-74)	1
	65/67	A(63, 76)	Less clips	C5AZ 6321456-B	C5AZ 6321457-B	1
	68	A(63, 65, 76)				1
	69/70	A(54, 71)		C9AZ 5421456-B	C9AZ 5421457-B	1
	69/71	A(57)		C9AZ 5721456-A	★C9AZ 5721457-A r/b D2AZ 5721457-A (12/74)	1
	69	A(62)	"Before 5/23/69"	C9AZ 6221456-B	C9AZ 6221457-A	1
	69	A(62)	"From 5/23/69"	C9AZ 6221456-B	C9AZ 6221457-B	1
	69/71	A(63, 65, 76)		C9AZ 6321456-A	C9AZ 6321457-A	1
	71	A(54, 71)		D1AZ 5421456-A	★D1AZ 5421457-A r/b D2AZ 5421457-A (12/74)	1
	72	A(53)		D2AZ 5321456-A	D2AZ 5321457-A	1
	72	A(54, 71)		D2AZ 5421456-A	D2AZ 5421457-A	1
	72	A(57)		D2AZ 5721456-A	D2AZ 5721457-A	1
	72	A(65, 76)		D2AZ 6521456-A	D2AZ 6521457-A	1
- B -						
	65	B(54, 71)		C2OZ 5421453-A	C2OZ 5421452-A	1
	66/67	B(54, 71)	With clips - not replaced	★C6OZ 5421456-A	C6OZ 5421457-A	1
	66/67	B(62, 66)	With clips	C6OZ 6221456-A	C6OZ 6221457-A	1
	66/67	B(63, 76)	With clips	C6OZ 6321456-A	C6OZ 6321457-A	1
	68	B(63, 65, 66, 76)	With clips & without rustless steel bead	C8OZ 6321456-B	C8OZ 6321456-B	2
	68/69	B(54A, B, 71)	With clips	C8OZ 5421456-B	C8OZ 5421457-B	1
	68/69	B(54C)		C8OZ 5421456-A	C8OZ 5421457-A	1
	68/69	B(63, 65, 66, 76)	With clips & rustless steel bead	C8OZ 6321456-A	C8OZ 6321456-A	2

GROUP NUMBER	YEAR	BODY TYPE	DESCRIPTION	PART NUMBER		QTY.
				RIGHT HAND	LEFT HAND	
<b>21456-7 WEATHERSTRIP - FRONT DOOR AT BELT INSIDE - continued</b>						
- B -						
	70/71	B(54)		D0OZ 5421456-A	D0OZ 5421457-A	1
	70/71	B(57)		D0OZ 5721456-A	D0OZ 5721457-A	1
	70	B(62)		D0OZ 6221456-A	D0OZ 6221457-A	1
	70/71	B(63,65,76)		D0OZ 6521456-A	D0OZ 6521456-A	2
	70/71	B(71)		D0OZ 7121456-A	D0OZ 7121456-A	2
	70/71	B(66)		D0OZ 6621456-A	D0OZ 6621456-A	2
	72	B(53,71)		D2OZ 5321456-A	D2OZ 5321457-A	1
	72	B(63,65,97)		D2OZ 6521456-A	D2OZ 6521457-A	1
- F -						
	65	F	"Before 9/7/64" With clips-Black bead	C5ZZ 6521456-B	C5ZZ 6521456-A	2
	65/66	F	"From 9/7/64" Stainless steel bead	C5ZZ 6521456-B	C5ZZ 6521456-B	2
	67/68	F		C7ZZ 6521456-A	C7ZZ 6521457-A	1
	69/70	F(63A, B, 65A, B, C, D, 76)		C9ZZ 6521456-A	C9ZZ 6521457-A	1
	71/	F		D1ZZ 6521456-B	D1ZZ 6521457-B	1
- L -						
	71/	L		D1FZ 6221456-B	D1FZ 6221457-B	1
- P -						
	71/72	P(62)		D2DZ 6221456-A	D2DZ 6221457-A	1
	71/72	P(54)		D2DZ 5421456-A	D2DZ 5421456-A	2
- S -						
	65/66	S		C4SZ 6321456-A	C4SZ 6321457-A	1
	67	S(65)		★C7SZ 6521456-B Not replaced (3-74)	C7SZ 6521457-B	1
	68/70	S(57)		C8SZ 5721456-A	C8SZ 5721456-A	2
	71	S(57)		C8SZ 5721456-A	D1SZ 5721457-A	1
	68/71	S(65)		D1SZ 6521456-A	D1SZ 6521457-A	1
	72	S		D2SZ 6521456-A	D2SZ 6521457-A	1
- U -						
	66/	U		C6TZ 9721453-A	C6TZ 9721452-A	1
- X -						
	65	X(54,71)	Cut to fit	C0DZ 6521452-E	C0DZ 6421453-E	1
	66/70	X(54,71)	With clips - not replaced	★C6OZ 5421456-A	C6OZ 5421457-A	1
	66/70	X(62,66)	With clips	C6OZ 6221456-A	C6OZ 6221457-A	1
<b>21458-9 CHANNEL and RETAINER ASSY. - FRONT DOOR GLASS</b>						
- A -						
	65/67	A(63,76)		★C5AZ 6321458-A Not replaced (3-74)	C5AZ 6321459-A	1
	65/68	A(54,71)		C5AZ 5421458-A	★C5AZ 5421459-A Not replaced (3/75)	1
	68	A(63,65,76)		★C8AZ 6321458-A Not replaced (3-74)	C8AZ 6321459-A	1
	69	A(54,71)		C9AZ 5421458-A	C9AZ 5421459-A	1
	69	A(62)		C9AZ 6221458-A	C9AZ 6221459-A	1
	69/70	A(57,63,65,76)	Serviced in assembly- refer to Group 21400-1			
	70	A(54,71)		D0AZ 5421458-A	D0AZ 5421459-A	1
	69	A	No. 8-32 x 1/2" oval head screw	50398-S13(U121)	50398-S13(U121)	2
- B -						
	66/67	B(54,71)		C6OZ 5421458-A	C6OZ 5421459-A	1
	66/67	B(62)		★C8OZ 6221458-A Not replaced (3-74)	C6OZ 6221459-A	1
	66/67	B(63,76)		★C8OZ 6321458-A Not replaced (3-74)	C6OZ 6321459-A	1
	67	B(66)		C6DZ 6621458-A	C6DZ 6621459-A	1

# FORD CAR PARTS

**BODY  
SECTION 210**

13

GROUP NUMBER	YEAR	BODY TYPE	DESCRIPTION	PART NUMBER		QTY.
				RIGHT HAND	LEFT HAND	
<b>21458-9 CHANNEL and RETAINER ASSY.- FRONT DOOR GLASS - continued</b>						
- B -						
	68/69 70/71	B(54, 71) B(71)	With manual windows	C8OZ 5421458-A	C8OZ 5421459-A	1 1
	70/71 70	B(54) B(62)	With manual windows	D0OZ 5421458-A	D0OZ 5421459-A	1 1
	68/69 70/71	B(54, 71) B(54, 57)	With power windows	C8OZ 5421458-B	C8OZ 5421459-B	1 1
	65	B	Screw-5/16"-24 x 5/8"- hex. head	359605-S8(BB590)	359605-S8(BB590)	4
	68/	B	Screw-No. 8-32 x 1/2"- oval head	50398-S13(U121)	50398-S13(U121)	2
- F -						
	65/66	F		★C5ZZ 6521458-B Not replaced (3-74)	C5ZZ 6521459-B	1
	67/68 69/70	F F	Serviced in assembly- refer to Group 21400-1	C7ZZ 6521458-C	C7ZZ 6521459-C	1
	65/66	F	Bolt-No. 8-32 x 3/8"- flat	358477-S8(BB93)	358477-S8(BB93)	2
	67/68	F	Bolt-5/16"-18 x 3/4" - hex. head	359662-S7(BB575A)	359662-S7(BB575A)	1
	67/68	F	Bolt-1/4"-20 x 1/2"- pan head	373460-S7(BB629)	373460-S7(BB629)	1
	67/68	F	Nut-No. 8-32-J-shape	379385-S2(MM284C)	379385-S2(MM284C)	2
- U -						
	66/72	U		C6TZ 9721458-A	C6TZ 9721458-A	1
- X -						
	65	X(59, 62, 66, 78)		C0DB 6421458-A	C0DB 6421459-A	1
	66/70	X(54, 71)		C6OZ 5421458-A	C6OZ 5421459-A	1
	67	X(62)		★C6OZ 6221458-A Not replaced (3-74)	C6OZ 6221459-A	1
	68/70	X(62)		C8DZ 6221458-A	C8DZ 6221459-A	1
<b>21464-5 BRACKET - FRONT DOOR VENT WINDOW - UPPER PIVOT</b>						
	65/68 69/70	A(57, 63, 76) A(54, 62, 71)	Includes attaching parts	C5AZ 6321464-A	C5AZ 6321465-A	1 1
	68 70/71	B, X B(54, 62)	Refer to Group 21408-9 Includes attaching parts	D0OZ 5421464-A	D0OZ 5421465-A	1
	66/ 65	U X(exc. 63, 76)	Includes attaching parts Includes attaching parts	C6TZ 9721464-A	C6TZ 9721465-A	1 1
	65/68	A	Screw-No. 8-18 x 3/8"- fillister head	52540-S13(U227)	52540-S13(U227)	2
	65/68 65	A B(54, 62, 71)	Rivet No. 8 x 3/8" Cross recess pan head screw	375965-S(SS39D) 52720-S8(U380)	375965-S(SS39D) 52720-S8(U380)	1 4
<b>21478 STRIP - GLASS RETAINER</b>						
	65/	All	Use bulk glass tape	★	★	
<b>21490-1 HINGE - FRONT DOOR VENT WINDOW - UPPER PIVOT</b>						
	65	X(63, 76)	On glass frame	★C3DZ 7621490-A Not Repl'd (11-73)	C3DZ 7621491-A	1
	65	B(65), X(63, 76)	No. 8-32 x .20" Special oval head screw	375802-S100(BB601C)	375802-S100(BB601C)	4

GROUP NUMBER	YEAR	BODY TYPE	DESCRIPTION	PART NUMBER		QTY.
				RIGHT HAND	LEFT HAND	
<b>21496</b>	<b>BUSHING - DOOR WINDOW GUIDE</b>					
	69/70	F	Tail gate-also serviced in assembly-refer to Group 41960-1	C9ZZ 6521496-A	C9ZZ 6521496-A	8
	69/	A(71)				8
<b>21504</b>	<b>BRACKET - FRONT DOOR WINDOW REGULATOR DRIVE ARM</b>					
	69/	A(53, 57)		C9AZ 5721504-A	C9AZ 5721504-A	2
	69/70	A(63, 65, 76)	With bonded design	C9AZ 6321504-A	C9AZ 6321504-A	2
	70/	A(63, 65, 76)	With bolt-on design	D0AZ 6321504-A	D0AZ 6321504-A	2
	71/	A(54, 71)		D1AZ 5421504-A	D1AZ 5421504-B	1
	68	B(63, 65, 66, 76)	Refer to Group 270A42			
	70/71	B(63, 65, 66, 76)		D0OZ 6521504-A	D0OZ 6521504-A	2
	69/70	F	With bolt on design	C9ZZ 6521504-A	C9ZZ 6521504-A	2
	71/	L		D2FZ 6221504-A	D2FZ 6221504-A	2
	67/71	S(57)		C7SZ 5721504-A	C7SZ 5721504-A	2
	67/71	S(65)		C7SZ 6521504-A	C7SZ 6521504-A	2
	67/71	S	No. 8-32 x 1/2" Cross recess oval head screw	50398-S13(U121)	50398-S13(U121)	4
	67/	A				4
	67/71	S(65)	No. 10-24 x 3/8" Pan head screw & washer assy.	★54540-S2	★54540-S2	4
	70	A(63, 65, 76), B	1/4"-20 Nut & washer-use with bolt-on channel	383278-S2(MM296AG)	383278-S2(MM296AG)	AR
<b>21508-9</b>	<b>RUN - FRONT DOOR GLASS - LATCH SIDE</b>					
	- B -					
	68/69	B(63, 65, 66, 76)	Includes bracket	C8OZ 6321508-A	C8OZ 6321508-A	2
	70/71	B(65, 66, 76)		D0OZ 6521508-A	D0OZ 6521508-A	2
	71	B(63)				2
	65	B	5/16"-24 Hex. jam nut	33923-S7(M32)	33923-S7(M32)	AR
	65	B	5/16"-24 x 1 3/16"-Set screw	354021-S7(UU113)	354021-S7(UU113)	AR
	65	B	5/16"-24 x 5/8"-Hex. head screw	359605-S8(BB590)	359605-S8(BB590)	2
	68/71	B	1/4"-20 x 1/4"-Hex. head bolt	371492-S2(BB569)	371492-S2(BB569)	2
	- F -					
	65/66	F		C5ZZ 6521508-B	C5ZZ 6521509-B	1
			5/16"-18 x 3/4" Screw & washer assy.	359662-S7-8(BB575A)	359662-S7-8(BB575A)	6
	- S -					
	67/71	S(57)		C7SZ 5721508-A	C7SZ 5721509-A	1
	67/71	S(65)		C7SZ 6521508-A	C7SZ 6521509-A	1
	67/71	S	1/4"-20 x 1/2" Pan head screw & washer assy.	373460-S7(BB629)	373460-S7(BB629)	4
	- U -					
	66/	U	Includes bracket	C6TZ 9721508-B	C6TZ 9721509-B	1
			1/4"-20 x .312" Cross recess pan head screw	★371360-S8	★371360-S8	6
			1/4"-20 x .312" Hex. head screw	★373289-S2	★373289-S2	2
	- X -					
	65/66	X	Refer to Group 21550			
GROUP NUMBER	YEAR	BODY TYPE	DESCRIPTION	PART NUMBER		QTY.
<b>21510</b>	<b>WEATHERSTRIP - DOOR GLASS CHANNEL</b>					
	65/68	A (54, 62, 71)	31 1/4" long-cut to fit front door, rear door or quarter	C5AZ 6221510-B		4
	66/69	B(54, 62, 66, 71)				4
	66/70	X				4
<b>21524</b>	<b>RIVET - DIVISION BAR WEATHERSTRIP</b>					
	65/68	A, B	3/32" x 5/32" Special oval head tubular	0A 7021524		8to16
	66/	U				10



# FORD CAR PARTS

## BODY SECTION 210

15

GROUP NUMBER	YEAR	BODY TYPE	DESCRIPTION	PART NUMBER	QTY.
<b>21528 SLIDE - FRONT DOOR WINDOW STABILIZER ARM - INNER - INCLUDES ATTACHING PARTS</b>					
	70	B(57)		DOGY 5721528-A	2
	71/	P			4
<b>21538-9 RUN and BRACKET ASSY. - FRONT DOOR VENT WINDOW DIVISION BAR GLASS</b>					
- B -					
	65	B(except 65)		C2OZ 6221538-B	2
			Hex. washer head screw-5/16"-18 x 1/2"	376976-S7-8(BB574M)	2
- F -					
	65/66	F	R. H.	C5ZZ 6521538-A	1
			L. H.	C5ZZ 6521539-A	1
	65/66	F	Hex. nut-5/16"-18	33797-S7(M50)	2
	65/66	F	Special washer-5/16"	*357789-S7	2
- S -					
	65/66	S	R. H.	C4SZ 6321538-A	1
			L. H.	C4SZ 6321539-A	1
	65/66	S	5/16"-24 x 2.38" Screw (set)	*378067-S8	2
	65/66	S	5/16"-18 x 2.38" Screw (set)	379182-S7-8(UU108F)	2
	65/66	S	5/16" I. D. x 7/8" O. D. Washer (special)	*357789-S7	2
	65/66	S	5/16"-18 Hex. nut	33797-S7(M50)	AR
- X -					
	65	X(except 63, 76)		C0DZ 6421538-D	2
	65	X	5/16"-18 x 1/2" Hex. washer head screw	376976-S7-8(BB574M)	2
<b>21546-7 RUN - FRONT DOOR GLASS - HINGE SIDE</b>					
- A -					
	65/67	A(57, 63, 76)	On division bar-36" long	C5AZ 6321546-A	2
	65/67	A(54, 62, 71)"Before 12/1/66"	Cut to length required		2
	67/	A(54, 62, 71)"From 12/1/66"	Refer to Group 21596		
	68	A(57, 63, 65, 76)	On division bar		2
	69/70	A(57)		C9AZ 6321546-A	6
	69/70	A(63, 65, 76)			4
	71/	A(53, 57, 65, 76)			4
	69/	A	Screw & washer-1/4"-20 x .77" hex. head	382682-S101(BB390XF)	AR
- B -					
	66	B(54, 62, 66, 71)	Cut to 31 3/4" at retainer end	C5AZ 6321546-A	2
	66/69	B(54, 71)	Rear door-cut to 30 3/4" at retainer end		2
	66/67	B(63, 76)	R. H.	C6OZ 6321546-A	1
			L. H.	C6OZ 6321547-A	1
	68/69	B(63, 65, 66, 76)	Includes bracket	C8OZ 6321546-A	2
			1/4-20 x 3/4" Hex. washer head screw & washer assy.	371492-S2(BB569)	4
	70/71	B(57)	R. H. -vent window division bar	D0OZ 5721546-A	1
			L. H.	D0OZ 5721547-A	1
	70/71	B(63, 65, 66, 76)	Includes bracket	D0OZ 6521546-A	2
	70/71	B(71)	Cut to fit	C7TZ 8121546-A	2
	72	B(53, 71)		D2OZ 5321546-A	2
	72	B(63, 65, 97)		D2OZ 6521546-A	2
- F -					
	67/68	F	R. H.	C7ZZ 6521546-A	1
			L. H.	C7ZZ 6521547-A	1
			No. 6-20 x 1/4" Cross recess flat head screw	52052-S13(U200A)	2
	69/70	F	R. H.	C9ZZ 6521546-A	2
			L. H.	C9ZZ 6521547-A	2
	71/	F		D1ZZ 6521546-B	2

GROUP NUMBER	YEAR	BODY TYPE	DESCRIPTION	PART NUMBER	QTY.
<b>21546-7</b>	<b>RUN - FRONT DOOR GLASS - HINGE SIDE - continued -</b>				
	- S -				
	67/71	S(57)	R.H.	C7SZ 5721546-A	1
			L.H.	C7SZ 5721547-A	1
	67/71	S(65)	R.H.	C7SZ 6521546-A	1
			L.H.	C7SZ 6521547-A	1
	72	S		D2SZ 6521546-A	2
	67/71	S	1/4"-20 x 1/2" Pan head screw & washer assy.	373460-S7(BB629)	4
	- X -				
	66/70	X	Cut to 31 3/4" at retainer end	C5AZ 6321546-A	2
	66/70	X(54, 71)	Rear door-cut to 30 3/4" at retainer end		2
<b>21550</b>	<b>RUN - DOOR GLASS - LATCH SIDE - Also refer to Group 25766</b>				
	- B -				
	65	B(62)	Front door-55 1/2" long	C2OZ 6221550-A	2
	65	B(54)	Rear door-cut to 52 3/8" long & notch		2
	65	B(62)	Quarter window-front-cut to 22" long		2
	65	B(62)	Quarter window top-cut to 43 3/16" long		2
	65	B(54, 71)	Front door-cut to 49 3/8" long & notch		2
	65	B(71)	Rear door-cut to 52 1/16" long & notch		2
	67	B(66)	"Before 11/21/66"	C6DZ 6621550-A	2
	67	B(66)	"From 11/21/66"	Refer to Group 21596	
	- X -				
	65	X(except 54, 71)	60.39" long-NOTE 3-front door-cut to 58 1/4" long	C3AZ 6221550-A	2
	65	X(54, 71)	Front door-cut to 49 3/16" long		2
	65	X(54)	Rear door-cut to 53 3/4" long		2
	65	X(71)	Rear door-cut to 53 1/4" long		2
	65	X(62)	Quarter window-upper-cut to 32 5/8" long		2
	65	X(59, 62)	Quarter window-front-cut to 19 5/8" long		2
	66	X(66)		C6DZ 6621550-A	2
<b>21572</b>	<b>RETAINER - FRONT DOOR GLASS RUN - FRONT</b>				
	71/	A(54, 71)	R.H.	D1AZ 5421572-A	1
			L.H.	D1AZ 5421572-B	1
	71/	L	R.H.	D1FZ 6221572-C	1
			L.H.	D1FZ 6221572-D	1
			1/4"-20 x 1 7/8" Screw	384345-S(UU59G)	2
	71/	P(54)	R.H.	D1DZ 5421572-A	1
			L.H.	D1DZ 5421572-B	1
	70/	P(62)	R.H.	D0DZ 6221572-A	1
			L.H.	D0DZ 6221572-B	1
	67/71	S		C7SZ 6521572-B	4or6
			1/4"-20 x 5/8" Flat head screw & washer assy.	354831-S7(BB115)	8or2
	70/	P(62)	No. 8-18 x 1/2"-washer head screw	375453-S100(BB658C)	2
<b>21596</b>	<b>RUN - FRONT DOOR GLASS TOP</b>				
	65/68	A(54, 71)	Approx. 87 1/2" long	C5AZ 5421596-A	2
	65/68	A(62)	Approx. 101" long	C5AZ 6221596-B	2
	69/70	A(54, 71)		C9AZ 5421596-A	2
	71/	A(54, 71)		D1AZ 5421596-A	2
	66/67	B(62)		C6OZ 6221596-B	2
	67	B(66)		C7OZ 6621596-A	2
	66/69	B(54, 71)		C6OZ 5421596-A	2
	70/71	B(71)			2
	70/71	B(54)		D0OZ 5421596-A	2
	70	B(62)		D0OZ 6221596-A	2

NOTE 3 - Also refer to Group 222A00-1 for retainer assy.

# FORD CAR PARTS

## BODY SECTION 210

GROUP NUMBER	YEAR	BODY TYPE	DESCRIPTION	PART NUMBER	QTY.
<b>21596 RUN - FRONT DOOR GLASS TOP - continued</b>					
	71/	L		D1FZ 6221596-C	2
	71/72	L	R.H.	D1DZ 6221596-A	1
			L.H.	D1DZ 6221596-B	1
	70/	P(62)	R.H.	D1DZ 6221596-A	1
			L.H.	D1DZ 6221596-B	1
	71/	P(54)		D1DZ 5421596-A	2
	66/	U		C6TZ 9721596-A	2
	66/70	X(54, 71)		C6OZ 5421596-A	2
	66/70	X(62)		C6OZ 6221596-B	2

GROUP NUMBER	YEAR	BODY TYPE	DESCRIPTION	PART NUMBER		QTY.
				RIGHT HAND	LEFT HAND	

**21608-9 FRAME - FRONT DOOR VENT WINDOW - LESS HANDLE and GLASS**

- A -						
	65/68	A(54, 62, 71)		C5AZ 6221608-B	C5AZ 6221609-B	1
	65/67	A(57, 63, 76)		C5AZ 6321608-B	C5AZ 6321609-B	1
	68	A(57, 63, 65, 76)				1
	69/70	A(54, 71)		C9AZ 5421608-A	C9AZ 5421609-A	1
	69	A(62)		C9AZ 6221608-A	C9AZ 6221609-A	1
	65/70	A	1/4"-20 x 7/8" Hex.hd.bolt	370519-S(BB125)	370519-S(BB125)	2
			1/4" Lockwasher (internal tooth)	34905-S7(X97)	34905-S7(X97)	2

- B -						
	65	B(54, 62, 71)		C5OZ 6221608-A	C5OZ 6221609-A	1
	66	B(54, 62, 71)		C6OZ 6221608-B	C6OZ 6221609-B	1
	67	B(54, 62, 66, 71)				1
	66/67	B(63, 76)	5/16"-18 x 1" Screw & washer assy.	C6OZ 6321608-B *378694-S2	C6OZ 6321609-B *378694-S2	4
	68/69	B(54, 71)		C8OZ 5421608-A	C8OZ 5421609-A	1
	70/71	B(71)				
	70/71	B(54, 62)		D0OZ 5421608-A	D0OZ 5421609-A	1
	70/71	B(57)		D0OZ 5721608-A	D0OZ 5721609-A	1
	65	B	Bolt-oval head - No. 8-32 x 13/64"	350085-S(BB598)	350085-S(BB598)	AR
	65	B	Nut-lock-5/16"-24	353618-S100(MM141)	353618-S100(MM141)	AR
	66/67	B	Screw-pan head - No. 10-24 x 1/2"	51765-S8(U370)	51765-S8(U370)	4
	66/71	B	Nut lock-5/16"-18	34392-S7(M93)	34392-S7(M93)	2
	66/71	B	Washer-flat-5/16"	375897-S(XX118A)	375897-S(XX118A)	2
	67/71	B	Screw-pan hd. - No. 8-18 x 3/16"	380530-S2(UU86F)	380530-S2(UU86F)	2

- F -						
	65/66	F		C5ZZ 6521608-A	C5ZZ 6521609-A	1
	67	F	5/16" Washer (flat)	C7ZZ 6521608-B 375897-S(XX118A)	C7ZZ 6521609-B 375897-S(XX118A)	4
			5/16"-18 Locknut	34392-S7-8(M93)	34392-S7-8(M93)	2
	68	F		C8ZZ 6521608-A	C8ZZ 6521609-A	1

- S -						
	65/66	S		C4SZ 6321608-A	C4SZ 6321609-A	1

- U -						
	66/67	U	Painted	C6TZ 9721608-A	C6TZ 9721609-A	1
	67	U	Chrome	C7TZ 9721608-A	*C7TZ 9721609-A Not replaced (7-73)	1
	68/	U	Painted	C8TZ 9721608-A	C8TZ 9721609-A	1
	68/	U	Rustless steel	C8TZ 9621608-A	C8TZ 9621609-A	1

**BODY  
SECTION 210**
**FORD CAR PARTS**

GROUP NUMBER	YEAR	BODY TYPE	DESCRIPTION	PART NUMBER		QTY.
				RIGHT HAND	LEFT HAND	
<b>21608-9 FRAME - FRONT DOOR VENT WINDOW - LESS HANDLE and GLASS - continued</b>						
- X -						
	65	X(except 63, 76)		C2DZ 6421608-C	C2DZ 6421609-C	1
	65	X(63, 76)		C3DZ 7621608-B	C3DZ 7621609-B	1
	66/67	X		C6OZ 6221608-B	C6OZ 6221609-B	1
	68/70	X		C8OZ 5421608-A	C8OZ 5421609-A	1
	66/70	X	Screw-pan head- No. 8-18 x 3/8"	52720-S8(U380)	52720-S8(U380)	2
	65	A, B, X	Stop	C2AZ 6222992-A	C2AZ 6222992-A	2
			5/16" Washer (flat)- acts as tensioner	375897-S(XX118A)	375897-S(XX118A)	4
			.26" I. D. x 3/4" O. D. - Washer (friction)	C2AZ 6222963-A	C2AZ 6222963-A	2
			5/16"-24 Hex. locknut	353618-S100(MM141)	353618-S100(MM141)	2
			Spring	B5A 7022926-A	B5A 7022926-A	2
GROUP NUMBER	YEAR	BODY TYPE	DESCRIPTION	PART NUMBER		QTY.
<b>21660 RUN - FRONT DOOR VENT WINDOW DIVISION BAR GLASS</b>						
	69	A(62)		C9AZ 6221660-A		2
<b>21758-9 STOP - DOOR WINDOW - LOWER</b>						
	65/68	A	Front door	C5AZ 6221758-A		2
	65/68	A(54, 57, 71)	Rear door			2
	65/68	A(62)	Quarter			2
	66/68	A(76)	Quarter			2
	66/67	B(54, 71), X(54, 71)	Rear door			2
	66/67	B(62), X(62)	Quarter			2
	68/69	B(54, 71), X(54, 71)		C8OZ 5421758-A		2
	70/71	B(71)				2
			1/4"-20 x 1/2" Pan head screw & washer assy.	373460-S7(BB629)		4
	69/	F(63)	Use with bolt on channel	C9ZZ 6321758-A		2
	71/	A(71)	Tailgate			1
	72	A(65, 76)	Door			1
	72	B(53, 71)				1
	71	L	"Before 10/5/70"	D1FZ 6221758-A		2
	71/	L	"From 10/5/70"	D1FZ 6221758-C		2
	67/69	S		C7SZ 6521758-C		2
	69	A(62)				2
	70/71	S(57)				2
	65/	A, B, F, X	5/16"-18 x 1/2" Hex. washer head screw	376976-S7-8(BB574M)		AR
			5/16"-18 Hex. nut	33797-S7(M50)		AR
<b>21760-1 BRACKET - DOOR WINDOW STOP</b>						
- A -						
	69/70	A(57, 63, 65, 76)		C9AZ 6321760-A		2
- B -						
	68/69	B(63, 65, 66, 76)	R. H.	C8OZ 6321760-A		1
			L. H.	C8OZ 6321761-A		1
	70	B(63, 65, 66, 76)		C9AZ 6321760-A		2
	68/70	B	Bolt-hex. hd. - 1/4"-20 x 3/4"	371492-S2(BB569)		1
	68/70	B	Screw-hex. hd. - 1/4"-20 x 1/2"	381560-S2(BB863K)		2
	72	B(53, 71)	Front door-upper rear	D2OZ 5321760-A		1or2
	72	B(63)	Quarter-rear	D1ZZ 6521760-A		1or2
	72	B(53, 71)	Front door-upper front, lower	D2OZ 6521760-A		2or4
	72	B(53, 71)	Rear door			6
	72	B(63, 65, 97)	Front door			6
- F -						
	69/	F		D1ZZ 6521760-A		2

# FORD CAR PARTS

**BODY  
SECTION 210**

19

GROUP NUMBER	YEAR	BODY TYPE	DESCRIPTION	PART NUMBER	QTY.
<b>21760-1 BRACKET - DOOR WINDOW STOP - continued</b>					
- S -					
	67/71	S	R. H.	C7SZ 6521760-B	1
			L. H.	C7SZ 6521761-B	1
			1/4"-20 x 1/2" Pan head screw & washer assy.	373460-S7(BB629)	4
			1/4"-20 x 3/4" Screw & washer assy.	★374371-S2	2
	72	S	Upper front, lower	D2OZ 6521760-A	4
	72	S	Upper rear	D2SZ 6521760-A	2
	65/66	S	Bolt-hex. head-No. 10-24 x 7/16"	350002-S(BB529)	2
	67/	S	Bolt-hex. head-1/4"-20 x 3/4"	371492-S2(BB569)	1
	68/	S	Screw-hex. head-1/4"-20 x 1/2"	381560-S2(BB863K)	2
- U -					
	66/	U		C6TZ 9721760-A	4
			1/4"-20 x 1/2" Hex. head screw & washer assy.	42742-S7-8(U2A)	8
			1/4" Flat washer	44720-S8(X18)	2
- X -					
	68/70	X(62)		C8DZ 6221760-A	2
<b>21762 BUMPER - DOOR WINDOW STOP</b>					
- A -					
	65/69	A	1 3/4" wide	C5AZ 6221762-B	2or4
	70	A(57, 63, 65, 76)	R. H. -front door-upper rear	D0AZ 6321762-A	1
			L. H.	D0AZ 6321762-B	1
	70	A(57, 63, 65, 76) - "Before 3/26/70"	Lower	D0AZ 6321762-C	2
	70	A(57, 63, 65, 76) - "From 3/26/70"	Lower	D0VY 5321762-A	2
	71	A(53, 57, 65, 76)	Front or rear door		2 or 4
	71	A(54, 71)	Rear door		2
	71	A(54, 71)	Front door	C7SZ 6521762-A	2
	72	A(53, 57)	Front or rear door	C7SZ 6521762-A	4
	72	A(54, 71, 76)	Front door		2
	72	A(54, 71)	Rear door	D0VY 5321762-A	2
	72	A(65, 76)	R. H.	D0AZ 6321762-A	1
			L. H.	D0AZ 6321762-B	1
- B -					
	66/67	B(54, 71)	Rear door-cut as required	C5AZ 6221762-B	4
	66/67	B(62)	Quarter-cut as required		1
	66/67	B	Front door-cut as required		2
	68	B(54, 71)			2
	70	B(62, 71)			2
	70/71	B(63, 65, 66)		C7ZZ 7621762-A	2
	70	B(76)		C5ZZ 6521762-B	2
	70	B(54, 71)	Front and rear	D0DZ 6221762-A	2or4
	71	B(54)			4
	71	B(57)	Rear		2
- F -					
	65/67	F	"Before 12/30/66"	C5ZZ 6521762-B	2
	69/70	F(63, 65)	"From 12/30/66"		2
	67/68	F(76)	"From 12/30/66"	C7ZZ 7621762-A	2
	69/71	F(63)	1 13/16" x 1 3/8" x 1 1/4"	C7SZ 6521762-A	2
	69/70	F(65, 76)	With bonded design	C9ZZ 6521762-A	2
	70	F(65, 76)	With bolt-on design	D0ZZ 6521762-A	2
	71/	F		C7SZ 6521762-A	2
- P -					
	70/	P	Rubber	D0DZ 6221762-A	2or4
- S -					
	67/71	S		C7SZ 6521762-A	2or4
- U -					
	33/	U		C6TZ 9721762-A	2
- X -					
	66/67	X(54, 71)	Rear door-cut as required	C5AZ 6221762-B	2
	66/67	X(62)	Quarter-cut as required		1
	66/67	X	Front door-cut as required		2
	68/70	X	1 3/4" wide		1

**BODY  
SECTION 210**
**FORD CAR PARTS**

GROUP NUMBER	YEAR	BODY TYPE	DESCRIPTION	PART NUMBER	QTY.
<b>21764 BRACKET - DOOR WINDOW STOP - UPPER</b>					
	65/67	A(57, 63, 76)		C5AZ 6321764-A	2to6
	68	A(57, 63, 65, 76)			2to6
	66	B(63)			2
			5/16"-18 x 1/2" Hex. washer head screw	376976-S7-8(BB574M)	2to6
			5/16"-18 x 7/16" Hex. head self-locking bolt	350211-S(BB413)	2
	67/71	S		C7SZ 6521764-A	2
			1/4"-20 x 3/4" Hex. washer head screw	371492-S2(BB569)	2
<b>21768-9 STOP - DOOR WINDOW - UPPER</b>					
<b>- A -</b>					
	65/67	A(57, 63, 76)	Front door	C5AZ 6321768-A	4
	68/70	A(57, 63, 65, 76)	Front door		4
	65/68	A(63, 76)	Quarter		2
	68	A(65)	Quarter		2
	65/68	A(57)	Rear door		2
	69/70	A(57)	R. H.	C9AZ 5721768-A	1
			L. H.	C9AZ 5721769-A	1
	69	A(63, 65, 76)	R. H. - use with square anchor base	C9AZ 6321768-A	1
			L. H.	C9AZ 6321769-A	1
	69/70	A(63, 65, 76)	R. H. - use with curved anchor base	C9AZ 6321768-B	1
			L. H.	C9AZ 6321769-B	1
	71	A(53, 57, 65, 76)	Upper-front	D1AZ 6521768-B	2
	71	A(65, 76)	R.H.	C9AZ 6321768-B	1
			L.H.	C9AZ 6321769-B	1
	71/	A(71)		D1ZZ 6521768-A	2 or 4
	72	A(57)	R.H.	C9AZ 5721768-A	1
			L.H.	C9AZ 5721769-A	1
	72	A(65, 76)	R.H.-upper rear	C9AZ 6321768-B	1
			L.H.	C9AZ 6321769-B	1
	72	A(65, 76)	Upper-front	D1AZ 6521768-B	4
	65/68	A(57, 63, 76)	5/16"-18 x 1/2" Hex. washer hd. screw & washer assy.	376976-S7-8(BB574M)	AR
	68	A(65)			
	69/	A	Screw & washer-1/4"-20 x 3/4" hex. head	382682-S101(BB390XF)	AR
<b>- B -</b>					
	66/67	B(63, 76)	Quarter	C5AZ 6321768-A	2or4
	68/69	B(63, 65, 66, 76)	R. H.	C8OZ 6321768-A	1
			L. H.	C8OZ 6321769-A	1
	70/71	B(57)	Upper front	D0OZ 5721768-A	4
	70/71	B(63, 65, 66, 76)	R. H. -upper rear	D0OZ 6521768-A	1
			L. H. -upper rear	D0OZ 6521769-A	1
	71	B(63, 65, 66, 76)- "Before 1/4/71"	Upper-front	D1AZ 6521768-A	2
	71	B(63, 65, 66, 76)- "From 1/4/71"	Upper-front	D1AZ 6521768-B	2
	72	B	Front-rear door	D1ZZ 6521768-A	2or4
	65	B	Screw-flat head-No. 12-24 x 7/16"	353908-S7(BB113)	AR
	68/	B	Bolt-hex. head-1/4"-20 x 3/4"	371492-S2(BB569)	2
	66/67	B(63, 76)	Screw & washer assy.-hex.washer hd.-5/16"- 18 x 1/2"	376976-S7-8(BB574M)	1
<b>- F -</b>					
	65/68	F		C5ZZ 6521768-A	2
			5/16"-18 x 3/4" Hex. head screw & washer assy.	359662-S7-8(BB575A)	4
	71/	F		D1ZZ 6521768-A	4
<b>- S -</b>					
	65/66	S	Upper	C4SZ 6321768-B	2
			No. 10-24 x 7/16" Hex. head bolt	350002-S(BB529)	8
	71	S		D1SZ 6521768-A	2
	72	S		D1ZZ 6521768-A	2

# FORD CAR PARTS

## BODY SECTION 210

21

GROUP NUMBER	YEAR	BODY TYPE	DESCRIPTION	PART NUMBER		QTY.
				RIGHT HAND	LEFT HAND	
<b>21770-1 STOP - FRONT DOOR WINDOW UPPER</b>						
	69/71	A(except 54, 71)		C8OZ 6321770-A		2
	68/71	B(63, 65, 66, 76)	R. H. L. H.	C8OZ 6321770-A C8OZ 6321771-A		1 1
	69/70	F		C8OZ 6321770-A		2
	67/70	S	R. H. L. H.	C7SZ 6521770-A C7SZ 6521771-A		1 1
			1/4"-20 x 3/4" Hex. washer head screw	371492-S2(BB569)		2
<b>21772 BRACKET - DOOR WINDOW STOP UPPER REAR</b>						
	67/68	F	Front door	C7ZZ 6521772-A		2
			1/4"-20 x 1/2" Pan head screw & washer assy.	373460-S7(BB629)		2
GROUP NUMBER	YEAR	BODY TYPE	DESCRIPTION	PART NUMBER		QTY.
				RIGHT HAND	LEFT HAND	
<b>21774-5 BUMPER - FRONT DOOR VENT WINDOW UPPER</b>						
	65/66	S		C6SZ 6321774-A	C6SZ 6321774-A	2
	65	X(63, 76)		★C4DZ 7621774-A Not replaced (7-73)	C4DZ 7621775-A	1
<b>21790 BRACKET - FRONT DOOR WINDOW LOWER STOP</b>						
	71/	F		D1ZZ 6521790-A	D1ZZ 6521790-A	2
	72	B				1
<b>21801 BUSHING - FRONT DOOR PAWL - INCLUDES WASHERS</b>						
	65	B		C4SZ 6321801-A	C4SZ 6321801-A	2
	65/66	F				2
<b>21812-3 LATCH ASSY. - FRONT DOOR - INCLUDES ATTACHING PARTS</b>						
- A -						
	65/66	A		C5AZ 6221812-C	C5AZ 6221813-C	1
	67	A		C7AZ 6221812-A	C7AZ 6221813-A	1
	68	A		C8AZ 6221812-A	C8AZ 6221813-A	1
	69/70	A		C9AZ 6221812-A	C9AZ 6221813-A	1
	71/72	A	"Before 5/3/71"	D1AZ 6521812-A	★D1AZ 6521813-A r/b D3OZ 6521813-A (3/75)	1
	71/72	A	"From 5/3/71 to 4/24/72"	★D1AZ 6521812-B r/b D3OZ 6521812-A (3/75)	★D1AZ 6521813-B r/b D3OZ 6521813-A (7-73)	1
	72	A	"From 4/24/72"	★D3AZ 6521812-A r/b D3OZ 6521812-A (3/75)	★D3AZ 6521813-A r/b D3OZ 6521813-A (3/75)	1
- B -						
	65	B		C4SZ 6321812-C	C4SZ 6321813-C	1
	66	B		C6OZ 6221812-A	C6OZ 6221813-A	1
	67	B	Without door warning light	C7OZ 6221812-A	C7OZ 6221813-A	1
	68	B	Without vacuum door latch or door ajar system	★C8OZ 5421812-A r/b C9AZ 6221812-A (11-73)	C8OZ 5421813-A	1
	68	B	With vacuum door latch or door ajar system	★C8OZ 5421812-B r/b C9AZ 6221812-A and C9WY 14018-A(10-72)	★C8OZ 5421813-B r/b C9AZ 6221813-A and C9WY 14018-B(10-72)	1
	69/70	B		C9AZ 6221812-A	C9AZ 6221813-A	1
	71/72	B	"Before 5/3/71"	D1AZ 6521812-A	★D1AZ 6521813-A r/b D3OZ 6531813-A (3/75)	1
	72	B	"From 5/3/71 to 4/24/72"	★D1AZ 6521812-B r/b D3OZ 6521812-A (3/75)	★D1AZ 6521813-B r/b D3OZ 6521813-A (7-73)	1
	72	B	"From 4/24/72"	★D3AZ 6521812-A r/b D3OZ 6521812-A (3/75)	★D3AZ 6521813-A r/b D3OZ 6521813-A (3/75)	1

**BODY  
SECTION 210**
**FORD CAR PARTS**

GROUP NUMBER	YEAR	BODY TYPE	DESCRIPTION	PART NUMBER		QTY.
				RIGHT HAND	LEFT HAND	
<b>21812-3 LATCH ASSY. - FRONT DOOR - INCLUDES ATTACHING PARTS - continued</b>						
- F -						
65/66	F			C4SZ 6321812-C	C4SZ 6321813-C	1
67	F		Without door warning lights	C7OZ 6221812-A	C7OZ 6221813-A	1
67	F		With door warning light	C7ZZ 6521812-A	C7ZZ 6521813-A	1
68	F		Without vacuum door latch or door ajar system	★C8OZ 5421812-A r/b C9AZ 6221812-A (11-73)	C8OZ 5421813-A	1
68	F		With vacuum door latch or door ajar system	★C8OZ 5421812-B r/b C9AZ 6221812-A and C9WY 14018-A(10-72)	★C8OZ 5421813-B r/b C9AZ 6221813-A and C9WY 14018-B(10-72)	1
69/70	F			C9AZ 6221812-A	C9AZ 6221813-A	1
71	F	"Before 5/3/71"		D1AZ 6521812-A	★D1AZ 6521813-A r/b D3OZ 6521813-A (3/75)	1
71/72	F	"From 5/3/71 to 4/24/72"		★D1AZ 6521812-B r/b D3OZ 6521812-A (3/75)	★D1AZ 6521813-B r/b D3OZ 6521813-A (7-73)	1
72	F	"From 4/24/72"		★D3AZ 6521812-A r/b D3OZ 6521812-A (3/75)	★D3AZ 6521813-A r/b D3OZ 6521813-A (3/75)	1
65/	F		Screw & washer-No. 12-24 x 1/2" flat head	356782-S8(BB114)	356782-S8(BB114)	AR
- L -						
71	L	"Before 5/3/71"		D1AZ 6521812-A	★D1AZ 6521813-A r/b D3OZ 6521813-A (3/75)	1
71/72	L	"From 5/3/71 to 4/24/72"		★D1AZ 6521812-B r/b D3OZ 6521812-A (3/75)	★D1AZ 6521813-B r/b D3OZ 6521813-A (7-73)	1
72	L	"From 4/24/72"		★D3AZ 6521812-A r/b D3OZ 6521812-A (3/75)	★D3AZ 6521813-A r/b D3OZ 6521813-A (3/75)	1
- P -						
70/	P			C9AZ 6221812-A	C9AZ 6221813-A	1
70/	P		Screw & washer-No. 12-24 x 1/2" flat head	356782-S8(BB114)	356782-S8(BB114)	6
- S -						
65/66	S			C5AZ 6221812-C	C5AZ 6221813-C	1
67	S			C7AZ 6221812-A	C7AZ 6221813-A	1
68/71	S			C8SZ 6521812-A	C8SZ 6521813-A	1
72	S	"Before 4/24/72"		★D1AZ 6521812-A r/b D3OZ 6521812-A (3/75)	D1AZ 6521813-A r/b D3OZ 6521813-A (7-73)	1
72	S	"From 4/24/72"		★D3AZ 6521812-A r/b D3OZ 6521812-A (3/75)	★D3AZ 6521813-A r/b D3OZ 6521813-A (3/75)	1
- U -						
66/67	U			C3OZ 6221812-F	C3OZ 6221813-F	1
68/	U			C8TZ 9721812-A	C8TZ 9721813-A	1
- X -						
65	X			C3OZ 6221812-F	C3OZ 6221813-F	1
66	X			C6OZ 6221812-A	C6OZ 6221813-A	1
67	X			C7OZ 6221812-A	C7OZ 6221813-A	1
68	X			★C8OZ 5421812-A r/b C9AZ 6221812-A (11-73)	C8OZ 5421813-A	1
69/70	X			C9AZ 6221812-A	C9AZ 6221813-A	1
65	X		Nut-sleeve-7/32"	377647-S(MM216J)	377647-S(MM216J)	4
GROUP NUMBER	YEAR	BODY TYPE	DESCRIPTION	PART NUMBER		QTY.
<b>21816 ADJUSTER - DOOR LATCH ACTUATING ROD</b>						
65/	A, S		Front door or tail gate	C5AZ 6221816-A		2 or 3
66/	B, X		Front door or tail gate			2 or 3
67/	F, L, P, U		Front door			2



# FORD CAR PARTS

## BODY SECTION 210

23

GROUP NUMBER	YEAR	BODY TYPE	DESCRIPTION	PART NUMBER		QTY.
				RIGHT HAND	LEFT HAND	
<b>21818-9 CONTROL and LINK ASSY. - DOOR LATCH REMOTE</b>						
<b>- A -</b>						
65/66	A		Front door	C5AZ 6221818-B	C5AZ 6221819-B	1
65/66	A(54, 57, 71)		Rear door			1
			5/16"-18 x 1/2" Hex. washer head screw	376976-S7-8(BB574M)	376976-S7-8(BB574M)	6or12
67	A		Front door-Includes handle screw	C6OZ 6221818-B	C6OZ 6221819-B	1
66/67	A(54, 57, 71)		Rear door-Includes handle screw	C5AZ 6221818-B	C5AZ 6221819-B	1
68	A			C8AZ 6221818-B	C8AZ 6221819-B	1
69	A		Includes attaching parts	C9AZ 6221818-A	C9AZ 6221819-A	1or2
70	A		Includes attaching parts	D0DZ 6221818-C	D0DZ 6221819-C	1or2
71	A	"Before 6/1/71"	Front or rear	D1AZ 6521818-B	D1AZ 6521819-B	1or2
71/72	A	"From 6/1/71 to 9/15/71"	Front or rear	★D2OZ 6521818-A r/b D2AZ 6521818-A (11-73)	★D2OZ 6521819-A r/b D2AZ 6521819-A (11-73)	1or2
72	A	"From 9/15/71"	Front or rear	D2AZ 6521818-A	D2AZ 6521819-A	1or2
<b>- B -</b>						
65	B		Refer to Group 26404-5			
66/67	B		Front door-Includes handle screw	C6OZ 6221818-B	C6OZ 6221819-B	1
66/67	B(54, 71)		Rear door			1
68	B	"Before 9/25/67"		C8AZ 6221818-B	C8AZ 6221819-A	1
68/69	B	"From 9/25/67"		C8AZ 6221818-B	C8AZ 6221819-B	1
70/71	B		Front or rear	D0DZ 6221818-C	D0DZ 6221819-C	1or2
72	B	"Before 9/15/71"	Front or rear	★D2OZ 6521818-A r/b D2AZ 6521818-A (11-73)	★D2OZ 6521819-A r/b D2AZ 6521819-A (11-73)	1or2
72	B	"From 9/15/71"	Front or rear	D2AZ 6521818-A	D2AZ 6521819-A	1or2
65	B		Retainer	357550-S(QQ1)	357550-S(QQ1)	2
65	B		Screw-hex. head-5/16"-24 x 5/8"	359605-S8(BB590)	359605-S8(BB590)	4
<b>- F -</b>						
65	F	"Before 3/8/65"	Refer to Group 26404-5			
65/66	F(63A, 65A, C, 76A, 76C)-	"From 3/8/65"		C5ZZ 6521818-C	C5ZZ 6521819-C	1
65/66	F(63B, 65B, 76B)			★C5ZZ 6521818-B Not replaced (3-74)	C5ZZ 6521819-B	1
67/68	F		Front door-Includes handle screw	C6OZ 6221818-B	C6OZ 6221819-B	1
69/70	F		Includes attaching parts	C9AZ 6221818-A	C9AZ 6221819-A	1or2
71	F-w/o molded armrest-	"Before 6/1/71"		D1AZ 6521818-B	D1AZ 6521819-B	1
71	F-w/molded armrest-	"Before 6/1/71"		D1ZZ 6521818-B	D1ZZ 6521819-B	1
71/72	F-w/o molded armrest-	"From 6/1/71 to 9/15/71"		★D2OZ 6521818-A r/b D2AZ 6521818-A (11-73)	★D2OZ 6521819-A r/b D2AZ 6521819-A (11-73)	1
71/72	F-w/molded armrest-	"From 6/1/71 to 9/15/71"		D2ZZ 6521818-A	★D2ZZ 6521819-A r/b D2ZZ 6521819-B (3/75)	1
72	F-w/o molded armrest -	"From 9/15/71"		D2AZ 6521818-A	D2AZ 6521819-A	1
72	F-w/molded armrest -	"From 9/15/71"		D2ZZ 6521818-B	D2ZZ 6521819-B	1
67/	F		Screw-oval head-No. 8-32 x 5/8"	381571-S13(UU56BA)	381571-S13(UU56BA)	2
<b>- L -</b>						
71/72	L	"Before 4/3/72"		D1FZ 6221818-A	D1FZ 6221819-A	1
72	L	"From 4/3/72"	Includes attaching parts	D2FZ 6221818-B	D2FZ 6221819-B	1

**BODY  
SECTION 210**
**FORD CAR PARTS**

GROUP NUMBER	YEAR	BODY TYPE	DESCRIPTION	PART NUMBER		QTY.	
				RIGHT HAND	LEFT HAND		
<b>21818-9</b>	<b>CONTROL and LINK ASSY. - DOOR LATCH REMOTE - continued</b>						
- P -							
	70	P	"Before 6/2/69"	Includes attaching parts	D0DZ 6221818-B	D0DZ 6221819-A	1
	70	P	"From 6/2/69"	Includes attaching parts	D0DZ 6221818-B	D0DZ 6221819-B	1
	71/	P-exc. LTD			D0DZ 6221818-C	D0DZ 6221819-C	1 or 2
	72	P(54A, 62A)-LTD			D2FZ 6221818-A	D2FZ 6221819-A	1 or 2
	70	P		Screw to washer-1/4"x 20 x 5/8" Hex. head	57472-S40 (B339V)	57472-S40 (B339V)	4
- S -							
	65/66	S			★C5SZ 6321818-A Not replaced (7-73)	C5SZ 6321819-A	1
				5/16"-18 x 1/2" Hex. washer head screw	376976-S7-8(BB574M)	376976-S7-8(BB574M)	6
				Screw-oval head- No. 10-24 x 7/16"	378446-S13(BB600P)	378446-S13(BB600P)	2
	67	S			C7SZ 6521818-A	★C7SZ 6521819-A Not replaced (3-74)	1 or 2
				Screw & washer assy. - pan head-1/4"-20 x 1/2"	373460-S7(BB629)	373460-S7(BB629)	6 or 12
	67	S		Screw-self-tapping- 5/16"-18 x 3/4"	378428-S7(UU48E)	378428-S7(UU48E)	6
	68	S	"Before 9/25/67"		C8AZ 6221818-B	C8AZ 6221819-A	1
	68/71	S	"From 9/25/67"		C8AZ 6221818-B	C8AZ 6221819-B	1
	72	S	"Before 9/15/71"		★D2OZ 6521818-A r/b D2AZ 6521818-A (11-73)	★D2OZ 6521819-A r/b D2AZ 6521819-A (11-73)	1
	72	S	"From 9/15/71"		D2AZ 6521818-A	D2AZ 6521819-A	1
	67/	S		Nut-hex. -No. 8-32	34052-S7(MM155)	34052-S7(MM155)	2
- U -							
	66	U			C1UZ 8921818-C	C1UZ 8921819-C	1
	67	U		Includes handle screw	C5ZZ 6521818-C	C5ZZ 6521819-C	1
	68	U	"Before Ser. B96, 001"		C8AZ 6221818-B	C8AZ 6221819-A	1
	68/	U	"From Ser. B96, 001"		C8AZ 6221818-B	C8AZ 6221819-B	1
- X -							
	66/67	X		Front door-Includes handle screw	C6OZ 6221818-B	C6OZ 6221819-B	1
	66/67	X(54, 71)		Rear door			1
	68	X	"Before 9/25/67"		C8AZ 6221818-B	C8AZ 6221819-A	1
	68/70	X	"From 9/25/67"		C8AZ 6221818-B	C8AZ 6221819-B	1
	65/67	X		No. 12-24 x 1/2" Cross recess pan head screw & washer assy.	50811-S8(U150A)	50811-S8(U150A)	6
	65/67/	F	"From 3/8/65"				6
	66	B					6
	67	A					6
GROUP NUMBER	YEAR	BODY TYPE	DESCRIPTION		PART NUMBER	QTY.	
<b>21842</b>	<b>SEAL - DOOR VACUUM LATCH ACTUATOR SHAFT</b>						
	69	A			C9AZ 6221842-A	2 or 4	
	68	S				2 or 4	
	71	B, S				2 or 4	
<b>218A42-3</b>	<b>ACTUATOR - FRONT DOOR VACUUM LATCH</b>						
	68	A(54, 57, 71)		R. H.	★C8AZ 54218A42-A Not replaced (3/75)	1	
				L. H.	C8AZ 54218A43-A	1	
	69	A(54, 57, 71)		R. H.	C9AZ 54218A42-A	1	
				L. H.	C9AZ 54218A43-A	1	
	69	A(62, 63, 65, 76)		R. H.	C9AZ 62218A42-A	1	
				L. H.	C9AZ 62218A43-A	1	
	70	A(54, 57, 71)		R. H.	D0AZ 54218A42-B	1	
				L. H.	D0AZ 54218A43-B	1	

# FORD CAR PARTS

**BODY  
SECTION 210**

25

GROUP NUMBER	YEAR	BODY TYPE	DESCRIPTION	PART NUMBER	QTY.
<b>218A42-3 ACTUATOR - FRONT DOOR VACUUM LATCH - continued</b>					
70	A(63, 65, 76)	"Before 11/3/69"	R. H.	D0AZ 62218A42-A	1
			L. H.	D0AZ 62218A43-A	1
70	A(63, 65, 76)	"From 11/3/69"	R. H.	D0AZ 62218A42-B	1
			L. H.	D0AZ 62218A43-B	1
71/	A(53, 54, 57, 71)		R. H.	D1AZ 54218A42-A	1
			L. H.	D1AZ 54218A43-A	1
71/	A(65, 76)		R. H.	D1AZ 65218A42-A	1
			L. H.	D1AZ 65218A43-A	1
67/	A		Screw-pan head-No. 12-24 x 8 1/2"	50811-S8(U150A)	2
72	B(63, 65, 97)		R. H.	D3OZ 65218A42-A	1
			L. H.	D3OZ 65218A43-A	1
72	B(53, 71)		R. H.	D3OZ 53218A42-A	1
			L. H.	D3OZ 53218A43-A	1
67	S(57)		R. H. - Includes attaching parts & I. S.	C7SZ 57218A42- D	1
			L. H.	C7SZ 57218A43- D	1
67	S(65)		R. H. - Includes attaching parts & I. S.	C7SZ 65218A42- C	1
			L. H.	C7SZ 65218A43- C	1
67	S		Clip assy.	C7SZ 6521952-A	2
68/71	S(57)		R. H.	C8SZ 57218A42-A	1
			L. H.	C8SZ 57218A43-A	1
68/71	S(65)		R. H.	C8SZ 65218A42-A	1
			L. H.	C8SZ 65218A43-A	1
72	S		R. H.-Includes motor	D2SZ 65218A42-A	1
			L. H.	D2SZ 65218A43-A	1
67	S		1/4"-20 x 1 1/2" Pan head screw & washer assy.	373460-S7(BB629)	4
67/	S		Screw-pan head-No. 12-24 x 1/2"	50811-S8(U150A)	AR
<b>21850 KNOB - DOOR LATCH CONTROL ROD</b>					
65/67	A, S		Chrome	C5AZ 6221850-A	2or4
66/67	B, X				2or4
67	F				2
68/70	A,			C8AZ 6221850-A	2or4
68/	F, L, P, U				2
68/71	B, S				2or4
72	B, S		W/o vacuum latch		1or2
71/	A		Front and rear-w/o vacuum latch		2 or 4
71/	A		Rear-w/vacuum latch		2
71	A	"Before 3/22/71"	Front-w/vacuum latch	D1AZ 6521850-A	2
71	A	"From 3/22/71"	Front-w/vacuum latch	D1AZ 6521850-C	2
72	A, B, S		Front-w/vacuum latch	D2AZ 6521850-A	1
65	B, F, X		Chrome	C5DZ 6221850-A	2or4
					2
66	F, U				2
67	U				2
65	F		Black	C3AZ 6221850-A	2
			Blue	C4AZ 6221850-AFK	2
<b>21850 LATCH KIT - REAR DOOR SAFETY</b>					
65/	A, B, P, S, X			C6AZ 5421850-B	1
<b>21852-3 ROD - FRONT DOOR LATCH PUSH BUTTON</b>					
- A -					
65/67	A(54, 71)		R. H.	C5AZ 5421852-B	1
			L. H. - not replaced (3-74)	★C5AZ 5421853-B	1
65/68	A(54, 71)		R. H.	C5AZ 5421852-B	1
			L. H. - not replaced (3-74)	★C5AZ 5421853-B	1
68	A(62, 63, 65, 76)		R. H.	C5AZ 6221852-B	1
			L. H.	C5AZ 6221853-B	1
69/70	A(54, 57, 71)		R. H.	C9AZ 5421852-A	1
			L. H.	C9AZ 5421853-A	1
69/70	A(62, 63, 65, 76)		R. H.	C9AZ 6221852-A	1
			L. H.	C9AZ 6221853-A	1

GROUP NUMBER	YEAR	BODY TYPE	DESCRIPTION	PART NUMBER	QTY.
<b>21852-3 ROD - FRONT DOOR LATCH PUSH BUTTON - continued</b>					
<b>- A -</b>					
71/	A(53, 57)	R.H.	D1AZ	5721852-A	1
		L.H.	D1AZ	5721853-A	1
71/	A(54, 71)	R.H.	D1AZ	5421852-A	1
		L.H.	D1AZ	5421853-A	1
71/	A(65, 76)	R.H.	D1AZ	6521852-B	1
		L.H.	D1AZ	6521853-B	1
<b>- B -</b>					
68/69	B(54, 71)	R.H.	C8OZ	5421852-A	1
		L.H.	C8OZ	5421853-A	1
68/69	B(63, 65, 66, 76)	R.H.	C8OZ	6321852-A	1
		L.H.	C8OZ	6321853-A	1
70/71	B(54, 57, 71)	R.H.	D0OZ	5421852-A	1
		L.H.	D0OZ	5421853-A	1
70/71	B(62, 63, 65, 66, 76)	R.H.	D0OZ	6521852-A	1
		L.H.	D0OZ	6521853-A	1
72	B(53, 71)	R.H.	D2OZ	5321852-A	1
		L.H.	D2OZ	5321853-A	1
72	B(63, 65, 97)	R.H. -w/o vacuum door latch	D2OZ	6521852-A	1
		L.H.	D2OZ	6521853-A	1
72	B(63, 65, 97)	R.H. -w/vacuum door latch	D2OZ	6521852-B	1
		L.H.	D2OZ	6521853-B	1
65	B	Nut-sleeve-7/32"	377647-S(MM216J)		1
<b>- F -</b>					
65/66	F	R.H. -Includes attaching parts	C5ZZ	6521852-A	1
		L.H.	C5ZZ	6521853-A	1
67	F	R.H.	C7ZZ	6521852-A	1
		L.H.	C7ZZ	6521853-A	1
68	F	R.H.	C8ZZ	6521852-A	1
		L.H.	C8ZZ	6521853-A	1
69/70	F	R.H.	C9ZZ	6521852-A	1
		L.H.	C9ZZ	6521853-A	1
71/	F	R.H.	D1ZZ	6521852-A	1
		L.H.	D1ZZ	6521853-A	1
<b>- L -</b>					
71/	L(62)	R.H.	D1FZ	6221852-A	1
		L.H.	D1FZ	6221853-A	1
<b>- P -</b>					
70/	P(62)	R.H.	D0DZ	6221852-A	1
		L.H.	D0DZ	6221853-A	1
71/	P(54)	R.H.	D1DZ	5421852-A	1
		L.H.	D1DZ	5421853-A	1
<b>- S -</b>					
68/71	S(57)	R.H.	C8SZ	5721852-A	1
		L.H.	C8SZ	5721853-A	1
69/71	S(65)		C8LY	6521852-A	2
72	S		D2SZ	6521852-A	2
<b>- U -</b>					
66/67	U	R.H.	C6TZ	9721852-A	1
		L.H.	C6TZ	9721853-A	1
68/	U	R.H.	C8TZ	9721852-A	1
		L.H.	C8TZ	9721853-A	1
<b>- X -</b>					
67	X	R.H.	C7OZ	6221852-A	1
		L.H.	C7OZ	6221853-A	1
68/70	X	R.H.	C8DZ	6221852-A	1
		L.H.	C8DZ	6221853-A	1

# FORD CAR PARTS

**BODY  
SECTION 210**

27

GROUP NUMBER	YEAR	BODY TYPE	DESCRIPTION	PART NUMBER	QTY.
<b>21872-3 SPRING - DOOR LATCH TOGGLE</b>					
	67	A, B, F, S, U, X	R. H.	C7AZ 6221872-B	1or2
	68	A			1or2
	68/70	S	L. H.	C7AZ 6221873-B	1or2
	68/70	B, F, U	"Before 11/17/69" R. H.	C8OZ 6221872-A	1or2
	68/70	X			1or2
	69/70	A	"Before 11/17/69" R. H.		1or2
	70	P	"Before 11/17/69" L. H.	C8OZ 6221873-A	1
	70	A, B, F, P, U-	R. H.	D0AZ 6221872-A	1or2
		"From 11/17/69"			
	71	B, P, U			1or2
	72	P, U			1or2
			L. H.	D0AZ 6221873-A	1or2
	71	A, F, L, S	R. H.	C7AZ 6221872-B	1or2
	72	A, B, F, L, S			1or2
			L. H.	C7AZ 6221873-B	1or2
<b>218A82 BEZEL - VACUUM DOOR LATCH CONTROL SWITCH</b>					
	65/66	S		C4SZ 63218A82-A	2
	67	S	With speed control-Includes attaching parts With vacuum door latch	C7SZ 65218A82-C	1
					1
<b>21900 BELLCRANK - FRONT DOOR LATCH CONTROL</b>					
	72	B(63, 65, 97)	W/o vacuum door latch	D2OZ 6521900-A	2
	72	B(63, 65, 97)	W/vacuum door latch	D2OZ 6521900-B	2
	72	S		D2SZ 6521900-A	2
<b>219A00 VALVE - VACUUM DOOR LATCH CONTROL</b>					
	67	A	Mounted on transmission	C5MY 54219A00-B	1
	67	A	"Before 5/1/67" Mounted on dash	C7MY 54219A00-A	1
	67/68	A	"From 5/1/67" Mounted on dash	C7AZ 62219A00-B	1
	69/70	A		C9AZ 62219A00-A	1
	71	A	Refer to Group 220A00		
	65/66	S		C4SZ 63219A00-A	1
	67	S	Mounted on transmission	C7SZ 65219A00-C	1
	70/	S	Refer to Group 220A00		
	67	S	"Before 2/13/67" With rolling door latch-mounted on dash	C7SZ 65219A00-D	1
	67/69	S	"From 2/13/67" Without rolling door latch-mounted on dash	C7SZ 65219A00-F	1
	67/	A	Fitting	378830-S(II-106H)	AR
	65/66	S	Screw-hex. head-No. 10-16 x 3/8"	42120-S8(U248)	2
	65/66	S	Screw-hex. washer head-No. 14-14 x 1/2"	31497-S8(U254)	1
	67	S	Bushing	380614-S(DD3)	AR
<b>219A02 RESERVOIR - VACUUM DOOR LATCH CONTROL</b>					
	65/67	A		C5AZ 62219A02-B	1
	68	A		C8AZ 62219A02-B	1
	69/70	A		C9AZ 62219A02-A	1
	71	A	Includes bracket	D1AZ 65219A02-A	1
	72	A		D2VY 65219A02-A	1
	65/66	S		C4SZ 63219A02-A	1
			No. 10-12 x 3/4" Hex. washer head screw	42141-S8(U250)	2
			No. 10-12 Nut (spring)	45145-S(M130)	2
	67/	S	Also refer to Group numbers 3E547 and 13A185 in Chassis section		
	68/69	S		C8SZ 65219A02-A	1
	70	S	Includes bracket	D0SZ 65219A02-A	1
	71	S	Includes bracket	D1SZ 65219A02-A	1
	67	A	Nut-No. 10-24	34053-S8(M156)	AR
	67	A	Washer-lock-No. 10	34903-S8(X96)	AR
	67	A	Screw-hex. head-1/4"-20 x 1/2"	40927-S8(U262)	1

**BODY  
SECTION 210**
**FORD CAR PARTS**

GROUP NUMBER	YEAR	BODY TYPE	DESCRIPTION	PART NUMBER	QTY.
<b>21910 SPRING - DOOR LATCH REMOTE CONTROL</b>					
	65	F	"Before 3/8/65"	C0DZ 6421910-A	2or4
	66	U			2
	65/66	B,X		C5DZ 6221910-A	2or4
	65/68	F	"From 3/8/65"		2
	67	A			2
<b>21927 HOSE - VACUUM DOOR LATCH - Refer to Chassis Section 17543</b>					
<b>21932 BUSHING - FRONT DOOR LATCH BELLCRANK</b>					
	72	B(63,65,97),S		D2OZ 6521932-A	4
<b>219A37 DAMPENER - DOOR LATCH SPRING VIBRATION</b>					
	67/68	A		C7AZ 62219A37-A	2or4
	67/71	S			2or4
<b>21938-9 INSULATION - FRONT DOOR LATCH ACTUATOR</b>					
	72	S	R.H.	D2SZ 6521938-A	1
			L.H.	D2SZ 6521939-A	1
<b>21940-1 LINK - FRONT DOOR LATCH REMOTE CONTROL</b>					
- A -					
	69	A(54,57,71)	R.H.	C9AZ 5421940-B	1
			L.H.	C9AZ 5421941-B	1
	69	A(62,63,65,76)		C9AZ 6221940-B	2
	70	A(54,57,71)	R.H.	D0AZ 5421940-A	1
			L.H.	D0AZ 5421941-A	1
	70	A(63,65,76)	R.H.	D0AZ 6221940-A	1
			L.H.	D0AZ 6221941-A	1
	71/	A(53,54,57,71)	R.H.	D1AZ 5421940-A	1
			L.H.	D1AZ 5421941-A	1
	71	A(65,76)	R.H.	D1AZ 6521940-A	1
			L.H.	D1AZ 6521941-A	1
	72	A(65,76)	R.H.	D2AZ 6521940-A	1
			L.H.	D2AZ 6521941-A	1
- B -					
	68/69	B(54,71)		C8OZ 5421940-A	2
	68/69	B(63,65,66,76)		C8OZ 6321940-A	2
	70/71	B(54,57,71)	R.H.	D0OZ 5421940-A	1
			L.H.	D0OZ 5421941-A	1
	70/71	B(62,63,65,66,76)	R.H.	D0OZ 6521940-A	1
			L.H.	D0OZ 6521941-A	1
	70/71	B	Screw & washer-hex.head-No. 8-32 x 1/2"	57075-S2(B330A)	2
	72	B(53,71)	R.H.	D2OZ 5321940-A	1
			L.H.	D2OZ 5321941-A	1
	72	B(63,65,97)	R.H.	D2OZ 6521940-A	1
			L.H.	D2OZ 6521941-A	1
	65/66	B	Screw-pan head-No. 12-24 x 1/2"	31061-S8(U50)	2
- F -					
	69/70	F		C9ZZ 6521940-B	2
	71/	F	R.H.	D1ZZ 6521940-A	1
			L.H.	D1ZZ 6521941-A	1
	65/66	F	Clip	380512-S2(GG244)	AR
	65/66	F	Screw-self-tapping pan head-No. 8-15 x 1/2"	52726-S13(U381)	AR
	67/	F	Screw-pan head-No. 12-24 x 1/2"	31061-S8(U50)	2
- L -					
	71/	L(62,64)		D1FZ 6221940-A	2

# FORD CAR PARTS

**BODY  
SECTION 210**

29

GROUP NUMBER	YEAR	BODY TYPE	DESCRIPTION	PART NUMBER	QTY.	
<b>21940-1 LINK - FRONT DOOR LATCH REMOTE CONTROL - continued</b>						
- P -						
70		P(62)	R. H.	D0DZ 6221940-B	1	
			L. H.	D0DZ 6221941-B	1	
			Clip-No. 8-32	380165-S2(GG286)	2	
71/		P(54)-exc. LTD	R.H.	D1DZ 5421940-A	1	
			L.H.	D1DZ 5421941-A	1	
72		P(54)-LTD	R.H.	D2DZ 5421940-A	1	
			L.H.	D2DZ 5421941-A	1	
71/		P(62)-exc. LTD	R.H.	D1DZ 6221940-A	1	
			L.H.	D1DZ 6221941-A	1	
72		P(62A)-LTD	R.H.	D2DZ 6221940-A	1	
			L.H.	D2DZ 6221941-A	1	
- S -						
68/71		S(57)		C8SZ 5721940-B	2	
68/71		S(65)		C8SZ 6521940-A	2	
72		S "Before 3/1/72"	R.H.	D2SZ 6521940-A	1	
			L.H.	D2SZ 6521941-A	1	
72		S "From 3/1/72"	R.H.	D2SZ 6521940-B	1	
			L.H.	D2SZ 6521941-B	1	
- U -						
66/67		U	R. H.	C6TZ 9721940-A	1	
68/		U	L. H.	C6TZ 9721941-A	1	
				C8TZ 9721940-A	2	
- X -						
66		X(62, 66)		C6OZ 6221940-A	2	
67		X(62)		C7OZ 6221940-A	2	
68/70		X(54, 71)		C8DZ 5421940-A	2	
68/70		X(62)		C8DZ 6221940-A	2	
65/		A, S	Clip or retainer	C5AZ 6221952-A	AR	
			66	B, X		AR
			66/	B, F, P, X	Clip	380165-S2(GG286)
<b>21952-4 RETAINER - DOOR LATCH ROD</b>						
65/		A, B, F, L, P, S, U, X	Black	C5AZ 6221954-A	AR	
65/		A, B, F, L, P, U, X	White-less washer	C5AZ 6221952-A	AR	
65/67		S "Before 3/27/67"			2 or 4	
72		A	Hood		1	
65		B, X		C3AZ 6221952-A	12	
65/66		F			12	
66/		U(98)	Liftgate		3	
66/		U	Door		12	
72		B(63, 65, 97)	W/vacuum door latch	D2OZ 6521952-A	2	
71/		F	White-includes washer	D1ZZ 6521952-A	2	
67		S "From 3/27/67"		C7SZ 6521952-A	2 or 4	
65		X(except 63)	Front door	B9AB 6421952-A	2 or 4	
65/66		X(except 63, 76)	Front door	C0AB 6421954-A	2	
<b>219A59 SEAL - DOOR LATCH REMOTE CONTROL</b>						
68/69		B, S, U, X		C8AZ 62219A59-B	2 or 4	
			68	F		2
			70/71	S		2 or 4
			70/	U		2
69		A, F	R. H.	C9AZ 62219A59-B	2 or 4	
			70	F		2
68/		F	L. H.	C9AZ 62219A59-C	2 or 4	
			72	A, B, F, P	Screw-flat head external tooth-No. 12-24 x 1/2"	356782-S8(BB114)
			Improvise	★		

GROUP NUMBER	YEAR	BODY TYPE	DESCRIPTION	PART NUMBER	QTY.
<b>219A61 HOUSING - VACUUM DOOR LATCH CONTROL</b>					
	69	A	Located on instrument cluster pad	C9AZ 62219A61-A	1
	70	A		D0AZ 62219A61-A	1
	68/69	S		C8SZ 65219A61-A	2or4
<b>21970 LEVER - FRONT DOOR LATCH OPERATING</b>					
	65	B, F, X		C2OZ 6221970-A	2
	66	F, U			2
	65/71	A, S	Includes retaining ring	D2AZ 6521970-A	2
	66/71	B, L, P, X			2
	67/71	F, U			2
	72	A, B, F, L, P, S, U	Includes retaining ring	D2AZ 6521970-A	2
	65/71	A, B, F, L, P, S, U, X	1/4" Ring (retaining)	97497-S2 (Q5)	3
	72	A, B, F, L, P, S, U	1/4" Ring (retaining)	97409-S(Q5A)	3
<b>21984-5 LOCK CYLINDER and KEYS - FRONT DOOR-Refer to Group 22050</b>					
<b>219A84 LINK - FRONT DOOR LATCH CONTROL ROD LEVER</b>					
	69/71	S(65)		C8LY 65219A84-A	2
<b>219A92 RETAINER - VACUUM DOOR LATCH CONTROL</b>					
	69/70	A	Located on instrument cluster pad	C9MY 54219A92-A	2
<b>21999 GROMMET - DOOR LATCH KNOB</b>					
- A -					
	65/67	A	Repl. by D0DZ 6221999-A (3/75)	★C5AZ 6221999-A	2or4
	68/71	A	Bright finish plastic	C7SZ 6521999-B	2or4
	70/	A	Stainless steel	D0AZ 6221999-A	2or4
	65/67	A	Stainless steel	D0DZ 6221999-A	2or4
- B -					
	65/67	B	Plastic	C5DZ 6221999-B	2or4
	68/70	B	Bright finish plastic	C7SZ 6521999-B	2or4
	70/	B	Stainless steel	D0AZ 6221999-A	2or4
- F -					
	65	F	"Before 6/5/64"	C2OZ 6221999-B	2
	65/69	F	"From 6/5/64"	C5DZ 6221999-B	2
	70	F(63A, 65A, 76A)	Plastic		2
	70	F(exc. 63A, 65A, 76A) - "Before 12/17/69"	Bright finish plastic	C7SZ 6521999-B	2
	70	F(exc. 63A, 65A, 76A) - "From 12/17/69"	Stainless steel	D0AZ 6221999-A	2
	71/	F(63R, 65F)			2
	71	F(63D, 65D, 76D)	Stainless steel	D0DZ 6221999-A	2
	71/	F(63D, 65D, 76D)	Plastic	C5DZ 6221999-B	2
- L -					
	71/	L		C5DZ 6221999-B	2
- P -					
	70/71	P	Stainless steel	D0DZ 6221999-A	2or4
	71/	P	Plastic	C5DZ 6221999-B	2or4
- S -					
	65/68	S		C5SZ 6321999-A	2or4
	67	S	"Before 3/1/67"	Repl. by D0DZ 6221999-A (3/75)	★C5AZ 6221999-A
	67/	S	"From 3/1/67"	Stainless steel	D0AZ 6221999-B
	67/70	S	"From 3/1/67"	Bright finish plastic	C7SZ 6521999-B
	67	S	Stainless steel	D0DZ 6221999-A	2
- X -					
	65/67	X	Plastic	C5DZ 6221999-B	2or4
	68/70	X	Bright finish plastic	C7SZ 6521999-B	2or4



# FORD CAR PARTS

**BODY  
SECTION 220**

1

GROUP NUMBER	YEAR	BODY TYPE	DESCRIPTION	PART NUMBER	QTY.
<b>220A00 SOLENOID and VALVE ASSY. - VACUUM DOOR LATCH CONTROL</b>					
	71	A	W/o circuit breaker	★D1AZ 65220A00-A	1
	72	A(71)	Use for tailgate latch	r/b D1AZ 65220A00-B	1
	71/	A	W/circuit breaker	D1AZ 65220A00-B	1
	70/71	S	Also refer to Group 219A00	D0VY 65220A00-A	1
<b>22008 PLATE - DOOR LATCH STRIKER</b>					
- A -					
	65/70	A		C5AZ 6222008-A	2 or 4
	71/72	A	" Before 3/20/72" r/b D2AZ 6522008-A (3-74)	★D1AZ 6522008-A	2 or 4
	72	A	" From 3/20/72"	D2AZ 6522008-A	2 or 4
- B -					
	65	B		C2OZ 6222008-B	2 or 4
	66/71	B		C5AZ 6222008-A	2 or 4
	72	B	" Before 3/20/72" r/b D2AZ 6522008-A (3-74)	★D1AZ 6522008-A	2 or 4
	72	B	" From 3/20/72"	D2AZ 6522008-A	2 or 4
- F -					
	65/66	F		C2OZ 6222008-B	2
	67/70	F		C5AZ 6222008-A	2
	71/72	F	" Before 3/20/72" r/b D2AZ 6522008-A (3-74)	★D1AZ 6522008-A	2
	72	F	" From 3/20/72"	D2AZ 6522008-A	2
- L -					
	71/ 72	L	" Before 3/20/72" r/b D2AZ 6522008-A (3-74)	★D1AZ 6522008-A	2
	72	L	" From 3/20/72"	D2AZ 6522008-A	2
- P -					
	70/	P		C5AZ 6222008-A	2 or 4
- S -					
	65/71	S		C5AZ 6222008-A	2 or 4
	72	S	" Before 3/20/72" r/b D2AZ 6522008-A (3-74)	★D1AZ 6522008-A	2
	72	S	" From 3/20/72"	D2AZ 6522008-A	2
- U -					
	66/67			C2OZ 6222008-B	2
	68/			C5AZ 6222008-A	2
- X -					
	65	X		C2OZ 6222008-B	2 or 4
	66/70	X		C5AZ 6222008-A	2 or 4
	65/	A, B, F, S, U, X	5/16"-18 x 3/4" Flat head locking screw	378428-S7-8(UU48E)	4or8
<b>220A14 BRACKET - FRONT DOOR LATCH ACTUATOR</b>					
	72	S		D2SZ 65220A14-A	2
<b>22021 RETAINER - DOOR LATCH STRIKER ANCHOR PLATE</b>					
	65	A		D0AZ 6222021-A	2or4
	66	A, B, X			2or4
	68/69	A, B, F, S, X			2or4
	70	A(54, 57, 62, 63, 65), B(66, 71), F(63, 65), P(62), S(65)			
	71	A(65, 76), B, F, L, P, S			2
	72	P			2
	70	B(54, 57)		D0OZ 5422021-A	2
	71	B(54, 57, 71)			2
<b>220A22 STOP - DOOR LATCH ACTUATOR REAR</b>					
	72	B(53, 71)	W/power latch front and rear	D2OZ 65220A22-A	4
<b>22023 RETAINER - DOOR LOCK CYLINDER - Also refer to Group 43629</b>					
- A -					
	65/	A	Doors ,l/compt.,,s/compt.,,t/gate	C5AZ 6222023-A	AR
- B -					
	65	B	Doors ,l/compt.,,s/compt.	C4AZ 6222023-A	AR
	66/71	B	Doors ,l/compt.,,s/compt.	C5AZ 6222023-A	AR
	72	B(71)	T/gate		1
	72	B	Doors	D1ZZ 6522023-B	AR

**BODY  
SECTION 220**
**FORD CAR PARTS**

GROUP NUMBER	YEAR	BODY TYPE	DESCRIPTION	PART NUMBER	QTY.
<b>22023</b>	<b>RETAINER - DOOR LOCK CYLINDER - continued</b> - Also refer to group 43629				
	- F -				
	65/66	F	Doors, 1/compt.	C4AZ 6222023-A	2
	67/70	F		C5AZ 6222023-A	2
	71/	F		D1ZZ 6522023-B	2
	- L -				
	71/	L		C5AZ 6222023-A	2
	- P -				
	70/	P		C5AZ 6222023-A	2
	- S -				
	65/71	S		C5AZ 6222023-A	2
	72	S		D1ZZ 6522023-B	2
	- U -				
	66/		Doors, t/gate	C4AZ 6222023-A	2or3
	- X -				
	65	X		C4DZ 6222023-A	2
	66/70	X	Doors, l/compt., t/gate	C5AZ 6222023-A	AR
<b>22024</b>	<b>PLATE - DOOR LATCH STRIKER TAPPING</b>				
	- A -				
	65/70	A		C5AZ 6222024-A	2 or 4
	71/	A(53, 54, 57, 71)		D1AZ 5422024-A	2
	71/	A(65, 76)		D1AZ 6522024-A	2
	- B -				
	68/69	B		C5AZ 6222024-A	2 or 4
	70/71	B(54, 57, 71)	On quarter pillar		2
	70/71	B(63, 65, 66, 76)	On quarter pillar		2
	70/71	B(54, 57, 71)	On center body pillar	D0OZ 5422024-A	2
	72	B(53, 71)	On center body pillar	D2OZ 5322024-A	2
	72	B	On quarter pillar	D1AZ 6522024-A	2
	- F -				
	68/70	F		C5AZ 6222024-A	2
	71/	F		D1AZ 6522024-A	2
	- L -				
	72	L		D1AZ 6522024-A	2
	- P -				
	70/	P		C5AZ 6222024-A	2 or 4
	- S -				
	68/71	S		C5AZ 6222024-A	2 or 4
	72	S		D1AZ 6522024-A	2
	- X -				
	68/70	X		C5AZ 6222024-A	2 or 4
<b>22035</b>	<b>CONNECTOR - VACUUM DOOR LATCH HOSE</b>				
	67/68	A	1 1/2" x 1 1/2" (X) shape-Nylon	C7VY 5322035-B	1
	67/69	S			1
	70	A, B, S	With vacuum door latch, with hidden head lamps	D0VY 6522035-A	AR
	71	B, S	With vacuum door latch and/or headlamp covers		1or2
	67	A	Fitting	376009-S(II-106HA)	AR
<b>22040</b>	<b>INSERT - DOOR LATCH STRIKER PLATE</b>				
	65	X(except 63, 76)	Front door	C2AZ 6222040-A	2
	65	X(54, 71)	Rear door		2
<b>22050</b>	<b>LOCK CYLINDER and KEYS - FRONT DOOR and IGNITION LOCKS</b> -Refer to Lock Set Chart Group 22050				

# FORD CAR PARTS

## BODY SECTION 220

3

### 22050 LOCK SET CHART

MODEL	CONSISTS OF LOCK CYLINDERS FOR							DESCRIPTION	PART NUMBER	QTY.
	DOOR	G/ COMPT.		IGN.	L/ COMPT.	S/ COMPT.	T/ GATE			
<b>1965</b>										
<b>SINGLE KEY SYSTEM</b>										
A(71)-power window	D	G/C		I		S/C	T/G		C5AZ 7122050-L	1
A	D	G/C		I	L/C	S/C	T/G	Key blank	★C5AZ 6222053-A	2
A	D	G/C		I	L/C	S/C	T/G	Key blank	♣CC5AB 6222053-A	2
<b>DUAL KEY SYSTEM</b>										
A	D			I					C9AZ 6222050-A	1
A	D								★C5AZ 6221984-B r/b D2AZ 6521984-A(10-74)	2
A	D								D2AZ 6521984-A	2
A	D								♣CC5AB 6221985-B	2
A				I					★C9AZ 11582-A	1
A				I					♣CC5AB 11582-A	1
A(exc. 71)		G/C			L/C				★C5AZ 6243507-C	1
A(exc. 71)		G/C			L/C				♣CC5AB 6243507-D	1
A		G/C							★C5AZ 6206081-A	1
A		G/C							C6OZ 6206081-A	1
A(exc. 71)					L/C				C5AZ 6243505-C	1
A(71)-manual window		G/C				S/C	T/G		C5AZ 7143507-B	1
A(71)-power window		G/C				S/C	T/G		C5AZ 7143507-J	1
A(71)-manual window		G/C					T/G		C5AZ 7143507-C	1
A(71)-power window		G/C					T/G		C5AZ 7143507-D	1
A(71)						S/C			★C5AZ 7143505-D	1
A(71)						S/C			♣CC5AB 71431C54-L	1
A(71)-manual window							T/G		C5AZ 7143505-D	1
A(71)-power window							T/G		C5AZ 7143505-E	1
A	D			I				Key blank	★C5AZ 6222053-A	2
A	D			I				Key blank	♣CC5AB 6222053-A	2
A		G/C			L/C	S/C	T/G	Key blank	★C5AZ 6243562-A	2
A		G/C			L/C	S/C	T/G	Key blank	♣CC5AB 6243562-A	2
B	D			I					★C5OZ 6222050-A	1
B	D			I					♣CC5OB 6222050-A	1
B	D								★C5OZ 6221984-A	2
B	D								C5OZ 6221984-A	2
B				I					★C5OZ 11582-A	1
B				I					♣CC5OB 11582-A	1
B(exc. 71)		G/C			L/C				★C5OZ 6243507-A	1
B(54, 62, 65)		G/C			L/C				♣CC5OB 6243507-B	1
B		G/C							★C5OZ 6206081-A	1
B		G/C							♣CC5OB 6206081-B	1
B(exc. 71)					L/C				C5OZ 6243505-B	1
B(71B)-manual window		G/C				S/C	T/G		★C5OZ 7143507-B Not replaced (5-75)	1
B(71D)-power window		G/C					T/G		★C5OZ 6243507-A	1
B(71)-manual window							T/G		B9A 6443505-A	1
B(71)-power window							T/G		★C5OZ 6243505-B	1
B(71)-power window							T/G		♣CC5OB 6243505-B	1
B	D			I				Key blank	★C5OZ 6222053-A	2
B	D			I				Key blank	♣CC5OB 6222053-A	2
B(71)						S/C		Key blank	B9A 6443562-A	2
F	D			I					★C5ZZ 6522050-B Not replaced (5-75)	1
F	D								C5OZ 6221984-A	2
F				I					C5OZ 11582-A	1
F		G/C							C4DZ 6206081-A	1
F					L/C				C5ZZ 6543505-C	1
F	D			I				Key blank	★C5ZZ 6522053-B Not replaced (12-74)	2
F		G/C			L/C			Key blank	C5ZZ 6543562-B	2

★ U.S. only  
May, 1975

♣ Canada only

COPYRIGHT © 1975 -

FORD MOTOR  
COMPANY

- DEARBORN, MICHIGAN

**FINAL ISSUE**

**22050 LOCK SET CHART - continued**

MODEL	CONSISTS OF LOCK CYLINDERS FOR						DESCRIPTION	PART NUMBER	QTY.
	DOOR	G/ COMPT.	IGN.	L/ COMPT.	S/ COMPT.	T/ GATE			
<b>1965</b>									
<b>DUAL KEY SYSTEM - continued</b>									
S	D		I				C5SZ 6322050-B	1	
S	D						★C5AZ 6221984-B r/b D2AZ 6521984-A(10-74)	2	
S	D						D2AZ 6521984-A	2	
S			I				C9AZ 11582-A	1	
S(63)		G/C		L/C			C5SZ 6343507-B	1	
S		G/C					C5SZ 7606081-A	1	
S(63)				L/C			C5AZ 7143505-D	1	
S		G/C		L/C		Key blank	C5SZ 6343562-A	2	
X(54, 62, 63, 66, 76)	D		I				★C5DZ 6222050-A	1	
X(54, 62, 63, 66, 76)	D		I				★CC5DB 6222050-A	1	
X	D						★C5OZ 6221984-A	2	
X	D						C5OZ 6221984-A	2	
X			I				★C5OZ 11582-A	1	
X			I				★CC5OB 11582-A	1	
X		G/C					C4DZ 6206081-A	1	
X(54, 62, 63, 76)				L/C			★C5DZ 6243505-B	1	
X(exc. 71)				L/C			★CC5DB 6243505-A	1	
X(59, 71, 78)						T/G	C5OZ 6243505-B	1	
X	D		I			Key blank	★CC5DB 6222053-A	2	
X(exc. 59, 71, 78)		G/C		L/C		Key blank	★C5DZ 6243562-A	2	
X(exc. 59, 71, 78)		G/C		L/C		Key blank	★CC5AZ 6243562-A	2	

**1966**

<b>SINGLE KEY SYSTEM</b>									
A(71)-manual window	D	G/C	I		S/C	T/G		C6AZ 7122050-G	1
A(71)-power window	D	G/C	I		S/C	T/G		C5AZ 7122050-L	1
A	D	G/C	I	L/C	S/C	T/G	Key blank	★C5AZ 6222053-A	2
A	D	G/C	I	L/C	S/C	T/G	Key blank	★CC5AB 6222053-A	2
<b>DUAL KEY SYSTEM</b>									
A	D		I					C9AZ 6222050-A	1
A	D							★C5AZ 6221984-B r/b D2AZ 6521984-A(10-74)	2
A	D							D2AZ 6521984-A	2
A	D							★CC5AB 6221985-B	2
A			I					★C9AZ 11582-A	1
A			I					★CC5AB 11582-B	1
A(exc. 71)		G/C		L/C				★C5AZ 6243507-C	1
A(exc. 71)		G/C		L/C				★CC5AB 6243505-D	1
A		G/C						C6OZ 6206081-C	1
A(exc. 71)				L/C				C5AZ 6243505-C	1
A(71)-manual window		G/C			S/C	T/G		C6AZ 7143507-F	1
A(71)-power window		G/C			S/C	T/G		★C5AZ 7143507-J	1
A(71)-power window					S/C	T/G		★CC5AB 71431C50-C	1
A(71)					S/C			★C5AZ 7143505-D	1
A(71)					S/C			★CC5AB 71431C54-L	1
A(71)-manual window						T/G		★C6AZ 7143505-B	1
A(71)-power window						T/G		★C5AZ 7143505-E	1
A	D		I				Key blank	★C5AZ 6222053-A	2
A	D		I				Key blank	★CC5AB 6222053-A	2
A		G/C		L/C	S/C	T/G	Key blank	★C5AZ 6243562-A	2
A		G/C		L/C	S/C	T/G	Key blank	★CC5AB 6243562-A	2
B	D		I					★C6OZ 6222050-A	1
B(exc. 71)	D		I					★CC6DB 6222050-A	1
B(71)	D		I			T/G		★CC6DB 7122050-B	1
B	D							★C5AZ 6221984-B	2
B	D							★CC5AB 6221985-B	2
B			I					★C9AZ 11582-A	1

### 22050 LOCK SET CHART - continued

MODEL	DOOR	CONSISTS OF LOCK CYLINDERS FOR					DESCRIPTION	PART NUMBER	QTY.
		G/ COMPT.	IGN.	L/ COMPT.	S/ COMPT.	T/ GATE			
<i>1966</i>									
<b>DUAL KEY SYSTEM - continued</b>									
B			I					♣CC5AB 11582-B	1
B(54,62,63,76)		G/C		L/C				*C6OZ 6243507-A	1
B(54A,B,62A,B,65A,B)		G/C		L/C				♣CC6OB 6243507-A	1
B		G/C						C6OZ 6206081-C	1
B(exc. 71)				L/C				*C5AZ 6243505-C	1
B(exc. 71)				L/C				♣CC5AB 6243505-D	1
B(71)-manual window		G/C				T/G		C6OZ 7143507-B	1
B(71)-power window					S/C	T/G		♣CC5AB 71431C50-C	1
B(71)-manual window						T/G		*B9A 6443505-A	1
B(71)-power window		G/C			S/C	T/G		C6OZ 7143507-C	1
B(71)-power window						T/G		C5AZ 7143505-E	1
B(71)					S/C			C5AZ 7143505-D	1
F	D		I					*C5ZZ 6522050-B	1
								Not replaced (12-74)	
F	D							C5OZ 6221984-A	2
F			I					C5OZ 11582-A	1
F		G/C						C4DZ 6206081-A	1
F				L/C				C5ZZ 6543505-C	1
F	D		I				Key blank	C5ZZ 6522053-B	2
F		G/C		L/C			Key blank	C5ZZ 6543562-B	2
S	D		I					C5SZ 6322050-B	1
S	D							*C5AZ 6221984-B	2
								r/b D2AZ 6521984-A (10-74)	
S	D							D2AZ 6521984-A	2
S			I					C9AZ 11582-A	1
S(63)		G/C		L/C				C5SZ 6343507-B	1
S		G/C						C5SZ 7606081-A	1
S(63)				L/C				C6AZ 7143505-B	1
S	D		I				Key blank	C5SZ 6322053-A	2
S		G/C		L/C			Key blank	C5SZ 6343562-A	2
U	D		I					C3AZ 6222050-B	1
								C3AZ 6221984-B	2
U			I					C3AZ 11582-A	1
U		G/C				T/G		C6TZ 9843507-C	1
U		G/C						C2OZ 6206081-A	1
U						T/G		C6TZ 9843507-B	1
U	D		I				Key blank	B9A 3685-A	2
U		G/C				T/G	Key blank	B9A 6443562-A	2
X(exc. 71)	D		I					C6DZ 6222050-A	1
X(exc. 71)	D		I					♣CC6DB 6222050-A	1
X(71)-manual window	D		I			T/G		C6DZ 7122050-D	1
X(71)-power window	D		I			T/G		C9AZ 7122050-A	1
X	D							*C5AZ 6221984-B	2
								r/b D2AZ 6521984-A (10-74)	
X	D							D2AZ 6521984-A	2
X	D							♣CC5AB 6221985-B	2
X			I					*C9AZ 11582-A	1
X			I					♣CC5AB 11582-B	1
X		G/C		L/C			Non-locking g/compt.	*C6DZ 6243507-C	1
								r/b (1) each C6AZ 7143505-B & C6DZ 6206072-B (4-72)	
X		G/C		L/C				♣CC6DB 6243507-A	1
X		G/C						C6OZ 6206081-C	1
X				L/C				C6AZ 7143505-B	1
X				L/C				♣CC5DB 6243505-A	1
X(71)-power window					S/C	T/G		♣CC5AB 71431C50-C	1

★ U.S. only  
May, 1975

● Canada only

COPYRIGHT © 1975 —

FORD MOTOR  
COMPANY

— DEARBORN, MICHIGAN

**FINAL ISSUE**

**BODY  
SECTION 220**
**FORD CAR PARTS**
**22050 LOCK SET CHART - continued**

MODEL	CONSISTS OF LOCK CYLINDERS FOR						DESCRIPTION	PART NUMBER	QTY.
	DOOR	G/ COMPT.	IGN.	L/ COMPT.	S/ COMPT.	T/ GATE			
<b>1966</b>									
<b>DUAL KEY SYSTEM - continued</b>									
X(71)-manual window						T/G		*C6AZ 7143505-B	1
X(71)-power window						T/G		*C5AZ 7143505-E	1
X(71)		G/C				T/G	Key blank	*C5AZ 6243562-A	2
<b>1967</b>									
<b>SINGLE KEY SYSTEM</b>									
A(exc. 71)-From 10/24/66	D	G/C		I	L/C			C7AZ 6222050-B	1
A(71)-manual window	D	G/C		I		S/C	T/G	C6AZ 7122050-G	1
A(71)-power window	D	G/C		I		S/C	T/G	C5AZ 7122050-L	1
A	D	G/C		I	L/C	S/C	T/G	C7AZ 6222053-A	2
<b>DUAL KEY SYSTEM</b>									
A	D			I				C9AZ 6222050-A	1
A	D							*C5AZ 6221984-B r/b D2AZ 6521984-A(10-74)	2
A	D							D2AZ 6521984-A	2
A				I				C9AZ 11582-A	1
A(exc. 71)		G/C			L/C			C7AZ 6243507-B	1
A		G/C						C6OZ 6206081-C	1
A					L/C			C7AZ 6243505-A	1
A(71)-manual window		G/C				S/C	T/G	C6AZ 7143507-F	1
A(71)-manual window							T/G	C6AZ 7143505-B	1
A(71)-power window		G/C				S/C	T/G	C5AZ 7143507-J	1
A(71)-power window							T/G	C5AZ 7143505-E	1
A(71)						S/C		C7AZ 71115A32-B	1
A	D			I			Key blank	C7AZ 6222053-A	2
A		G/C			L/C	S/C	T/G	C7AZ 6243562-A	2
B	D			I				C9AZ 6222050-A	1
B	D							*C5AZ 6221984-B r/b D2AZ 6521984-A(10-74)	2
B	D							D2AZ 6521984-A	2
B				I				C9AZ 11582-A	1
B(exc. 66, 71)		G/C			L/C			C7AZ 6243507-B	1
B		G/C						C6OZ 6206081-C	1
B(exc. 66, 71) - Before 10/24/66					L/C			C5AZ 6243505-C	1
B(exc. 66, 71) - From 10/24/66					L/C			C7AZ 6243505-A	1
B(71)-manual window		G/C				S/C	T/G	C6AZ 7143507-F	1
B(71)-manual window		G/C					T/G	C7OZ 7143507-B	1
B(71)-manual window							T/G	C6AZ 7143505-B	1
B(71)-power window		G/C				S/C	T/G	C5AZ 7143507-J	1
B(71)-power window		G/C					T/G	C7OZ 7143507-B	1
B(71)-power window							T/G	C5AZ 7143505-E	1
B(71)						S/C		C7AZ 71115A32-B	1
B	D			I			Key blank	C7AZ 6222053-A	2
B		G/C			L/C	S/C	T/G	C7AZ 6243562-A	2
F	D			I				C9AZ 6222050-A	1
F	D							*C5AZ 6221984-B r/b D2AZ 6521984-A(10-74)	2
F	D							D2AZ 6521984-A	2
F				I				C9AZ 11582-A	1
F-Before 10/24/66		G/C			L/C			C5AZ 6243507-C	1
F-From 10/24/66		G/C			L/C			C7AZ 6243507-B	1
F		G/C						C6OZ 6206081-C	1
F-Before 10/24/66					L/C			C5AZ 6243505-C	1
F-From 10/24/66					L/C			C7AZ 6243505-A	1

\* U.S. only

• Canada only

# FORD CAR PARTS

**BODY  
SECTION 220**

7

**22050 LOCK SET CHART - continued**

MODEL	CONSISTS OF LOCK CYLINDERS FOR						DESCRIPTION	PART NUMBER	QTY.
	DOOR	G/ COMPT.	IGN.	L/ COMPT.	S/ COMPT.	T/ GATE			
<i>1967</i>									
<b>DUAL KEY SYSTEM - continued</b>									
F	D		I				Key blank	C7AZ 6222053-A	2
F		G/C		L/C			Key blank	C7AZ 6243562-A	2
S	D		I					C9AZ 6222050-A	1
S	D							★C5AZ 6221984-B r/b D2AZ 6521984-A(10-74)	2
S	D							D2AZ 6521984-A	2
S			I					C9AZ 11582-A	1
S		G/C		L/C				C7SZ 6543507-B	1
S		G/C						C6OZ 6206081-C	1
S				L/C				C7SZ 6543505-A	1
S	D		I				Key blank	C7AZ 6222053-A	2
S		G/C		L/C			Key blank	C7AZ 6243562-A	2
U	D		I					C3AZ 6222050-B	1
U	D							C3AZ 6221984-B	2
U			I					C3AZ 11582-A	1
U-Before Ser. A84,001		G/C				T/G		C6TZ 9843507-C	1
U-From Ser. A84,001		G/C				T/G		C7TZ 9843507-B	1
U		G/C						C2OZ 6206081-A	1
U-Before Ser. A84,001						T/G		C6TZ 9843507-B	1
U-From Ser. A84,001						T/G		C7TZ 9843505-B	1
U	D		I				Key blank	B9A 3685-A	2
U		G/C				T/G	Key blank	B9A 6443562-A	2
X	D		I					C9AZ 6222050-A	1
X	D							★C5AZ 6221984-B r/b D2AZ 6521984-A(10-74)	2
X	D							D2AZ 6521984-A	2
X			I					C9AZ 11582-A	1
X(54,62)		G/C		L/C			Non-locking g/compt.	★C6DZ 6243507-C r/b (1) each C6AZ 7143505-B & C6DZ 6206072-B(4-72)	1
X		G/C						C6OZ 6206081-C	1
X(54,62)				L/C				C6AZ 7143505-B	1
X(71)-manual window	D		I			T/G		C6DZ 7122050-D	1
X(71)-manual window						T/G		C7DZ 7143505-A	1
X(71)-power window	D		I			T/G		C9AZ 7122050-A	1
X(71)-power window						T/G		C7DZ 7143505-B	1
X	D		I				Key blank	C7AZ 6222053-A	2
X		G/C		L/C		T/G	Key blank	C7AZ 6243562-A	2

*1968*

**SINGLE KEY SYSTEM**

A(exc. 71)	D	G/C	I	L/C				C7AZ 6222050-B	1
A(71)	D	G/C	I		S/C	T/G		C6AZ 7122050-G	1
A	D	G/C	I	L/C	S/C	T/G	Key blank	C7AZ 6222053-A	2

**DUAL KEY SYSTEM**

A	D		I					C9AZ 6222050-A	1
A	D							★C5AZ 6221984-B r/b D2AZ 6521984-A(10-74)	2
A	D							D2AZ 6521984-A	2
A			I					C9AZ 11582-A	1
A		G/C						C6OZ 6206081-C	1
A(exc. 71)		G/C		L/C				C7AZ 6243507-B	1
A(exc. 71)				L/C				C7AZ 6243505-A	1
A(71)	D		I			T/G		C6DZ 7122050-D	1
A(71)						T/G		C7DZ 7143505-A	1
A(71)		G/C			S/C			C8AZ 7106081-A	1

**22050 LOCK SET CHART - continued**

MODEL	CONSISTS OF LOCK CYLINDERS FOR						DESCRIPTION	PART NUMBER	QTY.
	DOOR	G/ COMPT.	IGN.	L/ COMPT.	S/ COMPT.	T/ GATE			
<i>1968</i>									
<b>DUAL KEY SYSTEM - continued</b>									
A(71)					S/C			C7AZ 71115A32-B	1
A	D		I			T/G	Key blank	C7AZ 6222053-A	2
A		G/C		L/C	S/C		Key blank	C7AZ 6243562-A	2
B	D		I					C9AZ 6222050-A	1
B	D							*C5AZ 6221984-B r/b D2AZ 6521984-A(10-74)	2
B	D							D2AZ 6521984-A	2
B			I					C9AZ 11582-A	1
B(exc. 66,71)		G/C		L/C				C7AZ 6243507-B	1
B		G/C						C6OZ 6206081-C	1
B(exc. 66,71)				L/C				C7AZ 6243505-A	1
B(71)	D		I			T/G		C6DZ 7122050-D	1
B(71)						T/G		C7DZ 7143505-A	1
B(71)		G/C			S/C			C8AZ 7106081-A	1
B(71)					S/C			C7AZ 71115A32-B	1
B	D		I			T/G	Key blank	C7AZ 6222053-A	2
B		G/C		L/C	S/C	T/G	Key blank	C7AZ 6243562-A	2
F	D		I					C9AZ 6222050-A	1
F	D							*C5AZ 6221984-B r/b D2AZ 6521984-A(10-74)	2
F	D							D2AZ 6521984-A	2
F			I					C9AZ 11582-A	1
F		G/C		L/C			Locking g/compt.	C7AZ 6243507-B	1
F		G/C		L/C			Non-locking g/compt.	*C8Z 6543507-A r/b C7AZ 6243505-A and C6DZ 6206072-B (11-73)	1
F		G/C						C6OZ 6206081-C	1
F	D		I	L/C				C7AZ 6243505-A	1
F		G/C		L/C			Key blank	C7AZ 6222053-A	2
F				L/C			Key blank	C7AZ 6243562-A	2
S	D		I					C9AZ 6222050-A	1
S	D							*C5AZ 6221984-B r/b D2AZ 6521984-A(10-74)	2
S	D							D2AZ 6521984-A	2
S			I					C9AZ 11582-A	1
S		●G/C		L/C				C7SZ 6543507-B	1
S		▲G/C		L/C				C8SZ 6543507-A	1
S		●G/C						C6OZ 6206081-C	1
S		⊗G/C						C8SZ 6506081-A	1
S				L/C				C7SZ 6543505-A	1
S	D		I				Key blank	C7AZ 6222053-A	2
S		G/C		L/C			Key blank	C7AZ 6243562-A	2
U	D		I					C8TZ 9722050-A	1
U	D							C8TZ 9721984-A	2
U			I					C3AZ 11582-A	1
U		G/C						C2OZ 6206081-A	1
U		G/C				T/G		C7TZ 9843507-B	1
U		G/C						C2OZ 6206081-A	1
U	D		I			T/G	Key blank	C7TZ 9843505-B	1
U		G/C				T/G	Key blank	B9A 3685-A	2
U								B9A 6443562-A	2

● Instrument Panel

⊕ Console

▲ Instrument Panel and Console



### 22050 LOCK SET CHART - continued

MODEL	CONSISTS OF LOCK CYLINDERS FOR							DESCRIPTION	PART NUMBER	QTY.
	DOOR	G/ COMPT.	IGN.	L/ COMPT.	S/ COMPT.	T/ GATE				

1968

#### DUAL KEY SYSTEM - continued

X	D		I					C9AZ 6222050-A	1
X	D							★C5AZ 6221984-B r/b D2AZ 6521984-A (10-74)	2
X	D							D2AZ 6521984-A	2
X			I					C9AZ 11582-A	1
X		G/C						C6OZ 6206081-C	1
X(54,62)		G/C		L/C			Non-locking g/compt.	★C6DZ 6243507-C r/b (1) each C6AZ 7143505-B & C6DZ 6206072-B (4-72)	1
X(54,62)		G/C		L/C			Locking g/compt.	C7OZ 6243507-A	1
X(54,62)				L/C				C6AZ 7143505-B	1
X(71)-manual window	D		I			T/G		C6DZ 7122050-D	1
X(71)-manual window						T/G		C7DZ 7143505-A	1
X(71)-power window	D		I			T/G		C9AZ 7122050-A	1
X(71)-power window						T/G		C7DZ 7143505-B	1
X	D		I				Key blank	C7AZ 6222053-A	2
X		G/C		L/C		T/C	Key blank	C7AZ 62242562-A	2

1969

#### SINGLE KEY SYSTEM

A(exc. 71)	D	G/C	I	L/C				C9AZ 6222050-B	1
A(71)	D	G/C	I		S/C	T/G		C9AZ 7122050-B	1
A	D	G/C	I	L/C	S/C	T/G	Key blank	C7AZ 6222053-A	2

#### DUAL KEY SYSTEM

A	D		I					C9AZ 6222050-A	1
A	D							★C5AZ 6221984-B r/b D2AZ 6521984-A (10-74)	2
A	D							D2AZ 6521984-A	2
A			I					C9AZ 11582-A	1
A(exc. 71)		G/C		L/C				D1AZ 6543507-A	1
A		G/C						D1OZ 6606081-A	1
A(exc. 71)				L/C				C8GY 5443505-A	1
A(71)	D		I			T/G		C9AZ 7122050-A	1
A(71)						T/G		C7DZ 7143505-B	1
A(71)		G/C			S/C			D1AZ 7106081-A	1
A(71)					S/C			C7AZ 71115A32-B	1
A	D		I			T/G	Key blank	C7AZ 6222053-A	2
A		G/C		L/C	S/C		Key blank	C7AZ 6243562-A	2
B	D		I					C9AZ 6222050-A	1
B	D							★C5AZ 6221984-B r/b D2AZ 6521984-A (10-74)	2
B	D							D2AZ 6521984-A	2
B			I					C9AZ 11582-A	1
B(exc. 66,71)		G/C		L/C				C7AZ 6243507-B	1
B		G/C						C6OZ 6206081-C	1
B(exc. 71)				L/C				C8GY 5443505-A	1
B(71)	D		I			T/G		C9OZ 7122050-A	1
B(71)						T/G		C6AZ 7143505-B	1
B(71)		G/C			S/C			C8AZ 7106081-A	1
B(71)					S/C			C7AZ 71115A32-B	1
B	D		I			T/G	Key blank	C7AZ 6222053-A	2
B		G/C		L/C	S/C		Key blank	C7AZ 6243562-A	2
F	D		I					C9AZ 6222050-A	1
F	D							★C5AZ 6221984-B r/b D2AZ 6521984-A (10-74)	2
F	D							D2AZ 6521984-A	2

**22050 LOCK SET CHART - continued**

MODEL	CONSISTS OF LOCK CYLINDERS FOR							DESCRIPTION	PART NUMBER	QTY.
	DOOR	G/ COMPT.		IGN.	L/ COMPT.	S/ COMPT.	T/ GATE			

1969

**DUAL KEY SYSTEM - continued**

F				I					C9AZ 11582-A	1
F		G/C			L/C			Non-locking g/compt.	C9ZZ 6543507-A	1
F		G/C			L/C			Locking g/compt.	D1AZ 6543507-A	1
F		G/C							D1OZ 6606081-A	1
F					L/C				C8GY 5443505-A	1
F	D			I				Key blank	C7AZ 6222053-A	2
F		G/C			L/C			Key blank	C7AZ 6243562-A	2
S	D			I					C9AZ 6222050-A	1
S	D								★C5AZ 6221984-B r/b D2AZ 6521984-A (10-74)	2
S	D								D2AZ 6521984-A	2
S				I					C9AZ 11582-A	1
S		●G/C			L/C				C7SZ 6543507-B	1
S		▲G/C			L/C				C8SZ 6543507-A	1
S		●G/C							C6OZ 6206081-C	1
S		⊕G/C							C8SZ 6506081-A	1
S					L/C				C7SZ 6543505-A	1
S	D			I				Key blank	C7AZ 6222053-A	2
S		G/C			L/C			Key blank	C7AZ 6243562-A	2
U	D			I					C8TZ 9722050-A	1
U	D								C8TZ 9721984-A	2
U				I					C3AZ 11582-A	1
U		G/C					T/G		C7TZ 9843507-B	1
U		G/C							C2OZ 6206081-A	1
U							T/G		C7TZ 9843505-B	1
U	D			I				Key blank	B9A 3685-A	2
U		G/C					T/G	Key blank	B9A 6443562-A	2
X	D			I					C9AZ 6222050-A	1
X	D								★C5AZ 6221984-B r/b D2AZ 6521984-A (10-74)	2
X				I					C9AZ 11582-A	1
X(54,62)		G/C			L/C			Non-locking g/compt.	★C6DZ 6243507-C r/b(1) each C6AZ 7143505-B & C6DZ 6206072-B (4-72)	1
X		G/C							C6OZ 6206081-C	1
X(54,62)					L/C				C6AZ 7143505-B	1
X(71)-manual window	D			I			T/G		C9OZ 7122050-A	1
X(71)-manual window							T/G		C6AZ 7143505-B	1
X(71)-power window	D			I			T/G		C9AZ 7122050-A	1
X(71)-power window							T/G		C7DZ 7143505-B	1
X	D			I			T/G	Key lock	C7AZ 622053-A	2
X		G/C			L/C			Key lock	C7AZ 6243562-A	2

1970

**SINGLE KEY SYSTEM**

A(exc. 71)	D	G/C		I	L/C				D2AZ 6522050-B	1
A(71)	D	G/C		I		S/C	T/G		D0AZ 7122050-K	1
A	D	G/C		I	L/C	S/C	T/G	Key blank	C7AZ 6222053-A	2

**DUAL KEY SYSTEM**

A	D			I					★D0AZ 6222050-J r/b D2AZ 6522050-A (3-75)	1
A(exc. 71)	D			I					D2AZ 6522050-A	1
A	D								★C5AZ 6221984-B r/b D2AZ 6521984-A (10-74)	2
A	D								D2AZ 6521984-A	2

● Instrument Panel

⊕ Console

▲ Instrument Panel and Console

### 22050 LOCK SET CHART - continued

MODEL	CONSISTS OF LOCK CYLINDERS FOR						DESCRIPTION	PART NUMBER	QTY.
	DOOR	G/ COMPT.	IGN.	L/ COMPT.	S/ COMPT.	T/ GATE			
<b>1970</b>									
<b>DUAL KEY SYSTEM - continued</b>									
A			I					D0AZ 11582-B	1
A(exc. 71)		G/C		L/C				D1AZ 6543507-A	1
A		G/C						D1OZ 6606081-A	1
A(exc. 71)				L/C				C8GY 5443505-A	1
A(71)	D		I			T/G		★D0AZ 7122050-E r/b D2AZ 7122050-A (5-73)	1
A(71)						T/G		C7DZ 7143505-B	1
A(71)		G/C			S/C			D1AZ 7106081-A	1
A(71)					S/C			C7AZ 71115A32-B	1
A	D		I			T/G	Key blank	C7AZ 6222053-A	2
A		G/C		L/C	S/C		Key blank	C7AZ 6243562-A	2
B	D		I					★D0AZ 6222050-J r/b D2AZ 6522050-A(3-75)	1
B	D		I					D2AZ 6522050-A	1
B	D							★C5AZ 6221984-B r/b D2AZ 6521984-A(10-74)	2
B	D							D2AZ 6521984-A	2
B			I					D0AZ 11582-B	1
B(exc. 66,71)		G/C		L/C				D1AZ 6543507-A	1
B		G/C						D1OZ 6606081-A	1
B(exc. 66,71)				L/C				C8GY 5443505-A	1
B(71)-Before 9/22/69	D		I			T/G		D0OZ 7122050-B	1
B(71)-From 9/22/69	D		I			T/G		D0OZ 7122050-D	1
B(71)-From 3/2/70	D		I			T/G		D0OZ 7122050-E	1
B(71)	D		I			T/G		D0OZ 7122050-E	1
B(71)						T/G		C6AZ 7143505-B	1
B(71)		G/C			S/C			D1AZ 7106081-A	1
B(71)					S/C			C7AZ 71115A32-B	1
B	D					T/G	Key blank	C7AZ 6222053-A	2
B		G/C		L/C	S/C		Key blank	C7AZ 6243562-A	2
F	D		I					★D0AZ 6222050-J r/b D2AZ 6522050-A(3-75)	1
F	D		I					D2AZ 6522050-A	1
F	D							★C5AZ 6221984-B r/b D2AZ 6521984-A(10-74)	2
F	D							D2AZ 6521984-A	2
F			I					D0AZ 11582-B	1
F		G/C		L/C			Non-locking g/compt.	C9ZZ 6543507-A	1
F		G/C		L/C			Locking g/compt.	D1AZ 6543507-A	1
F		G/C						D1OZ 6606081-A	1
F				L/C				C8GY 5443505-A	1
F	D		I				Key blank	C7AZ 6222053-A	2
F		G/C		L/C			Key blank	C7AZ 6243562-A	2
P	D		I				W/o locking s/column	C9AZ 6222050-A	1
P	D		I				W/locking s/column	D0AZ 6222050-E	1
P	D							★C5AZ 6221984-B r/b D2AZ 6521984-A(10-74)	2
P	D							D2AZ 6521984-A	2
P			I				W/o locking s/column	C9AZ 11582-A	1
P-Before 3/2/70			I				W/locking s/column	D0AZ 11582-B	1
P-From 3/2/70			I				W/locking s/column	D0AZ 11582-D	1
P		G/C		L/C				D1AZ 6543507-A	1
P		G/C						C9AZ 6206081-A	1

**22050 LOCK SET CHART - continued**

MODEL	CONSISTS OF LOCK CYLINDERS FOR						DESCRIPTION	PART NUMBER	QTY.
	DOOR	G/ COMPT.	IGN.	L/ COMPT.	S/ COMPT.	T/ GATE			
<b>1970</b>									
<b>DUAL KEY SYSTEM - continued</b>									
P				L/C				C8GY 5443505-A	1
P	D		I				Key blank	C7AZ 6222053-A	2
P		G/C		L/C			Key blank	C7AZ 6243562-A	2
S	D		I					★D0AZ 6222050-J r/b D2AZ 6522050-A(3-75)	1
S	D		I					D2AZ 6522050-A	1
S	D							★C5AZ 6221984-B r/b D2AZ 6521984-A(10-74)	2
S	D							D2AZ 6521984-A	2
S			I					D0AZ 11582-B	1
S		▲G/C		L/C				D1SZ 6543507-A	1
S		●G/C		L/C				D0SZ 6543507-B	1
S		⦿G/C						D1OZ 6606081-A	1
S		⊕G/C						C8SZ 6506081-A	1
S				L/C				C7SZ 6543505-A	1
S	D		I				Key blank	C7AZ 6222053-A	2
S		G/C		L/C			Key blank	C7AZ 6243562-A	2
U	D		I					C8TZ 9722050-A	1
U	D							C8TZ 9721984-A	2
U			I					C3AZ 11582-A	1
U		G/C				T/G		C7TZ 9843507-B	1
U		G/C						C6OZ 6206081-C	1
U						T/G		C7TZ 9843505-B	1
U	D		I				Key blank	B9A 3685-A	2
U		G/C				T/G	Key blank	B9A 6443562-A	2
X	D		I					C9AZ 6222050-A	1
X	D							★C5AZ 6221984-B r/b D2AZ 6521984-A(10-74)	2
X	D							D2AZ 6521984-A	2
X			I					C9AZ 11582-A	1
X(54,62)		G/C		L/C			Non-locking g/compt.	★C6DZ 6243507-C r/b (1 each) C6AZ 7143505-B & C6DZ 6206072-B (4-72)	1
X		G/C						C6OZ 6206081-C	1
X(71)-manual window	D		I			T/G		C9OZ 7122050-A	1
X(71)-manual window						T/G		C6AZ 7143505-B	1
X(71)-power window	D		I			T/G		C9AZ 7122050-A	1
X(71)-power window						T/G		C7DZ 7143505-B	1
X(54,62)				L/C				C6AZ 7143505-B	1
X	D		I			T/G	Key blank	C7AZ 6222053-A	2
X		G/C		L/C			Key blank	C7AZ 6243562-A	2

**1971**

<b>SINGLE KEY SYSTEM</b>									
A(exc. 71)	D	G/C	I	L/C				D2AZ 6522050-B	1
A(71)	D	G/C	I		#S/C	T/G		D0AZ 7122050-K	1
A(71)	D	G/C	I		◆S/C	T/G		D1AZ 7122050-A	1
A	D	G/C	I	L/C	S/C	T/G	Key blank	C7AZ 6222053-A	2
<b>DUAL KEY SYSTEM</b>									
A	D							★C5AZ 6221984-B r/b D2AZ 6521984-A(10-74)	2
A	D							D2AZ 6521984-A	2
A		G/C						D1OZ 6606081-A	1

▲ Instrument Panel and Console

● Instrument Panel

⊕ Console

# FORD CAR PARTS

**BODY  
SECTION 220**

13

**22050 LOCK SET CHART - continued**

MODEL	CONSISTS OF LOCK CYLINDERS FOR							DESCRIPTION	PART NUMBER	QTY.
	DOOR	G/ COMPT.	IGN.	L/ COMPT.	S/ COMPT.	T/ GATE				
<b>1971</b>										
<b>DUAL KEY SYSTEM - continued</b>										
A			I						D0AZ 11582-D	1
A					‡S/C				D1OZ 6606081-A	1
A(71)	D		I				T/G		★D0AZ 7122050-J r/b D2AZ 7122050-A (11-73)	1
A(71)		G/C			#S/C				D1AZ 7106081-A	1
A(71)		G/C			◆S/C				D1AZ 7143507-A	1
A(71)					#S/C				C7AZ 71115A32-B	1
A(71)							T/G		C7DZ 7143505-B	1
A(exc. 71)	D		I						★D1AZ 6522050-A r/b D2AZ 6522050-A (3-75)	1
A(exc. 71)	D		I						D2AZ 6522050-A	1
A(exc. 71)		G/C		L/C					D1AZ 6543507-A	1
A(exc. 71)				L/C					C8GY 5443505-A	1
A	D		I				T/G	Key blank	C7AZ 6222053-A	2
A		G/C		L/C	S/C			Key blank	C7AZ 6243562-A	2
B	D								★C5AZ 6221984-B r/b D2AZ 6521984-A (10-74)	2
B	D								D2AZ 6521984-A	2
B		G/C							D1OZ 6606081-A	1
B			I						D0AZ 11582-D	1
B(71)	D		I				T/G		D0OZ 7122050-E	1
B(71)		G/C			S/C				D1AZ 7106081-A	1
B(71)					S/C				C7AZ 71115A32-B	1
B(71)							T/G		C6AZ 7143505-B	1
B(exc. 71)	D		I						★D1AZ 6522050-A r/b D2AZ 6522050-A (3-75)	1
B(exc. 71)	D		I						D2AZ 6522050-A	1
B(exc. 66, 71)		G/C		L/C					D1AZ 6543507-A	1
B(exc. 66, 71)				L/C					C8GY 5443505-A	1
B	D		I				T/G	Key blank	C7AZ 6222053-A	2
B		G/C		L/C	S/C			Key blank	C7AZ 6243562-A	2
F	D		I						★D1AZ 6522050-A r/b D2AZ 6522050-A (3-75)	1
F	D		I						D2AZ 6522050-A	1
F	D								★C5AZ 6221984-B r/b D2AZ 6521984-A (10-74)	2
F	D								D2AZ 6521984-A	2
F			I						D0AZ 11582-D	1
F		G/C		L/C				Locking g/compt.	D1AZ 6543507-A	1
F		G/C		L/C				Non-locking g/compt.	★D1ZZ 6543507-A r/b (1 each) C8GY 5443505-A & D1ZZ 6506072-A (10-74)	1
F		G/C						Locking g/compt.	D1OZ 6606081-A	1
F				L/C					C8GY 5443505-A	1
F	D		I					Key blank	C7AZ 6222053-A	2
F		G/C		L/C				Key blank	C7AZ 6243562-A	2
L	D		I						★D1AZ 6522050-A r/b D2AZ 6522050-A (3-75)	1
L	D		I						D2AZ 6522050-A	1
L	D								★C5AZ 6221984-B r/b D2AZ 6521984-A (10-74)	2

‡ Side s/compt.  
May, 1975

# Floor s/compt.

◆ Floor s/compt. and side s/compt.

22050 LOCK SET CHART - continued

MODEL	CONSISTS OF LOCK CYLINDERS FOR						DESCRIPTION	PART NUMBER	QTY.
	DOOR	G/ COMPT.	IGN.	L/ COMPT.	S/ COMPT.	T/ GATE			

1971

DUAL KEY SYSTEM - continued

L	D							D2AZ 6521984-A	2
L			I					D0AZ 11582-D	1
L(62, 64)				L/C				C8GY 5443505-A	1
L		G/C		L/C			Locking g/compt.	D1AZ 6543507-A	1
L		G/C		L/C			Non-locking g/compt.	*D1ZZ 6543507-A	1
								r/b(1 each) C8GY 5443505-A & D1ZZ 6506072-A(10-74)	
L		●G/C					Locking g/compt.	D1OZ 6606081-A	1
L	D		I				Key blank	C7AZ 6222053-A	2
L		G/C		L/C			Key blank	C7AZ 6243562-A	2
P	D		I					*D1AZ 6522050-A	1
								r/b D2AZ 6522050-A (3-75)	
P	D		I					D2AZ 6522050-A	1
P	D							*C5AZ 6221984-B	2
								r/b D2AZ 6521984-A(10-74)	
P	D		I					D2AZ 6521984-A	2
P		G/C		L/C			Locking g/compt.	D0AZ 11582-D	1
P		G/C						D1AZ 6543507-A	1
P				L/C				D1OZ 6606081-A	1
P	D		I				Key blank	C8GY 5443505-A	1
P		G/C		L/C			Key blank	C7AZ 6222053-A	2
								C7AZ 6243562-A	2
S	D		I					*D1AZ 6522050-A	1
								r/b D2AZ 6522050-A(3-75)	
S	D		I					D2AZ 6522050-A	1
S	D							*C5AZ 6221984-B	2
								r/b D2AZ 6521984-A(10-74)	
S	D		I					D2AZ 6521984-A	2
S		▲G/C		L/C				D0AZ 11582-D	1
S		●G/C		L/C				D1SZ 6543507-A	1
S		⊕G/C						D1SZ 6543507-B	1
S		●G/C						C8SZ 6506081-A	1
S				L/C				D1OZ 6606081-A	1
S	D		I				Key blank	C7SZ 6543505-A	1
S		G/C		L/C			Key blank	C7AZ 622053-A	2
								C7AZ 6243562-A	2
U	D		I					C8TZ 9722050-A	1
U	D							C8TZ 9721984-A	2
U			I					C3AZ 11582-A	1
U		G/C						C2OZ 6206081-A	1
U		G/C				T/G		C7TZ 9843507-B	1
U						T/G		C7TZ 9843505-B	1
U	D		I				Key blank	B9A 3685-A	2
U		G/C				T/G	Key blank	B9A 6443562-A	1

1972

SINGLE KEY SYSTEM

A(exc.71)	D	G/C	1	L/C				D2AZ 6522050-C	1
A(71)	D	G/C	1		#S/C	T/G		D2AZ 7122050-B	1
A(71)	D	G/C	1		◆S/C	T/G		D2AZ 7122050-C	1
A	D	G/C	1	L/C	S/C	T/G	Key blank	C7AZ 6222053-A	2

● Instrument Panel  
# Floor s/compt.

⊕ Console  
● Also consolette

▲ Instrument Panel and Console  
◆ Floor s/compt. and side s/compt.

**22050 LOCK SET CHART - continued**

MODEL	CONSISTS OF LOCK CYLINDERS FOR						DESCRIPTION	PART NUMBER	QTY.
	DOOR	G/ COMPT.	IGN.	L/ COMPT.	S/ COMPT.	T/ COMPT.			
<b>1972</b>									
<b>DUAL KEY SYSTEM</b>									
A(exc.71)	D		I					D2AZ 6522050-A	1
A	D							D2AZ 6521984-A	2
A			I					D1AZ 11582-A	1
A(71)	D		I			T/G		D2AZ 7122050-A	1
A					‡S/C			D1OZ 6606081-A	1
A(71)		G/C			‡S/C			D1AZ 7106081-A	1
A(71)					‡S/C			C7AZ 71115A32-B	1
A(71)						T/G		C7DZ 7143505-B	1
A(71)					▲S/C			D1AZ 7143507-A	1
A(exc. 71)				L/C				D2AZ 6543505-A	1
A(exc. 71)		G/C		L/C				D2AZ 6543507-A	1
A	D		1			T/G	Key blank	C7AZ 6222053-A	2
A		G/C		L/C	S/C		Key blank	C7AZ 6243562-A	2
B(exc.71,97)		G/C		L/C				D2OZ 6543507-A	1
B(exc.71)	D		I					D2AZ 6522050-A	1
B	D							D2AZ 6521984-A	2
B			I					D1AZ 11582-A	1
B(71)	D		I			T/G		D2AZ 7122050-A	1
B		G/C						D2OZ 9706081-A	1
B(71)		G/C			S/C			D2OZ 7106081-A	1
B(71)					S/C			C7AZ 71115A32-A	1
B(71)						T/G		C7DZ 7143505-B	1
							Screw-hex. hd. tap - No. 8-15 x 1/2"	52012-S8(U202)	2
B(exc. 71,97)				L/C				D2AZ 6543505-A	1
B	D		I			T/G	Key blank	C7AZ 6222053-A	2
B		G/C		L/C	S/C		Key blank	C7AZ 6243562-A	2
F	D		I					D2AZ 6522050-A	1
F	D							D2AZ 6521984-A	2
F			I					D1AZ 11582-A	1
F		G/C		L/C			Locking g/compt.	D2AZ 6543507-A	1
F		G/C					Locking g/compt.	D1OZ 6606081-A	1
F				L/C				D2AZ 6543505-A	1
F	D		1				Key blank	C7AZ 6222053-A	2
F		G/C		L/C			Key blank	C7AZ 6243562-A	2
L(62)	D		I					D2AZ 6522050-A	1
L(64)	D		I	L/C				D2FZ 6422050-A	1
L(73)	D		I			T/G		D2FZ 7322050-A	1
L	D							D2AZ 6521984-A	2
L			I					D1AZ 11582-A	1
L		G/C					Locking g/compt.	D1OZ 6606081-A	1
L		⊕G/C						D1OZ 6606081-A	1
L(62)		G/C		L/C			Locking g/compt.	D1AZ 6543507-A	1
L(62)				L/C				C8GY 5443505-A	1
L(73)						T/G		D2FZ 7343505-A	1
L	D		I			T/G	Key blank	C7AZ 6222053-A	2
L		G/C		L/C			Key blank	C7AZ 6243562-A	2
P	D		I					D2AZ 6522050-A	1
P	D							D2AZ 6521984-A	2
P			I					D1AZ 11582-A	1
P		⊕G/C		L/C			Locking g/compt.	D1AZ 6543507-A	1
P		⊕G/C						D1OZ 6606081-A	1

▲ Instrument Panel and Console    ⊕ Console    # Floor s/compt.    ‡ Side s/compt.

**22050 LOCK SET CHART - continued**

MODEL	CONSISTS OF LOCK CYLINDERS FOR							DESCRIPTION	PART NUMBER	QTY.
	DOOR	G/ COMPT.	IGN.	L/ COMPT.	S/ COMPT.	T/ COMPT.				

1972

**DUAL KEY SYSTEM - continued**

P				L/C						
P	D		I				Key blank	C8GY 5443505-A	1	
P		G/C		L/C			Key blank	C7AZ 6222053-A	2	
								C7AZ 6243562-A	2	
S		G/C		L/C				D2OZ 6543507-A	1	
S		G/C						D2OZ 9706081-A	1	
S				L/C				D2AZ 6543505-A	1	
S	D		I					D2SZ 6522050-A	1	
S	D							D2SZ 6521984-A	2	
S			I					D1AZ 11582-A	1	
S	D		I				Key blank	C7AZ 6222053-A	2	
S		G/C		L/C			Key blank	C7AZ 6243562-A	2	
U	D		I					C8TZ 9722050-A	1	
U	D							C8TZ 9721984-A	2	
U			I					C3AZ 11582-A	1	
U		G/C						C2OZ 6206081-A	1	
U		G/C				T/G		C7TZ 9843507-B	1	
U						T/G		C7TZ 9843505-B	1	
U	D		I				Key blank	B9A 3685-A	2	
U		G/C				T/G	Key blank	B9A 6443562-A	2	

GROUP NUMBER	YEAR	BODY TYPE	DESCRIPTION	PART NUMBER	QTY.
--------------	------	-----------	-------------	-------------	------

**22053 KEY - FRONT DOOR AND IGNITION LOCK - BLANK** - Refer to Lock Set Chart - Group 22050

**22058 SHIM - FRONT DOOR LATCH STRIKER PLATE**

65/70	B,S,X		Refer to Group 265A06		
65/70	A				
67	F				
65	B,F,X		Front door	C2OB 6222058-A	AR
66	F,U				AR
67/	U				AR
65	B		Screw-5/16"-24 x 59/64" flat head	371402-S13(BB101A)	AR
65	B		Bumper	372617-S(CC24A)	AR
71/	A,B,F,L,S		Improvise	★	

GROUP NUMBER	YEAR	BODY TYPE	DESCRIPTION	PART NUMBER		QTY.
				RIGHT HAND	LEFT HAND	

**22134-5 ROD - FRONT DOOR LATCH CONTROL TO CYLINDER**

<b>- A -</b>						
69/70	A			C9AZ 6222134-A	C9AZ 6222134-A	2
71/	A			D1AZ 6522134-A	D1AZ 6522135-A	1
<b>- B -</b>						
66/67	B			C6OZ 6222134-B	C6OZ 6222134-B	2
68/69	B(54, 71)			C8OZ 5422134-A	C8OZ 5422134-A	2
68/69	B(63, 65, 66, 76)			C8OZ 6322134-A	C8OZ 6322134-A	2
70/71	B(54, 57, 71)			D0OZ 5422134-A	D0OZ 5422134-A	2
70/71	B(62, 63, 65, 66, 76)			D0OZ 6522134-A	D0OZ 6522134-A	2
72	B(53, 71)			D2OZ 5322134-A	D2OZ 5322135-A	1
72	B(63, 65, 97)			D2OZ 6522134-A	D2OZ 6522135-A	1
<b>- F -</b>						
65/66	F			C5ZZ 6522134-A	C5ZZ 6522135-A	1
67/68	F			★C7ZZ 6522134-A	C7ZZ 6522135-A	1
				Not repl'd. (3-74)		
69/70	F			C9ZZ 6522134-A	C9ZZ 6522134-A	2
71/	F			D1ZZ 6522134-B	D1ZZ 6523135-B	1



# FORD CAR PARTS

## BODY SECTION 220

17

GROUP NUMBER	YEAR	BODY TYPE	DESCRIPTION	PART NUMBER		QTY.
				RIGHT HAND	LEFT HAND	
<b>22134-5 ROD - FRONT DOOR LATCH CONTROL TO CYLINDER - continued</b>						
- L -						
	71/	L(62)		D1FZ 6222134-A	D1FZ 6222135-A	1
- P -						
	70/	P(62)		D0DZ 6222134-A	D0DZ 6222134-A	2
	71/	P(54)		D1DZ 5422134-A	D1DZ 5422134-A	2
- S -						
	67/71	S(57)		C7SZ 5722134-A	C7SZ 5722135-A	1
	67/71	S(65)		C7SZ 6522134-A	C7SZ 6522135-A	1
	72	S-w/o power door latch		D2SZ 6522134-A	D2SZ 6522135-A	1
	72	S-w/power door latch	Refer to Group 14028 in Chassis Section			
- U -						
	66	U		★C6TZ 9722134-A Not repl'd. (3-74)	C6TZ 9722135-A	1
	67	U		★C7TZ 9722134-A Not repl'd. (3-74)	C7TZ 9722135-A	1
	68/	U		C8TZ 9722134-A	C8TZ 9722134-A	2
- X -						
	66/67	X	"Before 3/13/67"	C6OZ 6222134-A	C6OZ 6222134-A	2
	67	X	"From 3/13/67"	C6OZ 6222134-B	C6OZ 6222134-B	2
	68/70	X				2
GROUP NUMBER	YEAR	BODY TYPE	DESCRIPTION	PART NUMBER		QTY.
<b>22152-3 ROD - FRONT DOOR LATCH ACTUATING</b>						
- A -						
	67/68	A(54, 57, 71)	With adjustable end		C7AZ 5422152-A	2
	67/68	A(62, 63, 76)	With adjustable end		C7AZ 6222152-A	2
	69/70	A				2
	71/	A(53, 54, 57, 71)	R.H.		D1AZ 5422152-A	1
			L.H.		D1AZ 5422153-A	1
	71/	A(65, 76)			D1AZ 6522152-A	2
- B -						
	66/67	B	R. H.		C6OZ 6222152-A	1
			L. H.		C6OZ 6222153-A	1
	68/69	B(54, 71)	With adjustable end		C8OZ 5422152-A	2
	68/69	B(63, 65, 66, 76)	With adjustable end		C8OZ 6322152-A	2
	70/71	B(54, 57, 71)			D0OZ 5422152-A	2
	70/71	B(62, 63, 65, 66, 76)			D0OZ 6522152-A	2
	72	B(53, 71)			D2OZ 5322152-A	2
	72	B(63, 65, 97)			D2OZ 6522152-A	2
- F -						
	65/66	F			C5ZZ 6522152-B	2
	67/68	F			C7ZZ 6522152-A	2
	69/70	F			C9ZZ 6522152-A	2
	71/	F			D1ZZ 6522152-A	2
- L -						
	71/	L	R.H.		D1FZ 6222152-A	1
			L.H.		D1FZ 6222153-A	1
- P -						
	70/	P(62)			D0DZ 6222152-A	2
	71/72	P(54)	"Before 3/1/72"		D1DZ 5422152-A	2
	72	P(54)	"From 3/1/72"		D2DZ 5422152-A	2
- S -						
	67/71	S(57)	With adjustable end		C7SZ 5722152-A	2
	67/71	S(65)	R. H. -with adjustable end		C7SZ 6522152-A	1
			L. H.		C7SZ 6522153-A	1

**BODY  
SECTION 220**
**FORD CAR PARTS**

GROUP NUMBER	YEAR	BODY TYPE	DESCRIPTION	PART NUMBER		QTY.
				RIGHT HAND	LEFT HAND	
<b>22152-3 ROD - FRONT DOOR LATCH ACTUATING - continued</b>						
- S -						
	70	S(65)	Nut-No. 12-24 locking	380331-S7-8 (MM173G)		2
	72	S(w/o power door latch)		D2SZ 6522152-A		2
	72	S(w/power door latch)		D2SZ 6522152-B		2
	67/	S(65)	Clip-No. 8-32	382055-S(GG276)		2
- U -						
	66/67	U	R. H.	C6TZ 9722152-A		1
			L. H.	C6TZ 9722153-A		1
	68	U	"Before Ser. C56,001"	R. H. -11 11/16" long -not repl'd. (3-74)		1
				L. H. -not repl'd. (3-74)		1
	68/72	U	"From Ser. C56,001 to Ser. M60,001"	R. H. -12 1/8" long		1
				L. H.		1
	72	U	"From Ser. M60,001"	R. H.		1
				L. H.		1
- X -						
	66/70	X	R. H.	C6OZ 6222152-A		1
			L. H.	C6OZ 6222153-A		1
<b>22158 NUT - VACUUM DOOR LATCH CONTROL MOUNTING</b>						
	67/68	A	Also used with electric antenna	C5MY 6222158-B		1 or 2
	68	A(71)	With power tail gate window			1
<b>22164-5 LINK - FRONT DOOR LATCH CONTROL ROD LEVER</b>						
	72	B(63,65,97)	R. H.	D2OZ 6522164-A		1
			L. H.	D2OZ 6522165-A		1
	72	S		D2SZ 6522164-A		2
<b>22192 GROMMET - VACUUM DOOR LATCH CONTROL</b>						
	68/70	S		C7VY 5322192-B		1
<b>22194 GROMMET - VACUUM DOOR LATCH HOSE</b>						
	70	A	Front-1 3/8" dia. hole	D0AZ 6222194-A		1
	70	A	Front-1 5/16" dia. hole	D0AZ 6222194-B		1
	71	S				1 or 2
	70/	A(53,54,57,71)	Rear-1 1/4" dia. hole	D0AZ 5422194-A		1 or 2
	70/	A(53,54,57,71)	Rear-2" dia. hole	D0AZ 5422194-B		1
	71	A,S	Fits 1" dia. hole-2 hoses	D1AZ 6522194-A		AR
GROUP NUMBER	YEAR	BODY TYPE	DESCRIPTION	PART NUMBER		QTY.
				RIGHT HAND	LEFT HAND	
<b>222A00-1 RETAINER - FRONT DOOR GLASS RUN LATCH SIDE</b>						
- A -						
	69	A(62)		C9AZ 62222A00-A	C9AZ 62222A01-A	1
	69/71	A(54,71)		C9AZ 54222A00-A	C9AZ 54222A01-A	1
- B -						
	68/69	B(54,71)		C8OZ 54222A00-A	C8OZ 54222A01-A	1
	70/71	B(71)				1
	70	B(62)		D0OZ 62222A00-A	D0OZ 62222A01-A	1
	70/71	B(54)		D0OZ 54222A00-A	D0OZ 54222A01-A	1
- L -						
	71/	L		D1FZ 62222A00-A	D1FZ 62222A01-A	1
- P -						
	70/	P(62)		D0DZ 62222A00-A	D0DZ 62222A01-A	1
	70/	P(62)	Bolt-No. 8-18 x 5/8" round head	375453-S100(BB658C)	375453-S100(BB658C)	2
	71/	P(54)		D1DZ 54222A00-A	D1DZ 54222A01-A	1

# FORD CAR PARTS

**BODY  
SECTION 220**

19

GROUP NUMBER	YEAR	BODY TYPE	DESCRIPTION	PART NUMBER		QTY.
				RIGHT HAND	LEFT HAND	
<b>222A00-1 RETAINER - FRONT DOOR GLASS RUN LATCH SIDE - continued</b>						
<b>- X -</b>						
	68/70	X(54, 71)		C8DZ 54222A00-A	C8DZ 54222A01-A	1
	68/70	X(62)		C8DZ 62222A00-A	C8DZ 62222A01-A	1
	68	B(54, 71), X(54, 62, 71)	1/4"-20 x 1/2" Hex. head screw & washer assy.	381560-S2(BB863K)	381560-S2(BB863K)	2
	70	B(54)	Screw-No. 8 x 18-1/2" washer head	375453-S100(BB658C)	375453-S100(BB658C)	2
<b>22204-5 FRAME and DIVISION BAR ASSY. - FRONT DOOR VENT WINDOW</b>						
<b>- A -</b>						
	65/67 68	A(57, 63, 76) A(57, 63, 65, 76)		C5AZ 6322204-B	C5AZ 6322205-B	1 1
			5/16"-18 x 1.88" Set screw	★378696-S2	★378696-S2	2
			5/16"-18 x 3/4" Hex. head screw & washer assy.	359662-S7-8(BB575A)	359662-S7-8(BB575A)	4
			5/16" I. D. x 7/8" O. D. Washer (special)	★357789-S7	★357789-S7	2
			5/16"-18 Hex. nut	33797-S7(M50)	33797-S7(M50)	2
			No. 8-18 x 3/8" Cross recess pan head screw	52720-S8(U380)	52720-S8(U380)	6
<b>- B -</b>						
	66/67	B(63, 76)		★C6OZ 6322204-B Not replaced (3-75)	C6OZ 6322205-B	1
			5/16"-18 x 1 3/4" Set screw	379721-S2(UU108H)	379721-S2(UU108H)	2
			5/16"-18 x 1 1/2" Screw & washer assy.	★380347-S2	★380347-S2	4
	66/67	B	No. 6-20 x 1/4" Screw-flat head	52052-S13(U200A)	52052-S13(U200A)	2
	66/67	B(except 63, 76)	Refer to Group 21408-9			
	70/71	B(57)		D0OZ 5722204-A	D0OZ 5722205-A	1
<b>- F -</b>						
	65/66	F		C5ZZ 6522204-A	C5ZZ 6522205-A	1
			5/16"-18 x 1.88" Set screw	★378696-S8	★378696-S8	2
			5/16"-18 x 1" Hex. head screw & washer assy.	★378694-S2	★378694-S2	4
			5/16"-18 x 2" Hex. head screw & washer assy.	★379384-S2	★379384-S2	2
			5/16" I. D. x 7/8" O. D. Washer (special)	★357789-S7	★357789-S7	2
			5/16"-18 Hex. nut	33797-S7(M50)	33797-S7(M50)	2
	67/68	F		C7ZZ 6522204-A	C7ZZ 6522205-A	1
			5/16"-18 x 1.88" Set screw	★378696-S8	★378696-S8	2
			5/16"-18 x 1.56" Oval head screw & washer assy.	★379384-S2	★379384-S2	2
			5/16"-18 x 1" Hex. head screw & washer assy.	★378694-S2	★378694-S2	2
			5/16"-18 Hex. nut & washer assy.	★375023-S2	★375023-S2	2
	67/68	F	Nut-hex.-5/16"-18	33797-S7(M50)	33797-S7(M50)	2
	67/68	F	Screw-flat head-No. 6-20 x 1/4"	52052-S13(U200A)	52052-S13(U200A)	2
	67/68	F	Washer-flat-5/16"	375897-S(XX118A)	375897-S(XX118A)	2
<b>- S -</b>						
	65/66	S		C6SZ 6322204-A	★C6SZ 6322205-A Not repl'd. (3-74)	1
	65/66	S	Rivet-tubular	351933-S(SS32)	351933-S(SS32)	2

**BODY  
SECTION 220**
**FORD CAR PARTS**

GROUP NUMBER	YEAR	BODY TYPE	DESCRIPTION	PART NUMBER		QTY.
				RIGHT HAND	LEFT HAND	
<b>22204-5 FRAME and DIVISION BAR ASSY. - FRONT DOOR VENT WINDOW - continued</b>						
- S -						
	65/66	S	Screw, set-5/16"- 18 x 1.62"	*379388-S2	*379388-S2	2
			Screw & washer assy., hex.hd.-5/16"-18 x 1.19"	*379446-S2	*379446-S2	4
			Screw & washer assy., hex.hd.-No.10-24 x 1.00"	378315-S2(BB869)	378315-S2(BB869)	2
			Washer, special- 5/16" I.D. x 7/8" O.D.	357789-S7(XX343)	357789-S7(XX343)	2
			Nut, hex-5/16"-18	33797-S7(M50)	33797-S7(M50)	2
			Nut & retainer assy.- No.10-24	*378154-S2	*378154-S2	2
- U -						
	66/	U	Painted	C6TZ 9722204-B	C6TZ 9722205-B	1
	67	U	Bright finish	C7TZ 9722204-A	C7TZ 9722205-B	1
	68/	U	Bright finish	C7TZ 9722204-B	C7TZ 9722205-B	1
	66/	U	Nut, hex.-5/16"	33923-S7(M32)	33923-S7(M32)	AR
	66/	U	Washer, flat-5/16"	375897-S(XX118A)	375897-S(XX118A)	1
	66/	U	Screw, pan head - #20 x 1 3/4"	*57455-S9	*57455-S9	2
<b>222A04 CLIP - FRONT DOOR WINDOW - FRONT - Also Refer to Groups 222B08 and 222A44</b>						
	68	B(63, 65, 66, 76)		C8OZ 63222A04-A	C8OZ 63222A04-A	2
	69	B(76)				2
	69	B(63, 65, 66), F(63, 65)		C9ZZ 65222A04-A	C9ZZ 65222A04-A	∅ 2
	67	S(65)		C7SZ 65222A04-A	C7SZ 65222A04-A	2
	68	S		C7SZ 65222A04-B	C7SZ 65222A04-B	2or6
	69	S(57, 65)				2or4
GROUP NUMBER	YEAR	BODY TYPE	DESCRIPTION	PART NUMBER		QTY.
<b>222B08 CLIP - FRONT DOOR WINDOW TOP OUTER - INCLUDES ATTACHING PARTS - Also Refer to Groups 222A04 and 222A44</b>						
	69	A(57, 63, 65)	With dog-leg mating surface		C9AZ 63222B08-A	2
	70/71	A(53, 57, 65, 76), B(57, 63, 65, 66, 76), F, S			D1AZ 65222B08-A	2
	72	F				2
	72	B	"Before 12/15/71" Replaced by D2AZ 65222B08-A (10-74)		*D2OZ 65222B08-A	2
	71/	L, P(62)			D1FZ 62222B08-A	2
	72	A, S			D2AZ 65222B08-A	2
	72	B	"From 12/15/71"			2
GROUP NUMBER	YEAR	BODY TYPE	DESCRIPTION	PART NUMBER		QTY.
<b>22220-1 FRAME - FRONT DOOR GLASS</b>						
- A -						
	65/68	A(57)	Includes attaching parts	C5AZ 5722220-A	C5AZ 5722221-A	1
	65/66	A(63, 76)	Includes attaching parts	*C5AZ 6322220-A Not repl'd. (3-74)	C5AZ 6322221-A	1
	67/68	A(76)				1
	68	A(63)		C8AZ 6322220-A	C8AZ 6322221-A	1
	68	A(65)		C8AZ 6522220-A	C8AZ 6522221-A	1
	69	A(57)		C9AZ 5722220-A	C9AZ 5722221-A	1
	69	A(63, 65, 76)		C9AZ 6322220-A	C9AZ 6322221-A	1
- B -						
	66/67	B(63)	Includes attaching parts	C6OZ 6322220-A	C6OZ 6322221-A	1
	66/67	B(76)	Includes attaching parts	C6OZ 7622220-A	C6OZ 7622221-A	1
	66/68	B(54, 71)	Window opening frame	C6OZ 5422220-A	C6OZ 5422221-A	1
	68	B(63, 65, 66, 76)	Serviced in 21400-1			
	69	B(63, 65, 66)		C9OZ 6322220-A	C9OZ 6322221-A	1
	69	B(76)		C9OZ 7622220-A	C9OZ 7622221-A	1

# FORD CAR PARTS

## BODY SECTION 220

21

GROUP NUMBER	YEAR	BODY TYPE	DESCRIPTION	PART NUMBER		QTY.
				RIGHT HAND	LEFT HAND	
<b>22220-1 FRAME - FRONT DOOR GLASS - continued</b>						
- F -						
	65/66	F(65)	Includes attaching parts	C5ZZ 6522220-A	C5ZZ 6522221-A	1
	67/68	F(63)	Includes attaching parts	C7ZZ 6322220-A	C7ZZ 6322221-A	1
	67/68	F(65)	Includes attaching parts	C7ZZ 6522220-B	C7ZZ 6522221-B	1
	69	F(65, 76)		C9ZZ 6522220-A	C9ZZ 6522221-A	1
	69/70	F(63)	Cement-on type	D0ZZ 6322220-A	D0ZZ 6322221-A	1
	70	F(63)	Press-on type	D0ZZ 63214A24-A	D0ZZ 63214A25-A	1
- S -						
	65	S	Includes attaching parts	C4SZ 6322220-A	C4SZ 6322220-A	2
	66	S(63A, 76)				2
	67/68	S(65)		C7SZ 6522220-A	C7SZ 6522221-A	1
	69	S(65A, C)				1
- U -						
	66/	U		C6TZ 9722220-A	C6TZ 9722221-A	1
			1/4"-20 x 1/2" Hex. head screw & washer assy.	42742-S7-8(U2A)	42742-S7-8(U2A)	4
			Screw-No. 8-18 x 3/8" Pan head	52720-S8(U380)	52720-S8(U380)	2
- X -						
	66/70	X(54, 71)	Window opening frame	C6OZ 5422220-A	C6OZ 5422221-A	1
	65/	A, B, F, S, X	No. 8-32 x 3/8" Bolt-flat head	358477-S8(BB93)	358477-S8(BB93)	AR
GROUP NUMBER	YEAR	BODY TYPE	DESCRIPTION	PART NUMBER		QTY.
<b>222A44-5 CLIP - FRONT DOOR WINDOW - TOP - Also refer to Groups 222A04, 222B08</b>						
	68	A(63, 65)		C8AZ 63222A44-A		2
	69	A(57, 63, 65)		C9AZ 63222A44-A		2or4
	70/71	B(57, 66)				2
	68/69	B(63, 65)		C8OZ 63222A44-A		2
	72	B(63, 65, 97), S		D2OZ 65222A44-B		2
	71/	F		D1ZZ 65222A44-A		2or4
	67/69	S(65A, C)		C7SZ 65222A44-B		2
<b>222A54-5 STOP - FRONT DOOR WINDOW UPPER REAR</b>						
	71/	A(53)	R.H.	C9MY 53222A54-A		1
			L.H.	C9MY 53222A55-A		1
	69/70	F	R.H.	C9ZZ 65222A54-A		1
			L.H.	C9ZZ 65222A55-A		1
	67/71	S(57)		C7SZ 57222A54-B		2
	67/68	S(65)	"Before 11/15/67" R.H. -not repl'd. (3-74)	★C7SZ 65222A54-B		1
			L.H. -not repl'd. (3-74)	★C7SZ 65222A55-B		1
	68/71	S(65)	"From 11/15/67" R.H.	C7SZ 65222A54-C		1
			L.H.	C7SZ 65222A55-C		1
	67/71	S	Screw, pan head-1/4"-20 x 1/2"	50992-S7(U154)		2
<b>222A56-7 GUIDE - DOOR WINDOW - LATCH SIDE</b>						
- A -						
	65/67	A(63, 76)	R.H.	C5AZ 63222A56-B		1
	68	A(63, 65, 76)	R.H.			1
			L.H.	C5AZ 63222A57-B		1
	69	A(57, 63, 65, 76)		C9AZ 63222A56-A		6or8
	70	A(57)	Use with bonded design	D0AZ 63222A56-C		8
	70	A(63, 65, 76)				4
	70/71	A(63, 65, 76)	R.H. -use with bolt-on design	D1AZ 65222A56-A		2
			L.H.	D0AZ 63222A57-B		2
	71	A(53, 57) "Before 6/7/71"	R.H.	D1AZ 65222A56-A		1
			L.H.	D0AZ 63222A57-B		1
	71/	A(54, 71)	R.H.	D1AZ 54222A56-A		1
			L.H.	D1AZ 54222A57-A		1
	71/	A(53, 57, 65, 76) - "From 6/7/71"	R.H. -front, rear door or power quarter	D1AZ 65222A56-A		AR
			L.H.	D1AZ 65222A57-A		AR

GROUP NUMBER	YEAR	BODY TYPE	DESCRIPTION	PART NUMBER	QTY.
<b>222A56-7 GUIDE - DOOR WINDOW - LATCH SIDE - continued</b>					
- A -					
65/68	A(57,63,65,76)		Screw, set-5/16"-18 x 2 1/2"	379386-S2(UU108G)	2
			Hex. washer head screw-5/16"-18 x 1/2"	376976-S7-8(BB574M)	4
			Washer, special-5/16" I.D. x 7/8" O.D.	*357789-S7	2
			Hex. nut-5/16"-18	33797-S7(M50)	2
65/68	A		Lockwasher-5/16"	356309-S7(XX299)	2
65/68	A		Screw, set-5/16"-18 x 2 1/2"	379386-S2(UU108G)	2
70	A(63,65,76), F, B(63,65,66,76)		Nut and washer-1/4"-20-use with Bolt-on design	383278-S2(MM296AG)	AR
- B -					
68/69	B(63,65,66,76)			C8OZ 63222A56-A	4
70/71	B(57)		R. H. -front door	D0OZ 57222A56-A	1
			L. H.	D0OZ 57222A57-A	1
70	B(57)		Rear door	C9AZ 63222A56-A	2
70/71	B(63,65,66,76)		R. H.	D0AZ 63222A56-A	2
			L. H.	D0AZ 63222A57-A	2
71	B(57)		R.H.-rear door	D0AZ 63222A56-A	1
			L.H.	D0AZ 63222A57-A	1
66/67	B		5/16"-18 Hex. nut	33797-S7(M50)	4
- F -					
67/68	F		R. H.	C7ZZ 65222A56-C	1
			L. H.	C7ZZ 65222A57-C	1
			5/16"-18 x 7/16" & 5/16"-18 x 1 1/8" Set screw	375694-S2(UU108E)	2
			5/16"-18 Nut & washer assy.	*375023-S2	2
67/68	F		1/4"-20 x 1/2" Pan head screw & washer assy.	373460-S7(BB629)	4
			5/16"-18 Hex. nut	33797-S7(M50)	2
69/70	F		Use with bonded design	C9ZZ 65222A56-A	4
69/70	F		Use with bolt-on design	D0ZZ 65222A56-A	4
- S -					
67/71	S(57)		R. H.	C7SZ 57222A56-A	1
			L. H.	C7SZ 57222A57-A	1
67/71	S(65)		R. H.	C7SZ 65222A56-A	1
			L. H.	C7SZ 65222A57-A	1
67/71	S		1/4"-20 x 3/4" Hex. washer head screw	371492-S2(BB569)	4
<b>222A80-1 SEAL - FRONT DOOR VENT WINDOW FRAME</b>					
67	A(57,63,76)			C7AZ 63222A80-A	2
68	A(57,63,65,76)				2
66/67	B(63,76)		10 1/4" long	C6OZ 63222A80-A	2
67/68	F		Cut to 9.52" long		2
<b>22285-6 BUTTON - FRONT DOOR ACCESS HOLE - PLUG</b>					
65/66	F		Latch side-for 1 1/2" diameter hole	C5ZZ 6522286-A	4
65	S		Lower	*B7A 6422285-A	4
<b>222A88-9 RETAINER - FRONT DOOR VENT WINDOW DIVISION BAR GLASS RUN</b>					
65/67	A(57,63,76)	R. H.		C5AZ 63222A88-A	1
					1
68	A(57,63,65,76)	L. H.		C5AZ 63222A89-A	1
			5/16"-18 x 2 1/2" Set screw	379386-S2(UU108G)	2
			5/16" I.D. x 7/8" O.D. Washer (special)	*357789-S7	2
			5/16"-18 Hex. nut	33797-S7(M50)	2
65/68	A(54,62,71)	R. H. -not repl'd. (3-74)		*C5AZ62222A88-A	1
			L. H.	C5AZ 62222A89-A	1
			5/16"-18 x 3/4" Hex. head screw & washer assy.	359662-S7-8(BB575A)	2
69/70	A(54,71)	R. H.		C9AZ 54222A88-A	1
			L. H.	C9AZ 54222A89-A	1

# FORD CAR PARTS

**BODY  
SECTION 220**

23

GROUP NUMBER	YEAR	BODY TYPE	DESCRIPTION	PART NUMBER	QTY.
<b>222A88-9 RETAINER - FRONT DOOR VENT WINDOW DIVISION BAR GLASS RUN - continued</b>					
	69	A(62)	R. H.	C9AZ 62222A88-A	1
			L. H.	C9AZ 62222A89-A	1
	65/68	A	Screw-5/16"-18 x 2 1/2" Set	379386-S2(UU108G)	2
	65/69	A	5/16" Lockwasher	356309-S7(XX299)	1
	66	B(54, 62, 71), X	R. H. -not repl'd. (3-74)	*C6OZ 62222A88-A	1
	67	B(54, 62, 66, 71), X	L. H.	C6OZ 62222A89-A	1
	68/69	B(54, 71)	R. H.	C8OZ 54222A88-A	1
	68/70	X			
	70/71	B(71)	L. H.	C8OZ 54222A89-A	1
	70/71	B(54, 62)	R. H. -Includes bracket	D0OZ 54222A88-A	1
			L. H.	D0OZ 54222A89-A	1
	70/71	B(57)	R. H. -Includes bracket	D0OZ 57222A88-A	1
			L. H.	D0OZ 57222A89-A	1
	66/71	B, X	5/16"-18 x 1 3/4" Set screw	379721-S2(UU108H)	2
			5/16"-18 Nut & washer assy.	*375023-S2	2
	68/71	B	Nut and washer-1/4"-20 Hex.	378289-S2(MM296)	2
	66/67	B, F, X	5/16"-18 Hex. nut	33797-S7(M50)	2
	67/68	F	R. H.	C7ZZ 65222A88-A	1
			L. H.	C7ZZ 65222A89-A	1
			5/16"-18 x 1.88" Set screw	*378696-S8	2
			5/16"-18 Nut & washer assy.	*375023-S2	2
			Plug (button)-1 1/2" diam. hole	352216-S(P3G)	2
	67/68	F	Screw-No. 6-20 x 1/4" Flat head	52052-S13(U200A)	AR
<b>222A92 GUIDE - FRONT DOOR WINDOW LOWER</b>					
	71/	F		D1ZZ 65222A92-B	2
	72	B(53, 71)	Front or rear door	D2OZ 65222A92-A	4
	72	B(63, 65, 97)			2
	72	S			2
<b>22296-7 BAR - FRONT DOOR VENT WINDOW DIVISION - INCLUDES ATTACHING PARTS</b>					
	65/68	A(54, 62, 71)	R. H.	C5AZ 6222296-C	1
			L. H. - not replaced (3-75)	*C5AZ 6222297-C	1
	69/70	A(54, 71)	R. H.	C9AZ 5422296-A	1
			L. H.	C9AZ 5422297-A	1
	69	A(62)	R. H.	C9AZ 6222296-A	1
			L. H.	C9AZ 6222297-A	1
	66/69	B(54, 62, 66, 71), X	R. H.	C6OZ 6222296-A	1
	70	B(71), X			
	71	B(71)	L. H.	C6OZ 6222297-A	1
	70/71	B(54, 62)	R. H.	D0OZ 5422296-A	1
			L. H.	D0OZ 5422297-A	1
	65/	A, B, X	For weatherstrip refer to Group 21448-9		
	66/	B, X	Rivet	351909-S8(SS30)	AR
	66/70	X	Screw-No. 8-18 x 3/8" Pan head	52720-S8(U380)	2
<b>223A00-1 GUIDE - FRONT DOOR WINDOW - FRONT - Also Refer to Group 222A56</b>					
	67/71	S	R. H.	C7SZ 65223A00-A	1
			L. H.	C7SZ 65223A01-A	1
			1/4"-20 x 3/4" Hex. washer head screw	371492-S2(BB569)	4
<b>22330-3A30 BEARING - FRONT DOOR VENT WINDOW LOWER PIVOT</b>					
	65	S	Outer	C4SZ 6322330-A	2
	65/66	S	Inner	C4SZ 63223A30-A	2
	66	S	Outer	C4SZ 6322330-B	2
<b>223A32-3 SEAL - FRONT DOOR VENT WINDOW LOWER FRONT</b>					
	67/68	F	R. H.	C7SZ 65223A32-C	1
			L. H.	C7ZZ 65223A33-C	1
	67/68	F	Screw-No. 6-20 x 1/4" Fillister head	52533-S(U226)	2

**BODY  
SECTION 220**
**FORD CAR PARTS**

GROUP NUMBER	YEAR	BODY TYPE	DESCRIPTION	PART NUMBER	QTY.
<b>223A48</b>	<b>RUN and CLIP ASSY. - FRONT DOOR VENT WINDOW DIVISION BAR GLASS - UPPER</b>				
	66/	U		C6TZ 97223A48-A	2
<b>223A54-5</b>	<b>RUN and BRACKET ASSY. - FRONT DOOR VENT WINDOW DIVISION BAR GLASS - LOWER</b>				
	66/	U	R. H.	C6TZ 97223A54-A	1
			L. H.	C6TZ 97223A55-A	1
			1/4"-20 x 1/2" Hex. headscrew & washer assy.	42742-S7-8(U2A)	2
<b>223A58</b>	<b>ANTI - RATTLE ASSY. - FRONT DOOR WINDOW LOWER GUIDE</b>				
	71/	F		D1ZZ 65223A58-A	4
	72	B, S		D2OZ 65223A58-A	2 2
<b>22362</b>	<b>GUIDE - DOOR WINDOW UPPER</b>				
	72	B	Front, rear doors	D2OZ 6522362-A	2 or 4
	72	S			2
	71/	F		D1ZZ 6522362-A	2
<b>22380</b>	<b>STABILIZER - DOOR WINDOW GLASS INNER</b>				
	72	B, S	Front, rear doors	D2OZ 6522380-B	4 or 8
	71	F	"Before 1/18/71"	D1ZZ 6522380-A	4
	71/	F	"From 1/18/71"	D1ZZ 6522380-B	4
<b>22384-5</b>	<b>LEVER - DOOR LATCH ACTUATING ROD</b>				
	- A -				
	65/68	A	R. H.	C5AZ 6222384-A	1
			L. H.	C5AZ 6222385-A	1
			3/16" x .88" Pin (clevis)	*76187-S8	2
	69/70	A	R. H.	C9AZ 6222384-A	1 or 2
			L. H.	C9AZ 6222385-A	1
	- B -				
	66/71	B		C6OZ 6222384-A	2
	- F -				
	65/66	F		C4DZ 6222384-A	2
	67/68	F		C7ZZ 6522384-A	2
			3/16" x .88" Pin (clevis)	*76187-S8	2
	69/70	F		C9ZZ 6522384-A	2
	65/70	F	Pin-self locking	353610-S8(NN126)	2
	65/70	F	Pin-3/16" x 1 5/32" flat	358678-S7-8(NN7B)	2
	- L -				
	71/	L		D1FZ 6222384-A	2
	- P -				
	70/	P		C7ZZ 6522384-A	2
	- S -				
	65/66	S		C5SZ 6322384-A	2
			3/16" x 1.29" Pin (clevis)	373919-S8(NN7C)	2
	65/66	S	Pin-self locking	353610-S8(NN126)	2
			No. 8-32 x 3/8" Pan head screw	*40514-S8	2
	67/71	S	R. H.	C5AZ 6222384-A	1
			L. H.	C5AZ 6222385-A	1
	- U -				
	66/67	U		C4DZ 6222384-A	1
	68	U	"Before Ser. C56, 001"	*C8TZ 9722384-B	2
	68/72	U	"From Ser. C56, 001 to Ser. M60, 001"	C8TZ 9722384-A	2
	72	U	"From Ser. M60, 001"	D2BZ 1022384-A	2
	- X -				
	65	X		C4DZ 6222384-A	2
	66/70	X		C6OZ 6222384-A	2
	65	X	3/16" x 1.16" overall-Pin (clevis)	358678-S7-8(NN7B)	2
	65/66	F			2
	66/67	U			2
	65/	A, B	Pin-self locking	353610-S8(NN126)	2
	65/66	F, X			2
	66/67	U			2
	66/70	X			2
			No. 8-32 x 3/8" Pan head screw	*40514-S8	2



# FORD CAR PARTS

## BODY SECTION 220

25

GROUP NUMBER	YEAR	BODY TYPE	DESCRIPTION	PART NUMBER		QTY.
				RIGHT HAND	LEFT HAND	
<b>22404-5 HANDLE ASSY. - FRONT DOOR OUTSIDE - Also refer to Group 26604-5</b>						
- A -						
65/66	A		Includes attaching parts	C5AZ 6222404-A	C5AZ 6222405-A	1or2
66/70	A(54, 57, 71)		Rear door-Refer to Group 26604-5			
67/68	A			C7AZ 6222404-A	C7AZ 6222405-A	1
69/70	A		Includes attaching parts	C9AZ 6222404-A	C9AZ 6222405-A	1
71/	A		Front or rear	D1AZ 6522404-A	D1AZ 6522405-A	1or2
- B -						
65	B		Includes attaching parts	C5OZ 6222404-A	C5OZ 6222405-A	1or2
66/71	B		Includes attaching parts	C6OZ 6222404-A	C6OZ 6222405-A	1or2
72	B			D3AZ 6522404-A	D3AZ 6522405-A	1or2
65	B		Clip	73878-S8(N2A)	73878-S8(N2A)	2
65	B		Pin-self locking	353610-S8(NN126)	353610-S8(NN126)	AR
65	B		Nut-7/32" sleeve	377647-S(MM216J)	377647-S(MM216J)	2
65	B		Screw-No. 12-24 x 1/2" Pan head	50811-S(U150A)	50811-S(U150A)	AR
66/	B		No. 12 Lockwasher	34927-S7(X87)	34927-S7(X87)	AR
- F -						
65/66	F		Includes attaching parts	C4DZ 6222404-A	C4DZ 6222405-A	1or2
69/70	F					1
67/68	F		Includes attaching parts	C7ZZ 6522404-A	C7ZZ 6522405-A	1
71/	F			D1AZ 6522404-A	D1AZ 6522405-A	1
65	F		No. 10 Lockwasher	34903-S8(X96)	34903-S8(X96)	2
67/68	F		Bolt-No. 10-24 x 1 3/8" Fillister head	378149-S(BB29D)	378149-S(BB29D)	2
67/	F		No. 10-24 nut	34053-S8(M156)	34053-S8(M156)	AR
- L -						
71/	L			D1FZ 6222404-A	D1FZ 6222405-A	1
- P -						
70/	P		Includes attaching parts	C7ZZ 6522404-A	C7ZZ 6522405-A	1
70/	P		Pin-spring retainer	353610-S40(NN126)	353610-S40(NN126)	1
70/	P		Nut & washer assy. - No. 10-24 hex.	34655-S8(M107)	34655-S8(M107)	2
- S -						
65/66	S		Includes attaching parts	C4SZ 6322404-A	C4SZ 6322405-A	1
67/71	S		Includes attaching parts	C5AZ 6222404-A	C5AZ 6222405-A	1or2
72	S			D1AZ 6522404-A	D1AZ 6522405-A	1
67/71	S		Nut-no. 12-24 locking	380331-S7(MM173G)	380331-S7(MM173G)	2
- U -						
66/	U		Includes attaching parts	C4DZ 6222404-A	C4DZ 6222405-A	1or2
66/	U		No. 10-24 Nut	34053-S8(M156)	34053-S8(M156)	AR
66/	U		No. 10 Lockwasher	34903-S8(X96)	34903-S8(X96)	AR
66/	U		Pin-self locking	353610-S8(NN126)	353610-S8(NN126)	1
66/	U		Screw-No. 10-24 x 1" round head	53866-S7(U169A)	53866-S7(U169A)	2
- X -						
65	X		Includes attaching parts	C4DZ 6222404-A	C4DZ 6222405-A	1or2
66/70	X		Includes attaching parts	C6OZ 6222404-A	C6OZ 6222405-A	1or2
65	X		Nut-No. 10-24 Hex.	34053-S8(M156)	34053-S8(M156)	2
65	X		No. 10 Lockwasher	34903-S8(X96)	34903-S8(X96)	2
66/70	X		No. 12 Lockwasher	34927-S7(X87)	34927-S7(X87)	AR
65/	A,S		Nut-No. 12-24 Locking	380331-S7(MM173G)	380331-S7(MM173G)	2
GROUP NUMBER	YEAR	BODY TYPE	DESCRIPTION	PART NUMBER		QTY.
<b>22408 ANTI-RATTLE - DOOR HANDLE OUTSIDE</b>						
72	A,F,S		Front & rear doors	D2AZ 6522408-A		2 or 4

GROUP NUMBER	YEAR	BODY TYPE	DESCRIPTION	PART NUMBER		QTY.
				RIGHT HAND	LEFT HAND	
<b>22428-9 PAD - DOOR OUTSIDE HANDLE LARGE</b>						
- A -						
65/66		A(except 71A, E)		C5AZ 6222428-A	C5AZ 6222429-A	1or2
67/68		A				1or2
69/70		A		C9AZ 6222428-A	C9AZ 6222429-A	1or2
71/		A		D1AZ 6522428-A	D1AZ 6522428-A	2or4
- B -						
65		B		C5AZ 6222428-A	C5AZ 6222429-A	1or2
66/71		B		C6OZ 6222428-A	C6OZ 6222429-A	1or2
65		B	Pin-self locking	353610-S8(NN126)	353610-S8(NN126)	AR
72		B	"Before 7/2/72" Serviced in assy. only- Refer to Group 22404-5			
72		B	"From 7/2/72"	D3AZ 6522428-A	D3AZ 6522428-A	2or4
- F -						
65/66		F	Rubber or vinyl	C0DZ 6422428-B	C0DZ 6422429-B	1
67/68		F	Nylon	C7ZZ 6522428-A	C7ZZ 6522429-A	1
69/70		F		C9ZZ 6522428-A	C9ZZ 6522429-A	1
71/		F		D1AZ 6522428-A	D1AZ 6522428-A	2
- L -						
71/		L		D1FZ 6222428-A	D1FZ 6222429-A	1
- P -						
70/		P		C7ZZ 6522428-A	C7ZZ 6522429-A	1or2
- S -						
65/66		S		C4SZ 6322428-A	★C4SZ 6322429-A Not Repl'd (11-73)	1
67/71		S		C5AZ 6222428-A	C5AZ 6222429-A	1or2
72		S		D1AZ 6522428-A	D1AZ 6522428-A	2
- U -						
66/		U	Rubber or vinyl	C0DZ 6422428-B	C0DZ 6422429-B	1
67/		U(98)	Lift gate handle	C6TZ 9122428-A	C6TZ 9122428-A	1
- X -						
65		X	Rubber or vinyl	C0DZ 6422428-B	C0DZ 6422429-B	1or2
66/70		X		C6OZ 6222428-A	C6OZ 6222429-A	1or2
<b>22448-9 PAD - DOOR OUTSIDE HANDLE SMALL</b>						
- A -						
65/66		A(except 71A, E)		C5AZ 6222448-A	C5AZ 6222449-A	1or2
67/68		A				1or2
69/70		A		C9AZ 6222448-A	C9AZ 6222449-A	1or2
- B -						
65		B		C5AZ 6222448-A	C5AZ 6222449-A	1or2
66/71		B		C6OZ 6222448-A	C6OZ 6222449-A	1or2
- F -						
65/70		F		C0DZ 6422448-C	C0DZ 6422449-C	1
- L -						
71/		L		D1FZ 6222448-A	D1FZ 6222449-A	1
- P -						
70/		P		C0DZ 6422448-C	C0DZ 6422449-C	1
- S -						
65/66		S		C4SZ 6322448-A	★C4SZ 6322449-A Not Repl'd (11-73)	ø1
67/71		S		C5AZ 6222448-A	C5AZ 6222449-A	1or2
- U -						
66/		U		C0DZ 6422448-C	C0DZ 6422449-C	1
<b>22448-9 PAD - DOOR OUTSIDE HANDLE SMALL - continued</b>						
- X -						
65		X		C0DZ 6422448-C	C0DZ 6422449-C	1or2
66/70		X		C6OZ 6222448-A	C6OZ 6222449-A	1or2

# FORD CAR PARTS

**BODY  
SECTION 220**

27

GROUP NUMBER	YEAR	BODY TYPE	DESCRIPTION	PART NUMBER	QTY.
<b>22454 BUTTON and PIN KIT - DOOR OUTSIDE HANDLE - Also refer to Groups 21984-5, 26602</b>					
- A -					
	65/68	A	R. H. or L. H. - Front door-Kit	C5AZ 6222454-B	2
			Consists of 1-Button & pin assy.    1-Retainer    1-Sleeve    1-Spring    1-Seal    1-Screw		
	69	A	R. H. or L. H. - Front door-Kit	C9AZ 6222454-A	2
			Consists of 1-Button & pin assy.    1-Retainer    1-Sleeve    1-Spring    1-Seal    1-Clip    1-Screw		
	70	A		C8GY 6222454-A	2
- B -					
	65	B	R. H. or L. H. -Kit	C5OZ 6222454-A	2or4
			Consists of 1-Button & pin assy.    1-Retainer    1-Spring    1-Seal    1-Clip    1-Screw		
	66/71	B	R. H. or L. H. -Kit	C6OZ 6222454-B	2
			Consists of 1-Button & pin assy.    1-Retainer    1-Spring    1-Sleeve    1-Pin (clevis)    1-Clip    1-Seal    1-Screw		
	65	B	Clip	73878-S8(N2A)	2
	65	B	Pin-self locking	353610-S8(NN126)	2
- F -					
	65/66	F	R. H. or L. H. - Front door-Kit	C8TZ 9722454-A	2
			Consists of 1-Button & pin assy.    1-Retainer    1-Spring    1-Seal    1-Screw		
	67/70	F	R. H. or L. H. -Kit	C9ZZ 6522454-A	2
			Consists of 1-Button & pin assy.    1-Retainer    1-Sleeve    1-Spring    1-Seal    1-Clip    1-Screw		
- L -					
	71/	L	R. H. or L. H. -Kit	D1FZ 6222454-A	2
			Consists of 1-Button & pin assy.    1-Retainer    1-Spring    1-Sleeve    1-Seal    1-Clip    1-Screw		
- P -					
	70/	P		C9ZZ 6522454-A	2
- S -					
	65/66	S	R. H. or L. H. - Kit	C4SZ 6322454-B	2
			Consists of 1-Button & pin assy.    1-Retainer-R. H.    1-Retainer-L. H.    1-Spring    1-Screw    1-Seal		
	67/71	S	R. H. or L. H. - Front door-kit	C5AZ 6222454-B	2
	65/66	S	Pin-self locking	353610-S8(NN126)	2
	65/66	S	Clevis pin-3/16" x 1 9/32"	373919-S8(NN7C)	2
- U -					
	66/	U	R. H. or L. H. - Front door-Kit	C8TZ 9722454-A	2
			Consists of 1-Button & pin assy.    1-Retainer    1-Spring    1-Seal    1-Screw		
- X -					
	65	X	R. H. or L. H. - Front door - Kit	C8TZ 9722454-A	2
			Consists of 1-Button & pin assy.    1-Retainer    1-Spring    1-Seal    1-Screw		
	66/70	X	R. H. or L. H. -Kit	C6OZ 6222454-B	2
			Consists of 1-Button & pin assy.    1-Retainer    1-Spring    1-Sleeve    1-Pin (Clevis)    1-Clip    1-Seal    1-Screw		
<b>22486 REINFORCEMENT - DOOR OUTSIDE HANDLE</b>					
	65/70	A		C5AZ 6222486-A	2or4
	67/71	S			2or4
<b>22600-1 HANDLE - DOOR INSIDE, - INCLUDES ATTACHING PARTS</b>					
- A -					
	65/66	A(57F, 63C, 63F, 76B)	R. H. - Front door - Pedal type	★C5AZ 6322600-A	1
	66	A(63D, 76D)		Not Repl'd (11-73)	1
	65/66	A(57F)	R. H. - Rear door		1
			L. H.	C5AZ 6322601-A	1
	65/66	A(54A, 57B, 63B, 71A, E, 76A)	R. H. - Front door - Pedal type	C5AZ 6322600-B	1
	65/66	A(54A, 57B, 71A, E)	R. H. - Rear door		1
			L. H.	C5AZ 6322601-B	1

GROUP NUMBER	YEAR	BODY TYPE	DESCRIPTION	PART NUMBER	QTY.
<b>22600-1 HANDLE - DOOR INSIDE - INCLUDES ATTACHING PARTS - continued</b>					
- A -					
65/67		A(54B, E, 62B, E, 71B, C, D)	R. H. and L. H. -pull type	C5AZ 6222600-B	2or4
67		A(54A, C, 57, 63, 71A, E, 76)	R. H.	C7AZ 5422600-B	1or2
67		A(71B, C)-R. P. O.	L. H.	C7AZ 5422601-B	1or2
68		A	R. H.	C8AZ 6222600-B	4or2
			L. H.	C8AZ 6222601-B	1or2
			No. 8-32 Nut & washer assy.	34653-S36(M106X)	4or8
69		A	R. H.	C9AZ 6222600-A	1or2
			L. H.	C9AZ 6222601-A	1or2
70		A	R. H. -Brush finish	D0DZ 6222600-D	1or2
			L. H.	D0DZ 6222601-D	1or2
70/		A	R. H. -Bright finish	D1AZ 6522600-A	1or2
			L. H.	D1AZ 6522601-A	1or2
65/67		A	Screw-No. 10-24 x 39/64" Fillister head	379259-S13(BB817AN)	2or4
- B -					
65		B	Front door	C3AZ 6222600-B	2
66		B(63C, D, 76C, D)	R. H.	★C5MY 5422600-A	1
			L. H.	Not Repl'd (11-73) C5MY 5422601-A	1
66		B	No. 8-32 Nut washer assy.	34653-S36(M106X)	2
66/67		B(54, 62, 63B, 66, 71, 76B)		C5ZZ 6522600-C	2or4
67		B(63C, D, 76C, D)	R. H.	C7AZ 5422600-B	1or2
			L. H.	C7AZ 5422601-B	1or2
68/69		B	R. H.	C8AZ 6222600-B	1or2
			L. H.	C8AZ 6222601-B	1or2
70		B	R. H. -Brush finish	D0DZ 6222600-D	1or2
			L. H.	D0DZ 6222601-D	1or2
70/71		B	R. H. -Bright finish	D1AZ 6522600-A	1or2
			L. H.	D1AZ 6522601-A	1or2
72/		B(63R, 97R)	R. H.	D2OZ 6322600-A	1
			L. H.	D2OZ 6322601-A	1
72/		B(exc. 63R, 97R)	R. H.	D1AZ 6522600-A	1
			L. H.	D1AZ 6522601-A	1
- F -					
65/66		F(63B, 65B, 76B)	R. H. -Wood grain	C5ZZ 6522600-A	1
			L. H.	C5ZZ 6522601-A	1
			No. 10-24 x .44" Oval head lock screw	378446-S13(BB600F)	2
65/67		F(63A, 65A, C, 76A, C)		C5ZZ 6522600-C	2
67		F(63B, 65B, 76B)		C7ZZ 6522600-A	2
68		F	R. H.	C7AZ 5422600-B	1
			L. H.	C7AZ 5422601-B	1
			Bumper	378760-S(CC41)	2or4
69		F	R. H.	C9AZ 6222600-A	1or2
			L. H.	C9AZ 6222601-A	1or2
70		F	R. H.	D0ZZ 6522600-A	1
			L. H.	D0ZZ 6522601-A	1
71/		F	R. H. -Rectangular	D1AZ 6522600-A	1
			L. H.	D1AZ 6522601-A	1
71/		F	R. H. -Spearhead	D1ZZ 6522600-A	1
			L. H.	D1ZZ 6522601-A	1
65/66		F	Screw-No. 10-24 x 7/16" Oval head	378446-S13(BB600F)	2
65/66		F	Bolt-No. 10-24 x 39/64" Fillister head	379259-S13(BB817AN)	2
67/		F	Screw-No. 8-32 x 5/8" Oval head	381571-S13(UU56BA)	2or4
67/		F	1/4"-20 Nut	33795-S7(M49)	1
68		F	Bumper	378760-S(CC41)	2
- L -					
71/72		L	"Before 4/3/72" Approx. 4 1/2" long	D1FZ 6222600-A	2
72		L	"From 4/3/72" Approx. 5 5/8" long	D2FZ 6222600-A	2

# FORD CAR PARTS

**BODY  
SECTION 220**

29

GROUP NUMBER	YEAR	BODY TYPE	DESCRIPTION	PART NUMBER	QTY.	
<b>22600-1 HANDLE - DOOR INSIDE - INCLUDES ATTACHING PARTS - continued</b>						
- P -						
	70	P	"Before 9/2/69"	R.H.-brush finish L.H.	D0DZ 6222600-B D0DZ 6222601-B	1or2 1or2
	70	P	"From 9/2/69"	R.H.-brush finish L.H.	D0DZ 6222600-D D0DZ 6222601-D	1or2 1or2
	70	P	"Before 9/2/69"	R.H.-bright finish L.H.	D0DZ 6222600-A D0DZ 6222601-A	1or2 1or2
	70/	P	"From 9/2/69"	R.H.-bright finish L.H.	D1AZ 6522600-A D1AZ 6522601-A	1or2 1or2
	70	P		No. 8-32 Nut washer assy.	34653-S36(MI06X)	2
- S -						
	65/66	S		R. H. L. H.	C4SZ 6322600-A C4SZ 6322601-A	1 1
	67	S		No. 10-24 x .44" Oval head lock screw	378446-S13(BB600F)	2
	68/72	S	"Before 3/1/72"	R. H. L. H.	C7SZ 6522600-A C8AZ 6222600-B C8AZ 6222601-B	2or4 1or2 1or2
	72	S	"From 3/1/72"	R.H. L.H.	D2SZ 6522600-A D2SZ 6522601-A	1 1
- U -						
	66	U			B7C 8122600-B	2
	67	U			C7TZ 8122600-A	2
	68/	U		R. H. L. H.	C8AZ 6222600-B C8AZ 6222601-B	1 1
	66/	U		Bolt-No. 8-32 x 15/32" Fillister head	371877-S8(BB27)	1
- X -						
	65	X		Front door	C3AZ 6222600-B	2
	66/67	X			C5ZZ 6522600-C	2or4
	68/70	X		R. H. L. H.	C8AZ 6222600-B C8AZ 6222601-B	1or2 1or2
	66/70	X		No. 8-32 Nut washer assy.	34653-S36(MI06X)	2
	65	B		Retainer (spring)	357550-S(QQ1)	2or4
	65	X				2or4
	66/	B, X		Bolt-No. 10-24 x 39/64" Fillister head	379259-S13(BB817AN)	AR
	66/	B, P, X		Bumper	379352-S(CC43A)	2
	67/	A, B, F, S, U, X		No. 8-32 x 5/8" Oval head tapping screw	381571-S13(UU56BA)	AR
<b>22606 BRACKET - FRONT DOOR INSIDE PULL HANDLE MOUNTING</b>						
	71/	F		R.H. L.H.	D1ZZ 6522606-A D1ZZ 6522606-B	1 1
<b>22620-1 ESCUTCHEON - FRONT DOOR INSIDE HANDLE</b>						
	65/66	F(63B, 65B, 76B)		R. H. L. H.	C4SZ 6322620-A C4SZ 6322621-A	1 1
	65/66	S		R. H. L. H.	C4SZ 6322620-A C4SZ 6322621-A	1 1
	70/	S		R. H. L. H.	C8LY 6522620-A C8LY 6522621-A	1 1
	65	X(63C, 66B, 71B, C, 76A, 78B)		Black	C5DZ 6322620-AGA	2
<b>22624 SPRING - DOOR INSIDE HANDLE</b>						
	70	A(except 54C, 57F, 65A)		Not used with Brougham trim	D0AZ 6322624-A	4or6
	71/	A, B, F, S				2 or 4
	65	B			B7A 7022624-A	4or6
	65	X				2or4
<b>22634-5 CUP - DOOR INSIDE HANDLE</b>						
	68	A, B		Aqua (Light)	C8AZ 6222634-A1K	2or4
	69	B(54A, 63D, F, 65A, D, F, 66A, C, D, 71B, D, 76F)				2or4

GROUP NUMBER	YEAR	BODY TYPE	DESCRIPTION	PART NUMBER	QTY.
<b>22634-5</b>	<b>CUP - DOOR INSIDE HANDLE - continued</b>				
68		A, B, X	Black	C8AZ 6222634-A1A	2or4
69		B(54A, 63D, F, 65A, D, F, 66A, C, D, 71B, D, 76F), X			2or4
70		U			2
68		A, B, X	Blue (Dark)	C8AZ 6222634-A1B	2or4
69		U			2
68		A, B	Blue (Light)	C8AZ 6222634-A2B	2or4
69		B(54A, 63D, F, 65A, D, F, 66A, C, D, 71B, D, 76F) X			2or4
68		A, B, X	Ivy Gold (Dark)	C8AZ 6222634-A1G	2or4
69		B(54A, 63D, F, 65A, D, F, 66A, C, D, 71B, D, 76F)U			2or4
68		A, B	Nugget Gold	C8AZ 6222634-A1Y	2or4
69		B(54A, 63D, F, 65A, D, F, 66A, C, D, 71B, D, 76F) X			2or4
68		A	Parchment (Medium)	C8AZ 6222634-A1U	2or4
68/		U			2
68		A, B, X	Parchment (Dark)	C8AZ 6222634-A2U	2or4
69/		U			2
68		A, B, X	Red (Dark)	C8AZ 6222634-A1D	2or4
69		B(54A, 63D, F, 65A, D, F, 66A, C, D, 71B, D, 76F), X			2or4
69		B(54A, 63D, F, 65A, D, F, 66A, C, D, 71D, 76F)	Walnut	C9AZ 6222634-ABN	2or4
69		B(54A, 63D, F, 65A, D, F, 66A, C, D, 71B, D, 76F)	White	C9AZ 6222634-ABW	2or4
69		F(63B, C, 65B, D, E, 76B)	R. H. -Black	C9ZZ 6522634-B1A	1
			L. H.	C9ZZ 6522635-B1A	1
			R. H. -Ivy Gold	★C9ZZ 6522634-B1G	1
			Not Repl'd. (1-73)		
			L. H.	C9ZZ 6522635-B1G	1
			R. H. -Nugget Gold	C9ZZ 6522634-B1Y	1
			L. H.	C9ZZ 6522635-B1Y	1
			R. H. -Red	★C9ZZ 6522634-B1D	1
			Not Repl'd. (1-73)		
			L. H.	C9ZZ 6522635-B1D	1
			R. H. -White	C9ZZ 6522634-B1W	1
			L. H.	C9ZZ 6522635-B1W	1
70		F	R. H. -Black	C9ZZ 6522634-B1A	1
			L. H.	C9ZZ 6522635-B1A	1
			R. H. -Blue	D0ZZ 6522634-C	1
			L. H.	D0ZZ 6522635-C	1
			R. H. -Ginger	D0ZZ 6522634-A	1
			L. H.	D0ZZ 6522635-A	1
			R. H. -Green	D0ZZ 6522634-E	1
			L. H.	D0ZZ 6522635-E	1
			R. H. -Vermillion	D0ZZ 6522634-F	1
			L. H.	D0ZZ 6522635-F	1
			R. H. -White	D0ZZ 6522634-D	1
			L. H.	D0ZZ 6522635-D	1
71/		A, F	Serviced in Assembly only - refer to Group 23942-3 in Soft Trim Section		
72		P(54, 62A)		D2DZ 6222634-A	2or4
70		U	Blue	D0TZ 1022634-A	2
			Green	D0TZ 1022634-D	2
			Nugget	D0TZ 1022634-C	2
			Red	D0TZ 1022634-B	2

# FORD CAR PARTS

**BODY  
SECTION 220**

31

GROUP NUMBER	YEAR	BODY TYPE	DESCRIPTION	PART NUMBER		QTY.
				RIGHT HAND	LEFT HAND	
<b>226A34-5 CUP and MOULDING ASSY. - DOOR INSIDE HANDLE</b>						
69	A	"Before 3/3/69"	Refer to Group 24168-9			
69	A	"From 3/3/69"	R.H.-Aqua	C9AZ 62226A34-A1K		2
			L.H.	C9AZ 62226A35-A1K		2
			R.H.-Black	C9AZ 62226A34-A1A		2
			L.H.	C9AZ 62226A35-A1A		2
			R.H.-Blue (Light)	C9AZ 62226A34-A1B		2
			L.H.	C9AZ 62226A35-A1B		2
			R.H.-Gold	C9AZ 62226A34-A1G		2
			L.H.	C9AZ 62226A35-A1G		2
			R.H.-Nugget	C9AZ 62226A34-A1Y		2
			L.H.	C9AZ 62226A35-A1Y		2
			R.H.-Red (Dark)	C9AZ 62226A34-A1D		2
			L.H.	C9AZ 62226A35-A1D		2
			R.H.-Walnut	C9AZ 62226A34-A1N		2
			L.H.	C9AZ 62226A35-A1N		2
			R.H.-White	C9AZ 62226A34-A1W		2
			L.H.	C9AZ 62226A35-A1W		2
69		B(54B, C, 63B, E, 65B, C, E, 66B, 71B, E, 76B, E)	Aqua	C8MY 54226A34-A1K		2or4
			Black	C8MY 54226A34-A1A		2or4
			Blue (Dark)	C8MY 54226A34-A1B		2or4
			Blue (Light)	C8MY 54226A34-A2B		2or4
			Ivy Gold	C8MY 54226A34-A1G		2or4
			Nugget Gold	C8MY 54226A34-A1Y		2or4
			Red	C8MY 54226A34-A1D		2or4
			Walnut	C9MZ 54226A34-ACN		2or4
69		F(63A, C, 65A, C, E, 76A)	Black	C9ZZ 65226A34-A1A		2
			Blue (Dark)	C9ZZ 65226A34-A2B		2
			Blue (Light)	C9ZZ 65226A34-A1B		2
			Ivy Gold (Dark)	C9ZZ 65226A34-A2G		2
			Ivy Gold (Light)	C9ZZ 65226A34-A1G		2
			Nugget Gold	C9ZZ 65226A34-A1Y		2
			Red	C9ZZ 65226A34-A1D		2
			White	C9ZZ 65226A34-A1W		2
70		F(63A, 65A, 76A)	Black	C9ZZ 65226A34-A1A		2
			Blue	D0ZZ 65226A34-B		2
			Ginger	D0ZZ 65226A34-A		2
			Green	D0ZZ 65226A34-D		2
			Vermillion	D0ZZ 65226A34-E		2
			White	D0ZZ 65226A34-C		2
<b>22642 COVER - FRONT DOOR INSIDE HANDLE</b>						
68/		S(65)	Aluminum	D0SZ 6522642-A		2
<b>22644 INSERT - DOOR INSIDE HANDLE</b>						
72		P(54, 62A)	Front & rear doors	D2DZ 6222644-A		2 or 4
<b>22670 COVER - FRONT DOOR PULL HANDLE RETAINER</b>						
68		F(63B, D, 65B, D, 76B)		C7WY 6522670-B		4
<b>22676 RETAINER - DOOR PULL HANDLE</b>						
68		F(63B, D, 65B, D, 76B)		C7WY 6522676-A		4
68/70		S		C8SZ 6522676-A		4or8
<b>22678 COVER - DOOR PULL HANDLE</b>						
68/70		S		C8SZ 6522678-A		4or8
GROUP NUMBER	YEAR	BODY TYPE	DESCRIPTION	PART NUMBER		QTY.
				RIGHT HAND	LEFT HAND	
<b>22800-1 HINGE ASSY. - FRONT DOOR - UPPER</b>						
<b>- A -</b>						
65/68	A			C5AZ 6222800-C	C5AZ 6222801-C	1
69/71	A			D3AZ 6222800-A	D0AZ 6222800-A	1
72	A	"Before 3/1/72"		D3AZ 6522800-A	D2AZ 6522800-A	1
72	A	"From 3/1/72"		D3AZ 6522800-A	D3AZ 6522800-A	1

**BODY  
SECTION 220**
**FORD CAR PARTS**

GROUP NUMBER	YEAR	BODY TYPE	DESCRIPTION	PART NUMBER		QTY.
				RIGHT HAND	LEFT HAND	
<b>22800-1 HINGE ASSY. - FRONT DOOR - UPPER - continued</b>						
- B -						
	65	B	Reverse pin for left hand	C5OZ 6222800-A	C5OZ 6222800-A	2
	66/69	B		C6OZ 6222800-B	C6OZ 6222801-B	1
	70	B		*D0OZ 6522800-A r/b D1OZ 6522800-A(10-74)	D0OZ 6522801-A	1
	71	B		D1OZ 6522800-A	D1OZ 6522801-A	1
	72	B		D2OZ 6522800-A	D2OZ 6522800-A	2
- F -						
	65/66	F		C5ZZ 6522800-B	C5ZZ 6522801-B	1
	67/68	F		C7ZZ 6522800-C	C7ZZ 6522801-C	1
	69/70	F		D0ZZ 6522800-A	D0ZZ 6522801-A	1
			5/16"-18 x 1 1/8" hex. hd. -Screw & washer	382623-S2(UU52AL)	382623-S2(UU52AL)	4
	71/	F		D1OZ 6522800-A	D1OZ 6522801-A	1
- L -						
	71/	L		D1OZ 6522800-A	D1OZ 6522801-A	1
- P -						
	70/71	P		*D0AZ 6222800-A r/b D2AZ 6522800-A(10-74)	D0AZ 6222800-A	1
	72	P	" Before 3/1/72"	*D2AZ 6522800-A r/b D3AZ 6522800-A(3-75)	D2AZ 6522800-A	1
	72	P	" From 3/1/72"	D3AZ 6522800-A	D3AZ 6522800-A	1
	70	P	5/16"-18 x 1 1/8" Hex. hd. screw & washer	382623-S(UU52AL)	382623-S(UU52AL)	6
- S -						
	65/66	S		C4SZ 6322800-C	C4SZ 6322801-C	1
	67/71	S	NOTE 4	C7SZ 6522800-B	C7SZ 6522810-C	1
	72	S		D2OZ 6522800-A	D2OZ 6522800-A	1
- U -						
	66/	U	Upper & lower-reverse pin for L. H.	C6TZ 9722800-B	C6TZ 9722800-B	1
			5/16"-18 x 3/4" Hex. head bolt	20346-S8(B50)	20346-S8(B50)	12
			5/16" Lockwasher	34806-S7(X64)	34806-S7(X64)	12
- X -						
	65	X		C4DZ 6222800-A	C4DZ 6222801-A	1
	66/70	X		C6OZ 6222800-B	C6OZ 6222801-B	1
	65/ 66/	A, B F, S, X	5/16"-18 x 1 5/8" Hex. hd. screw & washer assy.	359530-S8(BB576)	359530-S8(BB576)	AR
	67	A, B, F, X	"From 11/1/66"	351945-S2(UU52J)	351945-S2(UU52J)	8
	65	F, S, X	3/8"-16 x 1 1/2" Hex. washer hd, tapping screw	379043-S2(BB868)	379043-S2(BB868)	AR
	65	S	3/8"-16 x 1 1/8" Hex. hd. bolt & washer assy.	373162-S(BB563A)	373162-S(BB563A)	AR
<b>22810-1 HINGE and CHECK ASSY. - FRONT DOOR - LOWER</b>						
- A -						
	65/68	A		C5AZ 6222810-D	C5AZ 6222811-D	1
	69/72	A	"Before 12/1/71"	D0AZ 6222810-A	D0AZ 6222810-A	2
	72	A	"From 12/1/71"	D2AZ 6522810-A	D2AZ 6522810-A	2
- B -						
	65	B		C5OZ 6222810-A	C5OZ 6222811-A	1
	66/69	B		C6OZ 6222810-C	C6OZ 6222811-C	1
	70/71	B		D1OZ 6522810-A	D1OZ 6522811-A	1
	72	B		D2OZ 6522810-A	D2OZ 6522810-A	2
- F -						
	65/66	F		C5ZZ 6522810-B	C5ZZ 6522811-B	1
	67	F		*C7ZZ 6522810-B r/b C7ZZ 6522810-C (11-73)	C7ZZ 6522811-C	1
	68	F		C7ZZ 6522810-C	C7ZZ 6522811-C	1
	69/70	F		C9ZZ 6522810-A	C9ZZ 6522811-A	1
	71/	F		D1OZ 6522810-A	D1OZ 6522811-A	1

NOTE 4 - C7SZ 6522800-B includes check



GROUP NUMBER	YEAR	BODY TYPE	DESCRIPTION	PART NUMBER		QTY.
				RIGHT HAND	LEFT HAND	
<b>22810-1 HINGE and CHECK ASSY. - FRONT DOOR - LOWER - continued</b>						
- L -						
	71/	L		D1OZ 6522810-A	D1OZ 6522811-A	1
- P -						
	70/72	P	"Before 12/1/71"	D0AZ 6222810-A	D0AZ 6222810-A	2
	72	P	"From 12/1/71"	D2AZ 6522810-A	D2AZ 6522810-A	2
- S -						
	65	S	Includes check-NOTE 2 3/8"-16 x 1 1/8" Hex. head bolt & washer assy.	C4SZ 6322810-C 373162-S(BB563A)	C4SZ 6322811-C 373162-S(BB563A)	1 16
	66	S	Includes check - NOTE 2	C4SZ 6322810-C	C4SZ 6322811-C	1
	67/71	S		C7SZ 6522810-C	C7SZ 6522800-B	1
	72	S		D2OZ 6522810-A	D2OZ 6522810-A	2
- X -						
	65	X	Includes check	C4DZ 6222810-A	C4DZ 6222811-A	1
	66/70	X	Includes check	C6OZ 6222810-C	C6OZ 6222811-C	1
	65/ 66/	A, B F, S, X	5/16"-18 x 1 5/8" Hex. hd. screw & washer assy.	359530-S8(BB576)	359530-S8(BB576)	AR
	67/	A, B, F, X	"From 11/1/66" 5/16"-18 x 1 1/2" Hex. washer hd, tapping screw	351945-S2(UU52J)	351945-S2(UU52J)	8
	65	F, S, X	3/8"-16 x 1 1/2" Hex. washer head screw & washer assy.	379043-S2(BB866)	379043-S2(BB866)	AR
	66/	S	5/16"-18 x 3/4" Hex. head screw & washer assy.	359662-S7-8(BB575A)	359662-S7-8(BB575A)	16
<b>22822 SPACER - FRONT DOOR HINGE BUSHING</b>						
	69/	A, P		D1AZ 6522822-A	D1AZ 6522822-A	AR
<b>22840 PIN - DOOR HINGE - Refer to Group 43030</b>						
	65/	A, B, F, S, X	Use B9A 5943030-A & cut to fit		★	4or8
	66/67	U	Serviced in assembly only-refer to Group 22800-1			
	68/	U	Use C8AZ 8143030-A & cut to fit		★	4or8
GROUP NUMBER	YEAR	BODY TYPE	DESCRIPTION	PART NUMBER		QTY.
<b>22841 BUSHING - DOOR HINGE</b>						
	65/70	A, B, F, L, P, S, X	Bronze	C3AZ 5422841-A		8or16
	67/	A(76), B(76), F(76)	Folding top			2or4
	71	S				AR
	66/	U	Serviced in assembly only-refer to Group 22800-1			
	71/	A, B, F, L, P		D1AZ 6522841-A		AR
	72	S				AR
<b>229A00 BUSHING - FRONT DOOR VENT WINDOW UPPER PIVOT</b>						
	69/70	A(54, 62, 71)		C9AZ 62229A00-A		2
	70/71	B(54, 62)				2
<b>22916-7 HANDLE - FRONT DOOR VENT WINDOW</b>						
Handle serviced less knob unless otherwise indicated - for knob refer to Group 23352						
- A -						
	65/67	A		C5AZ 6222916-C		2
	68/70	A	Cover (screw)	C8AZ 6223362-A		AR
	68/70	A		C8AZ 6222916-A		2
	69	A	White	C9AZ 6222916-B1W		2
- B -						
	65	B	R. H.	C3OZ 6222916-A		1
			L. H.	C3OZ 6222917-A		1
	66/67	B	R. H.	C6OZ 6222916-A		1
			L. H.	C6OZ 6222917-A		1
	68/69	B(54)	R. H.	C8OZ 5422916-B		1
			L. H.	C8OZ 5422917-B		1

NOTE 2 - Use with 5/16"-18 thread screws

May, 1975

COPYRIGHT © 1975 -

FORD MOTOR  
COMPANY

- DEARBORN, MICHIGAN

**FINAL ISSUE**

GROUP NUMBER	YEAR	BODY TYPE	DESCRIPTION	PART NUMBER	QTY.
<b>22916-7</b>	<b>HANDLE - DOOR VENT WINDOW LOCKING - continued</b>				
Handle serviced less knob unless otherwise indicated - for knob - refer to Group 23352					
- B -					
	68/71	B(71)	R. H.	C8OZ 5422916-B	1
			L. H.	C8OZ 5422917-B	1
	70/71	B(54, 57, 62)	R. H.	D0OZ 5422916-A	1
			L. H.	D0OZ 5422917-A	1
- F -					
	65/66	F	R. H.	C3OZ 6222916-A	1
			L. H.	C3OZ 6222917-A	1
	67	F	R. H.	C6OZ 6222916-A	1
			L. H.	C6OZ 6222917-A	1
	68	F	R. H.	C8OZ 5422916-B	1
			L. H.	C8OZ 5422917-B	1
- S -					
	65/66	S		C4SZ 6322916-A	2
- U -					
	66/67	U	R. H.	C6OZ 6222916-A	1
			L. H.	C6OZ 6222917-A	1
	68/	U	R. H.	C8OZ 5422916-B	1
			L. H.	C8OZ 5422917-B	1
- X -					
	65	X	R. H.	C3OZ 6222916-A	1
			L. H.	C3OZ 6222917-A	1
	66/67	X	R. H.	C6OZ 6222916-A	1
			L. H.	C6OZ 6222917-A	1
	68/70	X	R. H.	C8OZ 5422916-B	1
			L. H.	C8OZ 5422917-B	1
	65/66	A	No. 10-24 x 1/2" Fillister socket head screw	379259-S13(BB817AN)	AR
			No. 10-24 x 15/16" Fillister socket head screw	379293-S13(BB817AM)	AR
	67	A	No. 8-32 x 7/8" Oval head tapping screw	382387-S9(UU59B)	AR
	67/71	A, B, F, U, X	No. 8-32 x 5/8" Oval head tapping screw	381571-S13(UU56BA)	AR
<b>22926</b>	<b>SPRING - FRONT DOOR VENT WINDOW PIVOT</b>				
	65/71	B, F, U, X		B5A 7022926-A	2
	72	U			2
<b>22954-5</b>	<b>BRACKET - FRONT DOOR VENT WINDOW LOWER PIVOT</b>				
	66	B(54, 62, 71), X	R. H. -Includes attaching parts	C6OZ 6222954-A	1
	67	B(54, 62, 66, 71), X			1
	68/70	B(54, 71), X			1
	71	B(71)			1
			L. H.	C6OZ 6222955-A	1
<b>22963</b>	<b>WASHER - FRONT DOOR VENT WINDOW PIVOT FRICTION</b>				
	65/71	B, F, U, X		C2AZ 6222963-A	2
	72	U			2
<b>22980</b>	<b>PLATE - FRONT DOOR VENT WINDOW HANDLE DIVISION BAR SCUFF</b>				
	66/67	U		C6TZ 9722980-A	2
	68/	U		C6TZ 9722980-B	2
<b>22982</b>	<b>WASHER - FRONT DOOR VENT WINDOW HANDLE</b>				
	66/	U		B7A 7022982-A	2
<b>22992</b>	<b>STOP - FRONT DOOR VENT WINDOW PIVOT</b>				
	65	B, X		C2AZ 6222992-A	2
	66/	U			2
	66/67	B, X		C6OZ 6222992-A	2
	68/70	B(71), X			2
	68/69	B(54)			2
	71	B(71)			2
	70	B(54, 62)		C7TZ 8122992-A	2
	71	B(54)			2
	65	B, X	5/16" Washer (flat)-acetal resin-acts as tensioner	375897-S(XX118A)	4

# FORD CAR PARTS

## BODY SECTION 230

1

GROUP NUMBER	YEAR	BODY TYPE	DESCRIPTION	PART NUMBER		QTY.		
				RIGHT HAND	LEFT HAND			
<b>23030 BUMPER - DOOR UPPER - Also refer to Group 265A28</b>								
- A -								
	65/	A	Quarter panel below belt	C2AZ	6223030-A	4 or 8		
	65	A(57)	Also Refer to Group 265A28					
- B -								
	66/67	B		C2AZ	6223030-A	4 or 8		
	68/71	B(71)				2 or 8		
	68/69	B		C7SZ	6523030-A	AR		
	72	B(53, 71)				4		
- F -								
	65/68	F	Door	C2AZ	6223030-A	4 or 8		
- P -								
	70/	P(62)	Door	C2AZ	6223030-A	2		
- S -								
	65/66	S	Door-rear	C4SZ	6323030-A	2		
	67/68	S(65)		C2AZ	6223030-A	2		
	67/71	S(57)	Rear door	C7SZ	6523030-A	2		
	67/71	S	Front door			2		
- X -								
	65	X(63, 76)		C3DZ	7623030-A	2		
	66/67	X		C2AZ	6223030-A	4 or 8		
	68/70	X				2 or 8		
GROUP NUMBER	YEAR	BODY TYPE	DESCRIPTION	PART NUMBER		QTY.		
				RIGHT HAND	LEFT HAND			
<b>23036-7 BUMPER - DOOR - AT BELT</b>								
	67/71	S(57)	Front door	C7SZ	5723036-A	C7SZ	5723037-A	1
			Rear door	C7SZ	5723037-A	C7SZ	5723036-A	1
			No. 8-18 x 3/4" Cross recess pan head screw	376389-S101(UU82D)		376389-S101(UU82D)		4
<b>23136 BRACKET - DOOR WINDOW REAR GUIDE ADJUSTING LOWER</b>								
	70/71	B(57)		D0OZ	5723136-A	D0OZ	5723136-A	2
<b>23200-1 REGULATOR ASSY. - FRONT DOOR WINDOW - MANUAL</b>								
- A -								
	65/68	A(54, 71)		C8AZ	5423200-C	C8AZ	5423201-C	1
	65/68	A(57)		C8AZ	5723200-B	C8AZ	5723201-B	1
	65/67	A(62)		C5AZ	6223200-C	C5AZ	6223201-B	1
	68	A(62)		C8AZ	6223200-B	C8AZ	6223201-B	1
	65/68	A(63, 65, 76)		C8AZ	6323200-B	C8AZ	6323201-B	1
	65/68	A	No. 8-32 x 5/8" Self-tapping-cross recess oval hd. screw	381571-S13(UU56BA)		381571-S13(UU56BA)		1
	69/70	A(54, 71)		C9AZ	5423200-A	C9AZ	5423201-A	1
	69/70	A(57)		C9AZ	5723200-A	C9AZ	5723201-A	1
	69	A(62)		C9AZ	6223200-A	C9AZ	6223201-A	1
	69/70	A(63, 65, 76)	Use w/bonded design	C9AZ	6323200-A	C9AZ	6323201-A	1
	70	A(63, 65, 76)	Use w/bolt on design	D0AZ	6323200-A	D0AZ	6323201-A	1
	71/	A(53, 57)		D1AZ	5723200-A	D1AZ	5723201-A	1
	71/	A(54, 71)		D1AZ	5423200-A	D1AZ	5423201-A	1
	71/	A(65)		D1AZ	6523200-A	D1AZ	6523201-A	1
	71/	A(76)		D0AZ	6323200-A	D0AZ	6323201-A	1
- B -								
	65	B(54, 71)		★C5OZ	5423200-A	C5OZ	5423201-A	1
					Not replaced (6-73)			
	65	B(62)		C5OZ	6223200-A	C5OZ	6223201-A	1
	66/67	B(54, 71)	Includes handle screw	C6OZ	5423200-B	C6OZ	5423201-B	1
	66/67	B(62, 66)	Includes handle screw	C6OZ	6223200-C	C6OZ	6223201-C	1
	66/67	B(63, 76)	Includes handle screw	C6OZ	6323200-C	C6OZ	6323201-C	1
	68/69	B(54)		C8OZ	5423200-B	C8OZ	5423201-B	1
	68/71	B(71)						1

**BODY  
SECTION 230**
**FORD CAR PARTS**

GROUP NUMBER	YEAR	BODY TYPE	DESCRIPTION	PART NUMBER		QTY.
				RIGHT HAND	LEFT HAND	
<b>23200-1</b>	<b>REGULATOR ASSY. - FRONT DOOR WINDOW - MANUAL - continued</b>					
		<b>- B -</b>				
	68	B(63, 65, 66, 76)- "Before 4/18/68"		C8OZ 6323200-A	C8OZ 6323201-B	1
	68/69	B(63, 65, 66, 76)- "From 4/18/68"		C8OZ 6323200-B	C8OZ 6323201-B	1
	70	B(62)		D0OZ 6223200-A	D0OZ 6223201-A	1
	70/71	B(54, 57)		D0OZ 5423200-A	D0OZ 5423201-A	1
	70/71	B(63, 65, 66, 76)		D0OZ 6523200-A	D0OZ 6523201-A	1
	72	B(53, 71)		D2OZ 5323200-A	D2OZ 5323201-A	1
	72	B(63, 65, 97)		D2OZ 6523200-A	D2OZ 6523201-A	1
	66/67	B	5/16"-18 hex.nut	33797-S7(M50)	33797-S7(M50)	2
		<b>- F -</b>				
	67	F	5/16"-18 x 1/2" Hex. washer head screw	C7ZZ 6523200-A 376976-S7-8(BB574M)	C7ZZ 6523201-A 376976-S7-8(BB574M)	1 8
	68	F		C8ZZ 6523200-A	C8ZZ 6523201-A	1
	69/70	F	Use w/bonded design	C9ZZ 6523200-A	C9ZZ 6523201-A	1
	69/70	F	Use with bolt on design	C9ZZ 6523200-B	C9ZZ 6523201-B	1
	71/	F		D1ZZ 6523200-A	D1ZZ 6523201-A	1
		<b>- L -</b>				
	71/	L		D1FZ 6223200-B	D1FZ 6223201-B	1
		<b>- P -</b>				
	70	P(62)		D0DZ 6223200-B	D0DZ 6223201-B	1
	71/	P(54)		D1DZ 5423200-A	D1DZ 5423201-A	1
	71/	P(62)		D1DZ 6223200-A	D1DZ 6223201-A	1
		<b>- S -</b>				
	65/66	S		C4SZ 6323200-B	C4SZ 3323201-B	1
	67	S(65)		★C7SZ 6523200-B Not replaced (3-74)	C7SZ 6523201-B	1
	68/71	S(57)		C8SZ 5723200-B	C8SZ 5723201-B	1
	68/71	S(65)		C8SZ 6523200-B	C8SZ 6523201-B	1
	72	S		D2SZ 6523200-A	D2SZ 6523201-A	1
	65/66	S	Bolt-5/16"-18 x 3/4" hex. head	359662-S7(BB575A)	359662-S7(BB575A)	AR
		<b>- U -</b>				
	66	U		C6TZ 9723200-A	C6TZ 9723201-A	1
	67	U		C7TZ 9723200-A	C7TZ 9723201-A	1
	68/	U		C8TZ 9723200-A	C8TZ 9723201-A	1
	66/67	U	No.12-24 x 1/2" Cross recess pan head screw	50811-S8(U150A)	50811-S8(U150A)	8
	66/	U	Screw-1/4"-20 x 1/2" hex. head	42742-S8(U2A)	42742-S8(U2A)	AR
		<b>- X -</b>				
	65	X(59, 62, 66, 78)		C0DZ 6423200-B	C0DZ 6423201-B	1
	65	X(54, 71)		C3DZ 5423200-B	C3DZ 5423201-B	1
	66	X(54, 71)		C6OZ 5423200-A	C6OZ 5423201-A	1
	67	X(54, 71)	Includes handle screw	C6OZ 5423200-B	C6OZ 5423201-B	1
	66	X(62, 66)		C6OZ 6223200-C	C6OZ 6223201-C	1
	67	X(62)				1
	68/70	X(54, 71)		C8OZ 5423200-B	C8OZ 5423201-B	1
	68/70	X(62)		C8DZ 6223200-B	C8DZ 6223201-B	1
	65/67	A, B, S, X	5/16"-18 x 1/2" Hex. washer head screw	376976-S7-8(BB574M)	376976-S7-8(BB574M)	8
	67/	S	1/4"-20 x 1/2" Pan head screw & washer assy.	373460-S7(BB629)	373460-S7(BB629)	8
			1/4"-20 x 1" Hex. head screw & washer assy.	★376775-S2	★376775-S2	2
			1/4" Internal & external tooth lockwasher	351274-S7(XX298)	351274-S7(XX298)	2
			.45" I.D. Spring washer	★353383-S2	★353383-S2	2
			1/4"-20 Hex. nut	33795-S7(M49)	33795-S7(M49)	2
			1/4"-20 Hex. nut	34055-S8(M158)	34055-S8(M158)	2

# FORD CAR PARTS

## BODY SECTION 230

3

GROUP NUMBER	YEAR	BODY TYPE	DESCRIPTION	PART NUMBER		QTY.
				RIGHT HAND	LEFT HAND	
<b>23202-3 REGULATOR ASSY. - FRONT DOOR WINDOW - MANUAL - LESS ARMS</b>						
- B -						
	65	B(65)		C3OZ 6523202-B	C3OZ 6523203-B	1
	65	B	Retainer	357550-S(QQ1)	357550-S(QQ1)	2
	65	B	Screw-5/16"-24 x 5/8" hex head	359605-S8(BB590)	359605-S8(BB590)	AR
- F -						
	65	F	"Before 3/8/65"	C5ZZ 6523202-A	C5ZZ 6523203-A	1
	65/66	F	"From 3/8/65"	C5ZZ 6523202-B	C5ZZ 6523203-B	1
- X -						
	65	X(63, 76)		C3DZ 7623202-B	C3DZ 7623203-B	1
	65	A, B(65), F, X(63, 76)	5/16"-18 x 1/2" Hex. washer head screw	376976-S7-8(BB574M)	376976-S7-8(BB574M)	8
	66	F				8
	65	B(65), X(63, 76)	Retainer (stud)	74274-S(R3)	74274-S(R3)	2
	65/66	F				2
<b>23208-9 REGULATOR ASSY. - FRONT DOOR WINDOW - ELECTRIC - LESS MOTOR and DRIVE</b>						
- A -						
	65/68	A(54, 57, 71)		C5AZ 5423208-B	*C5AZ 5423209-B Not replaced (12/74)	1
	65/66	A(62, 63, 76) "Before 8/16/65"		C5AZ 6223208-B	C5AZ 6223209-A	1
	66/68	A(63, 76) "From 8/16/65"		C5AZ 6223208-B	C5AZ 6223209-B	1
	69/70	A(54, 71)		C9AZ 5423208-A	C9AZ 5423209-A	1
	69/70	A(57)		C9AZ 5723208-A	C9AZ 5723209-A	1
	69/70	A(63, 65, 76) - "Before 1/5/70"	Bonded design	C9AZ 6323208-A	C9AZ 6323209-A	1
	70	A(63, 65, 76) - "From 1/5/70"	Bolt-on design	D0AZ 6323208-A	D0AZ 6323209-A	1
	71/	A(53, 57)		D1VY 5323208-A	D1VY 5323209-A	1
	71/	A(54, 71)		D1AZ 5423208-A	D1AZ 5423209-A	1
	71/	A(65, 76)		D0AZ 6323208-A	D0AZ 6323209-A	1
	65/68	A	Screw No.12-24 x 1/2" hex.head	378608-S8(UU52D)	378608-S8(UU52D)	2
- B -						
	68/69	B(54, 71)		C8OZ 5423208-A	C8OZ 5423209-A	1
	68/69	B(63, 65, 76)		C8OZ 6323208-B	C8OZ 6323209-B	1
	70/71	B(54, 57)		D0OZ 5423208-A	D0OZ 5423209-A	1
	70/71	B(63, 65, 66, 76)		D0OZ 6523208-A	D0OZ 6523209-A	1
	70/71	B(71)		C8OZ 5423208-A	C8OZ 5423209-A	1
	72	B(53, 71)		D2OZ 5323208-A	D2OZ 5323209-A	1
	72	B(63, 65) "Before 4/1/72"		D2OZ 6523208-B	D2OZ 6523209-B	1
	72	B(63, 65) "From 4/1/72"		D3OZ 6523208-A	D3OZ 6523209-A	1
- F -						
	71/	F		D1ZZ 6523208-B	D1ZZ 6523209-B	1
- S -						
	65/66	S		C5SZ 6323208-A	C5SZ 6323209-A	1
	67/71	S(57)		C8SZ 5723208-B	C8SZ 5723209-B	1
	67/71	S(65)		C7SZ 6523208-C	C7SZ 6523209-C	1
	72	S "Before 4/1/72"		D2OZ 6523208-B	D2OZ 6523209-B	1
	72	S "From 4/1/72"		D3OZ 6523208-A	D3OZ 6523209-A	1
	65/66	A, S	5/16"-18 x 1/2" Hex. washer head screw	376976-S7-8(BB574M)	376976-S7-8(BB574M)	8
	67/	S	Bolt-1/4"-20 x 1/2" pan head	373460-S7(BB629)	373460-S7(BB629)	2

GROUP NUMBER	YEAR	BODY TYPE	DESCRIPTION	PART NUMBER	QTY.
<b>23222 RETAINER - FRONT DOOR WINDOW GUIDE</b>					
	68/69	B(except 54, 71)		C8OZ 6323222-A	2
			Bolt-1/4"-20 x 3/4" hex.head	371492-S2(BB569)	2
<b>23227 SPACER - FRONT DOOR WINDOW REGULATOR HANDLE</b>					
	69/70	F(63A, 65A, C, 76A)		C7TZ 8123227-A	2
	71	F(63D, 65D, 76)			2
<b>23230-1 BRACKET - WINDOW REGULATOR EQUALIZER ARM</b>					
- A -					
	65/67	A		C5AZ 6223230-A	2
	68	A(54, 57, 62, 71)			2
	68	A(63, 65)	Quarter window	C7VY 5323230-A	2
	69/70	A(54, 71)		C9AZ 5423230-A	2
	69	A(62)	Front door & rear door	C8OZ 5423230-A	2
	69	A(63)			2
	71	A(54, 71)	R. H.	D1AZ 5423230-A	1
			L. H.	D1AZ 5423231-A	1
	72	A(54, 71)	R. H.	D2AZ 5423230-A	1
			L. H.	D2AZ 5423231-A	1
- B -					
	66	B(62, 63, 76)		C5AZ 6223230-A	2
	67	B(62, 63, 66, 76)			2
	68/69	B(54, 71)	Front & rear door with or without power windows	C8OZ 5423230-A	4
	70	B(62, 71)			2
	71	B(71)			2
	70/71	B(54, 57)		D0OZ 5423230-A	2
	68/71	B	Bolt-1/4"-20 x 1/2" pan head	373460-S7(BB629)	2
- F -					
	67/68	F		C5AZ 6223230-A	2
	65/66	F	Washer-5/16"	★357789-S7	2
	65/66	F	Nut-5/16"-18 hex.	33797-S7(M50)	2
- L -					
	71/			D1FZ 6223230-A	2
- X -					
	66	X(62, 66)		C5AZ 6223230-A	2
	67/68	X(62)			2
	65/66	A, F, S	Washer-5/16"	★357789-S7	4
	66/67	A, B, F, S, X	Screw & washer assy.-hex.hd.-5/16"-18 x 1/2"	376976-S7-8(BB574M)	4
	65/67	A, B, F, S, X	Nut-hex.-5/16"-18	33797-S7(M50)	4
<b>23234-5 ARM and PLATE ASSY. - FRONT DOOR WINDOW REGULATOR</b>					
	65	B(65), F, X(63, 76)	R. H. - manual	C5ZZ 6523234-A	1
	66	F	L. H.	C5ZZ 6523235-A	1
			Screw & washer assy.-hex.hd.-5/16"-18 x 1/2"	376976-S7-8(BB574M)	4
<b>23240 ROLLER WINDOW REGULATOR ARM - Also refer to Group 262A32</b>					
	65/70	A(71)	Tailgate	C0AB 6423240-B	2
	65	B	Front door		4 or 8
	65/66	F			6 or 10
	67/68	F(65, 76)	Quarter window		4
	65/66	S			10
	66/	U			2
	65	X			2 to 10
	65	X(59, 71)	Tailgate window		2

# FORD CAR PARTS

## BODY SECTION 230

5

GROUP NUMBER	YEAR	BODY TYPE	DESCRIPTION	PART NUMBER	QTY.
<b>23240 ROLLER WINDOW REGULATOR ARM - continued</b>					
	65	B(65)	Quarter window	C3OZ 6523240-B	2
	66/70	X(71)	Tailgate	C6OZ 7123240-A	2
	66/71	B(71)	Tailgate		2
	72	B	Doors, quarter and tailgate	D2OZ 5323240-A	AR
	72	S	Front door		AR
	65	B	Screw-hex.hd.-5/16"-24 x 5/8"	359605-S8(BB590)	AR
	65/66	F	Spring retainer	74274-S(R3)	2
<b>23242 PIVOT - DOOR WINDOW REGULATOR TO INNER PANEL - INCLUDES ATTACHING PARTS</b>					
	68	S		C8SZ 6523242-A	2or4
<b>23258 BUSHING - DOOR WINDOW GLASS BRACKET</b>					
	70/	A	Use w/bolt-on design	D0ZZ 6523258-A	AR
	70/	B(63, 65, 66, 76)			AR
	70/71	B(57)			AR
	71	B(54)			AR
	69/	F			AR
<b>23274 PIVOT - DOOR WINDOW REGULATOR ARM TO GLASS CHANNEL - INCLUDES ATTACHING PARTS</b>					
	67	S		C7SZ 6523274-A	2or4
	68/69	B(63, 65, 66, 76)		C8SZ 6523274-A	2or4
	68/	A(53, 57, 63, 65, 76)			2or4
	69/71	F, S			2or4
<b>23288 BRACKET - FRONT DOOR WINDOW CHANNEL</b>					
- A -					
	65/68	A(54, 71)		C5AZ 5423288-A	2
	65/68	A(57)		C5AZ 5723288-A	2
	65/67	A(63, 76)		C5AZ 6323288-A	2
	68	A(63, 65, 76)			2
	69	A(54, 71)		C9AZ 5423288-A	2
	69	A(62)		C9AZ 6223288-A	2
	70	A(54, 71)		C9AZ 5423288-A	2
	70/	A(63, 65, 76)	R. H. -use with bolt-on channel	D0AZ 6323288-F	1
			L. H.	D0AZ 6323288-F	1
	71/	A(53, 57)	R. H.	D1AZ 5723288-A	1
			L. H.	D1AZ 5723288-B	1
	65/	A(54, 57, 62, 63, 71)	Screw-flat hd.-No.8-32 x 3/8"	358477-S8(BB93)	4 or 6
	67/68	A	Screw-oval hd.-No.8-32 x 1/2"	50398-S13(U121)	6
- B -					
	68/71	B(54, 71)	Power windows	C6GY 5423288-A	2
	66	B(62)		C6OZ 6223288-A	2
	67	B(62, 66)			2
	68	B(66)			2
	70/71	B(54, 57)	Traverse channel-16 13/16" long	D0OZ 5423288-A	2
	70	B(57) "Before 12/1/69"	R. H.	D0OZ 5723288-A	1
			L. H.	D0OZ 5723288-B	1
	70/71	B(57) "From 12/1/69"	R. H.	D0OZ 5723288-C	1
			L. H.	D0OZ 5723288-D	1
	70	B(62)		D0OZ 6223288-A	2
	70	B(63, 65, 66, 76) - "Before 12/1/69"	R. H.	D0OZ 6523288-A	1
			L. H.	D0OZ 6523288-B	1
	70/71	B(63, 65, 66, 76) - "From 12/1/69"	R. H.	D0OZ 6523288-C	1
			L. H.	D0OZ 6523288-D	1
	72	B(53, 71) "Before 10/1/71"	R. H.	D2OZ 5323288-A	1
			L. H.	D2OZ 5323288-B	1
	72	B(53, 71) "From 10/1/71"	R. H.	D2OZ 5323288-C	1 1
			L. H.	D2OZ 5323288-D	1 1
	72	B(63, 65, 97)	R. H.	D2OZ 6523288-A	1
			L. H.	D2OZ 6523288-B	1

**BODY  
SECTION 230**
**FORD CAR PARTS**

GROUP NUMBER	YEAR	BODY TYPE	DESCRIPTION	PART NUMBER	QTY.	
<b>23288</b>	<b>BRACKET - FRONT DOOR WINDOW CHANNEL - continued</b>					
- F -						
	67/68	F		C7ZZ 6523288-A	2	
			Screw-cross recess oval hd.-No.8-32 x 1/2"	50398-S13(U121)	6	
			Nut-spring-No.8-32	379385-S2(MM284C)	6	
	69/70	F	Use with bonded glass channel	C9ZZ 6523288-A	2	
	69/70	F	R. H. - use with bolt-on channel	D0ZZ 6523288-A	1	
			L. H.	D0ZZ 6523288-B	1	
	71	F	"Before 8/19/70"	R. H.	D1ZZ 6523288-C	1
				L. H.	D1ZZ 6523288-D	1
	71/	F	"From 8/19/70"	R. H.	D1ZZ 6523288-E	1
				L. H.	D1ZZ 6523288-F	1
- P -						
	70/	P(62)		D0DZ 6223288-B	2	
	71	P(54)	"Before 6/14/71"	D1DZ 5423288-A	2	
	71/	P(54)	"From 6/14/71"	D2DZ 5423288-A	2	
- S -						
	72	S	R. H.	D2SZ 6523288-A	1	
			L. H.	D2SZ 6523288-B	1	
- X -						
	66/70	X(62, 66)		C6OZ 6223288-A	2	
	67/68	B, X	Screw-oval head-No.8-32 x 1/2"	50398-S13(U121)	6	
	70	A(63, 65, 76), B(57, 63, 65, 66, 76), F	Screw & washer assy.-hex. head-1/4"-20 x 49/64"	57472-S40(B339V)	2	
<b>23296</b>	<b>BRACKET - FRONT DOOR WINDOW GLASS CHANNEL - REAR</b>					
	66	B(62), X(62, 66)		C6OZ 6223296-A	2	
	67	B(62, 66), X(62)			2	
	68/70	X(62)			2	
	66/67	B(63, 76)		C6OZ 6323296-A	2	
	66/70	X	Screw-No.8-32 x 1/2" Oval head	50398-S13(U121)	4	
<b>23312-3</b>	<b>BRACKET - DOOR WINDOW REGULATOR MOTOR MOUNTING</b>					
- A -						
	69	A(54, 57, 71)	R. H.	C9AZ 5423312-A	1	
			L. H.	C9AZ 5423313-A	1	
	70/71	A	Front door	D0AZ 5423312-A	2	
	71	A(53, 54, 57, 71)	Rear door	C9AZ 5423312-A	2	
	72	A	Improvise	★		
- B -						
	68/69	B(54, 71)	R. H.	C6GY 5423312-B	1	
			L. H.	C6GY 5423313-B	1	
	68/69	B(63, 65, 76)		C8OZ 6323312-A	2	
			Locknut hex. -No. 10-24	55731-S2(M96E)	2	
			Screw & washer assy. -hex. head-No. 10-24 x 1"	380600-S2(BB541L)	2	
	70	B(63, 65, 66, 76)		C9WY 6523312-A	2	
	70	B(71)	R. H.	C6GY 5423312-B	1	
			L. H.	C6GY 5423313-B	1	
	72	B	Improvise	★		
- F -						
	71/	F	R. H.	D1ZZ 6523312-A	1	
			L. H.	D1ZZ 6523313-A	1	
- S -						
	72	S	Improvise	★		
	69	A(54, 62, 71)	Nut & washer-No. 10-24	34655-S8(M107)	1	
	69	A	Washer No.10-1/2" flat	44713-S8(X13)	AR	
	69	A	Washer-3/8" flat	44727-S8(X24)	AR	
	69/	A	Screw-No.8-32 x 3/4" washer hd.	57077-S2(B330B)	1	
<b>23314</b>	<b>ANTI - RATTLE - FRONT DOOR WINDOW GLASS</b>					
	72	B(63, 65, 97)		D2OZ 6523314-A	2	



# FORD CAR PARTS

## BODY SECTION 230

7

GROUP NUMBER	YEAR	BODY TYPE	DESCRIPTION	PART NUMBER	QTY.
<b>23318 SPRING - WINDOW REGULATOR - COUNTER BALANCE</b>					
- A -					
	65/	A(54, 57, 71)	Rear door-Refer to Group 27048		
	65/68	A(62)		C5AZ 6223318-A	2
	68	A(62, 63, 65, 76)	With manual regulator		2
	69/70	A(54, 71)	With manual regulator	C9AZ 5423318-A	2
	69/70	A(63, 65, 76)	Quarter		2
	69/70	A(54, 71)	With power regulator	C9AZ 5423318-B	2
	69/70	A(57)	With manual regulator	C9AZ 5723318-A	2
	69/70	A(57)	With power regulator	C9AZ 5723318-B	2
	69	A(62)	With manual regulator	C9AZ 6223318-A	2
	69/70	A(63, 65, 76)	With power or manual regulator	C9AZ 6323318-A	2
	69/70	A(71)	Tail gate	C9WY 6523318-A	2
	71/	A(65)	Quarter-with power regulator	C9AZ 5423318-A	2
	71/	A(54, 71)	With manual regulator		2
	71/	A(76)	Quarter-with manual regulator		2
	71/	A(54, 71)	With power regulator	C9AZ 5423318-B	2
	71/	A(53, 57)	With manual regulator	D1AZ 5723318-A	2
	71/	A(53, 57)	With power regulator	D1AZ 5723318-B	2
	71	A(65)		D1AZ 6523318-A	2
	72	A(65, 76)	With manual regulator		2
	71	A(76)		C9AZ 6323318-A	2
	72	A(65, 76)	With power regulator		2
	71/	A(71)	Tailgate	C9WY 6523318-A	1
- B -					
	66	B(63, 65, 76)		C5AZ 6323318-B	2
	68/71	B(63, 65, 66, 76)	With power regulator	C8OZ 6323318-A	2
	68/71	B(63, 65, 66, 76)	With manual regulator	C8CZ 6323318-B	2
	70	B(62)	With manual regulator	D0OZ 6223318-A	2
	70/71	B(54, 57)	With manual regulator	D0OZ 5423318-A	2
	70/71	B(54, 57)	With power regulator	D0OZ 5423318-B	2
	72	B(53, 71)		D2OZ 5323318-A	2
	72	B(71)	Tailgate	C9WY 6523318-A	1
	72	B(63, 65, 97)	With manual regulator	D2OZ 6523318-A	2
	72	B(63, 65, 97)	With power regulator	D2OZ 6523318-B	2
- F -					
	65/66	F		C5AZ 6323318-B	2
	69/70	F		C9AZ 6323318-A	2
	71/	F		D0OZ 6223318-A	2
- L -					
	71/	L		D1FZ 6223318-A	2
- P -					
	70/	P(62)		D0DZ 6223318-A	2
- S -					
	65/66	S		C3SZ 6323318-A	2
	67/71	S(57)		C7SZ 5723318-A	2
	67/71	S(65)		C7SZ 6523318-A	2
	72	S	With manual regulator	D2SZ 6523318-A	2
	72	S	With power regulator	D2OZ 6523318-B	2
- X -					
	66	X(54, 71)		C5AZ 6323318-B	2
	65/68	A	Screw-No. 12-24 x 1/2" hex. head	378608-S8(UU52D)	2
<b>23342 HANDLE - WINDOW REGULATOR</b>					
- A -					
	65/67	A(54, 57, 63, 71, 76)	Front door-incl. chrome knob	C5AZ 5423342-C	2
	65/67	A(54, 57, 71)	Rear door		2
	65/67	A(63, 76)	Quarter		2
	65/67	A(63C, 76)	Quarter - Refer to Group 30322		

GROUP NUMBER	YEAR	BODY TYPE	DESCRIPTION	PART NUMBER	QTY.
<b>23342 HANDLE - WINDOW REGULATOR - continued</b>					
- A -					
65/67		A(54B, E, 62B, E, 71B, C, D)	Front door-incl. black knob	C5AZ 6223342-C	2
65/67		A(54B, E, 71B, C, D)	Rear door		2
65/67		A(62B, E)	Quarter		2
68/69		A		C8AZ 6223342-A	2or4
68/69		A	Incl. aqua knob	C8SZ 6523342-B1K	2or4
			Incl. parchment knob	C8AZ 6223342-B1U	2or4
			Incl. red knob-r/b details-refer to groups 23352 (knob) and 30322 (handle)	★C8AZ 6223342-B1D	2or4
			Incl. white knob-r/b details-refer to groups 23352 (knob) and 30322 (handle)	★C9AZ 6223342-B1W	2
			Screw-No. 8-32 x 5/8" oval head	381571-S(UU56BA)	1
70		A(76)	Door - Refer to Group 30322		
70/72		A(exc. 76) "Before 10/1/71"	Less knob	C9UZ 8223342-A	2or4
71/72		A(76) "Before 10/1/71"	Door		2
71/		A(76)	Quarter - Refer to Group 30322		
72		A(exc. 76) "From 10/1/71"	Front and rear door or quarter -incl. clear plastic knob	D2OZ 6523342-A	2 or 4
72		A(76) "From 10/1/71"	Door		2
- B -					
65		B	Front door -incl. black knob	C4DZ 6223342-A	2
65		B(54, 71)	Rear door		2
66/67		B	Front door	C6OZ 6223342-B	2
66/67		B(54, 71)	Rear door		2
66/67		B(62, 63)	Quarter		2
68/69		B		C8AZ 6223342-A	2 or 4
68/69		B	Incl. aqua knob-r/b details-refer to groups 23352 (knob) and 30322 (handle)	★C8SZ 6523342-B1K	2 or 4
			Incl. red knob	C8AZ 6223342-B1D	2 or 4
			Incl. parchment knob	C8AZ 6223342-B1U	2 or 4
69		B	Incl. white knob	C9AZ 6223342-B1W	2
70/71		B	Front, rear and quarters refer to Group 30322		
72		B	Front and rear door - includes clear plastic knob	D2OZ 6523342-A	2or4
72		B	Quarter - Refer to Group 30322		
- F -					
65		F "Before 3/8/65"	Incl. chrome knob	C4SZ 6323342-A	2
65/67		F "From 3/8/65"	Incl. chrome knob	C5ZZ 6523342-C	2
68		F	Refer to Group 30322		
69		F(63A, C, 65A, C, 76A)- without Stereo	Incl. red knob	C8AZ 6223342-B1D	2or4
			Incl. white knob	C9AZ 6223342-B1W	2 or 4
69		F(63A, C, 65A, C, 76A)- without Stereo- "Before 12/2/68"	Less knob	C8AZ 6223342-A	2 or 4
69		F(63B, C, D, 65B, E, 76B)- with or without Stereo- "From 12/2/68"	Less knob	C9UZ 8223342-A	2or4
69		F-with Stereo			2 or 4
70/72		F "Before 10/1/71"	Less knob	C9UZ 8223342-A	2
72		F "From 10/1/71"	Door-incl. clear plastic knob	D2OZ 6523342-A	2
70/		F	Quarter - Refer to Group 30322		
- L -					
72		L "From 4/3/72"	Incl. clear plastic knob	D2FZ 6223342-A	2
71/72		L "Before 4/3/72"	Refer to group 30322		
- P -					
70		P "Before 7/21/69"	Less knob	C8AZ 6223342-A	2
70/72		P(62) "From 7/21/69" to 10/1/71"	Less knob	C9UZ 8223342-A	2
72		P(62) "From 10/1/71"	Door-incl. clear plastic knob	D2OZ 6523342-A	2
71/		P(54)	Refer to group 30322		



23352 KNOB - WINDOW REGULATOR HANDLE - INCLUDES ATTACHING PARTS - continued

BODY TYPE	R/L	PART NUMBER LESS SUFFIX	COLORS and APPLICABLE PART NUMBER SUFFIXES													QTY
			AQUA	BLACK	BLUE	GINGER	GREEN	GREY GOLD	IVY GOLD	NUGGET GOLD	PARCH- MENT	RED	SADDLE	TO- BACCO	VER- MILLION	
<b>1971/</b>																
A, B, F, L, P, S, U - "Before 2/1/71"		D0AZ 6223352													AR	
		D1MY 6523352													AR	
		D1AZ 6523352		C		G	H	J					A		D	AR
		D1OZ 6523352														AR
		D1SZ 6523352			B		C							A		AR
A, B, F, L, P, S, U - "From 2/1/71 to 10/1/71"		D1AZ 6523352		C	E	G	H	J				F			D	AR
		D1OZ 6523352														AR
		D1SZ 6523352			B		C							A		AR
		D1MY 6523352												A		AR
		D1MY 6523352												A		AR
A, B, F, L, P, S			Clear plastic knob-serviced only in assy. - refer to group 23342													

GROUP NUMBER	YEAR	BODY TYPE	DESCRIPTION	PART NUMBER	QTY.
<b>23362 COVER - WINDOW REGULATOR HANDLE SCREW</b>					
67		A(54A, C, 57, 63, 71A, E, 76)	Bright	C7AZ 6223362-A	AR
68/		A, B, F, L, P, S, U, X	Aluminum	C8AZ 6223362-A	AR
<b>23370 PLATE - WINDOW REGULATOR HANDLE</b>					
- A -					
65/67	A		Front Door-Nylon	C5AZ 6223370-A	2or4
65/67	A(54, 57, 71)		Rear Door		2or4
65/67	A(62, 63, 76)		Quarter		2
68/70	A		Nylon-3/4" I.D. x 1 9/16" O.D.	C8AZ 6223370-A	AR
70/	A		Bright finish-3/4" I.D. x 1 13/16" O.D. -3/8" thick	C9ZZ 6523370-A	AR
- B -					
66/67	B		Front door	C5AZ 6223370-A	4
66/67	B(54, 71)		Rear door		4
66/67	B(62, 63, 76)		Quarter		2
68/71	B		Nylon -3/4" I.D. x 1 9/16" O.D.	C8AZ 6223370-A	AR
70/71	B		Bright finish-3/4" I.D. x 1 13/16" O.D. -3/8" thick	C9ZZ 6523370-A	AR
72	B			D1DZ 6223370-A	2or4
- F -					
65	F	"Before 3/8/65"	Door	C3AZ 6223370-A	4
65/67	F	"From 3/8/65"	Door	C5AZ 6223370-A	2or4
65/67	F		Quarter	C4SZ 6323370-A	2
68/	F		Nylon -3/4" I.D. x 1 9/16" O.D.	C8AZ 6223370-A	2to6
69/	F		Bright finish-3/4" I.D. x 1 13/16" O.D. -3/8" thick	C9ZZ 6523370-A	2
- L -					
71/72	L	"Before 4/3/72"	1 5/8" O.D.	D1DZ 6223370-A	2or4
72	L	"From 4/3/72"	1 3/4" O.D.	D2FZ 6223370-A	2or4
- P -					
70	P		Nylon-3/4" I.D. x 1 9/16" O.D.	C8AZ 6223370-A	2or4
70	P		Bright finish-3/4" I.D. x 1 13/16" O.D. -3/8" thick	C9ZZ 6523370-A	2
71/	P			D1DZ 6223370-A	2or4
- S -					
65/66	S		Vent and door window regulator handle	C3AZ 6223370-A	4
65/66	S		Quarter	C4SZ 6323370-A	2
67	S(65)		Quarter		2
67	S		Front door	C5AZ 6223370-A	2
67	S(57)		Rear door		2
68/70	S		Nylon-3/4" I.D. x 1 9/16" O.D.	C8AZ 6223370-A	4
71/	S		Bright finish-3/4" I.D. x 1 13/16" O.D. -3/8" thick	C9ZZ 6523370-A	4

\* Exc. Thunderbird

• Thunderbird

■ R/b D1AZ 6523352-E (10/74)

# R/b D1AZ 6523352-F (12/74)

# FORD CAR PARTS

**BODY  
SECTION 230**

11

GROUP NUMBER	YEAR	BODY TYPE	DESCRIPTION	PART NUMBER	QTY.	
<b>23370 PLATE - WINDOW REGULATOR HANDLE - continued</b>						
- U -						
	67	U	Front door	C5AZ 6223370-A	2	
	68/	U		C8AZ 6223370-A	2to6	
- X -						
	65	X	Front door	C3AZ 6223370-A	4	
	65	X(54, 71)	Rear door		4	
	65	X(62, 63, 76)	Quarter		2	
	66/67	X	Front door	C5AZ 6223370-A	4	
	66/67	X(54, 71)	Rear door		4	
	66/67	X(62, 76)	Quarter		2	
	68/70	X	Nylon	C8AZ 6223370-A	2to6	
<b>23394-5 DRIVE ASSY. - WINDOW REGULATOR - ELECTRIC</b>						
- A -						
	65/68	A(71)	Tailgate - Refer to Group 40964			
	69/70	A(71)	"Before 3/16/70"	Tailgate-w/9 tooth drive gear	D0AZ 5723394-A	1
		A(71)	"From 3/16/70"	Tailgate-w/7 tooth drive gear	D0OZ 7123394-A	1
	65/	A	R. H. -front, rear doors and quarter	D0AZ 5723394-A	1	
			L. H. -front, rear doors and quarter	D0AZ 5723395-A	1	
	71/	A(71)	Tailgate-w/o wash and wipe system	D0OZ 7123394-A	1	
			Tailgate-w/wash and wipe system	D1AZ 7123394-A	1	
	65/68	A	Nut-No.10-24 lock	55731-S2(M96E)	4	
	65/68	A	Washer No.10-1/2" flat	44713-S8(X13)	AR	
	65/68	A	Washer-3/8" flat	44727-S8(X24)	1	
	65/68	A	Screw-No.10-24 x 1" round head	53866-S7(U169A)	2	
	69	A	Screw-No.8-32 x 3/4" washer head	57077-S2(B330B)	AR	
- B -						
	65	B(71)	Tailgate	C1AZ 5723394-B	1	
		B	For regulator drive gear kit - Refer to Group 234A24			
	66/67	B(71)	Tailgate - Refer to Group 40964			
		B	For regulator drive gear kit - Refer to Group 234A24			
	68/69	B(76)	R.H.-quarter	C6GY 7623394-A	1	
			L. H.	C6GY 7623395-A	1	
		B(71)	Tailgate - Refer to Group 40964			
	68/69	B	For regulator drive gear kit - Refer to Group 234A24			
	68/70	B	R.H.-front and rear doors	D0AZ 5723394-A	1or2	
	70	B	R.H.-quarter		1	
	68/70	B	L.H.-front and rear doors	D0AZ 5723395-A	1or3	
	70	B	L.H.-quarter		1	
	70	B(71)	"Before 3/16/70"	Tailgate-w/9 tooth drive gear	D0AZ 5723394-A	1
		B(71)	"From 3/16/70"	Tailgate-w/7 tooth drive gear	D0OZ 7123394-A	1
	71	B	R. H. -front, rear door and quarter	D0AZ 5723394-A	1	
			L. H.	D0AZ 5723395-A	1	
			Tailgate	D0OZ 7123394-A	1	
	72	B(53, 71)	R. H. -front door	D2OZ 5323394-A	1or2	
		B(65)	R. H. -quarter		1or2	
			L. H.	D2OZ 5323395-A	1or2	
		B(63, 65)	R. H. -front door	D0AZ 5723394-A	1or2	
		B(53, 71)	R. H.-rear door		1or2	
		B(63)	R. H. -quarter		1or2	
			L. H.	D0AZ 5723395-A	1or2	
		B(71)	Tailgate	D0OZ 7123394-A	1	
	68/71	B	Screw-No.8-32 x 5/8" oval head	381571-S13(UU56BA)	2	
	68/71	B	Bolt-1/4"-20 x 1/2" pan head	373460-S7(BB629)	2	
- F -						
	71/	F	R. H. -front door	D0AZ 5723394-A	1	
			L. H.	D0AZ 5723395-A	1	

**BODY  
SECTION 230**
**FORD CAR PARTS**

GROUP NUMBER	YEAR	BODY TYPE	DESCRIPTION	PART NUMBER	QTY.
<b>23394-5 DRIVE ASSY. - WINDOW REGULATOR - ELECTRIC - continued</b>					
- S -					
65/66	S		Quarter - Refer to Group 30304		
	S		R. H. -front door	C5SZ 6323394-A	1
	S		L. H.	C5SZ 6323395-A	1
	S		For regulator drive gear kit - Refer to Group 234A24		
67/69	S(65)		Quarter - Refer to Group 30380-1		
67/71	S		R. H. -front and rear doors	D0AZ 5723395-A	1or2
	S		L. H. -quarter		1
67/71	S		L. H. -front and rear doors	D0AZ 5723394-A	1or2
	S		R. H. -quarter		1
72	S		R.H. - door	D0AZ 5723394-A	1
	S		L.H. - quarter		1
72	S		L.H. - door	D0AZ 5723395-A	1
	S		R.H. - quarter		1
65/	S		Washer-3/8" flat	44727-S8(X24)	1
- X -					
65	X(59, 71, 78)		Tail gate	C1AZ 5723394-B	1
65/70	X		For regulator drive gear kit - Refer to Group 234A24		
66/70	X(71)		Tail gate- Refer to Group 40964		
69	A(54, 62, 71)		Screw-No. 8-32 x 3/4" washer head	57077-S2(B330B)	1
67/71	B, S		No.10-24 nut	34053-S8(M156)	AR
67/71	B, S		No.10-lockwasher	34903-S8(X96)	4
<b>23402-3 REGULATOR ASSY. - FRONT DOOR VENT WINDOW</b>					
65/68	A		R. H.	C8AZ 6223402-A	1
	A		L. H.	C8AZ 6223403-A	1
69/71	A(54, 62, 71)		R. H. -Manual	C9AZ 6223402-A	1
	A		L. H.	C9AZ 6223403-A	1
65/66	S		R. H.	C4SZ 6323402-B	1
	S		L. H.	C4SZ 6323403-B	1
65/66	A, S		5/16"-18 x 1/2" Hex. washer head screw	376976-S7-8(BB574M)	4
69/71	A(54, 62, 71)		Screw-No. 8-32 x 5/8" oval head	381571-S13(UU56BA)	1
65/68	A		Bolt-1/4"-20 x 7/8" hex. head	370519-S(BB125)	AR
65/68	A		Screw-No. 10-20 x 15/16" socket head	379293-S(BB817AM)	AR
65/66	S		Washer-1/4" lock	34805-S8(X62)	2
65/66	S		Bolt-1/4"-20 x 3/4" hex. head	20344-S8(B42)	2
<b>23406-7 MOTOR and COVER ASSY. - FRONT DOOR VENT WINDOW REGULATOR GEAR - ELECTRIC</b>					
65/66	S		R. H.	C3VY 5723406-C	1
	S		L. H.	C3VY 5723407-C	1
<b>234A18 SPACER - DOOR WINDOW REGULATOR MOTOR BRACKET</b>					
65/66	S		1. 20" long	C5SZ 63234A18-A	2
65/68	A		Cut . 30" from large end		AR
<b>234A24 GEAR KIT - WINDOW REGULATOR DRIVE</b>					
- A -					
65/69	A(71)		Tailgate	C9AZ 62234A24-B	1
65/70	A(71)		Door and quarter	D0AZ 62234A24-B	2or4
	A(71)		Tailgate w/9 tooth drive gear		1
71/	A(71)		Tailgate-w/7 tooth drive gear-w/o wash and wipe system	D0VY 53234A24-A	1
72	A(71)		Tailgate -w/7 tooth drive gear-w/wash and wipe system	D2VY 53234A24-A	1
- B -					
65/69	B(71)		Tailgate	C9AZ 62234A24-B	1
65/70	B(71)		Door and quarter	D0AZ 62234A24-B	2or4
	B(71)		Tailgate-w/9 tooth drive gear		1
71/	B(71)		Tailgate-w/7 tooth drive gear	D0VY 53234A24-A	1

# FORD CAR PARTS

**BODY  
SECTION 230**

13

GROUP NUMBER	YEAR	BODY TYPE	DESCRIPTION	PART NUMBER	QTY.
<b>234A24 GEAR KIT - WINDOW REGULATOR DRIVE - continued</b>					
- F -					
	71/	F	Door and quarter	D0AZ 62234A24-B	2or4
- S -					
	65/66	S	Door and quarter	C9AZ 62234A24-B	2or4
	67/	S	Door	D0AZ 62234A24-B	2or4
	70/		Quarter		1or2
	67/69	S	Quarter - serviced in Assembly only - refer to Group 30380-1		
- X -					
	66/70	X(71)	Tailgate	C9AZ 62234A24-B	1
<b>234A28 BUSHING - DOOR WINDOW REGULATOR ARM</b>					
	67/68	S	Front door	C7SZ 65234A28-A	2
	67/68	S(57)	Rear door		2
	68	B(63, 65, 66, 76)	Front door		2
	69	F			2
<b>234A30 COVER - FRONT DOOR WINDOW REAR STOP</b>					
	69/	A(57)		C9AZ 57234A30-B	2
	69/70	A(63, 65, 76)		C9AZ 63234A30-A	2
	71/	A(65, 76)			2
	72	A(53)		C9MY 53234A30-A	2
	68/69	B(63, 65, 66, 76)		C8OZ 63234A30-A	2
	69/71	F		C9ZZ 65234A30-A	2
	67/71	S(57) "Before 9/1/70"		C7SZ 57234A30-A	2
	71	S(57) "From 9/1/70"		D1SZ 57234A30-A	2
	67/71	S(65) "Before 9/1/70"		C7SZ 65234A30-A	2
	71	S(65) "From 9/1/70"		D1SZ 65234A30-A	2
	67/71	S	1/4"-20 x 3/4" Hex. washer head screw	371492-S2(BB569)	4or8
<b>23440 COUPLING - TAILGATE WINDOW REGULATOR DRIVE</b>					
	65/66	X(71)		C1VB 5723440-A	1
	65	B(71)			1
<b>23442 EXTENSION - FRONT DOOR VENT WINDOW REGULATOR SHAFT</b>					
	65/66	S		C4SZ 6323442-A	2
			5/16"-24 x 1 1/8" Hex. head screw	353483-S2(BB588)	4
			5/16"-24 Nut (lock)	34443-S7-8(M79)	4
<b>234A46 RETAINER - DOOR WINDOW GLASS CHANNEL BRACKET</b>					
	71/	A(54, 71)		D0DZ 62234A46-B	AR
	70/72	P "Before 3/1/72"	Use with 3/16" thick glass		4or8
	71	L	Rear		2
	71	L	Front	D1FZ 62234A46-A	2
	72	L	Front or rear		2or4
	72	P "From 3/2/72"	Use with 5/32" thick glass		4or8
<b>234A56-7 BRACKET - FRONT DOOR WINDOW GLASS REAR - INNER</b>					
	71/	A(54, 71)	R. H.	D1AZ 54234A56-A	1
			L. H.	D1AZ 54234A57-A	1
<b>23567 BUMPER - FRONT DOOR HINGE</b>					
	67/71	S		C7SZ 6523567-A	2
<b>23574 STRAP and BRACKET ASSY. - DOOR CHECK</b>					
	66/	U	Black	C6TZ 9623574-AAB	2
<b>23624 COUPLING ASSY. - FRONT DOOR VENT WINDOW DRIVESHAFT</b>					
	65/66	S		C2VY 5723624-B	2

**BODY  
SECTION 230**
**FORD CAR PARTS**

GROUP NUMBER	YEAR	BODY TYPE	DESCRIPTION	PART NUMBER	QTY.
<b>237A22-3 PANEL - FRONT DOOR TRIM PANEL FINISH</b>					
	67	F(63B, 65B, 76B)	R. H. L. H.	C7ZZ 65237A22-A C7ZZ 65237A23-A	1 1
	69/70	F(63B, C, 65B, E, 76B)	R. H. -Aluminum-includes light teakwood insert L. H.	C9ZZ 65237A22-A C9ZZ 65237A23-A	1 1
	69/70	F(63B, C, 65B, E, 76B)	R. H. -Aluminum-includes dark teakwood insert L. H.	C9ZZ 65237A22-B C9ZZ 65237A23-B	1 1
	71/	F(63R, 65F, 76)	R. H. -w/wood grain applique L. H.	C9ZZ 65237A22-A D1ZZ 65237A23-A	1 1
<b>237A24 RETAINER - DOOR TRIM PANEL</b>					
	65/66	S	Side-Chrome	C4SZ 63237A24-A	4
<b>237A48 SEAL - FRONT DOOR TRIM PANEL</b>					
	66/	U	Cut from C6AZ 19627-A	*	2
<b>23760-3 RETAINER - FRONT DOOR TRIM PANEL</b>					
	66/67	B(62, 63, 76)	R. H. -Upper-Chrome-Includes attaching parts L. H.	C6OZ 6223762-A C6OZ 6223763-A	1 1
	66/67	B(54, 71)	R. H. -Upper-Chrome-Includes attaching parts L. H.	C6OZ 5423762-A C6OZ 5423763-A	1 1
	67/69	B(54B, 71)	Lower-Chrome-paint when desired	C6GY 5423760-A	2
	66/70	X(54, 71)	R. H. -Upper L. H.	C6OZ 5423762-A C6OZ 5423763-A	1 1
	66/70	X(54, 71)	Lower	C6GY 5423760-A	2
	66/70	X(62, 66)	R. H. -Upper-Chrome-Includes attaching parts L. H.	C6OZ 6223762-A C6OZ 6223763-A	1 1
	66/70	X(62, 66)	R. H. -Upper-Paint to match L. H.	C6DZ 6223762-A C6DZ 6223763-A	1 1
	65	X	No. 8 x 3/8" Cross recess pan head screw	52720-S8 (U380)	8to12
<b>237A82 SPACER - DOOR TRIM PANEL EDGE REINFORCEMENT</b>					
	66	A		C6AZ 54237A82-A	AR
<b>237A96 BRACKET - DOOR TRIM PANEL REFLECTOR</b>					
	68/71	S		C8SZ 65237A96-A	2
<b>38A06-7 HOUSING - FRONT DOOR ASH RECEPTACLE</b>					
	72	S	R. H. - Includes cover L. H.	D2SZ 65238A06-A D2SZ 65238A07-A	1 1
<b>23820 REFLECTOR - DOOR TRIM PANEL</b>					
	68/71	S		C8SZ 6523820-A	2
	72	A, S		D2AZ 6523820-A	2
<b>23834 BRACKET - DOOR TRIM PANEL - UPPER</b>					
	69/70	A(54, 71)		C9AZ 6223834-A	8
	69	A(62)			4
	71/	A			4or8
	69/70	A(57)			8
	69/70	A(63, 65, 76)		C9AZ 6323834-A	6
<b>23886 MOULDING - FRONT DOOR TRIM PANEL - LOWER EDGE- INCLUDES ATTACHING PARTS</b>					
	65/70	A(54, 57, 71)		C5AZ 5423886-A -	2
	65/67	A(62, 63, 76)		C5AZ 6223886-A -	2
	68	A(62, 63, 65, 76)			2



# FORD CAR PARTS

**BODY  
SECTION 240**

1

GROUP NUMBER	YEAR	BODY TYPE	DESCRIPTION	PART NUMBER		QTY.
				RIGHT HAND	LEFT HAND	
<b>240A10 BRACKET - FRONT DOOR ARM REST FINGER TIP PLATE</b>						
	69	F(63B, C, 65B, D, E, 76B)		C9ZZ 65240A10-A	C9ZZ 65240A10-A	2
	70	F(63B, C, 65B, D, E, 76B)		D0ZZ 65240A10-A	D0ZZ 65240A10-A	2
			Nut-1/8" spring	374177-S2(MM265)	374177-S2(MM265)	4
	72	B(63R, 65R, 97R)		D2OZ 63240A10-A	D2OZ 63240A10-A	2
<b>240A16 RETAINER - FRONT DOOR ARM REST FINISH PANEL</b>						
	69	A(54, 57, 71)		C9AZ 62240A16-A	C9AZ 62240A16-A	12
	69	A(63, 65, 76)				6
<b>24038-9 HOUSING - FRONT DOOR ARM REST WINDOW REGULATOR SWITCH PLATE</b>						
	68/71	S(57)		C8SZ 5724038-A	C8SZ 5724039-A	1
	68/69	S(65) "Before 12/15/68"	7 7/16" long	C8SZ 6524038-B	C8SZ 6524039-C	1
	69/70	S(65) "From 12/15/68"	8" long	C9SZ 6524038-A		1
			7 7/16" long		C8SZ 6524039-C	1
<b>24058-9 PANEL - FRONT DOOR ARM REST FINISH - LOWER</b>						
	69	A(54, 57, 62, 63, 65, 71B, C, D, H, J, 76)	White-paint to match	C9AZ 6224058-A	C9AZ 6224059-A	1
	69	A(54C, 57F, 65A, 71A, E)	Dark Teak	C9AZ 5424058-A	C9AZ 5424059-A	1
<b>24116 BRACKET - FRONT DOOR ARM REST MOUNTING</b>						
	66/67	U		C6TZ 9724116-A	C6TZ 9724116-A	4
			1/4"-20 x 1/2" Cross recess pan head screw	51768-S8(U373)	51768-S8(U373)	16
<b>24146 CLIP - ARM REST</b>						
	65	X	Rear door	BA 7024146-A	BA 7024146-A	4or8
	65	F	Door			4
	66	F(63A, 65A, C, 76A, C)	Door			4
	65	B				4or8
	66/67	A, B, F(63A, 65A, 65C, 76A, 76C), U, X	Front door	C7AZ 6224146-A	C7AZ 6224146-A	4
	66/67	A(54, 57, 71), B(54, 71), X(54, 71)	Rear door			4
	67	A(62, 63, 76), B(62, 63, 76), X(62)	Quarter			4
	68/69	A, B, F, U, X				AR
	68/71	S(57)	Front and rear doors			AR
	72	S, U				AR
	67	F		C8ZZ 6524146-A	C8ZZ 6524146-A	AR
	65	S	Front door	C6AZ 6224146-B	C6AZ 6224146-B	4
	65	X				4 or 8
	65	B	Front door			2
	70/71	B	Front door			8
	65/66	A	Front door			2 or 4
	65/66	A(54, 57, 71)	Rear door			4
	65/66	A(62, 63)	Quarter			4
	69/	A	Front door			8 or 10
	69/ 70	F(63A, C, 65A, C, 76A)	Front door			6
	70/	P	Door			4
	71/	L	Door -w/o moulded arm rest			4
	71/	F(63D, 65D, 76D)				8
	72	B	With intermittent wipers			2
	72	B	Without door speakers			2
	72	B(63D, R, 65D, R)	With door speakers	D2OZ 6524146-A	D2OZ 6524146-A	2
	72	L, P	Door lower-w/moulded arm rest	D2FZ 6224146-A	D2FZ 6224146-A	4
	72	L, P	Door upper-w/moulded arm rest	★45263-S101	★45263-S101	1
	67	S(65)	Front door	C7SZ 6524146-A	C7SZ 6524146-A	2
			Quarter			4
	68/	S(65)	Front door	C8SZ 6524146-A	C8SZ 6524146-A	2or3
			Quarter			4

**BODY  
SECTION 240**
**FORD CAR PARTS**

GROUP NUMBER	YEAR	BODY TYPE	DESCRIPTION	PART NUMBER		QTY.	
				RIGHT HAND	LEFT HAND		
<b>24148-9 PLATE - FRONT DOOR ARM REST</b>							
	69	F(63B, C, 65B, D, E, 76B)	Includes attaching parts	C9ZZ 6524148-A	C9ZZ 6524149-A	1	
	70	F(63B, C, 65B, D, E, 76B)	Includes attaching parts	D0ZZ 6524148-A	D0ZZ 6524149-A	1	
			Screw-No. 8 x 1/2" pan head	52554-S8(U230)	52554-S8(U230)	2	
<b>24160 SUPPORT - FRONT DOOR ARM REST</b>							
	68/71	S(57)		C8SZ 5724160-A	C8SZ 5724160-A	2	
<b>24162-3 SUPPORT - REAR DOOR ARM REST - REAR</b>							
	65/66	A(54, 57, 71)		C5AZ 5424162-A	★C5AZ 5424163-A Not replaced (3-74)	1	
			No. 10-16 x 3/8" Cross recess pan head screw	52721-S8(U382B)	52721-S8(U382B)	4	
<b>24168-9 PANEL - FRONT DOOR ARM REST FINISH - INCLUDES ATTACHING PARTS</b>							
	69	A	"Before 3/2/69"	Rustless steel-snap on	C9AZ 6224168-A	C9AZ 6224169-A	1
	69	A	"From 3/3/69"	Refer to Group 226A34-5			
	68/69	S(57)	Without speaker	C8SZ 5724168-C	C8SZ 5724169-C	1	
	68/69	S(57)	With speaker	C8SZ 5724168-D	C8SZ 5724169-D	1	
	68/69	S(65)	Without speaker	C8SZ 6524168-A	C8SZ 6524169-A	1	
	68/69	S(65)	With speaker	C8SZ 6524168-B	C8SZ 6524169-B	1	
	70/71	S(57)	Without speaker	C8SZ 5724168-C	D0SZ 5724169-A	1	
	70/71	S(57)	With speaker	C8SZ 5724168-D	D0SZ 5724169-B	1	
	70/71	S(65)	Without speaker	C8SZ 6524168-A	D0SZ 6524169-A	1	
	70/71	S(65)	With speaker	C8SZ 6524168-B	D0SZ 6524169-B	1	
<b>24300-1 PILLAR ASSY. - CENTER BODY</b>							
- A -							
	65/68	A(54, 71)		C5AZ 5424300-B	C5AZ 5424301-B	1	
	69/70	A(54, 71)		C9AZ 5424300-A	C9AZ 5424301-A	1	
	69/70	A(57)		C9AZ 5724300-A	C9AZ 5724301-A	1	
	71/	A(53)		D1AZ 5324300-A	D1AZ 5324301-A	1	
	71/	A(54, 71)		D1AZ 5424300-A	D1AZ 5424301-A	1	
	71/	A(57)		D1AZ 5724300-A	D1AZ 5724301-A	1	
- B -							
	68/69	B(54, 71)		C8OZ 5424300-A	C8OZ 5424301-A	1	
	70/71	B(54)		D0OZ 5424300-A	D0OZ 5424301-A	1	
	70/71	B(57)		D0OZ 5724300-A	D0OZ 5724301-A	1	
	70/71	B(71)		D0OZ 7124300-A	D0OZ 7124301-A	1	
	72	B(53, 71)		D2OZ 5324300-A	D2OZ 5324301-A	1	
- P -							
	71/	P(54)		D1DZ 5424300-A	D1DZ 5424301-A	1	
- S -							
	68/71	S(57)		C9SZ 5724300-A	C9SZ 5724301-A	1	
- X -							
	66/70	X(54, 71)		C6OZ 5424300-C	C6OZ 5424301-C	1	
	65/	A(54, 57, 71), B(54, 71)	3/4" Plug (button)	352291-S(PP3)	352291-S(PP3)	2	
	65/70	X(54, 71)				2	
<b>24316-7 PILLAR - CENTER BODY OUTER - UPPER</b>							
	67/71	S(57)		C7SZ 5724316-A	C7SZ 5724317-A	1	
<b>243A18-9 REINFORCEMENT - CENTER BODY PILLAR AT BELT</b>							
	68/71	S(57)		C7SZ 57243A18-A	C7SZ 57243A19-A	1	
<b>24320-1 REINFORCEMENT - CENTER BODY PILLAR</b>							
	70	B(57)		D0OZ 5724320-A	D0OZ 5724321-A	1	
	71	B(57)		D1OZ 5724320-A	D1OZ 5724321-A	1	
<b>243A38-9 RETAINER - CENTER BODY PILLAR UPPER FRONT WEATHERSTRIP</b>							
	71/	A(53)		D1AZ 53243A38-B	D1AZ 53243A39-B	1	
	72	B(53, 71)		D2OZ 53243A38-A	D2OZ 53243A39-A	1	

# FORD CAR PARTS

**BODY  
SECTION 240**

3

GROUP NUMBER	YEAR	BODY TYPE	DESCRIPTION	PART NUMBER		QTY.	
				RIGHT HAND	LEFT HAND		
<b>243A56-7 RETAINER - CENTER BODY PILLAR UPPER REAR WEATHERSTRIP</b>							
	71/	A(53)		D1AZ	53243A56-B	D1AZ 53243A57-B	1
	72	B(53,71)		D2OZ	53243A56-A	D2OZ 53243A57-A	1
<b>243A60 REINFORCEMENT - CENTER BODY PILLAR UPPER INNER - CENTER</b>							
	68/71	S(57)		C7SZ	57243A60-A	C7SZ 57243A60-A	2
<b>243A62 REINFORCEMENT - CENTER BODY PILLAR UPPER INNER - TOP</b>							
	68/71	S(57)		C7SZ	57243A62-A	C7SZ 57243A62-A	2
<b>24426-7 REINFORCEMENT - CENTER BODY PILLAR - LOWER</b>							
	69/70	A(57)	"Before 9/5/69"	C9AZ	5724426-A	C9AZ 5724427-A	1
	70/	A(57)	"From 9/5/69"	D0AZ	5724426-A	D0AZ 5724427-A	1
	70/71	B(57)		D0OZ	5724426-A	D0OZ 5724427-A	1
	68/71	S(57)		C8SZ	5724426-A	C8SZ 5724427-A	1
	70/71	S(57)	Screw-No. 8-18 x 3/4" pan head	376328-S(UU67G)		376328-S(UU67G)	6
<b>24450-1 BRACKET - CENTER BODY PILLAR UPPER HINGE</b>							
	70	B(57)	"Before 9/29/69"	D0OZ	5724450-A	D0OZ 5724451-A	1
	70/71	B(57)	"From 9/29/69"	D0OZ	5724450-B	D0OZ 5724451-B	1
	70	B(57)	Screw-5/16" -18 x 1 1/8" hex washer tap	382623-S2(UU52AL)		382623-S2(UU52AL)	6
<b>24452-3 CAP - CENTER BODY PILLAR FINISH - Refer to Group in Soft Trim Section</b>							
<b>24458-9 MOULDING - CENTER BODY PILLAR OUTSIDE - UPPER - INCLUDES ATTACHING PARTS</b>							
- A -							
	65/68	A(54, 71)		C5AZ	5424458-A	C5AZ 5424459-A	1
- B -							
	66/67	B(71B,E)		C6OZ	5424458-A	C6OZ 5424459-A	1
	68/69	B(54C)-with vinyl roof cover-	Black-Levant grain	C8OZ	5424458-C1A	C8OZ 5424459-C1A	1
	68/71	B(71C,E)	Bright finish	C8OZ	5424458-A	C8OZ 5424459-A	1
	69	B(54C)-with vinyl roof cover	White-Levant grain	C9OZ	5424458-CBW	C9OZ 5424459-CBW	1
	70/71	B(54C,E)-with vinyl roof cover or two tone paint	Bright finish	D0OZ	5424458-A	D0OZ 5424459-A	1
- P -							
	72	P(54)	Blue	D2DZ	5424458-AB	D2DZ 5424459-AB	1
			Brown	D2DZ	5424458-AT	D2DZ 5424459-AT	1
			Copper	D2DZ	5424458-AC	D2DZ 5424459-AC	1
			Green	D2DZ	5424458-AR	D2DZ 5424459-AR	1
			White	D2DZ	5424458-AJ	D2DZ 5424459-AJ	1
- S -							
	68/71	S(57)		C8SZ	5724458-A	C8SZ 5724458-A	2
	70/71	S(57)	Screw & washer-No. 8-18 x 1/2" self tap.	381969-S(UU89A)		381969-S(UU89A)	12
- X -							
	67/70	X(71)		C6OZ	5424458-A	C6OZ 5424459-A	1
<b>24630-1 DOOR ASSY. - REAR - NOTE 1</b>							
- A -							
	65	A(54, 57, 71)	Bumper-on door	C2AZ	6223030-A	C2AZ 6223030-A	2or4
	65	A(57)	Bumper - upper	C5AZ	57265A28-B	C5AZ 57265A28-B	2
	65/66	A(57)	Bumper-on quarter panel	★379871-S		★379871-S	1
	67	A(54, 57, 71)	Bumper	C7AZ	54265A28-A	C7AZ 54265A28-A	2or4
	68	A(54)		★C8AZ	5424630-A	C8AZ 5424631-A	1
				Not replaced (1/75)			
	68	A(57)		C8AZ	5724630-A	C8AZ 5724631-A	1
	68	A(71)		C8AZ	7124630-A	C8AZ 7124631-A	1
	69	A(54)		C9AZ	5424630-A	C9AZ 5424631-A	1
	69	A(57)		C9AZ	5724630-A	C9AZ 5724631-A	1
	69	A(71)		C9AZ	7124630-A	C9AZ 7124631-A	1
	70	A(54)		D0AZ	5424630-A	D0AZ 5424631-A	1
	70	A(57)		D0AZ	5724630-A	D0AZ 5724631-A	1
	70	A(71)		D0AZ	7124630-A	D0AZ 7124631-A	1

NOTE 1 - Less hinges, paint, trim, window regulator, latch and Remote Control. Drill holes as required.

May, 1975

COPYRIGHT © 1975 -

FORD MOTOR  
COMPANY

-DEARBORN, MICHIGAN

**FINAL ISSUE**

**BODY  
SECTION 240**
**FORD CAR PARTS**

GROUP NUMBER	YEAR	BODY TYPE	DESCRIPTION	PART NUMBER		QTY.
				RIGHT HAND	LEFT HAND	
<b>24630-1</b>	<b>DOOR ASSY. - REAR - continued - NOTE 1</b>					
	- A -					
	71/	A(53)		D2AZ 5324630-A	D2AZ 5324631-A	1
	71/	A(54)		D2AZ 5424630-A	D2AZ 5424631-A	1
	71/	A(57)		D2AZ 5724630-A	D2AZ 5724631-A	1
	71/	A(71)		D2AZ 7124630-A	D2AZ 7124631-A	1
	- B -					
	68/69	B(54)		C8OZ 5424630-A	C8OZ 5424631-A	1
	68/69	B(71)		★C8OZ 7124630-A	C8OZ 7124631-A	1
				Not replaced (12/74)		
	70/71	B(54)		D0OZ 5424630-A	D0OZ 5424631-A	1
	70	B(57)		D0OZ 5724630-A	D0OZ 5724631-A	1
	71	B(57)		D1OZ 5724630-A	D1OZ 5724631-A	1
	70/71	B(71)		D0OZ 7124630-A	D0OZ 7124631-A	1
	72	B(53, 71)		D3OZ 5324630-B	D3OZ 5324631-B	1
	- P -					
	71/ 72	P(54)	"Before 3/1/72"	D2DZ 5424630-B	D1DZ 5424631-A	1
	72	P(54)	"From 3/1/72"	D3DZ 5424630-A	D2DZ 5424631-B	1
	- S -					
	68/71	S(57)		C9SZ 5724630-A	C9SZ 5724631-A	1
	- X -					
	68/ 70	X(54)		C8DZ 5424630-A	C8DZ 5424631-A	1
	67	A	5/16"-18 x 1 5/8" Hex. washer head screw	359530-S8(BB576)	359530-S8(BB576)	8
GROUP NUMBER	YEAR	BODY TYPE	DESCRIPTION	PART NUMBER		QTY.
<b>24648</b>	<b>HANDLE - REAR DOOR INSIDE ASSIST</b>					
	65/67	A(54), B(54)			B9A 5824648-A	1
	68/	A(54)-Taxi				1
	72	B(53B)-Taxi				1
			No. 12-24 x 1" Oval head screw		★52961-S13	4
<b>24650</b>	<b>PAD - REAR DOOR INSIDE ASSIST HANDLE</b>					
	65/72	A-Taxi			B6A 7324650-A	2
	65/72	B(53B)-Taxi				2
	65/68	X				2
GROUP NUMBER	YEAR	BODY TYPE	DESCRIPTION	PART NUMBER		QTY.
<b>24700-1</b>	<b>PANEL - REAR DOOR OUTSIDE - Drill holes as required</b>					
	- A -					
	65	A(54, 71)		★C5AZ 5424700-A	C5AZ 5424701-A	1
				Not replaced (3-74)		
	65	A(57)		C5AZ 5724700-A	C5AZ 5724701-A	1
	66	A(54, 71)		C6AZ 5424700-A	C6AZ 5424701-A	1
	66	A(57)		C6AZ 5724700-A	★C6AZ 5724701-A	1
				Not replaced (1/75)		
	67	A(54, 71)		C7AZ 5424700-A	C7AZ 5424701-A	1
	67	A(57)		C7AZ 5724700-A	C7AZ 5724701-A	1
	68	A(54, 71)		C8AZ 5424700-A	C8AZ 5424701-A	1
	68	A(57)		C8AZ 5724700-A	C8AZ 5724701-A	1
	69/ 70	A(54, 71)		C9AZ 5424700-A	C9AZ 5424701-A	1
	69/ 70	A(57)		C9AZ 5724700-A	C9AZ 5724701-A	1
	71/	A(53, 57)		D1AZ 5724700-A	D1AZ 5724701-A	1
	71/	A(54, 71)		D1AZ 5424700-A	D1AZ 5424701-A	1

NOTE 1 - Less hinges, paint, trim, window regulator, latch and Remote Control. Drill holes as required.

# FORD CAR PARTS

## BODY SECTION 240

5

GROUP NUMBER	YEAR	BODY TYPE	DESCRIPTION	PART NUMBER		QTY.
				RIGHT HAND	LEFT HAND	
<b>24700-1</b>	<b>PANEL - REAR DOOR OUTSIDE - continued - Drill holes as required</b>					
	- B -					
	66/67	B(54, 71)		C6OZ 5424700-A	C6OZ 5424701-A	1
	68/69	B(54)		C8OZ 5424700-A	C8OZ 5424701-A	1
	68/69	B(71)		C8OZ 7124700-A	C8OZ 7124701-A	1
	70/71	B(54, 57)		D0OZ 5424700-A	D0OZ 5424701-A	1
	70/71	B(71)		D0OZ 7124700-A	D0OZ 7124701-A	1
	72	B(53, 71)		D2OZ 5324700-A	★D2OZ 5324701-A r/b D3OZ 5324701-A(3-74)	1
	- P -					
	71/	P(54)		D1DZ 5424700-A	D1DZ 5424701-A	1
	- S -					
	67/71	S(57)		C9SZ 5724700-A	C9SZ 5724701-A	1
	- X -					
	66/ 70	X(54)		C6DZ 5424700-A	C6DZ 5424701-A	1
	66/ 70	X(71)		C6OZ 5424700-A	C6OZ 5424701-A	1
<b>247A10-1</b>	<b>SEAL - REAR DOOR WINDOW FRONT - UPPER</b>					
	69	A(57)		C9AZ 57247A10-A	C9AZ 57247A11-A	1
	70/	A(57)		D0AZ 57247A10-A	D0AZ 57247A11-A	1
	70/71	B(57)		D0OZ 57247A10-B	D0OZ 57247A11-B	1
<b>24730-1</b>	<b>PANEL - REAR DOOR OUTSIDE FINISH</b>					
	71/	A(53, 57H, K)		D1AZ 5724730-A	D1AZ 5724731-A	1
<b>25012-3</b>	<b>RETAINER - REAR DOOR OUTSIDE COVER - INCLUDES ATTACHING PARTS</b>					
	68/71	S(57B,C)		C7SZ 5725012-D	C7SZ 5725013-D	1
<b>25300-1</b>	<b>RAIL - REAR DOOR OUTSIDE FINISH - LOWER - Includes Attaching Parts</b>					
	- A -					
	66	A(71A, E)		C6AZ 7125300-A	C6AZ 7125301-A	1
	67	A(71A, E)		C7AZ 7125300-A	C7AZ 7125301-A	1
	68	A(71A, E)		C8AZ 7125300-A	C8AZ 7125301-A	1
	69/ 70	A(71A, E)		C9AZ 7125300-A	C9AZ 7125301-A	1
	71	A(71H)		D1AZ 7125300-A	D1AZ 7125301-A	1
	72	A(71H)		D2AZ 7125300-A	D2AZ 7125301-A	1
	- B -					
	66/67	B(71E)		★C6OZ 7125300-A Not replaced (12/74)	C6OZ 7125301-A	1
	68/69	B(71E)		C8OZ 7125300-A	C8OZ 7125301-A	1
	70/71	B(71E)		D0OZ 7125300-A	D0OZ 7125301-A	1
	72	B(71K)		D2OZ 7125300-A	D2OZ 7125301-A	1
<b>253A02-3</b>	<b>SEAL - REAR DOOR REAR AT BELT</b>					
	69/ 70	A(57)		C9AZ 57253A02-A	C9AZ 57253A03-A	1
	70/71	B(57)		D0OZ 57253A02-B	D0OZ 57253A03-B	1
<b>25320-1</b>	<b>RAIL - REAR DOOR OUTSIDE FINISH - UPPER - Includes Attaching Parts</b>					
	- A -					
	66	A(71A, E)		★C6AZ 7125320-A Not replaced (12/74)	C6AZ 7125321-A	1
	67	A(71A, E)		C7AZ 7125320-A	C7AZ 7125321-A	1
	68	A(71A, E)		C8AZ 7125320-A	C8AZ 7125321-A	1
	69/ 70	A(71A, E)		C9AZ 7125320-A	C9AZ 7125321-A	1
	71	A(71H)		D1AZ 7125320-A	D1AZ 7125321-A	1
	72	A(71H)		D2AZ 7125320-A	D2AZ 7125321-A	1
	- B -					
	68/69	B(71E)		C8OZ 7125320-A	C8OZ 7125321-A	1
	70/71	B(71E)		D0OZ 7125320-A	D0OZ 7125321-A	1
	72	B(71K)		D2OZ 7125320-A	D2OZ 7125321-A	1

**BODY  
SECTION 240**
**FORD CAR PARTS**

GROUP NUMBER	YEAR	BODY TYPE	DESCRIPTION	PART NUMBER		QTY.
				RIGHT HAND	LEFT HAND	
<b>25324-5 WEATHERSTRIP - REAR DOOR - Also refer to Group 513A68-9</b>						
- A -						
	65/68	A(54)		C5AZ 5425324-B	C5AZ 5425325-B	1
	65/66	A(57)		C5AZ 5725324-A	C5AZ 5725325-A	1
	65/68	A(71)		C5AZ 7125324-B	C5AZ 7125325-B	1
	67	A(57)		C7AZ 5725324-A	C7AZ 5725325-A	1
	68	A(57)		C8AZ 5725324-A	C8AZ 5725325-A	1
	69	A(54)	"Before 7/3/69"	C9AZ 5425324-A	C9AZ 5425325-A	1
	69	A(54)	"From 7/3/69"	C9AZ 5425324-B	C9AZ 5425324-B	2
	69	A(57)		C9AZ 5725324-A	D0AZ 5725325-A	1
	69	A(71)		C9AZ 7125324-B	C9AZ 7125325-B	1
	70	A(54)	"Before 11/24/69"	C9AZ 5425324-B	C9AZ 5425325-B	1
	70	A(54)	"From 11/24/69"	C9AZ 5425324-B	C9AZ 5425324-B	2
	70	A(57)		D0AZ 5725324-A	D0AZ 5725325-A	1
	70	A(71)		C9AZ 7125324-B	C9AZ 7125325-B	1
	71	A(53)		D1AZ 5325324-A	D1AZ 5325325-A	1
	71	A(57)		D1AZ 5725324-A	D1AZ 5725325-A	1
	72	A(53)		D2AZ 5325324-A	D2AZ 5325325-A	1
	71/	A(54)		D1AZ 5425324-A	D1AZ 5425325-A	1
	72	A(57)		D2AZ 5725324-A	D2AZ 5725325-A	1
	71/72	A(71)		D2AZ 7125324-A	D2AZ 7125325-A	1
- B -						
	65	B(54)		★C3OZ 5425324-B Not replaced (12/74)	C3OZ 5425325-B	1
	65	B(54, 71)	5/16" Plug	375547-S(PP14E)	375547-S(PP14E)	12
	66/67	B(54)		C6OZ 5425324-A	C6OZ 5425325-A	1
	66/67	B(71)		C6OZ 7125324-A	C6OZ 7125325-A	1
	68/69	B(54)		C8OZ 5425324-B	C8OZ 5425325-B	1
	68/71	B(71)		C8OZ 7125324-B	C8OZ 7125325-B	1
	70/71	B(54)	Lower-on door	D0OZ 5425324-A	D0OZ 5425325-A	1
	70/71	B(54)	Upper-on body-refer to Group 513A68-9			
	70/71	B(57)		D0OZ 5725324-A	D0OZ 5725325-A	1
	72	B(53, 71)		D2OZ 5325324-A	D2OZ 5325325-A	1
- P -						
	71/	P(54)		D1DZ 5425324-A	D1DZ 5425325-A	1
- S -						
	68/70	S(57)	"Before 1/15/70"	C8SZ 5725324-A	C8SZ 5725325-A	1
	70/71	S(57)	"From 1/15/70"	D0SZ 5725324-A	D0SZ 5725325-A	1
	67/71	S		376389-S101(UU82D)	376389-S101(UU82D)	2
- X -						
	66/70	X(54)		C6OZ 5425324-A	C6OZ 5425325-A	1
	66/70	X(71)		C6OZ 7125324-A	C6OZ 7125325-A	1
	65	X(54, 71)	7/16" Plug	375547-S(PP14E)	375547-S(PP14E)	10
	65/67	A	Retainer	C5AZ 6220586-A	C5AZ 6220586-A	AR
	66/67	B, X				AR
<b>25388-9 WEATHERSTRIP and SEAL ASSY. - REAR DOOR WINDOW REAR</b>						
	67/69	S(57)	"From 12/11/67"	C7SZ 5725388-C	C7SZ 5725589-C	1
	70/71	S(57)		D0SZ 5725388-A	D0SZ 5725389-A	1
	67/71	S	Screw No. 8-15 x 5/8" - oval head	53027-S13(U278)	53027-S13(U278)	AR

# FORD CAR PARTS

**BODY  
SECTION 240**

7

GROUP NUMBER	YEAR	BODY TYPE	DESCRIPTION	PART NUMBER		QTY.
				RIGHT HAND	LEFT HAND	
<b>254A12-3 MOULDING - REAR DOOR WINDOW FRAME FRONT</b>						
- A -						
	65/68	A(54, 71)		C5AZ 54254A12-A	C5AZ 54254A13-A	1
	69/	A(54, 71)	Chrome-w/o insert	C9AZ 54254A12-A	C9AZ 54254A13-A	1
	69	A(54)	Chrome-w/insert	C9AZ 54254A12-B	C9AZ 54254A13-B	1
	70/71	A(54)	Aluminum	D0AZ 54254A12-A	D0AZ 54254A13-A	1
- B -						
	66/67	B(54B, 71B, E)		C6OZ 54254A12-A	C6OZ 54254A13-A	1
	68/69	B(54B, 54C, 71B, E)		C8OZ 54254A12-A	C8OZ 54254A13-A	1
	70/71	B(71C, E)				1
	68/69	B(54C)-with vinyl roof cover	Black-Levant grain	C8OZ 54254A12-B1A	C8OZ 54254A13-B1A	1
	69	B(54C)-with vinyl roof cover	White-Levant grain	C9OZ 54254A12-BBW	C9OZ 54254A13-BBW	1
	70/71	B(54C)	Snap-on	D0OZ 54254A12-A	D0OZ 54254A13-A	1
- P -						
	71/	P(54)	Snap-on-dull finish	D1DZ 54254A12-A	D1DZ 54254A13-A	1
	72	P(54)	Snap-on-bright finish	D2DZ 54254A12-A	D2DZ 54254A13-A	1
- X -						
	65	X(54, 71)	Refer to group 20982-3			
	66/70	X(54, 71)		C6OZ 54254A12-A	C6OZ 54254A13-A	1
<b>25440-1 MOULDING - REAR DOOR OUTSIDE - FRONT</b>						
	65	B(54B, 71B)	Includes attaching parts	C5OZ 5425440-A	C5OZ 5425441-A	1
<b>254A46 RETAINER - REAR DOOR OUTSIDE MOULDING</b>						
REFER TO APPROPRIATE EXTERIOR MOULDING ILLUSTRATION FOR COMPLETE RETAINER PART NUMBER						
<b>254A84 MOULDING - REAR DOOR TRIM PANEL CENTER UPPER</b>						
	70/71	S(57)		D0SZ 57254A84-A	D0SZ 57254A84-A	2
<b>254A92-3 MOULDING - REAR DOOR OUTSIDE BELT-REAR - INCLUDES ATTACHING PARTS</b>						
	67/69	S(57)		C7SZ 57254A92-A	C7SZ 57254A93-A	1
	71	S(57)				1
<b>255A00-1 MOULDING - REAR DOOR OUTSIDE REAR EDGE - INCLUDES ATTACHING PARTS</b>						
	67/71	S(57)		C7SZ 57255A00-C	C7SZ 57255A01-C	1
<b>25502-3 MOULDING - REAR DOOR TRIM PANEL CENTER</b>						
	66	A(57F)		♣C6MY 5025502-A	♣C6MY 5025503-A	1
	68/71	S(57)		C8SZ 5725502-B	C8SZ 5725503-B	1
<b>25504-5 MOULDING - REAR DOOR TRIM PANEL UPPER FRONT - INCLUDES ATTACHING PARTS</b>						
	66	A(57F)		♣C6MY 5025504-A	♣C6MY 5025505-A	1
	68/69	B(54C)		C8OZ 5425504-A	C8OZ 5425504-A	2
	72	B(53)		D2OZ 5325504-A	D2OZ 5325505-A	1
<b>25510-1 MOULDING - REAR DOOR OUTSIDE REAR EDGE</b>						
	68	A(54, 57, 71)		C8AZ 5425510-A	C8AZ 5425511-A	1
	70	A(54, 57, 71)		D0AZ 5425510-A	D0AZ 5425511-A	1
	71/	A(53, 54, 57, 71)		D1AZ 5425510-A	D1AZ 5425511-A	1
	67	B(54, 71)		C7OZ 5425510-A	C7OZ 5425511-A	1
	72	B(53, 71)		D2OZ 5325510-A	D2OZ 5325511-A	1
	72	P(54)		D2DZ 5425510-A	D2DZ 5425511-A	1
	67/70	X(54)		C7DZ 5425510-A	C7DZ 5425511-A	1
	67/70	X(71)		C7OZ 5425510-A	C7OZ 5425511-A	1

♣ Canada only

**BODY  
SECTION 240**
**FORD CAR PARTS**

GROUP NUMBER	YEAR	BODY TYPE	DESCRIPTION	PART NUMBER		QTY.
				RIGHT HAND	LEFT HAND	
<b>25522-3 MOULDING - REAR DOOR WINDOW FRAME REAR</b>						
	67/68	A(54)		C7AZ 5425522-A	C7AZ 5425523-A	1
	67/68	A(71)		C7AZ 7125522-A	C7AZ 7125523-A	1
	69/70	A(71A,B,C,E)		D0AZ 7125522-A	D0AZ 7125523-A	1
	71/	A(71F,H)				1
	68/69	B(71B,E)	Snap on	C8OZ 7125522-A	C8OZ 7125523-A	1
	70/71	B(71C,E)				1
	66	B(71B,E)		C6OZ 7125522-A	C6OZ 7125523-A	1
	67	B(71B,E), X(71B)				1
	68/70	X(71)				1
<b>25532-3 MOULDING - REAR DOOR OUTSIDE - INCLUDES ATTACHING PARTS</b>						
<b>- A -</b>						
	65	A(54, 57B, 71B, C)		C5AZ 5425532-A	C5AZ 5425533-A	1
	66	A(54, 57B, 71B, C, D)		C6AZ 5425532-A	C6AZ 5425532-A	2
	67	A(54A, 57B, 71B, C)		C7AZ 5425532-A	C7AZ 5425533-A	1
	67	A(54C, 57F) - "Before 1/16/67"	With vinyl tape insert	C7AZ 5725532-A	C7AZ 5725533-A	1
	67	A(54C, 57F) - "From 1/16/67"	With painted insert	C7AZ 5425532-B	C7AZ 5425533-B	1
	68	A(54, 57, 71)		C8AZ 5425532-B	C8AZ 5425533-B	1
			No. 8-32 x .44" Hex head screw	381881-S(BB541ED)	381881-S(BB541ED)	4
	69/70	A(54B, 71D, H, J)	Upper-without insert	C9AZ 5425532-A	C9AZ 5425533-A	1
	69	A(54A, C, E, 57, 71B, C, D)				1
	70	A	Rivet 1/8" x 5/16" oval head	383229-S(SS44E)	383229-S(SS44E)	AR
	70	A(54, 57, 71)	Black insert	D0AZ 5425532-C	D0AZ 5425533-C	1
			Blue insert	D0AZ 5425532-D	D0AZ 5425533-D	1
			Brown insert	D0AZ 5425532-A	D0AZ 5425533-A	1
			Green insert	D0AZ 5425532-B	D0AZ 5425533-B	1
	71	A(53, 54, 57, 71B, D, F)	Less insert	D1AZ 5425532-A	D1AZ 5425532-A	2
	71	A(53, 54, 57, 71B, D, F)	Refer to Group 29038-9			2
	72	A(53, 54, 57, 71)		D2AZ 5425532-A	D2AZ 5425533-A	1
<b>- B -</b>						
	66	B(54A, B, 71B, D)		C6OZ 5425532-A	C6OZ 5425533-A	1
	67	B(54B)				1
	67	B(54A, 71D)		C7OZ 5425532-A	C7OZ 5425533-A	1
	68	B(54A, B)		C8OZ 5425532-A	C8OZ 5425533-A	1
	68	B(71B, D)		C8OZ 7125532-A	C8OZ 7125533-A	1
	69	B(54A, B, C)		C9OZ 5425532-A	C9OZ 5425533-A	1
	69	B(71B, D)		C9OZ 7125532-A	C9OZ 7125533-A	1
	72	B(53, 71B, D)	Black insert	D3OZ 5325532-A	D3OZ 5325533-A	1
	72	B(71K)	Wood grain insert	D3OZ 7125532-A	D3OZ 7125533-A	1
<b>- P -</b>						
	71	P(54)		D1DZ 5425532-A	D1DZ 5425533-A r/b D2DZ 5425533-A (10/74)	1
	72	P(54) -exc. LTD	Black insert	D2DZ 5425532-A	D2DZ 5425533-A	1
	72	P(54) -LTD	Blue insert	D2DZ 5425532-BB	D2DZ 5425533-BB	1
			Brown insert	D2DZ 5425532-BT	D2DZ 5425533-BT	1
			Copper insert	D2DZ 5425532-BC	D2DZ 5425533-BC	1
			Green insert	D2DZ 5425532-BR	D2DZ 5425533-BR	1
			White insert	D2DZ 5425532-BJ	D2DZ 5425533-BJ	1
<b>- S -</b>						
	70	S(57)	Black insert	D0SZ 5725532-C	D0SZ 5725533-C	1
			Blue insert	D0SZ 5725532-D	D0SZ 5725533-D	1
			Brown insert	D0SZ 5725532-A	D0SZ 5725533-A	1
			Green insert	D0SZ 5725532-B	D0SZ 5725533-B	1
	71	S(57)	Black insert	D0SZ 5725532-C	D0SZ 5725533-C	1
			Blue insert	D0SZ 5725532-D	D0SZ 5725533-D	1
			Brown insert	D0SZ 5725532-A	D0SZ 5725533-A	1
			Green insert	D1SZ 5725532-A	D1SZ 5725533-A	1



# FORD CAR PARTS

**BODY  
SECTION 240**

9

GROUP NUMBER	YEAR	BODY TYPE	DESCRIPTION	PART NUMBER		QTY.	
				RIGHT HAND	LEFT HAND		
<b>25532-3 MOULDING - REAR DOOR OUTSIDE - INCLUDES ATTACHING PARTS - continued</b>							
<b>- X -</b>							
	65	X(54B)		C5DZ	5425532-A	C5DZ 5425533-A	2
	65	X(71B)	"From 10/6/64"				2
	67	X(54B)		C7DZ	5425532-A	C7DZ 5425533-A	1
	67	X(71B)		C7DZ	7125532-A	C7DZ 7125533-A	1
	68	X(54)		C8DZ	5425532-A	C8DZ 5425533-A	1
	68	X(71)		C8DZ	7125532-A	C8DZ 7125533-A	1
<b>255A38-9 WEATHERSTRIP and RETAINER ASSY. - REAR DOOR UPPER REAR EXTENSION</b>							
	68/71	S(57)		C8SZ	57255A38-B	C8SZ 57255A39-B	1
	70	S(57)	Screw No. 8-32 x 5/16" pan head	353655-S100(UU86FD)	353655-S100(UU86FD)		6
<b>25540-1 MOULDING - REAR DOOR OUTSIDE UPPER - INCLUDES ATTACHING PARTS</b>							
<b>- A -</b>							
	67	A(54, 57B, 71B, C, D)		C7AZ	5425540-A	C7AZ 5425540-A	1
	70	A(54C)		D0AZ	5425540-A	D0AZ 5425541-A	1
	70	A(57F)		D0AZ	5725540-A	D0AZ 5725541-A	1
<b>- B -</b>							
	65	B(54, 71)		C5OZ	5425540-A	★C5OZ 5425541-A Not replaced (3-74)	1
	68	B(54C)		C8OZ	5425540-A	C8OZ 5425541-A	1
	70	B(54, 57)	Black insert	D0OZ	5425540-D	D0OZ 5425541-D	1
			Blue insert	D0OZ	5425540-E	D0OZ 5425541-E	1
			Brown insert	D0OZ	5425540-B	D0OZ 5425541-B	1
			Green insert	D0OZ	5425540-C	D0OZ 5425541-C	1
	70	B(71B, C, D)	Black insert	D0OZ	7125540-D	D0OZ 7125541-D	1
			Blue insert	D0OZ	7125540-E	D0OZ 7125541-E	1
			Brown insert	D0OZ	7125540-B	D0OZ 7125541-B	1
			Green insert	D0OZ	7125540-C	D0OZ 7125541-C	1
	71	B(54, 57)	Black insert-Cut to fit	†D1OZ	6529038-B	D1OZ 6529038-B	1
	71	B(54, 57)	Black insert	D0OZ	5425540-D	D0OZ 5425541-D	1
	71	B(71B, C, D)	Black insert	D0OZ	7125540-D	D0OZ 7125541-D	1
<b>- X -</b>							
	66	X(54B, 71B)		C6DZ	5425540-A	C6DZ 5425541-A	1
	66/67	X(54A)					1
<b>25542-3 MOULDING - REAR DOOR WINDOW FRAME TOP</b>							
<b>- A -</b>							
	65/66	A(54)		★C5AZ	5425542-A	C5AZ 5425543-A	1
						Not replaced (3-74)	
	65/68	A(71)		C5AZ	7125542-A	C5AZ 7125543-A	1
	67/68	A(54)		C7AZ	5425542-A	C7AZ 5425543-A	1
	69/70	A(54C)	Chrome-w/insert	C9AZ	5425542-B	C9AZ 5425543-B	1
	69/70	A(54A, C)	"Before 10/1/69"	C9AZ	5425542-A	C9AZ 5425543-A	1
	70	A(54A, C)	"From 10/1/69"	D0AZ	5425542-A	D0AZ 5425543-A	1
	71/	A(54F)					1
	70	A(54C)	Aluminum	D0AZ	5425542-C	D0AZ 5425543-C	1
	69/	A(71)		C9AZ	7125542-A	C9AZ 7125543-A	1

† For dealer installed adhesive backed moulding

May, 1975

COPYRIGHT © 1975 -

FORD MOTOR  
COMPANY

- DEARBORN, MICHIGAN

**FINAL ISSUE**

GROUP NUMBER	YEAR	BODY TYPE	DESCRIPTION	PART NUMBER		QTY.
				RIGHT HAND	LEFT HAND	
<b>25542-3 MOULDING - REAR DOOR WINDOW FRAME TOP - continued</b>						
- B -						
	66/67	B(54B)		C6OZ 5425542-A	C6OZ 5425543-A	1
	66/67	B(71B,E)		C6OZ 7125542-A	C6OZ 7125543-A	1
	68/69	B(54B,C)		C8OZ 5425542-A	C8OZ 5425543-A	1
	68/69	B(54C)-with vinyl roof cover	Black-Levant grain	C8OZ 5425542-B1A	C8OZ 5425543-B1A	1
	69	B(54C)-with vinyl roof cover	White-Levant grain	C9OZ 5425542-BBW	C9OZ 5425543-BBW	1
	70/71	B(54C)	Chrome-snap on	D0OZ 5425542-A	D0OZ 5425543-A	1
	68/71	B(71)		C8OZ 7125542-A	C8OZ 7125543-A	1
- P -						
	71/	P(54)	Snap-on -dull finish	D1DZ 5425542-A	D1DZ 5425543-A	1
	72	P(54)	Snap-on-bright finish	D2DZ 5425542-A	D2DZ 5425543-A	1
- X -						
	66/70	X(54)		C6OZ 5425542-A	C6OZ 5425543-A	1
	67/70	X(71)		C6OZ 7125542-A	C6OZ 7125543-A	1
<b>25546-7 MOULDING - REAR DOOR TRIM PANEL REAR</b>						
	69/ 70	A(54C, 57F)		C9AZ 5725546-A	C9AZ 5725547-A	1
	71	A(57K)				1
<b>25554-5 MOULDING - REAR DOOR OUTSIDE - BELT - INCLUDES ATTACHING PARTS</b>						
	65/66	A(57)		C5AZ 5725554-B	C5AZ 5725555-B	1
	67	A(57)		C7AZ 5725554-A	C7AZ 5725555-A	1
	68	A(57)		C8AZ 5725554-A	C8AZ 5725555-A	1
	71/	A(53, 57)-with vinyl roof		D1MY 5725554-A	D1MY 5725555-A	1
	71	A(53,57)-with out vinyl roof	Refer to Group 25596-7			
	72	B(53)	3 1/2" long	D2OZ 5325554-A	D2OZ 5325555-A	1
	72	P(54)		D2DZ 5425554-A	D2DZ 5425555-A	1
	67/71	S(57)		C7SZ 5725554-B	C7SZ 5725555-B	1
	67/71	S	Screw No. 8-18 x 3/8" - pan head	52720-S8(U380)	52720-S8(U380)	AR
<b>25556-7 MOULDING - REAR DOOR OUTSIDE LOWER - INCLUDES ATTACHING PARTS</b>						
- A -						
	69	A(54A, 57B, 71B, C)		C9AZ 5425556-A	C9AZ 5425557-A	1
	69	A(54C, 57F)		C9AZ 5425556-B	C9AZ 5425557-B	1
	71	A(54F, 57F, 71F)		D1AZ 5425556-A	D1AZ 5425557-A	1
	71/	A(53, 57H, K)		D1AZ 5725556-A	D1AZ 5725557-A	1
- B -						
	65	B(54B, 71B)		C5OZ 5425556-A	C5OZ 5425556-A	2
	67	B(54B, 71B)		C7OZ 5425556-A	C7OZ 5425557-A	1
	68	B(54C)		C8OZ 5425556-A	C8OZ 5425556-A	2
	69	B(54B)		C9OZ 5425556-A	C9OZ 5425556-A	2
	69	B(71B)		C9OZ 7125556-A	C9OZ 7125556-A	2
	71	B(57E)		D1OZ 5725556-A	D1OZ 5725557-A	1
	72	B(53, 71D)		D2OZ 5325556-A	D2OZ 5325557-A	1
- S -						
	69	S(57)		C9SZ 5725556-A	C9SZ 5725557-A	1
<b>25562-3 RETAINER - REAR DOOR OUTSIDE MOULDING</b>						
REFER TO APPROPRIATE EXTERIOR MOULDING ILLUSTRATION FOR COMPLETE RETAINER PART NUMBER						

# FORD CAR PARTS

## BODY SECTION 240

GROUP NUMBER	YEAR	BODY TYPE	DESCRIPTION	PART NUMBER		QTY.
				RIGHT HAND	LEFT HAND	
<b>25576 RETAINER - REAR DOOR TRIM PANEL - Also refer to Group 27590</b>						
	68/69	B(54A, B)		C8OZ 5425576-A	C8OZ 5425576-A	2
	68/69	B(71)		C8OZ 7125576-A	C8OZ 7125576-A	2
<b>25578-9 MOULDING - REAR DOOR TRIM PANEL - LOWER</b>						
	65/66	A(57F)		♣C5MY 5025578-C	★C5MY 5025579-C	1
					Not replaced (1-73)	
	69	A(54C, 57F)		C9AZ 5725578-A	C9AZ 5725579-A	1
	70	A(54C, 57F)	Bent over tabs	D0AZ 5425578-A	D0AZ 5425579-A	1
	71	A(57K)				1
<b>25596-7 WEATHERSTRIP - REAR DOOR GLASS AT BELT - OUTSIDE - INCLUDES CLIPS - Also refer to Group 25860-1</b>						
- A -						
	65	A(54, 71)	"Before 9/14/64"	C5AZ 5425596-B	C5AZ 5425596-A	2
	65/66	A(54, 71)	"From 9/14/64"	C5AZ 5425596-B	C5AZ 5425596-B	2
			No. 4 x 3/8" Cross recess flat head screw	52003-S13(U194)	52003-S13(U194)	4
	67/68	A(54, 71)		C7AZ 5425596-A	C7AZ 5425597-A	1
			No. 6-20 x 1/2" Flat head drill point screw	★380922-S2	★380922-S2	4
	69	A(54, 71)		C9AZ 5425596-A	C9AZ 5425597-A	1
	69	A(57)		C9AZ 5725596-A	C9AZ 5725597-A	1
	70	A(54, 71)		D0AZ 5425596-B	D0AZ 5425597-B	1
	70	A(57)	"Before 2/2/70"	D0AZ 5725596-A	D0AZ 5725597-A	1
	70	A(57)	"From 2/2/70"	D0AZ 5725596-B	D0AZ 5725597-B	1
	71	A(53,57)-with vinyl roof	Refer to Group 25554-5			
	71/	A(53, 57)-w/o vinyl roof	Incl. 1/4" moulding	D1AZ 5725596-A	D1AZ 5725597-A	1
	71/	A(54, 71)		D1AZ 5425596-A	D1AZ 5425597-A	1
	67/	A	No. 6-20 x 3/8" -screw-truss head	353803-S8(UU95)	353803-S8(UU95)	AR
- B -						
	65	B(54, 71)		C2OZ 5425596-A	C2OZ 5425597-A	1
	66/67	B(54, 71)		C6OZ 5425596-A	C6OZ 5425597-A	1
	68/69	B(54)	Without bright bead	C8OZ 5425596-A	C8OZ 5425597-A	1
	68/69	B(54)	With bright bead	C8OZ 5425596-B	C8OZ 5425597-B	1
	68/69	B(71)	Without bright bead	C8OZ 7125596-A	C8OZ 7125597-A	1
	68/69	B(71)	With bright bead	C8GY 7125596-A	C8GY 7125597-A	1
	70/71	B(54)	With bright bead	D0OZ 5425596-A	D0OZ 5425597-A	1
	70/71	B(54)	Without bright bead	D0OZ 5425596-B	D0OZ 5425597-B	1
	70/71	B(57)	With bright bead	D0OZ 5725596-A	D0OZ 5725597-A	1
	70/71	B(57)	Without bright bead	D0OZ 5725596-B	D0OZ 5725597-B	1
	70/71	B(71)	With bright bead	D0OZ 7125596-B	D0OZ 7125597-B	1
	70/71	B(71)	Without bright bead	D0OZ 7125596-A	D0OZ 7125597-A	1
	72	B(53, 71)		D2OZ 5325596-A	D2OZ 5325597-A	1
- P -						
	71/	P(54)		D1DZ 5425596-A	D1DZ 5425596-A	2
- X -						
	65	X(54, 71)		C0DZ 5825596-E	C0DZ 5825597-E	1
			1/4"-20 x 5/8" Hex. washer head screw	★373108-S2	★373108-S2	2
	66/70	X(54, 71)		C6OZ 5425596-A	C6OZ 5425597-A	1

**BODY  
SECTION 240**
**FORD CAR PARTS**

GROUP NUMBER	YEAR	BODY TYPE	DESCRIPTION	PART NUMBER		QTY.
				RIGHT HAND	LEFT HAND	
<b>25622-3</b>		<b>PLATE - QUARTER PANEL NAME - INCLUDES ATTACHING PARTS - Also refer to Chassis Group 16098</b>				
		<b>- A -</b>				
	65	A(54B, 62B)	"Custom 500"	C5AZ 6225622-A	C5AZ 6225623-A	1
	65	A(71D)	Front fender - Tailgate	C3OZ 7125622-A	C3OZ 7125622-A	2
	66	A(54E, 62E)	"Custom"-10 5/8" long	★C6AZ 6225622-A	C6AZ 6225623-A	1
				Not replaced (2/75)		
	66	A(54B, 62B)	"Custom"- 9 5/8" long	C6AZ 6225622-B	C6AZ 6225623-B	1
	66/67	A(71A,E)	"Country Squire"	C6AZ 7125622-B	C6AZ 7125622-B	2
	66/67	A(71B,C)	"Country Sedan"	C6AZ 7125622-A	C6AZ 7125622-A	2
	66/67	A(71D)	"Ranch Wagon"	C6AZ 7125622-C	C6AZ 7125622-C	2
	68	A(54A, 57B, 63B, 65C, 76A)	"Galaxie"	C8AZ 5425622-A	C8AZ 5425622-A	2
	68	A(54B, 62B, 71H, J)	"Custom" - Painted	C8AZ 6225622-A	C8AZ 6225622-A	2
	68	A(71H, J)	On tailgate			1
	68	A(54E, 62E)	"Custom" - Chrome	C8AZ 6225622-B	C8AZ 6225622-B	2
	68	A(71A, E)	"Country Squire"	C8AZ 7125622-E	C8AZ 7125622-E	2
	68	A(71B, C)	"Country Sedan"	C8AZ 7125622-D	C8AZ 7125622-D	2
	68	A(71D, H, J)	"Ranch Wagon"	C8AZ 7125622-C	C8AZ 7125622-C	2
	69	A(54A, 57B, 63B, 65C, 76A)	"Galaxie"	C9AZ 5425622-A	C9AZ 5425622-A	2
	69/70	A(54B, E, 62, 71H, J)	"Custom"	C9AZ 6225622-A	C9AZ 6225622-A	1
	69	A(71A, B, C, E) - "Before 4/14/69"	"Country"	C9AZ 7125622-A	C9AZ 7125623-A	1
	69	A(71A, E) "Before 4/14/69"	"Squire"	C9AZ 7125622-C	C9AZ 7125623-C	1
	69	A(71B, C) "Before 5/1/69"	"Sedan"	C9AZ 7125622-B	C9AZ 7125623-B	1
	69	A(71D, H, J) "Before 4/14/69"	"Ranch"	C9AZ 7125622-D	C9AZ 7125623-D	1
	69	A(71D, H, J) "Before 4/14/69"	"Wagon"	C9AZ 7125622-E	C9AZ 7125623-E	1
	69/70	A(71A,B,C,E) "From 4/14/69"	"Country"	C9AZ 7125622-F	C9AZ 7125623-F	1
	69/70	A(71A, E) "From 4/14/69"	"Squire"	C9AZ 7125622-H	C9AZ 7125623-H	1
	69/70	A(71B, C) "From 5/1/69"	"Sedan"	C9AZ 7125622-G	C9AZ 7125623-G	1
	69/70	A(71D, H, J) "From 4/14/69"	"Ranch"	C9AZ 7125622-J	C9AZ 7125623-J	1
	69/70	A(71D, H, J) "From 4/14/69"	"Wagon"	C9AZ 7125622-K	C9AZ 7125623-K	1
	70	A	"Galaxie"-Refer to Group 42528			
	70	A	"500"-Refer to Group 42495			
	70	A(54E, 62E)	Nut-1/8" crown self threading	382146-S100(MM290E)	382146-S100(MM290E)	8
	71/	A(71B, D)	"Wagon"	D1AZ 7125622-A	D1AZ 7125622-A	2
	71/	A(71B, D)	"Ranch"	D1AZ 7125622-B	D1AZ 7125622-B	2
	71/	A(71F)	"Sedan"	D1AZ 7125622-C	D1AZ 7125622-C	2
	71/	A(71H)	"Squire"	D1AZ 7125622-D	D1AZ 7125622-D	2
	71/	A(71F, H)	"Country"	D1AZ 7125622-E	D1AZ 7125622-E	2
		<b>- B -</b>				
	65	B(54B, 62B, 65, 71B)	"Fairlane 500"	C5OZ 6225622-A	C5OZ 6225622-A	1
	66	B(54B, 62B, 63B, 71B, 76B)				1
	66/67	B(71E)	"Fairlane Squire"	C6OZ 7125622-A	C6OZ 7125622-A	1
	68/69	B(54A, B, 63B, E, 65A, B, E, 71B, D, 76B, E)	"Fairlane"	C8OZ 5425622-A	C8OZ 5425622-A	1
	70	B(54B, 65B, 71B, D)				1
	68	B(63D, 65D, 76D)	"Torino"	C8OZ 6325622-A	C8OZ 6325622-A	1
	69	B(63D, F, 65D, F, 76D, F)				1
	68/69	B(71E)	Also on tailgate			3
	70	B(63F, 65F, 71C, D, E, 76F)				2or3
	68/69	B(71E)	"Squire"	C8OZ 7125622-A	C8OZ 7125622-A	1
	70/71	B(66E, 71E)				1
	72	B(97K)				1

# FORD CAR PARTS

**BODY  
SECTION 240**

13

GROUP NUMBER	YEAR	BODY TYPE	DESCRIPTION	PART NUMBER		QTY.	
				RIGHT HAND	LEFT HAND		
<b>25622-3 PLATE - QUARTER PANEL NAME - INCLUDES ATTACHING PARTS - continued - Also Refer to Chassis Group 16098</b>							
<b>- B -</b>							
71		B(63H)	"Cobra" w/snake (tape transfer) Blue Brown Green Red	D1OZ 6325622-B D1OZ 6325622-C D1OZ 6325622-D D1OZ 6325622-E	D1OZ 6325623-B D1OZ 6325623-C D1OZ 6325623-D D1OZ 6325623-E	1 1 1 1	
71		B(54, 57, 63, 65, 71, 76)	"Torino"- aluminum - Quarter Panel Tailgate "Torino"-bright zinc die cast-Quarter Panel Tailgate	D1OZ 6525622-A D1OZ 6525622-B	D1OZ 6525622-A D1OZ 6525622-B	2 2 1	
<b>- F -</b>							
68		F(65)GT/CS	"California Special"	C8ZZ 6525622-A	C8ZZ 6525622-A	2	
69/70		F-GT350/500	"Shelby"	C9ZZ 6325622-B	C9ZZ 6325622-B	2	
72		F(63, 65)	"USA" shield	D2ZZ 6525622-A	D2ZZ 6525622-A	1	
72		F(63, 65)	"Canada" shield	D2ZZ 6525622-B	D2ZZ 6525622-B	1	
<b>- L -</b>							
72		L(64)	"USA" shield	D2DZ 6225622-A	D2DZ 6225622-A	1	
72		L(64)	"Canada" shield	D2DZ 6225622-B	D2DZ 6225622-B	1	
<b>- P -</b>							
72		P(62)	"USA" shield	D2DZ 6225622-A	D2DZ 6225622-A	1	
72		P(62)	"Canada" shield	D2DZ 6225622-B	D2DZ 6225622-B	1	
<b>- S -</b>							
65/67		S	"Thunderbird"	C5SZ 6325622-A	C5SZ 6325622-A	2	
70		S	"Thunderbird"-Refer to Group 16098			0	
<b>- X -</b>							
67		X(54A, 62A, 71A)	"Falcon"	C7DZ 6225622-A	C7DZ 6225622-A	2	
67		X(71B)	"Futura"	C7DZ 7125622-A	C7DZ 7125622-A	2	
68/69		X(54A, 62A)	"Falcon"	C8DZ 6225622-A	C8DZ 6225622-A	2	
68/70		X(71A)	"Futura"	C8DZ 6225622-B	C8DZ 6225622-B	2	
68/70		X(54B, 62B, C, 71B)	"Futura"	C8DZ 6225622-B	C8DZ 6225622-B	2	
70		A, B	Nut-1/8" self threading	373888-S7(MM290)	373888-S7(MM290)	4or8	
70		A, B	Nut-1/8" sleeve	375890-S100(MM21R)	375890-S100(MM21R)	4or8	
<b>25700-1 GLASS, CHANNEL and FRAME ASSY. - REAR DOOR WINDOW - Tempered unless otherwise indicated</b>							
GROUP NUMBER	YEAR	BODY TYPE	DESCRIPTION	NAGS NUMBER	PART NUMBER		QTY.
					CLEAR	TINTED	
69		A(57)	R. H. L. H.	D4089 D4090	C9AZ 5725700-C C9AZ 5725701-C	C9AZ 5725700-D C9AZ 5725701-D	1 1
70		A(57)	R. H. -includes weatherstrip L. H.	D4317 D4318	D0AZ 5725700-A D0AZ 5725701-A	D0AZ 5725700-B D0AZ 5725701-B	1 1
68/69		B(54)	R. H. L. H.	D3915 D3916	C8OZ 5425700-A C8OZ 5425701-A	C8OZ 5425700-B C8OZ 5425701-B	1 1
70		B(57)	R. H.-includes weatherstrip L. H.	D4337 D4338	D00Z 5725700-A D00Z 5725701-A	D00Z 5725700-B D00Z 5725701-B	1 1

GROUP NUMBER	YEAR	BODY TYPE	DESCRIPTION	NAGS NUMBER	PART NUMBER				QTY.	
					CLEAR		TINTED			
<b>25700-1</b>	<b>GLASS, CHANNEL and FRAME ASSY. - REAR DOOR WINDOW - continued</b> - Tempered unless otherwise indicated									
	67/69	S(57)	R. H.	D3749	C7SZ	5725700-A	C7SZ	5725700-B	1	
			L. H.	D3750	C7SZ	5725701-A	C7SZ	5725701-B	1	
	67/69	S(57)	Screw-No. 8-32 x 1/2" - oval head		50398-S13(U121)		50398-S13(U121)		AR	
	70/71	S(57)	R. H.	D4368	D0SZ	5725700-A	D0SZ	5725700-B	1	
			L. H.	D4369	D0SZ	5725701-A	D0SZ	5725701-B	1	
<b>25712-3</b>	<b>GLASS - REAR DOOR WINDOW</b> - Tempered unless otherwise indicated									
	- A -									
	65/66	A(54)	R. H.	D3323	C5AZ	5425712-A	C5AZ	5425712-B	1	
			L. H.	D3324	C5AZ	5425713-A	C5AZ	5425713-B	1	
	65/66	A(57)	R. H.	D3309	C5AZ	5725712-A	C5AZ	5725712-B	1	
			L. H.	D3310	C5AZ	5725713-A	C5AZ	5725713-B	1	
	65/66	A(71)	R. H.	D3325	C5AZ	7125712-A	C5AZ	7125712-B	1	
			L. H.	D3326	C5AZ	7125713-A	C5AZ	7125713-B	1	
	67/68	A(54)	R. H.	D3726	C7AZ	5425712-A	C7AZ	5425712-B	1	
			L. H.	D3727	C7AZ	5425713-A	C7AZ	5425713-B	1	
	67	A(57)	R. H.	D3718	C7AZ	5725712-A	C7AZ	5725712-B	1	
			L. H.	D3719	C7AZ	5725713-A	C7AZ	5725713-B	1	
	68	A(57)	R. H.	D3901	C8AZ	5725712-A	C8AZ	5725712-B	1	
			L. H.	D3902	C8AZ	5725713-A	C8AZ	5725713-B	1	
	67/68	A(71)	R. H.	D3728	C7AZ	7125712-A	C7AZ	7125712-B	1	
			L. H.	D3729	C7AZ	7125713-A	C7AZ	7125713-B	1	
	69/70	A(54)	R. H.	D4105	C9AZ	5425712-A	C9AZ	5425712-B	1	
			L. H.	D4106	C9AZ	5425713-A	C9AZ	5425713-B	1	
	69/70	A(57)	Refer to Group 25700-1							
	69/70	A(71)	R. H.	D4107	C9AZ	7125712-A	C9AZ	7125712-B	1	
			L. H.	D4108	C9AZ	7125713-A	C9AZ	7125713-B	1	
	71/	A(53)	R. H.	D4514	D1AZ	5325712-A	D1AZ	5325712-B	1	
			L. H.	D4515	D1AZ	5325713-A	D1AZ	5325713-B	1	
	71/	A(54)	R. H.	D4518	D1AZ	5425712-A	D1AZ	5425712-B	1	
			L. H.	D4519	D1AZ	5425713-A	D1AZ	5425713-B	1	
	71/	A(57)	R. H.	D4508	D1AZ	5725712-A	D1AZ	5725712-B	1	
			L. H.	D4509	D1AZ	5725713-A	D1AZ	5725713-B	1	
	71/	A(71)	R. H.	D4522	D1AZ	7125712-A	D1AZ	7125712-B	1	
			L. H.	D4523	D1AZ	7125713-A	D1AZ	7125713-B	1	
	- B -									
	65	B(54)		4360T	C2OZ	5425712-A	C2OZ	5425712-B	2	
	65	B(71)		4389T	C3OZ	7125712-A	C3OZ	7125712-B	2	
	66/67	B(54)	R. H.	D3525	C6OZ	5425712-A	C6OZ	5425712-B	1	
			L. H.	D3526	C6OZ	5425713-A	C6OZ	5425713-B	1	
	66/67	B(71)	R. H.	D3530	C6OZ	7125712-A	C6OZ	7125712-B	1	
			L. H.	D3531	C6OZ	7125713-A	C6OZ	7125713-B	1	
	68	B(54)	Serviced in 25700-1							
	68/69	B(71)	R. H.	D3918	C8OZ	7125712-A	C8OZ	7125712-B	1	
			L. H.	D3919	C8OZ	7125713-A	C8OZ	7125713-B	1	
	70/71	B(54)	R. H.	D4352	D0OZ	5425712-A	D0OZ	5425712-B	1	
			L. H.	D4353	D0OZ	5425713-A	D0OZ	5425713-B	1	
	70/71	B(71)	R. H.	D4354	D0OZ	7125712-A	D0OZ	7125712-B	1	
			L. H.	D4355	D0OZ	7125713-A	D0OZ	7125713-B	1	
	71	B(57)	R. H.	D4558	D1OZ	5725712-A	D1OZ	5725712-B	1	
			L. H.	D4559	D1OZ	5725713-A	D1OZ	5725713-B	1	
	72	B(53)	R. H.	D4727	D2OZ	5325712-A	D2OZ	5325712-B	1	
			L. H.	D4728	D2OZ	5325713-A	D2OZ	5325713-B	1	
	72	B(71)	R. H.	D4729	D2OZ	7125712-A	D2OZ	7125712-B	1	
			L. H.	D4730	D2OZ	7125713-A	D2OZ	7125713-B	1	

# FORD CAR PARTS

## BODY SECTION 240

15

GROUP NUMBER	YEAR	BODY TYPE	DESCRIPTION	NAGS NUMBER	PART NUMBER				QTY.
					CLEAR		TINTED		
<b>25712-3</b>	<b>GLASS - REAR DOOR WINDOW - continued - Tempered unless otherwise indicated</b>								
- P -									
	71/	P(54)	R.H.	D4553	D2DZ	5425712-A	D2DZ	5425712-B	1
			L.H.	D4554	D2DZ	5425713-A	D2DZ	5425713-B	1
- X -									
	65	X(54)		4392T	C3DZ	5425712-A	C3DZ	5425712-B	2
	65	X(71)		4328T	★CIDZ	7125712-J	C1DZ	7125712-K	2
Not replaced (12/74)									
	66/70	X(54)	R.H.	D3525	C6OZ	5425712-A	C6OZ	5425712-B	1
			L.H.	D3526	C6OZ	5425713-A	C6OZ	5425713-B	1
	66/70	X(71)	R.H.	D3530	C6OZ	7125712-A	C6OZ	7125712-B	1
			L.H.	D3531	C6OZ	7125713-A	C6OZ	7125713-B	1
GROUP NUMBER	YEAR	BODY TYPE	DESCRIPTION	PART NUMBER				QTY.	
					RIGHT HAND	LEFT HAND			
<b>257A18-9</b>	<b>BRACKET - REAR DOOR GLASS - REAR</b>								
	71/	A(53, 57)			D1AZ	57257A18-A	D1AZ	57257A19-A	1
	71	B(57)			D1OZ	57257A18-A	D1AZ	57257A19-A	1
<b>25754</b>	<b>BUTTON - REAR DOOR WINDOW STABILIZER</b>								
	71/	A(53, 57)			D1AZ	5725754-A	D1AZ	5725754-A	2
	72	B							AR
<b>25764</b>	<b>RUN - REAR DOOR GLASS - Refer to Groups 21550 &amp; 25766</b>								
	65	B(54)	Cut to 52.38" long & notch from C2OZ 6221550-A						2
	65	B(71)	Cut to 52.06" long & notch from C2OZ 6221550-A						2
	65	X(54)	Cut to 53.73" long from C3AZ 6221550-A						2
	65	X(71)	Cut to 53.25" long from C3AZ 6221550-A						2
<b>25766</b>	<b>RUN - REAR DOOR GLASS - Also refer to groups 21550 &amp; 25764</b>								
- A -									
	65/66	A(71)			C5AZ	7125766-A	C5AZ	7125766-A	2
	67/68	A(54)			C7AZ	5425766-A	C7AZ	5425766-A	2
	67/68	A(71)			C7AZ	7125766-A	C7AZ	7125766-A	2
	69/70	A(54)			C9AZ	5425766-A	C9AZ	5425766-A	2
	69/70	A(71)			C9AZ	7125766-A	C9AZ	7125766-A	2
	71/	A(54)			D1AZ	5425766-A	D1AZ	5425766-A	2
	71/	A(71)			D1AZ	7125766-A	D1AZ	7125766-A	2
- B -									
	66/67	B(54)			C6OZ	5425766-B	C6OZ	5425766-B	2
	66/67	B(71)			C6OZ	7125766-B	C6OZ	7125766-B	2
	68/69	B(54)			C8OZ	5425766-A	C8OZ	5425766-A	2
	68/69	B(71)			C8OZ	7125766-B	C8OZ	7125766-B	2
	70/71	B(54)			D0OZ	5425766-A	D0OZ	5425766-A	2
	70/71	B(71)			D0OZ	7125766-A	D0OZ	7125766-A	2
- P -									
	71/	P(54)			D1DZ	5425766-A	D1DZ	5425766-A	2
- X -									
	66/70	X(54)			C6OZ	5425766-B	C6OZ	5425766-B	2
	66/70	X(71)			C6OZ	7125766-B	C6OZ	7125766-B	2
<b>25775</b>	<b>COVER - REAR DOOR WINDOW FRONT STOP</b>								
	69/70	A(57)			C9AZ	5725775-A	C9AZ	5725775-A	2
	71/	A(53, 57)			D1AZ	5725775-A	D1AZ	5725775-A	2
	67/71	S(57)			C7SZ	5725775-A	C7SZ	5725775-A	2
<b>25780-1</b>	<b>STOP - REAR DOOR WINDOW - UPPER</b>								
	67/71	S(57)			C7SZ	5725780-A	C7SZ	5725781-A	1
			1/4"-20 x 3/4" Hex. head screw & washer assy.		★372289-S13		★372289-S13		4

**BODY  
SECTION 240**
**FORD CAR PARTS**

GROUP NUMBER	YEAR	BODY TYPE	DESCRIPTION	PART NUMBER		QTY.
				RIGHT HAND	LEFT HAND	
<b>25796-7</b>	<b>RETAINER - REAR DOOR GLASS RUN - FRONT</b>					
	70/71	B(71)		D0OZ 7125796-A	D0OZ 7125797-A	1
	71/	P(54)		D1DZ 5425796-A	D1DZ 5425797-A	1
<b>25804-5</b>	<b>RETAINER - REAR DOOR GLASS RUN - LATCH SIDE</b>					
	69/70	A(54, 71)		C9AZ 5425804-A	C9AZ 5425805-A	1
	71/	A(54, 71)		D1AZ 5425804-A	D1AZ 5425805-A	1
	70/71	B(54)		D0OZ 5425804-A	D0OZ 5425805-A	1
			Screw-No. 8-18 x 5/8" - round head	375453-S100(BB658C)	375453-S100(BB658C)	2
<b>25824-5</b>	<b>WEATHERSTRIP - REAR DOOR GLASS - FRONT</b>					
	65/67	A(57)	"Before 1/18/67"	C5AZ 5725824-A	C5AZ 5725825-A	1
	67/68	A(57)	"From 1/18/67"	C5AZ 5725824-B	C5AZ 5725825-B	1
	70/	A(57)	Refer to Group 25854-5			
	70/71	B(57)		D0OZ 5725824-A	D0OZ 5725825-A	1
	65/68	A	Screw-No. 8-18 x 3/8" - pan head	52720-S8(U380)	52720-S8 (U380)	2
<b>25854-5</b>	<b>WEATHERSTRIP - REAR DOOR GLASS-FRONT</b>					
	70/	A(57)		D1AZ 5725854-A	D1AZ 5725855-A	1
<b>25858</b>	<b>RUN - REAR DOOR GLASS - UPPER HINGE SIDE</b>					
	65	A(71)	Cut to 15.10" from COAB 5825766-B			2
<b>25860-1</b>	<b>WEATHERSTRIP - REAR DOOR GLASS AT BELT - INSIDE - Also refer to Group 25596-7</b>					
			<b>- A -</b>			
	65/66	A(54, 71)	Use C5AZ 6221456-B by cutting to fit at forward end & drill holes for attaching screws			2
	67/68	A(54, 71)	Less clips	C7AZ 5425860-A	C7AZ 5425861-A	1
	69/72	A(54, 71)	"Before 10/15/71"	C9AZ 5425860-B	C9AZ 5425861-B	1
	69	A(57)		C9AZ 5725860-A	C9AZ 5725861-A	1
	70/72	A(57)	"Before 10/15/71"	D0AZ 5725860-A	D0AZ 5725861-A	1
	71/72	A(53)	"Before 10/15/71"	D1AZ 5325860-A	D1AZ 5325861-A	1
	72	A(53)	"From 10/15/71"	D2AZ 5325860-A	D2AZ 5325861-A	1
	72	A(54, 71)	"From 10/15/71"	D2AZ 5425860-A	D2AZ 5425861-A	1
	72	A(57)	"From 10/15/71"	D2AZ 5725860-A	D2AZ 5725861-A	1
			<b>- B -</b>			
	65	B(54, 71)		C2OZ 5425596-A	C2OZ 5425597-A	1
	66/67	B(54, 71)	With clips	C6OZ 5425860-A	C6OZ 5425861-A	1
	68/69	B(54A, B)		C8OZ 5425860-C	C8OZ 5425861-A	1
	68/69	B(54C)		C8OZ 5425860-C	C8OZ 5425861-C	1
	68/69	B(71)		C8OZ 7125860-A	C8OZ 7125861-A	1
	69	B(71E)		C9OZ 7125860-A	C9OZ 7125861-A	1
	70/71	B(54)		D0OZ 5425860-A	D0OZ 5425861-A	1
	70/71	B(57)		D0OZ 5725860-A	D0OZ 5725861-A	1
	70/71	B(71)		D0OZ 7125860-A	D0OZ 7125861-A	1
	72	B(53, 71)		D2OZ 5325860-A	D2OZ 5325861-A	1
			<b>- P -</b>			
	71/72	P(54)	"Before 3/20/72"	D1DZ 5425860-A	D1DZ 5425860-A	2
	72	P(54)	"From 3/20/72"	D2DZ 5425860-A	D2DZ 5425860-A	2
			<b>- S -</b>			
	67	S(57)	Less clips	C7SZ 5725860-B	C7SZ 5725861-B	1
	68/71	S(57)	Cut to fit-20 3/8" long			1
			<b>- X -</b>			
	65	X(54, 71)		C0DZ 5825596-E	C0DZ 5825597-E	1
	66/70	X(54, 71)	With clips	C6OZ 5425860-A	C6OZ 5425861-A	1



# FORD CAR PARTS

**BODY  
SECTION 260**

1

GROUP NUMBER	YEAR	BODY TYPE	DESCRIPTION	PART NUMBER	QTY.	
<b>26066 BUMPER - REAR DOOR WINDOW STOP</b>						
	71/	P(54)		D1DZ 5426066-A	2	
<b>26086-7 REINFORCEMENT - REAR DOOR OUTSIDE PANEL AT BELT</b>						
	71/72	A(53, 57)	R.H.	D1AZ 5726086-A	1	
			L.H.	D1AZ 5726087-A	1	
<b>26090-1 MOULDING - REAR DOOR OUTSIDE UPPER REAR - INCLUDES ATTACHING PARTS</b>						
	67/71	S(57)	R.H.	C7SZ 5726090-A	1	
			L.H.	C7SZ 5726091-A	1	
GROUP NUMBER	YEAR	BODY TYPE	DESCRIPTION	PART NUMBER		QTY.
				RIGHT HAND	LEFT HAND	
<b>26216-7 GUIDE - REAR DOOR WINDOW - FRONT</b>						
	68/69	B(54, 71)		C8OZ 5426216-A	C8OZ 5426216-A	2
	68/69	B	Bolt-hex. head- 1/4"-20 x 3/4"	371492-S2(BB569)	371492-S2(BB569)	AR
	68/69	B	Nut & retainer ("J")- 1/4"-20	356657-S32(MM186)	356657-S32(MM186)	AR
	67/71	S(57)		C7SZ 5726216-A	C7SZ 5726217-A	1
<b>262A16-7 RUN and RETAINER ASSY. - REAR DOOR GLASS - HINGE SIDE - Refer to groups 21550 and 25796-7</b>						
<b>262A20-1 STOP - REAR DOOR WINDOW UPPER - FRONT</b>						
	69/70	A(57)		C9AZ 57262A20-A	C9AZ 57262A21-A	1
	71/	A(53)		D1AZ 53262A20-A	D1AZ 53262A21-A	1
	71/	A(57)		D1AZ 57262A20-A	D1AZ 57262A21-A	1
	70	B(57)		D0OZ 57262A20-A	D0OZ 57262A20-A	2
	71	F				2
	71	B(57)		D1OZ 57262A20-A	D1OZ 57262A20-A	2
	70/	B	Screw & washer- 1/4"-20 x 5/8"	57472-S2(B339V)	57472-S2(B339V)	2
<b>26222-3 GUIDE - REAR DOOR WINDOW - REAR</b>						
	71/	A(53, 57)		D1AZ 5726222-A	D1AZ 5726223-A	1
	68/69	B(54)		C8OZ 5426222-B	C8OZ 5426222-B	2
			Nut & retainer-1/4"-20	356657-S32(MM186)	356657-S32(MM186)	AR
			Bolt-hex. head- 1/4"-20 x 3/4"	371492-S2(BB569)	371492-S2(BB569)	AR
	70	B(57)	Use with fixed type roller	D0OZ 5726222-A	D0OZ 5726223-A	1
	70/	B(57)	Use with swivel type roller	D0OZ 5726222-B	D0OZ 5726223-B	1
<b>26228-9 CHANNEL - REAR DOOR WINDOW GLASS LOWER</b>						
- A -						
	67/68	A(57)		C7AZ 5726228-A	★C7AZ 5726229-A Not replaced (3-74)	1
	69/70	A(54, 71)		C9AZ 5426228-A	C9AZ 5426229-A	1
	65/70	A	Bolt-hex. head- No. 8-32 x 3/8"	358477-S8(BB93)	358477-S8(BB93)	2
	65/70	A	Screw-oval head- No. 8-32 x 1/2"	50398-S13(U121)	50398-S13(U121)	AR
- B -						
	66/67	B(54, 71)		C6OZ 5426228-A	C6OZ 5426229-A	1
	68/69	B(71)		C8OZ 7126228-A	C8OZ 7126229-A	1
	70/71	B(54)		D0OZ 5426228-A	D0OZ 5426229-A	1
	70/71	B(71)		D0OZ 7126228-A	D0OZ 7126229-A	1
	65/71	B	Screw-oval head- No. 8-32 x 1/2"	50398-S13(U121)	50398-S13(U121)	AR
- X -						
	66/70	X(54, 71)		C6OZ 5426228-A	C6OZ 5426229-A	1
			Screw-oval head- No. 8-32 x 1/2"	50398-S13(U121)	50398-S13(U121)	AR

GROUP NUMBER	YEAR	BODY TYPE	DESCRIPTION	PART NUMBER	QTY.
<b>262A32</b>	<b>ROLLER - WINDOW REGULATOR ARM - Also refer to group 23240</b>				
65/71	A, B, X		Incl. attaching stud-11/16" O.D. x 1/2" thick	C5AZ 57262A32-A	AR
67/68	F				AR
68/	A, P, S, X		Incl. attaching stud-1" O.D. x 1/2" thick	C8SZ 57262A32-A	AR
68/71	B, F		Incl. attaching stud-1" O.D. x 1/2" thick	C8SZ 57262A32-A	AR
<b>262A34-5</b>	<b>RETAINER - REAR DOOR WINDOW WEATHERSTRIP</b>				
71/	A(57)		R.H.	D1AZ 57262A34-A	1
			L.H.	D1AZ 57262A35-A	1
70/71	B(57)		R.H.	D0OZ 57262A34-A	1
			L.H.	D0OZ 57262A35-A	1
<b>26258</b>	<b>WEATHERSTRIP - REAR DOOR GLASS CHANNEL</b>				
65/68	A(54, 71)		Cut from C5AZ 6221510-A		2
66/67	B(54, 71)		Cut to 21.65" long from C5AZ 6221510-A		2
66/70	X(54, 71)				2
<b>262A62</b>	<b>CARRIAGE - REAR DOOR WINDOW ROLLER - REAR</b>				
68/69	B(54)			C8OZ 54262A62-A	2
<b>262A84</b>	<b>STOP - REAR DOOR WINDOW REAR - UPPER</b>				
69/	A(53, 57)			C9AZ 57262A84-A	2
70	B(57)			D0OZ 57262A84-A	2
68/69	B(63, 65, 76)		Quarter window upper		2
71	B(57)			D1OZ 57262A84-A	2
<b>263A16</b>	<b>CARRIAGE - REAR DOOR WINDOW ROLLER - FRONT</b>				
68/69	B(54, 71)			C8OZ 54263A16-A	2
<b>263A24</b>	<b>BRACKET - REAR DOOR STATIONARY WINDOW DIVISION BAR - LOWER</b>				
68/71	B(71)			C8OZ 71263A24-A	2
<b>263A32</b>	<b>STABILIZER - REAR DOOR WINDOW</b>				
67/70	A(57)			C7AZ 57263A32-A	2
71/	A(53, 57)			D1AZ 57263A32-A	2
<b>26348</b>	<b>BRACKET - REAR DOOR WINDOW EQUALIZER ARM - UPPER</b>				
69	A(54)			C9AZ 5426348-A	2
70	A(54, 71)			D0AZ 5426348-A	2
71/	A(53, 54, 57, 71)			D1AZ 5426348-A	2
68/69	X(62)		Front door window	C8OZ 5426348-A	2
69	A(62)		Quarter window regulator arm		2
<b>263A48</b>	<b>RUN - REAR DOOR STATIONARY WINDOW DIVISION BAR</b>				
66/67	B(54, 71)		Cut from C5AZ 6321546-A		2
66/70	X(54, 71)		Cut from C5AZ 6321546-A		2
<b>263A52-3</b>	<b>BRACKET - REAR DOOR GLASS - FRONT</b>				
71/	A(53, 57)		R.H.	D1AZ 57263A52-A	1
			L.H.	D1AZ 57263A53-A	1
71/	A(54, 71)			D1AZ 54263A52-A	4
71	B(57)		R.H.	D1OZ 57263A52-A	1
			L.H.	D1CZ 57263A53-A	1
72	B(53, 71)		R.H.	D2OZ 53263A52-A	1
			L.H.	D2OZ 53263A53-A	1
71/	P(54)			D1DZ 54263A52-A	2
<b>263A54</b>	<b>STABILIZER - REAR DOOR WINDOW - REAR</b>				
70/	A(53, 57, 65, 76)			D0AZ 57263A54-A	2or4
<b>263A70-1</b>	<b>RUN and BRACKET ASSY. - REAR DOOR GLASS - FRONT</b>				
69/70	A(57)			C9AZ 57263A70-A	2
71/	A(53, 57)			D1AZ 53263A70-A	2
70/71	B(57)			D0OZ 57263A70-A	2
72	B(53, 71)			D2OZ 53263A70-A	2
67/71	S(57)		R.H.	C7SZ 57263A70-A	1
			L.H.	C7SZ 57263A71-A	1
			1/4"-20 x 1/2" Pan head screw & washer assy.	373460-S7(BB629)	4
70/	A, B		Screw & washer 1/4"-20 x 3/4" Hex. head	382682-S100(BB390XF)	2

# FORD CAR PARTS

## BODY SECTION 260

3

GROUP NUMBER	YEAR	BODY TYPE	DESCRIPTION	PART NUMBER		QTY.	
				RIGHT HAND	LEFT HAND		
<b>263A72-3 RUN and BRACKET ASSY. - REAR DOOR GLASS - REAR</b>							
67/71	S(57)		R. H.	C7SZ	57263A72-B	1	
			L. H.	C7SZ	57263A73-B	1	
			1/4"-20 x 3/4" Hex. washer head screw		371492-S2(BB569)	4	
			1/4" Flat washer		44720-S8(X18)	2	
67/71	S		Bolt-pan head-1/4"-20 x 1/2"		373460-S7(BB629)	2	
<b>263A80 CLIP - REAR DOOR WINDOW TOP</b>							
69/	A(54)			C9AZ	57263A80-A	2	
<b>26384 BRACKET - REAR DOOR WINDOW GLASS CHANNEL</b>							
69/70	A(54, 71)			C9AZ	5426384-A	2	
66/67	B(54, 71)			C6OZ	5426384-A	2	
66/70	X(54, 71)					2	
68/69	B(54, 71)			C8OZ	5426384-B	2	
70/71	B(54)			D0OZ	5426384-A	2	
70	B(57)			D0OZ	5726384-A	2	
70/71	B(71)			D0OZ	7126384-A	2	
<b>263A86 SPACER - WINDOW GLASS ROLLER</b>							
71	B(57)			D1OZ	57263A86-A	6	
72	B,S		Front Door, quarter			4	
71/	F		Front door			6	
<b>26404-5 CONTROL and LINK ASSY. - DOOR LATCH REMOTE</b>							
65	F	"Before 8/20/64"	R.H.-front door-not replaced (3-74)	★C2OZ	5426404-B	1	
			L. H.	C2OZ	5426405-B	1	
65	B		R. H. -Front or rear door	C5DZ	5426404-A	1 or 2	
65	F	"From 8/20/64 to 3/8/65"	R. H. -Front door			1	
65	X(54, 71)		R. H. -Rear door			1	
			L. H.	C5DZ	5426405-A	1 or 2	
65/66	F	"From 3/8/65"	Refer to Group 21818-9				
68/69	A(54, 57, 71), B(54, 71)		R. H.	C8AZ	5426404-B	1	
68/70	X(54, 71)		R. H.				
68/71	S(57)		R. H.			1	
			L. H.	C8AZ	5426405-B	1	
70	A,B		Refer to Group 21818-9				
65	B(54, 71), F,X(54, 71)		Cross recess pan head screw & washer assy. - No. 12-24 x 1/2"		50811-S8(U150A)	AR	
65	B		Screw-hex. head-5/16"-24 x 5/8"		359605-S8(BB590)	AR	
68/71	S(57)		Nut-hex. -No. 10-24		34053-S8(M156)	4	
68/71	S(57)		Washer-No. 8-external lock		34938-S8(X85)	4	
70	S(57)		Screw & washer No. 12-24 x 1/2"		356782-S8(BB114)	2	
<b>26412-3 LATCH ASSY. - REAR DOOR - INCLUDES ATTACHING PARTS</b>							
<b>- A -</b>							
65/67	A(54, 57, 71)		Without vacuum door latch	C7AZ	5426412-A	C7AZ 5426413-A	1
65/66	A(54, 57, 71)		With vacuum door latch	C5AZ	5426412-B	★C5AZ 5426413-B Not replaced (12-74)	1
68	A(54, 57, 71)			C8AZ	5426412-A	C8AZ 5426413-A	1
69/70	A(54, 57, 71)			C9AZ	5426412-A	C9AZ 5426413-A	1
71/	A(53, 54, 57, 71)			D1AZ	5426412-B	D1AZ 5426413-B	1
<b>- B -</b>							
65	B(54, 71)			C3OZ	5426412-C	C3OZ 5426413-C	1
66/68	B(54, 71)		Without vacuum door latch	C6OZ	5426412-C	C6OZ 5426413-C	1
69	B(54, 71)			C9OZ	5426412-A	C9OZ 5426413-A	1
70/71	B(54, 57, 71)			C9AZ	5426412-A	C9AZ 5426413-A	1
72	B(53, 71)			★D1AZ	5426412-B	D1AZ 5426413-B	1
				r/b D3OZ	5326412-A (10-74)		
65/	B		Screw-flat head with lockwasher-No. 12-24 x 7/16"		353908-S7(BB113)	353908-S7(BB113)	AR
66/	B		Screw-pan head	★359444-S8		★359444-S8	1

**BODY  
SECTION 260**
**FORD CAR PARTS**

GROUP NUMBER	YEAR	BODY TYPE	DESCRIPTION	PART NUMBER		QTY.
				RIGHT HAND	LEFT HAND	
<b>26412-3 LATCH ASSY. - REAR DOOR - INCLUDES ATTACHING PARTS - continued</b>						
- P -						
	71/	P(54)		C9AZ 5426412-A	C9AZ 5426413-A	1
- S -						
	67	S(57)		C7SZ 5726412-A	C7SZ 5726413-A	1
	68/71	S(57)		C8SZ 5726412-A	C8SZ 5726413-A	1
- X -						
	66/68	X(54, 71)	Without vac. door latch	C6OZ 5426412-C	C6OZ 5426413-C	1
	68	X(54, 71)	With vacuum door latch	C8OZ 5426412-A	C8OZ 5426413-A	1
	69/70	X(54, 71)		C9OZ 5426412-A	C9OZ 5426413-A	1
	65	A(54, 71, 75), B(54, 71)	No. 12-24 x .44" Cross recess flat head screw & washer assy.	356782-S7(BB114)	356782-S7(BB114)	6
	70	A(54, 57, 71)				6
	70	B(54, 57, 71)				6
	70	P				6
	70	S(57)				6
GROUP NUMBER	YEAR	BODY TYPE	DESCRIPTION	PART NUMBER		QTY.
<b>26420-1 LINK - REAR DOOR LATCH CONTROL ROD</b>						
- A -						
	65/68	A(57)	R. H. L. H. -not replaced (3-74)	C5AZ 5726420-A		1
	69/70	A(54, 57, 71)		*C5AZ 5726421-A		1
	71/	A(53, 54, 57, 71)		C9AZ 5426420-A		2
				DIAZ 5426420-A		2
- B -						
	66/67	B(54, 71)		C6OZ 5426420-A		2
			Clip	380165-S2(GG286)		2
			No. 8-32 x .40" Pan head screw	*359444-S8		2
	68/69	B(54)		C8OZ 5426420-A		2
	70/71	B(54, 57)	R. H.	D0OZ 5426420-A		1
			L. H.	D0OZ 5426421-A		1
	70/71	B(71)		D0OZ 7126420-A		2
	70/71	B(54, 57, 71)	Screw & washer No. 8-32 x 1/2" Hex. head	57075-S2(B330A)		2
	72	B(53, 71)	R.H.	D2OZ 5326420-A		1
			L.H.	D2OZ 5326421-A		1
- P -						
	71/	P(54)		D1DZ 5426420-A		2
- X -						
	66/70	X(54, 71)		C6OZ 5426420-A		2
	70/	A(53, 54, 57, 71)	Screw & washer No. 12-24 x 1/2" flat head	356782-S8(BB114)		2
	70/	B(54, 57, 71)				2

**26442-3 LINK - REAR DOOR LATCH REMOTE CONTROL**

- A -						
	69	A(54, 57, 71)		C9AZ 5426442-B		2
	70	A(54, 57, 71)	R. H.	D0AZ 5426442-A		1
			L. H.	D0AZ 5426443-A		1
	71/	A(53, 54, 57, 71)	R.H.	D1AZ 5426442-A		1
			L.H.	D1AZ 5426443-A		1
- B -						
	68/69	B(54)		C8OZ 5426442-A		2
	68/69	B(71)		C8OZ 7126442-A		2
	70/71	B(54, 57)	R. H.	D0OZ 5426442-A		1
			L. H.	D0OZ 5426443-A		1
	72	B(53, 71)	R.H.	D2OZ 5326442-A		1
			L.H.	D2OZ 5326443-A		1
	70/71	B(71)	R. H.	D0OZ 7126442-A		1
			L. H.	D0OZ 7126443-A		1
	65	B	Nut -7/32" sleeve	377647-S(MM216J)		2

# FORD CAR PARTS

**BODY  
SECTION 260**

5

GROUP NUMBER	YEAR	BODY TYPE	DESCRIPTION	PART NUMBER	QTY.
<b>26442-3 LINK - REAR LATCH REMOTE CONTROL - continued</b>					
- P -					
	71/	P(54) -exc. LTD	R.H.	D1DZ 5426442-A	1
			L.H.	D1DZ 5426443-A	1
	72	P(54)-LTD	R.H.	D2DZ 5426442-A	1
			L.H.	D2DZ 5426443-A	1
- S -					
	68/71	S(57)		C8SZ 5726442-A	2
- X -					
	68/70	X(54, 71)		C8DZ 5426442-A	2
<b>26448-9 BELLCRANK - REAR DOOR LATCH</b>					
- A -					
	69/	A(53,54,57,71)	Without vacuum door latch	C9AZ 5426448-A	2
	69/	A(53,54,57,71)	With vacuum door latch	C9AZ 5426448-B	2
	65/	A(53,54,57,71)	Screw-Hex.washer head-5/16"-18 x 1/2"	378976-S7-8(BB574M)	2
- B -					
	68/69	B(54, 71)		C8OZ 5426448-A	2
	70/71	B(54, 57, 71)		C9AZ 5426448-A	2
	72	B(53, 71)	R.H.	D2OZ 5326448-A	1
			L.H.	D2OZ 5326449-A	1
- P -					
	71/	P(54)		C9AZ 5426448-A	2
- S -					
	69/71	S(65)	Front door	C8DZ 5426448-A	2
- X -					
	68/70	X(54, 71)		C8DZ 5426448-A	2
<b>26460-1 ROD - REAR DOOR LATCH PUSH BUTTON</b>					
- A -					
	65/68	A(54, 57, 71)		C5AZ 5426460-B	2
	69/	A(53, 54, 57, 71)		C9AZ 5426460-A	2
- B -					
	65	B(54, 71)	Retainer	C3AZ 6221952-A	2
	66/69	B(54, 71), X(54, 71)		C6OZ 5426460-A	2
	70/71	B(71)			2
	70/71	B(54, 57)		D0OZ 5426460-A	2
	72	B(53, 71)		D2OZ 5326460-A	2
- P -					
	71/	P(54)		D1DZ 5426460-A	2
- S -					
	67/71	S(57)	R. H.	C7SZ 5726460-B	1
			L. H. -not replaced (3-74)	*C7SZ 5726461-B	1
<b>26480-1 RETAINER - REAR DOOR LATCH STRIKER ANCHOR PLATE</b>					
	71/	A(71)	R. H.	D1AZ 7126480-A	1
			L. H.	D1AZ 7126481-A	1
<b>265A04 STRIKER - DOOR LATCH- Also refer to Group 22008-9</b>					
	65	X(54, 71)	Rear door	C4DZ 54265A04-A	2
	66/	A(71), B(66, 71), X(66, 71)	R.H.-tailgate latch-upper		1
			L. H. -Refer to Group 43146		
	67	F	Front door		2
	65	X(54, 71)	5/16"-24 x 15/16" Flat head locking screw	371402-S13(BB101A)	4
	66	A(71), B(71), X(66, 71)	5/16"-18 x 1" Flat head locking screw	382541-S100(UU48DA)	4
<b>265A06 SHIM - DOOR LATCH STRIKER PLATE</b>					
	65	X(54, 71)		C4DZ 54265A06-A	AR
	65/71	A, B, P, S, U, X	Front or rear door		AR
	66/71	A(71), B(66, 71), X(66, 71)	R.H. - tailgate latch		AR
	72	P			AR
			L. H. -Refer to Group 43152		
	72	A	Improvise	★	

**BODY  
SECTION 260**
**FORD CAR PARTS**

GROUP NUMBER	YEAR	BODY TYPE	DESCRIPTION	PART NUMBER	QTY.
<b>26514</b>	<b>SPRING - TAILGATE LATCH RATCHET PAWL</b>				
	66/71	A(71), B(66,71), X(66,71)		C6AZ 7126514-A	3
	72	A(71), B(71)			3
<b>265A28</b>	<b>BUMPER - DOOR - Also refer to Group 23030</b>				
	65/66	A(57)	Lower	C5AZ 57265A28-B	2
	68	X(54,71)	Upper-NOTE 2		2
	69	S(65)	Front door-upper		2
	71	S(65)	Rear		2
	67/	A(54,71)	Lower		2
	67/	A(53,57)	Lower & upper	C7AZ 54265A28-A	2
	69/	F			4
	70/	P	Door		2
	71/	B,L	Door		4
	72	S			4
	68/69	B(54)		C8OZ 54265A28-A	2
	71/	A	Upper		2
<b>265A36</b>	<b>RETAINER - REAR DOOR LATCH VACUUM CONTROL HOSE</b>				
	65/	A(54,57,71)	Use 376914-S(Y2) adjustable strap		2
<b>265A66-7</b>	<b>PLATE - REAR DOOR LATCH REMOTE CONTROL</b>				
	68/71	S(57)	R. H.	C8SZ 57265A66-A	1
			L. H.	C8SZ 57265A67-A	1
<b>265A70</b>	<b>SUPPORT - REAR DOOR LATCH VACUUM HOSE</b>				
	69/71	A(53,54,57,71)		C9AZ 54265A70-A	2
<b>26594-5</b>	<b>ACTUATOR - REAR DOOR VACUUM LATCH</b>				
	68	A(54,57,71)	R. H.	C8AZ 5426594-A	1
			L. H.	C8AZ 5426595-A	1
	69/	A(53,54,57,71)	R. H.	C9AZ 5426594-A	1
			L. H.	C9AZ 5426595-A	1
	72	B(53,71)	R. H. - Electric	D2OZ 5326594-B	1
			L. H.	D2OZ 5326595-B	1
	67	S(57)	R. H. - Includes attaching parts & I. S. No. 3174	C7SZ 5726594-C	1
			L. H.	C7SZ 5726595-C	1
			Clip assy.	C7SZ 6521952-A	2
	68/71	S(57)	R. H.	C8SZ 5726594-A	1
			L. H.	C8SZ 5726595-A	1
			Screw-pan head-No. 12-24 x 1/2"	50811-S8(U150A)	2
<b>26596-7</b>	<b>ROD - REAR DOOR LATCH ACTUATING</b>				
	71/	A(53,54,57,71)	R.H.	D1AZ 5426596-B	1
			L.H.	D1AZ 5426597-B	1
	72	B(53,71)		D2OZ 5326596-A	1
<b>26602</b>	<b>BUTTON and PIN KIT - REAR DOOR OUTSIDE HANDLE - Also refer to Groups 22454-5</b>				
	<b>- A -</b>				
	65	A(54,57,71)	Includes attaching parts	C5AZ 5426602-A	2
	66	A(54,57,71)	R. H. or L. H. -Kit-Consists of 1-Button & Pin Assy.      1-Sleeve 1-Retainer                      1-Seal 1-Spring                         1-Screw	C6AZ 5426602-B	2
	67	A(54,57,71)	R. H. or L. H. -Kit-Consists of 1-Button & Pin Assy.      1-Sleeve 1-Retainer                      1-Seal 1-Spring                         1-Screw	C7AZ 5426602-A	2
	68	A(54,57,71)	R. H. or L. H. -Kit-Consists of 1-Button & Pin Assy.      1-Sleeve 1-Retainer                      1-Seal 1-Spring                         1-Screw	C8AZ 5426602-A	2
	69/70	A(54,57,71)	R. H. or L. H. -Kit-Consists of 1-Button & Pin Assy.      1-Sleeve 1-Retainer                      1-Seal 1-Spring                         1-Screw	C9AZ 5426602-A	2

NOTE 2 - Before 4/1/65 - refer to Group 23030

# FORD CAR PARTS

## BODY SECTION 260

7

GROUP NUMBER	YEAR	BODY TYPE	DESCRIPTION	PART NUMBER	QTY.
<b>26602 BUTTON and PIN KIT - REAR DOOR OUTSIDE HANDLE - continued - Also refer to Groups 22454-5</b>					
<b>- B -</b>					
65		B(54, 71)	Refer to Group 22454		
66/67		B(54, 71)	R. H. or L. H. -Kit-Consists of 1-Button & Pin Assy.      1-Sleeve 1-Retainer                      1-Seal 1-Spring                         1-Screw	C6OZ 5426602-B	2
68/69		B(54)	R. H. or L. H. -Kit-Consists of 1-Button & Pin Assy.      1-Sleeve 1-Retainer                      1-Seal 1-Spring                         1-Screw	C8OZ 5426602-A	2
68/69		B(71)	R. H. or L. H. -Kit-Consists of 1-Button & Pin Assy.      1-Sleeve 1-Retainer                      1-Seal 1-Spring                         1-Screw	C8OZ 7126602-A	2
70/71		B(54, 57)	Includes attaching parts R.H. or L.H. - consists of 1-Button & pin assy.        1-Retainer assy. 1-Spring                         1-Screw 1-Seal	D0OZ 5426602-A	2
70/71		B(71)	Includes attaching parts R.H. or L.H. - consists of 1-Button & pin assy.        1-Retainer assy. 1-Spring                         1-Screw 1-Seal	D0OZ 7126602-A	2
<b>- P -</b>					
71/		P(54)	Consists of 1-Button & pin                1-Sleeve 1-Retainer                      1-Screw 1-Spring                         1-Seal	D1DZ 5426602-A	2
<b>- S -</b>					
67/71		S(57)	R. H. or L. H. -Kit-Consists of 1-Button & Pin Assy.      1-Sleeve 1-Retainer                      1-Seal 1-Spring                         1-Screw	C7SZ 5726602-A	2
<b>- X -</b>					
65		X(54, 71)	R. H. or L. H. -Kit-Consists of 1-Button & Pin Assy.      1-Seal 1-Retainer                      1-Screw 1-Spring	C4DZ 5426602-A	2
66/70		X(54)	R. H. or L. H. -Kit-Consists of 1-Button & Pin Assy.      1-Sleeve 1-Retainer                      1-Seal 1-Spring                         1-Screw	C6DZ 5426602-B	2
66/70		X(71)	R. H. or L. H. -Kit-Consists of 1-Button & Pin Assy.      1-Sleeve 1-Retainer                      1-Seal 1-Spring                         1-Screw	C6OZ 5426602-B	2
<b>26604-5 HANDLE - REAR DOOR OUTSIDE</b>					
65		A	Refer to Group 22404-5		
66		A(54, 57, 71)	R. H. L. H. - not replaced (12/74)	C6AZ 5426604-A *C6AZ 5426605-A	1 1
67		A(54, 57, 71)	R. H. L. H.	C7AZ 5426604-A C7AZ 5426605-A	1 1
68		A(54, 57, 71)	R. H. L. H.	C8AZ 5426604-A C8AZ 5426605-A	1 1
69/70		A(54, 57, 71)	R. H. L. H.	C9AZ 5426604-A C9AZ 5426605-A	1 1
65/67		B(54, 71)	Refer to Group 22404-5		
71/		A, B	Refer to Group 22404-5		
71/		P(54)	R.H. L.H.	D1DZ 5426604-A D1DZ 5426605-A	1 1

**BODY  
SECTION 260**
**FORD CAR PARTS**

GROUP NUMBER	YEAR	BODY TYPE	DESCRIPTION	PART NUMBER	QTY.	
<b>266A24-5 CUP - REAR DOOR INSIDE HANDLE</b>						
	69	A(54, 57, 71)	Teakwood-refer to Group 27542-3			
			R. H. -Aqua	C9AZ 54266A24-E	1	
			L. H.	C9AZ 54266A25-E	1	
			R. H. -Black	C9AZ 54266A24-A	1	
			L. H.	C9AZ 54266A25-A	1	
			R. H. -Blue (light)	C9AZ 54266A24-B	1	
			L. H.	C9AZ 54266A25-B	1	
			R. H. -Gold	C9AZ 54266A24-D	1	
			L. H.	C9AZ 54266A25-D	1	
			R. H. -Nugget	C9AZ 54266A24-H	1	
			L. H.	C9AZ 54266A25-H	1	
			R. H. -Red (dark)	C9AZ 54266A24-C	1	
			L. H.	C9AZ 54266A25-C	1	
			R. H. -Walnut	C9AZ 54266A24-F	1	
			L. H.	C9AZ 54266A25-F	1	
			R. H. -White	C9AZ 54266A24-G	1	
			L. H.	C9AZ 54266A25-G	1	
<b>26642 BRACKET - REAR DOOR PULL HANDLE</b>						
	68	S(57C)	C8SZ 5726642-A	C8SZ 5726642-A	2	
<b>26800-1 HINGE ASSY. - REAR DOOR - UPPER</b>						
- A -						
	65/68	A(54,57,71)		C5AZ 5426800-E	C5AZ 5426801-E	1
			5/16"-18 x 1 1/2" Hex. washer head tapping screw	351945-S2(UU52J)	351945-S2(UU52J)	6
	69/	A(53,54,57,71)		C9AZ 5426800-A	C9AZ 5426801-A	1
			Screw-5/16"-18x1 1/8" hex.head	382623-S2(UU52AL)	382623-S2(UU52AL)	6
- B -						
	66/67	B(54, 71)		C6OZ 5426800-B	C6OZ 5426801-B	1
			5/16"-18 x 1 1/2" Hex. washer head tapping screw	351945-S2(UU52J)	351945-S2(UU52J)	6
	68/69	B(54, 71)		C8OZ 5426800-A	C8OZ 5426801-A	1
	70/71	B(54)		D0OZ 5426800-A	D0OZ 5426801-A	1
	70/71	B(57)		D0OZ 5726800-A	D0OZ 5726801-A	1
	70/71	B(71)		D0OZ 7126800-A	D0OZ 7126801-A	1
	72	B(53, 71)		D2OZ 5326800-A	D2OZ 5326801-A	1
	69	B(54, 71)	Screw-hex. - 11/32"-18 x 1 3/8"	383509-S2(UU52BB)	383509-S2(UU52BB)	AR
	70/	B(54,57,71)	Screw-5/16"-18x1 1/8" hex.head	382623-S2(UU52AL)	382623-S2(UU52AL)	6
- P -						
	71/	P(54)		C9AZ 5426800-A	C9AZ 5426801-A	1
- S -						
	67/71	S(57)		C7SZ 5726800-C	C7SZ 5726801-C	1
	67/69	S(57)	5/16"-18 x 1 5/8" hex. head screw & washer assy.	359530-S8(BB576)	359530-S8(BB576)	8
	70/71	S(57)	Screw & washer- 5/16"-18x1 1/4"hex.hd.	382531-S100 (BB569D)	382531-S100 (BB569D)	6



# FORD CAR PARTS

**BODY  
SECTION 260**

GROUP NUMBER	YEAR	BODY TYPE	DESCRIPTION	PART NUMBER		QTY.	
				RIGHT HAND	LEFT HAND		
<b>26800-1 HINGE ASSY. - REAR DOOR - UPPER - continued</b>							
- X -							
	65	X(54, 71)	Reverse hinge pin	C4DZ 5426800-A	C4DZ 5426800-A	1	
	65	X	3/8"-16 x 1 1/8" Hex. head screw & washer assy.	373162-S(BB563A)	373162-S(BB563A)	AR	
	66/67	X(54, 71)		C6OZ 5426800-B	C6OZ 5426801-B	1	
	68/70	X(54, 71)		C8DZ 5426800-A	C8DZ 5426801-A	1	
	69/70	X(54, 71)	Screw-hex. - 11/32"-18 x 1 3/8"	383509-S2(UU52BB)	383509-S2(UU52BB)	AR	
<b>26802-3 HINGE and CHECK ASSY. - REAR DOOR - LOWER</b>							
- A -							
	65/68	A(54,57,71)		C5AZ 5426802-C	C5AZ 5426803-C	1	
	65/67	A(54, 57, 71)- "Before 11/1/66"	5/16"-18 x 1 5/8" Hex. head screw & washer assy.	359530-S8(BB576)	359530-S8(BB576)	6	
	67/68	A(54, 57, 71)- "From 11/1/66"	5/16"-18 x 1 1/2" Hex. washer hd. tapping screw	351945-S2(UU52J)	351945-S2(UU52J)	6	
	69/	A(53, 54, 57, 71)		C9AZ 5426802-B	C9AZ 5426803-B	1	
			Screw-5/16"-18 x 1 1/8" hex. head	382623-S2(UU52AL)	382623-S2(UU52AL)	6	
- B -							
	66/69	B(54, 71)		C6OZ 5426802-C	C6OZ 5426803-C	1	
			5/16"-18 x 1 1/2" Hex. washer hd. tapping screw	351945-S2(UU52J)	351945-S2(UU52J)	6	
	70/71	B(54, 57, 71)		D0OZ 5426802-A	D0OZ 5426803-A	1	
	70/71	B(54, 57, 71)	Screw-5/16"-18 x 1 1/8" hex. head	382623-S2(UU52AL)	382623-S2(UU52AL)	6	
	72	B(53, 71)		D2OZ 5326802-A	D2OZ 5326803-A	1	
- P -							
	71	P(54)	Less check	D1DZ 5426802-A	D1DZ 5426803-A	1	
	71/	P(54)	Incl. check	C9AZ 5426802-B	C9AZ 5426803-B	1	
- S -							
	67/71	S(57)		C7SZ 5726802-B	C7SZ 5726803-B	1	
	68/69	S(57)	5/16"-18 x 1 5/8" Hex. hd. screw & washer assy.	359530-S8(BB576)	359530-S8(BB576)	8	
	70/71	S(57)	Screw & washer - 5/16"-18 x 1 1/4" hex. hd.	382531-S100(BB569D)	382531-S100(BB569D)	6	
- X -							
	66/70	X(54, 71)		C6OZ 5426802-C	C6OZ 5426803-C	1	
<b>26832 PIN - REAR DOOR HINGE</b>							
	65/70	A, B, P, S, X	Cut from B9A 5943030-A	★	★	4	
GROUP NUMBER	YEAR	BODY TYPE	DESCRIPTION	PART NUMBER		QTY.	
				CLEAR	TINTED		
<b>26870-1 GLASS - REAR DOOR STATIONARY WINDOW</b>							
NAGS NUMBER							
- B -							
	65	B(54)		2513T	C4OZ 5426870-A	C4OZ 5426870-B	2
	65	B(71)		2514T	C4OZ 7126870-A	C4OZ 7126870-B	2
	66/67	B(54)	R. H.	V3527	C6OZ 5426870-A	C6OZ 5426870-B	1
			L. H.	V3528	C6OZ 5426871-A	C6OZ 5426871-B	1
	66/67	B(71)	R. H.	V3532	C6OZ 7126870-A	C6OZ 7126870-B	1
			L. H.	V3533	C6OZ 7126871-A	C6OZ 7126871-B	1
	68/69	B(71)	R. H.	V3920	C8OZ 7126870-A	C8OZ 7126870-B	1
			L. H.	V3921	C8OZ 7126871-A	C8OZ 7126871-B	1
	70/71	B(71)	R. H.	V4356	D0OZ 7126870-A	D0OZ 7126870-B	1
			L. H.	V4357	D0OZ 7126871-A	D0OZ 7126871-B	1
- P -							
	71/	P(54)	R.H.	V4555	D1DZ 5426870-A	D1DZ 5426870-B	1
			L.H.	V4556	D1DZ 5426871-A	D1DZ 5426871-B	1

**BODY  
SECTION 260**
**FORD CAR PARTS**

GROUP NUMBER	YEAR	BODY TYPE	DESCRIPTION	PART NUMBER		QTY.
				CLEAR	TINTED	
<b>26870-1</b>	<b>GLASS - REAR DOOR STATIONARY WINDOW - continued</b>					
			NAGS NUMBER			
			- X -			
	65	X(54)		2518T	C5DZ 5426870-A	C5DZ 5426870-B 2
	65	X(71)		2517T	C5DZ 7126870-A	C5DZ 7126870-B 2
	66/70	X(54)	R. H.	V3527	C6OZ 5426870-A	C6OZ 5426870-B 1
			L. H.	V3528	C6OZ 5426871-A	C6OZ 5426871-B 1
	66/70	X(71)	R. H.	V3532	C6OZ 7126870-A	C6OZ 7126870-B 1
			L. H.	V3533	C6OZ 7126871-A	C6OZ 7126871-B 1
<b>268A86</b>	<b>SPRING - REAR DOOR UPPER HINGE ASSIST</b>					
	67/71	S(57)			C7SZ 57268A86-B	2
<b>268A90</b>	<b>PIN - REAR DOOR UPPER HINGE ASSIST SPRING</b>					
	67/71	S(57)			C7SZ 57268A90-A	2
<b>26894-5</b>	<b>WEATHERSTRIP - REAR DOOR STATIONARY WINDOW</b>					
	66/67	B(54)	R. H.		C6OZ 5426894-A	1
	66/70	X(54)	R. H.			1
			L. H.		C6OZ 5426895-A	1
	66/67	B(71)	R. H.		C6OZ 7126894-A	1
	66/70	X(71)	R. H.			1
			L. H.		C6OZ 7126895-A	1
	68/71	B(71)	R. H.		C8OZ 7126894-A	1
			L. H.		C8OZ 7126895-A	1
<b>268A98</b>	<b>BUMPER - REAR DOOR UPPER HINGE</b>					
	67/71	S(57)			C7SZ 57268A98-A	2
<b>26900-1</b>	<b>RETAINER and DIVISION BAR ASSY. - REAR DOOR GLASS RUN - Also refer to Group 262A02-3</b>					
			- B -			
	65	B(54, 71)	Serviced only in assembly-refer to Group 262A02-3			
	66/67	B(71)	R. H.		C6OZ 7126900-A	1
			L. H.		C6OZ 7126901-A	1
	68/69	B(71)	R. H.		C8OZ 7126900-A	1
			L. H.		C8OZ 7126901-A	1
	70/71	B(71)	R. H.		D0OZ 7126900-A	1
			L. H.		D0OZ 7126901-A	1
	68/71	B(71)	Bolt-pan head-1/4"-20 x 1/2"			373460-S7(BB629) 4
	68/71	B	Screw-truss head-No. 8-32 x 3/8"			376129-S7(UU97D) AR
			- P -			
	71/	P(54) -exc. LTD	R.H.		D1DZ 5426900-A	1
			L.H.		D1DZ 5426901-A	1
	72	P(54A)-LTD	R.H.		D2DZ 5426900-A	1
			L.H.		D2DZ 5426901-A	1
			- X -			
	65	X(54, 71)	Serviced only in assembly-refer to Group 262A02-3			
	68/70	X(54)	R. H.		C8DZ 5426900-A	1
			L. H.		C8DZ 5426901-A	1
	68/70	X(71)	R. H.		C8DZ 7126900-A	1
			L. H.		C8DZ 7126901-A	1
	66/67	B(54, 71), X(54, 71)	5/16"-18 x 1.38" Screw (set)			*379720-S2 2
			5/16"-18 Nut & washer assy.			*379307-S2 2
			No. 8-32 x .38" Truss head screw			376129-S8(UU97D) 2
<b>26928</b>	<b>WEATHERSTRIP - REAR DOOR STATIONARY WINDOW</b>					
	71/	P(54)			D1DZ 5426928-A	2

# FORD CAR PARTS

## BODY SECTION 270

1

GROUP NUMBER	YEAR	BODY TYPE	DESCRIPTION	PART NUMBER		QTY.
				RIGHT HAND	LEFT HAND	
<b>27000-1 REGULATOR ASSY. - REAR DOOR WINDOW - MANUAL</b>						
<b>- A -</b>						
	65/68	A(54, 57, 71)		C8AZ 5427000-B	C8AZ 5427001-B	1
	69/70	A(54, 71)		C9AZ 5427000-A	C9AZ 5427001-A	1
	69/70	A(57)		C9AZ 5727000-A	C9AZ 5727001-A	1
	71/	A(54, 71)		D1AZ 5427000-A	D1AZ 5427001-A	1
	71/	A(53, 57)		D1AZ 5727000-A	D1AZ 5727001-A	1
<b>- B -</b>						
	66/67	B(54, 71)	Includes handle screw	★C6OZ 5427000-B not repl'd. (3-74)	C6OZ 5427001-B	1
	68/69	B(54, 71)		C8OZ 5427000-B	C8OZ 5427001-B	1
	70/71	B(54, 57, 71)		D0OZ 5427000-A	D0OZ 5427001-A	1
	72	B(53, 71)		D2OZ 5327000-A	D2OZ 5327001-A	1
<b>- P -</b>						
	71/	P(54)		D1DZ 5427000-A	D1DZ 5427001-A	1
<b>- S -</b>						
	67	S(57)	"Before 4/21/69"	C7SZ 5727000-B	★C7SZ 5727001-A not repl'd. (1-73)	1
	67	S(57)	"From 4/21/69"	C7SZ 5727000-B	★C7SZ 5727001-B not repl'd. (1-73)	1
	68/71	S(57)		C8SZ 5727000-B	C8SZ 5727001-B	1
	67/71	S	Nut - 1/4"-20	33795-S7(M49)	33795-S7(M49)	AR
	67/71	B, S	Bolt - pan head - 1/4"-20 x 1/2"	373460-S7(BB629)	373460-S7(BB629)	4
	70	S(57)	Nut and spring	382206-S2(MM262A)	382206-S2(MM262A)	2
<b>- X -</b>						
	66	X(54, 71)		★C6OZ 5427000-B not repl'd. (3-74)	C6OZ 5427001-A	1
	67	X(54, 71)	Includes handle screw	★C6OZ 5427000-B not repl'd. (3-74)	C6OZ 5427001-B	1
	68/70	X(54, 71)		C8DZ 5427000-B	C8DZ 5427001-B	1
	65/66	A, B, X	5/16"-18 x 1/2" Hex. washer head screw	376976-S7-8(BB574M)	376976-S7-8(BB574M)	8
<b>270A02-3 BRACKET - REAR DOOR WINDOW REGULATOR MOTOR</b>						
	70	B(54, 71)		D0OZ 54270A02-A	D0OZ 54270A03-A	1
	71	B(54, 57)				1
<b>27008-9 REGULATOR ASSY. - REAR DOOR WINDOW ELECTRIC - LESS MOTOR, DRIVE and SPRING</b>						
	65/68	A(54, 57, 71)		★C5AZ 5427008-B not repl'd. (3-74)	C5AZ 5427009-B	1
			5/16"-18 x 1/2" Hex. washer head screw	376976-S7-8(BB574M)	376976-S7-8(BB574M)	8
	69/70	A(54, 71)		C9AZ 5427008-A	C9AZ 5427009-A	1
	69/70	A(57)		C9AZ 5727008-A	C9AZ 5727009-A	1
	71/	A(54, 71)		D1AZ 5427008-A	D1AZ 5427009-A	1
	71/	A(53, 57)		D1AZ 5727008-A	D1AZ 5727009-A	1
	68/69	B(54, 71)		C8OZ 5427008-A	C8OZ 5427009-A	1
	70/71	B(54, 57, 71)		D0OZ 5427008-A	D0OZ 5427009-A	1
	72	B(53, 71)		D2OZ 5327008-A	D2OZ 5327009-A	1
	67/71	S(57)		C7SZ 5727008-B	C7SZ 5727009-B	1
	67/71	B, S	Bolt - pan head - 1/4"-20 x 1/2"	373460-S7(BB629)	373460-S7(BB629)	4
<b>270A42 BRACKET - REAR DOOR WINDOW REGULATOR DRIVE ARM</b>						
	69/70	A(57)		C9AZ 57270A42-A	C9AZ 57270A42-A	2
	71/	A(53, 57)		D1AZ 57270A42-A	D1AZ 57270A42-A	2
	71	B(57)		D1OZ 57270A42-A	D1OZ 57270A42-A	2
	67/71	S(57)		C7SZ 57270A42-A	C7SZ 57270A42-A	2
	68/69	B(63, 65, 66, 76)	Front door No. 8-32 x 1/2" Cross recess oval head screw	50398-S13(U121)	50398-S13(U121)	4
	69/	A	Cross recess oval head screw - No. 8-32 x 1/2"	50398-S13(U121)	50398-S13(U121)	4

**BODY  
SECTION 270**
**FORD CAR PARTS**

GROUP NUMBER	YEAR	BODY TYPE	DESCRIPTION	PART NUMBER		QTY.
				RIGHT HAND	LEFT HAND	
<b>27048</b>	<b>SPRING - LIFT WINDOW REGULATOR COUNTER BALANCE</b>					
	65/68	A(57)		C5AZ 5727048-A	C5AZ 5727048-A	2
	68/71	B(63, 65, 76)	Quarter			2
	69/70	A(54, 71)	Manual or power regulator	C9AZ 5427048-A	C9AZ 5427048-A	2
	69/70	A(57)	Manual regulator	C9AZ 5727048-A	C9AZ 5727048-A	2
	69/70	A(57)	Power regulator	C9AZ 5727048-B	C9AZ 5727048-B	2
	71/	A(53, 57)		D1AZ 5727048-A	D1AZ 5727048-A	2
	71/	A(54, 71)		D1AZ 5427048-A	D1AZ 5427048-A	2
	70/71	B(54, 57, 71)		D0OZ 5427048-A	D0OZ 5427048-A	2
	72	B(53, 71)	Manual regulator	D2OZ 5327048-A	D2OZ 5327048-A	2
			Power regulator	D2OZ 5327048-B	D2OZ 5327048-B	2
<b>270A50</b>	<b>SPACER - REAR DOOR WINDOW REGULATOR MOTOR BRACKET</b>					
	68/69	B(54, 71)		C8OZ 54270A50-A	C8OZ 54270A50-A	AR
	70/71	A, B, F, P, S, X				AR
	72	A(65), F(65)				AR
<b>270A54</b>	<b>ROLLER - WINDOW GUIDE SWIVEL</b>					
	71/	A(53, 57)		D1AZ 57270A54-A	D1AZ 57270A54-A	2
	71/	B		D1OZ 57270A54-A	D1OZ 57270A54-A	2
	72	B(65)	Rear door and quarter			6
	72	F(65, 76)				4
	72	S				6
						4
<b>270A58</b>	<b>WASHER - WINDOW REGULATOR ROLLER</b>					
	71/	A	Front door and tailgate	D1OZ 57270A58-A	D1OZ 57270A58-A	AR
	71/	B				AR
	71/	F	Rear door and quarter			AR
	72	S				AR
<b>27112</b>	<b>RETAINER - REAR DOOR WINDOW GUIDE</b>					
	68/69	B(54, 71)		C8OZ 5427112-A	C8OZ 5427112-A	2
	70	B(71)				4
<b>27166</b>	<b>BRACKET - REAR DOOR WINDOW REGULATOR EQUALIZER ARM</b>					
	69/70	A(54, 71)		C9AZ 5427166-A	C9AZ 5427166-A	2
<b>274A48-9</b>	<b>FILLER - REAR DOOR UPPER EXTENSION - TRIM PANEL</b>					
	70/71	B(54)		D0OZ 54274A48-A	D0OZ 54274A49-A	1
<b>27458</b>	<b>SHIELD - REAR DOOR TRIM WATER - Refer to Group 20318</b>					
<b>27470-1</b>	<b>HOUSING - REAR DOOR ASH RECEPTACLE</b>					
	68/71	S(57)	Includes cover	C8SZ 5727470-B	C8SZ 5727471-B	1
<b>27542-3</b>	<b>PANEL - REAR DOOR ARM REST FINISH - INCLUDES ATTACHING PARTS</b>					
	69	A(54, 57, 71) - "Before 3/3/69"	Snap on	C9AZ 5427542-A	C9AZ 5427543-A	1
	69	A(54, 57, 71) - "From 3/3/69"	Refer to Group 266A24-5			
	68/71	S(57)		C8SZ 5727542-A	C8SZ 5727543-A	1
<b>27588</b>	<b>RETAINER - REAR DOOR TRIM PANEL</b>					
	66/67	B(54, 71)	Chrome-Includes attaching parts	C6OZ 5427588-A	C6OZ 5427588-A	2
	68	B(54, 71)	Refer to Group 25576-7			
	66/67	X(54B)	Chrome-Includes attaching parts	C6OZ 5427588-A	C6OZ 5427588-A	2
	66/70	X(54, 71)	Paint to match if desired			2
<b>27594-5</b>	<b>PANEL - REAR DOOR ARM REST FINISH - LOWER</b>					
	69	A(54C, 57F, 71A, E)	Dark teak finish	C9AZ 5427594-A	C9AZ 5427595-A	1
	69	A(54, 57, 71)	White-paint to match	C9AZ 5427594-E1W	C9AZ 5427595-E1W	1
<b>27700-1</b>	<b>PANEL ASSY. - BODY SIDE</b>					
	66/67	U		C6TZ 9627700-A	C6TZ 9627701-A	1
	68/69	U		C8TZ 9627700-B	*C8TZ 9627701-B r/b D0BZ 1027701-A(3-74)	1
	70/	U		D0BZ 1027700-A	D0BZ 1027701-A	1
	66/	U	Plug button	383573-S(KK60)	383573-S(KK60)	1

# FORD CAR PARTS

## BODY SECTION 270

GROUP NUMBER	YEAR	BODY TYPE	DESCRIPTION	PART NUMBER		QTY.
				RIGHT HAND	LEFT HAND	
<b>27702-3 EXTENSION ASSY. - QUARTER PANEL UPPER REAR</b>						
	65/66	F	Includes attaching parts	C5ZZ 6527702-A	C5ZZ 6527703-A	1
	67/68	F(65, 76), exc. F(65) GT/CS	W/out moulding holes	C7ZZ 6527702-A	C7ZZ 6527703-A	1
	67	F(63-GT350/500)		S7MS 6327702-A	S7MS 6327703-A	1
	67/68	F(63 -except GT350/500)		C7ZZ 6327702-A	C7ZZ 6327703-A	1
	68	F(63-GT350/500)	Refer to Group 28072-3			
	68	F(65) GT/CS		C8ZZ 6527702-A	C8ZZ 6527703-A	1
	69	F	Refer to Group 28010-1			
	67/69	F	1/4" Flat washer (3/4" O. D. x 1/16" thick)	*351308-S2	*351308-S2	6
			1/4"-20 Nut & washer assy.	373556-S100 (MM291F)	373556-S100 (MM291F)	6
<b>27726-7 BRACE - QUARTER PANEL TO REAR FLOOR</b>						
	72	A(exc.71)		D2AZ 6527726-A	D2AZ 6527727-A	1
	72	B(53, 65)		D2OZ 6527726-A	D2OZ 6527727-A	1
<b>27754 COVER - QUARTER WHEELHOUSE OPENING</b>						
	70	A(71)	Use with emission control system(California only)		D0AZ 7127754-A	1
<b>27766 GASKET - QUARTER WHEELHOUSE OPENING COVER</b>						
	70	A(except 71)	Use with emission control system		D0AZ 6227766-A	AR
<b>27790-1 PANEL - QUARTER INSIDE - FRONT</b>						
	68/71	B(66)		C8OZ 6627790-A	C8OZ 6627791-A	1
	67	B(66)	Refer to Group 278A08-9			
	72	L(73)		D2FZ 7327790-A	D2FZ 7327791-A	1
<b>27798-9 REINFORCEMENT - QUARTER WHEELHOUSE INNER PANEL</b>						
	69/71	A(71)	"Before 10/22/70"	C9AZ 7127798-A	C9AZ 7127798-A	2
	71/	A(71)	"From 10/22/70"	D1AZ 7127798-A	D1AZ 7127799-A	1
	66/71	B(66, 71)		C6OZ 7127798-A	C6OZ 7127798-A	2
	72	B(71)		D2OZ 7127798-A	D2OZ 7127799-A	1
	69/70	F(63)		C9ZZ 6327798-A	C9ZZ 6327799-A	1
	69/	F(76)		C9ZZ 7627798-A	C9ZZ 7627799-A	1
	66	X(66, 71)		C6OZ 7127798-A	C6OZ 7127798-A	2
	67/70	X(71)				2
<b>27800-1 BRACE - QUARTER PANEL TO WHEELHOUSE</b>						
	69/70	A(except 71, 76)		C9AZ 6227800-A	C9AZ 6227800-A	2
	71/	A(53, 54, 57, 65)		D1AZ 6527800-A	D1AZ 6527801-A	2
	71/	A(71)		D1AZ 7127800-A	D1AZ 7127801-A	1
	71/	A(76)		D1AZ 7627800-A	D1AZ 7627801-A	1
	68/69	B(54, 65)		C8OZ 5427800-A	C8OZ 5427801-A	1
	70/71	B(76)		D0OZ 7622800-A	D0OZ 7627801-A	1
	72	B(53, 65)		D2OZ 6527800-A	D2OZ 6527801-A	1
	68/69	S(65)	"From 1/29/68"	C7SZ 6527800-B	C7SZ 6527800-B	2
	71	S(65B, D)				2
<b>27802 SEAL - QUARTER PANEL OUTER REAR EXTENSION</b>						
	68	A(54B, C, E, 57, 62, 63, 65, 76)	21 13/64"-rubber-cut to fit	C8OZ 5427802-A	C8OZ 5427802-A	2
	68/69	A(except 71)	Washer type-3/4" O. D.	C8AZ 5427802-A	C8AZ 5427802-A	4
	69/70	A(except 71)	22 7/8" long	C9AZ 6227802-A	C9AZ 6227802-A	2
	69/70	A(71)	7 29/32" long-cut to fit	C9AZ 7127802-A	C9AZ 7127802-A	2
	68	B(except 71)	21 13/64"-rubber-cut to fit	C8OZ 5427802-A	C8OZ 5427802-A	2
	69/	B(except 71)	22 7/8" long	C9AZ 6227802-A	C9AZ 6227802-A	2
	65/68	F except F(65) GT/CS		C5ZZ 6527802-C	C5ZZ 6527802-C	2
	67	F	Front fender extension	C7AZ 6227802-A	C7AZ 6227802-A	2
	69/70	F	22 7/8" long	C9AZ 6227802-A	C9AZ 6227802-A	2
	71	F	Cut from D0MZ 16D130-A	★	★	

GROUP NUMBER	YEAR	BODY TYPE	DESCRIPTION	PART NUMBER		QTY.
				RIGHT HAND	LEFT HAND	
<b>27802</b>	<b>SEAL - QUARTER PANEL OUTER REAR EXTENSION - continued</b>					
	70/	P	Cut from D0MZ 16D130-A	★	★	
	68	X(except 71)	21 13/64"-rubber-cut to fit	C8OZ 5427802-A	C8OZ 5427802-A	2
	69/70	X(except 71)	22 7/8" long	C9AZ 6227802-A	C9AZ 6227802-A	2
<b>278C02-3</b>	<b>BEZEL ASSY. - QUARTER VENT AIR GRILLE SCREEN - INCLUDES ATTACHING PARTS</b>					
	65/66	F(63)	Quarter panel vent	C5ZZ 63278C08-A	C5ZZ 63278C09-A	1
				C5ZZ 63278C02-A	C5ZZ 63278C03-A	1
<b>278A08-9</b>	<b>PANEL - QUARTER PANEL INSIDE - FRONT</b>					
	67	B(66)		C6DZ 66278A08-A	C6DZ 66278A09-A	1
	68/	B(66,97)	Refer to Group 27790-1			
	67/69	S(65)		C7SZ 65278A08-A	C7SZ 65278A09-A	1
	71	S(65B, D)				1
	66	X(66)		C6DZ 66278A08-A	C6DZ 66278A09-A	1
<b>278C08-9</b>	<b>BEZEL - QUARTER PANEL VENT - Refer to group 278C02-3</b>					
<b>278A10-1</b>	<b>PANEL - QUARTER PANEL INSIDE - REAR</b>					
	72	B(97)		D2OZ 97278A10-A	D2OZ 97278A11-A	1
	66	X(66)		C6DZ 66278A10-A	C6DZ 66278A11-A	1
	67/71	B(66)				1
<b>27814-5</b>	<b>REINFORCEMENT - BODY SIDE PANEL - LOWER</b>					
	72	B(97)		D2OZ 9727814-A	D2OZ 9727815-A	1
<b>278B26-7</b>	<b>PANEL - BODY SIDE WINDOW OPENING</b>					
	66/	U(98)		C6TZ 98278B26-D	C6TZ 98278B27-D	1
<b>278A36-7</b>	<b>PILLAR - QUARTER WHEELHOUSE TO ROOF - INNER</b>					
	69/	A(71)		C9AZ 71278A36-A	C9AZ 71278A37-A	1
	66/71	B(71)		C6OZ 71278A36-A	C6OZ 71278A37-A	1
	66/70	X(71)		C6OZ 71278A36-A	C6OZ 71278A37-A	1
<b>278A38-9</b>	<b>PILLAR - QUARTER WHEELHOUSE TO ROOF - OUTER</b>					
	69/	A(71)		C9AZ 71278A38-A	C9AZ 71278A39-A	1
	66/71	B(71)		C6OZ 71278A38-A	C6OZ 71278A39-A	1
	72	B		D2OZ 71278A38-A	D2OZ 71278A39-A	1
	66/70	X(71)		C6OZ 71278A38-A	C6OZ 71278A39-A	1
<b>27840-1</b>	<b>PANEL ASSY. - QUARTER - Drill Holes as Required</b>					
	- A -					
	66	A(54)		C6AZ 5427840-A	C6AZ 5427841-A	1
	66	A(57)		C6AZ 5727840-A	C6AZ 5727841-A	1
	66	A(62)		C6AZ 6227840-A	★C6AZ 6227841-A	1
					Not replaced (12/74)	
	66	A(63)		C6AZ 6327840-A	C6AZ 6327841-A	1
	66	A(76)		C6AZ 7627840-A	C6AZ 7627841-A	1
	67	A(54)		C7AZ 5427840-A	C7AZ 5427841-A	1
	67	A(57)		C7AZ 5727840-A	C7AZ 5727841-A	1
	67	A(62)		C7AZ 6227840-A	★C7AZ 6227841-A	1
					Not replaced (12/74)	
	67	A(63)		C7AZ 6327840-A	C7AZ 6327841-A	1
	67	A(76)		C7AZ 7627840-A	C7AZ 7627841-A	1
	68	A(54)		C8AZ 5427840-A	C8AZ 5427841-A	1
	68	A(57)		C8AZ 5727840-A	C8AZ 5727841-A	1
	68	A(62)		C8AZ 6227840-A	C8AZ 6227841-A	1
	68	A(63)		C8AZ 6327840-A	C8AZ 6327841-A	1
	68	A(65)		C8AZ 6527840-A	C8AZ 6527841-A	1
	68	A(76)		C8AZ 7627840-A	C8AZ 7627841-A	1
	69	A(54)		C9AZ 5427840-A	C9AZ 5427841-A	1
	69	A(57)		C9AZ 5727840-A	C9AZ 5727841-A	1
	69	A(62)		C9AZ 6227840-A	C9AZ 6227841-A	1
	69	A(63)		C9AZ 6327840-A	C9AZ 6327841-A	1
	69	A(65)		C9AZ 6527840-A	C9AZ 6527841-A	1
	69	A(76)		C9AZ 7627840-A	C9AZ 7627841-A	1
	70	A(54)		D0AZ 5427840-A	D0AZ 5427841-A	1
	70	A(57)		D0AZ 5727840-A	D0AZ 5727841-A	1
	70	A(63)		D0AZ 6327840-A	D0AZ 6327841-A	1

# FORD CAR PARTS

## BODY SECTION 270

5

GROUP NUMBER	YEAR	BODY TYPE	DESCRIPTION	PART NUMBER		QTY.	
				RIGHT HAND	LEFT HAND		
<b>27840-1</b>	<b>PANEL ASSY. - QUARTER - continued - Drill Holes as required</b>						
<b>- A -</b>							
	70	A(65)		D0AZ	6527840-A	D0AZ 6527841-A	1
	70	A(76)		D0AZ	7627840-A	D0AZ 7627841-A	1
	71	A(54)		D1AZ	5427840-A	D1AZ 5427841-A	1
	71	A(53, 57)		D1AZ	5727840-A	D1AZ 5727841-A	1
	71	A(65)		D1AZ	6527840-A	D1AZ 6527841-A	1
	71	A(76)		D1AZ	7627840-A	D1AZ 7627841-A	1
	72	A(54)		D2AZ	5427840-A	D2AZ 5427841-A	1
	72	A(53, 57)		D2AZ	5727840-A	D2AZ 5727841-A	1
	72	A(65)		D2AZ	6527840-A	D2AZ 6527841-A	1
	72	A(76)		D2AZ	7627840-A	D2AZ 7627841-A	1
<b>- B -</b>							
	66	B(54)		C6OZ	5427840-A	C6OZ 5427841-A	1
	66	B(62)		C6OZ	6227840-A	C6OZ 6227841-A	1
	66	B(63)		C6OZ	6327840-A	C6OZ 6327841-A	1
	66	B(71, 76)	Refer to Group 27846-7				
	67	B(54)		C7OZ	5427840-A	C7OZ 5427841-A	1
	67	B(62)		C7OZ	6227840-A	C7OZ 6227841-A	1
	67	B(63)		C7OZ	6327840-A	C7OZ 6327841-A	1
	67	B(66, 71, 76)	Refer to Group 27846-7				
	68/69	B(63)		C8OZ	6327840-A	C8OZ 6327841-A	1
	68/69	B(65)	Less rear lamp opening reinforcement (27970-1)	C9OZ	6527840-B	C9OZ 6527841-B	1
	68/69	B(66, 71, 76)	Refer to Group 27846-7				
	68/69	B(54)	Less rear lamp opening reinforcement(27970-1)	C9OZ	5427840-B	C9OZ 5427841-B	1
	70/71	B(54, 57)		D0OZ	5427840-A	D0OZ 5427841-A	1
	70/71	B(63)		D0OZ	6327840-A	D0OZ 6327841-A	1
	70/71	B(62, 65)		D0OZ	6527840-A	D0OZ 6527841-A	1
	70/71	B(66, 71, 76)	Refer to Group 27846-7				
	72	B(53)		D3OZ	5327840-A	D3OZ 5327841-A	1
	72	B(63)		D3OZ	6327840-A	D3OZ 6327841-A	1
	72	B(65)		D3OZ	6527840-A	D3OZ 6527841-A	1
	72	B(71, 97)	Refer to Group 27846-7				
<b>- F -</b>							
	65/66	F	Refer to Group 27846-7				
	67	F(63)		C7ZZ	6327840-A	C7ZZ 6327841-A	1
	67	F(65)		C7ZZ	6527840-A	C7ZZ 6527841-A	1
	67	F(76)		C7ZZ	7627840-A	C7ZZ 7627841-A	1
	68	F(63)	"Before 2/15/68" With depression for reflector	C8ZZ	6327840-A	C8ZZ 6327841-A	1
	68	F(63)	"From 2/15/68" Less depression for reflector	C8ZZ	6327840-B	C8ZZ 6327841-B	1
	68	F(65)	"Before 2/15/68" With depression for reflector	C8ZZ	6527840-A	C8ZZ 6527841-A	1
	68	F(65)	"From 2/15/68" Less depression for reflector	C8ZZ	6527840-B	C8ZZ 6527841-B	1
	68	F(76)	"Before 2/15/68" With depression for reflector	C8ZZ	7627840-A	C8ZZ 7627841-A	1
	68	F(76)	"From 2/15/68" Less depression for reflector	★C8ZZ	7627840-B not repl'd. (3-74)	C8ZZ 7627841-B	1
	69	F(63) exc. Boss-302	With scoop	C9ZZ	6327840-A	C9ZZ 6327841-A	1
	70	F(63) GT 350/500					1
	69	F(63) Boss-302	Without scoop	C9ZZ	6327840-B	C9ZZ 6327841-B	1
	69	F(65)		C9ZZ	6527840-A	C9ZZ 6527841-A	1
	70	F(65) GT 350/500					1
	69	F(76)		C9ZZ	7627840-A	C9ZZ 7627841-A	1
	70	F(76) GT 350/500					1
	70	F(63), exc. GT 350/500		D0ZZ	6327840-A	D0ZZ 6327841-A	1
	70	F(65)		D0ZZ	6527840-A	D0ZZ 6527841-A	1
	70	F(76), exc. GT 350/500		D0ZZ	7627840-A	D0ZZ 7627841-A	1
	71/	F(63)		D3ZZ	6327840-A	D3ZZ 6327841-A	1
	71/	F(65)	Also refer to Group 45118-0	D1ZZ	6527840-A	D1ZZ 6527841-A	1
	71/	F(76)		D1ZZ	7627840-A	D1ZZ 7627841-A	1

**BODY  
SECTION 270**
**FORD CAR PARTS**

GROUP NUMBER	YEAR	BODY TYPE	DESCRIPTION	PART NUMBER		QTY.
				RIGHT HAND	LEFT HAND	
<b>27840-1</b>	<b>PANEL ASSY. - QUARTER - continued - Drill holes as required</b>					
	- L -					
	71/	L(62)		D1FZ 6227840-A	D1FZ 6227841-A	1
	71/72	L(64)	" Before 4/3/72"	D1FZ 6427840-A	D1FZ 6427841-A	1
	72	L(64)	" From 4/3/72"	D2FZ 6427840-A	D2FZ 6427841-A	1
	- P -					
	70/	P(62)		D0DZ 6227840-A	D0DZ 6227841-A	1
	71/	P(54)		D1DZ 5427840-A	D1DZ 5427841-A	1
	- S -					
	70/71	S(57)	Refer to Group 27846-7			
	70	S(65)		D0SZ 6527840-A	D0SZ 6527841-A	1
	71	S(65A, C)				1
	71	S(65B, D)		D1SZ 6527840-A	D1SZ 6527841-A	1
	72	S		D2SZ 6527840-A	D2SZ 6527841-A	1
	- U -					
	66/	U	Refer to Group 27700-1			
	- X -					
	66/70	X(66, 71)	Refer to Group 27846-7			
	66/67	X(54)		C6DZ 5427840-A	C6DZ 5427841-A	1
	66/67	X(62)		C6DZ 6227840-A	C6DZ 6227841-A	1
	68/70	X(54)		C9DZ 5427840-B	C9DZ 5427841-B	1
	68/70	X(62)		C9DZ 6227840-A	C9DZ 6227841-A	1
<b>278442</b>	<b>BRACE - BODY SIDE LOWER PANEL</b>					
	66/	U		C6TZ 96278A42-A	C6TZ 96278A42-A	2
<b>27846-7</b>	<b>PANEL - QUARTER - Drill holes as required</b>					
	- A -					
	65	A(54)		★C5AZ 5427846-A	C5AZ 5427847-A	1
	65	A(57)		not repl'd. (3-74)		
	65	A(62)		C5AZ 5727846-A	C5AZ 5727847-A	1
	65	A(63)		C5AZ 6227846-A	★C5AZ 6227847-A	1
	65	A(63)		C5AZ 6327846-A	Not replaced (12-74)	
	66/	A(except 71)	Refer to Group 27840-1	C5AZ 6327847-A	C5AZ 6327847-A	1
	66	A(71)		C6AZ 7127846-A	C6AZ 7127847-A	1
	67	A(71)		C7AZ 7127846-A	C7AZ 7127847-A	1
	68	A(71)		C8AZ 7127846-A	C8AZ 7127847-A	1
	69/ 70	A(71)		C9AZ 7127846-A	C9AZ 7127847-A	1
	71/	A(71)		D1AZ 7127846-A	D1AZ 7127847-A	1
	- B -					
	65	B(54)		C5OZ 5427846-A	C5OZ 5427847-A	1
	65	B(65)		C5OZ 6527846-A	★C5OZ 6527847-A	1
	66	B(71)		not repl'd. (3-74)		
	66	B(71)		★C6OZ 7127846-A	C6OZ 7127847-A	1
	66/67	B(76)		Not replaced (12-74)		
	66/	B(except 66, 71, 76)	Refer to Group 27840-1	C6OZ 7627846-A	C6OZ 7627847-A	1
	67	B(66)		C7OZ 6627846-A	C7OZ 6627847-A	1
	67	B(71)		C7OZ 7127846-A	C7OZ 7127847-A	1
	68	B(71)		C8OZ 7127846-A	C8OZ 7127847-A	1
	68/69	B(66)		C9OZ 6627846-A	C9OZ 6627847-A	1
	68/69	B(76)		C8OZ 6627846-A	C8OZ 6627847-A	1
	69	B(71)		C8OZ 7627846-B	C8OZ 7627847-B	1
	70/71	B(66)		C9OZ 7127846-A	C8OZ 7127847-A	1
	70/71	B(71)		D0OZ 6627846-A	D0OZ 6627847-A	1
	70/71	B(76)		D0OZ 7127846-A	D0OZ 7127847-A	1
	72	B(71)		D0OZ 7627846-A	D0OZ 7627847-A	1
	72	B(97)		D2OZ 7127846-A	D2OZ 7127847-A	1
	72	B(exc.71,97)	Refer to Group 27840-1	D2OZ 9727846-A	D2OZ 9727847-A	1
	- F -					
	65/66	F(63)		C5ZZ 6327846-A	C5ZZ 6327847-A	1
	65/66	F(65)		C5ZZ 6527846-B	C5ZZ 6527847-B	1
	65/66	F(76)		C5ZZ 7627846-B	C5ZZ 7627847-B	1



# FORD CAR PARTS

## BODY SECTION 270

7

GROUP NUMBER	YEAR	BODY TYPE	DESCRIPTION	PART NUMBER		QTY.
				RIGHT HAND	LEFT HAND	
<b>27846-7 PANEL - QUARTER - continued - Drill holes as required</b>						
- L -						
	72	L(73)		D2FZ 7327846-A	D2FZ 7327847-A	1
- S -						
	65	S(63)		C4SZ 6327846-A	C4SZ 6327847-A	1
	66	S(63A)				1
	66	S(63C, D)		C6SZ 6327846-A	C6SZ 6327847-A	1
	65/66	S(76)		C4SZ 7627846-A	C4SZ 7627847-A	1
	67/69	S(57)		C7SZ 5727846-B	C7SZ 5727847-B	1
	67/69	S(65)		C7SZ 6527846-B	C7SZ 6527847-B	1
	70/71	S(57)		D0SZ 5727846-A	D0SZ 5727847-A	1
	70/	S(65)	Refer to Group 27840-1			
- U -						
	66/	U	Refer to Group 27700-1			
- X -						
	65	X(62)		C4DZ 6227846-B	C4DZ 6227847-B	1
	65	X(63)		★C4DZ 6327846-B not repl'd. (3-74)	C4DZ 6327847-B	1
	65	X(66)		C4DZ 6627846-A	C4DZ 6627847-A	1
	66/70	X(54, 62)	Refer to Group 27840-1			
	66	X(66)		C7OZ 6627846-A	C7OZ 6627847-A	1
	66	X(71)		★C6OZ 7127846-A not replaced (12-74)	C6OZ 7127847-A	1
	67/70	X(71)		C7OZ 7127846-A	C7OZ 7127847-A	1
<b>278B50-1 FILL - QUARTER WHEELHOUSE - OUTER</b>						
	72	L(73)		D2FZ 73278B50-A	D2FZ 73278B51-A	1
<b>27858-9 PANEL - QUARTER PANEL INSIDE TO FLOOR PAN</b>						
	69/	A(71)		Refer to Groups 47028 and 47030	C9AZ 7127859-A	1
	67	B(66, 71)		C6DZ 6627858-A	C6DZ 7127859-A	1
	68/69	B(66)		C8OZ 6627858-A	C8OZ 6627859-A	1
	70	B(66)		D0OZ 6627858-A	D0OZ 6627859-A	1
	71	B(66)		D0OZ 6627858-A	D1OZ 6627859-A	1
	66	X(66)		★C6DZ 6627858-A not repl'd. (3-74)	C6DZ 7127859-A	1
	66/70	X(71)	Refer to Group 47028	C6DZ 7127859-A		1
<b>278C58-9 PANEL - QUARTER INSIDE - CENTER</b>						
	68/71	B(66)		C8OZ 66278C58-A	C8OZ 66278C59-A	1
	66	X(66)		C6DZ 66278C58-A	C6DZ 66278C59-A	1
	67	B(66)				1
<b>27864-5 PANEL - BODY SIDE - INNER</b>						
	68/69	B(66)		C8OZ 6627864-B	C8OZ 6627865-A	1
	70/71	B(66)		D0OZ 6627864-A	D0OZ 6627865-A	1
	72	B(97)		D2OZ 9727864-A	D2OZ 9727865-A	1
<b>27866-7 PANEL - QUARTER OUTSIDE FINISH - REAR</b>						
	71/	A(53, 57H, K, 65H, K, 76)		D1AZ 6527866-A	D1AZ 6527867-A	1
<b>278A68-9 REINFORCEMENT ASSY. - BODY REAR CORNER PANEL</b>						
	66/	U		D3BZ 10278A68-A	D3BZ 10278A69-A	1
<b>27870-1 PANEL - QUARTER WINDOW REGULATOR</b>						
- A -						
	65/66	A(76)		C5AZ 7627870-A	C5AZ 7627871-A	1
	65/66	A(76)	Plug (button)-1 1/4" dia. hole	352284-S(PP4)	352284-S(PP4)	2
	65/68	A(76)	Plug(button)-1 1/2" dia. hole	377901-S(PP14N)	377901-S(PP14N)	2
			Plug (button)-2.15"x5.32" hole	★379718-S	★379718-S	2

**BODY  
SECTION 270**
**FORD CAR PARTS**

GROUP NUMBER	YEAR	BODY TYPE	DESCRIPTION	PART NUMBER		QTY.
				RIGHT HAND	LEFT HAND	
<b>27870-1 PANEL - QUARTER WINDOW REGULATOR - continued</b>						
- A -						
	69	A(62)		★C9AZ 6227870-A not repl'd.(1-73)	C9AZ 6227871-A	1
	69	A(63)		C9AZ 6327870-A	C9AZ 6327871-A	1
	69	A(65)		C9AZ 6527870-A	C9AZ 6527871-A	1
	69	A(76)		C9AZ 7627870-A	C9AZ 7627871-A	1
	70	A(63)		D0AZ 6327870-A	D0AZ 6327871-A	1
	70	A(65)		D0AZ 6527870-A	D0AZ 6527871-A	1
	70	A(76)		D0AZ 7627870-A	D0AZ 7627871-A	1
	71/	A(65)		D1AZ 6527870-A	D1AZ 6527871-A	1
	71/	A(76)		D1AZ 7627870-A	D1AZ 7627871-A	1
- B -						
	68/69	B(76)		C8OZ 7627870-A	★C8OZ 7627871-A not repl'd. (3-74)	1
	70	B(62)		D0OZ 6227870-A	D0OZ 6226871-A	1
	70/71	B(63, 65)		D0OZ 6527870-A	D0OZ 6527871-A	1
	70/71	B(76)		D0OZ 7627870-A	D0OZ 7627871-A	1
	72	B(63)		D2OZ 6327870-A	D2OZ 6327871-A	1
	72	B(65)		D2OZ 6527870-A	D2OZ 6527871-A	1
- F -						
	67/68	F(76)		C7ZZ 7627870-A	C7ZZ 7627871-A	1
	69/70	F(65)		C9ZZ 6527870-A	C9ZZ 6527871-A	1
	69/70	F(76)		C9ZZ 7627870-A	C9ZZ 7627871-A	1
	71/	F(63, 65)		D1ZZ 6527870-A	D1ZZ 6527871-A	1
	71/	F(76)		D1ZZ 7627870-A	D1ZZ 7627871-A	1
- S -						
	68/69	S(65)		C8SZ 6527870-C	C8SZ 6527871-C	1
	70	S(65)		D0SZ 6527870-A	D0SZ 6527871-A	1
	71	S(65A, C)		D1SZ 6527870-A	D1SZ 6527871-A	1
	72	S		D2SZ 6527870-A	D2SZ 6527871-A	1
- X -						
	68/70	X(62)		C8DZ 6227870-A	C8DZ 6227871-A	1
<b>27874-5 REINFORCEMENT - QUARTER WINDOW REGULATOR PANEL - UPPER</b>						
	70	B(76)		D0OZ 7627874-A	D0OZ 7627875-A	1
<b>27874-5 PLATE - BODY SIDE UPPER PANEL ACCESS HOLE COVER</b>						
	66	X(66)		★C6DZ 66278C74-A not repl'd.(1-73)	C6DZ 66278C75-A	1
	67	B(66)		52012-S8(U202)	52012-S8(U202)	8
			No. 8-15 x 1/2" Flat head screw			
<b>278C80-1 EXTENSION - REAR CORNER INNER FRONT LOWER PILLAR</b>						
	66	X(66)		C6DZ 66278C80-A	C6DZ 66278C81-A	1
	67/71	B(66)				1
<b>27882-3 WHEELHOUSE ASSY. - REAR QUARTER</b>						
	65	A, B, F, S, X	Service Details -refer to Groups 27886-7 and 27894-5			
	69	B(63) -Talladega		C9OZ 6327882-A	C9OZ 6327883-A	1
	69/	B(exc. Talladega)	Service details-refer to Groups 27886-7 and 27894-5			
<b>278C82-3 EXTENSION - QUARTER INSIDE REAR PANEL</b>						
	66	X(66)		C6DZ 66278C82-A	C6DZ 66278C83-A	1
	67/71	B(66)				1
<b>27886-7 PANEL - QUARTER WHEELHOUSE - INNER</b>						
- A -						
	65/66	A(71)		C5AZ 7127886-A	★C5AZ 7127887-A not replaced (7-73)	1
	65/68	A(except 71)		C5AZ 6227886-A	C5AZ 6227887-A	1

# FORD CAR PARTS

## BODY SECTION 270 PART NUMBER

9

GROUP NUMBER	YEAR	BODY TYPE	DESCRIPTION	PART NUMBER		QTY.
				RIGHT HAND	LEFT HAND	
<b>27886-7 PANEL - QUARTER WHEELHOUSE - INNER - continued</b>						
- A -						
	67/68	A(71)		C5AZ 7127886-A	C7AZ 7127887-A	1
	69/	A(except 71)		C9AZ 6227886-A	C9AZ 6227887-A	1
	69/71	A(71) "Before 10/22/70"		D1AZ 7127886-A	C9AZ 7127887-A	1
	71	A(71) "From 10/22/70"		D1AZ 7127886-A	D1AZ 7127887-A	1
	72	A(71)		D2AZ 7127886-A	D2AZ 7127887-A	1
- B -						
	66/69	B(except 71, Talladega)		C6OZ 6227886-A	C6OZ 6227887-A	1
	69	B(63)-Talladega	Serviced in assy. -refer to Group 27882-3			
	70/71	B(exc. 71)		D0OZ 6527886-A	D0OZ 6527887-A	1
	66/71	B(71)		C6OZ 7127886-A	C6OZ 7127887-A	1
	72	B(exc. 71, 97)		D2OZ 6527886-A	D2OZ 6527887-A	1
	72	B(71)		D2OZ 7127886-A	D2OZ 7127887-A	1
- F -						
	65/70	F		C5ZZ 6527886-B	C5ZZ 6527887-A	1
	71/72	F "Before 12/1/71"		D2ZZ 6527886-B	D1ZZ 6527887-A	1
	72	F "From 12/1/71"		D2ZZ 6527886-B	D2ZZ 6527887-A	1
- L -						
	71/	L(62, 64)		D1FZ 6227886-A	D1FZ 6227887-A	1
	72	L(73)	Serviced in assy. -refer to Group 27790-1			
- P -						
	70/	P		D0DZ 6227886-A	D0DZ 6227887-A	1
- S -						
	67/71	S		C7SZ 6527886-A	C7SZ 6527887-A	1
	72	S		D2SZ 6527886-A	D2SZ 6527887-A	1
- X -						
	66/70	X(except 71)		C6OZ 6227886-A	C6OZ 6227887-A	1
	66/70	X(71)		C6OZ 7127886-A	C6OZ 6227887-A	1
<b>278A92-3 PANEL ASSY. - BODY SIDE UPPER</b>						
	66/	U(97)		C6TZ 97278A92-A	C6TZ 97278A93-A	1
<b>27894-5 PANEL - QUARTER WHEELHOUSE - OUTER</b>						
- A -						
	66	A(except 71)		C6AZ 6227894-A	C6AZ 6227895-A	1
	66	A(71)		C6AZ 7127894-A	★C6AZ 7127895-A not repl'd. (3-74)	1
			Plug (button) - 1" dia. hole	377678-S(PP3E)	377678-S(PP3E)	1
	67	A(except 71)		C7AZ 6227894-A	C7AZ 6227895-A	1
	67	A(71)		C7AZ 7127894-A	C7AZ 7127895-A	1
	68	A(54, 57, 62, 65, 76)		C8AZ 6227894-A	C8AZ 6227895-A	1
	68	A(63)		C8AZ 6327894-A	C8AZ 6327895-A	1
	68	A(71)		C8AZ 7127894-A	C8AZ 7127895-A	1
	69	A(71)		C9AZ 7127894-A	C9AZ 7127895-A	1
	69/70	A(except 71)		D0AZ 6227894-A	D0AZ 6227895-A	1
	71/	A(exc. 71)		D1AZ 6527894-A	D1AZ 6527895-A	1
	70/71	A(71) "Before 10/22/70"		D1AZ 7127894-B	D1AZ 7127895-A	1
	71/	A(71) "From 10/22/70"		D1AZ 7127894-B	D1AZ 7127895-B	1
- B -						
	66/67	B(except 66, 71)		C6OZ 6227894-A	C6OZ 6227895-A	1
	66/67	B(71)	Dual action tailgate	C6OZ 7127894-A	★C6OZ 7127895-A not repl'd. (3-74)	1
	67	B(66, 71)	Single action tailgate	C6OZ 7127894-A	C6DZ 7127895-B	1
	68	B(71)		C8OZ 7127894-B	C8OZ 7127895-B	1
	68/69	B(except 66, 71 & Talladega)		C8OZ 5427894-B	C8OZ 5427895-B	1
	69	B(63)-Talladega	Serviced in assy. -refer to Group 27882-3			
	68/69	B(66)		C8OZ 6627894-B	C8OZ 6627895-B	1
	70/71	B(54, 57, 62, 63, 65, 76)		D0OZ 6527894-A	D0OZ 6527895-A	1
	70/71	B(66)		D0OZ 7127894-A	D0OZ 6627895-A	1
	70/71	B(71)		D0OZ 7127894-A	D0OZ 7127895-A	1
	72	B(exc. 71, 97)		D2OZ 6527894-A	D2OZ 6527895-A	1
	72	B(71)		D2OZ 7127894-A	D2OZ 7127895-A	1
	72	B(97)		D2OZ 9727894-A	D2OZ 9727895-A	1

GROUP NUMBER	YEAR	BODY TYPE	DESCRIPTION	PART NUMBER		QTY.
				RIGHT HAND	LEFT HAND	
<b>27894-5 PANEL - QUARTER WHEELHOUSE - OUTER - continued</b>						
- F -						
	65/66	F		C5ZZ 6527894-A	★C5ZZ 6527895-A Not replaced (3/75)	1
	67/68	F		C7ZZ 6527894-A	C7ZZ 6527895-A	1
	69	F	Without F60-15 tire	C9ZZ 6527894-A	★C9ZZ 6527895-A r/b D0ZZ 6527895-A (1/75)	1
	69	F	With F60-15 tire	C9ZZ 6327894-A	C9ZZ 6327895-A	1
	70	F		D0ZZ 6527894-A	D0ZZ 6527895-A	1
	71/	F		D1ZZ 6527894-A	D1ZZ 6527895-A	1
- L -						
	71/	L(62, 64)		D1FZ 6227894-A	D1FZ 6227895-A	1
	72	L(73)		D2FZ 7327894-A	D2FZ 7327895-A	1
- P -						
	70/	P		D0DZ 6227894-A	D0DZ 6227895-A	1
- S -						
	65/66	S	Drill holes as required	★C4SZ 6327894-A Not replaced (1/75)	C4SZ 6327895-A	1
	67	S	Plug (button)-3/4" diam. hole	C7SZ 6527894-A	C8SZ 6527895-A 379150-S(KK23A)	1
	68/69	S			C8SZ 6527894-A	C8SZ 6527895-A
	70/71	S		D0SZ 6527894-A	D0SZ 6527895-A	1
	72	S		D2SZ 6527894-A	D2SZ 6527895-A	1
- X -						
	66/ 70	X(54, 62)		C6DZ 6227894-A	C6DZ 6227895-A	1
	66	X(66, 71)	Single action tailgate	C6OZ 7127894-A	C6DZ 7127895-B	1
	67/ 70	X(71)				1
	66/70	X(71)	Dual action tailgate	C6OZ 7127894-A	C6OZ 7127895-A	1
<b>27894-5 WEATHERSTRIP - BODY SIDE WINDOW OPENING PANEL LOWER</b>						
	66/	U(98)		C6TZ 98278C94-A	C6TZ 98278C95-A	1
<b>GROUP NUMBER YEAR BODY TYPE DESCRIPTION PART NUMBER QTY.</b>						
<b>27896-7 EXTENSION - QUARTER WHEELHOUSE REAR</b>						
	69/	A(71)	L.H.		C9AZ 7127897-A	1
	69/	A(71)	R.H.-Refer to Group 47122			
	70/71	B(66)	R.H.		D0OZ 6627896-A	1
	72	B(97)	R.H.		D2OZ 9727896-A	1
			L.H.		D2OZ 9727897-A	1
<b>278C96 RETAINER - BODY SIDE INNER PANEL</b>						
	66/	U(98)	Body side & windshield		C6TZ 98278C96-A	12
	66/	U(97)	Windshield			4
	66/	U(97)	Back window			3
<b>GROUP NUMBER YEAR BODY TYPE DESCRIPTION PART NUMBER QTY.</b>						
<b>278A98-9 PANEL - BODY SIDE - OUTER</b>						
	68/69	B(66)		C8OZ 66278A98-A	C8OZ 66278A99-A	1
	70/71	B(66)		D0OZ 66278A98-A	D0OZ 66278A99-A	1
	70	B(66)	Screw & washer-No.8-18 x 1/2" self tapping	381969-S2(UU89A)	381969-S2(UU89A)	2
<b>279B04 GAME TABLE</b>						
	69/	A(71)			D3AZ 71279B04-A	1
<b>279C18-9 REINFORCEMENT - BODY SIDE WINDOW OPENING - REAR</b>						
	66/68	U(98) "Before Ser. D40, 001"		C6TZ 98279C18-A	C6TZ 98279C19-A	1
			5/16"-18 x 3/4" Hex. hd. screw & washer assy.	359662-S7-8(BB575A)	359662-S7-8(BB575A)	2
	68/	U(98) "From Ser. D40, 001"	Refer to groups 279C20-1, 279C44-5, 279C72-3			

# FORD CAR PARTS

## BODY SECTION 270

11

GROUP NUMBER	YEAR	BODY TYPE	DESCRIPTION	PART NUMBER		QTY.	
				RIGHT HAND	LEFT HAND		
<b>279C20-1 REINFORCEMENT - BODY SIDE WINDOW OPENING - REAR</b>							
	68/	U(98)	"From D40,001"	C8TZ	98279C20-A	C8TZ 98279C21-A	1
<b>27926 EXTENSION - QUARTER WHEELHOUSE INNER PANEL</b>							
	71/	F(76)		D1ZZ	7627926-A	D1ZZ 7627926-A	2
<b>27930-1 COVER - QUARTER WINDOW REGULATOR PANEL ACCESS HOLE</b>							
	66	B(76)	"Before 11/24/65"	NOTE 1	★C6OZ 7627930-A	C6OZ 7627931-A	1
	66	B(76)	"From 11/24/65"		Not replaced (7/73)		
					★C6OZ 7627930-B	★C6OZ 7627931-B	1
					Not replaced (1/73)	Not replaced (11/73)	
			No. 8-18 x 1/2" Cross recess pan head screw		52723-S13(U381)	52726-S13(U381)	12
<b>279C30 WEATHERSTRIP - BODY SIDE UPPER PANEL</b>							
	66/	U(97)				C6TZ 97279C30-A	2
<b>27936 HOUSING - FUEL FILLER PIPE</b>							
	67	A(except 71)				C7AZ 6227936-B	1
			No. 10-12 x 3/4" Hex. washer head screw			42141-S8(U250)	2
			No. 10-12 Nut (speed)			45147-S8(M131)	2
	68	A(except 71)				C8AZ 6227936-A	1
	69	A	Refer to Group 40354				
	70	A				D2MZ 7127936-A	1
	71	A	"Before 1/25/71"	R/B D1AZ 6527936-B (1-73)		★D1AZ 6527936-A	1
	71	A	"From 1/25/71"			D1AZ 6527936-B	1
			Plug button-3/8" dia.			379286-S(PP2C)	1
	72	A				D2AZ 6527936-A	1
	72	B(71)				D2OZ 7127936-A	1
	67/69	S				C7SZ 6527936-B	1
	70	S(57)					1
	71	S(57, 65B, D)					1
	70	S(65)				D0SZ 6527936-A	1
	71	S(65A, C)					1
<b>279C44-5 SUPPORT - BODY SIDE WINDOW OPENING PANEL - REAR</b>							
	68/	U(98)	"From Ser. D40,001"	C8TZ	98279C44-A	C8TZ 98279C45-A	1
<b>27950-1 EXTENSION - QUARTER WHEELHOUSE FRONT</b>							
	72	B(97)		D2OZ	9727950-A	D2OZ 9727951-A	1
<b>279A51 EXTENSION - QUARTER WHEELHOUSE INNER PANEL REAR</b>							
	72	B(71)				D2OZ 71279A51-A	1
<b>279A62-3 REINFORCEMENT - LUGGAGE COMPARTMENT DOOR OPENING - SIDE</b>							
- A -							
	65	A(54, 57, 62, 63, 76)			C5AZ 62279A62-A	C5AZ 62279A62-A	2
	66	A(54, 57, 62, 76)					2
	67	A(54, 57, 62)					2
	68	A(54, 57, 62, 65)					2
	66	A(63)			C6AZ 63279A62-A	C6AZ 63279A62-A	2
- B -							
	66/69	B(54, 62, 63, 76)			C6OZ 62279A62-A	C6OZ 62279A62-A	2
	70/71	B(54, 57, 62, 63, 65, 76)			D0OZ 65279A62-A	D0OZ 65279A63-A	1
- F -							
	71	F(63)			D1ZZ 63279A62-A	D1ZZ 63279A63-A	1
- S -							
	67/70	S(57)	Front		C7SZ 57279A62-A	C7SZ 57279A63-A	1
	67/70	S(65)			C7SZ 65279A62-A	C7SZ 65279A62-A	2
	71	S(57, 65B, D)					2

NOTE 1 - Used on units with Power Tops

May, 1975

COPYRIGHT © 1975 -

FORD MOTOR  
COMPANY

- DEARBORN, MICHIGAN

**FINAL ISSUE**

**BODY  
SECTION 270**
**FORD CAR PARTS**

GROUP NUMBER	YEAR	BODY TYPE	DESCRIPTION	PART NUMBER		QTY.
				RIGHT HAND	LEFT HAND	
<b>27970-1 REINFORCEMENT - TAIL LAMP OPENING</b>						
- A -						
65		A(except 71)		C5AZ 6227970-A	C5AZ 6227970-A	2
65		A(except 71)		C6AZ 6227970-A	C6AZ 6227970-A	2
65		A(71)		C6AZ 7127970-A	C6AZ 7127970-A	2
67		A(71)		C7AZ 7127970-A	C7OZ 7127970-A	2
68		A(except 71)		C8AZ 6227970-A	C8AZ 6227971-A	1
68		A(71)		C8AZ 7127970-A	C8AZ 7127970-A	2
69		A(except 71)		C9AZ 6227970-A	C9AZ 6227971-A	1
69/70		A(71)		C9AZ 7127970-A	C9AZ 7127971-A	1
70		A(except 71)		D0AZ 6227970-A	D0AZ 6227971-A	1
71/		A(exc.71)		D1AZ 6527970-A	D1AZ 6527971-A	1
71/		A(71)		D1AZ 7127970-A	D1AZ 7127971-A	1
65		B(54, 62, 65)	Serviced only in assy.- refer to Group 40320			2
66		B(except 71)		C6OZ 6227970-A	C6OZ 6227970-A	2
66		B(71)		C6OZ 7127970-A	C6OZ 7127970-A	2
67		B(except 71)		C7OZ 6227970-A	C7OZ 6227970-A	2
67		B(71)		C7OZ 7127970-A	C7OZ 7127970-A	2
68		B(54, 65, 76)		C8OZ 5427970-A	C8OZ 5427971-A	1
68/69		B(66, 71)		C8OZ 7127970-A	C8OZ 7127970-A	2
69		B(54, 65, 76)		C9OZ 5427970-A	C9OZ 5427971-A	1
70		B(54, 57, 62, 65, 76)		D0OZ 6527970-A	D0OZ 6527971-A	1
71		B(54, 57, 65, 76)				1
70/71		B(63)		D0OZ 6327970-A	D0OZ 6327971-A	1
70		B(71)		D0OZ 7127970-A	D0OZ 7127971-A	1
71		B(66, 71)				1
72		B(exc.71,97)		D2OZ 6527970-A	D2OZ 6527971-A	1
72		B(71,97)		D2OZ 7127970-A	D2OZ 7127971-A	1
- L -						
72		L(73)		D2FZ 7327970-A	D2FZ 7327971-A	1
- P -						
70		P(62)	Rear	D0DZ 6227970-A	D1DZ 6227971-A	1
71/		P(54)	Rear	D1DZ 5427970-A	D1DZ 5427971-A	1
71/		P(62)		D1DZ 6227970-A	D1DZ 6227971-A	1
- S -						
72		S		D2SZ 6527970-A	D2SZ 6527971-A	1
- X -						
66		X(66, 71)		C6OZ 7127970-A	C6OZ 7127970-A	2
66/67		X(54, 62)		C7DZ 6227970-A	C7DZ 6227970-A	2
67/70		X(66, 71)		C7OZ 7127970-A	C7OZ 7127970-A	2
68/70		X(54, 62)		C8DZ 6227970-A	C8DZ 6227971-A	1
<b>279C72-3 BRACE - BODY SIDE WINDOW OPENING REAR REINFORCEMENT</b>						
68/		U(98) "From Ser. D40, 001"		C8TZ 98279C72-A	C8TZ 98279C73-A	1
<b>27974-5 PANEL - QUARTER WHEEL OPENING COVER - INCLUDES SEAL and ATTACHING PARTS</b>						
65/66		S		C4SZ 6327974-B	C4SZ 6327975-B	1
<b>279B76 RECREATION KIT - TABLE</b>						
69/		A(71)	Includes checkers		D3AZ 71279B76-A	1
Consists of						
1-D3AZ 71279B04-A		Game table	2-D3AZ 71280C38-A	Retainer	5-380098-S	Rivet
1-D3AZ 71280C36-A		Checkers	1-D3AZ 71280C40-A	Cable		
<b>279C80-1 FILLER - QUARTER PANEL OUTER REAR EXTENSION</b>						
68		A(except 71)		C8AZ 62279C80-A	C8AZ 62279C81-A	1
<b>27986-7 SEAL - QUARTER WHEEL OPENING COVER</b>						
65/66		S		C4SZ 6327986-A	C4SZ 6327987-A	1
<b>279C90-1 EXTENSION - QUARTER PANEL LOWER - REAR</b>						
72		B(71)		D2OZ 71279C90-A	D2OZ 71279C91-A	1
72		B(97)		D2OZ 97279C90-A	D2OZ 97279C91-A	1
71/		L		D1FZ 62279C90-A	D1FZ 62279C91-A	1
71/		F		D1ZZ 65279C90-A	D1ZZ 65279C91-A	1
<b>27998-9 EXTENSION - PANEL QUARTER INSIDE FRONT</b>						
70/71		B(66)		D0OZ 6627998-A	D0OZ 6627999-A	1

# FORD CAR PARTS

## BODY SECTION 280

1

GROUP NUMBER	YEAR	BODY TYPE	DESCRIPTION	PART NUMBER	QTY.
<b>28010-1 EXTENSION - QUARTER PANEL - REAR</b>					
<b>- A -</b>					
	67	A(54, 57, 62, 63, 76)	R. H. -Outer rear L. H.	C7AZ 6228010-A C7AZ 6228011-A	1 1
	67	A(54, 57, 62, 63, 76)	1/4" Flat washer & sealer assy. 1/4"-20 Nut & washer assy.	381923-S100(XX91B) 373556-S100(MM291F)	6 8
	68	A(54, 57, 63, 65, 76)	R. H. -Outer rear -without holes L. H.	C8AZ 6228010-A C8AZ 6228011-A	1 1
	69	A(except 71)	R. H. -outer L. H.	C9AZ 6228010-C C9AZ 6228011-C	1 1
	70	A(except 71)	R. H. L. H.	D0AZ 6228010-A D0AZ 6228011-A	1 1
	71	A(except 71)	R. H. L. H.	D1AZ 6528010-A D1AZ 6528011-A	1 1
	72	A(except 71)	R. H. L. H.	D2AZ 6528010-A D2AZ 6528011-A	1 1
	70	A	Nut 1/4" - 20 self threading	376842-S100(MM288A)	6
	70	A	Washer and sealer 7/8" dia.	383103-S100(XX119P)	6
<b>- B -</b>					
	65	B(54, 62, 65)	R. H. L. H.	C5OZ 6228010-A C5OZ 6228011-A	1 1
	65	B(71)	R. H. L. H.	C5OZ 7128010-A C5OZ 7128011-A	1 1
	68	B(54, 65, 76)	R. H. -Outer rear L. H.	C8OZ 5428010-A C8OZ 5428011-A	1 1
	68	B(63)	R. H. -Outer rear L. H.	C8OZ 6328010-A C8OZ 6328011-A	1 1
	69	B(54, 65, 76)	R. H. - Outer L. H.	C9OZ 5428010-A C9OZ 5428011-A	1 1
	69	B(63)	R. H. L. H.	C9OZ 6328010-A C9OZ 6328011-A	1 1
	70/71	B(54, 57, 62, 65, 76)	R. H. L. H.	D0OZ 6528010-A D0OZ 6528011-A	1 1
	70/71	B(63)	R. H. L. H.	D0OZ 6328010-A D0OZ 6328011-A	1 1
	70/71	B	Nut 1/4" - 20 self threading	376842-S100(MM288A)	6
	70/71	B	Washer and sealer 7/8" dia.	383103-S100(XX119P)	6
<b>- F -</b>					
	65/68	F	Refer to Group 27702-3		
	68	F(Shelby GT 350/500)	Refer to Group 28072-3		
	69	F(63 exc. Shelby GT350/500)	R. H. L. H.	C9ZZ 6328010-A C9ZZ 6328011-A	1 1
	69	F(65,76-exc. Shelby GT350/500)	R. H. L. H.	C9ZZ 6528010-A C9ZZ 6528011-A	1 1
	69/70	F(63-Shelby GT350/500)	R. H. -outer L. H.	C9ZZ 6328010-B C9ZZ 6328011-B	1 1
	69/70	F(76-Shelby GT350/500)	R. H. -outer L. H.	C9ZZ 7628010-B C9ZZ 7628011-B	1 1
	70	F(63)	R. H. L. H.	D0ZZ 6328010-A D0ZZ 6328011-A	1 1
	70	F(65)	R. H. L. H.	D0ZZ 6528010-A D0ZZ 6528011-A	1 1
	70	F(76)	R. H. L. H.	D0ZZ 7628010-A D0ZZ 7628011-A	1 1
	70	F	Washer and seal-1/4"	383103-S100(XX119P)	6
	71/	F(63)	R. H. L. H.	D1ZZ 6328010-A D1ZZ 6328011-A	1 1
	71/	F(65, 76)	R. H. L. H.	D1ZZ 6528010-A D1ZZ 6528011-A	1 1
<b>- P -</b>					
	70/	P(62)-w/o spoiler	R. H. L. H.	D0DZ 6228010-A D0DZ 6228011-A	1 1
	70/	P(62)-w/spoiler	R. H. L. H.	D1DZ 6228010-A D1DZ 6228011-A	1 1
	71/	P(54)	R. H. L. H.	D1DZ 5428010-A D1DZ 5428011-A	1 1
			Washer and seal assy.	381923-S100(XX91B)	4

GROUP NUMBER	YEAR	BODY TYPE	DESCRIPTION	PART NUMBER		QTY.
				RIGHT HAND	LEFT HAND	
<b>28010-1 EXTENSION - QUARTER PANEL - REAR - continued</b>						
- X -						
	68/70	X(54, 62)	R. H. -Outer rear-Zinc die cast L. H.	C8DZ 6228010-B		1
	66/70	X(66, 71)	Refer to Group 28072-3	C8DZ 6228011-B		1
<b>280A10-1 PANEL - QUARTER WINDOW REGULATOR HOUSING - INNER</b>						
	67/71	S(65)	R. H. L. H.	C7SZ 65280A10-B C7SZ 65280A11-B		1 1
	67/71	S	No. 8-18 x 3/8" Hex. washer head screw No. 8-18 x 3/8" screw pan head	42119-S8(UU246) 52720-S8(U380)		24 AR
	69/71	S	Screw-1/4"-20 x 1/4" set Nut & washer -1/4"-20	381742-S2(UU106A) 378289-S2(MM296)		AR AR
	69/71	S	Screw-No. 8-18 x 3/4" pan head	376389-S101(UU82D)		AR
<b>280B12 TUBE - FUEL FILLER HOUSING DRAIN</b>						
	66/67	A(exc. 71) "Before 11/1/66"		C5AZ 62280B12-B		1
	66	A(71)- "From 11/15/65 to 12/29/65"				1
	67/71	S				1
	67/	A(exc. 71) "From 11/1/66"	Refer to Chassis Group 9A129			
	65/71	A, S	Grommet	379150-S(KK23A)		1
<b>28022-3 REINFORCEMENT - QUARTER WHEELHOUSE AT SEAT BACK BRACKET</b>						
	69/70	F(63)	R. H. L. H.	C9ZZ 6328022-A C9ZZ 6328023-A		1 1
<b>280B24 BOOT - FUEL FILLER OPENING COLLAR TO WHEELHOUSE</b>						
	65/68	A(exc. 71), B(exc. 71)	Refer to Group 9008 in Chassis Section			
	66	A(71)		C6AZ 71280B24-A		1
	67	A(71)		C7AZ 71280B24-A		1
	68	A(71)		C8AZ 71280B24-A		1
	69/	A	Refer to Group 40354			
	66/67	B(71)		C6OZ 71280B24-A		1
	68/69	B(71)		C8OZ 71280B24-B		1
	70/71	B(71)		D0OZ 71280B24-A		1
	66/67	A(71), B(71)	No. 8-18 x .38" Cross recess truss head screw	376378-S101(UU97)		4
<b>280A26-7 PANEL - QUARTER WINDOW REGULATOR HOUSING - OUTER</b>						
	68/71	S(65)	R. H. L. H.	C8SZ 65280A26-B C8SZ 65280A27-B		1 1
	68/71	S	Screw-1/4"-20 x 1 1/4" set	381742-S2(UU106A)		AR
	68/71	S	Nut & washer-1/4"-20	378289-S2(MM296)		AR
<b>280B26 SPACER - QUARTER WHEELHOUSE INNER TO FUEL TANK</b>						
	65/68	A(71)		C5AZ 71280B26-A		1
	66/69	B(71)		C6OZ 71280B26-A		1
	70/71	B(71)		D0OZ 71280B26-A		1
GROUP NUMBER	YEAR	BODY TYPE	DESCRIPTION	PART NUMBER		QTY.
				RIGHT HAND	LEFT HAND	
<b>28032-3 ORNAMENT - QUARTER PANEL OUTSIDE - INCLUDES ATTACHING PARTS</b>						
	70	B(63F, 66C, 76F)		D0OZ 6528032-A	D0OZ 6528032-A	10
			Nut 1/8" Sleeve	375890-S100(MM222A)	375890-S100(MM222A)	20
	69	F(63 exc. Boss and Shelby GT350/500)	Paint to match	C9ZZ 6328032-A	C9ZZ 6328033-A	1
	69	F(65, 76-exc. Shelby GT350/500)	Paint to match-For Moulding refer to Group 290D14-5	C9ZZ 6528032-Y	C9ZZ 6528033-Y	1
	69/70	F(63-Shelby GT350/500)	Use on extension- adhesive backed	C9ZZ 6328032-B	C9ZZ 6328033-B	1
	69/70	F(76-Shelby GT350/500)	Use on extension-glue on type	C9ZZ 7628032-A	C9ZZ 7628033-A	1
	71	F(65D)	Refer to Group 8213 in Chassis Section			
	70	F(76)	Nut 5/16" self threading	382110-S100(MM284X)	382110-S100(MM284X)	12
<b>28034-5 FILLER - QUARTER PANEL LOWER REAR</b>						
	72	B(71)		D2OZ 7128034-A	D2OZ 7128035-A	1
	72	B(97)		D2OZ 9728034-A	D2OZ 9728035-A	1
<b>280A36-7 PILLAR - QUARTER WHEELHOUSE TO ROOF INNER - LOWER</b>						
	72	B(71)		D2OZ 71280A36-A	D2OZ 71280A37-A	1



# FORD CAR PARTS

## BODY SECTION 280

3

GROUP NUMBER	YEAR	BODY TYPE	DESCRIPTION	PART NUMBER	QTY.	
<b>280C36</b>	<b>GAME KIT</b>					
	69/	A(71)	Incl. 24 checkers	D3AZ 71280C36-A	1	
GROUP NUMBER	YEAR	BODY TYPE	DESCRIPTION	PART NUMBER		QTY.
				RIGHT HAND	LEFT HAND	
<b>28038-9</b>	<b>PLATE - BODY REAR CORNER PANEL REINFORCEMENT</b>					
	66/	U		C4TZ 9928038-B	C4TZ 9928039-B	1
GROUP NUMBER	YEAR	BODY TYPE	DESCRIPTION	PART NUMBER		QTY.
<b>280A38</b>	<b>RETAINER ASSY. - GAME TABLE</b>					
	69/	A(71)		D3AZ 71280A38-A		2
<b>280C40</b>	<b>CABLE ASSY. - GAME TABLE</b>					
	69/	A(71)		D3AZ 71280C40-A		1
<b>280A44</b>	<b>ABSORBER - QUARTER OUTSIDE PANEL REAR - SOUND - Refer to Group 54330</b>					
GROUP NUMBER	YEAR	BODY TYPE	DESCRIPTION	PART NUMBER		QTY.
				RIGHT HAND	LEFT HAND	
<b>28054-5</b>	<b>BRACKET - QUARTER WINDOW PANEL TO WHEELHOUSE</b>					
	71/	F(76)		D1ZZ 7628054-A	D1ZZ 7628055-A	1
<b>28058-9</b>	<b>EXTENSION - QUARTER PANEL - LOWER REAR</b>					
			- A -			
	65	A(54, 57, 62, 63, 76)		C5AZ 6228058-A	C5AZ 6228059-A	1
	66	A(except 71)		C6AZ 6228058-A	C6AZ 6228059-A	1
	66	A(71)		★C6AZ 7128058-A	C6AZ 7128059-A	1
			Not replaced(3-74)			
	67	A(except 71)		C7AZ 6228058-A	C7AZ 6228059-A	1
	67	A(71)		C7AZ 7128058-A	C7AZ 7128059-A	1
	68	A(71)		C8AZ 7128058-A	C8AZ 7128059-A	1
	69/70	A(71)		C9AZ 7128058-A	C9AZ 7128059-A	1
	71/	A(71)		D1AZ 7128058-A	D1AZ 7128059-A	1
			- B -			
	66/67	B(54, 62, 63, 76)		C7OZ 6228058-A	C7OZ 6228059-A	1
	66	B(71)		★C6OZ 7128058-A	C6OZ 7128059-A	1
	67	B(66, 71)		Not replaced (1-75)		1
	68/69	B(66)		C8OZ 6628058-A	C8OZ 6628059-A	1
	68/69	B(71)		C8OZ 7128058-A	C8OZ 7128059-A	1
	70/71	B(66)		D0OZ 6628058-A	D0OZ 6628059-A	1
	70/71	B(71)		D0OZ 7128058-A	D0OZ 7128059-A	1
			- F -			
	65/66	F		C5ZZ 6528058-A	C5ZZ 6528059-A	1
	67/68	F		C7ZZ 6528058-A	C7ZZ 6528059-A	1
	69	F(63)		C9ZZ 6328058-A	C9ZZ 6328059-A	1
	69	F(65, 76)		C9ZZ 6528058-A	D0ZZ 6528059-A	1
	70	F(63)		D0ZZ 6328058-A	D0ZZ 6328059-A	1
	70	F(65)		D0ZZ 6528058-A	D0ZZ 6528059-A	1
	70	F(76)		D0ZZ 7628058-A	D0ZZ 7628059-A	1
	71/	F(63)		D1ZZ 6328058-A	D1ZZ 6328059-A	1
	71/	F(65, 76)		D1ZZ 6528058-A	D1ZZ 6528059-A	1
			- P -			
	70/	P		D0DZ 6228058-A	D0DZ 6228059-A	1
			Washer & seal assy.	381923-S100(XX91B)	381923-S100(XX91B)	2
			- S -			
	67/69	S		C7SZ 6528058-A	C7SZ 6528059-A	1
	70/71	S		D0SZ 6528058-A	D0SZ 6528059-A	1
			Screw No. 8-18 x 1/2"-pan head	55997-S45X(U381-D)	55997-S45X(U381-D)	2
	72	S		D2SZ 6528058-A	D2SZ 6528059-A	1

**BODY  
SECTION 280**
**FORD CAR PARTS**

GROUP NUMBER	YEAR	BODY TYPE	DESCRIPTION	PART NUMBER		QTY.
				RIGHT HAND	LEFT HAND	
<b>28058-9 EXTENSION - QUARTER PANEL - LOWER REAR - continued</b>						
- X -						
	66/67	X(54, 62)		C7DZ 6228058-A	★C7DZ 6228059-A Not replaced (3/74)	1
	66	X(66)		C6OZ 7128058-A	C6OZ 7128059-A	1
	66/70	X(71)				1
<b>280A58-9 PANEL - BODY REAR CORNER</b>						
	66/69	U "Before Ser. E24, 001"		C4TZ 99280A58-A	C4TZ 99280A59-A	1
	69/	U "From Ser. E24, 001"		C9TZ 97280A58-A	C9TZ 97280A59-A	1
<b>28060-1 FILLER - QUARTER PANEL - UPPER FRONT - Also Refer to Group 27840</b>						
	66/67	B(62)		C6OZ 6228060-A	C6OZ 6228061-A	1
	66/70	X(62)				1
	69	F(65)		C9ZZ 6528060-A	C9ZZ 6528061-A	1
	70/	F(65)	Serviced in assy. - refer to Groups 27840-1 and 45118-9			
	67/69	S(65)		C7SZ 6528060-A	C7SZ 6528061-A	1
	71	S(65B,D)		C7SZ 6528060-A	C7SZ 6528061-A	1
<b>280B62-3 GRILLE ASSY. - QUARTER PILLAR VENT AIR - INCLUDES ATTACHING PARTS</b>						
	70	A(except 71)		D0AZ 62280B62-A	D0AZ 62280B63-A	1
	71/	A(53, 54, 57)		D1AZ 54280B62-A	D1AZ 54280B62-A	2
	71/	A(65, 76)		D1AZ 65280B62-A	D1AZ 65280B62-A	2
	70/71	B(54, 57)		D0AZ 62280B62-A	D0AZ 62280B63-A	1
	70/71	B(62, 63, 65, 66, 76)		D0OZ 65280B62-A	D0OZ 65280B62-A	2
	72	B(53)		D2OZ 53280B62-A	D2OZ 53280B62-A	2
	72	B(63, 65, 97)		D2SZ 65280B62-A	D2SZ 65280B62-A	2
	70/	F		D0ZZ 65280B62-A	D0ZZ 65280B63-A	1
	70	P(62)		D0OZ 65280B62-A	D0OZ 65280B62-A	2
	72	S		D2SZ 65280B62-A	D2SZ 65280B62-A	2
<b>280B62-3 AIR SCOOP - ROOF</b>						
	68	F(63-GT350/500)	On roof	S8MS 63280B62-A	S8MS 63280B63-A	1
<b>28072-3 EXTENSION - QUARTER PANEL - UPPER REAR - Also Refer to Group 28010-1</b>						
	67/69	B(71)		C7OZ 7128072-A	C7OZ 7128073-A	1
	68/69	B(66)		C8OZ 6628072-A	C8OZ 6628073-A	1
	67	B(66)		C6DZ 6628072-A	C6DZ 6628073-A	1
	70/71	B(66)		D0OZ 6628072-A	D0OZ 6628073-A	1
	72	B(71)		D2OZ 7128072-A	D2OZ 7128073-A	1
	66	X(66)		C6DZ 6628072-A	C6DZ 6628073-A	1
	67/70	X(71)		C7OZ 7128072-A	C7OZ 7128073-A	1
<b>28072-3 EXTENSION - QUARTER PANEL</b>						
	68	F(GT350/500)		S8MS 6328072-A	S8MS 6328073-A	1
	68	F(except GT350/500)	Refer to Group 27702			
	69	F(GT350/500)	Refer to Group 28010-1			
<b>280A94 SHIELD - QUARTER PANEL TO BUMPER END</b>						
	68/69	B(54, 63, 65, 76)	Rubber	C8OZ 54280A94-A	C8OZ 54280A94-A	2
<b>28106-7 PILLAR - QUARTER WHEELHOUSE TO ROOF INNER UPPER</b>						
	72	B(71)		D2OZ 7128106-A	D2OZ 7128107-A	1
<b>28126 REINFORCEMENT - BODY SIDE INNER PANEL</b>						
	72	B(97)		D2OZ 9728126-A	D2OZ 9728126-A	2
<b>28160-1 PILLAR ASSY. - QUARTER LATCH</b>						
- A -						
	67	A(54)		C7AZ 5428160-A	★C7AZ 5428161-A Not replaced (1/75)	1
	67	A(71)		C7AZ 7128160-A	★C7AZ 7128161-A Not replaced (1/75)	1
	68	A(54)		C8AZ 5428160-A	C8AZ 5428161-A	1
	68	A(57)		C8AZ 5728160-A	★C8AZ 5728161-A Not replaced (1/75)	1
	67	A(63, 76)		C7AZ 6328160-B	C7AZ 6328161-B	1
	68	A(63, 65, 76)				1
	68	A(71)		C8AZ 7128160-A	C8AZ 7128161-A	1
	69	A(54)		C9AZ 5428160-A	C9AZ 5428161-A	1
	69	A(57)		C9AZ 5728160-A	C9AZ 5728161-A	1
	69	A(62)		C9AZ 6228160-A	C9AZ 6228161-A	1
	69	A(63, 65, 76)		C9AZ 6328160-A	C9AZ 6328161-A	1
	69	A(71)		C9AZ 7128160-A	C9AZ 7128161-A	1

# FORD CAR PARTS

## BODY SECTION 280

5

GROUP NUMBER	YEAR	BODY TYPE	DESCRIPTION	PART NUMBER		QTY.
				RIGHT HAND	LEFT HAND	
<b>28160-1 PILLAR ASSY. - QUARTER LATCH - continued</b>						
<b>- A -</b>						
	70	A(54)		D0AZ 5428160-A	D0AZ 5428161-A	1
	70	A(57)		D0AZ 5728160-A	D0AZ 5728161-A	1
	70	A(63, 65, 76)		D0AZ 6328160-A	D0AZ 6328161-A	1
	70	A(71)		C9AZ 7128160-A	C9AZ 7128161-A	1
	71/	A(53, 57)		D1AZ 5728160-A	D1AZ 5728161-A	1
	71/	A(54)		D1AZ 5428160-A	D1AZ 5428161-A	1
	71/	A(65, 76)		D1AZ 6528160-A	D1AZ 6528161-A	1
	71/	A(71)		D1AZ 7128160-A	D1AZ 7128161-A	1
<b>- B -</b>						
	65	B(54)		C5OZ 5428160-A	★C5OZ 5428161-A Not replaced(3-74)	1
	66/67	B(54, 71)		C6OZ 5428160-A	C6OZ 5428161-A	1
	66/67	B(62)		C6OZ 6228160-A	C6OZ 6228161-A	1
	66/67	B(63, 76)		C6OZ 6328160-A	C6OZ 6328161-A	1
	67	B(66)		C6DZ 6628160-A	C6DZ 6628161-A	1
	68/69	B(54)		C8OZ 5428160-A	C8OZ 5428161-A	1
	68/69	B(63, 65, 76)		C8OZ 6328160-B	C8OZ 6328161-B	1
	68/69	B(66)		C8OZ 6628160-A	C8OZ 6628161-A	1
	68/69	B(71)		C8OZ 7128160-A	C8OZ 7128161-A	1
	70/71	B(54, 57)		D0OZ 5428160-A	D0OZ 5428161-A	1
	70	B(62)		D0OZ 6228160-A	D0OZ 6228161-A	1
	70/71	B(63, 65, 76)		D0OZ 6528160-A	D0OZ 6528161-A	1
	70/71	B(66)		D0OZ 6628160-A	D0OZ 6628161-A	1
	70/71	B(71)		D0OZ 7128160-A	D0OZ 7128161-A	1
	72	B(53)		D2OZ 5328160-A	D2OZ 5328161-A	1
	72	B(63, 65)		D2OZ 6528160-A	D2OZ 6528161-A	1
	72	B(71)		D2OZ 7128160-A	D2OZ 7128161-A	1
	72	B(97)		D2OZ 9728160-A	D2OZ 9728161-A	1
<b>- F -</b>						
	65/66	F(65, 76)		C5ZZ 6528160-A	C5ZZ 6528161-A	1
	67/68	F(63)		C7ZZ 6328160-A	C7ZZ 6328161-A	1
	67/68	F(65, 76)		C7ZZ 6528160-A	C7ZZ 6528161-A	1
	69	F(63)		C9ZZ 6328160-A	C9ZZ 6328161-A	1
	69	F(65, 76)		C9ZZ 6528160-A	C9ZZ 6528161-A	1
	70	F(63)		D0ZZ 6328160-A	D0ZZ 6328161-A	1
	70	F(65, 76)		D0ZZ 6528160-A	D0ZZ 6528161-A	1
	71/	F		D1ZZ 6528160-A	D1ZZ 6528161-A	1
<b>- L -</b>						
	71/72	L(62, 64)	"Before 5/1/72"	D1FZ 6228160-A	D1FZ 6228161-A	1
	72	L(62, 64)	"From 5/1/72"	D2FZ 6228160-A	D2FZ 6228161-A	1
	72	L(73)		D2FZ 7328160-A	D2FZ 7328161-A	1
<b>- P -</b>						
	70/	P(62)		D0DZ 6228160-A	D0DZ 6228161-A	1
	71/	P(54)		D1DZ 5428160-A	D1DZ 5428161-A	1
<b>- S -</b>						
	67/69	S(65)		C7SZ 6528160-B	C7SZ 6528161-B	1
	68/71	S(57)		C8SZ 5728160-A	C8SZ 5728161-A	1
	70	S(65)		D0SZ 6528160-A	D0SZ 6528161-A	1
	71	S(65A, C)		D0SZ 6528160-A	D0SZ 6528161-A	1
	71	S(65B, D)		D1SZ 6528160-A	D1SZ 6528161-A	1
	72	S		D2SZ 6528160-A	D2SZ 6528161-A	1
<b>- U -</b>						
	66/	U		C8TZ 9628160-A	C8TZ 9628161-A	1
			Plug (button)-1" dia. hole	377678-S(PP3E)	377678-S(PP3E)	2
<b>- X -</b>						
	66/67	X(62)		C6OZ 6228160-A	C6OZ 6228161-A	1
	66/67	X(71)		C6OZ 5428160-A	C6OZ 5428161-A	1
	66/70	X(54)		C6DZ 5428160-A	C6DZ 5428161-A	1
	66/70	X(62)		C6OZ 6228160-A	C6OZ 6228161-A	1
	66/70	X(71)		C6OZ 5428160-A	C6OZ 5428161-A	1

**BODY  
SECTION 280**
**FORD CAR PARTS**

GROUP NUMBER	YEAR	BODY TYPE	DESCRIPTION	PART NUMBER		QTY.
				RIGHT HAND	LEFT HAND	
<b>28182-3 SEAL - QUARTER LATCH PILLAR TO WINDOW FRAME</b>						
	65/68	A(63, 65, 76)		C5AZ 6328182-B	C5AZ 6328183-B	1
	69	A(63, 65, 76)		C9AZ 6328182-A	C9AZ 6328183-A	1
	70/	A(63, 65, 76)		D0AZ 6328182-A	D0AZ 6328183-A	1
	68/69	B(63, 65, 76)		C8OZ 6328182-A	C8OZ 6328183-A	1
	70/71	B(63, 65, 76)		D0OZ 6528182-A	D0OZ 6528183-A	1
	72	B(63, 65)		D2OZ 6528182-A	D2OZ 6528183-A	1
	65	F		C5ZZ 6528182-A	C5ZZ 6528183-A	1
	66	F(65, 76)				1
	67/68	F(65, 76)		C7ZZ 6528182-A	C7ZZ 6528183-A	1
	69/70	F(63)		C9ZZ 6328182-A	C9ZZ 6328183-A	1
	69	F(65, 76)		C9ZZ 6528182-A	C9ZZ 6528183-A	1
	70	F(65, 76)		D0ZZ 6528182-B	D0ZZ 6528183-B	1
	71	F "Before 3/29/71"		D1ZZ 6528182-A	D1ZZ 6528183-A	1
	71/	F "From 3/29/71"		D1ZZ 6528182-B	D1ZZ 6528183-B	1
	67/68	S(65)		C7SZ 6528182-C	C7SZ 6528183-C	1
	69	S(65A, C)				1
	70/71	S(65)				1
	72	S		D0SZ 6528182-A	D0SZ 6528183-A	1
	65	X(63, 76)		D2SZ 6528182-A	D2SZ 6528183-A	1
			No. 8-18 x 3/8" Cross recess pan head screw	C3DZ 7628182-B 52720-S8(U380)	C3DZ 7628182-B 52720-S8(U380)	2 2
	65/	A(63, 76), F	No. 6-18 x 3/8" Cross recess pan head screw	52718-S8(U377A)	52718-S8(U377A)	8or14
	66/67	B(63, 76)				
	70/	S (65)	No. 8-8 x 1/2" Washer head screw	381801-S2 (UU148)	381801-S2(UU148)	2
<b>28198-9 BRACE - QUARTER LATCH PILLAR TO FLOOR</b>						
	68/69	B(76)		★C8OZ 7628198-A	C8OZ 7628199-A	1
				Not replaced(1-73)		
	69/70	F(76)		C9ZZ 7628198-A	C9ZZ 7628199-A	1
<b>28200-1 REINFORCEMENT - QUARTER PANEL LATCH SIDE</b>						
<b>- A -</b>						
	67	A(63, 76)		C7AZ 6328200-A	C7AZ 6328201-A	1
	68	A(63, 65, 76)				1
<b>- B -</b>						
	66/67	B(63, 76)		★C6OZ 6328200-A	C6OZ 6328201-A	1
				Not replaced(3-74)		
	66/71	B(71)		C6OZ 7128200-A	C6OZ 7128201-A	1
	67	B(66)		C6DZ 6628200-A	C6DZ 6628201-A	1
	68/69	B(54)		C8OZ 5428200-A	C8OZ 5428201-A	1
	68/69	B(63, 65, 76)		C8OZ 6328200-A	C8OZ 6328201-A	1
	68/69	B(66)		C8OZ 6628200-A	C8OZ 6628201-A	1
	70/71	B(54, 57)	Lower	D0OZ 5428200-A	D0OZ 5428201-A	1
	70/71	B(66)		D0OZ 6628200-A	D0OZ 6628201-A	1
	72	B(53, 71)		D2OZ 5328200-A	D2OZ 5328201-A	1
<b>- F -</b>						
	65/66	F(65, 76)		C5ZZ 6528200-A	C5ZZ 6528201-A	1
	67/68	F		C7ZZ 6528200-A	C7ZZ 6528201-A	1
<b>- P -</b>						
	71/	P(54)		D1DZ 5428200-A	D1DZ 5428201-A	1
<b>- X -</b>						
	66/70	X(54)		C6DZ 5428200-A	C6DZ 5428201-A	1
	66/70	X(71)		C6OZ 7128200-A	C6OZ 7128201-A	1
<b>28208-9 REINFORCEMENT - QUARTER PANEL LATCH SIDE - UPPER</b>						
	69	A(62)		C9AZ 6228208-A	C9AZ 6228209-A	1
	66	B(62), X(62)		C6OZ 6228208-A	C6OZ 6228209-A	1
	67/68	B(62)		C6OZ 6228208-B	C6OZ 6228209-B	1
	67/70	X(62)				1

# FORD CAR PARTS

## BODY SECTION 280

7

GROUP NUMBER	YEAR	BODY TYPE	DESCRIPTION	PART NUMBER		QTY.
				RIGHT HAND	LEFT HAND	
<b>28216-7 REINFORCEMENT - QUARTER PANEL LATCH SIDE - LOWER - Also refer to Group 28200-1</b>						
	69/70	A(54, 57, 71)	Cut to fit	C9AZ 5428216-A	DIAZ 5428217-A	1
	71/	A(53, 54, 57, 71)	Cut to fit	D1AZ 5428216-A	D1AZ 5428217-A	1
<b>28230-1 EXTENSION - QUARTER WHEELHOUSE TO ROOF OUTER PILLAR</b>						
	69/70	A(71)		C9AZ 7128230-A	C9AZ 7128230-A	2
	71/	A(71)		D1AZ 7128230-A		1
	66/69	B(71), X(71)		C8OZ 7128230-A	★C6OZ 7128231-A Not replaced (1-73)	1
	70/71	B(71)		D0OZ 7128230-A	D0OZ 7128230-A	2
<b>28258-9 BRACE - QUARTER LATCH PILLAR TO WHEELHOUSE</b>						
	72	L		D2FZ 6228258-B	D2FZ 6228259-B	1
<b>28268-9 BRACE - QUARTER PANEL LATCH SIDE LOWER REAR REINFORCEMENT</b>						
	70/71	B(66)		D0OZ 6628268-A	D0OZ 6628269-A	1
<b>28290-1 EXTENSION - QUARTER LATCH PILLAR REINFORCEMENT TO WHEELHOUSE</b>						
	68/69	B		★C8OZ 5428290-A Not replaced (1-73)	C8OZ 5428291-A	1
<b>28324-5 PILLAR - QUARTER LATCH UPPER - OUTER</b>						
	65/68	A(62)	Refer to Group 30504-5			
	71/72	L(62, 64) "Before 5/1/72"		D1FZ 6228324-A	D1FZ 6228325-A	1
	72	L(62, 64) "From 5/1/72"		D2FZ 6228324-A	D2FZ 6228325-A	1
	70/	P		D0DZ 6228324-A	D0DZ 6228325-A	1
<b>28330-1 REINFORCEMENT - QUARTER LATCH PILLAR TO WHEELHOUSE</b>						
	68/69	B(54)		C8OZ 5428330-A	C8OZ 5428331-A	1
	71/	L		D1FZ 6228330-A	D1FZ 6228331-A	1
<b>28364-5 REINFORCEMENT - QUARTER LATCH PILLAR</b>						
	70/71	B(66)		D0OZ 6628364-A	D0OZ 6628365-A	1
<b>28438-9 FILLER - QUARTER LATCH PILLAR TO REINFORCEMENT</b>						
	69/70	F(65)		C9ZZ 6528438-A	C9ZZ 6528439-A	1
	71/	F(65)	Serviced in assembly - Refer to Group 28160-1			
<b>28442-3 BRACE - BODY REAR CORNER PANEL</b>						
	68/	U		C8TZ 9628442-A	C8TZ 9628443-A	1
<b>28518-9 EXTENSION - QUARTER PANEL OUTER REAR</b>						
	69/70	A(71)		C9AZ 7128518-A	C9AZ 7128519-A	1
	69/70	A(71)	Nut-1/4"-20 self tap	376842-S100 (MM288A)	376842-S100 (MM288A)	10
GROUP NUMBER	YEAR	BODY TYPE	DESCRIPTION	PART NUMBER		QTY.
<b>28600 RAIL ASSY. - QUARTER PANEL FUEL FILLER LID FINISH - INCLUDES ATTACHING PARTS</b>						
	66	A(71A, E)	L. H.	C6AZ 7128600-A		1
	67	A(71A, E)	L. H.	C7AZ 7128600-A		1
	68	A(71A, E)	L. H.	C8AZ 7128600-A		1
	69/70	A(71A, E)	L. H.	C9AZ 7128600-A		1
	68/69	B(71E)	L. H.	C8OZ 7128600-A		1
	72	B(71K)	L. H.	D2OZ 7128600-A		1
<b>28611 DOOR - FUEL FILLER - Refer to Group 405A26</b>						
<b>28630 SEAL - FUEL FILLER PIPE OPENING</b>						
	69/71	A			DIAZ 6528630-C	1
<b>28700-1 REINFORCEMENT - QUARTER PANEL AT BELT</b>						
	68/69	B(63)	R. H. L. H. -not replaced (12-74)	C8OZ 6328700-B	★C8OZ 6328701-B	1 1
<b>28702-3 PLATE - BELT SIDE RAIL TO WHEELHOUSE REINFORCEMENT MOUNTING</b>						
	69/70	F(76)	R. H. L. H.	C9ZZ 7628702-A C9ZZ 7628703-A		1 1
	71/	F(76)	R. H. L. H.	D1ZZ 7628702-A D1ZZ 7628703-A		1 1
GROUP NUMBER	YEAR	BODY TYPE	DESCRIPTION	PART NUMBER		QTY.
<b>28708 REINFORCEMENT - BELT SIDE RAIL</b>						
	69/	A(76)		C9AZ 7628708-A	C9AZ 7628708-A	2
	70/71	B(76)		D0OZ 7628708-A	D0OZ 7628708-A	2

**BODY  
SECTION 280**
**FORD CAR PARTS**

GROUP NUMBER	YEAR	BODY TYPE	DESCRIPTION	PART NUMBER		QTY.
				RIGHT HAND	LEFT HAND	
<b>28712-3</b>	<b>RAIL - QUARTER OUTSIDE FINISH</b>					
- A -						
	65	A(71A, E)	Front Fuel filler door Rear	C5AZ 7128712-A	C5AZ 71290A41-A C5AZ 7128600-A C5AZ 7128713-A	1 1 1 1
	66	A(71A, E)	Front Fuel filler door Rear	C6AZ 7128712-A	C6AZ 71290A41-A C6AZ 7128600-A C6AZ 7128713-A	1 1 1 1
	67	A(71A, E)	Front Fuel filler door Rear	C7AZ 7128712-A	C7AZ 71290A41-A C7AZ 7128600-A C7AZ 7128713-A	1 1 1 1
	68	A(71A, E)	Upper Fuel filler door Lower	C8AZ 7128712-A	C8AZ 71290A41-A C8AZ 7128600-A C8AZ 7128713-A	1 1 1 1
	69/70	A(71A, E)	Upper Fuel filler door Lower	C9AZ 7128712-A	C9AZ 71290A41-A C9AZ 7128600-A C9AZ 7128713-A	1 1 1 1
	71	A(71H)		D1AZ 7128712-A	D1AZ 7128713-A	1
	72	A(71H)		D2AZ 7128712-A	D2AZ 7128713-A	1
- B -						
	66/67	B(71E)	Fuel filler door	C6OZ 7128712-B	C6OZ 7128713-B C6OZ 7128600-A	1 1
	68/69	B(71E)	Front Fuel filler door Lower	C8OZ 7128712-A	C8OZ 71290A41-A C8OZ 7128600-A C8OZ 7128713-A	1 1 1 1
	70/71	B(66E)		D0OZ 6628712-A	D0OZ 6628713-A	1
	70/71	B(71E)		D0OZ 7128712-A	D0OZ 7128713-A	1
	72	B(71K)		D2OZ 7128712-A	D2OZ 7128713-A	1
	72	B(97K)		D2OZ 9728712-A	D2OZ 9728713-A	1
- L -						
	72	L(73)		D2FZ 7328712-A	D2FZ 7328713-A	1
<b>28714-5</b>	<b>RAIL - QUARTER BELT - INSIDE</b>					
	66	A(71)		★C6AZ 7128714-A Not replaced (7-73)	C5AZ 7128715-A	1
	69/70	A(71)		C9AZ 7128714-A	C9AZ 7128715-A	1
	71/72	A(71)		D1AZ 7128714-A	D1AZ 7128715-A	1
	65	B(71)		Refer to Group 279B68	C3OZ 7128715-A	1
	66/71	B(71)		C6OZ 7128714-A	C6OZ 7128715-A	1
	72	B(71)		D2OZ 7128714-A	D2OZ 7128715-A	1
<b>28716</b>	<b>RAIL - QUARTER BELT - REAR</b>					
	69/70	A(71)		C9AZ 7128716-A		1
	66/71	B(71)		C6OZ 7128716-A		1
	66/70	X(71)				1
<b>28750-1</b>	<b>EXTENSION - QUARTER PANEL INSIDE TO FLOOR PAN</b>					
	68/69	B(66)		C8OZ 6628750-A	C8OZ 6628751-A	1
	70/71	B(66)		D0OZ 6628750-A	D0OZ 6628751-A	1
<b>28772-3</b>	<b>STRAINER - QUARTER PANEL TO REAR FLOOR</b>					
	71/72	L(62)		D1FZ 6228772-A	D1FZ 6228773-A	1
	71/72	L(64)-w/lever prop		D1FZ 6428772-A	D1FZ 6428773-A	1
	72	L(64)-w/gas cylinder prop		D2FZ 6428772-A	D2FZ 6428773-A	1
<b>28787</b>	<b>EXTENSION - QUARTER BELT RAIL</b>					
	66/70	B(71)			C6OZ 7128787-A	1
<b>28788</b>	<b>STRAINER - QUARTER PANEL BELT TO FLOOR</b>					
	67/69	S(65)		C7SZ 6528788-A	C7SZ 6528788-A	2
	71	S(65D)				2
GROUP NUMBER	YEAR	BODY TYPE	DESCRIPTION	PART NUMBER		QTY.
<b>28880</b>	<b>RETAINER - QUARTER WINDOW GARNISH UPPER MOULDING</b>					
	72	B(71)		D2OZ 7128880-A		4

# FORD CAR PARTS

**BODY  
SECTION 290**

1

GROUP NUMBER	YEAR	BODY TYPE	DESCRIPTION	PART NUMBER		QTY.
				RIGHT HAND	LEFT HAND	

**290A00 RETAINER - QUARTER PANEL OUTSIDE REAR MOULDING**

REFER TO APPROPRIATE EXTERIOR MOULDING ILLUSTRATION  
FOR COMPLETE RETAINER PART NUMBER

**290D00 RETAINER - QUARTER PANEL LOWER REAR MOULDING**

REFER TO APPROPRIATE EXTERIOR MOULDING ILLUSTRATION  
FOR COMPLETE RETAINER PART NUMBER

**29002-3 MOULDING - QUARTER WINDOW GARNISH LOWER -Drill holes as required, paint to match**

- B -						
66/67	B(62)			C6OZ 6229002-A	C6OZ 6229003-A	1
68/70	B(63B, C)			C8OZ 6329002-A	C8OZ 6329003-A	1
68/70	B(65A, B, E)			C8OZ 6529002-B	C8OZ 6529003-B	1
68/70	B(76B, E)			C8OZ 7629002-B	C8OZ 7629003-B	1
- X -						
65	X(59)			★C0DB 5929002-BP Not replaced(1-73)	C0DB 5929003-BP	1
66/70	X(62)			C6OZ 6229002-A	C6OZ 6229003-A	1
66/67	B(63, 76)	No. 8-18 x 3/8" Cross recess pan head screw		52720-S8(U380)	52720-S8(U380)	2 or 4
66/67	B(76)	No. 8-18 x 3/8" Cross recess oval head screw		53008-S13(U275)	53008-S13(U275)	2
66/67	B(62)	No. 8-15 x 1 1/2" Cross recess oval head screw		52388-S13(U298)	52388-S13(U298)	2
65	X(59, 62, 64, 76)	No. 8-18 x 3/8" Cross recess pan head screw		52720-S8(U380)	52720-S8(U380)	8or12
65	X(59, 62, 63, 64, 76)	No. 8 x 1 1/2" Cross recess oval head screw		52388-S13(U298)	52388-S13(U298)	2to6
65	X(59)	No. 8 x 3/4" Cross recess oval head screw		52360-S13(U294)	52360-S13(U294)	4
66/67	X(62)	No. 8-15 x 1 1/2" Cross recess oval head screw		52388-S13(U298)	52388-S13(U298)	2

**29008-9 MOULDING - QUARTER WINDOW GARNISH - UPPER**

68/70	B(63)	Paint to match		C8OZ 6329008-B	C8OZ 6329009-B	1
-------	-------	----------------	--	----------------	----------------	---

**290B10-1 MOULDING - QUARTER PANEL LOWER REAR EDGE**

65	A(57F, 63B, C, 76A, B)			C5AZ 63290B10-A	C5AZ 63290B11-A	1
66	A(57F, 63C, D, F, 76B, D)			C6AZ 63290B10-A	C6AZ 63290B11-A	1
66	B(63B, C, 76B, C)			C6OZ 63290B10-A	C6OZ 63290B11-A	1

**290B12-3 PANEL - QUARTER OUTSIDE FINISH**

65	X(54B)	White		★C5DZ 54290B12-B Not replaced(3-74)	C5DZ 54290B13-B	1
65	X(62B, 63, 76)	White		C5DZ 62290B12-B	C5DZ 62290B13-B	1

**29014-5 MOULDING - QUARTER WINDOW GARNISH - UPPER FRONT**

69/	A(71)			C9AZ 7129014-A	C9AZ 7129015-A	1
		Screw-No. 8-15 x 5/8" fillister head		52554-S8(U230)	52554-S8(U230)	AR

- B -						
66/67	B(62)	Paint to match		C6OZ 6229014-A	C6OZ 6229015-A	1
72	B(71)	" Before 5/18/72"	Black	D2OZ 7129014-D	D2OZ 7129015-D	1
			Blue	D2OZ 7129014-C	D2OZ 7129015-C	1
			Ginger	D2OZ 7129014-A	D2OZ 7129015-A	1
			Green	D2OZ 7129014-B	D2OZ 7129015-B	1
			Black	D3OZ 7129014-A	D3OZ 7129015-A	1
72	B(71)	" From 5/18/72"	Blue	D3OZ 7129014-B	D3OZ 7129015-B	1
			Ginger	D3OZ 7129014-C	D3OZ 7129015-C	1
			Green	D3OZ 7129014-D	D3OZ 7129015-D	1

GROUP NUMBER	YEAR	BODY TYPE	DESCRIPTION	PART NUMBER		QTY.	
				RIGHT HAND	LEFT HAND		
<b>29014-5 MOULDING - QUARTER WINDOW GARNISH - UPPER FRONT - continued</b>							
- L -							
	71/	L (62, 64)	" Before 5/19/72"	Black	D1FZ 6229014-D	D1FZ 6229015-D	1
				Ginger	D1FZ 6229014-A	D1FZ 6229015-A	1
				Green	D1FZ 6229014-B	D1FZ 6220015-B	1
				White	D2FZ 6229014-A	D2FZ 6229015-A	1
	72	L (62, 64)	" From 5/19/72"	Black	D3FZ 6229014-A	D3FZ 6229015-A	1
				Ginger	D3FZ 6229014-F	D3FZ 6229015-F	1
				Green	D3FZ 6229014-J	★D3FZ 6229015-J Not replaced(3-74)	1
				White	D3FZ 6229014-K	D3FZ 6229015-K	1
	71/72	L(62, 64)	"Before 2/1/72"	Blue	D1FZ 6229014-C	D1FZ 6229015-C	1
	72	L(62,64)- "From 2/1/72 to 5/19/72"		Blue	D2FZ 6229014-D	D2FZ 6229015-D	1
	72	L(62, 64)	" From 5/19/72"	Blue	D3FZ 6229014-B	D3FZ 6229015-B	1
	72	L(62, 64)	" Before 5/19/72"	Avocado	D2FZ 6229014-B	D2FZ 6229015-B	1
				Orange	D2FZ 6229014-C	D2FZ 6229015-C	1
	72	L(62, 64)	" From 5/19/72"	Avocado	D3FZ 6229014-G	D3FZ 6229015-G	1
				Orange	D3FZ 6229014-C	D3FZ 6229015-C	1
	72	L(62, 64)		Beige	D3FZ 6229014-D	D3FZ 6229015-D	1
- X -							
	66/70	X(62)			C6OZ 6229014-A	C6OZ 6229015-A	1
<b>290A14-5 MOULDING - REAR QUARTER WINDOW GARNISH - UPPER - Paint to Match</b>							
	69	A(71)			C9AZ 71290A14-A	C9AZ 71290A15-A	1
	71/	A(71)					1
	66/67	B(62), X(62)			C6OZ 62290A14-A	C6OZ 62290A15-A	1
	68/70	X(62)					1
				No. 8-15 x 1 1/4" Cross recess oval head screw	53066-S13(U284)	53066-S13(U284)	2
	66/71	B(71)			C6OZ 71290A14-C	C6OZ 71290A15-C	1
	66/70	X(71)					1
	72	B(71)			D2OZ 71290A14-A	D2OZ 71290A14-A	2
<b>290D14-5 MOULDING - QUARTER OUTSIDE ORNAMENT</b>							
	69	F(65)		Includes attaching parts	C9ZZ 65290D14-A	C9ZZ 65290D15-A	1
<b>290B16 SPACER - QUARTER OUTSIDE CENTER BELT MOULDING</b>							
	65	X(66)			C0DB 66290B16-A	C0DB 66290B16-A	6
<b>29019 BRACKET - COAT HOOK</b>							
	69/70	A(54, 62, 71)			C9AZ 6229019-A	C9AZ 6229019-A	2
	71	A(65, 71)					2
	72	A(71)					2
	72	L(62, 64)			D2FZ 6229019-A	D2FZ 6229019-A	2
<b>29024-5 HOOK - COAT</b>							
	65/66	A(76)				B2A 7029025-A	2
	66	B(76)					2
	65/66	F(76)					2
	67	A, B, F, X					2
				No. 8 x 7/8" Cross recess oval head screw		52368-S23(U295)	2
	65/66	A(except 76)		Includes attaching parts		C4AZ 6229025-A	2
	65/66	B(except 76)					2
	65/66	F(63, 65)					2
	65	X(except 66, 76, 78)					2
	66	X(except 76)					2
	66	S(63C, D)		Includes attaching parts		C6SZ 6329025-A	2
	67	S(57)		Includes attaching parts		C7SZ 5729024-A	2



# FORD CAR PARTS

**BODY  
SECTION 290**

3

GROUP NUMBER	YEAR	BODY TYPE	DESCRIPTION	PART NUMBER	QTY.
<b>29024</b>		<b>COVER - COAT HOOK</b>			
	68	A, B, F, S, X	Ivy Gold	C8AZ 6229024-B1G	2
			Parchment	C8AZ 6229024-B2U	2
			Saddle (Brown)	C8AZ 6229024-A1F	2
			Silver (Gray)	C8AZ 6229024-B1L	2
	68/	A, B, F, S, X	Also refer to Group 60236		
	68/69	A, B, F, S, X	Also use for shoulder strap storage		
			Aqua	C8AZ 6229024-B1K	2or4
			Black	C8AZ 6229024-B1A	2or4
			Blue (Dark)	C8AZ 6229024-B2B	2or4
			Blue (Light)	C8AZ 6229024-B1B	2or4
			Ivy Gold	C8AZ 6229024-B2G	2or4
			Nugget (Gold)	C8AZ 6229024-B1Y	2or4
			Parchment	C8AZ 6229024-B1U	2or4
			Red	C8AZ 6229024-B1D	2or4
			White	C9AZ 6229024-A1W	2or4
	70	A, B, F, P, S, X	Aqua	D0AZ 6229024-J	4
			Beige	D0AZ 6229024-N	4
			Black	C8AZ 6229024-B1A	4
			Blue (Dark)	D0AZ 6229024-R	4
			Blue (Light)	C8AZ 6229024-B1B	4
			Ginger	D0AZ 6229024-F	4
			Green (Dark)	D0AZ 6229024-B	4
			Green (Medium)	D0AZ 6229024-A	4
			Nugget	D0AZ 6229024-L	4
			Red	D0AZ 6229024-D	4
			Tobacco	D0AZ 6229024-C	4
			Vermilion	D0AZ 6229024-E	4
			White	D0AZ 6229024-K	4
	71	A, B, F, L, P, S	Aqua	D0AZ 6229024-J	4
			Beige	D0AZ 6229024-N	4
			Black	C8AZ 6229024-B1A	4
			Blue (Dark)	D0AZ 6229024-R	4
			Blue (Light)	C8AZ 6229024-B1B	4
			Ginger	D0AZ 6229024-F	4
			Green (Dark)	D2AZ 6229024-A	4
			Green (Medium)	D1AZ 6229024-B	4
			Grey Gold	D1AZ 6229024-A	4
			Red	D0AZ 6229024-D	4
			Tobacco	D0AZ 6229024-C	4
			Vermilion	D1AZ 6229024-C	4
			White	D0AZ 6229024-K	4
			Screw No. 8 - 15 x 5/8" fillister head tap.	52554-S8(U230)	2
	72	A, B, F, L, P, S	Avocado	D2FZ 6229024-A	4
			Beige	D2AZ 6229024-G	4
			Black	C8AZ 6229024-B1A	4
			Blue	C8AZ 6229024-B1B	4
			Cranberry	D2AZ 6229024-C	4
			Ginger	D0AZ 6229024-F	4
			Gray Gold	D1AZ 6229024-A	4
			Green	D1AZ 6229024-B	4
			Green	# D2AZ 6229024-A	4
			Orange	D2FZ 6229024-B	4
			Red	D0AZ 6229024-D	4
			Tobacco	D2AZ 6229024-B	4
			Vermilion	D1AZ 6229024-C	4
			White	D0AZ 6229024-K	4
	68/	A, B, F, L, P, S, X	For retainer (hook)-Refer to Group 29232		

† Except Thunderbird

# Thunderbird

May, 1975

COPYRIGHT © 1975 —

FORD MOTOR  
COMPANY

— DEARBORN, MICHIGAN

**FINAL ISSUE**

GROUP NUMBER	YEAR	BODY TYPE	DESCRIPTION	PART NUMBER	QTY.
--------------	------	-----------	-------------	-------------	------

**290B32 FASTENER - BODY OUTSIDE FINISH PANEL**

ALSO REFER TO APPROPRIATE EXTERIOR MOULDING ILLUSTRATION  
FOR COMPLETE RETAINER PART NUMBER

GROUP NUMBER	YEAR	BODY TYPE	DESCRIPTION	PART NUMBER	QTY.
	67/70	S	Power window regulator	C5DZ 71290B32-A	2or4
			Washer-flat-3/8"	44727-S8(X24)	1

**29033 RETAINER - QUARTER OUTSIDE LOWER MOULDING**

REFER TO APPROPRIATE EXTERIOR MOULDING ILLUSTRATION  
FOR COMPLETE RETAINER PART NUMBER

GROUP NUMBER	YEAR	BODY TYPE	DESCRIPTION	PART NUMBER		QTY.
				RIGHT HAND	LEFT HAND	

**29034-5 MOULDING - QUARTER PANEL - OUTSIDE BELT - INCLUDES ATTACHING PARTS**

- A -						
GROUP NUMBER	YEAR	BODY TYPE	DESCRIPTION	RIGHT HAND	LEFT HAND	QTY.
65		A(63)	At belt-Includes outside weatherstrip	C5AZ 6329034-A	C5AZ 6329035-A	1
66		A(63)	At belt-Includes outside weatherstrip & extension	C6AZ 6329034-A	C6AZ 6329035-A	1
65/66		A(76)	At belt-Includes outside weatherstrip	C5AZ 7629034-A	C5AZ 7629035-A	1
67		A(63B, C)	At belt-Includes outside weatherstrip & extension	C7AZ 6329034-B	C7AZ 6329035-B	1
67		A(63J)	At belt-Includes outside weatherstrip - no extension	C7AZ 6329034-A	C7AZ 6329035-A	1
68		A(63)	At belt-Includes outside weatherstrip	C8AZ 6329034-A	C8AZ 6329035-A	1
68		A(65)	At belt-Includes outside weatherstrip	C8AZ 6529034-B	C8AZ 6529035-B	1
69/70		A(65)		D0AZ 6529034-A	D0AZ 6529035-A	1
69		A(76)		C9AZ 7629034-A	C9AZ 7629035-A	1
69/70		A(63)	At belt-outside-approx. 39" o/all length	D0AZ 6329034-A	D0AZ 6329035-A	1
70		A(63B, C)	At belt-outside-approx. 23 1/2" o/all length	D0AZ 6329034-C	D0AZ 6329035-C	1
70		A(76)		D0AZ 7629034-A	D0AZ 7629035-A	1
65/67		A	Screw-truss head- No. 8-20 x 3/8"	353803-S8(UU95)	353803-S8(UU95)	AR
70		A	Rivet 1/8" dia. x 5/16"	375203-S(SS44)	375203-S(SS44)	2

- B -						
GROUP NUMBER	YEAR	BODY TYPE	DESCRIPTION	RIGHT HAND	LEFT HAND	QTY.
67		B(66)		C6DZ 6629034-A	C6DZ 6629035-A	1
68/69		B(63)	At belt-Includes outside weatherstrip	C8OZ 6329034-B	C8OZ 6329035-B	1
68/69		B(65C)	At belt-Includes outside weatherstrip	C8OZ 6529034-A	C8OZ 6529035-A	1
68/69		B(66)	"Before 8/19/68" At belt	C8OZ 6629034-A	C8OZ 6629034-A	2
69		B(66)	"From 8/19/68"	C9OZ 6629034-A	C9OZ 6629034-A	2
70/71		B(66)	Belt front	D0OZ 6629034-A	D0OZ 6629034-A	2
72		B(97)		D2OZ 9729034-A	D2OZ 9729035-A	1

- P -						
GROUP NUMBER	YEAR	BODY TYPE	DESCRIPTION	RIGHT HAND	LEFT HAND	QTY.
72		P(62)		D3DZ 6229034-A	D3DZ 6229035-A	1

- S -						
GROUP NUMBER	YEAR	BODY TYPE	DESCRIPTION	RIGHT HAND	LEFT HAND	QTY.
67/68		S(65)		C7SZ 6529034-B	C7SZ 6529035-B	1
69		S(65A, C)				1
69		S	Screw-pan head- No. 8-18 x 3/8"	52720-S8(U380)	52720-S8(U380)	AR

- X -						
GROUP NUMBER	YEAR	BODY TYPE	DESCRIPTION	RIGHT HAND	LEFT HAND	QTY.
65		X(66)	At belt-Chrome	C0DB 6629034-B	C0DB 6629035-B	1
66		X(66)		C6DZ 6629034-A	C6DZ 6629035-A	1

# FORD CAR PARTS

BODY  
SECTION 290

5

GROUP NUMBER	YEAR	BODY TYPE	DESCRIPTION	PART NUMBER		QTY.
				RIGHT HAND	LEFT HAND	
<b>29038-9 MOULDING - QUARTER OUTSIDE - INCLUDES ATTACHING PARTS</b>						
- A -						
65		A(54, 57B)		C5AZ 5429038-A	C5AZ 5429038-A	2
65		A(62, 63B, 76A)		C5AZ 6229038-A	C5AZ 6229038-A	2
65		A(71B, C)		C5AZ 7129038-A	C5AZ 7129038-A	2
66		A(62, 63B, 76A)		C6AZ 6229038-B	C6AZ 6229038-B	2
67		A(54, 57)	Upper	C7AZ 5429038-A	C7AZ 5429038-A	2
67		A(54A, 57B, 63B, 76A)	Lower	C7AZ 5429038-B	C7AZ 5429039-B	1
67		A(54C, 57F, 63C, J, 76B) "Before 1/16/67"	Lower -With vinyl tape insert	C7AZ 6329038-A	C7AZ 6329039-A	1
67		A(54C, 57F, 63C, J, 76B) "From 1/16/67"	With painted insert	C7AZ 5429038-C	C7AZ 5429039-C	1
67		A(62, 63, 76)	Upper	C7AZ 6229038-A	C7AZ 6229038-A	1
67		A(71B, C, D)	Upper	C7AZ 7129038-A	C7AZ 7129038-A	1
67		A(71B, C)	Lower	C7AZ 7129038-B	C7AZ 7129039-B	1
68		A(54C, 57F, 63C, 65A, 76B)	Lower	C8AZ 5429038-A	C8AZ 5429039-A	1
69		A(54A, 57B, 63B, 65C, 76A)	Lower	C9AZ 5429038-A	C9AZ 5429039-A	1
69		A(54C, 57F, 65A)	Lower	C9AZ 5429038-B	C9AZ 5429039-B	1
69		A(71B, C)	Lower	C9AZ 7129038-A	C9AZ 7129039-A	1
70		A(54, 57)	Black insert	D0AZ 5429038-A	D0AZ 5429039-A	1
			Blue insert	D0AZ 5429038-C	D0AZ 5429039-C	1
			Brown insert	D0AZ 5429038-B	D0AZ 5429039-B	1
			Greeninsert	D0AZ 5429038-D	D0AZ 5429039-D	1
70		A(63, 65, 76)	Black insert	D0AZ 6529038-A	D0AZ 6529039-A	1
			Blue insert	D0AZ 6529038-C	D0AZ 6529039-C	1
			Brown insert	D0AZ 6529038-B	D0AZ 6529039-B	1
			Green insert	D0AZ 6529038-D	D0AZ 6529039-D	1
70		A(65M)		D0AB 6529066-E	D0AB 6529067-E	1
70		A(71B, C, D)	Black insert	D0AZ 7129038-A	D0AZ 7129039-A	1
			Blue insert	D0AZ 7129038-C	D0AZ 7129039-C	1
			Brown insert	D0AZ 7129038-B	D0AZ 7129039-B	1
			Green insert	D0AZ 7129038-D	D0AZ 7129039-D	1
71		A(54F, 57F, 65F)	Lower rear-aluminum	D1AZ 6529038-A	D1AZ 6529039-A	1
71/		A(53, 57H, K, 65H, K, 76)	Incl. Black painted groove approx. 29 1/2" long	D1AZ 6529038-B	D1AZ 6529039-B	1
71		A	Incl. vinyl insert-cut to fit door, quarter-79 1/4" long	†D1OZ 6529038-B	†D1OZ 6529038-B	AR
71		A(71F)	Aluminum	D1AZ 7129038-B	D1AZ 7129039-B	1
71/		A(65, 76)	Center-aluminum-20 1/2" long	D1AZ 6529038-C	D1AZ 6529038-C	1
72		A(53, 54, 57)	Black vinyl insert-approx. 57 1/4" long	D2AZ 5429038-A	D2AZ 5429039-A	1
72		A(65, 76)	Black vinyl insert-approx. 81 5/8" long	D2AZ 6529038-A	D2AZ 6529038-A	1
72		A(71B, D, F, H)	Black vinyl insert	D2AZ 7129038-A	D2AZ 7129039-A	1
- B -						
65		B(54B)		C5OZ 5429038-A	C5OZ 5429039-A	1
65		B(62B, 65)		C5OZ 6229038-A	C5OZ 6229039-A	1
66		B(54)		C6OZ 5429038-A	C6OZ 5429039-A	1
66		B(62, 63B, C, 76B, C)		C6OZ 6229038-A	C6OZ 6229039-A	1
66		B(71B, D)		C6OZ 7129038-A	C6OZ 7129039-A	1
67		B(54A)		C7OZ 5429038-A	C7OZ 5429039-A	1
67		B(54B)	Upper	C7OZ 5429038-B	C7OZ 5429039-B	1
67		B(54B, 62B, 63B, C, 76B, C)	Lower	C7OZ 6229038-B	C7OZ 6229039-B	1
67		B(62A)		C7OZ 6229038-A	C7OZ 6229039-A	1
67		B(62B, 63B, 76B)	Upper	C7OZ 6229038-C	C7OZ 6229039-C	1
67		B(66A)		C7OZ 6629039-A	C7OZ 6629039-A	1
67		B(66B, D)	Lower	C7OZ 7129038-B	C7OZ 7129039-B	1
67		B(71) "Before 3/6/67"				1
67		B(71) "From 3/6/67"	Lower	C7OZ 7129038-C	C7OZ 7129039-B	1
67		B(71D)		C7OZ 7129038-A	C7OZ 7129039-A	1

† Dealer installed adhesive backed moulding

May, 1975

COPYRIGHT © 1975 -

FORD MOTOR  
COMPANY

— DEARBORN, MICHIGAN

**FINAL ISSUE**

GROUP NUMBER	YEAR	BODY TYPE	DESCRIPTION	PART NUMBER		QTY.	
				RIGHT HAND	LEFT HAND		
<b>29038-9</b>	<b>MOULDING - QUARTER OUTSIDE - INCLUDES ATTACHING PARTS - continued</b>						
- B -							
	68	B(54C, 65C)	Lower	C9OZ	5429038-B	C9OZ 5429039-B	1
	69	B(54B, 63B, E, 65B, E, 76B, E)	Lower	C9OZ	5429038-B	C9OZ 5429039-B	1
	69	B(54C, 65C)	Lower	C9OZ	5429038-A	C9OZ 5429039-A	1
	69	B(66B)	Lower	C9OZ	6629038-A	C9OZ 6629039-A	1
	69	B(71B)		C9OZ	7129038-A	C9OZ 7129039-A	1
	70	B(54, 57)	Black insert	D0OZ	5429038-A	D0OZ 5429039-A	1
			Brown insert	D0OZ	5429038-B	D0OZ 5429039-B	1
			Blue insert	D0OZ	5429038-C	D0OZ 5429039-C	1
			Green insert	D0OZ	5429038-D	D0OZ 5429039-D	1
	70	B(62, 63, 65, 66A, B, 76)	Black insert	D0OZ	6629038-A	D0OZ 6629039-A	1
			Brown insert	D0OZ	6629038-B	D0OZ 6629039-B	1
			Blue insert	D0OZ	6629038-C	D0OZ 6629039-C	1
			Green insert	D0OZ	6629038-D	D0OZ 6629039-D	1
	70	B(71B, C, D)	Black insert	D0OZ	7129038-A	D0OZ 7129039-A	1
			Brown insert	D0OZ	7129038-B	D0OZ 7129039-B	1
			Blue insert	D0OZ	7129038-C	D0OZ 7129039-C	1
			Green insert	D0OZ	7129038-D	D0OZ 7129039-D	1
	71	B(54, 57)	Center-Black insert	D0OZ	5429038-A	D0OZ 5429039-A	1
	71	B(57E, 65E)	Lower-less insert	D1OZ	6529038-A	D1OZ 6529039-A	1
	71	B(63, 65, 66, 76)	Center-Black insert	D0OZ	6629038-A	D0OZ 6629039-A	1
	71	B(66A, C)	Bright-1" wide	D1OZ	6629038-A	D1OZ 6629039-A	1
	71	B(66B)	Bright-w/single Black stripe-2 5/8" wide	D1OZ	6629038-B	D1OZ 6629039-B	1
	71	B(66C)	Painted Black-2 5/8" wide	D1OZ	6629038-C	D1OZ 6629039-C	1
	71	B(71)	Black insert	D0OZ	7129038-A	D0OZ 7129039-A	1
	71	B(54, 57, 63, 65, 76)	Black insert-cut to fit fenders and doors	† D1OZ	6529038-B	† D1OZ 6529038-B	AR
	72	B(53)	Center-Black insert	D3OZ	5329038-A	D3OZ 5329039-A	1
	72	B(53D, 63R, 65D, R)	Lower rear	D2OZ	6529038-A	D2OZ 6529039-A	1
	72	B(63, 65)	Center-Black insert	D3OZ	6529038-A	D3OZ 6529038-A	2
	72	B(71B, D)	Center-Black insert	D3OZ	7129038-A	D3OZ 7129039-A	1
	72	B(71D)	Lower	D2OZ	7129038-B	D2OZ 7129039-B	1
	72	B(97D)	Center-Black insert	D3OZ	9729038-A	D3OZ 9729039-A	1
- F -							
	71/	F		D1ZZ	6329038-A	D1ZZ 6329039-A	1
- L -							
	71	L	Black insert	D1FZ	16003-A	D1FZ 16003-A	2
	72	L	"Before 2/29/72"	D2FZ	16003-A	D2FZ 16003-A	2
	72	L	"From 2/29/72"	D2FZ	16003-C	D2FZ 16003-C	2
	72	L(73)-Squire		D2FZ	16003-D	D2FZ 16003-D	2
- P -							
	70/	P(62)	Black insert	D0DZ	6229038-B	D0DZ 6229039-B	1
	71/	P(54)	Black insert	D1DZ	5429038-A	D1DZ 5429039-A	1
	72	P(54)	Blue insert	D2DZ	5429038-BB	D2DZ 5429039-BB	1
			Brown insert	D2DZ	5429038-BT	D2DZ 5429039-BT	1
			Copper insert	D2DZ	5429038-BC	D2DZ 5429039-BC	1
			Green insert	D2DZ	5429038-BR	D2DZ 5429039-BR	1
			White insert	D2DZ	5429038-BJ	D2DZ 5429039-BJ	1
			72	P(62A)	Blue insert	D2DZ	6229038-BB
	Brown insert	D2DZ			6229038-BT	D2DZ 6229039-BT	1
	Copper insert	D2DZ			6229038-BC	D2DZ 6229039-BC	1
	Green insert	D2DZ			6229038-BR	D2DZ 6229039-BR	1
	White insert	D2DZ			6229038-BJ	D2DZ 6229039-BJ	1
	70/	P	Cut to fit	† D1WY	16003-A	† D1WY 16003-A	2

† Dealer installed adhesive backed moulding

# FORD CAR PARTS

**BODY  
SECTION 290**

7

GROUP NUMBER	YEAR	BODY TYPE	DESCRIPTION	PART NUMBER		QTY.
				RIGHT HAND	LEFT HAND	
<b>29038-9 MOULDING - QUARTER OUTSIDE - INCLUDES ATTACHING PARTS - continued</b>						
<b>- S -</b>						
	65/66	S	Front	C4SZ 6329038-A	C4SZ 6329077-A	1
			Rear		C4SZ 6329039-A	1
			Fuel filler lid		C4SZ 63405A48-A	1
	68/69	S	End-refer to Group 291C84-5			
	69	S	Side	C9SZ 6529038-A	C9SZ 6529039-A	1
	70	S	Black insert	D0SZ 6529038-A	D0SZ 6529039-A	1
			Blue insert	D0SZ 6529038-C	D0SZ 6529039-C	1
			Brown insert	D0SZ 6529038-B	D0SZ 6529039-B	1
			Green insert	D0SZ 6529038-D	D0SZ 6529039-D	1
	71	S	Black insert	D0SZ 6529038-A	D0SZ 6529039-A	1
			Blue insert	D0SZ 6529038-C	D0SZ 6529039-C	1
			Brown insert	D0SZ 6529038-B	D0SZ 6529039-B	1
			Green insert	D1SZ 6529038-A	D1SZ 6529039-A	1
	72	S	Refer to Group 29164-5			
<b>- U -</b>						
	67/	U(97, 98)		C7TZ 9729038-A	C7TZ 9729039-A	1
<b>- X -</b>						
	65	X(66A, B)	Front	C4DZ 6629038-A	C4DZ 6629077-A	1
			Rear		C4DZ 7129039-A	1
			Fuel filler lid		C4DZ 59405A48-A	1
	65	X(66H)	Refer to Group 29068-9 & 29076-7			
	65	X(71B)	Upper front	C5DZ 7129038-A	C5DZ 7129038-A	2
			Upper rear		C5DZ 7129069-A	1
			Lower front		C5DZ 7129069-B	1
			Lower rear		C5DZ 7129077-A	1
	67	X(62B, C)		C7DZ 6229038-A	C7DZ 6229038-A	2
	67	X(71B)		C7DZ 7129038-A	C7DZ 7129039-A	1
<b>290C38-9 INSERT - QUARTER PANEL OUTSIDE LOWER ORNAMENT</b>						
	67	F	Paint to match	C7ZZ 65290C38-A	C7ZZ 65290C39-A	1
<b>290A41 RAIL - QUARTER PANEL OUTSIDE FINISH</b>						
	66	A(71A, E)	Front-Includes attaching parts		C6AZ 71290A41-A	1
	67	A(71A, E)	Upper-Includes attaching parts		C7AZ 71290A41-A	1
	68	A(71A, E)	Upper-Includes attaching parts		C8AZ 71290A41-A	1
	69/70	A(71A, E)	Upper-includes attaching parts		C9AZ 71290A41-A	1
	68/69	B(71E)	Upper-Includes attaching parts		C8OZ 71290A41-A	1
	70/71	B(71E)	Front		D0OZ 71290A41-A	1
	72	B(71K)			D2OZ 71290A41-A	1
<b>290B40-1 MOULDING - QUARTER WHEELHOUSE TRIM PANEL - FRONT - Paint to Match</b>						
	66/70	X(71)		C6DZ 71290B40-A	C6DZ 71290B41-A	1
<b>290A42-3 MOULDING ASSY. - QUARTER TRIM PANEL FRONT</b>						
	69	A(65A)	Upper	C9YZ 65290A42-A	C9YZ 65290A43-A	1
	72	B(65)		D2OZ 65290A42-A	D2OZ 65290A42-A	2
	70/71	S(65A, B)		D0SZ 65290A42-A	D0SZ 65290A43-A	1
	72	S		D2SZ 65290A42-A	D2SZ 65290A43-A	1
<b>29050-1 MOULDING - QUARTER WHEEL OPENING COVER - INCLUDES ATTACHING PARTS</b>						
	66	S		C6SZ 6329050-A	C6SZ 6329051-A	1

GROUP NUMBER	YEAR	BODY TYPE	DESCRIPTION	PART NUMBER		QTY.
				RIGHT HAND	LEFT HAND	
<b>290B52-3 MOULDING - QUARTER WINDOW OUTSIDE REAR</b>						
	67/68	A(71)		C7AZ 71290B52-A	C7AZ 71290B53-A	1
	66/67	B(62)		C6OZ 62290B52-A	C6OZ 62290B53-A	1
	66/70	X(62)				1
	67/	U(98)		C7TZ 98290B52-B	C7TZ 98290B53-B	1
<b>290D54 MOULDING - QUARTER WINDOW OUTSIDE LOWER REAR CORNER</b>						
	72	B(71)		D2OZ 71290D54-A	D2OZ 71290D54-A	2
<b>290A60-1 MOULDING - QUARTER WINDOW OUTSIDE - UPPER</b>						
- A -						
	65/68	A(71)	Includes attaching parts	C5AZ 71290A60-B	C5AZ 71290A61-B	1
	70	A(63)	W/two tone paint- includes moulding & attaching parts	D0AZ 63290A60-A	D0AZ 63290A61-A	1
	70	A (63)	W/o two tone paint-refer to Group 51726-7			
	69/	A(71)	Includes attaching parts	C9AZ 71290A60-A	C9AZ 71290A61-A	1
	65/66	A	Screw-oval pan head- No. 8-15 x 5/8"	53027-S13(U278)	53027-S13(U278)	2
	70	A(71)	Screw No. 8-18 x 3/8" self tap.	379560-S101(UU89CA)	379560-S101(UU89CA)	AR
- B -						
	66/67	B(62B)		C6OZ 62290A60-A	C6OZ 62290A61-A	1
	66/67	B(71)	Rustless steel	C6OZ 71290A60-A	C6OZ 71290A61-A	1
	66/71	B(71)	Paint to match	C6OZ 71290A60-B	C6OZ 71290A61-B	1
	68/71	B(71)	Rustless steel	C8OZ 71290A60-A	C8OZ 71290A61-A	1
	66/71	B(71)	Screw No. 8-18 x 1/2" self tap, oval head	52413-S13(U316)	52413-S13(U316)	2
	72	B(71)		D2OZ 71290A60-A	D2OZ 71290A61-A	1
- L -						
	71/72	L(62, 64)-w/stationary window "Before 5/1/72"	Paint to match -1 piece moulding	D1FZ 62290A60-A	D1FZ 62290A61-A	1
	72	L(62, 64) "From 5/1/72"	Bright finish	D1FZ 62290A60-B	D1FZ 62290A61-B	1
			Paint to match-2 piece moulding	D2FZ 62290A60-B	D2FZ 62290A61-B	1
	72	L(73)	Bright finish	D2FZ 62290A60-C	D2FZ 62290A61-C	1
				D2FZ 73290A60-A	D2FZ 73290A61-A	1
- P -						
	70/	P(62)	Dull finish	D0DZ 62290A60-A	D0DZ 62290A61-A	1
	72	P(62)	Bright finish	D2DZ 62290A60-A	D2DZ 62290A61-A	1
- U -						
	67/	U(98)		C7TZ 98290A60-B	C7TZ 98290A61-B	1
- X -						
	66/70	X(62)		C6OZ 62290A60-A	C6OZ 62290A61-A	1
	67/70	X(71B)	Bright finish	C6OZ 71290A60-A	C6OZ 71290A61-A	1
	66/70	X(71)	Paint to match	C6OZ 71290A60-B	C6OZ 71290A61-B	1
<b>290C60-1 INSERT - QUARTER PANEL OUTSIDE UPPER ORNAMENT</b>						
	67	F	Paint to match	C7ZZ 65290C60-A	C7ZZ 65290C61-A	1
	69/70	F(63)		C9ZZ 63290C60-A	C9ZZ 63290C61-A	1
<b>290C60-1 GRILLE - QUARTER PANEL SCOOP</b>						
	69	F(63-GT350/500)		C9ZZ 63290C60-D	C3ZZ 63290C61-D	1
	69	F(76-GT350/500)		C9ZZ 76290C60-A	C9ZZ 76290C60-B	1
<b>29066-7 MOULDING - QUARTER OUTSIDE LOWER REAR - Refer to group 29038-9</b>						

# FORD CAR PARTS

## BODY SECTION 290

GROUP NUMBER	YEAR	BODY TYPE	DESCRIPTION	PART NUMBER		QTY.
				RIGHT HAND	LEFT HAND	
<b>290A66-7 MOULDING - QUARTER WINDOW OUTSIDE FRONT</b>						
- A -						
	67/68	A(62B)		C7AZ 62290A66-A	C7AZ 62290A67-A	1
	69/	A(71)	Includes attaching parts	C9AZ 71290A66-A	C9AZ 71290A67-A	1
	65/66	A	Screw oval head- No. 8-15 x 5/8"	53027-S13(U278)	53027-S13(U278)	AR
	69/	A(71)	Screw-No. 8-18 x 3/8"- self tap	379560-S101 (UU89CA)	379560-S101 (UU89CA)	AR
- B -						
	66/67	B(62B)	Rustless steel	C6OZ 62290A66-A	C6OZ 62290A67-A	1
	66/67	B(71B, E)	Rustless steel	C6OZ 71290A66-B	C6OZ 71290A67-B	1
	66/71	B(71)	Paint as required	C6OZ 71290A66-C	C6OZ 71290A67-C	1
	68/71	B(71)	Bright finish	C8OZ 71290A66-A	C8OZ 71290A67-A	1
	70	B	Screw-No. 8-18 x 1/2"- self tap oval head	52413-S13(U316)	52413-S13(U316)	2
- L -						
	71/72	L(62, 64)-w/stationary window "Before 5/1/72"	Bright finish-3 retainer holes	D1FZ 62290A66-A	D1FZ 62290A67-A	1
	72	L(62, 64)-w/stationary window "From 5/1/72"	Bright finish-1 retainer hole	D2FZ 62290A66-B	D2FZ 62290A67-B	1
	71/	L(62, 64)-w/pivoting window	Refer to Group 29796-7			
- P -						
	70/	P(62)	Dull finish	D0DZ 62290A66-A	D0DZ 62290A67-A	1
	72	P(62)	Bright finish	D2DZ 62290A66-A	D2DZ 62290A67-A	1
- U -						
	67/	U(98)		C7TZ 98290A66-B	C7TZ 98290A67-B	1
- X -						
	66/70	X(62)		C6OZ 62290A66-A	C6OZ 62290A67-A	1
	67/70	X(71)	Bright finish	C6OZ 71290A66-B	C6OZ 71290A67-B	1
	66/70	X(71)	Paint as required	C6OZ 71290A66-C	C6OZ 71290A67-C	1
<b>29074 RETAINER - QUARTER OUTSIDE LOWER REAR MOULDING</b>						
	67	A(54A, 57B, 63B, 76A)		C7AZ 5429074-A	C7AZ 5429074-A	6
<b>290C74 RETAINER - QUARTER OUTSIDE FINISH PANEL - REAR</b>						
	71	A(53H, K, 57H, K, 65H, K, 71H, K)		D1AZ 65290C74-A	D1AZ 65290C74-A	AR
<b>29076-7 AIR SCOOP - QUARTER PANEL - BRAKE</b>						
	65/66	F(GT350)		S2MS 29076-A	S2MS 29077-A	1
	67	F(Shelby GT350/500)		S7MS 63290A76-A	S7MS 63290A77-A	1
	68	F(Shelby GT350/500)		S8MS 63290A76-B	S8MS 63290A77-B	1
	69/70	F(63-Shelby GT350/500)		C9ZZ 63290A76-A	C9ZZ 63290A77-A	1
	69/70	F(76-Shelby GT350/500)		C9ZZ 76290A76-A	C9ZZ 76290A76-B	1
<b>29076-7 MOULDING - QUARTER OUTSIDE - LOWER FRONT - INCLUDES ATTACHING PARTS</b>						
- A -						
	67	A(54C, 57F)	With vinyl tape insert	C7AZ 5729076-A	C7AZ 5729077-A	1
	67	A(54C, 57F)	With painted insert	C7AZ 5429076-A	★C7AZ 5429077-A Not replaced (1/75)	1
	67	A(63B, 76A)		C7AZ 6329076-B	C7AZ 6329077-B	1
	67	A(63C, J, 76B)	With vinyl tape insert	C7AZ 6329076-A	C7AZ 6329077-A	1
	67	A(63C, J, 76B)	With painted insert	C7AZ 6329076-C	C7AZ 6329077-C	1
	68	A(54, 57)		C8AZ 5429076-B	C8AZ 5429077-B	1
	68	A(62, 63, 65, 76)		C8AZ 6229076-B	C8AZ 6229077-B	1
	68	A(71B, C, D, H, J)		C8AZ 7129076-B	C8AZ 7129077-B	1
	69	A(54A, 57B, 71B, C)	Lower front	C9AZ 5429076-B	C9AZ 5429077-B	1
	69	A(54C, 57F)	Lower front	C9AZ 5429076-C	C9AZ 5429077-C	1
	69	A(63B, 65C, 76A)	Lower front	C9AZ 6329076-A	C9AZ 6329077-A	1
	69	A(65A)	Lower front	C9AZ 6529076-A	C9AZ 6529077-A	1
	69/70	A(54, 57, 71B, C, E)	Upper	C9AZ 5429076-D	C9AZ 5429076-D	2
	70	A(54B) "Before 12/22/69"	Less vinyl insert- 62 1/4" long	D0AZ 5429076-D	D0AZ 5429076-D	2
	70	A(54B) "From 12/22/69"	Less vinyl insert- 61 15/16" long	D0AZ 5429076-E	D0AZ 5429076-E	2
	69/70	A(62, 63B, 65, 76A)	Upper	C9AZ 6229076-B	C9AZ 6229077-B	1
	69/70	A(71B, C, D, H, J)	Upper-without insert	C9AZ 7129076-A	C9AZ 7129076-A	2

GROUP NUMBER	YEAR	BODY TYPE	DESCRIPTION	PART NUMBER		QTY.
				RIGHT HAND	LEFT HAND	
<b>29076-7 MOULDING - QUARTER OUTSIDE - LOWER FRONT - INCLUDES ATTACHING PARTS - continued</b>						
- A -						
	71	A(54F, 57F)		DIAZ 5429076-A	DIAZ 5429077-A	1
	71	A(65F)		DIAZ 6529076-A	DIAZ 6529077-A	1
	71/	A(65H, K, 76)		DIAZ 6529076-B	DIAZ 6529077-B	1
	71	A(71F)		DIAZ 7129076-A	DIAZ 7129077-A	1
	69/70	A	Screw-No. 8-18 x 3/8"- hex. head	379560-S101 (UU89CA)	379560-S101 (UU89CA)	12
	70	A	Rivet-1/4" x 5/16"- oval head	383229-S(SS44E)	383229-S(SS44E)	2
- B -						
	65	B(62B, 65)		C5OZ 6229076-A	C5OZ 6229077-A	1
	67	B(54B)		C7OZ 5429076-A	C7OZ 5429077-A	1
	67	B(62B, 63B, C, 76B, C)		C7OZ 6229076-A	C7OZ 6229077-A	1
	67	B(66B, D)		C7OZ 6629076-A	C7OZ 6629077-A	1
	67	B(71B)		C7OZ 7129076-A	C7OZ 7129077-A	1
	68	B(54A, B)		C8OZ 5429076-B	C8OZ 5429076-B	2
	68	B(54C) - "From 2/1/68"	Lower front	C9OZ 5429076-B	C9OZ 5429077-B	1
	68	B(63A, B, E, 65A, B, E, 76B, E)		C8OZ 6329076-B	C8OZ 6329076-B	2
	68	B(65C)	Lower front	C9OZ 6329076-A	C9OZ 6329077-A	1
	68	B(66A, B)		C8OZ 6629076-B	C8OZ 6629076-B	2
	68	B(71B, D)		C8OZ 7129076-B	C8OZ 7129076-B	2
	68	B(54C) "Before 2/1/68"	Lower front-Refer to group 291B20-1			
	69	B(54)	Upper	C9OZ 5429076-A	C9OZ 5429076-A	2
	69	B(54B, 71B)	Lower front	C9OZ 5429076-B	C9OZ 5429077-B	1
	69	B(63B, E, 65B, E, 76B, E)	Lower front	C9OZ 6329076-A	C9OZ 6329077-A	1
	69	B(63, 65, 76)	Upper	C9OZ 6529076-A	C9OZ 6529076-A	2
	69	B(66)	Upper-Refer to group 29140-1			
	69	B(66B)	Lower front	C9OZ 6629076-A	C9OZ 6629077-A	1
	69	B(71)		C9OZ 7129076-A	C9OZ 7129076-A	2
	71	B(57E)		D1OZ 5729076-A	D1OZ 5729077-A	1
	71	B(63F, 76)		D1OZ 6529076-B	D1OZ 6529077-B	1
	71	B(65E)		D1OZ 6529076-A	D1OZ 6529077-A	1
	71	B(66A, C)		D1OZ 6629076-A	D1OZ 6629077-A	1
	72	B(53D, 71D)		D2OZ 5329076-A	D2OZ 5329077-A	1
	72	B(63R, 65D, R)		D2OZ 6529076-A	D2OZ 6529077-A	1
- F -						
	69/70	F	Rear end cap-adhesive backed	C9ZZ 6529076-A	C9ZZ 6529076-A	2
	70	F(63C)	Includes attaching parts	D0ZZ 6329076-A	D0ZZ 6329077-A	1
	71/	F	Less insert	D1ZZ 6329076-A	D1ZZ 6329077-A	1
	71/	F	Black insert	D1ZZ 6529076-C	D1ZZ 6529077-C	1
	71	F	Blue insert	D1ZZ 6529076-D	D1ZZ 6529077-D	1
			Brown insert	D1ZZ 6529076-A	D1ZZ 6529077-A	1
			Green insert	D1ZZ 6529076-B	D1ZZ 6529077-B	1
- S -						
	65/66	S	Front		C4SZ 6329077-A	1
	70	S	Quarter moulding end cap-used with dealer installed aluminum mouldings	C9ZZ 6529076-A	C9ZZ 6529076-A	2
	70	S(57)	Black insert	D0SZ 5729076-A	D0SZ 5729077-A	1
			Blue insert	D0SZ 5729076-C	D0SZ 5729077-C	1
			Brown insert	D0SZ 5729076-B	D0SZ 5729077-B	1
			Green insert	D0SZ 5729076-D	D0SZ 5729077-D	1
	70	S(65)	Black insert	D0SZ 6529076-A	D0SZ 6529077-A	1
			Blue insert	D0SZ 6529076-C	D0SZ 6529077-C	1
			Brown insert	D0SZ 6529076-B	D0SZ 6529077-B	1
			Green insert	D0SZ 6529076-D	D0SZ 6529077-D	1



# FORD CAR PARTS

## BODY SECTION 290

11

GROUP NUMBER	YEAR	BODY TYPE	DESCRIPTION	PART NUMBER		QTY.
				RIGHT HAND	LEFT HAND	
<b>29076-7 MOULDING - QUARTER OUTSIDE - LOWER FRONT - INCLUDES ATTACHING PARTS - continued</b>						
- S -						
71	S(57)		Black insert	D0SZ 5729076-A	D0SZ 5729077-A	1
			Blue insert	D0SZ 5729076-C	D0SZ 5729077-C	1
			Brown insert	D0SZ 5729076-B	D0SZ 5729077-B	1
			Green insert	D1SZ 5729076-A	D1SZ 5729077-A	1
71	S(65)		Black insert	D0SZ 6529076-A	D0SZ 6529077-A	1
			Blue insert	D0SZ 6529076-C	D0SZ 6529077-C	1
			Brown insert	D0SZ 6529076-B	D0SZ 6529077-B	1
			Green insert	D1SZ 6529076-A	D1SZ 6529077-A	1
72	S	Refer to Group 29164-5				
70	S		Screw No. 8-18 x 3/8" self tap.	379560-S101(UU89CA)	379560-S101(UU89CA)	4
- U -						
68/	U(97, 98)	with swing away wheel carrier		C8TZ 9729076-A		1
- X -						
65	X(66G, H)			★C4DZ 6629076-A Not replaced (3-74)	C4DZ 6629077-B	1
65	X(62B, 63, 76)			C5DZ 6229076-A	C5DZ 6229077-A	2
68/69	X(54)			C8DZ 5429076-A	C8DZ 5429076-A	2
68/70	X(62)			C8DZ 6229076-A	C8DZ 6229076-A	2
68/70	X(71)			C8DZ 7129076-A	C8DZ 7129077-A	1
<b>290A76-7 ORNAMENT - QUARTER OUTSIDE REAR - INCLUDES ATTACHING PARTS UNLESS OTHERWISE INDICATED</b>						
- A -						
65	A(57F, 63C, F, 76B)			C5AZ 63290A76-A	C5AZ 63290A76-A	2
67	A(71A, E)			C7AZ 71290A76-A	C7AZ 71290A76-A	2
68	A(76)	"XL"		C8AZ 76290A76-A	C8AZ 76290A76-A	2
- F -						
65	F(65, 76)			C5ZZ 65290A76-A	C5ZZ 65290A77-A	1
66	F(65, 76)			C6ZZ 65290A76-A	C6ZZ 65290A77-A	1
67	F	Upper-die cast-Paint to match-No attaching parts		C7ZZ 65290A76-A	C7ZZ 65290A77-A	1
68	F exc. F(65)GT/CS	Less base-Refer to Group 290C82-3		C8ZZ 65290A76-A	C8ZZ 65290A77-A	1
68	F(65)GT/CS	Less insert-refer to Group 291C80-1		C8ZZ 65290A76-B	C8ZZ 65290A77-B	1
69	F(GT 350/500)			C9ZZ 76290A76-A	C9ZZ 76290A76-B	1
- X -						
65	X(66)			C4DZ 62290A76-A	C4DZ 62290A77-A	1
<b>290A76-7 AIR SCOOP - QUARTER PANEL - BRAKE - Refer to Group 29076-7</b>						
<b>290B76 COVER - QUARTER PANEL NAME PLATE STUD</b>						
66	A(54, 57B, 62, 63B, 76A)			C6AZ 62290B76-A	C6AZ 62290B76-A	AR
67	B(63D, 76D)	Improvise from sponge rubber weatherstrip		★	★	2
<b>29078-9 MOULDING - QUARTER PANEL EXTENSION</b>						
69	A(54A, B, C, 57, 62B, 63, 65, 76)	Includes attaching parts		C9AZ 6229078-A	C9AZ 6229079-A	1
70	A(54A, B, C, 57, 63, 65A, C, 76B)			D0AZ 6229078-A	D0AZ 6229079-A	1
71	A(53, 54, 57, 65, 76)			D1AZ 6529078-A	D1AZ 6529079-A	1
68/69	B(63)	Includes attaching parts		C9OZ 6329078-A	C9OZ 6329079-A	1
72	B(53D, 63R, 65)			D2OZ 6529078-A	D2OZ 6529079-A	1
67/68	F(63)	Rear-Includes attaching parts		C7ZZ 6329078-A	C7ZZ 6329079-A	1
67/68	F(65, 76)exc. F(65)GT/CS	Rear-Includes attaching parts		C7ZZ 6529078-A	C7ZZ 6529079-A	1
69	F(65, 76)	Includes attaching parts		C9ZZ 6529078-A	C9ZZ 6529079-A	1
71/	L(62, 64)	Bright finish		D1FZ 6229078-A	D1FZ 6229079-A	1
70	P(62)	Rear-Includes attaching parts		D0DZ 6229078-A	D0DZ 6229079-A	1
72	P(62A)-LTD					1
72	P(54)-LTD			D1DZ 5429078-A	D1DZ 5429079-A	1
70	P(62)	Nut No. 8-32 hex wshr.		377523-S100(MM291C)	377523-S100(MM291C)	2

**FORD CAR PARTS**

GROUP NUMBER	YEAR	BODY TYPE	DESCRIPTION	PART NUMBER		QTY.
				RIGHT HAND	LEFT HAND	
<b>29078-9 MOULDING - QUARTER PANEL EXTENSION - continued</b>						
	70	P(62)	Screw No. 8-18 x 3/8" round hd.	381671-S45X(UU89C)	381671-S45X(UU89C)	4
	72	S		D2SZ 6529078-A	D2SZ 6529079-A	1
GROUP NUMBER	YEAR	BODY TYPE	DESCRIPTION	PART NUMBER		QTY.
<b>29082 RETAINER - QUARTER OUTSIDE LOWER MOULDING - REAR - Also refer to Group 29033</b>						
	68	A(54C, 57F, 63C, 65A, 76B)		C8AZ	54290B82-A	2
<b>29082-3 BASE - QUARTER OUTSIDE ORNAMENT</b>						
	68	Exc. F(65)GT/CS		R. H. - Paint to match L. H.	C8ZZ 65290C82-A C8ZZ 65290C83-A	1 1
<b>29086-7 MOULDING - QUARTER WINDOW GARNISH FINISH - INCLUDES ATTACHING PARTS</b>						
	68/70	B(63B, E)		C8OZ	6329086-A	2
	68/70	B(65B, E)		C8OZ	6529086-A	2
	69	B(65A)		C8OZ	6529086-A	2
	68/69	B(76B, E)		R. H. - Not Repl'd. (1-73) L. H.	★C8OZ 7629086-A C8OZ 7629087-A	1 1
<b>290A88-9 MOULDING - QUARTER OUTSIDE BELT - CENTER - INCLUDES ATTACHING PARTS</b>						
	65	X(66)		R. H. - Chrome L. H.	C0DB 66290A88-B C0DB 66290A89-B	1 1
	65	X(66)		Spacer	C0DB 66290B16-A	6
	66	X(66)			C6DZ 66290A88-A	2
	67	B(66)				2
<b>29092 RETAINER - QUARTER PANEL EXTENSION MOULDING</b>						
REFER TO APPROPRIATE EXTERIOR MOULDING ILLUSTRATION FOR COMPLETE RETAINER PART NUMBER						
<b>29098-9 MOULDING - QUARTER OUTSIDE TO LOWER BACK PANEL - INCLUDES ATTACHING PARTS</b>						
	67/68	S		R. H. L. H.	C7SZ 6529098-A C7SZ 6529099-A	1 1
	69	S		R. H. L. H.	C9SZ 6529098-A C9SZ 6529099-A	1 1
	70/71	S		R. H. L. H.	D0SZ 6529098-A D0SZ 6529099-A	1 1
<b>291C02-3 MOULDING - QUARTER WINDOW OUTSIDE LOWER</b>						
	65/66	A(71)		R. H. - Includes attaching parts -not replaced(3-74) L. H.	★C5AZ 71291C02-B C5AZ 71291C03-B	1 1
	72	B(71)		R. H. L. H.	D2OZ 71291C02-A D2OZ 71291C03-A	1 1
	72	L(73)		R. H. L. H.	D2FZ 73291C02-A D2FZ 73291C03-A	1 1
	67/69	U(98)		R. H. L. H.	C7TZ 98291C02-A C7TZ 98291C03-A	1 1
	70/	U(98)		R. H. L. H.	C7TZ 98291C02-B C7TZ 98291C03-B	1 1
	65/66	A(71)		Nut and retainer-No. 10-24	379395-S35(MM295U)	2
<b>29108 RETAINER - QUARTER OUTSIDE UPPER MOULDING</b>						
	69/70	A(63)			C9AZ 6329108-A	2
<b>291C10 RETAINER - QUARTER PANEL LOWER REAR EDGE MOULDING</b>						
	65/66	A(57F, 63B, C, F, 76)			C5AZ 63291C10-A	4
	66	A(57F, 63C, F, 76B)			C6AZ 63291C10-A	4
<b>291C16 RETAINER - QUARTER PANEL UPPER EDGE MOULDING</b>						
	65	B(54, 71)		Rear door	C5OZ 62291C16-A	4
	65	B(54, 71)		Quarter		12
	65	B(62, 65)		Quarter		16
<b>291C18-9 RETAINER - QUARTER TRIM UPPER FRONT PANEL - UPPER</b>						
	67/68	F(63)		R. H. - Not Repl'd. (1-73) L. H.	★C7ZZ 63291C18-A C7ZZ 63291C19-A	1 1

# FORD CAR PARTS

## BODY SECTION 290

13

GROUP NUMBER	YEAR	BODY TYPE	DESCRIPTION	PART NUMBER		QTY.
				RIGHT HAND	LEFT HAND	

**29120 RETAINER - QUARTER MOULDING - OUTSIDE**

REFER TO APPROPRIATE EXTERIOR MOULDING ILLUSTRATION  
FOR COMPLETE RETAINER PART NUMBER

**291B20-1 MOULDING - QUARTER OUTSIDE LOWER - INCLUDES ATTACHING PARTS**

68	B(54C)	"Before 2/1/68"	R. H.	C8OZ	54291B20-A	1
			L. H.	★C8OZ	54291B21-A	1
				r/b C9OZ	5429077-B (10-72)	
68	B(54C)	"From 2/1/68"	Refer to Group 29076-7			
68	B(65C)		Refer to Group 29076-7			
67	S		R. H.	C7SZ	65291B20-A	1
			L. H.	C7SZ	65291B21-A	1
68/71	S		R. H. -rear	C8SZ	65291B20-A	1
			L. H.	C8SZ	65291B21-A	1
69	S(57)		R. H. -front	C9SZ	57291B20-A	1
			L. H.	C9SZ	57291B21-A	1
69	S(65)		Front	C9SZ	65291B20-A	2

**291B22-3 PANEL - QUARTER OUTSIDE FINISH - FRONT - INCLUDES ATTACHING PARTS**

71/	A(53, 57H, K)		R. H.	D1AZ	57291B22-A	1
			L. H.	D1AZ	57291B23-A	1
71/	A(65H, K, 76)		R. H.	D1AZ	65291B22-A	1
			L. H.	D1AZ	65291B23-A	1

**291C22 RETAINER - QUARTER WINDOW OUTSIDE LOWER MOULDING**

65/66	A(71)			C5AZ	71291C22-A	12
-------	-------	--	--	------	------------	----

**29124 RETAINER - QUARTER OUTSIDE LOWER REAR MOULDING**

REFER TO APPROPRIATE EXTERIOR MOULDING ILLUSTRATION  
FOR COMPLETE RETAINER PART NUMBER

GROUP NUMBER	YEAR	BODY TYPE	DESCRIPTION	PART NUMBER		QTY.
				RIGHT HAND	LEFT HAND	

**291A24-5 MOULDING - QUARTER PANEL OUTSIDE UPPER REAR END - INCLUDES ATTACHING PARTS**

67/71	S			C9SZ	65291A24-A	C9SZ	65291A25-A	1
-------	---	--	--	------	------------	------	------------	---

GROUP NUMBER	YEAR	BODY TYPE	DESCRIPTION	PART NUMBER	QTY.
--------------	------	-----------	-------------	-------------	------

**29128 RETAINER - QUARTER OUTSIDE FRONT BELT MOULDING**

70/71	B(66)			D0OZ	6629128-A	16
72	B(97)			D2OZ	9729128-A	18

**291B30-1 NUMERAL - MODEL IDENTIFICATION - INCLUDES ATTACHING PARTS**

66	A(54A, 57B, 63B, D, 76A, D)	"500" -quarter panel		C6AZ	54291B30-A	2
66	A(54B, 62B)	"500" -quarter panel		C6AZ	62291B30-A	2
66	A(63C, 76B)	R. H. -"500 XL" -quarter panel		C6AZ	63291B30-A	1
		L. H. -quarter panel		C6AZ	63291B31-A	1
67	A(54A, 57B, 63B, 76A)	"5" -quarter panel		C7AZ	54291B30-A	2
67	A(54A, 57B, 63B, 76A)	"0" -quarter panel		C7AZ	54291B30-B	4
68	A(54A, B, 57B, 62B, 63B, 65C, 76A)	"500" -quarter panel		C8AZ	62291B30-A	2
68	A(71H, J)	On tailgate				1
69	A(54A, B, 57B, 62B, 63B, 65C, 76A)	"500" -quarter panel		C9AZ	62291B30-A	2
69/70	A(71H, J)	On tailgate				1
70	A(54B, E)	"500" -Refer to Group 42495				
71	A(54D, 71D)	"500" -quarter panel		D1AZ	54291B30-A	1
72	A(54D, F, 57F, 65D, F)	"500" -quarter panel				1
66	B(63C, F, 76C)	"500 XL" -quarter panel		C6OZ	63291B30-A	2
67	B(54B, 62B, 63B, 76B)	R. H. -"500" -quarter panel		C7OZ	62291B30-A	1
		L. H. -quarter panel		C7OZ	62291B31-A	1
67	B(71B)	R. H. -"500" -quarter panel		C7OZ	71291B30-A	1
		L. H. -quarter panel		C7OZ	71291B31-A	1

GROUP NUMBER	YEAR	BODY TYPE	DESCRIPTION	PART NUMBER	QTY.	
<b>291B30-1 NUMERAL - MODEL IDENTIFICATION - INCLUDES ATTACHING PARTS - continued</b>						
	68/69	B(54B, 63B, E, 65B, E, 66B, 71B, 76B, E)	"500"-quarter panel	C8OZ 54291B30-A	2	
	70	B(54B, 65B, 71B)			2	
	72	B(97D)	Front fender-w/studs		2	
	72	B(97D)	"500"-front fender-adhesive backed	D0OZ 16098-J	2	
	71	B(54C, 57C, 63C, 65C, 71C)	"500"-Aluminum -quarter panel	D1OZ 65291B30-A	2	
	71	B(54C, 57C, 63C, 65C, 71C)	"500"-Zinc die cast-quarter panel	D1OZ 65291B30-B	2	
	71	B(65C)	"500" -Lime-quarter panel	D1OZ 65291B30-D	2	
			"500" -Red-quarter panel	D1OZ 65291B30-C	2	
			"500" -Yellow-quarter panel	D1OZ 65291B30-E	2	
	70	B(54, 57, 65, 71)	Nut 1/8" spring	373888-S7(MM290)	4	
GROUP NUMBER	YEAR	BODY TYPE	DESCRIPTION	PART NUMBER		QTY.
				RIGHT HAND	LEFT HAND	
<b>29138-9 MOULDING - QUARTER OUTSIDE REAR BELT</b>						
	67	B(66)		C6DZ 6629138-A	C6DZ 6629139-A	1
	68/69	B(66)		C8OZ 6629138-A	C8OZ 6629139-A	1
	70/71	B(66)		D0OZ 6629138-A	D0OZ 6629139-A	1
	72	B(97)		D2OZ 9729138-A	D2OZ 9729139-A	1
	65	X(66A, B)	Chrome	C0DB 6629138-B	★C0DB6629139-B Not replaced (1/75)	1
	66	X(66)		C6DZ 6629138-A	C6DZ 6629139-A	1
<b>29140-1 MOULDING - QUARTER OUTSIDE - UPPER - INCLUDES ATTACHING PARTS</b>						
- A -						
	69/70	A(63)-w/o vinyl roof or two tone paint	Use on roof side	C9AZ 6329140-A	C9AZ 6329141-A	1
	69/70	A(63) -w/ vinyl roof or two tone paint	Use on roof side	C9AZ 6329140-B	C9AZ 6329141-B	1
	70	A(63C)	Use on quarter under window	D0AZ 6329140-A	D0AZ 6329141-A	1
	70	A(76)		D0AZ 7629140-A	D0AZ 7629141-A	1
- B -						
	65	B(54)		C5OZ 5429140-A	★C5OZ5429141-A Not replaced (1/75)	1
	65	B(62, 65)		C5OZ 6229140-A	C5OZ 6229141-A	1
	68	B(54C)		C8OZ 5429140-B	C8OZ 5429141-B	1
	68	B(65C)		C8OZ 6529140-A	C8OZ 6529141-A	1
	69	B(66A, B)		C9OZ 6629140-A	C9OZ 6629140-A	2
- X -						
	66	X(71B)	Fuel filler lid	C6DZ 7129140-A	C6DZ 71405A48-A	1
	66/67	X(54)		C6DZ 5429140-A	C6DZ 5429141-A	1
	66/67	X(62)		C6DZ 6229140-A	C6DZ 6229141-A	1
<b>291C40 SUPPORT - QUARTER WINDOW LOWER GARNISH MOULDING</b>						
	70/	A(71)			C9AZ 71291C40-A	1
<b>29144 RETAINER - OUTSIDE MOULDING</b>						
REFER TO APPROPRIATE EXTERIOR MOULDING ILLUSTRATION FOR COMPLETE RETAINER PART NUMBER						
<b>291A50-1 MOULDING - QUARTER PANEL OUTSIDE REAR END - INCLUDES ATTACHING PARTS</b>						
	65	X(54B, 62B, 63, 76)		C5DZ 62291A50-A	C5DZ 62291A51-A	1
	65	X(71B)				1
<b>291C50 RETAINER - QUARTER WHEELHOUSE TRIM PANEL MOULDING</b>						
	66/70	X(71)			C6DZ 71291C50-A	1
<b>291A52-3 ORNAMENT - QUARTER PANEL</b>						
	67	F	Lower-Paint to match	C7ZZ 65291A52-A	C7ZZ 65291A53-A	1
<b>291C56 RETAINER - QUARTER PANEL OUTSIDE ORNAMENT</b>						
	69	F(63)		C9ZZ 63291C56-A	C9ZZ 63291C56-A	2
<b>29158-9 PANEL - QUARTER LOWER REAR EXTENSION FINISH - INCLUDES ATTACHING PARTS</b>						
	68	A(54A, B, 57B, 63B, 65C, 76A)		C8AZ 5429158-C	C8AZ 5429159-C	1
	68	A(54C, 57F, 63C, 65A, 76B)		C8AZ 5429158-D	C8AZ 5429159-D	1
	67	B(54B, 62B, 63, 76)		C7OZ 6229158-A	C7OZ 6229159-A	1
	69	B(54C, 65C, D, F, 76D, F)		C9OZ 5429158-A	C9OZ 5429159-A	1

GROUP NUMBER	YEAR	BODY TYPE	DESCRIPTION	PART NUMBER		QTY.
				RIGHT HAND	LEFT HAND	
<b>291A58-9 MOULDING - QUARTER LATCH PILLAR FINISH</b>						
	66/70	X(71)		C6DZ 71291A58-A	C6DZ 71291A59-A	1
<b>29164-5 MOULDING - QUARTER WHEEL OPENING - INCLUDES ATTACHING PARTS</b>						
<b>- A -</b>						
	65	A(54, 57, 63, 76)	Approx. 34 1/4" long	C5AZ 6229164-A	C5AZ 6229165-A	1
	65	A(57, 63, 76)	Approx. 30 3/4" long	C5AZ 6329164-A	C5AZ 6329165-A	1
	65	A(71B, C)		C5AZ 7129164-A	C5AZ 7129165-A	1
	66	A(54A, 57B, 63B, 76A)		C6AZ 5429164-A	C6AZ 5429165-A	1
	66	A(57F, 63C, D, F, 76B, D)		C6AZ 6329164-A	C6AZ 6329165-A	1
	66	A(71B, C)		C6AZ 7129164-A	C6AZ 7129165-A	1
	67	A(54A, 57B)		C7AZ 5429164-B	C7AZ 5429165-B	1
	67	A(54C, 57F, 63C, J, 76B)		C7AZ 6329164-B	C7AZ 6329165-B	1
	67	A(63B, 76A)		C7AZ 6329164-A	C7AZ 6329165-A	1
	67	A(71B, C)		C7AZ 7129164-B	C7AZ 7129165-B	1
	68	A(54, 57, 63, 65, 76)		C8AZ 5429164-B	C8AZ 5429165-B	1
	68	A(71B, C)		C8AZ 7129164-A	C8AZ 7129165-A	1
	69	A(54A, 57B, 63B, 65C, 76A)		C9AZ 5429164-A	C9AZ 5429165-A	1
	69	A(54C, 57F, 65A)		C9AZ 5429164-B	C9AZ 5429165-B	1
	69	A(71B, C)		C9AZ 7129164-A	C9AZ 7129165-A	1
	69	A(63C, 76B)		C9AZ 6329164-A	C9AZ 6329165-A	1
	70	A(54A, C, 57, 63, 65, 76)				1
	70	A(71B, C)- "Before 8/11/69"				1
	70	A(71B, C)- "From 8/11/69"		D0AZ 7129164-A	D0AZ 7129165-A	1
	71/	A(53H, K, 57H, K)		D1AZ 5729164-A	D1AZ 5729165-A	1
	71	A(54D, 65D)		D1AZ 5429164-A	D1AZ 5429165-A	1
	72	A(54D, F, 57F, 65D, F)				1
	71	A(54F, 57F, 65F)		D1AZ 6529164-A	D1AZ 6529165-A	1
	71/	A(65H, K, 76)		D1AZ 6529164-B	D1AZ 6529165-B	1
	71	A(71D)		D1AZ 7129164-A	D1AZ 7129165-A	1
	72	A(71D, F)				1
	71	A(71F)		D1AZ 7129164-B	D1AZ 7129165-B	1
	70	A	Screw No. 8-18 x 3/8" washer hd.	381671-S45X(UU89C)	381671-S45X(UU89C)	4
<b>- B -</b>						
	66	B(54B, 62B, 63, 76)		C6OZ 6229164-A	C6OZ 6229165-A	1
	66	B(71B)		C6OZ 7129164-A	C6OZ 7129165-A	1
	67	B(54B, 62B, 63B, C, 76B, C)		C7OZ 6229164-A	C7OZ 6229165-A	1
	67	B(66B, D, 71B)		C7OZ 7129164-A	C7OZ 7129165-A	1
	68	B(71B)		C8OZ 7129164-A	C8OZ 7129165-A	1
	68	B(54C, 65C)		C9OZ 5429164-A	C9OZ 5429165-A	1
	69	B(54A, B, 63B, E, 65A, B, E, 66B, 71D, 76B, E)				1
	68	B(54B, 63B, D, E, 65B, D, 65E, 66B, D, 76B, D, E)		C9OZ 5429164-B	C9OZ 5429165-B	1
	69	B(54C, 63D, F, H, 65C, D, F, H, 66C, D, 76D, F)				
	69	B(71B)		C9OZ 7129164-A	C9OZ 7129165-A	1
	70	B(54B, C, 57C, 63C, H, 65B, C)		D0OZ 6529164-A	D0OZ 6529165-A	1
	71	B(54C, 57C, 63, 65C, 76)				1
	70	B(57E, 63F, 65E, 76F)		D0OZ 6529164-B	D0OZ 6529165-B	1
	70/71	B(66B, C)		D0OZ 6629164-A	D0OZ 6629165-A	1
	70	B(71B, C)		D0OZ 7129164-A	D0OZ 7129165-A	1
	71	B(71C)				1
	71	B(57E, 65E)		D1OZ 6529164-A	D1OZ 6529165-A	1
	72	B(53, 63, 65)	Half wheel opening	D2OZ 6529164-B	D2OZ 6529165-B	1
	72	B(63, 65)	Full wheel opening	D2OZ 6529164-A	D2OZ 6529165-A	1
	72	B(71D)		D2OZ 7129164-B	D2OZ 7129165-B	1
	72	B(97D)		D2OZ 9729164-A	D2OZ 9729165-A	1
	70	B	Screw No. 8- 18 x 3/8" washer hd.	381671-S45X(UU89C)	38167-S45X(UU89C)	12

GROUP NUMBER	YEAR	BODY TYPE	DESCRIPTION	PART NUMBER		QTY.
				RIGHT HAND	LEFT HAND	
<b>29164-5 MOULDING - QUARTER WHEEL OPENING - INCLUDES ATTACHING PARTS - continued</b>						
- F -						
	67/68	F		C7ZZ 6529164-A	C7ZZ 6529165-A	1
	69	F(63)-except Boss		C9ZZ 6329164-A	C9ZZ 6329165-A	1
	69	F(65, 76)		C9ZZ 6529164-A	C9ZZ 6529165-A	1
	70	F(63)-except Boss	Without F60-15 tire	D0ZZ 6329164-A	D0ZZ 6329165-A	1
	70	F(65A, B, E, 76A, B)		D0ZZ 6529164-A	D0ZZ 6529165-A	1
	71/	F		D1ZZ 6529164-A	D1ZZ 6529165-A	1
	70	F(63, 65)	Screw No. 8-18 x 3/8" washer hd.	381671-S45X(UU89C)	381671-S45X(UU89C)	2
- L -						
	71/	L(62, 64)	Bright finish	D1FZ 6229164-A	D1FZ 6229165-A	1
	72	L(73)		D2FZ 7329164-A	D2FZ 7329165-A	1
- P -						
	70	P(62)		D0DZ 6229164-A	D0DZ 6229165-A	1
	70	P(62)	Screw No. 8-18 x 3/8" round washer hd.	381671-S45X(UU89C)	381671-S45X(UU89C)	12
- S -						
	66	S		C6SZ 6329164-A	C6SZ 6329165-A	1
	70/71	S(57)		D0SZ 5729164-A	D0SZ 5729165-A	1
	70/71	S(65)		D0SZ 6529164-A	D0SZ 6529165-A	1
	72	S	Black insert	D2SZ 6529164-CA	D2SZ 6529165-CA	1
- X -						
	66	X(54, 62)		C9DZ 6229164-B	C9DZ 6229165-B	1
	66	X(66, 71)		C9DZ 7129164-A	C9DZ 7129165-A	1
	67	X(54, 62)		C7DZ 6229164-A	C7DZ 6229165-A	1
	67/68	X(71)		C7DZ 7129164-A	C7DZ 7129165-A	1
	68/69	X(54, 62)	W/o rocker panel mldg.	C8DZ 6229164-A	C8DZ 6229165-A	1
	69/70	X(54, 62)	W/rocker panel mldg.	C9DZ 6229164-B	C9DZ 6229165-B	1
	69/70	X(71)		C9DZ 7129164-A	C9DZ 7129165-A	1
<b>291A66 RETAINER - QUARTER OUTSIDE FINISH PANEL - FRONT</b>						
	71/	A(65H, K, 76)		D1AZ 65291A66-A	D1AZ 65291A66-A	2
<b>291B66-8 RETAINER - QUARTER WHEEL OPENING MOULDING</b>						
REFER TO APPROPRIATE EXTERIOR MOULDING ILLUSTRATION FOR COMPLETE RETAINER PART NUMBER						
<b>291B74-5 BRACKET - QUARTER PANEL TO WHEELHOUSE BRACE</b>						
	66/71	B(76)		C6OZ 76291B74-A	C6OZ 76291B75-A	1
	72	B(53)		D2OZ 53291B74-A	D2OZ 53291B75-A	1
	72	B(65)		D2OZ 65291B74-A	D2OZ 65291B75-A	1
<b>291B80 RETAINER - QUARTER PANEL REAR EXTENSION MOULDING</b>						
REFER TO APPROPRIATE EXTERIOR MOULDING ILLUSTRATION FOR COMPLETE RETAINER PART NUMBER						
<b>291C80-3 INSERT - QUARTER PANEL OUTSIDE ORNAMENT</b>						
	67	F	Center-lower- paint to match	C7ZZ 65291C80-A	C7ZZ 65291C81-A	1
			Center-upper-paint to match	C7ZZ 65291C82-A	C7ZZ 65291C83-A	1
	68	F(65) GT/CS	With attaching parts	C8ZZ 65291C80-A	C8ZZ 65291C81-A	1
<b>291A84-5 MOULDING - QUARTER WINDOW GARNISH REAR - Paint to match</b>						
	69	A(62)		C9AZ 62291A84-A	C9AZ 62291A85-A	1
	66/67	B(62)		C6OZ 62291A84-A	C6OZ 62291A85-A	1
	66/70	X(62)				1
			No. 8-15 x 2 1/2" Cross recess oval head screw	371847-S13(UU56)	371847-S13(UU56)	4

# FORD CAR PARTS

**BODY  
SECTION 290**

17

GROUP NUMBER	YEAR	BODY TYPE	DESCRIPTION	PART NUMBER		QTY.	
				RIGHT HAND	LEFT HAND		
<b>291C84-5 MOULDING - QUARTER PANEL OUTSIDE REAR END - LOWER - INCLUDES ATTACHING PARTS</b>							
	67	S		C7SZ	65291C84-A	C7SZ 65291C85-A	1
	70/71	S	Use with body side mouldings	D0SZ	65291C84-A	D0SZ 65291C85-A	1
	68/71	S	Use with lower body mouldings	D0SZ	65291C84-B	D0SZ 65291C85-B	1
	70/71	S	Screw No. 8-18 x 1/2" oval head	52413-S13(U316)		52413-S13(U316)	2

<b>29188-9 SUPPORT - QUARTER TRIM PANEL UPPER EDGE REINFORCEMENT</b>							
	69/70	F(76)		C9ZZ	7629188-A	C9ZZ 7629189-A	1

**29192 RETAINER - QUARTER OUTSIDE UPPER MOULDING**

REFER TO APPROPRIATE EXTERIOR MOULDING ILLUSTRATION  
FOR COMPLETE RETAINER PART NUMBER

<b>291C96-7 MOULDING - QUARTER PANEL and PILLAR - INCLUDES ATTACHING PARTS</b>							
	68/69	B(66)		C8OZ	66291C96-A	C8OZ 66291C97-A	1

<b>29200-1 REINFORCEMENT - QUARTER PANEL TO WHEELHOUSE</b>							
	71/	A(53, 57, 65)		D1AZ	6529200-A	D1AZ 6529201-A	1

<b>292B02 DEADENER - QUARTER PANEL TO WHEELHOUSE - SOUND</b>							
	67	A(63J)	Includes retainer & bumper	C7AZ	63292B02-A	C7AZ 63292B02-A	2

<b>292A08-9 MOULDING - QUARTER VENT WINDOW FRAME</b>							
	71/	L(62, 64) -w/pivoting window		D1FZ	62292A08-A	D1FZ 62292A09-A	1

GROUP NUMBER	YEAR	BODY TYPE	DESCRIPTION	PART NUMBER		QTY.
<b>29210-1 LETTER - QUARTER PANEL - OUTSIDE - INCLUDES ATTACHING PARTS</b>						
	66	A(54A, 57B, 63B, C, D, 76)	"G"	C6AZ	5429210-A	2
			"A"	C6AZ	5429210-B	4
			"L"	C6AZ	5429210-C	2
			"X"	C6AZ	5429210-D	2
			"I"	C6AZ	5429210-E	2
			"E"	C6AZ	5429210-F	2
	67	A(54A, 57B, 63B, 76A)	"G"	C7AZ	5429210-A	2
			"A"	C7AZ	5429210-B	4
			"L"	C7AZ	5429210-C	2
			"X"	C7AZ	5429210-D	2
			"I"	C7AZ	5429210-E	2
			"E"	C7AZ	5429210-F	2
	67	B(63C, 76C)	R. H. -"XL"	C7OZ	6329210-A	1
			L. H.	C7OZ	6329211-A	1
	66/67	B(63D, 76D)	"F"	C6OZ	6329210-A	2
			"A"	C6OZ	6329210-B	4
			"T"	C6OZ	6329210-C	2
			"R"	C6OZ	6329210-D	2
			"L"	C6OZ	6329210-E	2
			"N"	C6OZ	6329210-F	2
			"E"	C6OZ	6329210-G	2

<b>29232 RETAINER - COAT HOOK</b>							
	68/69	A(exc. 76), B(exc. 76), F(exc. 76), S, U, X	Also used for shoulder strap storage	C8AZ	6229232-A	C8AZ 6229232-A	2
	70	A, B, F, P, S, U, X					4
	71/	A, B, F, L, P, S, U					4
	68/	A, B, F, L, P, S, U, X	For cover Refer to Group 29024				

**BODY  
SECTION 290**
**FORD CAR PARTS**

GROUP NUMBER	YEAR	BODY TYPE	DESCRIPTION	PART NUMBER		QTY.
				RIGHT HAND	LEFT HAND	
<b>292A32</b>			<b>BRACKET - COAT HOOK</b>			
	72	A(57)-w/sliding roof		D2AZ 57292A32-A	D2AZ 57292A32-A	1
	72	A(65)-w/sliding roof		D2AZ 65292A32-A	D2AZ 65292A32-A	1
<b>29250-1</b>			<b>MOULDING - QUARTER BELT INSIDE</b>			
	72	B(65)		D2OZ 6529250-A	D2OZ 6529251-A	1
	72	S		D2SZ 6529250-A	D2SZ 6529251-A	1
<b>29288</b>			<b>RETAINER - QUARTER OUTSIDE LOWER FRONT MOULDING</b>			

REFER TO APPROPRIATE EXTERIOR MOULDING ILLUSTRATION  
FOR COMPLETE RETAINER PART NUMBER

GROUP NUMBER	YEAR	BODY TYPE	DESCRIPTION	PART NUMBER	QTY.
<b>29308</b>			<b>RETAINER - QUARTER WINDOW GARNISH MOULDING - REAR</b>		
	69/	A(71)		C9AZ 7129308-A	1

GROUP NUMBER	YEAR	BODY TYPE	DESCRIPTION	PART NUMBER		QTY.
				RIGHT HAND	LEFT HAND	
<b>29312-3</b>			<b>MOULDING - QUARTER PANEL REAR EXTENSION - INCLUDES ATTACHING PARTS</b>			
	66	A(54A, 57B, 63B, 76A)		C6AZ 5429312-A	C6AZ 5429313-A	1
	67	A(54A, 57B, 63B, 76A)		C7AZ 5429312-A	C7AZ 5429313-A	1
	67	A(54C, 57F, 63C, J, 76B)		C7AZ 6329312-A	C7AZ 6329313-A	1
	68	A(54, 57, 63, 65, 76)		C8AZ 5429312-A	C8AZ 5429313-A	1
	69	B(54B, C, 65, 76)		C9OZ 5429312-A	C9OZ 5429313-A	1

GROUP NUMBER	YEAR	BODY TYPE	DESCRIPTION	PART NUMBER	QTY.	
<b>29318</b>			<b>RETAINER - BODY SIDE MOULDING</b>			
	67/	U(97, 98)	Tail gate	C7TZ 9729318-A	C7TZ 9729318-A	18 5

GROUP NUMBER	YEAR	BODY TYPE	DESCRIPTION	PART NUMBER	QTY.	
<b>29322-3</b>			<b>RETAINER - QUARTER OUTSIDE LOWER FRONT MOULDING</b>			
	70	S		D0SZ 6529322-A	D0SZ 6529322-A	4
	71	S		D0SZ 6529322-A	D0SZ 6529323-A	AR

GROUP NUMBER	YEAR	BODY TYPE	DESCRIPTION	PART NUMBER	QTY.	
<b>29388-9</b>			<b>BRACE - QUARTER LATCH PILLAR TO QUARTER SIDE MEMBER</b>			
	68/69	B(63, 65)		C8OZ 6329388-A	C8OZ 6329389-A	1
	70/71	B(62, 63, 65, 76)		D0OZ 6529388-A	D0OZ 6529389-A	1
	72	B(53, 63, 65)		D2OZ 5329388-A	D2OZ 5329389-A	1
	72	B(71)		D2OZ 7129388-A	D2OZ 7129389-A	1
	69/70	F(63)		C9ZZ 6329388-A	C9ZZ 6329389-A	1

GROUP NUMBER	YEAR	BODY TYPE	DESCRIPTION	PART NUMBER	QTY.	
<b>29396-7</b>			<b>MOULDING - QUARTER WINDOW OUTSIDE REAR</b>			
	68/69	B(65A, B, D, E)		C8OZ 6529396-A	C8OZ 6529397-A	1
	70	B(65F)				1
	67/68	S(65)	"Before 8/28/67" Includes weatherstrip	C7SZ 6529396-C	C7SZ 6529397-D	1
	68	S(65)	"From 8/28/67" Includes weatherstrip	C7SZ 6529396-D	C7SZ 6529397-D	1
	69	S(65A, C)				1

GROUP NUMBER	YEAR	BODY TYPE	DESCRIPTION	PART NUMBER	QTY.
<b>29432</b>			<b>BAR - ENGINE COMPARTMENT SUPPORT</b>		
	65/66	F(GT350)		S1MS 29432-A	1

GROUP NUMBER	YEAR	BODY TYPE	DESCRIPTION	PART NUMBER		QTY.
				RIGHT HAND	LEFT HAND	
<b>29436-7</b>			<b>FILLER - QUARTER WINDOW OPENING - FRONT CORNER - LOWER</b>			
	69/	A(71)		C9AZ 7129436-A	C9AZ 7129437-A	1
	66/	B(71)	Improvise	★	★	
	66/70	X(71)	Improvise	★	★	

GROUP NUMBER	YEAR	BODY TYPE	DESCRIPTION	PART NUMBER	QTY.	
<b>29458-9</b>			<b>FILLER - QUARTER WINDOW OPENING - REAR CORNER</b>			
	69/	A(71)		C9AZ 7129458-A	C9AZ 7129459-A	1
	66	B(71), X(71)	Improvise	★	★	
	72	B(63)		D2OZ 6329458-A	D2OZ 6329459-A	1
	72	B(71)		D2OZ 7129458-A	D2OZ 7129459-A	1
	69	F(63)		C9ZZ 6329458-A	C9ZZ 6329459-A	1
	69/70	F(65)		C9ZZ 6529458-A	C9ZZ 6529459-A	1
	71/	L(62, 64)		D1FZ 6229458-A	D1FZ 6229459-A	1



# FORD CAR PARTS

## BODY SECTION 295

GROUP NUMBER	YEAR	BODY TYPE	DESCRIPTION	PART NUMBER		QTY.	
				RIGHT HAND	LEFT HAND		
<b>29536-7 MOULDING - QUARTER WINDOW OUTSIDE REAR</b>							
	70	A(63)	Use with two tone paint	D0AZ 6329536-B	D0AZ 6329537-B	1	
	70	A(65)	Use with vinyl roof or two tone paint	D0AZ 6529536-B	D0AZ 6529537-B	1	
	70	A(65)	Use without vinyl roof or two tone paint	D0AZ 6529536-A	D0AZ 6529537-A	1	
	69/70	F(65)	Includes attaching parts	C9ZZ 6529536-A	C9ZZ 6529537-A	1	
<b>296A06-7 CARRIER - QUARTER WINDOW SLIDE</b>							
	67/71	S(65A,C)		C7SZ 65296A06-A	C7SZ 65296A07-A	1	
			1/4"-20 x 1" Shoulder set screw	★352332-S2	★352332-S2	4	
			1/4"-20 Nut & wshr. assy.	★376762-S2	★376762-S2	4	
<b>29610 ANTI-RATTLE - QUARTER WINDOW</b>							
	71/	F		D1ZZ 6529610-A	D1ZZ 6529610-A	2	
	72	B(65)		D2OZ 6529610-A	D2OZ 6529610-A	2	
<b>29622 MOULDING - QUARTER WINDOW OUTSIDE FRONT</b>							
	72	B(71)		D2OZ 7129622-A	D2OZ 7129622-A	2	
<b>29638-9 MOULDING - REAR QUARTER WINDOW REAR</b>							
	72	L(73)		D2FZ 7329638-B	D2FZ 7329639-B	1	
GROUP NUMBER	YEAR	BODY TYPE	DESCRIPTION	PART NUMBER		QTY.	
				CLEAR	TINTED		
<b>29700-1 WINDOW ASSY. - QUARTER</b> - Tempered, unless otherwise indicated Also refer to Groups 29710-1 and 29740-1 Nags No.							
	69	A(63)	R. H.	Q4082	C9AZ 6329700-A	C9AZ 6329700-B	1
			L. H.	Q4083	C9AZ 6329701-A	C9AZ 6329701-B	1
	69	A(65)	R. H.	Q4084	C9AZ 6529700-A	C9AZ 6529700-B	1
			L. H.	Q4085	C9AZ 6529701-A	C9AZ 6529701-B	1
	69	A(76)	R. H.	Q4092	C9AZ 7629700-A	C9AZ 7629700-B	1
			L. H.	Q4093	C9AZ 7629701-A	C9AZ 7629701-B	1
	69	A(63, 65, 76)	Screw-No. 8-32 x 1/2" o. hd.	50398-S13(U121)	50398-S13(U121)	AR	
	69	A	Screw & washer-1/4"-20 x 5/8" hex. hd.	57472-S40(B339V)	57472-S40(B339V)	AR	
	70	A(63)	R. H.	Q4307	D0AZ 6329700-A	D0AZ 6329700-B	1
			L. H.	Q4308	D0AZ 6329701-A	D0AZ 6329701-B	1
	70	A(65)	R. H.	Q4312	D0AZ 6529700-A	D0AZ 6529700-B	1
			L. H.	Q4313	D0AZ 6529701-A	D0AZ 6529701-B	1
	70/	A(76)	R. H.	Q4320	D0AZ 7629700-A	D0AZ 7629700-B	1
			L. H.	Q4321	D0AZ 7629701-A	D0AZ 7629701-B	1
	71/	A(65)	Refer to Group 29710-1				
	68	B(63)	R. H.	Q3905	C8OZ 6329700-A	C8OZ 6329700-B	1
			L. H.	Q3906	C8OZ 6329701-A	C8OZ 6329701-B	1
	68	B(65)	R. H.	Q3908	C8OZ 6529700-A	C8OZ 6529700-B	1
			L. H.	Q3909	C8OZ 6529701-A	C8OZ 6529701-B	1
	68	B(76)	R. H.	Q3913	C8OZ 7629700-A	C8OZ 7629700-B	1
			L. H.	Q3914	C8OZ 7629701-A	C8OZ 7629701-B	1
	69	B(63)	R. H.	Q4131	C9OZ 6329700-A	C9OZ 6329700-B	1
			L. H.	Q4132	C9OZ 6329701-A	C9OZ 6329701-B	1
	69	B(65)	R. H.	Q4133	C9OZ 6529700-A	C9OZ 6529700-B	1
			L. H.	C4134	C9OZ 6529701-A	C9OZ 6529701-B	1
	69	B(76)	R. H.	Q4137	C9OZ 7629700-A	C9OZ 7629700-B	1
			L. H.	Q4138	C9OZ 7629701-A	C9OZ 7629701-B	1
	70/71	B(63)	R. H.	Q4325	D0OZ 6329700-A	D0OZ 6329700-B	1
			L. H.	Q4326	D0OZ 6329701-A	D0OZ 6329701-B	1
	70/71	B(65)	R. H.	Q4330	D0OZ 6529700-A	D0OZ 6529700-B	1
			L. H.	Q4331	D0OZ 6529701-A	D0OZ 6529701-B	1
	70/71	B(76)	R. H.	Q4342	D0OZ 7629700-A	D0OZ 7629700-B	1
			L. H.	Q4343	D0OZ 7629701-A	D0OZ 7629701-B	1

**BODY  
SECTION 295**
**FORD CAR PARTS**

GROUP NUMBER	YEAR	BODY TYPE	DESCRIPTION	PART NUMBER				QTY.
				CLEAR		TINTED		
<b>29700-1</b>	<b>WINDOW ASSY. - QUARTER - continued -</b> Tempered, unless otherwise indicated - Also refer to Groups 29710-1 and 29740-1 Nags No.							
69	F(65, 76)	R. H.	Q4123	C9ZZ	6529700-A	C9ZZ	6529700-B	1
		L. H.	Q4124	C9ZZ	6529701-A	C9ZZ	6529701-B	1
70	F(65, 76) "Before 1/19/70"	R. H.	Q4284	D0ZZ	6529700-A	D0ZZ	6529700-B	1
		L. H.	Q4285	D0ZZ	6529701-A	D0ZZ	6529701-B	1
70	F(65, 76) "From 1/19/70"	R. H.	Q4284	D0ZZ	6529700-C	D0ZZ	6529700-D	1
		L. H.	Q4285	D0ZZ	6529701-C	D0ZZ	6529701-D	1
67/69	S(65)	R. H.	Q3744	C7SZ	6529700-E	C7SZ	6529700-F	1
		L. H.	Q3745	C7SZ	6529701-E	C7SZ	6529701-F	1
70	S(65A,C) "Before 1/19/70"	R.H.	Q4362	D0SZ	6529700-A	D0SZ	6529700-B	1
		L.H.	Q4363	D0SZ	6529701-A	D0SZ	6529701-B	1
70/71	S(65A,C) "From 1/19/70"	R. H.	Q4362	D0SZ	6529700-C	D0SZ	6529700-D	1
		L. H.	Q4363	D0SZ	6529701-C	D0SZ	6529701-D	1
72	S	Refer to Group 29710-1						
67/71	S	1/4" -20 nut		33795-S7(M49)		33795-S7(M49)		AR
67/71	S	No. 8-lockwasher		34803-S8(X60)		34803-S8(X60)		1
<b>29706-7</b>	<b>WINDOW - QUARTER VENT - LESS HANDLE</b>							
								Nags No.
69/70	F(63)	R. H. - includes frame	Q4118	C9ZZ	6329706-A	C9ZZ	6329706-B	1
		L. H.	Q4119	C9ZZ	6329707-A	C9ZZ	6329707-B	1
70	P(62)	Refer to Illustration Section 290 for details						
72	L(62, 64) "From 5/1/72"	R.H.-pivoting quarter window	Q4798	D2FZ	6229706-A	D2FZ	6229706-B	1
		L.H.	Q4799	D2FZ	6229707-A	D2FZ	6229707-B	1
72	L(73)-w/frame - "From 5/1/72"	R.H.	Q4796	D2FZ	7329706-A	D2FZ	7329706-B	1
		L.H.	Q4797	D2FZ	7329707-A	D2FZ	7329707-B	1
72	L(73)-w/o frame - "Before 5/1/72"	Refer to Group 29710-11						
<b>29710-1</b>	<b>GLASS - QUARTER WINDOW</b> - Tempered, unless otherwise indicated - Also refer to group 29700-1 Nags No.							
								- A -
65	A(63)	R. H.	Q3304	C5AZ	6329710-A	C5AZ	6329710-B	1
		L. H.	Q3305	C5AZ	6329711-A	C5AZ	6329711-B	1
65/66	A(62)	R. H.	Q3318	C5AZ	6229710-A	C5AZ	6229710-B	1
		L. H.	Q3319	C5AZ	6229711-A	C5AZ	6229711-B	1
65/66	A(76)	R. H.	Q3312	C5AZ	7629710-A	C5AZ	7629710-B	1
		L. H.	Q3313	C5AZ	7629711-A	C5AZ	7629711-B	1
66	A(63)	R. H.	Q3513	C6AZ	6329710-A	C6AZ	6329710-B	1
		L. H.	Q3514	C6AZ	6329711-A	C6AZ	6329711-B	1
67	A(63B, C)	R. H.	Q3716	C7AZ	6329710-A	C7AZ	6329710-B	1
		L. H.	Q3717	C7AZ	6329711-A	C7AZ	6329711-B	1
67	A(63J)	R. H.	Q3713	C7AZ	6329710-C	C7AZ	6329710-D	1
		L. H.	Q3714	C7AZ	6329711-C	C7AZ	6329711-D	1
67/68	A(62)	R. H.	Q3723	C7AZ	6229710-A	C7AZ	6229710-B	1
		L. H.	Q3724	C7AZ	6229711-A	C7AZ	6229711-B	1
69	A(62)	R. H.	Q4098	C9AZ	6229710-A	C9AZ	6229710-B	1
		L. H.	Q4099	C9AZ	6229711-A	C9AZ	6229711-B	1
68	A(63)	R. H.	Q3893	C8AZ	6329710-A	C8AZ	6329710-B	1
		L. H.	Q3894	C8AZ	6329711-A	C8AZ	6329711-B	1
68	A(65)	R. H.	Q3898	C8AZ	6529710-A	C8AZ	6529710-B	1
		L. H.	Q3899	C8AZ	6529711-A	C8AZ	6529711-B	1
67/68	A(76)	R. H.	Q3721	C7AZ	7629710-A	C7AZ	7629710-B	1
		L. H.	Q3722	C7AZ	7629711-A	C7AZ	7629711-B	1
67/	A(71)	Refer to Group 29740-1						
69/70	A(63, 65, 76)	Refer to Group 29700-1						
71/	A(65)	R. H.	Q4502	D1AZ	6529710-A	D1AZ	6529710-B	1
		L. H.	Q4503	D1AZ	6529711-A	D1AZ	6529711-B	1

# FORD CAR PARTS

## BODY SECTION 295

3

GROUP NUMBER	YEAR	BODY TYPE	DESCRIPTION	PART NUMBER		QTY.	
				CLEAR	TINTED		
<b>29710-1 GLASS - QUARTER WINDOW</b> - Tempered, unless otherwise indicated - <b>continued</b> - Also refer to group 29700-1							
Nags No.							
<b>- B -</b>							
	65	B(62)		4358T	C2OB 6229710-A	★C2OB 6229710-B Not replaced (10/74)	2
	65	B(65)		2428T	C3OZ 6529710-A	C3OZ 6529710-B	2
	66/67	B(62)	R. H.	Q3520	C6OZ 6229710-A	C6OZ 6229710-B	1
			L. H.	Q3521	C6OZ 6229711-A	C6OZ 6229711-B	1
	66/67	B(63)	R. H.	Q3543	C6OZ 6329710-A	C6OZ 6329710-B	1
			L. H.	Q3544	C6OZ 6329711-A	C6OZ 6329711-B	1
	66/67	B(76)	R. H.	Q3548	C6OZ 7629710-A	C6OZ 7629710-B	1
			L. H.	Q3549	C6OZ 7629711-A	C6OZ 7629711-B	1
	70	B(62)	R. H.	Q4348	D0OZ 6229710-A	D0OZ 6229710-B	1
			L. H.	Q4349	D0OZ 6229711-A	D0OZ 6229711-B	1
	68/71	B(63, 65, 76)	Refer to Group 29700-1				
	72	B(63)	R. H.	Q4715	D2OZ 6329710-C	D2OZ 6329710-D	1
			L. H.	Q4716	D2OZ 6329711-C	D2OZ 6329711-D	1
	72	B(65)	R. H.	Q4721	D2OZ 6529710-A	D2OZ 6529710-B	1
			L. H.	Q4722	D2OZ 6529711-A	D2OZ 6529711-B	1
<b>- F -</b>							
	65/66	F(65)-except GT 350	R. H.	Q3297	C5ZZ 6529710-A	C5ZZ 6529710-B	1
			L. H.	Q3298	C5ZZ 6529711-A	C5ZZ 6529711-B	1
	65/66	F(76)	R. H.	Q3293	C5ZZ 7629710-A	C5ZZ 7629710-B	1
			L. H.	Q3294	C5ZZ 7629711-A	C5ZZ 7629711-B	1
	66	F(GT 350)	R. H. -plexi glass		S2MS 29710-A		1
			L. H.		S2MS 29711-A		1
	67/68	F(65)	R. H.	Q3757	C7ZZ 6529710-A	C7ZZ 6529710-B	1
			L. H.	Q3758	C7ZZ 6529711-A	C7ZZ 6529711-B	1
	67/68	F(76)	R. H.	Q3761	C7ZZ 7629710-A	C7ZZ 7629710-B	1
			L. H.	Q3762	C7ZZ 7629711-A	C7ZZ 7629711-B	1
	69/70	F(65, 76)	Refer to Group 29700-1				
	69/70	F(63)	Refer to Group 29706-7				
	71/	F(63)	R. H.	Q4533	D1ZZ 6329710-A	D1ZZ 6329710-B	1
			L. H.	Q4534	D1ZZ 6329711-A	D1ZZ 6329711-B	1
	71/	F(65)	R. H.	Q4539	D1ZZ 6529710-A	D1ZZ 6529710-B	1
			L. H.	Q4540	D1ZZ 6529711-A	D1ZZ 6529711-B	1
	71/	F(76)	R. H.	Q4542	D1ZZ 7629710-A	D1ZZ 7629710-B	1
			L. H.	Q4543	D1ZZ 7629711-A	D1ZZ 7629711-B	1
<b>- L -</b>							
	71/	L(62, 64)	R. H. - stationary quarter window	Q4548	D1FZ 6229710-A	D1FZ 6229710-B	1
			L. H.	Q4549	D1FZ 6229711-A	D1FZ 6229711-B	1
	71/72	L(62, 64) "Before 5/1/72"	R. H.-pivoting quarter window	Q4546	D1FZ 6229710-C	D1FZ 6229710-D	1
			L. H.	Q4547	D1FZ 6229711-C	D1FZ 6229711-D	1
	72	L(73) - w/o frame "Before 5/1/72"	R. H.	Q4746	D2FZ 7329710-A	D2FZ 7329710-B	1
			L. H.	Q4747	D2FZ 7329711-A	D2FZ 7329711-B	1
	72	L(73) - w/frame "From 5/1/72"	Refer to Group 29706-7				
<b>- P -</b>							
	70/	P(62)	R. H.	Q4277	D0DZ 6229710-C	D0DZ 6229710-D	1
			L. H.	Q4278	D0DZ 6229711-C	D0DZ 6229711-D	1
<b>- S -</b>							
	65/66	S(63)		2491T	C4SZ 6329710-A	C4SZ 6329710-B	2
	65/66	S(76)		2492T	C4SZ 7629710-A	C4SZ 7629710-B	2
	72	S	R. H.	Q4736	D2SZ 6529710-A		1
			L. H.	Q4737	D2SZ 6529711-A		1
	72	S	R. H.	Q4740		D2LY 6529710-B	1
			L. H.	Q4741		D2LY 6529711-B	1

**BODY  
SECTION 295**
**FORD CAR PARTS**

GROUP NUMBER	YEAR	BODY TYPE	DESCRIPTION	PART NUMBER		QTY.	
				CLEAR	TINTED		
<b>29710-1</b>	<b>GLASS - QUARTER WINDOW</b> - Tempered, unless otherwise indicated - <b>continued</b> - Also refer to group 29700-1						
Nags No.							
- X -							
	65	X(59)		4393T	C3DZ 5929710-A	C3DZ 5929710-B	2
	65	X(62)		4390T	C2DZ 6229710-A	C2DZ 6229710-B	2
	65	X(63)		2487T	C3DZ 6329710-A	C3DZ 6329710-B	2
	65	X(76)		2432T	C3DZ 7629710-A	C3DZ 7629710-B	2
	66/70	X(62)	R. H.	Q3520	C6OZ 6229710-A	C6OZ 6229710-B	1
			L. H.	Q3521	C6OZ 6229711-A	C6OZ 6229711-B	1
GROUP NUMBER	YEAR	BODY TYPE	DESCRIPTION	PART NUMBER		QTY.	
				RIGHT HAND	LEFT HAND		
<b>297A20</b>	<b>BRACKET - QUARTER WINDOW GUIDE - REAR</b>						
	72	S			D2SZ 65297A20-A	D2SZ 65297A20-A	2
<b>297A22</b>	<b>GROMMET - QUARTER WINDOW GUIDE</b>						
	71/	A(65)			D1AZ 65297A22-A	D1AZ 65297A22-A	2
<b>29724</b>	<b>STRIP - QUARTER WINDOW GLASS RETAINING</b>						
	65/	A, B, S, X	Use bulk glass tape		★	★	
	67/	F	Use bulk glass tape		★	★	
GROUP NUMBER	YEAR	BODY TYPE	DESCRIPTION	PART NUMBER		QTY.	
				CLEAR	TINTED		
<b>29726</b>	<b>GLASS - QUARTER WINDOW REAR - STATIONARY</b> - Tempered, unless otherwise indicated						
NAGS NO.							
	66/	U(98)		1085T	C6TZ 9829726-A		2
	65	X(59, 71)	R. H.	Q3062	C0DB 5929726-A	C0DB 5929726-B	1
	65	X(59, 71)	L. H.	Q3063	C0DB 5929736-A	C0DB 5929736-B	1
GROUP NUMBER	YEAR	BODY TYPE	DESCRIPTION	PART NUMBER		QTY.	
				RIGHT HAND	LEFT HAND		
<b>297A30</b>	<b>SEAL - QUARTER VENT WINDOW LATCH RETAINER</b>						
	71/	L, P(62)			D1DZ 62297A30-A	D1DZ 62297A30-A	2
<b>29732-3</b>	<b>WEATHERSTRIP - QUARTER WINDOW AT BELT OUTER</b>						
- A -							
	65/66	A(62)			C5AZ 6229732-B	C5AZ 6229732-B	2
			No. 4-24 x 3/8" Cross recess flat head screw	52003-S13(U194)	52003-S13(U194)	2	
	67/68	A(62)			C7AZ 6229732-A	★C7AZ6229733-A	1
			No. 6-20 x 1/2" Flat head drill point screw	★380922-S2	★380922-S2	4	
	69	A(62)			C9AZ 6229732-A	C9AZ 6229733-A	1
	70	A(65A)	"Before 2/2/70"		D0AZ 6529732-C	D0AZ 6529733-A	1
	70	A(65C)	"Before 2/2/70"		D0AZ 6529732-B	D0AZ 6529733-B	1
	70	A(65A,C,M)	"From 2/2/70"	With two tone paint	D0AZ 6529732-C	D0AZ 6529733-C	1
	70	A(65C,M)	"From 2/2/70"	Less two tone paint	D0AZ 6529732-D	D0AZ 6529733-D	1
	71	A(65D,F)			D1AZ 6529732-A	D1AZ 6529733-A	1
	71	A(65H,K)			D1AZ 6529732-B	D1AZ 6529733-B	1
	71/	A(76)			D1AZ 7629732-A	D1AZ 7629733-A	1
- B -							
	65	B(62)			C2OZ 6229732-A	C2OZ 6229732-A	2
	66/67	B(62)			C6OZ 6229732-A	C6OZ 6229733-A	1
	66/67	B(63)			C6OZ 6329732-A	C6OZ 6329733-A	1
	66/67	B(76)			C6OZ 7629732-A	C6OZ 7629733-A	1
	68/69	B(65A, B, D, E, F)			C8OZ 6529732-A	C8OZ 6529733-A	1
	68/69	B(76)			C8OZ 7629732-A	C8OZ 7629733-A	1
	70	B(62)	With clips		D0OZ 6229732-A	D0OZ 6229733-A	1
	70/71	B(65)	With bright bead		D0OZ 6529732-A	D0OZ 6529733-A	1
	70/71	B(65)	Without bright bead		D0OZ 6529732-B	D0OZ 6529733-B	1
	70/71	B(76)			D0OZ 7629732-A	D0OZ 7629733-A	1

# FORD CAR PARTS

## BODY SECTION 295

5

GROUP NUMBER	YEAR	BODY TYPE	DESCRIPTION	PART NUMBER		QTY.	
				RIGHT HAND	LEFT HAND		
<b>29732-3 WEATHERSTRIP - QUARTER WINDOW AT BELT OUTER - continued</b>							
- B -							
	70/71	B(65, 76)	Screw-No. 8-18 x 1/2"- pan head	375452-S100 (BB630D)	375452-S100 (BB630D)	2	
	72	B(63)		D2OZ 6329732-A	D2OZ 6329733-A	1	
	72	B(65)		D2OZ 6529732-A	D2OZ 6529733-A	1	
- F -							
	65/66	F(65, 76)	Stainless steel bead Cut to length required	C5ZZ 6529732-B	C5ZZ 6529733-B	1	
	67/68	F(65)		C7ZZ 6529732-A	C7ZZ 6529733-A	1	
	67/68	F(76)	Cut to fit			1	
	67/68	F(65, 76)	No. 6-20 x 1/2" Flat head drill point screw	★380922-S2	★380922-S2	2	
	69/70	F(65)		C9ZZ 6529732-A	C9ZZ 6529733-A	1	
	69/70	F(76)		C9ZZ 7629732-A	C9ZZ 7629733-A	1	
	71/	F(63)		D1ZZ 6329732-A	D1ZZ 6329733-A	1	
	71/	F(65D)		D1ZZ 6529732-A	D1ZZ 6529733-A	1	
	71/	F(65F)		D1ZZ 6529732-B	D1ZZ 6529733-B	1	
	71/	F(76)		D1ZZ 7629732-A	D1ZZ 7629733-A	1	
- L -							
	71/	L (62, 64) "Before 5/1/72"		D1FZ 6229732-B	D1FZ 6229732-B	1	
	72	L(62, 64) "From 5/1/72"		D2FZ 6229732-A	D2FZ 6229733-A	1	
- S -							
	65/66	S(63)		C4SZ 6329732-A	C4SZ 6329732-A	2	
	65/66	S	Screw-fillister head- No. 4-24 x 3/8"	52003-S13(U194)	52003-S13(U194)	AR	
	72	S "Before 11/22/71"		D2SZ 6529732-A	D2SZ 6529733-A	1	
	72	S "From 11/22/71"	Serviced only in assembly-Refer to Group 29796-7				
- X -							
	65	X(63)		C3DZ 6329732-A	C3DZ 6329732-A	2	
	66/70	X(62)		C6OZ 6229732-A	C6OZ 6229733-A	1	
<b>29734-5 RETAINER - QUARTER WINDOW GLASS RUN</b>							
	69	A(62)		C9AZ 6229734-A	C9AZ 6229735-A	1	
	70	B(62)	Rear	D0OZ 6229734-B	D0OZ 6229735-B	1	
	68/70	X(62)		C8DZ 6229734-A	C8DZ 6229735-A	1	
	65/	A(62), B(62), X(62)	5/16"-18 x 1/2" Hex. washer head screw	376976-S7-8(BB574M)	376976-S7-8(BB574M)	4or6	
<b>29736 GLASS - QUARTER WINDOW REAR - STATIONARY - Refer to group 29726</b>							
GROUP NUMBER	YEAR	BODY TYPE	DESCRIPTION	PART NUMBER		QTY.	
				CLEAR	TINTED		
<b>29740-1 GLASS - QUARTER WINDOW REAR - STATIONARY - Tempered, unless otherwise indicated</b>							
NAGS NUMBER							
	65/66	A(71)	R. H. L. H.	Q3327 Q3328	C5AZ 7129740-A C5AZ 7129741-A	C5AZ 7129740-B C5AZ 7129741-B	1 1
	67/68	A(71)	R. H. L. H.	Q3730 Q3731	C7AZ 7129740-A C7AZ 7129741-A	C7AZ 7129740-B C7AZ 7129741-B	1 1
	69/	A(71)	R. H. L. H.	Q4109 Q4110	C9AZ 7129740-A C9AZ 7129741-A	C9AZ 7129740-B C9AZ 7129741-B	1 1
	65	B(71)		1062T	C3OZ 7129740-A	C3OZ 7129740-B	2
	66/69	B(71), X(71)	R. H.	Q3534	C6OZ 7129740-A	C6OZ 7129740-B	1
	70/71	B(71)					1
	70	X(71)					1
			L. H.	Q3535	C6OZ 7129741-A	C6OZ 7129741-B	1
	72	B(71)	R. H.	Q4731	D2OZ 7129740-A	D2OZ 7129740-B	1
			L. H.	Q4732	D2OZ 7129741-A	D2OZ 7129741-B	1
	72	L(73)	R. H.	Q4748	D2FZ 7329740-A	D2FZ 7329740-B	1
			L. H.	Q4749	D2FZ 7329741-A	D2FZ 7329741-B	1

GROUP NUMBER	YEAR	BODY TYPE	DESCRIPTION	PART NUMBER		QTY.
				RIGHT HAND	LEFT HAND	
<b>29742-3 WEATHERSTRIP - QUARTER WINDOW GLASS INNER</b>						
	65	B(62)	Inner-Use C2OZ 6229732-A and remove clips			2
<b>29744-5 WEATHERSTRIP - QUARTER WINDOW AT BELT INNER</b>						
- A -						
	69	A(62)	"Before 4/25/69"	C9AZ 6229744-B	C9AZ 6229744-B	1
	69	A(62)	"From 4/25/69"	C9AZ 6229744-B	C9AZ 6229745-B	1
	69	A(63)	"Before 12/2/68"	C9AZ 6329744-A	C9AZ 6329745-A	1
	69/70	A(63)	"From 12/2/68"	C9AZ 6329744-B	C9AZ 6329745-B	1
	69/70	A(65)		C9AZ 6529744-A	C9AZ 6529745-A	1
	69/72	A(76)	"Before 10/15/71"	C9AZ 7629744-A	C9AZ 7629745-A	1
	71/72	A(65)	"Before 10/15/71"	D1AZ 6529744-A	D1AZ 6529745-A	1
	72	A(65)	"From 10/15/71"	D2AZ 6529744-A	D2AZ 6529745-A	1
	72	A(76)	"From 10/15/71"	D2AZ 7629744-A	D2AZ 7629745-A	1
- B -						
	66/67	B(63)		C6OZ 6329744-A	★C6OZ 6329745-A Not replaced (1/75)	1
	66/67	B(76)		C6OZ 7629744-A	C6OZ 7629745-A	1
	66/67	B(62)		C6OZ 6229744-A	★C6OZ 6229745-A Not replaced (1/75)	1
	68/69	B(63)		C8OZ 6329744-A	C8OZ 6329745-A	1
	68/69	B(65)		C8OZ 6529744-B	★C8OZ 6529745-B Not replaced	1
	70	B(62)	At belt	D0OZ 6229744-A	D0OZ 6229745-A	1
	70/71	B(63)	At belt	D0OZ 6329744-A	D0OZ 6329745-A	1
	70/71	B(65)	At belt	D0OZ 6529744-A	D0OZ 6529745-A	1
	70/71	B(76)	At belt	D0OZ 7629744-A	D0OZ 7629745-A	1
	72	B(63)		D2OZ 6329744-A	D2OZ 6329745-A	1
	72	B(65)		D2OZ 6529744-A	D2OZ 6529745-A	1
- F -						
	67/68	F(65)		C7ZZ 6529744-A	C7ZZ 6529745-A	1
	67/68	F(76)		C7ZZ 7629744-A	C7ZZ 7629745-A	1
	69	F(65)	"Before 10/1/68"	C9ZZ 6529744-A	C9ZZ 6529745-A	1
	69/70	F(65)	"From 10/1/68"	C9ZZ 6529744-B	C9ZZ 6529745-B	1
	69/70	F(76)		C9ZZ 7629744-A	C9ZZ 7629745-A	1
	71/	F(63)		D1ZZ 6329744-A	D1ZZ 6329745-A	1
	71/	F(65)		D1ZZ 6529744-A	D1ZZ 6529745-A	1
	71/	F(76)		D1ZZ 7629744-A	D1ZZ 7629745-A	1
- S -						
	68	S(65)	"Before 10/2/67"	C8SZ 6529744-B	C8SZ 6529745-A	1
	68/69	S(65)	"From 10/2/67"	C8SZ 6529744-B	C8SZ 6529745-B	1
	70/71	S(65A,C)		D0SZ 6529744-A	D0SZ 6529745-A	1
	72	S		D2SZ 6529744-A	D2SZ 6529745-A	1
- X -						
	66/70	X(62)		C6OZ 6229744-A	C6OZ 6229745-A	1
<b>29752-3 GUIDE - QUARTER WINDOW - FRONT</b>						
- A -						
	65/67	A(63)		C5AZ 6329752-B	★C5AZ 6329753-B Not replaced(3-74)	1
	65/67	A(63)	5/16"-18 x 3/4" Hex. hd. screw & washer assy.	359662-S7-8 (BB575A)	359662-S7-8 (BB575A)	4
	65	A(63)	5/16"-18 x 1/2" Hex. washer head screw	376976-S(BB574M)	376976-S(BB574M)	2
	66/67	A(63)	5/16"-18 x 1 1/2" - screw & washer assy.	★380347-S2	★380347-S2	2
	71/	A(65)		D1AZ 6529752-A	D1AZ 6529753-A	1
- B -						
	68/69	B(63, 65, 76)		C8OZ 6329752-A	C8OZ 6329752-A	2
	70/71	B(63, 65, 76)		D0OZ 6529752-A	D0OZ 6529753-A	1
			Nut-1/4"-20 rivet type	376903-S40(MM120BF)	376903-S40(MM120BF)	2
			Screw-1/4"-20 x 1 1/4"-shoulder set	381742-S2(UU106A)	381742-S2(UU106A)	2
	72	B(63)		D2OZ 6329752-A	D2OZ 6329753-A	1
	72	B(65)		D2OZ 6529752-A	D2OZ 6529753-A	1

# FORD CAR PARTS

## BODY SECTION 295

7

GROUP NUMBER	YEAR	BODY TYPE	DESCRIPTION	PART NUMBER		QTY.
				RIGHT HAND	LEFT HAND	
<b>29752-3 GUIDE - QUARTER WINDOW - FRONT - continued</b>						
<b>- F -</b>						
67/68	F(65, 76)			C7ZZ 6529752-A	C7ZZ 6529753-A	1
			5/16"-18 x 3/4" Hex. head screw & washer assy.	359662-S7-8(BB575A)	359662-S7-8(BB575A)	6
			5/16"-18 Nut retainer assy.	370328-S2(MM188)	370328-S2(MM188)	6
69/70	F(65, 76)			C9ZZ 6529752-A	C9ZZ 6529753-A	1
			Screw-1/4"-20 x 1 1/4"-shoulder set	381742-S2(UU106A)	381742-S2(UU106A)	2
71/71	F(65, 76)			D1ZZ 6529752-A	D1ZZ 6529753-A	1
71/71	F(63)		W/movable quarter window			1
71/71	F(63)		W/stationary quarter window	D1ZZ 6327870-A	D1ZZ 6327871-A	1
71/71	F		Screw-shoulder set-1/4"-20 x 1 1/2"	381758-S2(UU106AA)	381758-S2(UU106AA)	2
<b>- S -</b>						
70/71	S(65A, C)			D0SZ 6529752-A	D0SZ 6529753-A	1
70/71	S(65)		Nut 1/4"-20 Rivet type	376903-S40(MM120BF)	376903-S40(MM120BF)	2
70/71	S(65)		Screw 1/4"-20 x 1 1/4" shoulder set	381742-S2(UU106-A)	381742-S2(UU106A)	2
72	S	"Before 5/8/72"		D2SZ 6529752-A	★D2SZ 6529753-A r/b D3SZ 6529753-A (1/75)	1
72	S	"From 5/8/72"		D3SZ 6529752-A	D3SZ 6529753-A	1
<b>29764-5 GUIDE - QUARTER WINDOW</b>						
<b>- A -</b>						
69/70	A(63)			★C9AZ 6329764-A Not replaced (2/75)	C9AZ 6329765-A	1
69/70	A(65, 76)			C9AZ 6529764-A	C9AZ 6529765-A	1
		71/71	A(76)			1
71/71	A(65)			D1AZ 6529764-A	D1AZ 6529765-A	1
69/70	A(63, 65, 76)		1/4"-20 Nut	33795-S7(M49)	33795-S7(M49)	AR
69/70	A(63, 65, 76)		No. 8 Lockwasher	34803-S8(X60)	34803-S8(X60)	1
69/70	A(63, 65, 76)		Screw-1/4"-20 x 1 1/4" set	381742-S2(UU106A)	381742-S2(UU106A)	2
69/70	A(63, 65, 76)		Screw & washer-1/4"-20 x 5/8" hex. head	57472-S40(B339V)	57472-S40(B339V)	AR
<b>- B -</b>						
68/69	B(63, 65, 76)			C8OZ 6329764-A	C8OZ 6329765-A	1
<b>- F -</b>						
65/66	F(65, 76)			C5ZZ 6529764-C	★C5ZZ 6529765-C Not replaced (3-74)	1
			5/16"-18 x 3/4" Hex. head screw & washer assy.	359662-S7-8(BB575A)	359662-S7-8(BB575A)	4
			5/16"-18 Nut retainer	370328-S2(MM188)	370328-S2(MM188)	4
<b>29778-9 BRACKET - QUARTER WINDOW GUIDE - LOWER - Also refer to Group 298A35</b>						
69/70	A(63)			C9AZ 6329778-A	C9AZ 6329778-A	2
69/70	A(65, 76)			C9AZ 6529778-A	C9AZ 6529779-A	1
68/69	B(63, 65, 76)			C8OZ 6329778-A	C8OZ 6329778-A	2
70/71	S(65A, C)			D0SZ 6529778-A	D0SZ 6529778-A	2
72	S			D2SZ 6529778-A	D2SZ 6529778-A	2
<b>29790-1 SUPPORT - QUARTER WINDOW GUIDE LOWER</b>						
70/71	B(63, 65, 76)			D0OZ 6529790-A	D0OZ 6529790-A	2
72	B(63)			D2OZ 6329790-B	D2SZ 6329791-B	1
72	B(65)			D2OZ 6529790-A	D2OZ 6529790-A	2
71/71	F(65, 76)			D1ZZ 6529790-A	D1ZZ 6529790-A	2
		71/71	F(63)			2
71/71	F		Nut & retainer-1/4"-20	374251-S2(MM206H)	374251-S2(MM206H)	4

GROUP NUMBER	YEAR	BODY TYPE	DESCRIPTION	PART NUMBER		QTY.
				RIGHT HAND	LEFT HAND	
<b>29796-7 MOULDING - QUARTER WINDOW OUTSIDE UPPER</b>						
- A -						
	71/	A(65)	W/o vinyl roof -incl. w/strip	D1AZ 6529796-A	D1AZ 6529797-A	1
	71/	A(65)	W/ vinyl roof -incl. w/strip	D1AZ 6529796-B	D1AZ 6529797-B	1
- B -						
	70/71	B(62, 65)		D0OZ 6529796-A	D0OZ 6529797-A	1
	70/71	B(63)		D0OZ 6329796-A	D0OZ 6329797-A	1
	72	B(65)	Incl. w/strip	D2OZ 6529796-A	D2OZ 6529797-A	1
- F -						
	69/70	F(63)		C9ZZ 6329796-A	C9ZZ 6329797-A	1
			Nut-5/16" self tapping	382110-S100 (MM284X)	382110-S100 (MM284X)	2
- L -						
	71/72	L(62, 64)-w/pivoting window - "Before 5/1/72"	Bright finish	D1FZ 6229796-A	D1FZ 6229797-A	1
	72	L(62, 64)-w/pivoting window - "From 5/1/72"	Not required			
- P -						
	70	P(62)	Bright finish	D0DZ 6229796-B	D0DZ 6229797-B	1
			Screw No. 8-18 x 3/4" oval head	55974-S45(U316D)	55974-S45(U316D)	2
			Nut 5/16" self threading	382110-S100(MM284X)	382110-S100(MM284X)	2
	70/	P(62)	Paint to match	D0DZ 6229796-A	D0DZ 6229797-A	1
	71/	P(62)	Bright finish	D1DZ 6229796-A	D1DZ 6229797-A	1
- S -						
	70/71	S(65)		D0SZ 6529796-A	D0SZ 6529797-A	1
	72	S	"Before 11/22/71"	D2SZ 6529796-A	D2SZ 6529797-A	1
	72	S	"From 11/22/71" Includes weatherstrip	D2SZ 6529796-B	D2SZ 6529797-B	1
GROUP NUMBER	YEAR	BODY TYPE	DESCRIPTION	PART NUMBER		QTY.
<b>29805 STOP - QUARTER WINDOW - LOWER</b>						
	69/70	A(62, 63)		C9AZ 6329805-A		2
	71/	A(65)		D1AZ 6529805-A		1
	68/71	B(63, 65, 76)		C8OZ 6329805-A		2
	70	B(62)		D0OZ 6229805-A		2
	72	B(65)		D2OZ 6529805-A		2
	71/	F(63)	W/movable quarter window	D1ZZ 6529805-A		1
	71/	F(65, 76)				1
	72	S	Angular-on run	D2SZ 6529805-A		1
	72	S	Square-on guide	D1ZZ 6529805-A		2
	68/70	X		C8DZ 6229805-A		2
<b>29814 STOP - WINDOW - FRONT GUIDE</b>						
	65/69	A(63), B(63, 76)	5/16"-18 x 1/2" Hex. washer head screw	376976-S7-8(BB574M)		2
			Bumper	378760-S(CC41)		2
	66/67	B(63, 76)	Upper front	C6OZ 6529814-A		2
	68/69	B(63, 65, 76)				2
<b>298A24 RETAINER - QUARTER WINDOW GLASS FRONT RUN - UPPER</b>						
	69	A(62)		C9AZ 62298A24-A		2
	66/67	B(62)		C6OZ 62298A24-A		2
	66/70	X(62)				2
	70	B(62)		D0OZ 62298A24-A		2
			Screw-No. 8-15 x 5/8" self tap-fillister head	52554-S8(U230)		6
	65/69	A(62)	Screw-No. 8-15 x 1/2" hex. washer head	*42126-S2		6
	66/70	B(62)				6
	66/70	X(62)				6
<b>298A26-7 RETAINER - QUARTER WINDOW GLASS UPPER RUN - REAR</b>						
	66/67	B(62)	R. H.	C6OZ 62298A26-A		1
	66/70	X(62)				1
			L. H.	C6OZ 62298A27-A		1
	66/70	B(62), X(62)	Screw-No. 8-15 x 1/2"-hex. washer head	*42126-S2		4or6



# FORD CAR PARTS

## BODY SECTION 295

9

GROUP NUMBER	YEAR	BODY TYPE	DESCRIPTION	PART NUMBER	QTY.	
<b>298A28-9 RETAINER - QUARTER WINDOW GLASS UPPER RUN - FRONT</b>						
	69	A(62)	R. H.	C9AZ 62298A28-A	1	
			L. H.	C9AZ 62298A29-A	1	
	65/70	A(62), B(62), X(62)	No. 8-15 x 1/2" Hex. washer head screw	52554-S8(U230)	4	
	66/67	B(62)	R. H.	C6OZ 62298A28-A	1	
	66/70	X(62)			1	
			L. H.	C6OZ 62298A29-A	1	
	70	B(62)	R. H. -Paint to match	D0OZ 62298A28-A	1	
			L. H.	D0OZ 62298A29-A	1	
<b>298A36 BRACKET - QUARTER WINDOW FRONT GUIDE LOWER - Also refer to Group 29778-9</b>						
	65/66	F(65, 76)		C5ZZ 65298A36-A	2	
	69/70	F(65, 76)		C9ZZ 65298A36-A	2	
	65/70	F(65, 76)	5/16"-18 x 3/4" Hex. washer head screw & washer assy.	359662-S7-8(BB575A)	4	
<b>29846-7 CLAMP - QUARTER VENT WINDOW</b>						
	69/70	F(63)	R. H.	C9ZZ 6329846-A	1	
			L. H.	C9ZZ 6329847-A	1	
<b>29848 BUSHING - QUARTER VENT WINDOW UPPER PIVOT</b>						
	69/70	F(63)		C9ZZ 6329848-A	2	
<b>29854 BRACKET - QUARTER WINDOW GUIDE ROLLER MOUNTING</b>						
	71/	A(65)		D1AZ 6529854-A	2	
<b>298A56-7 BRACKET - QUARTER WINDOW GUIDE LOWER</b>						
	70/71	B(63, 65, 76)		D0OZ 65298A56-A	2	
	72	B(63)		D2OZ 63298A56-A	2	
	72	B(65)	R. H.	D2OZ 65298A56-A	1	
			L. H.	D2OZ 65298A57-A	1	
	71/	F(63)	W/movable quarter window	D1ZZ 65298A56-A	1	
	71/	F(65, 76)			1	
<b>298A64 SLIDE - QUARTER WINDOW GUIDE - INCLUDES ATTACHING PARTS</b>						
	69/70	F(65, 76)		C9ZZ 65298A64-A	2	
GROUP NUMBER	YEAR	BODY TYPE	DESCRIPTION	PART NUMBER		QTY.
				RIGHT HAND	LEFT HAND	
<b>29892 ROLLER - QUARTER WINDOW GUIDE</b>						
	72	B(63)	"Before 12/1/71" Lower	★D2OZ 6329892-A r/b D2OZ 6329892-C (10/74)	D2OZ 6329892-A	4
	72	B(63)	"Before 12/1/71" Upper	D2OZ 6329892-B	D2OZ 6329892-B	2
	72	B(63)	"From 12/1/71" Upper and lower	D2OZ 6329892-C	D2OZ 6329892-C	6
<b>29900-1 CHANNEL - QUARTER WINDOW GLASS</b>						
	67/69	A(62)	Refer to Group 29958-9			
	70	B(62)		D0OZ 6229900-A	D0OZ 6229901-A	1
	66/67	B(62)		C6OZ 6229900-A	C6OZ 6229901-A	1
	66/70	X(62)				1
<b>29904-5 WEATHERSTRIP - QUARTER WINDOW REAR STATIONARY GLASS</b>						
	69/	A(71)		C9AZ 7129904-A	C9AZ 7129905-A	1
	66/71	B(71)		C6OZ 7129904-A	C6OZ 7129905-A	1
	72	B(71)	Refer to Group 19562 in Paint Section			
	66/70	X(71)		C6DZ 7129904-A	C6DZ 7129905-A	1
	72	L(73)	"Before 4/15/72"	D2FZ 7329904-A	D2FZ 7329905-A	1
	72	L(73)-	"From 4/15/72 to 5/1/72"	D2FZ 7329904-B	D2FZ 7329905-B	1
	72	L(73)	"From 5/1/72"	D2FZ 7329904-C	D2FZ 7329905-C	1
<b>29952-3 RETAINER - QUARTER WINDOW FRONT WEATHERSTRIP</b>						
	71/	A(65)		D1AZ 6529952-A	D1AZ 6529953-A	1
	70/71	B(63)		D0OZ 6329952-A	D0OZ 6329953-A	1
	70/71	B(65)		D0OZ 6529952-A	D0OZ 6529953-A	1
	70/71	B(76)		D0OZ 7629952-A	D0OZ 7629953-A	1
	72	B(63)		D2OZ 6329952-A	D2OZ 6329952-A	2
	72	B(65)		D2OZ 6529952-A	D2OZ 6529952-A	2
	71/	F(63)		D1ZZ 6329952-A	D1ZZ 6329953-A	1
	71/	F(65, 76)		D1ZZ 6529952-A	D1ZZ 6529953-A	1
	70/71	S(65)		D0SZ 6529952-A	D0SZ 6529953-A	1
	72	S		D2SZ 6529952-A	D2SZ 6529952-A	2

GROUP NUMBER	YEAR	BODY TYPE	DESCRIPTION	PART NUMBER		QTY.
				RIGHT HAND	LEFT HAND	
<b>29958-9</b>	<b>CHANNEL - QUARTER WINDOW - LOWER - Also Refer to Group 29700</b>					
	- A -					
	65/66	A(76)		C5AZ 7629958-B	C5AZ 7629959-B	1
	68	A(63)		C8AZ 6329958-A	★C8AZ 6329959-A Not replaced (3-74)	1
	68	A(65)		C8AZ 6529958-A	★C8AZ 6529959-A Not replaced (12/74)	1
	69	A(62)		C9AZ 6229958-A	C9AZ 6229959-A	1
	- F -					
	65/66	F(65)		C5ZZ 6529958-A	★C5ZZ 6529959-A Not replaced (12/74)	1
	67/68	F(65)		C7ZZ 6529958-A	C7ZZ 6529959-A	1
	65/66	F	5/16"-20 x 1/2" Hex. hd. screw	350211-S(BB413)	350211-S(BB413)	2
	65/68	F	No. 8-32 x 1/2" Pan head	51764-S8(U366)	51764-S8(U366)	2
<b>29958-9</b>	<b>FRAME SET - QUARTER WINDOW OUTER</b>					
	66	F(GT 350)		S2MS 29958-A	S2MS 29959-A	1
<b>29962-3</b>	<b>CHANNEL - QUARTER WINDOW - UPPER- INCLUDES ATTACHING PARTS</b>					
	65/66	A(76)		C5AZ 7629962-B	C5AZ 7629963-B	1
	65/68	F(65)		C5ZZ 6529962-A	C5ZZ 6529963-A	1
	65/66	S(76)		C4SZ 7629962-A	C4SZ 7629962-A	2
	65/66	S	No. 8-32 x 1/2" Oval head screw	50398-S13(U121)	50398-S13(U121)	2
<b>29962-3</b>	<b>FRAME SET - QUARTER WINDOW INNER</b>					
	66	F(GT 350)		S2MS 29962-A	S2MS 29963-A	1
<b>29968-9</b>	<b>STOP - QUARTER WINDOW - Also Refer to Group 262A84</b>					
	- A -					
	69/70	A(63)	Upper-front	C9AZ 6329968-A	C9AZ 6329968-A	2
	69/	A(65, 76)	Upper-front	D1AZ 6329968-A	D1AZ 6329968-A	2
	69/70	A(65, 76)	Upper-rear	C9AZ 6529968-A	C9AZ 6529968-A	2
	71/	A(65, 76)	Upper-rear	D1AZ 6529968-B	D1AZ 6529969-B	1
	69/70	A(63, 65, 76)	Screw & washer-1/4"-20	57472-S40(B339V)	57472-S40(B339V)	2
	- B -					
	68/69	B(76)	Rear	C8OZ 7629968-A	C8OZ 7629968-A	2
	70	B(63, 65, 76)	Upper	D0OZ 6529968-A	D0OZ 6529968-A	2or4
	71	B(63, 65, 76)	Upper	D1OZ 6529968-A	D1OZ 6529968-A	4
	72	B(63)	Upper-front	D2OZ 6329968-A	D2OZ 6329968-A	2
	72	B(65)	Upper	D2OZ 6529968-A	D2OZ 6529968-A	2
	- F -					
	69/70	F(65, 76)	Upper-rear	C9ZZ 6529968-A	C9ZZ 6529969-A	1
			Upper-front	C9ZZ 6529968-B	C9ZZ 6529968-B	2
	71/	F	Upper-front	D1ZZ 6529968-A	D1ZZ 6529968-A	2
	71/	F	Upper-rear	D1ZZ 6529968-B	D1ZZ 6529968-B	2
	- S -					
	67/69	S(65)		C7SZ 6529968-A	C7SZ 6529968-A	2
	71	S(65A, C)				2
			Bumper	378760-S(CC41)	378760-S(CC41)	2
			1/4"-20 x 1/2" Pan head screw & washer assy.	373460-S7(BB629)	373460-S7(BB629)	2
	70	S(65A, C)	Upper	D0SZ 6529968-A	D0SZ 6529968-A	4
	72	S		D2SZ 6529968-A	D2SZ 6529969-A	1
GROUP NUMBER	YEAR	BODY TYPE	DESCRIPTION	PART NUMBER		QTY.
<b>29994</b>	<b>BUMPER - WINDOW STOP - Also refer to Group 21762</b>					
	65/	A(63)	Cut to fit from C5AZ 6221762-B		★	2
	66/67	B(63)	Quarter			2
	66	B(54, 71), X(54, 71)	Rear door			2
	66/67	B(76)	Quarter			2
	68/70	A(65)	Quarter			2
	68/70	X(54, 71)	Rear door			2
	68/	B(54, 71)	Rear door		C7MY 6329994-A	2
	69/70	A(71)	Tail gate			2
<b>29998</b>	<b>BRACKET - QUARTER WINDOW STOP</b>					
	67/69	S(65)			C7SZ 6529998-A	2
			1/4"-20 x .62" Hex. head bolt & washer assy.		★374371-S2	4

# FORD CAR PARTS

## BODY SECTION 300

1

GROUP NUMBER	YEAR	BODY TYPE	DESCRIPTION	PART NUMBER	QTY.
<b>30010 RUN - QUARTER WINDOW GLASS - UPPER</b>					
	67/68	S(65)		C7SZ 6530010-A	2
	69	S(65A, C)			2
<b>30014-5 BRACKET - QUARTER WINDOW REGULATOR DRIVE ARM</b>					
	71/	A(65)	R.H. L.H.	D1AZ 6530014-A D1AZ 6530015-A	1 1
	72	B(63)		D2OZ 6330014-A	2
	72	B(65)	R.H. L.H.	D2OZ 6530014-A D2OZ 6530015-A	1 1
	72	S	R.H. L.H.	D2SZ 6530014-A D2SZ 6530015-A	1 1
<b>30046 BRACKET - QUARTER WINDOW GLASS RUN RETAINER</b>					
	72	B(65)		D2OZ 6530046-A	2
	72	S		D2SZ 6530046-A	2
<b>30056-7 EXTENSION - QUARTER WINDOW GUIDE</b>					
	69/70	F(65, 76)	R.H. L.H. Screw-set-1/4"-20 x 1 1/4"	C9ZZ 6530056-A C9ZZ 6530057-A 381742-S2(UU106A)	1 1 2
<b>30068 COVER - QUARTER WINDOW STOP</b>					
	69/70	F(65, 76)		C9ZZ 6530068-A	2
			Screw-washer hex. head-1/4"-20 x 1/2"	383049-S100 (BB551FA)	2
<b>30104-5 RUN - QUARTER WINDOW GLASS</b>					
- A -					
	69	A(62)		C9AZ 6230104-A	2
	69/70	A(63)		C9AZ 6330104-A	2
	69/	A(65, 76)		C9AZ 6530104-A	2
	69/	A(62, 63, 65, 76)	Screw & washer-hex. head-1/4"-20 x 5/8"	57472-S40(B339V)	2
- B -					
	66/67	B(62)		C6OZ 6230104-A	2
	68/69	B(63, 65, 76)		C8OZ 6330104-A	2
	70	B(62)		D0OZ 6230104-A	2
	72	B(65)	R.H. L.H.	D2OZ 6530104-A D2OZ 6530105-A	1 1
- S -					
	72	S	R.H. L.H.	D2SZ 6530104-A D2SZ 6530105-A	1 1
- X -					
	65	X(59, 62)	Refer to Group 21550		
	66/70	X(62)		C6OZ 6230104-A	2
<b>30146-7 WEATHERSTRIP - QUARTER WINDOW - FRONT</b>					
- A -					
	65/66	A(63)		C5AZ 6330146-B	1
	68	A(65)		C5AZ 6330147-B	1
	65/68	A(76)			1
	67/68	A(63)		C7AZ 6330146-B	1
	70	A(63, 76)		C7AZ 6330147-B	1
	71/	A(76)		D0AZ 6330146-A	1
	70	A(65)		D0AZ 6330147-A	1
	71/	A(65)		D0AZ 6530146-A	1
	65/68	A(63, 65, 76)	No. 8-18 x 3/8" Cross recess pan head screw	D1AZ 6530146-A 52720-S8(U380)	1 2
				D1AZ 6530147-A 52720-S8(U380)	1 2
- B -					
	66/67	B(63, 76)		C6OZ 6330146-A	1
	70/71	B(63)		C6OZ 6330147-A	1
	70/71	B(65)		D0OZ 6330146-A	1
	70/71	B(76)		D0OZ 6530147-A	1
	72	B(63)		D0OZ 7630146-A	1
	72	B(65)		D2OZ 6330146-A	1
				D2OZ 6330147-A	1
				★D2OZ 6530146-A	1
				★D2OZ 6530147-A	1
				r/b D5OZ 6530146-A (1/75)	
				r/b D5OZ 6530147-A (1/75)	
- F -					
	65/68	F(65)		C5ZZ 6530146-B	1
			No. 8-32 x 1/2" Cross recess pan head screw	C5ZZ 6530147-B 51764-S8(U366)	1 2

**BODY  
SECTION 300**
**FORD CAR PARTS**

GROUP NUMBER	YEAR	BODY TYPE	DESCRIPTION	PART NUMBER		QTY.
				RIGHT HAND	LEFT HAND	
<b>30146-7</b>	<b>WEATHERSTRIP - QUARTER WINDOW - FRONT - continued</b>					
	- F -					
	65/68	F(76)		C5ZZ 7630146-B	C5ZZ 7630147-B	1
	71/	F(63)		D1ZZ 6330146-A	D1ZZ 6330147-A	1
	70/	F(65, 76)		D1ZZ 6530146-A	D1ZZ 6530147-A	1
	- S -					
	65/66	S(63)		C4SZ 6330146-D	C4SZ 6330147-D	1
	70/71	S(65)		D0OZ 6330146-A	D0OZ 6330147-A	1
	72	S		D2SZ 6530146-A	D2SZ 6530147-A	1
	- X -					
	65	X(76)		C3DZ 7630146-A	C3DZ 7630147-A	1
<b>30153</b>	<b>SPACER - QUARTER WINDOW GARNISH MOULDING - REAR</b>					
	68/69	B(65A, B, E)		C8OZ 6530153-A	C8OZ 6530153-A	2
<b>302A00</b>	<b>SPACER - VENT WINDOW HANDLE</b>					
	70	F(63)	Quarter	D0ZZ 63302A00-A	D0ZZ 63302A00-A	2
	70/71	B(54, 57, 62, 71)	Front door			2
<b>302A02</b>	<b>RETAINER - QUARTER VENT WINDOW LATCH</b>					
	71/	L(62, 64)		D1FZ 62302A02-A	D1FZ 62302A02-A	2
	72	L(73)	"Before 5/1/72"	Bright finish	D2FZ 73302A02-A	2
	72	L(73)	"From 5/1/72"	Black chromium finish	D2FZ 73302A02-B	2
	70/	P(62)		For die cast latch	D0DZ 62302A02-A	2
				For plastic latch	D0DZ 62302A02-B	2
<b>302A06</b>	<b>SPACER - QUARTER WINDOW LATCH RETAINER</b>					
	70/	P(62)		D0DZ 62302A06-A	D0DZ 62302A06-A	4
	71/	L				AR
<b>302A08-9</b>	<b>STRIKER and CABLE - QUARTER WINDOW - INCLUDES ATTACHING PARTS</b>					
	69/70	F(63)		C9ZZ 63302A08-A	C9ZZ 63302A09-A	1
<b>302A10</b>	<b>RETAINER - QUARTER WINDOW HINGE INNER</b>					
	71/	L		D1FZ 62302A10-A	D1FZ 62302A10-A	4
<b>30212</b>	<b>RETAINER - WINDOW HANDLE</b>					
	69/70	F(63)	Quarter	C9ZZ 6330212-A	C9ZZ 6330212-A	2
	70/71	B(54, 57, 62, 71)	Front door vent			2
	70/	P	Quarter	D0DZ 6230212-B	D0DZ 6230212-B	2
	71/	L				2
	72	L(73)-w/o framed quarter window				2
	72	L(73)-w/framed quarter window		D2FZ 7330212-A	D2FZ 7330212-A	2
<b>302A12</b>	<b>RETAINER - QUARTER WINDOW HINGE</b>					
	72	L(73)		D2FZ 73302A12-A	D2FZ 73302A12-A	4
	72	L(62, 64)		D2FZ 62302A12-A	D2FZ 62302A12-A	4
<b>302A14</b>	<b>HINGE - QUARTER WINDOW - INNER</b>					
	71/72	L(62, 64)	"Before 5/1/72"	D1FZ 62302A14-A	D1FZ 62302A14-A	4
	72	L(62, 64)	"Before 5/1/72"			
	72	L(62, 64)	"From 5/1/72"	Serviced in assy. only - refer to Group 30218-9		
	72	L(73)	"Before 5/1/72"	D2FZ 73302A14-A	D2FZ 73302A14-A	2
	72	L(73)	"From 5/1/72"	Serviced in assy. only - refer to Group 30218-9		
<b>302A16</b>	<b>RETAINER - QUARTER WINDOW HINGE - OUTER</b>					
	71/72	L		D1FZ 62302A16-A	D1FZ 62302A16-A	4
<b>30218-9</b>	<b>FRAME - QUARTER WINDOW</b>					
	71/72	L(62, 64)-w/pivoting quarter window	"Before 5/1/72"	Paint to match	D1FZ 6230218-B	D1FZ 6230219-B
	71/72	L(62, 64)-w/pivoting quarter window	"Before 5/1/72"	Bright finish	D1FZ 6230218-A	D1FZ 6230219-A
	72	L(62, 64)-w/pivoting quarter window	"From 5/1/72"	Serviced in assy. - group 29706-7	★	★
	70/	P(62)		D0DZ 6230218-B	D0DZ 6230219-B	1

# FORD CAR PARTS

**BODY  
SECTION 300**

3

GROUP NUMBER	YEAR	BODY TYPE	DESCRIPTION	PART NUMBER		QTY.
				RIGHT HAND	LEFT HAND	
<b>30228-9 RETAINER - QUARTER WINDOW WEATHERSTRIP</b>						
	69/70	F(63)		C9ZZ 6330228-B	C9ZZ 6330229-B	1
<b>302A28 RETAINER - QUARTER WINDOW HINGE FRONT</b>						
	71/	L	Rivet blind-3/16" x 1/2"	383614-S100(SS45HX)	383614-S100(SS45HX)	4
<b>30238 SHAFT - VENT WINDOW HANDLE</b>						
	69/70	F(63)		C9ZZ 6330238-A	C9ZZ 6330238-A	2
	70/71	B(54, 57, 62)	Front door vent			2
<b>30246 COVER - QUARTER WINDOW LOWER PIVOT</b>						
	69/70	F(63)		C9ZZ 6330246-B	C9ZZ 6330246-B	2
<b>30248-9 WEATHERSTRIP - QUARTER WINDOW</b>						
	71/	L(62, 64)		D1FZ 6230248-A	*D1FZ 6230249-A r/b D3FZ 6230249-A (1/75)	1
	72	L(73)-w/o framed quarter window		D2FZ 7330248-A	D2FZ 7330249-A	1
	72	L(73)-w/framed quarter window		D2FZ 7330248-B	D2FZ 7330249-B	1
	70/	P(62)	Black	D0DZ 6230248-AB	D0DZ 6230249-AB	1
			Blue	D0DZ 6230248-BB	D0DZ 6230249-BB	1
			Red	D0DZ 6230248-CB	D0DZ 6230249-CB	1
			Nugget	D0DZ 6230248-EB	D0DZ 6230249-EB	1
	71/	P(62)	Gray Gold	D1DZ 6230248-B	D1DZ 6230249-B	1
			Vermillion	D1DZ 6230248-A	D1DZ 6230249-A	1
	72	P(62)	Beige	D2DZ 6230248-C	D2DZ 6230249-C	1
			Ginger	D2DZ 6230248-A	D2DZ 6230249-A	1
			Tan	D2DZ 6230248-D	D2DZ 6230249-D	1
			White	D2DZ 6230248-B	D2DZ 6230249-B	1
<b>30252 HANDLE - QUARTER WINDOW - INCLUDES ATTACHING PARTS</b>						
	69/70	F(63)		C9ZZ 6330252-A	C9ZZ 6330252-A	2
<b>30254-5 WEATHERSTRIP - QUARTER WINDOW - INNER REAR</b>						
	71/72	A(65)	"Before 11/10/71"	D1AZ 6530254-B	D1AZ 6530255-B	1
	72	A(65)	"From 11/10/71"	D2AZ 6530254-A	D2AZ 6530255-A	1
	72	B(65)		D2OZ 6530254-A	D2OZ 6530255-A	1
	67/68	S(65)		C7SZ 6530254-A	C7SZ 6530255-A	1
	69	S(65A, C)				1
	72	S		D2SZ 6530254-A	D2SZ 6530255-A	1
<b>30264-5 PIVOT - QUARTER WINDOW - UPPER</b>						
	69/70	F(63)		C9ZZ 6330264-A	*C9ZZ6330265-A Not replaced (3/75)	1
<b>30270-1 RETAINER - QUARTER WINDOW WEATHERSTRIP</b>						
	71/	L(62, 64)		D1FZ 6230270-A	D1FZ 6230271-A	1
<b>30272-3 BRACKET - QUARTER WINDOW LOWER PIVOT</b>						
	69/70	F(63)		C9ZZ 6330272-A	C9ZZ 6330273-A	1
			Screw-No. 8-15 x 3/4" pan head	52742-S8(U385)	52742-S8(U385)	2
<b>30304-5 DRIVE ASSY. - QUARTER WINDOW REGULATOR - ELECTRIC -Also Refer to Group 23394-5</b>						
	71/	F		C9WY 6530304-A	C9WY 6530304-A	2
	65/66	S	Includes motor	C5SZ 6330304-A	C5SZ 6330305-A	1
			No. 12-24 x 1/2" Hex. washer head screw	378608-S8(UU52D)	378608-S8(UU52D)	6
			7/16"-20 x .88" Screw (set)	*378113-S34	*378113-S34	2
			7/16"-20 Nut (stamped)	45219-S(M173)	45219-S(M173)	2
			For regulator drive gear kit refer to group 234A24			
	67/	S(65)	Serviced only in assy.- refer to Group 30380-1			

**BODY  
SECTION 300**
**FORD CAR PARTS**

GROUP NUMBER	YEAR	BODY TYPE	DESCRIPTION	PART NUMBER		QTY.
				RIGHT HAND	LEFT HAND	
<b>303A04 EXTENSION-QUARTER WINDOW REGULATOR</b>						
	69/70	F(76-GT350/500)		C9ZZ 76303A04-A	C9ZZ 76303A04-A	2
<b>30306-7 REGULATOR ASSY. - QUARTER WINDOW - MANUAL</b>						
<b>- A -</b>						
	65/66	A(76)		C5AZ 7630306-C	★C5AZ 7630307-C Not replaced (3-74)	1
	65/67	A(63)	Includes handle screw	C8MY 6330306-B	C8MY 6330307-B	1
	67	A(76)	Includes handle screw	C8AZ 7630306-B	★C5AZ 7630307-C Not replaced (3-74)	1
	68	A(63, 65)		C8AZ 6330306-B	C8AZ 6330307-B	1
	69	A(62)		C9AZ 6230306-A	C9AZ 6230307-A	1
	69/70	A(63)		C9AZ 6330306-A	C9AZ 6330307-A	1
	69/70	A(65, 76)		C9AZ 6530306-A	C9AZ 6530307-A	1
	71/	A(65)		D1AZ 6530306-A	D1AZ 6530307-A	1
	71/	A(76)		C9AZ 6530306-A	C9AZ 6530307-A	1
	65/67	A(62, 63, 76)	5/16"-18 x 1/2" Hex. washer head screw	376976-S7-8(BB574M)	376976-S7-8(BB574M)	8
<b>- B -</b>						
	66/67	B(63)	Includes handle screw	C6OZ 6330306-B	★C6OZ 6330307-B Not replaced (1/75)	1
	66/67	B(62, 63, 76)	5/16"-18 x 1/2" Hex. washer head screw	376976-S7-8(BB574M)	376976-S7-8(BB574M)	8
	68/71	B(63, 65, 76)		C8OZ 6330306-B	C8OZ 6330307-B	1
	70	B(62)		D0OZ 6230306-A	D0OZ 6230307-A	1
	72	B(63)		D2OZ 6330306-A	D2OZ 6330307-A	1
	72	B(65)		D2OZ 6530306-A	D2OZ 6530307-A	1
<b>- F -</b>						
	65/67	F(65, 76)		C5ZZ 6530306-A	C5ZZ 6530307-A	1
			5/16"-18 x 1/2" Hex. washer head screw	376976-S7-8(BB574M)	376976-S7-8(BB574M)	8
	68	F(65, 76)		C8ZZ 6530306-A	C8ZZ 6530307-A	1
	69/70	F(65, 76)		C9ZZ 6530306-B	C9ZZ 6530307-B	1
	71/	F(65, 76)		D1ZZ 6530306-A	D1ZZ 6530307-A	1
<b>- S -</b>						
	68	S(65)		C8SZ 6530306-B	C8SZ 6530307-B	1
	69	S(65A, C)				1
	70/71	S(65)		C9ZZ 6530306-B	C9ZZ 6530307-B	1
	72	S		D2SZ 6530306-A	D2SZ 6530307-A	1
	65/67	S	5/16"-18 x 1/2" Hex. washer head screw	376976-S7-8(BB574M)	376976-S7-8(BB574M)	8
<b>- X -</b>						
	68/70	X(62)		C8DZ 6230306-B	C8DZ 6230307-B	1
	66/67	X(62)	5/16"-18 x 1/2" Hex. washer head screw	376976-S7-8(BB574M)	376976-S7-8(BB574M)	8
	66/70	X	Hex. head washer screw - 5/16"-24 x 5/8"	359605-S8(BB590)	359605-S8(BB590)	AR
<b>303A06 EXTENSION - QUARTER PANEL WINDOW REGULATOR</b>						
	68	F(76-GT 350/500)		S8MS 76303A06-A	S8MS 76303A06-A	1
<b>303A06-7 BRACKET - QUARTER WINDOW REGULATOR EQUALIZER ARM</b>						
	69/70	A(63)		C9AZ 63303A06-A	C9AZ 63303A07-A	1
	71/	A(65)		D1AZ 65303A06-A	D1AZ 65303A06-A	1
	68/70	X(62)		C8DZ 62303A06-A	C8DZ 62303A06-A	1
	65/70	A, B, X	3/8" Flat washer	351405-S7(XX147)	351405-S7(XX147)	2
			5/16" I. D. x 7/8" O. D. Washer (special)	★357789-S7	★357789-S7	2
			5/16"-18 Hex. nut	33797-S7(M50)	33797-S7(M50)	4
<b>303B07-8 BRACKET - QUARTER REGULATOR EXTENSION SUPPORT</b>						
	68	F(76-GT 350/500)		S8MS 76303B07-A	S8MS 76303B08-A	1
<b>30308 BRACKET - QUARTER TRIM PANEL SUPPORT</b>						
	69/70	F(76-GT 350/500)		C9ZZ 7630308-A	C9ZZ 7630308-B	1

GROUP NUMBER	YEAR	BODY TYPE	DESCRIPTION	PART NUMBER	QTY.
<b>30322 HANDLE - WINDOW REGULATOR</b>					
Handles are serviced less knob unless otherwise indicated - for knob refer to Group 23352					
- A -					
	65	A(76A)	Chrome knob	C5AZ 7630322-A	2
	66	A(76)			2
	68/69	A(76)		C8AZ 7630322-A	2
	70/72	A(76)	"Before 10/1/71"	D0AZ 7630322-A	2
	72	A(76)	"From 10/1/71"	D2AZ 7630322-A	2
			Includes clear plastic knob		
- B -					
	65	B(62, 65)	Black knob	C4DZ 6230322-A	2
			Retainer-spring	357550-S(QQ1)	2or4
	66	B(76)		C6OZ 7630322-A	2
	68/69	B(76)		C8AZ 7630322-A	2
	70/71	B	Front, rear and quarters	D0AZ 7630322-A	AR
	72	B(63, 65)	Includes clear plastic knob	D2AZ 7630322-A	2
- F -					
	65/67	F(65, 76)	Chrome knob	C5ZZ 6530322-B	2
			No. 10-24 x 3/4" Socket set lock screw	377720-S7(UU29D)	2
	68/70	F		C8ZZ 6530322-A	2
	71/72	F	"Before 10/1/71"	D0AZ 7630322-A	2
	72	F	"From 10/1/71"	D2AZ 7630322-A	2
			Includes clear plastic knob		
- L -					
	71/72	L	"Before 10/1/71"	D0AZ 7630322-A	2
	72	L	"From 10/1/71 to 4/3/72"	D2AZ 7630322-A	2
	72	L	"From 4/3/72"	Refer to Group 23352-3	
- P -					
	71/72	P(54)	"Before 10/1/71"	D0AZ 7630322-A	4
	72	P(54)	"From 10/1/71"	D2AZ 7630322-A	4
			Front door, rear door - includes clear plastic knob		
- S -					
	68/69	S(65)		C8ZZ 6530322-A	2
	70/72	S	"Before 10/1/71"	D0AZ 7630322-A	2
	72	S	"From 10/1/71"	D2AZ 7630322-A	2
			Includes clear plastic knob		
- X -					
	65	X(59, 62, 63, 76)	Black knob	C4DZ 6230322-A	2
			Retainer-spring	357550-S(QQ1)	2or4
<b>303A24 LATCH - QUARTER WINDOW</b>					
	70/	P(62)	Plastic with 5/32" hole	D0DZ 62303A24-C	2
	71/	L(62, 64)			2
	72	L(73)		D2FZ 73303A24-A	2
<b>30330 PIN - QUARTER WINDOW LATCH</b>					
	70/	L, P(62)	3/4" long	D0DZ 6230330-A	4
			1/2" long	D0DZ 6230330-B	2
<b>303A30-1 GUIDE - QUARTER WINDOW ACTUATOR</b>					
	65/68	F(65, 76)	R. H.	C5ZZ 65303A30-A	1
			L. H.	C5ZZ 65303A31-A	1
			5/16"-18 x 1/2" Hex. washer head screw	376976-S7-8(BB574M)	4
<b>30351 SPRING - QUARTER WINDOW REGULATOR COUNTERBALANCE</b>					
	65/69	A(76)		C5AZ 6230351-A	2
	65/68	A(62)			2
	69	A(62)		C9AZ 6230351-A	2
	70/	A	Refer to group 23318		
	65	B(65)		B5A 7630351-A	2
	66/67	B(62)		C6OZ 6230351-A	2
	68	B(54, 66, 71), X(54, 71)			2
	66/70	X(62)			2

GROUP NUMBER	YEAR	BODY TYPE	DESCRIPTION	PART NUMBER	QTY.	
<b>30351</b>	<b>SPRING - QUARTER WINDOW REGULATOR COUNTER BALANCE - continued</b>					
	72	B(63)		D2OZ 6330351-A	2	
	65/68	F(65, 76)		C5ZZ 6530351-A	2	
	69/	F(65, 76)		C9ZZ 6530351-A	2	
	70	S(65)			2	
	71/	P(54)			2	
GROUP NUMBER	YEAR	BODY TYPE	DESCRIPTION	PART NUMBER		QTY.
				RIGHT HAND	LEFT HAND	
<b>30380-1</b>	<b>REGULATOR ASSY. - QUARTER WINDOW - ELECTRIC - LESS MOTOR and DRIVE</b>					
	<b>- A -</b>					
	69	A(63)		C9AZ 6330380-A	C9AZ 6330380-A	1
	69/70	A(65, 76)		C9AZ 6530380-A	C9AZ 6530381-A	1
	70	A(63)		D0AZ 6330380-A	D0AZ 6330380-A	1
	71/	A(65)		D1AZ 6530380-A	D1AZ 6530381-A	1
	71/	A(76)		D1AZ 7630380-A	D1AZ 7630381-A	1
	65/67	A(62, 63, 65, 76)	Hex.washer head screw- 5/16"-18 x 1/2"	376976-S7(BB574M)	376976-S7(BB574M)	AR
	<b>- B -</b>					
	68	B(63, 76)		C8OZ 6330380-B	C8OZ 6330381-B	1
	69/71	B(63, 65, 76)				1
	72	B(63)		D2OZ 6330380-A	D2OZ 6330381-A	1
	72	B(65)		D2OZ 6530380-A	D2OZ 6530381-A	1
	<b>- F -</b>					
	71/	F		D1ZZ 6530380-A	D1ZZ 6530381-A	1
	<b>- S -</b>					
	67/69	S(65)	"From 12/19/66"	C7SZ 6530380-B	C7SZ 6530381-B	1
			Includes Motor, drive & guide assy.			
			No.10-24 x 3/8" Pan head screw & washer assy.	★54540-S2	★54540-S2	12
			Clip (wire)	379485-S(GG263)	379485-S(GG263)	2
	70/71	S(65)		D0SZ 6530380-A	D0SZ 6530381-A	1
	72	S		D2LY 6530380-A	D2LY 6530381-A	1
	65/66	S	Hex.head screw- 5/16"-24 x 1 1/8"	353483-S2(BB588)	353483-S2(BB588)	AR
<b>303A80</b>	<b>SEAL - QUARTER WINDOW REGULATOR PANEL - REAR</b>					
	65/68	A(76)		C5AZ 76303A80-A	C5AZ 76303A80-A	1
<b>30384</b>	<b>RETAINER - QUARTER WINDOW LATCH ANCHOR PLATE</b>					
	72	L(73)		D2FZ 7330384-A	D2FZ 7330384-A	\$ 1
<b>30394-5</b>	<b>SUPPORT - QUARTER WINDOW REGULATOR MOTOR</b>					
	70	S(65)		D0SZ 6530394-A	D0SZ 6530395-A	1
	71	S(65)		D1SZ 6530394-A	D1SZ 6530395-A	1
<b>303A98</b>	<b>CASE - QUARTER WINDOW REGULATOR CABLE - LOWER</b>					
	67/	S(65)	Improvise from A9A 17543-A	*	*	
<b>30484-5</b>	<b>EXTENSION - QUARTER WINDOW REGULATOR PANEL</b>					
	66/67	B(76)		C6OZ 7630484-A	C6OZ 7630485-A	1
	65/68	F(76)		C5ZZ 7630484-A	C5ZZ 7630485-A	1
	69/70	F(76)		C9ZZ 7630484-A	C9ZZ 7630485-A	1
	71/	F(76)		D1ZZ 7630484-A	D1ZZ 7630485-A	1
<b>305A02-3</b>	<b>BRACKET - QUARTER WINDOW GLASS</b>					
	71/	A(65)		D1AZ 65305A02-A	D1AZ 65305A03-A	1
	72	B(63)		D2OZ 63305A02-A	D2OZ 63305A03-A	1
	71/	F(63)	W/stationary window	D1ZZ 63305A02-A	D1ZZ 63305A03-A	1
	71/	F(65, 76)		D1ZZ 65305A02-A	D1ZZ 65305A03-A	1
	71/	F(63)	W/movable window			1
<b>30504-5</b>	<b>FRAME - QUARTER WINDOW GLASS</b>					
	69	A(62)		C9AZ 6230504-A	C9AZ 6230505-A	1
	66/67	B(62)		C6OZ 6230504-A	C6OZ 6230505-A	1
	70	B(62)		D0OZ 6230504-A	D0OZ 6230505-A	1
	66/70	X(62)		C6OZ 6230504-A	C6OZ 6230505-A	1



# FORD CAR PARTS

## BODY SECTION 300

7

GROUP NUMBER	YEAR	BODY TYPE	DESCRIPTION	PART NUMBER		QTY.
				RIGHT HAND	LEFT HAND	
<b>30510</b>	<b>BRACKET - QUARTER WINDOW GLASS CHANNEL - REAR</b>					
	68	A(63, 65)		C6VY 6530510-A	C6VY 6530510-A	1
	69/70	A(65, 76)		C9AZ 6530510-A	C9AZ 6530510-A	1
	71/	A(76)				1
	70/71	B(63, 65, 76)		D0OZ 6530510-A	D0OZ 6530510-A	1
	70	A, B	Screw No. 8-32 x 1/2" oval head tapping	50398-S13(U121)	50398-S13(U121)	4
<b>305A26-7</b>	<b>WEATHERSTRIP - BODY SIDE WINDOW</b>					
	66/	U(98)	Without window mouldings	C6TZ 98305A26-B	C6TZ 98305A27-B	1
	67/	U(98)	With window mouldings	C7TZ 98305A26-C	C7TZ 98305A27-C	1
<b>30550</b>	<b>BRACKET - QUARTER WINDOW GLASS CHANNEL</b>					
	68	A(63, 65, 76), B(63, 65, 76)	Rear	C6VY 6530550-A	C6VY 6530550-A	1
	69	A(62)		C9AZ 6230550-A	C9AZ 6230550-A	1
	65/67	A	Pan head screw-No. 8-32 x 3/8"	52720-S8(U380)	52720-S8(U380)	AR
	65/	A	No. 8-32 x 1/2" Cross recess oval head screw	50398-S13(U121)	50398-S13(U121)	4
	69	A	Screw & washer-hex. head-1/4"-20 x 5/8"	57472-S40(B339V)	57472-S40(B339V)	AR
	66/67	B(62)		C6OZ 6230550-A	C6OZ 6230550-A	1
	66/70	X(62)				1
	70	B(62)		C9AZ 6230550-A	C9AZ 6230550-A	1
	66/67	B(62, 63, 76), X(62)	No. 8-32 x 3/8" Cross recess flat head screw	358477-S8(BB93)	358477-S8(BB93)	2or4
<b>30584</b>	<b>COVER - QUARTER WINDOW LATCH BRACKET RETAINER</b>					
	71/	L		D0DZ 6230584-B	D0DZ 6230584-B	1
	70/	P(62)	Use with die cast latch	D0DZ 6230584-A	D0DZ 6230584-A	1
			Use with plastic latch	D0DZ 6230584-B	D0DZ 6230584-B	1
<b>30698</b>	<b>STOP - QUARTER WINDOW LOWER</b>					
	72	B(63)		D2OZ 6330698-A	D2OZ 6330698-A	1
<b>30702</b>	<b>RECEPTACLE ASH</b>					
	- A -					
	65/67	A(62, 63)	Quarter-Less cover	C5AZ 6230702-A	C5AZ 6230702-A	1
	65/67	A(54, 57, 71)	Rear door			1
	65/67	A	Front door			1
	65/68	A(76)	Less cover	C5AZ 7630702-A	C5AZ 7630702-A	2
	71	A(53, 57)	Front seat back	D1MY 6530702-A	D1MY 6530702-A	1
	- B -					
	65	B(62, 65)	Quarter-Less cover	C5AZ 6230702-A	C5AZ 6230702-A	1
	65/67	B(54, 71)	Rear door			1
	66	B	Front door			1
	66/67	B(62, 63)	Quarter			1
	66/71	B(76)	Less cover	C5AZ 7630702-A	C5AZ 7630702-A	1
	- F -					
	65/67	F(65)	Quarter-Less cover	C5AZ 6230702-A	C5AZ 6230702-A	1
	68	F(63A, B, 65A, B, 76A, B)	On console			1
	71/	F				1
	66/68	F(76)	Less cover	C5AZ 7630702-A	C5AZ 7630702-A	1
	68	F(GT 350/500)	Saddle (Brown)	S8MS 6330702-B	S8MS 6330702-B	1
	- L -					
	71/	L		C5AZ 6230702-A	C5AZ 6230702-A	1
	- P -					
	70/	P	Quarter	C5AZ 6230702-A	C5AZ 6230702-A	1
	- S -					
	67	S(57)	Rear door	C5AZ 6230702-A	C5AZ 6230702-A	1
	68/71	S	Rear door or quarter- For R.H. & L.H.	D1MY 6530702-A	D1MY 6530702-A	1
	72	S	Front door-rear			1
	- X -					
	66/67	X(54, 71)	Rear door	C5AZ 6230702-A	C5AZ 6230702-A	1
	66/67	X(62)	Quarter			1
	66	X	Front door			1

**BODY  
SECTION 300**
**FORD CAR PARTS**

GROUP NUMBER	YEAR	BODY TYPE	DESCRIPTION	PART NUMBER		QTY.
				RIGHT HAND	LEFT HAND	
<b>30714 RETAINER - ASH RECEPTACLE</b>						
65/66		A(62, 63B), F(65)	Quarter-Includes cover	C5AZ 6230714-A	C5AZ 6230714-A	1
65/66		A(except 57F, 63C, F, 76B)	Front door			1
65/66		A(54, 57B, 71)	Rear door			1
65		B(54, 71)	Rear door			1
65		B(62, 65)	Quarter			1
66		B(62, 63), X(62)	Quarter			1
66		B(54, 71), X(54, 71)	Rear door			1
66		B(76)	Front door-with A/C			1
66		B, X	Front door			1
71		L	Quarter			1
70/		P	Quarter			1
65/66		A(63C, D, F)	Quarter-Includes cover	C5AZ 6330714-A	C5AZ 6330714-A	1
65/66		A(57F)	Rear door			1
65/66		A(57F, 63C, F, 76B)	Front door			1
67		A(54A, B, E, 57B, 71), B(54, 71), X(54B, 71B)	Rear door-Includes cover-Bright Finish	C7AZ 6230714-A	C7AZ 6230714-A	2
67		A(62), B(62, 63), X(62)	Quarter			2
67		A(54C, 57F), S(57)	Rear door-Includes cover-Center Brush Finish	C7AZ 6330714-A	C7AZ 6330714-A	2
67		A(63C, J)	Quarter			2
68		F(63A, B, 65A, B, 76A, B)	Console			2
71/		F	Quarter	D1ZZ 6530714-A	D1ZZ 6530714-A	2
68/69		S(65)	Quarter -includes cover	C8SZ 6530714-A	C8SZ 6530714-A	2
65		X(54, 59, 62, 63, 71)		C4MY 6530714-A	C4MY 6530714-A	2
65		X(76)		C1AB 7630714-A	C1AB 7630714-A	2
65/70		F(76)				2
<b>30716 SHIELD - ASH RECEPTACLE</b>						
68/		S		C2VY 5730716-A	C2VY 5730716-A	4
<b>30728 SPRING - ASH RECEPTACLE RETAINER COVER TENSION</b>						
68/69		S	Front door, rear door and quarter	C8VZ 5330728-A	C8VZ 5330728-A	3
70/		S	Rear door & quarter			2
<b>310A02-3 PANEL - QUARTER TRIM FINISH</b>						
- F -						
69		F(63E)	Light Wood grain	C9ZZ 65310A02-A	C9ZZ 65310A03-A	1
69		F(63E)	Dark Wood grain	C9ZZ 65310A02-B	C9ZZ 65310A03-B	1
- S -						
68/69		S(65)	Upper-Includes attaching parts	C8SZ 65310A02-A	C8SZ 65310A03-A	1
<b>310A62-3 EXTENSION - QUARTER TRIM PANEL TO PACKAGE TRAY</b>						
69/70		F(63)	Without folding rear seat -paint to match	C9ZZ 63310A62-A	C9ZZ 63310A63-A	1
<b>31066-7 RETAINER - QUARTER TRIM PANEL</b>						
- A -						
65/66		A(71)	Paint to match	C5AZ 7131066-A	C5AZ 7131066-A	2
			No. 8-15 x 1/2" Cross recess pan head screw	52726-S13(U381)	52726-S13(U381)	4
67/68		A(71) "Before 12/11/67"	Upper front	★C7AZ 7131066-B Not replaced (3-74)	C7AZ 7131067-B	1

GROUP NUMBER	YEAR	BODY TYPE	DESCRIPTION	PART NUMBER		QTY.
				RIGHT HAND	LEFT HAND	
<b>31066-7 RETAINER - QUARTER TRIM PANEL - continued</b>						
- A -						
68	A(71)	'From 12/11/67"	Upper front	★C7AZ 7131066-C Not replaced (3-74)	★C7AZ7131067-C Not replaced (3-74)	1
			No. 8-15 x 3/8" Cross recess pan head screw	52720-S8(U380)	52720-S8(U380)	5
69/	A(71)		Refer to Group 31200-1			
- B -						
66/67	B(71)		Upper	★C6OZ 7131066-A Not replaced (3-74)	C6OZ 7131067-A	1
66/67	B(76)		Chrome	★C6OZ 7631066-A Not replaced (3-74)	C6OZ 7631067-A	1
66	B(62, 63), X(62B, C)		Chrome	C6OZ 6231066-A	C6OZ 6231067-A	1
67	B(62, 63), X(62)					1
66/67	B(62, 63, 71, 76)		No. 8-15 x 3/8" Cross recess pan head screw	52720-S8(U380)	52720-S8(U380)	4or6
- X -						
66	X(62)		Paint to match	C6DZ 6231066-A	C6DZ 6231067-A	1
66/70	X(71)			Refer to Group 47176		
			Paint to match		C6DZ 7131067-A	1
66/70	X(62)		Chrome	C6OZ 6231066-A	C6OZ 6231067-A	1
66/70	X(62, 71)		No. 8-15 x 3/8" Cross recess pan head screw	52720-S8(U380)	52720-S8(U380)	4or6
<b>310A84-5 BRACKET - QUARTER TRIM PANEL - LOWER</b>						
65/70	F(63)			C5ZZ 63310A84-B	C5ZZ 63310A85-B	1
69/70	F(76A)			C9ZZ 76310A84-A	C9ZZ 76310A84-A	2
71	F(63)			D1ZZ 63310A84-A	D1ZZ 63310A85-A	1
71/	F(65)			D0DZ 62310A84-A	D0DZ 62310A84-A	4
71/	F(76)			D1ZZ 76310A84-A	D1ZZ 76310A84-A	2
72	F(63)			C5ZZ 63310A84-A	C5ZZ 63310A85-A	1
70/	P(62)			D0DZ 62310A84-A	D0DZ 62310A84-A	4
70/	P(62)		No. 8-15 x 5/8" fill.screw	52554-S8(U230)	52554-S8(U230)	4
72	U(98)			D2BZ 1031084-A	D2BZ 1031084-A	8
<b>31090-1 SHIELD - QUARTER TRIM WATER</b>						
65/	A, S, X		Refer to Group 20318			
65/	B(62, 65)					
65/	F(65, 76)					
65/68	F(63)			★C5ZZ 6331090-A Not replaced (7-73)	C5ZZ 6331091-A	1
<b>310A90-1 RETAINER - QUARTER TRIM PANEL UPPER REAR</b>						
65/66	F(63)			C5ZZ 63310A90-A	C5ZZ 63310A91-A	1
		No. 8-18 x 3/8" Cross recess pan head screw	52720-S8(U380)	52720-S8(U380)	4	
70	F(65)			C9WY 65310A90-A	C9WY 65310A90-A	2
<b>310A94 RETAINER - QUARTER TRIM LOWER REAR PANEL LOWER - FRONT</b>						
65/68	F(63)			C5ZZ 63310A94-A	C5ZZ 63310A94-A	1
69/70	F(63)		Without folding rear seat	C9ZZ 63310A94-A	C9ZZ 63310A94-A	1
<b>310A96 RETAINER - QUARTER TRIM FRONT PANEL - LOWER</b>						
67/68	A(71)			C7AZ 71310A96-A	C7AZ 71310A96-A	1
69/	A(71)			C9AZ 71310A96-A	C9AZ 71310A96-A	1
69/70	F(63)		Without folding rear seat	C9ZZ 63310A96-A	C9ZZ 63310A96-A	2
<b>310A98-9 RETAINER - QUARTER TRIM FRONT PANEL - CENTER</b>						
67/68	A(71)			C7AZ 71310A98-A	C7AZ 71310A99-A	1
69/	A(71)			C9AZ 71310A98-A	C9AZ 71310A98-A	1
69/70	F(63)		Without folding rear seat	C9ZZ 63310A98-A	C9ZZ 63310A98-A	1
69/	A		Screw-No. 8-18 x 1/2"	52413-S13(U316)	52413-S13(U316)	AR
<b>311A00-1 RETAINER - QUARTER TRIM LOWER FRONT PANEL UPPER - FRONT</b>						
69/70	F(63)		Without folding rear seat	C9ZZ 63311A00-A	C9ZZ 63311A01-A	1

**BODY  
SECTION 300**
**FORD CAR PARTS**

GROUP NUMBER	YEAR	BODY TYPE	DESCRIPTION	PART NUMBER		QTY.
				RIGHT HAND	LEFT HAND	
<b>311A00-1</b>	<b>RETAINER - QUARTER TRIM FRONT PANEL - UPPER</b>					
	67/68	A(71)		C7AZ 71311A00-A	C7AZ 71311A01-A	1
	69/	A(71)		C9AZ 71311A00-A	C9AZ 71311A01-A	1
	69/	A(71)	Screw-oval head- No. 8-18 x 1/2"	52413-S13(U316)	52413-S13(U316)	AR
<b>311A14-5</b>	<b>RETAINER - QUARTER TRIM UPPER FRONT PANEL LOWER</b>					
	65/68	F(63)		C5ZZ 63311A14-A	C5ZZ 63311A15-A	2
			No. 8-18 x 3/8" Cross recess pan head screw	52720-S8(U380)	52720-S8(U380)	8
<b>311A22-3</b>	<b>BRACKET - QUARTER TRIM PANEL RETAINER - REAR</b>					
	66/67	B(71), X(71)			C6OZ 71311A23-A	1
	68/71	B(71)				2
	72	B(63, 65)		D2OZ 65311A22-A	D2OZ 65311A22-A	1
	70/71	P(62)	No. 8- 15 x 5/8" Fillister head screw	52554-S8(U230)	52554-S8(U230)	4
	70/	P(62)	Upper rear	D2DZ 62311A22-A	D2DZ 62311A22-A	1
<b>311A24</b>	<b>BRACKET - QUARTER TRIM PANEL</b>					
	66/67	B(76)		C6OZ 76311A24-A	C6OZ 76311A24-A	1
	68/69	B(76)	Upper	C8OZ 76311A24-A	C8OZ 76311A24-A	1
	68/69	B(76)	Lower	C8OZ 76311A24-B	C8OZ 76311A24-B	1
	69/70	F(76)		C9ZZ 76311A24-A	C9ZZ 76311A24-A	1
	70/	P(62)	Upper front	D0DZ 62311A24-A	D0DZ 62311A24-A	1
	70/	P(62)	No. 8-15 x 5/8" fillister head screw	52554-S8(U230)	52554-S8(U230)	4
<b>311A0-1</b>	<b>MOULDING - QUARTER TRIM PANEL</b>					
	67	A(63J)		C7AZ 6331140-A	C7AZ 6331140-A	1
	67	A(76)		C7AZ 7631140-A	C7AZ 7631141-A	1
<b>311A62-3</b>	<b>EXTENSION - QUARTER TRIM PANEL TO PACKAGE TRAY</b>					
	69/70	F(63)	Without folding rear seat	C9ZZ 63311A62-A	C9ZZ 63311A63-A	1
<b>31168</b>	<b>CLIP - QUARTER TRIM PANEL RETAINER</b>					
	65/66	A(71)		C5AZ 7131168-A		1
	67/68	A(71)	"Before 12/11/67"	C7AZ 7131168-A	C7AZ 7131168-A	2or4
	68	A(71)	On wheel well cover			2
	68	A(71)	"From 12/11/67"	C8AZ 7131168-A	C8AZ 7131168-A	2or4
			No. 8-15 x 1/2" Cross recess pan head screw	52726-S13(U381)	52726-S13(U381)	2
<b>31172-3</b>	<b>RETAINER - QUARTER TRIM PANEL REAR - Paint to match</b>					
	65/66	A(71)			C5AZ 7131173-E	1
			No. 8-15 x 1/2" Cross recess pan head screw		52726-S13(U381)	3
	67/68	A(71)		C7AZ 7131172-A	C7AZ 7131173-A	1
	69	A(62)		C9AZ 6231172-A	C9AZ 6231172-A	1
	69/	A(71)		C9AZ 7131172-A	C9AZ 7131173-A	1
	69/	A(71)	Screw-self tapping- drilled end-No. 8- 18 x 3/4"	382413-S2(UU148A)	382413-S2(UU148A)	
	72	B(71)		D2OZ 7131172-A	D2OZ 7131173-A	1
	71/	L(64)		D1FZ 6431172-A	D1FZ 6431173-A	1
	72	L(73)		D2FZ 7331172-A	D2FZ 7331173-A	1
<b>311A78</b>	<b>BRACKET - QUARTER TRIM PANEL UPPER CENTER</b>					
	69	A(76)		C9AZ 76311A78-A	C9AZ 76311A78-A	1
<b>311A90</b>	<b>EXTENSION - QUARTER TRIM PANEL TO PACKAGE TRAY - Paint to match</b>					
	69/70	F(63)	W/o folding rear seat	C9ZZ 63311A90-A	C9ZZ 63311A90-A	1
<b>311A96-7</b>	<b>EXTENSION - QUARTER TRIM PANEL - Paint to match</b>					
	71	L(62)		D1FZ 62311A96-A	D1FZ 62311A97-A	1
	72	L(62)	"Before 5/15/72"	D2FZ 62311A96-A	D2FZ 62311A97-A	1
	72	L(62)	"From 5/15/72"	D2FZ 62311A96-B	D2FZ 62311A97-B	1
	70/71	P(62)		D0DZ 62311A96-A	D0DZ 62311A97-A	1
	71	P(54)		D1DZ 54311A96-A	D1DZ 54311A97-A	1

# FORD CAR PARTS

## BODY SECTION 300

11

GROUP NUMBER	YEAR	BODY TYPE	DESCRIPTION	PART NUMBER		QTY.
				RIGHT HAND	LEFT HAND	
<b>311A96-7 EXTENSION - QUARTER TRIM PANEL - continued - Paint to match</b>						
	72	P(54)	"Before 3/1/72"	D2DZ 54311A96-A	D2DZ 54311A97-A	1
	72	P(54)	"From 3/1/72"	D2DZ 54311A96-B	D2DZ 54311A97-B	1
	72	P(62)	"Before 3/1/72"	D2DZ 62311A96-A	D2DZ 62311A97-A	1
	72	P(62)	"From 3/1/72"	D2DZ 62311A96-B	D2DZ 62311A97-B	1
<b>311A98 BRACKET - QUARTER TRIM PANEL TO FLOOR - Refer to Group 310A84-5</b>						
<b>31200-1 RETAINER - QUARTER TRIM PANEL - UPPER</b>						
	69/	A(71)		D2AZ 7131200-A	D2AZ 7131201-A	1
	72	B(71)	Smooth steel	D2OZ 7131200-A	D2OZ 7131201-A	1
	72	B(71)	Textured steel	D2OZ 7131200-B	D2OZ 7131201-B	1
<b>31210-1 FILLER - QUARTER TRIM PANEL TO QUARTER REGULATOR PANEL - REAR</b>						
	65/68	A(63C)		C5AZ 6331210-A	C5AZ 6331211-A	1
			No. 8-15 x 1/2" Cross recess panhead screw	52726-S13(U381)	52726-S13(U381)	10
<b>31214-5 MOULDING - QUARTER TRIM PANEL - LOWER</b>						
	69	A(65A)		C9YZ 6531214-A	C9YZ 6531215-A	1
	70	A(65A)		D0AZ 6531214-A	D0AZ 6531215-A	1
	71/	A(65K)				1
<b>31218 REINFORCEMENT - QUARTER TRIM PANEL</b>						
	66/71	B(71)		C6OZ 7131218-A	C6OZ 7131218-A	2
<b>31226 COVER - QUARTER TRIM AT LUGGAGE COMPARTMENT DOOR PROP</b>						
	71/	L(64)		D1FZ 6431226-A	D1FZ 6431226-A	2
<b>312A40-1 RETAINER ASSY. - BODY SIDE TRIM PANEL UPPER EDGE</b>						
	72	U(98)-Ranger		D2BZ 10312A40-A	D2BZ 10312A41-A	1
<b>31284 BRACKET - QUARTER TRIM PANEL - UPPER RETAINER</b>						
	68	A(71)	R. H. side only	C8AZ 7131284-A		1
<b>31296-7 REINFORCEMENT - QUARTER TRIM PANEL LOWER</b>						
	72	B(63, 65)		D2OZ 6531296-A	D2OZ 6531297-A	1
<b>31322-3 MOULDING - QUARTER TRIM PANEL - BELT - Paint to match</b>						
	66/70	X(71)		C6DZ 7131322-A	C6DZ 7131323-A	1
<b>31392 SPACER - QUARTER TRIM PANEL</b>						
	67/68	S(65)		C7SZ 6531392-A	C7SZ 6531392-A	4
	69	S(65A, C)				4
<b>31412-3 RETAINER - QUARTER TRIM PANEL UPPER EDGE - Paint to match</b>						
	66	B(71)		★C6OZ 7131412-A	C6OZ 7131413-A	1
				Not replaced (7/73)		
	67/69	B(71)		C7OZ 7131412-A	C6OZ 7131413-A	1
	70/71	B(71)		D0OZ 7131412-A	C6OZ 7131413-A	1
<b>31424-5 BRACKET - QUARTER TRIM PANEL TO WHEELHOUSE</b>						
	69/70	F(65)		C9ZZ 6531424-A	C9ZZ 6531425-A	1
<b>31462 REINFORCEMENT - QUARTER TRIM PANEL UPPER EDGE</b>						
	69	F(65)		C9ZZ 6531462-A	C9ZZ 6531462-A	2
	72	U(98)		D2BZ 1031462-A	D2BZ 1031462-A	1
<b>31464 REINFORCEMENT - QUARTER TRIM PANEL UPPER EDGE - REAR</b>						
	69	F(65)		C9ZZ 6531464-A	C9ZZ 6531464-A	2
GROUP NUMBER	YEAR	BODY TYPE	DESCRIPTION	PART NUMBER		QTY.
<b>31468 SUPPORT - QUARTER TRIM PANEL</b>						
	68/69	B(71)			C8OZ 7131468-A	1
	70/71	B(71)			D0OZ 7131468-A	1

**BODY  
SECTION 300**
**FORD CAR PARTS**

GROUP NUMBER	YEAR	BODY TYPE	DESCRIPTION	PART NUMBER		QTY.
				RIGHT HAND	LEFT HAND	
<b>31490-1</b>	<b>CAP - QUARTER TRIM PANEL - UPPER - INCLUDES ATTACHING PARTS</b>					
	68	F(65B)	Paint to match	C7WY 6531490-B	C7WY 6531491-B	1
	66/70	X(71)	Paint to match	C6DZ 7131490-A	C6DZ 7131491-A	1
			No. 8-15 x 1/2" Cross recess oval head screw	52344-S13(U292)	52344-S13(U292)	2
GROUP NUMBER	YEAR	BODY TYPE	DESCRIPTION	PART NUMBER		QTY.
<b>31500</b>	<b>COMPARTMENT - STORAGE - Paint to match</b>					
	71/	A(71)		D1AZ 7131500-B		1
<b>31518</b>	<b>HINGE - STORAGE COMPARTMENT DOOR</b>					
	71/	A(71)		D1AZ 7131518-A		1
<b>31560</b>	<b>DOOR - STORAGE COMPARTMENT - Paint to match</b>					
	71/	A(71)		D1AZ 7131560-B		1
GROUP NUMBER	YEAR	BODY TYPE	DESCRIPTION	PART NUMBER		QTY.
<b>316A02-3</b>	<b>PANEL - QUARTER ARM REST FINISH - INCLUDES ATTACHING PARTS - Also Refer to Group 31796</b>					
	69	A(62, 63, 65, 76)		C9AZ 62316A02-A	C9AZ 62316A02-A	2
	68/71	S(65)		C8SZ 65316A02-A	C8SZ 65316A03-A	1
	67/71	S(65)	Stud fastener	358592-S2(HH17N)	358592-S2(HH17N)	4
<b>31608-9</b>	<b>SUPPORT - QUARTER ARM REST</b>					
	67	A(62)		C7AZ 6231608-A	C7AZ 6231609-A	1
	67/68	A(63)		★C7AZ 6331608-A	C7AZ 6331609-A	1
				Not replaced (3-74)		
<b>31644</b>	<b>PANEL - QUARTER ARM REST FINISH - LOWER</b>					
	69	A(65A)	Teak	C9AZ 6531644-A	C9AZ 6531644-A	2
	69	A(62, 63, 65A, C, 76)	Aqua-cloth & vinyl base	C9AZ 6231644-B1K	C9AZ 6231644-B1K	2
			Black-cloth & vinyl base	C9AZ 6231644-B1A	C9AZ 6231644-B1A	2
			Blue-cloth & vinyl base	C9AZ 6231644-B1B	C9AZ 6231644-B1B	2
			Ivy Gold-cloth & vinyl base	C9AZ 6231644-B1G	C9AZ 6231644-B1G	2
			Nugget Gold-cloth & vinyl base	C9AZ 6231644-B1Y	C9AZ 6231644-B1Y	2
			Red-cloth & vinyl base	C9AZ 6231644-B1D	C9AZ 6231644-B1D	2
			White-cloth & vinyl base	C9AZ 6231644-B1W	C9AZ 6231644-B1W	2
GROUP NUMBER	YEAR	BODY TYPE	DESCRIPTION	PART NUMBER		QTY.
<b>31700</b>	<b>LATCH - STORAGE COMPARTMENT DOOR</b>					
	72	A(71)	Refer to group 11598			
	72	B(71)		D2OZ 7131700-A		1
<b>31710</b>	<b>STRIKER - STORAGE COMPARTMENT DOOR LATCH</b>					
	72	A(71)	Refer to group 105A90			
	72	B(71)		D2OZ 7131710-A		1
GROUP NUMBER	YEAR	BODY TYPE	DESCRIPTION	PART NUMBER		QTY.
<b>31796</b>	<b>MOULDING - QUARTER ARM REST</b>					
	69	A(62, 63, 65, 76)		C9AZ 6231796-A	C9AZ 6231796-A	2
<b>31840</b>	<b>RETAINER - QUARTER ARM REST FINISH PANEL</b>					
	69	A(62)		C9AZ 6231840-A	C9AZ 6231840-A	4
<b>32222</b>	<b>RAIL - BODY SIDE - INCLUDES ATTACHING PARTS</b>					
	69	B(66A, B)		C9OZ 6632222-A	C9OZ 6632222-A	2
<b>32224</b>	<b>SUPPORT - BODY SIDE RAIL TOP - INCLUDES ATTACHING PARTS</b>					
	69	B(66A, B)		C9OZ 6632224-A	C9OZ 6632224-A	2
<b>32240-1</b>	<b>SUPPORT - BODY SIDE RAIL END - INCLUDES ATTACHING PARTS</b>					
	69	B(66A, B)	Rear	C9OZ 6632240-A	C9OZ 6632241-A	1
	69	B(66A, B)	Front	C9OZ 6632241-A	C9OZ 6632240-A	1
<b>32242</b>	<b>PAD - BODY SIDE RAIL END SUPPORT</b>					
	69	B(66A, B)		C9OZ 6632242-A	C9OZ 6632242-A	4

# FORD CAR PARTS

## BODY SECTION 400

GROUP NUMBER	YEAR	BODY TYPE	DESCRIPTION	PART NUMBER	QTY.
<b>40010</b>		<b>LIFTGATE - Less Paint, Trim and Glass</b>			
	72	L(73)	"Before 2/14/72" With handle	D2FZ 7340010-A	1
	72	L(73)	"From 2/14/72" Less handle - for handle refer to Group 43400	D2FZ 7340010-C	1
	66/67	U(98)		C7TZ 9840010-A	1
<b>40104</b>		<b>MOULDING - LUGGAGE COMPARTMENT DOOR</b>			
	66	A(54A, 57B, 63B, 76A)	Lower - includes attaching parts	C6AZ 5440104-A	1
<b>40110</b>		<b>DOOR - LUGGAGE COMPARTMENT - Less latch and hinges - drill holes as required</b>			
		- A -			
	65	A(except 71)		C5AZ 6240110-B	1
	66	A(except 63, 71)			1
	67	A(except 63, 71)		C7AZ 6240110-B	1
	67	A(63)		C7AZ 6340110-B	1
	68	A(except 63, 71)	Fill moulding holes when not required	C8AZ 6240110-A	1
	68	A(63)		C8AZ 6340110-A	1
	69	A(except 71)		C9AZ 6240110-A	1
	70	A(except 71)		D0AZ 6240110-A	1
	71	A(except 71)		D1AZ 6540110-A	1
	72	A(except 71)		D2AZ 6540110-A	1
	70/	A(except 71)	Bumper (round rubber)-1/2"	371496-S(CC2)	2
		- B -			
	66/67	B(except 71)		C6OZ 6240110-C	1
	68/69	B(63)		C8OZ 6340110-A	1
	68/69	B(54, 65, 76)		C9OZ 5440110-A	1
	70/71	B(except 63, 66, 71)		D0OZ 6540110-A	1
	70/71	B(63)		D1OZ 6340110-A	1
	72	B(except 71, 97) - "Before 8/11/71"		D2OZ 6540110-A	1
	72	B(except 71, 97)- "From 8/11/71"		D3OZ 6540110-B	1
	70/	B	5/16"-18 x 1 3/16" Nut & retaining assy. - "J" shape	379831-S2(MM192M)	4
		- F -			
	65/66	F(63)		C5ZZ 6340110-A	1
	65/66	F(65, 76)		C5ZZ 6540110-A	1
	67/68	F(63)		C7ZZ 6340110-C	1
	67/68	F(65 except GT/CS and 63 except GT350/500, 76 except GT350/500)		C7ZZ 6540110-C	1
	68	F(63-GT 350/500)		S8MS 6340110-A	1
	69/70	F(63 exc. GT 350/500)	Includes moulding holes	D0ZZ 6340110-A	1
	70	F(63)	Less moulding holes	D0ZZ 6340110-B	1
	69/70	F(63-GT 350/500)		C9ZZ 6340110-C	1
	69/70	F(65)		C9ZZ 6540110-A	1
	69/70	F(76 exc. GT 350/500)			1
	69/70	F(76-GT 350/500)		C9ZZ 7640110-A	1
	71/72	F(63) "Before 3/1/72"	r/b (1 ea.) D2ZZ 6340110-A, D2ZZ 6343629-A, D2ZZ 65433A28-A and (2) 375203-S(SS44) (6-72)	★D1ZZ 6340110-A	1
	72	F(63) "From 3/1/72"	Includes instruction sheet	D2ZZ 6340110-A	1
	71/72	F(65, 76) "Before 3/1/72"	r/b (1 ea.) D2ZZ 6540110-A, C9ZZ 16098-A, D2ZZ 6543629-A, D2ZZ 65433A28-A and (2) 375203-S(SS44) (6-72)	★D1ZZ 6540110-A	1
	72	F(65, 76) "From 3/1/72"	Includes instruction sheet	D2ZZ 6540110-A	1
	67/70	F	Bumper (round rubber)-1/2"	371496-S(CC2)	2
		- L -			
	71/	L(62)		D1FZ 6240110-A	1
	71/72	L(64) "Before 7/12/71"	R/b following parts-(12-71) (1) D2FZ 6442006-A (1) D2FZ 6442701-A (1) D2FZ 6442084-A (2) D2FZ 6442840-A (1) D2FZ 6442492-A (1) D2FZ 6442842-A (1) D2FZ 6442493-A (1) D2FZ 6442843-A (1) D2FZ 6442700-A (1) D2FZ 6440110-A	★D1FZ 6440110-A	1
	71/	L(64) "From 7/12/71"	Glass size 28" x 47"	D4FZ 6440110-A	1
	71/	L(73)	Refer to Group 40010		

GROUP NUMBER	YEAR	BODY TYPE	DESCRIPTION	PART NUMBER	QTY.
<b>40110</b>	<b>DOOR - LUGGAGE COMPARTMENT - continued</b> -Less latch and hinges - drill holes as required.				
			- P -		
	71/	P(54)		D1DZ 5440110-A	1
	70/	P(62)		D0DZ 6240110-A	1
			Bumper(round rubber)-1/2"	371496-S(CC2)	2
			- S -		
	65/66	S(63)		C5SZ 6340110-A	1
	67/69	S		C7SZ 6540110-A	1
	70/71	S(57)			1
	71	S(65B, D)			1
	70	S(65)		D0SZ 6540110-A	1
	71	S(65A, C)			1
	72	S		D2SZ 6540110-A	1
			- X -		
	66/70	X(54, 62)		C7DZ 6240110-B	1
<b>40204-5</b>	<b>RETAINER - TAILGATE OUTSIDE BELT SIDE MOULDING</b>				
	70/71	B(66)	R. H.	D0OZ 6640204-A	1
			L. H.	D0OZ 6640205-A	1
<b>402A06</b>	<b>RETAINER - TAILGATE LOWER WEATHERSTRIP - Paint to Match</b>				
	68	A(71)		C8AZ 71402A06-A	1
	66/71	B(71)		C6OZ 71402A06-A	1
			No. 8-18 x 1/2" Cross recess washer head screw	381969-S2(UU89A)	2
<b>40212-3</b>	<b>COVER - TAILGATE AT BELT</b>				
	72	B(71)	R. H.	D2OZ 7140212-A	1
			L. H.	D2OZ 7140213-A	1
<b>402A12-3</b>	<b>RETAINER - TAILGATE SIDE WEATHERSTRIP</b>				
	66/67	U(98)	R. H.	C6TZ 98402A12-A	1
			L. H.	C6TZ 98402A13-A	1
			No. 8-15 x 1/2" Cross recess pan head screw	52726-S13(U381)	12
	68/	U(98)	R. H.	C8TZ 98402A12-A	1
			L. H.	C8TZ 98402A13-A	1
<b>40222</b>	<b>RETAINER - TAILGATE OUTSIDE BELT MOULDING</b>				
	70/71	B(66)		D0OZ 6640222-A	1
	72	B(97)		D2OZ 9740222-A	1
<b>40224</b>	<b>BUMPER - TAILGATE - ON PILLAR</b>				
	66/	U	For service use B7A 16993-A		
<b>40248</b>	<b>RETAINER - BACK BELT MOULDING</b>				
			REFER TO APPROPRIATE EXTERIOR MOULDING ILLUSTRATION FOR COMPLETE RETAINER PART NUMBER		
<b>40249</b>	<b>SPACER - BACK BELT MOULDING</b>				
	68/70	A(76), B(76), F(76)		C8AZ 7640249-A	AR
	71	B(76)			AR
<b>40262</b>	<b>PANEL - BACK CENTER</b>				
	72	B(97)		D2OZ 9740262-A	1
<b>40282</b>	<b>LETTER - LUGGAGE COMPARTMENT DOOR - INCLUDES ATTACHING PARTS</b>				
			- A -		
	65	A	Refer to Chassis Group 16606		
	66	A(54A, 57B, 63B, 76A)	"F"-3/4" high x 1 3/4" long-w/studs	C6AZ 5440282-A	1
			"O"-13/16" high x 1 15/16" long	C6AZ 5440282-B	1
			"R"-3/4" high x 1 13/16" long	C6AZ 5440282-C	1
			"D"-3/4" high x 1 3/4" long	C6AZ 5440282-D	1
	67	A(71A, E)	"F" - Stake type-no attaching parts necessary	C7AZ 7140282-A	1
			"O"	C7AZ 7140282-B	1
			"R"	C7AZ 7140282-C	1
			"D"	C7AZ 7140282-D	1
	67	A(54A, C, E, 57, 62E, 63, 71, 76)	"F"-1 3/4" high x 3/4" long-adhesive-backed	C7AZ 5440282-A	1
	68	A(54A, C, E, 57, 63, 65, 71, 76)			1
	69	A(54A, 57B, 63B, 65C, 71B, C, D, H, J, 76A)			1
	70	A(71B, C, D, H, J)	"O"-1 3/4" high x 11/16" long	C7AZ 5440282-B	1
	71/	A(71B, D, F)	"R"-1 3/4" high x 7/8" long	C7AZ 5440282-C	1
			"D"-1 3/4" high x 3/4" long	C7AZ 5440282-D	1
			3/32" Nut (sleeve)	378362-S102(MM228)	8



# FORD CAR PARTS

**BODY  
SECTION 400**

3

GROUP NUMBER	YEAR	BODY TYPE	DESCRIPTION	PART NUMBER	QTY.
<b>40282 LETTER - LUGGAGE COMPARTMENT DOOR - INCLUDES ATTACHING PARTS - continued</b>					
<b>- A -</b>					
69/70		A(54B, E, 62, 65M)	"F"-3/4" high x 1 11/16" long-w/studs	C9AZ 6240282-A	1
			"O"-13/16" high x 1 3/4" long	C9AZ 6240282-B	1
			"R"-3/4" high x 1 11/16" long	C9AZ 6240282-C	1
			"D"-3/4" high x 1 5/8" long	C9AZ 6240282-D	1
70		A(63H)	Refer to Group 425A02		
71		A(54B, D, 65D)	"F"-3/4" high x 1 11/16" long-w/studs	D1AZ 5440282-A	1
			"O"-13/16" high x 1 3/4" long	D1AZ 5440282-B	1
			"R"-3/4" high x 1 11/16" long	D1AZ 5440282-C	1
			"D"-3/4" high x 1 5/8" long	D1AZ 5440282-D	1
72		A(54B, D, F, 57F, 65F)	"F"-7/8" high x 1 13/16" long-w/studs-on bumper	D2AZ 6540282-A	1
			"O"-7/8" high x 2 3/64" long	D2AZ 6540282-B	1
			"R"-7/8" high x 1 15/16" long	D2AZ 6540282-C	1
			"D"-7/8" high x 1 7/8" long	D2AZ 6540282-D	1
<b>- B -</b>					
68/69		B(63)	"F"-3/4" high x 1 9/16" long-w/studs	C8OZ 6340282-A	1
			"O"-3/4" high x 1 3/4" high long	C8OZ 6340282-B	1
			"R"-3/4" high x 1 5/8" long	C8OZ 6340282-C	1
			"D"-3/4" high x 1 9/16" long	C8OZ 6340282-D	1
68/69		B(66)	"F"-5 5/16" high x 9 7/8" long-w/studs	C8OZ 6640282-A	1
			"O"-5 9/16" high x 9 9/16" long	C8OZ 6640282-B	1
			"R"-5 5/16" high x 9 3/4" long	C8OZ 6640282-C	1
			"D"-5 5/16" high x 9 7/16" long	C8OZ 6640282-D	1
70		B(66A, E)	"F"-5 5/16" high x 9 7/8" long-w/studs	D0OZ 6640282-A	1
			"O"-5 9/16" high x 9 9/16" long	D0OZ 6640282-B	1
			"R"-5 5/16" high x 9 3/4" long	D0OZ 6640282-C	1
			"D"-5 5/16" high x 9 7/16" long	D0OZ 6640282-D	1
70		B(66B)	"F"- "O"- "R"- "D"-serviced only in assembly - refer to Group 42507		
72		B(97D, K, R)	"F"-1 3/64" high x 2 5/8" long-w/studs	D2OZ 9740282-A	1
			"O"-1 7/64" high x 2 9/16" long	D2OZ 9740282-B	1
			"R"-1 3/64" high x 2 39/64" long	D2OZ 9740282-C	1
			"D"-1 3/64" high x 2 1/2" long	D2OZ 9740282-D	1
70		B(63)	Refer to Chassis Group 16606		
<b>- F -</b>					
65/67		F	"F"-1/2" high x 1 5/8" long-w/studs	C4OZ 6240282-A	1
			"O"-9/16" high x 1 11/16" long	C4OZ 6240282-B	1
			"R"-1/2" high x 1 9/16" long	C4OZ 6240282-C	1
			"D"-1/2" high x 1 9/16" long	C4OZ 6240282-D	1
67		F	Refer to Chassis Group 16606 for hood letters		
70		F(63C)	"M"	D0ZZ 6340282-A	1
			"A"	D0ZZ 6340282-B	1
			"C"	D0ZZ 6340282-C	1
			"H"	D0ZZ 6340282-D	1
			"I"	D0ZZ 6340282-E	1
71		F(63D, 65, 76, exc. Boss)	"M"	D1ZZ 6540282-A	1
			"U"	D1ZZ 6540282-B	1
72		F(63D exc. Boss)	"S"	D1ZZ 6540282-C	1
			"T"	D1ZZ 6540282-D	1
			"A"	D1ZZ 6540282-E	1
			"N"	D1ZZ 6540282-F	1
			"G"	D1ZZ 6540282-G	1
			72		F(65, 76)
<b>- S -</b>					
70/		S	Refer to Group 13489 in Chassis Section		
<b>- X -</b>					
65		X(except 66, 78)	"F"	C4DZ 16606-A	1
			"A"	C4DZ 6240282-A	1
			"L"	C4DZ 6240282-B	1
			"C"	C4DZ 6240282-C	1
			"O"	C4DZ 16606-B	1
			"N"	C4DZ 6240282-D	1
65		X(66, 78)	Refer to Chassis Group 16606		

GROUP NUMBER	YEAR	BODY TYPE	DESCRIPTION	PART NUMBER	QTY.
<b>40282</b>	<b>LETTER - LUGGAGE COMPARTMENT DOOR - INCLUDES ATTACHING PARTS - continued</b>				
	- X -				
	66/67	X(54A, 62A)	"F"	C6DZ 6240282-A	1
			"A"	C6DZ 6240282-B	1
			"L"	C6DZ 6240282-C	1
			"C"	C6DZ 6240282-D	1
			"O"	C6DZ 6240282-E	1
			"N"	C6DZ 6240282-F	1
<b>40300</b>	<b>PANEL - BACK</b>				
	67/71	B(66)		C8OZ 6640300-A	1
	65	X(66)			1
	66	X(66)		C6DZ 6640300-A	1
	65/66	X(66)	No. 8 x 3/8" Cross recess pan head screw	52720-S8 (U380)	11
<b>40304-5</b>	<b>PANEL - BODY REAR</b>				
	72	B(97)	R.H.	D2OZ 9740304-A	1
			L.H.	D2OZ 9740305-A	1
<b>40310</b>	<b>PANEL - UPPER BACK</b>				
	65/66	A(76)		C5AZ 7640310-B	1
	69/70	A(54, 62)		C9AZ 6240310-A	1
	69/70	A(57)		C9AZ 5740310-A	1
	69/70	A(63)		C9AZ 6340310-A	1
	69/70	A(65)		C9AZ 6540310-A	1
	69/70	A(76)		C9AZ 7640310-A	1
	71/	A(53, 57)		D1AZ 5740310-A	1
	71/	A(54)		D1AZ 5440310-A	1
	71/	A(65)		D1AZ 6540310-A	1
	71/72	A(76)		D1AZ 7640310-A	1
	68/69	B(54)		C8OZ 5440310-A	1
	68/69	B(63)		C8OZ 6340310-A	1
	70/71	B(54, 57, 62, 65)		D0OZ 6540310-A	1
	70/71	B(63)		D0OZ 6340310-A	1
	70/71	B(76)		D0OZ 7640310-A	1
	72	B(53, 65)		D2OZ 6540310-A	1
	65/66	F(65)		C5ZZ 6540310-B	1
	67/68	F(65)		C7ZZ 6540310-B	1
	69	F(65)		C9ZZ 6540310-A	1
	69/70	F(63)		C9ZZ 6340310-A	1
	69/70	F(76)		C9ZZ 7640310-A	1
	70	F(65)		D0ZZ 6540310-A	1
	71/	F(65)		D1ZZ 6540310-A	1
	71/	F(76)		D1ZZ 7640310-A	1
	67/71	S(57)		C7SZ 5740310-A	1
	70/71	S(65A, C)		D0SZ 6540310-C	1
	70/71	S(65B, D)		D0SZ 6540310-D	1
	72	S		D2SZ 6540310-A	1
	66/70	X(54)		C6DZ 5440310-B	1
<b>403C10</b>	<b>BRACKET - LOWER BACK FINISH PANEL</b>				
	67/71	S		C7SZ 65403C10-A	1
<b>40314</b>	<b>PANEL - UPPER BACK</b>				
	66/	U(97)		C6TZ 9740314-A	1
<b>40316</b>	<b>ORNAMENT - LOWER BACK PANEL - INCLUDES ATTACHING PARTS</b>				
	68	B(63D)	"GT"	C8OZ 6340316-A	1
	69	B(63B, E exc. Talladega)	Ford symbol insert	C9OZ 6340316-A	1
	69	B(63)-Talladega	Ⓢ	C9OZ 6340316-C	1
	69	B(63D, F)	"Torino GT" insert	C9OZ 6340316-B	1
	71	B(63H)	Cobra symbol-also used on radiator grille	D1OZ 6340316-A	1
<b>403E18-9</b>	<b>BRACKET - UPPER BACK PANEL BRACE TO ROOF RAIL</b>				
	69/70	F(63)	R. H.	C9ZZ 63403E18-A	1
			L. H.	C9ZZ 63403E19-A	1
<b>40320</b>	<b>PANEL - LOWER BACK - Refer to Group 40324</b>				
<b>403A22</b>	<b>COVER - BACK BELT MOULDING JOINT - Paint to Match</b>				
	69/70	A(65)		C9AZ 65403A22-A	1
	71/	A(53, 57)	Center - Approx. 1 1/4" wide - includes attaching parts - two tone paint or vinyl roof cover Also Refer to Group 42426	D1AZ 57403A22-A	1
	69/71	S(65B, D)		C9SZ 65403A22-A	1

# FORD CAR PARTS

## BODY SECTION 400

5

GROUP NUMBER	YEAR	BODY TYPE	DESCRIPTION	PART NUMBER	QTY.
<b>403B22 SHIELD - LOWER BACK PANEL TO BUMPER - INCLUDES ATTACHING PARTS</b>					
	71	A(except 71)		D1MZ 65403B22-A	1
<b>40324 PANEL - LOWER BACK</b>					
- A -					
	66	A(except 71)		C6AZ 6240320-A	1
	65/	A(71)	Plug (button)-1 3/4" x 3" hole size-rubber	380009-S (PP13M)	2
	67	A(except 71)		C7AZ 6240320-A	1
	67/68	A(71)		C7AZ 7140320-A	1
	68	A(except 71)		C8AZ 6240320-A	1
	69	A(except 71)		C9AZ 6240320-A	1
	70	A(except 71)		D0AZ 6240320-A	1
	71	A(54, 57F, 65D, F)		D1AZ 6540320-C	1
	71	A(53H, K, 57H, K, 65H, K, 76)- "Before 11/2/70"		D1AZ 6540320-B	1
	71	A(53H, K, 57H, K, 65H, K, 76)- "From 11/2/70"		D1AZ 6540320-D	1
	72	A(except 71)		D2AZ 6540320-A	1
	69/	A(71)		C9AZ 7140324-A	1
- B -					
	65	B(54, 62, 65)		C5OZ 6240320-A	1
	66/67	B(54, 62, 63, 76)		C6OZ 6240320-B	1
	68/69	B(54, 65, 76)		C8OZ 5440324-A	1
	68/69	B(63)		C8OZ 6340320-B	1
	70/71	B(except 66, 71)		D0OZ 6540324-A	1
	66/71	B(66, 71)	Drill holes as required for weatherstrip	C6DZ 6640324-B	1
	72	B(53, 65)		D2OZ 6540320-A	1
	72	B(63)		D2OZ 6340320-A	1
	72	B(71)		D3OZ 7140320-A	1
	72	B(97)		D2OZ 9740320-A	1
- F -					
	65/66	F		C6ZZ 6540324-A	1
	67	F(63-GT350/500)	Fiberglas -outer	S7MS 6340324-B	1
	68	F(65-GT/CS, GT 350/500)	Fiberglas -outer	C8ZZ 6540324-A	1
	67/68	F(exc. 65GT/CS, GT350/500)		C7ZZ 6540324-B	1
	67/68	F(GT 350/500)	Inner		1
	66/68	F(exc. 65 GT/CS, GT350/500)	Plug (button)-3/8" hole-steel-improvise	379286-S(PP2C)	2
	69	F(exc. GT 350/500)		C9ZZ 6540320-A	1
	70	F(exc. GT350/500)	Includes moulding holes	D0ZZ 6540320-A	1
			Less moulding holes	D0ZZ 6540320-B	1
	69/70	F(GT 350/500)	Fiberglas	C9ZZ 6540320-B	1
	71/	F		D3ZZ 6540320-A	1
- L -					
	71/	L(62, 64)		D1FZ 6240320-A	1
	72	L(73)		D2FZ 7340320-A	1
- P -					
	70/	P		D0DZ 6240324-A	1
- S -					
	65/66	S(63)		C6SZ 6340324-A	1
	67/68	S		C8SZ 6540320-A	1
	69	S		C9SZ 6540320-A	1
	70/71	S		D0SZ 6540320-A	1
	72	S		D2SZ 6540320-A	1
- U -					
	66/	U(97)		C6TZ 9740324-A	1
			Washer-flat-5/16"-1 1/8" O.D.	44725-S8(X22)	1
- X -					
	65	X(54, 62, 63, 76)		C4DZ 6240320-B	1
	66/67	X(54, 62)		C6DZ 6240320-B	1
	66	X(66)		C6DZ 6640324-B	1
	68/70	X(54, 62)		C8DZ 6240324-A	1
	66/71	X(71)	Drill holes as required for weatherstrip	C6DZ 6640324-B	1

GROUP NUMBER	YEAR	BODY TYPE	DESCRIPTION	PART NUMBER	QTY.
<b>403B26-7 PANEL - LOWER BACK PANEL TO BUMPER</b>					
	65/66	A(except 71)		C5AZ 62403B26-B	1
	72	A(except 71)		D2AZ 65403B26-A	1
	66/67	B(54, 62, 63, 76)	R. H.	C6OZ 62403B26-A	1
			L. H.	C6OZ 62403B27-A	1
	67	F	Refer to Group 40544		
	65/66	S		C6SZ 63403B26-A	1
	67	S	Rustless steel	C7SZ 65403B26-B	1
			Bolt and retainer assy.-1/4"-20 x 5/8"	371544-S100(BB879)	2
			Nut-hex.-1/4"-20	33795-S7 (M49)	2
			Lockwasher-No.10	34903-S8 (X96)	2
	68/71	S	Incl. license plate support	D0SZ 65403B26-A	1
	67/68	S	Bolt and retainer assy.-1/4"-20 5/8"	371544-S100(BB879)	2
<b>403D26 RETAINER - BACK TRIM PANEL - UPPER - Paint to Match</b>					
	70/71	B(66)	Center	D0OZ 66403D26-A	1
	72	B(97)		D2OZ 97403D26-A	1
	66	X(66B, D)	Side	C6DZ 6640471-A	1
	67	B(66B, D)			1
	70/71	B(66)	Side	D0OZ 6640471-A	2
<b>40328-9 FILLER - UPPER BACK PANEL TO UPPER OUTER PANEL</b>					
	68/71	S(57)	R. H.	C8SZ 5740328-A	1
			L. H.	C8SZ 5740329-A	1
<b>403C28 GRILLE - UPPER BACK PANEL VENT AIR</b>					
	66	S(63C, D)		C6SZ 63403C28-A	1
			Nut and washer assy.	353911-S(MM191E)	1
	67/71	S(57)		C7SZ 57403C28-A	1
	67/69	S(65)		C7SZ 65403C28-A	1
	71	S(65B, D)			1
	70/	S(65)	Refer to Group 40310		
	66/69	S	No.8-18 x 1" Cross recess oval head screw	52445-S13(U317)	7
<b>403B32 REINFORCEMENT - BACK LOWER TRIM PANEL</b>					
	72	B(97)		D2OZ 97403B32-A	1
<b>40338-9 REINFORCEMENT - LOWER BACK CENTER PANEL</b>					
	71/	L(62)	R.H.	D1FZ 6240338-A	1
			L.H.	D1FZ 6240339-A	1
<b>40354 HOUSING - FUEL FILLER PIPE - OUTER</b>					
	65/66	A(except 71)		C5AZ 6240354-B	1
	67	A(except 71)	Refer to Group 27936		
	69	A		C9AZ 6240354-A	1
	70/	A	Refer to Group 27936		
<b>403D54-5 STRAINER - UPPER BACK PANEL TO WHEELHOUSE-LOWER</b>					
	67	S	Refer to Group 41966-7		
<b>403D56 SUPPORT - LOWER BACK PANEL FINISH</b>					
	67/71	S		C7SZ 65403D56-A	1
			No.8-18 x 1/2" Hex. washer head screw	*380923-S2	4
<b>403C66-7 BRACKET - UPPER BACK PANEL BRACE</b>					
	69/70	F(63)	R. H.	C9ZZ 63403C66-A	1
			L. H.	C9ZZ 63403C67-A	1
<b>40368 RETAINER - LOWER BACK PANEL MOULDING</b>					
	65	B(54B, 62B, 65, 71)	Lower	C5OZ 6240368-A	9 or 12
	70	F	Refer to Group 291B80		
	71/	F(63 D, R, 65, 76)		D1ZZ 6540368-A	12
<b>403C68 SUPPORT - UPPER BACK PANEL TO PACKAGE TRAY</b>					
	68/71	S(57)		C8SZ 57403C68-A	1
<b>403A70 MOULDING - TAILGATE OUTSIDE BELT - Includes attaching parts</b>					
	67	B(66)		C6DZ 66403A70-B	1
	68/69	B(66)		C8OZ 66403A70-A	1
	70/71	B(66)		D0OZ 66403A70-A	1
	66/71	B(71)		C6OZ 71403A70-A	1
	72	B(71)	Incl. weatherstrip	D2OZ 71403A70-A	1
	72	B(97)	"Before 8/12/71"	D2OZ 97403A70-A	1
	72	B(97)	"From 8/12/71"	D2OZ 97403A70-B	1
	66	X(66)		C6DZ 66403A70-B	1
	66/70	X(71)		C6OZ 71403A70-A	1

# FORD CAR PARTS

**BODY  
SECTION 400**

7

GROUP NUMBER	YEAR	BODY TYPE	DESCRIPTION	PART NUMBER	QTY.
<b>40371</b>		<b>SEAL - TAILGATE INNER PANEL</b>			
	72	B(71)	1" O.D. x 1 1/4" long	D2OZ 7140371-A	1
<b>403A72</b>		<b>PLATE - LOWER BACK PANEL NAME - INCLUDES ATTACHING PARTS</b>			
	68/70	B(71B)	"Fairlane"	C8OZ 63403A72-A	1
	68/69	B(71D)			1
	69	B(63B, E)	Cobra snake -on lower back panel	C9OZ 63403A72-B	1
	69	B(65A, E)	On luggage compartment door		1
	69	B(63B, E, 65A, E)	Cobra name plate - refer to Group 42528		
	70/71	B(63H)	Refer to Group 16B196 in Chassis Section		
<b>40378-9</b>		<b>BRACE - UPPER BACK PANEL</b>			
	69/70	F(63)	R. H.	C9ZZ 6340378-A	1
			L. H.	C9ZZ 6340379-A	1
	71/	F(63)	R.H.-with folding rear seat	D1ZZ 6340378-A	1
			L.H.	D1ZZ 6340379-A	1
<b>403D90-1</b>		<b>BRACKET - UPPER BACK PANEL BRACE LOWER</b>			
	71/	F(63)	R.H.-with folding rear seat	D1ZZ 63403D90-A	1
			L.H.	D1ZZ 63403D91-A	1
<b>40396</b>		<b>BRACE - LOWER BACK PANEL FLOOR INNER</b>			
	70	A		D0AZ 6240396-A	2
<b>403A96-7</b>		<b>MOULDING - LOWER BACK PANEL EXTENSION</b>			
	72	B(53D, 63R, 65D, R)	R.H.	D3OZ 65403A96-A	1
			L.H.	D3OZ 65403A97-A	1
<b>404A06</b>		<b>WEATHERSTRIP - LIFTGATE - Also refer to Group 43964-5</b>			
	72	L(73)		D2FZ 73404A06-A	1
	66/	U	Upper	C6TZ 98404A06-B	1
<b>404A10</b>		<b>PROP - LIFTGATE</b>			
	66/67	U(98) "Before Ser. A84, 001"		C6TZ 98404A10-A	2
	67/	U(98) "From Ser. A84, 001"		C7TZ 98404A10-A	2
	66/	U(98)	1/4"-20 x 3/4" Hex. head bolt	20344-38(B42)	4
			1/4" Lockwasher	34805-S8(X62)	4
			No. 14-10 x 5/8" Hex. washer head screw	31498-S8(U253B)	4
<b>40427</b>		<b>SHIELD - REAR LICENSE PLATE LAMP</b>			
	69/70	F		C9ZZ 6540427-A	1
	69/70	F	No. 8-15 x 1/2" Washer head tapping screw	378729-S(UU87R)	3
<b>40433</b>		<b>RETAINER - LOWER BACK PANEL LINING BOARD</b>			
	67/69	S		C7SZ 6540433-A	5
	70/71	S		D0SZ 6540433-A	5
<b>404A38-9</b>		<b>ROD - LIFTGATE LATCH ACTUATOR</b>			
	66/67	U(98) "Before Ser. A42, 001"	R. H.	C6TZ 98404A38-B	1
			L. H. - not replaced (5-75)	*C6TZ 98404A39-B	1
	67/68	U(98) "From Ser. A42, 001"	R. H.	C7TZ 98404A38-A	1
			L. H.	C7TZ 98404A39-A	1
	69/	U(98)	R. H.	C9TZ 98404A38-A	1
			L. H.	C9TZ 98404A39-A	1
	66/	U(98)	Retainer	C3AZ 6221952-A	1
<b>404B40</b>		<b>PAD - TAILGATE BUMPER</b>			
	72	L(73)	Nylon	D2FZ 73404B40-A	2
<b>404A42</b>		<b>STRIKER - LIFTGATE LATCH</b>			
	72	L(73)		D2FZ 73404A42-A	1
	66/68	U(98)		C6TZ 98404A42-A	1
	69/	U(98)		C9TZ 98404A42-A	2
	66/	U(98)	No. 10-24 x 5/8" Oval head tapping screw	373712-S(BB602D)	4
<b>404A44</b>		<b>PLATE - LIFTGATE PROP ARM ANCHOR</b>			
	66/	U(98)		C6TZ 98404A44-A	2
<b>404A48</b>		<b>RETAINER - LIFTGATE LATCH SPRING</b>			
	72	L(73)		D2FZ 73404A48-A	1
	66/68	U(98)		C6TZ 98404A48-A	2
	69/	U(98)	1 1/16" diameter	C9TZ 98404A48-A	2
			1 1/16" diameter	C9TZ 98404A48-B	2
<b>404A50</b>		<b>BRACKET - LIFTGATE LATCH RELEASE LEVER</b>			
	66/67	U(98) "Before Ser. A42, 001"		C6TZ 98404A50-B	1
	67/68	U(98) "From Ser. A42, 001"		C7TZ 98404A50-A	1
	69/	U(98)		C9TZ 98404A50-A	1
<b>40452</b>		<b>BUMPER - LIFTGATE</b>			
	66/	U(98)		C6TZ 9840452-A	2

May, 1975

COPYRIGHT © 1975 -

FORD MOTOR  
COMPANY

- DEARBORN, MICHIGAN

**FINAL ISSUE**

GROUP NUMBER	YEAR	BODY TYPE	DESCRIPTION	PART NUMBER		QTY.
				RIGHT HAND	LEFT HAND	
<b>40454-5 PANEL - REAR CORNER INNER FINISH UPPER</b>						
69	A(71B, C, H, J)		Blue (light)	C9AZ 7140454-B1B	★C9AZ 7140455-B1B	1
			Nugget gold	C9AZ 7140454-B1Y	★C9AZ 7140455-B1Y	1
			Red	C9AZ 7140454-B1D	★C9AZ 7140455-B1D	1
70	A(71)		Black	D0AZ 7140454-E	D0AZ 7140455-E	1
			Blue	D0AZ 7140454-D	D0AZ 7140455-D	1
			Ginger	D0AZ 7140454-A	D0AZ 7140455-A	1
			Green	D0AZ 7140454-B	D0AZ 7140455-B	1
			Nugget gold	D0AZ 7140454-C	D0AZ 7140455-C	1
			Red	D0AZ 7140454-F	D0AZ 7140455-F	1
71/	A(71)		Black	D0AZ 7140454-E	D0AZ 7140455-E	1
			Blue	D0AZ 7140454-D	D0AZ 7140455-D	1
			Ginger	D0AZ 7140454-A	D0AZ 7140455-A	1
			Green	D1AZ 7140454-A	D1AZ 7140455-A	1
			Red	D0AZ 7140454-F	D0AZ 7140455-F	1
72	B(71)		Black	D2OZ 7140454-D	D2OZ 7140455-D	1
			Blue	D2OZ 7140454-C	D2OZ 7140455-C	1
			Ginger	D2OZ 7140454-A	D2OZ 7140455-A	1
			Green	D2OZ 7140454-B	D2OZ 7140455-B	1
GROUP NUMBER	YEAR	BODY TYPE	DESCRIPTION	PART NUMBER		QTY.
<b>404A54 BOLT - LIFTGATE LATCH</b>						
66/68	U(98)			C6TZ	98404A54-A	2
69/	U(98)		Includes bracket-2 3/16" long	C9TZ	98404A54-A	2
			2 27/32" long	C9TZ	9840480-A	1
<b>404A56 BRACKET - LIFTGATE LATCH</b>						
66/67	U(98)	"Before Ser. A42, 001"		C6TZ	98404A56-A	2
67/68	U(98)	"From Ser. A42, 001"		C7TZ	98404A56-A	1
69/	U(98)		3 3/4" long	C9TZ	98404A56-A	1
			2 7/8" long	C9TZ	98404A56-B	2
<b>40466 PLATE - LIFTGATE LOCK ACCESS HOLE COVER</b>						
66/	U(98)			C6TZ	9840466-B	1
			No. 10-12 x 1/2" Pan head screw		52727-S8(U382)	2
<b>404A68-9 SHIELD - LIFT GATE LATCH</b>						
66/	U(98)		R. H.	C6TZ	98404A68-A	1
			L. H.	C6TZ	98404A69-A	1
<b>40471 RETAINER - BACK TRIM PANEL - SIDE - Refer to Group 403D26</b>						
<b>404A76 ANTI-RATTLER - LIFTGATE BELT</b>						
67/	U(98)			C7TZ	98404A76-A	2
<b>40480 BOLT - LIFTGATE LATCH - Refer to Group 404A54</b>						
<b>40492 PANEL - LOWER BACK INSIDE</b>						
71/72	L(64)	" Before 3/1/72"		D1FZ	6440492-A	1
72	L(64)	" From 3/1/72"		D2FZ	6440492-A	1
<b>405A02 TRANSFER - FUEL FILLER DOOR</b>						
69/70	A(71A, E)		Cherry wood grain	C9AZ	71405A02-A	1
69/70	A(71A, E)-units built in Dallas		Cherry wood grain	C9AZ	71405A02-B	1
71/	A(71H)		Cherry wood grain	D1AZ	71405A02-A	1
<b>405A22 BUMPER - FUEL FILLER DOOR</b>						
67/	A(except 71), F		Rubber	C5SZ	63405A22-A	1or2
69	B(54)					1
65/71	S					1
<b>405A24 SPRING - FUEL FILLER DOOR HINGE</b>						
65/67	A(except 71)			C7SZ	65405A24-A	1
65/71	S					
65/69	A(71)			C5AZ	71405A24-A	1
68/	A			C8AZ	62405A24-A	1
66/67	B(71)			C6OZ	71405A24-A	1
68/71	B(71)			C8OZ	71405A24-A	1
72	B(71)			D2OZ	71405A24-A	1
66/70	X(71)			C6OZ	71405A24-A	1

# FORD CAR PARTS

**BODY  
SECTION 400**

9

GROUP NUMBER	YEAR	BODY TYPE	DESCRIPTION	PART NUMBER	QTY.
<b>405A26 DOOR - FUEL FILLER OPENING</b>					
<b>- A -</b>					
	65	A(except 71)	Bumper	C5AZ 62405A26-A 378399-S(CC40)	1 2
	66	A(except 71)		C6AZ 62405A26-A	1
	67	A(except 71)-"Before 11/1/66"	Use with metal fuel tank housing	C7AZ 62405A26-A	1
	67	A(except 71)-"From 11/1/66"	Use with plastic fuel tank housing	C7AZ 62405A26-B	1
	67	A(71)		C7AZ 71405A26-A	1
	67	A(71)	Bumper-on boot	379162-S(CC34A)	2
			Bumper-on body	377781-S(CC34)	1
	67	A	Bumper-on lid	★378437-S	2
	68	A(except 71)		C8AZ 62405A26-A	1
	68	A(71)		C8AZ 71405A26-A	1
	69/70	A		C9AZ 62405A26-A	1
	71/	A		D1AZ 65405A26-A	1
<b>- B -</b>					
	65	B(except 71)	Bumper	C5OZ 62405A26-A ★379070-S	1 2
	66/	B(except 71)	Refer to Chassis Group 13422		
	66/67	B(71)		C6OZ 71405A26-A	1
	66/67	B(71)	Bumper	377781-S(CC34)	2
			Bumper-on boot	379162-S(CC34A)	2
			No. 12-24 x .62 screw and washer assy.	379358-S2(BB580DA)	2
	68/69	B(71)		C8OZ 71405A26-A	1
	70/71	B(71)		D0OZ 71405A26-A	1
			1/4"-20 x 3/4" Hex. screw & washer, assy.	57472-S40(B339-V)	2
			Bumper	354860-S(CC-6)	1
	72	B(71)	Includes shim	D2OZ 71405A26-A	1
<b>- S -</b>					
	65/66	S		C4SZ 63405A26-B	1
	65	S	Bumper	357549-S(CC44A)	1
			Bumper	358713-S(CC16)	1
			Bumper	370374-S(CC20)	1
	66	S	Bumper	375838-S(CC32)	2
	67/71	S		C7SZ 65405A26-A	1
<b>- X -</b>					
	67/70	X(71)		C6OZ 71405A26-A	1
	67/70	X(71)	Bumper-on boot	379162-S(CC34A)	2
			Bumper-on body	377781-S(CC34)	1
<b>40544 EXTENSION - LOWER BACK PANEL</b>					
	72	A(except 71)	Refer to Group 403B26		
	70/71	B(except 66,71)		D1OZ 6540544-A	1
	72	B(exc. 71,97)		D3OZ 6540544-A	1
	65/66	F	With single exhaust-cut hole for backup light when required	C5ZZ 6540544-B	1
			No. 10-24 x .98" Bolt & clip assy.	372719-S100(BB643)	2
			No. 10-16 x 1/2" Round head washer screw	350754-S8(UU86)	11
	65/66	F	With dual exhaust	C5ZZ 6540544-C	1
	67/68	F	Without exhaust opening	C7ZZ 6540544-C	1
	67/68	F	With exhaust opening	C7ZZ 6540544-D	1
	65/67	F	For exhaust pipe moulding refer to group 5C299 in Chassis Section		
	69/70	F	Without exhaust opening	C9ZZ 6540544-A	1
	69/70	F(GT350/500)	Cut opening for exhaust		1
	69/70	F	With exhaust opening	C9ZZ 6540544-B	1
	71/	F	Without exhaust opening	D1ZZ 6540544-A	1
	71/	F	With exhaust opening & 351 C.I.D. engine	D1ZZ 6540544-B	1
	67/	F	No. 8-18 x 1/2" Pan head drive screw	380934-S100(UU67F)	11
	71/	L		D3FZ 6240544-A	1
	70/	P		D0DZ 6240544-A	1
	67	S	Refer to Group 403B26		

GROUP NUMBER	YEAR	BODY TYPE	DESCRIPTION	PART NUMBER	QTY.
<b>405A48</b>	<b>MOULDING - FUEL FILLER DOOR - INCLUDES ATTACHING PARTS</b>				
65		B(54B, 62B, 65)	6" long	C5OZ 62405A48-A	2
70/71		B(71E)	At quarter panel	D0OZ 71405A48-A	1
65		X(66B, 71B, C)		C4DZ 59405A48-A	1
<b>405A62</b>	<b>COLLAR - FUEL FILLER</b>				
68/69		B(66, 71)		C8OZ 71405A62-A	1
70/71		B(71)		D0OZ 71405A62-A	1
<b>405B64</b>	<b>REINFORCEMENT - FUEL FILLER PIPE HOUSING</b>				
69/70		A(71)		D2MZ 71405B64-A	1
71		A		D2AZ 65405B64-A	1
<b>405B72</b>	<b>RETAINER - FUEL FILLER DOOR BUMPER</b>				
66/70		X(71)		C6DZ 71405B72-A	1
			No.8-15 x 3/8" cross recess screw	376378-S101(UU97)	2
			Bumper	377781-S(CC34)	1
<b>40582-3</b>	<b>HINGE - UPPER BACK PANEL FINISH</b>				
65/66		S(76)	R. H. -Refer to Group 403A52 L. H. - not replaced (3-74)		
<b>40584-5</b>	<b>PANEL - LOWER BACK APPLIQUE - INCLUDES ATTACHING PARTS</b>				
67		F(63)	R. H. L. H.	C7ZZ 6340584-A C7ZZ 6340585-A	1 1
67		F(65, 76)	R. H. L. H.	C7ZZ 6540584-A C7ZZ 6540585-A	1 1
<b>40586</b>	<b>BRACKET - FUEL FILLER DOOR HINGE - ON BODY</b>				
72		B(71)		D2OZ 7140586-A	1
<b>405A86</b>	<b>ORNAMENT - FUEL FILLER DOOR - INCLUDES ATTACHING PARTS</b>				
65		B(54B, 62B, 65)		C5OZ 62405A86-A	1
<b>405A98</b>	<b>COLLAR - QUARTER PANEL FUEL FILLER</b>				
66/70		X(71)		C6DZ 71405A98-A	1
<b>406A06-8</b>	<b>HOSE - VACUUM LATCH - Also refer to Group 17543 in Chassis Section</b>				
69		A(54, 71)	Improvise from 3/16" bulk hose	*	
70		A	Improvise	*	
65/66		S(76)	Upper -approx. 128" long Lower-approx. 94" long	C4SZ 76406A07-A C4SZ 76406A08-A	1 1
<b>40610</b>	<b>NUT and HOUSING ASS'Y. - LUGGAGE COMPARTMENT DOOR LATCH</b>				
65		S(76)	Refer to Group 432A34		
<b>406A10</b>	<b>LIFT - LUGGAGE COMPARTMENT DOOR HYDRAULIC</b>				
65/66		S(76)		C4SZ 76406A10-A	2
			Pin (flat head shoulder)	373022-S8(NN65)	2
			1/2" I. D. x 1 1/16" O. D. x 7/64" thick	44735-S8(X32)	2
			3/8" x 1 13/16" Pin (clevis)	76073-S8(N25)	2
			1/16" Pin (self-locking)	352358-S(NN127)	4
72		L(64)	"Before 12/1/71"	Refer to Group 44206-7	
72		L(64)	"From 12/1/71"	D2FZ 64406A10-A	2
<b>40628</b>	<b>DOOR - LOWER BACK PANEL FUEL FILLER</b>				
65		A, B	Refer to Group 405A26		
<b>40654-5</b>	<b>LIFT - LUGGAGE COMPARTMENT DOOR - LESS BRACKET</b>				
65/66		S(76)	Refer to Group 406A10		
<b>40676</b>	<b>DOOR - FUEL FILLER - WITH HINGES</b>				
65/		A, B, S	Refer to Group 405A26		
<b>40700</b>	<b>PANEL - TAILGATE ASSY.</b>				
66/		U		C6TZ 9640700-A	1
			1/4"-20 x 5/8" Screw & washer assy.	*374928-S40	2



# FORD CAR PARTS

**BODY  
SECTION 400**

11

GROUP NUMBER	YEAR	BODY TYPE	DESCRIPTION	PART NUMBER	QTY.
<b>40704</b>	<b>COVER - TAILGATE PANEL INSIDE - Paint to Match</b>				
	66/68	A(71)		C6AZ 7140704-A	1
	69/72	A(71)		D2AZ 7140704-A	1
	66/70	B(71), X(71)	Paint to match	C6OZ 7140704-B	1
	71	B(71)		1	
	68/71	B(66)		C8OZ 6640726-A	1
	72	B(71)		D2OZ 7140704-A	1
	72	B(97)		D2OZ 9740704-A	1
<b>40705</b>	<b>PANEL - TAILGATE INSIDE COVER</b>				
	65	X(59, 66, 71, 78)	Remove belt moulding retainer	C0DZ 6640705-D	1
			No. 10-32 x 3/8" Pan head screw & washer assy.	42802-S8(U33)	13
<b>40709</b>	<b>TAILGATE ASSY. - LESS MOULDING HOLES and HINGES - Less paint and trim</b>				
- A -					
	65	A(71)	With power window	C5AZ 7140709-A	1
	66/68	A(71)	Dual action - use C6AZ 7144048-A when manual tail gate window is installed	C6AZ 7140709-C	1
	69/70	A(71)	Dual action - use C6AZ 7144048-A when manual tail gate window is installed	C9AZ 7140709-A	1
	71	A(71) "Before 12/1/70"	Dual action	D1AZ 7140709-A	1
	71/	A(71) "From 12/1/70"	Dual action - use C6AZ 7144048-A when manual tail gate window is installed	D1AZ 7140709-B	1
- B -					
	65	B(71)	Plug (button)- 29/32" x 2 29/32"	C3OZ 7140709-B	1
			Plug (button)- 1 13/32" x 3 13/32"	378688-S(PP14C)	1
	66/67	B(71)	Dual action - use C6OZ 7144048-A when manual tail gate window is installed	377844-S(PP14A)	1
				C6OZ 7140709-A	1
	68/69	B(71)	Dual action - use C6OZ 7144048-A when manual tail gate window is installed	C8OZ 7140709-B	1
	68/70	B(71)	Single action - use C6DZ 7144048-A when manual tail gate window is installed	C6DZ 7140709-C	1
	67/71	B(66)		C6DZ 6640709-D	1
	70/71	B(71)	Dual action - use C6OZ 7144048-A when manual tail gate window is installed	D0OZ 7140709-A	1
	72	B(71)	Includes instruction sheet	D3OZ 7140709-A	1 §
	72	B(97)		D2OZ 9740709-A	1
- L -					
	72	L(73)	Refer to Group 40010		
- X -					
	65	X(59, 66, 71, 78)		C4DZ 5940709-B	1
	66/67	X(71)	Dual action - use C6OZ 7144048-A when manual tail gate window is installed	C6OZ 7140709-A	1
	66/70	X(66, 71)	Single action - use C6DZ 7144048-A when manual tail gate window is installed - Incl. I. S. 3749	C6DZ 7140709-C	1
	68/70	X(71)	Dual action - use C6OZ 7144048-A when manual tail gate window is installed	C8OZ 7140709-B	1
<b>40710</b>	<b>PANEL - TAILGATE OUTSIDE</b>				
	69/70	A(71)		C9AZ 7140710-A	1
	71/	A(71)		D1AZ 7140710-A	1
<b>407A10</b>	<b>RETAINER - TAILGATE PANEL COVER - Paint to match</b>				
	65	A(71)		C5AZ 71407A10-A	1
	66/69	A(71)		C6AZ 71407A10-A	1
	66/70	B(71), X(71)	With dual action tail gate	C6OZ 71407A10-A	1
	71	B(71)		1	
	67/71	B(66)		C6DZ 66407A10-A	1
	66	X(66)		C6DZ 66407A10-A	1
	65/71	B(66, 71)	No. 8-18 x 1/2" Cross recess oval head screw	52413-S13(U316)	6
	65/70	X(66, 71)		6	
	72	U(98)	Lower	D2BZ 10407A10-A	1
			Upper-cut to fit		2

GROUP NUMBER	YEAR	BODY TYPE	DESCRIPTION	PART NUMBER	QTY.
<b>407A12</b>	<b>RETAINER - TAILGATE OUTSIDE MOULDING</b>				
REFER TO APPROPRIATE EXTERIOR MOULDING ILLUSTRATION FOR COMPLETE RETAINER PART NUMBER					
<b>407A16-7</b>	<b>STRIP - TAILGATE INSIDE COVER PANEL</b>				
65	X(59, 71, 78)	R. H. -Not replaced (1-73) L. H.	★C1DB 59407A16-B		1
			C1DB 59407A17-B		1
		No. 6-18 x 1/2" Binding head screw	32921-S8 (U334)		4
<b>40718</b>	<b>REINFORCEMENT - TAILGATE PANEL HINGE</b>				
72	B(71, 97)		D2OZ 7140718-A		2
<b>40720-1</b>	<b>MOULDING - REAR CORNER PILLAR - OUTSIDE - INCLUDES ATTACHING PARTS</b>				
65/66	A(71)	R. H. L. H.	C5AZ 7140720-B		1
			C5AZ 7140721-B		1
67/69	A(71)	R. H. L. H.	C7AZ 7140720-A		1
			C7AZ 7140721-A		1
<b>40722</b>	<b>TRANSFER - TAILGATE GRAINING</b>				
71/72	A(71H)	Cherry wood grain-w/black plank lines-	D3AZ 7140722-B		1
70/71	B(66E, 71E)	non-reflective-w/instruction sheet			1
72	B(71K, 97K)	Cherry wood grain-w/o planking lines-	D2OZ 7140722-A		1
		reflective-w/instruction sheet			
71	A, B	For non-reflective tailgate transfer-Refer to Group 20748			
72	B(71K, 97K)	Refer to Group 20748			
<b>40726</b>	<b>COVER - TAILGATE INSIDE - Refer to Group 40704</b>				
<b>407A32</b>	<b>BUSHING - TAILGATE COUNTER BALANCE TORSION BAR-LOWER</b>				
65	A(71)	Refer to Group 44466			
<b>40740</b>	<b>RETAINER - TAILGATE OUTSIDE MOULDING</b>				
69	B(54A, 65A, 66A, 71D)	Also on front fender	C9GY 7140740-A		14
70/	B(54C, 57C, E, 63C, F, 65C, E, 76)	Also on front fender	C9MY 7140740-A		14
<b>407A40-1</b>	<b>FILLER - TAILGATE OUTER TO INNER PANEL</b>				
67/71	B(66)	R. H. L. H.	C6DZ 66407A40-A		1
			C6DZ 66407A41-A		1
66	X(66)	R. H. L. H.	C6DZ 66407A40-A		1
			C6DZ 66407A41-A		1
66/71	B(66)	No. 8-18 x 3/8" Cross recess screw & washer assy.	376378-S101(UU97)		2
66/70	X(66)				2
<b>407A46</b>	<b>SEAL - TAILGATE INNER PANEL BOTTOM DRAIN - INCLUDES ATTACHING PARTS</b>				
66/67	A(71)		C6AZ 71407A46-A		2
<b>40790</b>	<b>COVER - TAILGATE WINDOW REGULATOR ACCESS HOLE - Also refer to Group 43114</b>				
66	A(71), B(71), X(66, 71)-	Approx. 3 1/2" wide	C6AZ 7140790-B		1
67/71	A(71), B(66, 71)				1
72	A(71), B(71, 97)				1
67/70	X(71)				1
		Screw-self tapping pan head-No.10-16 x 1/2"	52787-S13(U367A)		4
<b>40867</b>	<b>SPRING - TAILGATE WINDOW REGULATOR COUNTER BALANCE</b>				
65/68	A(71), B(71), X(71)	With power window regulator	C5AZ 7140867-A		1
69/72	B(71) "Before 6/1/72"				1
69/70	X(71)				1
72	B(71) "From 6/1/72"		D3OZ 7140867-A		1
<b>40964</b>	<b>MOTOR AND DRIVE - TAILGATE WINDOW REGULATOR</b>				
65/68	A(71)		C5AZ 7140964-A		1
66/69	B(71)				1
66/70	X(71)				1
		Screw-hex.washer head-No.12-24 1/2"	378608-S8(UU52D)		3
		Nut (stamped)-7/16"-20	379800-S2(MM1212E)		1
		For gear replacement kit refer to group 234A24			
69/	A(71)	Refer to Group 23394-5			
70/	B(71)				

GROUP NUMBER	YEAR	BODY TYPE	DESCRIPTION	PART NUMBER	QTY.	
<b>41006-7 RETAINER - REAR CORNER PILLAR COVER - Paint to Match</b>						
	70/	A(71)	R. H.-with vinyl roof cover	C9MY 7141006-A	1	
			L. H.	C9MY 7141007-A	1	
<b>41018 MOULDING - TAILGATE OUTSIDE - INCLUDES ATTACHING PARTS</b>						
	65/68	A(71)		C5AZ 7141018-C	1	
	69/70	A(71)	Upper	C9AZ 7141018-B	1	
	71	A(71)	Without back lite washer-upper edge- includes weatherstrip	D1AZ 7141018-B	1	
	71/	A(71)	With back lite washer-upper edge - includes weatherstrip and cap	D2AZ 7141018-A	1	
	72	A(71)	Without back lite washer-upper edge- includes weatherstrip	D2AZ 7141018-B	1	
	65	B(71B, E)	Upper -52 3/4" long	C3OZ 7141018-B	1	
	65	B(71)	Lower -51 3/16"	C5OZ 7141018-A	2	
	67/	U(97, 98)		C7TZ 9741018-A	1	
GROUP NUMBER	YEAR	BODY TYPE	DESCRIPTION	PART NUMBER		QTY.
				RIGHT HAND	LEFT HAND	
<b>410A37 EXTENSION - REAR CORNER INNER PILLAR REAR</b>						
	69/	A(71)		C9AZ 71410A37-A	C9AZ 71410A37-A	1
	66	B(71), X(66, 71)		C6OZ 71410A37-A	C6OZ 71410A37-A	1
	67/71	B(66, 71)				1
	67/70	X(71)				1
<b>41038-9 PILLAR - REAR CORNER</b>						
	69/70	A(71)		D1AZ 7141038-A	C9AZ 7141039-A	1
	71/	A(71)		D1AZ 7141038-A	D1AZ 7141039-A	1
	66/71	B(71)		C6OZ 7141038-A	C6OZ 7141039-A	1
	66/70	X(71)				1
	72	B(71)	Outer	D2OZ 7141038-A	D2OZ 7141039-A	1
	72	L(73)		D2FZ 7341038-A	D2FZ 7341039-A	1
<b>410A42-3 REINFORCEMENT - REAR CORNER INNER REAR PILLAR LOWER</b>						
	72	B(97)		D2OZ 97410A42-A	D2OZ 97410A43-A	1
<b>41058-9 REINFORCEMENT - REAR CORNER LOWER PILLAR</b>						
	66/71	B(71)		C6OZ 7141058-A	C6OZ 7141059-A	1
	66/70	X(71)				1
	67/71	B(66)		C6DZ 6641058-A	C6OZ 7141059-A	1
	66	X(66)				1
<b>41090-1 PANEL - REAR CORNER PILLAR VENTURI - OUTER</b>						
	67/69	A(71)		C7AZ 7141090-A	C7AZ 7141091-A	1
<b>41096-7 PANEL - REAR CORNER PILLAR VENTURI - INCLUDES ATTACHING PARTS</b>						
	67/69	A(71)		★C7AZ 7141096-A	C7AZ 7141097-A	1
				Not repl. (3-74)		
			Nut & washer-No.10-24	373265-S7(MM291D)	373265-S7(MM291D)	2
<b>41098-9 PLATE - REAR CORNER OUTER PANEL END</b>						
	69 /	A(71)		C9AZ 7141098-A	C9AZ 7141099-A	1
	72	B(71)		D2OZ 7141098-A	D2OZ 7141099-A	1
<b>412A02-3 PILLAR - REAR CORNER INNER</b>						
	69/70	A(71)		C9AZ 71412A02-A	C9AZ 71412A03-A	1
	71/	A(71)		D1AZ 71412A02-A	D1AZ 71412A03-A	1
	65	B(71)		C5OZ 71412A02-A	C5OZ 71412A03-A	1
	70	B(71D)	Single action tailgate	C6DZ 71412A02-A	C6DZ 71412A03-A	1
	67/71	B(66)	Single action tailgate	C6DZ 66412A02-A	C6DZ 66412A03-A	1
	66/71	B(71)	Dual action tailgate	C6OZ 71412A02-B	C6OZ 71412A03-A	1
	72	B(71)	Dual action tailgate	D2OZ 71412A02-A	D2OZ 71412A03-A	1
	72	B(97)		D2OZ 97412A02-A	D2OZ 97412A03-A	1
	66	X(66)	Single action tailgate	C6DZ 66412A02-A	C6DZ 66412A03-A	1
	66	X(71B)	Dual action tailgate	★C6OZ 71412A02-A	C6OZ 71412A03-A	1
				Not repl. (5-75)		
	66/70	X(71)	Single action tailgate	C6DZ 71412A02-A	C6DZ 71412A03-A	1
	67/70	X(71)	Dual action tailgate	C6OZ 71412A02-B	C6OZ 71412A03-A	1

GROUP NUMBER	YEAR	BODY TYPE	DESCRIPTION	PART NUMBER		QTY.
				RIGHT HAND	LEFT HAND	
<b>412A08-9 MOULDING - REAR CORNER PILLAR VENTURI PANEL - INCLUDES ATTACHING PARTS</b>						
	65/66	A(71)		C5AZ 71412A08-C	★C5AZ 71412A09-C Not replaced (5-75)	1
	67/69	A(71)		C7AZ 71412A08-A	C7AZ 71412A09-A	1
<b>41210-1 PILLAR - REAR CORNER INNER FRONT UPPER</b>						
	69/	A(71)		C9AZ 7141210-A	C9AZ 7141211-A	1
	66/71	B(71)		C6OZ 7141210-A	C6OZ 7141211-A	1
	66/70	X(71)				1
	72	B(71)		D2OZ 7141210-A	D2OZ 7141211-A	1
<b>412A20-1 PANEL - REAR CORNER PILLAR VENTURI INNER - INCLUDES ATTACHING PARTS</b>						
	67/68	A(71)		★C7AZ 71412A20-A Not replaced (5-75)	C7AZ 71412A21-A	1
<b>412A22-3 ORNAMENT - REAR CORNER PILLAR VENTURI PANEL - INCLUDES ATTACHING PARTS</b>						
	67/68	A(71)	Paint to match	C7AZ 71412A22-A	C7AZ 71412A23-A	1
<b>412A24-5 MOULDING - REAR CORNER PILLAR VENTURI PANEL LOWER - INCLUDES ATTACHING PARTS</b>						
	67/68	A(71)		C7AZ 71412A24-A	C7AZ 71412A25-A	1
<b>41228-9 PILLAR - REAR CORNER INNER FRONT - LOWER</b>						
	69/	A(71)		C9AZ 7141228-A	C9AZ 7141229-A	1
	66	B(71), X(66, 71)	Cut 2.07" from upper end and fill holes for Body Type 66	C6OZ 7141228-A	C6OZ 7141229-A	1
	67/71	B(66, 71)	Cut 2.07" from upper end and fill holes for Body Type 66			1
	67/70	X(71)				1
	72	B(71)		D2OZ 7141228-A	D2OZ 7141229-A	1
<b>412A28 RETAINER - REAR CORNER PILLAR VENTURI PANEL MOULDING UPPER</b>						
	67/68	A(71)		C7AZ 71412A28-A	C7AZ 71412A28-A	8
<b>41230-1 PANEL - REAR CORNER OUTER</b>						
	69/	A(71)		C9AZ 7141230-A	C9AZ 7141231-A	1
	68/71	B(71)		C8OZ 7141230-A	C8OZ 7141231-A	1
<b>412A32-3 PILLAR - REAR CORNER INNER FRONT CENTER</b>						
	67/68	A(71)		★C7AZ 71412A32-A Not repl. (1-73)	C7AZ 71412A33-A	1
	66/71	B(71)		C6OZ 71412A32-A	C6OZ 71412A33-A	1
	66/70	X(71)				1
GROUP NUMBER	YEAR	BODY TYPE	DESCRIPTION	PART NUMBER		QTY.
<b>41302 RAIL - BACK WINDOW HEADER</b>						
	69/	A(71)		C9AZ 7141302-A		1
	66/71	B(71)		C6OZ 7141302-A		1
	72	B(71)		D2OZ 7141302-A		1
	72	L(73)		D2FZ 7341302-B		1
	66/70	X(71)		C6OZ 7141302-A		1
<b>41608 WEATHERSTRIP - TAILGATE</b>						
	65	A(71)		C5AZ 7141608-B		1
	65	A(71)	Fastener (button)	C1AB 6220807-A		2or4
	66/68	A(71)		C6AZ 7141608-A		1
	69	A(71)	Less grooves	C9AZ 7141608-C		1
	70/	A(71)	Includes grooves	D0AZ 7141608-A		1
	65/	A(71)	Screw-cross recess pan head-No.6 x 3/8"	52718-S8(U377A)		4or8
			Retainer	C5AZ 6220586-A		21
	65	B(71)		C3OZ 7141608-B		1
			Screw-cross recess truss hd.tap.-No.6-20 x 3/8"	353803-S8(UU95)		2
			Screw-cross recess pan head-No.6 x 3/8"	52718-S8(U377A)		4or8
	67/71	B(71)		C6OZ 7141608-B		1
	72	B(71)		D2OZ 7141608-A		1
	65/71	B(71)	Retainer	C5AZ 6220586-A		21
	67/70	X(71)		C6OZ 7141608-B		1
	65/70	X(71)	Retainer	C5AZ 6220586-A		21

# FORD CAR PARTS

## BODY SECTION 400

15

GROUP NUMBER	YEAR	BODY TYPE	DESCRIPTION	PART NUMBER	QTY.	
<b>41610</b>	<b>WEATHERSTRIP - TAILGATE OUTER PANEL TO BELT</b>					
	65	A(71)		C5AZ 7141610-A	1	
			No. 8-18 x 3/8" Cross recess truss head screw	376378-S101(UU97)	7	
	66/68	A(71)		C6AZ 7141610-B	1	
	65	B(71)		C3OZ 7141610-B	1	
			No. 8 x 3/8" Cross recess pan head screw	52720-S8 (U380)	2	
	66/71	B(71)		C6OZ 7141610-B	1	
	66/70	X(71)			1	
<b>41612</b>	<b>RETAINER KIT - REAR SPOILER</b>					
	70/72	P		D0DZ 6241612-A	4	
<b>41626</b>	<b>WEATHERSTRIP - TAILGATE SIDE - Also refer to Group 43964-5</b>					
	68/	U(98)	One piece	C8TZ 9841626-A	1	
<b>41643</b>	<b>SUPPORT - TAILGATE SIDE WEATHERSTRIP</b>					
	72	B(71)	L.H.	D2OZ 7141643-A	1	
GROUP NUMBER	YEAR	BODY TYPE	DESCRIPTION	PART NUMBER		QTY.
				RIGHT HAND	LEFT HAND	
<b>41708-9</b>	<b>RAIL - QUARTER BELT SIDE - FRONT</b>					
	- A -					
	69	A(63)	Includes bracket	C9AZ 6341708-A	D0AZ 6341709-A	1
	69	A(65)		C9AZ 6541708-A	D0AZ 6541709-A	1
	69	A(76)		C9AZ 7641708-A	C9AZ 7641709-A	1
	70	A(63)		D0AZ 6341708-A	D0AZ 6341709-A	1
	70	A(65)		D0AZ 6541708-A	D0AZ 6541709-A	1
	70	A(76)		D0AZ 7641708-A	D0AZ 7641709-A	1
	71/	A(65)		D1AZ 6541708-A	D1AZ 6541709-A	1
	71/	A(76)		D1AZ 7641708-A	D1AZ 7641709-A	1
	- B -					
	68/69	B(65)		C8OZ 6541708-A	C8OZ 6541709-A	1
	70/71	B(63)		D0OZ 6341708-A	D0OZ 6341709-A	1
	70/71	B(65)		D0OZ 6541708-A	D0OZ 6541709-A	1
	70/71	B(76)		D0OZ 7641708-A	D0OZ 7641709-A	1
	- F -					
	69/70	F(65)		C9ZZ 6541708-A	C9ZZ 6541709-A	1
	69/70	F(76)		C9ZZ 7641708-A	C9ZZ 7641709-A	1
	69/70	F(63)		C9ZZ 6341708-A	C9ZZ 6341709-A	1
	71/72	F(63,65,76)		D1ZZ 6541708-A	D1ZZ 6541709-A	1
	- L -					
	71/72	L		D1FZ 6241708-A	D1FZ 6241709-A	1
	- P -					
	70/	P		D0DZ 6241708-A	D0DZ 6241709-A	1
	- S -					
	70	S(65)		D0SZ 6541708-A	D0SZ 6541709-A	1
	71	S(65A,C)				1
<b>41732-3</b>	<b>RAIL - QUARTER BELT SIDE - Refer to Group 41736-7</b>					
<b>41736-7</b>	<b>RAIL - QUARTER BELT SIDE</b>					
	69/70	A(76)		C9AZ 7641736-A	C9AZ 7641737-A	1
	71/	A(76)		D1AZ 7641736-A	D1AZ 7641737-A	1
	68/69	B(76)		*C8OZ 7641736-A	C8OZ 7641737-A	1
			Not repl. (1-73)			
	70/71	B(76)		D0OZ 7641736-A	D0OZ 7641737-A	1
	65	F(65)	"Before 10/1/64"	*C5ZZ 6541736-A	C7ZZ 6541737-A	1
				Not repl. (1-73)		
	65/69	F(65)	"From 10/1/64"	C7ZZ 6541736-A	*C7ZZ 6541737-A	1
					Not replaced (3-74)	
	69/70	F(76)		C9ZZ 7641736-A	C9ZZ 7641737-A	1
	71/	F(76)		D1ZZ 7641736-A	D1ZZ 7641737-A	1
	67/68	S(65)		C7SZ 6541736-A	C7SZ 6541737-A	1
	69	S(65A,C)				1

**BODY  
SECTION 400**
**FORD CAR PARTS**

GROUP NUMBER	YEAR	BODY TYPE	DESCRIPTION	PART NUMBER		QTY.
				RIGHT HAND	LEFT HAND	
<b>41740-1 EXTENSION - BACK BELT SIDE MOULDING - INCLUDES ATTACHING PARTS</b>						
	67/68	S(65)	R.H.	C7SZ	6541740-A	1
			L.H.	C7SZ	6541741-A	1
<b>41745 STRIP - BACK BELT RAIL TACKING CENTER</b>						
	69/	A(76)		C9AZ	7641745-A	1
	69/71	F(76)		C9ZZ	7641745-A	1
	65/66	S(76)	Serviced in assembly-refer to Group 46506			
	65/69	B(76), F(76)	1/4"-20 x 1 1/4" Hex. head screw & washer assy.	379392-S2(BB574F)		6
			1/4"-20 x 2" Hex. head screw & washer assy.	380462-S2(UU52R)		4
			1/4" Flat washer	44719-S8(X17)		6
<b>41772-3 STRIP - BELT SIDE FRONT TACKING</b>						
	69/	A(76)		C9AZ	7641772-A	1
	68/70	B(76)		C8OZ	7641772-A	1
	69/70	F(76)		C9ZZ	7641772-A	1
	71/	F(76)		D1ZZ	7641772-A	1
<b>41782-3 STRIP - BELT SIDE REAR TACKING</b>						
	65/66	S(76)		C4SZ	7641782-A	1
			No. 10-16 x 1/2" Cross recess flat head screw	52013-S8(U209)	52013-S8(U209)	8
<b>41836 BRACKET - LUGGAGE COMPARTMENT DOOR LIFT ON DOOR</b>						
	72	L(64)		D2FZ	6441836-A	1
				D2FZ	6441837-A	1
<b>41882-3 TROUGH - BELT SIDE CORNER DRAIN</b>						
	69/70	A(76)		C9AZ	7641882-A	1
	68/69	B(76)		★C8OZ	7641882-A	1
					Not repl. (1-73)	
	70/71	B(76)		D0OZ	7641882-A	1
	69/70	F(76)		C9ZZ	7641882-A	1
	71/	F(76)		D1ZZ	7641882-A	1
<b>41910 STABILIZER - TAILGATE WINDOW INNER</b>						
	72	B(71)	Approx. 1 3/4" long		D2OZ	7141910-A
						2
<b>41958 STOP - BACK WINDOW UPPER</b>						
	69/70	A(71)		C9AZ	7141958-A	2
	72	B(71)		D2OZ	7141958-A	2
<b>41960-1 GUIDE - BACK WINDOW GLASS</b>						
	69/70	A(71)	Includes guide & bushing	C9AZ	7141960-A	1
	71/	A(71)	For bushing only-refer to Group 21496			
	71/	A(71)		D1AZ	7141960-A	1
	72	B(71)	For R.H.-refer to Group 222A92		D2OZ	7141960-A
						1
<b>41966-7 BRACKET - LUGGAGE COMPARTMENT DOOR HINGE TO HINGE SUPPORT</b>						
	67/69	S		C7SZ	6541966-A	1
	70/71	S(57)				1
	71	S(65B, D)				1
<b>41974-3 FRAME - BACK WINDOW LOWER SIDE</b>						
	67/	A	Refer to Group 52566			
	70/71	B(54, 57, 62, 65)		D0OZ	6541974-A	1
	70/71	B(63)		D0OZ	6341974-A	1
	71/	F(65)		D1ZZ	6541974-A	1

# FORD CAR PARTS

**BODY  
SECTION 420**

GROUP NUMBER	YEAR	BODY TYPE	DESCRIPTION	PART NUMBER	QTY.
<b>420A00 WEATHERSTRIP - BACK WINDOW GLASS AT BELT</b>					
	65	X(59, 71, 78)	No. 8 x 1/2" Cross recess pan head screw	C3DZ 59420A00-A 52726-S13 (U381)	1 2or6
<b>42006 GLASS - BACK WINDOW</b>					
Nags Number					
- A -					
	65/66	A(54, 62)		B3320 C5AZ 6242006-A C5AZ 6242006-B	1
	65/66	A(57)		B3311 C5AZ 5742006-A C5AZ 5742006-B	1
	65	A(63)		B3306 C5AZ 6342006-A C5AZ 6342006-B	1
	66	A(63)		B3515 C6AZ 6342006-A C6AZ 6342006-B	1
	67/68	A(54, 62)		B3725 C7AZ 6242006-A C7AZ 6242006-B	1
	67	A(57)		B3720 C7AZ 5742006-A C7AZ 5742006-B	1
	68	A(57, 65)		B3900 C8AZ 5742006-A C8AZ 5742006-B	1
	67	A(63)		B3715 C7AZ 6342006-A C7AZ 6342006-B	1
	68	A(63)		B3895 C8AZ 6342006-A C8AZ 6342006-B	1
	65/68	A(71)		4466T C5AZ 7142006-A C5AZ 7142006-B	1
	69/70	A(54, 62)	Unheated	B4100 C9AZ 6242006-A C9AZ 6242006-B	1
	70	A(54)	Heated	B4322 D0AZ 5442006-A	1
	69/70	A(57)	Unheated	B4091 C9AZ 5742006-A C9AZ 5742006-B	1
	70	A(57)	Heated	B4319 D0AZ 5742006-A	1
	69/70	A(63)	Unheated	4528T C9AZ 6342006-A C9AZ 6342006-B	1
	70	A(63)	Heated	B4309 D0AZ 6342006-A	1
	69/70	A(65)	Unheated	B4086 C9AZ 6542006-A C9AZ 6542006-B	1
	70	A(65)	Heated	B4314 D0AZ 6542006-A	1
	69/70	A(71)	Refer to Group 42030		
	71/	A(53, 57)	Unheated	B4511 D1AZ 5742006-B D1AZ 5742006-C	1
			Heated	B4510 D1AZ 5742006-A	1
	71/	A(54)	Unheated	B4521 D1AZ 5442006-B D1AZ 5442006-C	1
			Heated	B4520 D1AZ 5442006-A	1
	71/	A(65)	Unheated	B4505 D1AZ 6542006-B D1AZ 6542006-C	1
			Heated	B4504 D1AZ 6542006-A	1
	71/	A(71)	Unheated	B4524 D1AZ 7142006-C D1AZ 7142006-D	1
- B -					
	65	B(54, 62)		B3285 C4OZ 6242006-A C4OZ 6242006-B	1
	65/67	B(65)		B317C C3OZ 6542006-A C3OZ 6542006-B	1
	65	B(71)		1063T C3OZ 7142006-A C3OZ 7142006-B	1
	66/67	B(54)		B3529 C6OZ 5442006-A C6OZ 5442006-B	1
	66/67	B(62)		B3522 C6OZ 6242006-A C6OZ 6242006-B	1
	66/67	B(63)		B3545 C6OZ 6342006-A C6OZ 6342006-B	1
	67	B(66)		2526T C6DZ 6642006-A C6DZ 6642006-B	1
	68/69	B(54)		B3917 C8OZ 5442006-A C8OZ 5442006-B	1
	68/69	B(63)		B3907 C8OZ 6342006-B	1
	68/69	B(65)		B3910 C8OZ 6542006-A C8OZ 6542006-B	1
	70/71	B(54, 57)	Unheated	B4339 D0OZ 5442006-A D0OZ 5442006-B	1
	71	B(54, 57)	Heated	B4562 D1OZ 5442006-A	1
	70/71	B(63)	Unheated	B4327 D0OZ 6342006-A D0OZ 6342006-B	1
	71	B(63)	Heated	B4560 D1OZ 6342006-A	1
	70/71	B(65)	Unheated	B4332 D0OZ 6542006-A D0OZ 6542006-B	1
	71	B(65)	Heated	B4561 D1OZ 6542006-A	1
	66/71	B(66)		1099T C8OZ 6642006-A C8OZ 6642006-B	1
	66/71	B(71)		B3536 C6OZ 7142006-A C6OZ 7142006-B	1
	72	B(53, 65)	Unheated	B4724 D2OZ 6542006-B D2OZ 6542006-C	1
			Heated	B4723 D2OZ 6542006-A	1
	72	B(63)	Unheated	B4718 D2OZ 6342006-B D2OZ 6342006-C	1
			Heated	B4717 D2OZ 6342006-A	1
	72	B(71)		B4733 D2OZ 7142006-C D2OZ 7142006-D	1
	72	B(97)		1110 D2OZ 9742006-B D2OZ 9742006-A	1

GROUP NUMBER	YEAR	BODY TYPE	DESCRIPTION	PART NUMBER		QTY.
				CLEAR	TINTED	
<b>42006</b>	<b>GLASS - BACK WINDOW - continued</b>		Nags Number			
- F -						
	65/66	F(63)		B3332		
	67/68	F(63)		B3754		C5ZZ 6342006-B 1 C7ZZ 6342006-A 1
	69/70	F(63)	Unheated	B4120		C9ZZ 6342006-A 1
	65/68	F(65)		B3299	C5ZZ 6542006-A	C5ZZ 6542006-B 1
	69/70	F(65)	Unheated	B4125	C9ZZ 6542006-A	C9ZZ 6542006-B 1
	71/72	F(63)	Unheated	B4536		D1ZZ 6342006-B 1
		"Before 6/15/72"	Heated	B4535		D1ZZ 6342006-A 1
	72	F(63)	"From 6/15/72"	B4800		D3ZZ 6342006-A 1
	71/72	F(65)	Unheated	1109	D1ZZ 6542006-B	D1ZZ 6542006-C 1
		"Before 6/15/72"	Heated	B4541		D1ZZ 6542006-A 1
	72	F(65)	"From 6/15/72"	B4801		D3ZZ 6542006-A 1
- L -						
	71/	L(62)	Unheated	B4550	D1FZ 6242006-A	D1FZ 6242006-B 1
	72	L(62)	Heated	B4794		D2FZ 6242006-B 1
	71	L(64)	Small window	B4709		D1FZ 6442006-B 1
	72	L(64)	Unheated-large window	B4752	D2FZ 6442006-B	D2FZ 6442006-A 1
			Heated-large window	B4795		D2FZ 6442006-C 1
	72	L(73)	Unheated	B4751	D2FZ 7342006-A	D2FZ 7342006-B 1
			Heated	B4750		D2FZ 7342006-C 1
- P -						
	71/	P(54)		B4557	D1DZ 5442006-A	D1DZ 5442006-B 1
	70/	P(62)		B4279	D0DZ 6242006-A	D0DZ 6242006-B 1
- S -						
	65	S(63)		B3286	C4SZ 6342006-A	C4SZ 6342006-B 1
	66	S(63A)				1
	66	S(63C, D)		B3565	C6SZ 6342006-A	C6SZ 6342006-B 1
	69	S(65)	Heated	B4143		C9SZ 6542006-A 1
	69/70	S(57)	"Before 6/15/70"	B4144		C9SZ 5742006-A 1
	70	S(65)	"Before 6/15/70"	B4364		D0SZ 6542006-C 1
	70/71	S(57)	"From 6/15/70"	B4711		D1SZ 5742006-A 1
	67/71	S(57)	Unheated	B3751	C7SZ 5742006-A	C7SZ 5742006-B 1
	70	S(65)	Unheated	B4365	D0SZ 6542006-A	D0SZ 6542006-B 1
	71	S(65A, C)				1
	70/71	S(65A, C)	"From 6/15/70"	B4563		D1SZ 6542006-B 1
	67/69	S(65)	Unheated	B3746	C7SZ 6542006-A	C7SZ 6542006-B 1
	71	S(65B, D)				1
	71	S(65B, D)	Heated	B4710		D1SZ 6542006-A 1
	72	S	Unheated	B4739		D2SZ 6542006-B 1
			Heated	B4738		D2SZ 6542006-A 1
- U -						
	66/	U(97)		2528T	C6TZ 9742006-A	1
	66/	U(98)		2529T	C6TZ 9842006-A	1
- X -						
	65	X(54, 62)		B3134	C2DZ 6242006-A	C2DZ 6242006-B 1
	65	X(59, 71, 78)		1074T	C3DZ 5942006-A	C3DZ 5942006-B 1
	65	X(63)		B3198	C3DZ 6342006-A	C3DZ 6342006-B 1
	65	X(66)		1042T	C0DB 6642006-A	C1DZ 6642006-A 1
	66/70	X(54)		B3529	C6OZ 5442006-A	C6OZ 5442006-B 1
	68/69	X(63)		B3907		C8OZ 6342006-B 1
	66/70	X(62)		B3522	C6OZ 6242006-A	C6OZ 6242006-B 1
	66	X(66)		2526T	C6DZ 6642006-A	C6DZ 6642006-B 1
	66/70	X(71)		B3536	C6OZ 7142006-A	C6OZ 7142006-B 1



# FORD CAR PARTS

**BODY  
SECTION 420**

3

GROUP NUMBER	YEAR	BODY TYPE	DESCRIPTION	PART NUMBER		QTY.	
				RIGHT HAND	LEFT HAND		
<b>420A20-1 WEATHERSTRIP - BACK WINDOW GLASS LOWER SIDE RUN</b>							
66/68		A(71)		C6AZ 71420A20-A	C6AZ 71420A21-A	1	
69		A(71)	"Before 3/19/69"	D1AZ 71420A20-A	C9AZ 71420A21-A	1	
69/70		A(71)	"From 3/19/69"	D1AZ 71420A20-A	D1AZ 71420A21-A	1	
71/		A(71)		D1AZ 71420A20-A	D1AZ 71420A21-A	1	
66/71		B(71)		C6OZ 71420A20-B	C6OZ 71420A21-B	1	
66/70		X(71)				1	
66/		A(71), B(71)	No. 10-16 x 3/8" Cross	52721-S(U382B)	52721-S(U382B)	AR	
66/70		X(71)	recess pan hd. screw			AR	
<b>420A22 SPACER - BACK WINDOW GLASS LOWER</b>							
65/66		A(57, 63)		C5AZ 63420A22-A	C5AZ 63420A22-A	2	
67		A(57)				2	
68		A(57, 65)				2	
69/70		A(except 71, 76)				2	
68/70		B(63)				2	
72		L(64)				2	
67/70		S				2	
68/69		B(66)		C8OZ 66420A22-A	C8OZ 66420A22-A	1	
65/68		F(63)	3 1/2" long	C5ZZ 63420A22-B	C5ZZ 63420A22-B	4	
69/70		F(63)		C9ZZ 63420A22-A	C9ZZ 63420A22-A	4	
70		S(65)	Rubber	D0SZ 65420A22-A	D0SZ 65420A22-A	2	
<b>420A28 SEAL - BACK WINDOW GLASS - Refer to Group 19562 in Paint Section</b>							
GROUP NUMBER	YEAR	BODY TYPE	DESCRIPTION	PART NUMBER		QTY.	
				CLEAR	TINTED		
<b>42030 GLASS and CHANNEL ASSY. - BACK WINDOW</b> <span style="float: right;">Nags Number</span>							
69/70		A(71)		B4111	C9AZ 7142030-A	C9AZ 7142030-B	1
<b>420A58 RETAINER - BACK WINDOW GLASS SEAL</b>							
70		S(65)			D0SZ 65420A58-A	1	
<b>42072 WEATHERSTRIP - BACK WINDOW GLASS - INNER</b>							
65		A(71)	Includes retainer		C5MY 7142072-A	1	
			No. 8-15 x 3/8" Cross recess washer head screw		52720-S8(U380)	8	
66/68		A(71)	52 3/8" long-Includes retainer		C6AZ 7142072-A	1	
66/68		B(71), X(71)	Cut to 47 1/2" long			1	
69/72		A(71)			D2AZ 7142072-A	1	
69/71		B(71)			C9OZ 7142072-A	1	
69/70		X(71)				1	
72		B(71)			D2OZ 7142072-A	1	
65		X(59, 71, 78)	Refer to Group 422A36				
<b>42084 WEATHERSTRIP - BACK WINDOW GLASS</b>							
- A -							
65/66		A(54, 62)			C5AZ 6242084-A	1	
67/68		A(54, 62)			C8AZ 6242084-A	1	
67/69		A(63)			C7AZ 6342084-B	1	
67/		A(57)	Cut from C6AZ 19562-B		★	1	
68/		A(65)	Cut from C6AZ 19562-B		★	1	
- B -							
66/67		B(54)			C6OZ 5442084-A	1	
67		B(66)			C6DZ 6642084-A	1	
68/69		B(54)			C8OZ 5442084-A	1	
68/69		B(65)			C8OZ 6542084-A	1	
70		B(54C, 57)	Blue -vinyl		D0OZ 5442084-C	1	
			Green -vinyl		D0OZ 5442084-B	1	
			Nugget gold -vinyl		D0OZ 5442084-E	1	
			Red -vinyl		D0OZ 5442084-D	1	
70		B(62, 85)	Blue -vinyl		D0OZ 6542084-C	1	
			Green -vinyl		D0OZ 6542084-B	1	
			Nugget gold -vinyl		D0OZ 6542084-E	1	
			Red -vinyl		D0OZ 6542084-D	1	
			Ginger -vinyl		D0OZ 6542084-F	1	
			Rubber		D0OZ 6542084-A	1	

GROUP NUMBER	YEAR	BODY TYPE	DESCRIPTION	PART NUMBER	QTY.
<b>42084</b>	<b>WEATHERSTRIP - BACK WINDOW GLASS - continued</b>				
- B -					
	70/71	B(54A, 57E)	Rubber	D00Z 5442084-A	1
	71	B(54C, 57C)	Blue	D10Z 5442084-A	1
			Gray gold	D10Z 5442084-C	1
			Green	D10Z 5442084-B	1
	71	B(62, 65)	Blue-vinyl	D00Z 6542084-C	1
			Ginger-vinyl	D00Z 6542084-F	1
			Gray gold-vinyl	D10Z 6542084-B	1
			Green-vinyl	D10Z 6542084-A	1
	68/71	B(63)	Cut from C6AZ 19562-B		1
	71	B(65A)	Rubber	D00Z 6542084-A	1
	68/71	B(66)		C80Z 6642084-A	1
	72	B(53, 65)	Black	D20Z 6542084-D	1
			Blue	D20Z 6542084-B	1
			Ginger	D20Z 6542084-A	1
			Gold	D20Z 6542084-G	1
			Green	D20Z 6542084-E	1
			Tobacco	D20Z 6542084-F	1
			White	D20Z 6542084-C	1
	72	B(63)	Black	D20Z 6342084-D	1
			Blue	D20Z 6342084-B	1
			Ginger	D20Z 6342084-A	1
			Gold	D20Z 6342084-G	1
			Green	D20Z 6342084-E	1
			Tobacco	D20Z 6342084-F	1
			White	D20Z 6342084-C	1
	72	B(97)		D20Z 9742084-A	1
- F -					
	65/66	F(63)		C5ZZ 6342084-A	1
	67/68	F(63)		C7ZZ 6342084-A	1
	65/68	F(65)		C5ZZ 6542084-A	1
	69/70	F(63)		C9ZZ 6342084-A	1
	69/70	F(65)		D0ZZ 6542084-A	1
	71/	F(63)		D1ZZ 6342084-A	1
	71/	F(65)		D1ZZ 6542084-A	1
- L -					
	71/	L(62)	With moulding	D1FZ 6242084-B	1
	71	L(64)	"Before 7/12/71" With small window	D1FZ 6442084-B	1
	71/	L(64)	"From 7/12/71" With large window	D2FZ 6442084-A	1
	72	L(73)		D2FZ 7342084-A	1
- P -					
	71/	P(54)		D1DZ 5442084-A	1
	70/	P(62)		D0DZ 6242084-A	1
- S -					
	67/	S	Cut from C6AZ 19562-B	★	1
- U -					
	66/	U(98)	Less mouldings	C6TZ 9842084-B	1
	67/	U(97)		C7TZ 9742084-A	1
	67/	U(98)	Use with mouldings	C7TZ 9842084-A	1
- X -					
	65	X(54, 62)		C2DZ 6242084-A	1
	65	X(66)		C0DB 6642084-A	1
	66/70	X(54)		C6OZ 5442084-A	1
	66/70	X(62)		C6OZ 6242084-A	1
	66	X(66)		C6DZ 6642084-A	1
<b>42126</b>	<b>BUSHING - BACK WINDOW GUIDE</b>				
	69/70	A(71)		C9AZ 7142126-A	2
	71/	A(71)		D1AZ 7142126-A	1
<b>42138</b>	<b>BUSHING - BACK WINDOW GLASS</b>				
	71/	A(71)	Nylon-1 1/2" diameter	D1AZ 7142138-A	4
	72	B(63, 65, 71), S			AR

# FORD CAR PARTS

## BODY SECTION 420

5

GROUP NUMBER	YEAR	BODY TYPE	DESCRIPTION	PART NUMBER	QTY.
<b>422A00 RUN - BACK WINDOW GLASS</b>					
	69/70	A(71)		C9AZ 71422A00-A	2
	71/72	A(71)		D1AZ 71422A00-A	2
		B(71)		D2OZ 71422A00-A	2
<b>422B00 SEAL - BACK WINDOW HOUSING DRAIN</b>					
	69/70	S	Foam rubber	C9SZ 65422B00-A	2
<b>42202-3 BRACKET - BACK WINDOW UPPER STOP</b>					
	69/70	A(71)	R. H.	C9AZ 7142202-A	1
			L. H.	C9AZ 7142203-A	1
	72	B(71)		D2OZ 7142202-A	2
<b>422A08 CHANNEL - BACK WINDOW GLASS</b>					
	65/69	A(71)		C5AZ 71422A08-B	1
	65	B(71)		C3OZ 71422A08-A	1
	66/71	B(71)		C9OZ 71422A08-A	1
	66/70	X(71)			1
	65	X(59, 71, 78)		C3DZ 59422A08-A	1
<b>422B12 SEAL - WINDOW REGULATOR DRIVE</b>					
	65/69	A(71), B(71), X(71)	Tailgate	C9AZ 71422B12-A	1
	65/69	S	On front door and quarter		2or4
<b>422B18-9 BRACKET - BACK WINDOW GLASS</b>					
	72	B(71)	R. H.	D2OZ 71422B18-A	1
			L. H.	D2OZ 71422B19-A	1
<b>42220 FRAME - BACK WINDOW - UPPER</b>					
- A -					
	69/70	A(63)		C9AZ 6342220-A	1
	69/70	A(65)		C9AZ 6542220-A	1
	71/72	A(53, 57)		D1AZ 5742220-A	1
	69/70	A(54, 57, 62)		C9AZ 6242220-A	1
	71/72	A(54)			1
	71/72	A(65)		D1AZ 6542220-A	1
- B -					
	66/67	B(54)		C6OZ 5442220-A	1
	66/67	B(62)		C6OZ 6242220-A	1
	67	B(66)		C6DZ 6642220-A	1
	68/69	B(54)		C8OZ 5442220-A	1
	68/69	B(63)		C8OZ 6342220-A	1
	68/69	B(65)		C8OZ 6542220-A	1
	68/71	B(66)		C8OZ 6642220-A	1
	70/71	B(54, 57)		D0OZ 5442220-A	1
	70/71	B(62, 65)		D0OZ 6542220-A	1
	70/71	B(63)		D0OZ 6342220-A	1
	72	B(53, 65)		D2OZ 6542220-A	1
	72	B(63)		D2OZ 6342220-A	1
	72	B(97)	Outer	D2OZ 9742220-A	1
			Inner	D2OZ 9742220-B	1
- F -					
	69/70	F(63)		C9ZZ 6342220-A	1
	69/70	F(65)		C9ZZ 6542220-A	1
	71/72	F(63)		D1ZZ 6342220-A	1
	71/72	F(65)		D1ZZ 6542220-A	1
- P -					
	71/72	P(54)		D1DZ 5442220-A	1
	70/72	P(62)		D0DZ 6242220-A	1
- S -					
	68/69	S(65)		C8SZ 6542220-A	1
	67/71	S(57)		C7SZ 5742220-A	1
	70	S(65)		D0SZ 6542220-A	1
	71	S(65A, C)			1
	71	S(65B, D)		D0LY 6542220-A	1
	72	S	" Before 1/3/72"	D2SZ 6542220-A	1
	72	S	" From 1/3/72"	D2SZ 6542220-B	1
- X -					
	66/70	X(54)		C6OZ 5442220-A	1
	66/70	X(62)		C6OZ 6242220-A	1

**BODY  
SECTION 420**
**FORD CAR PARTS**

GROUP NUMBER	YEAR	BODY TYPE	DESCRIPTION	PART NUMBER		QTY.
				RIGHT HAND	LEFT HAND	
<b>422A20-1 RUN - BACK WINDOW GLASS LOWER SIDE</b>						
- A -						
65	A(71)			C5AZ 71422A20-C	C5AZ 71422A21-C	1
			5/16"-18 x 1/2" Hex. hd. screw & washer assy.	42718-S7-8 (U9)	42718-S7-8 (U9)	2
			5/16"-18 Nut & washer assy.	33797-S7(M50)	33797-S7(M50)	2
66/70	A(71)			C6AZ 71422A20-A	C6AZ 71422A21-A	1
- B -						
65	B(71)			C3OZ 71422A20-B	★C3OZ 71422A21-B Not replaced (3-74)	1
			5/16"-18 x 3/4" Hex. hd. screw & washer assy.	359662-S7-8(BB575A)	359662-S7-8(BB575A)	4
66/71	B(71)			C6OZ 71422A20-A	C6OZ 71422A21-A	1
- X -						
65	X(59, 71, 78)			C0DB 59422A20-E	C0DB 59422A20-E	2
			5/16" Lockwasher (internal & external tooth)	356309-S7(XX299)	356309-S7(XX299)	4
			5/16"-18 x 1 1/2" Set screw	★379356-S2	★379356-S2	4
			5/16"-18 Hex. nut	33922-S8(M27)	33922-S8(M27)	4
66/70	X(71)			C6OZ 71422A20-A	C6OZ 71422A21-A	1
<b>422A24-5 RUN - BACK WINDOW GLASS SIDE UPPER - Includes Retainer</b>						
65	A(71)			C5AZ 71422A24-A	C5AZ 71422A25-A	1
66/69	A(71)			C6AZ 71422A24-A	C6AZ 71422A25-A	1
66/71	B(71)			C6OZ 71422A24-B	C6OZ 71422A25-B	1
66/70	X(71)					1
GROUP NUMBER	YEAR	BODY TYPE	DESCRIPTION	PART NUMBER		QTY.
<b>422B26 STABILIZER - BACK WINDOW AT BELT WEATHERSTRIP OUTSIDE</b>						
66/67	B(71), X(71)				C6AZ 71422B26-A	1
66/69	A(71)					1
68/71	B(71)				C8OZ 71422B26-A	1
68/70	X(71)					1
			No. 8-18 x 1/2" cross recess washer head screw		381969-S2(UU89A)	3
<b>422B32 FRAME - BACK WINDOW LOWER</b>						
67	B(66)				C6DZ 6642232-A	1
66	X(66)					1
70/71	B(54, 57, 62, 65)	Center			D0OZ 6542232-A	1
68/71	B(66)				C8OZ 6642232-A	1
72	B(97)				D2OZ 9742232-A	1
71/	F(63)				D1ZZ 6342232-A	1
71/	L(62)	Inner			D1FZ 6242232-A	1
71/	P(54)	Center			D1DZ 5442232-A	1
70/	P(62)				D0DZ 6242232-A	1
<b>422B32 WEATHERSTRIP - LIFTGATE - LOWER</b>						
66/68	U(98)		Refer to Group 42289			
69/	U(98)				C9TZ 98422B32-A	1
			No. 8-18 x 3/8" cross recess screw		★55944-S45X	2
<b>422B34 CLIP - BACK WINDOW GLASS</b>						
69/71	A(71)		On body-at roof		C9AZ 71422B34-A	1
<b>422A36 RUN - BACK WINDOW GLASS - TOP- Also refer to Group 422A24-5</b>						
65/68	A(71)				C5AZ 71422A36-B	1
65	B(71)		Top and sides-76.22" long		C3OZ 71422A36-A	1
66/71	B(71)				C6OZ 71422A36-B	1
66/70	X(71)					1
65	X(59, 71, 78)		Top and sides-72" long.		C3DZ 59422A36-A	1
<b>422A38-9 EXTENSION - BACK WINDOW UPPER INNER FRAME</b>						
68/69	B(65)		R. H.		C8OZ 65422A38-A	1
			L. H.		C8OZ 65422A39-A	1

# FORD CAR PARTS

**BODY  
SECTION 420**

7

GROUP NUMBER	YEAR	BODY TYPE	DESCRIPTION	PART NUMBER	QTY.
<b>42246-7 EXTENSION - FRONT LOWER BRACKET TO INNER REAR RAIL</b>					
	68/69	B(54)	R. H.	C8OZ 5442246-A	1
			L. H. - Not repl'd (1-73)	★C8OZ 5442247-A	1
	68/69	B(65)	R. H.	C8OZ 6542246-A	1
			L. H.	C8OZ 6542247-A	1
<b>42248-9 FRAME - BACK WINDOW - SIDE</b>					
	68/69	B(66)	R. H.	C8OZ 6642248-A	1
			L. H.	C8OZ 6642249-A	1
	70/71	B(66)	R. H.	DOOZ 6642248-A	1
			L. H.	DOOZ 6642249-A	1
	72	B(97)	R. H.	D2OZ 9742248-A	1
			L. H.	D2OZ 9742249-A	1
<b>422B50 WASHER - BACK WINDOW GLASS BRACKET</b>					
	71/	A(71)		D1AZ 71422B50-A	4
<b>422A64-5 EXTENSION - BACK WINDOW LOWER FRAME</b>					
	69/70	F(65)	R. H.	C9ZZ 65422A64-A	1
			L. H.	C9ZZ 65422A65-A	1
	71/	F(63)	R. H.	D1ZZ 63422A64-A	1
			L. H.	D1ZZ 63422A65-A	1
<b>42289 WEATHERSTRIP - LIFTGATE LOWER</b>					
	66/68	U(98)	Rubber	C6TZ 9842289-B	1
			Retainer	C5AZ 6220586-A	14
	69/	U(98)	Refer to Group 422B32		
<b>423A00-1 MOULDING - BACK WINDOW OUTSIDE UPPER - INCLUDES ATTACHING PARTS</b>					
	69	F(65)	Paint to match	C9ZZ 65423A00-A	1
	70	F(65)	R. H.	DOZZ 65423A00-A	1
			L. H.	DOZZ 65423A01-A	1
<b>423A04 RETAINER-BACK BELT MOULDING</b>					
	71	B(54B, C, 57C, 63C, F, 65B, C, 66A, B, C, 71B, C, 76)		C8MY 57423A04-A	4or8
<b>423A06 RETAINER - BACK WINDOW LOWER GARNISH MOULDING</b>					
	70/71	B(63)	Without counter sunk holes in moulding	DOOZ 63423A06-A	3
	67/71	S(57)		C7SZ 57423A06-B	5
<b>423B06 RETAINER - BACK BELT SIDE MOULDING</b>					
	69/70	A(54, 57, 62, 65)		C9AZ 65423B06-A	2
	69/70	A(63)		C9AZ 63423B06-A	1or2
	68	A(63)		C8AZ 63423B06-A	10
	71/	A(54B, D, F)	With vinyl roof cover or two-tone paint		8
	72	B(65, 97)			AR
	71/	F(63)	With vinyl roof cover		8
	71/	A(53, 57F, 65)	With vinyl roof cover-front	D1AZ 65423B06-A	6or8
	72	B(53, 63, 65)	With vinyl roof cover	D2OZ 53423B06-A	AR
	72	B(63)	Without vinyl roof cover	D2OZ 63423B06-A	8
	70/71	S(65B, D)		DOSZ 65423B06-A	4
<b>42308 STOP - BACK WINDOW - LOWER</b>					
	69/	A(71)		C9AZ 7142308-A	1
	72	B(71)		D2OZ 7142308-A	1
<b>42309 CLIP - BACK WINDOW - OUTSIDE LOWER MOULDING</b>					
	70	F(65)		DOZZ 6542309-A	6
<b>423B10 RETAINER - BACK WINDOW OUTSIDE UPPER OUTER MOULDING</b>					
	67/	A(71)		C9AZ 71423B10-B	4
<b>42312 NOZZLE - BACK WINDOW HOUSING DRAIN</b>					
	67/69	S		C7SZ 6542312-A	2
	71	S			2
<b>423B12 CLAMP - BACK WINDOW HOUSING DRAIN TUBE</b>					
	65/66	A(57), S(63)		C4SZ 63423B12-B	2
	67/69	S		C7MY 54423B12-A	2
<b>423A14 MOULDING - LOWER BACK PANEL CENTER - INCLUDES ATTACHING PARTS</b>					
	65	B(54B, 62B, 65)		C5OZ 62423A14-A	2
<b>42318 RETAINER - BACK WINDOW OUTSIDE SIDE MOULDING</b>					
	69/	A(71)	Lower	C9AZ 7142318-B	2
	69/70	F(65)	Lower	C9ZZ 6542318-A	2

GROUP NUMBER	YEAR	BODY TYPE	DESCRIPTION	PART NUMBER		QTY.
				RIGHT HAND	LEFT HAND	
<b>423A18-9 MOULDING - BACK BELT OUTSIDE SIDE - INCLUDES ATTACHING PARTS</b>						
<b>- A -</b>						
	66	A(54, 62)		C6AZ 62423A18-A	C6AZ 62423A19-A	1
	66	A(63)	With vinyl roof cover or two-tone paint	C6AZ 63423A18-A	C6AZ 63423A19-A	1
	67	A(57)		C7AZ 57423A18-A	C7AZ 57423A19-A	1
	67	A(63B, 63C)	With vinyl roof cover or two-tone paint	C7AZ 63423A18-A	C7AZ 63423A19-A	1
	67	A(63J)		C7AZ 63423A18-B	C7AZ 63423A19-B	1
	68	A(57)	With vinyl roof cover or two-tone paint	C8AZ 57423A18-A	C8AZ 57423A19-A	1
	68	A(65)	With vinyl roof cover or two-tone paint	C8AZ 65423A18-A	C8AZ 65423A19-A	1
	69/70	A(54, 62)		C9AZ 62423A18-A	C9AZ 62423A19-A	1
	69/70	A(57)		C9AZ 57423A18-A	C9AZ 57423A19-A	1
	69/70	A(63)	With vinyl roof cover or two tone paint	C9AZ 63423A18-A	C9AZ 63423A19-A	1
	69/70	A(65)		C9AZ 65423A18-A	C9AZ 65423A19-A	1
	69/70	A(76)		C9AZ 76423A18-A	C9AZ 76423A19-A	1
	70	A(65A, C)	With vinyl roof cover	D0AZ 65423A18-A	D0AZ 65423A19-A	1
	71/	A(53, 57)	Front-with vinyl roof cover or two-tone paint-paint to match	D1AZ 57423A18-A	D1AZ 57423A19-A	1
			Rear-with vinyl roof cover or two-tone paint-paint to match	D1AZ 57423A18-B	D1AZ 57423A19-B	1
	71/	A(54)	Front-with vinyl roof cover or two-tone paint-paint to match	D1AZ 54423A18-A	D1AZ 54423A19-A	1
	71/	A(65)	Front-with vinyl roof cover or two-tone paint-paint to match-black	D1AZ 65423A18-A	D1AZ 65423A19-A	1
			Rear-with vinyl roof cover or two-tone paint-paint to match-black	D1AZ 65423A18-B	D1AZ 65423A19-B	1
	71/	A(65)	Front-with vinyl roof cover or two-tone paint-white	D1AZ 65423A18-C	D1AZ 65423A19-C	1
			Rear-with vinyl roof cover or two-tone paint-white	D1AZ 65423A18-D	D1AZ 65423A19-D	1
	71/72	A(76)		D1AZ 76423A18-A	D1AZ 76423A19-A	1
	69/	A(71)		C9MZ 71423A18-B	C9MZ 71423A19-B	1
<b>- B -</b>						
	66/67	B(54)	With two-tone paint	C6OZ 54423A18-A	C6OZ 54423A19-A	1
	67	B(63)	With vinyl roof cover	C7OZ 63423A18-A	C7OZ 63423A19-A	1
	68/69	B(54A, 54B)	With vinyl roof cover or two-tone paint	C8OZ 54423A18-A	C8OZ 54423A19-A	1
	68/69	B(54C)	With vinyl roof cover-paint to match	★C8OZ 54423A18-B Not replaced (5-75)	C8OZ 54423A19-B	1
	68/69	B(65C)	With vinyl roof cover-paint to match	C8OZ 65423A18-A	C8OZ 65423A19-A	1
	68/69	B(65A, 65B, 65D, 65E)	With vinyl roof cover or two-tone paint	C8OZ 65423A18-B	C8OZ 65423A19-B	1
	68/69	B(76)		C8OZ 76423A18-B	C8OZ 76423A19-B	1
	70/71	B(54, 57)	With two tone paint-rustless steel	D0OZ 54423A18-A	D0OZ 54423A19-A	1
			With vinyl roof cover-paint to match	D0OZ 54423A18-B	D0OZ 54423A19-B	1
	70/71	B(62, 65)	With two tone paint - rustless steel	D0OZ 65423A18-A	D0OZ 65423A19-A	1
			With vinyl roof cover-w/o halo roof moulding-paint to match	★D0OZ 65423A18-B Not replaced (5-75)	D0OZ 65423A19-B	1

# FORD CAR PARTS

**BODY  
SECTION 420**

9

GROUP NUMBER	YEAR	BODY TYPE	DESCRIPTION	PART NUMBER		QTY.
				RIGHT HAND	LEFT HAND	
<b>423A18-9 MOULDING - BACK BELT - OUTSIDE - SIDE - INCLUDES ATTACHING PARTS - continued</b>						
<b>- B -</b>						
	71	B(65C)	With vinyl roof cover and halo roof moulding-paint to match	D1OZ 65423A18-A	D1OZ 65423A19-A	1
	70/71	B(66)	With two tone paint	D0OZ 66423A18-A	D0OZ 66423A19-A	1
	70/71	B(76)	With vinyl roof cover	D0OZ 66423A18-B	D0OZ 66423A19-B	1
	72	B(53)	With vinyl roof cover	D0OZ 76423A18-A	D0OZ 76423A19-A	1
	72	B(63)	With vinyl roof cover	D4OZ 53423A18-A	D4OZ 53423A19-A	1
	72	B(65)	With vinyl roof cover	D2OZ 63423A18-A	D2OZ 63423A19-A	1
			With vinyl roof cover-rear	D4OZ 65423A18-A	D4OZ 65423A18-A	1
	72	B(97)	With vinyl roof cover-White	D4OZ 65423A18-T	D4OZ 65423A19-T	1
			With vinyl roof cover-Black	D2OZ 97423A18-A	D2OZ 97423A19-A	1
				D2OZ 97423A18-B	D2OZ 97423A19-B	1
<b>- F -</b>						
	65/66	F(76)		C5ZZ 76423A18-A	★C5ZZ 76423A19-A Not replaced (5-75)	1
	67	F(76)		C7ZZ 76423A18-A	C7ZZ 76423A19-A	1
			No. 8-32 x .41" Stud fastener	372958-S100(HH21F)	372958-S100(HH21F)	13
	67/68	F(65)	With vinyl roof cover	C7ZZ 65423A18-A	C7ZZ 65423A19-A	1
	69	F(65)	With vinyl roof cover-White-paint to match	C9ZZ 65423A18-C	C9ZZ 65423A19-C	1
			With vinyl roof cover-Black	C9ZZ 65423A18-D	C9ZZ 65423A19-D	1
	70	F(65)	Without decorative design and with or without vinyl roof cover-paint to match	D0ZZ 65423A18-A	D0ZZ 65423A19-A	1
			With decorative design and with vinyl roof cover	★D0ZZ 65423A18-B Not replaced (5-75)	D0ZZ 65423A19-B	1
	69/70	F(76)		C9ZZ 76423A18-A	C9ZZ 76423A19-A	1
	71/	F(65)	Front- with vinyl roof cover-paint to match	D1ZZ 65423A18-A	D1ZZ 65423A19-A	1
			Rear- with vinyl roof cover-paint to match	D1ZZ 65423A18-C	D1ZZ 65423A19-C	1
	71/	F(76)		D1ZZ 76423A18-A	D1ZZ 76423A19-A	1
<b>- L -</b>						
	71/	L(62)	With vinyl roof cover	D1FZ 62423A18-B	D1FZ 62423A19-B	1
	72	L(64)	With vinyl roof cover	D2FZ 64423A18-A	D2FZ 64423A19-A	1
<b>- P -</b>						
	71/	P(54)	With vinyl roof cover or two-tone paint	D1DZ 54423A18-A	D1DZ 54423A19-A	1
	70/	P(62)	With vinyl roof cover or two-tone paint	D0DZ 62423A18-A	D0DZ 62423A19-A	1
<b>- S -</b>						
	67/68	S(65)		C7SZ 65423A18-A	C7SZ 65423A19-A	1
	67/71	S(57)		C7SZ 57423A18-A	C7SZ 57423A19-A	1
	69	S(65B, D)	Front-paint to match	C9SZ 65423A18-A	C9SZ 65423A19-A	1
			71	S(65B, D)	Rear-paint to match	C9SZ 65423A18-B
	70	S(65B, D)	Front-paint to match	D0SZ 65423A18-A	D0SZ 65423A19-A	1
			71	S(65A, C)	Rear-paint to match	D0SZ 65423A18-B
	72	S	With vinyl roof cover	D2SZ 65423A18-A	D2SZ 65423A19-A	1
<b>- X -</b>						
	68/70	X(54)	With two-tone paint	C8DZ 54423A18-A	★C8DZ 54423A19-A Not replaced (5-75)	1
	68/70	X(62)	With vinyl roof cover or two-tone paint	C8DZ 62423A18-A	C8DZ 62423A19-A	1

GROUP NUMBER	YEAR	BODY TYPE	DESCRIPTION	PART NUMBER		QTY.
				RIGHT HAND	LEFT HAND	
<b>423B18-9 RETAINER - BACK WINDOW GARNISH SIDE MOULDING</b>						
	67/70	S(65)		C7SZ 65423B18-A	C7SZ 65423B18-A	4
	67/71	S(57)		C7SZ 57423B18-A	C7SZ 57423B19-A	2
	71	S(65B, D)		D1SZ 65423B18-A	D1SZ 65423B18-A	4
<b>423A20-1 MOULDING - BACK BELT OUTSIDE CENTER - INCLUDES ATTACHING PARTS</b>						
<b>- A -</b>						
	65/66	A(57)		C5AZ 57423A20-B	C5AZ 57423A20-B	1
	65	A(63)		C5AZ 63423A20-A	★C5AZ 63423A21-A Not replaced (3-74)	1
	66	A(63)	With vinyl roof cover or two-tone paint	C6AZ 63423A20-A	C6AZ 63423A21-A	1
	67	A(54, 62)	With two-tone paint	C7AZ 62423A20-B	C7AZ 62423A21-B	1
	67	A(57)		C7AZ 57423A20-A	C7AZ 57423A20-A	1
	67	A(63B, C, J)	With vinyl roof cover or two-tone paint	C7AZ 63423A20-A	C7AZ 63423A21-A	1
	68	A(54, 62)	With vinyl roof cover or two-tone paint	C8AZ 62423A20-A	C8AZ 62423A21-A	1
	68	A(57, 65)	With vinyl roof cover or two-tone paint	C8AZ 57423A20-A	C8AZ 57423A21-A	1
	69/70	A(54, 62)		C9AZ 62423A20-A	C9AZ 62423A21-A	1
	69/70	A(57)		C9AZ 57423A20-A	C9AZ 57423A21-A	1
	69/70	A(65)		C9AZ 65423A20-A	C9AZ 65423A21-A	1
	71/	A(53, 57)	With vinyl roof cover or two-tone paint-paint to match	D1AZ 57423A20-A	D1AZ 57423A21-A	1
	71/	A(54)	With vinyl roof cover or two-tone paint-paint to match	D1AZ 54423A20-A	D1AZ 54423A21-A	1
<b>- B -</b>						
	66/67	B(54)	With two-tone paint	C6DZ 54423A20-A	C6DZ 54423A20-A	1
	66/67	B(62)	With vinyl roof cover or two-tone paint	C6DZ 62423A20-A	C6DZ 62423A20-A	1
	67	B(63)	With vinyl roof cover	C7OZ 63423A20-A	C7OZ 63423A21-A	1
	68/69	B(54A, B)	With vinyl roof cover or two-tone paint	C8OZ 54423A20-A	C8OZ 54423A21-A	1
	68/69	B(54C)	With vinyl roof cover-paint to match	C8OZ 54423A20-B	★C8OZ 54423A21-B Not replaced (5-75)	1
	68	B(65A, B, D, E)	With vinyl roof cover or two-tone paint	C8OZ 65423A20-A	C8OZ 65423A21-A	1
	69	B(65A, B, D, E, F)	With vinyl roof cover or two-tone paint	C8OZ 65423A20-A	C8OZ 65423A21-A	1
	68/69	B(65C)	With vinyl roof cover-paint to match	C8OZ 65423A20-B	C8OZ 65423A21-B	1
	68/69	B(76)		C8OZ 76423A20-C	C8OZ 76423A21-C	1
	70/71	B(54, 57, 62, 65)	With two tone paint - rustless steel	D0OZ 65423A20-A	D0OZ 65423A21-A	1
			With vinyl roof cover-w/o halo roof moulding-paint to match	D0GY 65423A20-A	D0GY 65423A21-A	1
	71	B(65C)	With vinyl roof cover and halo roof moulding-paint to match	D1OZ 65423A20-A	D1OZ 65423A21-A	1
	72	B(53, 65)	Aluminum-one piece	D2OZ 65423A20-A	D2OZ 65423A20-A	1
<b>- F -</b>						
	69	F(65)	With vinyl roof cover-White-paint to match	C9ZZ 65423A20-C	C9ZZ 65423A21-C	1
	69	F(65)	With vinyl roof cover-Black	C9ZZ 65423A20-D	C9ZZ 65423A21-D	1
	70	F(65)	Without decorative design and with or without vinyl roof cover	D0ZZ 65423A20-A	D0ZZ 65423A21-A	1
			With decorative design and with vinyl roof cover	D0ZZ 65423A20-B	D0ZZ 65423A21-B	1
	69/70	F(76)		C9ZZ 76423A20-A	C9ZZ 76423A21-A	1
	71/	F(76)		D1ZZ 76423A20-A	D1ZZ 76423A20-A	1



# FORD CAR PARTS

**BODY  
SECTION 420**

11

GROUP NUMBER	YEAR	BODY TYPE	DESCRIPTION	PART NUMBER		QTY.
				RIGHT HAND	LEFT HAND	
<b>423A20-1 MOULDING - BACK BELT - OUTSIDE - CENTER - INCLUDES ATTACHING PARTS - continued</b>						
- S -						
	67/68	S(65)		C7SZ	65423A20-A	1
	69	S(65A, C)		C7SZ	65423A20-A	1
	67/71	S(57)		C7SZ	57423A20-A	1
	69	S(65B, D)	Paint to match	C9SZ	65423A20-A	1
	71	S(65B, D)		C9SZ	65423A21-A	1
	72	S	Aluminum-with vinyl roof cover	D2SZ	65423A20-A	1
				D2SZ	65423A21-A	1
- X -						
	66/67	X(54)	With two-tone paint	C6DZ	54423A20-A	1
	66/67	X(62)	With vinyl roof cover or two-tone paint	C6DZ	62423A20-A	1
	68/70	X(54)	With two-tone paint	C8DZ	54423A20-A	1
	68/70	X(62)	With vinyl roof cover or two-tone paint	C8DZ	62423A20-A	1
				C8DZ	54423A21-A	1
				C8DZ	62423A21-A	1
GROUP NUMBER	YEAR	BODY TYPE	DESCRIPTION	PART NUMBER		QTY.
<b>423A26 RETAINER - BACK WINDOW OUTSIDE CENTER MOULDING</b>						
	65	A(57)		C5AZ	63423A26-A	10
	65	A(63)				8
	66	A, B, F, S, X	Refer to Group 42413			
	65	F(63, 65)	Top moulding Side moulding Lower moulding	C5ZZ	65423A26-A	6or7 6or7 7or8
<b>42331 RETAINER - LOWER BACK PANEL MOULDING</b>						
REFER TO APPROPRIATE EXTERIOR MOULDING ILLUSTRATION FOR COMPLETE RETAINER PART NUMBER						
<b>423A42 PANEL - LOWER BACK FINISH - INCLUDES ATTACHING PARTS</b>						
- A -						
	69	A(54A, B, E, 57B, 62, 63B, 65C, 76A)		C9AZ	54423A42-A	1
	69	A(54C, 57F, 63C, 65A, 76B)	Refer to Group 13380 in Chassis Section			
	70	A(54A, 57B, 63B, 65C)		D0AZ	54423A42-B	1
	70	A(54C, 57F, 63C, 65A, 76)		D0AZ	54423A42-A	1
	71	A(54F, 57F, 65F)		D1AZ	65423A42-A	1
- B -						
	68	B(63)		C8OZ	63423A42-B	1
	69	B(63)	Refer to Groups 423A58-9 and 423A84			
	70	B(54C, 57C, E, 63C, 65C, E, 76)		D0OZ	65423A42-A	1
	71	B(57E, 65E)		D1OZ	65423A42-A	1
	70/71	B(63F, H)	Refer to Group 425A02			
- F -						
	70	F(63C)		D0ZZ	63423A42-A	1
	71/72	F(63-w/Boss)		D2ZZ	63423A42-A	1
	71/	F(63 exc. Boss)	Retained with mouldings	D1ZZ	65423A42-A	1
	71/	F(65, 76)				1
<b>42353 COVER - BACK WINDOW GARNISH UPPER MOULDING JOINT - Paint to match</b>						
	71/	A(53, 57)		D1AZ	5742353-A	1
<b>423A58 MOULDING - LOWER BACK PANEL - INCLUDES ATTACHING PARTS</b>						
	71	A(54D, 65D)	Side	D1AZ	54423A58-A	2
	65	B(54B, 62B, 65)	18.56" long	C5OZ	62423A58-A	4
	69	B(63)	Upper	C9OZ	63423A58-A	2
<b>42364 RETAINER - MOULDING</b>						
	65	B(54, 71)	Rear door	C4GY	6242364-A	2
	65	B	Quarter			2or4
<b>423A64 RETAINER - LOWER BACK FINISH PANEL</b>						
	69	A(54A, 57B, 63B, 65C, 76A)		C9AZ	54423A64-A	7



**BODY  
SECTION 420**
**FORD CAR PARTS**

GROUP NUMBER	YEAR	BODY TYPE	DESCRIPTION	PART NUMBER	QTY.
<b>423A66</b>	<b>NUT - BACK BELT MOULDING RETAINING</b>				
68/71	A(76), B(76), F(76)			C8AZ 76423A66-A	AR
72	A(76), F(76)				AR
<b>423A70</b>	<b>RAIL - TAILGATE OUTSIDE FINISH UPPER - INCLUDES ATTACHING PARTS</b>				
65	A(71A, E)			C5AZ 71423A70-A	1
66	A(71A, E)			C6AZ 71423A70-A	1
67	A(71A, E)		Includes "FORD" letters	C7AZ 71423A70-B	1
68	A(71A, E)			C8AZ 71423A70-A	1
69/70	A(71A, E)			C9AZ 71423A70-A	1
71	A(71H)				1
72	A(71H)			D2AZ 71423A70-A	1
66/67	B(71E)			C6OZ 71423A70-B	1
68/69	B(71E)			C8OZ 71423A70-A	1
70/71	B(66E, 71E)			D0OZ 71423A70-A	1
72	B(71K, 97K)			D2OZ 71423A70-A	1
72	L(73)			D2FZ 73423A70-A	1
<b>423B70</b>	<b>TRANSFER - LOWER BACK PANEL</b>				
70	F(65E, 76B)	Black		D0ZZ 65423B70-A	1
<b>42372</b>	<b>RETAINER - BACK WINDOW GLASS RUN - UPPER</b>				
65/69	A(71)			C5AZ 7142372-A	1
			No. 8-15 x 1/2" Cross recess pan head screw	52726-S13(U381)	6
66/71	B(71)			C6OZ 7142372-A	1
66/70	X(71)				1
			No. 8-15 x 3/4" Cross recess washer head screw	350075-S13(UU88)	4
65	B(71)		No. 8-15 x 1/2" Cross recess pan head screw	52726-S13(U381)	6
<b>42376-7</b>	<b>MOULDING - BACK WINDOW OUTSIDE UPPER CORNER</b>				
65	A(71)	"Before 10/15/64"	Refer to Group 424A90-1		
65/67	A(71) - "From 10/15/64 to 1/24/67"		R. H. -Includes attaching parts L. H.	C5AZ 7142376-B C5AZ 7142377-C	1 1
67/69	A(71)	"From 1/24/67"	R. H. -Includes attaching parts L. H.	C5AZ 7142376-C C5AZ 7142377-C	1 1
70/71	B(66)		Refer to Group 42452-3		
65/66	F(65)			C5ZZ 6542376-A	2
67/69	F(63)		R. H. L. H.	C7ZZ 6342376-A C7ZZ 6342377-A	1 1
65	X(54, 62)		R. H. -Not repl'd (1-73) L. H.	★C2DZ 6242376-A C2DZ 6242377-A	1 1
<b>423A82</b>	<b>MOULDING - LOWER BACK PANEL - UPPER - INCLUDES ATTACHING PARTS</b>				
70	F(63C, 65E)			D0ZZ 65423A82-A	2
71/	F(63-w/Boss)			D1ZZ 63423A82-A	1
71/	F(63 exc. Boss)			D1ZZ 65423A82-A	1
71/	F(65, 76)				1
<b>423A84</b>	<b>MOULDING - LOWER BACK PANEL - LOWER - INCLUDES ATTACHING PARTS</b>				
69	B(63D, F)			C9OZ 63423A84-A	1
70	F(63C, 65E)			D0ZZ 65423A84-A	1
71/	F(63-w/Boss)			D1ZZ 63423A84-A	1
71/	F(63 exc. Boss)			D1ZZ 65423A84-A	1
71/	F(65, 76)				1
<b>424B02</b>	<b>RETAINER - BACK BELT MOULDING JOINT COVER</b>				
71/	A(53, 57)		With vinyl roof cover or two-tone paint	D1AZ 57424B02-A	1
<b>42404-5</b>	<b>MOULDING - BACK WINDOW OUTSIDE LOWER - INCLUDES ATTACHING PARTS</b>				
- A -					
65	A(54)		R. H. -2.50" wide L. H.	C6AZ 5442404-A C6AZ 5442405-A	1 1
66	A(54, 62)		R. H. -With insert L. H.	C6AZ 5442404-A C6AZ 5442405-A	1 1
66	A(63)		R. H. L. H.	C6AZ 6342404-A C6AZ 6342405-A	1 1
67/68	A(54, 62)		R. H. L. H.	C7AZ 6242404-A C7AZ 6242405-A	1 1
67	A(63)		R. H. L. H.	C7AZ 6342404-A C7AZ 6342405-A	1 1

# FORD CAR PARTS

## BODY SECTION 420

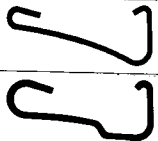
13

GROUP NUMBER	YEAR	BODY TYPE	DESCRIPTION	PART NUMBER	QTY.
<b>42404-5 MOULDING - BACK WINDOW OUTSIDE LOWER - INCLUDES ATTACHING PARTS - continued</b>					
- A -					
68	A(57, 65)	R. H. L. H.		C8AZ 5742404-A C8AZ 5742405-A	1 1
68	A(63)	R. H. L. H.		C8AZ 6342404-A C8AZ 6342405-A	1 1
69/70	A(54, 62)	R. H. L. H.		C9AZ 6242404-A C9AZ 6242405-A	1 1
69/70	A(57)	R. H. L. H.		C9AZ 5742404-A C9AZ 5742405-A	1 1
69	A(63) "Before 3/3/69"	R. H. - end view shaped like this		C9AZ 6342404-A	1
		L. H.		C9AZ 6342405-A	1
69/70	A(63) "From 3/3/69"	R. H. - end view shaped like this		C9AZ 6342404-B	1
		L. H.		C9AZ 6342405-B	1
69/70	A(65)	R. H. L. H.		C9AZ 6542404-A C9AZ 6542405-A	1 1
71/	A(53, 57)	R. H. L. H.		D1AZ 5742404-A D1AZ 5742405-A	1 1
71/	A(54)	R. H. L. H.		D1AZ 5442404-A D1AZ 5442405-A	1 1
71/	A(65)	R. H. L. H.		D1AZ 6542404-A D1AZ 6542405-A	1 1
- B -					
66/67	B(54)	R. H. - not replaced (5-75) L. H.		★C6OZ 5442404-A C6OZ 5442405-A	1 1
66/67	B(62)			C6OZ 6242404-A	1
66/67	B(63)	R. H. L. H.		C6OZ 6342404-A C6OZ 6342405-A	1 1
67	B(66)	R. H. - snap-on type - Not replaced (2-74) L. H.		★C6DZ 6642404-A	1
68/69	B(54)	R. H. L. H.		C6DZ 6642405-A C8OZ 5442404-A	1 1
68/69	B(63)	R. H. L. H.		C8OZ 5442405-A C8OZ 6342404-A	1 1
68/69	B(65)			C8OZ 6342405-A	1
68/69	B(66)	R. H. L. H.		C8OZ 6542404-A C8OZ 6642404-A	1 1
70/71	B(54, 57, 62, 65)			C8OZ 6642405-A	1
70/71	B(63)	R. H. L. H.		D0OZ 6542404-A D0OZ 6342404-A	1 1
70/71	B(66)			D0OZ 6342405-A D0OZ 6642404-A	1 1
72	B(53, 65)	No. 8-18 x 3/8" Round washer head screw R. H. L. H.		379560-S101(UU89CA) D4OZ 6542404-A	AR 1
72	B(63)	R. H. L. H.		D4OZ 6542405-A D2OZ 6342404-A	1 1
72	B(97)	R. H. L. H.		D2OZ 6342405-A D2OZ 9742404-A	1 1
				D2OZ 9742405-A	1
- F -					
65/66	F(63)	R. H. L. H.		C5ZZ 6342404-A C5ZZ 6342405-A	1 1
67/68	F(63)			C7ZZ 6342404-A	1
65/66	F(65)			C5ZZ 6542404-A	1
67/68	F(65)	Less vinyl roof cover.		C7ZZ 6542404-A	1
69	F(65)	Paint to match		C9ZZ 6542404-A	1
69/70	F(63)	R. H. - bright finish L. H.		C9ZZ 6342404-A C9ZZ 6342405-A	1 1
70	F(63)	R. H. - black L. H.		D0ZZ 6342404-A D0ZZ 6342405-A	1 1
70	F(65)	R. H. L. H. Clip		D0ZZ 6542404-B D0ZZ 6542405-B D0ZZ 6542309-A	1 1 6

**BODY  
SECTION 420**
**FORD CAR PARTS**

GROUP NUMBER	YEAR	BODY TYPE	DESCRIPTION	PART NUMBER	QTY.
<b>42404-5</b>	<b>MOULDING - BACK WINDOW OUTSIDE - LOWER - INCLUDES ATTACHING PARTS - continued</b>				
	- F -				
	71/	F(63)	R.H. L.H.	D1ZZ 6342404-A D1ZZ 6342405-A	1 1
	71/	F(65)	R.H. L.H.	D1ZZ 6542404-A D1ZZ 6542405-A	1 1
	- L -				
	71/	L(62)	R.H. L.H.	D1FZ 6242404-A D1FZ 6242405-A	1 1
	71	L(64)	R.H. L.H.	D1FZ 6442404-B D1FZ 6442405-B	1 1
	- P -				
	70	P(62)	R.H. L.H.	D0DZ 6242404-A D0DZ 6242405-A	1 1
	71/	P(54)	R.H. L.H.	D1DZ 5442404-A D1DZ 5442405-A	1 1
	71/	P(62)	R.H. L.H.	D1DZ 6242404-A D1DZ 6242405-A	1 1
	- S -				
	67/71	S(57)	R.H. L.H.	C7SZ 5742404-B C7SZ 5742405-B	1 1
	70 71	S(65) S(65A, C)	R.H. L.H.	D0SZ 6542404-A D0SZ 6542405-A	1 1
	67/69 71	S(65) S(65B, D)	R.H. L.H.	C7SZ 6542404-A C7SZ 6542405-A	1 1
	72	S	R.H. L.H.	D2SZ 6542404-A D2SZ 6542405-A	1 1
	- U -				
	67/72 67/72	U(97) U(98)	Alumnum-back window Alumnum-used on lift gate	C7TZ 9742404-B	1 1
	- X -				
	66/70	X(54)	R.H. - not replaced (5-75) L.H.	★C6OZ 5442404-A C6OZ 5442405-A	1 1
	66/70	X(62)		C6OZ 6242404-A	1
<b>424A04</b>	<b>COVER - BACK WINDOW MOULDING JOINT</b>				
	70	F(65)	Saddle finish-includes attaching parts	D0ZZ 65424A04-A	1
<b>424B04</b>	<b>SHIELD - BACK WINDOW WIRING</b>				
	71	F(63)		D1ZZ 63424B04-A	2
	72	B(65)	Black	D2OZ 65424B04-A	1
			Blue	D2OZ 65424B04-C	1
			Ginger	D2OZ 65424B04-G	1
			Gold	D2OZ 65424B04-E	1
			Green	D2OZ 65424B04-D	1
			Tobacco	D2OZ 65424B04-F	1
			White	D2OZ 65424B04-B	1
	72	L(64)	Refer to group 14A099 in Chassis Section		
<b>42410</b>	<b>MOULDING - BACK WINDOW GARNISH UPPER - PAINT TO MATCH</b>				
	69/70	A(54, 62)	R.H. L.H.	C9AZ 6242410-A C9AZ 6242410-B	1 1
	69/70	A(57)	R.H. L.H.	C9AZ 5742410-A C9AZ 5742410-B	1 1
	69/70	A(63)	R.H. L.H.	C9AZ 6342410-A C9AZ 6342410-B	1 1
	69/70	A(65)	R.H. L.H.	C9AZ 6542410-A C9AZ 6542410-B	1 1
	71/	A(53, 57)	R.H. L.H.	D1AZ 5742410-A D1AZ 5742410-B	1 1
	71/	A(54)	R.H. L.H.	D1AZ 5442410-A D1AZ 5442410-B	1 1
	71/	A(65)	R.H. L.H.	D1AZ 6542410-A D1AZ 6542410-B	1 1

# FORD CAR PARTS

**BODY  
SECTION 420**

15

GROUP NUMBER	YEAR	BODY TYPE	DESCRIPTION	PART NUMBER		QTY.
				RIGHT HAND	LEFT HAND	
<b>42410 MOULDING - BACK WINDOW GARNISH - UPPER - PAINT TO MATCH - continued</b>						
	69/	A(71)			C9AZ 7142410-A	1
	68	B(63)	R. H.		C8OZ 6342410-A	1
			L. H.		C8OZ 6342410-B	1
	70/	B(63)	R. H.		DOOZ 6342410-A	1
			L. H.		DOOZ 6342410-B	1
	67/71	S(57)	R. H. -Includes attaching parts		C7SZ 5742410-A	1
			L. H.		C7SZ 5742410-B	1
	67/68	S(65)			C7SZ 6542410-B	1
	71	S(65B, D)				1
	70	S(65)			D0SZ 6542410-A	1
	71	S(65A, C)				1
	72	S	R. H.		D2SZ 6542410-A	1
			L. H.		D2SZ 6542410-B	1
<b>42413 RETAINER - OUTSIDE MOULDING</b>						
	65	A(54, 62)			C5AZ 6242413-A	12or20
	66/	A(except 76), B(except 76)-	No. 8-18 x .38" Cross recess truss head-screw		376378-S101(UU97)	20
			Also used on side, lower, windshield, roof extension moulding and quarter		D1AZ 6542413-B	AR
	65/	F				AR
	71/	L	Windshield			24
	70	P				AR
	66/	S	Also used on lower, center and windshield			AR
	66/70	X	Also used on side and lower			AR
	68/70	B(71), F(63, 65), S	No. 8-18 x 3/8" Round washer head-screw		379560-S101(UU89CA)	AR
	70/71	B(66)			D0CZ 6642413-A	7
	65	F(63, 65)	Refer to Group 423A26			
	67/68	F(65)			C7ZZ 6542413-A	6
	69/70	F(65)			C9ZZ 6542413-A	1
	70	F(65)			D0ZZ 6542413-A	10
					D0ZZ 6542413-B	6
GROUP NUMBER	YEAR	BODY TYPE	DESCRIPTION	PART NUMBER		QTY.
				RIGHT HAND	LEFT HAND	
<b>42416-7 MOULDING - BACK WINDOW GARNISH - SIDE - INCLUDES ATTACHING PARTS</b>						
	65/68	A(71)	Refer to Group 40428-9			
	69/70	A(54, 62)	Paint to match	C9AZ 6242416-A	C9AZ 6242417-A	1
	69/70	A(57)	Paint to match	C9AZ 5742416-A	C9AZ 5742417-A	1
	69/70	A(63)	Paint to match	C9AZ 6342416-A	C9AZ 6342417-A	1
	69/70	A(65)	Paint to match	C9AZ 6542416-A	C9AZ 6542417-A	1
	71/	A(53, 57)	Paint to match	D1AZ 5742416-A	D1AZ 5742417-A	1
	71/	A(54)	Paint to match	D1AZ 5442416-A	D1AZ 5442417-A	1
	71/72	A(65) "Before 7/19/72"	Paint to match	D3AZ 6542416-A	D1AZ 6542417-A	1
	72	A(65) "From 7/19/72"	Paint to match	D3AZ 6542416-A	D3AZ 6542417-A	1
	67/68	B(71)	Gold	★C7OZ 7142416-DIG	C7OZ 7142417-E1G	1
			Not replaced (3-74)			
			Red	C6OZ 7142416-DBD	C6OZ 7142417-EBD	1
	68/69	B(63)	Paint to match	★C8OZ 6342416-B	C8OZ 6342417-B	1
			Not replaced (3-74)			
	69	B(71)	Black	C9OZ 7142416-DCA	C9OZ 7142417-ECA	1
			Nugget gold	C9OZ 7142416-DBY	C9OZ 7142417-EBY	1
			Red	C9OZ 7142416-DBD	★C9OZ 7142417-EBD	1
			Not repl'd (1-73)			
	70	B(71)	Black	D0OZ 7142416-D	D0OZ 7142417-D	1
			Blue	D0OZ 7142416-A	D0OZ 7142417-A	1
			Ginger	D0OZ 7142416-B	D0OZ 7142417-B	1
			Green	D0OZ 7142416-E	D0OZ 7142417-E	1
			Red	D0OZ 7142416-C	D0OZ 7142417-C	1
	70/71	B(63)	Paint to match	D0OZ 6342416-A	D0OZ 6342417-A	1
	71	B(71)	Black	D1OZ 7142416-E	D1OZ 7142417-E	1
			Blue	D1OZ 7142416-C	D1OZ 7142417-C	1
			Ginger	D1OZ 7142416-B	D1OZ 7142417-B	1
			Gray gold	D1OZ 7142416-A	D1OZ 7142417-A	1
			Green	D1OZ 7142416-F	D1OZ 7142417-F	1
			Vermilion	D1OZ 7142416-D	D1OZ 7142417-E	1

May, 1975

COPYRIGHT © 1975 -

FORD MOTOR  
COMPANY

-DEARBORN, MICHIGAN



**FINAL ISSUE**

GROUP NUMBER	YEAR	BODY TYPE	DESCRIPTION	PART NUMBER		QTY.	
				RIGHT HAND	LEFT HAND		
<b>42416-7 MOULDING - BACK WINDOW GARNISH - SIDE - INCLUDES ATTACHING PARTS - continued</b>							
	65	S(63)		C4SZ 6342413-B	★C4SZ 6342417-B Not replaced (3-74)	1	
	66	S(63A)				1	
	65/66	S(63)	No. 8-15 x 1" Cross recess oval head screw	52376-S13(U296)	52376-S13(U296)	AR	
	67/71	S(57)	Paint to match	C7SZ 5742416-B	C7SZ 5742417-B	1	
	70	S(65)		D0SZ 6542416-A	D0SZ 6542417-A	1	
	71	S(65A, C)				1	
	67/69	S(65)	Paint to match	C7SZ 6542416-B	C7SZ 6542417-B	1	
	71	S(65B, D)				1	
	72	S	Black	D3SZ 6542416-M	D3SZ 6542417-A	1	
			Ginger - paint to match	D3SZ 6542416-Q	D3SZ 6542417-A	1	
			Gold - paint to match	D3SZ 6542416-P	D3SZ 6542417-A	1	
			White - paint to match	D3SZ 6542416-N	D3SZ 6542417-A	1	
	66	X(71)	"Before 4/1/66"	Aqua	C6OZ 7142416-ABG	C6OZ 7142417-ABG	1
				Parchment	C6OZ 7142416-ABF	C6OZ 7142417-ABF	1
				Red	C6OZ 7142316-ABD	C6OZ 7142417-ABD	1
	66	X(71)	"From 4/1/66"	Use with C6OZ 71290A14-5-A			
				Aqua	C6OZ 7142416-DBG	★C6DZ 7142417-ABG Not replaced (3-74)	1
				Black	C6OZ 7142416-DBC	★C6DZ 7142417-ABC Not replaced (3-74)	1
	66/68	X(71)		Red	C6OZ 7142416-DBD	★C6DZ 7142417-ABD Not replaced (1-73)	1
	67/68	X(71)		Black	C6OZ 7142416-DBC	C6OZ 7142417-ABC	1
				Parchment	C7OZ 7142416-D1U	★C7DZ 7142417-A1U Not replaced (1-73)	1
	67/69	X(71)		Blue	C7OZ 7142416-BDE	C7DZ 7142417-ABE	1
	69/70	X(71)		Black	C9OZ 7142416-DCA	C9DZ 7142417-ACA	1
				Nugget gold	C9DZ 7142416-DBY	C9DZ 7142417-ABY	1
				Red	C9OZ 7142416-DBD	C9DZ 7142417-ABD	1
GROUP NUMBER	YEAR	BODY TYPE	DESCRIPTION	PART NUMBER		QTY.	
<b>42426 COVER - BACK WINDOW OUTSIDE MOUNTING JOINT</b>							
	68	A(63)	Lower Corner	C8AZ 6342426-A		1	
	69/70	A(65)	Lower Corner	C9AZ 6542426-A		1	
	71/	A(53, 57)	Center	D1AZ 5742426-A		1	
	71	A(53, 57)	Also refer to Group 403A22				
	67/69	S(65)	Center	C7SZ 6542426-A		1	
	71	S(65B, D)				1	
<b>42430-1 MOULDING - BACK WINDOW OUTSIDE TOP - INCLUDES ATTACHING PARTS</b>							
- A -							
	65/66	A(54, 62)	R. H.	C5AZ 6242430-B		1	
			L. H.	C5AZ 6242431-B		1	
	67/68	A(54, 62)	R. H.	C7AZ 6242430-A		1	
			L. H.	C7AZ 6242431-A		1	
	65/67	A(57)	R. H.	C5AZ 5742430-B		1	
			L. H.	C5AZ 5742431-B		1	
	68	A(57, 65)	R. H.	C8AZ 5742430-A		1	
			L. H.	C8AZ 5742431-A		1	
	66	A(63)	R. H.	C6AZ 6342430-A		1	
			L. H. - Not replaced (3-74)	★C6AZ 6342431-A		1	
	67	A(63)	R. H.	C7AZ 6342430-A		1	
			L. H.	C7AZ 6342431-A		1	
	68	A(63)	R. H.	C8AZ 6342430-A		1	
			L. H.	C8AZ 6342431-A		1	
	65/69	A(71)		C5AZ 7142430-D		1	
	69/70	A(54, 62)	R. H.	C9AZ 6242430-A		1	
			L. H.	C9AZ 6242431-A		1	
	69/70	A(57)		C9AZ 5742430-A		1	

# FORD CAR PARTS

## BODY SECTION 420

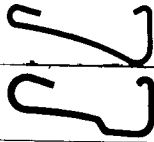
17

GROUP NUMBER	YEAR	BODY TYPE	DESCRIPTION	PART NUMBER	QTY.	
<b>42430-1 MOULDING - BACK WINDOW OUTSIDE - TOP - INCLUDES ATTACHING PARTS - continued</b>						
	69	A(63)	"Before 3/3/69"	R. H. -end view shaped like this 	C9AZ 6342430-A	1
			L. H.	C9AZ 6342431-A	1	
	69/70	A(63)	"From 3/3/69"	R. H. -end view shaped like this 	C9AZ 6342430-B	1
			L. H.	C9AZ 6342431-B	1	
	69/70	A(65)		R. H. C9AZ 6542430-A	1	
				L. H. C9AZ 6542431-A	1	
	71/	A(53, 57)		R. H. D1AZ 5742430-A	1	
				L. H. D1AZ 5742431-A	1	
	71/	A(54)		R. H. D1AZ 5442430-A	1	
				L. H. D1AZ 5442431-A	1	
	71/	A(65)	R. H. - bright finish-w/o two-tone paint or vinyl roof cover	D1AZ 6542430-A	1	
			L. H.	D1AZ 6542431-A	1	
			R. H. - black-w/two-tone paint or vinyl roof cover	D1AZ 6542430-B	1	
			L. H.	D1AZ 6542431-B	1	
			R. H. -white-w/two-tone paint or vinyl roof cover	D1AZ 6542430-C	1	
			L. H.	D1AZ 6542431-C	1	
<b>- B -</b>						
	66/67	B(54)	R. H. -Also used on side	C6OZ 5442430-A	1	
			L. H.	C6OZ 5442431-A	1	
	66/67	B(62)	R. H.	C6OZ 6242430-A	1	
			L. H.	C6OZ 6242431-A	1	
	67	B(66)	R. H. -snap on type	C6DZ 6642430-A	1	
			L. H.	C6DZ 6642431-A	1	
	68/69	B(54)	R. H.	C8OZ 5442430-A	1	
			L. H.	C8OZ 5442431-A	1	
	68/69	B(63)	R. H.	C8OZ 6342430-A	1	
			L. H.	C8OZ 6342431-A	1	
	68/69	B(65)	R. H.	C8OZ 6542430-A	1	
			L. H.	C8OZ 6542431-A	1	
	68/69	B(66)	R. H.	C8OZ 6642430-B	1	
			L. H.	C8OZ 6642431-B	1	
			No. 8-18 x 3/8" Round washer head screw	379560-S101(UU89CA)	AR	
	70/71	B(54, 57)	R. H.	D0OZ 5442430-A	1	
			L. H.	D0OZ 5442431-A	1	
	70/71	B(63)	R. H.	D0OZ 6342430-A	1	
			L. H.	D0OZ 6342431-A	1	
	70/71	B(62, 65)	R. H.	D0OZ 6542430-A	1	
			L. H.	D0OZ 6542431-A	1	
	70/71	B(66)		D0OZ 6642430-B	1	
	66/71	B(71)		C6OZ 7142430-A	1	
	72	B(53, 65)	R. H.	D2OZ 6542430-A	1	
			L. H.	D2OZ 6542431-A	1	
	72	B(63)	R. H.	D2OZ 6342430-A	1	
			L. H.	D2OZ 6342431-A	1	
<b>- F -</b>						
	65/66	F(63)	R. H.	C5ZZ 6342430-A	1	
			L. H.	C5ZZ 6342431-A	1	
	65/66	F(65)		C5ZZ 6542430-A	1	
	67/68	F(63)		C7ZZ 6342430-A	1	
	69/70	F(63)	R. H. -bright finish	C9ZZ 6342430-A	1	
			L. H.	C9ZZ 6342431-A	1	
	67/70	F(65)		C7ZZ 6542430-A	1	
	70	F(63)	R. H. -black	D0ZZ 6342430-A	1	
			L. H.	D0ZZ 6342431-A	1	
	71/	F(63)	R. H.	D1ZZ 6342430-A	1	
			L. H.	D1ZZ 6342431-A	1	
	71/	F(65)	R. H.	D1ZZ 6542430-A	1	
			L. H.	D1ZZ 6542431-A	1	

GROUP NUMBER	YEAR	BODY TYPE	DESCRIPTION	PART NUMBER	QTY.
<b>42430-1</b>	<b>MOULDING - BACK WINDOW OUTSIDE - TOP - INCLUDES ATTACHING PARTS - continued</b>				
	- L -				
	71/	L(62)	R. H.	D1FZ 6242430-A	1
			L. H.	D1FZ 6242431-A	1
	71	L(64) " Before 7/12/71"	R. H.-with small window	D1FZ 6442430-B	1
			L. H.	D1FZ 6442431-B	1
	71/	L(64) " From 7/12/71"	Refer to Group 42492-3(large window)		
	- P -				
	70/72	P(62) " Before 4/3/72"	Snap-on	D0DZ 6242430-A	1
	72	P(62) " From 4/3/72"		D2DZ 6242430-A	1
	71/	P(54)	R. H.	D1DZ 5442430-A	1
			L. H.	D1DZ 5442431-A	1
	- S -				
	65/66	S(63A)		C4SZ 6342430-A	1
	72	S	R. H.	D2SZ 6542430-A	1
			L. H.	D2SZ 6542431-A	1
	- U -				
	67/72	U(97)	R. H.	C7TZ 9742430-B	1
			L. H.	C7TZ 9742431-B	1
	67/72	U(98)	R. H.	C7TZ 9842430-B	1
			L. H.	C7TZ 9842431-B	1
	- X -				
	66/70	X(54)	R. H. -also used on side	C6OZ 5442430-A	1
			L. H.	C6OZ 5442431-A	1
	66/70	X(62)	R. H.	C6OZ 6242430-A	1
			L. H.	C6OZ 6242431-A	1
	66/70	X(71)		C6OZ 7142430-A	1
<b>42435</b>	<b>RETAINER - BACK WINDOW OUTSIDE UPPER MOULDING</b>				
	69/	A(71)		C9AZ 7142435-A	6
<b>42450</b>	<b>COVER - BACK WINDOW OUTSIDE MOULDING JOINT UPPER</b>				
	71/	A(53, 57)		D1AZ 5742450-A	1
<b>42450</b>	<b>CLIP - QUARTER WINDOW MOULDING OUTER FRAME SET</b>				
	66	F(GT350)		S2MS 42450-A	4
<b>42452-3</b>	<b>MOULDING - BACK WINDOW OUTSIDE UPPER CORNER-INCLUDES ATTACHING PARTS</b>				
	70/71	B(66)	R. H.	DOOZ 6642452-B	1
			L. H.	DOOZ 6642453-B	1
<b>42456-7</b>	<b>MOULDING - BACK WINDOW GARNISH LOWER - PAINT TO MATCH - INCLUDES ATTACHING PARTS</b>				
	67	A(54, 62)	Refer to Group 02600 in Soft Trim Section		
	69/70	A(54, 62)		C9AZ 6242456-A	1
	69/70	A(57)		C9AZ 5742456-A	1
	69/70	A(63)		C9AZ 6342456-A	1
	69/70	A(65)	R. H.	C9AZ 6542456-A	1
			L. H.	C9AZ 6542457-A	1
	71/	A(53, 57)		D1AZ 5742456-A	1
	71/	A(54)		D1AZ 5442456-A	1
	71/	A(65)	R. H.	D1AZ 6542456-A	1
			L. H.	D1AZ 6542457-A	1
	68/69	B(63)		C8OZ 6342456-A	1
	70	B(63) "Before 12/15/69"		DOOZ 6342456-A	1
	70/71	B(63) "From 12/15/69"		DOOZ 6342456-B	1
	67/71	S(57)		C7SZ 5742456-B	1
	72	S		D2SZ 6542456-A	1
<b>42458</b>	<b>COVER - BACK WINDOW GARNISH MOULDING JOINT</b>				
	69/70	A(65)	Paint to match	C9AZ 6542458-A	1
<b>42460</b>	<b>COVER - BACK WINDOW OUTSIDE SIDE MOULDING JOINT</b>				
	67/69	S(65)		C7SZ 6542460-A	1
	71	S(65B, D)			1
<b>424A62-3</b>	<b>TUBE and BAFFLE ASSY. - BACK WINDOW HOUSING DRAIN</b>				
	65/66	A(57)	R. H.	C5AZ 57424A62-B	1
			L. H.	C5AZ 57424A63-B	1
			Clamp	C4SZ 63423B12-B	2
	65/66	S(63)	R. H.	C4SZ 63424A62-D	1
			L. H.	C4SZ 63424A63-D	1
			No.10-12 x 1/2" Hex.washer head screw	42127-S7-8(U248C)	8
	67/71	S		C7SZ 65424A62-A	2



# FORD CAR PARTS

## BODY SECTION 420

GROUP NUMBER	YEAR	BODY TYPE	DESCRIPTION	PART NUMBER		QTY.		
<b>42468</b>	<b>RETAINER - BACK WINDOW UPPER GARNISH MOULDING</b>							
	67/70	S(65)		C7SZ	6542468-A	4		
	67/71	S(57)		C7SZ	5742468-A	5		
	71	S(65B, D)		D1SZ	6542468-A	4		
<b>424A68</b>	<b>PANEL - BACK WINDOW LOWER FRAME TRIM - Paint to match</b>							
	69/70	F(63)	With folding rear seat	C9ZZ	63424A68-A	1		
	71/	F(63)	With folding rear seat	D1ZZ	63424A68-A	1		
			Without folding rear seat	D1ZZ	63424A68-B	1		
<b>424A78</b>	<b>RETAINER - BACK WINDOW LOWER FRAME TRIM PANEL - CENTER</b>							
	69	F(63)	Paint to match -with folding rear seat	C9ZZ	63424A78-A	1		
<b>424A80</b>	<b>RETAINER - BACK WINDOW LOWER FRAME TRIM PANEL</b>							
	69/70	F(63)	With folding rear seat	C9ZZ	63424A80-A	2		
			Without folding rear seat	C9ZZ	63424A80-B	2		
<b>424A86</b>	<b>RETAINER - BACK WINDOW OUTSIDE LOWER MOULDING - CENTER</b>							
	69/70	F(65)		C9ZZ	65424A86-A	1		
<b>424A90</b>	<b>MOULDING - BACK WINDOW - OUTSIDE - INCLUDES ATTACHING PARTS</b>							
	65/66	A(71)	Upper outer	C5AZ	71424A90-C	1		
	67/69	A(71)	Upper outer	C7AZ	71424A90-B	1		
<b>42492-3</b>	<b>MOULDING - BACK WINDOW OUTSIDE - SIDE - INCLUDES ATTACHING PARTS</b>							
- A -								
	65/66	A(54,62)		C5AZ	6242492-B	C5AZ 6242493-B	1	
	67	A(57)		C7AZ	5742492-A	C7AZ 5742493-A	1	
	69/70	A(57)		C9AZ	5742492-A	C9AZ 5742493-A	1	
	71/	A(65)	Bright finish -w/o two-tone paint or vinyl roof cover	D1AZ	6542492-A	D1AZ 65 42493-A	1	
			Black-w/two-tone paint or vinyl roof cover	D1AZ	6542492-B	D1AZ 6542493-B	1	
			White-w/two-tone paint or vinyl roof cover	D1AZ	6542492-C	D1AZ 6542493-C	1	
	69/	A(71)		C9AZ	7142492-A	C9AZ 7142493-A	1	
- B -								
	66/67	B(62)		C6OZ	6242492-A	C6OZ 6242493-A	1	
	68/69	B(65)		C8OZ	6542492-A	C8OZ 6542493-A	1	
	68	B(66)	With vinyl roof cover	C8OZ	6642492-D	C8OZ 6642493-D	1	
	68/69	B(66)	Without vinyl roof cover	C8OZ	6642492-C	C8OZ 6642493-C	1	
	68/69	B(66)	No. 8-18 x 3/8" Round washer head	379560-S101(UU89CA)		379560-S101(UU89CA)	AR	
	70/71	B(54, 57)		D0OZ	5442492-A	D0OZ 5442493-A	1	
	70/71	B(62, 65)		D0OZ	6542492-A	D0OZ 6542493-A	1	
	70/71	B(66)		D0OZ	6642492-A	D0OZ 6642493-A	1	
	66/	B(71)		C6OZ	7142492-A	C6OZ 7142493-A	1	
	72	B(97)		D2OZ	9742492-A	D2OZ 9742493-A	1	
- F -								
	65/66	F(65)		C5ZZ	6542492-A	C5ZZ 6542493-A	1	
	67/68	F(65)		C7ZZ	6542492-A	C7ZZ 6542493-A	1	
	67/69	F(63)		C7ZZ	6342492-A	C7ZZ 6342493-A	1	
	69	F(65)	Paint to match	C9ZZ	6542492-A	C9ZZ 6542493-A	1	
- L -								
	71/	L(64)	" From 7/12/71"	w/large window	D2FZ	6442492-A	D2FZ 6442493-A	1
	72	L(73)			D2FZ	7342492-A	D2FZ 7342493-A	1
	71	L(64)	" Before 7/12/71"	Refer to Group 42430-1 (small window)				
- P -								
	70/	P(62)		D0DZ	6242492-A	D0DZ 6242493-A	1	
- S -								
	67/71	S(57)		C7SZ	5742492-B	C7SZ 5742493-B	1	
	67/69	S(65)		C7SZ	6542492-A	C7SZ 6542493-A	1	
	71	S(65B, D)					1	
	70	S(65)		D0SZ	6542492-A	D0SZ 6542493-A	1	
	71	S(65A, C)					1	

**BODY  
SECTION 420**
**FORD CAR PARTS**

GROUP NUMBER	YEAR	BODY TYPE	DESCRIPTION	PART NUMBER		QTY.
				RIGHT HAND	LEFT HAND	
<b>42492-3 MOULDING - BACK WINDOW OUTSIDE - SIDE - INCLUDES ATTACHING PARTS - continued</b>						
- U -						
	67/	U(97)	Insert joint	C7TZ 9742492-B	C7TZ 9742493-B	1
	67/	U(98)	Insert joint	C7TZ 9842492-B	C7TZ 9842493-B	1
- X -						
	66/70	X(62)		C6OZ 6242492-A	C6OZ 6242493-A	1
	66/70	X(71)		C6OZ 7142492-A	C6OZ 7142493-A	1
GROUP NUMBER	YEAR	BODY TYPE	DESCRIPTION	PART NUMBER		QTY.
<b>42495 PLATE - LUGGAGE COMPARTMENT NAME</b>						
	70	A(54A, B, 57B, 63B, 65C, 76A)	"500"	D0AZ 6242495-A		1
<b>425A02-3 PANEL - LUGGAGE COMPARTMENT DOOR OUTSIDE FINISH - INCLUDES ATTACHING PARTS</b>						
- A -						
	68	A(54A, 57B, 63B, 65C, 76A)		C8AZ	54425A02-A	1
	68	A(54B, 62B)		C8AZ	62425A02-A	1
	68	A(54C, 57F, 63C, 65A, 76B)		C8AZ	54425A02-B	1
- B -						
	66	B(54B, 62B, 63B, 76B)	"FAIRLANE 500"-Refer to Group 42528			
	66	B(63C, 76C)	"FAIRLANE XL"	C6OZ	63425A02-D	1
	66	B(63D, 76D)	"FAIRLANE G. T."	C6OZ	63425A02-E	1
			"FAIRLANE G. T. A."	C6OZ	63425A02-F	1
	67	B(54B, 62B, 63, 76)		C7OZ	62425A02-A	1
	69	B(54C, 65C)	"FORD"	C9OZ	54425A02-A	1
	69	B(65D, F, 76D, F)	"GT"	C9OZ	65425A02-B	1
	70	B(63)	R. H. -includes "FORD" letters	D0OZ	63425A02-A	1
	71	B(63F)	L. H. - less "FORD" letters	D0OZ	63425A03-A	1
- X -						
	66	X(54B, 62B, C)	"FALCON"	C6DZ	62425A02-A	1
	67	X(54B, 62B, C)	"FALCON"	C7DZ	62425A02-A	1
<b>42507 PANEL - TAILGATE OUTSIDE FINISH - INCLUDES ATTACHING PARTS - Also refer to Group 40282</b>						
	70/71	B(66B)	Includes "FORD" letters	D0OZ 6642507-A		1
	72	B(97D)		D2OZ 9742507-A		1
<b>42510 MOULDING - LUGGAGE COMPARTMENT DOOR UPPER - INCLUDES ATTACHING PARTS</b>						
	66	A(54A, 57B, 63B, 76A)		C6AZ	5442510-A	1
	69/70	F(63-GT350/500)	Adhesive backed	C9ZZ	6342510-A	1
	69/70	F(76-GT350/500)	Adhesive backed	C9ZZ	7642510-A	1
<b>42512-3 MOULDING - LUGGAGE COMPARTMENT DOOR - INCLUDES ATTACHING PARTS</b>						
- A -						
	65	A(54A, 57, 63, 76)	R. H. L. H.	C5AZ	5442512-A	1
				C5AZ	5442513-A	1
	66	A(54B, 62B)		C6AZ	6242512-A	1
	67	A(54A, 57B, 63B, 76A)		C7AZ	5442512-A	1
	67	A(54B, 62B)		C7AZ	6242512-A	1
	67	A(54C, 57F, 63C, J, 76B)		C7AZ	6342512-B	1
	68	A(54A, B, C, 57, 63, 65, 76)		C8AZ	5442512-B	1
	69	A(54A, B, C, 57, 62B, 63, 65, 76)		C9AZ	5442512-A	1
	70	A(54A, B, C, 57, 62B, 63, 65, 76)	R. H. L. H.	D0AZ	6242512-A	1
				D0AZ	6242513-A	1
	71	A(53, 54D, F, 57, 65, 76)		D1AZ	6542512-A	1
- B -						
	68	B(54B, 65B, D, E, 76)		C8OZ	5442512-B	1
	69	B(54B, C, 65A, B, C, D, E, F, 76)		C9OZ	5442512-A	1
	68/69	B(63)		C9OZ	6342512-A	1
	72	B(53D, 63R, 65D, R)		D2OZ	6542512-B	1
- F -						
	67/68	F(65, 76)		C7ZZ	6542512-A	1
	67/69	F(63)		C7ZZ	6342512-A	1
			No. 8-32 Nut & washer assy. (hex.)	377523-S100(MM291C)		2
	69	F(65, 76)		C9ZZ	6542512-A	1
	67	F	No. 8-32 Nut (crown)	377522-S100(MM115D)		9
- L -						
	71/	L		D1FZ 6242512-A		1

# FORD CAR PARTS

**BODY  
SECTION 420**

21

GROUP NUMBER	YEAR	BODY TYPE	DESCRIPTION	PART NUMBER	QTY.
<b>42512-3 Moulding - Luggage Compartment Door - Includes Attaching Parts - continued</b>					
- P -					
	70	P(62)		D0DZ 6242512-A	1
	71/	P(except 62A, LTD)		D1DZ 5442512-A	1
	72	P(62A, LTD)		D14Z 6242512-A	1
- S -					
	67/68	S		C7SZ 6542512-A	1
	67	S	No. 8-32 Nut (crown)	377522-S100(MM115D)	9
	69/71	S		C9SZ 6542512-A	1
	72	S		D2SZ 6542512-A	1
- X -					
	65	X(54B, 62B, 63B, 76A)		C5DZ 6242512-A	1
	68/70	X(54B, 62B, C)		C9DZ 6242512-A	2
<b>425A16 Retainer - Body Outside Moulding</b>					
	71	A(54F, 57F, 65F)		C8MY 71425A16-A	AR
	71	B(57E, 65E)			AR
<b>425A20 Panel - Tailgate Inside Belt Finish</b>					
	65	B(71)	Includes attaching parts	C3OZ 71425A20-A	1
<b>42527 Retainer - Moulding</b>					

REFER TO APPROPRIATE EXTERIOR Moulding ILLUSTRATION  
FOR COMPLETE RETAINER PART NUMBER

**42528 Plate - Name - Includes Attaching Parts**

- A -					
	70	A(54A, 57B, 63B, 65C, 76A)	"Galaxie"	D0AZ 5442528-A	1
	70	A(54A, B, 57B, 63B, 65C, 76A)	"500" - Refer to Group 42495		
	70	A(54B)	"Custom"	D0AZ 6242528-A	1
	70	A(71)	Refer to Group 25622 for "Custom" name plate		
	71	A(54B, D, 71B, D, F)	"Custom"	D1AZ 5442528-A	1
	72	A(54B, D, 71D)			1
	72	A(54F, 57F, 65F)	"Galaxie"	D2AZ 6542528-A	1
- B -					
	65	B(65B)	"Sports Coupe"	C2OZ 6242528-A	1
	66	B(54B, 62B, 63B, 76B)	"Fairlane 500"	C6OZ 6242528-A	1
	66	B(63C, D, 76C, D)	Refer to Group 425A02		
	67	B(54B, 62B, 63B, 66B, 76B)	"Fairlane 500"	C7OZ 6242528-A	1
	67	B(63D, 76D) -Std. trans.	Fairlane "GT"	C7OZ 6342528-B	1
	67	B(66, 71)	"Ford Fairlane"	C7OZ 7142528-B	1
	68/69	B(54A, B, 65B, 76B, E)	"Fairlane"	C8OZ 5442528-A	1
	69	B(63B, E, 65A, E)	"Cobra" -on front fender, lower back panel or luggage compartment door-for Cobra snake refer to Group 403A72	C9OZ 6542528-A	1
	68/69	B(66)	"Ranchero" - also used on front fender	C8OZ 6642528-A	1
	70/71	B(63H, 65H)	Refer to Group 16B196 in Chassis Section		1
	70	B(54A, 62)	"Falcon"	C8DZ 6242528-A	1
	70	B(71D)	"Falcon"		3
	71	B(66C)	"GT" - On tail gate	D1OZ 6642528-A	1
	72	B(53B, 65B)	"Torino" -#D2OB 6542528-AA	D2OZ 6542528-A	1
	72	B(53D, 63R, 65D, R)	"Gran"	D2OZ 6542528-B	1
			"Torino" -#D2OB 6542528-BA	D2OZ 6542528-C	1
- F -					
	72	F(63D, exc. Boss)	"Mustang"	D2ZZ 6342528-A	1
- L -					
	71/	L(64)	"Runabout"	D1FZ 6442528-A	2
	72	L(73)	"Squire" -with studs	D2FZ 7342528-A	1
- P -					
	70/	P(62)	"Maverick" -adhesive backed-also used on radiator grille ornament (8213)	D0DZ 6242528-A	1
- X -					
	67	X(71)	"Falcon"	C7DZ 7142528-A	1
	68/70	X	"Falcon" - on quarter panel	C8DZ 6242528-A	1
<b>42531 Retainer - Liftgate Outside Upper Moulding</b>					
	72	L(73)	Nylon	D2FZ 7342531-A	7

**BODY  
SECTION 420**
**FORD CAR PARTS**

GROUP NUMBER	YEAR	BODY TYPE	DESCRIPTION	PART NUMBER	QTY.
<b>42533</b>	<b>RETAINER - MOULDING</b>				
	69/70	A(except 54E, 71)	Also used with front door moulding	C9AZ 6242533-A	9
	71	A(except 71H)	Also used with front door moulding	D1AZ 6542533-A	AR
	70/71	S	Luggage compt.	D0SZ 6542533-A	9
	72	B(53D,63R,65D,R)	Used with lower back panel extension moulding	D3OZ 6542533-A	8
<b>42552</b>	<b>SPACER - BACK WINDOW OUTSIDE SIDE MOULDING</b>				
	69/70	F(65)		C9ZZ 6542552-A	4
<b>42554</b>	<b>SPACER - BACK WINDOW OUTSIDE MOULDING</b>				
	71/	A(65)		D1AZ 6542554-A	1
<b>425A82</b>	<b>PLATE - LUGGAGE COMPARTMENT DOOR ORNAMENT</b>				
	65	A(54A, 57, 63, 76)		C5AZ 54425A82-A	1

**42592 RETAINER - LUGGAGE COMPARTMENT DOOR OUTSIDE FINISH PANEL**

REFER TO APPROPRIATE EXTERIOR MOULDING ILLUSTRATION  
FOR COMPLETE RETAINER PART NUMBER

**425A94 RETAINER - TAILGATE OUTSIDE FINISH RAIL**

REFER TO APPROPRIATE EXTERIOR MOULDING ILLUSTRATION  
FOR COMPLETE RETAINER PART NUMBER

<b>42602</b>	<b>STRIPE - TAILGATE DOOR</b> -Also refer to Group 20000-1				
	72	B(97R)	Blue	D2OZ 9742602-A	1
			Orange	D2OZ 9742602-C	1
			Silver	D2OZ 9742602-D	1
			Yellow	D2OZ 9742602-B	1

<b>42624</b>	<b>PLATE - TAILGATE SCUFF</b>				
	66/68	B(71)	Used with manual window	C6OZ 7142624-B	1
	69/71	B(71)	Also used with auxiliary seat		1
	66/	B(71)	No. 8-18 x 3/8" Cross recess truss head screw	376378-S101(UU97)	7

GROUP NUMBER	YEAR	BODY TYPE	DESCRIPTION	PART NUMBER		QTY.
				RIGHT HAND	LEFT HAND	

**42700-1 HINGE - LUGGAGE COMPARTMENT DOOR**

- A -

	65/66	A(except 57, 71)		C5AZ 6242700-B	★C5AZ 6242701-B Not replaced (3-74)	1
	67	A(54, 57, 62, 76)		C7AZ 6242700-B	★C7AZ 6242701-B Not replaced (5-75)	1
	68	A(54, 57, 62, 65, 76)		C8AZ 6242700-A	C8AZ 6242701-A	1
	68	A(63)		C8AZ 6342700-B	C8AZ 6342701-B	1
	69/	A(except 71)		C9AZ 6242700-A	C9AZ 6242701-A	1
	65/68	A(except 71)	5/16"-18 x 1 5/8" Hex. hd. screw & washer assy.	359530-S8(BB576)	359530-S8(BB576)	AR
			5/16"-18 x 1.19" Nut & retainer assy. "J" shape	379831-S2(MM192M)	379831-S2(MM192M)	AR

- B -

	68/69	B(54, 65, 76)		C8OZ 5442700-B	C8OZ 5442701-B	1
	68/69	B(63)		C8OZ 6342700-B	C8OZ 6342701-B	1
	70/71	B(except 66, 71)		C9AZ 6242700-A	C9AZ 6242701-A	1
	65/71	B(except 71)	5/16"-18 x 1 5/8" Hex. hd. screw & washer assy.	359530-S8(BB576)	359530-S8(BB576)	AR
			5/16"-18 x 1 3/16" Nut & retainer assy. "J" shape	379831-S2(MM192M)	379831-S2(MM192M)	AR
	65/71	B(except 66, 71)	5/16"-18 x 3/4" Hex. hd. screw & washer assy.	359662-S7-8(BB575A)	359662-S7-8(BB575A)	AR
	72	B(53, 65)		D4OZ 6542700-A	D2OZ 6542701-A	1
	72	B(63)		D2OZ 6342700-A	D2OZ 6342701-A	1

- F -

	65/66	F(65, 76)		C4DZ 6242700-A	C4DZ 6242701-B	1
	67/68	F(63)		C7ZZ 6342700-D	C7ZZ 6342701-C	1
	67/68	F(65, 76)		C7ZZ 6542700-C	C7ZZ 6542701-C	1
	69	F(65, 76)	Also use D0ZZ 6544890-A with L. H. hinge when reworking R. H. hinge- incl. I. S.	C9ZZ 6542700-A	C9ZZ 6542701-A	1

# FORD CAR PARTS

**BODY  
SECTION 420**

23

GROUP NUMBER	YEAR	BODY TYPE	DESCRIPTION	PART NUMBER		QTY.
				RIGHT HAND	LEFT HAND	
<b>42700-1 HINGE - LUGGAGE COMPARTMENT DOOR - continued</b>						
- F -						
69/70	F(63)			C9ZZ 6342700-A	C9ZZ 6342701-A	1
70	F(65,76)			D0ZZ 6542700-A	D0ZZ 6542701-A	1
71/	F(63)			D1ZZ 6342700-A	D1ZZ 6342701-A	1
71	F(65,76)	"Before 4/1/71"		D1ZZ 6542700-B	D1ZZ 6542701-A	1
71/	F(65,76)	"From 4/1/71"		D1ZZ 6542700-B	D1ZZ 6542701-B	1
65/	F		5/16" - 18 x 3/4" Hex. hd. screw & washer assy.	359662-S7-8(BB575A)	359662-S7-8(BB575A)	AR
			5/16" - 18 x 1 3/16" Nut & retainer assy. "J" shape	379831-S2(MM192M)	379831-S2(MM192M)	4
- L -						
71/	L(62)			D1FZ 6242700-A	D4FZ 6242701-A	1
71	L(64)	"Before 7/12/71"	With small window	D1FZ 6442700-A	D1FZ 6442701-A	1
71/	L(64)	"From 7/12/71"	With large window	D2FZ 6442700-A	D2FZ 6442701-A	1
			Nut & washer-1/4" x 20 x 3/4	383278-S2(MM296AG)	383278-S2(MM296AG)	4
- P -						
70/	P(62)			D0DZ 6242700-A	D0DZ 6242701-A	1
71/	P(54)			D1DZ 5442700-A	D1DZ 5442701-A	1
- S -						
65/66	S(63)			C4SZ 6342700-A	C4SZ 6342701-A	1
			5/16" - 18 x 3/4" Hex. hd. screw & washer assy.	359662-S7-8(BB575A)	359662-S7-8(BB575A)	10
67	S			C7SZ 6542700-A	C7SZ 6542701-A	1
68/69	S			C8SZ 6542700-B	C8SZ 6542701-B	1
70/71	S(57)					1
71	S(65B, D)					1
70	S(65)			D0SZ 6542700-B	D0SZ 6542701-B	1
71	S(65A, C)					1
72	S	" Before 8/16/71"		D2SZ 6542700-B	D2SZ 6542701-A	1
72	S	" From 8/16/71"		D2SZ 6542700-B	D2SZ 6542701-B	1
- X -						
65	X(54,62,63,76)			★ C4DZ 6242700-B Not replaced (5-75)	C4DZ 6242701-B	1
66/67	X(54,62)			C6OZ 6242700-A	C6OZ 6242701-A	1
68/70	X(54,62)			C8OZ 5442700-B	C8OZ 5442701-B	1
65/70	X(54,62,63,76)		5/16" - 18 x 3/4" Hex. hd. screw & washer assy.	359662-S7-8(BB575A)	359662-S7-8(BB575A)	AR
<b>42704-5 BRACKET - LUGGAGE COMPARTMENT DOOR HINGE TO WHEELHOUSE-Refer to Group 42738-9</b>						
<b>427A24 BRACKET - LUGGAGE COMPARTMENT DOOR HINGE TO FLOOR PAN</b>						
67/69	A(except 71,76)			C7AZ 62427A24-A	C7AZ 62427A24-A	2
70	S(65)			D0SZ 65427A24-A	D0SZ 65427A24-A	2
71	S(65A, C)					2
67/69	S			C7AZ 62427A24-A	C7AZ 62427A24-A	2
71	S(57,65B,D)					2
<b>42738-9 BRACKET - LUGGAGE COMPARTMENT DOOR HINGE TO WHEELHOUSE</b>						
68/69	B(54,65)			C8OZ 5442738-A	C8OZ 5442739-A	1
70/71	B(54,57,62,65,76)			D0OZ 6542738-A	D0OZ 6542739-A	1
70/71	B(63)			D0OZ 6342738-A	D0OZ 6342739-A	1
72	B(53,63,65)			D2OZ 6542738-A	D2OZ 6542738-A	1
65/66	F(65,76)			C2GB 6242704-A	C2GB 6242705-A	1
65/70	F(65,76)		Upper	C5ZZ 6542704-A	C5ZZ 6542705-A	1
70/	P			D0DZ 6242738-A	D0DZ 6242738-A	2
68/70	X(54,62)			C8DZ 6242738-A	C8DZ 6242739-A	1
<b>42744-5 BRACKET - LUGGAGE COMPARTMENT DOOR HINGE TO WHEELHOUSE</b>						
69/70	F(65,76)		Lower	C9ZZ 6542744-A	C9ZZ 6542745-A	1
71/	F(65,76)			D1ZZ 6542744-A	D1ZZ 6542745-A	1
72	S			D2SY 6542744-A	D2SY 6542744-A	2

**BODY  
SECTION 420**
**FORD CAR PARTS**

GROUP NUMBER	YEAR	BODY TYPE	DESCRIPTION	PART NUMBER	QTY.
<b>427A48</b>	<b>BRACKET - LUGGAGE COMPARTMENT DOOR LIFT ON BODY</b>				
72	L(64)		Paint to match	D2FZ 64427A48-A	2
<b>42752</b>	<b>PLATE - LUGGAGE COMPARTMENT DOOR HINGE ANCHOR ON DOOR</b>				
69/71	A(exc. 71)			C9AZ 6242752-A	2
69/71	B(exc. 66, 71)				2
72	B(exc. 71, 97), F(65, 76)				2
69/70	F				2
71	F	"From 3/31/71"			2
70/71	P, S				2
71	F	"Before 3/31/71"		D1ZZ 6542752-A	2
<b>42758</b>	<b>ROLLER - LUGGAGE COMPARTMENT DOOR TORSION BAR</b>				
66/67	B(54, 62, 63, 76), X(54, 62)			C6OZ 6242758-A	2
<b>42760</b>	<b>SPRING - LUGGAGE COMPARTMENT DOOR HINGE</b>				
71/72	L(64)	"Before 12/1/71"		D1FZ 6442760-A	2
<b>427A88</b>	<b>COVER - LUGGAGE COMPARTMENT DOOR HINGE ACCESS HOLE</b>				
71/72	L(64)		Black	D1FZ 64427A88-A	AR
			Blue	D1FZ 64427A88-B	AR
			Ginger	D1FZ 64427A88-D	AR
			Green	D1FZ 64427A88-C	AR
72	L(64)		Beige	D2FZ 64427A88-A	AR
			White	D2FZ 64427A88-B	1
			Avocado	D2FZ 64427A88-C	1
			Orange	D2FZ 64427A88-D	1
<b>42792</b>	<b>SUPPORT - LUGGAGE COMPARTMENT DOOR HINGE TO BODY</b>				
67/71	S(57)		R. H.	C7SZ 5742792-A	1
			L. H.	C7SZ 5742792-B	1
67/69	S(65)		R. H.	C7SZ 6542792-A	1
71	S(65B, D)		L. H.	C7SZ 6542792-B	1
<b>427A94-5</b>	<b>SUPPORT - LUGGAGE COMPARTMENT DOOR LIFT BRACKET</b>				
72	L(64)	"From 12/1/71"	R. H.	D2FZ 64427A94-A	1
		"From 12/1/71"	L. H.	D2FZ 64427A95-A	1
<b>42810-1</b>	<b>BRACKET - LUGGAGE COMPARTMENT DOOR HINGE SUPPORT</b>				
68/69	B(63)		R. H.	C8OZ 6342810-A	1
			L. H.	C8OZ 6342811-A	1
<b>42840-1</b>	<b>PAD - LUGGAGE COMPARTMENT DOOR HINGE ON BODY</b>				
71	L(64)	"Before 7/12/71"	R. H. -with small window	D1FZ 6442840-A	1
			L. H.	D1FZ 6442841-A	1
71/72	L(64)	"From 7/12/71"	R. H. and L.H. -with large window	D2FZ 6442840-A	2
<b>42842-3</b>	<b>PAD - LUGGAGE COMPARTMENT DOOR HINGE ON DOOR</b>				
71	L(64)	"Before 7/12/71"	R. H. -with small window	D1FZ 6442842-A	1
			L. H.	D1FZ 6442843-A	1
71/72	L(64)	"From 7/12/71"	R. H. -with large window	D2FZ 6442842-A	1
			L. H.	D2FZ 6442843-A	1
<b>42858</b>	<b>SPRING - LUGGAGE COMPARTMENT DOOR COUNTERBALANCE</b>				
67/70	F(63)		Without torsion bar	C7ZZ 6342858-A	1
<b>42900-1</b>	<b>HINGE - LIFTGATE</b>				
72	L(73)		R. H.	D3FZ 7342900-A	1
			L. H.	D3FZ 7342901-A	1
			Screw & washer -1/4" -20 x 3/4"	371492-S2(BB569)	8
<b>42942</b>	<b>REINFORCEMENT - LIFTGATE HINGE ON BODY</b>				
69/70	U(98)			C9TZ 9842942-A	1
<b>42946</b>	<b>COVER - LIFTGATE HINGE</b>				
72	L(73)		Paint to match-(Black)	D3FZ 7342946-A	1

# FORD CAR PARTS

**BODY  
SECTION 430**

1

GROUP NUMBER	YEAR	BODY TYPE	DESCRIPTION	PART NUMBER		QTY.
				RIGHT HAND	LEFT HAND	
<b>43000-1 HINGE - TAILGATE</b>						
	65	A(71)		C5AZ 7143000-A	C5AZ 7143001-A	1
	65	B(71)		C3OZ 7143000-A	C3OZ 7143001-A	1
	66/71	B(66, 71)	Single action tail gate	C6DZ 7143000-B	C6DZ 7143001-B	1
	72	B(97)		D2OZ 9743000-A	D2OZ 9743001-A	1
	66/	U		C4TZ 9943000-A	C4TZ 9943000-A	2
			Bolt-hex. head-3/8" - 16 x 1"	20388-S8(B80)	20388(B80)	4
			Lockwasher - 3/8"	34847-S8(X74)	34847-S8(X74)	4
	66	X(66, 71)	"Before 3/21/66" Single action tail gate	C6DZ 7143000-A	C6DZ 7143001-B	1
	66	X(66, 71)	"From 3/21/66" Single action tail gate	C6DZ 7143000-B	C6DZ 7143001-B	1
	67/70	X(71)				1
	66/71	B(66)	3/8"-16 x 1 1/2" Flat hd.	380837-S7-8	380837-S7-8	2
	66/70	X(66, 71)	screw & washer assy.	(BB110D)	(BB110D)	2
<b>GROUP NUMBER YEAR BODY TYPE DESCRIPTION PART NUMBER QTY.</b>						
<b>430B06 HINGE - TAILGATE LOWER - ON BODY</b>						
	69/72	A(71)			C9AZ 71430B06-A	1
	72	B(71)				1
<b>430B08 HINGE - TAILGATE LOWER ON GATE</b>						
	69/	A(71)	"Before 9/5/72"		C9AZ 71430B08-A	1
	72	B(71)				1
<b>430A12 ANTI-SQUEAK - TAILGATE COUNTERBALANCE SPRING</b>						
	69/	A(71), B(66, 71)	Refer to Group 44890-1			
	65	X(59, 71, 78)	2" long- cut from B9A 17543-A		★	
<b>430A16-7 RETAINER - TAILGATE FILLER AT BELT</b>						
	69/	U(98)	R. H.		C9TZ 98430A16-A	1
			L. H.		C9TZ 98430A17-A	1
<b>430A20 PIVOT - TAILGATE LOWER HINGE</b>						
	66/69	A(71), B(71), X(71)	7/16"-14 x 2 1/2" Hex. head		C6AZ 71430A20-A	1
	69/	A(71), B(71)	1/2" x 2 3/16" Round head		C9AZ 71430A20-A	1
<b>430A28 PLATE - TAILGATE COUNTERBALANCE TORSION BAR MOUNTING</b>						
	66	A(71), B(71), X(66, 71)			C6AZ 71430A28-A	1
	67/68	A(71), B(66, 71), X(71)				1
	69/71	B(66, 71)				1
	69/70	X(71)				1
			5/16"-15 x 5/8" Flat head screw & washer assy.	★380212-S8		2
	69/	A(71)			C9AZ 71430A28-A	1
	72	B(71, 97)				1
			5/16"-18 x 15/16" Hex. head screw & washer assy.	359662-S7-8(BB575A)		4
<b>43030 PIN - HINGE</b>						
	65/66	S(76)	11/32" dia. x 3 9/16" long-luggage compartment		B9A 5943030-A	2
	65/	A, B, F, S	Doors cut to fit			AR
	65/71	X	Doors - cut to fit			AR
	66/67	U	Door - 1/4" dia. x 2 5/16" long - serviced only in assy. - Refer to Group 22800-1			
	68/	U	Door-9/32" dia. x 2 3/8" long		C8AZ 8143030-A	4
<b>430A30 BRACKET - TAILGATE COUNTERBALANCE TORSION BAR CENTER</b>						
	65/67	A(71)			C5AZ 71430A30-A	1 or 2
	66	B(71), X(66, 71)	In tail gate			2
	67/71	B(66, 71)				2
	67/70	X(71)				2
	66	A(71), B(71), X(66, 71)	On body		C6AZ 71430A30-A	1
	67/68	A(71), B(66, 71), X(71)				1
	69/71	B(66, 71)				1
	69/70	X(71)				1
	69/	A(71)	One hole-9/32" dia.		C9AZ 71430A30-A	2
			Two holes-9/32" dia.		C9AZ 71430A30-B	2
	72	B(71, 97)			D2OZ 71430A30-A	1

**BODY  
SECTION 430**
**FORD CAR PARTS**

GROUP NUMBER	YEAR	BODY TYPE	DESCRIPTION	PART NUMBER	QTY.
<b>430A48 STOP - TAILGATE LOWER HINGE</b>					
	66/68	A(71), B(71), X(71) - "Before 5/13/68"	Dual action tail gate	C6AZ 71430A48-A	1
	66/68	A(71), B(71)- "From 5/13/68"	Dual action tail gate	C6AZ 71430A48-B	1
			5/16"-18 x 5/8" Flat hd.screw & washer assy.	382528-S100(BB116B)	2or3
			5/16"-18 Pierce nut	34362-S(M91)	3
<b>43050 RETAINER - TAILGATE COUNTERBALANCE TORSION BAR</b>					
	65	A(71)		C5AZ 7143050-A	1
	66	A(71), B(71), X(71)	Dual action tail gate	C6AZ 7143050-A	1
	67/	A(71)			1
	67/71	B(66, 71)			1
	67/70	X(71)			1
			5/16"-18 x 3/4" Hex. head screw & washer assy.	359662-S7-8(BB575A)	2
			1/4"-20 x 1/2" Hex. washer head tapping screw	40927-S8(U262)	1
	72	B(71)	Dual action tail gate - on body	D2OZ 7143050-A	1
	72	B(97)	On body	D2OZ 9743050-A	1
<b>43052 CABLE - TAILGATE CHECK</b>					
	66	A(71), B(71), X(66, 71)		C6AZ 7143052-A	1or2
	67/68	A(71), B(66, 71), X(71)			1or2
	69/71	B(66, 71)			1or2
	69/70	X(71)			1or2
	69/	A(71)		C9AZ 7143052-A	1
	72	B(71, 97)		D2OZ 7143052-A	1or2
<b>43056 HINGE - TAILGATE - LOWER</b>					
	66/68	A(71), B(71), X(71)	Dual action	C6AZ 7143056-C	1
	69/71	B(71)			1
	69/70	X(71)			1
			3/8"-16 Hex. nut	377605-S7-8(MM151G)	2
			3/8"-16 x 1 1/2" Flat head screw & washer assy.	380837-S7-8(BB110D)	2
			3/8"-16 x 1 1/2" Hex. head screw & washer assy.	378015-S7-8(BB580E)	2
	69/72	A(71)	Dual action	D3AZ 7143056-A	1
	72	B(71)			1
<b>43061 REINFORCEMENT - TAILGATE UPPER HINGE ON GATE</b>					
	66	B(71), X(71)	Dual action	C6OZ 7143061-A	1
	67/	B(71)	Dual action	C6OZ 7143061-B	1
	67/70	X(71)			1
<b>430A66 BRACKET - TAILGATE OUTSIDE HANDLE</b>					
	68	A(71), B(71), X(71)	With manual window - Dual action	C6AZ 71430A66-B	1
	69/71	B(71)	With manual window		1
	69/70	X(71)			1
	68	A(71), B(71), X(71)	With power window - Dual action	C8AZ 71430A66-A	1
	69/71	B(71)	With power window		1
	69/70	X(71)			1
	69/	A(71)	With manual or power window - Dual action	C9AZ 71430A66-B	1
<b>430A70 HANDLE and HOUSING ASSY. - TAILGATE OUTSIDE LATCH RELEASE</b>					
	66/67	A(71)	With manual or electric window-Includes attaching parts - Dual action	C6AZ 71430A70-B	1
	68	A(71)	With manual window-Includes attaching parts		1
	68	A(71)	With power window - Dual action	C8AZ 71430A70-A	1
	69/	A(71)	With manual or power windows - Dual action	C9AZ 71430A70-A	1
	66/71	B(71)	With manual window - Dual action	C6OZ 71430A70-B	1
	66/70	X(71)			1
			No. 12-24 Hex. head locking nut	34054-S(M157)	2
			No. 12 Lockwasher	34927-S7-8(X87)	2
	68/71	B(71)	With power window - Dual action	C8OZ 71430A70-A	1
	68/70	X(71)	Dual action		1
	72	B(71)		D2OZ 71430A70-A	1



GROUP NUMBER	YEAR	BODY TYPE	DESCRIPTION	PART NUMBER	QTY.
<b>43074</b>	<b>BUSHING - TAILGATE COUNTERBALANCE TORSION BAR ON BODY</b>				
	66	A(71), B(71), X(71)		C6AZ 7143074-A	1
	67/	A(71)			1
	67/71	B(71)			1
	67/70	X(71)			1
	72	B(71), Y(71)			1
	72	B(97)	On body		2
<b>43082</b>	<b>BUMPER - TAILGATE UPPER HINGE ON GATE</b>				
	66	A(71), B(71), X(71)	Dual action	C6AZ 7143082-A	1
	67/	B(71)	Dual action	C7AZ 7143082-A	1
	67/70	X(71)			1
	67/69	A(71)	"Before 12/30/68"		1
	69/	A(71)	"From 12/30/68" Dual action	C9AZ 7143082-A	1
<b>430A82</b>	<b>SPRING - TAILGATE OUTSIDE HANDLE</b>				
	66/68	A(71), B(71), X(71)	With manual window regulator - Dual action	C6AZ 71430A82-A	1
	69/71	B(71)			1
	69/70	X(71)			1
	68	A(71), B(71), X(71)	With power window regulator - Dual action	C8AZ 71430A82-A	1
	69/71	B(71)			1
	69/70	X(71)			1
	69/	A(71)		C9AZ 71430A82-A	1
<b>430A84</b>	<b>SEAL - TAILGATE UPPER HINGE - ON GATE</b>				
	66/71	B(71)	Dual action	C6OZ 71430A84-A	1
	66/70	X(71)			1
<b>43086</b>	<b>HINGE - TAILGATE UPPER - ON BODY - Also Refer to Groups 43090 &amp; 43096</b>				
	66/67	A(71), B(71), X(71) - "Before 12/27/66"	With C6AZ 7143090-C or C6OZ 7143090-C - Dual action	C6AZ 7143086-B	1
	67/68	A(71), B(71), X(71) - "From 12/27/66"	3/8"-16 x 1 1/2" Hex. head screw & washer assy. With C7AZ 7143090-A or C7OZ 7143090-A - Dual action	378015-S7-8(BB580E) C7AZ 7143086-A	2 1
	69/71	B(71)			1
	69/70	X(71)			1
	69/	A(71)	Dual action	C9AZ 7143086-A	1
	66/	A(71)	5/16"-18 x 1 7/8" Oval head screw & washer assy.	380685-S7-8 (BB817AV)	2
	66/	B(71)	3/8"-16 x 1.84" Flat head screw & washer assy.	380838-S7-8(BB112)	2
	66/70	X(71)			2
	72	B(71)	"Before 3/1/72" Dual action	D2OZ 7143086-A	1
	72	B(71)	"From 3/1/72"	D2OZ 7143086-B	1
<b>43090</b>	<b>HINGE - TAILGATE UPPER - ON GATE</b>				
	66/67	A(71)	"Before 12/27/66" Use with C6AZ 7143086-B	C6AZ 7143090-C	1
	67/68	A(71)	"From 12/27/66" Use with C7AZ 7143086-A - Dual action	C7AZ 7143090-A	1
			5/16"-18 Clinch nut	34274-S(M8D)	4
	69/70	A(71)	Dual action	C9AZ 7143090-B	1
	71/	A(71)	Dual action	D1AZ 7143090-A	1
	69/	A(71)	5/16"-18 x 1 3/8" Fillister head screw & washer assy.	380687-S7-8(BB110C)	4
	66/67	B(71), X(71)	"Before 12/27/66" Use with C6AZ 7143086-B	C6OZ 7143090-C	1
	67/71	B(71)	Dual action	D0OZ 7143090-A	1
	67/70	X(71)			1
			5/16-18 x 1 3/8" Fillister hd.screw & washer assy.	380687-S7(BB110C)	4
	66/	A(71), B(71)	Bumper	C6AZ 7143082-A	1
	66/70	X(71)			1
	72	B(71)	"Before 3/1/72"	D2OZ 7143090-A	1
	72	B(71)	"From 3/1/72"	D2OZ 7143090-B	1

GROUP NUMBER	YEAR	BODY TYPE	DESCRIPTION	PART NUMBER	QTY.
<b>43096 PIVOT KIT - TAILGATE UPPER HINGE - ON BODY</b>					
	66/70	A(71), B(71), X(71)	Dual action	C6MY 7143096-A	1
	71/72	A(71), B(71)			1
	Consists of				
	1-Pivot	1-Pin	1-Bushing	1-Instruction sheet	
<b>43098 SPACER - TAILGATE UPPER HINGE ON BODY</b>					
	66	A(71), B(71), X(66, 71)	.030" thick	C6AZ 7143098-A	AR
	67/68	A(71), B(66, 71), X(71)			AR
	69/71	B(71)			AR
	69/70	X(71)			AR
	69/	A(71), B(71)	.060" thick	C9AZ 7143098-A	AR
			.030" thick	C9AZ 7143098-B	AR
	72	L(64)		D2FZ 6443098-A	2
<b>431A06 SPACER - LIFTGATE LATCH RELEASE LEVER</b>					
	66/	U(98)		C6TZ 98431A06-A	1
<b>43108 PLATE - LIFTGATE LATCH</b>					
	69/	U(98)		C9TZ 9843108-A	1
<b>43119 LEVER - LIFTGATE LATCH RELEASE</b>					
	66/	U(98)		C6TZ 9843119-B	1
<b>431A24 LINK - TAILGATE UPPER LATCH TO LOWER LATCH ACTUATOR</b>					
	66	A(71), B(71), X(66, 71)		C6AZ 71431A24-A	1
	67/68	A(71), B(66, 71), X(71)			1
	69/71	B(71)			1
	69/70	X(71)			1
	69/	A(71)		D3AZ 71431A24-A	1
	72	B(71)		D2OZ 71431A24-B	1
<b>431A26 BRACKET - TAILGATE LATCH</b>					
	66/	U(98)		C6TZ 98431A26-A	2
			No. 10-12 x 1/2" Cross recess pan head screw	52727-S8(U382)	4
<b>431A32 ROD - TAILGATE LATCH PUSH BUTTON</b>					
	69/	A(71)		C9AZ 71431A32-A	1
	72	B(71)		D2OZ 71431A32-A	1
<b>431A34 GROMMET - TAILGATE LATCH KNOB</b>					
	69/	A(71)		C9AZ 71431A34-A	1
	72	B(71)			1
<b>431A36 KNOB - TAILGATE LATCH CONTROL ROD</b>					
	69/	A(71)		C9AZ 71431A36-A	1
	72	B(71)			1
<b>431A38 ACTUATOR - TAILGATE LATCH</b>					
	70/	A(71)	With vacuum door latch	D0AZ 71431A38-A	1
	72	B(71)		D3OZ 71431A38-A	1
<b>431A40 ROD - TAILGATE OUTSIDE HANDLE</b>					
	72	B(71)		D2OZ 71431A40-B	1
<b>43146 PLATE - TAILGATE LATCH STRIKER</b>					
	65	A(71)		C2AZ 7143146-B	2
	65	B(71)			2
	67/71	B(66, 71)			1
	72	B(97)			1
	66	X(66, 71)	L.H. - For R.H. refer to Group 265A04		1
	67/70	X(71)			1
	65	X(59, 66, 71, 78)	Refer to Group 431A72		
	65	B(71)	5/16"-18 x 3/4" Flat head locking screw	378428-S7-8(UU48E)	4

# FORD CAR PARTS

## BODY SECTION 430

GROUP NUMBER	YEAR	BODY TYPE	DESCRIPTION	PART NUMBER	QTY.
<b>43150-1 LATCH - TAILGATE</b>					
	65	A(71)	R. H.	C5AZ 7143150-A	1
			L. H.	C6DZ 7143151-B	1
	66/68	A(71)	Dual action-Includes attaching parts	C6AZ 7143150-D	1
	69/70	A(71) "Before 2/2/70"	Upper-dual action-incl.attaching parts	C9AZ 7143150-B	1
	70/	A(71) "From 2/2/70"	Upper-dual action-incl.attaching parts	D4AZ 7143150-A	1
	65	B(71)	R. H.	C3AZ 7143150-A	1
			L. H. - not replaced (5-75)	★C3AZ 7143151-A	1
	66/71	B(71)	Dual action-Includes attaching parts	C6AZ 7143150-D	1
	67/71	B(66, 71)	R. H. -Single action-Includes attaching parts	C6DZ 7143150-D	1
	72	B(97)			1
			L. H.	C6DZ 7143151-B	1
	72	B(71)		D2OZ 7143150-A	1
	72	L(73)	Includes attaching parts	D2FZ 7343150-A	1
	66	X(66, 71)	R. H. -Single action-Includes attaching parts	C6DZ 7143150-D	1
	67/70	X(71)			1
			L. H.	C6DZ 7143151-B	1
	66/70	X(71)	Dual action-Includes attaching parts	C6AZ 7143150-D	1
	65	A(71)	No. 12-24 x 1/2" Cross recess flat head screw &	356782-S8(BB114)	6
	65	B(71)	washer assy.		6
<b>431A50-1 LINK - TAILGATE LATCH RELEASE</b>					
	66	B(71), X(66, 71)	R. H. -Dual or single action tail gate-Includes	C6OZ 71431A50-A	1
	67/71	B(66, 71)	attaching parts		1
	67/70	X(71)			1
	66	B(71), X(66, 71)	L. H.-Single action tail gate	C6DZ 71431A51-A	1
	67/71	B(66, 71)			1
	67/70	X(71)			1
	72	B(71)		D2OZ 71431A50-A	1
<b>431B50 SPRING - TAILGATE LATCH</b>					
	65	A(71)		C1AB 59431B50-B	2
	65	B(71)			2
	67	B(66), X(71)			1
	68/71	B(66, 71)			1
	72	B(97)			1
	65	X(59, 66, 71, 78)			2
	66	X(66, 71)	Single action tail gate		1
	68/70	X(71)			1
	66/68	U(98)		C6TZ 98431B50-A	2
	69/	U(98)		C9TZ 98431B50-A	2
<b>431C50 CYLINDER ASSY. - TAILGATE LOCK - WITH KEYS - Refer to Group 22050</b>					
<b>43152 SHIM - TAILGATE LATCH STRIKER PLATE</b>					
	66	A(71), B(71), X(71) -	Lower	C6AZ 7143152-A	AR
		"Before 3/7/66"			
	67/	A(71), B(71)			AR
	67/70	X(71)			AR
	66	A(71), B(71), X(66, 71)-	Upper	C6AZ 7143152-B	AR
		"From 3/7/66"			
	67/	A(71)			AR
	72	B(71, 97)			AR
	67/71	B(66, 71)			AR
	67/70	X(71)			AR
	65	A(71)	1 3/4" wide x 2 11/16" long	C1AZ 5943152-A	AR
	65	B(71)			AR
	67/71	B(66, 71)			AR
	72	B(97)			AR
	65	X(59, 66, 71, 78)			AR
	66	X(66, 71)			AR
	67/70	X(71)			AR

**BODY  
SECTION 430**
**FORD CAR PARTS**

GROUP NUMBER	YEAR	BODY TYPE	DESCRIPTION	PART NUMBER	QTY.
<b>43154</b>	<b>SEAL - TAILGATE LATCH COVER</b>				
	72	B(71)		D2OZ 7143154-A	1
<b>431B54</b>	<b>LATCH - TAILGATE ON BODY</b>				
	66/	U		C4TZ 99431B54-A	2
			Screw-flat head-cross recess-5/16"-18 x 3/4"	379630-S2(BB116)	4
			Lockwasher-5/16"	34956-S8(X82)	4
<b>431E58</b>	<b>LINK - TAILGATE UPPER HINGE RELEASE</b>				
	69/	A(71)	Upper-with anti-rattler	C9AZ 71431E58-A	1
			Lower-with anti-rattler-27.74" long	C9AZ 71431E58-B	1
	66	B(71), X(71)-"Before 1/17/66"	L. H. -Dual action tail gate	C6OZ 71431E58-A	1
	66/71	B(71) "From 1/17/66"	L. H. -Dual action tail gate-with anti-rattler-	C6OZ 71431E58-B	1
	66/70	X(71)	Includes attaching parts		1
			R. H. -Refer to Group 431A50-1		
	72	B(71)		D3OZ 71431E58-A	1
<b>431F60</b>	<b>LEVER - TAILGATE LOCK CYLINDER - Also refer to Group 14529 in Chassis Section</b>				
	69/71	A(71)	Manual	C9AZ 71431F60-A	1
	72	B(71)	Manual	D2OZ 71431F60-A	1
<b>431B62-3</b>	<b>BUMPER - TAILGATE LATCH</b>				
	65	A(71)	R. H.	★C1AZ 71431B62-A	1
	65	B(71)		Not Repl'd. (1-73)	1
	65	X(59, 66, 71, 78)			1
			L. H.	C1AZ 71431B63-B	1
	66	A(71), B(71), X(66, 71)	R. H.	C6AZ 71431B62-B	1
	67/71	A(71), B(66, 71)			1
	72	B(97)			1
	67/70	X(71)			1
			L. H.	C1AZ 71431B63-B	1
	66/	A(71)	Dual action tail gate-lower	C6AZ 71431B62-A	1
	72	B(71)			1
	66/71	B(71)			1
	66/70	X(71)			1
<b>431C62</b>	<b>HANDLE - TAILGATE LATCH RELEASE</b>				
	66/68	A(71), B(66, 71), X(66, 71)	Includes attaching parts	C6AZ 71431C62-B	1
	69/71	B(66, 71)			1
	69/70	X(71)			1
	69/	A(71)	Includes attaching parts	C9AZ 71431C62-A	1
	72	B(71)			1
	72	B(97)		D2OZ 97431C62-A	1
<b>431F62</b>	<b>REINFORCEMENT - LIFTGATE LATCH STRIKER</b>				
	69/	U(98)		C9TZ 98431F62-A	2
<b>431A66</b>	<b>EXTENSION - TAILGATE LOCK CYLINDER</b>				
	65	X(59, 71, 78)		C0DB 59431A66-C	1
	66/70	X(71)		C6DZ 71431A66-A	1
<b>43170</b>	<b>CONTROL - TAILGATE LATCH REMOTE</b>				
	66	A(71), B(71), X(66, 71)	Includes attaching parts	C6AZ 7143170-A	1
	67/68	A(71), B(66, 71), X(71)			1
	69/71	B(66, 71)			1
	72	B(97)			1
	69/70	X(71)			1
	69/	A(71)		C9AZ 7143170-A	1
	72	B(71)			1
<b>431A72</b>	<b>PLATE - TAILGATE LATCH STRIKER</b>				
	65	X(59, 66, 71, 78)		C0DB 59431A72-B	2
			5/16"-24 x .92" Flat head locking screw	371402-S13(BB101A)	4

GROUP NUMBER	YEAR	BODY TYPE	DESCRIPTION	PART NUMBER	QTY.
<b>431B72 CLIP - TAILGATE LATCH RELEASE LEVER KNOB RETAINING</b>					
	65	X(59, 66, 71, 78)		C0DB 59431B72-B	1
<b>431D72 BOLT - TAILGATE LATCH RELEASE LEVER</b>					
	66/	U		C4TZ 99431D72-B	1
<b>431E72 STRIKER - TAILGATE LOWER LATCH</b>					
	66/	A(71), B(71)	Dual action tail gate	C6AZ 71431E72-A	1
	66/70	X(71)			1
			5/16"-18 x 1" Flat head tapping screw	379790-S7-8(UU48D)	4
<b>431B74 LINK - TAILGATE UPPER LATCH RELEASE</b>					
	66/69	A(71)	R. H.-Dual action tail gate	C6AZ 71431B74-A	1
			L. H.-Refer to Group 431E58		
<b>431A75 LEVER - TAILGATE LATCH RELEASE</b>					
	66/	U		C4TZ 99431A75-A	2
<b>431A76 KNOB - TAILGATE LATCH RELEASE LEVER</b>					
	65	X(59, 66, 71, 78)		C0DB 59431A76-B	1
			Clip (retaining)	C0DB 59431B72-B	1
<b>431D76 BRACKET - TAILGATE LATCH</b>					
	66/	U		C4TZ 99431D76-A	2
<b>431E76 HOUSING - TAILGATE OUTSIDE LATCH RELEASE HANDLE</b>					
	66/71	B(71)	Manual window regulator	C6OZ 71431E76-B	1
	66/70	X(71)			1
	68/71	B(71)	Electric window regulator	C8OZ 71431E76-A	1
	68/70	X(71)			1
<b>431A78-9 LINK - TAILGATE LATCH RELEASE</b>					
	72	B(97)	R. H.	D2OZ 97431A78-A	1
			L. H.	D2OZ 97431A79-A	1
	66/	U	R. H.	C6TZ 96431A78-A	1
			L. H.	C6TZ 96431A79-A	1
			Washer-flat-3/16"	44710-S8(X10)	2
<b>431C78 PLATE - TAILGATE LATCH RELEASE HANDLE MOUNTING</b>					
	66/	U		C4TZ 99431C78-B	1
<b>431B82 HANDLE - TAILGATE LATCH</b>					
	66/	U		C4TZ 99431B82-A	1
<b>431D82 ANTI-RATTLE - TAILGATE COUNTERBALANCE TORSION BAR</b>					
	66/70	A(71), B(71), X(66, 71)	5" long-Cut from A9A 17543-C	★	1
			Nut-hex. -5/16" -18	379930-S2(MM173M)	1
			Washer-spring-7/16"	356383-S2(XX362)	1
<b>431D88 LATCH - TAILGATE - LOWER - INCLUDES ATTACHING PARTS</b>					
	66/68	A(71), B(71), X(71)	Dual action tail gate	C6AZ 71431D88-B	1
	69/	B(71)			1
	69/70	X(71)			1
			No. 12-24 x 1/2" Screw & washer assy.	356782-S8(BB114)	3
	69/	A(71)		C9AZ 71431D88-A	1
<b>43200 LATCH - LUGGAGE COMPARTMENT DOOR</b>					
	65/	A (except 71)	W/o power release	C5AZ 6243200-A	1
	66/71	B(except 71)			1
	67/	F			1
	71/72	L "Before 9/1/71"			1
	70/	P			1
	67/	S			1
	66/70	X(54, 62)			1

**BODY  
SECTION 430**
**FORD CAR PARTS**

GROUP NUMBER	YEAR	BODY TYPE	DESCRIPTION	PART NUMBER	QTY.
<b>43200 LATCH - LUGGAGE COMPARTMENT DOOR - continued</b>					
	72	A (except 71)	W/power release	D1MY 6543200-A	1
	65	A, B (except 71)	5/16"-24 x 1 1/8" Hex. washer head screw	353483-S2(BB588)	2or3
	65	X(54, 62, 63, 76)			2
	65/	A (except 71)	1/4" - 20 x 3/4" Hex. washer head screw	371492-S2(BB569)	3
	65	B(except 71)	W/o power release	C2OZ 6243200-B	1
	65/66	F			1
	65	X(54, 62, 63, 76)			1
	65/66	F	5/16"-18 x 3/4" Hex. head screw & washer assy.	359662-S7-8(BB575A)	2
	65/66	S (63)	W/o power release	C4SZ 6343200-B	1
	71/	S	W/power release	D1MY 6543200-A	1
	72	B(except 71, 97)		D2OZ 6543200-A	1
	72	L(64) "From 9/1/71"	Black chromate finish	D2FZ 6443200-A	1
<b>432A00 LOCK RELEASE KIT - LUGGAGE COMPARTMENT DOOR REMOTE CONTROL</b>					
	67/	A, F, S(exc. 71)	Electric	D5MZ 65432A00-A	1
	67/71	B			1
	71/	L(62, 64)			1
	70/	P			1
	67/70	X			1
	Consists of				
	1-C9AZ	43248-A	Spacer	4-57033-S	Screw
	1-C9PJ	14487-A	Connector	4-378858-S	Washer
	1-D5MJ	19C542-AA	Wire assy.	1-	Installation sketch
	1-D4VB	6543200-AA	Latch		
<b>432A06 PLATE - LUGGAGE COMPARTMENT DOOR LATCH STRIKER -Also refer to Group 43146</b>					
	65/66	S(63)		C4VY 53432A06-A	1
			5/16"-24 x .92" Flat head locking screw	371402-S13(BB101A)	2
<b>43226 LINK - LUGGAGE COMPARTMENT DOOR LATCH ACTUATING</b>					
	65/66	S(63)		C4SZ 6343226-A	1
<b>43232 ACTUATOR - LUGGAGE COMPARTMENT DOOR VACUUM LATCH</b>					
	65/66	S(63)		C5SZ 6343232-B	1
			1/4"-20 x 3/4" Hex. head screw & washer assy.	371492-S2(BB569)	2
	67/69	S		C4VY 5343232-A	1
	70/71	S	7 5/16" pigtail-with power release	D0SZ 6543232-A	1
<b>43235 BRACKET - LUGGAGE COMPARTMENT DOOR LATCH STRIKER</b>					
	67	A(54, 62, 63, 76)		C7AZ 6243235-A	1
	67	A(57)			1
	69	A(except 71)		C9AZ 6243235-B	1
	70	A(except 71)		D0AZ 6243235-A	1
	71	A(except 71)		D1MZ 6543235-A	1
	72	A (except 71)		D2AZ 6543235-A	1
	68/69	B(54, 65)		C8OZ 5443235-A	1
	68/69	B(76)		C8OZ 7643235-A	1
	70/71	B(except 66, 71)		D0OZ 6543235-A	1
	72	B(53, 65)		D2OZ 6543235-A	1
	72	B(63)		D2OZ 6343235-A	1
	65/66	F(63, 65)		C5ZZ 6543235-A	1
	67/69	F		C7ZZ 6543235-B	1
	71/	F		D1ZZ 6543235-A	1
	72	S		D2SZ 6543235-A	1
	66/70	X(54, 62)		C6DZ 6243235-A	1

# FORD CAR PARTS

## BODY SECTION 430

GROUP NUMBER	YEAR	BODY TYPE	DESCRIPTION	PART NUMBER	QTY.
<b>432A36 BRACKET - LUGGAGE COMPARTMENT DOOR LATCH VACUUM ACTUATOR MOUNTING</b>					
	67/69	S		C7SZ 65432A36-A	1
	70/71	S		D0SZ 65432A36-A	1
<b>43240 HOSE - LUGGAGE COMPARTMENT DOOR LATCH VACUUM CONTROL - Also refer to Chassis Group 17543</b>					
	65/66	S(63)	1/4" I.D. -Cut from D0PZ 17543-A	★	AR
			1/8" I.D. -Cut from A9A 17543-A	★	AR
			5/64" I.D. -Cut from D0PZ 17543-B	★	AR
			3/16" x 3/16" x 3/16" "T" Connector	378830-S(II-106H)	1
			1/4" x 1/8" Reducer	380731-S(II-191S)	1
	67	S(57)	9/64" O.D. -Used on door latch-Cut 72" long from D0PZ 17543-B	★	1
	67	S(65)	9/64" O.D. -Used on door latch-Cut 144" long from D0PZ 17543-B	★	1
	68	S	1/8" I.D. -Cut from A9A 17543-A	★	AR
	69	S	Clamp	352436-S2(GG365)	AR
<b>432A44 SEAL - LUGGAGE COMPARTMENT DOOR LATCH CYLINDER SHAFT</b>					
	67/69	S		C7SZ 65432A44-A	1
<b>432A48 BRACKET - LUGGAGE COMPARTMENT DOOR LATCH MOUNTING</b>					
	68/69	B(63)		C8OZ 63432A48-A	1
	69	F		C9ZZ 65432A48-A	1
	70	F		D0ZZ 65432A48-A	1
	71/72	L(62)	" Before 3/1/72"	D1FZ 62432A48-A	1
	72	L(62)	" From 3/1/72"	D2FZ 62432A48-A	1
	70/72	P		D2DZ 62432A48-A	1
	67/69	S		C7SZ 65432A48-A	1
	70	S		D0SZ 65432A48-A	1
	71	S		D1SZ 65432A48-A	1
<b>43252 PLATE - LUGGAGE COMPARTMENT DOOR LATCH STRIKER</b>					
- A -					
	65/69	A(except 71)		C5AZ 6243252-B	1
	70	A(except 71)		C6OZ 6243252-A	1
	71/	A(except 71)		D3AZ 6543252-A	1
- B -					
	65	B(54, 62, 65)		C4OZ 6243252-A	1
	66/67	B(54, 62, 63, 76)		C6OZ 6243252-A	1
	70/71	B(except 66, 71)			1
	65/69	B(54, 65, 76)		C5AZ 6243252-B	1
	68/69	B(63)		C8OZ 6343252-A	1
	72	B (except 71, 97)		D1AZ 6543252-A	1
- F -					
	65/66	F		C4OZ 6243252-A	1
	67/70	F		C7ZZ 6543252-A	1
	71/	F		D1AZ 6543252-A	1
- L -					
	71/72	L(62, 64)		D1FZ 6243252-B	1
- P -					
	70/	P		C7ZZ 6543252-A	1
- S -					
	67/71	S		C7SZ 6543252-A	1
	72	S		D2SZ 6543252-A	1
- X -					
	65	X(54, 62, 63, 76)		C4OZ 6243252-A	1
	66/70	X(54, 62)		C6OZ 6243252-A	1
	65/70	A(except 71), F	Screw-hex.washer head-1/4"-20 x 3/4"	371492-S2(BB569)	2
	65	B, F, X	Screw & washer assy.-hex.hd.-5/16"-18 x 3/4"	359662-S7-8(BB575A)	2

GROUP NUMBER	YEAR	BODY TYPE	DESCRIPTION	PART NUMBER	QTY.
<b>43275</b>	<b>BRACKET - LUGGAGE COMPARTMENT DOOR LATCH STRIKER</b> - Refer to Group 43235				
<b>43279</b>	<b>CYLINDER - TAILGATE LOCK - WITH KEYS</b> -Refer to Group 22050				
<b>43283</b>	<b>EXTENSION - LUGGAGE COMPARTMENT DOOR LATCH</b>				
65/67		A(except 71)		C5AZ 6243283-A	1
66/67		B(except 71)			1
68		A(except 71)		C8AZ 6243283-A	1
69		A(except 71)		C9AZ 6243283-A	1
70		A(except 71)		D0AZ 6243283-A	1
71/		A(except 71)		D3AZ 6543283-A	1
65		B(except 71)		C2YB 6243283-A	1
68/69		B(54, 65, 76)		C8OZ 5443283-A	1
68/69		B(63)		C8OZ 6343283-A	1
70/71		B(63)		D0OZ 6343283-A	1
70/71		B(except 63, 66, 71)		D0OZ 6543283-A	1
72		B(except 71)		D2OZ 6543283-A	1
65/66		F		C5ZZ 6543283-A	1
67/68		F		C7ZZ 6543283-A	1
69		F		C9ZZ 6543283-A	1
70		F	Cut to fit	D0OZ 6343283-A	1
71/		F		D1ZZ 6543283-A	1
71/		L		D1FZ 6243283-A	1
70/		P	Cut to fit	D0OZ 6343283-A	1
67/68		S		C7SZ 6543283-A	1
69		S		C9SZ 6543283-B	1
70/71		S		D0SZ 6543283-A	1
72		S		D2SZ 6543283-A	1
65		X(54, 62, 63, 76)		C2YB 6243283-A	1
66/70		X(54, 62)		C6DZ 6243283-A	1
<b>433A28</b>	<b>SEAL - LUGGAGE COMPARTMENT DOOR LOCK CYLINDER RETAINER</b>				
72		A,B(exc. 71,97),S		D2OZ 65433A28-A	1
72		F		D2ZZ 65433A28-A	1
<b>43358</b>	<b>LEVER - LUGGAGE COMPARTMENT DOOR LATCH OPERATING</b>				
65		S(63)		C5SZ 6343358-A	1
<b>43382</b>	<b>VALVE - LUGGAGE COMPARTMENT VACUUM DOOR LATCH RELEASE CONTROL</b>				
65/66		S(63)		C2VY 5743382-A	1
67/69		S		C7SZ 6543382-A	1
70/71		S		D0SZ 6543382-A	1
<b>43385</b>	<b>HANDLE - LUGGAGE COMPARTMENT VACUUM DOOR LATCH RELEASE CONTROL VALVE</b>				
65/66		S(63)		C2VY 5743385-A	1
<b>43387</b>	<b>NUT - LUGGAGE COMPARTMENT VACUUM DOOR LATCH RELEASE CONTROL</b>				
65/66		S(63)		C2VY 5743387-A	1
<b>43400</b>	<b>HANDLE - LIFTGATE - INCLUDES ATTACHING PARTS</b>				
72		L(73)		D2FZ 7343400-A	1
66/67		U(98) "Before Ser. A42, 001"		C6TZ 9843400-A	1
67/		U(98) "From Ser. A42, 001"	Less cylinder and keys	C7TZ 9843400-A	1
66/		U(98)	Cylinder and keys - refer to Group 22050		
<b>43480-1</b>	<b>PLATE - TAIL GATE HINGE ON BODY ANCHOR</b>				
66/		U		C4TZ 9943480-A	2
72		B(97)	R. H.	D2OZ 9743480-A	1
			L. H.	D2OZ 9743481-A	1



# FORD CAR PARTS

## BODY SECTION 430

11

GROUP NUMBER	YEAR	BODY TYPE	DESCRIPTION	PART NUMBER	QTY.
<b>43500-4 ORNAMENT - INCLUDES ATTACHING PARTS</b>					
- A -					
	65	A(54A, 57, 63, 76)	Luggage compartment door	C5AZ 5443504-A	1
	65	A(54B, 62B)	Luggage compartment door	C5AZ 6243504-B	1
	66	A(57F, 63F)	"LTD" -luggage compartment door	C6AZ 6343504-B	1
	66	A(63C, 76B)	"XL" -luggage compartment door	C6AZ 6343504-D	1
	66	A(63D, 76D)	"7 Litre"-luggage compartment door	C6AZ 6343504-E	1
	67	A(54A, 57B, 63B, 71B,C, 76A)	Luggage compartment door and tailgate	C7AZ 5443504-A	1
	68	A(71B, C)			1
	68	A(71A, E)	"LTD"-tailgate	C8AZ 7143500-A	1
	67	A(54C, 57F, 63J)	"LTD"-luggage compartment door	C7AZ 6343504-A	1
	67	A(63C, 76B)	"XL"-luggage compartment door	C7AZ 6343504-C	1
	68	A(54C, 57 F, 65A)	"LTD"-luggage compartment door	C8AZ 5443504-A	1
	68	A(63C, 76B)	"XL"-luggage compartment door	C8AZ 6343504-A	1
	69	A(71B, C)	Refer to Group 22050		
	69/70	A(71A, E)	"LTD" -tailgate	C9AZ 7143500-A	1
			Lower emblem	C9AZ 7143500-B	1
- B -					
	67	B(66)	Tail gate	C6DZ 6643500-A	1
	67	B(66B, D)	Roof side		2
	68	B(54C, 65C)	"Torino"-luggage compartment door	C8OZ 5443504-A	1
	68	B(65D, 76D)	"GT"-luggage compartment door	C8OZ 6543504-B	1
	68	B(63D)	Refer to group 40316		
	69	B(54C, 65C, D, F, 76D, F)		C9OZ 5443504-A	1
- L -					
	71/	L(64)	Moulding -liftgate	D1FZ 6443500-A	5
- X -					
	66	X(66)	Tail gate	C6DZ 6643500-A	1
			Roof side		2
	68/70	X(54B, 62B, C)		C8DZ 6243504-A	1
<b>43505 LOCK CYLINDER and KEYS- Refer to Group 22050</b>					
<b>43507 LOCK CYLINDER and KEYS.- Refer to Group 22050</b>					
<b>43514 COVER - LUGGAGE COMPARTMENT DOOR LOCK KEY HOLE - Also refer to Group 43603</b>					
- A -					
	69	A(63C, 76B)	Includes retaining spring	C9AZ 6343514-A	1
	69/70	A(54C, 57F, 65A)		@ D0AZ 5443514-A	1
	70	A(63C, 76B)		@ D0AZ 6343514-A	1
	72	A(53H, K, 57H, K, 65H, K, 76H)	Includes retaining spring	D2AZ 6543514-A	1
- B -					
	72	B(53D, 63R, 65D, R)		D2OZ 6543514-A	1
- S -					
	65/66	S(63)	Insert on cover -paint to match	@ C5SZ 6343514-A	1
	70/71	S	Includes attaching parts	D0SZ 6543514-A	1
			Bumper	378760-S(CC41)	2
<b>43539 PAD - HANDLE</b>					
	66/67	A(71B, C, D), B(71), X(71)	Vinyl	C6AZ 7143539-A	1
	68	A(71B, C, D), B(71), X(71)	With manual window		1
	69/71	B(71)			1
	69/70	X(71)			1
	68	A(71), B(71), X(71)	With power window	C8AZ 7143539-A	1
	69/71	B(71)			1
	69/70	X(71)			1
	69/	A(71)		C9AZ 7143539-A	1
	72	B(71)		D2OZ 7143539-A	1
	72	L(73) "Before 2/14/72"	Liftgate	D2FZ 7343539-A	1

@ Includes Attaching Parts  
May, 1975

GROUP NUMBER	YEAR	BODY TYPE	DESCRIPTION	PART NUMBER	QTY.
<b>43562</b>	<b>KEY - GLOVE and LUGGAGE COMPARTMENT DOOR CYLINDER LOCK - BLANK - Refer to Group 22050</b>				
<b>43565</b>	<b>SPACER - LUGGAGE COMPARTMENT DOOR HANDLE LOCK CYLINDER SLEEVE</b>				
	65	B(except 71)		C2OB 6243565-A	1
	65/66	F		C5ZZ 6543565-A	1
	65	X(54, 62, 63, 76)		C4DZ 6243565-A	1
	66/70	X(54, 62)		C6DZ 6243565-B	1
<b>43603</b>	<b>SLEEVE - LUGGAGE COMPARTMENT DOOR LOCK CYLINDER - INCLUDES ATTACHING PARTS</b>				
- A -					
	69	A(54C, 57F, 63C, 65A, 76B)		C9AZ 5443603-A	1
	70	A(54C, 57F, 65A)		D0AZ 5443603-A	1
	70	A(63C, 76B)		D0AZ 6343603-A	1
	72	A(53H, K, 57H, K, 65H, K, 76H)		D2AZ 6543603-A	1
- B -					
	70	B(57E, 65E)	Includes cover (43514)	D0OZ 6543603-A	1
	71	B(54C, 57C, 65C)			1
	72	B(53D, 63R, 65D, R)		D3OZ 6543603-A	1
- F -					
	65/66	F		C5ZZ 6543603-B	1
- S -					
	65/66	S(63)		C5SZ 6343603-A	1
	67	S		C7SZ 6543603-A	1
	68	S		C8SZ 6543603-A	1
	69	S		C9SZ 6543603-A	1
	70/71	S	Less cover-refer to Group 43514	D0SZ 6543603-A	1
- X -					
	65	X(54, 62, 63, 76)		C5DZ 6243603-A	1
	66/70	X(54, 62)		C6DZ 6243603-A	1
<b>43625</b>	<b>PAD - LUGGAGE COMPARTMENT DOOR LOCK CYLINDER SLEEVE</b>				
- A -					
	65/67	A(except 71)- "Before 10/24/66"	Use with 3 lug cylinder	C5AZ 6243625-B	1
	67/	A(except 71)"From,10/24/66"	Use with 4 lug cylinder	C7AZ 6243625-A	1
- B -					
	65	B(except 71)		C2OB 6243625-A	1
	66/67	B(except 66, 71)- "Before 10/24/66"	Use with 3 lug cylinder	C5AZ 6243625-B	1
	67/71	B(except 66, 71)- "From 10/24/66"	Use with 4 lug cylinder	C7AZ 6243625-A	1
	72	B (except 71, 97)			1
- F -					
	65/66	F		C5ZZ 6543625-B	1
	67	F "Before 10/24/66"	Use with 3 lug cylinder	C5AZ 6243625-B	1
	67/	F "From 10/24/66"	Use with 4 lug cylinder	C7AZ 6243625-A	1
- L -					
	71	L		C7AZ 6243625-A	1
- P -					
	70/	P		C7AZ 6243625-A	1

# FORD CAR PARTS

## BODY SECTION 430

GROUP NUMBER	YEAR	BODY TYPE	DESCRIPTION	PART NUMBER	QTY.
<b>43625 PAD - LUGGAGE COMPARTMENT DOOR LOCK CYLINDER SLEEVE - continued</b>					
- S -					
	66	S	Front door-use with remote control mirror	C5AZ 6243625-B	1
	72	S		C7AZ 6243625-A	1
- X -					
	65	X(54, 62, 63, 76)		C4DZ 6243625-A	1
	65/70	X(54, 62)		C6DZ 6243625-A	1
<b>43629 RETAINER - LUGGAGE COMPARTMENT DOOR LOCK CYLINDER - Also refer to Group 22023</b>					
	66	A(except 71), B(54, 62, 63, 76) - "From 5/2/66"		C6AZ 6243629-A	1
	67/71	A(except 71), B(except 66, 71)		C7AZ 6243629-A	1
	67/72	F "Before 3/1/72"			1
	71/72	L "Before 3/1/72"			1
	70/72	P "Before 3/1/72"			1
	72	A(Except 71)"Before 3/1/72"			1
	72	A(except 71)" From 3/1/72"		D2AZ 6543629-A	1
	72	B (except 71, 97)		D2MY 6543629-A	1
	72	F(63) " From 3/1/72"		D2OZ 6543629-A	1
	72	F(65,76) " From 3/1/72"		D2ZZ 6343629-A	1
	72	L(62) " From 3/1/72"		D2ZZ 6543629-A	1
	72	L(64) " From 3/1/72"		D2FZ 6243629-A	1
	72	P " From 3/1/72"		D2FZ 6443629-A	1
	72	S		D2DZ 6243629-A	1
	72	S		D2SZ 6543629-A	1
<b>43634 BUMPER - LUGGAGE COMPARTMENT DOOR INSIDE</b>					
	65	B(except 71)		C2OZ 6243634-A	2
	65/66	F			2
	72	L(73)		D1FZ 7343634-A	2
	68/70	X	Includes attaching parts	C8DZ 6243634-A	2
<b>43662 BEZEL - LUGGAGE COMPARTMENT DOOR LATCH RELEASE SWITCH</b>					
	72	A (except 71)		C9MY 5443662-A	1
	67/	S		C7SZ 6543662-A	1
<b>43720 WEATHERSTRIP - LUGGAGE COMPARTMENT DOOR</b>					
- A -					
	65/	A(except 71)	219" long-cut to fit	D0AZ 6243720-A	1
- B -					
	65/67	B(except 66, 71)	165 1/2" long-cut to fit	D0AZ 6243720-A	1
	68/69	B(54, 65, 76)	159" long-cut to fit		1
	68/69	B(63)	144" long-cut to fit		1
	70/71	B(except 66, 71)	219" long-cut to fit		1
	72	B (except 71, 97)			1
- F -					
	65/68	F(63)	125" long-cut to fit	C5ZZ 6343720-B	1
	65/68	F(65, 76)	142" long-cut to fit	COMB 6443720-C	1
	69/70	F(65, 76)	130" long-cut to fit		1
	69/70	F(76-GT350/500)	132" long	C9ZZ 7643720-B	1
	69/70	F(63)	109" long	C9ZZ 6343720-A	1
	71/72	F "Before 3/1/72"	219" long-cut to fit	D0AZ 6243720-A	1
	72	F(65,76) " From 3/1/72"	16" long-cut to fit	D2WY 6543720-A	2
- L -					
	71/	L(62)	138" long - cut to fit	D1DZ 5443720-A	1
	71/72	L(64)	155" long	D2FZ 6543720-A	1
- P -					
	70/71	P "Before 1/4/71"	135" long	D0DZ 6243720-A	1
	71/	P "From 1/4/71"	138" long	D1DZ 5443720-A	1

**BODY  
SECTION 430**
**FORD CAR PARTS**

GROUP NUMBER	YEAR	BODY TYPE	DESCRIPTION	PART NUMBER		QTY.	
				RIGHT HAND	LEFT HAND		
<b>43720-1 WEATHERSTRIP - LUGGAGE COMPARTMENT DOOR - continued</b>							
- S -							
	65/66	S(63)	Cut to 203" long	C3AZ	6243720-A	1	
	67/69	S	Cut to 168" long			1	
	70/	S	219" long - cut to fit	DOAZ	6243720-A	1	
- X -							
	65/66	X(54, 62, 63, 76) - "Before 8/15/66"	Cut to fit	DOAZ	6243720-A	1	
	66	X(54, 62) "From 8/15/66"	Cut to fit	C6DZ	6243720-A	1	
	67/70	X(54, 62)	Cut to fit	C3AZ	6243720-A	1	
<b>43730 WEATHERSTRIP - TAILGATE LOWER</b>							
	66/67	U(98)	Cut to 56 11/16" long	C6TZ	9843730-A	1	
	68/	U(98)		1			
<b>43732 RETAINER - TAILGATE LOWER WEATHERSTRIP</b>							
	66/	U(98)	No. 8-15 x 1/2" Cross recess pan head screw	C6TZ	9843732-A	1	
				52726-S8(U381)	11		
<b>43738 RETAINER - LIFTGATE WEATHERSTRIP</b>							
	69/	U(98)		C9TZ	9843738-A	1	
	72	L(73)	Improvise from wire	★			
<b>43830 ORNAMENT - TAILGATE LOCK CYLINDER HOLE - INCLUDES ATTACHING PARTS</b>							
	67/69	A(71A, B, C, E, H, J)	Also used with power lift window regulator	C7AZ	7143830-A	1	
<b>43876 ROD - TAILGATE LOCK CYLINDER TO RELEASE</b>							
	69/	A(71)		C9AZ	7143876-B	1	
	72	B(71)		D2OZ	7143876-A	1	
<b>43884 ROD - TAILGATE LATCH CONTROL</b>							
	66/68	A(71)		C6AZ	7143884-A	1	
	69/71	A(71) "Before 12/1/70"		C9AZ	7143884-A	1	
	71/	A(71) "From 12/1/70"		D1AZ	7143884-A	1	
	66/71	B(71)		C6OZ	7143884-A	1	
	66/70	X(71)				1	
	72	B(71)		D2OZ	7143884-A	1	
	66/71	A(71), B(71)	3/16" x 1/4" x 5/32" Grommet	380511-S(KK73)		2	
	66/70	X(71)				2	
GROUP NUMBER	YEAR	BODY TYPE	DESCRIPTION	PART NUMBER		QTY.	
				RIGHT HAND	LEFT HAND		
<b>43896-7 FILLER - TAILGATE AT BELT</b>							
	69/70	A(71)		C9AZ	7143896-A	C9AZ 7143897-A	1
	68/	U(98)		C8TZ	9843896-A	C8TZ 9843897-A	1
<b>439A00-1 BUMPER - TAILGATE ON PILLAR</b>							
	67/71	B(66)		C6DZ	66439A00-A		2
	68	X(66)					2
	72	B(97)					2
	72	U		D3TZ	99439A00-A		2or4
	65	X(59, 66, 71, 78)	R. H.	C0DZ	66439A00-B		1
			L. H.	C0DZ	66439A01-B		1
			No. 10-12 x 5/8" Cross recess pan head screw	52735-S13(U382C)			4
<b>43964-5 WEATHERSTRIP - TAILGATE SIDE ON BODY</b>							
	66/68	U(98)	R. H.	C6TZ	9843964-B		1
			L. H.	C6TZ	9843965-B		1

# FORD CAR PARTS

**BODY  
SECTION 440**

1

GROUP NUMBER	YEAR	BODY TYPE	DESCRIPTION	PART NUMBER	QTY.
<b>44000 REGULATOR - BACK WINDOW</b>					
<b>- A -</b>					
	65	A(71B)	Manual regulator	C5AZ 7144000-A	1
	66/68	A(71)			1
	65/68	A(71)	Power-less drive & motor	C5AZ 7144000-B	1
			5/16"-18 x .62" Hex. washer head screw & washer assy.	*379487-S2	4
			Spring replacement refer to Group 40867		
	69/70	A(71B, D, H, J)	Manual regulator	C9AZ 7144000-A	1
		"Before 12/1/69"			
	70	A(71)	Manual regulator	D0AZ 7144000-A	1
	69/70	A(71)	Power regulator-9 tooth pinion	D1AZ 7144000-A	1
	70	A(71)	Power regulator-7 tooth pinion	D0AZ 7144000-B	1
	71	A(71)	Manual regulator	D1AZ 7144000-A	1
	71/72	A(71)	Power regulator-less motor	D1AZ 7144000-B	1
<b>- B -</b>					
	65	B(71)	Install motor then remove manual gear when power regulator is required	C3OZ 7144000-C	1
	66/69	B(71B, D, E)	Manual regulator	C6OZ 7144000-A	1
	70	B(71B)	"Before 12/1/69"		1
			5/16"-18 x 1/2" Hex. head screw & washer assy.	376976-S7-8(BB574M)	1
	70/71	B(71)	"From 12/1/69"		1
			Manual regulator	D0OZ 7144000-A	1
	66/69	B(71)	Power regulator-less motor	C6OZ 7144000-B	1
	69/70	B(71)	Power regulator-less motor-9 tooth pinion	C9OZ 7144000-A	1
	70/71	B(71)	Power regulator-less motor-7 tooth pinion	D0OZ 7144000-B	1
	72	B(71)	Manual regulator	D2OZ 7144000-A	1
	72	B(71)	Power regulator	D2OZ 7144000-B	1
<b>- X -</b>					
	66/70	X(71)	Manual regulator	C6OZ 7144000-A	1
			5/16"-18 x 1/2" Hex. head screw & washer assy.	376976-S7-8(BB574M)	1
	66/68	X(71)	Power regulator-less motor	C6OZ 7144000-B	1
	69/70	X(71)	Power regulator-less motor	C9OZ 7144000-A	1
<b>440A06 BUMPER - BACK WINDOW STOP LOWER</b>					
	65/68	A(71)		C5AZ 71440A06-A	1
	66/	B(71)			1
	66/70	X(71)			1
<b>44008 HANDLE and KNOB ASSY. - BACK WINDOW REGULATOR</b>					
	65/67	A(71B, D)		C5AZ 7144008-A	1
	68	A(71B, D, H)			1
	66/71	B(71)			1
	66/70	X(71)			1
	69/71	A(71)		C9AZ 7144008-A	1
	72	B(71)		D2OZ 7144008-A	1
	65/	A(71), B(71)	1/4"-20 x 1/4" Set screw (headless)	89571-S8B(U409X)	2
<b>44009 HANDLE - BACK WINDOW REGULATOR</b>					
<b>- A -</b>					
	65	A(71)	Manual regulator	C5AZ 7144009-A	1
	66/68	A(71)	Manual regulator	C6AZ 7144009-C	1
	69/71	A(71)	Manual regulator-Includes attaching parts	C9AZ 7144009-B	1
	65	A(59, 71)	No. 10 Internal tooth lockwasher	34903-S8(X96)	3
			No. 10-24 Hex. nut	34053-S8 (M156)	3
<b>- B -</b>					
	65	B(71)	Manual regulator-with constant engagement	C1AZ 5944009-H	1
			No. 10 Internal tooth lockwasher	34903-S8(X96)	3
			No. 10-24 Hex. nut	34053-S8(M156)	3
	66/71	B(71)	Manual regulator-Includes attaching parts	C6OZ 7144009-C	1
	72	B(71)	Manual regulator-includes attaching parts	D2OZ 7144009-A	1

**BODY  
SECTION 440**
**FORD CAR PARTS**

GROUP NUMBER	YEAR	BODY TYPE	DESCRIPTION	PART NUMBER	QTY.
<b>44009</b>	<b>HANDLE - BACK WINDOW REGULATOR - continued</b>				
	- X -				
	65	X(59, 71, 78)	Manual regulator	C5DZ 5944009-A	1
	66/70	X(71)	Manual regulator-Single action tail gate- Includes attaching parts	C6DZ 7144009-A	1
	66/70	X(71)	Dual action tail gate	C6OZ 7144009-C	1
<b>44011</b>	<b>PAD - BACK WINDOW REGULATOR HANDLE</b>				
	- A -				
	65	A(71)		C5AZ 7144011-A	1
	66/67	A(71)	Power regulator		1
	66/68	A(71)	Manual regulator	C6AZ 7144011-A	1
	69/71	A(71)	Manual regulator	C9AZ 7144011-A	1
	- B -				
	65	B(71)	Manual regulator	C1AB 5944011-C	1
	66/71	B(71)	Manual regulator	C5AZ 7144011-A	1
	72	B(71)	Manual regulator	D2OZ 7144011-A	1
	- X -				
	65	X(59, 71, 78)	Manual or power regulator	C0DB 5944011-B	1
	66/70	X(71)	Rectangular-with power regulator	C5AZ 7144011-A	1
	69	X(71)	Manual regulator-dual action		1
	66/70	X(71)	Round-Manual regulator	C6DZ 7144011-A	1
<b>44016</b>	<b>SPRING - BACK WINDOW REGULATOR HANDLE PAWL - MANUAL</b>				
	65/	A(71), B(71)		C5AZ 7144016-A	1
	68/70	X(71)			1
<b>44017</b>	<b>SOCKET - BACK WINDOW REGULATOR STEM - MANUAL</b>				
	65	A(71B, D)		C5AZ 7144017-C	1
			Spring (retaining)-refer to Group 44050		
	69/	A(71)	Refer to Group 431F60		
	66/68	A(71)		C6AZ 7144017-A	1
	66/	B(71)			1
	66/70	X(71)			1
	65	X(59, 71, 78)	Use with C0DB 5944009-G	C0DB 5944017-D	1
<b>44036</b>	<b>SPRING - BACK WINDOW REGULATOR HANDLE</b>				
	65/68	A(71), B(71)		C1AZ 7144036-A	2
	69/71	A(71B, D, H)			2
	72	B(71)			1
<b>44044</b>	<b>HOUSING - BACK WINDOW REGULATOR HANDLE - MANUAL</b>				
	69/71	A(71)		C9AZ 7144044-A	1
	72	B(71)			1
<b>44048</b>	<b>PLATE - BACK WINDOW REGULATOR HANDLE ANCHOR - MANUAL</b>				
	66/67	A(71)		C6AZ 7144048-A	1
	71	A(71)			1
	66/71	B(71)		C6OZ 7144048-A	1
	65	X(59, 71, 78)		C0DB 5944048-A	1
			No. 8 External tooth lockwasher	34938-S8(X85)	2
			No. 8 x 3/8" Cross recess pan head screw	52720-S8(U380)	2
	66/70	X(71)		C6DZ 7144048-A	1
<b>44050</b>	<b>SPRING - BACK WINDOW REGULATOR SOCKET RETAINING - MANUAL</b>				
	65	A(71B, D) "Before 6/7/65"		C5AZ 7144050-A	1
	65/67	A(71B, C, D) - "From 6/7/65 to 3/15/67"		C5AZ 7144050-B	1
	66/67	B(71B, D), X(71)			1
	67/69	A(71B, C, D)-"From 3/15/67"		C5AZ 7144050-C	1
	67/69	B(71B, D)			1
	70/71	B(71)			1
	67/70	X(71)			1
	70/	A(71)	Serviced only in assembly-refer to Group 44009		
	72	B(71)			

# FORD CAR PARTS

## BODY SECTION 440

GROUP NUMBER	YEAR	BODY TYPE	DESCRIPTION	PART NUMBER	QTY.
<b>44062 BRACKET - BACK WINDOW LOWER STOP</b>					
	65/71	A(71), B(71)		C5AZ 7144062-A	1
	65/70	X(71)			1
			5/16"-18 x 1/2" Hex. washer head screw	376976-S7-8(BB574M)	1
<b>44074-5 BRACKET - BACK WINDOW REGULATOR ARM</b>					
	69/70	A(71)		C9AZ 7144074-A	1
	71/	A(71)	Approx. 9 3/8" long	D1AZ 7144075-A	2
	66/71	B(71), X(71)	Use with C9OZ 71422A08-A	C6OZ 7144074-A	1
				C6OZ 7144075-A	1
<b>44084 BUTTON - BACK WINDOW REGULATOR</b>					
	69/71	A(71)		C9AZ 7144084-A	1
	72	B(71)			1
<b>44085 ACTUATOR - BACK WINDOW REGULATOR</b>					
	69/71	A(71)	Manual regulator	C9AZ 7144085-A	1
	72	B(71)			1
<b>44088 RETAINER - BACK WINDOW REGULATOR BUTTON</b>					
	69/71	A(71)	Manual regulator	C9AZ 7144088-A	1
	72	B(71)			1
<b>44160 ROD - BACK WINDOW REGULATOR HANDLE REGULATOR</b>					
	69/71	A(71B,D,H)	With manual regulator	C9AZ 7144160-A	1
	72	B(71)		D2OZ 7144160-A	1
<b>44206-7 PROP SPOILER - LUGGAGE COMPARTMENT DOOR</b>					
	69/70	F(63)		D0ZZ 6344206-A	1
	71/72	L(64)	"Before 12/1/71" R. H.	D1FZ 6444206-A	1
			L. H.	D1FZ 6444207-A	1
			Screw-hex. washer head-1/4"-20 x 9/16"	384653-S2(UU52GB)	6
	72	L(64)	"From 12/1/71" Refer to Group 406A10		
<b>442A08 LATCH KIT - BACK WINDOW LOUVER</b>					
	70/71	B(63)	Includes catch	D0OZ 63442A08-A	1
<b>44210 SPOILER KIT - REAR</b>					
	69/70	F(63)		D0ZZ 6344210-A	1
		Consists of			
		(1) C5AZ 6221952-A	Clip & bushing	(2) D0ZB 6344296-C	Retainer-outer
		(1) D0WB 6544202-A	Bracket	(1) D0ZB 6344298-9-C	Retainer-inner
		(1) D0ZB 63442A02-D	Spoiler & support	(1) 55926-S2	Screw
		(1) D0ZB 6344206-A	Prop	(4) 380613-S	Cap
		(1) D0ZB 6344228-9-B	Gasket	(4) 383278-S2	Nut & washer
	69/70		Screw-No.10-16 x 5/8" oval head tapping	384354-S100(UU59G)	12
	71/	F(63)	Black	D1ZZ 6344210-A	1
			Gray	D1ZZ 6344210-B	1
		Consists of			
		(1) D1ZZ 6344228-A	Gasket(R.H.)	(1) D1ZB 6344299	Retainer
		(1) D1ZZ 6344229-A	Gasket(L.H.)	(4) 378289-S39	Nut & washer assy.
		(AR) D1ZB 6344296	Retainer	(4) 380613-S	Cap
		(1) D1ZB 6344298	Retainer		
	70/	P	Includes attaching parts	D0DZ 6244210-A	1
<b>442A14 SPACER - BACK WINDOW LOUVER - Refer to Group 44284</b>					
<b>44228-9 GASKET - REAR SPOILER SUPPORT</b>					
	71/	F(63)		D1ZZ 6344228-A	1
				D1ZZ 6344229-A	1

GROUP NUMBER	YEAR	BODY TYPE	DESCRIPTION	PART NUMBER		QTY.
<b>44268</b>	<b>LOUVER KIT - BACK WINDOW</b>					
	69/70	F(63)		C9ZZ	6344268-A	1
<b>44270</b>	<b>LOUVER - BACK WINDOW</b>					
	70/71	B(63)	Includes (5) louvers	D0OZ	6344270-A	1
GROUP NUMBER	YEAR	BODY TYPE	DESCRIPTION	PART NUMBER		QTY.
				RIGHT HAND	LEFT HAND	
<b>44272-3</b>	<b>HINGE - BACK WINDOW LOUVER</b>					
	70/71	B(63)		D0OZ	6344272-A	1
	69/70	F(63)		C9ZZ	6344273-A	1
				D0OZ	6344273-A	1
				C9ZZ	6344273-A	1
GROUP NUMBER	YEAR	BODY TYPE	DESCRIPTION	PART NUMBER		QTY.
<b>44274</b>	<b>LATCH - BACK WINDOW LOUVER</b>					
	69/70	F(63)		C9ZZ	6344274-A	2
<b>44280</b>	<b>PAD - BACK WINDOW LOUVER HINGE</b>					
	70/71	B(63)	Rubber	D0OZ	6344280-A	2
<b>44284</b>	<b>SPACER - BACK WINDOW LOUVER</b>					
	70/71	B(63)		D0OZ	63442A14-A	3
	69/70	F(63)		C9ZZ	6344284-A	2
<b>44288</b>	<b>INSERT - BACK WINDOW LOUVER LATCH</b>					
	69/70	F(63)		C9ZZ	6344288-A	2
GROUP NUMBER	YEAR	BODY TYPE	DESCRIPTION	PART NUMBER		QTY.
				RIGHT HAND	LEFT HAND	
<b>44400</b>	<b>SUPPORT - TAILGATE</b>					
	66/	U		C4TZ	9944400-A	2
			5/16"-24 x 1 1/8" Hex head screw & washer	353483-S2(BB588)	353483-S2(BB588)	4
<b>44400-1</b>	<b>ROD - TAILGATE SUPPORT</b>					
	65	A(71)		C5AZ	7144400-A	2
	65	A(71)	5/16"-18 x .56" Pan head locking screw	379935-S8(BB838P)	379935-S8(BB838P)	4
			7/16" Washer (spring)	379934-S2(XX362A)	379934-S2(XX362A)	2
	65/67	B(71)		★C3OZ	7144400-B	1
				Not replaced (2-74)		1
	65/67	B(71)	5/16"-18 x .56" Pan head locking screw	379935-S(BB838P)	379935-S8(BB838P)	4
			7/16" Washer (spring)	379934-S2(XX362A)	379934-S2(XX362)	2
GROUP NUMBER	YEAR	BODY TYPE	DESCRIPTION	PART NUMBER		QTY.
<b>444A12-3</b>	<b>SPRING - TAILGATE CHECK CABLE</b>					
	66/	A(71), B(71)	Dual action tail gate	C6AZ	71444A12-A	1
	66/70	X(71)				1
	67/71	B(66,71)	R. H. -Single action tail gate	C6DZ	71444A12-A	1
	72	B(97)				1
	66	X(66,71)				1
	67/70	X(71)				1
			L. H.	C6DZ	71444A13-A	1
<b>444A16</b>	<b>STOP - TAILGATE CHECK CABLE SPRING</b>					
	67/71	B(66,71)	Single action tail gate	C6DZ	71444A16-A	2
	72	B(97)				1
	66	X(66,71)				2
	67/70	X(71)				1
<b>44482</b>	<b>BUMPER - TAIL-GATE SUPPORT</b>					
	66/	U		C4TZ	9944482-A	2
			Cross recess pan head screw-No. 10-12 x 1/2"	52727-S8(U382)		2
			Nut-hex. washer lock-5/16" -18	379930-S2(MM173M)		9



# FORD CAR PARTS

**BODY  
SECTION 440**

5

GROUP NUMBER	YEAR	BODY TYPE	DESCRIPTION	PART NUMBER	QTY.	
<b>44486 BOLT - TAILGATE CHECK CABLE</b>						
	66/	A(71), B(71)	Upper-dual action tail gate-3/8"-16 x 2.20"-hex. head-on body	C6AZ 7144486-C	1	
	66	X(66, 71)	Upper-single action tail gate		4	
	67/69	B(66), X(71)			4	
	72	B(97)			2	
	66/	A(71), B(71), X(71)	Lower-Dual action tail gate-7/16"-14 x 1 9/32"-cross recess head-on gate	C6AZ 7144486-B	1	
	66/71	B(66, 71)	Lower-Single action tail gate		4	
	72	B(97)			2	
	66/70	X(66, 71)			4	
<b>44558 RETAINER - TAILGATE HINGE ON BODY ANCHOR PLATE</b>						
	72	B(97)		D2OZ 9744558-A	1	
<b>44588-9 BRACKET - LUGGAGE COMPARTMENT DOOR</b>						
	71/72	L(64)	"Before 12/1/71" R.H.	D1FZ 6444588-A	1	
			L.H.	D1FZ 6444589-A	1	
GROUP NUMBER	YEAR	BODY TYPE	DESCRIPTION	PART NUMBER		QTY.
				RIGHT HAND	LEFT HAND	
<b>44822 REINFORCEMENT - LUGGAGE COMPARTMENT DOOR UPPER CORNER</b>						
	67/69	S		C7SZ 6544822-A	C7SZ 6544822-A	2
	70/71	S(57)				2
	71	S(65B, D)				2
GROUP NUMBER	YEAR	BODY TYPE	DESCRIPTION	PART NUMBER	QTY.	
<b>44840 TROUGH - LUGGAGE COMPARTMENT DOOR UPPER DRAIN</b>						
	71/72	L(64)		D2FZ 6444840-A	1	
GROUP NUMBER	YEAR	BODY TYPE	DESCRIPTION	PART NUMBER		QTY.
				RIGHT HAND	LEFT HAND	
<b>44846-7 TROUGH - UPPER BACK PANEL END DRAIN</b>						
	71/	A(65)		D1AZ 6544846-A	D1AZ 6544847-A	1
<b>44890-1 BAR - HINGE TORSION</b>						
- A -						
	65	A(except 71)		C5AZ 6244890-A	C5AZ 6244891-A	1
	66	A(except 63, 71)				1
	65	A(71)		C5AZ 7144890-A		1
	67	A(63)		C7AZ 6344890-A	C7AZ 6344891-A	1
	67/68	A(except 63, 71)		C7AZ 6244890-A	C7AZ 6244891-A	1
	68	A(63)		C8AZ 6344890-C	C8AZ 6344891-C	1
	69	A(except 71)		C9AZ 6244890-A	C9AZ 6244891-A	1
	70	A(except 71)		D0AZ 6244890-A	D0AZ 6244891-A	1
	71	A(except 71)		D1AZ 6544890-A	D1AZ 6544891-A	1
	72	A(except 71)		D2AZ 6544890-A	D2AZ 6544891-A	1
	69/	A(71)		C9AZ 7144890-A	C9AZ 7144890-A	1
- B -						
	66/67	B(except 71)		C6OZ 6244890-B	C6OZ 6244891-B	1
			Roller (nylon)	C6OZ 6242758-A	C6OZ 6242758-A	2
	68	B(54, 65, 76) -"Before 12/7/67"		C8OZ 5444890-B	C8OZ 5444891-C	1
	68/69	B(54, 65, 76) -"From 12/7/67"		C8OZ 5444890-C	C8OZ 5444891-C	1
	68	B(63) "Before 11/6/67"		C8OZ 6344890-B	C8OZ 6344891-B	1
	68/69	B(63)		C8OZ 6344890-C	C8OZ 6344891-C	1
	70/71	B(except 66, 71)		D0OZ 6544890-A	D0OZ 6544891-A	1
	66/71	B(66)		C6DZ 6644890-A		1
	66/71	B(71)	Dual action tail gate	C6OZ 7144890-A		1
	66/70	B(71)	Single action tail gate	C6DZ 7144890-A		1
	72	B(53, 65)		D2OZ 6544890-A	D2OZ 6544891-A	1
	72	B(63)		D2OZ 6344890-A	D2OZ 6344891-A	1
	72	B(71)		D2OZ 7144890-A	D2OZ 7144890-A	1
	72	B(97)		D2OZ 9744890-B	D2OZ 9744890-B	1

GROUP NUMBER	YEAR	BODY TYPE	DESCRIPTION	PART NUMBER		QTY.
				RIGHT HAND	LEFT HAND	
<b>44890-1</b>	<b>BAR - HINGE TORSION - continued</b>					
- F -						
	65/66	F(65)		C5ZZ 6544890-C	C5ZZ 6544891-C	1
	67	F(63)		C7ZZ 6344890-A	C7ZZ 6344890-A	2
	67/68	F(65 except GT/CS, 76)		C7ZZ 6544890-A	C7ZZ 6544891-A	1
	69	F(65, 76)		C9ZZ 6544890-A	C9ZZ 6544891-A	1
	68/70	F(63)	Refer to Group 42700-1			
	70	F(65, 76)		D0ZZ 6544890-A	D0ZZ 6544890-A	1
	71/	F(63)	Without rear spoiler	D1ZZ 6344890-A	D1ZZ 6344891-A	1
			With rear spoiler	D1ZZ 6344890-B	D1ZZ 6344891-B	1
	71/	F(65, 76)		D1ZZ 6544890-A	D1ZZ 6544890-A	2
- L -						
	71/	L(62)		D1FZ 6244890-B	D1FZ 6244891-A	1
	72	L(73)		D2FZ 7344890-A	D2FZ 7344891-A	1
- P -						
	71/	P(54)		D1DZ 5444890-B	D1DZ 5444891-A	1
	70/	P(62A)		D0DZ 6244890-A	D0DZ 6244890-A	2
	71/	P(62D)		D1DZ 6244890-A	D1DZ 6244890-A	2
- S -						
	65/66	S(63A)		C1SB 6344890-A	★C1SB 6344891-A Not replaced (5-75)	1
	68/71	S		C8SZ 6544890-A	C8SZ 6544891-A	1
	72	S		D2SZ 6544890-A	D2SZ 6544891-A	1
- X -						
	66/67	X(54, 62)		C6DZ 6244890-A	C6OZ 6244891-B	1
	68	X(54, 62) "Before 12/7/67"		C8DZ 6244890-B	C8DZ 6244891-C	1
	68/70	X(54, 62) "From 12/7/67"		C8DZ 6244890-C	C8DZ 6244891-C	1
	66/70	X(66)		C3DZ 6644890-A		1
	66/70	X(71)	Dual action tail gate	C6OZ 7144890-A		1
	66/70	X(71)	Single action tail gate	C6DZ 7144890-A		1
<b>45028</b>	<b>ANTI-RATTLE - TORSION BAR</b>					
	65	A(71), B(71)	Cut from A9A 17543-C			
	65/67	B(except 71)	Cut from A9A 17543-C			
	65/67	A(except 71), X(54, 62, 63, 76)				
	65/68	F(63)				
	68	A(71), B(66, 71), X(71)	Cut from B9A 17543-A			
	68	A(except 71), B(except 63, 66, 71), X(except 71)	Cut from B9A 17543-A			
	68	B(63), F(65, 76)	Cut from B9A 17543-A			
	69/	A, B, F, P	Refer to Group 19627 in Paint Section			
	71	L(62)		D1FZ 6245028-A	D1FZ 6245028-A	2
<b>45036-7</b>	<b>BRACKET - LUGGAGE COMPARTMENT DOOR HINGE MOUNTING</b>					
	69/70	F(63)		C9ZZ 6345036-A	C9ZZ 6345037-A	1
<b>45114-5</b>	<b>TROUGH - LUGGAGE COMPARTMENT DOOR - SIDE DRAIN</b>					
	71/	L(62)		D1FZ 6245114-A	D1FZ 6245115-A	1
	72	S		D2SZ 6545114-A	D2SZ 6545115-A	1
<b>45118-9</b>	<b>TROUGH - LUGGAGE COMPARTMENT DOOR LOWER CORNER DRAIN</b>					
- A -						
	65/66	A(except 63, 71)		C6AZ 6245118-A	C6AZ 6245119-A	1
	67	A(except 71)	Includes retainer for rear lamp wire	C7AZ 6245118-A	C7AZ 6245119-A	1
	68	A(54, 57, 62, 65, 76)		C8AZ 6245118-A	C8AZ 6245119-A	1
	68	A(63)		C8AZ 6345118-A	C8AZ 6345119-A	1
	69	A(except 71)		C9AZ 6245118-A	C9AZ 6245119-A	1
	70	A(except 71)		D0AZ 6245118-A	D0AZ 6245119-A	1
	71	A(except 71)		D1AZ 6545118-A	D1AZ 6545119-A	1
	72	A(except 71)		D2AZ 6545118-A	D2AZ 6545119-A	1

# FORD CAR PARTS

**BODY  
SECTION 440**

7

GROUP NUMBER	YEAR	BODY TYPE	DESCRIPTION	PART NUMBER		QTY.
				RIGHT HAND	LEFT HAND	
<b>45118-9 TROUGH - LUGGAGE COMPARTMENT DOOR LOWER CORNER DRAIN - continued</b>						
- B -						
	66/67	B(except 66, 71)		★C6OZ 6245118-A Not replaced (5-75)	C6OZ 6245119-A	1
	68/69	B(54, 65, 76)		C8OZ 5445118-A	C8OZ 5445119-A	1
	68/69	B(63)		C8OZ 6345118-A	C8OZ 6345119-A	1
	70/71	B(except 66, 71)		D0OZ 6545118-A	D0OZ 6545119-A	1
- F -						
	65/66	F(65, 76)		C5ZZ 6545118-A	C5ZZ 6545119-A	1
	67/68	F(63)	L.H. - Includes retainer for rear lamp wire	C7ZZ 6345118-A	C7ZZ 6345119-A	1
	67/68	F(65, 76)	L.H. - Includes retainer for rear lamp wire	C7ZZ 6545118-A	C7ZZ 6545119-A	1
	69/70	F(63)		C9ZZ 6345118-A	C9ZZ 6345119-A	1
	69/70	F(65, 76)		C9ZZ 6545118-A	C9ZZ 6545119-A	1
	71/	F(63)		D1ZZ 6345118-A	D1ZZ 6345119-A	1
	71/	F(65, 76)		D1ZZ 6545118-A	D1ZZ 6545119-A	1
- L -						
	71/	L(64)		D1FZ 6445118-A	D1FZ 6445119-A	1
- P -						
	71/	P(54)		D1DZ 5445118-A	D1DZ 5445119-A	1
	70/	P(62)		D0DZ 6245118-A	D0DZ 6245119-A	1
- S -						
	67/69	S		C7SZ 6545118-A	C7SZ 6545119-A	1
	70/71	S(57)				1
	71	S(65B, D)				1
	70	S(65)		D0SZ 6545118-A	D0SZ 6545119-A	1
	71	S(65A, C)				1
- X -						
	65	X(54, 62, 63, 76)		★C4DZ 6245118-A Not Repl'd. (1-73)	C4DZ 6245119-A	1
	66/67	X(54, 62)		C6DZ 6245118-B	★C6DZ 6245119-B Not replaced (3-74)	1
	68/70	X(54, 62)		C8DZ 6245118-A	C8DZ 6245119-A	1
<b>45120 TROUGH - LUGGAGE COMPARTMENT DOOR - FRONT CORNER DRAIN</b>						
	67/68	A(except 63, 71)		C7AZ 6245120-A	C7AZ 6245120-A	2
	66/67	B(except 71)		C6OZ 6245120-A	C6OZ 6245120-A	2
	68/71	B(54, 62, 65, 76)				2
	67/69	S				2
	71	S(65B, D)				2
	70	S		D0SZ 6545120-A	D0SZ 6545120-A	2
	71	S(57, 65)				2
	66/70	X(54, 62)		C6OZ 6245120-A	C6OZ 6245120-A	2
<b>45408-9 RETAINER - LUGGAGE COMPARTMENT SIDE LINING BOARD - LOWER</b>						
	67/69	S		C7SZ 6545408-A	C7SZ 6545409-A	1
	70/71	S		D0SZ 6545409-A	D0SZ 6545409-A	1
	67/71	S	Screw & washer- No. 8-18 x 1/2"	381969-S2(UU89A)	381969-S2(UU89A)	1
GROUP NUMBER	YEAR	BODY TYPE	DESCRIPTION	PART NUMBER		QTY.
<b>45592 SPRING - LUGGAGE COMPARTMENT DOOR LIFT RETAINER</b>						
	72	L(64)			D2FZ 6445592-A	4
<b>45702 HINGE - LUGGAGE COMPARTMENT FRONT ACCESS DOOR - Paint to match</b>						
	67/70	F(63)	With folding rear seat		C7ZZ 6345702-B	2
	71/	F(63)	With folding rear seat		D1ZZ 6345702-A	1

May, 1975

COPYRIGHT © 1975 —

FORD MOTOR  
COMPANY

— DEARBORN, MICHIGAN

**FINAL ISSUE**

GROUP NUMBER	YEAR	BODY TYPE	DESCRIPTION	PART NUMBER	QTY.
<b>45704</b>	<b>LATCH - LUGGAGE COMPARTMENT FRONT ACCESS DOOR</b>				
	65/70	F(63)	With folding rear seat	C5ZZ 6345704-C	1
	71/	F(63)	With folding rear seat	D1ZZ 6345704-A	1
<b>45728</b>	<b>DOOR - LUGGAGE COMPARTMENT FRONT ACCESS</b>				
	67/70	F(63)	With folding rear seat-paint to match	C9ZZ 6345728-A	1
	71/	F(63)	With folding rear seat	D1ZZ 6345728-A	1
	71/72	L(62)	"Before 9/1/71" With folding rear seat-w/steady rest	D1FZ 6245728-A	1
	72	L(62)-	With folding rear seat-w/steady rest	D2FZ 6245728-B	1
			"From 9/1/71 to 12/1/71"		
	72	L(62)	"From 12/1/71" With folding rear seat-w/o steady rest	D2FZ 6245728-A	1
	71/72	L(64)-	With folding rear seat-w/steady rest-	D2FZ 6445728-B	1
			"Before 12/1/71" paint to match		
	72	L(64)	"From 12/1/71" With folding rear seat-w/o steady rest-	D2FZ 6445728-A	1
			paint to match		
<b>45732</b>	<b>BRACKET - LUGGAGE COMPARTMENT FRONT ACCESS DOOR PROP ON BODY</b>				
	69/70	F(63)	With folding rear seat	C9ZZ 6345732-A	1
<b>45734</b>	<b>PROP - LUGGAGE COMPARTMENT FRONT ACCESS DOOR</b>				
	69/70	F(63)	With folding rear seat	C9ZZ 6345734-A	1
	65/68	F(63)	Screw-hex.washer hd.-No.8-32 x 1/2"	40917-S8(U259)	2
<b>45746</b>	<b>STRIKER - LUGGAGE COMPARTMENT FRONT ACCESS DOOR LATCH</b>				
	65/70	F(63)	With folding rear seat	C5ZZ 6345746-A	1
			Screw & washer assy.-hex.hd.-No.8-32 x 1/2"	42722-S8(X19)	2
<b>45770</b>	<b>MOULDING - LUGGAGE COMPARTMENT FRONT ACCESS DOOR TRIM</b>				
	72	L(64)	Steel-includes attaching parts	D2FZ 6445770-A	1
<b>45780-1</b>	<b>STRAINER - LUGGAGE COMPARTMENT FRONT ACCESS DOOR OPENING</b>				
	71	F(63)	"Before 2/15/71" R.H. -with folding rear seat	D1ZZ 6345780-A	1
			L.H.	D1ZZ 6345781-A	1
	71/	F(63)	"From 2/15/71" R.H.-with folding rear seat	D1ZZ 6345780-B	1
			L.H.	D1ZZ 6345781-B	1
<b>45782</b>	<b>MEMBER - LUGGAGE COMPARTMENT FRONT ACCESS DOOR HINGE MOUNTING</b>				
	71/	F(63)	With folding rear seat	D1ZZ 6345782-A	1
<b>45786</b>	<b>RETAINER - LUGGAGE COMPARTMENT FRONT ACCESS DOOR COVER - LOWER</b>				
	71/	F(63)	With folding rear seat	D1ZZ 6345786-A	1
<b>45788-9</b>	<b>RETAINER - LUGGAGE COMPARTMENT FRONT ACCESS DOOR COVER - SIDE</b>				
	71/	F(63)	R.H.	D1ZZ 6345788-A	1
			L.H.	D1ZZ 6345789-A	1
<b>45790</b>	<b>RETAINER - LUGGAGE COMPARTMENT FRONT ACCESS DOOR COVER - UPPER</b>				
	71/	F(63)	With folding rear seat	D1ZZ 6345790-A	1
<b>45792</b>	<b>COVER - LUGGAGE COMPARTMENT DOOR ACCESS HOLE</b>				
	71/	L(64)	Rubber-paint to match	D1FZ 6445792-A	2
<b>45848</b>	<b>LATCH - SPARE WHEEL COVER HOLD DOWN</b>				
	69/	A(71)		C9AZ 7145848-A	2
<b>45849</b>	<b>HANDLE - SPARE WHEEL COVER HOLD DOWN</b>				
	69/72	A(71)		C9AZ 7145849-A	2
	72	B(71)			2
<b>46004</b>	<b>CLIP - LUGGAGE COMPARTMENT CARRIER RETAINER</b>				
	71/	L	1" long	D1FZ 6246004-A	8

GROUP NUMBER	YEAR	BODY TYPE	DESCRIPTION	PART NUMBER	QTY.
<b>46018-20 STRAP - LUGGAGE COMPARTMENT CARRIER HOLD-DOWN</b>					
	69/71	A(except 63, 71)	Front-use w/C9AZ 6255100-A-rear deck mount	C9AZ 6246018-A	2
			Rear-use w/C9AZ 6255100-A-rear deck mount	C9AZ 6246020-A	2
	68/71	B(except 66, 71)	Front-use w/C8AZ 6255100-A-rear deck mount	C8OZ 5446018-A	2
				C8OZ 5446020-A	2
	66/68	F(65, 76)	Front-2.88" long -use w/C6AZ 6255100-A rear deck mount	C6ZZ 6546018-A	2
	69	F(except 63)	Use with C9AZ 6255100-A rear deck mount		2
	68/69	X(except 71)			2
			Rear-2.50" long -use with C6AZ 6255100-A rear deck mount	C6ZZ 6546020-A	2
	66/68	F(65, 76)	No.10-32 Square nut	★380294-S	4
			No.10-32 x 3/4" Screw & washer assy.	★380295-S	4
	70/71	P(62)	Front-use with C9AZ 6255100-A kit	D0DZ 6246018-A	2
			Rear-use with C9AZ 6255100-A kit	D0DZ 6546020-A	2
	69/70	X(54, 62)	Rear-2.28" long-removable installation-use with C9AZ 6255100-A rear deck mount-dealer installed	C9DZ 6246020-A	2

GROUP NUMBER	YEAR	BODY TYPE	DESCRIPTION	PART NUMBER		QTY.
				RIGHT HAND	LEFT HAND	
<b>465A00-1 MOULDING - PACKAGE TRAY FINISH - INTERMEDIATE - INCLUDES ATTACHING PARTS - PAINT TO MATCH</b>						
	70/71	B(62, 65)		D0OZ 65465A00-A	D0OZ 65465A01-A	1
	71/	F(63)	Without folding rear seat	D1ZZ 63465A00-A	D1ZZ 63465A01-A	1

<b>465A04-5 MOULDING - PACKAGE TRAY FINISH - END - INCLUDES ATTACHING PARTS</b>						
	70/71	B(54, 57)	Paint to match	D0OZ 54465A04-A	D0OZ 54465A05-A	1
	70/71	B(62, 65)	Paint to match	D0OZ 65465A04-A	D0OZ 65465A05-A	1
	70/71	B(63)	Paint to match	D0OZ 63465A04-A	D0OZ 63465A05-A	1
	72	B(53)	Black	D2OZ 53465A04-C	D2OZ 53465A05-C	1
			Blue	D2OZ 53465A04-D	D2OZ 53465A05-D	1
			Ginger	D2OZ 53465A04-A	D2OZ 53465A05-A	1
			Gold	D2OZ 53465A04-F	D2OZ 53465A05-F	1
			Green	D2OZ 53465A04-B	D2OZ 53465A05-B	1
			Tobacco	D2OZ 53465A04-E	D2OZ 53465A05-E	1
	72	B(63)	Black	D3OZ 63465A04-A	D3OZ 63465A05-A	1
			Blue	D3OZ 63465A04-B	D3OZ 63465A05-B	1
			Ginger	D3OZ 63465A04-F	D3OZ 63465A05-F	1
			Gold	D2OZ 63465A04-G	D2OZ 63465A05-G	1
			Green	D3OZ 63465A04-C	D2OZ 63465A05-B	1
			Tobacco	D3OZ 63465A04-E	D3OZ 63465A05-E	1
			White	D2OZ 63465A04-E	D2OZ 63465A05-E	1

GROUP NUMBER	YEAR	BODY TYPE	DESCRIPTION	PART NUMBER	QTY.
<b>46506 PANEL - PACKAGE TRAY</b>					
	68/69	B(63)		C8OZ 6346506-B	1
	70/71	B(63)		D0OZ 6346506-A	1
	72	B(63)		D2OZ 6346506-A	1
	70/71	B(54, 57, 62, 65)		D0OZ 6546510-A	1
	71/	F(63)	Without folding rear seat	D1ZZ 6346506-A	1
	69/70	F(63)		C9ZZ 6346510-A	1
	71/	L(62)		D1FZ 6246506-A	1
	71/	P(54)		D1DZ 5446506-A	1
	70/	P(62)		D0DZ 6246506-A	1

GROUP NUMBER	YEAR	BODY TYPE	DESCRIPTION	PART NUMBER		QTY.
				RIGHT HAND	LEFT HAND	
<b>46510</b>	<b>PANEL - PACKAGE TRAY - Refer to Group 46506</b>					
<b>46512</b>	<b>PANEL - PACKAGE TRAY UPPER</b>					
	68/69	S		C8SZ	6546512-B	1
	70/71	S(57)				1
	70	S(65)		D0SZ	6546512-A	1
	71	S(65A,C)		D1SZ	6546512-A	1
	71	S(65B,D)		D1SZ	6546512-B	1
<b>46514-5</b>	<b>PANEL - PACKAGE TRAY END</b>					
	68/71	S(57)	R. H.	C8SZ	5746514-B	1
			L. H.	C8SZ	5746515-B	1
	68/69	S(65)	R. H.	C8SZ	6546514-B	1
	71	S(65B,D)				1
			L. H.	C8SZ	6546515-B	1
	70	S(65)	R. H.	D0SZ	6546514-A	1
	71	S(65A,C)				1
			L. H.	D0SZ	6546515-A	1
<b>46516</b>	<b>REINFORCEMENT - PACKAGE TRAY TO FLOOR PAN</b>					
	72	B(except 71,97)		D2OZ	6546516-A	1
<b>46519</b>	<b>PANEL - PACKAGE TRAY - LOWER</b>					
	70/71	S(57)		D0SZ	5746519-A	1
	71	S(65B,D)				1
	70	S(65)		D0SZ	6546519-A	1
	71	S(65A,C)				1
<b>46552</b>	<b>RETAINER - PACKAGE TRAY ON BODY - OUTER</b>					
	67/70	S(65)	Finish end moulding	C7SZ	6546552-A	2
<b>465A62</b>	<b>RETAINER - PACKAGE TRAY TRIM PANEL INNER</b>					
	67/71	S(57)		C7SZ	57465A62-A	2
<b>465A92</b>	<b>RETAINER - PACKAGE TRAY TRIM PANEL END</b>					
	67/71	S(57)		C7SZ	57465A92-A	2
<b>46593</b>	<b>COUPLING - PACKAGE TRAY LIFT ASSY. TO MOTOR</b>					
	65/66	S(76)		BAD	5146593-A	1
GROUP NUMBER	YEAR	BODY TYPE	DESCRIPTION	PART NUMBER		QTY.
				RIGHT HAND	LEFT HAND	
<b>466A04</b>	<b>COVER - PACKAGE TRAY VENT</b>					
	68/69	S		C8SZ	65436A04-A	2
	71	S(57,65B,D)		C8SZ	65466A04-A	1
<b>46608-9</b>	<b>BRACKET - PACKAGE TRAY STRAINER TO WHEELHOUSE</b>					
	69/70	A(54,57,62)		C9AZ	6246608-A	1
	71/	A(except 71,76)				1
	69/70	A(63,65)		C9AZ	6346608-A	1
	70/71	B(except 66,71)		D0OZ	6546608-A	1
	72	B(except 71,97)		D2OZ	6546608-A	1
	71/	F(63)	Without folding rear seat	D1ZZ	6346608-A	1
	65/	F(65)		C5ZZ	6546608-A	1
	67/71	S		C7SZ	6546608-A	1
	72	S		D2SZ	6546608-A	1

# FORD CAR PARTS

## BODY SECTION 440

11

GROUP NUMBER	YEAR	BODY TYPE	DESCRIPTION	PART NUMBER		QTY.
				RIGHT HAND	LEFT HAND	
<b>46610-1 STRAINER - PACKAGE TRAY TO FLOOR</b>						
- A -						
	65/68	A(54, 57, 63, 65)		C5AZ 6246610-B	★C5AZ 6246611-B Not replaced (3-74)	1
	65/68	A(63)		C5AZ 6346610-A	★C5AZ 6346611-A Not replaced (3-74)	1
	65/68	A(76)		★C5AZ 7646610-A Not Repl'd. (1-73)	C5AZ 7646610-A	2
	69/70	A(63)		C9AZ 6346610-A	C9AZ 6346611-A	1
	69/70	A(54, 57, 62)		C9AZ 6246610-A	C9AZ 6246611-A	1
	71/72	A(53, 54, 57)				1
	72	A(65)				1
	69/71	A(65)		C9AZ 6546610-A	C9AZ 6546611-A	1
- B -						
	68/69	B(54)		C6OZ 5446610-B	C6OZ 5446611-B	1
	68/71	B(63)		C8OZ 6346610-A	C8OZ 6346611-A	1
	68/69	B(65)		C8OZ 6546610-A	C8OZ 6546611-A	1
	70/71	B(54, 57, 65)		D0OZ 6546610-A	D0OZ 6546611-A	1
	72	B(except 71, 97)		D2OZ 6546610-A	D2OZ 6546611-A	1
- F -						
	65/70	F(65)		C5ZZ 6546610-A	C5ZZ 6546611-A	1
	65/70	F(76)		C5ZZ 7646610-B	C5ZZ 7646610-B	1
	71/72	F(63)	Without folding rear seat	D2ZZ 6346610-A	D2ZZ 6346611-A	1
	71/72	F(65)		D1ZZ 6546610-A	D1ZZ 6546611-A	1
	71	F(76)	Refer to Group 62400			
- S -						
	68/71	S		C7SZ 6546610-B	C8SZ 6546611-A	1
	72	S		D2SZ 6546610-A	D2SZ 6546611-A	1
- X -						
	66/70	X(54, 62)		C6DZ 6246610-B	C6DZ 6246611-B	1
GROUP NUMBER	YEAR	BODY TYPE	DESCRIPTION	PART NUMBER		QTY.
<b>46668 PANEL - PACKAGE TRAY TRIM</b> - Refer to Groups 46656 and 46668 in Soft Trim Section						
<b>46674-5 BRACE - PACKAGE TRAY STRAINER TO FLOOR</b>						
	71/72	F(63)	R.H. -paint to match-w/o folding rear seat L.H.	D1ZZ 5346674-B		1
	70/72	P(62)	R.H. -paint to match L.H.	D1ZZ 6346675-B		1
	71/72	P(54)	R.H. -15 5/8" long L.H.	D0DZ 6246674-A		1
				D0DZ 6246675-A		1
				D1DZ 5446674-A		1
				D1DZ 5446675-A		1
<b>46698-9 RETAINER - PACKAGE TRAY TRIM</b>						
	67	A(63)		C7AZ 6346698-C		4
	68	A(63)		C8AZ 6346698-A		4
	68/71	B(54, 63), F(65)	Improvise		★	
	70	B(62, 65)		D0OZ 6546698-A		4
	71	B(65)				4
	72	B(except 71, 97), F(65)		D1DZ 6246698-A		3
	70/71	P	"Before 11/2/70"			
	71/72	P	"From 11/2/70"	D0DZ 6246698-A		2
	71/72	P	"From 11/2/70"	D1DZ 6246698-A		2
	67/71	S(57)	R.H.	C7SZ 5746698-A		1
			L.H.	C7SZ 5746699-A		1
	67/71	S(65)	R.H.	C7SZ 6546698-A		1
			L.H.	C7SZ 6546699-A		1
	72	S		D1DZ 6246698-A		3

GROUP NUMBER	YEAR	BODY TYPE	DESCRIPTION	PART NUMBER	QTY.		
<b>46705 CLIP - PACKAGE TRAY TRIM PANEL FRONT</b>							
	70	A(65)		D0AZ 6546705-A	6		
	70/71	S(65)		D0SZ 6546705-A	5		
<b>46722-3 RETAINER - PACKAGE TRAY PANEL REAR - Paint to Match</b>							
	67/69	S(65)	R.H.	C7SZ 6546722-A	1		
	71	S(65B,D)			1		
			L.H.	C7SZ 6546723-A	1		
	70	S(65)	R.H.	D0SZ 6546722-A	1		
	71	S(65A,C)			1		
			L.H.	D0SZ 6546723-A	1		
<b>46774-5 STRAINER - PACKAGE TRAY TO WHEELHOUSE</b>							
	71/	L(62)	R.H.	D1FZ 6246774-A	1		
			L.H.	D1FZ 6246775-A	1		
	70/	P(62)	R.H.	D0DZ 6246774-A	1		
			L.H.	D0DZ 6246775-A	1		
<b>46884 COVER - PACKAGE TRAY DEFOGGER</b>							
	68/71	S		C8SZ 6546884-A	1		
GROUP NUMBER	YEAR	BODY TYPE	DESCRIPTION	PART NUMBER		QTY.	
				RIGHT HAND	LEFT HAND		
<b>46918-9 PANEL - PACKAGE TRAY TRIM END FRONT</b>							
	68	S(57)	"Before 11/1/67"	Paint to match	C8SZ 5746918-A	★C8SZ 5746919-A Not Repl'd. (1-73)	1
	68/69	S(57)-	"From 11/1/67 to 12/16/68"	Paint to match-crinkle grain	C8SZ 5746918-B	★C8SZ 5746919-B Not repl'd. (1-73)	1
	69/71	S(57)	"From 12/16/68"	Paint to match-Corinthian grain	C9SZ 5746918-A	C9SZ 5746919-A	1
	68/69	S(65)	"Before 12/16/68"	Paint to match-crinkle grain	C8SZ 6546918-A	C8SZ 6546919-A	1
	70	S(65)		Paint to match	D0SZ 6546918-A	D0SZ 6546919-A	1
	71	S(65A,C)					1
	71	S(65B,D)		Paint to match	D1SZ 6546918-A	D1SZ 6546919-A	1
	65/66	S(63)		Screw-cross recess oval head-No.8-15 x 1"	52376-S13(U296)	52376-S13(U296)	2
	65/66	S(76)		Screw-cross recess truss head-No.8-18 x .38"	376378-S101(UU97)	376378-S101(UU97)	2
GROUP NUMBER	YEAR	BODY TYPE	DESCRIPTION	PART NUMBER	QTY.		
<b>46940 RETAINER - PACKAGE TRAY SIDE MOULDING REAR</b>							
	70	B(54, 57, 62, 65)		D0OZ 6546940-A	2		
	71	B(54, 57, 65)			2		
	70/	B(63)		D0OZ 6346940-A	2		
<b>46942-3 RETAINER - PACKAGE TRAY SIDE MOULDING FRONT</b>							
	70	B(54, 57, 62, 65)		D0OZ 6546942-A	2		
	71	B(54, 57, 65)			2		
	70/	B(63)	R.H.	D0OZ 6346942-A	1		
			L.H.	D0OZ 6346943-A	1		
<b>47028 PANEL - SPARE WHEEL WELL SIDE INNER</b>							
	65	A(71)		Refer to Group 11215			
	66	A(71B, D, E)					
	69/	A(71)		R.H. -for left side refer to Group 27859			
	66/69	B(71), X(71)		R.H.	C9AZ 7147028-A	1	
	66/67	B(71), X(71)			C6OZ 7147028-B	1	
	70/71	B(71)			D0OZ 7147028-A	1	
	72	B(71)			D2OZ 7147028-A	1	
	65	X(59, 71, 78)		R.H.	C4DZ 5947028-A	1	
	66/70	X(71)		L.H.-refer to Group 27859			



GROUP NUMBER	YEAR	BODY TYPE	DESCRIPTION	PART NUMBER	QTY.
<b>47030</b>	<b>PANEL - SPARE WHEEL WELL SIDE LOWER</b>				
	65/68	A(71)	R.H.	C7AZ 7147030-B	1
	65/68	A(71)	Plug (button)-1 1/2" diameter hole	377901-S(PP14N)	1
	69/	A(71)	R.H.	C9AZ 7147030-A	1
	69/	A(71)	L.H.-refer to Group 27859		
	66/69	B(71), X(71)	Dual action tail gate	C6OZ 7147030-A	1
	70/71	B(71)		D0OZ 7147030-A	1
	72	B(71)		D2OZ 7147030-A	1
	65	A(71)	Plug (button)-1 1/2" diameter hole	352285-S(PP5)	1
	65	X(59, 71, 78)			1
<b>47040</b>	<b>BRACE - SPARE WHEEL</b>				
	69/70	A(63)		C9AZ 6347040-A	1
	69/70	A(65)		C9AZ 6547040-A	1
	69/70	A(54, 57, 62)		C9AZ 6247040-A	1
	71	A(53, 54)			1
	72	A(53, 54, 57)			1
	71	A(57)		C9MY 5747040-A	1
	71/72	A(65)		D1AZ 6547040-A	1
<b>47042</b>	<b>COVER - SPARE WHEEL WELL - Also refer to Soft Trim Sections</b>				
	65	A(71)	Refer to Groups 47042 & 45826 in Soft Trim Section		
	65	B(71)	Paint to match	C3OZ 7147042-A	1
	72	L(73)	No. 8 x 3/8" Cross recess pan head screw	52720-S8(U330)	2
				D2FZ 7347042-A	1
<b>47043</b>	<b>PANEL - SPARE WHEEL WELL</b>				
	72	L(73)		D2FZ 7347043-A	1
<b>47062</b>	<b>RETAINER - SPARE WHEEL HOLD DOWN BRACKET</b>				
	66/	U	On tail gate	C6TZ 9647062-A	1
<b>47066</b>	<b>SUPPORT - SPARE WHEEL TO FLOOR</b>				
	72	F	With folding rear seat	D2ZZ 6347066-A	1
			With F60 tire w/o folding rear seat		1
<b>47076</b>	<b>BRACKET - SPARE WHEEL MOUNTING</b>				
	67	A(54, 57, 62, 63, 76)		C7AZ 6247076-A	1
	68/69	A(54, 57, 62, 76)			1
	67/68	B(54, 62, 63, 66, 76)			1
	69/71	B(exc. 71)	With trunk mounted battery		1
	68/72	F(exc. 63)	With 302, 351, 390 engines & trunk mounted battery		1
	71	L			1
	70/	P(62)			1
	67/69	S			1
	67/70	X(54, 62)			1
	69/	A(76)		C9AZ 7647076-A	1
	69/71	F	With 427, 428 engines		1
	69/70	B(54, 63, 65, 66, 76)	With 428 engines (4) speed transmission	C9OZ 5447076-A	1
	71	B(63, 65, 76)	With 429 engine (4) speed transmission	D1OZ 6547076-A	1
	72	B(except 71, 97)		D2OZ 6547076-A	1
	72	B(97)		D2OZ 9747076-A	1
	71	F(63, 65)	Without folding rear seat	D1ZZ 6547076-A	1
	71/72	F(63)	"Before 10/18/71" With folding rear seat	D1ZZ 6347076-A	1
	72	F(63)	"From 10/18/71" With folding rear seat	D2ZZ 6347076-A	1
			With F60 tire w/o folding rear seat		1
	72	L		C9AZ 6247076-A	1
	72	P		C9AZ 6247076-A	1
	70/71	S		D0SZ 6547076-A	1
	72	S		D2OZ 6547076-A	1
	66/	U	On tail gate	C6TZ 9647076-A	1

GROUP NUMBER	YEAR	BODY TYPE	DESCRIPTION	PART NUMBER	QTY.
<b>47088</b>	<b>RETAINER - SPARE WHEEL WELL COVER REAR</b>				
	69/	A(71)		C9AZ 7147088-A	2
	66/71	B(71)		C6OZ 7147088-A	1
	72	B(71)		D2OZ 7147088-A	2
<b>47108</b>	<b>SHAFT - SPARE WHEEL COVER HOLD DOWN HANDLE</b>				
	69/	A(71)		C9AZ 7147108-A	2
<b>47112</b>	<b>BUSHING - SPARE WHEEL COVER HOLD DOWN HANDLE</b>				
	69/	A(71)		C9AZ 7147112-A	2
<b>47120</b>	<b>EXTENSION - SPARE WHEEL WELL SIDE LOWER REAR</b>				
	66/69	A(71)		C6AZ 7147120-A	1
	66/69	B(71), X(71)		C6OZ 7147120-B	1
	70/71	B(71)		D0OZ 7147120-A	1
<b>47122</b>	<b>EXTENSION - SPARE WHEEL WELL SIDE LOWER FRONT</b>				
	65	A(71)		C5AZ 7147122-A	1
	66	A(71)		C6AZ 7147122-A	1
	67	A(71)		C7AZ 7147122-A	1
	68	A(71)		C8AZ 7147122-A	1
	69/70	A(71)	R.H.	C9AZ 7147122-A	1
	69/70	A(71)	L.H.-refer to Group 27897		
	71/	A(71)		D1AZ 7147122-A	1
	66/67	B(71)		C6OZ 7147122-A	1
	66/69	X(71)			1
	70/71	B(71)		D0OZ 7147122-A	1
	72	B(71)		D2OZ 7147122-A	1
<b>47154</b>	<b>CLIP - SPARE WHEEL WELL COVER PANEL</b>				
	66/69	B(71)	Front	C6OZ 7147154-B	1
	66/70	X(71)			1
	66/69	B(71)	Rear	C6OZ 7147154-A	1
	66/70	X(71)			1
<b>47178</b>	<b>BRACKET - SPARE WHEEL COVER SUPPORT FRONT</b>				
	69/	A(71)		C9AZ 7147178-A	1
	72	B(71)		D2OZ 7147178-A	1
<b>47180</b>	<b>BRACKET - SPARE WHEEL COVER SUPPORT REAR</b>				
	69/	A(71)		C9AZ 7147180-A	1
<b>47182</b>	<b>BRACKET - SPARE WHEEL WELL - LOWER PANEL</b>				
	70/71	B(71)		D0OZ 7147182-A	1
<b>47250</b>	<b>BRACKET - SPARE WHEEL COVER HOLD DOWN AT BELT</b>				
	65/66	A(71)		C5AZ 7147250-A	1
			No. 8-15 x 1/2" Cross recess tapping screw	52726-S13(U381)	2
<b>47256</b>	<b>LATCH - SPARE WHEEL WELL COVER</b>				
	65/66	A(71)	Paint to match	C5AZ 7147256-B	1
			No. 8-15 x .38" Pan head self-tapping screw	52720-S8(U380)	2
<b>47262</b>	<b>SEAL - SPARE WHEEL WELL COVER REAR</b>				
	66/	B(71)	Supplied in assy. 47042-Refer to Group in Soft Trim Section		
<b>47264</b>	<b>SEAL - SPARE WHEEL WELL COVER UPPER</b>				
	66/	B(71)	Supplied in assy. 47042-Refer to Group in Soft Trim Section		
<b>47276</b>	<b>FILLER - SPARE WHEEL WELL SIDE LOWER</b>				
	66/68	B(71), X(71)"Before 5/18/67"		C6OZ 7147276-A	1
	68/	B(71), X(71)"From 5/18/67"	Serviced in assembly-refer to Group 47028		
<b>47282</b>	<b>RETAINER - SPARE WHEEL WELL COVER PANEL LOWER</b>				
	69	A(71)		C9AZ 7147282-A	1

# FORD CAR PARTS

**BODY  
SECTION 500**

1

GROUP NUMBER	YEAR	BODY TYPE	DESCRIPTION	PART NUMBER	QTY.
<b>50002</b>			<b>RETAINER - ROOF OUTSIDE REAR MOULDING -</b> Refer to Group 50030		
<b>50030</b>			<b>RETAINER - ROOF OUTSIDE REAR MOULDING</b>		
	69/70	A(63)	Side	C9AZ 6350030-A	4
	69/70	A(63)	Upper	C9AZ 6350034-A	6
	72	B(71)		D2OZ 7150002-A	2
			Nut-hex stamped w/sealer-No.8-32	45271-S36(M180)	AR
<b>50034</b>			<b>RETAINER - ROOF OUTSIDE REAR MOULDING-</b> Refer to Group 50030		
<b>50044</b>			<b>MOULDING - ROOF OUTSIDE REAR CENTER</b>		
	69	A(63)	Includes attaching parts - one piece design	C9AZ 6350044-A	1
	69/70	A(63)	Two piece design-refer to Group 517A02		
<b>50140-1</b>			<b>BASE - FOLDING TOP MAIN PIVOT SUPPORT -</b> Refer to Group 506A44-5		
<b>50156</b>			<b>RETAINER - FOLDING TOP BOW LISTING</b>		
	69/	A(76)		C9AZ 7650156-A	2
	66/71	B(76)	37" long	C6OZ 7650156-A	2
	69/70	F(76)		C9ZZ 7650156-A	2
	71/	F(76)	33" long	D1ZZ 7650156-A	1
<b>50202</b>			<b>PANEL - ROOF</b>		
- A -					
	69/70	A(57)		C9AZ 5750202-A	1
	69/70	A(63)		C9AZ 6350202-A	1
	69/70	A(65)		C9AZ 6550202-A	1
	69/70	A(54, 62)		C9AZ 6250202-A	1
	71/	A(54)			1
	69/	A(65)			1
	69/	A(71)		D1AZ 6550202-A	1
	71/	A(53, 57)		C9AZ 7150202-A	1
				D1AZ 5750202-A	1
- B -					
	66/67	B(54)		C6OZ 5450202-B	1
	66/69	B(62)		C6OZ 6250202-B	1
	66/71	B(71)		D0OZ 7150202-A	1
	67	B(66)		C6DZ 6650202-A	1
	68/69	B(54)		C8OZ 5450202-A	1
	68/69	B(63)		C8OZ 6350202-A	1
	68/69	B(65)		C8OZ 6550202-A	1
	68/69	B(66)		D0OZ 6650202-A	1
	70/71	B(54, 57)		D0OZ 5450202-A	1
	70/71	B(62, 65)		D0OZ 6550202-A	1
	70/71	B(63)		D0OZ 6350202-A	1
	70/71	B(66)		D0OZ 6650202-A	1
	72	B(53)		D2OZ 5350202-A	1
	72	B(63)		D2OZ 6350202-A	1
	72	B(65)		D2OZ 6550202-A	1
	72	B(71)		D2OZ 7150202-A	1
	72	B(97)		D2OZ 9750202-A	1
- F -					
	65/66	F(65)		C5ZZ 6550202-A	1
	69/70	F(63)		C9ZZ 6350202-A	1
	69	F(65)		C9ZZ 6550202-A	1
	70	F(65)		D0ZZ 6550202-A	1
	71/	F(63)		D1ZZ 6350202-A	1
	71/	F(65)		D1ZZ 6550202-A	1
- L -					
	71 /	L(62, 64)	W/o sliding roof	D1FZ 6250202-A	1
	72	L(62, 64)	W/sliding roof	D2FZ 6250202-A	1
	72	L(73)		D2FZ 7350202-A	1

**BODY  
SECTION 500**
**FORD CAR PARTS**

GROUP NUMBER	YEAR	BODY TYPE	DESCRIPTION	PART NUMBER	QTY.
<b>50202 PANEL - ROOF - continued</b>					
- P -					
	71/	P(54)		D1DZ 5450202-A	1
	70/	P(62)		D0DZ 6250202-A	1
- S -					
	67/68	S(65)	"Before 3/4/68"	C7SZ 6550202-A	1
	68	S(65)	"From 3/4/68"	C7SZ 6550202-B	1
	69	S(65A,C)			1
	67/71	S(57)		C7SZ 5750202-A	1
	69	S(65B,D)		C9SZ 6550202-A	1
	71	S(65B,D)			1
	70	S(65)		D0SZ 6550202-A	1
	71	S(65A,C)			1
	72	S		D2SZ 6550202-A	1
- U -					
	66/	U(97)	Short roof	C6TZ 9750202-A	1
	66/	U(98)	Long roof	C6TZ 9850202-A	1
- X -					
	66/67	X(54)		C6OZ 5450202-B	1
	66/70	X(62)		C6OZ 6250202-B	1
	68/70	X(54)		C6OZ 5450202-B	1
	68/70	X(71)		C6OZ 7150202-B	1
<b>502L02 DAMPENER - SLIDING ROOF MOTOR MOUNTING BRACKET VIBRATION</b>					
	69/70	S	Rubber	C9SZ 65502L02-A	4
<b>502L04 BRACKET - SLIDING ROOF MOTOR MOUNTING - INCLUDES ATTACHING PARTS</b>					
	69/70	S		C9SZ 65502L04-A	1
<b>502L05 RETAINER - SLIDING ROOF SWITCH MOUNTING</b>					
	69/70	S		C9SZ 57502L05-A	1
			24 x 21/32"	378148-S(BB29)	1
<b>502C06-7 RAIL &amp; GUIDE - SLIDING ROOF - INCLUDES ATTACHING PARTS</b>					
	72	A	R. H.	C9SZ 65502C06-A	1
	69/	S	L.H.	C9SZ 65502C07-A	1
	72/	L	R.H.	D2FZ 62502C06-A	1
			L.H.	D2FZ 62502C07-A	1
<b>502L08-9 GUIDE - SLIDING ROOF - FRONT - INCLUDES ATTACHING PARTS</b>					
	72	A	R. H. - includes plate	C8WY 65502L08-A	1
	69/	S	L.H.	C8WY 65502L09-A	1
	72/	L	R.H. & L.H.	D2FZ 62502L08-A	2
<b>502L10 HOUSING - SLIDING ROOF CABLE DRIVE - INCLUDES ATTACHING PARTS</b>					
	72	A		C9SZ 65502L10-A	1
	69/	S			1
<b>502C12 WEATHERSTRIP - SLIDING ROOF PANEL</b>					
	72	A(exc.71)	"Before 7/12/71" Rear	D2AZ 65502C12-B	1
	72	A(exc.71)	"From 7/12/71" Rear-black velvet	D4SZ 65502C12-A	1 §
	72	A(exc.71)	"Before 12/13/71" Front of rear	D2AZ 65502C12-A	1
	72	A(exc.71)	"From 12/13/71" Front of rear	D2AZ 65502C12-D	1
	72/	L	Front	D2FZ 62502C12-A	1
			Rear	D2FZ 62502C12-B	1
	69/71	S	Black velvet	C9SZ 65502C12-A	1
	69/72	S	"Before 12/13/71" Flange-rubber	C9SZ 65502C12-B	1
	72	S	"From 12/13/71" Rear flange-rubber	D2SZ 65502C12-D	1
<b>502L14 COVER - SLIDING ROOF CABLE DRIVE HOUSING - INCLUDES ATTACHING PARTS</b>					
	72	A		C8WY 65502L14-A	1
	69/	S			1
	72/	L	Front	D2FZ 62502L14-A	1

# FORD CAR PARTS

## BODY SECTION 500

3

GROUP NUMBER	YEAR	BODY TYPE	DESCRIPTION	PART NUMBER	QTY.
<b>502L16-7 GUIDE - SLIDING ROOF CABLE - INCLUDES ATTACHING PARTS</b>					
	72	A(except 71)	Lower front	D2AZ 65502L16-A	2
			Front	D2AZ 65502L16-B	2
	72	A	R.H.-lower elbow	C8WY 65502L16-A	1
			L.H.	C8WY 65502L17-A	1
	72/	L	Front	D2FZ 62502L16-A	1
	69/	S	R.H. - upper elbow	C9SZ 65502L16-A	1
			L.H.	C9SZ 65502L17-A	1
	69/	S	R.H. - lower elbow	C8WY 65502L16-A	1
			L.H.	C8WY 65502L17-A	1
	71	S	R.H. - front	C9SZ 65502L16-B	2
			L.H.	C9SZ 65502L17-B	2
			Lower front connection	C9SZ 65502L16-C	2
	72	S	Lower front connection	D2SZ 65502L16-A	1
<b>50217 REINFORCEMENT - ROOF PANEL - REAR - Refer to Group 50244</b>					
<b>502C19 GEAR BOX and DRIVE ASSY.- SLIDING ROOF - INCLUDES ATTACHING PARTS</b>					
	72	L		D2FZ 62502C19-A	1
	69/70	S	With friction clutch	C8WY 65502C19-A	1
	71/	S	Refer to Group 15790 in Chassis Section		
<b>502L19 RAIL - SLIDING ROOF PANEL HEADLINING RETAINER</b>					
	72	A		D2AZ 65502L19-A	1
	69/71	S		C9SZ 65502L19-A	1
	72	S		D2SZ 65502L19-A	1
<b>502A20 COUPLING - SLIDING ROOF MOTOR TO GEAR BOX</b>					
	69/70	S		C9SZ 65502A20-A	1
<b>502B20-1 CABLE and SLIDE ASSY. - SLIDING ROOF</b>					
	72	A	R.H.		
	69/	S		C8WY 65502B20-B	1
			L.H.		1
	72/	L	R.H.	C8WY 65502B20-A	1
			L.H.	D2FZ 62502B20-B	1
				D2FZ 62502B21-B	1
<b>50222 REINFORCEMENT - ROOF PANEL - FRONT - Refer to Group 50244</b>					
<b>502C22 HOUSING - SLIDING ROOF PANEL</b>					
	72/	L		D2FZ 62502C22-B	1
			Screw-hex.washer hd.-No.10-24	385036-S2(BB893C)	2
<b>502L26 PLATE - SLIDING ROOF RETAINING</b>					
	72	A			
	69/	S		C8WY 65502L26-A	1
					1
<b>502L30 GUIDE - SLIDING ROOF LOWER FRONT</b>					
	69/	S	Contact American Sun Roof Corp. for availability	★C9SS 65502L30-A	2
<b>502L31 INSERT - SLIDING ROOF GUIDE RAIL</b>					
	72/	L		D2FZ 62502L31-A	2
<b>502B40 RETAINER - SLIDING ROOF GUIDE RAIL TO FRAME - REAR</b>					
	72	A			
	69/	S		C8WY 65502B40-A	2
					2
	72/	L		D2FZ 62502B40-A	2
<b>502L40 PAD - SLIDING ROOF</b>					
	69/70	S	Plastic -front	C9SZ 57502L40-A	1
<b>502A42 FRAME - SLIDING ROOF HEADLINING - LESS HEADLINING - INCLUDES ATTACHING PARTS</b>					
	72	A,S		D2SZ 65502A42-A	1
	72/	L		D2FZ 62502A42-A	1
	71	S		DISZ 65502A42-A	1

May, 1975

COPYRIGHT © 1975 —

FORD MOTOR COMPANY

— DEARBORN, MICHIGAN

**FINAL ISSUE**

GROUP NUMBER	YEAR	BODY TYPE	DESCRIPTION	PART NUMBER	QTY.
<b>50244 REINFORCEMENT - ROOF PANEL</b>					
- A -					
	65/70	A(71)	Rear	C5AZ 7150217-B	1
	69/70	A(54, 62)	Center	C9AZ 6250244-A	1
	69/70	A(63)	Rear	C9AZ 6350217-A	1
	69/70	A(57, 63, 65)	Center	C9AZ 6350244-A	1
	71/	A(53, 54, 57)			1
	69/71	A(71)	Front	C9AZ 7150222-A	1
	69/71	A(71) "Before 6/1/71"	Center and rear	C9AZ 7150244-A	2
	71/	A(71) "From 6/1/71"	Center	D1AZ 7150244-A	2
	71/	A(65)	Center	D1AZ 6550244-A	1
	71/	A(65)	Rear	D1AZ 6550217-A	1
- B -					
	66	B(71)	Rear	C6OZ 7150217-A	1
	66/67	B(54, 62, 71)	Center	C6OZ 6250244-A	1
	68/69	B(54, 71)			1
	70/71	B(71)			1
	67/69	B(71)	Rear	C6OZ 7150217-B	1
	68/69	B(63)	Center	C8OZ 6350244-A	1
	68/71	B(65)	Center	C8SZ 6550244-A	1
	70/71	B(54, 57)	Center	D0OZ 5450244-A	1
	70/71	B(63)	Center	D0OZ 6350244-A	1
	70/	B(71)	Rear	D0OZ 7150217-A	3
	72	B(53)	Center	D2OZ 5350244-A	1
	72	B(63, 65)	Center	D2OZ 6550244-A	1
	72	B(63)	Rear	D2OZ 6350217-A	1
	72	B(71)	Front	D2OZ 7150222-A	1
			Center	D2OZ 7150244-A	1
- F -					
	65/70	F(exc. 65E)-w/vinyl roof	Center	C9ZZ 6550244-A	1
	70	F(65E)-w/vinyl roof	Center	D0ZZ 6550244-A	1
	71/	F(63)	Center	D1ZZ 6350244-A	1
	71/	F(63)-w/vinyl roof	Rear	D1ZZ 6350217-A	1
	71/	F(65) "Before 9/1/71"	Center	D1ZZ 6550244-A	1
	72	F(65) "From 9/1/71"	Center	D2ZZ 6550244-A	1
- L -					
	72	L(73)	Rear	D2FZ 7350217-A	1
- P -					
	70/	P(62)	Center	D0DZ 6250244-A	1
	71/	P(54)	Center	D1DZ 5450244-A	1
- S -					
	67/71	S(57)	Center	C7SZ 5750244-A	1
	68/69	S(65)	Center	C8SZ 6550244-A	1
	71	S(65B, D)			1
	70	S(65)	Center	D0SZ 6550244-A	1
	71	S(65A, C)			1
	72	S	Center	D2SZ 6550244-A	1
- X -					
	66	X(71)	Rear	C6OZ 7150217-A	1
	66/67	X(54, 62, 71)	Center	C6OZ 6250244-A	1
	68/70	X			1
	67/69	X(71)	Rear	C6OZ 7150217-B	1
<b>502L46 SPACER - SLIDING ROOF FRICTION CLUTCH</b>					
	69/71	S		C8WY 65502L46-A	AR
<b>502A50 CRANK HANDLE - SLIDING ROOF EMERGENCY</b>					
	72	A		C9SZ 65502A50-A	1
	69/	S			1
	72/	L	With attaching parts	D2FZ 62502A50-A	1

# FORD CAR PARTS

**BODY  
SECTION 500**

5

GROUP NUMBER	YEAR	BODY TYPE	DESCRIPTION	PART NUMBER	QTY.
<b>502B50 WASHER HANDLE - SLIDING ROOF</b>					
	72	A,S		D2AZ 65502B50-A	1
<b>502C50 WEATHERSTRIP - SLIDING ROOF PANEL</b>					
	72	A	Black	D2AZ 65502C50-A	1
			Gray	D2AZ 65502C50-B	1
	72/	L	Manual-less vinyl roof cover-front	D2FZ 62502C50-A	1
			Manual-Silver-with vinyl roof cover-front	D2FZ 62502C50-B	1
	69/71	S	Front and intermediate - Gray velvet	C9SZ 65502C50-A	1
			Front and sides - Black	C9SZ 65502C50-B	1
	72	S	Front and intermediate - Black	D2SZ 65502C50-A	1
			Front and sides - Gray velvet	D2SZ 65502C50-B	1
<b>502C52-3 HOSE - SLIDING ROOF FRAME DRAIN</b>					
	72	A	Front	C8WY 65502C52-A	2
	68/	S			2
	72	A	Rear	C8WY 65502C53-A	2
	71/	S			2
	69/70	S	Front	C9SZ 65502C52-A	2
			Rear	C9SZ 65502C53-A	2
<b>502L52 CAP - SLIDING ROOF DRIVE HOUSING SHAFT</b>					
	72	A	Cover with headlining	C8WY 65502L52-A	1
	69/71	S			1
<b>50263 REINFORCEMENT - ROOF PANEL FRONT</b>					
	71/	L(62, 64)		D1FZ 6250263-A	1
	72	L(73)		D2FZ 7350263-A	1
<b>502L63 CLAMP - SLIDING ROOF DRAIN HOSE - Refer to Group 8287 in Chassis Section</b>					
<b>502L65 VALVE - SLIDING ROOF - REAR DRAIN HOSE</b>					
	69	S		C9SZ 65502L65-A	2
<b>50266-7 ORNAMENT - ROOF SIDE - INNER - INCLUDES ATTACHING PARTS - PAINT TO MATCH</b>					
	68	S(57)	R. H.	C8SZ 5750266-A	1
			L. H. -not replaced (1-73)	★ C8SZ 5750267-A	1
	69/71	S(57)	R. H.	C9SZ 5750266-A	1
			L. H.	C9SZ 5750267-A	1
<b>502B66 NUT - SLIDING ROOF PANEL FRONT ADJUSTING</b>					
	72/	L		D2FZ 62502B66-A	2
<b>502B74 ABSORBER (SLIDING ROOF PANEL)</b>					
	72	A(65)		D2AZ 65502B74-A	1
<b>502A82 PANEL - SLIDING ROOF OUTER</b>					
	72	A-w/steel sliding roof		D2AZ 65502A82-A	1
	71/	S-w/sliding roof		D1SZ 65502A82-A	1
<b>50284-5 PANEL - ROOF SIDE</b>					
	69/70	A(57)	R. H.-also serviced in assy. (27840)	C9AZ 5750284-A	1
			L. H.-also serviced in assy. (27841)	C9AZ 5750285-A	1
<b>502L87 GEAR - SLIDING ROOF DRIVE PINION</b>					
	69/71	S	Use with sun roof	C8WY 65502L87-A	1
<b>50290 REINFORCEMENT - ROOF PANEL CENTER - Refer to Group 50244</b>					
<b>50291 REINFORCEMENT - ROOF PANEL REAR - Refer to Group 50244</b>					
<b>502A96 CUP - SLIDING ROOF HANDLE - INCLUDES ATTACHING PARTS</b>					
	72/	L		D2FZ 62502A96-A	1
<b>502B98 PANEL - SLIDING ROOF</b>					
	72/	L	Manual-use appropriate cover (53700)	D2FZ 62502B98-A	1
			Plug (button)-Nylon	385034-S(PP9A)	2
<b>503A02 PIN - FOLDING TOP HOLD DOWN CLAMP CONTROL LINK</b>					
	65/68	A(76)		C5AZ 76503A02-A	2
	69/	A(76)		C9AZ 76503A02-A	2
	66/71	B(76)		C6OZ 76503A02-A	2
	69	F(76)			2
	70	F(76)	1 7/8" long	D0ZZ 76503A02-A	1
	71/	F(76)	1 17/64" long	D1ZZ 76503A02-A	1
			1 7/8" long	D1ZZ 76503A02-B	1

May, 1975

COPYRIGHT © 1975 -

FORD MOTOR  
COMPANY

- DEARBORN, MICHIGAN

**FINAL ISSUE**

**BODY  
SECTION 500**
**FORD CAR PARTS**

GROUP NUMBER	YEAR	BODY TYPE	DESCRIPTION	PART NUMBER	QTY.	
<b>503A04 BUSHING - FOLDING TOP CENTER SIDE RAIL REAR</b>						
	66/67	B(76)	"Before 12/22/66"	C6OZ 76503A04-A	2	
	67/71	B(76)	"From 12/22/66"	C7OZ 76503A04-A	2	
<b>503A08 STRIKER - FOLDING TOP HOLD DOWN SIDE CLAMP</b>						
	66/69	B(76)		C6OZ 76503A08-A	2	
			No. 8-18 x 1/2" oval head tapping screw	52413-S13(U316)	2	
<b>503A10 PIN - FOLDING TOP REAR SIDE RAIL</b>						
	69/	A(76)		C9AZ 76503A10-A	2	
	71/	F(76)	59/64" long	D1ZZ 76503A10-A	2	
			1 3/16" long	D1ZZ 76503A10-B	1	
GROUP NUMBER	YEAR	BODY TYPE	DESCRIPTION	PART NUMBER		QTY.
				RIGHT HAND	LEFT HAND	
<b>50316-7 LINK - FOLDING TOP CONTROL - Paint to match</b>						
	66	B(76)		C6OZ 7650316-A	C6OZ 7650317-A	1
	67/71	B(76)		C8OZ 7650316-A	C8OZ 7650317-A	1
GROUP NUMBER	YEAR	BODY TYPE	DESCRIPTION	PART NUMBER	QTY.	
<b>50340 SLAT - FOLDING TOP NO. 4 BOW</b>						
	69/70	F(76)		C9ZZ 7650340-A	2	
<b>50352 LINK - FOLDING TOP POWER</b>						
	71/	F(76)	Upper & lower assy.	D1ZZ 7650352-A	1	
<b>50399-400 PLATE - OUTER NAME - INCLUDES ATTACHING PARTS - Also refer to Group 16096</b>						
	65	B(54B, 62B)	R. H. - "Fairlane 500" - On roof side	C2OZ 6250399-G	1	
			L. H. - not replaced (3-74)	★ C2OZ 6250399-H	1	
	65	B(65B)	"Sports Coupe" - On roof side	C4OZ 6550399-A	2	
	66	X(62C)			2	
	68/69	B(54C, 65C)	"Torino"	C8OZ 5450399-A	2	
	70	B(57E, 65E)	"Brougham"	D0OZ 6550399-A	2	
	71	B(57E, 65E)	"Brougham"	C7MY 5450400-A	2	
	69/70	F(65E)	"Grande" - on roof side	C9ZZ 6550399-A	2	
	71/	F(65F)			2	
	69/70	F(GT350/500)	Refer to Group 8213 in Chassis Section			
	69/71	S	Refer to Group 16098 in Chassis Section			
	67	X(62C)	"Futura Sports Coupe" - On roof sides	C7DZ 6250399-A	2	
	68/69	X(62C)	R. H. - "Sports Coupe"	C8DZ 6250399-A	1	
			L. H.	C8DZ 6250399-B	1	
	67	X(54B, 62B, C)	Nut-sleeve-3/32"	378362-S102(MM228)	5	
<b>50412 BUSHING - FOLDING TOP REAR SIDE RAIL TO POWER CYLINDER</b>						
	65/	A(76)	Nylon	C3AZ 7650412-A	4	
	66/71	B(76)			4	
	65/	F(76)	Power operated top only		4	
	65/66	S(76)			4	
	65	X(76)			4	
<b>50453 BUSHING - FOLDING TOP LOWER POWER LINK.</b>						
	65/66	S(76)		C0SB 7650453-A	4	
GROUP NUMBER	YEAR	BODY TYPE	DESCRIPTION	PART NUMBER		QTY.
				RIGHT HAND	LEFT HAND	
<b>50454-5 LINK - FOLDING TOP BALANCE - Paint to Match</b>						
	67/71	B(76)		C7OZ 7650454-B	C7OZ 7650455-B	1



# FORD CAR PARTS

**BODY  
SECTION 500**

7

GROUP NUMBER	YEAR	BODY TYPE	DESCRIPTION	PART NUMBER	QTY.
<b>50471 BUSHING - FOLDING TOP CENTER RAIL</b>					
	65/66	A(76), F(76)	Nylon	C5ZZ 7650471-A	2
<b>50473 BUSHING - FOLDING TOP MAIN PIVOT BRACKET</b>					
	65/68	A(76)	Nylon-1 1/4" dia.	C5AZ 7650473-A	4
	66/71	B(76)			4
	69	A(76)	3/4" dia.	C9AZ 7650473-A	6
	71	A(76)			3
	69/	A(76)	3/4" dia.	C6OZ 7650473-A	2
	69/71	B(76)	3/4" dia.		AR
	65/69	F(76)	Nylon	C5ZZ 7650473-A	2
	65	X(76)			8
	71/	F(76)	11/64" long	D1ZZ 7650473-A	1
			13/32" long	D1ZZ 7650473-B	1
			1/4" long	D1ZZ 7650473-C	1
	65/66	S(76)	Side rail-rear	C0SB 7650473-A	8or10
<b>50486-7 BUSHING - FOLDING TOP MAIN CONTROL</b>					
	65	A(76), F(76)	Rear	C5AZ 7650487-A	6or22
	66/67	A(76), F(76)			2or16
	69/	A(76)			1
	66	B(76)			2or16
	65	A(76), S(76), X(76)	Rear	C5AZ 7650486-A	2
	66	A(76), B(76), S(76)			2
	67/69	A(76)			2
	67/71	B(76) "Before 12/22/66"			2
	68	A(76) "From 12/22/66"	Rear	C7OZ 7650487-A	1or3
	67/71	B(76)			1or3
	68/71	F(76)			2or3
	68	A(76)	Center	C8OZ 7650487-A	AR
	68/71	B(76)			1
	69/	F(76)			1
<b>50491 SCREW - FOLDING TOP BALANCE LINK ADJUSTING</b>					
	69/	A(76)		C9AZ 7650491-A	1
<b>50492 PIN - FOLDING TOP CENTER SIDE RAIL FRONT</b>					
	65/66	A(76), B(76), F(76)- "Before 10/20/65"	1.10" long	C5ZZ 7650492-A	2
	66/68	A(76), B(76), F(76)- "From 10/20/65"	Refer to Group 54052		
	69/70	F(76)	2.25" long	C9ZZ 7650492-A	1
	71/	F(76)	13/32" long	D1ZZ 7650492-A	1
			1 23/64" long	D1ZZ 7650492-B	1
<b>50500-1 CLAMP - FOLDING TOP HOLD DOWN SIDE</b>					
	65/68	F(76)	R. H.	C5ZZ 7650500-D	1
			L. H.	C5ZZ 7650501-D	1
	69/70	F(76)	With manual top	C9ZZ 7650500-A	2
<b>50508 CLAMP - FOLDING TOP HOLD DOWN FRONT</b>					
- A -					
	65/68	A(76)	R. H.	C5AZ 7650508-E	1
			L. H.	C5AZ 7650508-F	1
			7/16" x 1 1/8" overall length-Pin (oval head)	379219-S13(NN156H)	2
			7/16" Washer (spring)	356573-S2(XX357)	2
			7/16" Washer (flat)	376668-S(XX166A)	2
			1/8" x 1 1/8" Pin (roll)	372929-S(NN103)	2
	69/	A(76)	R. H.	C9AZ 7650508-A	1
			L. H.	C9AZ 7650508-B	1
- B -					
	66/71	B(76)	R. H. -Includes bushing (54800)	C8OZ 7650508-A	1
			L. H.	C8OZ 7650508-B	1

GROUP NUMBER	YEAR	BODY TYPE	DESCRIPTION	PART NUMBER	QTY.	
<b>50508 CLAMP - FOLDING TOP HOLD DOWN FRONT - continued</b>						
- F -						
	65/67	F(76)	R. H.	C5ZZ 7650508-E	1	
			L. H.	C5ZZ 7650508-F	1	
			5/16" Washer	356316-S(XX114)	2	
			7/16" x 1 1/8" overall length-Pin (oval head)	379219-S2(NN156H)	2	
	68	F(76)	R. H.	C8ZZ 7650508-A	1	
			L. H.	C8ZZ 7650508-B	1	
	69/70	F(76)	R. H.	C9ZZ 7650508-A	1	
			L. H.	C9ZZ 7650508-B	1	
			5/16"-18 x 1 1/8" Truss head shoulder tapping screw	380348-S2(UU97J)	2	
- F -						
	71/	F(76)	R. H.	D1ZZ 7650508-C	1	
			L. H.	D1ZZ 7650508-D	1	
- S -						
	65/66	S(76)		C4SZ 7650508-A	2	
			5/16"-18 x 5/8" Cross recess oval trim hd. 1 kg. screw	378926-S13(BB600H)	4	
	65/66	A(76), F(76)	1/4"-20 x 5/8" Pan head tapping screw	379872-S2(UU86G)	6	
<b>50527 SPRING - FOLDING TOP HOLD DOWN CLAMP LATCH</b>						
	65	A(76), F(76)		C5ZZ 7650527-A	2	
	66/	A(76), F(76)			2	
	66/71	B(76)			2	
<b>50532 BODY - FOLDING TOP HOLD DOWN CLAMP</b>						
	71/	F(76)	Brass	D1ZZ 7650532-A	1	
<b>50536-7 LATCH or LEVER - FOLDING TOP HOLD DOWN CLAMP</b>						
	65	A(76), F(76)		C5ZZ 7650536-A	2	
	66	A(76), B(76), F(76) - "Before 11/8/65"			2	
	66/69	A(76), B(76), F(76) - "From 11/8/65"	Refer to Group 506A48			
	71/	F(76)	R. H.	D1ZZ 7650536-A	1	
			L. H.	D1ZZ 7650537-A	1	
<b>50572 SPRING - FOLDING TOP HOLD DOWN CLAMP LEVER</b>						
	65	A(76), F(76)		C5ZZ 7650572-A	2	
	66/70	A(76), B(76), F(76)			2	
	72	A(76)			2	
	71/	F(76)			2	
<b>50600-1 LIFT - FOLDING TOP</b>						
- A -						
	65/68	A(76)	R. H.	C5AZ 7650600-A	1	
			L. H.	C5AZ 7650601-A	1	
	69/70	A(76)	"Before 10/15/69"	R. H.	D0AZ 7650600-A	1
			L. H.	C9AZ 7650601-A	1	
	70/	A(76)	"From 10/15/69"	R. H.	D0AZ 7650600-A	1
			L. H.	D0AZ 7650601-A	1	
- B -						
	66/71	B(76)		C6OZ 7650600-A	2	
- F -						
	65/69	F(76)		D0ZZ 7650600-A	2	
			3/8" x .80" Pin (clevis)	378887-S13(NN30L)	2	
			.39" I. D. x .745" O. D. Washer (plain)	356403-S8(XX126)	2	
			.45" I. D. x .75" O. D. Spring wave washer	356383-S7(XX362)	2	
			1/16" Pin (self-locking)	352358-S(NN127)	2	
			5/16"-18 x 3/4" Hex. head screw & washer assy.	359662-S7-8(BB575A)	2	
	70	F(76)		D0ZZ 7650600-A	2	
			Clip (tube)	358341-S2(GG46)	3	

# FORD CAR PARTS

**BODY  
SECTION 500**

9

GROUP NUMBER	YEAR	BODY TYPE	DESCRIPTION	PART NUMBER	QTY.
<b>50600-1 LIFT - FOLDING TOP - continued</b>					
- F -					
	71	F(76)		D1ZZ 7650600-A	2
			Clip (tube)	381837-S2(GG163A)	2
	72	F(76)	R.H.	D1WY 7650600-A	1
			L.H.	D1WY 7650601-A	1
- S -					
	65/66	S(76)		C4SZ 7650600-A	2
			3/8" x 1, 156" Oval head pin	359236-S13(NN12)	2
			3/8" x 1 13/16" Clevis pin	76073-S8 (N25)	2
			3/8" Flat washer	44727-S8(X24)	4
			.45" I. D. x .75" O. D. Special spring washer	356383-S7(XX362)	2
			1/16" Pin (self-locking)	352358-S(NN127)	4
			Bushing	COSB 7650453-A	2
			7/16" Flat washer	359820-S8(XX203)	2
			7/16" x 1.71" Pin	370588-S8(NN33)	2
			No. 10-12 x 1/2" Cross recess pan head screw	32924-S7(U344)	6
			1/4" Flat washer	44720-S8(X18)	2
			1/4"-20" Hex. nut	34055-S8 (M158)	2
- X -					
	65	X(76)		C4DZ 7650600-A	2
	65	A(76), X(76)	1/16" Pin (self locking)	352358-S(NN127)	2
			.45" I. D. x .75" O. D. Special spring washer	356383-S7(XX362)	2
	65/66	A(76), X(76)	No. 10-12 x 5/8" Hex. washer head screw	42134-S8(U249)	2or3
			No. 10-32 x 1/2" Cross recess oval head screw & washer assy.	350056-S13(BB107)	4
			1/4" Flat washer	44720-S8(X18)	2
			1/4"-20 Hex. nut	34055-S8 (M158)	2
	65/	A(76)	.45" I. D. x .75" O. D. Special spring washer	356383-S7(XX362)	4
			3/8" x 1 13/16" Clevis pin	76073-S8 (N25)	2
			3/8" Flat washer	44727-S8(X24)	4or6
			1/16" Pin (self locking)	352358-S(NN127)	2or4
	66/	A(76)	Clip assy. - tube - improvise	★380935-S2	2
<b>50636 BUSHING - FOLDING TOP BALANCE LINK TO CENTER SIDE RAIL -Nylon</b>					
	69/	A(76)		C7OZ 7650636-A	2
	67/71	B(76)			1
	66	B(76)		C6OZ 7650636-A	4
	65/68	F(76)		C5ZZ 7650636-A	2
	69/71	F(76)		C9ZZ 7650636-A	1
<b>506A44-5 BASE - FOLDING TOP MAIN PIVOT SUPPORT</b>					
	65/66	S(76)	R.H.-paint to match-not replaced (3-74)	★C4SZ 76506A44-D	1
			L. H.	C4SZ 76506A45-C	1
			5/16"-24 x 1" Hex. head bolt	20387-S8(B157)	6or8
			5/16" Flat washer	44722-S8 (X19)	6or8
			3/8" Lockwasher	34807-S8(X66)	6or8
<b>506A48 LATCH - FOLDING TOP HOLD DOWN CLAMP</b>					
	66	A(76), B(76), F(76)- "Before 11/8/65"	Refer to Group 50536		
	66/70	A(76), B(76), F(76)- "From 11/8/65"	5/16"-24 thread end	C6AZ 76506A48-A	1
	71/	F(76)			1
<b>506A52 LINK - FOLDING TOP POWER - UPPER</b>					
	67	B(76) "Before 12/22/66"		C7OZ 76506A52-A	2
	67/71	B(76) "From 12/22/66"		C7OZ 76506A52-B	2
<b>50660 BRACKET - FOLDING TOP MAIN PIVOT BRACKET EXTENSION TO WHEELHOUSE</b>					
	69	A(76)		C9AZ 7650660-A	2
	70	A(76)		C9MY 7650660-A	2

GROUP NUMBER	YEAR	BODY TYPE	DESCRIPTION	PART NUMBER	QTY.
<b>50664</b>	<b>BUSHING - FOLDING TOP BALANCE LINK TO MAIN PIVOT BRACKET - NYLON</b>				
	69/	A(76)		C6OZ 7650664-A	2
	66/71	B(76)			2
	69/	A(76)		C5ZZ 7650664-A	1
	65/68	F(76)			4
	71	F(76)			4
	69/	F(76)		C9ZZ 7650664-A	1
<b>506A76</b>	<b>PIN - FOLDING TOP BALANCE LINK TO CENTER SIDE RAIL</b>				
	65/68	A(76)		C5AZ 76506A76-A	2
	67	B(76)		C7OZ 76506A76-A	2
	68/69	B(76)		C8OZ 76506A76-A	2
	70/71	B(76)		D0OZ 76506A76-A	2
	69/70	F(76)		C9ZZ 76506A76-A	2
<b>50678</b>	<b>BUSHING - FOLDING TOP HYDRAULIC LIFT</b>				
	65	A(76), X(76)		C4DZ 7650678-A	4
	65	F(76)			4
	66/70	A(76), B(76), F(76)			4
<b>506A78</b>	<b>BUSHING - FOLDING TOP SIDE FRONT LINK</b>				
	65	A(76), F(76)		C5ZZ 76506A78-A	2
<b>506A82</b>	<b>PIN - FOLDING TOP SIDE FRONT LINK</b>				
	65	A(76), F(76) "Before 12/1/64"		C5ZZ 76506A82-A	2
<b>506A84</b>	<b>BUSHING - FOLDING TOP NO. 2 BOW PIVOT</b>				
	69/	A(76), F(76)		C9AZ 76506A84-A	2
<b>506A88</b>	<b>BUSHING - FOLDING TOP MAIN CENTER LINK</b>				
	71/	F(76)	3/32" thick	D1ZZ 76506A88-A	1
<b>506A90-1</b>	<b>LINK - FOLDING TOP SIDE FRONT</b>				
	67/71	B(76)	R. H.	C7OZ 76506A90-A	1
			L. H.	C7OZ 76506A91-A	1
<b>506A94</b>	<b>NUT - FOLDING TOP BALANCE LINK</b>				
	65/67	F(76)		C5ZZ 76506A94-A	2
<b>506A96</b>	<b>PIN - FOLDING TOP MAIN PIVOT BRACKET TO REAR SIDE RAIL</b>				
	65/68	F(76)	1.60" long	C5ZZ 76506A96-A	2
	69/70	F(76)		C9ZZ 76506A96-A	2
<b>50698</b>	<b>PIN - FOLDING TOP HYDRAULIC LIFT</b>				
	65/	A(76), F(76)	Serviced in assembly-refer to Group 53118-9		
	65/71	B(76)			
<b>506A98</b>	<b>COUNTERBALANCE - FOLDING TOP</b>				
	65/66	F(76)	"Before 3/1/66" Manual top	C5ZZ 76506A98-A	2
	66/70	F(76)	"From 3/1/66" Manual top	C5ZZ 76506A98-B	2
	65/70	F(76)	3/8" x .80" Pin (clevis)	378887-S13(NN30L)	2
			3/8" Wave washer	356383-S7(XX362)	2
			3/8" flat washer	356403-S7(XX136)	2
			1/16" Pin (self-locking)	352358-S2(NN127)	2
<b>507A12</b>	<b>ROD - FOLDING TOP COUNTERBALANCE SPRING - UPPER</b>				
	65/71	F(76)	Manual top	C5ZZ 76507A12-A	2
<b>50745</b>	<b>GASKET KIT - FOLDING TOP MOTOR and RESERVOIR</b>				
	69/	A(76), F(76)		59MK 7650745-A	2
	69/71	B(76)			2
	Consists of				
	(1) FDH	15686-A	"O" Ring	(2) BN	7650745-A "O" Ring
	(2) BN	7650745-E	"O" Ring	(1) 1P	77265-B "O" Ring

# FORD CAR PARTS

## BODY SECTION 500

11

GROUP NUMBER	YEAR	BODY TYPE	DESCRIPTION	PART NUMBER		QTY.		
				RIGHT HAND	LEFT HAND			
<b>50763 GROMMET - FOLDING TOP LIFT HYDRAULIC PUMP MOUNTING</b>								
	65/66	S(76)		C4SZ	7650763-A	4		
<b>507A66-7 LINK - FOLDING TOP NO. 4 BOW CONTROL</b>								
	65/67	A(76)	R. H.	C5AZ	76507A66-B	1		
			L. H.	C5AZ	76507A67-B	1		
	69/	A(76)		C9AZ	76507A66-A	2		
	68/71	B(76)	R. H.	C8OZ	76507A66-A	1		
			L. H.	C8OZ	76507A67-A	1		
<b>507A74 BUSHING - FOLDING TOP LOWER LINK</b>								
	71/	F(76)	13/64" long	D1ZZ	76507A74-A	1		
<b>508A16 BRACKET - ROOF BOW MOUNTING</b>								
	66/	U(98)		C6TZ	98508A16-B	4		
			5/16"-18 x 15/16" long nut & retainer assy.	370328-S2(MM188)		4		
			5/16"-18 x 1/2" Hex. head screw & washer assy.	42718-S7-8(U9)		4		
<b>50822 PANEL - ROOF AIR DEFLECTOR - Refer to Group 50860</b>								
<b>50842-3 STRIP - ROOF HEADLINING SIDE RETAINING</b>								
	69/70	A(71)	R. H. -rear corner	C9AZ	7150842-A	1		
			L. H.	C9AZ	7150843-A	1		
<b>50844-5 REINFORCEMENT - ROOF PANEL REAR SIDE</b>								
	71/	L(64)	R. H.	D1FZ	6450844-A	1		
			L. H.	D1FZ	6450845-A	1		
<b>50847 EXTENSION - ROOF PANEL REAR</b>								
	65/69	A(71)	R. H.	C5AZ	7150847-F	1		
			L. H.	C5AZ	7150847-G	1		
			No. 10-24 Nut & washer assy.	373265-S7(MM291D)		2		
<b>50860 PANEL - ROOF AIR DEFLECTOR</b>								
	69	A(71)	Less support	C9AZ	7150822-A	1		
	69/	A(71), B(71)	For wood grain transfer refer to Group 20748					
	70	A(71)	Less support-wood grain	D0AZ	7150860-A	1		
	71/	A(71)				1		
	71/	A(71)	Less support-stainless steel - 45" long	D1AZ	7150860-A	1		
			Supports - refer to Group 50862					
	70	B(71)	"Before 11/3/69"	D0OZ	7150860-A	1		
	70/71	B(71)	"From 11/3/69"	D0OZ	7150860-B	1		
	72	B(71)		D2OZ	7150860-B	1		
<b>50862 SUPPORT - ROOF AIR DEFLECTOR PANEL</b>								
	69	A(71)	Rustless steel-adjustable carrier	C9AZ	7150862-A	1		
	71/	A(71)	Includes attaching parts-adjustable carrier	D1AZ	7150862-A	1		
<b>50870 PAD - ROOF AIR DEFLECTOR PANEL SUPPORT</b>								
	69/	A(71), B(71)	Rubber-adjustable carrier	C9AZ	7150870-A	1		
GROUP NUMBER	YEAR	BODY TYPE	DESCRIPTION	PART NUMBER		QTY.		
				RIGHT HAND	LEFT HAND			
<b>50900-1 STRIP - ROOF HEADLINING SIDE RETAINING REAR LOWER</b>								
	69/70	A(54, 62)		C9AZ	6250900-A	C9AZ	6250901-A	1
	71/	A(54)						1
	72	B(53)		D2OZ	5350900-A	D2OZ	5350901-A	1
	70/71	B(54, 57)		D0OZ	5450900-A	D0OZ	5450901-A	1
	70	B(62, 63, 65)		D0OZ	6550900-A	D0OZ	6550901-A	1
	71/	B(63, 65)						1
	68/71	B(66)		C8OZ	6650900-A	C8OZ	6650900-A	2
	69/70	F(63)	Refer to Group 50956-7					
	71/	L(62)		D1FZ	6250900-A	D1FZ	6250901-A	1
	71/72	L(64)	"Before 12/1/71"	D1FZ	6450900-A	D1FZ	6450901-A	1
	72	L(64)	"From 12/1/71"	D2FZ	6450900-A	D2FZ	6450901-A	1
	71/	P(54)		D1DZ	5450900-A	D1DZ	5450901-A	1
	70/	P(62)		D0DZ	6250900-A	D0DZ	6250901-A	1

GROUP NUMBER	YEAR	BODY TYPE	DESCRIPTION	PART NUMBER	QTY.
<b>50928 SEAL - SLIDING ROOF PANEL OPENING REAR</b>					
	72/	L	Manual-rubber	D2FZ 6250928-A	1
<b>50936-7 STRIP - ROOF HEADLINING SIDE RETAINING FRONT</b>					
	65	X(59, 71, 78)		C1DZ 5950936-A C1DZ 5950937-A	1
<b>50956-7 STRIP - ROOF HEADLINING RETAINING</b>					
	69/70	F(63)	Rear	C9ZZ 6350956-A C9ZZ 6350957-A	1
	69/70	F(65)	Improvise from .024" thick steel x 9" long	★ ★	
	66/67	U(98)	Side	C6TZ 9850956-A C6TZ 9850956-A	2
			No. 10-12 x 1/2" Cross recess pan head screw	52727-S8(U382) 52727-S8(U382)	10
	65	X	Refer to 50936-7		
<b>50966 RETAINER - ROOF HEADLINING HEADER STRIP</b>					
	70	A(71)		C6OZ 6250966-A	1
	66	B(54, 62, 71), X(54, 62, 66, 71)			1
	67	B(54, 62, 66, 71), X(54, 62, 71)			1
	68/69	B(54, 71), X(54, 62, 71)			1
	71	B(71)			1
	66	B(63) "Before 2/7/66"		C6OZ 6350966-A	1
	66/67	B(63) "From 2/7/66"		C6OZ 6350966-B	1
	68/69	B(63, 65, 66)			1
	70	B(54, 57, 62, 63, 65) -			1
	71	B(54, 57, 65, 66)			1
		"Before 9/28/70"			
	71	B(54, 57, 65, 66)-		D1OZ 6550966-A	1
		"From 9/28/70"			
	70/ 71	B(63)	Attaches windshield header panel-inner	D0OZ 6350966-A	1
<b>50980 RETAINER - ROOF HEADLINING FRONT</b>					
	66/	U(97, 98)	Paint to match	C6TZ 9850980-B	1
	67/	U(98)	Bright finish	C7TZ 9850980-A	1
			No. 8-15 x 5/8" Oval head tapping screw	52360-S13(U294)	8
<b>50982-3 RETAINER - ROOF HEADLINING REAR</b>					
	71/	A(54)	R.H.	D1AZ 5450982-A	1
			L.H.	D1AZ 5450983-A	1
	72	L(73)		D5FZ 7350982-A	1
<b>50986 STRIP - ROOF HEADLINING AT QUARTER WINDOW REAR TACKING</b>					
	68	S(65)		C8SZ 6550986-A	2
	69/71	S			2
<b>50996 STRIP - ROOF HEADLINING SIDE CENTER TACKING</b>					
	69	S(65)	Improvise from .093" thick steel-16 7/8" x 50"	★ ★	2
<b>50998-9 STRIP - ROOF HEADLINING SIDE REAR TACKING</b>					
	69/70	A(57)		C9AZ 5750998-A C9AZ 5750999-A	1
	69/70	A(65)		C9AZ 6550998-A C9AZ 6550999-A	1

# FORD CAR PARTS

## BODY SECTION 310

GROUP NUMBER	YEAR	BODY TYPE	DESCRIPTION	PART NUMBER	QTY.	
<b>51026 CLIP - ROOF HEADLINING RETAINER</b>						
	71	A(53K, 57K, 65K)		D0VY 6551026-A	6	
	72	B, S			5	
	72/	L	Manual sliding roof	D2FZ 6251026-A	6	
<b>51054 CLIP - ROOF HEADLINING SIDE RETAINING STRIP</b>						
	65/66	A	Windshield garnish-lower	BJ 7051054-A	5	
	65	B, X			8or26	
GROUP NUMBER	YEAR	BODY TYPE	DESCRIPTION	PART NUMBER		QTY.
				RIGHT HAND	LEFT HAND	
<b>51154-5 RAIL - FOLDING TOP CENTER SIDE</b>						
- A -						
	69/	A(76)		C9AZ 7651154-B	C9AZ 7651155-B	1
- B -						
	67	B(76)- "From 12/22/66 to 7/1/67"		C7OZ 7651154-D	C7OZ 7651155-C	1
	67/71	B(76) "From 7/1/67"		C7OZ 7651154-D	C7OZ 7651155-D	1
	66/71	B(76)	Locknut-3/8"-16	33924-S8(M-28)	33924-S8(M-28)	2
			Lockwasher-3/8"	34807-S8(X-66)	34807-S8(X-66)	1
			Screw-truss head-3/8"-16 x 2.18"	379163-S2(BB675D)	379163-S2(BB675D)	2
			Bolt-hex.hd.-3/8"-16 x 2"	370967-S(BB158)	370967-S(BB158)	2
- F -						
	66/67	F(76)- "From 5/1/66 to 9/15/66"	Paint to match	C6ZZ 7651154-B	★C6ZZ 7651155-B Not replaced (3-74)	1
	65/67	F(76) - "From 10/15/65 to 5/1/66"	Screw-truss head-3/8"-16 x 1.62"	378839-S7-8 (BB675C)	378839-S7-8 (BB675C)	2
			Locknut-hex.3/8"-16	★55738-S8	★55738-S8	2
			Screw & lockwasher assy.-pan hd.-1/4"-20 x 1/2"	50992-S7(U154)	50992-S7(U154)	2
	69/70	F(76)		C9ZZ 7651154-A	C9ZZ 7651155-A	1
	71/	F(76)	Refer to Group 53104-5			
<b>51180-1 RAIL - ROOF SIDE FRONT INNER</b>						
- A -						
	65/66	A(71)		C5AZ 7151180-A	★C5AZ7151181-A	1
	69/70	A(57)		C9AZ 5751180-A	C9AZ 5751181-A	1
	69/70	A(62)		C9AZ 6251180-A	C9AZ 6251181-A	1
	69/70	A(63, 65)		C9AZ 6351180-A	C9AZ 6351181-A	1
	69/	A(54)		C9AZ 5451180-A	C9AZ 5451181-A	1
	69/	A(71)		C9AZ 7151180-A	C9AZ 7151181-A	1
	71/	A(53, 57)		D1AZ 5751180-A	D1AZ 5751181-A	1
- B -						
	66/67	B(62), X(62)		C6OZ 6251180-E	C6OZ 6251181-E	1
	67	B(66)		C6DZ 6651180-A	C6DZ 6651181-A	1
	68/70	B(71)		C8OZ 7151180-C	C8OZ 7151181-C	1
	68/71	B(66)		C8OZ 6651180-A	C8OZ 6651181-A	1
	68/69	B(65)		C8OZ 6551180-D	C8OZ 6551181-D	1
	70	B(54, 57)		D0OZ 5451180-A	D0OZ 5451181-A	1
	70	B(62, 65)		D0OZ 6551180-A	D0OZ 6551181-A	1
	70/71	B(63)		D0OZ 6351180-A	D0OZ 6351181-A	1
	71	B(54, 57)		D1OZ 5451180-A	D1OZ 5451181-A	1
	71	B(65)		D1OZ 6551180-A	D1OZ 6551181-A	1
	71	B(71)		D1OZ 7151180-A	D1OZ 7151181-A	1
	72	B(97)		D2OZ 9751180-A	D2OZ 9751181-A	1
- F -						
	69/70	F(63)		C9ZZ 6351180-A	C9ZZ 6351181-A	1
	69/70	F(65)		C9ZZ 6551180-A	C9ZZ 6551181-A	1
- L -						
	71/	L(62, 64)		D1FZ 6251180-A	D1FZ 6251181-A	1
	72	L(73)		D2FZ 7351180-A	D2FZ 7351181-A	1

**BODY  
SECTION 510**
**FORD CAR PARTS**

GROUP NUMBER	YEAR	BODY TYPE	DESCRIPTION	PART NUMBER		QTY.
				RIGHT HAND	LEFT HAND	
<b>51180-1 RAIL - ROOF SIDE FRONT INNER - continued</b>						
- P -						
	70	P(62)		D0DZ 6251180-A	D0DZ 6251181-A	1
	71/	P(54)		D1DZ 5451180-A	D1DZ 5451181-A	1
	71/	P(62)		D1DZ 6251180-A	D1DZ 6251181-A	1
- S -						
	67	S(57)		C7SZ 5751180-B	C7SZ 5751181-B	1
	68/71	S(57)		C7SZ 5751180-E	C7SZ 5751181-E	1
	68/69	S(65)		C8SZ 6551180-C	C8SZ 6551181-C	1
	71	S(65B, D)				1
	70	S(65)		D0SZ 6551180-A	D0SZ 6551181-A	1
	71	S(65A, C)				1
- X -						
	65	X(63)		C3DZ 6351180-A	C3DZ 6351181-A	1
	68	X(62)	"Before 12/15/67"	C6OZ 6251180-E	C6OZ 6251181-C	1
	68/69	X(62)	"From 12/15/67 to 1/1/68"	C6OZ 6251180-E	C6OZ 6251181-D	1
	68/70	X(62)	"From 1/1/68"	C6OZ 6251180-E	C6OZ 6251181-E	1
	68/70	X(71)		C8OZ 7151180-C	C8OZ 7151181-C	1
<b>51186-7 RAIL - ROOF SIDE FRONT OUTER</b>						
- A -						
	69	A(57)		C9AZ 5751186-A	C9AZ 5751187-A	1
	69	A(62)		C9AZ 6251186-A	C9AZ 6251187-A	1
	69	A(63, 65)		C9AZ 6351186-A	D0AZ 6351187-A	1
	69/	A(54)		C9AZ 5451186-A	C9AZ 5451187-A	1
	69/	A(71)		C9AZ 7151186-A	C9AZ 7151187-A	1
	70	A(57)		D0AZ 5751186-A	D0AZ 5751187-A	1
	70	A(63, 65)		D0AZ 6351186-A	D0AZ 6351187-A	1
	71/	A(53, 57)		D1AZ 5751186-A	D1AZ 5751187-A	1
	71/	A(65)		D1AZ 6551186-A	D1AZ 6551187-A	1
- B -						
	66/67	B(54)		C6OZ 5451186-B	★C6OZ 5451187-B	1
	66/67	B(62)		C6OZ 6251186-B	C6OZ 6251187-B	1
	66/67	B(71)		C6OZ 7151186-B	C6OZ 7151187-B	1
	67	B(66)		C6DZ 6651186-A	C6DZ 6651187-A	1
	68/69	B(63)	"From 12/18/67"	C8OZ 6351186-B	C8OZ 6351187-B	1
	68/69	B(65)		C8OZ 6551186-B	C8OZ 6551187-B	1
	68/71	B(71)		C8OZ 7151186-B	C8OZ 7151187-B	1
	68/69	B(54)		C8OZ 5451186-B	C8OZ 5451187-B	1
	68/71	B(66)		C8OZ 6651186-A	C8OZ 6651187-A	1
	70/71	B(54, 57)		D0OZ 5451186-A	D0OZ 5451187-A	1
	70/71	B(62, 65)		D0OZ 6551186-A	D0OZ 6551187-A	1
	70/71	B(63)		D0OZ 6351186-A	D0OZ 6351187-A	1
	72	B(53)		D2OZ 5351186-A	D2OZ 5351187-A	1
	72	B(63)		D2OZ 6351186-A	D2OZ 6351187-A	1
	72	B(65)		D2OZ 6551186-A	D2OZ 6551187-A	1
	72	B(71)		D2OZ 7151186-A	D2OZ 7151187-A	1
	72	B(97)		D2OZ 9751186-A	D2OZ 9751187-A	1
- F -						
	69/70	F(63)		C9ZZ 6351186-A	C9ZZ 6351187-A	1
	69/70	F(65)		C9ZZ 6551186-A	C9ZZ 6551187-A	1
	71/	F(63)		D1ZZ 6351186-A	D1ZZ 6351187-A	1
	71/	F(65)		D1ZZ 6551186-A	D1ZZ 6551187-A	1
- P -						
	70/	P(62)		D0DZ 6251186-A	D0DZ 6251187-A	1
	71/	P(54)		D1DZ 5451186-A	D1DZ 5451187-A	1
- S -						
	72	S		D2SZ 6551186-A	D2SZ 6551187-A	1
- X -						
	65	X(66)		C0DB 6651186-A	C0DB 6651187-A	1
	66/68	X(62)	"Before 1/1/68"	C6OZ 6251186-A	C6OZ 6251187-A	1
	66/68	X(71)	"Before 1/1/68"	C6OZ 7151186-A	C6OZ 7151187-A	1
	66/70	X(54)		C6OZ 5451186-B	C6OZ 5451187-B	1
	68/70	X(62)	"From 1/1/68"	C6OZ 6251186-B	C6OZ 6251187-B	1
	68/70	X(71)	"From 1/1/68"	C6OZ 7151186-B	C6OZ 7151187-B	1



# FORD CAR PARTS

## BODY SECTION 510

3

GROUP NUMBER	YEAR	BODY TYPE	DESCRIPTION	PART NUMBER				QTY.
				RIGHT HAND		LEFT HAND		
<b>51206-7 EXTENSION - ROOF SIDE OUTER REAR RAIL</b>								
	68/69	B(65)		C8OZ	6551206-A	C8OZ	6551207-A	1
	70/71	B(54, 57)		D0OZ	5451206-A	D0OZ	5451207-A	1
	70/71	B(62, 65)		D0OZ	6551206-A	D0OZ	6551207-A	1
	70/71	B(63)		D0OZ	6351206-A	D0OZ	6351207-A	1
	72	B(65)		D2OZ	6551206-A	D2OZ	6551207-A	1
	69/70	F(65)		C9ZZ	6551206-A	C9ZZ	6551207-A	1
<b>51212-3 RAIL - ROOF SIDE INNER REAR</b>								
- A -								
	69	A(65)		C9AZ	6551212-A	★C9AZ	6551213-A	1
	69/70	A(54, 62)		C9AZ	6251212-A	C9AZ	6251213-A	1
	69/70	A(57)		C9AZ	5751212-A	C9AZ	5751213-A	1
	69/70	A(63)		C9AZ	6351212-A	C9AZ	6351213-A	1
	69/70	A(71)		D1AZ	7151212-A	D1AZ	7151213-A	1
	70	A(65)		D0AZ	6551212-A	D0AZ	6551213-A	1
	71/	A(53, 57)		D1AZ	5751212-A	D1AZ	5751213-A	1
	71/	A(54)		D1AZ	5451212-A	D1AZ	5451213-A	1
- B -								
	66	B(71)		C6OZ	7151212-C	C6OZ	7151213-E	1
	67	B(66)		★C6DZ	6651212-A	C6DZ	6651213-A	1
	67	B(71)		C6OZ	7151212-E	C6OZ	7151213-E	1
	68/69	B(54)		★C8OZ	5451212-A	C8OZ	5451213-A	1
				Not replaced (1-73)				
	68/69	B(63)		C8OZ	6351212-B	C8OZ	6351213-B	1
	68/69	B(65)		C8OZ	6551212-B	C8OZ	6551213-B	1
	68	B(71)	"Before 1/1/68"	C6OZ	7151212-D	C6OZ	7151213-E	1
	68/71	B(71)	"From 1/1/68"	C6OZ	7151212-E	C6OZ	7151213-E	1
	70/71	B(54, 57)		D0OZ	5451212-A	D0OZ	5451213-A	1
	70/71	B(62, 65)		D0OZ	6551212-A	D0OZ	6551213-A	1
	70/71	B(63)		D0OZ	6351212-A	D0OZ	6351213-A	1
	72	B(53)		D2OZ	5351212-A	D2OZ	5351213-A	1
	72	B(63)		D2OZ	6351212-A	D2OZ	6351213-A	1
	72	B(71)		D2OZ	7151212-A	D2OZ	7151213-A	1
	72	B(97)		D2OZ	9751212-A	D2OZ	9751213-A	1
- F -								
	69/70	F(63)		C9ZZ	6351212-A	C9ZZ	6351213-A	1
	69/70	F(65)		C9ZZ	6551212-A	C9ZZ	6551213-A	1
	71/	F(63)		D1ZZ	6351212-A	D1ZZ	6351213-A	1
	71/	F(65)		D1ZZ	6551212-A	D1ZZ	6551213-A	1
- L -								
	71/	L(62)		D1FZ	6251212-A	D1FZ	6251213-A	1
	72	L(64)		D2FZ	6451212-A	D2FZ	6451213-A	1
- P -								
	70/	P(62)		D0DZ	6251212-A	D0DZ	6251213-A	1
	71/	P(54)		D1DZ	5451212-A	D1DZ	5451213-A	1
- S -								
	68/69	S(65)		C8SZ	6551212-A	C8SZ	6551213-A	1
	68/71	S(57)		C8SZ	5751212-A	C8SZ	5751213-A	1
	70	S(65)		D0SZ	6551212-A	D0SZ	6551213-A	1
	71	S(65A, C)		D1SZ	6551212-B	D0SZ	6551213-A	1
	71	S(65B, D)		D1SZ	6551212-C	D1SZ	6551213-C	1
			Also refer to Group 513C06-7					
- X -								
	66	X(71)		C6OZ	7151212-C	C6OZ	7151213-E	1
	66/67	X(54)		C6DZ	5451212-A	★C6DZ	5451213-A	1
				Not replaced (1-73)				
	66/67	X(62)		C6DZ	6251212-B	C6DZ	6251213-B	1
	67	X(71)	"Before 7/1/67"	C6OZ	7151212-B	C6OZ	7151213-C	1
	67/70	X(71)	"From 7/1/67"	C6OZ	7151212-E	C6OZ	7151213-E	1
	68/70	X(54)		C6DZ	5451212-A	C8DZ	5451213-A	1
	68/70	X(62)		C6DZ	6251212-B	C6DZ	6251213-B	1

GROUP NUMBER	YEAR	BODY TYPE	DESCRIPTION	PART NUMBER		QTY.
				RIGHT HAND	LEFT HAND	
<b>51216-7 RAIL - ROOF SIDE OUTER REAR</b>						
- A -						
	68	A(65)		★C8AZ 6551216-A Not replaced (3-74)	C8AZ 6551217-A	1
	69/70	A(54, 62)		C9AZ 6251216-A	C9AZ 6251217-A	1
	69/70	A(57)		C9AZ 5751216-A	C9AZ 5751217-A	1
	69/70	A(63)		D0AZ 6351216-A	D0AZ 6351217-A	1
	69/70	A(65)		D0AZ 6551216-A	D0AZ 6551217-A	1
	69/	A(71)		C9AZ 7151216-A	C9AZ 7151217-A	1
	71/	A(53, 57)		D1AZ 5751216-A	D1AZ 5751217-A	1
	71/	A(54)		D1AZ 5451216-A	D1AZ 5451217-A	1
	71/	A(65)		D1AZ 6551216-A	D1AZ 6551217-A	1
- B -						
	66/67	B(54)		C6OZ 5451216-A	C6OZ 5451217-A	1
	66/67	B(62)		C6OZ 6251216-B	C6OZ 6251217-B	1
	66/71	B(71)		C6OZ 7151216-A	C6OZ 7151217-A	1
	68/69	B(54)		C8OZ 5451216-A	C8OZ 5451217-A	1
	68/69	B(65)		C8OZ 6551216-A	C8OZ 6551217-A	1
	70/71	B(54, 57)		D0OZ 5451216-A	D0OZ 5451217-A	1
	70/71	B(63)		D0OZ 6351216-A	D0OZ 6351217-A	1
	70/71	B(62, 65)		D0OZ 6551216-A	D0OZ 6551217-A	1
	72	B(53)		D2OZ 5351216-A	D2OZ 5351217-A	1
	72	B(63)		D2OZ 6351216-A	D2OZ 6351217-A	1
	72	B(65)		D2OZ 6551216-A	D2OZ 6551217-A	1
- F -						
	69/70	F(63)		C9ZZ 6351216-A	C9ZZ 6351217-A	1
	69/70	F(65)		C9ZZ 6551216-A	C9ZZ 6551217-A	1
	71/	F(63)		D1ZZ 6351216-A	D1ZZ 6351217-A	1
	71/	F(65)		D1ZZ 6551216-A	D1ZZ 6551217-A	1
- P -						
	71/	P(54)		D1DZ 5451216-A	D1DZ 5451217-A	1
- S -						
	68/71	S(57)		C7SZ 5751216-B	C7SZ 5751217-B	1
	70	S(65)		D0SZ 6551216-A	D0SZ 6551217-A	1
	71	S(65A, C)				1
	71	S(65B, D)		D1SZ 6551216-A	D1SZ 6551217-A	1
	72	S		D2SZ 6551216-A	D2SZ 6551217-A	1
- X -						
	66/70	X(54)		C6OZ 5451216-A	C6OZ 5451217-A	1
	66/67	X(62)		C6OZ 6251216-A	C6OZ 6251217-B	1
	68/70	X(62)		C6OZ 6251216-B	C6OZ 6251217-B	1
	66/70	X(71)		C6OZ 7151216-A	C6OZ 7151217-A	1
<b>51220-1</b>	<b>EXTENSION - ROOF SIDE INNER REAR RAIL - Refer to Group 513A34-5</b>					
<b>51222-3</b>	<b>WEATHERSTRIP - ROOF SIDE RAIL</b>					
- A -						
	65/66	A(57)		C5AZ 5751222-A	C5AZ 5751223-A	1
			Fastener	C1AB 6220807-A	C1AB 6220807-A	2
	65	A(63)		C5AZ 6351222-A	C5AZ 6351223-A	1
	66	A(63)		C6AZ 6351222-A	C6AZ 6351223-A	1
	67	A(57)		C7AZ 5751222-B	C7AZ 5751223-B	1
	67	A(63B, C)		C7AZ 6351222-C	C7AZ 6351223-C	1
	67	A(63J)		C7AZ 6351222-D	C7AZ 6351223-D	1
	68	A(57)		C8AZ 5751222-B	C8AZ 5751223-B	1
	68	A(63)		C8AZ 6351222-A	★C8AZ 6351223-B Not replaced (3-74)	1
	68	A(65)		C8AZ 6551222-A	C8AZ 6551223-A	1
	69	A(57)		C9AZ 5751222-B	C9AZ 5751223-B	1

# FORD CAR PARTS

**BODY  
SECTION 510**

GROUP NUMBER	YEAR	BODY TYPE	DESCRIPTION	PART NUMBER		QTY.
				RIGHT HAND	LEFT HAND	
<b>51222-3 WEATHERSTRIP - ROOF SIDE RAIL - continued</b>						
- A -						
69		A(63,65)		C9AZ 6551222-B	C9AZ 6551223-B	1
70		A(57)		D0AZ 5751222-A	D0AZ 5751223-A	1
70		A(63, 65)		D0AZ 6351222-A	D0AZ 6351223-A	1
71		A(53, 71)	"Before 5/28/71" Front	D1AZ 5351222-C	D1AZ 5351223-C	1
71/72		A(53, 71)	"From 5/28/71 to 10/4/71"	D2AZ 5351222-A	D1AZ 5351223-D	1
72		A(53, 71)	"From 10/4/71"	D2AZ 5351222-A	D2AZ 5351223-A	1
71/72		A(57)	"Before 9/1/71"	D1AZ 5751222-A	D2AZ 5751223-A	1
72		A(57)	"From 9/1/71 to 10/4/71"	D2AZ 5751222-A	D2AZ 5751223-A	1
72		A(57)	"From 10/4/71"	D2AZ 5751222-B	D2AZ 5751223-B	1
71/72		A(65)		D2AZ 6551222-A	D2AZ 6551223-A	1
65/		A	No. 8-15 x 1/2" Cross recess pan head screw	52726-S13(U381)	52726-S13(U381)	AR
- B -						
65		B(65)		C3OZ 6551222-E	C3OZ 6551223-E	1
			No. 8-18 x 3/8" Cross recess pan head screw	52720-S8(U380)	52720-S8(U380)	36
66/67		B(63)		C6OZ 6351222-B	C6OZ 6351223-B	1
68/69		B(63)		C8OZ 6351222-A	C8OZ 6351223-A	1
68/69		B(65)		C8OZ 6551222-A	C8OZ 6551223-A	1
68/69		B(66)		C8OZ 6651222-A	C8OZ 6651223-A	1
70		B(54)	Front			
			Incl. Black windlace	D0OZ 5451222-J	D0OZ 5451223-J	1
			Incl. Blue windlace	D0OZ 5451222-G	D0OZ 5451223-G	1
			Incl. Green windlace	D0OZ 5451222-H	D0OZ 5451223-H	1
			Incl. Nugget gold windlace	D0OZ 5451222-F	D0OZ 5451223-F	1
			Incl. Red windlace	D0OZ 5451222-K	D0OZ 5451223-K	1
70		B(62)	Incl. Black windlace	D0OZ 6251222-D	D0OZ 6251223-D	1
			Incl. Blue windlace	D0OZ 6251222-F	D0OZ 6251223-F	1
			Incl. Nugget gold windlace	D0OZ 6251222-E	D0OZ 6251223-E	1
71		B(54)	Front			
			Incl. Black windlace	D0OZ 5451222-J	D0OZ 5451223-J	1
			Incl. Blue windlace	D0OZ 5451222-G	D0OZ 5451223-G	1
			Incl. Gray windlace	D1OZ 5451222-B	D1OZ 5451223-B	1
			Incl. Green windlace	D1OZ 5451222-A	D1OZ 5451223-A	1
70/71		B(54)	Rear-Refer to Group 513A68-9			
70/71		B(57)		D0OZ 5751222-B	D0OZ 5751223-B	1
70/71		B(63)		D0OZ 6351222-A	D0OZ 6351223-A	1
70/71		B(65)		D0OZ 6551222-A	D0OZ 6551223-A	1
70/71		B(66)		D0OZ 6651222-A	D0OZ 6651223-A	1
72		B(53, 71)	"Before 2/21/72"	D2OZ 5351222-A	D2OZ 5351223-A	1
72		B(53, 71)	"From 2/21/72"	D2OZ 5351222-B	D2OZ 5351223-B	1
72		B(63)		D3OZ 6351222-A	D3OZ 6351223-A	1
72		B(65)		D3OZ 6551222-A	D3OZ 6551223-A	1
72		B(97)	"Before 2/21/72"	D2OZ 9751222-A	D3OZ 9751223-A	1
72		B(97)	"From 2/21/72"	D2OZ 9751222-B	D3OZ 9751223-B	1
- F -						
65/66		F(63)		C5ZZ 6351222-C	C5ZZ 6351223-C	1
65/66		F(65)		C5ZZ 6551222-C	C5ZZ 6551223-C	1
67/68		F(63)		C7ZZ 6351222-A	C7ZZ 6351223-A	1
67/68		F(65)		C7ZZ 6551222-B	C7ZZ 6551223-B	1
69/70		F(63)		C9ZZ 6351222-C	C9ZZ 6351223-C	1
69/70		F(65)		C9ZZ 6551222-A	C9ZZ 6551223-A	1
71/		F(except 76)		D1ZZ 6551222-A	D1ZZ 6551223-A	1
65/		F(63, 65)	No. 8-15 x 1/2" Cross recess pan head screw	52726-S13(U381)	52726-S13(U381)	AR

GROUP NUMBER	YEAR	BODY TYPE	DESCRIPTION	PART NUMBER		QTY.	
				RIGHT HAND	LEFT HAND		
<b>51222-3 WEATHERSTRIP - ROOF SIDE RAIL - continued</b>							
- P -							
70	P(62)		Incl. Black windlace	D0DZ 6251222-A	D0DZ 6251223-A	1	
			Incl. Blue windlace	D0DZ 6251222-B	D0DZ 6251223-B	1	
			Incl. Nugget gold windlace	D0DZ 6251222-E	D0DZ 6251223-E	1	
			Incl. Red windlace	D0DZ 6251222-C	D0DZ 6251223-C	1	
71/	P(54)		Incl. Black windlace	D1DZ 5451222-G	D1DZ 5451223-G	1	
			Incl. Blue windlace	D1DZ 5451222-E	D1DZ 5451223-E	1	
			" Before 1/18/71" " From 1/18/71"	Incl. Gray gold windlace	D1DZ 5451222-D	D1DZ 5451223-D	1
			Incl. Gray gold windlace	D1DZ 5451222-H	D1DZ 5451223-H	1	
			Incl. Vermilion windlace	D1DZ 5451222-F	D1DZ 5451223-F	1	
71/	P(62)		Incl. Black windlace	D0DZ 6251222-A	D0DZ 6251223-A	1	
			Incl. Blue windlace	D0DZ 6251222-B	D0DZ 6251223-B	1	
			Incl. Gray gold windlace	D1DZ 6251222-B	D1DZ 6251223-B	1	
			Incl. Vermilion windlace	D1DZ 6251222-A	D1DZ 6251223-A	1	
72	P(54)		Incl. Beige windlace	D2DZ 5451222-B	D2DZ 5451223-B	1	
			Incl. Ginger windlace	D2DZ 5451222-A	D2DZ 5451223-A	1	
			Incl. Tan windlace	D2DZ 5451222-C	D2DZ 5451223-C	1	
72	P(62)		Incl. Beige windlace	D2DZ 6251222-C	D2DZ 6251223-C	1	
			Incl. Ginger windlace	D2DZ 6251222-A	D2DZ 6251223-A	1	
			Incl. Tan windlace	D3DZ 6251222-A	D3DZ 6251223-A	1	
			Incl. White windlace	D2DZ 6251222-B	D2DZ 6251223-B	1	
- S -							
65	S(63)			C4SZ 6351222-A	C4SZ 6351223-A	1	
66	S(63A, B)			C6SZ 6351222-A	C6SZ 6351223-A	1	
66	S(63C, D)			C6SZ 6351222-B	C6SZ 6351223-B	1	
67/68	S(65)			C7SZ 6551222-A	C7SZ 6551223-A	1	
67/71	S(57)			D0SZ 5751222-A	D0SZ 5751223-A	1	
69	S(65A, C)			C9SZ 6551222-B	C9SZ 6551223-B	1	
69	S(65B, D)			C9SZ 6551222-A	C9SZ 6551223-A	1	
70	S(65)			D0SZ 6551222-A	D0SZ 6551223-A	1	
71	S(65A, C)					1	
71	S(65B, D)			D1SZ 6551222-A	D1SZ 6551223-A	1	
72	S	"Before 6/1/72"		D2SZ 6551222-A	D3SZ 6551223-A	1	
72	S	"From 6/1/72"		D3SZ 6551222-A	D3SZ 6551223-A	1	
- U -							
66/	U			C9TZ 9751222-A	C9TZ 9751223-A	1	
- X -							
65	X(63)			C3DZ 6351222-A	C3DZ 6351223-A	1	
			No. 8-15 x 1/2" Cross recess pan head screw	52726-S13(U381)	52726-S13(U381)	12	
GROUP NUMBER	YEAR	BODY TYPE	DESCRIPTION	PART NUMBER		QTY.	
<b>51262-3 BRACKET - ROOF SIDE OUTER FRONT RAIL EXTENSION</b>							
72	B(65)		R. H.	D2OZ 6551262-A		1	
			L. H.	D2OZ 6551263-A		1	
<b>51266 INSERT - ROOF SIDE RAIL WEATHERSTRIP</b>							
72	A(53, 57, 65)		Rubber	D2AZ 5751266-A		2	
<b>51269 BOW - FOLDING TOP - NO.3 - Paint to Match</b>							
65	A(76)	"Before 4/19/65"	No. 3 bow-Refer to Group 51274				
69/	A(76)			C9AZ 7651269-A		1	
66/68	B(76)			D0OZ 7651269-A		1	
70/71	B(76)			D0OZ 7651269-A		1	
71/	F(76)			D1ZZ 7651269-A		1	
66/	U(98)			C6TZ 9851269-B		2	
65/	A(76), B(76)		1/4" - 28 x 5/8" Cross recess oval head screw	52931-S13(U329)		4	
			1/4" External tooth countersunk lockwasher	34954-S7(X81)		4	

# FORD CAR PARTS

## BODY SECTION 510

7

GROUP NUMBER	YEAR	BODY TYPE	DESCRIPTION	PART NUMBER	QTY.	
<b>51274</b>			<b>BOW - FOLDING TOP - NO.2 -</b> Paint to Match			
	65/67	A(76)	"From 4/19/65"	No. 3 bow-Refer to Group 51269		
	69/	A(76)		C9AZ 7651274-A	1	
	69/71	B(76)		C9OZ 7651274-A	1	
	69/70	F(76)		C9ZZ 7651274-A	1	
	71/	F(76)		D1ZZ 7651274-A	1	
	65	F(76)	No.10-24 x 7/16" Screw & washer assy.	378446-S13(BB600F)	4	
	66/70	F(76)	No.10-24 x 1/2" Oval head tapping screw	376490-S101(UU56B)	2	
	65	X(76)		C3DZ 7651274-A	1	
	65/	A(76),B(76),X(76)	1/4"-28 x 5/8"-cross recess oval head screw	52931-S13(U329)	4	
			1/4" External tooth countersunk lockwasher	34954-S7-8(X81)	4	
<b>51278</b>			<b>BOW - FOLDING TOP REAR - NO.4 -</b> Paint to Match			
	69/	A(76)		C9AZ 7651278-A	1	
	67	B(76)		C9OZ 7651278-A	1	
	68/69	B(76)	"Before 2/15/69"	C8OZ 7651278-A	1	
	69	B(76)	"From 2/15/69"	C9OZ 7651278-A	1	
	70/71	B(76)		D0OZ 7651278-A	1	
	69/70	F(76)		C9ZZ 7651278-A	1	
	71/	F(76)		D1ZZ 7651278-A	1	
GROUP NUMBER	YEAR	BODY TYPE	DESCRIPTION	PART NUMBER		QTY.
				RIGHT HAND	LEFT HAND	
<b>513B00-1</b>			<b>RETAINER - ROOF FRONT SIDE RAIL WEATHERSTRIP</b>			
	71/	A(53,57,65,76)		D1AZ 65513B00-A	D1AZ 65513B01-A	1
<b>513A06-7</b>			<b>REINFORCEMENT - ROOF SIDE RAIL</b>			
	66	U(98)		C6TZ 97513A06-A	C6TZ 97513A07-A	1
	66	U(97)	"Before 4/4/66"			1
	66/	U(97)	"From 4/4/66"	C6TZ 97513A06-B	C6TZ 97513A07-A	1
	67/	U	Refer to Group 278B26-7			
<b>513B06</b>			<b>RAIL - ROOF REAR</b>			
	66/	U(97,98)	Refer to Groups 513A58 and 51704			
<b>513C06-7</b>			<b>PANEL - ROOF SIDE INNER REAR</b>			
	71	S(65B,D)		D1SZ 65513C06-A	D1SZ 65513C07-A	1
<b>513C10-1</b>			<b>STRAINER - ROOF SIDE REAR RAIL TO FLOOR</b>			
	72	S		D2SZ 65513C10-A	D2SZ 65513C11-A	1
<b>513A24-5</b>			<b>REINFORCEMENT - ROOF REAR RAIL</b>			
	66/68	U(98)	"Before Ser. D40,001"	C6TZ 98513A24-A	C6TZ 98513A25-A	1
	68/	U(98)	"From Ser. D40,001"	C8TZ 98513A24-A	C8TZ 98513A25-A	1
<b>51325</b>			<b>WEATHERSTRIP - FOLDING TOP NO.1 BOW</b>			
	71/	F(76)	48 3/4" long		D1ZZ 7651325-A	1
<b>513A34-5</b>			<b>EXTENSION - ROOF SIDE INNER REAR RAIL</b>			
	71/	A(65)		D1AZ 65513A34-A	D1AZ 65513A35-A	1
	67	S(57)		C7SZ 57513A34-A	C7SZ 57513A35-A	1
	67/69	S(65)		C7SZ 65513A34-A	C7SZ 65513A35-A	1
	71	S(65B,D)				1
	68/71	S(57)		C8SZ 57513A34-A	C8SZ 57513A35-A	1
	72	S		D2SZ 65513A34-A	D2SZ 65513A35-A	1
<b>513B34-5</b>			<b>REINFORCEMENT - ROOF SIDE OUTER REAR RAIL</b>			
	69/	A(71)		C9AZ 71513B34-A	C9AZ 71513B35-A	1

GROUP NUMBER	YEAR	BODY TYPE	DESCRIPTION	PART NUMBER		QTY.
				RIGHT HAND	LEFT HAND	
<b>51338</b>	<b>WEATHERSTRIP - FOLDING TOP NO. 1 BOW FRONT - Refer to Soft Trim Section</b>					
<b>513A44-5</b>	<b>EXTENSION - ROOF OUTER REAR RAIL TO WHEELHOUSE - Also refer to Group 513A86-7</b>					
		- A -				
	66	A(54, 62)		C6AZ 62513A44-A ★	C6AZ 62513A45-A Not replaced (3-74)	1
	67	A(54, 62)		★C7AZ 62513A44-A Not Repl'd. (1-73)	C7AZ 62513A45-A	1
	67	A(57, 63)	Refer to group 51654-5 in Soft Trim Section			
	68	A(63)		★C8AZ 63513A44-A Not replaced (4-74)	C8AZ 63513A45-A	1
	69/70	A(57)		C9AZ 57513A44-A	C9AZ 57513A45-A	1
	69/70	A(63)		C9AZ 63513A44-A	C9AZ 63513A45-A	1
	69/70	A(65)		C9AZ 65513A44-A	C9AZ 65513A45-A	1
	69/71	A(54, 62)		C9AZ 62513A44-A	C9AZ 62513A45-A	1
	72	A(54)				1
	71/	A(53, 57)		D1AZ 57513A44-A	D1AZ 57513A45-A	1
	71/	A(65)		D1AZ 65513A44-A	D1AZ 65513A45-A	1
		- B -				
	68/69	B(63)		★C8OZ 63513A44-A Not Repl'd. (1-73)	C8OZ 63513A45-A	1
	68/69	B(65)		C8OZ 65513A44-A	C8OZ 65513A45-A	1
	70/71	B(54, 57, 62, 63, 65)				1
	72	B(53)		D2OZ 53513A44-A	D2OZ 53513A44-A	2
	72	B(63)		D2OZ 63513A44-A	D2OZ 63513A45-A	1
	72	B(65)		D2OZ 65513A44-A	D2OZ 65513A45-A	1
		- F -				
	69/70	F(63)		C9ZZ 63513A44-A	C9ZZ 63513A44-A	2
	69/70	F(65)		C9ZZ 65513A44-A	C9ZZ 65513A45-A	1
	71/	F(63, 65)		D1ZZ 65513A44-A	D1ZZ 65513A44-A	2
		- P -				
	71/	P(54)		D1DZ 54513A44-A	D1DZ 54513A45-A	1
		- S -				
	67/69	S(65)		C7SZ 65513A44-A	C7SZ 65513A45-A	1
	70	S(65)		D0SZ 65513A44-A	D0SZ 65513A45-A	1
	71	S(65A, C)				1
	72	S		D2SZ 65513A44-A	D2SZ 65513A44-A	2
		- X -				
	66/70	X(54)		C6DZ 54513A44-A	C6DZ 54513A45-A	1
	66/70	X(62)		C6DZ 62513A44-A	C6DZ 62513A45-A	1
<b>51352</b>	<b>RETAINER - FOLDING TOP NO. 1 BOW REAR WEATHERSTRIP</b>					
	69/	A(76)		C9AZ 7651352-A	C9AZ 7651352-A	1
	66/71	B(76)		C6OZ 7651352-A	C6OZ 7651352-A	1
	69/70	F(76)		C9ZZ 7651352-A	C9ZZ 7651352-A	1
	71/	F(76)		D1ZZ 7651352-A	D1ZZ 7651352-A	1
<b>513A52-3</b>	<b>RAIL - ROOF SIDE</b>					
	66/	U(97, 98)	75 1/8" long Cut to length	C6TZ 98513A52-A	C6TZ 98513A53-A	1
						1
<b>513A54-5</b>	<b>RAIL and MOULDING ASSY. - ROOF SIDE OUTER</b>					
	67/71	S(57)	Includes drip moulding & reinforcement	C7SZ 57513A54-C	C7SZ 57513A55-D	1
	67/68	S(65)	Includes drip moulding	C7SZ 65513A54-D	C7SZ 65513A55-D	1
	69	S(65A, C)				1
	69	S(65B, D)		C9SZ 65513A54-A	C9SZ 65513A55-A	1
	70	S(65)		D0SZ 65513A54-A	D0SZ 65513A55-A	1
	71	S(65A, C)				1
	71	S(65B, D)		C9SZ 65513A54-A	C9SZ 65513A55-A	1
<b>513A58</b>	<b>RAIL - ROOF - REAR</b>					
	66/	U(98)		C6TZ 98513A58-A	C6TZ 98513A58-A	1

# FORD CAR PARTS

**BODY  
SECTION 510**

9

GROUP NUMBER	YEAR	BODY TYPE	DESCRIPTION	PART NUMBER		QTY.
				RIGHT HAND	LEFT HAND	
<b>513A66-7 RETAINER - ROOF SIDE RAIL WEATHERSTRIP - INCLUDES ATTACHING PARTS</b>						
<b>- A -</b>						
	66	A(63)	Less attaching parts	★C6AZ 63513A66-A Not replaced (3-74)	C6AZ 63513A67-A	1
	65/66 65/66	A(63), X(63) A(57), F(63, 65)	No. 8-18 x 1/2" Flat head screw	377948-S2(UU48G)	377948-S2(UU48G)	14or16 20or24
	67	A(57)	Seal-Improvise-Refer to Group 19560 in Paint Section	★	★	
	67	A(63J)		C7AZ 63513A66-D	C7AZ 63513A67-D	1
	69	A(57, 63, 65)	Front-includes moulding	C9AZ 63513A66-B	C9AZ 63513A67-B	1
	69	A(57)	Rear-includes retainer extension	C9AZ 57513A66-A	C9AZ 57513A67-A	1
	69	A(63)	Rear-includes retainer extension	★C9AZ 63513A66-A Not replaced (5-75)	C9AZ 63513A67-A	1
	69	A(65)	Rear-includes retainer extension	C9AZ 65513A66-A	C9AZ 65513A67-A	1
	70	A(57, 63, 65, 76)	Front	D0AZ 63513A66-A	D0AZ 63513A67-A	1
	70	A(57)	Center	D0AZ 57513A66-B	D0AZ 57513A67-B	1
	70	A(57) "Before 12/19/69"	Rear	D0AZ 57513A66-A	D0AZ 57513A67-A	1
	70	A(57) "From 12/19/69"	Rear	D0AZ 57513A66-C	D0AZ 57513A67-C	1
	70	A(63)		D0AZ 63513A66-B	D0AZ 63513A67-B	1
	70	A(65)		D0AZ 65513A66-A	D0AZ 65513A67-A	1
	71	A(53, 57, 65, 76)	Front-also refer to Group 513B00-1			
	71/72	A(53) "Before 11/1/71"	Front-Bright finish	D1AZ 53513A66-A	D1AZ 53513A67-A	1
	72	A(53) "From 11/1/71"	Front-Bright finish-use with D2AZ 65222B08-A clip	D2AZ 53513A66-B	D2AZ 53513A67-B	1
	71/72	A(57) "Before 11/1/71"	Front-Bright finish	D1AZ 57513A66-A	D1AZ 57513A67-A	1
	72	A(57) "From 11/1/71"	Front-Bright finish-Use with D2AZ 65222B08-A clip	D2AZ 57513A66-C	D2AZ 57513A67-C	1
	71/	A(53, 57)	Rear- Bright finish	D2AZ 57513A66-A	D1AZ 57513A67-B	1
	71/72	A(65) "Before 11/1/71"	Bright finish-includes w/strip	D1AZ 65513A66-A	D1AZ 65513A67-A	1
	72	A(65) "From 11/1/71"	Bright finish-includes w/strip - Use with D2AZ 65222B08-A clip	D2AZ 65513A66-B	D2AZ 65513A67-B	1
	70/	A(76)	Rear	D0AZ 76513A66-A	D0AZ 76513A67-A	1
<b>- B -</b>						
	66	B(63) "Before 11/19/65"	Less attaching parts	C6OZ 63513A66-A	★C6OZ 63513A67-A Not replaced (3-74)	1
	67	B(63) "From 11/19/65 to 2/1/67"	Less attaching parts	★C6OZ 63513A66-C Not replaced (3-74)	★C6OZ 63513A67-C Not replaced (3-74)	1
	67	B(63) "From 2/1/67"		C6OZ 63513A66-C	★C6OZ 63513A67-D Not replaced (3-74)	1
	68/69	B(63)		C8OZ 63513A66-A	C8OZ 63513A67-A	1
	68/69	B(65)		C8OZ 65513A66-A	C8OZ 65513A67-A	1
	68/69	B(66)		C8OZ 66513A66-A	C8OZ 66513A67-A	1
	70	B(57)		D1OZ 57513A66-B	D0OZ 57513A67-B	1
	70	B(63)		D9OZ 63513A66-A	D0OZ 63513A67-A	1
	70	B(65)		D0OZ 65513A66-A	D0OZ 65513A67-A	1
	70	B(66)		D0OZ 66513A66-A	D0OZ 66513A67-A	1
	71	B(57) "Before 9/8/70"		D1OZ 57513A66-B	D1OZ 57513A67-A	1
	71	B(57) "From 9/8/70"		D1OZ 57513A66-B	D1OZ 57513A67-B	1
	71	B(63)		D1OZ 63513A66-A	D1OZ 63513A67-A	1
	71	B(65) "Before 9/8/70"		D1OZ 65513A66-A	D1OZ 65513A67-A	1
	71	B(65) "From 9/8/70"		D1OZ 65513A66-B	D1OZ 65513A67-B	1
	71	B(66)		D1OZ 66513A66-B	D1OZ 66513A67-B	1
	72	B(53, 71) "Before 2/21/72"	Front	D2OZ 53513A66-A	D2OZ 53513A67-A	1
	72	B(53, 71) "From 2/21/72"	Front- Use with D2AZ 65222B08-A clip	D4OZ 53513A66-A	D4OZ 53513A67-A	1

GROUP NUMBER	YEAR	BODY TYPE	DESCRIPTION	PART NUMBER				QTY.
				RIGHT HAND		LEFT HAND		
<b>513A66-7 RETAINER - ROOF SIDE RAIL WEATHERSTRIP - INCLUDES ATTACHING PARTS - continued</b>								
- B -								
	72	B(53)	Rear	D2OZ	53513A66-B	D2OZ	53513A67-B	1
	72	B(63)	"Before 2/21/72"	D2OZ	63513A66-A	D2OZ	63513A67-A	1
	72	B(63)	"From 2/21/72"	Use with D2AZ 65222B08-A clip	D2OZ	63513A66-C	D2OZ	63513A67-C
	72	B(65)	"Before 10/25/71"	D2OZ	65513A66-A	D2OZ	65513A67-A	1
	72	B(65)	"From 10/25/71 to 2/21/72"	D2OZ	65513A66-B	D2OZ	65513A67-B	1
	72	B(65)	"From 2/21/72"	Use with D2AZ 65222B08-A clip	D4OZ	65513A66-A	D2OZ	65513A67-D
	72	B(71)	Rear	D2OZ	71513A66-A	D2OZ	71513A67-A	1
	72	B(97)	"Before 2/21/72"	D2OZ	97513A66-A	D2OZ	97513A67-A	1
	72	B(97)	"From 2/21/72"	Use with D2AZ 65222B08-A clip	D2OZ	97513A66-C	D3OZ	97513A67-A
- F -								
	65/66	F(63)	Less attaching parts	C5ZZ	63513A66-A	C5ZZ	63513A67-A	1
	65/68	F(65)		C5ZZ	65513A66-B	C5ZZ	65513A67-B	1
	67/68	F(63)		C7ZZ	63513A66-A	C7ZZ	63513A67-A	1
	69	F(63)		D0ZZ	63513A66-A	C9ZZ	63513A67-B	1
	69	F(65)		C9ZZ	65513A66-A	C9ZZ	65513A67-A	1
	70	F(63)		D0ZZ	63513A66-A	D0ZZ	63513A67-A	1
	70	F(65)		D0ZZ	65513A66-A	D0ZZ	65513A67-A	1
	71/	F(63)		D1ZZ	63513A66-A	D1ZZ	63513A67-A	1
	71/	F(65)		D1ZZ	65513A66-A	D1ZZ	65513A67-A	1
- S -								
	66	S(63C, D)	Front-less attaching parts	C6SZ	63513A66-A *	C6SZ	63513A67-A Not replaced (3-74)	1
			Rear-less attaching parts	C6SZ	63513A66-B *	C6SZ	63513A67-B Not replaced (3-74)	1
	65/66	S(63)	No. 8-15 x 1" Cross recess oval head screw	52376-S13(U296)		52376-S13(U296)		4
	67	S(57)	Front	C7SZ	57513A66-F	C7SZ	57513A67-F	1
			Rear-less attaching parts	C7SZ	57513A66-D	D0SZ	57513A67-B	1
			No. 6-18 x 3/8"-Cross recess pan head screw	★374842-S100		★374842-S100		8
			No. 8-18 x 1/2" Cross recess flat head screw	377948-S2(UU48G)		377948-S2(UU48G)		2
	67/68	S(65)	"Before 8/21/67"	C7SZ	65513A66-C	C7SZ	65513A67-C	1
	68/69	S(57)	Rear	C7SZ	57513A66-D	C7SZ	57513A67-B	1
	68	S(57)	"Before 8/21/67"	C7SZ	57513A66-F	C7SZ	57513A67-E	1
	68/69	S(57)	"From 8/21/67"	C7SZ	57513A66-F	C7SZ	57513A67-F	1
	68	S(65)	"From 8/21/67"	C9SB 65516A02-A seal (NS) r/b C6AZ 19627-A tape-cut to fit (4-72)	C7SZ	65513A66-C	C7SZ	65513A67-C
	69	S(65A, C)						1
	69	S(65B, D)		C9SZ	65513A66-A	C9SZ	65513A67-A	1
	70	S(57)	Front	D0SZ	57513A66-A	D0SZ	57513A67-A	1
			Rear-11 5/16" long	D0SZ	57513A66-B	D0SZ	57513A67-B	1
	70	S(65)		D0SZ	65513A66-A	D0SZ	65513A67-A	1
	71	S(57)	Front	D1SZ	57513A66-A	D1SZ	57513A67-A	1
	71	S(57)	Rear-16" long	D0SZ	57513A66-C	D0SZ	57513A67-C	1
	71	S(57)	Rear-11 5/16" long	D1SZ	57513A66-B	D1SZ	57513A67-B	1
	71	S(65A, C)		D1SZ	65513A66-B	D1SZ	65513A67-B	1
	71	S(65B, D)	"Before 9/22/70"	D1SZ	65513A66-C	D1SZ	65513A67-A	1
	71	S(65B, D)	"From 9/22/70"	D1SZ	65513A66-C	D1SZ	65513A67-C	1
	72	S	Use with D2AZ 65222B08-A clip	D2SZ	65513A66-B	D2SZ	65513A67-B	1



# FORD CAR PARTS

## BODY SECTION 510

11

GROUP NUMBER	YEAR	BODY TYPE	DESCRIPTION	PART NUMBER		QTY.	
				RIGHT HAND	LEFT HAND		
<b>513A68-9 WEATHERSTRIP - ROOF SIDE RAIL REAR</b>							
	71/72	A(53)		D2AZ	53513A68-A	D2AZ 53513A69-A	1
	70	B(54)	"Before 1/5/70"	Incl. Black windlace	D0OZ 54513A68-J	D0OZ 54513A69-J	1
				Incl. Blue windlace	D0OZ 54513A68-G	D0OZ 54513A69-G	1
				Incl. Green windlace	D0OZ 54513A68-H	D0OZ 54513A69-H	1
				Incl. Nugget gold windlace	D0OZ 54513A68-F	D0OZ 54513A69-F	1
	70	B(54)	"From 1/5/70"	Incl. Red windlace	D0OZ 54513A68-K	D0OZ 54513A69-K	1
				Incl. Black windlace	D0OZ 54513A68-J	D0OZ 54513A69-J	1
				Incl. Blue windlace	D0OZ 54513A68-G	D0OZ 54513A69-G	1
				Incl. Green windlace	D0OZ 54513A68-H	D0OZ 54513A69-H	1
	70/71	B(54)	Front-Refer to Group 51222-3	Incl. Nugget gold windlace	D0OZ 54513A68-F	D0OZ 54513A69-F	1
				Incl. Red windlace	D0OZ 54513A68-K	D0OZ 54513A69-K	1
	71	B(54)		Incl. Black windlace	D0OZ 54513A68-J	D0OZ 54513A69-J	1
				Incl. Blue windlace	D0OZ 54513A68-G	D0OZ 54513A69-G	1
				Incl. Gray gold windlace	D1OZ 54513A68-B	D1OZ 54513A69-B	1
				Incl. Green windlace	D1OZ 54513A68-A	D1OZ 54513A69-A	1
	72	B(53,71)		D3OZ	53513A68-A	D3OZ 53513A69-A	1
	71/	P(54)		Incl. Black windlace	D1DZ 54513A68-C	D1DZ 54513A69-C	1
				Incl. Blue windlace	D1DZ 54513A68-A	D1DZ 54513A69-A	1
				Incl. Gray gold windlace	D1DZ 54513A68-D	D1DZ 54513A69-D	1
				Incl. Vermilion windlace	D1DZ 54513A68-B	D1DZ 54513A69-B	1
	72	P(54)		Incl. Beige windlace	D2DZ 54513A68-B	D2DZ 54513A69-B	1
				Incl. Ginger windlace	D2DZ 54513A68-A	D2DZ 54513A69-A	1
				Incl. Tan windlace	D2DZ 54513A68-C	D2DZ 54513A69-C	1
	68/71	S(57)		C8SZ	57513A68-B	C8SZ 57513A69-B	1
<b>513B68-9 WEATHERSTRIP - ROOF SIDE RAIL REAR</b>							
	67	S(57)		C7SZ	57513B68-C	C7SZ 57513B69-C	1
<b>513B76 RAIL - ROOF FRONT</b>							
	66/	U(97, 98)		C6TZ	97513B76-C	C6TZ 97513B76-C	2
				Washer-flat- 5/16"-11/16" O.D.	44722-S8(X19)	44722-S8(X19)	1
				Bolt-hex.hd.- 5/16"-18 x 1 1/8"	352464-S8(BB139)	352464-S8(BB139)	2
<b>513A84-5 BRACKET - ROOF SIDE OUTER REAR RAIL TO RAIL EXTENSION</b>							
	70/	A(65)		D0AZ	65513A84-A	D0AZ 65513A85-A	1
<b>513A86-7 EXTENSION - ROOF SIDE REAR RAIL -Also Refer to Group 513A44-5</b>							
	72	B(65)		D2OZ	65513A86-A	D2OZ 65513A87-A	1
<b>513B96-7 REINFORCEMENT - ROOF SIDE RAIL LOWER</b>							
	66/	U(97, 98)		C6TZ	97513B96-A	C6TZ 97513B97-A	1
<b>514A00-1 TIP - FOLDING TOP REAR BOW</b>							
	65/66	A(76)	"Before 2/15/66"	Use at binding	C3AZ 76514A00-A	C3AZ 76514A00-A	2
	65/66	F(76), S(76), X(76)					2
	66	A(76), B(76), F(76), S(76)	"From 2/15/66"		C3AZ 76514A00-B	C3AZ 76514A00-B	2
	67/	A(76), F(76)					2
	67/71	B(76)		No. 8-18 x .75" Cross recess oval head screw	376362-S101(UU56C)	376362-S101(UU56C)	2
	66	B(76)	"Before 2/15/66"	No. 6-20 x .88" Cross recess oval head screw	C6OZ 76514A00-A	C6OZ 76514A01-A	2
							*378993-S
	65	X(76)		No. 6-18 x .88" Cross recess oval head screw	357556-S15(UU53)	357556-S15(UU53)	2or4
	65/66	A(76), F(76), S(76)					
<b>514B02 CLIP - ROOF SIDE RAIL WEATHERSTRIP SUPPORT</b>							
	69/70	A		C9AZ	63514B02-A	C9AZ 63514B02-A	2
<b>514A26-7 RETAINER - FOLDING TOP NO. 1 BOW REAR WEATHERSTRIP - Refer to Group 51352-3</b>							

GROUP NUMBER	YEAR	BODY TYPE	DESCRIPTION	PART NUMBER		QTY.
				RIGHT HAND	LEFT HAND	
<b>514A28</b>	<b>WEATHERSTRIP - FOLDING TOP NO. 1 BOW</b> - Refer to Group 53986-7					
<b>514A30-1</b>	<b>BRACKET - FOLDING TOP NO. 2 BOW</b> - Paint to match					
	68	A(76)		C8AZ	76514A30-A	2
	69/	A(76)		C9AZ	76514A30-A	2
	70/71	B(76)		D0OZ	76514A30-A	1
	69/70	F(76)		C9ZZ	76514A30-A	2
	71/	F(76)	R.H.	D1ZZ	76514A30-A	1
			L.H.	D1ZZ	76514A31-A	1
<b>514A38</b>	<b>DOWEL - FOLDING TOP NO. 1 BOW</b>					
	65/66	A(76), B(76), F(76)		C5ZZ	76514A38-B	2
	68	A(76), B(76), F(76)				2
	69	A(76), F(76)		C9AZ	76514A38-A	2
	67	A(76), F(76)		C7OZ	76514A38-A	2
	70/	A(76), F(76)				2
	67/71	B(76)				2
<b>51514</b>	<b>BOLT - FOLDING TOP BOW ADJUSTING</b>					
	65	A(76)" From 12/1/64 to 4/19/65"	5/16"-18 x 1 5/32" long- NOTE 6	C5AZ	7651514-A	2
	65	F(76)				2
	66/68	A(76)	Center side rail-5/16"-24 x 1 1/2" long	C6AZ	7651514-B	2
	69/70	A(76)		C9AZ	7651514-A	1
	66/67	B(76)	5/16"-24 x 1 1/4" long	C6AZ	7651514-A	2
	68	A(76), F(76)				2
	66/71	B(76)	5/16"-24 x 1 7/16" long	C6OZ	7651514-A	2
	69/70	F(76)		C9ZZ	7651514-A	1
	71	F(76)	21/64" long	D1ZZ	7651514-A	1
<b>51542-3</b>	<b>RETAINER - FOLDING TOP FRONT SIDE RAIL WEATHERSTRIP</b>					
	68/71	B(76)	R.H.	C8OZ	7651542-A	1
			L.H.	C8OZ	7651543-A	1
<b>51548</b>	<b>WASHER - FOLDING TOP BOW ADJUSTING BOLT</b>					
	65	A(76), B(76), F(76)- "From 12/1/64"	NOTE 3 or 7	C5AZ	7651548-A	AR
GROUP NUMBER	YEAR	BODY TYPE	DESCRIPTION	PART NUMBER		QTY.
				RIGHT HAND	LEFT HAND	
<b>51554-5</b>	<b>RETAINER - FOLDING TOP REAR SIDE RAIL WEATHERSTRIP</b>					
	66/67	B(76)		C6OZ	7651554-A	1
					★C6OZ 7651555-A Not replaced (3-74)	
	68/71	B(76)		D0OZ	7651554-A	1
					D0OZ 7651555-A	
<b>51560-1</b>	<b>RETAINER - FOLDING TOP CENTER SIDE RAIL WEATHERSTRIP</b>					
	68/71	B(76)		C8OZ	7651560-A	1
					C8OZ 7651561-A	
<b>51562-3</b>	<b>WEATHERSTRIP - FOLDING TOP SIDE RAIL - FRONT</b>					
	65/66	A(76), S(76)	Refer to Group 53986-7			
	65	X(76)		C3DZ	7651562-A	1
	65	A(76), X(76)	No. 10-32 x .44" Special head moulding bolt	353014-S8(BB80)	353014-S8(BB80)	4 or 6
	65	A(76), X(76)	No. 8 x 1/2" Cross	52726-S13(U381)	52726-S13(U381)	2 or 4
	65	X(76)	No. 10-32 Nut (tee) recess pan head screw	373855-S8(MM131)	373855-S8(MM131)	4
			.27" I.D. x .75" O.D. x .164" thick-washer (special)	351320-S8(XX310)	351320-S8(XX310)	4

# FORD CAR PARTS

## BODY SECTION 510

13

GROUP NUMBER	YEAR	BODY TYPE	DESCRIPTION	PART NUMBER		QTY.
				RIGHT HAND	LEFT HAND	
<b>51564-5 WEATHERSTRIP - FOLDING TOP SIDE RAIL CENTER</b>						
	65/68	A(76)		C5AZ 7651564-A	C5AZ 7651565-A	1
			No. 10-24 Nut (tee)	379270-S2(MM131G)	379270-S2(MM131G)	6
	69/	A(76)		C9AZ 7651564-A	C9AZ 7651565-A	1
	66/67	B(76)		C6OZ 7651564-A	C6OZ 7651564-A	2
			No. 10-24 Nut (tee)	379361-S2(MM130X)	379361-S2(MM130X)	6
	68/71	B(76)		C8OZ 7651564-A	C8OZ 7651565-A	1
	65/68	F(76)		C5ZZ 7651564-A	C5ZZ 7651565-A	1
	69/70	F(76)		C9ZZ 7651564-A	C9ZZ 7651565-A	1
	71/	F(76)		D1ZZ 7651564-A	D1ZZ 7651565-A	1
	65	X(76)		C3DZ 7651564-A	C3DZ 7651565-A	1
	65/68	A(76), X(76)	No. 10-32 x .44" Special head moulding bolt	353014-S8(BB806)	353014-S8(BB806)	6 or 8
	65	X(76)	.27" I.D. x .75" O.D. x .164" thick-washer (special)	351320-S8(XX310)	351320-S8(XX310)	6
	65/68	A(76), F(76)				6
	65	X(76)	No. 10-32 Nut (tee)	373855-S8(MM131)	373855-S8(MM131)	8
<b>51566-7 WEATHERSTRIP - FOLDING TOP SIDE RAIL REAR</b>						
- A -						
	65/68	A(76)		C5AZ 7651566-B	★C5AZ 7651567-B Not replaced (5-75)	1
			No. 10-24 Nut (tee)	379270-S2(MM131G)	379270-S2(MM131G)	8
	65/68	A(76), X(76)	No. 10-32 x .44" Special head moulding bolt	353014-S8(BB806)	353014-S8(BB806)	6 or 8
	69/	A(76)		C9AZ 7651566-A	C9AZ 7651567-A	1
	65/68	A(76)	.27" I.D. x .75" O.D. x .164" thick-washer (special)	351320-S8(XX310)	351320-S8(XX310)	6 or 8
- B -						
	66/67	B(76)		C6OZ 7651566-A	C6OZ 7651567-A	1
	68/69	B(76)		C8OZ 7651566-A	C8OZ 7651567-A	1
	70/71	B(76)		D0OZ 7651566-A	D0OZ 7651567-A	1
- F -						
	65/68	F(76)		C5ZZ 7651566-A	C5ZZ 7651567-A	1
			No. 10-24 Nut (tee)	379361-S2(MM130X)	379361-S2(MM130X)	6
			.27" I.D. x .75" O.D. x .164" thick-washer (special)	351320-S8(XX310)	351320-S8(XX310)	6 or 8
	69/70	F(76)		C9ZZ 7651566-A	C9ZZ 7651567-A	1
	71/	F(76)		D1ZZ 7651566-A	D1ZZ 7651567-A	1
<b>51628-9 MOULDING - ROOF SIDE - Includes Attaching Parts</b>						
	71	B(65C)	Halo type-paint to match	D1OZ 6551628-A	D1OZ 6551629-A	1
	71/	F(65)	With vinyl roof paint to match	D1ZZ 6551628-A	D1ZZ 6551629-A	1
<b>51700-1 RAIL - ROOF SIDE DRIP</b>						
- A -						
	69	A(54, 62)		C9AZ 6251700-A	C9AZ 6251701-A	1
	69	A(63)		C9AZ 6351700-A	C9AZ 6351701-A	1
	69	A(65)		C9AZ 6551700-A	★C9AZ 6551701-A Not replaced (5-75)	1
	70	A(54)		D0AZ 6251700-A	D0AZ 6251701-A	1
	69/70	A(57)		C9AZ 5751700-A	C9AZ 5751701-A	1
	70	A(63)		D0AZ 6351700-A	D0AZ 6351701-A	1
	70	A(65)		D0AZ 6551700-A	D0AZ 6551701-A	1
	71/	A(53, 57)		D1AZ 5751700-A	D1AZ 5751701-A	1
	71/	A(54)		D1AZ 5451700-A	D1AZ 5451701-A	1
	69/	A(71)	Front	C9AZ 7151700-A	C9AZ 7151701-A	1
			Rear	C9AZ 7151700-B	C9AZ 7151701-B	1
			Center - snap on type	C9AZ 7151700-C	C9AZ 7151701-C	1

**BODY  
SECTION 510**
**FORD CAR PARTS**

GROUP NUMBER	YEAR	BODY TYPE	DESCRIPTION	PART NUMBER		QTY.
				RIGHT HAND	LEFT HAND	
<b>51700-1 RAIL - ROOF SIDE DRIP - continued</b>						
- B -						
66/69	B(71)		Front	★C6OZ 7151700-A Not replaced (5-75)	D0OZ 7151701-A	1
67	B(66)		Front	C6DZ 6651700-A	C8DZ 6651701-A	1
			Rear	C6DZ 6651700-B	★C6DZ 6651701-B Not replaced (1-73)	1
68/69	B(63)			C8OZ 6351700-A	C8CZ 6351701-A	1
68/69	B(65)			C8CZ 6551700-A	C8OZ 6551701-A	1
68/69	B(66)		Front	C8OZ 6651700-A	C8OZ 6651701-A	1
			Rear	C8OZ 6651700-B	C8OZ 6651701-B	1
68/71	B(71)		Rear	C8OZ 7151700-A	C8OZ 7151701-A	1
70/71	B(54, 57)			D0OZ 5451700-A	D0OZ 5451701-A	1
70/71	B(62, 65)		Front	D0OZ 6551700-A	D0OZ 6551701-A	1
			Rear	D0OZ 6551700-B	D0OZ 6551701-B	1
70/71	B(63)			D0OZ 6351700-A	D0OZ 6351701-A	1
70/71	B(66)		Front	D0OZ 6651700-A	D0OZ 6651701-A	1
			Rear	D0OZ 6651700-B	D0OZ 6651701-B	1
70/71	B(71)		Front	D0OZ 7151700-A	D0OZ 7151701-A	1
- F -						
65/66	F(65)			C7ZZ 6551700-A	C7ZZ 6551701-A	1
67/68	F(63)			C7ZZ 6351700-A	C7ZZ 6351701-A	1
67/68	F(65)			C7ZZ 6551700-A	C7ZZ 6551701-A	1
69/70	F(63)		Front	C9ZZ 6351700-B	C9ZZ 6351701-B	1
			Rear	C9ZZ 6351700-C	C9ZZ 6351701-C	1
69/70	F(65)		Snap on type	C9ZZ 6551700-A	C9ZZ 6551701-A	1
- P -						
71/	P(54)			D1DZ 5451700-A	D1DZ 5451701-A	1
70/72	P(62)	"Before 3/1/72"	Snap on	D0DZ 6251700-A	D0DZ 6251701-A	1
72	P(62)	"From 3/1/72"		D2DZ 6251700-A	D2DZ 6251701-A	1
- L -						
72	L(73)			D2FZ 7351700-A	D2FZ 7351701-A	1
- S -						
66	S(63C, D)		Refer to Group 51726-7			
- U -						
66/	U(97)		Short roof	C6TZ 9751700-A	C6TZ 9751701-A	1
66/	U(98)		Long roof	C6TZ 9851700-A	C6TZ 9851701-A	1
- X -						
66/67	X(71)	"Before 11/3/69"	Front	C6OZ 7151700-A	D0OZ 7151701-A	1
70	X(71)	"From 11/3/69"	Front	D0OZ 7151700-A	D0OZ 7151701-A	1
66/70	X(54)			C6OZ 5451700-A	C6OZ 5451701-A	1
66/70	X(62)			C6OZ 6251700-A	C6OZ 6251701-A	1
68/70	X(71)		Rear	C8OZ 7151700-A	C8OZ 7151701-A	1
<b>517A00-1 ORNAMENT - ROOF SIDE INNER - Refer to Group 50266-7</b>						
<b>517A02-3 MOULDING - ROOF OUTSIDE - REAR SIDE - Includes attaching parts</b>						
69	A(63)	"Before 7/1/69"	(2) pc. design	C9AZ 63517A02-A	C9AZ 63517A02-B	1
69/70	A(63)	"From 7/1/69"	(2) pc. design	C9AZ 63517A02-C	C9AZ 63517A02-D	1
69	A(63)		For (1) pc. design refer to Group 50044			
71/	F(63)		With vinyl roof cover	D1ZZ 63517A02-A	D1ZZ 63517A03-A	1
<b>51704 MOULDING - ROOF DRIP - REAR</b>						
66/	U(97)		Serviced in assy. - refer to Group 40314 or 51834			
66/	U(98)			C6TZ 9851704-A	C6TZ 9851704-A	1

# FORD CAR PARTS

**BODY  
SECTION 510**

15

GROUP NUMBER	YEAR	BODY TYPE	DESCRIPTION	PART NUMBER		QTY.	
				RIGHT HAND	LEFT HAND		
<b>517A10-1 EXTENSION - ROOF DRIP FINISH MOULDING - INCLUDES ATTACHING PARTS</b>							
	67/68	F(63)	36" long	C7ZZ 63517A10-A	★C7ZZ63517A11-A	1	
	69/70	F(65)		C9ZZ 65517A10-A	Not replaced (5-75) C9ZZ 65517A11-A	1	
<b>517A12 EXTENSION - ROOF DRIP SIDE MOULDING</b>							
	67/71	S(57)		C7SZ 57517A12-A	C7SZ 57517A12-A	2	
<b>51718-9 MOULDING - ROOF DRIP FINISH - FRONT - INCLUDES ATTACHING PARTS</b>							
	67/69	S		C7SZ 6551718-A	C7SZ 6551718-A	1	
	71	S(57, 65B, D)				1	
	67/	U(97, 98)		C7TZ 9751718-A	C7TZ 9751719-A	1	
GROUP NUMBER	YEAR	BODY TYPE	DESCRIPTION	PART NUMBER		QTY.	
<b>517A18 ORNAMENT - ROOF SIDE OUTSIDE - INCLUDES ATTACHING PARTS - Also Refer to Group 517A56-7</b>							
	65	A(54A, 57B)			C5AZ 62517A18-A	2	
	65	A(54B, 62B)			C5AZ 62517A18-B	2	
	65/66	A(57F, 63F)			C5AZ 63517A18-B	2	
	65	S(63A)			C5SZ 63517A18-A	2	
	66	S(63A)			C6SZ 63517A18-A	2	
	66	S(63C)			C6SZ 63517A18-B	2	
GROUP NUMBER	YEAR	BODY TYPE	DESCRIPTION	PART NUMBER		QTY.	
<b>517A20-1 ORNAMENT - OUTSIDE - INCLUDES ATTACHING PARTS</b>							
- A -							
	65/66	A(57F, 63F)	"From 11/9/64"	"LTD"	C5AZ 63517A20-B	C5AZ 63517A20-B	2
	66	A(63B, C, D)- With or W/o vinyl roof	Black		C6AZ 63517A20-A	C6AZ 63517A21-A	3
	66	A(63B, C, D)-w/vinyl roof	White		C6AZ 63517A20-B ★	C6AZ 63517A21-B Not replaced (3-74)	3
	67	A(54C, 57F, 63J)	"LTD"		C8AZ 54517A20-A	C8AZ 54517A20-A	2
	68	A(54C, 57C, 65A)					2
	67	A(57F)	3/16" Nut(sleeve)		375480-S102(MM222E)	375480-S102(MM222E)	6
	68	A(63C)			C8AZ 63517A20-A	C8AZ 63517A20-A	2
	68	A(76B)	Quarter panel				2
	69	A(54C, 57F, 65A)	"LTD"		C9AZ 54517A20-A	C9AZ 54517A20-A	2
	69	A(63C)			C9AZ 63517A20-A	C9AZ 63517A20-A	2
	70	A(54C, 57F, 65A)	"LTD"		D0AZ 54517A20-A	D0AZ 54517A20-A	2
			"Brougham"		D0AZ 54517A20-B	D0AZ 54517A20-B	2
	70	A(63C, 76B)	"XL"		D0AZ 63517A20-A	D0AZ 63517A21-A	1
	71/	A(53H, 57H, 65H, 71H)	"LTD" -also used on tailgate		D1AZ 65517A20-A	D1AZ 65517A20-A	2
	71/	A(53K, 57K, 65K)	"Brougham"		D1AZ 65517A20-B	D1AZ 65517A20-B	2
	70	A(54C, 57F, 63C, 65A)	Wreath ornament-refer to Group 517A58				
	71/	A(53K, 57K, 65K)					
	72	A(65F)	"Galaxie 500"		D2AZ 65517A20-A	D2AZ 65517A20-A	2
- B -							
	65	B(65B)	Refer to Group 50399				
	68	B(63)	6 1/8" long		C8OZ 63517A20-G	C8OZ 63517A21-G	1
			5 7/8" long		C8OZ 63517A20-H	C8OZ 63517A21-H	1
			5 1/2" long		C8OZ 63517A20-J	C8OZ 63517A21-J	1
			5 1/8" long		C8OZ 63517A20-K	C8OZ 63517A21-K	1
			4 7/8" long		★C8OZ 63517A20-L	C8OZ 63517A21-L	1
					Not replaced (5-75)		
	68	B(65D)			C8OZ 65517A20-A	C8OZ 65517A21-A	1
	69	B(65D, F)					1
	69	B(63)	Front		C9OZ 63517A20-A	C9OZ 63517A21-A	1
	69	B(63)	Rear		C9OZ 63517A56-A	C9OZ 63517A57-A	1
			Rivet-1/8" x .30" oval head (attach ornament roof side)		383229-S(SS44E)	383229-S(SS44E)	AR
	70/	B	Refer to Group 50399				
	68/71	B(66)	With vinyl roof cover		D0OZ 66517A56-A	D0OZ 66517A56-A	2
	72	B(53D, 65D)			D2OZ 65517A56-A	D2OZ 65517A56-A	2

May, 1975

COPYRIGHT © 1975 —

FORD MOTOR  
COMPANY

— DEARBORN, MICHIGAN

**FINAL ISSUE**

GROUP NUMBER	YEAR	BODY TYPE	DESCRIPTION	PART NUMBER		QTY.
				RIGHT HAND	LEFT HAND	
<b>517A20-1 ORNAMENT - ROOF SIDE - OUTSIDE - INCLUDES ATTACHING PARTS - continued</b>						
- F -						
	65/66	F(65)	With vinyl roof cover or two-tone paint	C5ZZ 65517A56-A	C5ZZ 65517A57-A	1
	69/70	F(63)		C9ZZ 63517A20-A	C9ZZ 63517A21-A	1
	69/70	F(GT350/500)	Refer to Group 8213 in Chassis Section			
	69/	F(65)	Refer to Group 50399			
- S -						
	66	S(63D)	Black	★C6SZ 63517A20-A Not replaced (3-74)	C6SZ 63517A21-A	1
	67	S(57B)		★C7SZ 57517A20-A Not replaced (3-74)	C7SZ 57517A21-A	1
	65 65/66	S(63) "Before 2/10/65" S(63A) "From 2/10/65"		C5SZ 63517A56-A	C5SZ 63517A57-A	1 1
	66	S(63C, D)		C6SZ 63517A56-A	C6SZ 63517A57-A	1
	67	S(65A)	Black	C7SZ 65517A20-AA	C7SZ 65517A20-AA	2
			Blue (dark)	C7SZ 65517A20-G	C7SZ 65517A20-G	2
			Blue (medium)	C7SZ 65517A20-AP	C7SZ 65517A20-AP	2
			Diamond green	C7SZ 65517A20-AU	C7SZ 65517A20-AU	2
			Gray	C7SZ 65517A20-P	C7SZ 65517A20-P	2
			Gray (medium)	★C7SZ 65517A20-AJ Not Repl'd. (1-73)	C7SZ 65517A20-AJ	2
			Green (dark)	C7SZ 65517A20-K	C7SZ 65517A20-K	2
			Platinum	C7SZ 65517A20-AV	C7SZ 65517A20-AV	2
			Red	C7SZ 65517A20-AH	C7SZ 65517A20-AH	2
			White	C7SZ 65517A20-AB	C7SZ 65517A20-AB	2
			Yellow	C7SZ 65517A20-G	C7SZ 65517A20-G	2
	67	S(65B)	Black	C7SZ 65517A20-B	C7SZ 65517A21-B	1
			White-Use with White vinyl roof	C7SZ 65517A20-E	C7SZ 65517A21-E	1
			Dark Brown	C7SZ 65517A20-G	★C7SZ 65517A21-G Not replaced (3-74)	1
	68	S(65A, C)	Aqua	C8SZ 65517A20-N	C8SZ 65517A20-N	2
			Black	C7SZ 65517A20-AA	C7SZ 65517A20-AA	2
			Blue (dark)	C8SZ 65517A20-G	C8SZ 65517A20-G	2
			Blue (medium)	C7SZ 65517A20-AP	C7SZ 65517A20-AP	2
			Ivy Gold	C8SZ 65517A20-E	C8SZ 65517A20-E	2
			Diamond green	C7SZ 65517A20-AU	C7SZ 65517A20-AU	2
			Gray (medium)	C8SZ 65517A20-P	C8SZ 65517A20-P	2
			Pewter	C7SZ 65517A20-AW	C7SZ 65517A20-AW	2
			Platinum	C7SZ 65517A20-AV	C7SZ 65517A20-AV	2
			Red	C7SZ 65517A20-AH	C7SZ 65517A20-AH	2
			Turquoise (medium)	C7SZ 65517A20-AL	C7SZ 65517A20-AL	2
			White	C7SZ 65517A20-AB	C7SZ 65517A20-AB	2
			Yellow	C8SZ 65517A20-M	C8SZ 65517A20-M	2
	68	S(65B, D)	Black	C8SZ 65517A20-A	C8SZ 65517A21-A	1
			Parchment	C8SZ 65517A20-C	★C8SZ 65517A21-C Not replaced (5-75)	1
	68/71	S(57)	Wood grain finish	C8SZ 57517A20-B	C8SZ 57517A21-B	1
	69	S(65A, C)	Aqua	C8SZ 65517A20-N	C8SZ 65517A20-N	2
			Black	C7SZ 65517A20-AA	C7SZ 65517A20-AA	2
			Blue (dark)	C8SZ 65517A20-G	C8SZ 65517A20-G	2
			Blue (medium)	C7SZ 65517A20-AP	C7SZ 65517A20-AP	2
			Diamond green	C7SZ 65517A20-AU	C7SZ 65517A20-AU	2
			Gray (medium)	C8SZ 65517A20-P	C8SZ 65517A20-P	2
			Ivy gold	C8SZ 65517A20-E	C8SZ 65517A20-E	2
			Maroon	C8SZ 65517A20-F	C8SZ 65517A20-F	2
			Platinum	C7SZ 65517A20-AV	C7SZ 65517A20-AV	2
			Red	C7SZ 65517A20-AH	C7SZ 65517A20-AH	2
			Turquoise (medium)	C7SZ 65517A20-AL	C7SZ 65517A20-AL	2
			White	C7SZ 65517A20-AB	C7SZ 65517A20-AB	2

# FORD CAR PARTS

## BODY SECTION 510

17

GROUP NUMBER	YEAR	BODY TYPE	DESCRIPTION	PART NUMBER		QTY.
				RIGHT HAND	LEFT HAND	
<b>517A20-1 ORNAMENT - ROOF SIDE - OUTSIDE - INCLUDES ATTACHING PARTS - continued</b>						
- S -						
69		S(65A, C)	Yellow	C8SZ 65517A20-M	C8SZ 65517A20-M	2
			Copper	C9SZ 65517A20-K	C9SZ 65517A20-K	2
			Gold (light)	C9SZ 65517A20-G	C9SZ 65517A20-G	2
			Gold (medium)	C9SZ 65517A20-J	C9SZ 65517A20-J	2
			Green (dark ivy)	C9SZ 65517A20-L	C9SZ 65517A20-L	2
69		S(65B, D)	Black	C9SZ 65517A20-A	C9SZ 65517A21-A	1
			Blue (dark)	C9SZ 65517A20-D	C9SZ 65517A21-A	1
			Gold (dark)	C9SZ 65517A20-C	C9SZ 65517A21-C	1
			White	C9SZ 65517A20-B	C9SZ 65517A21-B	1
			Also used on quarter panel	D0SZ 65517A20-A	D0SZ 65517A20-A	2
70/71		S(65)	W/o vinyl roof	D2SZ 65517A20-A	D2SZ 65517A21-A	1
72		S	Landau type-w/vinyl roof	D2SZ 65517A20-B	D2SZ 65517A21-B	1
			W/ vinyl roof & glamour paint	D2SZ 65517A20-C	D2SZ 65517A21-C	1

### 51726-7 MOULDING - ROOF DRIP SIDE FINISH

- A -						
65/66		A(54, 62)	Front	C5MY 5051726-A	C5MY 5051727-A	1
65/66		A(71D)	Includes attaching parts	C5AZ 7151726-A	C5AZ 7151727-A	1
65/66		A(71A, B, C, E)				1
67/68		A(71)				1
65/67		A(57)	Front	C5AZ 5751726-C	C5AZ 5751727-C	1
66		A(63)	Rear-includes attaching parts	C6AZ 6351726-B	C6AZ 6351727-B	1
67		A(63B, C)		C7AZ 6351726-C	C7AZ 6351727-C	1
67/68		A(54, 62)	Front-snap on	C7AZ 6251726-A	C7AZ 6251727-A	1
			Rear-snap on	C7AZ 6251726-C	C7AZ 6251727-C	1
68		A(57)		C8AZ 5751726-A	C8AZ 5751727-A	1
68		A(63)		C8AZ 6351726-A	C8AZ 6351727-A	1
68		A(65)		C8AZ 6551726-A	C8AZ 6551727-A	1
69		A(54, 62)	Without vinyl roof cover-snap on	D0AZ 6251726-A	C9AZ 6251727-A	1
			Front - includes attaching parts	C9AZ 5751726-A	C9AZ 5751727-A	1
69		A(57)	Rear - includes attaching parts	C9AZ 5751726-B	C9AZ 5751727-B	1
			Includes attaching parts	C9AZ 6351726-A	C9AZ 6351727-A	1
69		A(65)	Includes attaching parts	C9AZ 6551726-A	C9AZ 6551727-A	1
69		A(71)	Front-snap on	D0AZ 7151726-A	D0AZ 7151727-A	1
69/		A(54)	With vinyl roof-snap on	D1AZ 5451726-B	D1AZ 5451727-B	1
69/		A(71)	Rear-Refer to Group 51728-9			
70		A(54)	Without vinyl roof	D0AZ 6251726-A	D0AZ 6251727-A	1
70		A(57)	Front	D0AZ 5751726-A	D0AZ 5751727-A	1
			Rear	D0AZ 5751726-B	D0AZ 5751727-B	1
70		A(63)	Without two tone paint	D0AZ 6351726-A	D0AZ 6351727-A	1
			Refer to Group 02512-3 for front finish moulding			
			With two tone paint refer to Group 290A60-1			
70		A(65)		D0AZ 6551726-A	D0AZ 6551727-A	1
70/		A(71)	Without vinyl roof includes 3" joint cover	D0AZ 7151726-A	D0AZ 7151727-A	1
			With vinyl roof	D0MY 7151726-A	D0MY 7151727-A	1
71/		A(53, 57)	Front	D1AZ 5751726-A	D1AZ 5751727-A	1
			Rear	D1AZ 5751726-B	D1AZ 5751727-B	1
71/		A(54)	Without vinyl roof with two-tone paint-snap on	D1AZ 5451726-A	D1AZ 5451727-A	1
71/		A(65)		D1AZ 6551726-A	D1AZ 6551727-A	1

May, 1975

COPYRIGHT © 1975 -

FORD MOTOR COMPANY

— DEARBORN, MICHIGAN

**FINAL ISSUE**

GROUP NUMBER	YEAR	BODY TYPE	DESCRIPTION	PART NUMBER				QTY.
				RIGHT HAND		LEFT HAND		
<b>51726-7 MOULDING - ROOF DRIP SIDE FINISH - continued</b>								
- B -								
	65	B(71)	Rear-Refer to Group 51728-9					
	66/67	B(54)		C6OZ	5451726-A	C6OZ	5451727-A	1
	66/67	B(62)	Front	C6OZ	6251726-A	C6OZ	6251727-A	1
			Rear	C6OZ	6251726-D	C6OZ	6251727-D	1
	66/67	B(63)		C6OZ	6351726-A	C6OZ	6351727-A	1
	66/70	B(71)	Front	C6OZ	7151726-A	C6OZ	7151727-A	1
			Rear	C6OZ	7151726-B	C6OZ	7151727-B	1
	67	B(66)		C6DZ	6651726-A	C6DZ	6651727-A	1
	68/69	B(54)	Snap on	C8OZ	5451726-A	C8OZ	5451727-A	1
	68/69	B(63)	Includes attaching parts	C8OZ	6351726-B	C8OZ	6351727-B	1
	68/69	B(65)	Snap on	C8OZ	6551726-B	C8OZ	6551727-B	1
	68/69	B(66)	Snap on	C8OZ	6651726-A	C8OZ	6651727-A	1
	70/71	B(54, 57)	Without vinyl roof	D0OZ	5451726-A	D0OZ	5451727-A	1
			With vinyl roof	D0OZ	5451726-B	D0OZ	5451727-B	1
	70/71	B(62, 65)	Without vinyl roof	D0OZ	6551726-A	D0OZ	6551727-A	1
	70/71	B(63)	Includes attaching parts	D0OZ	6351726-A	D0OZ	6351727-A	1
	70/71	B(65)	With vinyl roof	D0OZ	6551726-B	D0OZ	6551727-B	1
	70/71	B(66)		D0OZ	6651726-A	D0OZ	6651727-A	1
	72	B(53)	Front-includes attaching parts	D2OZ	5351726-A	D2OZ	5351727-A	1
			Rear-includes attaching parts	D2OZ	5351726-B	D2OZ	5351727-B	1
	72	B(63)	Front-includes attaching parts	D2OZ	6351726-A	D2OZ	6351727-A	1
			Rear-includes attaching parts	D2OZ	6351726-B	D2OZ	6351727-B	1
	72	B(65)	Front-with vinyl roof - includes attaching parts	D2OZ	6551726-A	D2OZ	6551727-A	1
			Rear-with vinyl roof - includes attaching parts	D2OZ	6551726-C	D2OZ	6551727-C	1
			Without vinyl roof - includes attaching parts	D2OZ	6551726-B	D2OZ	6551727-B	1
	72	B(71)	Front-includes attaching parts	D2OZ	7151726-A	D2OZ	7151727-A	1
			Rear-includes attaching parts	D4OZ	7151726-B	D2OZ	7151727-B	1
	72	B(97)	Includes attaching parts	D2OZ	9751726-A	D2OZ	9751727-A	1
- F -								
	65/66	F(63)		C5ZZ	6351726-A	C5ZZ	6351727-A	1
	65/68	F(65)		C5ZZ	6551726-B	C5ZZ	6551727-B	1
	67/68	F(63)		C7ZZ	6351726-A	C7ZZ	6351727-A	1
	69/70	F(65)	Without vinyl roof	C9ZZ	6551726-C	C9ZZ	6551727-C	1
	69/70	F(65)	With vinyl roof	C9ZZ	6551726-D	C9ZZ	6551727-D	1
	69/70	F(63)	Snap on type	C9ZZ	6351726-A	C9ZZ	6351727-A	1
	71/	F(63)	Cut forward lower-inboard end	D1ZZ	6351726-B	D1ZZ	6351727-B	1
	71/	F(65)	Cut forward lower-inboard end	D1ZZ	6551726-B	D1ZZ	6551727-B	1
- L -								
	71/72	L(62, 64)	Front-w/o vinyl roof	D2FZ	6251726-A	D2FZ	6251727-A	1
	71/72	L(62, 64)	Rear-w/o vinyl roof	D1FZ	6251726-C	D1FZ	6251727-C	1
	71/72	L(62, 64) "Before 4/3/72"	Front-w/vinyl roof	D1FZ	6251726-B	D1FZ	6251727-B	1
	72	L(62, 64) "From 4/3/72"	Front-w/vinyl roof	D2FZ	6251726-B	D2FZ	6251727-B	1
	71/72	L(62, 64)	Rear-w/vinyl roof	D1FZ	6251726-D	D1FZ	6251727-D	1
	72	L(73)	Refer to Group 51700-1					



# FORD CAR PARTS

**BODY  
SECTION 510**

GROUP NUMBER	YEAR	BODY TYPE	DESCRIPTION	PART NUMBER		QTY.
				RIGHT HAND	LEFT HAND	
<b>51726-7 MOULDING - ROOF DRIP SIDE FINISH - continued</b>						
<b>- P -</b>						
	70/	P(62)-exc. LTD	Front-snap on type- without vinyl roof -dull finish	D3DZ 6251726-A	D3DZ 6251727-A	1
			Rear-snap on type- without vinyl roof	D0DZ 6251726-C	D0DZ 6251727-C	1
			Front-snap on type- with vinyl roof - dull finish	D0DZ 6251726-B	D0DZ 6251727-B	1
			Rear-snap on type- with vinyl roof - dull finish	D0DZ 6251726-D	D0DZ 6251727-D	1
	71/	P(54) -exc. LTD	Front-without vinyl roof	D3DZ 5451726-A	D3DZ 5451727-A	1
			Rear-without vinyl roof	D1DZ 5451726-C	D1DZ 5451727-C	1
			Front-with vinyl roof - dull finish	D1DZ 5451726-B	D1DZ 5451727-B	1
<b>- S -</b>						
	65 66	S(63) S(63A)	Front	C4SZ 6351726-A	★C4SZ 6351727-A Not replaced (3-74)	1 1
	65/66	S(63)	Rear-Refer to Group 51728-9			
	66	S(63C, D)	Includes attaching parts	★C6SZ 6351726-A Not replaced (3-74)	C6SZ 6351727-A	1
	67/68	S(65A, C)	Without two-tone paint- includes attaching parts	C7SZ 6551726-F	C7SZ 6551727-F	1
	67/68 69	S(65) S(65A, C)	With vinyl roof or two-tone paint- includes attaching parts	C7SZ 6551726-E	C7SZ 6551727-E	1 1
	67/71	S(57)	Includes attaching parts	★C7SZ 5751726-B Not replaced (3-74)	C7SZ 5751727-C	1
	69 71	S(65B, D) S(65B, D)	Includes attaching parts	C9SZ 6551726-A	C9SZ 6551727-A	1 1
	70	S(65)	Includes attaching parts Refer to Group 026A16-7 for front body pillar finish moulding	D0SZ 6551726-A	D0SZ 6551727-A	1
	71	S(65A, C)		D1SZ 6551726-A	D1SZ 6551727-A	1
	72	S	Without vinyl roof	D2SZ 6551726-C	D2SZ 6551727-C	1
			Front-with vinyl roof - includes attaching parts	D2SZ 6551726-B	D2SZ 6551727-B	1
	72	S	"Before 7/10/72" Rear-with vinyl roof - includes attaching parts	D2SZ 6551726-A	D2SZ 6551727-A	1
			"From 7/10/72 to 10/31/72" Rear-with vinyl roof - includes attaching parts	D2SZ 6551726-D	D2SZ 6551727-D	1
	72	S	"From 10/31/72" Rear-with vinyl roof - includes attaching parts	D2SZ 6551726-E	D2SZ 6551727-E	1
<b>- U -</b>						
	67/	U(97)		C7TZ 9751726-A	C7TZ 9751727-A	1
<b>- X -</b>						
	65	X(63)	"From 3/16/64" Used without vinyl roof	C4DZ 6351726-A	★C4DZ 6351727-A Not replaced (3-74)	1
	65	X(66)		C3DZ 6651726-A	C3DZ 6651727-A	1
	66	X(66)		C6DZ 6651726-A	C6DZ 6651727-A	1
	66/70	X(54)		C6OZ 5451726-A	C6OZ 5451727-A	1
	66/70	X(62)	Front	C6OZ 6251726-A	C6OZ 6251727-A	1
			Rear	C6OZ 6251726-D	C6OZ 6251727-D	1
	66/70	X(71)	Front	C6OZ 7151726-A	C6OZ 7151727-A	1
			Rear	C6OZ 7151726-B	C6OZ 7151727-B	1

**BODY  
SECTION 510**
**FORD CAR PARTS**

GROUP NUMBER	YEAR	BODY TYPE	DESCRIPTION	PART NUMBER		QTY.
				RIGHT HAND	LEFT HAND	
<b>517B26-7 CAP-ROOF SIDE INNER REAR MOULDING - Paint to Match- Also refer to Group 24452-3 in Soft Trim Section</b>						
	69	A(54, 71)		C9AZ 54517B26-A	C9AZ 54517B27-A	1
	70/	A(54, 71)		D0AZ 54517B26-A	D0AZ 54517B27-A	1
	71/	A(53)		D1AZ 53517B26-A	D1AZ 53517B27-A	1
<b>51728-9 MOULDING - ROOF DRIP SIDE FINISH</b>						
	69/	A(71)	Rear-without vinyl roof	D0AZ 7151728-A	D0AZ 7151729-A	1
			Rear-w/vinyl roof	D0MY 7151728-A	D0MY 7151729-A	1
<b>GROUP NUMBER YEAR BODY TYPE DESCRIPTION PART NUMBER QTY.</b>						
<b>517A28-9 ORNAMENT - ROOF SIDE - CENTER - Includes attaching parts</b>						
	69	B(63)	R. H.	C9OZ 63517A28-A		1
			L. H.	C9OZ 63517A29-A		1
<b>517C30 SPACER - ROOF SIDE INNER FRONT MOULDING</b>						
	70	S(65)	Plastic	D0SZ 65517C30-A		2
	71	S(65A, C)				2
<b>GROUP NUMBER YEAR BODY TYPE DESCRIPTION PART NUMBER QTY.</b>						
<b>517A36-7 MOULDING - ROOF OUTSIDE REAR - INCLUDES ATTACHING PARTS</b>						
	69	A(63)	Refer to Group 50044			
	67	B(66)	Rustless steel	C6DZ 66517A36-B *	C6DZ 66517A37-B	1
	66	X(66)			Not replaced (3-74)	1
			No.8-18 x 1 1/2" Oval head screw	376290-S100(UU56D)	376290-S100(UU56D)	4
	68/69	B(66)		C8OZ 66517A36-A	C8OZ 66517A37-A	1
	72	B(71)		D2OZ 71517A36-A	D2OZ 71517A37-A	1
	72	B(97)		D2OZ 97517A36-A	D2OZ 97517A36-A	1
	71/	F(65)	With vinyl roof paint to match	D1ZZ 65517A36-A	D1ZZ 65517A37-A	1
	72	L(64)	With vinyl roof aluminum	D2FZ 64517A36-A	D2FZ 64517A37-A	1
	65	X(66)	Chrome-paint as required	C0DB 66517A36-B	C0DB 66517A37-B	1
<b>GROUP NUMBER YEAR BODY TYPE DESCRIPTION PART NUMBER QTY.</b>						
<b>517C40 RETAINER - ROOF SIDE INNER REAR MOULDING</b>						
	70	A(57)		D0AZ 57517C40-A		2
	70	A(63)		D0AZ 63517C40-A		2
	71/	A(53, 57)		D1AZ 57517C40-A		2
	70/71	B(63)		D0OZ 63517C40-A		12

# FORD CAR PARTS

**BODY  
SECTION 510**

21

GROUP NUMBER	YEAR	BODY TYPE	DESCRIPTION	PART NUMBER		QTY.
				RIGHT HAND	LEFT HAND	
<b>51744-5 COVER - ROOF SIDE INNER MOULDING JOINT</b>						
69	A(57)	"Before 2/3/69"	Paint to match	C9AZ 5751744-A	C9AZ 5751744-A	2
69	A(57)	"From 2/3/69"	Aqua -with coat hook	C9AZ 5751744-B2K	C9AZ 5751744-B2K	2
			Black	C9AZ 5751744-B2A	C9AZ 5751744-B2A	2
			Blue (dark)	C9AZ 5751744-B4B	C9AZ 5751744-B4B	2
			Blue (light)	C9AZ 5751744-B3B	C9AZ 5751744-B3B	2
			Ivy Gold	C9AZ 5751744-B2G	C9AZ 5751744-B2G	2
			Nugget Gold	C9AZ 5751744-B2Y	C9AZ 5751744-B2Y	2
			Red	C9AZ 5751744-B2D	C9AZ 5751744-B2D	2
69	A(63)		Aqua-with coat hook	C9AZ 6351744-A1K	★C9AZ6351745-A1K Not replaced (1-73)	1
			Black	C9AZ 6351744-A1A	C9AZ 6351745-A1A	1
			Blue (dark)	C9AZ 6351744-A2B	C9AZ 6351745-A2B	1
			Blue (light)	C9AZ 6351744-A1B	C9AZ 6351745-A1B	1
			Ivy Gold	C9AZ 6351744-A1G	C9AZ 6351745-A1G	1
			Nugget Gold	C9AZ 6351744-A1Y	C9AZ 6351745-A1Y	1
			Red	C9AZ 6351744-A1D	C9AZ 6351745-A1D	1
White	C9AZ 6351744-A1W	C9AZ 6351745-A1W	1			
72	B(53,63,71)		Paint to match	D2OZ 6351744-A	D2OZ 6351744-A	2
<b>51752-3 MOULDING - ROOF SIDE INNER FRONT - INCLUDES ATTACHING PARTS - Paint to match</b>						
69/	A, B, F, S		Refer to Group in Soft Trim Section			
67/68	S(57)	"Before 11/20/67"		C7SZ 5751752-C	C7SZ 5751753-B	1
68	S(57)	"From 11/20/67"		C7SZ 5751752-C	C7SZ 5751753-C	1
68	S(65)			C8SZ 6551752-A	C8SZ 6551753-A	1
<b>51754-5 MOULDING - ROOF SIDE INNER REAR - INCLUDES ATTACHING PARTS - Paint to match</b>						
69/	A, B, F, S		Refer to Group in Soft Trim Section			
67/68	S(65)			C7SZ 6551754-B	C7SZ 6551755-B	1
<b>51756 RETAINER - ROOF SIDE INNER FRONT MOULDING</b>						
70	A(57, 63, 65)			D0AZ 6351756-A	D0AZ 6351756-A	AR
71/	A(63, 57)					6
71/	A(65), F(65)			D1AZ 6551756-A	D1AZ 6551756-A	4
72	B(65, 97)			D2OZ 6551756-A	D2OZ 6551756-A	6
67	S			C7SZ 6551756-A	C7SZ 6551756-A	6or8
68	S(57)					8
70/71	S(65)			D0SZ 6551756-A	D0SZ 6551756-A	2
72	S			D2SZ 6551756-A	D2SZ 6551756-A	4
<b>517A56-7 ORNAMENT - ROOF SIDE - OUTSIDE - Refer to Group 517A20-1</b>						
<b>517B56-7 MOULDING - ROOF OUTSIDE SIDE CENTER - INCLUDES ATTACHING PARTS</b>						
66	A(57F)			C6AZ 57517B56-A	★C6AZ57517B57-A	1
71	F(63)		Refer to Group 517A02-3			

GROUP NUMBER	YEAR	BODY TYPE	DESCRIPTION	PART NUMBER	QTY.
<b>517A58 ORNAMENT- LOWER - INCLUDING ATTACHING PARTS</b>					
	69	A(54C, 57F, 65A)	Lower-round wreath - roofside	C9AZ 54517A58-A	2
	69/70	A(54C, 57F, 63C, 65A)	Lower-square wreath - roofside Refer to Group 517A20-1 for upper ornament	C9AZ 63517A58-A	2
	71/	A(53H, K, 57H, K, 65H, K, 71H)	Lower-also used on tailgate	D1AZ 65517A58-A	1or2
<b>517B58-9 MOULDING - ROOF OUTSIDE CENTER REAR - INCLUDES ATTACHING PARTS</b>					
	70	F(65E)	R.H. L.H.	D0ZZ 65517B58-A D0ZZ 65517B59-A	1 1
<b>51762 COVER - ROOF DRIP MOULDING JOINT</b>					
	69/70	A(71), B(71), X(71)	3/4" long	B5A 7051762-A	2or4
	69/	A(71)			4
	65	B(65, 71B)			2
	66	B(71), X(66)			2
	67/68	B(71B, E)			2
	72	L(73)			2
	69/	A(71)	3" long-serviced in assy. -refer to Group 51726-7		
	66/	U(97, 98)	Rear corner	C6TZ 9751762-A	4
<b>517A62-3 MOULDING - ROOF OUTSIDE SIDE REAR - INCLUDES ATTACHING PARTS</b>					
	72	B(97)	R. H. -corner L. H.	D2OZ 97517A62-A D2OZ 97517A63-A	1 1
	70	F(65E)	R.H. L.H.	D0ZZ 65517A62-A D0ZZ 65517A63-A	1 1
	71/	F(65)	R.H. - with vinyl roof - paint to match L.H.	D1ZZ 65517A62-A D1ZZ 65517A63-A	1 1
<b>517B76 RETAINER - ROOF DRIP SIDE FINISH REAR MOULDING</b>					
	72	B(65),S	With vinyl roof	D2OZ 65517B76-A	AR
<b>517A78 RETAINER - ROOF OUTSIDE MOULDING - CENTER</b>					
	72	B(71)		D2OZ 71517A78-A	12
<b>518A06 KNOB - SLIDING ROOF PANEL HANDLE - INCLUDES ATTACHING PARTS</b>					
	72/	L	Manual	D2FZ 62518A06-A	1
<b>51812 PLATE - SLIDING ROOF PANEL REAR GUIDE</b>					
	72/	L		D2FZ 6251812-B	2
<b>518A16 NUT - SLIDING ROOF PANEL REAR GUIDE ADJUSTING</b>					
	72/	L	Manual	D2FZ 62518A16-A	1
<b>51828-9 COVER - ROOF DRIP SIDE FINISH MOULDING JOINT - Includes attaching parts</b>					
	70/71	B(63)	R.H. L.H.	D0OZ 6351828-A D0OZ 6351829-A	1 1
	69/70	F(63)	R.H. L.H.	C9ZZ 6351828-A C9ZZ 6351829-A	1 1

# FORD CAR PARTS

**BODY  
SECTION 510**

23

GROUP NUMBER	YEAR	BODY TYPE	DESCRIPTION	PART NUMBER		QTY.
				RIGHT HAND	LEFT HAND	
<b>51834-5 MOULDING - ROOF DRIP REAR FINISH</b>						
	67/	U(97)			C7TZ 9751834-A	1
	67/	U(98)	R. H.		C7TZ 9851834-A	1
			L. H.		C7TZ 9851835-A	1
	69/	U(97)	1/8" x 1/4" Rivet (blind)		375936-S(SS44DA)	9
<b>518A36 SPRING - SLIDING ROOF PANEL REAR</b>						
	72/	L	5 23/32" long		D2FZ 62518A36-A	2
<b>518A38 COVER - SLIDING ROOF PANEL OPENING SIDE REINFORCEMENT TAB</b>						
	72/	L	Manual		D2FZ 62518A38-A	2
<b>518A40 RETAINER - SLIDING ROOF PANEL HEADLINING</b>						
	72/	L	Manual		D2FZ 62518A40-A	7
<b>518A42 RETAINER - SLIDING ROOF PANEL CABLE GUIDE</b>						
	72/	L	Manual		D2FZ 62518A42-A	1
			Screw-hex.hd.-No.8-32 x 25/64"		385035-S2(BB893)	1
<b>518A56 SHIM - SLIDING ROOF PANEL HOUSING</b>						
	72	L			D2FZ 62518A56-A	AR
<b>51880 RETAINER - SLIDING ROOF PANEL REAR GUIDE PLATE</b>						
	72/	L	Manual		D2FZ 6251880-A	2
<b>519A06 STRIP - ROOF HEADLINING BACK WINDOW TACKING UPPER</b>						
	68/71	S(65)			C8SZ 65519A06-A	1
<b>519B06 RETAINER - ROOF CONSOLE FRONT</b>						
	70/71	S(65A,C)			D0SZ 65519B06-A	1
	71	S(57,65B,D)			D1SZ 65519B06-A	1
<b>519B12-3 STRIP - ROOF HEADLINING SIDE TACKING - UPPER</b>						
	70/71	B(63)	R. H.		D0OZ 63519B12-A	1
			L. H.		D0OZ 63519B13-A	1
<b>519A16 RETAINER - ROOF SIDE REAR TRIM PANEL</b>						
	65/68	A(57,63)			C3AZ 63519A16-A	AR
	69	B(65)				AR
	66	S(63C,D)				6
	67	S(65)				2
<b>519B24 SUPPORT - ROOF CONSOLE</b>						
	67/71	S(57)			C7SZ 57519B24-A	1
	68/69	S(65)			C8LY 65519B24-A	1
	71	S(65B,D)				1
GROUP NUMBER	YEAR	BODY TYPE	DESCRIPTION	PART NUMBER		QTY.
<b>519A48-9 RETAINER - ROOF HEADLINING SIDE LOWER REAR</b>						
	72	B(63)		D2OZ 63519A48-A	D2OZ 63519A49-A	1
	71/	F(63)		D1ZZ 63519A48-A	D1ZZ 63519A49-A	1
	71/	F(65)		D1ZZ 65519A48-A	D1ZZ 65519A49-A	1

May, 1975

COPYRIGHT © 1975 —

FORD MOTOR  
COMPANY

—DEARBORN, MICHIGAN

**FINAL ISSUE**

GROUP NUMBER	YEAR	BODY TYPE	DESCRIPTION	PART NUMBER	QTY.
<b>519A58 CONSOLE - ROOF</b>					
	68	F(63B)	Saddle (Brown)	C8ZZ 63519A58-AIF	1
	66	S(63C)-Front	Aqua	C6SZ 63519A58-EAF	1
	70	S(57)-long	Cut hole for switch when sliding roof is used		
			Black	D0LY 65519A58-G	1
			Blue	D0LY 65519A58-J	1
			Red	D0LY 65519A58-H	1
			Tobacco	D0LY 65519A58-E	1
		White	D0LY 65519A58-C	1	
	70	S(65)-short	Cut hole for switch when sliding roof is used		
			Black	D0SZ 65519A58-B	1
			Blue	D0SZ 65519A58-F	1
			Ginger	D0SZ 65519A58-C	1
			Red	D0SZ 65519A58-D	1
		White	D0SZ 65519A58-G	1	
	71	S(57, 65B, D)-short	Includes visor arm clips (04131-2) and retainer (10918) for warning indicator lamp-cut hole for switch when sliding roof is used		
			Black	D1SZ 65519A58-H	1
			Blue	D1SZ 65519A58-L	1
			Ginger	D1SZ 65519A58-E	1
			Gray Gold	D1SZ 65519A58-M	1
			Green	D1SZ 65519A58-J	1
			Red	D1SZ 65519A58-K	1
			Tobacco	D1SZ 65519A58-F	1
		White	D1SZ 65519A58-G	1	
	71	S(57, 65B, D)-long	Cut hole for switch when sliding roof is used		
			Black	D0LY 65519A58-G	1
			Blue	D0LY 65519A58-J	1
			Ginger	D0LY 65519A58-A	1
			Gray gold	D1SZ 65519A58-D	1
			Green	D1SZ 65519A58-C	1
			Red	D0LY 65519A58-H	1
			Tobacco	D0LY 65519A58-E	1
		White	D0LY 65519A58-C	1	
	71	S(65A, C)-short	Cut hole for switch when sliding roof is used		
			Black	D0SZ 65519A58-B	1
			Blue	D0SZ 65519A58-F	1
			Ginger	D0SZ 65519A58-C	1
			Gray Gold	D1SZ 65519A58-B	1
		Green	D1SZ 65519A58-A	1	
<b>519B66 PAD - SLIDING ROOF CONSOLE HEADER</b>					
	72/	L		D2FZ 62519B66-A	1
	71	S		D1SZ 65519B66-A	1
	72	S		D2SZ 65519B66-A	1
<b>51982-3 PANEL - ROOF SIDE INSIDE REAR - Refer to Group 513C06-7</b>					
<b>519B92 SUPPORT - ROOF SIDE REAR TRIM PANEL</b>					
	72	S		D2SZ 65519B92-A	2
<b>519B94 PAD - SLIDING ROOF SIDE RAIL</b>					
	72	A		D2SZ 65519B94-A	1
	72	S			2

52101 SUPPORT - ROOF HEADLINING

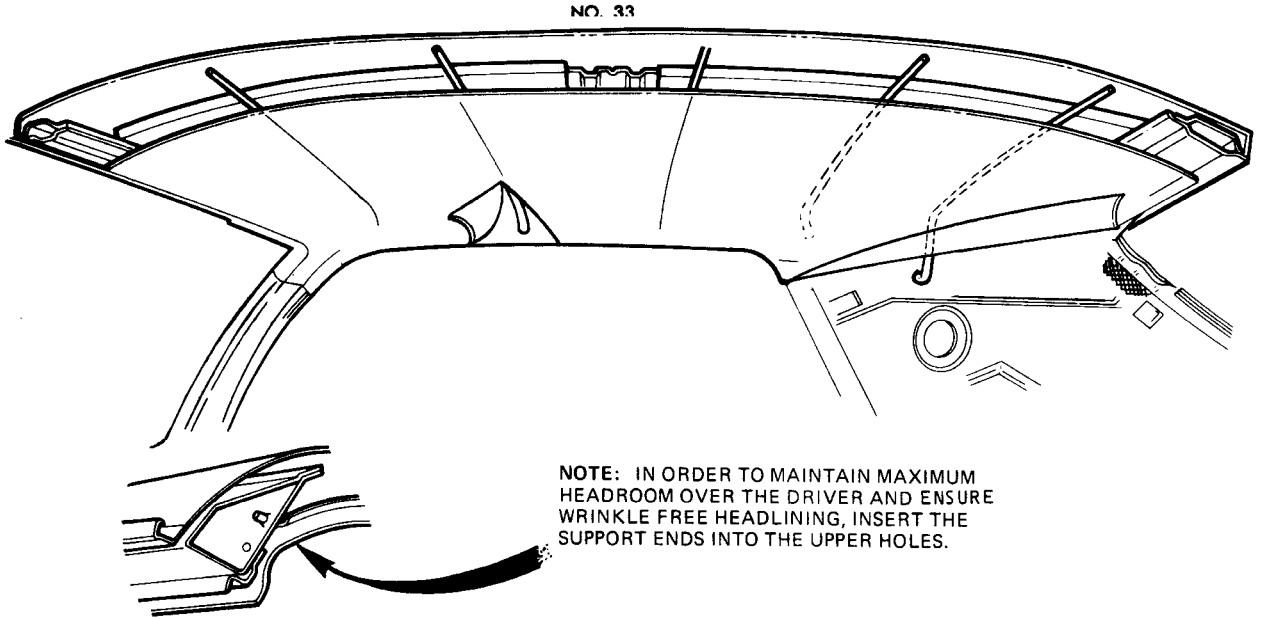

TYPICAL ROOF BOW and HEADLINING INSTALLATION

D4AZ 6552101 -A

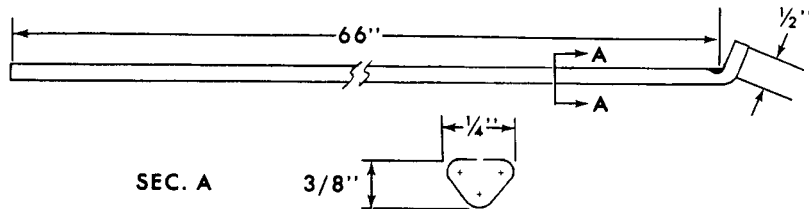

USED FOR ALL HEADLINING LOCATIONS EXCEPT SLIDING ROOF PANEL ON 1974/ MUSTANG AND 1971/ BOBCAT AND PINTO

P-11625-A

STEP NO. 1

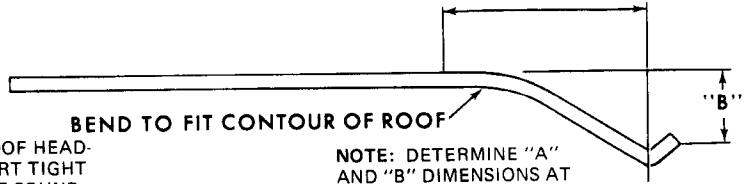

NOTE: FIT ROOF HEADLINING SUPPORT TIGHT AGAINST ROOF SOUND ABSORBER WHEN CUSTOM BENDING AND CUTTING ARE COMPLETED.

NOTE: DETERMINE "A" AND "B" DIMENSIONS AT TIME OF INSTALLATION BY BENDING TO FIT CONTOUR OF ROOF

STEP NO. 2



STEP NO. 3

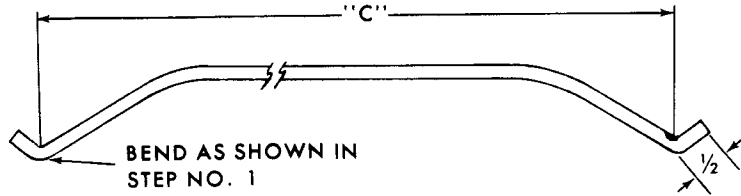

NOTE: DETERMINE "C" DIMENSION AT TIME OF INSTALLATION.

STEP NO. 4

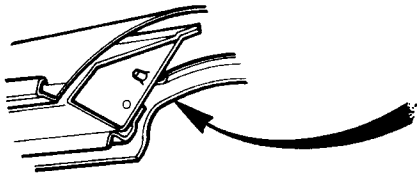

NOTE: IN ORDER TO MAINTAIN MAXIMUM HEADROOM OVER THE DRIVER AND ENSURE WRINKLE FREE HEADLINING, INSERT THE SUPPORT ENDS INTO THE UPPER HOLES.

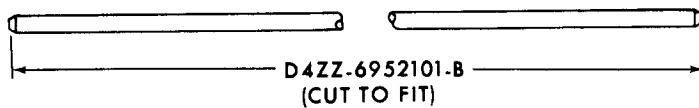

USED ONLY FOR SLIDING ROOF PANEL ON 1974/ MUSTANG AND 1971/ BOBCAT AND PINTO



# FORD CAR PARTS

**BODY  
SECTION 520**

3

GROUP NUMBER	YEAR	BODY TYPE	DESCRIPTION	PART NUMBER	QTY.		
<b>52124 RETAINER - SLIDING ROOF HEADLINING</b>							
	72	L(62,64)	Avocado-manual	D2FZ 6252124-D	1		
			Beige	D2FZ 6252124-G	1		
			Black	D2FZ 6252124-H	1		
			Blue	D2FZ 6252124-F	1		
			Ginger	D2FZ 6252124-C	1		
			Green	D2FZ 6252124-E	1		
			Orange	D2FZ 6252124-B	1		
			White	D2FZ 6252124-A	1		
<b>52126 CAP - ROOF TRIM PANEL SUPPORT</b>							
	65	A(71)	Front-chrome finish	♦ B9KB 7152126-A	2		
GROUP NUMBER	YEAR	BODY TYPE	DESCRIPTION	PART NUMBER	QTY.		
				RIGHT HAND	LEFT HAND		
<b>52136-7 RETAINER - ROOF HEADLINING - SIDE - FRONT</b>							
- A -							
	69/70	A(54, 62, 71)		C9AZ 6252136-A	C9AZ 6252137-A	1	
	71/	A(54, 71)				1	
	71/	A(65)		D1MY 6552136-A	D1MY 6552137-A	1	
- B -							
	68/69	B(54, 71)	"Before 6/2/69"	Paint to match	C8OZ 5452136-A	C8OZ 5452137-A	1
	69	B(54, 71)	"From 6/2/69"	Aqua	C9OZ 5452136-E	★C9OZ 5452137-E Not repl'd (1-73)	1
				Black	C9OZ 5452136-A	C9OZ 5452137-A	1
				Blue (light)	C9OZ 5452136-B	C9OZ 5452137-B	1
				Ivy Gold	C9OZ 5452136-D	★C9OZ 5452137-D Not repl'd (1-73)	1
				Nugget Gold	C9OZ 5452136-F	C9OZ 5452137-F	1
				Red	★C9OZ 5452136-C Not repl'd (1-73)	C9OZ 5452137-C	1
	68/69	B(63, 65)	"Before 6/2/69"	Paint to match	C8OZ 6352136-A	C8OZ 6352137-A	1
	69	B(66)					1
	69	B(63, 65, 66)	"From 6/2/69"	Black	C9OZ 6352136-A	C9OZ 6352137-A	1
				Blue (dark)	C9OZ 6352136-G	C9OZ 6352137-G	1
				Blue (light)	C9OZ 6352136-B	C9OZ 6352137-B	1
				Ivy Gold	C9OZ 6352136-D	★C9OZ 6352137-D Not repl'd (1-73)	1
				Nugget Gold	C9OZ 6352136-F	C9OZ 6352137-F	1
				Red	C9OZ 6352136-C	C9OZ 6352137-C	1
				White	C9OZ 6352136-H	C9OZ 6352137-H	1
	70	B(54)	"Before 11/3/69"	Black	D0OZ 7152136-E	D0OZ 7152137-E	1
	70	B(71)					1
				Blue	D0OZ 7152136-D	D0OZ 7152137-D	1
				Ginger	D0OZ 7152136-A	D0OZ 7152137-A	1
				Green	D0OZ 7152136-B	D0OZ 7152137-B	1
				Nugget Gold	D0OZ 7152136-C	D0OZ 7152137-C	1
				Red	D0OZ 7152136-F	D0OZ 7152137-F	1
	70	B(57,63,65)	"Before 11/3/69"	Black	D0OZ 6352136-E	D0OZ 6352137-E	1
				Blue	D0OZ 6352136-D	D0OZ 6352137-D	1
				Ginger	D0OZ 6352136-A	D0OZ 6352137-A	1
				Green	D0OZ 6352136-B	D0OZ 6352137-B	1
				Nugget Gold	D0OZ 6352136-C	D0OZ 6352137-C	1
				Red	D0OZ 6352136-F	D0OZ 6352137-F	1
				White	D0OZ 6352136-G	D0OZ 6352137-G	1
	70	B(54,57,63,65,66)-	"From 11/3/69"	Black	D0OZ 6552136-E	D0OZ 6552137-E	1
				Blue	D0OZ 6552136-D	D0OZ 6552137-D	1
				Ginger	D0OZ 6552136-A	D0OZ 6552137-A	1
				Green	D0OZ 6552136-B	D0OZ 6552137-B	1
				Nugget Gold	D0OZ 6552136-C	D0OZ 6552137-C	1
				Red	D0OZ 6552136-F	D0OZ 6552137-F	1
				White	D0OZ 6552136-G	D0OZ 6552137-G	1

♦ Canada only

May, 1975

COPYRIGHT © 1975 —

FORD MOTOR  
COMPANY

— DEARBORN, MICHIGAN

**FINAL ISSUE**

**BODY  
SECTION 520**
**FORD CAR PARTS**

GROUP NUMBER	YEAR	BODY TYPE	DESCRIPTION	PART NUMBER		QTY.
				RIGHT HAND	LEFT HAND	
<b>52136-7 RETAINER - ROOF HEADLINING - SIDE - FRONT - continued</b>						
- B -						
71		B(54, 57, 65, 66)	Black	D0OZ 6552136-E	D0OZ 6552137-E	1
			Blue	D0OZ 6552136-D	D0OZ 6552137-D	1
			Ginger	D0OZ 6552136-A	D0OZ 6552137-A	1
			Gray	D1OZ 6552136-A	D1OZ 6552137-A	1
			Green	D1OZ 6552136-C	D1OZ 6552137-C	1
			Vermillion	D1OZ 6552136-B	D1OZ 6552137-B	1
			White	D0OZ 6552136-G	D0OZ 6552137-G	1
71		B(71)	Black	D0OZ 7152136-E	D0OZ 7152137-E	1
			Blue	D0OZ 7152136-D	D0OZ 7152137-D	1
			Ginger	D0OZ 7152136-A	D0OZ 7152137-A	1
			Gray	D1OZ 7152136-A	D1OZ 7152137-A	1
			Green	D1OZ 7152136-C	D1OZ 7152137-C	1
			Vermillion	D1OZ 7152136-B	D1OZ 7152137-B	1
72		B(53)	Stainless steel	D2OZ 5352136-A	D2OZ 5352137-A	1
72		B(63)	Stainless steel	D2OZ 6352136-A	D2OZ 6352137-A	1
72		B(65)	Stainless steel	D2OZ 6552136-A	D2OZ 6552137-A	1
72		B(71)	Plastic	D2OZ 7152136-A	D2OZ 7152137-A	1
72		B(97)	Stainless steel	D2OZ 9752136-A	D2OZ 9752137-A	1
- F -						
71/		F(63)		D1ZZ 6352136-A	D1ZZ 6352137-A	1
71/		F(65)		D1ZZ 6552136-A	D1ZZ 6552137-A	1
- L -						
72		L(73)	Stainless steel	D2FZ 7352136-A	D2FZ 7352137-A	1
- P -						
70/72		P(62)	"Before 4/3/72"	D0DZ 6252136-B	D0DZ 6252136-B	2
72		P(62)	"From 4/3/72"	D3DZ 6252136-A	D3DZ 6252136-A	2
70		P(62)	Center-refer to group 52208			
- S -						
72		S		D2SZ 6552136-B	D2SZ 6552137-B	1
- X -						
68/69	X		"Before 6/2/69"	C8OZ 5452136-A	C8OZ 5452137-A	1
69	X		"From 6/2/69"	C9OZ 5452136-E	★C9OZ 5452137-E	1
					Not repl'd (1-73)	
			Black	C9OZ 5452136-A	C9OZ 5452137-A	1
			Blue (light)	C9OZ 5452136-B	C9OZ 5452137-B	1
			Ivy Gold	C9OZ 5452136-D	★C9OZ 5452137-D	1
					Not repl'd (1-73)	
			Nugget Gold	C9OZ 5452136-F	C9OZ 5452137-F	1
			Red	★C9OZ 5452136-C	C9OZ 5452137-C	1
					Not repl'd (1-73)	
<b>52148-9 RETAINER - ROOF HEADLINING SIDE REAR</b>						
69/70	A(62)			C9AZ 6252148-A	C9AZ 6252148-B	1
69/	A(54)			C9AZ 5452148-A	C9AZ 5452148-B	1
69/	A(71)			C9AZ 7152148-A	C9AZ 7152149-A	1
72	B(53)			D2OZ 5352148-A	D2OZ 5352149-A	1
72	B(63)			D2OZ 6352148-A	D2OZ 6352149-A	1
72	B(65)			D2OZ 6552148-A	D2OZ 6552149-A	1
72	B(71)			D2OZ 7152148-A	D2OZ 7152149-A	1
71/	F(63)			D1ZZ 6352148-A	D1ZZ 6352149-A	1
71/	F(65)			D1ZZ 6552148-A	D1ZZ 6552149-A	1
72	S			D2SZ 6552148-A	D2SZ 6552149-A	1
<b>52152-3 RETAINER - ROOF HEADLINING SIDE UPPER</b>						
69/70	A(63)			C9AZ 6352152-A	C9AZ 6352153-A	1
71/	A(53, 57)		17 21/32" long	D1AZ 5752152-A	D1AZ 5752153-A	1
71/	A(65)		20 3/4" long	D1AZ 6552152-A	D1AZ 6552153-A	1
70/	B		Refer to Group 50900			
70/71	S(65)			D0SZ 6552152-A	D0SZ 6552153-A	1

# FORD CAR PARTS

**BODY  
SECTION 520**

5

GROUP NUMBER	YEAR	BODY TYPE	DESCRIPTION	PART NUMBER	QTY.	
<b>52182-3 RETAINER - ROOF HEADLINING SUPPORT</b>						
69/70	A(57)			C9AZ 5752182-A	1	
69/70	A(63)			C9AZ 6352182-A	1	
69/70	A(65)			C9AZ 6552182-A	1	
71/	A(53, 57)			D1AZ 5752182-A	1	
71/	A(65)			D1AZ 6552182-A	1	
68/69	B(65)			C8OZ 6552182-A	1	
70	B(62, 65)			D0OZ 6552182-A	1	
71	B(65)				1	
72	B(53)			D2OZ 5352182-A	1	
72	B(63)			D2OZ 6352182-A	1	
72	B(65)			D2OZ 6552182-A	1	
71/	L(62, 64)	R.H.		D1FZ 6252182-A	1	
		L.H.		D1FZ 6252183-A	1	
70	S(65)			D0SZ 6552182-A	1	
71	S(65A, C)				1	
68/69	S(65)			C8SZ 6552182-A	1	
71	S(65B, D)				1	
72	S			D2SZ 6552182-A	1	
<b>52208 RETAINER - ROOF HEADLINING - CENTER</b>						
70	B(54)	Paint to match		D0OZ 5452208-D	1	
71	B(54)	Paint to match		D1OZ 5452208-A	2	
<b>525A12-3 HOUSING - QUARTER WINDOW - AT REAR ROOF</b>						
72	S	R.H.		D2SZ 65525A12-A	1	
		L.H.		D2SZ 65525A13-A	1	
<b>52562-3 EXTENSION - REAR ROOF OUTER RAIL TO WHEELHOUSE -Refer to Group 513A44-5</b>						
GROUP NUMBER	YEAR	BODY TYPE	DESCRIPTION	PART NUMBER		QTY.
<b>52564-5 HOUSING - QUARTER WINDOW at REAR ROOF RAIL</b>						
71/	A(65)			D1AZ 6552564-A	D1AZ 6552565-A	1
72	S			D2SZ 6552564-A	D2SZ 6552565-A	1
<b>52566-7 SUPPORT - PACKAGE TRAY TO ROOF RAIL - INNER</b>						
- A -						
69/70	A(54, 62)			C9AZ 6252566-A	C9AZ 6252567-A	1
69/70	A(57)			C9AZ 5752566-A	C9AZ 5752567-A	1
69/70	A(63)			C9AZ 6352566-A	C9AZ 6352567-A	1
69/70	A(65)			C9AZ 6552566-A	C9AZ 6552567-A	1
71/	A(53, 57)			D1AZ 5752566-A	D1AZ 5752567-A	1
71/	A(54)			D1AZ 5452566-A	D1AZ 5452567-A	1
71/	A(65)			D1AZ 6552566-A	D1AZ 6552567-A	1
- B -						
68/69	B(63)			C8OZ 6352566-B	C8OZ 6352567-B	1
68/69	B(65)			C8OZ 6552566-B	C8OZ 6552567-B	1
70	B(54, 57, 62, 65)			D0OZ 6552566-A	D0OZ 6552567-A	1
71	B(54, 57, 65)					1
70/71	B(63)			D0OZ 6352566-A	D0OZ 6352567-A	1
72	B(53, 65)			D2OZ 6552566-A	D2OZ 6552567-A	1
72	B(63)			D2OZ 6352566-A	D2OZ 6352567-A	1
- F -						
71/	F(63)	Without folding rear seat		D1ZZ 6352566-A	D1ZZ 6352567-A	1
69/70	F(65)			C9ZZ 6552566-A	C9ZZ 6552567-A	1
71/	F(65)			D1ZZ 6552566-A	D1ZZ 6552567-A	1
- L -						
71/	L(62)			D1FZ 6252566-A	D1FZ 6252567-A	1
- P -						
71/	P(54)			D1DZ 5452566-A	D1DZ 5452567-A	1
70/	P(62)			D0DZ 6252566-A	D0DZ 6252567-A	1
- S -						
72	S			D2SZ 6552566-A	D2SZ 6552567-A	1
- X -						
68/70	X(54)			C8DZ 5452566-B	C8DZ 5452567-B	1
68/70	X(62)			C8DZ 6252566-B	C8DZ 6252567-B	1

GROUP NUMBER	YEAR	BODY TYPE	DESCRIPTION	PART NUMBER	QTY.	
<b>52806</b>	<b>WIRING - FOLDING TOP SIDE TENSION</b>					
65/68	A(76)		33 5/8" long - includes spring	C5AZ 7652806-B	2	
69/	A(76)		35 3/8" long	C9AZ 7652806-A	2	
66/71	B(76)		30 7/8" long - includes spring	C6OZ 7652806-A	2	
65/68	F(76)		28 3/16" long - includes spring	C5ZZ 7652806-B	2	
69/70	F(76)		28 35/64" long	C9ZZ 7652806-A	2	
71/	F(76)			D1ZZ 7652806-A	2	
65/66	A(76)		No. 8-18 x 3/8" Cross recess tapping screw	52720-S8(U380)	2	
65/70	F(76)				2	
			1/4" Flat washer	44719-S8(X17)	2	
			1/4"-20 Hex. nut	34055-S8(M158)	4	
<b>53000</b>	<b>TOP - FOLDING - LESS TRIM, MOTOR and LIFTS - Paint to Match</b>					
69/	A(76)			C9AZ 7653000-A	1	
70/71	B(76)			D0OZ 7653000-A	1	
69/70	F(76)			C9ZZ 7653000-A	1	
71/	F			D1ZZ 7653000-A	1	
<b>53008</b>	<b>PIN - FOLDING TOP - NO. 8 BOW</b>					
71/	F(76)		17/64" long	D1ZZ 7653008-A	2	
<b>53038</b>	<b>HEADER - FOLDING TOP- Paint to Match</b>					
69/	A(76)			C9AZ 7653038-A	1	
67/71	B(76)			C7OZ 7653038-A	1	
69/70	F(76)			C9ZZ 7653038-A	1	
71/	F(76)			D1ZZ 7653038-A	1	
<b>53072</b>	<b>BUSHING - FOLDING TOP SIDE RAIL HINGE - Refer to Group 22841</b>					
<b>53082</b>	<b>SPACER - FOLDING TOP MAIN PIVOT BRACKET</b>					
72	F(76)			D2ZZ 7653082-A	AR	
GROUP NUMBER	YEAR	BODY TYPE	DESCRIPTION	PART NUMBER		QTY.
				RIGHT HAND	LEFT HAND	
<b>53104-5</b>	<b>RAIL - FOLDING TOP FRONT SIDE - Paint to Match</b>					
69/	A(76)			C9AZ 7653104-A	C9AZ 7653105-A	1
67/	A(76)		1/4"-20 x 1/2" hex. head slotted locking tap tite screw	381793-S2(BB413A)	381793-S2(BB413A)	2
67/69	B(76)			C7OZ 7653104-A	C7OZ 7653105-A	1
70/71	B(76)			D0OZ 7653104-A	D0OZ 7653105-A	1
69/70	F(76)			C9ZZ 7653104-A	C9ZZ 7653105-A	1
71/	F(76)			D1ZZ 7653104-A	D1ZZ 7653105-A	1
67	F(76)		1/4"-20 x 1/2" hex. head slotted locking tap tite screw	381793-S2(BB413A)	381793-S2(BB413A)	2
<b>531A08-9</b>	<b>RAIL - FOLDING TOP REAR SIDE INNER</b>					
71/	F(76)			D1ZZ 76531A08-A	D1ZZ 76531A09-A	1
<b>531A10</b>	<b>SPACER - FOLDING TOP REAR SIDE RAIL TO UPPER REINFORCEMENT</b>					
65/69	A(76), F(76)			C5ZZ 76531A10-A	C5ZZ 76531A10-A	2
<b>531A16-7</b>	<b>EXTENSION-FOLDING TOP MAIN PIVOT BRACKET SUPPORT</b>					
69/	A(76)			C9AZ 76531A16-A	C9AZ 76531A17-A	1
69/70	F(76)			C9ZZ 76531A16-A	C9ZZ 76531A17-A	1
71/	F(76)			D1ZZ 76531A16-A	D1ZZ 76531A17-A	1
<b>53118-9</b>	<b>BRACKET - FOLDING TOP MAIN PIVOT - Paint to Match</b>					
- A -						
69/	A(76)			C9AZ 7653118-A	C9AZ 7653119-A	1
66/	A(76)		5/16"-18 x 3/4" Hex. hd. tapping screw & washer assy.	375822-S2 (MM52Q)	375822-S2 (MM52Q)	6or8
- B -						
67/71	B(76)	"From 12/22/66"		C7OZ 7653118-B	C7OZ 7653119-B	1
66/71	B(76)		5/16"-18 x 3/4" Hex. head tapping screw & washer assy.	375822-S2(MM52Q)	375822-S2(MM52Q)	6or8

# FORD CAR PARTS

**BODY  
SECTION 520**

7

GROUP NUMBER	YEAR	BODY TYPE	DESCRIPTION	PART NUMBER		QTY.
				RIGHT HAND	LEFT HAND	
<b>53118-9 BRACKET - FOLDING TOP MAIN PIVOT - continued - Paint to match</b>						
- F -						
	69/70	F(76)	Includes pin	C9ZZ 7653118-A	C9ZZ 7653119-A	1
	71/	F(76)	Includes pin	D1ZZ 7653118-A	D1ZZ 7653119-A	1
	69/	F(76)	5/16"-18 x 3/4" Hex. head tapping screw & washer assy.	375822-S2(MM52Q)	375822-S2(MM52Q)	6or8
<b>531A18-9 EXTENSION - FOLDING TOP MAIN PIVOT BRACKET- Paint to Match</b>						
	65	A(76), X(76)		C4DZ 76531A18-A	C4DZ 76531A18-A	2
	66	A(76), B(76)				2
	67/68	A(76)				2
	67/71	B(76) "From 12/22/66"				2
	69/	A(76)		C9AZ 76531A18-A	C9AZ 76531A18-A	2
	65/70	F(76)		C5ZZ 76531A18-A	C5ZZ 76531A19-A	1
			5/16"-18 x 3/4" Hex. head screw & washer assy.	359662-S7(BB575A)	359662-S7(BB575A)	2
	71/	F(76)		D1ZZ 76531A18-A	D1ZZ 76531A18-A	2
<b>53138-9 RAIL - FOLDING TOP REAR SIDE - Paint to Match</b>						
- A -						
	67/68	A(76)		C7AZ 7653138-A	C7AZ 7653139-A	1
	69/	A(76)		C9AZ 7653138-A	C9AZ 7653139-A	1
	65/	A(76)	.45" I.D. x .75" O.D. Spring wave washer	356383-S7(XX362)	356383-S7(XX362)	2or4
			3/32" x 1" Cotter pin	72034-S(N45)	72034-S(N45)	4
			7/16" x 1, 58" Oval hd. pin	359224-S2(NN35F)	359224-S2(NN35F)	2
- B -						
	66	B(76)		C6OZ 7653138-A	C6OZ 7653139-A	1
	67	B(76) "Before 12/22/66"		C7OZ 7653138-A	C7OZ 7653139-A	1
	67/71	B(76) "From 12/22/66"		C7OZ 7653138-B	C7OZ 7653139-B	1
- F -						
	69/70	F(76)		C9ZZ 7653138-A	C9ZZ 7653139-A	1
	71/	F(76)		D1ZZ 7653138-A	D1ZZ 7653139-A	1
<b>53142-3 EXTENSION - FOLDING TOP MAIN PIVOT BRACKET TO WHEELHOUSE SUPPORT</b>						
	69/	A(76)		C9AZ 7653142-A	C9AZ 7653143-A	1
	66/71	B(76)		C6OZ 7653142-C	C6OZ 7653143-C	1
<b>53144-5 BRACKET - FOLDING TOP - NO. 3 BOW - Paint to Match</b>						
	68	A(76)		C8AZ 7653144-A	C8AZ 7653145-A	1
	69/	A(76)		C9AZ 7653144-A	C9AZ 7653145-A	1
	66/69	B(76)		C6OZ 7653144-A	C6OZ 7653144-A	2
	70/71	B(76)		D0OZ 7653144-A	D0OZ 7653144-A	2
	69/70	F(76)		C9ZZ 7653144-A	C9ZZ 7653144-A	2
	71/	F(76)		D1ZZ 7653144-A	D1ZZ 7653145-A	1
<b>53150 PIN - FOLDING TOP BRACKET - NO. 3 BOW</b>						
	71/	F(76)	3/16" long	D1ZZ 7653150-A	D1ZZ 7653150-A	2
<b>53152-3 BRACE - FOLDING TOP MAIN PIVOT BRACKET SUPPORT.</b>						
	65/66	F(76)		C5ZZ 7653152-A	C5ZZ 7653153-A	1
	67/71	F(76)		C5ZZ 7653152-B	C5ZZ 7653153-B	1
	72	F(76)		D2ZZ 7653152-A	D2ZZ 7653153-A	1
<b>53158-9 SUPPORT - FOLDING TOP MAIN PIVOT BRACKET</b>						
	69/	A(76)		C9AZ 7653158-A	C9AZ 7653159-A	1
	68/71	B(76)		C8OZ 7653158-A	C8OZ 7653159-A	1
<b>53222 PIN - FOLDING TOP POWER LINK</b>						
	66/67	B(76)	.369" dia. x 1.08" long	C6OZ 7653222-A	C6OZ 7653222-A	2
	71/	F(76)	1 5/64" long	D1ZZ 7653222-A	D1ZZ 7653222-A	2
			2 3/8"	D1ZZ 7653222-B	D1ZZ 7653222-B	2

GROUP NUMBER	YEAR	BODY TYPE	DESCRIPTION	PART NUMBER	QTY.
<b>533A00 MOTOR and PLATE KIT - FOLDING TOP HYDRAULIC LIFT</b>					
	65/	A(76)		D1AZ 76533A00-A	1
	66/71	B(76)			1
	65/	F(76)			1
	65	X(76)			1
Consists of					
1-Motor & pump end plate assy.		2-Grommets	2-Tetra seals		
1-"O" ring		2-Lockwashers	2-Plugs		
1-Mounting bracket		2-Screws			
	65/66	S(76)		C3SZ 76533A00-A	1
Consists of					
1-Motor & pump end plate assy.		2-Sleeves	1-"O" ring		
2-Screws		2-Grommets	2-Plugs		
2-Lockwashers		1-Bracket	1-Connector adapter		
2-Grommets		2-Hydraulic packing	1-Inner rotor		
<b>53337 PUMP REPAIR KIT - FOLDING TOP HYDRAULIC LIFT</b>					
	65/66	S(76)	Used with "D" and "O" type motor shafts	C3SZ 7653337-A	1
Consists of					
1-Plate assy.		1-Outer rotor	2-"O" rings		
1-Ball bearing (1/8" dia.)		2-Ball bearings (1/4" dia.)	1-Inner rotor		
1-"O" ring		1-Inner rotor			
	65/	A(76)		C4DZ 7653337-A	1
	66/71	B(76)			1
	65/	F(76)			1
	65	X(76)			1
Consists of					
1-Plate assy.		1-"O" ring	1-Inner rotor		
1-"O" ring (reservoir)		2-Ball bearings (1/4")	1-Outer rotor		
<b>53357 MOTOR and PLATE ASSY. - FOLDING TOP HYDRAULIC LIFT PUMP - Refer to Group 533A00</b>					
<b>53376 RESEVOIR REPAIR KIT - FOLDING TOP HYDRAULIC LIFT</b>					
	69/	A(76)	Repair kit	C9AZ 7653376-A	1
	66/71	B(76)	Repair kit	C4DZ 7653376-A	1
	65/	F(76)			1
	65	X(76)			1
Consists of					
1-Reservoir and bracket assy.		1-"O" ring	1-Bolt, washer and "O" ring assy.		
1-Filler plug and "O" ring assy.					
	65/66	S(76)	Kit for round pump lifts-(Repair)	B5A 7653376-A	1
Consists of					
1-Plate		1-Bolt	1-"O" ring		
1-Reservoir		2-Seals	2-Grommets		
<b>53390-2 HOSE - FOLDING TOP HYDRAULIC LIFT</b>					
- A -					
	65/72	A(76)	Upper and lower	D0AZ 7653456-A	2
- B -					
	66/71	B(76)	Upper or lower	D0AZ 7653456-A	1
- F -					
	65/66	F(76)	Upper and lower	D0AZ 7653456-A	2
	67/70	F(76)	Lower-91" long	C7ZZ 7653390-A	1
	67/	F(76)	Upper and lower-78" long-includes fittings	D0AZ 7653456-A	2
- S -					
	65/66	S(76)	Lower-approx. 58" long	C4SZ 7653392-A	1
- X -					
	65/70	X(76)	Upper and lower	D0AZ 7653456-A	2
<b>53456 HOSE - FOLDING TOP HYDRAULIC LIFT -Refer to Group 53390-2</b>					
<b>53510 NUT - LUGGAGE COMPARTMENT DOOR LATCH</b>					
	65/66	S(76)		B7A 5153510-A	2
			No. 8-32 x 5/8" Socket head set screw	371293-S13(UU8B)	4

# FORD CAR PARTS

**BODY  
SECTION 520**

9

GROUP NUMBER	YEAR	BODY TYPE	DESCRIPTION	PART NUMBER		QTY.
				RIGHT HAND	LEFT HAND	
<b>537A02 PAD - ROOF OUTSIDE SIDE FRONT</b>						
	69	S(65B, D)	Rubber	C9SZ	65537A02-A	2
	70/71	S(57)	Rubber	C7SZ	57537A02-A	2
	72	S		D2SZ	65537A02-A	2
<b>53728-9 RETAINER - ROOF OUTSIDE VINYL COVER SIDE - INCLUDES ATTACHING PARTS</b>						
- A -						
	65	A(63)	66 3/4" long-Aluminum	C5AZ	6353729-A	2
	66	A(63)	61 1/2" long-Aluminum	C6AZ	6353729-A	2
	67	A(54C)		C7MY	5453728-A	2
	67	A(57)		C7AZ	5753729-A	2
	67	A(63B,C)		C7AZ	6353729-A	2
	67	A(63J)		C7AZ	6353729-B	2
	68	A(54C, 57)	Snap on	C8ZZ	6553729-A	2
- B -						
	67	B(63)		C6GY	6353728-A	2
	68	B(65)	Snap on	C8OZ	6553729-A	2
	69/71	B(66)				2
	72	B	R. H.	D2OZ	5353728-A	1
			L. H.	D2OZ	5353729-A	1
- F -						
	65/67	F(65)	"Before 4/3/67"	C5ZZ	6553729-A	2
	67/69	F(65)	"From 4/3/67"	C8ZZ	6553729-A	2
- S -						
	67	S(57)	R. H. -Paint to match	C7SZ	5753729-A	1
	68/71	S(57B, C)				1
			L. H.	C7SZ	5753729-B	1
- X -						
	65	X(63C)	55 1/4" long - Aluminum	C3DZ	6353729-A	2
	68	X(54)	Snap on	C8OZ	5453729-A	2
<b>53740 PAD - ROOF OUTSIDE SIDE FRONT- Also Refer to Soft Trim Section</b>						
	69	S(65B, D)		C9SZ	6553740-A	2
	70/71	S		D0SZ	6553740-A	2
	72	S		D2SZ	6553740-A	2
GROUP NUMBER	YEAR	BODY TYPE	DESCRIPTION	PART NUMBER		QTY.
				RIGHT HAND	LEFT HAND	
<b>53900-1 WEATHERSTRIP - FOLDING TOP SIDE INTERMEDIATE REAR RAIL</b>						
	65/66	S(76)		C4SZ	7653900-A	1
			No. 10-32 x .75" Special head moulding screw	352222-S8(BB807)	352222-S8(BB807)	8
			No. 10 Flat washer	44716-S8(X15)	44716-S8(X15)	8
			No. 10 Lockwasher	34803-S7(X60)	34803-S7(X60)	8
			No. 10-32 Hex. nut	34079-S7(M163)	34079-S7(M163)	8
			No. 7 Flat washer	44709-S8B(X9)	44709-S8B(X9)	2or4
GROUP NUMBER	YEAR	BODY TYPE	DESCRIPTION	PART NUMBER		QTY.
				RIGHT HAND	LEFT HAND	
<b>53928-9 WEATHERSTRIP - FOLDING TOP SIDE FRONT RAIL INTERMEDIATE</b>						
	65/66	S(76)	R. H.	C4SZ	7653928-A	1
			L. H.	C4SZ	7653929-A	1
			No. 10-32 x .75" Special head moulding screw	352222-S8(BB807)		6
			No. 10 Flat washer	44716-S8(X15)		8
			No. 10 Lockwasher	34803-S7(X60)		6
			No. 10-32 Hex. nut	34079-S7(M163)		6

**BODY  
SECTION 520**
**FORD CAR PARTS**

GROUP NUMBER	YEAR	BODY TYPE	DESCRIPTION	PART NUMBER	QTY.
<b>53986-7 WEATHERSTRIP - FOLDING TOP RAIL</b>					
- A -					
	65/68	A(76)	Header and front sides	C5AZ 7653986-B	1
			No. 10-24 x .56" "T" bolt	379279-S2(BB815D)	4
			No. 10-24 Nut (tee capped)	379270-S2(MM131G)	4
			No. 8-18 x 3/8" Cross recess pan head screw	52720-S8(U380)	4
	69/	A(76)		C9AZ 7653986-A	1
- B -					
	66/67	B(76)	Header and front sides	C6OZ 7653986-B	1
	68/69	B(76)		C8OZ 7653986-A	1
			No. 8-18 x 1/2" Round washer head screw	378729-S(UU87R)	2
	70/71	B(76)		D0OZ 7653986-A	1
- F -					
	69/70	F(76)		C9ZZ 7653986-A	1
	71/	F(76)	R. H.	D1ZZ 7653986-A	1
			L. H.	D1ZZ 7653987-A	1
- S -					
	65/66	S(76)	Header & front sides	C4SZ 7653986-B	1
			No. 10-32 x .75" Special head moulding screw	352222-S8(BB807)	4or6
			No. 10 Flat washer	44716-S8(X15)	4or6
			No. 10 Lockwasher	34803-S7(X60)	4or6
			No. 10-32 Hex. nut	34079-S8 (M163)	4or6
<b>54052 PIN - FOLDING TOP SIDE RAIL HINGE</b>					
	66	A(76), B(76), F(76)- "Before 10/20/65"	Refer to Group 50492		
	66/	A(76), B(76), F(76)- "From 10/20/65"		C6OZ 7654052-B	1
<b>54054 BUSHING - FOLDING TOP BALANCE LINK</b>					
	66/71	B(76)		C6OZ 7654054-A	2
<b>54212 REINFORCEMENT - FOLDING TOP SIDE QUARTER STAY</b>					
	71/	A(76)	With black top	C9AZ 7654212-AAB	1
			With white top	D1AZ 7654212-B	1
<b>54254-5 RETAINER - SLIDING ROOF OUTSIDE COVER CENTER - Paint to match</b>					
	72	L	R.H.-vinyl roof cover	D2FZ 6254254-A	1
			L.H.	D2FZ 6254255-A	1
<b>54330 ABSORBER - ROOF PANEL SOUND</b>					
	71/72	L	Fibre board-31" x 42"-cut to fit	D3DZ 5454330-A	1
<b>54676 RETAINER - FOLDING TOP DUST HOOD FRONT</b>					
	67	A(76)	Refer to Group 61138-9		
	66/70	B(76)		C6OZ 7654676-A	1
	65/70	F(76)		C5ZZ 7654676-A	1
	71/	F(76)		D1ZZ 7654676-A	1
<b>54712 SUPPORT - ROOF SIDE RAIL WEATHERSTRIP</b>					
	68/70	S(57)		C7SZ 5754712-C	2
			No. 8-18 x 1/2" cross recess washer lead screw	381969-S2(UU89A)	2
<b>54732 WEATHERSTRIP - ROOF REAR</b>					
	66/	U(97)		C6TZ 9754732-A	1
			5/16"-1 1/8" O.D. Flat washer	44725-S8(X22)	1
<b>54784-5 SEAL - FOLDING TOP REAR SIDE RAIL</b>					
	71/	F(76)	R.H. -rubber	D1ZZ 7654784-A	1
			L. H.	D1ZZ 7654785-A	1
<b>54790-1 SEAL - FOLDING TOP CENTER SIDE RAIL</b>					
	70	A(76)	R.H.	D0AZ 7654790-A	1
			L.H.	D0AZ 7654791-A	1



# FORD CAR PARTS

**BODY  
SECTION 520**

11

GROUP NUMBER	YEAR	BODY TYPE	DESCRIPTION	PART NUMBER	QTY.
<b>54800</b>	<b>BUSHING - FOLDING TOP HOLD DOWN CLAMP CONTROL -</b> Also refer to group 50508				
	69/	A(76),F(76)		C9AZ 7654800-A	2
	69/71	B(76)			2
<b>55008</b>	<b>CLAMP - SKI CARRIER HOLD DOWN</b>				
	65/71	All (except S roof mount)	Roof or luggage compartment	C3AZ 2555008-A	4
<b>550A20</b>	<b>STUD - ROOF LUGGAGE CARRIER FRONT RAIL</b>				
	66/67	A(71),B(71),X(71)- "Before 2/20/67"	With 5 slat-adjustable	C5MY 71550A20-A	8
	67/69	A(71),B(71),X(71)- "From 2/20/67"	With 5 slat-adjustable	C7AZ 71550A20-A	1
<b>550A22</b>	<b>PLATE - ROOF LUGGAGE CARRIER FRONT RAIL</b>				
	67/69	A(71),B(71),X(71)- "From 2/20/67"	With 5 slat-adjustable carrier	C7AZ 71550A22-A	1
	66/69	A(71),B(71),X(71)	1/4" -28 x 1/4" Oval point set screw	375377-S100(UU37D)	4
<b>550A24</b>	<b>RETAINER - ROOF LUGGAGE CARRIER REAR RAIL</b>				
	66/68	A(71),B(71),X(71)	With 5 slat-adjustable carrier	C7AZ 71550A24-A	1
	69	A(71),B(71)	R.H. -with adjustable carrier L.H.	C9AZ 71550A24-A C9AZ 71550A24-B	1 1
	70/	A(71),B(71)	With adjustable carrier-refer to Group 55106 for aluminum side rail		
	71/	A(71)	With stainless steel side rail and chrome deflector	D1AZ 71550A24-A	2
<b>55026</b>	<b>NUT - ROOF LUGGAGE CARRIER LOCK</b>				
	70/	A(71),B(71)		D0AZ 7155026-A	2
<b>550A30-1</b>	<b>BASE - ROOF LUGGAGE CARRIER</b>				
	66/68	A(71),B(71),X(71)	R. H. -rear & L. H. -front L. H. -rear & R. H. -front	C6OZ 71550A30-A C6OZ 71550A31-A	2 2
<b>550A50</b>	<b>RETAINER - ROOF LUGGAGE CARRIER SUPPORT</b>				
	69	A(71),B(71)		C9AZ 71550A50-A	8
	69/70	X(71)			8
<b>550A52-3</b>	<b>CAP - ROOF LUGGAGE CARRIER SIDE RAIL END</b>				
	69	A(71),B(71)	R. H. -with adjustable carrier L. H. -not replaced (5/75)	C9AZ 71550A52-A ★ C9AZ 71550A53-A	1 1
<b>550A54-5</b>	<b>PLATE - ROOF LUGGAGE CARRIER SUPPORT COVER</b>				
	69/70	A(71)	R. H. -with adjustable carrier L. H.	C9AZ 71550A54-A C9AZ 71550A55-A	1 1
<b>550A56-7</b>	<b>EXTENSION - ROOF LUGGAGE CARRIER SIDE RAIL FRONT</b>				
	69	A(71)	R. H. -with adjustable carrier L. H.	C9AZ 71550A56-A C9AZ 71550A57-A	1 1
<b>55058-9</b>	<b>EXTENSION - ROOF LUGGAGE CARRIER SIDE RAIL REAR</b>				
	69	A(71),B(71)	R.H.-with adjustable carrier L.H.	C9AZ 7155058-A C9AZ 7155059-A	1 1
	70/	A(71),B(71)	R. H. - with adjustable carrier-alum. side rail & deflector L. H.	D0AZ 7155058-A D0AZ 7155059-A	1 1
	71/	A(71)	R.H.-with stainless steel side rail & chrome deflector L.H.	D1AZ 7155058-A D1AZ 7155059-A	1 1
<b>550A58</b>	<b>ROLLER - ROOF LUGGAGE CARRIER RETAINER</b>				
	69/70	A(71),B(71)		C9AZ 71550A58-A	1

**BODY  
SECTION 520**
**FORD CAR PARTS**

GROUP NUMBER	YEAR	BODY TYPE	DESCRIPTION	PART NUMBER	QTY.
<b>550A60 SLAT KIT - ROOF LUGGAGE CARRIER</b>					
	70	A(71), B(71)	With adjustable carrier-refer to Groups 55124, 55147, 55150		
<b>550A64 WASHER - ROOF LUGGAGE CARRIER RAIL NUT</b>					
	70/	A(71), B(71)	With adjustable carrier	D0AZ 71550A64-A	2
<b>55068-9 RETAINER - ROOF LUGGAGE CARRIER FRONT RAIL</b>					
	71/	A(71), B(71)	R.H.-includes attaching parts L.H.	D1AZ 7155068-A D1AZ 7155069-A	1 1
<b>550A68 COVER - ROOF LUGGAGE CARRIER RETAINER</b>					
	70/	B(71)	Rubber	D0OZ 71550A68-A	6
<b>55078 BRACKET and SCREW KIT - LUGGAGE CARRIER</b>					
	65/71	All (except S roof mount)	Luggage compt. or roof	C3AZ 2555078-A	2
<b>55078 RETAINER - ROOF LUGGAGE CARRIER</b>					
	69	A(71), B(71), X(71)	46.75" long	C9AZ 7155078-A	5
	70/	B(71)	Refer to Groups 55124 and 55147		
<b>55100 CARRIER KIT - ROOF LUGGAGE</b>					
	65 66/68	A(59, 71), B(71), X(59, 71, 78) A(71)	5 Slats-Permanent installation-less crossmember member-non adjustable carrier - service details	★C5AZ 7155100-B	1
Consists of					
	4-C6OZ	71550A30-1-A	Base (R. H. & L. H.)	4-C6OB 7155156-A	Pad
	2-C6AZ	7155106-A	Rail	4-371429-S100	Screw-No. 10-24 x 3/4"
	2-C6AZ	7155114-A	Rail (side)	10-375959-S101	Screw-No. 10-16 x 3/4"
	4-C6OZ	7155140-A-B	Support (R. H. & L. H.)	4-378979-S100	Screw-No. 10-24 x 3/8"
	5-C6AB	7155147-A	Pad	4-378980-S100	Screw-No. 10-24 x 3/8"
	5-C6AZ	7155150-B	Slat assy.	1-Installation sketch	
	66/68	A(71)	5 slats-permanent installation-adjustable carrier-service details	★C5MY 7155100-A	1
Consists of					
	4-C5MY	71550A20-A	Stud	5-C5MY 7155150-A	Slat
	4-C5MY	71550A22-A	Plate	2-C5MY 7155170-B	Pad (rear)
	2-C5MY	71550A24-A	Retainer	2-C5MY 7155176-B	Pad (front)
	2-C5MY	7155068-A	Retainer	4-50421-S13	Screw-1/4"-20 x 3/4"
	2-C5MY	7155106-A	Rail (front)	4-374067-S100	Screw-No. 10-24 x 7/16"
	2-C5MY	7155114-A	Rail (side)	4-375377-S100	Screw-1/4"-28 x 1/4"
	4-C5MY	7155140-1-A	Support	12-376370-S101	Screw-No. 10-16 x 3/4"
	5-C5MY	7155147-B	Pad (slat)	10-376525-S101	Screw-No. 10-16 x 3/8"

# FORD CAR PARTS

**BODY  
SECTION 520**

13

GROUP NUMBER	YEAR	BODY TYPE	DESCRIPTION	PART NUMBER	QTY.
<b>55100</b>		<b>CARRIER KIT - ROOF LUGGAGE - continued</b>			
	69	A(71),B(71),X(71)	5 slats-permanent installation-non-adjustable carrier-service details	★C9AZ 7155100-A	1
Consists of					
	8-C9AZ	71550A50-A	Retainer	5-C9AZ 7155150-A	Slat
	5-C9AZ	7155078-A	Retainer (slat)	2-C9AZ 7155156-A	Pad (support-R. H.)
	2-C9AZ	7155106-A	Rail	2-C9AZ 7155157-A	Pad (support-L. H.)
	2-C9AZ	7155114-C	Rail (side)	15-55997-S45X	Screw-No. 8-18 x 1/2"
	2-C9AZ	7155140-A	Support (R. H.)	8-376608-S100	Screw-1/4"-20 x 3/4"
	2-C9AZ	7155141-A	Support (L. H.)	8-383141-S45	Screw-No. 8-32 x 3/8"
	69	A(71)	5 Slats-Permanent installation-adjustable carrier-service details	★C9AZ 7155100-B	1
Consists of					
	1-C9AZ	7150822-A	Panel (air deflector)	1-C9AZ 7155106-B	Rail
	1-C9AZ	7150870-A	Pad (air deflector)	4-C9AZ 7155156-B	Pad (support)
	5-C9AB	7155022-A	Slat assy.	1-C9AB 7155190-A	Rail assy.
	8-C9AZ	71550A50-A	Retainer	17-55974-S45X	Screw No. 8-15 x 3/4"
	2-C9AZ	7155104-5-A	Rail (R. H. & L. H.)	8-376608-S100	Screw-No. 8-20 x 3/4"
	70/71	A(71)	5 slats-Permanent installation-non-adjustable carrier-service details	★D0AZ 7155100-A	1
Consists of					
	8-D0AZ	6455180-A	Rivet nut	5-D0AZ 7155124-A	Reinforcement
	2-D0AZ	7155140-A	Support (R. H.)	5-D0AZ 7155147-A	Pad
	2-D0AZ	7155141-A	Support (L. H.)	5-D0AZ 7155150-A	Slat
	2-D0AZ	7155106-A	Rail	15-55997-S45X	Screw
	2-C9AZ	7155114-C	Rail	8-383141-S45	Screw
	2-C9AZ	7155156-A	Pad (R. H.)	8-383905-S45X	Screw
	2-C9AZ	7155157-A	Pad (L. H.)	1-Installation sketch	
	66/68	B(71),X(71)	5 Slats-Permanent installation-w/cross member-non-adjustable-service details	★C6OZ 7155100-A	1
Consists of					
	2-C6OZ	71550A30-A	Base (R. H.)	5-C6OA 7155147-A	Pad (slat)
	2-C6OZ	71550A31-A	Base (L. H.)	5-C6OA 7155150-B	Slat
	2-C6OZ	7155106-A	Rail	4-C6OB 7155156-A	Pad (support)
	2-C6OZ	7155109-A	Member assy.	4-371429-S100	Screw-No. 10-24 x 3/4"
	2-C6OZ	7155114-A	Rail (side)	8-375959-S101	Screw-No. 10-16 x 3/4"
	2-C6OZ	7155140-A	Support	4-378979-S100	Screw-No. 10-24 x 3/8"
	2-C6OZ	7155140-B	Support	4-378980-S100	Screw-No. 10-24 x 3/8"
				4-378981-S100	Screw-No. 8-22 x 1 1/8"

GROUP NUMBER	YEAR	BODY TYPE	DESCRIPTION	PART NUMBER	QTY.
<b>55100</b>	<b>CARRIER KIT - ROOF LUGGAGE - continued</b>				
	66/69	B(71), X(71)	5 Slat-Permanent installation - adjustable carrier <u>service details</u>	★C6GY 7155100-A	1
Consists of					
	4-C5MY	71550A20-A	Stud	5-C6GY 7155150-A	Slat
	4-C5MY	71550A22-A	Plate	2-C6GY 7155170-1-A	Pad (R. H. & L. H.)-rear
	2-C5MY	71550A24-A	Retainer	2-C6GY 7155176-7-A	Pad (R. H. & L. H.)-front
	2-C5MY	7155068-A	Retainer	4-50421-S13	Screw-1/4"-20 x 3/4"
	2-C5MY	7155100-A	Rail (front)	4-374067-S100	Screw-No. 10-24 x 7/16"
	2-C5MY	7155114-A	Rail (side)	4-375377-S100	Screw-1/4"-28 x 1/4"
	4-C5MY	7155140-1-A	Support (R. H. & L. H.)	12-376370-S101	Screw-No. 10-16 x 3/8"
	5-C6GY	7155147-A	Pad (slat)	10-376525-S101	Screw-No. 10-16 x 3/8"
				10-380555-S	Spacer-3/16"
	70/71	B(71)	5 Slat-Permanent installation-non-adjustable carrier - <u>service details</u>	★D0OZ 7155100-A	1
Consists of					
	8-D0AZ	6455180-A	Rivet nut	1-C9AZ 7155156-A	Pad-R. H. - Rear
	2-C9AZ	7155106-A	Rail-Front & Rear	1-D0OZ 7155156-B	Pad-R. H. - Front
	2-C9AZ	7155114-C	Rail-Side	1-C9AZ 7155157-A	Pad-L. H. - Rear
	5-D0AZ	7155124-A	Reinforcement	1-D0OZ 7155157-B	Pad-L. H. - Front
	2-C9AZ	7155140-A	Support-R. H.	8-376608-S100	Screw
	2-C9AZ	7155141-A	Support-L. H.	8-383141-S	Screw
	5-C9AZ	7155147-A	Pad	1-Installation sketch	
	5-D0AZ	7155150-A	Slat		
	70/71	B(71)	5 Slat-Permanent installation-adjustable carrier - <u>service details</u>	★D0OZ 7155100-B	1
Consists of					
	8-D0AZ	6455180-A	Rivet-nut	1-D0AZ 7155140-D	Support-R. H. -Rear
	1-D0AZ	7150860-B	Panel (air deflector)	1-D0AZ 7155141-C	Support-L. H. -Front
	2-D0AZ	7155026-A	Nut	1-D0AZ 7155141-D	Support-L. H. -Rear
	1-D0AZ	7155058-A	Extension-R. H.	5-D0AZ 7155147-A	Pad
	1-D0AZ	7155059-A	Extension-L. H.	5-D0AZ 7155150-A	Slat
	2-D0AZ	71550A64-A	Washer	1-C9AZ 7155156-A	Pad-R. H. -Rear
	1-D0OZ	7155106-D	Rail-Front	1-D0OZ 7155156-B	Pad-R. H. -Front
	1-D0OZ	7155114-A	Rail-R. H. -Side	1-C9AZ 7155157-A	Pad-L. H. -Rear
	1-D0OZ	7155115-A	Rail-L. H. -Side	1-D0OZ 7155157-B	Pad-L. H. - Front
	5-D0AZ	7155124-A	Reinforcement	8-383141-S	Screw
	1-D0OZ	7155138-B	Rail-Rear	1-Installation sketch	
	1-D0AZ	7155140-C	Support-R. H. -Front		
	72	B(71)	5 slats-permanent installation-adjustable carrier	D2OZ 7155100-A	1
	71/	L(62,64)	<u>Collapsible installation</u>	D0RY 6255100-A	1
			Permanent installation-non-adjustable carrier	D1FZ 6255100-A	1
Consists of					
	1-D1FZ	6255106-A	Rail-Front	2-D1FZ 6255156-A	Pad-support-R.H.
	2-D1FZ	6255114-A	Rail-Side	2-D1FZ 6255157-A	Pad-support-L.H.
	4-D1FZ	6255124-A	Reinforcement	8-D0AZ 6455180-A	Rivet-nut
	1-D1FZ	6255138-A	Rail-Rear	16-	Screws
	2-D1FZ	6255140-A	Support-R.H.	1-	Bolt
	2-D1FZ	6255141-A	Support-L.H.	3-	Washers
	4-D1FZ	6255147-A	Pad	1-	Nut
	4-D1FZ	6255150-A	Slat	1-Installation sketch	
	72	L(73)	Permanent installation-non-adjustable carrier	D2FZ 7355100-A	1
Consists of					
	1-D2FZ	7355106-A	Rail-Front	2-D2FZ 7355157-A	Pad-support-L.H.
	2-D2FZ	7355114-A	Rail-Side	8-D0AZ 6455180-A	Rivet-nut
	1-D2FZ	7355124-A	Reinforcement	16-	Screws
	1-D2FZ	7355138-A	Rail-Rear	1-	Bolt
	2-D1FZ	6255140-A	Support-R.H.	3-	Washers
	2-D1FZ	6255141-A	Support-L.H.	1-	Nut
	1-D2FZ	7355147-A	Pad-slat	8-	Sealer
	4-D2FZ	7355150-A	Slat	1-Installation sketch	
	2-D2FZ	7355156-A	Pad-support-R. H.		

# FORD CAR PARTS

**BODY  
SECTION 520**

15

GROUP NUMBER	YEAR	BODY TYPE	DESCRIPTION	PART NUMBER	QTY.
<b>55100</b>	<b>CARRIER KIT - LUGGAGE COMPARTMENT</b>				
	69/	A(except 63, 71)	Permanent installation  Use w/DODZ 6255196-A kit-for removeable installation	C9AZ 6255100-A	1
	69/	B(except 66, 71, 97)			1
	69/	F(except 63)			1
	69/	S			1
	69/70	X(except 63, 71)			1
	71	L			1
	70/	P			1

Consists of

1-★C9AJ 6246002-A Carrier assy.	4-★C6AA 6255014-A Fastener	1-Installation sketch
4-★C6AA 6246012-A Pad	4-50421-S8 Screw-1/4"-20 x 3/4"	

GROUP NUMBER	YEAR	BODY TYPE	DESCRIPTION	PART NUMBER		QTY.
				FRONT	REAR	
<b>55106</b>	<b>RAIL - ROOF LUGGAGE CARRIER - FRONT and REAR</b>					
	65/66	A(71)	Non-adjustable carrier-5 slat type-41 7/8" long	C4DZ 5955106-A	C4DZ 5955138-A	1
	66/68	A(71)	Non-adjustable carrier-5 slat type-43" long x 1 1/16" oval	C6AZ 7155106-A	C6AZ 7155106-A	2
	65/68	A(71)	Adjustable carrier-5 slat type-41 5/32" long	C5MY 7155106-A	C5MY 7155106-A	2
	69	A(71)	Non-adjustable carrier	C9AZ 7155106-A	C9AZ 7155138-A	1
	69	A(71)	Adjustable carrier	C9AZ 7155106-B	C9AZ 7155138-B	1
	70	A(71) "Before 3/2/70"	Non-adjustable carrier	D0AZ 7155106-A	D0AZ 7155106-A	2
	70/71	A(71) "From 3/2/70"	Non-adjustable carrier	D0AZ 7155106-E	D0AZ 7155106-E	2
	70	A(71) "Before 11/3/69"	Adjustable carrier- includes retainer	D0AZ 7155106-C	D0AZ 7155138-A	1
	70/	A(71) "From 11/3/69"	Adjustable carrier- with alum. side rail & deflector- includes retainer	D0AZ 7155106-D	D0AZ 7155138-B	1
	71/	A(71)	Adjustable carrier- with stainless steel side rail & chrome deflector	D1AZ 7155106-A	D1AZ 7155138-A	1
			8/32" x 1/2" -screw	376358-S(BB637XA)	376358-S(BB637XA)	AR
	65/66	B(71), X(59, 71)	Non-adjustable carrier-5 slat type-41 7/8" long	C4DZ 5955106-A	C4DZ 5955138-A	1
	66/68	B(71), X(71)	Non-adjustable carrier-5 slat type-38" long	C6OZ 7155106-A	C6OZ 7155106-A	2
	65/68	B(71), X(71)	Adjustable carrier-5 slat type-41 5/32" long	C5MY 7155106-A	C5MY 7155106-A	2
	69	B(71), X(71)	Adjustable carrier	C9AZ 7155106-B	C9AZ 7155138-B	1
	69/70	B(71), X(71)- "Before 3/2/70"	Non-adjustable carrier	C9AZ 7155106-A	C9AZ 7155106-A	2
	70/71	B(71) "From 3/2/70"	Non-adjustable carrier	D0OZ 7155106-E	D0OZ 7155106-E	2
	70	X(71)				2
	70	B(71), X(71)- "Before 11/3/69"	Adjustable carrier- includes retainer	D0OZ 7155106-C	D0OZ 7155138-A	1
	70/71	B(71), X(71)- "From 11/3/69"	Adjustable carrier- includes retainer	D0OZ 7155106-D	D0OZ 7155138-B	1

GROUP NUMBER	YEAR	BODY TYPE	DESCRIPTION	PART NUMBER		QTY.
				FRONT	REAR	
<b>55106 RAIL - ROOF LUGGAGE CARRIER - FRONT and REAR - continued</b>						
	72	B(71)	Adjustable carrier- includes retainer	D2OZ 7155106-A	D2OZ 7155138-A	1
	71/	L(62, 64)	Non-adjustable carrier	D1FZ 6255106-A	D1FZ 6255138-A	1
			No.8-32 x 3/8" pan head screw	383141-S45(UU81WK)	383141-S45(UU81WK)	8
	72	L(73)	Non-adjustable carrier	D2FZ 7355106-A	D2FZ 7355138-A	1
GROUP NUMBER	YEAR	BODY TYPE	DESCRIPTION	PART NUMBER		QTY.
<b>55114-5 RAIL - ROOF LUGGAGE CARRIER SIDE</b>						
	65	A(71), X(59, 71)	63" long-non-adjustable carrier	C1DZ 5955114-A		2
	65	B(71)				2
	66/68	A(71), B(71), X(71)	With 5 slat-52.82" long-adjustable carrier	C5MY 7155114-A		2
	66/68	A(71)	With 5 slat-57.66" long-non-adjustable carrier	C6AZ 7155114-A		2
	69	A(71)	R. H.- adjustable carrier	C9AZ 7155114-A		1
			L. H.	C9AZ 7155114-B		1
	69/71	A(71)	Non-adjustable carrier	C9AZ 7155114-C		2
	70/	A(71)	R. H. - adjustable carrier-with alum. side rail & deflector-wood grain	D0AZ 7155114-C		1
			L. H.	D0AZ 7155115-A		1
	71/	A(71)	R.H.-adjustable carrier-with stainless steel side rail & chrome deflector-wood grain	D1AZ 7155114-A		1
			L. H.	D1AZ 7155115-A		1
	66/68	B(71), X(71)	With 5 slat-52.82" long-non-adjustable carrier	C6OZ 7155114-A		2
	69/71	B(71)	Non-adjustable carrier	C9AZ 7155114-C		2
	70/71	B(71)	R. H. - adjustable carrier	D0OZ 7155114-A		1
			L. H.	D0OZ 7155115-A		1
	72	B(71)	R. H. - adjustable carrier	D2OZ 7155114-B		1
			L. H.	D2OZ 7155115-B		1
	71/	L(62, 64)	R. H. & L.H.-non-adjustable carrier	D1FZ 6255114-A		2
	72	L(73)	R.H. & L.H.-non adjustable carrier	D2FZ 7355114-A		2
	65/	A(71)	No. 10-24 x .44" pan head screw	374067-S100(BB637D)		4
	66/	A(71), B(71), X(71)	No. 10-24 x 1 7/8" oval head screw	★371409-S		4
<b>55124 REINFORCEMENT - ROOF LUGGAGE CARRIER SLAT</b>						
	69	A(71), B(71)		C9AZ 7155124-A		5
	69/70	X(71)				5
	70/71	A(71), B(71)		D0AZ 7155124-A		5
	71/	L(62, 64)	Non-adjustable carrier	D1FZ 6255124-A		1
	72	L(73)	Non-adjustable carrier	D2FZ 7355124-A		1
<b>55134-5 EXTENSION - ROOF LUGGAGE CARRIER SIDE RAIL - Refer to Group 55058</b>						
<b>55138 RAIL - ROOF LUGGAGE CARRIER REAR - Refer to Group 55106</b>						
<b>55140-1 SUPPORT - ROOF LUGGAGE CARRIER</b>						
	65	A(71), B(71), X(59, 71)	Non-adjustable carrier	C4DZ 5955140-A		4
	66/68	A(71), B(71), X(71)	Left front or right rear	C6OZ 7155140-A		2
			Right front or left rear-non-adjustable carrier	C6OZ 7155140-B		2
			R. H. - adjustable carrier	C5MY 7155140-A		2
			L. H.	C5MY 7155141-A		2
			Screw-oval head-No.10-16 x 3/4"	376370-S101(UU56F)		12
	69	A(71)	R. H.-adjustable carrier	C9AZ 7155140-C		1
			L. H.	C9AZ 7155141-C		1
	69/70	A(71)	Assy. -R.H. -includes attaching parts-adjustable	C9AZ 7155140-B		2
			L. H.	C9AZ 7155141-B		2
	69/70	A(71), B(71), X(71) - "Before 3/2/70"	R. H. -non-adjustable carrier	C9AZ 7155140-A		2
			L. H.	C9AZ 7155141-A		2
	70/71	A(71), B(71)	R. H. -non-adjustable carrier	D0AZ 7155140-E		2
	70	X(71) "From 3/2/70"	L. H.	D0AZ 7155141-E		2
	70/	A(71), B(71)	R. H. -front-adjustable carrier-with alum. side side rail & deflector	D0AZ 7155140-C		1
			L. H.	D0AZ 7155141-C		1

# FORD CAR PARTS

**BODY  
SECTION 520**

17

GROUP NUMBER	YEAR	BODY TYPE	DESCRIPTION	PART NUMBER	QTY.
<b>55140-1 SUPPORT - ROOF LUGGAGE CARRIER - continued</b>					
	71/	A(71)	R.H.-front-with stainless steel side rail & chrome deflector	D1AZ 7155140-A	1
			L.H.	D1AZ 7155141-A	1
	70/	A(71), B(71)	R.H.-rear-with adjustable carrier-with alum. side rail & deflector	D0AZ 7155140-D	1
			L.H.	D0AZ 7155141-D	1
			Nut-rivet-1/4"-20 x 15/32"	D0AZ 6455180-A	8
	71/	A(71)	R.H.-rear-with stainless steel side rail & chrome deflector	D1AZ 7155140-B	1
			L.H.	D1AZ 7155141-B	1
	71/	L	R.H.	D1FZ 6255140-A	2
			L.H.	D1FZ 6255141-A	2
	65	A(59, 71), B(71), X(59, 71)	Screw-fillister hd.machine-No.10-32 x 1.187"	374468-S13(BB26G)	4
<b>55147 PAD - ROOF LUGGAGE CARRIER SLAT</b>					
	65	A(71), B(71)	Adjustable carrier	C5MY 7155147-A	5
	69/70	A(71), B(71)	Non-adjustable carrier	C9AZ 7155147-A	5
	69/70	X(71)			5
	70/71	A(71), B(71)	Adjustable carrier	D0AZ 7155147-A	5
	66/68	B(71), X(71)	Adjustable carrier	C6GY 7155147-A	5
	72	B(71)	Adjustable carrier	D2OZ 7155147-A	1
	71/	L(62, 64)	Non-adjustable carrier	D1FZ 6255147-A	1
	72	L(73)	Non-adjustable carrier	D2FZ 7355147-A	1
<b>55150 SLAT - ROOF LUGGAGE CARRIER</b>					
- A -					
	66/68	A(71)	Adjustable carrier	C5MY 7155150-A	5
	69	A(71)	Non-adjustable carrier-for pad refer to Group 55147	C9AZ 7155150-A	5
			Adjustable carrier-includes pad	C9AZ 7155150-B	5
			Screw-cross recess pan hd.-No.10-16 x 3/8"	*376525-S101	10
			Screw-oval hd.-No.8-18 x 3/4"	55974-S45X(U316D)	17
			Screw-cross recess pan hd.-No.8-15 x 1/2"	55997-S45X(U381D)	15
	70/71	A(71)	Permanent installation-non-adjustable carrier	D0AZ 7155150-A	1
	71/	A(71)	Adjustable carrier-with alum. & stainless steel side rails	D1AZ 7155150-A	5
			Screw-head washer-No.8-18 x 1/2"	384654-S45X(UU89JA)	20
- B -					
	66/68	B(71)	With 5 slat-less cross member-52" long-non-adjustable carrier	C6OZ 7155150-D	5
			No. 10-16 x 3/4" Oval head screw	376370-S101(UU56F)	15
	69	B(71)	With 5 slat-adjustable carrier	C6GY 7155150-A	5
			With 5 slat-non-adjustable carrier	C9AZ 7155150-A	5
	70/71	B(71)	No. 8-15 x 1/2" Pan head cross recess screw	55997-S45X(U-381-D)	15
	71	B(71)	Non-adjustable carrier	D0AZ 7155150-A	1
			Adjustable carrier-with alum. side rail	D1OZ 7155150-A	5
	72	B(71)	No. 8-18 x 1/2" rd. head washer screw	384654-S45X(UU89JA)	20
				D2OZ 7155150-A	1
- L -					
	71/	L(62, 64)	Inner-non adjustable carrier	D1FZ 6255150-A	4
	72	L(73)	Inner-35 13/32"-non-adjustable carrier	D2FZ 7355150-A	4
- X -					
	66/68	X(71)	With 5 slat-adjustable carrier	C6GY 7155150-A	5
	69/70	X(71)		C9AZ 7155150-A	5

GROUP NUMBER	YEAR	BODY TYPE	DESCRIPTION	PART NUMBER	QTY.	
<b>55156-7 PAD - ROOF LUGGAGE CARRIER SUPPORT</b>						
	69/	A(71), B(71)	R.H. -front or rear	C9AZ 7155156-A	1	
	69/70	X(71)	L.H.	C9AZ 7155157-A	1	
	69	A(71)	With adjustable carrier	C9AZ 7155156-B	4	
	70/	A(71)	R. H. -front-with alum. side rail & deflector	D0OZ 7155156-B	1	
	70/71	B(71)			1	
	70	X(71)	L. H.	D0OZ 7155157-B	1	
	71/	A(71)	R.H.-front-with stainless steel side rail & chrome deflector	D1AZ 7155156-A	1	
			L.H.	D1AZ 7155157-A	1	
	71/	A(71)	R.H.-rear-with alum. side rail & chrome deflector	D1AZ 7155156-B	1	
			L.H.	D1AZ 7155157-B	1	
	72	B(71)	R. H. -front-adjustable carrier	D2OZ 7155156-B	1	
			L. H.	D2OZ 7155157-B	1	
			R. H. -rear-adjustable carrier	D2OZ 7155156-A	1	
			L. H.	D2OZ 7155157-A	1	
	71/	L(62, 64)	R. H. -non-adjustable carrier	D1FZ 6255156-A	2	
			L. H.	D1FZ 6255157-A	2	
	72	L(73)	R.H.-black-non adjustable carrier	D2FZ 7355156-A	2	
			L.H.	D2FZ 7355157-A	2	
<b>GROUP NUMBER YEAR BODY TYPE DESCRIPTION PART NUMBER FRONT REAR QTY.</b>						
<b>55170-7 PAD - ROOF LUGGAGE CARRIER SUPPORT</b>						
	66/68	A(71)-adjustable carrier	R. H.	C5MY 7155176-B		2
			L. H.		C5MY 7155170-B	2
	68/69	B(71), X(71)-adjustable carrier	R. H.	C6GY 7155176-A	C6GY 7155170-A	1
			L.H.	C6GY 7155177-A	C6GY 7155171-A	1
<b>GROUP NUMBER YEAR BODY TYPE DESCRIPTION PART NUMBER QTY.</b>						
<b>55180 FASTENER - ROOF LUGGAGE CARRIER SUPPORT</b>						
	69/	A(71), B(71)	Rivet nut	D0AZ 6455180-A	8	
	71/	L(73)			8	
<b>55182-3 CAP - LUGGAGE CARRIER RAIL</b>						
	65/68	A(59, 71)	Roof	C0DZ 5955182-A	4	
	65	B(71)			4	
	65	X(59, 71)			4	
			1/4"-28 x 1/4" Set screw	375377-S100(UU37D)	8	
	70/	A(71), B(71)	R.H.-chrome finish-for side rail end roof	DOMY 7155182-A	1	
			L.H.	DOMY 7155183-A	1	
	66/70	A, B, F, S, X	Plastic-use with C6AZ 6255100-A luggage carrier	C6AZ 6255182-A	AR	
	69/	A(except 63,71),B(exc. 71,97), F(65,76),P,S	Brown plastic-use with C9AZ 6255100-A luggage compartment mount	C9AZ 6255182-A	9	
<b>55196 STRAP KIT - ROOF LUGGAGE CARRIER HOLD DOWN</b>						
	70	P(62)	Use with C9AZ 6255100-A kit-deck mounted	D0DZ 6255196-A	1	
Consists of						
	4-C4RA 2546012-A	Pad	4-C5ZA 6546022-A	Clamp		
	4-C6AA 6246016-B	Retainer	4-52344-S40	Screw-No. 8-15 x 1/2"		
	2-D0DZ 6546020-A	Strap (rear)	4-380294-S	Nut-No. 10-32		
	2-D0DZ 6246018-A	Strap (front)	4-380295-S	Screw & washer-No. 10-32 x 3/4"		
	2-C5ZA 6546012-A	Pad				
1-Installation sketch						



# FORD CAR PARTS

## BODY SECTION 600

1

GROUP NUMBER	YEAR	BODY TYPE	DESCRIPTION	PART NUMBER	QTY.
<b>60056 BOLT - FRONT SEAT TRACK ATTACHING</b>					
	68	S(57A,B,65A,B)	Front	C8SZ 6560056-A	2
			Rear	C8SZ 6560056-B	2
	66/	U	R. H. -driver seat-5/16"-18 x 11/16" shoulder bolt-1 3/4" overall length	C6TZ 9660056-A	1
			L. H. -passenger seat		2
<b>60060 PLATE - FRONT SEAT BACK SCUFF</b>					
	65	B(71)	S/compt.	C3UZ 8960060-A	1
	65	A(63C, 76B), S, X(76B, D)			2
	66	A(63C, D, 76B, D), B(63C, D, 76C, D), S, X(62C, 66D)			2
	67	A(62-Police and Taxi)- "Before 12/15/66"	Refer to Group 61642-3		
	67/68	A(62-Police and Taxi)- "From 12/15/66"			2
	67	A(63C, 76B), B(63C, D, 66D, 76C, D), X(62C)			2
	71	S	Not used with reclining seat		2
	68	F	Screw & washer-pan head-No. 10-32 x 3/8"	50804-S8(U157)	2
	71/	F, L(62), P(62)		C8ZZ 6560060-A	2
				D1ZZ 6560060-A	8
<b>600A74-5 BRACKET - AUXILIARY SEAT BACK SUPPORT</b>					
	65/68	A(71B,D,E,H)	R. H.	C5AZ 71600A74-C	1
			L. H.	C5AZ 71600A75-C	1
			Screw & washer-hex. head-5/16"-18 x 5/8"	★55805-S8	10
	65	A(71B,D,E)	Bumper	★379366-S	2
	66	A(71B,D,E)	Bumper	C6AZ 71115A72-A	2
	66/71	B(71)		C6OZ 71600A74-A	2
			Screw & washer-hex. head-5/16"-18 x 3/4"	★55615-S2	4
<b>60116 GROMMET - FRONT SEAT SHOULDER STRAP PIN</b>					
	70/71	A,B,F,L,P,S		D1AZ 6560116-A	AR
<b>60126 BELT - REAR SEAT SHOULDER STRAP</b>					
- A -					
	68	A(except 71, 76)	Black-finger tip release lever	C8AZ 6260126-A1A	2
	68	A(except 71, 76)	Black-push button release lever	C8AZ 6260126-B1A	2
	68	A(71)	Black-finger tip release lever	C8AZ 7160126-B1A	2
	68	A(71)	Black-push button release lever	C8AZ 7160126-A1A	2
- B -					
	68	B(54, 63, 65)	Black-finger tip release lever	C8ZZ 6360126-A1A	2
	68	B(54, 63, 65)	Black-push button release lever	C8ZZ 6360126-B1A	2
	68	B(71)	Black-finger tip release lever	C8AZ 7160126-B1A	2
	68	B(71)	Black-push button release lever	C8AZ 7160126-A1A	2
- F -					
	68	F(63)	Black-finger tip release lever	C8ZZ 6360126-A1A	2
	68	F(63)	Black-push button release lever	C8ZZ 6360126-B1A	2
	68	F(65)	Black-finger tip release lever	C8ZZ 6560126-B1A	2
	68	F(65)	Black-push button release lever	C8ZZ 6560126-A1A	2
- S -					
	68	S	Black-finger tip release lever	C8SZ 6560126-B1A	2
	68	S	Black-push button release lever	C8SZ 6560126-A1A	2
- U -					
	68/	U(98)	Refer to Group 60232		
- X -					
	68	X(54, 62)	Black-finger tip release lever	C8ZZ 6360126-A1A	2
	68	X(54, 62)	Black-push button release lever	C8ZZ 6360126-B1A	2
	68	X(71)	Black-finger tip release lever	C8AZ 7160126-B1A	2
	68	X(71)	Black-push button release lever	C8AZ 7160126-A1A	2

GROUP NUMBER	YEAR	BODY TYPE	DESCRIPTION	PART NUMBER	QTY.
<b>60126 BELT - REAR SEAT SHOULDER STRAP - continued</b>					
AT ROOF RAIL OR PACKAGE TRAY					
68		A(except 76), B(except 76), F(except 76), S, X, U(98)	Bolt-hex. hd., shoulder-3/8" -16 x 1 1/2"	382517-S36(BB445LD)	2
68		A(71), F(63)	Nut and retainer -3/8" -16	382537-S100 (MM207AH)	2
68		F(63)	Washer-Flat-7/16"	382581-S100(XX173E)	2
68		U(98)	Screw-pan hd.-No. 8-32 x 3/8"	50803-S2(U150B)	4
AT FLOOR PAN					
68		A, B, S(57), X	Bolt-hex. hd., shoulder-7/16"-20 x 2"-7/8"	382518-S100(BB155A)	2
68		A, B, F(except 76), S, X, U	Washer-flat-7/16"	382581-S100(XX173E)	2
68		A, B, X	Spacer-1/2" x 1/4"	382582-S100(XX179A)	4
68		S(65)	Washer-serrated-1/2"	382583-S100 (XX340AC)	4
68		U(98)	Bolt-hex. hd., shoulder-11/16"-20 x 1 1/2"	382516-S100(UU155B)	2
68		U(98)	Washer-flat-7/16"	354959-S(XX178C)	4
<b>601A48 SUPPORT - REAR SEAT BACK RADIO SPEAKER GRILLE</b>					
65/66		A(76)		C5AZ 76601A48-A	1
			Screw-oval head, cross recess-No. 8-32 x 3/8"	376378-S101(UU97)	6
<b>601A68 PLATE - REAR SEAT BACK CATCH STRIKER</b>					
67/71		F(63)-w/folding rear seat		C7ZZ 63601A68-A	1
			Screw-oval head, cross recess-No. 8-15 x 5/8"	52352-S8(U293)	4
			Screw-oval head, cross recess-No. 8-15 x 5/8"	★53100-S8	2
<b>601A80-1 REINFORCEMENT - FRONT SEAT SHOULDER STRAP MOUNTING</b>					
71/		L	R.H.	D1FZ 62601A80-A	1
			L.H.	D1FZ 62601A81-A	1
<b>60213 LOOP - TIE DOWN</b>					
68/70		F(76-GT 350/500)		S8MS 7660213-A	1
<b>60220 BEZEL - SHOULDER STRAP OPENING</b>					
69/71		B(66)		C9OZ 6660220-A	2
72		B(97)			2
<b>60226 PLATE - FRONT SEAT SHOULDER STRAP ANCHOR</b>					
68/		U(98)		C8TZ 9860226-A	2
<b>60228 SPACER - SHOULDER STRAP ANCHOR PLATE</b>					
- A -					
67		A(54, 62, 71)	Front seat	C7TZ 8160228-A	2
68		A(76)		C8UZ 8260228-A	2
67/69		A(57, 63, 65)	Front or rear seat	C7AZ 6260228-B	2or4
71/		A(except 76)			2
68/70		A(54, 62, 71, 76)	Front or rear seat	C7AZ 6260228-C	2or4
- B -					
67		B(54, 62, 63, 71)	Front seat	C7TZ 8160228-A	2
68		B(54, 63, 65)	Rear seat	C7AZ 6260228-B	2
68		B(71)	Front or rear seat	C7AZ 6260228-C	2or4
68		B(except 71)	Front seat		2
69/		B(except 76)	Front seat		2
- F -					
68		F(63, 65)	Rear seat	C7TZ 8160228-A	2
68		F(65)	Rear seat	C7AZ 6260228-B	2
72		F(63)	Front seat		2
68/71		F(63, 65)	Front seat	C7AZ 6260228-C	2
72		F(65)			2
- L -					
71/		L		D2FZ 6260228-A	2
- P -					
70/		P	Front seat	C7AZ 6260228-C	2

# FORD CAR PARTS

**BODY  
SECTION 600**

3

GROUP NUMBER	YEAR	BODY TYPE	DESCRIPTION	PART NUMBER	QTY.
<b>60228 SPACER - SHOULDER STRAP ANCHOR PLATE - continued</b>					
- S -					
	67	S	Front seat	C7SZ 6560228-A	2
	68	S	Front or rear seat	C7SZ 6560228-A	2or4
	69/70	S	Front seat		2
	71/	S		C7AZ 6260228-B	2
- U -					
	68/	U	Front or rear seat	C7AZ 6260228-B	2or4
- X -					
	67	X	Front seat	C7TZ 8160228-A	2
	68	X(54, 62)	Rear seat	C7AZ 6260228-B	2
	68	X(71)	Front or rear seat	C7AZ 6260228-C	2or4
	68	X(54, 62)	Front seat		2
	69/70	X	Front seat		2
<b>60230 COVER - FRONT SEAT SHOULDER STRAP OPENING</b>					
	68	A(except 76), B(except 66, 76), F(except 76), S, X	Parchment-on roof side rail	C9AZ 6260230-A	2
<b>60232 STRAP ASSY. - SHOULDER</b>					
	67/70	F(63-Shelby GT 350/500)	Inertia type-safety	C9ZZ 6560232-A	2
	68/70	F(76-Shelby GT 350/500)		C9ZZ 7660232-A	2
<b>60232 BELT KIT - FRONT SEAT SHOULDER STRAP</b>					
	67	A(54, 57, 62, 63, 71)	Black	C7AZ 6260232-D1A	2
Consists of					
1 Belt assy. -Complete 1-C7AZ 62612A56-A Spacer					
1-C7AZ 6260228-A Spacer 2-★51754-S13 Screw-pan hd., tapping-No.6-32 x 3/8"					
1-C7TZ 8160228-A Spacer 1-381512-S36(BB513K) Bolt-hex. hd., shoulder-3/8"-16 x 1 1/2"					
1-C7AZ 6260234-C1A Boot-black(upper) 1-381513-S2(MM207AF) Nut & retainer-3/8"-16					
1-C7AZ 6260236-B Retainer 1-381873-S100(BB701V) Bolt-hex. hd., shoulder-7/16"-20 x 2"					
	67	A(76), B(76) - "Before 2/1/67"	Black	C7AZ 7660232-A1A	2
	67	F(76)			2
Consists of					
1- Belt assy. -Complete 1-44727-S8(X24) Washer-flat-3/8"					
1-C7AZ 6260228-A Spacer 1-381512-S36(BB513K) Bolt-hex. hd., shoulder-3/8"-16 x 1 1/2"					
1-C7AZ 62612A56-A Spacer 1-381873-S100(BB701V) Bolt-hex. hd., shoulder-7/16"-20 x 2"					
1-33799-S7(M52) Nut-hex. -3/8"-16 1- Instruction Sheet No. 2566-D					
	67	A(76), B(76) "From 2/1/67"	Black	C7AZ 7660232-B1A	2
Consists of					
1- Belt assy. -Complete 1-44727-S8(X24) Washer-flat-3/8"					
1-C7AZ 6260228-A Spacer 1-381512-S36(BB513K) Bolt-hex. hd., shoulder-3/8"-16 x 1 1/2"					
1-C7AZ 62612A56-A Spacer 1-381873-S100(BB701V) Bolt-hex. hd., shoulder-7/16"-20 x 2"					
1-33799-S2(M52) Nut-hex. -3/8"-16 1- Instruction sheet No. 2566-D					
	68	A(except 76), B, F(63, 65), S, X	Plastic buckle-less boot		
			Black	C8AZ 6260232-E1A	2
			Blue	C8AZ 6260232-E1B	2
			Parchment	C8AZ 6260232-E1U	2
	68	A(except 76), B(except 66, 76), F(63, 65), S, X	Chrome and Plastic buckle-less boot		
			Aqua	C8AZ 6260232-F1K	2
			Black	C8AZ 6260232-F1A	2
			Blue	C8AZ 6260232-F1B	2
			Ivy Gold	C8AZ 6260232-F1G	2
			Nugget Gold	C8AZ 6260232-F1Y	2
			Parchment	C8AZ 6260232-F1U	2
			Red	C8AZ 6260232-F1D	2
			Saddle (Brown)	C8AZ 6260232-F1F	2
	68	A(76), B(76)	Chrome and Plastic buckle-less boot		
			Black	C8AZ 7660232-D1A	2
	69/	A	Refer to Group 611A72-3		

May, 1975

COPYRIGHT © 1975 —

FORD MOTOR  
COMPANY

— DEARBORN, MICHIGAN

**FINAL ISSUE**

GROUP NUMBER	YEAR	BODY TYPE	DESCRIPTION	PART NUMBER	QTY.
<b>60232</b>	<b>BELT KIT - FRONT SEAT SHOULDER STRAP - continued</b>				
67	B(54, 62, 63, 71), F(63, 65), X	Black		C7OZ 6260232-C1A	2
	Consists of				
	1-	Belt assy. -Complete	2- *51754-S13	Screw-pan hd., tapping-No. 6-32 x 3/8"	
	1-C7TZ 8160228-A	Spacer	1- *375950-S100	Screw-pan hd., tapping-No. 6-32 x 3/8"	
	1-C7AZ 6260234-C1A	Boot-black(upper)	1-381512-S36(BB513K)	Bolt-hex. hd., shoulder-3/8"-16 x 1 1/2"	
	1-C7AZ 6260236-A	Retainer	1-381513-S2(MM207AF)	Nut & retainer-3/8"-16	
	1-C7AZ 62612A56-A	Spacer	1-381873-S100(BB701V)	Bolt-hex. hd., shoulder-7/16"-20 x 2"	
67	B(66)	"Before 2/1/67"	Black	C7OZ 6660232-A1A	2
	Consists of				
	1-	Belt assy. -Complete	1-381512-S36(BB513K)	Bolt-hex. hd., shoulder-3/8"-16 x 1 1/2"	
	1-C7AZ 6260228-A	Spacer	1-381513-S2(MM207AF)	Nut & retainer-3/8"-16	
	1-C7AZ 6260234-B1A	Boot-black(upper)	1-381559-S2(XX340AB)	Washer-serrated-1/2"	
	1-C7AZ 62612A56-A	Spacer	1- *381602-S100	Bolt-hex. hd. -7/16"-20 x 1 1/2"	
			1-381873-S100(BB701V)	Bolt-hex. hd., shoulder-7/16"-20 x 2"	
67	B(66)	"From 2/1/67"	Black	C7OZ 6660232-B1A	2
	Consists of				
	1-	Belt assy. -Complete	1-381513-S2(MM207AF)	Nut & retainer-3/8"-16	
	1-C7TZ 8160228-A	Spacer	1-381559-S2(XX340AB)	Washer-serrated-1/2"	
	1-C7AZ 6260234-C1A	Boot-black(upper)	1-381872-S100(BB701U)	Bolt-hex. hd., shoulder-7/16"-20 x 1 1/2"	
	1-C7AZ 62612A56-A	Spacer	1-381873-S100(BB701V)	Bolt-hex. hd., shoulder-7/16"-20 x 2"	
	1-381512-S36(BB513K)	Bolt-hex. hd., shoulder-3/8"-16 x 1 1/2"		Instruction sheet-No. 2566-B	
68	B(66)	Chrome and Plastic buckle-less boot			
		Black		C8OZ 6660232-C1A	2
		Blue		C8OZ 6660232-C1B	2
		Parchment		C8OZ 6660232-C1U	2
69/	B	Refer to Group 611A72-3			
68	F(76)	Chrome and Plastic buckle-less boot			
		Black		C8ZZ 7660232-H1A	2
69/	F	Refer to Group 611A72-3			
67	S	Black		C7SZ 6560232-D1A	2
	Consists of				
	1-	Belt assy. -Complete	1- *356420-S	Washer-flat-7/16"	
	1-C7SZ 6560228-A	Spacer	1-381872-S100(BB701U)	Bolt-hex. hd., shoulder-7/16"-20 x 1 1/2"	
	1-C7AZ 6260234-C1A	Boot-black(upper)	1-381512-S36(BB513K)	Bolt-hex. hd., shoulder-3/8"-16 x 1 1/2"	
	1-C7AZ 6260236-B	Retainer	1-381513-S2(MM207AF)	Nut & retainer-3/8"-16	
	2- *51754-S13	Screw-pan hd. tapping-1- No. 6-32 x 3/8"		Instruction sheet-No. 2566-B	
69/	S	Refer to Group 611A72-3			
68	U	Parchment-front and rear seat		C8OZ 6660232-C1U	2 or 4
69	U	Black-front and rear seat		C9TZ 9660232-A1A	2 or 4
70/	U	Black-front and rear seat		DOBZ 1060232-A	2 or 4
	AT ROOF RAIL OR REAR QUARTER				
68	A(except 76), B(except 76), F, S, X	Nut and retainer-3/8" x 16"		382537-S100 (MM207AH)	2
68	A, B, F, S, X, U(97, 98)	Bolt-hex. hd., shoulder-3/8"-16 x 1 1/2"		382517-S36(BB445LD)	2
68	A(76), B(76), U(97, 98)	Nut-3/8" -16" hex. hd.		383406-S100 (MM173MY)	2
68	B(76)	Washer-flat-5/16"		351360-S(XX112)	2
68	U(97, 98)	Washer-flat-3/8"		382548-S100(XX163)	2
	AT FLOOR PAN				
68	A(full width or split bench seat), B, S, X(full width seat), U(full width or bucket seat)	Bolt-hex. hd., shoulder-7/16"-20 x 2" -7/8" shoulder		382518-S100 (BB701VA)	2
68	A, B, F, S, X, U	Washer-flat-7/16"		382581-S100(XX173E)	2
68	A, B, F, S, X, U	Spacer-1/2" x 1/4"		382582-S100(XX179A)	2 or 4
68	U	Washer-flat-7/16"		354959-S(XX178C)	4



**BODY  
SECTION 600**
**FORD CAR PARTS**

GROUP NUMBER	YEAR	BODY TYPE	DESCRIPTION	PART NUMBER	QTY.
<b>60234</b>	<b>LABEL - SHOULDER STRAP INSTRUCTIONS</b>				
	67/68	F(63-GT 350/500)		S7MS 6360234-A	2
<b>60235</b>	<b>COVER - SHOULDER STRAP REEL - Also refer to Group 20235</b>				
	67	F(63)-GT 350/500	Snap on	S7MS 6360235-A	2
	72	P(54, 62A)	Tan	D2DZ 6560235-A	2
<b>60236-7</b>	<b>RETAINER - FRONT SEAT SHOULDER STRAP</b>				
	67	A(54,57,62,63,71), B(54,62,63,71), F(63, 65), S, X		C7AZ 6260236-B	2
	68	A(except 76), F(63, 65), S, X	R. H. -front seat	C8AZ 6260236-A	1
	68	B(except 76)	R. H. -front seat		1
	68	A(71), B(71), X(71)	R. H. -rear seat		1
	71	L "Before 12/1/70"			1
			L. H.	C8AZ 6260237-A	1
	68/	A, B, F, L, P, S, U, X	Also refer to Group 29024		
	71/	L-w/o sun roof- "From 12/1/70"	Refer to group 60242		
	72	L-w/sun roof		D2FZ 6260236-A	2
<b>60242</b>	<b>SUPPORT - FRONT SEAT SHOULDER STRAP - LOOP</b>				
	72	B		D2OZ 6560242-A	2
	71/	F(63)	Stainless steel wire	D1ZZ 6360242-A	2
	71/	L-w/o sun roof		D1FZ 6260242-A	2
	72	L-w/sun roof	Refer to group 60236-7		
	70	S	Stainless steel wire	D0SZ 6560242-A	2
<b>60246</b>	<b>REINFORCEMENT - SHOULDER STRAP MOUNTING</b>				
	69/71	B(66)		C9OZ 6660246-A	2
	72	B(97)		D2OZ 9760246-A	2
<b>60310</b>	<b>STOP - FRONT SEAT BACK - TO CUSHION</b>				
	65/71	A, B, F, U, X	21/64" x 1" x 1 1/2"	C7MY 6360310-B	2or4
	68/	A, B, F, U	15/64" x 1" x 1 1/2"	C8AZ 6260310-A	2or4
	68/	A, F, U	21/32" x 1" x 3/4"	C8ZZ 6560310-A	2or4
	71	A, B	13/64" I.D. x 1 1/16" O.D. x 1/2" thick	D1GY 6560310-A	4
	68/	A, B, F, U, X	No. 8-32 x 3/4" pan head (stop to cushion to seat back)	51786-S8(U367)	4
<b>603A46-7</b>	<b>HOUSING - FRONT SEAT HORIZONTAL REGULATOR GEAR</b>				
	67/68	A	R.H.-Driver power bucket seat-also serviced in assy. (60471)	C7AZ 62603A46-A	2
	67/68	S			2
	67/69	A	R. H.-Power full width seat		2
	67/68	A	R. H.-Power split seat		4
	67/68	A, S	L. H.-Driver power bucket seat-also serviced in assy. (60472)	C7AZ 62603A47-A	2
	67/69	A	L. H.-Power full width seat		2
	67/68	A	L. H. - Power split seat		4
	70/	A, S	Serviced in assembly-refer to Group 60471-2		
<b>603A48-9</b>	<b>HOUSING - FRONT SEAT VERTICAL REGULATOR GEAR - Refer to Group 60465-6</b>				
<b>60392</b>	<b>BOLT - FRONT SEAT BACK PIVOT ARM</b>				
	68/69	A	Bolt-hex. head shoulder-3/8"-16 x 1/2" - (1 1/4" overall length)	C8AZ 6360392-A	4
	66/67	B			4
	69	S			4
	71/	F, L, P		D1ZZ 6560392-A	4
<b>60394</b>	<b>SPACER - FRONT SEAT BACK PIVOT ARM</b>				
	68/	A, B, P, X	Inboard pivot	C8OZ 6260394-A	2
	65	B(62, 65), X(63C, D, 66G, H)	Rubber-1/2" I. D. x 1" O. D. x 7/16" thick - improvise	★	4
	68	F(63C, D, 65C, D)	Use between center arm rest and inner seat pivot	C8VY 6260394-A	2

# FORD CAR PARTS

**BODY  
SECTION 600**

7

GROUP NUMBER	YEAR	BODY TYPE	DESCRIPTION	PART NUMBER	QTY.	
<b>60394 SPACER - FRONT SEAT BACK PIVOT ARM - continued</b>						
	68	A(57F, 65A)	Use with split seat-inboard pivot	C8MZ 5460394-A	2	
	68	B(63B, D, 65A, B, C, D, 66A, B, 76B, D), X(62E)	Outboard pivot arm		2	
	69	A(63C, 76B), B(63B, F, 65, 66A, B, C, 76D), X(62A, B)			2	
	69	A	Used with reclining seat		1	
	70	A	With automatic seat back latch		2	
	70	A(63, 65C, 76)	Use with bucket seat		1	
	70	B(63, 65, 66, 76)	Use with manual bucket seat		2	
	71/	A(65)	Used with automatic seat back latch-non/reclining		1	
<b>60406-7 GEAR - FRONT SEAT VERTICAL REGULATOR</b>						
	67/	A, S	Serviced only in assembly-refer to group 60465-6			
<b>60422 SUPPORT - FRONT SEAT TRACK TO FLOOR</b>						
	67	A	Power split seat	C7AZ 6260422-A	2or4	
	67/68	A	Power full width seat	C7AZ 6260422-A	2	
	67/68	A	Driver power bucket seat	C7AZ 6360422-A	2	
	69/	A	Power full width seat	C9AZ 6260422-A	2	
	71/	A	Power-split seat		2	
	67/	S	Power seat		2	
<b>604K22 BAR - FRONT SEAT TORSION</b>						
	72	P	R.H. - with reclining seat	DORY 62604K22-A	2	
			L.H.	DORY 62604K36-A	2	
<b>60436 BRACKET - FRONT SEAT HORIZONTAL REGULATOR</b>						
	67/71	A	Driver power bucket seat	C7AZ 6260436-A	2	
	67/71	S	Power full width and driver bucket		2	
	67/71	A	Power split seat		4	
	67/71	A	Power full width seat		2	
<b>604K36 BAR - FRONT SEAT TORSION - Refer to group 604K22</b>						
<b>60465-6 GEAR ASSY. - FRONT SEAT VERTICAL REGULATOR</b>						
	67/68	A-split seat	R. H. -rear-Passenger	C7AZ 6260466-A	1	
			L. H. -front	C7AZ 6260466-B	1	
	67/70	A-bucket seat	R. H. -rear-Driver	C7AZ 6360466-A	1	
			L. H. -front		1	
	67/70	A-split seat	R. H. -rear-Driver	C7AZ 6260466-A	1	
			L. H. -front	C7AZ 6260466-B	1	
	67/70	A-full width seat	R. H. -rear	C7AZ 6260465-A	1	
			L. H. -rear	C7AZ 6260466-A	1	
			R. H. -front	C7AZ 6260465-B	1	
			L. H. -front	C7AZ 6260466-B	1	
	71/	A-split seat or bucket seat	R.H.-Driver or Passenger	D0SZ 6560465-B	1or2	
			L.H.	D0VY 6560465-B	1or2	
	71/	A-full width seat	R.H.-front	D0SZ 6560465-B	1	
			R.H.-rear	D0VY 6560466-B	1	
			L.H.-front	D0SZ 6560466-B	1	
			L.H.-rear	D0VY 6560465-B	1	
	68/69	S-full width seat	R. H. -front	C8SZ 6560465-A	1	
			L. H. -rear		1	
			R. H. -rear	D0SZ 6560466-B	1	
			L. H. -front		1	
	69	S-bucket seat	R. H. -Driver	C8SZ 6560465-A	1	
			L.H.	D0SZ 6560466-B	1	
	70	S-split seat	R.H.-rear-Driver or Passenger	D0SZ 6560466-B	2	
			L.H.-front	D0SZ 6560465-B	2	
	70/71	S-bucket seats	R.H.-rear-Driver or Passenger	D0SZ 6560466-B	2	
			L.H.-front	D0SZ 6560465-B	2	
	70/71	S-full width seat	R.H.-front	D0SZ 6560465-B	1	
			L.H.-front	D0SZ 6560466-B	1	
			R.H.-rear	D0SZ 6560466-B	1	
			L.H.-rear	D0SZ 6560465-B	1	
	71	S-split seat	R.H.-Driver or Passenger	D0SZ 6560465-B	2	
			L.H.	D0SZ 6560466-B	2	
	67	S-bucket seats	R.H. & L.H.-Driver	C7AZ 6360466-A	1	

May, 1975

COPYRIGHT © 1975 —

FORD MOTOR  
COMPANY

— DEARBORN, MICHIGAN

**FINAL ISSUE**

GROUP NUMBER	YEAR	BODY TYPE	DESCRIPTION	PART NUMBER	QTY.
<b>60471-2</b>	<b>GEAR ASSY. - FRONT SEAT HORIZONTAL REGULATOR</b>				
	67/	A	R.H.	D0VY 6560471-A	1or2
			L.H.	D0VY 6560472-A	1or2
			Bolt-hex. head-3/8"-16 x 3"	45534-S8(B95)	4or8
	67/71	S	R.H.	D0VY 6560471-A	1or2
			L.H.	D0VY 6560472-A	1or2
			Bolt-hex. head-3/8"-16 x 3"	45534-S8(B95)	4or8
	72	S	"Before 7/3/72"	D2LZ 6560472-A	1or2
	72	S	"From 7/3/72"	D3LZ 6560472-A	1
<b>60480</b>	<b>SHAFT - FRONT SEAT ADJUSTING REGULATOR</b>				
	69/71	B	Power full width seat	C6GY 6260480-A	2
<b>60508</b>	<b>PANEL ASSY. - REAR SEAT BACK - Paint to Match</b>				
	<b>- A -</b>				
	69/72	A(71)	"Before 12/1/71"	D0AZ 7160508-A	1
	72	A(71)	"From 12/1/71"	D2AZ 7160508-A	1
	<b>- B -</b>				
	66	B(71)	"Before 1/3/66"	C6OZ 7160508-A	1
	66/67	B(71)	"From 1/3/66"	C9OZ 7160508-B	1
	68/69	B(71)	"Before 6/2/69"	C8OZ 7160508-A	1
	69/71	B(71)	"From 6/2/69"	C9OZ 7160508-A	1
	72	B(71)	"Before 12/1/71"	D2OZ 7160508-A	1
	72	B(71)	"From 12/1/71"	D2OZ 7160508-B	1
	<b>- L -</b>				
	72	L(73)		D2FZ 7360508-B	1
	<b>- X -</b>				
	68/69	X(71)	19" high	C8DZ 7160508-A	1
	66/70	X(71)	22" high-not replaced (5-75)	★C9DZ 7160508-A	1
<b>605A10-1</b>	<b>PANEL ASSY. - AUXILIARY SEAT BACK FLOOR - Paint to Match</b>				
	66/67	A(71A, C)	R.H. -not replaced (3-74)	★C5AZ 71605A10-G	1
			L.H.	C5AZ 71605A11-G	1
	69/	A(71)	Refer to Group 11698-9		
<b>605A12</b>	<b>SUPPORT - REAR SEAT BACK FLOOR - CENTER</b>				
	71/	L(62, 64)		D1FZ 62605A12-A	1
<b>605A16-7</b>	<b>COVER - AUXILIARY SEAT BACK LATCH - Paint to Match</b>				
	68/	A(71)	R.H.	C8AZ 71605A16-A	1
			L.H.	C8AZ 71605A17-A	1
	68/	B(71)	R.H.	C8OZ 71605A16-A	1
			L.H.	C8OZ 71605A17-A	1
<b>605A18</b>	<b>BUMPER - AUXILIARY SEAT BACK FLOOR PANEL</b>				
	65/67	A(71B, D, E)	Rubber	C5AZ 71605A18-A	2
	68	A(71B, D, E, H)			2
	65/67	A(71A, C)	Rubber	C5AZ 71605A18-B	2
	68	A(71A, C, J)			2
	69/	A(71)	Also used on stowage compartment	C9AZ 71605A18-A	2
	66/71	B(71)		C6OZ 71605A18-A	2
	72	B(71)		D2OZ 71605A18-A	2
<b>605A40</b>	<b>PLATE - REAR SEAT FRONT ANCHOR</b>				
	65	X(59, 71)		C5DZ 59605A40-A	2
<b>605A44</b>	<b>PLATE - REAR SEAT REAR ANCHOR</b>				
	66/71	B(71), X(71)		C6OZ 71605A44-A	2
<b>605A50-1</b>	<b>SUPPORT - REAR SEAT BACK FLOOR - Paint to Match</b>				
	66/71	B(71), X(71)	R.H.	C6OZ 71605A50-A	1
			L.H.	C6OZ 71605A51-A	1



# FORD CAR PARTS

**BODY  
SECTION 600**

9

GROUP NUMBER	YEAR	BODY TYPE	DESCRIPTION	PART NUMBER	QTY.
<b>60575 CATCH - REAR SEAT BACK</b>					
	66/70	F(63)	With folding rear seat	C6ZZ 6360575-A	2
			Screw-pan head, cross recess-No.10-24 x 1/2"	★54505-S13	2
			Screw-pan head, cross recess-No.10-24 x 1 1/2"	★54511-S13	2
	71/	F(63)	With folding rear seat	D1ZZ 6360575-A	2
<b>60578 BUMPER - REAR SEAT CUSHION PANEL</b>					
	65	X(59, 71)		B7A 5960578-A	2
			Screw & washer assy. -pan head, cross recess- No.12-24 x 3/8"	★50805-S8	2or4
<b>60596-7 STOP - REAR SEAT BACK FLOOR - Refer to Group 115A73</b>					
<b>60615-6 HINGE - REAR SEAT BACK FLOOR PANEL - Paint to Match</b>					
	65/67	A(54)	Used with folding rear seat	C5AZ 7160615-A	1
	65/	A(71)			
	72	B(71)		D2OZ 7160615-A	1
	65/70	F(63)	R. H.	C5ZZ 6360615-B	1
			L. H.	C5ZZ 6360616-B	1
	71/	F(63)	R.H.-with folding rear seat	D1ZZ 6360615-A	1
			L.H.	D1ZZ 6360616-A	1
	71/	L (62, 64)	With folding rear seat-refer to Group 45728		
	72	L(73)	Refer to Group 60508		
<b>606A42 BRACKET - REAR SEAT CUSHION TORSION BAR OUTER TO FLOOR</b>					
	65	B(71)		C2AB 71606A42-A	2
			Screw-hex., washer head-5/16"-24 x 1 1/4"	★359950-S8	8
<b>60650 RISER - REAR SEAT - FRONT</b>					
	65/	A(63, 76), B(63, 65), X(63, 76)	Improvise from sheet metal	★	
	68/71	S		C8SZ 6560650-A	1
	72	S	Improvise from sheet metal	★	
<b>606A54 COVER - REAR SEAT ACCESS HOLE</b>					
	68/71	S		C8SZ 65606A54-A	1
<b>60675 HINGE - REAR SEAT BACK FLOOR EXTENSION</b>					
	65/68	A(71)		C5AZ 7160675-A	1
			Screw-hex. head-No. 8-18 x 3/8"	42I19-S8(U246)	8
	69/	A(71)		C9AZ 7160675-A	1
	72	B(71)			1
<b>606A78 BRACKET - AUXILIARY SEAT CUSHION FLOOR PIVOT</b>					
	65	A(71A, C)		C5AZ 71606A78-A	2
			Screw & washer-hex. head-5/16"-18 x 5/8"	★55605-S2	8
<b>60700 PANEL - REAR SEAT BACK SPRING SUPPORT</b>					
	65	S(63)		C4SZ 6360700-C	1
<b>607A00 RETAINER - REAR SEAT BACK FLOOR CENTER SUPPORT</b>					
	71/	L		D1FZ 62607A00-A	1
<b>607A04-5 BRACKET - AUXILIARY SEAT BACK FLOOR PIVOT - Paint to Match</b>					
	66/68	B(71)	R.H.-Palomino	C6OZ 71607A04-A	1
			L.H. -not replaced (3-74)	★C6OZ 71607A05-A	1
<b>607A26 PANEL - AUXILIARY SEAT BACK - Refer to groups 11550 and 60534</b>					

GROUP NUMBER	YEAR	BODY TYPE	DESCRIPTION	PART NUMBER	QTY.
<b>607A48 RETAINER - AUXILIARY SEAT CUSHION FRAME - OUTER</b>					
	65/68	A(71A,C,J)		C5AZ 71607A48-A	2
			Screw & washer-hex, head-5/16"-18 x 5/8"	359662-S7-8(BB575A)	4
	69/	A(71)		C9AZ 71607A48-A	2
<b>607A60 BASE - AUXILIARY SEAT CUSHION</b>					
	66/71	B(71)		C8OZ 71607A60-A	1
	72	B(71)		D2OZ 71607A60-A	1
<b>60762 SHIELD - FRONT SEAT BACK</b>					
	65/66	S	Textured steel - not used with reclining seat	C4SZ 6360762-A	2
	65	A(63C, 76B)			2
	66	A(63C, D, 76B, D)			2
	67	A(63C, 76B)	Textured steel-paint to match-includes attaching parts	C7AZ 6560762-A	2
	65/66	S	Textured steel-used with reclining seat	C4SZ 6360762-B	1
	65	A(63C, 76B)			1
	66	A(63C, D, 76B, D)			1
	67	S	Textured steel-Parchment-paint to match	C7SZ 6560762-A	2
	67/68	S	Refer to Soft Trim Section		
<b>607A62 SUPPORT - AUXILIARY SEAT CUSHION</b>					
	66/	B(71)		C6OZ 71607A62-A	2
			Screw & washer-hex, head-5/16"-18 x 5/8"	*55605-S2	4
<b>607A64 REINFORCEMENT - AUXILIARY SEAT CUSHION SUPPORT</b>					
	66/	B(71)		C6OZ 71607A64-A	2
			Washer-spring-7/16"	356383-S7(XX362)	2
<b>60774 BRACKET - AUXILIARY SEAT SUPPORT TO REAR FLOOR</b>					
	65/68	B(71)		C5OZ 7160774-A	2
<b>60780-1 PLATE - AUXILIARY SEAT BACK FLOOR PIVOT</b>					
	68/	B(71)	R. H.	C8OZ 7160780-A	1
			L. H.	C8OZ 7160781-A	1
<b>60786 BRACKET - AUXILIARY SEAT CUSHION FLOOR SUPPORT</b>					
	69/	A(71)	Paint to match	C9AZ 7160786-A	2
<b>607A86 HINGE - REAR SEAT BACK FLOOR SUPPORT ANCHOR - Refer to group 605A12</b>					
<b>60925 COVER SET - CARGO FLOOR COMPLETE - Refer to Group 11488 in Soft Trim Section</b>					
<b>60928 HINGE - AUXILIARY SEAT BACK FLOOR</b>					
	65/68	A(71B,D,E,H)		C5AZ 7160928-A	1
	65/	B(71)	Serviced in assy. -refer to Group 60940		
<b>60940 PANEL - AUXILIARY SEAT BACK FLOOR - FRONT - Paint to Match</b>					
	65/68	A(71B,D,E,H)	Remove seat cushion spring retainer	C8MY 7160940-A	1
	68/71	B(71)		C8OZ 7160940-A	1
	72	B(71)		D2OZ 7160940-A	1
<b>60942 PANEL - AUXILIARY SEAT BACK FLOOR - REAR</b>					
	68/71	B(71)		C8OZ 7160942-A	1
	72	B(71)		D2OZ 7160942-A	1

# FORD CAR PARTS

## BODY SECTION 610

GROUP NUMBER	YEAR	BODY TYPE	DESCRIPTION	PART NUMBER	QTY.
<b>610A02 ACTUATOR ASSY. - FRONT SEAT BACK ADJUSTING</b>					
	69/70	A		C9AZ 62610A02-A	1
	71	A		D1AZ 65610A02-E	1
	72	A		D2AZ 65610A02-A	1
	65/66	S		C4SZ 63610A02-B	1
	65	A(63C, 76B)			1
	66	A(63C, D, 76B, D)			1
			Pin-roll-1/4" x 1 1/2"	352506-S(NN115)	1
			Pin-roll-1/4" x 1"	305080-S(NN113)	1
			Pin-clevis-1/4" x 1"	352547-S(NN6)	1
			Nut-spring-1/4"	*356728-S	1
	67	S	Includes solenoid	C7VY 53610A02-A	1
			Pin - spring - 1/4" x 3/4"	*67769-S2	3
			Pin - clevis - 1/4" x 1 1/16"	*73910-S13	1
			Pin - self locking	358883-S7-8(NN128)	1
	68/69	S		C8SZ 65610A02-B	1
	70	S	"Before 1/7/70"	R/b D0SZ 65610A02-B (1-73)	
	70/71	S	"From 1/7/70"	*D0SZ 65610A02-A	1
	72	S-split seat		D0SZ 65610A02-B	1
	72	S-bucket seat		D2LZ 65610A02-A	1
				D2SZ 65610A02-A	1
<b>610B10-1 BRACKET - FRONT SEAT HEAD REST MOUNTING</b>					
	68	A -full width seat	R. H.	C8AZ 62610B10-B	2
			L. H.	C8AZ 62610B11-B	2
	69/70/71	A		C9AZ 62610B10-A	2
	72	B, P-full width seat			2
		P-full width seat			2
	68	B, X -full width seat	R. H.	C8OZ 54610B10-B	2
			L. H.	C8OZ 54610B11-B	2
	69	B, X		C9OZ 63610B10-A	2
	68	F, S, U	R. H.	C8ZZ 65610B10-B	2
			L. H.	C8ZZ 65610B11-B	2
	69/71	F, S		C9ZZ 65610B10-A	2
	70/71	B-bucket seat			2
	72	L, S		C9AZ 62610B10-A	2
	69/70/71	A, B, F, P, S, U, X	Screw 1/4" -20 x 3/4" -hex. head tapping	383184-S2(UU52AD)	8
<b>610A14 SPRING - FRONT SEAT BACK ADJUSTING HANDLE</b>					
	69	A	Use with split seat or reclining seat	C9AZ 62610A14-A	1
<b>610A16 SLEEVE - FRONT SEAT HEAD REST GUIDE ROD</b>					
	68	A, B, F, S	3 13/32" Long	C8AZ 63610A16-A	2or4
	68	A, B, X	2 3/4" Long	C8AZ 62610A16-A	2or4
	69	A, B, F	Chrome	C9MZ 65610A16-A	2
	69/70/71	S			2
	69/71	A, B, F, X	Paint to match	C9AZ 62610A16-A	2
	70/71	P			2
	72	A			2
	68	S	4" Long	C8MZ 54610A16-A	4
<b>610B22 STEM - FRONT SEAT BACK ADJUSTING</b>					
	69/71	A		C9AZ 62610B22-A	1
	72	A		D2AZ 65610B22-A	1
	70/71	S		D0SZ 65610B22-B	1
	72	P(54, 62A)		D0RY 62610B22-A	1
<b>61040-1 MOULDING - REAR SEAT BACK UPPER - INCLUDES ATTACHING PARTS</b>					
	69/70/71	A(76)	Refer to Group 61138-9		

GROUP NUMBER	YEAR	BODY TYPE	DESCRIPTION	PART NUMBER	QTY.
<b>610B40</b>	<b>PANEL - FRONT SEAT HEAD REST TRIM - Paint to match</b>				
	69	A, B, F, S, X	Used on 11" head rest	C9OZ 63610B40-A	2
	70	B(63, 65C, F, H, 66C, 76), F, S			2
	69/ 70/71	A, B, X P	Used on 13" head rest	C9AZ 62610B40-A	2
	71	S			2
<b>61046-7</b>	<b>REINFORCEMENT - FRONT SEAT BACK FRAME</b>				
	72	B(53)	R.H.	D2OZ 5361046-A	1
			L.H.	D2OZ 5361047-A	1
<b>610A60</b>	<b>PAD - FRONT SEAT BACK HEAD REST</b>				
	67	S- w/vinyl trims	Used with reclining seat	C7SZ 65610A60-A	1
<b>610B62</b>	<b>DAMPER - FRONT SEAT BACK LATCH VIBRATION</b>				
	68	A(62, 63, 65, 76), B(63, 65, 66B, 76) S(65), X(62)	1 3/4" long	C8AZ 62610B62-A	2
	69	A(62, 63, 65, 76), S(65), X(62)			
	69	B(62, 63, 65, 66, 76)			2
<b>61064</b>	<b>STOP - FRONT SEAT BACK - Also Refer to Group 60310</b>				
	<b>- A -</b>				
	65	A(63C, 76B)	Driver side-bolt hex. hd. ,pointed-5/16"- 18 x 1 5/8"	379390-S13(BB140C)	2
	66	A(63C, D, 76B, D)			2
			Passenger side-2 1/4" long w/pointed head	C9TZ 8161064-A	2
			Passenger side-2 1/8" long w/flat head- used with reclining seat	C5SZ 6361064-A	2
			Nut-hex. -5/16" x 18	33922-S8(M27)	2
			Washer-flat-5/16"	44722-S8(X19)	2
	65/68A	full width seat	Refer to Group 60310		
	67	A(63C, 76B)		C9TZ 8161064-A	2
	68	A(63C, 76B)	Shoulder bolt type	C8AZ 6261064-A	4
	<b>- B -</b>				
	66	B(63C, D, 76C, D)		C9TZ 8161064-A	2
	67	B(63C, D, 66D, 76C, D)			2
	66/69B	full width seat	Refer to Group 60310		
	68	B(63D, E, 65D, E, 66D, 76E)	Shoulder bolt type	C8AZ 6261064-A	4
	69	B(63D, E, 65D, E, 66B, D, 76D, E)			4
	68/69	B	Screw-No. 10-12 x 1/2" -pan head	52727-S8(U382)	2
	<b>- F -</b>				
	69	F	Bolt type-5/16"-18 x 1 3/4"	★	
	<b>- S -</b>				
	65/66	S	Driver side-bolt hex.hd.pointed-5/16"-18 x 1 5/8"	379390-S13(BB140C)	2
			Passenger side-2 1/4" long w/pointed head	C9TZ 8161064-A	2
			Passenger side-2 1/8" long w/flat head-used with reclining seat	C5SZ 6361064-A	2
			Nut-hex. 5/16" x 18	33922-S8(M27)	2
			Washer-flat-5/16"	44722-S8(X19)	2
	67	S		C5AZ 6361064-A	2
	<b>- U -</b>				
	69	U	Bolt type-5/16"-18 x 1 3/4"	★	
	<b>- X -</b>				
	65	X(76B, 76D)		C9TZ 8161064-A	2
	66/67	X(62C, 66D)			
			Nut-hex. -5/16"-18	33922-S8(M27)	2
			Washer-flat-5/16"	44722-S8(X19)	2
	66	X(62A, B, 66A, B)	On cushion -Repl. by C7MY 6360310-B	★C5AZ 6261064-A	2
	67	X(62A, B)	Full width seat		2
	69	X(62)			2or4
	68/70	X(62C)	Shoulder bolt type	C8AZ 6261064-A	4
	68/70	X	Screw-pan head-No.10-12 x 1/2"	52720-S8(U380)	2
<b>610B64</b>	<b>SPACER - FRONT SEAT HEAD REST GUIDE ROD SLEEVE</b>				
	68	A, B, X		C8AZ 62610B64-A	4

# FORD CAR PARTS

## BODY SECTION 610

3

GROUP NUMBER	YEAR	BODY TYPE	DESCRIPTION	PART NUMBER	QTY.
<b>61066 BRACKET - FRONT SEAT BACK HINGE</b>					
	70	A, B		D0AZ 6561066-A	1
	70	F			1
<b>61066 RETAINER - FRONT SEAT BACK LATCH SPRING</b>					
	71	F	Used w/automatic seat latch-center mounted	D1ZZ 65610B66-C	2
	71	P-bucket seat- "Before 6/15/71"	Used with center mounted seat latch		2
	71	F	Used w/o automatic seat latch-center mounted	D1ZZ 65610B66-D	2
	71	L "Before 5/3/71"			2
	71/	L "From 5/3/71"		D3ZZ 62610B66-A	2
	71/	P-bucket seat- "From 6/15/71"	Used with outboard mounted seat latch		2
	72	F	Without automatic seat latch		2
	71/	F	Used with outboard mounted seat latch with automatic seat latch	D1ZZ 65610B66-E	2
	72	B, S		D2OZ 65610B66-A	2
<b>610A68-9 SHIELD - FRONT SEAT BACK INSIDE</b>					
	69/71	A	R. H. -use on split seat L. H.	C9MZ 65610A68-A C9MZ 65610A69-A	1 1
	69	A(65A)	R. H. -use on full width seat with center arm rest	C9AZ 65610A68-A	1
	70	A(54, 57)	R. H. -use with reclining bench seat		1
	70	A(65)	R. H. -use with bench seat or reclining bench		1
	69	A(65A)	L. H. -use on full width seat with center arm rest	C9AZ 65610A69-A	1
	69	A(54C, 57F, 65A)	L. H. -used with reclining seat		1
	70/	A(54, 57, 65)	L. H. -use with reclining bench seat		1
	70/	A(65)	L. H. -use with bench seat		1
<b>610B68 SHAFT - FRONT SEAT BACK PIVOT</b>					
	72	S-bucket seat		D2LZ 65610B68-A	1
	72	S-split bench seat		D2SZ 65610B68-B	1
<b>610B70 LEVER - FRONT SEAT BACK PIVOT SHAFT</b>					
	69/71	A	Use with reclining seat	D0AZ 62610B70-A	1
<b>61082 BUMPER - REAR SEAT BACK STOP</b>					
	69/	A(71)	Rubber	C9AZ 7161082-A	1
	66/	B(71)	Rubber-also serviced in assembly (group 62426)	C6OZ 7161082-B	1
	67/68	A(71)			1
<b>610B82 BUSHING - FRONT SEAT BACK PIVOT SHAFT</b>					
	71/	A	Used with reclining seat	D1AZ 65610B82-A	1
	72	A(53K, 57K, 65K)	Hi Back seat-inner	D2AZ 65610B82-A	1
			-outer	D2AZ 65610B82-B	1
<b>610A84 CABLE - FRONT SEAT BACK ADJUSTING ACTUATOR - INCLUDES ATTACHING PARTS</b>					
	65/66	S	Used with reclining seat	C4SZ 63610A84-C	1
	65	A(63C, 76B)			1
	66	A(63C, D, 76B, D)			1
<b>610B84 ROD - FRONT SEAT BACK ADJUSTING ACTUATOR</b>					
	69/	A		C9AZ 62610B84-A	1
	70	S	2 9/32" long-use with reclining seat	D0SZ 65610B84-A	1
	71	S		D1SZ 65610B84-A	1
	72	S-bucket seat		D2SZ 65610B84-A	1
	72	S-split bench seat- "Before 11/1/71"		D2LY 65610B84-A	1
	72	S-split bench seat- "From 11/1/71"		D2LY 65610B84-B	1

GROUP NUMBER	YEAR	BODY TYPE	DESCRIPTION	PART NUMBER		QTY.
				RIGHT HAND	LEFT HAND	
<b>610A88-9 RETRACTOR ASSY. - FRONT SEAT BELT - Includes Outboard Belt and Attaching Parts</b>						
65	S		Used on vehicles with seat belt warning lamp switch in console			1
			Black	C4SZ 63610A88-AAG	C4SZ 63610A88-AAG	2
65	S		Used on vehicles with seat belt warning lamp switch in retractor			
			Beige	⊕	C5SZ 63610A89-CAJ	1
			Black	C5SZ 63610A88-CAB	C5SZ 63610A89-CAB	1
			Blue	⊕	C5SZ 63610A89-CAC	1
			Burgundy	⊕	⊕	1
			Emberglo	C5SZ 63610A88-BBA	⊕	1
			Ivy Gold	C5SZ 63610A88-BAG	⊕	1
65	S		Used on vehicles with seat belt warning lamp switch in retractor			
			Palomino	C5SZ 63610A88-BAF	⊕	1
			Red	⊕	⊕	1
			Silver Mink	⊕	⊕	1
			Turquoise	⊕	⊕	1
70/	F(76)			D0ZZ 76610A88-A	D0ZZ 76610A88-A	2
<b>GROUP NUMBER YEAR BODY TYPE DESCRIPTION PART NUMBER QTY.</b>						
<b>610B90 LEVER - FRONT SEAT BACK PIVOT SHAFT</b>						
72	S			D2SZ 65610B90-A		1
<b>61097-8 SPRING - FRONT SEAT BACK LATCH</b>						
68	A, B, X		Used with full width seat	C8AZ 6261097-A		2
69	A		Used with full width seat with recliner			2
70/	A		Used with full width or split seat	D0AZ 6261097-A		2
70	X(62)					2
70/71	A		R. H.-Use with bucket seats-use on pawl-free length 1/2"-8 1/2 coils with 2 tangs	D0ZZ 6561097-C		1
			L. H.	D0ZZ 6561097-D		1
70/71	B(63, 65, 66, 76)		Use with split bench-free length 1 1/4"-10 3/4 coils	D0AZ 6261097-A		4
70/71	B(63, 65, 66, 76)		R. H. -use on pawl-bucket seat-free length 1/2" - 8 1/2 coils with 2 tangs	D0ZZ 6561097-C		1
			L. H.	D0ZZ 6561097-D		1
72	B(63, 65, 97)		R.H.	D2OZ 6561097-A		1
			L.H.	D2OZ 6561097-B		1
68/69	F, U(96, 98)		R. H. -full width or bucket seat	C8ZZ 6561097-A		1
69	A(63B, 65C, 76A)		R. H. -used with bucket seat			2
			L. H.	C8ZZ 6561097-B		1
70	F		R. H. -use with bucket seat-free length 1/2"- 8 1/2 coils	D0ZZ 6561097-C		1
			L. H. -free length 1/2"-8 1/2 coils	D0ZZ 6561097-D		1
70	F		Bucket seat-free length 1 1/4"-10 3/4 coils	D0AZ 6261097-A		2
71/	F			D1ZZ 6561097-A		2
71/	L			D1ZZ 6561097-A		2
70/	P		R. H. - w/full width seat	D0DZ 6261097-A		1
			L. H.	D0DZ 6261098-A		1
71/	P		W/bucket seats	D1ZZ 6561097-A		2
70/	U		Full width seat	D0BZ 9661097-A		1

⊕ Use black

GROUP NUMBER	YEAR	BODY TYPE	DESCRIPTION	PART NUMBER	QTY.
<b>61097-8 SPRING - FRONT SEAT BACK LATCH - continued</b>					
	68/69	S	Used with reclining seat-pivot	C8SZ 6561097-B	2
	68/69	S	Used with full width or bucket seat-seat back latch	C8SZ 6561097-A	2
	70/71	S(65)	Free length-1 1/4"-10 3/4 coils Also use as an assist spring for front seat back adjust lever	DOAZ 6261097-A	4 2
	72	S	R.H.	D2OZ 6561097-A	1
			L.H. -also used with reclining seat	D2OZ 6561097-B	1
	70/	U	Use w/bkt. seats-free length-1 1/4"-10 3/4 coils	DOAZ 6261097-A	1
	70/	U	R. H. -use with bucket seat at pawl-free length 1/2"-8 1/2 coils with 2 tangs	DOZZ 6561097-C	1
			L. H.	DOZZ 6561097-D	1
	70/	U	Full width seat	DOBZ 9661097-A	1
<b>61097-8 SPRING - REAR SEAT BACK LATCH HANDLE</b>					
	68/	A(71), B(71)		C8AZ 7161097-A	2
	65	A(71), B(71)	R. H.	C2AZ 7161097-A	1
	65/67	A(54)	Use with folding rear seat		1
	66	A(71)			1
	66/70	X(71)			2
			L. H.	C2AZ 7161098-A	1
			Pin-roll-1/8" x 7/8"	352146-S (NN99)	2

**611C02 ORNAMENT - SEAT BELT BUCKLE**

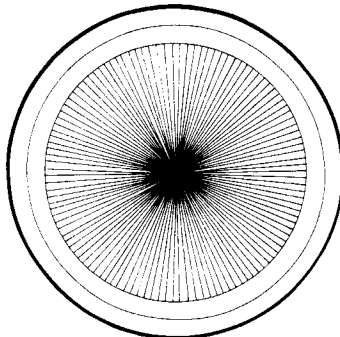

TYPE 1

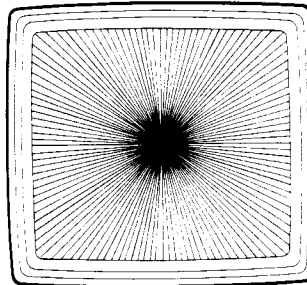

TYPE 2



TYPE 3

P-10769

	72	A, B, F, L, P, S	Type 1	D2AZ 65611C02-A	6
			Type 2	D2AZ 65611C02-B	6
			Type 3	D2AZ 65611C02-C	6
<b>611B12 BRACKET - FRONT SEAT HEAD REST MOUNTING - REAR</b>					
	69	A	"Before 1/1/69" Full width or split seat	C9AZ 62611B12-B	2
	69	B, X	"Before 1/1/69" Full width seat	C9MZ 65611B12-A	2
	69/	A	"From 1/1/69" Full width, split or bucket seat	C9AZ 62611B12-A	2
	69	B, X	"From 1/1/69" Full width seat		2
	69/71	B, X	Bucket seat	C9OZ 65611B12-B	2
	70/71	A(54C, 57F, 65A)			2
	69	F, S	"Before 1/1/69" Bucket seat	C9AZ 62611B12-A	2
	69/70	F, S	"From 1/1/69" Bucket seat	C9OZ 63611B12-A	2
	72	L		C9AZ 62611B12-A	2
	70/	P	Full width seat	C9AZ 62611B12-A	2

GROUP NUMBER	YEAR	BODY TYPE	DESCRIPTION	PART NUMBER	QTY.
<b>61118</b>	<b>SUPPORT - REAR SEAT TO FLOOR</b>				
	68/71	B(63)		C8OZ 6361118-A	2
<b>611C22</b>	<b>EXTENSION ASSY. - SEAT BELT</b>				
	72	L	Use with 19E535 Tot Guard Kit-rear seat only	†D3FZ 62611C22-B	1
			Use with 19E535 Tot Guard Kit-rear seat only	▲D3FZ 62611C22-A	1
<b>611B24</b>	<b>PIN - FRONT SEAT BACK PIVOT</b>				
	72	B(63, 65, 97)		D2OZ 65611B24-A	2
	72	S	"From 10/15/71"		2
	72	S	"Before 10/15/71"	D2SZ 65611B24-A	2
<b>611B32</b>	<b>PLUG - SEAT BELT RETRACTOR COVER BOLT ACCESS</b>				
	70/71	A, B, F, L, P, S, X	Use to plug hole in retractor		
			Aqua	D0AZ 62611B32-C	2
			Black	D0AZ 62611B32-A	2
			Blue (dark)	D0AZ 62611B32-J	2
			Blue (medium)	D0AZ 62611B32-H	2
			Ginger	D0AZ 62611B32-B	2
			Gray-1970	D0AZ 62611B32-F	2
			Gray (gold)-1971	D1AZ 62611B32-B	2
			Green (dark)-1970	D0AZ 62611B32-L	2
			Green (dark)-1971	D1AZ 62611B32-A	2
			Green (medium)	D0AZ 62611B32-K	2
			Nugget	D0AZ 62611B32-D	2
			Red	D0AZ 62611B32-G	2
			Tobacco	D0AZ 62611B32-E	2
	72	A, B, S	<b>SQUARE</b>		
			Black	D2SZ 65611B32-E	2
			Blue ●	D2SY 65611B32-G	2
			Blue \$	D2SZ 65611B32-C	2
			Gray Gold	D2SY 65611B32-B	2
			Green ●	D2SZ 65611B32-F	2
			Green \$	D2SZ 65611B32-A	2
			Red	D2SZ 65611B32-B	2
			Tobacco	D2SZ 65611B32-D	2
			<b>ROUND</b>		
			Black	D0AZ 62611B32-A	2
			Blue	D0AZ 62611B32-H	2
			Gray Gold	D1AZ 62611B32-B	2
			Green	D2AZ 62611B32-B	2
			Red	D0AZ 62611B32-G	2
			Tobacco	D2AZ 62611B32-A	2
	72	F, L, P	<b>SQUARE</b>		
			Avocado	D2FZ 62611B32-C	2
			Beige	D2ZZ 65611B32-G	2
			Black	D2ZZ 65611B32-D	2
			Blue	D2ZZ 65611B32-A	2
			Ginger	D2ZZ 65611B32-F	2
			Green	D2ZZ 65611B32-E	2
			Orange	D2FZ 62611B32-D	2
			<b>ROUND</b>		
			Beige	D2DZ 62611B32-B	2
			Black	D0AZ 62611B32-A	2
			Blue	D0AZ 62611B32-H	2
			Ginger	D0AZ 62611B32-B	2
			Gray Gold	D1AZ 62611B32-B	2
			Green	D1AZ 62611B32-A	2
			Vermilion	D2DZ 62611B32-A	2

● - Exc. Thunderbird

\$ - Thunderbird

† - Standard

▲ - Deluxe



# FORD CAR PARTS

**BODY  
SECTION 610**

GROUP NUMBER	YEAR	BODY TYPE	DESCRIPTION	PART NUMBER	QTY.
<b>611B32 PLUG - SEAT BELT RETRACTOR COVER BOLT ACCESS - continued</b>					
	72	L	Avocado-round	D2FZ 62611B32-A	2
			Orange-round	D2FZ 62611B32-B	2
			Avocado-round	D3AZ 65611B32-E	2
			Orange-round	D3AZ 65611B32-D	2
	72	P(54,62A)	Tan	D2DZ 62611B32-C	2
<b>61138 MOULDING - REAR SEAT BACK TOP - INCLUDES ATTACHING PARTS</b>					
	69/	A(76)		C9AZ 7661138-A	1
	69/	A(76)	Screw-No. 8-18 x 1/2" self tap	381969-S2(UU89A)	9
<b>61140 COVER - FRONT SEAT BELT ANCHOR BOLT (BOOT)</b>					
	69	S	Black-use with center belt	D0MY 6261140-A	2
			Blue	D0MY 6261140-J	2
			Nugget Gold	D0MY 6261140-D	2
	70/72	A,S "Before 4/3/72"	Black-at tunnel	D0MY 6261140-A	2
			Blue	D0MY 6261140-J	2
			Ginger	D0MY 6261140-E	2
			Green	D0MY 6261140-G	2
			Nugget	D0MY 6261140-D	2
			Red	D0MY 6261140-F	2
			Tobacco	D0MY 6261140-B	2
	72	A "From 4/3/72 to 7/17/72"	Black-at tunnel	D3AZ 6561140-T	2
			Blue	D2AZ 6561140-D	2
			Gold	D2AZ 6561140-N	2
			Green	D2AZ 6561140-E	2
			Red	D2AZ 6561140-K	2
			Tobacco	D2AZ 6561140-F	2
	72	A "From 7/17/72"	Black-at tunnel	D3OZ 6561140-E	2
			Blue	D3OZ 6561140-A	2
			Green	D3OZ 6561140-C	2
			Red	D3OZ 6561140-B	2
			Tobacco	D3OZ 6561140-D	2
	72	B	Black-at tunnel	D2AZ 6561140-T	2
			Blue	D2AZ 6561140-G	2
			Ginger	D2AZ 6561140-B	2
			Gold	D2AZ 6561140-N	2
			Green	D2AZ 6561140-S	2
	72	F	Black-at tunnel	D2AZ 6561140-T	2
			Blue	D2AZ 6561140-D	2
			Green	D2AZ 6561140-E	2
			Red	D2AZ 6561140-K	2
			Tobacco	D2AZ 6561140-F	2
	72	L	Avocado-at tunnel	D2AZ 6561140-M	2
			Beige	D2AZ 6561140-H	2
			Black	D2AZ 6561140-T	2
			Blue	D2AZ 6561140-D	2
			Ginger	D2AZ 6561140-P	2
			Green	D2AZ 6561140-E	2
			Orange	D2AZ 6561140-C	2
	72	P	Beige-at tunnel	D2AZ 6561140-H	2
			Black	D2AZ 6561140-T	2
			Blue	D2AZ 6561140-D	2
			Ginger	D2AZ 6561140-P	2
			Tan	D2AZ 6561140-R	2
	72	S "From 4/3/72"	Black-at tunnel	D2AZ 6561140-T	2
			Blue	D2AZ 6561140-L	2
			Gold	D2AZ 6561140-N	2
			Green	D2AZ 6561140-J	2
			Red	D2AZ 6561140-K	2
			Tobacco	D2AZ 6561140-F	2

GROUP NUMBER	YEAR	BODY TYPE	DESCRIPTION	PART NUMBER	QTY.										
<b>61140</b>	<b>COVER - FRONT SEAT BELT RETRACTOR (BOOT) - Also Refer to group 610A88-9</b>														
<b>61142-3</b>	<b>LATCH ASSY. - AUXILIARY SEAT BACK FLOOR - Paint to Match</b>														
69/	A(71)	R.H. -includes attaching parts L.H.	C9AZ 7161142-A C9AZ 7161143-A	1 1											
69/	A(71)	Screw-pan head-No.8-32 x 1/4"	51751-S8 (U365)	1											
68/	B(71)	R.H. -with auxiliary seat L.H.	C8OZ 7161142-A C8OZ 7161143-A	1 1											
68/	B(71)	Without auxiliary seat-refer to Group 11500-1													
<b>611A42-3</b>	<b>FILLER - FRONT SEAT LOWER CORNER</b>														
69/70	A(62, 63, 65, 76)	R.H.	C9AZ 62611A42-A	1											
69/71	A(54C, 57C)	R.H. -use with split seat		1											
70	A(54A, 57B, 65C, 71A, B, C, E)	R.H. -use with reclining full width seat L.H.	C9AZ 62611A43-A	1											
71/	A(65, 76)	R.H. L.H.	D1AZ 65611A42-A D1AZ 65611A43-A	1 1											
<b>61144-5</b>	<b>MOULDING - REAR SEAT BACK OUTER - Refer to Group 61138</b>														
<b>611B46</b>	<b>RETAINER - SEAT BELT SHIELD</b>														
72	A	Front and rear	D2AZ 65611B46-A	2or4											
<b>611B60</b>	<b>BELT ASSY. - CENTER PASSENGER - Refer to Group 611A72-3 or 613B84-5</b>														
<b>611A70</b>	<b>SHIELD - FRONT SEAT BELT</b>														
65/66	A(54, 57, 71)	Used with power seat Full width seat	C5AZ 54611A70-A	2											
66	A(63C, D, 76B, D), S			1or2											
67/71	A(53, 54, 57, 71)	Screw-pan head, cross recess-No. 10-12 x 5/8"	*52735-S8	4											
72	A, S	Black	D2AZ 65611A70-A	2											
		Blue	D2AZ 65611A70-J	2											
		Gold	D2AZ 65611A70-E	2											
		Green	D2AZ 65611A70-H	2											
		Tobacco	D2AZ 65611A70-G	2											
		White	D2AY 65611A70-A	2											
<b>611A72-3</b>	<b>BELT ASSY. - FRONT SEAT COMPLETE</b>														
BODY TYPE	R/L	PART NUMBER LESS SUFFIX	RETRC. or NON- RETRC.	INCL. S/ HAR- NESS	COLORS and APPLICABLE PART NUMBER SUFFIXES										Q T Y.
															<b>1966</b>
A	*	†C6AZ 62611A72	N		FAF		FAH	FAG	FAE		FAJ	FAC		FAK	2
	*	†C7AZ 62611A72	R			C1A	C1B								1
	*	†C7AZ 62611A73	R			B1A									1
A	*	#C6AZ 62611A72	R					KAG	KAE			KAC		KAK	2
	*	R #C7AZ 62611A72	R		⊕	A1A		⊕			⊕				1
	*	L #C7AZ 62611A73	R		⊕	A1A	⊕	⊕			⊕				1
B(54, 62, 63, 71)	*	†C6OZ 62611A72	N		CAF		CAD		CAG	⊕		CAC			2
	*	†C7OZ 62611A72	N			B1A					⊕				2
	*	#C6OZ 62611A72	R		⊕	GAB	GAD		⊕		⊕	GAC			2
	*	R #C7OZ 76611A72	R			A1A	⊕								
	*	L #C7OZ 76611A73	R			A1A	⊕		⊕	⊕					1
B(76)	*	#C6AZ 62611A72	N		FAF		FAH	FAG	FAE		FAJ	FAC		FAK	2
	*	†C7AZ 62611A72	N			C1A	C1B								1
	*	†C7AZ 62611A73	N			B1A	B1B								1
	*	†C6AZ 62611A72	R					KAG	KAE		KAJ	KAC		KAK	2
	*	R #C7AZ 62611A72	R		⊕	A1A	A1B	⊕							1
	*	L #C7AZ 62611A73	R		⊕	A1A	⊕								1

\* Includes attaching parts    † With finger tip release    # With push button release    ⊕ Use black

### 611A72-3 BELT ASSY. - FRONT SEAT COMPLETE - continued

BODY TYPE	R/L	PART NUMBER LESS SUFFIX	RETRC. or NON- RETRC.	INCL. S/ HAR- NESS	COLORS and APPLICABLE PART NUMBER SUFFIXES											QTY.
					AQUA	BLACK	BLUE	BUR- GUNDY	EMBER- GLO	IVY GOLD	PALO- MINO	PARCH- MENT	RED	SADDLE	SILVER	
<b>1966</b>																
F(63, 65)	*	†C6OZ 62611A72	N		⊕	GAB	⊕	⊕	⊕	⊕		⊕	CAC		2	
	*	†C7OZ 62611A72	R			B1A	B1B					⊕			2	
	*	R # C7OZ 76611A72	R			A1A	⊕								1	
	*	L # C7OZ 76611A73	R			A1A	⊕			⊕					1	
F(63, 65) "Before 3/28/66"	*	#C6OZ 62611A72	R			DAF	DAB	GAD		GAG		⊕	GAC		2	
F(63, 65) "From 3/28/66 to 5/16/66"	*	#C6OZ 62611A72	R			⊕	GAB					⊕	GAC		2	
F(63, 65) "From 5/16/66"	*	#C6ZZ 65611A72	R			DAF	DAB	⊕		DAG	DAE		DAJ	DAC	2	
F(76)	*	†C6ZZ 76611A72	N			⊕	DAB	⊕		⊕	⊕		⊕	⊕	2	
F(76) "Before 5/16/66"	*	#C6ZZ 76611A72	N			⊕	EAB	⊕		⊕	⊕		⊕	⊕	2	
F(76) "From 5/16/66"	*	#C6ZZ 76611A72	N			⊕	EAB	⊕		⊕	⊕		⊕	⊕	2	
S "Before 11/15/65"	*	R # C6SZ 63611A72	R							CAG	⊕	⊕	CAC		1	
	*	R # C7SZ 65611A72	R			⊕	B1A						⊕		1	
	*	L # C6SZ 63611A73	R			BAF	BAB	⊕	BAH	BAG	BAE	BBB	BAJ	BAC	BBA	1
Left Hand Includes Seat Belt Warning Switch																
S "From 11/15/65"	*	#C6SZ 63611A72	R					⊕		CAG	⊕		CAC		2	
	*	#C7SZ 65611A72	R			⊕	B1A						⊕		2	
Used with Time Delay Seat Belt Warning Lamp Switch																
U-front -rear		C6TZ 81611A72					AAB								2 2	
X	*	†C6OZ 62611A72	N			CAF			CAD		CAG	CAE		CAC	2	
	*	†C7OZ 62611A72	N				B1A						⊕		2	
X "From 3/28/66"	*	#C6OZ 62611A72	R			GAF	GAB						⊕	GAC	2	
X "Before 3/28/66"	*	#C6OZ 62611A72	R			GAF	GAB	GAD		GAG			DAJ	⊕	2	
X	*	R # C7OZ 76611A72	R				A1A	⊕							1	
	*	L # C7OZ 76611A73	R				A1A	⊕			⊕				1	

MODEL	PART NUMBER	DESCRIPTION	QTY.
A, B (76)	380527-S13(BB453D)	Bolt-hex, head, shoulder 7/16"-20 x 1 1/8"	2
A, B (76)	380528-S13(BB449C)	Bolt-hex, head, shoulder 7/16"-20 x 1 1/4"	2
B(54, 62, 63, 71), F, S, X			4
A, B (76)	359820-S8(XX203)	Washer-flat-9/16"	2
B(54, 62, 63, 71), F, S, X			4
A, B (76), U	*34921-S13	Lockwasher-spring-7/16"	AR
B(54, 62, 63, 71), F(63, 65), X	354959-S(XX178C)	Washer-flat-7/16" (rubber)	2
U	379936-S13(BB481E)	Bolt-hex, head, shoulder 7/16"-20 x 7/8"	4or8

BODY TYPE	R/L	PART NUMBER LESS SUFFIX	RETRC. or NON- RETRC.	INCL. S/ HAR- NESS	COLORS and APPLICABLE PART NUMBER SUFFIXES											QTY.
					AQUA	BLACK	BLUE	BUR- GUNDY	EMBER- GLO	IVY GOLD	PALO- MINO	PARCH- MENT	RED	SADDLE	SILVER	
<b>1967</b>																
A	*	R # C7AZ 62611A72	R			A1K	A1A	⊕			⊕		⊕	⊕	⊕	1
	*	L # C7AZ 62611A73	R				A1A	⊕			⊕		⊕	A1D	⊕	1
A	*	R †C7AZ 62611A72	R				C1A	⊕					C1U			1
	*	L †C7AZ 62611A73	R													1
A-center	*	†C7AZ 62611A72					F1A	⊕				⊕				1
	*	#C7AZ 62611A72						⊕			⊕		⊕	G1F		1
	*	#C8MY 54611A72					F1A									1

\* Includes attaching parts      † With finger tip release      # With push button release      ⊕ Use black  
 May, 1975      COPYRIGHT © 1975 - FORD MOTOR COMPANY      - DEARBORN, MICHIGAN      **FINAL ISSUE**

**611A72-3 BELT ASSY. - FRONT SEAT COMPLETE - continued**

1967

BODY TYPE	R/L	PART NUMBER LESS SUFFIX	RETRC. or NON- RETRC.	INCL. S/ HAR- NESS	COLORS and APPLICABLE PART NUMBER SUFFIXES										QTY.	
					AQUA	BLACK	BLUE	BUR- GUNDY	EMBER- GLO	IVY GOLD	PALO- MINO	PARCH- MENT	RED	SADDLE		SILVER
B(54, 62, 63, 66, 71)	*	# C7OZ 62611A72	R		⊕	A1A	A1B				A1G		A1U	A1D	A1F	2
	*	†C7OZ 62611A72	R			B1A	B1B						⊕			2
B(76)	* R	# C7OZ 76611A72	R		⊕	A1A	⊕			⊕		⊕	⊕	⊕		1
	* L	# C7OZ 76611A73	R		⊕	A1A	⊕			⊕		⊕	⊕	⊕		1
B(76)	* R	†C7OZ 76611A72	R			B1A	⊕					⊕				1
	* L	†C7OZ 76611A73	R			B1A	⊕					⊕				1
B-center	*	†C7AZ 62611A72				F1A	F1B					F1U				1
	*	# C7AZ 62611A72			⊕	G1A	G1B			G1G		G1U	G1D	G1F		1
F(63, 65)	*	# C7ZZ 65611A72	R		⊕	D1A	⊕			⊕		⊕	⊕	⊕		2
F(76)	*	# C7ZZ 76611A72	N		⊕	A1A	⊕			⊕		⊕	⊕	⊕		2
	*	†C7ZZ 76611A72	N			B1A	⊕					⊕				2
F(63, 65-exc. Shelby-GT350/500)	*	†C7ZZ 65611A72	R			B1A	B1B					⊕				2
F(63-Shelby GT350/500)		S7MS 65611A72-A		Includes Emblem												2
S	*	# C7SZ 65611A72	R			BIK	B1A	⊕		⊕		BIU	⊕	⊕	⊕	2
U-front -rear	*	C7TZ 81611A72				D1A										2
						D1A										2
X	*	# C7OZ 62611A72	R		⊕	A1A	A1B			A1G		A1U	⊕	⊕		2
	*	†C7OZ 62611A72	R			B1A	⊕					⊕				2
X-center	*	†C7AZ 62611A72				F1A	F1B					F1U				1
	*	# C7AZ 62611A72			⊕	G1A	G1B			G1G		G1U	G1D	G1F		1

MODEL	PART NUMBER	DESCRIPTION	QTY.
A, B (76), S	*381870-S100	Bolt-hex. head, shoulder 7/16"-20 x 1 1/2"	AR
A, B (76)	382627-S100(UU156)	Bolt-hex. head, shoulder 7/16"-20 x 2"	2
B(54, 62, 63, 66, 71)-side, F, X U			4 4or8
A, B (76)	356420-S13(XX167A)	Washer-flat-7/16"	2
B(54, 62, 63, 66, 71)-side, F, X			4
A, B(76), U	382583-S100(XX340AC)	Washer-serrated-1/2"	AR
A-center, B-center, X-center	359820-S8(XX203)	Washer-flat-9/16"	2
A-center, B-center, X-center	*381874-S100	Bolt-hex. head, shoulder 7/16"-20 x 2"	2
A-center, B-center, X-center	*382072-S100	Washer-flat-1/2"	2
B(54, 62, 63, 66, 71)-side F, X	354959-S(XX178C)	Washer-flat-7/16" (rubber)	2 4
S	351453-S8(XX186)	Washer-flat-1/2"	2

BODY TYPE	R/L	PART NUMBER LESS SUFFIX	RETRC. or NON- RETRC.	INCL. S/ HAR- NESS	COLORS and APPLICABLE PART NUMBER SUFFIXES										QTY.
					AQUA	BLACK	BLUE	BUR- GUNDY	EMBER- GLO	IVY GOLD	PALO- MINO	PARCH- MENT	RED	SADDLE	

1968

A	R	†C8AZ 62611A72			E1K	E1A	E1B			⊕	⊕	E1U	⊕			1
	L	†C8AZ 62611A73			E1K	E1A	⊕			E1G	⊕	E1U	E1D			1
A	R	◇C8AZ 62611A72				F1A	F1B					⊕				1
	L	◇C8AZ 62611A73				F1A	⊕					F1U				1
A-center		†C8AZ 62611A72			⊕	G1A	G1B			G1G	G1Y	G1U	⊕	⊕		1
		◇C8AZ 62611A72				H1A	H1B					H1U				1
B(except 76)		†C8WZ 65611A72			B1K	B1A	B1B			B1G	B1Y	B1U	B1D			2
		◇C8ZZ 65611A72					E1B									2

\* Includes attaching parts    † With finger tip release    # With push button release    ⊕ Use black  
 ◇ Plastic buckle    ‡ Chrome and plastic buckle

**611A72-3 BELT ASSY. - FRONT SEAT COMPLETE - continued**

1968

BODY TYPE	R/L	PART NUMBER LESS SUFFIX	RETRC. or NON- RETRC.	INCL. S/ HAR- NESS	COLORS and APPLICABLE PART NUMBER SUFFIXES										Q T Y.		
					AQUA	BLACK	BLUE	GINGER	GREEN	IVY GOLD	NUG- GET GOLD	PARCH- MENT	RED	SADDLE		TOB- ACCO	
B(76)		‡C8OZ 76611A72				F1A	⊕						⊕	⊕			2
		◇C8OZ 76611A72						E1B									2
B-center		‡C8AZ 62611A72				⊕	G1A	G1B			G1G	G1Y	G1U	G1D	G1F		1
		◇C8AZ 62611A72					H1A	H1B					H1U				1
F(63, 65-except Shelby GT350/500)		‡C8WZ 65611A72			B1K	B1A	B1B			B1G	B1Y	B1U	B1D				2
F(76-exc. Shelby- GT350/500)		‡C8ZZ 76611A72	N		⊕	E1A	⊕			⊕	⊕	⊕	⊕				2
		◇D1TZ 10611B60	N			E											2
S-full width seat	R	‡C8SZ 65611A72			⊕	G1A	⊕			⊕	⊕	⊕	⊕	⊕	⊕		1
	L	‡C8SZ 65611A73			⊕	G1A	⊕			⊕	⊕	⊕	⊕	⊕	⊕		1
S-full width seat	R	◇C8SZ 65611A72				E1A	⊕						⊕				1
	L	◇C8SZ 65611A73				E1A	⊕						⊕				1
S-bucket seat		‡C8SZ 65611A72			⊕	M1A	⊕			⊕	⊕	⊕	M1D	⊕			2
S-center		‡C8AZ 62611A72				G1K	G1A	G1B			G1G	G1Y	G1U	G1D	G1F		1
		◇C8AZ 62611A72					H1A	H1B					H1U				1
U-front & rear seat		◇C9TZ 81611A72	N			C1A											AR
U	R	‡C9TZ 96611A72	R										B2U				1
	L	‡C9TZ 96611A73	R										B2U				1
X		‡C8WZ 65611A72				B1K	B1A	B1B			B1G	B1Y	B1U	B1D			2
		◇C8Z 65611A72						E1B									2
X-center		‡C8AZ 62611A72				G1K	G1A	G1B			G1G	G1Y	G1U	G1D	G1F		1
		◇C8AZ 62611A72					H1A	H1B					H1U				1

MODEL	PART NUMBER	DESCRIPTION	QTY.
<b>OUTBOARD BELT</b>			
A, B(76), S	382624-S100(UU170)	Bolt-torx head, tapping-7/16"-20 x 1 3/8"	2
B(exc.76), F, U, X	382627-S100(UU156)	Bolt-torx head, tapping-7/16"-20 x 1 3/4"	2
B(exc.76), F, U, X	382629-S100(XX173AA)	Washer-flat-7/16"	2
F	354959-S100(XX178C)	Washer-flat-1/2" x 9/64" thick-rubber	4
<b>INBOARD BELT</b>			
A(w/3 belts), B(w/3 belts), X(w/3 belts)	382628-S100(UU157)	Bolt-torx head, tapping-7/16"-20 x 2 1/4"	2
A(w/2 belts), B(w/2 belts), F, U, X(w/2 belts)	382627-S100(UU156)	Bolt-torx head, tapping-7/16"-20 x 1 3/4"	2
S	382624-S100(UU170)	Bolt-torx head, tapping-7/16"-20 x 1 3/8"	2
A(w/3 belts), B(w/3 belts), S(w/3 belts), X(w/3 belts)	382582-S100(XX179A)	Washer-flat-1/2"	4
A(w/2 belts), B(w/2 belts), F, U(w/3 belts), X(w/2 belts)			2
A, B, F, S(w/3 belts), U, X	382629-S100(XX173AA)	Washer-flat-7/16"	2
S	382583-S100(XX340AC)	Washer-serrated-1/2"	2
U	354959-S100(XX178C)	Washer-flat-1/2" x 9/64" thick-rubber	4
<b>SHOULDER STRAP</b>			
A, B, F, S(w/bench seat), U, X	382517-S100(BB445LD)	Bolt-hex., shoulder, locking-3/8"-16 x 1 1/2"	2
S(w/bucket seat)-upper			2
S(w/bucket seat)-lower	382627-S100(XX156)	Bolt-torx head, tapping-7/16"-20 x 1 3/4"	2
A, B, F, S, U, X		Spacer - refer to Group 60228	
U	382548-S100(XX163)	Washer-flat-3/8"	2
U	382535-S100(MM173MX)	Nut-hex., -3/8"-16	2

‡ Chrome and plastic buckle  
May, 1975

◇ Plastic buckle  
COPYRIGHT © 1975 -

⊕ Use black  
FORD MOTOR COMPANY  
- DEARBORN, MICHIGAN

**FINAL ISSUE**

**611A72-3 BELT ASSY. - FRONT SEAT COMPLETE - continued**

1969

BODY TYPE	R/L	PART NUMBER LESS SUFFIX	RETRC. or NON- RETRC.	INCL. S/ HAR- NESS	COLORS and APPLICABLE PART NUMBER SUFFIXES										Q T. Y.		
					AQUA	BLACK	BLUE	GINGER	GREEN	IVY GOLD	NUG- GET GOLD	PARCH- MENT	RED	SADDLE		TGB- ACCO	
UNLESS OTHERWISE INDICATED, BELTS SHOWN ARE STANDARD LENGTH WITH DELUXE BUCKLE																	
A(except 76)		†C9AZ 62611A72	R	Yes	H1K	H1A	H1B				H1G	H1Y		H1D			2
A(76)		†C9AZ 76611A72	R	No		D2A	⊕				⊕	D2Y		⊕			2
A-center, rear and auxiliary seat		†C9AZ 62611A72	N		⊕	K1A	K1B				K1G	K1Y		K1D			AR
B(except 76)		†C9ZZ 65611A72	R	Yes	F2K	F2A	F2B				F2G	F2Y		F2D	F2F		2
B(76)		†C9OZ 76611A72	R			F2A								⊕			2
B-center, rear and auxiliary seat		†C9AZ 62611A72	N		K1K	K1A	K1B				K1G	K1Y		K1D			AR
F(63, 65)		†C9ZZ 65611A72	R	Yes	F2K	F2A	F2B				F2G	F2Y		F2D	F2F		2
F(76)		†C9ZZ 76611A72	N		⊕	B1A	⊕				⊕	⊕		⊕	⊕		2
F-center & rear seat		†C9AZ 62611A72	N		K1K	K1A	K1B				K1G	K1Y		K1D			AR
S		†C9AZ 62611A72	R	Yes	H1K	H1A	H1B				H1G	H1Y		H1D			2
S-center & rear seats		†C9AZ 62611A72	N		K1K	K1A	K1B				K1G	K1Y		K1D			AR
U	R	†C9TZ 96611A72	R											B2U			1
	L	†C9TZ 96611A73	R											B2U			1
U-center & rear seats		#C8AZ 71613B84												D1U			AR
X		†C9ZZ 65611A72	R	Yes	F2K	F2A	F2B				F2G	F2Y		F2D	F2F		2
X-center & rear seat		†C9AZ 62611A72	N		K1K	K1A	K1B				K1G	K1Y		K1D			AR

MODEL	PART NUMBER	DESCRIPTION	QTY.
<b>OUTBOARD BELT (FRONT SEAT)</b>			
A,B(76),S	382624-S100(UU170)	Bolt-torx head, tapping-7/16"-20 x 1 3/8"	2
B(exc.76), F(exc.76), U, X	382627-S100(UU156)	Bolt-torx head, tapping-7/16"-20 x 1 3/4"	2
A, S	382582-S100(XX179A)	Washer-flat-1/2"	2
F(exc.76), U	354959-S(XX178C)	Washer-flat-1/2" x 9/64" thick-rubber	4
B(exc.76), F(exc.76), U, X	382629-S100(XX173AA)	Washer-flat-7/16"	2
<b>INBOARD BELT (FRONT SEAT)</b>			
A, B, F, S, U(w/1 or 2 belts), X	382627-S100(UU156)	Bolt-torx head, tapping-7/16"-20 x 1 3/4"	2
U(w/3 belts)	382628-S100(UU157)	Bolt-torx head, tapping-7/16"-20 x 1 1/4"	2
A, B, F, S, U, X	382629-S100(XX173AA)	Washer-flat-7/16"	2
U(w/2 belts)	382582-S100(XX179A)	Washer-flat-1/2"	2
U(w/3 belts)			4
<b>SHOULDER STRAP (FRONT SEAT)</b>			
A, B, F, S, U, X	382626-S100(UU175)	Bolt-torx head, tapping-3/8"-16 x 1 1/2"	2
U	382535-S100(MM173MX)	Nut-hex.-3/8"-16	2
A, B, F, S, U, X		Spacer - refer to Group 60228	
U	★382554-S100	Washer-spring lock-3/8"	2
U	382548-S100(XX163)	Washer-flat-3/8"	2
<b>OUTBOARD BELT (REAR SEAT)</b>			
A, B, F, S, X	382624-S100(UU170)	Bolt-torx head, tapping-7/16"-20 x 1 3/8"	2
U	382627-S100(UU156)	Bolt-torx head, tapping-7/16"-20 x 1 3/4"	2
U	382629-S100(XX173AA)	Washer-flat-7/16"	2
U	354959-S(XX178C)	Washer-flat-1/2" x 9/64" thick-rubber	4
A, B, F, S, X	382583-S100(XX340AC)	Washer-serrated-1/2"	2
<b>INBOARD BELT (REAR SEAT)</b>			
A, B, S(57), U	382627-S100(UU156)	Bolt-torx head, tapping-7/16"-20 x 1 3/4"	2
F, S(65)	382624-S100(UU170)	Bolt-torx head, tapping-7/16"-20 x 1 3/8"	2
A, B, S(57), U	382629-S100(XX173AA)	Washer-flat-7/16"	2
A, B, S(57), U(w/2 belts)	382582-S100(XX179A)	Washer-flat-1/2"	2
U(w/1 belt)	354959-S(XX178C)	Washer-flat-1/2" x 9/64" thick-rubber	4
F, S(65)	382583-S100(XX340AC)	Washer-serrated-1/2"	2
<b>SHOULDER STRAP (REAR SEAT)</b>			
U(98)	382626-S100(UU175)	Bolt-torx head, tapping-3/8"-16 x 1 1/2"	2
U(98)		Spacer - refer to Group 60228	
U(98)	★382554-S100	Washer-spring lock-3/8"	2
<b>AUXILIARY SEAT</b>			
A(71), B(71)	382624-S100(UU170)	Bolt-torx head, tapping-7/16"-20 x 1 3/8"	4
A(71), B(71)	382583-S100(XX340AC)	Washer-serrated-1/2"	4

† Chrome and plastic buckle

# With push button release

⊕ Use black

# FORD CAR PARTS

**BODY  
SECTION 610**

13

**611A72-3 BELT ASSY. - FRONT SEAT COMPLETE - continued**

1970

BODY TYPE	LOC.	PART NUMBER LESS SUFFIX	RETRC. or NON- RETRC.	INCL. S. HAR- NESS	COLORS and APPLICABLE PART NUMBER SUFFIXES										QTY.
					AQUA	BLACK	BLUE	GINGER	GREEN	IVY GOLD	NUG- GET GOLD	PARCH- MENT	RED	SADDLE	
<b>UNLESS OTHERWISE INDICATED, BELTS SHOWN ARE STANDARD LENGTH WITH DELUXE BUCKLE</b>															
A(exc.76)	R	D0AZ 62611A72	R	Yes	G	A	C	E	H		F	D	B	1	
	L	D0AZ 62611A73	R	Yes	G	A	C	E	H		F	D	B	1	
	R	◆D0AZ 62611A72		Yes		L								1	
	L	◆D0AZ 62611A73		Yes		L								1	
A(76)	R	D0MZ 76611A72	R	No		E	B	C	F		G	A	D	1	
	L	D0MZ 76611A73	R	No		E	B	C	F		G	A	D	1	
A-center		◆D0AZ 62611A72	N	No		M								1	
		D0MZ 76611A72	N	No	T	N	J	K	R		M	H	L	1	
B(54, 62, 63, 65, 71)		D0ZZ 65611A72	R	Yes		J	G	H	K		L	F	M	2	
		◆D0ZZ 65611A72				N								2	
B(57)		D0OZ 57611A72	R	Yes		E	B		F		D		C	2	
		◆D0OZ 57611A72				G								2	
B(66)		D0OZ 66611A72	R	Yes			B	D	G		H	E	C	2	
		D2ZZ 76611A72	N	No		C								2	
B(76)		D0OZ 76611A72	R	No		E	B	⊕				⊕	⊕	2	
		D2ZZ 76611A72	N	No								B		2	
B-center		D0MZ 76611A72	N	No		N	J	K	R		M	H	L	1	
B(exc.66,76)-center		◆D0OZ 65611A72				A								1	
B(76)-center		◆D0DZ 62611A72				U								1	
F(63, 65)		D0ZZ 65611A72	R	Yes		J	G	H	K			F		2	
		◆D0ZZ 65611A72				N								2	
F(76)		D0ZZ 76611A72	N	No		B	A	E	C					2	
P		D0DZ 62611A72	N	Yes		A	B				E			2	
P-with 4 point belt assemblies "Before 10/1/69"		D0DZ 62611A72	R	Yes		K	F				J		G	2	
		D0DZ 62611A72	R	Yes		S	L				R		M	2	
P-with 4 point belt assemblies "From 10/1/69"		D0DZ 62611A72	R	Yes		S	L				R		M	2	
P-with 3 point belt assemblies		D0ZZ 65611A72	R	Yes		E	C				B		D	2	
S	R	D0AZ 62611A72	R	Yes		A	◇C	E	H		F	D	B	J 1	
	L	D0AZ 62611A73	R	Yes		A	◇C	E	H		F	D	B	J 1	
	R	D0AZ 62611A72	R	Yes			@K							1	
	L	D0AZ 62611A73	R	Yes			@K							1	
	R	◆D0AZ 62611A72				L								1	
	L	◆D0AZ 62611A73				L								1	
S-center		D0AZ 76611A72	N	No			@B							1	
		◆D0AZ 62611A72				M								1	
		D0MZ 76611A72	N	No		N	◇J	K	R		M	H	L	S 1	
U-full width seat	R	C9TZ 96611A72	R	No								B2U		1	
	L	C9TZ 96611A73	R	No								B2U		1	
U-bucket seat	R	D0BZ 10611A72	R	No								F		1	
	L	D0BZ 10611A73	R	No								F		1	
U-center, front or rear		D0BZ 10611A72	N	No		E	B		D		A	C		AR	
X		C9ZZ 65611A72	R	Yes	F2K	F2A	F2B			F2G	F2Y		F2D	F2F	2
X-center		C9AZ 62611A72	N	No	K1K	K1A	K1B			K1G	K1Y		K1D		AR

MODEL	PART NUMBER	DESCRIPTION	QTY.
<b>OUTBOARD BELT</b>			
A, B(57,76), S, U(w/bucket seat)	382624-S100(UU170)	Bolt-torx head, tapping-7/16"-20 x 1 3/8"	2
B(exc.57,76), F, P, U(w/bench seat)	382627-S100(UU156)	Bolt-torx head, tapping-7/16"-20 x 1 3/4"	2
S(57)	382582-S100(XX179A)	Washer-flat-1/2"	2
F, P, U(w/bench seat)	354959-S(XX178C)	Washer-flat-1/2" x 9/64" thick-rubber	4
F, P, U(w/bench seat)	382629-S100(XX173AA)	Washer-flat-7/16"	2

◆ Standard buckle - plastic covered    ● Loc - Location    R - Right Hand    L - Left Hand    ⊕ Use black  
 @ Medium    ◇ Dark

May, 1975

COPYRIGHT © 1975 — FORD MOTOR COMPANY — DEARBORN, MICHIGAN

**FINAL ISSUE**

**611A72-3 BELT ASSY. - FRONT SEAT COMPLETE - continued**

1970

MODEL	PART NUMBER	DESCRIPTION	QTY.
<b>INBOARD BELT</b>			
A, B, F, P, S, U(w/1 or 2 belts)	382627-S100(UU156)	Bolt-torx head, tapping-7/16"-20 x 1 3/4"	2
U(w/3 belts)	382628-S100(UU157)	Bolt-torx head, tapping-7/16"-20 x 2 1/4"	2
A, B, F, P, S, U	382629-S100(XX173AA)	Washer-flat-7/16"	2
U(w/1 belt)	354959-S(XX178C)	Washer-flat-1/2" x 9/64" thick-rubber	4
U(w/3 belts)	382582-S100(XX179A)	Washer-flat-1/2"	4
U(w/2 belts)			2
<b>SHOULDER STRAP</b>			
A, B, F, P, S, U	382626-S100(UU175)	Bolt-torx head, tapping-3/8"-16 x 1 1/2"	2
U	382535-S100(MM173MX)	Nut-hex.-3/8"-16	2
A, B, F, P, S, U		Spacer - refer to Group 60228	
U	★382554-S100	Washer-spring lock-3/8"	2
U	382548-S100(XX163)	Washer-flat-3/8"	2

BODY TYPE	Loc.	PART NUMBER LESS SUFFIX	RETRC. or NON- RETRC.	INCL. S/ HAR- NESS	COLORS and APPLICABLE PART NUMBER SUFFIXES												Q T Y.
					AQUA	BLACK	BLUE	GINGER	GRAY	GRAY GOLD	GREEN	PARCH MENT	RED	TOB- ACCO	VER- MIL- ION		

1971

UNLESS OTHERWISE INDICATED, BELTS SHOWN ARE STANDARD LENGTH WITH DELUXE BUCKLE

A	C	D0MZ	76611A72	N	No		N	J	K				H	L			1
	C	D1AZ	76611A72	N	No						A	B					1
A(exc.76)	♦D1AZ	65611A72	R	No		J											1
	R	D1AZ	62611A72	R	Yes						B	A					1
	L	D1AZ	62611A73	R	Yes						B	A					1
	R	D1AZ	65611A72	R	Yes		F	B	D				A	E	C		1
	L	D1AZ	65611A73	R	Yes		F	B	D				A	E	C		1
	R	♦D1AZ	65611A72				H										1
	L	♦D1AZ	65611A73				H										1
	R	#D1AZ	65611A72				AA										1
	L	#D1AZ	65611A73				AA										1
	A(76)	R	D1AZ	76611A72	R	No		F	⊕		⊕			J	G		
R		D2AZ	76611A72	R	No		L			⊕		D					1
L		D1AZ	76611A73	R	No				⊕	⊖			J	G			1
L		D2AZ	76611A73	R	No		L	B				D					1
R		#D3AZ	76611A72	R	No		L										1
L		#D3AZ	76611A73	R	No		L										1
L		#D1AZ	76611A73	R	No		AA										1
B	C	D1OZ	65611A72	N	No											A	1
	C	D0MZ	76611A72	N	No		N	J	K				H	L			1
B(54, 63, 65, 71)	R/L	D0ZZ	65611A72	R	Yes		J	G	H		A	B		F			2
	R/L	D1ZZ	65611A72	R	Yes						B	A				C	2
B(54, 63, 65, 71)	R/L	#D1OZ	65611A72	R	Yes		AA										2
B(54, 63, 65, 71)	R/L	♦D1ZZ	65611A72	R	Yes		D										2
B(57)	R/L	D1OZ	57611A72	R	Yes		C	D			B	A					2
B(57)	R/L	♦D1OZ	57611A72	R	Yes		F										2
B(57)	R/L	#D1OZ	57611A72	R	Yes		AA										2
B(exc.66)	C	♦D1OZ	65611A72	R	Yes		B										1
B(66)	R/L	D0OZ	66611A72	R	Yes		A	B	D				E	C			2
	R/L	D1OZ	66611A72	R	Yes						B	A				C	2
B(66)	R/L	#D1OZ	66611A72	R	Yes		AA										2
B(76)	R/L	D0OZ	76611A72	R	Yes		E		C				A				2
	R/L	D1OZ	76611A72	R	Yes							A				B	2
F(63, 65)	R/L	D0ZZ	65611A72	R	Yes		J	G	H				F	M			2
	R/L	D1ZZ	65611A72	R	Yes							A					2
F(63, 65)	R/L	♦D1ZZ	65611A72	R	Yes		D										2
	R/L	#D1OZ	65611A72	R	Yes		AA										2
F(76)	R/L	D0ZZ	76611A72	N	No		B	A	E			⊕					2
	R/L	D1ZZ	76611A72	N	No							⊕	C				2
L	R/L	D1FZ	62611A72	N	Yes		A		B								2
	R/L	♦D1FZ	62611A72	N	Yes		C										2

♦ Standard buckle - plastic covered    ● Loc - Location    # Extra length belt    R - Right Hand    L - Left Hand    C - Center  
⊕ Use black



**611A72-3 BELT ASSY. - FRONT SEAT COMPLETE - continued**

BODY TYPE	Loc. ●	PART NUMBER LESS SUFFIX	RETRC. or NON- RETRC.	INCL. S/ HAR- NESS	COLORS and APPLICABLE PART NUMBER SUFFIXES											Q T Y.				
					AQUA	BLACK	BLUE	GINGER	GRAY	GRAY GOLD	GREEN	PARCH MENT	RED	TOB- ACCO	VER- MIL- ION					
<b>1971</b>																				
<b>UNLESS OTHERWISE INDICATED, BELTS SHOWN ARE STANDARD LENGTH WITH DELUXE BUCKLE</b>																				
P-with 3 point belt	R/L	D1DZ 62611A72	R	Yes										B					A	2
	R/L	D0ZZ 65611A72	R	Yes		E	C													2
P-with 4 point belt	R/L	D0DZ 62611A72	N	Yes		A														2
P	R/L	#D1DZ 62611A72	N	Yes		AA														2
S	R	D1AZ 62611A72	R	Yes										B						1
	L	D1AZ 62611A73	R	Yes										B						1
	R	D1SZ 62611A72	R	Yes								A								1
	L	D1SZ 62611A73	R	Yes								A								1
	R	D1AZ 65611A72	R	Yes		F	G	D					A	E	C					1
	L	D1AZ 65611A73	R	Yes		F	G	D					A	E	C					1
	C	D0AZ 76611A72	N	No			B													1
	C	DOMZ 76611A72	N	No		N		K						H	L	S				1
	C	D1AZ 76611A72	N	No								A								1
	C	D1SZ 76611A72	N	No									A							1
	R	◆D1AZ 65611A72	R	Yes		H														1
	L	◆D1AZ 65611A73	R	Yes		H														1
	C	◆D1AZ 65611A72	R	Yes		J														1
R	#D1AZ 65611A72	R	Yes		AA														1	
L	#D1AZ 65611A73	R	Yes		AA														1	
U- full width seat	R	C9TZ 96611A72	R	No											B2U					1
	L	C9TZ 96611A73	R	No											B2U					1
U-bucket seat	R	D0BZ 10611A72	R	No											F					1
	L	D0BZ 10611A73	R	No											F					1
U-front or rear	C	D0BZ 10611A72	N	No		E	B								A	C				AR
	C	D1TZ 10611A72	N	No									B							AR

MODEL	PART NUMBER	DESCRIPTION	QTY.
<b>INBOARD BELT</b>			
A, B, F, L, P, S, U(w/1 or 2 belts)	382627-S100(UU156)	Bolt-torx head, tapping-7/16"-20 x 1 3/4"	2
U(w/3 belts)	372628-S100(UU157)	Bolt-torx head, tapping-7/16"-20 x 2 1/4"	2
A, B, F, L, P, S, U	382629-S100(XX173AA)	Washer-flat-7/16"	2
U(w/3 belts)	382582-S100(XX179A)	Washer-flat-1/2"	4
U(w/2 belts)			2
L, U(w/1 belt)	354959-S(XX178C)	Washer-flat-1/2" x 9/64" thick-rubber	4
<b>OUTBOARD BELT</b>			
A, B(57, 76), S	383608-S100(UU160)	Bolt-torx head, tapping-7/16"-20 x 7/8"	2
B(exc. 57, 66, 76)	382627-S100(UU156)	Bolt-torx head, tapping-7/16"-20 x 1 3/4"	2
B(66), F, L, P, U(w/bench seat)	382627-S100(UU156)	Bolt-torx head, tapping-7/16"-20 x 1 3/4"	2
U(w/bucket seat)	382624-S100(UU170)	Bolt-torx head, tapping-7/16"-20 x 1 3/8"	2
B(exc. 57, 76), F, L, P, U(w/bench seat)	382629-S100(XX173AA)	Washer-flat-7/16"	2
B(exc. 57, 76), F(w/retractor), P(w/retractor)	382552-S100(XX191B)	Washer-1/2"	2
S(57)	382582-S100(XX179A)	Washer-flat-1/2"	2
B(exc. 57, 76), F(w/o retractor), L, P(w/o retractor), U(w/bench seat), F(w/retractor), P(w/retractor)	354959-S(XX178C)	Washer-flat-1/2" x 9/64" thick-rubber	4
<b>SHOULDER STRAP</b>			
A, B, F, L, P, U	382626-S100(UU175)	Bolt-torx head, tapping-3/8"-16 x 1 1/2"	2
S	382627-S100(UU156)	Bolt-torx head, tapping-7/16"-20 x 1 3/4"	2
U	382535-S100(MM173MX)	Nut-hex.-3/8"-16	2
A, B, F, L, P, S, U		Spacer - refer to Group 60228	
U	★382554-S100	Washer-spring lock-3/8"	2
U	382548-S100(XX163)	Washer-flat-3/8"	2

◆ Standard buckle - plastic covered ● Loc - Location # Extra length belt R - Right Hand L - Left Hand C - Center

**611A72-3 BELT ASSY. - FRONT SEAT COMPLETE - continued**

BODY TYPE	Loc.	PART NUMBER LESS SUFFIX	RETRC. or NON- RETRC.	INCL S/ HAR- NESS	COLORS and APPLICABLE PART NUMBER SUFFIXES										Q T Y.
					BLACK	BLUE	GINGER	GRAY GOLD	GREEN	PARCH MENT	RED	TOB- ACCO	OTHER	OTHER	
<i>1972 - "Before 12/1/71"</i>															
UNLESS OTHERWISE INDICATED, BELTS SHOWN ARE STANDARD LENGTH WITH DELUXE BUCKLE															
A	C	D2AZ 76611B60	N	No		A			B						1
	C	D2AY 76611B60	N	No	F		B	H		A	C	E			1
A(exc. 76)	R	D2AZ 65611A72	R	Yes	H	C	D	J	F	B	E	G			1
	L	D2AZ 65611A73	R	Yes	H	C	D	J	F	B	E	G			1
	R	♦D2AZ 65611A72	R	Yes	A										1
	L	♦D2AZ 65611A73	R	Yes	A										1
	C	♦D2AZ 65611B60	N	No	A										1
	R	♦♦D2AY 65611A72	R	Yes	E										1
	L	♦♦D2AY 65611A73	R	Yes	E										1
	R	# D2AY 65611A72	R	Yes	F										1
	L	# D2AY 65611A73	R	Yes	F										1
A(76)	R	D2AZ 76611A72	R	Yes	E	B			D	A	C				1
	L	D2AZ 76611A73	R	Yes	E	B			D	A	C				1
	R	# D2AZ 76611A72	R	No	L										1
	L	# D2AZ 76611A73	R	No	L										1
B	C	♦D2OZ 65611B60	N	No	A										1
	C	D2OZ 97611B60	N	No	C	E	A	D	F			B			1
B(53,71)	R/L	D2OZ 53611A72	R	Yes	F	B	C	G	D			E			2
	R/L	♦D2OZ 53611A72	R	Yes	A										2
	R/L	♦♦D2OZ 53611A72	R	Yes	S										2
	R/L	# D2OZ 53611A72	R	Yes	T										2
B(63,65)	R	D2OZ 65611A72	R	Yes	E	G	B	F	C			D			1
	L	D2OZ 65611A73	R	Yes	E	G	B	F	C			D			1
	R	♦D2OZ 65611A72	R	Yes	A										1
	L	♦D2OZ 65611A73	R	Yes	A										1
	R	♦♦D2OZ 65611A72	R	Yes	R										1
	L	♦♦D2OZ 65611A73	R	Yes	R										1
	R	# D2OZ 65611A72	R	Yes	S										1
	L	# D2OZ 65611A73	R	Yes	S										1
B(97)	R	D2OZ 97611A72	R	Yes	E	A	B	F	C			D			1
	L	D2OZ 97611A73	R	Yes	E	A	B	F	C			D			1
	R	# D2OZ 97611A72	R	Yes	V										1
	L	# D2OZ 97611A73	R	Yes	V										1
F(63,65)	R/L	D2ZZ 65611A72	R	Yes	H	D	E		G	B	F			\$C	2
	R/L	♦D2ZZ 65611A72	R	Yes	A										2
F(exc. 76)	R/L	♦♦D2ZZ 65611A72	R	Yes	S										2
	R/L	# D2ZZ 65611A72	R	Yes	T										2
F(76)	R/L	D2ZZ 76611A72	N	No	A	C	F		D	G	B			\$E	2
	R/L	# D2ZZ 76611A72	R	No	S										2
L	R/L	D2FZ 62611A72	N	Yes	E	P	C		D				▲L		2
	R/L	♦D2FZ 62611A72	N	Yes	A										2
	R/L	♦♦D2FZ 62611A72	N	Yes	N										2
	R/L	# D2FZ 62611A72	N	Yes	P										2
P	R/L	D2DZ 62611A72	R	Yes	D	C	P	E					▲L	\$B	2
	R/L	♦D2DZ 62611A72	N	Yes	A										2
	R/L	♦♦D2DZ 62611A72	R	Yes	R										2
	R/L	#D2DZ 62611A72	R	Yes	S										2
S	R	D2LY 65611A72	R	Yes			A								1
	L	D2LY 65611A73	R	Yes			A								1
	R	D2LZ 65611A72	R	Yes	E	F		G	C		B	D			1
	L	D2LZ 65611A73	R	Yes	E	F		G	C		B	D			1
	C	D2OY 97611B60	N	No		D			C		B				1
	C	D2OZ 97611B60	N	No	C		A	D				B			1
	C	♦D2OZ 65611B60	N	No	A										1
	R	♦♦D2SZ 65611A72	R	Yes	B										1
	L	♦♦D2SZ 65611A73	R	Yes	B										1
	R	# D2SZ 65611A72	R	Yes	C										1
	L	# D2SZ 65611A73	R	Yes	C										1

♦ Standard buckle-plastic covered # Extra length belt ● Loc-Location R - Right Hand L - Left Hand C - Center

# FORD CAR PARTS

**BODY  
SECTION 610**

17

**611A72-3 BELT ASSY. - FRONT SEAT COMPLETE - continued**

BODY TYPE	L O C.	PART NUMBER LESS SUFFIX	RETRC. or NON- RETRC.	INCL. S/ HAR- NESS	COLORS and APPLICABLE PART NUMBER SUFFIXES										Q T Y.
					BLACK	BLUE	GINGER	GRAY GOLD	GREEN	PARCH MENT	RED	TOB- ACCO	OTHER	OTHER	

*1972 - "Before 12/1/71"*

UNLESS OTHERWISE INDICATED, BELTS SHOWN ARE STANDARD LENGTH WITH DELUXE BUCKLE

S-"Before 9/1/71"	R	◆ D2SZ	65611A72	R	Yes	A													1
	L	◆ D2SZ	65611A73	R	Yes	A													1
S-"From 9/1/71"	R	◆ D2AZ	65611A72	R	Yes	K													1
	L	◆ D2AZ	65611A73	R	Yes	K													1
U	C	D1TZ	10611B60	N	No	E	B			D	A	C							1
	R	D1BZ	10611A72	R	No		⊕			⊕	A	⊕							1
	L	D1BZ	10611A73	R	No		⊕			⊕	A	⊕							1
	R	D3BZ	10611A72	R	Yes	A													
	L	D3BZ	10611A73	R	Yes	A													

*1972 - "From 12/1/71"*

UNLESS OTHERWISE INDICATED, BELTS SHOWN ARE STANDARD LENGTH WITH DELUXE BUCKLE

A	C	D2AZ	65611B60	N	No	G	J	D	H	K	C	E	F						1	
	C	◆ D2AZ	65611B60	N	No	B													1	
A(exc. 76)	R	D2AZ	65611A72	R	Yes	T	M	N	U	R	L	P	S						1	
	L	D2AZ	65611A73	R	Yes	T	M	N	U	R	L	P	S						1	
	R	◆ D3AZ	65611A72	R	Yes	A													1	
	L	◆ D3AZ	65611A73	R	Yes	A													1	
	R#	◆ D2AY	65611A72	R	Yes	G													1	
	L#	◆ D2AY	65611A73	R	Yes	G													1	
	R#	D2AY	65611A72	R	Yes	H													1	
	L#	D2AY	65611A73	R	Yes	H													1	
A(76)	R	D2AZ	76611A72	R	Yes	K	F	G		J		H						1		
	L	D2AZ	76611A73	R	Yes	K	F	G		J		H						1		
	R#	D2AZ	76611A72	R	No	M													1	
	L#	D2AZ	76611A73	R	No	M													1	
B	C	D2AZ	65611B60	N	No	G	J	D	H	K			F						1	
	C	D2AZ	65613B84	N	No	A													1	
B(53,71)	R	D2OZ	53611A72	R	Yes	N	J	K	R	L								1		
	R	D3OZ	53611A72	R	Yes								F						1	
	L	D2OZ	53611A73	R	Yes	N	J		R	L								1		
	R	◆ D2OZ	53611A72	R	Yes	H							F						1	
	L	◆ D2OZ	53611A73	R	Yes	H													1	
	R#	◆ D2OZ	53611A72	R	Yes	U													1	
	L	◆ D2OZ	53611A73	R	Yes	H													1	
	R#	D2OZ	53611A72	R	Yes	V													1	
	L	#D3OZ	53611A73	R	Yes	J													1	
	B(63,65)-bucket seat	R	D2OZ	65611A72	R	Yes	N	P	J		L		K	M						1
		L	D2OZ	65611A73	R	Yes	N	P	J		L		K	M						1
		R	◆ D2OZ	65611A72	R	Yes	H													1
L		◆ D2OZ	65611A73	R	Yes	H													1	
R#		◆ D2OZ	65611A72	R	Yes	T													1	
L#		◆ D2OZ	65611A73	R	Yes	T													1	
R#		D2OZ	65611A72	R	Yes	U													1	
L#		D2OZ	65611A73	R	Yes	U													1	
B(63,65)-full width seat	R	D2AZ	65611A72	R	Yes	T	M	N	U	R			S						1	
	L	D2AZ	65611A73	R	Yes	T	M	N	U	R			S						1	
	R	◆ D3OZ	65611A72	R	Yes	R													1	
	L	◆ D3OZ	65611A73	R	Yes	R													1	
	R#	◆ D2AY	65611A72	R	Yes	G													1	
	L#	◆ D2AY	65611A73	R	Yes	G													1	
	R#	D2AY	65611A72	R	Yes	H													1	
	L#	D2AY	65611A73	R	Yes	H													1	

● Loc.-Location C-Center L-Left Hand R-Right Hand ◆ Standard buckle-plastic covered # Extra length belt

⊕ Use black

May, 1975

COPYRIGHT © 1975 -

FORD MOTOR  
COMPANY

- DEARBORN, MICHIGAN

**FINAL ISSUE**

611A72-3 BELT ASSY. - FRONT SEAT COMPLETE - continued

BODY TYPE	LOC.	PART NUMBER LESS SUFFIX	RETRC. or NON-RETRC.	INCL. S HAR-NESS	COLORS and APPLICABLE PART NUMBER SUFFIXES										QTY
					BLACK	BLUE	GINGER	GRAY GOLD	GREEN	PARCH MENT	RED	TOB. ACCO	OTHER	OTHER	

1972 - "From 12/1/71"

UNLESS OTHERWISE INDICATED, BELTS SHOWN ARE STANDARD LENGTH WITH DELUXE BUCKLE

B(97)-bucket seat	R	D2OZ	97611A72	R	Yes	T	N	⊕	U	⊕				S					1	
	R	D3OZ	97611A72	R	Yes			C	⊕	D									1	
	L	D2OZ	97611A73	R	Yes	T	N	⊕	U	⊕				S					1	
	L	D3OZ	97611A73	R	Yes	M													1	
	R	#D3OZ	97611A72	R	Yes	M													1	
	L	#D3OZ	97611A73	R	Yes	M													1	
B(97)-full width seat	R	D2OZ	97611A72	R	Yes			⊕	⊕	M	⊕			K					1	
	R	D3OZ	97611A72	R	Yes	E	A	C		D									1	
	L	D2OZ	97611A73	R	Yes	L	⊕	H	M	⊕				K					1	
	L	D3OZ	97611A73	R	Yes		A		⊕	D									1	
	R	D3OZ	97611A72	R	Yes	L													1	
	L	#D3OZ	97611A73	R	Yes	L													1	
F(63,65)	R/L	D2ZZ	65611A72	R	Yes	R	M	N		Q	K	P					\$L		2	
	R/L	♦D2ZZ	65611A72	R	Yes	J													2	
	R/L	#♦D2ZZ	65611A72	R	Yes	U													1	
	R/L	#D2ZZ	65611A72	R	Yes	V													1	
F(76)	R/L	D2ZZ	76611A72	R	No	H	L	M		P	J	N					\$K		2	
	R/L	#D2ZZ	76611A72	R	No	R													2	
L	R	D2FZ	62611A72	R	Yes	K	G	H		J								▲M	1	
	L	D2FZ	62611A73	R	Yes	K	G	H		J								▲M	1	
	R	♦D2FZ	62611A72	N	Yes	F													1	
	L	♦D2FZ	62611A73	N	Yes	F													1	
	R#	♦D2FZ	62611A72	R	Yes	R													1	
	L#	♦D2FZ	62611A73	R	Yes	R													1	
	R#	D2FZ	62611A72	R	Yes	S													1	
	L#	D2FZ	62611A73	R	Yes	S													1	
	R	D3FZ	62611A72	R	Yes										♦C	†D			1	
	L	D3FZ	62611A73	R	Yes										♦C	†D			1	
	R	♦D3FZ	62611A72	R	Yes										♦A	†B			1	
	L	♦D3FZ	62611A73	R	Yes										♦A	†B			1	
P	R/L	D2DZ	62611A72	R	Yes	J	H	N										▲M	†V	2
	R/L	♦D2DZ	62611A72	R	Yes	T														2
	R/L	#D2DZ	62611A72	R	Yes	U														2
S	C	D2AY	76613B84	N	No		G			D									1	
	C	♦D2AZ	65613B84	N	No	A													1	
S-full width or split bench seat	R	D3LZ	65611A72	R	Yes					D									1	
	L	D3LZ	65611A73	R	Yes					D									1	
	R	D2AZ	65611A72	R	Yes	T	M	N	U				P	S					1	
	L	D2AZ	65611A73	R	Yes	T	M	N	U				P	S					1	
	R	♦D3SZ	65611A72	R	Yes	A													1	
	L	♦D3SZ	65611A73	R	Yes	A													1	
	R#	♦D2AY	65611A72	R	Yes	G													1	
	L#	♦D2AY	65611A73	R	Yes	G													1	
	R#	D2AY	65611A72	R	Yes	H													1	
	L#	D2AY	65611A73	R	Yes	H													1	
S-bucket seat	R	D2OZ	65611A72	R	Yes	N	P	J		L			K	M					1	
	L	D2OZ	65611A73	R	Yes	N	P	J		L			K	M					1	
	R	♦D2OZ	65611A72	R	Yes	H													1	
	L	♦D2OZ	65611A73	R	Yes	H													1	
	R#	♦D2OZ	65611A72	R	Yes	T													1	
	L#	♦D2OZ	65611A73	R	Yes	T													1	
	R#	D2OZ	65611A72	R	Yes	U													1	
	L#	D2OZ	65611A73	R	Yes	U													1	

♦ Standard buckle - plastic covered      ● Loc.-Location    C - Center    L - Left Hand    R - Right Hand  
 ▲ Beige    \$ Vermilion    † Tan    † Orange    ♦ Avocado    # Extra length belt    ⊕ Use black



**BODY  
SECTION 610**
**FORD CAR PARTS**

GROUP NUMBER	YEAR	BODY TYPE	DESCRIPTION	PART NUMBER	QTY.
<b>61212 BOLT - SEAT BELT ANCHOR EYE</b>					
	65	A, B, F, X	Front or rear seat	C4AZ 6261212-C	4
<b>612A12 INSULATOR - FRONT SEAT BELT ANCHOR BOLT</b>					
	66	A	Black	C6AZ 62612A12-AAB	2
			Ivy Gold	C6AZ 62612A12-AAE	2
			Parchment	C6AZ 62612A12-AAJ	2
<b>61216 REINFORCEMENT SEAT BELT ANCHOR TO FLOOR PAN</b>					
	65/66	A, B, S, X	3 7/32" O.D. x 1/8" thick	C2AZ 6261216-A	2or4
	66	A, B, F, S, X	7/16" x 1 5/8" x 3 3/4"-rear seat belts	C6AZ 6261216-A	2
	66	A(71), B(71)	Auxiliary seat belts		2or4
	67/70	A	Front seat inboard	C7AZ 6261216-A	2
			Rear seat outboard	C7AZ 6261216-B	2
			Rear seat inboard	C7AZ 6261216-A	2
	69/70	A(71A, C)	Auxiliary seats	C7AZ 7161216-A	4
	71	A		D1AZ 6561216-B	2
	72	A		C7AZ 6261216-A	2
	67/70	B, X	Front seat inboard	C7AZ 7161216-A	2
	67/70	B, X	Front seat outboard	C7AZ 6261216-A	2
	67/70	B(except 66), X	Rear seat	C7AZ 7161216-A	4
	70	B(76)		C7AZ 6261216-B	2
	71	B		D1AZ 6561216-B	2
	67/68	F	Front seat outboard	C7AZ 6261216-B	2
	67/	F	Front seat inboard	C7AZ 7161216-A	2
	67/	F	Rear seat inboard and outboard	C7AZ 7161216-A	4
	71/	L		C7AZ 6261216-A	2
	70/	P		C7AZ 6261216-A	2
	67/68	S	Rear seat inboard	C7AZ 6261216-A	2
	67/70	S	Rear seat outboard	C7AZ 6261216-B	2
	71	S		D1AZ 6561216-B	2
	67/	U	Front seat inboard and outboard	C7AZ 6261216-B	4
			Rear seat inboard and outboard		4
<b>61216 REINFORCEMENT - FRONT SEAT BELT ANCHOR TO SIDE MEMBER</b>					
	65	A, B, F, S	1/8" x 1 13/16" x 2 1/2"	C6AZ 6261216-A	2
	66	A, B(54, 62, 63, 71), F, S, U, X			2or4
	67	B(54, 62, 63, 66, 71), F, X			2or4
	66	U	1/8" x 1 3/8" x 3 9/16"	C6TZ 9661216-A	4
	67/	U			2
<b>612A16 SPACER - FRONT SEAT BELT RETRACTOR</b>					
	72	A, B, F, L, P, S		D2AZ 65612A16-A	2
<b>61222 LOOP - FRONT SEAT BELT RETAINING - INCLUDES ATTACHING PARTS</b>					
	65	A, B, F, S, X	Transparent plastic	C4AZ 6261222-AAB	2or4
	67/	A	Use with split seat		2
	69/	A			2
			Screw-oval head, cross recess-No. 10-12 x 3/4"	52361-S13(U303A)	2or4
			Washer-countersunk-No. 10	*34970-S	2or4
<b>612A22-3 MEMBER - FRONT SEAT BACK FRONT SIDE LOWER</b>					
	68	S	R. H. -Use with reclining seat	C8SZ 65612A22-A	1
			L. H.	C8SZ 65612A23-A	1
<b>612A34 SPRING ASSY. - PASSENGER RECLINING SEAT HEAD REST</b>					
	67	S		C7SZ 65612A34-A	1
<b>612A56 SPACER - FRONT SEAT BELT</b>					
	67/68	A, B, F, X	Used with shoulder harness	C7AZ 62612A56-A	2
	67/68	A, B, F, S, X	Used with front seat belt		4
	67/68	A, B, S, X	Front seat-center		2
<b>61280 HOOK ASSY. - SEAT BELT</b>					
	65	A, B, F, S, X	Use with Rotunda seat belts only	C3AZ 6261280-A	4
			Pin-cotter-1/16" x 3/8"	72000-S7(N37)	AR
<b>612K83 PLATFORM - FRONT SEAT BACK</b>					
	72	P(54, 62)		D0RY 62612K83-B	2

# FORD CAR PARTS

**BODY  
SECTION 610**

21

GROUP NUMBER	YEAR	BODY TYPE	DESCRIPTION	PART NUMBER	QTY.
<b>613B02</b>	<b>PIN - REAR SEAT BACK FLOOR PANEL</b>				
	65/	A(71)	46 1/2" long-cut to fit	C5AZ 71613B02-A	2
	65/67	A(54)	Use with folding rear seat		1
<b>613A04</b>	<b>FRAME - REAR SEAT BACK - UPPER - Paint to Match</b>				
	65/71	B(71)		C6OZ 71613A04-A	1
	72	B(71)		D2OZ 71613A04-A	1
	66/70	X(71)		C6OZ 71613A04-A	1
	65	X(59, 71)		C0DB 59613A04-AP	1
<b>613A10</b>	<b>FRAME - REAR SEAT</b>				
	66/67	U		C6TZ 96613A10-A	1
	68/	U		C6TZ 96613A10-B	1
<b>613B10</b>	<b>SUPPORT ASSY. - REAR SEAT BACK FLOOR PANEL HINGE BRACKET</b>				
	69/70	F(63)		C9ZZ 63613B10-A	2
	71/	F(63)		D1ZZ 63613B10-A	2
<b>613A12</b>	<b>BUMPER - REAR SEAT BACK FLOOR</b>				
	72	B(71)		D2OZ 71613A12-A	1
<b>613B18</b>	<b>BRACKET - REAR SEAT BACK LATCH</b>				
	65/66	A(71)	Reinforcement	C6AZ 7128022-A	1
	71/	L(64)		D1FZ 64613B18-A	1
	72	L(73)		D2FZ 73613B18-A	1
<b>613B24</b>	<b>COVER - REAR SEAT BACK LATCH BRACKET</b>				
	65	A(71)	R. H. -Black	C5AZ 71613B24-AAB	1
			R. H. -Blue	C5AZ 71613B24-AAD	1
	66	A(71)	R. H. -Aqua	C6AZ 71613B24-CAK	1
			R. H. -Black	C5AZ 71613B24-AAB	1
			R. H. -Blue	C5AZ 71613B24-AAD	1
			R. H. -Parchment	C6AZ 71613B24-CBA	1
			R. H. -Red	C6AZ 71613B24-CAH	1
	65/66	A(71)	Screw-pan head, cross recess-No. 8-18 x 3/8"	52720-S8(U380)	3
			Washer-flat-No. 8	44710-S8(X10)	3
	65/66	A	Screw-hex.head-5/16"-18 x 1 1/8"	55644-S13(U2E)	4
<b>613B26-7</b>	<b>ESCUTCHEON - REAR SEAT BACK LATCH HANDLE</b>				
	66	F(63)	"Before 2/1/66" R.H.-not replaced (3-74)	★C6ZZ 63613B26-A	1
	65	F(63)	R.H.	C5ZZ 63613B26-A	1
	66	F(63)	"From 2/1/66"		1
	67	F(63)	R. H. -use with folding rear seat	C7ZZ 63613B26-A	1
			L. H.	C7ZZ 63613B26-B	1
	68	F(63)	R. H. -use with folding rear seat	C8ZZ 63613B26-A	1
			L. H.	C8ZZ 63613B27-A	1
	71/	L-w/folding rear seat	Black	D1FZ 62613B26-A	1
			Blue	D3FZ 62613B26-E	1
			Ginger	D3FZ 62613B26-B	1
			Green	D1FZ 62613B26-C	1
<b>61328</b>	<b>PLATE - REAR SEAT BACK STOP ANCHOR</b>				
	71/72	L(62, 64)		D2FZ 6261328-A	1
	72	L(73)		D2FZ 7361328-A	1
	66/70	X(71)	L. H.	C6DZ 7161328-A	1
<b>613B28</b>	<b>CATCH - REAR SEAT BACK</b>				
	65/66	F(63)		C5ZZ 63613B28-B	1
	67/	F(63)	Refer to Group 601A68		
<b>613B30-1</b>	<b>BUMPER - REAR SEAT BACK LATCH</b>				
	67/70	F(63)	R.H.-use with folding rear seat - refer to group 61382-3	★C5ZZ 63613B30-A	1
			L. H.	C7ZZ 63613B31-A	1
	71/	F(63), L	Use with folding rear seat	D1ZZ 63613B30-A	1
<b>61332</b>	<b>ROD - REAR SEAT BACK LATCH HANDLE</b>				
	65/66	A(71)		C5AZ 7161332-A	1
	65/67	A(54)	Use with folding rear seat		1
	66/70	X(71)			2
	72	B(71)		D2OZ 7161332-A	1
<b>61339</b>	<b>BUMPER - REAR SEAT BACK LATCH HANDLE STOP PIN</b>				
	65/67	A(54)	Used with folding rear seat	C2AZ 7161339-A	1
	65/66	A(71)			1or2
	66/70	X(71)			1

GROUP NUMBER	YEAR	BODY TYPE	DESCRIPTION	PART NUMBER	QTY.
<b>61340</b>	<b>PLATE - REAR SEAT BACK LATCH STRIKER ANCHOR</b>				
	71/	F(63)	Use with folding rear seat	D1ZZ 6361340-A	1
<b>61346</b>	<b>BEARING - REAR SEAT BACK LATCH HANDLE</b>				
	65/67	A(54)	Used with folding rear seat	C2AB 7161346-A	1 1or2 1or2 2
	65	A(71), B(71)			
	66	A(71)			
	66/70	X(71)			
<b>613B77</b>	<b>BRACKET - REAR SEAT BACK SUPPORT BUMPER</b>				
	71	L(64)	"Before 1/18/71"	D1FZ 64613B77-A	1
	71/72	L(64)-	"From 1/18/71 to 12/1/71"	D1FZ 64613B77-B	1
	72	L(64, 73)		"From 12/1/71"	D2FZ 64613B77-A
<b>61382-3</b>	<b>LATCH ASSY. - REAR SEAT BACK RELEASE</b>				
	65	F(63)	R. H.	C5ZZ 6361382-B	1
	66	F(63)	R. H.	C6ZZ 6361382-B	1
	67/70	F(63)	R. H. -Use with folding rear seat	C7ZZ 6361382-A	1
			L. H.	C7ZZ 6361383-A	1
	71/	F(63), L	Used with folding rear seat	D1ZZ 6361382-A	1
			Screw and washer - hex. head - No. 10-24 x 1/2"	★55590-S2	8
	65/67	F(63)	Screw & washer-hex. head-No. 10-24 x 3/8"	375921-S13(BB551C)	4
<b>613A82</b>	<b>EXTENSION ASSY. - REAR SEAT BACK FLOOR PANEL - Paint to Match</b>				
	65/	A(71)	Paint to match	C5AZ 71613A82-H	1
	66/71	B(71), X(71)	Palomino-paint to match	C6OZ 71613A82-A	1
	72	B(71)		D2OZ 71613A82-A	1
<b>613B84-5</b>	<b>BELT ASSY. - REAR SEAT COMPLETE</b>				

BODY TYPE	R/L	PART NUMBER LESS SUFFIX	COLORS and APPLICABLE PART NUMBER SUFFIXES										Q T Y.
			AQUA	BLACK	BLUE	BUR- GUNDY	EMBER- GLO	IVY GOLD	PALD- MINO	PARCH- MENT	RED	SADDLE	

1966

A-also aux. seats- "Before 5/16/66"	*	+C6AZ 62613B84						DAH	DAG	DAE		⊕	DAC		DAK	4
	*	+C7AZ 62613B84				B1A	B1B									AR
A-also aux. seats- "From 5/16/66"	*	# C6AZ 63613B84					EAD	⊕	■	⊕		EAJ			EAK	4
	*	# C7AZ 62613B84		A1K	A1A								A1D			AR
A(71)-aux. seat	*	# C6AZ 63613B84					EAH									2
B(54)"Before 5/16/66"	*	+C6OZ 54613B84		AAF						AAE		AAJ	AAC			2
	*	+C7AZ 62613B84				A1B										2
B(54) "From 5/16/66"	*	# C6SZ 63613B84		CAF	CAB	CAD	CAH	CAG	CAE			CAJ	CAC		CBA	2
B(62, 63, 71, 76)- also auxiliary seat- "Before 5/16/66"	*	+C6AZ 62613B84							DAE			⊕	DAC		DAK	4
	*	# C7AZ 62613B84		A1K	A1A								A1D			AR
	*	+C7AZ 62613B84				B1A	B1B									AR
B "From 5/16/66"	*	# C6AZ 63613B84					EAD		■			EAJ			EAK	4
B(71)-aux. seat	*	# C6AZ 62613B84					EAH									2
F "Before 1/3/66"	*	+C6AZ 62613B84								DAE			DAC		DAK	4
F "From 1/3/66 to 5/16/66"	*	# C6AZ 63613B84					EAD		■			EAJ			EAK	4
F "From 5/16/66"	*	# C6ZZ 65613B84					BAD		BAG			BAJ				2
S	*	# C6SZ 63613B84		CAF	CAB	⊕	CAH	CAG	⊕			⊕	CAC		⊕	2
X(54)"Before 5/16/66"	*	†C6OZ 54613B84		AAF					AAE		AAJ	AAC				2
	*	+C7AZ 62613B84				A1B										2
X(54)"From 5/16/66"	*	# C6SZ 63613B84		CAF	CAB	⊕	CAH	CAG	⊕		⊕	CAC		⊕	CAC	2
X(62, 71)- "Before 5/16/66"	*	+C6AZ 62613B84							DAE				DAC		DAK	4
X(62, 71)- "From 5/16/66"	*	# C6AZ 63613B84					EAD		■			EAJ			EAK	4

\* Includes attaching parts  
■ Use C7AZ 62613B84-A1D

† With finger tip release  
⊕ Use black

# With push button release



# FORD CAR PARTS

**BODY  
SECTION 610**

23

**613B84-5 BELT ASSY. - REAR SEAT COMPLETE - continued**

BODY TYPE	R/L	PART NUMBER LESS SUFFIX	COLORS and APPLICABLE PART NUMBER SUFFIXES											QTY.	
			AQUA	BLACK	BLUE	BUR GUNDY	EMBER- GLO	IVY GOLD	NUG- GET GOLD	PARCH- MENT	RED	SADDLE	TOB- ACCO		
<i>1967</i>															
A	*	#C7AZ 62613B84	A1K	A1A	A1B				A1G		A1U	A1D	A1F	⊕	3
	*	†C7AZ 62613B84		B1A	B1B						⊕				3
A(71)-aux. seat	*	#C8MY 71613B84		A1A	⊕			⊕		⊕	⊕	⊕			2
	*	†C7AZ 71613B84		E1A	⊕					⊕					2
B-also aux. seat	*	#C7AZ 62613B84	A1K	A1A	A1B				A1G		A1U	A1D	A1F	⊕	5
	*	†C7AZ 62613B84		B1A	B1B						⊕				5
F(exc. Shelby GT350/500)*	*	#C7AZ 62613B84	A1K	A1A	A1B				A1G		A1U	A1D	A1F	⊕	3
	*	†C7AZ 62613B84		B1A	B1B						⊕				3
S	*	#C7AZ 62613B84	A1K	A1A	A1B				A1G		A1U	A1D	A1F	⊕	3
U			Refer to Group 611A72-3												
X	*	#C7AZ 62613B84	A1K	A1A	A1B				A1G		A1U	A1D	A1F	⊕	5
	*	†C7AZ 62613B84		B1A	B1B						⊕				5

<i>1968</i>															
A		▲C8AZ 62613B84		C1A	⊕						⊕				3
		†C8WZ 65613B84	A1K	A1A	⊕				A1G	A1Y	A1U	⊕	⊕		3
A(71)-aux. seat		▲C8AZ 71613B84		C1A	⊕						⊕				2
		†C8AZ 71613B84	D1K	D1A	⊕			⊕		D1Y					2
B-also aux. seat		▲C8AZ 62613B84		C1A	C1B						⊕				3
		†C8WZ 65613B84	A1K	A1A	A1B				A1G	A1Y	A1U	A1D	A1F		3
F(exc. Shelby GT350/500)		▲C8AZ 62613B84		C1A	C1B						⊕				3
		†C8WZ 65613B84	A1K	A1A	A1B				A1G	A1Y	A1U	A1D	A1F		3
S		▲C8AZ 62613B84		C1A	C1B						⊕				3
		†C8WZ 65613B84	A1K	A1A	A1B				A1G	A1Y	A1U	A1D	A1F		3
X		▲C8AZ 62613B84		C1A	C1B						⊕				3
		†C8WZ 65613B84	A1K	A1A	A1B				A1G	A1Y	A1U	A1D	A1F		3
U			Refer to Group 611A72-3												

MODEL	PART NUMBER	DESCRIPTION	QTY.
<b>OUTBOARD BELT</b>			
A, B, F, S, X	382624-S100(UU170)	Bolt-torx head, tapping-7/16"-20 x 1 3/8"	2
U	382627-S100(UU156)	Bolt-torx head, tapping-7/16"-20 x 1 3/4"	2
S	382582-S100(XX179A)	Washer-flat-1/2"	2
U	382629-S100(XX173AA)	Washer-flat-7/16"	2
U	354959-S(XX178C)	Washer-flat-1/2" x 9/64" thick-rubber	4
A, F, S	382583-S100(XX340AC)	Washer-serrated-1/2"	2
B			4
<b>INBOARD BELT</b>			
A, B, S(57), U, X	382627-S100(UU156)	Bolt-torx head, tapping-7/16"-20 x 1 3/4"	2
F, S(65)	382624-S100(UU170)	Bolt-torx head, tapping-7/16"-20 x 1 3/8"	2
A, B, S(57), X	382582-S100(XX179A)	Washer-flat-1/2"	2
A, B, S(57), U, X	382629-S100(XX173AA)	Washer-flat-7/16"	2
U	354959-S(XX178C)	Washer-flat-1/2" x 9/64" thick-rubber	4
F, S(65)	382583-S100(XX340AC)	Washer-serrated-1/2"	2

\* Includes attaching parts      † With finger tip release      # With push button release      ⊕ Use black  
 ‡ Chrome and plastic buckle      ▲ Plastic buckle      ■ Use D1AZ 62613B84-A1D

May, 1975

COPYRIGHT © 1975 -

FORD MOTOR  
COMPANY

- DEARBORN, MICHIGAN

**FINAL ISSUE**

**BODY  
SECTION 610**
**FORD CAR PARTS**
**613B84-5 BELT ASSY. - REAR SEAT COMPLETE - continued**

MODEL	PART NUMBER	DESCRIPTION	QTY.
1968			
<b>SHOULDER STRAP</b>			
U(98)	382517-S100(BB445LD)	Bolt-hex., shoulder, locking-3/8"-16 x 1 1/2"	2
U(98)		Spacer - refer to Group 60228	
<b>AUXILIARY SEAT</b>			
A(71), B(71)	382624-S100(UU170)	Bolt-torx head, tapping-7/16"-20 x 1 3/8"	4
A(71), B(71)	382583-S100(XX340AC)	Washer-serrated-1/2"	4

BODY TYPE	R/L	PART NUMBER LESS SUFFIX	COLORS and APPLICABLE PART NUMBER SUFFIXES											QTY.	
			AQUA	BLACK	BLUE	GINGER	GREEN	IVY GOLD	NUG- GET GOLD	PARCH- MENT	RED	SADDLE	TOB- ACCO		
1969															
A, B, F, S, U, X- rear & aux. seat		Refer to Group 611A72-3													

1970

UNLESS OTHERWISE INDICATED, BELTS SHOWN  
ARE STANDARD LENGTH WITH DELUXE BUCKLE

A-rear and aux.	DOMZ 76613B84				D	A	B	E	e		G	⊕	F			AR
	●D0AZ 62613B84					A										AR
B-rear and aux.	DOMZ 76613B84					A	B	E	H		G	J				AR
	●D0AZ 62613B84					A										AR
F	DOMZ 76613B84					A	B	E	H			J				2
	●D0AZ 62613B84					A										AR
P "Before 10/1/69"	D0DZ 62613B84					E	⊕				D		⊕			2
P "From 10/1/69"	DOMZ 76613B84					A	B				G		F			2
	●D0AZ 62613B84					A										AR
S	DOMZ 76613B84					A	◇B	E	H		G	J	F		C	3
S	D0SZ 76613B84						◆A									3
	●D0AZ 62613B84					A										AR
U					Refer to Group 611A72-3											
X-rear and aux.	‡C9AZ 62611A72				KIK	KIA	KIB				KIG	KIY		KID		AR

MODEL	PART NUMBER	DESCRIPTION	QTY.
<b>OUTBOARD BELT</b>			
A, B, F, P, S	382624-S100(UU170)	Bolt-torx head, tapping-7/16"-20 x 1 3/8"	2
U	382627-S100(UU156)	Bolt-torx head, tapping-7/16"-20 x 1 3/4"	2
U	382629-S100(XX173AA)	Washer-flat-7/16"	2
U	354959-S(XX178C)	Washer-flat-1/2" x 9/64" thick-rubber	4
A, B, F, P, S	382583-S100(XX340AC)	Washer-serrated-1/2"	2
<b>INBOARD BELT</b>			
A, B, S(57), U	382627-S100(UU156)	Bolt-torx head, tapping-7/16"-20 x 1 3/4"	2
F, P, S(65)	382624-S100(UU170)	Bolt-torx head, tapping-7/16"-20 x 1 3/8"	2
A, B, S(57), U(w/2 belts)	382582-S100(XX179A)	Washer-flat-1/2"	2
A, B, S(57), U	382629-S100(XX173AA)	Washer-flat-7/16"	2
U(w/I belt)	354959-S(XX178C)	Washer-flat-1/2" x 9/64" thick-rubber	4
F, P, S(65)	382583-S100(XX340AC)	Washer-serrated-1/2"	2
<b>SHOULDER STRAP</b>			
U(98)	382626-S100(UU175)	Bolt-torx head, tapping-3/8"-16 x 1 1/2"	2
U(98)		Spacer - refer to Group 60228	
U(98)	★382554-S100	Washer-spring lock-3/8"	2
<b>AUXILIARY SEAT</b>			
A(71), B(71)	382624-S100(UU170)	Bolt-torx head, tapping-7/16"-20 x 1 3/8"	4
A(71), B(71)	382583-S100(XX340AC)	Washer-serrated-1/2"	4

◇ Medium      ◆ Dark      ‡ Chrome and plastic buckle      ● Standard buckle - plastic covered (Black only)  
⊕ Use black

# FORD CAR PARTS

**BODY  
SECTION 610**

25

**613B84-5 BELT ASSY. - REAR SEAT COMPLETE - continued**

BODY TYPE	Loc.	PART NUMBER LESS SUFFIX	COLORS and APPLICABLE PART NUMBER SUFFIXES											QTY.		
			AQUA	BLACK	BLUE	GINGER	GRAY	GRAY GOLD	GREEN	PARCHMENT	RED	TOB-ACCO	VER-MIL-ION			
<b>1971</b>																
UNLESS OTHERWISE INDICATED, BELTS SHOWN ARE STANDARD LENGTH WITH DELUXE BUCKLE																
A-rear and aux.		DOMZ 76613B84					A									AR
		DOMZ 76611A72				J	K									AR
		DIAZ 76611A72							A	B		H	L	S		AR
A(71)-aux.		◆D0AZ 71613B84					A									AR
A-rear		◆D1AZ 65613B84					A									AR
B-rear and aux.		DOMZ 76613B84					A									AR
		◆DIAZ 65613B84					A									AR
		DIAZ 76611A72							A	B						AR
F		DOMZ 76611A72				J	K					H	L	S		AR
		DOMZ 76613B84					A									2
		◆DIAZ 65613B84					A									2
		DIAZ 76611A72							A	B					E	2
L		DOMZ 76611A72				J	K					H	L	S		2
		DIFZ 62613B84					A	⊕								2
P		◆D2FZ 62613B84					C									2
		DOMZ 76613B84					A									2
		◆DIAZ 65613B84					A									2
		DIAZ 76611A72							A	B						2
		DOMZ 76611A72				J	K					H	L	S		2
S		DOMZ 76613B84					A									AR
		◆DIAZ 65613B84					A									AR
		DIAZ 76611A72							A	B						AR
		DOMZ 76611A72				J	K					H	L	S		AR
U		D0BZ 10611A72				E	B					A	C			AR
		DITZ 10611A72									B					AR

MODEL	PART NUMBER	DESCRIPTION	QTY.
<b>OUTBOARD BELT</b>			
A, B, F, P, S	382624-S100(UU170)	Bolt-torx head, tapping-7/16"-20 x 1 3/8"	2
L			4
U	382627-S100(UU156)	Bolt-torx head, tapping-7/16"-20 x 1 3/4"	2
S(57)	382582-S100(XX179A)	Washer-flat-1/2"	2
U	382629-S100(XX173AA)	Washer-flat-7/16"	2
U	354959-S(XX178C)	Washer-flat-1/2" x 9/64" thick-rubber	4
A, B, F, P, S	382583-S100(XX340AC)	Washer-serrated-1/2"	2
L, U			4
<b>INBOARD BELT</b>			
A, B, P(54), U	382627-S100(UU156)	Bolt-torx head, tapping-7/16"-20 x 1 3/4"	2
P(62), S	382624-S100(UU170)	Bolt-torx head, tapping-7/16"-20 x 1 3/8"	2
A, B, P(54), S, U	382582-S100(XX179A)	Washer-flat-1/2"	2
A, B, P(54), S, U	382629-S100(XX173AA)	Washer-flat-7/16"	2
P(62)	382583-S100(XX340AC)	Washer-serrated-1/2"	2
<b>AUXILIARY SEAT</b>			
A(71), B(71)	382624-S100(UU170)	Bolt-torx head, tapping-7/16"-20 x 1 3/8"	4
A(71), B(71)	382583-S100(XX340AC)	Washer-serrated-1/2"	4
<b>SHOULDER STRAP</b>			
U(98)	382626-S100(UU175)	Bolt-torx head, tapping-3/8"-16 x 1 1/2"	2
U(98)		Spacer - refer to Group 60228	
U(98)	★382554-S100	Washer-spring lock-3/8"	2

◆ Standard buckle - plastic covered (Black only)  
● Loc. - Location

R - Right Hand  
⊕ Use black  
L - Left Hand

May, 1975

Copyright © 1975 -

FORD MOTOR  
COMPANY

-DEARBORN, MICHIGAN

**FINAL ISSUE**



# FORD CAR PARTS

**BODY  
SECTION 610**

27

**513B84-5 BELT ASSY. - REAR SEAT COMPLETE - continued**

BODY TYPE	LOC	PART NUMBER LESS SUFFIX	RETRC or NON RETRC.	COLORS and APPLICABLE PART NUMBER SUFFIXES											QTY.
				BLACK	BLUE	GINGER	GRAY GOLD	GREEN	PARCH MENT	RED	TOB- ACCO	OTHER	OTHER	OTHER	
<i>1972 - "From 12/1/71" - continued</i>															
UNLESS OTHERWISE INDICATED, BELTS SHOWN ARE STANDARD LENGTH WITH DELUXE BUCKLE															
B	C	D2OZ 65613B84	N	E	⊕	⊕		⊕				⊕		1	
	C	D2OY 65613B84	N				B							1	
	C	◆D2OZ 65613B84	N	J										1	
B(exc. 71)	R	◆D3OZ 65611B66			J	C		L			F		1		
	R	D2OZ 65613B84	R	P	S		R				N		1		
	R	D3OZ 65613B84	R			D		E					1		
	L	D2OZ 65613B85	R	E	G		F				D		1		
	L	D3OZ 65613B85	R			D		E					1		
	R	◆D2OZ 65613B84	R	K									1		
B(71)-rear	L	◆D2OZ 65613B85	R	A									1		
	R/L	D3OZ 71613B84	R	E	B	C		D					2		
B(71)-aux.	R/L	◆D2OZ 65613B84	R	A									2		
	R/L	D2OZ 65613B84	N	E	⊕	⊕				H	⊕		2		
	R/L	◆D3OZ 65611B66			J	C					F		2		
F	R/L	◆D2OZ 65613B84	N	J									2		
	R/L	D2ZZ 76613B84	R	M	H	J		L	G	K			2		
L	R/L	◆D2ZZ 65613B84	R	A									2		
	R	D2FZ 62613B84	R	T	P	R		S			ΔU		1		
	L	D2FZ 62613B85	R	T	P	R		S			ΔU		1		
	R	◆D2FZ 62613B84	R	N									1		
	L	◆D2FZ 62613B85	R	N									1		
	R	D3FZ 62613B84	R									†B	♣A	1	
	L	D3FZ 62613B85	R									†B	♣A	1	
	R	◆D3FZ 62613B84	R									†D	♣C	1	
P(54)	L	◆D3FZ 62613B85	R								†D	♣C	1		
	R/L	D3DZ 54613B84	R	F	B	E					ΔC		#D	2	
	R/L	◆D2DZ 54613B84	R	A		M					ΔF			2	
	C	D2AZ 76613B84	N		A						ΔK			1	
	C	D2AY 76613B84	N	F		B								1	
	C	◆D2DZ 62613B84	N	A										1	
P(62)	C	D2DZ 76613B84	N									#A		1	
	R/L	D2DZ 62613B84	R	J										2	
	R/L	D3DZ 62613B84	R		B	E					ΔC		#D	2	
S	R/L	◆D2DZ 62613B84	R	F										2	
	R	D2LY 65613B84	R					D						1	
	L	D2LY 65613B85	R					B						1	
	R	D2LZ 65613B84	R	N	P	J		L		K	M			1	
	L	D2LZ 65613B85	R	E	F	A		C		B	D			1	
	R	◆D2SZ 65613B84	R	B										1	
	L	◆D2SZ 65613B85	R	A										1	
	C	D2OZ 65613B84	N	E										1	
	C	D3OZ 65611B66	N		H	C		E		D	F			1	
U	C	◆D2OZ 65613B84	N	J										1	
	R/L	D1TZ 10611B60	N	E	B			D	A	C				2	

MODEL	PART NUMBER	DESCRIPTION	QTY.
<b>OUTBOARD BELT</b>			
A,B(exc.71),F,L,P,S,U	382624-S100(UU170)	Bolt-torx head,tapping-7/16"-20 x 1 3/8"	2
B(71)	383608-S100(UU160)	Bolt-torx head,tapping-7/16"-20 x 7/8"	2
A,B(exc.71)		Spacer-refer to Group 612A16	2
F,L	382583-S100	Washer	4

♦ Loc - Location      R - Right hand      L - Left hand      C - Center      ⊕ Use deluxe belt  
 ◆ Standard buckle - plastic covered      Δ Beige      \$ Vermillion      † Orange      ♣ Avocado      # Tan  
 May, 1975      COPYRIGHT © 1975 —      FORD MOTOR COMPANY      — DEARBORN, MICHIGAN      **FINAL ISSUE**

## 613B84-5 BELT ASSY. - REAR SEAT COMPLETE - continued

MODEL	PART NUMBER	DESCRIPTION	QTY.
<i>1972 - "From 12/1/71" - continued</i>			
<b>INBOARD BELT</b>			
A,B	382624-S100(UU170)	Bolt-torx head, tapping-7/16"-20 x 1 3/8"	2
P(54),U	382627-S100(UU156)	Bolt-torx head, tapping-7/16"-20 x 1 3/4"	2
F	382583-S100	Washer	
P(54)		Spacer-refer to Group 612A16	2
P(54),U	382629-S100(XX173AA)	Washer-flat-7/16"	
U	354959-S(XX178C)	Washer-flat-1/2" x 9/16" thick-rubber	4
<b>AUXILIARY BELT</b>			
A(71),B(71)	382624-S100(UU170)	Bolt-torx head, tapping-7/16"-20 x 1 3/8"	4
B(71)	C2AB 6210034-A	Plug-to plug seat belt hole when seat belts are not used	4

GROUP NUMBER	YEAR	BODY TYPE	DESCRIPTION	PART NUMBER	QTY.
<b>61386 RETAINER - REAR SEAT FLOOR SUPPORT TO FLOOR</b>					
	69/71	F(63)		C9ZZ 6361386-A	2
<b>61390 PANEL ASSY. - REAR SEAT BACK FLOOR</b>					
	65/	A(54, 71)	Refer to Group 60508		
	65/71	F(63)		C5ZZ 6361390-A	1
<b>61400-1 MOULDING - FRONT SEAT CUSHION SIDE SHIELD</b>					
	70/	A	R. H. -snap on -with bucket seat	C9YZ 6561400-A	1
			L. H.	C9YZ 6561401-A	1
	72	B	R.H.	D2GZ 6561400-A	1
			L.H.	D2GZ 6561401-A	1
	72	S	R.H.	D2LZ 6561400-A	1
			L.H.	D2LZ 6561401-A	1
<b>61402-3 MOULDING - FRONT SEAT BACK SIDE SHIELD</b>					
	69	A(63C, 76B)-"Before 4/23/69"	R. H. -snap on -with bucket seat	C9YZ 6561402-A	1
	69	A "From 4/23/69"	R. H. -with bucket seat	C9YZ 6561402-B	1
			L. H.	C9YZ 6561403-A	1
	70/71	A	R. H. -with bucket seat		1
			L. H.	C9YZ 6561403-B	1
	70/71	A	R. H. -15 5/8" long-upper-with bucket seats	D0YZ 6561402-A	1
			L. H.	D0YZ 6561403-A	1
	72	S-bucket seat	Side	D2GZ 6561402-A	2
	72	B	Top	D2LZ 6561402-A	2
	72	S-split bench seat			2
<b>61404-5 MOULDING - FRONT SEAT BACK SIDE SHIELD-TOP - INCLUDES ATTACHING PARTS</b>					
	69/71	S(57, 65)	R. H.	C8SZ 6561404-A	1
			L. H.	C8SZ 6561405-A	1
<b>61410-1 MOULDING - FRONT SEAT CUSHION SIDE SHIELD - INCLUDES ATTACHING PARTS</b>					
	67	A(63C, 76B)	R. H.	C7AZ 6361410-B	2
			L. H.	C7AZ 6361411-B	2
	70/71	A	R. H. -with bucket seat	D0YZ 6561410-A	1
			L. H.	D0YZ 6561411-A	1
	67/71	S	R.H.	C7AZ 6361410-B	2
			L.H.	C7AZ 6361411-B	2
<b>61424-5 MOULDING - FRONT SEAT BACK SIDE SHIELD - INCLUDES ATTACHING PARTS</b>					
	68/71	S	R. H. -inner	C8SZ 6561424-A	1
			L. H.	C8SZ 6561425-A	1
	70/71	S(65)	R. H. -outer	D0SZ 6561424-B	1
			L. H.	D0SZ 6561425-B	1
<b>61482-3 CAP - FRONT SEAT BACK SIDE SHIELD MOULDING</b>					
	69	A(63C, 76B)	R. H. -Lower front -with bucket seat	C9AZ 6361482-A	1
			L. H.	C9YZ 6561483-A	1
	69	A(63C, 76B)	R. H. -Upper rear -with bucket seat	C9YZ 6561482-A	1
			L. H.	C9YZ 6561483-B	1
	70/71	A	R. H. -Lower front-with bucket seat	C9AZ 6361482-A	1
			L. H.	C9YZ 6561483-A	1
	70/71	A	R. H. -Upper rear-with bucket seat	C9YZ 6561482-A	1
			L. H.	C9YZ 6561483-B	1

# FORD CAR PARTS

## BODY SECTION 615

1

GROUP NUMBER	YEAR	BODY TYPE	DESCRIPTION	PART NUMBER	QTY.
<b>61506 BUMPER - AUXILIARY SEAT BACK FLOOR PIVOT ARM</b>					
	68/	A(71),B(71)		D3AZ 7161506-A	§ 2
<b>61606 SUPPORT - FRONT SEAT BACK TRIM PANEL</b>					
	72	B,S		D2SZ 6561606-A	1
<b>61610 SPACER - FRONT SEAT BACK PIVOT OUTER COVER</b>					
	68	A(63C, 76C), B(63D, E, 65D, 66B, D, 76D, E), X(62C)		C7AZ 6361610-A	4
	69	B(63B, E, 65D, E, 66B, D, 76D, E), X(62C)			4
	67	F(63A, 65A, C, 76A, C), U	Approx. 17/32" x 5/8" x 1 3/8"	C7ZZ 6561610-A	2

GROUP NUMBER	YEAR	BODY TYPE	DESCRIPTION	PART NUMBER		QTY.
				RIGHT HAND	LEFT HAND	
<b>61616-7 SHIELD - FRONT SEAT BACK SIDE - Also refer to Group 60762 in Soft Trim Section</b>						

- A -

	65/67	A(62, 63, 76)-full width seat	Aluminum	C5AZ 6361616-A	C5AZ 6361617-A	1
	68	A-bucket seat	Driver	C7MY 6361616-B	C8AZ 6361617-A	1
			Passenger	C8AZ 6361616-A	C7MY 6361617-B	1
	69	A(54, 57, 71)-full width or split seat	Wood grain insert	C9AZ 5461616-A	C9AZ 5461617-A	1
	69	A(62, 63, 65, 76)-full width or split seat	Wood grain insert	C9AZ 6561616-A	C9AZ 6561617-A	1
	69	A-bucket seat		C9AZ 6361616-A	C9AZ 6361617-A	1
	70	A(54, 57, 71)-full width seat	W/o recliner-wood grain insert	D0AZ 5461616-A	D0AZ 5461617-A	1
	70	A(54, 57, 71)-full width or split seat	W/recliner-wood grain insert	D0AZ 6261616-A	D0AZ 6261617-A	1
	70	A(63, 65, 76)-full width or split seat				1
	70/71	A-bucket seat		D0YZ 6561616-A	D0YZ 6561617-A	1
	71/72	A(53, 57)-w/hi-back split bench seat "Before 5/1/72"		D1AZ 5761616-A	D1AZ 5761617-A	1
	72	A(53, 57)-w/hi-back split bench seat "From 5/1/72"		D2AZ 5361616-A	D1AZ 5761617-A	1
	71/	A-w/lo-back seat		D1AZ 6561616-A	D1AZ 6561617-A	1
	71/72	A(65)-w/hi-back split bench seat "Before 5/1/72"		D1AZ 6561616-B	D1AZ 6561617-B	1
	72	A(65)-w/hi-back split bench seat "From 5/1/72"		D2AZ 6561616-A	D1AZ 6561617-B	1

- B -

	68/69	B-bucket seat	Driver	C7MY 6361616-B	C8AZ 6361617-A	1
			Passenger	C8AZ 6361616-A	C7MY 6361617-B	1

- F -

	65/66	F	Aluminum	C5ZZ 6561616-A	C5ZZ 6561617-A	1
			Screw-oval head-cross recess-No.10-12 x 5/8"	52353-S13(U303)	52353-S13(U303)	4
			Screw-oval head-cross recess-No.10-16 x 3/4"	★52430-S13	★52430-S13	2
			Washer-flat-5/16"	★377902-S	★377902-S	4
	67	F(63A, 65A, C, 76A, C)	Aluminum	C7ZZ 6561616-A	C7ZZ 6561617-A	1

GROUP NUMBER	YEAR	BODY TYPE	DESCRIPTION	PART NUMBER		QTY.
				RECLINING	NON-RECLINING	
<b>61616-7 SHIELD - FRONT SEAT BACK SIDE - continued</b> - Also refer to Group 60762 in Soft Trim Section						
- S -						
68	S	"Before 5/27/68"	W/(9) holes	★C8SZ 6561616-B Not replaced (1-73)	★C8SZ 6561616-A Not replaced (6-75)	ø 2
68/69	S	"From 5/27/68 to 12/12/68"	W/o (9) holes	★C8SZ 6561616-D Not replaced (6-75)	★C8SZ 6561616-C Not replaced (6-75)	ø 2
69/70	S	"From 12/12/68 to 10/13/69"		C9SZ 6561616-A	C9SZ 6561616-A	1or2
70/71	S	"From 10/13/69"		D0SZ 6561616-A	D0SZ 6561616-A	1or2
69/71	S		Screw-truss head- No.8-18 x 3/8"	376378-S101(UU97)	376378-S101(UU97)	4
			Screw-self-tap.pan head- No.10-16 x 1/2"	350754-S8(UU86)	350754-S8(UU86)	2
72	S-split bench seat-passenger-	"Before 3/15/72"	Black	D3LZ 6561616-B	D3LZ 6561616-B	§ 1
			Blue	D3LZ 6561616-G	D3LZ 6561616-G	§ 1
			Ginger	D3LZ 6561616-E	D3LZ 6561616-E	§ 1
			Green	D3LZ 6561616-F	D3LZ 6561616-F	§ 1
			Red	D3LY 6561616-F	D3LY 6561616-F	§ 1
			Tobacco	D3LZ 6561616-C	D3LY 6561616-C	§ 1
			White	D3LZ 6561616-C	D3LZ 6561616-D	§ 1
72	S-split bench seat-passenger-	"From 3/15/72"	Black	D3LZ 6561616-B	D3LZ 6561616-B	§ 1
			Blue	†D2LZ 6561616-E	D3LZ 6561616-G	§ 1
			Ginger	D3LZ 6561616-E	D3LZ 6561616-E	§ 1
			Green	D3LZ 6561616-F	D3LZ 6561616-F	§ 1
			Red	D3LY 6561616-F	D3LY 6561616-F	§ 1
			Tobacco	D3LZ 6561616-C	D3LZ 6561616-C	§ 1
			White	D3LZ 6561616-D	D3LZ 6561616-D	§ 1
72	S-bucket seat-passenger-	"Before 3/15/72"	Black	D3SZ 6561616-C	D3SZ 6561616-C	§ 1
			Blue	D3SZ 6561616-F	D2GY 6561616-C	§ 1
			Ginger	D2GY 6561616-G	D2GY 6561616-G	§ 1
			Green	D3SZ 6561616-E	D2GY 6561616-A	§ 1
			Red	D2GZ 6561616-G	D2GZ 6561616-G	§ 1
72	S-bucket seat-passenger-	"From 3/15/72"	Black	D3SZ 6561616-C	D3SZ 6561616-C	§ 1
			Blue	D3SZ 6561616-F	D2GY 6561616-C	§ 1
			Ginger	†D2GY 6561616-G	D2GY 6561616-G	1
			Green	D3SZ 6561616-E	D2GY 6561616-A	§ 1
			Red	†D2GZ 6561616-G	D2GZ 6561616-G	1
72	S-split bench seat-driver		Black		D3LZ 6561616-B	§ 1
			Blue		D3LZ 6561616-G	1
			Ginger		D3LZ 6561616-F	§ 1
			Gold		D2LZ 6561616-G	1
			Green		D3LZ 6561616-F	§ 1
			Red		D3LY 6561616-F	§ 1
			Tobacco		D3LZ 6561616-C	§ 1
			White		D3LZ 6561616-D	§ 1
72	S-bucket seat-driver		Black		D3SZ 6561616-C	§ 1
			Blue		D2GY 6561616-C	1
			Ginger		D2GY 6561616-G	1
			Green		D2GY 6561616-A	1
			Red		D2GZ 6561616-G	1
GROUP NUMBER	YEAR	BODY TYPE	DESCRIPTION	PART NUMBER		QTY.
				RIGHT HAND	LEFT HAND	
- U -						
67	U		Aluminum	C7TZ 9661616-A	C7ZZ 6561617-A	2
- X -						
66		X(62C,66D)		C6OZ 6361616-A	★C6OZ 6361617-A	2
67		X(62C)			Not replaced (3-74)	2
68/70	X	Bucket seat	Driver	C7MY 6361616-B	C8AZ 6361617-A	1
			Passenger	C8AZ 6361616-A	C7MY 6361617-B	1

† Drill hole for reclining seat



# FORD CAR PARTS

**BODY  
SECTION 615**

3

GROUP NUMBER	YEAR	BODY TYPE	DESCRIPTION	PART NUMBER	QTY.	
<b>61632 PANEL - FRONT SEAT BACK REAR TRIM</b>						
	72	L		D3FZ 6261632-AA	2	
<b>61642-3 PLATE - FRONT SEAT BACK SCUFF</b>						
- A -						
	65	A(63C, 76B)	Passenger bucket seat	C2SZ 6361642-B	2	
	66/67	A(62-Police and Taxi) - "Before 12/15/66"			2	
	67	A(62-Police and Taxi)- "From 12/15/66"	Refer to Group 60060			
	65	A(63C, 76B)	Driver bucket seat	C2SZ 6361643-A	2	
	66	A(63C, D, 76B, D)			2	
	67	A(63C, 76B)			2	
	65/66	A(63B, F, 76A)		C5AZ 6261642-A	2	
	66	A(62 except Police and Taxi)			2	
	67	A(62B, E, 63B, J, 76A)			2	
	68	A(57F, 62, 63B, 65, 76)			2	
	67/69	A	Split seat	C6VY 5361642-A	8	
			Screw-flat head, tapping-No.10-12 x 3/4"	52023-S8(U210)	16	
- B -						
	66/67	B(63C, D, 76C, D)	Driver bucket seat	C2SZ 6361643-A	2	
	65	B(62, 65A)		PB9M 5661642-A	4	
	65	B(65B)	Improvise	★	4	
	65	B(71)	Storage compartment-refer to Group 60060			
- F -						
	65	F		PB9M 5661642-A	2	
	65/69	F	Bucket seats	C1DZ 6461643-A	2	
- S -						
	65	S	Passenger bucket seat	C2SZ 6361642-B	2	
	65/67	S	Driver bucket seat	C2SZ 6361643-A	2	
- U -						
	66/	U	Bucket seats	C1DZ 6461643-A	2	
- X -						
	65	X(59, 62, 63B, 66A, B, 78)		PB9M 5661642-A	4	
	65	X(76B, D)	Driver bucket seat	C2SZ 6361643-A	2	
	66	X(62C, 66D)			2	
	67	X(62C)			2	
	65	X(63C, D)	Improvise	★	4	
<b>61644-5 TRACK - FRONT SEAT</b>						
	72	A	"From 12/1/71"	6-way bench seat-inner -R.H.	D2AZ 6561644-B	1
			"From 12/1/71"	6-way bench seat--inner-L.H.	D2AZ 6561645-A	1
			"From 12/1/71"	6-way split-bench seat-upper -driver	D2AZ 6561644-A	1
	72	S	"Before 7/3/72"	Split seat or bucket-inner	D2LZ 6561644-A	4
	72	S	"From 7/3/72"	Split seat or bucket-inner	D3LZ 6561644-A	1or2
<b>GROUP NUMBER YEAR BODY TYPE DESCRIPTION PART NUMBER QTY.</b>						
<b>61692-5 COVER - FRONT SEAT BACK PIVOT SIDE</b>						
- A -						
	65/66	A(63C, D, 76B, D)	Outer-aluminum-w/ reclining seat	★C4SZ 6361694-B Not replaced (7-73)	C4SZ 6361695-A	1
			Outer-aluminum-w/o reclining seat	C4SZ 6361694-A	★C6SZ 6361695-A Not replaced (7-73)	1
	69	A(63B, C, 65C, 76A, B)-Bucket seat	Black	C8ZZ 6561692-B1A	C8ZZ 6561693-B1A	1
			Blue (Light)	C8ZZ 6561692-B1B	C8ZZ 6561693-B1B	1
			Ivy Gold (Dark)	C8ZZ 6561692-B2G	C8ZZ 6561693-B2G	1
			Nugget Gold	C8ZZ 6561692-B1Y	C8ZZ 6561693-B1Y	1
			Red	C8ZZ 6561692-B2D	C8ZZ 6561693-B2D	1

**BODY  
SECTION 615**
**FORD CAR PARTS**

GROUP NUMBER	YEAR	BODY TYPE	DESCRIPTION	PART NUMBER				QTY.
				RIGHT HAND		LEFT HAND		
<b>61692-5 COVER - FRONT SEAT BACK PIVOT SIDE - continued</b>								
- A -								
70	A-Bucket seat		Black	C8ZZ	6561692-B1A	C8ZZ	6561693-B1A	1
			Blue	D0ZZ	6561692-G	D0ZZ	6561693-G	1
			Ginger	D0ZZ	6561692-J	D0ZZ	6561693-J	1
			Green	D0ZZ	6561692-K	D0ZZ	6561693-K	1
			White	D0ZZ	6561692-L	D0ZZ	6561693-L	1
71	A-Bucket seat		Black-inner	C8ZZ	6561692-B1A	C8ZZ	6561693-B1A	1
			Ginger-inner	D0ZZ	6561692-J	D0ZZ	6561693-J	1
			Red-inner	D0WY	6561692-B	D0WY	6561693-B	1
			White-inner	D0ZZ	6561692-L	D0ZZ	6561693-L	1
			Black-outer	D0ZZ	6561694-G	D0ZZ	6561695-G	1
			Blue-outer	D0ZZ	6561694-A	D0ZZ	6561695-A	1
			Ginger-outer	D0ZZ	6561694-C	D0ZZ	6561695-C	1
			Green-outer	D1AZ	6561694-B	D1AZ	6561695-B	1
			Vermilion-outer	D1AZ	6561694-A	D1AZ	6561695-A	1
			White-outer	D0ZZ	6561694-E	D0ZZ	6561695-E	1
		71/	A-w/hi-back full width seat		BLACK	D1AZ	6561692-A	D1AZ
	BLUE			D1AZ	6561692-B	D1AZ	6561693-B	1
	GINGER			D1AZ	6561692-C	D1AZ	6561693-C	1
	GRAY GOLD			D1AZ	6561692-F	D1AZ	6561693-F	1
	GREEN			D1AZ	6561692-E	D1AZ	6561693-E	1
	RED			D1AZ	6561692-D	D1AZ	6561693-D	1
	TOBACCO(1971)			D1AY	6561692-A	D1AY	6561693-A	1
	TOBACCO(1972)			D2AZ	6561692-A	D2AZ	6561693-A	1
				PASSENGER- NON-RECLINING		DRIVER		
71/	A-w/hi-back split bench seat-non-reclining	#	BLACK	D1MY	6561692-A	D1MY	6561693-A	1
		•	BLACK	D1AZ	6561692-A	D1AZ	6561693-A	1
		#	BLUE	D1MY	6561692-D	D1MY	6561693-D	1
		•	BLUE	D1AZ	6561692-B	D1AZ	6561693-B	1
		#	GINGER	D1MY	6561692-B	D1MY	6561693-B	1
		•	GINGER	D1AZ	6561692-C	D1AZ	6561693-C	1
		#	GRAY GOLD	D1MY	6561692-G	D1MY	6561693-G	1
		•	GRAY GOLD	D1AZ	6561692-F	D1AZ	6561693-F	1
		#	GREEN	D1MY	6561692-F	D1MY	6561693-F	1
		•	GREEN	D1AZ	6561692-E	D1AZ	6561693-E	1
		#	RED	D1MY	6561692-E	D1MY	6561693-E	1
		•	RED	D1AZ	6561692-D	D1AZ	6561693-D	1
		#	TOBACCO	D1MY	6561692-C	D1MY	6561693-C	1
		•	TOBACCO	D1AY	6561692-A	D1AY	6561693-A	1
71/	A-w/hi-back split bench seat-reclining	#	BLACK	D1MY	6561692-A	D1MY	6561693-A	1
		•	BLACK	D1AZ	6561692-L	D1AZ	6561693-A	1
		#	BLUE	D1MY	6561692-D	D1MY	6561693-D	1
		•	BLUE	D1AZ	6561692-K	D1AZ	6561693-B	1
		#	GINGER	D1MY	6561692-B	D1MY	6561693-B	1
		•	GINGER	D1AZ	6561692-G	D1AZ	6561693-C	1
		#	GRAY GOLD	D1MY	6561692-G	D1MY	6561693-G	1
		•	GRAY GOLD	D1AZ	6561692-N	D1AZ	6561693-F	1
		#	GREEN	D1MY	6561692-F	D1MY	6561693-F	1
		•	GREEN	D1AZ	6561692-J	D1AZ	6561693-E	1
		#	RED	D1MY	6561692-E	D1MY	6561693-E	1
		•	RED	D1AZ	6561692-M	D1AZ	6561693-D	1
		#	TOBACCO(1971)	D1MY	6561692-C	D1MY	6561693-C	1
		•	TOBACCO(1971)	D1AZ	6561692-H	D1AY	6561693-A	1
#	TOBACCO(1972)	D2AZ	6561692-A	D2AZ	6561693-A	1		
•	TOBACCO(1972)	D2MY	6561692-A	D2MY	6561693-A	1		

# Armrest pivot

• Seat pivot

# FORD CAR PARTS

BODY  
SECTION 615

5

GROUP NUMBER	YEAR	BODY TYPE	DESCRIPTION	PART NUMBER				QTY.
				RIGHT HAND		LEFT HAND		
<b>61692-5 COVER - FRONT SEAT BACK PIVOT SIDE - continued</b>								
- B -								
68		B(63B, 65A, B, C, J, 66A, B, 76B)	Aqua	C8OZ	6361694-A1K	C8OZ	6361695-A1K	1
			Black	C8OZ	6361694-A1A	C8OZ	6361695-A1A	1
			Blue (Dark)	C8OZ	6361694-A2B	C8OZ	6361695-A2B	1
			Blue (Light)	C8OZ	6361694-A1B	C8OZ	6361695-A1B	1
			Nugget Gold	C8OZ	6361694-A1Y	C8OZ	6361695-A1Y	1
			Red	C8OZ	6361694-A2D	C8OZ	6361695-A2D	1
69		B(63B, F, 65A, B, C, F, 66A, B, C, D, 76B, F)	Aqua	C8OZ	6361694-A1K	C8OZ	6361695-A1K	1
			Black	C8OZ	6361694-A1A	C8OZ	6361695-A1A	1
			Blue (Dark)	C8OZ	6361694-A2B	C8OZ	6361695-A2B	1
			Blue (Light)	C8OZ	6361694-A1B	C8OZ	6361695-A1B	1
			Ivy Gold (Dark)	C9OZ	6361694-A2G	C9OZ	6361695-A2G	1
			Nugget Gold	C8OZ	6361694-A1Y	C8OZ	6361695-A1Y	1
			Red	C8OZ	6361694-A2D	C8OZ	6361695-A2D	1
			White	C9OZ	6361694-A1W	C9OZ	6361695-A1W	1
70		B-Full width seat	Black-outer	C8OZ	6361694-A1A	C8OZ	6361695-A1A	1
			Blue-outer	D0OZ	6361694-A	D0OZ	6361695-A	1
			Ginger-outer	D0OZ	6361694-D	D0OZ	6361695-D	1
			Green-outer	D0OZ	6361694-B	D0OZ	6361695-B	1
			Nugget Gold-outer	C8OZ	6361694-A1Y	C8OZ	6361695-A1Y	1
			Red-outer	D0OZ	6361694-C	D0OZ	6361695-C	1
70		B-Bucket seat	Black-inner	C8ZZ	6561692-B1A	C8ZZ	6561693-B1A	1
			Blue-inner	D0ZZ	6561692-G	D0ZZ	6561693-G	1
			Ginger-inner	D0ZZ	6561692-J	D0ZZ	6561693-J	1
			Green-inner	D0ZZ	6561692-K	D0ZZ	6561693-K	1
			Nugget Gold-inner	C8ZZ	6561692-B1Y	C8ZZ	6561693-B1Y	1
			Red-inner	D0WY	6561692-B	D0WY	6561693-B	1
			White-inner	D0ZZ	6561692-L	D0ZZ	6561693-L	1
			Black-outer	D0ZZ	6561694-G	D0ZZ	6561695-G	1
			Blue-outer	D0ZZ	6561964-A	D0ZZ	6561695-A	1
			Ginger-outer	D0ZZ	6561694-C	D0ZZ	6561695-C	1
			Green-outer	D0ZZ	6561694-D	D0ZZ	6561695-D	1
			Red-outer	D0WY	6561694-A	D0WY	6561695-A	1
			White-outer	D0ZZ	6561694-E	D0ZZ	6561695-E	1
			71		B-Bucket seat	Black-inner	C8ZZ	6561692-B1A
Blue-inner	D0ZZ	6561692-G				D0ZZ	6561693-G	1
Ginger-inner	D0ZZ	6561692-J				D0ZZ	6561693-J	1
Green-inner	D1ZZ	6561692-B				D1ZZ	6561693-B	1
Vermilion-inner	D1ZZ	6561692-A				D1ZZ	6561693-A	1
White-inner	D0ZZ	6561692-L				D0ZZ	6561693-L	1
Black-outer	D0ZZ	6561694-G				D0ZZ	6561695-G	1
Blue-outer	D0ZZ	6561694-A				D0ZZ	6561695-A	1
Ginger-outer	D0ZZ	6561694-C				D0ZZ	6561695-C	1
Green-outer	D1AZ	6561694-B				D1AZ	6561695-B	1
Vermilion-outer	D1AZ	6561694-A				D1AZ	6561695-A	1
White-outer	D0ZZ	6561694-E				D0ZZ	6561695-E	1
71		B-Full width seat				Black	C8OZ	6361694-A1A
			Blue	D0OZ	6361694-A	D0OZ	6361695-A	1
			Ginger	D0OZ	6361694-D	D0OZ	6361695-D	1
			Gray Gold	D1OZ	6361694-D	D1OZ	6361695-D	1
			Green	D1OZ	6361694-C	D1OZ	6361695-C	1
			Vermilion	D1OZ	6361694-B	D1OZ	6361695-B	1
			White	D1OZ	6361694-A	D1OZ	6361695-A	1

GROUP NUMBER	YEAR	BODY TYPE	DESCRIPTION	PART NUMBER				QTY.		
				RIGHT HAND		LEFT HAND				
<b>61692-5 COVER - FRONT SEAT BACK PIVOT SIDE - continued</b>										
- F -										
68	F(63A, B, 65A, B, 76)		Black-inner	C8ZZ	6561692-B1A	C8ZZ	6561693-B1A	1		
			Blue-inner	C8ZZ	6561692-B1B	C8ZZ	6561693-B1B	1		
			Nugget Gold-inner	C8ZZ	6561692-B1Y	C8ZZ	6561693-B1Y	1		
			Red-inner	C8ZZ	6561692-B2D	C8ZZ	6561693-B2D	1		
68	F		Parchment-outer	C8ZZ	6561694-A1U	C8ZZ	6561695-A1U	1		
68/69	F		Aqua-outer	C8ZZ	6561694-A1K	C8ZZ	6561695-A1K	1		
			Black-outer	C8ZZ	6561694-A1A	C8ZZ	6561695-A1A	1		
			Blue (Dark)-outer	C8ZZ	6561694-A2B	★C8ZZ	6561695-A2B	1		
								Not replaced (1-73)		
			Blue (Light)-outer	C8ZZ	6561694-A1B	C8ZZ	6561695-A1B	1		
			Nugget Gold-outer	C8ZZ	6561694-A1Y	C8ZZ	6561695-A1Y	1		
			Saddle (brown)-outer	C8ZZ	6561694-A1F	C8ZZ	6561695-A1F	1		
Red-outer	C8ZZ	6561694-A1D	C8ZZ	6561695-A1D	1					
69	F		Ivy Gold (Light)-outer	C9ZZ	6561694-A3G	★C9ZZ	6561695-A3G	1		
								Not replaced (1-73)		
			White-outer	C9ZZ	6561694-A1W	C9ZZ	6561695-A1W	1		
69	F(63, 65A, C, E, 76)		Black-inner	C8ZZ	6561692-B1A	C8ZZ	6561693-B1A	1		
			Blue-inner	C8ZZ	6561692-B1B	C8ZZ	6561693-B1B	1		
			Nugget Gold-inner	C8ZZ	6561692-B1Y	C8ZZ	6561693-B1Y	1		
			Ivy Gold (Dark)-inner	C8ZZ	6561692-B2G	C8ZZ	6561693-B2G	1		
			Red-inner	C8ZZ	6561692-B2D	C8ZZ	6561693-B2D	1		
69/70	F(65C, D)		Black-inner	C9ZZ	6561692-A2A	C9ZZ	6561693-A2A	1		
70	F(63, 65A, B, E, 76)		Black-inner	C8ZZ	6561692-B1A	C8ZZ	6561693-B1A	1		
			Blue-inner	D0ZZ	6561692-G	D0ZZ	6561693-G	1		
			Ginger-inner	D0ZZ	6561692-J	D0ZZ	6561693-J	1		
			Green-inner	D0ZZ	6561692-K	D0ZZ	6561693-K	1		
			Tobacco-inner	D0ZZ	6561692-M	D0ZZ	6561693-M	1		
			Vermilion-inner	D0ZZ	6561692-H	D0ZZ	6561693-H	1		
			White-inner	D0ZZ	6561692-L	D0ZZ	6561693-L	1		
			Black-outer	D0ZZ	6561694-G	D0ZZ	6561695-G	1		
			Blue-outer	D0ZZ	6561694-A	D0ZZ	6561695-A	1		
			Ginger-outer	D0ZZ	6561694-C	D0ZZ	6561695-C	1		
Green-outer	D0ZZ	6561694-D	D0ZZ	6561695-D	1					
Tobacco-outer	D0ZZ	6561694-F	D0ZZ	6561695-F	1					
Vermilion-outer	D0ZZ	6561694-B	D0ZZ	6561695-B	1					
White-outer	D0ZZ	6561694-E	D0ZZ	6561695-E	1					
71	F	"Before 2/1/71"	Black-driver & passenger	D1ZZ	6561694-A	D1ZZ	6561695-A	2		
			Blue-driver & passenger	D1ZZ	6561694-B	D1ZZ	6561695-B	2		
			Ginger-driver & passenger	D1ZZ	6561694-N	D1ZZ	6561695-F	2		
71	F	"Before 2/1/71"	Green-driver & passenger	D1ZZ	6561694-G	D1ZZ	6561695-G	2		
			Red-driver & passenger	D1ZZ	6561694-D	D1ZZ	6561695-D	2		
			Vermilion-driver & passenger	D1ZZ	6561694-E	D1ZZ	6561695-E	2		
71/	F	"From 2/1/71"	White-driver & passenger	D1ZZ	6561694-C	D1ZZ	6561695-C	2		
			Black (1971)	D1ZZ	6561694-H	D1ZZ	6561695-H	2		
			Black (1972)	D2ZZ	6561694-A	D2ZZ	6561695-A	2		
			Blue	D1ZZ	6561694-J	D1ZZ	6561695-J	2		
			Ginger	D1ZZ	6561694-N	D1ZZ	6561695-N	2		
			Green	D1ZZ	6561694-P	D1ZZ	6561695-P	2		
			Red	D1ZZ	6561694-L	D1ZZ	6561695-L	2		
			Vermilion	D1ZZ	6561694-M	D1ZZ	6561695-M	2		
White	D1ZZ	6561694-K	D1ZZ	6561695-K	2					

# FORD CAR PARTS

**BODY  
SECTION 615**

GROUP NUMBER	YEAR	BODY TYPE	DESCRIPTION	PART NUMBER				QTY.
				RIGHT HAND		LEFT HAND		
<b>61692-5 COVER - FRONT SEAT BACK PIVOT SIDE - continued</b>								
- L -								
71/	L		Beige-driver & passenger	D2FZ	6261694-B	D2FZ	6261695-B	1
			Black (1971)-driver & passenger	D1FZ	6261694-A	D1FZ	6261695-A	1
			Black (1972)-driver & passenger	D2FZ	6261694-A	D2FZ	6261695-A	1
			Blue (exc.GB,HB trim code)-driver & passenger	D1FZ	6261694-B	D1FZ	6261695-B	1
			Ginger-driver & passenger	D1FZ	6261694-D	D1FZ	6261695-D	1
			Green-driver & passenger	D1FZ	6261694-C	D1FZ	6261695-C	1
			White (exc.GH,HB trim code)-driver & passenger	D2FZ	6261694-C	D2FZ	6261695-C	1
71/72	L	"Before 2/1/72"	Blue (GB, HB trim code)-driver & passenger	D0DZ	6261694-A1B	D0DZ	6261695-A1B	1
			White(GB, HB trim code)-driver & passenger	D2DZ	6261694-C	D2DZ	6261695-C	1
72	L		Avocado-driver & passenger	D3FZ	6261694-B	D3FZ	6261695-B	1
			Orange-driver & passenger	D3FZ	6261694-A	D3FZ	6261695-A	1
- P -								
70	P(62)		Aqua	D0DZ	6261694-A1K	D0DZ	6261695-A1K	1
			Black	D0DZ	6261694-A1A	D0DZ	6261695-A1A	1
			Blue	D0DZ	6261694-A1B	D0DZ	6261695-A1B	1
			Nugget Gold	D0DZ	6261694-A1Y	D0DZ	6261695-A1Y	1
			Red	D0DZ	6261694-A1D	D0DZ	6261695-A1D	1
71	P-w/bucket seat- "Before 2/1/71"		Black-driver & passenger	D1ZZ	6561694-A	D1ZZ	6561695-A	2
			Blue-driver & passenger	D1ZZ	6561694-J	D1ZZ	6561695-J	§ 2
			Grey Gold-driver & passenger	D14Y	6561694-A	D14Y	6561695-A	2
			Red-driver & passenger	D1ZZ	6561694-L	D1ZZ	6561695-L	§ 2
71/	P-w/bucket seat- "From 2/1/71"		Vermilion-driver & passenger	D1ZZ	6561694-M	D1ZZ	6561695-M	§ 2
			Black (1971)	D1ZZ	6561694-H	D1ZZ	6561695-H	2
			Black (1972)	D2ZZ	6561694-A	D2ZZ	6561695-A	2
			Blue	D1ZZ	6561694-J	D1ZZ	6561695-J	2
			Ginger	D1ZZ	6561694-N	D1ZZ	6561695-N	2
			Grey Gold	D14Y	6561694-A	D14Y	6561695-A	2
			Green	D1ZZ	6561694-P	D1ZZ	6561695-P	2
			Red	D1ZZ	6561694-L	D1ZZ	6561695-L	2
			Vermilion	D1ZZ	6561694-M	D1ZZ	6561695-M	2
			White	D1ZZ	6561694-K	D1ZZ	6561695-K	2
			Tan	D3DZ	6261694-C	D3DZ	6261695-C	§ 1
72	P(54, 62A)-w/reclining bucket seat		Button-tan	130055-ESJX	130055-ESJX		2	
71/	P-w/full width seat		Beige	D2DZ	6261694-A	D2DZ	6261695-A	1
			Black-outer	D0DZ	6261694-A1A	D0DZ	6261695-A1A	1
			Blue-outer	D0DZ	6261694-A1B	D0DZ	6261695-A1B	1
			Ginger	D2DZ	6261694-B	D2DZ	6261695-B	1
			Gray Gold-outer	D1DZ	6261694-B	D1DZ	6261695-B	1
			Vermilion-outer	D1DZ	6261694-A	D1DZ	6261695-A	1
			White	D2DZ	6261694-C	D2DZ	6261695-C	1
72	P(54, 62A)-w/full width seat		Tan	D2ZZ	6561694-D	D2ZZ	6561695-D	1

**BODY  
SECTION 615**
**FORD CAR PARTS**

GROUP NUMBER	YEAR	BODY TYPE	DESCRIPTION	PART NUMBER		QTY.
				RIGHT HAND	LEFT HAND	
<b>61692-5 COVER - FRONT SEAT BACK PIVOT SIDE - continued</b>						
- S -						
65/66	S		Outer-aluminum-w/ reclining seat	★C4SZ 6361694-B Not replaced (7-73)	C4SZ 6361695-A	1
			Outer-aluminum-w/o reclining seat	C4SZ 6361694-A	★C6SZ 6361695-A Not replaced (7-73)	1
72	S-Split seat		Black	D2LZ 6561692-C	D2LZ 6561693-C	1or2
			Blue	D2LZ 6561692-F	D2LZ 6561693-F	1or2
			Ginger	D2LZ 6561692-A	D2LZ 6561693-A	1or2
			Green	D2LZ 6561692-D	D2LZ 6561693-D	1or2
			Red	D2LZ 6561692-E	D2LZ 6561693-E	1or2
			Tobacco	D2LZ 6561692-G	D2LZ 6561693-G	1or2
			White	D2LZ 6561692-B	D2LZ 6561693-B	1or2
- U -						
67	U-bucket seat		Parchment	C7WY 6561693-A1U	★C7TZ 9661695-B1U Not replaced (3-74)	1
67	U-full width seat		Parchment	C7TZ 9661694-C1U	C7TZ 9661695-C1U	1
68	U-bucket seat		Black	C8ZZ 6561695-A1A	C8ZZ 6561695-A1A	1
			Blue	C8ZZ 6561695-A1B	C8ZZ 6561695-A1B	1
			Parchment	C8ZZ 6561695-A1U	C8ZZ 6561695-A1U	1
			Red	C8ZZ 6561695-A1D	C8ZZ 6561695-A1D	1
70/71	U-bucket seat		Parchment	C7TZ 9661694-C1U	C7TZ 9661695-C1U	1
70/71	U-full width seat		Parchment	D0TZ 9761694-A	D0TZ 9761695-A	1
72	U		Parchment	D0TZ 9761692-A	D0TZ 9761693-A	1
72	U		Black-inboard	D2BZ 1061692-A	D2BZ 1061693-A	1
72	U		Black-outboard	D2BZ 1061694-A	D2BZ 1061695-A	1
70/	U		Screw-self-tap, pan head- No.8-32 x 1/2"	51764-S8(U366)	51764-S8(U366)	4
- X -						
65	X(63,66) -bucket seat		Bright plastic-outer	C3DZ 6361694-A	C3DZ 6361695-A	1
66	X(62B,66B)		Blue	C6OZ 6261694-ABA	C6OZ 6261695-ABA	1
66	X(62A, B, 66A, B)		Black	C6OZ 6261694-AAH	C6OZ 6261695-AAH	1
			Parchment	C6OZ 6261694-AAK	C6OZ 6261695-AAK	1
68/70	X(62A, B)		Aqua	C8OZ 6361694-A1K	C8OZ 6361695-A1K	1
			Black	C8OZ 6361694-A1A	C8OZ 6361695-A1A	1
			Blue (Dark)	C8OZ 6361694-A2B	C8OZ 6361695-A2B	1
			Blue (Light)	C8OZ 6361694-A1B	C8OZ 6361695-A1B	1
			Nugget Gold	C8OZ 6361694-A1Y	C8OZ 6361695-A1Y	1
			Red	C8OZ 6361694-A2D	C8OZ 6361695-A2D	1
69/70	X		Screw-fillister head- tapping-No.10-32 x 1/2"	357456-S13(UU43)	357456-S13(UU43)	4
- X -						
<b>61696-7 SLEEVE - FRONT SEAT BACK HINGE PIVOT</b>						
65	X(76B, D)		Outer-Chrome plated-2 3/32" O.D.		C1SB 6361697-B	2
			Pin-self-locking-1/16" x 15/16"		352358-S(NN127)	4
			Washer-flat-1/2"		★351455-S	4

# FORD CAR PARTS

**BODY  
SECTION 617**

1

GROUP NUMBER	YEAR	BODY TYPE	DESCRIPTION	PART NUMBER	QTY.
<b>61704-5 TRACK ASSY. - FRONT SEAT</b>					
- A -					
65/66	A		R. H. -Driver manual bucket seat	C5AZ 6361704-G	1
			L. H.	C5AZ 6361705-G	1
			R. H. -Passenger manual bucket seat	C5AZ 6361704-F	1
			L. H.	C5AZ 6361705-F	1
			Stud-3/8"-16	★380558-S2	8
			Lockwasher-spring-3/8"	34808-S8(X67)	8
			Nut-hex. -3/8"-16	33799-S8(M52)	8
65/66	A		Power full width seat-refer to Group 617A44-5		
65/67	A(54, 57, 62, 63B, F, 71, 76A)		R. H. -Manual full width seat	C5AZ 6261704-A	1
			L. H.	C5AZ 6261705-A	1
			Stud-5/16"-18 x 1 5/8"	★379054-S2	8
			Nut & washer-hex. -5/16"-18	★376838-S2	8
66	A		Power bucket seat-refer to Groups 61710 (upper track), 61714-5 (lower track) and 619A34 (slide)		
67	A		R. H. -Driver manual bucket seat	C7AZ 6361704-A	1
			L. H.	C7AZ 6361705-A	1
			R. H. -Passenger manual bucket seat	C7AZ 6361704-B	1
			L. H.	C7AZ 6361705-B	1
67	A	"Before 9/26/66"	R. H. -Driver manual split seat	C7AZ 6361704-C	1
			L. H.	C7MY 6361705-B	1
			R. H. -Passenger manual split seat	C7MY 6361704-A	1
			L. H.-not repl'd. (3-74)	★C7AZ 6361705-C	1
67/68	A	"From 9/26/66"	R. H. -Driver manual split seat	C7AZ 6361704-C	1
			L. H.	C7MY 6361705-B	1
			R. H. -Passenger manual split seat	C7MY 6361704-A	1
			L. H.-not repl'd. (3-74)	★C7AZ 6361705-C	1
68	A		R. H. -Manual full width seat	C8AZ 6261704-A	1
			L. H.	C8AZ 6261705-A	1
			R. H. -Manual bucket seat	C7MY 6361704-C	2
			L. H.	C7MY 6361705-C	2
69	A		R.H.-Driver manual split seat	C9MZ 6561704-A	1
			L. H.	C9AZ 6261705-A	1
			R. H. -Passenger manual split seat	C9MZ 6561704-B	1
			L. H.	C9MZ 6561705-C	1
69/70	A		R. H. -Manual full width seat	C9AZ 6261704-A	1
			L. H.	C9AZ 6261705-A	1
69/70	A		R.H.-Manual bucket seat	C9AZ 6361704-A	2
			L. H.	C9AZ 6361705-A	2
70	A		R.H.-Driver manual split bench seat	D0AZ 6561704-A	1
			L. H.	C9AZ 6261705-A	1
			R.H.-Passenger manual split bench seat	C9MZ 6561704-A	1
			L. H.	C9MZ 6561705-C	1
71/72	A	"Before 12/1/71"	R.H.-Manual full width seat	D1AZ 6561704-A	1
			L. H.	D1AZ 6561705-A	1
			R. H. -Driver or passenger-manual bucket seat	D1AZ 6561704-B	2
			L. H.	D1AZ 6561705-B	2
			R.H.-Driver manual split seat	D1AZ 6561704-A	1
			L. H.	D1AZ 6561705-A	1
			R.H.-Passenger manual split seat	D2AZ 6561704-A	§ 1
72	A	"From 12/1/71"	L. H.	D1AZ 6561705-C	1
			R.H.-Passenger split seat	D2AZ 6561704-A	1
			L. H.	D2AZ 6561705-A	1
			R.H.-Driver split seat	D2AZ 6561704-B	1
			L. H.	D2AZ 6561705-B	1
			R.H.-Full width seat	D2AZ 6561704-B	1
			L. H.	D2AZ 6561705-B	1

GROUP NUMBER	YEAR	BODY TYPE	DESCRIPTION	PART NUMBER	QTY.
<b>61704-5 TRACK ASSY. - FRONT SEAT - continued</b>					
- B -					
65		B(except 65B)	R. H. -Manual full width seat-5" travel	C3OZ 6261704-E	1
			L. H.	C3OZ 6261705-D	1
			Bolt-square head-5/16"-24 x 1"	★373749-S8	2
			Nut-spring-5/16"-18	353766-S(MM269)	4
			Screw & washer-cross recess-5/16"-24 x 1"	★378142-S7	4
			Washer-flat-7/16"	44730-S8(X26)	4
66		B(63C,D)	R. H. -Manual bucket seat	C6OZ 6361704-A	2
			L. H.	C6OZ 6361705-B	2
66		B(76C,D)	R. H. -Manual bucket seat	C6OZ 7661704-A	2
			L. H. -not replaced (5-75)	★C6OZ 7661705-B	φ 2
66		B(63C, D, 76C, D)	Nut & washer-hex. -5/16"-18	378643-S2(MM295L)	8
66/71		B	R. H. -Manual full width seat	C6OZ 6261704-C	1
			L. H.	C6OZ 6261705-C	1
67/69		B(63, 65, 66)	R. H. -Manual bucket seat	C6OZ 6361704-A	2
			L. H.	C6OZ 6361705-B	2
67/69		B(76)	R. H. -Manual bucket seat	C6OZ 7661704-A	2
			L. H.	C6OZ 7661705-B	2
69/71		B	R. H. -Power full width seat	C6GY 6261704-A	1
			L. H.	C6GY 6261705-A	1
69/71		B	Nut & washer-5/16"-18 (track to front floor pan)	382590-S100 (MM295K)	8
70/71		B(63, 65, 66, 76)	R. H. -Manual bucket seat	D0OZ 6561704-A	2
			L. H.	D0OZ 6561705-A	2
72		B	R. H.	D2OZ 6561704-A	1or2
			L. H.	D2OZ 6561705-A	1or2
- F -					
65/66		F	R. H. -Manual full width seat	C5ZZ 6561704-E	1
			L. H.	C5ZZ 6561705-E	1
			Screw & washer assy.	★379874-S2	4
			Nut & washer-hex. -5/16"-18	378643-S2(MM295L)	4
65/70		F	R. H. -Manual bucket seat	C5ZZ 6561704-F	2
			L. H.	C5ZZ 6561705-F	2
67/69		F	R. H. -Manual full width seat	C7ZZ 6561704-A	1
			L. H.	C7ZZ 6561705-A	1
71/72		F	"Before 12/1/71" R. H.-Driver and passenger bucket seat	D1ZZ 6561704-A	2
			L. H.	D2ZZ 6561705-A	2
72		F	"From 12/1/71" R. H.-Driver or passenger	D2ZZ 6561704-A	2
			L. H.	D2ZZ 6561705-A	2
71/		F(76)	Screw-washer head-5/16"-18 x 1 1/2"-attach seat track to cushion	384872-S2(UU52AH)	8
- L -					
71		L	R. H.-Driver and passenger	D1FZ 6261704-A	2
			L. H.	D1FZ 6261705-A	2
72		L	R. H.-Driver or passenger	D2FZ 6261704-A	2
			L. H.	D2FZ 6261705-A	2
- P -					
70		P	R. H.-Full width seat	C6OZ 6261704-C	1
			L. H.	D0DZ 6261705-B	1
			Screw & washer assy. (torx head)-5/16"-18 X 7/8"	383500-S100	4
			Nut-5/16"-18 -washer assy.	382590-S100(MM269K) (BB817YE)	4
			Screw & washer assy. (torx head)-5/16"-18 x 1 1/4"	383501-S100 (BB817YF)	2
			Screw & washer assv. 5/16"-18 x 7/8" fillister head	382592-S100 (BB817CM)	4



# FORD CAR PARTS

## BODY SECTION 617

GROUP NUMBER	YEAR	BODY TYPE	DESCRIPTION	PART NUMBER	QTY.
<b>61704-5 TRACK ASSY. - FRONT SEAT - continued</b>					
- P -					
71	P		R.H.-Full width seat	C6OZ 6261704-C	1
			L.H.	C6OZ 6261705-C	1
			R.H.-Driver and passenger bucket seat	D1DZ 6261704-A	2
			L.H.	D1DZ 6261705-A	2
72	P-exc. LTD		R.H.-Bucket seat	D2DZ 6261704-A	2
			L.H.	D2DZ 6261705-A	2
			R.H.-Full width seat	D2DZ 6261704-B	1
			L.H.	D2DZ 6261705-B	1
72	P(54, 62A)-LTD		R.H. -Driver bucket seat	D2DZ 6261704-D	1
			L.H. -Driver bucket seat	D2DZ 6261705-D	1
			R.H. -Passenger bucket seat	D2DZ 6261704-C	1
			L.H. -Passenger bucket seat	D2DZ 6261705-C	1
- S -					
65	S		R. H. -Power bucket seat	C4SZ 6361704-C	1or2
			L. H.	C4SZ 6361705-C	1or2
			Nut-hex. -3/8"-16	33799-S8(M52)	4or8
			Screw & washer assy.-fillister head, cross recess-5/16"-24 x 7/8"	★378103-S7	2or4
			Stud-3/8"-16 x 7/16" & 3/8"-16 x 1 1/4"	★378174-S8	4or8
			Washer-flat-3/8"	352981-S(XX143)	4or8
			Washer-lock, spring-3/8"	34808-S8(X67)	4or8
65/66	S		R. H. -Driver manual bucket seat	C4SZ 6361704-E	1
			L. H.	C4SZ 6361705-E	1
			R. H. -Passenger manual bucket seat	C4SZ 6361704-F	1
			L. H.	C4SZ 6361705-F	1
			Stud-3/8"-16 x 7/16" & 3/8"-16 x 1 1/4"	★378174-S8	16
			Nut-hex. -3/8"-16	★379748-S2	16
66	S		Power bucket seat-refer to Groups 61710 (upper track), 61714-5 (lower track)and 619A34 (slide)		
67/68	S		R. H. -Driver manual bucket seat	C7SZ 6561704-H	1
			L. H. -Driver manual bucket seat	C7SZ 6561705-H	1
			R. H. -Passenger manual bucket seat	C7SZ 6561704-J	1
			L. H. -Passenger manual bucket seat	C7SZ 6561705-J	1
68	S		R. H. -Manual full width seat	C8SZ 6561704-A	1
			L. H. -Manual full width seat	C8SZ 6561705-A	1
69	S		R.H.-Manual full width seat & driver bucket seat	D0SZ 6561704-B	1
			L.H.	D0SZ 6561705-B	1
69/70	S		R. H. -Passenger manual bucket seat	D0SZ 6561704-C	1
69/70	S		L. H. -Passenger manual bucket seat	D0SZ 6561705-C	1
70	S		R.H.-Manual full width seat & driver bucket seat	D0SZ 6561704-B	1
			L. H.	D0SZ 6561705-B	1
71	S		R.H.-Driver bucket or split bench	D0SZ 6561704-B	1
			R.H.-Full width seat		1
			L.H.	D0SZ 6561705-B	1
			R.H.-Passenger bucket or split bench	D0SZ 6561704-C	1
			L.H.	D0SZ 6561705-C	1
			R.H.	D2OZ 6561704-A	1or2
72	S		L.H.	D2OZ 6561705-A	1or2
- U -					
66/71	U		R. H. -Driver bucket seat	C6TZ 9661704-C	1
			L. H.	C6TZ 9661705-A	1
			Bolt-hex. head-3/8"-16 x 3/4"	20346-S8(B50)	12
			Lockwasher-external tooth-5/16"	34956-S7-8(X82)	12
			Washer-flat-7/16"	44730-S8(X26)	12
			Washer-flat-5/16"	354054-S8(XX121)	12

GROUP NUMBER	YEAR	BODY TYPE	DESCRIPTION	PART NUMBER	QTY.
<b>61704-5 TRACK ASSY. - FRONT SEAT - continued</b>					
- U -					
66/71	U		R. H. - Full width seat	D2BZ 1061704-A	1
			L. H.	C6TZ 9661705-B	1
			Bolt-hex, head-3/8"-18 x 3/4"	20346-S8(B50)	8
			Lockwasher-external tooth-5/16"	34956-S7-8(X82)	8
			Bolt-hex, head-5/16"-18 x 7/8"	20366-S8(B52)	4
			Washer-flat-5/16"	354054-S8(XX121)	12
72	U	"Before Ser. P00,001"	R.H.	D2BZ 1061704-A	2
			L.H.	D2BZ 1061705-A	2
72	U	"From Ser. P00,001"	R. H. -Driver	D2BZ 1061704-B	1
			L. H.	D2BZ 1061704-B	1
- X -					
65	X(54, 62, 63B, 66A, B, 78)		R. H. -Manual full width seat-steel ball slide-5" travel	C4DZ 6261704-D	1
			L. H.	C4DZ 6261705-D	1
			Bolt-square head-5/16"-18 x 1"	★379402-S2	2
			Bolt-square head-5/16"-18 x 1 1/4"	★379423-S2	2
			Nut-spring-5/16"-18	353766-S(MM269)	4
			Nut & washer assy. -5/16"-18	378643-S2(MM295L)	4
			Nut & washer-hex. -5/16"-18	378643-S2(MM295L)	4
65	X(63C, D, 66G, H)		R. H. -Manual bucket seat	C3DZ 6261704-C	2
			L. H. -not repl'd. (3-74)	★C3DZ 6261705-C	2
66	X(62C, 66D)		R. H. -Manual bucket seat	C6OZ 6361704-A	2
			L. H.	C6OZ 6361705-B	2
			Nut & washer-hex. -5/16"-18	378643-S2(MM295L)	8
66/70	X		R. H. -Manual full width seat	C6OZ 6261704-C	1
			L. H.	C6OZ 6261705-C	1
67/69	X		R. H. -Manual bucket seat	C6OZ 6361704-A	2
			L. H.	C6OZ 6361705-B	2
69/70	X		Nut-5/16"-18 washer assy.	382590-S100(MM295K)	4
<b>617C04-5 SUPPORT - FRONT SEAT BACK PIVOT</b>					
69/70	A		Less bumper-with split bench reclining seat	D0AZ 54617C04-A	1
70	A		Heavy duty springs-non-reclining seat	D0AZ 62617C04-A	2
71/	A	A-bucket seat	Non-reclining seat		2
71/	A		R.H.-full width or split bench seat-non reclining	D1AZ 65617C04-A	1
			L.H.	D1AZ 65617C05-A	1
71/	A	A-split seat	Reclining seat	D1AZ 65617C04-B	1
70/71	S		R. H. -with bench and bucket seat-non-reclining	D0SZ 65617C04-A	1
			R. H. -with bucket and bench reclining seat	D0SZ 65617C04-B	1
			L. H.	D0SZ 65617C05-A	1
72	S		Reclining seat	D2SZ 65617C04-A	1
<b>617A06-7 SCREW - FRONT SEAT ADJUSTING VERTICAL REGULATOR</b>					
67/68	A, S		R. H. -rear-Driver power bucket seat-2 27/32" long-also serviced in assy. (60466)	C7AZ 63617A07-A	1
			L. H. -front-Driver power bucket seat		1
67/68	A		R. H. -front-Power full width seat-2 19/32" long-also serviced in assy. (60465)	C7AZ 62617A06-B	2
			L. H. -front-Power full width seat-2 19/32" long-also serviced in assy. (60466)	C7AZ 62617A07-B	2
67/68	A		R. H. -rear-Driver power split seat-3 15/16" long-also serviced in assy. (60466)	★C7AZ 62617A07-A Not repl'd. (3-74)	1
			L. H. -front-Driver power split seat-2 19/32" long-also serviced in assy. (60466)	C7AZ 62617A07-B	1
			R. H. -rear-Passenger power split seat-3 15/16" long-also serviced in assy. (60466)	★C7AZ 62617A07-A Not repl'd. (3-74)	1
			L. H. -front-Passenger power split seat-2 19/32" long-also serviced in assy. (60466)	C7AZ 62617A07-B	1

# FORD CAR PARTS

**BODY  
SECTION 617**

5

GROUP NUMBER	YEAR	BODY TYPE	DESCRIPTION	PART NUMBER	QTY.
<b>61710 TRACK ASSY. - FRONT SEAT UPPER</b>					
	72	A	"From 12/1/71"	6-way split bench-driver	D2AZ 6561710-A 1
	72	S		Split bench & bucket seat	D2LZ 6561710-A 2
<b>61710-1 TRACK - FRONT SEAT SIDE</b>					
	67/72	A	"Before 12/1/71"	R. H. -outer- Power split seat	C7AZ 6261710-A 1
				L. H. -outer- Power split seat	C7AZ 6261711-A 1
				R. H. -inner- Power split seat	C7AZ 6261711-A 1
				L. H. -inner- Power split seat	C7AZ 6261710-A 1
	67/68	A		R. H. -outer- Driver power bucket seat	C7AZ 6361710-A 1
				L. H. -outer- Driver power bucket seat	C7AZ 6361711-A 1
				R. H. -inner- Driver power bucket seat	C7AZ 6361711-A 1
				L. H. -inner- Driver power bucket seat	C7AZ 6361710-A 1
	67/72	A	"Before 12/1/71"	R. H. -outer- Power full width seat	C7AZ 6261710-A 1
				L. H. -outer- Power full width seat	C7AZ 6261711-A 1
				R. H. -inner- Power full width seat	C7AZ 6261711-A 1
				L. H. -inner- Power full width seat	C7AZ 6261710-A 1
	72	A	"From 12/1/71"	With power seat-refer to group 617C80-1	
	72	A	"From 12/1/71"	6-way split bench-driver	D2AZ 6561710-A 1
	72	B		R.H.-full width seat	D2OZ 6561710-A 1
				L.H.	D2OZ 6561711-A 1
	72	B		R.H.-6-way full bench seat	D3OZ 6561710-A 1
				L.H.	D3OZ 6561711-A 1
	67/71	S		R. H. -outer- Power full width or bucket seat	C7AZ 6361710-A 1
				L. H. -outer- Power full width or bucket seat	C7AZ 6361711-A 1
				R. H. -inner- Power full width or bucket seat	C7AZ 6361711-A 1
				L. H. -inner- Power full width or bucket seat	C7AZ 6361710-A 1
	72	S		R. H. -Power hi back bench seat	D2OZ 6561710-A 1
				L. H.	D2OZ 6561711-A 1
	72	S	"From 7/3/72"	R. H. and L. H. -6-way split bench	D3LZ 6561710-A 1or2
<b>617B10 CABLE - FRONT SEAT ADJUSTING FRONT VERTICAL ACTUATING</b>					
	67/68	A		Split seat-7 1/16" long	C7MY 63617B10-A 2
	69/70	A		Passenger split seat	
	67/72	A	"Before 12/1/71"	Full width seat-7 13/16" long	C7AZ 62617B10-A 1
	69/71	A		Driver split seat	C9AZ 54617B10-A 1
	70/71	A(54C, 57F, 65A)		Driver split seat	C7AZ 62617B10-B 1
	72	A	"From 12/1/71"	Full width or split bench seat - Refer to Group 617B12	
	67/71	S		Driver bucket seat-5 9/16" long	C7AZ 62617B10-B 1
	69/71	S		Full width seat-7 13/16" long	C7AZ 62617B10-A 1
<b>617B12-3 CABLE - FRONT SEAT ADJUSTING REAR VERTICAL ACTUATING</b>					
	67/68	A		Driver bucket seat-20 1/16" long	C7AZ 63617B12-A 1
	67/70	S			
	67/72	A	"Before 12/1/71"	Full width seat-9 7/16" long	C7AZ 62617B12-A 1
	67/72	A	"Before 12/1/71"	Split seat-23 1/16" long	C7MY 63617B12-A 2
	72	A	"From 12/1/71"	Full width or split bench seat	D2LZ 65617B12-A 4
	69/71	B(except 76)		Power full width seat-35 1/4" long	C6GY 62617B12-A 1
	69/71	B(76)		Power full width seat-36 1/8" long	C6GY 76617B12-A 1
	72	B		Full width seat-12 1/16" long	D2LZ 65617B12-A 2
	68	S		Power full width seat-9 7/16" long	C8SZ 65617B12-A 1
	69/71	S		Power full width seat-9 7/16" long	C7AZ 62617B12-A 1
	72	S		Used for horizontal and rear vertical	D2LZ 65617B12-A 4
<b>61714-5 TRACK ASSY. - FRONT SEAT LOWER</b>					
	66	S		R. H. -Power bucket seat-not replaced (7-73)	★C6SZ 6361714-A 2
				L. H.	C6SZ 6361715-A 2

GROUP NUMBER	YEAR	BODY TYPE	DESCRIPTION	PART NUMBER	QTY.
<b>617B14-5 CABLE - FRONT SEAT ADJUSTING - HORIZONTAL ACTUATING</b>					
	67/68	A	Power split seat-6 3/4" long	C7MY 63617B15-A	2
	69	A	Driver power split seat		1
	67/71	A, S	R. H. -Power full width seat -39" long L. H. -7 11/16" long	C7AZ 62617B14-A C7AZ 62617B15-A	1 1
	69/71	A	Driver power split bench	C9AZ 54617B15-A	1
	72	A	"Before 12/1/71" R.H.-Full width seat L.H.	C7AZ 62617B14-A C7AZ 62617B15-A	1 1
	72	A	"Before 12/1/71" R.H.-Driver split bench seat L.H.	C7AZ 63617B14-A C9AZ 54617B15-A	1 1
	72	A	"From 12/1/71" Full width or split bench seat	D2LZ 65617B14-A	1
	69/71	B(except 76)	R. H. -Power full width seat-32 3/8" long L. H. -Power full width seat-14 1/8" long	C6GY 62617B14-A C6GY 62617B15-A	1 1
	69/71	B(76)	R. H. -Power full width seat-33 1/4" long L. H. -Power full width seat-14 1/8" long	C6GY 76617B14-A C6GY 62617B15-A	1 1
	72	B	Full width seat-37 1/16" long	D0SZ 65617B14-A	3
	72	B	Horizontal and front vertical-15 9/16" long	D2LZ 65617B14-A	1
	67/71	S	R. H. -Driver power bucket seat -3 1/4" long L. H. -3 1/4" long	C7AZ 63617B14-A C7AZ 63617B15-A	1 1
	70/71	S	Power full width seat-39" long-use with 38" tube (618A86)	C7AZ 62617B14-A	AR
	70/71	S	Power full width seat-37" long-use with 36" tube (618A86)	D0SZ 65617B14-A	AR
	72	S		D2LZ 65617B14-A	2
<b>617A15 GEAR - FRONT SEAT ADJUSTING REGULATOR</b>					
	69/71	B	Power full width seat	C6GY 62617A15-A	1
<b>617C20-1 SHIELD - FRONT SEAT ADJUSTER</b>					
	65	A(54, 57, 62, 63B, F, 71, 76A)	R. H. -Burgundy-Power full width seat L. H.	C5AZ 63617C20-AAH C5AZ 63617C21-AAH	1 1
	65	A(54, 57, 62, 63B, F, 71, 76A)	R. H. -Turquoise-Power full width seat L. H.	C5AZ 63617C20-AAE C5AZ 63617C21-AAE	1 1
	66	A(54, 57, 62, 63B, F, 71, 76A)	R. H. -Black-Power full width seat L. H.	C5AZ 63617C20-AAB C5AZ 63617C21-AAB	1 1
	66	A(54, 57, 62, 63B, F, 71, 76A)	R. H. -Blue-Power full width seat L. H.	C5AZ 63617C20-AAC C5AZ 63617C21-AAC	1 1
	66	A(54, 57, 62, 63B, F, 71, 76A)	R. H. -Ivy Gold-Power full width seat L. H.	C5AZ 63617C20-AAF C5AZ 63617C21-AAF	1 1
	66	A(54, 57, 62, 63B, F, 71, 76A)	R. H. -Palomino-Power full width seat L. H.	C5AZ 63617C20-AAD C5AZ 63617C21-AAD	1 1
<b>61726 ROD - FRONT SEAT TRACK LATCH TIE</b>					
	65/66	A	Manual bucket seat-12 1/2" long- includes adjusting nut	C4SZ 6361726-A	2
	65/68	A	Manual full width seat-50" long-includes adjusting nut	C5AZ 6261726-A	1
	67/68	A	Manual split seat-16 3/16" long- includes adjusting nut	C7MY 6361726-A	2
	68	A	Manual bucket seat-14" long-includes adjusting nut	C6OZ 6361726-A	2
	69/71	A	Manual bucket seat-12 7/16" long-includes adjusting nut	C9AZ 6361726-A	1or2
	69/71	A	Manual split seat-15 1/2" long-includes adjusting nut	C9MZ 6561726-A	2
	69/	A	With split bench-14 3/4" long	C9MZ 6561726-B	1or2
	69/	A	Manual full width seat-48" long-includes adjusting nut	C9AZ 6261726-A	1

# FORD CAR PARTS

**BODY  
SECTION 617**

7

GROUP NUMBER	YEAR	BODY TYPE	DESCRIPTION	PART NUMBER	QTY.
<b>61726 ROD - FRONT SEAT TRACK TIE - continued</b>					
- B -					
	65	B	Full width seat-includes adjusting nut-48 7/8" long	C1DZ 6261726-A	1
	65	B	Manual bucket seat-14 7/16" long-includes adjusting nut	C3DZ 7661726-B	2
	66/69	B	Manual bucket seat-14" long-includes adjusting nut	C6OZ 6361726-A	2
	67/68	B	Manual full width seat-44" long-includes adjusting nut	C6OZ 6261726-A	1
	70/71	B	Manual bucket seat	C9AZ 6361726-A	2
	72	B	Full width seat-41 1/8" long	D2OZ 6561726-A	1
	72	B	Split bench or bucket seat-9 1/4" long	D2OZ 6561726-B	1
- F -					
	65/71	F	Manual bucket seat	C5ZZ 6561726-A	2
	65/69	F	Manual full width seat	C5ZZ 6561726-B	1
- P -					
	70/	P(exc. LTD)		D0DZ 6261726-A	1
	72	P(LTD)	Serviced in assy. only - refer to Group 61704-5		
- S -					
	65/66	S	Manual bucket seat-12 1/2" long-includes adjusting nut	C4SZ 6361726-A	2
	67/69	S	Manual bucket seat-8 3/4" long-includes adjusting nut	C7SZ 6561726-A	2
	68/71	S	Manual full width seat-45 1/16" long-includes adjusting nut	C8SZ 6561726-A	1
	70/71	S	Bucket seat or split seat	C5ZZ 6561726-A	2
	72	S		D2OZ 6561726-A	2
- U -					
	66/	U	Manual bucket seat	C5ZZ 6561726-A	2
	66/71	U	Manual full width seat-46 3/4" long-includes adjusting nut	C4DZ 7661726-A	1
- X -					
	65	X(54, 59, 62, 63B, 66A, B, 71, 78)	Includes adjusting nut-48 7/8" long	C1DZ 6261726-A	1
	65	X(76A)	Manual full width seat-46 3/4" long-includes adjusting nut	C4DZ 7661726-A	1
	66/70	X	Manual bucket seat-14" long-includes adjusting nut	C6OZ 6361726-A	2
	67/68	X	Manual full width seat-44" long-includes adjusting nut	C6OZ 6261726-A	1
<b>617A44 SPRING - FRONT SEAT TRACK VERTICAL ASSIST</b>					
	69/71	S		C9SZ 62617A44-A	2
<b>617A46 REINFORCEMENT- FRONT SEAT TRACK</b>					
	66	S		C6SZ 63617A46-A	1
<b>617B48 BRACKET - FRONT SEAT TRACK MOTOR MOUNTING</b>					
	67/68	A-split bench seat	Passenger	C7AZ 62617B48-A	1
	67/70	A-split bench seat	Driver	C7AZ 63617B48-A	1
	67/70	A,S -bucket seat	Driver	C7AZ 63617B48-A	1
	67/70	A,S -full width seat		C7AZ 62617B48-A	1
	71	A-full width seat	W/terminal bracket	D0VY 65617B48-A	1
	71/72	A-split bench seat - "Before 12/1/71"	Driver	D0VY 65617B48-B	1
	72	A-6-way split bench seat- "From 12/1/71"	Driver	D2AZ 65617B48-A	1

GROUP NUMBER	YEAR	BODY TYPE	DESCRIPTION	PART NUMBER	QTY.
<b>617B48 BRACKET - FRONT SEAT TRACK MOTOR MOUNTING - continued</b>					
	71/72	A-full width seat - "Before 12/1/71"	W/o terminal bracket	D0VY 65617B48-C	1
	72	A-full width or split seat- "From 12/1/71"		D2OZ 65617B48-A	1
	72	B-full width seat, S-full width seat			1
<b>61753 HANDLE - FRONT SEAT TRACK ADJUSTING</b>					
	65	A	Manual bucket seat-includes attaching parts	C5AZ 6261753-B	2
	65	B, F, X	Manual seat		1or2
	66/70	A, B, F, U, X	Manual bucket seat		2
	71	A, B, F, L, U	Manual bucket seat		2
	72	B, F, L, P, S, U			1or2
			Retainer-refer to Group 62060		
	65/68	A	Manual full width seat	C7AZ 6261753-B	1
	65/68		Manual split seat		2
	69/70	A	Manual full width seat	C9AZ 6261753-A	1
	71/	A	Manual full width seat	D1AZ 6561753-A	1or2
	66/69	B, X	Manual full width seat	D0OZ 6261753-A	1
	70/71	B, P	Manual full width seat		1
	71	P	Manual bucket seat		1 or 2
	65/68	F	Manual full width seat-includes attaching parts	C5AZ 6261753-B	1or2
			Screw-socket head, set-No. 8-32 x 1/4"	375504-S8(UU28A)	1or2
	65/71	S	Manual bucket seat	C4SZ 6361753-A	1or2
			Screw-socket head, set-No. 8-32 x 1/4"	375504-S8(UU28A)	1or2
<b>617A64 SPRING - FRONT SEAT TRACK VERTICAL ASSIST</b>					
	67/69	A, S	Driver power bucket seat	C7AZ 62617A64-B	1
	67/69	A, S	Power full width seat		2
	67/69	A	Power split seat		2
	71/72	A "Before 12/1/71"	Driver power split seat		2
	70/71	S	Power full width seat		2
	69/71	A	Power full width seat	C9AZ 62617A64-A	2
	72	A "Before 12/1/71"	Full width or split bench seat		2
	72	A "From 12/1/71"	Full width or split bench seat	D2LZ 65617A64-A	1
	72	S			1
<b>617B70-1 REINFORCEMENT - FRONT SEAT TRACK TO FLOOR</b>					
	66/71	B(except 76)	R. H. -Driver bucket seat	C6OZ 63617B70-A	1
	66/69	X	L. H. -Passenger bucket seat		1
					1
	66/71	B(76)	R. H. -Full width seat	C6OZ 76617B70-B	1
			R. H. -Passenger bucket seat		1
	66/71	B(76)	L. H. -Full width seat	C6OZ 76617B71-B	1
			L. H. -Driver bucket seat		1
<b>617K74 SPRING - FRONT SEAT BACK LOCKING CATCH RETRACTING</b>					
	72	P(54A, 62A)-LTD		D0RY 62617K74-A	4
<b>617K79 SPACER - FRONT SEAT BACK TO CUSHION OUTER</b>					
	72	P(54A, 62A)-LTD		D0RY 62617K79-A	2
<b>617B80 GEAR - FRONT SEAT ADJUSTER TRANSMISSION</b>					
	65/66	A	Power full width seat	C5AZ 62617B80-A	3
<b>617C80-1 BASE - FRONT SEAT ADJUSTER REGULATOR</b>					
	67/68	A	R. H. -Driver power split seat -not repl'd. (3-74)	★C7MY 63617C81-A	1
			L. H.	C7AZ 62617C80-A	1
			R. H. -Passenger power split seat	C7AZ 62617C80-B	1
			L. H. -not repl'd. (3-74)	★C7MY 63617C80-A	1
			R. H. -Power full width seat	C7AZ 62617C80-B	1
			L. H.	C7AZ 62617C80-A	1

# FORD CAR PARTS

## BODY SECTION 617

9

GROUP NUMBER	YEAR	BODY TYPE	DESCRIPTION	PART NUMBER	QTY.
<b>617C80-1 BASE - FRONT SEAT ADJUSTER REGULATOR - continued</b>					
69/70	A		R. H. - Power full width seat	C9AZ 62617C80-A	1
			L. H.	C9AZ 62617C81-A	1
			R. H. - Power split seat	C9AZ 65617C80-A	1
			L. H.	C9AZ 65617C81-A	1
71	A		R.H.-Power full width seat	DOVY 65617C80-B	1
72	A	"Before 12/1/71"	R.H.-Power full width or split seat		1
			L.H.	DOVY 65617C81-B	1
72	A	"From 12/1/71"	R.H.-6-way split bench-driver	D2AZ 65617C80-A	1
			L.H.	D2AZ 65617C81-A	1
72	A	"From 12/1/71"	R.H.-6-way full bench	D2AZ 65617C80-B	1
			L.H.	D2AZ 65617C81-B	1
72	B, S	"Before 7/3/72"	R.H.	D2OZ 65617C80-A	1
			L.H.	D2OZ 65617C81-A	1
72	B	"From 7/3/72"	R.H.-6-way full width seat	D3OZ 65617C80-A	1
72	S	"From 7/3/72"	R.H.-6 way split bench		1
			L.H.	D3OZ 65617C81-A	1
67/69	S		R. H. -Driver power bucket seat	C7SZ 65617C80-A	1
70/71	S		R.H.-Passenger power bucket seat		
			L. H.	C7SZ 65617C81-A	1
70/71	S		R. H. -Driver power bucket or split bench	D0SZ 65617C80-A	1
			L. H.	D0SZ 65617C81-A	1
<b>61781 BUSHING - FRONT SEAT TRACK LINK</b>					
67/69	A, S		Power driver bucket seat -3/8" I. D. x 7/16" O. D. x 1 7/8" long	C7AZ 6261781-A	4
67/69	A, S		Power full width seat		4
67/69	A		Power split seat		8
70/	A		Power seat		4
70/71	S		Power bucket seat		4
<b>617C88 BRACKET - REAR SEAT FRAME FRONT TO FLOOR - Refer to group 11246</b>					
<b>617C90-1 BRACKET - REAR SEAT FRAME REAR TO FLOOR</b>					
66/	U		R. H.	C6TZ 96617C90-A	1
			L. H.	C6TZ 96617C91-A	1
<b>617C94-5 DRIVE ASSY. - FRONT SEAT TRACK</b>					
69/71	B		R. H. -Power full width seat	C6GY 62617C94-A	1
			L. H.	C6GY 62617C95-A	1
<b>61796 SUPPORT - FRONT SEAT TRACK REAR</b>					
66/69	B		Manual bucket seat	C6OZ 6361796-A	2
66/70	X				2
70/	B		Manual bucket seat	D0OZ 6561796-A	2
71/	P		Use on inboard side	D1DZ 6561796-A	2
<b>61802 ROD ASSY. - FRONT SEAT TRACK TIE - Refer to Group 61726</b>					
<b>618C04 PIVOT - FRONT SEAT BACK</b>					
68/69	S		Used with reclining seat	C8SZ 65618C04-A	1
<b>618C10 RETAINER - FRONT SEAT TRACK RACK</b>					
69/71	B		Power full width seat	C6GY 62618C10-A	3
<b>618A20 COVER - FRONT SEAT ADJUSTING VERTICAL REGULATOR</b>					
67/68	A, S		Driver power bucket seat-also serviced in assy. (60465-6)	C7AZ 62618A20-A	2
67/68	A		Power full width seat		4
67/68	A		Power split seat		4
69/	A, S		Serviced in assembly-refer to Group 60465-6		

GROUP NUMBER	YEAR	BODY TYPE	DESCRIPTION	PART NUMBER	QTY.
<b>618C24-5 BUSHING - FRONT SEAT ADJUSTING TRANSMISSION</b>					
67/68	A		R. H. -rear-Power full width seat-also serviced in assy. (60465)	C7AZ 62618C24-A	1
			L. H. -rear-Power full width seat-also serviced in assy. (60466)	C7AZ 62618C25-A	1
			R. H. -front-Power full width seat-also serviced in assy. (60465)	C7AZ 62618C24-A	1
			L. H. -front-Power full width seat-also serviced in assy. (60466)	C7AZ 62618C25-A	1
67/68	A		R. H. -rear-Driver power split seat-also serviced in assy. (60466)	C7AZ 62618C25-A	1
			L. H. -front-Driver power split seat		1
			R. H. -rear-Passenger power split seat		1
			L. H. -front-Passenger power split seat		1
67/68	A,S		R. H. -rear-Driver power bucket seat-also serviced in assy. (60466)	C7AZ 62618C25-A	1
			L. H. -front-Driver power bucket seat		1
69/	A,S		Serviced in assembly-refer to Group 60465-6		
<b>618C26 RETAINER - FRONT SEAT ADJUSTING TRANSMISSION PINION</b>					
67/71	A		Driver power bucket seat	C7AZ 62618C26-A	2
67	S		Driver power bucket seat		2
67/72	A	"Before 12/1/71"	Full width or split bench seat		2 or 4
68/71	S		Power bucket or full width seat	C8SZ 62618C26-A	2
72	A	"From 12/1/71"	Full width or split bench seat	D2LZ 65618C26-A	2
72	B,S				4
<b>61828 SPRING - FRONT SEAT TRACK ASSIST</b>					
- A -					
65/71	A		Manual bucket seat	C1SY 6361828-A	2
72	A	"Before 12/1/71"	Full width or split seat		1 or 2
72	A	"From 12/1/71"		D2SZ 6561828-A	1
- B -					
65/	B		Manual bucket seat	C1SY 6361828-A	2
69/71	B		Power full width seat-horizontal	C6GY 6261828-C	1
69/71	B		Power full width seat-vertical	C6GY 6261828-D	1
72	B			D2OZ 6561828-A	2
- F -					
65/70	F		Manual seat	C5ZZ 6561828-A	2
71/	F			D1ZZ 6561828-A	2
- L -					
71/	L			D1ZZ 6561828-A	2
- P -					
70/	P		Full width seat	C1SY 6361828-A	2
70	P		Bucket seat	C5ZZ 6561828-A	2
71/	P(exc. LTD)		Bucket seat	D1ZZ 6561828-A	2
72	P(54A, 62A)-LTD		Bucket seat	D2DZ 6561828-A	2
- S -					
65/66	S		Manual bucket seat	C4SZ 6361828-B	2
68	S		Manual full width seat	C8SZ 6561828-A	2
68	S		Manual bucket seat		4
69	S		Manual bucket seat	C1SY 6361828-A	2
69/71	S		Manual bucket or full width seat	C9SZ 6561828-A	2 or 4
72	S		Manual bucket or split bench seat	D2OZ 6561828-A	2
72	S		Power bucket seat	D2SZ 6561828-A	2
72	S		Power split bench or full width seat	D2LZ 6561828-A	1



# FORD CAR PARTS

**BODY  
SECTION 617**

11

GROUP NUMBER	YEAR	BODY TYPE	DESCRIPTION	PART NUMBER	QTY.
<b>61828 SPRING - FRONT SEAT TRACK ASSIST - continued</b>					
- U -					
	66/71	U	Manual full width seat	C4DZ 7661828-A	2
	66/	U	Manual bucket seat	C5ZZ 6561828-A	2
- X -					
	65	X(76A)	Manual full width seat	C4DZ 7661828-A	2
	65/70	X	Manual bucket seat	C1SY 6361828-A	2
<b>618C28 RETAINER - FRONT SEAT ADJUSTER SPRING</b>					
	67	A	"Before 2/6/67"	★C7AZ 63618C28-A Not repl'd. (3-74)	2
	67	A,S	"Before 2/6/67"		1
	67	A	"Before 2/6/67"		1
	67/71	A,S	"From 2/6/67"	C7AZ 63618C28-B	2
	67/71	A,S	"From 2/6/67"		1
	67/71	A,S	"From 2/6/67"		1
	72	A	"From 2/6/67"		2
<b>618C30 BAR and LINK ASSY. - FRONT SEAT ADJUSTER FRONT TORSION</b>					
	67/71	A,S	Driver power bucket seat	C7AZ 63618C30-A	1
	69	A	Driver power split seat	C9AZ 54618C30-A	1
	70	S(57B, 65A, B)	Power bucket seat		1
	70/71	A(54C, 57F, 65A)	Power split seat		1
<b>61832 BAR ASSY. - FRONT SEAT ADJUSTER TORSION</b>					
	67/	A,S	Driver power bucket seat-refer to Group 618C32		
	69/	A	Driver power split seat-refer to Group 618C32		
	66/71	B	Power bench seat	C6GY 7661832-A	1
<b>618C32 BAR and LINK ASSY. - FRONT SEAT ADJUSTER REAR TORSION</b>					
	67/68	A	Driver power bucket seat	C7AZ 63618C32-A	1
	67/71	S			1
	69/71	A	Driver power split seat	C9AZ 54618C32-A	1
<b>618C34 SPACER - FRONT SEAT ADJUSTER REGULATOR SOLENOID RETAINER</b>					
	67/71	A,S	Driver power bucket seat- 11/32" I. D. x 7/16" O. D. x 1/4" long	C7AZ 62618C34-A	3
	67/	A	Power full width seat		3
	67/	A	Power split seat		6
	70/71	S	Power full width seat		1
	72	S	Power split seat		2
<b>618C36 HOUSING - FRONT SEAT ADJUSTER TRANSMISSION PINION</b>					
	67/70	A	Power full width seat	C7AZ 62618C36-A	1
	67/70	A	Power split seat		2
	67/70	A	Driver power bucket seat		1
	71	A	Driver power split seat	D0VY 65618C36-A	2
	71	A	Power full width seat		2
	72	A	Power full width or split seat		1or2
	67/	S	Driver power bucket seat	C7SZ 65618C36-A	1or2
<b>618C38 PLATE - FRONT SEAT ADJUSTING REGULATOR</b>					
	67/	A,S	Serviced in assembly-refer to Group 60471-2		
<b>618C40 WASHER - FRONT SEAT TRACK LINK</b>					
	67/71	A	Driver power bucket seat	C7AZ 62618C40-A	4
	67/71	S	Power bucket seat		4
	67/	A	Power full width seat		4
	67/71	A	Power split seat		8
	68/71	S	Power full width seat		4
	71	S	Power split bench seat		4

**BODY  
SECTION 617**
**FORD CAR PARTS**

GROUP NUMBER	YEAR	BODY TYPE	DESCRIPTION	PART NUMBER	QTY.
<b>618A42-3 GEAR - FRONT SEAT ADJUSTING HORIZONTAL</b>					
	67/	A,S	Serviced in assembly-refer to Group 60471-2		
<b>618A42-3 WORM - FRONT SEAT ADJUSTING HORIZONTAL</b>					
	67/	A,S	Serviced in assembly-refer to Group 60471-2		
<b>618B42 BRACKET - FRONT SEAT TRACK MOUNTING REAR</b>					
	70/	B(76)		D00Z 76618B42-A	2
<b>618C42 SPACER - FRONT SEAT REGULATOR GEAR</b>					
	67/68	A,S	Driver power bucket seat-washer-flat-1/4" (plastic)-also serviced in assy.(60466) vertical regulator gear	C7AZ 62618C42-A	2
	67/68	A	Driver power bucket seat-also serviced in assy. (60471-2) horizontal regulator gear		6
	67/68	A	Power full width seat-also serviced in assy. (60465-6) vertical regulator gear		4
	67/68	A	Power full width seat-also serviced in assy. (60471-2) horizontal regulator gear		6
	67/68	A	Power split seat-also serviced in assy.(60465-6) vertical regulator gear		4
	67/68	A	Power split seat-also serviced in assy.(60471-2) horizontal regulator gear		12
	69/	A,S	Serviced in assembly-refer to Group 60465-6 or 60471-2		
<b>618A45 COVER - FRONT SEAT ADJUSTING HORIZONTAL ACTUATOR - Refer to Group 60471-2</b>					
<b>618C46 BRACKET - FRONT SEAT BACK PIVOT</b>					
	70	A	R.H.-Full width seat with recliner	D0AZ 54618C46-A	1
	70	A	R.H.-Split seat	D0AZ 54618C46-B	1
<b>618A48 TRANSMISSION ASSY. - FRONT SEAT ADJUSTING</b>					
	65/69	A	6-way full width seat	C5AZ 62618A48-A	1
	72	A	Split bench seat	D2LY 65618A48-A	1
	72	A,S	Full width seat	D2OZ 65618A48-A	1
	69/71	B	Power full width seat	C6GY 62618A48-A	1
	72	B	"Before 7/3/72" 6-way full width seat	D2OZ 65618A48-A	1
	72	B(53, 63, 65, 71) - "From 7/3/72"	6-way full width seat	D3OZ 65618A48-A	1
	72	S	"Before 7/3/72" 6-way split bench seat	D2LY 65618A48-A	1
	72	S	"From 7/3/72" 6-way split bench seat	D3LZ 65618A48-A	1
<b>618A54 PINION - FRONT SEAT ADJUSTING TRANSMISSION - Also refer to Group 60471-2</b>					
	66/70	B	Power full width seat and driver power bucket seat	C6GY 62618A54-A	1or2
<b>618A55 BUSHING - FRONT SEAT ADJUSTING TRANSMISSION - Refer to Group 60465-6 or 60471-2</b>					
<b>618C56 PIVOT - FRONT SEAT BACK ADJUSTER ACTUATOR</b>					
	72	S	Split seat	D2LY 65618C56-A	1
	72	S	Bucket seat	D2SZ 65618C56-A	1
<b>618B58 RETAINER - FRONT SEAT TRACK ADJUSTING HANDLE</b>					
	68/	A	Manual full width seat	C8AZ 62618B58-B	1
	72	B, F, L, P, S	Manual split seat		2
	68/71	B, F, U, X	Refer to Group 62060		1or2
<b>618A59 COUPLING - FRONT SEAT ADJUSTER TRANSMISSION DRIVE</b>					
	69/70	B	Power full width seat and driver power bucket seat	C4VY 53618A59-A	2

# FORD CAR PARTS

## BODY SECTION 617

13

GROUP NUMBER	YEAR	BODY TYPE	DESCRIPTION	PART NUMBER	QTY.
<b>618A60 SHAFT - FRONT SEAT ADJUSTING TRANSMISSION</b>					
	69/70	B	Power full width seat and driver power bucket seat	C6GY 62618A60-A	2
<b>618C64 RETAINER - FRONT SEAT TRACK ASSIST SPRING</b>					
	72	S		D2LZ 65618C64-A	1
<b>618A67 BUSHING - FRONT SEAT ADJUSTING</b>					
	67/	A	Power full width seat-3/4" x 1 1/2" with 5/16" x 1 1/4" slot	C7AZ 62618A67-A	4
	67/	A	Power split seat		8
	67/71	A,S	Driver power bucket seat		4
	67/	S			4
<b>618A78-9 GEAR - FRONT SEAT ADJUSTER VERTICAL</b>					
	67/68	A	R. H. -rear-Power full width seat-15/32" diam. x 1 53/64" long-also serviced in assy. (60465)	C7AZ 62618A78-A	1
			L. H. -rear-Power full width seat-15/32" diam. x 1 53/64" long-also serviced in assy. (60466)	C7AZ 62618A79-A	1
			R. H. -front-Power full width seat-15/32" diam. x 1 53/64" long-also serviced in assy. (60465)	C7AZ 62618A78-A	1
			L. H. -front-Power full width seat-15/32" diam. x 1 53/64" long-also serviced in assy. (60466)	C7AZ 62618A79-A	1
	67/68	A	R. H. -rear-Driver power split seat-15/32" dia. x 1 53/64" long-also serviced in assy. (60466)	C7AZ 62618A79-A	1
			L. H. -front-Driver power split seat		1
			R. H. -rear-Passenger power split seat		1
			L. H. -front-Passenger power split seat		1
	67/68	A,S	R. H. -rear-Driver power bucket seat-15/32" dia. x 1 53/64" long-also serviced in assy. (60466)	C7AZ 62618A79-A	1
			L. H. -front-Driver power bucket seat		1
	69/	A,S	Serviced in assembly-refer to Group 60465-6		
<b>61880 PIN - FRONT SEAT TRACK</b>					
	68/71	S	Front-Power full width seat	C8SZ 6561880-A	4
	72	A	Power full width seat		4
	69	A			4
	68/71	S	Rear-Power full width seat	C8SZ 6561880-B	4
<b>61883 SPRING - FRONT SEAT TRACK LATCH</b>					
	65/66	A(76)	Top folding compartment	C0AB 6461883-A	2
	65	A(63C, 76B), F	Manual bucket seat-3" long	C0DZ 6461883-A	2 or 4
	65	X(except 76B, D)			2or4
	65/	F(76)	Top folding compartment		2
	65	B(65B)	Manual bucket seat		4
	66	A(63C, D, 76B, D), B(63C, D, 76C, D), S, X(62C, 66D)	Manual bucket seat		1or2
	66	F, U	Manual seat		1or2
	67	A, B, X	Manual bucket seat		4
	67/70	F	Manual full width or bucket seat		2or4
	68/	A	Manual bucket seat		2
	68/70	F	Manual full width or bucket seat		1or2
	69/71	S	Manual full width or bucket seat		2
	70/71	B(63, 65C, F, H, 66C, 76)	Bucket seat		2
	65/66	A	Manual full width seat-7/8" long	C5AZ 6261883-A	1
	67/	A	Manual full width seat		2
	67/68	A	Manual split seat		4
	71/	A	Manual split bench seat		2

GROUP NUMBER	YEAR	BODY TYPE	DESCRIPTION	PART NUMBER	QTY.
<b>61883</b>	<b>SPRING - FRONT SEAT TRACK LATCH - continued</b>				
65		B(except 65B)	Manual full width seat-2 5/16" long	C4OZ 6261883-A	2
65		X(54,62,63B,66A,B,76A,78)			2
66		B(54,62,63B,71,76B),X(54,62A,B,66A,B,71)			2
67		B(54,62,63B,66A,B,71,76B), U,X(54,62A,B,71)			2
68		B,X	Manual bucket seat		2
68		B(66)	Manual full width or bucket seat		1or2
70/71		P			2
70/		U			2
71		B	Manual full width seat		1
72		B,P(exc. LTD),S	R.H.-manual seat L.H.	D2OZ 6561883-B D2OZ 6561883-A	1 1
72		P(54A,62A)-LTD	L.H.	D2OZ 6561883-A	1
65		F(76)	Top folding compartment	C1SB 6361883-A	2
71		F	Manual bucket seat	D1ZZ 6561883-A	2
71/		F,L,P	Manual bucket seat	D1DZ 6261883-A	2
72		B	Manual bucket or full width seat	D2OZ 6561883-A	1or2
72		P	Manual full width seat		1
72		S	Manual bucket or split seat		1
67		S	Manual bucket seat-1 5/8" long	C7SZ 6561883-A	4
68		S	Manual full width or bucket seat		2or4
<b>618A84-6</b>	<b>TUBE - FRONT SEAT ADJUSTER VERTICAL ACTUATOR REAR</b>				
67/71		A,S	R.H. -Power full width seat-38" long L.H. -Power full width seat-8 3/8" long	C7AZ 62618A86-A C7AZ 62618A85-A	1 1
67/		A	Power split seat-refer to Group 618A98		
67/68		A	Driver power bucket seat-19" long	C7AZ 63618A84-A	1
67/70		S			1
71		S	Power seat-8 3/8" long	C7AZ 62618A85-A	1
72		A	Full width seat		1
<b>618A86-7</b>	<b>TUBE - FRONT SEAT ADJUSTER HORIZONTAL ACTUATOR</b>				
67/69		A,S	R.H. -Power full width seat-38" long L.H. -Power full width seat-6 9/16" long	C7AZ 62618A86-A C7AZ 62618A87-A	1 1
67/		A	Power split seat-refer to Group 618A92		
67/70		S	Driver power bucket seat-4 1/8" long	C7AZ 63618A87-A	1
71/72		A	"Before 12/1/71" R.H. -Full width seat-38" long	C7AZ 62618A86-A	3
71		S	R.H.-Split bench or bucket seat L.H. -6 9/16" long	C7AZ 62618A87-A	3 3
72		B,S	R.H. -Horizontal-full width seat-37 1/16" long	D2OZ 65618A86-A	1
72		A	"From 12/1/71" R.H.-Vertical-front and rear-bucket or split seat L.H. -Horizontal-11 5/8" long L.H. -Vertical-front and rear-12 1/16" long	D2LZ 65618A86-A D2LZ 65618A92-A	1 2 2 2
70/71		S	Power full width seat-38" long-use with 39" cable (617B14)	C7AZ 62618A86-A	AR
70/71		S	Power full width seat-36" long-use with 37" cable (617B14)	D0SZ 65618A86-A	AR

# FORD CAR PARTS

## BODY SECTION 617

15

GROUP NUMBER	YEAR	BODY TYPE	DESCRIPTION	PART NUMBER	QTY.
<b>618A88 BRACKET - FRONT SEAT ADJUSTING TUBE</b>					
	67/71	A,S	Driver power bucket seat	C7AZ 62618A88-A	1
	67/70	A	Power full width seat		1
	67/72	A	"Before 12/1/71" Power split seat		2
	72	B,S	Power full width seat		1
	71/72	A	"Before 12/1/71" Full width seat	D0VY 65618A88-B	1
	71/72	A	"Before 12/1/71" Split bench seat	D1AZ 65618A88-A	1
	71	S			1
	72	B,S		D2LZ 65618A88-A	1
	72	A	"From 12/1/71 to 5/22/72" Full width or split bench seat		1
	72	A	"From 5/22/72" Passenger-split bench		1
	72	A	"From 12/1/71" 6-way bench seat	D2AZ 65618A88-A	2
	72	A	"From 5/22/72" Driver-split bench		1
<b>618A90 TUBE - FRONT SEAT ADJUSTER FRONT VERTICAL ACTUATOR</b>					
	67/	A	R. H. - Power full width seat-38" long	C7AZ 62618A86-A	1
			L. H. - Power full width seat-6 3/4" long	C7AZ 62618A90-A	1
	67/	A	Power split seat-6" long	C7MY 63618A90-A	1
	68/69	A	Driver power bucket seat-3 5/8" long	C7MY 63618A90-B	1
	69/71	B(except 76)	Power full width seat	C6GY 62618A90-A	1
	69/71	B(76)	Power full width seat	C6GY 76618A90-A	1
	67/70	S	Driver power bucket seat-4 1/2" long	C7AZ 63618A90-A	1
	67/71	S	R.H.-Power full width seat-38" long	C7AZ 62618A86-A	1
			L.H.-Power full width seat-6 3/4" long	C7AZ 62618A90-A	1
<b>618A92-3 TUBE - FRONT SEAT ADJUSTER HORIZONTAL ACTUATOR</b>					
	67	A	Power full width seat-refer to Group 618A86-7		
	67/72	A	"Before 12/1/71" L.H.-Driver power split seat-5 5/8" long	C7MY 63618A92-A	1
	68	A	Driver power bucket seat-3 5/8" long	C7MY 63618A92-B	1
	69/70	A	L. H. - Passenger power split seat	★ C9MB 63618A92-A	1
	72	A	"From 12/1/71" Split bench seat -11" long	D2LZ 65618A92-A	∅ 2
	69/71	B(except 76)	R. H. - Power full width seat	C6GY 62618A92-A	1
			L. H.	C6GY 62618A93-A	1
	69/71	B(76)	R H. -Power full width seat	C6GY 76618A92-A	1
			L. H.	C6GY 62618A93-A	1
	72	B	Refer to Group 618A86-7		
	67/	S	Driver power bucket seat-refer to Group 618A86-7		
<b>618A98 TUBE - FRONT SEAT ADJUSTER REAR VERTICAL ACTUATOR</b>					
	67/	A	Power full width seat-refer to Group 618A84-5		
	67/	A,S	Driver power bucket seat-refer to Group 618A84-5		
	67/	A	Power split seat-22" long	C7MY 63618A98-A	1

**BODY  
SECTION 617**
**FORD CAR PARTS**

GROUP NUMBER	YEAR	BODY TYPE	DESCRIPTION	PART NUMBER	QTY.
<b>619A02 HOOK - FRONT SEAT TRACK RELEASE CABLE</b>					
	69/70	A	Manual full width seat	C9AZ 62619A02-A	1
	72	B,S			1
	65	B(except 65B)	Manual full width seat	C4DZ 62619A02-A	1or2
	65	A(54, 57, 62, 63B, F, 71, 76A), X(54, 62A, B, D, 63B, 66A, B, 76A, 78)			1or2
	65	X(59, 71)			1
	66	A(54, 57, 62, 63B, F, 71, 76A), U			1or2
	66	B(54, 62, 63B, 71, 76B), X(54, 62A, B, 66A, B, 71)			1
	67/68	A			1
	67/71	B, X			1
	70/	P	Manual full width seat	D0AZ 62619A02-A	1
	71/	A			1
<b>61918 BRACKET - FRONT SEAT MOUNTING</b>					
	67	U	Passenger bucket seat	C7TZ 9661918-A	1
			Bolt-hex. head-5/16"-18 x 3/4"	20346-S8(B50)	1
			Nut-hex. -5/16"-18	34392-S7(M93)	1
<b>619A34 SLIDE - FRONT SEAT TRACK</b>					
	66	A, S	R. H. -front-plastic-1 1/2" long-includes 1 tab- Power bucket seat	C6AZ 63619A34-A	2or4
			L. H. -front-plastic-1 1/2" long-includes 1 notch- Power bucket seat	*C6AZ 63619A34-C Not repl'd. (7-73)	2or4
			R. H. -rear-plastic-3 1/2" long-includes 2 tabs- Power bucket seat	C6AZ 63619A34-B	2or4
			L. H. -rear-plastic-2 1/2" long-includes 2 notches-Power bucket seats	*C6AZ 63619A34-D Not repl'd. (7-73)	2or4
	67/68	A	Power full width seat-plastic-1 1/4" long	C7AZ 62619A34-A	8
	67/68	A	Driver power split seat		8
	67/68	A	Passenger power split seat		8
	67/68	A	Driver power bucket seat-zinc die cast-1 1/8" long	C7AZ 63619A34-A	8
	67/71	S	Power full width seat		8
	68/71	S	Power full width seat		8
	70/71	S	Driver power split seat		8
	69/	A	Power full width seat	C9AZ 62619A34-A	8
	69	A	Power bucket seat		8
	69/72	A	"Before 12/1/71" Power split bench seat		8
	71	S			8
	72	A	"From 12/1/71" 6-way bench-driver	D2AZ 65619A34-A	8
	72	B	"Before 7/3/72" Full width seat	D2LZ 65619A34-A	16
	72	S			16
	72	B	"From 7/3/72" Full width seat	D2AZ 65619A34-A	4or8
	72	S			4or8
<b>619A86 LATCH - FRONT SEAT</b>					
	67	U	Passenger bucket seat	C7TZ 96619A86-A	1
			Bolt-fillister head-5/16"-18 x 3/4"	*55431-S2	1
<b>619A94-8 BRACKET - FRONT SEAT TRACK FRONT</b>					
	66/	U	"Before Ser.788,001" R. H. - Passenger bucket seat	C6TZ 96619A94-A	1
			L. H.	C6TZ 96619A98-A	1
			"From Ser.788,001" R. H. - Passenger bucket seat	C6TZ 96619A94-B	1
			L. H.	C6TZ 96619A98-B	1

# FORD CAR PARTS

## BODY SECTION 620

1

GROUP NUMBER	YEAR	BODY TYPE	DESCRIPTION	PART NUMBER	QTY.
<b>62016 SPACER - FRONT SEAT TRACK TO FLOOR</b>					
	65	B	1/4" x 1 3/4" x 2 1/8"-improvise from fiber board	★	1
	66	B, X		C6OZ 6362016-A	2
	67/70	X			4or6
	67/71	B			4or6
	70	P			2
<b>62060 RETAINER - FRONT SEAT TRACK ADJUSTING HANDLE</b>					
	65	A, B, F, X	Manual bucket seat	C5AZ 6262060-A	1or2
	66/67	A, F, U, X	Manual full width or bucket seat		1or2
	68/70	F, U, X			1or2
	70/71	A, B, F	Manual bucket seat		2
	72	B, F			2
	71	L (62)			2
	68/	A	Refer to Group 618B58		
	66/71	B	Manual full width seat	C6OZ 6262060-A	1
	70/	P			1
	72	L	Folding rear seat		1
<b>621A10-1 BRACKET - FRONT SEAT BACK SIDE SHIELD UPPER SUPPORT</b>					
	71/	A	R.H.	DIAZ 65621A10-C	1
			L.H.	D1AZ 65621A11-C	1
<b>62116 SHIELD - FRONT SEAT ADJUSTER</b>					
	72	A		D2LZ 6562116-B	4
	72	B, S	"Before 7/3/72"		2
	72	B	"From 7/3/72"	D3LZ 6562116-A	2
	72	S	"From 7/3/72"		2
<b>62168-9 SUPPORT - FRONT SEAT CUSHION SIDE SHIELD FRONT</b>					
- A -					
	67	A-bucket seat		C7SZ 6562168-A	2
	65/67	A	Screw-pan head, tapping- No.10-12 x 3/4"	32938-S7(U345)	2
	69	A	Full width seat	C9MZ 6562168-A	2
	69	A	Used with split seat	C9MZ 6562168-A	2
	69/71	A	Used with bucket seat	C9YZ 6562168-A	1
	70	A	Full width seat	D0AZ 6262168-A	1or2
	71/	A	Full width or split bench seat	D1AZ 6562168-A	2
- B -					
	72	B(53K,65K)		D2GZ 6562168-A	1
- S -					
	67/71	S		C7SZ 6562168-A	1or2
	72	S	With split seat	D2LZ 6562168-A	1
	72	S	With bucket seat	D2SZ 6562168-A	2
<b>62178 RETAINER - FRONT SEAT BACK SIDE SHIELD</b>					
	68/71	S		C8SZ 6562178-A	4
<b>62186-7 SHIELD - FRONT SEAT CUSHION SIDE</b>					
- A -					
	65/66	A(54,57,71)- "Before 11/15/65"	Power full width seat	C5AZ 5462186-A	★C5AZ 5462187-C Not replaced (1-73)
		"From 11/15/65"	Power full width seat	C5AZ 5462186-A	★C6AZ 5462187-A Not replaced (7-73)
	65/66	A(62,63B,F,76A)	Manual full width seat- aluminum	C5AZ 6362186-A	C5AZ 6362187-A
		"Before 11/15/65"	Power full width seat	C5AZ 6362186-A	★C5AZ 6362187-C Not replaced (3-74)
		"From 11/15/65"	Power full width seat	C5AZ 6362186-A	C6AZ 6362187-A

GROUP NUMBER	YEAR	BODY TYPE	DESCRIPTION	PART NUMBER		QTY.
				RIGHT HAND	LEFT HAND	
<b>62186-7 SHIELD - FRONT SEAT CUSHION SIDE - continued</b>						
- A -						
67/68	A(54, 57, 71)	Manual full width seat-aluminum	C5AZ 5462186-A	C5AZ 5462187-A	1	
		Power full width seat	C5AZ 5462186-A	★C7AZ 5462187-A Not replaced (3-74)	1	
		Screw-oval hd., tapping-No. 10-16 x 1/2"	52345-S6(U302C)	52345-S6(U302C)	6	
		Nut-spring-No. 10-24	45139-S2(M128)	45139-S2(M128)	4	
67/68	A(62, 63, 65, 76)	Manual full width seat-aluminum	C5AZ 6362186-A	C5AZ 6362187-A	1	
		Power full width seat	C5AZ 6362186-A	★C7AZ 6262187-A Not replaced (3-74)	1	
		Screw-oval hd., tapping-No. 10-16 x 1/2"	52345-S6(U302C)	52345-S6(U302C)	8	
		Nut-spring-No. 10-24	45139-S2(M128)	45139-S2(M128)	4	
68	A(63, 76)	Driver power bucket seat	★C7AZ 6362186-A Not replaced (3-74)	C7MY 6362187-C	1	
69	A	Manual full width seat w/o recliner-includes wood grain insert	C9AZ 5462186-B	D0AZ 5462187-C	1	
69	A	Manual full width seat w/ recliner-includes wood grain insert	C9AZ 5462186-C	D0AZ 5462187-C	1	
69	A	Manual split seat w/o recliner-includes wood grain insert	C9AZ 5462186-B	D0AZ 5462187-C	1	
69	A	Manual split seat w/ recliner-includes wood grain insert	C9AZ 5462186-C	D0AZ 5462187-C	1	
69	A	Power full width seat w/o recliner-includes wood grain insert	C9AZ 5462186-B	C9AZ 5462187-B	1	
69	A	Power full width seat w/ recliner-includes wood grain insert	C9AZ 6262186-D	C9AZ 5462187-B	1	
69	A	Driver power split seat w/o recliner-includes wood grain insert	C9AZ 5462186-B	C9AZ 5462187-B	1	
69	A	Driver power split seat w/ recliner-includes wood grain insert	C9AZ 5462186-C	C9AZ 5462187-B	1	
69/70	A(63, 65, 76)	Driver and passenger manual bucket seat	C9AZ 6362186-A	C9AZ 6362187-A	1	
		Driver power bucket seat	C9AZ 6362186-A	C9YZ 6562187-A	1	
70	A	Manual full width seat w/o recliner-includes wood grain insert	D0AZ 5462186-A	D0AZ 5462187-A	1	
70	A	Manual full width seat w/ recliner-includes wood grain insert	D0AZ 5462186-B	D0AZ 5462187-A	1	
70	A	Manual split seat w/o recliner-includes wood grain insert	D0AZ 5462186-A	D0AZ 5462187-A	1	
70	A	Manual split seat w/ recliner-includes wood grain insert	D0AZ 5462186-B	C9AZ 5462187-B	1	



# FORD CAR PARTS

## BODY SECTION 620

3

GROUP NUMBER	YEAR	BODY TYPE	DESCRIPTION	PART NUMBER		QTY.
				RIGHT HAND	LEFT HAND	
<b>62186-7 SHIELD - FRONT SEAT CUSHION SIDE - continued</b>						
<b>- A -</b>						
	70	A	Power full width seat w/o recliner-includes wood grain insert	D0AZ 5462186-A	C9AZ 5462187-B	1
	70	A	Power full width seat w/recliner-includes wood grain insert	C9AZ 5462186-C	C9AZ 5462187-B	1
	70	A	Power split seat w/o recliner-includes wood grain insert	D0MY 6562186-A	C9AZ 5462187-B	1
	70	A	Power split seat w/recliner-includes wood grain insert	D0MY 6562186-B	C9AZ 5462187-B	1
	71	A	Manual full width seat-w/o recliner	D1AZ 6562186-A	D1MZ 6562187-A	1
	71	A	Manual full width seat-w/recliner	D1AZ 6562186-B	D1MZ 6562187-A	1
	71	A	Power full width seat-w/o recliner	D1AZ 6562186-A	D1AZ 6562187-A	1
	71	A	Power full width seat-w/recliner	D1AZ 6562186-B	D1AZ 6562187-A	1
	71	A	Manual split bench seat	D1AZ 6562186-C	D1MZ 6562187-A	1
	71	A	Power split bench seat	D1AZ 6562186-C	D1AZ 6562187-A	1
	72	A	Manual full width seat	D1AZ 6562186-A	D2MZ 6562187-A	1
			Power full width seat	D1AZ 6562186-A	D1AZ 6562187-A	1
			Manual split bench seat-non-reclining	D2MY 6562186-A	D2MZ 6562187-A	1
			Manual split bench seat-reclining	D2AZ 6562186-A	D2MZ 6562187-A	1
			Power split bench seat-non-reclining	D1MY 6562186-C	D1AZ 6562187-A	1
			Power split bench seat-reclining	D1MY 6562186-B	D1AZ 6562187-A	1
<b>- B -</b>						
	72	B(53K)-w/o power seat	Black	D2GZ 5362186-B	D2GZ 5362187-B	1
			Blue	D2GZ 5362186-A	D2GZ 5362187-A	1
			Gold	D2GZ 5362186-E	D2GZ 5362187-E	1
			Green	D2GZ 5362186-C	D2GZ 5362187-C	1
			Tobacco	D2GZ 5362186-D	D2GZ 5362187-D	1
	72	B(53K)-w/power seat	Black	D2GZ 5362186-B	D2GZ 5362187-G	1
			Blue	D2GZ 5362186-A	D2GZ 5362187-F	1
			Gold	D2GZ 5362186-E	D2GZ 5362187-K	1
			Green	D2GZ 5362186-C	D2GZ 5362187-H	1
			Tobacco	D2GZ 5362186-D	D2GZ 5362187-J	1
	72	B(65K)-w/o power seat	Black	D2GZ 6562186-B	D2GZ 6562187-B	1
			Blue	D2GZ 6562186-A	D2GZ 6562187-A	1
			Gold	D2GZ 6562186-E	D2GZ 6562187-E	1
			Green	D2GZ 6562186-C	D2GZ 6562187-C	1
			Tobacco	D2GZ 6562186-D	D2GZ 6562187-D	1
	72	B(65K)-w/power seat	Black	D2GZ 6562186-B	D2GZ 6562187-G	1
			Blue	D2GZ 6562186-A	D2GZ 6562187-F	1
			Gold	D2GZ 6562186-E	D2GZ 6562187-K	1
			Green	D2GZ 6562186-C	D2GZ 6562187-H	1
			Tobacco	D2GZ 6562186-D	D2GZ 6562187-J	1
<b>- F -</b>						
	67	F(63B,65B,76B)	Blue	C7ZZ 6562186-A1B	★C7ZZ 6562187-A1B Not replaced (3-74)	1

**BODY  
SECTION 620**
**FORD CAR PARTS**

GROUP NUMBER	YEAR	BODY TYPE	DESCRIPTION	PART NUMBER		QTY.
				RIGHT HAND	LEFT HAND	
<b>62186-7</b>			<b>SHIELD - FRONT SEAT CUSHION SIDE - continued</b>			
			- P -			
	72	P(54, 62A)-LTD	Tan	D2DZ 6262186-A	D2DZ 6262187-A	1
			- S -			
	67	S	Driver manual bucket seat Parchment-paint to match	C7SZ 6562186-E	C7SZ 6562187-E	1
			Driver power bucket seat- Parchment-paint to match	C7SZ 6562186-E	★C7SZ 6562187-C Not replaced (3-74)	1
			Passenger manual bucket seat w/o reclining back- Parchment-paint to match	C7SZ 6562186-E	C7SZ 6562187-E	1
			Passenger manual bucket seat with reclining back- Parchment-paint to match	C8SZ 6562186-E	C7SZ 6562187-E	1
			Screw-oval head, cross recess-No.10-12 x 1 1/2"	★53073-S13	★53073-S13	8
	68/69	S	Power full width seat- paint to match	C8SZ 6562186-C	C8LY 6562187-A	1
			Power full width seat- with reclining back- paint to match	C8SZ 6562186-C	C8LY 6562187-A	1
			Manual full width seat w/o recliner-paint to match	C8SZ 6562186-C	C7SZ 6562187-E	1
			Manual full width seat w/ recliner-paint to match	C8SZ 6562186-C	C7SZ 6562187-E	1
	68/69	S	"Before 3/17/69" Crinkle grain-driver manual bucket seat- Parchment-paint to match	C7SZ 6562186-E	C7SZ 6562187-E	1
			Crinkle grain-driver power bucket seat- Parchment-paint to match	C7SZ 6562186-E	★C7SZ 6562187-C Not replaced (3-74)	1
			Crinkle grain-passenger manual bucket seat- w/o reclining back- Parchment-paint to match	C7SZ 6562186-E	C7SZ 6562187-E	1
			Crinkle grain-passenger manual bucket seat- with reclining back- Parchment-paint to match -cut hole 1 7/64" x 1 35/64" for switch	C7SZ 6562186-E	C7SZ 6562187-E	1
	69	S	"Before 3/17/69" Corinthian grain-driver manual bucket seat- paint to match	★C9SZ 6562186-B Not replaced (5/75)	C9SZ 6562187-A	1
	69	S	"Before 3/17/69" Corinthian grain- passenger manual bucket seat-w/o recliner- paint to match	★C9SZ 6562186-B Not replaced (5/75)	C9SZ 6562187-A	1
			Corinthian grain- passenger manual bucket seat-w/ recliner-paint to match-add hole for switch	★C9SZ 6562186-B Not replaced (5/75)	C9SZ 6562187-A	1

# FORD CAR PARTS

## BODY SECTION 620

5

GROUP NUMBER	YEAR	BODY TYPE	DESCRIPTION	PART NUMBER		QTY.
				RIGHT HAND	LEFT HAND	
<b>62186-7 SHIELD - FRONT SEAT CUSHION SIDE - continued</b>						
- 5 -						
69	S	"From 3/17/69"	Corinthian grain-driver power bucket seat-paint to match	C9SZ 6562186-C	★C9SZ 6562187-B Not replaced (5/75)	1
			Corinthian grain-driver manual bucket seat-paint to match	C9SZ 6562186-C	C9SZ 6562187-A	1
			Corinthian grain-passenger manual bucket seat-w/o recliner-paint to match	C9SZ 6562186-C	C9SZ 6562187-A	1
			Corinthian grain-passenger manual bucket seat-w/ recliner-paint to match-add hole for switch	C9SZ 6562186-C	C9SZ 6562187-A	1
70/71	S		Manual bucket seats	D0SZ 6562186-A	D0SZ 6562187-A	1
			Power bucket seats	D0SZ 6562186-B	D0SZ 6562187-B	1
			Manual full width seat	D0SZ 6562186-A	D0SZ 6562187-A	1
			Power full width seat	D0SZ 6562186-B	D0SZ 6562187-B	1
72	S-w/o reclining seat		Black	D2LZ 6562186-C	D2LZ 6562187-C	1
			Blue	D2LZ 6562186-E	D2LZ 6562187-E	1
			Ginger	D2LZ 6562186-A	D2LZ 6562187-A	1
			Gold	D2LZ 6562186-G	D2LZ 6562187-G	1
			Green	D2LZ 6562186-D	D2LZ 6562187-D	1
			Red	D2LY 6562186-B	D2LY 6562187-B	1
			Tobacco	D2LZ 6562186-F	D2LZ 6562187-F	1
			White	D2LZ 6562186-B	D2LZ 6562187-B	1
72	S-w/reclining seat		Black	D2SZ 6562186-C	D2LZ 6562187-C	1
			Blue	D2SZ 6562186-E	D2LZ 6562187-E	1
			Ginger	D2SZ 6562186-A	D2LZ 6562187-A	1
			Green	D2SZ 6562186-D	D2LZ 6562187-D	1
			Red	D2SZ 6562186-G	D2LY 6562187-B	1
			Tobacco	D2SZ 6562186-F	D2LZ 6562187-F	1
			White	D2SZ 6562186-B	D2LZ 6562187-B	1
<b>62194-5 SUPPORT - FRONT SEAT CUSHION SIDE SHIELD REAR</b>						
- A -						
69	A		Full width or split seat	C9MZ 6562194-A	C9MZ 6562194-A	2
69/71	A		Bucket seat	C9YZ 6562194-A	C9YZ 6562195-A	1
70	A		Full width or split bench seat	D0AZ 6262194-A	D0AZ 6262194-A	1or2
71/72	A			D3AZ 6562194-A	D3AZ 6562195-A	1
<b>62296-7 SUPPORT - FRONT SEAT BACK SIDE SHIELD LOWER</b>						
70	A(except 54A, 57B)				D0AZ 6262296-A	2
71/	A(53,54,57,71)		R.H.-used w/lo-back full width seat L.H.		D1AZ 5462296-A	1
71/	A(65,76)		Used w/lo-back full width seat		D1AZ 5462297-A	1
71	A	"Before 5/1/71"	R.H.-used w/hi-back full width seat L.H.		D1AZ 6562296-A	2
71/	A	"From 5/1/71"	R.H.-used w/hi-back full width seat L.H.		D1AZ 6562296-B	1
					D1AZ 6562297-B	1
					D1AZ 6562296-C	1
					D1AZ 6562297-C	1
<b>62298 SUPPORT - FRONT SEAT BACK SIDE SHIELD</b>						
69	A				C9AZ 6262298-A	2or4
70	A		Full width seat-upper and lower		D0AZ 6262298-A	2or4
65/68	A(54, 57, 63B, F, J, 71, 76A)		Screw-pan head, tapping-No. 10-12 x 3/4"		32938-S7(U345)	4or8

**BODY  
SECTION 620**
**FORD CAR PARTS**

GROUP NUMBER	YEAR	BODY TYPE	DESCRIPTION	PART NUMBER	QTY.	
<b>62332</b>	<b>SUPPORT - REAR SEAT BACK</b>					
	69/	A(76)		C9AZ 7662332-A	1	
	66/71	B(76)		C6OZ 7662332-A	1	
	65/70	F(76)		C5ZZ 7662332-B	1	
<b>62400</b>	<b>SUPPORT - REAR SEAT BACK</b>					
	71/	F(76)		D1ZZ 7662400-AA	1	
<b>624A08</b>	<b>BEZEL - REAR SEATBACK LATCH</b>					
	72	B(71)	Black	D2OZ 71624A08-C	2	
			Blue	D2OZ 71624A08-D	2	
			Ginger	D2OZ 71624A08-A	2	
			Green	D2OZ 71624A08-B	2	
<b>62416</b>	<b>SUPPORT - REAR SEAT BACK REAR TO FLOOR</b>					
	65/67	F(76)		C5ZZ 7662416-B	1	
	68	F(76)	Drill 1/2" hole for attaching shoulder harness		1	
<b>62418-9</b>	<b>HANDLE - REAR SEATBACK LATCH</b>					
	65	B(71)	R. H. - Not Replaced (7-73)	★C2AZ 7162418-B	1	
			L. H.	C2AZ 7162419-B	1	
	65/66	F(63)	R. H. -use with folding rear seat	C5ZZ 6362418-B	1	
	67/70	F(63)			2	
	71/	F(63)	Use with folding rear seat	D1ZZ 6362418-A	1	
	71/	L	Use with folding rear seat	D2FZ 6262418-A	1	
	66/70	X(71)	L. H.	C2AZ 7162419-B	1	
<b>62424-5</b>	<b>BRACKET - REAR SEAT BACK FILLER</b>					
	68/71	S(65)	To floor	C8SZ 6562424-A	1	
			To package tray	C8SZ 6562425-A	1	
<b>62426</b>	<b>STOP - REAR SEAT BACK - Paint to Match</b>					
	- A -					
	67/68	A(71)	Retainer	C8AZ 7162426-A	1	
			Screw & washer-flat head, cross recess- No. 12-24 x 1 1/2"	C5AZ 6221952-A 356782-S8(BB114)	1 3	
	69/71	A(71)		D0AZ 7162426-A	1	
	72	A(71)		D2AZ 7162426-A	1	
	- B -					
	66/67	B(71)	Retainer	C8AZ 7162426-A	1	
	66/71	B(71)	Screw & washer-flat head, cross recess- No. 12-24 x 1 1/2"	C5AZ 6221952-A 356782-S8(BB114)	1 3	
	68/71	B(71)		D0OZ 7162426-A	1	
	72	B(71)		D2OZ 7162426-A	1	
	- F -					
	66/	F(63)	Used with folding rear seat	C6ZZ 6362426-A	2	
			Nut-hex, -5/16"-18	33922-S8(M27)	2or4	
	- X -					
	65	X(59, 71)	Bolt-hex, washer head-5/16"-24 x 1 1/8"	C1DZ 5962426-B 353483-S2(BB588)	1 3	
<b>62430</b>	<b>BUMPER - REAR SEAT BACK</b>					
	- A -					
	65/66	A(54, 71)	1 7/8" long	C5AZ 5462430-A	1or2	
	67	A(54)			2	
	66	A(54, 71)	"From 1/3/66"	R. H. - 1 5/8" long-spring mounted-refer to Group 62434 for spring	C6AZ 7162430-B	1
	67	A(54)			1	
	- B -					
	66/71	B(71)	1 7/8" long	C5AZ 5462430-A	1or2	
	- L -					
	71	L(64)	"Before 6/15/71"	1 3/8" long- r/b D1FZ 6462430-B (7-73)	★D1FZ 6462430-A	1
	71/72	L(64)	"From 6/15/71 to 12/1/71"	1 3/8" long	D1FZ 6462430-B	1
	72	L(64, 73)	"From 12/1/71"	2 3/4" long	D2FZ 6462430-A	1

# FORD CAR PARTS

**BODY  
SECTION 620**

7

GROUP NUMBER	YEAR	BODY TYPE	DESCRIPTION	PART NUMBER	QTY.	
<b>62430 BUMPER - REAR SEAT BACK - continued</b>						
- X -						
	66/70	X(71)	"From 1/3/66"	L. H. -1 5/8" long-spring mounted - Refer to to group 62434 for spring	C6AZ 7162430-B	1
	66/70	X(71)		1 7/8" long	C5AZ 5462430-A	1or2
<b>62432 BUTTON - REAR SEAT BACK LATCH RELEASE</b>						
	66/	B(71)			C6OZ 7162432-B	1
	67/	A(71)				1
<b>62434 SPRING - REAR SEAT BACK BUMPER</b>						
	66	A(54, 71)	"From 1/3/66"	R. H.	C6AZ 7162434-A	1
	67	A(54)				1
	66/70	X(71)		L. H.		1
<b>62440-1 STRIKER - REAR SEAT BACK LATCH</b>						
- A -						
	65/66	A(54, 71)			C2AZ 7162440-A	1
	67	A(54)				1
	67/	A(71)			D3AZ 7162440-A	1
	65/	A(54, 71)		Washer-flat-5/16"	44722-S8(X19)	2
	65/	A(54, 71)		Lockwasher-spring-5/16"	34806-S7(X64)	4
	65/	A(54, 71)		Nut-blind-5/16"-24	34179-S13(M5)	2
	65/	A(54, 71)		Bolt-carrlage-5/16"-24 x 3/4"	23379-S8(B25)	
- B -						
	66/	B(71)			D3AZ 7162440-A	1
	65/	B(71)		Washer-flat-5/16"	44722-S8(X19)	2
	65/	B(71)		Lockwasher-spring-5/16"	34806-S7(X64)	4
	65/	B(71)		Lockwasher-spring-5/16"	34806-S7(X64)	4
	65/	B(71)		Nut-blind-5/16"-24	34179-S13(M5)	2
- F -						
	71/	F(63)		Use with folding rear seat	D1ZZ 6362440-A	1
- X -						
	66/70	X(71)			C6DZ 7162440-A	1
				Nut-blind-5/16"-18	34163-S13(M2A)	2
				Lockwasher-spring-3/8"	34806-S7(X64)	2
				Washer-flat-5/16"	44725-S8(X22)	2
<b>62442-3 BRACKET - REAR SEAT SUPPORT TO FLOOR</b>						
	71/	L(62)		R.H.-use with folding rear seat	D1FZ 6262442-A	1
				L.H.	D1FZ 6262443-A	1
<b>62444 BRACKET - REAR SEAT BACK SUPPORT TO SIDE</b>						
	69/70	A(63, 65)			C9AZ 6362444-A	2
<b>62446 BRACE - REAR SEAT BACK SUPPORT TO STRAINER</b>						
	71/	F(63)		Use without folding rear seat	D1ZZ 6362446-A	1
<b>62506 SUPPORT - PASSENGER SEAT</b>						
	71/72	L			D1FZ 6262506-A	2
<b>62512-3 LINK - FRONT SEAT TRACK REAR</b>						
	67/71	A, S		R. H. -Power full width seat and driver bucket	C7AZ 6262512-A	1
				L. H. -Power full width seat	C7AZ 6262512-B	1
	67/71	A, S		R. H. -Driver power split seat	C7AZ 6362512-A	1
				L. H. -Driver power split seat	C7MY 6362513-A	1
				R. H. -Passenger power split seat	C7AZ 6362512-A	1
				L. H. -Passenger power split seat	C7MY 6362513-A	1
	67/71	A, S		R. H. -Driver power bucket seat	C7AZ 6262512-A	1
				L. H. -Driver power bucket seat	C7AZ 6362512-A	1
	72	A	" Before 12/1/71"	R. H. -split seat	C7AZ 6362512-A	1
				L. H.	C7AZ 6262512-B	1
<b>625A12 BOLT - FRONT SEAT TRACK LINK</b>						
	67/71	A, S		Driver power bucket seat-bolt-slotted head-3/8"-16 x 1" (3 1/2" overall length)	C7AZ 63625A12-A	4
	68/71	S		Power full width seat and split bench seat		4
	68/72	A	" Before 12/1/71"	L. H. -Power split seat		4

May, 1975

COPYRIGHT © 1975 —

FORD MOTOR  
COMPANY

— DEARBORN, MICHIGAN

**FINAL ISSUE**

**BODY  
SECTION 620**
**FORD CAR PARTS**

GROUP NUMBER	YEAR	BODY TYPE	DESCRIPTION	PART NUMBER	QTY.
<b>62520-1 LINK - FRONT SEAT TRACK FRONT</b>					
	67/68	A	R. H. -Power full width seat	C7AZ 6262520-A	1
			L. H. -Power full width seat	C7AZ 6262521-A	1
	67/69	A	R. H. -Driver power split seat	C7AZ 6362520-B	1
			L. H. -Driver power split seat	C7AZ 6262521-A	1
			R. H. -Passenger power split seat	C7AZ 6362520-B	1
			L. H. -Passenger power split seat	C7AZ 6262521-A	1
	67/71	A, S	R. H. -Driver power bucket seat	C7AZ 6362520-A	1
			L. H. -Driver power bucket seat	C7AZ 6362521-A	1
	69/71	A	R. H. - Power full width seat	C9AZ 6262520-A	1
			L. H. - Power full width seat	C9AZ 6262521-A	1
	69/72	A	" Before 12/1/71" R. H. -Driver power split seat	C9AZ 5462520-A	1
			L. H. -Driver power split seat	C9AZ 6262521-A	1
			R. H. - Passenger power split seat	C9AZ 5462520-A	1
			L. H. - Passenger power split seat	C9AZ 6262521-A	1
	68/72	S	R. H. - Power full width seat	C8SZ 6562520-A	1
	72	S	R. H. -power 6-way split bench seat		1
			L. H. -Power full width seat	C7AZ 6362521-A	1
<b>625A56-7 BRACKET - FRONT SEAT BACK LATCH SOLENOID</b>					
	70/	A(63,65,76)	R. H.	D0AZ 62625A56-A	1
			L. H.	D0AZ 62625A57-A	1
	72	B		D2OZ 65625A56-A	2
<b>62606-7 PAWL - FRONT SEAT BACK LATCH</b>					
- A -					
	68	A	R. H. -Used with split seat	C8MZ 6362606-B	1
	68/69	S	R. H. -Used with full width or bucket seat		1
			L. H.	C8MZ 6362607-B	1
	69	A	R. H. -Used with full width seat	C9AZ 6262606-A	1
			L. H.	C9AZ 6262607-A	1
	69	A	Used with full width seat with recliner	C9AZ 6262606-A	2
	70/71	A(63,65,76)-full width seat	R. H.	D0AZ 6262606-B	1
			L. H.	C9AZ 6262607-A	1
	70/71	A(54,57,71) -full width seat	R. H. - with recliner	D0AZ 6262606-B	1
	70/71	A -bucket seat		D0ZZ 6562606-B	2
	70/71	A-split seat		D0AZ 6262606-B	2
	72	A (65F,H,76)		D0AZ 6262606-B	2
	72	A(65K)		D0SZ 6562606-A	2
- B -					
	68/69	B	Serviced in assembly-see Group 60136-7 in Soft Trim Section	★	
	70/71	B(62,63,65,66)	Full width seat	D0OZ 6562606-A	2
	70/71	B	Bucket seat	D0ZZ 6562606-B	2
	72	B(63,65,97)		D2OZ 6562606-B	2
- F -					
	68/69	F		C8ZZ 6562606-A	2
	70	F		D0ZZ 6562606-B	1
	71	F	" Before 6/15/71"	D1FZ 6262606-A	2
	71/	F	" From 6/15/71"	D1FZ 6262606-B	2
- L -					
	71	L	"Before 5/3/71"	D1FZ 6262606-A	2
	71	L	"From 5/3/71"	D1FZ 6262606-B	2
- P -					
	70/	P-full width seat		D0DZ 6262606-A	2
	71	P-bucket seat -		D1FZ 6262606-A	2
		" Before 6/15/71"			
	71/	P-bucket seat -		D1FZ 6262606-B	2
		" From 6/15/71"			

# FORD CAR PARTS

**BODY  
SECTION 620**

9

GROUP NUMBER	YEAR	BODY TYPE	DESCRIPTION	PART NUMBER	QTY.
<b>62606-7 PAWL - FRONT SEAT BACK LATCH - continued</b>					
- S -					
	68/71	S	On cushion-used with reclining seat	C8SZ 6562606-A	1
	70/71	S(65)	On back	D0SZ 6562606-A	2
	72	S-split bench seat		D2OZ 6562606-B	2
	72	S - bucket seat	With recliner	D2SZ 6562606-A	2
- U -					
	68/69	U-full width or bucket seat	Driver side	C8ZZ 6562606-A	2
	70/	U-bucket seat	Driver side	D0ZZ 6562606-B	1
			Passenger side	D0BZ 1062606-A	1
- X -					
	70	X(62)-full width seat		D0OZ 6562606-A	1
<b>62608 BUSHING - FRONT SEAT BACK LATCH</b>					
	68/69	A, B, F, S, U, X		C8AZ 6262608-A	AR
	69	A	Used with reclining seat		2
	71/	A	Used with reclining seat		1
	71	B	Used with bucket seat		2
	71	A-bucket seat	W/automatic seat back latch		2
	70/71	F	Full width seat or split seat	D0VZ 6562608-A	2or4
	70/71	S(65)			2or4
	70/	A(63, 65, 76)			2
	72	B, P, S		D2FZ 6262608-A	2
<b>62614 BRACKET - FRONT SEAT BACK LATCH</b>					
	72	B, S	Used with automatic seat latch	D2SZ 6562614-A	2
	71/	L		D1FZ 6262614-A	2
	71/	F, P			2
	72	F	Used with automatic seat latch	D2ZZ 6562614-A	2
	68	S	Use with reclining seat	C8SZ 6562614-B	1
	68	U	Driver side		2
	68/69	S	Without reclining seat	C8SZ 6562614-A	2
	69	A	Used with bucket seat		2
	68/69	F, U			1
<b>62622 HANDLE - FRONT SEAT BACK LATCH - INCLUDES ATTACHING PARTS - Also refer to Group 61198</b>					
	68/69	A	Used with full width seat with side shields	C8AZ 6362622-B	2
	68/69	A	Used with split seat		2
	69	A	Used with full width seat with recliner		2
	69	A	"Before 11/4/68" With reclining seat	C9AZ 6262622-A	1
	72	A(65K)	With reclining seat		1
	69/71	S	With reclining seat		1
	72	S	Used on seat cushion reclining		1
	68	A	Used with full width seat less side shields	C8AZ 6262622-B	2
	68/70	B, F, S(65), X	Used with full width or bucket seat		2
	68/71	A, U	Used with bucket seat		2
	68/	U			2
	69/71	A	"From 11/4/68" With reclining seat		2
	69	S	"Before 8/26/68" Without reclining seat		2
	69	S	"From 8/26/68" Without reclining seat	C9SZ 6562622-A	2
	70/	A		C8AZ 6262622-B	2
	70/	B, F, U			2
	72	B, S	Used on seat cushion - non-reclining	D2OZ 6562622-A	2
	71	F	With center mounted latch	D1FZ 6262622-A	2
	71	P			2
	71	L			2
	71/	F, L, P	R.H. -with outboard mounted latch	D1FZ 6262622-B	1
			L.H.	D1FZ 6262622-C	1
	70/	P	Used w/full width seat	D0DZ 6262622-A	2
	70/71	S		D0VZ 6562622-A	2
	72	S	Used on seat back-reclining		1
	68/	B, P, X	Screw-oval head-No. 8-32 x 1/2"	50398-S13(U121)	AR

**BODY  
SECTION 620**
**FORD CAR PARTS**

GROUP NUMBER	YEAR	BODY TYPE	DESCRIPTION	PART NUMBER	QTY.
<b>62624-5 ESCUTCHEON - FRONT SEAT BACK LATCH</b>					
	68/71	B	R. H. -Used with full width seat L.H.	C8OZ 6362624-A C8OZ 6362625-A	1 1
	68/71	B	Screw-fillister head-self-tap. -No. 8-18 x 5/8"	52554-S8(U230)	4
<b>62634 STEM ASSY. - FRONT SEAT BACK LATCH</b>					
- A -					
	69	A	Used with full width or bucket seat	C9AZ 6262634-A	2
	69	A	Used with full width seat with recliner		2
	69	A	Used with bucket seats or split seats	C9YZ 6562634-A	2
	70/	A(63,65,76)-full width seat		D0AZ 6262634-A	1
	70/	A(54,57,71)-full width seat	Used with recliner		1
	71/	A	Used with hi-back full width seat	D1AZ 6562634-A	2
- B -					
	68/69	B(63,65,66,76)-	Used with full width seat	C8OZ 6262634-A	2
	70/71	B(62,63,65,66,76)	Used with full width seat	D0OZ 6562634-A	1
	70/71	B(63,65,66,76)	Used with bucket seat	D0ZZ 6562634-A	2
	72	B-full width or bucket seat	W/o automatic latch	D5OZ 6562634-B	2
	72	B-full width seat - "Before 7/12/71"	With automatic latch-service in assy. 62648-9	★D2LZ 6562634-A	2
	72	B-full width seat - "From 7/12/71"	With automatic latch - service in assy. 62648-9	★D2LZ 6562634-B	2
	72	B-bucket seat	With automatic latch	D2OZ 6562634-B	2
	70/71	B	Nut-spring-1/2"	351092-S32(MM262)	2
- F -					
	68/69	F		C8ZZ 6562634-A	2
	70	F		D0ZZ 6562634-A	2
	71/	F	Used w/o automatic seat latch	D1ZZ 6562634-D	2
	71/	F	Used w/automatic seat latch	D1ZZ 6562634-E	2
	70	F	Washer-11/16" x 1/32" thick(between stem and latch handle)	351513-S8(XX213)	2
- L -					
	71/	L	Used with outboard seat latch	D1ZZ 6562634-D	2
- P -					
	70/	P-full width seat		C8OZ 6262634-A	2
	71/	P-bucket seat		D1ZZ 6562634-D	2
- S -					
	68/69	S	Used with full width or bucket seat	C8SZ 6562634-C	2
	68/69	S	Used with reclining seat	C8SZ 6562634-A	1
	70/71	S(65)	Used with full width or bucket seat	D0SZ 6562634-B	1
	72	S-split bench seat - "Before 7/12/71"	With automatic seat latch-service in assy. 62648-9	★D2LZ 6562634-A	2
	72	S-split bench seat - "From 7/12/71"	With automatic seat latch-service in assy. 62648-9	★D2LZ 6562634-B	2
	72	S-bucket seat	With automatic seat latch	D2OZ 6562634-B	2
	72	S-bucket seat	W/o automatic seat latch-non reclining	D5OZ 6562634-B	2
	72	S-bucket seat	W/o automatic seat latch-reclining	D2SZ 6562634-B	1
- U -					
	68/69	U-bucket seat		C8ZZ 6562634-A	1
	70/	U-bucket seat		D0ZZ 6562634-A	1
			Ring-retainer 1/2"	★97519-S	1
- X -					
	68/70	X(62)		C8OZ 6262634-A	2



# FORD CAR PARTS

**BODY  
SECTION 620**

11

GROUP NUMBER	YEAR	BODY TYPE	DESCRIPTION	PART NUMBER	QTY.
<b>62634 BRACKET - FRONT SEAT BACK LATCH</b>					
	71	F	Used w/automatic seat latch-center mounted	D1ZZ 6562634-C	2
	71/72	F	"Before 1/3/72" R.H.-Used w/automatic seat latch - outboard mounted	D1ZZ 6562634-F	1
			L.H.	D1ZZ 6562634-G	1
	72	F	"From 1/3/72" Used w/automatic seat latch	D2ZZ 6562634-A	2
<b>62638-9 STRIKER - FRONT SEAT BACK LATCH</b>					
	68/71	B, X	R.H.-Used with full width seat	C8OZ 6362638-A	1
			L.H.	C8OZ 6362639-A	1
	68	A	R.H.-Used with bucket seat	C8AZ 6362638-A	1
	68/69	B, X	R.H.-Used with bucket seat	C8AZ 6362639-A	1
			L.H.	C8AZ 6362639-A	1
	68/69	F	R.H.-Used with full width or bucket seat	C8ZZ 6562638-A	1
	69	A	R.H.-Used with bucket seat		1
	68/69	U	R.H.-Used with bucket seat		1
			L.H.	C8ZZ 6562639-A	1
	70	A, F	R.H.-Used with full width or bucket seat	D0ZZ 6562638-A	1
	70	B	R.H.-Used with bucket seat		1
			L.H.	D0ZZ 6562639-A	1
	71	A, B	R.H.-used with bucket seat	D1GY 6562638-A	1
			L.H.	D1GY 6562639-A	1
	71/	F, L, P	Used with bucket seat	D1ZZ 6562638-A	2
	70/	U	R.H.	D0BZ 9662638-A	1
			L.H.	D0ZZ 6562639-A	1
<b>62642-3 ROD - FRONT SEAT BACK LATCH ACTUATING</b>					
- A -					
	68	A	R.H.-Used with split seat	C8AZ 6562642-A	1
			L.H.	C8AZ 6562643-A	1
	69	A	R.H.-bucket seat	C8ZZ 6562642-B	1
			L.H.	C9ZZ 6562643-A	1
	69	A	R.H.-full width seat	C9AZ 6262642-A	1
			L.H.	C9AZ 6262642-B	1
	70	A(54, 57, 71)	R.H.-used with reclining full width seat	D0AZ 6262642-A	1
- B -					
	68/70	B-full width seat		C8OZ 6362642-A	2
	68/70	B-bucket seat		C8AZ 6362642-A	2
- F -					
	68/69	F	Used with full width seat	C8ZZ 6562642-B	1
	69/70	F	R.H.-Used with bucket seat		1
	69/70	F	L.H.-Used with bucket seat	C9ZZ 6562643-A	1
- S -					
	68/69	S	Used with reclining full width seat	C8SZ 6562642-A	2
	68/69	S	R.H.-used w/manual bucket seat w/o recliner	C9SZ 6562642-B	1
	68/69	S	Used with full width seat		1
	68/69	S	L.H.-used w/manual bucket seat w/o recliner	C9SZ 6562643-A	1
	68/69	S	Used with full width seat		1
- U -					
	68/69	U	Driver bucket seat	C8ZZ 6562642-B	1
	70	U	Bucket seat	D0BZ 9662642-A	1
- X -					
	68/70	X-full width seat		C8OZ 6362642-A	2
	68/70	X-bucket seat		C8AZ 6362642-A	2
<b>62648-9 LATCH ASSY. - FRONT SEAT BACK</b>					
	72	B, S	R.H.-w/manual seat latch	D2OZ 6562648-A	1
			L.H.	D2OZ 6562649-A	1
	72	B, S	R.H.-w/automatic seat latch	D2LZ 6562648-A	1
			L.H.	D2LZ 6562649-A	1
	72	B(63R, 65)	R.H.-lo-back bench seat-automatic seat latch	D2LZ 6562648-A	1
			L.H.	D2LZ 6562649-A	1

**BODY  
SECTION 620**
**FORD CAR PARTS**

GROUP NUMBER	YEAR	BODY TYPE	DESCRIPTION	PART NUMBER	QTY.
<b>62650-1 LINK ASSY. - FRONT SEAT BACK LATCH</b>					
	68/69	B, X	R. H. -bucket seat	C8AZ 6362650-B	1
			L. H.	C8AZ 6362651-B	1
	68	A	R. H. -bucket seat		1
			L. H.		1
	72	B(63,65),S	Serviced in assembly only - refer to Group 62690		
<b>62672-3 BEZEL - FRONT SEAT BACK LATCH HANDLE</b>					
	68	A, B, X	Used with bucket seat	C8VY 5362672-A	2
	69	A	Used with full width seat with recliner		2
	71/	A	Used with reclining seat		2
	68	A	Used with full width seat	C8AZ 6262672-A	2
	68/	B, F, X	Used with full width seat		2
	68/69	U	Used with bucket seat		2
	68/	S	Used with reclining seat		1
	69	A	Used with full width seat	C9AZ 6262672-A	2
	70/71	F	Bucket seat		2
	71	B	Used with bucket seat		2
	70	B(65F,H)	With automatic seat back latch		2
	70	A(62,63,65,76)	Used with side shields	D0AZ 6262672-A	1 or 2
	70	A	Used with reclining seat		1
	71/	A		D1AZ 6562672-A	1
	70/71	A	R. H. -Used with bucket seats	D0YZ 6562672-A	1
			L. H.	D0YZ 6562673-A	1
	72	B(63,65)		D2OZ 6562672-A	2
	72	L	Beige	D2FZ 6262672-F	2
			Black	D2FZ 6262672-C	2
			Blue	D2FZ 6262672-B	2
			Ginger	D2FZ 6262672-E	2
			Green	D2FZ 6262672-A	2
			White	D2FZ 6262672-D	2
	72	S	Bright finish	D2OZ 6562672-A	2
			Black	D2SZ 6562672-B	1
			Blue (Dark)	D2SZ 6562672-H	1
			Ginger	D2SZ 6562672-A	1
			Gray Gold	D2SZ 6562672-E	1
			Green (Dark)	D2SZ 6562672-F	1
			Red	D2SZ 6562672-G	1
			Tobacco	D2SZ 6562672-D	1
			White	D2SZ 6562672-C	1
	70/	U	Bucket seat	C9AZ 6262672-A	1
<b>62680 ESCUTCHEON - FRONT SEAT BACK LATCH HANDLE</b>					
	70/	S		C8LY 6562680-A	1
<b>62690 SOLENOID ASSY. - FRONT SEAT BACK LATCH - INCLUDES WIRING</b>					
	70	A(62,63,65,76)	Used with full width or split seat	D0AZ 6262690-A	2
	71/	A(65,76)	Full width seat		2
	71/	A(65,76)	Split bench seat	D0SZ 6562690-A	2
	70/71	B(63,65,66,76)	Used with full width seat	D0OZ 6562690-A	2
	70/71	B(63,65,66,76)	Used with bucket seats	D0ZZ 6562690-A	2
	71	A-bucket seat			2
	70	F			2
	72	B	Bucket seat	D2OZ 6562690-A	2
	72	B	Full width or split bench seat	D2LZ 6562690-B	2
	71	F	Used with center mounted seat latch	D1ZZ 6562690-A	2
	71/	F	Used with outboard mounted seat latch	D1ZZ 6562690-B	2
	70/71	S(65)		D0SZ 6562690-A	2
	72	S	Bucket seat	D2OZ 6562690-A	2
	72	S "Before 10/15/71"	Full width or split bench seat	D2LZ 6562690-B	2
	72	S "From 10/15/71 to 7/17/72"	Full width or split bench seat-reclining	D2SZ 6562690-A	1
	72	S "From 7/17/72"	Full width or split bench seat-reclining	D3SZ 6562690-A	1

# FORD CAR PARTS

**BODY  
SECTION 620**

13

GROUP NUMBER	YEAR	BODY TYPE	DESCRIPTION	PART NUMBER	QTY.
<b>62704 SPACER - FRONT SEAT BACK LATCH PAWL</b>					
	70/	B(63,65,66,76)		DOOZ 6562704-A	2
	70	X(62)			2
<b>62718-9 SHIELD - FRONT SEAT BACK LATCH ACTUATOR</b>					
	72	B,S	R.H.-bucket seat L.H.	D2SZ 6562718-B	1
				D2SZ 6562719-B	1
	72	B,S	R.H.-split bench seat L.H.	D2LZ 6562718-A	1
				D2LZ 6562719-A	1
<b>62720 LEVER - FRONT SEAT BACK LATCH</b>					
	72	S		D2SZ 6562720-B	1
<b>62730 SHIELD - FRONT SEAT BACK LATCH</b>					
	72	P(62)	" Before 9/18/72" Tan-reclining seat	D2DZ 6262730-A	2
<b>62868 RETAINER - FRONT SEAT BACK ASH RECEPTACLE</b>					
	68/69	A, B, X	Used with full seat back	C8AZ 5462868-A	1
	70	A	Without split bench and/or center arm rest		1
	71	A " Before 7/11/71"			1
	71	P(54) " Before 7/11/71"			1
	71	B "Before 6/1/71"			1
	71/	A,P(54) " From 7/11/71"		D2AZ 6562868-A	1
	71/	B "From 6/1/71"			1
	72	S	Used with console and seat back		2
	68/69	A, B, X	Use with split seat back	C8AZ 6262868-A	2
	70	A	With split bench and/or center arm rest		1or2
	70/71	B(63, 65, 76)	Used with console		1
	70	X			2
	72	L	Used on R.H. quarter		1
<b>62876 RECEPTACLE - FRONT SEAT BACK ASH - Paint to Match</b>					
	68/69	A, B, X	Used with full seat back	C8AZ 5462876-A	1
	70	A	Without split bench and/or center arm rest		1
	71	A " Before 7/11/71"			1
	70/71	B "Before 6/1/71"	Not used in console		1
	71	P(54) " Before 7/11/71"			1
	70	X			2
	71/	A,P(54) " From 7/11/71"		D2AZ 6562876-A	1
	71/	B "From 6/1/71"			2
	72	S	Used with console and seat back		2
	68/69	A, B, X		C8AZ 6262876-A	2
	69/	A, F	Used with console		1
	70	A	With split bench and/or center arm rest		1or2
	70/71	B(63, 65, 76)	Used in console		1
	72	L "Before 12/1/71"	Used on R.H. quarter		1
	68/70	X			2
	72	L "From 12/1/71"	Used on R.H. quarter-Bright finish	D2FZ 6262876-A	1
<b>63084 SPRING - FRONT SEAT CUSHION HELPER</b>					
	70	A		D0AZ 6263084-A	1
<b>63100 SPRING ASSY. - FRONT SEAT CUSHION</b>					
	65/66	A(62- Police & Taxi)		C7AZ 6263100-A	1
	67	A(54, 62, 71)			1
	67	A(62 Police)		C7AZ 6263100-F	1
	68	A(62)		C8AZ 6263100-A	1
	69	A(54, 71)		C9AZ 5463100-G	1
	69	A(62, 65)		C9AZ 6263100-L	1
	70	A(54, 71)		D0AZ 5463100-A	1
	70	A(63, 65)		D0AZ 6263100-A	1
	71	A(54, 71)		D1AZ 5463100-A	1

GROUP NUMBER	YEAR	BODY TYPE	DESCRIPTION	PART NUMBER	QTY.
<b>63100 SPRING ASSY. - FRONT SEAT CUSHION - continued</b>					
	71	A(65)		D1AZ 6563100-A	1
	72	A(65)	"Before 12/1/71"	D2AZ 6563100-B	1
	72	A(53,54,57,71)	Remove center pivot bracket		1
			"Before 12/1/71"		
	72	A(65)-"From 12/1/71 to 4/3/72"		D2AZ 6563100-C	1
	72	A(53,54,57,71)	Remove center pivot bracket		1
			"From 12/1/71 to 4/3/72"		
	72	A(65)	"From 4/3/72"	D3AZ 6563100-A	1
	72	A(53,54,57,71)	Remove center pivot bracket		1
			"From 4/3/72"		
	70/71	B(54)		D0GY 5463100-A	1
	72	B(53)		D2OZ 5363100-A	1
	72	B(65)		D2OZ 6563100-A	1
<b>631A02-3 BRACKET - REAR SEAT BACK STOP TO WHEELHOUSE</b>					
	69/	A(71)		C9AZ 71631A02-A	1
	66/67	B(71)		C6OZ 71631A02-A	1
	68/71	B(71)		C6OZ 71631A02-C	1
	72	B(71)		D2OZ 71631A02-A	1
	65/68	F(63)	R. H.	C5ZZ 63631A02-B	1
	67/68	F(63)	L. H. -not replaced (3-74)	*C7ZZ 63631A03-A	1
	69/70	F(63)	R. H.	C9ZZ 63631A02-A	1
			L. H.	C9ZZ 63631A03-A	1
	71/	F(63) -with folding rear seat		D1ZZ 63631A02-A	1
	71	L(62) -with folding rear seat-		D1FZ 62631A02-A	1
		"Before 2/1/70"			
	71/	L(62) -with folding rear seat-		D1FZ 62631A02-B	1
		"From 2/1/70"			
	71/	L(64) -with folding rear seat		D1FZ 64631A02-A	1
	72	L(73)		D2FZ 73631A02-A	1
	65	X(59,71)	L. H.	C5DZ 59631A03-A	1
	69	A	Screw-flat head-No.12-24 x 1/2"	382542-S(BB114A)	AR
<b>631A05 COVER - REAR SEAT BACK STOP TO WHEELHOUSE - Paint to Match</b>					
	66	A(71)	L.H.-Black	C5AZ 71631A05-AAB	1
			L. H. -Blue	C5AZ 71631A05-AAD	1
	65/66	A(71)	Screw-pan head, cross recess-No.8-18 x 3/8"	52720-S8(U380)	3
			Washer-flat-No.8	44710-S8(X10)	1
<b>63120 SPRING ASSY. - REAR SEAT CUSHION</b>					
	65/68	A(54-Police & Taxi)		C5AZ 5463120-J	1
	69/70	A(54-Taxi)		C9AZ 5463120-E	1
	72	A(54)		D2AZ 5463120-A	1
	69/71	B(54)		C9GZ 5463120-A	1
<b>63150 SPRING - REAR SEAT CUSHION</b>					
	70/	A(54)	Use with heavy duty seat	D0AZ 5463150-A	6
<b>63174 COVER - FRONT SEAT BACK HINGE PIN</b>					
	69	A	Aqua-use with full width reclining seat	C9AZ 5463174-A1K	1
			Black	C9AZ 5463174-A1A	1
			Nugget Gold	C9AZ 5463174-A1Y	1
			White	C9AZ 5463174-A1W	1
	70	A	Aqua-use with full width reclining seat	C9AZ 5463174-A1K	1
			Black	C9AZ 5463174-A1A	1
			Blue	D0AZ 5463174-A	1
			Ginger	D0AZ 5463174-D	1
			Green	D0AZ 5463174-B	1
			Nugget Gold	C9AZ 5463174-A1Y	1
			Red	D0AZ 5463174-C	1
			White	C9AZ 5463174-A1W	1

# FORD CAR PARTS

**BODY  
SECTION 620**

15

GROUP NUMBER	YEAR	BODY TYPE	DESCRIPTION	PART NUMBER	QTY.
<b>63174 COVER - FRONT SEAT BACK HINGE PIN - continued</b>					
	70	A	Aqua-use with split seat w/ recliner	C9MY 6563174-A1K	1
			Black	C9MY 6563174-A1A	1
			Blue	D0AZ 6563174-A	1
			Ginger	D0AZ 6563174-D	1
			Green	D0AZ 6563174-B	1
			Nugget Gold	C9MY 6563174-A1Y	1
			Red	D0AZ 6563174-E	1
			Tobacco	D0AZ 6563174-C	1
			White	C9MY 6563174-A1W	1
<b>63186 SPRING - FRONT SEAT CUSHION HELPER</b>					
	70/	A		D0AZ 6263186-B	1
<b>63218-9 SHIELD - FRONT SEAT CUSHION REAR</b>					
	68/69	S(57C, 65C, D)	Plastic		
	70/71	S(57B)	R.H.	C8SZ 6563218-A	1
			L.H.	C9LY 6563218-A	1
	70/71	S(57C, 65C, D)		C9LY 6563219-A	1
				D0SZ 6563218-A	1
<b>632A22 PAD - FRONT SEAT CUSHION</b>					
	67	A(54, 62, 71)			
	68	A(54, 71)		C8AZ 62632A22-B	1
	69/70	A(54, 62, 65, 71)			1
	71/72	A(54, 65, 71) Police & Taxi	W/o sensor	C9AZ 62632A22-A	1
				D2AZ 65632A22-A	1
	72	A(54, 65, 71) Police & Taxi- "Before 6/1/72"	W/sensor	D2AZ 65632A22-D	1
	72	A(54, 65, 71)-Police & Taxi- "From 6/1/72"		D2AZ 65632A22-E	1
<b>63370 RETAINER - REAR SEAT CUSHION - FRONT</b>					
	65/67	A, B, F(65, 76), S, X	Bend to fit	C5AZ 6263370-A	2
	68	A, F(65, 76), S, X		C5AZ 6263370-B	2
	70	S			2
	69/	A			2
	70/71	P		C9AZ 6263370-A	2
	68/71	B			2
	68/70	X		C8OZ 5463370-A	2
	72	B			2
	65/	F(63)		D2OZ 6563370-A	2
	71	F(65, 76)		C5ZZ 6363370-A	2
				C9AZ 6263370-A	2
<b>63520 RETAINER - SEAT BACK BUTTON and STRAP -Also Refer to Group 64402</b>					
	67	S-w/o reclining seat	Front seat back-used with cloth trim only	C7SZ 6563520-A	2
	67	S-w/reclining seat	L. H. -front seat back		1
	67	S	Rear seat back		2
<b>63844 SUPPORT - REAR SEAT CUSHION PAD</b>					
	69/	A(54, 57)	Use with heavy duty seat	C9AZ 5463844-A	1
<b>642A98 RETAINER - LOAD RESTRAINER - INNER PANEL BODY SIDE</b>					
	72	B(97)		D2OZ 97642A98-A	4
<b>64384 HOLD DOWN ASSY. - LOAD RESTRAINER</b>					
	69	B(66A, B)		C9OZ 6664384-A	4
<b>644A36 MOULDING - FRONT SEAT BACK CENTER ARM REST - INCLUDES ATTACHING PARTS</b>					
	65/69	F	Used with full width seat	C5ZZ 65644A36-A	1
	68/71	S	Used with full width seat	C8SZ 65644A36-A	1
	71	S	Use with split bench seat	C8LY 65644A36-A	2

GROUP NUMBER	YEAR	BODY TYPE	DESCRIPTION	PART NUMBER	QTY.
<b>64462</b>	<b>RETAINER - SEAT BACK ORNAMENT - Also Refer to Group 63520</b>				
67		B(66B, D), X(54B, 62B, C, 71B)		C7DZ 6264462-A	2or4
69		B(54, 63, 66, 76)			2
<b>64700-1</b>	<b>SPRING ASSY. - FRONT SEAT BACK - HEAVY DUTY</b>				
69		A(54, 71 Police and Taxi)	With head rest	C9AZ 5464700-A	1
71		A(54, 71-Police and Taxi)		D1AZ 5464700-B	1
71		A(65-Police)	R.H.	D1AZ 6564700-B	1
			L.H.	D1AZ 6564701-B	1
72		A(54-Police and Taxi)		D2AZ 5464700-A	1
72		A(65-Police and Taxi)	R. H.	D2AZ 6564700-A	1
			L. H.	D2AZ 6564701-A	1
70/71		B(54)		D0OY 5464700-A	1
<b>64744</b>	<b>SUPPORT - FRONT SEAT BACK PIVOT</b>				
70		S	R.H.-use with reclining seat	D0SZ 6564744-A	1
<b>64752</b>	<b>SPACER - FRONT SEAT BACK TO CUSHION</b>				
70/		P		D0DZ 6264752-A	2
<b>64754</b>	<b>STOP - FRONT SEAT BACK PIVOT</b>				
68/71		A, S		C8SZ 6564754-A	2or4
<b>64810-1</b>	<b>PAD - FRONT SEAT BACK - INCLUDES SPRINGS</b>				
72		B-bucket seat	R. H.	D2OZ 6564810-A	1
			L. H.	D2OZ 6564811-A	1
71/		L(62)		D1FZ 6264810-A	2
<b>64824</b>	<b>ORNAMENT - SEAT BACK</b>				
	<b>- A -</b>				
65/66		A(57F, 63F)	Refer to Group in Soft Trim Section		
68		A	Front seat back-includes attaching parts	C8AZ 5464824-A	2
			Rear seat back		2
69		A(54C, 57F, 65A)	Refer to Group 63500 in Soft Trim Section		
70		A	Aqua-includes attaching parts	D0AZ 5464824-H	AR
	<b>- B -</b>				
68		B(54B, 63B, 65B, 66B, 71B, E, 76B)	Front seat back-includes attaching parts	C8OZ 5464824-A	2
			Rear seat back		2
69		B(54B, 63B, 65B, C)	Front seat-used with cloth and vinyl trim		2
69		B(66B, C)	Front seat-use with all vinyl trim		2
			Rear seat		2
68		B(63D, 63E, 65D, E, 66D, E, 76D, E)	Front seat back-includes attaching parts	C8OZ 6364824-A	2
			Rear seat back		2
69		B(54B, 63B, D, E, F, 65B, F, 66A, D, 76B, D, E, F)	Front seat-use with all vinyl trim		2
			Rear seat		2
	<b>- F -</b>				
69		F(63, 65A, B, C, 76)	Front seat -Light Teak Wood	C9ZZ 6564824-A	4
	<b>- S -</b>				
65/66		S	Front seat backs-refer to Group 64824 in Soft Trim Section		
			Package tray-refer to Group 465A38 in Soft Trim Section		
69		S(57B, 65A, B)	Front seat - White - includes attaching parts	C9SZ 6564824-A	4
			Rear seat		4
69		S(65A, B)	R. H. -Rear seat-White-includes attaching parts	C9SZ 6564824-C	1
			L. H.	C9SZ 6564824-D	1
69		S(65A, B)	R. H. -Rear seat-Black-includes attaching parts	C9SZ 6564824-E	1
			L. H.	C9SZ 6564824-F	1
<b>64825</b>	<b>PLATE - SEAT BACK ORNAMENT MOUNTING</b>				
69		A		C9AZ 5464825-A	1or2
69		F(63, 65A, B, C, 76)	Front seat backs	C9ZZ 6564825-A	4
			Rear seat backs		4

# FORD CAR PARTS

**BODY  
SECTION 620**

17

GROUP NUMBER	YEAR	BODY TYPE	DESCRIPTION	PART NUMBER	QTY.	
<b>65206 MOULDING - FRONT SEAT BACK - INCLUDES ATTACHING PARTS</b>						
	65	A(63C, 76B), S	Aluminum	C4SZ 6365206-A	2	
	66	A(63C, D, 76B, D), S	Clip-trim	358372-S3(GG120)	18	
			Screw-oval head, cross recess-No. 8-32 x 3/8"	376378-S100(UU97)	18	
	66	B(63C, D, 76C, D), X(62C, 66D)		C6OZ 6365206-A	2	
	67	B(63C, D, 66D, 76C, D), X(62C)			2	
			Screw-oval head, cross recess-No. 10-12 x 1 1/2"	*53073-S13	4	
			Nut-spring-No. 10-12	*376286-S2	4	
<b>65406 LINK and SUPPORT ASSY. - FRONT SEAT BACK CENTER ARM REST</b>						
	69/	A(53, 54, 57)	Used with full width seat	C9MZ 5765406-A	1	
	69/	A(53, 54, 57, 65)	Used with split seat	C9MZ 6565406-A	2	
	69/	A(65)	Used with full width seat		2	
	70/71	S(57B)	R. H.	C8LY 6565406-A	1	
			L. H.	C8LY 6565406-B	1	
	70/71	S(57C, 65C, D)		D0SZ 6565406-A	2	
<b>654A28 BUSHING - FRONT SEAT BACK CENTER ARM REST PAD</b>						
	65/70	F	Used with full width seat	C5ZZ 65654A28-A	2	
	71/	A			2	
	72	B, S			2	
<b>654A54 RETAINER - FRONT SEAT BACK CENTER ARM REST COVER</b>						
	67/	A	Split seat	C7MY 63654A54-A	2	
	69	A	Full width seat with recliner		2	
<b>654A76 SPACER - FRONT SEAT BACK CENTER ARM REST SUPPORT</b>						
	70/71	S(57C, 65C, D)		D0SZ 65654A76-A	2	
<b>65478-9 PAD - FRONT SEAT BACK CENTER ARM REST</b>						
	67/68	A	Split seat	C7AZ 6365478-A	1	
	69	A(54, 57)	Used with split seat	C9MZ 6565478-A	2	
	69	A(65A)	Used with full width or split seat		2	
	69/	A(53, 54, 57, 71)	Used with full width seat	C9MZ 5465478-A	1	
	70/	A(53, 54, 57)	Used with lo-back split seat	D0MZ 6565478-A	2	
	70/	A(65)	Used with lo-back split or full width seat		2	
	71/	A(53, 57, 65)	R.H.-use with hi-back split seat	D4AZ 6565478-A	1	
			L.H.	D4AZ 6565479-A	1	
	71/	A	Used with hi-back full width seat	D3AZ 6565478-B	1	
	72	B		D2GZ 6565478-A	1	
	68/69	S	Used with full width seat	C8SZ 6565478-A	1	
	70/71	S(57B)	R. H.	C8LY 6565478-A	1	
			L. H.	C8LY 6565479-A	1	
	70/71	S(57C, 65C, D)		D0SZ 6565478-A	1	
	72	S	Full width seat	D2SZ 6565478-B	1	
	72	S	"Before 4/6/72"	R. H. - split seat	D2LZ 6565478-B	1
			L. H.	D2LZ 6565479-B	1	
	72	S	"From 4/6/72"	R. H. - split seat	D3SZ 6565478-C	1
			L. H.	D3SZ 6565479-C	1	
<b>654A82 SHIELD - FRONT SEAT COVER ARMREST</b>						
	72	B, S	Black	D3GZ 65654A82-B	1	
			Blue	D3GY 65654A82-C	1	
			Gold	D2SZ 65654A82-K	1	
			Green	D3GY 65654A82-A	1	
			Tobacco	D3GZ 65654A82-E	1	
<b>66456-7 COVER - FRONT SEAT BACK SIDE SHIELD</b>						
	68	S	R. H. -use with reclining seat-Paint to match	C8SZ 6566456-A	1	
			L. H.	C8SZ 6566457-A	1	
<b>66488 PAD - FRONT SEAT BACK SIDE SHIELD</b>						
	70/71	A	15/32" x 41/64 x 29/32" - used with bucket seat	D0AZ 6366488-A	4	
	70/71	A	5/16" x 41/64 x 29/32"-used with power full width seat or bucket seats	D0MZ 6566488-A	AR	

GROUP NUMBER	YEAR	BODY TYPE	DESCRIPTION	PART NUMBER	QTY.
<b>666A56 RETAINER - REAR SEAT BACK COVER TOP</b>					
	71	L-with fixed rear seat - "Before 10/12/70"		D1FZ 62666A56-A	1
	71/	L-with fixed rear seat - " From 10/12/70"		D1FZ 62666A56-E	1
	71	L-with folding rear seat - "Before 10/12/70"		D1FZ 62666A56-B	1
	71/	L-with folding rear seat - "From 10/12/70"		D1FZ 62666A56-D	1
<b>66700 SPRING ASSY. - REAR SEAT BACK</b>					
	65/67	A(54, 62-Police and Taxi)		C5AZ 6266700-D	1
	70	A(54, 71)		D0AZ 5466700-A	1
	71/	A(54)		D1AZ 5466700-A	1
	70/	B(54)		D0GY 5466700-A	1
<b>667A02-3 BRACKET - REAR SEAT BACK SPRING HANGER OUTER</b>					
	72	B,S		D2OZ 65667A02-A	3
	70/71	S(65)	R.H.	D0SZ 65667A02-A	1
			L.H.	D0SZ 65667A03-A	1
<b>66740-1 RETAINER - REAR SEAT BACK SPRING TO WHEELHOUSE - Paint to match</b>					
	67/70	F(63)-with fixed rear seat	R.H.	C7ZZ 6366740-A	1
			L.H.	C7ZZ 6366741-A	1
	67/70	F(63)	Washer-flat-3/4"	351360-S(XX112)	4
<b>668A14 PAD - REAR SEAT BACK CENTER ARM REST FILLER</b>					
	67	S(65)	Use with vinyl trim	C7SZ 65668A14-A	1
	68	S(65)		C8SZ 65668A14-A	1
	69	S(65)		C9SZ 65668A14-A	1
	71	S(65)			1
<b>66856 PAD - AUXILIARY SEAT CUSHION</b>					
	66/71	B(71)		C6OZ 7166856-A	1
	72	B(71)		D2OZ 7166856-A	1
<b>66894 SUPPORT - REAR SEAT BACK CENTER ARM REST FILLER BASE</b>					
	67/69	S		C7SZ 6566894-A	1
	70/71	S(65)	Upper	D0SZ 6566894-A	1
<b>67204 BASE - REAR SEAT BACK CENTER ARM REST</b>					
	67/68	A(54C,57F,63J)		C5MY 6367204-A	1
<b>67210 LINK and VERTICAL STRAINER ASSY. - REAR SEAT BACK CENTER ARM REST</b>					
	65/66	A(57F, 63F)		C5AZ 6367210-A	1
	67	A(54C, 57F, 63J)			1
	68	A(54C, 57F, 63D)			1
	70	A(53, 65)			1
			Screw-hex., washer head-No, 14-10 x 1"	42154-S8(U256)	4
			Nut-spring-No, 14-10	*350940-S32	4
	67/71	S(57)		C7SZ 5767210-A	1
			Screw-hex. washer hd., tapping-No, 10-12 x 3/4"	42141-S8(U250)	4
			Nut-spring-No, 10	*372980-S2	4
	67/71	S(65)		C7SZ 6567210-A	1
			Screw-pan head, tapping-No, 10-16 x 1/2"	350754-S8(UU86)	4
	69/71	S	Washer-flat-1/4"-attach to panel 67248	44719-S2(X17)	2
<b>67248 PANEL - REAR SEAT BACK CENTER ARM REST</b>					
	68/71	S(65)		C8SZ 6567248-A	1
<b>67254 REINFORCEMENT - REAR SEAT BACK CENTER ARM REST FLAP</b>					
	65/66	S	Improvise from spring steel	*	1
<b>67273 PAD - REAR SEAT BACK CENTER ARM REST</b>					
	65/66	A(57F, 63F)		C5AZ 6367273-A	1
	67	A(54C, 57F, 63J)			1
	68	A(54C, 57F, 65A)			1
	67/71	S(57)		C7SZ 5767273-A	1
	67/71	S(65)		C7SZ 6567273-A	1
	72	S		D0VY 6567273-A	1
<b>67277 HINGE - REAR SEAT BACK CENTER ARM REST FLAP UPPER</b>					
	67/71	S(65)		C7SZ 6567277-A	1