

PRE-CLASSICAL SURVEY IN EASTERN TURKEY. FIFTH PRELIMINARY
REPORT. VAN LAKE BASIN AND MT. AGRI REGION

by Aynur Özfirat

Surveys that we conduct at the eastern borderland of eastern Turkey since 1995 have been continued in 2006. Forty nine sites have been listed within the provinces of Iğdır, Ağrı and Van (Fig. 1-2)¹.

In the survey area, sites investigated by Ch. Burney in 1956 were also considered in addition to new ones and the latest conditions of the sites were observed. The earliest period was Late Chalcolithic and the region has been inhabited continuously until the Late Iron Age, except for abandonment in Middle Bronze Age.

The Late Chalcolithic Period (ca. M. Ö. 3750-3400)

Material belonging to this period found in three sites: Deliktaş (I73/13)², Lanetlitepe (I73/14) in Iğdır/Aras plain and Otbiçer Mound (P70/9)³ in Gürpınar plain (Fig. 1-2).

Deliktaş and Lanetlitepe are noticeable sites for this period, they lies on the low lava hills that extend to Iğdır plain of Mt. Ağrı. Late Chalcolithic Period pottery comes from Iron Age fortresses established on rocky hills and their skirts. With respect to shards, Deliktaş can be considered as an important site in Iğdır plain/Araxes valley. Small amounts of pottery has been collected in Otbiçer mound.

Late Chalcolithic sherds from Deliktaş and Lanetlitepe in terms of form consist of deep simple rim bowls with mouths mostly opening outward, jars with vertical necked and rounded body and jars with mouth slightly outward and low neck (Fig. 3-4). They are divided into three wares which are cream slipped, red-brown and gray. Red-brown and gray wares are made of brown and gray paste and have slipped in the

¹ Our survey have been carried out with the permission of the Turkish Ministry of Culture and Tourism, General Directorate for Monuments and Museums. I wish to express my appreciation to the General Directorate for Monuments and Museums for granting me permission to undertake the surveys. This survey was supported by TÜBİTAK (The Scientific and Technical Research Council of Turkey, Project No. SOBAG-105K063) and TTK (Turkish Historical Society). I wish to thank the for their support of this project. I am especially grateful to Veli Sevin for providing considerable and valuable assistance. Also I am gratefull team, the team was Sema Dayan (Representative of the Turkish Antiquities), Nilgün Coşkun Köse (Yüzüncü Yıl Üniversitesi, assistant, PhD student), Davut Yiğitpaşa (Yüzüncü Yıl Üniversitesi, assistant, PhD student), Gulan Ayaz (Yüzüncü Yıl Üniversitesi, assistant, PhD student).

² Ceylan 2004, 268-269.

³ Burney 1957, Fig. I; Burney 1958, 178; Russell 1980, No: 204. Otbiçer is then referred to as İremir I.

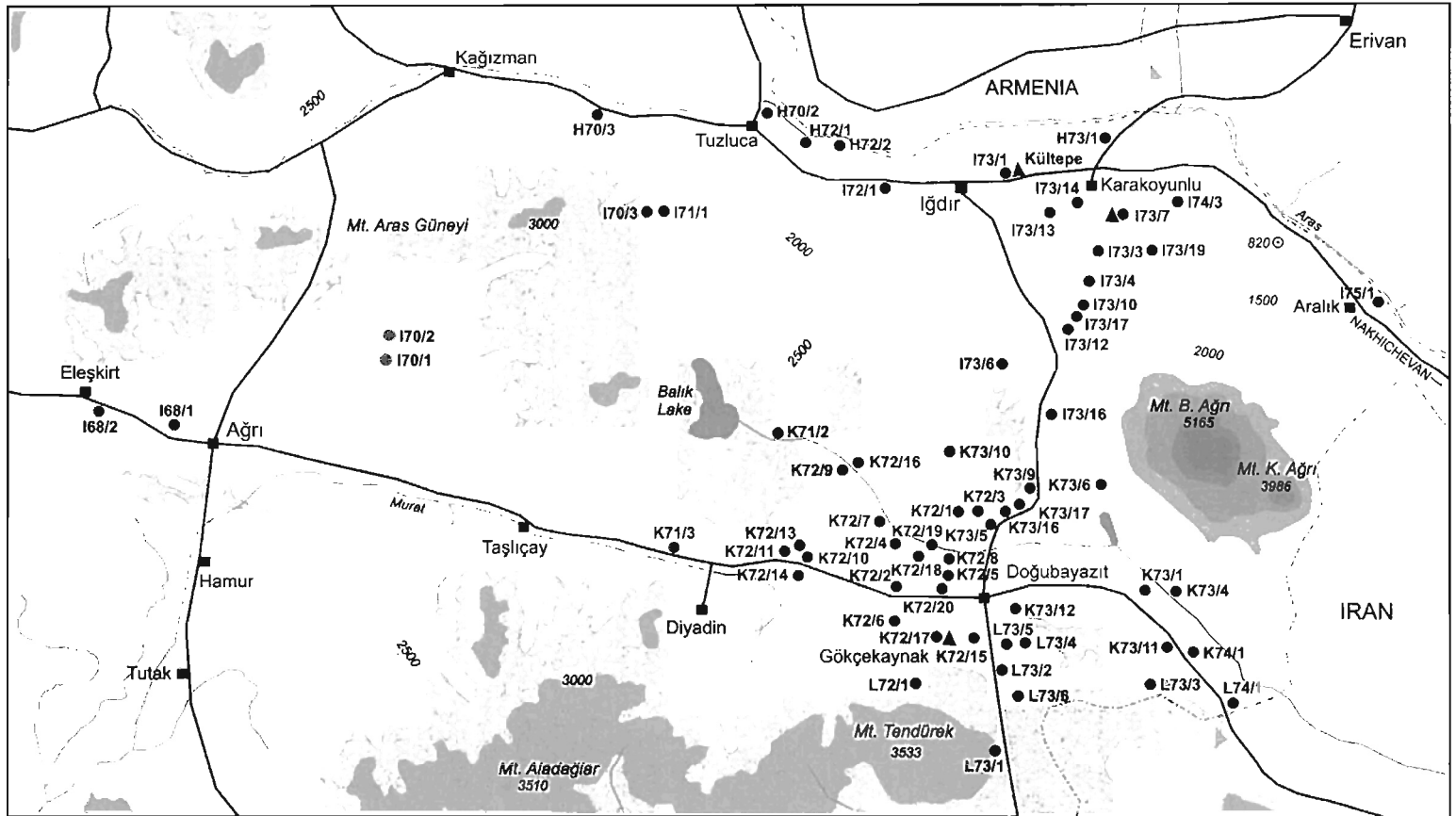
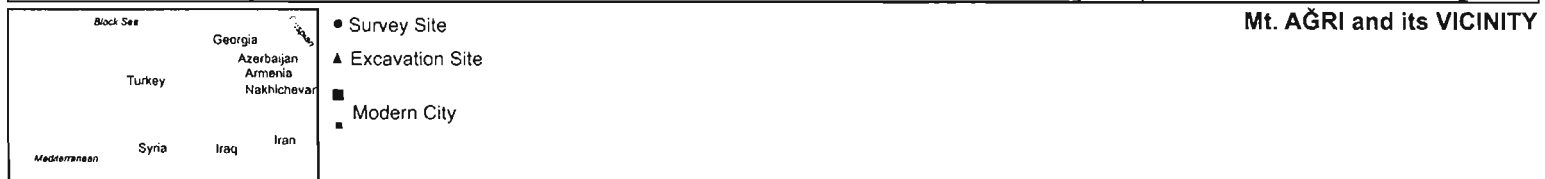

Fig. 1a – Survey map



Mt. AĞRI and its VICINITY

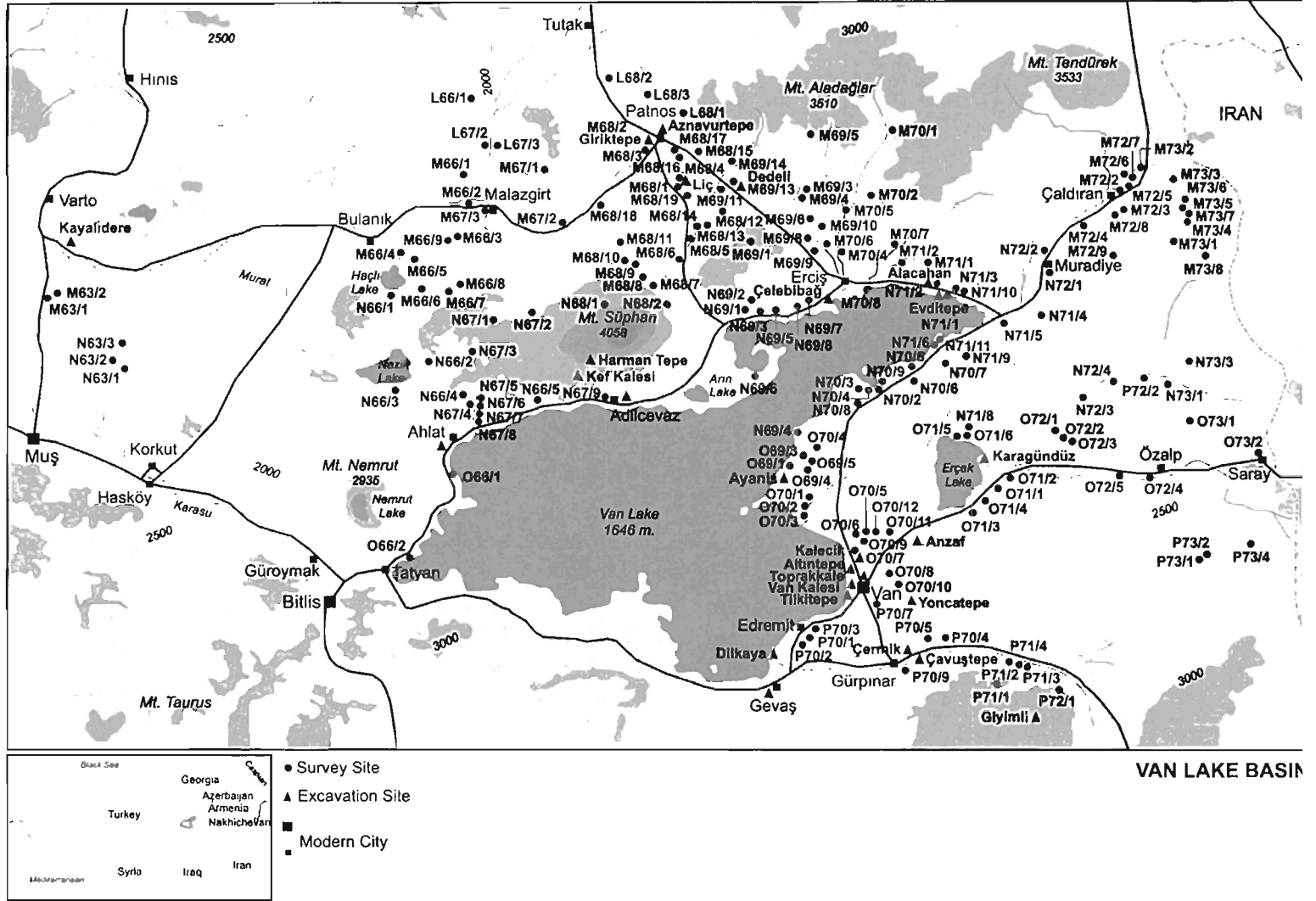

Fig. 1b – Survey map

<i>Site Code</i>	<i>Site Name</i>	<i>Village</i>	<i>District</i>	<i>Province</i>
H70/3	Küllütepe	Gaziler	Tuzluca	Iğdır
I68/1	Yığıntepe	Yığıntepe	Merkez	Ağrı
I68/2	Sadaklı	Sadaklı	Eleşkirt	Ağrı
I70/3	Kalaca	Kalaca	Tuzluca	Iğdır
I71/1	Hasankent	Hasankent	Tuzluca	Iğdır
I73/13	Deliktaş	Karakoyunlu	Karakoyunlu	Iğdır
I73/14	Lanetlitepe	Melekli	Merkez	Iğdır
K71/3	Guc	Yeşildurak	Diyadin	Ağrı
K72/17	Gökçekaynak	Gökçekaynak	Doğubayazıt	Ağrı
K72/18	Şehittepe	Seslitaş	Doğubayazıt	Ağrı
K73/1	Ömerağa	Gölyüzü	Doğubayazıt	Ağrı
L73/6	Çetenli	Çetenli	Doğubayazıt	Ağrı
M68/2	Giriktepe	Merkez	Patnos	Ağrı
M68/3	Bağdışan	Merkez	Patnos	Ağrı
M69/11	Zali	Dedeli	Patnos	Ağrı
M69/12	Dedeli Kurganı	Dedeli	Patnos	Ağrı
M69/13	Dedeli Kalesi	Dedeli	Patnos	Ağrı
M72/2	Abide Tepe/Çaldıran	-	Çaldıran	Van
M72/3	Çavuşbaşı	Sellik	Çaldıran	Van
M72/4	Gümüştepe	Gümüştepe	Muradiye	Van
M72/5	Aşağı Mutlu	Aşağı Mutlu	Çaldıran	Van
M72/6	Şehitlik	Yukarı Mutlu	Çaldıran	Van
M72/7	Yukarı Mutlu	Yukarı Mutlu	Çaldıran	Van
M73/1	Kümbet	Yeniyaka	Çaldıran	Van

Fig. 2 – List of 2006 survey sites

M73/2	Soğuksu	Soğuksu	Çaldıran	Van
M73/3	Hacı Hatun	Hangediği	Çaldıran	Van
M73/4	Boztepe	Zülfübulak	Çaldıran	Van
M73/5	Umuttepe Kalesi	Umuttepe	Çaldıran	Van
M73/6	Umuttepe Yerleşimi	Umuttepe	Çaldıran	Van
N68/1	Dizginkale	Dizginkale	Patnos	Ağrı
N68/2	Dağalan	Dağalan	Patnos	Ağrı
N69/8	Zinarizer	Bayramlı	Erciş	Van
N69/7	Mino	Bayramlı	Erciş	Van
N73/1	Eski Karakol	Dorutay	Özalp	Van
O70/5	Siyahtaş	Aşit	Merkez	Van
O70/10	Kavuncu	Kavuncu	Merkez	Van
O72/4	Boyaldı	Boyaldı	Özalp	Van
O72/5	Aşağı Mollahasan	Aşağı Mollahasan	Özalp	Van
O73/1	Su Deposu	Dağdeviren	Özalp	Van
O73/2	Şehitlik/Usobiti	-	Saray	Van
P70/9	Otbiçer	-	Gürpınar	Van
P71/1	Bajergeh	Hamurkesen	Gürpınar	Van
P71/2	Hamurkesen Mezarı	Hamurkesen	Gürpınar	Van
P71/3	Hamurkesen Yerleşimi	Hamurkesen	Gurpınar	Van
P73/2	Yeşilaliç I Kalesi	Yeşilaliç	Saray	Van

Fig. 2 – List of 2006 survey sites

same color, coarse gritty and plant tempered, and of medium or bad firing. Plant temper marks are dense on the surface of these hand-made sherds. The cream slipped ware separated from others with their cream slip on red-brown paste are same. Two body pieces, similar to Amuq E-F type, are decorated with bands of red color.

The Early Bronze Age (ca. M. Ö. 3400-2300/2200)

The Early Bronze Age sites are as follows: Şehitlik/Usibiti (O73/2)⁴ in Saray, Aşağı Mollahasan (O72/5)⁵ in Karasu valley, Otbiçer (P70/9) in Gürpınar plain, Boztepe (M73/4) and Umuttepe (M73/6)⁶ in Çaldıran plain, Giriktepe (M68/2)⁷ and Zali (M69/11)⁸ in Patnos, Sadaklı (I68/2)⁹ and Yığıntepe (I68/1)¹⁰ in Eleşkirt, Küllütepe (H70/3)¹¹ in Araxes valley, Çetenli (L73/6)¹² mounds in Doğubayazıt and Hacı Hatun (M73/3) and Şehitlik (M72/6) fortress type settlements on a high rocky hill in Çaldıran plain (Fig. 1-2).

Hacı Hatun¹³ has been used until Late Iron Age and the visible architecture contains Iron Age characteristics. The issue whether it was used as a fortress in Early Bronze Age or not is not clear. In northwest of the plain, Şehitlik fortress above Tendürek lava currents was settled only in Early Bronze Age. We have collected numerous Early Bronze Age sherds here except for a sherd from Middle Bronze Age. Fortress with a rectangular plan is made of small semi-processed stones. Surrounding wall is 150 m. in the northeast, 50 m in the south and its thickness is 2.50 m (Fig. 5-6). Traces of buildings with rectangular and square plans can be seen inside.

Other noticeable sites of this period are Giriktepe, Zali, Aşağı Mollahasan, Umuttepe, Boztepe and Çetenli mounds. Boztepe¹⁴ located at the eastern border of Çaldıran plain is the second sites which we gathered most information about Early Bronze Age after Şehitlik fortress with its single period settlement and large number of sherds. Preliminary studies done up to now show that this period is represented with all phases. There are a few Early and Middle Iron Age materials also.

Early Bronze Age is represented by Kura-Araxes pottery in the region. Four ware groups have been determined: Black-gray burnished, red-brown, red-brown burnished and cream slipped (Fig. 7-9). They are handmade, rough or medium gritty tempered and badly fired. Black-gray burnished and red-brown wares has

⁴ Burney 1957, Fig. I; Russell 1980, No: 228. Şehitlik/Usibiti is then referred to as Saray.

⁵ Burney 1957, Fig. I; Burney 1958, 178; Russell 1980: No: 226.

⁶ Burney 1957, Fig. I; Russell 1980, No: 216. Umuttepe mound is then referred to as Sint II.

⁷ Balkan 1964.

⁸ Marro and Özfırat 2005, 326-327; Özfırat and Marro, in press.

⁹ Burney 1958, 187; Russell 1980, No: 316.

¹⁰ Burney 1958, 187; Russell 1980, No: 314.

¹¹ Ceylan 2004, 268.

¹² Marro and Özfırat 2005, 322-333; Özfırat and Marro in press.

¹³ Burney 1957, 53; Russell 1980, No: 217.

¹⁴ Burney 1958, 171-172, 178-187; Russell 1980, No: 214. Boztepe is then referred to as Zülfübulak.

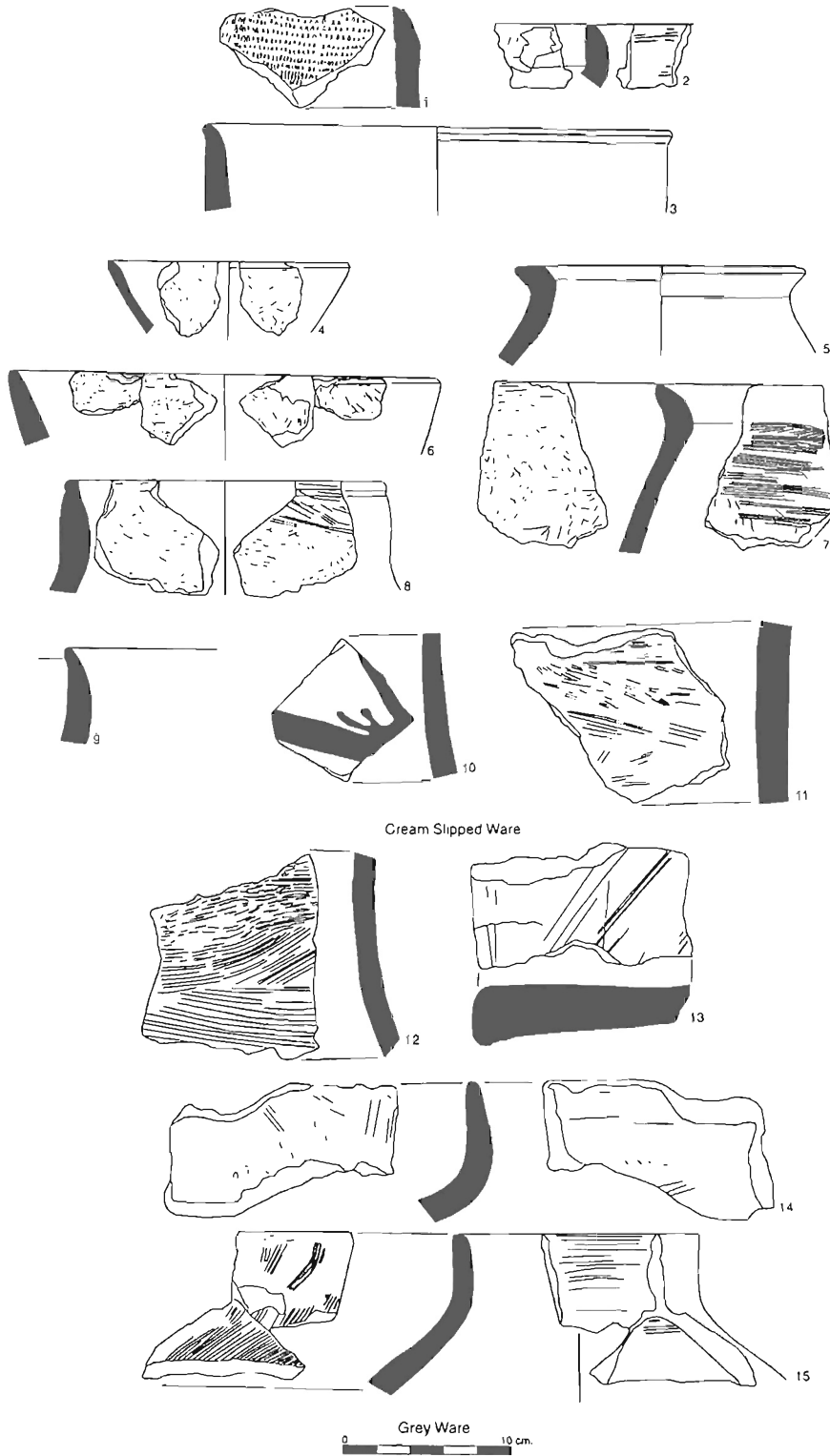

Fig. 3 – Late Chalcolithic Period sherds (Deliktaş: 1-2, 4-8, 11-15; Otbiçer: 3, 9; Lanetlitepe: 10)

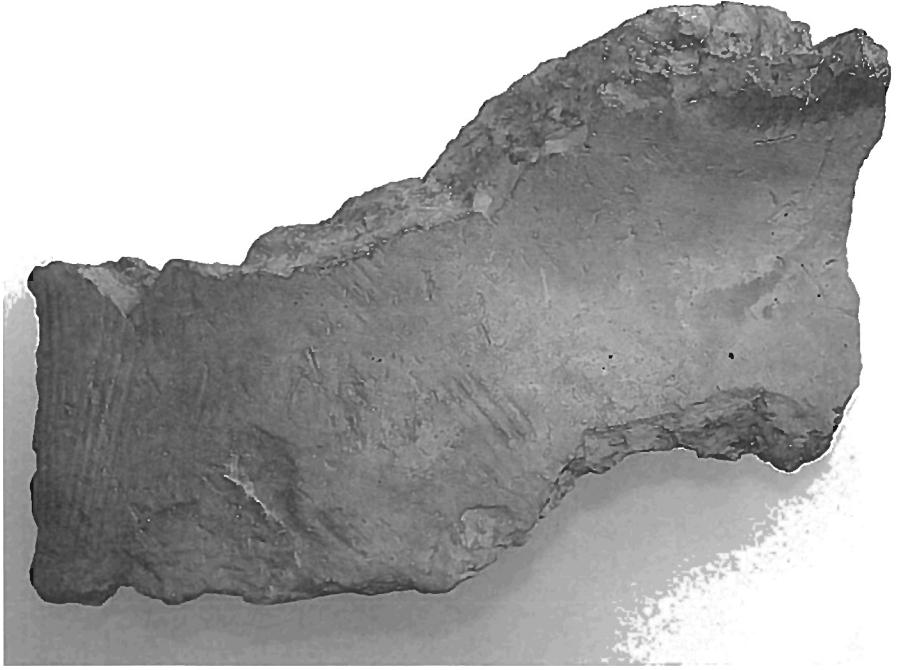

Fig. 4 – Late Chalcolithic Period jar (Deliktaş)



Fig. 5 – Şehitlik fortress

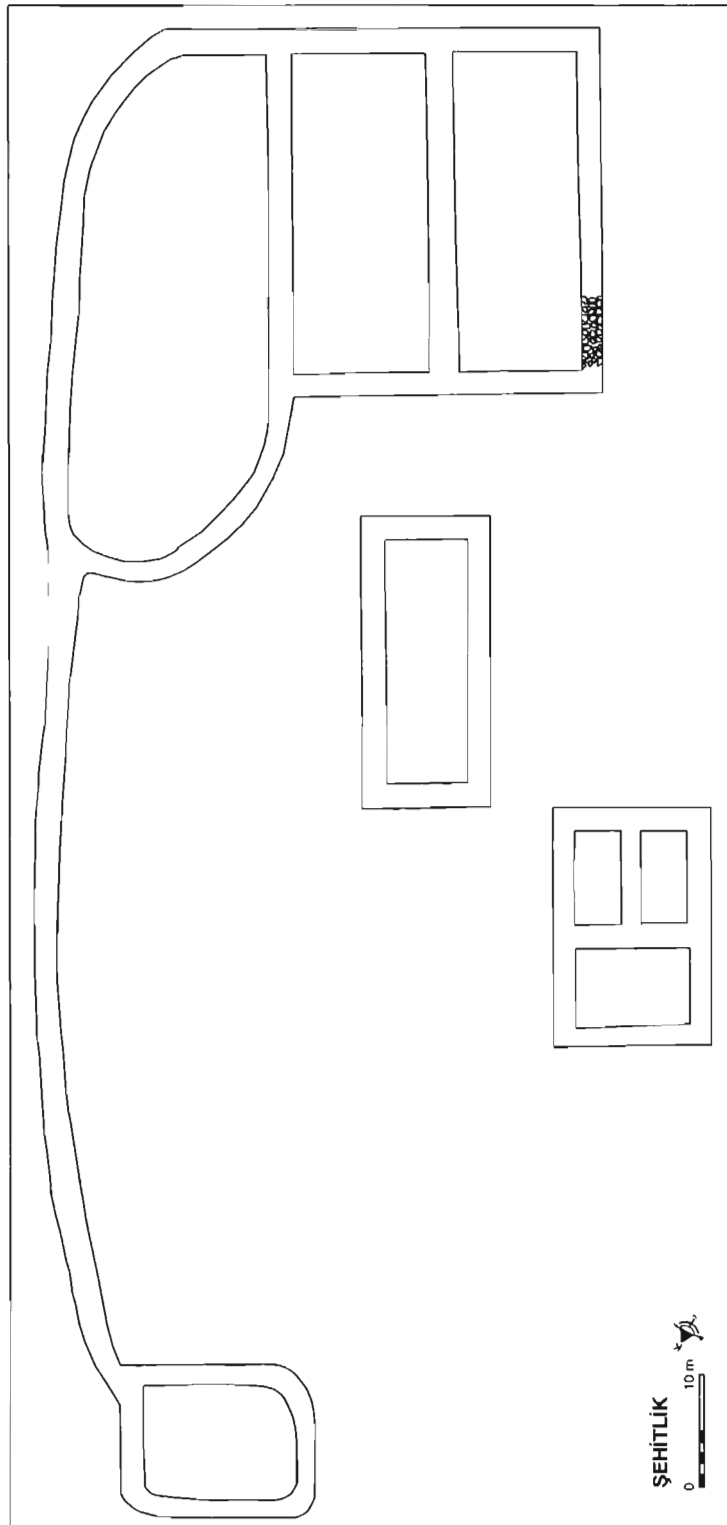

Fig. 6 – Şehitlik fortress

same paste and slip color. Red-brown burnished ware has the same properties however it is separated by neck and mouth parts of pots with black appearance being different color, either red or cream, due to baking. Cream slip ware have been found very few compared to others. In terms of form, jars with vertical mouth, long neck and oval body or closed mouth and rounded body; bowls with simple and open mouths, and everted rims with rounded bodies are dominant. Decorated pieces are large in number. Kura-Araxes pottery decoration types are almost represented by its entire repertoire; geometric patterns made with incision, impress and grooving, concentric circles, spirals and Nakhichevan handles are seen.

The Middle Bronze Age (*ca.* M. Ö. 2300/2200-1400/1300)

Very few sites of this period are as follows: Tuzluca Hasankent Kurgan (I71/1), Deliktaş in Iğdır Plain (I73/13), Yukarı Mutlu (M72/6), Şehitlik (M72/6) and Hacı Hatun (M73/3) fortresses in Çaldıran Plain and Saray Şehitlik/Usibiti (O73/2) Mound (Fig. 1-2).

No pottery have been found in Hasankent kurgan, however, as a result of its structural characteristics and comparison with many Middle Bronze and Iron Age kurgans in the region, we find it appropriate to evaluate it in this period. The kurgan composed of small stones has 9 m height, and 34 m base and 7 m top diameter (Fig. 10).

Two bowls belonging to Middle Bronze Age that Yukarı Mutlu villager's gave have been extracted from cemetery which should be lying underneath the village.

Middle Bronze Age pottery is divided into two ware groups (Fig. 11): Red-Brown and black burnished. All these sherds made on a wheel are generally medium gritty, slightly burnished and of medium firing. Burnish in this period's pottery is not shiny. Sherds with monochrome (black paint on red slip) and polychrome (black and red paint on cream slip) paint decoration are included in red-brown ware, they have no differences as ware except for paint decoration. Jars with rounded body with grooved rims and low necked and carinated bowls are dominant.

The Late Bronze Age/Early Iron Age (*ca.* M. Ö. 1400/1300-900)

The investigated Late Bronze/Early Iron Age sites are as follows: Bağdısan (M68/3), Zali (M69/11), Şehitlik/Usibiti (O73/2), Aşağı Mollahasan (O72/5), Otbiçer (P70/9) and Boztepe (M73/4) mounds in Van Lake Basin; Kalaca (I70/3), Çetenli (L73/6) and Ömerağa (K73/1)¹⁵ in Mt. Ağrı region, Dedeli (M69/13) in north part of Van Lake Basin, Dizinkale in northeastern skirt of Süphan mountain (N68/1), Zinarizer (N69/8) and Mino (N69/7) in northern shore of Lake Van, Yukarı Mutlu and Hacı Hatun (M73/3), Çavuşbaşı (M72/3)¹⁶ and Abide Tepe/Çaldıran (M72/2)¹⁷ in Çaldıran

¹⁵ Marro and Özfirat 2003, 395-396; Özfirat and Marro 2004, 20.

¹⁶ Özfirat in press; 2007a; 2007b, 115-117.

¹⁷ Özfirat in press; 2007a; 2007b, 115-117.

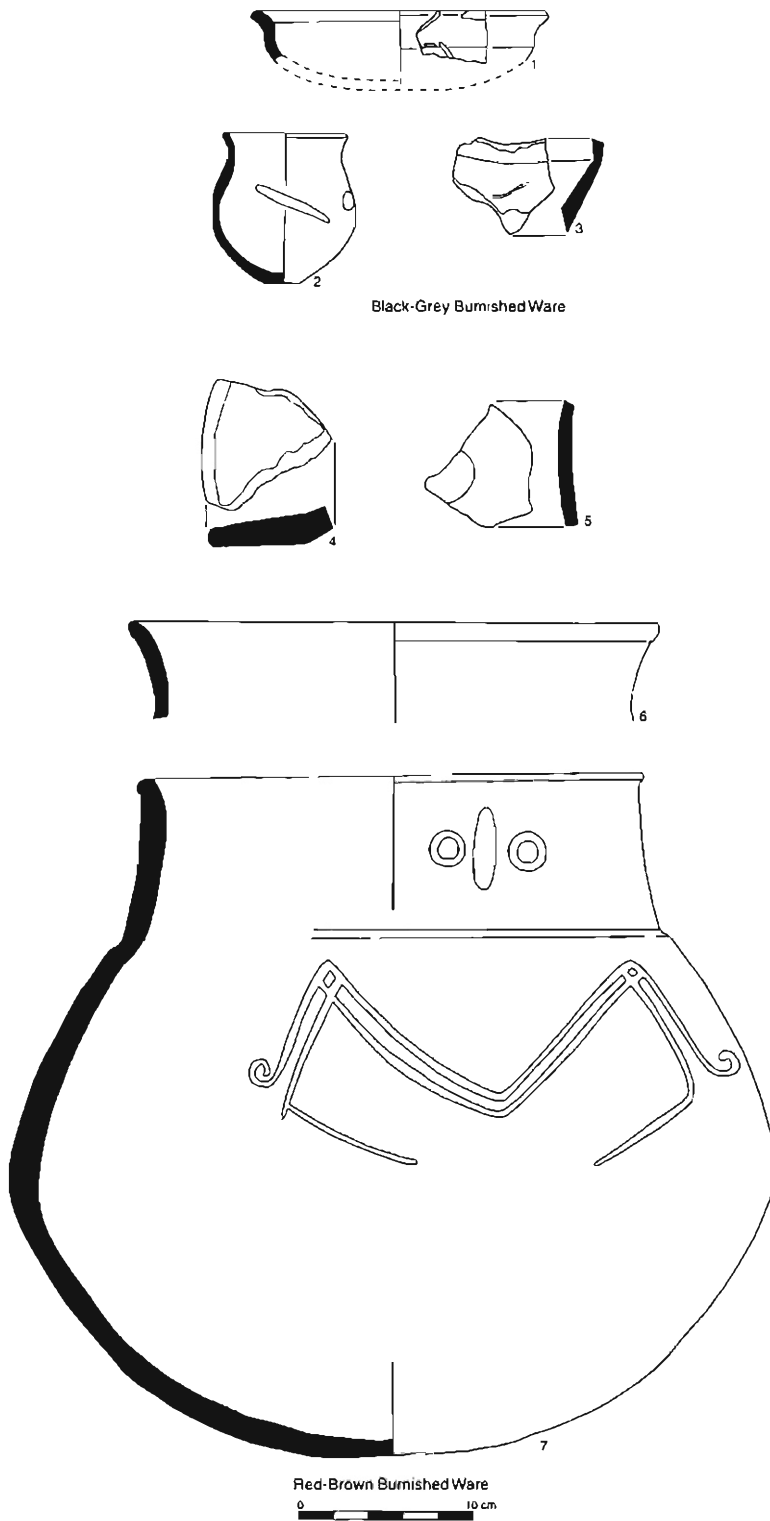

Fig. 7 – Early Bronze Age sherds (Aşağı Mollahasan)



Fig. 8 – Early Bronze Age jar (Boztepe)

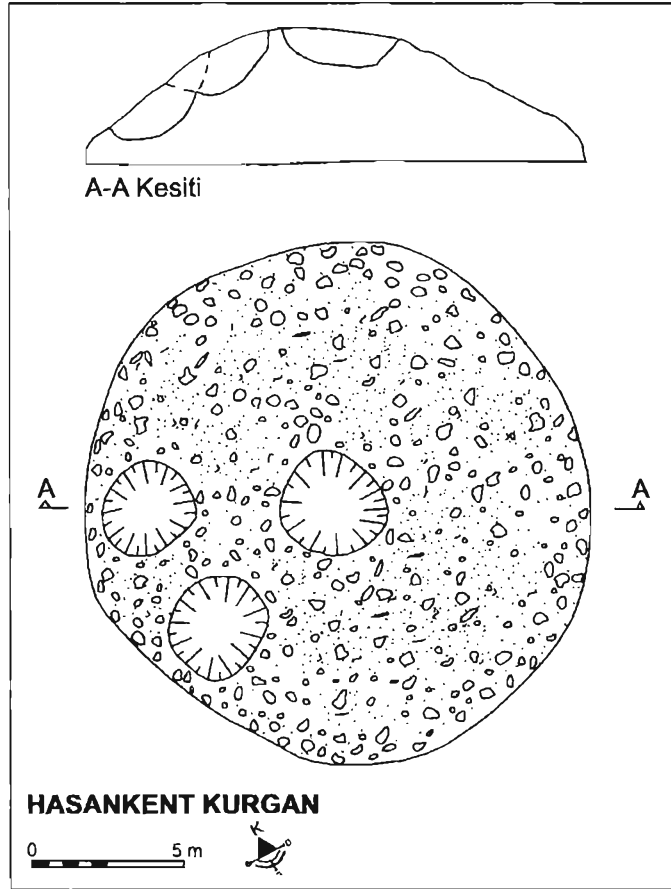

Fig. 9 – Early Bronze Age jar (Boztepe)

Fig. 10 – Hasankent *kurgan*

plain, Eski Karakol (N73/1)¹⁸ fortresses in the east of Lake Van, Kümbet (M73/1)¹⁹ in Çaldıran plain, Su Deposu (O73/1), and Siyahtaş (O70/5)²⁰ cemeteries in the east of Lake Van (Fig. 1-2).

Limited number of material has been obtained from settlement mounds. Fortresses and cemeteries seem to be inhabited much more densely in this period. Because fortresses were used in Middle Iron Age and sometimes Late Iron Age, it is hard to make exact dating in architecture. Except for new fortresses built by Urartians, local characteristics continued in architecture. Fortresses, surrounded by defensive walls made of semi-cyclopean or roughest boulders are constructed on rocky hills dominating over small or large plains and they have cemeteries in their skirts.

The most noticeable fortress of this type is Kalaca located in the west of Tuzluca in a mountainous region²¹. No surface sherds has been found here however its

¹⁸ Burney 1957, Fig. I; Russell 1980, No: 230. Eski Karakol is then referred to as Taşrumi.

¹⁹ Marro and Özfiat 2003, 395-396; Özfiat and Marro 2004, 20.

²⁰ Özfiat 2007a; Özfiat 2007b, 115-117, 145-148.

²¹ Ceylan 2005, 196.

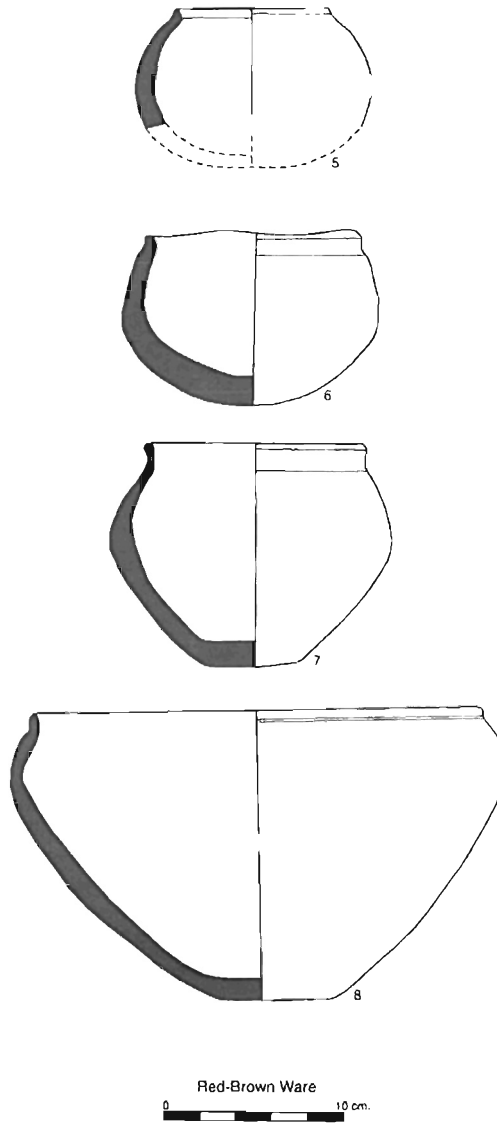
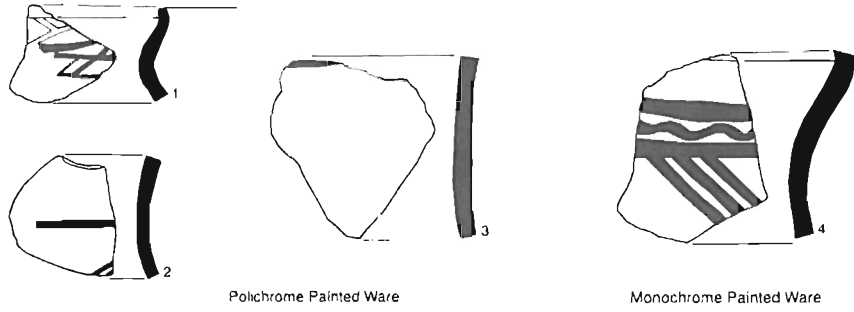

Fig. 11 – Middle Bronze Age sherds (Hacı Hatun: 1, 5, 7; Deliktaş: 2-3; Yukarı Mutlu: 6, 8)

architectural characteristics are very similar to Late Bronze/Early Iron Age fortresses of this region. The surrounding wall of the fortress with a rectangular plan is 85.50 m long with 21m width in northeast and 3m thickness (Fig. 12). Wall made of semi-cyclopean stones are preserved up to 1 m in certain places. There are some wall traces with rectangular plans inside and their inner wall thickness is 1.50 m.

Dedeli is a village a few kms south of Patnos (Fig. 13). It consists of a fortress on the high rocky hill in northwest of the village and a cemetery in its skirt. The fortress was first examined by B. Ögün²² and some Urartian graves in the skirt by V. Sevin too²³. Wall with rectangular plan with buttresses is made of semi-cyclopean stones on the fortress. The perimeter wall is 85 m with 30.50 m width in northeast, 25.50 m in southeast and 2.40 m thickness. The southeastern part is very steep and the wall cannot be traced in this direction. Cemetery is on the western and northern skirts of the fortress. Besides the Urartian chamber tombs there are some stone boxes here. The dimensions of one of the boxes are 2.00 × 0.90 m. In addition there is a kurgan on a high hill in the west of the fortress (Fig. 13). The kurgan is made of small rough stones and it is surrounded by two rows of stones with 10 m and 6 m diameters (Fig. 14). There is a tomb covered with large stone lids inside the second row. No material has been found here but it has to belong to Early/Middle Iron Age due to its structural characteristics and the fortress right in its northeast.

Yukarı Mutlu, another site considered as important for this period spans a large area with a citadel and lower city in its skirt. It is located above Tendürek lava hills in the northwestern end of Çaldıran plain. The modern village is located to a large extend on the lower city and completely on cemetery. The fortress with a rectangular plan is made of semi-cyclopean masonry and its wall have been preserved up to 2 m height (Fig. 15). Northern wall is 15 m, southern wall is 20 m, western wall is 45 m, and eastern wall is 50 m long; its thickness is 2.80 m. Wall thickness of inner residences with rectangular plans is 1.30 m. Lower city citadel has the same architectural character.

Zinarizer fortress which is on a high hill on the northern shore of Lake Van, west of Erciş has quite large dimensions. It has a rectangular plan and some traceable with square and rectangular plans in it (Fig. 16-17). The thickness of the surrounding wall 2.40 m. dimensions is 250 × 40 m that constructed with medium size semi-cyclopean stones.

There are three types of graves in cemeteries in this period: kurgans that have low piled hills, rectangular stone graves for an individual and chamber tombs for successive burials. Kurgan tradition is dominant in Mt. Ağrı region. Beneath the piled hills, there are single stone cists or chamber tombs. In Ömerağa low kurgans, inside these large cemeteries Mt Ağrı region, there are stone cists beneath considerably low piled hills made of rough stones. Graves with rectangular plans are surrounded by two-three rows of stone circles; they are covered by on average two to four large stones. There are kurgans with chamber tombs in Çetenli where many people are buried (Fig. 18).

²² Ögün 1976, 6-10; Ögün 1978a, 64, 66; Ögün 1978b, 646, 663-671; Ögün 1982, 219-220; Ögün 1984a, 60-61; Ögün 1984b, 68.

²³ Sevin 1986, 157, fig. I/2.



Fig. 12 – Kalaca fortress.

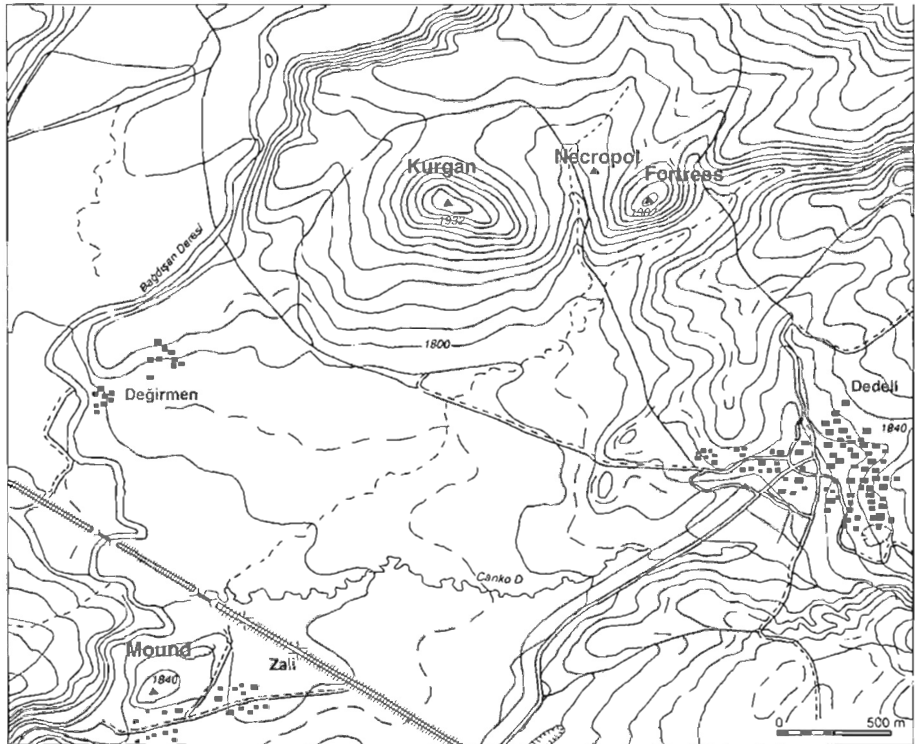

Fig. 13 – Dedeli Topographical Plan.

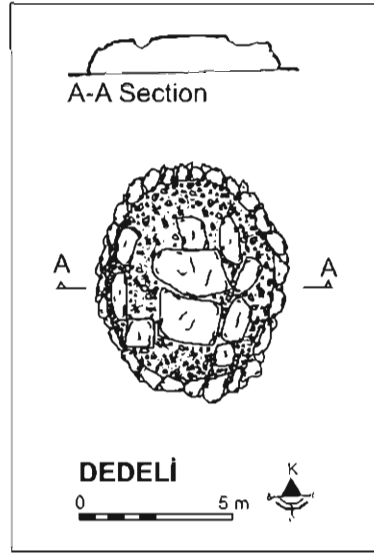

Fig. 14 – Dedeli *kurgan*

In Lake Van basin no chamber tombs under kurgans are found. The burial chambers of this region as in Siyahtaş had no stone-built mounds²⁴. Just one exceptional example near Dedeli rises on a high hill.

Pinkish-buff ware that represents Late Bronze/ Early Iron Age in the eastern part of Lake Van basin has pink, brown, red paste, slip is in paste color, thin-medium gritty tempered, no burnish or slight burnish and is made by wheel²⁵. In the surface of the pots, mottled colors generated by baking are seen frequently. Bowls and small size jars are dominant. Bowls usually have spherical and carinated bodies, simple rims and closed mouth. Jars have low necks and round bodies in general. Decoration in this ware group is uniform; grooves, triangles, wavy lines made with incision technique used very frequently. Especially the grooves seen on the bowls and grooves inside or outside the rims of jars are typical for this ware.

The second pottery group is red-brown ware. In Erciş-Patnos-Çaldıran region in the north of Lake Van basin, pinkish-buff ware is replaced by red-brown ware to a large extent. These sherds have paste in red-brown color, slip in paste color and burnished (Fig. 19). They are usually thin-medium gritty tempered and medium fired. Because this ware was used frequently in Middle Iron Age as well, it is hard to separate two periods except for some forms and some decorations such as triangle rows. In terms of form that have similar properties to pinkish-buff ware put in the Early Iron Age seems to be more appropriate with the current data.

The third ware is red slipped. This ware belong to transition phase from Late Bronze/Early Iron Age to Middle Iron Age in Lake Van basin²⁶. They usually have

²⁴ Özfirat 2007b, 115-117.

²⁵ Özfirat 2007b, 116.

²⁶ Özfirat 2007b, 115-117.



Fig. 15 Yukarı Mutlu fortress

red-brown paste, thin and medium gritty temper, a burnished thick red slip, medium fired and wheel made. They do not resemble to the classical red polished ware of the Urartian period and have in red color which is different in technique and appearance. Forms that are frequently seen are carinated bowls with simple and bent rims and jars with low necks and round structures.

Mt. Ağrı region shows very different characteristics from Lake Van basin in pottery tradition in this period. This region's Black-Gray ware shows direct parallelism with black burnished wares spread over entire Southern Caucuses in Late Bronze/Early Iron Age (Fig. 20). Red slipped and red-brown wares are almost non-existent. Some pieces in gray-black ware show similar characteristics to pinkish-buff ware in form and decoration. However decorations made with deep grooves and bright burnish are the characteristics of these pieces.

The Middle Iron Age/Urartu (M. Ö. 900- ca. 600)

Middle Iron Age pottery existed in all sites that have examined except for Hasankent kurgan and Kalaca fortress. In addition to ones above, the sites of this period are the following: Guc (K71/3) in Diyadin, Gümüštepe (M72/4)²⁷ in Muradiye,

²⁷ Burney 1957, Fig. 1; Russell 1980, No: 220.

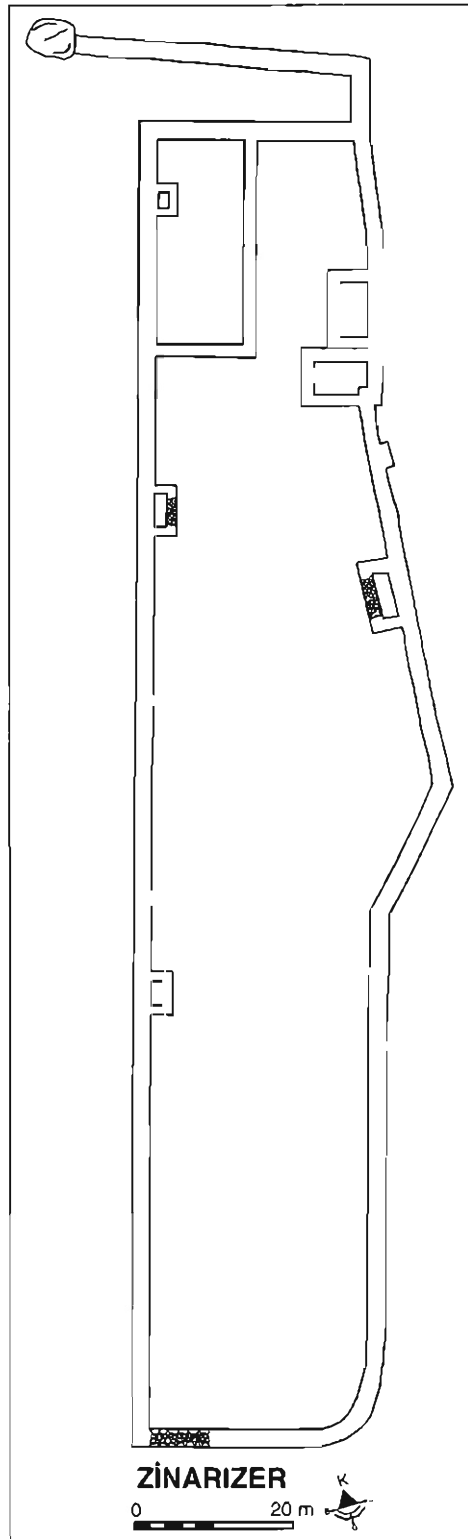

Fig. 16 – Zinarizer fortress



Fig. 17 – Zinarizer fortress



Fig. 18 – Çetenli *kurgan*

Hamurkesen (P71/3) in Gürpınar settlements; Yeşilalıç I (P73/2) in Saray, Soğuksu (M73/2) and Umuttepe (M73/5)²⁸ in Çaldıran plain, Kavuncu (O70/10) fortresses just north of Van and ^aehittepe kurgan (K72/18) in Doğubayazıt (Fig. 1-2).

Except for fortresses with local characteristics where found Late Bronze/Early Iron Age and Middle Iron Age potteries together, Giriktepe Urartian layers excavated by K. Balkan²⁹; Lanetlitepe, Yeşilalıç I, Kavuncu fortresses, Bağdısan mound and Hamurkesen grave possess architecture that display Urartian characteristics. In Yeşilalıç I³⁰ and Kavuncu³¹ fortresses examined by Sevin and Belli, only traces of rock cut stone foundations have remained. Hamurkesen rock cut tomb at the eastern side of Gürpınar plain is at the northern end of the village with the same name, on the western skirt of the rocky hill where Zerneç and Hiris rivers meet. The tomb has a passageway (dromos) and a chamber (Fig. 21). Dromos with rectangular plan has the dimensions of 1.00 × 2.30 × 2.60 m. From here, tomb is reached through a entrance with 0.80 m width, 0.60 m thickness and 1.30 m height. The chamber has 2.30 × 1.70 m dimension and 1.50 m height; a part in the eastern corner with 1.00 m width and 1.50 m height has been dug 5 cm inward and then left straightened.

Lanetlitepe fortress is located on a lava hill in Iğdır plain of Mt. Ağrı. It has a rectangular plan, and its walls are made of large stones. The perimeter of the surrounding wall is 61 m, its width is 26m and thickness is 2.70m. The thickness of some residence walls that can be seen inside is 1.60m.

Deliktaş, very close to Lanetlitepe is worthy of attention with its interesting structure (Fig. 22). Here, a 85 m long and 3 m thick wall made of medium size semi-cyclopean masonry virtually surrounds the low cairns in it. Thus, the nature of the settlement has not been fully understood. It probably is a cemetery comprised of low kurgans surrounded by perimeter walls rather than a fortress. It is assumed that it was a settlement in Late Chalcolithic Period and a cemetery in Middle Iron Age. The graves underneath the low mounds are stone built and covered with stones.

While pottery belonging to Early Iron Age are found in Dizinkale, it is seen that it was inhabited more intensely in the Middle Iron Age. It is on the high rocky hill, southwest of the village with the same name. Because it was shaped according to topography and not preserved except for some walls, its plan is not completely clear. The thickness of the perimeter wall approximately with 130 × 80 m dimensions is 3.30 m (Fig. 23). The walls can be traced partially in east, west and south directions.

Bağdısan mound is at the center of Patnos district. The settlement that covers an area of approximately 700 m at the right bank of Bağdısan creek has height of 10 m. Traces of Urartian walls with 2.50 m thickness can be seen in some trenches. It seems to be an important center for the region due to its dimensions, rich variety of pottery, architectural remains and its location below Aznavurtepe.

²⁸ Burney 1957, Fig. I; Russell 1980, No: 215. Umuttepe fortress is then referred to as Sint I.

²⁹ Balkan 1964

³⁰ Sevin and Belli 1976-1977.

³¹ Belli 1985, 166-177.

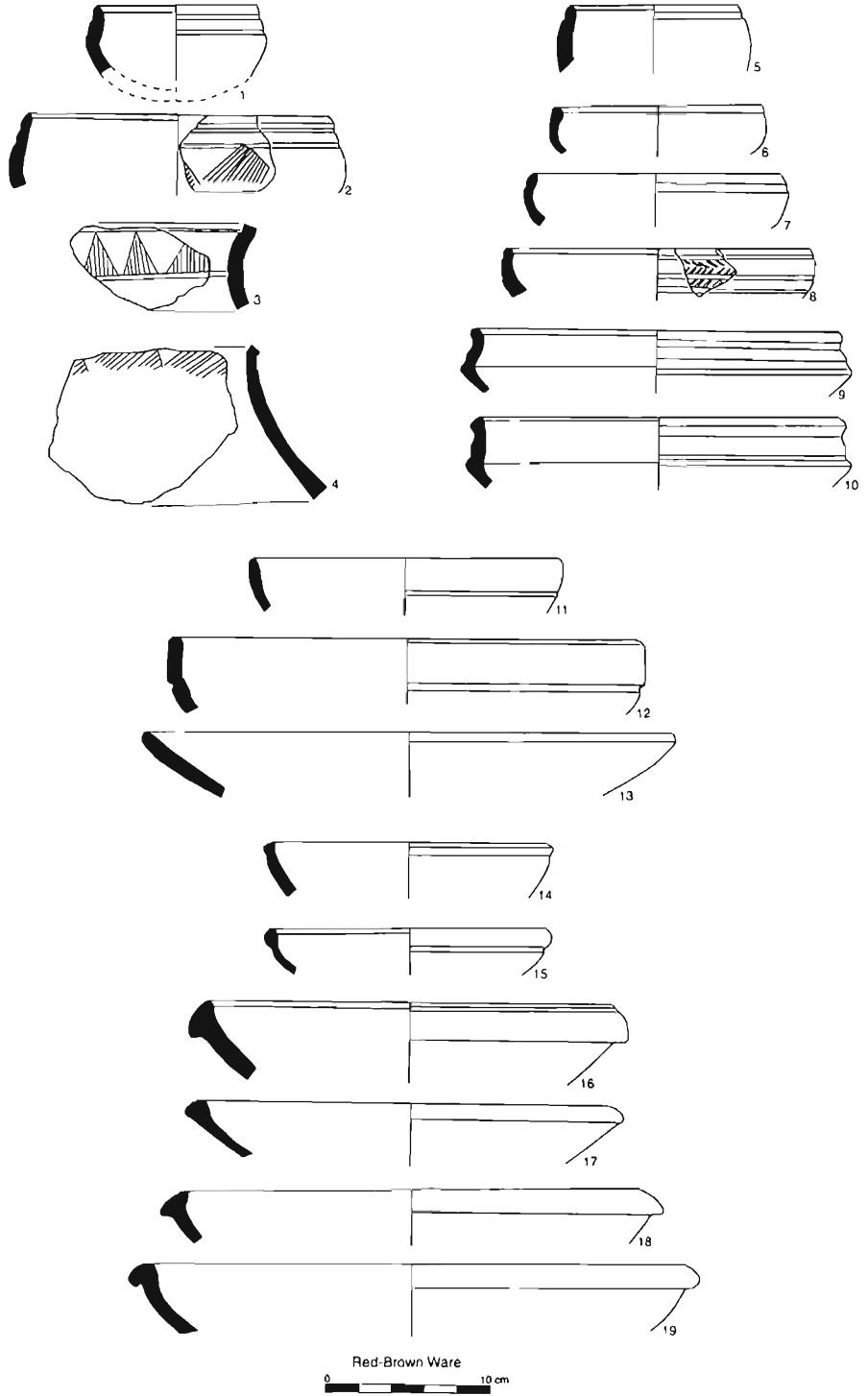

Fig. 19 – Early/Middle Iron Age sherds (Yukarı Mutlu: 1; Hacı Hatun: 2-4; Su Deposu: 5, 9, 14; Dizginkale: 6, 16; Çetenli: 7; Dedeli: 8; Şehitlik/Usobiti: 10; Giriktepe: 11, 18; Aşağı Mollahasan: 12; Umuttepe fortress: 13, 19; Lanetlitepe: 15; Otbiçer: 17)

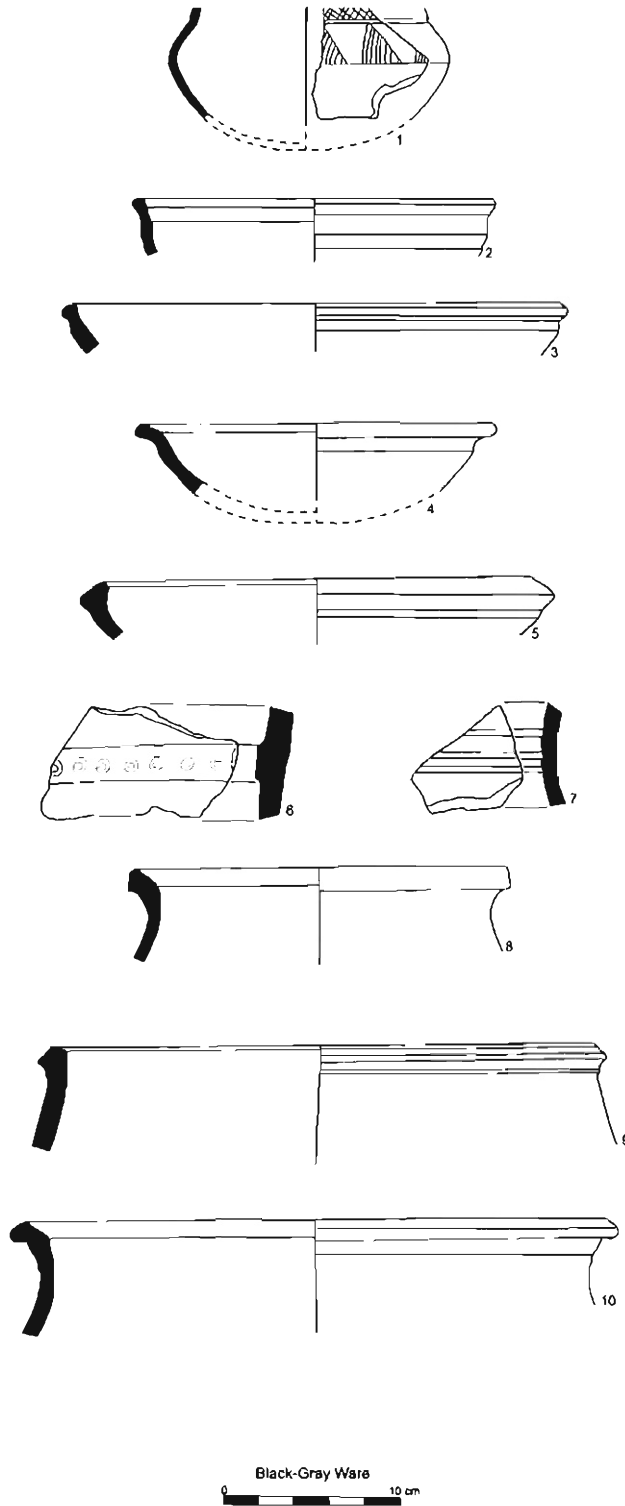

Fig. 20 – Early/Middle Iron Age sherds (Su Deposu: 1; Hacı Hatun: 2; Zinanzer: 3, 10; Bağdısan: 4; Çetenli: 5; Şehitlik/Usobiti: 6; Gümüştepe: 7; Ümuttepe fortress: 8; Yukarı Mutlu: 9)

Şehittepe kurgan is on a low rocky hill on the Balık Lake road in Doğubayazıt. Its mound is made of small unprocessed stones. It has a rectangular plan, 40 × 15 m dimensions and surrounded by a wall with 2 m thickness. We could not obtain any information regarding the grave underneath the mound.

The largest group of Middle Iron Age pottery comprises red-brown ware. These sherds have red, brown paste, slipped in the color of paste, mostly thin or medium gritty tempered, burnished, are of medium fired and wheel made. In terms of form, bowls generally have open mouths, rounded bodies or are carinated. Simple rims and rims thickening outward are seen frequently. Jars generally have two forms: low necked and rounded body; high necked and oval body. Urartian red burnished ware is found less in our survey.

The Late Iron Age (*ca.* M.Ö. 600-334)

The sites of this period are the following: Şehitlik/Usibiti (O73/2), Aşağı Mollahasan (O72/5), Otbiçer (P70/9), Bağdişan (M68/3), Giriktepe (M68/2) mounds; Çetenli (L73/6), Umuttepe (M73/5), Çavuşbaşı (M72/3), Abide Tepe/Çaldıran (M72/2), Dizginkale (N68/1), Aşağı Mutlu (M72/5) and Bajergeh (P71/1) fortresses; Su Deposu (O73/1) and Kümbet (M73/1) necropolises (Fig. 1-2).

Aşağı Mutlu and Bajergah fortresses were settled only in Late Iron Age. Aşağı Mutlu at the northwest of Çaldıran plain is on the hill formed by Tendürek lava currents and 200-250 m west of Aşağı Mutlu village³². The fortress with a rectangular plan is made of medium size stones. The thickness of the wall is 2.20 m. and with 125.50 × 49.50 m dimensions (Fig. 24). There is a tower with rectangular plan at its northern corner; in addition it was supported with a few small pillars.

Bajergah fortress is established on a very high point on Van-Hakkari road in the eastern side of Gürpınar plain. Structure whose only southern section has survived today has a rectangular plan (Fig. 25). The wall made of semi processed stones, 55 m in the south and 35 m in the west could be preserved and its thickness is 2.50 m. It has tower like projections in its southwestern and southeastern corners. The entrance on the east wall has 2.30 m width. At the slope approximately 250 m south of the fortress, there are a cemetery and a lower city where some remains can be traced.

The pottery of this period is represented by three ware: red-brown, cream slipped and red slipped (Fig. 26). In red-brown ware, sherds have slipped in paste color, generally medium gritty tempered and are of medium fired, burnished and wheel made. Red slipped ware has same characteristics except for the slip color. Cream slipped ware has paste in pink, brown and red color, slip in cream color, thin gritty tempered and are of fine or medium firing and burnished. Fine and paint decorated pieces are mostly seen in this ware. Bowls generally have simple rims, open mouths; jars with low necked and rounded bodies are dominant.

³² Burney 1957, Fig. 1; Russell 1980, No: 218. Aşağı Mutlu is then referred to as Aşağı Şerefhane.

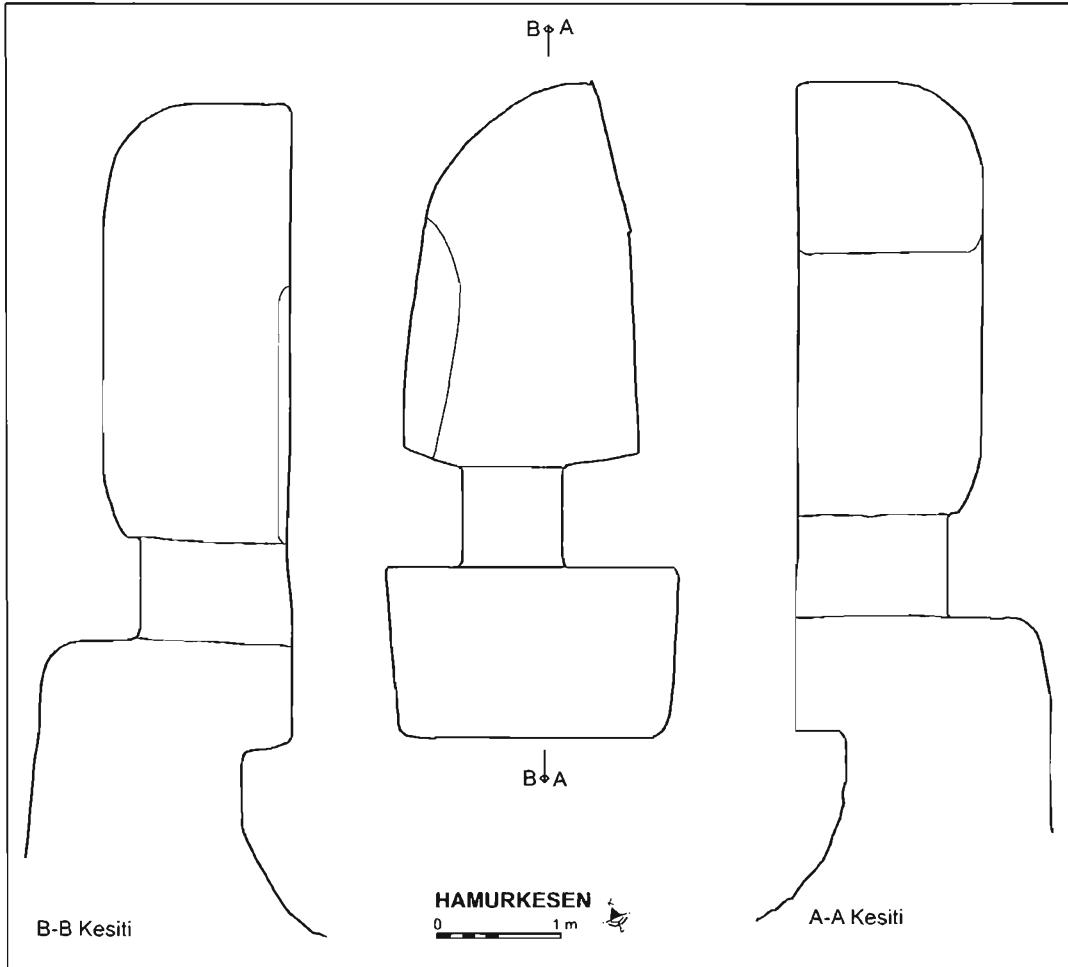

Fig. 21 – Hamurkesen rock cut tomb

Conclusion

Late Chalcolithic Period was found mostly in Araxes valley of Mt. Ağrı region. The pottery of these sites are Amuq E-F type.

Besides the mounds in plains, we have encountered findings of Early Bronze Age in fortress type settlements in mountain skirts that surround plains. It was understood that especially Çaldıran Plain sites have quite rich material for this period. The pottery belongs to Kura Araxes/Karaz culture in Early Bronze Age.

It is not yet clear why findings of Middle Bronze Age are so few in number. It can be assumed that this situation fits the view that life in Middle Bronze Age has moved to very high pasture fields. However for the solution of this problem, we have to wait until all surveys in the region are concluded. Transhumance and semi nomadic life brought by livestock economy is dominant in the region which sustains a pastoral life as in the past. This kind of life style requires long or short range



Fig. 22 · Deliktaş fortress



Fig. 23 · Dizginkale fortress

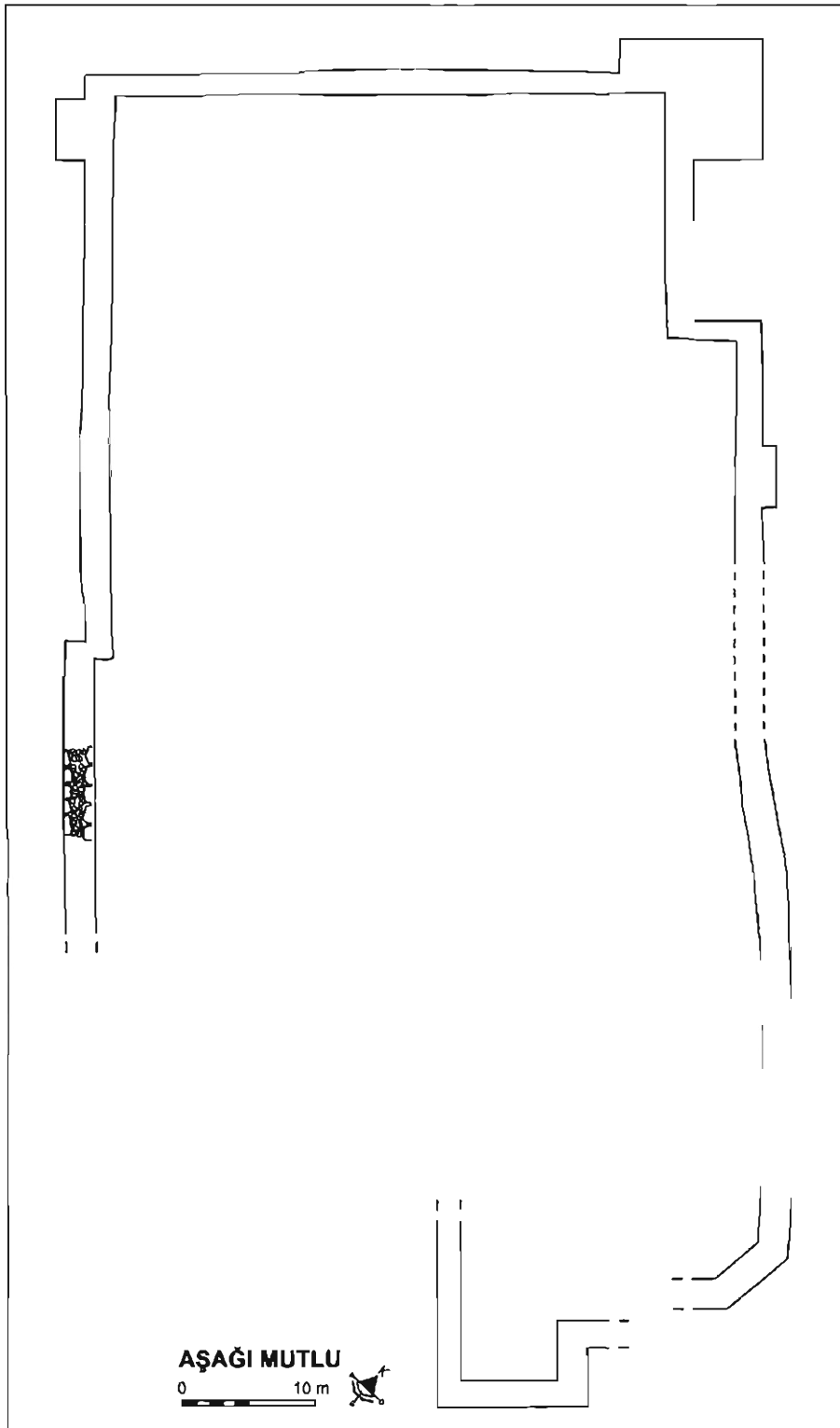

Fig. 24 – Aşağı Mutlu fortress

pasturing. We have not found permanent habitation areas for this period in our survey. While data is little for now, it can be considered as a view that long range pasturing could be done from the large sites such as II. Kültepe, Metsamor, Elar in Araxes valley to high pasturelands of Eastern Anatolian High Plateau. The presence of Amuq E-F groups that we have determined in our survey of Late Chalcolithic Period, in high pasturelands supports this assumption. In fact, long range pasturing is not necessary for Mt. Ağrı region (Iğdır plain/Araxes valley). In Armenia and Nakhichevan in Iğdır plain/Araxes valley, there are multi layer settlements belonging to this period that we mentioned above. Middle Bronze Age pottery that we have found in survey is included in 'Araxes Painted Ware' which represents this period in Southern Caucasus, Eastern Anatolian High Plateau and Urmiye Basin.

In late Bronze/Early and Middle Iron Age, the number of settlements has increased as in the entire region; we have obtained findings of this period both in plains and high areas. It can be deduced from many fortresses and settlements that community in Late Bronze/Early Iron Age started to cluster around certain centers and plains and mountain skirts were utilized more systematically. The pottery and burial tradition of this period display characteristics of two separate cultures. Gray-black ware and kurgan type burial tradition in Mt. Ağrı region shows direct resemblance to Lchaschen-Metsamor culture of Southern Caucasus. The second culture region, Lake Van Basin has pinkish-buff and red-brown ware and chamber graves are common. The north of the basin - Çaldıran and Erciş region-seems to have the effects of Mt. Ağrı region. The effect appears to us with pottery and small number of Kurgan type burial tradition.

Findings related to Urartian Kingdom (Middle Iron Age) is found in all sites that we have examined. Despite that there are no sharp regional differences as much as in previous period, the local characteristics continued in pottery together with the homogeneous culture brought by the central authority. This period demonstrates itself with clear differences in architecture and pottery except for fortresses used since Early Iron Age in Van lake Basin. Mt. Ağrı region has continued the Late Bronze/Early Iron Age tradition in pottery and burial.

Late Iron Age findings have added new information about Eastern Anatolia's least known period. It bears a special importance that these findings which will enlighten long lasting dark phase of the region after the collapse of Urartian Kingdom come from fortress type settlements. The pottery of this period is parallel to pottery of sites of Eastern Anatolia, mainly Karagündüz II, Southern Caucasus and Urmiye Basin³³.

Aynur Özfirat
Yüzüncü Yıl Üniversitesi
Arkeoloji Bölümü
Kampus
TR - 65080 Van

³³ Özfirat 2007a, 148-150; Özfirat 2007b, 118-119; Sevin 1998; Sevin 2002.



Fig. 25 – Bajergeh fortress

BIBLIOGRAPHY

- Balkan, K., 1964, "Patnos'ta Keşfedilen Urartu Tapınağı ve Urartu Sarayı", *Türk Tarih kurumu Yıllık Konferansları I: Atatürk Konferansları*, 235-243, Ankara: Turkish Historical Society Publications, XVII. Series-No I.
- Belli, O., 1985, "Van Ovasında Yeni Urartu Merkezleri", *II. Araştırma Sonuçları Toplantısı* (İzmir, 16-20 April 1984), 163-178, Ankara: T.C. Kültür Bakanlığı.
- Burney, Ch. A., 1957, "Urartian Fortresses and Towns in the Van Region", *Anatolian Studies* VII: 37-53.
- Burney, Ch. A., 1958, "Eastern Anatolia in the Chalcolithic and Early Bronze", *Anatolian Studies* VIII: 157-209.
- Ceylan, A., 2004, "2002 Yılı Erzincan, Erzurum, Kars ve Iğdır İlleri Yüzey Araştırması", *21. Araştırma Sonuçları Toplantısı 2* (Ankara, 26-31 May 2003), 263-272, Ankara: T.C. Kültür Bakanlığı.
- Ceylan, A., 2005, "2003 Yılı Erzincan, Erzurum, Kars ve Iğdır İlleri Yüzey Araştırması", *22. Araştırma Sonuçları Toplantısı 2* (Konya, 24-28 May 2004), 189-200, Ankara: T.C. Kültür Bakanlığı.
- Marro, C. and Özfirat, A., 2003, "Pre-classical Survey in Eastern Turkey. First Preliminary Report: the Ağrı Dağ (Mount Ararat) region", *Anatolia Antiqua* XI: 385-422.
- Marro, C. and Özfirat, A., 2005, "Pre-classical Survey in Eastern Turkey. Third Preliminary Report: Doğubayazıt and the Eastern shore of Lake Van", *Anatolia Antiqua* XIII: 319-356.

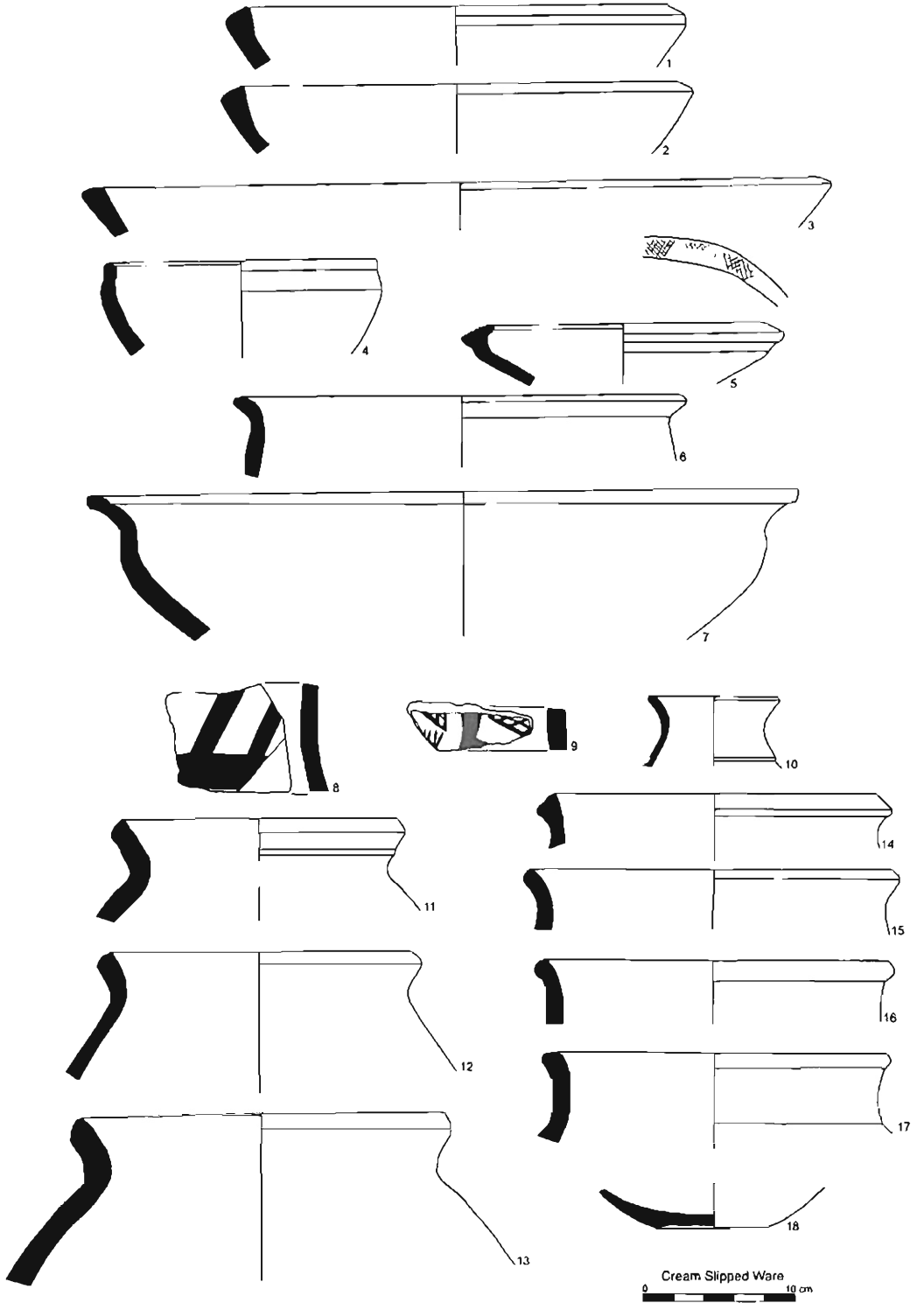

Fig. 26 – Late Iron Age sherds (Çetenli: 1, 3, 5, 14-17; Otbiçer: 2; Aşağı Mutlu: 4, 12; Bajergeh: 6; Dizginkale: 7; Bağdısan 8, 10-11, 13; Şehitlik/Usobiti: 9; 9-21; Umuttepe fortress: 18)

- Öğün, B., 1976, "Türkiye'de Eski eser Kaçakçılığı, Turizm ve Arkeolojik Kazılar", 50. Yıl Konferansları, 1-28, Ankara: University of Ankara, Dil-Tarih ve Coğrafya Faculty Publications, No. 257.
- Öğün, B., 1978a, „Die Urartäischen Gräber in der Gegend von Adilcevaz und Patnos“, *The Proceedings of the X th International Congress of Classical Archaeology* (Ankara 23-30 September 1973), 61-67, Ankara: Turkish Historical Society Publications.
- Öğün, B., 1978b, „Die Urartäischen Bestattungsbräuche“, *Studien zur Religion und kultur Kleinasiens, Festschrift für F. K. Dörner zum 65. Geburtstag am 28 Februar 1978*, 639-678, Leiden.
- Öğün, B., 1982, "Die Urartäischen Paläste die Bestattungsbräuche der Urartäer", *Palast und Hütte*, 217-236, Mainz.
- Öğün, B., 1984a, "Urartu Mezarları", *Türk Ansiklopedisi*, XXXIII: 58-62.
- Öğün, B., 1984b, "Urartu Seramiği", *Türk Ansiklopedisi*, XXXIII: 67-69.
- Özfirat, A., 2007a, "Van, Ağrı ve Iğdır Illeri Yüzey Araştırması, 2005", 24. Araştırma Sonuçları Toplantısı 1 (Çanakkale, 29 May-02 June 2006), 143-162, Ankara: T.C. Kültür Bakanlığı.
- Özfirat, A., 2007b, "Pre-classical Survey in Eastern Turkey. Fourth Preliminary Report: The Eastern shore of Lake Van", *Ancient Near Eastern Studies*, XLIV, 113-140.
- Özfirat, A. and Marro, C., 2004, "2002 Yılı Van, Ağrı ve Iğdır Yılleri Yüzey Araştırması", 21. Araştırma Sonuçları Toplantısı 1 (Ankara, 26-31 May 2003), 15-32, Ankara: T.C. Kültür Bakanlığı.
- Özfirat, A. and Marro, C., in press: "2004 Yılı Van, Ağrı ve Iğdır Yılleri Yüzey Araştırması", *Türk Arkeoloji ve Etnografya Dergisi*.
- Russell, H. F., 1980, *Pre Classical Pottery of Eastern Anatolia: Based on a Survey by Charles Burney of sites along the Euphrates and around Lake Van*, Oxford, BAR International Series 85.
- Sevin, V., 1986, "Urartu Mezar Mimarisine Yeni Katkılar", *Anadolu Araştırmaları* X: 329-340.
- Sevin, V., 1998, "Van/Karagündüz Kazılarının Işığında Doğu Anadolu Geç Demir Çağ Çanak Çömleği", *In Light on Top of the Black Hill, studies presented to Halet Çambel/Karatepe'deki Işık, Halet Çambel'e Sunulan Yazılar*, eds. G. Arsebük, M. J. Mellink and W. Schirmer, 715-726, İstanbul: Ege Publications.
- Sevin, V., 2002: "Late Iron Age Pottery of the Van Region Eastern Anatolia: In the Light of the Karagündüz Excavations", *Festschrift für Manfred Korfmann Mauerschau I*, eds. R. Aslan *et al*, 475-482, Remshalden-Grunbach.
- Sevin, V. and Belli, O., 1976-1977, "Yeşilaliç Kutsal Alanı ve Kalesi", *Anadolu Araştırmaları* IV-V: 367-411.