



OTIS

QUICK LOCATOR GUIDE

- Brushes And Brush Holders** 675-677
- Capacitors** 698
- Car Signal Components** 656-657
 - Button Components..... 656-660
 - Direction Indicator Panels..... 662
 - Emergency Stop Switches 663
 - Gongs 667
 - Jewel Module 665
 - Key Switches, Keys..... 666-667
 - Stainless Steel Faceplates 656
 - Switches, Pushbutton..... 661
- Car Switch Components** 679
- Coils**..... 669-674
- Connectors, Shunts** 694
- Contacts, Carbon and Copper**..... 677-678
- Contacts and Paddle Contacts**..... 680-681
- Detector Shields**..... 695
- Door Parts and Equipment**..... 681-694
 - Door Locks 674-685
 - Gibs, Guides 690-691
 - Keys, Escutcheons 689
 - Interlock Switches 687
 - Limit Switches, Floor Switches..... 688
 - Motors..... 693
 - Spirators, Reel Closer..... 690
- Machine Parts** 715-716
- Printed Circuit Boards** 696-697
- Rectifiers** 700
- Relay Parts**..... 703-709
- Resistors**..... 699
- Safety Edge Components** 715
- Selector Parts** 710-712
- Transformers** 700-701
- Wheels and Rollers** 717-722
 - Guide Shoes..... 691
 - Hanger Assemblies 717-718
 - Roller Guide Assemblies 719-722

Car Signal Components

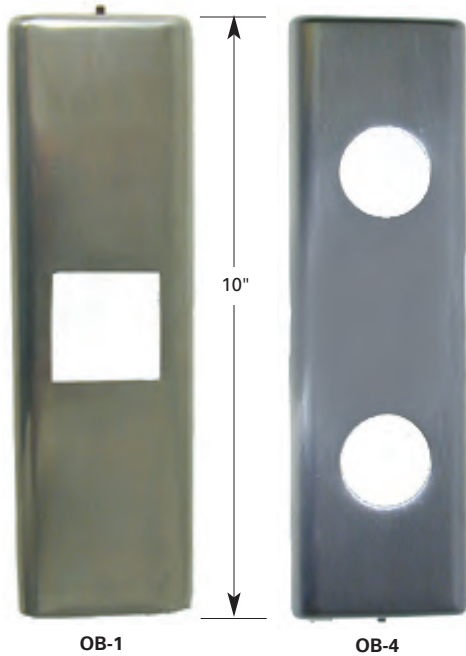

Stainless Steel Faceplates

S.E.E.S. #	O.E.M.#	Description
OB-1	147FD1-25	Hall plate , only, for one square button (1-3/4" hole), terminal floors
OB-2	147FD2-25	Hall plate , only, for two square buttons, (1-3/4" hole) intermediate floors
OB-3	147FD7-25	Hall plate , only, for one round button, (1-1/2" hole) terminal floors
OB-4	147FD8-25	Hall plate , only, for two round buttons, intermediate floors (1-1/2" hole)



OB-1

OB-4

OB-16

OB-17

OB-18

OB-34

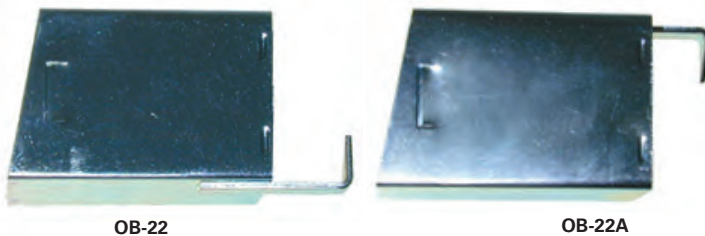

OB-22

OB-22A

Buttons

S.E.E.S. #	O.E.M.#	Description
OB-16	B306GC2	Base , square, clear butyrate
OB-17	306JG1	Halo , button, 1"
OB-18	306JH1	Base , clear butyrate
OB-34	306KH1	Base , round, clear, for OB-33
OB-34A	306KH2	Base , round, frosted, for OB-33
OB-22	278AN3	Shield , Square tube shield, R.H.
OB-22A	278AN4	Shield , Square tube shield, L.H.
OB-33-	323BL2	Button , Electronic touch button, Black with white marking, 7/8" diameter with threaded stem, specify marking, i.e. OB-33-ARROW
OB-19-	323BH2	Button , Black square button with white markings, 7/8" specify marking, i.e. OB-19-ARROW
OB-20	72CG1	Nut , Touch button nut, 5-40 tap thread
OB-21	90WE14	Spring , cone shaped
OB-7	B6849C7	Base , hall terminal, single socket, for touch buttons
OB-8	B6849C5	Base , intermediate hall, double socket, for touch buttons
OB-8A	B6849C6	Base , car station, double socket, for touch buttons

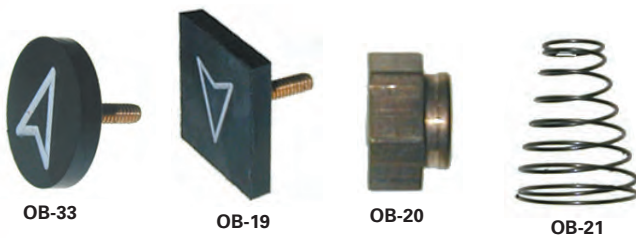

OB-33

OB-19

OB-20

OB-21

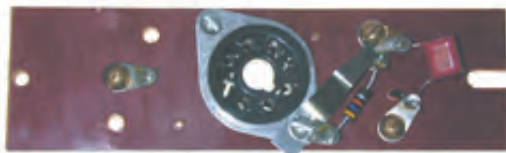

OB-7



OB-8

Car Signal Components

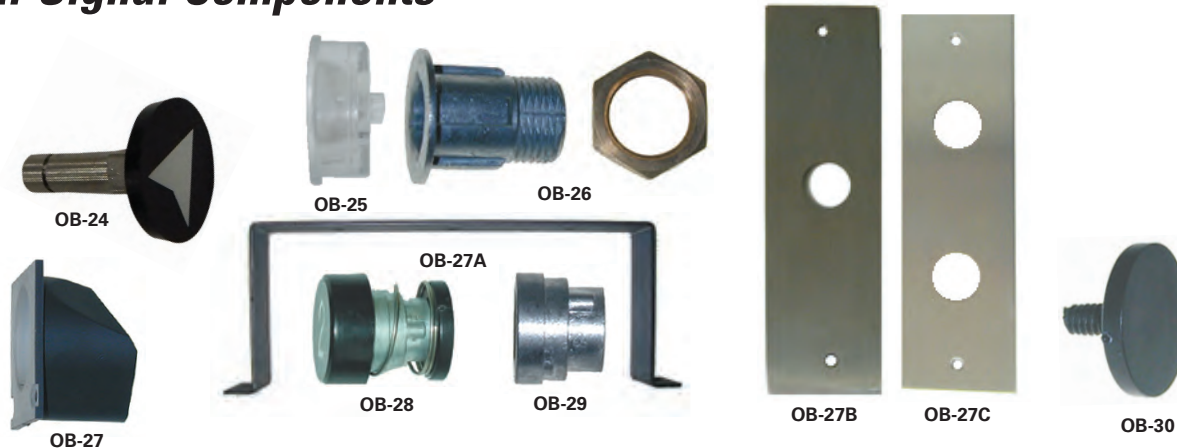

S.E.E.S. #	O.E.M.#	Description
OB-24-	A323BP1	Button , 7/8" dia. with square shaft, black with white markings, specify marking. i.e. OB-24-ARROW
OB-24A	CAA127C1	Retaining Ring , for OB-24 shaft, 1/4" external ring
OB-25	306JG2	Halo used on OB-24 button
OB-26	A385KC1	Button guide and nut for A323BP1
OB-27	306JK1	Button base for A323BP1
OB-27A	6600S80	Mounting bracket for hall pushbutton
OB-27AA		Spring Cup for OB-27A
OB-27B	147JF3-3	Cover plate , stainless steel plate 3" x 10" with one hole 1.180" diameter for OB-24 series
OB-27C	147JF4-3	Cover plate , stainless steel plate 3" x 10" with two holes 1.180" diameter for OB-24 series
OB-27D	147JF3-BR7	Cover plate , bronze, 3" x 10" with one hole 1.180" diameter
OB-27E	147JF4-BR7	Cover plate , bronze, 3" x 10" with two holes 1.180" diameter
OB-28-	323AM1	Button assembly , complete, .98" O.D., 1.14" L, specify marking i.e. OB-28-2
OB-29	A385AV1	Guide , Push button guide
OB-30	A323AF4	Button bottom
OB-31	90YA26	Spring , 25/32" x 1" L, 2 active coils
OB-31A-	323AM	Button , alone, black lexan button top 1" diameter with white markings, specify marking
OB-32-	323AF1	Button assembly complete, specify marking i.e. OB-32-BLANK
OB-32A-	A323AF	Button , alone, black lexan 7/8" diameter with white markings, specify marking i.e. OB-32A-ARROW
OB-23	MT114289	Swedging tool used to install OB-29 button guide for button assemblies OB-28, OB-32, and OB-50
OB-50-	A323BD2	Button assembly complete, 1" dia. button with white marking and clear cap, replaces series 323BD, 323AF, 323AM and 323AP. Specify marking, i.e. OB-50-ARROW



Car Signal Components

OTIS

Pushbuttons

S.E.E.S. #	O.E.M.#	Description
OTBT-1		Button, BR27
OTBT-3		Pushbutton, T-40
OTBT-4		Pushbutton, OTIS 3200
OTBT-5		Button, BR24
OTBT-6		Button, BR27
OTBT-6A		Pushbutton, 24V Otis 2000 brush finished LED Illuminated
OTBT-7		Button, A311
OTBT-7-A313	FAA25090A313	Button, Otis A311 Unpolished SS finish, White Light
OTBT-7-A318	FAA2509A318	Button, Otis A318 Unpolished SS finish, Blue Light
OTBT-9		Button, GAK-AB
OTBT-18		Button, Otis Push Button with LED Light
OTBT-VANDAL-RING		Reinforcing Vandal Ring, OTBT Series Push Button
OTLO-2K	XAA431AB1	Key, Triangle
OTPCB-80	B9693C2	Pushbutton PCB, Otis B9693C2
OTPCB-80A	B9693C3	Pushbutton PCB, Otis B9693C3



OTBT-3



OTBT-4



OTBT-5



OTBT-6



OTBT-6A



OTBT-7



OTBT-9



OTBT-18



OTBT-VANDAL-RING



OTLO-2K



OTPCB-80



OTPCB-80A

Car Signal Components

Contact Assembly

S.E.E.S. #	O.E.M.#	Description
OB-35	6526G1	Contact assembly
OB-36	150H5	Contact for OB-35 contact assembly
OB-37	150H7	Contact with spring and eyelet for OB-35
OB-38	150H9	Contact with spring, eyelet and guide for OB-35 pushbutton contact assembly

Rotodial

S.E.E.S. #	O.E.M.#	Description
OB-39	297F1	Rotodial band, 24 slots
OB-40-	428E1	Rotodial insert, 7/16" x 1", specify marking i.e. OB-40-1
OB-41	443AS1	Rotodial glass, 1-3/8"

Jewel

S.E.E.S. #	O.E.M.#	Description
OB-41A-	499AD1	Jewel, 1-9/16" square, white plexiglass with black character, specify marking i.e. OB-41A-ARROW
OB-41B-	499AA1	Jewel, 1-1/8" square with 7/8" dia. round raised face, white with black character, specify marking i.e. OB-41B-1
OB-41C-	499AE1-1	Jewel, 1-1/8" square with 1" diameter round raised face, white with black character, specify marking i.e. OB-41C-2
OB-200	AAA336AAB1	Housing, for Button
OB-201	AAA23500AL78	Jewel, for Button
OB-202	AAA23500AL84	Jewel, Seismic
OB-203	465D2	Sleeve, for Button
OB-204	AAA462HV2	Spacer
OB-205	AAA462HV1	Spacer



OB-35



OB-36



OB-37



OB-38



OB-39



OB-40



OB-41



OB-41A



OB-41C



OB-41B



OB-200



OB-201



OB-202



OB-203



OB-204



OB-47



OB-48



OB-49A-1



OB-48A



OB-49



OB-48B



OB-49B



OB-49C



OB-64-ADA



OB-64A-ADA



OB-64B-ADA

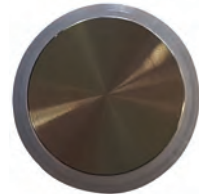

OPB-110



OPB-120



OPB-130



OPB-140

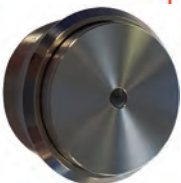

OPB-150

S.E.E.S. #	O.E.M.#	Description
OB-47	306MK1	Halo, locking
OB-48	462GR1	Spacer, felt
OB-48A	323CK1	Button actuator
OB-48B	306MM1	Button base
OB-49	386BNM1	Plate halo, 1-5/16" diameter opening
OB-49A-	250C1	Button insert, black with white markings, 7/8" diameter, specify marking, i.e. OB-49A-1
OB-49B	177BS1	Button Switch assembly, 2 N.O. with 120V lamp
OB-49C	PB1-0227N	Button Switch, 2 N.O. 2 N.C. 120V with lamp, 177BS2
OB-49D		Button Switch, 2 N.O. 2 N.C. 28V
OB-64-ADA	323AD5	Target, White Raised LRV ADA Style
OB-64A-ADA	323AD6	Target, Green Raised LRV ADA Style
OB-64B-ADA	323AD7	Target, Yellow Raised LRV ADA Style
OPB-110	AAA23500CH5	Pushbutton, 24VDC SS SS4, Flat Projecting, Red LED
OPB-120	AAA235000AM2	Pushbutton, 24VDC SS Red LED, Micro Mot III, Flat Projecting
OPB-130	AAA23500AM5	Pushbutton, 24VDC SS Non Illum with Micro Mot III, Flat Projecting
OPB-140	AAA23500AM9	Pushbutton, 6VDC SS Red Led with Screw Conn, Concave Flush
OPB-150	AAA23500BZ18	Pushbutton, 6VDC SS Red Led Vandal Resist, Concave Flush

■ For complete button assembly order one each of the above items and specify marking required.

Car Signal Components

Switches

S.E.E.S. #	O.E.M.#	Description
OPB-1	7035A8	Switch, Single (making-breaking) contact
OPB-2	7035A9	Switch, Single (making) contact
OPB-4	7035A11	Switch, Double (making) contact
OPB-5	7035A10	Switch, Double (making-breaking) contact
OPB-6	7035A28	Switch, Single (making) contact with lamp assembly
OPB-7	7035A12	Switch, Single (make-break) contact, with plastic button 3/4" diameter x 3/4" long
OPB-8	7035A14	Switch, Single (make-break) contact with plastic button 3/4" diameter x 3/8" long
OTSW-12	XAA177H2	Switch, Limit
OTSW-13		Switch, Limit
OTSW-14	J06098E5	Switch, 6098 Mechanical
OTSW-15	XAA177BE1	Silicon Controller
OTSW-16		Switch, SDK 716-1 Combined
OTSW-17		Switch, SDK 716-2 Combined
OTSW-18		Switch, SDK 716-3 Combined
OTSW-19		Switch, SDK 716-3 Combined
OTSW-20		Switch, SDK-740 40A Host Command
OTSW-21		Switch, for Landing Door PB78
OTSW-25		Contact, Otis



OPB-1



OPB-2



OPB-4



OPB-5



OPB-6



OPB-7



OPB-8



OTSW-12



OTSW-13



OTSW-16



OTSW-25

OTIS

Car Signal Components



OB-9A



OB-10



OB-11



OB-11C

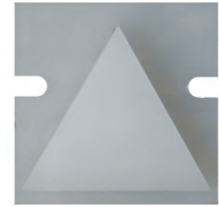

OB-11A

S.E.E.S. # Description

OB-9	Direction indicator panel , stainless steel plate 1/8" x 3-3/8" x 10", with one triangular cutout for up or down arrows
OB-9A	Direction indicator panel , as above but with two triangular cutouts for up and down arrows (shown)
OB-10	Direction indicator , white frosted arrow 2-3/8" with red plastic back plate, 2-5/8 square
OB-11	Direction indicator , white frosted arrow 2-3/8" with green plastic back plate, 2-5/8" square
OB-11B	Direction indicator , 2" frosted arrow on clear backing plate, 2-1/4" wide x 2" high
OB-11C	Direction indicator , 2" frosted arrow on red backing plate, 2-1/4" wide x 2" high
OB-11A	Direction indicator , with clear arrow 2-3/8" on backing plate, 2-5/8" square white markings, 5/16" I.D., 1/4" thick, specify marking i.e. OB-6-LIGHT OFF ON

Digital Displays

S.E.E.S. # O.E.M.# Description

OTIDS-13	XBA23550B1	Digital Display , Otis Twin
-----------------	------------	------------------------------------



OB-42



OB-42B



OB-44



OB-44A

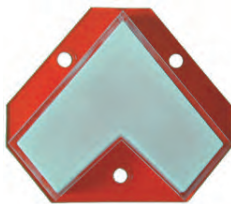

OB-43A



OB-5



OB-6

S.E.E.S. # O.E.M.# Description

OB-42	449AA2	Jewel , Hall lantern, white arrow on red
OB-42A	449AA3	Jewel , Hall lantern, white arrow on white
OB-42B	449AA1	Jewel , Hall lantern, white arrow on green
OB-43	449AM3	Chevron arrow , white on clear plate
OB-43A	449AM2	Chevron arrow , white on red plate
OB-44	449BB3	Lens cover , Position indicator, black "up" arrow on white molded plastic
OB-44A	449BB2	Lens cover , Position indicator, black "down" arrow on white molded plastic
OB-5-	340AA2, 340AA3	Indicator ring , 1" O.D., black or red with white markings, 1/2" I.D., 3/16" thick specify marking i.e. OB-5-OFF-ON-EMERG.
OB-6-	329J4	Indicator ring , 3/4" O.D., black with white markings, 5/16" I.D., 1/4" thick, specify marking i.e. OB-6-LIGHT OFF ON

Car Signal Components



Emergency Stop Switches

S.E.E.S. #	O.E.M.#	Description
OSS-1	A7014B1	Button , 1" diameter without collar
OSS-2	A7014B5	Button , 1" diameter with collar
OSS-3	GS17014B1	Button , 3/4" diameter for GS17014A1
OSS-4	GS17014B2	Button , 3/4" diameter with spring
OSS-6	7014A9	Switch , with 1" dia. red phenolic button with collar and auxiliary contact marked "PUSH TO STOP/PULL TO RUN", 2 N.C., 1 N.O.
OSS-7	7014A1	Switch , without collar, with auxiliary contact marked "PUSH TO STOP/PULL TO RUN" with red phenolic button 1" diameter
OSS-8	7014A2	Switch , without collar, or auxiliary contact marked "PUSH TO STOP/PULL TO RUN" with red phenolic button 1" diameter
OSS-9	7014A10	Switch , with 1" dia. red phenolic button and collar without auxiliary contact marked "PUSH TO STOP/PULL TO RUN"
OSS-10	GS17014A1	Switch , with auxiliary contact, with red phenolic button 3/4" dia.
OSS-11	GS17014A2	Switch , without auxiliary contact, with red phenolic button 3/4" dia.



OSS-6



OSS-7



OSS-8



OSS-5



OSS-14



OSS-15



OSS-9



OSS-10

Emergency Stop Switch Components

S.E.E.S. #	O.E.M.#	Description
OSS-5	6800DJ1	Mounting base
OSS-14	94AA1	Spring
OSS-15	323BR1	Button collar
OSS-16	150AY2	Stationary contact
OSS-17	150R12	Movable contact
OSS-20	90FE2	Compression spring for collar



OSS-16



OSS-17



OSS-20

Car Signal Components

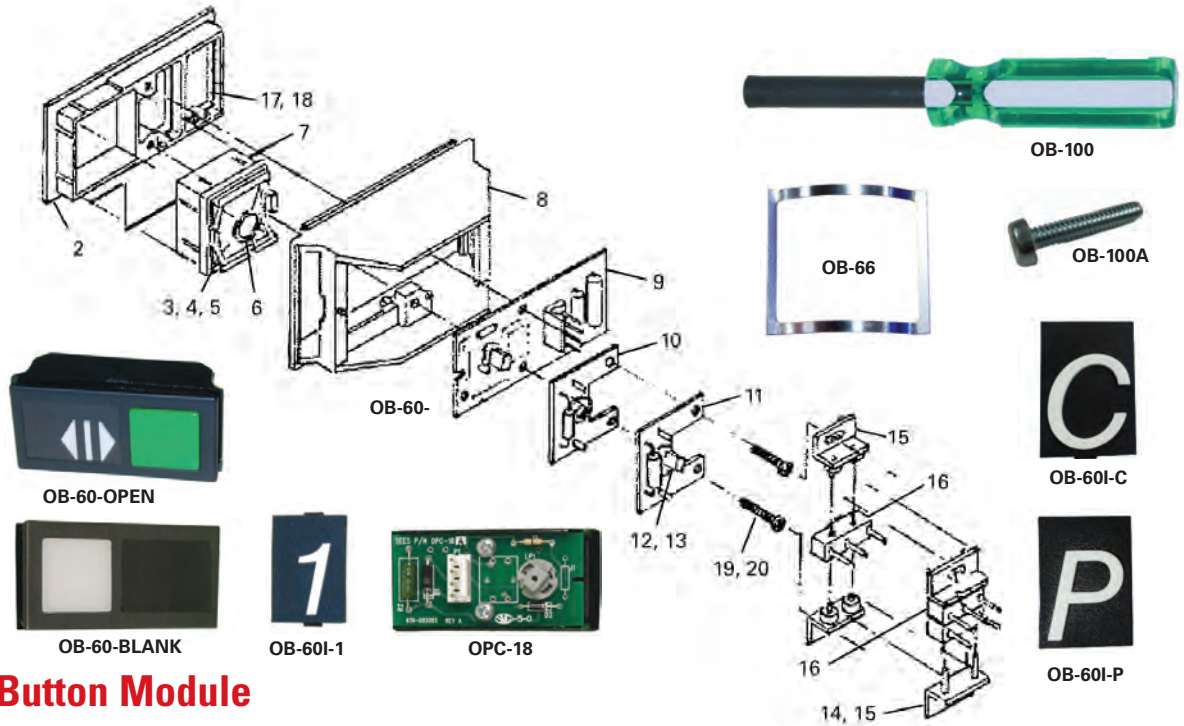

Button Module

Fig. S.E.E.S. #	O.E.M.#	Description
1	OB-60-	7069AF- Pushbutton module (specify marking, and required PC board or microswitch(es))
	OB-60-UP_W/_OPC-18	Button Module, "UP ARROW" PCB (Hall) 28V
2	OB-61	396BP1 Chicklet, 2-3/4" L x 1-3/8" H
	OB-61-BLANK	396LB1 Chicklet, blank frame for LRV
3	OB-64	323DA1 Target, white
4	OB-64A	323DA2 Target, green
5	OB-64B	323DA3 Target, yellow
6	OB-65	278EA1 Reflector
7	OB-66	94FA1 Button spring, S/S, 61/64
8	OB-67	396VB1 Housing
9	OPC-18	8200KA1 PC Board, Button Board with 28V, #85 lamp & socket (hall)
	OPC-18A	8200KA2 PC Board, Button Board w/ 28V, #85 lamp & socket (car)
	OPC-18B	8200KA3 PC Board, Button Board with 28V, orange LED & socket (hall)
	OPC-18C	A26800PZ1 PC Board, button board with white LED and socket (car)
	OPC-18D	A26800PZ2 PC Board, for hall, orange LED, 2 button
10	OPC-20	8200AL3 Neon Lamp PC Board with 120V neon lamp
11	OPC-19	8200AL1 Lamp PC Board with 28V #85 lamp and socket
12	OB-62	467AT1 Socket, #85 for 28V lamp
13	ML-108	424R1 Lamp, #85 for 28V, .04 amps,
	ML-108-LED-O	AAA629AY3 Lamp, orange LED replacement for #85 lamp

Fig. S.E.E.S. #	O.E.M.#	Description
14	OB-68	180DA1 Double switch holder, 2 pins, 15/64"L
15	OB-69	180DA2 Single switch holder, 2 pins, 1/8"L
16	OB-70	177DA1 Microswitch, 5 Amps, 125/250VAC
17	OB-60I-	250D-- Single graphic insert, 21/32" L x 15/16" H, (specify marking)
18	OB-60I-	250E-- Double graphic insert, 1-5/16" L x 15/16" H, (specify marking)
	OB-60I-C	250D12 LRV INSERT "C"
	OB-60I-P	396LB1 LRV INSERT "P"
	OB-60I-FIRE-RESET	Insert, for Keyswitch Fire Reset
19	OB-66A	124CY2 Pan head screw, Plastite, 1/2" L
20	OB-66B	124CY4 Pan head screw, Plastite, 3/4" L

S.E.E.S. #	O.E.M.#	Description
OB-100	MT-105024	Tool, manual driver for security fasteners used on LRV car panels
OB-100A		Security Screw, LRV Car Panel screw used with OB-100
OB-60-BLANK-W/OPC-18B		PB Assy Module, Blank for Hall with OPC-18B, Orange LED
OB-60-BLANK-W/OPC-18C		PB Assy Module, Blank for Car with OPC-18C, White LED

■ International symbols are now being supplied for some markings. Available in Vandal Proof as Special Order

Car Signal Components

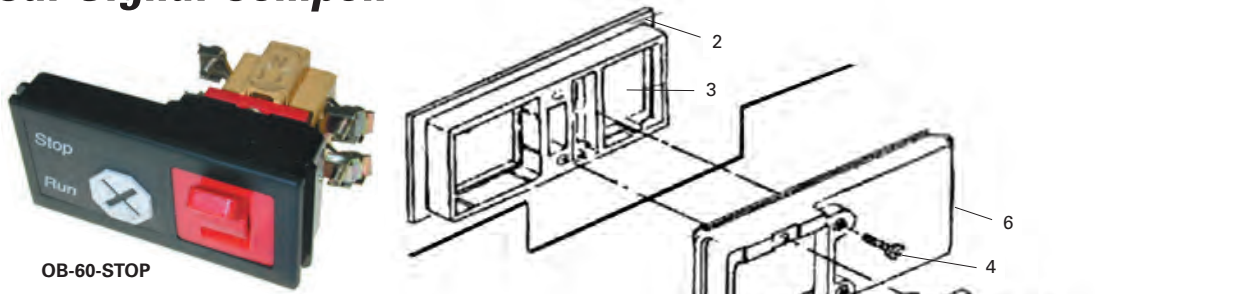

OB-60-STOP

Emergency Stop Module

Fig.	S.E.E.S. #	O.E.M.#	Description
1	OB-60-STOP	7069AK1	Emergency stop module assembly
2	OB-61	396BP1	Chicklet, 2-3/4" L x 1-3/8" H
	OB-61-BLANK	396LB1	Chicklet, blank frame for LRV
3	OB-60I-STOP	250E7	Insert, raised white stop symbol
4	OB-66A	124CY2	Pan head screw, Plastite, 1/2" L
5	OB-60A	6073F1	Paddle Switch 2 Pole DPDT Red
6	OB-61A	396WB1	Stop Switch Housing



OB-60I-STOP

Emergency Stop Key Switch

S.E.E.S. #	O.E.M.#	Description
OB-60K	7069AH60	Key Switch Module, "STOP-RUN", remove 2 position, with UTA key
OB-60K-A03		Key Switch Assembly, Run-Stop 2Pos, A03 Key
OB-60K-UTC		Key Switch Assembly, Run-Stop 2Pos, Rmv2 UTC Key



OB-60K



OB-60K-UTC



OB-80

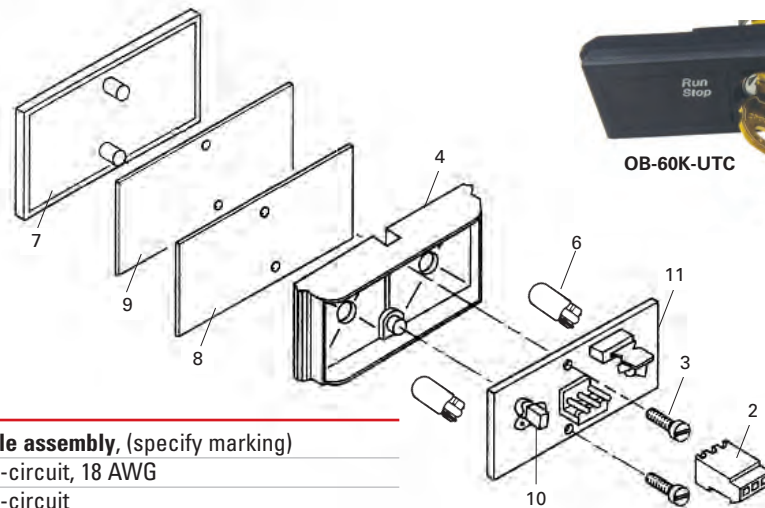

Jewel Module

Fig.	S.E.E.S. #	O.E.M.#	Description
1	OB-80-	7069AG-	Jewel module assembly, (specify marking)
2	OB-71A	P614AS1	Connector, 3-circuit, 18 AWG
	OB-71	P164AS2	Connector, 4-circuit
3	OB-66B	124CY4	Pan head screw, Plastite, 18 mm
4, 5	OB-81	278FA1, A2	Jewel reflector, with shield, white, 2-55/64" x 1-23/24"
6	ML-108	424R1	Lamp, incandescent, wedge base, 28V
7	OB-63A	443CB1	Lens, red, 2-3/4" x 1-3/8"
	OB-63	443CH1	Lens, green, 8-1/2" x 8"
	OB-63C		Lens, clear, 2-3/4" x 1-3/8"
8	OB-83	443CP1	Lens spacer, for flat fixtures, clear
9	OB-80I-	449BJ3	Mask, (specify marking)
10	OB-62	467AT1	Lamp socket, Type 85
11	OPC-17	8200JA1	P.C. Board with lamps and sockets
	OB-84	AAA23851B22	Emerg. Light Indicator, Round Red Lamp and Holder



OB-80I-1 and 2

Car Signal Components

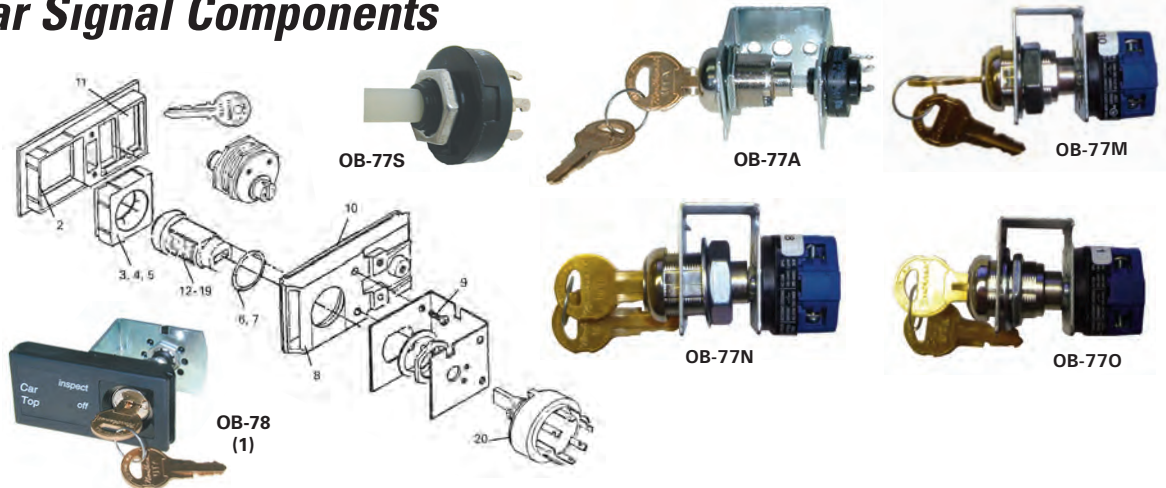

Keyswitches

Fig.	S.E.E.S. #	O.E.M.#	Description
1	OB-78	7069AH33	Keyswitch module , Inspection Initiation, UTA
	OB-78A	7069AH34	Keyswitch module , Independent Service
	OB-78B	7069AH35	Keyswitch module , Hospital Service
	OB-78C	7069AH36	Keyswitch module , SES Phase II ANSI
	OB-78D	7069AH42	Keyswitch module , fan, 2-speed
	OB-78F	7069AH58	Keyswitch module , Fire Service, 3Pos ON/OFF/HOLD
	OB-78F-3502	7069AH58-3502	Keyswitch module , LRV PH2 3P/R2, Off-Hold-On, 3502
	OB-78G	7069AH48	Keyswitch module , Fire Service, 3Pos ON/OFF/BYPASS
	OB-78G-3502	7069AH48-3502	Keyswitch module , LRV PH1 3P/R2, Byp-Off-On, 3502
	OB-78G-3502R	7069AH48-3502	Keyswitch module , LRV PH1 3P/R2, Reset-Off-On, 3502 Reset
	OB-78H	7069AH21	Keyswitch module , 2Pos LIGHT OFF/ON
	OB-78L		Keyswitch module , Blank 2PR2 A03
	OB-78L-UTB		Keyswitch module , Blank 2Pos, Rmv 2, UTB Key
	OB-78-A03		Key Switch Assembly , Inspection with A03 Key
2	OB-61	396PB1	Chicklet , color black, 2-3/4" L x 1-3/8" H
3	OB-72	396XB1	Mount , color blue
4	OB-72A	396XB2	Mount , color red
5	OB-72B	396XB3	Mount , color black
6	OB-73	182H7	O-ring , 35/64" I.D.
7	OB-73A	182H8	O-ring , 47/64" I.D.
8	OB-74-	396KC1	Keyswitch housing , black
9	OB-75	124CY1	Pan head screw , self-tapping
10	OB-76	316DMD2	Bracket , maintaining, double-keyed cutout
11	OB-60I-	250E--	Double graphic insert , 1-5/16" L, 15/16" H, (specify marking)
12	OB-77A	6410W23	Keyswitch assembly , removed at CTR-CW, key 6410W-UTA (includes A, B, & C)
13	OB-77B	6410W24	Keyswitch assembly , removed at CTR-CW, key 6410W-UTD (includes A, B, & C)
14	OB-77C	6410W25	Keyswitch assembly , 2Pos, removed at CTR, key 6410W-UTF (includes A, B, & C)
15	OB-77D	6410W27	Keyswitch assembly , removed at CCW-CTR-CW, key 6410W-UTA (includes A, B, & C)
16	OB-77E	6410W28	Keyswitch assembly , removed at CCW-CTR-CW, key 6410W-UTA (includes A, B, & C)
17	OB-77F	6410W1	Keyswitch assembly , 2Pos, spring return to CTR off, key J200 (includes A, B, & C)
18	OB-77G	6410W30	Keyswitch assembly , 3Pos removed at CCW-CTR-CW, key 6410W-UTF (incl. A, B, & C)
19	OB-77H	6410W7	Keyswitch assembly , 3Pos, removed at CTR-CW, key 6410W-UTF (incl. A, B, & C)
	OB-77K		Keyswitch assembly , GA Key, 3Pos Rem 1 Spring Return To Center
	OB-77M	ABA6410AB30	Keyswitch assembly , 3Pos Sprg Return Rmv At Center, DPDT, UTA Key
	OB-77N	ABA6410AB11	Keyswitch assembly , 2Pos Rmv1 UTF Key DPST
	OB-77O	ABA6410AB8	Keyswitch assembly , 2Pos Rmv1 UTF Key DPST
20	OB-77S	177CC5	Switch , 3Pos, 8 pin, 2 pole
	OB-77T	ABA636A9	Switch , 2Pos, NC DPST
	OB-77U	ABA636A10	Switch , 2Pos, NO DPST
	OB-77V	ABA636A11	Switch , 3Pos, Spring Return to Center, NO, DPDT

Car Signal Components

Keys and Keyswitches

S.E.E.S. #	O.E.M.#	Description
OB-77-UTA	6410WUTA	Key , UTA, light, fan, independent service inspection enable
OB-77-UTB	6410WUTB	Key , UTB, light, fan
OB-77-UTC	6410WUTC	Key , UTC, floor, lockout, attendant service
OB-77-UTD	6410WUTD	Key , UTD, floor lockout, main lockout key
OB-77-UTE	6410WUTE	Key , UTE, priority service
OB-77-UTF	6410WUTF	Key , UTF, fire service, emergency power OP
OB-77-UTG	6410WUTG	Key , UTG, floor lockout
OB-77-UTH	6410WUTH	Key , UTH, floor lockout, inspection/access
OB-77F-UTA	6410W1	Keyswitch Spring Return with UTA Key
OB-77F-UTC	6410W1UTC	Keyswitch assembly , 2Pos, MOM R1, UTC key
OB-77F-UTD	6410W1UTD	Keyswitch assembly , 2Pos, spring return to CTR off, UTD key
OB-77J-UTD	6410WUTH	Keyswitch , 2 Pos, Rmv 2 with UTD key
OB-77J-UTF		Keyswitch , Ph II 3Pos, Rmv 2 UTF Key
OB-77L-UTA		Keyswitch assembly , 2 Pos, Rmv 2 w/ UTA key
OB-77K-UTC	6410WUTH	Keyswitch , 2 Pos, Rmv 2 with UTC key
OB-77K-UP-OFF-DN		Keyswitch , GA Key, with 1-3/4" Black Bezel 3Pos Rem 1, Momentary, Up-Off-Down
OB-77M-UTE		Keyswitch assembly , 3Pos Sprg Return Rmv At Center, DPDT, UTE Key
OB-77P-UTH		Keyswitch , 2 Position, UTH Key
OB-77P-UTG		Keyswitch , 2 Position, UTG Key
OB-77P-UTB		Keyswitch , 2 Position, UTB Key
OB-207	ABA23500F30	Stop Key Switch , Emergency
OB-208	AAA23851A130	Keyswitch , FEO Phase II
OB-209	ABA23500G206	Keyswitch , Independent Service
OB-210	ABA23500G293	Keyswitch Assembly
OB-211		Keyswitch , M3 "Access" UTA Key Up-Off-Down 3 Pos Momentary
OSS-KS-001	O471K1	Keyswitch , 2NC OSS Replacement



OB-77-UTD



OB-77F-UTA



OB-77F-UTC



OB-77F-UTD



OB-77J-UTD



OB-77J-UTF



OB-77P-UTB



OB-77K-UTC



OB-207



OB-208



OB-209

Single Stroke Gongs

S.E.E.S. #	O.E.M.#	Resistance	Description/Gong Application
OB-51A**	311B1	840. ohms	Gong , Across the line, 115VAC
OB-51B*	311B2	32. ohms	Gong , In series with 25 watt lamp, 115VAC
OB-51C*	311B3	14. ohms	Gong , In series with 40 watt lamp or two 25 watt lamps in parallel, 115VAC
OB-51**	311B4	2130. ohms	Gong , Across the line, 115VDC
OB-51D*	311B5	18. ohms	Gong , In series with 25 watt lamp, 120VAC
OB-51E*	311B6	50. ohms	Gong , In series with 40 watt lamp or two 25 watt lamps in parallel, 115VDC

* Used with incandescent lamps only (not lumiline) ** For fluorescent or lumiline lamps



OB-51A



OB-206

Gong Parts

S.E.E.S. #	O.E.M.#	Description
OB-206	AAA08200AAA002	PCB , Gong Assembly

Coils



OC-1 thru OC-3

27/32" I.D. x 1-15/16" O.D. x 1-7/8" L

S.E.E.S. #	O.E.M.#	Resistance	
OC-1	222CC1	21	Ohms
OC-2	222CC2	25	Ohms
OC-3	222CC3	35	Ohms



OC-4 thru OC-8

25/32" I.D. x 1-5/8" O.D. x 1-7/8" L

S.E.E.S. #	O.E.M.#	Resistance	
OC-4	222CD1	1690	Ohms
OC-5	222CD2	1118	Ohms
OC-6	222CD3	242	Ohms
OC-7	222CD4	455	Ohms
OC-8	222CD5	119	Ohms



OC-9 thru OC-16

1-1/32" I.D. x 2" O.D. x 2-15/32" L

S.E.E.S. #	O.E.M.#	Resistance	
OC-9	222CV1	1410	Ohms
OC-11	222CV3	900	Ohms
OC-12	222CV4	375	Ohms
OC-13	222CV5	900	Ohms
OC-14	222CV6	375	Ohms
OC-15	222CV7	2230	Ohms
OC-16	222CV8	155	Ohms



OC-17, OC-18

21/32" I.D. x 1-13/32" O.D. x 1-15/32" L

S.E.E.S. #	O.E.M.#	Resistance	
OC-17	222CX1	X=3233	Ohms
		Y=162	Ohms
OC-18	222CX2	X=1753	Ohms
		Y=1649	Ohms

■ X=Inner winding resistance.
Y=Outer winding resistance.



OC-19 thru OC-29

21/32" I.D. x 1-13/32" O.D. x 1-15/32" L

S.E.E.S. #	O.E.M.#	Resistance	
OC-19	222CY1	3384	Ohms
OC-20	222CY2	1488	Ohms
OC-21	222CY3	213	Ohms
OC-22	222CY4	49	Ohms
OC-23	222CY5	9	Ohms
OC-24	222CY6	0.1	Ohms
OC-25	222CY7	870	Ohms
OC-26	222CY8	2	Ohms
OC-27	222CY9	116	Ohms
OC-28	222CY10	386	Ohms
OC-29	222CY11	1110	Ohms



OC-30 thru OC-35

21/32" I.D. x 1-13/32" O.D. x 1-15/32" L

S.E.E.S. #	O.E.M.#	Resistance	
OC-30	222CZ1	X=1753	Ohms
		Y=1649	Ohms
OC-31	222CZ2	X=968	Ohms
		Y=509	Ohms
OC-32	222CZ3	X=3233	Ohms
		Y=162	Ohms
OC-33	222CZ4	X=1075	Ohms
		Y=0.31	Ohms
OC-34	222CZ5	X=634	Ohms
		Y=821	Ohms
OC-35	222CZ6	X=0.73	Ohms
		Y=1475	Ohms



OC-36 thru OC-37

1-13/32" I.D. x 3-1/16" O.D. x 2-23/32" L

S.E.E.S. #	O.E.M.#	Resistance	
OC-36	222CM1	806	Ohms
OC-37	222CM2	204	Ohms



OC-39

1-1/32" I.D. x 2" O.D. x 2-15/32" L

S.E.E.S. #	O.E.M.#	Resistance	
OC-39	222DE1	X=477	Ohms
		Y=108	Ohms

■ X=Inner winding resistance.
Y=Outer winding resistance.

Coils

9/16" I.D. x 1-5/16" O.D. x 1-21/64" L

S.E.E.S. #	O.E.M.#	Resistance	
OC-40	222E14	9	Ohms
OC-41	222E15	12	Ohms
OC-42	222E16	13	Ohms
OC-43	222E17	18	Ohms
OC-44	222E18	21	Ohms
OC-45	222E19	29	Ohms
OC-46	222E20	34	Ohms
OC-47	222E21	47	Ohms
OC-48	222E22	54	Ohms
OC-49	222E23	73	Ohms
OC-50	222E24	83	Ohms
OC-51	222E25	113	Ohms
OC-52	222E26	129	Ohms
OC-53	222E27	177	Ohms
OC-54	222E28	204	Ohms
OC-55	222E29	278	Ohms
OC-56	222E30	320	Ohms
OC-57	222E31	437	Ohms
OC-58	222E32	500	Ohms



OC-40 thru OC-58

29/32" I.D. x 1-3/4" O.D. x 1-27/32" L

S.E.E.S. #	O.E.M.#	Resistance	
OC-59	222EB1	1860	Ohms
OC-60	222EB2	1230	Ohms
OC-62	222EB4	495	Ohms
OC-63	222EB5	316	Ohms
OC-64	222EB6	201	Ohms
OC-65	222EB7	129	Ohms



OC-59 thru OC-65

27/32" I.D. x 1-5/16" O.D. x 2-3/64" L

S.E.E.S. #	O.E.M.#	Resistance	
OC-66F	222F1	2	Ohms
OC-66A	222F2	3	Ohms
OC-66B	222F3	5	Ohms
OC-66C	222F4	8	Ohms
OC-66D	222F5	13	Ohms
OC-66E	222F6	20	Ohms
OC-66	222F7	31	Ohms
OC-67	222F8	51	Ohms
OC-68	222F9	80	Ohms
OC-69	222F10	119	Ohms
OC-70	222F11	196	Ohms
OC-71	222F12	310	Ohms
OC-72	222F13	476	Ohms
OC-73	222F14	745	Ohms
OC-74	222F15	1210	Ohms
OC-74A	222F16	1882	Ohms
OC-75	222F17	2885	Ohms
OC-76	222F18	4570	Ohms
OC-77	222F19	6760	Ohms



OC-66F thru OC-77

Coils



OC-78 thru OC-90

- Used in Type 7055C Pile up Contact.
X=Inner winding resistance.
Y=Outer winding resistance.



OC-91 thru OC-98

- Used in Type 7055C Pile up
X=Inner winding resistance.
Y=Outer winding resistance.

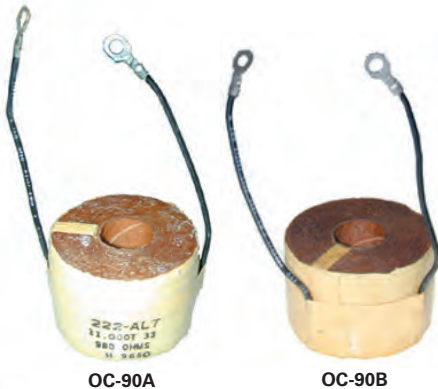

OC-90A

OC-90B



OC-90C



OC-99A thru OC-111

- X=Inner winding resistance.
Y=Outer winding resistance.

41/64" I.D. x 1-3/32" O.D. x 1-15/16" L

S.E.E.S. #	O.E.M.#	Resistance
OC-78	222FF1	3397 Ohms
OC-79	222FF2	923 Ohms
OC-80	222FF3	348 Ohms
OC-81	222FF4	258 Ohms
OC-82	222FF5	200 Ohms
OC-83	222FF6	16 Ohms
OC-84	222FF7	3163 Ohms
OC-85	222FF8	796 Ohms
OC-86	222FF9	1849 Ohms
OC-87	222FF10	805 Ohms
OC-88	222FF11	194 Ohms
OC-89	222FF12	394 Ohms
OC-90	222FF13	12 Ohms

41/64" I.D. x 1-3/32" O.D. x 1-15/16" L

S.E.E.S. #	O.E.M.#	Resistance
OC-91	222FD1	X=16 Ohms Y=2820 Ohms
OC-92	222FD2	X=1434 Ohms Y=1268 Ohms
OC-93	222FD3	X=656 Ohms Y=464 Ohms
OC-94	222FD4	X=392 Ohms Y=2800 Ohms
OC-95	222FD5	X=470 Ohms Y=815 Ohms
OC-96	222FD6	X=1240 Ohms Y=1640 Ohms
OC-97	222FD7	X=575 Ohms Y=1513 Ohms
OC-98	222FD8	X=177 Ohms Y=1915 Ohms

- X=Inner winding resistance.
Y=Outer winding resistance.

27/32" I.D. x 1-15/16" O.D. x 1-3/32" L

S.E.E.S. #	O.E.M.#	Resistance
OC-99	222G14	16 Ohms
OC-99A	222G1	0.8 Ohms
OC-99B	222G2	1 Ohms
OC-99F	222G6	2.6 Ohms
OC-99G	222G7	3.5 Ohms
OC-99J	222G10	7 Ohms
OC-99K	222G11	9 Ohms
OC-99M	222G13	14 Ohms
OC-100	222G15	21 Ohms
OC-101	222G16	25 Ohms
OC-102	222G17	35 Ohms
OC-103	222G18	42 Ohms
OC-104	222G19	55 Ohms
OC-105	222G20	65 Ohms
OC-106	222G21	86 Ohms
OC-107	222G22	100 Ohms
OC-108	222G23	135 Ohms
OC-109	222G24	160 Ohms
OC-110	222G27	336 Ohms
OC-111	222G31	826 Ohms

27/32" I.D. x 2-7/16" O.D. x 1-19/32" L

S.E.E.S. #	O.E.M.#	Resistance
OC-90A	222FG1	980 Ohms
OC-90B	222FG2	404 Ohms

1-1/16" I.D. x 2-1/4" O.D. x 4-5/16" L

S.E.E.S. #	O.E.M.#	Resistance
OC-90C	222FN1	X=83 Ohms Y=22 Ohms

Coils

9/16" I.D. x O.D. 1-5/16" x 1-7/16" L

S.E.E.S. #	O.E.M.#	Resistance			
OC-112	222T4	X=238	Ohms	Y=57	Ohms
OC-113	222T5	X=1480	Ohms	Y=369	Ohms
OC-114	222T8	X=1130	Ohms	Y=307	Ohms
OC-115	222T10	X=307	Ohms	Y=3	Ohms
OC-115A	222T15	X=10	Ohms	Y=510	Ohms

■ X=Inner winding resistance.
Y=Outer winding resistance.



OC-112 thru OC-115A

9/16" I.D. x O.D. 1-5/16" x 1-7/16" L

S.E.E.S. #	O.E.M.#	Resistance			
OC-116	222Z1	X=948	Ohms	Y=380	Ohms
OC-117	222Z2	X=1450	Ohms	Y=1875	Ohms
OC-118	222Z3	X=715	Ohms	Y=109	Ohms
OC-119	222Z4	X=491	Ohms	Y=31	Ohms
OC-120	222Z5	X=1880	Ohms	Y=140	Ohms
OC-121	222Z6	X=1880	Ohms	Y=72	Ohms
OC-122	222Z7	X=830	Ohms	Y=1190	Ohms
OC-123	222Z8	X=1270	Ohms	Y=58	Ohms
OC-124	222Z9	X=1200	Ohms	Y=4	Ohms

■ X=Inner winding resistance.
Y=Outer winding resistance.

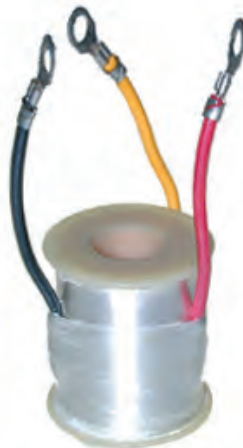

OC-116 thru OC-124

9/16" I.D. x 1-5/16" O.D. x 1-7/16" L

S.E.E.S. #	O.E.M.#	Resistance	
OC-125	222W1	0.6	Ohms
OC-126	222W2	0.9	Ohms
OC-127	222W3	1	Ohms
OC-128	222W4	2	Ohms
OC-129	222W5	4	Ohms
OC-130	222W6	6	Ohms
OC-131	222W7	9	Ohms
OC-132	222W8	14	Ohms
OC-133	222W9	23	Ohms
OC-134	222W10	36	Ohms
OC-134A	222W11	55	Ohms
OC-135	222W12	90	Ohms
OC-136	222W13	135	Ohms
OC-137	222W14	209	Ohms
OC-138	222W15	337	Ohms
OC-139	222W16	539	Ohms
OC-140	222W17	826	Ohms
OC-141	222W18	1329	Ohms
OC-142	222W19	2070	Ohms
OC-143	222W20	3325	Ohms

■ X=Inner winding resistance.
Y=Outer winding resistance.



OC-125 thru OC-143

Coils



1



2



3



4



5



6



7



OC-147



OC-185



OC-220

Fig.	S.E.E.S. #	O.E.M.#	Resistance
1	OC-145A	118193	236 Ohms
2	OC-145B	136224	X=20 Ohms Y=75 Ohms
1	OC-145C	137907	158 Ohms
6	OC-145	177296	2760 Ohms
3	OC-146	177297	600 Ohms
5	OC-148	178720	472 Ohms
3	OC-149	178721	66 Ohms
6	OC-150	180713	64 Ohms
3	OC-151	182356	119 Ohms
3	OC-152	182357	260 Ohms
3	OC-153	182726	290 Ohms
7	OC-154	182731	560 Ohms
5	OC-187	183887	605 Ohms
6	OC-153A	183915	90 Ohms
6	OC-153B	183919	14 Ohms
7	OC-188	183920	1865 Ohms
2	OC-188A	183935	X=75 Ohms Y=140 Ohms
5	OC-188B	183973	50 Ohms
4	OC-188C	183978	235 Ohms

■ X=Inner winding resistance.
Y=Outer winding resistance.

S.E.E.S. #	O.E.M.#	Resistance	Description
OC-147	177299A	565 Ohms	Flat bobbin type coil 3/8" I.D., 1-5/8" O.D., 13/16" L
OC-185	177299	700 Ohms	Paper section type coil 5/8" I.D., 1-1/8" O.D., 2-1/4" L

S.E.E.S. #	O.E.M.#	Description
OC-220	146406	Phase Splitter Coil

Coils

13/16" I.D. x 1-7/8" O.D. x 1-3/4" L

S.E.E.S. #	O.E.M.#	Resistance	
OC-177A	103586	1.2	Ohms
OC-177B	103587	1.3	Ohms
OC-159	103588	1.6	Ohms
OC-159A	103589	1.8	Ohms
OC-155	103590	2.3	Ohms
OC-155B	103591	2.8	Ohms
OC-155A	103592	3.5	Ohms
OC-156	103593	3.9	Ohms
OC-157	103594	5.3	Ohms
OC-157B	103595	5.8	Ohms
OC-160	103596	8	Ohms
OC-160A	103597	9	Ohms
OC-157A	103598	11	Ohms
OC-158	103599	14	Ohms
OC-158A	103600	18	Ohms
OC-161	103601	20	Ohms

13/16" I.D. x 1-7/8" O.D. x 1-3/4" L

S.E.E.S. #	O.E.M.#	Resistance	
OC-161A	103602	28	Ohms
OC-161B	103603	32	Ohms
OC-161C	103604	41	Ohms
OC-162	104909	61	Ohms
OC-163	114536	148	Ohms
OC-164	135805	41	Ohms
OC-165	139784	56	Ohms
OC-166	144993	314	Ohms
OC-167	146121	406	Ohms
OC-168	146123	282	Ohms
OC-168A	147281	250	Ohms
OC-169	150071	75	Ohms
OC-170	151171	161	Ohms
OC-171	157302	51	Ohms



OC-155 thru OC-171, OC-177A & OC-177B

1-1/8" I.D. x 2-1/2" O.D. x 2-1/4" L

S.E.E.S. #	O.E.M.#	Resistance	
OC-172A	13463	2.8	Ohms
OC-172B	13464	3.7	Ohms
OC-172C	13467	6	Ohms
OC-172D	13469	10	Ohms
OC-173	13470	15	Ohms
OC-173A	13471	17	Ohms
OC-174	13474	39	Ohms

1-1/8" I.D. x 2-1/2" O.D. x 2-1/4" L

S.E.E.S. #	O.E.M.#	Resistance	
OC-175	13475	45	Ohms
OC-176	13476	52	Ohms
OC-176A	13477	70	Ohms
OC-176B	13480	116	Ohms
OC-176C	13481	155	Ohms
OC-176D	13482	175	Ohms
OC-176E	13484	270	Ohms
OC-176F	103582	11	Ohms
OC-178	136228	241	Ohms



OC-172A thru OC-178

1-5/8" I.D. x 3-1/2" O.D. x 3-1/4" L

S.E.E.S. #	O.E.M.#	Resistance	
OC-179A	12932	1.6	Ohms
OC-179	12934	2.4	Ohms
OC-180	12937	4.5	Ohms
OC-180A	12939	5.7	Ohms
OC-181	12940	7.9	Ohms
OC-182	12941	8.5	Ohms
OC-183	12942	12.5	Ohms
OC-182A	12944	18.7	Ohms
OC-182B	12947	37	Ohms
OC-184A	12950	62	Ohms



OC-179A thru OC-184A

Coils



OC-190 thru OC-201

21/32" I.D. x 1-5/16" O.D. x 1-7/16" L
 S.E.E.S. # O.E.M.# Resistance

OC-190	222DF2	0.005	Ohms
OC-191	222DF3	0.008	Ohms
OC-193	222DF5	0.02	Ohms
OC-194	222DF6	0.04	Ohms
OC-195	222DF7	0.25	Ohms
OC-196	222DF8	0.003	Ohms
OC-198	222DF10	0.03	Ohms
OC-199	222DF11	0.05	Ohms
OC-201	222DF13	0.26	Ohms

21/32" x I.D. x 1-5/16" O.D. x 1-3/8" L
 S.E.E.S. # O.E.M.# Resistance

OC-202	222DS1	0.0011	Ohms
OC-203	222DS2	0.0015	Ohms
OC-204	222DS3	0.0018	Ohms
OC-205	222DS4	0.0037	Ohms
OC-206	222DS5	0.005	Ohms
OC-207	222DS6	0.0108	Ohms
OC-208	222DS7	0.0157	Ohms



OC-202 thru OC-208

9/16" I.D. x 1-5/16" O.D. x 1-7/16" L
 S.E.E.S. # O.E.M.# Resistance

OC-209	222FA1	0.05	Ohms
OC-210	222FA2	0.08	Ohms
OC-211	222FA3	0.13	Ohms
OC-213	222FA5	0.34	Ohms



OC-214



OC-216 thru OC-219

25/64" I.D. x 1" O.D. x 1-1/32" L

S.E.E.S. # O.E.M.# Resistance

OC-214	222A2	62	Ohms
--------	-------	----	------

13/32" I.D. x 1-1/8" O.D. x 51/64" L

S.E.E.S. # O.E.M.# Resistance

OC-216	222DK1	1520	Ohms
OC-217	222DK2	1520	Ohms
OC-218	222DK3	1520	Ohms
OC-219	222DK4	3080	Ohms

OC-209 thru OC-213

Brake Coils

4-1/32" I.D. x 6-1/4" O.D. x 5-3/4" L

S.E.E.S. # O.E.M.# Resistance

OC-111A	222J1	149	Ohms
OC-111D	222J5	787	Ohms
OC-111E	222J9	373	Ohms
OC-111F	222J10	317	Ohms
OC-111G	222J11	54	Ohms
OC-111H	222J12	500	Ohms
OC-111I	222J14	84	Ohms
OC-111J	222J15	16	Ohms



OC-111A thru OC-111J

Brake Coils

3-3/32" I.D. x 5" O.D. x 5-1/4" L

S.E.E.S. # O.E.M.# Resistance

OC-215A	222KA1	188	Ohms
OC-215	222KA5	137	Ohms
OC-215E	222KA6	55	Ohms



OC-215A thru OC-215E

Brush Holders

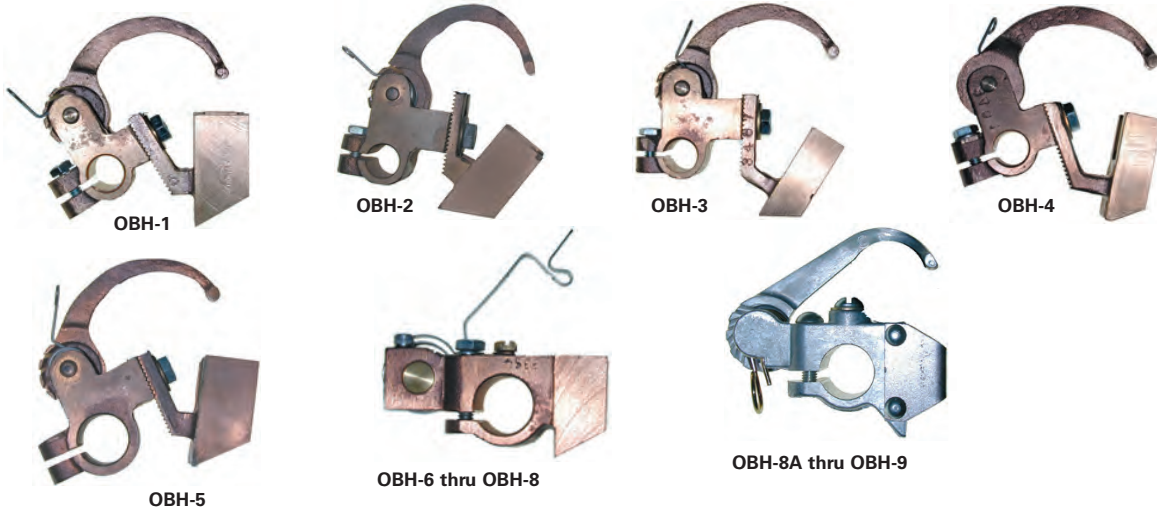

S.E.E.S. #	O.E.M.#	Dimensions
OBH-1	131468, 6134G1	5/8" x 1-1/2", 5/8" stud, short base
OBH-2	140535	5/8" x 1-1/2", 5/8" stud, long base
OBH-3	6134G6	3/8" x 1", 5/8" stud, long base
OBH-4	6134G7	3/8" x 1", 5/8" stud, short base
OBH-5	140538	5/8" x 1-1/2", 7/8" stud, long base
OBH-6	6134A1	5/8" x 1-1/2", stud 7/8"
OBH-7	6134B2, B5	3/8" x 1-1/2", stud 7/8"
OBH-8	6134C2	3/8" x 1-1/2", stud 5/8"
OBH-8A	6134D2	3/8" x 1-1/2", stud 5/8"
OBH-9	6134B1, B4	1/2" x 1-1/2", stud 7/8"
OBH-11	6134H1	.375" x 1", for 7/8" brush stem



Spring Clip

S.E.E.S. #	Dimensions
OBH-10	Spring clip for constant pressure brush holder, brush box 3/4" x 2-15/16"

Brushes



S.E.E.S. #	O.E.M.#	Thick	Width	Length	Material	Grade
OCB-1	240B3	1/2	1-1/2	2	Carbon	OE127
OCB-2	240B4	1/2	1-1/2	2	Graphite	OE116D
OCB-3	240B6	5/8	1-1/2	2	Carbon	OE127
OCB-4	240C1	1/4	1	1-1/8	Graphite	OE116D
OCB-5	240G1	1/2	1	1-1/2	Graphite	OE122
OCB-6	240E2	1/2	1-1/2	2-3/4	Carbon	OE117
OCB-7	240E4	5/8	1-1/2	2-3/4	Carbon	OE117
OCB-8	240E8	5/8	1-1/2	2-3/4	Carbon	OE116D
OCB-9	240E10	1/4	7/8	2	Carbon	OE116D
OCB-10	240E13	3/8	1	2-3/4	Carbon	OE116D
OCB-11	240E14	3/8	1-1/4	2-3/4	Graphite	OE116D

Brushes

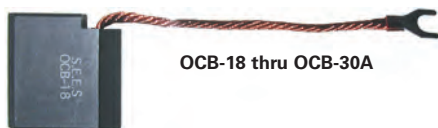

OCB-18 thru OCB-30A

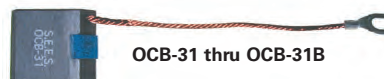

OCB-31 thru OCB-31B

S.E.E.S. #	O.E.M.#	Thick	Width	Length	Material	Grade
OCB-12	GS240E14	3/8	1-1/4	2-3/4	Graphite	OE130
OCB-13	240E16	3/8	1-1/2	2-3/4	Graphite	OE116D
OCB-14	240E17	3/8	1-3/4	2-3/4	Graphite	OE116D
OCB-15	240E18	3/8	2	2-3/4	Graphite	OE116D
OCB-16	240E20	5/8	1-3/4	2-3/4	Graphite	OE116D
OCB-17	240E22	3/4	1-3/4	2-3/4	Graphite	OE116D



OCB-32, OCB-33, OCB-36



OCB-33A

OCB-18	240F1	1/2	2	2	Carbon	OE116D
OCB-19	240F3	3/8	1	2	Carbon	OE116D
OCB-20	240F11	5/8	1-1/2	2	Carbon	OE116D
OCB-21	240F12	5/8	1-1/2	2	Carbon	OE117
OCB-22	240F14	3/8	1	2	Carbon	OE116D
OCB-23	240F15	7/8	1-1/2	2	Graphite	OE116D
OCB-24	240F19	1/2	1-1/2	1-3/4	Graphite	OE116D
OCB-24A		1/2	1-1/2	1-3/4	Graphite	H41
OCB-25	240F20	3/8	1-1/2	2	Graphite	OE116D
OCB-26	240F21	1/2	1-1/2	2	Carbon	OE127
OCB-27	240F22	3/8	1	2	Carbon	OE127
OCB-28	240F23	5/8	1-1/2	2	Carbon	OE127
OCB-29	240F25	5/8	1-1/2	2	Graphite	OE130
OCB-30	240F26	3/8	1	2	Graphite	OE130
OCB-30A	240F27	5/8	1	2	Graphite	OE130

OCB-31	240J1	3/8	1-1/2	1-3/4	Graphite	OE116D
OCB-31A	240J2	1/2	1-1/2	2	Carbon	OE127
OCB-31B	240J3	3/8	1-1/2	1-3/4	Carbon	OE140



OCB-34, OCB-34A, OCB-35



OCB-37, OCB-37A



OCB-37B

S.E.E.S. #	O.E.M.#	Thick	Width	Length	Material	Grade
OCB-32	240P1	3/8	1-1/2	1-3/4	Graphite	OE116D
OCB-33	240P2	3/8	1-1/2	1-3/4	Carbon	OE127
OCB-33A	240P9	3/8	1-1/2	1-3/4	Carbon	GR H619
OCB-36	240P3	3/8	1-1/2	1-3/4	Graphite	OE130

OCB-34	240R1	1/2	1-1/2	2	Carbon	OE150
OCB-34A	240R3	1/2	1-1/2	2	Carbon	OE151
OCB-35	240R5	1/2	1-1/2	2	Graphite	OE152
OCB-37	240AA1	.492	1.56	2.0	Carbon	OE151
OCB-37A	240AA3	.497	1.56	2.0	Carbon	OE127
OCB-37B	240AA4	.49	1.57	2.0	Carbon	OE127

OCB-38	240W3	1/2	1-1/2	2	Carbon	OE153
OCB-39	240T1	3/8	1	2	Carbon	OE130
OCB-39A	240T5	3/8	1	2	Carbon	OE154
OCB-41	240W1	1/2	1-1/2	2	Carbon	OE151
OCB-44	240R9	1/2	1-1/2	2.125	Carbon	OE157
OCB-45	240T9	3/8	1	2	Carbon	OE157



OCB-38, OCB-39, OCB-39A, OCB-41

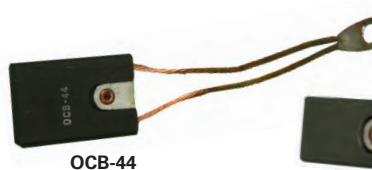

OCB-44



OCB-45

Brushes



OCB-40A, OCB-40B



OCB-40

S.E.E.S. #	O.E.M.#	Thick	Width	Length	Used On
OCB-40A	1450941/4	1/4	11/16	J2A Motor	6850A Selector (OS-70)
OCB-40B	186142	1/4	5/16	11/16	6850A Selector
OCB-42	240BA1	1/4	1/2	3/4	6333CC1 (ODO-75D), 6333CC2 (ODO-75C)

S.E.E.S. #	O.E.M.#	Thick	Width	Length	Material	Door Operator
OCB-40	186207	1/4	3/8	1	Carbon	6970A, 1/2hp

■ Used on 6333AJ2 and 6333AL1 Door Motors (ODO-75).

S.E.E.S. #	O.E.M. #	Thick	Width	Length	Material	Used On
OCB-43	625A682HA001	1/4	1/2	3/4	Carbon	DC Motors ODO-75C and ODO-75D

S.E.E.S. #	O.E.M.#	Thick	Width	Length	Selector
OS-70A	J0240A1	1/4	5/16	11/16	OLL Selector Motor



OCB-43



OS-70A

Contacts

S.E.E.S. #	O.E.M.#	Dimensions	Hole Dia.	Material
OCC-1	154AA1	1" sq. x 1-1/4"	5/16"	Graphite
OCC-1A	154AA1	1" sq. x 1-1/4"	5/16"	Carbon
OCC-2	154AB1	7/16" sq. x 29/32"	5/32"	Carbon
OCC-3	154AB2	7/16" sq. x 29/32"	5/32"	Graphite
OCC-4	154C1	5/8" sq. x 1"	3/16"	Carbon
OCC-5	154C2	5/8" sq. x 1"	3/16"	Graphite
OCC-6	154G1	1-1/4" sq. x 1-1/2"	5/16"	Carbon
OCC-7	1077	2" x 2" x 1"		Carbon



OCC-1



OCC-7



ORC-1

S.E.E.S. #	O.E.M.#	Dimensions	Material
ORC-1	1113	1/2" dia. x 3/4"	Carbon
ORC-2	1312	1/2" dia. x 7/8"	Carbon
ORC-3	1576	3/4" dia. x 7/8"	Carbon
ORC-4	1310	1" dia. x 5/8"	Carbon
ORC-5		1-1/4" dia. x 2"	Carbon
ORC-6	1577	1-1/2" dia. x 1"	Carbon
ORC-7		1-1/2" dia. x 2"	Carbon
ORC-8		2" dia. x 2"	Carbon



OSR-3



OSC-1



OSC-4



OSC-6

Round Slotted Carbon Contacts

S.E.E.S. #	O.E.M.#	Dimensions
OSC-1	1197	1/2" diameter x 1/2"
OSC-2	144553	1/2" diameter x 11/16"
OSC-3	1123	1/2" diameter x 1"
OSC-4	103921	5/8" diameter x 1/2"
OSC-5		5/8" diameter x 5/8"
OSC-6		5/8" diameter x 3/4"
OSC-6A		5/8" diameter x 1"
OSC-7	121992	3/4" diameter x 3/4"
OSC-8	1144	3/4" diameter x 7/8"
OSC-10		7/8" diameter x 3/4"

S.E.E.S. #	O.E.M.#	Dimensions
OSC-11		7/8" diameter x 7/8"
OSC-12		7/8" diameter x 1"
OSC-13	114255	1" diameter x 3/4"
OSC-14		1" diameter x 7/8"
OSC-15	1168	1" diameter x 1"
OSC-16	1173	1" diameter x 1-13/16"
OSC-17	1207	1-1/2" diameter x 3/4"
OSC-18	1194	1-3/4" dia. x 1-3/8"
OSC-19	1203	2" diameter x 1-1/16"
OSC-20	1195	2-1/4" dia. x 1-3/8"
OSC-21	166083	1.75" x .75"
OSC-22	169941	1.75" x 1.5"



OSC-6A



OSC-11



OSC-16



OSC-22

Contacts

Carbon Contact Holders Stem



OCH-1

S.E.E.S. #	O.E.M.#	Description	Material	Stem	Thread
OCH-1	103623	Holder for 1"	Carbon	2"	3/8-16
OCH-2	141436	Holder for 5/8"	Carbon	1-1/4"	1/4-20
OCH-3	106671	Holder for 1/2"	Carbon	1-1/8"	1/4-20
OCH-5	214SW11	Holder for 1-1/2"	Carbon	1-1/2"	3/8-16
OCH-6	126223	Holder for 1"	Carbon	1-1/2"	3/8-16
OCH-7	109578	Holder for 1-3/4"	Carbon	1-3/4"	1/2-13
OCH-8	108713	Holder for 2"	Carbon	1-3/4"	1/2-13
OCH-10	106184	Holder for 2-1/4"	Carbon	3-5/8"	5/8-11
ORCC-28	150272	Holder with 1/2"	Carbon	2-1/16"	1/4-20

Round Copper Contacts



ORCC-1



ORCC-5A



ORCC-17



ORCC-25

S.E.E.S. #	O.E.M.#	Face	Stem	Thread
ORCC-1	1559	2-1/2" x 3/8"	3-1/4" x 5/8"	1-3/8" x 1/2"
ORCC-2	1559-S	2-1/2" x 3/8"	2-7/8" x 5/8"	1" x 1/2"
ORCC-3	1561	2-1/2" x 3/8"	2-13/16" x 5/8"	1-1/4" x 1/2"
ORCC-4	13234	2-1/4" x 3/8"	2-7/8" x 1/2"	1-1/8" x 3/8"
ORCC-5	1555	2" x 3/8"	3-1/4" x 5/8"	1-3/8" x 1/2"
ORCC-5A	1555	2" x 3/8"	3/4" x 1/2"	3/4" x 1/2-13
ORCC-6	13417	2" x 3/8"	2-7/8" x 1/2"	1-3/16" x 3/8"
ORCC-7	106569	1-3/4" x 3/8"	2-3/8" x 7/16"	1" x 5/16"
ORCC-8	1191	1-1/8" x 1/4"	2-7/16" x 7/16"	1-1/8" x 5/16"
ORCC-9	114228	1-1/8" x 1/4"	2-1/8" x 7/16"	1-1/8" x 5/16"
ORCC-10	1189	7/8" x 1/4"	2-5/16" x 7/16"	1" x 5/16"
ORCC-11	1533	7/8" x 3/8"	1-5/16" x 7/16"	1" x 5/16"
ORCC-12		5/8" x 3/16"	1-5/8" x 5/16"	13/16" x 3/16"
ORCC-12A	1534	1" x 1/4"	3/4" x 1/4"	7/8" x 1/4"
ORCC-13	1560	2-1/2" x 3/8"	2-11/16" x 1/2"	1-13/16" x 1/2"
ORCC-14	1558	2-1/2" x 3/8"	1-3/4" x 1/2"	1-7/16" x 1/2"
ORCC-15	130190	1" x 1/4"	2-5/8" x 3/8"	2" x 3/8"
ORCC-16	12852	1" x 1/4"	1-3/4" x 3/8"	1" x 3/8"
ORCC-17	1493	3/4" x 3/16"	1-1/8" x 3/8"	1-1/8" x 3/8"
ORCC-18	1506	3/4" x 3/16"	1-15/16" x 1/4"	7/8" x 1/4"
ORCC-19	1518	3/4" x 1/4"	3" x 3/8"	1" x 3/8"
ORCC-20	1505	3/4" x 3/16"	1-13/16" x 5/16"	1-1/4" x 5/16"
ORCC-21	106571	5/8" x 5/32"	1-19/32" x 7/32"	1-1/8" x 7/32"
ORCC-22	103994	5/8" x 1/8"	1/2" x 7/32"	1/2" x 7/32"
ORCC-23	112000	5/8" x 3/16"	1-3/16" x 1/4"	1-3/16" x 1/4"
ORCC-24	1467	1/2" x 3/8"	1-1/2" x 1/4"	7/8" x 1/4"

S.E.E.S. #	O.E.M.#	Description
ORCC-24A	106573, 106574	Insulator Kit for ORCC-24 Contact

S.E.E.S. #	O.E.M.#	Face	Stem	Thread
ORCC-25	113903	1-1/8" x 1/4"	1-1/4"	3/8"
ORCC-26	1503	3/4" x 1/4"	1-3/4"	3/8"
ORCC-27	1528	3/4" x 3/16"	1-1/8"	3/8"
ORCC-28	150272	1/2" x 5/8"	1-1/8"	3/8"

Contacts

Square Copper Contacts

S.E.E.S. #	O.E.M.#	Face	Stem	Thread
OCC-1	1436	2" x 1 x 3/8"	2" x 1/2"	1-3/8" x 1/2"
OCC-2	1387	2" x 1-1/2" x 3/8"	2-5/8" x 1/2"	2-1/8" x 1/2"
OCC-3	1383	2" x 1-1/2" x 3/8"	1-3/4" x 1/2"	1-1/4" x 1/2"
OCC-4	1374	1-1/2" x 1-1/2" x 3/8"	2-1/4" x 1/2"	1-3/4" x 1/2"
OCC-5	1398	1-9/16" x 1-9/16" x 3/8"	1-13/16" x 3/8"	1-5/16" x 3/8"



OCC-1 thru OCC-5

Car Switch Components



OCS-1



OCS-2



OCS-3



OCS-5



OCS-10



OCS-6A



OCS-11



OCS-13



OCS-15

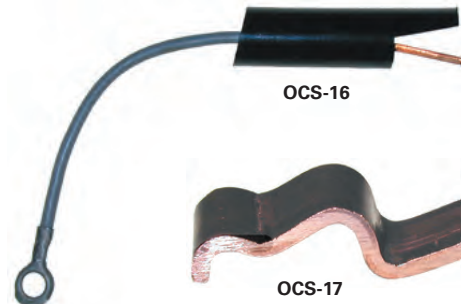

OCS-16



OCS-17

S.E.E.S. #	O.E.M.#	Description
OCS-1	1571	Segment, Type G brass car switch segment
OCS-2	329F1	Gib cap for gib holder for 5/8" rail
OCS-3	8697	Spring, Type G car switch, spring steel 1" I.D., 1.25" W, 1/2" H
OCS-4	8608	Spring, Type K car switch, spring steel 7/8" I.D., 1" W, 5/8" H
OCS-5	12164	Car switch segment, Type K
OCS-6	137743	Fibre door striker, 5-9/16" L x 13/16" W x 1/2" Thick
OCS-10	1763	Contact door lock, brass
OCS-6A	A154B1	Contact, carbon, 1-5/8" x 1-1/2" x 3/8" Thick, for 21-0 car switch
OCS-9	126388	Car switch, Insulator bushing phenolic
OCS-9A		Car switch, Insulator segment bakelite
OCS-11	1338	Car switch finger, Type K, 1/2" x 1-7/8"
OCS-13	103243	Contact car switch finger, Type G, 1/2" x 2-1/2"
OCS-15	13514	Copper angle, 1-1/16" L x 3/4" W x 1/4" Thick, 5/16" hole
OCS-16	126650	Door lock finger, with wire lead, 5-1/2" L
OCS-17	126391	Car switch finger, Type O
OCS-18	1682	Brass contact, 1" x 2-5/8"
OCS-21	166083	Carbon contact
OCS-22	140759	Car switch contact, metal graphite, 3-1/4" L x 5/8" W
OCS-23	126646	Door lock bridge, 1-3/16" Sq.



OCS-18



OCS-22



OCS-23

Contacts

Side A
(Front)

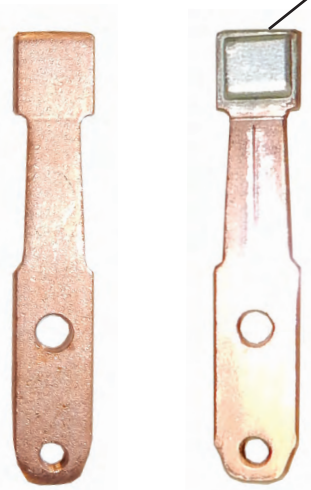

O1CC-1 thru O1CC-9A

Paddle Contacts 2-3/4" O.L.

S.E.E.S. #	O.E.M.#	Side A (front)	Side B (back)	Offset 3/32"
O1CC-1	153Z1	Plain	Plain	Without (use with OCC-2)
O1CC-2	153Z4	Plain	Plain	With
O1CC-3	153AE8	7/16" Sq. Silver	---	Without
O1CC-4	150Y4	3/8" Rd. Silver	---	Without
O1CC-5	150Y6	---	3/8" Rd. Silver	With
O1CC-6	150Y7	3/8" Rd. Silver	---	With
O1CC-8	153AE10	3/8" Rd. Silver	7/16" Sq. Silver	Without
O1CC-9A	153AG5	3/8" Sq. Silver	---	With



ODC-001

DC Contactor

S.E.E.S. #	O.E.M.#	Description
ODC-001	AAA638AE6	DC Contactor



O1CC-10 thru O1CC-16



O1CC-17, O1CC-18



O1CC-19, O1CC-20

O1CC-21

Paddle Contacts 4-3/16" O.L.

S.E.E.S. #	O.E.M.#	Face	Offset 1/8"
O1CC-10	153B1	Plain	Without (use with OCC-4 Carbon)
O1CC-11		Plain	With
O1CC-14	150Y2/Y5	3/8" Rd. Silver	Without
O1CC-14A	153AG6	1/2" Sq. Silver	Without
O1CC-16	150AK2	1/2" Rd. Silver	With

S.E.E.S. #	O.E.M.#	Description
O1CC-17	153T1	Movable paddle contact , 5-1/2" L used on 6744 A and B magnet switch, use with OCC-1 or OCC-1A
O1CC-18	153D1	Movable paddle contact , 6-1/2" L used on 6520 magnet switch, use with OCC-6
O1CC-19	150AK3	Copper contact with silver tip, 5/8" x 5/8" x 1" L with 1/2" diameter tip
O1CC-20	150AL3	Copper contact with silver tip, 7/16" x 7/16" x 13/16" with 3/8" diameter tip
O1CC-21	150W6	Contact with silver tip, 3/8" dia. x 24 thread, 13/16" L
O2CC-1	150P4	Movable contact , 2-1/8" L with 1/4" dia. silver tip used for A6164 BP Magnet Switch
O2CC-2	93A2	Movable contact , 2-3/4" L with 1/4" dia. silver tip, auxilliary, used for 6830 DC Magnet Switch
O2CC-3	93D2	Leaf spring , 1-5/8" L x 5/16" W, used for A6164 BP Magnet Switch

O2CC-1 O2CC-2 O2CC-3

Contacts

S.E.E.S. #	O.E.M.#	Description
O2CC-4	150P7	Contact , with 1/4" dia. silver tip, 2-1/4" L, used for type 6164 Magnet Switch
O2CC-6	150P13	Contact , with 1/4" dia. silver tip, 2-3/4" L, used for type 6164 Magnet Switch
O2CC-5	150P8	Contact , with 1/4" dia. silver tip 3-1/64" L, used for type 6164 Magnet Switch
O2CC-7	150P14	Contact , with 1/4" dia., 3-19/32" L silver tip used for type 6164 Magnet Switch
O2CC-9	150P26	Steel angle contact , with 1/4" dia. 2-5/8" L, silver contact for A6164 Magnet Switch
O2CC-10	150P27	Steel angle contact , 3-3/32" L, with 1/4" dia. silver contact for A6164 Magnet Switch
O2CC-8	150P25	Steel "L" contact , with 1/4" dia. 1-3/4" x 5/8" L silver tip used for type A6164 Magnet Switch
O2CC-11	150C13	Auxiliary contact , with 1/4" dia. 7/16" x 13/16" L silver contact tip used for type 6754 Magnet Switch
O2CC-12	150C14	Auxiliary contact , with 1/4" dia. 7/16" x 13/16" L silver contact tip used for type 6754 Magnet Switch

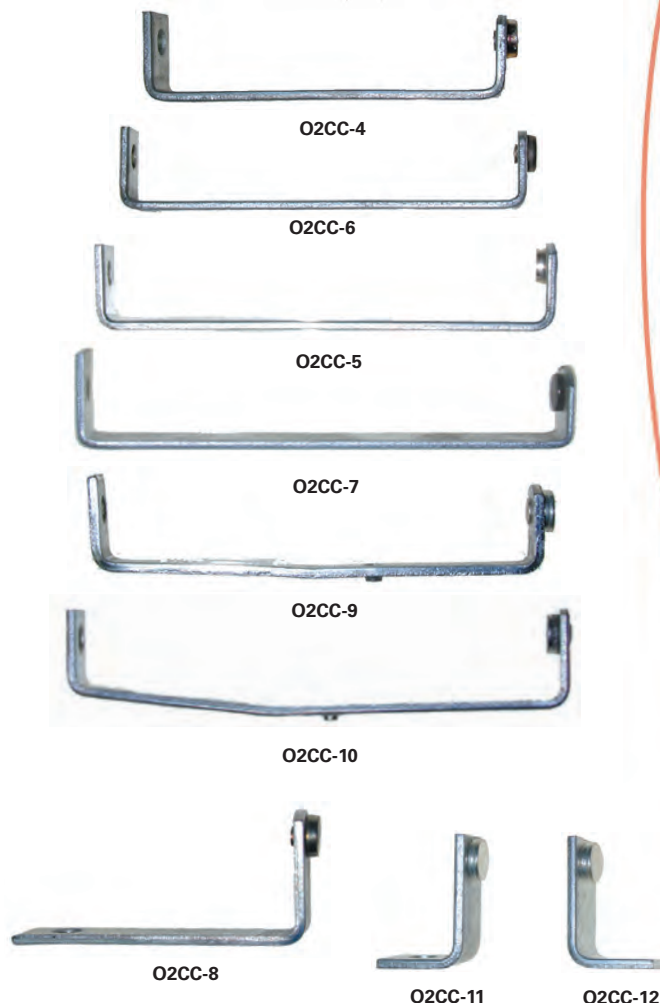

Door Parts and Equipment

S.E.E.S. #	O.E.M.#	Description
ODO-12A	165D1	Quadrant arm and seal for 7300A Operator
ODO-78	332BC2	Chain assembly with studs for 7300 Door Operator, 37" L
ODO-47	320BE2	Bumper roller for chain of 7300 Door Operator, Polyurethane, 3/8" I.D.
ODO-12B	442AL1	Piston for 7300A Operator
ODO-12C	288LK1	Arm lever for 7300A Door Operator
ODO-1A	177AR1	Micro Switch for safe edge
ODO-4	125028	Aircord hitch
OW-200B	395E4	Lever Arm , 14.25
OW-200D	477EA1	Stop , 1-1/2 in. (38 mm) long 1/2-13 thread

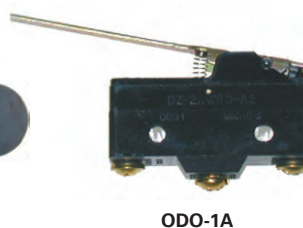
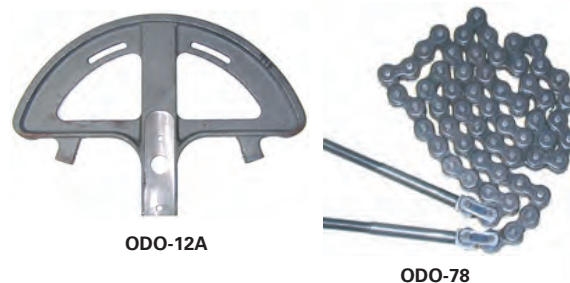

Drive Assembly



OTPC-001

S.E.E.S. #	O.E.M.#	Description
OTPC-001	AA21255J15	Drive, E335 AAA21255J15
OTPC-002	AA21255J16	Drive, E335 AAA21255J16
OTPC-003	AAA24350AE1	Drive Asembly, Door Operator
OTPC-004	ACA26800ABB001	MCSS I/O Board
OTPC-005	GHA21270A3	PCB RCB II
OTPC-006	AAA616HK1	Eprom, V-16/V-17 (AAA616LX3)
OTPC-007	AAA616KM2	Eprom, V-20/V-21
OTPC-009	LA4652691-0041	DBSS Board
OTPC-010	AAA26800QMI	CPU
OTPC-011	AAA26800AJV1	MLB III PCB
OTPC-012	AAA26800XH1	PCB, Motion Log
OTPC-013	LA46S02692-0031	PCB, Power Supply
OTPC-014	L46S02945-0012	BRL Control
OTPC-015	ABA26800AJV1	MLB III PCB
OTPC-016	LA46S03013-0020	PCB, Snubber
OTPC-017	AAA21255J14	Drive E335, AAA21255J14
OTPC-018	ADA21290AK2	Drive OVF, ADA21290AK2
OTPC-019	ABA26800KK4	PCB, ADISS Board with Loadweighing Device
OTPC-020	ACA26800XH1	PCB, Motion Logic Board (MLB III)
OTPC-021	AAA26800AMS	PC Board Assembly
OTPC-022	A8200BE1	PC Board, Gong
OTPC-023	ADA26800HS1	PC Board, Video Received
OTPC-024	C8121AX1	PC Board, LRVM Relay



OTPC-002



OTPC-003



OTPC-004



OTPC-006



OTPC-007

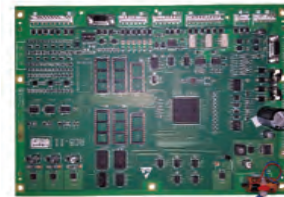

OTPC-005



OTPC-017



OTPC-018



OTPC-019



New features

Loaded is the new standard! Check out all these features that come with every SEES residential elevator package.

- ★ LED cab lighting
- ★ SEEScreen Electronic Door Detector
- ★ Dimmer for adjusting light intensity
- ★ Built-in emergency battery backup (illuminates 2 lights)
- ★ Hoistway door, in place of bulky space-savers / door baffles
- ★ Optional on/off switch. Also used as under-cab device to meet code.

Fully
LOADED

SHE comes Equipped LOOK!

The SEEScreen's 94 infrared beams act as an invisible safety curtain across the door entrance. When an obstacle breaks the screen, the sensors detect it and immediately stop the elevator to avoid any accidents.



Made in the USA

S.H.E. is constructed from the finest materials at the SEES Modernization Center in Fort Lauderdale.



Dimmable

SHE cab lights are dimmable so that you can adjust for your desired brightness.

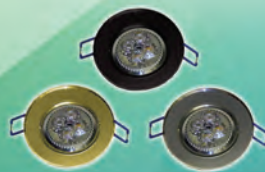

Cab Lights Included

Every elevator comes with four LED lights in the color of your choosing



Back-up power

SHE lights are connected to a backup battery serving as an emergency light.

All the bells and whistles



A : 2781 W. McNab Rd.
Pompano Beach, FL 33069
P : +954.971.1115, +800.526.0026
E : info@seesinc.com



ODO-67

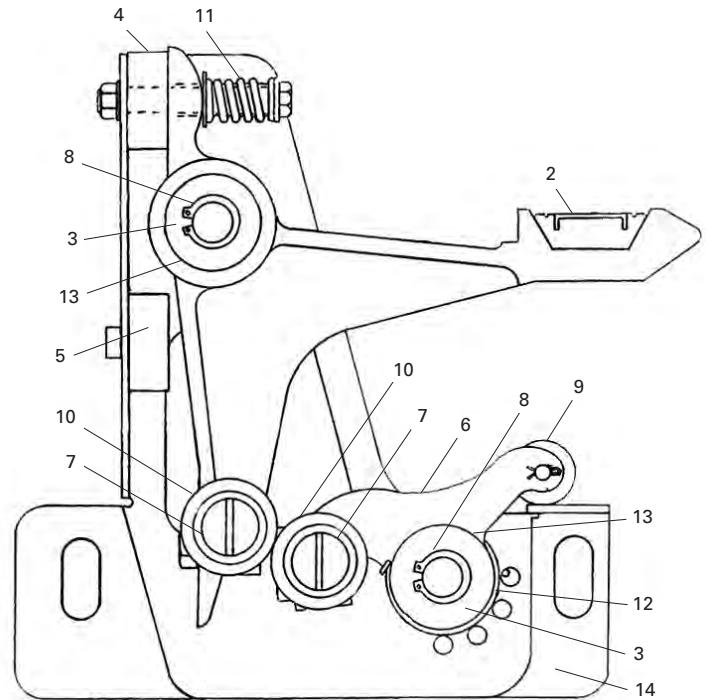

6940A Door Lock

Fig.	S.E.E.S. #	O.E.M.#	Description
1	ODO-67	B6940C2	Door lock assembly, L.H. (shown above)
	ODO-68	B6940C1	Door lock assembly, R.H.
2	ODO-30	306FM1	Contact base for 6940A Door Lock
3	ODO-63	209E1, 172DE11	Roller bearing
4	ODO-18	320AY1	Bumper , Polyurethane, 15/16" W, 1-1/2" L, 5/8" thick
5	ODO-16	320P4	Bumper , Polyurethane, 1-1/2" D, 1-7/16" L
6	ODO-59	307AE1	Lever , bell crank, R.H.
	ODO-60	307AE2, AE4	Lever , bell crank, L.H.
7	ODO-9	77A1	Eccentric pin , 2-1/2"
	ODO-10	77A2	Eccentric pin , 2-7/32"
	ODO-11	77A3	Eccentric pin , 2-11/32"
	ODO-12	77A4	Eccentric pin , 2-19/32"
8	ODO-64	172DE9	Retaining ring , 5/8" (circlip)
9	ODO-17	456BT1	Roller , 1" D x 7/16" W
10	ODO-5	456C1	Skate roller , 1-5/8" L
	ODO-6	456C2	Skate roller , 1-5/32" L
	ODO-7	456C3	Skate roller , 1-9/32" L
	ODO-8	456C4	Skate roller , 1-1/2" L
11	ODO-52	90HB9	Spring , Compression
12	ODO-50	92AG1	Torsion spring , 1-25/32" I.D., R.H. (shown)
	ODO-53	A92AG1	Torsion spring , 1-15/16" I.D., R.H. (shown)
	ODO-51	92AG2	Torsion spring , 1-25/32" I.D., L.H.
	ODO-54	A92AG2	Torsion spring , 1-15/16" I.D., L.H.
13	ODO-65	127VB83	Washer , 1-1/2" O.D., 41/64" I.D., 3/64" thick
14	ODO-67A	A316CBA4, 316BJC2	Base , Door lock base, L.H.
	ODO-67B	127L4	Shim , Roller shim for 6940A R
	ODO-67C	127L5	Shim , Roller shim for 6940A R
	ODO-68A	A316CBA3, 316BJC1	Base , Door lock base, R.H.



ODO-30



ODO-68A

Door Parts and Equipment

6940A Door Lock

S.E.E.S. #	O.E.M.#	Description
ODO-5	456C1	Skate roller 1-5/8" L, Rubber
ODO-5-P	456C1P	Skate roller 1-5/8" L, Polyurethane
ODO-6	456C2	Skate roller 1-5/32" L, Rubber
ODO-6-P	456C2P	Skate roller 1-5/32" L, Polyurethane
ODO-7	456C3	Skate roller 1-9/32" L, Rubber
ODO-7-P	456C3P	Skate roller 1-9/32" L, Polyurethane
ODO-8	456C4	Skate roller 1-1/2" L, Rubber
ODO-8-P	456C4P	Skate roller 1-1/2" L, Polyurethane
ODO-9	77A1	Eccentric pin 2-1/2"
ODO-10	77A2	Eccentric pin 2-7/32"
ODO-11	77A3	Eccentric pin 2-11/32"
ODO-12	77A4	Eccentric pin 2-19/32"
ODO-16	320P4	Bumper, polyurethane
ODO-18	320AY1	Bumper, polyurethane, for type 6940A

■ Eccentric pins compatible with Skate Rollers shown (poly or rubber rollers)



S.E.E.S. #	O.E.M.#	Description
ODO-69	B9940G2	Door Lock Assembly, R.H., 3 Roller
ODO-69A	B9940G4	Door Lock Assembly, L.H., 3 Roller
ODO-69B		Roller, Replacement for ODO-69 Polyurethane
ODO-69C		Shaft, Replacement for ODO-69 with Screw

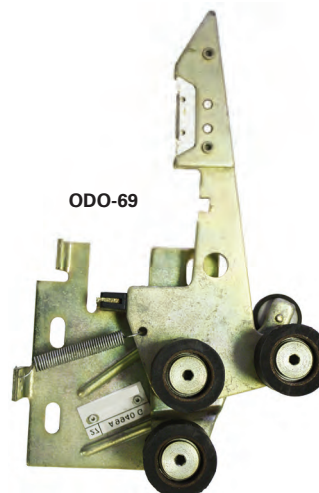

ODO-240

S.E.E.S. #	O.E.M.#	Description
ODO-240	ABA6940CD1	Door Restrictor, cam
ODO-240A	ABA283ANE1	Door Restrictor, flag
ODO-240B	ABA283ANE6	Door Restrictor, flag

S.E.E.S. #	O.E.M.#	Description
OTDV-3		Door Vane
ODO-20		Bumper, 1" dia. x 5/8", stem 11/16" dia. x 9/16"
ODO-20A		Bumper, 1" dia. x 3/4", stem 11/16" dia. x 5/8"
ODO-20B		Bumper, 1.25" dia, 1" L, .55" stem
ODO-17	456BT1	Roller, 1" dia. x 7/16"W for 6940A
ODO-17A	78C2	Shaft for ODO-17 roller
ODO-30	306FM1	Contact base for 6940A Door Lock

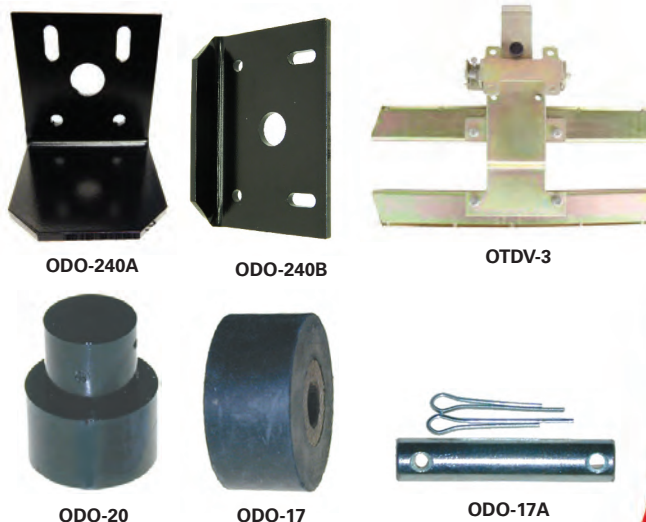

Door Parts and Equipment



ODO-50



ODO-52



ODO-53



ODO-59



ODO-62



ODO-63



ODO-64

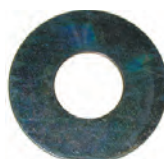

ODO-65



ODO-66



ODO-203



ODO-205



ODO-206



ODO-210



ODO-207



ODO-209



ODO-211



ODO-212



OTLO-2K



OTLO-5



OTLO-6

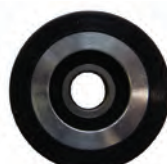

OTLO-9



OTLO-10



OTLO-11

S.E.E.S. #	O.E.M.#	Description
ODO-50	92AG1	Spring, R.H., 1- 25/32" I.D.
ODO-51	92AG2	Spring, L.H., 1-25/32" I.D.
ODO-52	90HB9	Compression spring
ODO-53	A92AG1	Torsion spring R.H.
ODO-54	A92AG2	Torsion spring L.H. For 6940A Door Lock
ODO-59	307AE1	Lever, bell crank R.H. (shown)
ODO-60	307AE2	Lever, bell crank L.H. For 6940A Door Operator
ODO-62	0-801B2	Sleeve for roller bearing
ODO-63	209E1	Roller bearing
ODO-64	172DE9	Retaining ring, 5/8" (c clip)
ODO-65	127VB83	Washer, 1-1/2" O.D., 41/64" I.D., 3/64"
ODO-66	353Y1	Rubber coupler for "O" operator

S.E.E.S. #	O.E.M.#	Description
ODO-202	AAA288AAZ2	Pivot Arm
ODO-203	307AT2	Lever, with Bearing (without Roller and Pin)
ODO-204	77MF1	Pin
ODO-205	77YK1	Pin
ODO-206	CAA340A5	Collar
ODO-207	78FA41	Pin
ODO-209	A96AJ1	Stud
ODO-210	477FK1	Stop Roller, compare with GDO-35A
ODO-211	321W1	Bushing
ODO-212	AAA494LW2	Shaft, for roller

S.E.E.S. #	O.E.M.#	Description
OTLO-1	XAA431Z1	Electric Switch Lock
OTLO-2	XAAA431AB2	Lock, Triangle, left/right
OTLO-2K	XAA431AB1	Key, Triangle
OTLO-3		Key, Landing
OTLO-4	XAA177CR1	Door Lock, Passive
OTLO-5		Door Lock, Side Contact, PB123
OTLO-6		Mandril, for Door Lock
OTLO-7	XAA431R1	Door Lock, 161
OTLO-9		Roller, for Door Lock 52mm O.D. x 20mm W, bearing 6201 ID:12mm
OTLO-10		Wheel, for Door Lock GS09, 37mm O.D. x 20mm W, ID:12mm
OTLO-11		Lock Box
OTLO-13		Door Lock Contact for Otis Elevator
OTLO-15		Door Lock Contact



OTLO-15

Door Parts and Equipment



ODO-6940RBK-003



ODO-6940RBK-001

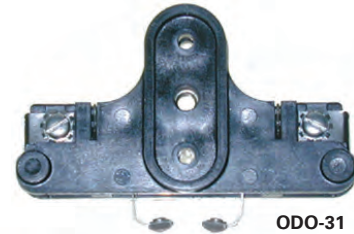

ODO-31



ODO-32

6940AG Interlock Switch

S.E.E.S. #	O.E.M.#	Description
ODO-6940RBK-001	B6940C503	Otis Interlock Rebuild Kit, Full Service 1962-1991, 97-Up
ODO-6940RBK-002	B6940C500	Otis Interlock Rebuild Kit, Min Rebuild for Post 196
ODO-6940RBK-003	B6940C504	Otis Interlock Rebuild Kit, Full Rebuild 92-96, with Red Cont
ODO-6940RBK-004	B6940C502	Otis Interlock Rebuild Kit, Full Service, Vintage Pre-1962
ODO-31	6940AF1	Interlock Switch, complete assembly for Type 6940AG
ODO-31-BRKT		Interlock Switch Bracket, for ODO-35 Replacement Kit
ODO-31A	AA7710202E3	Interlock Switch, 1992-1996 Red Colored Base, OVL Lock Only
ODO-31B	AA7710202E4	Interlock Switch, 1992-1996 Red Colored Base, Type 6940 Lock
ODO-31C	AAA6940BP1	Interlock Switch, For Original Phenolic base with 4 Mov. Cont
ODO-32	306JJ1	Base, molded plastic for interlock switch, two required
ODO-33	152BE2	Contact, R.H. replacement for switch
ODO-34	152BE4	Contact, L.H. replacement for switch
ODO-57	6940AG1	Switch and housing R.H., complete assembly includes ODO-31, 32, 33
ODO-58	6940AG2	Switch and housing L.H., complete assembly includes ODO-31, 32, 34
ODO-84	339FH1	Switch Clip for ODO-31



ODO-34

ODO-33

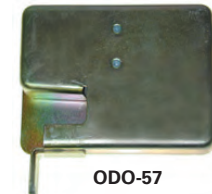

ODO-57



ODO-84

6940B Interlock Switch

S.E.E.S. #	O.E.M.#	Description
ODO-35	6940BCH49800	Interlock switch, for 6940B interlock assembly
ODO-35-KIT	6940BCH49800/ 6940BP1	Interlock replacement switch, ODO-31 and Bracket
ODO-35C	6940B3	Interlock assembly, R.H., switch and steel cover
ODO-35D	6940B4	Interlock assembly, L.H., switch and steel cover
ODO-35E	90LA3	Spring, 1" L x .281" I.D.
ODO-35G		Screw, for ODO-35
ODO-36	306FX1	Base for contacts
ODO-37	152AV2	Movable contact for interlock switch
ODO-38	152AW2	Stationary contact for interlock switch



ODO-35



ODO-35D



ODO-36



ODO-37



ODO-38

Door Parts and Equipment



OHE-9

OHE-12

OHE-15

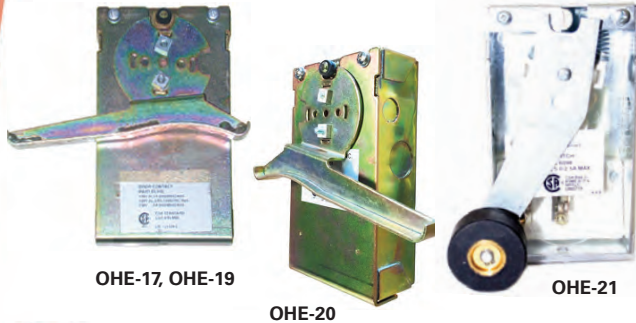

OHE-17, OHE-19

OHE-20

OHE-21



ODO-39

ODO-39A

ODO-40

ODO-41

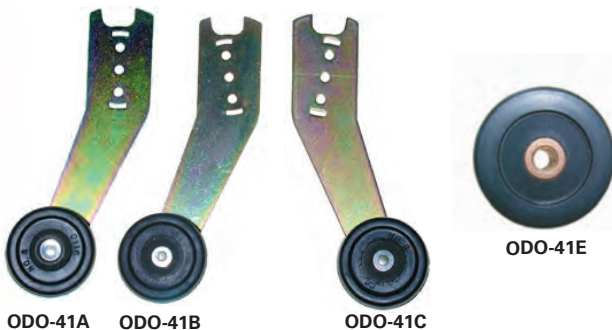

ODO-41A

ODO-41B

ODO-41C

ODO-41E

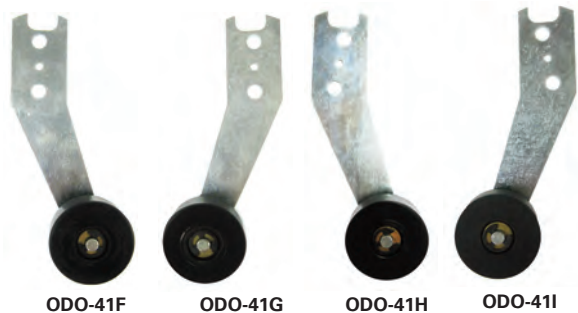

ODO-41F

ODO-41G

ODO-41H

ODO-41I

6098 Switches

S.E.E.S. #	O.E.M.#	Description
OHE-9	A6098A1	Floor Stop Switch, SPDT with arm A287E2
OHE-10	A6098A3	Floor Stop Switch, DPST, LH make, with arm A287E2, maintains
OHE-11	A6098A4	Floor Stop Switch, DPST, RH make, with arm A287E2
OHE-12	A6098B1	Limit Switch, SPM with arm ODO-41B (287F4)
OHE-13	A6098B3	Limit Switch, SPB with arm ODO-41A (287F2)
OHE-13A	A6098B11	Limit Switch, SPB with arm ODO-40 (287F6)
OHE-14	A6098B5	Limit Switch, DPM with arm ODO-41B (287F4)
OHE-14A	A6098B15	Limit Switch, DPM with arm ODO-41C (287F8)
OHE-15	6098D1	Tripper Switch, SPB, hand as shown
OHE-16	6098D3	Tripper Switch, SPB, hand opposite
OHE-17	6098E1	Gate Switch, SPM, hand as shown
OHE-18	6098E2	Gate Switch, SPM, hand opposite
OHE-19	6098E5	Gate Switch, DPM, hand as shown
OHE-20	6098E6	Gate Switch, DPM, hand opposite
OHE-21		Limit Switch, DPB 6098 with 287F2 arm & roller
ODO-39	A287E2	Arm with roller, straight long arm, 5-1/4" (shown on OHE-9)
ODO-39A		Arm with roller, 5-1/4" New 3 hole style, straight, with 10 degree offset holes
ODO-40	287F6	Arm with roller, 5-1/4", R.H.
ODO-41	287BA4	Arm with roller, short arm, 3" (shown on OHE-12)
ODO-41A	287F2	Arm with roller, 5-1/4", L.H.
ODO-41B	287F4	Arm with roller, 5-1/4", L.H., mounting holes 10 degrees off center
ODO-41C	287F8	Arm with roller, 5-1/4", R.H., mounting holes 10 degrees off center
ODO-41D	456BY1	Limit Switch Roller, 1-5/8" diameter with nylon bushing, 1/4" I.D.
ODO-41E	456AA2	Floor Switch Roller, 1-1/4" diameter with bushing, 3/8" I.D.s
ODO-41F		Arm with roller, 5-1/4" RH New 3 hole style, straight
ODO-41G		Arm with roller, 5-1/4" LH New 3 hole style, straight
ODO-41H		Arm with roller, 5-1/4" RH New 3 hole style, 10 degree offset
ODO-41I		Arm with roller, 5-1/4" LH New 3 hole style, 10 degree offset

Door Parts and Equipment



Keys

S.E.E.S. #	O.E.M.#	Description
ODO-45	194AD2	Lunar key 10-1/2" Emergency Hoistway
ODO-46	194AD7	Key, Double drop door key
ODO-46A	194AD3	Door Key, Single drop
ODO-46B	194AD6	Key, Close couple key
MIS-210	320CX1	Bumper, rubber collar for keys
ODO-46-P	AAA194AZ1	Door Key, Double drop with plastic safety handle
ODO-46A-P	AAA194AZ6	Key, Triple Drop, with Plastic Handle and flexible safety shaft

Escutcheons

S.E.E.S. #	O.E.M.#	Description
ODO-73	ES27SS	Escutcheon, Door Key Hole, 2.75" L x 0.5" dia., Lip=0.625" dia, stainless steel
ODO-73A	ES27YB	Escutcheon, Door Key Hole, 2.75" L x 0.5" dia., Lip=0.625" dia, Brass
ODO-73B	386TZ13	Escutcheon, lunar key
ODO-73C		Escutcheon, lunar key, brass finish, 1.580" L
ODO-73D	ES27AL	Escutcheon, Door Key Hole, 2.75" L x 0.5" dia., Lip=0.625" dia, Aluminum
ODO-73E	ES20SS	Escutcheon, Door Key Hole, 2.0" L x 0.5" dia., Lip=0.625" dia, Stainless Steel
ODO-73F	ES20YB	Escutcheon, Door Key Hole, 2.0" L x 0.5" dia., Lip=0.625" dia, Brass
ODO-73G	ES20AL	Escutcheon, Door Key Hole, 2.0" L x 0.5" dia., Lip=0.625" dia, Aluminum
ODO-73H	ES15SS	Escutcheon, Door Key Hole, 1.5" L x 0.5" dia., Lip=0.625" dia, Stainless Steel
ODO-73I	ES15YB	Escutcheon, Door Key Hole, 1.5" L x 0.5" dia., Lip=0.625" dia, Brass
ODO-73J	ES15AL	Escutcheon, Door Key Hole, 1.5" L x 0.5" dia., Lip=0.625" dia, Aluminum
ODO-73K		Escutcheon, Door Sleeve, SS 1.75" L x .50" dia x .625" Lip
ODO-73L		Escutcheon, Door Sleeve, Brass 1.75" L x .50" dia x .625" Lip
ODO-73M		Escutcheon, Door Sleeve, Alum 1.75" L x .50" dia x .625" Lip
ODO-73N		Escutcheon, Door Sleeve, Alum 3.25" L x .50" Dia x .625" Lip
ODO-73O		Escutcheon, Door Sleeve, Brass 4.0" L x .50" dia x .625" Lip
ODO-73P		Escutcheon, Door Sleeve, Alum 2.50" L x .50" Dia x .625" Lip
ODO-73R		Escutcheon, Door Sleeve, Brass 3.25" L x .50" Dia x .625" Lip
ODO-73S		Escutcheon, Door Sleeve, SS 5.00" L x .50" Dia x .625" Lip
ODO-73-SP-NUT		Escutcheon Speed Nut, 1/2" for ODO-73 series
ODO-201	CAA340A1	Collar, for Escutcheon
MIS-144		Escutcheon, Hall door key hole, 1-3/4" L for 3/8" dia. keys, 27/64" I.D., 15/16" O.D., 1-1/4" length threaded
MIS-144B		Escutcheon, Hall door key hole, 1-3/8" L, 7/16" I.D., 3/4" O.D.
MIS-189V		Plug Lock, door escutcheon with SEES#5 key

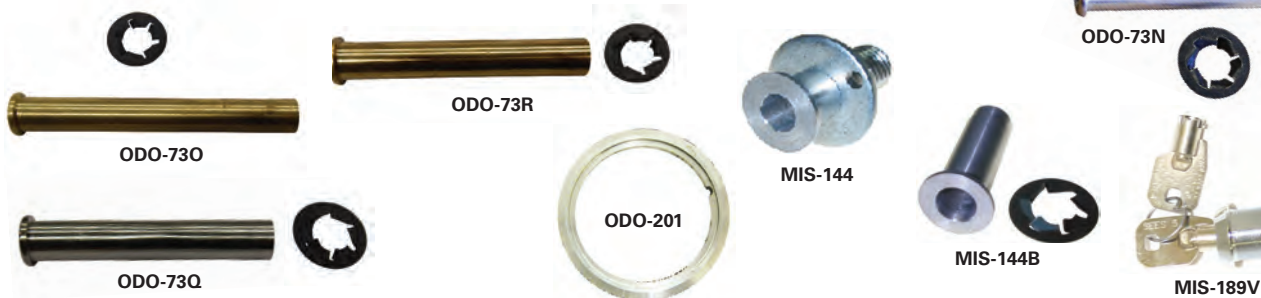

OTIS



ODO-200A

S.E.E.S. #	O.E.M.#	Description
ODO-200	AAA483WW11	Track , for Hoistway Door
ODO-200A	AAA483XC40	Track , for Hoistway Door
ODO-76	443J4	Key box glass , 11-3/8" x 1-5/8" x 1/16" replacement glass for Emergency Key Box
ODO-3	288LV1	Lever , hoistway door
ODO-3A	AAA288ZU2	Door Arm Lever , Kit Lever, Collar, hardware
ODO-3B	0826K1, 288LS1	Emergency Kit , Lever, Escutcheon & push nut
ODO-3C		Unlocking Kit , Tall Door Up to 108" Entrance Door Height
ODO-25	A332AS2	Chain with hitch and link for 6940D spring door closer, 11-1/4" L
ODO-26	A332AS3	Chain with hitch and link for 6940D spring door closer, 14-1/4" L
ODO-81	265BD3	Sheave and guard for relating cable
ODO-81A	B316CCB2	Sheave and bracket assembly
ODO-81B	AAA316FHG6	Sheave & Bracket Assembly , LH
ODO-81C	AAA316FHG5	Sheave & Bracket Assembly , RH
ODO-82	YYL0174HH1	Cable , 12 ft., door detector
ODO-83	YYL0174HH2	Cable , 20 ft., door detector
ODO-74	299ADP2	Spirator bracket
ODO-74A	316DER2	Spirator bracket with offset
MIS-124	6940AR1	Spirator , reel closer, 5" with combo hub
MIS-124-ST		Spirator , 6" SmarTork door closer up to 20% more tension
MIS-124E-20PAC		Spirator , 5" Heavy Duty with Combo Hub, Pack of 20



ODO-76

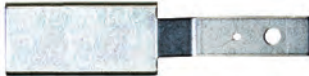

ODO-3



ODO-3A



ODO-25, ODO-26



ODO-81



ODO-81A



ODO-74

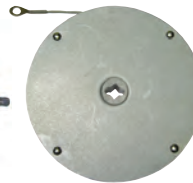

MIS-124



MIS-124-ST



MIS-197A



ODO-19A



ODO-70



ODO-71



ODO-71A



ODO-71A



ODO-71B



ODO-71D



ODO-71E



ODO-72



ODO-77

Door Gibs

S.E.E.S. #	O.E.M.#	Description
MIS-197A	AAA6098NS1	Emergency Ceiling Exit , TOC Emergency contact kit
ODO-19A	6168F5	Air Check Valve , new type
ODO-70	2220D16	Door Gib , 8" assembly complete
ODO-71	2213R1	Door Gib , 6-1/4" assembly complete
ODO-71A	251BJ1	Gib Insert , 3", for ODO-70 and ODO-71
ODO-71B		Hardware kit , for ODO-71A used on gib assembly
ODO-71D	456DD1	Gib Roller
ODO-71E		Gib Roller Replacement for ODO-71D
ODO-72	VP869750	Gib , 1/2" offset nylon door guide
ODO-77	237AR2	Door guide , 4-1/2" L, for vertical gates
ODO-77A	237AR1	Door guide , 8" OAL, Bronze



ODO-79



ODO-79A



ODO-79B



ODO-79D



ODO-79E



WDO-59

Door Gibs & Guide Shoes

S.E.E.S. #	O.E.M.#	Description
ODO-79	380BS2	Guide shoe insert, LRV 6-3/4"
ODO-79A	380BV2	Guide shoe insert, 6", LRV
ODO-79B	380AHI	Gib, 15# Rail, Nylon, 1-7/8" x Slot 8-1/2" L x 1-11/16" W x 2-3
ODO-79D	380CE1	Insert, Slide Guide 6 Knob Folding Type
ODO-79E	339LG1	Gib Clip, for ODO-79A, 2 clips required
WDO-59	237GAN	Gib insert for ODO-72 assembly, 4" L
WDO-59G	691B971G05	Solid Gib Bracket, 1/8" Offset, 3-1/2" Lg w/ Gib Insert & hwd
WDO-59H		Gib Assembly, 5/8" Offset x 4" W 1-1/2" Deep, with Gib
OTDS-2		Door Gib, 80/50mm x 35mm x 12mm, Canvas
OTDS-3		Door Gib, 80/50mm x 35mm x 12mm, Plastic
OTDS-4		Door Gib, 76mm x 16mm x 13mm
OTDS-5		Door Gib, 70mm x 12mm
OTDS-7		Door Gib, Slider
OTDS-7A		Door Gib, Bracket Only
OTGS-6		Cushion, for Guide Shoe Insert
OTGS-15		Roller, For Roller Guide Assy 160mm x 30mm 6203 Brg ID 17
OTGS-20		Guide Shoe Insert, Set of 3 200mm x 25mm x 6mm
OTGS-21		Guide Shoe Insert, Set of 3 200mm x 30mm x 6mm
OTGS-22		Guide Shoe Insert, Set of 3 (1) 215mm x 42mm x 4mm, (2) 203mm x 47mm
OTGS-26		Guide Shoe Insert
OTGS-28		Guide Shoe Insert
OTGS-31		Guide Shoe Insert
OTGS-33-16		Guide Shoe Insert, 100X30X28 16mm
OTGS-38		Guide Shoe Insert for Otis Elevator
OTDC-1		Door Control Box, Otis
ORG-001	380BS2	Insert, Otis 3" round tube rail gib



OTDS-2



OTDS-3



OTDS-4



OTDS-5



OTDS-7



OTDS-7A

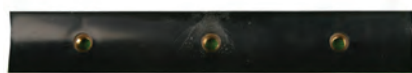

ORG-001



OTGS-22



OTDC-1

Door Parts and Equipment

S.E.E.S. #	O.E.M.#	Description
ODO-27	195FK1	Sprocket for 7300A Operator, 10 teeth, 1/2" pitch, 1.839" O.D., 5/8 bore for 40ASA roller chain
ODO-27A	195CP2	Sprocket for 30S Operator, 9 teeth, 1-1/4" O.D. x 3/4" wide, 3/8" I.D.
ODO-27B	195GK2	Sprocket , .626 I.D. with 10 teeth
ODO-28	125021	Bearing and seal kit for 6970A Door Operator
ODO-28A	E6970A500	Rebuild Kit , 6970A Door Operator complete kit
ODO-28B	E6970A501	Rebuild Kit , 6970A Door Operator seals and gaskets only
ODO-29	125022	Bearing and seal kit for 7300A Door Operator
ODO-42	132037	Base for "L" and "LA" door lock contact (mounted with ODO-43 or ODO-44)
ODO-43	147976	Contact holder for "L" door lock
ODO-44	156144	Contact holder for "LA" door lock
ODO-48	A306EB2	Interlock switch base with formed leaf spring contact, two required, used on N.O. and N.C. style interlocks
ODO-49	327DJ2C	Cam and clamp assembly for power door operator switches and 6850 selector
ODO-55	6554B1	Mechanical switch , "make" for 6970A door operator
ODO-56	6554B2	Mechanical switch , "break" for 6970A door operator
ODO-61	A325P1	Polyurethane cup for M.L. A6940AD1 to AD3 Door Closer
ODO-66	353Y1	Rubber coupler , O operator



ODO-27



ODO-27A



ODO-28



ODO-29



ODO-28B



ODO-43



ODO-48



ODO-42



ODO-44



ODO-49

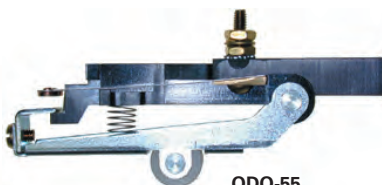

ODO-55



ODO-56



ODO-61



ODO-66

Door Parts and Equipment

Door Motors

S.E.E.S. #	O.E.M.#	Description
ODO-75	6333AJ1	Door motor, 115-230VDC, 1/2 HP, 1/2" shaft, 1/8" key
ODO-75A	6333BX1	Door motor, 220V, 60 cycle, 90 RPM
ODO-75B	6333AM1	Door motor, 32 oz/ft, 220V, 3 phase 900RPM
ODO-75C	6333CC2	Door motor/Gear assembly, 90 VDC, 69 RPM, 190 in./lb. torque
ODO-75C-A		Brush Cap for ODO-75C
ODO-75D	6333CC1	Door Motor, 90v, 100-110 RPM, 190 in./lb. torque
ODO-75E	6333DP1	Door Motor, 1140RPM, 1/6 HP with 1/2" conduit 36" lead
WCB-142		Carbon Brush, for WDO-61
ODO-80	74358	Chain hitch assembly, O operator
ODO-86	209A1	Bearing and bushing set for 6585A1 chain idler
OCB-42	240BA1	Carbon Brush, 1/2" thick., x 1/4" W x 3/4" L 6333CC1 (ODO-75D), 6333CC2 (ODO-75C)
OBLT-01	AAA717J2, 717B1	Belt, Otis Door Operator Belt
OTLO-13		Door Lock Contact For Otis Elevator

Encoders

S.E.E.S. #	O.E.M.#	Description
OTCOD-1A	AAA633L1	Encoder
OTCOD-1B	JAA00633ABF003	Encoder
OTCOD-1C	AAA659C4	Encoder
OTCOD-1D	AAA659C3	Encoder
OTCOD-3		Rotary Encoder, D02 #00 Operator - FAA633B1
OTCOD-4		Rotary Encoder, Otis-LG

Encoders

S.E.E.S. #	O.E.M.#	Description
OTCOD-6	H100-40-1024UL	Encoder, Otis-LG



Door Parts and Equipment



ODO-13



ODO-14



ODO-15



ODO-15A



ODO-15B



ODO-15C



Fig. 1



Fig. 2

Upthrust Rollers

S.E.E.S. #	O.E.M.#	Description
ODO-13	456CP1	Upthrust roller, 1-3/8" diameter x 1/2" (Spacing 1/2")
ODO-14	456CP2	Upthrust roller, 1-3/8" diameter x 1/2" (Spacing 3/8")
ODO-15	207Z4	Upthrust roller, 1-3/8" diameter x 7/16" (Spacing 1/8")
ODO-15A	456Z1	Upthrust roller, 3/4" diameter x 7/16" (Spacing 1/8")
ODO-15B	456Z1	Upthrust roller, 3/4" diameter x 7/16" (Spacing 1/8")
ODO-15C	207Z23	Otis Car Bearing
ODO-15D	J619000B204	Upthrust roller, 35mm OD x 11mm, 11mm Spcr, M12 Thrd

Springs

Fig. #	S.E.E.S. #	O.E.M.#	Spring Dia.	Overall Length	Coils	Wire Dia.
1	ODO-24A	91W1	2-19/32"	14-5/8"	30	.331"
1	ODO-24C	91W2	1-3/8"	10-3/4"	64	.125"
1	ODO-23	91W5	1-3/8"	11-3/4"	60	.148"
1	ODO-24	91AE1	1-1/2"	12-1/16"	51	.187"
2	ODO-24B	91T1	2-1/8"	10-3/4"	28	.250"
2	ODO-22C	91T4	1-27/32"	6-3/16"	12	.225"
2	ODO-22D	91T5	1-7/8"	7-1/4"	16	.250"
2	ODO-22E	91T7	1-7/8"	7"	14	.250"
2	ODO-22	91T9	1-11/16"	6-3/4"	18	.187"
2	ODO-22B	91T11	2-7/16"	8"	16-1/2	.312"
2	ODO-22F	91T12	2-9/32"	7-9/16"	17	.281"

Connectors



OSS-1A



OBS-1 thru OBS-8



OL-5



OL-2

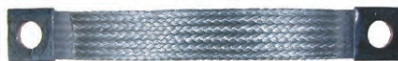

OL-8



OL-6

OL-7

Silicone Shunts

S.E.E.S. #	O.E.M.#	Length	Hole I.D.
OSS-1A	175J88	3-3/4"	.193"
OSS-2A	175J89	4-3/4"	.193"
OSS-3A	175J90	5-3/4"	.193"
OSS-4A	175J122	7-5/8"	.193"

Braided Shunts

S.E.E.S. #	O.E.M.#	Shunt Length	Hole I.D.	Hole I.D.	Thick	Width
OBS-1	176AK1	6-3/4"	25/64"	25/64"	3/32"	3/4"
OBS-2	176KA4	7"	17/64"	25/64"	3/32"	1/2"
OBS-3	176KA6	8"	17/64"	25/64"	1/32"	3/4"
OBS-4	176KA8	9-3/4"	17/64"	17/64"	3/32"	3/4"
OBS-5	176KA13	6-3/8"	13/64"	17/64"	1/32"	1/2"
OBS-6	176KA14	6-3/8"	25/64"	17/64"	3/32"	1/2"
OBS-7	176KA3	13-1/2"	21/64"	21/64"	3/32"	3/4"
OBS-8	176KA10	7"	17/64"	17/64"	3/32"	1/2"

S.E.E.S. # O.E.M.# Description

OL-1	112926	Triple cable with 2 leads 13" L
OL-2	264	Cable, 10-1/4" L
OL-3	106594	Cable, 11" L, mounting holes c/c 10-1/4"
OL-5	104148	Double cable, 22-1/2" L
OL-5A	142741	Cable, 16" L
OL-6		Double cable
OL-7	263	Cable, 15-1/4" L
OL-8	175	Braided connector, 8-1/2" L x 1" W
OL-9	118	Braided connector, 4-1/2" L x 1/2" W
OL-10	175H1	Braided connector, 8-1/4" L

Detector Shields

Shape 50ADD female

S.E.E.S.#	O.E.M.#	Description
ODS-4	147EW1, 147FC1, 147EW2, 147FC2	Shield, door faceplate, 69" L, Shield, L.H./R.H. door faceplate, 69" L

Shape 50ADC male

S.E.E.S.#	O.E.M.#	Description
ODS-5	147EY1, 147FB1	Shield, Car door faceplate, 68-3/4" L 15-1/4" L

Shape A50DD female

S.E.E.S.#	O.E.M.#	Description
ODS-2	147CX3	Shield, 84"
ODS-1	278BG2	Shield, 84", Sight Guard, 2-1/2" at door face, 2-1/8" protrusion ribbed face, 3/4" finish leg

Shape A50ADC male

S.E.E.S.#	O.E.M.#	Description
ODS-7	A147EY1, A147FB1	Shield, door faceplate 69-1/8" L 14.88" L

Shape 50AFF male

S.E.E.S.#	O.E.M.#	Description
ODS-9	147JV1, 147JW1, B147JV3, B147JW3	Shield, Faceplate, 84" L, L.H./R.H.

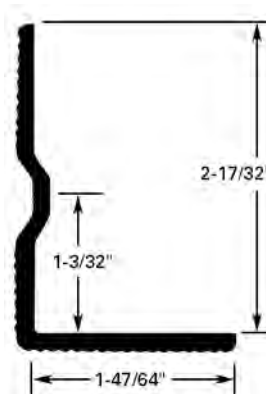

50ADD=ODS-4

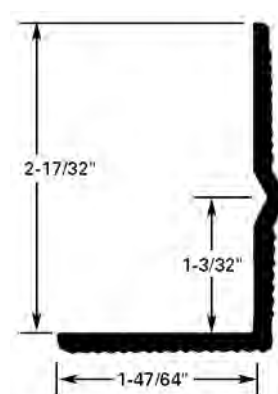

50ADC=ODS-5

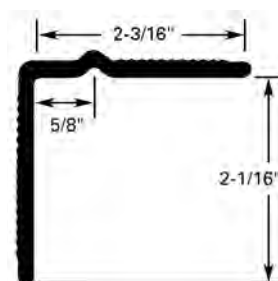

A50ADC=ODS-7

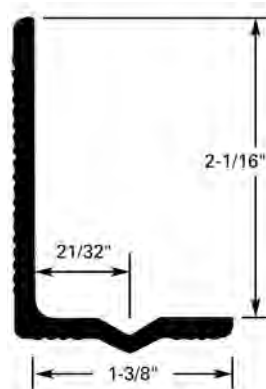

50AFF=ODS-9

■ Shields are furnished 84" in length and are not pre-drilled to enable the installer to match job requirements. Manufactured in impact resistant butyrate for durability.

Printed Circuit Boards and Electronic Components

OTIS



OPC-8

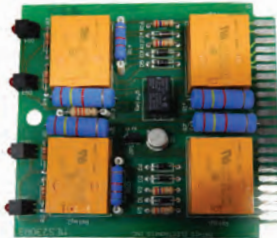

OPC-14



OPC-15

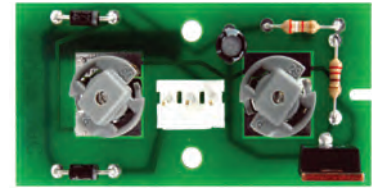

OPC-17

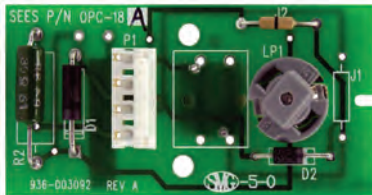

OPC-18

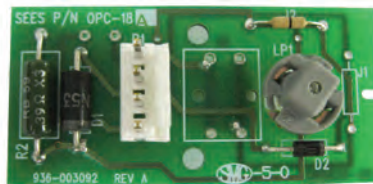

OPC-18A

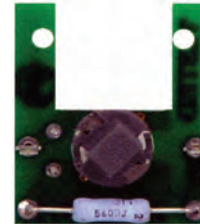

OPC-19

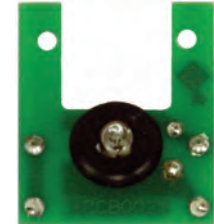

OPC-20



OPC-21

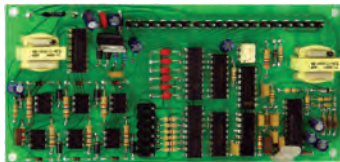

OPC-22

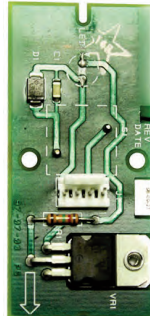

OPC-26



OPC-22A



OPC-30

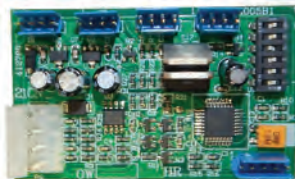

OTCOP-4



OTPCB-80



OTPCB-80A

S.E.E.S. #	O.E.M.#	Description
OPC-1	6840AY1	Timer, 65 and 73 Controller
OPC-3	7088B1	SCR's, resistors and diodes, 65 and 73 Controller
OPC-4	7088B2	SCR's, resistors and diodes, 65 and 73 Controller
OPC-5	7088C1	Neons, resistors and diodes, 65 and 73 Controller
OPC-6	7088AN1	SCR's, pots, transistors, diodes and neons
OPC-7	7088AM1	SCR's, pots and diodes, 65 and 73 Controller
OPC-8	7088AR1	Relays and neons, 65 and 73 Controller
OPC-9	6840BV1	Power Supply Board
OPC-11	7088AS1	Printed Circuit Board, relay interface
OPC-12	A8121D3	Relay driver - latching interface
OPC-13	A8121E3	Double gong
OPC-14	A8119AK1	Fire Service
OPC-15	A8121B1	Hall/Car Call Board (Terminal Floors)
OPC-16	A8121B2	Hall/Car Call Board (Intermediate Floors)
OPC-17	8200JA1	LRV3 Hall/Car P.I. Board
OPC-18	8200KA1	LRV3 Hall Button Board
OPC-18A	8200KA2	Board, car button
OPC-18B	8200KA3	Board, LED, hall
OPC-18E		PCB Connector, 4pin .156 female PCB Connector 18Ga MTA insulation displacment
OPC-19	8200AL1	Lighted button module
OPC-20	8200AL3	Lighted button module, neon
OPC-21	A8121BA1	LRV3 Power Supply
OPC-22	A8121AY1	LRV3 hall button interface
OPC-22A	E8121BE	Hall Button Interface For LRV IV
OPC-24	A8121AB1	Timer Board
OPC-25	A7048AK1	Pre-amp Board for PC Board
OPC-26	A26800TY1	Board, Otis Pushbutton
OPC-30	E8121DB1	PCB, LRV4 Micro Processor
OPC-31	F8121BC1	Micro Controller, F8121BC1
OTCOP-4	GCA25005B1	PCB, COP Address Board RS14
OTPCB-80	B9693C2	Pushbutton OCB, Otis B9693C2
OTPCB-80A	B9693C3	Pushbutton OCB, Otis B9693C3

Printed Circuit Boards and Electronic Components

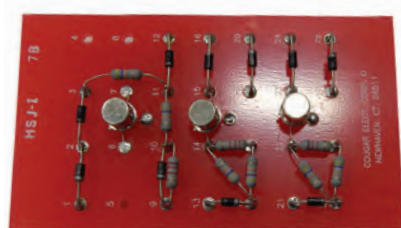

OTB-4



OTB-6



OTB-7



OT-1



OT-2



OT-3



OT-4



OTB-8

S.E.E.S. #	O.E.M.#	Description
OTB-1	XPR	PCB, for hall button
OTB-2	CSG	PCB, for CSG car button
OTB-3	HSJ	PCB, for HSJ hall button
OTB-4	HSG1	PCB, for HSG1 hall button
OTB-5	1A6843R12	PCB, call registry
OTB-6	16840E2	Thyratron board, socket and transistor (less tube)
OTB-7	16480E2SS	Solid State 2050 tube socket (less 607C1 switch)
OTB-8	607C1	Solid State SCR activated switch (replaces 2050 tube)
OT-1	425R1	Oscillator tube, Type 6080 used in 7048 power supplies
OT-2	6N010	Tube, Time delay relay, Thermostatic, octal base 8 pin
OT-2A	2N030	Time delay relay, Thermostatic, octal base 8 pin
OT-3	425G1	Tube, 5727 Cold cathode starter-anode type, octal base 6 pin
OT-4	425P1	Tube, 5751 octal base 8 pin
OT-8A	2040	Solid State Module to replace touch button tubes OT-5 thru OT-8, includes instructions for conversion to conventional button operation
OT-9	425C1	Electronic pickup tube, 2050 Thyatron, octal base 8 pin
OT-10	OA3	Electronic tube
OT-11	P425W1	Digital read-out tube (nixie tube)



OT-8A



OT-9



OT-11

OTIS

Capacitors



OCAP-1



OCAP-2



OCAP-3



OCAP-4, OCAP-5



OCAP-6, OCAP-7

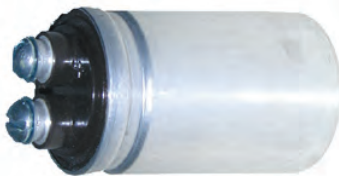

OCAP-8, OCAP-11



OCAP-9, OCAP-10



OCAP-12, OCAP-12A



OCAP-13

Capacitors

S.E.E.S. #	O.E.M.#	Description
OCAP-1	226W1	Capacitor, 1600MFD, 150VDC
OCAP-2	226W2	Capacitor, 1600MFD, 150VDC capacitor with OCAP-3 resistor on positive terminal
OCAP-14	226W3	Capacitor, 1600MFD, 200VDC
OCAP-3	232AE1	Resistor 250 ohm, used on capacitors
OCAP-4	226H1	Capacitor, 125MFD, 150VDC
OCAP-5	226H2	Capacitor, 250MFD, 150VDC
OCAP-6	226H3	Capacitor, 125MFD, 150VDC capacitor with OCAP-3 resistor on positive terminal
OCAP-7	226H4	Capacitor, 250MFD, 150VDC capacitor with OCAP-3 resistor on positive terminal
OCAP-8	226C1	Capacitor, 8MFD, 450VDC
OCAP-11	226H5	Capacitor, 5MFD, 400VDC
OCAP-9	226D1	Capacitor, 1MFD, 600VDC
OCAP-10	226D2	Capacitor, 2.5MFD, 600VDC
OCAP-12	226AN1	Capacitor, 5MFD, 200VAC-60HZ
OCAP-12A	226AN2	Capacitor, 5MFD, 200VAC capacitor with OCAP-3 resistor
OCAP-13	226H9	Capacitor, 250MFD, 200VDC
OCAP-1A		Mounting bracket for capacitors 2" diameter

Resistors



ORES-AA10 thru ORES-AA18



ORES-E121 thru ORES-E144

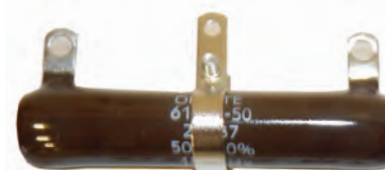

ORES-B1 thru ORES-B24

■ Metal bands not included

700 Watt Adjustable Resistor 10-1/8"

S.E.E.S. #	O.E.M.#	Resistance
ORES-AA10	232AA10	1.32 Ohms
ORES-AA11	232AA11	1.65 Ohms
ORES-AA12	232AA12	2.08 Ohms
ORES-AA13	232AA13	2.61 Ohms
ORES-AA14	232AA14	3.82 Ohms
ORES-AA15	232AA15	4.93 Ohms
ORES-AA16	232AA16	6.12 Ohms
ORES-AA17	232AA17	9.28 Ohms
ORES-AA18	232AA18	14.1 Ohms

65 Watt Adjustable Resistor 8"

S.E.E.S. #	O.E.M.#	Resistance
ORES-E121	232E121	10 Ohms
ORES-E122	232E122	15 Ohms
ORES-E123	232E123	20 Ohms
ORES-E124	232E124	25 Ohms
ORES-E125	232E125	30 Ohms
ORES-E126	232E126	40 Ohms
ORES-E127	232E127	50 Ohms
ORES-E128	232E128	75 Ohms
ORES-E129	232E129	100 Ohms
ORES-E130	232E130	125 Ohms
ORES-E131	232E131	150 Ohms
ORES-E132	232E132	175 Ohms
ORES-E133	232E133	200 Ohms
ORES-E134	232E134	250 Ohms
ORES-E135	232E135	300 Ohms
ORES-E136	232E136	350 Ohms
ORES-E137	232E137	400 Ohms
ORES-E138	232E138	500 Ohms
ORES-E139	232E139	600 Ohms
ORES-E140	232E140	750 Ohms
ORES-E141	232E141	1K Ohms
ORES-E142	232E142	1.5K Ohms
ORES-E143	232E143	2K Ohms
ORES-E144	232E144	2.5K Ohms

30 Watt Adjustable Resistor 3"

S.E.E.S. #	O.E.M.#	Resistance
ORES-B1	232B1	5 Ohms
ORES-B3	232B3	10 Ohms
ORES-B4	232B4	15 Ohms
ORES-B5	232B5	20 Ohms
ORES-B6	232B6	25 Ohms
ORES-B7	232B7	50 Ohms
ORES-B8	232B8	75 Ohms
ORES-B9	232B9	100 Ohms
ORES-B10	232B10	150 Ohms
ORES-B11	232B11	200 Ohms
ORES-B12	232B12	250 Ohms
ORES-B13	232B13	300 Ohms
ORES-B14	232B14	400 Ohms
ORES-B15	232B15	500 Ohms
ORES-B16	232B16	750 Ohms
ORES-B17	232B17	800 Ohms
ORES-B18	232B18	1K Ohms
ORES-B19	232B19	1.25K Ohms
ORES-B20	232B20	1.5K Ohms
ORES-B21	232B21	2K Ohms
ORES-B24	232B24	3K Ohms

Rectifiers



ORT-1



ORT-8



ORT-9



ORT-11

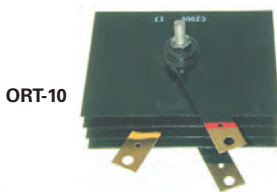

ORT-10

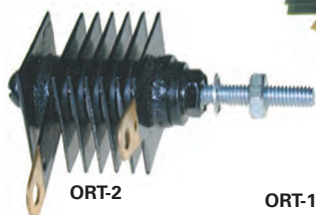

ORT-2

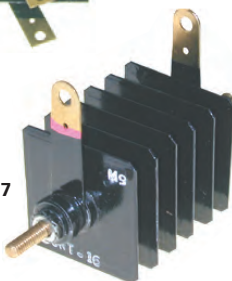

ORT-16, ORT-17

S.E.E.S. #	O.E.M.#	Input	Output	Watts	Description
ORT-1	230BA1	100VAC	130VDC	2000	3 phase, 30 plates, 4 x 5
ORT-4	230BJ4	100VAC	130VDC	1000	3 phase, 30 plates, 4 x 4
ORT-6	230BJ1	100VAC	130VDC	125	3 phase, 30 plates, 1.6 x 1.6
ORT-7	230BJ2	100VAC	130VDC	250	3 phase, 30 plates, 2 x 2
ORT-8	230BJ3	100VAC	130VDC	500	3 phase, 30 plates, 2 x 4
ORT-9	230AL2	105VAC	131VDC	25	3 phase, 30 plates, 1 x 1
ORT-10	230AV1	104VAC	44VDC	350	2 phase, 4 plates, 4 x 5
ORT-11	230AW1	130VAC	157VDC	85	3 phase, 30 plates, 1.3 x 1.3
ORT-12	230AY3	115VAC	93VDC	45	Single phase, 20 plates, 1.3 x 2
ORT-13	230AG1	156VAC	190VDC	250	3 phase, 36 plates, 2 x 4
ORT-14	230AL1	130VAC	157VDC	125	3 phase, 30 plates, 2 x 2
ORT-15	230AJ1	130VAC	157VDC	400	3 phase, 30 plates, 2.6 x 2.6

S.E.E.S. #	O.E.M.#	Description
ORT-2	230AR1, 230AR2, 230AR3	Rectifier , Single phase, 6 plates, 1" x 1"
ORT-16	230AZ1	Rectifier , Single phase, 6 plates, 1.3 x 2" original, 60 watt 156VAC in, .85 amp 68VDC out
ORT-17	230AZ1	Rectifier , Single phase, 8 plates, 1.3 x 2" heavy duty, 176VAC in, 80VDC out
ORT-20	LA5P30-1128	IGBT Block , Otis AC Drive 0

■ Rectifier electrical parameters equal or exceed OEM specs, minor differences can exist in physical dimensions.



OTF-1



OTF-2

Transformers

S.E.E.S. #	O.E.M.#	Single Phase Transformers
OTF-1	A225DR1	37 VA , 50-60 Hz, Prim.=105, Sec.=100/150/250
OTF-2	B235AS1	50 VA , 50-60Hz, Prim.=105, Sec.=35/100/170
OTF-3	235BJ1	10 VA , 50-60Hz, Prim.=105/115, Sec.=120/125/130
OTF-5	A235Y1	150 VA , 50-60 Hz, Full load current-0.75 amps, controller voltage: 95-125 Prim.=110/115/120, Sec.=90/180
OTF-6	235BN1	300 VA , 50-60 Hz, Prim.=208/220/240, Sec.=100/135
OTF-7	235BN2	300 VA , 50-60 Hz, Prim.=420/440/480, Sec.=100/135
OTF-7A	235CC2	250 VA , 50-60 Hz, Prim.=208/220/240, Sec.=110/115/120
OTF-8	235CC3	250 VA , 50-60 Hz, Prim.=440/460/480, Sec.=110/115/120



OTF-3



OTF-7A



OTF-7

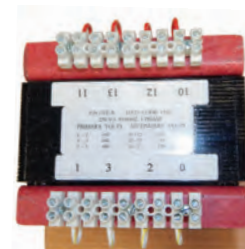

OTF-8

Transformers

S.E.E.S. #	O.E.M.#	Description
OTF-4	A7011A2	Saturable Reactor used on door operator
S.E.E.S. #	O.E.M.#	Three Phase Transformers
OTF-8A	235G1	250 VA , 50-60Hz, Prim.=208/220/240, Sec.=90/100/105
OTF-8B	235G6	250 VA , 50-60Hz, Prim.=440/460/480, Sec.=90/100/105
OTF-8C	235G2	250VA , 50-60Hz, Prim.=380/418/460, Sec.=90/100/105
OTF-9	235F1	500 VA , 50-60Hz, Prim.=208/220/240, Sec.=100/105
OTF-9A		500 VA , 50-60Hz, Prim.=440/460/480, Sec.=100/105
OTF-10	235A1	1K VA , 50-60Hz, Prim.=208/220/240, Sec.=100/105
OTF-10A	235A6	1K VA , 50-60Hz, Prim.=440/460/480, Sec.=100/105
OTF-11	235B1	2 KVA , 50-60Hz, Prim.=208/220/240, Sec.=100/105
OTF-11A	235B6	2 KVA , 50-60Hz, Prim.=440/460/480, Sec.=100/105
OTF-12	235C1	3 KVA , 50-60Hz, Prim.=208/220/240, Sec.=100/105
OTF-12A	235C6	3 KVA , 50-60Hz, Prim.=440/460/480, Sec.=100/105
OTF-13		Transformer, 341 VA
OTF-14	ABA225JP2	Transformer, ABA225JP2
OTF-15	ABA225JP3	Transformer, ABA225JP3
OTF-16	AAA225JQ1	Transformer, AAA225JQ1
OTF-17	235E6	Transformer, 235E6
OTHT-001		Transformer, 500V A, Prim. 240V, Sec. 220V

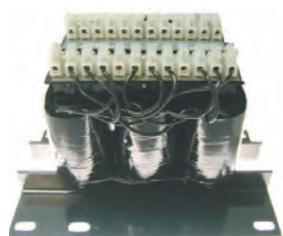

OTF-4A



OTF-8C



OTF-8B

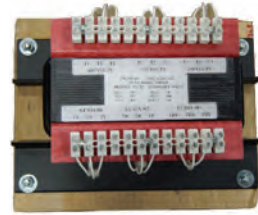

OTF-8D



OTF-9



OTF-9A



OTF-10



OTF-10A



OTF-11A



OTF-12



OTF-12A



OTF-13



OTF-14



OTF-16

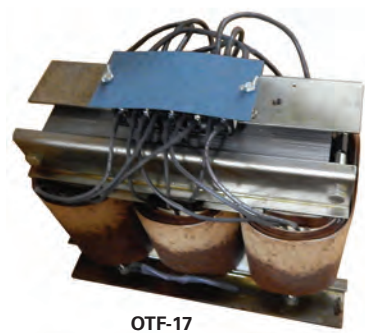

OTF-17

SEES Cab Lighting

- ★ LED Lighting at 1/5th the energy of halogen
- ★ Affordable price tag
- ★ Built-in emergency battery backup (illuminates 2 lights)
- ★ All kits come with dimmer module

Hot!
Hot!

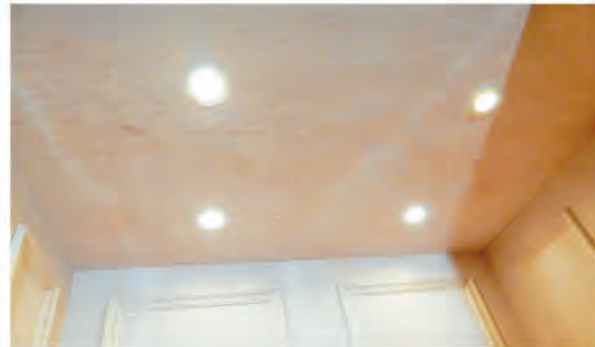

Light Bulbs

Light kits use readily available ML-162-LED bulbs, so finding replacement bulbs will never be a problem.



S.E.E.S. #	Description
SEES-LED-001K	SEES LED HL Light Kit, Set of 4 bulbs w/ power supply, chrome finish
SEES-LED-002K	SEES LED HL Light Kit, Set of 4 bulbs w/ power supply, gold finish
SEES-LED-003K	SEES LED HL Light Kit, Set of 4 bulbs w/ power supply, white finish
SEES-LED-004K	SEES LED HL Light Kit, Set of 4 bulbs w/ power supply, black finish
SEES-LED-005K	SEES LED HL Light Kit, Set of 6 pure white w/ power supply, chrome
SEES-LED-001-PW	SEES LED HL LED, pure white
SEES-LED-001-PW-B	SEES LED HL LED, bulb only, pure white
SEES-LED-001-PW-F	SEES LED HL LED, fixture and socket
SEES-LED-001-DIM	SEES LED Dimmer Module, for SEES-LED-001-PW-B
SEES-LED-001-DIM-B	SEES LED Dimmer Module, with battery backup
ML-161-LED-W	Lamp, Elevator Cab White LED 12V AC/DC
ML-162-LED-W	Lamp, MR16 White LED Dimmable 12VAC/DC



SEES-LED-001-DIM-B



SEES-LED-001-PW-B



SEES-LED-001-DIM



SEES-LED-001-PW-F



SEES-LED-1-001K



A : 2781 W. McNab Rd.
Pompano Beach, FL 33069
P : +954.971.1115, +800.526.0026
E : info@seesinc.com

Relay Parts

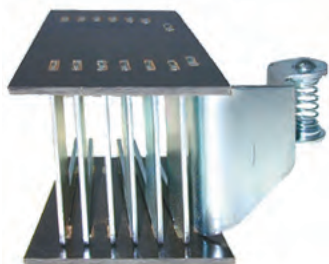

ORP-1 thru ORP-3



ORP-4 thru ORP-7



ORP-8, ORP-9



ORP-10, ORP-11, ORP-11A

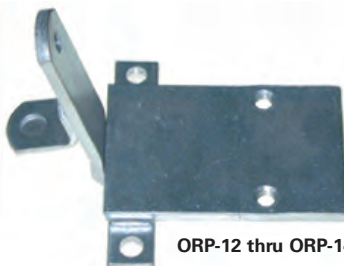

ORP-12 thru ORP-14A



ORP-15

S.E.E.S. #	O.E.M.#	Description
ORP-1	6743A1	Arc deflector for 6744A and B Magnet Switches, 3" L, 2.25" W
ORP-2	6313A1	Arc deflector for 6830 Magnet Switch, 2.5" L, 1.5" W
ORP-3	6534B1	Arc deflector for 6754 Magnet Switch, 1.75" L, 1-1/8" W
ORP-4	179AP3	Holder for carbon contacts OCC-4 and 5
ORP-5	A179AK3	Holder for carbon contacts OCC-2 and 3
ORP-6	179AD1	Holder for carbon contacts OCC-6
ORP-7	179AJ3	Holder for carbon contacts OCC-1 and 1A
ORP-8	276B1	Arc barrier for 6163 Magnet Switch
ORP-9	276H1	Arc barrier for 6754 Magnet Switches
ORP-10	A336BR1	Clamp for carbon holder ORP-5
ORP-11	A336Z1	Clamp for carbon holder ORP-4
ORP-11A	336BN1	Clamp for carbon holder ORP-6 and 7
ORP-12	A245AE1	Armature, 1-1/2 x 2-1/4 x 5/32" thick, for 6754, A and B Magnet Switches
ORP-14A	B245AE1	Armature, 1-9/16 x 2-7/16 x 3/16" thick, for C and E 6754 Magnet Switches
ORP-15	245Z2	Armature for 6164 Magnet Switch
ORP-16	384FS1	Brass guard for 6754 A and B Magnet Switch 1-1/2" W
ORP-16A	A384FS1	Brass guard for 6754 C and E Magnet Switch 1-13/16" W
ORP-18	384FN1	Brass guard for A6164 BP Magnet Switch
ORP-19	384FX1	Brass guard for 6830 DC Magnet Switch 1-3/4" W
ORP-47B	400AY1	Core
ORP-15A	400AY2	Core, set and reset
ORP-20	179AL2	Contact holder for 6830 Magnet Switch
ORP-21	6810A1	Auxiliary contact assembly, without spring for 6754 A and B Magnet Switches
ORP-21A	6810A3	Auxiliary contact assembly, with spring for 6754 A and B Magnet Switches
ORP-22	150H10	Contact, 1-9/16" L with double silver tip, 1/4" diameter x 1-32" thick
ORP-23	150P22	Contact for lower base G and GA contacts
ORP-25	150P23	Contact for 306CE1 base



ORP-47B



ORP-16



ORP-20



ORP-15A



ORP-21



ORP-21A



ORP-22



ORP-25

Relay Parts

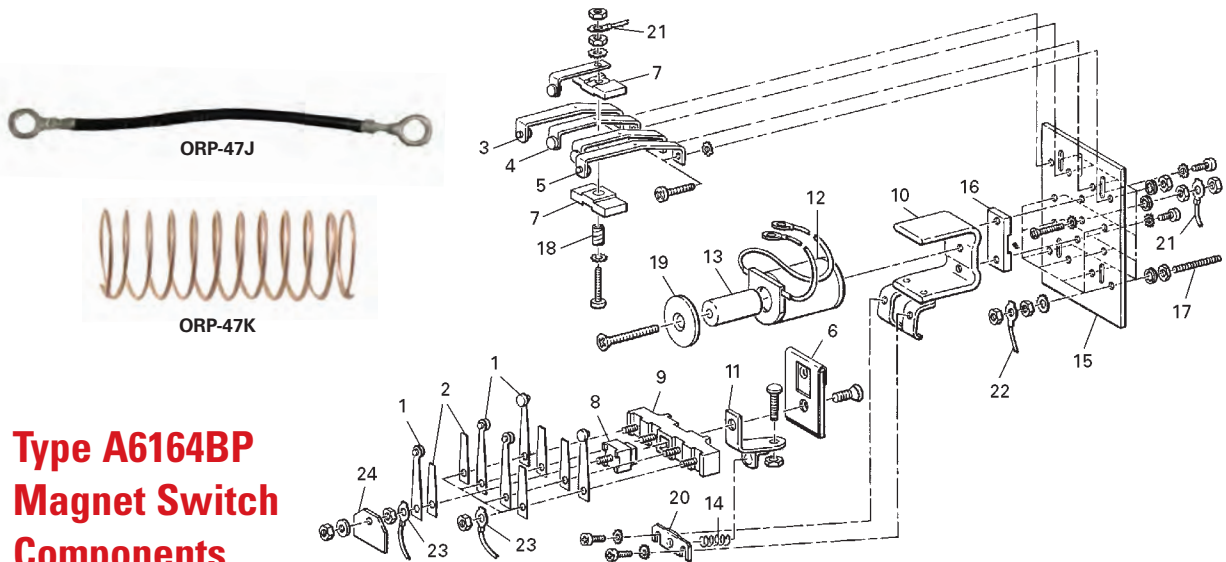

Type A6164BP Magnet Switch Components

Fig.	S.E.E.S. #	O.E.M.#	Description
1	O2CC-1	150P4	Movable contact
2	O2CC-3	93D2	Flat spring
3	O2CC-8	150P25	Stationary contact
4	O2CC-9	150P26	Stationary contact
5	O2CC-10	150P27	Stationary contact
6	ORP-15	245Z2	Armature
6	ORP-18	384FN1	Brass guard
7	ORP-26	306CN1	Contact base
8	ORP-32	306EF1	Contact base
9	ORP-33	306CZ1	Contact base
10	ORP-47	374FV1	Magnet base
11	ORP-47A	A477BH1	Stop
12	OC-19	222CY1	Coil
13	ORP-47B	400AY1	Magnetic core

Fig.	S.E.E.S. #	O.E.M.#	Description
14	ORP-47C	90TA6	Spring
	ORP-47K	90LA4	Spring
	ORP-47L	90VA16	Spring
15	ORP-47D	433AG1	Panel
16	ORP-47E	298BV1	Strip
17	ORP-47F	99G1	Stud
18	ORP-47G	137E5	Tube
19	ORP-47H	131BH1	Washer, magnet core
20	ORP-47I	A477BJ1	Stop
21	ORP-47J	175J6	Conductor
22	OSS-2A	175J89	Conductor
23	OSS-3A	175J90	Conductor
24	ORP-43A	102DA1	Tag, marking



ORP-112

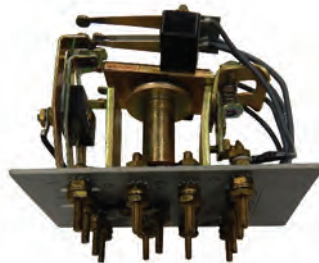

ORP-115



ORP-103

Type A6164BP Magnet Switches

S.E.E.S. #	O.E.M.#	Make	Break
ORP-100	A6164BP104CY1	0M	4B
ORP-103	A6164BP114CY1	1M	4B
ORP-108	A6164BP123CY2	2M	3B
ORP-112	A6164BP132CY2	3M	2B
ORP-113	A6164BP132CY1	3M	2B

S.E.E.S. #	O.E.M.#	Make	Break
ORP-114	A6164BP140CY1	4M	0B
ORP-115	A6164BP141CX1	4M	1B
ORP-116	A6164BP150CY1	5M	0B
ORP-120	A6164BP320CX1	2M	0B
ORP-122	A6164BP332CX1	3M	2B
ORP-124	A6164BP341CX1	4M	1B
ORP-125	A6164BP732CZ1	3M	2B
ORP-126	A6164BP741CZ1	4M	1B

Relay Parts

OTIS

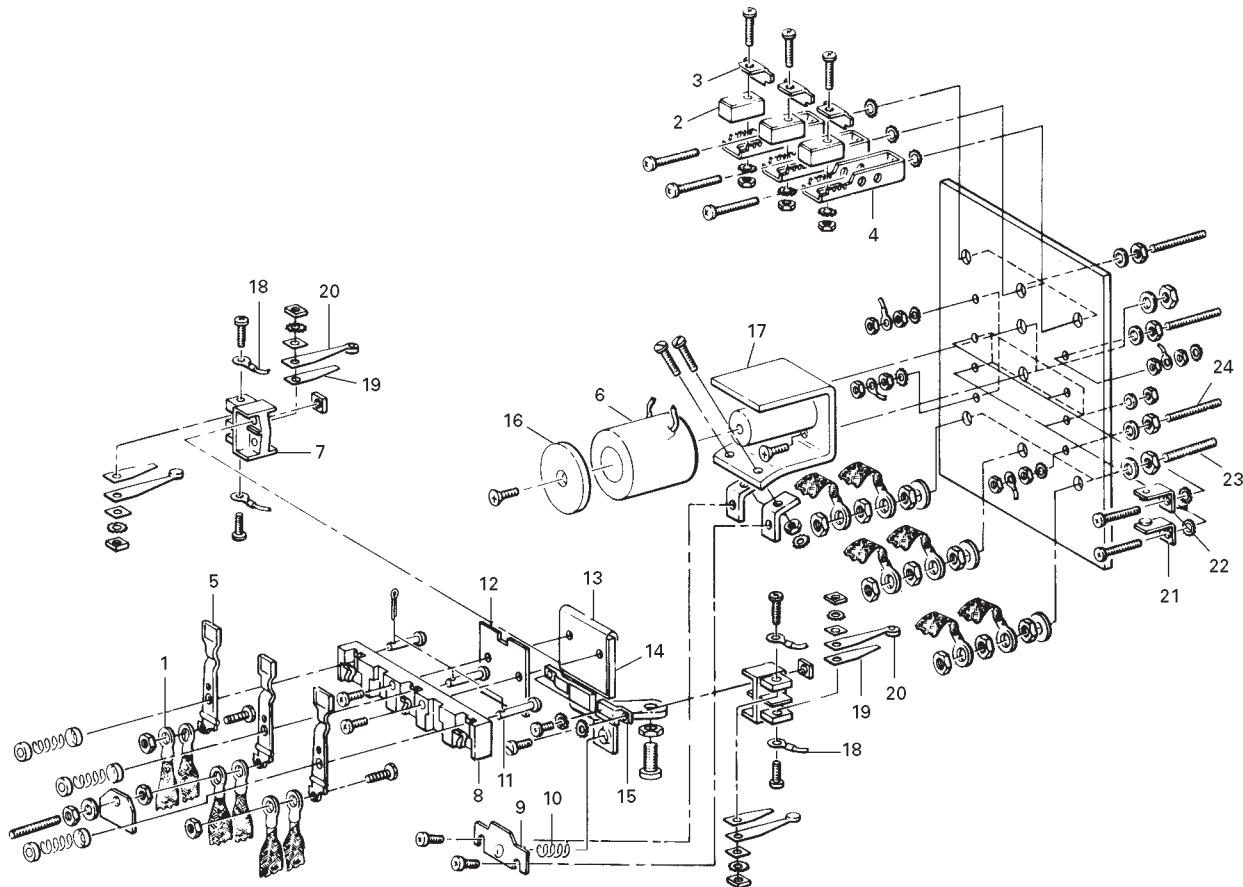

Type E6744A Magnet Switch Components

Fig.	S.E.E.S. #	O.E.M.#	Description	Fig.	S.E.E.S. #	O.E.M.#	Description
1	OBS-4	176KA8	Braided shunt	13	ORP-48E	464AZ1	Brass guard
2	OCC-1	154AA1	Carbon contact	14	ORP-48F	A245AG1	Armature
3	ORP-11A	336BN1	Carbon clamp	15	ORP-48G	316ANZ1	Bracket, auxiliary contact
4	ORP-7	179AJ3	Carbon holder	16	ORP-48H	127AH1	Core washer
5	O1CC-17	153T1	Contact, movable	17	ORP-48I	A374FJ2	Frame
6	OC-36	222CM1	Coil	18	ORP-48J	175J150	Conductor
7	ORP-31	306CJ1	Contact base	19	ORP-48K	93AD1	Flat spring
8	ORP-48	306BM1	Contact base	20	O2CC-2	93A2	Auxiliary contact
9	ORP-48A	A477BR1	Stop	21	O2CC-11	150C13	Auxiliary contact
10	ORP-48B	90JB6	Spring	22	O2CC-12	150C14	Auxiliary contact
11	ORP-48C	141H1	Rivet	23	ORP-48M	99E1	Stud
12	ORP-48D	A384EV1	Separator	24	ORP-47F	99G1	Stud

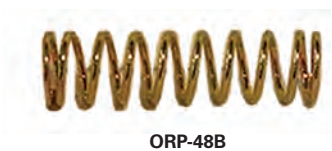

ORP-48B

Relay Parts



ORP-44

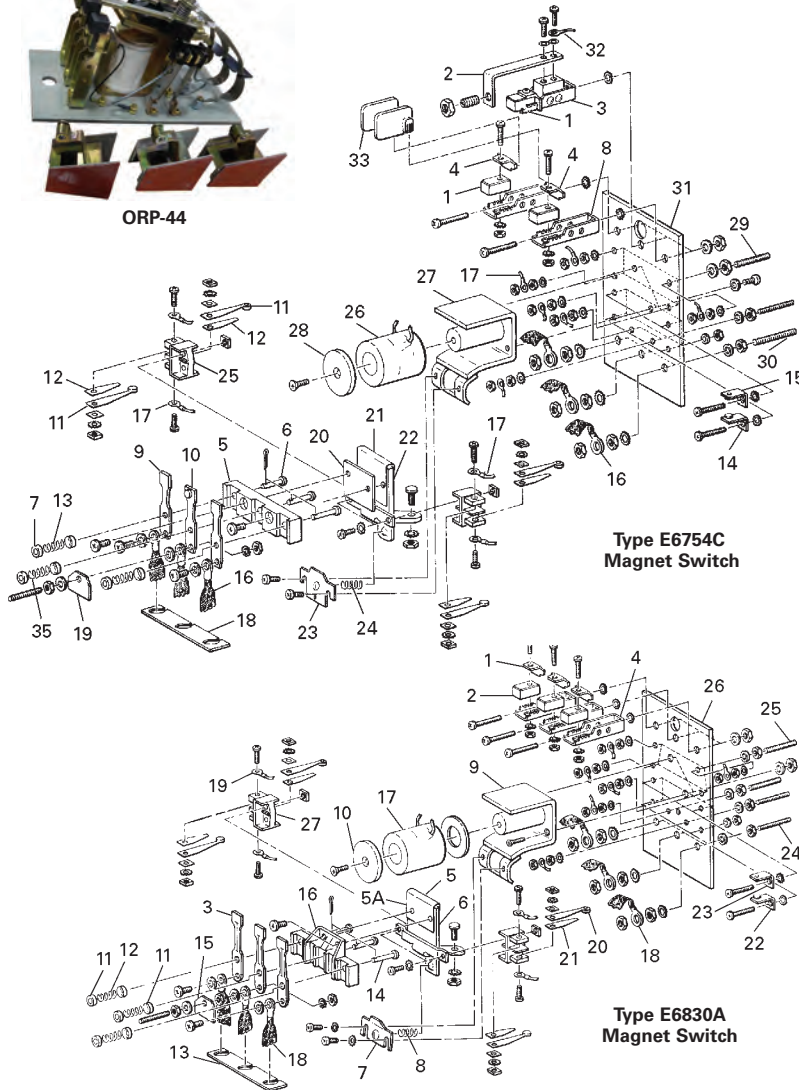

Type E6754C
Magnet Switch

Type E6830A
Magnet Switch

Type E6830A Magnet Switch

Fig	S.E.E.S. #	O.E.M.#	Description
	ORP-44	A141CV4	Magnetic Switch Assy.
1	ORP-11	A336Z1	Carbon clamp
2	OCC-4	154C1	Carbon contact
3	O1CC-10	153B1	Copper contact
4	ORP-4	179P3	Carbon holder
5	ORP-19	384FX1	Brass guard
5A	ORP-50	384EW1	Phenolic guard
6	ORP-50A	A245AA1	Armature
7	ORP-50B	A477CP1	Stop
8	ORP-50C	90BB8	Spring
9	ORP-50D	A374FM2	Frame & core
10	ORP-50E	131BD1	Core washer
11	ORP-50F	133A1	Washer
12	ORP-50G	90DB4	Spring

Fig	S.E.E.S. #	O.E.M.#	Description
13	ORP-50H	464BJ3	Separator
14	ORP-50I	141Y2	Rivet
15	ORP-43A	102DA1	Plate, marking
16	ORP-30	306CL1	Contact base
17	OC-9	222CV1	Coil
18	OBS-8	176KA10	Connector
19	ORP-48J	175J150	Conductor
20	O2CC-2	93A2	Contact
21	ORP-48K	93AD1	Flat spring
22	O2CC-11	150C13	Aux. contact
23	O2CC-12	150C14	Aux. contact
24	ORP-49L	99G2	Stud
25	ORP-47F	99G1	Stud
26	ORP-50M	433AB1	Panel
27	ORP-31	306CJ1	Contact base

Type E6754C Magnet Switch

Fig	S.E.E.S. #	O.E.M.#	Description
1	OCC-2	154AB1	Carbon contact
2	ORP-49	179AM1	Contact holder
3	ORP-49A	A179AK5	Contact holder
4	ORP-10	A336BR1	Carbon clamp
5	ORP-28	306BR1	Contact base
6	ORP-49C	141Y1	Rivet
7	ORP-49D	133A6	Washer
8	ORP-5	A179AK3	Contact holder
9	O1CC-2	153Z4	Copper contact
10	O1CC-6	150Y7	Copper contact
11	O2CC-1	150P4	Movable contact
12	O2CC-3	93D2	Contact spring
13	ORP-47C	90TA6	Spring
14	O2CC-11	150C13	Stationary contact
15	O2CC-12	150C14	Stationary contact
16	OBS-5	176KA13	Connector, braided copper
17	OSS-1A	175J88	Conductor
18	ORP-43	464BJ2	Fibre separator
19	ORP-43A	102DA1	Plate, marking
20	ORP-49F	384EW3	Guard
21	ORP-16A	A384FS1	Guard
22	ORP-14A	B245AE1	Magnet armature
23	ORP-49G	A477BL1	Stop
24	ORP-49H	90VA15	Compression spring
25	ORP-31	306CJ1	Contact base
26	OC-60	222EB2	Coil
27	ORP-49I	B374CP1	Magnet frame and core
28	ORP-49J	131AY1	Washer
29	ORP-47F	99G1	Stud
30	ORP-49L	99G2	Stud
31	ORP-49K	A433Z1	Panel
32	ORP-49M	175J204	Conductor
33	ORP-9	276H1	Arc barrier
34	ORP-49N	306CP1	Contact mounting block
35	ORP-49P	90TA3	Spring Compression

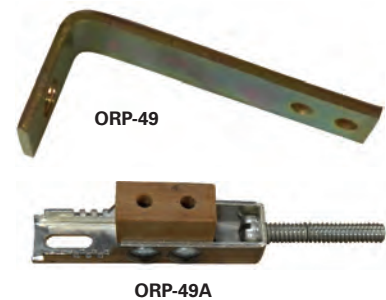

ORP-49

ORP-49A

Relay Parts

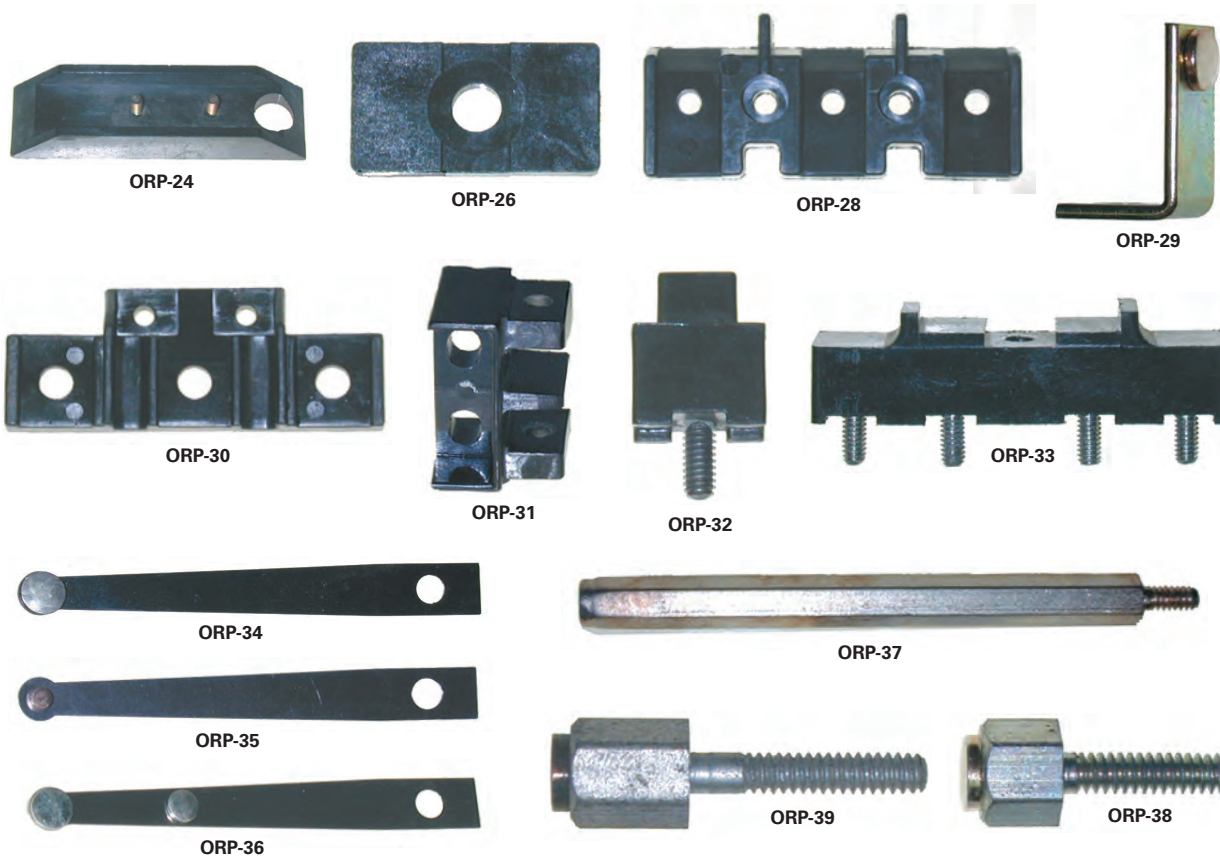

S.E.E.S. #	O.E.M.#	Description
ORP-24	306CE1	Base, upper contacts for G and GA contacts
ORP-26	306CN1	Base, bakelite for 150P25 contact
ORP-28	306BR1, 306BR2	Base, red phenolic for movable paddle contact
ORP-29	152AN1	Contact, stationary auxiliary, for 6744 A and B Magnet Switch
ORP-30	306CL1	Base, bakelite 1" x 9/16" x 4-1/16" for 153B1 copper contact
ORP-31	306CJ1	Base, 1-1/8" L, contact, selector stopping switch
ORP-32	306EF1	Base, bakelite
ORP-33	306CZ1	Base, bakelite for 4 inserts of 150P4
ORP-34	150H2	Contact leaf spring, 2-3/4" L with 1/4" double tip
ORP-35	150HA2	Contact leaf spring, 2-3/4" L with 1/8" double tip
ORP-36	150HA3	Contact leaf spring, 2-3/4" L with 1/4" double contact tip
ORP-37	150C7	Contact, 1/4" hex., 3-1/4" L with silver contact tip
ORP-38	150C2	Contact, 5/16" hex. x 3/4" with silver contact
ORP-39	150C3	Contact, 5/16" hex. x 1-1/8" with silver contact
ORP-40A		Dashpot oil, clear dashpot fluid for overload relay



ORP-40A

Relay Parts



ORP-42



ORP-43A



MIS-100K



ORP-46A

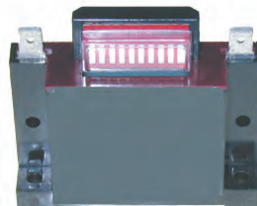

PR-98

S.E.E.S. #	O.E.M.#	Description
ORP-42	153AE6	Copper contact , stationary, 1-3/16" square silver face
ORP-43	464BJ2	Fibre separators
ORP-43A	102DA1	Tag
ORP-44B	P613BY1	Stepper Switch Assembly , 2 level, 40 point, 120VAC, bi-directional
MIS-100K		Stepper Lube Kit , Assorted lubricants, specially formulated for maintaining stepping switch wear points. Prolongs life, improves performance



OSL-1

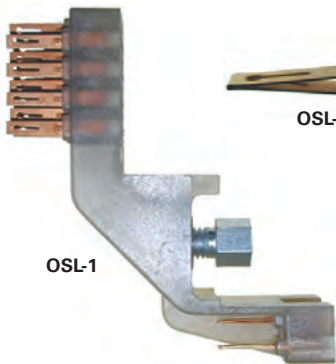

OSL-2



OSL-12



OSL-1T



OSL-13

Type 7058B Slimline Relay Components

S.E.E.S. #	O.E.M.#	Description
OSL-1	306JL4	Base , plug in, with maximum available terminals. Used for 2 or 4 lead coils.
OSL-2	245AL2	Armature , with flat spring
OSL-12	477EB1	Stop , contact, phenolic, 1.460" L, used on magnet arrangement 1 and 2
OSL-13	477EB2	Stop , contact, phenolic, 29/32" L, used on magnet arrangement 3 and 4
OSL-1T	187BM1	Terminal for OSL-1 base

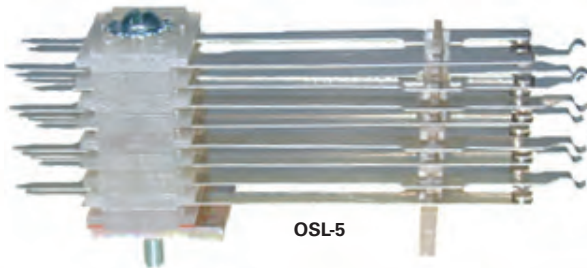

OSL-5

Type 7055C Pile Up Contact Assemblies

S.E.E.S. #	O.E.M.#	Contact Arrangement
OSL-3	7055C081	8 break
OSL-4	7055C171	1 make, 7 break
OSL-5	7055C261	2 make, 6 break
OSL-6	7055C351	3 make, 5 break
OSL-7	7055C441	4 make, 4 break
OSL-8	7055C531	5 make, 3 break
OSL-9	7055C621	6 make, 2 break
OSL-10	7055C711	7 make, 1 break
OSL-11	7055C801	8 make

Relay Parts



ORP-45

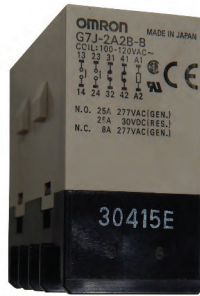

ORP-45-S



ORP-45A-S



ORP-45B



ORP-45AB



PR-97



OPR-51



PR-15, PR-21, PR-23, PR-24

S.E.E.S. #	O.E.M.#	Description
ORP-45	P613AP6	Relay, 120VAC, 2 N.O. & 2 N.C., VC15-2A2B-AC120V
ORP-45-S		Relay, 4 pole VC15A-2A2b 120 VAC w/ screw terminals
ORP-45A	P613AP9	Relay, 120VAC, 3 N.O. & 1 N.C., VC15-3A1B-AC120V
ORP-45A-S		Relay, 4 pole VC15A-3A1B 120 VAC w/ screw terminals
ORP-45B	P613AP7	Relay, 120VAC, 4 N.O., VC15-4A-AC-120V
ORP-45AB		Clip, mounting for ORP-45, 45A, 45B
PR-15	P613AB9	Relay 115VAC, 3PDT
PR-24	P613AB3, KUP14D1548	Relay 48VDC, 3PDT
PR-23	P613AB1, KUP14D15110	Relay 110VDC, 3PDT
PR-21	P613AB2, P613AB8, KUP14D35110	Relay 110VDC, 3PDT
PR-97	P613AP5	Relay 115VDC
OPR-51	613BX7	Relay, 110VDC, 3 phase, 20 Amp

■ Additional Relays starting on pg 253

Timers

S.E.E.S. #	O.E.M.#	Description
PR-18B	P613BX1	Timer, 120VAC, 1-10 second adjustable timer
PR-110	P613AY8	Timer, 120VAC, 1 to 3 seconds
PR-110A	P613AY9	Timer, 120VAC, 1 to 10 seconds
PR-110B	P613AY10	Timer, 120VAC, 1 to 60 seconds
ORP-46	P623B1	Timer, 1 amp, 115VAC, 120 sec.
ORP-46A		Timer, 1 amp, 115VAC, 480 sec.
PR-98		Timer, adjustable universal time switch 24-240 Volts AC/DC 1-360 sec.
PR-98A		Timer, 12/240 VAC/DC SPDT, universal adjustable, .1 sec- 20hr on/off delay, compatible with 3", 35mm din rail mounting kit (MIS-004)
PR-98B		Trip Counter, universal electric, 8 digit ICD read out with battery
PR-98C	H7EC-NFV-B	Trip Counter, 8 Digit LCD Read Out with Battery



PR-18B



PR-110

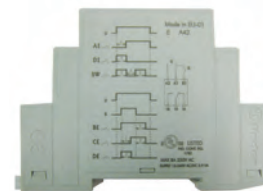

PR-98A

Selector Parts



S.E.E.S. #	O.E.M.#	Description
OS-1	6839D1, 6839D3	Contact brush with 154AD2 contact, short blade 2"
OS-2	6839D2, 6839D4	Contact brush with 154AD4 contact, long blade 2-1/2", for 6851 leveling switch
OS-3	269R1	Indicator with copper finger contact, not shown above
OS-3A	306CH1	Base for OS-1 and OS-2
OS-3B	131BA1	Washer, Hillside washer for OS-1 and 2
OS-35	154AD2, 154AD7	Contacts for OS-1 contact brush 6839D Series, 3/8" x 2"
OS-36	154AD4, 154AD8	Contacts for OS-2 contact brush 6839D Series, 3/8" x 2-1/2"
OS-4	6839F3	Brush contact for crosshead and advancer panel, carbon contact 7/16" L
OS-4A	156J2	Carbon contact, contacts for OS-4
OS-4B		Fiber contact, for OS-12
OS-5	6839F4	Brush contact for crosshead and advancer panel, metal graphite, 7/16" L
OS-6	6839F5	Brush contact for crosshead and advancer panel, carbon contact, 11/16" L
OS-6A	156D5	Carbon contact, contacts for OS-6
OS-37	93CC1	Blade spring for A6839F3 type brush contact
OS-31	6839F2	Brush contact, 7/8" L, carbon contact for crosshead panel
OS-31A	156D2	Carbon contact, contacts for OS-31
OS-59	6839AB1	Contact brush assembly with silver contact and cam
OS-60	327JE1	Cam with silver contact for OS-59
OS-7	6839B2	Brush switch with graphite contact
OS-8	6839B3	Brush switch with silver contact
OS-9	6839B4	Brush switch with fibre cam
OS-41A	327FT2	Cam for selector switch, use with OS-11A
OS-10	327DE2	Cam for selector switch, use with OS-11A
OS-11	0-327A	Cam and clamp, includes OS-10 and OS-11A
OS-11A	336CM1	Clamp only, use with OS-10 or OS-41A
OS-12	6839Y1, 6839Y3	Switch brush, with 7/16" L fibre cam
OS-13	6839Y2, 6839Y4	Switch brush, with 7/16" L carbon

Selector Parts

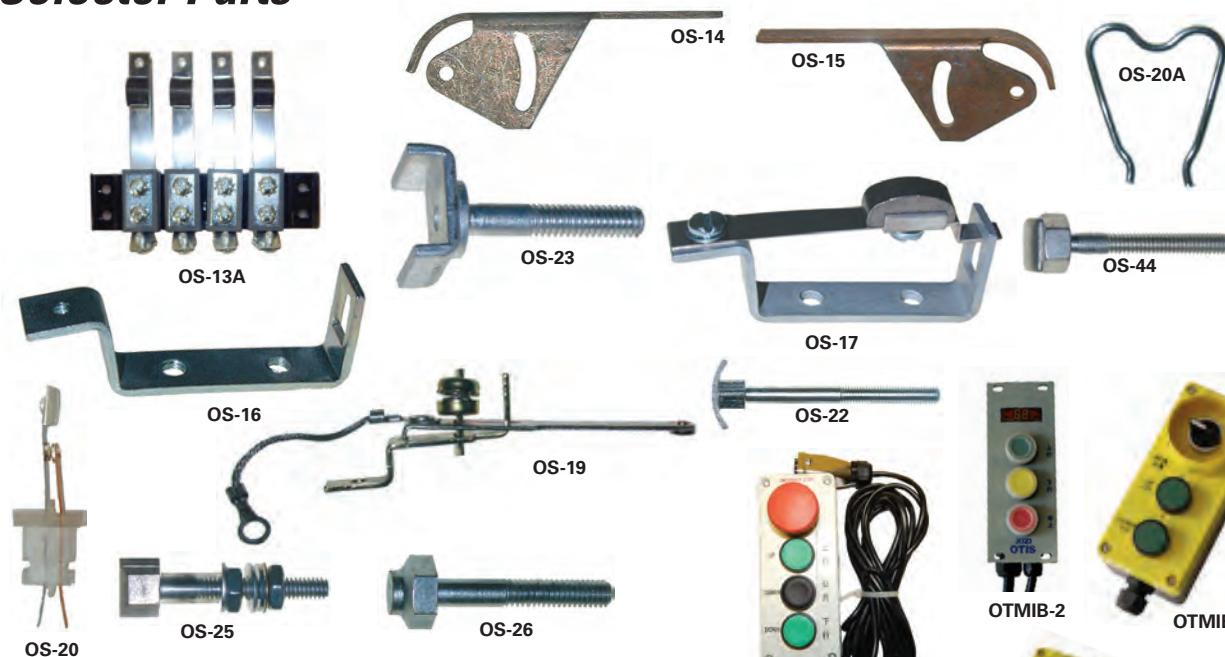

S.E.E.S. #	O.E.M.#	Description
OS-13A	6251E1	Mechanical Switch Set , STPN for A6706A
OS-13B	150BA7	Contact , stationary
OS-14	156H1	Down stop contact for stop control switch
OS-15	156H2	Up stop contact for stop control switch
OS-16	181892	Bracket only for OS-17 and 18 selector brush
OS-17	181893	Selector brush with graphite contact 5/8" for ML6104 crosshead and brush advancer panels and 140M selector
OS-18	181894	Selector brush , same as above but with graphite contact 15/16"
OS-19	156AB2	Contact finger and spring guide
OS-20	177AH1	Brush switch
OS-20A	339FV1	Clip for OS-20 brush switch
OS-44	156AV2, 156G4, 502236	Selector contact , 1-1/2" L
OS-22	0-347	Selector contact , 2-1/2" x 3/8" x 3/4" contact face with 3/4" radius
OS-23	152AX2, 156AX2	Cam selector , 7/16" wide, "U" form
OS-24	152AX4, 156AX4	Cam selector , 5/8" wide, "U" form
OS-25	6850F2	Selector contact
OS-26	150C10	Selector contact , 3/8" hex w/1/4" dia. silver tip, overall 1-5/16" L with 8-32 thread
OTMIB-1		Inspection Station , 4 Button w/ Emergency Stop
OTMIB-2		Movable Inspection Box
OTMIB-3		Switch , Emergency Electric Box
OTMIB-4		Switch Panel , Control Cabinet Inspection Box
OTMIB-5		Switch Panel , Control Cabinet Inspection Box
OTMIB-6	XBA24830D4	Inspection Box Of MCS321
OTMIB-7	XAA24350AD3	AT25 Inspection Box Of MCS321
OTPIB-3		Switch Panel , Car Top Inspection Box For GEN 2
OTSS-3	XAA177AZ4	Sensor , Photo
OTSS-4	SSGD-1H(NO)	Sensor , Photo
OTPO-1		Master Feeder Box
OTHUB-1		Block Terminal
OTHUB-2		Block Terminal
OTHUB-3	P303BA5	Block Terminal



Selector Parts



OS-27



OS-28

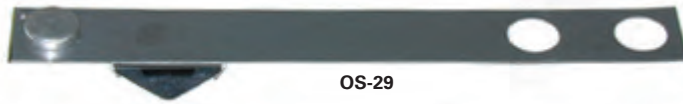

OS-29



OS-32

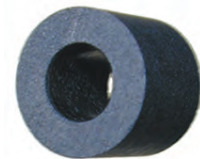

OS-33



OS-30

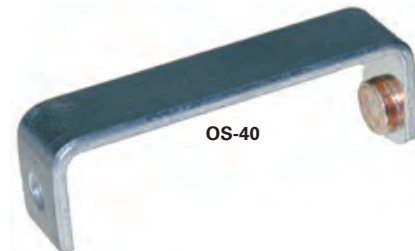

OS-40



OS-34

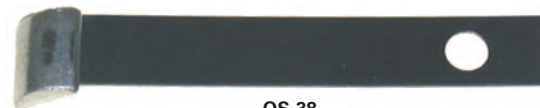

OS-38



OS-42



OS-43



OS-44



OS-45



OS-45B

S.E.E.S. #	O.E.M.#	Description
OS-27	102990	Finger contact, floor selector
OS-28	B152H2	Contact floor bar, rectangular head, 3/8" x 5/8", 2-11/32" L with 10-32 thread
OS-29	150P31	Contact for selector stopping switch with fibre cam, blade 3/8" x 3-1/8" with 1/4" dia. contact tip
OS-30	150P32	Contact blade, makes with OS-29
OS-32	15387	Floor selector roller, copper 1/2" x 1/2"
OS-33	1659	Floor selector roller, metal graphite 1/2" x 1/2"
OS-34	156E1, E2, E3	Selector contact, 1-11/32" L with 8-32 threaded stem
OS-38	156A6	Selector contact
OS-39	150P33	Pawl magnet contact, 1-5/8" L for crosshead panel
OS-40	150P34	Pawl magnet contact, 1-1/2" L for crosshead panel
OS-42	327GJ1	Cam, toggle cam for advancer panel
OS-43	327GS1	Cam on bracket used at end of crosshead panel
OS-44	156AV2, 502236	Floor bar contact
OS-45	306GD1	Contact base for three (3) OS-44 contacts, for floor bar assembly
OS-45A	306GD2	Contact base for one OS-44 contact
OS-45B	306GD3	Contact base for two OS-44 contacts

Selector Parts

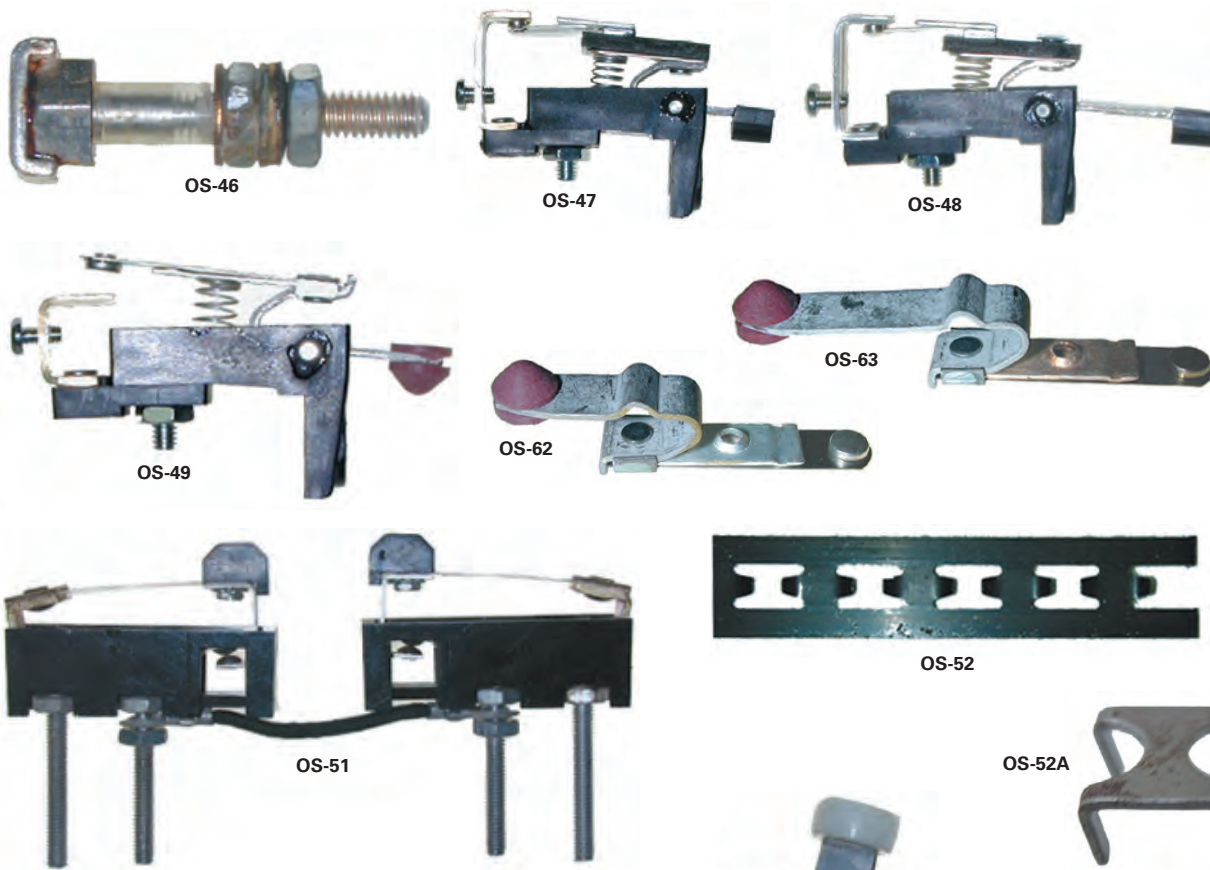

S.E.E.S. #	O.E.M.#	Description
OS-46	6850F1	Contact
OS-47	A6839G1	Leveling switch with short cam arm
OS-48	A6839G3	Leveling switch with long cam arm
OS-49	A6839E1	Door zone contact with short cam arm
OS-50	A6839E2	Door zone contact with long cam arm
OS-62	150P37	Contact assembly, short arm for OS-49
OS-63	150P41	Contact assembly, long arm for OS-50
OS-51	6839J1	Brush switch with fibre cam and shunt, double unit
OS-52	297B1	Selector tape, perforated, polished spring steel, cut to your specified length
OS-52A	VP741965	Clip, splice for selector tape
OS-52B	297B2	Selector Tape, 1" Wide, Plain no perforations, for Otis Selectors
OS-52C	AAA00279, AAA001	Selector Tape, 2" Wide, for Otis SPT Floating Tape Device
OS-52D	AAA297AV1	Selector Tape, 3-15/16" Wide Otis AAA22439AAF Application
OS-53	7042A1	Toggle switch for position indicator
OS-54	6839W1	Brush switch assembly used for 6850 selectors, 1-7/8" overall length
OS-55	6839H1, 6850	Brush switch assembly used for selectors



Selector Parts



OS-56



OS-57

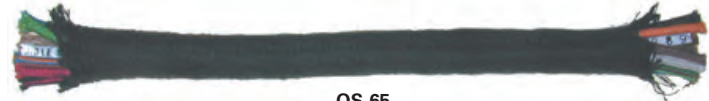

OS-65



OS-58



OS-66



OS-64



OS-68



OS-67



OS-69A



OSB-001



OS-69



OS-70



OS-70A



OS-200



OS-201



OS-202



OS-203

S.E.E.S. #	O.E.M.#	Description
OS-56	6482C2	Brush plunger, carbon contact assembly
OS-57	A151C2	Contact with carbon tip for OS-56 assembly
OS-58	181874	Floor bar assembly with silver contact
OS-65	VP-730550	Selector cable, (10 conductor) cloth covered, cut to length
OS-64	127VB132	Leveling washer, stainless steel
OS-68	129BT1	Flexible washer, 1-1/2" O.D. x 1" I.D.
OS-66	6809C1	Door zone switch
OS-67	156F2	Carbon contact, 4" L
OS-69	400DR2	Selector core and rod
OS-69A	465BG1	Bushing for 400DR2
OSB-001		Otis Safety Bushing 1.5" OD x .555" ID x 1" L, 80 Duro
OS-70	A6333E1	Selector motor, 60VDC
OS-70A	J0240A1	Brush 1/4" x 5/16" x 11/16" for OS-70
OS-200	AAA3855V1	Guide, for Selector Tape
OS-201	288TF4	Lever, with Bushing
OS-202	494JY1	Shaft Extension 1/4" x 5/16" x 11/16" for OS-70
OS-203	AAA27076AU1	Switch Kit, 1/4" x 5/16" x 11/16" for OS-70

Safety Edge Components

S.E.E.S. #	O.E.M.#	Description
ODO-1A	177AR1	Micro Switch for safety edge
OSE-2	6993D1 & D2	Replacement Boot for safety edges, 3-1/4" W x 83-1/4" L

■ See MIS-SE-5 and Universal Safety Edge Replacements starting on page 225.

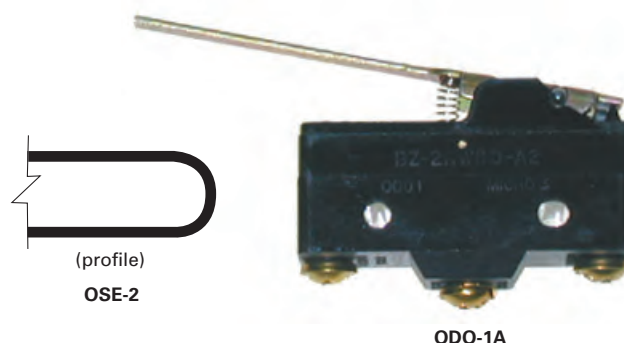

Miscellaneous Components

Washers, Nuts and Pins

BRASS JAM NUT

S.E.E.S. #	Description
BJN-1	Jam nut, 10 - 32
BJN-2	Jam nut, 1/4 - 20
BJN-3	Jam nut, 5/16 - 18
BJN-4	Jam nut, 3/8 - 16
BJN-5	Jam nut, 1/2 - 13
BJN-6	Jam nut, 5/8 - 11



BJN-1 thru BJN-6



BW-1 thru BW-4

BRASS WASHER

S.E.E.S. #	O.E.M.#	Description
BW-1		Washer, 1-1/4" O.D. x 9/16 I.D. x 3/32" thick
BW-3	133A7	Washer, 7/8" O.D. x 11/32" I.D. x 1/16" thick
BW-4		Washer, 9/16" O.D. x 1/4" I.D. x 1/32" thick
OWS-200	133E23	Washer, for Wedge Socket .78" ID 3.5" OD



OWS-200

BRASS HINGE PIN

S.E.E.S. #	Description
BHP-1	1/2" Diameter x 4" L
BHP-2	3/8" Diameter x 4" L



BHP-1 thru BHP-2



ODP-1 thru ODP-5

Distance Pieces

S.E.E.S. #	O.E.M.#	Hex Size
ODP-1	133615	1/2" x 3-1/8" x 3-1/4"
ODP-2	127782	1" x 2-1/8" x 3-1/2"
ODP-3	126229	7/8" x 1-5/8" x 3-1/2"
ODP-4	129422	1/2" x 1-7/16" x 3-1/4"
ODP-5	118716	5/8" x 1" x 3-1/4"

Couplings

S.E.E.S. #	Description
OM-3	Sureflex pump coupling, 2-3/4" O.D. x 1-3/4" I.D. x 1-9/16" L
OM-3A	Sureflex pump coupling, 4" O.D. x 2-3/4" I.D. x 2-3/16" L
OMP-001	Coupling, 3/8" x 3/8"



OM-3, OM-3A



OMP-001

Otis Seals & Packing

S.E.E.S. #	O.E.M.#	Description
OPAC-001	AAA182AN1	Packing Kit, 2-7/8", Otis Holeless, Mfg. Prior to 2000
OPAC-002	AAA182AN2	Packing Kit, 3-15/16", Otis Holeless, Roped, Mfg After 2000
OPAC-003	AAA182AN11	Packing Kit, 4-7/16", Otis Holeless, Roped, Mfg After 2000
OPAC-004	AAA172SV1	Wiper Ring
OPAC-005	AAA182AN9	Packing Set, 6-1/2" Diameter Plunger for Welded Head Cylinder
OPAC-006	AAA182AN12	Packing Set, 5-1/2" Otis Holeless Roped, Mfg After 2000
OPAC-007	AAA182AN3	Packing Set, 3-15/16" Otis Welded Head, Mfg After 1991

Machine Parts and Miscellaneous Components

Seals



PAC-38 thru PAC-38H



OWPAC-32A



OKS-1



OWPAC-34



OB-46

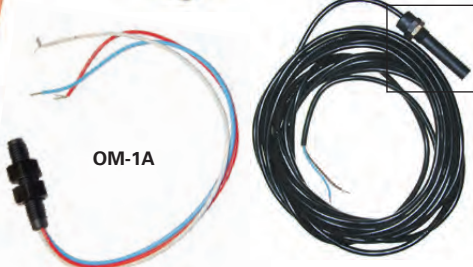

OM-1A



OM-1



OM-4 thru OM-4D



OM-2BT3 thru OM-2BT9



OM-2BT18

■ OM-2BT1 thru OM-2BT17 for 1/2" rope.
BV series for 5/8" rope available upon request.

S.E.E.S.#	O.E.M.#	Otis Worm Gear Seals	Seal Dimensions
PAC-38	182A4	Packing Worm Shaft	1 - 7/8" x 3-1/8" x 2-1/16"
PAC-38A	182A3	Packing Worm Shaft	1 - 9/16" x 2-9/16" x 1-11/16"
PAC-38B	182A5	Packing Worm Shaft	2 - 1/8" x 3-3/8" x 2-5/8"
PAC-38C	182A6	Packing Worm Shaft	2 - 1/4" x 3-1/2" x 2"
PAC-38D	182A14	Packing Worm Shaft	1 - 7/16" x 2-7/16" x 1"
PAC-38E	182A15	Packing Worm Shaft	1 - 9/16" x 2-9/16" x 1-1/4"
PAC-38F	182A17	Packing Worm Shaft	1 - 7/8" x 3-1/8" x 1-11/16"
PAC-38G	182A18	Packing Worm Shaft	1 - 7/8" x 3" x 2-5/8"
PAC-38H	182A19	Packing Worm Shaft	2 - 1/2" x 3-3/4" x 1-7/16"
OWPAC-32	33D26, 1R019-06	Worm Gear Seal, Split	3" x 4-1/2" (for 29 CT Machine)
OWPAC-32A	33D26, 1R019-06	Seal Kit w/ retaining plate	3" x 4-1/2" (for 29 CT Machine)
OWPAC-33	33D29, 1R020-06	Worm Gear Seal, Split	2" x 3" (for 22 CT Machine)
OWPAC-34	9726834	Locking Tab Washer	1" ID

S.E.E.S. #	O.E.M.#	Description
OKS-1	6410R2	Key Switch for light switch
OSS-18		Key for light switch, long style
OB-46	VP79605	Key "GA"
OB-46A	VP79705	Key "GB"
OM-1	F0177BP1	Hatch Proximity Switch Interrupter for LRV
OM-1A		Switch, Magnetic Reed 100 VDC, SPDT N.C.

Brake Cushions, Bronze Bushings

S.E.E.S. #	O.E.M.#	Description
OM-4	335W1	.75" O.D. x 1" L
OM-4A	321CJ1	1.125" O.D. x .75" L
OM-4B	321CJ4	1.475" O.D. x 1.12" L
OM-4C	321CJ3	1.398" O.D. x 1.13" L
OM-4D	321CJ2	1.875" O.D. x 1.62" L

Sheave Liners

S.E.E.S. #	O.E.M.#	Description
OM-2BT3	251BT3	With tread for 27" sheave
OM-2BT5	251BT5	With tread for 30" sheave
OM-2BT8	251BT8	Smooth for 28" sheave
OM-2BT9	251BT9	With tread for 32" sheave
OM-2BT18	251CE8	Smooth 26" sheave for 5/8" Rope

Blower

S.E.E.S. #	Description
OMP-002	Blower, 115V, AAA24720D1

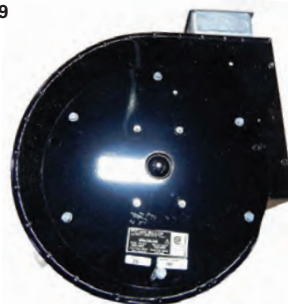

OMP-002

Wheels and Rollers



Hanger Rollers

S.E.E.S. #	O.E.M.#	Description
OW-1	456DH1	Door hanger roller, 3-3/8" O.D. x 13/16" poly tire with eccentric, 1/2" NF threaded shaft
OW-1B		Hanger Roller, 3-3/8" OD Flat/Radius, with OW-13B
OW-1BA		Hanger Roller, 3-3/8" OD Flat/Radius, Roller Only
OW-1C		Hanger Roller, 3-3/8" OD Flat/Radius, with Shaft, metric (M8)
OW-1D	456EW1, 456EW2	Hanger Roller, 3-3/8" Flat/Radius with eccentric shaft, 1/2-20 Thread
OW-1E	AAA456YA1, AAA456YA3	Hanger Roller, 3-3/8" Flat/Radius with eccentric shaft, metric (M12)
OW-1E-A		Hanger Roller, 3-3/8" Flat/Rad with Eccentric Shaft Reversed
OW-1S	0403X	Hanger Roller, 3-3/8" OD Steel, Flat Track with eccentric
OW-40		Hanger Roller, 3-3/8" Poly 6203 with Eccentric Shaft 7/16-20
OW-40A		Hanger Roller, 3-3/8" Poly 6203 with Straight Shaft 7/16-20
OW-2	456W1	Door hanger roller, 3-1/4" O.D. x 11/16" with .9841" bore I.D., polyurethane tire
OW-11	0-401	Door hanger roller, 3-1/4" O.D. x 11/16" 1/2" I.D. aluminum with polyurethane tire
OW-11S	A456W1	Door hanger roller, 3-1/4" O.D. x 11/16", 1/2" I.D. steel roller with polyurethane tire
OW-12	456CX4	Door hanger roller, 3-3/8" O.D. x 13/16", .7874 bore I.D., with 11/32" radius on concave polyurethane tire surface
OW-12B		Eccentric shaft for OW-12 door roller, 1/2" NF threaded
OW-12A		Door hanger roller, 3-3/8" O.D. x 13/16", .7874" I.D., all steel construction for flat track
OW-12C		Door hanger roller, 3-3/8" OD x 13/16", .7874" I.D., aluminum with polyurethane tire for flat track
OW-12S		Door hanger roller, 3-3/8" O.D. x 13/16" .7874" I.D., steel with polyurethane tire for flat track
OW-13	0-404	Hanger roller, 2-3/4" O.D. x 3/4" thick, .7872" bore, steel, for OW-23
OW-13A	0-404P, 456CC2	Hanger roller, 2-3/4" O.D. x 11/16" thick, polyurethane, for OW-23
OW-13AW		Hanger roller, 2-3/4" OD Flat track (wide), .7874" ID
OW-13B	77RK1	Eccentric shaft for OW-13 roller
OW-18	0-402, A456EA1	Steel hanger roller for 6178A assembly 3-1/4" O.D. x 11/16", bore 1/2"



OW-13AW



OW-18

Wheels and Rollers

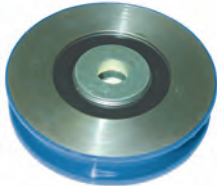

OW-18A



OW-23



OTHR-1



OTHR-2



OTHR-3



OTHR-4



OTWH-1



OTDH-1



OTDH-2



OW-202



OW-3



OW-3A



OW-4



OW-205

Hanger Rollers & Assemblies

S.E.E.S. #	O.E.M.#	Description
OW-18A	A456EA1	Hanger roller, 11/16" wide, 3-1/4" O.D. for 6178A assembly steel with polyurethane tire
OW-23	389J2	Hanger assembly for Type B & 7087
OTHR-1		Roller, for Hanger Assembly 86mm O.D. x 20mm W, bearing 6204 ID:20mm
OTHR-2		Roller, Hanger, 90mm x 18mm
OTHR-3		Hanger assembly, Hanger
OTHR-4	XAA520C1	Roller, for Hanger Assembly
OTWH-1		Sheave
OTDH-1		Hanger assembly, Car
OTDH-2		Hanger assembly, Landing
OW-202	389P2	Bracket, for Hanger Assembly
OW-203	77RK1	Pin, for Roller

Rollers

S.E.E.S. #	O.E.M.#	Description
OW-204		Roller, 3-3/8" OD (3" Run Dia) .75" W, with 1/2-20 Ext Shaft
OW-205		Roller, Convex Tire 2.20" OD x 7/8" W x .370" ID
OW-3	456AK2	Roller guide wheel, 3-3/4" O.D., polyurethane tire, sealed maintenance free bearing with 5/8" shaft
OW-3A	A59J1	Pivot bolt for pivot arm
OW-4	456DN1	Roller guide wheel, 3" O.D., 3/8" flat polyurethane tire face, with 1/2" NC threaded eccentric shaft 1" L, 1/4 spacer
OW-4A	456DN2	Roller guide wheel, shaft 1-3/4" L, 1/2" spacer

Rollers and Slide Guides

S.E.E.S. #	O.E.M.#	Description
OW-4B	456DN3	Roller guide wheel , shaft 2-3/8" L, 7/8" spacer
OW-17	456CE4	Door roller with eccentric shaft, 2" O.D. x 9/16" with threaded shaft 1/2-20
OW-19	B6037B6, B6037B1	Hanger assembly , for hoistway, includes heavy bracket, rollers and wiper
OW-19A	456G1, 456EP2	Door roller kit , bolt and washer. Replacement roller kit for OW-19. 2-1/4" O.D., 3/4" I.D.
OW-20	456FC1	Hanger roller , LRV, 2" O.D.
OW-21	A6037D1	Wheel , 3.15" O.D., .587" W, 1/2" face, .875" I.D., aluminum
OW-24	HT200983-1	Tachometer drive wheel . Velocity transducer wheel for geared & gearless equipment, 4.332" O.D. x .490", tapered I.D.
OW-28		Roller , Guide Roller 4-7/8" OD 1-1/16" Wx.7874" ID (2x6204)
OW-29		Roller , Guide Roller 6-5/16" OD 1-1/4" Wx.9843" ID (2x6205)
OW-30B	KAA25830A2	Roller Guide Assy , 4.92" OD, Bottom for 2 & 1-1/2# Rail, Each
OW-30H	KAA25830A402	Service Kit , postwise upper pivot
OW-30G	KAA25830A401	Service Kit , postwise lower pivot
OW-30I	KAA90A1	Spring , for Roller Guide
OW-30A	KAA25830A1	Roller Guide Assy , 4.92" OD, Top for 2 & 1-1/2# Rail, Each
OW-30F	KAA25830A403	Service Kit , Front to Back Roller Bolt
OW-30E	KAA456K1	Roller , 125mm (4.92") for Roller Guide Assembly
OW-30C	KAA25830A3	Roller Guide Assembly , Set of 4 for 2 & 1-1/2# Rail
OW-30D	KAA384C1	Guard , for Guide Assembly
OW-30J	KAA133A1	Spring Seat , for Roller Guide



OW-17



OW-19



OW-19A



OW-20



OW-21

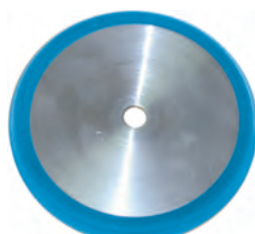

OW-24



OW-28



OW-29

S.E.E.S. #	O.E.M.#	Description
OTDV-4		Roller , for Door Vane 30mm x 8mm ID:6mm 6g-M8
OTDV-5		Roller , for Door Vane 37mm x 20mm ID:12mm
OTGS-1	XAA237D	Guide Shoe Inside , CS
OTGS-2	XAA380N1	Guide Shoe , 120mm x 16mm
OTGS-3	XAA24161A1	Guide Shoe , with spring
OTGS-6		Cushion , for guide shoe insert
OTGS-7		Guide Shoe Insert , 146mm x 35mm x 6mm
OTGS-12		Guide Shoe Groove , 150mm x 48mm
OTGS-13		Guide Shoe Groove , 150mm x 48mm
OTGS-14		Roller , for Guide Shoe 114mm x 36mm, bearing 6203



OTDV-4

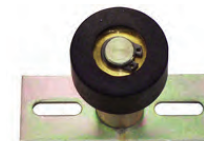

OTDV-5



OTGS-6



OTGS-7



OTGS-12

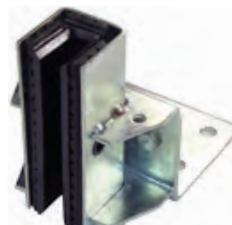

OTGS-13



OTGS-14

Rollers and Slide Guides



OTGS-15



OTGS-16



OW-7

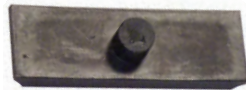

OTGS-19



OTGS-20



OTGS-21



OTGS-22



OW-7A



OW-7B



OW-7C



OW-7D



OW-7J



OW-7H



OW-200



OW-200A



OW-200C



OW-201

S.E.E.S. #	O.E.M.#	Description
OTGS-15		Roller , for Guide Shoe 160mm x 30mm, bearing 6203 ID:17
OTGS-16		Roller , for Guide Shoe 114mm x 36mm, bearing 6202 with Shaft
OTGS-19		Guide Shoe Insert , 98mm x 32mm x 10mm
OTGS-20		Guide Shoe Insert , 3 in 1, 200mm x 25mm x 6mm
OTGS-21		Guide Shoe Insert , 200mm x 30mm x 6mm
OTGS-22		Guide Shoe Insert , 3 in 1, 215mm x 42mm x 4mm
OTGS-200	380AT1	Gib , for Guide Shoe, cast iron, 12" long
OTGS-201	380BP1	Gib , for Guide Shoe, cast iron, 8.525" L, for # 3/4 rail
OTGS-202	6079	Gib , for Guide Shoe, cast iron, 8.5" L, for 5/8" thick rails

S.E.E.S. #	O.E.M.#	Description
OW-7	456CL4	Roller guide wheel , 7-7/8" O.D. x 1-1/2" Poly tire w/ sealed maintenance free bearing, hub extends past tire width on shaft side, after Dec. '62
OW-7A	59P2	Bolt , pivot, for 7-7/8" roller guide assembly
OW-7B	335H1	Bushing , brass, for roller guide assembly
OW-7C	B288CK1	Lever , for 7-7/8" roller guide assembly, R.H.
OW-7D	B288CK2	Lever , for 7-7/8" roller guide assembly, L.H.
OW-7E	6261C1	Roller Guide Assembly , 7-7/8" OD for #1 & #1-1/2 Rail, Top
OW-7F	6261C4	Roller Guide assembly , 7-7/8" OD for #1 & #1-1/2 Rail, Bottom
OW-7G	6261C400	Hardware Kit , For Roller Guide OW-7E and OW-7F
OW-7F	6261C4	Roller Guide Assembly , 7-7/8" OD for #1 & #1-1/2 Rail, Bottom
OW-7H	456CL4/O423	Roller Guide wheel , 7-7/8" OD x 1-1/2" W with shaft, HD 90 Duro
OW-7J	O421X	Otis Bolt and Bushing , assembly with hardware
OW-7K	F6261C2	Roller Guide Assembly , 7-7/8" OD for #3/4 Rail, Top
OW-7L	F6261C5	Roller Guide Assembly , 7-7/8" OD for #3/4 Rail, Bottom
OW-7M	F6261C3	Roller Guide Assy , Counterweight, 7-7/8" OD for #1 and #1-1/2 Rail, Top
OW-200	A395D2	Lever , for Roller Guide
OW-200A	B288LJ2	Lever , for Roller Guide
OW-200C	A288LM2	Lever
OW-201	A288RL2	Lever , for Roller Guide

Rollers and Slide Guides

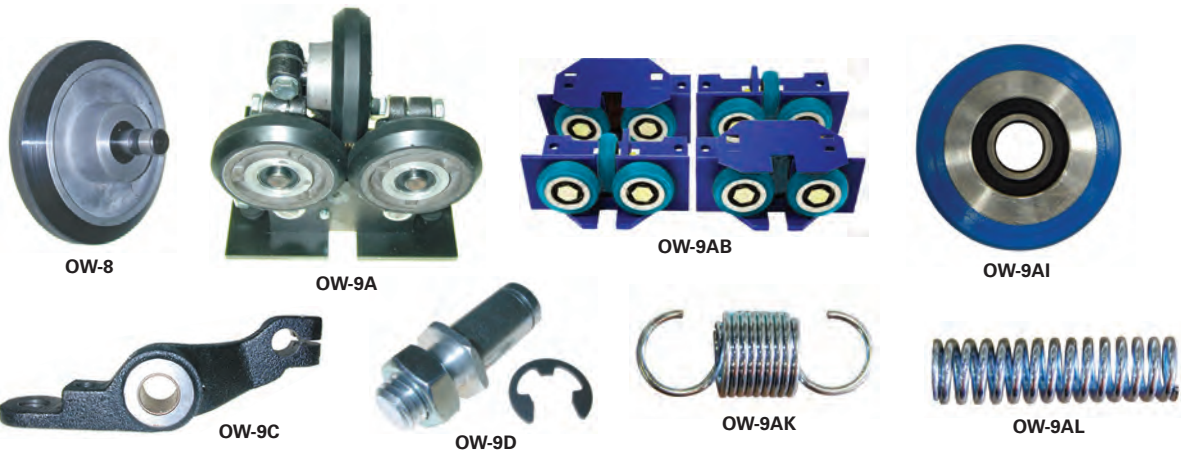

S.E.E.S. #	O.E.M.#	Description
OW-8	456CM4	Roller guide wheel, 4-7/8" O.D. x 2-5/8" overall hub width. Polyurethane tire, 1" shaft, maintenance free sealed pump shaft bearing
OW-9	456CN4	Roller guide wheel, 3-3/4" O.D. x 7/8" Polyurethane tire, 5/8" hub, 1" shaft, maintenance free sealed pump shaft bearing
OW-9A	6261P1	Roller guide assembly complete, with three OW-9 rollers, 3-3/4" O.D.
OW-9AB	KAA25830B5	Roller Guide Assy, New Style 76mm Wheel, set of 4, hardware included
OW-9AD	KAA25830B2	Roller Guide Assembly, 3" OD, Bottom for 2# Rail, Each
OW-9AC	KAA25830B1	Roller Guide Assembly, 3" OD, Top for 2# Rail, Each
OW-9AE	KAA25830B3	Roller Guide Assembly, 3" OD, Top for 1-1/2# Rail, Each
OW-9AF	KAA25830B4	Roller Guide Assembly, 3" OD, Bottom for 1-1/2# Rail, Each
OW-9AG	AAA384AHH1	Guard, for 3" Guide Assembly
OW-9AH	KAA2v5830B401	Screw, for 3" Roller Guide Assembly
OW-9AI	90BC12	Roller, 3" (76mm) OD for Roller Guide
OW-9AJ	KAA25830B401	Arm lever, M5x10 for Guide
OW-9AK	90BC12	Spring, Tension Spring, Double
OW-9AL	91B19	Spring, Compression Spring, for OW-9A
OW-9B	288LM2	Arm Lever, roller guide assembly, 3-3/4"
OW-9C	288LL2	Post, arm lever for roller guide assembly, 3-3/4"
OW-9D	288LL2	Pivot Pin, for OW-9A Roller Guide Assembly
OW-10	456CV4	Roller guide wheel, 10" O.D. x 1-1/2" Polyurethane tire, shaft with maintenance free sealed bearing
OW-10A		Spring, Replacement for OW-10
OW-10B	59BR2	Pivot bolt, for roller guide assembly
OW-10C	456ACH1	Roller Guide Wheel, 10" OD x 1.5" W x .20 Face, with Shaft
OW-10D	B261AM3	Roller Guide Assembly, 10" OD for #1 Rail, Top
OW-10E	B261AM4	Roller Guide Assembly, 10" OD for #1 Rail, Bottom
OW-10F	B261AM5	Roller Guide Assembly, 10" OD for #1/2 Rail, Top
OW-10G	B261AM6	Roller Guide Assembly, 10" OD for #1/2 Rail, Bottom
OW-10H	B6261AM1	Roller Guide Assembly, 10" OD for #3/4 Rail, Top
OW-10K	B261AM7	Roller Guide Assembly, 10" OD for #OA Rail, Top
OW-10L	B261AM8	Roller Guide Assembly, 10" OD for #OA Rail, Bottom



OW-9B



OW-10



OW-10B



OW-15



OW-15H

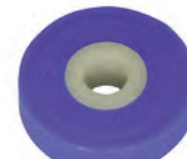

OTWH-8



OTLO-9



OTLO-10

Rollers and Slide Guides

S.E.E.S. #	O.E.M.#	Description
OW-15	456AJ2	Roller guide wheel , 7-7/8" O.D. x 1-1/2" Polyurethane tire with sealed maintenance free bearing with shaft, hub extends past tire width on side opposite shaft, 1941 thru 1962
OW-15H	456AJ2/0421	Roller Guide wheel , 7-7/8" OD x 1-1/2" W w/ shaft, HD 90 Duro
OTWH-8		Roller , for Hanger Nylon Hub 76.2mm x 21.4mm, ID:19.1mm
OTWH-11		Roller Guide wheel , 3-1/8" OD x .79"(80mm x 20mm) Bearing 6204
OTLO-9		Roller , for Door Lock 52mm x 20mm, bearing 6201, ID:12mm
OTLO-10		Roller , for Door Lock for GS09 37mm x 20mm, ID:12mm
OTLO-13		Door Lock Contact For Otis Elevator
ORG-001	380BS2	Insert , Otis 3" round tube rail gib



ORG-001