



# Cisco UCS C240 M4 High-Density Rack Server (Small Form Factor Disk Drive Model)

# CONTENTS

<b>OVERVIEW</b>	<b>5</b>
<b>DETAILED VIEWS</b>	<b>6</b>
Chassis Front View	6
Chassis Rear View	9
<b>BASE SERVER STANDARD CAPABILITIES and FEATURES</b>	<b>10</b>
<b>CONFIGURING the SERVER</b>	<b>14</b>
STEP 1 VERIFY SERVER SKU	15
STEP 2 SELECT RISER CARDS (OPTIONAL)	16
STEP 3 SELECT CPU(s)	17
STEP 4 SELECT MEMORY	19
STEP 5 SELECT DISK CONTROLLERS	24
RAID Internal Drive Control	24
HBA JBOD Internal Drive Control	24
HBA JBOD External Drive Control	24
RAID Volumes and Groups	25
STEP 6 SELECT HARD DISK DRIVES (HDDs) or SOLID STATE DRIVES (SSDs)	33
STEP 7 SELECT PCIe OPTION CARD(s)	36
STEP 8 ORDER OPTIONAL NETWORK CARD ACCESSORIES	40
STEP 9 ORDER GPU CARDS AND GPU POWER CABLES (OPTIONAL)	44
STEP 10 ORDER POWER SUPPLY	46
STEP 11 SELECT AC POWER CORD(s)	47
STEP 12 ORDER RAIL KIT AND OPTIONAL REVERSIBLE CABLE MANAGEMENT ARM	50
STEP 13 SELECT NIC MODE (OPTIONAL)	51
STEP 14 ORDER A TRUSTED PLATFORM MODULE (OPTIONAL)	52
STEP 15 ORDER CISCO FLEXIBLE FLASH SD CARD MODULE (OPTIONAL)	53
STEP 16 ORDER OPTIONAL USB 3.0 DRIVE	54
STEP 17 SELECT OPERATING SYSTEM AND VALUE-ADDED SOFTWARE	55
STEP 18 SELECT OPERATING SYSTEM MEDIA KIT	58
STEP 19 SELECT SERVICE and SUPPORT LEVEL	59
<b>OPTIONAL STEP - ORDER RACK(s)</b>	<b>64</b>
<b>OPTIONAL STEP - ORDER PDU</b>	<b>65</b>
<b>SUPPLEMENTAL MATERIAL</b>	<b>66</b>
CHASSIS	66
CPUs and DIMMs	67
Physical Layout	67
Memory Population Rules	68
DIMM Population Order	69
Recommended Memory Configuration	70
Additional DIMM Populations	71
RAID Details	72
Cisco 12G SAS Modular RAID Controller (RAID Support)	72
Cisco 9300-8i 12G SAS HBA (JBOD Only Support)	72
RAID Option ROM (OPROM) Settings	73
Riser Card Configuration and Options	74
Embedded SATA RAID: Two SATA Controllers	76
Serial Port Details	79
Upgrade and Servicing-Related Parts	80
Adding an Additional CPU (with CPU heat sink)	81
Motherboard Lithium Battery	81

---

Thermal Grease (with syringe applicator) for CPU to Heatsink Seal . . . . .	81
Air Baffle Replacement Kit . . . . .	82
CPU Heat Sink Cleaning Kit . . . . .	82
<b>RACKS</b> . . . . .	<b>83</b>
PDU's . . . . .	85
KVM CABLE . . . . .	86
Motherboard USB and SD Ports, and RAID Card Backup Locations . . . . .	87
<b>TECHNICAL SPECIFICATIONS</b> . . . . .	<b>88</b>
Dimensions and Weight . . . . .	88
Power Specifications . . . . .	89
Environmental Specifications . . . . .	91
Compliance Requirements . . . . .	92

---

# CONTENTS

## OVERVIEW

The UCS C240 M4 SFF server is the newest 2-socket, 2U rack server from Cisco, designed for both performance and expandability over a wide range of storage-intensive infrastructure workloads from big data to collaboration.

The enterprise-class UCS C240 M4 SFF server extends the capabilities of Cisco's Unified Computing System portfolio in a 2U form factor with the addition of the Intel® Xeon E5-2600 v3 series processor family that delivers the best combination of performance, flexibility, and efficiency gains. In addition, the UCS C240 M4 SFF server provides 24 DIMM slots, up to 6 PCI Express (PCIe) 3.0 slots, up to 24 front-loading drives plus two (optional) internal SATA boot drives for a total of 26 internal drives.

The C240 M4 server includes a modular LAN on motherboard (mLOM) slot for installation of a Cisco Virtual Interface Card (VIC) or third-party network interface card (NIC) without consuming a PCI slot in addition to 2 x 1 GbE embedded (on the motherboard) LOM ports. These features combine to provide outstanding levels of internal memory and storage expandability along with exceptional performance.

The Cisco UCS C240 M4 server can be used standalone, or as part of the Cisco Unified Computing System, which unifies computing, networking, management, virtualization, and storage access into a single integrated architecture enabling end-to-end server visibility, management, and control in both bare metal and virtualized environments.

Figure 1 Cisco UCS C240 M4 High-Density SFF Rack Server (24-drive version)

### Front View



# DETAILED VIEWS

## Chassis Front View

Figure 2 shows the 24-drive Cisco UCS C240 M4 High-Density SFF Rack Server.

Figure 2 Chassis Front View (24-drive version)

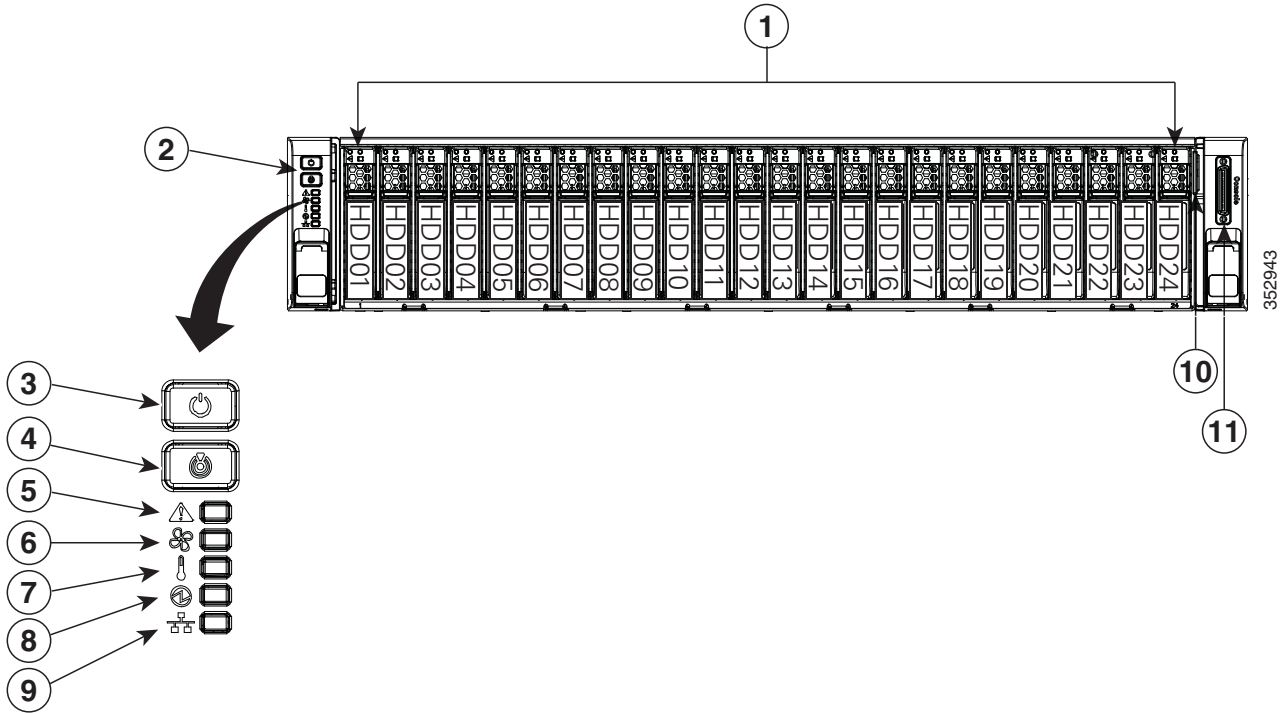

1	Drive bays 1-24 (up to 24 2.5-inch drives)	7	Temperature status LED
2	Operations panel buttons and LEDs	8	Power supply status LED
3	Power button/LED	9	Network link activity LED
4	Unit Identification button/LED	10	Pull-out asset tag
5	System status LED	11	KVM connector (used with KVM cable that provides two USB 2.0, one VGA, and one serial connector)
6	Fan status LED		

Figure 3 shows the 16-drive Cisco UCS C240 M4 High-Density SFF Rack Server.

Figure 3 Chassis Front View (16-drive version)

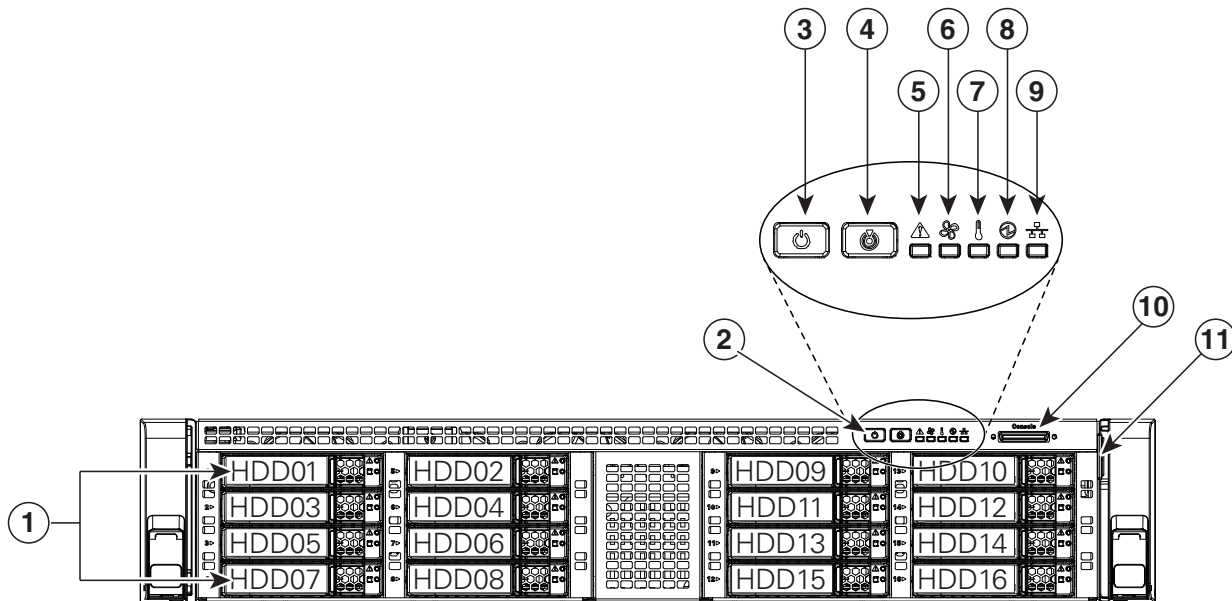

352944

1	Drive bays 1-16 (up to 16 2.5-inch drives)	7	Temperature status LED
2	Operations panel buttons and LEDs	8	Power supply status LED
3	Power button/LED	9	Network link activity LED
4	Unit Identification button/LED	10	KVM connector (used with KVM cable that provides two USB 2.0, one VGA, and one serial connector)
5	System status LED	11	Pull-out asset tag
6	Fan status LED		

Figure 3 shows the 8-drive Cisco UCS C240 M4 High-Density SFF Rack Server.

Figure 4 Chassis Front View (8-drive version)

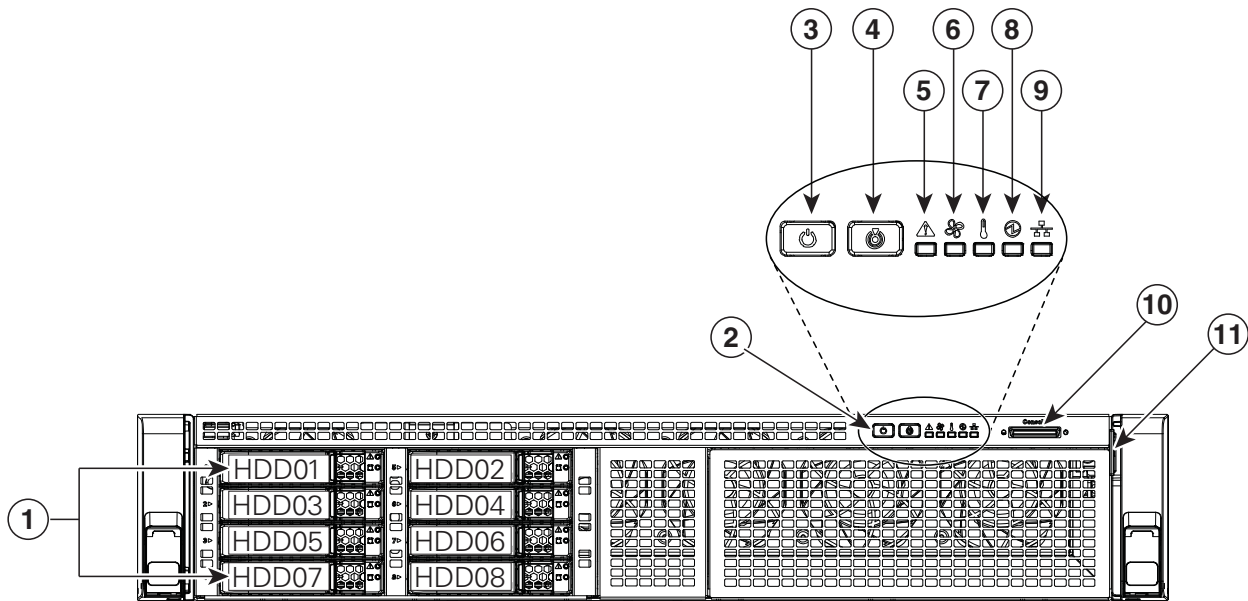

352945

1	Drive bays 1-8 (up to 8 2.5-inch drives)	7	Temperature status LED
2	Operations panel buttons and LEDs	8	Power supply status LED
3	Power button/LED	9	Network link activity LED
4	Unit Identification button/LED	10	KVM connector (used with KVM cable that provides two USB 2.0, one VGA, and one serial connector)
5	System status LED	11	Pull-out asset tag
6	Fan status LED		

For more information about the KVM cable connection, see [KVM CABLE, page 86](#).



## Chassis Rear View

Figure 5 shows the external features of the rear panel (identical for all server versions).

Figure 5 Chassis Rear View

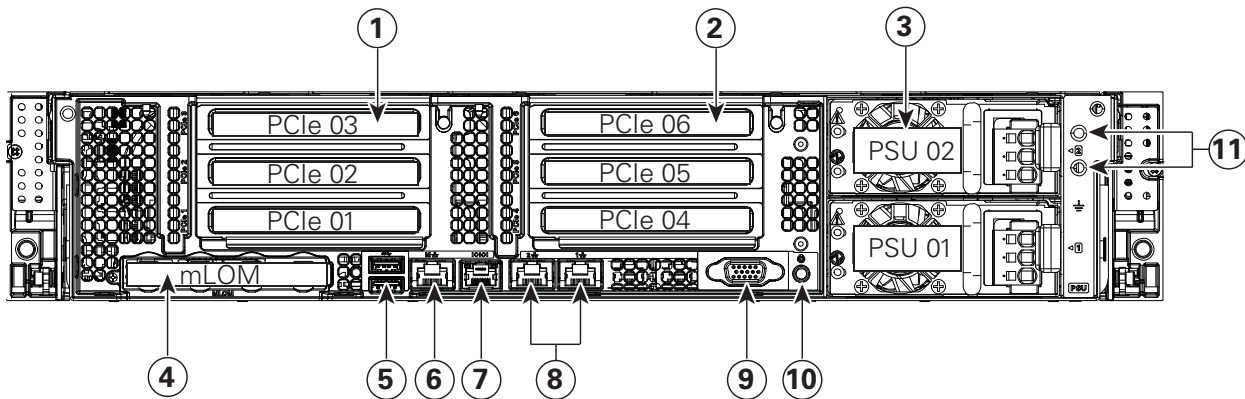

352947

1	PCIe riser 1 (slots 1, 2, 3*) *Slot 3 not present in all versions. See <a href="#">Riser Card Configuration and Options, page 74</a> for details.	7	Serial connector (RJ-45) <sup>1</sup>
2	PCIe riser 2 (slots 4, 5, 6), See <a href="#">Riser Card Configuration and Options, page 74</a> for details.	8	Two embedded (on the motherboard) Intel i350 GbE Ethernet controller ports (LAN1, LAN2)
3	Power supplies (DC power supplies shown)	9	VGA video port (DB-15 connector)
4	Modular LAN-on-motherboard (mLOM) card slot	10	Rear Unit Identification button/LED
5	USB 3.0 ports (two)	11	Grounding-lug holes (for DC power supplies)
6	1-Gbps dedicated management port		—

Notes . . .

1. For serial port pinout details, see [Embedded SATA RAID: Two SATA Controllers, page 76](#)

## BASE SERVER STANDARD CAPABILITIES and FEATURES

*Table 1* lists the capabilities and features of the base server. Details about how to configure the server for a particular feature or capability (for example, number of processors, disk drives, or amount of memory) are provided in *CONFIGURING the SERVER, page 14*.

Table 1 Capabilities and Features

Capability/Feature	Description
Chassis	Two rack unit (2RU) chassis
CPU	One or two Intel Xeon E5-2600 v3 series processor family CPUs
Chipset	Intel® C610 series chipset
Memory	24 slots for registered ECC DIMMs (RDIMMs) or load-reduced DIMMs (LRDIMMs)
Multi-bit Error Protection	This server supports multi-bit error protection.
Expansion slots	<p>Up to six PCIe slots (on two riser cards)</p> <ul style="list-style-type: none"> <li>■ Riser 1 (PCIe slots 1, 2, and 3) <ul style="list-style-type: none"> <li>• Option A: Two slots available. Slot 1 = full height, 3/4 length, x8, NCSI<sup>1</sup>. Slot 2 = full height, full length, x16, NCSI, GPU capable. NCSI is supported on only one slot at a time.</li> <li>• Option B: Three slots available. Slot 1 = full height, 3/4 length, x8. Slot 2 = full height, full length, x8, NCSI. Slot 3 = full height, full length, x8.</li> <li>• Option C: Two slots available. Slot 1 = full height, 3/4 length, x8, NCSI. Slot 2 = full height, full length, x16, NCSI. In addition, the riser contains two connectors for connecting up to two SATA boot drives.</li> </ul> </li> <li>■ Riser 2 (PCIe slots 4, 5, and 6). Three slots available. Slot 4 = full height, 3/4 length, x8, NCSI. Slot 5 = full height, full length, x16, NCSI, GPU capable. Slot 6 = full height, full length, x8. NCSI is supported on only one slot at a time.</li> <li>■ Dedicated RAID controller slot <ul style="list-style-type: none"> <li>• An internal slot is reserved for the Cisco 12G SAS Modular RAID controller.</li> </ul> </li> </ul> <p>For more details on riser 1 and riser 2 see <a href="#">Riser Card Configuration and Options, page 74</a>.</p>
Video	<p>The Cisco Integrated Management Controller (CIMC) provides video using the Matrox G200e video/graphics controller:</p> <ul style="list-style-type: none"> <li>■ Integrated 2D graphics core with hardware acceleration</li> <li>■ DDR2/3 memory interface supports up to 512 MB of addressable memory (8 MB is allocated by default to video memory)</li> <li>■ Supports display resolutions up to 1920 x 1200 16bpp @ 60Hz</li> <li>■ High-speed integrated 24-bit RAMDAC</li> <li>■ Single lane PCI-Express host interface running at Gen 1 speed</li> </ul>

Capability/Feature	Description
Internal storage devices	<p>Drives are installed into front-panel drive bays that provide hot-pluggable access.</p> <ul style="list-style-type: none"> <li>■ Small Form Factor (SFF) drives. The server can hold up to: <ul style="list-style-type: none"> <li>• 24 2.5 inch (63.5 mm) SAS/SATA hard drives (HDDs) or SAS/SATA solid state drives (SSDs) with the 24-drive backplane (with expander) server configuration, plus two optional internal 2.5 inch SATA SSDs for booting an OS.</li> <li>• 16 2.5 inch (63.5 mm) SAS/SATA HDDs or SAS/SATA SSDs with the 16-drive backplane (with expander) server configuration</li> <li>• 8 2.5 inch (63.5 mm) SAS/SATA HDDs or SAS/SATA SSDs with the 8-drive backplane server (no expander) configuration.</li> </ul> </li> <li>■ The server also contains one internal USB 3.0 port on the motherboard that you can use with an optional 16 GB USB thumb drive for additional storage</li> <li>■ UCS Storage Accelerators are also available. These PCIe plug-in flash storage cards provide independent high-speed storage.</li> </ul>
Cisco Flexible Flash drives	<p>The server supports up to two internal 32 GB or two internal 64 GB Cisco Flexible Flash drives (SD cards).</p> <p>The second SD card is blank and can be used to mirror the first SD card. It can be used to protect the Hypervisor Partition with RAID1.</p>
Interfaces	<ul style="list-style-type: none"> <li>■ Rear panel <ul style="list-style-type: none"> <li>• One DB15 VGA connector</li> <li>• One RJ45 serial port connector</li> <li>• Two USB 3.0 port connectors</li> <li>• One RJ-45 10/100/1000 Ethernet management port, using Cisco Integrated Management Controller (CIMC) firmware</li> <li>• Two Intel i350 embedded (on the motherboard) GbE LOM ports</li> <li>• One flexible modular LAN on motherboard (mLOM) slot that can accommodate various interface cards</li> </ul> </li> <li>■ Various PCIe card ports (dependent on which cards are installed) <ul style="list-style-type: none"> <li>• Virtual Interface Card (VIC) ports</li> <li>• Converged Network Adapter (CNA) ports</li> <li>• Network Interface Card (NIC) ports</li> <li>• Host Bus Adapter (HBA) ports</li> </ul> </li> <li>■ Front panel <ul style="list-style-type: none"> <li>• One KVM console connector (supplies two USB 2.0 connectors, one VGA DB15 video connector, and one serial port (RS232) RJ45 connector)</li> </ul> </li> </ul>
Power subsystem	<p>Up to two of the following hot-swappable power supplies:</p> <ul style="list-style-type: none"> <li>■ 650 W (AC)</li> <li>■ 1200 W (AC)</li> <li>■ 1400 W (AC)</li> </ul> <p>One power supply is mandatory; one more can be added for 1 + 1 redundancy.</p>

Capability/Feature	Description
--------------------	-------------

- |                    |  |
|--------------------|--|
| Storage controller | <ul style="list-style-type: none"> <li>■ Embedded Software RAID (6 Gbps)                             <ul style="list-style-type: none"> <li>• Embedded SATA-only RAID controller, supporting up to 8 SATA-only drives (RAID 0, 1), or</li> <li>• Embedded Software RAID 5 key upgrade, supporting up to 8 SATA-only drives (RAID 0, 1, 10, 5)</li> </ul> </li> </ul> |
|--------------------|--|

Note that embedded RAID options can be supported only with the version of the C240 M4 SFF server that has been configured with an 8-drive backplane.

- Cisco 12G SAS Modular RAID controller card with internal SAS connectivity.
  - Supports up to 24 internal drives
  - Plugs into a dedicated RAID controller slot
- Can be purchased alone, or along with an onboard Flash-Backed Write Cache (FBWC) upgrade option, as shown in the table below

RAID Card Version	Supported RAID Levels	Onboard FBWC
UCSC-MRAID12G <sup>1</sup>	JBOD, 0, 1, 10	None
UCSC-MRAID12G-1GB <sup>2</sup>	JBOD, 0, 1, 10, 5, 6, 50, 60	1 GB
UCSC-MRAID12G-2GB <sup>2</sup>	JBOD, 0, 1, 10, 5, 6, 50, 60	2 GB
UCSC-MRAID12G-4GB <sup>2</sup>	JBOD, 0, 1, 10, 5, 6, 50, 60	4 GB

Notes . . .

1. Base RAID controller card
2. FBWC option

All versions of the UCSC-MRAID12G RAID controller support up to 24 internal SAS drives on the 24-drive backplane version of the server, up to 16 drives on the 16-drive backplane version, or up to 8 drives on the 8-drive backplane version.

- Cisco 9300-8i 12G SAS HBA with internal SAS connectivity
  - Supports up to 24 internal drives (compatible only with the 24-drive backplane)
  - Plugs into a dedicated PCIe slot at the rear of the server (slot 1 of riser 1)
  - Supports JBOD only, not RAID.
- Cisco 9300-8E 12G SAS HBA with external SAS connectivity
  - Provides 8 external SAS ports
  - Plugs into a PCIe slot at the rear of the server
  - No FBWC (cache) or cache power backup
  - SAS 3.0 compliant

Capability/Feature	Description
Embedded NIC	Two embedded (on the motherboard) Intel i350 GbE ports, supporting the following: <ul style="list-style-type: none"> <li>■ Pre-Execution Boot (PXE boot)</li> <li>■ iSCSI boot</li> <li>■ Checksum and segmentation offload</li> <li>■ NIC teaming</li> </ul>
Modular LAN on Motherboard (mLOM) slot	The mLOM slot can flexibly accommodate the following cards: <ul style="list-style-type: none"> <li>■ Cisco Virtual Interface Cards (VIC)</li> <li>■ Quad Port Intel i350 1GbE RJ45 Network Interface Card (NIC)</li> </ul>
 <p><b>NOTE:</b> The four Intel i350 ports are provided on an optional card that plugs into the mLOM slot, and are separate from the two embedded (on the motherboard) LAN ports</p>	
WoL	The 1-Gb Base-T Ethernet LAN ports support the wake-on-LAN (WoL) standard.
Front Panel	A front panel controller provides status indications and control buttons
ACPI	This server supports the advanced configuration and power interface (ACPI) 4.0 standard.
Fans	Chassis: <ul style="list-style-type: none"> <li>■ Six hot-swappable fans for front-to-rear cooling</li> </ul>
Integrated management processor	Baseboard Management Controller (BMC) running Cisco Integrated Management Controller (CIMC) firmware. Depending on your CIMC settings, the CIMC can be accessed through the 1-GbE dedicated management port, the 1-GbE LOM ports, or a Cisco virtual interface card (VIC).
Boot drives	Up to two optional SATA drives can be installed internal to the chassis on riser 1. The two SATA boot drives are supported only on the 24-drive backplane chassis version and are managed in AHCI mode, using OS-based software RAID.

Notes . . .

1. NCSI = Network Communications Services Interface protocol. An NCSI slot is powered even when the server is in standby power mode.

## CONFIGURING the SERVER

Follow these steps to configure the Cisco UCS C240 M4 High-Density SFF Rack Server:

- *STEP 1 VERIFY SERVER SKU, page 15*
- *STEP 2 SELECT RISER CARDS (OPTIONAL), page 16*
- *STEP 3 SELECT CPU(s), page 17*
- *STEP 4 SELECT MEMORY, page 19*
- *STEP 5 SELECT DISK CONTROLLERS, page 24*
- *STEP 6 SELECT HARD DISK DRIVES (HDDs) or SOLID STATE DRIVES (SSDs), page 33*
- *STEP 7 SELECT PCIe OPTION CARD(s), page 36*
- *STEP 8 ORDER OPTIONAL NETWORK CARD ACCESSORIES, page 39*
- *STEP 9 ORDER GPU CARDS AND GPU POWER CABLES (OPTIONAL), page 44*
- *STEP 10 ORDER POWER SUPPLY, page 46*
- *STEP 11 SELECT AC POWER CORD(s), page 47*
- *STEP 12 ORDER RAIL KIT AND OPTIONAL REVERSIBLE CABLE MANAGEMENT ARM, page 50*
- *STEP 13 SELECT NIC MODE (OPTIONAL), page 51*
- *STEP 14 ORDER A TRUSTED PLATFORM MODULE (OPTIONAL), page 52*
- *STEP 15 ORDER CISCO FLEXIBLE FLASH SD CARD MODULE (OPTIONAL), page 53*
- *STEP 16 ORDER OPTIONAL USB 3.0 DRIVE, page 54*
- *STEP 17 SELECT OPERATING SYSTEM AND VALUE-ADDED SOFTWARE, page 55*
- *STEP 18 SELECT OPERATING SYSTEM MEDIA KIT, page 58*
- *STEP 19 SELECT SERVICE and SUPPORT LEVEL, page 59*
- *OPTIONAL STEP - ORDER RACK(s), page 64*
- *OPTIONAL STEP - ORDER PDU, page 65*

## STEP 1 VERIFY SERVER SKU

Select one server product ID (PID) from [Table 2](#).

Table 2 PID of the C240 M4 High-Density SFF Rack Base Server

Product ID (PID)	Description
UCSC-C240-M4SX	UCS C240 M4 SFF, no CPU, memory, HDD, SSD, PCIe cards, rail kit, or power supply, with 24-drive backplane with SAS expander
UCSC-C240-M4S2	UCS C240 M4 SFF, no CPU, memory, HDD, SSD, PCIe cards, rail kit, or power supply, with 16-drive backplane with SAS expander
UCSC-C240-M4S	UCS C240 M4 SFF, no CPU, memory, HDD, SSD, PCIe cards, rail kit, or power supply, with 8-drive backplane with no SAS expander

The Cisco UCS C240 M4 server:

- Includes either a 24-, 16-, or 8-drive backplane.



**NOTE:** Embedded Software RAID can only be used with the 8-drive backplane version of the server.

The Cisco 12G SAS Modular RAID controller can be used with any backplane version.

The Cisco 9300-8i 12G SAS HBA is compatible only with the 24-drive backplane version.

- Does not include power supply, CPU, memory, hard disk drives (HDDs), solid-state drives (SSDs), boot drives, SD cards, riser 1, riser 2, rail kit, or PCIe cards.



**NOTE:** Use the steps on the following pages to configure the server with the components that you want to include.

## STEP 2 SELECT RISER CARDS (OPTIONAL)

There are two optional riser cards, riser card 1 and 2. There are three options for riser card 1. Order one riser card 1 from [Table 3](#) and one riser 2 card from [Table 4](#). Riser card 1 is the one on the left when viewed from the back of the server and riser card 2 is on the right.

Table 3 Riser 1 Options

Product ID (PID)	Description
UCSC-PCI-1A-240M4	C240 M4 PCIe Riser 1 Assy (option A) (2 PCIe slots: 1x8 and 1x16 GPU capable)
UCSC-PCI-1B-240M4	C240 M4 PCIe Riser 1 Assy (option B) (3 PCIe slots: 3x8)
UCSC-PCI-1C-240M4	C240 M4 PCIe Riser 1 Assy (option C) (2 PCIe slots: 1x8 and 1x16 plus connectors for 2 SATA boot drives)

The selection of riser card 1 determines the number and type of PCIe cards and SATA boot drives supported in the riser.

Table 4 Riser 2 Options

Product ID (PID)	Description
UCSC-PCI-2-C240M4	Left PCIe Riser Board (Riser 2) for C240 M4 (3 slots: 2x8 and 1x16)



**NOTE:** If no riser is selected, a riser blanking panel will be installed. You will not be able to install any PCIe cards without a riser selected

For additional details, see [Riser Card Configuration and Options, page 74](#).



### STEP 3 SELECT CPU(s)

The standard CPU features are:

- Intel Xeon E5-2600 v3 series processor family CPUs
- Intel C610 series chipset
- Cache size of up to 45 MB

#### Select CPUs

The available CPUs are listed in [Table 5](#).

Table 5 Available Intel CPUs: E5-2600 v3 Series Processor Family CPUs

Product ID (PID)	Intel Number	Clock Freq (GHz)	Power (W)	Cache Size (MB)	Cores	QPI	Highest DDR4 DIMM Clock Support (MHz) <sup>1</sup>
UCS-CPU-E52699D	E5-2699 v3	2.30	145	45	18	9.6 GT/s	2133
UCS-CPU-E52698D	E5-2698 v3	2.30	135	40	16	9.6 GT/s	2133
UCS-CPU-E52697D	E5-2697 v3	2.60	145	35	14	9.6 GT/s	2133
UCS-CPU-E52695D	E5-2695 v3	2.30	120	35	14	9.6 GT/s	2133
UCS-CPU-E52690D	E5-2690 v3	2.60	135	30	12	9.6 GT/s	2133
UCS-CPU-E52683D	E5-2683 v3	2.00	120	35	14	9.6 GT/s	2133
UCS-CPU-E52680D	E5-2680 v3	2.50	120	30	12	9.6 GT/s	2133
UCS-CPU-E52670D	E5-2670 v3	2.30	120	30	12	9.6 GT/s	2133
UCS-CPU-E52667D	E5-2667 v3	3.20	135	20	8	9.6 GT/s	2133
UCS-CPU-E52660D	E5-2660 v3	2.60	105	25	10	9.6 GT/s	2133
UCS-CPU-E52650D	E5-2650 v3	2.30	105	25	10	9.6 GT/s	2133
UCS-CPU-E52650LD	E5-2650L v3	1.80	65	30	12	9.6 GT/s	1866
UCS-CPU-E52643D	E5-2643 v3	3.40	135	20	6	9.6 GT/s	2133
UCS-CPU-E52640D	E5-2640 v3	2.60	90	20	8	8.0 GT/s	1866
UCS-CPU-E52637D	E5-2637 v3	3.50	135	15	4	9.6 GT/s	2133
UCS-CPU-E52630D	E5-2630 v3	2.40	85	20	8	8.0 GT/s	1866
UCS-CPU-E52630LD	E5-2630L v3	1.80	55	20	8	8.0 GT/s	1866
UCS-CPU-E52623D	E5-2623 v3	3.00	105	10	4	8.0 GT/s	1866
UCS-CPU-E52620D	E5-2620 v3	2.40	85	15	6	8.0 GT/s	1866
UCS-CPU-E52609D <sup>2</sup>	E5-2609 v3	1.90	85	15	6	6.4 GT/s	1600

Notes . . .

1. If higher or lower speed DIMMs are selected than what is shown in the table for a given CPU, the DIMMs will be clocked at the lowest common denominator of CPU clock and DIMM clock.
2. The E5-2609 v3 CPU does not support Intel Hyper-Threading or Intel Turbo Boost technologies.

### Approved Configurations

---

(1) 1-CPU configurations:

- Select any one CPU listed in [Table 5 on page 17](#).

(2) 2-CPU Configurations:

- Select two identical CPUs from any one of the rows of [Table 5 on page 17](#).

### Caveats

---

- You can select either one processor or two identical processors.

## STEP 4 SELECT MEMORY

The standard memory features are:

- DIMMs
  - Clock speed: 2133 MHz
  - Ranks per DIMM: 1, 2, or 4
  - Operational voltage: 1.2 V
  - Registered ECC DDR4 DIMMs (RDIMMs) or load-reduced DIMMs (LRDIMMs)
- Memory is organized with four memory channels per CPU, with up to three DIMMs per channel, as shown in [Figure 6](#).

Figure 6 C240 M4 SFF Memory Organization

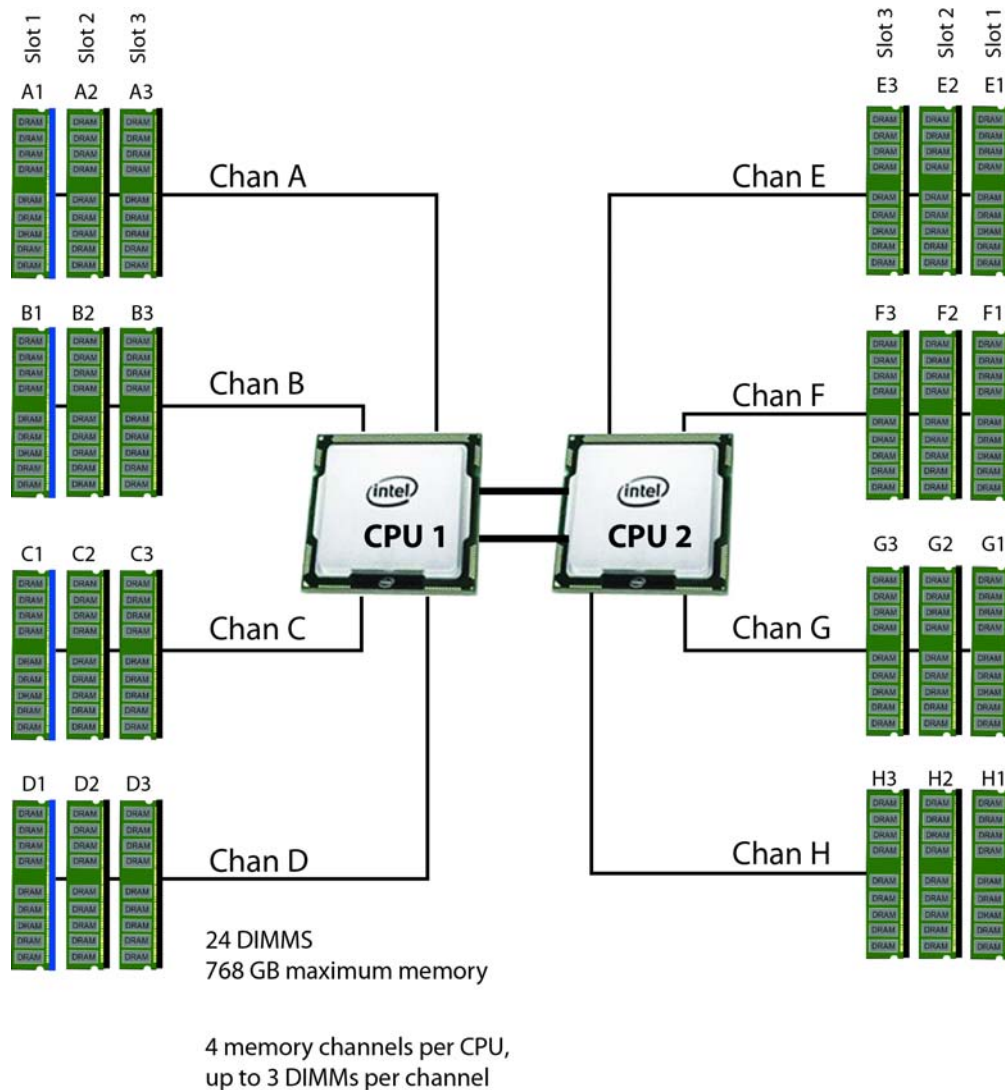

Select DIMMs and Memory Mirroring

Select the memory configuration and whether or not you want the memory mirroring option. The available memory DIMMs and mirroring option are listed in [Table 6](#).



**NOTE:** When memory mirroring is enabled, the memory subsystem simultaneously writes identical data to two channels. If a memory read from one of the channels returns incorrect data due to an uncorrectable memory error, the system automatically retrieves the data from the other channel. A transient or soft error in one channel does not affect the mirrored data, and operation continues unless there is a simultaneous error in exactly the same location on a DIMM and its mirrored DIMM. Memory mirroring reduces the amount of memory available to the operating system by 50% because only one of the two populated channels provides data.

Table 6 Available DDR4 DIMMs

Product ID (PID)	PID Description	Voltage	Ranks /DIMM
<b>DIMM Options</b>			
UCS-ML-1X324RU-A	32GB DDR4-2133-MHz LRDIMM/PC3-17000/quad rank/x4	1.2 V	4
UCS-MR-1X162RU-A	16GB DDR4-2133-MHz RDIMM/PC3-17000/dual rank/x4	1.2 V	2
UCS-MR-1X081RU-A	8GB DDR4-2133-MHz RDIMM/PC3-17000/single rank/x4	1.2 V	1
<b>Memory Mirroring Option</b>			
N01-MMIRROR	Memory mirroring option		

Approved Configurations

(1) 1-CPU configuration without memory mirroring:

- Select from 1 to 12 DIMMs. Refer to [Memory Population Rules, page 68](#), for more detailed information.

(2) 1-CPU configuration with memory mirroring:

- Select 2, 4, 6, 8, or 12 identical DIMMs. The DIMMs will be placed by the factory as shown in the following table.

Total Number of DIMMs	CPU 1 DIMM Placement in Channels (for identical dual-rank DIMMs for 3DPC or identical quad-rank DIMMs for 2DPC)		
	Blue Slots	Black Slots	White Slots
2	(A1, B1)	—	—
4	(A1,B1); (C1,D1)	—	—
8	(A1,B1); (C1,D1)	(A2,B2); (C2,D2)	—
12	(A1,B1); (C1,D1)	(A2,B2); (C2,D2)	(A3,B3); (C3,D3)

- Select the memory mirroring option (N01-MMIRROR) as shown in [Table 6 on page 20](#).

(3) 2-CPU configuration without memory mirroring:

- Select from 1 to 12 DIMMs per CPU. Refer to [Memory Population Rules, page 68](#), for more detailed information.

(4) 2-CPU configuration with memory mirroring:

- Select 2, 4, 6, 8, or 12 identical DIMMs per CPU. The DIMMs will be placed by the factory as shown in the following table.

Number of DIMMs per CPU	CPU 1 DIMM Placement in Channels (for identical dual-rank DIMMs for 3DPC or identical quad-rank DIMMs for 2DPC)			CPU 2 DIMM Placement in Channels (for identical dual-rank DIMMs for 3DPC or identical quad-rank DIMMs for 2DPC)		
	Blue Slots	Black Slots	White Slots	Blue Slots	Black Slots	White Slots
2	(A1, B1)	—	—	(E1, F1)	—	—
4	(A1,B1); (C1,D1)	—	—	(E1,F1); (G1,H1)	—	—
8 (CPU1) and 4 (CPU2) <sup>1</sup>	(A1,B1); (C1,D1)	(A2,B2); (C2,D2)	—	(E1,F1); (G1,H1)	(E2, F2)	—
8	(A1,B1); (C1,D1)	(A2,B2); (C2,D2)	—	(E1,F1); (G1,H1)	(E2,F2); (G2,H2)	—
12	(A1,B1); (C1,D1)	(A2,B2); (C2,D2)	(A3, B3); (C3, D3)	(E1,F1); (G1,H1)	(E2,F2); (G2,H2)	(E3,F3); (G3,H3)

Notes . . .

1. Not recommended (for performance reasons)

- Select the memory mirroring option (N01-MMIRROR) as shown in [Table 6 on page 20](#).



**NOTE:** System performance is optimized when the DIMM type and quantity are equal for both CPUs, and when all channels are filled equally across the CPUs in the server.

**Caveats**

- System speed is dependent on how many DIMMs are populated per channel and the CPU DIMM speed support. See [Table 7](#) for details.

**Table 7 DIMM Memory Speeds with Different CPUs**

DIMM Speed	DPC	1600-MHz Capable CPU		1866-MHz Capable CPU		2133-MHz Capable CPU	
		LRDIMM (QR)	RDIMM (DR, SR)	LRDIMM (QR)	RDIMM (DR, SR)	LRDIMM (QR)	RDIMM (DR, SR)
2133 DIMM <sup>1</sup>	1DPC	1600	1600	1866	1866	2133	2133
	2DPC	1600	1600	1866	1866	2133	2133
	3DPC	1600	1600	1600	1600	1866	1866 (16 GB DIMMs) 1600 (8 GB DIMMs)

Notes . . .

1. 2133-MHz DIMMs are the only offered and supported DIMMs for the C220 M4 server

- The C240 M4 server supports four different memory reliability, availability, and serviceability (RAS) modes:
  - Independent Channel Mode
  - Mirrored Channel Mode
  - Lockstep Channel Mode
- Below are the system level RAS Mode combination limitations:
  - Mixing of Independent and Lockstep channel mode is not allowed per platform.
  - Mixing of Non-Mirrored and Mirrored mode is not allowed per platform.
  - Mixing of Lockstep and Mirrored mode is not allowed per platform.
- Do not mix RDIMMs with LRDIMMs
- Single-rank DIMMs can be mixed with dual-rank DIMMs in the same channel
- Do not mix quad-rank DIMMs with single- or dual-rank DIMMs in the same channel
- For best performance, observe the following:
  - DIMMs with different timing parameters can be installed on different slots within the same channel, but only timings that support the slowest DIMM will be applied to all.

As a consequence, faster DIMMs will be operated at timings supported by the slowest DIMM populated.

- When one DIMM is used, it must be populated in DIMM slot 1 (farthest away from the CPU) of a given channel.
- When single, dual or quad rank DIMMs are populated for 2DPC or 3DPC, always populate the higher number rank DIMM first (starting from the farthest slot). For a 3DPC example, first populate with quad-rank DIMMs in the DIMM slot 1. Then dual-rank DIMMs in the DIMM 2 slot. Then single-rank DIMMs in the DIMM 3slot.
- DIMMs for CPU 1 and CPU 2 (when populated) must always be configured identically.
- When using mirroring, DIMMs must be installed in identical pairs across paired DDR4 buses. That is, mirrored pairs in channels A and B must be identical and pairs in channels C and D must be identical. However, the DIMMs used in channels A and B can be different from those in channels C and D.
- Memory mirroring reduces the amount of available memory by 50% (quantity of DIMMs must be even for mirroring).
- Non-ECC DIMMs are not supported.
- Pairs of DIMMs (A1/B1, A2/B2, etc) MUST be the exact same (same PID, rev, DIMM loading order)
- Cisco memory from previous generation servers (DDR3) is not compatible with this server

For more information regarding memory, see [CPUs and DIMMs, page 67](#).

## STEP 5 SELECT DISK CONTROLLERS

### RAID Internal Drive Control

The default RAID configuration is embedded software RAID, which supports SATA HDDs (RAID 0, 1, 10). However, you can instead choose one of the following optional RAID upgrades:

- Embedded software RAID 5 key upgrade



**NOTE:** The embedded software RAID in the Intel chipset hub is split into two, SATA and sSATA (secondary SATA). They are seen as separate software RAID controllers and are configurable separately. For more details, see [Embedded SATA RAID: Two SATA Controllers, page 76](#).

---

- Cisco 12G SAS Modular RAID Controller upgrade



**NOTE:** The number of RAID groups (virtual drives) supported per RAID controller is as follows:

- Embedded RAID = 8
  - Cisco 12G SAS Modular RAID controller = 64
- 

### HBA JBOD Internal Drive Control

Instead of a RAID controller, you can choose the following SAS HBA for internal JBOD drive connectivity (non-RAID):

- Cisco 9300-8i 12G SAS HBA (compatible only with the 24-drive backplane)

### HBA JBOD External Drive Control

In addition to a RAID controller or JBOD controller for internal drives, you can choose the following SAS HBA for external JBOD drive connectivity (non-RAID):

- Cisco 9300-8e 12G SAS HBA (provides 8 SAS ports for external JBOD connectivity).



**NOTE:** The UCSC-C240-M4SX (24-drive server) and UCSC-C240-M4S2 (16-drive server) do not support the default embedded software RAID or the embedded software RAID 5 key upgrade (UCSC-SWRAID5), which is installed on the motherboard. The only drive controller support available for the 24-drive version is through the Cisco 12G SAS Modular RAID controller (provides RAID control) or the Cisco 9300-8i 12G SAS HBA (provides JBOD control) for internal drives. The only RAID support available for the 16-drive version is through the Cisco 12G SAS Modular RAID controller for internal drives. The only RAID support available for the 8-drive version is through the Cisco 12G SAS Modular RAID controller for internal drives, embedded software RAID, or the embedded software RAID 5 key upgrade.

---



## RAID Volumes and Groups

When creating each RAID volume, follow these guidelines:

- Use the same capacity for each drive in each RAID volume
- For embedded software RAID or the embedded software RAID 5 key upgrade:
  - Use only SATA HDDs
  - Embedded software RAID has two ports and each port can control 4 drives, for 8 drives total.
  - Each set of 4 SATA HDDs for a port must be in separate RAID volumes.
  - You cannot mix drives across ports to create a RAID volume.
  - For more details, see [Embedded SATA RAID: Two SATA Controllers, page 76](#).
- For the Cisco 12G SAS modular RAID controller upgrade:
  - Use either all SAS HDDs, or all SAS SSDs, or all SATA SSDs in each RAID volume

The number of RAID groups (virtual drives) supported per RAID controller is as follows:

- Embedded RAID = 8
- Cisco 12G SAS Modular RAID controller = 64

### Select Controller Options

---

Select as follows (these choices are dependent on the backplane used (24-drive, 16-drive, or 8-drive backplane)):

- For a 24-drive backplane system, select one of the following:
  - Cisco 12G SAS Modular RAID controller upgrade option or Cisco 9300-8i 12G SAS HBA upgrade option from [Table 9 on page 27](#), or
  - Cisco 9300-8E 12G SAS HBA upgrade option (JBOD support only for external drives) from [Table 9 on page 27](#), or
  - Dual controllers:
    - One Cisco 12G SAS Modular RAID controller upgrade option or one Cisco 9300-8i 12G SAS HBA upgrade option from [Table 9 on page 27](#), and
    - One Cisco 9300-8E 12G SAS HBA (JBOD support only for external drives) from [Table 9 on page 27](#)

Select an appropriate optional RAID configuration listed in [Table 9 on page 27](#) (note that the Cisco 9300-8i 12G SAS HBA supports JBOD only and is not a RAID controller).

- For a 16-drive backplane system, select one of the following:
  - Cisco 12G SAS Modular RAID controller upgrade option from [Table 9 on page 27](#), or
  - Cisco 9300-8E 12G SAS HBA upgrade option from [Table 9 on page 27](#), or
  - Dual controllers:
    - One Cisco 12G SAS Modular RAID controller upgrade option from [Table 9 on page 27](#), and
    - One Cisco 9300-8E 12G SAS HBA (JBOD support only for external drives) from [Table 9 on page 27](#)

Select an appropriate optional RAID configuration listed in [Table 9 on page 27](#).

- For an 8-drive backplane system, select one of the following:
  - Embedded software RAID (this is the default if no other selection is made), or
  - Embedded software RAID 5 key upgrade option for internal drives (see [Table 8](#)), or
  - Cisco 12G SAS modular RAID controller upgrade (see [Table 9 on page 27](#)), or
  - Cisco 9300-8E 12G SAS HBA upgrade option from [Table 9 on page 27](#), or
  - Dual controllers:
    - One Cisco 12G SAS modular RAID controller upgrade, and
    - One Cisco 9300-8E 12G SAS HBA for external SAS JBOD/enclosure connectivity support (see [Table 9 on page 27](#)).

For the Cisco 12G SAS modular RAID controller upgrade, select an appropriate optional RAID configuration listed in [Table 9 on page 27](#)



**NOTE:** The Cisco 12G SAS modular RAID controller can be ordered with or without an optional FBWC (cache). The FBWC option backs up the RAID controller write cache. The FBWC is available in 1 GB, 2 GB, or 4 GB sizes. See [Table 9 on page 27](#) for details.

---



**NOTE:** For all valid combinations of embedded RAID and internal/external controller combinations, see [RAID Details, page 72](#).

---

[Table 8](#) shows the product ID for the C240 M4 server entry-level RAID solution. This RAID option is accomplished with embedded software that supports a limited number of drives, operating systems, and virtualized environments. For a more comprehensive enterprise RAID solution, choose the Cisco 12G SAS modular RAID controller listed in [Table 9](#).

Table 8 Entry Level RAID Solution

Product ID (PID)	PID Description
<b>Embedded Software RAID 5 Key Upgrade</b>	
UCSC-SWRAID5	<p>Embedded Software RAID 5 key upgrade, consisting of a storage controller unit (SCU) module that plugs into a 2-pin header on the motherboard, supporting up to eight internal SATA only HDDs. See <a href="#">Embedded SATA RAID: Two SATA Controllers, page 76</a>. This module upgrades the embedded software RAID controller option to add RAID 5. This option supports RAID 0, 1, 10, 5 and operates at 6 Gbps. Operating systems supported are Windows and Linux only (no VMware support).</p> <p>VMware ESX/ESXi or any other virtualized environments (such as Hyper-V, Xen, or KVM) are not supported for use with the embedded software RAID controller.</p>

Table 9 Hardware Controller Options

Product ID (PID)	PID Description
<b>Controllers for Internal Drives</b>	
<p>Note that if the following Cisco 12G SAS Modular RAID controller is selected, it is factory-installed in the dedicated internal slot. The Cisco 9300-8i 12G SAS HBA is installed only in slot 1 of riser 1.</p>	
UCSC-MRAID12G	<p>Cisco 12G SAS Modular Raid Controller with internal connectivity</p> <ul style="list-style-type: none"> <li>■ Supports up to 24 internal SAS HDDs and SAS/SATA SSDs</li> <li>■ Supports JBOD, RAID 0, 1, 10</li> </ul>
UCSC-SAS9300-8i	<p>Cisco 9300-8i 12G SAS HBA with internal connectivity</p> <ul style="list-style-type: none"> <li>■ Supports up to 24 internal SAS HDDs, and SAS/SATA SSDs (compatible only with the 24-drive backplane)</li> <li>■ Supports JBOD only and is targeted at supporting scale out applications that do not require local RAID support.</li> </ul>
<b>Flash-Backed Write Cache (FBWC) Upgrade Options for Cisco 12G SAS Modular RAID controller</b>	
UCSC-MRAID12G-1GB	1 GB FBWC, which includes a 1 GB memory plus a SuperCap for write cache backup. Supports JBOD, RAID 0, 1, 10, 5, 6, 50, and 60.
UCSC-MRAID12G-2GB	2 GB FBWC, which includes a 2 GB memory plus a SuperCap for write cache backup. Supports JBOD, RAID 0, 1, 10, 5, 6, 50, and 60.
UCSC-MRAID12G-4GB	4 GB FBWC, which includes a 4 GB memory plus a SuperCap for write cache backup. Supports JBOD, RAID 0, 1, 10, 5, 6, 50, and 60.

Table 9 Hardware Controller Options (*continued*)

Product ID (PID)	PID Description
SAS HBA for External JBOD Attach	
Two SFF8644 mini-SAS x4 connectors on this card are accessible at the rear of the chassis.	
UCSC-SAS9300-8E	Cisco 12G 9300-8e 12G SAS HBA for external JBOD attach <ul style="list-style-type: none"> <li>■ Supports external JBOD using x8 wide SAS ports</li> </ul>
<hr/> <div style="display: flex; align-items: flex-start;">  <div> <p><b>NOTE:</b> For Cisco 9300-8e 12G SAS HBA external drive enclosure support, see the enclosure section of the compatibility list at the following link:</p> <p style="color: blue;"><a href="http://tinyurl.com/pp83xyk">http://tinyurl.com/pp83xyk</a></p> <p>Customers should contact their storage vendor for technical support related to external JBOD enclosures.</p> </div> </div> <hr/>	
RAID Configuration Options (not available for Cisco 9300-8i 12G SAS HBA or embedded software RAID)	
R2XX-SRAID0	Enable Single Disk Raid 0 Setting
R2XX-RAID0	Factory preconfigured RAID striping option Enable RAID 0 Setting. Requires a minimum of one hard drive.
R2XX-RAID1	Factory preconfigured RAID mirroring option Enable RAID 1 Setting. Requires exactly two drives with the same size, speed, capacity.
R2XX-RAID5	Factory preconfigured RAID option Enable RAID 5 Setting. Requires a minimum of three drives of the same size, speed, capacity.
R2XX-RAID6	Factory preconfigured RAID option Enable RAID 6 Setting. Requires a minimum of four drives of the same size, speed, capacity.
R2XX-RAID10	Factory preconfigured RAID option Enable RAID 10 Setting. Requires a even number of drives (minimum of four drives) of the same size, speed, capacity.



**NOTE:** Although RAID levels 50 and 60 are not orderable from the factory, they are supported for selected controllers as shown in [Table 9](#)

## Approved Configurations

The C240 M4 SFF server can be ordered as a UCSC-C240-M4SX (24-drive backplane with SAS expander), a UCSC-C240-M4S2 (16-drive backplane with SAS expander), or UCSC-C240-M4S (8-drive backplane with no SAS expander).

- The embedded software RAID (default) supports up to 8 internal SATA HDDs with RAID 0, 1, 10 support.
- The embedded software RAID 5 upgrade key option supports up to 8 internal SATA HDDs with RAID 0, 1, 10, 5 support.
- The Cisco 12G SAS Modular RAID controller upgrade option supports up to 24 internal SAS HDDs and SAS/SATA SSDs with up to RAID 0, 1, 10, 5, 50, 60 support.
- The Cisco 9300-8i 12G SAS HBA upgrade option supports up to 24 internal SAS HDDs and SAS/SATA SSDs (compatible only with the 24-drive backplane) with JBOD support.
- The Cisco 9300-8e 12G SAS HBA supports up to 8 external SAS ports with JBOD support.

See [Table 10](#) for a summary of the supported controller configuration options.

Table 10 Supported Controller Configurations

Server	# CPUs	Embedded RAID <sup>1</sup>	Cisco 12G SAS Modular RAID Controller or Cisco 9300-8i 12G SAS HBA <sup>2</sup> (only one can be installed at a time)		Cisco 9300-8E 12G SAS HBA <sup>3</sup>	# Drives Supported	RAID Support	Internal Drive Types Allowed
			Cisco 12G SAS Modular RAID Controller	Cisco 9300-8i 12G SAS HBA				
C240 M4 SFF 24 HDD	1	Not allowed	Installed in dedicated slot	Installed in PCIe slot 1	Card absent	24 internal	0,1,10,5,6,50,60 (for 12G SAS) or JBOD (for 9300-8i)	SAS HDDs, SAS/SATA SSDs
C240 M4 SFF 24 HDD	1	Not allowed	Card absent	Card absent	Installed slot 1, 2, or 3	0 internal 1024 external	JBOD	None
C240 M4 SFF 24 HDD	1	Not allowed	Installed in dedicated slot	Installed in PCIe slot 1	Installed slot 2 or 3	24 internal 1024 external	0,1,10,5,6,50,60 (for 12G SAS) or JBOD (for 9300-8i and 9300-8e)	SAS HDDs, SAS/SATA SSDs
C240 M4 SFF 24 HDD	2	Not allowed	Installed in dedicated slot	Installed in PCIe slot 1	Card absent	24 internal	0,1,10,5,6,50,60 (for 12G SAS) or JBOD (for 9300-8i)	SAS HDDs, SAS/SATA SSDs

Table 10 Supported Controller Configurations (continued)

Server	# CPUs	Embedded RAID <sup>1</sup>	Cisco 12G SAS Modular RAID Controller or Cisco 9300-8i 12G SAS HBA <sup>2</sup> (only one can be installed at a time)		Cisco 9300-8E 12G SAS HBA <sup>3</sup>	# Drives Supported	RAID Support	Internal Drive Types Allowed
			Cisco 12G SAS Modular RAID Controller	Cisco 9300-8i 12G SAS HBA				
C240 M4 SFF 24 HDD	2	Not allowed	Card absent	Card absent	Installed any slot	0 internal 1024 external	JBOD	None
C240 M4 SFF 24 HDD	2	Not allowed	Installed in dedicated slot	Installed in PCIe slot 1	Installed slot 2 through 6	24 internal 1024 external	0,1,10,5,6,50,60 (for 12G SAS) or JBOD (for 9300-8i and 9300-8e)	SAS HDDs, SAS/SATA SSDs
C240 M4 SFF 16 HDD	1	Not allowed	Installed in dedicated slot	Not allowed	Card absent	16 internal	0,1,10,5,6,50,60 (for 12G SAS)	SAS HDDs, SAS/SATA SSDs
C240 M4 SFF 16 HDD	1	Not allowed	Card absent	Card absent	Installed slot 1, 2, or 3	0 internal 1024 external	JBOD	None
C240 M4 SFF 16 HDD	1	Not allowed	Installed in dedicated slot	Not allowed	Installed slot 1, 2, or 3	16 internal 1024 external	0,1,10,5,6,50,60 (for 12G SAS) and JBOD (for 9300-8e)	SAS HDDs, SAS/SATA SSDs
C240 M4 SFF 16 HDD	2	Not allowed	Installed in dedicated slot	Not allowed	Card absent	16 internal	0,1,10,5,6,50,60 (for 12G SAS)	SAS HDDs, SAS/SATA SSDs
C240 M4 SFF 16 HDD	2	Not allowed	Card absent	Card absent	Installed any slot	0 internal 1024 external	JBOD	None
C240 M4 SFF 16 HDD	2	Not allowed	Installed in dedicated slot	Not allowed	Installed any slot	16 internal 1024 external	0,1,10,5,6,50,60 (for 12G SAS) and JBOD (for 9300-8e)	SAS HDDs, SAS/SATA SSDs

Table 10 Supported Controller Configurations (continued)

Server	# CPUs	Embedded RAID <sup>1</sup>	Cisco 12G SAS Modular RAID Controller or Cisco 9300-8i 12G SAS HBA <sup>2</sup> (only one can be installed at a time)		Cisco 9300-8E 12G SAS HBA <sup>3</sup>	# Drives Supported	RAID Support	Internal Drive Types Allowed
			Cisco 12G SAS Modular RAID Controller	Cisco 9300-8i 12G SAS HBA				
C240 M4 SFF 8 HDD	1	Enabled	Not allowed	Not allowed	Not allowed	8 internal	0, 1, 10 (default) or 0, 1, 10, 5 (RAID 5 key upgrade)	SATA HDDs
C240 M4 SFF 8 HDD	1	Not allowed	Installed in dedicated slot	Not allowed	Card absent	8 internal	0,1,10,5,6,50,60 (for 12G SAS)	SAS HDDs, SAS/SATA SSDs
C240 M4 SFF 8 HDD	1	Not allowed	Card absent	Card absent	Installed slot 1, 2, or 3	0 internal 1024 external	JBOD	None
C240 M4 SFF 8 HDD	1	Not allowed	Installed in dedicated slot	Not allowed	Installed slot 1, 2, or 3	8 internal 1024 external	0,1,10,5,6,50,60 (for 12G SAS) and JBOD (for 9300-8e)	SAS HDDs, SAS/SATA SSDs
C240 M4 SFF 8 HDD	2	Enabled	Not allowed	Not allowed	Not allowed	8 internal SATA only	0, 1, 10 (default) or 0, 1, 10, 5 (RAID 5 key upgrade)	SATA HDDs
C240 M4 SFF 8 HDD	2	Not allowed	Installed in dedicated slot	Not allowed	Card absent	8 internal	0,1,10,5,6,50,60 (for 12G SAS)	SAS HDDs, SAS/SATA SSDs
C240 M4 SFF 8 HDD	2	Not allowed	Card absent	Card absent	Installed any slot	0 internal 1024 external	JBOD	None
C240 M4 SFF 8 HDD	2	Not allowed	Installed in dedicated slot	Not allowed	Installed any slot	8 internal 1024 external	0,1,10,5,6,50,60 (for 12G SAS) and JBOD (for 9300-8e)	SAS HDDs, SAS/SATA SSDs

Notes . . .

1. Embedded RAID is only compatible with the 8 HDD backplane. It cannot be used with the 16 or 24 HDD backplane, because those backplanes have SAS extenders.

2. If you want to boot from a device other than the Cisco 12G SAS Modular RAID controller or Cisco 9300-8i 12G SAS HBA, you can leave the card installed. Just disable the OPROM for its slot, and the system will boot even with the card installed.
3. External drive PCIe controller card is the Cisco 12G 9300-8e 12G SAS HBA and can be installed simultaneously with the Cisco 12G SAS Modular RAID controller card or Cisco 9300-8i 12G SAS HBA.

### Caveats

---

- A maximum of one Cisco 9300-8e 12G SAS HBA can be installed, and it can be installed in any slot (depending on the number of CPUs installed). The system can support combinations of Storage Accelerator cards and one Cisco 9300-8e 12G SAS HBA.
- The Cisco SAS 9300-8i 12G SAS HBA is supported only in riser 1 slot 1. It can be combined with one UCS 9300-8e 12G SAS HBA. It can also be combined with AHCI support for internal SSDs (SATA Boot Drives) in 24-drive systems (only) and cannot be mixed with Embedded RAID. The Cisco 9300-8i 12G SAS HBA is not a RAID controller and supports JBOD only.
- For the Cisco 12G SAS Modular RAID controller you can choose an optional RAID configuration (RAID 0, 1, 10, 5, or 6), which is preconfigured at the factory. The RAID level you choose must be an available RAID choice for the controller selected. RAID levels 50 and 60 are supported, although they are not available as configuration options. It can also be combined with AHCI support for internal SSDs (SATA Boot Drives) in 24-drive systems (only) and cannot be mixed with Embedded RAID.
- A system supports up to 8 SATA-only drives through the embedded software RAID controller if no Cisco 12G SAS Modular RAID controller or Cisco 9300-8i 12G SAS HBA is chosen.



**NOTE:** For more important information regarding RAID support, see [RAID Details, page 72](#) and [RAID Option ROM \(OPROM\) Settings, page 73](#).

---



## STEP 6 SELECT HARD DISK DRIVES (HDDs) or SOLID STATE DRIVES (SSDs)

The standard disk drive features are:

- 2.5-inch small form factor
- Hot-pluggable
- Drives come mounted in sleds

### Select Drives

The available HDDs and SSDs are listed in [Table 11](#).

Table 11 Available Hot-Pluggable Sled-Mounted HDDs and SSDs

Product ID (PID)	PID Description	Drive Type	Capacity
<b>HDDs (15K RPM)</b>			
UCS-HD600G15KS2-E	600 GB 6 Gbps SAS 15K RPM SFF HDD	SAS	600 GB
UCS-HD450G15KS2-E	450 GB 6 Gbps SAS 15K RPM SFF HDD	SAS	450 GB
UCS-HDD300GI2F105	300 GB 6 Gbps SAS 15K RPM SFF HDD	SAS	300 GB
<b>HDDs (10K RPM)</b>			
UCS-HD12T10KS2-E	1.2 TB 6 Gbps SAS 10K RPM SFF HDD	SAS	1.2 TB
UCS-HDD900GI2F106	900 GB 6 Gbps SAS 10K RPM SFF HDD	SAS	900 GB
A03-D600GA2	600 GB 6 Gbps SAS 10K RPM SFF HDD	SAS	600 GB
A03-D300GA2	300 GB 6 Gbps SAS 10K RPM SFF HDD	SAS	300 GB
<b>HDDs (7.2K RPM)</b>			
UCS-HD1T7KS2-E	1 TB 6 Gbps SAS 7.2K RPM SFF HDD	SAS	1 TB
A03-D1TBSATA	1 TB SATA 7.2K RPM SFF HDD	SATA	1 TB
<b>Enterprise Performance SSDs (High endurance, supports up to 10 FDWP (full drive writes per day))<sup>1</sup></b>			
UCS-SD16T12S2-EP	1.6 TB Enterprise Performance 12 Gbps SAS eMLC SSD (high endurance)	SAS	1.6 TB
UCS-SD800G0KS2-EP	800 GB Enterprise Performance 6 Gbps SAS eMLC SSD (high endurance)	SAS	800 GB
UCS-SD400G12S2-EP	400 GB Enterprise Performance 12 Gbps SAS eMLC SSD (high endurance)	SAS	400 GB
UCS-SD400G0KS2-EP	400 GB Enterprise Performance 6 Gbps SAS eMLC SSD (high endurance)	SAS	400 GB
UCS-SD200G0KS2-EP	200 GB Enterprise Performance 6 Gbps SAS eMLC SSD (high endurance)	SAS	200 GB

Table 11 Available Hot-Pluggable Sled-Mounted HDDs and SSDs (continued)

Product ID (PID)	PID Description	Drive Type	Capacity
Enterprise Value SSDs (Low endurance, supports up to 1 FDWP (Full drive write per day)) <sup>2</sup>			
UCS-SD960G0KS2-EV	960 GB 2.5 inch Enterprise Value 6 Gbps SSD	SATA	960 GB
UCS-SD480G0KS2-EV	480 GB 2.5 inch Enterprise Value 6 Gbps SSD	SATA	480 GB
UCS-SD240G0KS2-EV	240 GB 2.5 inch Enterprise Value 6 Gbps SSD	SATA	240 GB
UCS-SD120G0KS2-EV	120 GB 2.5 inch Enterprise Value 6 Gbps SSD	SATA	120 GB

Notes . . .

1. Targeted for write centric IO applications. Supports endurance of 10 FDWP (Full drive writes per day). Target applications are caching, online transaction processing (OLTP), data warehousing, and virtual desktop infrastructure (VDI).
2. Targeted for read centric IO applications. Supports endurance of 1 FDWP (Full drive write per day). Target applications are boot, streaming media, and collaboration.

The available boot drives are listed in [Table 12](#).

Table 12 Available Boot Drives (mounted inside chassis)

Product ID (PID)	PID Description	Drive Type	Capacity
Boot Drives			
UCS-SD960G0KSB-EV	960 GB 2.5 inch Enterprise Value 6G SATA SSD (BOOT)	SATA	960 GB
UCS-SD480G0KSB-EV	480 GB 2.5 inch Enterprise Value 6G SATA SSD (BOOT)	SATA	480 GB
UCS-SD120G0KSB-EV	120 GB 2.5 inch Enterprise Value 6G SATA SSD (BOOT)	SATA	120 GB

Approved Configurations

(1) For systems with an 8-drive backplane:

- The embedded software RAID default supports up to 8 internal SATA HDDs with RAID 0, 1, 10 support.
- The embedded software RAID 5 upgrade key option supports up to 8 internal SATA HDDs with RAID 0, 1, 10, 5 support.
- The Cisco 12G SAS Modular RAID controller upgrade option supports up to 8 internal SAS HDDs and SAS/SATA SSDs.

(2) For systems with a 16-drive backplane:

- The Cisco 12G SAS Modular RAID controller upgrade option supports up to 16 internal SAS HDDs and SAS/SATA SSDs.

## (3) For systems with a 24-drive backplane:

- The Cisco 12G SAS Modular RAID controller upgrade option supports up to 24 internal SAS HDDs and SAS/SATA SSDs.
- The Cisco 9300-8i 12G SAS HBA upgrade option supports up to 24 internal SAS HDDs and SAS/SATA SSDs.



NOTE: If you selected a Cisco 12G SAS Modular RAID controller for internal HDDs/SSDs, you have the following options:

- Cisco 12G SAS Modular RAID controller with *no FBWC* option (supports JBOD, RAID 0, 1, 10)
- Cisco 12G SAS Modular RAID controller *with FBWC* option (supports JBOD, RAID 0, 1, 10, 5, 6, 50, and 60)
- For either option, select up to 8, 16, or 24 SAS HDDs or SAS/SATA SSDs, as appropriate listed in [Table 11 on page 33](#).
- See [SELECT DISK CONTROLLERS, page 24](#) for more details.

## (4) Systems Using Boot Drives

- If you are configuring a 24-drive backplane system that uses SATA SSD boot drives, choose up to two identical boot drives from [Table 12 on page 34](#).



NOTE: The two SATA SSD boot drives are supported only on the 24-drive backplane chassis version. The drives are managed in AHCI mode, using OS-based software RAID. These two drives, managed with OS software RAID, can coexist with drives managed by either embedded RAID, a Cisco UCS 12G SAS modular RAID controller, or the Cisco 9300-8i 12G SAS HBA. The drives are plugged directly into the SATA boot drive connectors on riser card 1 (option 3). The internal boot drives come mounted to their own unique internal drive sleds, which are different from the front loading hot-swappable drive sleds. See [Riser Card Configuration and Options, page 74](#).

## Caveats

- You can choose only SATA HDDs when using embedded software RAID.
- You can choose only SAS HDDs or SAS/SATA SSDs when using the Cisco 12G SAS Modular RAID Controller or Cisco 9300-8i 12G SAS HBA.
- You can mix HDDs and SSDs as long as you keep all HDDs in their own RAID volume and all SSDs in their own RAID volume.
- You can mix SAS HDDs and SAS/SATA SSDs when using the Cisco 12G SAS Modular RAID Controller or Cisco 9300-8i 12G SAS HBA.
- If you order one or two boot drives, you can order a maximum of one GPU and it must be installed in Riser 2 (UCSC-PCI-2-C240M4) slot 5.

## STEP 7 SELECT PCIe OPTION CARD(s)

The standard PCIe card offerings are:

- Modular LAN on Motherboard (MLOM)
- Virtual Interface Cards (VICs)
- Network Interface Cards (NICs)
- Converged Network Adapters (CNAs)
- Host Bus Adapters (HBAs)
- UCS Storage Accelerators

### Select PCIe Option Cards

The available PCIe option cards are listed in [Table 13](#).

Table 13 Available PCIe Option Cards<sup>1</sup>

Product ID (PID)	PID Description	Card Height
<b>Modular LAN on Motherboard (mLOM)<sup>2</sup></b>		
UCSC-MLOM-CSC-02	Cisco UCS VIC1227 VIC MLOM - Dual Port 10Gb SFP+	N/A
UCSC-MLOM-IRJ45	Intel i350 MLOM NIC	N/A
<b>Virtual Interface Cards (VICs)</b>		
UCSC-PCIE-CSC-02	Cisco VIC 1225 Dual Port 10Gb SFP+ CNA	Half
UCSC-PCIE-C10T-02	Cisco VIC 1225T Dual Port 10GBaseT CNA	Half
<b>Network Interface Cards (NICs)</b>		
<b>1 Gb NICs</b>		
N2XX-ABPCI01-M3	Broadcom 5709 Dual-Port Ethernet PCIe Adapter M3 & later	Half
UCSC-PCIE-IRJ45	Intel i350 Quad Port 1Gb Adapter	Half
<b>10 Gb NICs</b>		
N2XX-AIPCI01	Intel X520 Dual Port 10Gb SFP+ Adapter	Half
UCSC-PCIE-ITG	Intel X540 Dual Port 10GBase-T Adapter	Half

Table 13 Available PCIe Option Cards<sup>1</sup> (continued)

Product ID (PID)	PID Description	Card Height
<b>10 Gb Converged Network Adapters (CNAs)</b>		
UCSC-PCIE-E14102	Emulex OCe14102-UX dual-port 10 GbE FCoE CNA	Half
<b>Host Bus Adapters (HBAs)</b>		
N2XX-AQPCI05	Qlogic QLE2562 Dual Port 8Gb Fibre Channel HBA	Half
UCSC-PCIE-Q2672	Qlogic QLE2672-CSC, 16Gb Fibre Channel HBA with SR Optics	Half
N2XX-AEPCI05	Emulex LPe 12002 Dual Port 8Gb Fibre Channel HBA	Half
UCSC-PCIE-E16002	Emulex LPe16002-M6, 16Gb Fibre Channel HBA with SR Optics	Half
<b>UCS Storage Accelerators<sup>3</sup></b>		
UCSC-F-FIO-1000PS	UCS 1000 GB Fusion ioMemory3 PX Performance line for C-Series	Half
UCSC-F-FIO-1300PS	UCS 1300 GB Fusion ioMemory3 PX Performance line for C-Series	Half
UCSC-F-FIO-2600PS	UCS 2600 GB Fusion ioMemory3 PX Performance line for C-Series	Half
UCSC-F-FIO-5200PS	UCS 5200 GB Fusion ioMemory3 PX Performance line for C-Series	Full
UCSC-F-FIO-3200SS	UCS 3200GB Fusion ioMemory3 SX Scale line for C-Series	Half
UCSC-F-FIO-6400SS	UCS 6200GB Fusion ioMemory3 SX Scale line for C-Series	Full

## Notes . . .

1. The GPU cards (see [ORDER GPU CARDS AND GPU POWER CABLES \(OPTIONAL\), page 44](#)) must be inserted into a full length x16 (electrical) PCIe slot. See [Riser Card Configuration and Options, page 74](#) for more details. The rest of the PCIe cards are x8 (electrical) and can be plugged into any PCIe slot of riser 1 or riser 2.
2. The mLOM cards do not plug into any of the riser 1 or riser 2 card slots; instead, they plug into a connector inside the server chassis.
3. A maximum of six storage accelerator cards are supported and some are riser dependent. 1.3 TB, 2.6 TB, or 3.2 TB cards should not be installed in slots 5 or 6 so the total number of those capacity points is four.

## Caveats

- If you choose an external drives controller (Cisco 9300-8e 12G SAS HBA), it will consume one PCIe slot.
- A maximum of six storage accelerator cards are supported and some are riser dependent. 1.3 TB, 2.6 TB, or 3.2 TB cards should not be installed in to slots 5 or 6 so the total number of those capacity points is four.
- For 1-CPU systems:
  - Only the PCIe slots on PCIe riser 1 are available for 1-CPU system.
  - The PCIe slots on riser 2 are not supported on 1-CPU systems. The slots are full-height PCIe slots 4, 5, and 6 (see [Figure 5 on page 9](#)). These are the slots on the right when looking at the rear of the server.
  - Only a single plug-in PCIe VIC card may be installed on a 1-CPU system, and it must be installed in slot 2 of riser 1. You can order an mLOM VIC card to be installed in the mLOM slot internal to the chassis and thus have two VIC cards in operation at

the same time. See [Table 13 on page 36](#) for the selection of plug-in and mLOM VIC cards. See also [Table 1 on page 10](#) and [Riser Card Configuration and Options, page 74](#) for the PCIe slot physical descriptions.

- For 2-CPU systems:
  - Depending on the riser 1 option chosen, up to six PCIe slots are available, three on PCIe riser 1 (PCIe slots 1, 2, and 3) and three on PCIe riser 2 (PCIe slots 4, 5, and 6).
  - All of the slots are full-height.
  - Two plug-in PCIe VIC cards can be installed in 2-CPU systems, using slots 2 or 5. In addition, you can order an mLOM VIC card, which is installed in the mLOM slot inside the chassis and thus have three VIC cards in operation at the same time. See [Table 13 on page 36](#) for the selection of plug-in and mLOM VIC cards. See also [Table 1 on page 10](#) and [Riser Card Configuration and Options, page 74](#) for the PCIe slot physical descriptions.
  - If GPUs are installed in slots 2 (Riser 1 option A) and 5 (Riser 2), the NCSI capability automatically switches over to slots 1 (Riser 1 option A) and 4 (Riser 2). Therefore, Cisco PCIe VICs can be installed in slots 1 and 4 if GPUs are installed in slots 2 and 5.
- Other considerations for the Cisco VIC 1225/1227/1225T cards:
  - VIC 1225 and VIC 1227 Supports 10G SFP+ optical and copper twinax connections
  - VIC 1225T Supports RJ45 Category 6 or better twisted pair cable connections
  - The server supports installation of one PCIe Cisco VIC 1225/1225Tcard and it is supported only in PCIe slot 1.
  - For the Cisco UCS VIC1225, requires that the server has CIMC firmware version 1.4(6) or later installed and VIC firmware of 2.1(0) or later. For the Cisco UCS VIC1225T, requires that the server has CIMC firmware version 1.5(1) or later installed and VIC firmware of 2.1(1) or later.

- The server supports installation of up to two plug-in Cisco VIC 1225/1225T cards and they are supported only in certain slots. A third simultaneously operating VIC can be the mLOM VIC card, which is installed in a slot inside the chassis. See [Table 14](#) for details.

Table 14 Cisco UCS 240 M4 Requirements for Plug-in Virtual Interface Cards

VIC PID	Number of Plug-in VICs Supported in Server	Slots That Support VICs <sup>1</sup>	Primary Slot For UCS Integration or Cisco Card NIC Mode	Minimum Cisco IMC Firmware	Minimum VIC Firmware
Cisco UCS VIC1225 (UCSC-PCIE-CSC-02)	2	PCIe 2 PCIe 1	Riser 1: PCIe 2 Riser 2: PCIe 5	1.4(6)	2.1(0)
Cisco UCS VIC1225T (UCSC-PCIE-C10T-02)	2	PCIe 5 PCIe 4 See footnote <sup>2</sup>	See footnote	1.5(1)	2.1(1)

## Notes . . .

1. For riser PID UCSC-PCI-1B-240M4 (riser 1 option B) only: Slot 2 is the only slot that supports a VIC.
2. For riser PIDs UCSC-PCI-1A-240M4 (riser 1 option A) only: When a GPU card is present in slot 2 of riser 1 option A, NCSI support automatically shifts to slot 1, which becomes the primary slot for a VIC. When a GPU card is present in riser 2 slot 5, NCSI support automatically shifts to slot 4, which becomes the primary slot for a VIC.

- The quantity and type of PCIe cards that can be installed depends in the riser card options. See [Riser Card Configuration and Options, page 74](#) for additional details.
- To help ensure that your operating system is compatible with the card you have selected, or to see additional cards that have been qualified to work with the UCS C240 M4 server, but are not sold on the Cisco pricelist, check the Hardware Compatibility List at this URL:

[http://www.cisco.com/en/US/products/ps10477/prod\\_technical\\_reference\\_list.html](http://www.cisco.com/en/US/products/ps10477/prod_technical_reference_list.html)

## STEP 8 ORDER OPTIONAL NETWORK CARD ACCESSORIES

Copper twinax cables and SFP optical modules may be ordered to support the two-port network cards that are available with the server.

### Choose Optional Twinax Cables

---

*Table 15* lists the copper twinax cables available for the PCIe cards. You can choose cable lengths of 1, 3, 5, 7, or 10 meters. The two longer cables (7 and 10 meters) are active, which means that they contain active components within the SFP+ housing to improve signal quality.

Table 15 Available Twinax Cables

Product ID (PID)	PID Description
SFP-H10GB-CU1M	10GBASE-CU SFP+ Cable (1 M)
SFP-H10GB-CU3M	10GBASE-CU SFP+ Cable (3 M)
SFP-H10GB-CU5M	10GBASE-CU SFP+ Cable (5 M)
SFP-H10GB-ACU7M	10GBASE-CU SFP+ Cable (7 M)
SFP-H10GB-ACU10M	10GBASE-CU SFP+ Cable (10 M)

### Approved Configurations

---

(1) Choose Up to Two Twinax Cables for Each Network Card Ordered

- You may choose one or two twinax cables for each compatible PCIe network card ordered. The cables can be different lengths; however, you would normally order two cables of equal lengths to connect to the primary and redundant network switching equipment.

### Choose Optional SFP Modules

---

Optical Cisco SFP+ modules are listed in *Table 16*.

Table 16 Available SFP Modules

Product ID (PID)	PID Description
SFP-10G-SR	10GBASE-SR SFP+ Module 850 nm, multimode, SR, 3.3V, LC connector, with Digital Optical Monitoring
DS-SFP-FC8G-SW	8 Gbit SFP+ Module 850 nm, multimode, SR, 3.3V, LC connector, with Digital Optical Monitoring

### Approved Configurations

---

(1) Choose Up to Two SFP+ Modules for Each Network Card Ordered

- You may choose one or two SFP+ optical modules cables for each compatible PCIe network card ordered. You would normally order two modules for connecting to the primary and



redundant network switching equipment. With the SFP+ optical modules, you can use common fiber optic cables, widely available.

See the [Figure 7 on page 43](#) for typical SFP+ and twinax connections to the network cards.

### Caveats

---

Check the table on the following page for compatibility between the PCIe network cards and SFPs or twinax cables.



**NOTE:** The table shows all PCIe network cards for all C-series servers. Not all of the cards shown in the table are supported in this server. The intent of the table is to show compatibility between cards and twinax cables or SFPs.

---

Table 17 PCIe Card Compatibility

PCIe Cards	Twinax Cables	Cisco SFP Modules	
		SFP-10G-SR	DS-SFP-FC8G-SW
<b>Converged Network Adapters (CNAs)</b>			
UCSC-PCIE-BSFP (Broadcom 57712 Dual Port 10Gb SFP+ w/TOE iSCSI)	Yes	Yes	No
UCSC-PCIE-CSC-02 (Cisco VIC 1225 Dual Port 10Gb SFP+ CNA)	Yes	Yes	No
UCSC-PCIE-C10T-02 (Cisco VIC 1225T Dual Port 10GBaseT CNA)	No	No	No
UCSC-PCIE-C40Q-02 (Cisco VIC 1285 Dual Port 40Gb QSFP CNA)	Yes	No <sup>1</sup>	No
UCSC-PCIE-C40Q-03 (Cisco VIC 1385 Dual Port 40Gb QSFP+ CNA w/RDMA)	Yes	No <sup>1</sup>	No
UCSC-PCIE-ESFP (Emulex OCe11102-FX dual-port 10 GbE FCoE CNA (Gen 3 CNA))	Yes	Yes	No
UCSC-PCIE-QSFP (QLogic QLE8242-CU dual-port 10 GbE FCoE CNA)	Yes	Use Qlogic SFP	
UCSC-PCIE-B3SFP (Broadcom 57810 10Gb A-FEX SFP+)	Yes	Yes	No
UCSC-PCIE-Q8362 (Qlogic QLE8362 dual-port 10 GbE FCoE CNA)	Yes	Use Qlogic SFP	
UCSC-PCIE-E14102 (Emulex OCe14102-UX dual-port 10 GbE FCoE CNA)	Yes	Yes	No
<b>Network Interface Cards (NICs)</b>			
N2XX-ABPCI01-M3 (Broadcom 5709 Dual-Port Ethernet PCIe Adapter for M3 Servers)	Yes	No	No
N2XX-ABPCI03-M3 (Broadcom 5709 Quad Port 10/100/1Gb NIC w/TOE iSCSI for M3 Servers)	Use RJ45 Ethernet cable		
N2XX-AIPCI01 (Intel X520 Dual Port 10Gb SFP+ Adapter)	Yes	Use Intel SFP	
UCSC-PCIE-ITG (Intel X540 Dual Port 10GBase-T Adapter)	Yes	No	No
UCSC-PCIE-IRJ45 (Intel i350 Quad Port 1Gb Adapter)	Use RJ45 Ethernet cable		
UCSC-PCIE-BTG (Broadcom 57712 Dual Port 10GBASE-T w/TOE iSCSI)	Yes	No	No
<b>Host Bus Adapters (HBAs)</b>			
N2XX-AEPCI03 (Emulex LPe 11002 Dual Port 4Gb Fibre Channel HBA)	No	Preinstalled - do not change SFP	
N2XX-AEPCI05 (Emulex LPe 12002 Dual Port 8Gb Fibre Channel HBA)	No	Preinstalled - do not change SFP	
N2XX-AQPCI03 (QLogic QLE2462 Dual Port 4Gb Fibre Channel HBA)	No	Preinstalled - do not change SFP	

Table 17 PCIe Card Compatibility (continued)

PCIe Cards	Twinax Cables	Cisco SFP Modules	
		SFP-10G-SR	DS-SFP-FC8G-SW
N2XX-AQPCI05 (QLogic QLE2562 Dual Port 8Gb Fibre Channel HBA)	No	Preinstalled - do not change SFP	
UCSC-PCIE-Q2672 (QLogic QLE2672-CSC, 16Gb Fibre Channel HBA with SR Optics)	No	Preinstalled - do not change SFP	
UCSC-PCIE-E16002 (Emulex LPe16002-M6, 16Gb Fibre Channel HBA with SR Optics)	No	Preinstalled - do not change SFP	

Notes . . .

1. This card supports a 4x10 Gbps QSFP to SFP breakout fiber cable.

Figure 7 Network Card Connections

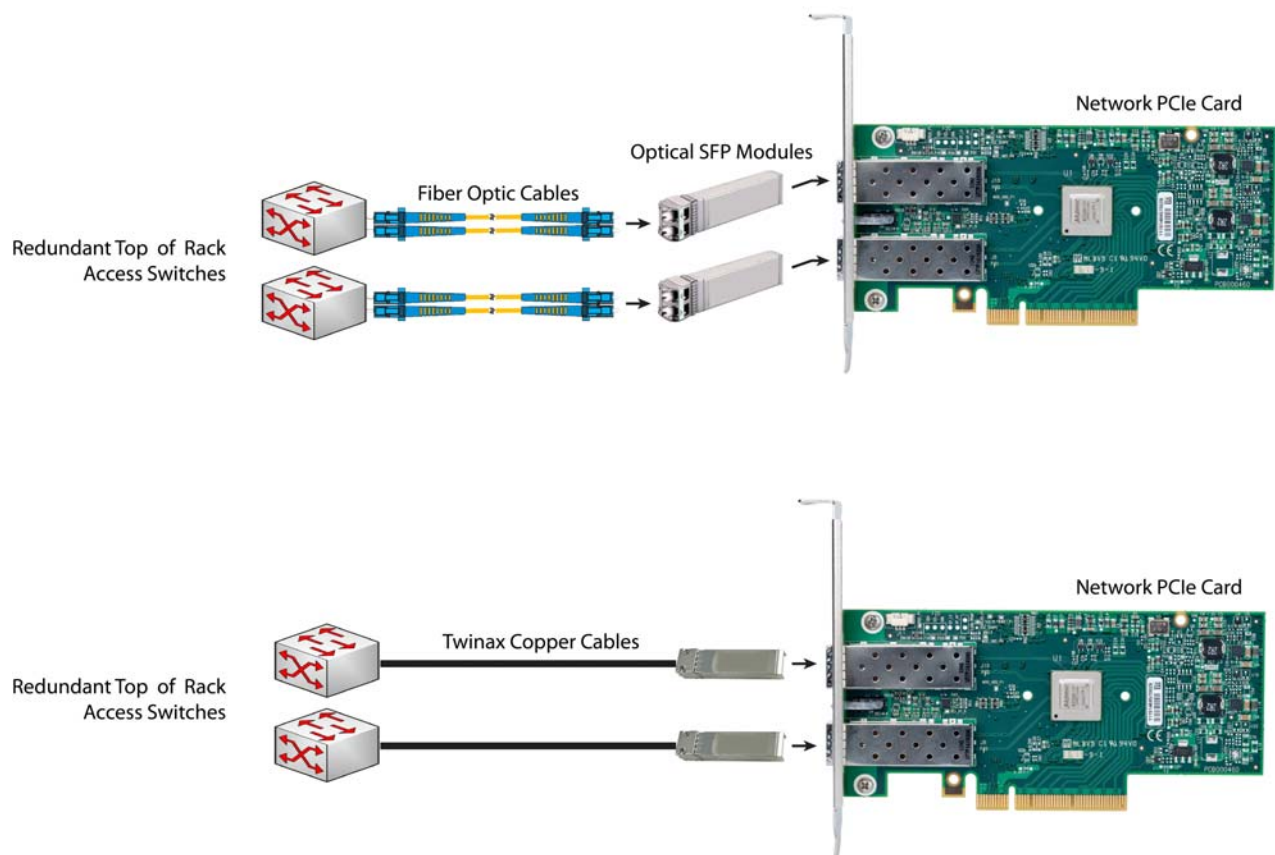

## STEP 9 ORDER GPU CARDS AND GPU POWER CABLES (OPTIONAL)

### Select GPU Options

The available GPU PCIe options are listed in [Table 18](#).

Table 18 Available PCIe Option Cards

Product ID (PID)	PID Description	Card Size
GPU PCIe Cards		
UCSC-GPU-K10	NVIDIA K10	Full-height, double wide
UCSC-GPU-K20	NVIDIA K20	Full-height, double wide
UCSC-GPU-K20X	NVIDIA K20X	Full-height, double wide
UCSC-GPU-VGXX1	NVIDIA GRID K1	Full-height, double wide
UCSC-GPU-VGXX2	NVIDIA GRID K2	Full-height, double wide
UCSC-GPU-K40	NVIDIA Tesla K40	Full-height, double wide



**CAUTION:** When using GPU cards, the operating temperature range is 32° to 95°F (0° to 35°C).



**NOTE:** All GPU cards require two CPUs and a minimum of two power supplies in the server. 1400 W power supplies are recommended. Use the power calculator at the following link to determine the needed power based on the options chosen (CPUs, drives, memory, and so on):

<https://mainstayadvisor.com/Go/Cisco/Cisco-UCS-Power-Calculator.aspx>

### Select GPU Power Cables

Whenever you select a K1/K2/K10/K20/K20X/K40 GPU for this server, you must also select one power cable for each GPU selected. The available GPU power cables are listed in [Table 19](#).

Table 19 Available GPU Power Cables

Product ID (PID)	PID Description
UCSC-GPUCBL-240M4	C240 M4 GPU Power Cable

---

## Caveats

---

- NVIDIA GRID K1 and K2 GPUs can be mixed. No other GPU mixing is allowed.
- Slot 5 on riser card 2 is the required slot for the first GPU.
- Slot 2 on riser card 1 is the secondary slot for a second GPU. The riser card 1 options that are compatible with GPUs are:
  - Riser card 1 option A (UCSC-PCI-1A-240M4)



NOTE: For more information on the riser 1 card options, see [Riser Card Configuration and Options, page 74](#).

---

- If you order one or two boot drives, you can order a maximum of one GPU and it must be installed in Riser 2 (UCSC-PCI-2-C240M4) slot 5.



NOTE: See [Figure 8 on page 66](#) for the location of the 8-pin GPU power connector on the motherboard. Connect cable(s) as appropriate from this connector to the power connector on the GPU(s).

---



NOTE: See [Figure 8 on page 66](#) for the location of the 8-pin GPU power connector on the motherboard. Connect cable(s) as appropriate from this connector to the power connector on the GPU(s).

---

## STEP 10 ORDER POWER SUPPLY

The C240 M4 server requires at least one power supply. A lightly loaded server may require one or two 650 W power supplies. A fully loaded server might need to be powered with two larger capacity power supplies. A server with one GPU requires at least two power supplies (1400 W power supplies are recommended). A server with two GPUs also requires at least two power supplies (1400 W power supplies are recommended). Use the power calculator at the following link to determine the needed power based on the options chosen (CPUs, drives, memory, and so on):

<https://mainstayadvisor.com/Go/Cisco/Cisco-UCS-Power-Calculator.aspx>

Table 20 Power Supply

Product ID (PID)	PID Description
UCSC-PSU2-1400W	1400 W AC Power Supply for 2U & 4U C Series Servers
UCSC-PSU2V2-1200W <sup>1</sup>	1200W / 800W V2 AC Power Supply for 2U C-Series Servers
UCSC-PSU2V2-650W	650W V2 AC Power Supply for C-Series Servers

Notes . . .

1. The power output is 1200W with a 200-240V input and 800W with a 100-120V input.



**NOTE:** In a two power supply server, both power supplies must be identical.

---

## STEP 11 SELECT AC POWER CORD(S)

Using [Table 21](#), select the appropriate AC power cords. You can select a minimum of no power cords and a maximum of two. If you select the option R2XX-DMYPWRCORD, no power cord is shipped with the server.

Table 21 Available Power Cords

Product ID (PID)	PID Description	Images
R2XX-DMYPWRCORD	No power cord (dummy PID to allow for a no power cord option)	Not applicable
CAB-N5K6A-NA	Power Cord, 200/240V 6A, North America	
CAB-AC-L620-C13	AC Power Cord, NEMA L6-20 - C13, 2M/6.5ft	
CAB-C13-CBN	CABASY,WIRE,JUMPER CORD, 27" L, C13/C14, 10A/250V	
CAB-C13-C14-2M	CABASY,WIRE,JUMPER CORD, PWR, 2 Meter, C13/C14,10A/250V	
CAB-C13-C14-AC	CORD,PWR,JMP,IEC60320/C14,IEC60320/C13, 3.0M	

Table 21 Available Power Cords

Product ID (PID)	PID Description	Images
SFS-250V-10A-AR	Power Cord, SFS, 250V, 10A, Argentina	
CAB-9K10A-AU	Power Cord, 250VAC 10A 3112 Plug, Australia	
SFS-250V-10A-CN	Power Cord, SFS, 250V, 10A, China	
CAB-250V-10A-CN	AC Power Cord - 250V, 10A - PRC	
CAB-9K10A-EU	Power Cord, 250VAC 10A CEE 7/7 Plug, EU	
SFS-250V-10A-ID	Power Cord, SFS, 250V, 10A, India	
SFS-250V-10A-IS	Power Cord, SFS, 250V, 10A, Israel	

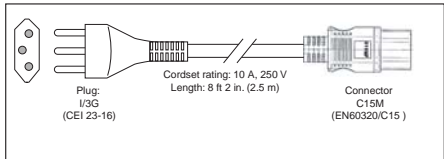
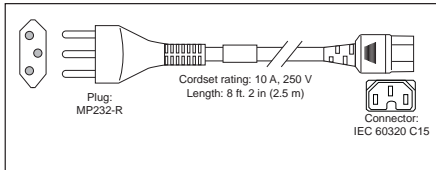
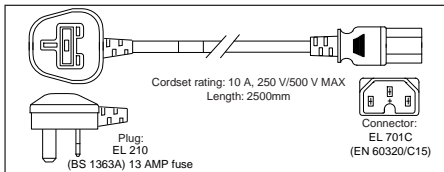
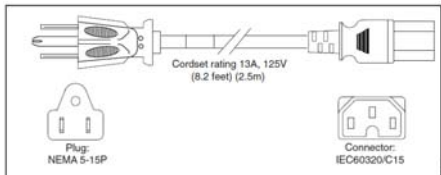
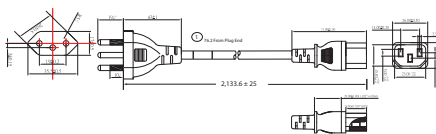

Table 21 Available Power Cords

Product ID (PID)	PID Description	Images
CAB-9K10A-IT	Power Cord, 250VAC 10A CEI 23-16/VII Plug, Italy	 <p>Plug: I/3G (CEI 23-16)</p> <p>Cordset rating: 10 A, 250 V Length: 8 ft 2 in (2.5 m)</p> <p>Connector: C15M (EN60320/C15)</p>
CAB-9K10A-SW	Power Cord, 250VAC 10A MP232 Plug, Switzerland	 <p>Plug: MP232-R</p> <p>Cordset rating: 10 A, 250 V Length: 8 ft 2 in (2.5 m)</p> <p>Connector: IEC 60320 C15</p>
CAB-9K10A-UK	Power Cord, 250VAC 10A BS1363 Plug (13 A fuse), UK	 <p>Cordset rating: 10 A, 250 V/500 V MAX Length: 2500mm</p> <p>Plug: EL 210 (BS 1363A) 13 AMP fuse</p> <p>Connector: EL 701 C (EN 60320/C15)</p>
CAB-9K12A-NA	Power Cord, 125VAC 13A NEMA 5-15 Plug, North America	 <p>Cordset rating: 13A, 125V (8.2 feet) (2.5m)</p> <p>Plug: NEMA 5-15P</p> <p>Connector: IEC60320/C15</p>
CAB-250V-10A-BR	Power Cord - 250V, 10A - Brazil	
CAB-JPN-3PIN	Power Cord 3PIN, Japan	Image not available

## STEP 12 ORDER RAIL KIT AND OPTIONAL REVERSIBLE CABLE MANAGEMENT ARM

### Select a Rail Kit

---

Select a rail kit from [Table 22](#).

Table 22 Rail Kit Options

Product ID (PID)	PID Description
UCSC-RAILB-M4	Ball Bearing Rail Kit for C220 M4 and C240 M4 Rack Servers

---

### Select an Optional Reversible Cable Management Arm

---

The reversible cable management arm mounts on either the right or left slide rails at the rear of the server and is used for cable management. Use [Table 23](#) to order a cable management arm.

Table 23 Cable Management Arm

Product ID (PID)	PID Description
UCSC-CMA-M4	Reversible CMA for C240 M4 ball bearing rail kit

---

For more information about the rail kit and cable management arm, see the *Cisco UCS C240 M4 Installation and Service Guide* at this URL:

[http://www.cisco.com/c/en/US/td/docs/unified\\_computing/ucs/c/hw/C240M4/install/C240M4.html](http://www.cisco.com/c/en/US/td/docs/unified_computing/ucs/c/hw/C240M4/install/C240M4.html)



**NOTE:** If you plan to rackmount your UCS C240 M4 server, you must order a tool-less rail kit.

---

## STEP 13 SELECT NIC MODE (OPTIONAL)

By default, the C240 M4 server NIC mode is configured to be Shared LOM Extended. This NIC mode allows any LOM port or adapter card port to be used to access the Cisco Integrated Management Controller (CIMC). The Cisco adapter card must be installed in a slot with NCSI support.

To change the default NIC mode to Dedicated, select the PID shown in *Table 24*. In Dedicated NIC mode, the CIMC can be accessed only through the dedicated management port. See *Chassis Rear View, page 9* for the location of the management port.

For more details on all the NIC mode settings, see [http://www.cisco.com/c/en/us/td/docs/unified\\_computing/ucs/c/sw/gui/config/guide/1-4-1/b\\_Cisco\\_UCS\\_C-Series\\_GUI\\_Configuration\\_Guide\\_141/b\\_Cisco\\_UCS\\_C-Series\\_GUI\\_Configuration\\_Guide\\_141\\_chapter\\_01000.html](http://www.cisco.com/c/en/us/td/docs/unified_computing/ucs/c/sw/gui/config/guide/1-4-1/b_Cisco_UCS_C-Series_GUI_Configuration_Guide_141/b_Cisco_UCS_C-Series_GUI_Configuration_Guide_141_chapter_01000.html)

Table 24 Dedicated NIC Mode Ordering Information

Product ID (PID)	PID Description
UCSC-DLOM-01	Dedicated Mode BIOS setting for C-Series Servers

## STEP 14 ORDER A TRUSTED PLATFORM MODULE (OPTIONAL)

Trusted Platform Module (TPM) is a computer chip (microcontroller) that can securely store artifacts used to authenticate the platform (server). These artifacts can include passwords, certificates, or encryption keys. A TPM can also be used to store platform measurements that help ensure that the platform remains trustworthy. Authentication (ensuring that the platform can prove that it is what it claims to be) and attestation (a process helping to prove that a platform is trustworthy and has not been breached) are necessary steps to ensure safer computing in all environments.

The TPM ordering information is listed in [Table 25](#).

Table 25 Trusted Platform Module

Product ID (PID)	PID Description
UCSX-TPM1-001	Trusted Platform Module 1.2 SPI-based for UCS Servers



NOTE: The module used in this server conforms to TPM v1.2/1.3, as defined by the Trusted Computing Group (TCG). It is also SPI-based.

---

## STEP 15 ORDER CISCO FLEXIBLE FLASH SD CARD MODULE (OPTIONAL)

Order 64 GB SD cards or 32 GB SD cards. See [Figure 8 on page 66](#) for the location of the SD cards. There are two locations, SD1 and SD2.

Table 26 64 GB Secure Digital (SD) Card (blank)

Product ID (PID)	PID Description
UCS-SD-64G-S	64 GB SD Card for UCS Servers

Table 27 32 GB Secure Digital (SD) Card (blank)

Product ID (PID)	PID Description
UCS-SD-32G-S	32 GB SD Card for UCS Servers

### Caveats

- Install either one or two 64 GB SD cards or one or two 32 GB SD cards
- Do not mix SD card sizes

## STEP 16 ORDER OPTIONAL USB 3.0 DRIVE

You can order one optional USB 3.0 drive. The USB drive ordering information is listed in [Table 28](#).

Table 28 USB 3.0 Drive

Product ID (PID)	PID Description
UCS-USBFLSHB-16GB	UCS Servers 16 GB Flash USB Drive

See [Figure 8 on page 66](#) for the location of the USB connector

## STEP 17 SELECT OPERATING SYSTEM AND VALUE-ADDED SOFTWARE

Several operating systems and value-added software programs are available. Select as desired from [Table 29](#).

Table 29 OSs and Value-Added Software (for 2-CPU servers)

PID Description	Product ID (PID)
<b>Microsoft Windows Server</b>	
MSWS-12-ST2S	Windows Server 2012 Standard (2 CPU/2 VMs)
MSWS-12-DC2S	Windows Server 2012 Datacenter (2 CPU/Unlimited VMs)
MSWS-12-ST2S-NS	Windows Server 2012 Standard (2 CPU/2 VMs) No Cisco SVC
MSWS-12-DC2S-NS	Windows Server 2012 Datacenter (2 CPU/Unlim VM) No Cisco SVC
MSWS-12R2-ST2S	Windows Server 2012 R2 Standard (2 CPU/2 VMs)
MSWS-12R2-DC2S	Windows Server 2012 R2 Datacenter (2 CPU/Unlimited VMs)
MSWS-12R2-ST2S-NS	Windows Server 2012 R2 Standard (2 CPU/2 VMs) No Cisco SVC
MSWS-12R2-DC2S-NS	Windows Server 2012 R2 Datacen (2 CPU/Unlim VM) No Cisco Svc
<b>SUSE</b>	
SLES-SVR-2S-1G-1A	SUSE Linux Enterprise Svr (1-2 CPU,1 Phys);1yr Support Reqd
SLES-SVR-2S-1G-3A	SUSE Linux Enterprise Svr (1-2 CPU,1 Phys);3yr Support Reqd
SLES-SVR-2S-1G-5A	SUSE Linux Enterprise Svr (1-2 CPU,1 Phys);5yr Support Reqd
SLES-SVR-2S-UG-1A	SUSE Linux Enterprise Svr (1-2 CPU,Unl Vrt);1yr Support Reqd
SLES-SVR-2S-UG-3A	SUSE Linux Enterprise Svr (1-2 CPU,Unl Vrt);3yr Support Reqd
SLES-SVR-2S-UG-5A	SUSE Linux Enterprise Svr (1-2 CPU,Unl Vrt);5yr Support Reqd
SLES-SHA-2S-1A	SUSE Linux High Availability Ext (1-2 CPU); 1yr Support Reqd
SLES-SHA-2S-3A	SUSE Linux High Availability Ext (1-2 CPU); 3yr Support Reqd
SLES-SHA-2S-5A	SUSE Linux High Availability Ext (1-2 CPU); 5yr Support Reqd
SLES-HGC-2S-1A	SUSE Linux GEO Clustering for HA (1-2 CPU); 1yr Support Reqd
SLES-HGC-2S-3A	SUSE Linux GEO Clustering for HA (1-2 CPU); 3yr Support Reqd
SLES-HGC-2S-5A	SUSE Linux GEO Clustering for HA (1-2 CPU); 5yr Support Reqd
SLES-SAP-2S-1G-1A	SLES for SAP Applications (1-2 CPU,1 Phys); 1yr Support Reqd
SLES-SAP-2S-1G-3A	SLES for SAP Applications (1-2 CPU,1 Phys); 3yr Support Reqd
SLES-SAP-2S-1G-5A	SLES for SAP Applications (1-2 CPU,1 Phys); 5yr Support Reqd
SLES-SAP-2S-UG-1A	SLES for SAP Applications (1-2 CPU,Unl Vrt);1yr Support Reqd
SLES-SAP-2S-UG-3A	SLES for SAP Applications (1-2 CPU,Unl Vrt);3yr Support Reqd
SLES-SAP-2S-UG-5A	SLES for SAP Applications (1-2 CPU,Unl Vrt);5yr Support Reqd

Table 29 OSs and Value-Added Software (for 2-CPU servers) (continued)

PID Description	Product ID (PID)
<b>Red Hat Enterprise Linux</b>	
RHEL-2S-1G-1A	RHEL/2 Socket/1 Guest/1Yr Svcs Required
RHEL-2S-1G-3A	RHEL/2 Socket/1 Guest/3Yr Svcs Required
RHEL-HA-2S-1A	RHEL Option/High-Availability/2 Socket/1Yr Svcs Required
RHEL-HA-2S-3A	RHEL Option/High-Availability/2 Socket/3Yr Svcs Required
RHEL-RS-2S-1A	RHEL Option/Resilient w/Ha /2 Socket/1 Yr Svcs Required
RHEL-RS-2S-3A	RHEL Option/Resilient Storage w/ HA /2 Socket/3 Yr Svcs Reqd
RHEL-SFS-2S-1A	RHEL Option/Scalable File System/2 Socket/1 Yr Svcs Required
RHEL-SFS-2S-3A	RHEL Option/Scalable File System/2 Socket/1 Yr Svcs Required
<b>Nexus 1000V for Hyper-V and vSphere</b>	
N1K-VSG-UCS-BUN	Over half off N1K and VSG w/ purchase of UCS B/C Series
N1K-VLEM-UCS-1	Nexus 1000V License Paper Delivery (1 CPU) for bundles
VSG-VLEM-UCS-1	VSG License Paper Delivery (1 CPU) for bundles
<b>UCS Director</b>	
CUIC-PHY-SERV-BM-U	Cisco Cloupia Resource Lic - One Phy Server node bare metal
CUIC-PHY-SERV-U	Cisco Cloupia Resource Lic - One physical Server node
CUIC-TERM	Acceptance of Cisco Cloupia License Terms
<b>UCS Performance Manager</b>	
UCS-PM-IE	UCS Performance Manager
UCS-PM-EE	UCS Performance Manager Express
EVAL-UCS-PM-IE	UCS Performance Manager - 60 days evaluation
EVAL-UCS-PM-EE	UCS Performance Manager Express - 60 days evaluation
NFR-UCS-PM-IE	UCS Performance Manager - Not For Resale
NFR-UCS-PM-EE	CS Performance Manager Express - Not For Resale
<b>IMC Supervisor</b>	
EVAL-CIMC-SUP	EVAL: IMC Supervisor-Branch Mgt SW for C/E-Series - 50 Svrs
EVAL-CIMC-SUP-BAS	EVAL: IMC Supervisor One-time Site Installation License
CIMC-SUP-B01	IMC Supervisor-Branch Mgt SW for C-Series & E-Series up to 100 Svrs
CIMC-SUP-B02	IMC Supervisor- Branch Mgt SW for C-Series & E-Series up to 250 Svrs
CIMC-SUP-B10	IMC Supervisor- Branch Mgt SW for C-Series & E-Series up to 1K Svrs
CIMC-SUP-BASE-K9	IMC Supervisor One-time Site Installation License
CIMC-SUP-TERM	Acceptance of Cisco IMC Supervisor License Terms
<b>VMware 5</b>	
VMW-VS5-STD-1A	VMware vSphere 5 Standard for 1 Processor, 1 Year, Support Rqd
VMW-VS5-STD-2A	VMware vSphere 5 Standard for 1 Processor, 2 Year, Support Rqd
VMW-VS5-STD-3A	VMware vSphere 5 Standard for 1 Processor, 3 Year, Support Rqd
VMW-VS5-STD-4A	VMware vSphere 5 Standard for 1 Processor, 4 Year, Support Rqd
VMW-VS5-STD-5A	VMware vSphere 5 Standard for 1 Processor, 5 Year, Support Rqd



Table 29 OSs and Value-Added Software (for 2-CPU servers) *(continued)*

PID Description	Product ID (PID)
VMW-VS5-ENT-1A	VMware vSphere 5 Enterprise for 1 Processor, 1 Year Support Rqd
VMW-VS5-ENT-2A	VMware vSphere 5 Enterprise for 1 CPU, 2 Yr Support Rqd
VMW-VS5-ENT-3A	VMware vSphere 5 Enterprise for 1 CPU, 3 Yr Support Rqd
VMW-VS5-ENT-4A	VMware vSphere 5 Enterprise for 1 Processor, 4 Year Support Rqd
VMW-VS5-ENT-5A	VMware vSphere 5 Enterprise for 1 CPU, 5 Yr Support Rqd
VMW-VS5-ENTP-1A	VMware vSphere 5 Enterprise Plus for 1 Processor, 1 Year Support Rqd
VMW-VS5-ENTP-2A	VMware vSphere 5 Enterprise Plus for 1 CPU, 2 Yr Support Rqd
VMW-VS5-ENTP-3A	VMware vSphere 5 Enterprise Plus for 1 Processor, 3 Year Support Rqd
VMW-VS5-ENTP-4A	VMware vSphere 5 Enterprise Plus for 1 Processor, 4 Year Support Rqd
VMW-VC5-STD-1A	VMware vCenter 5 Server Standard, 1 yr support required
VMW-VC5-STD-2A	VMware vCenter 5 Server Standard, 2 yr support required
VMW-VC5-STD-3A	VMware vCenter 5 Server Standard, 3 yr support required
VMW-VC5-STD-4A	VMware vCenter 5 Server Standard, 4 yr support required
VMW-VC5-STD-5A	VMware vCenter 5 Server Standard, 5 yr support required

## STEP 18 SELECT OPERATING SYSTEM MEDIA KIT

Select the optional operating system media listed in [Table 30](#).

Table 30 OS Media

Product ID (PID)	PID Description
RHEL-6	RHEL 6 Recovery Media Only (Multilingual)
SLES-11	SLES 11 media only (multilingual)
MSWS-08R2-STHV-RM	Windows Svr 2008 R2 ST (1-4CPU, 5CAL), Media
MSWS-08R2-ENHV-RM	Windows Svr 2008 R2 EN (1-8CPU, 25CAL), Media
MSWS-08R2-DCHV-RM	Windows Svr 2008 R2 DC (1-8CPU, 25CAL), Media
MSWS-12-ST2S-RM	Windows Server 2012 Standard (2 CPU/2 VMs) Recovery Media
MSWS-12-DC2S-RM	Windows Server 2012 Datacenter(2 CPU/Unlimited VM) Rec Media
MSWS-12R2-ST2S-RM	Windows Server 2012 R2 Standard (2 CPU/2 VMs) Recovery Media
MSWS-12R2-DC2S-RM	Windows Server 2012 R2 Datacen(2 CPU/Unlimited VM) Rec Media

## STEP 19 SELECT SERVICE and SUPPORT LEVEL

A variety of service options are available, as described in this section.

### Unified Computing Warranty, No Contract

If you have noncritical implementations and choose to have no service contract, the following coverage is supplied:

- Three-year parts coverage.
- Next business day (NBD) onsite parts replacement eight hours a day, five days a week.
- 90-day software warranty on media.
- Ongoing downloads of BIOS, drivers, and firmware updates.
- UCSM updates for systems with Unified Computing System Manager. These updates include minor enhancements and bug fixes that are designed to maintain the compliance of UCSM with published specifications, release notes, and industry standards.

### SMARTnet for UCS

For support of the entire Unified Computing System, Cisco offers the Cisco SMARTnet for UCS Service. This service provides expert software and hardware support to help sustain performance and high availability of the unified computing environment. Access to Cisco Technical Assistance Center (TAC) is provided around the clock, from anywhere in the world.

For UCS blade servers, there is Smart Call Home, which provides proactive, embedded diagnostics and real-time alerts. For systems that include Unified Computing System Manager, the support service includes downloads of UCSM upgrades. The Cisco SMARTnet for UCS includes flexible hardware replacement options, including replacement in as little as two hours. There is also access to Cisco's extensive online technical resources to help maintain optimal efficiency and uptime of the unified computing environment. You can choose a desired service listed in [Table 31](#).

Table 31 Cisco SMARTnet for UCS Service

Product ID (PID)	On Site?	Description
CON-PREM-C240M4SF	Yes	ONSITE 24X7X2 UCS C240 M4 Server - SFF
CON-OSP-C240M4SF	Yes	ONSITE 24X7X4 UCS C240 M4 Server - SFF
CON-OSE-C240M4SF	Yes	ONSITE 8X5X4 UCS C240 M4 Server - SFF
CON-OS-C240M4SF	Yes	ONSITE 8X5XNBD UCS C240 M4 Server - SFF
CON-S2P-C240M4SF	No	SMARTNET 24X7X2 UCS C240 M4 Server - SFF
CON-SNTP-C240M4SF	No	SMARTNET 24X7X4 UCS C240 M4 Server - SFF
CON-SNTE-C240M4SF	No	SMARTNET 8X5X4 UCS C240 M4 Server - SFF
CON-SNT-C240M4SF	No	SMARTNET 8X5XNBD UCS C240 M4 Server - SFF

### SMARTnet for UCS Hardware Only Service

For faster parts replacement than is provided with the standard Cisco Unified Computing System warranty, Cisco offers the Cisco SMARTnet for UCS Hardware Only Service. You can choose from two levels of advanced onsite parts replacement coverage in as little as four hours. SMARTnet for UCS Hardware Only Service provides remote access any time to Cisco support professionals who can determine if a return materials authorization (RMA) is required. You can choose a service listed in [Table 32](#).

Table 32 SMARTnet for UCS Hardware Only Service

Product ID (PID)	Service Level GSP	On Site?	Description
CON-UCW7-C240M4SF	UCW7	Yes	UC PLUS 24X7X40S UCS C240 M4 Server - SFF
CON-UCW5-C240M4SF	UCW5	Yes	UC PLUS 8X5XNBDOS UCS C240 M4 Server - SFF

### Unified Computing Partner Support Service

Cisco Partner Support Service (PSS) is a Cisco Collaborative Services service offering that is designed for partners to deliver their own branded support and managed services to enterprise customers. Cisco PSS provides partners with access to Cisco's support infrastructure and assets to help them:

- Expand their service portfolios to support the most complex network environments
- Lower delivery costs
- Deliver services that increase customer loyalty

Partner Unified Computing Support Options enable eligible Cisco partners to develop and consistently deliver high-value technical support that capitalizes on Cisco intellectual assets. This helps partners to realize higher margins and expand their practice.

PSS is available to all Cisco PSS partners, but requires additional specializations and requirements. For additional information, see the following URL:

[www.cisco.com/go/partnerucssupport](http://www.cisco.com/go/partnerucssupport)

The two Partner Unified Computing Support Options include:

- Partner Support Service for UCS
- Partner Support Service for UCS Hardware Only

Partner Support Service for UCS provides hardware and software support, including triage support for third party software, backed by Cisco technical resources and level three support. See [Table 33](#).

Table 33 Partner Support Service for UCS

Product ID (PID)	Service Level GSP	On Site?	Description
CON-PSJ1-C240M4SF	PSJ1	No	UCS SUPP PSS 8X5XNBD UCS C240 M4 Server - SFF
CON-PSJ2-C240M4SF	PSJ2	No	UCS SUPP PSS 8X5X4 UCS C240 M4 Server - SFF
CON-PSJ3-C240M4SF	PSJ3	No	UCS SUPP PSS 24X7X4 UCS C240 M4 Server - SFF
CON-PSJ4-C240M4SF	PSJ4	No	UCS SUPP PSS 24X7X2 UCS C240 M4 Server - SFF

Partner Support Service for UCS Hardware Only provides customers with replacement parts in as little as two hours. See [Table 34](#).

Table 34 Partner Support Service for UCS (Hardware Only)

Product ID (PID)	Service Level GSP	On Site?	Description
CON-PSW2-C240M4SF	PSW2	No	UCS W PL PSS 8X5X4 UCS C240 M4 Server - SFF
CON-PSW3-C240M4SF	PSW3	No	UCS W PL PSS 24X7X4 UCS C240 M4 Server - SFF
CON-PSW4-C240M4SF	PSW4	No	UCS W PL PSS 24X7X2 UCS C240 M4 Server - SFF

### Unified Computing Combined Support Service

Combined Services makes it easier to purchase and manage required services under one contract. SMARTnet services for UCS help increase the availability of your vital data center infrastructure and realize the most value from your unified computing investment. The more benefits you realize from the Cisco Unified Computing System (Cisco UCS), the more important the technology becomes to your business. These services allow you to:

- Optimize the uptime, performance, and efficiency of your UCS
- Protect your vital business applications by rapidly identifying and addressing issues
- Strengthen in-house expertise through knowledge transfer and mentoring
- Improve operational efficiency by allowing UCS experts to augment your internal staff resources
- Enhance business agility by diagnosing potential issues before they affect your operations

You can choose a service listed in [Table 35](#).

Table 35 UCS Computing Combined Support Service

Product ID (PID)	Service Level GSP	On Site?	Description
CON-NCF2-C240M4SF	NCF2	No	CMB SPT SVC 24X7X2 UCS C240 M4 Server - SFF
CON-NCF2P-C240M4SF	NCF2P	Yes	CMB SPT SVC 24X7X2OS UCS C240 M4 Server - SFF
CON-NCF4P-C240M4SF	NCF4P	Yes	CMB SPT SVC 24X7X4OS UCS C240 M4 Server - SFF
CON-NCF4S-C240M4SF	NCF4S	Yes	CMB SPT SVC 8X5X4OS UCS C240 M4 Server - SFF
CON-NCFCS-C240M4SF	NCFCS	Yes	CMB SPT SVC 8X5XNBDOS UCS C240 M4 Server - SFF
CON-NCFE-C240M4SF	NCFE	No	CMB SPT SVC 8X5X4 UCS C240 M4 Server - SFF
CON-NCFP-C240M4SF	NCFP	No	CMB SPT SVC 24X7X4 UCS C240 M4 Server - SFF
CON-NCFT-C240M4SF	NCFT	No	CMB SPT SVC 8X5XNBD UCS C240 M4 Server - SFF

#### Unified Computing Drive Retention Service

With the Cisco Unified Computing Drive Retention (UCDR) Service, you can obtain a new disk drive in exchange for a faulty drive without returning the faulty drive. In exchange for a Cisco replacement drive, you provide a signed Certificate of Destruction (CoD) confirming that the drive has been removed from the system listed, is no longer in service, and has been destroyed.

Sophisticated data recovery techniques have made classified, proprietary, and confidential information vulnerable, even on malfunctioning disk drives. The UCDR service enables you to retain your drives and ensures that the sensitive data on those drives is not compromised, which reduces the risk of any potential liabilities. This service also enables you to comply with regulatory, local, and federal requirements.

If your company has a need to control confidential, classified, sensitive, or proprietary data, you might want to consider one of the Drive Retention Services listed in [Table 36 on page 63](#).



**NOTE:** Cisco does not offer a certified drive destruction service as part of this service.

Table 36 Drive Retention Service Options

Service Description	Service Program Name	Service Level GSP	Service Level	Product ID (PID)
SMARTnet for UCS Service with Drive Retention	UCS DR	UCSD7	24x7x4 Onsite	CON-UCSD7-C240M4SF
		UCSD5	8x5xNBD Onsite	CON-UCSD5-C240M4SF
SMARTnet for UCS HW ONLY+Drive Retention	UCS HW+DR	UCWD7	24x7x4 Onsite	CON-UCWD7-C240M4SF
		UCWD5	8x5xNBD Onsite	CON-UCWD5-C240M4SF

For more service and support information, see the following URL:

[http://www.cisco.com/en/US/services/ps2961/ps10312/Unified\\_Computing\\_Services\\_Overview.pdf](http://www.cisco.com/en/US/services/ps2961/ps10312/Unified_Computing_Services_Overview.pdf)

For a complete listing of available services for Cisco Unified Computing System, see this URL:

[http://www.cisco.com/en/US/products/ps10312/serv\\_group\\_home.html](http://www.cisco.com/en/US/products/ps10312/serv_group_home.html)

## OPTIONAL STEP - ORDER RACK(S)

The optional R42610 rack is available from Cisco for the C-Series servers, including the C240 M4 SFF server. This rack is a standard 19-inch rack and can be ordered with a variety of options, as listed in [Table 37](#). Racks are shipped separately from the C240 M4 SFF server.

Table 37 Racks and Rack Options

Product ID (PID)	PID Description
RACK-UCS <sup>1</sup>	Cisco R42610 expansion rack, no side panels
RACK-UCS2 <sup>1</sup>	Cisco R42610 standard rack, w/side panels
RACK-BLANK-001	Filler panels (qty 12), 1U, plastic, toolless
RACK-CBLMGT-001	Cable mgt D rings (qty 10), metal
RACK-CBLMGT-011	Cable mgt straps (qty 10), Velcro
RACK-FASTEN-001	Mounting screws (qty 100), M6
RACK-FASTEN-002	Cage nuts (qty 50), M6
RACK-JOIN-001	Rack joining kit

Notes . . .

1. Use these same base PIDs to order spare racks (available only as next-day replacements).

For more information about the R42610 rack, see [RACKS, page 83](#).



## OPTIONAL STEP - ORDER PDU

An optional power distribution unit (PDU) is available from Cisco for the C-Series rack servers, including the C240 M4 server. This PDU is available in a zero rack unit (RU) style (see [Table 38](#)).

Table 38 PDU Options

Product ID (PID)	PID Description
RP208-30-2P-U-2	Zero RU PDU

For more information about the PDU, see [PDUs, page 85](#).

# SUPPLEMENTAL MATERIAL

## CHASSIS

An internal view of the C240 M4 chassis with the top cover removed is shown in *Figure 8*.

Figure 8 C240 M4 SFF With Top Cover Off

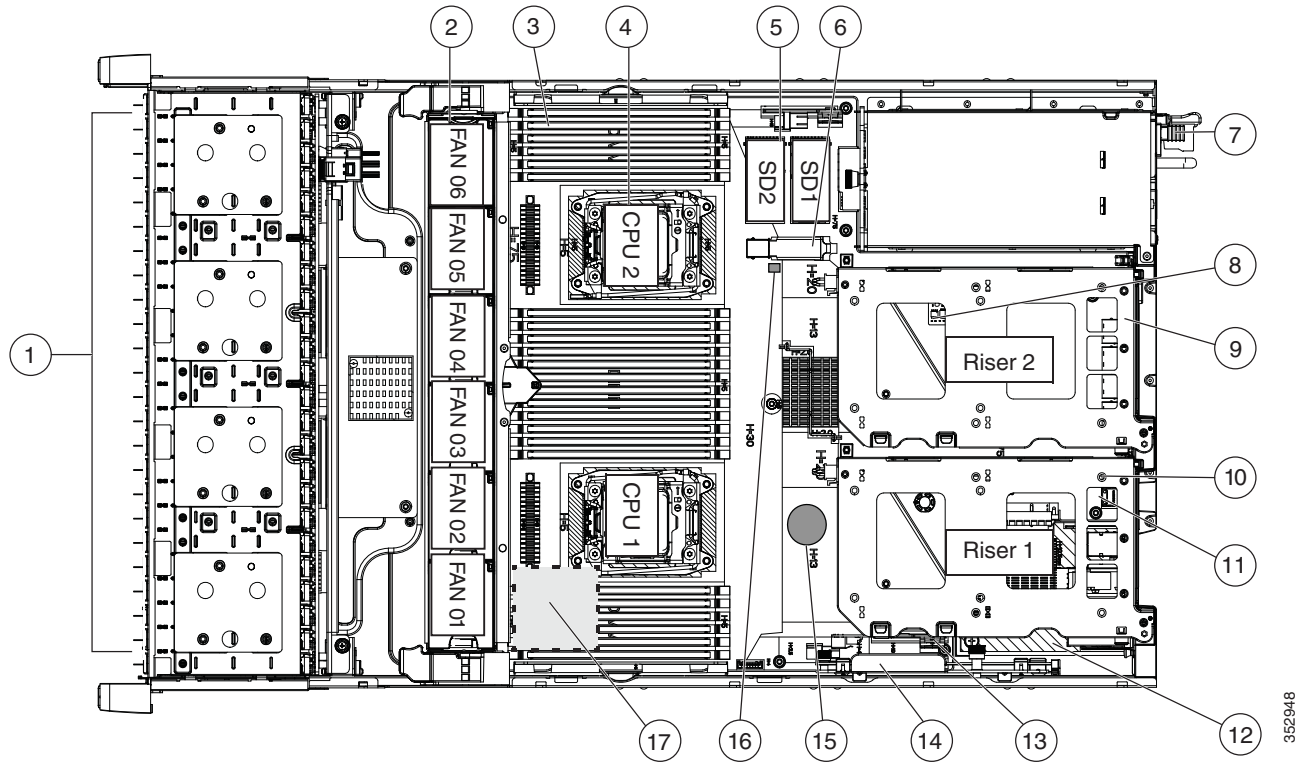

352948

1	Drives (hot-swappable, accessed through front panel)	10	PCIe riser 1 (PCIe slots 1, 2, 3*) *Slot 3 not present in all versions. See <a href="#">Riser Card Configuration and Options, page 74</a> for riser options and slot specifications.
2	Fan modules (six, hot-swappable)	11	SATA boot drives (two sockets available only on PCIe riser 1 option C)
3	DIMM sockets on motherboard (up to 24 DIMMs)	12	mLOM card socket on motherboard under PCIe riser 1
4	CPUs and heatsinks (two)	13	Socket for embedded RAID interposer board
5	Cisco SD card slots on motherboard (two)	14	Cisco modular RAID controller PCIe slot (dedicated slot and bracket)

6	USB 3.0 slot on motherboard	15	RTC battery on motherboard
7	Power supplies (hot-swappable, accessed through rear panel)	16	Embedded RAID header for RAID key
8	Trusted platform module (TPM) socket on motherboard, under PCIe riser 2	17	SuperCap power module (RAID backup) mounting location on air baffle (not shown)
9	PCIe riser 2 (PCIe slots 4, 5, 6)		

## CPU and DIMMs

### Physical Layout

Each CPU has four DIMM channels:

- CPU1 has channels A, B, C, and D
- CPU2 has channels E, F, G, and H

Each DIMM channel has three slots: slot 1, slot 2, and slot 3. The blue-colored DIMM slots are for slot 1, the black-colored slots for slot 2, and the white slots for slot 3.

As an example, DIMM slots A1, B1, C1, and D1 belong to slot 1, while A2, B2, C2, and D2 belong to slot 2.

*Figure 9* shows how slots and channels are physically laid out on the motherboard. The DIMM slots on the right half of the motherboard (channels A, B, C, and D) are associated with CPU 1, while the DIMM slots on the left half of the motherboard (channels E, F, G, and H) are associated with CPU 2. The slot 1 (blue) DIMM slots are always located farther away from a CPU than the corresponding slot 2 (black) and slot 3 (white) slots. Slot 1 slots (blue) are populated before slot 2 slots (black) and slot 3 (white) slots.

Figure 9 Physical Layout of CPU DIMM Channels and Slots

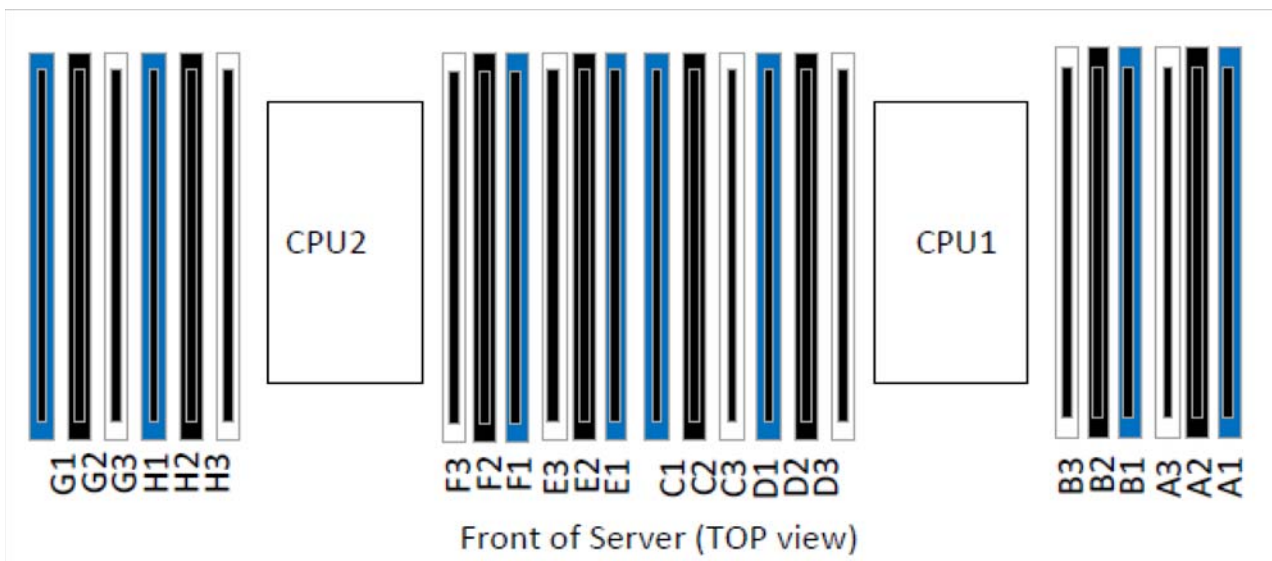

## Memory Population Rules

When considering the memory configuration of your server, consider the following items:

- Each channel has three DIMM slots (for example, channel A = slots A1, A2, and A3).
  - A channel can operate with one, two, or three DIMMs installed.
  - If a channel has only one DIMM, populate slot 1 first (the blue slot).
- When both CPUs are installed, populate the DIMM slots of each CPU identically.
  - Fill blue slots in the channels first: A1, E1, B1, F1, C1, G1, D1, H1
  - Fill black slots in the channels second: A2, E2, B2, F2, C2, G2, D2, H2
  - Fill white slots in the channels third: A3, E3, B3, F3, C3, G3, D3, H3
- Any DIMM installed in a DIMM socket for which the CPU is absent is not recognized.
- Observe the DIMM mixing rules shown in [Table 39](#)

Table 39 DIMM Rules for C220 M4 Servers

DIMM Parameter	DIMMs in the Same Channel	DIMM in the Same Slot <sup>1</sup>
<u>DIMM Capacity</u>		
RDIMM = 8 or 16 GB	DIMMs in the same channel (for example, A1, A2, and A3) can have different capacities.	For best performance, DIMMs in the same slot (for example, A1, B1, C1, D1) should have the same capacity.
LRDIMM = 32 GB	Do not mix LRDIMMs with RDIMMs	Do not mix LRDIMMs RDIMM s
<u>DIMM Speed</u>		
2133-MHz <sup>2</sup>	DIMMs will run at the lowest speed of the DIMMs/CPUs installed	DIMMs will run at the lowest speed of the DIMMs/CPUs installed
<u>DIMM Type</u>		
RDIMMs or LRDIMMs	Do not mix DIMM types in a channel	Do not mix DIMM types in a slot
1 DPC, 2 DPC, or 3 DPC		
DIMMs per Channel (DPC)	See <a href="#">Table 7 on page 22</a> for valid LRDIMM and RDIMM 1 DPC, 2 DPC, and 3 DPC memory configurations	

Notes . . .

1. Although different DIMM capacities can exist in the same slot, this will result in less than optimal performance. For optimal performance, all DIMMs in the same slot should be identical.
2. Only 2133-MHz DIMMs are currently available for the C240 M4 server.

## DIMM Population Order

Populate the DIMMs for a CPU according to [Table 40](#).

Table 40 DIMM Population Order per CPU

DIMMs per CPU	Populate CPU 1 Slots	Populate CPU 2 Slots
1	A1	E1
2	A1, B1	E1, F1
3	A1, B1, C1	E1, F1, G1
4	A1, B1, C1, D1	E1, F1, G1, H1
6 <sup>1</sup>	A1, B1, C1, A2, B2, C2	E1, F1, G1, E2, F2, G2
8	A1, B1, C1, D1, A2, B2, C2, D2	E1, F1, G1, H1, E2, F2, G2, H2
12	A1, B1, C1, D1, A2, B2, C2, D2 A3, B3, C3, D3	E1, F1, G1, H1, E2, F2, G2, H2 E3, F3, G3, H3

Notes . . .

1. Not recommended (for performance reasons)

## Recommended Memory Configuration

This section explains the recommended DIMM population order rules for the C240 M4 server.

- All DIMMs must be DDR4 DIMMs.
- Do not mix:
  - DIMMs with different clock rates in a channel
  - RDIMMs and LRDIMMs
- There are blue, black, and white DIMM slots. Populate blue slots first.
- When DIMMs ranks are mixed in the same channel, always populate the highest rank DIMM in the blue DIMM slot and lower rank DIMM(s) in the black and white DIMM slots.

Many memory configurations are possible. For best results, follow [Table 41](#) when populating 2133-MHz DIMMs for Intel Xeon E5-2600 v3 CPUs.

Table 41 Recommended Memory Configurations for Intel Xeon E5-2600 v3 CPUs (with 2133-MHz DIMMs)<sup>1</sup>

Total System Memory Size	CPU 1 DIMMs			CPU 2 DIMMs			DIMM Max Speed (MHz)	Total DIMMs
	Blue Slots Slot 1 (A1,B1, C1,D1)	Black Slots Slot 2 (A2,B2, C2,D2)	White Slots Slot 3 (A3,B3, C3,D3)	Blue Slots Slot 1 (E1,F1, G1,H1)	Black Slots Slot 2 (E2,F2, G2,H2)	White Slots Slot 3 (E3,F3, G3,H3)		
64 GB	4x8 GB	—	—	4x8 GB	—	—	2133	8
96 GB	4x8 GB <sup>2</sup>	2x8 GB <sup>2</sup>	— <sup>2</sup>	4x8 GB <sup>2</sup>	2x8 GB <sup>2</sup>	— <sup>2</sup>	2133	12
	3x16 GB	—	—	3x16 GB	—	—	2133	6
128 GB	4x8 GB	4x8 GB	—	4x8 GB	4x8 GB	—	2133	16
	4x16 GB	—	—	4x16 GB	—	—	2133	8
192 GB	4x8 GB	4x8 GB	4x8 GB	4x8 GB	4x8 GB	4x8 GB	1600	24
	4x16 GB <sup>2</sup>	2x16 GB <sup>2</sup>	— <sup>2</sup>	4x16 GB <sup>2</sup>	2x16 GB <sup>2</sup>	— <sup>2</sup>	2133	12
	4x16 GB	4x8 GB	—	4x16 GB	4x8 GB	—	2133	16
256 GB	4x16 GB	4x16 GB	—	4x16 GB	4x16 GB	—	2133	16
	4x32 GB	—	—	4x32 GB	—	—	2133	8
384 GB	4x16 GB	4x16 GB	4x16 GB	4x16 GB	4x16 GB	4x16 GB	1866	24
512 GB	4x32 GB	4x32 GB	—	4x32 GB	4x32 GB	—	2133	16
768 GB	4x32 GB	4x32 GB	4x32 GB	4x32 GB	4x32 GB	4x32 GB	1866	24

Notes . . .

1. Rows marked in yellow indicate best performance.
2. Unbalanced configuration (memory not populated equally across the four memory channels). These configurations are possible but not recommended due to poor performance.

## Additional DIMM Populations

The list in [Table 42](#) is not a complete list of all supported DIMM populations, but highlights common configuration options.

Table 42 Supported DIMM Configurations

CPU 1 DIMMs	Total DIMMs for CPU 1	CPU 1 Capacity	CPU 2 DIMMs	Total DIMMs for CPU 2	CPU 2 Capacity	Total Capacity for 2 CPUs
1 x 8 GB	1	8 GB	1 x 8 GB	1	8 GB	16 GB
2 x 8 GB	2	16 GB	2 x 8 GB	2	16 GB	32 GB
1 x 16 GB	1	16 GB	1 x 16 GB	1	16 GB	32 GB
4 x 8 GB	4	32 GB	4 x 8 GB	4	32 GB	64 GB
2 x 16 GB	2	32 GB	2 x 16 GB	2	32 GB	64 GB
1 x 32 GB	1	32 GB	1 x 32 GB	1	32 GB	64 GB
8 x 8 GB	8	64 GB	8 x 8 GB	8	64 GB	128 GB
4 x 16 GB	4	64 GB	4 x 16 GB	4	64 GB	128 GB
2 x 32 GB	2	64 GB	2 x 32 GB	2	64 GB	128 GB
12 x 8 GB	12	96 GB	12 x 8 GB	12	96 GB	192 GB
6 x 16 GB	6	96 GB	6 x 16 GB	6	96 GB	192 GB
8 x 16 GB	8	128 GB	8 x 16 GB	8	128 GB	256 GB
4 x 32 GB	4	128 GB	4 x 32 GB	4	128 GB	256 GB
12 x 16 GB	12	192 GB	12 x 16 GB	12	192 GB	384 GB
6 x 32 GB	6	192 GB	6 x 32 GB	6	192 GB	384 GB
8 x 32 GB	8	256 GB	8 x 32 GB	8	256 GB	512 GB
12 x 32 GB	12	384 GB	12 x 32 GB	12	384 GB	768 GB

## RAID Details

The available disk drive support configurations are shown in this section.



**NOTE:** You can select either a Cisco 12G Modular RAID controller or a Cisco 9300-8i 12G SAS HBA, but not both at the same time.

By default, the server comes with embedded software RAID

To upgrade from the default, select one of these:

### Cisco 12G SAS Modular RAID Controller (RAID Support)

- For a 24-drive or 16-drive backplane system, select one of the following:
  - Cisco 12G SAS Modular RAID controller from [Table 9 on page 27](#), or
  - Cisco 9300-8E 12G SAS HBA from [Table 9 on page 27](#), or
  - One Cisco 12G SAS Modular RAID controller and one Cisco 9300-8E 12G SAS HBA from [Table 9 on page 27](#).

Select an appropriate optional RAID configuration listed in [Table 9 on page 27](#).

- For an 8-drive backplane system, select one of the following:
  - Embedded software RAID 5 key upgrade option from [Table 9 on page 27](#), or
  - Cisco 12G SAS Modular RAID controller from [Table 9 on page 27](#), or
  - Cisco 9300-8E 12G SAS HBA from [Table 9 on page 27](#)
  - One Cisco 12G SAS Modular RAID controller from [Table 9 on page 27](#) and one Cisco 9300-8E 12G SAS HBA from [Table 9 on page 27](#)

Select an appropriate optional RAID configuration listed in [Table 9 on page 27](#).

### Cisco 9300-8i 12G SAS HBA (JBOD Only Support)

- For a 24-drive backplane system (only), select one of the following:
  - Cisco 9300-8i 12G SAS HBA from [Table 9 on page 27](#), or
  - Cisco 9300-8E 12G SAS HBA from [Table 9 on page 27](#), or
  - One Cisco 9300-8i 12G SAS HBA from [Table 9 on page 27](#) and one Cisco 9300-8E 12G SAS HBA from [Table 9 on page 27](#).



## RAID Option ROM (OPROM) Settings

The server contains an Option ROM (OPROM) for the PCIe slots. The server has a finite amount of option ROM with which it can boot up devices. Go into the BIOS and disable the OPROM on the PCIe slots not used for booting so that resources are available for the slots that are used for booting. An example OPROM BIOS screen is shown in *Figure 10*.

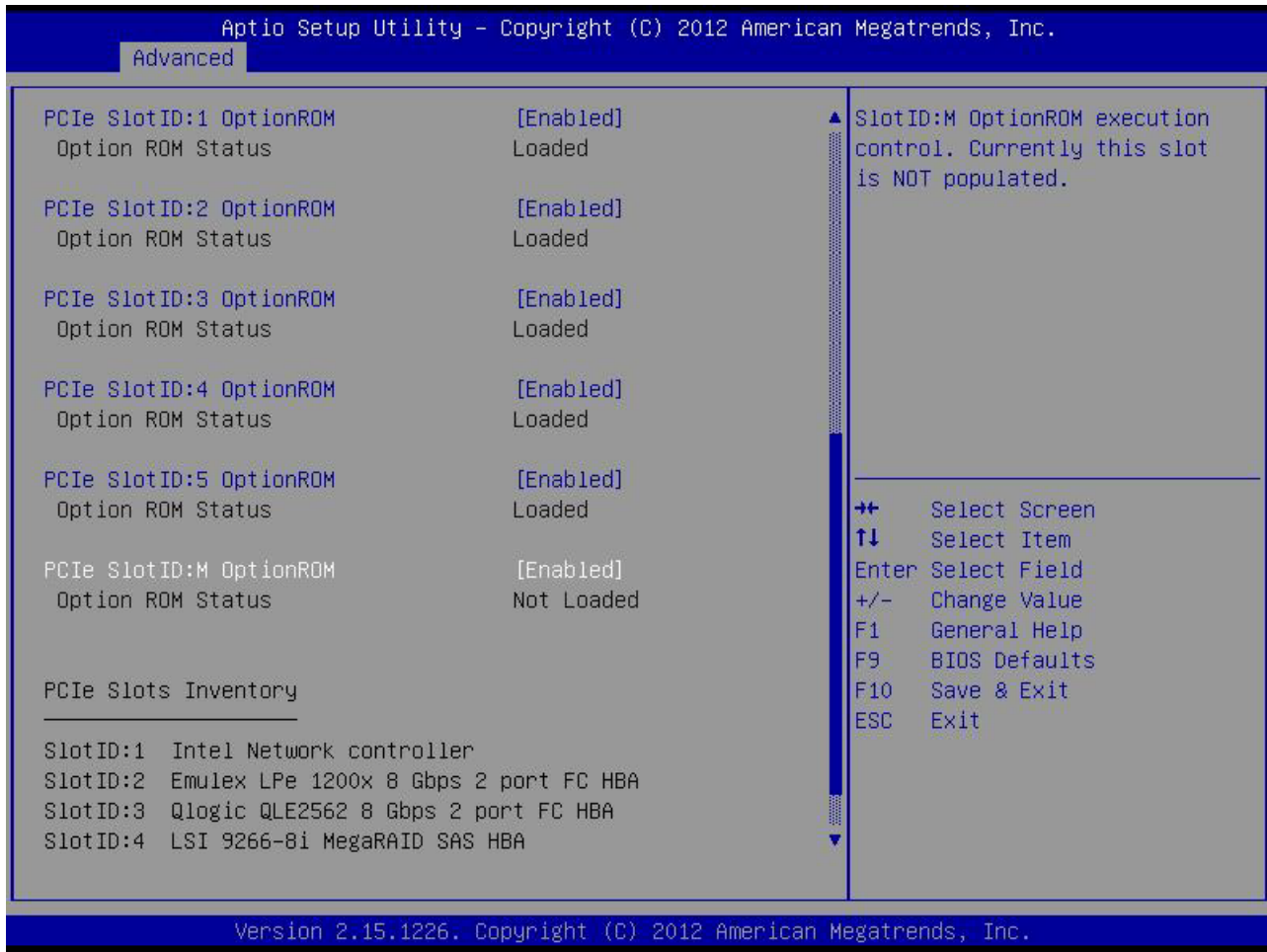
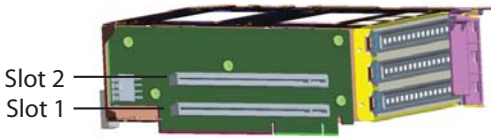

Figure 10 Example BIOS Screen for OPROM



## Riser Card Configuration and Options

The three riser card 1 options are shown in [Table 43](#). The number of PCIe card slots and connectors for SATA boot drives depends on which option is selected for riser 1. The riser card 2 slot assignments are fixed and are shown in [Table 44 on page 75](#).

Table 43 Riser Card 1 Slot Options

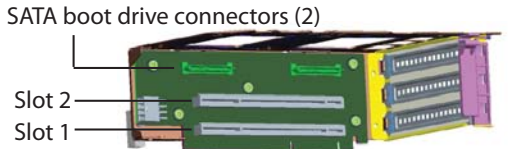
Slot #	Height	Length	Electrical	Mechanical	NCSI	Physical
Riser Card 1 (option A, PID UCSC-PCI-1A-240M4)						
						
3	No slot available					
2	Full	Full <sup>1</sup>	x16	x24	Yes <sup>2</sup>	
1	Full	3/4	x8	x24	Yes <sup>2</sup>	
Riser Card 1 (option B, PID UCSC-PCI-1B-240M4) <sup>3</sup>						
						
3	Full	Full	x8	x16	No	
2	Full	Full	x8	x24	Yes	
1	Full	3/4	x8	x16	No	
Riser Card 1 (option C, PID UCSC-PCI-1C-240M4)						
						
3	No slot available <sup>4</sup>					
2	Full	Full	x16	x24	Yes <sup>2</sup>	
1	Full	3/4	x8	x24	Yes	

Notes . . .

1. GPU capable slot
2. NCSI supported in only one slot at a time (default slot 2). If a GPU card is present in slot 2, NCSI support automatically moves to slot 1.
3. No GPUs are supported on this riser. There is no GPU power connector in this version. Use riser version 1A for GPU cards.
4. There is no PCIe connector in slot 3; instead, there are two connectors available for connecting SATA boot drives.

Table 44 Riser Card 2 Slots

Slot #	Height	Length	Electrical	Mechanical	NCSI	Physical
Riser Card 2						
						
6	Full	Full	x8	x16	No	
5	Full	Full <sup>1</sup>	x16	x24	Yes <sup>2</sup>	
4	Full	3/4	x8	x24	Yes <sup>2</sup>	

Notes . . .

1. GPU capable slot
2. NCSI supported in only one slot at a time (default slot 5). If a GPU card is present in slot 5, NCSI support automatically moves to slot 4.

## Embedded SATA RAID: Two SATA Controllers

The embedded SATA RAID controller hub is split into two controllers, SATA and sSATA (secondary SATA). These two controllers are seen as separate RAID controllers in the Cisco IMC interface and are configurable separately.

- The first SATA controller controls drives 1-4; the secondary sSATA controller controls drives 5-8.
- When configuring RAID groups, you cannot create a group that spans more than four drives.
  - The first SATA controller can control a RAID group of up to four drives, consisting only of drives 1-4.
  - The secondary sSATA controller can control a RAID group of up to four drives, consisting only of drives 5-8. See [Figure 11](#).

Figure 11 Embedded RAID Controller RAID Groups

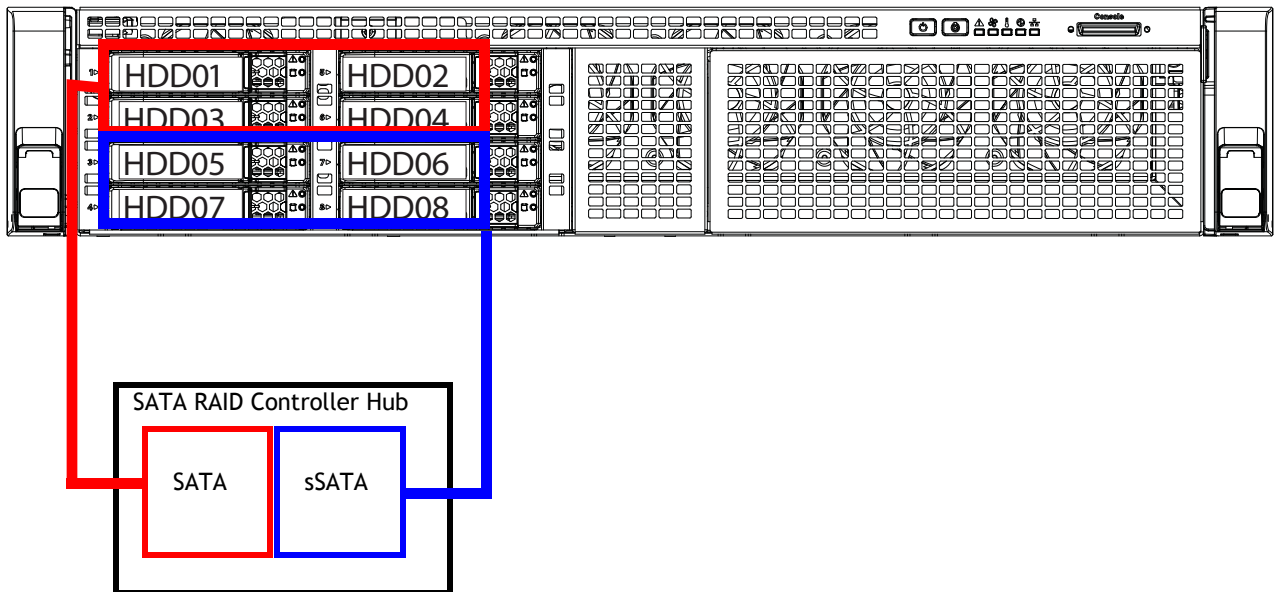

- Each controller is listed separately in the BIOS. You can select the boot order of the controllers in the BIOS (use the Boot Options tab in the BIOS Setup Utility).

Note the following considerations:

- The default setting for this embedded controller hub is SATA RAID 0, 1, and 10 support for up to eight SATA drives (in two groups of four drives).
- You can upgrade this to support to SATA RAID 0, 1, 10, and 5 support for up to eight SATA drives (in two groups of four drives) by installing a RAID 5 key module on the motherboard.
- When you order the server with this embedded controller, the controller is enabled in the BIOS.
- You cannot downgrade from using a HW RAID controller card to using the SW RAID embedded controller.

## To Create a RAID Group

(1) While the server is booting, wait for the prompt and press function key F2 as shown in [Figure 12](#).

Figure 12 Function Key F2 Prompt

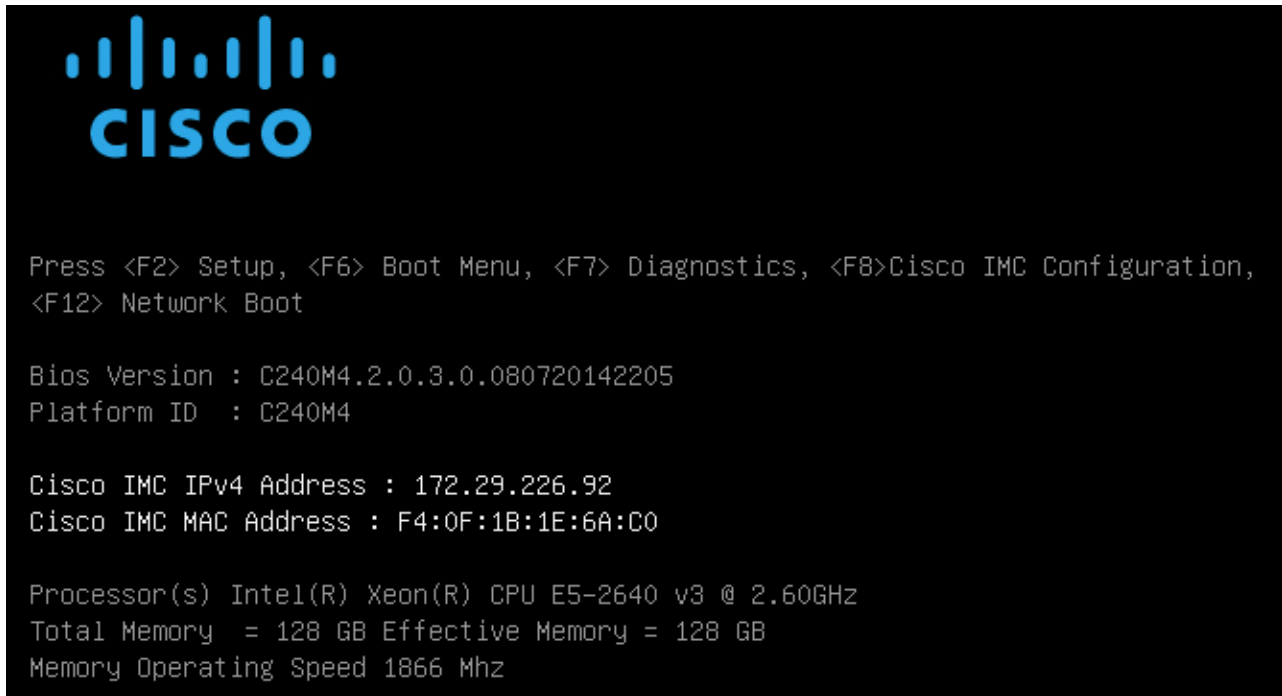

```

CISCO

Press <F2> Setup, <F6> Boot Menu, <F7> Diagnostics, <F8>Cisco IMC Configuration,
<F12> Network Boot

Bios Version : C240M4.2.0.3.0.080720142205
Platform ID : C240M4

Cisco IMC IPv4 Address : 172.29.226.92
Cisco IMC MAC Address : F4:0F:1B:1E:6A:C0

Processor(s) Intel(R) Xeon(R) CPU E5-2640 v3 @ 2.60GHz
Total Memory = 128 GB Effective Memory = 128 GB
Memory Operating Speed 1866 Mhz

```

In a few seconds, you will see the screen that allows you to set up a RAID group for the primary SATA controller (see [Figure 13](#)).

Figure 13 Screen to Configure Primary SATA RAID Group

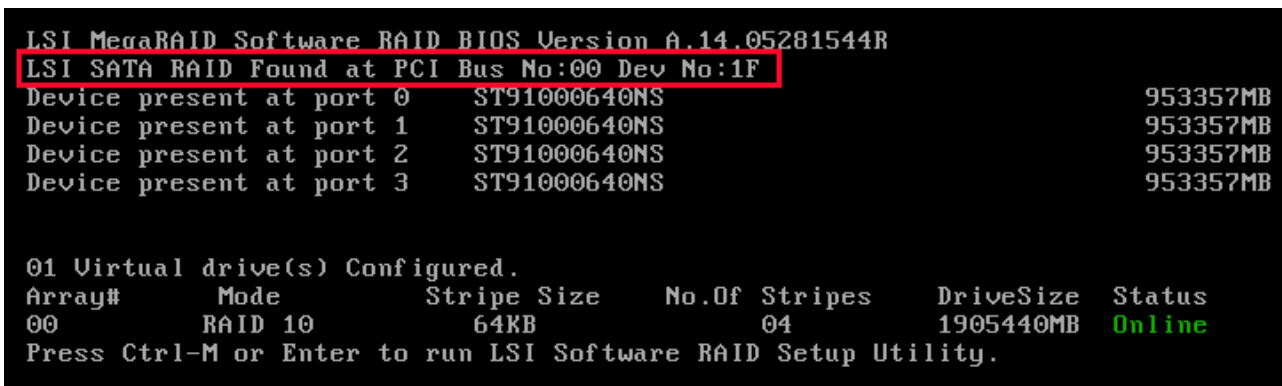

```

LSI MegaRAID Software RAID BIOS Version A.14.05281544R
LSI SATA RAID Found at PCI Bus No:00 Dev No:1F
Device present at port 0      ST91000640NS      953357MB
Device present at port 1      ST91000640NS      953357MB
Device present at port 2      ST91000640NS      953357MB
Device present at port 3      ST91000640NS      953357MB

01 Virtual drive(s) Configured.
Array#      Mode      Stripe Size      No.Of Stripes      DriveSize      Status
00          RAID 10      64KB             04                  1905440MB      Online
Press Ctrl-M or Enter to run LSI Software RAID Setup Utility.

```

(2) Press Ctrl+M to start the RAID group creation process for the primary SATA controller (for drives 1-4, as shown in [Figure 11 on page 76](#)). Or, do nothing and wait for the next screen, which allows you to create a RAID group for the secondary SATA (sSATA) controller see [Figure 14](#)).

Figure 14 Screen to Configure Secondary SATA (sSATA) RAID Group

```

Device present at port 3      ST91000640NS      953357MB

01 Virtual drive(s) Configured.
Array#      Mode      Stripe Size      No.Of Stripes      DriveSize      Status
00          RAID 10      64KB             04                 1905440MB     Online
Press Ctrl-M or Enter to run LSI Software RAID Setup Utility.

LSI MegaRAID Software RAID BIOS Version A.14.05281544R
LSI sSATA RAID Found at PCI Bus No:00 Dev No:11
Device present at port 0      INTEL SSDSC2BA200G3      190270MB
Device present at port 1      INTEL SSDSC2BA200G3      190270MB
Device present at port 2      INTEL SSDSC2BB120G4      113961MB
Device present at port 3      Micron_P400e-MTFDDAK100MAR      94884MB

04 Virtual drive(s) Configured.
Array#      Mode      Stripe Size      No.Of Stripes      DriveSize      Status
00          RAID 0      64KB             01                 189781MB     Online
01          RAID 0      64KB             01                 189781MB     Online
02          RAID 0      64KB             01                 113487MB     Online
03          RAID 0      64KB             01                 94413MB      Online
Press Ctrl-M or Enter to run LSI Software RAID Setup Utility.

```

(3) Press Ctrl+M to start the RAID group creation process for the secondary SATA (sSATA) controller (for drives 5-8, as shown in [Figure 11 on page 76](#)).

## Serial Port Details

The pinout details of the rear RJ-45 serial port connector are shown in [Figure 15](#).

Figure 15 Serial Port (Female RJ-45 Connector) Pinout

### Serial Port (RJ-45 Female Connector)

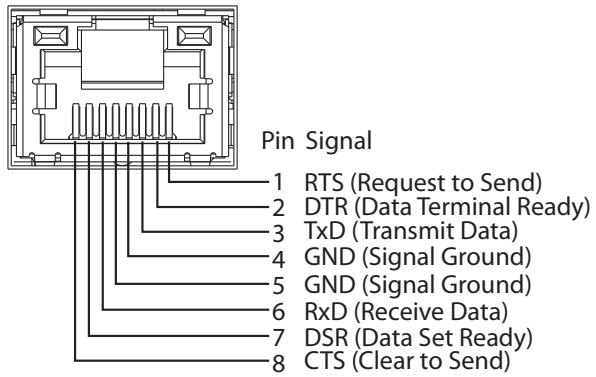

## Upgrade and Servicing-Related Parts

This section lists the upgrade and servicing-related parts you may need during the life of your server. Some of these parts are configured with every server, and some may be ordered when needed or may be ordered and kept on hand as spares for future use. See [Table 45](#).

Table 45 Upgrade and Servicing-related Parts for UCS C240 M4 SFF Server

Spare Product ID (PID)	Description
UCSC-PCIF-01F=	PCIe Full Height blanking panel for UCS C-Series Server <sup>1</sup>
UCSC-PCIF-C240M4=	C240 M4 PCIe Riser Blanking Panel <sup>1</sup>
UCSC-PCI-2-C240M4=	C240 M4 PCIe Riser 2 Assembly <sup>1</sup>
UCSC-PCI-1A-240M4=	C240 M4 PCIe Riser 1 Assembly (x8 slot + GPU) <sup>1</sup>
UCSC-PCI-1B-240M4=	C240 M4 PCIe Riser 1 Assembly (3 x8 slots) <sup>1</sup>
UCSC-PCI-1C-240M4=	C240 M4 PCIe Riser 1 Assembly (SATA Boot + 2 PCIe slots) <sup>1</sup>
UCSC-IP-PCH-240M4=	Interposer board + cables for onboard PCH SATA 6G Embedded Software RAID <sup>1</sup>
UCSC-MLOM-BLK=	MLOM Blanking Panel
UCS-240CBLMR8=	C240 M4 (2) RAID controller cables for 8 HD backplane <sup>2</sup>
UCS-240CBLMR16=	C240 M4 (2) RAID controller cables for 16 HD backplane <sup>2</sup>
UCS-240CBLMR24=	C240 M4 (2) RAID controller cables for 24 HD backplane <sup>2</sup>
UCSC-HS-C240M3=	Heat Sink for UCS C240 M4 Rack Server <sup>1</sup>
UCS-CPU-LPCVR=	CPU load plate dust cover (for unpopulated CPU sockets)
UCSC-GPUCBL-240M4=	C240 M4 GPU Power Cable (1 cable per GPU card) <sup>1</sup>
N20-MBLIBATT=	Replacement Lithium Battery for Server Motherboard (CR2032) <sup>1</sup>
UCSC-FAN-C240M4=	C240 M4 Fan Module (one)
UCSC-BAFF-C240M4=	C240 M4 Air Baffle Replacement Kit
UCSC-PSU-BLKP240=	Power Supply Blanking Panel for C240 M4 Servers <sup>1</sup>
UCSC-RAILB-M4=	Ball Bearing Rail Kit for C220 M4 and C240 M4 rack servers
UCSC-CMAB-M4=	Reversible CMA for C240 M4 ball bearing rail kit
UCS-SD-32G-S=	32 GB SD Card for UCS servers <sup>3</sup>
UCS-SD-64G-S=	64 GB SD Card for UCS servers <sup>2</sup>
UCS-USBFLSHB-16GB=	UCS Servers 16 GB Flash USB Drive
N20-BKVM=	KVM local IO cable for UCS servers console port



Table 45 Upgrade and Servicing-related Parts for UCS C240 M4 SFF Server

Spare Product ID (PID)	Description
UCS-CPU-GREASE3=	M4 Server CPU thermal grease syringe - needed for heatsink seal <sup>4</sup>
UCSX-HSCK=	UCS Processor Heat Sink Cleaning Kit (when replacing a CPU) <sup>3</sup>
UCSC-MRAID-SC=	SuperCap for Cisco 12G SAS Modular RAID, including all cables.

## Notes . . .

1. This part is included/configured with your UCS server (in some cases, as determined by the configuration of your server).
2. Required if ordering the RAID controller as a spare or to replace damaged cables
3. This SD card is blank.
4. This part should be ordered with the purchase of each optional or spare Intel Xeon E5-2600 v3 CPU processor kit

### Adding an Additional CPU (with CPU heat sink)

All Cisco UCS two CPU socket-capable servers can be upgraded from having one to having two CPUs configured. You will need to order and install a heat sink when adding any additional CPU to a server. Instructions for installing the new CPU and heat sink can be found at the following link:

[http://www.cisco.com/c/en/us/td/docs/unified\\_computing/ucs/c/hw/C240M4/install/C240M4.html](http://www.cisco.com/c/en/us/td/docs/unified_computing/ucs/c/hw/C240M4/install/C240M4.html)

See the section titled “Replacing CPUs and Heatsinks.”

### Motherboard Lithium Battery

You can order a replacement motherboard battery. Installation instructions are found at this link:

[http://www.cisco.com/c/en/us/td/docs/unified\\_computing/ucs/c/hw/C240M4/install/C240M4.html](http://www.cisco.com/c/en/us/td/docs/unified_computing/ucs/c/hw/C240M4/install/C240M4.html)

See the section titled “Replacing the Motherboard RTC Battery.”

### Thermal Grease (with syringe applicator) for CPU to Heatsink Seal

Thermal grease must be applied to the top of the CPU where it comes in contact with the heat sink. Instructions for applying thermal grease are found at:

[http://www.cisco.com/c/en/us/td/docs/unified\\_computing/ucs/c/hw/C240M4/install/C240M4.html](http://www.cisco.com/c/en/us/td/docs/unified_computing/ucs/c/hw/C240M4/install/C240M4.html)

See the section titled “Replacing CPUs and Heatsinks.”



**CAUTION:** Use only the thermal grease specified for this server (UCS-CPU-GREASE3=). This thermal grease comes in a white-tipped syringe and is to be used only in the C220 M4 and C240 M4 servers. Other servers use thermal grease in a blue-tipped syringe (UCS-CPU-GREASE=).

Thermal grease for other systems may have different thermal conductivity properties and may cause overheating if used in the C220 M4 or C240 M4 servers.

**DO NOT** use thermal grease available for purchase at any commercial electronics store. If these instructions are not followed, the CPU may overheat and be destroyed.



**NOTE:** When you purchase a spare CPU, the thermal grease with syringe applicator is included.

---

### Air Baffle Replacement Kit

Air baffles are designed to direct airflow through the server to maintain server temperature at a safe operating level. These baffles must always remain installed during server operation. The Air Baffle Replacement Kit includes the air baffles needed for one UCS C220 M4 server.

### CPU Heat Sink Cleaning Kit

The cleaning kit is used to remove the existing thermal compound from the bottom of the heat sink during a CPU replacement process. Instructions for cleaning are found at the following link:

[http://www.cisco.com/c/en/us/td/docs/unified\\_computing/ucs/c/hw/C220M4/install/C220M4.html](http://www.cisco.com/c/en/us/td/docs/unified_computing/ucs/c/hw/C220M4/install/C220M4.html)

See the section titled “Replacing CPUs and Heatsinks.”



**NOTE:** When you purchase a spare CPU, the CPU cleaning kit is included.

## RACKS

The Cisco R42610 rack (see [Figure 16 on page 84](#)) is certified for Cisco UCS installation at customer sites and is suitable for the following equipment:

- Cisco UCS B-Series servers and fabric interconnects
- Cisco UCS C-Series and select Nexus switches

The rack is compatible with hardware designed for EIA-standard 19-inch racks. Rack specifications are listed in [Table 46](#).

Table 46 Cisco R42610 Rack Specifications

Parameter	Standard Rack	Expansion Rack
Dimensions (H x W x D)	78.74 x 24 x 43.38 in. (2000 x 610 x 1102 mm)	78.74 x 23.58 x 43.38 in. (2000 x 599 x 1102 mm)
Dimensions (H x W x D) with packaging	89 x 33 x 47 in. (2261 x 838 x 1194 mm)	89 x 33 x 47 in. (2261 x 838 x 1194 mm)
Distance from front mounting rail to rear mounting rail	29.2 in (741 mm)	29.2 in (741 mm)
Weight	299.83 lb (136 kg)	231.49 lb (105 kg)
Weight with packaging	354 lb (161 kg)	284 lb (129 kg)
Side panels included	Yes	No
Equipment mounting capacity	42RU	42RU
Static load capacity	2100 lb (954 kg)	2100 lb (954 kg)
Dynamic load capacity	Not applicable	Not applicable



NOTE: The AC input connector is an IEC 320 C-14 15 A/250 VAC power inlet.

Figure 16 Cisco R42610 Rack



Front view - door closed



Front view - door open



Front view - door removed

## PDU

Cisco RP Series Power Distribution Units (PDUs) offer power distribution with branch circuit protection.

Cisco RP Series PDU models distribute power to up to 24 outlets. The architecture organizes power distribution, simplifies cable management, and enables you to move, add, and change rack equipment without an electrician.

With a Cisco RP Series PDU in the rack, you can replace up to two dozen input power cords with just one. The fixed input cord connects to the power source from overhead or under-floor distribution. Your IT equipment is then powered by PDU outlets in the rack using short, easy-to-manage power cords.

The C-series severs accept the zero-rack-unit (ORU) PDU. See [Figure 17](#).

Figure 17 Zero Rack Unit PDU (PID = RP208-30-2P-U-2)

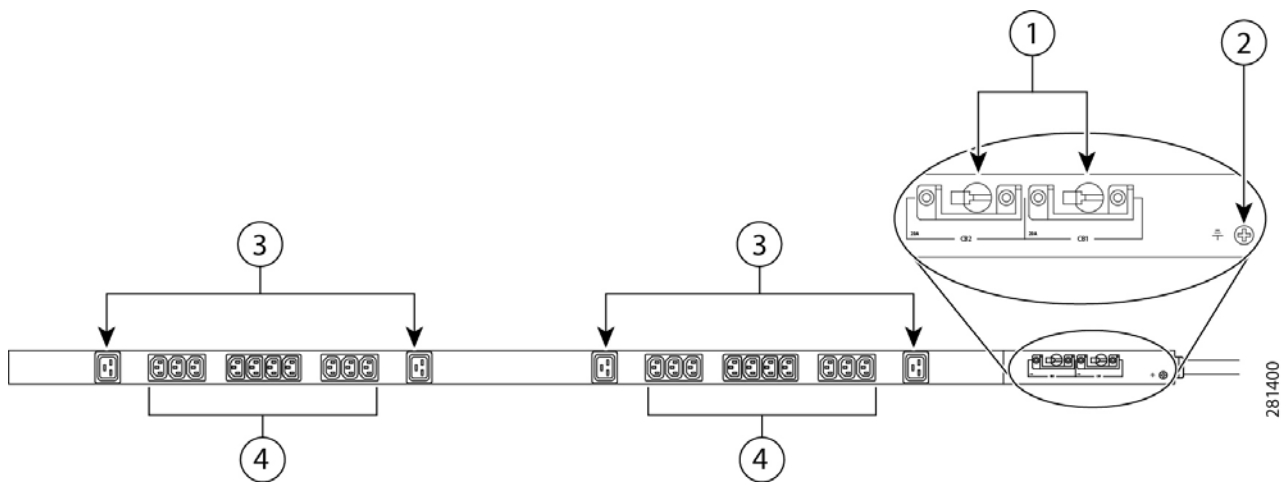

1	Breakers	3	C19 plugs
2	Ground connection	4	C13 plugs

Cisco RP Series PDU models provide two 20-ampere (A) circuit breakers for groups of receptacles. The effects of a tripped circuit are limited to a receptacle group. Simply press a button to reset that circuit.

## KVM CABLE

The KVM cable provides a connection into the server, providing a DB9 serial connector, a VGA connector for a monitor, and dual USB 2.0 ports for a keyboard and mouse. With this cable, you can create a direct connection to the operating system and the BIOS running on the server.

The KVM cable ordering information is listed in [Table 47](#).

Table 47 KVM Cable

Product ID (PID)	PID Description
N20-BKVM=	KVM cable for server console port

Figure 18 KVM Cable

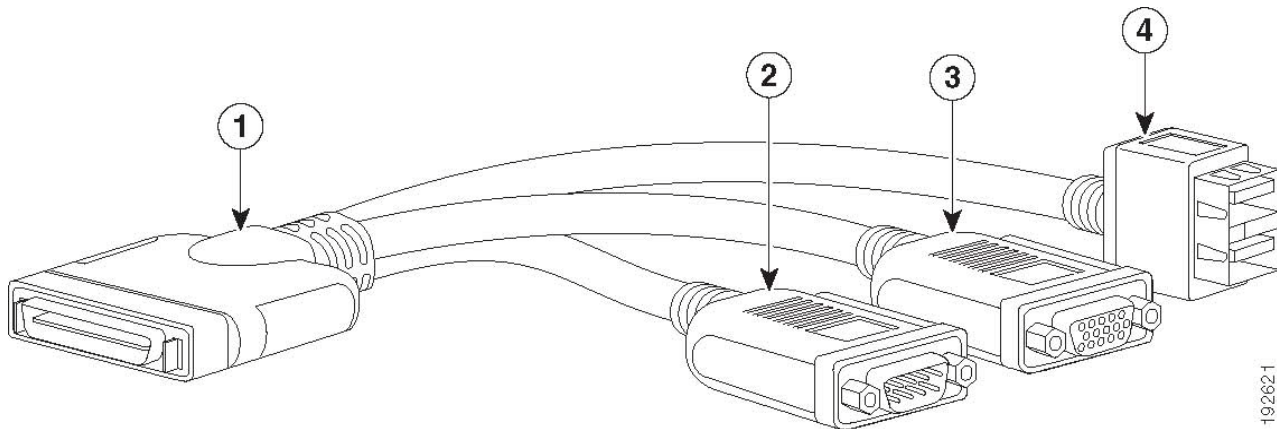

1	Connector (to server front panel)	3	VGA connector (for a monitor)
2	DB-9 serial connector	4	Two-port USB 2.0 connector (for a mouse and keyboard)

## Motherboard USB and SD Ports, and RAID Card Backup Locations

The C240 M4 SFF motherboard has a general-purpose USB socket and two SD sockets, as shown in *Figure 19*. The mounting locations for RAID card backup are also shown

Figure 19 Motherboard USB and SD Ports and RAID Backup Location

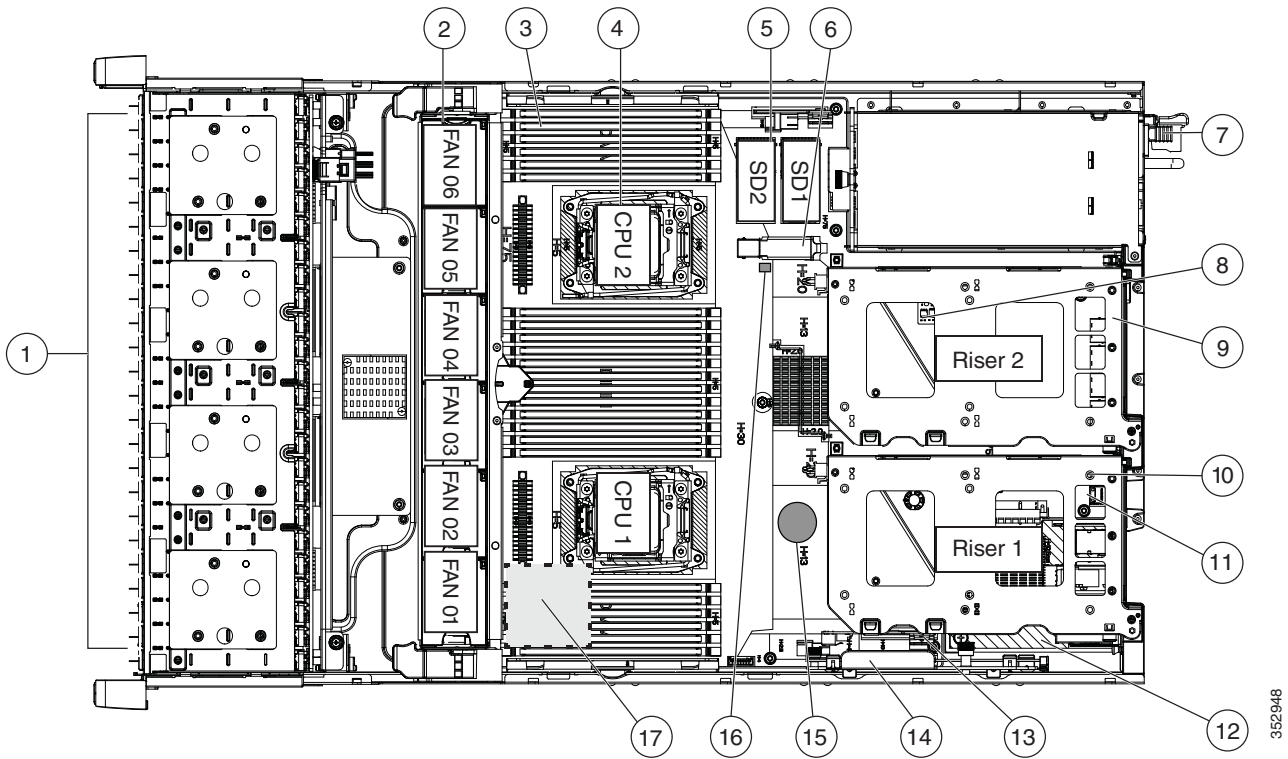

1	Drives (hot-swappable, accessed through front panel)	10	PCIe riser 1 (PCIe slots 1, 2, 3*) *Slot 3 not present in all versions.
2	Fan modules (six, hot-swappable)	11	SuperCap RAID data cache power backup unit mounting locations (two, on air baffle not shown in this view)
3	DIMM sockets on motherboard (up to 24 DIMMs)	12	SATA boot drives (two sockets available only on PCIe riser 1 option C)
4	CPUs and heatsinks (two)	13	Socket for embedded RAID interposer board
5	Cisco SD card slots on motherboard (two)	14	Cisco modular RAID controller PCIe slot (dedicated slot and bracket)
6	USB 3.0 slot on motherboard	15	RTC battery on motherboard
7	Power supplies (hot-swappable, accessed through rear panel)	16	Embedded RAID header for RAID key
8	Trusted platform module (TPM) socket on motherboard, under PCIe riser 2	17	SuperCap power module (RAID backup) mounting location on air baffle (not shown)
9	PCIe riser 2 (PCIe slots 4, 5, 6)		

# TECHNICAL SPECIFICATIONS

## Dimensions and Weight

Table 48 UCS C240 M4 Dimensions and Weight

Parameter	Value
Height	3.43 in. (8.70 cm)
Width (including slam latches)	17.65 in. (44.8 cm) Including handles: 18.96 in. (48.2 cm)
Depth	29.0 in. (73.8 cm) Including handles: 30.18 in. (76.6 cm)
Front Clearance	3 in. (76 mm)
Side Clearance	1 in. (25 mm)
Rear Clearance	6 in. (152 mm)
Weight <sup>1</sup>	
Maximum	
(24 HDD model with 24 HDDs, 2 CPUs, 24 DIMMs, 2 1200 W power supplies)	62.7 lbs (28.4 kg)
(16 HDD model with 16 HDDs, 2 CPUs, 24 DIMMs, 2 1200 W power supplies)	58.9 lbs (27.7 kg)
(8 HDD model with 8 HDDs, 2 CPUs, 24 DIMMs, 2 1200 W power supplies)	52.9 lbs (24.0 kg)
Minimum	
(24 HDD model with 1 HDD, 1 CPU, 1 DIMM, 1 1200 W power supply)	40.1 lbs (18.2 kg)
(16 HDD model with 1 HDD, 1 CPU, 1 DIMM, 1 1200 W power supply)	40.7 lbs (18.5 kg)
(8 HDD model with 1 HDD, 1 CPU, 1 DIMM, 1 1200 W power supply)	39.2 lbs (17.8 kg)
Bare	
(24 HDD model with 0 HDD, 0 CPU, 0 DIMM, 1 1200 W power supply)	37.9 lbs (17.2 kg)
(16 HDD model with 0 HDD, 0 CPU, 0 DIMM, 1 1200 W power supply)	38.5 lbs (17.5 kg)
(8 HDD model with 0 HDD, 0 CPU, 0 DIMM, 1 1200 W power supply)	37.0 lbs (16.8 kg)

## Notes . . .

1. Weight includes inner rail, which is attached to the server. Weight does not include outer rail, which is attached to the rack.



## Power Specifications

The server is available with the following types of power supplies:

- 650 W (AC)
- 1200 W (AC)
- 1400 W (AC)

The general power specifications for the C240 M4 SFF server are listed as follows:

- 650 W (AC) power supply (see [Table 49](#)).
- 1200 W (AC) power supply (see [Table 50 on page 90](#)).
- 1400 W (AC) power supply (see [Table 51 on page 90](#)).

Table 49 UCS C240 M4 SFF Power Specifications 650 W AC power supply)

Description	Specification
AC input voltage range	90 to 264 VAC (self-ranging, 180 to 264 VAC nominal)
AC input frequency	Range: 47 to 63 Hz (single phase, 50 to 60 Hz nominal)
Maximum AC inrush current	11 A Peak at +35 degree C, 208V (charging current for EMI-X capacitors is not considered to be inrush current. The first 200 us of inrush time can be ignored to allow X-cap charging current)
Maximum AC input current	7.6 Amps maximum at 100 VAC 3.65 Amps maximum at 208 VAC
Maximum output power for each power supply	650 W
Power supply output voltage	Main power: 12 VDC Standby power: 12 VDC
Power supply efficiency	80Plus Platinum



NOTE: AC input connector is an IEC 320 C-14 15A/250VAC power inlet.

Table 50 UCS C240 M4 SFF Power Specifications 1200 W AC power supply)

Description	Specification
AC input voltage range	90 to 264 VAC (self-ranging, 180 to 264 VAC nominal)
AC input frequency	Range: 47 to 63 Hz (single phase, 50 to 60Hz nominal)
Maximum AC inrush current	< 30A Peak at 25 degree C (charging current for X capacitors is not considered to be inrush current)
Maximum AC input current	<11 A peak at 100 VAC <7 A peak at 208 VAC
Maximum output power for each power supply	In the 180–264 VAC range, the maximum rated output power is 1200 watts, including the standby 12VDC. In the 90–180vac range, the maximum rated output power is 800 watts minimum, including the standby 12VDC.
Power supply output voltage	Main power: 12 VDC Standby power: 12 VDC
Power supply efficiency	CSCI Platinum



NOTE: AC input connector is an IEC 320 C-14 15A/250VAC power inlet.

Table 51 UCS C240 M4 SFF Power Specifications 1400 W AC power supply)

Description	Specification
AC input voltage range	180 to 264 VAC
AC input frequency	47 to 63 Hz, single phase
Maximum AC inrush current	<30A peak at 25 degree C (charging current for X capacitors is not considered to be inrush current)
Maximum AC input current	<8.5A at 200 VAC
Maximum output power for each power supply	In the 180–264 VAC range, the maximum rated output power is 1400 watts, not including the standby 12VDC.
Power supply output voltage	Main power: 12 VDC Standby power: 12 VDC
Power supply efficiency	80Plus Platinum



NOTE: AC input connector is an IEC 320 C-14 15A/250VAC power inlet.

For configuration-specific power specifications, use the Cisco UCS Power Calculator at this URL:

<http://ucspowercalc.cisco.com>

## Environmental Specifications

The power specifications for the C240 M4 server are listed in [Table 52](#).

Table 52 UCS C240 M4 SFF Environmental Specifications

Parameter	Minimum
Temperature operating	41 to 95° F (5 to 35° C) derate the maximum temperature by 1° C per every 1000 ft. (305 m) of altitude above sea level
Temperature nonoperating	-40 to 149° F (-40 to 65° C)
Humidity (RH) operating	10 to 90%, non-condensing at 82° F (28° C)
Humidity (RH) nonoperating	5 to 93% at 82° F (28° C)
Altitude operating	0 to 3,000 m (0 to 10,000 ft.)
Altitude nonoperating	0 to 12,192 m (0 to 40,000 ft.)
Sound Power level, Measure A-weighted per ISO7779 LWAd (Bels) Operation at 73° F (23° C)	5.4
Sound Pressure level, Measure A-weighted per ISO7779 LpAm (dBA) Operation at 73° F (23° C)	37

## Compliance Requirements

The regulatory compliance requirements for C-Series servers are listed in [Table 53](#).

Table 53 UCS C-Series Regulatory Compliance Requirements

Parameter	Description
Regulatory Compliance	Products should comply with CE Markings per directives 2004/108/EC and 2006/95/EC
Safety	UL 60950-1 Second Edition CAN/CSA-C22.2 No. 60950-1 Second Edition EN 60950-1 Second Edition IEC 60950-1 Second Edition AS/NZS 60950-1 GB4943 2001
EMC - Emissions	47CFR Part 15 (CFR 47) Class A AS/NZS CISPR22 Class A CISPR22 Class A EN55022 Class A ICES003 Class A VCCI Class A EN61000-3-2 EN61000-3-3 KN22 Class A CNS13438 Class A
EMC - Immunity	EN55024 CISPR24 EN300386 KN24



**Americas Headquarters**  
Cisco Systems, Inc.  
San Jose, CA

**Asia Pacific Headquarters**  
Cisco Systems (USA) Pte. Ltd.  
Singapore

**Europe Headquarters**  
Cisco Systems International BV Amsterdam,  
The Netherlands

Cisco has more than 200 offices worldwide. Addresses, phone numbers, and fax numbers are listed on the Cisco Website at [www.cisco.com/go/offices](http://www.cisco.com/go/offices).

Cisco and the Cisco Logo are trademarks of Cisco Systems, Inc. and/or its affiliates in the U.S. and other countries. A listing of Cisco's trademarks can be found at [www.cisco.com/go/trademarks](http://www.cisco.com/go/trademarks). Third party trademarks mentioned are the property of their respective owners. The use of the word partner does not imply a partnership relationship between Cisco and any other company. (1005R)