

Price List OF-2200-a  
Effective May 1st, 2012  
Supercedes all previous price lists

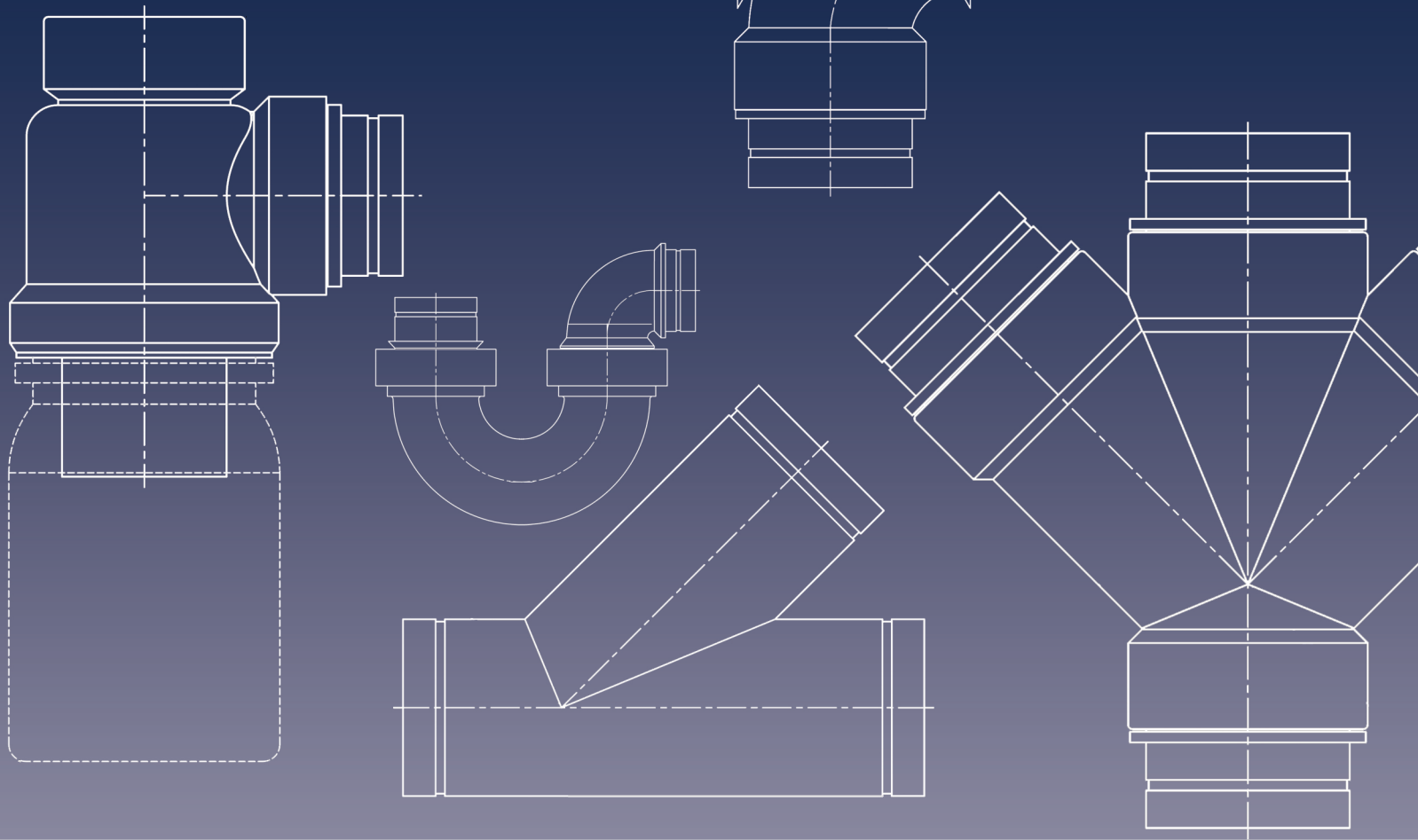

# ORION

## PRICE GUIDE OF-2200-a

**Acid Waste Piping Systems  
Tanks & Monitoring  
High Purity Piping Systems**

## TABLE OF CONTENTS

### ACID WASTE SYSTEMS

No-Hub/Rionfuse CF Polypropylene Acid Waste Drainage	Page 3
Combination Stainless Steel / Polypropylene Floor Drains and Sinks	Page 9
Large Diameter Rionfuse CF Polypropylene Acid Waste Drainage	Page 10
Socket Fusion Polypropylene Acid Waste Drainage	Page 13
No-Hub/Rionfuse CF PVDF Acid Waste Drainage	Page 19
Combination Stainless Steel / PVDF Floor Drains and Sinks	Page 23
Socket Fusion PVDF Acid Waste Drainage	Page 24

### HIGH PURITY SYSTEMS

Whiteline Polypropylene Homopolymer Socket Fusion	Page 28
Whiteline Polypropylene Homopolymer Riontite	Page 31
Standardline Polypropylene Copolymer Socket Fusion	Page 33
EuroGreyline Polypropylene Socket Fusion	Page 35
Whiteline PVDF Socket Fusion	Page 37
FluoroStar PVDF Socket Fusion	Page 39
Ultra Pure Laboratory Faucets and Flexible Connectors	Page 41

### TANKS, pH MONITORING and SINKS

Neutralization and Dilution Tanks	Page 43
Trap Doors	Page 47
NeutraGuard pH Monitoring / Data Logging Systems	Page 49
Corrosion Resistant Laboratory Sinks and Waste Assemblies	Page 51

### TOOLS

No-Hub Acid Waste Mechanical Joint Tools & Accessories	Page 53
Riontite High Purity Facing / Grooving Tools & Accessories	Page 53
Socket Fusion Acid Waste / High Purity Tools & Accessories	Page 54
Rionfuse CF Electrofusion Tools & Accessories	Page 54

Terms and Conditions of Sale	Page 55
------------------------------	---------

**SUGGESTED COUPLING QUANTITY ESTIMATION FORMULA\*:**  
 USE 1 COUPLING PER FITTING + 1 COUPLING PER 5 FEET OF PIPE

**EXAMPLE:**

Qty 2,000 ft. - 3" Sch. 40 Blueline FRPP Pipe ÷ 1 Coupling per 5ft. = (400) 3" Couplings

Qty 200 - 3" Plain End 90° Elbows X 1 Coupling per fitting = (200) 3" Couplings

**TOTAL SUGGESTED COUPLING COUNT = (600) 3" Couplings**

\*NOTE: The above formula is for estimation purposes only. Final coupling count should be reviewed for accuracy before ordering.

## No-Hub/Rionfuse Polypropylene Acid Waste Drainage



**Pipe Cut Charge (Prices are NET)**  
 1½" - 6"-\$5.00/Cut      8" & Larger -\$10.00/Cut

**Pipe**  
 Priced Per 100 Feet • 10ft. Lengths Standard

**Blueline® Polypropylene Schedule 40**

Size	Part #	MFG#	Price
1-1/2"	0110156440	790100	\$1,490.00
2"	0110206440	790103	\$2,040.00
3"	0110306440	790106	\$3,690.00
4"	0110406440	790110	\$5,210.00
6"	0110606440	790116	\$8,840.00

**Blueline® Polypropylene Schedule 80**

Size	Part #	MFG#	Price
1-1/2"	0110156480	790101	\$2,100.00
2"	0110206480	790104	\$2,620.00
3"	0110306480	790107	\$4,990.00
4"	0110406480	790112	\$6,530.00
6"	0110606480	790117	\$13,850.00

**Brownline® Polypropylene Schedule 40**

Size	Part #	MFG#	Price
1-1/2"	0120156440	790200	\$950.00
2"	0120206440	790203	\$1,300.00
3"	0120306440	790206	\$2,650.00
4"	0120406440	790210	\$3,380.00
6"	0120606440	790214	\$6,770.00

**Brownline® Polypropylene Schedule 80**

Size	Part #	MFG#	Price
1-1/2"	0120156480	790201	\$1,520.00
2"	0120206480	790204	\$1,980.00
3"	0120306480	790207	\$3,630.00
4"	0120406480	790211	\$5,090.00
6"	0120606480	790215	\$9,790.00

All pipe is non-returnable.

**No-Hub\* Coupling**



Size	Part #	MFG#	Price
1-1/2"	11101501	711602	\$14.20
2"	11102001	711606	\$18.20
3"	11103001	711610	\$27.30
4"	11104001	711614	\$45.90
6"	11106001	711617	\$85.80

**RF CF\* Coupling**



Size	Part #	MFG#	Price
1-1/2"	131101501	718000	\$21.50
2"	131102001	718002	\$27.00
3"	131103001	718004	\$32.20
4"	131104001	718008	\$43.10
6"	131106001	718011	\$121.90

\*Non-cancelable, non-returnable item

**90° Elbow - 1/4 Bend**



Size	Part #	MFG#	Price
1-1/2"	01101503	710001	\$26.40
2"	01102003	710101	\$31.80
3"	01103003	710201	\$75.70
4"	01104003	710301	\$142.00
6"	01106003	710401	\$296.00

See page 8 for long sweep 90s

**45° Elbow - 1/8 Bend**



Size	Part #	MFG#	Price
1-1/2"	01101502	710000	\$24.20
2"	01102002	710100	\$29.60
3"	01103002	710200	\$77.90
4"	01104002	710300	\$136.40
6"	01106002	710400	\$205.20

**Sanitary Tee - 90 Tee**



Size	Part #	MFG#	Price
1-1/2"	01101505	710003	\$35.50
2"	01102005	710103	\$64.40
3"	01103005	710203	\$100.40
4"	01104005	710303	\$166.50

For 6", use long turn wye

**Reducing Sanitary Tee**



Size	Part #	MFG#	Price
2" x 1-1/2"	011021506	710140	\$36.00
3" x 1-1/2"	011031506	710241	\$100.90
3" x 2"	011030206	710215	\$120.30
4" x 1-1/2"	011041506	710344	\$178.30
4" x 2"	011040206	710315	\$188.20
4" x 3"	011040306	710327	\$211.30

For 6", use long turn wye

**Reducing Lateral Wye**



Size	Part #	MFG#	Price
2" x 1-1/2"	011021509	710141	\$56.40
3" x 1-1/2"	011031509	710242	\$141.40
3" x 2"	011030209	710216	\$161.80
4" x 1-1/2"	011041509	710345	\$252.60
4" x 2"	011040209	710316	\$265.00
4" x 3"	011040309	710328	\$286.80
*6" x 2"	011060209	710414	\$367.20
*6" x 3"	011060309	710422	\$421.10
*6" x 4"	011060409	710428	\$585.10

**45° Lateral Wye**



Size	Part #	MFG#	Price
1-1/2"	01101508	710005	\$23.10
2"	01102008	710105	\$39.30
3"	01103008	710205	\$113.50
4"	01104008	710305	\$168.70
*6"	01106008	710404	\$363.30

**Reducing Long Turn Wye**

Reducing Combo wye + 1/8 bend



Size	Part #	MFG#	Price
2" x 1-1/2"	011021511	710142	\$71.50
3" x 1-1/2"	011031511	710243	\$147.40
3" x 2"	011030211	710219	\$163.60
4" x 1-1/2"	011041511	710346	\$262.00
4" x 2"	011040211	710319	\$280.30
4" x 3"	011040311	710329	\$297.90
*6" x 2"	011060211	710416	\$481.70
*6" x 3"	011060311	710423	\$537.20
*6" x 4"	011060411	710429	\$582.00

**Long Turn Tee Wye**

(combo wye + 1/8 bend)



Size	Part #	MFG#	Price
1-1/2"	01101510	710006	\$48.60
2"	01102010	710106	\$66.90
3"	01103010	710206	\$141.70
4"	01104010	710306	\$206.10
*6"	01106010	710405	\$707.40

\*Non-cancelable, non-returnable item

**Clean Out Tee With Plug**



Size	Part #	MFG#	Price
1-1/2"	01101507	710004	\$74.10
2"	01102007	710104	\$93.60
3"	01103007	710204	\$162.10
4"	01104007	710304	\$227.40
*6"	01106007	710403	\$763.30

**Double Lateral Wye**



Size	Part #	MFG#	Price
1-1/2"	01101513	710009	\$98.30
2"	01102013	710109	\$158.40
3"	01103013	710209	\$221.50
4"	01104013	710309	\$289.50
*6"	01106013	710408	\$743.60

**Double Long Turn Tee Wye**  
(combo wye+1/8 bend)



Size	Part #	MFG#	Price
1-1/2"	01101515	710010	\$133.90
2"	01102015	710110	\$197.10
3"	01103015	710210	\$382.30
4"	01104015	710310	\$499.30
6"	01106015	710409	\$1,173.70

**Male Adapter - MA**



Size	Part #	MFG#	Price
1-1/2"	01101517	710011	\$21.50
2"	01102017	710111	\$22.90
3"	01103017	710211	\$52.00
4"	01104017	710311	\$118.90
6"	01106017	710410	\$274.60

**Clean-Out Adapter With Plug**



Size	Part #	MFG#	Price
1-1/2"	01101519	710013	\$39.30
2"	01102019	710113	\$60.80
3"	01103019	710213	\$134.20
4"	01104019	710313	\$205.50
6"	01106019	710412	\$436.20

**Reducing Double Lateral Wye**



Size	Part #	MFG#	Price
2" x 1-1/2"	011021514	710143	\$275.90
3" x 1-1/2"	011031514	710244	\$293.80
3" x 2"	011030214	710220	\$311.50
4" x 1-1/2"	011041514	710347	\$361.00
4" x 2"	011040214	710320	\$367.20
4" x 3"	011040314	710330	\$385.00
*6" x 2"	011060214	710417	\$811.00
*6" x 3"	011060314	710424	\$825.40
*6" x 4"	011060414	710430	\$843.40

**Reducing Double Long Turn Tee Wye**  
(combo wye +1/8 bend)



Size	Part #	MFG#	Price
2" x 1-1/2"	011021516	710144	\$211.30
3" x 1-1/2"	011031516	710245	\$214.90
3" x 2"	011030216	710221	\$243.50
4" x 1-1/2"	011041516	710348	\$522.80
4" x 2"	011040216	710321	\$537.50
4" x 3"	011040316	710331	\$546.30
*6" x 2"	011060216	710418	\$943.80
*6" x 3"	011060316	710425	\$977.80
*6" x 4"	011060416	710431	\$1,001.00

**Female Adapter - FA**



Size	Part #	MFG#	Price
1-1/2"	01101518	710012	\$23.90
2"	01102018	710112	\$36.50
3"	01103018	710212	\$77.90
4"	01104018	710312	\$127.50
6"	01106018	710411	\$272.70

**Clean-Out Plug - CPC**



Size	Part #	MFG#	Price
1-1/2"	01101520	710014	\$15.30
*2"	01102020	710114	\$24.40
*3"	01103020	710214	\$56.30
*4"	01104020	710314	\$78.10
*6"	01106020	710413	\$163.50

\*Counter sunk plug available at same price. Add "CSK" at end of part#

\*Non-cancelable, non-returnable item

**Duriron x Spigot Adapter**



Size	Part #	MFG#	Price
1-1/2"	01101523	710016	\$59.50
2"	01102023	710117	\$71.90
3"	01103023	710224	\$80.40
4"	01104023	710323	\$102.60
6"	01106023	710447	\$187.60

**Cap**



Size	Part #	MFG#	Price
1-1/2"	01101521	710015	\$46.90
2"	01102021	710116	\$51.70
3"	01103021	710218	\$87.50
4"	01104021	710318	\$138.10
6"	01106021	710415	\$145.20

**Cast Iron Hub Adapter**



Size	Part #	MFG#	Price
*1-1/2"	01101524	710017	\$59.50
*2"	01102024	710118	\$71.90
*3"	01103024	710225	\$80.40
*4"	01104024	710324	\$102.60
*6"	01106024	710420	\$163.80

**P Trap - RBP**



Size	Part #	MFG#	Price
*1-1/2"	01101528	710021	\$84.70
*2"	01102028	710122	\$112.50
3"	01103028	710226	\$225.10
4"	01104028	710325	\$480.60
*6"	01106028	710421	\$1,208.80

**Duriron Hub Adapter**



Size	Part #	MFG#	Price
*1-1/2"	01101524	710017	\$59.50
*2"	01102024	710118	\$71.90
*3"	01103024	710225	\$80.40
*4"	01104024	710324	\$102.60
*6"	01106024	710420	\$163.80

**S Trap - RPB S**



Size	Part #	MFG#	Price
*1-1/2"	01101529	710022	\$114.60
*2"	01102029	710123	\$140.00
*3"	01103029	710228	\$417.00
*4"	01104029	710326	\$566.80

**P Trap - UTP**



Size	Part #	MFG#	Price
1-1/2"	01101525	710018	\$122.70
2"	01102025	710119	\$200.00

**S Trap - UTP S**



Size	Part #	MFG#	Price
*1-1/2"	01101527	710020	\$158.00
*2"	01102027	710121	\$251.60

**Running Trap - UTR**



Size	Part #	MFG#	Price
*1-1/2"	01101526	710019	\$142.20
*2"	01102026	710120	\$221.20

\*Non-cancelable, non-returnable item

**RLNS**



Size	Part #	MFG#	Price
1-1/2"	01101530	710023	\$55.80
2"	01102030	710124	\$77.40

RLNS EPDM Gaskets: \$3.50 net ea.  
\*GASKETS FOR USE WITH OTHER  
MANUFACTURER'S SINKS

**Slip Joint Adapter**



Size	Part #	MFG#	Price
1-1/2"	01101532	710025	\$54.50
2"	01102032	710126	\$63.00

**Double Sanitary Cross**



Size	Part #	MFG#	Price
*1-1/2"	01101579	710032	\$224.00
*2"	01102079	710136	\$313.40
*3"	01103079	710238	\$420.90
*4"	01104079	710341	\$635.80

**Flange 150# - FLG**



Size	Part #	MFG#	Price
1-1/2"	01101535	710028	\$156.50
2"	01102035	710128	\$196.00
3"	01103035	710230	\$319.20
4"	01104035	710333	\$392.40
6"	01106035	710427	\$512.30

**Backing Ring**



Size	Part #	MFG#	Price
1-1/2"	04001536	808057	\$80.30
2"	04002036	808059	\$88.90
3"	04003036	808061	\$117.20
4"	04004036	808064	\$140.70
6"	04006036	808067	\$154.40

**Floor Sink**



Size	Part #	MFG#	Price
*2"	03102091	710171	\$791.70
*3"	03103091	800295	\$791.70
*4"	03104091	808151	\$896.10

**Reducing Bushing - RB**



Size	Part #	MFG#	Price
2" x 1-1/2"	011021522	710145	\$44.80
3" x 1-1/2"	011031522	710246	\$48.40
3" x 2"	011030222	710222	\$50.30
4" x 1-1/2"	011041522	710349	\$94.60
4" x 2"	011040222	710322	\$99.20
4" x 3"	011040322	710332	\$102.40
6" x 2"	011060222	710419	\$162.90
6" x 3"	011060322	710426	\$168.10
6" x 4"	011060422	710432	\$171.90

**Sink Tail Piece Extension RLNS x 12"**



Size	Part #	MFG#	Price
1-1/2"	01101531	710024	\$97.50
2"	01102031	710125	\$111.10

RLNS EPDM Gaskets: \$3.50 net ea.  
\*GASKETS FOR USE WITH OTHER  
MANUFACTURER'S SINKS

**Slip Joint Adapter Extension SJA x 12"**



Size	Part #	MFG#	Price
1-1/2"	01101533	710026	\$102.70
2"	01102033	710127	\$113.00

**Double Reducing Sanitary Cross**



Size	Part #	MFG#	Price
*2" x 1-1/2"	011021580	710146	\$340.20
*3" x 2"	011030280	710227	\$438.80
*4" x 2"	011040280	710371	\$546.30
*4" x 3"	011040380	710370	\$582.00

**Glass Adapter x Plain End**



Size	Part #	MFG#	Price
*1-1/2"	011015100	710007	\$71.60
*2"	011020100	710107	\$93.10
*3"	011030100	710207	\$152.50
*4"	011040100	710307	\$211.30
*6"	011060100	710406	\$281.20

\*Non-cancelable, non-returnable item

**\*Bottle Trap**



Size	Part #	Price
*BT - 1	01101537	\$134.80
BT - 2 w. pt bottle	01101581	\$159.30
*BT - 3	01101582	\$207.90
BT - 4 w. pt bottle	01101593	\$181.00
1 Pt.	01450076	\$73.60
1 Qt.	01451076	\$80.10
2 Qt.	01452076	\$89.50

\*Does not include bottle

BT-1 EPDM Gaskets: \$3.50 net ea.

**Floor Drain FD-1**



Size	Part #	MFG#	Price
2"	01102045	710133	\$773.50
3"	01103045	710235	\$848.10
4"	01104045	710338	\$922.10
*6"	01106045	710435	\$1,058.00

**Side Outlet Floor Drain FD-2**



Size	Part #	MFG#	Price
*2"	01102046	710134	\$929.50
*3"	01103046	710236	\$1,077.20
*4"	01104046	710339	\$1,142.00

**Integral Trap Floor Drain - FD-3**



Size	Part #	MFG#	Price
*2"	01102047	710135	\$1,104.40
*3"	01103047	710237	\$1,227.30
*4"	01104047	710340	\$1,459.70

**Floor Drain Accessories**

Description	Part #	MFG#	Price
*Funnel - 4" x 9"	01300065	808096	\$119.20
*1/2" Trap Primer	01000066	808095	\$80.10
*Connection FIP			
*Sediment Bucket	01300067	808097	\$121.30
*Flashing Clamp	04000068	808098	\$94.10
*Vandal Proofing	000000VP	- - -	\$137.10
*Solid Cover	01300069	808099	\$153.10

**Long Sweep 90**



Size	Part #	MFG#	Price
1-1/2"	01101504	710002	\$65.90
2"	01102004	710102	\$80.60
3"	01103004	710202	\$187.00
4"	01104004	710302	\$311.70
*6"	01106004	710402	\$508.50

**Swivel Drum Trap**



Size	Part #	MFG#	Price
1-1/2"	01101538	710030	\$312.70
2"	01102038	710129	\$326.90

**Acid Waste Floor Clean-Out**



Size	Part #	Price
<b>Brushed Bronze</b>		
3"	01103044SBB (square)	\$798.10
4"	01104044SBB (square)	\$860.50
3"	01103044RBB (round)	\$798.10
4"	01104044RBB (round)	\$860.50
<b>Nickle Bronze</b>		
3"	01103044SNB (square)	\$798.10
4"	01104044SNB (square)	\$860.50
3"	01103044RNB (round)	\$798.10
4"	01104044RNB (round)	\$860.50

With adjustable top for finished floors

**Adjustable Stainless Steel Floor Cleanout**



Size	Part #	Price
<b>Stainless Steel</b>		
2"	710194	\$685.90
3"	710275	\$685.90
4"	710373	\$739.50

With adjustable top for finished floors

\*Non-cancelable, non-returnable item



# Combination Stainless Steel and Polypropylene Floor Drains and Floor Sinks

<b>5" Round Stainless Strainer</b>			
	<b>Size</b>	<b>Part #</b>	<b>Price</b>
	*2"	01102045-SSR5	\$1,343.00
	*3"	01103045-SSR5	\$1,459.50
	*4"	01104045-SSR5	\$1,584.80
	*6"	01106045-SSR5	\$1,969.60

<b>6" Round Stainless Strainer</b>			
	<b>Size</b>	<b>Part #</b>	<b>Price</b>
	*2"	01102045-SSR6	\$1,432.50
	*3"	01103045-SSR6	\$1,549.00
	*4"	01104045-SSR6	\$1,674.40
	*6"	01106045-SSR6	\$2,059.20

<b>8" Round Stainless Strainer</b>			
	<b>Size</b>	<b>Part #</b>	<b>Price</b>
	*2"	01102045-SSR8	\$1,522.10
	*3"	01103045-SSR8	\$1,638.50
	*4"	01104045-SSR8	\$1,763.90
	*6"	01106045-SSR8	\$2,148.70

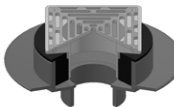
<b>5" x 5" Square Stainless Strainer</b>			
	<b>Size</b>	<b>Part #</b>	<b>Price</b>
	*2"	01102045-SSS5	\$1,343.00
	*3"	01103045-SSS5	\$1,459.50
	*4"	01104045-SSS5	\$1,584.80
	*6"	01106045-SSS5	\$1,969.60

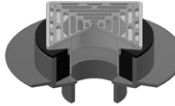
<b>6" x 6" Square Stainless Strainer</b>			
	<b>Size</b>	<b>Part #</b>	<b>Price</b>
	*2"	01102045-SSS6	\$1,432.50
	*3"	01103045-SSS6	\$1,549.00
	*4"	01104045-SSS6	\$1,674.40
	*6"	01106045-SSS6	\$2,059.20

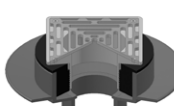
<b>8" x 8" Square Stainless Strainer</b>			
	<b>Size</b>	<b>Part #</b>	<b>Price</b>
	*2"	01102045-SSS8	\$1,522.10
	*3"	01103045-SSS8	\$1,638.50
	*4"	01104045-SSS8	\$1,763.90
	*6"	01106045-SSS8	\$2,148.70

<b>12x12x6 Floor Sink with Stainless Strainer</b>			
	<b>Size</b>	<b>Part #</b>	<b>Price</b>
	*2"	12126FS02-SS	\$3,091.00
	*3"	12126FS03-SS	\$3,206.50
	*4"	12126FS04-SS	\$3,331.90
	*6"	12126FS06-SS	\$3,714.70

<b>12x12x8 Floor Sink with Stainless Strainer</b>			
	<b>Size</b>	<b>Part #</b>	<b>Price</b>
	*2"	12128FS02-SS	\$3,186.70
	*3"	12128FS03-SS	\$3,302.20
	*4"	12128FS04-SS	\$3,427.60
	*6"	12128FS06-SS	\$3,810.40

\*Non-cancelable, non-returnable item

# Rionfuse PP Acid Waste Drainage - Large Diameter

\*ALL LARGE DIAMETER ITEMS ARE NON-CANCELABLE AND NON-RETURNABLE

## \*Pipe - Schedule 40



Flame Retardant			
Size	Part #	MFG#	Price/ft.
8"	011080644020	790120	\$224.00
10"	---	---	\$313.40
12"	---	---	\$420.90

Non-Flame Retardant			
Size	Part #	MFG#	Price/ft.
8"	---	---	\$81.70
10"	---	---	\$126.50
12"	---	---	\$166.90

\*8", 10" & 12" PIPE IS SUPPLIED AS 20' LENGTHS STANDARD

## Coupling



Flame Retardant			
Size	Part #	MFG#	Price
8"	131108001	718014	\$440.80
10"	---	785049	\$680.40
12"	---	785058	\$755.90

## 45° Elbow

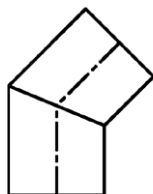

Flame Retardant			
Size	Part #	MFG#	Price
8"	01108002	710517	\$942.50
10"	---	783413	\$970.00
12"	---	783339	\$981.30

Non-Flame Retardant			
Size	Part #	MFG#	Price
8"	---	---	\$806.90
10"	---	---	\$814.90
12"	---	---	\$823.70

## 90° Elbow

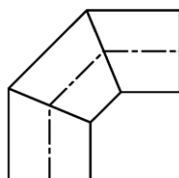

Flame Retardant			
Size	Part #	MFG#	Price
8"	01108003	710518	\$1,320.80
10"	---	783336	\$1,423.50
12"	---	783340	\$1,750.30

Non-Flame Retardant			
Size	Part #	MFG#	Price
8"	---	---	\$1,177.30
10"	---	---	\$1,242.00
12"	---	---	\$1,467.20

## Tee

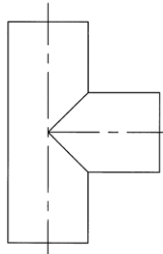

Flame Retardant			
Size	Part #	MFG#	Price
8"	01108005	710520	\$1,269.60
10"	---	782233	\$3,589.20
12"	---	---	\$3,987.70

Non-Flame Retardant			
Size	Part #	MFG#	Price
8"	---	---	\$1,244.20
10"	---	---	\$3,458.60
12"	---	---	\$3,842.70

\*\*\* STRAIGHT TEE DESIGN \*\*\*  
FOR LARGE DIAMETER SWEEP FITTINGS,  
USE COMBO WYE + 1/8TH BEND

## Reducing Tee

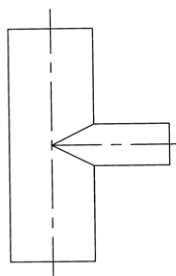

Flame Retardant			
Size	Part #	MFG#	Price
8 x 4	011080406	710523	\$1,269.60
8 x 6	011080606	710526	\$3,589.20
10 x 4	---	782212	\$3,987.70
10 x 6	---	782215	\$3,987.70
10 x 8	---	---	\$3,987.70

Non-Flame Retardant			
Size	Part #	MFG#	Price
8 x 4	---	---	\$1,244.20
8 x 6	---	---	\$3,458.60
10 x 4	---	---	\$3,842.70
10 x 6	---	---	\$3,842.70
10 x 8	---	---	\$3,842.70

\*\*\* STRAIGHT TEE DESIGN \*\*\*  
FOR LARGE DIAMETER SWEEP FITTINGS,  
USE COMBO WYE + 1/8TH BEND

## Lateral Wye

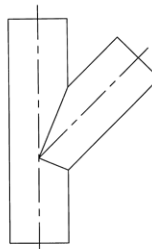

Flame Retardant			
Size	Part #	MFG#	Price
8"	01108008	710519	\$2,369.20
10"	---	783305	\$2,558.70
12"	---	783352	\$3,066.00

Non-Flame Retardant			
Size	Part #	MFG#	Price
8"	---	---	\$2,122.00
10"	---	---	\$2,256.10
12"	---	---	\$2,685.90

**Reducing Lateral Wye**

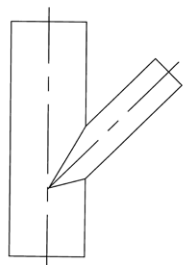

<b>Flame Retardant</b>			
Size	Part #	MFG#	Price
8 x 4	011080409	710509	\$1,103.90
8 x 6	011080609	710513	\$1,676.20
10 x 4	---	782213	\$2,495.50
10 x 6	---	782223	\$2,514.10
10 x 8	---	782218	\$2,548.30
12 x 8	---	782314	\$3,141.80
12 x 10	---	782510	\$3,205.50

<b>Non-Flame Retardant</b>			
Size	Part #	MFG#	Price
8 x 4	---	710510	\$1,002.80
8 x 6	---	710514	\$1,493.40
10 x 4	---	782214	\$2,123.80
10 x 6	---	782216	\$2,156.00
10 x 8	---	782219	\$2,238.20
12 x 8	---	782306	\$2,641.30
12 x 10	---	782308	\$2,730.80

**Combo Wye + 1/8th Bend**

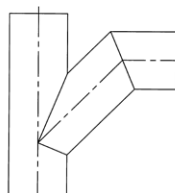

<b>Flame Retardant</b>			
Size	Part #	MFG#	Price
8"	---	710503	\$2,484.70
10"	---	782222	\$3,746.90
12"	---	782300	\$4,900.50

<b>Non-Flame Retardant</b>			
Size	Part #	MFG#	Price
8"	---	---	\$2,217.40
10"	---	---	\$2,595.90
12"	---	---	\$4,407.50

**Reducing Combo Wye + 1/8th Bend**

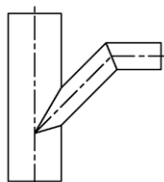

<b>Flame Retardant</b>			
Size	Part #	MFG#	Price
8 x 4	---	---	\$1,754.20
8 x 6	---	---	\$1,799.30
10 x 4	---	---	\$2,683.10
10 x 6	---	---	\$2,880.20
10 x 8	---	---	\$2,934.00
12 x 8	---	---	\$3,441.20
12 x 10	---	---	\$4,404.00

<b>Non-Flame Retardant</b>			
Size	Part #	MFG#	Price
8 x 4	---	---	\$1,395.90
8 x 6	---	---	\$1,570.50
10 x 4	---	---	\$2,335.90
10 x 6	---	---	\$2,462.10
10 x 8	---	---	\$2,544.40
12 x 8	---	---	\$2,885.60
12 x 10	---	---	\$4,059.40

**Double Combo Wye + 1/8th Bend**

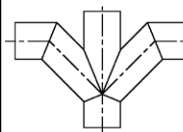

<b>Flame Retardant</b>			
Size	Part #	MFG#	Price
8"	---	---	\$2,823.60
10"	---	782227	\$4,257.90
12"	---	---	\$5,444.10

<b>Non-Flame Retardant</b>			
Size	Part #	MFG#	Price
8"	---	---	\$2,614.80
10"	---	---	\$3,061.20
12"	---	---	\$4,734.10

<b>Double Reducing Combo Wye + 1/8th Bend</b>				
<b>Flame Retardant</b>				
Size	Part #	MFG#	Price	
8 x 4	---	710532	\$2,631.30	
8 x 6	---	710529	\$2,698.90	
10 x 4	---	782285	\$4,025.20	
10 x 6	---	782226	\$4,320.30	
10 x 8	---	782228	\$4,401.10	
12 x 8	---	782315	\$5,162.00	
12 x 10	---	---	\$6,605.80	
<b>Non-Flame Retardant</b>				
Size	Part #	MFG#	Price	
8 x 4	---	---	\$2,093.90	
8 x 6	---	---	\$2,355.70	
10 x 4	---	---	\$3,503.70	
10 x 6	---	---	\$3,693.30	
10 x 8	---	---	\$3,816.70	
12 x 8	---	---	\$4,328.50	
12 x 10	---	---	\$6,089.10	

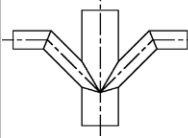

<b>Reducer</b>				
<b>Flame Retardant</b>				
Size	Part #	MFG#	Price	
8 x 4	---	710511	\$851.80	
8 x 6	---	710515	\$942.40	
10 x 4	---	782224	\$1,337.70	
10 x 6	---	782221	\$1,390.20	
10 x 8	---	782220	\$1,434.30	
<b>Non-Flame Retardant</b>				
Size	Part #	MFG#	Price	
8 x 4	---	---	\$788.40	
8 x 6	---	---	\$877.40	
10 x 4	---	---	\$1,209.30	
10 x 6	---	---	\$1,218.30	
10 x 8	---	---	\$1,246.70	
12 x 10	---	---	\$1,485.00	

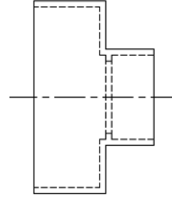

<b>Flange - 150#</b>				
Need to order backing ring for 10" and 12"				
<b>Flame Retardant</b>				
Size	Part #	MFG#	Price	
8"	---	710522	\$895.10	
10"	---	782229/783990	\$1,167.20	
12"	---	783315/783310	\$1,887.90	
<b>Non-Flame Retardant</b>				
Size	Part #	MFG#	Price	
8"	---	---	\$857.90	
10"	---	---	\$1,077.60	
12"	---	---	\$1,756.50	

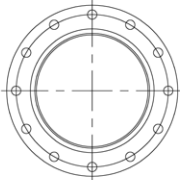

# Socket Fusion Polypropylene Acid Waste Drainage



**Pipe Cut Charge (Prices are NET)**  
 1½" - 6" - \$5.00/Cut      8" & Larger - \$10.00/Cut

**Pipe**

Priced Per 100 Feet • 10ft. Lengths Standard

**Blueline® Polypropylene Schedule 40**

Size	Part #	MFG#	Price
1-1/2"	0110156440	790100	\$1,490.00
2"	0110206440	790103	\$2,040.00
3"	0110306440	790106	\$3,690.00
4"	0110406440	790110	\$5,210.00
6"	0110606440	790116	\$8,840.00

**Blueline® Polypropylene Schedule 80**

Size	Part #	MFG#	Price
1-1/2"	0110156480	790101	\$2,100.00
2"	0110206480	790104	\$2,620.00
3"	0110306480	790107	\$4,990.00
4"	0110406480	790112	\$6,530.00
6"	0110606480	790117	\$13,850.00

**Brownline® Polypropylene Schedule 40**

Size	Part #	MFG#	Price
1-1/2"	0120156440	790200	\$950.00
2"	0120206440	790203	\$1,300.00
3"	0120306440	790206	\$2,650.00
4"	0120406440	790210	\$3,380.00
6"	0120606440	790214	\$6,770.00

**Brownline® Polypropylene Schedule 80**

Size	Part #	MFG#	Price
1-1/2"	0120156480	790201	\$1,520.00
2"	0120206480	790204	\$1,980.00
3"	0120306480	790207	\$3,630.00
4"	0120406480	790211	\$5,090.00
6"	0120606480	790215	\$9,790.00

All pipe is non-returnable.

**Coupling**



Size	Part #	MFG#	Price
1-1/2"	31101501	712000	\$21.80
2"	31102001	712200	\$28.10
3"	31103001	712300	\$45.90
4"	31104001	712400	\$61.50
6"	31106001	712600	\$105.50

**45° Elbow - 1/8 Bend**



Size	Part #	MFG#	Price
1-1/2"	31101502	712001	\$41.30
2"	31102002	712201	\$42.50
3"	31103002	712301	\$77.70
4"	31104002	712401	\$98.20
6"	31106002	712601	\$239.10

**Single Socket 45° Elbow - 1/8 Bend**



Size	Part #	MFG#	Price
1-1/2"	31101548	712026	\$41.30
2"	31102048	712228	\$42.50
3"	31103048	712328	\$77.70
4"	31104048	712434	\$98.20
6"	31106048	712630	\$239.10

**90° Elbow - 1/4 Bend**



Size	Part #	MFG#	Price
1-1/2"	31101503	712002	\$43.50
2"	31102003	712202	\$48.10
3"	31103003	712302	\$82.50
4"	31104003	712402	\$127.40
6"	31106003	712602	\$293.40

\*Non-cancelable, non-returnable item

**Single Socket 90° Elbow - 1/4 Bend**



Size	Part #	MFG#	Price
1-1/2"	31101549	712027	\$43.50
2"	31102049	712229	\$48.10
3"	31103049	712329	\$82.50
4"	31104049	712435	\$127.40
6"	31106049	712631	\$293.40

**Sanitary Tee - 90T**



Size	Part #	MFG#	Price
1-1/2"	31101505	712004	\$53.10
2"	31102005	712204	\$60.30
3"	31103005	712304	\$112.60
4"	31104005	712404	\$172.80

**Cleanout Tee w/Plug - COT**



Size	Part #	MFG#	Price
1-1/2"	31101507	712005	\$104.90
2"	31102007	712205	\$113.00
3"	31103007	712305	\$222.20
4"	31104007	712405	\$296.70
6"	31106007	712604	\$958.00

**45° Lateral Wye**



Size	Part #	MFG#	Price
1-1/2"	31101508	712006	\$74.10
2"	31102008	712206	\$93.60
3"	31103008	712306	\$119.10
4"	31104008	712406	\$177.90
6"	31106008	712605	\$431.00

**Long Turn Tee Wye**  
(combo wye + 1/8 bend)



Size	Part #	MFG#	Price
1-1/2"	31101510	712008	\$137.60
2"	31102010	712208	\$160.30
3"	31103010	712307	\$220.90
4"	31104010	712407	\$298.80
*6"	31106010	712606	\$561.30

**Reducing Sanitary Tee**



Size	Part #	MFG#	Price
2" x 1-1/2"	311021506	712231	\$76.90
3" x 1-1/2"	311031506	712331	\$113.20
3" x 2"	311030206	712314	\$119.20
4" x 1-1/2"	311041506	712437	\$198.10
4" x 2"	311040206	712413	\$200.90
4" x 3"	311040306	712423	\$206.90

For 6", use long turn wye

**Reducing Lateral Wye**



Size	Part #	MFG#	Price
2" x 1-1/2"	311021509	712232	\$69.70
3" x 1-1/2"	311031509	712332	\$106.40
3" x 2"	311030209	712315	\$112.60
4" x 1-1/2"	311041509	712438	\$188.40
4" x 2"	311040209	712414	\$210.30
4" x 3"	311040309	712424	\$250.60
*6" x 2"	311060209	712612	\$410.70
*6" x 3"	311060309	712617	\$415.60
*6" x 4"	311060409	712623	\$427.20

**Reducing Long Turn Wye**

Reducing Combo wye + 1/8 bend



Size	Part #	MFG#	Price
2" x 1-1/2"	311021511	712233	\$107.40
3" x 1-1/2"	311031511	712333	\$130.50
3" x 2"	311030211	712317	\$146.70
4" x 1-1/2"	311041511	712439	\$193.90
4" x 2"	311040211	712416	\$197.20
4" x 3"	311040311	712425	\$209.90
*6" x 2"	311060211	712614	\$429.60
*6" x 3"	311060311	712618	\$435.90
*6" x 4"	311060411	712624	\$439.00

\*Non-cancelable, non-returnable item

**Reducing Double Lateral Wye**



Size	Part #	MFG#	Price
2" x 1-1/2"	311021514	712234	\$130.00
3" x 1-1/2"	311031514	712334	\$195.70
3" x 2"	311030214	712318	\$199.90
4" x 1-1/2"	311041514	712440	\$376.50
4" x 2"	311040214	712417	\$365.40
4" x 3"	311040314	712426	\$371.80
*6" x 2"	311060214	712638	\$891.40
*6" x 3"	311060314	712619	\$905.90
*6" x 4"	311060414	712625	\$924.90

**Double Lateral Wye**



Size	Part #	MFG#	Price
1-1/2"	31101513	712010	\$82.50
2"	31102013	712210	\$128.60
3"	31103013	712309	\$200.00
4"	31104013	712408	\$411.10
*6"	31106013	712607	\$894.90

**Reducing Double Long Turn Tee Wye**  
(combo wye +1/8 bend)



Size	Part #	MFG#	Price
2" x 1-1/2"	311021516	712235	\$157.00
3" x 1-1/2"	311031516	712335	\$214.40
3" x 2"	311030216	712319	\$224.70
4" x 1-1/2"	311041516	712441	\$357.60
4" x 2"	311040216	712418	\$361.20
4" x 3"	311040316	712427	\$366.50
*6" x 2"	311060216	712637	\$891.90
*6" x 3"	311060316	- - -	\$901.70
*6" x 4"	311060416	712626	\$914.30

**Double Long Turn Tee Wye**  
(combo wye+1/8 bend)



Size	Part #	MFG#	Price
1-1/2"	31101515	712011	\$98.60
2"	31102015	712211	\$151.00
3"	31103015	712310	\$219.50
4"	31104015	712409	\$598.60
*6"	31106015	712608	\$1,313.30

**Female Adapter - FA**



Size	Part #	MFG#	Price
1-1/2"	31101518	712013	\$31.80
2"	31102018	712213	\$40.00
3"	31103018	712312	\$49.80
4"	31104018	712411	\$95.90
6"	31106018	712610	\$259.70

**Male Adapter - MA**



Size	Part #	MFG#	Price
1-1/2"	31101517	712012	\$31.50
2"	31102017	712212	\$39.70
3"	31103017	712311	\$49.90
4"	31104017	712410	\$95.90
6"	31106017	712609	\$259.70

**Clean-Out Adapter With Plug**





Size	Part #	MFG#	Price
1-1/2"	31101519	712014	\$47.30
2"	31102019	712214	\$64.40
3"	31103019	712313	\$106.00
4"	31104019	712412	\$173.90
6"	31106019	712611	\$423.30

\*Non-cancelable, non-returnable item

<b>Cap</b>				
	Size	Part #	MFG#	Price
	1-1/2"	31101521	712015	\$27.40
	2"	31102021	712215	\$35.40
	3"	31103021	712316	\$45.70
	4"	31104021	712415	\$84.70
	6"	31106021	712613	\$142.60

<b>Reducing Bushing - RB</b>				
	Size	Part #	MFG#	Price
	2" x 1-1/2"	311021522	712236	\$32.00
	3" x 1-1/2"	311031522	712336	\$49.40
	3" x 2"	311030222	712320	\$52.10
	4" x 1-1/2"	311041522	712442	\$76.80
	4" x 2"	311040222	712419	\$77.40
	4" x 3"	311040322	712428	\$79.90
	6" x 2"	311060222	712615	\$168.30
	6" x 3"	311060322	712620	\$171.40
	6" x 4"	311060422	712627	\$181.00

<b>Reducing Coupling - RCLS</b>				
	Size	Part #	MFG#	Price
	2" x 1-1/2"	311021551	712237	\$32.10
	3" x 1-1/2"	311031551	712337	\$64.20
	3" x 2"	311030251	712321	\$68.10
	4" x 1-1/2"	311041551	712443	\$107.30
	4" x 2"	311040251	712420	\$111.10
	4" x 3"	311040351	712430	\$119.90
	6" x 2"	311060251	- - -	\$144.40
	6" x 3"	311060351	712622	\$149.60
	6" x 4"	311060451	712629	\$155.40

<b>P Trap - UTP</b>				
	Size	Part #	MFG#	Price
	1-1/2"	31101525	712016	\$155.30
	2"	31102025	712216	\$221.00

<b>Running Trap - UTR</b>				
	Size	Part #	MFG#	Price
	1-1/2"	31101526	712017	\$161.00
	2"	31102026	712217	\$227.80

<b>S Trap - UTP S</b>				
	Size	Part #	MFG#	Price
	*1-1/2"	31101527	712018	\$214.80
	*2"	31102027	712218	\$285.20

<b>P Trap - RBP</b>				
	Size	Part #	MFG#	Price
	*1-1/2"	31101528	712019	\$71.90
	*2"	31102028	712219	\$89.50
	*3"	31103028	712322	\$266.00
	*4"	31104028	712421	\$361.80
	*6"	31106028	712616	\$719.70

<b>S Trap - RPB S</b>				
	Size	Part #	MFG#	Price
	*1-1/2"	31101529	712020	\$119.80
	*2"	31102029	712220	\$148.20
	*3"	31103029	712323	\$242.90
	*4"	31104029	712422	\$388.50

\*Non-cancelable, non-returnable item



**RLNS**



Size	Part #	MFG#	Price
1-1/2"	31101530	712021	\$38.40
2"	31102030	712221	\$57.30

RLNS EPDM Gaskets: \$3.50 net ea.  
\*GASKETS FOR USE WITH OTHER MANUFACTURER'S SINKS

**Sink Tail Piece Extension RLNS x 12"**



Size	Part #	MFG#	Price
1-1/2"	01101531	710024	\$97.50
2"	01102031	710125	\$111.10

RLNS EPDM Gaskets: \$3.50 net ea.  
\*GASKETS FOR USE WITH OTHER MANUFACTURER'S SINKS

**Slip Joint Adapter**



Size	Part #	MFG#	Price
1-1/2"	31101532	712022	\$71.90
2"	31102032	712222	\$85.90

**Slip Joint Adapter Extension SJA x 12"**



Size	Part #	MFG#	Price
1-1/2"	01101533	710026	\$102.70
2"	01102033	710127	\$113.00

**Swivel Drum Trap**



Size	Part #	MFG#	Price
1-1/2"	31101538	712025	\$282.80
2"	31102038	712224	\$289.30

**Flange 150# - FLG**



Size	Part #	MFG#	Price
1-1/2"	31101535	712023	\$142.00
2"	31102035	712223	\$155.30
3"	31103035	712324	\$204.50
4"	31104035	712429	\$242.90
6"	31106035	712621	\$333.30

**Backing Ring**



Size	Part #	MFG#	Price
1-1/2"	04001536	808057	\$80.30
2"	04002036	808059	\$88.90
3"	04003036	808061	\$117.20
4"	04004036	808064	\$140.70
6"	04006036	808067	\$154.40

**\*Bottle Trap**



Size	Part #	Price
*BT - 1	31101537	\$92.40
BT - 2 w. pt bottle	31101581	\$127.90
*BT - 3	31101582	\$175.80
1 Pt.	01450076	\$73.60
1 Qt.	01451076	\$80.10
2 Qt.	01452076	\$89.50

\*Does not include bottle

BT-1 EPDM Gaskets: \$3.50 net ea.

\*Non-cancelable, non-returnable item

**Floor Drain FD-1**



Size	Part #	MFG#	Price
2"	31102045	712225	\$846.00
3"	31103045	712325	\$871.70
4"	31104045	712431	\$932.10
*6"	31106045	712628	\$1,251.80

**Side Outlet Floor Drain FD-2**



Size	Part #	MFG#	Price
*2"	31102046	712226	\$1,142.70
*3"	31103046	712326	\$1,161.30
*4"	31104046	712432	\$1,165.30

**Integral Trap Floor Drain - FD-3**



Size	Part #	MFG#	Price
*2"	31102047	712227	\$1,121.50
*3"	31103047	712327	\$1,299.30
*4"	31104047	712433	\$1,458.00

**Acid Waste Floor Clean-Out**



Size	Part #	Price
<b>Brushed Bronze</b>		
3"	01103044SBB (square)	\$789.10
4"	01104044SBB (square)	\$860.50
3"	01103044RBB (round)	\$789.10
4"	01104044RBB (round)	\$860.50
<b>Nickle Bronze</b>		
3"	01103044SNB (square)	\$789.10
4"	01104044SNB (square)	\$860.50
3"	01103044RNB (round)	\$789.10
4"	01104044RNB (round)	\$860.50

*With adjustable top for finished floors*

**Floor Drain Accessories**

Description	Part #	MFG#	Price
*Funnel - 4" x 9"	01300065	808096	\$119.20
*1/2" Trap Primer	01000066	808095	\$80.10
*Connection FIP			
*Sediment Bucket	01300067	808097	\$121.30
*Flashing Clamp	04000068	808098	\$94.10
*Vandal Proofing	000000VP	- - -	\$137.10
*Solid Cover	01300069	808099	\$153.10

**Adjustable Stainless Steel Floor Cleanout**



Size	Part #	Price
<b>Stainless Steel</b>		
2"		\$685.90
3"		\$685.90
4"	712473	\$739.50

\*Non-cancelable, non-returnable item

# No-Hub/Rionfuse PVDF Acid Waste Drainage

ALL PVDF MATERIAL IS NON-CANCELABLE AND NON-RETURNABLE

**Pipe Cut Charge (Prices are NET)**  
 1 1/2" - 6"-\$5.00/Cut      8" & Larger -\$10.00/Cut

\*NOTE: All material is CREAM in color



**Pipe**  
 Priced Per 100 Feet

## Plenum Plus® PVDF Schedule 40

Size	Part #	MFG#	Price
1-1/2"	0280156440	792500	\$5,340.00
2"	0280206440	792510	\$7,570.00
3"	0280306440	792520	\$14,640.00
4"	0280406440	792530	\$23,980.00
6"	0280606440	792540	\$55,230.00

## RF CF\* Coupling



Size	Part #	MFG#	Price
1-1/2"	132801501	728100	\$45.90
2"	132802001	728110	\$58.20
3"	132803001	728120	\$121.50
4"	132804001	728130	\$149.60
6"	132806001	728140	\$233.10

## No-Hub\* Coupling



Size	Part #	MFG#	Price
1-1/2"	12801501	723900	\$28.70
2"	12802001	723901	\$31.30
3"	12803001	723902	\$38.10
4"	12804001	723903	\$51.10
6"	12806001	723904	\$109.50

## 45° Elbow - 1/8 Bend



Size	Part #	MFG#	Price
1-1/2"	02801502	723000	\$33.10
2"	02802002	723102	\$38.60
3"	02803002	723202	\$224.00
4"	02804002	723301	\$380.60
6"	02806002	723400	\$844.60

## 90° Elbow - 1/4 Bend



Size	Part #	MFG#	Price
1-1/2"	02801503	723001	\$71.00
2"	02802003	723101	\$102.00
3"	02803003	723201	\$247.60
4"	02804003	723300	\$482.10
6"	02806003	723401	\$989.10

## Sanitary Tee - 90 Tee



Size	Part #	MFG#	Price
1-1/2"	02801505	723003	\$95.90
2"	02802005	723107	\$205.10
3"	02803005	723212	\$403.00
4"	02804005	723303	\$678.20

For 6", use long turn wye

## Long Sweep 90



Size	Part #	MFG#	Price
1-1/2"	02801504	723002	\$120.60
2"	02802004	723110	\$135.90
3"	02803004	723218	\$379.20
4"	02804004	723302	\$660.40

## Reducing Sanitary Tee





Size	Part #	MFG#	Price
2" x 1-1/2"	028021506	723131	\$135.50
3" x 1-1/2"	028031506	723235	\$233.90
3" x 2"	028030206	723200	\$290.80
4" x 1-1/2"	028041506	723335	\$1,255.20
4" x 2"	028040206	723313	\$1,293.40
4" x 3"	028040306	723324	\$1,315.30

For 6", use long turn wye

<b>45° Lateral Wye</b>				
	Size	Part #	MFG#	Price
	1-1/2"	02801508	723005	\$104.90
	2"	02802008	723103	\$180.40
	3"	02803008	723203	\$371.50
	4"	02804008	723305	\$622.00
	6"	02806008	723403	\$1,253.70

<b>Long Turn Tee Wye</b> (combo wye + 1/8 bend)				
	Size	Part #	MFG#	Price
	1-1/2"	02801510	723006	\$179.80
	2"	02802010	723108	\$259.10
	3"	02803010	723213	\$646.90
	4"	02804010	723306	\$1,029.90
	6"	02806010	723404	\$2,281.30

<b>Double Lateral Wye</b>				
	Size	Part #	MFG#	Price
	1-1/2"	02801513	723007	\$277.80
	2"	02802013	723112	\$439.10
	3"	02803013	723207	\$604.00
	4"	02804013	723307	\$775.00
	6"	02806013	723405	\$1,520.80

<b>Double Sanitary Cross</b>				
	Size	Part #	MFG#	Price
	1-1/2"	02801579	723036	\$491.90
	2"	02802079	723129	\$542.20
	3"	02803079	723245	\$1,006.80
	4"	02804079	723350	\$1,398.50

<b>Glass Adapter x Plain End</b>				
	Size	Part #	MFG#	Price
	1-1/2"	028015100	723041	\$123.00
	2"	028020100	723147	\$159.90
	3"	028030100	723248	\$261.90
	4"	028040100	723354	\$362.90
	6"	028060100	723437	\$482.90

<b>Reducing Lateral Wye</b>				
	Size	Part #	MFG#	Price
	2" x 1-1/2"	028021509	723132	\$131.30
	3" x 1-1/2"	028031509	723236	\$264.00
	3" x 2"	028030209	723208	\$269.70
	4" x 1-1/2"	028041509	723336	\$530.00
	4" x 2"	028040209	723314	\$559.40
	4" x 3"	028040309	723325	\$583.80
	6" x 2"	028060209	723411	\$1,607.70
	6" x 3"	028060309	723417	\$1,641.00
6" x 4"	028060409	723423	\$1,682.70	

<b>Reducing Long Turn Wye</b> Reducing Combo wye + 1/8 bend				
	Size	Part #	MFG#	Price
	2" x 1-1/2"	028021511	723133	\$238.10
	3" x 1-1/2"	028031511	723237	\$344.30
	3" x 2"	028030211	723214	\$347.10
	4" x 1-1/2"	028041511	723337	\$596.40
	4" x 2"	028040211	723317	\$625.90
	4" x 3"	028040311	723326	\$742.60
	6" x 2"	028060211	723413	\$1,925.40
	6" x 3"	028060311	723418	\$1,960.90
	6" x 4"	028060411	723424	\$2,110.90

<b>Reducing Double Lateral Wye</b>				
	Size	Part #	MFG#	Price
	2" x 1-1/2"	028021514	723134	\$512.50
	3" x 1-1/2"	028031514	723238	\$674.90
	3" x 2"	028030214	723222	\$685.60
	4" x 1-1/2"	028041514	723338	\$1,378.80
	4" x 2"	028040214	723318	\$1,382.50
	4" x 3"	028040314	723327	\$1,485.90
	6" x 2"	028060214	- - -	\$2,776.80
	6" x 3"	028060314	723419	\$2,876.10
	6" x 4"	028060414	723425	\$2,901.10

<b>Clean Out Tee With Plug</b>				
	Size	Part #	MFG#	Price
	1-1/2"	02801507	723004	\$193.90
	2"	02802007	723111	\$266.80
	3"	02803007	723216	\$517.50
	4"	02804007	723304	\$866.70
	6"	02806007	723434	POA

**Double Long Turn Tee Wye**  
(combo wye+1/8 bend)



Size	Part #	MFG#	Price
1-1/2"	02801515	723008	\$392.90
2"	02802015	723113	\$523.80
3"	02803015	723215	\$1,144.10
4"	02804015	723308	\$1,768.60
6"	02806015	723406	\$3,596.30

**Reducing Double Long Turn Tee Wye**  
(combo wye +1/8 bend)



Size	Part #	MFG#	Price
2" x 1-1/2"	028021516	723135	\$654.10
3" x 1-1/2"	028031516	723239	\$820.00
3" x 2"	028030216	723223	\$876.00
4" x 1-1/2"	028041516	723339	\$1,390.80
4" x 2"	028040216	723319	\$1,430.00
4" x 3"	028040316	723328	\$1,759.50
6" x 2"	028060216	- - -	\$2,725.30
6" x 3"	028060316	723420	\$3,515.60
6" x 4"	028060416	723426	\$3,816.40

**Male Adapter - MA**



Size	Part #	MFG#	Price
1-1/2"	02801517	723009	\$42.90
2"	02802017	723114	\$56.70
3"	02803017	723219	\$117.70
4"	02804017	723309	\$158.10
6"	02806017	723407	\$409.00

**Female Adapter - FA**



Size	Part #	MFG#	Price
1-1/2"	02801518	723010	\$42.90
2"	02802018	723104	\$56.70
3"	02803018	723204	\$117.70
4"	02804018	723310	\$158.10
6"	02806018	723408	\$409.00

**Clean-Out Adapter With Plug**



Size	Part #	MFG#	Price
1-1/2"	02801519	723011	\$101.10
2"	02802019	723109	\$128.70
3"	02803019	723217	\$269.00
4"	02804019	723311	\$378.40
6"	02806019	723409	\$937.40

**Clean-Out Plug - CPC**



Size	Part #	MFG#	Price
1-1/2"	02801520	723012	\$52.70
**2"	02802020	723115	\$68.70
**3"	02803020	723220	\$157.20
**4"	02804020	723312	\$228.40
**6"	02806020	723410	\$528.50

\*\*Counter sunk plug available at same price. Add "CSK" at end of part#

**Cap**



Size	Part #	MFG#	Price
1-1/2"	02801521	723013	\$103.60
2"	02802021	723116	\$123.30
3"	02803021	723221	\$194.50
4"	02804021	723316	\$237.60
6"	02806021	723412	\$381.80

**P Trap - UTP**



Size	Part #	MFG#	Price
1-1/2"	02801525	723016	\$430.10
2"	02802025	723119	\$613.70

**Reducing Bushing - RB**



Size	Part #	MFG#	Price
2" x 1-1/2"	028021522	723136	\$68.70
3" x 1-1/2"	028031522	723240	\$97.40
3" x 2"	028030222	723209	\$115.20
4" x 1-1/2"	028041522	723340	\$168.50
4" x 2"	028040222	723320	\$175.50
4" x 3"	028040322	723329	\$191.40
6" x 2"	028060222	723414	\$404.10
6" x 3"	028060322	723421	\$467.30
6" x 4"	028060422	723427	\$537.60

**Running Trap - UTR**



Size	Part #	MFG#	Price
1-1/2"	02801526	723017	\$504.70
2"	02802026	723120	\$720.10

**P Trap - RBP**



Size	Part #	MFG#	Price
1-1/2"	02801528	723018	\$276.30
2"	02802028	723121	\$382.90
3"	02803028	723226	\$973.80
4"	02804028	723323	\$1,825.50
6"	02806028	723416	\$7,010.20

**Sink Tail Piece Extension RLNS x 12"**



Size	Part #	MFG#	Price
1-1/2"	02801531	723020	\$168.90
2"	02802031	723146	\$255.60

**Flange 150# - FLG**



Size	Part #	MFG#	Price
1-1/2"	02801535	723022	\$182.10
2"	02802035	723124	\$256.00
3"	02803035	723229	\$405.70
4"	02804035	723330	\$504.90
6"	02806035	723422	\$643.70

**Backing Ring**



Size	Part #	MFG#	Price
1-1/2"	04001536	808057	\$80.30
2"	04002036	808059	\$88.90
3"	04003036	808061	\$117.20
4"	04004036	808064	\$140.70
6"	04006036	808067	\$154.40

**Adjustable Stainless Steel Floor Cleanout**



Size	Part #	Price
<b>Stainless Steel</b>		
2"	723390	\$834.70
3"	- - -	\$834.70
4"	723373	\$895.20

*With adjustable top for finished floors*

**RLNS**



Size	Part #	MFG#	Price
1-1/2"	02801530	723019	\$95.70
2"	02802030	723123	\$154.60

**Acid Waste Floor Clean-Out**



Size	Part #	Price
<b>Brushed Bronze</b>		
3"	02803044SBB (square)	\$929.10
4"	02804044SBB (square)	\$996.30
3"	02803044RBB (round)	\$929.10
4"	02804044RBB (round)	\$996.30
<b>Nickle Bronze</b>		
3"	02803044SNB (square)	\$929.10
4"	02804044SNB (square)	\$996.30
3"	02803044RNB (round)	\$929.10
4"	02804044RNB (round)	\$996.30

*With adjustable top for finished floors*

**Swivel Drum Trap**



Size	Part #	MFG#	Price
1-1/2"	02801538	723024	\$961.20
2"	02802038	723125	\$1,049.20

**Floor Drain FD-1**



Size	Part #	MFG#	Price
2"	02802045	723127	\$900.00
3"	02803045	723232	\$1,024.00
4"	02804045	723333	\$1,136.50
6"	02806045	723433	\$1,374.50

**Floor Drain Accessories**

Description	Part #	MFG#	Price
*Funnel - 4" x 9"	02300065	808096	\$119.20
*1/2" Trap Primer	02000066	808100	\$91.60
*Connection FIP	01300067	808097	\$121.30
*Sediment Bucket	04000068	808098	\$94.10
*Vandal Proofing	000000VP	- - -	\$137.10
*Solid Cover	02300069	808099	\$175.30

## Combination Stainless Steel and PVDF Floor Drains and Floor Sinks

### 5" Round Stainless Strainer



Size	Part #	Price
*2"	02802045-SSR5	\$1,570.90
*3"	02803045-SSR5	\$1,741.20
*4"	02804045-SSR5	\$1,911.50
*6"	02806045-SSR5	\$2,426.50

### 6" Round Stainless Strainer



Size	Part #	Price
*2"	02802045-SSR6	\$1,671.50
*3"	02803045-SSR6	\$1,841.80
*4"	02804045-SSR6	\$2,012.30
*6"	02806045-SSR6	\$2,527.20

### 8" Round Stainless Strainer



Size	Part #	Price
*2"	02802045-SSR8	\$1,772.10
*3"	02803045-SSR8	\$1,942.30
*4"	02804045-SSR8	\$2,112.80
*6"	02806045-SSR8	\$2,627.90

### 5" x 5" Square Stainless Strainer

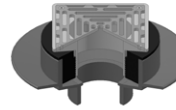

Size	Part #	Price
*2"	02802045-SSS5	\$1,570.90
*3"	02803045-SSS5	\$1,741.20
*4"	02804045-SSS5	\$1,911.50
*6"	02806045-SSS5	\$2,426.50

### 6" x 6" Square Stainless Strainer

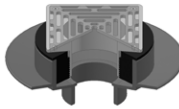

Size	Part #	Price
*2"	02802045-SSS6	\$1,671.50
*3"	02803045-SSS6	\$1,841.80
*4"	02804045-SSS6	\$2,012.30
*6"	02806045-SSS6	\$2,527.20

### 8" x 8" Square Stainless Strainer

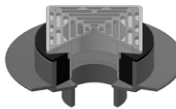

Size	Part #	Price
*2"	02802045-SSS8	\$1,772.10
*3"	02803045-SSS8	\$1,942.30
*4"	02804045-SSS8	\$2,112.80
*6"	02806045-SSS8	\$2,627.90

### 12x12x6 Floor Sink with Stainless Strainer



Size	Part #	Price
*2"	02126FS02-SS	\$3,523.30
*3"	02126FS03-SS	\$3,677.90
*4"	02126FS04-SS	\$3,826.20
*6"	02126FS06-SS	\$4,265.10

### 12x12x8 Floor Sink with Stainless Strainer



Size	Part #	Price
*2"	02128FS02-SS	\$3,646.90
*3"	02128FS03-SS	\$3,770.60
*4"	02128FS04-SS	\$3,956.00
*6"	02128FS06-SS	\$4,388.70

# Socket Fusion PVDF Acid Waste Drainage

ALL PVDF MATERIAL IS NON-CANCELABLE AND NON-RETURNABLE

## Pipe Cut Charge (Prices are NET)

1 1/2" - 6"-\$5.00/Cut      8" & Larger -\$10.00/Cut

\*NOTE: All material is CREAM in color



### Pipe Priced Per 100 Feet

#### Plenum Plus® PVDF Schedule 40

Size	Part #	MFG#	Price
1-1/2"	0280156440	792500	\$5,340.00
2"	0280206440	792510	\$7,570.00
3"	0280306440	792520	\$14,640.00
4"	0280406440	792530	\$23,980.00
6"	0280606440	792540	\$55,230.00

### Coupling



Size	Part #	MFG#	Price
1-1/2"	32801501	726000	\$48.40
2"	32802001	726103	\$60.60
3"	32803001	726203	\$110.40
4"	32804001	726300	\$176.80
6"	32806001	726400	\$534.90

### 45° Elbow - 1/8 Bend



Size	Part #	MFG#	Price
1-1/2"	32801502	726001	\$60.80
2"	32802002	726104	\$69.80
3"	32803002	726204	\$257.10
4"	32804002	726301	\$436.90
6"	32806002	726401	\$985.90

### Single Socket 45° Elbow - 1/8 Bend



Size	Part #	MFG#	Price
1-1/2"	32801548	726017	\$60.80
2"	32802048	726100	\$69.80
3"	32803048	726201	\$257.10
4"	32804048	726331	\$436.90
6"	32806048	726430	\$985.90

### 90° Elbow - 1/4 Bend



Size	Part #	MFG#	Price
1-1/2"	32801503	726002	\$73.90
2"	32802003	726105	\$101.90
3"	32803003	726200	\$287.80
4"	32804003	726302	\$558.70
6"	32806003	726402	\$1,929.40

### Single Socket 90° Elbow - 1/4 Bend



Size	Part #	MFG#	Price
1-1/2"	32801549	726018	\$73.90
2"	32802049	726101	\$101.90
3"	32803049	726227	\$287.80
4"	32804049	726332	\$558.70
6"	32806049	726431	\$1,929.40

### Sanitary Tee - 90T



Size	Part #	MFG#	Price
1-1/2"	32801505	726003	\$99.50
2"	32802005	726107	\$171.90
3"	32803005	726206	\$426.30
4"	32804005	726304	\$670.90

### Reducing Sanitary Tee



Size	Part #	MFG#	Price
2" x 1-1/2"	328021506	726123	\$171.90
3" x 1-1/2"	328031506	726228	\$299.50
3" x 2"	328030206	726215	\$338.70
4" x 1-1/2"	328041506	726333	\$1,323.90
4" x 2"	328040206	726313	\$1,341.20
4" x 3"	328040306	726322	\$1,358.90

For 6", use long turn wye



**Cleanout Tee w/Plug - COT**



Size	Part #	MFG#	Price
1-1/2"	32801507	726004	\$178.10
2"	32802007	726108	\$181.20
3"	32803007	726207	\$485.10
4"	32804007	726305	\$873.90

**45° Lateral Wye**



Size	Part #	MFG#	Price
1-1/2"	32801508	726005	\$158.90
2"	32802008	726109	\$257.90
3"	32803008	726208	\$458.20
4"	32804008	726306	\$721.20
6"	32806008	726403	\$1,524.90

**Long Turn Tee Wye**

(combo wye + 1/8 bend)



Size	Part #	MFG#	Price
1-1/2"	32801510	726006	\$221.80
2"	32802010	726110	\$321.30
3"	32803010	726209	\$658.50
4"	32804010	726307	\$1,187.00
6"	32806010	726404	\$2,305.80

**Double Lateral Wye**



Size	Part #	MFG#	Price
1-1/2"	32801513	726007	\$198.30
2"	32802013	726111	\$369.40
3"	32803013	726210	\$676.60
4"	32804013	726308	\$918.30
6"	32806013	726405	\$2,420.60

**Double Long Turn Tee Wye**

(combo wye+1/8 bend)



Size	Part #	MFG#	Price
1-1/2"	32801515	726008	\$358.20
2"	32802015	726112	\$549.90
3"	32803015	726211	\$1,241.10
4"	32804015	726309	\$1,855.30
6"	32806015	726406	\$3,674.00

**Reducing Lateral Wye**



Size	Part #	MFG#	Price
2" x 1-1/2"	328021509	726124	\$178.10
3" x 1-1/2"	328031509	726229	\$326.60
3" x 2"	328030209	726216	\$346.70
4" x 1-1/2"	328041509	726334	\$620.60
4" x 2"	328040209	726314	\$638.20
4" x 3"	328040309	726323	\$655.80
6" x 2"	328060209	726410	\$1,661.80
6" x 3"	328060309	726418	\$1,679.40
6" x 4"	328060409	726424	\$1,700.20

**Reducing Long Turn Wye**

Reducing Combo wye + 1/8 bend



Size	Part #	MFG#	Price
2" x 1-1/2"	328021511	726125	\$281.20
3" x 1-1/2"	328031511	726230	\$413.90
3" x 2"	328030211	726218	\$433.20
4" x 1-1/2"	328041511	726335	\$676.60
4" x 2"	328040211	726316	\$746.60
4" x 3"	328040311	726324	\$878.80
6" x 2"	328060211	726412	\$1,718.10
6" x 3"	328060311	726419	\$1,887.40
6" x 4"	328060411	726425	\$2,042.00

**Reducing Double Lateral Wye**



Size	Part #	MFG#	Price
2" x 1-1/2"	328021514	---	\$647.20
3" x 1-1/2"	328031514	726231	\$676.80
3" x 2"	328030214	726219	\$735.20
4" x 1-1/2"	328041514	---	\$1,436.70
4" x 2"	328040214	726317	\$1,475.90
4" x 3"	328040314	726325	\$1,535.10
6" x 2"	328060214	---	\$2,690.20
6" x 3"	328060314	---	\$2,805.10
6" x 4"	328060414	726426	\$2,844.30

**Reducing Double Long Turn Tee Wye**

(combo wye +1/8 bend)



Size	Part #	MFG#	Price
2" x 1-1/2"	328021516	726126	\$704.40
3" x 1-1/2"	328031516	726232	\$873.90
3" x 2"	328030216	726220	\$977.40
4" x 1-1/2"	328041516	726337	\$1,490.10
4" x 2"	328040216	726318	\$1,547.70
4" x 3"	328040316	726326	\$1,834.10
6" x 2"	328060216	726413	\$2,844.30
6" x 3"	328060316	726420	\$3,717.20
6" x 4"	328060416	726427	\$3,973.00

**Male Adapter - MA**



Size	Part #	MFG#	Price
1-1/2"	32801517	726009	\$67.00
2"	32802017	726113	\$80.40
3"	32803017	726212	\$136.10
4"	32804017	726310	\$194.70
6"	32806017	726407	\$467.20

**Female Adapter - FA**



Size	Part #	MFG#	Price
1-1/2"	32801518	726010	\$67.00
2"	32802018	726114	\$80.40
3"	32803018	726213	\$136.10
4"	32804018	726311	\$194.70
6"	32806018	726408	\$467.20

**Clean-Out Adapter With Plug**



Size	Part #	MFG#	Price
1-1/2"	32801519	726011	\$122.70
2"	32802019	726115	\$149.10
3"	32803019	726214	\$287.50
4"	32804019	726312	\$415.10
6"	32806019	726409	\$995.60

**Cap**



Size	Part #	MFG#	Price
1-1/2"	32801521	726012	\$69.60
2"	32802021	726116	\$87.20
3"	32803021	726217	\$127.60
4"	32804021	726315	\$179.30
6"	32806021	726411	\$313.80

**Reducing Bushing - RB**



Size	Part #	MFG#	Price
2" x 1-1/2"	328021522	726127	\$55.70
3" x 1-1/2"	328031522	726233	\$130.20
3" x 2"	328030222	726221	\$139.90
4" x 1-1/2"	328041522	726338	\$157.30
4" x 2"	328040222	726319	\$180.80
4" x 3"	328040322	726327	\$219.00
6" x 2"	328060222	726414	\$488.70
6" x 3"	328060322	726421	\$515.40
6" x 4"	328060422	726428	\$592.40

**Reducing Coupling - RCLS**



Size	Part #	MFG#	Price
2" x 1-1/2"	328021551	726128	\$62.90
3" x 1-1/2"	328031551	726234	\$134.80
3" x 2"	328030251	726222	\$158.10
4" x 1-1/2"	328041551	726339	\$220.60
4" x 2"	328040251	726320	\$235.70
4" x 3"	328040351	726329	\$275.70
6" x 2"	328060251	726415	\$488.70
6" x 3"	328060351	726423	\$515.40
6" x 4"	328060451	726429	\$592.40

**P Trap - UTP**





Size	Part #	MFG#	Price
1-1/2"	32801525	726013	\$292.80
2"	32802025	726117	\$380.20

**P Trap - RBP**





Size	Part #	MFG#	Price
1-1/2"	32801528	726014	\$270.90
2"	32802028	726118	\$310.50
3"	32803028	726223	\$927.10
4"	32804028	726321	\$1,661.50
6"	32806028	726416	\$6,906.30

<b>Flange 150# - FLG</b>				
	Size	Part #	MFG#	Price
	1-1/2"	32801535	726016	\$175.30
	2"	32802035	726120	\$278.50
	3"	32803035	726225	\$503.90
	4"	32804035	726328	\$756.00
	6"	32806035	726422	\$1,064.80

<b>RLNS</b>				
	Size	Part #	MFG#	Price
	1-1/2"	32801530	726015	\$81.10
	2"	32802030	726119	\$116.00

<b>Backing Ring</b>				
	Size	Part #	MFG#	Price
	1-1/2"	04001536	808057	\$80.30
	2"	04002036	808059	\$88.90
	3"	04003036	808061	\$117.20
	4"	04004036	808064	\$140.70
	6"	04006036	808067	\$154.40

<b>Sink Tail Piece Extension RLNS x 12"</b>				
	Size	Part #	MFG#	Price
	1-1/2"	02801531	723020	\$168.90
	2"	02802031	723146	\$255.60

<b>Floor Drain FD-1</b>				
	Size	Part #	MFG#	Price
	2"	32802045	726121	\$933.90
	3"	32803045	726226	\$1,066.40
	4"	32804045	726330	\$1,190.10

<b>Acid Waste Floor Clean-Out</b>				
	Size	Part #	Price	
			<b>Brushed Bronze</b>	
	3"	02803044SBB (square)	\$929.10	
	4"	02804044SBB (square)	\$996.60	
	3"	02803044RBB (round)	\$929.10	
	4"	02804044RBB (round)	\$996.60	
			<b>Nickle Bronze</b>	
	3"	02803044SNB (square)	\$929.10	
	4"	02804044SNB (square)	\$996.60	
	3"	02803044RNB (round)	\$929.10	
	4"	02804044RNB (round)	\$996.60	
	<i>With adjustable top for finished floors</i>			

<b>Floor Drain Accessories</b>				
Description	Part #	MFG#	Price	
*Funnel - 4" x 9"	02300065	808096	\$119.20	
*1/2" Trap Primer	02000066	808100	\$91.60	
*Connection FIP	01300067	808097	\$121.30	
*Sediment Bucket	04000068	808098	\$94.10	
*Flashing Clamp	000000VP	- - -	\$137.10	
*Vandal Proofing	02300069	808099	\$175.30	
*Solid Cover				

<b>Adjustable Stainless Steel Floor Cleanout</b>				
	Size	Part #	Price	
			<b>Stainless Steel</b>	
	2"		\$834.70	
	3"		\$834.70	
	4"		\$895.20	
	<i>With adjustable top for finished floors</i>			

# Whiteline Polypropylene Homopolymer Socket Fusion High Purity Piping Systems

## Pipe

Priced Per 100 Feet • 10ft. Lengths Standard

### Whiteline® Polypropylene Schedule 80

Size	Part #	MFG#	Price
1/2"	0140506480	790401	\$760.00
3/4"	0140756480	790404	\$950.00
1"	0140106480	790406	\$1,330.00
1-1/2"	0140156480	790409	\$1,760.00
2"	0140206480	790416	\$2,500.00

All pipe is non-returnable.

HIGH PURITY SYSTEMS

### Coupling - CLS



Size	Part #	MFG#	Price
1/2"	31405001	740100	\$17.50
3/4"	31407501	740200	\$21.60
1"	31401001	740300	\$28.50
1-1/2"	31401501	740400	\$41.70
2"	31402001	740500	\$53.90

### 45° Elbow - 1/8 bend



Size	Part #	MFG#	Price
1/2"	31405002	740101	\$24.80
3/4"	31407502	740201	\$32.00
1"	31401002	740301	\$39.70
1-1/2"	31401502	740401	\$55.30
2"	31402002	740501	\$71.60

### 90° Elbows - 1/4 bend



Size	Part #	MFG#	Price
1/2"	31405003	740102	\$25.20
3/4"	31407503	740202	\$31.20
1"	31401003	740302	\$39.30
1-1/2"	31401503	740402	\$53.60
2"	31402003	740502	\$71.60

### Tee - 90T



Size	Part #	MFG#	Price
1/2"	31405052	740108	\$30.10
3/4"	31407552	740207	\$35.40
1"	31401052	740308	\$41.30
1-1/2"	31401552	740407	\$62.20
2"	31402052	740512	\$81.80

### Reducing Tee - R90T



Size	Part #	MFG#	Price
3/4" x 1/2"	314750553	740214	\$41.80
1" x 1/2"	314010553	740312	\$49.50
1" x 3/4"	314017553	740317	\$51.60
1-1/2" x 1"	314150153	740412	\$67.80
2" x 1-1/2"	314021553	740517	\$84.40

### CAP



Size	Part #	MFG#	Price
1/2"	31405021	740106	\$22.80
3/4"	31407521	740205	\$24.70
1"	31401021	740305	\$31.20
1-1/2"	31401521	740405	\$41.70
2"	31402021	740509	\$53.90

**Male Adapter - MA**



Size	Part #	MFG#	Price
1/2"	31405017	740104	\$25.30
3/4"	31407517	740203	\$30.60
1"	31401017	740303	\$34.30
1-1/2"	31401517	740403	\$42.20
2"	31402017	740507	\$65.80

**Female Adapter - FA**



Size	Part #	MFG#	Price
1/2"	31405018	740105	\$25.30
3/4"	31407518	740204	\$30.60
1"	31401018	740304	\$34.30
1-1/2"	31401518	740404	\$42.20
2"	31402018	740508	\$65.80

**Reducing Female Adapter**



Size	Part #	MFG#	Price
1/2" x 1/4"	314052554	740111	\$83.80
1/2" x 3/8"	314053854	740113	\$83.80

**Reducing Bushing - RB**



Size	Part #	MFG#	Price
3/4" x 1/2"	314750522	740212	\$27.40
1" x 1/2"	314010522	740309	\$32.00
1" x 3/4"	314017522	740315	\$32.00
1-1/2" x 1/2"	314150522	740413	\$43.90
1-1/2" x 3/4"	314157522	740416	\$43.90
1-1/2" x 1"	314150122	740410	\$43.90
2" x 1/2"	314020522	740511	\$76.10
2" x 3/4"	314027522	740518	\$76.10
2" x 1"	314020122	740504	\$76.10
2" x 1-1/2"	314021522	740515	\$76.10

**Flange 150# - Slip-On**



Size	Part #	MFG#	Price
1/2"	31405035	740107	\$48.20
3/4"	31407535	740206	\$53.90
1"	31401035	740306	\$61.70
1-1/2"	31401535	740406	\$85.90
2"	31402035	740510	\$107.10

**Reducing Coupling - RCLS**



Size	Part #	MFG#	Price
3/4" x 1/2"	314750551	740213	\$27.40
1" x 1/2"	314010551	740311	\$32.00
1" x 3/4"	314017551	740316	\$32.00
1-1/2" x 1/2"	314150551	740414	\$43.90
1-1/2" x 3/4"	314157551	740417	\$43.90
1-1/2" x 1"	314150151	740411	\$43.90
2" x 1/2"	314020551	740513	\$76.10
2" x 3/4"	314027551	740519	\$76.10
2" x 1"	314020151	740505	\$76.10
2" x 1-1/2"	314021551	740516	\$76.10

**Backing Ring**



Size	Part #	MFG#	Price
1/2"	04005036	808051	\$41.30
3/4"	04007536	808053	\$49.10
1"	04001036	808055	\$57.40
1-1/2"	04001536	808057	\$80.30
2"	04002036	808059	\$88.90

**Union w/Viton O-Rings**



Size	Part #	MFG#	Price
1/2"	31405055	740109	\$99.30
3/4"	31407555	740208	\$114.20
1"	31401055	740310	\$135.00
1-1/2"	31401555	740422	\$226.70
2"	31402055	740526	\$296.80

150psi

**Diaphragm Valve**



Size	Part #	MFG#	Price
1/2"	31405056	740121	\$410.00
3/4"	31407556	740223	\$432.00
1"	31401056	740326	\$486.00
1-1/2"	31401556	740423	\$648.00
2"	31402056	740527	\$864.00

150psi

**True Union Ball Valve**



Size	Part #	MFG#	Price
1/2"	31405057	740122	\$151.00
3/4"	31407557	740224	\$164.00
1"	31401057	740327	\$192.00
1-1/2"	31401557	740424	\$312.00
2"	31402057	740528	\$410.00

150psi

**Needle Valve**



Size	Part #	MFG#	Price
1/2"	31405059	740124	\$156.00
3/8"	31403859	740002	\$156.00

Supplied with FIP threading

**Hose Connection**



Size	Part #	MFG#	Price
3/4" soc x	31407560	740232	\$72.80
3/4" -N.R. hose thread			

**Hose Barb**



Size	Part #	MFG#	Price
3/8" Angled	814053861A	740001	\$38.50
3/8" Straight	84053861S	740004	\$38.50

**Double Union Spring Check Valve**



Size	Part #	MFG#	Price
1/2"	---	740133	\$151.00
3/4"	---	740237	\$164.00
1"	---	740336	\$192.00
1-1/2"	---	740437	\$312.00
2"	---	740541	\$410.00

150psi

HIGH PURITY SYSTEMS

# Whiteline Polypropylene Homopolymer Riontite® High Purity Piping Systems

**Pipe - Grooved for Riontite®**  
Priced Per 100 Feet • 10ft. Lengths Standard

**Whiteline Riontite® Polypropylene Schedule 80**

Size	Part #	MFG#	Price
1/2"	5140506480	790900	\$780.00
3/4"	5140756480	790902	\$990.00
1"	5140106480	790904	\$1,390.00
1-1/2"	5140156480	790906	\$1,830.00
2"	5140206480	790908	\$2,570.00

All pipe is non-returnable.

**Coupling - CLS**



Size	Part #	MFG#	Price
1/2"	51405001	741000	\$25.60
3/4"	51407501	741100	\$30.30
1"	51401001	741200	\$35.20
1-1/2"	51401501	741300	\$55.20
2"	51402001	741400	\$72.30

**45° Elbow - 1/8 bend**



Size	Part #	MFG#	Price
1/2"	51405002	741001	\$27.80
3/4"	51407502	741101	\$35.20
1"	51401002	741201	\$42.80
1-1/2"	51401502	741301	\$71.10
2"	51402002	741401	\$94.20

**90° Elbows - 1/4 bend**



Size	Part #	MFG#	Price
1/2"	51405003	741002	\$27.80
3/4"	51407503	741102	\$35.20
1"	51401003	741202	\$42.80
1-1/2"	51401503	741302	\$71.10
2"	51402003	741402	\$94.20

**Tee - 90T**



Size	Part #	MFG#	Price
1/2"	51405052	741007	\$34.30
3/4"	51407552	741107	\$41.00
1"	51401052	741207	\$48.20
1-1/2"	51401552	741307	\$83.80
2"	51402052	741408	\$105.50

**Reducing Tee - R90T**



Size	Part #	MFG#	Price
3/4" x 1/2"	514750553	741119	\$54.60
1" x 1/2"	514010553	741210	\$66.90
1" x 3/4"	514017553	741220	\$66.90
1-1/2" x 1"	514150153	741317	\$101.00
2" x 1-1/2"	514021553	741419	\$126.50

**CAP**



Size	Part #	MFG#	Price
1/2"	51405021	741005	\$25.60
3/4"	51407521	741105	\$30.60
1"	51401021	741205	\$35.80
1-1/2"	51401521	741305	\$53.90
2"	51402021	741422	\$71.50

**Male Adapter - MA**



Size	Part #	MFG#	Price
1/2"	51405017	741003	\$27.80
3/4"	51407517	741103	\$35.20
1"	51401017	741203	\$42.80
1-1/2"	51401517	741303	\$66.20
2"	51402017	741405	\$87.60

**Female Adapter - FA**



Size	Part #	MFG#	Price
1/2"	51405018	741004	\$27.80
3/4"	51407518	741104	\$35.20
1"	51401018	741204	\$42.80
1-1/2"	51401518	741304	\$66.20
2"	51402018	741406	\$87.60

HIGH PURITY SYSTEMS

**Reducing Female Adapter**



Size	Part #	MFG#	Price
1/2" x 1/4"	514052554	741015	\$107.80
1/2" x 3/8"	514053854	741016	\$107.80

**Flange 150# - Slip-On**



Size	Part #	MFG#	Price
1/2"	51405035	741006	\$55.90
3/4"	51407535	741106	\$63.40
1"	51401035	741206	\$71.50
1-1/2"	51401535	741306	\$100.40
2"	51402035	741407	\$126.10

**Union w/Viton O-Rings**



Size	Part #	MFG#	Price
1/2"	51405055	741008	\$129.00
3/4"	51407555	741108	\$143.90
1"	51401055	741208	\$164.70
1-1/2"	51401555	741308	\$286.10
150psi 2"	51402055	741409	\$356.20

**Double Union Spring Check Valve**



Size	Part #	MFG#	Price
1/2"	---	741035	\$205.00
3/4"	---	741137	\$218.00
1"	---	741246	\$246.00
1-1/2"	---	---	\$420.00
150psi 2"	---	---	\$518.00

**Riontite Repair Kit**

Includes 5 gaskets, 5 split lock rings, 5 nuts



Size	Part #	MFG#	Price
1/2"	51405072	741012	\$27.80
3/4"	51407572	741110	\$31.60
1"	51401072	741211	\$38.30
1-1/2"	51401572	741309	\$55.20
2"	51402072	741412	\$72.80

**Reducing Coupling - RCLS**



Size	Part #	MFG#	Price
3/4" x 1/2"	514750551	741118	\$35.80
1" x 1/2"	514010551	741209	\$45.50
1" x 3/4"	514017551	741219	\$45.50
1-1/2" x 1/2"	514150551	741318	\$66.20
1-1/2" x 3/4"	514157551	741320	\$66.20
1-1/2" x 1"	514150151	741316	\$66.20
2" x 1/2"	514020551	741410	\$86.70
2" x 3/4"	514027551	741420	\$86.70
2" x 1"	514020151	741403	\$86.70
2" x 1-1/2"	514021551	741418	\$86.70

**Backing Ring**



Size	Part #	MFG#	Price
1/2"	04005036	808051	\$41.30
3/4"	04007536	808053	\$49.10
1"	04001036	808055	\$57.40
1-1/2"	04001536	808057	\$80.30
2"	04002036	808059	\$88.90

**Diaphragm Valve**



Size	Part #	MFG#	Price
1/2"	51405056	741024	\$464.00
3/4"	51407556	741131	\$486.00
1"	51401056	741233	\$540.00
1-1/2"	51401556	741337	\$821.00
150psi 2"	51402056	741433	\$972.00

**True Union Ball Valve**



Size	Part #	MFG#	Price
1/2"	51405057	741025	\$205.00
3/4"	51407557	741132	\$218.00
1"	51401057	741234	\$246.00
1-1/2"	51401557	741338	\$420.00
150psi 2"	51402057	741434	\$518.00

HIGH PURITY SYSTEMS



# Standardline Polypropylene Copolymer Socket Fusion High Purity Piping Systems

ALL STANDARDLINE PRODUCT IS NON-CANCELABLE AND NON-RETURNABLE

**Pipe**  
Priced Per 100 Feet • 10ft. Lengths Standard

Standardline® Polypropylene Schedule 80			
Size	Part #	MFG#	Price
1/2"	0150506480	790500	\$290.00
3/4"	0150756480	790502	\$360.00
1"	0150106480	790504	\$540.00
1-1/2"	0150156480	790507	\$980.00
2"	0150206480	790509	\$1,340.00

All pipe is non-returnable.

Coupling - CLS				
	Size	Part #	MFG#	Price
	1/2"	31505001	745111	\$7.30
	3/4"	31507501	745200	\$9.10
	1"	31501001	745300	\$12.40
	1-1/2"	31501501	745400	\$18.30
	2"	31502001	745500	\$25.50

45° Elbow - 1/8 bend				
	Size	Part #	MFG#	Price
	1/2"	31505002	745100	\$11.00
	3/4"	31507502	745201	\$13.10
	1"	31501002	745301	\$15.10
	1-1/2"	31501502	745401	\$22.80
	2"	31502002	745501	\$27.90

90° Elbows - 1/4 bend				
	Size	Part #	MFG#	Price
	1/2"	31505003	745101	\$11.00
	3/4"	31507503	745202	\$13.10
	1"	31501003	745302	\$15.10
	1-1/2"	31501503	745402	\$22.80
	2"	31502003	745502	\$27.90

Tee - 90T				
	Size	Part #	MFG#	Price
	1/2"	31505052	745106	\$13.10
	3/4"	31507552	745207	\$15.10
	1"	31501052	745307	\$17.20
	1-1/2"	31501552	745407	\$30.60
	2"	31502052	745510	\$39.90

Reducing Tee - R90T				
	Size	Part #	MFG#	Price
	3/4" x 1/2"	315750553	745212	\$38.50
	1" x 1/2"	315010553	745311	\$46.60
	1" x 3/4"	315017553	745314	\$46.60
	1-1/2" x 1"	315150153	745411	\$61.70
	2" x 1-1/2"	315021553	745515	\$71.60

CAP				
	Size	Part #	MFG#	Price
	1/2"	31505021	745104	\$9.60
	3/4"	31507521	745205	\$10.70
	1"	31501021	745305	\$11.90
	1-1/2"	31501521	745405	\$18.20
	2"	31502021	745508	\$24.20

Male Adapter - MA				
	Size	Part #	MFG#	Price
	1/2"	31505017	745102	\$14.40
	3/4"	31507517	745203	\$17.20
	1"	31501017	745303	\$19.60
	1-1/2"	31501517	745403	\$26.10
	2"	31502017	745506	\$35.80

Female Adapter - FA				
	Size	Part #	MFG#	Price
	1/2"	31505018	745103	\$14.40
	3/4"	31507518	745204	\$17.20
	1"	31501018	745304	\$19.60
	1-1/2"	31501518	745404	\$26.10
	2"	31502018	745507	\$35.80

HIGH PURITY SYSTEMS

**Reducing Female Adapter**



Size	Part #	MFG#	Price
1/2" x 1/4"	315052554	745108	\$57.10
1/2" x 3/8"	315053854	745109	\$57.10

**Reducing Coupling - RCLS**



Size	Part #	MFG#	Price
3/4" x 1/2"	315750551	745210	\$16.50
1" x 1/2"	315010551	745308	\$22.30
1" x 3/4"	315017551	745312	\$22.30
1-1/2" x 1/2"	315150551	745412	\$33.90
1-1/2" x 3/4"	315157551	745415	\$33.90
1-1/2" x 1"	315150151	745409	\$33.90
2" x 1/2"	315020551	745511	\$57.10
2" x 3/4"	315027551	745516	\$57.10
2" x 1"	315020151	745503	\$57.10
2" x 1-1/2"	315021551	745513	\$57.10

**Flange 150# - Slip-On**



Size	Part #	MFG#	Price
1/2"	31505035	745105	\$35.10
3/4"	31507535	745206	\$39.30
1"	31501035	745306	\$45.70
1-1/2"	31501535	745406	\$69.00
2"	31502035	745509	\$79.90

**Reducing Bushing - RB**



Size	Part #	MFG#	Price
3/4" x 1/2"	315750522	745211	\$16.50
1" x 1/2"	315010522	745310	\$22.30
1" x 3/4"	315017522	745313	\$22.30
1-1/2" x 1/2"	315150522	745413	\$33.90
1-1/2" x 3/4"	315157522	745416	\$33.90
1-1/2" x 1"	315150122	745410	\$33.90
2" x 1/2"	315020522	---	\$57.10
2" x 3/4"	315027522	745520	\$57.10
2" x 1"	315020122	745504	\$57.10
2" x 1-1/2"	315021522	745514	\$57.10

**Backing Ring**



Size	Part #	MFG#	Price
1/2"	04005036	808051	\$41.30
3/4"	04007536	808053	\$49.10
1"	04001036	808055	\$57.40
1-1/2"	04001536	808057	\$80.30
2"	04002036	808059	\$88.90

**Union w/Viton O-Rings**



Size	Part #	MFG#	Price
1/2"	31505055	745107	\$99.30
3/4"	31507555	745208	\$114.20
1"	31501055	745309	\$135.00
1-1/2"	31501555	745408	\$226.80
2"	31502055	745512	\$296.80

150psi

**True Union Ball Valve**



Size	Part #	MFG#	Price
1/2"	31405057	740122	\$151.00
3/4"	31407557	740224	\$164.00
1"	31401057	740327	\$192.00
1-1/2"	31401557	740424	\$312.00
2"	31402057	740528	\$410.00

150psi

**Hose Barb**



Size	Part #	MFG#	Price
3/8" Angled	814053861A	740001	\$38.50
3/8" Straight	814053861S	740004	\$38.50

**Double Union Spring Check Valve**



Size	Part #	MFG#	Price
1/2"	---	740133	\$151.00
3/4"	---	740237	\$164.00
1"	---	740336	\$192.00
1-1/2"	---	740437	\$312.00
2"	---	740541	\$410.00

150psi

# EuroGreyline Polypropylene Socket Fusion High Purity Piping Systems

**Pipe**  
Priced Per 100 Feet • 20ft. Lengths Standard

*EuroGreyline Polypropylene SDR11 - 150psi*

Size	MFG#	Price
20mm	794019	\$310.00
25mm	794022	\$420.00
32mm	794004	\$590.00
40mm	794020	\$610.00
50mm	794021	\$790.00
63mm	794013	\$1,500.00

All pipe is non-returnable.

**Coupling - CLS (185psi)**

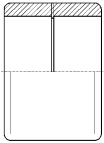

Size	MFG#	Price
20mm	783522	\$7.70
25mm	783552	\$8.40
32mm	783575	\$10.60
40mm	783587	\$11.00
50mm	783617	\$24.20
63mm	783633	\$34.20

**45° Elbow - 1/8 bend (185psi)**

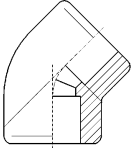

Size	MFG#	Price
20mm	783509	\$15.20
25mm	783541	\$17.40
32mm	783556	\$19.50
40mm	783588	\$21.30
50mm	783622	\$32.30
63mm	783641	\$42.20

**90° Elbows - 1/4 bend (185psi)**

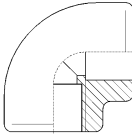

Size	MFG#	Price
20mm	783508	\$11.80
25mm	783536	\$13.10
32mm	783558	\$15.20
40mm	783602	\$16.60
50mm	783613	\$30.10
63mm	783634	\$38.30

**Tee - 90T (185psi)**

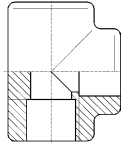

Size	MFG#	Price
20mm	783504	\$13.10
25mm	783530	\$14.20
32mm	783557	\$16.30
40mm	783583	\$18.30
50mm	783618	\$34.20
63mm	783645	\$50.20

**Male Adapter - MA (185psi)**

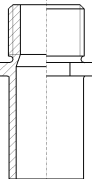

Size	MFG#	Price
20mm	783523	\$20.60
25mm	783531	\$23.80
32mm	783574	\$32.10
40mm	783579	\$35.30
50mm	783608	\$79.50
63mm	783644	\$105.80

**Female Adapter - FA (185psi)**

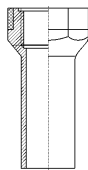

Size	MFG#	Price
20mm	783520	\$17.70
25mm	783547	\$23.80
32mm	783562	\$29.20
40mm	783581	\$30.10
50mm	783615	\$54.50
63mm	783630	\$65.20

HIGH PURITY SYSTEMS

**End Cap (185psi)**

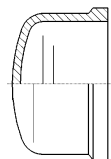

Size	MFG#	Price
20mm	783521	\$10.90
25mm	783550	\$12.00
32mm	783561	\$15.10
40mm	783586	\$16.00
50mm	783619	\$22.30
63mm	783646	\$30.10

**Stub Flange (185psi)**



Size	MFG#	Price
20mm	783507	\$9.10
25mm	783549	\$13.60
32mm	783573	\$16.90
40mm	- - -	\$23.20
50mm	783605	\$29.30
63mm	783635	\$34.20

**Reducing Bushing - RB (185psi)**

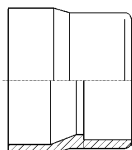

Size	MFG#	Price
25mm x 20mm	783527	\$11.30
32mm x 20mm	783555	\$13.90
32mm x 25mm	783554	\$13.90
40mm x 20mm	783599	\$19.00
40mm x 25mm	783603	\$19.00
40mm x 32mm	783580	\$19.00
50mm x 20mm	783607	\$20.20
50mm x 25mm	783612	\$20.20
50mm x 32mm	783616	\$20.20
50mm x 40mm	783627	\$20.20
63mm x 25mm	783653	\$24.20
63mm x 32mm	783651	\$24.20
63mm x 40mm	783637	\$24.20
63mm x 50mm	783652	\$24.20

**Glass Filled PP/Steel Backing Ring**



Size	MFG#	Price
20mm	782702	\$26.80
25mm	782721	\$30.40
32mm	782746	\$40.00
40mm	782771	\$47.20
50mm	782790	\$50.30
63mm	782824	\$59.70

**Union w/Viton O-Rings**

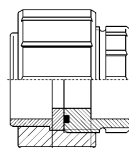

150psi

Size	MFG#	Price
20mm	783524	\$50.20
25mm	783539	\$53.10
32mm	783577	\$66.20
40mm	783601	\$89.80
50mm	783659	\$127.30
63mm	783642	\$176.40

**Diaphragm Valve**



150psi

Size	MFG#	Price
20mm	783525	\$410.00
25mm	783551	\$432.00
32mm	783572	\$486.00
40mm	783597	\$562.00
50mm	783621	\$713.00
63mm	783656	\$864.00

**True Union Ball Valve**



150psi

Size	MFG#	Price
20mm	783519	\$151.00
25mm	783542	\$164.00
32mm	783565	\$192.00
40mm	783590	\$307.00
50mm	783623	\$312.00
63mm	783636	\$410.00

# Whiteline PVDF Socket Fusion High Purity Piping Systems

ALL PVDF MATERIAL IS NON-CANCELABLE AND NON-RETURNABLE

**Pipe**  
Priced Per 100 Feet • 10ft. Lengths Standard

<i>Whiteline® PVDF Schedule 80</i>			
Size	Part #	MFG#	Price
1/2"	0240506480	792201	\$3,380.00
3/4"	0240756480	792206	\$3,960.00
1"	0240106480	792211	\$5,740.00
1-1/2"	0240156480	792216	\$7,460.00
2"	0240206480	792221	\$10,270.00

All pipe is non-returnable.

<b>Coupling - CLS</b>				
	Size	Part #	MFG#	Price
	1/2"	32405001	750107	\$22.80
	3/4"	32407501	750210	\$27.90
	1"	32401001	750308	\$32.10
	1-1/2"	32401501	750512	\$59.10
	2"	32402001	750611	\$84.80

<b>45° Elbow - 1/8 bend</b>				
	Size	Part #	MFG#	Price
	1/2"	32405002	750108	\$30.80
	3/4"	32407502	750211	\$41.50
	1"	32401002	750309	\$63.30
	1-1/2"	32401502	750513	\$90.20
	2"	32402002	750612	\$140.20

<b>90° Elbows - 1/4 bend</b>				
	Size	Part #	MFG#	Price
	1/2"	32405003	750109	\$26.00
	3/4"	32407503	750212	\$32.90
	1"	32401003	750310	\$61.90
	1-1/2"	32401503	750514	\$110.40
	2"	32402003	750613	\$145.50

<b>Tee - 90T</b>				
	Size	Part #	MFG#	Price
	1/2"	32405052	750115	\$48.30
	3/4"	32407552	750217	\$51.10
	1"	32401052	750315	\$78.00
	1-1/2"	32401552	750519	\$133.20
	2"	32402052	750619	\$209.20

<b>Reducing Tee - R90T</b>				
	Size	Part #	MFG#	Price
	3/4" x 1/2"	324750553	750223	\$55.40
	1" x 1/2"	324010553	750319	\$83.80
	1" x 3/4"	324017553	750323	\$83.80
	1-1/2" x 1"	324150153	750524	\$154.10
	2" x 1-1/2"	324021553	750625	\$238.90

<b>CAP</b>				
	Size	Part #	MFG#	Price
	1/2"	32405021	750113	\$17.40
	3/4"	32407521	750215	\$27.90
	1"	32401021	750313	\$32.10
	1-1/2"	32401521	750517	\$57.00
	2"	32402021	750617	\$83.10

<b>Male Adapter - MA</b>				
	Size	Part #	MFG#	Price
	1/2"	32405017	750111	\$48.30
	3/4"	32407517	750213	\$60.70
	1"	32401017	750311	\$68.30
	1-1/2"	32401517	750515	\$80.00
	2"	32402017	750615	\$111.80

<b>Female Adapter - FA</b>				
	Size	Part #	MFG#	Price
	1/2"	32405018	750112	\$48.30
	3/4"	32407518	750214	\$61.00
	1"	32401018	750312	\$68.30
	1-1/2"	32401518	750516	\$80.00
	2"	32402018	750616	\$111.80

HIGH PURITY SYSTEMS

**Reducing Female Adapter**



Size	Part #	MFG#	Price
1/2" x 1/4"	324052554	750118	\$104.90
1/2" x 3/8"	324053854	750119	\$104.90

**Reducing Bushing - RB**



Size	Part #	MFG#	Price
3/4" x 1/2"	324750522	750221	\$28.70
1" x 1/2"	324010522	750316	\$39.70
1" x 3/4"	324017522	750321	\$39.70
1-1/2" x 1"	324150122	750522	\$72.00
2" x 1/2"	324020522	750601	\$101.40
2" x 3/4"	324027522	750626	\$101.40
2" x 1"	324020122	750614	\$101.40
2" x 1-1/2"	324021522	750623	\$101.40

**Flange 150# - Slip-On**



Size	Part #	MFG#	Price
1/2"	32405035	750114	\$64.10
3/4"	32407535	750216	\$81.80
1"	32401035	750314	\$107.30
1-1/2"	32401535	750518	\$151.80
2"	32402035	750618	\$259.70

**Reducing Coupling - RCLS**



Size	Part #	MFG#	Price
3/4" x 1/2"	324750551	750222	\$28.70
1" x 1/2"	324010551	750318	\$39.70
1" x 3/4"	324017551	750322	\$39.70
1-1/2" x 3/4"	324157551	750530	\$72.00
1-1/2" x 1"	324150151	750523	\$72.00
2" x 1/2"	324020551	750631	\$101.40
2" x 3/4"	324027551	750628	\$101.40
2" x 1"	324020151	750600	\$101.40
2" x 1-1/2"	324021551	750624	\$101.40

**Backing Ring**



Size	Part #	MFG#	Price
1/2"	04005036	808051	\$41.30
3/4"	04007536	808053	\$49.10
1"	04001036	808055	\$57.40
1-1/2"	04001536	808057	\$80.30
2"	04002036	808059	\$88.90

**Union w/Viton O-Rings**



Size	Part #	MFG#	Price
1/2"	32405055	750116	\$158.60
3/4"	32407555	750218	\$182.40
1"	32401055	750317	\$215.50
1-1/2"	32401555	750520	\$333.80
150psi 2"	32402055	750620	\$410.60

**Double Union Spring Check Valve**



Size	Part #	MFG#	Price
1/2"	---	784507	\$231.00
3/4"	---	784526	\$251.00
1"	---	750328	\$294.00
1-1/2"	---	759512	\$477.00
150psi 2"	---	---	\$627.00

**True Union Ball Valve**



Size	Part #	MFG#	Price
1/2"	32405057	750102	\$231.00
3/4"	32407557	750206	\$251.00
1"	32401057	750304	\$294.00
1-1/2"	32401557	750505	\$477.00
150psi 2"	32402057	750607	\$627.00

**Diaphragm Valve**



Size	Part #	MFG#	Price
1/2"	32405056	750101	\$627.00
3/4"	32407556	750205	\$660.00
1"	32401056	750303	\$743.00
1-1/2"	32401556	750504	\$1,089.00
150psi 2"	32402056	750606	\$1,320.00

HIGH PURITY SYSTEMS

# FluoroStar PVDF Socket Fusion High Purity Piping Systems

ALL PVDF MATERIAL IS NON-CANCELABLE AND NON-RETURNABLE

## Pipe

Priced Per 100 Feet • 20ft. Lengths Standard

### FluoroStar® PVDF SDR21 - 230psi

Size	MFG#	Price
20mm	795000	\$1,980.00
25mm	795001	\$2,580.00
32mm	795002	\$3,930.00
40mm	795003	\$5,910.00
50mm	795004	\$7,870.00
63mm	795005	\$10,190.00

All pipe is non-returnable.

### Coupling - CLS (185psi)

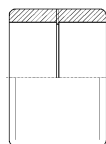

Size	MFG#	Price
20mm	784519	\$16.00
25mm	784537	\$29.40
32mm	784566	\$42.00
40mm	784579	\$62.00
50mm	784609	\$81.90
63mm	784634	\$129.00

### 45° Elbow - 1/8 bend (185psi)

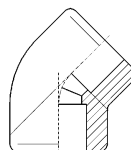

Size	MFG#	Price
20mm	784509	\$25.80
25mm	784540	\$29.10
32mm	784551	\$31.50
40mm	784576	\$57.70
50mm	784599	\$83.70
63mm	784632	\$121.40

### 90° Elbows - 1/4 bend (185psi)

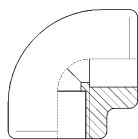

Size	MFG#	Price
20mm	784506	\$20.40
25mm	784539	\$24.70
32mm	784550	\$48.20
40mm	784593	\$76.60
50mm	784608	\$104.80
63mm	784623	\$180.30

### Tee - 90T (185psi)

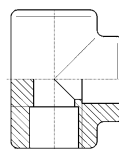

Size	MFG#	Price
20mm	784503	\$31.40
25mm	784533	\$38.00
32mm	784547	\$58.80
40mm	784765	\$97.60
50mm	784610	\$136.60
63mm	784622	\$214.50

### Male Adapter - MA (185psi)

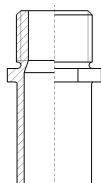

Size	MFG#	Price
20mm	784504	\$35.90
25mm	784527	\$35.90
32mm	784548	\$65.20
40mm	784577	\$91.90
50mm	784611	\$118.50
63mm	784616	\$148.00

### Female Adapter - FA (185psi)

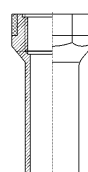

Size	MFG#	Price
20mm	784516	\$40.30
25mm	784528	\$44.40
32mm	784549	\$71.30
40mm	784575	\$104.00
50mm	784595	\$136.60
63mm	784619	\$167.00

HIGH PURITY SYSTEMS

**End Cap (185psi)**

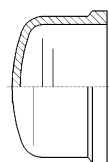

Size	MFG#	Price
20mm	784520	\$25.80
25mm	784541	\$35.90
32mm	784564	\$37.80
40mm	784578	\$59.80
50mm	784612	\$81.90
63mm	784636	\$118.50

**Stub Flange (185psi)**



Size	MFG#	Price
20mm	784502	\$13.60
25mm	784523	\$27.80
32mm	784543	\$27.80
40mm	784588	\$31.00
50mm	784598	\$34.20
63mm	784633	\$52.30

**Reducing Bushing - RB (185psi)**

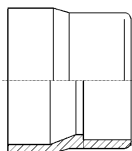

Size	MFG#	Price
25mm x 20mm	784535	\$22.40
32mm x 25mm	784554	\$29.40
40mm x 25mm	784569	\$36.70
40mm x 32mm	784586	\$36.70
50mm x 32mm	784600	\$36.70
50mm x 40mm	784607	\$44.00
63mm x 32mm	784628	\$81.90
63mm x 50mm	784629	\$81.90

**Glass Filled PP/Steel Backing Ring**



Size	MFG#	Price
20mm	782702	\$26.80
25mm	782721	\$30.40
32mm	782746	\$40.00
40mm	782771	\$47.20
50mm	782790	\$50.30
63mm	782824	\$59.70

**Union w/Viton O-Rings**

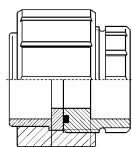

150psi

Size	MFG#	Price
20mm	---	\$66.80
25mm	---	\$80.00
32mm	784644	\$107.00
40mm	784584	\$160.70
50mm	784603	\$214.50
63mm	784618	\$320.70

**True Union Ball Valve**



150psi

Size	MFG#	Price
20mm	784501	\$231.00
25mm	784534	\$251.00
32mm	784557	\$294.00
40mm	784585	\$386.00
50mm	784087	\$477.00
63mm	784627	\$627.00

**Diaphragm Valve**



150psi

Size	MFG#	Price
20mm	784513	\$627.00
25mm	---	\$660.00
32mm	784559	\$743.00
40mm	784037	\$916.00
50mm	---	\$1,089.00
63mm	---	\$1,320.00



# Ultra Pure Water Flexible Conntectors

Manufactured from 1/16" Kynar PVDF tubing. 1/2" O.D.  
 Custom lengths available. All items non-cancelable and non-returnable.

Decription	Part#	Price	Decription	Part#	Price
12" LG x 3/8" FIP x 1/2" FIP	38F-12-12F	\$112.90	24" LG x 3/8" FIP x 1/2" FIP	38F-24-12F	\$144.70
12" LG x 3/8" FIP x 1/2" MIP	38F-12-12M	\$112.90	24" LG x 3/8" FIP x 1/2" MIP	38F-24-12M	\$144.70
12" LG x 3/8" MIP x 1/2" FIP	38M-12-12F	\$112.90	24" LG x 3/8" MIP x 1/2" FIP	38M-24-12F	\$144.70
12" LG x 3/8" MIP x 1/2" MIP	38M-12-12M	\$112.90	24" LG x 3/8" MIP x 1/2" MIP	38M-24-12M	\$144.70
12" LG x 1/2" FIP x 1/2" FIP	12F-12-12F	\$112.90	24" LG x 1/2" FIP x 1/2" FIP	12F-24-12F	\$144.70
12" LG x 1/2" MIP x 1/2" MIP	12M-12-12M	\$112.90	24" LG x 1/2" MIP x 1/2" MIP	12M-24-12M	\$144.70
12" LG x 1/2" MIP x 1/2" FIP	12M-12-12F	\$112.90	24" LG x 1/2" MIP x 1/2" FIP	12M-24-12F	\$144.70
<hr/>					
18" LG x 3/8" FIP x 1/2" FIP	38F-18-12F	\$132.70	36" LG x 3/8" FIP x 1/2" FIP	38F-36-12F	\$161.90
18" LG x 3/8" FIP x 1/2" MIP	38F-18-12M	\$132.70	36" LG x 3/8" FIP x 1/2" MIP	38F-36-12M	\$161.90
18" LG x 3/8" MIP x 1/2" FIP	38M-18-12F	\$132.70	36" LG x 3/8" MIP x 1/2" FIP	38M-36-12F	\$161.90
18" LG x 3/8" MIP x 1/2" MIP	38M-18-12M	\$132.70	36" LG x 3/8" MIP x 1/2" MIP	38M-36-12M	\$161.90
18" LG x 1/2" FIP x 1/2" FIP	12F-18-12F	\$132.70	36" LG x 1/2" FIP x 1/2" FIP	12F-36-12F	\$161.90
18" LG x 1/2" MIP x 1/2" MIP	12M-18-12M	\$132.70	36" LG x 1/2" MIP x 1/2" MIP	12M-36-12M	\$161.90
18" LG x 1/2" MIP x 1/2" FIP	12M-18-12F	\$132.70	36" LG x 1/2" MIP x 1/2" FIP	12M-36-12F	\$161.90

## LABORATORY FAUCETS

Rated to 150 psi

**Deck Mounted Recirculating Faucet**

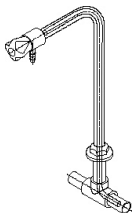

<b>Socket Fusion</b>	<b>SF16410.009</b>	<b>POA</b>
<b>Riontite</b>	<b>RT16410.009</b>	<b>POA</b>

Brass body with polyester powder coated finish and polypro liner

**Panel Mounted Recirculating Faucet**

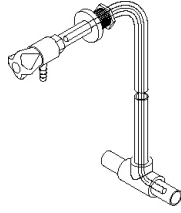

<b>Socket Fusion</b>	<b>SF16411.009</b>	<b>POA</b>
<b>Riontite</b>	<b>RT16411.009</b>	<b>POA</b>

Brass body with polyester powder coated finish and polypro liner

**Deck Mounted DI Faucet**

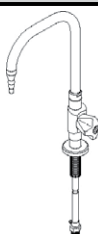

**06978.009** **POA**

Brass body with polyester powder coated finish and polypro liner

**Panel Mounted DI Faucet**

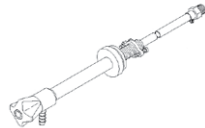

**06202.009** **POA**

Brass body with polyester powder coated finish and polypro liner

HIGH PURITY SYSTEMS

# Ultra Pure Laboratory Faucets - 150psi Rating

## GNF 10 - WELDED VALVE ASSEMBLY



Material	Part #	MFG#	Price
PP	GNF10-1	742000	\$599.10
*PVDF	GNF10-2	752000	\$791.10

Deck mounted

## GNF 10VB - WELDED VALVE ASSEMBLY WITH VACUUM BREAKER



Material	Part #	MFG#	Price
PP	GNF10VB-1	742004	\$704.90
*PVDF	GNF10VB-2	752002	\$918.50

Deck mounted with integral vacuum breaker

## GNF 20 - WELDED VALVE ASSEMBLY



Material	Part #	MFG#	Price
PP	GNF20-1	742005	\$634.20
*PVDF	GNF20-2	752003	\$871.90

Wall mounted

## GNF 20VB - WELDED VALVE ASSEMBLY WITH VACUUM BREAKER



Material	Part #	MFG#	Price
PP	GNF20VB-1	742009	\$752.30
*PVDF	GNF20VB-2	752005	\$1,162.90

Wall mounted with integral vacuum breaker

## GNF 30 - THREADED VALVE ASSEMBLY



Material	Part #	MFG#	Price
PP	GNF30-1	742011	\$688.40
*PVDF	GNF30-2	752006	\$871.90

Deck mounted

## GNF 30VB - THREADED VALVE ASSEMBLY WITH VACUUM BREAKER



Material	Part #	MFG#	Price
PP	GNF30VB-1	742014	\$769.30
*PVDF	GNF30VB-2	752007	\$953.80

Deck mounted with Integral vacuum breaker

## GNF 40 - THREADED VALVE ASSEMBLY



Material	Part #	MFG#	Price
PP	GNF40-1	742015	\$647.10
*PVDF	GNF40-2	752008	\$871.90

Wall Mounted

## GNF 40VB - THREADED VALVE ASSEMBLY WITH VACUUM BREAKER



Material	Part #	MFG#	Price
PP	GNF40VB-1	742016	\$688.40
*PVDF	GNF40VB-2	752009	\$1,034.90

Wall Mounted with Intergral vacuum breaker

## Recirculating Faucet



Material	Part #	MFG#	Price
PP	GNFRF-1	742018	\$1,124.80
*PVDF	GNFRF-2	752010	\$1,317.60

Deck Mounted

## Lab Faucet Repair Kits

### NEEDLE VALVE REPAIR KITS

	MFG#	Price
PP	742100	\$111.90
*PVDF	752100	\$122.10

### VACUUM BREAKER REPAIR KITS

	MFG#	Price
PP	742124	\$137.60
*PVDF	752114	\$154.60

\*Non-cancelable, non-returnable item

# NEUTRALIZATION AND DILUTION TANKS

ALL TANKS AND ACCESSORIES ARE NON-CANCELABLE AND NON-RETURNABLE

**Style 4, 5 & 7** All tanks are free standing and self supporting except 1200, which requires bracing or FRP wrap.

**Style 4**  
Welded Top



**Style 5**  
Bolted Top

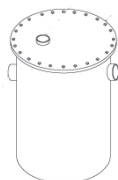

+ FRP  
Style 7

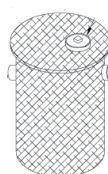

+ TAF  
Tank Anchor Flange

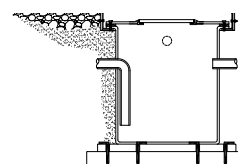

+ RAF  
Reinforcing Anchor Flange

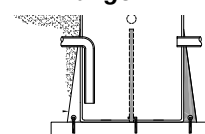

Standard Tank Pricing					Optional Extras			Dims In Inches			Limestone	
Style 4		Style 5			ADD TO STANDARD TANK PRICE			Ht.	Dia.	Std. Cover Dia.	Load In lbs	List Price
Gallons	Model #	List Price	Model #	List Price	+ FRP Style 7	+ TAF Tank Anchor Flange	+ RAF Reinforcing Anchor Flange					
5	4-222-5	\$673	5-222-5	\$668	\$460	\$281	\$310	16.25	11	16	50	\$23
15	4-332-15	\$1,481	5-332-15	\$965	\$1,332	\$295	\$331	15.5	17.25	22.25	150	\$69
30	4-332-30	\$1,813	5-332-30	\$1,320	\$1,547	\$316	\$352	30.5	17.25	22.25	250	\$115
55	4-332-55	\$2,169	5-332-55	\$1,617	\$1,891	\$337	\$375	33.5	22.5	27.5	500	\$230
100	4-443-100	\$2,504	5-443-100	\$2,028	\$2,783	\$384	\$426	49	24	29	1000	\$460
150	4-443-150	\$3,542	5-443-150	\$2,644	\$3,330	\$437	\$486	48	30	35	1700	\$782
180	4-443-180	\$4,363	5-443-180	\$3,416	\$3,488	\$448	\$495	42	36	41	2000	\$920
200	4-443-200	\$4,530	5-443-200	\$3,593	\$3,765	\$458	\$507	53	36	41	2500	\$1,150
275	4-443-275	\$5,018	5-443-275	\$4,211	\$4,198	\$488	\$543	48	42	47	3600	\$1,656
360	4-443-360	\$5,608	5-443-360	\$4,876	\$5,757	\$594	\$656	48	48	53	4500	\$2,070
500	4-443-500	\$7,575	5-443-500	\$6,827	\$6,535	\$733	\$810	60	52	57	6000	\$2,760
600	4-443-600	\$9,855	5-443-600	\$8,982	\$6,787	\$856	\$953	84	48	53	7500	\$3,450
1200	4-443-1200	\$17,400	5-443-1200	\$16,608	\$7,457	\$1,256	\$1,136	84	69	74	14500	\$6,670

Limestone is sold in 50 lbs. bags. List price is \$23 per bag.

Standard Inlet, Outlet & Vent Sizes (FIP)				*Standard Cleanout Access	
Gallons	Inlet	Outlet	Vent	Gallons	Cleanout Type
5	2"	2"	2"	5 - 100	4" Cleanout
15 - 55	3"	3"	2"	150 - 1200	Gamma Top
100 - 1200	4"	4"	3"	* Style 4 Only*	

## PRICING EXAMPLE: (ADDITIONAL OPTION PRICING)

For a 360-Gallon Style 5 Tank, with FRP, TAF, 1/8" steel x 1/2" plastic composite cover.  
Add standard tank price and additional options together.

360-Gallon Style 5 Tank	→ PLUS →	FRP	→ PLUS →	TAF	→ PLUS →	1/8" steel x 1/2" plastic composite cover
\$4,876		\$5,757		\$594		\$2,093
<b>Total Tank Price = \$13,320</b>						

## PRICING EXAMPLE: (UP-SIZED CONNECTION PRICING)

For a 360-Gallon Style 5 Tank, with 6" FIP Inlet.  
Add standard tank price and the difference in price of the standard connection from the desired connection.

360-Gallon Style 5 Tank	Desired Connection Size	Standard Connection Size	Added Difference
\$4,876	\$651	\$278	\$373
	→ Minus →	→ Equals →	
<b>Total Tank Price = \$5,249</b>			

TANKS, pH MONITORING & SINKS

# Style 5 Optional Covers (Add Prices To Standard Tank Price)

Gallons	Flat Top		Load Bearing				Adjustable Height
	1/2" Thick Plastic Top	3/4" Thick Plastic Top	1/8" steel x 1/2" plastic composite cover	1/4 steel x 1/2 plastic composite cover	1/8" steel x 3/4" plastic composite cover	1/4 steel x 3/4 plastic composite cover	Extension 1/4 Steel Cover, 2" Adjustment
5	\$250	\$275	\$1,196	\$1,243	\$1,255	\$1,306	\$2,122
15	\$372	\$406	\$1,196	\$1,243	\$1,255	\$1,306	\$2,747
30	\$374	\$411	\$1,196	\$1,243	\$1,255	\$1,306	\$2,747
55	\$424	\$464	\$1,196	\$1,243	\$1,255	\$1,306	\$3,083
100	\$554	\$612	\$1,708	\$1,902	\$1,966	\$2,164	\$3,817
150	\$608	\$669	\$1,708	\$1,902	\$1,966	\$2,164	\$4,070
180	\$672	\$738	\$1,708	\$1,902	\$1,966	\$2,164	\$4,402
200	\$716	\$789	\$1,708	\$1,902	\$1,966	\$2,164	\$4,629
275	\$755	\$887	\$1,708	\$1,902	\$1,966	\$2,164	\$4,990
360	\$805	\$1,246	\$2,093	\$2,394	\$2,496	\$2,804	\$5,565
500	\$1,209	\$1,331	\$2,093	\$2,394	\$2,496	\$2,804	\$5,851
600	\$1,315	\$1,444	\$2,093	\$2,394	\$2,496	\$2,804	\$5,851
1200	\$1,817	\$1,987	\$3,828	\$4,611	\$4,866	\$5,647	P.O.A

# Optional Connections & Access Ports (Add Prices To Standard Tank Price)

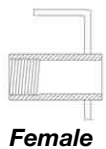

Female

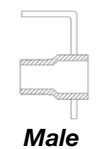

Male

Inlet, Outlet & Vent FIP Connection			Inlet, Outlet & Vent Male Connection		
Fitting Size	Inlet w/Invert Price Ea.	Outlet/Vent Price Ea.	Fitting Size	Inlet w/Invert Price Ea.	Outlet/Vent Price Ea.
1 1/2"	\$83	\$23	1 1/2"	\$83	\$23
2"	\$103	\$28	2"	\$103	\$28
3"	\$182	\$44	3"	\$182	\$44
4"	\$278	\$85	4"	\$278	\$85
6"	\$651	\$229	6"	\$651	\$229

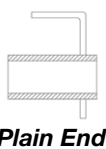

Plain End

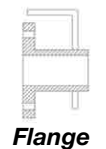

Flange

Inlet, Outlet & Vent Plain End Connection			Inlet, Outlet & Vent Flange Connection		
Fitting Size	Inlet w/Invert Price Ea.	Outlet/Vent Price Ea.	Fitting Size	Inlet w/Invert Price Ea.	Outlet/Vent Price Ea.
1 1/2"	\$70	\$9	1 1/2"	\$222	\$162
2"	\$85	\$13	2"	\$288	\$216
3"	\$161	\$23	3"	\$431	\$295
4"	\$222	\$28	4"	\$545	\$352
6"	\$479	\$56	6"	\$866	\$444

Access Port	
Access Port Type	Applicable Tanks Price Each
3" Cleanout	5 - 1200 \$152
4" Cleanout	5 - 1200 \$221
6" Cleanout	5 - 1200 \$282
Gamma Top 12"	5 - 1200 \$205
Gamma Plus 16"	55 - 1200 \$287
20" Manway x 1/2"	150 - 1200 \$457
20" Manway x 3/4"	150 - 1200 \$457
24" Manway x 1/2"	150 - 1200 \$548
24" Manway x 3/4"	150 - 1200 \$604



3" Cleanout 4" Cleanout 6" Cleanout

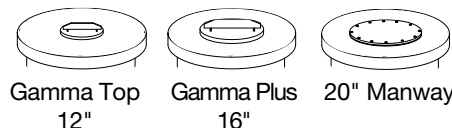

Gamma Top 12" Gamma Plus 16" 20" Manway



24" Manway

Maintenance Sign	
Description	List Price
17" Wide x 11" High	\$288

**IMPORTANT**  
 FOLLOW MAINTENANCE PROCEDURES WITH TANK. FAILURE TO DO SO CAN RESULT IN DAMAGE TO THE PIPING SYSTEMS.  
 FOR FURTHER INFORMATION CALL 1-913-342-1653

TANKS, pH MONITORING & SINKS

# Tank Extensions

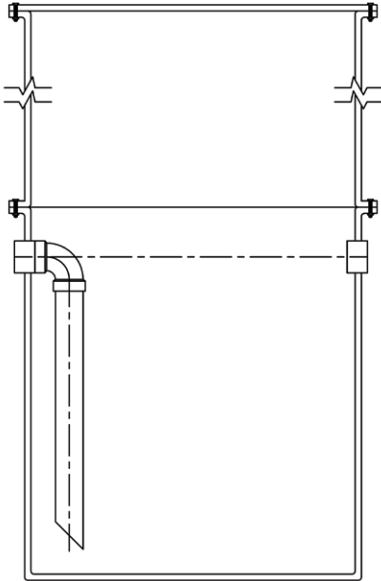

Gallons	Std. Tank Ht.	Single Lift Ext. Min/Max	Single Lift Ext. Total Height Min/Max	Single Lift Ext. List Price	Double Lift Ext. Min/Max	Double Lift Ext. List Price
5	16.25	4 / 14	20.25 / 30.25	\$668	24.25 / 44.25	\$1,336
15	15.5	4 / 14	19.5 / 29.5	\$965	23.5 / 43.5	\$1,930
30	30.5	4 / 28	34.5 / 58.5	\$1,320	38.5 / 86.5	\$2,640
55	33.5	4 / 31	37.5 / 64.5	\$1,617	41.5 / 95.5	\$3,234
100	49	4 / 47	53 / 96	\$2,028	57 / 143	\$4,056
150	48	4 / 46	52 / 94	\$2,644	56 / 140	\$5,288
180	42	4 / 40	46 / 82	\$3,416	50 / 122	\$6,832
200	53	4 / 51	57 / 104	\$3,593	61 / 144	\$7,186
275	48	4 / 46	52 / 94	\$4,211	56 / 140	\$8,422
360	48	4 / 46	52 / 94	\$4,876	56 / 140	\$9,752
500	60	4 / 58	64 / 118	\$6,827	68 / 144	\$13,654
600	84	4 / 58	88 / 142	\$8,982	92 / 144	\$17,964
1200	84	4 / 36	88 / 120	\$16,608	92 / 144	\$33,216

All Dimensions In Inches

Note: All prices for tanks and tank options are listed separately. For tank extensions with FRP wrap, FRP wrap prices on page 30 must be added for the standard tank and for each extension.

# Rectangular Polyethylene Tanks

Standard Inlet, Outlet & Vent Sizes (FIP)

Gallons	Inlet	Outlet	Vent
5	2"	2"	2"
15 - 55	3"	3"	2"
100 - 1200	4"	4"	3"

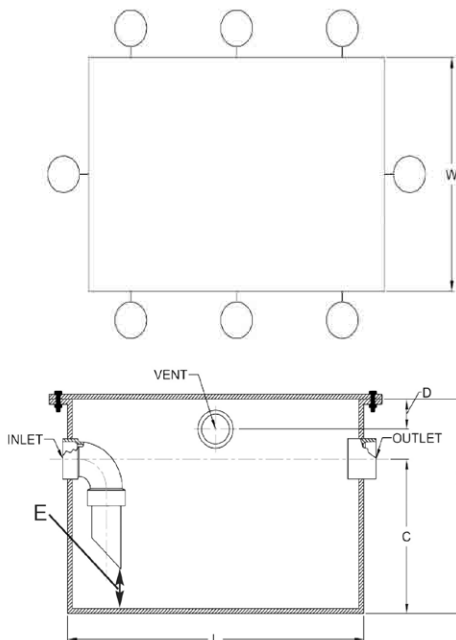

Part #	Size	L	W	H	C	D	E	List Price
ORT0001	1 Gal.	6"	12"	6"	3"	1.5"	2"	\$465
ORT0002	2 Gal.	8"	8"	8"	5"	1.5"	2"	\$504
ORT0005	5 Gal.	10"	16"	8"	5"	1.5"	2"	\$763
ORT0015	15 Gal.	12"	24"	12"	7"	2"	4"	\$956
ORT0030	30 Gal.	12"	24"	24"	18"	2"	4"	\$1,118
ORT0055	55 Gal.	24"	30"	18"	12"	2"	4"	\$1,976
ORT0115	115 Gal.	30"	30"	30"	24"	2"	4"	\$2,290
ORT0150	150 Gal.	24"	48"	30"	24"	2"	4"	\$2,566
ORT0215	215 Gal.	36"	36"	42"	36"	2"	4"	\$5,006
ORT0265	265 Gal.	36"	72"	24"	18"	2"	4"	\$5,426
ORT0540	540 Gal.	36"	72"	48"	42"	2"	4"	\$7,355
ORT0670	670 Gal.	36"	72"	60"	54"	2"	4"	\$7,451

Note: Rectangular tanks with heights greater than 18" require external supports.

## Double Wall Tanks

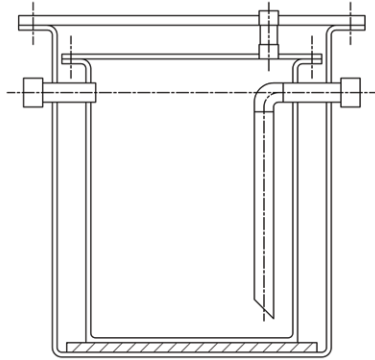

Gallons Carrier/Containment	List Price
5/30	\$2,388
15/55	\$3,099
30/55	\$3,526
55/150	\$5,114
100/200	\$6,744
150/200	\$7,486
180/360	\$9,951
200/500	\$12,505
275/600	\$15,830
360/1200	\$25,784
500/1200	\$25,949
600/1200	\$30,710

Variations in tank sizing can be manufactured, please contact Orion for more information.

## Solids Interceptors

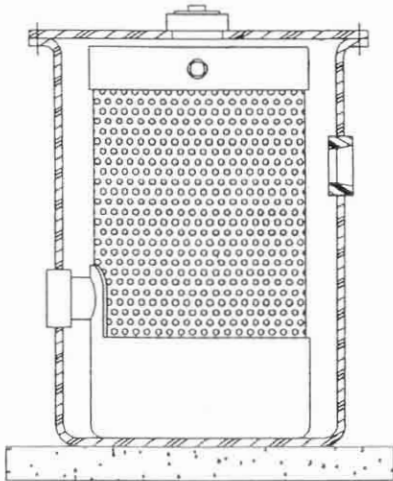

Part #	Tank Size	List Price
SI-5PB	5 Gallon	\$1,262
SI-15PB	15 Gallon	\$1,636
SI-30PB	30 Gallon	\$1,997
SI-55PB	55 Gallon	\$2,358

## Decontamination Tanks

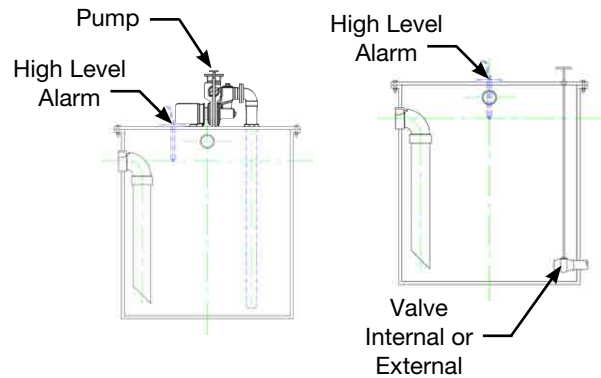

Tank Size	List Price
150 Gallon	P.O.A.
200 Gallon	P.O.A.
275 Gallon	P.O.A.
360 Gallon	P.O.A.
500 Gallon	P.O.A.
600 Gallon	P.O.A.
1200 Gallon	P.O.A.

Decontamination & Holding Tank Collects & Stores Chemical Waste.

# Trap Doors



<b>TYPE OR: 150 PSF Steel, Loose Cover</b>			<b>TYPE K / TYPE Q: 150 PSF Hinged Cover</b>			
Model	Dimensions	List Price	Model	Model	Dimensions	List Price
OR-24	24"X24"	\$1,553	AL	Steel		
OR-36	36"X36"	\$2,063	K1	Q1	24"X24"	POA
OR-48	48"X48"	\$2,574	K4	Q4	36"X36"	POA
			KD2	- - -	48"X48"	POA
			KD4	- - -	60"X60"	POA

"D" represents a double door version

<b>TYPE J: 300 PSF Hinged Cover</b>				<b>TYPE JH20: H-20 Wheel Loading</b>			
Model	Model	Dimensions	List Price	Model	Dimensions	List Price	
AL	Steel			Steel			
J1AL	J1	24"X24"	POA	J1H20	24"X24"	POA	
J4AL	J4	36"X36"	POA	J4H20	36"X36"	POA	
JD2AL	JD2	48"X48"	POA	JD2H20	48"X48"	POA	
JD4AL	JD4	60"X60"	POA	JD4H20	60"X60"	POA	

"D" represents a double door version

<b>Suggested Trap Door Sizes For Orion Standard Tanks</b>	
Tank Size	Trap Door Size
5, 15, 30 galls	24"x24"
55, 100 galls	36"x36"
150, 180, 200 galls	48"x48"
275, 360, 500, 1200	60"x60"

# Point Of Use Dilution & Neutralization Tanks & Traps



**Style 8** Dilution Tank or Trap

Capacity	Inlet-Outlet	Inside Dimensions	List Price
1.5 gal	1-1/2" FIP	12.3"x9"x6"	\$420.20
1.5 gal	2" FIP	12.3"x9"x6"	\$420.20



**Style 9** Neutralization or Dilution Tank

Capacity	Inlet-Outlet	Dimensions	List Price
5 gal	1-1/2" FIP	15" Dia.x12"	\$572.90
5 gal	2" FIP	15" Dia.x12"	\$572.90



**Style 10** Dilution Trap  
1-1/2 Gallon

Part #	Description	Price
OF59155-200	2- 1-1/2" inlets 1- 2" outlet	\$516.60
OF59155-201	1- 1-1/2" inlet 1- 2" outlet	\$512.70
OF59155-202	1- 2" inlet 1- 2" outlet	\$720.00
OF59155-203	2- 2" inlets 1- 2" outlet	\$739.50

To order a white tank, use (56) in place of 55



**Style 11** Anti-Siphon Dilution Trap  
1-1/2" Connections

Part #	Description	Price
OF31586-151	1 gallon	\$345.20
OF31586-152	2 gallon	\$374.80
OF31586-153	5 gallon	\$394.50



**Style 12** Dilution Trap

Capacity	Part #	Description	List Price
6 gal	OF32505-150	1-1/2 " inlet/outlet	\$493.00
6 gal	OF32505-200	2" Inlet/Outlet	\$542.30



**Style 13** Bookshelf Tank  
1-1/2" or 2" Connections

Part #	Description	Price
OF121206-001	3 gallon	\$558.70
OF181406-001	5 gallon	\$575.10



# NeutraGuard pH Monitoring and Data Logging Systems

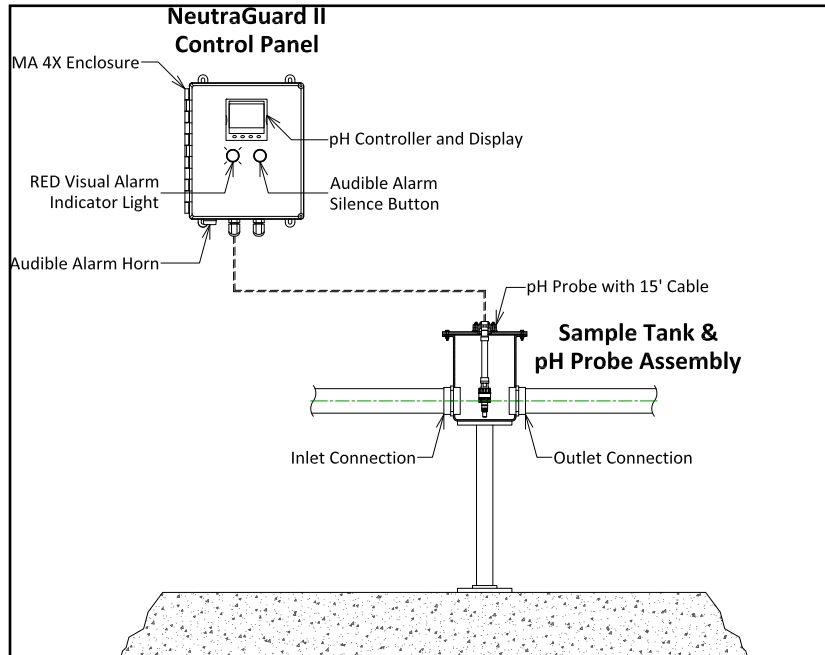

## NeutraGuard II pH Monitoring & Recording System

Model M11-1-01-003: \$16,778

Includes panel, pH probe, sampling tank, 4-20mA and Modbus TCP/IP pH retransmission, digital controls and display, high / low level pH alarms (audible & visual), digital data logging, local data download capability, preloaded Orion USB flash drive (with Review software) for data retrieval

### Optional Extras

- Second pH Probe Assembly & Display (configurable at factory)
- Tank High and/or Low Level Alarms



## NeutraGuard Chemical Doser: POA

Includes panel, pH probe, sampling tank, dry contacts for building management system, digital controls and display, high / low level pH alarms - audio & visual, digital data logger with 57,000 data points, 9 pin serial port connection, local data download capability, ethernet remote data download, real time data logging, metering pumps, reagent tanks and alarms.

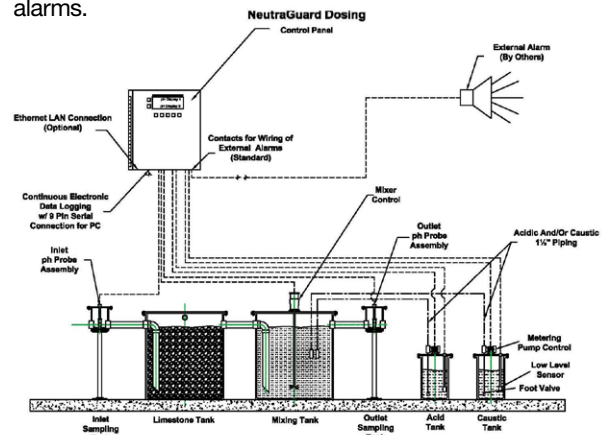

**Added Options all Neutraguard models**

Second pH sampling tank	\$846
Second pH probe	\$1,455
Spare electrode, 3-2724-10	\$802
Spare pre-amplifier, 15ft cable, 3-2750	\$653

**Single Station High Level Alarm**

Model MPN550: 738221 \$1,770.00

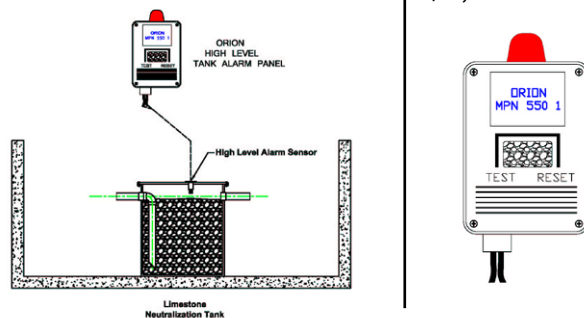

**Dual High Level Alarm / Leak Detector**

Model 732: 738245 \$4,682.00

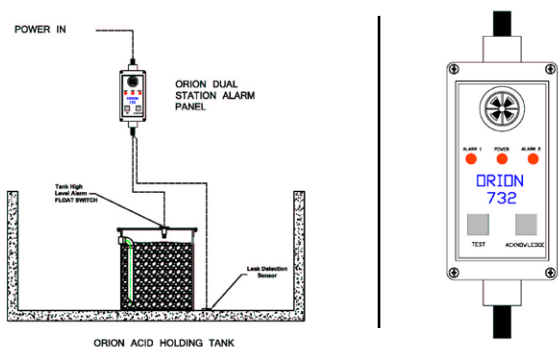

**Shelf Liner**

Size	Price
18" x 12"	\$51.60
24" x 12"	\$51.60
24" x 18"	\$51.60
30" x 12"	\$52.50
30" x 18"	\$53.90
36" x 12"	\$53.90
36" x 18"	\$56.00
42" x 12"	\$56.00
42" x 18"	\$57.40
42" x 24"	\$59.40
48" x 12"	\$57.40
48" x 18"	\$59.40
48" x 24"	\$60.70
60" x 12"	\$67.70
60" x 18"	\$69.60
60" x 24"	\$71.10

**Drip Trays**



Width	Length Options	Price	Width	Length Options	Price
19" x	(12", 13", 14", 15", 16", 18")	\$101.20	39" x	(19")	\$116.20
20" x	(10", 11", 13", 14", 17", 19")	\$104.70	40" x	(15", 16", 17")	\$116.70
21" x	(15", 16", 17", 18", 19")	\$106.40	41" x	(10", 14", 19")	\$121.60
22" x	(10", 12", 15", 16", 17", 18", 19")	\$105.10	42" x	(14")	\$120.00
23" x	(10", 15", 16", 17", 19", 21")	\$105.40	43" x	(16")	\$126.50
24" x	(9", 12", 24")	\$128.50	44" x	(11", 17")	\$129.80
25" x	(12", 15", 16", 18", 19", 25")	\$130.70	45" x	(11", 19")	\$133.90
26" x	(11", 17", 19", 20")	\$109.10	46" x	(10", 16", 19")	\$135.60
27" x	(17", 18", 19")	\$114.70	47" x	(10", 19", 28")	\$158.60
28" x	(10", 14", 15", 16", 17", 18")	\$112.20	48" x	(28")	\$158.60
29" x	(10", 16", 19")	\$113.10	57" x	(18", 19")	\$163.40
30" x	(16", 19", 20", 28")	\$130.70	58" x	(5")	\$151.00
31" x	(16", 18", 19", 26")	\$130.50	59" x	(12")	\$154.10
32" x	(11", 14", 17", 19", 20")	\$115.70			
33" x	(10", 11", 13", 18", 19", 23")	\$120.80			
34" x	(10", 16", 18", 19", 22", 26", 28")	\$147.00			
35" x	(10", 11", 17", 18", 19", 28")	\$152.80			
36" x	(16", 17")	\$116.90			
37" x	(14", 16")	\$116.10			
38" x	(14", 19")	\$115.10			

Width	Length Options	Price
10" x	9"	\$79.30
12" x	9"	\$79.30
14" x	(10", 11", 13")	\$92.00
16" x	(8", 11", 13")	\$96.90
17" x	(9", 14", 16", 17")	\$100.30
18" x	(9", 14", 16", 18")	\$100.00

## Corrosion Resistant Laboratory Sinks

Model	MEASUREMENTS			MFG#	Price Each
	A-Length	B-Width	C-Depth		
ARLS-11	12"	12"	8"	737102	\$263.70
ARLS-12	16"	8"	7"	737104	\$263.70
ARLS-13	16"	16"	8"	737106	\$449.80
ARLS-14	18"	12"	8"	737110	\$449.80
ARLS-15	18"	15"	12"	737114	\$449.80
ARLS-16	21"	18"	10"	737118	\$472.80
ARLS-17	23"	18"	12"	737120	\$515.60
ARLS-18	25"	15"	10"	737122	\$544.70
ARLS-DB-1	12"	12"	8"	737159	\$903.10
ARLS-DB-2	18"	15"	10"	737161	\$1,290.90
ARLS-CDB	18"	15"	10"	737157	\$3,076.00
CTU-1				737533	\$1,529.70

### Sinks Compliant with The Americans with Disabilities Act (ADA)



ARLS-13-ADA	16"	16"	6"	737107	\$458.90
ARLS-14-ADA	18"	12"	6"	737111	\$458.90
ARLS-15-ADA	18"	15"	6"	737115	\$417.00

\*\*\*SSBasket Sink Strainer OF38958-153 \$61.00

\*\*\* NOT FOR USE WITH ORION Sinks

### Over Flow

385551-150 \$116.20

Over Flow assembly is sold as part of a sink. Assemblies are not sold as separate components. When ordering, please specify sink number + OVFASSY. Does Not Include bottle trap.

### Rims

Stainless Steel Flush Mounting Rims	All sizes available	\$98.50
Steel Under Counter Mounting Frames	737000	\$85.30

Must be ordered with proper sink number to ensure sizing.

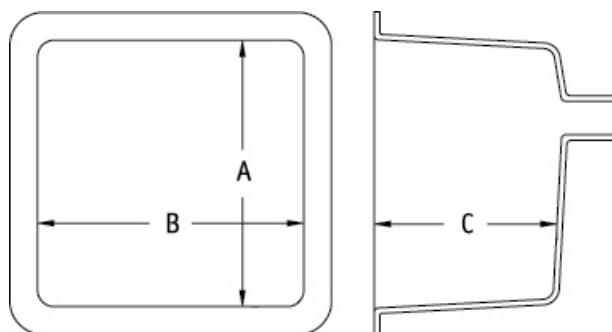

Standard sinks are one piece molded black polyethylene with a 1 1/2" NPS integral corner drain.

**All sinks supplied with stopper and strainer.**

All sinks F.O.B. Kansas City, Kansas Non-cancelable, non-returnable

Prices subject to change without notice. Possession of this price list shall not be construed as an offer to sell to bearer.

## Corrosion Resistant Laboratory Waste Assemblies and Cup Sinks

<b>Waste Assemblies</b>			
	<b>Size</b>	<b>Part #</b>	<b>Price</b>
	WA-1, 1 1/2" IPS	WA-1	\$77.30
	WA-2, 1 1/2" IPS	WA-2	\$84.70
	WA-3, 1 1/2" IPS	WA-3	\$107.60
	WA-4, 1 1/2" IPS	WA-4	\$112.20
WA-5, 2" IPS	WA-5	\$116.50	

<b>Standing Waste Assemblies</b>			
	<b>Size</b>	<b>Part #</b>	<b>Price</b>
	<b>OPEN TOP</b>		
	*6" Long	013060400T	\$24.20
	*10" Long	013100400T	\$26.80
	<b>CLOSED TOP</b>		
	*6" Long	01306040CT	\$41.10
*10" Long	01310040CT	\$60.10	
<i>To fit waste assembly outlets.</i>			

<b>Cup Sink - Oval</b>			
	<b>Size</b>	<b>Part #</b>	<b>Price</b>
	CS1	81363441	\$108.90
	**CS2	81363441-1	\$132.10
	CS5	81393441	\$123.40
	**CS6	81393441-1	\$146.50
<b>**Side outlet</b>			

<b>Cup Sink - Round</b>			
	<b>Size</b>	<b>Part #</b>	<b>Price</b>
	CS3	81306342	\$103.30

<b>Cup Sink - Fast Flow</b>			
	<b>Size</b>	<b>Part #</b>	<b>Price</b>
	CS7	81300643	\$81.30

\*Non-cancelable, non-returnable item

# MECHANICAL JOINT TOOLS

## INDIVIDUAL TOOLS

ALL TOOLS AND ACCESSORIES ARE NON-CANCELABLE AND NON-RETURNABLE

### GROOVING TOOLS

1-1/2"	MJGT1	\$119.40 Ea.
2"	MJGT2	\$149.80 Ea.
3"	MJGT3	\$197.40 Ea.
4"	MJGT4	\$231.20 Ea.
6"	MJGT6	\$874.00 Ea.

### GROOVER REPAIR KIT

(blade, cam assembly, cover & screw) \$47.50 Ea.

### ADDITIONAL TOOLS

Ratchet wrench w/socket & extension	\$89.70 Ea.
Deep sockets only	\$30.90 Ea.
1-1/2" - 4" deburring tool	\$159.70 Ea.

### PIPE CUTTERS

1/2" - 3"	PC3	\$218.60 Ea.
2" - 4"	PC4	\$241.00 Ea.
6"	PC6	\$352.90 Ea.

### EXTRA CUTTER WHEELS

All Sizes	CW1	\$40.60 Ea.
-----------	-----	-------------

**\*NOTE: GROOVER REPAIR KITS ARE NOT AVAILABLE FOR RIONTITE GROOVING TOOLS. CONTACT FACTORY FOR MORE INFORMATION REGARDING REPAIR OF RIONTITE GROOVING TOOLS**

## TOOL KITS

MJGTSet (1-1/2" - 4")	\$676.80 Set
MJKit 1	\$1,038.30 Ea.

1-1/2" - " Pipe Cutter  
 1-1/2" - 2" & 3" Grooving Tools  
 Tool Box  
 Instructions  
 Deburring Tools  
 (2) Two Marking Pencils  
 1/2" Combination Socket & End Wrench  
 Ratchet Wrench with 1/2" Deep Socket & Extension

Kit #2	MJKIT2	\$1,258.40 Ea.
1-1/2" -3" Pipe Cutter		
4" Pipe Cutter		
Tool Box		
Instructions		
1-1/2" - 4" Grooving Tools		
Deburring Tools		
(2) Two Marking Pencils		
1/2" Combination Socket & End Wrench		
Ratchet Wrench with 1/2" Deep Socket & Extension		

## RIONTITE TOOLS

### GROOVING TOOLS:

1/2"	RTGT050	\$201.70 Ea.
3/4"	RTGT075	\$201.70 Ea.
1"	RTGT010	\$201.70 Ea.
1-1/2"	RTGT015	\$243.80 Ea.
2"	RTGT020	\$243.80 Ea.
Set of 5 Tools	RTGTSet	\$1,092.50 Set

### FACING TOOLS

FT-1 Faces 1/2", 3/4", 1"	\$311.00
FT-2 Faces 1-1/2", 2"	\$311.00

## SLIP FIT / SOCKET FUSION TOOLS INDIVIDUAL ITEMS

### TOOLS

**Includes Heater tool, tool box and table clamp - does not include head sets  
See below for head set pricing.**

HT 2 (up to 2" sizes)	\$1,190.10 Ea.
HT 4 (up to 4" sizes)	\$1,596.50 Ea.
HT 6 (up to 6" sizes)	\$4,615.60 Ea.
Back Welder	\$2,185.40 Ea.

### SOCKET FUSION HEAD SETS

*IPS	1/2"	3/4"	1"	1-1/2"	2"	3"	4"	6"
Teflon Coated	\$221.20	\$232.50	\$252.20	\$336.20	\$410.30	\$605.00	\$655.40	\$1423.00
Part #	HS005	HS075	HS010	HS015	HS020	HS030	HS040	HS060

*METRIC	20mm	25mm	32mm	40mm	50mm	63mm
Teflon Coated	\$221.20	\$232.50	\$252.20	\$320.60	\$410.30	\$605.00
Part #	HS20MM	HS25MM	HS32MM	HS40MM	HS50MM	HS63MM

### TOOL KITS

#### HTK2 (COMPLETE KIT)

Teflon Coated \$3,164.80 Ea.  
includes 1/2" thru 2" head sets

#### HTK4 (COMPLETE KIT)

Teflon Coated \$3,431.70 Ea.  
Includes 3" & 4" head sets

#### HTK2MM (COMPLETE KIT)

Teflon Coated \$3,164.80 Ea.  
includes 20mm thru 63mm head sets

#### BACK WELDING KIT

\$2,520.80 Ea.

Includes: Backwelding Gun, Speed Tip, Standard Tip, Heavy Duty Tool Box, Complete Book on Plastic Welding

#### TOOL ACCESSORIES

Pair Tempil Sticks TSK \$69.80 Ea.

#### Welding Rod

Polypropylene or Polyethylene \$38.90/lb.  
PVDF \$72.10/lb.

All Socket Fusion Kits include: headsets as listed above, cleaning towels, (2) two marking pencils, (1) one pair tempil sticks 488° - 525°, (1) one pair gloves, (6) six sets of sample welding parts, (1) one tool box

### RIONFUSER POWER UNIT

Includes (2) sets of jumper cables

\$5,589.00

### RIONFUSER POWER UNIT ACCESSORIES

Rionfuse Clamp-Free jumper cable	\$50.90/ea.
4mm Replacement Tips For Rionfuser Cables (sold as single piece)	\$66.90/ea.
Twist Lock Rionfuser Lead Cables	\$299.40/ea.

# General Terms & Conditions

## FREIGHT CONDITIONS:

All orders are shipped F.O.B. Kansas City, Kansas. Once the material leaves our dock it becomes the property and responsibility of the consignee. If freight is lost, or damaged, all freight claims must be filed by the consignee. When shipping to a job site, freight will be third party billed.

## FULL FREIGHT ALLOWANCE:

To meet the full freight allowance, orders must be for immediate complete shipment to one location within the contiguous United States. Shipments to Alaska, Puerto Rico, Hawaii or for export are not freight allowed. For shipments to Alaska, Hawaii, Puerto Rico or for export, the freight allowances shown below, for qualified items, are good only for shipment to East Coast, Gulf Coast or West Coast Ports only

### ORION MATERIAL:

#### 1. Single Wall PP and PVDF Products:

**\$7000** net on single wall pipe and fitting products excluding Sinks, Tanks, Chemical Treatment Systems, 8", 10", 12" Pipe & Fittings for which there is no freight allowance.

#### 2. Double Containment Products:

**\$30,000** net for double wall products, with no freight allowance on prefabricated pipe spools pieces, or rental machines.

#### 3. EuroGreyline & Fluorostar Single-Wall Products:

**\$7500** net for pipe and pipe + fittings order combinations

**\$2500** net for fitting-only orders

**\$2500** net for valves

## PAYMENT TERMS:

A 2% cash discount is allowed if payment of invoice is mailed, or delivered, to Orion within 10 days of invoice date. All invoices are due net 30 days, with all Past Due accounts subject to a service charge of 1.5% per month. Minimum billing or credit is for \$50.00 net for Orion Products. Any order under minimum will carry a \$10.00 surcharge.

## ORDER ACCEPTANCE:

No catalog, price list, literature or other material describing our products is to be construed as an offer to sell same. Orders are subject to acceptance by us at our facilities in Kansas City, Kansas. Your order, when shipped by us, shall be the complete contract between us, subject to, and incorporating therein, the terms and conditions, herein set forth, and any provisions contained in your order that are inconsistent with our terms and conditions shall be inapplicable and invalid. Prices and discounts contained in any of our catalogs, price lists or other literature are subject to change without notice.

## WARRANTY:

Our products are carefully inspected for manufacturing defects. However, it is not always possible to detect hidden defects. Our products are warranted only to the extent that we will replace them without charge if they are proved to have manufacturing defects within one year of the date of delivery to the site where they are to be used, or installed, and provided we have been given an opportunity to inspect any product alleged to be defective and the installation or use thereof. NO WARRANTY IS INCLUDED AGAINST ANY EXPENSE FOR REMOVAL, REINSTALLATION OR OTHER CONSEQUENTIAL DAMAGES ARISING FROM ANY DEFECT. THE WARRANTIES SET OUT ABOVE ARE THE ONLY WARRANTIES MADE AND ARE EXPRESSLY IN LIEU OF ALL OTHER WARRANTIES, EXPRESSED OR IMPLIED, INCLUDING THE WARRANTIES OF MERCHANTABILITY AND FITNESS FOR A PARTICULAR PURPOSE.

## SHIPPING DATES – DELAYS – SHORTAGE CLAIMS:

Promises of shipping dates are estimates, and therefore cannot be guaranteed. Orion Enterprises, Inc. will not be liable for any delay in a delivery. Any claims for shipping errors, shortages or defects must be made to Orion within 24 hours of receipt of the goods. Buyer shall be required to make timely payment to seller of any amount which is undisputed, or not subject to such claims.

## TAXES:

Any sales or manufacturers' taxes existing, or under future statutes, are to be paid by the buyer.

## OTHER:

All pipe cuts on sizes of 8" and smaller will carry a \$5.00 per-cut charge. 10" and larger pipe will have a \$10.00 per cut charge

## RETURNED GOODS POLICY:

1. Permission to return goods must be requested in written form via email, fax or mail. The request must identify original shipment of material by invoice number and date of invoice, and list all goods to be returned.
2. All pipe, any non-standard items, special order items, sinks, tanks, "Standard Line" products, all PVDF product, expansion joints, 8"-10"-12" fittings, electrofusion equipment, socket fusion tools, accessories and specially manufactured items are sold non-cancelable and non-returnable. No credit will be issued upon their return.
3. All pipe and those fittings so marked (\*) on price sheets are non-returnable and no credit will be issued upon their return.
4. Goods must be returned within one year after purchase in order to receive credit.
5. Only 10% of any invoice total (not including the pricing for pipe) can be returned for credit.
6. All goods must be returned "prepaid." For any goods purchased on an FFA basis, outgoing freight charges will be deducted from total credit amount.
7. All goods returned must be in a pristine and resalable condition. All returns are subject to our inspection. Any product that is determined, in our sole judgment, to be not in a resalable condition will be either disposed of by Orion, or returned freight collect to the purchaser. In either event no credit will be given.
8. A restocking charge of 25% will be charged against all returned goods, except Whiteline materials, for which the charge will be 35%. If goods are returned in a non-pristine condition and need special cleaning to allow them to be resold a 40% restock will apply to the entire returned shipment.
9. All goods returned must have Orion's Return Authorization Number on boxes or cartons, and must freight pre paid. If not, they will be refused at our dock.
10. All credit memos issued may be applied to current account balances, or to future purchases. No cash refunds will be issued.

# Represented By:



**Orion Enterprises**  
*a Watts Water Technologies Company*

---

2850 Fairfax Trafficway  
Kansas City, Kansas 66115

Phone: 913-342-1653 Fax: 800-777-1653  
[www.orionfittings.com](http://www.orionfittings.com)