



ORAC[®]
D E C O R

BY OUTWATER

NEW
CLASSICS

Reinventing tradition

Samples



Samples are available for many of the products within this catalog; to test their suitability for your intended use or application. Most samples are shipped free of charge via standard U.S. mail or UPS ground. Other shipping options are available, at customer's expense. Please discuss with our sales representatives.

See pages 113-115 for samples available

TERMS AND CONDITIONS

"Vendor": Outwater Plastics Industries, Inc. & Architectural Products by Outwater, LLC

PRICES:

All prices are subject to change without notice. No deduction will be allowed at settlement. Minimum order is \$25.00 (Merchandise only). Orders less than this minimum will be billed as \$25.00 plus shipping charges and tax, if applicable.

NOTE:

Orders are accepted with the understanding that they will be billed at the price in effect on the day of shipment.

PICK UP ORDERS:

Orders placed for pick up must be picked up within 2 weeks from the date placed, or the date material becomes available. Orders not picked up within 2 weeks will be canceled.

To secure material for a longer time period; arrangements may be made for non-refundable prepayment and pick up by a specified date.

SHIPPING TERMS:

Shipments are F.O.B. shipping point.



2 LOCATIONS

(800) 835-4400

EAST COAST

24 River Road • Bogota, NJ 07603

WEST COAST

4720 West Van Buren Street • Phoenix, AZ 85043

*** WE RESERVE THE RIGHT TO SUBSTITUTE OR "EQUAL" ***

Family

“While others take care of their investors, we take care of our customers.” Family owned and operated since 1972, Architectural Products by Outwater, LLC began as a brick and mortar company serving those in the architectural and interior design industries. Having 300,000 square feet of distribution and warehousing facilities in New Jersey and Arizona enables Outwater to provide reasonable shipping costs and lead times for customers throughout the country. Outwater strives to provide innovative and exciting products for our clients. This desire led to our partnership with ORAC Décor®, another family owned business with an enthusiasm for all things beautiful and elegant. For over 50 years, ORAC Décor® has developed and manufactured traditional, modern and unique high quality 3D ornaments resulting in a complete collection for the design professional.



Award Winning Designs



ORAC Décor’s breathtaking line of architectural mouldings brings new meaning to interior design and features many award-winning products. In 2014, ORAC Décor’s Wave Profile for Indirect Lighting won the internationally acclaimed Red Dot Award for Product Design, and in 2016 the new SX171 Baseboard Moulding was the winner of the Smart Design on Intirio. ORAC Décor® remains Europe’s #1 choice for interior design and this award-winning, designer collection is available in North America exclusively through Architectural Products by Outwater, LLC.



Our Designers

Ulf Moritz

Xavier Donck

Orio Tonini

Pierre Daems

Jacques Vergracht



ORAC Décor® has teamed up with many of the industry's top European designers and architects to develop new and innovative profiles. Working with these designers allows ORAC Décor® to stay up to date on the latest design trends and create truly inspired profiles that fit an array of different styles.

Collaborating with these world-renowned designers and architects resulted in a collection of unique profiles and 3D wall decor that the industry has never seen before. ORAC Décor's new MODERN Collection of profiles and high-quality 3D ornaments breaks away from traditional style mouldings and features a "less is more" theme employed by designers and architects like Ulf Moritz, Xavier Donck, Orio Tonini, Pierre Daems and Jacques Vergracht.

Incorporating their ideas into the clean-cut lines and styles of this collection has enabled ORAC Décor® to open up a whole new era of architectural mouldings and designs that will continue to grow.

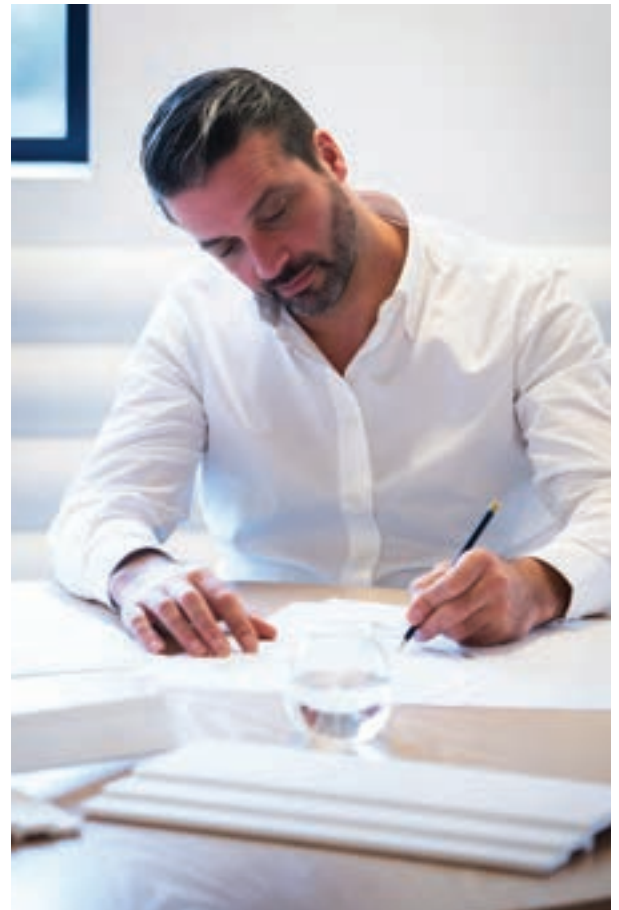

Technical

ORAC Décor® strives to produce the highest quality products for its customers and provides any information needed for a smooth installation. Technical drawings can be downloaded by visiting www.oracdecorusa.com, where you can also find videos that show various methods of installation for the complete ORAC Décor® line of products.

Available In



ORAC DECOR Rue de l'Industrie 22 8400 Croisotville - Belgium Tel. +32 (0)519 80 32 12 www.oracdecor.com info@oracdecor.com	Part name: CNE1 Designed by: Pierre Daems Designed on: 27-Jul-2011 <small>All dimensions are in millimeters unless otherwise specified. All information on this document is for your information only. It may be used for reference only. No responsibility is taken for any errors or omissions. Further information can be found at www.oracdecor.com</small>
---	---

Materials

As a pioneer, ORAC Decor® has introduced synthetic technology for the production of their decorative elements. Synthetic materials have more advantages than traditional plaster, wood or MDF solutions.

ORAC's synthetic materials are not only lightweight, easy to handle, sturdy and durable but also completely recyclable.

Boasting product quality that is second-to-none, ORAC's decorative mouldings and ornaments are primed and ready for painting/finishing.

PUROTOUCH®

A high-quality, high-density polyurethane that allows fine details.

DUROPOLYMER®

An extruded and impact-resistant polymer based on a high-density polystyrene.

DUROFOAM®

An extruded lightweight polymer based on a medium-density polystyrene blend.

FLEX

A wide range of cornice mouldings, panel mouldings and baseboards are also available in a flexible version.



Steel Molds

the benefits of

ORAC Décor® has become a leader in the industry through innovation and creative design. Part of what makes ORAC Décor® so unique is the use of steel molds to produce the high level of defined, rich detail that ORAC Décor® is known for. The use of steel molds also enhances all of ORAC Décor's exclusive materials, formulated specifically to create long lasting, beautiful products.

This process provides crisp, sharp details and unlike rubber molds, steel molds do not warp or degrade during production ensuring that each and every ORAC Décor® moulding is identical.



Build Up

ORAC Décor's standard mouldings and new MODERN Collection feature large, one-piece profiles that provide an effortless installation. These mouldings feature one-piece construction, and eliminate the need for build-up and the possibility of post construction separation or cracks. ORAC Décor's mouldings are incredibly lightweight, easy to work with, and can be installed with everyday woodworking tools.

The large profiles are more cost effective than traditional build-ups, saving time and labor during installation and will enhance any pre-existing architecture with ease.

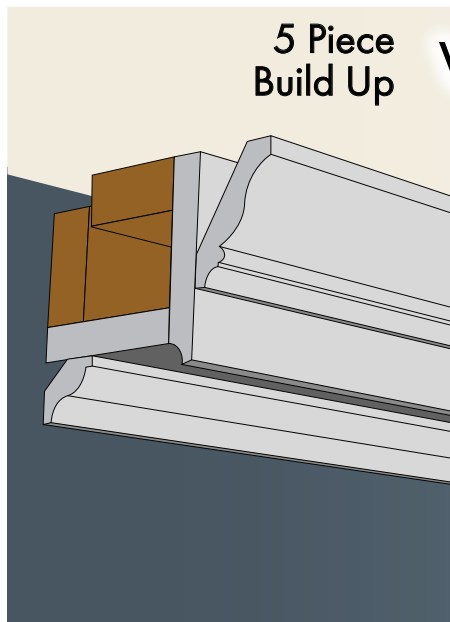

vs.

ORAC's One-Piece Construction





50
YEARS
CREATIVITY &
INNOVATION

50 Years of Passion

ORAC celebrates 50 years of passion, creativity, and innovation. Drawing inspiration from historical architecture, we have recreated the stately profiles of the 17th century using modern day technology. Our 2021 collection consists of baseboards, crown mouldings, crown mouldings for LED lighting, and a ready-made paneling system to transform to your décor effortlessly.



Heritage

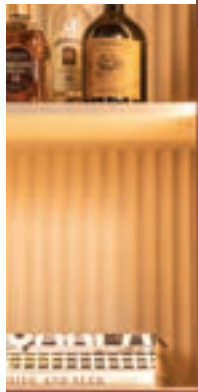

Nobility



New for 2021

The past comes to life



Manor



Baroque

Introducing The Heritage Collection

History with a modern twist

Imagine yourself in an nineteenth century manor home, living in a space full of large intricate cornice mouldings that emphasize the height of your rooms. A space where rich hues and ornate wainscoting come together in perfect harmony.



1 FP4025 pg. 76



2 W109 pg. 95



3 C324 pg. 46



4 W120 pg. 95



5 W121 pg. 95

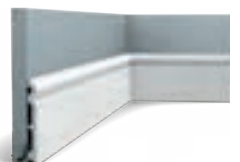

6 SX138 pg. 86

Prefabricated Wall Panels



Do you like tall wainscoting and want to get going fast? These prefabricated panels can be mounted directly to the wall without any prep work.



1 C324 pg. 46



2 W120 pg. 95

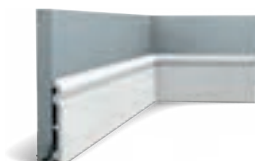

3 SX138 pg. 86



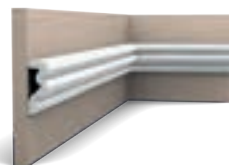

❶ FP4025 pg. 76



❷ W120 pg. 95



❸ W121 pg. 95

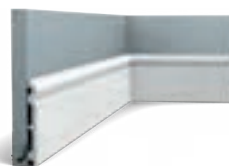

❹ SX138 pg. 86

Mix & Match

Create your own unique designs as renowned designers did for country manors 200 years ago. Insert panels can be mix-and-matched, offering endless possibilities.



1 C324 pg. 46



2 W123 pg. 95



3 W122 pg. 95



4 W120 pg. 95

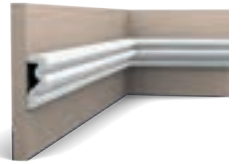

5 P4025 pg. 76



6 W121 pg. 95

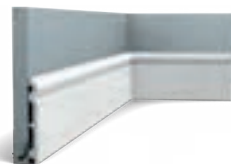

7 SX138 pg. 86

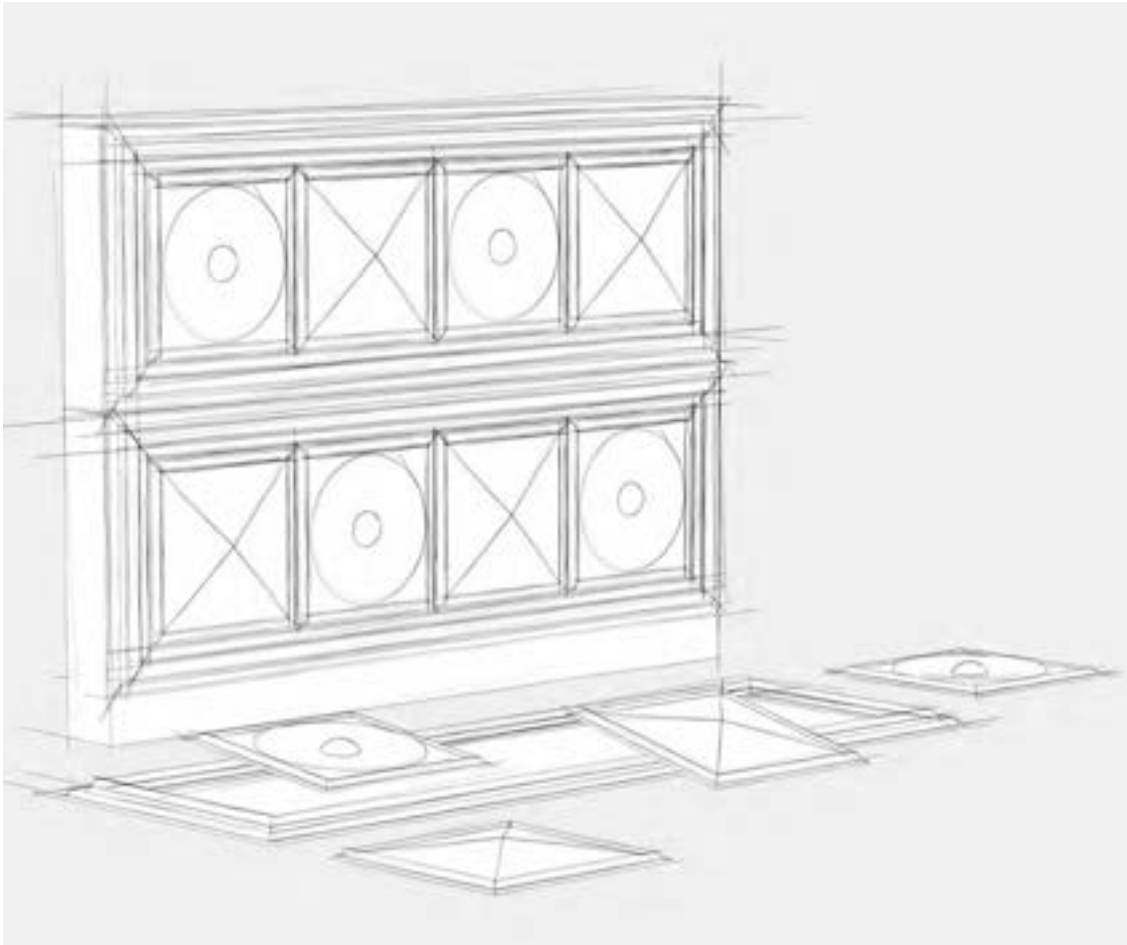

Reign over your wall decoration. These authentic designs with precise details immediately conjure up depth and structure for your wall.

This innovative paneling system consists of primed, prefabricated wall panels W120 and W121 and insert options W122 and W123. It is an economical solution for wall depth creation and allows for fast, effortless installation. Unlike traditional wood millwork, there is no mitering necessary, which eliminates cracks and cuts down on labor costs, too.

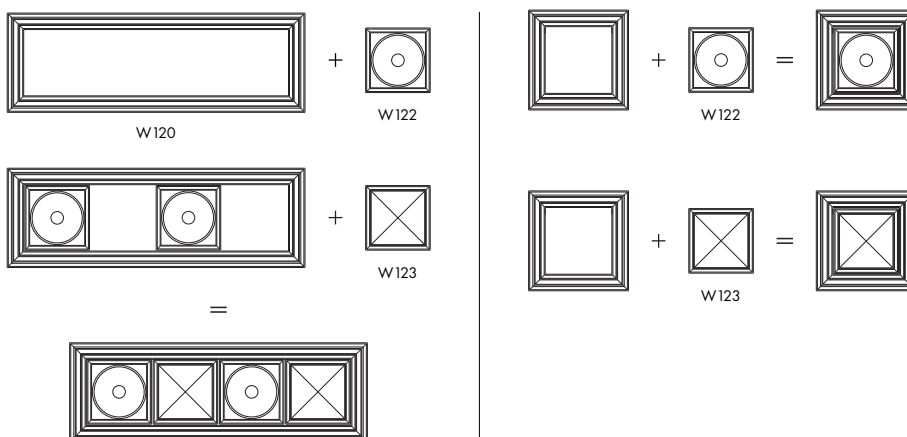

Design tips & tricks

Keep it classic or make it creative. Combine the seven design elements for walls and ceilings exactly as you desire.

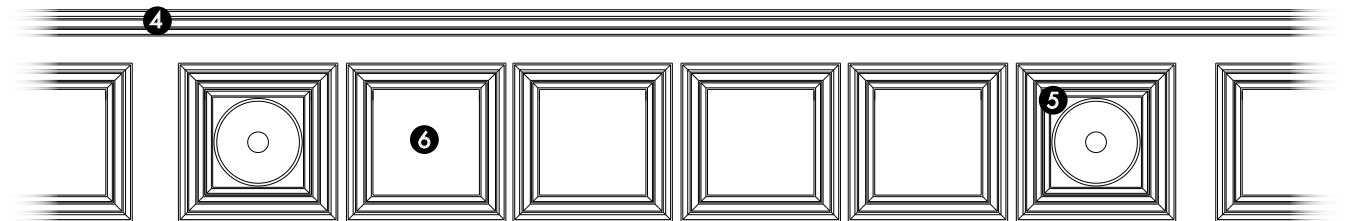
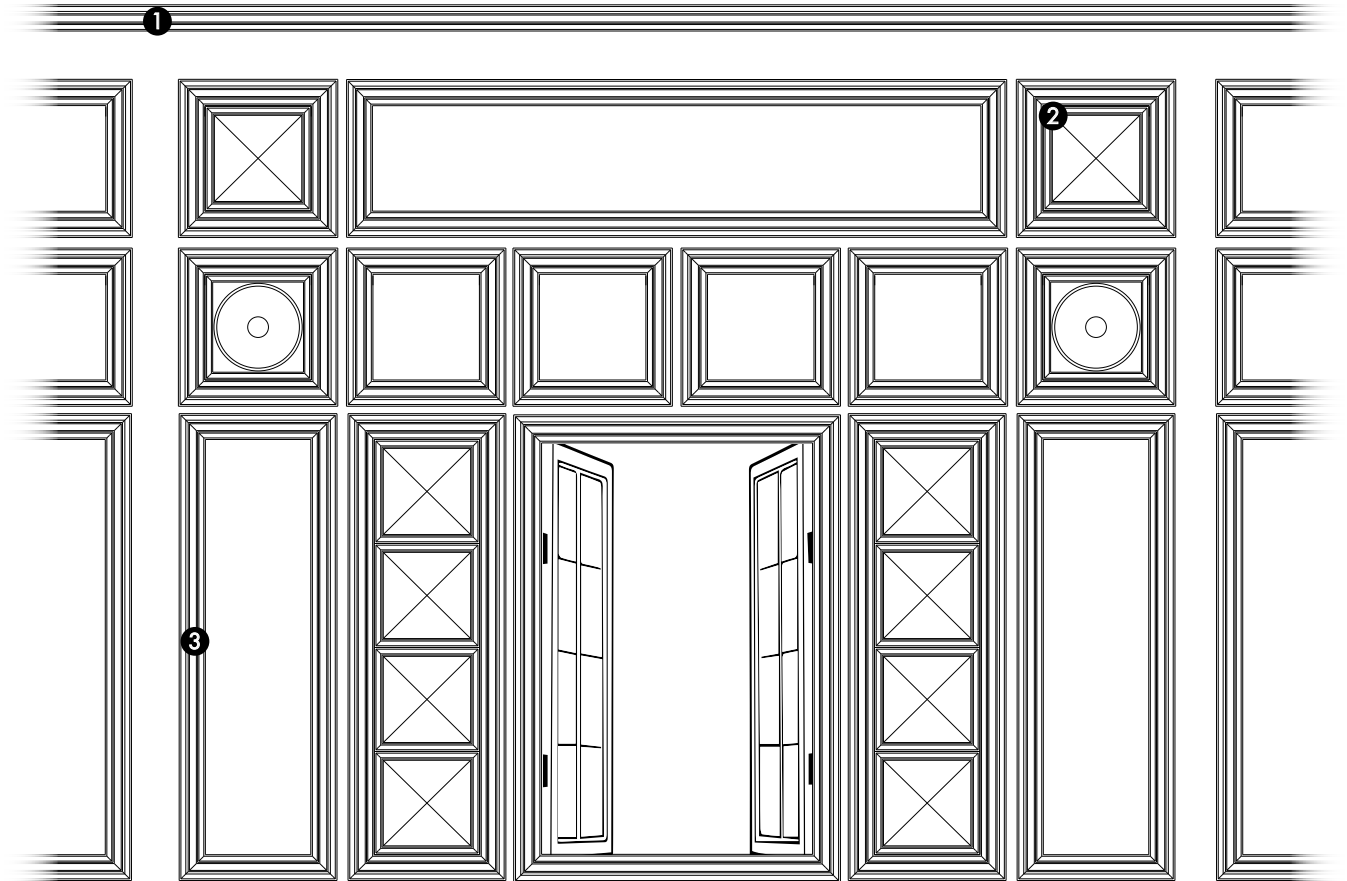

1 C324 pg. 46

2 W123 pg. 95

3 W120 pg. 95

4 P4025 pg. 76

5 W122 pg. 95

A repeating pattern immediately makes a plain wall look more interesting and put-together.



6 W121 pg. 95

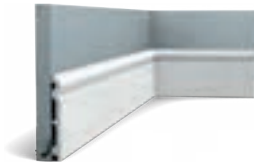

7 SX138 pg. 86



8 C344 pg. 65

Specially Created Profiles for the Heritage Collection

Create a special space with character. Use a separate frame with an identical design to create your own made-to-measure panels.

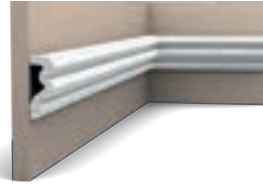

P4025

Our P4025 customizable framing profile allows you to create any sized panel to complete your design. This panel profile is also available in flexible form (FP4025) which is ideal for vaulted ceilings or curved walls.

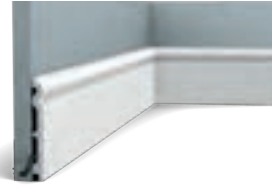

SX138

SX138 baseboard is the perfect foundation for building the Heritage wall system and elegantly ties the room together. Like all ORAC baseboards, the SX138 is impact resistant and impervious to moisture.



C324

C324 is designed to house LED lighting strips to illuminate recessed bookcases, bars, and niches.



C323

C323 is the top cap for the Heritage paneling system. This creates a seamless connection between the crown moulding and paneling.



Express creativity. Flexible moulding is ideal for vaulted ceilings or curved walls.

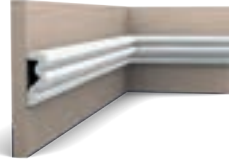

1 FP4025 pg. 76



2 W109 pg. 95



3 C324 pg. 46

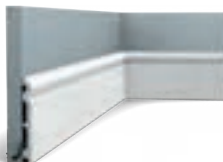

6 SX138 pg. 86



5 W121 pg. 95



4 W120 pg. 95

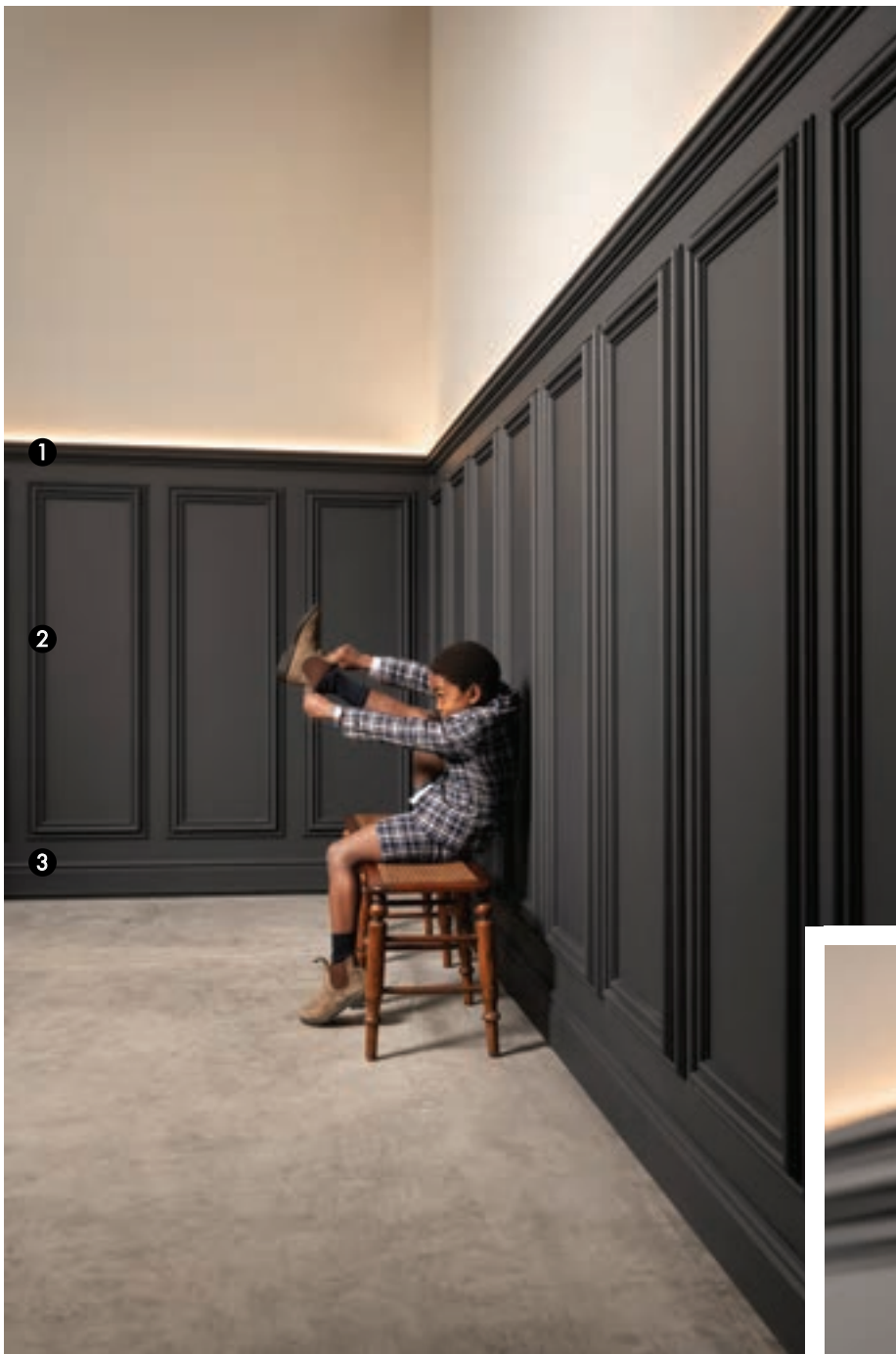

Integrate smart LED lighting now with classic wainscoting.

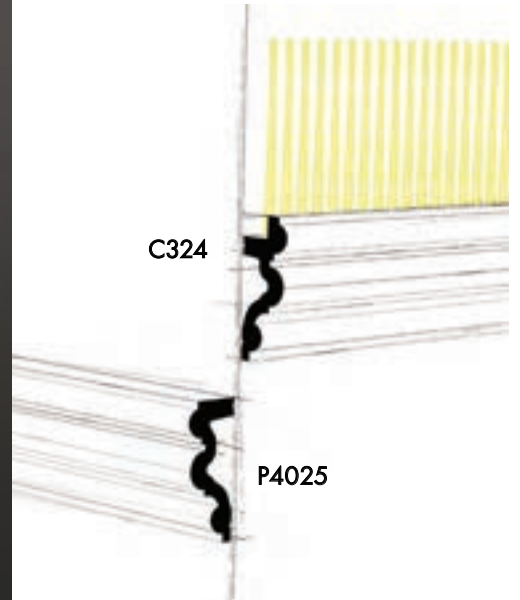

1 C324 pg. 46



2 W120 pg. 95

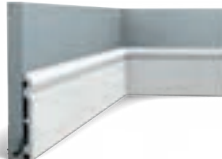

3 SX138 pg. 86



1 C324 pg. 46

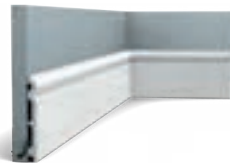

2 SX138 pg. 86

Introducing The Nobility Collection

Discover how the clever use of baseboards and door frames give this space a dignified appearance.



Elevated
baseboard

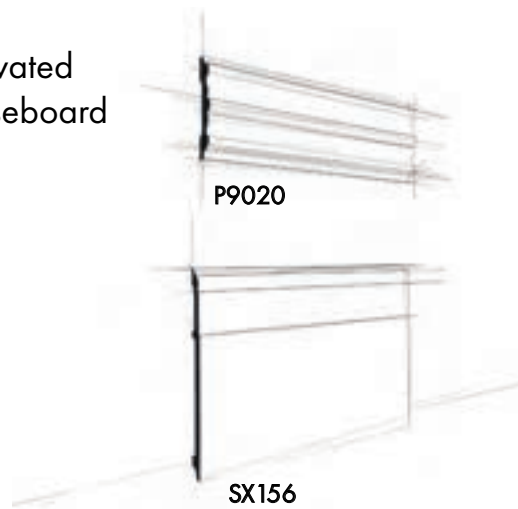



Do you like the effect of an extra-tall baseboard? Place a second profile above your baseboard and connect them through the use of color.

Door surrounds

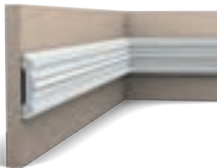
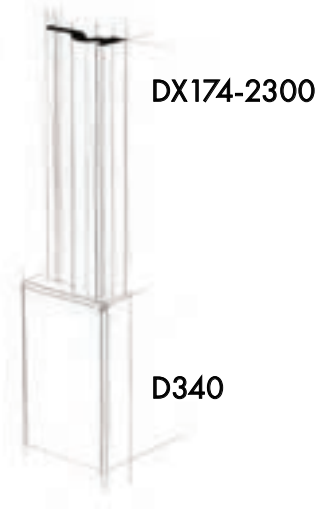

1 P9020 pg. 76



2 DX174-2300 pg. 105



3 SX156 pg. 87

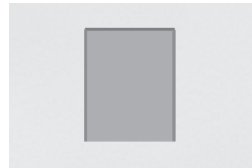

4 D340 pg. 105

Tall baseboards provide a distinctive accent and add decorative value to your interior. Go for a stately effect. Combine narrower profiles and coordinated color for a luxurious look.



1 P9020 pg. 76



3 SX156 pg. 87



1 C332 pg. 62



2 C323 pg. 54



3 DX170-2300 pg. 105



4 SX156 pg. 87

Introducing The Manor Collection

A classic interior traditionally combines floor, wall and ceiling ornaments. Discover the various elements we used to bring this space to life!



DX170-2300

Door surround

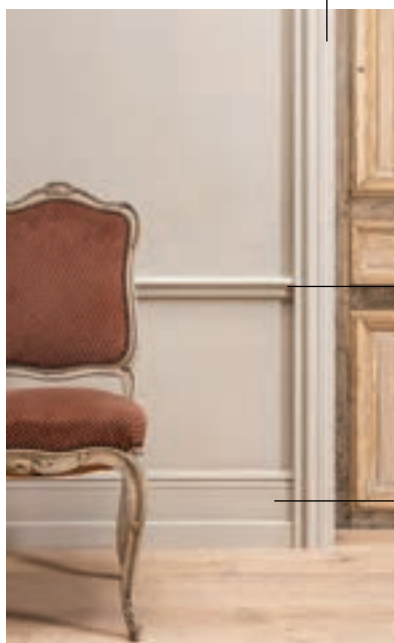

Chair rail

High baseboard

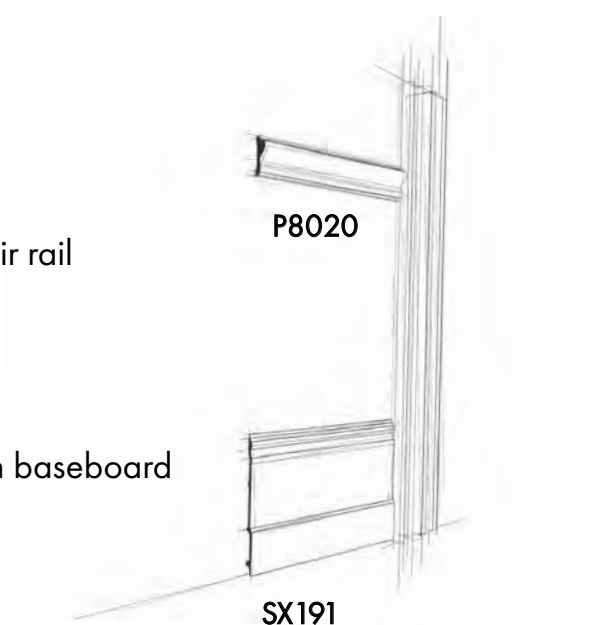

P8020

SX191



Constructed cornice

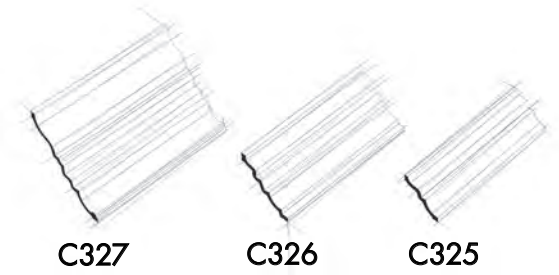

Light and shadow: a classic contrast that has earned its stripes. Fragmented cornice mouldings give your interior an instantly refined look.



1 C327 pg. 60

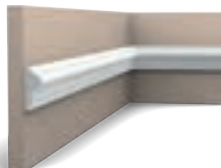

2 P8030 pg. 73



3 DX170-2300 pg. 105



4 P8020 pg. 75



5 SX191 pg. 87



Pull out all the stops when it comes to tradition. Ornaments add depth, liveliness and history. Employ flat chalk paint in warm greys for a natural look.



1 P8020 pg. 75



2 C340 pg. 64



3 PX103 pg. 73



4 P8030 pg. 73



5 SX156 pg. 87

Place one or more decorative profiles just below a narrow cornice moulding. This allows you to quickly and easily add an extra note to your space.



1

2

3

4



1 C327 pg. 60

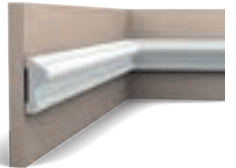

2 P8020 pg. 75

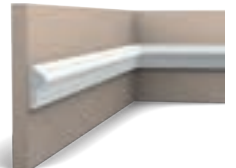

3 P8030 pg. 73

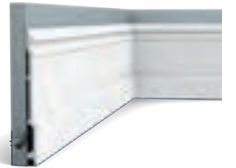

4 SX191 pg. 87

Introducing The Baroque Collection

Discover how we use an original combination of traditional decorative elements to make a room hip and trendy.



P3020A



1 P3020A pg. 78

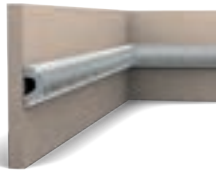

2 P3020 pg. 75



Ornamented
profiles



W130

3D wall covering



Even classic decorations can benefit from a (figurative) mismatch. Using a creative approach, you can transform traditional ornaments into a contemporary and stylish total picture.



1 C338B

pg. 63





2 W130

pg. 95

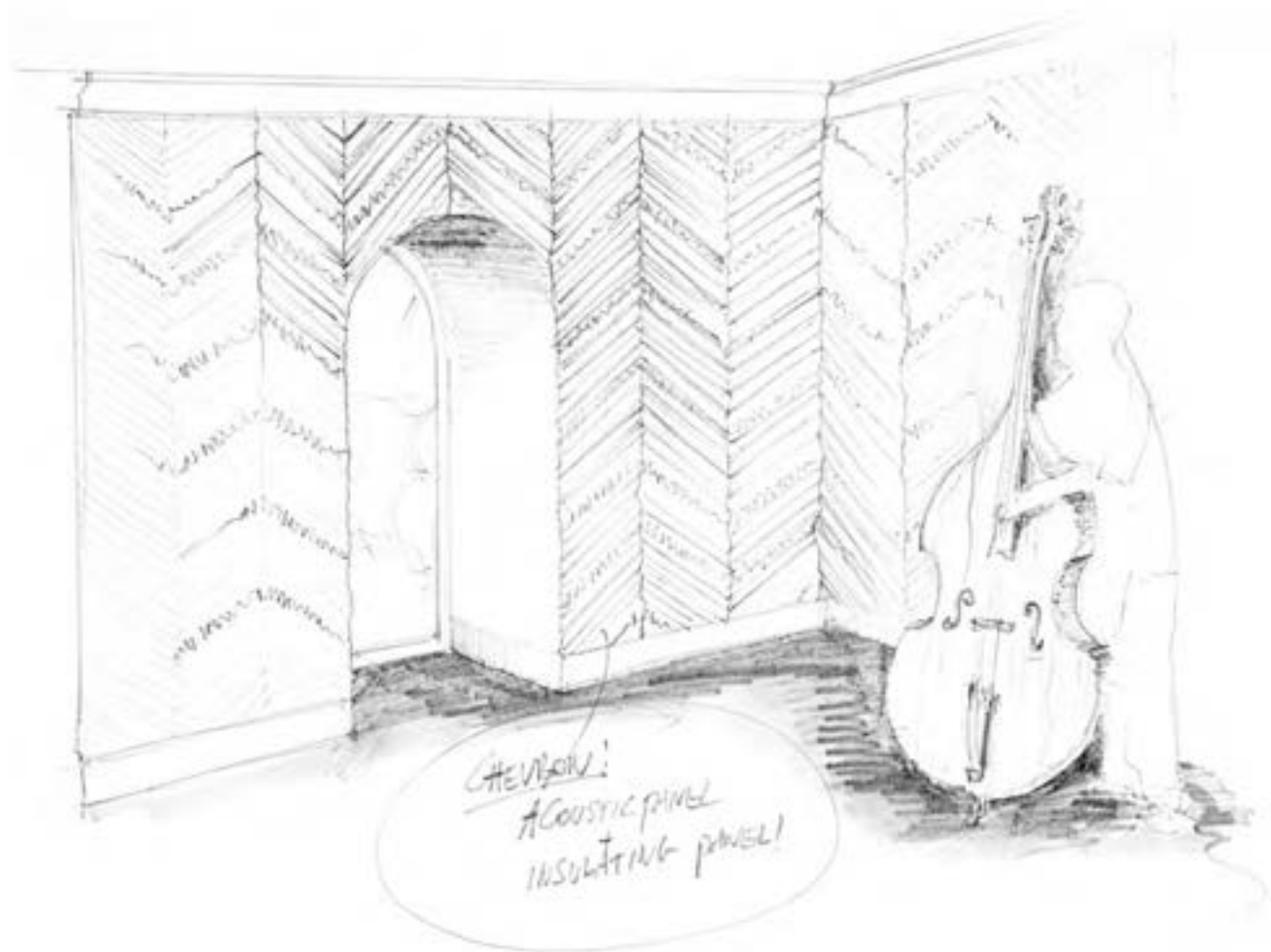
Eye-catching wall decorations with added acoustic and thermal value? Chevron combines the best of three worlds.

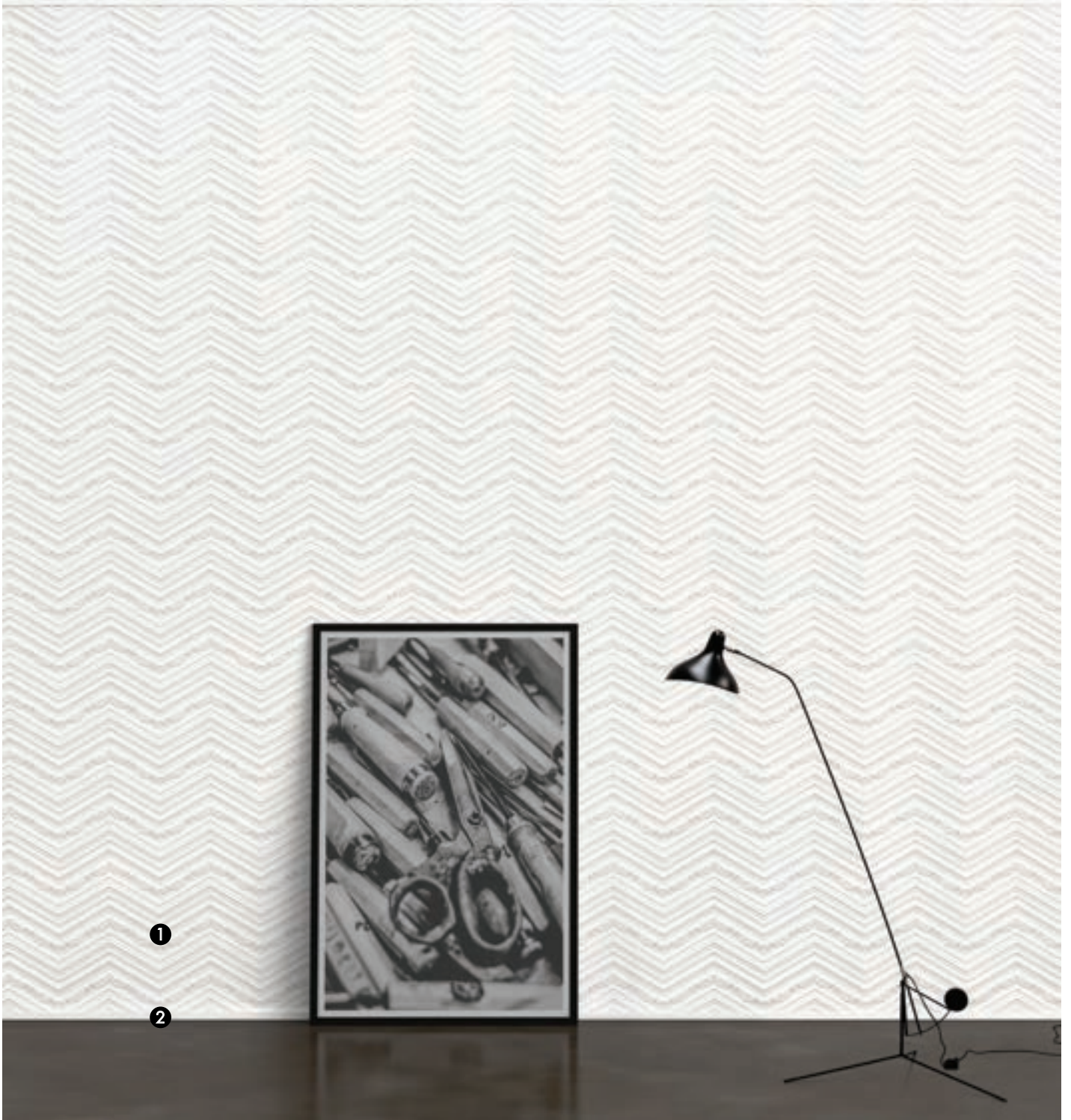



 Thermal Insulation

 Acoustic Absorption

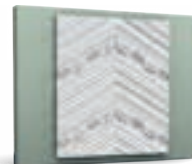

1 W130 pg. 95



2 CX190 pg. 45

Design tips & tricks

Elegant

Make your baseboards visually taller by painting the baseboard, wall paneling and the wall between in the same color!



1 C327 pg. 60



2 P8030 pg. 73

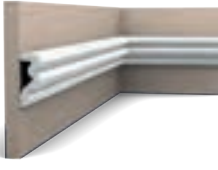

3 P4025 pg. 76



4 DX170-2300 pg. 105



5 DX174-2300 pg. 105



6 PX175 pg. 74



7 SX191 pg. 87

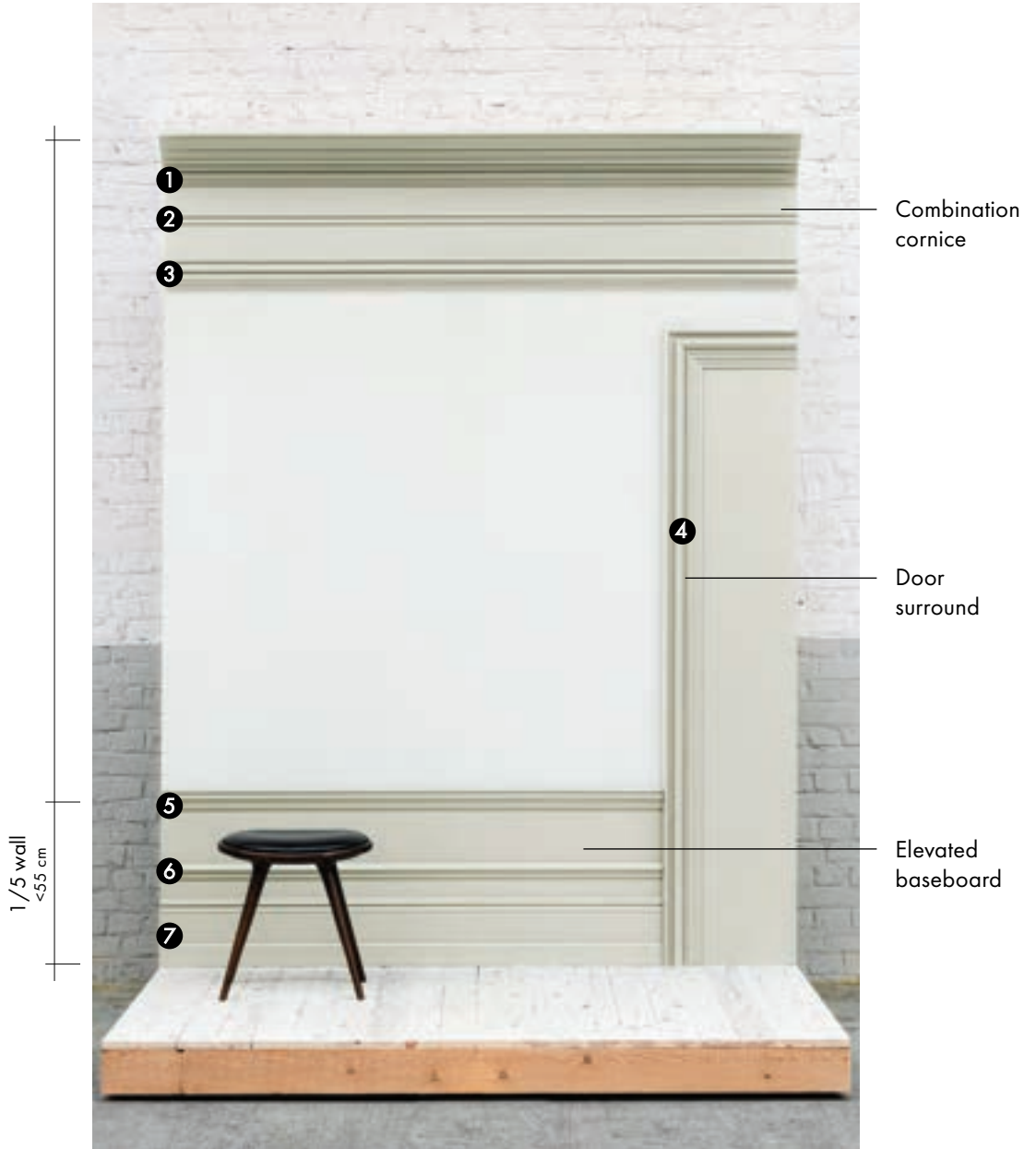

Design tips & tricks

Majestic

Position the chair rail at the height of your chair back. A little low is better than too high. Combine with wallpaper for a more ornate effect!

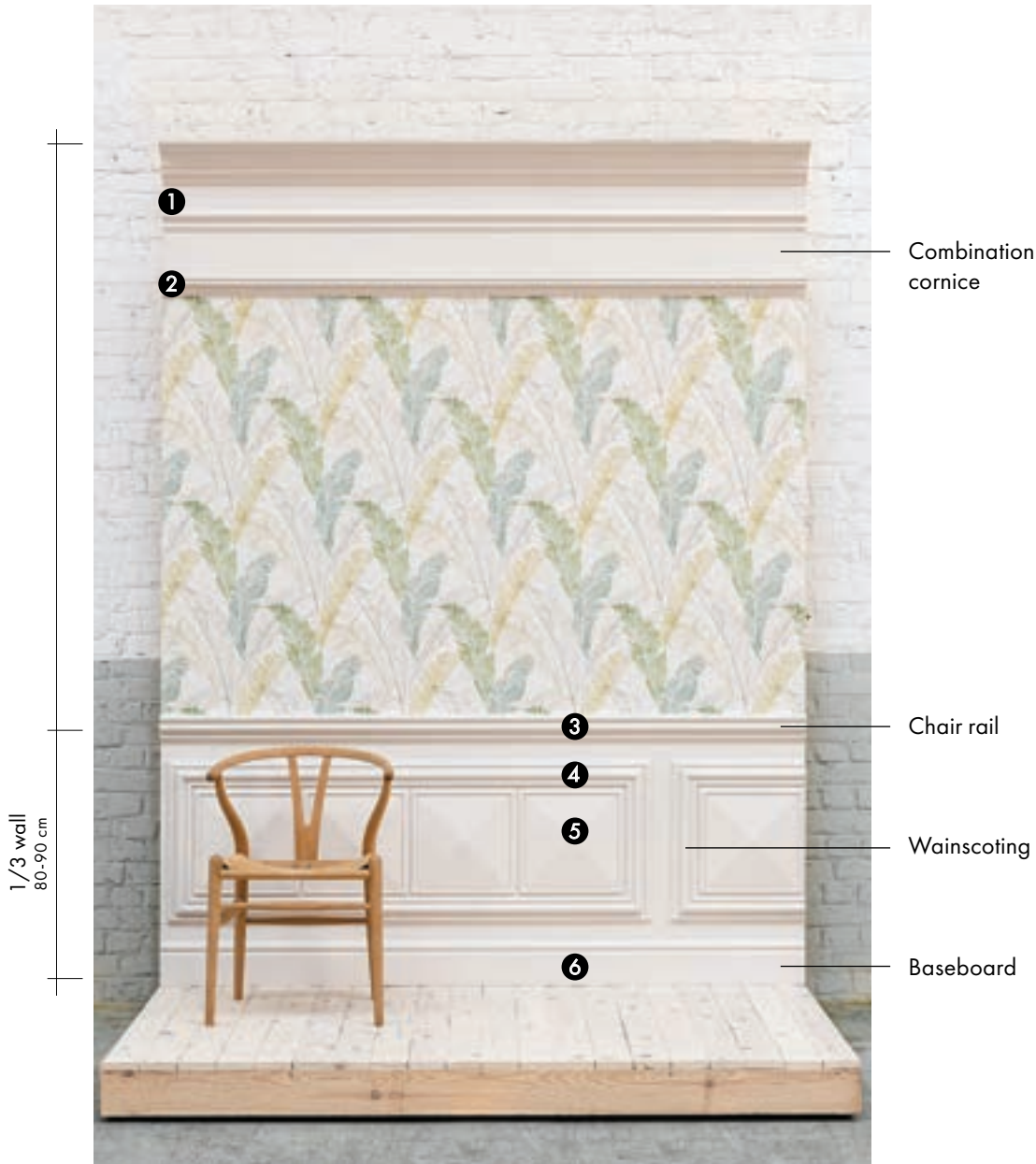

1 C340 pg. 64



2 C323 pg. 54

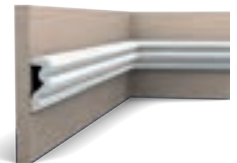

3 P4025 pg. 76



4 W120 pg. 95



5 W123 pg. 95

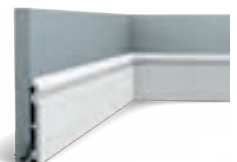

6 SX138 pg. 86

Design tips & tricks

Prestige

Perfect baseboard height for wainscoting? Baseboards are traditionally taller than the distances between other panels.



1 C332 pg. 62

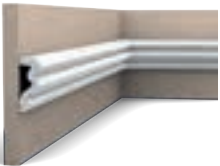

2 P4025 pg. 76



3 W120 pg. 95

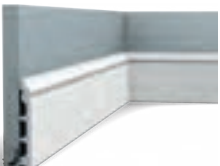

4 SX118 pg. 86



5 CX132 pg. 52

2/3 wall
160-180 cm



Cornice

Wainscoting

Baseboard

Design tips & tricks

High Class

Photo rails or borders at the top of your wall are usually positioned 30 to 50 cm below the ceiling. The taller the space, the greater the distance.

Full wall
30-50cm from ceiling

1
2
3
4
5

Cornice

Picture rail

Wainscoting

Baseboard

1 C343 pg. 64

2 C324 pg. 56

3 W120 pg. 95

4 W121 pg. 95

5 SX191 pg. 87

Design tips & tricks

Ceilings with cachet

The ceiling deserves as much attention as the other walls in your room. Well-thought-out decorations can make small spaces visually larger and large spaces more intimate. Use the same profiles as for the wall. It couldn't be simpler!



1 W121 pg. 95



2 W123 pg. 95



3 C327 pg. 60



4 C323 pg. 54

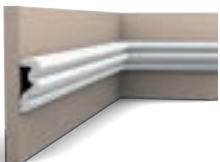

5 P4025 pg. 76



6 W120 pg. 95



7 DX170-2300 pg. 105

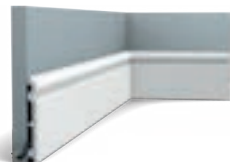

8 SX138 pg. 86

Design tips & tricks

Tranquil simplicity or playful movement on your ceiling

Are you looking for a simple border along the edges or a playful combination of frames and inserts? Follow your instincts and use the existing lines in your room such as windows and patterns on the walls.



1 W121 pg. 95



2 W120 pg. 95



3 W122 pg. 95



4 P4025 pg. 76

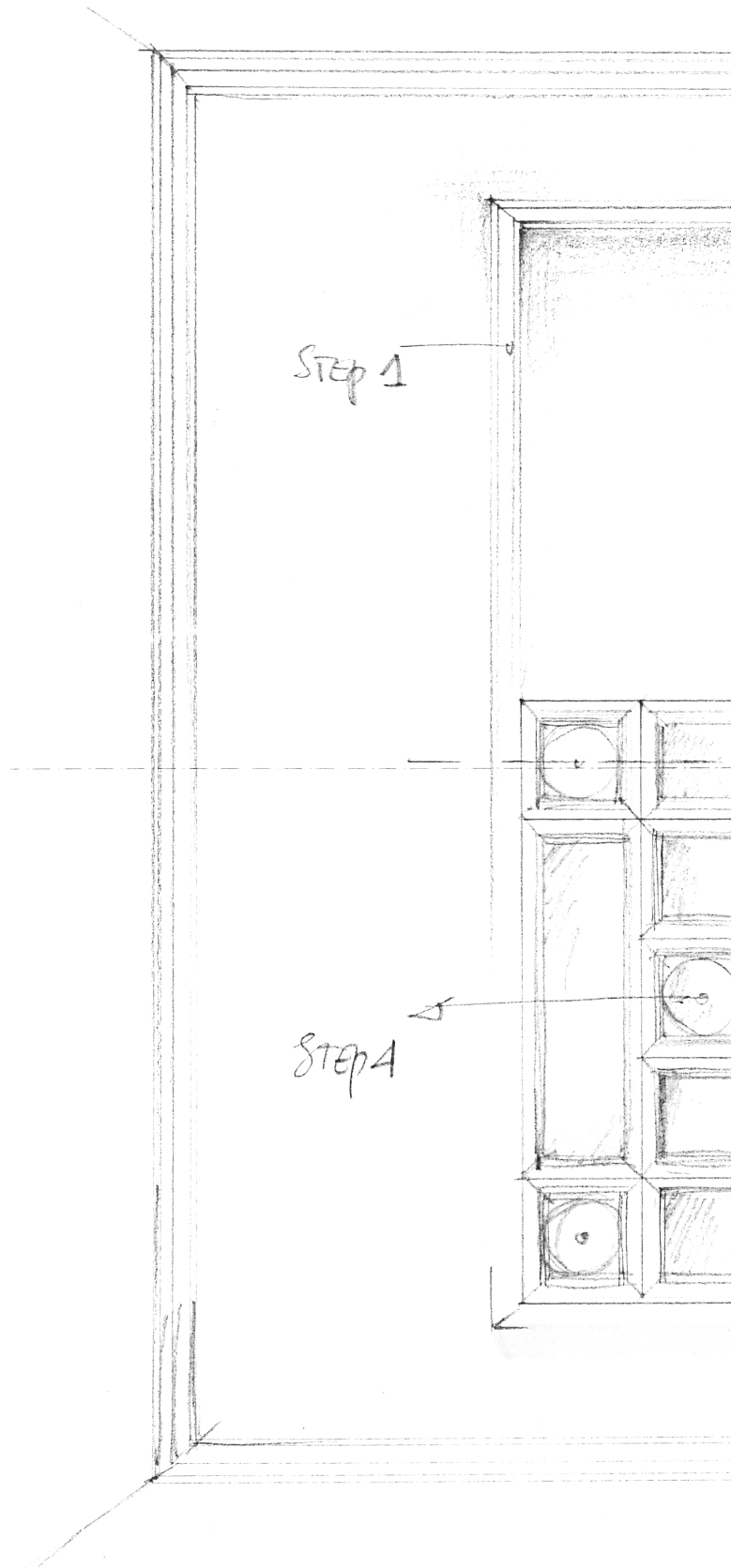

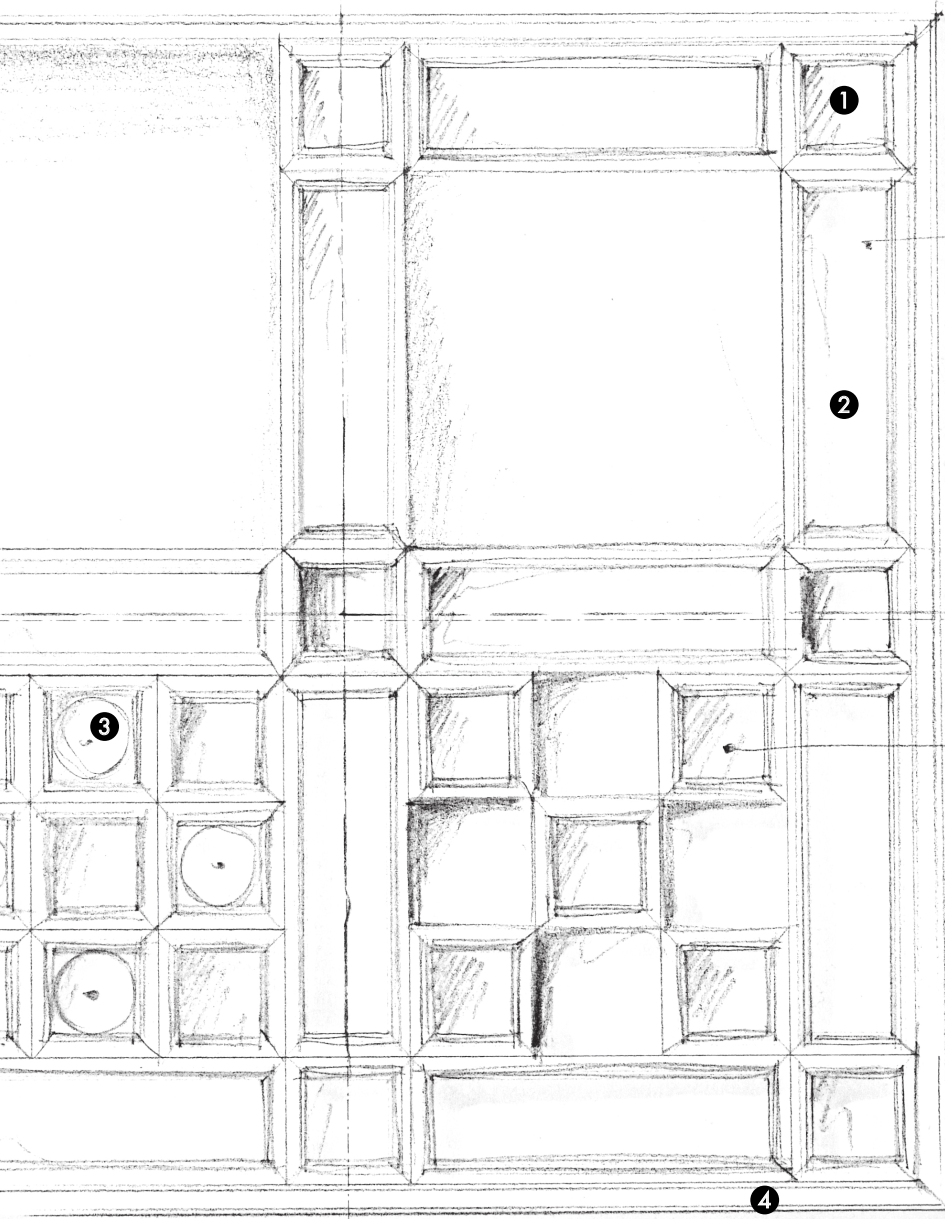

STEP 2

STEP 3

Design tips & tricks

Creative with color



Unicolor:

Continue the wall's color palette for a clean, coordinated effect.

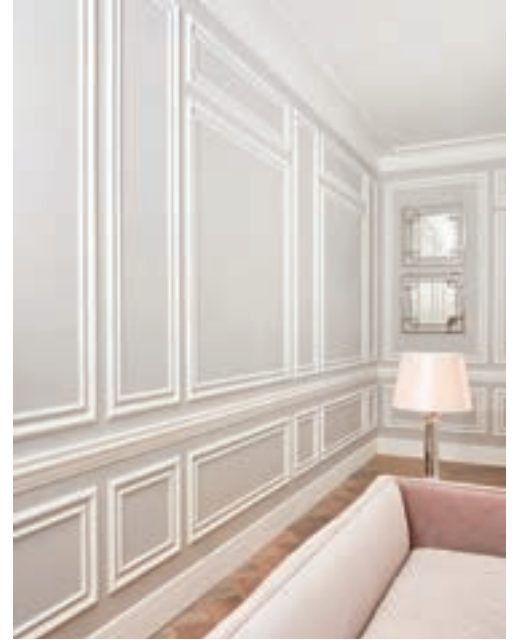

White mouldings:

Paint your photo and chair rails in classic white. For large mouldings, this draws attention to the architectural added value.



Horizontal blocks of color:

Use profiles to define the boundaries when employing multiple colors.



Graphic elements:

Highlight your wallpaper or wall decoration by framing it with one or more wall mouldings.

Advantages

 Paintable



 Water resistant



 Shock resistant

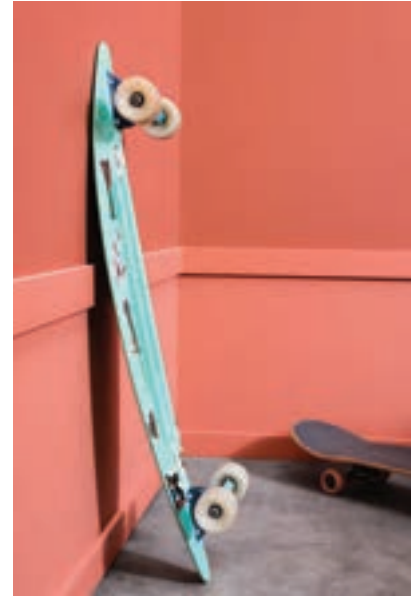

 Flexible



 Multifunctional

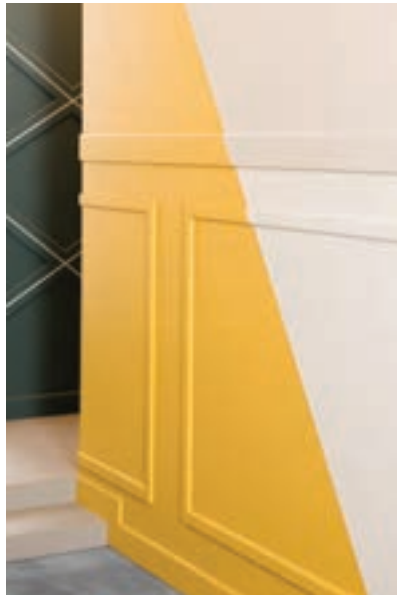

 Cover baseboard



Indirect Lighting

Indirect lighting creates a warm atmosphere and adds depth to a room by producing subtle lighting effects. Our innovative profiles for indirect lighting are specially designed to incorporate compact LEDs and disperse light evenly. They can direct light upward or downward and are offered in a variety of shapes and sizes to fit seamlessly into any interior.





Indirect Mouldings



CX190 | CX190F (Flexible)

Duropolym[®]
H: 3/4" | 2cm
P: 1-1/8" | 3cm
L: 6'6" | 200cm
Designed By
Orio Tonini

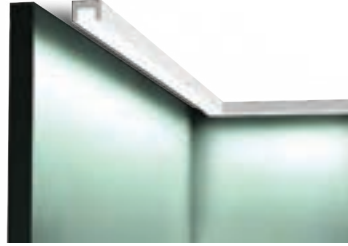

CX190 | CX190F (Flexible)

Duropolym[®]
H: 3/4" | 2cm
P: 1-1/8" | 3cm
L: 6'6" | 200cm
Designed By
Orio Tonini

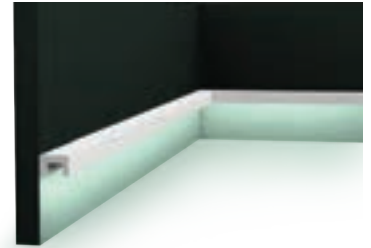

CX190 | CX190F (Flexible)

Duropolym[®]
H: 3/4" | 2cm
P: 1-1/8" | 3cm
L: 6'6" | 200cm
Designed By
Orio Tonini



CX189 | CX189F (Flexible)

Duropolym[®]
H: 1" | 2,7cm
P: 1" | 2,7cm
F: 1-3/8" | 3,5cm
L: 6'6" | 200cm
Designed By
Orio Tonini



CX188 | CX188F (Flexible)

Duropolym[®]
H: 1-3/8" | 3,4cm
P: 1-1/8" | 3cm
F: 1-1/2" | 3,9cm
L: 6'6" | 200cm
Designed By
Orio Tonini



C380

Purotouch[®]
H: 2" | 5cm
P: 2" | 5cm
F: 2-1/2" | 6,4cm
L: 6'6" | 200cm
Designed By
Orio Tonini

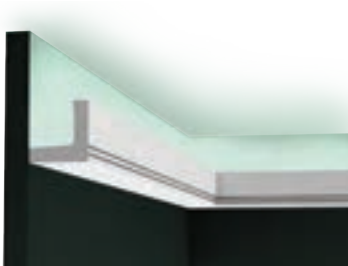

C361

Purotouch[®]
H: 2" | 5cm
P: 2" | 5cm
F: 2-3/4" | 7cm
L: 6'6" | 200cm
Designed By
Pierre Daems



C362

Purotouch[®]
H: 2" | 5cm
P: 2" | 5cm
F: 2-3/4" | 7cm
L: 6'6" | 200cm
Designed By
Pierre Daems



Purotouch[®] a proprietary polymer blend formulated to create deep reliefs and crisp details.

Collections

Duropolym[®] high impact resin blend. Ideally suited for baseboards and chair rails.



Indirect Mouldings



C323

Purotouch[®]

H: 2-1/8" | 5,5cm
P: 1-5/8" | 4,2cm
F: 2-3/4" | 7cm
L: 6'6" | 200cm

Designed By
Orio Tonini



C373 | FC373 (Flexible)

Purotouch[®]

H: 3-1/8" | 8cm
P: 2" | 5cm
F: 3-3/4" | 9,5cm
L: 6'6" | 200cm

Designed By
Ulf Moritz



C324

Purotouch[®]

H: 3-1/4" | 8,3cm
P: 1-3/8" | 3,4cm
L: 6'6" | 200cm

Designed By
Orio Tonini



C394

Purotouch[®]

H: 3-3/4" | 9,5cm
P: 1-1/4" | 3,1cm
F: 3-3/4" | 9,6cm
L: 6'6" | 200cm

Designed By
Orio Tonini



C381

Purotouch[®]

H: 3-3/4" | 9,5cm
P: 2" | 5cm
F: 3-3/4" | 9,6cm
L: 6'6" | 200cm

Designed By
Orio Tonini

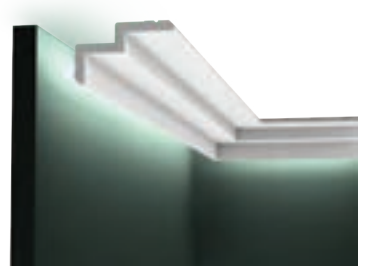

C390

Purotouch[®]

H: 2-3/8" | 6cm
P: 3-7/8" | 10cm
F: 4-1/8" | 10,5cm
L: 6'6" | 200cm

Designed By
Orio Tonini

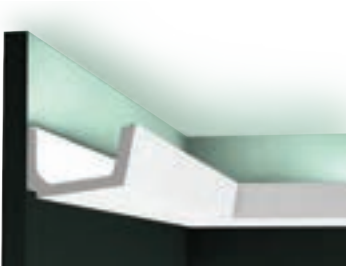

C357

Purotouch[®]

H: 2-3/4" | 7,1cm
P: 4-3/8" | 11cm
F: 5" | 12,6cm
L: 6'6" | 200cm

Designed By
Jacques Verfracht



C382

Purotouch[®]

H: 5-1/2" | 14cm
P: 2" | 5cm
F: 5" | 12,7cm
L: 6'6" | 200cm

Designed By
Orio Tonini



Purotouch[®] a proprietary polymer blend formulated to create deep reliefs and crisp details.

Collections

Duropolym[®] high impact resin blend. Ideally suited for baseboards and chair rails.



Indirect Mouldings



C383

Purotouch[®]

H: 5-1/2" | 14cm
P: 2" | 5cm
F: 5" | 12,8cm
L: 6'6" | 200cm

Designed By
Orio Tonini



C364

Purotouch[®]

H: 5-1/2" | 14cm
P: 3-1/8" | 8cm
F: 5-5/8" | 14,2cm
L: 6'6" | 200cm

Designed By Ulf Moritz
Red Dot Design Award 2014

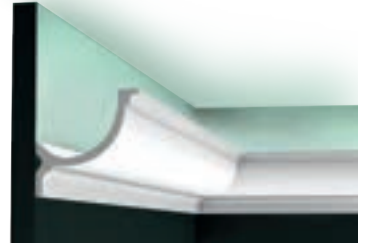

C902 | FC902 (Flexible)

Purotouch[®]

H: 4" | 10,3cm
P: 4" | 10,3cm
F: 5-5/8" | 14,2cm
L: 6'6" | 200cm

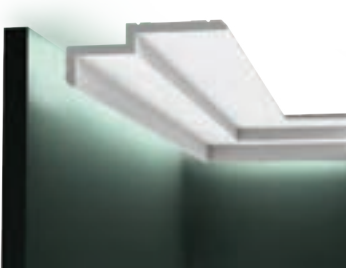

C391

Purotouch[®]

H: 2-3/8" | 6cm
P: 6-1/4" | 16cm
F: 5-7/8" | 14,8cm
L: 6'6" | 200cm

Designed By
Orio Tonini

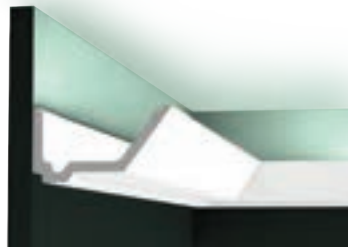
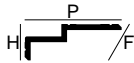

C358

Purotouch[®]

H: 2-7/8" | 7,3cm
P: 5-1/2" | 14cm
F: 6" | 15,3cm
L: 6'6" | 200cm

Designed By
Jacques Verfracht

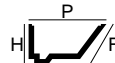

C395

Purotouch[®]

H: 6-1/8" | 15,5cm
P: 1-1/4" | 3,1cm
F: 6-1/8" | 15,6cm
L: 6'6" | 200cm

Designed By
Orio Tonini

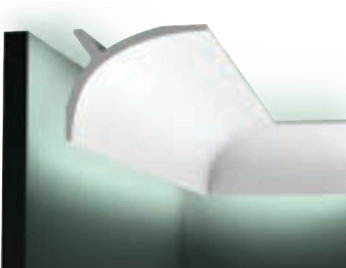

C991

Purotouch[®]

H: 4-3/8" | 11cm
P: 5-1/2" | 14cm
F: 7" | 17,8cm
L: 6'6" | 200cm

Designed By
Ulf Moritz

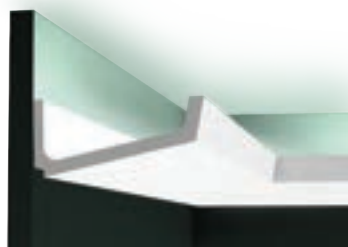
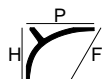

C352

Purotouch[®]

H: 3" | 7,6cm
P: 6-3/4" | 17,1cm
F: 7-1/8" | 18,1cm
L: 6'6" | 200cm

Designed By
Jacques Verfracht

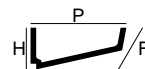

Purotouch[®] a proprietary polymer blend formulated to create deep reliefs and crisp details.

Collections

Duopolymer[®] high impact resin blend. Ideally suited for baseboards and chair rails.



Indirect Mouldings



C374 | FC374 (Flexible)

Purotouch[®]

H: 7-1/8" | 18cm
P: 2" | 5cm
F: 7-3/8" | 18,6cm
L: 6'6" | 200cm

Designed By
Ulf Moritz



C396

Purotouch[®]

H: 7-1/4" | 18,5cm
P: 2-3/8" | 6,1cm
F: 7-1/2" | 19,1cm
L: 6'6" | 200cm

Designed By
Orio Tonini

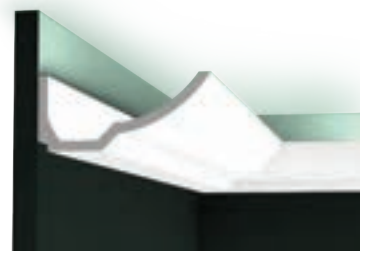
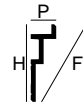

C351

Purotouch[®]

H: 2-7/8" | 7,4cm
P: 6-3/4" | 17,3cm
F: 7-1/2" | 19cm
L: 6'6" | 200cm

Designed By
Jacques Verfracht

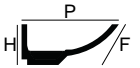

C371

Purotouch[®]

H: 7-1/4" | 18,5cm
P: 2-1/4" | 5,8cm
F: 7-1/2" | 19cm
L: 6'6" | 200cm

Designed By
Ulf Moritz

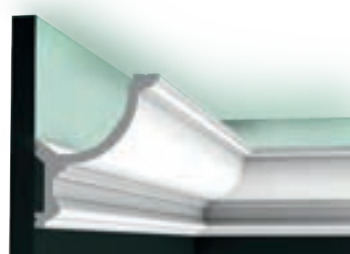
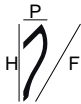

C901 | FC901 (Flexible)

Purotouch[®]

H: 5-7/8" | 14,8cm
P: 4-7/8" | 12,4cm
F: 7-1/2" | 19,2cm
L: 6'6" | 200cm

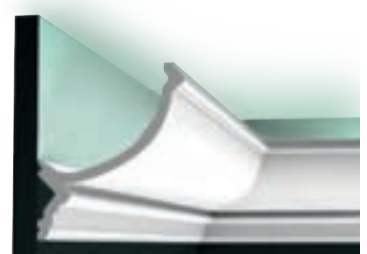
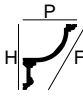

C900

Purotouch[®]

H: 6-3/4" | 17,1cm
P: 5-3/4" | 14,6cm
F: 8-5/8" | 21,8cm
L: 6'6" | 200cm

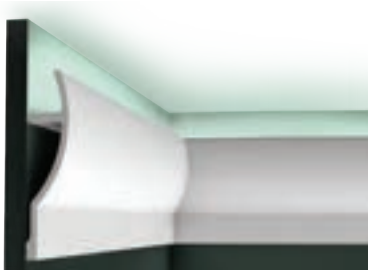
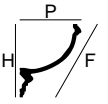

C372

Purotouch[®]

H: 11" | 28cm
P: 2-3/4" | 7cm
F: 11-1/8" | 28,4cm
L: 6'6" | 200cm

Designed By
Ulf Moritz

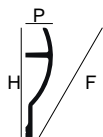

SX179

Duropolym[®]

H: 3-7/8" | 9,7cm
P: 1-1/8" | 2,9cm
F: 3-7/8" | 9,8cm
L: 6'6" | 200cm

Designed By
Orio Tonini



Purotouch[®] a proprietary polymer blend formulated to create deep reliefs and crisp details.

Collections

Duropolym[®] high impact resin blend. Ideally suited for baseboards and chair rails.

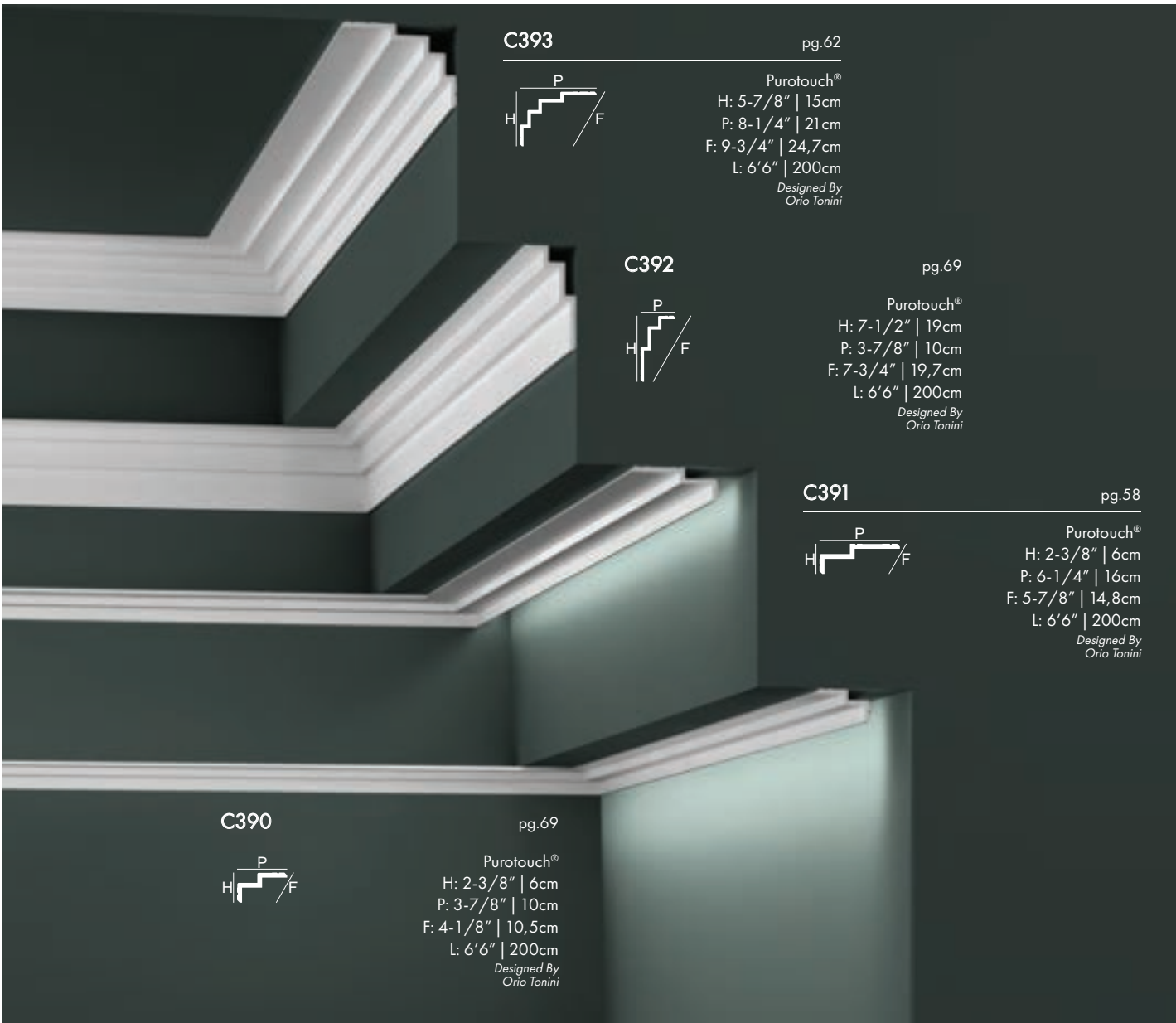

C393

pg.62



Purotouch®
 H: 5-7/8" | 15cm
 P: 8-1/4" | 21cm
 F: 9-3/4" | 24,7cm
 L: 6'6" | 200cm
Designed By
Orio Tonini

C392

pg.69



Purotouch®
 H: 7-1/2" | 19cm
 P: 3-7/8" | 10cm
 F: 7-3/4" | 19,7cm
 L: 6'6" | 200cm
Designed By
Orio Tonini

C391

pg.58



Purotouch®
 H: 2-3/8" | 6cm
 P: 6-1/4" | 16cm
 F: 5-7/8" | 14,8cm
 L: 6'6" | 200cm
Designed By
Orio Tonini

C390

pg.69



Purotouch®
 H: 2-3/8" | 6cm
 P: 3-7/8" | 10cm
 F: 4-1/8" | 10,5cm
 L: 6'6" | 200cm
Designed By
Orio Tonini





Steps

Linear Movement

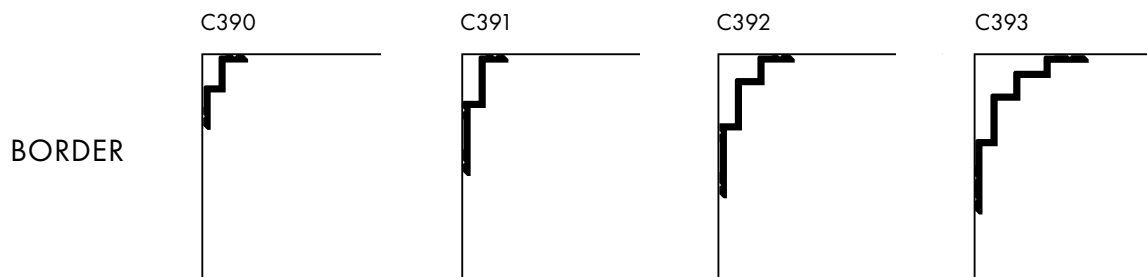
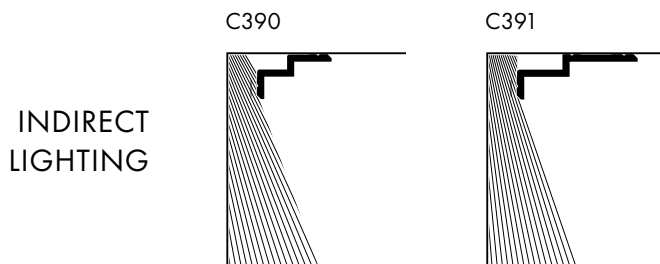
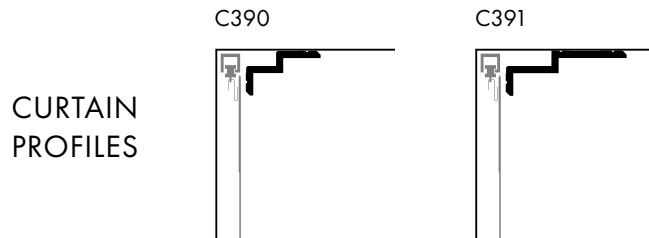
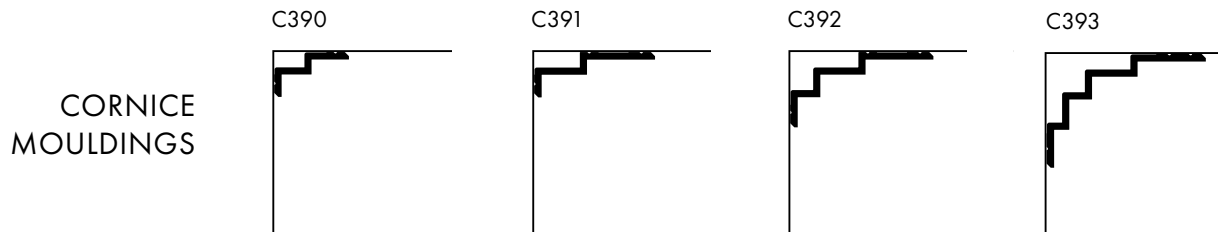
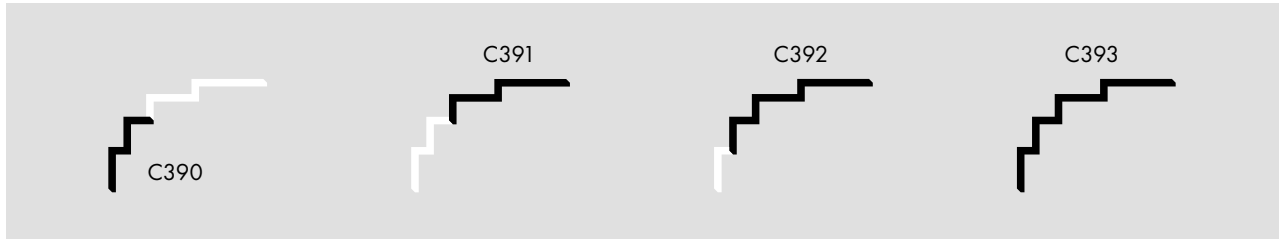

Cornice Mouldings

A cornice creates a visually attractive transition from wall to ceiling. From sleek to baroque, from decorative to functional, we offer a quality solution for every budget. The profiles are easy to install and a large number of designs are available in flexible versions.





Cornice Mouldings



C250 | FC250 (Flexible)

Purotouch[®]

H: 5/8" | 1,6cm
P: 5/8" | 1,6cm
F: 7/8" | 2,2cm
L: 6'6" | 200cm



CX133

Duopolymer[®]

H: 3/4" | 2cm
P: 3/4" | 2cm
F: 1-1/8" | 2,7cm
L: 6'6" | 200cm



CX111

Duopolymer[®]

H: 1" | 2,6cm
P: 5/8" | 1,5cm
F: 1-1/8" | 2,8cm
L: 6'6" | 200cm



CX132 | CX132F (Flexible)

Duopolymer[®]

H: 3/4" | 2cm
P: 3/4" | 2cm
F: 1-1/8" | 2,8cm
L: 6'6" | 200cm

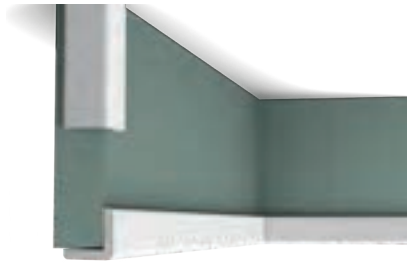

CX134

Duopolymer[®]

H: 1-1/8" | 3cm
P: 1-1/8" | 3cm
L: 6'6" | 200cm



PX164

Duopolymer[®]

H: 1-1/8" | 3cm
P: 1" | 2,4cm
F: 1-1/2" | 3,9cm
L: 6'6" | 200cm



CX115

Duopolymer[®]

H: 1-1/8" | 3cm
P: 1-1/8" | 2,9cm
F: 1-1/2" | 3,9cm
L: 6'6" | 200cm



C230 | FC230 (Flexible)

Purotouch[®]

H: 1-1/8" | 2,9cm
P: 1-1/8" | 2,9cm
F: 1-5/8" | 4cm
L: 6'6" | 200cm



CX154

Purotouch[®]

H: 1-1/8" | 3cm
P: 1-1/8" | 3cm
F: 1-5/8" | 4,1cm
L: 6'6" | 200cm



Purotouch[®] a proprietary polymer blend formulated to create deep reliefs and crisp details.

Collections

Duopolymer[®] high impact resin blend. Ideally suited for baseboards and chair rails.



Cornice Mouldings



CX151

Duopolymer[®]

H: 1-5/8" | 4cm

P: 7/8" | 2,3cm

F: 1-3/4" | 4,6cm

L: 6'6" | 200cm



CX148 | CX148F (Flexible)

Duopolymer[®]

H: 1-3/4" | 4,3cm

P: 1-1/8" | 2,9cm

F: 2" | 5,1cm

L: 6'6" | 200cm



CX150

Duopolymer[®]

H: 1-3/4" | 4,3cm

P: 1-1/8" | 2,9cm

F: 2" | 5,1cm

L: 6'6" | 200cm



CX110 | CX110F (Flexible)

Duopolymer[®]

H: 1-3/4" | 4,5cm

P: 1-5/8" | 4,1cm

F: 2-1/4" | 5,8cm

L: 6'6" | 200cm



C360

Purotouch[®]

H: 7/8" | 2,1cm

P: 2-3/8" | 6cm

F: 2-3/8" | 6cm

L: 6'6" | 200cm

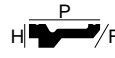

C260 | FC260 (Flexible)

Duopolymer[®]

H: 1-5/8" | 4,1cm

P: 1-7/8" | 4,8cm

F: 2-3/8" | 6cm

L: 6'6" | 200cm



CX109 | CX109F (Flexible)

Duopolymer[®]

H: 1-3/4" | 4,4cm

P: 1-3/4" | 4,4cm

F: 2-3/8" | 6,1cm

L: 6'6" | 200cm



C322 | FC322 (Flexible)

Purotouch[®]

H: 2" | 5cm

P: 1-5/8" | 4,2cm

F: 2-1/2" | 6,3cm

L: 6'6" | 200cm



C215 | FC215 (Flexible)

Purotouch[®]

H: 1-7/8" | 4,7cm

P: 1-7/8" | 4,7cm

F: 2-5/8" | 6,6cm

L: 6'6" | 200cm



Purotouch[®] a proprietary polymer blend formulated to create deep reliefs and crisp details.

Collections

Duopolymer[®] high impact resin blend. Ideally suited for baseboards and chair rails.



Cornice Mouldings



CX112

Duropolym[®]
H: 2-1/8" | 5,4cm
P: 1-1/2" | 3,8cm
F: 2-5/8" | 6,6cm
L: 6'6" | 200cm



CX141

Duropolym[®]
H: 2-3/8" | 5,9cm
P: 1-1/4" | 3,1cm
F: 2-5/8" | 6,7cm
L: 6'6" | 200cm



CX124 | CX124F (Flexible)

Duropolym[®]
H: 1-7/8" | 4,9cm
P: 1-7/8" | 4,9cm
F: 2-5/8" | 6,8cm
L: 6'6" | 200cm



C323

Purotouch[®]
H: 2-1/8" | 5,5cm
P: 1-5/8" | 4,2cm
F: 2-3/4" | 6,9cm
L: 6'6" | 200cm
*Designed By
Orio Tonini*



C602 | FC602 (Flexible)

Purotouch[®]
H: 2-1/8" | 5,3cm
P: 2" | 5cm
F: 2-7/8" | 7,2cm
L: 6'6" | 200cm



C214 | FC214 (Flexible)

Purotouch[®]
H: 2-5/8" | 6,6cm
P: 1-1/8" | 3,1cm
F: 2-7/8" | 7,3cm
L: 6'6" | 200cm



CX108

Duropolym[®]
H: 2-1/8" | 5,4cm
P: 2-1/8" | 5,4cm
F: 3" | 7,6cm
L: 6'6" | 200cm



C200 | FC200 (Flexible)

Purotouch[®]
H: 2-1/2" | 6,5cm
P: 2-1/4" | 5,7cm
F: 3-3/8" | 8,5cm
L: 6'6" | 200cm



C212 | FC212 (Flexible)

Purotouch[®]
H: 2-7/8" | 7,3cm
P: 1-3/4" | 4,5cm
F: 3-3/8" | 8,5cm
L: 6'6" | 200cm



Purotouch[®] a proprietary polymer blend formulated to create deep reliefs and crisp details.

Collections

Duropolym[®] high impact resin blend. Ideally suited for baseboards and chair rails.



Cornice Mouldings



CX176

Duopolymer[®]

H: 3-1/8" | 8cm
P: 1-5/8" | 4cm
F: 3-1/2" | 8,9cm
L: 6'6" | 200cm



CX177

Duopolymer[®]

H: 2-3/4" | 7cm
P: 2-3/8" | 6cm
F: 3-5/8" | 9,2cm
L: 6'6" | 200cm



C394

Purotouch[®]

H: 3-3/4" | 9,5cm
P: 1-1/4" | 3,1cm
F: 3-3/4" | 9,6cm
L: 6'6" | 200cm

Designed By
Orio Tonini



C394

Purotouch[®]

H: 1-1/4" | 3,1cm
P: 3-3/4" | 9,5cm
F: 3-3/4" | 9,6cm
L: 6'6" | 200cm

Designed By
Orio Tonini



CX325 | FC325 (Flexible)

Purotouch[®]

H: 2-3/4" | 7cm
P: 2-1/2" | 6,5cm
F: 3-3/4" | 9,6cm
L: 6'6" | 200cm



CX100 | CX100F (Flexible)

Duopolymer[®]

H: 2-3/4" | 6,9cm
P: 2-3/4" | 7,1cm
F: 3-3/4" | 9,7cm
L: 6'6" | 200cm



CX101

Duopolymer[®]

H: 2-3/4" | 6,9cm
P: 2-3/4" | 7,1cm
F: 3-3/4" | 9,7cm
L: 6'6" | 200cm



CX136

Purotouch[®]

H: 2-3/4" | 6,9cm
P: 2-3/4" | 7,1cm
F: 3-3/4" | 9,7cm
L: 6'6" | 200cm



C356

Purotouch[®]

H: 3/4" | 2cm
P: 3-7/8" | 10cm
F: 3-7/8" | 10cm
L: 6'6" | 200cm

Designed By
Jacques Verfracht

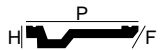

Purotouch[®] a proprietary polymer blend formulated to create deep reliefs and crisp details.

Collections

Duopolymer[®] high impact resin blend. Ideally suited for baseboards and chair rails.



Cornice Mouldings



C390

Purotouch[®]

H: 2-3/8" | 6cm
P: 3-7/8" | 10cm
F: 4-1/8" | 10,5cm
L: 6'6" | 200cm

Designed By
Orio Tonini



C321 | FC321 (Flexible)

Duopolymer[®]

H: 3-7/8" | 9,9cm
P: 2" | 5cm
F: 4-1/4" | 10,8cm
L: 6'6" | 200cm



C355

Purotouch[®]

H: 1-3/8" | 3,5cm
P: 4-3/8" | 11,1cm
F: 4-3/8" | 11,1cm
L: 6'6" | 200cm

Designed By
Jacques Verfracht

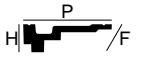

CX123 | CX123F (Flexible)

Purotouch[®]

H: 3-1/8" | 8cm
P: 3-1/8" | 8cm
F: 4-3/8" | 11cm
L: 6'6" | 200cm

Designed By
Jacques Verfracht



C240 | FC240 (Flexible)

Duopolymer[®]

H: 3-1/8" | 8cm
P: 3-1/8" | 8cm
F: 4-1/2" | 11,3cm
L: 6'6" | 200cm



C213 | FC213 (Flexible)

Purotouch[®]

H: 3-1/8" | 8cm
P: 3-1/8" | 8cm
F: 4-1/2" | 11,4cm
L: 6'6" | 200cm

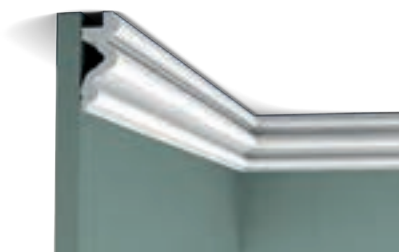

C324

Purotouch[®]

H: 3-1/4" | 8,3cm
P: 1-3/8" | 3,4cm
L: 6'6" | 200cm

Designed By
Orio Tonini



C400

Purotouch[®]

H: 2-3/8" | 6cm
P: 3-7/8" | 10cm
F: 4-5/8" | 11,7cm
L: 6'6" | 200cm



CX126

Duopolymer[®]

H: 3-3/8" | 8,7cm
P: 3-3/8" | 8,7cm
F: 4-3/4" | 12,2cm
L: 6'6" | 200cm



Purotouch[®] a proprietary polymer blend formulated to create deep reliefs and crisp details.

Collections

Duopolymer[®] high impact resin blend. Ideally suited for baseboards and chair rails.



Cornice Mouldings



C201 | FC201 (Flexible)

Purotouch[®]

H: 4-5/8" | 11,6cm
P: 1-7/8" | 4,8cm
F: 4-7/8" | 12,5cm
L: 6'6" | 200cm



CX127 | CX127F (Flexible)

Duopolymer[®]

H: 3-3/4" | 9,4cm
P: 3-3/4" | 9,4cm
F: 5-1/8" | 13cm
L: 6'6" | 200cm



CX128

Duopolymer[®]

H: 3-3/4" | 9,4cm
P: 3-3/4" | 9,4cm
F: 5-1/8" | 13cm
L: 6'6" | 200cm



CX129

Duopolymer[®]

H: 3-3/4" | 9,4cm
P: 3-3/4" | 9,4cm
F: 5-1/8" | 13cm
L: 6'6" | 200cm



CX192

Duopolymer[®]

H: 4-3/4" | 12cm
P: 2-3/8" | 6cm
F: 5-1/4" | 13,4cm
L: 6'6" | 200cm

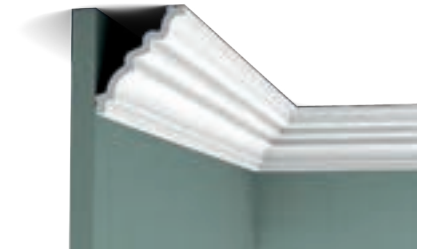

C326 | FC326 (Flexible)

Purotouch[®]

H: 4-1/8" | 10,5cm
P: 3-1/2" | 9cm
F: 5-3/8" | 13,8cm
L: 6'6" | 200cm



C220 | FC220 (Flexible)

Purotouch[®]

H: 3" | 7,6cm
P: 4-5/8" | 11,6cm
F: 5-3/8" | 13,6cm
L: 6'6" | 200cm

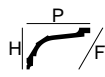

C402 | FC402 (Flexible)

Purotouch[®]

H: 4-1/4" | 10,7cm
P: 3-3/4" | 9,4cm
F: 5-1/2" | 13,9cm
L: 6'6" | 200cm



C304 | FC304 (Flexible)

Purotouch[®]

H: 4-3/4" | 12,2cm
P: 2-7/8" | 7,2cm
F: 5-1/2" | 13,9cm
L: 6'6" | 200cm



Purotouch[®] a proprietary polymer blend formulated to create deep reliefs and crisp details.

Collections

Duopolymer[®] high impact resin blend. Ideally suited for baseboards and chair rails.



Cornice Mouldings



C902 | FC902 (Flexible)

Purotouch[®]

H: 4" | 10,3cm
P: 4" | 10,3cm
F: 5-5/8" | 14,2cm
L: 6'6" | 200cm



C331 | FC331 (Flexible)

Purotouch[®]

H: 2-1/2" | 6,4cm
P: 5-3/8" | 13,5cm
F: 5-3/4" | 14,5cm
L: 6'6" | 200cm

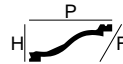

C391

Purotouch[®]

H: 2-3/8" | 6cm
P: 6-1/4" | 16cm
F: 5-7/8" | 14,8cm
L: 6'6" | 200cm

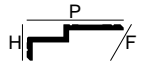

C302 | FC302 (Flexible)

Purotouch[®]

H: 5" | 12,8cm
P: 3-3/8" | 8,5cm
F: 5-7/8" | 15cm
L: 6'6" | 200cm



C341 | FC341 (Flexible)

Purotouch[®]

H: 3-1/2" | 8,8cm
P: 4-3/4" | 12,2cm
F: 5-7/8" | 15cm
L: 6'6" | 200cm

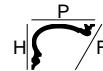

C339 | FC339 (Flexible)

Purotouch[®]

H: 5-1/2" | 14,1cm
P: 2-1/2" | 6,4cm
F: 6" | 15,2cm
L: 6'6" | 200cm



C303 | FC303 (Flexible)

Purotouch[®]

H: 5-5/8" | 14,4cm
P: 2-1/2" | 6,5cm
F: 6" | 15,3cm
L: 6'6" | 200cm



C395

Purotouch[®]

H: 6-1/8" | 15,5cm
P: 1-1/4" | 3,1cm
F: 6-1/8" | 15,6cm
L: 6'6" | 200cm
Designed By
Orio Tonini



C395

Purotouch[®]

H: 1-1/4" | 3,1cm
P: 6-1/8" | 15,5cm
F: 6-1/8" | 15,6cm
L: 6'6" | 200cm
Designed By
Orio Tonini

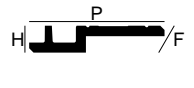

Purotouch[®] a proprietary polymer blend formulated to create deep reliefs and crisp details.

Collections

Duropolym[®] high impact resin blend. Ideally suited for baseboards and chair rails.



Cornice Mouldings



C211 | FC211 (Flexible)

Purotouch[®]

H: 4-5/8" | 11,6cm
P: 4-3/8" | 11,2cm
F: 6-1/4" | 15,8cm
L: 6'6" | 200cm



C305

Purotouch[®]

H: 1-7/8" | 4,7cm
P: 6-1/8" | 15,5cm
F: 6-1/4" | 15,9cm
L: 6'6" | 200cm



C333 | FC333 (Flexible)

Purotouch[®]

H: 4-3/4" | 12,2cm
P: 4-3/8" | 11,1cm
F: 6-3/8" | 16,2cm
L: 6'6" | 200cm



CX106 | CX106F (Flexible)

Duropolym[®]

H: 4-5/8" | 11,8cm
P: 4-5/8" | 11,7cm
F: 6-3/8" | 16,3cm
L: 6'6" | 200cm



CX107

Duropolym[®]

H: 4-5/8" | 11,8cm
P: 4-5/8" | 11,7cm
F: 6-3/8" | 16,3cm
L: 6'6" | 200cm
*Designed By
Jacques Vergracht*



C353

Purotouch[®]

H: 1-1/8" | 3cm
P: 6-1/2" | 16,5cm
F: 6-1/2" | 16,5cm
L: 6'6" | 200cm



C216 | FC216 (Flexible)

Purotouch[®]

H: 4-5/8" | 11,6cm
P: 5-1/4" | 13,3cm
F: 6-3/4" | 17,3cm
L: 6'6" | 200cm

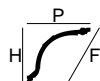

C991

Purotouch[®]

H: 5-1/2" | 14cm
P: 4-3/8" | 11cm
F: 7" | 17,8cm
L: 6'6" | 200cm



C991

Purotouch[®]

H: 4-3/8" | 11cm
P: 5-1/2" | 14cm
F: 7" | 17,8cm
L: 6'6" | 200cm

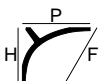

Purotouch[®] a proprietary polymer blend formulated to create deep reliefs and crisp details.

Collections

Duropolym[®] high impact resin blend. Ideally suited for baseboards and chair rails.



Cornice Mouldings



C217 | FC217 (Flexible)

Purotouch[®]

H: 6-1/8" | 15,6cm
P: 4" | 10,3cm
F: 7-1/4" | 18,3cm
L: 6'6" | 200cm



C217 | FC217 (Flexible)

Purotouch[®]

H: 4" | 10,3cm
P: 6-1/8" | 15,6cm
F: 7-1/4" | 18,3cm
L: 6'6" | 200cm

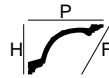

C396

Purotouch[®]

H: 7-1/4" | 18,5cm
P: 2-3/8" | 6,1cm
F: 7-1/2" | 19,1cm
L: 6'6" | 200cm

Designed By
Orio Tonini

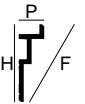

C396

Purotouch[®]

H: 2-3/8" | 6,1cm
P: 7-1/4" | 18,5cm
F: 7-1/2" | 19,1cm
L: 6'6" | 200cm

Designed By
Orio Tonini

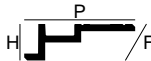

C218 | FC218 (Flexible)

Purotouch[®]

H: 5-7/8" | 15cm
P: 4-3/4" | 12cm
F: 7-1/2" | 19,1cm
L: 6'6" | 200cm



C901 | FC901 (Flexible)

Purotouch[®]

H: 5-7/8" | 14,8cm
P: 4-7/8" | 12,4cm
F: 7-1/2" | 19,2cm
L: 6'6" | 200cm



C305 + C213

Purotouch[®]

H: 5" | 12,7cm
P: 6-1/8" | 15,5cm
F: 7-5/8" | 19,3cm
L: 6'6" | 200cm

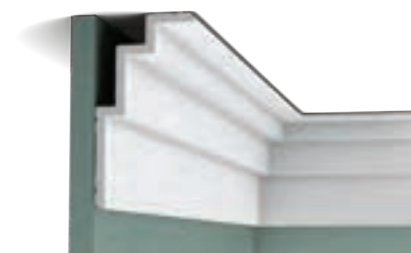

C392

Purotouch[®]

H: 7-1/2" | 19cm
P: 3-7/8" | 10cm
F: 7-3/4" | 19,7cm
L: 6'6" | 200cm

Designed By
Orio Tonini

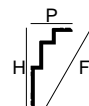

C327

Purotouch[®]

H: 5-5/8" | 14,3cm
P: 6-1/4" | 15,9cm
F: 8-3/8" | 21,4cm
L: 6'6" | 200cm

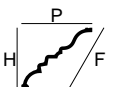

Purotouch[®] a proprietary polymer blend formulated to create deep reliefs and crisp details.

Collections

Duopolymer[®] high impact resin blend. Ideally suited for baseboards and chair rails.



Cornice Mouldings

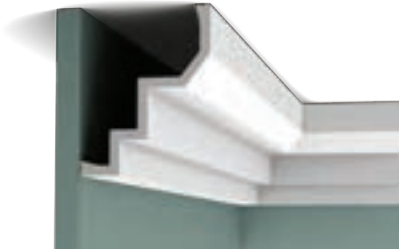

C300

Purotouch[®]

H: 6-1/2" | 16,5cm
P: 5-1/8" | 13cm
F: 8-3/8" | 21,2cm
L: 6'6" | 200cm

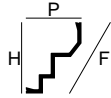

C354

Purotouch[®]

H: 1-5/8" | 4cm
P: 8-1/2" | 21,5cm
F: 8-1/2" | 21,5cm
L: 6'6" | 200cm

Designed By
Jacques Vergracht

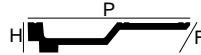

C305 + C211

Purotouch[®]

H: 6-3/8" | 16,3cm
P: 6-1/8" | 15,5cm
F: 8-1/2" | 21,5cm
L: 6'6" | 200cm

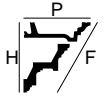

C900

Purotouch[®]

H: 6-3/4" | 17,1cm
P: 5-3/4" | 14,6cm
F: 8-5/8" | 21,8cm
L: 6'6" | 200cm

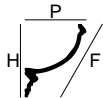

C219

Purotouch[®]

H: 6-7/8" | 17,6cm
P: 5-1/8" | 13cm
F: 8-5/8" | 21,8cm
L: 6'6" | 200cm



C301 | FC301 (Flexible)

Purotouch[®]

H: 6-3/4" | 17cm
P: 5-5/8" | 14,4cm
F: 8-5/8" | 22cm
L: 6'6" | 200cm

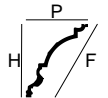

C991 + P9900

Purotouch[®]

H: 5-7/8" | 15cm
P: 6-3/4" | 17cm
F: 8-7/8" | 22,6cm
L: 6'6" | 200cm

Designed By
Ulf Moritz



C991 + P9900

Purotouch[®]

H: 4-3/4" | 12cm
P: 7-7/8" | 20cm
F: 9-1/8" | 23,3cm
L: 6'6" | 200cm

Designed By
Ulf Moritz

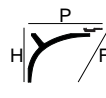

C342

Purotouch[®]

H: 5-1/2" | 14cm
P: 7-1/2" | 19cm
F: 9-1/4" | 23,6cm
L: 6'6" | 200cm

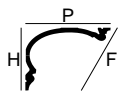

Purotouch[®] a proprietary polymer blend formulated to create deep reliefs and crisp details.

Collections

Duropolym[®] high impact resin blend. Ideally suited for baseboards and chair rails.



Cornice Mouldings



C334 | FC334 (Flexible)

Purotouch[®]

H: 5-7/8" | 15cm
P: 7-3/4" | 19,6cm
F: 9-1/2" | 24,1cm
L: 6'6" | 200cm

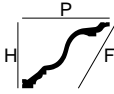

C393

Purotouch[®]

H: 5-7/8" | 15cm
P: 8-1/4" | 21cm
F: 9-3/4" | 24,7cm
L: 6'6" | 200cm

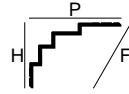

C332

Purotouch[®]

H: 9" | 23cm
P: 4-1/2" | 11,4cm
F: 9-7/8" | 25cm
L: 6'6" | 200cm

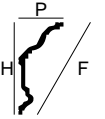

C332

Purotouch[®]

H: 4-1/2" | 11,4cm
P: 9" | 23cm
F: 9-7/8" | 25cm
L: 6'6" | 200cm



C308 | FC308 (Flexible)

Purotouch[®]

H: 9-3/4" | 24,8cm
P: 2-1/2" | 6,3cm
F: 9-7/8" | 25cm
L: 6'6" | 200cm

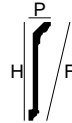

C422

Purotouch[®]

H: 6-1/2" | 16,4cm
P: 7-5/8" | 19,4cm
F: 10" | 25,4cm
L: 6'6" | 200cm

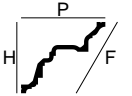

C338

Purotouch[®]

H: 7-1/4" | 18,4cm
P: 7-1/4" | 18,4cm
F: 10" | 25,5cm
L: 6'6" | 200cm

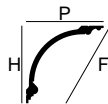

C338A

Purotouch[®]

H: 7-1/4" | 18,4cm
P: 7-1/4" | 18,4cm
F: 10" | 25,5cm
L: 6'6" | 200cm

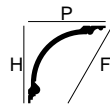

Purotouch[®] a proprietary polymer blend formulated to create deep reliefs and crisp details.

Collections

Duopolymer[®] high impact resin blend. Ideally suited for baseboards and chair rails.



Cornice Mouldings



C338B

Purotouch[®]

H: 7-1/4" | 18,4cm
P: 7-1/4" | 18,4cm
F: 10" | 25,5cm
L: 6'6" | 200cm

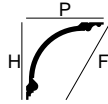

C307

Purotouch[®]

H: 7-5/8" | 19,5cm
P: 7-5/8" | 19,5cm
F: 10-3/8" | 26,5cm
L: 6'6" | 200cm

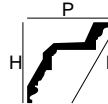

C307 + C-307A

Purotouch[®]

H: 7-5/8" | 19,5cm
P: 7-5/8" | 19,5cm
F: 10-3/8" | 26,5cm
L: 6'6" | 200cm

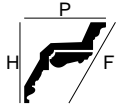

C990

Purotouch[®]

H: 6-1/4" | 15,9cm
P: 8-1/2" | 21,6cm
F: 10-1/2" | 26,8cm
L: 6'6" | 200cm

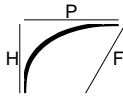

Designed By
Xavier Donck



C990 + P9001

Purotouch[®]

H: 6-1/4" | 15,9cm
P: 12-5/8" | 32cm
F: 10-1/2" | 26,8cm
L: 6'6" | 200cm

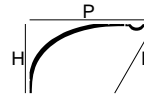

Designed By
Xavier Donck



C990

Purotouch[®]

H: 8-1/2" | 21,6cm
P: 6-1/4" | 15,9cm
F: 10-1/2" | 26,8cm
L: 6'6" | 200cm

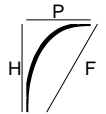

Designed By
Xavier Donck



C990 + P9901

Purotouch[®]

H: 8-1/2" | 21,6cm
P: 10-7/8" | 27,5cm
F: 10-1/2" | 26,8cm
L: 6'6" | 200cm

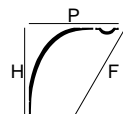

Designed By
Xavier Donck



C991 + 2x P9900

Purotouch[®]

H: 7-1/8" | 18cm
P: 8-1/4" | 21cm
F: 10-7/8" | 27,6cm
L: 6'6" | 200cm

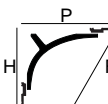

Designed By
Ulf Moritz

Purotouch[®] a proprietary polymer blend formulated to create deep reliefs and crisp details.

Collections

Duopolymer[®] high impact resin blend. Ideally suited for baseboards and chair rails.



Cornice Mouldings



C991 + 2x P9900

Purotouch[®]

H: 8-1/4" | 21cm
P: 7-1/8" | 18cm
F: 10-7/8" | 27,6cm
L: 6'6" | 200cm

Designed By
Ulf Moritz

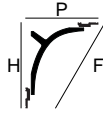

C340

Purotouch[®]

H: 10-1/8" | 25,6cm
P: 5-3/8" | 13,5cm
F: 11-1/4" | 28,6cm
L: 6'6" | 200cm

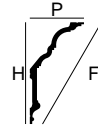

C340

Purotouch[®]

H: 5-3/8" | 13,5cm
P: 10-1/8" | 25,6cm
F: 11-1/4" | 28,6cm
L: 6'6" | 200cm



C335

Purotouch[®]

H: 8-3/4" | 22,2cm
P: 8" | 20,2cm
F: 11-1/2" | 29,3cm
L: 6'6" | 200cm

Designed By
Xavier Donck

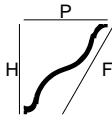

C335

Purotouch[®]

H: 8" | 20,2cm
P: 8-3/4" | 22,2cm
F: 11-1/2" | 29,3cm
L: 6'6" | 200cm

Designed By
Xavier Donck

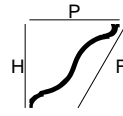

C337

Purotouch[®]

H: 6-3/4" | 17,2cm
P: 10-1/8" | 25,6cm
F: 11-3/4" | 30cm
L: 6'6" | 200cm

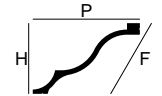

C343

Purotouch[®]

H: 7-1/2" | 19cm
P: 9-7/8" | 25cm
F: 12-3/8" | 31,4cm
L: 6'6" | 200cm

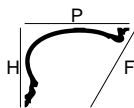

C990 + P9900

Purotouch[®]

H: 8-5/8" | 21,9cm
P: 8-7/8" | 22,6cm
F: 12-3/8" | 31,5cm
L: 6'6" | 200cm

Designed By
Xavier Donck

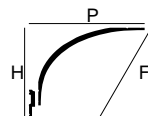

Purotouch[®] a proprietary polymer blend formulated to create deep reliefs and crisp details.

Collections

Duopolymer[®] high impact resin blend. Ideally suited for baseboards and chair rails.



Cornice Mouldings



C990 + P9900

Purotouch[®]

H: 8-7/8" | 22,6cm
P: 8-5/8" | 21,9cm
F: 12-3/8" | 31,5cm
L: 6'6" | 200cm

Designed By
Xavier Donck

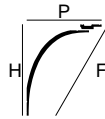

C990 + 2x P9900

Purotouch[®]

H: 9" | 22,9cm
P: 11-1/4" | 28,6cm
F: 14-1/2" | 36,6cm
L: 6'6" | 200cm

Designed By
Xavier Donck

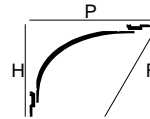

C990 + 2x P9900

Purotouch[®]

H: 11-1/4" | 28,6cm
P: 9" | 22,9cm
F: 14-1/2" | 36,6cm
L: 6'6" | 200cm

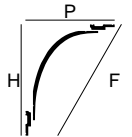

C336

Purotouch[®]

H: 10-5/8" | 27,1cm
P: 10-1/2" | 26,6cm
F: 14-3/4" | 37,5cm
L: 6'6" | 200cm

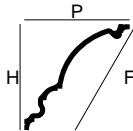

C344

Purotouch[®]

H: 10-3/4" | 27,3cm
P: 13-3/4" | 35cm
F: 17-1/2" | 44,4cm
L: 6'6" | 200cm

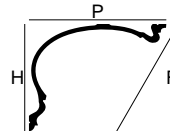

CX160

Duopolymer[®]

H: 1/2" | 1,3cm
P: 1-1/2" | 3,9cm
L: 6'6" | 200cm



CX161

Duopolymer[®]

H: 1/2" | 1,3cm
P: 2-3/4" | 6,9cm
L: 6'6" | 200cm



Purotouch[®] a proprietary polymer blend formulated to create deep reliefs and crisp details.

Collections

Duopolymer[®] high impact resin blend. Ideally suited for baseboards and chair rails.



Cornice Mouldings



CB500

Durofoam[®]

H: 1" | 2,5cm
P: 3/4" | 1,8cm
F: 1-1/8" | 3cm
L: 6'6" | 200cm



CB530

Durofoam[®]

H: 1-1/8" | 2,7cm
P: 5/8" | 1,5cm
F: 1-1/4" | 3,2cm
L: 6'6" | 200cm



CB520

Durofoam[®]

H: 1-3/8" | 3,5cm
P: 1-3/8" | 3,5cm
F: 2" | 5cm
L: 6'6" | 200cm



CB531

Durofoam[®]

H: 1-5/8" | 4,2cm
P: 1" | 2,6cm
F: 2" | 5,2cm
L: 6'6" | 200cm



CB501

Durofoam[®]

H: 1-5/8" | 4,1cm
P: 1-3/8" | 3,5cm
F: 2-1/8" | 5,3cm
L: 6'6" | 200cm



CB510

Durofoam[®]

H: 1-5/8" | 4cm
P: 1-5/8" | 4cm
F: 2-1/4" | 5,6cm
L: 6'6" | 200cm



CB521

Durofoam[®]

H: 2" | 5cm
P: 2" | 5cm
F: 2-3/4" | 7,1cm
L: 6'6" | 200cm



CB523

Durofoam[®]

H: 2-3/8" | 5,9cm
P: 1-3/4" | 4,4cm
F: 2-7/8" | 7,2cm
L: 6'6" | 200cm



Collections

Durofoam[®] a extruded lightweight polymer based on a medium-density polystyrene blend.



Cornice Mouldings



CB502

Durofoam[®]

H: 2-3/8" | 5,9cm
P: 1-7/8" | 4,9cm
F: 3-1/8" | 7,8cm
L: 6'6" | 200cm



CB525

Durofoam[®]

H: 2-1/2" | 6,5cm
P: 2-3/8" | 6cm
F: 3-1/2" | 8,9cm
L: 6'6" | 200cm



CB522

Durofoam[®]

H: 2-5/8" | 6,7cm
P: 2-5/8" | 6,7cm
F: 3-7/8" | 9,7cm
L: 6'6" | 200cm



CB511

Durofoam[®]

H: 2-5/8" | 6,7cm
P: 2-5/8" | 6,7cm
F: 3-7/8" | 9,8cm
L: 6'6" | 200cm



CB503

Durofoam[®]

H: 3-1/4" | 8,2cm
P: 3-5/8" | 9,2cm
F: 4-7/8" | 12,3cm
L: 6'6" | 200cm



CB524

Durofoam[®]

H: 3-1/2" | 9cm
P: 3-1/2" | 9cm
F: 5" | 12,7cm
L: 6'6" | 200cm



CB512

Durofoam[®]

H: 3-7/8" | 10cm
P: 3-7/8" | 10cm
F: 5-3/8" | 13,8cm
L: 6'6" | 200cm



PB513

Durofoam[®]

H: 5/8" | 1,5cm
P: 1-3/8" | 3,4cm
L: 6'6" | 200cm



Panel

Collections

Durofoam[®] a extruded lightweight polymer based on a medium-density polystyrene blend.

1-800-835-4400 | For Wholesale Pricing: www.oracdecorusa.com

English measurements converted from metric. Metric is the most accurate. All profiles copyrighted and protected by International Law.

Curtain Mouldings

Make your curtain hardware disappear

The innovative, new curtain mouldings featured in the MODERN Collection are the perfect addition to your space. These state-of-the-art mouldings were designed to be attached to the ceiling and allows adjustable space for curtain rods and drapes to be hidden behind. It is also possible to use these new curtain mouldings to hide lighting and other hardware. When installed these mouldings also offer an uninterrupted perimeter around the room and are a beautiful transition from wall to ceiling. These mouldings can also be used with other products from the ORAC Décor[®] line for a seamless, modern design.





Curtain Mouldings



C394

Purotouch[®]

H: 1-1/4" | 3,1cm
P: 3-3/4" | 9,5cm
F: 3-3/4" | 9,6cm
L: 6'6" | 200cm

Designed By
Orio Tonini



C390

Purotouch[®]

H: 2-3/8" | 6cm
P: 3-7/8" | 10cm
F: 4-1/8" | 10,5cm
L: 6'6" | 200cm

Designed By
Orio Tonini



C395

Purotouch[®]

H: 1-1/4" | 3,1cm
P: 6-1/8" | 15,5cm
F: 6-1/8" | 15,6cm
L: 6'6" | 200cm



C391

Purotouch[®]

H: 2-3/8" | 6cm
P: 6-1/4" | 16cm
F: 5-7/8" | 14,8cm
L: 6'6" | 200cm

Designed By
Orio Tonini



C341 | FC341 (Flexible)

Purotouch[®]

H: 3-1/2" | 8,8cm
P: 4-3/4" | 12,2cm
F: 5-7/8" | 15cm
L: 6'6" | 200cm

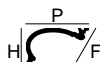

C991

Purotouch[®]

H: 4-3/8" | 11cm
P: 5-1/2" | 14cm
F: 7" | 17,8cm
L: 6'6" | 200cm

Designed By
Ulf Moritz

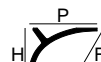

C396

Purotouch[®]

H: 2-3/8" | 6,1cm
P: 7-1/4" | 18,5cm
F: 7-1/2" | 19,1cm
L: 6'6" | 200cm

Designed By
Orio Tonini

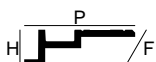

C392

Purotouch[®]

H: 3-7/8" | 10cm
P: 7-1/2" | 19cm
F: 7-3/4" | 19,7cm
L: 6'6" | 200cm

Designed By
Orio Tonini

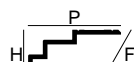

Purotouch[®] a proprietary polymer blend formulated to create deep reliefs and crisp details.

Collections

Duopolymer[®] high impact resin blend. Ideally suited for baseboards and chair rails.



Curtain Mouldings



C342

Purotouch[®]

H: 5-1/2" | 14cm
P: 7-1/2" | 19cm
F: 9-1/4" | 23,6cm
L: 6'6" | 200cm

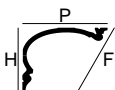

C343

Purotouch[®]

H: 7-1/2" | 19cm
P: 9-7/8" | 25cm
F: 12-3/8" | 31,4cm
L: 6'6" | 200cm

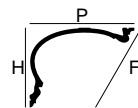

Purotouch[®] a proprietary polymer blend formulated to create deep reliefs and crisp details.

Collections

Duopolymer[®] high impact resin blend. Ideally suited for baseboards and chair rails.



ORAC[®] Flexible Cornice Mouldings

ORAC[®]
D E C O R
BY OUTWATER



PUROTOUCH[®]

Part #	R min	
FC200	5' 3"	160cm
FC201	6' 7"	200cm
FC211	8' 3"	250cm
FC212	4'	120cm
FC213	9' 3"	280cm
FC214	4' 8"	140cm
FC215	5' 3"	160cm
FC216	11' 2"	340cm
FC217	12' 6"	380cm
FC218	11' 10"	360cm
FC220	13' 2"	400cm
FC230	5'	150cm
FC240	8' 11"	270cm
FC250	2' 4"	70cm
FC260	4' 4"	130cm
FC301	10' 6"	320cm
FC302	8' 3"	250cm
FC303	5' 11"	180cm
FC304	8' 3"	250cm
FC308	4'	120cm
FC321	4' 8"	140cm
FC322	5' 3"	160cm
FC325	9' 11"	300cm
FC326	16' 5"	500cm
FC331	13' 10"	420cm
FC333	9' 11"	300cm
FC334	12' 6"	380cm
FC339	12' 6"	380cm
FC341	13' 2"	400cm
FC373	3' 4"	100cm
FC374	4' 4"	130cm
FC402	9' 11"	300cm
FC602	3' 4"	100cm
FC901	19' 9"	600cm
FC902	19' 9"	600cm

DUROPOLYMER[®]

Part #	R min	R* min
CX100F	6' 7"	200cm
CX106F	11' 10"	361cm
CX109F	5' 3"	160cm
CX110F	5' 11"	180cm
CX123F	9' 3"	282cm
CX124F	5' 3"	160cm
CX127F	7' 11"	240cm
CX132F	2' 4"	70cm
CX148F	5' 11"	180cm
CX188F	3' 8"	110cm
CX189F	3'	90cm
CX190F	1'	30cm
		4' 130cm

Purotouch[®] a proprietary polymer blend formulated to create deep reliefs and crisp details.

Collections

Duropolym[®] high impact resin blend. Ideally suited for baseboards and chair rails.

Panel Mouldings

Make flat walls come to life using “wallscaping” with our extensive range of panel mouldings. Create attractive paneling or frames on walls and ceilings in a jiffy. All designs are easy to install and many are available in a flexible format for use on curved walls and ceilings.





Panel Mouldings

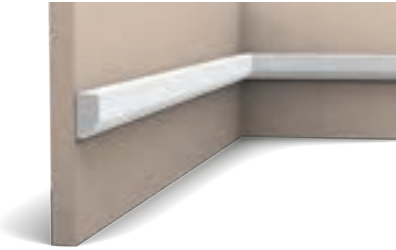

P9050 | FP9050 (Flexible)

Purotouch[®]

H: 1" | 2,5cm
P: 1/2" | 1,3cm
L: 6'6" | 200cm

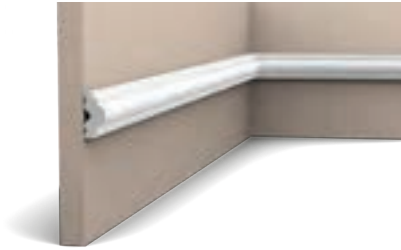

PX103 | PX103F (Flexible)

Duopolymer[®]

H: 1" | 2,5cm
P: 1/2" | 1,2cm
L: 6'6" | 200cm



PX116

Duopolymer[®]

H: 1-1/4" | 3,1cm
P: 3/8" | 1cm
L: 6'6" | 200cm

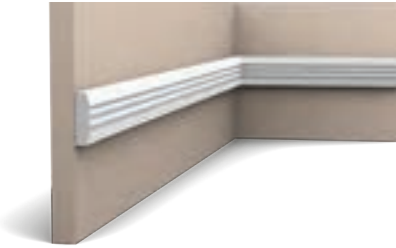

P5021 | FP5021 (Flexible)

Purotouch[®]

H: 1-1/4" | 3,1cm
P: 3/8" | 0,9cm
L: 6'6" | 200cm



PX117

Duopolymer[®]

H: 1-3/8" | 3,5cm
P: 5/8" | 1,5cm
L: 6'6" | 200cm

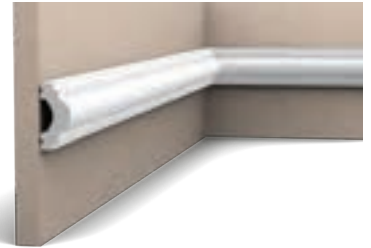

PX120

Duopolymer[®]

H: 1-5/8" | 4cm
P: 3/4" | 1,9cm
L: 6'6" | 200cm



PX131

Duopolymer[®]

H: 1-5/8" | 4cm
P: 3/4" | 1,9cm
L: 6'6" | 200cm



P8030 | FP8030 (Flexible)

Purotouch[®]

H: 1-5/8" | 4,1cm
P: 5/8" | 1,7cm
L: 6'6" | 200cm



Purotouch[®] a proprietary polymer blend formulated to create deep reliefs and crisp details.

Collections

Duopolymer[®] high impact resin blend. Ideally suited for baseboards and chair rails.



Panel Mouldings

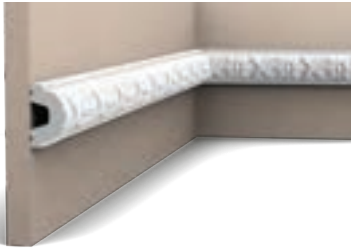

P2020 | FP2020 (Flexible)

Purotouch[®]
H: 1-3/4" | 4,4cm
P: 1" | 2,6cm
L: 6'6" | 200cm



PX144 | PX144F (Flexible)

Duopolymer[®]
H: 1-7/8" | 4,7cm
P: 3/8" | 0,8cm
L: 6'6" | 200cm

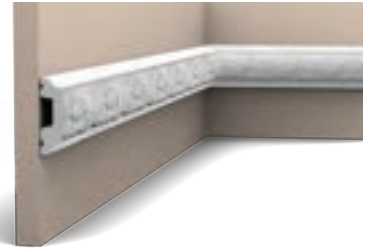

P1020 | FP1020 (Flexible)

Purotouch[®]
H: 1-7/8" | 4,9cm
P: 1" | 2,4cm
L: 6'6" | 200cm



P9040 | FP9040 (Flexible)

Purotouch[®]
H: 2" | 5cm
P: 1" | 2,5cm
L: 6'6" | 200cm

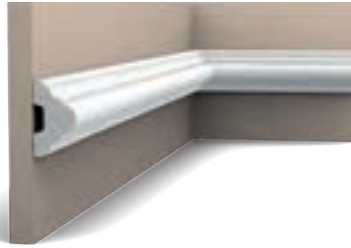

P4020 | FP4020 (Flexible)

Purotouch[®]
H: 2" | 5cm
P: 1-1/8" | 2,9cm
L: 6'6" | 200cm

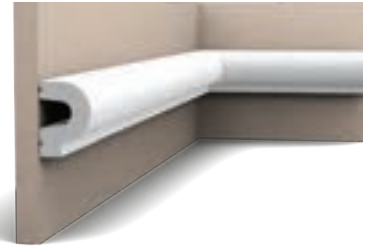

P8060 | FP8060 (Flexible)

Purotouch[®]
H: 2" | 5cm
P: 1-3/8" | 3,5cm
L: 6'6" | 200cm



PX175 | PX175F (Flexible)

Duopolymer[®]
H: 2" | 5cm
P: 5/8" | 1,73cm
L: 6'6" | 200cm



PX113

Duopolymer[®]
H: 2-3/8" | 6cm
P: 1" | 2,7cm
L: 6'6" | 200cm



Purotouch[®] a proprietary polymer blend formulated to create deep reliefs and crisp details.

Collections

Duopolymer[®] high impact resin blend. Ideally suited for baseboards and chair rails.



Panel Mouldings

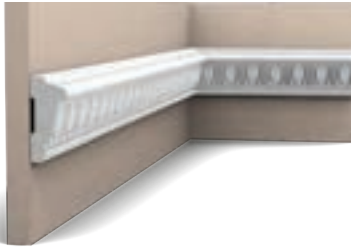

PX114

Duropolymers[®]
H: 2-3/8" | 6cm
P: 1" | 2,7cm
L: 6'6" | 200cm



P8020 | FP8020 (Flexible)

Purotouch[®]
H: 2-3/8" | 6cm
P: 1" | 2,6cm
L: 6'6" | 200cm

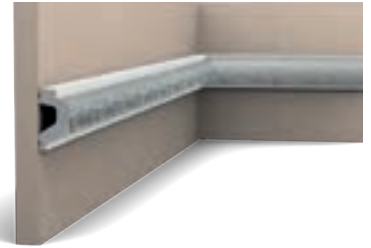

P3020 | FP3020 (Flexible)

Purotouch[®]
H: 2-3/8" | 6,1cm
P: 1-1/4" | 3,2cm
L: 6'6" | 200cm

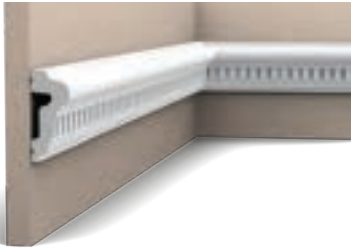

P6020 | FP6020 (Flexible)

Purotouch[®]
H: 2-1/2" | 6,4cm
P: 1-1/8" | 2,8cm
L: 6'6" | 200cm



P9901 | FP9901 (Flexible)

Purotouch[®]
H: 2-3/4" | 7cm
P: 1/2" | 1,4cm
L: 6'6" | 200cm



P7070 | FP7070 (Flexible)

Purotouch[®]
H: 2-7/8" | 7,4cm
P: 7/8" | 2,2cm
L: 6'6" | 200cm



PX102

Duropolymers[®]
H: 3-1/8" | 7,9cm
P: 5/8" | 1,6cm
L: 6'6" | 200cm

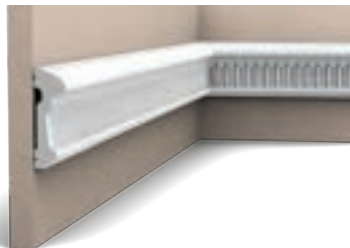

P7040 | FP7040 (Flexible)

Purotouch[®]
H: 3-1/8" | 7,9cm
P: 1" | 2,6cm
L: 6'6" | 200cm



Purotouch[®] a proprietary polymer blend formulated to create deep reliefs and crisp details.

Collections

Duropolymers[®] high impact resin blend. Ideally suited for baseboards and chair rails.



Panel Mouldings



P9900 | FP9900 (Flexible)

Purotouch[®]
H: 3-1/8" | 8cm
P: 3/8" | 1cm
L: 6'6" | 200cm

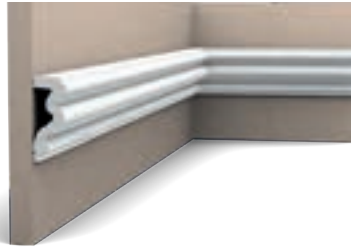

P4025 | FP4025 (Flexible)

Purotouch[®]
H: 3-1/4" | 8,3cm
P: 1-3/8" | 3,4cm
L: 6'6" | 200cm



P5051

Purotouch[®]
H: 3-1/4" | 8,4cm
P: 5/8" | 1,5cm
L: 6'6" | 200cm
*Designed By
Jacques Vergracht*

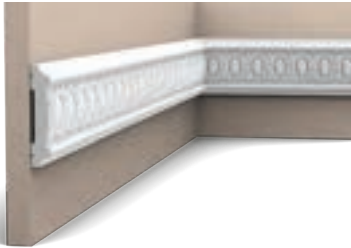

P7030 | FP7030 (Flexible)

Purotouch[®]
H: 3-3/8" | 8,5cm
P: 5/8" | 1,7cm
L: 6'6" | 200cm



P5020 | FP5020 (Flexible)

Purotouch[®]
H: 3-5/8" | 9,1cm
P: 1/2" | 1,3cm
L: 6'6" | 200cm



P9010 | FP9010 (Flexible)

Purotouch[®]
H: 3-5/8" | 9,1cm
P: 1-1/8" | 3cm
L: 6'6" | 200cm



P9020 | FP9020 (Flexible)

Purotouch[®]
H: 3-3/4" | 9,6cm
P: 7/8" | 2,1cm
L: 6'6" | 200cm



P8040 | FP8040 (Flexible)

Purotouch[®]
H: 4" | 10,1cm
P: 7/8" | 2,2cm
L: 6'6" | 200cm



Purotouch[®] a proprietary polymer blend formulated to create deep reliefs and crisp details.

Collections

Duopolymer[®] high impact resin blend. Ideally suited for baseboards and chair rails.



Panel Mouldings

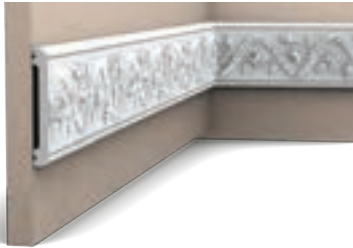

P7010 | FP7010 (Flexible)

Purotouch[®]

H: 4-1/8" | 10,5cm
P: 3/4" | 2cm
L: 6'6" | 200cm

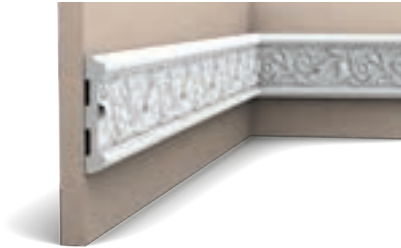

P7020 | FP7020 (Flexible)

Purotouch[®]

H: 4-3/8" | 11,1cm
P: 3/4" | 1,9cm
L: 6'6" | 200cm



P8050 | FP8050 (Flexible)

Purotouch[®]

H: 4-3/4" | 12cm
P: 1-1/8" | 3cm
L: 6'6" | 200cm



P3070

Purotouch[®]

H: 4-7/8" | 12,5cm
P: 1-1/4" | 3,2cm
L: 6'6" | 200cm



Designed By
Ulf Moritz



P5050

Purotouch[®]

H: 7-7/8" | 20cm
P: 5/8" | 1,5cm
L: 6'6" | 200cm



Designed By
Jacques Vergracht



P7080

Purotouch[®]

H: 8-5/8" | 21,8cm
P: 3/4" | 2cm
L: 6'6" | 200cm



P3071

Purotouch[®]

H: 14-5/8" | 37,2cm
P: 3" | 7,6cm
L: 6'6" | 200cm

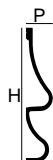

Designed By
Ulf Moritz

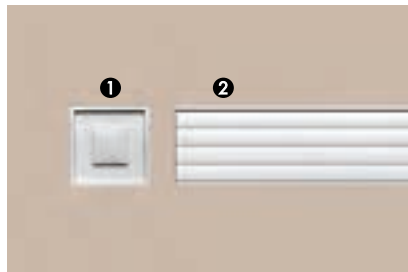

① P-5020B + P5020 ②

Purotouch[®]

P-5020B

H: 3-1/2" | 9cm
P: 1/2" | 1,3cm
L: 3-1/2" | 9cm

P5020

H: 3-5/8" | 9,1cm
P: 1/2" | 1,3cm
L: 6'6" | 200cm

Purotouch[®] a proprietary polymer blend formulated to create deep reliefs and crisp details.

Collections

Duropolym[®] high impact resin blend. Ideally suited for baseboards and chair rails.



Panel Mouldings

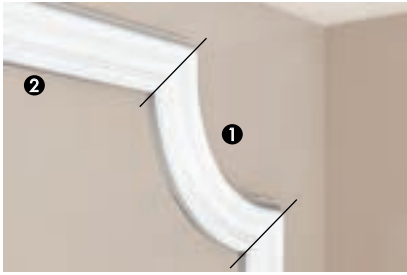

① P-801C + P8020 ②

Purotouch[®]

P-801C

H: 4-3/8" | 11cm
P: 1" | 2,6cm
L: 7-3/4" | 19,8cm

P8020

H: 2-3/8" | 6cm
P: 1" | 2,6cm
L: 6'6" | 200cm

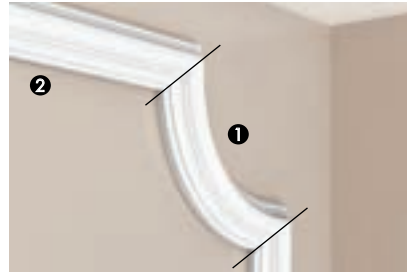

① P-4020A + P4020 ②

Purotouch[®]

P-4020A

H: 3-5/8" | 9,1cm
P: 1-1/8" | 2,9cm
L: 6-1/2" | 16,4cm

P4020

H: 2" | 5cm
P: 1-1/8" | 2,9cm
L: 6'6" | 200cm



① P-21 + ② P-201A + ③ P2020

Purotouch[®]

P-21

H: 2-5/8" | 6,7cm
P: 3/8" | 0,9cm
L: 2-5/8" | 6,7cm

P-201A

H: 7-5/8" | 19,5cm
P: 1" | 2,6cm
L: 7-5/8" | 19,5cm



① P-20 + ② P-101A + ③ P1020

Duropolym[®]

P-20

H: 2-3/8" | 6,1cm
P: 3/8" | 0,8cm
L: 2-3/8" | 6,1cm

Purotouch[®]

P-101A

H: 9-5/8" | 24,5cm
P: 1" | 2,4cm
L: 9-5/8" | 24,5cm



① P3020A + P3020 ②

Purotouch[®]

P3020A

H: 16-3/4" | 42,5cm
P: 1-5/8" | 4cm
L: 16-3/4" | 42,5cm

P3020

H: 2-3/8" | 6,1cm
P: 1-1/4" | 3,2cm
L: 6'6" | 200cm

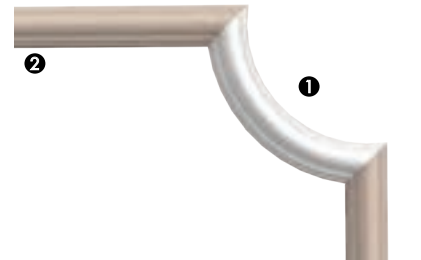

① PX120A + PX120 ②

Duropolym[®]

PX120A

H: 3-1/2" | 8,8cm
P: 3/4" | 0,9cm
L: 7-1/2" | 19cm

PX120

H: 1-5/8" | 4cm
P: 3/4" | 1,9cm
L: 6'6" | 200cm

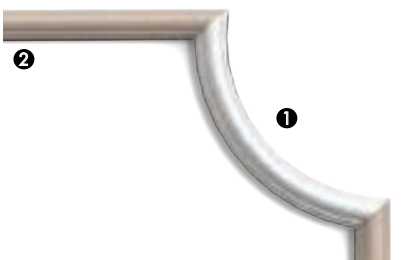

① PX103A + PX103 ②

Duropolym[®]

PX103A

H: 2-5/8" | 6,8cm
P: 1/2" | 1,2cm
L: 7-1/2" | 19cm

PX103

H: 1" | 2,5cm
P: 1/2" | 1,2cm
L: 6'6" | 200cm

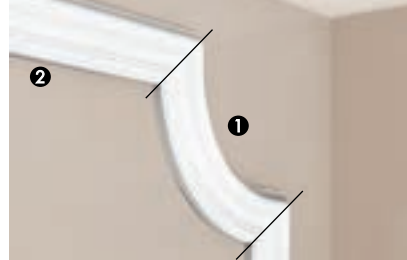

① P-8030C + P8030 ②

Duropolym[®]

P-8030C

H: 2-5/8" | 6,8cm
P: 1/2" | 1,2cm
L: 7-1/2" | 19cm

Purotouch[®]

P8030

H: 9-5/8" | 24,5cm
P: 1" | 2,4cm
L: 9-5/8" | 24,5cm



P8030D

Duropolym[®]

H: 5-3/8" | 13,2cm

P: 5/8" | 1,7cm
L: 5-3/8" | 13,2cm



ORAC[®] Flexible Panel Mouldings

ORAC[®]
D E C O R
BY OUTWATER



PUROTOUCH[®]

Part #	R min	R* min
FP1020	1' 30cm	2' 8" 80cm
FP2020	1' 30cm	2' 8" 80cm
FP3020	1' 8" 50cm	5' 11" 180cm
FP4020	1' 4" 40cm	6' 7" 200cm
FP4025	2' 4" 70cm	
FP5020	1' 30cm	
FP5021	8" 20cm	2' 4" 70cm
FP6020	1' 30cm	8' 3" 250cm
FP7010	8" 20cm	
FP7020	1' 30cm	
FP7030	1' 30cm	8' 3" 250cm
FP7040	1' 4" 40cm	10' 6" 320cm
FP7070	1' 30cm	7' 7" 230cm
FP8020	1' 4" 40cm	4' 4" 130cm
FP8030	8" 20cm	2' 4" 70cm
FP8040	1' 30cm	
FP8050	2' 8" 80cm	6' 7" 200cm
FP8060	2' 8" 80cm	6' 7" 200cm
FP9010	1' 4" 40cm	10' 3" 310cm
FP9020	1' 30cm	
FP9040	1' 30cm	2' 8" 80cm
FP9050	8" 20cm	2' 60cm
FP9900	8" 20cm	8' 3" 250cm
FP9901	8" 20cm	5' 11" 180cm

DUROPOLYMER[®]

Part #	R min	R* min
PX103F	8" 20cm	2' 8" 80cm
PX120F	1' 30cm	3' 8" 110cm
PX144F	8" 20cm	7' 3" 220cm
PX175F	1' 30cm	2' 8" 80cm

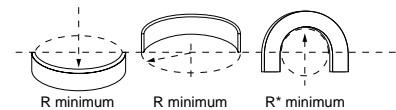

Purotouch[®] a proprietary polymer blend formulated to create deep reliefs and crisp details.

Collections

Duropolym[®] high impact resin blend. Ideally suited for baseboards and chair rails.

1-800-835-4400 | For Wholesale Pricing: www.oracdecorusa.com
English measurements converted from metric. Metric is the most accurate. All profiles copyrighted and protected by International Law.

Baseboard Mouldings

All baseboards are made from Duropolymer®, an impact and water resistant polymer mix that is fully recyclable. Cables can be hidden easily and the flexible versions allow curved walls to be finished elegantly. For your convenience, our baseboards are pre-primed and ready for paint.





3 Baseboard Families

CHOOSE YOUR STYLE. GET CREATIVE

SQUARE



CASCADE



CONTOUR

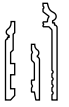

SMALL

SX162 | SX162F (Flexible)

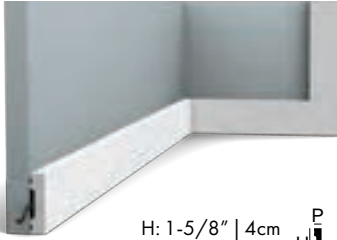

H: 1-5/8" | 4cm
P: 3/8" | 1cm



SX182 | SX182F (Flexible)

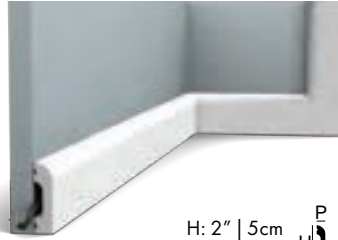

H: 2" | 5cm
P: 1/2" | 1,3cm



SX165 | SX165F (Flexible)



H: 2-3/4" | 6,9cm
P: 1/2" | 1,1cm



MEDIUM

SX157 | SX157F (Flexible)



H: 2-5/8" | 6,6cm
P: 1/2" | 1,3cm



SX183 | SX183F (Flexible)



H: 3" | 7,5cm
P: 1/2" | 1,3cm



SX173 | SX173F (Flexible)

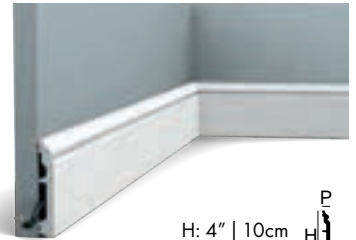

H: 4" | 10cm
P: 5/8" | 1,6cm



BIG

SX163 | SX163F (Flexible)

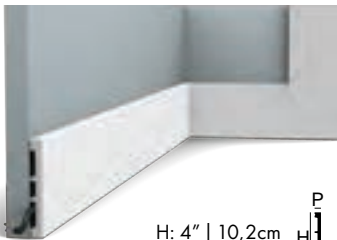

H: 4" | 10,2cm
P: 1/2" | 1,3cm



SX184 | SX184F (Flexible)



H: 4-3/8" | 11cm
P: 1/2" | 1,3cm



SX118 | SX118F (Flexible)

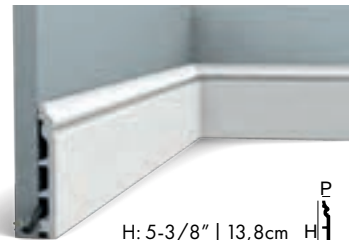

H: 5-3/8" | 13,8cm
P: 3/4" | 1,8cm



COVER

SX171



H: 3-7/8" | 10cm
P: 7/8" | 2,2cm



SX185



H: 4-3/4" | 12cm
P: 1" | 2,5cm



SX186



H: 5-1/2" | 13,8cm
P: 7/8" | 2,2cm





Cover Baseboard Mouldings



SX171 (*Square*)

Duopolymer[®]
H: 3-7/8" | 10cm
P: 7/8" | 2,2cm
L: 6'6" | 200cm



1 SX185 (*Cascade*)

Duopolymer[®]
H: 4-3/4" | 12cm
P: 1" | 2,5cm
L: 6'6" | 200cm



SX186 (*Contour*)

Duopolymer[®]
H: 5-1/2" | 13,8cm
P: 7/8" | 2,2cm
L: 6'6" | 200cm



 **Paintable**

 **Water resistant**

 **Ideal for renovations**



2 PX175 pg. 74



SX180 | SX180F (Flexible)

pg. 86

Duropolym[®]
 H: 4-3/4" | 12cm
 P: 5/8" | 1,6cm
 L: 6'6" | 200cm
 Designed By
 Pierre Daems



SX181

pg. 87

Duropolym[®]
 H: 7-7/8" | 20cm
 P: 7/8" | 2,2cm
 L: 6'6" | 200cm
 Designed By
 Pierre Daems

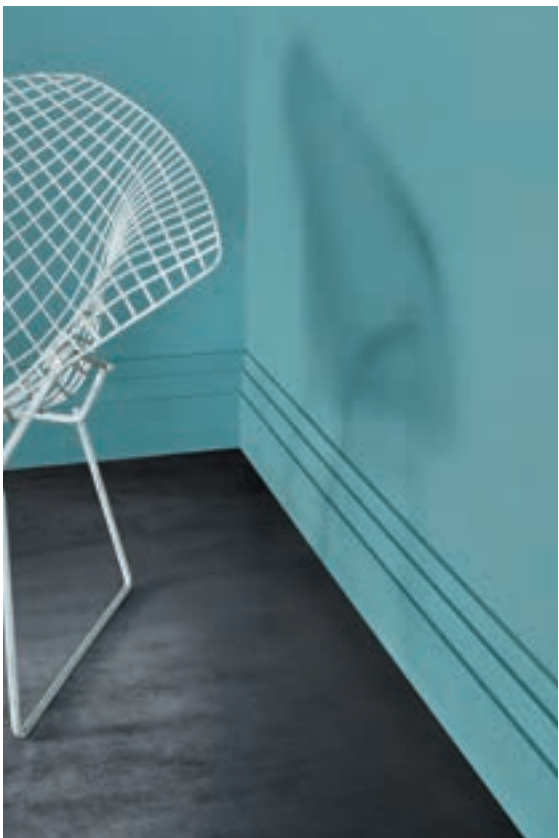



Baseboard Mouldings



SX162 | SX162F (Flexible)

Duopolymer[®]
H: 1-5/8" | 4cm
P: 3/8" | 1cm
L: 6'6" | 200cm



SX182 | SX182F (Flexible)

Duopolymer[®]
H: 2" | 5cm
P: 1/2" | 1,3cm
L: 6'6" | 200cm



SX159

Duopolymer[®]
H: 2-3/8" | 6cm
P: 1/2" | 1,2cm
L: 6'6" | 200cm



SX157 | SX157F (Flexible)

Duopolymer[®]
H: 2-5/8" | 6,6cm
P: 1/2" | 1,3cm
L: 6'6" | 200cm



SX165 | SX165F (Flexible)

Duopolymer[®]
H: 2-3/4" | 6,9cm
P: 1/2" | 1,1cm
L: 6'6" | 200cm



SX125

Duopolymer[®]
H: 2-3/4" | 6,9cm
P: 1/2" | 1,4cm
L: 6'6" | 200cm



SX183 | SX183F (Flexible)

Duopolymer[®]
H: 3" | 7,5cm
P: 1/2" | 1,3cm
L: 6'6" | 200cm



SX187 | SX187F (Flexible)

Duopolymer[®]
H: 3" | 7,5cm
P: 1/2" | 1,2cm
L: 6'6" | 200cm



Purotouch[®] a proprietary polymer blend formulated to create deep reliefs and crisp details.

Collections

Duopolymer[®] high impact resin blend. Ideally suited for baseboards and chair rails.



Baseboard Mouldings



SX122

Duopolymer[®]
H: 3-1/8" | 7,9cm
P: 7/8" | 2,2cm
L: 6'6" | 200cm



SX172 | SX172F (Flexible)

Duopolymer[®]
H: 3-3/8" | 8,5cm
P: 1/2" | 1,4cm
L: 6'6" | 200cm



SX179 | SX179F (Flexible)

Duopolymer[®]
H: 3-7/8" | 9,7cm
P: 1-1/8" | 2,9cm
F: 3-7/8" | 9,8cm
L: 6'6" | 200cm
*Designed By
Orio Tonini*



SX137 | SX137F (Flexible)

Duopolymer[®]
H: 3-7/8" | 9,9cm
P: 5/8" | 1,5cm
L: 6'6" | 200cm



SX171

Duopolymer[®]
H: 3-7/8" | 10cm
P: 7/8" | 2,2cm
L: 6'6" | 200cm



SX173 | SX173F (Flexible)

Duopolymer[®]
H: 4" | 10cm
P: 5/8" | 1,6cm
L: 6'6" | 200cm



SX163 | SX163F (Flexible)

Duopolymer[®]
H: 4" | 10,2cm
P: 1/2" | 1,3cm
L: 6'6" | 200cm



Purotouch[®] a proprietary polymer blend formulated to create deep reliefs and crisp details.

Collections

Duopolymer[®] high impact resin blend. Ideally suited for baseboards and chair rails.



Baseboard Mouldings



SX105 | SX105F (Flexible)

Duopolymer[®]
H: 4-1/4" | 10,8cm
P: 1/2" | 1,3cm
L: 6'6" | 200cm



SX155 | SX155F (Flexible)

Duopolymer[®]
H: 4-1/8" | 10,8cm
P: 1" | 2,5cm
L: 6'6" | 200cm



SX184 | SX184F (Flexible)

Duopolymer[®]
H: 4-3/8" | 11cm
P: 1/2" | 1,3cm
L: 6'6" | 200cm



SX185

Duopolymer[®]
H: 4-3/4" | 12cm
P: 1" | 2,5cm
L: 6'6" | 200cm



SX180 | SX180F (Flexible)

Duopolymer[®]
H: 4-3/4" | 12cm
P: 5/8" | 1,6cm
L: 6'6" | 200cm



SX138 | SX138F (Flexible)

Duopolymer[®]
H: 5-3/8" | 13,8cm
P: 5/8" | 1,5cm
L: 6'6" | 200cm



SX118 | SX118F (Flexible)

Duopolymer[®]
H: 5-3/8" | 13,8cm
P: 3/4" | 1,8cm
L: 6'6" | 200cm



Purotouch[®] a proprietary polymer blend formulated to create deep reliefs and crisp details.

Collections

Duopolymer[®] high impact resin blend. Ideally suited for baseboards and chair rails.



Baseboard Mouldings



SX186

Duopolymer[®]

H: 5-1/2" | 13,8cm

P: 7/8" | 2,2cm

L: 6'6" | 200cm



SX104 | SX104F (Flexible)

Duopolymer[®]

H: 5-7/8" | 14,8cm

P: 5/8" | 1,7cm

L: 6'6" | 200cm



SX168

Duopolymer[®]

H: 5-7/8" | 15,1cm

P: 1/2" | 1,4cm

L: 6'6" | 200cm



SX167

Duopolymer[®]

H: 6-3/4" | 17,3cm

P: 1-3/4" | 4,3cm

L: 6'6" | 200cm



SX181

Duopolymer[®]

H: 7-7/8" | 20cm

P: 7/8" | 2,2cm

L: 6'6" | 200cm



SX156

Duopolymer[®]

H: 7-7/8" | 20cm

P: 5/8" | 1,6cm

L: 6'6" | 200cm



SX191

Duopolymer[®]

H: 8-1/4" | 21cm

P: 7/8" | 2,1cm

L: 6'6" | 200cm



Purotouch[®] a proprietary polymer blend formulated to create deep reliefs and crisp details.

Collections

Duopolymer[®] high impact resin blend. Ideally suited for baseboards and chair rails.



ORAC[®] Flexible Baseboard Mouldings

ORAC[®]
D E C O R
BY OUTWATER

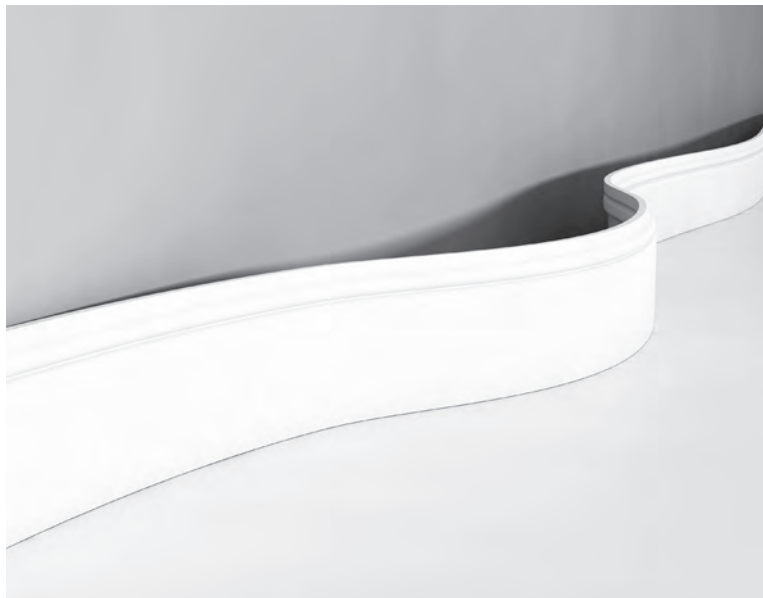

DUROPOLYMER[®]

Part #	R min	R* min	
SX104F	1' 4"	40cm	
SX105F	1'	30cm	
SX118F	1' 4"	40cm	
SX137F	1' 4"	40cm	
SX138F	1' 4"	40cm	
SX155F	1'	30cm	
SX157F	1' 2"	35cm	8' 7" 260cm
SX162F	8"	20cm	2' 8" 80cm
SX163F	1' 2"	35cm	
SX165F	1' 4"	40cm	
SX172F	1' 2"	35cm	
SX173F	1' 6"	45cm	
SX179F	1' 2"	35cm	
SX180F	1' 6"	45cm	
SX182F	1' 2"	35cm	
SX183F	1' 4"	40cm	
SX184F	1' 6"	45cm	
SX187F	1' 4"	40cm	

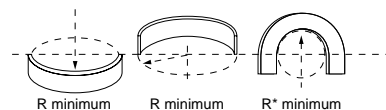

Purotouch[®] a proprietary polymer blend formulated to create deep reliefs and crisp details.

Collections

Duropolymer[®] high impact resin blend. Ideally suited for baseboards and chair rails.

3D Wallscapes

Follow your imagination. The sleek, modern designs suit contemporary homes by adding a dramatic 3D form. The elements of these ornaments allow considerable opportunities to personalize any room.



Valley

1



1. W109: Pg. 95

2. W108: Pg. 95

3. W110: Pg. 95



2

Zig Zag



Hill

3

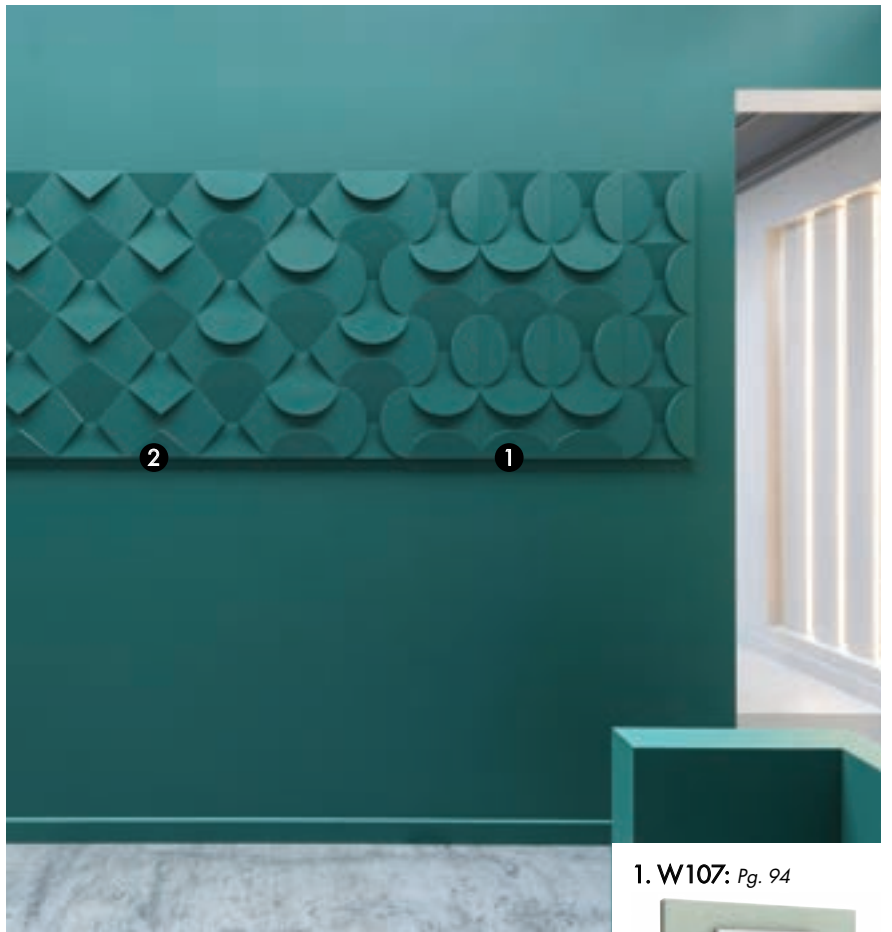

1. W107: Pg. 94



2. W106: Pg. 94



3. W101: Pg. 94



4. W100: Pg. 94



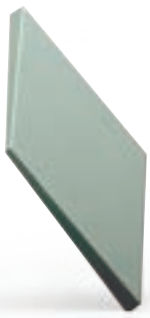

Rombus

W100

pg.94

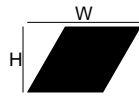

Purotouch®
H: 5-7/8" | 15cm
W: 10-1/8" | 25,8cm
P: 1-1/8" | 2,9cm

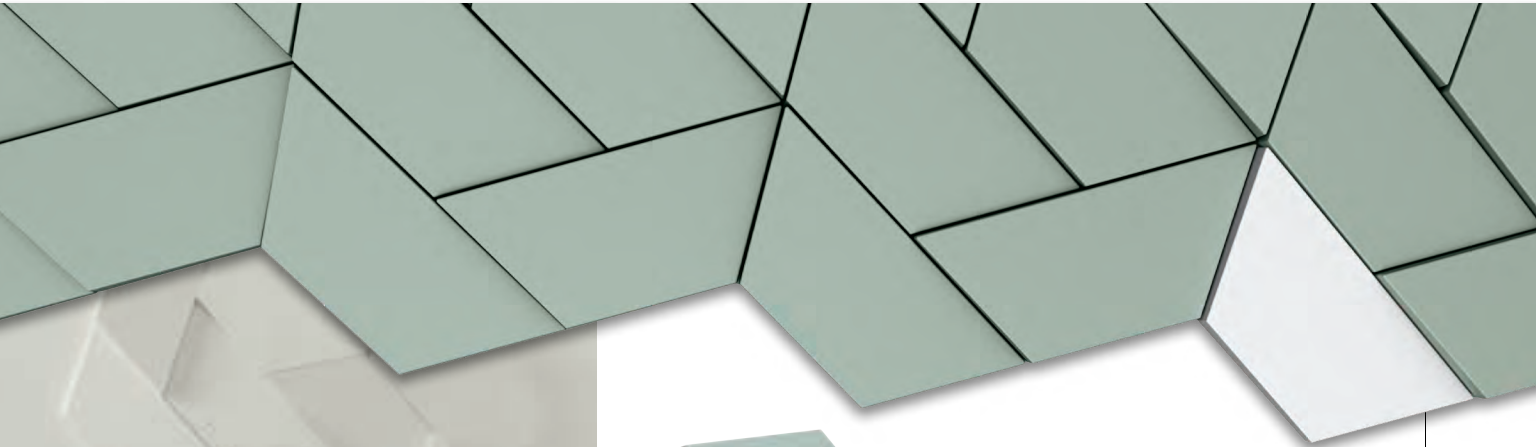
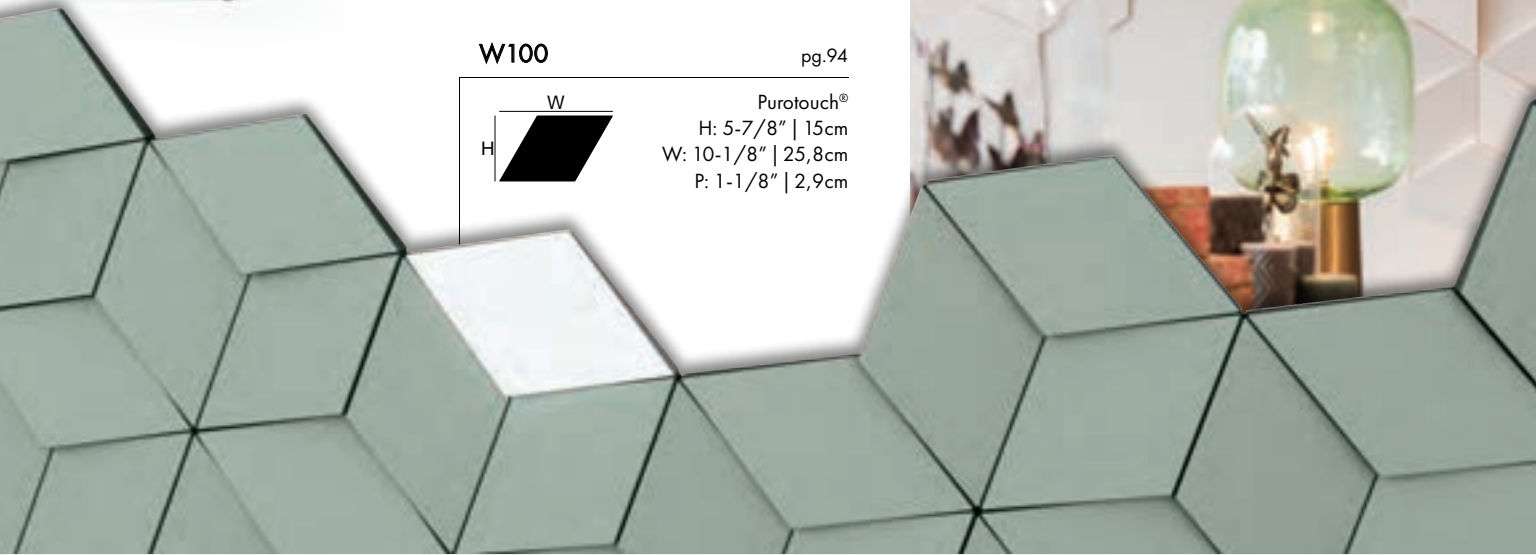

W101

pg.94

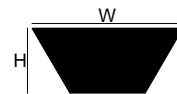

Purotouch®
H: 5-7/8" | 15cm
W: 13-5/8" | 34,5cm
P: 1-1/8" | 2,9cm

Trapezium

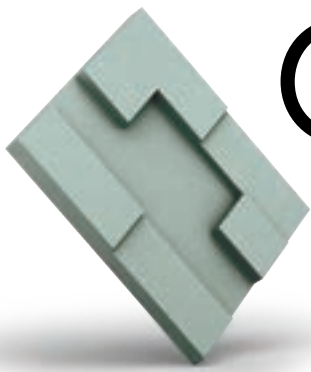

Cubi

W103

pg.94

Purotouch®

H: 13-1/8" | 33,3cm

W: 13-1/8" | 33,3cm

P: 1" | 2,5cm

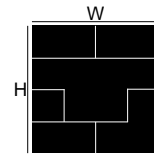

W102

pg.94

Purotouch®

H: 13-1/8" | 33,3cm

W: 13-1/8" | 33,3cm

P: 1" | 2,5cm

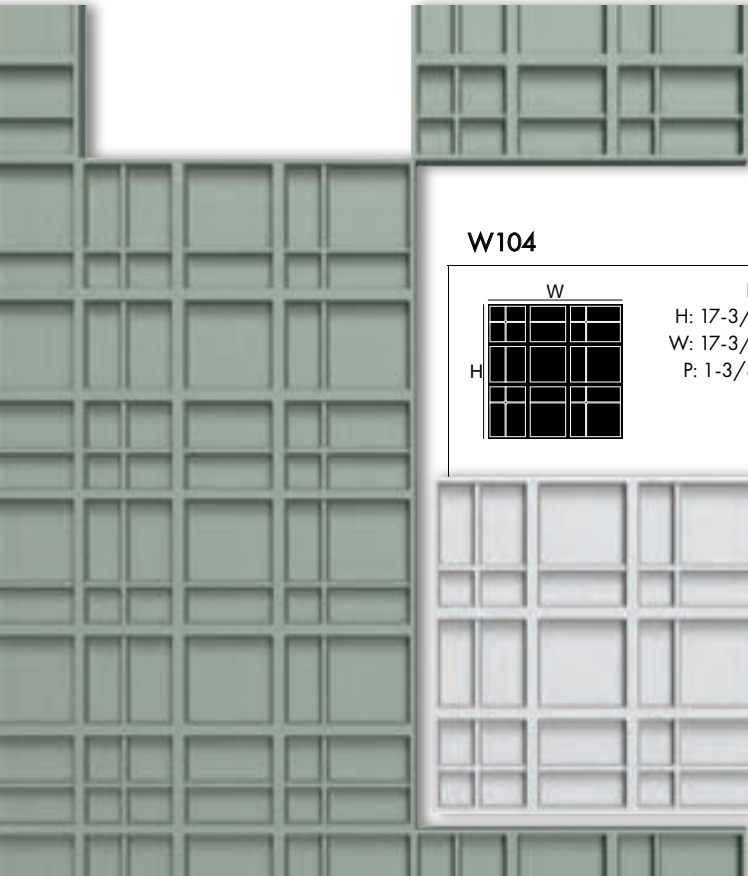
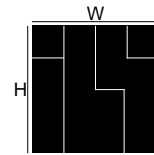

W104

pg.94

Purotouch®

H: 17-3/4" | 45cm

W: 17-3/4" | 45cm

P: 1-3/8" | 3,6cm

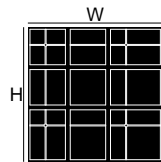

Kilt

Designed By
Orio Tonini

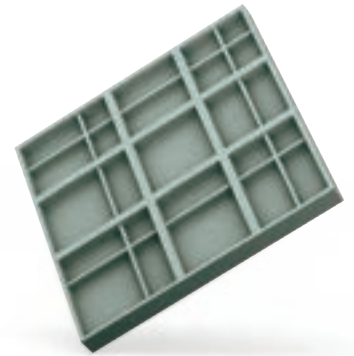



3D Wallscapes



W100 (Rhombus)

Purotouch[®]

H: 5-7/8" | 15cm
W: 10-1/8" | 25,8cm
P: 1-1/8" | 2,9cm



W101 (Trapezium)

Purotouch[®]

H: 5-7/8" | 15cm
W: 13-5/8" | 34,5cm
P: 1-1/8" | 2,9cm

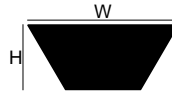

W102 (Cubi 1)

Purotouch[®]

H: 13-1/8" | 33,3cm
W: 13-1/8" | 33,3cm
P: 1" | 2,5cm

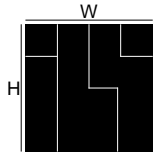

W103 (Cubi 2)

Purotouch[®]

H: 13-1/8" | 33,3cm
W: 13-1/8" | 33,3cm
P: 1" | 2,5cm

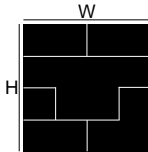

W104 (Kilt)

Purotouch[®]

H: 17-3/4" | 45cm
W: 17-3/4" | 45cm
P: 1-3/8" | 3,6cm

Designed By
Orio Tonini

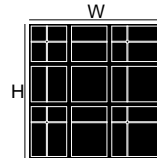

W105 (Rhombus)

Purotouch[®]

H: 11-3/4" | 30cm
W: 13-5/8" | 34,6cm
P: 1-1/8" | 3cm

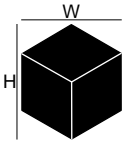

W106 (Envelope)

Purotouch[®]

H: 13-1/8" | 33,3cm
W: 13-1/8" | 33,3cm
P: 1-1/8" | 2,9cm

Designed By
Orio Tonini

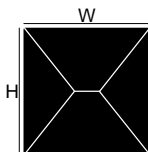

W107 (Circle)

Purotouch[®]

H: 13-1/8" | 33,3cm
W: 13-1/8" | 33,3cm
P: 1-1/8" | 2,9cm

Designed By
Orio Tonini

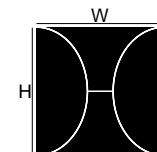

Purotouch[®] a proprietary polymer blend formulated to create deep reliefs and crisp details.

Collections

Duopolymer[®] high impact resin blend. Ideally suited for baseboards and chair rails.



3D Wallscapes



W108 (Zig Zag)

Purotouch[®]

H: 5/8" | 1,8cm
W: 9-7/8" | 25cm
L: 6'6" | 200cm

Designed By
Orio Tonini



W109 (Valley)

Purotouch[®]

H: 1/2" | 1,3cm
W: 9-7/8" | 25cm
L: 6'6" | 200cm

Designed By
Orio Tonini



W110 (Hill)

Purotouch[®]

H: 5/8" | 1,6cm
W: 9-7/8" | 25cm
L: 6'6" | 200cm

Designed By
Orio Tonini



W120 (Autoire)

Purotouch[®]

H: 19-3/4" | 50cm
W: 59" | 150cm
P: 1-1/4" | 3,2cm

Designed By
Orio Tonini

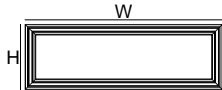

W121 (Autoire)

Purotouch[®]

H: 19-3/4" | 50cm
W: 19-3/4" | 50cm
P: 1-1/4" | 3,2cm

Designed By
Orio Tonini

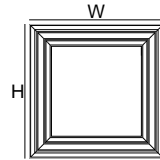

W122 (Autoire)

Purotouch[®]

H: 13-1/8" | 33,3cm
W: 13-1/8" | 33,3cm
P: 1" | 2,6cm

Designed By
Orio Tonini

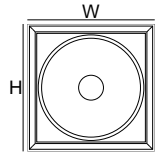

W123 (Autoire)

Purotouch[®]

H: 13-1/8" | 33,3cm
W: 13-1/8" | 33,3cm
P: 1-3/8" | 3,5cm

Designed By
Orio Tonini

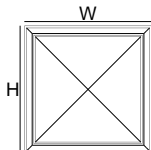

W130 (Chevron)

Purotouch[®]

H: 3/4" | 2cm
W: 15-3/4" | 40cm
L: 6'6" | 200cm

Designed By
Orio Tonini



Purotouch[®] a proprietary polymer blend formulated to create deep reliefs and crisp details.

Collections

Duropolym[®] high impact resin blend. Ideally suited for baseboards and chair rails.



3D Wallscapes



W120 + P4025 + W121

Purotouch[®]
Designed By
Orio Tonini



W120 + 4*W122

Purotouch[®]
Designed By
Orio Tonini



W121 + W122

Purotouch[®]
Designed By
Orio Tonini



W120 + 4*W123

Purotouch[®]
Designed By
Orio Tonini



W121 + W123

Purotouch[®]
Designed By
Orio Tonini



3*W130 + 2*CX190

Purotouch[®]
Designed By
Orio Tonini



Purotouch[®] a proprietary polymer blend formulated to create deep reliefs and crisp details.

Collections

Duropolimer[®] high impact resin blend. Ideally suited for baseboards and chair rails.



3D Wallscapes



G70

Duopolymer[®]
H: 3-1/2" | 9cm
W: 7-7/8" | 20cm
P: 1-1/8" | 2,7cm
Designed By
Ulf Moritz

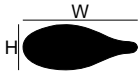

G71

Purotouch[®]
H: 13-3/4" | 35cm
W: 16-5/8" | 42,2cm
P: 5/8" | 1,5cm
Designed By
Ulf Moritz

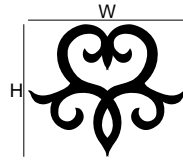

G72 (Smile)

Duopolymer[®]
H: 2-5/8" | 6,8cm
W: 16-3/4" | 42,5cm
P: 3/8" | 1cm
Designed By
Ulf Moritz

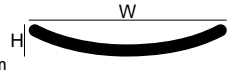

G75 (Scala)

Purotouch[®]
H: 8-1/4" | 21cm
W: 10-5/8" | 27cm
P: 1/2" | 1,4cm
Designed By
Ulf Moritz

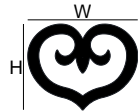

G76 (Scala)

Purotouch[®]
H: 3-1/8" | 8cm
W: 7" | 17,8cm
P: 5/8" | 1,5cm
Designed By
Ulf Moritz



G77 (Lily)

Duopolymer[®]
H: 3-1/2" | 8,8cm
W: 7-5/8" | 19,4cm
P: 3/4" | 1,8cm



G78 (Lily)

Duopolymer[®]
H: 1-3/4" | 4,4cm
W: 3-1/2" | 8,8cm
P: 3/4" | 1,9cm
Designed By
Ulf Moritz



D170

H: 9-5/8" | 24.5cm
W: 41-3/4" | 105cm
P: 1-1/4" | 3,2cm

Purotouch[®]

Purotouch[®] a proprietary polymer blend formulated to create deep reliefs and crisp details.

Collections

Duopolymer[®] high impact resin blend. Ideally suited for baseboards and chair rails.



Medallions

Ceiling medallions, with or without floral designs, enliven your ceiling and are a great way to break up larger ceiling surfaces. You can choose repetitive decorative elements for playful effects or combine them with mirror lighting to add a modern touch. Rosettes can also be applied to walls. The possibilities are endless, so let your imagination run wild.





Ceiling Medallions



D62

H: 4-5/8" | 11,6cm
W: 6-1/8" | 15,6cm
P: 1/2" | 1,4cm

Purotouch[®]



R-10

Dia.: ø 5-7/8" | 15cm
P: 1-5/8" | 4,2cm
Cut Max Dia.: ø 3/4" | 2cm

Purotouch[®]



R-11

Dia.: ø 7-1/2" | 19cm
P: 1-3/8" | 3,6cm
Cut Max Dia.: ø 1-1/8" | 3cm

Purotouch[®]



R-12

H: 7-5/8" | 19,5cm
P: 3/4" | 1,8cm
Cut Max Dia.: ø 3/8" | 1cm

Purotouch[®]



R-07

Dia.: ø 10-1/4" | 26cm
P: 1-1/8" | 3cm
Cut Max Dia.: ø 2" | 5cm

Purotouch[®]



R-13

Dia.: ø 11" | 28cm
P: 1-1/4" | 3,1cm
Cut Max Dia.: ø 1" | 2,5cm

Purotouch[®]



R-14

Dia.: ø 13" | 33cm
P: 1-1/8" | 3cm
Cut Max Dia.: ø 1" | 2,5cm

Purotouch[®]



R-08

Dia.: ø 15" | 38cm
P: 1-5/8" | 4,2cm
Cut Max Dia.: ø 2" | 5cm

Purotouch[®]



R-31

Dia.: ø 15-1/8" | 38,5cm
P: 1-1/8" | 2,7cm
Cut Max Dia.: ø 1-3/8" | 3,5cm

Purotouch[®]

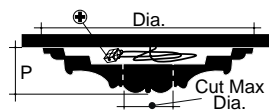

Purotouch[®] a proprietary polymer blend formulated to create deep reliefs and crisp details.

Collections

Duropolym[®] high impact resin blend. Ideally suited for baseboards and chair rails.



Ceiling Medallions



R-61

H: 15-3/4" | 40cm
P: 1-1/4" | 3,1cm
Cut Max Dia.: ø 1" | 2,5cm

Purotouch[®]



R-17

Dia.: ø 18-1/2" | 47cm
P: 1-3/8" | 3,5cm
Cut Max Dia.: ø 2-1/2" | 6,5cm

Purotouch[®]



R-09

Dia.: ø 19-1/8" | 48,5cm
P: 1-1/2" | 3,7cm
Cut Max Dia.: ø 2-3/8" | 6cm

Purotouch[®]



R-18

H: 19-1/4" | 49cm
P: 1-7/8" | 4,7cm
Cut Max Dia.: ø 2-3/4" | 7cm

Purotouch[®]



G77

Dia.: ø 19-3/4" | 50cm (6 pcs.)
H: 3-1/2" | 8,8cm (ea.)
W: 7-5/8" | 19,4cm (ea.)
P: 3/4" | 1,8cm (ea.)

Duopolymer[®]
Designed By
Ulf Moritz



R-46

Dia.: ø 21-1/8" | 53,5cm
P: 1-5/8" | 4,2cm
Cut Max Dia.: ø 1-1/8" | 3cm

Purotouch[®]



R-66

Dia.: ø 21-1/2" | 54,5cm
P: 1" | 2,4cm
Cut Max Dia.: ø 16-7/8" | 43cm

Purotouch[®]



R-76

Dia.: ø 24-3/8" | 62cm
P: 1-5/8" | 4,1cm
Cut Max Dia.: ø 4-1/8" | 10,5cm

Purotouch[®]



R-77

Dia.: ø 24-3/8" | 62cm
P: 1-5/8" | 4,2cm
Cut Max Dia.: ø 4-1/8" | 10,5cm

Purotouch[®]

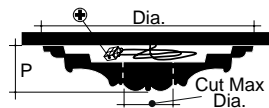

Purotouch[®] a proprietary polymer blend formulated to create deep reliefs and crisp details.

Collections

Duopolymer[®] high impact resin blend. Ideally suited for baseboards and chair rails.



Ceiling Medallions



R-52

Dia.: \varnothing 27-3/8" | 69,5cm

P: 1-7/8" | 4,8cm

Cut Max Dia.: \varnothing 4-7/8" | 12,5cm

Purotouch[®]



R-73

Dia.: \varnothing 27-1/2" | 70cm

P: 2-3/8" | 5,9cm

Cut Max Dia.: \varnothing 3-1/8" | 8cm

Purotouch[®]



R-38

Dia.: \varnothing 28" | 71cm

P: 1-5/8" | 4,2cm

Cut Max Dia.: \varnothing 7-1/2" | 19cm

Purotouch[®]



R-23

H: 28" | 71cm

P: 1-3/4" | 4,4cm

Cut Max Dia.: \varnothing 2-3/8" | 6cm

Purotouch[®]



R-40

Dia.: \varnothing 29-3/8" | 74,5cm

P: 1-1/4" | 3,1cm

Cut Max Dia.: \varnothing 3-7/8" | 10cm

Purotouch[®]



R-27

Dia.: \varnothing 29-1/2" | 75cm

P: 1-3/4" | 4,5cm

Cut Max Dia.: \varnothing 3-1/2" | 9cm

Purotouch[®]



R-22

Dia.: \varnothing 20-7/8" | 53cm

W: 30-1/2" | 77,5cm

P: 1-3/8" | 3,6cm

Purotouch[®]



R-24

Dia.: \varnothing 31-1/8" | 79cm

P: 2-3/8" | 6cm

Cut Max Dia.: \varnothing 3-1/8" | 8cm

Purotouch[®]



R-64

Dia.: \varnothing 37-1/2" | 95,2cm

P: 1-7/8" | 4,8cm

Cut Max Dia.: \varnothing 2-3/4" | 7cm

Purotouch[®]

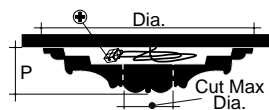

Purotouch[®] a proprietary polymer blend formulated to create deep reliefs and crisp details.

Collections

Duropolym[®] high impact resin blend. Ideally suited for baseboards and chair rails.

Raised Panels & Wainscoting

Door or wall panels create a feeling of depth, which makes the room appear larger and more interesting than it would if all of the surfaces were flat.

Wainscoting can evoke the atmosphere of stately homes, and tastefully protect your walls. They are equally suitable for both modern and classical homes, and can bring texture to any wall.





Raised Panels & Wainscoting



D504

Duopolymer[®]

H: 8-5/8" | 22cm
W: 21-5/8" | 55cm
P: 5/8" | 1,7cm



D506

Duopolymer[®]

H: 16-7/8" | 43cm
W: 16-7/8" | 43cm
P: 5/8" | 1,7cm



D503

Duopolymer[®]

H: 21-5/8" | 55cm
W: 21-5/8" | 55cm
P: 5/8" | 1,7cm



D507

Duopolymer[®]

H: 35-5/8" | 90,5cm
W: 21-5/8" | 55cm
P: 5/8" | 1,7cm

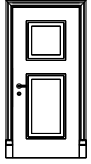

DX121 + D310,
D503, D507

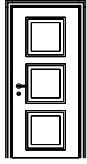

DX119,
3x D503



K201L/R + K200,
2x K200,
2x D504,
D507, D320

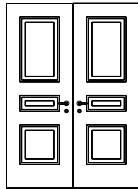

D507, D504,
D503

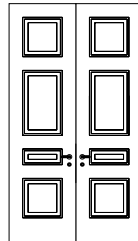

D503, D507,
D504, D503

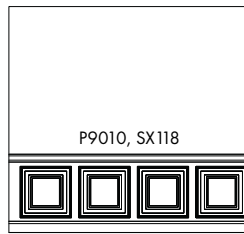

P9010, SX118

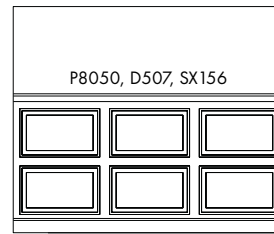

P8050, D507, SX156



PX147

H: 6-5/8" | 16,9cm
W: 3/8" | 0,9cm
P: 6'6" | 200cm

Duopolymer[®]

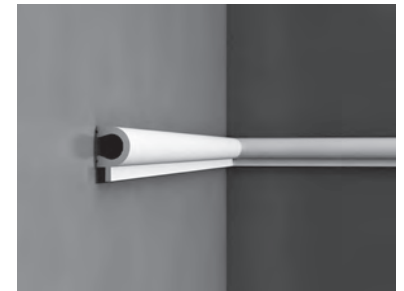

PX169

H: 2-1/8" | 5,5cm
W: 1-3/8" | 3,4cm
P: 6'6" | 200cm

Duopolymer[®]



PX147 + PX169

Purotouch[®] a proprietary polymer blend formulated to create deep reliefs and crisp details.

Collections

Duopolymer[®] high impact resin blend. Ideally suited for baseboards and chair rails.

Door Frames & Pediments

With ORAC Décor's architraves and door panels you can quickly and easily transform your interior. Architraves give your door a stately look while panels add rhythm and relief.

Pediments are commonly featured in hallways or door entries to enhance interior archways. In addition, you can use pediments to make doors or windows the focal point of a room.



Door Frames & Pediments



D200

Duopolymer[®]
H: 3-3/4" | 9,6cm
P: 1-1/8" | 3cm
L: 3-3/4" | 9,6cm

DX119

Duopolymer[®]
H: 3-5/8" | 9,2cm
P: 7/8" | 2,2cm
L: 7'6" | 230cm



DX174-2300

Duopolymer[®]
H: 2-3/8" | 6cm
P: 7/8" | 2,2cm
L: 7'6" | 230cm



DX170-2300

Duopolymer[®]
H: 4-5/8" | 11,9cm
P: 1-1/4" | 3,2cm
L: 7'6" | 230cm



DX310

Duopolymer[®]
H: 9-3/4" | 24,9cm
P: 1-1/4" | 3,1cm
W: 3-3/4" | 9,5cm



D340

Duopolymer[®]
H: 4-3/4" | 11cm
P: 1" | 2,5cm
W: 2-3/4" | 7cm

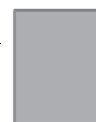

D330LR

Duopolymer[®]
H: 6-1/4" | 16cm
P: 1-5/8" | 4,1cm
W: 5" | 12,6cm



D402

Purotouch[®]
H: 5-7/8" | 15cm
W: 4-3/4" | 12,1cm
P: 2-1/4" | 5,8cm



D400

H: 5-3/4" | 14,5cm
W: 50-1/4" | 127,5cm
P: 2-1/8" | 5,5cm



D400 + D402

Purotouch[®]



D401

H: 5-3/4" | 14,5cm
W: 50-1/4" | 127,5cm
P: 2-1/8" | 5,5cm



2x D401 + D402

Purotouch[®]

Purotouch[®] a proprietary polymer blend formulated to create deep reliefs and crisp details.

Collections

Duopolymer[®] high impact resin blend. Ideally suited for baseboards and chair rails.

Door Frames & Pediments

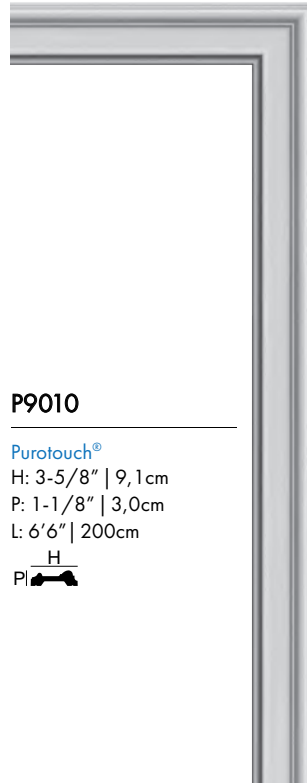

P9010

Purotouch[®]
H: 3-5/8" | 9,1cm
P: 1-1/8" | 3,0cm
L: 6'6" | 200cm
Pl 



D210

Duopolymer[®]
H: 3-3/4" | 9,6cm
P: 1-3/8" | 3,5cm
W: 3-3/4" | 9,6cm

DX121

Duopolymer[®]
H: 3-3/4" | 9,4cm
P: 7/8" | 2,3cm
L: 7'6" | 230cm
Pl 

D310

Duopolymer[®]
H: 9-3/4" | 24,9cm
P: 1-1/4" | 3,1cm
W: 3-3/4" | 9,5cm

D310

Duopolymer[®]
H: 9-3/4" | 24,9cm
P: 1-1/4" | 3,1cm
W: 3-3/4" | 9,5cm



Purotouch[®] a proprietary polymer blend formulated to create deep reliefs and crisp details.

Collections

Duopolymer[®] high impact resin blend. Ideally suited for baseboards and chair rails.

Door Frames & Pediments

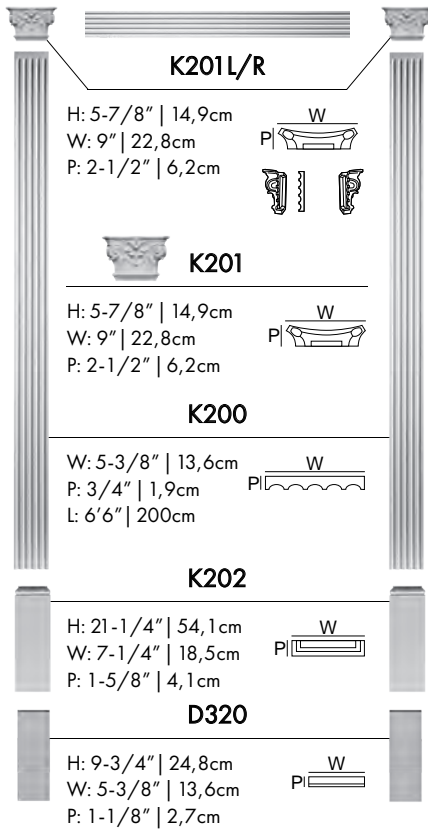

K201L/R

H: 5-7/8" | 14,9cm
W: 9" | 22,8cm
P: 2-1/2" | 6,2cm

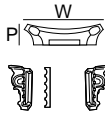

K201

H: 5-7/8" | 14,9cm
W: 9" | 22,8cm
P: 2-1/2" | 6,2cm



K200

W: 5-3/8" | 13,6cm
P: 3/4" | 1,9cm
L: 6'6" | 200cm

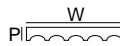

K202

H: 21-1/4" | 54,1cm
W: 7-1/4" | 18,5cm
P: 1-5/8" | 4,1cm



D320

H: 9-3/4" | 24,8cm
W: 5-3/8" | 13,6cm
P: 1-1/8" | 2,7cm



D320 + K200 + K201 = H: 94-3/8" | 239,7cm
K202 + K200 + K201 = H: 105-7/8" | 269cm

SX162

Duopolymer[®]
H: 1-5/8" | 4cm
P: 3/8" | 1cm
L: 6'6" | 200cm



SX157

Duopolymer[®]
H: 2-5/8" | 6,6cm
P: 1/2" | 1,3cm
L: 6'6" | 200cm



SX159

Duopolymer[®]
H: 2-3/8" | 6cm
P: 1/2" | 1,2cm
L: 6'6" | 200cm



SX163

Duopolymer[®]
H: 4" | 10,2cm
P: 1/2" | 1,3cm
L: 6'6" | 200cm



SX168

Duopolymer[®]
H: 5-7/8" | 15,1cm
P: 1/2" | 1,4cm
L: 6'6" | 200cm



Purotouch[®] a proprietary polymer blend formulated to create deep reliefs and crisp details.

Collections

Duopolymer[®] high impact resin blend. Ideally suited for baseboards and chair rails.

Columns & Pilasters

Columns remind us of the ancient world and if you want to add a hint of this to your project, the ORAC Decor® collection offers plenty to choose from: half and full pillars to many pedestals and shafts. Pillars can be crowned by capitals available in different designs. This allows you to put together your pillars à la carte to suit your project.

A rectangular wall element, such as a pilaster or wall pillar, is perfect for decorating a book case or breaking up a large plain wall surface. Pilasters at specific distances in a long corridor, for example, add rhythm and dynamics.





Columns & Pilasters

Full Columns

K1112

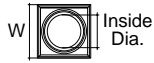

H: 11-3/4" | 30cm
W: 14-3/8" | 36,5cm
P: ø9" | 22,9cm

K1122



H: 11-3/4" | 30cm
W: 14-1/8" | 36cm
P: ø9-1/4" | 23,5cm

K1002

H: 78-1/2" | 199,5cm
Dia: ø8-5/8" | 22cm



K1142 + K1002 + K1152= H: 88-9/16" | 225,5cm
K1142 + K1002 + K1132= H: 106-5/16" | 270cm
K1112 + K1002 + K1152= H: 95-1/4" | 242,5cm
K1112 + K1002 + K1132= H: 113" | 287cm
K1122 + K1002 + K1152= H: 95-1/4" | 242,5cm
K1122 + K1002 + K1132= H: 113" | 287cm

K1102

H: 79-1/2" | 202cm
Dia: ø8-5/8" | 22cm



K1142 + K1102 + K1152= H: 89-9/16" | 227,5cm
K1142 + K1102 + K1132= H: 107-5/16" | 272,5cm
K1112 + K1102 + K1152= H: 96-1/4" | 244,5cm
K1112 + K1102 + K1132= H: 114" | 289,5cm
K1122 + K1102 + K1152= H: 96-1/4" | 244,5cm
K1122 + K1102 + K1132= H: 114" | 289,5cm

K1152

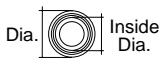

H: 4-7/8" | 12,5cm
Dia: ø12-5/8" | 32cm
ID: ø8-7/8" | 22,5cm

K1132



H: 22-7/8" | 57,5cm
Dia: ø13-3/4" | 35cm
ID: ø9-1/4" | 23,6cm

Half Columns

K1111



H: 11-3/4" | 30cm
W: 14-3/8" | 36,5cm
P: 7-1/4" | 18,3cm
A: 9" | 22,9cm
B: 7-3/8" | 18,9cm

K1121



H: 11-3/4" | 30cm
W: 14-1/8" | 36cm
P: 7-1/8" | 18cm
A: 9-1/4" | 23,5cm
B: 5-3/4" | 14,7cm

K1001

H: 78-1/2" | 199,5cm
W: 8-5/8" | 22cm
P: 4-3/8" | 11cm
A: 5-3/4" | 14,7cm



K1141 + K1001 + K1151= H: 88-9/16" | 225,5cm
K1141 + K1001 + K1131= H: 106-5/16" | 270cm
K1111 + K1001 + K1151= H: 95-1/4" | 242,5cm
K1111 + K1001 + K1131= H: 113" | 287cm
K1121 + K1001 + K1151= H: 95-1/4" | 242,5cm
K1121 + K1001 + K1131= H: 113" | 287cm

K1101

H: 79-1/2" | 202cm
W: 8-5/8" | 22cm
P: 4-3/8" | 11cm
A: 5-5/8" | 14,3cm



K1141 + K1101 + K1151= H: 89-9/16" | 227,5cm
K1141 + K1101 + K1131= H: 107-5/16" | 272,5cm
K1111 + K1101 + K1151= H: 96-1/4" | 244,5cm
K1111 + K1101 + K1131= H: 114" | 289,5cm
K1121 + K1101 + K1151= H: 96-1/4" | 244,5cm
K1121 + K1101 + K1131= H: 114" | 289,5cm

K1151



H: 4-7/8" | 12,5cm
W: 12-5/8" | 32cm
P: 6-1/4" | 16cm
A: 8-7/8" | 22,5cm
B: 6-5/8" | 17cm

K1131



H: 22-5/8" | 57,5cm
W: 13-3/4" | 35cm
P: 6-7/8" | 17,5cm
A: 9-1/4" | 23,6cm

Pilasters

K251

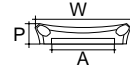

H: 13-3/4" | 35cm
W: 16-3/4" | 42,5cm
P: 4-1/8" | 10,5cm
A: 10-7/8" | 27,8cm

K250

H: 78-3/4" | 200cm
W: 10-5/8" | 27cm
P: 1-1/8" | 2,9cm

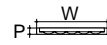

K254 + K250 = H: 104-3/4" | 266,5cm
K254 + K250 + K251 = H: 113-1/2" | 288,5cm



K254

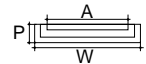

H: 21-1/8" | 53,5cm
W: 15-3/8" | 39cm
P: 2-1/2" | 6,5cm
A: 12-1/4" | 31,2cm



Purotouch® a proprietary polymer blend formulated to create deep reliefs and crisp details.

Collections

Duropolymex® high impact resin blend. Ideally suited for baseboards and chair rails.

Adhesive

ORAC® adhesives save time and money. Eliminate nails, putty, sanding and refilling. Installation times are significantly reduced.



Installation Guarantee: ORAC Decor® products are guaranteed.
Protect your warranty by using genuine ORAC® adhesives

Adhesive



ORAC[®] adhesive & joint compound creates a seamless connection.

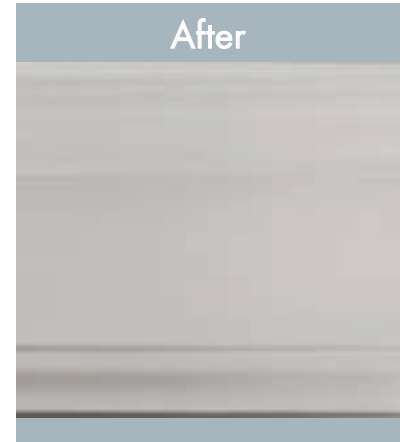
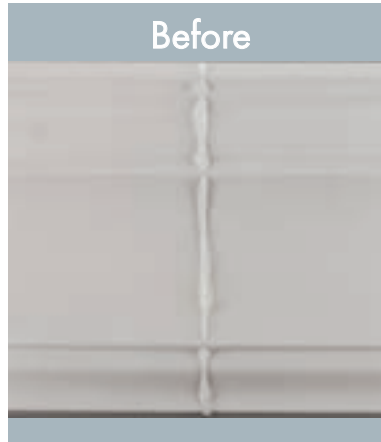

Once the moulding is adhered to your surface, you can walk away to prepare the next length. Conventional installation takes days to finish. With ORAC[®] adhesives, you can finish in hours.

DecoFix Pro

ORAC Décor's DecoFix Pro was engineered for mounting all products from the Duropolymer[®] and Purotouch[®] collections. This adhesive provides a strong bond between the mouldings and mounting surfaces.



For wall and ceiling applications

A strong, water-based acrylic installation adhesive. For interior, porous, and dry surfaces.

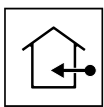

- An all-in-one adhesive for all ORAC profiles: cornice, panel and baseboard mouldings.
- Additional Benefits:
DecoFix Pro acts as a filler
- Remove with damp sponge or cloth
- Should be kept frost free
- Paintable after hardening (min. 24 hours)

FDP-500

310ml
> 7 - 8m

FDP-600

4200ml
> 65 - 110m



Adhesive

DecoFix Power

ORAC Décor's Decofix Power was manufactured for use with both the Duropolymer[®] and Purotouch[®] lines when installed in particularly damp or humid environments. The Decofix Power can be used in bathrooms, kitchens, outdoor environments, or anywhere else where there is a consistent change in humidity.



For wall and ceiling applications and heavy profiles

A very strong, MS-Polymer-based installation adhesive. For exterior, non-porous, and humid surfaces.

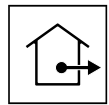

- Use when installing with one point of contact.
- The perfect adhesive for indirect mouldings, bathrooms, and basements.
- Remove with soap solution
- Paintable after hardening (min. 24 hours)

FDP-700

290ml

> 7 - 8m



DecoFix Extra

The final adhesive created specifically for ORAC Décor[®] is the Decofix Extra which is used for seaming joints between mouldings. The Decofix Extra provides a tight bond and nearly seamless look that keeps that joints from separating over time.



For joints between mouldings



A polyurethane-based adhesive. For interior, exterior, porous, non-porous, dry and humid surfaces

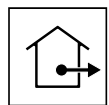

- Remove excess glue before hardening (max. 1 hour and repeat after 2-3 hours)
- Clean with acetone or Synth Thinner
- Can be painted after 24 hrs.
- The more humidity, the faster the drying time

Caution: DO NOT use DecoFix Extra with Durofoam Mouldings

FX-200

310ml

> 80m

FX-210

4200ml

> 20m



Index

C

C200 ◆■ FC200 ■	54, 71	C337 ◆■	64	C901 ◆■ FC901 ■	48, 60, 71
C201 ◆■ FC201 ■	57, 71	C338 ◆■	62	C902 ◆■ FC902 ■	47, 58, 71
C211 ◆■ FC211 ■	59, 71	C338A	62	C990 ◆■	63
C212 ◆■ FC212 ■	54, 71	C338B	63	C990 + 2x P9900	65
C213 ◆■ FC213 ■	56, 71	C339 ◆■ FC339 ■	58, 71	C990 + P9900	64, 65
C214 ◆■ FC214 ■	54, 71	C340 ◆■	64	C990 + P9901	63
C215 ◆■ FC215 ■	53, 71	C341 ◆■ FC341 ■	58, 69, 71	C991 ◆■	47, 59, 69
C216 ◆■ FC216 ■	59, 71	C342 ◆■	61, 70	C991 + 2x P9900	63, 64
C217 ◆■ FC217 ■	60, 71	C343 ◆■	64, 70	C991 + P9900	61
C218 ◆■ FC218 ■	60, 71	C344 ◆■	65	CB500 ◆■	66
C219 ◆■	61	C351 ◆■	48	CB501 ◆■	66
C220 ◆■ FC220 ■	57, 71	C352 ◆■	47	CB502 ◆■	67
C230 ◆■ FC230 ■	52, 71	C353 ◆■	59	CB503 ◆■	67
C240 ◆■ FC240 ■	56, 71	C354 ◆■	61	CB510 ◆■	66
C250 ◆■ FC250 ■	52, 71	C355 ◆■	56	CB511 ◆■	67
C260 ◆■ FC260 ■	53, 71	C356 ◆■	55	CB512 ◆■	67
C300 ◆■	61	C357 ◆■	46	CB520 ◆■	66
C301 ◆■ FC301 ■	61, 71	C358 ◆■	47	CB521 ◆■	66
C302 ◆■ FC302 ■	58, 71	C360 ◆■	53	CB522 ◆■	67
C303 ◆■ FC303 ■	58, 71	C361 ◆■	45	CB523 ◆■	66
C304 ◆■ FC304 ■	57, 71	C362 ◆■	45	CB524 ◆■	67
C305 ◆■	59	C364 ◆■	47	CB525 ◆■	67
C305 + C211	61	C371 ◆■	48	CB530 ◆■	66
C305 + C213	60	C372 ◆■	48	CB531 ◆■	66
C307 ◆■	63	C373 ◆■ FC373 ■	46, 71	CX100 ◆■ CX100F	55, 71
C307 + C-307A	63	C374 ◆■ FC374 ■	48, 71	CX101 ◆■	55
C308 ◆■ FC308 ■	62, 71	C380 ◆■	45	CX106 ◆■ CX106F	59, 71
C321 ◆■ FC321 ■	56, 71	C381 ◆■	46	CX107 ◆■	59
C322 ◆■ FC322 ■	53, 71	C382 ◆■	46	CX108 ◆■	54
C323 ◆■	46, 54	C383 ◆■	47	CX109 ◆■ CX109F ■	53, 71
C324 ◆■	46, 56	C390 ◆■	46, 49, 56, 69	CX110 ◆■ CX110F ■	53, 71
C325 ◆■ FC325 ■	55, 71	C391 ◆■	47, 49, 58, 69	CX111 ◆■	52
C326 ◆■ FC326 ■	57, 71	C392 ◆■	49, 60, 69	CX112 ◆■	54
C327 ◆■	60	C393 ◆■	49, 62	CX115 ◆■	52
C331 ◆■ FC331 ■	58, 71	C394 ◆■	46, 55, 69	CX123 ◆■ CX123F ■	56, 71
C332 ◆■	62	C395 ◆■	47, 58, 69	CX124 ◆■ CX124F ■	54, 71
C333 ◆■ FC333 ■	59, 71	C396 ◆■	48, 60, 69	CX126 ◆■	56
C334 ◆■ FC334 ■	62, 71	C400 ◆■	56	CX127 ◆■ CX127F ■	57, 71
C335 ◆■	64	C402 ◆■ FC402 ■	57, 71	CX128 ◆■	57
C336 ◆■	65	C422 ◆■	62	CX129 ◆■	57
		C602 ◆■ FC602 ■	54, 71	CX132 ◆■ CX132F ■	52, 71
		C900 ◆■	48, 61	CX133 ◆■	52

◆ 4" moulding samples available ■ 36" architect's samples available Contact sales for sampling discounts

Index

CX134 ◆■	52
CX136 ◆■	55
CX141 ◆■	54
CX148 ◆■ CX148F ■	53, 71
CX150 ◆■	53
CX151 ◆■	53
CX154 ◆■	52
CX160 ◆■	65
CX161 ◆■	65
CX176 ◆■	55
CX177 ◆■	55
CX188 ◆■ CX188F ■	45, 71
CX189 ◆■ CX189F ■	45, 71
CX190 ◆■ CX190F ■	45, 71
CX192 ◆■	57

D

D170	97
D200	105
D210	106
D310	106
D320	107
D330LR	105
D340	105
D400	105
D401	105
D402	105
D503	103
D504	103
D506	103
D507	103
D62	99
DX119 ◆■	105
DX121 ◆■	106
DX170-2300 ◆■	105
DX174-2300 ◆■ DX174F ■	105
DX310	105

F

FDP-500	111
FDP-600	111
FPD-700	112
FX-200	112
FX-210	112

G

G70	97
G71	97
G72	97
G75	97
G76	97
G77	97, 100
G78	97

K

K1001	109
K1002	109
K1101	109
K1102	109
K1111	109
K1112	109
K1121	109
K1122	109
K1131	109
K1132	109
K1151	109
K1152	109
K200	107
K201	107
K201L/R	107
K202	107
K250	109
K251	109
K254	109

P

P-101A	78
P-20	78
P-20 + P-101A + P1020	78
P-201A	78
P-21	78
P-21 + P-201A + P2020	78
P-4020A	78
P-4020A + P4020	78
P-5020B	77
P-801C	78
P-801C + P8020	78
P-8030C	78
P-8030C + P8030	78
P1020 ◆■ FP1020 ■	74, 78, 79
P2020 ◆■ FP2020 ■	74, 78, 79
P3020 ◆■ FP3020 ■	75, 78, 79
P3020A	78
P3020A + P3020	78
P3070 ◆■	77
P3071 ◆■	77
P4020 ◆■ FP4020 ■	74, 78, 79
P4025 ◆■ FP4025 ■	76, 79
P5020 FP5020 ■	76, 79
P5020B + P5020	77
P5021 ◆■ FP5021 ■	73, 79
P5050 ◆■	77
P5051 ◆■	76
P6020 ◆■ FP6020 ■	75, 79
P7010 ◆■ FP7010 ■	77, 79
P7020 ◆■ FP7020 ■	77, 79
P7030 ◆■ FP7030 ■	76, 79
P7040 ◆■ FP7040 ■	75, 79
P7070 ◆■ FP7070 ■	75, 79
P7080 ◆■	77
P8020 ◆■ FP8020 ■	75, 78, 79
P8030 ◆■ FP8030 ■	73, 78, 79
P8030D	78
P8040 ◆■ FP8040 ■	76, 79
P8050 ◆■ FP8050 ■	77, 79

◆ 4" moulding samples available ■ 36" architect's samples available Contact sales for sampling discounts

Index

P8060 ◆■ FP8060 ■	74, 79
P9010 ◆■ FP9010 ■	76, 79, 106
P9020 ◆■ FP9020 ■	76, 79
P9040 ◆■ FP9040 ■	74, 79
P9050 ◆■ FP9050 ■	73, 79
P9900 ◆■ FP9900 ■	61, 76, 79
P9901 ◆■ FP9901 ■	75, 79
PB513 ◆■	67
PX102 ◆■	75
PX103 ◆■ PX103F ■	73, 78, 79
PX103A	78
PX103A + PX103	78
PX113 ◆■	74
PX114 ◆■	75
PX116 ◆■	73
PX117 ◆■	73
PX120 ◆■ PX120F ■	73, 78, 79
PX120A	78
PX120A + PX120	78
PX131 ◆■	73
PX144 ◆■ PX144F ■	74, 79
PX147 ◆■	103
PX164 ◆■	52
PX169 ◆■	103
PX175 ◆■ PX175F ■	74, 79

R

R-07	99
R-08	99
R-09	100
R-10	99
R-11	99
R-12	99
R-13	99
R-14	99
R-17	100
R-18	100
R-22	101
R-23	101
R-24	101

R-27	101
R-31	99
R-38	101
R-40	101
R-46	100
R-52	101
R-61	100
R-64	101
R-66	100
R-73	101
R-76	100
R-77	100

S

SX104 ◆■ SX104F ■	87, 88
SX105 ◆■ SX105F ■	86, 88
SX118 ◆■ SX118F ■	86, 88
SX122 ◆■	85
SX125 ◆■	84
SX137 ◆■ SX137F ■	85, 88
SX138 ◆■ SX138F ■	86, 88
SX155 ◆■ SX155F ■	86, 88
SX156 ◆■	87
SX157 ◆■ SX157F ■	84, 88, 107
SX159 ◆■	84, 107
SX162 ◆■ SX162F ■	84, 88, 107
SX163 ◆■ SX163F ■	85, 88, 107
SX165 ◆■ SX165F ■	84, 88
SX167 ◆■	87
SX168 ◆■	87, 107
SX171 ◆■	82, 85
SX172 ◆■ SX172F ■	85, 88
SX173 ◆■ SX173F ■	85, 88
SX179 ◆■ SX179F ■	48, 85, 88
SX180 ◆■ SX180F ■	83, 86, 88
SX181 ◆■	83, 87
SX182 ◆■ SX182F ■	84, 88
SX183 ◆■ SX183F ■	84, 88
SX184 ◆■ SX184F ■	86, 88
SX185 ◆■	82, 86

SX186 ◆■	82, 87
SX187 ◆■ SX187F ■	84, 88
SX191 ◆■	87

W

W100	94
W101	94
W102	94
W103	94
W104	94
W105	94
W106	94
W107	94
W108 ◆■	95
W109 ◆■	95
W110 ◆■	95
W120	95
W120 + P4025 + W121	96
W120 + 4*W122	96
W120 + 4*W123	96
W121	95
W121 + W123	96
W121 + W122	96
W122	95
W123	95
W130 ◆■	95
3*W130 + 2*CX190	96

ORAC[®]
D E C O R
BY OUTWATER

New Jersey
24 River Road
Bogota, NJ 07603

Arizona
4720 West Van Buren St.
Phoenix, AZ 85043

Belgium
Biekorfstraat 32,
8400 Ostend, Belgium

1-800-835-4400
www.oracdecorusa.com

CATALOG 032

