

Overview

The HP ProLiant DL380p Gen8 sets the next generation standards of 2U 2-socket rack servers for the industry. With enhanced configuration flexibility, unmatched performance, and leading energy efficient design the DL380p Gen8 offers the perfect solution for the dynamic compute requirements of today's demanding datacenters.

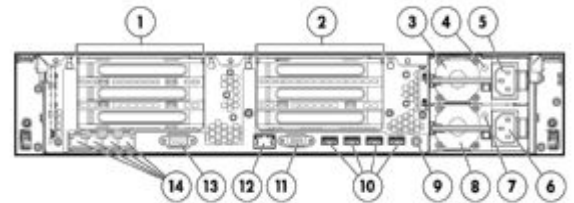
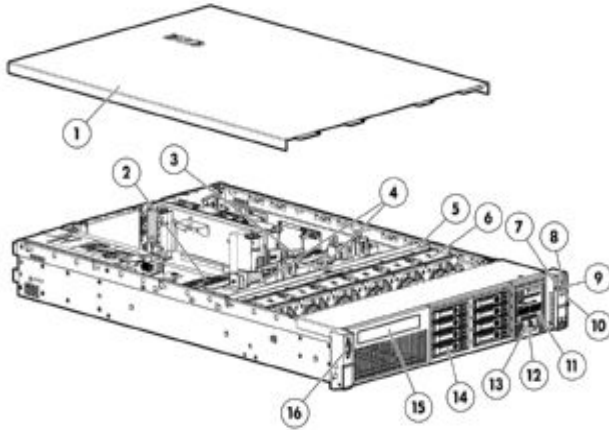

Front View:

1. Quick removal access panel
2. Second Intel Processor
3. First Intel Processor
4. 24 DIMM slots: DDR3 Registered (RDIMM), Load Reduced (LRDIMM), or Unbuffered (UDIMM) memory
5. Air Baffle
6. Hot-plug fans, full N+1 redundancy
7. Health LED
8. Power On /Standby button and system power LED button
9. USB connector
10. Unit ID LED
11. Systems Insight Display
12. Asset Tag
13. USB connector
14. Drive Bays
15. Optional Slim Optical Bay (SATA DVD-RW /ROM Optical Drive)
16. Video connector

Rear View:

1. PCIe 3.0 Slots 1, 2, 3-PCIe 2.0 top to bottom
2. PCIe 3.0 Slots 4-6 top to bottom
3. Power supply 1
4. Power supply 1 Power LED
5. Power supply 1 Power connection (with Intelligent PD communication)
6. Power supply 2 Power connection (with Intelligent PD communication)
7. Power supply 2 Power LED
8. Power supply 2
9. Unit ID LED/Button
10. USB connectors (4)
11. Video connector
12. iLO connector
13. Serial connector
14. FlexibleLOM ports (Shown: 4 ports 1Gb each /Option: 2 ports 10Gb each)

What's New

- Releasing the new 12LFF and 25SFF CTO Server

Standard Features

NOTE: For the Standard Features shipped in the "Factory Integrated Models", please see the "Configuration Information - Factory Integrated Models" section.

Processor
One of the following
depending on Model

Entry Processors

NOTE: All support up to 1066MHz memory speeds.

Intel® Xeon® E5-2609 (2.4GHz/4-core/10MB/6.4GT-s QPI/80W)

Intel® Xeon® E5-2603 (1.8GHz/4-core/10MB/6.4GT-s QPI/80W)

Base Processors

NOTE: All support up to 1333MHz DDR3 memory speeds.

Intel® Xeon® E5-2640 (2.5GHz/6-core/15MB/7.2GT-s QPI/95W, DDR3-1333, HT, Turbo2-3/3/4/4/5/5)

Intel® Xeon® E5-2630 (2.3GHz/6-core/15MB/7.2GT-s QPI/95W, DDR3-1333, HT, Turbo2-3/3/4/4/5/5)

Intel® Xeon® E5-2620 (2.0GHz/6-core/15MB/7.2GT-s QPI/95W, DDR3-1333, HT, Turbo2-3/3/4/4/5/5)

Intel® Xeon® E5-2630L (2.0GHz/6-core/15MB/8.0GT-s QPI/60W, DDR3-1333, HT, Turbo2-3/3/4/4/5/5)

Performance Processors

NOTE: All support up to 1600MHz DDR3 memory speeds.

Intel® Xeon® E5-2690 (2.9GHz/8-core/20MB/8GT-s QPI/135W, DDR3-1600, HT, Turbo2-4/4/4/5/5/7/7/9)

Intel® Xeon® E5-2680 (2.7GHz/8-core/20MB/8GT-s QPI/130W, DDR3-1600, HT, Turbo2-4/4/5/5/5/7/8/8)

Intel® Xeon® E5-2670 (2.6GHz/8-core/20MB/8GT-s QPI/115W, DDR3-1600, HT, Turbo2-4/4/5/5/6/6/7/7)

Intel® Xeon® E5-2667 (2.9GHz/6-core/15MB/8GT-s QPI/130W, DDR3-1600, HT, Turbo2-3/3/3/4/5/6)

Intel® Xeon® E5-2665 (2.4GHz/8-core/20MB/8GT-s QPI/115W, DDR3-1600, HT, Turbo2-4/4/5/5/6/6/7/7)

Intel® Xeon® E5-2660 (2.2GHz/8-core/20MB/8GT-s QPI/95W, DDR3-1600, HT, Turbo2-5/5/6/6/7/7/8/8)

Intel® Xeon® E5-2650 (2.0GHz/8-core/20MB/8GT-s QPI/95W, DDR3-1600, HT, Turbo2-4/4/5/5/5/7/8/8)

Intel® Xeon® E5-2650L (1.8GHz/8-core/20MB/8.0 GT-s QPI/70W, DDR3-1600, HT, Turbo2-2/2/3/3/4/4/5/5)

Intel® Xeon® E5-2643 (3.3GHz/4-core/10MB/8GT-s QPI/130W, DDR3-1600, HT, Turbo2-1/1/2/2)

Intel® Xeon® E5-2637 (3.0GHz/2-core/5MB/8.0GT-s QPI/80W, DDR3-1600, HT, Turbo2-5/5)

NOTE: HT indicates that the processor model supports Intel® Hyper-Threading Technology.

NOTE: Turbo indicates the maximum potential frequency increment when using Intel® Turbo Boost Technology, with 8, 7, 6, 5, 4, 3, 2 and 1 cores active.

NOTE: DDR3 speed is the maximum memory speed of the processor. Actual memory speed may depend on the quantity and type of DIMMs installed.

NOTE: Up to 2 processors supported. Mixing different processor models is not supported.

NOTE: For the Intel® C600 Chipset E5-2600 Series, the letter preceding the model number indicates the Product Line (E3, E5, E7); 2600x v#, 2 = number of CPUs in a Node, 6 is socket/segment designation, 00 = Processor SKU, x = L for low power SKUs and v# (not yet designated) = version number.

Standard Features

Cache Memory 20MB (1x20MB) Level 3
One of the following depending on Model **NOTE:** For Eight-core processors.
15MB (1x15MB) Level 3
NOTE: For Six-core processors.
10MB (1x10MB) Level 3
NOTE: For Quad-core processors.
5MB (1x5MB) Level 3
NOTE: For Dual-core processors.
NOTE: All processor models above list the L3 Cache associated with that particular processor.

Chipset Intel® C600 Series Chipset
Intel® E5-2600 Processor Family
NOTE: For more information regarding Intel chipsets, please see the following URL:
<http://www.intel.com/products/server/chipsets/>.

Upgradeability Upgradeable to 2 processors (16 Cores)
Up to 24 DIMM slots available for higher Memory capacity
FlexibleLOM connector for 1 Gigabit or 10 Gigabit networking options
8SFF Hard drive bays (total of 16 with optional upgrade)
Optional 3 slot riser (x16, x8, x8), or 2 slot (x16, x16)
NOTE: To take advantage of the additional 3 PCI slot upgrade, the second processor must be installed.
Redundant Power Supply
Optical Drive (8SFF/8LFF only)

On System Management Chipset HP iLO (Firmware: HP iLO 4)
NOTE: For more information, visit: <http://www.hp.com/go/ilo>

Memory Protection Advanced ECC
NOTE: Advanced ECC uses single device data correction (SDDC) to detect and correct single and all multi-bit error that occurs within a single DRAM chip. Both x4 and x8 SDDC are supported (x8 requires lockstep mode).
Online Spare
NOTE: Memory online spare mode (also known as rank spare mode) detects a rank that is degrading and switches operation to the spare rank.
Lock-step mode
NOTE: Memory Lockstep mode is used to correct a single x8 DRAM device failure on a DIMM. The DIMMs in each paired memory channel must have identical HP part numbers.

Standard Features

Memory

One of the following depending on Model

Type	HP SmartMemory DDR3 Load Reduced (LRDIMM), Registered (RDIMM) or Unbuffered (UDIMM)
DIMM Slots Available	24 (12 DIMM slots per processor /4 channels per processor/3 DIMMs per channel)
Standard (Entry Model)	4GB (1x4GB) PC3L-10600R (DDR3-1333) Registered DIMMS
Standard (Base Models)	16GB (4x4GB) PC3L-10600R (DDR3-1333) Registered DIMMS
Standard (High Performance Models)	32GB (4x8GB) PC3-12800R (DDR3-1600) Registered DIMMS
Maximum Capacity (LRDIMM)	768GB (24 x 32GB LRDIMM @1066MHz)
Maximum Capacity (RDIMM)	384GB (24x 16GB RDIMM @1600MHz)
Maximum Capacity (UDIMM)	128GB (16 x 8GB UDIMM @1333MHz)
Maximum Capacity (HDIMM)	384GB (24 x 16GB UDIMM @1333MHz)

NOTE: HP memory from previous generation servers are not qualified or warranted with this HP ProLiant Server. HP SmartMemory is required to realize the memory performance improvements and enhanced functionality listed in this document for Gen8. For additional information, please see the HP SmartMemory QuickSpecs at:

http://h18000.www1.hp.com/products/quickspecs/14225_na/14225_na.html

NOTE: LRDIMM, RDIMM and UDIMMs are all distinct memory technologies and cannot be mixed within a server. The majority of ProLiant Gen8 servers support RDIMM, UDIMM and LRDIMM.

NOTE: If only one processor is installed, only half the DIMM slots are available

NOTE: UDIMM max DIMM population is 16

NOTE: Depending on the memory configuration and processor model, the memory speed may run at 1600MHz, 1333MHz, or 1066MHz. Please see Memory Population Table or the Online Memory Configuration Tool at: www.hp.com/go/ddr3memory-configurator.

Network Controller

One of the following depending on Model

HP ProLiant Gen8 servers offer a new networking technology - Flexible Network Technology. The HP ProLiant DL380p Gen8 server offers the customer the choice of 1 Gigabit and/or 10 Gigabit networking solutions. For additional details see the Networking Section of this document.

Entry Models	HP Ethernet 1Gb 4-port 331FLR Adapter
Base Models	HP Ethernet 1Gb 4-port 331FLR Adapter
High Performance Models	HP Ethernet 10Gb 2-port 530FLR-SFP+ Adapter HP Ethernet 1Gb 4-port 331FLR Adapter
Energy Star - Base Models	HP Ethernet 1Gb 4-port 331FLR Adapter

Standard Features

Expansion Slots

Primary Riser (Standard)	Expansion Slots #	Technology	Bus Width**	Connector Width	Bus Number*	Form Factor	Notes
	1	PCIe 3.0	X16	X16	7	Full Length, Full Height Slot	Proc 1
	2	PCIe 3.0	X8	X8	10	Half Length, Full Height Slot	Proc 1
	3	PCIe 2.0	X4	X8	13	Half Length, Full Height Slot	Proc 1

* Default bus assignment (in decimal). Inserting cards with PCI bridges may alter the actual bus assignment number

** Indicates the number of physical electrical lanes running to the connector.

NOTE: When populating the second optional riser slot, the second processor must be installed.

NOTE: All slots support up to 150w PCIe cards, but an additional Power Cord Option is required (PN 669777-B21). See Option Section below for offering.

PCIe Riser (Optional 3-slot)	Expansion Slots #	Technology	Bus Width**	Connector Width	Bus Number*	Form Factor	Notes
	4	PCIe 3.0	X16	X16	16	Full length, full height slot	Proc 2
	5	PCIe 3.0	X8	X8	20	Half length, full height slot	Proc 2
	6	PCIe 3.0	X8	X8	23	Half length, full height slot	Proc 2

* Default bus assignment (in decimal). Inserting cards with PCI bridges may alter the actual bus assignment number

** Indicates the number of physical electrical lanes running to the connector.

NOTE: When populating the second optional riser slot, the second processor must be installed.

NOTE: All slots support up to 150w PCIe cards, but an additional Power Cord Option is required (669777-B21). See Option Section below for offering

PCIe Riser (Optional 2-slot)	Expansion Slots #	Technology	Bus Width**	Connector Width	Bus Number*	Form Factor	Notes
	4	PCIe 3.0	X16	X16	16	Full length, Full height slot	Proc 2
	5	PCIe 3.0	X16	X16	16	Half Length, Full Height	Proc 2

* Default bus assignment (in decimal). Inserting cards with PCI bridges may alter the actual bus assignment number

** Indicates the number of physical electrical lanes running to the connector.

Standard Features

HP Server ROM

HP ROM (Read Only Memory) is now digitally signed using HP's Corporate Signing Service. This signature is verified before the flash process starts, reducing accidental programming and preventing malicious efforts to corrupt system ROM.

HP ROM provides for essential initialization and validation of hardware components before control is passed to the customer-installed operating system. The ROM also provides the capability of booting from various fixed media (HDD, CD-ROM) and removable media (USB), to continue operation to the operating system.

HP ROM performs very early configuration of the video controller, to allow monitoring of initialization progress via an attached monitor. If configuration or hardware errors are discovered during this early phase of hardware initialization, suitable messages are now displayed on the connected monitor. Additionally, these configuration or hardware errors are logged to the Integrated Management Log (IML) to assist in diagnosis.

HP's ProLiant ROM is used to configure the following:

- Processor and chipset status registers
- System memory, memory map, and memory initialization
- System hardware configuration (Integrated PCI devices and optional PCIe cards).
- Customer-specific BIOS configuration (using the HP ROM-Based Setup Utility (RBSU)).

NOTE: For further information, please refer to HP's RBSU (ROM based setup utility) user guide: www.hp.com/support/rbsu.

Storage Controller

One of the following depending on Model

Entry Models	HP Smart Array P420i/ZM (RAID 0/1/1+0)
Base Models	HP Smart Array P420i/1GB with FBWC (RAID 0/1/1+0/5/5+0)
High Performance Models	HP Smart Array P420i/2GB with FBWC (RAID 0/1/1+0/5/5+0)
Energy Star - Base Models	HP Smart Array P420i/1GB with FBWC (RAID 0/1/1+0/5/5+0)

Internal Storage Devices

Diskette Drive	None
Optical Drive	Ships standard in Performance Models *Optional: DVD-ROM, DVD-RW
Hard Drives	None ship standard
Drive Bays	Standard: 8SFF drive bays total with Optical Bay or 8 LFF drive bays total with Optical Bay Optional: +8SFF drive bay (total of 16SFF drive bays) NOTE: HP ProLiant DL380p series servers offer both LFF and SFF versions. The Optical Drive bay is not available with the optional +8SFF drive bay upgrade. NOTE: The Optical drive bay is not available with the +8SFF drive bay optional upgrade nor 12LFF and 25SFF server models NOTE: The 8LFF, 12LFF, and 25SFF drive cage versions are not field upgradeable options from the 8SFF model. NOTE: The optional +8SFF drive bay requires an additional internal storage controller be selected. HP recommends the HP Smart Array P420/1GB FBWC 6Gb 2-ports Int SAS Controller (P/N 631670-B21). NOTE: All Pre-configured Models come populated with some hard drive blanks installed. Should the customer need additional hard drive blanks, they can order more using either P/N 666987-B21: HP SFF Gen8 Hard Drive Blank Kit or P/N 666986-B21: HP LFF Gen8 Hard Drive Blank Kit. These part numbers for single HDD blanks

Standard Features

below are also provided should the customer require replacement HDD blanks for their server.

Maximum Internal Storage	Hot Plug SFF SAS	25.0TB	25 x 1TB (with optional SFF drive cage)
	Hot Plug SFF SATA	25.0TB	25 x 1TB (with optional SFF drive cage)
	Hot Plug LFF SAS	36.0TB	12 x 3TB (with optional LFF drive cage)
	Hot Plug LFF SATA	36.0TB	12 x 3TB (with optional LFF drive cage)
	Hot Plug SFF SAS SSD	20.0TB	25 x 800GB (with optional SFF drive cage)
	Hot Plug LFF SATA SSD	4.8TB	12 x 400GB (with optional LFF drive cage)

Interfaces	Serial	1
	Video	2 (1 front, 1 back) not active simultaneously
	FlexibleLOM Network Ports	Some models come standard with 4 x 1GB ports while others come with 2 x 10GB ports (See HP Networking section below for more details and options).
	HP iLO Remote Management Network Port	1 Gb Dedicated
	SD slot	1 Internal Secure
	USB 2.0 Ports	Up to 7 total: up to 2 front, 4 back, 1 internal

Industry Standard Compliance	ACPI 2.0b Compliant
	PCIe 3.0 Compliant
	PXE Support
	WOL Support
	Microsoft® Logo certifications
	USB 2.0 Compliant

Server Power Cords All Pre-configured servers ship with a high voltage server-to-PDU power cord.
NOTE: HP ProLiant DL servers no longer ship standard with a 12-foot NEMA 5-15P to C13 power cord that connects to 110V US wall outlets in a home or office. ProLiant DL servers are primarily connected to power distribution units (PDUs) in data center racks and now ship standard with a PDU 6-foot C-14 to C13 power cord (A0K02A). If a user wishes to power a ProLiant DL server using a 110V receptacle (NEMA-15), the 6-foot NEMA 5-15 to C13 power cord must be ordered separately (AF556A). See Power Cords section for Worldwide Power Cord options.

Power Specifications To review typical system power ratings use the HP Power Advisor which is available via the online tool located at URL: www.hp.com/go/proliant-energy-efficient or www.hp.com/go/hppoweradvisor.

NOTE: Power Specification and Technical Content for supported power supplies can be found at: http://h18000.www1.hp.com/products/quickspecs/14209_div/14209_div.html

Standard Features

Common Slot Power Supply HP's Common Slot (CS) power supplies allow for commonality of power supplies across a wide range of ProLiant and Integrity servers, as well as HP Storage solutions, and are designed to provide the highest power supply efficiency without degrading system performance. HP CS power supplies are tested by the Electric Power Research Institute (EPRI) and certified through the ECOS 80 Plus power supply program. HP CS power supply options provide efficiency ratings of up to 94% (80 Plus Platinum) and are available in three power output options - 460W, 750W, and 1200W - allowing the customer to "right-size" a power supply for their specific server configuration. All HP Common Slot power sources are UL, CE Mark Compliant, hot-plug and support redundant configurations.

NOTE: Mixing of power supplies in the same server is not supported. All power supplies must be of the same output and efficiency rating. If non-matched power supplies are inserted you will get errors and operation will fail.

HP CS Platinum Plus power supplies are required when enabling HP's Intelligent Power Discovery (IPD) solution. IPD is the first technology to create an automated, energy-aware network between IT systems and facilities. This allows your company to reclaim millions of dollars in wasted power capacity and downtime costs across data centers. For more information on HP's IPD solution, go to www.hp.com/go/ipd.

It is highly recommended that you use the HP Power Advisor in defining the "Right-Size" power supply for your needs. HP Power Advisor can be accessed at: www.hp.com/go/hppoweradvisor.

NOTE: The 80 PLUS program is a unique forum that unites electric utilities, the computer industry, and consumers in an effort to bring energy efficient technology solutions to the marketplace. 80 Plus independently tests power supply efficiency and publicly posts the results on 80Plus.org.

Redundant Power: Optional (1+ 1 or n+n redundant) power supplies can be purchased through power supply option kits (see Power Supplies for part numbers).

NOTE: Power Specification and Technical Content for supported power supplies can be found at: http://h18000.www1.hp.com/products/quickspecs/14209_na/14209_na.html

System Fans 2P Models have (6) (N+1 redundancy standard)
One of the following depending on Model 1P Models have (4) (N+1 redundancy standard)

Required Cabling For required cabling information, refer to the HP Web site at: www.hp.com/servers/dl380p-gen8.

Operating Systems and Virtualization Software Support for ProLiant Servers [Microsoft Windows Server](#)
[Red Hat Enterprise Linux \(RHEL\)](#)
[SUSE Linux Enterprise Server \(SLES\)](#)
[Oracle Solaris](#)
[VMware](#)
[Citrix XenServer](#)

NOTE: For more information on HP's Certified and Supported ProLiant Servers for OS and Virtualization Software and latest listing of software drivers available for your server, please visit our Support Matrix at: <http://www.hp.com/go/ossupport> and our driver download page: <http://www.hp.com/support/DL380pGen8>

Standard Features

Graphics

Integrated Matrox G200 video standard

- 1280 x 1024 (32 bpp)
- 1920 x 1200 (16 bpp)

Form Factor

One of the following depending on Model

2U Rack form factor, ships with ball bearing rails and cable management system

8 SFF Drive Bay Version:

3.44 (8.74 cm) Height x 17.54" (44.55 cm) Width x 27.5" (69.85 cm) Length

8 LFF Drive Bay Version:

3.44 (8.74 cm) Height x 17.54" (44.55 cm) Width x 29.5" (74.94cm) Length

On System Management

HP iLO Management Engine

HP iLO Management Engine is a complete set of embedded management features supporting the complete lifecycle of the server, from initial deployment, through ongoing management, to service alerting and remote support. HP iLO Management Engine comes standard on all HP ProLiant Gen8 Servers. HP iLO Management Engine portfolio includes:

- **HP iLO:** The HP iLO management processor is the core **foundation for HP iLO Management Engine. HP iLO for HP ProLiant** servers simplify server setup, engage health monitoring, power and thermal control, and promote remote administration for HP ProLiant ML, DL, BL and SL servers. Furthermore with the new HP iLO is the ability to access, deploy, and manage your server anytime from anywhere with your Smartphone device.
- **HP Agentless Management:** With HP iLO Management Engine in every HP ProLiant Gen8 server, the base hardware monitoring and alerting capability is built into the system (running on the HP iLO chipset) and starts working the moment that a power cord and an Ethernet cable is connected to the server.
- **HP Active Health System:** HP Active Health System is an essential component of the HP iLO Management Engine. It provides: Diagnostics tools/scanners wrapped into one; Always on, continuous monitoring for increased stability and shorter downtimes; Rich configuration history; Health and service alerts; Easy export and upload to Service and Support.
- **HP Intelligent Provisioning (previously known as SmartStart):** HP Intelligent Provisioning offers the ability for out-of-the box single-server deployment and configuration without the need for media.

NOTE: For more information, visit: <http://www.hp.com/go/ilo>

Standard Features

HP Insight management software

HP Service Pack for
ProLiant (SPP)

HP Service Pack for ProLiant (SPP) and HP Smart Update Manager (HP SUM) version 5 provide a new, comprehensive approach to firmware and system software maintenance. Together they provide better operating stability and ensure maximum uptime. The SPP will be updated at a predictable cadence, typically coinciding with new HP server hardware launches. By enabling all firmware to be updated online and integrating firmware and system software updates in one operation HP SUM and the SPP offer faster updates of individual servers and dramatically faster updates of entire BladeSystem enclosures. Further improving system uptime and stability is the fact that HP provides 12 months of support on each Service Pack for ProLiant.

The user experience around HP SUM and the SPP has been improved in several ways, starting with the web download. A single web page provides access to a single download containing both the latest version of HP SUM version 5 and the latest SPP. Optional smaller subsets with only specific types of servers or specific operating systems are offered to save on download time. The HP SUM application has been re-written to provide a more straightforward, intuitive user interface that guides the user through the steps of discovery, analyses and update, providing comprehensive information on available updates, criticality and interdependencies. This information is also available in reports. By providing the option of multiple local or shared repositories which can be easily updated from hp.com, HP SUM provides the tools to optimize stability and consistency throughout the company. While HP SUM and the SPP will recommend the combinations of firmware and system software that HP has found to be the best practice, the application gives customers the flexibility to set their own specific baseline.

The Service Pack for ProLiant has been rigorously tested with specific attention for interaction between firmware, drivers and agents both within the server as well as in interaction with the BladeSystem enclosure components (Onboard Administrator and Virtual Connect). This testing ensures the highest quality as well as providing the input for HP SUM to deploy updates taking into account all interdependencies, when determining the correct updates and order of update deployment.

NOTE: The Service Pack for ProLiant (which includes HP SUM 5) can be downloaded from www.hp.com/go/spp/download. More information can be found: www.hp.com/go/spp and <http://www.hp.com/go/hpsum>

Security

Power-on password
Serial interface control
Administrator's password

Standard Features

Warranty

This product is covered by a global limited warranty and supported by HP Services and a worldwide network of HP Authorized Channel Partners resellers. Hardware diagnostic support and repair is available for three years from date of purchase. Support for software and initial setup is available for 90 days from date of purchase. Enhancements to warranty services are available through HP Care Pack services or customized service agreements. Hard drives have either a one year or three year warranty; refer to the specific hard drive QuickSpecs for details.

NOTE: Server Warranty includes 3-Year Parts, 3-Year Labor, 3-Year Onsite support with next business day response. Warranty repairs may be accomplished through the use of Customer Self Repair (CSR) parts. These parts fall into two categories: 1) Mandatory CSR parts are designed for easy replacement. A travel and labor charge will result when customers decline to replace a Mandatory CSR part; 2) Optional CSR parts are also designed for easy replacement but may involve added complexity. Customers may choose to have HP replace Optional CSR parts at no charge. Additional information regarding worldwide limited warranty and technical support is available at: <http://h18004.www1.hp.com/products/servers/platforms/warranty/index.html>

Optional Features

HP Insight management software

HP Insight Control

HP Insight Control, a product option, delivers essential infrastructure management that can help save time and money by making it easy to deploy, migrate, monitor, remote control, and optimize your IT infrastructure through a single, simple management console.

Two versions of Insight Control are available, to serve environments requiring either a Linux-based or a Windows-based central management server: HP Insight Control for Linux, and HP Insight Control. See www.hp.com/go/insightcontrol

HP Insight Control includes one year of 24 x 7 HP Software Technical Support and Update Service ensuring rapid access to HP support staff and proactive delivery of software updates. For more information about this service, please visit: <http://www.hp.com/services/insight>.

HP Matrix Operating Environment

The HP Matrix Operating Environment (Matrix OE) for ProLiant and Integrity servers is an integrated command center that helps you instantly adjust to dynamic business demands. This advanced infrastructure management software lets you reduce the cost of common data center tasks by up to 40 percent while keeping pace with your changing business.

The HP Matrix OE includes the automated provisioning, optimization, and recovery management capabilities for HP CloudSystem Matrix, the ideal platform for private cloud and Infrastructure as a Service (IaaS).

NOTE: For more information, visit: <http://www.hp.com/go/matrixoe>

HP iLO Advanced License for ProLiant Servers

HP iLO management processors for HP ProLiant Gen8 servers virtualizes system controls to help simplify server setup, engage health monitoring and power and thermal control, and promote remote administration. HP iLO functions out-of-the-box without additional software installation and functions regardless of the servers' state of operation. Basic system board management functions, diagnostics, and essential Lights-Out functionality ships standard across all HP ProLiant Gen8 rack, tower and blade servers. The HP iLO can be accessed from any location via a web browser and works hand-in-hand with HP Systems Insight Manager, Insight Control, and HP Matrix Operating Environment, helping customers unleash the value of the ProLiant platform and deliver the highest possible quality of IT service to the business.

Advanced functionality, such as graphical remote console, multi-user collaboration, and video record/playback can be activated with the optional HP iLO Advanced or HP iLO Advanced for BladeSystem licenses. The Advanced licensed features offer sophisticated remote administration of servers in dynamic data center and remote locations and can help significantly reduce cost associated with IT-related travel and unplanned downtime.

NOTE: For more information, visit: <http://www.hp.com/go/ilo>

Optional Features

High Performance Clusters	HP Cluster Platforms	HP Cluster Platforms are specifically engineered, factory-integrated large-scale ProLiant clusters optimized for High Performance Computing, with a choice of servers, networks and software. Operating system options include specially priced offerings for Red Hat Enterprise Linux and SUSE Linux Enterprise Server, as well as Microsoft Windows HPC Server. A Cluster Platform Configurator simplifies ordering. http://www.hp.com/go/clusters
	HP HPC Interconnects	High Performance Computing (HPC) interconnect technologies are available for this server as part of the HP Cluster Platform portfolio. These high-speed InfiniBand and Gigabit interconnects are fully supported by HP when integrated within an HP cluster. Flexible, validated solutions can be defined with the help of configuration tools. http://www.hp.com/techservers/clusters/ucp/index.html
	HP Insight Cluster Management Utility	HP Insight Cluster Management Utility (CMU) is an HP-licensed and HP-supported suite of tools that are used for lifecycle management of hyperscale clusters of Linux ProLiant systems. CMU includes software for the centralized provisioning, management and monitoring of nodes. CMU makes the administration of clusters user friendly, efficient, and effective. http://www.hp.com/go/cmu
	HP HPC Linux Value Pack	HP HPC Linux Value Pack (Value Pack) is an HP-licensed and HP-supported option to HP Insight CMU, for the development and deployment of applications on HPC Cluster Platforms. Value Pack includes the Platform LSF workload scheduler and Platform Application Center, as well as the HP-MPI parallelization library. HP HPC Linux Value Pack

HP Insight Online HP Insight Online is a new addition to the HP Support Center for one stop, secure access to product and HP support information personalized to your IT environment. Insight Online can automatically display devices remotely monitored by HP Insight Remote Support. With Insight Online's easy navigation you can efficiently track your IT support contracts and device status from anywhere and at anytime. www.hp.com/go/insightonline

Factory Express Portfolio for Servers and Storage HP Factory Express offers configuration, customization, integration and deployment services for HP servers and storage products. Customers can choose how their factory solutions are built, tested, integrated, shipped and deployed.

Factory Express offers service packages for simple configuration, racking, installation, complex configuration and design services as well as individual factory services, such as image loading, asset tagging, and custom packaging. HP products supported through Factory Express include a wide array of servers and storage: HP Integrity, HP ProLiant, HP ProLiant Server Blades, HP BladeSystem, HP 9000 servers as well as the MSAxxxx, EVA7xxx, EVA, XP, rackable tape libraries and configurable network switches.

For more information on Factory Express services for your specific server model please contact your sales representative or go to: <http://www.hp.com/go/factory-express>.

HP Enterprise Configurator The HP eConfigure-Enterprise Configurator now provides factory default racking for our HP hardware portfolio. This approach is aligned with our strategic direction to meet the needs and expectations of our valued customers. If you require "custom" rack configuration, please contact HP's Customer Business Center or an Authorized Partner for assistance. <http://www.hp.com/products/configurator>.

Service and Support

Service and Support **HP Technology Services for Industry Standard Servers and BladeSystem**

Capitalizing on HP ProLiant server and HP BladeSystem capabilities requires a service partner who understands your increasingly complex business technology environment. That's why it makes sense to team up with the people who know HP infrastructure hardware and software best - the experienced professionals at HP Services.

What HP ProLiant and BladeSystem Services can do for you

HP ProLiant and BladeSystem Services can help you design, deploy, test, integrate, support, and manage IT and infrastructure solutions. This way, HP proposes services solutions that include more than just uplift of base warranty. Foundation Care services deliver scalable support-packages for HP industry-standard servers and software. You can choose the type and level of service that is most suitable for their business needs. New to this portfolio is HP Collaborative Support. If you are running business critical environments, HP offers Proactive Care or Critical Advantage. These services help deliver high levels of application availability through proactive service management and advanced technical response

You can get the support you need by choosing from one of a number of service packaged solutions we have designed to address wider set of customer support needs.

HP Technology Services meets business challenges with services offered in three support recommendations - **Optimized Care, Standard Care, and Basic Care** - available for each product group. Such support solutions enable customers to optimize technology operations, minimize risk and drive better business outcomes with easy-to-buy, easy-to-use scalable support recommendations for servers, storage, networking and software designed to meet your specific needs.

All three service recommendations include support services from the broader portfolio of Foundation Care and Proactive Care services.

Optimized Care

Optimized Care : Supports maintaining servers at optimum performance availability

HP ProLiant Server Hardware Installation

Provides for the basic hardware installation of HP branded servers, storage devices and networking options to assist you in bringing your new hardware into operation in a timely and professional manner <http://h20195.www2.hp.com/V2/GetPDF.aspx/5981-9356EN.pdf>

HP Installation and Startup for Insight Control Software / HP SIM

Provides for the deployment and basic configuration of HP Insight Control or HP SIM (Systems Insight Manager) on HP ProLiant ML and DL series servers or HP BladeSystem servers <http://h20195.www2.hp.com/v2/GetPDF.aspx/4AA0-9972ENW.pdf>

3-Year HP 24x7 4 hour Response, Proactive Care

Helps optimize your systems and delivers high levels of application availability through proactive service management and advanced technical response. A skilled Technical Manager will own your call and end to end until resolved, delivering a single point of contact for you. Helping you to resolve your hardware and software issues and minimizing downtime in your business critical environment.

Additional Services: Factory Express, Education Services, Proactive Select - 30 Credit Package

Service and Support

Standard Care **Standard Care : Service recommendation that maintains high level of server availability**

HP ProLiant Server Hardware Installation

Provides for the basic hardware installation of HP branded servers, storage devices and networking options to assist you in bringing your new hardware into operation in a timely and professional manner <http://h20195.www2.hp.com/V2/GetPDF.aspx/5981-9356EN.pdf>

HP Installation and Startup for Insight Control Software / HP SIM

Provides for the deployment and basic configuration of HP Insight Control or HP SIM (Systems Insight Manager) on HP ProLiant ML and DL series servers or HP BladeSystem servers <http://h20195.www2.hp.com/v2/GetPDF.aspx/4AA0-9972ENW.pdf>

3-Year HP 24x7 4 hour Response, Collaborative Support

Provides problem resolution support across the stack of HW, firmware, and HP and 3rd party SW. In case the issue is with 3rd party SW, HP does known issue resolution. If HP cannot solve the issue, it will contact the third-party vendor and create a problem incident on your behalf.

<http://h20195.www2.hp.com/V2/GetPDF.aspx/4AA3-8232ENW.pdf>

Additional Services: Software support service with 24X7 availability with a 2 hour response, Training courses on Microsoft, Linux (Red Hat and SUSE), VMware, and HP Insight Software, 10 Proactive Select Credit package, Factory Express

<http://www8.hp.com/us/en/business-services/it-services.html?compURI=1078865>

Basic Care

Basic Care: delivers minimum recommended support service level

HP ProLiant Server Hardware Installation

Provides for the basic hardware installation of HP branded servers, storage devices and networking options to assist you in bringing your new hardware into operation in a timely and professional manner <http://h20195.www2.hp.com/V2/GetPDF.aspx/5981-9356EN.pdf>

3-Year HP 24x7 4 hour Response, Hardware Support Onsite Service

Provides you with rapid remote support and if required an HP authorized technical engineer will be on site 24X7 begin hardware maintenance service within 4 hours of the service request being logged

<http://h20195.www2.hp.com/V2/GetPDF.aspx/5982-6547EEE.pdf>

3-Year , HP 24x7 Software Support for Insight Control

Provides remote 3-year software support service that delivers comprehensive software services, including access to HP technical resources and software updates

<http://h20195.www2.hp.com/V2/GetPDF.aspx/5981-6645EEE.pdf>

Additional Services: Factory Express, Education Services, Proactive Select - 10 Credits

Insight Remote Support

Provides 24 X 7 remote monitoring, proactive notifications, and problem resolution. Learn more <http://www.hp.com/go/insightremotesupport>

Service and Support

HP Support Center Personalized online support portal with access to information, tools and experts to support HP business products. Submit support cases online, chat with HP experts, access support resources or collaborate with peers. Learn more <http://www.hp.com/go/hpsc>

HP's Support Center Mobile App* allows you to resolve issues yourself or quickly connect to an agent for live support. Now, you can get access to personalized IT support anywhere, anytime.

HP Insight Remote Support and HP Support Center are available at no additional cost with a HP warranty, HP Care Pack or HP contractual support agreement.

*HP' Support Center Mobile App is subject to local availability

Warranty / Service Coverage

For ProLiant servers and storage systems, the services cover HP-branded hardware options qualified for the server, purchased at the same time or afterward, internal to the enclosure, as well as external monitors up to 22" and tower UPS products; these items will be covered at the same service level and for the same coverage period as the server unless the maximum supported lifetime and/or the maximum usage limitation has been exceeded. Coverage of the UPS battery is not included; standard warranty terms and conditions apply.

The defective media retention service feature option applies only to Disk or eligible SSD/Flash Drives replaced by HP due to malfunction. It does not apply to any exchange of Disk or SSD/Flash Drives that have not failed. SSD/Flash Drives that are specified by HP as consumable parts and/or that have exceeded maximum supported lifetime and/or the maximum usage limit as set forth in the manufacturer's operating manual or the technical data sheet are not eligible for the defective media retention service feature option.

For more information To learn more on HP ProLiant servers and HP BladeSystem servers, please contact your HP sales representative or HP Authorized Channel Partner. Or visit: <http://www.hp.com/services/proliant>

Pre-configured Models

NOTE: For the Standard Features shipped in the "Factory Integrated Models", please see the "Configuration Information - Factory Integrated Models" section.

NOTE: Pre-configured models ship with the configurations below. Options can be selected from the Core or Additional options section of this QuickSpecs.

NOTE: HP does not allow factory integration of options into pre-configured models. Any additional options purchased will be shipped separately.

NOTE: If you desire a custom configuration please see "Configuration Information - Factory Integrated Models" section of this QuickSpecs.

NOTE: All Pre-configured Models come populated with some hard drive blanks installed. Should the customer need additional hard drive blanks, they can order more using either P/N 666987-B21: HP SFF Gen8 Hard Drive Blank Kit or P/N 666986-B21: HP LFF Gen8 Hard Drive Blank Kit.

Entry Models

HP ProLiant DL380p Gen8 E5-2609 1P 4GB-R P420i SFF 460W PS Entry Server 642121-001	Processor(s)	(1) Intel® Xeon® E5-2609 (2.4GHz/4-core/10MB/6.4GT-s QPI/80W) Processor
	Cache Memory	10MB (1x10MB) Level 3
	Memory	4GB (1x4GB) PC3L-10600R (DDR3-1333) Registered DIMMS NOTE: Total 24 DIMM slots available with processor upgrade (2P configuration)
	Network Controller	HP Ethernet 1Gb 4-port 331FLR Adapter
	Storage Controller	HP Smart Array P420i/ZM (RAID 0/1/1+0)
	Hard Drive	None ship standard
	Internal Storage	Standard: 8 SFF SAS/SATA HDD Bays; includes 6 SFF hard drive blanks Optional: +8 SFF (total of 16) SFF SAS/SATA HDD Bays
	Optical Drive Bay	Optional Slim Optical Bay (SATA DVD-RW/ROM Optical Drive)
	PCI-Express Slots	3 PCIe slots (+3 PCI slots available with upgrade option)
	Power Supply	(1) HP 460W Common Slot Gold Hot Plug Power Supply (92% Efficient)
	Fans	(4) (N+1 redundancy standard)
	Management	HP iLO Management Engine (standard) Optional: HP Insight Control
	Energy Star	Meets Energy Star requirements
	Form Factor	Rack (2U), HP Friction Rail Kit NOTE: The Friction Rail Kit is not compatible with the Cable Management Arm option.
Warranty	Server Warranty includes 3-Year Parts, 3-Year Labor, 3-Year Onsite support with next business day response.	

Pre-configured Models

Base Models

<p>Six-Core Models HP ProLiant DL380p Gen8 E5-2640 1P 16GB-R P420i SFF 460W PS Base Server 642107-001</p>	<p>Processor(s) One of the following depending on Model</p>	<p>(1) Intel® Xeon® E5-2640 (2.5GHz/6-core/15MB/7.2GT-s QPI/95W, DDR3-1333, HT, Turbo2- 3/3/4/4/5/5) Processor (1) Intel® Xeon® E5-2630 (2.3GHz/6-core/15MB/7.2GT-s QPI/95W, DDR3-1333, HT, Turbo2- 3/3/4/4/5/5) Processor (1) Intel® Xeon® E5-2620 (2.0GHz/6-core/15MB/7.2GT-s QPI/95W, DDR3-1333, HT, Turbo2- 3/3/4/4/5/5) Processor</p>
<p>HP ProLiant DL380p Gen8 E5-2630 1P 16GB-R P420i SFF 460W PS Base Server 642119-001</p>	<p>Cache Memory Memory</p>	<p>15MB (1x15MB) Level 3 16GB (4x4GB) PC3L-10600R (DDR3-1333) Registered DIMMS NOTE: Total 24 DIMM slots available with processor upgrade (2P configuration)</p>
<p>HP ProLiant DL380p Gen8 E5-2620 1P 16GB-R P420i SFF 460W PS Base Server 642120-001</p>	<p>Network Controller Storage Controller Hard Drive Internal Storage</p>	<p>HP Ethernet 1Gb 4-port 331FLR Adapter HP Smart Array P420i/1GB FBWC (RAID 0/1/1+0/5/5+0) None ship standard Standard: 8 SFF SAS/SATA HDD Bays; includes 6 SFF hard drive blanks Optional: +8 SFF (total of 16) SFF SAS/SATA HDD Bays</p>
	<p>Optical Drive Bay PCI-Express Slots Power Supply</p>	<p>Optional Slim Optical Bay (SATA DVD-RW/ROM Optical Drive) 3 PCIe slots (+3 PCI slots available with upgrade option) (1) HP 460W CS Platinum Plus Hot Plug Power Supply (94% Efficient)</p>
	<p>Fans Management</p>	<p>(4) (N+1 redundancy standard) HP iLO Management Engine (standard) Optional: HP Insight Control</p>
	<p>Energy Star Form Factor</p>	<p>Meets Energy Star requirements Rack (2U), HP Ball Bearing Rail Kit /Cable Management Arm standard</p>
	<p>Warranty</p>	<p>Server Warranty includes 3-Year Parts, 3-Year Labor, 3-Year Onsite support with next business day response.</p>

High Performance Models

NOTE: These Models are Energy Star Certified.

<p>Eight-Core Models HP ProLiant DL380p Gen8 E5-2690 2P 32GB-R P420i SATA SFF 750W PS High Perf Server 662257-001</p>	<p>Processor(s) One of the following depending on Model</p>	<p>(2) Intel® Xeon® E5-2690 (2.9GHz/8-core/20MB/8GT-s QPI/135W, DDR3-1600, HT, Turbo2- 4/4/4/5/5/7/7/9) Processor (2) Intel® Xeon® E5-2665 (2.4GHz/8-core/20MB/8GT-s QPI/115W, DDR3-1600, HT, Turbo2- 4/4/5/5/6/6/7/7) Processor (2) Intel® Xeon® E5-2650 (2.0GHz/8-core/20MB/8GT-s QPI/95W, DDR3-1600, HT, Turbo2- 4/4/5/5/5/7/8/8) Processor</p>
<p>HP ProLiant DL380p Gen8 E5-2665 2P 32GB-R P420i SFF 750W PS High Perf Server 642105-001</p>	<p>Cache Memory Memory</p>	<p>20MB (1x20MB) Level 3 32GB (4x8GB) PC3-12800R (DDR3-1600) Registered DIMMS NOTE: Total 24 DIMM slots available.</p>
<p>HP ProLiant DL380p Gen8 E5-2650 2P 32GB-R P420i SFF 750W PS High Perf Server</p>	<p>Network Controller One of the following depending on Model Storage Controller Hard Drive Internal Storage Optical Drive Bay</p>	<p>HP Ethernet 10Gb 2-port 530FLR-SFP+ Adapter (on E5-2690/E5-2665 Models) HP Ethernet 1Gb 4-port 331FLR Adapter (on E5-2650 Model) HP Smart Array P420i/2GB FBWC (RAID 0/1/1+0/5/5+0) None ship standard Standard: 8 SFF SAS/SATA HDD Bays; includes 6 SFF hard drive blanks Optional: +8 SFF (total of 16) SFF SAS/SATA HDD Bays DVD-RW standard</p>



Pre-configured Models

642106-001	PCI-Express Slots	6 PCIe slots (includes second riser slot upgrade option)
	Power Supply	(2) HP 750W CS Platinum Plus Hot Plug Power Supplies (94% Efficient)
	Fans	(6) (N+1 redundancy standard)
	Management	HP iLO Management Engine (standard) HP Insight Control Standard
	Energy Star	Meets Energy Star requirements
	Form Factor	Rack (2U), HP Ball Bearing Rail Kit /Cable Management Arm standard
	Warranty	Server Warranty includes 3-Year Parts, 3-Year Labor, 3-Year Onsite support with next business day response.

Energy Star - Base Models

NOTE: These Models are Energy Star Certified.

Six-Core Model HP ProLiant DL380p Gen8 E5-2630 2P 16GB-R P420i Hot Plug SFF 460W PS ES Server 677278-001	Processor(s)	(2) Intel® Xeon® E5-2630 (2.3GHz/6-core/15MB/7.2GT-s QPI/95W, DDR3-1333, HT, Turbo2- 3/3/4/4/5/5)
	Cache Memory	15MB (1x15MB) Level 3
	Memory	16GB (4x4GB) PC3L-10600R (DDR3-1333) Registered DIMMS NOTE: Total 24 DIMM slots.
	Network Controller	HP Ethernet 1Gb 4-port 331FLR Adapter
	Storage Controller	HP Smart Array P420i/1GB with FBWC (RAID 0/1/1+0/5/5+0)
	Hard Drive	None ship standard
	Internal Storage	Standard: 8 SFF SAS/SATA HDD Bays; includes 6 SFF hard drive blanks Optional: +8 SFF (total of 16) SFF SAS/SATA HDD Bays
	Optical Drive Bay	Optional Slim Optical Bay (SATA DVD-RW/ROM Optical Drive)
	PCI-Express Slots	3 PCIe slots (+3 PCI slots available with upgrade option)
	Power Supply	(1) 460W HP CS Platinum Plus Hot Plug Power Supply (94% Efficient)
	Fans	(6) (N+1 redundancy standard)
	Management	HP iLO Management Engine (standard) Optional: HP Insight Control
	Energy Star	Meets Energy Star requirements
	Form Factor	Rack (2U), HP Ball Bearing Rail Kit /Cable Management Arm standard
	Warranty	Server Warranty includes 3-Year Parts, 3-Year Labor, 3-Year Onsite support with next business day response.

Smart Buys

HP ProLiant DL380p Gen8 E5-2670 2P Svr/S-Buy 670852-S01	Processor(s)	(2) Intel® Xeon® E5-2670 (2.60GHz/8-core/20MB/8GT-s QPI/115W, DDR3-1600, HT, Turbo2- 4/4/5/5/6/6/7/7)
	Cache Memory	20MB (1x20MB) Level 3
	Memory	32GB (4x8GB) PC3L-10600R (DDR3-1333) Registered DIMMS NOTE: Total 24 DIMM slots
	Network Controller	One HP Ethernet 1Gb 4-port 331FLR Adapter
	Storage Controller	HP Smart Array P420i/1GB with FBWC (RAID 0/1/1+0/5/5+0)
	Hard Drive	None ship standard
	Internal Storage	Standard: 8 SFF SAS/SATA HDD Bays
	Optical Drive Bay	Optional Slim Optical Bay (SATA DVD-RW /ROM Optical Drive)
	PCI-Express Slots	3 PCIe slots
	Power Supply	2 x HP 750W CS Platinum Plus Hot Plug Redundant Power Supply
	Fans	(6) (N+1 redundancy standard)
	Management	iLO Management Engine Standard Also includes HP Insight Control Control including 1yr 24x7 Technical Support and Updates Single Server License
	Form Factor	Rack (2U), HP Ball Bearing Rail Kit /Cable Management Arm standard
Warranty	Server Warranty includes 3-Year Parts, 3-Year Labor, 3-Year Onsite support with next business day response.	

HP ProLiant DL380p Gen8 E5-2660 2P Svr/S-Buy 670853-S01	Processor(s)	(2) Intel® Xeon® E5-2660 (2.20GHz/8-core/20MB/8GT-s QPI/95W, DDR3-1600, HT, Turbo2- 5/5/6/6/7/7/8/8)
	Cache Memory	20MB (1x20MB) Level 3
	Memory	32GB (4x8GB) PC3L-10600R (DDR3-1333) Registered DIMMS NOTE: Total 24 DIMM slots
	Network Controller	One HP Ethernet 1Gb 4-port 331FLR Adapter
	Storage Controller	HP Smart Array P420i/1GB with FBWC (RAID 0/1/1+0/5/5+0)
	Hard Drive	None ship standard
	Internal Storage	Standard: 8 SFF SAS/SATA HDD Bays
	Optical Drive Bay	Optional Slim Optical Bay (SATA DVD-RW /ROM Optical Drive)
	PCI-Express Slots	3 PCIe slots
	Power Supply	2 x HP 750W CS Platinum Plus Hot Plug Redundant Power Supply
	Fans	(6) (N+1 redundancy standard)
	Management	iLO Management Engine Standard Also includes HP Insight Control Control including 1yr 24x7 Technical Support and Updates Single Server License
	Form Factor	Rack (2U), HP Ball Bearing Rail Kit /Cable Management Arm standard
Warranty	Server Warranty includes 3-Year Parts, 3-Year Labor, 3-Year Onsite support with next business day response.	

Smart Buys

HP ProLiant DL380p Gen8 E5-2640 2P Svr/S-Buy 670854-S01	Processor(s)	(2) Intel® Xeon® E5-2640 (2.50GHz/6-core/15MB/7.2GT-s QPI/95W, DDR3-1333, HT, Turbo2- 3/3/4/4/5/5)
	Cache Memory	15MB (1x15MB) Level 3
	Memory	16GB (2x8GB) PC3L-10600R (DDR3-1333) Registered DIMMS NOTE: Total 24 DIMM slots
	Network Controller	One HP Ethernet 1Gb 4-port 331FLR Adapter
	Storage Controller	HP Smart Array P420i/1GB with FBWC (RAID 0/1/1+0/5/5+0)
	Hard Drive	None ship standard
	Internal Storage	Standard: 8 SFF SAS/SATA HDD Bays
	Optical Drive Bay	Optional Slim Optical Bay (SATA DVD-RW /ROM Optical Drive)
	PCI-Express Slots	3 PCIe slots
	Power Supply	2 x HP 460W CS Platinum Plus Hot Plug Redundant Power Supply
	Fans	(6) (N+1 redundancy standard)
	Management	iLO Management Engine Standard
	Form Factor	Rack (2U), HP Ball Bearing Rail Kit /Cable Management Arm standard
Warranty	Server Warranty includes 3-Year Parts, 3-Year Labor, 3-Year Onsite support with next business day response.	

HP ProLiant DL380p Gen8 E5-2620 1P Svr/S-Buy 670856-S01	Processor(s)	Intel® Xeon® E5-2620 (2.0GHz/6-core/15MB/7.2GT-s QPI/95W, DDR3-1333, HT, Turbo2- 3/3/4/4/5/5)
	Cache Memory	15MB (1x15MB) Level 3
	Memory	16GB (2x8GB) PC3L-10600R (DDR3-1333) Registered DIMMS NOTE: Total 24 DIMM slots
	Network Controller	One HP Ethernet 1Gb 4-port 331FLR Adapter
	Storage Controller	HP Smart Array P420i/1GB with FBWC (RAID 0/1/1+0/5/5+0)
	Hard Drive	None ship standard
	Internal Storage	Standard: 8 SFF SAS/SATA HDD Bays
	Optical Drive Bay	Optional Slim Optical Bay (SATA DVD-RW /ROM Optical Drive)
	PCI-Express Slots	3 PCIe slots
	Power Supply	2 x HP 460W CS Platinum Plus Hot Plug Redundant Power Supply
	Fans	(6) (N+1 redundancy standard)
	Management	iLO Management Engine Standard
	Form Factor	Rack (2U), HP Ball Bearing Rail Kit /Cable Management Arm standard
Warranty	Server Warranty includes 3-Year Parts, 3-Year Labor, 3-Year Onsite support with next business day response.	

Smart Buys

HP ProLiant DL380p Gen8 E5-2609 1P Svr/S-Buy 670857-S01	Processor(s)	Intel® Xeon® E5-2609 (2.40GHz/4-core/10MB/6.4GT-s QPI/80W)
	Cache Memory	10MB (1x10MB) Level 3
	Memory	8GB (1x8GB) PC3L-10600R (DDR3-1333) Registered DIMMS NOTE: Total 12 DIMM slots
	Network Controller	One HP Ethernet 1Gb 4-port 331FLR Adapter
	Storage Controller	HP Smart Array P420i/ZM (RAID 0/1/1+0)
	Hard Drive	None ship standard
	Internal Storage	Standard: 8 SFF SAS/SATA HDD Bays
	Optical Drive Bay	Optional Slim Optical Bay (SATA DVD-RW /ROM Optical Drive)
	PCI-Express Slots	3 PCIe slots
	Power Supply	2 x HP 460W CS Platinum Plus Hot Plug Redundant Power Supply
	Fans	(4) (N+1 redundancy standard)
	Management	iLO Management Engine Standard
	Form Factor	Rack (2U), HP Ball Bearing Rail Kit /Cable Management Arm standard
Warranty	Server Warranty includes 3-Year Parts, 3-Year Labor, 3-Year Onsite support with next business day response.	

HP ProLiant DL380p Gen8 12-LFF E5-2650 2P Svr/S-Buy 692278-S01	Processor(s)	(2) Intel® Xeon® E5-2650 (2.0GHz/8-core/20MB/8GT-s QPI/95W, DDR3-1600, HT, Turbo2- 4/4/5/5/5/7/8/8)
	Cache Memory	20MB (1x20MB) Level 3
	Memory	8GB (2x4GB) 1Rx4 PC3L-12800R (DDR3-1600) Registered DIMMS NOTE: Total 12 DIMM slots
	Network Controller	One HP Ethernet 1Gb 4-port 331FLR Adapter
	Storage Controller	HP Smart Array P420i/2GB with FBWC (RAID 0/1/1+0/5/5+0)
	Hard Drive	None ship standard
	Internal Storage	Standard: 12 LFF SAS/SATA HDD Bays
	Optical Drive Bay	Optional Slim Optical Bay (SATA DVD-RW /ROM Optical Drive)
	PCI-Express Slots	3 PCIe slots
	Power Supply	2 x HP 750W CS Platinum Plus Hot Plug Redundant Power Supply
	Fans	(6) (N+1 redundancy standard)
	Management	iLO Management Engine Standard
	Form Factor	Rack (2U), HP Ball Bearing Rail Kit /Cable Management Arm standard
Warranty	Server Warranty includes 3-Year Parts, 3-Year Labor, 3-Year Onsite support with next business day response.	

Smart Buys

HP ProLiant DL380p Gen8 25-SFF E5-2680 2P Svr/S-Buy 692279-S01	Processor(s)	(2) Intel® Xeon® E5-2680 (2.7GHz/8-core/20MB/8GT-s QPI/130W, DDR3-1600, HT, Turbo2- 4/4/5/5/5/7/8/8)
	Cache Memory	20MB (1x20MB) Level 3
	Memory	8GB (2x4GB) 1Rx4 PC3L-12800R (DDR3-1600) Registered DIMMS NOTE: Total 12 DIMM slots
	Network Controller	One HP Ethernet 1Gb 4-port 331FLR Adapter
	Storage Controller	HP Smart Array P420i/2GB with FBWC (RAID 0/1/1+0/5/5+0)
	Hard Drive	None ship standard
	Internal Storage	Standard: 25 SFF SAS/SATA HDD Bays
	Optical Drive Bay	Optional Slim Optical Bay (SATA DVD-RW /ROM Optical Drive)
	PCI-Express Slots	3 PCIe slots
	Power Supply	2 x HP 750W CS Platinum Plus Hot Plug Redundant Power Supply
	Fans	(6) (N+1 redundancy standard)
	Management	iLO Management Engine Standard
	Form Factor	Rack (2U), HP Ball Bearing Rail Kit /Cable Management Arm standard
	Warranty	Server Warranty includes 3-Year Parts, 3-Year Labor, 3-Year Onsite support with next business day response.

Configuration Information - Factory Integrated Models

NOTE: This section lists some of the steps required to configure a Factory Integrated Model. To ensure only valid configurations are ordered, HP recommends the use of an HP approved configurator. Contact your local sales representative for information on configurable product offerings and requirements.

NOTE: Factory Integrated Models must start with a CTO Server.

NOTE: FIO indicates that this option is only available as a factory installable option.

NOTE: All Factory Integrated Models will be populated with sufficient hard drive blanks based on the number of initial hard drives ordered with the server.

Step 1: Base Configuration (choose one of the following configurable models)

HP Models HP ProLiant DL380p Gen8 8 LFF Configure-to-order Server 665553-B2

Factory Integrated Model ships with:

2 x HP Smart Socket Guides for fast processor installation.
24 DIMM slots for RDIMM, LRDIMM and UDIMM Memory installation
1 FlexibleLOM connector: (see Step2: HP FlexibleNIC section below for NIC choices to populate the embedded connector)
Smart Array P420i Controller w/ Zero Memory (ZM)
I/O slots - 3 Slots come standard:

- Slot 1 - FL/FH x16 PCIe 3.0 (x16 connector)
- Slot 2 - HL/FH x8 PCIe 3.0 (x8 connector)
- Slot 3 - HL/FH x4 PCIe 2.0 (x8 connector)
- Additional Slots may be added via selections from the PCI Information and Options subsection

System Fans - 4 (2 additional fans included with second processor)

Drive Cage - 8LFF (Optical media drive optional)

USB - 4 Rear, 2 Front, 1 Internal, 1 SD slot

HP iLO Management Engine (standard)

NOTE: Power Supply not included - choose from Options section

HP ProLiant DL380p Gen8 8 SFF Configure-to-order Server 653200-B2

Factory Integrated Model ships with:

1 FlexibleLOM connector: (see Step2: HP FlexibleLOM section below for NIC choices to populate the embedded connector)
Smart Array P420i Controller w/ Zero Memory (ZM)
I/O slots - 3 Slots come standard:

- Slot 1 - FL/FH x16 PCIe 3.0 (x16 connector)
- Slot 2 - HL/FH x8 PCIe 3.0 (x8 connector)
- Slot 3 - HL/FH x4 PCIe 2.0 (x8 connector)
- Additional Slots may be added via selections from the PCI Information and Options subsection

System Fans - 4 (2 additional fans included with second processor)

Drive Cage - 8SFF (Optical media drive OR Second 8SFF drive cage optional)

USB - 4 Rear, 2 Front, 1 Internal, 1 SD slot

HP iLO Management Engine (standard)

NOTE: Power Supply not included - choose from Step2 section below

HP ProLiant DL380p Gen8 12 LFF Configure-to-order Server 665552-B2

Factory Integrated Model ships with:

1 FlexibleLOM connector: (see Step2: HP FlexibleLOM section below for NIC choices to populate the embedded connector)
Smart Array P420i Controller w/ Zero Memory (ZM)
I/O slots - 3 Slots come standard:

- Slot 1 - FL/FH x16 PCIe 3.0 (x16 connector)
- Slot 2 - HL/FH x8 PCIe 3.0 (x8 connector)
-
-

Configuration Information - Factory Integrated Models

- Slot 3 - HL/FH x4 PCIe 2.0 (x8 connector)
- Additional Slots may be added via selections from the PCI Information and Options subsection

System Fans - 4 (2 additional fans included with second processor)

Drive Cage - 12LFF

USB - 4 Rear, 2 Front, 1 Internal, 1 SD slot

HP iLO Management Engine (standard)

NOTE: Power Supply not included - choose from Step2 section below

NOTE: Customer can only choose from 95W or lower E5-2600 processors.

NOTE: This chassis comes with a built-in expander. All drives can be driven off of the embedded P420i controller.

NOTE: Customers must add a minimum of a 512MB controller cache module when choosing this CTO server.

NOTE: If a P822 controller is required, it cannot be populated in slot 3.

NOTE: If a P421 controller is required, it cannot be populated in slot 1.

NOTE: HyperCloud DIMMs are not supported in this CTO server.

NOTE: Customer will not be able to get an optical drive, SID, second front USB, and ID label.

HP ProLiant DL380p Gen8 25 SFF Configure-to-order Server

665554-B2

Factory Integrated Model ships with:

1 FlexibleLOM connector: (see Step2: HP FlexibleLOM section below for NIC choices to populate the embedded connector)

Smart Array P420i Controller w/ Zero Memory (ZM)

I/O slots - 3 Slots come standard:

- Slot 1 - FL/FH x16 PCIe 3.0 (x16 connector)
- Slot 2 - HL/FH x8 PCIe 3.0 (x8 connector)
- Slot 3 - HL/FH x4 PCIe 2.0 (x8 connector)
- Additional Slots may be added via selections from the PCI Information and Options subsection

System Fans - 4 (2 additional fans included with second processor)

Drive Cage - 25SFF

USB - 4 Rear, 2 Front, 1 Internal, 1 SD slot

HP iLO Management Engine (standard)

NOTE: Power Supply not included - choose from Step2 section below

NOTE: Customer can only choose from 95W or lower E5-2600 processors.

NOTE: This chassis comes with a built-in expander. All drives can be driven off of the embedded P420i controller.

NOTE: Customers must add a minimum of a 512MB controller cache module when choosing this CTO server.

NOTE: If a P822 controller is required, it cannot be populated in slot 3.

NOTE: HyperCloud DIMMs are not supported in this CTO server.

NOTE: Customer will not be able to get an optical drive, SID, second front USB, and ID label.

Step 2: Choose Required Options (only one of the following from each list unless otherwise noted)

HP Processors

NOTE: If two processors are desired, select one xxxxxx-L21 and one xxxxxx-B21

Entry Processors

NOTE: All support up to 1066MHz memory speeds.

HP DL380p Gen8 Intel® Xeon® E5-2609 (2.40GHz/4-core/10MB/80W) FIO Processor Kit

662252-L2



Configuration Information - Factory Integrated Models

HP DL380p Gen8 Intel® Xeon® E5-2603 (1.80GHz/4-core/10MB/80W) FIO Processor Kit 662254-L2

Base Processors

NOTE: All support up to 1333MHz DDR3 memory speeds.

HP DL380p Gen8 Intel® Xeon® E5-2640 (2.5GHz/6-core/15MB/95W) FIO Processor Kit 662246-L2

HP DL380p Gen8 Intel® Xeon® E5-2630 (2.3GHz/6-core/15MB/95W) FIO Processor Kit 662248-L2

HP DL380p Gen8 Intel® Xeon® E5-2620 (2.0GHz/6-core/15MB/95W) FIO Processor Kit 662250-L2

HP DL380p Gen8 Intel® Xeon® E5-2630L (2.0GHz/6-core/15MB/60W) FIO Processor Kit 675092-L2

Performance Processors

NOTE: All support up to 1600MHz DDR3 memory speeds

HP DL380p Gen8 Intel® Xeon® E5-2690 (2.9GHz/8-core/20MB/135W) FIO Processor Kit 662226-L2

HP DL380p Gen8 Intel® Xeon® E5-2680 (2.7GHz/8-core/20MB/130W) FIO Processor Kit 662228-L2

HP DL380p Gen8 Intel® Xeon® E5-2670 (2.6GHz/8-core/20MB/115W) FIO Processor Kit 662240-L2

HP DL380p Gen8 Intel® Xeon® E5-2667 (2.9GHz/6-core/15MB/130W) FIO Processor Kit 662214-L2

HP DL380p Gen8 Intel® Xeon® E5-2665 (2.4GHz/8-core/20MB/115W) FIO Processor Kit 666509-L2

HP DL380p Gen8 Intel® Xeon® E5-2660 (2.2GHz/8-core/20MB/95W) FIO Processor Kit 662242-L2

HP DL380p Gen8 Intel® Xeon® E5-2650 (2.0GHz/8-core/20MB/95W) FIO Processor Kit 662244-L2

HP DL380p Gen8 Intel® Xeon® E5-2650L (1.8GHz/8-core/20MB/70W) FIO Processor Kit 662256-L2

HP DL380p Gen8 Intel® Xeon® E5-2643 (3.3GHz/4-core/10MB/130W) FIO Processor Kit 662216-L2

HP DL380p Gen8 Intel® Xeon® E5-2637 (3.0GHz/2-core/5MB/80W) FIO Processor Kit 662224-L2

HP Memory

NOTE: HP memory from previous generation servers are not qualified or warranted with this HP ProLiant Server. HP SmartMemory is required to realize the memory performance improvements and enhanced functionality listed in this document for Gen8. For additional information, please see the HP SmartMemory QuickSpecs at:

http://h18000.www1.hp.com/products/quickspecs/14225_na/14225_na.html

NOTE: LRDIMM, RDIMM and UDIMMs are all distinct memory technologies and cannot be mixed within a server. The majority of ProLiant Gen8 servers support RDIMM, UDIMM and LRDIMM.

Registered DIMMs (RDIMMs)

HP 4GB (1x4GB) Single Rank x4 PC3L-10600R (DDR3-1333) Registered CAS-9 Low Voltage Memory Kit 647893-B2

HP 4GB (1x4GB) Single Rank x4 PC3-12800R (DDR3-1600) Registered CAS-11 Memory Kit 647895-B2

HP 8GB (1x8GB) Dual Rank x4 PC3L-10600R (DDR3-1333) Registered CAS-9 Low Voltage Memory Kit 647897-B2

HP 8GB (1x8GB) Single Rank x4 PC3-12800R (DDR3-1600) Registered CAS-11 Memory Kit 647899-B2

Configuration Information - Factory Integrated Models

HP 8GB (1x8GB) Dual Rank x4 PC3-12800R (DDR3-1600) Registered CAS-11 Memory Kit 690802-B2

HP 16GB (1x16GB) Dual Rank x4 PC3L-10600R (DDR3-1333) Registered CAS-9 Low Voltage Memory Kit 647901-B2

HP 16GB (1x16GB) Dual Rank x4 PC3-12800R (DDR3-1600) Registered CAS-11 Memory Kit 672631-B2

Unbuffered with ECC DIMMs (UDIMMs)

HP 2GB (1x2GB) Single Rank x8 PC3-12800E (DDR3-1600) Unbuffered CAS-11 Memory Kit 669320-B2

HP 2GB (1x2GB) Single Rank x8 PC3L-10600E (DDR3-1333) Unbuffered CAS-9 Low Voltage Memory Kit 647905-B2

HP 4GB (1x4GB) Dual Rank x8 PC3-12800E (DDR3-1600) Unbuffered CAS-11 Memory Kit 669322-B2

HP 4GB (1x4GB) Dual Rank x8 PC3L-10600E (DDR3-1333) Unbuffered CAS-9 Low Voltage Memory Kit 647907-B2

HP 8GB (1x8GB) Dual Rank x8 PC3-12800E (DDR3-1600) Unbuffered CAS-11 Memory Kit 669324-B2

HP 8GB (1x8GB) Dual Rank x8 PC3L-10600E (DDR3-1333) Unbuffered CAS-9 Low Voltage Memory Kit 647909-B2

Load Reduced DIMMs (LRDIMMs)

HP 32GB (1x32GB) Quad Rank x4 PC3L-10600L (DDR3-1333) Load Reduced CAS-9 Low Voltage Memory Kit 647903-B2

HyperCloud DIMMs (HDIMM)

HP 16GB (1x16GB) Dual Rank x4 PC3-10600H (DDR3-1333) HyperCloud CAS-9 FIO Memory Kit 678279-B2

NOTE: In order to use HyperCloud memory, 12 DIMMs per processor must be populated.

NOTE: All DDR3 memory option kits consist of one DIMM per kit. For detailed memory configuration rules and guidelines, please use the Online DDR3 Memory Configuration Tool: www.hp.com/go/ddr3memory-configurator.

NOTE: Kits described as LP include Low Power DIMMs. For more information on ProLiant Energy Efficient Features, see: www.hp.com/go/proliant-energy-efficient

NOTE: PC3L is a low voltage memory

HP Networking

FlexibleLOM Adapters

NOTE: The HP ProLiant DL380p Gen8 server requires one FlexibleLOM to be installed in the FlexibleLOM slot.

HP Ethernet 1Gb 4-port 331FLR FIO Adapter 684208-B2

HP Ethernet 10Gb 2-port 530FLR-SFP+ FIO Adapter 684210-B2

HP FlexFabric 10Gb 2-port 554FLR-SFP+ FIO Adapter 684213-B2

NOTE: Please see the QuickSpecs for Technical Specifications and additional information: www.hp.com/go/ProLiantNICs.

HP InfiniBand

HP InfiniBand FDR/EN 10/40Gb Dual Port 544FLR-QSFP Adapter 649282-B2

HP InfiniBand QDR/EN 10Gb Dual Port 544FLR-QSFP Adapter 649283-B2

NOTE: Please see the QuickSpecs for additional information:

http://h18000.www1.hp.com/products/quickspecs/13078_na/13078_na.html

HP Power Supplies

NOTE: Prior to making a power supply selection it is highly recommended that the HP Power Advisor is run to determine the right size power supply for your server configuration. The HP Power Advisor is located at:

www.hp.com/go/hppoweradvisor.

HP Common Slot Platinum Plus Power Supply Kits

NOTE: The following Power Supplies offer 94% Efficiency with support for Intelligent Power Discovery.

Configuration Information - Factory Integrated Models

HP 460W Common Slot Platinum Plus Hot Plug Power Supply Kit	656362-B2
HP 750W Common Slot Platinum Plus Hot Plug Power Supply Kit	656363-B2
HP 1200W Common Slot Platinum Plus Hot Plug Power Supply Kit	656364-B2

HP Common Slot Gold Power Supplies

NOTE: The following Power Supplies offer 92% Efficiency.

HP 460W Common Slot Gold Hot Plug Power Supply Kit	503296-B2
HP 750W Common Slot Gold Hot Plug Power Supply Kit	512327-B2

HP Common Slot -48VDC Power Supplies

NOTE: The following Power Supplies offer 92% Efficiency.

HP 750W Common Slot -48VDC Hot Plug Power Supply Kit	636673-B2
--	-----------

NOTE: The HP 750W Common Slot -48VDC power supply does not ship with a power cable. It has been designed with a terminal block connection allowing for custom design of power cords by the user.

NOTE: Option Kits for AC power supplies include the power supply and one PDU IEC cable.

NOTE: Power Specification and Technical Content for supported power supplies can be found at:

http://h18000.www1.hp.com/products/quickspecs/14209_na/14209_na.html

Step 3: Choose Additional Factory Integratable Options (only one of the following from each list unless otherwise noted)

HP Rack Kits

NOTE: Gen8 rail kits have changed significantly from prior generation rail kits. Please take a moment to review the installation documentation that comes with the server to help you with the installation of your Gen8 server.

NOTE: Rail kits are optional for DL380p Gen8 and are no longer included standard with the server. Customers have the option to purchase their server without a rail kit.

NOTE: Should you need it, HP can provide a tool to assist in the installation of the server into the rack. P/N 695539-001 is available by contacting your local services representative.

CAUTION: HP recommends that at least two people are used for all rack server installations. Please refer to your installation instructions for proper tools and number of people to use for any installation.

NOTE: See HP Rack Options in Additional Options section of this QuickSpecs for more rack kit choices.

HP 2U Friction Gen8 Rail FIO Kit	663476-B2
----------------------------------	-----------

NOTE: Kit contains non-telescoping friction rails which do not allow for in-rack serviceability. The HP Gen8 Cable Management Arm is not available when using Friction Rails.

HP Insight Software

HP Insight Control including 1yr 24x7 Support ProLiant ML/DL/BL-bundle Single Server FIO License	582765-B2
--	-----------

HP Insight Control for Linux including 1yr 24x7 Support ML/DL Bundle 1 Server FIO License	TC203
---	-------

Step 4: Choose Additional Options for Factory Integration

NOTE: For additional options, please refer to the "Core Options and Additional Options" section below.

Core Options

NOTE: Some options may not be integrated at the factory. Contact your local sales representative for additional information.

HP Unique Options	HP 380p/385p Gen8 8-SFF Cage/Bkpln Kit	662883-B2
	NOTE: With upgrade of 8SFF Cage/Bkpln (662883-B21), there is no Optical Drive support.	
	NOTE: With upgrade of 8SFF Cage/Bkpln (662883-B21), an additional storage controller is required. HP recommends the HP Smart Array P420/1GB FBWC 6Gb 2-ports Int SAS Controller (P/N 631670-B21).	
	HP DL380p/385p Gen8 3 Slot PCI-E Riser Kit	653206-B2
	HP DL380p Gen8 2 Slot 2x16 PCI-E Riser Kit	653208-B2
	HP 150W PCI-E Power Cable Kit	669777-B2

HP Processors

Entry Processors

NOTE: All support up to 1066MHz memory speeds.

HP DL380p Gen8 Intel® Xeon® E5-2609 (2.40GHz/4-core/10MB/80W) Processor Kit 662252-B21

HP DL380p Gen8 Intel® Xeon® E5-2603 (1.80GHz/4-core/10MB/80W) Processor Kit 662254-B21

Base Processors

NOTE: All support up to 1333MHz DDR3 memory speeds.

HP DL380p Gen8 Intel® Xeon® E5-2640 (2.5GHz/6-core/15MB/95W) Processor Kit 662246-B21

HP DL380p Gen8 Intel® Xeon® E5-2630 (2.3GHz/6-core/15MB/95W) Processor Kit 662248-B21

HP DL380p Gen8 Intel® Xeon® E5-2620 (2.0GHz/6-core/15MB/95W) Processor Kit 662250-B21

HP DL380p Gen8 Intel® Xeon® E5-2630L (2.0GHz/6-core/15MB/60W) Processor Kit 675092-B21

Performance Processors

NOTE: All support up to 1600MHz DDR3 memory speeds.

HP DL380p Gen8 Intel® Xeon® E5-2690 (2.9GHz/8-core/20MB/135W) Processor Kit 662226-B21

HP DL380p Gen8 Intel® Xeon® E5-2680 (2.7GHz/8-core/20MB/130W) Processor Kit 662228-B21

HP DL380p Gen8 Intel® Xeon® E5-2670 (2.6GHz/8-core/20MB/115W) Processor Kit 662240-B21

HP DL380p Gen8 Intel® Xeon® E5-2667 (2.9GHz/6-core/15MB/130W) Processor Kit 662214-B21

HP DL380p Gen8 Intel® Xeon® E5-2665 (2.4GHz/8-core/20MB/115W) Processor Kit 666509-B21

HP DL380p Gen8 Intel® Xeon® E5-2660 (2.2GHz/8-core/20MB/95W) Processor Kit 662242-B21

HP DL380p Gen8 Intel® Xeon® E5-2650 (2.0GHz/8-core/20MB/95W) Processor Kit 662244-B21

HP DL380p Gen8 Intel® Xeon® E5-2650L (1.8GHz/8-core/20MB/70W) Processor Kit 662256-B21

HP DL380p Gen8 Intel® Xeon® E5-2643 (3.3GHz/4-core/10MB/130W) Processor Kit 662216-B21

HP DL380p Gen8 Intel® Xeon® E5-2637 (3.0GHz/2-core/5MB/80W) Processor Kit 662224-B21

NOTE: Up to 2 processors supported. Performance and Energy Star Model

Core Options

configurations include two processors.

NOTE: HT indicates that the processor model supports Intel® /Hyper-Threading Technology

NOTE: Turbo2: Intel® Turbo Boost Technology 2.0 provides more computing power when you need it with performance that adapts to spikes in your workload and delivers more performance upside than then previous generation turbo technology.

NOTE: DDR3 speed is the maximum memory speed of the processor. Actual memory speed may depend on the quantity and type of DIMMs installed.

HP Memory

NOTE: HP memory from previous generation servers are not qualified or warranted with this HP ProLiant Server. HP SmartMemory is required to realize the memory performance improvements and enhanced functionality listed in this document for Gen8. For additional information, please see the HP SmartMemory QuickSpecs at:

http://h18000.www1.hp.com/products/quickspecs/14225_na/14225_na.html

NOTE: RDIMM, RDIMM and UDIMMs are all distinct memory technologies and cannot be mixed within a server. The majority of ProLiant Gen8 servers support RDIMM, UDIMM and LRDIMM.

Registered DIMMs (RDIMMs)

HP 4GB (1x4GB) Single Rank x4 PC3L-10600R (DDR3-1333) Registered CAS-9 Low Voltage Memory Kit	647893-B21
HP 4GB (1x4GB) Single Rank x4 PC3-12800R (DDR3-1600) Registered CAS-11 Memory Kit	647895-B21
HP 8GB (1x8GB) Dual Rank x4 PC3L-10600R (DDR3-1333) Registered CAS-9 Low Voltage Memory Kit	647897-B21
HP 8GB (1x8GB) Single Rank x4 PC3-12800R (DDR3-1600) Registered CAS-11 Memory Kit	647899-B21
HP 8GB (1x8GB) Dual Rank x4 PC3-12800R (DDR3-1600) Registered CAS-11 Memory Kit	690802-B21
HP 16GB (1x16GB) Dual Rank x4 PC3L-10600R (DDR3-1333) Registered CAS-9 Low Voltage Memory Kit	647901-B21
HP 16GB (1x16GB) Dual Rank x4 PC3-12800R (DDR3-1600) Registered CAS-11 Memory Kit	672631-B21

Unbuffered with ECC DIMMs (UDIMMs)

HP 2GB (1x2GB) Single Rank x8 PC3-12800E (DDR3-1600) Unbuffered CAS-11 Memory Kit	669320-B21
HP 2GB (1x2GB) Single Rank x8 PC3L-10600E (DDR3-1333) Unbuffered CAS-9 Low Voltage Memory Kit	647905-B21
HP 4GB (1x4GB) Dual Rank x8 PC3-12800E (DDR3-1600) Unbuffered CAS-11 Memory Kit	669322-B21
HP 4GB (1x4GB) Dual Rank x8 PC3L-10600E (DDR3-1333) Unbuffered CAS-9 Low Voltage Memory Kit	647907-B21
HP 8GB (1x8GB) Dual Rank x8 PC3-12800E (DDR3-1600) Unbuffered CAS-11 Memory Kit	669324-B21
HP 8GB (1x8GB) Dual Rank x8 PC3L-10600E (DDR3-1333) Unbuffered CAS-9 Low Voltage Memory Kit	647909-B21

Load Reduced DIMMs (LRDIMMs)

HP 32GB (1x32GB) Quad Rank x4 PC3L-10600L (DDR3-1333) Load Reduced CAS-9 Low Voltage Memory Kit	647903-B21
---	------------

NOTE: All DDR3 memory option kits consist of one DIMM per kit. For detailed memory configuration rules and guidelines, please use the Online DDR3 Memory Configuration Tool: www.hp.com/go/ddr3memory-

Core Options

[configurator](#).

NOTE: Kits described as LP include Low Power DIMMs. For more information on ProLiant Energy Efficient Features, see:

www.hp.com/go/proliant-energy-efficient

NOTE: PC3L is a low voltage memory.

HP Optical Drives	HP 12.7mm Slim SATA DVD ROM JackBlack Optical Drive	652232-B21
	HP 12.7mm Slim SATA DVD RW JackBlack Optical Drive	652235-B21

HP Hard Drives

NOTE: The HP ProLiant DL380p Gen8 Smart Storage solutions are equipped with entirely re-designed Small Form Factor (SFF 2.5 in) and Large Form Factor (LFF 3.5 in) hot plug carriers for HP Qualified Hard Drives and Solid State Drives. These new carriers provide status and activity indicators as well as caution indicators for "Do Not Remove".

NOTE: The components of a storage subsystem (e.g. the drive, the HBA/controller, firmware, and the server backplane) should operate at the same data transfer rate or the system bandwidth will be negotiated down to an acceptable level for all components.

NOTE: Hard drives have either a one year or three year warranty; refer to the specific hard drive QuickSpecs for details.

SAS Hot Plug with SmartDrive SFF (2.5-inch) Enterprise Drives

HP 900GB 6G SAS 10K rpm SFF (2.5-inch) SC Enterprise 3yr Warranty Hard Drive	652589-B21
--	------------

HP 600GB 6G SAS 10K rpm SFF (2.5-inch) SC Enterprise 3yr Warranty Hard Drive	652583-B21
--	------------

HP 450GB 6G SAS 10K rpm SFF (2.5-inch) SC Enterprise 3yr Warranty Hard Drive	652572-B21
--	------------

HP 300GB 6G SAS 10K rpm SFF (2.5-inch) SC Enterprise 3yr Warranty Hard Drive	652564-B21
--	------------

HP 300GB 6G SAS 15K rpm SFF (2.5-inch) SC Enterprise 3yr Warranty Hard Drive	652611-B21
--	------------

HP 146GB 6G SAS 15K rpm SFF (2.5-inch) SC Enterprise 3yr Warranty Hard Drive	652605-B21
--	------------

HP 72GB 6G SAS 15K rpm SFF (2.5-inch) SC Enterprise 3yr Warranty Hard Drive	652597-B21
---	------------

SAS Hot Plug SmartDrive SFF (2.5-inch) Midline Drives

HP 1TB 6G SAS 7.2K rpm SFF (2.5-inch) SC Midline 1yr Warranty Hard Drive	652749-B21
--	------------

HP 500GB 6G SAS 7.2K rpm SFF (2.5-inch) SC Midline 1yr Warranty Hard Drive	652745-B21
--	------------

SAS Hot Plug SmartDrive LFF (3.5-inch) Enterprise Drives

HP 600GB 6G SAS 15K rpm LFF (3.5-inch) SC Enterprise 3yr Warranty Hard Drive	652620-B21
--	------------

HP 450GB 6G SAS 15K rpm LFF (3.5-inch) SC Enterprise 3yr Warranty Hard Drive	652615-B21
--	------------

SAS Hot Plug SmartDrive LFF (3.5-inch) Midline Drives

HP 3TB 6G SAS 7.2K rpm LFF (3.5-inch) SC Midline 1yr Warranty Hard Drive	652766-B21
--	------------

HP 2TB 6G SAS 7.2K rpm LFF (3.5-inch) SC Midline 1yr Warranty Hard Drive	652757-B21
--	------------

Core Options

HP 1TB 6G SAS 7.2K rpm LFF (3.5-inch) SC Midline 1yr Warranty Hard Drive 652753-B21

NOTE: Please see the QuickSpecs for Technical Specifications and additional information:

http://h18000.www1.hp.com/products/quickspecs/12244_na/12244_na.html (Worldwide)

6G SATA Hot Plug with SmartDrive SFF (2.5-inch) Midline (MDL) Drives

HP 1TB 6G SATA 7.2K rpm SFF (2.5-inch) SC Midline 1yr Warranty Hard Drive 655710-B21

HP 500GB 6G SATA 7.2K rpm SFF (2.5-inch) SC Midline 1yr Warranty Hard Drive 655708-B21

6G SATA Hot Plug with SmartDrive LFF (3.5-inch) Midline (MDL) Drives

HP 3TB 6G SATA 7.2K rpm LFF (3.5-inch) SC Midline 1yr Warranty Hard Drive 628061-B21

HP 2TB 6G SATA 7.2K rpm LFF (3.5-inch) SC Midline 1yr Warranty Hard Drive 658079-B21

HP 1TB 6G SATA 7.2K rpm LFF (3.5-inch) SC Midline 1yr Warranty Hard Drive 657750-B21

HP 500GB 6G SATA 7.2K rpm LFF (3.5-inch) SC Midline 1yr Warranty Hard Drive 658071-B21

NOTE: Please see the QuickSpecs for Technical Specifications and additional information:

http://h18000.www1.hp.com/products/quickspecs/13021_na/13021_na.html (Worldwide)

6G SAS MLC Hot Plug SFF (2.5-inch) Enterprise Mainstream Solid State Drives

HP 800GB 6G SAS MLC SFF (2.5-inch) SC Enterprise Mainstream 3yr Warranty Solid State Drive 653109-B21

HP 400GB 6G SAS MLC SFF (2.5-inch) SC Enterprise Mainstream 3yr Warranty Solid State Drive 653105-B21

HP 200GB 6G SAS MLC SFF (2.5-inch) SC Enterprise Mainstream 3yr Warranty Solid State Drive 658478-B21

6G SAS SLC Hot Plug SFF (2.5-inch) Enterprise Performance Solid State Drives

HP 400GB 6G SAS SLC SFF (2.5-inch) SC Enterprise Performance 3yr Warranty Solid State Drive 653082-B21

HP 200GB 6G SAS SLC SFF (2.5-inch) SC Enterprise Performance 3yr Warranty Solid State Drive 653078-B21

3G SATA MLC Hot Plug SFF (2.5-inch) Enterprise Mainstream Solid State Drives

HP 400GB 3G SATA MLC SFF (2.5-inch) SC Enterprise Mainstream 3yr Warranty Solid State Drive 653120-B21

HP 200GB 3G SATA MLC SFF (2.5-inch) SC Enterprise Mainstream 3yr Warranty Solid State Drive 653118-B21

HP 100GB 3G SATA MLC SFF (2.5-inch) SC Enterprise Mainstream 3yr Warranty Solid State Drive 653112-B21

3G SATA MLC Hot Plug LFF (3.5-inch) Enterprise Mainstream Solid State Drives

HP 400GB 3G SATA MLC LFF (3.5-inch) SC Enterprise Mainstream 3yr Warranty Solid State Drive 653126-B21

HP 200GB 3G SATA MLC LFF (3.5-inch) SC Enterprise Mainstream 3yr Warranty Solid State Drive 653124-B21

Core Options

HP 100GB 3G SATA MLC LFF (3.5-inch) SC Enterprise Mainstream 3yr Warranty Solid State Drive 653122-B21

NOTE: Please see the QuickSpecs for Technical Specifications and additional information:

http://h18000.www1.hp.com/products/quickspecs/14038_na/14038_na.html (Worldwide)

Hard Drive Kits

NOTE: All Factory Integrated Models will be populated with sufficient hard drive blanks based on the number of initial hard drives ordered with the server.

NOTE: The part numbers for single HDD blanks below are provided should the customer require replacement HDD blanks for their server.

HP SFF Gen8 Hard Drive Blank Kit 666987-B21

HP LFF Gen8 Hard Drive Blank Kit 666986-B21

HP 380p/385p Gen8 8-SFF Cage/Bkpln Kit 662883-B21

NOTE: With upgrade of 8SFF Cage/Bkpln (662883-B21), there is no Optical Drive support.

NOTE: With upgrade of 8SFF Cage/Bkpln (662883-B21), an additional storage controller is required. HP recommends the HP Smart Array P420/1GB FBWC 6Gb 2-ports Int SAS Controller (P/N 631670-B21).

Hard Drive Cables

HP DL38x/DL360 Gen8 Embedded SATA Cable Kit 664009-B21

HP Networking

Gigabit Ethernet adapters

HP NC112T PCI Express Gigabit Server Adapter 503746-B21

HP NC365T 4-port Ethernet Server Adapter 593722-B21

HP Ethernet 1Gb 4-port 331T Adapter 647594-B21

HP Ethernet 1Gb 2-port 361T Adapter 652497-B21

HP Ethernet 1Gb 2-port 332T Adapter 615732-B21

10 Gigabit Ethernet Adapters

NOTE: A minimum of two Gigabytes (2 GB) of server memory is required per each adapter.

NOTE: Direct Attach Cable (DAC) for copper environments or fiber transceivers and cables for fiber-optic environments must be purchased separately.

HP NC523SFP 10Gb 2-port Server Adapter 593717-B21

HP Ethernet 10Gb 2-port 530SFP Adapter 652503-B21

HP NC552SFP 10Gb 2-port Ethernet Server Adapter 614203-B21

FlexibleLOM Adapters

HP Ethernet 1Gb 4-port 331FLR Adapter 629135-B21

HP Ethernet 10Gb 2-port 530FLR-SFP+ Adapter 647581-B21

HP FlexFabric 10Gb 2-port 554FLR-SFP+ Adapter 629142-B21

NOTE: Please see the QuickSpecs for Technical Specifications and additional information: www.hp.com/go/ProLiantNICs

SFP+

HP X132 10G SFP+ LC LR Transceiver J9151A

HP X132 10G SFP+ LC SR Transceiver J9150A

Core Options

HP InfiniBand	QLogic InfiniBand 4X QDR PCI-E G2 Dual Port HCA	583211-B21
	HP InfiniBand 4X QDR ConnectX-2 PCIe G2 Dual Port HCA	592520-B21
	HP InfiniBand FDR/EN 10/40Gb Dual Port 544QSFP Adapter	649281-B21
	NOTE: For the following two InfiniBand Adapters, only 1 FlexibleLOM can be added to the server, which is selected in Step 2 for the "Configuration Information - Factory Integrated Models" section. These two options are for upgrade or change from original configuration.	
	HP InfiniBand FDR/EN 10/40Gb Dual Port 544FLR-QSFP Adapter	649282-B21
	HP InfiniBand QDR/EN 10Gb Dual Port 544FLR-QSFP Adapter	649283-B21

NOTE: FLR Indicates new HP FlexibleLOM Adapter series.

NOTE: Please see the QuickSpecs for additional information:
http://h18000.www1.hp.com/products/quickspecs/13078_na/13078_na.html

HP I/O Expansion Options	HP DL380p/385p Gen8 3 Slot PCI-E Riser Kit	653206-B21
	HP DL380p Gen8 2 Slot 2x16 PCI-E Riser Kit	653208-B21

HP Power Supplies	NOTE: Prior to making a power supply selection it is highly recommended that the HP Power Advisor is run to determine the right size power supply for your server configuration. The HP Power Advisor is located at: www.hp.com/go/hppoweradvisor .	
	HP Common Slot Platinum Plus Power Supply Kits	
	NOTE: The following Power Supplies offer 94% Efficiency with support for Intelligent Power Discovery.	
	HP 460W Common Slot Platinum Plus Hot Plug Power Supply Kit	656362-B21
	HP 750W Common Slot Platinum Plus Hot Plug Power Supply Kit	656363-B21
	HP 1200W Common Slot Platinum Plus Hot Plug Power Supply Kit	656364-B21
	HP Common Slot Gold Power Supplies	
	NOTE: The following Power Supplies offer 92% Efficiency.	
	HP 460W Common Slot Gold Hot Plug Power Supply Kit	503296-B21
	HP 750W Common Slot Gold Hot Plug Power Supply Kit	512327-B21
	HP Common Slot -48VDC Power Supplies	
	NOTE: The following Power Supplies offer 92% Efficiency.	
HP 750W Common Slot -48VDC Hot Plug Power Supply Kit	636673-B21	
NOTE: The HP 750W Common Slot -48VDC power supply does not ship with a power cable. It has been designed with a terminal block connection allowing for custom design of power cords by the user.		
NOTE: Option Kits contain optional power supply, an IEC power cable and PDU IEC cables.		
NOTE: Power Specification and Technical Content for supported power supplies can be found at: http://h18000.www1.hp.com/products/quickspecs/14209_na/14209_na.html		

HP Graphic Options	HP 150W PCI-E Power Cable Kit	669777-B21
---------------------------	-------------------------------	------------

Additional Options

NOTE: Some options may not be integrated at the factory. To ensure only valid configurations are ordered, HP recommends the use of an HP approved configurator. Contact your local sales representative for additional information.

HP Insight Software	HP Insight Control	
	HP Insight Control including 1yr 24x7 Technical Support and Updates Electronic License	T9074BAE
	HP Insight Control including 1yr 24x7 Technical Support and Updates Single Server License	452148-B22
	HP Insight Management Media Kit	436222-B21
	NOTE: HP Insight Management Media Kit contains DVDs without licenses. Contains HP Systems Insight Manager, HP Insight Control, HP Matrix Operating Environment, and Virtual Connect Enterprise Manager software. Uses an integrated installer to perform quick and accurate software installation and updates.	
	HP Insight Control Server Deployment	
	HP Insight Control Server Deployment including 1yr 24x7 Support Electronic License	T9082AAE
	HP Insight Control Server Deployment including 1yr 24x7 Support Single Server License	452151-B21
	NOTE: Electronic and Flexible-Quantity licenses can be used to purchase multiple licenses with a single activation key.	
	NOTE: Customer will receive a license entitlement certificate. The license entitlement certificate must be redeemed online or via fax in order to obtain the license activation key(s). Includes one year of 24 x 7 HP Software Technical Support and Update Service.	
	NOTE: Licenses ship without media. The HP Insight Management Media Kit can be ordered separately, or can be downloaded at: http://www.hp.com/go/insightupdates .	
	NOTE: For additional license options please see the Insight Control QuickSpecs at: http://h18000.www1.hp.com/products/quickspecs/12631_na/12631_na.html	
	HP Insight Control for Linux	
	HP Insight Control for Linux including 1yr 24x7 Support Electronic License	TC213AAE
	HP Insight Control for Linux including 1yr 24x7 Support Single Server License	TC209A
	HP Insight Control for Linux Media Kit	TC208A
	NOTE: Media pack DVD contains the ISO image for HP Insight Control for Linux, HP Systems Insight Manager, HP Insight Control power management, HP Insight Control virtual machine management, and an integrated installer. Servers must be acquired separately.	
	NOTE: Licenses ship without media. The Media Kit for Insight Control for Linux can be ordered separately, or can be downloaded at: http://www.hp.com/go/ic-linux (click on Download button).	
	NOTE: Electronic and Flexible-Quantity licenses can be used to purchase multiple licenses with a single set of activation keys.	
	NOTE: For additional License Kits, including electronic licensing options, please see the QuickSpecs at: http://h18000.www1.hp.com/products/quickspecs/13019_na/13019_na.html	

Additional Options

HP iLO Advanced License	HP Integrated Lights-Out (iLO) Advanced for ProLiant Remote Management	
	HP iLO Advanced Pack Electronic License with 3yr 24x7 Tech Support and Updates	BD506AAE
	HP iLO Advanced 1 Server License with 3yr 24x7 Tech Support and Updates	BD505A
	HP iLO Advanced including 1yr 24x7 Technical Support and Updates Single Server License	512485-B21
	NOTE: For more information, visit: http://www.hp.com/go/ilo .	

High Performance Clusters	HP Cluster Management Utility	
	HP Insight Cluster Management Utility 1yr 24x7 Flexible License	QL803B
	HP Insight Cluster Management Utility 3yr 24x7 Flexible License	BD476A
	NOTE: These part numbers can be used to purchase one certificate for multiple licenses and support with a single activation key. Each license is for one node (server). Customer will receive a printed end user license agreement and license entitlement certificate via physical shipment. The license entitlement certificate must be redeemed online in order to obtain a license key. Customer also will receive a support agreement.	
	HP Insight Cluster Management Utility Media	BD477A
	NOTE: For additional license kits please see the QuickSpecs at: http://h18004.www1.hp.com/products/quickspecs/12612_na/12612_na.html	
	HP HPC Linux Value Pack	
	HP High Performance Computing Linux Value Pack 1 Processor Flexible License	TC293B
	NOTE: This part number can be used to purchase one certificate for multiple licenses with a single activation key. Each license is for one socket (a.k.a. processor). Customer will receive a printed end user license agreement and license entitlement certificate via physical shipment. The license entitlement certificate must be redeemed online in order to obtain a license key.	
	HP High Performance Computing Linux Value Pack Media Kit	TC294A
	NOTE: This part number can be used to purchase media including software and documentation, which will be delivered to the customer.	
	NOTE: For additional license kits please see the QuickSpecs at: http://h18004.www1.hp.com/products/quickspecs/13485_na/13485_na.html	

Additional Options

HP I/O Accelerator Options	Second Generation Accelerators	
	HP 365GB Multi Level Cell G2 PCIe ioDrive2 for ProLiant Servers	673642-B21
	HP 785GB Multi Level Cell G2 PCIe ioDrive2 for ProLiant Servers	673644-B21
	HP 1205GB Multi Level Cell G2 PCIe ioDrive2 for ProLiant Servers	673646-B21
	HP 2410GB Multi Level Cell G2 PCIe ioDrive2 Duo for ProLiant Servers	673648-B21
	First Generation Accelerators	
	HP 160GB Single Level Cell PCIe ioDrive for ProLiant Servers	600278-B21
	NOTE: A low-profile PCI bracket is included for use in low-profile slots.	
	HP 320GB Multi Level Cell PCIe ioDrive for ProLiant Servers	600279-B21
	NOTE: A low-profile PCI bracket is included for use in low-profile slots.	
	HP 320GB Single Level Cell PCIe ioDrive Duo for ProLiant Servers	600281-B21
	HP 640GB Multi Level Cell PCIe ioDrive Duo for ProLiant Servers	600282-B21
	HP 1.28TB Multi Level Cell PCIe ioDrive Duo for ProLiant Servers	641027-B21

NOTE: Please see the QuickSpecs for Technical Specifications and additional information:
http://h18000.www1.hp.com/products/quickspecs/13587_na/13587_na.html
 (Worldwide)

HP Security	HP Trusted Platform Module Option	488069-B21
	<p>NOTE: The TPM (Trusted Platform Module) is a microcontroller chip that can securely store artifacts used to authenticate the server platform. These artifacts can include passwords, certificates and encryption keys. Windows® BitLocker™ Drive Encryption (BitLocker) is a data protection feature available in Windows Server® 2008. BitLocker leverages the enhanced security capabilities of a Trusted Platform Module (TPM) version 1.2. The TPM works with BitLocker to help protect user data and to ensure that a server running Windows Server 2008 has not been tampered with while the system was offline. For more information about TPM, including a white paper, go to: www.hp.com/go/TPM.</p> <p>NOTE: ProLiant OS pre-installed units will come with the partition required for TPM deployment.</p> <p>NOTE: The TPM key is unique to every TPM deployed server and must be retained. Misplacing or losing the key could result in data loss.</p>	
	HP 2U Security Bezel Kit	666988-B21

HP Storage Controllers	SAS Controllers	
	Smart Array P222 Controller	
	NOTE: P222 requires (1) HP Mini SAS Straight to Straight 37in Cable Assembly (P/N 662897-B21)	
	HP Smart Array P222/512 FBWC 6Gb 1-port Int/1-port Ext SAS Controller	631667-B21
	Smart Array P420 Controller	
	NOTE: P420 requires (2) HP Mini SAS Straight to Straight 37in Cable Assemblies (P/N 662897-B21)	
	HP Smart Array P420/1GB FBWC 6Gb 2-ports Int SAS Controller	631670-B21
	HP Smart Array P420/2GB FBWC 6Gb 2-ports Int SAS Controller	631671-B21
	Smart Array P421 Controller	
	HP Smart Array P421/1GB FBWC 6Gb 2-ports Ext SAS Controller	631673-B21
	HP Smart Array P421/2GB FBWC 6Gb 2-ports Ext SAS Controller	631674-B21
Smart Array P822 Controller		
HP Smart Array P822/2GB FBWC 2-ports Int/4-ports Ext SAS Controller	615418-B21	

Additional Options

Optional Upgrades

HP 1GB P-series Smart Array Flash Backed Write Cache	631679-B21
HP 2GB P-series Smart Array Flash Backed Write Cache	631681-B21
HP 512MB P-series Smart Array Flash Backed Write Cache	661069-B21
HP Smart Array Advanced Pack 2.0 No Media 1 Server 1yr 24x7 Support Software	BC377A
HP Smart Array Advanced Pack 2.0 No Media Electronic Lic 1yr 24x7 Support Software	BC390AAE

HP Cable Options

HP Double Mini SAS Y 36in Cable Assembly	662901-B21
HP Mini SAS Straight to Straight 37in Cable Assembly	662897-B21

NOTE: Please see the QuickSpecs for Technical Specifications and additional information:

http://h18000.www1.hp.com/products/quickspecs/14227_na/14227_na.html
(Smart Array P222 Controller)

http://h18000.www1.hp.com/products/quickspecs/14228_na/14228_na.html
(Smart Array P420 Controller)

http://h18000.www1.hp.com/products/quickspecs/14229_na/14229_na.html
(Smart Array P421 Controller)

http://h18000.www1.hp.com/products/quickspecs/14341_na/14341_na.html
(Smart Array P822 Controller)

http://h18000.www1.hp.com/products/quickspecs/13200_na/13200_na.html
(Smart Array Advanced Pack)

Host Bus Adapter

HP H220 Host Bus Adapter	650933-B21
HP H221 Host Bus Adapter	650931-B21
HP H222 Host Bus Adapter	650926-B21

NOTE: Please see the QuickSpecs for Technical Specifications and additional information:

http://h18004.www1.hp.com/products/quickspecs/14336_na/14336_na.html
(HBA 220)

http://h18004.www1.hp.com/products/quickspecs/14222_na/14222_na.html
(HBA 221)

http://h18004.www1.hp.com/products/quickspecs/14337_na/14337_na.html
(HBA 222)

SCSI HBA

HP SC11Xe Ultra320 Single Channel/ PCIe x4 SCSI Host Bus Adapter	412911-B21
--	------------

NOTE: Please see the following QuickSpecs for additional information:

http://h18000.www1.hp.com/products/quickspecs/12566_na/12566_na.html
(SC11Xe HBA)

HP Power Cords

NOTE: HP ProLiant servers ships with an IEC-IEC power cord used for rack mounting with Power Distribution Units (PDUs).

HP C13 - Nema 6-15P US 250V 15A JP 3.6m Power Cord	A0N33A
HP C13 - Nema 5-15P US/CA 110V 10Amp 1.83m Power Cord	AF556A

Additional Options

HP Tape Backup	<p>NOTE: For the complete range of tape drives, autoloaders, libraries and media see: http://www.hp.com/go/tape. For hardware and software compatibility of HP tape backup products see: http://www.hp.com/storage/SPOCK</p> <p>HP 1/8 G2 LTO-4 Ultrium 1760 SAS Tape Autoloader AK377A</p> <p>NOTE: Requires HP 1U Tape Autoloader Rack Kit (AH166A) for rack installation. Connection using HP Smart Array P222 Controller (631667-B21) recommended.</p> <p>HP Ultrium 920 SAS Internal Tape Drive EH847A</p> <p>NOTE: For installation into 1U SAS rack kit (AE459B) or 3U SAS rack kit (AG576B). No peripheral bay available for installation into the server. Connection using HP Smart Array P222 Controller (631667-B21) recommended.</p> <p>HP LTO-5 Ultrium 3000 SAS Tape Drive in 1U Rackmount EJ014A</p> <p>NOTE: Connection using HP Smart Array P222 Controller (631667-B21) recommended.</p> <p>HP MSL2024 1 LTO-4 Ultrium 1760 SAS Tape Library AK378A</p> <p>NOTE: Connection using HP Smart Array P222 Controller (631667-B21) recommended.</p> <p>HP MSL4048 2 LTO-4 Ultrium 1760 SAS Tape Library AK380A</p> <p>NOTE: Connection using HP Smart Array P222 Controller (631667-B21) recommended.</p>
-----------------------	---

HP Disk Backup	<p>NOTE: For the complete range of RDX drives and media see: http://www.hp.com/go/rdx. For hardware and software compatibility of HP disk backup products see: http://www.hp.com/storage/SPOCK.</p> <p>HP RDX External Disk Backup Systems</p> <p>HP RDX160 External Removable Disk Backup System AJ766A</p> <p>HP RDX320 External Removable Disk Backup System AJ768A</p> <p>HP RDX500 External Removable Disk Backup System AJ935A</p> <p>HP RDX1000 External Removable Disk Backup System BV849A</p> <p>HP RDX Removable Disk Backup Systems USB</p> <p>HP RDX320 Internal Removable Disk Backup System AJ767A</p> <p>NOTE: For installation into 1U USB Rack-Mount Kit (A8007A). No peripheral bay available for drive installation into the server. 320GB of disk capacity per data cartridge</p> <p>HP RDX500 Internal Removable Disk Backup System AJ934A</p> <p>NOTE: For installation into 1U USB Rack-Mount Kit (A8007A). No peripheral bay available for drive installation into the server. 500GB of disk capacity per data cartridge.</p> <p>HP RDX1000 Internal Removable Disk Backup System BV847A</p> <p>NOTE: For installation into 1U USB Rack-Mount Kit (A8007A). No peripheral bay available for drive installation into the server. 1 TB of disk capacity per data cartridge.</p>
-----------------------	--

Additional Options

HP Storage Options	Storage Fibre Channel HBA	
	NOTE: For the complete listing of Fibre Channel Host Bus Adapters for Windows 2000, Windows Server 2003 and Linux, please see: http://h18006.www1.hp.com/storage/saninfrastructure/hba.html	
	Brocade Fibre Channel HBAs	
	HP 81B 8Gb 1-port PCIe Fibre Channel Host Bus Adapter	AP769A
	HP 82B 8Gb 2-port PCIe Fibre Channel Host Bus Adapter	AP770A
	Emulex Fibre Channel HBAs	
	HP 81E 8Gb 1-port PCIe Fibre Channel Host Bus Adapter	AJ762A
	HP 82E 8Gb 2-port PCIe Fibre Channel Host Bus Adapter	AJ763A
	HP SN1000E 16Gb 1-port PCIe Fibre Channel Host Bus Adapter	QR558A
	HP SN1000E 16Gb 2-port PCIe Fibre Channel Host Bus Adapter	QR559A
	QLogic Fibre Channel HBAs	
	HP 81Q 8Gb 1-port PCIe Fibre Channel Host Bus Adapter	AK344A
	HP 82Q 8Gb 2-port PCIe Fibre Channel Host Bus Adapter	AJ764A
	Converged Network Adapter	
	HP CN1100E Dual Port Converged Network Adapter	BK835A
HP CN1000Q Dual Port Converged Network Adapter	BS668A	

HP Disk Storage Systems

	Modular Smart Arrays	
	HP P2000 G3 10GbE iSCSI MSA Dual Controller LFF Array System	AW596
	HP P2000 G3 10GbE iSCSI MSA Dual Controller SFF Array System	AW597
	HP P2000 G3 iSCSI MSA Dual Controller LFF Array System	BK83C
	HP P2000 G3 iSCSI MSA Dual Controller SFF Array System	BK831
	HP P2000 G3 MSA FC Dual Controller LFF Modular Smart Array System	AP84E
	HP P2000 G3 MSA FC Dual Controller SFF Modular Smart Array System	AP84E
	HP P2000 G3 MSA FC/iSCSI Dual Combo Controller LFF Array	AW567
	HP P2000 G3 MSA FC/iSCSI Dual Combo Controller SFF Array	AW56E
	HP P2000 G3 SAS MSA Dual Controller LFF Array System	AW593
	HP P2000 G3 SAS MSA Dual Controller SFF Array System	AW594

NOTE: Please see the QuickSpecs for additional options and configuration information at:

http://h18000.www1.hp.com/products/quickspecs/13551_na/13551_na.html

Disk Enclosures

HP D2000 Disk Enclosures

HP D2600 Disk Enclosure	AJ94C
HP D2700 Disk Enclosure	AJ941

NOTE: Please see the QuickSpecs for additional options and configuration information at:

http://h18000.www1.hp.com/products/quickspecs/13404_na/13404_na.html

Additional Options

HP Uninterruptible Power Systems

HP Rack-mountable UPS

HP R1500 G3 Uninterruptible Power Supply (UPS)

HP R1.5kVA G3 1U NA Uninterruptible Power System

AF46C

NOTE: Please see the QuickSpecs for additional information:

http://h18000.www1.hp.com/products/quickspecs/14059_na/14059_na.html

HP R/T3000 G2 Uninterruptible Power System (UPS)

HP R/T3000 G2 2U L530 Low Voltage NA/JP Uninterruptible Power System

AF46E

HP R/T3000 G2 2U L620 High Voltage NA/JP Uninterruptible Power System

AF467

NOTE: Please see the QuickSpecs for additional information:

http://h18000.www1.hp.com/products/quickspecs/14058_na/14058_na.html

R5000 Uninterruptible Power System (UPS)

HP R5KVA 3U L630 High Voltage NA/JP Uninterruptible Power System

AF46C

NOTE: Please see the QuickSpecs for additional information:

http://h18000.www1.hp.com/products/quickspecs/14109_na/14109_na.html

R7000 Uninterruptible Power System (UPS)

HP R7KVA 4U 50A High Voltage NA/JP Uninterruptible Power System

AF46Z

HP R5KVA and R7KVA 3U Extended Runtime Module

AF46A

NOTE: Please see the QuickSpecs for additional information:

http://h18000.www1.hp.com/products/quickspecs/14110_na/14110_na.html

NOTE: For additional information on HP Uninterruptible Power Systems please go to: www.hp.com/servers/rackups.

NOTE: For additional information on sizing your server, please reference:

<http://www.upssizer.com>.

NOTE: Please see the UPS and PDU cable matrix's on the HP Power Protection and Management page. Under Power Cords, click on the "HP Power Cord Matrix" link. That link will list cable descriptions, requirements, and specifications for UPS and PDU units. Please see the following link:

www.hp.com/products/powercords.

HP Power Distribution Units

Monitored PDUs

HP Monitored Power Distribution Unit: Full Rack Version

HP 17.3kVA 24A Dual Three Phase Monitored Power Distribution Unit

AF50Z

HP 8.6kVA 24A Single Input Three Phase Monitored Power Distribution Unit

AF504

HP 16.6kVA 40A Dual Input Single Phase Monitored Power Distribution Unit

AF50E

HP 8.3kVA 40A Single Input Single Phase Monitored Power Distribution Unit

AF50E

HP Monitored Power Distribution Unit: Half Rack Version

HP 4.9kVA 24A Single Input Single Phase NA/JP Monitored Power Distribution Unit

AF914

HP 17.3kVA 48A Single Input Three Phase NA/JP Monitored Power Distribution Unit

AF91E

NOTE: Please see the QuickSpecs for Technical Specifications and additional information:

http://h18000.www1.hp.com/products/quickspecs/12118_na/12118_na.html

Modular PDUs 1U/0U

NOTE: 1U/0U mounting brackets shipped with the unit (optimized for 10000 G2 and 9000 series racks).

HP 2.8kVA 24A Low Voltage Modular Power Distribution Unit

252663-D7

HP 4.9kVA 24A High Voltage Modular Power Distribution Unit

252663-D7

HP 8.3kVA 40A High Voltage Modular Power Distribution Unit

252663-D7

HP 8.3kVA 40A High Voltage Core Modular Power Distribution Unit

252663-D7

Additional Options

HP 4.9kVA 24A High Voltage Core Modular Power Distribution Unit 252663-D7

NOTE: For additional information on HP Power Distribution Units including accessories please go to: www.hp.com/go/pdu.

NOTE: Please see the UPS and PDU cable matrix's on the HP Power Protection and Management page. Under Power Cords, click on the "HP Power Cord Matrix" link. That link will list cable descriptions, requirements, and specifications for UPS and PDU units. Please see the following link: www.hp.com/products/powercords.

NOTE: This PDU has a detachable input power cord and allows for adaptability to country specific power requirements.

NOTE: Please see the following QuickSpecs for additional options including shorter jumper cables and country specific power cords: http://h18000.www1.hp.com/products/quickspecs/11041_na/11041_na.html

HP Intelligent Power Distribution Units (iPDU)

iPDU Core Units

HP 4.9kVA 24A Single Phase NA/JP Core Intelligent Modular Power Distribution Unit AF52C

HP 8.3kVA 40A Single Phase NA/JP Core Intelligent Modular Power Distribution Unit AF521

HP 8.6kVA 24A Three Phase NA/JP Core Intelligent Modular Power Distribution Unit AF522

HP 14.4kVA 40A Three Phase NA/JP Intelligent Modular Power Distribution Unit AF533

HP 17.3kVA 48A Three Phase NA/JP Core Intelligent Modular Power Distribution Unit AF523

HP 11.4kVA 16A 415V Three Phase L22-20 NA Core Intelligent Power Distribution Unit AF90C

HP 17.3kVA 24A 415V Three Phase L22-30 NA Core Intelligent Power Distribution Unit AF902

HP 17.3kVA 24A 415V Three Phase IEC309 NA Core Intelligent Power Distribution Unit AF901

HP 17.3kVA 48A 208V Three Phase 12 Outlet Core NA/JP Intelligent Power Distribution Unit AF535

HP 17.3kVA 24A 415V Three Phase 12 Outlet Core NA/JP Intelligent Power Distribution Unit AF537

iPDU Kits with Standard Extension Bars

HP 4.9kVA 24A Single Phase NA/JP Intelligent Modular Power Distribution Kit AF531

HP 8.6kVA 24A Three Phase NA/JP Intelligent Modular Power Distribution Kit AF532

iPDU Extension Bars

HP 5xC13 Outlets Power and UID LEDs Pair Standard Extension Bar AF52E

NOTE: Please see the QuickSpecs for Technical Specifications and additional information: http://h18000.www1.hp.com/products/quickspecs/13650_na/13650_na.html

Additional Options

HP Rack Series

HP Rack 10000 G2 Series (Carbon/Graphite Metallic)

HP 10642 G2 Shock Universal Rack

AF002

NOTE: It is mandatory to use a shock pallet when shipping racks with equipment installed.

NOTE: Please see the QuickSpecs for Technical Specifications and additional information:

http://h18000.www1.hp.com/products/quickspecs/12402_na/12402_na.html
(Worldwide)

NOTE: For additional information regarding Rack Cabinets, please see the following URL: <http://www.hp.com/go/rackandpower>.

NOTE: The increasing power of new high-performance processor technology requires increased cooling efficiency for rack-mounted servers. The 10000 G2 Series Racks provide enhanced airflow for maximum cooling, allowing these racks to be fully loaded with servers using the latest processors.

CAUTION: If a third-party rack is used, observe the following additional requirements to ensure adequate airflow and to prevent damage to the equipment: Front and rear doors: If your 42U server rack includes closing front and rear doors, you must allow 830 square inches (5,350 sq cm) of hole evenly distributed from top to bottom to permit adequate airflow (equivalent to the required 64 percent open area for ventilation). Side: The clearance between the installed rack component and the side panels of the rack must be a minimum of 2.75 inches (7 cm).

CAUTION: Always use blanking panels to fill all remaining empty front panel U-spaces in the rack. This arrangement ensures proper airflow. Using a rack without blanking panels results in improper cooling that can lead to thermal damage.

NOTE: Quick deploy rail system provides tool-free support for racks with square or round mounting holes (including Compaq/HP 7000, 9000, 10000 G2 and HP series), with an adjustment range of 24" - 36". The ambidextrous cable management arm can be mounted on either the left or right side for improved cable management.

NOTE: High Airflow Inserts (High Air Flow Rack Door Insert for the 7142 Rack (single) - PN: 327281-B21; or High Air Flow Rack Door Insert for the 7142 Rack (6-pack) - PN: 327281-B22) are required to support the server in the 7000 series racks. The Cable Management Arm is not supported on 7000 series racks.

NOTE: Cable management arm must be removed to access hot-plug power supplies when the cable management arm is mounted on the right.

Additional Options

HP Rack Options

HP USB Keyboard and Mouse

NOTE: Please see the QuickSpecs for Technical Specifications and additional information:

http://h18000.www1.hp.com/products/quickspecs/13972_na/13972_na.html

HP Server Console Switches

HP Server Console 0x2x8 Port Analog Switch

AF616

HP Server Console 0x2x16 Port Analog Switch

AF617

NOTE: Please see the QuickSpecs for Technical Specifications and additional information:

http://h18000.www1.hp.com/products/quickspecs/11834_na/11834_na.html

HP Server Console Switch G2 with Virtual Media & CAC

HP 0x2x16 KVM Server Console Switch G2 with Virtual Media CAC Software

AF618

HP 0x2x32 KVM Server Console Switch G2 with Virtual Media CAC Software

AF619

NOTE: Please see the QuickSpecs for Technical Specifications and additional information:

http://h18000.www1.hp.com/products/quickspecs/13475_na/13475_na.html

HP IP Console Switch G2 with Virtual Media & CAC

HP 1x1Ex8 KVM IP Console Switch G2 with Virtual Media CAC Software

AF620

HP 2x1Ex16 KVM IP Console Switch G2 with Virtual Media CAC Software

AF621

HP 4x1Ex32 KVM IP Console Switch G2 with Virtual Media CAC Software

AF622

NOTE: Please see the QuickSpecs for Technical Specifications and additional information:

http://h18000.www1.hp.com/products/quickspecs/13474_na/13474_na.html

Rail Kits

NOTE: Gen8 rail kits have changed significantly from prior generation rail kits. Please take a moment to review the installation documentation that comes with the server to help you with the installation of your Gen8 server.

NOTE: Rail kits are optional for DL380p Gen8 and are no longer included standard with the server. Customers have the option to purchase their server without a rail kit.

NOTE: Should you need it, HP can provide a tool to assist in the installation of the server into the rack. P/N 695539-001 is available by contacting your local services representative.

HP 2U Large Form Factor Ball Bearing Gen8 Rail Kit

663480-B2

NOTE: Kit contains telescoping LFF ball bearing rails for LFF drive cage chassis which allow for in-rack serviceability. The HP Gen8 Cable Management Arm is included.

HP 2U Small Form Factor Ball Bearing Gen8 Rail Kit

663478-B2

NOTE: Kit contains telescoping SFF ball bearing rails for SFF drive cage chassis which allow for in-rack serviceability. The HP Gen8 Cable Management Arm is included.

Additional Options

HP USB and SD options	HP USB 2-Button Optical Scroll Mouse	DC172
	HP USB 04 Standard Keyboard	DT528A#AB
	HP 4GB Secure Digital High Capacity Flash Media Kit	580387-B2
	NOTE: Blank SD media device is supported for use with VMware and Citrix. SD media must be installed in the internal slot of the ProLiant server. Learn more at: http://www.hp.com/go/proliantvirtualization .	
	HP 2GB USB Flash Media Drive Key Kit	608447-B2
	NOTE: HP qualified blank USB key for use with HP ProLiant servers that support the VMware virtualization environment and other HP value-add software like SmartStart. HP recommends this industry standard USB flash device for use with VMware ESXi. USB device must be installed in the internal slot of the ProLiant server for use with VMware ESXi. Refer to HP VMware Getting Started Guide for installation instructions.	

HP Care Pack Services	HP 3 year 24x7 24 hour Call to Repair ProLiant DL38x(p) Hardware Support	UP717
	HP 3 year 4 hour 13x5 ProLiant DL38x(p) Hardware Support	U4544
	HP 3 year 4 hour 24x7 ProLiant DL38x(p) Hardware Support	U4545
	HP 3 year 6 hour 24x7 Call to Repair ProLiant DL38x(p) Hardware Support	U4546
	HP 3 year Support Plus 24 Microsoft ProLiant DL38x(p) Service	U4557
	HP 3 year Support Plus 24 SuSE ProLiant DL38x(p) Service	U6312
	HP 4 year 24x7 24 hour Call to Repair ProLiant DL38x(p) Hardware Support	UP71E
	HP 4 year 4 hour 13x5 ProLiant DL38x(p) Hardware Support	U8101
	HP 4 year 4 hour 24x7 ProLiant DL38x(p) Hardware Support	U8118
	HP 5 year 4 hour 13x5 ProLiant DL38x(p) Hardware Support	U8067
	HP 5 year 4 hour 24x7 ProLiant DL38x(p) Hardware Support	U8084
	HP 4 year 6 hour 24x7 Call to Repair ProLiant DL38x(p) Hardware Support	U9738
	HP 4 year Next business day ProLiant DL38x(p) Hardware Support	UA01C
	HP 5 year 6 hour 24x7 Call to Repair ProLiant DL38x(p) Hardware Support	U9737
	HP 5 year Next business day ProLiant DL38x(p) Hardware Support	UA00E
	HP Install ProLiant DL38x(p) Service	U4554
	HP Startup ProLiant DL38x(p) Service	U4555
	HP 5 year 24x7 24 hour Call to Repair ProLiant DL38x(p) Hardware Support	UP71E
	HP Installation of ProLiant Add On/In Options Service	UH74E
	HP Installation and Startup for Insight Control Server Deployment - previously Rapid Deployment Pack	U5683
	HP 3 year Next business day ProLiant DL38x(p) Proactive Care Service	U2Z44
	HP 3 year 4 hour 24x7 ProLiant DL38x(p) Proactive Care Service	U2Z5C
	HP 3 year Next business day ProLiant DL38x(p) Collaborative Support	U1J24
	HP 3 year 4 hour 24x7 ProLiant DL38x(p) Collaborative Support	U1J3C
	HP 3 year Next business day ProLiant DL38x(p) with Insight Control Proactive Care Service	U3N17
	HP 3 year 4 hour 24x7 ProLiant DL38x(p) with Insight Control Proactive Care Service	U3N23
	HP 3 year Support Plus 24 Insight Control ProLiant DL38x(p) Service	UM812
	NOTE: For more information, customer/resellers can contact: http://www.hp.com/services/carepack	

Memory

For detailed memory configuration rules and guidelines, please use the Online DDR3 Memory Configuration Tool: www.hp.com/go/ddr3memory-configurator

Memory Subsystem Architecture

Each Intel® Xeon® E5-2600 family processor socket contains four memory channels that support three DIMMs each for a total of twelve (12) DIMM per installed processor or a grand total of twenty-four (24) DIMMs for the server. Up to 32GB capacity DIMMs are supported for 768GB of memory (24 DIMM slots x 32GB per DIMM).

Memory population guidelines

DIMM configuration

NOTE: This information is only for Advanced EEC memory mode. See the user guide for other memory modes.

Key: Alpha - population order
 Numeric - DIMM slot ID for spare replacement

- Before installing DIMMs, review the population rules:
 - Do not install DIMMs if the corresponding processor is not installed.
 - When two processors are installed, balance the DIMMs across the two processors
 - DIMM slots that are white denote the first slot of a channel (Ch 1-A, Ch 2-B, Ch 3-C, Ch 4-D...).
 - Do not mix UDIMMs, RDIMMs, or LRDIMMs.
 - Do not install more than two UDIMMs per channel. UDIMMs should be installed in slots Ch 1-I, Ch 2-J, Ch 3-K, Ch 4-L
- When two processors are installed, install DIMMs in sequential alphabetical order balanced between the two processors: P1-A, P2-A, P1-B, P2-B, P1-C, P2-C...
- For DIMM spare replacement, install the DIMMs per slot number as instructed by your system software.

For additional DIMM information, see the user guide at: hp.com > support & drivers > product support & troubleshooting > enter your product

General Memory Population Rules and Guidelines:

- White DIMM slots denote the first slot of a channel. For 1 DPC (DIMM per channel) populate white slots only.
- Install DIMMs only if the corresponding processor is installed.
- If only one processor is installed in a two processor system, only half of the DIMM slots are available.
- To maximize performance, it is recommended to balance the total memory capacity between all installed processors and to load the channels similarly whenever possible.
- Populate DIMMs from heaviest load (quad-rank) to lightest load (single-rank) within a channel. Heaviest load (DIMM with most ranks) within a channel goes furthest from the processor
- RDIMMs operating at either 1.35V or 1.5V may be mixed in any order, but the system will power them at the higher voltage.
- Do not mix RDIMMs, LRDIMMs, and UDIMMs.
- LRDIMMs are supported up to 3 DIMMs per channel.
- Using the HP RBSU, 1.35V DIMMs can be changed to operate at 1.5V.
- DIMMs of different speeds may be mixed in any order; the server will select a common optimal speed.
- The maximum memory speed is a function of the memory type, memory configuration, and processor model.
- The maximum memory capacity is a function of the memory type and number of installed processors.
- HP memory from previous generation servers is not qualified on the DL380p Gen8 Server. Certain HP SmartMemory features such as memory authentication and enhanced performance may not be supported.
- To realize the performance memory capabilities listed in this document, HP SmartMemory is required. For additional information, please see the HP SmartMemory QuickSpecs at: http://h18000.www1.hp.com/products/quickspecs/14225_na/14225_na.html.
- For memory population rules and additional memory guidelines, please see the DL380p Gen8 user guide at <http://www.hp.com/support>.

Memory

DL380p Gen8 Supported Memory Bandwidth and Capacity

DIMM Type	Registered DIMMS (RDIMMs)							Load Reduced (LRDIMMs)	Unbuffered with ECC DIMMs (UDIMMs)					
	Single Rank (1R)			Dual Rank (2R)					Quad Rank (4R)	Single Rank (1R)		Dual Rank (2R)		
DIMM Rank														
DIMM Capacity	4GB	4GB	8GB	8GB	8GB	16GB	16GB	32GB	2GB	2GB	4GB	4GB	8GB	8GB
DIMM Native Speed (MHz)	1333	1600	1600	1333	1600	1333	1600	1333	1333	1600	1333	1600	1333	1600
Voltage	LV	Std	Std	LV	Std	LV	Std	LV	LV	Std	LV	Std	LV	Std

SLOTS THAT CAN BE POPULATED

24 slot servers	24	24	24	24	24	24	24	24	16	16	16	16	16	16
-----------------	----	----	----	----	----	----	----	----	----	----	----	----	----	----

MAXIMUM CAPACITY (GB)

	96	96	192	192	192	384	384	768	32	32	64	64	128	128
--	----	----	-----	-----	-----	-----	-----	-----	----	----	----	----	-----	-----

POPULATED DIMM SPEED (MHz)

1 DIMM Per Channel	1333	1600	1600	1333	1600	1333	1600	1333***	1333	1600	1333	1600	1333	1600
2 DIMM Per Channel	1333	1600	1600	1333	1600	1333	1600	1333***	1333****	1600	1333****	1600	1333***	1600
3 DIMM Per Channel	1066**	1333##	1333##	1066**	1333##	1066**	1333##	1066	n/a	n/a	n/a	n/a	n/a	n/a

NOTE: Memory speed is a function of the processor QPI bus speed. To realize the performance memory capabilities listed HP SmartMemory is required.

* Maximum capacity will vary based on individual server platform qualification schedule

** For HP SmartMemory RDIMM supports up to 3DPC@1066 at 1.35V. Third party memory may only support up to 3DPC 1.5V.

*** LRDIMMs enable 3 DIMMs per channel. HP SmartMemory will support up to 3DPC@1066 at 1.35V. Third party memory support 3DPC @1066 at 1.5V.

**** For HP SmartMemory, UDIMM is supported at 2DPC@1333 at 1.35V. Third party memory may only support up to 2DI at 1.5V.

RBSU setting required

Memory Speed by Processor Model

Processor Models	Supported Memory Speeds
E5-2690 E5-2680, E5-2670, E5-2667, E5-2665, E5-2660, E5-2650, E5-2650L, E5-2643	1600/1333/1066MHz
E5-2640, E5-2637, E5-2630, E5-2630L, E5-2620	1333/1066MHz
E5-2609, E5-2603	1066MHz

Standard and Maximum Memory Capacity (Pre-configured Models)

Memory

Pre Configured Models	Standard Memory	Maximum Memory Plus Optional Memory	Standard Memory Replace with Optional Memory
Intel Xeon E5-2690, E5-2665, E5-2650	32GB (4x 8GB)	352GB (20x16GB, 4x8GB)	768GB (24 x 32GB)
Intel Xeon E5-2640, E5-2630, E5-2620	16GB (4x 4GB)	336GB (20x16GB, 4x4GB)	768GB (24 x 32GB)
Intel Xeon E5-2609	4GB (1x 4GB)	372GB (23x16GB, 1x4GB)	768GB (24 x 32GB)

DIMM slot and configuration diagram

Population order; start with "A" first, "B" second, "C" third, etc.

When one processor is installed, install DIMMs in sequential alphabetic order: A, B, C, D, E, F ...

When two processors are installed, install DIMMs in sequential alphabetic order: CPU1-A, CPU2-A, CPU1-B, CPU2-B, CPU1-C, CPU2-C

24 DIMM SLOTS (12 per CPU node)					
	slot #	population order	slot #	population order	
Chnl 3	1	C	1	C	Chnl 3
	2	G	2	G	
	3	K	3	K	
Chnl 4	4	D	4	D	Chnl 4
	5	H	5	H	
	6	L	6	L	
CPU1			CPU2		
Chnl 2	7	J	7	J	Chnl 2
	8	F	8	F	
	9	B	9	B	
Chnl 1	10	I	10	I	Chnl 1
	11	E	11	E	
	12	A	12	A	

NOTE: Capacity references are rounded to the common Gigabyte values.

- 1GB = 1024MB
- 2GB = 2048MB
- 4GB = 4096MB
- 8GB = 8192MB
- 16GB = 16384MB
- 32GB = 32768MB

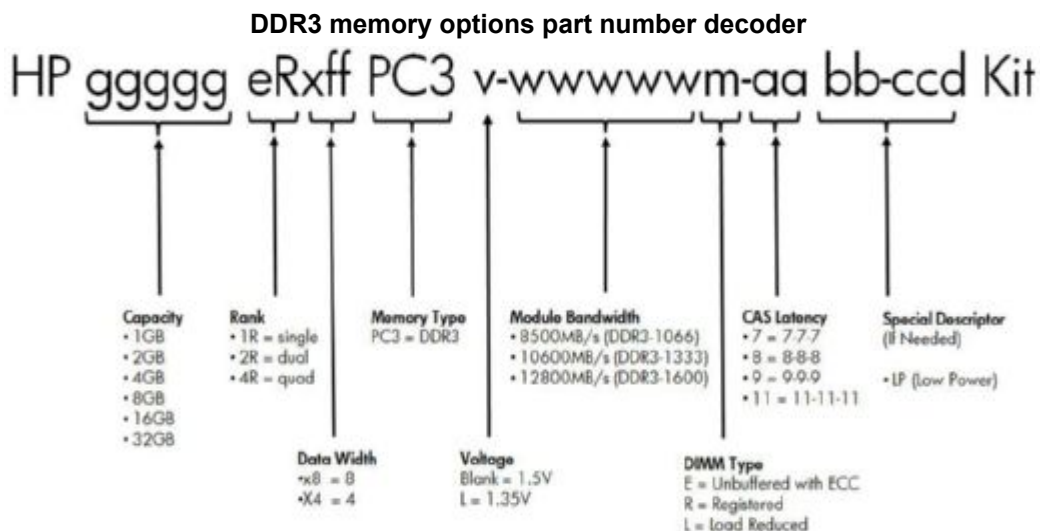

Memory

Following are memory options available from HP:

HP Memory

NOTE: HP memory from previous generation servers are not qualified or warranted with this HP ProLiant Server. HP SmartMemory is required to realize the memory performance improvements and enhanced functionality listed in this document for Gen8. For additional information, please see the HP SmartMemory QuickSpecs at:

http://h18000.www1.hp.com/products/quickspecs/14225_na/14225_na.html

NOTE: LRDIMM, RDIMM and UDIMMs are all distinct memory technologies and cannot be mixed within a server. The majority of ProLiant Gen8 servers support RDIMM, UDIMM and LRDIMM.

Registered DIMMs (RDIMMs)

HP 4GB (1x4GB) Single Rank x4 PC3L-10600R (DDR3-1333) Registered CAS-9 Low Voltage Memory Kit 647893-B2

HP 8GB (1x8GB) Dual Rank x4 PC3L-10600R (DDR3-1333) Registered CAS-9 Low Voltage Memory Kit 647897-B2

HP 16GB (1x16GB) Dual Rank x4 PC3L-10600R (DDR3-1333) Registered CAS-9 Low Voltage Memory Kit 647901-B2

HP 4GB (1x4GB) Single Rank x4 PC3-12800R (DDR3-1600) Registered CAS-11 Memory Kit 647895-B2

HP 8GB (1x8GB) Single Rank x4 PC3-12800R (DDR3-1600) Registered CAS-11 Memory Kit 647899-B2

HP 8GB (1x8GB) Dual Rank x4 PC3-12800R (DDR3-1600) Registered CAS-11 Memory Kit 690802-B2

HP 16GB (1x16GB) Dual Rank x4 PC3-12800R (DDR3-1600) Registered CAS-11 Memory Kit 672631-B2

Unbuffered with ECC DIMMs (UDIMMs)

HP 2GB (1x2GB) Single Rank x8 PC3L-10600E (DDR3-1333) Unbuffered CAS-9 Low Voltage Memory Kit 647905-B2

HP 2GB (1x2GB) Single Rank x8 PC3-12800E (DDR3-1600) Unbuffered CAS-11 Memory Kit 669320-B2

HP 4GB (1x4GB) Dual Rank x8 PC3-12800E (DDR3-1600) Unbuffered CAS-11 Memory Kit 669322-B2

HP 4GB (1x4GB) Dual Rank x8 PC3L-10600E (DDR3-1333) Unbuffered CAS-9 Low Voltage Memory Kit 647907-B2

HP 8GB (1x8GB) Dual Rank x8 PC3L-10600E (DDR3-1333) Unbuffered CAS-9 Low Voltage Memory Kit 647909-B2

HP 8GB (1x8GB) Dual Rank x8 PC3-12800E (DDR3-1600) Unbuffered CAS-11 Memory Kit 669324-B2

Load Reduced DIMMs (LRDIMMs)

HP 32GB (1x32GB) Quad Rank x4 PC3L-10600L (DDR3-1333) Load Reduced CAS-9 Low Voltage Memory Kit 647903-B2

NOTE: All DDR3 memory option kits consist of one DIMM per kit. For detailed memory configuration rules and guidelines, please use the Online DDR3 Memory Configuration Tool: www.hp.com/go/ddr3memory-configurator.

NOTE: PC3L is a low voltage memory

Storage

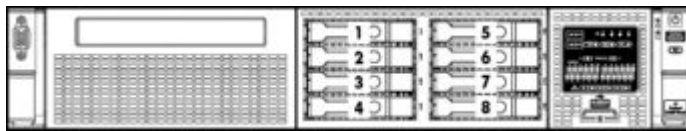

1-8 Eight SFF SAS hot plug drive bays

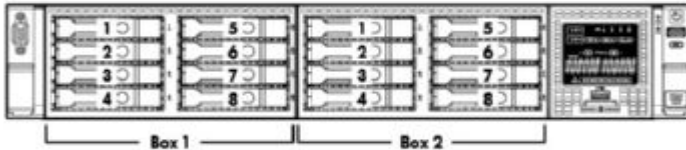

1-16 Sixteen SFF SAS hot plug drive bays
NOTE: This configuration does not support optical drive.

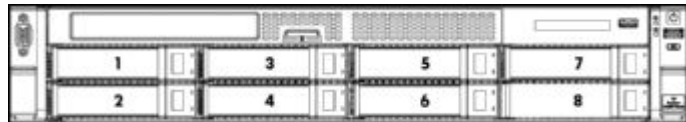

1-8 Eight LFF SAS hot plug drive bays.

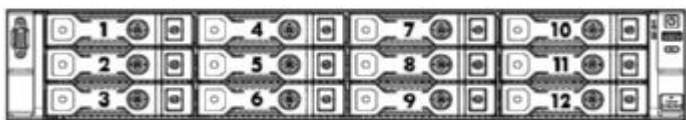

1-12 Twelve LFF SAS hot plug drive bays.
NOTE: This configuration does not support optical drive.

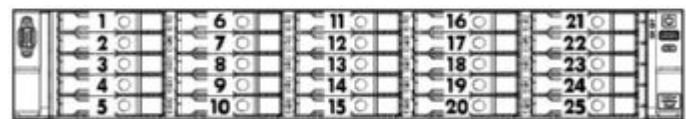

1-25 Twenty-five SFF SAS hot plug drive bays.
NOTE: This configuration does not support optical drive.

Drive Support

External Storage

	Quantity Supported	Position Supported	Host Controller or Adapter
D2600 Disk Enclosure	Up to 4	External	HP Smart Array P222 Controller
	Up to 8	External	HP Smart Array P421 Controller HP Smart Array P822 Controller
D2700 Disk Enclosure	Up to 4	External	HP Smart Array P222 Controller
	Up to 8	External	HP Smart Array P421 Controller HP Smart Array P822 Controller

Maximum Storage Capacity - (with D2700, SAS/SATA HDD)

Internal	16TB (16 SFF HDs x 1TB SAS/SATA SFF with addition 8 SFF drive cage)
Internal	24TB (8 LFF HDs x 3TB SAS/SATA LFF)
External	200TB (200 x 1TB SAS SFF)
Total	216TB

Technical Specifications

System Unit	Dimensions (H x W x D) (with bezel)	SFF Drives: 3.44 x 17.54 x 27.50 in (8.73 x 44.55 x 69.85 cm) LFF Drives: 3.44 x 17.54 x 29.50 in (8.73 x 44.55 x 74.93 cm)							
	Weight (approximate)	<table border="0"> <tr> <td>Maximum</td> <td>61.00 lb (27.66 kg)</td> </tr> <tr> <td colspan="2">(all LFF hard drives, power supply, and processor installed)</td> </tr> <tr> <td>Minimum</td> <td>41.0 lb (18.59 kg)</td> </tr> <tr> <td colspan="2">(one SFF hard drive, power supply, and processor installed, ODD not installed)</td> </tr> </table>	Maximum	61.00 lb (27.66 kg)	(all LFF hard drives, power supply, and processor installed)		Minimum	41.0 lb (18.59 kg)	(one SFF hard drive, power supply, and processor installed, ODD not installed)
Maximum	61.00 lb (27.66 kg)								
(all LFF hard drives, power supply, and processor installed)									
Minimum	41.0 lb (18.59 kg)								
(one SFF hard drive, power supply, and processor installed, ODD not installed)									
Input Requirements (per power supply)	Rated Line Voltage	100 to 120 VAC 200 to 240 VAC							
	Rated Input Current	For 1200 W Power Supply: 10 A (at 100 VAC), 4.9 A (at 200 VAC) For 750 W Power Supply: 8.9 A (at 100 VAC), 4.3 A (at 200 VAC) For 460 W Power Supply: 5.5 A (at 100 VAC), 2.6 A (at 200 VAC)							
	Rated Input Frequency	50 to 60 Hz							
	Rated Input Power	For 1200 W Power Supply: 930 W (at 100 VAC), 1348 W (at 200 VAC) For 750 W Power Supply: 857 W (at 100 VAC), 824 W (at 200 VAC) For 460 W Power Supply: 526 W (at 100 VAC), 505 W (at 200 VAC)							
	BTU Rating	<table border="0"> <tr> <td>Maximum</td> <td>For 1200 W Power Supply: 3530 BTU/hr (at 100 VAC), 4600 BTU/hr (at 200 VAC) For 750 W Power Supply: 2925 BTU/hr (at 100 VAC), 2812 BTU/hr (at 200 VAC) For 460 W Power Supply: 1794 BTU/hr (at 100 VAC), 1725 BTU/hr (at 200 VAC)</td> </tr> </table>	Maximum	For 1200 W Power Supply: 3530 BTU/hr (at 100 VAC), 4600 BTU/hr (at 200 VAC) For 750 W Power Supply: 2925 BTU/hr (at 100 VAC), 2812 BTU/hr (at 200 VAC) For 460 W Power Supply: 1794 BTU/hr (at 100 VAC), 1725 BTU/hr (at 200 VAC)					
Maximum	For 1200 W Power Supply: 3530 BTU/hr (at 100 VAC), 4600 BTU/hr (at 200 VAC) For 750 W Power Supply: 2925 BTU/hr (at 100 VAC), 2812 BTU/hr (at 200 VAC) For 460 W Power Supply: 1794 BTU/hr (at 100 VAC), 1725 BTU/hr (at 200 VAC)								
Power Supply Output (per power supply)	Rated Steady-State Power	For 1200 W Power Supply: 800 W (at 100 VAC), 900 W (at 120 VAC), 1200 W (at 200 to 240 VAC) For 750 W Power Supply: 750 W (at 100 to 120 VAC), 750 W (at 200 to 240 VAC) For 460 W Power Supply: 460 W (at 100 to 120 VAC), 460 W (at 200 to 240 VAC)							
	Maximum Peak Power	For 1200 W Power Supply: 800 W (at 100 VAC), 900 W (at 120 VAC), 1200 W (at 200 to 240 VAC)							

Technical Specifications

		For 750 W Power Supply: 750 W (at 100 to 120 VAC), 750 W (at 200 to 240 VAC) For 460 W Power Supply: 460 W (at 100 to 120 VAC), 460 W (at 200 to 240 VAC)		
System Inlet Temperature	Operating	10° to 35°C (50° to 95°F) at sea level with an altitude derating of 1.0°C per every 304.8 m (1.8°F per every 1000 ft) above sea level to a maximum of 3048 m (10,000 ft), no direct sustained sunlight. Maximum rate of change is 10°C/hr (18°F/hr). The upper limit may be limited by the type and number of options installed. System performance may be reduced if operating with a fan fault or above 30°C (86°F).		
	Non-operating	-30° to 60°C (-22° to 140°F). Maximum rate of change is 20°C/hr (36°F/hr).		
Relative Humidity (non-condensing)	Operating	10% to 90% relative humidity (Rh), 28°C (82.4°F) maximum wet bulb temperature, non-condensing.		
	Non-operating	5% to 95% relative humidity (Rh), 38.7°C (101.7°F) maximum wet bulb temperature, non-condensing.		
Altitude	Operating	3048 m (10,000 ft). This value may be limited by the type and number of options installed. Maximum allowable altitude change rate is 457 m/min (1500 ft/min).		
	Non-operating	9144 m (30,000 ft). Maximum allowable altitude change rate is 457 m/min (1500 ft/min).		
Acoustic Noise	Listed are the declared A-Weighted sound power levels (LWAd) and declared average bystander position A-Weighted sound pressure levels (LpAm) when the product is operating in a 23°C ambient environment. Noise emissions were measured in accordance with ISO 7779 (ECMA 74) and declared in accordance with ISO 9296 (ECMA 109). The listed sound levels apply to standard shipping configurations. Additional options may result in increased sound levels. NOTE: The Listed sound levels apply to standard shipping configurations. Additional options may result in increased sound levels			
		Entry Base Performance		
	Idle			
	LWAd	4.1 B	4.1 B	4.1 B
	LpAm	25 dBA	25 dBA	25 dBA
	Operating			
	LWAd	4.3 B	4.7 B	5.0 B
	LpAm	27 dBA	31 dBA	35 dBA
Emissions Classification (EMC)	FCC Rating	Class A		
	Normative Standards	CISPR 22; EN55022; EN55024; FCC CFR 4 Pt 15; ICES-003; CNS13438; GB9254; K22;K24; EN 61000-3-2; EN 61000-3-3; EN 60950-1; IEC 60950-1		

Technical Specifications

NOTE: Product conformance to cited product specifications is based on sample (type) testing, evaluation, or assessment. This product or family of products is eligible to bear the appropriate compliance logos and statements.

NOTE: The Listed sound levels apply to standard shipping configurations. Additional options may result in increased sound levels

HP iLO 4 On System Management	Architecture	PCI Express based health and remote management ASIC
	Processor	Embedded ARM processor core operating at 400MHz
	Upgradeability	Firmware upgradeable via Flash ROM
	Video Support	1920 x 1200 (16 bpp) DVR max resolution
	Interfaces	HP iLO Dedicated* Network connection (10/100/1000 Mb/s) on rack, tower and SL systems *Optional Module on some servers HP iLO Shared Network connection (10/100/1000 Mb/s) on rack, tower and SL systems HP iLO network connection to blades (100 Mb/s) to Onboard Administrator (with 10/100/1000 Mb/s uplink) on blade systems
	Memory	16 MB Flash 256 MB DDR 3 with ECC (112 MB after ECC and video)
	Operating System Support	For information on HP's Certified and Supported ProLiant Servers for OS and Virtualization Software and latest listing of software drivers available for your server including how to purchase from HP, please visit our OS Support Site at: http://www.hp.com/go/ossupport
	Client System Support	For information on Client System Support, please visit the HP iLO Feature Comparison Site at: www.hp.com/go/compareilo
	Client Browser Support	Microsoft Internet Explorer 9 NOTE: For customers using Protected Mode, please use the Java based version of Integrated Remote Console. Microsoft Internet Explorer 8 NOTE: For customers using Protected Mode, please use the Java based version of Integrated Remote Console. Microsoft Internet Explorer 7 Firefox Extended Support Release (ESR) 10 (on supported Windows and Linux systems) Firefox 3.6 (on supported Windows and Linux systems)
	Command Line Support	Secure Shell and serial port access Secure Socket Layer Secure Shell version 2
	Security	Advanced Encryption Standard (AES) and Triple Data Encryption Standard (3DES) on browser, CLP and XML scripting interface AES encryption of video RC4 encryption of video
	Directory Support Services	Active Directory v1.0 (Windows 2003)
	Driver Support	HP ProLiant iLO 4 Management Controller Driver Package
	Management protocols supported	SNMP, IPMI 2.0 (system and LAN interface), DMTF Systems Management Architecture for Server Hardware Command Line Protocol (SMASH CLP), HP RIBCL XML

Technical Specifications

HP Smart Array P420i Controller	Dimensions	Embedded
	Disk Drive and Enclosure Interface - Transfer Rate	6Gb/s SAS (Serial Attached SCSI) 6Gb/s SATA (Serial ATA)
	SAS Connectors	2 internal 4X connectors
	Cache Memory Speed	512MB FBWC - DDR3-1333MHz with 40-bit wide bus, 1GB or 2GB FBWC DDR3-1333MHz with 72-bit wide bus
	Server Interface	x8 PCIe 3.0 provides 2GB/s maximum bandwidth
	SAS Speed	(8) 6Gb/s SAS links provide 4.8GB/s maximum bandwidth
	Cache Memory	Zero Memory RAID has no cache memory 40-bit 512MB ECC protected flash back write cache 72-bit 1GB FBWC or 72-bit 2GB FBWC
	Logical Drives Supported	Zero Memory, Up to 2 logical volumes (8SFF or 4LFF physical drives) Up to 64 logical drives with cache
	Host Memory Addressing	64-bit, supporting greater than 4GB server memory space
	RAID Support	RAID 6, 6+0 (Advanced Data Guarding) NOTE: RAID 6, 6+0 can be enabled with one of the following combinations: <ul style="list-style-type: none"> • 512MB FBWC and Smart Array Advanced Pack License key option upgrades • 1GB or 2GB FBWC and Smart Array Advanced Pack License key option upgrades RAID 5, 5+0 (Distributed Data Guarding) NOTE: A minimum of 512MB cache is required to enable RAID 5, 5+0 support RAID 1+0 (Striping & Mirroring) RAID 0 (Striping), RAID 1 (Mirroring)

HP Ethernet 1Gb 4-port 331FLR Adapter	HP Flexible Network Technology	HP Flexible Network Technology consists of replaceable network solutions to meet the customers require now or in the future.	
	Network Interface	10Base-T/100Base-TX/1000Base-TX	
	Compatibility	IEEE 802.3 10Base-T	
		IEEE 802.3ab 1000Base-T	
		IEEE 802.3u 100Base-TX	
		IEEE 802.3ad 1000Base-TX	
		IEEE 802.1p 100Base-TX	
		IEEE 802.1q 100Base-TX	
	Data Transfer Method	PCI Express, four lanes (x4)	
	Chipset	BCM5719	
Network Transfer Rate	10Base-T (Half-Duplex)	10 Mb/s	
	10Base-T (Full-Duplex)	20 Mb/s	
	100Base-TX (Half-Duplex)	100 Mb/s	
	100Base-TX (Full-Duplex)	200 Mb/s	
	1000Base-TX (Half and Full-Duplex)	2000Mb/s	
Connector	Two RJ-45		

Technical Specifications

	Cable Support	10Base-T	Categories 3, 4 or 5 UTP; up to 328 ft (100 m)
		100Base-TX	Category 5 or higher UTP; up to 328 ft (100 m)
		1000BaseTX	Category 5 or higher UTP; up to 328 ft (100 m)
HP Ethernet 10Gb 2-port 530FLR-SFP+ Adapter	Network Interface Compatibility	SFP+ for Direct Attach Cable copper or fibre EEE 802.3 SFP+ (SX, SR & LR) IEEE 802.3xx IEEE 802.3ad IEEE 802.1q IEEE 802.3x IEEE 802.1au IEEE 802.3ap	
	Data Transfer Method	PCI Express, eight lanes (x8)	
	Chipset	BCM57810S	
	Network Transfer Rate	10Base-T (Half-Duplex)	10Gbps
		10Base-T (Full-Duplex)	1Gbps
	Connector	Two SFP+	
	Cable Support	10Base-T	Categories 3, 4 or 5 UTP; up to 328 ft (100 m)
		100Base-TX	Category 5 or higher UTP; up to 328 ft (100 m)
		1000BaseTX	Category 5 or higher UTP; up to 328 ft (100 m)
Environment-friendly Products and Approach	End-of-life Management and Recycling	<p>Hewlett-Packard offers end-of-life HP product return, trade-in, and recycling programs in many geographic areas. For trade-in information please go to: http://www.hp.com/go/green. To recycle your product, please go to: http://www.hp.com/go/green or contact your nearest HP sales office. Products returned to HP will be recycled, recovered or disposed of in a responsible manner.</p> <p>The EU WEEE directive (2002/95/EC) requires manufacturers to provide treatment information for each product type for use by treatment facilities. This information (product disassembly instructions) is posted on the Hewlett Packard web site at: http://www.hp.com/go/green. These instructions may be used by recyclers and other WEEE treatment facilities as well as HP OEM customers who integrate and re-sell HP equipment.</p>	

Technical Specifications

© Copyright 2012 Hewlett-Packard Development Company, L.P.

The information contained herein is subject to change without notice.

Microsoft and Windows NT are US registered trademarks of Microsoft Corporation.

Intel, the Intel logo, Xeon and Xeon Inside are trademarks of Intel Corporation in the U.S. and other countries.

The only warranties for HP products and services are set forth in the express warranty statements accompanying such products and services. Nothing herein should be construed as constituting an additional warranty. HP shall not be liable for technical or editorial errors or omissions contained herein.

For hard drives, 1GB = 1 billion bytes. Actual formatted capacity is less.