



**ELECTRIC MANUFACTURING**

# **WHOLESALE PRICE LIST**

**EFFECTIVE**

**MARCH 15, 2010**

**SUPERSEDES ALL PREVIOUS PRICE LISTS**

\* Due to fluctuations in the metal market,  
prices are subject to change without notice.

Feel free to call for an exact quote.

(Form 2010 W)

# TABLE OF CONTENTS

Dryer Elements - Complete .....	3
Dryer Element - Restriring Kits .....	4 thru 6
for Franklin (Electrolux) .....	4
for Frigidaire (Electrolux) .....	4
for GE - Hotpoint .....	4
for Huebsch (Alliance) .....	4
for Maytag .....	4 thru 5
for Norge (Maytag) .....	5
for Speed Queen/Amana .....	5
for Westinghouse (Electrolux) .....	5
for WCI (Electrolux) .....	5
for Whirlpool/Kenmore .....	6
Installation Accessories .....	6
Dryer Thermostats .....	7
Restriring Kits for Electric Heat .....	8 thru 10
Standard O.D. 3/8" or less .....	8
True 3/8" O.D. ....	8
Large Diameter - 7/16", 1/2", 5/8", 3/4" O.D. ....	9
Direct OEM Replacements:	
Bryant, Cadet, Carrier, Climatrol, Climate Master, Coleman,	
Crafft, Fedders, Frigidaire, GE/Trane, Janitrol, Lennox,	
Mathews Brick/Federal Pacific Brick .....	10
Dishwasher Heating Element Restrings .....	10
Fuse Links & Ceramic Cutouts .....	10
Electric Heat Sequencers .....	11
Multi-Purpose Replacement Coils - Free Air .....	12 thru 14
120V Series .....	12
240V Series .....	13 thru 14
Commercial Cooking Elements .....	14 thru 15
Terms & Conditions of Sale .....	16

# DRYER ELEMENTS

H&H NUMBER	OEM NUMBER	WATTS	VOLTS	PRICE
<b>For Newton Style Maytag</b>				
<a href="#">HE3404</a>	303404	5000W	240V	
<a href="#">HE8612</a>	308612	5300W	240V	

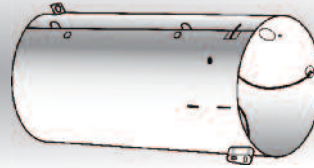
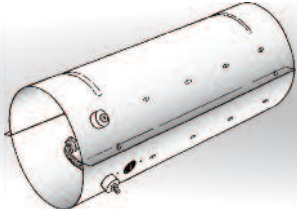

**For Herrin Style Admiral - Crosley - Magic Chef - Norge**

<a href="#">HE1044</a>	LA1044	5000W	236V	
------------------------	--------	-------	------	--

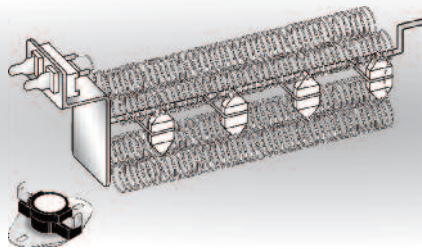

**For Alliance/ Amana/ Speed Queen**

<a href="#">HE927</a>	61927	5000W	240V	
-----------------------	-------	-------	------	--

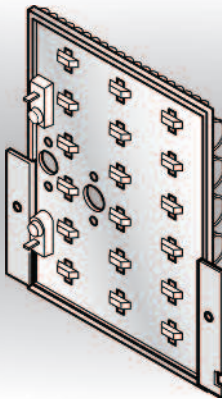

**For Kenmore - Whirlpool**

<a href="#">HE9838</a>	279838	5200W	240V	
------------------------	--------	-------	------	--

**Element with shroud**

<a href="#">HE747</a>	3387747	5400W	240V	
-----------------------	---------	-------	------	--

**New Models with Blower In Front - 5/16" Terminals**

<a href="#">HE1960</a>	4391960	5200W	240V	
------------------------	---------	-------	------	--

**5/16" Terminals with 2 HT2500 (279457) Wire Kits**

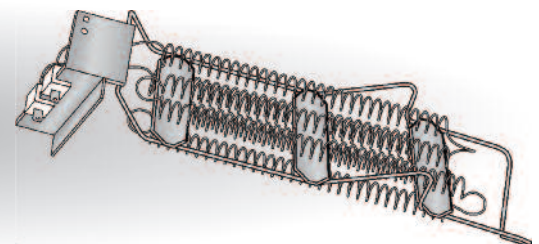
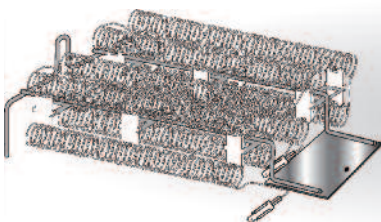

Prices subject to change without notice. Part numbers & illustrations are intended solely for identification. Items offered for sale are not represented to be manufactured by the company that built the original equipment.

# RESTRING KITS FOR DRYER ELEMENTS

OEM NUMBER	H&H	WATTS	VOLTS	PRICE
<b>For Franklin:</b>				
8-1C	H8-1	4300W	240V	
8-38C	H8-38	4300W	230V	
D60135C	H135	5000W	230V	
F133285	H285	5000W	240V	
F134266	H266	1500W	120V	
F134266-1	H266-1	3500W	240V	
F136870C	H870	3200W	240V	
F137022C	H022	5000W	240V	
F137094C	H094	2400W	240V	
F141683C	H683	3200W	240V	
F63527	H527	4700W	230V	
F63527-1	H527-1	4700W	265V	

## For Frigidaire:

5429628*	H9628	1870W	240V	
3161050C	H1050	3240W	240V	
3204252C	H4252	4600W	240V	
3206873C	H6873	3500W	240V	
3937005C	H7005	5000W	240V	
3937010	H7010	5000W	240V	
3937065C	H7065	4600W	240V	
633668C	H3668	5400W	240V	
633897C	H3897	3000W	240V	
6563099C	H3099	4400W	250V	
7523552C	H3552	4400W	240V	
7525459C	H5459	5400W	240V	
7533742C	H3742	4400W	240V	
7533743C	H3743	5400W	240V	
7533744C	H3744	5400W	240V	
8001554C	H1554	5000W	240V	
8006968C	H6968	5000W	240V	
8015855C	H5855	3240W	240V	
8027626C	H7626	1500W	120V	
8950035C	H0035	5000W	240V	
8950109C	H0109	2400W	240V	
9948886C	H8886	5400W	240V	
9956777C	H6777	5400W	240V	

\*Tubular Element

## For G.E./Hotpoint

WE11M11C	HM11	1500W	120V	
WE11M21C	HM21	5000W	240V	
WE11M22C	HM22	5000W	240V	
WE11M23C	HM23	5000W	240V	
WE11M27C	HM27	5000W	240V	
WE11X59	H591	5000W	208V	
WE11X60	H601	2500W	230V	
WE11X60D	H602	5000W	230V	
WE11X60W/I	H601W/I	2500W	230V	
Includes 2 male & 2 female ceramic insulators				
WE11X61	H611	2500W	250V	
WE11X61D	H612	5000W	230V	
WE11X68	H681	1100W	115V	
WE11X71	H711	3500W	240V	

## For G.E./Hotpoint (Continued)

WE11X72	H721	1500W	120V	
WE11X80C	H801	5400W	230V	
WE11X81	H811	1500W	120V	
WE11X82C	H822	2500W	230V	
WE11X83	H831	2750W	230V	
WE11X85C	H851	3240W	240V	
WE11X88C	H881	5300W	240V	
WE11X89C	H891	5100W	240V	
WE11X90C	H902	5000W	230V	
WE11X91C	H912	5300W	240V	
WE11X92C	H922	5300W	240V	
WE11X93C	H932	5100W	208V	
WE11X95C	H952	5300W	240V	
WE11X99C	H991	4500W	240V	
WE11X101C	H101	5100W	208V	
WE11X103C	H103	5300W	240V	
WE11X104C	H104	3000W	240V	
WE11X10007	H0007	5000W	240V	
WE11X203	H203	5300W	240V	
WE11X260	H602	5000W	230V	
WE11X5014C	H5014	4650W	230V	
WE14X10015	H5015	5000W	240V	
WE25M27C	HM27	5000W	240V	

## For Huebsch:

250-21C	H0-21	5000W	208V	
250-24C	H0-24	5000W	240V	
250-38C	H0-38	5000W	380V	
250-46C	H0-46	5000W	460V	
251-38C	H1-38	7000W	380V	
251-46C	H1-46	7000W	460V	
251-55C	H1-55	7000W	575V	
251-60C	H1-60	7000W	600V	
252-24C	H2-24	10000W	208V	
252-38C	H2-38	10000W	380V	
252-46C	H2-46	10000W	460V	
252-55C	H2-55	10000W	575V	
M405253C	H5253	7000W	240V	
M405254C	H5254	10000W	208V	
M405256C	H5256	10000W	240V	

## For Maytag

0250037C	H0037	3240W	240V	
307178C	H7178	5300W	240V	
307184C	H7184	5300W	240V	
308612C	H8612	5300W	240V	
308614C	H8614	5300W	240V	
3-11944	H944	4400W	230V	
3-11945	H945	4400W	208V	
3-11946	H946	4400W	240V	
3-12532	H532	1450W	118V	
3-13322	H322	5600W	240V	
3-13369	H3369	5600W	208V	
3-13537	H537	5000W	230V	

# RESTRING KITS FOR DRYER ELEMENTS

**OEM NUMBER H&H WATTS VOLTS PRICE**

**For Maytag (Continued)**

3-13538	H538	5000W	240V
3-13539	H539	5000W	208V
3-14503	H4503	4500W	240V
3-2000C	H000	4000W	230V
3-3404C	H404	5000W	240V
3-4837C	H837	5000W	208V

**For Norge**

53-0180C	H180	4750W	240V
53-1641C	H641	4750W	240V
53-0920C	H920	4750W	240V
60-1050C	H050	4200W	220V
60-3161C	H161	5600W	236V
60-3605C	H605	4200W	230V
60-7505C	H505	5300W	236V
60-8673C	H673	4750W	240V
63-1394C	H394	5000W	236V
63-1395C	H395	5000W	236V
63-4265	H265	5000W	240V
63-5255	H255	5000W	240V
63-5259	H259	5000W	240V
63-6369	H369	5300W	240V
73-0077	H077	4000W	240V
73-0154	H154	3000W	120V

**For Speed Queen**

51079C	H079	4800W	230V
52608C	H608	5000W	250V
52626C	H626	5200W	240V
56047C	H047	5000W	240V
56179C	H179	5000W	230V
61195C	H195	5000W	240V
61927C	H927	5000W	240V

**For Westinghouse:**

Q142836	H836	5600W	240V
Q142885	H885	5200W	255V
Q142885LD	H885LD	5200W	255V
Q171873	H873	3800W	255V
Q39585C	H585	4600W	255V
Q48418	H418	4600W	230V
Q616426	H426	5000W	240V
Q622032	H032	4600W	240V
Q000622032	H52032	4600W	240V
Q000622034	H52034	4600W	240V
Q000142836	H52836	5600W	240V
Q000142885	H52885	5200W	255V

**OEM NUMBER H&H WATTS VOLTS PRICE**

**For WCI (Electrolux):**

K1030867C	H50867	5600W	233V
00633897C	H53897	3000W	240V
06563099C	H53099	4400W	250V
06564848C	H54848	4400W	240V
06591048C	H51048	3500W	240V
07521171C	H51171	4100W	240V
07523127C	H53127	4100W	240V
07523552C	H53552	4400W	240V
07525459C	H55459	5400W	240V
07533742C	H53742	4400W	240V
07533743C	H53743	5400W	240V
07533744C	H53744	5400W	240V
08001554C	H51554	5000W	240V
08004643C	H54643	1400W	120V
08006968C	H56968	5000W	240V
08015795	H55795	1500W	120V
08015855C	H55855	3240W	240V
08950035	H50035	5000W	240V
09948886C	H58886	5400W	240V
09948887C	H58887	5400W	240V
131475300C	H55300	4500W	240V
131234600C	H54600	4500W	240V
131234900C	H54900	4500W	240V
3201130C	H5113	5000W	240V
3937010	H57010	5000W	240V
5300136143C	H56143	3000W	240V
5300142885	H52885	5200W	255V
5300171482	H51482	4600W	240V
5300171873	H51873	3800W	255V
5300622032	H52032	4600W	240V
5300622034	H62034	4600W	240V
5300635271C	H55271	4700W	265V
5303161050C	H51050	3240W	240V
5303201130	H51130	5000W	240V
5303204252C	H54252	4600W	240V
5303206873C	H56873	3500W	240V
5303269829C	H59829	4600W	240V
5303276585	H56585	1300W	115V
5303937005C	H57005	5000W	240V
5303937010	H57010	5000W	240V
5303937065C	H57065	4600W	240V
5306564848C	H54848	4400W	240V
5307533742C	H53742	4400W	240V
5307533743C	H53743	5400W	240V
5308001554	H51554	5000W	240V
5308027626C	H57626	1500W	120V
5308950109C	H50109	2400W	240V
5309948886C	H58886	5400W	240V
5309956777C	H56777	5400W	240V

Prices subject to change without notice. Part numbers & illustrations are intended solely for identification. Items offered for sale are not represented to be manufactured by the company that built the original equipment.

© 2010 H&H Electric Manufacturing Company

## RESTRING KITS FOR DRYER ELEMENTS

OEM NUMBER    H&H    WATTS    VOLTS    PRICE

### For Whirlpool /Kenmore

229739C	H9739	5200W	240V	
230227C	H0227	4400W	236V	
236292C	H6292	8400W	230V	
239690C	H9690	4200W	230V	
239775C	H9775	5600W	240V	
239790C	H9790	4200W	236V	
239869C	H9869	4200W	230V	
279247C	H9247	5600W	240V	
279248C	H9248	5200W	240V	
279249C	H9249	4400W	240V	
279250C	H9250	3200W	240V	
279251C	H9251	1400W	120V	
279337C	H9337	5600W	240V	
279411C	H9411	5200W	240V	
279455C	H9455	5200W	240V	
279502C	H9502	3200W	240V	
279506C	H9506	1400W	120V	
279559C	H9559	5400W	240V	
279598C	H9598	5200W	240V	
279606C	H9606	4400W	240V	
279698C	H9698	5200W	240V	
279838C	H9838	5200W	240V	
297665C	H7665	5600W	240V	
298181C	H8181	5600W	240V	
299187C	H9187	5600W	240V	
299188C	H9188	5600W	240V	
299189C	H9189	5600W	236V	
299190C	H9190	5200W	236V	
299191C	H9191	4400W	240V	
337365C	H7365	5600W	236V	
337378C	H7378	5600W	240V	
338212C	H8212	5600W	240V	
3387747C	H7747	5400W	240V	
3387749C	H7749	4600W	240V	
339655C	H9655	5600W	240V	
3398064C	H8064	5400W	240V	
340003C	H0003	5600W	240V	
340468C	H0468	5200W	240V	
4391960C	H1960	5200W	240V	
685592C	H5592	3200W	240V	
685942C	H5942	5600W	240V	
686019C	H6019	3800W	240V	
690241C	H0241	5200W	240V	
691724C	H1724	5200W	240V	
696632C	H6632	3600W	240V	

## INSTALLATION ACCSSORIES

### PB125

25 Per Pack  
• 3/4" OD • 5/16" ID • 3/8" High

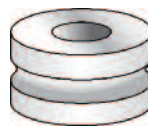

### PB136

Terminal Insulator  
6 Sets Per Pack  
1" OD • 1/4" ID

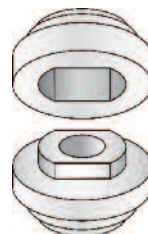

### PB139

Terminal Insulator  
6 Sets Per Pack  
3/4" OD • 13/32" ID



### 1129

Terminal Block  
for two 1/4" quick-connect  
terminals

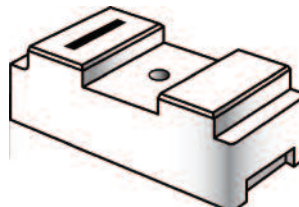

### 21DB

Bracket & Insulators  
for medium OD  
GE Dryer Elements

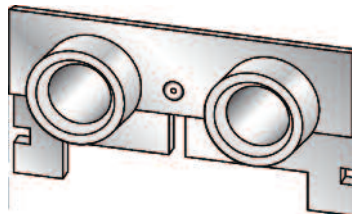

### 279139 Lead wire

Lead wire with male Molex terminal



### HT2500 Red Wire Kit

Set of 2 lead wires with spade terminals

### 279457 Lead wire

Lead wire with spade terminals



### 10G

Insulator & Bolt Kit  
PB139 Insulator  
& #10-32 x 1-3/4" Bolt

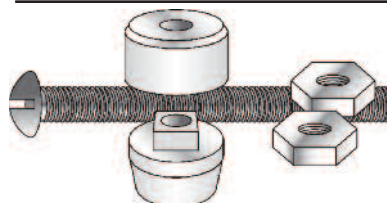

## Dryer Thermostats

Thermostats for laundry and HVAC applications. Rated 25 amps at 120 or 240 volts with 1/4" quick connect terminals.

### L Series single pole/single throw

Part No	Open	Close	Price
L120-1	120°F	110°F	
L125-1	125°F	115°F	
L130-1	130°F	115°F	
L135-1	135°F	120°F	
L140-2	140°F	130°F	
L145-2	145°F	125°F	
L150-2	150°F	130°F	
L155-2	155°F	135°F	
L165-4	165°F	125°F	
L170-4	170°F	130°F	
L175-4	175°F	135°F	
L180-4	180°F	140°F	
L190-4	190°F	150°F	
L200-4	200°F	160°F	
L205-4	205°F	165°F	
L225-4	225°F	185°F	
L240-4	240°F	200°F	
L250-4	250°F	210°F	
L260-4	260°F	220°F	
L270-4	270°F	230°F	
L290-4	290°F	250°F	
L300-4	300°F	260°F	
L320-5	320°F	270°F	
L340-5	340°F	290°F	

**L Series  
single pole/  
single throw**

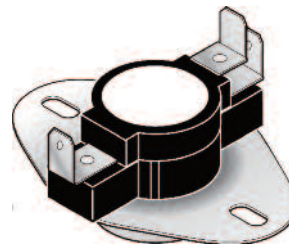
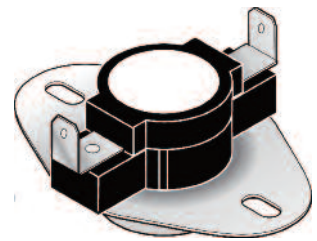

**LD Series  
single pole/  
double throw**

### LD Series single pole/double throw

Part No	Open	Close	Price
LD120-2	120°F	105°F	
LD130-2	130°F	115°F	
LD135-2	135°F	120°F	
LD140-2	140°F	120°F	
LD145-2	145°F	125°F	
LD155-2	155°F	135°F	
LD170-2	170°F	150°F	
LD200-4	200°F	160°F	
LD225-4	225°F	185°F	
LD240-4	240°F	195°F	
LD270-4	270°F	225°F	
LD290-4	290°F	240°F	

## Thermal Fuse Kits

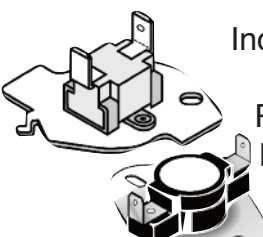

**HET184**  
Includes 352°F Fuse  
& L250-8F Auto  
Reset Thermostat  
Replaces: 279769



**HET401**  
3/16" Terminals  
91°C (196°F)  
Replaces: WE4X857  
3392519, 3388651



**HET402**  
1/4" Terminals 91°C (196°F)  
Replaces:  
3390719, 690198

## Dishwasher Rack Patch

- Dishwasher safe
- Air-Dries overnight
- Dries rubbery-like original
- Also repair interior liners

### Counter display of 20 (1/2 ounce bottles)

- |         |          |
|---------|----------|
| 6 Blue  | 9 White  |
| 1 Green | 1 Almond |
| 3 Gray  |          |

**DWRD20BLUE**



- DWR1BLUE**
- DWR1ALMOND**
- DWR1WHITE**
- DWR1GREEN**
- DWR1CLEAR**
- DWR1GRAY**
- DWRD20BLUE**

Prices subject to change without notice. Part numbers & illustrations are intended solely for identification. Items offered for sale are not represented to be manufactured by the company that built the original equipment.

© 2010 H&H Electric Manufacturing Company

# Electric Heat Service Coil Kits

## STANDARD OD 3/8" or less:

Primarily for all air-over heat applications: duct heaters, furnaces, auxiliary inserts in heat pumps, etc. Standard kits come with attached 10-32 x 1 3/4" screws, terminal insulators, nuts and washers for installation. Only the DH500 is packaged with a 300°F in-line fuse link. Standard diameter 3/8" coils fit most older applications as well as many newer applications.

Part No.	Wattage @				Install Length		Price
	240V	208V	480V	277V	Min	Max	
DH500*	5000	3750	-	-	40"	125"	
	*with 300° Fuse Link						
DH500C	5000	3750	-	-	40"	125"	
DH500-3	-	-	5000	-	41"	135"	
DH500-4	-	-	-	5000	42"	140"	
DH501	3500	2625	-	-	32"	105"	
DH501-3	-	-	3500	-	47"	155"	
DH501-4	-	-	-	3500	32"	105"	
DH502	2000	1500	-	-	28"	93"	
DH502-3	-	-	2000	-	30"	100"	
DH502-4	-	-	-	2000	30"	100"	
DH503	2500	1875	-	-	28"	90"	
DH503-3	-	-	2500	-	35"	110"	
DH503-4	-	-	-	2500	32"	105"	
DH504	1500	1125	-	-	27"	88"	
DH505	4500	3375	-	-	36"	118"	
DH505-3	-	-	4500	-	51"	170"	
DH505-4	-	-	-	4500	47"	155"	
DH506	4000	3000	-	-	40"	132"	
DH506-3	-	-	4000	-	41"	135"	
DH506-4	-	-	-	4000	53"	175"	
DH507	5000	3750	-	-	28"	93"	
DH507-3	-	-	3000	-	28"	93"	
DH507-4	-	-	-	3000	27"	88"	
DH508	2750	2063	-	-	30"	100"	
DH509	-	1000	-	-	12"	36"	
DH510	1000	750	-	-	21"	67"	
DH510-3	-	-	1000	-	21"	68"	
DH511	4250	3188	-	-	38"	125"	
DH512	4750	3563	-	-	39"	130"	
DH516	4666	3500	-	-	34"	112"	
DH520	6600	4950	-	-	47"	156"	
DH520-3	-	-	6600	-	69"	230"	
DH534	6000	4500	-	-	38"	127"	
DH534-3	-	-	6000	-	55"	185"	
DH534-4	-	-	-	6000	45"	150"	
DH550	5500	4125	-	-	42"	140"	
DH556	3300	2475	-	-	29"	96"	
DH560	5600	4200	-	-	41"	137"	
DH570-4	-	-	-	7000			
DH575	7500	5625	-	-	41"	135"	
DH575-4	-	-	-	7500	51"	173"	
DH580	8000	6000	-	-	38"	127"	
DH580-3	-	-	8000	-	54"	180"	
DH1000-3	-	-	10,000	-	126"	420"	

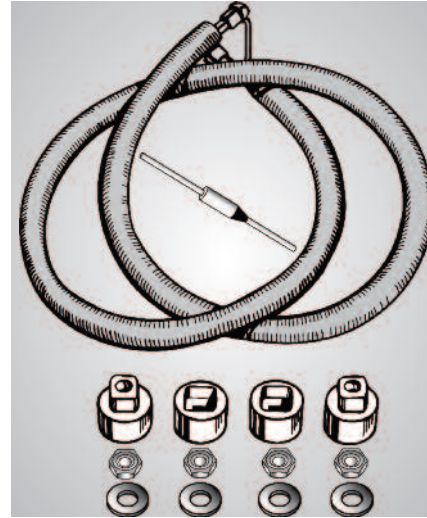

**DH500  
Standard OD**

## TRUE 3/8" OD:

Unless specified, ships as a "convertible kit" - the coil ends with 1/4" quick connect terminals attached. Package also includes 10-32 x 1 3/4" screws, terminal insulators, nuts and washers to be used if quick connect terminals are to be removed. If required specify 5/16" quick connects.

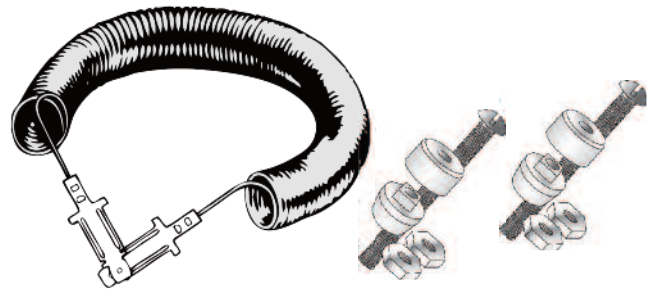

Part No.	Wattage @				Install Length		Price
	240V	208V	480V	277V	Min	Max	
DH500T	5000	3750	-	-	31"	103"	
DH501-4T	-	-	-	3500	27"	84"	
DH502T	2000	1500	-	-	16"	60"	
DH502-3T	-	-	2000	-	25"	80"	
DH502-4T	-	-	-	2000	18"	53"	
DH503-3T	-	-	2500	-	30"	85"	
DH506-4T	-	-	-	4000	30"	100"	
DH507-3T	-	-	3000	-	20"	68"	
DH507-4T	-	-	-	3000	20"	68"	
DH509T	-	1000	-	-	12"	36"	
DH510T	1000	750	-	-	16"	48"	
DH570-3T	-	-	7000	-	39"	129"	



# Large Diameter Electric Heat Service Coil Kits

Unless specified, ships as a "convertible kit" - the coil ends with 1/4" quick connect terminals attached. Package also includes 10-32 x 1 3/4" screws, terminal insulators, nuts and washers to be used if quick connect terminals are to be removed. If required, specify 5/16" quick connects.

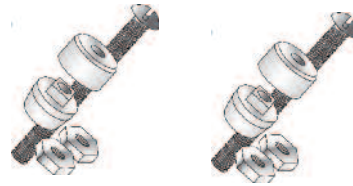
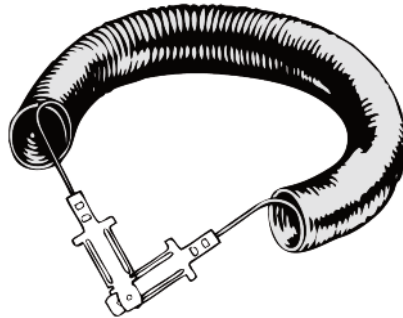

Part No.	Wattage @				Install Length		Price
	240V	208V	480V	277V	Min	Max	

## 7/16" OD:

DH500S	5000	3750	-	-	40"	125"	
DH500-3S	-	-	5000	-	30"	110"	
DH501S	3500	2625	-	-	30"	100"	
DH501-3S	-	-	3500	-	30"	107"	
DH501-4S	-	-	-	3500			
DH503-4S	-	-	-	2500	22"	70"	
DH504S	1500	1125	-	-	16"	51"	
DH505-3S	-	-	4500	-	33"	125"	
DH506-3S	-	-	4000	-	34"	102"	
DH507S	3000	2250	-	-	24"	72"	
DH507-4S	-	-	-	3000	20"	63"	

## 1/2" OD:

DH5005	5000	3750	-	-	30"	90"	
DH500-35	-	-	5000	-	26"	95"	
DH5015	3500	2625	-	-	18"	65"	
DH5025	2000	1500	-	-	15"	45"	
DH5035	2500	1875	-	-	15"	50"	
DH503-45	-	-	-	2500	20"	66"	
DH5055	4500	3375	-	-	24"	75"	
DH505-35	-	-	4500	-	33"	95"	
DH505-45	-	-	-	4500	47"	155"	
DH5065	4000	3000	-	-	28"	84"	
DH507-45	-	-	-	3000	18"	55"	
DH5085	2750	2063	-	-	23"	69"	
DH5165	4666	3500	-	-	24"	72"	
DH5345	6000	4500	-	-	31"	93"	
DH534-35	-	-	6000	-	47"	141"	
DH5565	3300	2475	-	-	18"	54"	
DH5605	5600	4200	-	-	33"	99"	
DH5805	8000	6000	-	-	32"	96"	

Part No.	Wattage @				Install Length		Price
	240V	208V	480V	277V	Min	Max	

## 5/8" OD:

DH500FC	5000	3750	-	-	25"	70"	
*with 300° Fuse Link							
DH500FCB	5000	3750	-	-	25"	70"	
*with 300° Fuse Link							
DH500-3FC	-	-	5000	-	30"	90"	
DH500-4FC	-	-	-	5000	20"	70"	
DH501FC	3500	-	-	-	20"	60"	
DH501FCB	3500	-	-	-	20"	60"	
DH501-4FC	-	-	-	3500	20"	60"	
DH505FC	4500	3375	-	-	22"	66"	
DH506FC	4000	3000	-	-	23"	75"	
DH506FCB	4000	3000	-	-	23"	75"	
DH506-4FC	-	-	-	4000	33"	99"	
DH507FC	3000	2250	-	-	18"	54"	
DH508FC	2750	2063	-	-	18"	57"	
DH511FC	4250	3188	-	-	23"	70"	
DH512FC	4750	3563	-	-	26"	79"	
DH520-3FC	-	-	6600	-	43"	129"	
DH534FC	6000	4500	-	-	24"	72"	
DH534-3FC	-	-	6000	-	34"	103"	
DH560FC	5600	4200	-	-	25"	76"	
DH580FC	8000	6000	-	-	25"	75"	
Part Numbers ending in FC terminate with 1/4" Spade terminals and are complete with insulators, screws & washers.							
Numbers ending in FCB have bolts welded to the coil.							
<b>3/4" OD:</b>							
DH500N	5000	3750	-	-	40"	125"	
DH500-4N	-	-	-	5000	17"	64"	
DH501N	3500	2625	-	-	16"	50"	
DH504N	1500	1125	-	-	21"	62"	
DH505-4N	-	-	-	4500	23"	79"	
DH506-4N	-	-	-	4000	27"	81"	
DH511N	4250	3188	-	-	19"	57"	
DH512N	4750	3563	-	-	22"	66"	
DH520N	6600	4950	-	-	25"	75"	
DH534N	6000	4500	-	-	20"	63"	
DH560N	5600	4200	-	-	20"	63"	

Prices subject to change without notice. Part numbers & illustrations are intended solely for identification. Items offered for sale are not represented to be manufactured by the company that built the original equipment.

© 2010 H&H Electric Manufacturing Company

## Restring Kits for Electric Heat

H&H can quickly fill your need for direct replacement heating coils for Bryant, Cadet, Carrier, Climate Master, Coleman, Crafft, Fedders, Federal Electric Brick, Frigidaire, G.E./Trane, Intertherm, Janitrol, Lennox, Mathews Brick, Miller, Westinghouse, York and others.

H&H can also supply restring coils for KitchenAid and Thermadore Waste King Dishwashers.

## FUSE LINKS & CERAMIC CUTOUTS



Part No.	Open °F	Open °C	Price
<b>FUSE LINKS</b>			
<b>M257</b>	257°F	125°C	
<b>M300</b>	300°F	149°C	
<b>M333</b>	333°F	167°C	
<b>M358</b>	358°F	181°C	
<b>M438</b>	438°F	225°C	
<b>M468</b>	468°F	242°C	

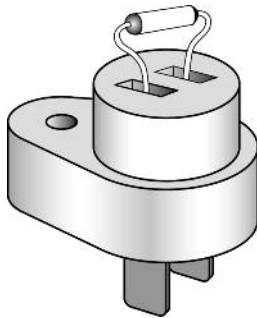

### CERAMIC CUTOUTS TEARDROP

<b>TC5194</b>	194°F	90°C	
<b>TC5204</b>	204°F	95.5°C	
<b>TC5218</b>	218°F	103.3°C	
<b>TC5227</b>	227°F	108.3°C	
<b>TC5257</b>	257°F	125°C	
<b>TC5300</b>	300°F	149°C	
<b>TC5333</b>	333°F	167°C	

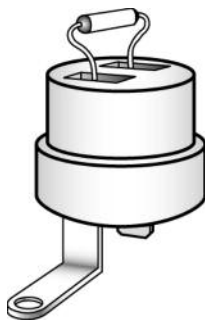

### ROUND

<b>TC6194</b>	194°F	90°C	
<b>TC6204</b>	204°F	95.5°C	
<b>TC6218</b>	218°F	103.3°C	
<b>TC6227</b>	227°F	108.3°C	
<b>TC6257</b>	257°F	125°C	
<b>TC6300</b>	300°F	149°C	
<b>TC6333</b>	333°F	167°C	

# Electric Heat Sequencers

Direct replacement for most fan and heat sequencing functions  
 • 24 Volt input control • Solid State. Quick Connect Terminals

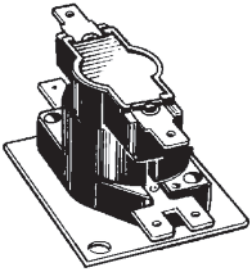

**GS101** Q101 OFF 40-110 Sec.  
 33241 ON 1-20 Sec.  
 TDR10  
 24A34-1

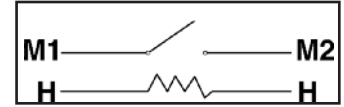

**GS102** Q102 OFF 1-30 Sec.  
 33242 ON 30-90 Sec.  
 TDR15  
 24A34-2

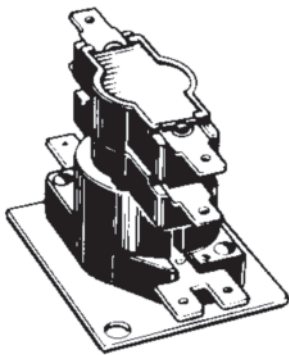
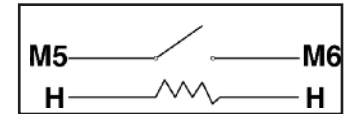

**GS103** Q103 OFF 40-110 Sec.  
 33244 ON 1-20 Sec.  
 TDR20  
 24A34-3

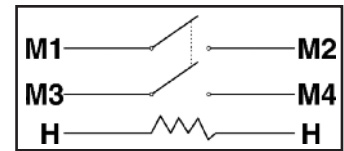

**GS104** Q104 OFF 1-30 Sec.  
 33245 ON 30-90 Sec.  
 TDR25  
 24A34-4

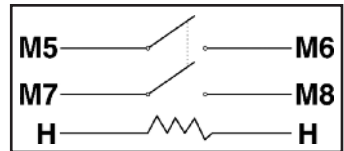

**GS105** Q105 OFF 1-110 Sec.  
 33232 ON 1-110 Sec.  
 TDR30  
 24A34-5

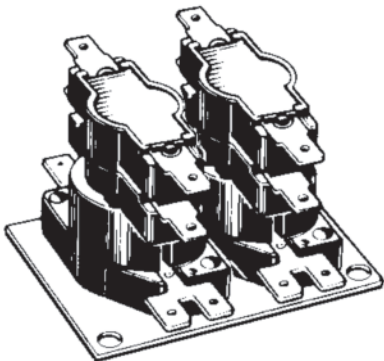
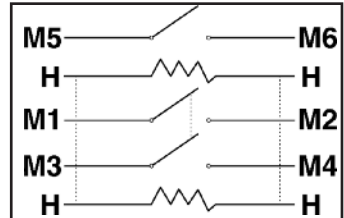

**GS106** Q106 OFF 1-30 Sec.  
 33233 ON 30-90 Sec.  
 24A34-6

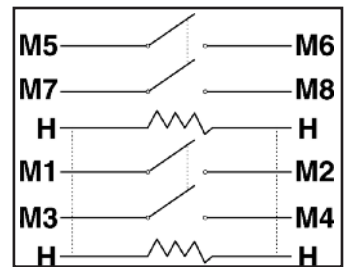

**GS107** Q107 OFF 40-110  
 Sec.

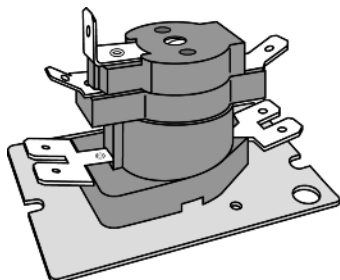
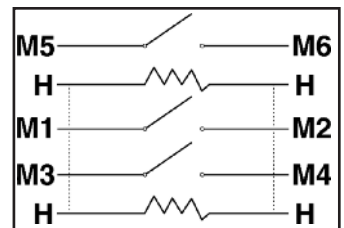

**GS108** Q108 OFF 65-115 Sec.  
 GOODMAN ON 1-25 Sec.  
 B13707-38

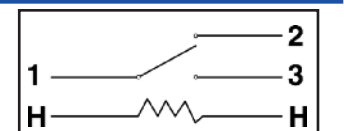

## Multi-Purpose Replacement Coils 120V Series

Replacements for many applications, manufactured to function best in applications where there is no air blower: small appliances, commercial warmers, radiant heaters, industrial applications, antique electric stoves.

### Unstretched Replacement Coils

Part No	Watts	O.D.	Length		Price
			Min	Max	
1150	150	3/16"	9"	30"	
1200	200	3/16"	7.5"	25"	
1250	250	3/16"	7.5"	25"	
1300	300	3/16"	10.5"	35"	
1350	350	3/16"	10.5"	35"	
1400	400	7/32"	12"	40"	
1450	450	7/32"	10.5"	35"	
1451	450	3/16"	7.5"	25"	
1500	500	7/32"	15"	50"	
1501	500	11/64"	12"	40"	
1502	500	7/32"	18.75"	62.5"	
1550	550	7/32"	13.5"	45"	
1551	550	11/64"	15"	50"	
1600	600	3/16"	19.5"	65"	
1601	600	13/64"	10.5"	35"	
1602	600	15/64"	13.5"	45"	
1603	600	11/64"	13.5"	45"	
1605	600	9/64"	16.5"	55"	
1660	660	13/16"	18"	60"	
1700	700	13/64"	21"	70"	
1750	750	13/64"	21"	70"	
1751	750	7/16"	10.5"	35"	
1752	750	3/8"	7.5"	25"	
1800	800	13/64"	18"	60"	
1801	800	3/16"	15"	50"	
1802	800	13/32"	18"	60"	
1803	800	7/32"	12.75"	42.5"	
1850	850	13/64"	18"	60"	
1900	900	7/32"	22.5"	75"	
1901	900	7/32"	18"	60"	
11000	1000	7/32"	21"	70"	
11001	1000	3/16"	15"	50"	
11002	1000	1/4"	19.5"	65"	

### Unstretched Replacement Coils

Part No	Watts	O.D.	Length		Price
			Min	Max	
11003	1000	3/8"	15.75"	52.5"	
11004	1000	5/32"	15"	50"	
11005	1000	1/2"	6.75"	22.5"	
11006	1000	5/16"	16.5"	55"	
11007	1000	15/64"	26.25"	87.5"	
11008	1000	3/16"	17"	56.25"	
11009	1000	5/32"	27.75"	92.5"	
11100	1100	7/32"	27"	90"	
11200	1200	7/32"	27.75"	92.5"	
11201	1200	7/32"	18"	60"	
11202	1200	3/16"	14.25"	47.5"	
11320	1320	7/32"	24"	80"	
11321	1320	5/16"	19.5"	65"	
11322	1320	1/4"	25.5"	85"	
11350	1350	7/32"	31.5"	105"	
11400	1400	1/4"	30"	100"	
11401	1400	1/4"	24"	80"	
11450	1450	7/32"	28.5"	95"	
11500	1500	7/32"	28.5"	95"	
11501	1500	1/4"	24"	80"	
11502	1500	5/16"	18"	60"	
11503	1500	25/64"	10.5"	35"	
11505	1500	5/16"	9.75"	32.5"	
11506	1500	3/8"	24"	80"	
11507	1500	3/8"	7.5"	25"	
11600	1600	3/8"	21"	70"	
11750	1750	7/32"	24"	80"	
11800	1800	7/32"	24"	80"	
11801	1800	1/4"	28.5"	95"	
12000	2000	7/32"	28.5"	95"	
12001	2000	5/16"	19.5"	65"	
12200	2200	7/32"	28.5"	95"	

# Multi-Purpose Replacement Coils

## 240V Series

### Unstretched Replacement Coils

Part No	Watts	O.D.	Length		Price
			Min	Max	
2300	300	3/16"	10.5"	35"	
2350	350	3/16"	10.25"	34.25"	
2400	400	3/16"	16.5"	55"	
2401	400	3/16"	18"	60"	
2450	450	3/16"	15"	50"	
2500	500	3/16"	13.5"	45"	
2600	600	3/16"	22.5"	75"	
2660	660	3/16"	21"	70"	
2700	700	3/16"	19.5"	65"	
2750	750	7/32"	27"	90"	
2800	800	7/32"	24"	80"	
2801	800	7/32"	18"	60"	
2900	900	13/64"	28.5"	95"	
21000	1000	13/64"	40.5"	135"	
21002	1000	1/4"	91.5"	305"	
21003	1000	7/32"	25.5"	85"	
21004	1000	3/8"	16.5"	55"	
21100	1100	7/32"	27"	90"	
21200	1200	3/16"	37.5"	125"	
21203	1200	3/8"	22.5"	75"	
21250	1250	13/64"	37.5"	125"	
21320	1320	7/32"	39"	130"	
21350	1350	3/16"	45"	150"	
21500	1500	7/32"	42"	140"	
21501	1500	7/32"	34.5"	115"	
21502	1500	1/4"	21"	70"	
21503	1500	5/16"	22.5"	75"	
21600	1600	3/16"	55.5"	185"	
21650	1650	3/16"	54"	180"	
21700	1700	1/4"	37.5"	125"	
21701	1700	11/32"	28"	92"	
21750	1750	3/16"	51"	170"	
21751	1750	1/4"	36"	120"	
21800	1800	3/16"	49.5"	165"	
21801	1700	15/64"	40.5"	135"	
22000	2000	7/32"	70"	200"	
22001	2000	1/4"	51"	170"	
22002	2000	3/16"	45"	150"	
22003	2000	3/16"	48"	160"	
22004	2000	9/32"	28"	92.5"	
22005	2000	21/64"	45"	150"	
22200	2200	3/16"	57"	190"	
22201	2200	1/4"	46.5"	155"	

### Unstretched Replacement Coils

Part No	Watts	O.D.	Length		Price
			Min	Max	
22300	2300	7/32"	54"	180"	
22301	2300	1/4"	45"	150"	
22400	2400	7/32"	51"	175"	
22401	2400	1/4"	45"	150"	
22500	2500	7/32"	66"	220"	
22501	2500	1/4"	54"	180"	
22502	2500	7/32"	49.5"	165"	
22503	2500	11/32"	39"	130"	
22504	2500	5/16"	34.5"	115"	
22505	2500	13/64"	52.5"	175"	
22600	2600	7/32"	64.6"	215"	
22601	2600	1/4"	54"	180"	
22700	2700	7/32"	61.5"	205"	
22800	2800	7/32"	58.5"	195"	
22801	2800	1/4"	49.5"	165"	
22900	2900	7/32"	57"	190"	
23000	3000	7/32"	57"	190"	
23001	3000	1/4"	48"	160"	
23002	3000	3/8"	33"	110"	
23003	3000	7/32"	79.5"	265"	
23004	3000	3/8"	33"	110"	
23200	3200	7/32"	52.5"	175"	
23400	3400	7/32"	67.5"	225"	
23401	3400	1/4"	57"	190"	
23402	3400	5/16"	46.5"	155"	
23403	3400	3/8"	42"	140"	
23404	3400	5/16"	40.5"	135"	
23500	3500	7/32"	64.5"	215"	
23501	3500	1/4"	55.5"	185"	
23502	3500	5/16"	43.5"	145"	
23800	3800	1/4"	60"	200"	
24000	4000	15/64"	70.5"	235"	
24001	4000	7/32"	57"	190"	
24002	4000	3/8"	36"	120"	
24003	4000	11/32"	42"	140"	
24004	4000	3/8"	55.5"	185"	
24005	4000	13/32"	40.5"	135"	
24006	4000	3/8"	36"	120"	
24200	4200	15/64"	67.5"	225"	
24201	4200	3/8"	34.5"	115"	
24202	4200	7/32"	57"	190"	
24203	4200	11/32"	43"	142.5"	
24300	4300	15/64"	66"	220"	

Prices subject to change without notice. Part numbers & illustrations are intended solely for identification. Items offered for sale are not represented to be manufactured by the company that built the original equipment.  
© 2010 H&H Electric Manufacturing Company

# Multi-Purpose Replacement Coils 240V Series

Unstretched Replacement Coils						Unstretched Replacement Coils					
Part No	Watts	O.D.	Length		Price	Part No	Watts	O.D.	Length		Price
			Min	Max					Min	Max	
24301	4300	7/32"	55.5"	185"		24802	4800	5/16"	33"	110"	
24302	4300	5/16"	49"	162.5"		24803	4800	3/8"	34.5"	115"	
24400	4400	9/32"	37.5"	125"		25000	5000	3/8"	33"	110"	
24401	4400	7/32"	52.5"	175"		25001	5000	17/64"	48"	160"	
24402	4400	3/8"	33"	110"		25002	5000	11/32"	37"	123"	
24403	4400	5/16"	36"	120"		25003	5000	5/16"	67.5"	225"	
24404	4400	11/32"	46.5"	155"		25004	5000	11/32"	37"	123"	
24405	4400	7/32"	35"	117"		25005	5000	3/8"	28"	92"	
24500	4500	15/64"	63"	210"		25200	5200	3/8"	32"	107"	
24501	4500	3/8"	37"	123"		25300	5300	3/8"	31"	103"	
24502	4500	7/32"	52.5"	175"		25400	5400	3/8"	32.5"	107.5"	
24503	4500	5/16"	33"	110"		25500	5500	11/32"	34"	112.5"	
24504	4500	5/16"	37"	123"		25501	5500	1/4"	52.5"	175"	
24600	4600	15/64"	61.5"	205"		25600	5600	3/8"	28.5"	95"	
24601	4600	3/8"	36"	120"		25601	5600	11/32"	33"	110"	
24700	4700	11/32"	51"	170"		25800	5800	11/32"	32"	107"	
24750	4750	9/32"	37"	123"		26000	6000	11/32"	39"	130"	
24800	4800	9/32"	36"	120"		26900	6900	3/8"	28.5"	95"	
24801	4800	11/32"	43"	142.5"							

## Commercial Cooking Elements

### DUKE STEAM TABLE ELEMENTS

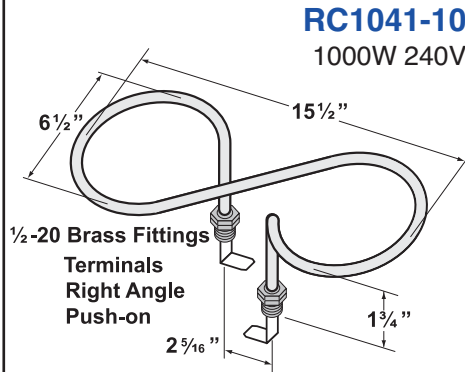
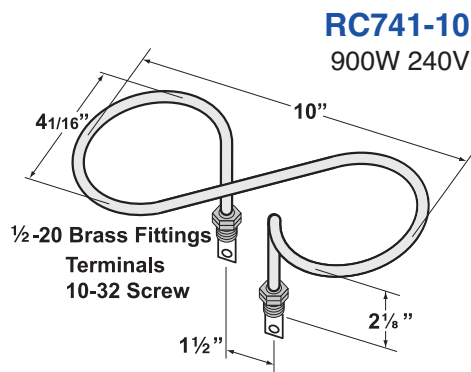

### DUKE ELEMENTS

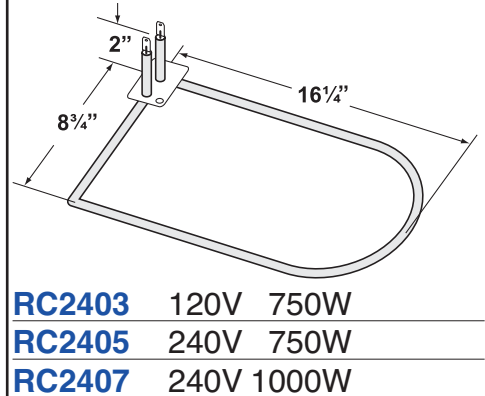

### CHARCOOK MODEL 523

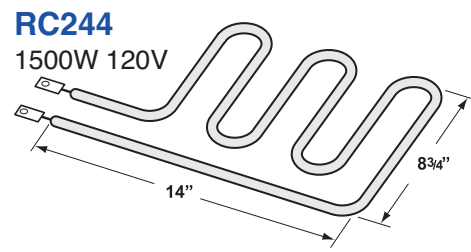

### GE HOBART

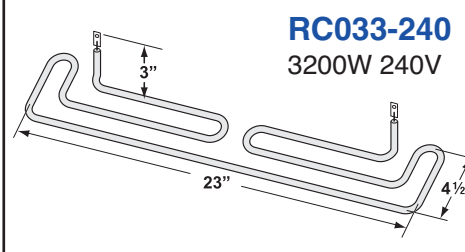

### STANLEY KNIGHT

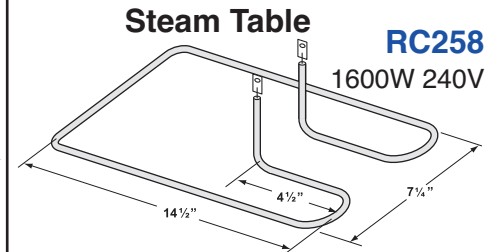

# Commercial Cooking Elements

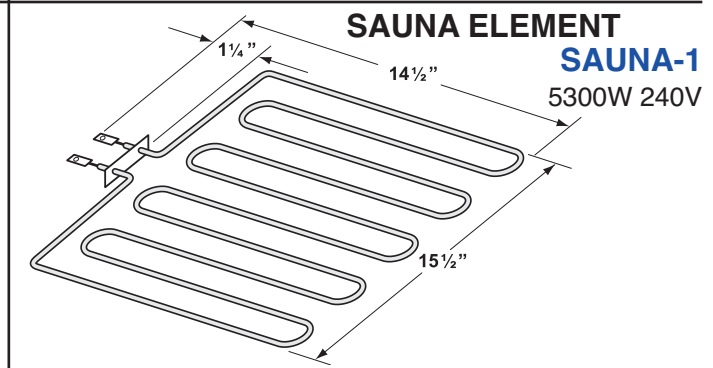
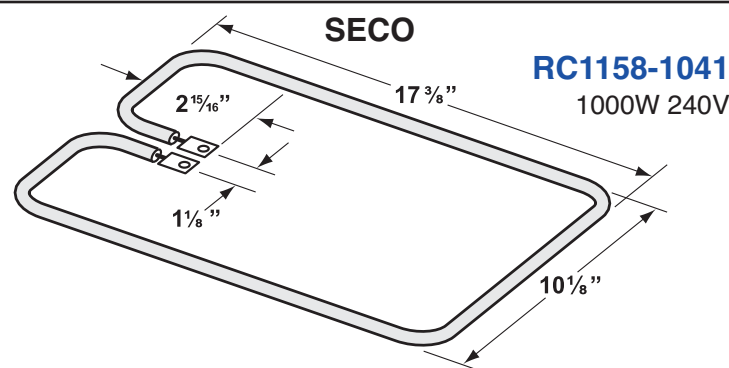
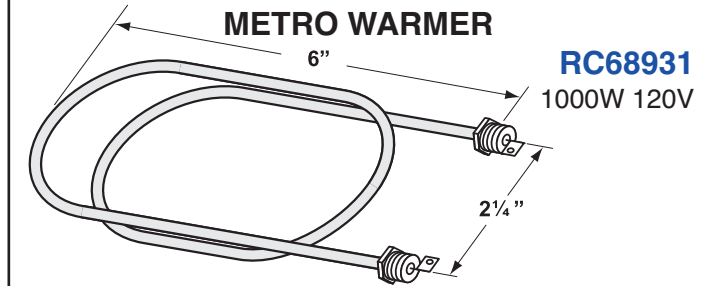
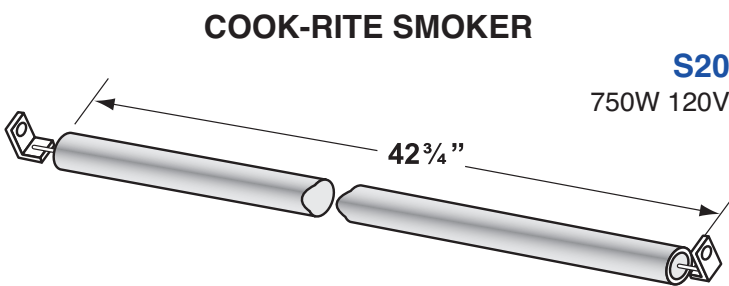
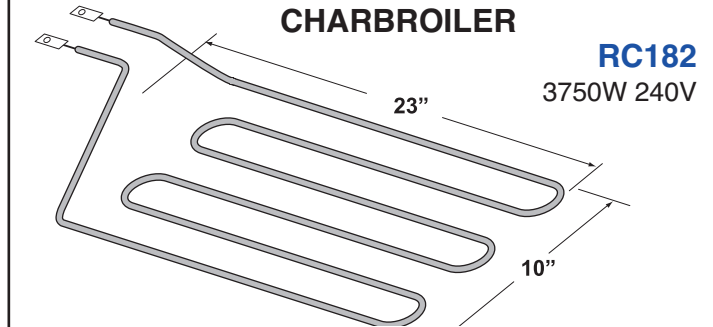
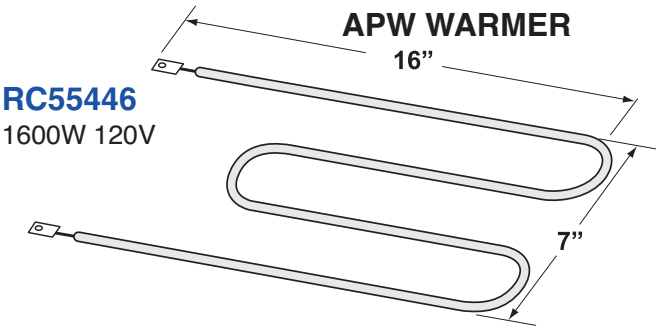
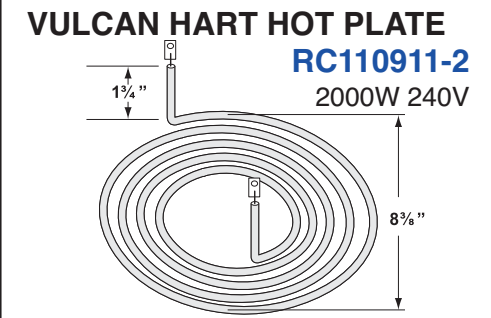
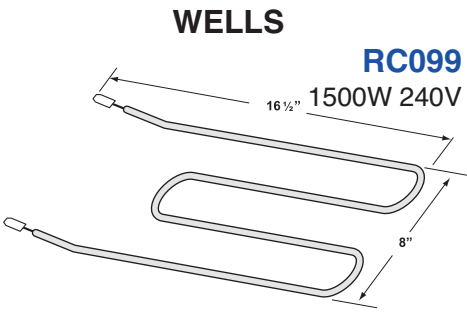
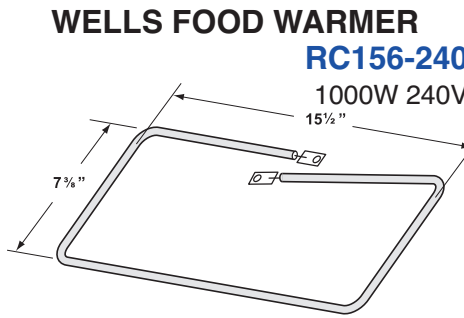
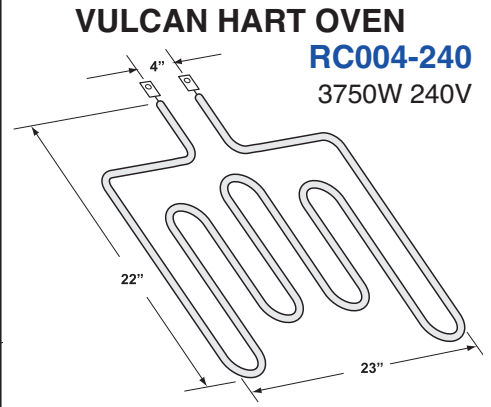
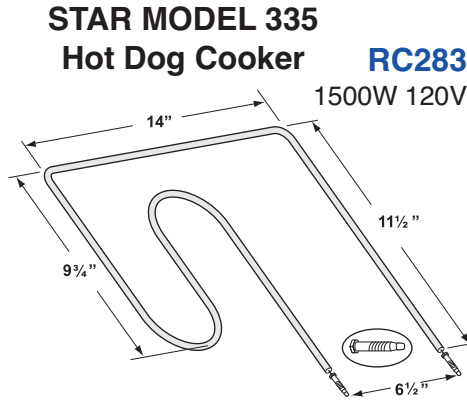
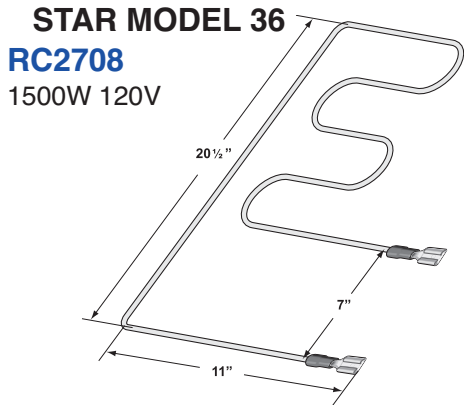

Prices subject to change without notice. Part numbers & illustrations are intended solely for identification. Items offered for sale are not represented to be manufactured by the company that built the original equipment.  
 © 2010 H&H Electric Manufacturing Company



## ELECTRIC MANUFACTURING

H&H Electric Manufacturing Company

PO Box 2063

Augusta, GA 30903

**Phone: 706-667-0422**

**Order Fax: 706-667-0994**

**[www.hhelectricmfg.com](http://www.hhelectricmfg.com)**

**Technical Help: [support@hhelectricmfg.com](mailto:support@hhelectricmfg.com)**

**E-mail: [sales@hhelectricmfg.com](mailto:sales@hhelectricmfg.com)**

© 2010 H&H Electric Manufacturing Company

### TERMS & CONDITIONS OF SALES

<b>Terms:</b>	Net 30
<b>Freight:</b>	F.O.B. 1405 15th Street, Augusta, GA 30904
<b>Minimum Billing:</b>	None
<b>Warranty:</b>	This warranty does not cover damage from misapplication, corrosion, improper application, or any products that have been altered, changed, repaired or treated in any manner whatsoever.

H & H Electric warranty is expressly limited to the repair or replacement of defective parts. **EXCEPT AS SET FORTH HEREIN, H & H ELECTRIC MAKES NO WARRANTY OF MERCHANTABILITY OR FITNESS FOR A PARTICULAR PURPOSE OR OTHER WARRANTY (WHETHER EXPRESS, IMPLIED OR STATUTORY).** H & H Electric shall not under any circumstances be liable for incidental, consequential or other damages, loss of profits or expenses in connection with or by reason of the use of or inability to use goods purchased for any purpose.

Warranty Products must be returned to H & H Electric Freight Prepaid with a return authorization number obtained from customer service.