



# Maintenance and Service Guide

## P21b G4 model

### **SUMMARY**

This guide provides information about spare parts, removal and replacement of parts, diagnostic tests, problem troubleshooting, and more.

© Copyright 2020 HP Development Company, L.P.

AMD is a trademark of Advanced Micro Devices, Inc. Bluetooth is a trademark owned by its proprietor and used by HP Inc. under license. NVIDIA is a trademark and/or registered trademark of NVIDIA Corporation in the U.S. and other countries. USB Type-C and USB-C are registered trademarks of USB Implementers Forum. DisplayPort and the DisplayPort logo are trademarks owned by the Video Electronics Standards Association (VESA) in the United States and other countries.

The information contained herein is subject to change without notice. The only warranties for HP products and services are set forth in the express warranty statements accompanying such products and services. Nothing herein should be construed as constituting an additional warranty. HP shall not be liable for technical or editorial errors or omissions contained herein.

First Edition: July 2021

Document Part Number: L96939-P21b  
G4-MSG-V1

Assembly part number: L96939-001

#### **Product notice**

Only trained service personnel familiar with this product should service it. Before performing any maintenance or service, be sure to read "Important Safety Information".

# Table of Contents

1	Getting started .....	1
	Important safety information .....	1
	Important service information and precautions .....	1
	RoHS (2002/95/EC) requirements .....	2
	General descriptions .....	2
	Firmware updates .....	2
	Before returning the repaired product to the customer .....	2
2	Monitor features .....	3
	Features .....	3
	Front components .....	4
	Rear components .....	5
	Locating the serial number and product number .....	6
3	Illustrated parts catalog .....	8
	How to order parts .....	9
4	Removal and replacement procedures .....	10
	Preparation for disassembly .....	10
	RC .....	10
	Function test .....	19
	Support and troubleshooting .....	19
	Index .....	21

---

# 1 Getting started

Read this chapter to learn about safety information and where to find additional HP resources.

## Important safety information

Carefully read the cautions and notes within this document to minimize the risk of personal injury to service personnel. The cautions and notes are not exhaustive. Proper service methods are important to the safe, reliable operation of equipment. Improper service methods can damage equipment.

The service procedures recommended and described in this service manual provide effective methods of performing service operations. Service engineers should have prior repair knowledge and experience as well as appropriate training for the product before performing service procedures.

- Be sure your working environment is dry and clean and meets all government safety requirements.
- Be sure that other persons are safe while you are servicing the product.
- Do not perform any action that can cause a hazard to the customer or make the product unsafe.
- Use proper safety devices to ensure your personal safety.
- Always use approved tools and test equipment for servicing.
- Never assume the product's power is disconnected from the main power supply. Check that it is disconnected before opening the product's cabinet.
- Modules containing electrical components are sensitive to electrostatic discharge (ESD). Follow ESD safety procedures while handling these parts.
- Some products contain more than one battery. Do not disassemble or expose a battery to high temperatures, such as throwing into fire, or the battery may explode.
- Refer to government requirements for battery recycling or disposal.

This information provides general service information for the monitor. Adherence to the procedures and precautions is essential for proper service.

---

**IMPORTANT:** Only trained service personnel who are familiar with this HP product should perform service or maintenance for it. Before performing any service or maintenance, personnel must read the important safety information.

---

**IMPORTANT:** You must disconnect the power cord from the power source before opening the monitor to prevent component damage.

---

## Important service information and precautions

- Repair must be performed by professional service technicians in a repair center. End users should not perform these procedures.
- Please note during servicing that the primary side is the high voltage area.
- This monitor meets ROHS requirements. Be sure to use lead-free solder wire when soldering.
- If you must change a capacitor, be sure to match the polarity as printed on the PCB.
- If you must replace a capacitor, make sure the specification and part number match the BOM and location.

- If you must replace a capacitor, insert new parts carefully to avoid a short circuit caused by the near pin.
- Do not get the board wet. Water and moisture can cause a short circuit that causes malfunctions.
- To avoid damage, be sure to use lead-free solder.
- When soldering, work quickly to avoid overheating the circuit board.
- Keep the soldering iron tip clean and well tinned when replacing parts.
- After repair, perform a close inspection of the circuit board to confirm it is in good condition.
- After repair, perform a function test to confirm the power supply is working properly.

#### **ERP Lot5 requirement**

1. A professional repairer must have the technical competence to repair electronic displays and comply with the applicable regulations for repairers of electrical equipment in the Member States where the repairer operates. Reference to an official registration system as professional repairer, where such a system exists in the Member States, shall be accepted as proof of compliance.
2. A professional repairer must have insurance that covers liabilities resulting from repairs, regardless of whether required by the Member State.

## **RoHS (2002/95/EC) requirements**

### **Applied to all countries that require RoHS.**

The RoHS (Restriction of Hazardous Substance in Electrical and Electronic Equipment Directive) is a legal requirement by the EU (European Union) for the global electronics industry sold in the EU and other countries. Any electrical and electronics products launched in the market after June 2006 should meet this RoHS requirement. Products launched in the market before June 2006 are not required to be compliant with RoHS parts. If the original parts are not RoHS compliant, the replacement parts can be non-ROHS compliant. If the original parts are RoHS compliant, the replacement parts **MUST** be RoHS compliant.

If product service or maintenance requires replacing parts, confirm the RoHS requirement before replacement.

## **General descriptions**

This manual contains general information. There are two levels of service:

Level 1: Cosmetic/appearance/alignment service

Level 2: Circuit board or standard parts replacement

## **Firmware updates**

Firmware updates for the monitor are available at [support.hp.com](http://support.hp.com). If no firmware is posted, the monitor does not need a firmware update.

## **Before returning the repaired product to the customer**

Perform an AC leakage current check on exposed metallic parts to be sure the product is safe to operate without the potential of electrical shock. Do not use a line isolation transformer during this check.

Measurements that are not within specified limits present a possible shock hazard. You must check and repair the product before returning it to the customer.

---

## 2 Monitor features

This chapter provides an overview of the monitor's features.

### Features

Depending on the model, your monitor might include the following features:

- 52.6 cm (20.7-inch) diagonal viewable screen area with 1920 x 1080 resolution, plus full-screen support for lower resolutions; includes custom scaling for maximum image size while preserving original aspect ratio
- Anti-Glare panel with an LED backlight
- Wide viewing angle to allow viewing from a sitting or standing position, or when moving from side to side
- Tilt capability
- VGA video input
- Removable stand for flexible monitor head mounting solutions
- High-Definition Multimedia Interface (HDMI) video input (Select Models)
- Audio-in jack (Select Models)
- Plug-and-play capability if supported by your operating system
- Security cable slot provision on rear of monitor for optional security cable
- On-Screen Display (OSD) adjustments in several languages for easy setup and screen optimization
- High-Bandwidth Digital Content Protection (HDCP) copy protection on all digital inputs
- Energy saver feature to meet requirements for reduced power consumption

---

**NOTE:** For safety and regulatory information, refer to the Product Notices provided in your documentation kit. To access the latest user guides or manuals for your product, go to <http://www.hp.com/support> and follow the instructions to find your product. Then select **Manuals**.

---

## Front components

To identify the components on the front of the monitor, use this illustration and table.

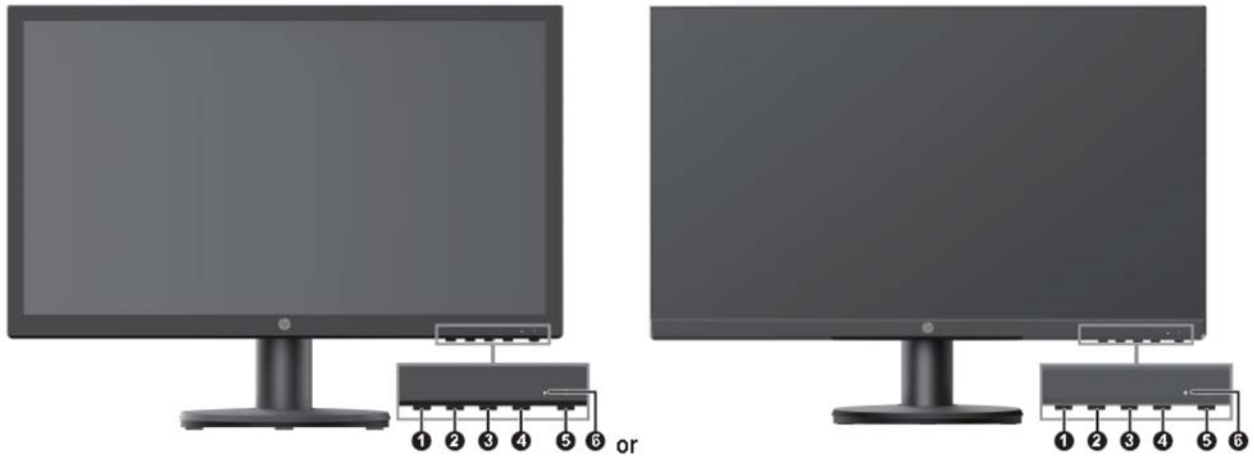

Control	Description
1 Menu button	Press to open the OSD menu, select a menu item from the OSD, or close the OSD menu.
2-4 Function buttons	When the OSD menu is open, press the buttons to navigate through the menu. The function light icons indicate the default button functions. For a description of these functions, see <a href="#">Using the function buttons on page 14</a> . You can reassign the function buttons to quickly select the most commonly used operations. See <a href="#">Reassigning the function buttons on page 14</a> .
5 Power	Turns the monitor on or off.
6 Power light	White: The monitor is on. Amber: The monitor is in standby mode.

## Rear components

To identify the components on the rear of the monitor, use this illustration and table.

### 52.6 cm/20.7-inch model



Component	Description
1 Power connector	Connects the power cable to the monitor
2 HDMI connector	Connects the HDMI cable to the monitor (Select Models)
3 VGA connector	Connects the VGA cable to the monitor
4 Audio-in jack	Connects the audio cable to the monitor (Select Models)





For India:

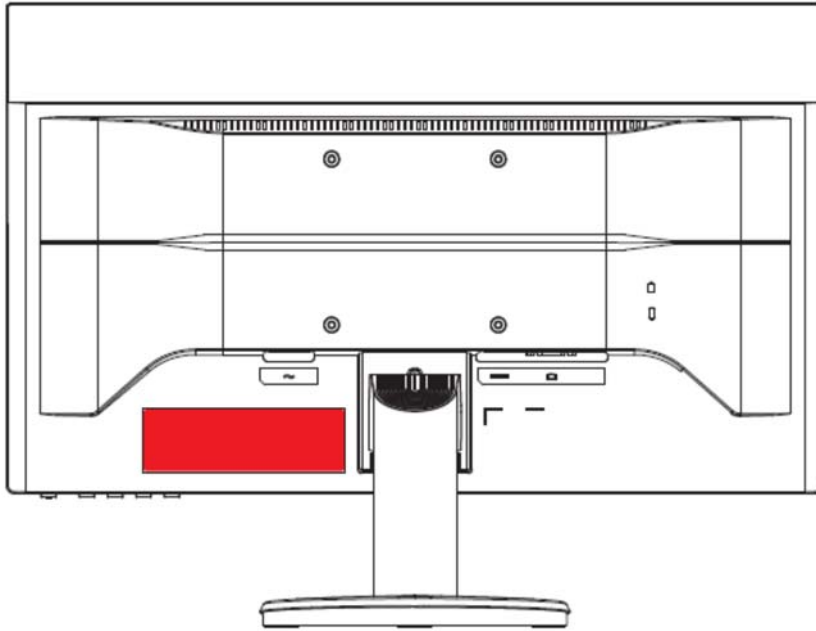

 <b>Video Monitor/液晶显示器/液晶顯示器/모니터</b>		<b>Regulatory Model No./規定型号/型號/모델명: HSD-0063-V</b> <b>Input Rating/电源电压 交流/電壓電流/정격입력:</b> 100-240V~ 0.7A (0.7A) 50/60Hz	
		    	
Serial No./序号/序號 Product No./제품명 Assembly Part No. Spares No. Rev. Manufactured/制造日期/ 製造日期/제조년월 Made in China/中国制造/中國製造/제조국:중국	1CRYWWZZZZ 9TY24AA/9TY24A7 L96116-001 L96939-001 CTM111 May 2020 警語: 使用過度恐傷害視力	       	
		R-R-hpi-HSD-0063-V XU101974-20010 K-Tronics (Suzhou) Technology Co., Ltd A/S 연락처 : 1588-3003 <b>www.bis.gov.in</b>	

# 3 Illustrated parts catalog

To identify the monitor major components, use this illustration and table.

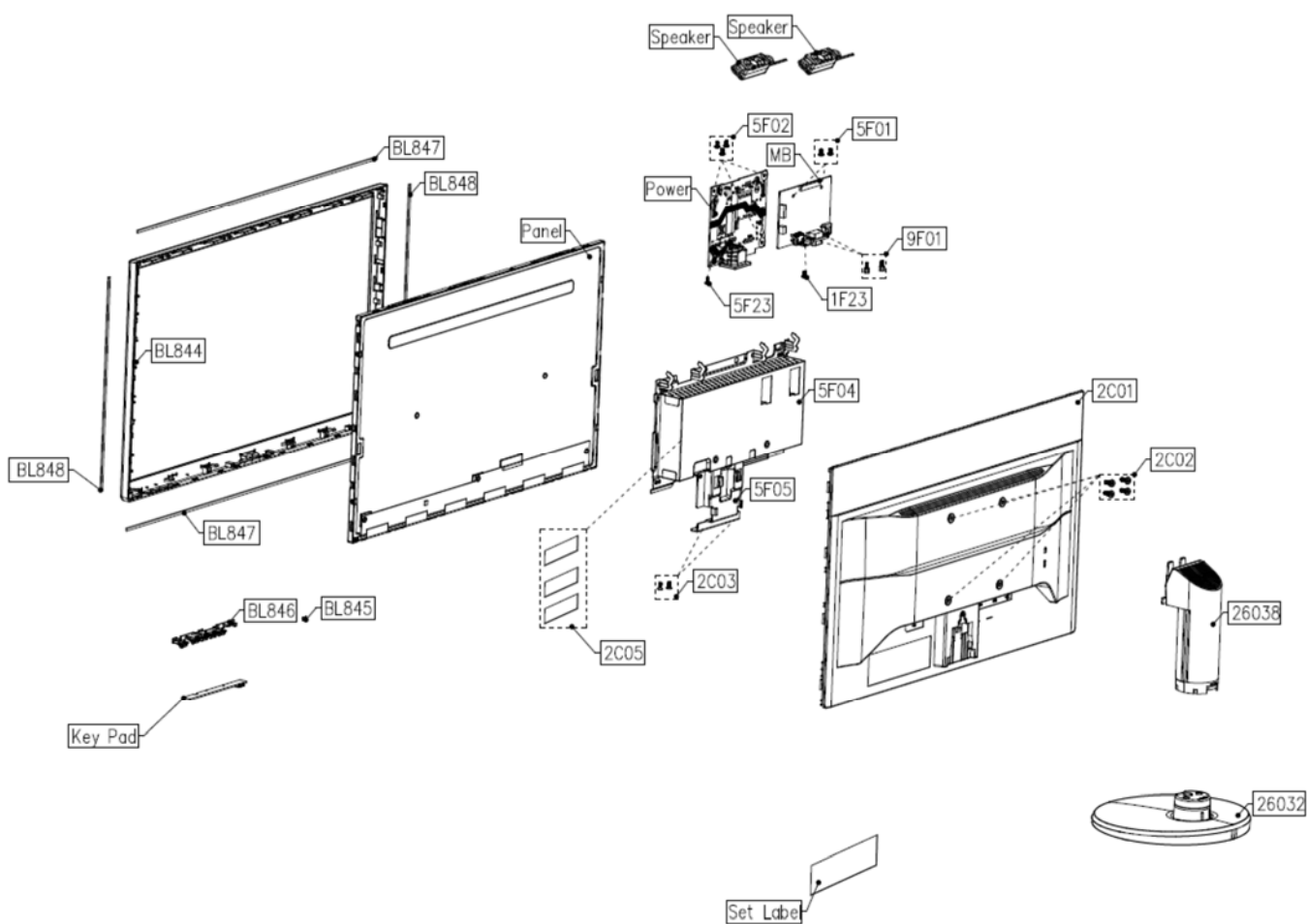

# How to order parts

The HP authorized repair center can purchase the power board from HP.

## Power board

Description	HP spare part number	Manufacturer part number
PSU P21b G4, 21204-00942-S01	M84527-001	21204-00942

Capacitors Connectors are available for purchase from the following EU distributors:

- Digi-Key: [digikey.co.uk](http://digikey.co.uk)

## Capacitors by distributor

Component description	Location	Component distributor	Distributor part number
Capacitor_47uF_450V_18*25	C816	Digi Key	565-1478-ND

## Connectors by manufacturer

Component description	Location identifier	Component distributor	Distributer part number
VGA	P103	Digi Key	609-5181-ND
HDMI	P108	Digi Key	1175-1701-ND

---

**NOTE:** The connector may need to be modified to meet functionality, regulatory and safety requirements if it is not an exact match.

---

You can purchase cables from the HP part store at <https://partsurfer.hp.com/Search.aspx>.

---

**NOTE:** HP continually improves and changes product parts. For complete and current information about supported parts for your computer, go to <http://partsurfer.com>, select your country or region, and then follow the on-screen instructions.

---

## 4 Removal and replacement procedures

Adherence to these procedures and precautions is essential for proper service.

### Preparation for disassembly

Use this information to properly prepare to disassemble and reassemble the monitor.

- 1) Read the “Important safety information” and “Important service information and precautions” sections in the “Getting started” chapter of this guide.
- 2) Clean the room for disassembly.
- 3) Identify the disassembly area.
- 4) Check the position that the monitors are to be placed along with the number of monitors. Prepare the area for material flow according to the disassembly layout.
- 5) Be sure to have the following equipment and materials:
  - Press fixture
  - Working table
  - Screwdriver
  - Knife
  - Gloves
  - Cleaning cloth
  - ESD protection
  - Scraper bar in the following dimensions:

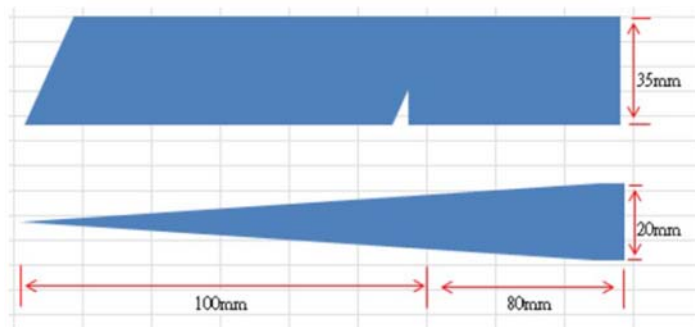

### RC

Before removing the RC, follow these steps:

- ▲ Prepare the monitor for disassembly.

- 1) Remove the base. Push the button of base to unlock the base, then pull out the base form the stand.



- 2) Remove the stand. Push the button of stand to unlock the stand, then pull out the stand form the monitor head.



- 3) Remove the rear cover. Remove the screws that lock the rear case and use the knife to remove the case.



- 4) Remove shielding case/cables. Remove the acetate tape (red frame) that fixes the wire and the isolation cover as shown in the figure, unplug the backlight (green frame), and then remove the aluminum foil (yellow frame) that fixes the wire and the shield cover. Remove the LVDS cable (press the tabs on both sides and pull the LVDS cable upwards).

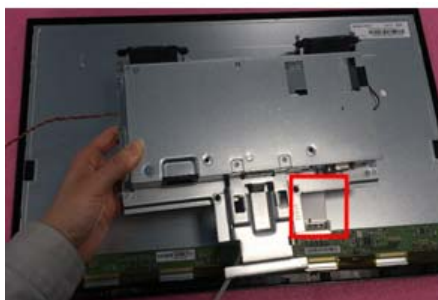
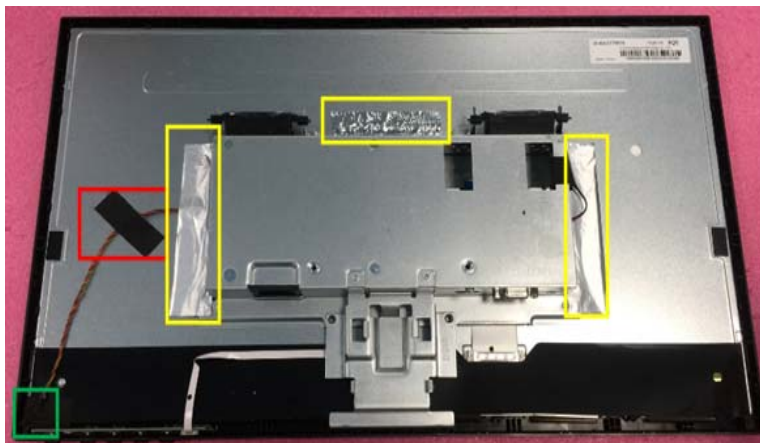



- 5) Remove KB from rear cover. Take the function key board out of the front frame, remove the tab on the function key board, and pull out the function key wire.



- 6) Remove speaker. Remove the acetate tape (red frame) that fixes the wire and the shielding case as shown in the figure and pull the speaker out.

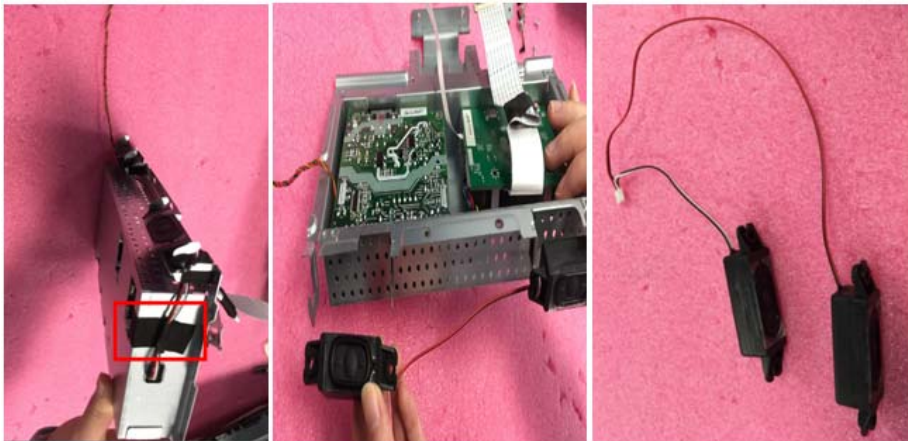



- 7) Remove M/B & P/B from shielding case. Remove the screws\*4 fixing the power board, screws\*2 fixing the mainboard and remove the conductive foam and acetate tape. Remove the screws at the mainboard interface & screw on the bottom of the shielding case

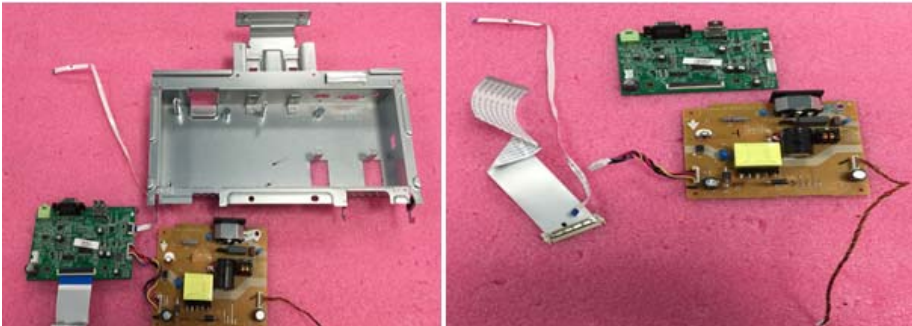
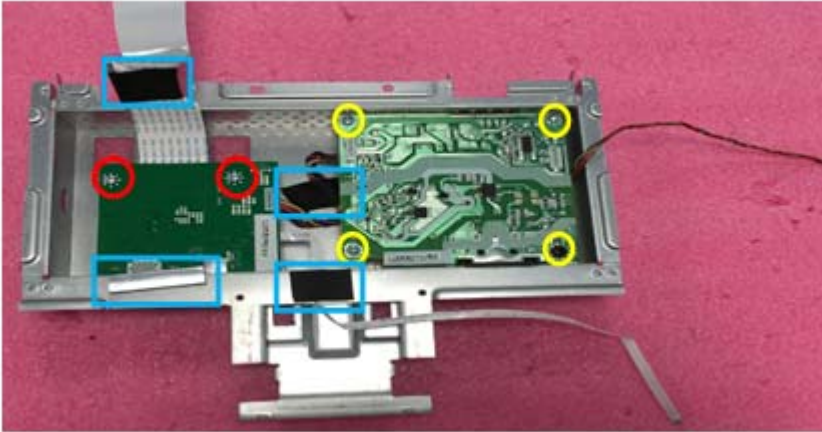

# Power board

The power board part number is 21204-00942.

Before removing the power board, follow these steps:

- ▲ Prepare the monitor for disassembly.

Remove the power board:

- 1) The HP P21b G4 power board connector position is as follows:

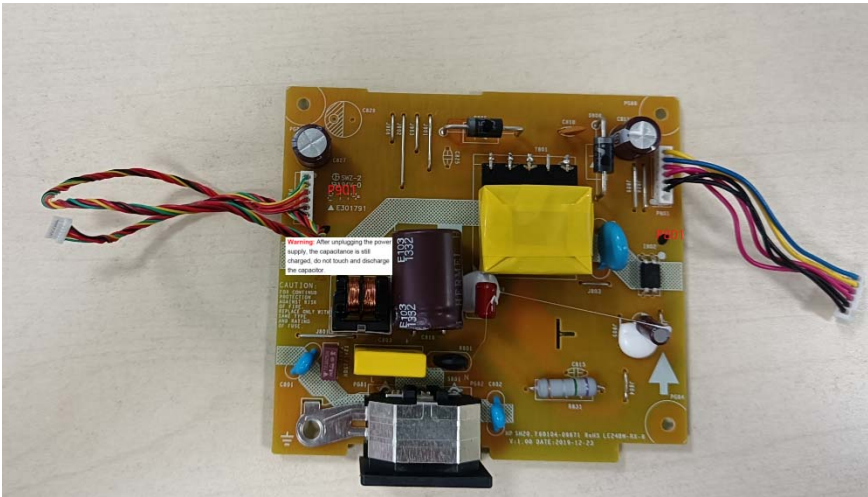

- 2) Locate the part number location on the board.



## Connector repair

This procedure includes HDMI, VGA connectors.

The connectors are on the main board (board part number 60104-09633).

The connectors identifiers are as follows:

Connector	Location
HDMI	P108
VGA	P103

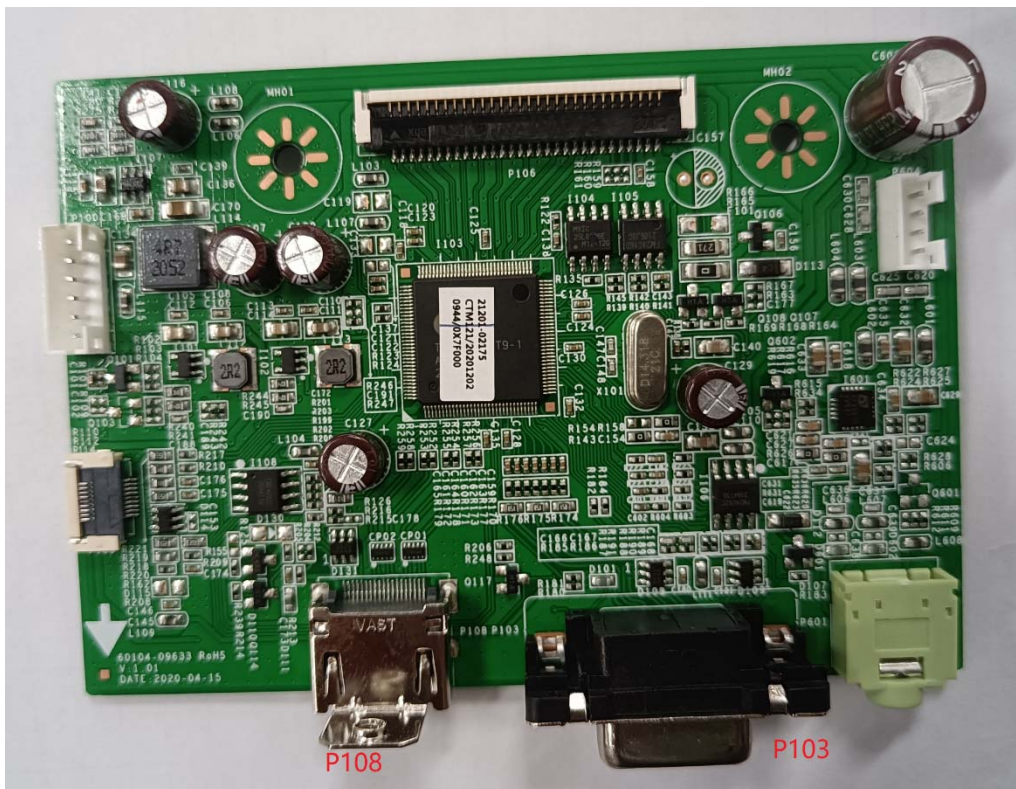

Before repairing connectors, follow these steps:

- ▲ Prepare the monitor for disassembly. See [Preparation for disassembly](#) on page 10.

## HDMI connector P108

Repair the HDMI connector:

- 3) Use a soldering iron and a desoldering pump to remove as much solder as possible from the pin.



- 4) Use a hot air gun to melt the solder on the pins.



- 5) Lift the P108 connector from the PCB.
- 6) Place the new component on the PCB. Be sure that it matches the PCB footprint.
- 7) Solder the new component.

## VGA connector P103

Repair the VGA connector:

- 8) Use a soldering iron and a desoldering pump to remove as much solder as possible from the pin.





- 9) Lift the P103 connector from the PCB.
- 10) Place the new component on the PCB. Be sure that it matches the PCB footprint.
- 11) Solder the new component.

## Function test

After repair, be sure to confirm that all functions are working.

**Table 4-1:** Function test

Test item	Operating description	Tool used
HDMI test	Confirm whether image displays and sound plays correctly on the monitor.	Computer or DVD player
VGA test	Confirm whether image displays and sound plays correctly on the monitor.	Computer

## Support and troubleshooting

The following table lists possible problems, the possible cause or each problem, and the recommended solutions.

**Table 4-2:** Solving common problems

Problem	Possible cause	Solution
Screen is blank or video is flashing.	Power cord is disconnected.	Connect the power cord.
	Monitor is off.	Power the power button. NOTE: If pressing the Power button has no effect, press and hold the power button for 10 seconds to disable the Power button lockout feature.
	Video cable is improperly connected.	Connect the video cable properly.
	System is in Sleep mode.	Press any key on the keyboard or move the mouse to exit Sleep mode.
	Video card is incompatible.	Open the OSD menu and select the Input Control menu. Set Auto-Switch Input to Off and manually select the input
Image appears blurred, indistinct, or too dark.	Brightness is too low.	Open the OSD menu and select <b>Brightness</b> to adjust the brightness scale as needed.
<b>Check Video Cable</b> is displayed on screen.	Monitor video cable is disconnected.	Connect the appropriate video signal cable between the computer and monitor. Be sure that the computer power is off

		while you connect the video cable.
<b>Input Signal Out of Range</b> is displayed on screen.	Video resolution and/or refresh rate are set higher than what the monitor supports.	Change the settings to a supported setting.
The monitor is off, but it did not seem to enter into Sleep mode.	The monitor's power saving control is disabled.	Open the OSD menu and select <b>Power Control &gt; Auto-Sleep Mode</b> and set auto-sleep to <b>On</b> .
<b>On-Screen Menus are Locked</b> is displayed.	The monitor's OSD lock function is enabled.	Press and hold the <b>Menu</b> button on the front bezel to 10 seconds to disable the OSD lockout function.
<b>Power Button is Locked</b> is Displayed	The monitor's power button is locked.	Press and hold the power button for 10 seconds to disable the power button lock function.

# Index

- components
  - front, 4
  - rear, 5
- connector repair, 14
- features, 3
- firmware updates, 2
- front components, 4
- function test, 17
- HDMI connector location, 15
- how to order parts, 9
- illustrated parts catalog, 8
- menu button, 18
- parts, 9
- power board removal, 15
- power button location, 18
- precautions, 1
- preparation for disassembly, 10
- RC removal, 12
- rear components, 5
- removal
  - power board, 15
  - RC, 12
- removal and replacement procedures, 10
- RoHS (2002/95/EC) requirements, 2
- safety information, 1
- serial number location, 6
- service information, 1
- support and troubleshooting, 17
- troubleshooting, 17
- VGA connector location, 16