

Maximum Listing Exposure 24/7/365:

Continually striving to provide the most complete online advertising for our listings, Baird & Warner has developed a powerful presence on the companion websites of nearly 100 city and suburban publications. We also harness the unprecedented reach of the Internet by sending our listings to hundreds of heavily trafficked sites across the web.

Make sure you choose the real estate firm that provides the most comprehensive online advertising exposure to market your property in today's competitive environment. Time for maximum exposure?

Time for Baird & Warner.

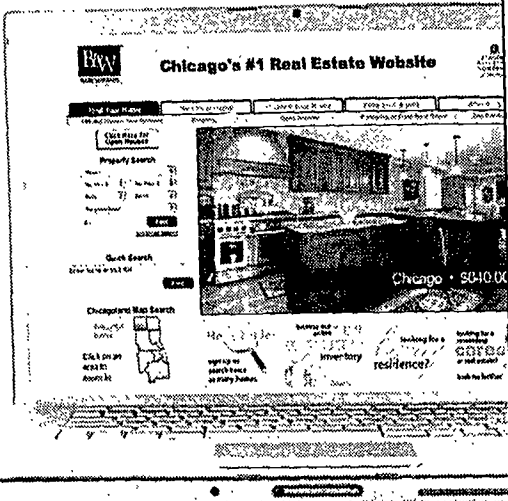

 Park Ridge Spacious home w/6br,6 baths in grt loc.Fin 3rd fl,deck & pergola off mstr. Kathryn Cloney \$1,649,000 ID#84718225 847-823-1855	 Park Ridge Mint condition,new appls & gran ctrtps in kit.2 updatd baths,refind hdwd fls Jill O'malley \$680,000 ID#84718206 847-823-1855	 Skokie Spacious 3br, 2.1ba Georgian on huge park-like lot Large rms. Remodeled kit Nicole Flores \$500,000 ID#84408142 773-775-1855	 Park Ridge Everything's done in this 4br 2ba Split Level. Hdwd flrs,skylights,2 frpl. Shirlee Ehlers \$499,000 ID#84718124 847-823-1855	 Skokie Renovated ranch-4 bed, 2.2 bths. Entirely new kitchen! Refinished oak flrs. John Creighton \$429,000 ID#83108085 847-491-1855
 Morton Grove Bungalow with 3 kitchens, 3BED/3BA, 2 decks and a beautiful yard! Sheila Doyle \$395,000 ID#83158136 847-724-1855	 Skokie Enjoy 1700 sq ft of luxury in this 2br/2.1 Ba. Just 3 yrs old. 2 Car garage Doug Wurtzel \$385,000 ID#83158147 847-724-1855	 Skokie New constr.2BR/2BA condo close to town & train. In-unit Indry,2 gar spaces. Maureen Dunn \$369,000 ID#83158154 847-724-1855	 Lincolnwood Great lincolnwood location!3 br. Brick georgian with many, many updates. Mera Wei \$365,000 ID#84408115 773-775-1855	 Skokie Rock solid 4BR VNTG bungalow quiet st, spotless, FNCD YD W/garages 2c gar. Julie Naumiak \$359,000 ID#83108114 847-491-1855
 Harwood Heights 3br Raised Ranch.Large eating area,enclosed porch.Full fin bsmt.Great loc. Linda Montana \$329,000 ID#74717200 847-823-1855	 Lincolnwood Charming brick Cape Cod nestled on tree lined street. Entertain in lge rms Pauline Dreuth \$319,000 ID#84408164 773-775-1855	 Skokie Skokie brick Georgian - original cond with great potential & curb appeal. Irene Yungerman \$299,900 ID#84408156 773-775-1855	 Lincolnwood Beautiful lge & well maint townhome.2 bedroom 1.1 bath and in move-in cond Sargon Hajey \$298,900 ID#84408259 773-775-1855	 Skokie Quality Sun-Filled LGE BRK RNCH on Peaceful CulDeSac-3BR, Full BSMT. Ready! Julie Naumiak \$295,000 ID#83108166 847-491-1855
 Skokie Devonshire Highlands- BRK Ranch 2-3BR 2BTH Pretty Yard, Wood Flrs, FAM RM. Charlie Vernon \$289,900 ID#83108163 847-491-1855	 Chicago Contemporary 3BR townhse w/hrdwd flrs, new patio, lg Fam rm & \$17/mo asses. Gordon Smith \$289,900 ID#83108179 847-724-1855	 Skokie Fab newer 2br 2ba! Sunset view balcony, w/d in-unit, gar pkg & fresh decor! Julie Naumiak \$289,000 ID#83108179 847-491-1855	 Skokie Skokie Home Shines 2 bdrm, 2ba. HDWD Flrs, fplc, bsmt 2nd kitch, huge bsmt. Debbie Shore \$289,000 ID#83108170 847-491-1855	 Morton Grove 3BD/2BA home w/newhrdwd, wndws, Fam Rm & patio. Best price in Morton Grove Gordon Smith \$279,950 ID#83158124 847-724-1855
 Des Plaines Downtown DesPlaines. 2br.2ba.Low asmts.Walk to train.Heated garage sp.Elev. Shirlee Ehlers \$249,900 ID#84718184 847-823-1855	 Des Plaines Rivers Edge cmplx,2BR,2BA,kit has eat-in area/atrium window.1 car att gar. Shirlee Ehlers \$225,000 ID#84718218 847-823-1855	 Skokie Gorgeous condo!Completely remodeled.Recent conversion in corner building. Sargon Hajey \$189,900 ID#84408255 773-775-1855	 Evanston Rehabbed condo has an ample amount of 42' maple cabs, granite, SS.Pkg spc Angela Riley \$157,900 ID#84408303 773-775-1855	 Des Plaines Great 1st flr 2 bed/1ba unit in Casa Blanco!Eat in kit,new paint,patio. Gabi Gates \$139,399 ID#83158105 847-724-1855



Learn more about any of the homes shown above by simply entering the ID Number in our homepage Quick Lookup box. Also on our website, find complete information on all our Open Houses this weekend.

bairdwarner.com

Multiple Photos
Robust Details
Dynamic Mapping
e-Mail Alerts

News

24/7:
Check out
pioneerlocal.com
for more

HOROSCOPE

In the stars

Check out this week's horoscope online.
www.pioneerlocal.com

MOVIE REVIEW



Growing pains

Bruce Ingram reviews the man-child comedy, "Role Models."

www.pioneerlocal.com

FOOD



All heart

A Chef, a nutritionist and doctors team up for a healthy-cooking class.

SUBURBODDITY

Crazy crimes

Find out about wacky crooks and their crimes.
www.pioneerlocal.com

MANAGING EDITOR: Marc Alberts
malberts@pioneerlocal.com | (847) 486-7259

Blase admits guilt

Ex-Niles mayor pleads guilty to corruption charges



Nicholas Blase

Feds alleged insurance scam paid him \$420K in kickbacks

By **TONY BERTUCA**
tbertuca@pioneerlocal.com

There were no Halloween treats Friday for former longtime Niles mayor Nicholas Blase.

Blase, 80, changed his plea Friday from innocent to guilty on federal corruption charges of mail fraud and tax evasion, and admitted to steering local businesses to buy insurance from an agency that paid him \$420,000 in kickbacks over the past 20 years.

The veteran mayor and former Maine Township Democratic committee-man pleaded guilty to one count of mail fraud in the kickback scheme, which carries a sentence of up to 20 years in prison and a fine of up to \$250,000. He

also pleaded guilty to one count of tax evasion, which carries a prison sentence of three years and a fine of up to \$100,000.

In exchange for Blase's plea, the federal government agreed to drop nine additional corruption charges.

Upon changing his plea, a visibly emotional Blase asked to read a prepared statement before U.S. District Judge Wayne

Andersen.

"I am here today because I made a mistake," Blase said. "I have tried to do what I thought was right. I want to take this opportunity to apologize to those I let down — my family, my friends, and most of all, the people of Niles. We've been through a lot together. I was wrong and for that I am very sorry."

The judge was gentle with Blase and offered

him consolation regarding his political legacy.

"What is wrong is deeply wrong," Andersen said. "The good things that happened, fortunately, will not be undone."

Blase and his attorney, Chris Stetler, both declined to comment after the hearing. Federal prosecutor Dan Collins would not further elaborate on the deal struck with Blase and said the sentence for his crimes would be up to the discretion of the judge.

In changing his plea to guilty, Blase ends a two-year legal battle and months of speculation over whether he would continue to fight the charges or cut a deal with the government.

Blase initial trial was scheduled for Sept. 8, but his attorneys asked for more time to negotiate with prosecutors. The case was set for another status hearing on Sept. 25, but that was rescheduled

to today. Attorneys at the time would not say whether a deal was in the works.

Blase, who served as mayor of Niles for 47 years before retiring in August, was arrested at his home in 2006 and indicted on several counts of mail fraud and accused of inappropriately using his elected office to pressure local businesses into buying high-priced insurance from Ralph Weiner & Associates, of Wheeling. He initially pleaded not guilty.

The government had alleged that the scheme netted Blase about \$420,000 in bribes kicked back by Weiner's company.

"I'll be absolved of all this and I'll stay in office," Blase told reporters at the time.

Blase is scheduled to appear in court Jan. 29 to be sentenced.

Comment: pioneerlocal.com



BUZZ ORR/STAFF PHOTOGRAPHER
Children's librarian Clara Sheffer reads a story to children and parents during "Boo Time" Halloween activities at Niles Public Library.



BOO TIME
Samira Benjamin, of Niles, holds her daughter Mary Rioni, 4, during "Boo Time" Halloween activities Oct. 29 at Niles Public Library. Children dressed in costumes attended the event.

BUZZ ORR/STAFF PHOTOGRAPHER

Starters

Students return early to Gemini

By **TONY BERTUCA**
tbertuca@pioneerlocal.com

East Maine School District 63 announced Friday that the asbestos-abatement process at Gemini Junior High School had been completed ahead of schedule, and said students would be returning to the building Wednesday.

It was previously thought that students would not be able to return to Gemini until Monday.

"We are happy to let you know that final testing indicates no trace of asbestos, mold, or any other contaminants any-

where in the building," Superintendent Kathleen Williams wrote in a letter to parents.

Asbestos was discovered in the adhesive beneath Gemini's first-floor carpeting Sept. 13 when work crews were cleaning up after a flood.

"New carpet has been installed," Williams wrote, "and the areas impacted have been completely disinfected."

While no trace of airborne asbestos was detected at Gemini, school board members voted to keep the school closed until the substance was completely removed to avoid problems in the future.

"The abatement process was conducted in three phases with affected areas completely sealed off/contained from the rest of the building," Williams wrote. "After each phase, additional air quality testing was conducted, and each time this testing indicated that there were no airborne contaminants at Gemini."

All of Gemini's students took up residence in other District 63 schools and worked out of mostly makeshift classrooms set up in gymnasiums.

Students returning to Gemini will be given copies of their class schedules and lock combi-

nations to jog their memories.

"In addition a letter will be placed in the files of eighth grade students when transitioning to high school referencing the situation and its subsequent impact on instructional areas not addressed during this time period," Williams wrote. "The Board of Education and we are excited about our return to Gemini and would like to thank our 'host' elementary schools for their gracious hospitality, as well as our parents and staff for their support and patience."

Comment: pioneerlocal.com

www.pioneerlocal.com

INDEX

CLASSIFIED ADVERTISING	C1	IMAGES	66
CROSSWORD	B26	MOVIE REVIEW	B5
DEATH NOTICES	B2	POLICE BLOTTER	20
DIVERSIONS	B1	SCHOOLS	22
FOOD	71	SHOWTIME	B6
FORUM	21	SPORTS	85



NILES HERALD-SPECTATOR

SERVING READERS SINCE 1951 ★ YOUR LOCAL SOURCE

EDITORIAL

Managing Editor-News
Marc Alberts (847) 486-7259
E-mail: malberts@pioneerlocal.com
Fax: (847) 486-7495
Assistant Managing Editor-News
Matt Schmitz (847) 486-7273
E-mail: mschmitz@pioneerlocal.com
Fax: (847) 486-7495

Managing Editor-Sports
Rick Hibbert (708) 524-4440
E-mail: rhibbert@pioneerlocal.com
Fax: (847) 383-3678

Managing Editor-Diversions
Michael Bonesteel (847) 486-6854
E-mail: mbonesteel@pioneerlocal.com
For go calendar listings or questions, e-mail: sparker@pioneerlocal.com

Got news?
News tips: (847) 486-7259
Sports tips: (708) 524-4440
E-mail: parkridge@pioneerlocal.com

Editor in Chief
Jeff Wisser (847) 486-6848
E-mail: jwisser@pioneerlocal.com

WEB SITE
www.pioneerlocal.com

MAIL
Niles Herald-Spectator
3701 W. Lake Ave., Glenview, IL 60026

CUSTOMER SERVICE AND DELIVERY ISSUES

Hours: Mon-Fri, 6:30 a.m.-6 p.m.; Sat. 6:30 a.m.-12 p.m.; Sun, 8 a.m.-12 p.m.
Phone: (847) 486-9300

TO SUBSCRIBE

Phone: (847) 486-9300
E-mail: circulation@pioneerlocal.com

Circulation Director

Jay Beaton (847) 486-7208

ADVERTISING

Display advertising
Display ads (847) 486-7300
E-mail: display@pioneerlocal.com

Display sales representatives
Rick Branham (847) 486-7283

Display Advertising Manager
Mike Shalin (847) 486-7326

Vice President of Advertising
Peggy Cunniff (847) 486-7317

Classified sales representatives
Classified ads (847) 998-3400
E-mail: classified@pioneerlocal.com

Classified Sales Director
Frank Gaziano (847) 486-7247

PRESIDENT AND PUBLISHER
Larry Green

ADVERTISING TERMS AND CONDITIONS
Acceptance of all orders by Publisher is expressly conditioned on and subject to the following terms and conditions. As used in these paragraphs, "Publisher" means this publication, its parent(s), subsidiaries and affiliates. Advertiser agrees that Publisher's liability in relation to any act, omission, failure to publish, or error in the printing/publishing of any ad will not exceed the amount paid for such ad. Under no circumstances will Publisher ever be liable for any indirect, consequential or special damages, or any other costs arising out or related to any act, omission, failure to publish, or error in the printing/publishing of an ad. It is the sole responsibility of the advertiser to check the correctness of each insertion. Publisher assumes no responsibility for the repetition of errors in advertising orders for more than one insertion, unless notified before the printing closing time on the same day the error occurred. Publisher reserves the right to limit the amount of advertising, to edit or reject any copy, and to cancel any advertising at its sole discretion without notice. Advertiser agrees to indemnify and hold Publisher harmless from and against any liability, loss or expense (including reasonable attorneys fees) arising from any claims, including but not limited to, libel, unfair competition, plagiarism, infringement of trademarks or copyrights, or violation of rights of privacy or publicity resulting from publication by Publisher of the Advertiser's ads.

PUBLICATION INFORMATION
Niles Herald-Spectator (USPS 390-680) Vol. 59, No. 47. Published weekly by Pioneer Newspapers Inc., 3701 West Lake Ave., Glenview, IL 60026. Single copy \$1.25. Periodicals postage paid at Glenview, IL 60026 and additional offices. One-year subscription: \$25.00. In county only. Call (847) 486-9300 to subscribe. Postmaster: Send address changes to Niles Herald-Spectator, c/o Pioneer Newspapers Inc., 3701 West Lake Ave., Glenview, IL 60026.

Holiday dance to replace aborted Homecoming

Maine South High School in Park Ridge will host a free dance in December to make up for the cancellation of the Homecoming dance on Oct. 4.

The dance, described as informal, will be from

6:30-9:30 p.m. on Dec. 6 in the school's Spectator Gym. The radio station KISS-FM has offered to provide a disc jockey and music for the dance free of charge.

The Homecoming

Dance was canceled midway through the evening following a bomb threat called into 911 that night. Students were evacuated from the building and sent home while school officials waited for the Cook

County Bomb Squad to arrive and search the building. No explosives were found, and the source of the 911 calls remains under investigation by the Park Ridge Police Department.

Residents to pay 25 cents a month for public TV

By **TONY BERTUCA**
tbertuca@pioneerlocal.com

In a move that will give Niles its very own government access cable-TV channel, village trustees at their Oct. 23 meeting voted 5-1 to approve a 10-year franchise agreement with Comcast.

The new channel will have a range of programming, including news and information, emergency warnings, educational specials, sports, entertainment and arts and culture.

But the new agreement with Comcast states that the channel will be established by a 25-cent "pass-through" fee for every sub-

scriber every month (\$3 a year) for a period of time deemed necessary to pay for the equipment used to provide the channel.

Assistant village manager Steve Vinezeano estimated the cost of the equipment to be between \$65,000 and \$80,000.

"We've got 24 hours to cover," he said. "There's an awful lot of information we can get on there."

Niles now receives an educational channel from Triton College, but the school does not serve Niles and does not provide local information.

Acting Mayor Robert Callero said he was in favor of the new channel be-

cause the opportunity is presented to provide residents with emergency warnings and additional information about the village.

"All our sister cities could even put a little presentation on there," he said. "It's \$3 a year."

But while Trustee Kim Biederman agreed with Callero and the rest of the board regarding the value of the channel, she voted against the Comcast agreement because she was reluctant to pass the 25-cent cost on to residents.

Instead, Biederman said, she would like to see the village pay for the

channel using funds from the franchise fee it will receive from Comcast. The new agreement states that the village will continue to receive a franchise fee from Comcast that is 5 percent of the company's annual gross revenues.

"I'm opposed to passing the tax on to residents," Biederman said. "I believe this public channel should be funded with the revenues from the franchise agreement."

But other trustees said the village would need the franchise fee funds to help balance this year's budget. The measure passed 5-1.

Comment: pioneerlocal.com



STACIA TIMONERE/FOR PIONEER PRESS

Linda Marionello plays a Baroque-style flute with Amadeus Consort Oct. 26 at Niles Public Library.



STACIA TIMONERE/FOR PIONEER PRESS

Garry Clark discusses an authentic Baroque violin before a performance by Amadeus Consort Oct. 26 at Niles Public Library.

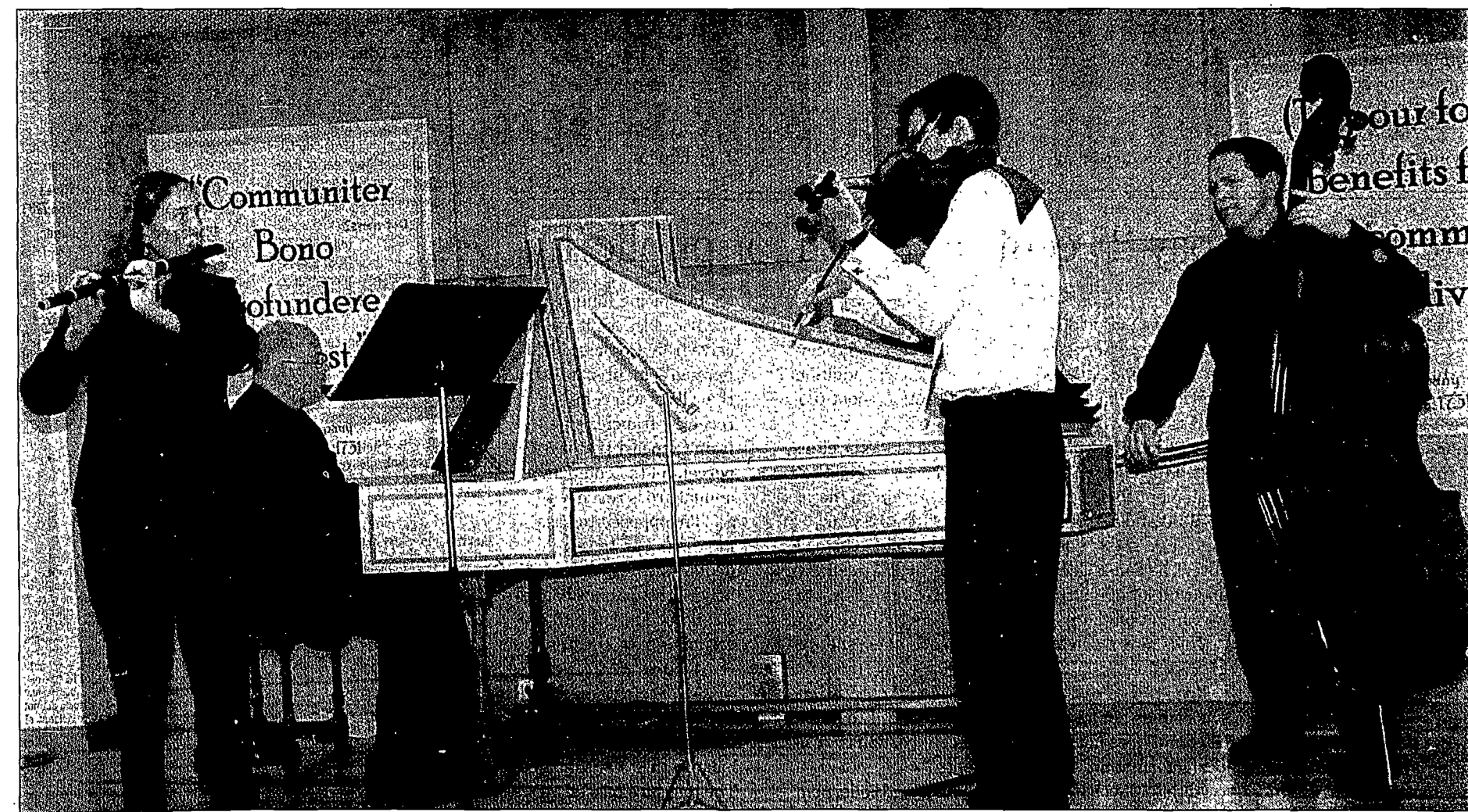

STACIA TIMONERE/FOR PIONEER PRESS

Amadeus Consort performs Oct. 26 at Niles Public Library.

Since 1891

NorthShore

University Health System

- Evanston Hospital
- Glenbrook Hospital
- Highland Park Hospital
- Over 2,000 Affiliated Physicians

A teaching affiliate of the University of Chicago
Pritzker School of Medicine

For more information visit northshore.org

Special Veteran's Day Weekend

Coupon Savings

Basement prices are *always* 30-60% off department & specialty store prices.

Save even more Nov. 5th thru Nov. 11th when you use these coupons!

take **20% off** any one item with this coupon

the best prices & selection of international designer & famous brand fashions for women, men & home

Offer valid Nov. 5 - Nov. 11, 2008. Discount taken at register. No adjustments for prior purchases. Not valid with any other discount offer or on purchase of gift cards. Excludes Swiss watches & "Special Buys" in fine jewelry. Must bring in coupon to receive offer. No photocopies.

FILENE'S BASEMENT

take **20% off** any one item with this coupon

the best prices & selection of international designer & famous brand fashions for women, men & home

Offer valid Nov. 5 - Nov. 11, 2008. Discount taken at register. No adjustments for prior purchases. Not valid with any other discount offer or on purchase of gift cards. Excludes Swiss watches & "Special Buys" in fine jewelry. Must bring in coupon to receive offer. No photocopies.

FILENE'S BASEMENT

Where Bargains Were Born

FILENE'S BASEMENT

One North State St. / 830 N. Michigan Ave. / Schaumburg, across from the Woodfield Mall
Orland Park Place at 153rd & La Grange Road www.filenesbasement.com

Selection varies by store.

Department Store Price
\$90.00

Original Basement Price
\$49.99

20% Coupon Discount
-\$10.00

Your Final Price:
\$39.99

Plus...

save 60-85% OFF
original department & specialty store prices

when you take **40% OFF**
Our Entire Stock of
European & American
Designer Labels

FILENE'S
VAULT
INTERNATIONAL DESIGNER FASHIONS

Selection varies by store. Discount taken at register. Valid on merchandise with dept. numbers 900 & Up.

Democrats 'win' big in Maine South 'election'

By JENNIFER JOHNSON
jjohnson@pioneerlocal.com

Like those who took advantage of early voting, Maine South High School seniors had an opportunity to cast ballots prior to the Nov. 4 general election — even though theirs was more of the “mock” variety.

The mock election, consisting of races and referendum questions that appeared on actual Park Ridge ballots, took place in all senior social science classes on Thursday, Oct. 30. Students used real voting booths and selected their candidates and referendum positions using Scantron sheets commonly used for multiple choice tests.

The Democrats swept the election, something

that did not come as a complete surprise to social science teacher Warren Scott who said he has found high school students to be, in general, more democratically-minded.

Barack Obama was the winner of the presidential race, receiving 64 percent of the vote, Scott reported.

“We actually have quite a few students who have campaigned for Mr. Obama,” he said, adding that several had plans to campaign in Hammond, Ind. prior to the election, and some were looking to attend the Chicago rally for Obama on election night.

In other races, students overwhelmingly re-elected Dick Durbin to the U.S. Senate and Jan Schakowsky to the 9th

Congressional district. More locally, incumbent State Senator Dan Kotowski of the 33rd District received 75 percent of the vote to opponent Mike Sweeney's 20 percent. In the highly contested 66th Representative District race, students overwhelmingly elected newcomer Aurora Abella-Austriaco over 16-year incumbent Rosemary Mulligan.

Kotowski, Sweeney, Austriaco and Mulligan all spoke to the seniors prior to the election, Scott said.

On the referendum issues, 54 percent of seniors voted against the state conducting a Constitutional Convention. Sixty-two percent voted in support of a state provision that would allow state officials to be recalled from office. When asked if Park

Ridge should adopt a system of staggered terms for its aldermen, 50 percent of students said “yes,” 38 percent said “no” and the remainder did not vote on this question.

Scott said 95 percent of Maine South seniors participated in the mock election and were educated about many of the issues inside their classrooms.

In actual elections, Maine South students have been particularly active, Warren added, with 48 students signed up as election judges on Nov. 4. During the primary election, Maine South had the most students serving as election judges than any other high school in Cook County, Scott said.

“We’re really trying to push that involvement,” he said.

The Woodlands of Morton Grove

OPEN SATURDAY, Nov. 8 1-4 and SUNDAY, Nov. 9 12-3

Elliott Group Last 3 New Units Remaining

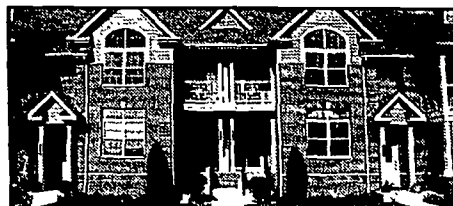

606 Callie
2Br, 2.1Ba townhome w/gourmet kitchen,
hardwood flrs & full basement. \$409,900



844 Callie
Unit 206 2Br, 2Ba corner unit w/maple &
granite kitchen, hdwd flrs & underground
parking. \$347,900
Unit 601 1Br, 1Ba, top floor unit w/quality
finishes, balcony & underground parking. \$289,900

Contact The Marla Schneider Team or visit our website
for more information on great offerings from Elliott Builders

847-657-3790

www.movewithmarla.com



COLDWELL BANKER

RESIDENTIAL BROKERAGE

Independently Owned and Operated by MFL, LLC

CONGRATULATIONS TO NILES TOWNSHIP HIGH SCHOOLS' NEWEST BOARD OF EDUCATION SUPERSTARS!

Presented Oct. 27, 2008



Our winners (from left): From Niles North, Lauren Smyth, Athletics/Activities; Anam Syed, Academics; and Michael Sugihara, Community Spirit/Citizenship. From Niles West, Nicole Rusek, Athletics/Activities; Elise Lee, Community Spirit/Citizenship; and Morgan Yates, Academics.



Thanks to our Superstars for making a positive difference in their schools and in our community!

Because I'm committed to playing football with my son.

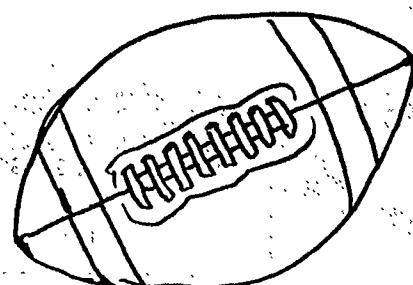

...I'm looking for a doctor who's committed to my weight-loss goals.



Pictured left to right: Anthony E. Rospani, MD, FACS; James F. Boffa, MD, FACS; Andrew S. Agos, MD, FACS

At Partners in Weight Management Surgery, our commitment is to you, every step of the way. We offer the latest in adjustable gastric band technology, including the proven LAP-BAND® and Realize™ systems, providing a safe and effective weight-loss solution for our patients.

PARTNERS IN WEIGHT
MANAGEMENT SURGERY
at North Shore Surgical Center

877.847.PWMS

3725 W. Touhy Ave., Lincolnwood, IL 60712 | Phone: 847-324-7770 | Fax: 312-896-5583

NOW THROUGH TUESDAY VETERANS DAY SALE

25%-50% OFF STOREWIDE savings & values

EXTRA 10%-15% OFF† when you use your Macy's card or pass

†Exclusions apply; see pass.

ALL-DAY SAVINGS PASS

EXTRA 15% OFF†

A SELECTION OF SALE & CLEARANCE PURCHASES STOREWIDE INCLUDING FINE & BRIDGE JEWELRY! (10% OFF) A SELECTION OF SALE & CLEARANCE HOME ITEMS INCLUDING RUGS & FLOOR COVERINGS; SHOES, COATS, SUITS, INTIMATES, DRESSES; SPORTCOATS FOR HIM) VALID THROUGH 11/11/08. CANNOT BE USED ON SPECIALS



†Excludes: specials, Geoffrey Beene, Everyday Values (edv), super buys; bridge & designer intimate apparel, shoes, handbags & sportswear; cashmere, cosmetics/fragrances, fashion jewelry, watches, premium tops & bottoms for him (D 567/571), swim for her, electronics, electronics, furniture (including Martha Stewart), mattresses, sterling flatware; Holiday Lane Dept., trim, cards & wrap. Also excludes: All-Clad, American Rag, Baccarat, Barbara Barry, BCBGMAXAZRIA, Burton, Calvin Klein, Coach, DKNY, DKNYC, Dooney & Bourke, Ed Hardy, Emporio Armani, Ghurka, Henckels, Hugo Boss, Impulse, INC, Joseph Abboud, Juicy, Karastan, Kate Spade, Kenneth Cole, Lacoste, L'etiquette, L'etiquette, Louis Vuitton, Lucky, Material London, Michael Kors, Havaianas, Nautica, The North Face, Oval Room, Perry Ellis, Polo/Ralph Lauren, St. John, I. Tahari, Tasso Elba, Thomas Pink, Tommy Bahama, Tommy Hilfifer, Tumi, 28 Shop, Ugg, Vera Wang, Waterford, William Yeoward, Wüsthof (designer exclusions don't apply to outerwear depts.); previous purchases, special orders, services, gift registry kiosks, gift cards, macys.com, macys weddingchannel.com, payment on credit accounts, bridal salons, e-spot, FAO Schwarz, J&R Express, maternity, Signoria Firenze, Stride Rite, Ticketmaster, Vision Express, wigs, restaurants, alcoholic beverages, wine. Cannot be combined with any savings pass/coupon, extra discount or credit offer, except opening a new Macy's account. Macy's employees not eligible. EXTRA SAVINGS % APPLIED TO REDUCED PRICES. MNO



the magic of
macys
macys.com

†New cardholder savings are subject to credit approval; savings valid the day your account is opened and the next day; excludes services, certain lease departments and gift cards; on furniture, mattresses, and floor coverings, the new account savings is limited to \$100; application must qualify for immediate approval to receive extra savings; employees not eligible. SALE PRICES IN EFFECT THROUGH 11/11/08. For store locations & hours, log on to macys.com



New Macy's cardholders get an extra 30%-35% off!†
When you open a new Macy's account and shop during our Veterans Day Sale, you'll save another 20% on top of the extra savings mentioned above during your first two days with your new Macy's card.

Too young to vote, not to have a voice

Maine West students favor Obama in largest-ever online mock election

By **TONY BERTUCA**
tbertuca@pioneerlocal.com

By now, America knows who the next president will be (hopefully).

But it is still interesting to note that many youths at Maine West High School participated in the largest online student mock election in American history last week and wanted their voices heard — even though most were too young to vote.

Of the 1,771 students who voted at Maine West, Barack Obama came out far ahead by receiving 80 percent, while John McCain received only 18 percent. Independent Party candidate Ralph Nader picked up 1.8 percent and

various write-in candidates accounted for rest.

"We've done mock elections in the past in almost every presidential election but I'd say this is the largest-scale mock election we've ever done, and the first electronic voting we've ever done," said Maine West Social Science Department Chair Susan Gahagan Mueller.

Maine West began the mock-election process by signing up to be part of the Youth Leadership Initiative, the nation's largest student mock election. The group mock election was organized by of the University of Virginia Center for Politics.

Vote, **PAGE 11**

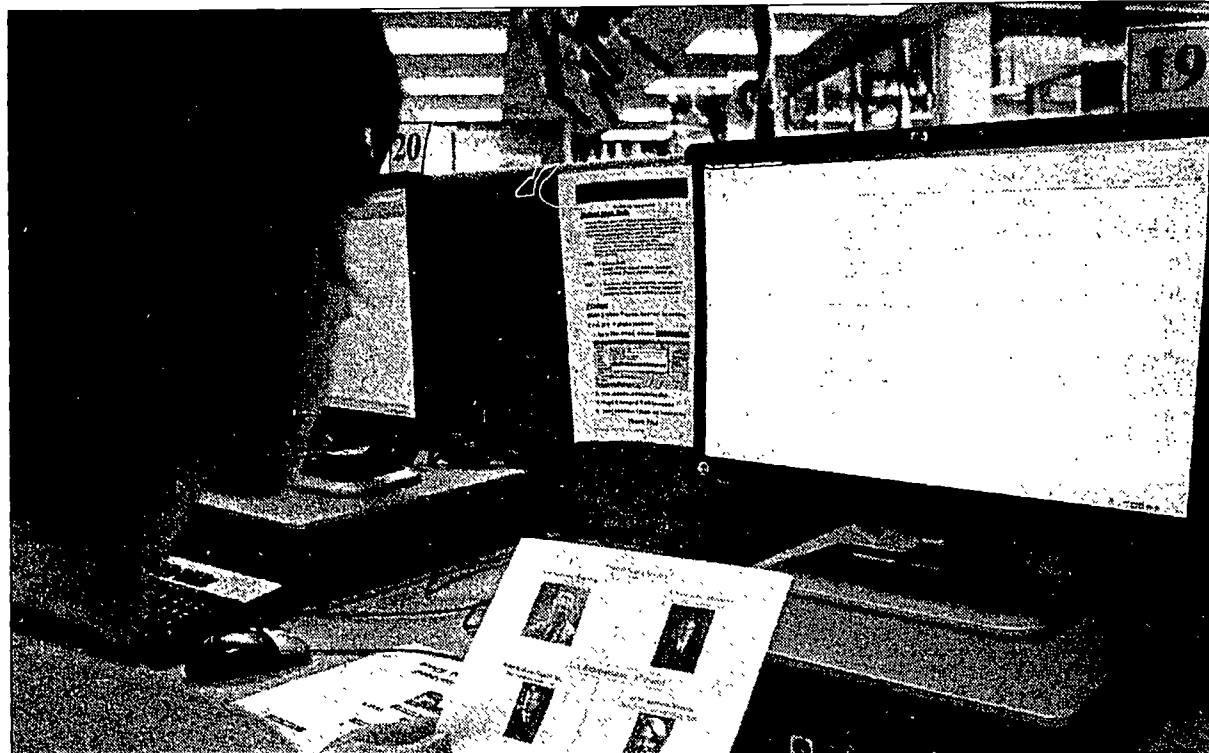

A Maine West High School student takes part in the school's online mock election last week.

CONTRIBUTED PHOTO

Maine high schools' mock elections support Democrats

Maine Township High School District 207 students made Barack Obama a landslide winner in mock elections conducted at Maine East, South and West high schools.

At Maine East, Social Science Department teachers and editors of the student newspaper, *The Pioneer*, worked together to give all students a chance to vote. Ballots were handed out on Oct. 23 and 24 and collected Oct. 27 to 29. Obama re-

ceived 743 votes, or 73 percent, for president. John McCain received 11 percent, or 115 votes, with other choices drawing 16 percent.

At Maine South, only seniors cast ballots in their social science classes. They supported Obama and his running mate, Joe Biden, to McCain and his running mate, Sarah Palin, by 306 to 128, or 64 percent to 27 percent of all votes cast.

Among Maine South seniors, U.S. Sen. Dick

Durbin outpolled his opponent, Steve Sauerberg, with 66 percent of the vote, compared to Sauerberg's 17 percent. In other races, South gave 9th District U.S. Rep. Jan Schakowsky, the incumbent Democrat, 63 percent of their votes; her opponents, Republican Michael Younan and Green Party candidate Morris Shanfield, received a combined 33 percent. State Sen. Dan Kotowski, D-33rd, outpolled his Republican opponent

Mike Sweeney, 76 percent to 20 percent. State Rep. Rosemary Mulligan, R-65th, earned 39 percent of the votes, behind Democratic challenger Aurora Austriaco, who received 57 percent.

South seniors also voted on three ballot questions. They opposed a state constitutional convention by 54 percent to 44 percent; favored establishing a recall process for elected officials by 62 to 34 percent — a Cook County advi-

sory question — and favored staggered terms for Park Ridge aldermen by 50 percent to 38 percent.

Maine West students gave Obama and Biden 80 percent of their votes. They cast 74 percent of their ballots for Durbin in the U.S. Senate race; 67 percent for Jill Morganthaler in the 6th District U.S. House race against incumbent Republican Peter Roskam; 75 percent for Kotowski in the 33rd District state Senate

race; and 65 percent for Austriaco in the 65th District state House contest.

Asked to identify the issue most important to them, a plurality of 49 percent chose the economy.

Nearly all of Maine West's 2,364 students cast online ballots during 91 sections of social science classes. West's social science faculty and the school's student chapter of Mikva Challenge Youth in Action organized the election.

Vote

Continued from **PAGE 10**

Mock voting took place electronically at schools across the nation and the tallies were fed into the

YLI Web site. Obama also won on the national level with 60 percent of the YLI's 3 million votes, compared with McCain's 36 percent.

"We brought 91 classes down to vote in three different computer labs,"

said Maine West social-studies teacher Gwynne Ryan. "We did it because we wanted to get kids excited about voting."

Ryan said the school's social-science faculty and student chapter of the Mikva Challenge Youth in

Action group spent many hours preparing for the vote and organizing the event.

Maine West student Juan Salgado, 17, is a member of the Mikva Challenge Group, named after Abner Mikva, a re-

tired federal judge.

"Based on what my peers have been saying, I believe Obama will win," Salgado said before the election.

Salgado said he wished he could cast an actual vote in the presidential

election, but did not feel being too young to do so robbed him of his right to be politically active.

"I still have voice," he said. "And I can encourage other people to vote."

Comment: pioneerlocal.com

North Suburban Business and Community Development Foundation

CAREER TRANSITIONS FAIR

PREPARING YOURSELF IN A COMPETITIVE JOB ENVIRONMENT

Interface with professionals who can offer advice and resources to assist in your job search.

Tuesday, November 11, 2008
 Program Presentation: 9 a.m. - 11 a.m.
 Open Networking & Fair: 11 a.m. - 1 p.m.
 Skokie Public Library, 5215 Oakton, Skokie

RSVP by calling the Skokie Chamber of Commerce at 847-673-0240.
 Admission is free

Hosted by
Skokie Public Library **SKOKIE Chamber of Commerce**

Sponsored by
Northwestern Mutual FINANCIAL NETWORK **FIRST BANK & TRUST**
IMMIGRATION LAW ASSOCIATES, P.C. **PIONEER PRESS**
 A PREMIER MIDWEST IMMIGRATION LAW FIRM YOUR LOCAL SOURCE

Independent for 110 Years

Head spinning from bank changes? For 110 years Liberty Bank has been locally managed and family operated. We've never been sold or merged, and we're not changing our name. For the kind of independence and stability established by our founding fathers, come to Liberty Bank.

Liberty Bank
 Trust & Integrity Since 1898

For more information on Liberty Bank, visit www.libertybank.com

2392 N. Milwaukee Ave. Chicago, IL 60647 773.384.4000
 7111 W. Foster Ave. Chicago, IL 60656 773.792.2211
 6210 N. Milwaukee Ave. Chicago, IL 60646 773.763.4100
 6666 N. Lincoln Ave. Lincolnwood, IL 60472 847.674.1300
 1010 W. Touhy Ave. Park Ridge, IL 60068 847.823.2693

Love your pet

love Pioneer Press' Pets & Vets!

A monthly feature devoted to our animal companions.

Look to Pioneer Press Classified for all the products and services you need and want for your favorite family member.

PIONEER PRESS YOUR LOCAL SOURCE
Classified

MORTON GROVE CHAMBER OF COMMERCE AND INDUSTRY

"Thank You" to Mayor Richard Krier and the village of Morton Grove for the 2008 State of the Village Business Lunch

For more info, please call (847) 965-0330 or email Mark at director@mgeci.org
www.mgeci.org
 6101 Capulina • Morton Grove, IL 60053

RE/MAX 1ST CLASS Premier Real Estate Service 847-674-9797

RE/MAX Outstanding Agents Outstanding Results

The #1 Selling RE/MAX Office in Skokie Since 1986. Serving the Entire North Shore.

Thinking of SELLING Your Home? Call for a Free Market Analysis 847-674-9797

Each office Independently Owned & Operated

SKOKIE GATLINBALLS \$314K Custom quality renovation! Completely gutted brick ranch! Shuang li cleaning Oak fls in living/dining & 1st fl fr Br's. Refined bent w/4th bed or den, full bath & a massive lam rm. Master bed w/2nd bdr w/2 closets. 2 bedrooms, full microwave, 5 burner cooktop & double oven. Sp. entry area opens to family rm w/16 ft vaulted ceilings. Finished lower level rec rm w/putc.	SKOKIE 331 & WYESTONE \$314K Fabulous new 4000 sq ft contemporary in prime Desmette highlands. Upper level: 4 Br's w/parquet wood floors plus full play rm or den. Main level: large living, dining, kitchen, granite, stainless steel appliances, maple cabinets. New built-in w/pantry, island, new windows, concrete driveway & Paved All 1 car gar. newer mechanicals! Heat, C/A, 120 Hz, 200 amp electric, \$469,900	SKOKIE 9220 KOSTNER \$314K Beautiful completely remodeled jumbo bi-level in desirable dist 68! New gleaming hardwood fls in liv/din & family rms. Porcelain kit w/granite tops & maple cabinets. New built-in w/pantry, island, new windows, concrete driveway & Paved All 1 car gar. newer mechanicals! Heat, C/A, 120 Hz, 200 amp electric, \$469,900	CHICAGO GREAT SAUNASHI LOCATION awesome open floor plan in the 95% new stunning granite gourmet kit that opens to family rm, fabulous master suite w/parquet deck, Jacuzzi, skylight, 2nd fl laundry, hardwood fls, crown moldings, 2 bpc, lower level rec rm w/4th BR/office, study rm & bath, brick pavers, 1 car gar & walking to park. www.danflorian.com
Harris All 847-322-6277	Barry Benveniste 847-708-1149	Elena Dan 773-230-5985	Dan Florian 847-208-7944
EVANSTON Exceptional center entry colonial. Quality renovations include, new windows & doors, top of the line gourmet kitchen w/granite counters and stainless steel appliances. New stainless steel appliances. New & mirrored tiled fls on 1st level. Lovely deck and yard. New garage. Four bedrooms 2 full bath on 2nd level & 3rd floor 1 1/2 baths on 1st fl. Best values in Evanston. \$535,000 Elizabeth Lindsay 847-630-3796	LINCOLN PARK Diversey, Clark & Broadway. Well established food & liquor convenience. Business w/long-term business clientele. 1st fl. store in a 7 story central condo bldg. Heavy woodwork, 6' x 6" mahogany millwork. Family Health forces to sell. \$149,900 John Dlas 847-409-2382	SKOKIE Fabulous curb appeal. Wonderful cared for 4th fl out. Big lot (52.5 x 123). New roof, furnace, washer/dryer & hot water heater. Hardwood floors thru the home, spacious lam rm w/brick fireplace & wet bar that leads out to professionally landscaped yard w/mature trees. Newer mechanicals & exterior. Ivy Moy 847-913-3710	PARK RIDGE Just listed! The best deal in town! This large 4 bed/2.5 bath split level home w/interior finished 4th flrm is in immaculate condition. Hardwood flooring thru the home, stainless steel appliances, very good school district! Call for more info! Sam Trahas 847-921-8681

NORBERT POOLS
 Patio Furniture
 Pools • Spas
 And More...

Family Owned & Operated
 Since 1953
 South of Golf, North of Dempster
 9141 N. Milwaukee • Niles
 847-965-2222

WE CARRY:
 DARTS • DART BOARDS
 FOOTBALL • BAR STOOLS
 POKER TABLES • VIKING CUES
 AND MUCH, MUCH MORE!

FAMILY FUN STARTS @ NORBERT POOLS
8' SLATE POOL TABLES from \$999⁹⁹

FREE DELIVERY*
FREE INSTALLATION**
FREE PLAYING KIT

*WITHIN 25 MILES
 **SLATE TOP POOL TABLES ONLY

Most major credit cards accepted • Financing available to qualified customers
 www.norbertpoolandpatio.com • Mon.-Thurs. 10-8 • Fri. 10-5 • Sat. 10-5 • Sun. 11-5

Before, During and After the Storm, Al Air and Carrier are Names You Can Trust.

In addition to the most energy efficient home comfort system available, we also offer the Carrier Home Standby Generator. It delivers electricity whenever you need it. Call for details!
Carrier quality, Carrier savings.

Al Air Inc.
 Heating and Cooling
888-886-3491
 7703 W. Lawrence • Norridge, IL www.alairinc.com
 Visit us at www.carrier.com

Turn to the Experts

Century 21
 Agents of Change

MARINO REALTORS
 5800 Dempster - Morton Grove
 (847) 967-5500
 (OUTSIDE ILLINOIS CALL 1-800-253-0021)

CONDO LIVING AT ITS FINEST!
 Morton Grove...Super spacious 6 room Condo in sought after "Coventree" Location! Giant rooms. 20' Living rm + huge dining rm. 2 full baths and huge family room. 18' kitchen with separate breakfast area. In unit laundry room. Indoor heated garage parking space. Sliding glass doors from living room & kitchen to large 22' balcony. Superb quiet upper floor! Quality construction!\$220,000

3 BEDROOMS-3 BATHS-\$370'S!!
 Skokie...Great Price! Custom built Lannanstone sprawling corner ranch located in "Devonshire Manor." Large living rm/dining rm, eat-in kitchen. Lovely master br with master bath. Hardwood floors. 2 car attached gar w/wood entry. New neutral draperies. 1 year old flood control system. Close to school, Devonshire Park & pool. Professionally landscaped. Priced to Sell!\$370's

RARE "FOUNTAIN TERRACE" CONDO!
 Skokie...Price Stashed! Super Luxury 4 room Condo in mint condition! Quality appointed w/finest materials! Large living rm & dining rm. Master br w/walk in closet. Updated bath. Eat-in kitchen. Laundry on same level. Large storage. This condo reflects the truest pride of ownership & has been diligently maintained. Located near library, shops, trans & downtown Skokie.\$125,000

RARE "WOODLANDS" PENTHOUSE!
 Morton Grove...Impeccable 5 rm Condo in fabulous location near forest preserve. Metra, shopping & transportation! 2 br - 2 baths, split floor plan. Spacious living rm/dining rm opens to balcony w/great views! Gourmet eat-in kit w/granite & 42" cabinets. Huge master br with full master bath. Large 2nd br, in-unit laundry & 1 garage parking space w/storage.\$275,000

Village to use \$120K grant for energy-efficient lighting

By TONY BERTUCA
 tbertuca@pioneerlocal.com

The Niles Village Board met Oct. 23 and approved a request for proposals to provide sustainable-lighting services that will redesign the existing lighting at two fire houses to use less electricity.

The village recently received a \$120,000 grant from the Clean Energy Community Foundation, an independent foundation affiliated with ComEd, under the 2008 Public Safety Buildings Lighting Upgrade Grant Program, that will pay for the project.

The grant will fund new lighting at Fire Station 2, which located near the intersection Dempster Street and Cumberland Avenue, and Fire Station 3, located at 6611 Jarvis Ave.

A new LED-based lighting system, not yet widely adopted in Illinois,

will reduce overall electricity demand at both stations by 283.14 kilowatts.

The village will also use the grant to inform and educate the public about the benefits of energy-efficient lighting upgrades.

In other board business, the village adopted federal "red flag rules," which requires municipalities with utility services to prevent the misappropriation of consumer information by implementing written identity-theft policies by Nov. 1.

The board also allotted \$207,124 to buy a new ambulance for the Public Services Department to replace a 1996 model, and waived a \$2,500 demolition fee for St. Haralambos Greek Orthodox Church, which wants to demolish a house on its property so that it can build a new community center and expand its parking lot.

GO <http://www.pioneerlocal.com>
Sights and Sounds
 For enhanced coverage of people and places in your community, check out Pioneer Press' videos at www.pioneerlocal.com

Acting Mayor Robert Callero said it was the village's normal procedure to waive demolition fees for houses of worship.

It was also announced at the meeting that Niles recently passed its annual audit with flying colors, according to Wolf and Company LLP.

Comment: pioneerlocal.com

Maine East earns Blue Ribbon for health, physical education

By TONY BERTUCA
 tbertuca@pioneerlocal.com

Maine East High School recently received Blue Ribbon status from the Illinois Association of Health, Physical Education, Recreation and Dance.

The school also has the distinction of being one of only two high schools in Illinois to have achieved Blue Ribbon status in both physical education and health education, reported Dave Beery, a spokesman for Maine Township High School District 207.

Beery said Blue Ribbon evaluators took special note of Maine East's commitment to ensuring gen-

der equality; its inclusiveness, from special education to mainstream programs; its facility upgrades; its development of a Web site for course information; and its partnership with Advocate Lutheran General Hospital on eight separate initiatives, including the school-based Health Center.

Maine East Physical Education and Health Department Chair Scott Chovanec said winning the award was a testament to the commitment of his staff.

"Being recognized as a true leader in physical education and health doesn't happen without a strong commitment from the en-

tire department, along with the proper framework for support from district as well as school administration," he said. "District 207 enjoys a unique success in this area due, in large part, to an administrative hierarchy that fosters collaboration among schools and a willingness to challenge the status quo from every levels."

All three Maine Townships high schools are past Blue Ribbon winners. Schools that are awarded Blue Ribbons have the certification of excellence for three years before they must reapply.

Comment: pioneerlocal.com



First and Second grade students at St. Juliana School listen to Skokie officer Jeff Groberski and his K-9 partner Dino on Oct. 22.

Red ribbons help kids remember abstinence

From Oct. 20 to 24 students at St. Juliana School, Chicago, concentrated on learning about the dangers of drug abuse. The students joined

with an annual nationwide campaign, Red Ribbon Week. Red Ribbon Week was organized in 1986 by a grassroots organization of parents ded-

icated to protecting communities from the destruction caused by alcohol and drug abuse. The red ribbon was adopted as a symbol of the move-

ment in honor of Enrique Camarena, an agent with the U.S. Drug Enforcement Administration kid-

Ribbons, PAGE 14



As part of Red Ribbon Week, St. Juliana School students held a mini-parade around the school building.

Enjoy a little taste of Heaven.

2008 WINERY OF THE YEAR Wine & Spirits

Santa Rita

Save Up to \$6.00 by Mail on Any Santa Rita Wine

CONSUMER: PLEASE CHECK ONE BOX ONLY:
 TO RECEIVE \$6.00: 1 purchased three bottles of Santa Rita wine (750ml)
 TO RECEIVE \$3.50: 1 purchased two bottles of Santa Rita wine (750ml)
 TO RECEIVE \$1.50: 1 purchased one bottle of Santa Rita wine (750ml)

To receive your rebate check by mail, please fill out this official rebate form and mail it with the original cash register receipt(s) with the Santa Rita Wine purchase price circled and the actual Santa Rita wine neck label or back label UPC from the Santa Rita bottle for proof of purchase.
 Please mail to: C&S Retail Center - Santa Rita Wine Offer, P.O. Box 429008, Dallas, TX 75242-9008
 Offer expires 12/31/08. Campaign must be received by 1/31/09.
 PALM BAY INTERNATIONAL, INC. BOCA RATON, FL 33431
 Not valid in Illinois.

Niles
 CHAMBER OF COMMERCE AND INDUSTRY

The Niles Chamber of Commerce Reminds you to Shop Locally

Call the Chamber office for referrals on businesses in the area
(847) 268-8180
www.nileschamber.com
 Visit us at our new location
8060 Oakton Street
 (Inside the NorthSide Community Bank)

Save on heating costs
with a high efficiency system -
great savings available.
Call now.
847-967-2200
Free estimates on
new equipment



We're Family-owned and
Operated for 40 years.

**Skokie Valley
Air-Control**
Heating & Air Conditioning, Sales & Service

TOP
Reasons to
Advertise
in
Newspapers

REASON #1

FAR-REACHING
Newspapers reach the
majority of adults daily
and on Sundays.

PIONEER PRESS
CALL 847-486-7300

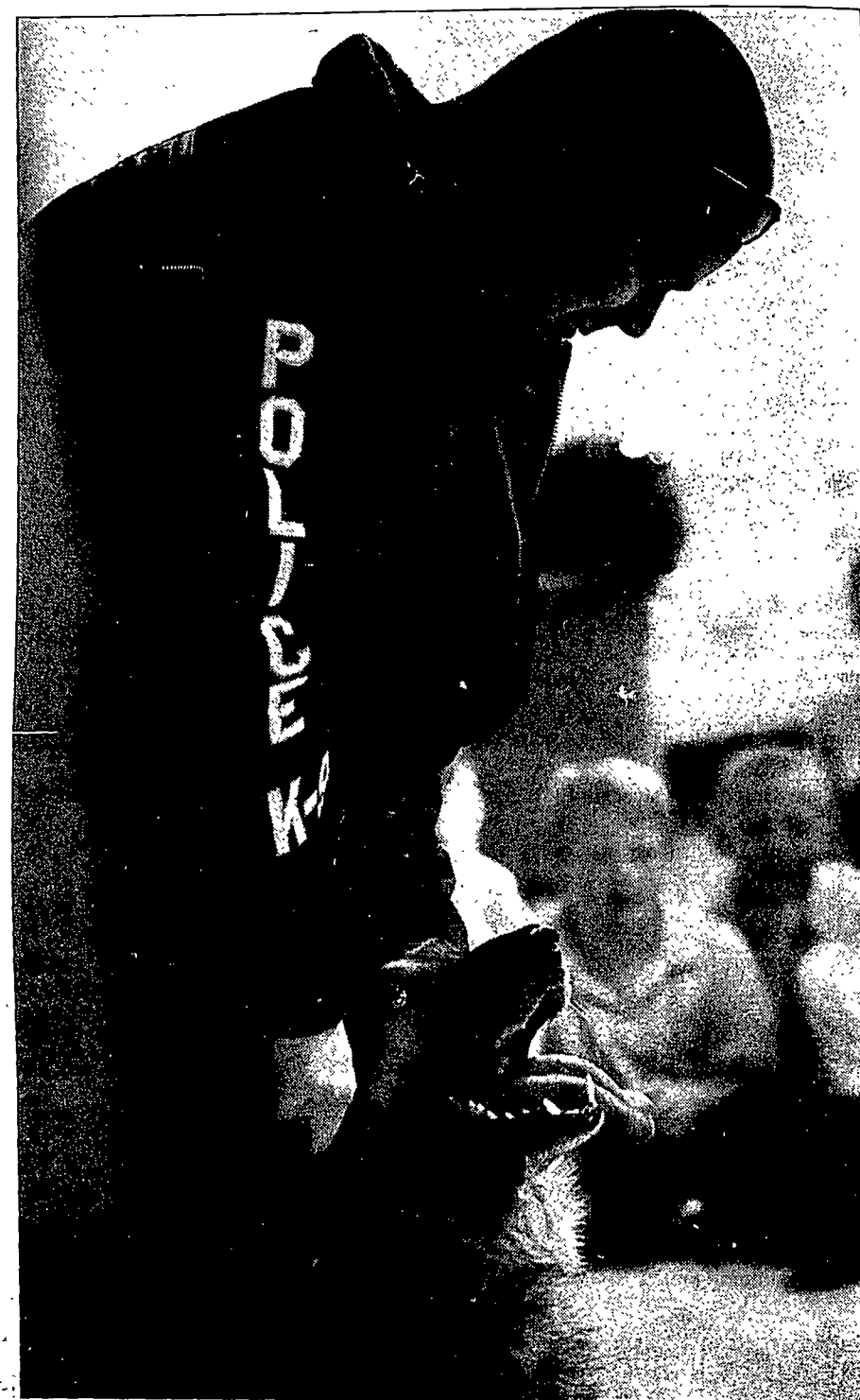

TAMARA BELL/STAFF PHOTOGRAPHER

Skokie officer Jeff Groberski and his K-9 partner, Dino, visited St. Juliana School, Chicago, on Oct. 22 to demonstrate Dino's talents in sniffing for drugs. The visit was part of Red Ribbon Week activities.

Ribbons
Continued from PAGE 13

napped and killed while investigating drug traffickers. The Red Ribbon Campaign has reached millions of U.S. children and has been recognized by U.S. Congress.

Local activities began on Oct. 20 with a visit from Illinois Secretary of State Jesse White who brought his Jesse White Tumblers to perform for the students in the Ahern Activity Center.

White spoke to the students, stressing the importance of working hard to reach their goals. He also reminded the children to "do something good for another person every day."

On Oct. 22, Officer Jeff Groberski from the Skokie Police Department and his partner Dino, the drug detecting dog, came to visit the students. Groberski showed the audience how Dino is able to find drugs that are hidden. The students asked Officer Groberski any questions about his work

in law enforcement.

Oct. 24 was marked by an all school parade. Each homeroom from kindergarten through grade 8 built a float on a wagon, with a message concerning making good choices about alcohol and drugs. Leading the parade was St. Juliana School principal Kathleen Barton and Assistant Principal Mary Werner.

Barton said, "Red Ribbon Week activities are a positive way to stress the importance of making good choices concerning alcohol and drugs!"

Stock up.



Open a 15-month **4.25%** APY* Stock Up CD from Cole Taylor Bank today.

Stay well fortified for the cold months ahead. Call or visit a Cole Taylor banking specialist to open a **Stock Up CD** and your money will earn 4.25% APY for the next 15 months. Can't wait that long? Try our 11-month 3.75% APY CD. Already a customer? You may be able to open your CD by phone. Call **847-653-7978** to learn more.



Chicago - Loop 20 S. Clark St. 312-960-5300	Chicago - North 1965 N. Milwaukee 312-738-7000	Chicago - South 1542 W. 47th St. 773-927-7000
Burbank 5501 W. 79th St. 708-424-9450	Lombard 3 Yorktown Center 630-629-3800	Rosemont 9550 W. Higgins Rd. 847-653-7978
Skokie 4400 W. Oakton St. 847-653-7978 4801 W. Golf Rd. 847-653-7978	Wheeling 350 E. Dundee Rd. 847-537-0020	

*Annual Percentage Yield (APY) is effective October 30, 2008 and is subject to change at any time. Minimum \$10,000 deposit to open and earn APY. Not applicable to IRAs. New money only. Substantial penalty for early withdrawal. Fees, if any, may reduce earnings. This is a limited time offer and subject to change at any time.

Member FDIC

COLDWELL BANKER
RESIDENTIAL BROKERAGE

Glenview • 1420 Waukegan Rd • 847-724-5800

ColdwellBankerOnline.com

Any house. Anytime. Anywhere.

 Morton Grove New custom 4 br, 4.5 ba home. Master ste w/jacuzzi, steam shower, stone fir. Huge granite kit, custom cabinets, ss appl. 1st flr fam rm w/plc, full fin bsmt w/full ba. Dina Svistunov 847-480-4050	 Morton Grove Delaine Farms 4 br, 2.5 ba 2-story. Hdwd fir, 10' volume cell on 1st flr, 9' tray cell on 2nd. Granite kit w/ss appl. Fam rm w/plc. 1st flr br. Marble master ba. Marla Schneider 847-724-5800	 Morton Grove Pvt 3 br, 2.5 ba end unit overlooks forest preserve. Large rooms & cathedral ceiling. Corian kit, brkfst bar, eating area. Laundry. Flpc w/marble. Master ste & huge loft. Sabine Russo 847-866-8200	 Morton Grove Beautiful 2 br, 2.5 ba unit w/upgrades. Fresh paint, cherry cab & hdwd fir in kit w/sliders to patio. Liv & din rm w/plc. Mstr w/volume cell. 2-car att garage. Den. Jozephene Aramanda 847-724-5800	 Morton Grove 5 br, 3 ba brick English bungalow. Main flr office/den. Huge liv rm w/stone flpc. Formal din rm. Updated eat-in kit. Hdwd fir. Fin bsmt. Newer roof, windows. 2-tier deck. Gary Hauch 847-384-7505
 Morton Grove Newer 3 br, 2.5 ba Trafalgar Sqre upgraded TH w/3 levels! Maple kit w/granite, ss appl, undermount sink. Vault mstr ste. Full-size laundry rm, 2-car att garage. Fam rm. Sue Oleksy/Cam Benson 773-467-5300	 Morton Grove 4 br, 2 ba Cape Cod. Great location. Hardwood under carpet. Eat-in kitchen. Landscaped backyard. 1-car garage with attached screened-in porch. John Gearhart/Violet Hakopian 773-467-5300	 Morton Grove Solid 2 br, 2 ba home. Dining rm. Hardwood floor thruout except for fam rm. Eat-in kitchen. Fam rm w/fireplace. Lg walk-out bsmt w/bar, office. 2-car garage. Workshop. Mari Berlog GRI ABR 847-724-5800	 Morton Grove Rehabbed 3 br, 2 ba brick home. 3-car garage! Large kit w/white cab & ss appl. Hdwd fir on 1st & 2nd levels. Updated ba. All br w/dbl closets. Next to school, playground. Jennifer Barcal 847-384-7503	 Morton Grove Large 4 br, 2 ba home. Newer 2nd-floor addition. Refinished hdwd fir. Professionally painted. Newer windows, a/c & furnace. Fenced-in yard. Beautiful tree-lined street. Lori Progar 847-990-3110
 Morton Grove Charming 2 br home. Wooded lot. Living room with vaulted ceiling and wood paneling. Great opportunity to rehab or rebuild. Manuela Papazisi 773-467-5300	 Morton Grove Beautiful 1 br unit. Den. Kitchen with 42-inch cabinets. Laundry room with washer/dryer & sink. Large balcony. Htd gar w/storage & car wash area. Exercise rm. Great loc. Al Michel 312-397-3061	 Morton Grove Beautiful 2 br, 2 ba renovated condo in park-like setting. New stunning kit with eating area. Lrg rms, patio overlooking grounds, huge mstr. Updated baths, 2 prkg spots. Mindy Shea 847-866-8200	 Morton Grove Delaine Farms 5BR, 3.1BA with gourmet kitchen, family room with surround sound & fireplace, master suite with his and her closets, finished basement and generous yard. Marla Schneider 847-724-5800	 Niles Beautifully updated 4 br, 3 ba brick English home. Side drive prkg. Fin bsmt w/br, liv rm, kit & ba. Hdwd fir, carpet. Newer oak kit cab, roof, a/c, furnace. Lrg deck & yd. Edward Khachi 773-935-4466
 Morton Grove 2 br, 2 ba condo w/new carpet thruout! Mstr br w/ba. Living rm walks out to brick paver balcony. Living on same flr. Low assessment. Great bldg. of guest parking. Gary Hauch 847-384-7505	 Morton Grove Wonderful 1 br spacious unit w/great closet space. Living rm w/bay window. Newer appl. Laundry & storage on same flr. Low assessment. Great bldg. Clean & neutral. Greg Fisher 847-433-5400	 Morton Grove Inviting 4BR, 2.1BA home w/in English bsmt. Open flr plan, sunny LR, oak kit, nice size BR's, Jacuzzi tub, newer baths, gleaming hdwd flrs, vaulted ceiling, skylites. Gina Jordanov 847-382-3600	 Morton Grove 4 bedroom, 2 bath home on quiet street near Palma Lane Park. Large 74x160 lot. Flexible floor plan with screened porch and full basement. 2-car detached garage. Barbara Komblatt 847-433-5400	 Morton Grove Spacious 2 br, 2 bath condo on 4th flr w/terrific views. Huge balc. Newer wndws, drs, ac, furn, kit Pergo flc, cab, countertops sink, updt'd hall bth. Walk to shops. Jackie Hughes 847-724-5800
 Morton Grove 606 Callie, Morton Grove The Woodlands 2BR, 2.1BA townhome with two story living room, gourmet kitchen with granite counters, master suite with balcony, and more. Enjoy this outstanding complex. \$409,900 Marla Schneider 847-724-5800	 Morton Grove Upgraded 2 br, 2.5 ba TH w/20 ft cell in liv rm. Sep din rm, eat-in granite & maple kit. Hdwd fir. Fin LL w/lrg fam rm & 3rd br/den. Impressive mstr ste w/pvt balcony. Christina DeGreco & Lynn DeGreco 312-915-4609	 Morton Grove Spacious 2 br, 2 ba condo. Balcony. Huge master w/bay windows, sep dressing area w/walk-in closet. Newer windows, doors, c/a, furnace, kit cab, counters. Updated hall ba. Jackie Hughes 847-724-5800	 Morton Grove Spacious & sunny 1 br unit. Freshly painted in soft neutral colors. Neutral crpt. Eat-in kit. 22-ft balcony w/great view. In-unit laundry. Underground htd gar. Great loc. Beth Durfy 847-753-6210	 Morton Grove Spacious 2 br, 2 ba home. Upstairs is in the process of being finished. Larry Bolton 708-424-4000

COLDWELL BANKER
HOME LOANS

Call today for your
Free Pre-Approval.*

1-312-635-3330

Financing provided by Coldwell Banker Mortgage, 3000 Leadenhall Road, Mt. Laurel, NJ 08054, Illinois Residential Mortgage Licensee. Some restrictions apply. Please contact us for details. *Subject to applicable secondary market credit and property approval guidelines.

Put **More** into your home
by getting **More** out of it



**Home Equity
Line of Credit**

It's easy with a U.S. Bank Home Equity Line of Credit.
No closing costs. No points. Fast decisions.

So go ahead, fix up the house, consolidate your debt, take a trip
you'll never forget. A rate this small means you can dream big.

Apply today at your local U.S. Bank, usbank.com,
or call 888-444-BANK (2265).

Niles Office
8500 W. Dempster St. 847-298-3300



usbank.com



Veterans are invited Nov. 10 to commemorative program

The community is invited to join veterans, residents, their friends and families for a special Veterans Day Commemorative Program, at 2:30 p.m. Nov. 10, at Norwood Crossing (formerly Norwood Park Home), 6016-20 N. Nina Ave. in Chicago. Parking is located off of Northcott Avenue.

Highlight of the afternoon will be a special performance of patriotic music by the five-member "Brass Ambassadors" from Naval Station Great Lakes.

Tom Mouhelis, executive director of the Midwest Shelter for Homeless Veterans, will discuss the role of his agency in assisting homeless veterans.

Mouhelis, a 30-year retired U.S. Air Force veteran, served initially as the enlisted ranks, achieving the rank of TSGT as a

loadmaster on C-130 USAF cargo planes. In 1977, he received a direct commission to second lieutenant, later serving as aerial port officer, services officer, wing mobility officer, and chief of plans and programs. He retired in 1997 from the reserves with the rank of major, having been called up for actions in Grenada, Panama and elsewhere.

Also on the program will be: Richard L. Corrin, Jr., Norwood Life Care Foundation board member; a presentation of the colors by American Legion Post 541; pledge of allegiance led by Gerald Skotzko, commander of Edison American Legion Post 541, and Lucille Janssens, a past commander of Norwood American Legion Post 740; an invocation by Chaplain Lt. Col. Paul Pfeffer (Senior Army Reserve Ret.); recognition of veterans present; and remarks by Commander Rhonda Harder, executive officer of the Navy Recruiting District of Chicago.

Members of eight American Legion and VFW posts in the immediate area also have been invited.

Veterans will be recognized individually during the program. All active and non-active military personnel who are planning to attend the event are asked to provide upon arrival their name, rank, military unit, service branch, armed conflict (if any), where served, and dates of service. Refreshments will be served.

Veterans planning to attend are asked to RSVP to Stan Banash, director of public relations, at (773) 577-5324.

Dist. 64 scores well on ISAT

By JENNIFER JOHNSON
jjohnson@pioneerlocal.com

Park Ridge-Niles School District 64 officials say their students continue to perform well on the Illinois Standards Achievement Test, which determines student progress in relation to the federal No Child Left Behind Act.

Results of the 2008 ISAT, taken by third-through eighth-graders in March, were shared with members of the Board of Education on Oct. 27. Results show that District 64 as a whole made annual yearly progress, as 92 percent of students met or exceeded state standards in reading and 94 percent met or exceeded standards in math, the two subjects NCLB looks at most closely. This year's NCLB benchmark required at

least 62.5 percent of students to make AYP in these subjects.

Collectively, students with disabilities met AYP with 66.4 percent meeting or exceeding standards in reading and 72.3 percent meeting or exceeding standards in math. However, the sub-group of students with disabilities at Field School scored below the AYP benchmark in reading, which resulted in that school as a whole not achieving AYP.

Field ISAT results show that 40.4 percent of students with disabilities met or exceeded standards in reading. Just over 55 percent met or exceeded standards in math, but a 14 percent flexibility provision allowed the school to meet AYP in math.

Diane Betts, assistant superintendent for District 64, said extra sup-

port is provided for students who are struggling, and a review of the district's reading curriculum is currently taking place.

School district officials across have long expressed concerns about NCLB requiring students with learning difficulties to meet the same standards as other students.

Board member John Heyde said the district needs to come up with a "strategy" for how to proceed if schools or sub-groups do not make AYP. He also said he would like to know "sooner than later" if there are grade levels or sub-groups in danger of falling below the ever-increasing AYP benchmarks.

"I think it would be helpful to have a school by school look as to where we might fall off the AYP wagon," Heyde said.

Open house to cover free transit service for disabled riders

Individuals currently living with disabilities soon will be eligible to ride trains and fixed route buses on Pace, Metra, and CTA for free. For Pace riders that means free rides on more than 220 fixed routes throughout the suburbs and Chicago.

Pace, ARC of Illinois and the Illinois Department on Aging is encouraging riders of ADA Paratransit to take advantage of a new law by hosting a series of open houses throughout the service area to promote the benefits and help riders become familiar with fixed route service.

The local information open house will be held from 4 to 7 p.m. Nov. 6 by Community Alternatives Unlimited at 8765 W. Higgins, Chicago, not far from the CTA Cumberland station.

"We are committed to helping our customers make a smooth transition to fixed route services so they can fully benefit from the reliability and flexibility of this service," says Richard Kwaseski, chairman of the board for Pace.

Pace staff will guide riders through the application process. All Pace buses are wheelchair accessible and are equipped with securement devices and priority seating for people with mobility disabilities. To improve access for persons with visual disabilities, stops are announced, and for persons with hearing disabilities, route instructions have large print and Braille signs are posted.

Ray Campbell is visually impaired and says Pace fixed route service is convenient and straightforward. "I like using fixed route service because it allows for

spontaneity. It's easy to use and it gives me more options," says Ray Campbell.

Fixed route service allows customers to live a more spontaneous life because, unlike ADA Paratransit service, there is no need to schedule rides a day in advance.

"While fixed route services may not meet the needs of some individuals with disabilities it is certainly a viable option for many," says Tony Paulauski, Executive Director, of The Arc of Illinois. "This is a major victory for our community and we look forward to assisting all of the people who can comfortably use the service into an improved lifestyle."

To qualify for the free rides, individuals must become certified in the Circuit Breaker with Disabilities Program which is administered by the Illinois Department of Aging (IDA). Eligibility requirements include earning an annual income not to exceed: \$22,218 for a household of one; \$29,480 for a household of two; \$36,740 for a household of three.

Once applicants have received the appropriate certification from IDA and have filled out a short application form from the Regional Transportation Authority, riders will receive a Circuit Permit in three to four weeks allowing them to ride Pace fixed route buses, Metra trains and CTA trains and fixed route buses for free. The free rides program is the result of legislation that was signed into law by Governor Blagojevich on Aug. 26.

More information is available at www.pace-bus.com.

Comment: pioneerlocal.com

LOYOLA ACADEMY
Forming the mind, heart, body and spirit.

Find out more at our **OPEN HOUSE!**
An orientation event for prospective students and their parents.
Thursday, November 20 6 to 9 p.m.
ENTRANCE EXAM: Saturday, January 10, 2009 8 a.m. to 12:30 p.m.
Pre-registration is not required for the Open House or the Entrance Exam.

Over \$2.75 million in financial aid is available.

Questions?
Call our Admissions Office at **847.920.2481** or look us up on the web at www.goramblers.org.

A JESUIT COLLEGE PREPARATORY SCHOOL • 1100 LARAMIE AVENUE • WILMETTE, IL 60091-1089 • 847.920.2481

the vein care center

Solutions Without Surgery®
Treatment of:

- Varicose Veins • Leg Swelling
- Spider Veins • Leg Discomfort

• Full spectrum of therapies available • 15 yrs experience
• Ultrasound guided laser therapy
• Board Certified University Affiliated staff
• Voted one of Americas "Top Doctors"
• We accept most major insurance plans including Medicare

JOBST Visit us at www.theveincarecenter.com

Non-Invasive Solutions for:

- Sun Damage • Age Spots
- Uneven Color Tone
- Rough/Dry Skin • Acne • Wrinkles
- Unwanted Hair

Now pleased to offer:
Complimentary Skin Care consultation by a medically trained licensed aesthetician.
Full line of skin care products tailored to fit your needs.

Convenient locations in Oak Park and Old Orchard
1-866-204-5100

Setting the pace in health care

Innovative Cancer Care

Dedicated oncologists use the latest diagnostics and precision treatments available, including:

- TomoTherapy®—precisely targets and destroys cancer cells using 3-D technology
- PET Scanner—a powerful cancer diagnostic tool that allows for early diagnosis and treatment

We also participate in clinical trials that offer patients access to new treatments not yet available to the general population. For more information, call the Clinical Research Department at 773-594-7821.

To find a doctor, call **877-RES-INFO (877-737-4636)** or visit us at rnc.reshealth.org

Resurrection Medical Center
Resurrection Health Care

Resurrection awards scholarships to students

The Resurrection High School community celebrated a liturgy, followed by scholarship awards, on Oct. 22. The school liturgy and awards ceremony was attended by scholarship donors and family members of the students receiving awards. A total of \$95,200 in scholarships were awarded:

The Dr. Chris Kelly Student Mentor Scholarship to senior Cory Grapenthien, in memory of Dr. Chris Kelly '59, a

former Resurrection High School mathematics teacher and board member.

The Mary and Jerry Fahey Scholarship to senior Loren Velasquez, on behalf of Mary Mathis Fahey '66, a strong advocate of single-gender education, and her husband, Jerry.

The Nicole Brunke Scholarship to seniors Amy Schultz and Theresa Sciaraffa, in



Resurrection High students cheer during the first pep rally of the year celebrating Spirit Week, Oct. 22.

TAMARA BELL/STAFF PHOTOGRAPHER



Resurrection High School sophomores pose for a picture during the Spirit Week pep rally.

TAMARA BELL/STAFF PHOTOGRAPHER

Spirit week inspires Resurrection High students

By WYNN KOEBEL FOSTER
wfooster@pioneerlocal.com

Spirit Week at Resurrection High School, in Chicago, was short. Students only had three days — Oct. 20, 21 and 22 — of classes. But the students managed to fill the week with a lot of school spirit. The three-day week

ended with a pep rally. "The pep rally was wildly peppy this year," said Kathleen Heneghan, Resurrection's grants and communications coordinator. "I think the students were excited about their four-day weekend."

Res's Orchestra dance team performed for the rally, which featured the

Resurrection/Notre Dame Band and the Bandit, Resurrection's raccoon mascot. Each fall sports team was recognized: volleyball, swimming, cross country, tennis and golf.

The evening of Oct. 20 of Spirit Week was devoted to Vocal Music Family Night; Oct. 21 was Chamber Family Night.

On Oct. 22, the day began with a Liturgy of the Spirit and a scholarship awards ceremony. "A total of \$95,200 in scholarships were awarded," Heneghan said.

Also on Oct. 22, there was an hour-long home-room between the liturgy/scholarship awards ceremony and the pep

rally. Students used the time for a scavenger hunt and pep rally poster making contest.

Spirit Week was also Red Ribbon Week at Resurrection. Members of SADD — Students Against Drunk Driving — distributed red sunglasses and wrist bands to represent living alcohol and

drug free. They also tied red ribbons around trees outside of the school building, at 7500 W. Talcott Ave., in Chicago. And each morning, during prayer and announcements, there was a special prayer that included a petition that each student live free of drugs and alcohol.

Awards

Continued from PAGE 18

memory of Nicole Brunke '89, who dedicated her short life to caring for others.

The Sr. Gregory Resurrection Medical Center Staff Scholarship to freshman Angelina Russo, funded by the medical staff at Resurrection Medical Center.

The Mark Teach Scholarship to senior Jenna Princivalli, in honor of the deceased infant son of Gordon and Mary Teach, awarded to a student who works or volunteers at Resurrection Medical Center and plans a future in health care.

The Florence and Johanna Scholarship to junior Angela Betancourt, sophomore Angela Christides and senior Hadeal Salamah, based on their strong academic standing and the ability to define their future goals.

The Susan Fyda Scholarship to senior Kathryn Karlin, in memory of Susan Fyda '66.

The Blessed Celine and Mother Hedwig Scholarship to sophomore Erin Kay Foley and juniors Alexandra Murray and Catherine Nelson, for leadership roles in the school, parish and/or community.

The Mary Guerrieri-Bertolini Scholarship to seniors Nicole Marie Foley and Erin Warren, in celebration of the life of Mary Guerrieri Bertolini '78.

The Sr. Monica Hope Scholarship to students who articulate a strong belief in single-gender Catholic education: seniors Kathryn Karlin, Gabriella Landin, Colleen McAleer and Loren Velasquez; juniors Jacqueline Barajas, Mary McAleer, Colleen Mikrut, Alexandra Murray, Catherine Nelson, Megan Peters, Stacey England, Cecélie Garcia, Patricia

Garcia, Yari Martinez, Lauren McNeela, Alison Miller, Vivian Moreno, Melissa Pennino, Carolyn Schoenbeck and Faith Stachulski.

The Jessica Martin Scholarship to senior Colleen McAleer, dedicated to the memory of Jessica Martin '01.

The Christine Olender Scholarship was awarded to junior Anita Traczyk and sophomores Mary Rose Moss in memory of Christine Olender '80.

The Knudsen Family Band Scholarship to Madelyn Grish, an incoming freshman who shows ability and interest in participating in the Resurrection/Notre Dame High School Band.

The Matys Rakoczy Scholarship to junior Bianca D'Amico and sophomore Paloma Luviano, who believe attending Resurrection is making a vital difference in their lives and their futures.

The newly established Pay It Forward Scholarship to freshmen Lauren McNeela and Caroline Piszkiwicz. Established by Nancy Slack Stachnik '67 and her family to fund two scholarships annually — one to the daughter of an active duty Chicago firefighter and the other to the daughter of an active duty Chicago police officer.

The Sophie and Edward Grabarczyk Scholarship to freshman Faith Stachulski. Funded by Maria Sniękowski Grabarczyk '77 and her husband, Gary, for a student who expresses her faith by putting other people's needs above her own.

The John and Adeline Sniękowski Scholarship was awarded to freshman Carolyn Schoenbeck, in honor of the parents of Maria Sniękowski Grabarczyk '77 and Sr. Mary Barbara Sniękowski '65.

The Sr. Stephanie Corporate Board Schol-

arship to freshman Melissa Pennino. Funded by personal donations from Resurrection's Corporate Board in honor of Sr. Stephanie Blaszczyński C.R. — who served as both principal and president of the school — it is awarded to a freshman who exhibits leadership through her parish, school, scouts or other volunteer activities.

The Fanchon and Jerry Fishman Scholarship to senior Hadeal Salamah, in honor of the in-laws of Dr. Marie Cleary Fishman '79.

The Burchard Scholarship to junior Alexandra Murray, in honor of Grace and Ellen Burchard and funded by Patricia DiBenedetto '43.

The Ramon and Alaida Estrada Scholarship was awarded to junior Natalia Filipek, awarded to a student from an immigrant family who shows an interest in the arts, biology or math.

The Elaine Zold Koepke Fine Arts Scholarship to freshman Alyssa Carrillo and two runners up, sophomore Kaitlyn Barone and freshman Angelina Russo, who each received a \$100 saving bond.

The Weber High Alumni Scholarship to sophomore Staci Smolicek, senior Cory Grapenthien, junior Alexandra Murray and senior Valerie Weber, students who have a father, uncle, grandfather or brother who is a Weber alumni.

The Charlotte Lennon Memorial Scholarship to sophomore Jenna Rice in honor of Charlotte Lennon '78.

The Marie Costello Scholarship to sophomore Makenzie Donnelly in honor of Marie Costello.

The Carrie Hall Jaworski Leadership Scholarship, established by Dr. Carrie Hall Jaworski '88, to junior Ashley Maiden.

TOP 5
Reasons to Advertise
Newspapers

REASON #8
TIMELY
With short deadlines, newspaper advertising can be tailored for immediacy

PIONEER PRESS
CALL 847-486-7300

Srbo Radisavljevic, CFP®
Formerly of Fidelity Investments Private Access
announces the opening of

Strategic Edge Wealth Management LLC

a registered investment advisory firm, specializing in wealth management strategies for high net worth individuals and their families.

Strategic Edge Wealth Management LLC
1500 Skokie Blvd. Suite 312
Northbrook, IL 60062
847-849-5550
srbo@StrategicEdgeWealth.com
StrategicEdgeWealth.com

SEPTEMBER 25-
DECEMBER 20

dream HOME
THE DESIGN HOUSE AT THE MERCHANDISE MART

BEDROOM ANNE COYLE

FASHION AT HOME
THE MERCHANDISE MART ♦ FIRST FLOOR
merchandisemartdesigncenter.com/dreamhome

SPONSORED BY **EDECOR** LOCAL MEDIA SPONSOR **PIONEER PRESS** \$5 SUGGESTED DONATION BENEFITTING: **THE UNIVERSITY OF CHICAGO** The Merchandise Mart Design Center

POLICE BLOTTER

The following incidents were listed among the official reports of the Niles Police Department. An arrest does not constitute a finding of guilt. Only a court of law can make that determination.

DUI

- Daniel Antone, 20, of 8433 Westmoreland Road, Vernon Hills, was charged with driving under the influence of alcohol Nov. 2 on the 8400 block of Crain Street. He was released on \$1,000 bond and is due in court Nov. 25.
- Mark Mallett, 25, of 7762 W. Higgins Ave., Chicago, was charged with driving under the influence of alcohol Nov. 2 on the 7100 block of West Oakton Street. He was released on \$3,000 bond and is due in court Nov. 20.
- John Bracken, 41, of 3531 N. Newcastle Ave., Chicago, was charged with driving under the

- influence of alcohol Oct. 31 on the 8800 block of North Harlem Avenue. He was released on \$1,000 bond and is due in court Nov. 25.
- Leonard Morgan, 26, of 4714 N. Keystone Ave., Chicago, was charged with driving under the influence of alcohol Oct. 31 on the 7600 block of North Harlem Avenue. He was released on \$1,000 bond and is due in court Dec. 28.
- Peter Valaitis, 28, of 6917 N. Tonty Ave., Chicago, was charged with driving under the influence of alcohol Oct. 28 on the 6700 block of West Touhy Avenue. He was released on \$1,000 bond and is due in

court Dec. 4.

- Lukasz Cudzich, 26, of 3857 N. Oriole Ave., Chicago, was charged with driving under the influence of drugs Oct. 27 near the corner of Milwaukee Avenue and Ballard Road. He was released on \$3,000 bond and is due in court Dec. 18.

THEFT

- Robert Dozie, 17, of 9107 W. Terrace Place, Des Plaines, was charged with retail theft Oct. 31 after he allegedly stole \$171 worth of merchandise from a store on the 500 block of Golf Mill Center. He was released on \$1,000 bond and is due in court Dec. 4.

Opinion

WE SAY

Thank veterans for their contributions

If you're old enough, you may remember the day an announcement came that war was over.

A few still living remember the announcement of the Armistice on Nov. 11, 1918, when Germany signed an agreement to stop the war it was waging with Britain, France, the United States and their other allied forces. It took effect at 11 a.m. — the 11th hour of the 11th day of the 11th month — and was considered at the time to have ended the War to End All Wars. That hope was fleeting.

Armistice Day would be converted later into the more lasting Veterans Day. World War I's veterans — now only a handful left — were followed by those from World War II, Korea, Vietnam, Grenada, Desert Storm, Iraq and Afghanistan. And as each new generation adds their military service to their country, there continues to be a need to recognize not only the service but the patriotic spirit and dedication which backed up the time in uniform.

Recognition does not always come swiftly. The long Vietnam conflict took years to be classified as a war. It split the country politically, spawned protests at home, and left many returning veterans questioning the mixed reactions they received.

Healing came later, with the construction of the Vietnam Memorial in Washington, D.C., and its touring replicas which brought images to cities and small towns around the country. At every stop, friends and family leave remembrances — notes or flowers or memorabilia they wish they could show their loved ones. A museum is now being constructed to house all those treasures to the men and women whose lives were cut short, who never had a chance to become veterans.

The men and women serving in World War II had to wait even longer for their own national memorial. It is only five years since the National World War II memorial was dedicated — honoring 16 million who served and more than 400,000 who died in the war, along with those supporting the war effort at home. These days, veterans of World War II, once the bulwark of local veterans' associations, are dying too.

On Nov. 11, in many communities, veterans will be gathering — at local monuments or memorial walls or community flagpoles — usually at 10:30 a.m. so they will all be gathered for that 11th hour on the 11th day ... in solemn remembrance. They remember their comrades — the ones who came home and the ones who could not — and the long, hard hours and days and weeks of battle and the things they gave up or set aside to fight for freedom.

If you can, join the local vets at their ceremonies, ask about their service and recognize their efforts to keep our country free.

1000 WORDS



YOU SAY

Get out glue to mend moral cracks

Today's simultaneous explosion of financial, political and military crises is straight out the ancient myth of Pandora's Box. All the world's troubles unleashed all at one dangerous time! Only, in our panic, we may fail to recognize the greatest of these troubles.

Our disasters are not only a matter of failed markets, presidential rivalries, and over-extended armies. A closer and scarier look reveals it is the moral collapse inherent in each of these traumas. Even in an amoral age like ours, it's no longer possible to ignore this terrible moral truth.

We can't possibly understand the economic collapse without coming to grips with the enormous moral crime of Greed. Nor can we fathom the debilitating divisiveness of our political system without confronting the perfidious crime of Pride. Nor will we grasp why we find our armies virtually alone in the world without first facing our crime of Avarice.

Attacking symptoms is one thing, but without curing the disease, Pandora's troubles continue to fly free. And both history and religion have taught us this disease is the same ugly one that has plagued our species from the beginning.

A broken human nature that, in the final measure, only heaven can help ...!

**Jack Spatafora
Park Ridge**

No more political ads!



CHERYL O'DONOVAN
VAN MOM STRIKES AGAIN

my skin green, dull my teeth, use the awful 1998 photo of me post-pregnancy with three chins. Some conspiratorial female voice would accuse me of bad house-keeping, laundry fraud and yacketeering — talking when I should be working.

At the end of the hatchet job, I'd be waving my arms: "This is Van Mom and no way did I ever approve this message."

Over the past month, I've dodged leaflets, pundits, door-to-door campaigners and Joe the Plumber asking me what my position was on capital gains. I told him to never say the word "gain" to a woman, especially if she's retaining water.

I overdosed on U.S. maps and endless speculation on whether a state would turn blue or red. Still politically hung over this morning, I did an exit poll of what the kids thought of breakfast.

The political landscape is frittered with rancor and classic lines. "You're no Jack Kennedy." "It's the economy, stupid." "The American people have to know their president isn't a crook." Well, we've progressed way beyond that. Americans now believe everyone is a crook.

Politics, like pop culture, seeps into our consciousness, becoming unwelcome guests who use all the towels in our brain motel. I don't even watch "Dancing with the Stars" but I know the one dancer gained 5 pounds. Madonna's divorcing. Exxon just posted its highest earnings ever. And why on earth do I remember that ShamWow's guy name is Vince, when I can barely recall our street address?

Negative campaigning may be torture, but wait. Something equally oppressive is coming around the bend.

Holiday advertising

This week, we elected a new president.

At last, I can erase my voicemail greeting.

"Hello, negative political recordings. This is Van Mom. I've relocated to New Zealand until the election is over. Don't leave a message."

The negativity was impossible to avoid: Mud-slinging via direct mail, television, radio and even from the Planet Krypton.

All the ranting and accusations really got to me, but finally, my husband left for the office and the house was peaceful again.

Imagine if they did TV smear campaigns on moms. They'd Photoshop

444

Choose Your Term!

13 Months | 25 Months

Republic Bank

DO YOU NEED SERVICE ON YOUR BUICK, PONTIAC, GMC, CADILLAC or CHEVROLET??

BREDEMANN CHEV CAN HELP!

Our Team of GM Certified Service and Parts Professionals invites you to maintain your Buick, Pontiac, GMC, Cadillac or Chevrolet at Bredemann Chevrolet.

We deliver quality service at competitive prices in a clean, convenient and well-equipped GM facility. We accept most extended warranties, and are pleased to offer our customers local courtesy transportation.

We have taken care of GM customers for the past 96 years, and look forward to the opportunity to earn your business.

Sincerely,
Joe Bredemann Sr.

Mike Dellas Service Manager | Service & Parts Hotline 847.655.1555 | Mike Marken Parts Manager

BREDEMANN CHEVROLET

LOCATED AT DEMPSTER & GREENWOOD
NEXT TO LUTHERAN GENERAL HOSPITAL

1401 W. DEMPSTER ST. • PARK RIDGE, IL

Schools

Schools urge smart choices during Red Ribbon Week

Every October, Park Ridge-Niles School District 64 encourages students to make smart decisions regarding drug and alcohol use by recognizing Red Ribbon Week, an annual drug prevention campaign.

As they do every year, students at each school in the district tied red ribbons around trees on their campuses to promote drug-free lifestyles.

At **Emerson Middle School**, Lt. Jeff Flyke of the Cook County Sheriff's Department spoke to eighth-grade P.E. classes about his undercover work apprehending drug traffickers and the dangers of drugs and alcohol that many teens may use in order to be just part of the crowd.

"For the sake of being cool, you're putting your life at risk and your future at risk," Flyke told the students. He then showed a video of a drug dealer being arrested following a nine-month operation where Flyke posed as a buyer.

Flyke, who is a supervisor for the Sheriff's Department's gang and drug intelligence units, also works to combat gang and drug activity in unincorporated Maine Township just north of Park Ridge.

At **Franklin School**, 5th-graders continued a Red Ribbon Week tradition by writing personal goals and dreams for themselves on a large banner and pledging to remain drug free. The banner, which has been signed for several years by fifth-grade classes, was

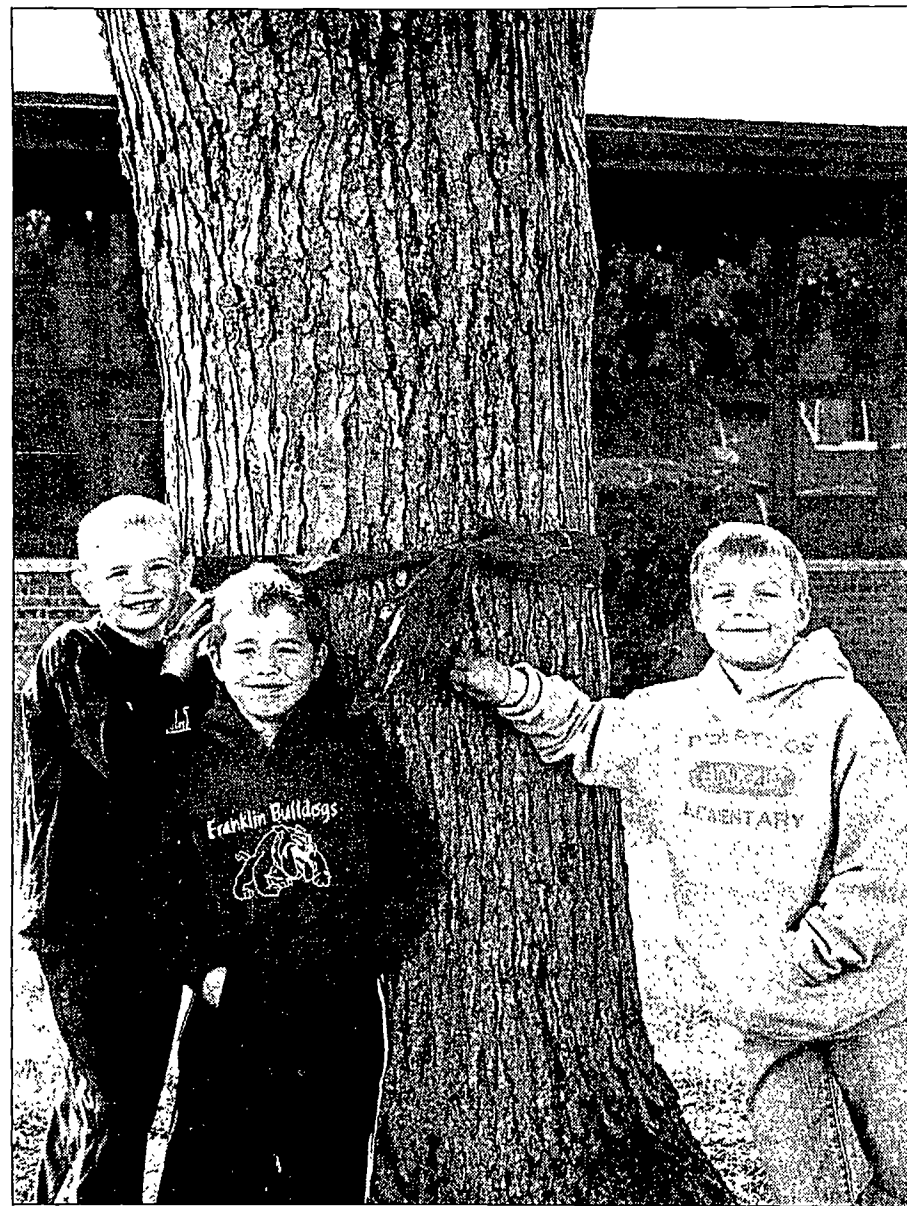

To get the message across for Red Ribbon Week - a national campaign against drug and alcohol use - red ribbons are tied outside as a reminder. T.J. Fleita, Dylan Harris and Ryan Malin of Franklin School in Park Ridge stand next to one of several trees on the school grounds decorated to recognize Red Ribbon Week in Park Ridge-Niles School District 64.

hung in the school's auditorium.

At **Lincoln Middle School**, the Lincoln Student Government Association (SGA) decided to call attention to Red Ribbon Week with "spirit" days from Oct. 27-31. On Monday, students dressed in red, Tuesday was "crazy hair day," on Wednesday students dressed in the school colors of blue and

gold, Thursday was "clash day," and Friday, in honor of Halloween, will be orange and black day. SGA students also made short announcements each day to remind their classmates about why Red Ribbon Week is recognized each year.

At **Franklin School**, an officer from the Park Ridge Police Department spoke to students about

making positive choices during an assembly on drug awareness. The Student Council planned activities for each day and the Parent-Teacher Organization hosted a poster contest. Winners of the contest received gift certificates to Burke's Books in Park Ridge to encourage reading as one positive alternative to using drugs.

www.pioneerlocal.com

SCHOOLS DIGEST

Maine East

Maine East High School students will present their annual V-Show, "Demon Night Live." More than 200 Maine East students will participate - in cast, crew or pit - in this year's V-Show, to be presented in the school auditorium, Dempster Street and Potter Road, Park Ridge, at 4 p.m. today (Nov. 6) and at 7:30 p.m. Nov. 7 and Nov. 8.

Entertainers include the Maine East Rhythm Project, the Nerd & Geek Squad, the Demonaires, the Varsity Demon squad, the Orchestra, the Jazz Band, co-ed cheerleaders and even the East football team. Acts also include solos, couples and ensembles from sophomore, junior and senior classes.

Directing the show is East Director of Choral Activities **Patrick Barnett**. Making it all possible behind the scenes, along with Barnett, are **Sarah A. Djordjevic**, assistant director; **Debra B. Spiegel**, cho-

reographer; **Jessica N. Bruzcek**, technical direction; Maine East Fine Arts Department Chair **Edward J. Eubank**, musical direction; **Natalie M. Bourn**, student council sponsor; **Tony N. Montesano**, assistant student council sponsor; and **Gregory W. Ruehs** and **Magdelene A. Gorecki**, assistant technical direction.

Maine South

Five Maine South students are among the recently announced National Merit semi-finalists, while 17 students have been named commended students by the National Merit Scholarship Corp.

The semi-finalists are **Elizabeth K. Clarke**, **Kyle J. Hannon**, **Shui-Sum Lau**, **Brian Wagner** and **Laura K. Walsh**.

They are among approximately 16,000 high school students nationwide who are eligible, based on high test scores, to be named National Merit finalists in

Digest PAGE 23

CAMPUS

Dean's list

Kristiyana Kaneva, **Michael McNally** and **Jenny Poliwnka**, of Niles, were named to the spring dean's list at Illinois Wesleyan University.

Mathew Shimanovsky, of Niles, was included on the dean's list for the spring term at Cornell College.

Young-Shik Chang, of Niles, received a bachelor's degree in mathematics from the University of Iowa.

Named to the spring dean's list at the University of Iowa were Niles students **Daniel S. Barone**, **Paul A. Kazmierczak** and **Micahel P. Palermo**.

Included on the spring dean's list at Marquette University were Niles students **Lisa Heiderman**, **Colleen Kearns**, **Christopher Langlo** and **Antonino Mule**.

Graduating from Western Illinois University were: Niles students **Robert P. Dulski**, with a bachelor's degree in law enforcement and justice administration; and **Patrick J. McDonagh**, who earned a degree in finance.

Michael W. Dulski, of Niles, received a master's degree in social welfare from the University of Wisconsin-Milwaukee.

Sarah A. Sherry, of Niles, earned a degree in

Campus, PAGE 68

Digital

Continued from PAGE 22

February 2009. About half of all finalists are awarded scholarships based on school officials' written recommendations and evidence of each student's leadership and school activities in addition to test scores.

Commended students are those who place among the top 5 percent of the more than 1.5 million students who entered this year's competition by taking the 2007 preliminary SAT/National Merit Scholarship Qualifying Test.

Maine South's commended students are **Leah Artwick**, **Megan Auld**, **Leah Barsanti**, **Thomas Berg**, **Lisa Daul**, **Matthew Frank**, **Robert Juckett**, **Erin Klein**, **Patrick Klimmeck**, **Dora Koppa**, **Cassi Lee**, **Megan Maher**, **Nicole Moersch**, **Alyssa O'Neil**, **Gregory Piekos**, **Robert Porter** and **Timothy Warnock**.

Oakton

The College Bowl team at Oakton Community College has captured the Illinois Skyway Collegiate Conference championship for the seventh time in nine years.

Led by **Cheryl Valloni**, of Des Plaines, the Oakton team won six of seven matches Oct. 17 at Elgin Community College. Team members also included **Pourya (Peter) Assem**, of Northbrook, **Pinal Chokshi**, of Des Plaines, and **Derek Newhouse**, of Skokie, the tourney's highest scorer. Newhouse and Chokshi also were named to the All-Region Team.

Also competing were College of Lake County, Elgin Community College, McHenry County College, Morton College, Moraine Valley Community College, Prairie State College and Waubesa Community College.

Oakton is slated to host

Digital, PAGE 68

OPEN HOUSE DATES:
NOVEMBER 6, 2008
 5:30 - 8:30 PM
NOVEMBER 16, 2008
 11 AM - 2 PM
 PLACEMENT EXAM DATE:
JANUARY 10, 2009
 AT 8 AM

NOTRE DAME HIGH SCHOOL
College Prep for Young Men

7655 WEST DEMPSTER, NILES IL, 60714
 PHONE: 847.779.8615 • WWW.NDHS.DONS.ORG



5-YEAR CD **1-YEAR CD**
5.21%* APY **Call for today's rate!**

Call to schedule an appt. today!
 Monday-Friday 9AM - 5PM

Glenview (847) 729-0400
Deerfield (847) 597-7006
Rolling Meadows (847) 981-6980
N. Barrington (847) 380-3555
Oak Brook (630) 684-2206
Naperville (630) 799-8250

"Ask about high yielding annuities offering 5% & 10% bonuses for your IRA/Rollovers"

AMERIFIRST DIRECT
 FL • GA • IL • IN • KY • MN • NC • SC • TN
 AMERIFIRSTDIRECT.COM

*Annual Percentage Yield (APY): \$20,000 minimum deposit. Yield and deposit amount subject to availability, subject to change without notice. Penalty for early withdrawal. Deposits exceeding \$50,000 may be eligible for yield other than advertised. FDIC-insured to \$250,000 per institution. Promotional incentive may be included to obtain yield. **Annuities are products of the insurance industry and are not guaranteed by any bank, federal agency or insured by the FDIC. Annuities contain limitations including withdrawal charges and fees which may affect contract values.

WOODLANDS ACADEMY
 OF THE SACRED HEART

OPEN HOUSE
 NOVEMBER 18, 2008 AT 7:00PM

At Woodlands Academy of the Sacred Heart, we believe education is a transformative process. We've designed a rigorous academic program that allows you to realize your passions while giving you the tools you need to achieve excellence. Discover boundless opportunities that entice you to uncover new interests, talents, and passions, and to grow into the person you want to become!

Woodlands Academy of the Sacred Heart, a leader in the education of young women since 1858, is an independent, Catholic, day and boarding, college preparatory school for young women, grades 9-12, who wish to pursue a course of study committed to academic excellence within the context of a faith-based community. Woodlands Academy is member of the Network of Sacred Heart Schools.

760 EAST WESTLEIGH ROAD, LAKE FOREST IL 60045
 CALL 847.234.4300 OR VISIT WOODLANDSACADEMY.ORG

MANAGING EDITOR: Michael Bonesteel
mbonesteel@pioneerlocal.com | (847) 486-6854

Diversions

Beth 'n' Bella, to the rescue!

By JACK BESS
Contributor



**PIONEER PLUS
CLICK LIST**

Go to www.pioneerlocal.com/entertainment.



John Hodgman

» BOOKS »

A report on a book signing in Oak Brook with comedian, author and PC Guy John Hodgman.

» STAGE »

Preview of "Someone to Watch over Me" at Piven Theatre.

» MUSIC »

Dorothy Andries reviews a "Fairy Tales and Legends" concert by Northbrook Symphony.

» BLOGS »

In Entertaining Ideas, Jennifer Thomas writes about "CSI" star William Petersen's return to the Chicago stage. Bruce Ingram talks with graphic novelist Charles Burns about the animated fright fest "Fears of the Dark" in Reel Time.

» DVDS »

"Hellboy II" saves the world and climbs to the top of our DVD column.

» FAMILY »

For a timely list of family-friendly activities, check out Family Fun in Chicago Suburbs.

» HOROSCOPE »

Check online for this week's forecast.

BRUCE'S TAKE

"There are a few inspired little touches in 'Role Models' that could make it worth a look if you're in a forgiving mood."
SEE MOVIE REVIEW PAGE B5

They were voted off CBS-TV's "Greatest American Dog," but Morton Grove native Beth Joy Knutsen and Bella Starlet Dog refuse to stay in the doghouse and whine.

Since leaving the reality show in August, Knutsen



and-human jewelry, a new clothing line, and a new foundation to help raise money for rescue agencies.

Knutsen's resilience was forged in Morton Grove and Niles West High School, where she was mocked by the local counterparts of "Mean Girls." Even worse, at age 4, she

"We have an appeal to people who are passionate about their dogs and about life."

was "almost mauled to death" by a neighbor's German shepherd.

"The dog came charging around the corner and knocked me down," she said. "My face was on the ground and the dog was about to go for my neck. The only reason I'm alive today is my neighbor was outside and somehow got the dog away."

She was "absolutely terrified" by dogs until one day, at age 13, she fell in love with a Yorkie named Ernie at a Skokie pet store. Today, Knutsen enjoys helping children overcome their fear of dogs, believing that kids who don't understand animals may someday become animal abusers.

"I like to make sure everyone's treated fairly," she said.

Comment:
pioneerlocal.com

JUMP START HOLIDAY SHOPPING...

Save 15% off any purchase under \$75.00

Save 20% off any purchase over \$75.00



28 Main Street
Park Ridge, IL
847.698.3808

www.shop2sisters.com

offer good thru 11.27.08 Must present this ad at time of purchase



Knutsen sports a tattoo of Bella Starlet on her left leg.

"Totally Paw-some": Morton Grove native Beth Joy Knutsen and Bella Starlet Dog have been on television and in videos, and parades.

"We have an appeal to people who are passionate about their dogs and about life," said Knutsen, who sports a tattoo of Bella Starlet on her left leg. "I get e-mails from a woman with lupus and a woman with cancer, say-

ing they are in so much pain, but watching us on TV makes them smile."

Rescue dog advocate

Knutsen tirelessly advocates for rescue dogs, warning that more pets

are being abandoned as economic times get tougher. Scarcely less busy is Bella Starlet, a blonde mixed breed with strawberry and silver highlights. A rescue dog herself, Bella Starlet has a forthcoming line of dog-

Switch to the network with the best coverage.

More bars in more places.

BUY ONE FOR \$49.99
GET ONE FREE



\$79.99



FREE SHIPPING | 1.866.MOBILITY - ATT.COM/WIRELESS - VISIT A STORE

ILLINOIS

- Arlington Heights 1482 S. Randall Rd.
- Aurora 1023 W. Dundee Rd.
- Aurora 1190 N. Ardmore Ave.
- Aurora 4412 E. New York St.
- Bolingbrook 524 S. East St.
- Bolingbrook 720 E. Boughton Rd., Ste. 109
- Calumet City River Oaks Mall, 56 River Oaks Dr.
- Chicago 1101 S. Canal Street
- Chicago 8123 N. Sedgewick St.
- Chicago 1168 N. State St.
- Chicago 1730 W. Fullerton Ave.
- Chicago 235 W. Monroe St.
- Chicago 3735 W. 26th St.
- Chicago 574 W. Elmhurst Pl.
- Chicago 57 E. Chicago Ave.
- Chicago 7601 S. Cicero Ave.
- Chicago 5658 S. Cottage Grove Ave.
- Chicago 9327 S. Western Ave.
- Chicago 4754 W. Cal Sag Rd.
- Chicago 4912 Northwood Hwy., Ste. A
- Chicago 2415 75th St., Unit B
- Chicago 21690 W. Long Grove Rd., Ste. A
- Chicago 619 N. York Rd.
- Chicago 1620 Chicago Ave.

- Cicero 1749 S. Randall Rd., Ste. G
- Cicero 6170 W. Grand Ave. #17
- Cicero 8025 Grand Ave.
- Highland Park 36 Skokie Valley Rd.
- Homewood 17850 S. Halsted St.
- Joliet 3340 Mall Loop Dr., Ste. 1254
- La Grange 34 N. La Grange Rd.
- Lisle 3333 W. Touhy Ave., D02A
- Oak Park 3817 W. Elm St.
- Oak Park 1124 W. Lincoln Hwy.
- Oak Park 9479 Milwaukee Ave.
- Oak Park 4155 1/2 N. Harlem Ave.
- Oak Park 41 Laramie Irving Mall, Ste. 32
- Oak Park 114 W. North Ave.
- Oak Park 5145 W. 95th St.
- Oak Park 425 N. Harlem Ave.
- Oak Park 1705 W. 23rd St.
- Oak Park 15135 S. La Grange Rd.
- Oswego 2754 Rte. 34
- Pewaukee 4371 Venture Dr.
- Plainfield 12720 S. Rte. 59, Ste. 300
- Rockford 6270 E. State St.
- Skokie 2200 N. Milwaukee Ave.
- Skokie 1635 Algonquin Rd.
- Schaumburg 1408 E. Golf Rd.
- Woodfield Mall, Unit F123

INDIANA

- Bloomington 9725 N. Skokie Blvd.
- Carmel 312 S. Randall Rd.
- Chandler 2700 E. Main St.
- Wesley 445 E. Towline Rd., Ste. C
- Westfield 729 W. Main St.
- Weston 8 Danada Sq.

ILLINOIS

- Addicks 1435 W. Lake St.
- Aurora 1330 Orchard Rd.
- Berwyn 6621 W. Ogden Ave.
- Bolingbrook 207 N. Naperville Rd.
- Bradley 1620 N. State Route 50, Ste. 110
- Broadview 114 Broadview Village Sq.
- Cherry Valley 2241 S. Ploverville Rd.
- Chicago 1457 E. 53rd St.
- Chicago 1513 N. Milwaukee Ave.
- Chicago 2867 N. Milwaukee Ave.
- Chicago 2201 N. Cicero Ave.
- Chicago 3946 N. Lincoln Ave.
- Chicago 405 E. 35th St.

Chicago (cont.)

- A.S. 1 LaSalle St.
- Dunwoody 2321 Ogden Ave., Ste. A
- Evanston 170 Beaufield Rd.
- Glen Ellyn 547 Roosevelt Rd.
- Highland Park 1671 Old Skokie Rd.
- Highland Park 9430 Joliet Rd., Unit 300
- Lisle 1027 E. 9th St.
- Machanoy Park 1574 Westlawn Rd.
- Matteson 4736 Lincoln Hwy.
- Naperville 1160 E. Ogden Ave.
- Oak Brook 423 S. Washington St.
- Ottawa 369 W. Stevenson Rd.
- Pekin Rte. 251 & Winnet Rd.
- Rosemont 7024 N. Mannheim Rd.
- Riverside 7181 Rollin Rd.
- Schmiedel 2644 W. Schaumburg Rd.
- Summit 7200 W. Archer Ave.
- Tinley Park 16649 S. Oak Park Ave.
- Tinley Park 17150 W. 18th St.
- Waukegan 15 N. Green Bay Rd.
- West Chicago 7245 North Ave.
- Woodstock 810 74th St.
- Woodstock 1465 S. Leavewood Dr.
- York 920 N. Main St.

Indiana Estates 4610 Hoffman Blvd.

- Homer Glen 1403 S. Bell Rd.
- Lisle 910 Milwaukee, Ste. B

INDIANA

- Caldwell 146 N. Broad St.
- Merrillville 1943 Southlake Mall
- Portage 6279 US Hwy. 6
- Scherville 1505 US Rte. 41
- St. John 9627 Weber Ave.
- Valparaiso 2912 N. Calumet Ave.

•Servicio En Español
•Open Sunday
•High Speed Internet Sold Here

ALSO AVAILABLE FROM:
Radio Shack



*AT&T also imposes monthly a Regulatory Cost Recovery Charge of up to \$1.25 to help defray costs incurred in complying with State and Federal telecom regulation; State and Federal Universal Service charges; and surcharges for customer-based and revenue-based state and local assessments on AT&T. These are not taxes or government-required charges.

Early Termination Fee: None if cancelled in the first 30 days; thereafter up to \$175. Some agents impose add'l fees. Offer available on select phones. Limited-time offer. Other conditions & restrictions apply. See contract & rate plan brochure for details. Subscriber must live & have a mailing addr. within AT&T's owned wireless network coverage area. Up to \$36 activ. fee applies. Equipment price & avail may vary by mkt & may not be available from independent retailers. Rebate Debit Cards: LG Shine™ prices before mail-in rebate debit card, qualified feature package purchase, and with 2-year wireless service agreement per phone are \$99.99 and \$49.99, respectively. BlackBerry® CURVE™ 8310 prices before BlackBerry data plan, mail-in rebate debit card, and with 2-year wireless service agreement is \$179.99. BlackBerry data plan and minimum \$39.99 voice plan required. Allow 60 days for fulfillment. Card may be used only in the U.S. and is valid for 120 days after issuance date but is not redeemable for cash and cannot be used for cash withdrawal at ATMs or automated gasoline pumps. Card request must be postmarked by 12/11/2008; you must be a customer for 30 consecutive days to receive card. Sales tax calculated based on price of unactivated equipment. Offer Usage: If your mins of use (including untd svcs) on other carriers' networks ("offnet usage") during any two consecutive months exceed your offnet usage allowance, AT&T may at its option terminate your svcs, deny your contd use of other carriers' coverage, or change your plan to one imposing usage charges for offnet usage. Your offnet usage allowance is equal to the lesser of 750 mins or 40% of the Anytime mins incl'd with your plan (data offnet usage allowance is the lesser of 6 MB or 20% of the KB incl'd with your plan). Unactivated svcs: Untd svcs are provided solely for live dialing between two individuals. No additional discounts are available with unlimited plan. Service provided by AT&T Mobility. ©2008 AT&T Intellectual Property. All rights reserved. AT&T, the AT&T logo, and all other marks contained herein are trademarks of AT&T Intellectual Property and/or AT&T affiliated companies. All other marks contained herein are the property of their respective owners.

WRITERS' THEATRE
IN GLENCOE
PICNIC
BY WILLIAM INGE DIRECTED BY DAVID CROMER
"ONE OF THE BEST PERFORMANCES OF ANYTHING... I'VE SEEN IN MY LIFE."
MUST CLOSE NOVEMBER 30TH!
847-242-6000
WRITERSTHEATRE.ORG

Rolling Stone
"ROLE MODELS IS KILLER FUNNY"
Peter Travers
FRESH FUN AND AWESOME
SIMPLY OUTRAGEOUS!
SEANN WILLIAM SCOTT PAUL RUDD
ROLE MODELS
They're about to get more than they plea-bargained for.
UNIVERSAL PICTURES PRESENTS IN ASSOCIATION WITH RELATIVITY MEDIA A STURGER/PARENT PRODUCTION
"ROLE MODELS" SEANN WILLIAM SCOTT PAUL RUDD "THE GRAND WEDDING" JUAN CASTRO
EXECUTIVE PRODUCERS DAN KOLSRUD ANDREW Z. DAVIS MATT SEIGEL WILLIAM SHERAK JASON SHUMAN
PRODUCED BY MARY PARENT SCOTT STUBER LUC GREENEEDIT BY TIMOTHY DOWLING AND WILLIAM BLAKE HERON
DIRECTED BY PAUL RUDD & SEANN WILLIAM SCOTT
CASTING BY DAVID WAIN & KEAN MARINO AND TIMOTHY DOWLING
www.rolemodelsmovie.com
OPENS FRIDAY, NOVEMBER 7TH
CHECK LOCAL LISTINGS FOR THEATRES AND SHOWTIMES

OPENING THIS WEEK

BOY IN THE STRIPED PAJAMAS
The son of a Nazi officer forges a forbidden friendship with a Jewish boy in a concentration camp. (93 min.) Rated PG-13 for some mature thematic material involving the Holocaust.

REPO! THE GENETIC OPERA
A company specializing in organ transplants sends particularly vicious agents to repossess in case of nonpayment. Darren Lynn Bousman ("Saw" 2, 3 and 4) directed the horror musical. Paris Hilton is featured. (98 min.) Rated R for strong bloody violence and gore, language, some drug and sexual content.

ROLE MODELS
A couple of slackers (Paul Rudd, Seann William Scott) agree to participate in a youth-mentoring program to avoid going to jail. David Wain ("Wet, Hot American Summer") directed the comedy. (99 min.) Rated R.

SYNECDOCHE, NY
A theater director whose life is crumbling (Philip Seymour Hoffman) builds a replica of New York inside a warehouse to dramatize his personal struggles. Screenwriter Charlie Kaufman ("Eternal Sunshine of the Spotless Mind") makes his directorial debut. (124 min.) Rated R for language and some sexual content/nudity.

STILL PLAYING

APPALOOSA
★★★ 1/2
We're back to good guys vs. bad guys in this very traditional Western and it works quite nicely. Appaloosa is the name of the town that has sent out a distress call to marshal-for-hire Virgil Cole (Ed Harris) and his long-time deputy Everett Hitch (Viggo Mortensen), because evil rancher Randall Bragg (Jeremy Irons) and his thugs have been making life intolerable. At first it seems that "Appaloosa" might be gearing up to deliver the standard revisionist-Western line that there's not much difference between the mercenary Cole and Bragg, but it soon becomes apparent that he and Hitch are old-school heroes at heart. They smile at children, treat women with respect and always give fair warning before the slaughtering begins. As director and star, Harris (who also made the excellent "Pollock" 8 years ago) demonstrates a deep understanding of what makes an old-school horse-opera satisfying. When a character rides off into the sunset in "Appaloosa" it feels just right. (B) (114 min.) Rated R for some

FILM CLIPS

violence and language.
BEVERLY HILLS CHIHUAHUA
A pampered pooch (voice of Drew Barrymore) gets lost in Mexico. Raja Gosnell ("Scooby-Doo") directed the comedy featuring the voices of Andy Garcia, Placido Domingo, George Lopez, Cheech Marin and Paul Rodriguez. (91 min.) Rated PG for some mild thematic elements.

BODY OF LIES
A CIA field agent (Leonardo DiCaprio) in the Middle East clashes with his armchair-warrior boss (Russell Crowe). Ridley Scott ("Kingdom of Heaven") directed the espionage thriller. Rated R for strong violence including some torture and for language throughout.

CHANGELING
★★ 1/2
As you might expect, this somber drama about a mother's quest for her missing child has been handsomely mounted by Clint Eastwood, Ron Howard and company and it features an impressive emotional workout from Angelina Jolie. It's a bit too coolly detached to be completely involving, though, with supporting characters that border dangerously on caricature (Righteously Indignant Crusading Preacher, Evil Psycho Ward Doctor, Twitchy Serial Killer) and it doesn't have the luxury of providing a satisfying resolution to its central mystery. The tailor-made-for-the-movies true story revolves around the disappearance in 1928 of nine-year-old Walter Collins and the media circus that develops when the corrupt Los Angeles police department return the wrong boy to his mother (Jolie) and then attempt to force her to accept him to save themselves embarrassment - even resorting to throwing her into a nightmarish psycho ward when she protests to reporters. Eastwood balances this with a parallel story about an ax murderer who has been kidnapping little boys and hacking them up on his isolated ranch and he manages to achieve some particularly disturbing moments that are guaranteed to have parents staring sleepless at the ceiling for many nights to come. Unfortunately, the elements of horror in "Changeling" are symptomatic of a general willingness to resort to melodrama (a few of the more lurid touches in the mental ward could have been taken from the 1948 shocker "The Snake Pit") that calls the entire film into question. (B) (140 min.) Rated R for some violent and disturbing content, and language.

PRIDE AND GLORY
★★ 1/2
You've seen it all before, but you've probably never seen all the elements of the good cop/bad cop,

loyal-to-the-force or loyal-to-the-law morality tale mixed together to more agonizing effect than they are in "Pride and Glory." Edward Norton is effectively tormented Ray as an ace NYPD detective whose investigation into the slaughter of four cops in a drug-bust gone wrong turns up evidence that dirty cops might be involved - possibly including his brother (Noah Emmerich) and brother-in-law (Colin Farrell). And Ray knows from bitter experience that his career-cop dad (Jon Voight) puts the force and family above the letter of the law. (B) (125 min.) Rated R for strong violence, pervasive language and brief drug content.

RACHEL GETTING MARRIED
★★★★
Hardcore bad-news girl Kym (Anne Hathaway, achieving the antithesis of her role in "The Princess Diaries") is released from rehab just long enough to throw her sister's wedding into an uproar in this involving (and sometimes exceedingly painful) drama about a family coping with a terrible trauma from its past. Working from a debut screenplay by actress Jenny Lumet (daughter of director Sidney Lumet), which emphasizes naturalism over button-pushing plot manipulation, director Jonathan Demme ("Silence of the Lambs," "Philadelphia") does his best to make us feel that we're not so much watching this story as we are participating in it. And that's not always a comfortable feeling. Demme emphasized spontaneity from his large ensemble cast, shooting without rehearsals with roving hand-held cameras and the results are fresh, surprising and unfailingly intimate. It will be quite a surprise if Hathaway doesn't receive an Oscar nomination for her complex, multi-layered performance. (B) (114 min.) Rated R for language and brief sexuality.

ROCKNROLLA
★★ 1/2
If you've seen writer/director Guy Ritchie's "Lock, Stock and Two Smoking Barrels" and "Snatch," there's really no reason to check out "Rocknrolla," unless you're in the mood for more of the same - only less so. After unsuccessfully taking his ultra-stylized, ultra-violent, incongruously humorous gangster movie formula more seriously with last year's "Revolver," Ritchie returns his emphasis to entertainment this time around. And he delivers, intermittently, though the freshness and excitement are long gone. The setting, as usual, is London's underworld, where an assortment of blasé tough guys (for Ritchie, coolness is all) are trying to make an honest living by stealing from each other. You've got an old-school London mob boss named Lenny (Tom Wilkinson, almost unrecognizable), an imperturbable Russian crime czar (Karel Roden), a couple of

genial armed robbers named One Two and Mumbles (Gerard Butler of "300" and Idris Elba), the Russian billionaire's sexy accountant (Thandie Newton), a junkie rock star named Johnny Quid who's faking, his death to boost record sales (Toby Kebbell) and a handful of quirky supporting characters (including Jeremy Piven and Ludicris as hustling music promoters and a couple of unkillable and Russian hitmen) to keep things lively as needed. The general idea is to keep all these characters chasing after each other, all the while commenting wryly on life in general, with enough flashy camera work and tricky editing to keep things visually interesting and just enough outrageous violence (such as Lenny's proclivity for crawfish torture) to remind us we're watching a gangster movie. Ritchie makes it work reasonably well one more time, but it seems even he might be getting a little weary of the formula. (B) (114 min.) Rated R for pervasive language, violence, drug use and brief sexuality.

ZACK AND MIRI MAKE A PORN
★★★
The raunch is wall-to-wall in "Zack and Miri Make a Porno," but it's really a sweet romantic comedy at heart. As sweet as you can get with former porn star Traci Lords playing a character called Bubbles - and graphically demonstrating how she got the nickname with a bottle of bubble liquid and... You don't want to know. Well, maybe you do, but I can't tell you about it here. Gen-X hero Kevin Smith, who has demonstrated a flair for transgression since his 1994 indie debut "Clerks" was slapped with an NC-17 rating for language alone, wrote and directed this surprisingly upbeat and good-hearted story of a couple of lifelong friends (Seth Rogen and Elizabeth Banks) who decide to produce and star in their own porn movies to restore their squandered finances. What they won't know, until their first sex scene, is that they're in love with each other - a revelation that complicates the scenario in not-especially interesting ways. The stuff that really resonates for Smith and his excellent cast is the outrageously tawdry comedy that arises from the premise of a crew of gung-ho amateurs going the full monty and much, much more. More evidence that the end of civilization is near, perhaps, but at least there's laughter involved. (B) (101 min.) Rated R for strong crude sexual content including dialogue, graphic nudity and pervasive language.

OLIVER STONE ("JFK," "NIXON")
directed this biography of George W. Bush. Rated PG-13 for language including sexual references, some alcohol abuse, smoking and brief disturbing war images.

OLIVER STONE ("JFK," "NIXON")
directed this biography of George W. Bush. Rated PG-13 for language including sexual references, some alcohol abuse, smoking and brief disturbing war images.

BUY EARLY. SAVE BIG.
Gift certificate good for two tickets only \$99!
Visit BLUEMAN.COM or call 1.800.BLUEMAN now to purchase a Blue Man Group Gift Certificate and save \$29.
Tickets regularly \$64 each. Must purchase by 12/15. Offer valid for BMG Chicago shows only. Not valid on previously purchase tickets. Restrictions apply.
BRIAR 3133 North Halsted Street 773.348.4000

NOW PLAYING AT THE APOLLO THEATER
COMPLETE COSTUME TONIGHT & SAVE \$5!
"A HIT! ...JAW-DROPPING...CAPTURES THE THRILLS OF ELVIS PRESLEY, JOHNNY CASH, JERRY LEE LEWIS AND CARL PERKINS." CHRIS JONES, CHICAGO TRIBUNE
"THIS QUARTET CAN ROCK! ...MUSICALLY DAZZLING...ALTOGETHER ROLLICKING 90-MINUTE FANTASIA." HEDY WEISS, CHICAGO SUN-TIMES
MILLION DOLLAR QUARTET
★ THE NIGHT ROCK 'N' ROLL CAME ALIVE ★
★ APOLLO THEATER ★
(773)935-6100 ★ TICKETMASTER.COM
FOR GROUP DISCOUNTS CALL GROUP THEATER TIX (312)423-6612
MILLIONDOLLARQUARTETLIVE.COM
TONIGHT AT 8:00; SAT AT 5:00 & 8:00; SUN AT 3:30 & 6:30

Chicagoland's Premier Live Theater Guide

<p>NOW PLAYING AT THE APOLLO THEATER</p> <p>MILLION DOLLAR QUARTET</p> <p>"A HIT!" CHICAGO TRIBUNE</p> <p>(773) 935-6100 TICKETMASTER.COM GROUP DISCOUNTS (312) 422-6612</p>	<p>Late Nite Catechism</p> <p>Royal George Theatre 1641 N. Orchard Chicago 312-988-0000 All Shows \$10</p> <p>Sunday School Cinema</p> <p>7pm Sundays</p> <p>It's All About the Nuts in Charge!</p> <p>8pm Fridays 1pm Saturdays</p>	<p>"Funny! Dazzling! Beautiful! Like Billy Crystal's 700 Sundays!" The New York Times</p> <p>Is This Your Family?</p> <p>Jackie Ehrenreich's A JEW GROWS IN BROOKLYN</p> <p>A rock 'n' roll true story, Holocaust family, borscht belt... COMEDY MUSICAL!</p> <p>Nov 5-9 One Week Only! Direct From The Heart Of Broadway! NORTH SHORE CENTER FOR THE PERFORMING ARTS 9501 Skokie Blvd., Skokie, IL 847-673-6300 www.AJewGrowsInBrooklyn.com</p>	<p>"RED RIDING HOOD"</p> <p>SEBASTIAN BRONSTEIN For Young Audiences</p> <p>Saturdays at 10:30am & 1:00pm through November 22</p> <p>847 291-02367</p>	<p>BLUE MAN GROUP</p> <p>IF YOU HAVEN'T SEEN BLUE MAN GROUP, YOU HAVEN'T SEEN CHICAGO!</p> <p>Box Office 773.348.4000 1.800.BLUEMAN blueman.com Ticketmaster 312.902.1500 ticketmaster.com Group Sales 773.348.3300</p> <p>3133 North Halsted Chicago</p>
<p>Amundson Mystery Train™</p> <p>Murder on New Year's Eve Overnight / Mystery Train</p> <p>Murder Mystery. Open Bar Audience Participation Prime Rib Dinner. Breakfast</p> <p>773-267-6400 mysteryttd.com</p>	<p>steppenwolf</p> <p>Theatre Company Tue - Sun at 7:30, Sat & Sun at 3:00</p> <p>Kafka on the Shore Based on the work by Haruki Murakami</p> <p>Adapted and directed by Frank Galati Begins September 18th* Call 312-335-1650 or www.steppenwolf.org</p>	<p>Nov 5-9 One Week Only! Direct From The Heart Of Broadway! NORTH SHORE CENTER FOR THE PERFORMING ARTS 9501 Skokie Blvd., Skokie, IL 847-673-6300 www.AJewGrowsInBrooklyn.com</p> <p>Scruffy Letters</p> <p>www.scruffyletters.com</p>	<p>CHRISTMAS STORIES</p> <p>NOVEMBER 12-13 DECEMBER 19-20, 2008</p> <p>The Second City</p> <p>DISTINGUISHED THEATRE ARTS DECEMBER 19 & 20, 2008</p> <p>SPECIAL NEW YEAR'S EVE SHOW DECEMBER 31, 2008</p> <p>Non-Fool</p> <p>THEATRE JESUS ROBERT 630-584-6342 • www.theassault.com</p>	<p>Stephen Hough, piano</p> <p>Thurs. Nov. 13, 7:30 p.m. Pick-Staiger Concert Hall www.pickstaiger.org 847-467-4000</p> <p>AMADEUS</p> <p>Now playing Tuesdays through Sundays</p> <p>TICKETS: 312.595.5600 www.chicagoshakes.com</p> <p>CHICAGO SHAKESPEARE THEATRE</p>
<p>ShawChicago</p> <p>presents THE APPLE CART by George Bernard Shaw</p> <p>Political intrigue written in 1923—funny, then, funnier (and more true) today!</p> <p>SAT & SUN @ 2; MON @ 7 THROUGH NOV 10</p> <p>Ruth Page Theater 1016 N. Dearborn, Chicago Call today for tickets! 312-587-7390</p>	<p>COMING NOV 12</p> <p>meet me in St. Louis</p> <p>DRURY LANE THEATRE - WATER TOWER PLACE 312.642.2000 or www.ticketmaster.com</p> <p>CHRISTMAS CAROL</p> <p>ATKINSON TOM MULL</p> <p>THEATER BUILDING CHICAGO 1225 W. Belmont 773-327-6222 www.theaterbuilding.com</p>	<p>Margaret Garner</p> <p>November 1-9, 2008</p> <p>Final Weekend!</p> <p>312.902.1500 ticketmaster.com</p> <p>AUDITORIUM THEATRE BROADWAY DISTRICT auditoriumtheatre.org</p>	<p>COMING TO CHICAGO</p> <p>Bill Blagg - Nov 7</p> <p>Rik Emmett - Nov 8</p> <p>Gab Galloway Orch. - Nov 9</p> <p>Bjorn Again - Nov 22</p> <p>Cheap Trick - Dec 12</p> <p>The Letterman Christmas - Dec 13</p> <p>Winter Dance Party - Feb 3 (A Tribute to Buddy Holly, Ritchie Valens and The Big Bopper)</p> <p>847-931-5900 45 Symphony Way, Elgin www.hcmms.com</p>	<p>"A JOYOUS PRESENT FOR THE ENTIRE FAMILY."</p> <p>A Christmas Carol</p> <p>NOVEMBER 21 DECEMBER 31</p> <p>GOODMAN</p> <p>GoodmanTheatre.org 312.443.3800</p>
<p>TOMORROW MORNING</p> <p>An Extraordinary New Musical from London Victory Gardens Cabaret Theatre Tickets: 773.404.7216 www.tomorrowmorningmusical.com</p> <p>MAME</p> <p>DRURY LANE THEATRE</p>	<p>Jackie Taylor's THE OTHER CINDERELLA</p> <p>(Welcome To The Kingdom)</p> <p>Call 773-769-4451 for reservations & information</p>	<p>SALIMBANO</p> <p>CIRQUE DU SOLEIL</p> <p>JANUARY 21-FEBRUARY 1 SEARS CENTRE ARENA cirquedusoleil.com</p>	<p>Celebrate da holidays with da gang!</p> <p>Book Your Holiday Parties Now!</p> <p>Da Holiday show runs Nov 28 thru Dec 31, 2008.</p> <p>Tommy Gunn's Garage</p> <p>2114 South Wabash, Chicago Phone 773-RAFA-1A1 www.tommygunns.com</p>	<p>SEE THE MAGIC OF LIVE THEATRE FOR YOURSELF</p> <p>The Brothers</p> <p>LOOKINGGLASS THEATRE COMPANY 100 N. LAUREL ST. CHICAGO, ILLINOIS MICHIGAN AVE AT PEARSON 312.337.0665 OR VISIT LOOKINGGLASSTHEATRE.ORG</p>

To Advertise, Please Call Greg Tardi @ 312-321-2490

Predictable: That's how we 'Role'

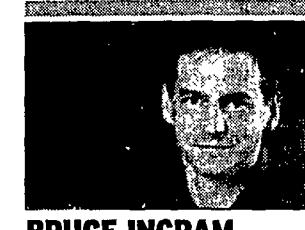

BRUCE INGRAM
FILM CRITIC

Role Models ★★ 1/2

Considering the somewhat-edgy comic talent involved in "Role Models," it's surprising and a little disappointing that the plot about a couple of man-children who finally grow up when they have to care for a couple of actual kids turns out to be so thoroughly formulaic. Fortunately, the writers and performers put just enough mildly transgressive spin on the material to make it intermittently amusing and the formula itself provides a modest feel-good payoff. That's an uneasy combination,

though, and it doesn't provide complete satisfaction on either count.

The simplest way to explain what's going on with "Role Models" may be that it's an attempt to make something more-or-less mainstream by co-writer/director David Wain. Wain has a solid reputation among cult-comedy aficionados as one of the founding members of the early-'90s MTV sketch comedy series "The State" and he's previously co-written and directed the parody of summer-camp comedies "Wet, Hot American Summer" and "The Ten," riffing in a very uneven way on the 10 commandments. Neither found the sort of breakthrough audience Wain needs and this one's not likely to either. Though it might have, if someone like Adam Sandler or Bill Murray or anyone else with a track record for this sort of out-

wardly snarky, inwardly sentimental comedy (and a pre-sold fan base) had taken the assignment.

Not that there's anything wrong with either Seann William Scott or Paul Rudd, though their fans will probably be surprised to see them going a bit gooey. They play good-natured babe-crazy party-animal Wheeler (Mr. Scott of "American Pie") and repressed-grouch Danny (Mr. Rudd, a member of the Judd Apatow stock company, also featured in Wain's previous films). Wheeler and Danny spend their days driving around in a monster truck customized to look like a demented bull, delivering just-say-no lectures to kids in school auditoriums and selling a legal-high energy drink called Minotaur ("It's not poison; it's got juice in it"). By the end of a long day of swilling Minotaur, they're typically wound up pretty tight.



Thou art in violation of the dress code: Ken Jeong, Christopher Mintz-Plassé and Paul Rudd in "Role Models."

And by the end of one particularly bad day, during which Danny gets dumped by his longtime girlfriend Beth (Elizabeth Banks in a thankless role), they get involved in a fracas that means 30 days jail time. Unless they agree to do 150 hours community service at a Big Brothers-type mentorship agency called Sturdy Wings.

Most of the laughs arise from them being assigned weird kids nobody else can cope with: Foul-mouthed Ronnie (Bobb'e J.

Thompson), who immediately accuses Wheeler of trying to molest him, and painfully shy Augie (Christopher Mintz-Plassé of "Superbad"), a cape-wearing super-nerd obsessed with a medieval fantasy role-playing game. Though there's also some freaky stuff being dished out by the reformed junkie Sturdy Wings founder (Jane Lynch), who loves to do disturbing things with bagel dogs.

It doesn't take long, though, for the big boys to bond with the little boys

(Wheeler and Ronnie share a reverential appreciation for women's breasts) and for the story to slip into paint-by-numbers mode. But there are a few inspired little touches that could make it worth a look if you're in a forgiving mood — like Augie's lament that he looks like a young Marvin Hamlish.

A young Marvin Hamlish with a cape and a foam-rubber broadsword.

Comment: pioneerlocal.com

DADDER'S FAMILY RESTAURANT

5050 N. CUMBERLAND, NORRIDGE
(708) 456-2005
28 YEARS IN BUSINESS

NEW DINNER SPECIALS

\$7.95

Includes Soup or Salad
Rottini w/Sausage

Honey Glazed BBQ Spare-Ribs

Sauteed Chicken w/ Broccoli & Fettuccini

Breaded Filet of Sole

Liver & Onions

Sweet & Sour Chicken

Egg Plant Parmegian

Grecian Style Chicken

Breaded Veal Cutlet

Grecian Style Chicken Breast

\$2.99

BREAKFAST SPECIALS from \$5.99

LUNCH SPECIALS

Includes Soup

Hot Turkey \$6.95
Julien Salad \$7.25
Greek Salad \$7.25
Perch Sandwich \$6.95
Pita Wrap \$7.25
Italian Sausage on French Bread w/Grilled Green Peppers \$7.25

Glass of Wine \$1.50 with meal
SPECIALS VALID MONDAY THRU FRIDAY ONLY

Comedy Coming Soon to CENTRE EAST

This Weekend Only

Curb Your Enthusiasm's Susie Essman

SAT., NOVEMBER 15 AT 8 P.M.

"Like Joan Rivers before her, Essman has the great Jewish comedian's knack for being astoundingly insulting and mostly harmless."
—THE TIMES OF LONDON

(May include language not suitable for younger or more sensitive audience members.)

Inaugurate Our New President With The Capitol Steps

ONE WEEK ONLY JANUARY 22 - 25

Election Week Special!

Present your voting receipt or use the code word VOTE and receive \$5.00 off tickets to select performances of the Capitol Steps

*Tickets must be purchased by Nov 9, 2008. Offer valid for Thu Jan 22 and Fri Jan 23 performances only. Not valid on previously purchased tickets or with other discounts. Limit 8 tickets per order.

Tickets: 847-673-6300 or www.centreeast.org

Save 10% with groups of 15 or more: call 877.447.7849

Performances at the NORTH SHORE CENTER FOR THE PERFORMING ARTS
9501 SKOKIE BOULEVARD, SKOKIE | FREE PARKING
Across from Old Orchard Shopping Center

DOUBLE TRIP
PIONEER PRESS

PASTA
TRATTORIA D'ARTE
ITALIANA

REGIONAL ITALIAN CUISINE
Celebrating Our 6th Anniversary

Buy 1 Entree Get 1 Free!
Up to \$12.00

*3pm Minimum
Dine in Only
Only valid Sun - Thurs
(Not valid with other offers or coupons)
Expires 11/20/08

OPEN FOR LUNCH & DINNER
Sun & Mon. 3:00pm-10:00pm • Tues-Thurs. 11:30am-10:00pm • Fri. 11:30am-11:00pm • Sat. 3:00pm-11:00pm

6311 NORTH MILWAUKEE AVE. • CHICAGO
773-763-1181

Free Valet
Weekend Parking

www.pastadarte.com



"For five decades her ringing soprano has been a prophetic sound."
—Rolling Stone

Joan Baez

TUESDAY, NOVEMBER 11, 8:00
\$25-\$50

Legendary folk singer-songwriter Joan Baez returns to Symphony Center in her first appearance since 2003. She'll perform cherished favorites and songs from *Day After Tomorrow*, her latest CD.

SYMPHONY CENTER PRESENTS

312-294-3000
CSO.ORG
220 S. MICHIGAN AVE.
CHICAGO, ILLINOIS

Artists, prices, and programs subject to change

STAGE

East meets West at Rising Stars

'THE KING AND I'
7:30 p.m. Saturdays and 2 p.m. Sundays, Nov. 8-23 at Stahl Family Theatre, 5900 W. Belmont Ave., Chicago. \$15, \$13 seniors and children under 12. (773) 736-2490 or risingstarstc.org.

By MYRNA PETLICKI
Contributor



Scott Kelley and Synoma Hays star in The Rising Stars Theatre Company's "The King and I."

Scott Kelley is contemplating getting a buzz cut, but he definitely won't be shaving his head (ala Yul Brynner) for his starring role in The Rising Stars Theatre Company's "The King and I." It's attitude rather than appearance that defines the king, anyhow.

"I see him as somebody undergoing an internal struggle," the Schaumburg actor said. "He's very complex because he's enormously well read but he's trying to reconcile his

traditional culture with the coming of the modern world into his kingdom. He sees some benefits to that, but he also sees a conflict." The king doesn't

want to risk losing "the values that he holds dear." When he meets Anna, a British governess for his children and the "I" of the title, "He immediately recognizes her as somebody who is intelligent, who challenges him, somebody who could have an impor-

Stars, PAGE B9

Murder at the Holiday Mansion Mystery™



Reservations Limited
Call 24 hrs (773) 267-6400
www.mysteryltd.com

Murder on New Year's Eve™



Overnight / Mystery Train / Open Bar
Prime Rib Dinner / Breakfast

"Fresh, Upbeat, Witty and Poignant!" ★★★ —What's on Stage, London



An Extraordinary New Musical from London!
2006 Award Winner with *Wicked* and *Avenue Q*
Theatre Radio's Best Musical

Four ordinary people, two life-changing events,
one extraordinary new musical!

TOMORROW MORNING

Everything changes...

Chicago Premiere—Limited Engagement
Now Playing through December 7, 2008

Thursdays & Fridays at 8 p.m.
Saturdays at 5 & 8 p.m.
Sundays at 3 p.m.

Special 2pm matinee—11/12 only

Victory Gardens Greenhouse Theater
Tickets: 773.404.7336 | Groups of 10 or more: 877.447.7849
www.tomorrowmorningthemusical.com



THE IDOL RICH — IN TALENT! Des Plaines Idol 2008 vocal competition, held Oct. 25 at the Prairie Lakes Community Theater, produced winners in three age-range categories: Angela Jepsen (left), 15, won with her cappella version of "Bubbly"; Julia Rose Melone (center), 10, won with "Good Morning Baltimore" from "Hairspray"; and Pamela Powell (right), 9, won with her version of "This Is Me." Contestants were selected based on an audition tape. Winners in each category received \$100. Contestants have also been invited to perform at the City of Des Plaines New Year's Eve Celebration.

Stars

Continued from PAGE 8

of Franklin Park, who plays Anna. When Anna first meets the king, "She doesn't like him very much because he's not following through on promises made to her," Hays said. But later, "They really form a strong friendship. He is impressed by her. She doesn't back down from him and he's never had that before. She sees all the good he is trying to do. He just doesn't know how to go about it."

Kelley indicated that a challenge of the role is letting the king's softer side emerge so he won't come across as an ogre.

The relationship between the King and Anna is always fascinating to watch, but it is the memorable Rodgers and Hammerstein score which makes "The King and I" a perennial favorite. It's includes such numbers as "Getting to Know You" and "Shall We Dance."

Both actors are enjoying working with the many young people in the cast.

"They're interested in learning how to act and how to create a character," said Kelley, a technical trainer by day who enjoys helping the children.

"The kids are so great!" exclaimed Hays, a corporate trainer who has worked with Rising Stars for a decade. She admitted, "I broke my golden rule" about not acting with children.

She may next create a "golden rule" about not wearing hoopskirts on stage. Hays reported that the first time she tried negotiating with one, the cast, "was laughing at me trying to get up off the floor."

'I am strong, I am invincible ...'

"She's a very strong-willed woman, back in the 1800s," said Synoma Hays

Comment: pioneerlocal.com

Mexican Restaurants

4610 North Harlem Avenue
Harwood Heights
Phone: 708-867-4072

MONDAYS MARGARITA MADNESS 1/2 PRICE

Mondays, regular small house margaritas 1/2 price with the purchase of any Mexican dinner entree.

The Bead Society of Greater Chicago presents

Art of Beadwork

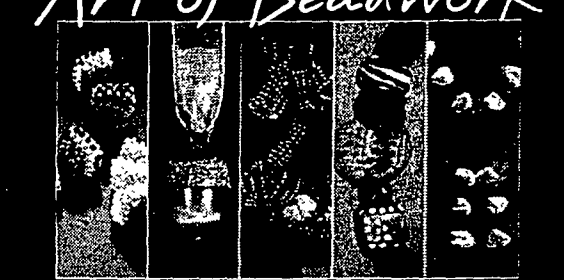

12th annual sale of members' handcrafted jewelry and beaded items

Sunday, November 16, 2008, 12-5pm

Skokie Banquet and Conference Center • Holiday Inn North Shore
5300 W. Touhy, Skokie—just west of the Edens Expwy.

Over 40 artists represented • Admission \$4
For information contact 312.243.3244 or 847.432.7495 • www.bsgc.org

ON STAGE

NOVEMBER 12 — DECEMBER 27, 2008

A CHRISTMAS STORY



\$5 OFF
YOUR TICKETS

"Hilarious and touching!"

DINNER & OVERNIGHT PACKAGES AVAILABLE

NOBLE FOOL THEATRICALS
PHEASANT RUN RESORT

4051 East Main Street • St. Charles, IL ticketmaster
www.pheasantrun.com • BOX OFFICE: 630-584-6342

PREMIER PROFESSIONAL THEATER IN THE FOX VALLEY AREA

*Call 630-584-6342 for discount. Reservations required. Mention offer when ordering tickets. Subject to availability. For show-only tickets: Cannot be combined with any other offers or to previously purchased tickets. One coupon per order. Good for up to four total purchased tickets. Restrictions may apply. Valid thru 11/30/08.

Chambers SEAFOOD GRILLE & CHOP HOUSE

TRADITIONAL THANKSGIVING Family Style Dinner
OPEN AT 11:00
 Soup & Salad, Baked Ham, Roast Turkey, Dressing, Sweet Potatoes, Mashed Potatoes, Pumpkin Pie, Corn Bread

7620 N. MILWAUKEE, NILES
 (847) 647-8282
 6881 N. Milwaukee Ave., Niles, IL

AMICI

PARTY ROOM UP TO 80
 LUNCH Mon.-Fri.
 Catering
 PARTY ROOM - up to 80 Guests
 Dinner 7 days a week
 (847) 967-0606
 7620 N. MILWAUKEE, NILES
 2 Blocks South of Oakton
 www.amicifood.com

Kids hit the Yellow Brick Road to Oz

By MYRNA PETLICKI
 Contributor

Tracy MacKenzie. "There will be song and dance, and lots of imagination." The audience is expected to do their part, too. "They will make the sounds of the tornado. They will help sing Dorothy down the Yellow Brick Road. They will dance the jitterbug and they will — like the Lion, Tinman and Scarecrow — be Dorothy's friends on her journey to Oz," MacKenzie said. "This performance is all about the kids in the audience. We want them to be part of the story and to have a great time."

Tickets are \$6 for adults, \$5 for seniors, and \$4 for students and children.

For details, call (847) 467-4000.

Running hot and cold
 Young children will be amazed and entertained by "Mad Science: Fire and Ice," 10:30-11:15 a.m. Tuesday, Nov. 11, at Skokie Public Library, 5215 Oakton St. Kids and adults will learn about the science of magic, movie effects, dry ice and bubbling potions. Free tickets will be available at 10 a.m. For details, call (847) 673-7774.

A (Prince) Charming evening
 Your 3- to 8-year-old will be the belle — and/or prince — of the "Cinderella Ball," 6-8 p.m. Friday, Nov. 14 or Saturday, Nov. 15, at Maine Park Leisure Center, 2701 Sibley Ave., Park Ridge. Parents and children should dress in their finest attire for a buffet dinner, dancing and fun. Advance registration is required. For details, call (847) 692-5127.



Ben there, done that
 Learn about an amazing Founding Father when you "Meet Ben Franklin," 2-3 p.m. Sunday, Nov. 9, at Niles Public Library, 6960 W. Oakton St. After enjoying this theatrical performance, your family can learn more about the man by visiting the special traveling Ben Franklin exhibit in the library. Call to reserve tickets. For details, call (847) 663-6622.

"Not in Kansas Anymore: Music from 'The Wizard of Oz'" is staged at Northwestern University's Pick-Staiger Concert Hall.

Doe, a deer, a female deer ...
 Get ready to join in during "Sound of Music Sing-a-Long," 7 p.m. Friday, 1 p.m. Saturday and

10 a.m. Sunday, Nov. 7-9, at Wilmette Theatre, 1122 Central Ave., Wilmette. Your family will warm up their voices during a live show, and then participate in the 1965 movie version using items in their free goody bags. Tickets are \$15. For details, call (847) 251-7424. Comment: pioneerlocal.com

"The rumor of our demise is greatly exaggerated!"

Call today to make your holiday reservations

RIVALS SPORTS BAR & GRILL

Come, Relax, Eat, Drink & Have Fun With Us

- Bulls games • Bear games
- Blackhawk games
- The Big Game • 2009 World Series

847.581.1888
 9001 Waukegan Road • Morton Grove, IL.

RAVINIA FESTIVAL

RISEING STARS 2008-09

WORLD'S ALL-TIME CLASSICS JUST \$20

Friday, November 7, 2008 at 8 p.m.
Gavriel Lipkind/Bach
 Cello
 "Lipkind is a total one-off... he plays as if possessed... This was edge-of-the-seat, white knuckle playing."
 —The Independent
 Dinner/concert package available tonight.

Friday, November 14, 2008 at 8 p.m.
Alessio Bax/Rachmaninoff
 Piano
 "Bax continues to win his audiences with his brilliant and clear tones that are refreshingly dazzling."
 —Chopin Magazine

Friday, February 13, 2009 at 8 p.m.
Lincoln Trio/World Premiere
 "The three musicians in the Lincoln Trio are a pleasure to see and hear, and we'll surely be hearing more of from them as time goes on."
 —Pioneer Press
 The trio will perform the world premiere of a winning composition from Ravinia's Lincoln Competition entry inspired by the words of the 16th president. Narrated by Welz Kauffman.
 Dinner/concert package available tonight.

847-266-5100
www.ravinia.org
 Lead Sponsor: **UBS**

"SEETHING AND SENSATIONAL"
 —Chicago Sun-Times

The Brothers Karamazov

Now Playing

The Brothers Karamazov by Fyodor Dostoevsky
 Translated by Richard Pevear and Larissa Volokhonsky
 Adapted and Directed by Ensemble Member Heidi Stömann

CALL 312.337.0665 OR VISIT LOOKINGGLASSTHEATRE.ORG

Looking Glass Theatre Company in the Heart of Chicago

NORTHBROOK Musical THEATRE
 FOR YOUNG AUDIENCES
 3323 Walters Avenue - Northbrook, IL 60062
 Northbrook Park District, Producing Organization
 Gregory C. Dennyhardt, Artistic Director
 Tel. 847 291-2367
 web. www.northbrooktheatre.org

TYA

"Red Riding Hood"

Saturdays at 10:30 and 1:00
 October 11 - November 22, 2008

FREE TRANSPORTATION FOR QUALIFYING SCHOOLS

FOR INFORMATION OR TICKETS...
847 291-2367

Weekday performances on Tuesday, Wednesday and Thursdays for schools and similar groups during the run of the shows at a discount with FREE transportation to and from the theatre for qualifying institutions.

TARGET.
 FREE transportation brought to you by a grant from TARGET.

LAST WEEKEND OF OKTOBERFEST!

SEATINGS: 11:30, 12:00, 1:30, 3:00, 4:00, 5:30

HUNTERS FEST
 Nov. 14 - 23
 OPEN 7 DAYS A WEEK
 For lunch, dinner, and late night fun!

MAKE YOUR THANKSGIVING RESERVATION

PARTIES OF 6 OR MORE RESERVE YOUR WHOLE TURKEY FOR FAMILY STYLE DINNER

BANQUET ROOM & AUTHENTIC GERMAN CATERING MENU AVAILABLE FOR ALL YOUR BUSINESS AND FAMILY EVENTS
 Great Food, Great Service, Great People
RESERVE NOW FOR YOUR HOLIDAY PARTIES
 THURSDAYS, FRIDAYS, SATURDAYS & SUNDAYS
 Live Entertainment

Edelweiss German American Cuisine
 7650 W. Irving Park Rd. Norridge
708-452-6040
 Valet Parking Fri. & Sat.

PHOENIX RESTAURANT
 708-453-8100

-- Specials Starting At \$6.95 --
 Starting from November 6th to November 20th
 These specials are from Monday-Friday Only

All entrees include soup or salad.

- Breaded Pork Tenderloin w/gravy, mashed potatoes & vegetables... \$6.95
- Fried Perch w/rice \$6.95
- Homemade Meatloaf w/mashed potatoes & gravy..... \$6.95
- Sauteed Filet of Sole w/lemon butter sauce & rice \$7.95
- Grecian Style Chicken Breast w/rice..... \$7.95
- Chicken Broccoli Linguini w/olive oil & garlic sauce..... \$7.95
- Liver & Onions w/mashed potatoes & gravy \$7.95
- Breaded Veal Cutlet w/gravy, mashed potatoes & vegetables ... \$7.95
- 2 Piece Grecian Style Pork Chops w/rice \$7.95

Wine \$ 2.50 per Glass with Specials Only

Breakfast Specials Starting at \$4.65
 Open 7 Days a Week Serving Breakfast, Lunch and Dinner

8349 W. LAWRENCE • NORRIDGE
 (at Lawrence & Cumberland)
 Open Sun.-Thurs. 6:00 am - 12:00 Midnight., Fri. & Sat. 6:00 am - 1:00 am

"THE MOST ANTICIPATED FALL PRODUCTION"

-Chicago Magazine

"AN EXPERIENCE NO PASSIONATE THEATREGOER SHOULD MISS"

-New York Times

GREY GARDENS

THE MUSICAL

BOOK BY **Doug Wright** MUSIC BY **Scott Frankel** LYRICS BY **Michael Korie**
 DIRECTED BY **BJ Jones** MUSIC DIRECTION **Doug Peck**

PERFORMANCES BEGIN **NOVEMBER 12** - EXTENDED THROUGH **DECEMBER 28**

northlight theatre

847/673-6300 or www.northlight.org

Group Rates: 847/679-9501 ext.3555 | Student Discounts Available!

go.

Continued from PAGE B7

students or groups of 10 or more. Nov. 15, 7:30 p.m.: "From Generation to Generation: Songs of the Jewish People" will be presented in Nichols Concert Hall, Music Institute of Chicago, 1490 N. Chicago Ave., Evanston. The choir explores Jewish choral music through a program of psalms, liturgical music, folk songs and dances. The program includes Leonard Bernstein's Chichester Psalms, with organ, harp, percussion and soloist; two world premieres by Bob Applebaum; and works by Salomone Rossi, Louis Lewandowski, Max Janowski and Israeli composer Yedidyah Admon.

Chicago Chamber Musicians, (312) 225-5226, www.chicagochambermusic.org. Concerts are held at 7:30 p.m. Sundays at Pick-Staiger Concert Hall on Northwestern University's campus, 50 Arts Circle Drive, Evanston. Season subscriptions are available in six-, five- and three-concert packages. Flex Pass subscriptions are also available along with tiered, senior and student pricing. Single tickets are \$20-\$40. Nov. 16: Böhm: Sextet for Brass in E-Flat Minor, Op. 30; Broughton: "Hudson River Valley"; and Dvorak: Piano Trio in F Minor, Op. 65. The Chicago Philharmonic Orchestra performs at 7 p.m. Sundays at Pick-Staiger Concert Hall on the Northwestern University campus, 50 Arts Circle Drive, Evanston, (847) 866-6888, www.chicagophilharmonic.org. Tickets are \$70 on the main floor; \$33 main

front wings; \$60, \$33 and \$20 in the balcony; \$20 obstructed view. Nov. 9: "Tribute to Poland," with Craig Terry, piano soloist. Chopin: Piano Concerto No. 1 in E Minor, Op. 11; Tchaikovsky: Symphony No. 3 in D Major, Op. 29 ("Polish"). Classical Symphony Orchestra of Chicago, a professionally oriented training orchestra, and its sister group, the Protégé Philharmonic of Chicago, include Sam Park, trombone, of Morton Grove, Jaimie Connelly, oboe, of Park Ridge, and Rebecca Goldberg, oboe, of Skokie, (312) 334-7777. Nov. 23, 3 p.m.: The Classical Symphony Orchestra of Chicago will present their Fall Showcase Joint Concert in the Harris Theater for Music & Dance at Millennium Park, 205 E. Randolph Drive, Chicago. The program includes works by Verdi,

Rimsky-Korsakov, Mussorgsky, Ravel and Tchaikovsky. Tickets: \$15-\$10 seniors and students; \$5 for children under 12. "Dr. Atomic" will be transmitted live from the Metropolitan Opera in New York at noon Nov. 8 at the Niles Showplace, 301 Golf Mill Center, Niles. For information or to purchase tickets, visit www.fathomevents.com. Evanston Chapter, Lyric Opera of Chicago, will sponsor a program and social hour at 3 p.m. Nov. 9 at the North Shore Retirement Hotel, 1611 Chicago Ave., Evanston. Philip Seward, composer, conductor, pianist and singer, will present a program on "Porgy and Bess." Cost: \$8 members, \$10 guests. Call (847) 328-0158 or (847) 478-1110 for more information. Lutkin Hall at Northwestern University, 700 University Place, Evanston. Most ticket prices listed in three categories:

general public; senior citizens and N faculty and staff; and student rate. (847) 467-4000. Nov. 11, 2-4 p.m.: Master class by British pianist Stephen Hough. Free. Nov. 15, 7:30 p.m.: "An Evening of Opera Scenes," featuring graduate students from Northwestern's voice and opera program. Free. Nov. 23, 3 p.m.: Women's Chorus presents a program of choral music from various periods and genres, composed for treble voices. \$7/\$5/\$4. Alice Millar Chapel at Northwestern University, 1870 Sheridan Road, Evanston. Information: (847) 491-5441; tickets: (847) 467-4000. Nov. 9, 7 p.m.: Baroque Music Ensemble, "Italian Glories." Program includes Egidio Duni's "Nerone" (1735); Vivaldi's violin concerto in C Major; and Baldassare Galuppi's "Lauda Jerusalem" for solo voices, chamber choir and orchestra. \$7/\$5/\$4.

Nov. 23, 6 p.m.: World premiere of a musical piece by Max Raimi, CSO violist, commissioned by Midwest Young Artists, and played by flutist Mathieu Dufour. The program will be comprised of early and new music, including a Vivaldi concerto for flute played on period instruments. Tickets are \$7-\$20 and can be purchased by calling (847) 926-9898. Mount Prospect Community Band presents "World's Most Loved Melodies" at 2 p.m. Nov. 9 at the Forest View Educational Center theater, 2121 S. Goebbert Road, Arlington Heights. Guest soloists are Allan Kaye for a Rachmaninoff piano concerto and Paulina Swiatowicz for a Tchaikovsky violin concerto. Tickets: \$7 in advance; \$9 at the door. (847) 640-1000.

go., PAGE B14

Psst...do you's know da password?

Gangsters & Flappers

Celebrate da holidays with da gang!
 It's holiday time again at Tommy Gun's Garage, so bring da friends or da family to da Windy City's only Audience Interactive Dinner Show!

Enjoy authentic food, killer hooch & a musical comedy revue wit da mugs, da flappers!

Book Your Holiday Parties Now!
 Da Holiday show runs Nov 28 thru Dec 31, 2008.



TOMMY GUN'S garage

2114 South Wabash, Chicago
 Da Phone 773-RAT-A-TAT
www.tommygunsgarage.com
 Gift Certificates Now Available!

Extended by Popular Demand!
 Tickets Going Fast

JOE LEWIS' THE SCREWTAPE LETTERS

JEFF AWARDS RECOMMENDED

"PHENOMENAL!
 Sizzling Entertainment...Wonderfully Clever.
SENSATIONAL!"
Hedy Weiss, Chicago Sun-Times

"VERY SMART...
 Richly rewarding...
EXUBERANT THEATRICALITY!"
Chris Jones, Chicago Tribune

The Mercury Theater, 3745 N. Southport, Chicago
 Box Office 773.325.1700 ticketmaster 312.902.1500
www.ScrewTapeOnStage.com

CHICAGOLAND
ANTIQUA ADVERTISING, SLOT MACHINE & JUKEBOX

SHOW

Saturday, Nov. 15, 2008
9:30 a.m. to 5:00 p.m.
Admission: \$7.00

Sunday, Nov. 16, 2008
9:30 a.m. to 5:00 p.m.
Admission: \$7.00

Friday, Nov. 14, 2008
7:00 a.m. to 5:00 p.m.
Dealer Preview: \$50.00
(Good for all 3 days)

www.chicagolandshow.com

PROMOTIONS, INC.
DEALER INFORMATION: **Bob Traynoff**
SHOW INFORMATION: **Kevin Greco**
1-847-244-9263 1-815-353-1593

PHASANT RUN RESORT
RT. 64, NORTH AVE. & 1/2 MILES WEST OF RT. 59, ST. CHARLES, IL

Rossini's

20% OFF
on complete dinners only.
Dining room only.
VALID MON-THUR. ONLY
Not valid on holidays or parties of more than 12.
Not valid with any other discounts or specials.

EXPIRES 11/20/08

CATERING SPECIAL
\$7.45 PER PERSON
Feed 20 people for \$149
(SAT. LIVE ENTERTAINMENT)

8808 N. Milwaukee Ave.
NILES, IL
(847)297-5555

go.

Continued from PAGE B13

Music Institute of Chicago, Nichols Concert Hall, 1490 Chicago Ave., Evanston. (847) 905-1500. www.musicinst.org. Nov. 12, 12:15 p.m.: Chicago organist David Schrader presents a free concert featuring works by Max Reger and Julius Reubke. Nov. 14, 7 p.m.: Sundays @ 7 free faculty recital featuring Bill Dresden, in the Thornton Performance Center. Free. Nov. 15, 9:30 a.m.: Organ master class presented by Chicago organist David Schrader. Free. Nov. 22, 7:30 p.m.: High school students in MIC's Academy program present an orchestra concert. Free. Nov. 23, 3 p.m.: Lincoln Trio presents a chamber music concert celebrating the Lincoln Bicentennial. Joined by Ravinia Festival President and CEO Weiz Kauffman as narrator, the group will perform a commissioned "Lincoln" work as well as Mendelssohn's Trio No. 2 in C minor, Op. 66. \$20/\$15/\$7.

The North Shore Chamber Orchestra will dedicate a Family Concert to the memory of Sidney Zimbalist at 3 p.m. Nov. 16 in Northwestern University's Alice Millar Chapel, 1870 Sheridan Road, Evanston. The program includes Johann Strauss's Voices of Spring; Rachmaninoff's Vocalise for Mezzo Soprano and Orchestra, featuring soprano Aimee Thompson as soloist; Aaron Copland's Nocturne; Ravel's Kaddish for Baritone and Orchestra, featuring Dane Thomas as soloist; and Bizet's Carmen Suite No. 2. Admission is \$10; free for those under 18 and all Northwestern University students. Call (847) 864-2288.

North Shore Choral Society concerts are at 3 p.m. Sundays at the Parish Church of Saint Luke, 939 Hinman Ave., Evanston. Season subscriptions are \$60; \$50 for seniors; \$30 students. Single tickets at the door are \$25; \$15 for seniors and students. (847) 272-2351. www.northshorechoral.org. Nov. 23: "The Extraordinary Ordinary," with guest conductor Julia Davids. The program includes mass movements by Giovanni Palestrina, Antonio Vivaldi, W. A. Mozart and Franz Schubert. Soloists are Laura Heimes, soprano, Nina Heebink, mezzo-soprano, Trevor Mitchell, tenor, and Ryan O'Mealey, baritone.

Northeastern Illinois University Steinberg Fine Arts Center Recital Hall, 3701 W. Bryn Mawr Ave., Chicago. (773) 442-4636. Nov. 21, 8 p.m.: Pianist Vanessa Perez. Northfield Chapter of the Lyric Opera of Chicago will host a luncheon followed by a lecture, "Puccini Heroines in a New Light: Their Untold Stories," on Nov. 20 at the Evanston Golf Club, 4401 Dempster St., Skokie. The lecture will be presented by Geoffrey and Ryan Edwards, authors of Verdi and Puccini Heroines. Social hour at 11 a.m.; luncheon at noon, and program at 1:15 p.m. \$40. Call (847) 729-8648 for reservations by Nov. 15.

Northshore Concert Band performs at 3 p.m. Sundays at Pick-Staiger Concert Hall, 50 Arts Circle Drive, Evanston, unless otherwise noted. Individual tickets \$15; \$12 seniors; \$6 students. (847) 432-2263. www.northshoreband.org. Nov. 9: The program includes "Music for Prague 1968" by Karel Husa; "Homage to Perotin"; and a special arrangement of "Greenfeéves." Guest soloist is Debra A. Richtmeyer, professor of saxophone at the University of Illinois at Urbana-Champaign.

Northwest Symphony Orchestra: Paul Vermet, music director, presents concerts at 3:30 p.m. Sundays in the Theatre for the Performing Arts at Maine West High School, 1755 S. Wolf Road, Des Plaines. Pre-concert commentaries by Carolyn Paulin, a staff member of radio station WFMT, begin one hour prior to each concert. Individual concert tickets are \$20; \$15 for seniors; \$10 for students. Season tickets for the four-concert series are \$60; \$45 for seniors; \$30 for students. Children under age 14 are admitted free when accompanied by a paying adult. www.northwestsymphony.org. Nov. 8: "Mozart & Friends," featuring Larry Combs, principal clarinet, Chicago Symphony Orchestra. Debussy; Nocturnes I. II. Mozart: Clarinet Concerto; Grieg; Peer Gynt Suites I, II.

The Norwood Park Historical Society will offer a free chamber music concert at 7:30 p.m. Nov. 10 at the Noble-Seymour-Crippen House, 5624 N. Newark Ave., Chicago. "Stylus Phantasticus: The Fantastical Style in 17th Century Italy" will be presented by Spanish violinist Joan Plana, Canadian cellist Anna Sampson and Chicago harpsichordist Jason Moy. They will perform 17th-century Italian masterpieces by Castello, Cima, Bertali, Uccellini and their contemporaries on period instruments.

The Orion Ensemble performs at the Music Institute of Chicago, 1490 Chicago Ave., Evanston. Tickets are \$25; \$22 for senior citizens; \$10 for students. Free for children 12 and younger. (630) 628-9591 or www.orionensemble.org. Nov. 9, 3 p.m.: Franz Schubert: Adagio and Rondo Concertante in F Major for Violin, Viola, Cello and Piano. D. 487; Alberto Ginastera Pampeana No. 2; Rhapsody for Cello and Piano; Manuel de Falla's "Fantasia Baetica"; and Carl Maria von Weber's Quintet in B-flat Major for Clarinet and String Quartet, Op. 34.

Park Ridge Civic Orchestra presents concerts at the Pickwick Theatre, 5 S. Prospect, Park Ridge. Individual tickets are \$25; \$20 for students and senior citizens. Call (847) 692-PRCO or (847) 823-8861. Dec. 3, 7:30 p.m.: Holiday Pops and Sing-Along, with Cheryl Wilson, soprano.

Pick-Staiger Concert Hall at Northwestern University, 50 Arts Circle Drive, Evanston. Information: (847) 491-5441; tickets: (847) 467-4000. www.pickstaiger.org. Most ticket prices listed in three categories: general public; senior citizens and NU faculty and staff; and student rate. Nov. 8, 7:30 p.m.: NU Voices, "A Choral Showcase." \$12/\$9/\$6. Nov. 10, 7:10 p.m.: Master class by British pianist Stephen Hough. Free. Nov. 11, 7:30 p.m.: Percussion Ensemble. \$7/\$5/\$4. Nov. 13, 7:30 p.m.: British pianist Stephen Hough in concert. \$22/\$20/\$10. Nov. 14, 7:30 p.m.: Symphonic Wind Ensemble in a program that includes Richard Strauss' Serenade in E-flat; Boyd and Votta's arrangement of Richard Wagner's "Trauermusik"; Bernard Rands' "Cerebral"; and more. \$7/\$5/\$4. Nov. 18, 7:30 p.m.: Evening of Brass, "400 years of Masterworks for Brass Ensemble." \$7/\$5/\$4. Nov. 20, 7:30 p.m.: The International Contemporary Ensemble will present a chamber music concert. \$7/\$5/\$4. Nov. 22, 7:30 p.m.: Northwestern University Symphony Orchestra. "Russian Treasures," including Yuri Falik's "Symphonic Etudes"; Sergei Rachmaninoff's Piano Concerto No. 2 in C Minor; and Sergei Prokofiev's Symphony No. 3 in C Minor. \$9/\$7/\$5. Nov. 23,

"A SPECTACULAR SHOW!"
CHICAGO TRIBUNE

"TERRIFIC PERFORMANCES! A STUNNER."
CHICAGO SUN-TIMES

MAME

MUSIC AND LYRICS BY JERRY HERMAN
BOOK BY JEROME LAWRENCE
AND ROBERT E. LEE

THROUGH DECEMBER 21

A CHRISTMAS CAROL

A MAGICAL & MUSICAL HOLIDAY GIFT FOR THE WHOLE FAMILY

NOVEMBER 20 - DECEMBER 20

Dinner Theater Packages • Group Discounts • Free Parking
Gift Certificates Available • Only 20 Minutes from Downtown Chicago!

Drury Lane
100 Drury Lane
Oakbrook Terrace

www.ticketmaster.com 312.902.1500
www.drurylaneoakbrook.com
630.530.8300

Regenstein Recital Hall at Northwestern University, 60 Arts Circle Drive, Evanston. (847) 467-4000. Most ticket prices listed in three categories: general public; senior citizens and NU faculty and staff; and student rate. Nov. 11, 7:30 p.m.: Faculty Recital with Trio Cayenne. The program features Jean Francaix's Divertissement; Oubradous' arrangement of Mozart's Divertimento No. 4; Alexandre Tansman's "Suite pour Trio D'Anches"; and Erwin Schulhoff's "Divertissement." \$9/\$7/\$5. Dec. 7, 10 a.m.: Guarneri String Quartet will present a master class. Free.

Rembrandt Chamber Players perform in Nichols Hall at the Music Institute of Chicago, 1490 Chicago Ave., Evanston. Tickets: \$30; \$10 students. (312) 360-3145. www.rembrandtchamberplayers.org. Dec. 7, 3 p.m.: "Vivaldi's Seasons," with guest artists Emily Lodine, mezzo-soprano, and violinists Teresa Fream, Kathleen Brauer and Yuan-Qing Yu. Program includes Brahms' Two Songs for Alto; Bach's Arias from Cantata No. 182; Vivaldi's "The Four Seasons"; and Mozart's Quintet for Clarinet and Strings.

Allstate Arena, 6920 N. Mannheim Road, Rosemont. Tickets are available at www.ticketmaster.com or (312) 559-1212; the ticket prices listed below do not include service fees. The information line is (847) 635-6601. Dec. 9: Neil Young with guests Willie Nelson and Everest. \$50-\$250. Dec. 12, 7 p.m.: Oasis with special guest Ryan Adams & The Cardinals. \$69.50, \$49.50, \$39.50. Jan. 3, 2009, 3 p.m. and 8 p.m.: Trans-Siberian Orchestra. \$48, \$38. Jan. 26-27, 2009, 7 p.m.: Metallica with Machine Head, The Sword. \$79.50, \$59.50. American Legion Music Hall, 1030 Central St., Evanston. (847) 573-0443. www.chicagobluegrass.com. Bluegrass Legends Concerts - doors open at 7:30

www.chicagobluegrass.com. Bluegrass Legends Concerts - doors open at 7:30 p.m.: Philharmonia, "Great British Composers," including William Walton's "Crown Imperial" ("Coronation March"); Benjamin Britten's "Young Person's Guide to the Orchestra" ("Variations and Fugue on a Theme of Purcell"); Eric Coates' "London Suite" ("London Every Day"); and Edward Elgar's "The Wand of Youth Suite" and "Pomp and Circumstance, Military March No. 1 in D Major." \$7/\$5/\$4. Nov. 24, 7:30 p.m.: Contemporary Music Ensemble, "Concertinis." \$7/\$5/\$4. Dec. 7, 7:30 p.m.: Guarneri String Quartet, with special guest string bassist Peter Lloyd. \$25/\$22/\$12. Dec. 11, 11:30 a.m.: Mezzo-soprano Denyce Graves will conduct a master class featuring gifted students from the Biene School of Music's voice and opera program. \$7/\$5/\$4. Dec. 12, 7:30 p.m.: Pianist Jeffrey Siegel's Keyboard Conversations program, "Basking in Beethoven." Featured works will include Beethoven's "Für Elise" and "Farewell" Sonata in E-flat. \$23/\$21/\$16.

Presbyterian Homes Westminster Place campus, Elliott Chapel, 3131 Simpson (Golf) Road, Evanston. (847) 492-2915. Gift of Music recital series - Nov. 11, 7:15 p.m.: Free classical organ recital by Volodymyr Koshuba, principal organist of the Kiev Concert Hall of Organ and Chamber Music in Ukraine. The program includes works by Antonio Soler, J.S. Bach, Antonio Vivaldi, Richard Strauss, Mikola Kolossa, P.I. Tchaikovsky, Igor Stravinsky and Georgi Mushel.

Regenstein Recital Hall at Northwestern University, 60 Arts Circle Drive, Evanston. (847) 467-4000. Most ticket prices listed in three categories: general public; senior citizens and NU faculty and staff; and student rate. Nov. 11, 7:30 p.m.: Faculty Recital with Trio Cayenne. The program features Jean Francaix's Divertissement; Oubradous' arrangement of Mozart's Divertimento No. 4; Alexandre Tansman's "Suite pour Trio D'Anches"; and Erwin Schulhoff's "Divertissement." \$9/\$7/\$5. Dec. 7, 10 a.m.: Guarneri String Quartet will present a master class. Free.

Rembrandt Chamber Players perform in Nichols Hall at the Music Institute of Chicago, 1490 Chicago Ave., Evanston. Tickets: \$30; \$10 students. (312) 360-3145. www.rembrandtchamberplayers.org. Dec. 7, 3 p.m.: "Vivaldi's Seasons," with guest artists Emily Lodine, mezzo-soprano, and violinists Teresa Fream, Kathleen Brauer and Yuan-Qing Yu. Program includes Brahms' Two Songs for Alto; Bach's Arias from Cantata No. 182; Vivaldi's "The Four Seasons"; and Mozart's Quintet for Clarinet and Strings.

Allstate Arena, 6920 N. Mannheim Road, Rosemont. Tickets are available at www.ticketmaster.com or (312) 559-1212; the ticket prices listed below do not include service fees. The information line is (847) 635-6601. Dec. 9: Neil Young with guests Willie Nelson and Everest. \$50-\$250. Dec. 12, 7 p.m.: Oasis with special guest Ryan Adams & The Cardinals. \$69.50, \$49.50, \$39.50. Jan. 3, 2009, 3 p.m. and 8 p.m.: Trans-Siberian Orchestra. \$48, \$38. Jan. 26-27, 2009, 7 p.m.: Metallica with Machine Head, The Sword. \$79.50, \$59.50. American Legion Music Hall, 1030 Central St., Evanston. (847) 573-0443. www.chicagobluegrass.com. Bluegrass Legends Concerts - doors open at 7:30

www.chicagobluegrass.com. Bluegrass Legends Concerts - doors open at 7:30 p.m.: Philharmonia, "Great British Composers," including William Walton's "Crown Imperial" ("Coronation March"); Benjamin Britten's "Young Person's Guide to the Orchestra" ("Variations and Fugue on a Theme of Purcell"); Eric Coates' "London Suite" ("London Every Day"); and Edward Elgar's "The Wand of Youth Suite" and "Pomp and Circumstance, Military March No. 1 in D Major." \$7/\$5/\$4. Nov. 24, 7:30 p.m.: Contemporary Music Ensemble, "Concertinis." \$7/\$5/\$4. Dec. 7, 7:30 p.m.: Guarneri String Quartet, with special guest string bassist Peter Lloyd. \$25/\$22/\$12. Dec. 11, 11:30 a.m.: Mezzo-soprano Denyce Graves will conduct a master class featuring gifted students from the Biene School of Music's voice and opera program. \$7/\$5/\$4. Dec. 12, 7:30 p.m.: Pianist Jeffrey Siegel's Keyboard Conversations program, "Basking in Beethoven." Featured works will include Beethoven's "Für Elise" and "Farewell" Sonata in E-flat. \$23/\$21/\$16.

ADVERTISE HERE!
Reach
2,940,209*
print & online
readership

Source: 2008 Chicago Scarborough Sun-Times Release 1 Study
Your Listing Will Appear in...

STANG SUNTIMES CHICAGO NEWS GROUP SUN-TIMES

SOUTHTOWNSTAR FOX VALLEY NEWSPAPERS NEWS-SUN PostTribune

BaconNews HeraldNews

CourierNews Naperville Sun

PIONEER PRESS The Hoings

www.gigisresort.com or 800-910-2357

Swiss Chalet Bed and Breakfast
Great location and comfortably furnished across from Busch Gardens and Adventure Island in North Tampa. Delicious breakfast and discounted tickets to Busch Gardens and Adventure Island. Unlimited access to both parks while you are a guest at our Inn. 3 Beautiful bedrooms. Ideal for a entire family. Accommodations for up to 8. Reservations suggested. Non-smoking, no pets. All credit cards accepted. 2 Night Minimum.
www.swisschaletbedandbreakfast.com or 813-985-3601

FT MYERS / CROSS CREEK
2BR/2BA Pool, Golf Course, Tennis, Dining, Hot Tub.
2600.00/Month.
Peggy 708-712-4168

BeautifulBeach.com
Leads you to NW Florida's Best Beach Vacation Rentals along the Beaches of South Walton. Luxurious gulf front homes, seaside condos and cottages. Dune Allen Realty, 50 yrs of excellent service and accommodations.
888-267-2121 or BeautifulBeach.com

POP/FOLK/JAZZ
Allstate Arena, 6920 N. Mannheim Road, Rosemont. Tickets are available at www.ticketmaster.com or (312) 559-1212; the ticket prices listed below do not include service fees. The information line is (847) 635-6601. Dec. 9: Neil Young with guests Willie Nelson and Everest. \$50-\$250. Dec. 12, 7 p.m.: Oasis with special guest Ryan Adams & The Cardinals. \$69.50, \$49.50, \$39.50. Jan. 3, 2009, 3 p.m. and 8 p.m.: Trans-Siberian Orchestra. \$48, \$38. Jan. 26-27, 2009, 7 p.m.: Metallica with Machine Head, The Sword. \$79.50, \$59.50. American Legion Music Hall, 1030 Central St., Evanston. (847) 573-0443. www.chicagobluegrass.com. Bluegrass Legends Concerts - doors open at 7:30

www.gigisresort.com or 800-910-2357

Swiss Chalet Bed and Breakfast
Great location and comfortably furnished across from Busch Gardens and Adventure Island in North Tampa. Delicious breakfast and discounted tickets to Busch Gardens and Adventure Island. Unlimited access to both parks while you are a guest at our Inn. 3 Beautiful bedrooms. Ideal for a entire family. Accommodations for up to 8. Reservations suggested. Non-smoking, no pets. All credit cards accepted. 2 Night Minimum.
www.swisschaletbedandbreakfast.com or 813-985-3601

FT MYERS / CROSS CREEK
2BR/2BA Pool, Golf Course, Tennis, Dining, Hot Tub.
2600.00/Month.
Peggy 708-712-4168

BeautifulBeach.com
Leads you to NW Florida's Best Beach Vacation Rentals along the Beaches of South Walton. Luxurious gulf front homes, seaside condos and cottages. Dune Allen Realty, 50 yrs of excellent service and accommodations.
888-267-2121 or BeautifulBeach.com

POP/FOLK/JAZZ
Allstate Arena, 6920 N. Mannheim Road, Rosemont. Tickets are available at www.ticketmaster.com or (312) 559-1212; the ticket prices listed below do not include service fees. The information line is (847) 635-6601. Dec. 9: Neil Young with guests Willie Nelson and Everest. \$50-\$250. Dec. 12, 7 p.m.: Oasis with special guest Ryan Adams & The Cardinals. \$69.50, \$49.50, \$39.50. Jan. 3, 2009, 3 p.m. and 8 p.m.: Trans-Siberian Orchestra. \$48, \$38. Jan. 26-27, 2009, 7 p.m.: Metallica with Machine Head, The Sword. \$79.50, \$59.50. American Legion Music Hall, 1030 Central St., Evanston. (847) 573-0443. www.chicagobluegrass.com. Bluegrass Legends Concerts - doors open at 7:30

www.gigisresort.com or 800-910-2357

Swiss Chalet Bed and Breakfast
Great location and comfortably furnished across from Busch Gardens and Adventure Island in North Tampa. Delicious breakfast and discounted tickets to Busch Gardens and Adventure Island. Unlimited access to both parks while you are a guest at our Inn. 3 Beautiful bedrooms. Ideal for a entire family. Accommodations for up to 8. Reservations suggested. Non-smoking, no pets. All credit cards accepted. 2 Night Minimum.
www.swisschaletbedandbreakfast.com or 813-985-3601

www.gigisresort.com or 800-910-2357

Swiss Chalet Bed and Breakfast
Great location and comfortably furnished across from Busch Gardens and Adventure Island in North Tampa. Delicious breakfast and discounted tickets to Busch Gardens and Adventure Island. Unlimited access to both parks while you are a guest at our Inn. 3 Beautiful bedrooms. Ideal for a entire family. Accommodations for up to 8. Reservations suggested. Non-smoking, no pets. All credit cards accepted. 2 Night Minimum.
www.swisschaletbedandbreakfast.com or 813-985-3601

FT MYERS / CROSS CREEK
2BR/2BA Pool, Golf Course, Tennis, Dining, Hot Tub.
2600.00/Month.
Peggy 708-712-4168

BeautifulBeach.com
Leads you to NW Florida's Best Beach Vacation Rentals along the Beaches of South Walton. Luxurious gulf front homes, seaside condos and cottages. Dune Allen Realty, 50 yrs of excellent service and accommodations.
888-267-2121 or BeautifulBeach.com

POP/FOLK/JAZZ
Allstate Arena, 6920 N. Mannheim Road, Rosemont. Tickets are available at www.ticketmaster.com or (312) 559-1212; the ticket prices listed below do not include service fees. The information line is (847) 635-6601. Dec. 9: Neil Young with guests Willie Nelson and Everest. \$50-\$250. Dec. 12, 7 p.m.: Oasis with special guest Ryan Adams & The Cardinals. \$69.50, \$49.50, \$39.50. Jan. 3, 2009, 3 p.m. and 8 p.m.: Trans-Siberian Orchestra. \$48, \$38. Jan. 26-27, 2009, 7 p.m.: Metallica with Machine Head, The Sword. \$79.50, \$59.50. American Legion Music Hall, 1030 Central St., Evanston. (847) 573-0443. www.chicagobluegrass.com. Bluegrass Legends Concerts - doors open at 7:30

www.gigisresort.com or 800-910-2357

Swiss Chalet Bed and Breakfast
Great location and comfortably furnished across from Busch Gardens and Adventure Island in North Tampa. Delicious breakfast and discounted tickets to Busch Gardens and Adventure Island. Unlimited access to both parks while you are a guest at our Inn. 3 Beautiful bedrooms. Ideal for a entire family. Accommodations for up to 8. Reservations suggested. Non-smoking, no pets. All credit cards accepted. 2 Night Minimum.
www.swisschaletbedandbreakfast.com or 813-985-3601

FT MYERS / CROSS CREEK
2BR/2BA Pool, Golf Course, Tennis, Dining, Hot Tub.
2600.00/Month.
Peggy 708-712-4168

BeautifulBeach.com
Leads you to NW Florida's Best Beach Vacation Rentals along the Beaches of South Walton. Luxurious gulf front homes, seaside condos and cottages. Dune Allen Realty, 50 yrs of excellent service and accommodations.
888-267-2121 or BeautifulBeach.com

POP/FOLK/JAZZ
Allstate Arena, 6920 N. Mannheim Road, Rosemont. Tickets are available at www.ticketmaster.com or (312) 559-1212; the ticket prices listed below do not include service fees. The information line is (847) 635-6601. Dec. 9: Neil Young with guests Willie Nelson and Everest. \$50-\$250. Dec. 12, 7 p.m.: Oasis with special guest Ryan Adams & The Cardinals. \$69.50, \$49.50, \$39.50. Jan. 3, 2009, 3 p.m. and 8 p.m.: Trans-Siberian Orchestra. \$48, \$38. Jan. 26-27, 2009, 7 p.m.: Metallica with Machine Head, The Sword. \$79.50, \$59.50. American Legion Music Hall, 1030 Central St., Evanston. (847) 573-0443. www.chicagobluegrass.com. Bluegrass Legends Concerts - doors open at 7:30

Destinations Inns & Resorts

FLORIDA

DESTIN.
Edgewater Beach Condos on the Gulf Special: Rent 3 or 4 nights, get 1 extra night free (Valid through 12/31/08. Some restrictions, call for details.) 1-3BR beachfront, pvt. balconies, FREE wi-fi, beach set-up (in season) and use of new fitness center. New massage & facial salon, 2 pools, spa, area golf & deep sea fishing. FREE \$20 gift certificate to pool-side grill (w/ky. rentals in season).
800-822-4929, www.edgewaterbeach.com

Coral Reef Guesthouse Fort Lauderdale
South Florida's finest upscale gay owned all-male clothing-optional resort since 1997, ideally located near the beach, restaurants and the Galleria Mall. Rooms are scrupulously clean, tastefully decorated, and overlook the beautifully landscaped, tropical pool-area, including a 14-man Jacuzzi. Catering to the sophisticated, discerning male traveler that enjoys a relaxed, pampered experience.
www.coralreefguesthouse.com or 888-365-6948

De Luxe Bed and Breakfast
Charming, elegant marble floor suites located on a private estate five minutes from Old Kolosa Town. Each suite has a full size bathtub, walk-in closet, king size bed, cable TV, phones, fax, refrigerator, lounge area, and a lanai. Culinary breakfast includes fresh island grown fruit. \$85/night.
www.aquasorts.com or 866-406-2782

MICHIGAN

Stafford's Bay View Inn
For over 40 years the Stafford Smith family has owned, operated, and lovingly restored, this grand Victorian Country Inn on the shores of Lake Michigan's Little Traverse Bay. Built in 1886 in the Historic Landmark District of Bay View, this Inn sets the standard in country inn dining and gracious service.
www.stafford.com/bay-view-inn or 800-258-1886

Autumn in Lake Geneva, It's Always been the Place!
Warm days, cool nights and everything Lake Geneva has to offer is yours, only 90 minutes Northwest of downtown Chicago. Everything you've heard about Lake Geneva is true, so visit today and discover your own little piece of beautiful Lake Geneva, Wisconsin. Visit now! September and October are beautiful here in Lake Geneva. Now Showing Fall Color!
Call 1-800-345-1020 or visit our web site at www.lakegenevawi.com.

THE HIGGINS HOUSE Bed & Breakfast
Walk in the Higgins House and step back 100 years, to gracious Victorian living. Luxurious furniture and antiques; a butterfly garden; a shabby chic dining room; the view of the gazebo and the green expanse of Centennial park from one of the porch swings. A cup of tea or glass of wine can be enjoyed on the upstairs veranda. The Higgins House has 3 guest rooms; all with private baths.
www.higginshouse.com or 866-416-9238

1-2-3-It's That Easy!
America's favorite Vacation Homes by Florida Leisure! 3 to 7BR, luxury pool homes, close to all attractions, from \$99/nt. Just 1-Call, 2-Book, 3-Stay in the Best Vacation Home in Kissimmee. We Guarantee It!
800-216-7165 or www.floridaleisure.com

ILINOIS

Mayan Adventure Indoor Water Park
Get in on our FANTASTIC FALL FARES!!! NOT FAR from Chicago! Prices are "FALL"ing and you could be to from our giant tube & body slides!!! From our interactive play area for tots, lazy river, activity pool, a parents only hot tub, a FAMILY arcade & more! You'll find lots to do to spend time with the FAMILY. Book our FANTASTIC FALL FARE now! \$129 plus tax includes a 2 day, 1 night Stay & (FOUR) passes to the water park. Must present this ad at time of check-in to receive this FANTASTIC FALL FARE rate. Offer valid through 11/20/08 based on availability, restrictions apply.
Book now (630) 279-1100 www.mayanindoorwaterpark.com.

Applesauce Inn Bed & Breakfast
Applesauce Inn Bed & Breakfast is a beautifully restored 1893 four-square farmhouse; five minutes from world-famous Torch Lake, Alden, Shanty Creek Resort and the Grass River Natural Area. Charlevoix, Petoskey, Bay Harbor, Traverse City, Sleeping Bear Dunes & Mackinac Island are all great day trips from the Inn.
www.applesauceinn.com or 888-533-6448

A RIVER RUNS THROUGH IT!
Suites in a circa 1858 renovated stone flour mill. Many with whirl-pools, fireplace & decks over the Fox River. A truly unique inn, hidden just outside Green Bay, James Street Inn, 201 James St., De Pere, WI. 54115. Call for brochure 1-800-897-8483

Gigi's Resort By the Beach
Walk to the beach from this Superior Motel Lodging property. Gigi's Resort by the Beach is a unique Art Deco Florida hotel in Port Lauderdale. Less than a minute's walk to the Port Lauderdale beach, here you get rare value for your money. Our "pool" is the Atlantic Ocean. Personal, individual service makes this guesthouse truly unique. Stay in touch with loved ones or work by high speed, wireless (Wi-Fi) Internet.
www.gigisresort.com or 800-910-2357

Timeshare Resales
60 to 80% off retail! Best Resorts & Seasons! Call for a FREE Timeshare Magazine!
1-800-354-1346. www.holidaygroup.com/csn

River Rose Inn
Elegant Greek Gothic Mansion, Bed & Breakfast situated in a picturesque rivertown on the historic Ohio River by the Shawnee Nation Forest. Luxurious accommodations with whirlpool tubs for 2, fireplaces, antique furnishings, swimming pool & jacuzzi hot tub, romance & pampering all year long.
www.shawneelink.com or 618-287-8811

DeLano Inn Victorian Bed and Breakfast
A tribute to Victorian elegance, the DeLano Inn is decorated in high Victorian furnishings, five suites with period antiques throughout. Gourmet breakfast every morning. Romance packages and specials are listed on our website.
www.delanoinn.com or 866-686-0240

COUNTRY HOUSE RESORT
Sister Bay, on the Door County Peninsula. In the Woods, On the Water, Off the Highway. 46 rooms/suites. Adult, Relaxed, Elegant. STRESS RELIEF amid breathtaking natural beauty. Value-added MIDWEEK PROMOTIONS.
www.CountryHse.com, 1-888-424-7601

Swiss Chalet Bed and Breakfast
Great location and comfortably furnished across from Busch Gardens and Adventure Island in North Tampa. Delicious breakfast and discounted tickets to Busch Gardens and Adventure Island. Unlimited access to both parks while you are a guest at our Inn. 3 Beautiful bedrooms. Ideal for a entire family. Accommodations for up to 8. Reservations suggested. Non-smoking, no pets. All credit cards accepted. 2 Night Minimum.
www.swisschaletbedandbreakfast.com or 813-985-3601

FT MYERS / CROSS CREEK
2BR/2BA Pool, Golf Course, Tennis, Dining, Hot Tub.
2600.00/Month.
Peggy 708-712-4168

Greenbriar Country Inn & Suites, Galena
Step back in time relax in historic lodgings. Frpl, whirlpool tubs, TV's, hand delivered breakfast baskets to your door. Walk to restaurants, shops, Midweek special.
1-815-777-3153 www.greenbriargalena.com

LAKEFRONT RESORT
Nov., Buy One Night Get One Night Free. Elegant Rooms & dining. Whirlpool fireplace suites, Indoor Pool, massages & love pkgs.
www.baypointeinn.com 1-888-Gun-Lake, MI

ADVERTISE HERE!
Reach
2,940,209*
print & online
readership

Source: 2008 Chicago Scarborough Sun-Times Release 1 Study
Your Listing Will Appear in...

STANG SUNTIMES CHICAGO NEWS GROUP SUN-TIMES

SOUTHTOWNSTAR FOX VALLEY NEWSPAPERS NEWS-SUN PostTribune

BaconNews HeraldNews

CourierNews Naperville Sun

PIONEER PRESS The Hoings

Hale Kua Bed and Breakfast Ocean View!
Located on the sunny South Shore of Kauai, our secluded hillside bed and breakfast offers peace and serenity in one of our five choice accommodations. All are private and completely self-contained, with many thoughtful amenities. The breathtaking panoramic views from these South Shore Kauai vacation rentals extend from the ocean to the south, along the rolling pastured hillsides of Lawai valley, to the majestic peaks of Mount Kahlili to the north.
www.halekua.com or 800-440-4353

Montego Bay-Celebrity Chateau
New luxury 7 Br / 7 Ba Private Villa -spectacular ocean/mountain views. Come enjoy the warm sunny beaches and fun. Full staff with chef. Rent 1 to 7 br. Book your winter get away now!
www.chicago2jamaica.com or 773-619-9513

Bernadine's Stillman Inn
Romantic 1858 French Italiane located across from General Grant's home

"THE BEST SHOW TO GET AT THE HEART OF THE TRUE MEANING OF CHRISTMAS."

—SouthtownStar

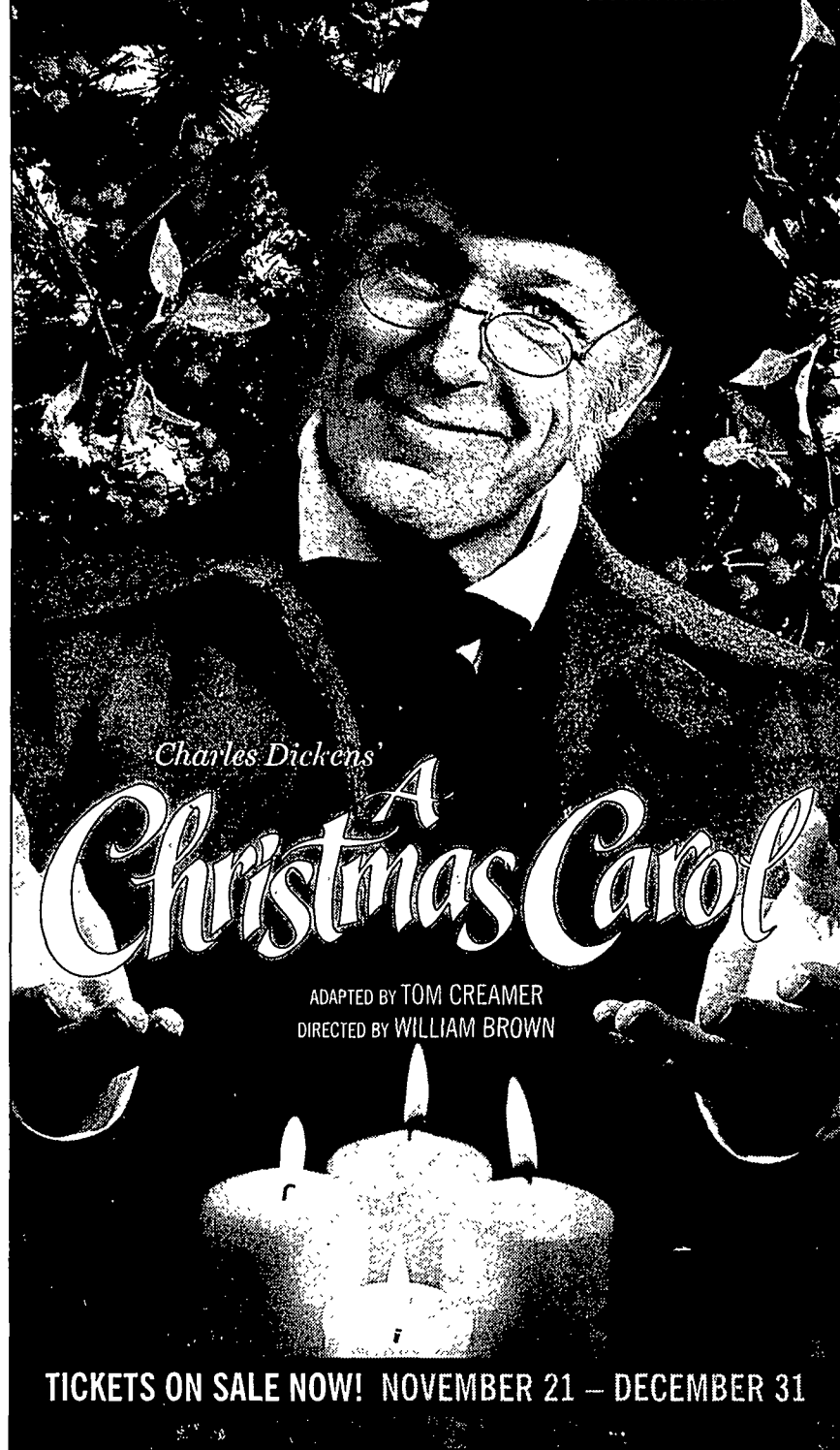

TICKETS ON SALE NOW! NOVEMBER 21 – DECEMBER 31

SPECIAL GROUP SAVINGS FOR 15 OR MORE!
E-mail KimFurganson@GoodmanTheatre.org or call 312.443.3820.

GOODMAN THEATRE
GoodmanTheatre.org
312.443.3800

HARRIS Aon KPMG
AMERICAN AIRLINES, Exclusive Airline of Goodman Theatre. KRAFT FOODS, Principal Sponsor of the Free Student Subscription Series. THE MELTING POT, Promotional Partner for A Christmas Carol. Photo of Larry Yando by Brian Waring. Design and direction by Kelly Rickert.

go.

Continued from PAGE B14

p.m., show at 8 p.m. Admission: \$20; \$15 for senior citizens and children. Nov. 14: Carrie Hassler & Hard Rain. Nov. 29: The Chapmans. Bill's Blues, 1029 Davis St., Evanston. (847) 424-9800. www.billbluesbar.com. Cover charges vary. Sundays, 4 p.m.: Lifest Open Mike. Mondays, 9 p.m.: Paul Doppelt and Friends (blues/rock). Tuesdays, 8:30 p.m.: Blues Jam hosted by The TFB Band. Wednesdays, 7:30 p.m.: Pro Jazz Jam with Mike Finnerty. Nov. 7, 5:30 p.m.: Mark Adamczyk (jazz fusion). Nov. 7, 8:30 p.m.: Aron Burton & the TFB Band (blues). Nov. 7, 11:45 p.m.: Razzo Razoo (world music). Nov. 8, 3 p.m.: Big Time Entertainment (rock). Nov. 8, 8:30 p.m.: Melvin Taylor & the Slack Band. Nov. 8, 11:45 p.m.: Larry Smith Presents (R&B). Nov. 9, 7 p.m.: Trillium (folk). Nov. 13, 7 p.m.: The Railjacks (rock). Nov. 14, 6 p.m.: The Sidemen Big Band (jazz). Nov. 14, 8:30 p.m.: The Johnny B. Moore Blues Band. Nov. 15, 3 p.m.: Big Time Entertainment (rock). Nov. 15, 8:30 p.m.: Eddy "The Chief" Clearwater Blues Band. Nov. 15, 11:45 p.m.: TRC Events Presents (world music). The Celtic Knot Public House, 626 Church St., Evanston. (847) 864-1679. www.celticknotpub.com. No cover unless noted otherwise. Mondays, 8 p.m.-midnight: Bluegrass and roots music with the Mudtapps. Tuesdays, 7-10 p.m.: Irish music session. Nov. 8, 10 p.m.: Breakin' Up A Dogfight. Nov. 16 and 30, 5-8 p.m.: Eric Lugosch. Nov. 22,

10 p.m.: Creek Road Ramblers. Centre East in the North Shore Center for the Performing Arts, 9501 Skokie Blvd., Skokie. (847) 673-6300. www.centreast.org. Dec. 27, 8 p.m., and Dec. 28, 3 p.m.: Mandy Patinkin performs popular standards from Rodgers and Hammerstein, Stephen Sondheim, Harry Chapin, Irving Berlin and Cole Porter, with Paul Ford on piano. Tickets: \$85. Des Plaines Public Library, 1501 Ellinwood St. (847) 376-2787. www.dppl.org. Advance registration required for activities unless noted otherwise. Nov. 23, 2 p.m.: "Abraham Lincoln in Song." Using period music and Lincoln's own stories, folksinger and songwriter Chris Vallilio will bring Abraham Lincoln to life. Ethical Humanist Society Second Saturday Coffeehouse, 7574 N. Lincoln Ave. (at Howard), Skokie. (847) 677-3334. www.ethicalhuman.org. Nov. 8, 8 p.m.: CD release party of "February Sky," featuring Phil Cooper and Susan Urban playing modern and original folk and Celtic music, along with special guests Cooper & Nelson, Bob and Micky Holdsworth, Kathy Folkerts, Moose River, Sassi and Joe Wadz. No open mic this evening to allow for longer concert. \$7. Famous Freddie's Roadhouse, 1799 S. Busse Road, Mount Prospect. (847) 593-2200. www.famousfreddiesroadhouse.com. Shows start at 9 p.m. Fridays and 10 p.m. Saturdays. Nov. 7: HI Infidelity. Nov. 14: Libido Funk Circus. Nov. 15: C-Factor (classic to current pop rock covers). Nov. 21: Spunk (party rock) with an opening set by Camouflage Sun. Nov. 22: Bad Medicine (Bon Jovi tribute). Nov. 26: Covergrip (party rock). Nov. 28: Reverie (alternative rock covers and originals) with an opening set by Sure Fire Groove (blues rock). Nov. 29: J.P. & the Cals (disco 70s, MTV '80s). Hogeve Folk Arts hosts concerts at Lake Street Church of Evanston, 607 Lake St. (847) 475-6165. www.hogevefolkarts.org. All concerts start at 7:30 p.m.; doors open at 7 p.m. \$15; \$13 for senior citizens; \$5 for students; free for children under 12. Nov. 22: Larry & Nicole with Rick Veras. Irish American Heritage Center, 4626 N. Knox Ave., Chicago. (773) 282-7035. www.irishamh.com. Nov. 15, 7:30 p.m.: Irish Heritage Singers will present "Cead Mile Fáilte/One Hundred Thousand Welcomes." \$15; \$12 for IAHC members; free for children 11 and under. Entertainment at 9 p.m. Fridays and Saturdays in the Fifth Province Lounge, no cover - Nov. 7: Celli Dancing with Ceoltóirí Chicago. Nov. 8: Pat Daly. Nov. 14: Paddy Homan's Band. Nov. 15: Celtic Groundhogs. Morton Grove Public Library, 6140 Lincoln Ave. (847) 965-4220. Nov. 16, 2 p.m.: Nightclub in the Afternoon, featuring Mary Anne Riehl. Niles North High School, 9800 Lawler, Skokie. Nov. 18, 7 p.m.: Barrage, featuring an international cast performing an eclectic mix of music, song and dance. The cast of Barrage includes six violinists/vocalists, one drummer, one bass player, and a guitarist. Niles West and Niles North musicians will also perform onstage with Barrage. Tickets: \$15; \$10 students and seniors. For tickets and information, call (847) 626-2116. Oakton Community College, 1600 E. Golf Road, Des Plaines. Nov. 16, 1 p.m.: "What Is This Thing Called Love?" music from the American songbook,

Broadway, and opera presented by Eileen Berman and John Cina. The performance is preceded by a buffet-style brunch. \$25. Reservation deadline is Nov. 6. Call (847) 635-1900. Park Ridge Public Library, 20 S. Prospect Ave., Park Ridge. (847) 825-3123. www.parkridgelibrary.org. Nov. 13, 7 p.m.: Jazz Lizards present music of Duke Ellington, the Garthwin brothers, Cole Porter and others. Pete Miller's, 1557 Sherman Ave., Evanston. (847) 328-0399. www.petemillers.com. No cover charge, no minimum. Music from 8:30 p.m.-12:30 a.m. Monday-Thursday; 9 p.m.-1 a.m. Fridays and Saturdays. Wednesdays: Bobby Broom Trio. Thursdays: The Skinny. Nov. 7-8: Corky McClerkin Trio. Nov. 14-15: Eddie Harrison's Jump Stars. Nov. 21-22: Bob Dogan Trio. Nov. 26: Dan Zemelman Trio. Nov. 28-29:

Brian Gephart Quartet. Pick a Cup Coffeehouse, 1813 Dempster, Evanston. (847) 332-2834. Thursdays, 7-9 p.m.: Thursday Nile Mic Check, sponsored by Mic Check Productions, Inc. All artists welcome. \$5 for performers/\$7 for nonperformers. E-mail miccheckpr@publicist.com. Pick-Staiger Concert Hall at Northwestern University, 50 Arts Circle Drive, Evanston. Most ticket prices listed in three categories: general public; senior citizens and NU faculty and staff; and student rate. Information: (847) 491-5444; tickets: (847) 467-4000. www.pickstaiger.org. Nov. 12, 7:30 p.m.: Northwestern University Jazz Orchestra. \$7/\$5/\$4. "Queen + Paul Rodgers: Let the Cosmos Rock," a concert filmed at the Freedom Square in Kharkov, Ukraine, on Sept. 12, will be shown at 7:30 p.m.

Nov. 6 at the Niles Showplace, 301 Golf Mill Center, Niles; and Evanston 18, 1715 Maple Ave., Evanston. Tickets available at the theatre box offices and at www.fathomevents.com. Skokie Theatre Music Foundation presents concerts in the Skokie Theatre, 7924 Lincoln Ave., Skokie. Call (847) 677-7761 or visit www.skokietheatre.com. Concert tickets \$15 in advance; \$20 at the door, unless noted otherwise. Nov. 9, 7 p.m.: Jeff Hedberg & C11 (jazz). \$20/\$25. Nov. 12, 1:30 p.m.: Best of Broadway, \$5. Nov. 14, 8 p.m.: Doug Lofstrom and the New Quartet present classical, jazz and world music. Nov. 15, 7:30 p.m.: Bounding Main (nautical music). Nov. 16, 2 p.m.: "Songs From My Heart," a one-woman cabaret show featuring Kimber Leigh Nussbaum, Maxwell Street Klezmer Band vocalist. Nov. 16, 7 p.m.: Sons of

the Never Wrong (folk). \$20/\$25. Nov. 28-29, 8 p.m.: Jim Post, with special guest Randy Sabien (folk). \$20/\$25. Dec. 5, 8 p.m.: Mill Trenier holiday concert. Dec. 6-7, 2 p.m. and 8 p.m.: Charlene Brooks presents "Love Stinks." Dec. 12, 8 p.m.: "Holiday For Swing," presented by the Bob Acri Octet. Dec. 13-14, 8 p.m.: Guitars of Spain. Dec. 19, 8 p.m.: The Pinups present "I'll Be Home for Christmas." \$20/\$25. S.P.A.C.E., 1245 Chicago Ave., Evanston. (847) 492-8860. www.evanspace.com. Nov. 7: Lurie Bell Acoustic Show. Nov. 9: Neva Dinova with McCarthy Trenching. Nov. 12: Tony do Rosario's New Chicago Jazz Quartet. Nov. 14: Liquid Soul with My Dear Disco. Nov. 16: Anne Heaton and Rose Polenzani. Nov. 19: The Steak House Mints CD release show with Nicholas Barron Band. Nov. 20: Trina

Hamlin and Katie Smith. Nov. 21: Mike Flynn's North of Memphis with The Tabasco Sound Kitchen. Nov. 22: Brendan James with Kelsey Wild. Nov. 23: Adrienne with Daphne Willis. Nov. 24: Chicago Barn Dance Company. Nov. 26: An Evening with Acoustic Chicago. Nov. 28: Pro Cause & the Dysfunction Hipnotik. Nov. 29: Hogeve Folk Arts 30th Anniversary Show.

ART GALLERIES

As You Like It Gallery, 825-8 Chicago Ave., second floor, Evanston. (847) 864-3101. www.asyoulikeitsaion.net. Through February: "The World at Large," paintings by Larry Geni, featuring landscapes, abstracts, figures and still lifes expressing the evolution of the artist's work over the last decade. Brickton Art Center, 306 Busse High-

way, Park Ridge. (847) 823-6611. www.bricktonartcenter.org. Nov. 8, 7-9 p.m.: Art Evolution, featuring artwork created live in the gallery by local artists to the rhythms of music. Throughout the evening visitors can enjoy refreshments and experience the creative process first-hand. A selection of artwork will be available for purchase and auction. The auction of artwork created during the event will begin at 9:15 p.m. Artists include Aviva Alter, Alan Lerner, Nancy Rosen, Emily Rutledge and Johanna Silva. \$20 per person. Must be 21 and over to attend. Dittmar Memorial Gallery at Northwestern University's Norris Center, 1999 Campus Drive, Evanston. (847) 491-2348. www.norris.northwestern.edu/dittmar.

go., PAGE B18

PUBLIC AUCTION INTERNATIONAL AUTO MART

Over 150 & TRUCKS/SUVS to AUCTION

Bidding Starts at \$100 on over 25 cars

Sat. Nov. 08, 2008
1441 Rand Rd.
Des Plaines, IL
(Between Golf & River Rd.)
Auctioneer Joel Langer Lic: 44000753

Register at 9:00 AM. to enter a Raffle to WIN a CAR Financing Available 847-699-8500 Auction starts at 11:00 AM.

Devonshire Playhouse Presents

Into the Woods, Jr.

A Children's Theater Production
Book by James Lapine
Lyrics and Music by Stephen Sondheim

November 14, 15, 16, 21, 22, 23.

Friday & Saturday at 7 p.m.
Sundays at 3 p.m.

A twisted modern take on classic fairy tales.

"Meet the Characters" Tea
Enjoy tea and snacks with the cast following the Sunday performances.
Tea tickets: \$10

Show Tickets
Adults: \$10
Students/Seniors: \$8
Groups (10+): \$7

CULTURAL *Devonshire* CENTER
4400 Greenwoos St. Skokie, IL
(847) 674-1500, ext. 2400

SKOKIE PARK DISTRICT
SkokieParkDistrict.org

THE BRITISH STAGE COMPANY PRESENTS

JEFFREY DONOVAN and PATRICIA KALEMBER

Starring in

A Delicious Comedy

don't dress for dinner

by MARC CAMOLETTI
THE AUTHOR OF THE 2008 TONY AWARD WINNER BOEING BOEING

Directed by JOHN TILLINGER

Adapted by ROBIN HAWDON

PERFORMANCES BEGIN NOVEMBER 14

THE ROYAL GEORGE THEATRE
1641 N. HALSTED ST., CHICAGO
Tickets call 312-988-9000 or TICKETMASTER.COM

Discounts for groups! Call 312-423-6012

CELEBRATE THE HOLIDAYS WITH TONY N' TINA!

Tony n' Tina's Wedding

RESERVE YOUR HOLIDAY PARTY TODAY!
Ask about our group party packages!

RSVP TODAY 312-664-8844 www.tonyntina.com
GROUPS OF 15 OR MORE CALL TODAY 312-664-0773
PIPER'S ALLEY-3RD LEVEL 230 W. North Ave. (North Ave. & Wells St.)

"THE GRANDEST HOLIDAY SHOW OF ALL TIME. BRING THE WHOLE FAMILY!"

TIME MAGAZINE

RADIO CITY CHRISTMAS SPECTACULAR
with THE ROCKETTES

30-50% OFF KIDS TICKETS 12 & UNDER FOR ALL SHOWS!
NOV. 20-DEC. 7 • ROSEMONT THEATRE

FOR TICKETS CALL: 312-559-1212
VISIT: WWW.TICKETMASTER.COM OR
VISIT THE ROSEMONT THEATRE BOX OFFICE
FOR GROUP TICKETS CALL: 847-891-8916
WWW.ROSEMONTTHEATRE.COM

UPCOMING IN 2009
MOVIE OUT: FEB. 20-22
RIVERDANCE: MARCH 17-22
DAVID CASSIDY: MARCH 28
JESUS CHRIST SUPERSTAR: APRIL 30 - MAY 2

DECEMBER 26-27

go.

Continued from PAGE B17

php. Gallery hours are 10 a.m.-10 p.m. daily. Admission is free. Nov. 7-Dec. 17: "Focus on Africa: Celebrating 60 Years of the Program of African Studies." Opening reception from 5:30-8 p.m. Nov. 7.

Evanston Art Center, 2603 Sheridan Road, (847) 475-5300. www.evanstonartcenter.org. Through Nov. 9: "Heating Up." works by concerned artists who are responding to environmental challenges with creative and practical applications that educate and engage the public. Through Dec. 1: "12 x 12" adult student exhibit. Nov. 21-Dec. 13: Sixth annual Winter Arts + Crafts Expo. Categories include jewelry, ceramics, wood, glass, metal, fiber, leather, wearable textile accessories, mixed media, small 3-D sculpture and 2-D works including printmaking, photography and painting. Hours are 10 a.m.-4 p.m. Monday-Saturday (closed Thanksgiving); noon-4 p.m. Sundays. Preview party from 6-9 p.m. Nov. 21. \$30 in advance; \$35 at the door. A silent auction of works donated by participating artists will be held Nov. 21-23, with proceeds benefiting programs at the center. The Expo also includes an eight day, non-juried, adult student sale from Dec. 6-13.

Frame Warehouse, 814 Dempster St., Evanston, (847) 869-5210. Nov. 7-9 p.m.: Reception featuring photographs of south India by Evanston designer/photographer Jack Weiss. All images in the exhibition are high resolution digital reproductions from film originals.

Noyes Cultural Art Center Gallery, 927 Noyes St., Evanston, (847) 491-0266. Open 10 a.m.-6 p.m. daily. Through Nov. 11: "Rock, Paper, Scissors." works by Melissa Jay Craig, John Devylder, Agnieszka Jachymczyk, Michael Montenegro, Pamela Pushrod and Isaac Williams.

Oakton Community College, Koehline Museum of Art, 1600 E. Golf Road, Des Plaines, (847) 635-2633. www.oakton.edu/museum. Gallery hours: 10 a.m.-6 p.m. Monday-Friday; 11 a.m.-4 p.m. Saturdays. Through Nov. 7: "Feminist Ecology: Women and the Earth." Refuge: Center for Artists in Recovery, 4811 Main St., Skokie, (847) 673-3737. www.refuge.com. Through Dec. 12: "The 12 x 12 Show." The group exhibit requires all artists to create works of art that have a 12"x12" boundary.

AUDITIONS & OPPORTUNITIES

DANCERS

The Chicago Rush arena football team will hold auditions for the 2009 Adrenaline Rush Dancers on Nov. 30 at the Stephens Convention Center, Rosemont. Registration begins at 8 a.m., and auditions start at 9 a.m. Semifinalists will continue with mandatory training camp sessions from 7-10 p.m. Dec. 2 and 4 in preparation for the final round, to be held Dec. 6. Representing the Rush both on and off the field, dancers participate in all home games (held at Allstate Arena in Rosemont), attend community events, take part in media interviews and promotional opportunities and attend photo shoots throughout the year. Dancers wishing to audition must submit a \$25 non-refundable registration fee, be able to

commit to the squad for a full year and be 18 years old by Nov. 30, 2008. For information and to pre-register, visit www.chicagorush.com or call (773) 243-3434.

ARTISTS

St. Beatrice School in Schiller Park is seeking crafters for its 26th annual Christmas Craft Show, to be held Dec. 5-6. Call (847) 678-1752 or visit www.st-beatricecraftshow.com.

MISCELLANEOUS

The Des Plaines Public Library's Teen Advisory Board is conducting a competition to select the logo that best depicts the group's spirit. TAB is a group of teens who meet at the library each month to plan teen library programs, talk about books, movies, and music, volunteer for community projects, and more. The competition is open to teens in grades 7 through 12 and the winning graphic design will become the official TAB logo used on the library Web site and new TAB T-shirts. Designs can be words, pictures, or a combination of both, with the following stipulations: Only original 2D artwork can be submitted; one submission per artist; design must be no larger than an 8 and one-half inch by 11 inch piece of paper. Entries should be submitted in person at the library's third floor Readers' Services Desk no later than Friday, Nov. 7, at 5 p.m. Voting will take place online on the Teen Express Yourself Page (accessed via www.dppl.org) from Nov. 10 through Nov. 17. For information, call (847) 376-2840 or e-mail TAB@dppl.org. Ringling Bros. and Barnum & Bailey Clown College will hold open auditions at 1:30 p.m. Nov. 12 at the Allstate Arena, 6920 N. Mannheim Road, Rosemont. Auditioners will be asked to show im-

provisational ability, a sense of timing, and a sincere desire to be a clown. Those who attend the auditions will also take part in a Ringling Bros. Clown College workshop on improvisation and physical comedy. Previous clowning experience is not required, nor are costumes and props. However, those wishing to spotlight specialty skills such as juggling, unicycle riding, etc. should come prepared with their own tools. Those contracted to perform with one of Ringling Bros. and Barnum & Bailey's nationally touring productions must be 18 years of age or older, but younger auditioners are welcome. For information or to register for an audition, call (773) 250-3203.

BENEFITS

"An Evening with Rising Stars," an

auction, raffle, food, wine and musical gala to benefit North Shore Choral Society, will be held at 6:30 p.m. Nov. 15 at Jewish Reconstructionist Congregation, 303 Dodge Ave., Evanston. Lyric Opera artist Philip Kraus emcees the program starring vocalists chosen by the music schools of DePaul, North Park, Northwestern and Roosevelt universities. Tickets are \$50, \$75 and \$100. Raffle tickets are \$20, \$50 for three, and \$100 for six. Visit www.northshore-choral.org or (847) 272-2351. The Park Ridge Civic Orchestra will hold its 12th annual tea at 12:15 p.m. Nov. 22 at the Park Ridge Country Club, \$45 per person. Call (847) 692-7726 or visit www.parkridgecivicorchestra.org.

BOOKS & POETRY

Des Plaines Public Library, 1501

Ellinwood St. (847) 376-2787. www.dppl.org. Advance registration required for activities unless noted otherwise. Nov. 13, 7:30 p.m.: Discussion of *Digging To America* by Anne Tyler. Irish American Heritage Center, 4626 N. Knox Ave., Chicago, (773) 282-7035. www.irishamhc.com. Great Irish American Books and Authors book discussion group meets at 2 p.m. the second Sunday of the month, unless noted otherwise. The discussion is led by Virginia Gibbons, a teacher at Oakton Community College. Nov. 9: *The Light of Evening* by Edna O'Brien. Morton Grove Public Library, 6140 Lincoln Ave. (847) 965-4220. Nov. 23, 2 p.m.: Betsy Means of Woman Lore portrays the title character in the book, *Alicia: My Story* by Alicia Appleman Jrman. Oakton Community College, 1600 E.

Golf Road, Des Plaines. Nov. 12, 2 p.m.: The Chicago Writers Series welcomes National Book Critics Circle Award finalist Aleksandar Hemon, who will showcase his current novel, *The Lazarus Project*. Contact Lynn Woodbury at (847) 635-1953 or woodbury@oakton.edu. Park Ridge Public Library, 20 S. Prospect Ave., Park Ridge, (847) 825-3123. www.parkridgepubliclibrary.org. Nov. 7, 10 a.m.: Discussion of *Stealing Lincoln's Body* by Thomas Craughwell. Nov. 12, 7 p.m.: Discussion of *Christine Falls* by Benjamin Black. Nov. 13 or 20, 10 a.m.: Discussion of *Whiteman* by Tony D'Souza. Nov. 15, 10:30 a.m.: Discussion of *Last Child in the Woods* by Richard Louv, led by representatives of the Wildwood Nature Center. Reservations for this special book discussion can only be made by calling (847) 692-3570.

CHILD'S PLAY

Des Plaines Public Library, 1501 Ellinwood St., Des Plaines, (847) 827-5551. www.dppl.org. Registration required for programs unless noted otherwise. Nov. 11, 7 p.m.: PJ StoryTime, for ages 3-6. Nov. 13, 4 p.m.: Story Explorers. Children in grades 3-5 enjoy theme-based activities including stories, craft and a snack. Nov. 15, 11 a.m.: Family Time, for children with autism in grades K-8. Nov. 20, 4 p.m.: Stories & More, for grades K-2. Nov. 22, 1 p.m.: Drop-In Thanksgiving craft. Nov. 30, 2 p.m.: Seasons Greetings Magic Show. Morton Grove Public Library, 6140 Lincoln Ave. (847) 965-4220. Nov. 9, 2 p.m.: Fall Voice and Piano Concert, presented by local children. Nov. 13, 6:30 p.m.: Paint A Picture Workshop for ages 6-12. Nov. 14, 4 p.m.: Screening of "Kung Fu

Panda." rated PG. Nov. 15, 2 p.m.: Roberts Marionettes presents "A Secret Garden." Nov. 15, 3 p.m.: Beads for Teens and Chainmaille Jewelry. Supplies and instruction will be provided. Nov. 20, 6:30 p.m.: Family Reading Night! Featuring Imagination Theatre's Read All About It! Nov. 28, 2 p.m.: Screening of "WALL-E." rated G. Rosemont Theatre, 5400 N. River Road, Rosemont. Tickets are available at www.ticketmaster.com or (312) 559-1212; the ticket prices listed below do not include service fees. For more information about the theater, call (847) 671-5100. Dec. 13, 11 a.m.: The Laurie Berkner Band, \$35, \$25. Stahl Family Theatre, 5900 W. Belmont Ave., Chicago. Nov. 7, 10-11, 13-14, 17, 20-21, 24-26, Dec. 1, 4-5, 8-10, 12, 10:30 a.m.: Nov. 7, 14, 21, 24-26, noon: go, PAGE B20

WIT presents **the santaland diaries** by david s. daris & JACOB MARLEY'S CHRISTMAS CAROL by tom mula

"80 MINUTES OF LEGIT LAUGHS!" - SUN TIMES

STARTS NOVEMBER 21ST. THURSDAYS THROUGH SUNDAYS @ THEATER BUILDING CHICAGO 1225 W. BELMONT. For tickets and showtimes call 773.327.5252 or visit theaterwit.org

"Astonishing!" - Chicago Reader

TREAT YOURSELF THIS HOLIDAY SEASON! November 12 - December 21

meet me in ST. LOUIS

"EXQUISITELY CAST, MAGNIFICENTLY DESIGNED, AND IDEALLY STAGED!" - Chicago Sun Times

"Take your family -- kids, grandkids, whoever -- to see 'Meet Me in St. Louis' at Drury Lane. Beautiful costumes, crisp choreography, and MEMORABLE songs like 'Have Yourself a Merry Little Christmas' and 'The Trolley Song' add to the enjoyment." - The Northwest Indiana Times

Drury Lane THEATRE WATER TOWER PLACE

FOR TICKETS CALL 312.642.2000 www.drurylanewatertower.com ticketmaster 312.902.1500 www.ticketmaster.com

Magnificent...one of the subtlest and smartest productions of Tennessee Williams I've seen. - Newcity

Compelling...there's an uncommon spark, freshness and vitality to this production. - Chicago Tribune

Steppenwolf for Young Adults presents Tennessee Williams' **The Glass Menagerie** directed by ensemble member Yasen Peyankov featuring James T. Alfred, Shanésia Davis, Anthony Fleming III and Nambi E. Kelley

Now Playing! Tickets \$20

Target 2-for-1 Sunday Matinees Sunday, November 9 Tickets \$10

Sponsored by CHASE

Exclusive Corporate Sponsor of The Glass Menagerie

Corporate Sponsor of Steppenwolf for Young Adults

steppenwolf buy online at www.steppenwolf.org or call 312-335-1650

KRAFT

Due to demand
Extended through December 28!

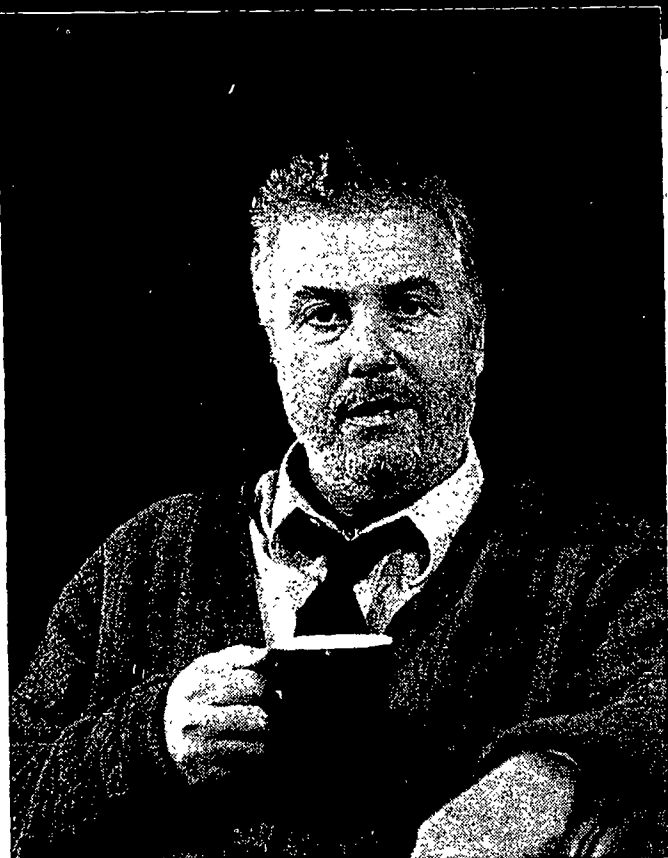

Dublin Carol

by **Conor McPherson**
directed by ensemble member **Amy Morton**
featuring **Stephen Louis Grush, William Petersen and Nicole Wiesner**

John, a man whose life was nearly destroyed by drinking, now holds down a steady job at a Dublin undertaker's office. When his estranged daughter appears on Christmas Eve with disturbing news, it sets off a series of painful confessions that ultimately offer John a chance to escape the burdens of his past.

Begins **November 6**
in the **Upstairs Theatre**

steppenwolf

buy online at www.steppenwolf.org
or call **312-335-1650**

Production sponsor for
FOLEY
FOLEY & LARDNER LLP

go.

Continued from **PAGE B19**

and Nov. 15, 1 p.m.: "Sleeping Beauty," presented by Chicago Kids Company. Tickets: \$10. Call (773) 205-9600 or visit www.chicagokidscompany.com.

COMEDY

Centre East in the North Shore Center for the Performing Arts, 9501 Skokie Blvd., Skokie. (847) 673-6300. www.centreast.org. Nov. 15, 8 p.m.: Comedienne Susie Essman. Opening for Essman will be Scott Blakeman, a co-host of NBC's "Sunday Today" and frequent contributor to National Public Radio and Air America. Tickets: \$60. May include language not suitable for younger or more sensitive audience members.

Pick a Cup Coffeehouse, 1813 Dempster, Evanston. (847) 332-2834. Nov. 15, 7:30-10 p.m.: Skokie resident Debbie Sue Goodman presents a comedy performance based on her two books, *Still Single* and *Still Dating*. No cover.

Rosemont Theatre, 5400 N. River Road, Rosemont. Tickets are available at www.ticketmaster.com or (312) 559-1212; the ticket prices listed below do not include service fees. For more information about the theater, call (847) 671-5100. Nov. 8, 7:30 and 10 p.m.: Cheech & Chong: Light Up America. \$59.50, \$39.50.

Skokie Theatre, 7924 Lincoln Ave., Skokie. Call (847) 677-7761 or visit www.skokietheatre.com. Tickets are \$15 in advance; \$20 at the door, unless noted otherwise. Nov. 7, 8 p.m.: Laugh Tour. \$20.

DANCE

PERFORMANCES

Artistry in Motion, the resident dance company of the Des Plaines Park District, will present its fifth annual Winter Spectacular at 6:30 p.m. Dec. 20 and 1:30 p.m. Dec. 21 at the Prairie Lakes Community Center, 515 E. Thacker St., Des Plaines. Tickets go on sale Nov. 24. For information, call (847) 391-5700 or visit www.desplainesparks.org.

GROUPS & LESSONS

Chicago Dance Club, (847) 622-4466. Dance to DJ music from the '50s to today from 7:30-11:30 p.m. Saturdays at American Legion Hall, 9757 Pacific Ave., Franklin Park. Mostly swing dancing, some ballroom, Latin and line dancing. Open to ages 21 and older. \$5 members; \$9 nonmembers. Membership fee \$25. Upcoming dates: Nov. 22, Dec. 13.

Chicago's Windy City Jitterbug Club holds dances to the music of the '50s, '60s and more, from 8 p.m.-midnight at the American Legion Hall, 9757 W. Pacific Ave., Franklin Park, unless otherwise noted. Admission to club dances is \$5 for members; \$10 for nonmembers. Proper attire required; no blue jeans or shorts allowed. Must be 21 or older. Call (773) 467-0177 or visit www.jitterbugchicago.com. Upcoming dances include Nov. 15: Dinner dance, at the Chevy Chase Country Club. Advance tickets required; see Web site for details.

Des Plaines School of Dance, 515 E. Thacker St., Des Plaines. (847) 391-5700. www.desplainesparks.org. Nov. 13-20, 7 p.m. Thursdays: Salsa and Latin dance for ages 16-plus, featuring cha-

cha, rumba and salsa. Resident: \$38; nonresidents \$48.
Happy Twirlers Dance Club provides round and square dancing at 7:30 p.m. the second Saturday of the month, September-May, in Immanuel Lutheran Church, Thacker and Lee streets, Des Plaines. Call (847) 827-6500 or (773) 685-8407.

Prairie Lakes Senior Center, 515 E. Thacker, Des Plaines. Nov. 8 and 22, 8-10:30 p.m.: Alice Lowy will host ballroom dancing with taped music. Admission is \$15 per couple at the door. Nov. 14 and Dec. 12, 8:10-10:30 p.m.: Alice Lowy will host ballroom dancing to live music. \$25 per couple at the door. Nov. 16 and 23: Alice Lowy offers swing (jitterbug) classes. Beginners from 6:30-7:30 p.m., advanced from 7:30-8:30 p.m. \$75 per couple. For information, call (847) 825-2901 or (847) 825-6637. **Spare Sunday Evening Club** holds ballroom dances from 7:30-10:30 p.m. the first and third Sunday of the month at the American Legion, 9757 Pacific Ave., Franklin Park. Admission is \$8 for members; \$9 guests. Nov. 16: **The Stan Warren Trio**.

Square Spares & Pairs Square Dance Club, a club for couples and singles, dances the second and fourth Mondays of the month all year long at the Park Ridge Senior Center, 100 S. Western Ave., Park Ridge. Rounds start at 7:30 p.m., with squares from 8-10 p.m. For information, call (773) 775-9427 or (708) 442-8646. **Square dance lessons** are held from 7:30-9:30 p.m. Tuesdays at the Glen Park Center, Room 201, 2400 Chestnut Ave., Glenview. First lesson is free. Nov. 10: "Ferris Wheel to Fall."

USA Dance Chicago/land Chapter

go., **PAGE B22**

NONNA SILVIA'S
trattoria & pizzeria

\$8 off purchase of \$40 or more

FREE Buy Any 18" Pizza get a 10" Cheese Pizza FREE

Order Your
**Holiday Catering
& Party Reservations**

1400 S. CANFIELD | PARK RIDGE, IL 60068
PHONE: 847-292-9970
DINE IN | CARRY OUT | DELIVERY

SHAKER FURNITURE & HANDWORKS

17 Year
Anniversary Sale
Has Been Extended

Help keep our country strong... **BUY AMERICAN!**
♦ ONLY American Made Solid Wood Furniture-all styles
♦ Custom Made Furniture in any style
♦ Handworked Arts and Crafts

THE HOLIDAYS ARE APPROACHING.
PLEASE DON'T FORGET THOSE IN NEED.
Drop off any non perishable food donations here
for the Maine Township Food Depository.

7 S. Fairview Ave. Park Ridge, IL 60068 847-696-4700
www.ShakerFurniture-Chicago.com

GreatGenevaGetaway.com

The
Lake
Geneva
Area...
Your
Backyard
Getaway!

Reasons to
Advertise
TOP
Newspapers

REASON #4

DECISION MAKERS
People in higher-responsibility
professional positions read
newspapers more frequently
than the average person

PIONEER PRESS
CALL 847-486-7300

FIRST TAKE: FALL CLEARANCE
40%-70% OFF
WHEN YOU TAKE AN EXTRA 25% TO 40% OFF
ALREADY-REDUCED PRICES STOREWIDE
FOR HER: SPORTSWEAR,
DRESSES, SUITS & MORE
FOR HIM: GREAT FALL STYLES



TAKE AN EXTRA 15% OFF
SALE MERCHANDISE*
WITH YOUR LORD & TAYLOR
CREDIT CARD NOW
THROUGH TUESDAY

DON'T HAVE ONE?
GET AN EXTRA 15% OFF
YOUR FIRST DAY'S
PURCHASES IN ADDITION TO
YOUR FIRST TAKE SAVINGS!
WHEN YOU OPEN A
LORD & TAYLOR ACCOUNT.

Shop online at lordandtaylor.com *Offer ends Tuesday, November 11th and excludes: Sweater Dress Sale, Buy More, Save More Ladies' Sleep Separates Event and Men's Wardrobe Sale, BRAND NAMES: All Aquatalia, BCBG/BCBGMaxAzria, Juicy Couture, Merrell, Papyrus, Tumi and Ugg; men's merchandise from Andrew Marc outerwear, Cole Haan, Hugo Boss, Indigo Palms, Island Soft, Lacoste, Marc New York outerwear and Tommy Bahama. DEPARTMENTS: Ladies' cashmere departments; cosmetics, fragrances, beauty accessories; all Fine Jewelry; all kids' toys/giftables; Beauty Salon, restaurants, alterations & gift cards. Cannot be combined with Savings Passes or Coupons. Not valid on prior purchases. Bonus savings % applied to reduced prices. Not valid on telephone or internet orders, or at Levittown. *Subject to normal credit approval, some exclusions apply. See your sales associate for details. Sale ends Monday, December 1st, except as noted. Savings off regular and original prices. No adjustments to prior sale purchases. Our regular and original prices are offering prices only and may or may not have resulted in sales. Advertised merchandise may be available at sale prices in upcoming sale events. For the Lord & Taylor nearest you, visit our website or call 1-800-223-7440.

DIRECT FROM THE HEART OF BROADWAY! THE STAR & SHOW YOU'VE HEARD ABOUT!

Sold Out in New York, Philadelphia & W. Palm Beach— Now Coming to Skokie!

"Funny! Dazzling! Beautiful! Like Billy Crystal's 700 Sundays!"
The New York Times

"Lots of Laughs, But Also Very Serious. This Hit Show Has Taken New York By Storm!"
FOX TV



jake ehrenreich's
A JEW GROWS IN BROOKLYN

a rock 'n roll true story, holocaust family, borscht belt... **COMEDY MUSICAL?!**

One Week Only - Nov. 5-9, 2008

Wed 2 & 7:30pm, Thurs 7:30pm, Fri 8pm, Sat 2 & 8pm, Sun 1 & 5pm

NORTH SHORE CENTER FOR THE PERFORMING ARTS

9501 Skokie Blvd., Skokie, IL 60077

Box Office: 847-673-6300 • Group Sales: 312-423-6612

www.AJewGrowsInBrooklyn.com

go.

Continued from PAGE B20

#2001 Autumn Gala dinner dance and showcase, 5-11:30 p.m. Nov. 8 at the Sheraton Chicago Northwest Hotel, 3400 W. Euclid Ave., Arlington Heights. Featuring performances by U.S. Standard Champions Igor Mikushov and Anna Dimedova and U.S. Senior II Standard Champions Lonny and Susie Tsang. Black tie optional. Tickets: \$65 for members; \$70 nonmembers. Registration deadline is Oct. 31. For tickets, visit www.usadancechicago.org or call Susie Johnson, (847) 541-1585.

FAIRS & FESTIVALS

Holly and Ivy Bazaar and Holiday

Bake Sale, presented by the Ladies Philoptochos Society, 9 a.m.-9 p.m. Nov. 21 and 9 a.m.-5 p.m. Nov. 22 at St. Haralambos Greek Orthodox Church, 7373 N. Caldwell Ave., Niles. Lunch will be served on both days from 11:30 a.m.-2:30 p.m. and dinner will be served on Friday only, from 5:30-9 p.m. (847) 647-8880.

FILM

Des Plaines Public Library, 1501 Elinwood St. (847) 376-2787. www.dpl.org. Advance registration required for activities unless noted otherwise. Nov. 16, 2 p.m.: Screening and discussion of "Persepolis."

Morton Grove Public Library, 6140 Lincoln Ave. (847) 965-4220. Nov. 10, 2 p.m.: "Das Boot: Director's Cut." In German with English subtitles. Nov. 11, 11:30

a.m.: "Flags of Our Fathers," rated R. Nov. 13, 2 p.m.: "The Breakfast Club," rated R. Reel Conversation to follow the film. Nov. 18, 11:30 a.m.: "Turtles Can Fly," rated PG-13. In Kurdish with English subtitles. Nov. 19, 7 p.m.: "Do the Right Thing," rated R. Nov. 20, 2 and 7 p.m.: "Iron Man," rated PG-13. Nov. 21, 2 p.m.: "Pretty in Pink," rated PG-13. Reel Conversation to follow the film. Nov. 22, 2 p.m.: "Bella," rated PG-13. Reel Conversation to follow the film.

Park Ridge Public Library, 20 S. Prospect Ave., Park Ridge. (847) 825-3123. www.parkridgelibrary.org. Films @ the Library—No registration needed. Doors open for seating one-half hour before show time. Nov. 11, 2 and 7 p.m.: "Forgetting Sarah Marshall," rat-

go., PAGE B24

Wrap up the season with an ad in our

HOLIDAY GIFT Guides

Publishing: Nov. 19/20 & Dec. 4/5

for print and online opportunities
Call (847) 486-7300
to advertise your business today!

PIONEER PRESS LAKE COUNTY NEWS-SUN *The Hoings*
YOUR LOCAL SOURCE

A VALUE *every* CHICAGO FAMILY CAN SUPPORT.

Families talk all they want with anyone they want on the Unlimited National Family Plan from U.S. Cellular.

Our Unlimited National Family Plan gives you:

- Unlimited calling with anyone on any wireless network or landline in the nation
- Free Incoming Texts and Pix
- Get the first line for \$99.99 and the second line for \$49.99
- Add up to three more lines for just \$49.99 each

Get up to five LG UX300s for 1¢ each when you get a line for yourself and up to four other lines for family members.

LG UX300 Camera and Bluetooth® Technology

UP TO FIVE 1¢ EACH

New 2-yr. agmts. required. \$30 act. fees may apply.

Save over \$150 each instantly.

Available in Blue or Silver.

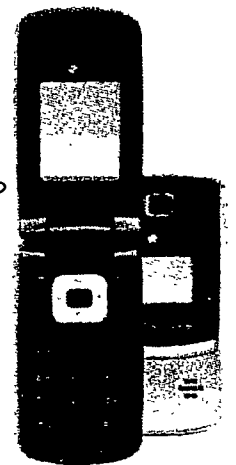

U.S. Cellular
believe in something better

Exclusive wireless provider of the Chicago Bears.

Discover the Difference: Put our network, products and customer service to the test for 30 days - Change your calling plan at any time during your service agreement without signing a new contract - Renew your contract and take advantage of new phone pricing before your current contract ends

Let us help you find a location: visit uscellular.com or call **1-888-BUY-USCC**

Things we want you to know: Offer valid on plans of \$39.95 per month or higher. New two-year agreement (subject to early termination fee), credit approval and a \$30 activation fee required. 9¢ Regulatory Cost Recovery Fee applies; this is not a tax or government-required charge. Additional fees, taxes, terms, conditions and coverage areas apply and vary by plan, service and phone. Use of service constitutes acceptance of the terms of our Customer Service Agreement. See store for details or visit uscellular.com. Unlimited National Plan: Customers must have a billing address within U.S. Cellular's Wide Calling Area to be eligible. U.S. Cellular reserves the right to terminate your service if less than 50% of your overall minutes in each of three consecutive billing cycles is used in U.S. Cellular's Wide Calling Area. The Unlimited National Family Plan may not be used for conference calling. Call Forwarding, monitoring services, transmission of data, broadcasts or recorded material, or other connections that do not consist of uninterrupted live dialogue between two persons. The Unlimited National Family Plan requires a minimum of two lines at \$149.98 per month. Maximum of five lines per account. 30-Day Guarantee: Customer is responsible for any usage charges incurred prior to return. Phone must be returned undamaged in the original packaging. Contract Renewals: Customers who have completed at least 18 months of a two-year agreement are eligible for promotional equipment pricing. See store for eligibility. Promotional Phone subject to change. U.S. Cellular Visa Debit Card issued by MetaBank pursuant to a license from Visa U.S.A. Inc. Allow 10-12 weeks for processing. Card does not have cash access and can be used at any merchant location that accepts Visa Debit Cards. Card valid for 120 days after issued. \$9.95 unlimited easedge access plan applies. Limited-time offer. Trademarks and trade names are the property of their respective owners. ©2008 U.S. Cellular.

10% OFF 15% OFF
FRI-SUN TUES-THURS
 With This Coupon. Dine In Only.
 (Not Valid w/Lunch Specials, Holidays.)

Thanksgiving Celebrations
 Glass of wine: Chardonnay • Merlot • Cabernet • White Zinfandel
 Choice of Soups: Cream of Pumpkin • Sage & Smoked Ham
 • Chicken Noodle Soup
 Appetizer: Smoked Salmon & Jumbo Shrimp
 Salad: Baby Spinach, Cranberries, Walnuts, Gorgonzola cheese,
 Raspberry & Balsamic Reductions Vinaigrette
 Choice of Entrees served w/sweet potatoes, veggies, & risotto rice:
 Roasted Turkey stuffing & cranberry sauce • Turkey Orloff • Dijon
 & Peppercorn crusted N.Y. Steak • Lamb Shanks Provençal,
 Brunoise of Vegetables & fresh Herbs • Salmon Filet • Lake
 Superior White Fish • Almond Crusted Tilapia Filet
 • Caesar Salad w/Roasted Turkey
 Dessert choice: Coffee or Tea Included: Apple Pie Ala Mode
 • Pumpkin Pie • Carrot Cake • Ice Cream or Sorbet \$28.95 + Tax &
 Gratuity • Kids Menu Available

9925 GROSS POINT RD • SKOKIE (847) 982-1400
 (Formerly the Tower Garden)

ARE YOU A VETERAN?

Join your fellow Vets in Chicago!
 Over 25 posts in your area are accepting members now!

AMVETS offers open membership to all military men and women with an honorable discharge.

Call (800) 638-8387 for more information, or visit us at www.ilamvets.org.

AMVETS is one of the most respected volunteer-led organizations in the country. Please join our organization of Veterans Serving Veterans.



go.

Continued from PAGE B22

ed R. Nov. 25, 7 p.m.: "Pieces of April" rated PG-13.
 Skokie Theatre, 7924 N. Lincoln Ave., Skokie, (847) 677-7761. www.skokietheatre.com. Tickets: \$13 for feature films, \$11 students and seniors; \$10 for documentaries, \$8 students and seniors.
 Nov. 21-23: Polish Film Festival in America. Friday: "Katyn" at 6:30 p.m.; "Chronicle of the Ghetto Uprising According to Marek Edelman" at 8:30 p.m. Saturday: "Death to Zygelmbojm" at 6 p.m.; "The Purim Miracle" at 7 p.m.; "Deborah" at 8:30 p.m. Sunday: "The Sender's List" at 3 p.m.; "Photoauteur" at 4 p.m.; "Far from a Window" at 5 p.m.; and "Austeria" at 7 p.m.

WORKSHOPS & CLASSES

Alliance for Lifelong Learning at Oakton Community College offers a variety of single-session continuing education courses that meet evenings at various locations. To register, visit www.oakton.edu/all or call (847) 982-9888 and press 3. Nov. 18, 7:30-9 p.m.: "Impressionism: The Hand and Glove of Debussy and Monet" (MUS 542-01) explores the influence of Impressionist art on Claude Debussy. Course meets at Glenbrook South High School, 4000 W. Lake Ave., Glenview. Fee is \$20.

ET CETERA

The Art of Beadwork, the Bead Society of Greater Chicago's sale of members' work, noon-5 p.m. Nov. 16 at the Skokie Banquet and Conference Center at the Holiday Inn North Shore, 5300 W. Touhy Ave., Skokie. \$4 admission. www.bsgc.org.

ORGANIZATIONS

Des Plaines Art Guild meets at 7 p.m. on the second Tuesday of the month at the Prairie Lakes Community Center, 515 Thacker St., Des Plaines. New members are welcome. For information, call Margaret Newman, (847) 824-8952, or visit www.dpag.org. Nov. 11: Dianne Kovack from the Clayground Art Studio in Mount Prospect will show techniques in hand-building clay forms.
 Des Plaines Camera Club meets at 7 p.m. on the second and fourth Mondays of the month, September through June, in the Prairie Lakes Community Center, 515 E. Thacker St., Des Plaines. Call (847) 384-9487 or visit www.desplainscameraclub.com.

Park Ridge Public Library, 20 S. Prospect Ave., Park Ridge, (847) 825-3123. www.parkridgelibrary.org. Nov. 18, 2 p.m.: "Thankful Tales." Professional storyteller Elyne Handler will entertain with tales from Japan, Alaska, Cuba and Europe that uniquely illustrate thankfulness.
 Skokie Theatre, 7924 Lincoln Ave., Skokie, (847) 677-7761. www.skokietheatre.com. Nov. 8-9, 2 p.m. and 8 p.m.: "A Conversation with Teddy Roosevelt." \$15/\$20.

November 23 at 4:30 p.m. • November 24 at 7:30 p.m.

Passion & Power



Rachel Barton Pine

Arsvival
 Symphony Orchestra
 Alan Heatherington, Music Director

BIZET Carmen Suite No. 1
 SAINT-SAËNS Introduction and Rondo Capriccioso
 Rachel Barton Pine, violin
 SARASATE Carmen Fantasy
 Rachel Barton Pine, violin
 BRAHMS Symphony No. 4

847 673-6300 www.arsviva.org
 North Shore Center for the Performing Arts in Skokie
 9501 Skokie Blvd. Ample free parking



Your passion is our passion.

Read reviews each week in Diversions of dance performances coming soon to suburban stages — in addition to shows, musicals, concerts, and special recitals.



PIONEER PRESS
 YOUR LOCAL SOURCE

Diversions
 Call (847) 486-9300 to subscribe.

Continued from previous page

LIABILITY
 ICMA Retirement Trust 55,048; AFLAC 5,613; The United Way Of Skokie 3,328; National Guardian Life Ins Co 1,171; Byerly & Company 3,592; Blue Cross Blue Shield 91,954; Delta Dental Of Illinois 6,694; Vision Service Plan 2,042; Total 170,304

EXPENDITURE SUMMARY:

Chicago Party Rental 22,341; 2XL Corporation 5,818; 910 Productions 4,250; Able Services & Supply 58,553; Ace Hardware 18,207; Action Sports Hitting 60,300; Active Electrical Supply 4,400; Joe Alst 2,506; All American Music & Sound, Inc. 10,000; All American Trophy King 4,470; All Star Security, Inc. 25,568; Astrow Bus Service 97,959; Amateur Hockey Association Of Ill 3,763; Ametek Company 5,221; American Auning & Window 14,789; American Carpet & Janitorial 3,800; American English 5,000; American Express 150,035; American Messaging 3,687; Ameritech/AT&T 24,830; Anderson Lock 7,189; Aquatic Ecosystems Management 4,634; Archival Designs, Inc. 17,403; Arena Development Enterprises, 6,600; Arthur Clear, Inc. 15,756; AT&T Mobility Computer 6,999; Matt Baldwin 7,600; Basic Chemical Solutions, LLC 17,901; Beacon Advertis 3,485; Bell Funks, Inc. 89,325; Best Quality Clearing, Inc. 19,954; Blue Cross Blue Shield 375,462; Bob Hickox, Inc. 27,000; Brian M. Peterson, d.b.a. 5,715; Broadway In Chicago Group 3,688; Broadwing Communications, LLC 17,419; Brooks, Adams and Tanaka 12,507; Brusseau Design Group, LLC 10,575; BTC-Building Technology 79,787; Buck Dies, Inc. 3,222; Callaway Golf Sales 20,405; Joe Cantano 5,000; Cassidy Tires 3,440; Casey, Denigan & Moore, Inc. 2,500; CDP, Inc. 116,600; Cedar Store 3,947; Cedar Valley Express 2,816; Central Management Svcs/ICN 6,255; Central Pool Supply, Inc. 5,929; Challenger Industries, Inc. 10,171; Challenger Sports Corp 5,247; Chase Bank 9,560; Chase Card Services 35,820; Chase Wrauch, Inc. 2,886; Chicago Backflow Inc. 8,671; Chicago Cased Group Sales 11,510; Chicago Friend 19,908; Chicago Sun Times 2,522; ChicagoLand Paving Contractors 111,250; Conular Wrease 2,599; Centia 18,005; City Wedding Sales 0,378; Classic Bowl 5,570; Casual Design Awards, Inc. 3,422; Classic Graphic Industries 9,000; Climate Service, Inc. 49,278; Coca-Cola Enterprises, 2,925; CorvRad 2,735; Commonwealth Edison 56,025; Commonwealth Edison 3,862; Concerta Medical Centers 3,548; Concept II, Inc. 0,559; 13,145; Consery FIS 5,732; Crafty Beaver Home Center 10,305; Creative Soundz 6,256; Crown Chicks & Co 16,544; Crown Trophy of Skokie 3,018; Cyber International, Inc. 13,451; Cytogen 3,271; Jerry DeJage 8,150; Delta Floor & Wax Co. 17,901; Dancer Trina, Inc. 9,190; David Group Inc. 5,166; DeSater Flooring 4,736; Delta Dental of Illinois 29,224; Direct Fillets Solutions 44,445; Discount School Supply 4,189; Dog Obedience Group, LLC 9,347; Dog Zone 19,400; Stephen Duman White 52,086; E Process Solutions 29,700; Earth Way, LLC 4,000; Easy Packer God Products 10,992; Edge Marketing & Management 4,210; Enkor Services Midwest 53,674; Employee Resource Systems, Inc 2,540; Enterprise Fleet Svcs 3,578; Enterprise Rent-A-Car 3,358; Esco Lighting, Inc. 5,572; Evacston Part 3,761; Exclusively Expo 3,716; Federal Express Corp 3,733; Fenceworks 6,501; Jim Filmerly d/b/a Fiber-Tech 3,150; Mark Findlay 5,475; Julie Finkestein 4,544; Footcage Paving 2,600; Fire & Security Systems, Inc. 8,069; First Impressions, Inc. 36,635; First United Methodist Church 7,000; Fourth July Parade Committee 12,000; Frank Sacku Tennis Camps, Inc. 0,164; Fun Crus 4,125; GMMK Enterprises 3,065; G Hydro Irrigation Svcs 6,468; Green Up Landscapes Inc. 51,003; Grever Wedding Company 4,882; Hugg Nurseries 4,495; Hi-Lite Graphics 74,145; Hi-Tech Auto Body of Skokie 8,560; High Pail, LTD 4,005; Holiday Inn North Shore 7,150; Home Carpet One 33,875; Home Depot 6,075; House of Rental 15,359; Emily Hughes 5,000; Identity Sports 40,386; IL Park & Recreation Assoc. 10,058; Illinois Association of Park 6,182; Illinois Hockey Official Assoc 5,672; Inroils Pumps, Inc. 11,872; Inroils Shotokan Karate Club 14,413; Inroils State Police Bureau 9,000; International Merchandising 71,721; J P Morgan Chase Bank 509,678; Jennifer Becker Design, Inc 7,800; Jerry's Pro Shop 11,736; John Beete Co 24,605; Joseph Mahoney Distributors 2,708; Jr Varsity Football 4,485; Kathy Huser aka Kathy's 1,646; Kallen Munchin Rossman LLP 20,000; Kate Co. 2,542; Kierrealita, LTD 7,650; Kleber Music Foundation 2,500; Kohler Rental Power 17,540; Landmark Ford-Springfield 31,310; Lawnkeeper 4,250; Lubaco Brothers Inc. 15,319; Lee Auto Parts 8,914; Leo's 3,103; Lesco 10,789; Lighthouse Sars 8,701; Loyola Academy Bowling Assoc. 3,200; Lurvey Landscaping 11,657; Evan Lyzarski 5,218; M & A Cement Work, Inc 9,210; Moore Niles Association of 457,358; Mylo's Plumbing 14,864; Mark 1 Restoration Company 507,915; MyProForm 3,992; Myron Protoshkin, Inc. 25,000; Myrtle 20,106; Midwestern Energy 611,159; Michael Fertman 5,170; Mober Cooper & Co., LTD 20,751; Moody's Investment Services 5,600; Morton Grove Supply Co. 2,722; Mr. K Garden Center 5,195; Municipal Software 11,053; MWM Consulting Group, Inc. 5,000; National Recreation & Park 2,760; National School Texts 5,668; National Seed USA 5,854; National Taverner Da Academy 3,734; Nels J. Johnson Tree Experts 17,010; Net Connection 21,000; Neuman Pools, Inc. 4,512; Richard Neuman 3,299; Nick & Ernie 3,221; Nitor 9,906; Niles Township Property Tax 5,593; Nordico 41,312; North American Sill Company 5,359; North Shore Baptist Church 5,000; North Shore Electrical Supply 5,470; North Shore Uniform 3,125; Northern Illinois Official 8,965; Nulays Leisure Products 20,065; Oriental Trading Co., Inc 4,050; Ota Elevator Company 10,073; Tom Panocha 5,560; Passion Atlanta, Inc. 1,750; Park District Risk Management 200,633; Pease School 3,797; Peak Body Systems d/b/a 11,225; Peay Turfelles 4,345; Peat Enters, Inc. 4,228; Fay Andrews d/b/a 2,953; Pike Rock 3,634; Pioneer Press 19,492; Pinyon Books Inc. 3,096; Poney Bowes Reserve Accounts 29,050; Pooleville 4,367; Nancy Porto 3,038; Professional Fitness Concepts 53,605; Prosource 1,950; Public Storage 2,979; Purchase Advantage 7,010; Quality Catering Inc. 25,541; Quality Mink Products, LLC 3,410; R&H Theatricals 2,736; R&R Specialties 3,006; Range Automation Systems LLC 34,476; Rachel Associates 55,240; Reinhold 6,701; Resizable I Pe Equipment 4,821; Reubin Mail Svc. 22,214; AMC Inc. 42,412; Todd Ruhl 2,995; Rowing Repair Center, Inc. 5,200; Scott Hunka 4,519; Russo Ace Hardware 19,605; Alex Saegula 40,290; Sams Club 15,253; Emanuel Sandoz 3,000; Schirm Carpet 40,370; SCD Golf Co. Pares-Hatrock 8,604; Sheffield Press 5,215; Shaman Nurseries 25,778; Shawn Williams 5,747; Sights And Body 2,894; Signs Now 9,982; Saddle Indian Lake League 23,130; Saddle River Club 15,452; Shake Your 71,525; Sheedys In The City 3,600; Scott Smith 5,000; Specialty Floors, Inc. 0,966; Sports Supply Group/ESN 3,365; Starfish Aquatics Yallville 3,883; Stearns Electric 4,028; Technique Eng., Inc. 2,716; Temple Display 3,685; Testing Service Corporation 2,700; Three Oaks Grounds Care 15,900; Total Optimal Performance Inc 3,954; Tru-Link Fence 3,488; Eugene Chumson 17,601; Turf Professionals Equipment 5,274; U.S. Postal Service 37,917; US Toys Company 3,353; Richard Ungar 5,160; Umjusus Greenhouse Inc 15,417; US Floor 21,065; US Food Service 10,082; USA Hockey 3,070; Crystal Vending 3,716; Vantage 4,514; Vesta Environmental Svcs 34,703; Verco Systems 16,520; Village of Skokie 123,655; Village Profile 5,990; Vision Service Plan 12,047; VW Granger 23,873; Walshaw Direct 22,798; Walpusa Sund 3,034; Webdotins LLC 10,733; Wells Fargo Bank Minnesota, NA 4,498,672; Windy City Heavy Equipment 2,537; Wiring, Inc. 0,974; Wilco Golf Supply Co. 2,642; Winco Auto, Inc. 3,234; World Data Reports, Inc. 4,559; Xerox Corporation 84,197; Zennon Co. 5,565; Expense Disbursements Under 2,560.00 482,745; total 11,515,589

SUMMARY STATEMENT OF CONDITION
 (Excerpt from Comptroller's Report)

	GENERAL	SPECIAL REVENUE	DEBT SERVICE	CAPITAL PROJECT	ENTERPRISE	FIDUCIARY
Revenues	3,568,858	11,619,153	4,657,316	31,447	0	0
Expenditures	2,627,563	10,965,641	4,667,954	1,494,370	0	0
Excess of Revenues Over (Under) Expenditures	941,295	653,512	(10,638)	(1,463,023)	0	0
Transfers In	0	112,600	0	1,000,000	0	0
Transfer Out	1,112,600	0	0	0	0	0
Bond Proceeds	0	0	46,502	2,064,273	0	0
Other	0	0	0	0	0	0
Net Increase (Decrease) In Fund Balance	(171,307)	746,112	35,864	1,601,250	0	0
Previous Year Fund Balance	3,136,906	2,592,029	408,499	71,661	0	0
Other	0	(213,814)	0	0	0	0
Current Year Ending Fund Balance	2,965,601	3,124,527	444,363	1,673,111	0	0
TOTAL DEBT	OUTSTANDING BEGINNING OF YEAR	ISSUED CURRENT FISCAL YEAR	RETIRED CURRENT FISCAL YEAR	OUTSTANDING END OF YEAR		
	44,275,362	7,736,791	7,902,700	44,109,453		

Subscribed and sworn to Andrew Bufla this day of October 24, 2008.
 Published in Pioneer Press 11/6/08 (1643396) 31

THE GREATEST SHOW ON EARTH
RINGLING BROS. & BARNUM & BAILEY
OVER-TOP

Unbelievable. Unforgettable.
Affordable.

OPENS TONIGHT ★ TICKETS \$11!*

Thu. NOV. 6	Fri. NOV. 7	Sat. NOV. 8	Sun. NOV. 9
7:00 PM*	7:00 PM	11:30 AM 3:30 PM 7:30 PM	1:00 PM 5:00 PM
Wed. NOV. 12	Thu. NOV. 13	Fri. NOV. 14	Sat. NOV. 15
7:00 PM*	7:00 PM*	7:00 PM	11:30 AM 3:30 PM 7:30 PM

*Tickets \$11
 *Excludes Circus Celebrity™ and VIP seats. No double discounts.

NOV. 18 - 30 UNITED CENTER

Tue. NOV. 18	Wed. NOV. 19	Thu. NOV. 20	Fri. NOV. 21	Sat. NOV. 22	Sun. NOV. 23
7:00 PM*	7:00 PM*	7:00 PM*	7:00 PM*	11:30 AM 3:30 PM 7:30 PM	1:00 PM 5:00 PM
NOV. 24 NO SHOWS	NOV. 25	NOV. 26	NOV. 27	NOV. 28	NOV. 29
	7:00 PM*	7:00 PM*	NO SHOWS	11:30 AM 3:30 PM 7:30 PM	11:30 AM 3:30 PM 7:30 PM

*Tickets \$11
 *Excludes Circus Celebrity™ and VIP seats. No double discounts.

Buy tickets online, at **ticketmaster**™ Retail Locations, Arena Box Offices or call (312) 559-1212

For information call (847) 635-6601 Rosemont or (312) 455-4500 Chicago Groups (847) 891-8916 Rosemont or (312) 455-7469 Chicago

TICKET PRICES: \$13 - \$19 - \$24
 Limited number of VIP and Circus Celebrity seats available. Call for details.
 (Service charges, facility and handling fees may apply.)

Come one hour early to meet our animals and performers at the All Access Pre-show - FREE with your ticket!

Stay Connected At The All-New **Ringling.com**

- ACROSS**
- 1 TV host John
 - 5 Full of oneself
 - 9 Amontillado container
 - 13 Beseched Nile feature
 - 17 Nile feature in good health
 - 19 "— Without Love" ('68 hit)
 - 20 Sanctuary
 - 22 Hood's handle
 - 23 Admiral Zumwalt
 - 24 Tiny part of a second
 - 25 Wagner work
 - 26 Annealing oven
 - 27 Flagon filler
 - 28 Newspaper
 - 30 Take-home
 - 31 Start of a remark
 - 35 Ring stat
 - 36 Thwack
 - 37 Compact cotton
 - 38 "Great Expectations" character
 - 40 Cad
 - 42 Mythical being
 - 44 Hateful
 - 50 Give a little
 - 51 Green
- DOWN**
- 2 Yesterday's thrasher
 - 3 Lillian or Dorothy
 - 4 Ivy Leaguer
 - 5 Fancy dessert
 - 6 First dog in space
 - 7 Where cats congregate
 - 8 Pie — mode
 - 9 Lofty peak
 - 10 Distribute the donuts
 - 11 Keats composition
 - 12 Middle of remark
 - 13 Born
 - 14 '87 Peace Prize winner
 - 15 Solidly
 - 16 "— Shook Up" ('57 smash)
 - 17 Corny goddess?
 - 18 Colossal commotion
 - 19 Malicious to the max
 - 20 Where rams romp
 - 21 Bus starter?
 - 22 Thirteen, to a baker
 - 23 Soprano Fleming
 - 24 — impasse
 - 25 Dachshund or donkey
- ACROSS**
- 3 Stiffened a shirt
 - 4 Contains
 - 5 Expand
 - 6 Free-for-all
 - 7 City on the Danube
 - 8 Day —
 - 9 Finger food
 - 10 Stun
 - 11 Less loopy
 - 12 TV's "— Landing"
 - 13 Symbol of immortality
 - 14 Drink like a Doberman
 - 15 Happening
 - 16 Writer Walcott
 - 17 Tyne of "Cagney & Lacey"
 - 21 West. alliance
 - 27 Coldest cont.
 - 28 Audacity
 - 29 Teyve's portrayer
 - 32 Sneeze and wheeze
 - 33 Superior to city
 - 34 Chip's chum
 - 39 Infant oinker
 - 40 "Greetings!"
 - 41 Early computer
 - 42 Buccaneers' head-quarters
 - 43 Spare part?
- DOWN**
- 1 Word form for "end"
 - 2 Nobelist
 - 3 Pianist Jorge
 - 4 "— Old Cow Hand" ('36 song)
 - 5 Objective
 - 6 Counter change
 - 7 Botanist Gray
 - 8 Age
 - 9 End of remark
 - 10 Road to enlightenment
 - 11 Generally
 - 12 — choy
 - 13 Rocker Billy
 - 14 Tracking tool
 - 15 Manuscript enc.
 - 16 "Surely you —"
 - 17 Lowliest cadet
 - 18 Caustic
 - 19 Yemeni port
 - 20 "New Jack City" actor
 - 21 Beast of Borden
 - 22 Long lunch?
 - 23 For fear that
 - 24 Non-stereo
 - 25 Little ones
- ACROSS**
- 34 With 47 Down, Italian export
 - 35 Produces pies
 - 36 City on the Danube
 - 37 Actress Long
 - 38 See 44 Down
 - 39 Manipulate
 - 40 Diffident
 - 41 Drum din
 - 42 Nick of "Q&A"
 - 43 Gets on
 - 44 Perkins role
 - 45 "Frederica" composer
 - 46 Mature
 - 47 Descendant
 - 48 Ready to reduce
 - 49 Silverware city
 - 50 Infirmary item
 - 51 Went wrong
 - 52 Snowy bird
 - 53 "Big Three" site
 - 54 New York city
 - 55 — Bator
 - 56 — au vin
 - 57 Aussie walker
 - 58 Cell stuff
 - 59 Dandy
 - 60 Hailing from
 - 61 Aberystwyth
 - 62 In accord
- DOWN**
- 38 Swash-bucking novelist
 - 39 '48 Hitchcock film
 - 40 Texas town
 - 41 "I Love Lucy" surname
 - 42 Tour-de-France vehicle
 - 43 Adjectival suffix
 - 44 Aptitude
 - 45 Say please
 - 46 Pound of poetry
 - 47 Extend
 - 48 Wrestling giant
 - 49 Twangy
 - 50 Commerce
 - 51 Classical nonet
 - 52 "Hedda Gabler" playwright
 - 53 What i.e. stands for
 - 54 "Ora pro —"
 - 55 Painter Paul
 - 56 Word on a pump
 - 57 Bowie or Bakker
 - 58 Author Umberto
 - 59 Cosset a corgi

1	2	3	4	5	6	7	8	9	10	11	12	13	14	15	16
17				18				19				20			21
22				23				24				25			
26				27				28				29			30
31				32				33	34					35	
				36				37				38		39	
				40	41			42	43			44	45	46	
				47				48				49			
50				51				52				53			
54				55				56				57			
58				59				60				61			
62				63				64	65			66		67	68
				69				70				71		72	73
74	75	76						77				78	79		80
81				82				83				84			
85				86				87				88			
				89				90				91			
92	93	94		95				96	97	98		99	100		101
104				105				106				107			
108				109				110				111	112		113
114				115				116				117			
				118				119				120			121

Answers: inside today's classified section
 See the Web for the horoscope, www.pioneerlocal.com

THREE DAYS ONLY! Wed-Thurs-Fri Nov 12th, 13th, 14th

IMMEDIATE PAYMENT FOR

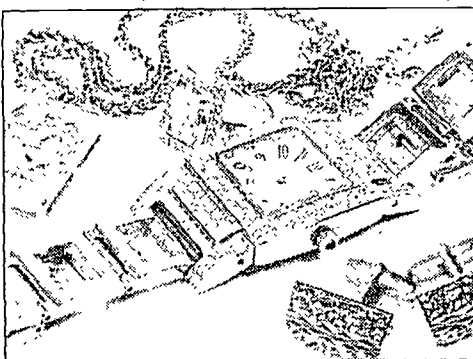

Old Gold and Platinum
 WE ARE PAYING THE HIGHEST PRICES EVER! We buy all old & unwanted gold and platinum in any condition. Solid Gold Chains, Bracelets, Rings, Earrings, Charms, Pendants, Pins, Brooches, Clips, Gold Nuggets, Dental Gold (white and yellow), Broken Bits and Pieces of Gold. COME AND SEE US TO GET OUR BEST OFFER!



Estate Jewelry
 Quit insuring it, dusting it, hiding it or worrying if your children will fight over or dispose of it. You know, CASH in the bank is better than unused items sitting in your jewelry, safety deposit box or dresser drawer. If you haven't worn it in 3 years, chances are you won't wear it again. Bring your items in for a free evaluation and receive cash for your jewelry.

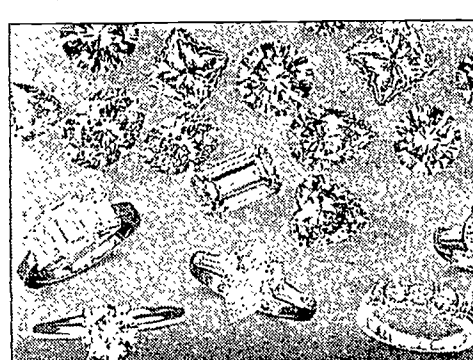

Diamonds-All sizes from 1 carat and up
 We buy diamonds with or without certificates. Loose or Mounted Diamonds. All Shapes and Sizes. All Diamond Rings. Diamond Bracelets. Diamond Earrings. Diamond Pins. Diamond Necklaces. Diamond Pendants. All Platinum and Diamond Jewelry. ALL JEWELRY SET WITH DIAMONDS.

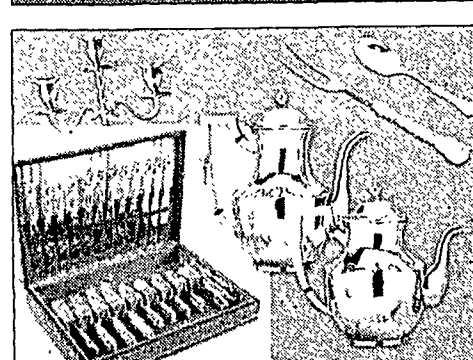

Sterling Silver
 All sterling silver flatware and hollowware by any maker, foreign or domestic: Sterling silver tea sets - Full or partial flatware sets - Sterling pitchers, bowls & trays - Sterling candelabrum - Sterling dresser sets, figurines & novelty items - Sterling silver spoons and any item in sterling silver. ITEM MUST SAY STERLING SILVER. No silver-plated items please. Not sure? Bring it in.

U.S. Coins & Paper Money
PAYING HIGHEST PRICES
 SILVER COINS & SILVER DOLLARS
 Silver Dollars (PRE-1936 \$10.00 TO \$20,000.00)
 10C, 25C, 50C (PRE-1965 UP TO \$THOUSANDS)
 COMPLETE AND PARTIAL SETS AND ACCUMULATIONS.
 ALL GOLD COIN JEWELRY.
 PAPER MONEY.
 PROFESSIONAL NUMISMATIST ON PREMISES.
 BUYING OLD RUSSIAN COINS - Especially Need Russian Gold Coins.
 RUSSIAN COIN EXPERT ON PREMISES.



Wristwatches
 all ROLEX (especially, EXPLORER, DAYTONA, GMT, MILGAUS, SUBMARINER)
 all PATEK PHILIPPE, CARTIER, AUDEMARS PIGUET, VACHERON CONSTANTIN all Chronographs - BREITLING, HEUER, OMEGA, LECOULTRE, LONGINES, MOVADO all Alarm, Moon Calenders, Diamond Dials, Military, Platinum and Gold Cased Watches all Ladies Watches with Platinum and Diamond Cases
 Watches need not be running

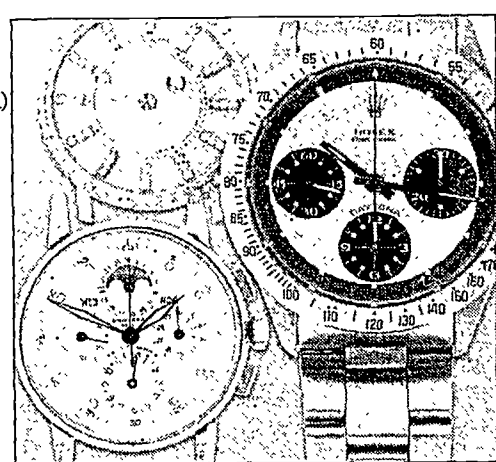

Pocketwatches
 all Railroad (BALL, ELGIN, HAMILTON, HOWARD, ILLINOIS, WALTHAM)
 all PATEK PHILIPPE, CARTIER, AUDEMARS PIGUET, VACHERON CONSTANTIN all Chiming Watches, Military, Fancy Dials & Cases (Enamel-Multi-Color, Diamonds)
 CLOCKS - We also buy ATMOS, CARTIER, CARRIAGE, CHELSEA, LECOULTRE
 Watches need not be running

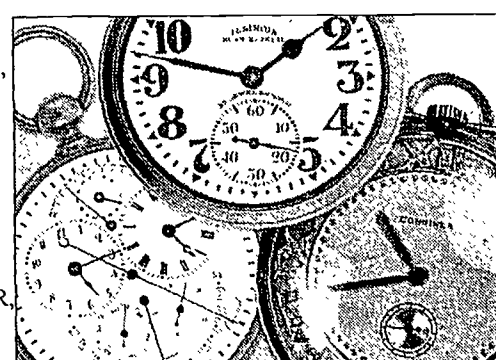

L & B LONDON BRIDGE ESTATE BUYERS (847) 323-8530

Wednesday, Nov 12th 10am-5pm
Thursday, Nov 13th 10am-7pm
Friday, Nov 14th 10am-5pm

Hampton Inn & Suites - Skokie
 5201 Old Orchard Road
 (West of Egens on Old Orchard Road)

Make us a part of your family.

Call (847) 486-9300 today to subscribe to your local paper.

PIONEER PRESS
YOUR LOCAL SOURCE
www.pioneerlocal.com

WILDCAT FANS WEAR PURPLE!
NOVEMBER 22 - RYAN FIELD
WILDCATS VS. ILLINOIS

TICKETS START AS LOW AS \$35!
U.S. CELLULAR DAY - THE FIRST 12,500 FANS INTO THE STADIUM WILL RECEIVE A WILDCAT STOCKING CAP!

YOUTH FOOTBALL DAY
Members of area youth football teams and their families can purchase end zone tickets to the game at half price. That's only \$10 per ticket! Plus, all youth football participants can take part in exclusive activities throughout the day.

WILDCAT BASKETBALL SEASON IS ALMOST HERE!
WILDCAT MEN'S BASKETBALL HOME SEASON OPENER
TAKE A KID TO THE GAME DAY

Sunday, November 16 at 7 p.m. - Welsh-Ryan Arena
One adult ticket gets two kids (8th grade and under) in FREE. (Valid on the day of the game only) Plus, Face painting, Wildcat Crafts, Ballon Animals and a POSTGAME AUTOGRAPH SESSION with the team!

NUsports.com
WILDCATMARKETING@NORTHWESTERN.EDU
847.491.CATS

THE CENTER FOR PERFORMING ARTS
CONCERTS & STAGE PRODUCTIONS

Inspired by Mary Pope Osborne's Best-Selling Book Series

Smokey Joe's Cafe
National Touring Production

MAGIC TREE HOUSE THE MUSICAL
Tickets start at just \$22!

3 Show Only! Brand New Show!

A rock star in the children's literary world.
The Times Picayune

Enjoy '50s hits like "Jailhouse Rock," "Yakety Yak" and "Love Potion No. 9"

Saturday, November 15 at 8 pm
Saturday, November 22 at 11am & 3pm
Sunday, November 23 at 2pm

Show Sponsor: **Old Second**

Order your tickets today! TICKETS: 708-235-2222 | centertickets.net
The Center is located minutes off I-57 at the Sauk Trail exit. Free Parking Available.

CLASSIFIED

IMPORTANT INFO

Hours/Locations
Call-In Hours: 8:30 am - 5:00 pm, Mon - Fri
Walk-In Hours: 9:30 am - 4:30 pm, Mon - Fri
Address: - 3701 W. Lake Ave., Glenview

Payment - We accept American Express, Diners Club, Discover, Mastercard and VISA.

Deadlines
Private Party Ads: West & Doings - 3:00 pm Tues
All Other Zones - 4:30 pm Tues

Legal Ads: 5:00 pm Monday

Classified Display Ads: 5:00 pm Mon

Logos or Artwork: 5:00 pm Mon

Commercial Ads: May vary - consult your rep

Terms

Please check your ad: The publisher will not be responsible for more than one incorrect insertion. Pioneer Press Classified must be notified before the second insertion.

Acceptability: The newspaper reserves the right to edit or reject any advertisement.

Cancellations: No classified ad can be cancelled after deadline. Display ads and ads containing artwork may incur a charge if cancelled prior to first insertion.

YOUR LOCAL ZONE

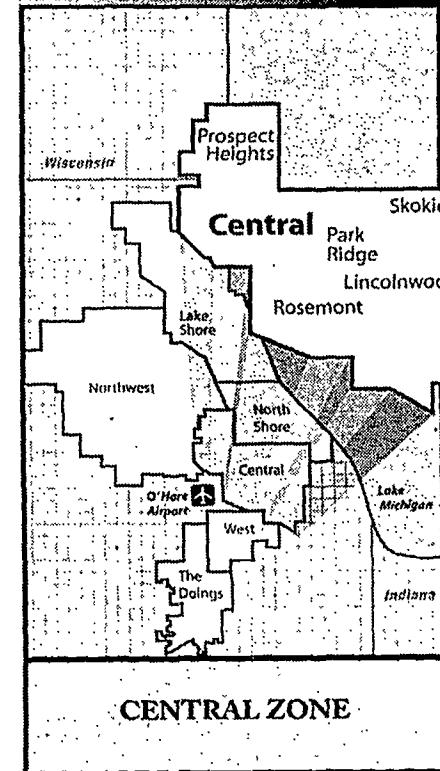

ADVERTISE WITH US

Classified Ads...847 998-3400

Help Wanted
Hotline .847 998-3404

Real Estate
to place ads call
North Shore, Lake Shore847 486-7254
Northwest, Central847 486-7252
West, The Doings847 486-7252

Home Services
to place ads call
847 486-7239

INDEX

- Announcements100s
- Business Directory200s
- Homes Services300s
- Employment400s
- Rentals500s
- Real Estate For Sale600s
- Marketplace700s
- Sporting Mart800s
- Automobiles900s
- Legal Notices1000s

Private Party Self-Service Classifieds 24/7

Go to www.pioneerlocal.com, click the Classified link, and follow a few simple steps for placing your classified ad!

www.pioneerlocal.com

Call: 847 998-3400

Email: classified@pioneerlocal.com

Fax: 847 486-7456

The Meeting Place

TO PLACE AN AD FOR FREE CALL
1-888-228-9060

TO LISTEN AND RESPOND, CALL
1-900-226-1096
Calls cost \$2.19/min. Must be 18+.

TO RESPOND USING YOUR CREDIT CARD, CALL
1-888-491-5625

WOMEN SEEKING MEN

ARE YOU THE ONE?
SWF, 29, mother, looking for a gentleman, 28-40, for friendship progressing into a relationship. **2297468**

TOTAL LOSER!

I have no looks, no interests, no talent, no I.Q., no friends, no job, and haven't dated since 1982! In truth, I am a SJFF, 47, 5'8", blonde, shapely, bright (advanced degree), fun, caring, passionate, and one of the nicest people you will ever meet. Among other things, I love great conversations, a great sense of humor, integrity, and great kissing. Seeking compatible male, late 40s to mid 60s, for permanent best friend/lover. **22749453**

ATTRACTIVE

Successful SBF, 32, seeks gorgeous, successful, mature male, 30-36, independent and spontaneous, not into games. Face open. **2294303**

DOWN-TO-EARTH

BF, 32, looking for SM, 27-45, to hang out and spend time with. If you're out there, give me a ring. **2259962**

SOMEONE SPECIAL

Sweet, down-to-earth SWF, 32, in search of mature, older man who enjoys dining, movies and quiet evenings at home. **2280146**

ARE YOU THE ONE?

SBF, 31, 5'9", enjoys bowling, bingo, shopping, dining out, quiet times at home. Seeking SBM, 35-40, for possible relationship. **2257696**

DOWN-TO-EARTH

SWF, 59, 5'4", good-looking, HW proportionate, wants to meet a SWM, 55-75, for friendship first. Call, let's talk! **2296684**

RETIRED SWF...

75, attractive, 5'2", blonde/blue, ISO honest, special man, 60-70s, for dining, travel, movies, theater, downtown. **2289576**

SPECIAL PERSON

Attractive senior, WBF, author and motivational speaker, sexy, I love the lord, love dancing, theater, great SOH. Looking for sincere male, 61-75, with same qualities. **2297468**

OLDER GENTLEMAN

WWF, 5'1", 110lbs, college grad, attractive, active, 70s, caring, friendly, enjoys walks, movies, music, theater. Seeking intelligent man, 77-82, to share pleasant times together. **224625**

PRETTY ITALIAN GAL

SF, 40, nice figure, would like to meet a gentleman, who enjoys dining out, quiet evenings, and fun times. Looking for a companion call now. **2246258**

LATINA LADY

Pretty SBF, 50s, 5'2", 120lbs, seeks honest, kind SWM, 55-63, tall, slim, good-looking, respectful, nice personality, for friendship first maybe more. **2293158**

MEN SEEKING WOMEN

I'M YOUR MAN
SWM, 51, 5'9", brown/blue, fit, very good job, laid-back, N/S, likes bowling, live theater, painting, travel, cooking, ISO nice lady, 25-45, to spend time with. **2266544**

TAKE A CHANCE

SWM, 34, looks younger, 5'6", 135lbs, brown/green, likes all kinds of music, fishing, camping, hiking, sports. Looking for a lady, 21-40, for casual dating first. **2298262**

HOMEBODY

Tall BM, 6'2", would like to meet a good woman, 34-42, ND, N/S, who likes spending time at home. **2298279**

GIVE ME A CALL!

SBM, 25, 5'7", medium build, light complexion, handsome, looking for SF, 18-30, N/S, for possible relationship. **2296376**

ARE WE A MATCH?

SWM, 33, 5'11", 185lbs, goatee and glasses, likes karaoke, music, video games, just chilling out. Seeking SF, 21-50, who is loyal, faithful, sweet, caring. **2296469**

CALL ME!

SBM, 32, 5'9", looking for a good woman, 25-35, for fun friendship, maybe more. I love sports, bowling, beaches. **2296527**

ARE WE A MATCH?

SAM, 27, 190lbs, black hair, dark brown eyes, wants to meet a sexy, fun SF, 18-38, for friendship first, maybe more. **2296308**

INTERESTED

Affectionate WM, 57, 6', 165lbs, looking for an average woman, who is kissable, huggable, HWF, I'm looking for an LTR who likes to travel. **2290315**

OLD COUNTRY BOY

SWM, 60, 6'4", 260lbs, enjoys dining in/out, flea markets, outdoor activities, casinos, c&w music, seeking nice SWF, 50-60, Waukegan area. **2281889**

A CATCH FOR YOU?

WM, 57", 140lbs, financially secure, very healthy, active, optimistic, independent, well-traveled, graduate-degreed, affectionate, considerate, enjoys dining in or out, walks, dancing, movies, theater, concerts, travel, classic music, etc. Seeks secure lady for LTR, possible marriage. **2290528**

Self Service Classifieds
TWENTY FOUR SEVEN

www.pioneerlocal.com

PIONEER PRESS
YOUR LOCAL SOURCE
The Doings

Log on to our website at www.pioneerlocal.com then click "Place an Ad" and follow a few simple steps for placing your classified ad!

FOR PRIVATE PARTY ADVERTISERS ONLY.

MEET SOMEONE YOU CLICK WITH AT: WWW.PIONEERMEETINGPLACE.COM

Free Ads: Free ads placed in this section are not guaranteed to run every week. Be sure to renew your ad frequently to keep it fresh. Guidelines: Profiles are for adults 18 or over seeking monogamous relationships. To ensure your safety, carefully screen all responses and have first meetings occur in a public place. This publication reserves the right to edit, revise, or reject any advertisement at any time at its sole discretion and assumes no responsibility for the content of or replies to any ad. Not all ads have corresponding voice messages. To review our complete guidelines, call (617) 425-2638

Answers to Super Crossword

Crossword puzzle grid with answers filled in. The grid is 15x15. The answers are: TESH, SMUG, CASK, PLED, DELTA, WELL, AMAN, HAVEN, ALIAS, ELMO, NANO, OPERA, LEHR, ALE, GAZETTE, NET, YOU, CAN, LEAD, APERSON, TKO, HIT, BALE, PIP, HEEL, TROLL, OBNOXIOUS, BEND, NAIVE, FLAIL, GISH, ELI, BOMB, LAIKA, ALLEY, ALA, ALP, SERVE, ODE, TOCOTT, AGE, CHEESE, BUTYOU, NEE, ARIAS, GEL, ALL, CERES, FUROR, WORST, LEA, OMNI, DOZEN, RENEE, ATAN, QUADRUPED, BOLET, IMAN, AIM, TIPS, ASA, ERA, CANT, MAKE, HIM, SHRINK, ZEN, ASARULE, BOK, IDOL, RADAR, SASE, JEST, PLEBE, ACRID, ADEN, ICET, ELSIE, HERO, LEST, MONO, TOTS.

108- Personals

Glory be to the Father, Son & Holy Spirit. Thanks to: Mary & Joseph The Entire Heavenly Body For: -Everyday -Halloween & ussen -Joys of the heart -Comfort/Hope -Being there (here) Offered by one who 'KNOWS' JUST BELIEVE IT'S MAGIC! Then say thanks

110- Adoptions Wanted

Adopt a Bech house full of LOVE, fun, b-day parties, prof'l dad, FT mom w/for baby. Expenses paid. Brian & Cindy 909-967-6766

SERVICE GUIDE For Business and Home

Business Services

- Accounting Services/Income tax...204
Art Work...205
Beauty Services...206
Bridal Services...207
Business Services...212
Catering, Party Services...218
Computer, Electronic Svcs...220
Counseling Services...222
Dressmaking, Alterations...224
Entertainment...226
Equipment Rental...228
Financial Services...230
Florists, Greenhouses...232
Fortune Telling, Astrology, Advisors, Psychics...234
Health Services...236
Insurance Services...238
Internet Services...239
Investors Wanted...240
Legal Services...242
Limousine Services...244
Loans & Investments...245
Medical Instruction...250
Personal Fitness...254
Personal Services...255
Photographers...256
Piano, Organ Tuning...260
Printing Services...268
Schools & Instructions...284
Video Taping...280
Travel & Travel Services Agencies...285
Amusement Parks...286
Bod & Breakfasts...287
Campsgrounds...288
Festivals...289
Resorts...290
Senior Discounts...291
Time Shares...292
Tour Companies...293
Vacation Rentals...294

Classified Avenue

\$3,000 to \$7,000 weekly. Full Training and Support 24/7. NO Selling. NO Products. NO MLM. 866-931-3048 www.livertcheasy.com
Classified Avenue provides Pioneer Press with advertising of a national appeal. To advertise in this category, please call Cliff at 888-486-2466. Pioneer Press recommends discretion with responding. Please refer questions and comments directly to Classified Avenue.

Classified Avenue

Advertise your product or service nationwide or by region in up to 14 million households in North America's best suburban! Place your classified ad over 1000 suburban newspapers just like this one. Call the Classified Avenue at 888-486-2466 www.classifiedavenue.net
ALL CASH CANDY ROUTE Do you earn \$800 in a day? Your own local candy route. Includes 30 Machines and Candy. All for \$9,995. 800-895-1185 VOID IN SD

Classified Avenue

DONATE YOUR CAR-SPECIAL KIDS FUNDI! Help Disabled Children with Camp and Education. Non-Runners OK. Quickest Free Towing. Free Cruise/Voucher. Tax Deductible. Call 1-866-448-2254.
GET A NEW COMPUTER Brand Name laptops & desktops. Bad or NO Credit. No Problem! Smallest weekly payments. Call us NOW. Call 1-800-618-3765



SERVICE GUIDE For Business and Home

Classified Avenue

SELL/RENT YOUR TIMESHARE NOW!!! Maintenance fees too high? Need Cash? Sell your unused timeshare today. No commissions or Broker Fees. Free Consultation. www.selltimeshare.com 1-666-708-3696
Computer Consulting: Technology Installations, repairs & tutoring for home & sm. business. \$50/hr. Special Senior Citizen rates! 20 yrs exp. 312-238-9392 www.computerexp.com

Home Services

- Abatement...302
Audio, Video Services...303
Air Conditioning, Heating...304
Appliance Services, Repair...306
Basements...307
Bathrooms...308
Backpacking, Paving, Sealcoating...310
Carpentry/Cabinet Work...312
Carpeting & Rugs...313
Cleaning Services...314
Clock Repair...315
Closset Design...318
Concrete, Brick Work...319
Cone Refining...320
Drapery, Slipcovers...323
Drycleaning & Laundry Svcs...324
Electrical Services...325
Excavating, Grading...327
Exterminating, Pest Control...328
Flooring...335
Firewood...336
Floor Water Drainage...337
Floors...338
Foundation Repair...339
Home Inspection...345
Interior Decorating...346
Insulation...347
Kitchen & Bath Remodeling...348
Landscape, Nurseries, Gardens...349
Lawnmower Services...350
Lawn Sprinkler Systems...351
Light Hauling...352
Locksmith, Security Devices...355
Masonry...356
Movers (Licensed), Storage...356
Organizing Services...357
Painting, Papering...358
Pest Services...359
Pest Control...360
Plumbing (Licensed)...361
Porcelain Resurfacing...362
Power Washing...363
Remodeling...364
Roofing...365
Sewer & Septic...366
Siding...367
Snow Removal & Awnings...371
Stucco...372
Swimming Pools...373
Telephone Installation...374
Tie...375
Turf...376
Tuckpointing...380
Upholstery...382
Water Conditioning, Testing...383
Waterproofing...380
Welding...385
Windows & Doors...384
Wood Restoration...395

Cleaning Services

HOME DELIGHT, INC. Cleaning Service, Detailing, Oriented, Affordable, 15 Yrs. Exp. Ins./Bonded/Exc. Refs. 312-961-0087 773-625-2676
Concrete, Brick Work -319-
CARRENO CONCRETE Sidewalks, Patios, Driveways & Steps. Fully Ins/Free Est. 847-288-9213 847-736-37

Gutters & Downspouts

COX & SONS GUTTERS INSTALLED & REPAIRED 25 yr Family Bus. CLEANED & SCREENED 1-847-253-1622
JOHN'S GUTTER SERVICE Cleaning, Gutter & Repairs 888-927-5531 or 847-527-5353

Movers

Illinois law requires movers to be licensed by the Illinois Commerce Commission. The ICC number and respective business license must appear in the advertisement in this column. Licensed movers must have insurance on file. For more information, contact the Illinois Commerce Commission

Roofing

1-847-714-9200
AVONDALE Roofing & Siding Gutters/Windows www.avondarroofing.com
Siding -367-
SIDING & WINDOWS Softi Focsi Gutters Free Est. Insured. Warranty Call John ... 773-230-6688

Handyman

1-847-520-5301
A to Z SERVICES INC. Call Dan for Quality Repairs & Remodeling 30 Yrs Exp. Ins. Visa/MC
1-773-973-2151 CALL ALEX Clearing, Carpentry, Painting & All Other Repairs
1-847-965-8114 Rich The Handyman Gutters/Painting/Carpentry Etc./Pimbs/Snowplowing Specializing in: Painting Klt. Cabinets & Old Wood Trim. Free Estimate

Painting, Papering

1-847-299-1005 1-847-222-0589
AT FRITZ & SON PAINTING Int'l/Ext. Free Est. Wallpaper
1-847-479-1534 CALL MARC STARVING PAINTER 20 Yrs Exp Int'l/Ext. Painting Specializing in: Painting Klt. Cabinets & Old Wood Trim. Free Estimate

Tree Trimming & Care

MR. GROUT 847-359-4156 REPAIR, CAULK, BATHROOM REMODELS TILE/MARBLE INSTALLS EUROPEAN CRAFTSMAN
CHRIS TREE SERVICE Tree Removals, Trimming, Cut Downs, Stump Removal Senior Discounts. Free Est. Fully Ins. Chris-312-607-5555

Announcements

- 100s
Birth Announcements...101
Car Pool & Rides...103
Disclaimer of Debt...104
Greetings...105
In Memoriam...106
Lost & Found...107
Personals...108
Adoption Wanted...110
Adoption Services...111
Just a Friend...112
Single Scene...113

101- Announcements

ROLL ENDS Available at our production facility located at 275 Northfield Road in Northfield. The cost is \$3.00 per inch based on the depth of the paper on the roll. For more information, please contact Bob or Julie at 847-265-4163 Bob: 847-740-5528 or Julie: 847-501-2197
PIONEER PRESS YOUR LOCAL SOURCE
Buying or Selling, Pioneer Classified is the place for you!

107- Lost & Found

3 ponds brown cat w/black stripes and a hint of orange and white chin. Last seen September 12th behind Acon Ct. In Round Lake beach. Reward upon return. Please leave your return phone numbers. Bob & Poulette: 847-265-4163 Bob: 847-740-5528 or Poulette: 847-536-5254
LOST CAT. He is a grey Siberian Forest Cat who answers to 'Fari' and who weighs about 11 pounds. He seems to have left our home Tuesday October 21, 2008 and we'd love to get him back. If found, please call 847-847-1174
Buying or Selling, Pioneer Classified is the place for you!

Buying or Selling, Pioneer Classified is the place for you! (847) 998-3400

The Doings

PIONEER PRESS YOUR LOCAL SOURCE
The Doings and Pioneer Press Newspapers
I ABSOLUTE GOLDMINE! Recession Proof Business Make a Full-Time Income On a Part-Time Basis From Your Home CALL 1-888-323-0278

The Doings

ALL CASH VENDING! Incredible Income Opportunity! Candy, Gumballs, Snacks, Soda... Minimum \$4K-\$10K Investment Required. Excellent Quality Machines. We Can Save You \$\$\$\$. Toll Free 800-962-9189
ATTEND COLLEGE ONLINE from home. Medical, Business, Paralegal, Computers, Criminal Justice. No placement assistance. Computer available. Financial Aid if qualified. Call 800-498-0386, www.CenturyOnline.com

The Doings

REDUCE YOUR CABLE BILL! Get a 4-Room Digital Satellite system installed for FREE and programming starting under \$20 and Showtime. Call Expert Satellite 1-866-976-2067 (credit card required)

The Doings

PSYCHIC READINGS BY JESSICA TATE
TELLS PAST, PRESENT, & FUTURE WITH PINPOINT ACCURACY. SPECIALIZING IN REUNITING LOVED ONES. SOLVES ALL LIFE'S PROBLEMS. STRICTLY PRIVATE & CONFIDENTIAL. 773-653-0069

CHICAGOLAND'S PREMIER ANTIQUE SHOW
NOVEMBER 29 & 30 Saturday 10-8 Sunday 10-4
DU PAGE EXPO ACROSS FROM PHEASANT RUN RESORT ST. CHARLES, IL (Rt. 64)
2-DAY ADMISSION: \$6 (\$1.00 off w/ad)
DURKO • 715-526-9769

Legal Services

FLAT FEE LEGAL SERVICES-A Debt Relief Agency, Collections, Traffic & DUI Ejection, Criminal Bankruptcy & Foreclosure Def. Divorce \$200 and up 1-2-3-97-41
www.111attfeellegal.com

CaULK

Tubs, Stalls, Windows, Tile Repair, Grout, Shower Doors Visa/MC. Dan 847-529-5301

Fencing

A-1 FENCE INC. New & Repair-All Types 708-452-1210

Floors

A Floors By Tom Sanding • Staining- Install 847-255-6500 www.hardwoodfloorsbytom.com

Home Improvement

1-708-945-0788 Derek & Sons Complete Home Remodeling Baths- Kitchens- Basements

Plastering

DRYWALL & PLASTER Repairs: Also Painting Dous: 708-453-5921

Window Washing

MIKE'S WINDOW CLEANING Power Wash- Gutter Cleaning Free Est. 847-276-3089

Plumbing (Licensed)

AFFORDABLE REPAIRS Big or small - Reasonable Prices. Call 708-814-6755 847-674-1584

Collector's Corner
NOVEMBER 29 & 30 Saturday 10-8 Sunday 10-4
DU PAGE EXPO ACROSS FROM PHEASANT RUN RESORT ST. CHARLES, IL (Rt. 64)
2-DAY ADMISSION: \$6 (\$1.00 off w/ad)
DURKO • 715-526-9769

Buying or Selling, Pioneer Classified is the place for you! (847) 998-3400

Quality Antiques and Estates Wanted!
Why not sell some of your antiques, jewelry or collectibles? FOR UPCOMING AUCTIONS...
Antique Furniture, Oriental Rugs, Paintings, Pottery, Figurines, Lighting, Bronzes & Jewelry
Antique & Collectible Auctions Every 2 Weeks!
Quality Consignments Accepted, One Piece or Entire Estate!
We buy Antiques & Estates!
Visit our Website for Photos & Results, Upcoming Auction Dates, & Current Listing
Direct Auction Galleries
2732 N. Western Ave., Chgo., IL (773) 465-3300 www.directauction.com

GRAYS LAKE • NEW LOCATION
★ ZURKO ★ ANTIQUE COLLECTIBLES • MARKET
SUNDAY, NOV. 9th • 8am-3pm/\$5
EARLY BUYERS: SUN. 6am-8am/\$25
LAKE COUNTY FAIRGROUNDS GRAYS LAKE (RT. 83/Peterson Rd.)
ANTIQUÉ • FLEA MARKET
SUN., Nov. 16th • 8am-3pm/\$5
EARLY BUYERS 6am-8am/\$10
DuPage County Fairgrounds WHEATON, IL 715-526-9769 www.zurkopromotions.com
ANTIQUÉ SHOW • NOV. 29th & 30th DuPage Expo - ST. CHARLES, IL

Is Your Silver Tarnished and Collecting Dust?
Flatware • Tea Sets • Trays • Bowls • Candlesticks Jewelry Other Sterling Silver
We buy sterling silver with careful evaluation for maximal payment
Contact: Zach Douglas 847-251-3225 KENILWORTH

100's of OLD Stained Glass Windows
Funderburg Antiques
815-547-8186 www.FunAntiques.com
4650 Newburg Rd. Belvidere, IL

Employment
422-Domestic Agency Employment
American Caregivers Agency offers you services with care givers, companions, CNA nurses & housekeepers. (847)673-5089
432-Business Opportunities, Franchises
Pursuant to the Business Opportunity Sales Law of 1995, every business opportunity must be registered with the Illinois Securities Department. Protect yourself and get the facts before you hand over your hard earned money by contacting the Illinois Secretary of State's Securities Department at (800) 628-7977.
The Doings PIONEER PRESS YOUR LOCAL SOURCE
The Doings and Pioneer Press Newspapers
INVESTOR with capital needed for new restaurant in Glenview. Low figures for 12 month term. High percentage rate of return. Please call: 847-299-2515
Looking for moms and others Earn \$2000-\$5000/mo. FT/PT Betsy 847-251-8915
Printing Co. or DayCare Operator with outside playground, O'Hare Area Office Complex, 5100 sq ft. Katz Mami 847-971-1717
Truck Drivers Wanted-Best Pay and Home Time! Apply Online Today over 750 Companies! In-Home Application. Hundreds of Offers! http://hammerjobs.com
440-Help Wanted
ACCOUNTING Evergreen Healthcare Center a leader in long-term, subacute care facilities in the SW Suburbs of Chicago, seeking experienced:
COORDINATOR Must be experienced with ADP & E-Time. We offer a competitive salary, 401K, tuition reimbursement, medical/dental/vision. Please fax resume to: 708-907-7003 or call: 708-907-7055
Evergreen Healthcare 1012 S. Kedzie Ave. Evergreen Park, IL 60805 EOE/DFW/Fair Workplace
Administrative
Executive Assistant Professional admin. assistant sought for Executive Director of national, non-profit medical organization. Will coordinate office & volunteer communications & fundraising activities. Superior organization, MS office & word processing comm. skills req'd. Must be able to multi-task & meet deadlines in fast-paced environment. Database exper. pref'd. Exp'd full & part-time candidates apply to: diana@demtoinfofoundation.org with salary history.
BOOKKEEPER Full Charge with experience with A/P, A/R, GL and Trial Balance. Knowledge of Yardi Computer plus. Starting salary \$35,000.00 plus benefits. Send resume to: 847-498-4844
CARPENTER Exp. in remodeling. Own truck and tools. English literature. Non tobacco, drug, alcohol. Energetic, trustworthy. Ref. Req'd. Age 25-30. \$20/hr. Fax resume and/or leave message 847-685-1271.
CDL-OTR Drivers Home weekly \$30.40 per mile Complete Benefits package Inc. 401K/Vac/Holiday pay Class "A" CDL w/2 yrs exp. Call 800-551-8808 or 847-373-0056
415-Seeking Employment-Household I will clean your house or apt. Exc. experience and ref call Lucy 847-749-3379
JENNY'S AGENCY Babysitters, Caregivers, Hsekeepers. Live In/Out. Certified and Bonded. Good career position. Fax: 847-470-7898
Customer Service Morton Grove Tool Co. needs Customer Service Asslt. Computer savvy. Non-smoking. Good career position. Fax: 847-470-7898

Sold by Pioneer Classified

24" Long Human Hair Show Girl Wig
Crab Meat Sticks
Coyote Fur Coat
32 Variety of Large Healthy Trees
Alaskan Bear Hide
Cheesecakes
Baklava
Video Telegrams
Beehive Urns
Louis XVI Armchairs
Muskrat Stroller Coat w/raccoon collar
4 ft Ceramic Tiger
Seeburg 1950s Jukebox
Barn Lumber
White Barber Pedestal Sink
Player Pianos
Buckskin Quarterhorse
Elvis Presley
Decanters
1961 Studebaker
Oriental telephone chest
1500 lbs Candle Wax
114 pes King Richard Sterling Flatware
Log Splitters
2-one-way tickets to Las Vegas
French Candelabra
Bombay Chest
60s Steamer Trunk
Guns Life Magazine
1926 Dodge
1935 Louis XV
Steinway Grand Piano
English Jumping Saddle
Peruvian Guinea Pigs
Lucky Bingo Necklace
Russian Brass
Samovar
Butterfly Collection
Long White Mink Scarf
French Legion of Honor Medal
BF Kitching Orchestra Bell
Chinese Brass Incense Burner
Massage Table
Billy Beer Can Brass
Buttons from England
Key Ring from Eastern Steamship Lines
Cigar Box Collection
Frozen Custard Machine
Mission Library Table
Chugall Lithograph
Polar Bear Skin
Spiral Stairs

We Deliver Results!

847-998-3400

440- Help Wanted

Customer Service
Small friendly Lincolnwood office seeks outgoing, dynamic individual with strong people skills, outstanding follow-through and exceptional sales support experience to join our team. This position serves the highly intense and ever changing advertising specialty market. Excellent computer skills, essential PC skills and the ability to multitask required. Adobe Illustrator preferred but not required. Call 647.673.4780 or fax 647.673.7381

DRIVER
Mazda, Honda/Toyota, etc. No CDL Required to Start, Paid Training.

Can You Drive a Regular Van and Assist Clients in Wheelchairs?

Full-Time and Part-Time Working Driver Operates Driver Buses, Paid Training and Great Employee Benefits. Full HMO or PPO, Co-pay Small Amount, Dental, Vision, \$20K FREE Life Insurance and Company provided Full Uniform Program.

Requirements: At least 25yrs old with No Felonies. Pass Drug, Physical, Background, and South Cub/City Streets Tests. No more than 2 Moving Violations within the last 5yrs. Must undergo Company Paid Training and COLI Licensing. Great Year 2008 Employee Incentive Program.

Apply In Person: Mon-Fri, 8:30-4:30pm at 6801 Greenwood, Chgo. Bring in Court Records and COLI Vehicle Record from any other state. (612)

Buying or Selling, Pioneer Classified is the place for you!
(847) 998-3400

440- Help Wanted

DRIVERS
BE YOUR OWN BOSS!

The NEW Hanover Park Menards is looking for an aggressive and responsible person to own and operate their own store with a Class "A" COL to own AND FRANCHISE their own Delivery Truck and deliver materials out of our BIG NEW store! This opportunity has SUPER SECURITY with a GROWING COMPANY. Don't wait, this is your opportunity of a lifetime! Call or stop in for more exciting information about this GREAT opportunity.

7435 Barrington Road
Hanover Park, IL 60133
630-213-5190

MENARDS

DRIVERS EXP. COLI Class A for both Regional & Long Haul Positions Home week-ends. Call 708-418-3168

DRIVERS - OWNER OPERATORS ONLY
C/MARRON EXPRESS IS GROWING!
NEED SEMI TRACTOR OWNER OPERATORS
Planned Home Time + Monthly Bonus + Fuel Surcharge + No Tolls Loads + Call Us at: 800-846-7713 ext. 123
www.cimarronexpress.com

Buying or Selling, Pioneer Classified is the place for you!

440- Help Wanted

OWNER OPERATORS
Regional from Chicago to Cleveland, Columbus, Louisville, Indianapolis & E. Iowa. Your Choice. Excellent Rate & FSC Paid on LD & Empty Miles. 2008-2009 Mgr. Opp. with a Class "A" COL to own AND FRANCHISE their own Delivery Truck and deliver materials out of our BIG NEW store! This opportunity has SUPER SECURITY with a GROWING COMPANY. Don't wait, this is your opportunity of a lifetime! Call or stop in for more exciting information about this GREAT opportunity.

7435 Barrington Road
Hanover Park, IL 60133
630-213-5190

MENARDS

DRIVERS EXP. COLI Class A for both Regional & Long Haul Positions Home week-ends. Call 708-418-3168

DRIVERS - OWNER OPERATORS ONLY
C/MARRON EXPRESS IS GROWING!
NEED SEMI TRACTOR OWNER OPERATORS
Planned Home Time + Monthly Bonus + Fuel Surcharge + No Tolls Loads + Call Us at: 800-846-7713 ext. 123
www.cimarronexpress.com

Buying or Selling, Pioneer Classified is the place for you!

440- Help Wanted

HEALTHCARE
Hospital Hiring P/T CNA, for North Cook County office. Call Chain: 847-952-2300

HealthCare PHYSICAL THERAPISTS HOME CARE RNs
Exp'd. PT's & RN's needed for Home Care Visits. So. Side, near Chicago. Call City Subs & Indiana. ANREX 708-952-4900

Healthcare RN/LPN/MA
wanted FT, for busy Geriatric/long term care. Min. 2 yrs. exp. required. Allergy exp. o. plus. Fax resume 847-855-1890

LEGAL SECRETARY
for North Shore law firm. Some experience preferred. Please call 847-323-9497

Restaurant SHIFT MANAGERS
for new restaurant, opening in Glenview. Opening/closing ordering exp. required. Fax resumes to: 847-299-2514

Retail-SALES ASSOCIATES
Health Food Store. Knowledgeable Associate for Part Time. 10-15 hrs weekly. b/w. hrs. hours of 10:30-3:30. 630-789-2279 JoAnn

Sales Account Service Manager
Mature, hard-working, responsible team player needed for outside and inside sales involving home improvement and construction. Knowledge of building trades or home improvement helpful. We offer a complete compensation package that includes bonuses. Apply in person!

MENARDS

6401 Grand Ave.
Gurnee, IL 60031
847-835-3107

DRIVERS EXP. COLI Class A
for both Regional & Long Haul Positions Home week-ends. Call 708-418-3168

DRIVERS - OWNER OPERATORS ONLY
C/MARRON EXPRESS IS GROWING!
NEED SEMI TRACTOR OWNER OPERATORS
Planned Home Time + Monthly Bonus + Fuel Surcharge + No Tolls Loads + Call Us at: 800-846-7713 ext. 123
www.cimarronexpress.com

Buying or Selling, Pioneer Classified is the place for you!

440- Help Wanted

SALES REP
needed for the Ralph Singer Co. - a Chicago based jewelry co. in business since 1921! Dynamic, energetic individual, motivated, energetic individual. You work to expand our clientele base. Call Carol 773-473-3542 or email resume: cmthgh@ralphsingerjewelry.com

STATISTICIANS
MedFocus LLC a division of Invently Health seeks Statistical Analysts for Assignments throughout the U.S. Master's req'd. Education or exp. must include: SAS. Send resume to: ATTN: Leticia Guadalupe, 1625 Park Ten Place, Suite 200, Houston, TX 77054

Restaurant SHIFT MANAGERS
for new restaurant, opening in Glenview. Opening/closing ordering exp. required. Fax resumes to: 847-299-2514

Retail-SALES ASSOCIATES
Health Food Store. Knowledgeable Associate for Part Time. 10-15 hrs weekly. b/w. hrs. hours of 10:30-3:30. 630-789-2279 JoAnn

Sales Account Service Manager
Mature, hard-working, responsible team player needed for outside and inside sales involving home improvement and construction. Knowledge of building trades or home improvement helpful. We offer a complete compensation package that includes bonuses. Apply in person!

MENARDS

6401 Grand Ave.
Gurnee, IL 60031
847-835-3107

DRIVERS EXP. COLI Class A
for both Regional & Long Haul Positions Home week-ends. Call 708-418-3168

DRIVERS - OWNER OPERATORS ONLY
C/MARRON EXPRESS IS GROWING!
NEED SEMI TRACTOR OWNER OPERATORS
Planned Home Time + Monthly Bonus + Fuel Surcharge + No Tolls Loads + Call Us at: 800-846-7713 ext. 123
www.cimarronexpress.com

Buying or Selling, Pioneer Classified is the place for you!

440- Help Wanted

Warehouse LEADING LOGISTICS
Dealing with all kinds of International and Domestic Freight. Fast moving operation. Must love numbers. Send resume to: 310 Busse Hwy, Box 152, Park Ridge, IL 60068

445- Help Wanted - Part Time
Retail
Career Growth Made Solid.
TCF Bank offers solid career growth with strong community bank. We are now hiring for: Polkville, Mundelein, Deerfield, Crystal Lake, Wauconda, Mt. Prospect, Elk Grove Village, and Arlington Heights. Learn more at our upcoming:

JOB FAIR
Wednesday, Nov. 12th
TCF Bank
1589 Rand Road
Palatine, IL
10 AM to 4 PM

PT Sales Associates
Starts at \$ 8.88/hour + incentives

Must be 17 years of age or older and have a minimum of 12 months previous work experience. Prior or Retail cash handling a plus. Bilingual Spanish is a plus. Prior banking experience is not required for these positions.

TCF Bank offers competitive compensation and excellent benefits. If unable to attend, please send resume to e-mail: jrw@tcfbank.com or apply online at www.tcfbank.com EOE

OFFICE MANAGER
P/T (approx 20 hrs/wk) for fast paced medical office of practitioners. Responsibilities include: ensuring coordination of patient care, maintaining computerized patient records, managing front desk operations and overall office workflow with no billing responsibilities. Send resume to: all@wecoreadlung.com

Work For The Industry Leader!
Top Commissions Paid We are the best! The business presentation skills to sell our (largest) business consulting firm in our marketplace. IPR recognizes that the quality of our employees is the primary reason for our success and they are earning top commissions in our industry.

We are currently seeking individuals with good phone presentation skills to sell our business development services to business owners throughout the US & Canada from our Buffalo Grove offices. IPR offers the best pay in our industry. Our formerers are earning commissions of \$15k per year (50-75% realistic first year commissions); full benefits package. Excellent growth and corporate advancement opportunities. We are looking for an opportunity to earn what you wish.

Call Mr. Durham
1-800-531-2542
or email resume to: kyle.christopherson@ipr-ib.com
Equal Opportunity Employer

440- Help Wanted

RECEPTIONIST
PT individual for Skokis dental office. Exp. a plus. Please fax resume to: 815-223-0957

General Office-PT
for small medical office. Some computer, phone appointment setting. Self-motivated, organized, friendly & mature individual. Call Barbara: 847-827-0666

TELEMARKETING

Work For The Industry Leader!
Top Commissions Paid We are the best! The business presentation skills to sell our (largest) business consulting firm in our marketplace. IPR recognizes that the quality of our employees is the primary reason for our success and they are earning top commissions in our industry.

We are currently seeking individuals with good phone presentation skills to sell our business development services to business owners throughout the US & Canada from our Buffalo Grove offices. IPR offers the best pay in our industry. Our formerers are earning commissions of \$15k per year (50-75% realistic first year commissions); full benefits package. Excellent growth and corporate advancement opportunities. We are looking for an opportunity to earn what you wish.

Call Mr. Durham
1-800-531-2542
or email resume to: kyle.christopherson@ipr-ib.com
Equal Opportunity Employer

445- Help Wanted - Part Time

RECEPTIONIST
PT individual for Skokis dental office. Exp. a plus. Please fax resume to: 815-223-0957

General Office-PT
for small medical office. Some computer, phone appointment setting. Self-motivated, organized, friendly & mature individual. Call Barbara: 847-827-0666

TELEMARKETING

Work For The Industry Leader!
Top Commissions Paid We are the best! The business presentation skills to sell our (largest) business consulting firm in our marketplace. IPR recognizes that the quality of our employees is the primary reason for our success and they are earning top commissions in our industry.

We are currently seeking individuals with good phone presentation skills to sell our business development services to business owners throughout the US & Canada from our Buffalo Grove offices. IPR offers the best pay in our industry. Our formerers are earning commissions of \$15k per year (50-75% realistic first year commissions); full benefits package. Excellent growth and corporate advancement opportunities. We are looking for an opportunity to earn what you wish.

Call Mr. Durham
1-800-531-2542
or email resume to: kyle.christopherson@ipr-ib.com
Equal Opportunity Employer

445- Help Wanted - Part Time

RECEPTIONIST
PT individual for Skokis dental office. Exp. a plus. Please fax resume to: 815-223-0957

General Office-PT
for small medical office. Some computer, phone appointment setting. Self-motivated, organized, friendly & mature individual. Call Barbara: 847-827-0666

TELEMARKETING

Work For The Industry Leader!
Top Commissions Paid We are the best! The business presentation skills to sell our (largest) business consulting firm in our marketplace. IPR recognizes that the quality of our employees is the primary reason for our success and they are earning top commissions in our industry.

We are currently seeking individuals with good phone presentation skills to sell our business development services to business owners throughout the US & Canada from our Buffalo Grove offices. IPR offers the best pay in our industry. Our formerers are earning commissions of \$15k per year (50-75% realistic first year commissions); full benefits package. Excellent growth and corporate advancement opportunities. We are looking for an opportunity to earn what you wish.

Call Mr. Durham
1-800-531-2542
or email resume to: kyle.christopherson@ipr-ib.com
Equal Opportunity Employer

445- Help Wanted - Part Time

RECEPTIONIST
PT individual for Skokis dental office. Exp. a plus. Please fax resume to: 815-223-0957

General Office-PT
for small medical office. Some computer, phone appointment setting. Self-motivated, organized, friendly & mature individual. Call Barbara: 847-827-0666

TELEMARKETING

Work For The Industry Leader!
Top Commissions Paid We are the best! The business presentation skills to sell our (largest) business consulting firm in our marketplace. IPR recognizes that the quality of our employees is the primary reason for our success and they are earning top commissions in our industry.

We are currently seeking individuals with good phone presentation skills to sell our business development services to business owners throughout the US & Canada from our Buffalo Grove offices. IPR offers the best pay in our industry. Our formerers are earning commissions of \$15k per year (50-75% realistic first year commissions); full benefits package. Excellent growth and corporate advancement opportunities. We are looking for an opportunity to earn what you wish.

Call Mr. Durham
1-800-531-2542
or email resume to: kyle.christopherson@ipr-ib.com
Equal Opportunity Employer

445- Help Wanted - Part Time

RECEPTIONIST
PT individual for Skokis dental office. Exp. a plus. Please fax resume to: 815-223-0957

General Office-PT
for small medical office. Some computer, phone appointment setting. Self-motivated, organized, friendly & mature individual. Call Barbara: 847-827-0666

TELEMARKETING

Work For The Industry Leader!
Top Commissions Paid We are the best! The business presentation skills to sell our (largest) business consulting firm in our marketplace. IPR recognizes that the quality of our employees is the primary reason for our success and they are earning top commissions in our industry.

We are currently seeking individuals with good phone presentation skills to sell our business development services to business owners throughout the US & Canada from our Buffalo Grove offices. IPR offers the best pay in our industry. Our formerers are earning commissions of \$15k per year (50-75% realistic first year commissions); full benefits package. Excellent growth and corporate advancement opportunities. We are looking for an opportunity to earn what you wish.

Call Mr. Durham
1-800-531-2542
or email resume to: kyle.christopherson@ipr-ib.com
Equal Opportunity Employer

445- Help Wanted - Part Time

RECEPTIONIST
PT individual for Skokis dental office. Exp. a plus. Please fax resume to: 815-223-0957

General Office-PT
for small medical office. Some computer, phone appointment setting. Self-motivated, organized, friendly & mature individual. Call Barbara: 847-827-0666

TELEMARKETING

Work For The Industry Leader!
Top Commissions Paid We are the best! The business presentation skills to sell our (largest) business consulting firm in our marketplace. IPR recognizes that the quality of our employees is the primary reason for our success and they are earning top commissions in our industry.

We are currently seeking individuals with good phone presentation skills to sell our business development services to business owners throughout the US & Canada from our Buffalo Grove offices. IPR offers the best pay in our industry. Our formerers are earning commissions of \$15k per year (50-75% realistic first year commissions); full benefits package. Excellent growth and corporate advancement opportunities. We are looking for an opportunity to earn what you wish.

Call Mr. Durham
1-800-531-2542
or email resume to: kyle.christopherson@ipr-ib.com
Equal Opportunity Employer

445- Help Wanted - Part Time

RECEPTIONIST
PT individual for Skokis dental office. Exp. a plus. Please fax resume to: 815-223-0957

General Office-PT
for small medical office. Some computer, phone appointment setting. Self-motivated, organized, friendly & mature individual. Call Barbara: 847-827-0666

TELEMARKETING

Work For The Industry Leader!
Top Commissions Paid We are the best! The business presentation skills to sell our (largest) business consulting firm in our marketplace. IPR recognizes that the quality of our employees is the primary reason for our success and they are earning top commissions in our industry.

We are currently seeking individuals with good phone presentation skills to sell our business development services to business owners throughout the US & Canada from our Buffalo Grove offices. IPR offers the best pay in our industry. Our formerers are earning commissions of \$15k per year (50-75% realistic first year commissions); full benefits package. Excellent growth and corporate advancement opportunities. We are looking for an opportunity to earn what you wish.

Call Mr. Durham
1-800-531-2542
or email resume to: kyle.christopherson@ipr-ib.com
Equal Opportunity Employer

445- Help Wanted - Part Time

RECEPTIONIST
PT individual for Skokis dental office. Exp. a plus. Please fax resume to: 815-223-0957

General Office-PT
for small medical office. Some computer, phone appointment setting. Self-motivated, organized, friendly & mature individual. Call Barbara: 847-827-0666

TELEMARKETING

Work For The Industry Leader!
Top Commissions Paid We are the best! The business presentation skills to sell our (largest) business consulting firm in our marketplace. IPR recognizes that the quality of our employees is the primary reason for our success and they are earning top commissions in our industry.

We are currently seeking individuals with good phone presentation skills to sell our business development services to business owners throughout the US & Canada from our Buffalo Grove offices. IPR offers the best pay in our industry. Our formerers are earning commissions of \$15k per year (50-75% realistic first year commissions); full benefits package. Excellent growth and corporate advancement opportunities. We are looking for an opportunity to earn what you wish.

Call Mr. Durham
1-800-531-2542
or email resume to: kyle.christopherson@ipr-ib.com
Equal Opportunity Employer

445- Help Wanted - Part Time

RECEPTIONIST
PT individual for Skokis dental office. Exp. a plus. Please fax resume to: 815-223-0957

General Office-PT
for small medical office. Some computer, phone appointment setting. Self-motivated, organized, friendly & mature individual. Call Barbara: 847-827-0666

TELEMARKETING

Work For The Industry Leader!
Top Commissions Paid We are the best! The business presentation skills to sell our (largest) business consulting firm in our marketplace. IPR recognizes that the quality of our employees is the primary reason for our success and they are earning top commissions in our industry.

We are currently seeking individuals with good phone presentation skills to sell our business development services to business owners throughout the US & Canada from our Buffalo Grove offices. IPR offers the best pay in our industry. Our formerers are earning commissions of \$15k per year (50-75% realistic first year commissions); full benefits package. Excellent growth and corporate advancement opportunities. We are looking for an opportunity to earn what you wish.

Call Mr. Durham
1-800-531-2542
or email resume to: kyle.christopherson@ipr-ib.com
Equal Opportunity Employer

445- Help Wanted - Part Time

RECEPTIONIST
PT individual for Skokis dental office. Exp. a plus. Please fax resume to: 815-223-0957

General Office-PT
for small medical office. Some computer, phone appointment setting. Self-motivated, organized, friendly & mature individual. Call Barbara: 847-827-0666

TELEMARKETING

Work For The Industry Leader!
Top Commissions Paid We are the best! The business presentation skills to sell our (largest) business consulting firm in our marketplace. IPR recognizes that the quality of our employees is the primary reason for our success and they are earning top commissions in our industry.

We are currently seeking individuals with good phone presentation skills to sell our business development services to business owners throughout the US & Canada from our Buffalo Grove offices. IPR offers the best pay in our industry. Our formerers are earning commissions of \$15k per year (50-75% realistic first year commissions); full benefits package. Excellent growth and corporate advancement opportunities. We are looking for an opportunity to earn what you wish.

Call Mr. Durham
1-800-531-2542
or email resume to: kyle.christopherson@ipr-ib.com
Equal Opportunity Employer

445- Help Wanted - Part Time

RECEPTIONIST
PT individual for Skokis dental office. Exp. a plus. Please fax resume to: 815-223-0957

General Office-PT
for small medical office. Some computer, phone appointment setting. Self-motivated, organized, friendly & mature individual. Call Barbara: 847-827-0666

TELEMARKETING

Work For The Industry Leader!
Top Commissions Paid We are the best! The business presentation skills to sell our (largest) business consulting firm in our marketplace. IPR recognizes that the quality of our employees is the primary reason for our success and they are earning top commissions in our industry.

We are currently seeking individuals with good phone presentation skills to sell our business development services to business owners throughout the US & Canada from our Buffalo Grove offices. IPR offers the best pay in our industry. Our formerers are earning commissions of \$15k per year (50-75% realistic first year commissions); full benefits package. Excellent growth and corporate advancement opportunities. We are looking for an opportunity to earn what you wish.

Call Mr. Durham
1-800-531-2542
or email resume to: kyle.christopherson@ipr-ib.com
Equal Opportunity Employer

Rentals

500s
Apartments, Condos-Suburban (Unfurnished).....505
Apartments, Condos-Chicago (Unfurnished).....506
Apartments, Condos-Suburban (Furnished).....510
Apartments, Houses (Unfurnished).....515
Duplexes, Townhouses.....545
Garage, Parking Spaces.....525
Halls, Studios.....530
Houses.....535
Industrial, Commercial.....545
Out of State Property.....550
Rooms for Rent.....560
Storage Space.....565
Stores, Offices.....570
Vacation Rentals.....580
Wanted to Rent.....585

505s
Apartments, Condos-Suburban (Unfurnished).....505
Apartments, Condos-Chicago (Unfurnished).....506
Apartments, Condos-Suburban (Furnished).....510
Apartments, Houses (Unfurnished).....515
Duplexes, Townhouses.....545
Garage, Parking Spaces.....525
Halls, Studios.....530
Houses.....535
Industrial, Commercial.....545
Out of State Property.....550
Rooms for Rent.....560
Storage Space.....565
Stores, Offices.....570
Vacation Rentals.....580
Wanted to Rent.....585

506s
Apartments, Condos-Suburban (Unfurnished).....505
Apartments, Condos-Chicago (Unfurnished).....506
Apartments, Condos-Suburban (Furnished).....510
Apartments, Houses (Unfurnished).....515
Duplexes, Townhouses.....545
Garage, Parking Spaces.....525
Halls, Studios.....530
Houses.....535
Industrial, Commercial.....545
Out of State Property.....550
Rooms for Rent.....560
Storage Space.....565
Stores, Offices.....570
Vacation Rentals.....580
Wanted to Rent.....585

570s
Stores & Offices

695s
Judicial Sales

695s
Judicial Sales

695s
Judicial Sales

505s Apartments, Condominiums-Suburban

Chicago LAKE LIVING AT SHERIDAN SHORES
7703 SHERIDAN RD. Studio, 1 & 2 BRs nr park, beach, tennis cts, & shopping areas. Well main, prop. on-site owner/mgmt. Hl, wator, gas incl. \$275-\$310. 1-2 MONTHS FREE! APPOINTMENTS ONLY 773-627-2675

DES PLAINES 1BR 1st flr.
SUPER LOC nr 17th, grocery & shops. \$649/mo. 847-530-627

DES PLAINES 1BR \$725.
2BR apt. incl. util. 11mm. GRE 847-991-0770

DES PLAINES 2BR, 1BA.
Indy in new build, util. incl. \$470-601-8351

Oak Plaines 603 River River
rd (updated) cont. 2br, 1 1/2 bath no pet, nr metro & shopping \$1000 mo. McLennan 847-825-0011

DES PLAINES Downtown
Studio \$750, 2BR \$1025. Elevator, Retail & Gym. Gork pk ovl. GRE 847-824-9970

Edison Park Area
1br/1bath no pet nr metro & shopping \$865 mo. McLennan 847-825-0011

EVANSTON 1029 Dewey
2nd flr, 2BRs + Oen, 1 BA, \$1100/mo. No pet. No incl. call 847-905-0612

EVANSTON 1BR, 1BA.
new build, 11mm, pet. no pet. incl. \$999. 847-747-1656

EVANSTON 3BR, 1.5BA.
nr. 17th, 2BR, 1BA, 1.5BA, W/O, eat-in kitch, parking in back. Non-smoker, no dogs. Hl. \$1700/mo. 847-366-4757

FOSTER & CUMBERLAND
Studio apt. pet. ok, util. pks. \$555/mo. 847-338-8993

GLENNVIEW
1 & 2 BR, w/central, O/W, w/ll to wall crtns. CAC, wsh/drwr, in bldg. Excl. furn. \$1500. KALE REALTY. 847-574-5150

SKOKIE 1BR, best location
near to park & c/c. Indry, prks. 847-707-8253

SKOKIE 1BR, 1.5 BA.
Gar. indy & dryer incl. 1st & 2nd flr ovt. Call 773-407-8994 or 773-759-5014

SKOKIE 4615 Davis 2BR
for \$1200. Modern courtyard building. Well landscaped property. Central air & heat. Parking & laundry. Available Now. Close to shopping, parks. Call Valentin 708-243-1140

SKOKIE 4999 CHURCH 1BR
\$845, 2BR \$945. Close to transportation. Heat, water and parking included. Storage room and laundry. Must see!!! Tony 708-417-5897

SKOKIE 4921 Crain 1BR \$845
& 2BR \$995. Close to transportation and shopping. Heat and water included. To see call Valentin 708-243-1140

SKOKIE 4937 CHURCH
1BR, 1BA, modern A/C, heat incl. prks, ovt. Next to park, close to Old Orchard. Call Barbara 847-673-1317 or Hallmark@hennson773-545-6161

SKOKIE 8201 N. Knox
2BR, Avonl new \$900 + utils 410-747-1613-H 443-928-1074-C

SKOKIE 8250-60 NILES CENTER RD.
Lovely 1BR for \$845. Larger, modern kitchen & bath. A/C, heat and laundry & parking. Heat Incl. Tony (708) 417-5897

SKOKIE Lg. Arm. 1BR, heat
& decor, h/dw, hrs. appls. \$750-850/(847)676-2124. No pets.

505s Apartments, Condominiums-Suburban

Chicago LAKE LIVING AT SHERIDAN SHORES
7703 SHERIDAN RD. Studio, 1 & 2 BRs nr park, beach, tennis cts, & shopping areas. Well main, prop. on-site owner/mgmt. Hl, wator, gas incl. \$275-\$310. 1-2 MONTHS FREE! APPOINTMENTS ONLY 773-627-2675

DES PLAINES 1BR 1st flr.
SUPER LOC nr 17th, grocery & shops. \$649/mo. 847-530-627

DES PLAINES 1BR \$725.
2BR apt. incl. util. 11mm. GRE 847-991-0770

DES PLAINES 2BR, 1BA.
Indy in new build, util. incl. \$470-601-8351

Oak Plaines 603 River River
rd (updated) cont. 2br, 1 1/2 bath no pet, nr metro & shopping \$1000 mo. McLennan 847-825-0011

DES PLAINES Downtown
Studio \$750, 2BR \$1025. Elevator, Retail & Gym. Gork pk ovl. GRE 847-824-9970

Edison Park Area
1br/1bath no pet nr metro & shopping \$865 mo. McLennan 847-825-0011

EVANSTON 1029 Dewey
2nd flr, 2BRs + Oen, 1 BA, \$1100/mo. No pet. No incl. call 847-905-0612

EVANSTON 1BR, 1BA.
new build, 11mm, pet. no pet. incl. \$999. 847-747-1656

EVANSTON 3BR, 1.5BA.
nr. 17th, 2BR, 1BA, 1.5BA, W/O, eat-in kitch, parking in back. Non-smoker, no dogs. Hl. \$1700/mo. 847-366-4757

FOSTER & CUMBERLAND
Studio apt. pet. ok, util. pks. \$555/mo. 847-338-8993

GLENNVIEW
1 & 2 BR, w/central, O/W, w/ll to wall crtns. CAC, wsh/drwr, in bldg. Excl. furn. \$1500. KALE REALTY. 847-574-5150

SKOKIE 1BR, best location
near to park & c/c. Indry, prks. 847-707-8253

SKOKIE 1BR, 1.5 BA.
Gar. indy & dryer incl. 1st & 2nd flr ovt. Call 773-407-8994 or 773-759-5014

SKOKIE 4615 Davis 2BR
for \$1200. Modern courtyard building. Well landscaped property. Central air & heat. Parking & laundry. Available Now. Close to shopping, parks. Call Valentin 708-243-1140

SKOKIE 4999 CHURCH 1BR
\$845, 2BR \$945. Close to transportation. Heat, water and parking included. Storage room and laundry. Must see!!! Tony 708-417-5897

SKOKIE 4921 Crain 1BR \$845
& 2BR \$995. Close to transportation and shopping. Heat and water included. To see call Valentin 708-243-1140

SKOKIE 4937 CHURCH
1BR, 1BA, modern A/C, heat incl. prks, ovt. Next to park, close to Old Orchard. Call Barbara 847-673-1317 or Hallmark@hennson773-545-6161

SKOKIE 8201 N. Knox
2BR, Avonl new \$900 + utils 410-747-1613-H 443-928-1074-C

SKOKIE 8250-60 NILES CENTER RD.
Lovely 1BR for \$845. Larger, modern kitchen & bath. A/C, heat and laundry & parking. Heat Incl. Tony (708) 417-5897

SKOKIE Lg. Arm. 1BR, heat
& decor, h/dw, hrs. appls. \$750-850/(847)676-2124. No pets.

506s Apartments, Condominiums-Suburban

Chicago LAKE LIVING AT SHERIDAN SHORES
7703 SHERIDAN RD. Studio, 1 & 2 BRs nr park, beach, tennis cts, & shopping areas. Well main, prop. on-site owner/mgmt. Hl, wator, gas incl. \$275-\$310. 1-2 MONTHS FREE! APPOINTMENTS ONLY 773-627-2675

DES PLAINES 1BR 1st flr.
SUPER LOC nr 17th, grocery & shops. \$649/mo. 847-530-627

DES PLAINES 1BR \$725.
2BR apt. incl. util. 11mm. GRE 847-991-0770

DES PLAINES 2BR, 1BA.
Indy in new build, util. incl. \$470-601-8351

Oak Plaines 603 River River
rd (updated) cont. 2br, 1 1/2 bath no pet, nr metro & shopping \$1000 mo. McLennan 847-825-0011

DES PLAINES Downtown
Studio \$750, 2BR \$1025. Elevator, Retail & Gym. Gork pk ovl. GRE 847-824-9970

Edison Park Area
1br/1bath no pet nr metro & shopping \$865 mo. McLennan 847-825-0011

EVANSTON 1029 Dewey
2nd flr, 2BRs + Oen, 1 BA, \$1100/mo. No pet. No incl.

Coming Soon to your Local Pioneer Press & Doings Newspapers

Our *NEW* Weekly Feature *Celebrate!*

Announce Your Special Family Events:



Engagements & Weddings



Birthdays



Graduations



Birth Announcements



Anniversaries



Bar & Bat Mitzvahs



Sweet Sixteens

For more information contact:

Liz Maier

847-486-7230

celebrate@pioneerlocal.com

Sample Ad:



It's a Boy!

Jack Caldwell Bucciarelli

January 7, 2008 9:15 p.m.

9 pounds, 13 ounces • 22 inches

Jack was welcomed with lots of love by two overjoyed parents. His grandparents, Gisela & Peter Bucciarelli and Gail & Mike Hilgart, are doting over their new grandson. From around Chicago and across the country, Jack's family is looking forward to getting to know him. His parents would like to thank the staff at Evanston Hospital for all the care and support they provided Jack and his parents.

***Congratulations to his loving parents
Ellie & John Bucciarelli***

Actual Dimensions of ad 3.1" x 5.9"

EACH ANNOUNCEMENT \$50
(per one newspaper)

EACH ADDITIONAL PAPER \$10
Six Announcements per Page

*Any Orders of two or more towns will
receive a FREE print suitable for framing!*

The Doings

PIONEER PRESS
YOUR LOCAL SOURCE

SPRING FORWARD INTO GARAGE SALE SEASON!

Pioneer Press Classified has the advertising you're looking for.



Lets face it... a sign doesn't always work.

Run an ad in the paper for nearly the same price!

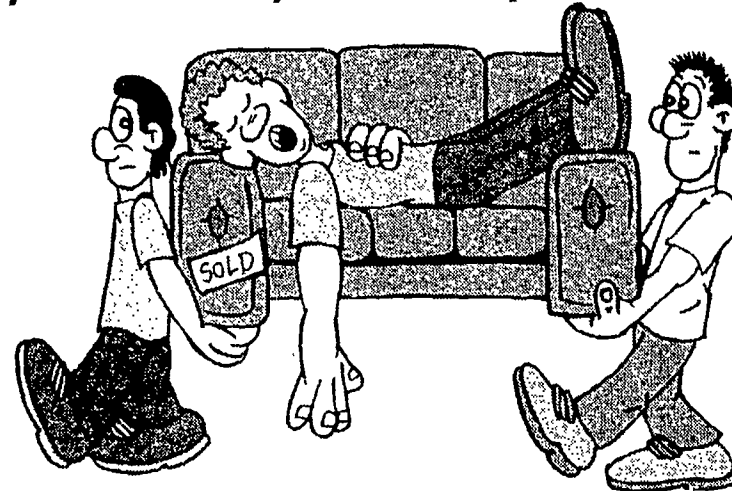

SIX FOR \$6.00

- Place a Six-Line Garage Sale ad for only \$6.00 per line!

VALUE PACK

- Place a 14-Line "Attention Getter" ad with a border for only \$75.00.

The garage sale kit is included with either package!

CALL US TODAY!

Ph: (847) 998-3400

Fax: (847) 486-7456

classified@pioneerlocal.com

PIONEER PRESS
YOUR LOCAL SOURCE

The Doings

www.pioneerlocal.com

Your local source 24 hours a day.



EACH KIT INCLUDES:

- 3 Fluorescent 11"x 14" Signs
- 140 Bright Pre-Priced Labels
- Successful Garage Sale Tips
- Pre-Sale Checklist
- Sales Record Form



Local News—
Delivered right
to your mailbox

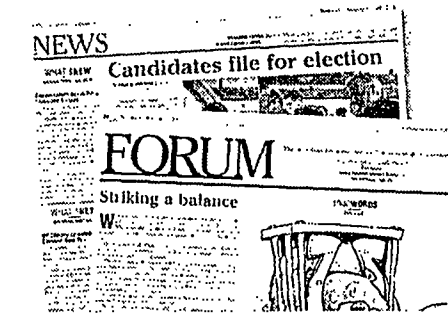
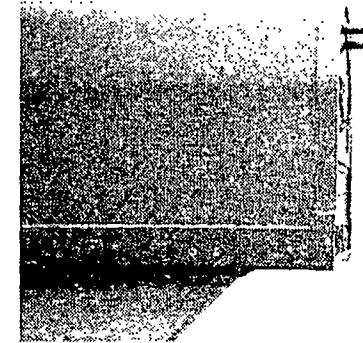

Local News & Opinions



Your Schools & Teams



Entertainment & Events

PIONEER PRESS

YOUR LOCAL SOURCE

Now offering 51 intensely local editions to choose from.

North

- Antioch Review
- Deerfield Review
- Grayslake Review
- Gurnee Review
- Highland Park News
- Lake Forester
- Libertyville Review
- Lincolnshire Review
- Mundelein Review
- Lake Villa/Lindenhurst Review
- Vernon Hills Review

North Shore

- Evanston Review
- Glencoe News
- Glenview Announcements
- Northbrook Star
- Wilmette Life
- Winnetka Talk

West

- Elm Leaves
- Forest Leaves
- Franklin Park Herald-Journal
- Oak Leaves
- River Grove Messenger

Doings

- Clarendon Hills Doings
- Elmhurst Doings
- Hinsdale Doings
- La Grange Doings
- Oak Brook/Oakbrook Terrace Doings
- Weekly Doings
- Western Springs Doings

Northwest

- Algonquin Countryside
- Arlington Heights Post
- Barrington Courier-Review
- Buffalo Grove Countryside
- Cary-Grove Countryside
- Hoffman Estates Review
- Lake Zurich Courier
- Palatine Countryside
- Rolling Meadows Review
- Schaumburg Review
- Wauconda Courier
- Wheeling Countryside

Central

- Des Plaines Times
- Edison/Norwood Times Review
- Lincolnwood Review
- Morton Grove Champion
- Mount Prospect Times
- Niles Herald-Spectator
- Norwood-Harwood Hts.
- Park Ridge Herald

Visit our Web site at PioneerLocal.com to subscribe and check our **E-Z Pay option** which guarantees you the best renewal rate for continuous service.

OR

Call 847-486-9300 to order your subscription.

Visit your community online at:

PioneerLocal.com



STNG

http://www.pioneerlocal.com/index.html

Google

SUN-TIMES NEWS GROUP

Your local news source ::
Select a community or newspaper >

Select a community



Select a STNG publication or site



Your Community ONLINE!

PIONEERLOCAL

PioneerLocal.com Member of the Sun-Times News Group



50°F
Mostly Cloudy

Search »
Pioneer STNG

Subscribe
Customer Service

Home | Community | Classifieds | Business | Real Estate | News | Local News | Special Sections | Calendar



go to www.pioneerlocal.com

and click on **Communities**



Small Format
Large Format
Non-Traditional

Pioneer Press has
the right solution
for your project!

All the vital community information, with interactive ads available in an easy-to-view document you can download. Check out these Pioneer Press publications today! Pioneer Press is the key partnership for organizations who want to do more.

- Antioch
- Barrington
- Barrington Holiday
- Bellwood
- Belmont-Central
- Buffalo Grove
- Deerfield
- Des Plaines
- Evanston
- Edison Park
- Franklin Park/Schiller Park
- Galewood
- Glen Ellyn
- Glencoe
- Glenview
- GLMV (Green Oaks, Libertyville, Mundelein & Vernon Hills)
- Grayslake
- Gurnee
- Harwood Heights
- Highland Park
- Hinsdale
- Hoffman Estates
- Lake Forest/Lake Bluff
- Lake Forest/Lake Bluff Summer Guide
- Lincoln Park
- Lincolnshire
- MainStreet Libertyville
- Lincolnwood
- Matteson Area
- Mokena
- Mont Clare/Elmwood Park
- Mount Prospect Holiday
- Northbrook
- Northfield
- Norwood Park
- Oak Park/River Forest
- Oak Park Area Visitors Guide
- Old Town
- Palatine
- Park Ridge
- Portage Park
- Schaumburg
- Skokie
- Wauconda
- West Suburban Chamber
- West Town
- Wilmette & Kenilworth
- Winnetka
- Winnetka Holiday Guide

For more information call:

Kurt Kuras
Project Developer
847.486.7537

Michelle Weiss
Niche Publications Manager
847.486.7285



PIONEER PRESS
YOUR LOCAL SOURCE

Celebrating 5 Years in The Glen!



CHESTNUT SQUARE AT THE GLEN

CHESTNUT

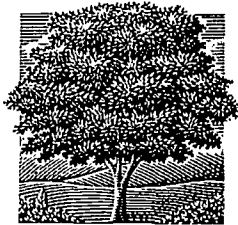

SQUARE

at The Glen

“Independent Senior Living at its Best!”

It's hard to imagine, but Chestnut Square at The Glen is now celebrating its 5-year anniversary! Designed in an elegant prairie style, the community is a truly beautiful place to call home. Envision yourself in a one- or two-bedroom apartment, fully equipped with kitchen and spacious living areas. Extensive common areas include a library, barber/beauty salon, fitness center, cafe and gardens.

And at Chestnut Square, you can step out your door and find yourself surrounded by beauty and activity, right in the heart of The Glen! Walk to the fabulous Town Center and enjoy a movie or stroll through the shops. Dine out at top-of-the-line restaurants, enjoy the 140-acre park of gardens or socialize at the Glenview Senior Center just across the street. You'll be hard pressed to find a more ideal location.

The community features a 100% Refundable Entrance Fee, 24-hour emergency response system, on-site health center, Signature Dining Program, scheduled transportation and diverse leisure activities and outings. Makes sense, doesn't it? Daytime, evening and weekend appointments are available. Call us today at (847) 998-1118.



Message from the CEO

When Chestnut Square at The Glen first opened its doors, our goal was to provide seniors of all faiths and backgrounds a rewarding lifestyle at a sensible price. Today, I'm proud to say that Chestnut Square has lived up to its promise and earned a reputation as one of the North Shore's premier senior living communities.

Our dedicated staff and dynamic community of residents have been an example for the entire Bethany Methodist Family, and I look forward with great anticipation to another extraordinary five years!

Respectfully yours,

Rev. Dr. Stephen A. Dahl

President & CEO, Bethany Methodist Communities

Why Choose Retirement Living?

As we age, the everyday tasks of home owning, from shoveling the driveway to preparing meals, becomes more and more of a burden. Why continue this year-after-year struggle when a more rewarding option is so close-by?

Chestnut Square at The Glen is a community for seniors who choose a retirement lifestyle that is active, stimulating and fulfilling. If it is your week for bridge club, entertain in the beautiful game room. Visit the Country Cafe, read a book in the library, or have your hair styled in the beauty salon. Since we provide all of your normal maintenance and weekly maid service, you will have the time and freedom to enjoy life and pursue your interests. Winter is just around the corner...schedule your tour today! (847) 998-1118.

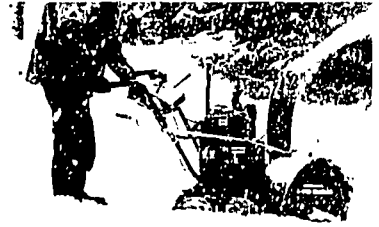

"Balance in Life" Well-Being Program

Chestnut Square promotes a secure, holistic lifestyle that covers every aspect of our residents' well-being, including physical, social, intellectual and spiritual needs. Exercise in the state-of-the-art fitness center, enjoy yoga or tai chi class, or go for a morning stroll with the walking club.

Group outings, social mixers, lecture presentations, card and game clubs, music performances, horticulture workshops and services for a variety of faiths are other highlights of our community. With your interests always in mind, Chestnut Square offers a vibrant lifestyle.

A Reputation You Can Trust

With over 115 years of experience in senior housing and healthcare, Bethany Methodist Communities is proud to be the non-profit owner and operator of Chestnut Square at The Glen. Chestnut Square's sister community, The Bethany Terrace, is only minutes away and specializes in a variety of extended care programs. Partners in Healthcare, a home care agency affiliated with Chestnut Square, is also available to residents if such a need should ever arise.



CHESTNUT S Q U A R E

at The Glen

2601 Chestnut Avenue • Glenview, Illinois 60026
(847) 998-1118 • chestnutsquare.info

***Ask about our FREE "MoveAssist" Program!**

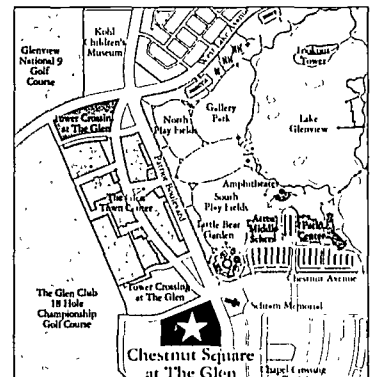

Chestnut Square at The Glen
(847) 998-1118
chestnutsquare.info

The Bethany Terrace
(847) 965-8100
bethanyterrace.org

Partners in Healthcare
(847) 904-5113
partners-healthcare.com



Crafty Beaver Home Centers

74th Year

A HOME CENTER...PLUS A COMPLETE LUMBER YARD!

Skokie 4810 W. Oakton Chicago 1522 W. Lawrence Chicago 3850 W. Montrose Chicago 4306 N. Central

Special of the Month!

8⁹⁹

Smoke Alarm w/Light Super bright KRYPTON escape light. Includes batteries. 519451

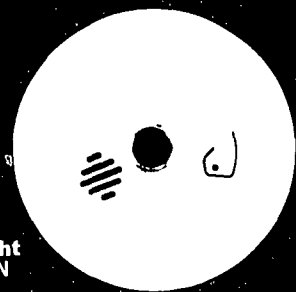

Big Fall Savings!



7⁹⁹

Hefty Club Pack
13 gal. 85 count or
33 gal 33 count
626252/60



8⁹⁹

Swiffer Starter Kit
Contains 1 sweeper with
2 dry cloths and 1 wet
cloth. 615917

Special Purchase!

12⁹⁷

4' x 8' - 1/2" T-111 Siding
Grooved 4" on center. Exterior glue.
Ready to finish. DECO

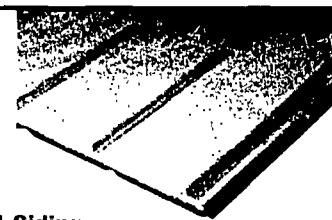

9⁹⁷

50' 16/3 Outdoor Extension Cord
Medium-duty, all-weather use.
13A/125V/1625W. UL listed. NEMA 5-15.
513867

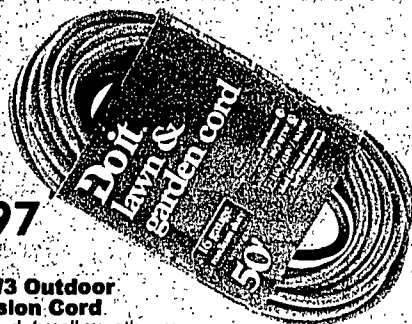

SYLVANIA
BRILLIANT LIGHT™

13 Watt Compact Fluorescent Bulb
5207962

1⁵⁰ Sale

-1⁵⁰ Instant Rebate

FREE After Rebate

SYLVANIA



3M Window Indoor Insulator Kits
Stops Cold Drafts, Saves Heating Costs!

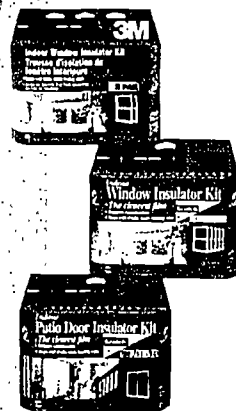

6⁹⁷

2-Window
62" x 84"
268623

14⁹⁷

5-Window
Film 62" x 190"
263841

12⁹⁷

Patio Door Film
84" x 112"
264500

CAL LOCK

19⁸⁸

2 Pack Combo Pack
Contains Two Entry Locksets
& Two Single Cylinder
Deadbolts. Keyed alike.
Polished brass. 5025434



1⁹⁷

Duct Tape
2" x 60 yds.
6111418

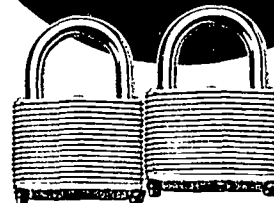

4⁸⁸

2 Pack Padlock
1-1/2" laminated
hardened steel.
Keyed alike.
5025504

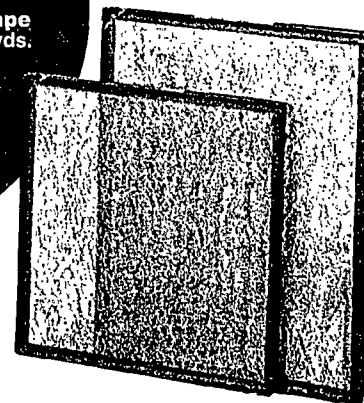

2/97[¢] Limit 12

1" Furnace Filters
16" x 20" 20" x 20"
16" x 25" 20" x 25"
430037/46173182

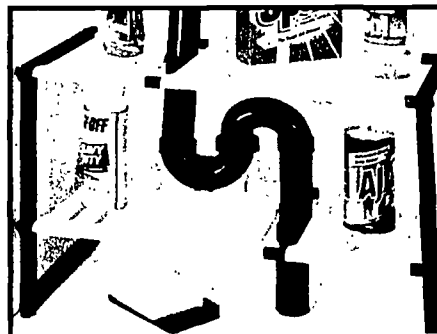

9⁹⁹ New item!

Undersink Storage Shelf
Allows room for pipes. Expandable width from 18" to 28". 604643

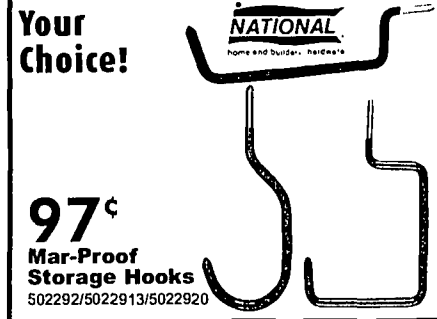

Your Choice!

97^c Mar-Proof Storage Hooks
502292/5022913/5022920

can honey

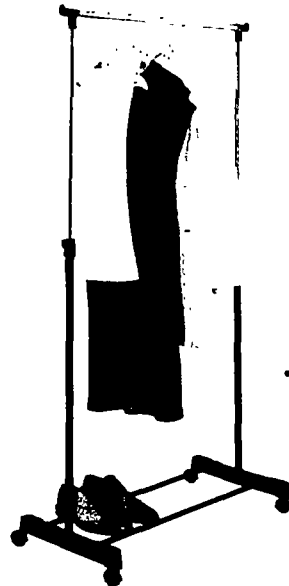

Your Choice!
14⁹⁷

Adjustable Height Garment Rack
6501633

18" Commercial Drying Rack
6501685

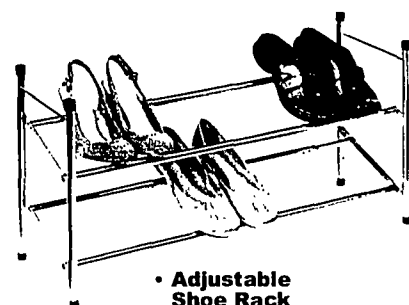

Adjustable Shoe Rack
6501729

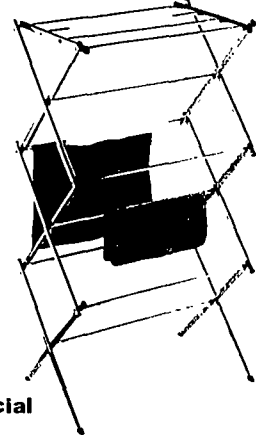

Deluxe Ironing Board
6501660

Your Choice!
19⁹⁹

27" Storage Closet With Shoe Organizer
6501666



Organization never looked so good!

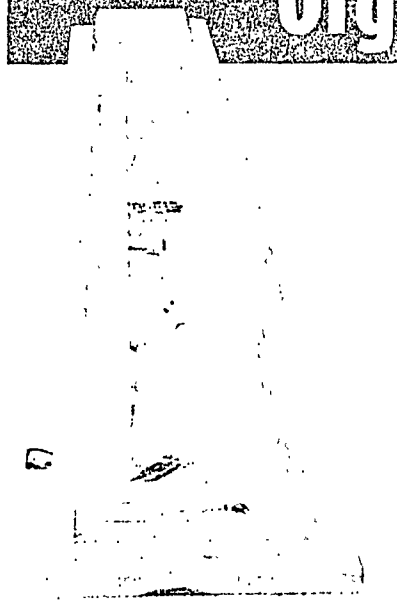

Common Pine Shelving
1 x 4 . . . 30¢ lin. ft.
1 x 6 . . . 40¢ lin. ft.
1 x 8 . . . 60¢ lin. ft.
1 x 10 . . . 75¢ lin. ft.
1 x 12 . . . 99¢ lin. ft.

4', 6', 8', 10' and 12' lengths

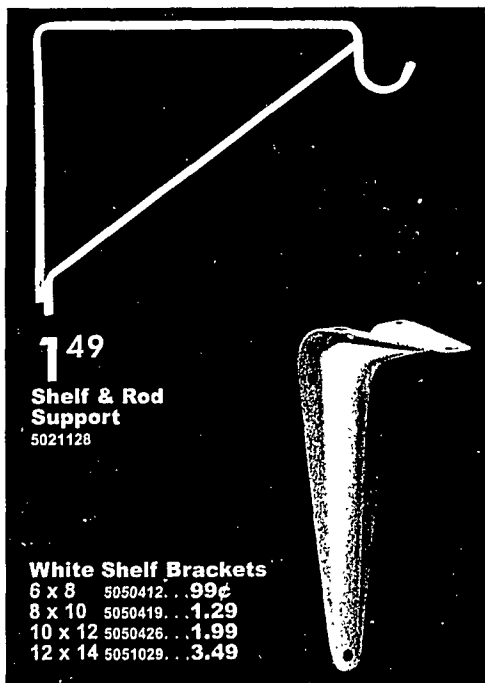

1⁴⁹ Shelf & Rod Support
5021128

White Shelf Brackets
6 x 8 5050412 . . . 99¢
8 x 10 5050419 . . . 1.29
10 x 12 5050426 . . . 1.99
12 x 14 5051029 . . . 3.49



9⁹⁹ 30 Gallon Storage Tote
611700

3⁹⁹ 10 Gallon Tote Box
4-way handles. 610486



4⁹⁹ Ziploc Big Bags w/Handles
Choose from lg/5 ct., xl/4 ct., or xxl/3 ct. sizes. 602887 629948 629957



1⁹⁹ 5 Qt. Clear View Storage Box
612782 Other sizes available.

69⁹⁹

16' Aluminum Extension Ladder
1-1/2" flat top rung for sure footed comfort. 2-3/4" heavy side rail. Type III household duty rating 200 lb. UL listed. 791012

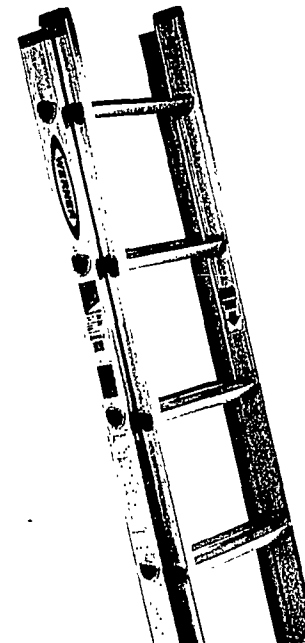

\$5 OFF Per Gallon

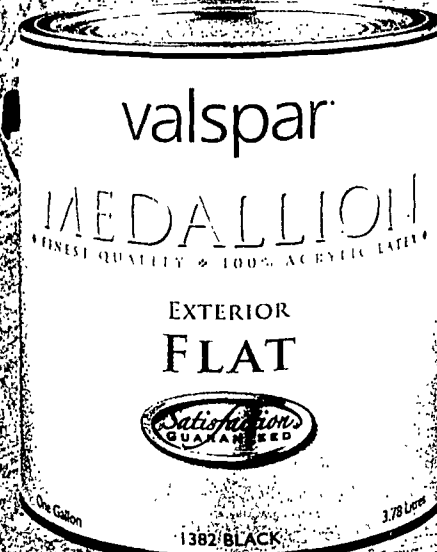

Medallion Ultra Premium Interior Wall Paint
100% Acrylic for a lifetime of beauty. 72785

69⁹⁹

6' Fiberglass Stepladder
Features slip-resistant 3" steps. Type I duty rating 250 lb. 791598

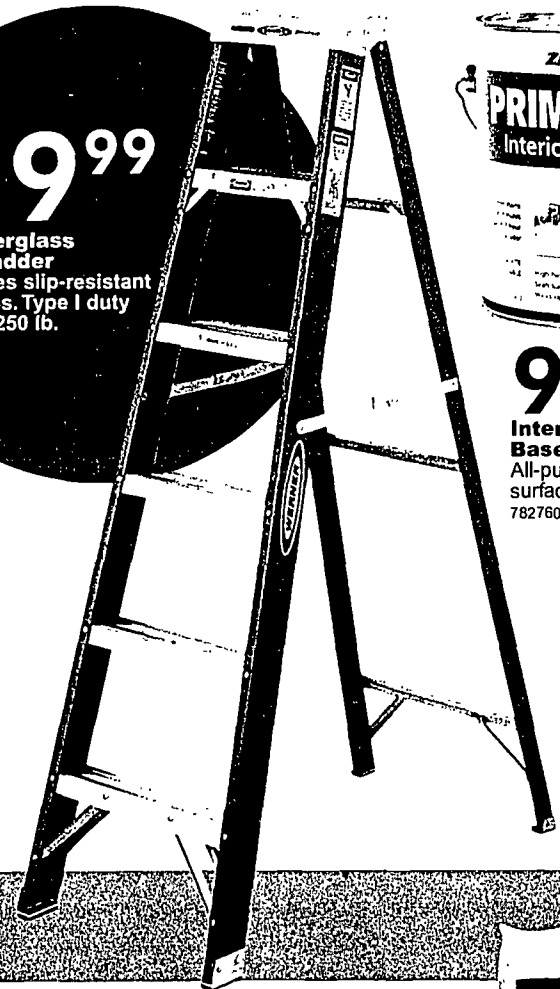

9⁹⁹

Interior Water Base Primer
All-purpose for interior surfaces. Gallon. 782760

Paint projects made easy.

1⁴⁹

Alex Plus Acrylic Latex Caulk w/Silicone
Paintable. White. 10.1 oz. 6101830

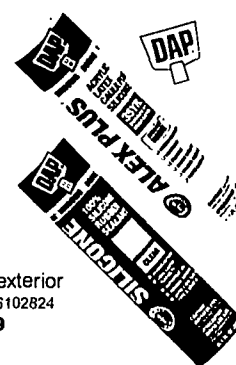

1⁷⁹

Long Handle Wire Brush
3" x 19" long handle, with scraper. 772464

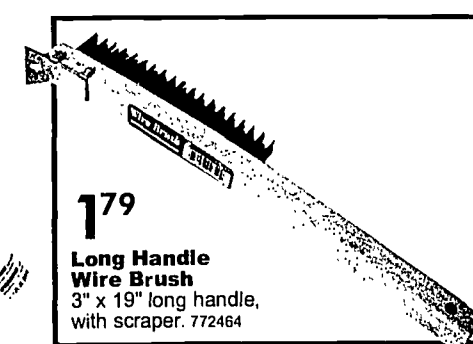

3⁹⁹

Silicone Sealant
Waterproof. Interior/exterior use. Clear. 10.1 oz. 6102824
White 6102817...\$3.99



1⁷⁹

9" Ratcheting Caulk Gun
5531931

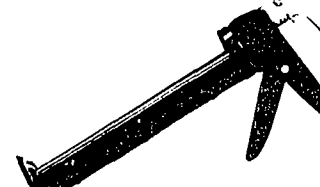

2⁹⁷

2" x 60 Yds Blue Masking Tape
UV Resistant. 6100161



4⁹⁹

Pry Bar and Scraper
9-1/2" long. 5531889

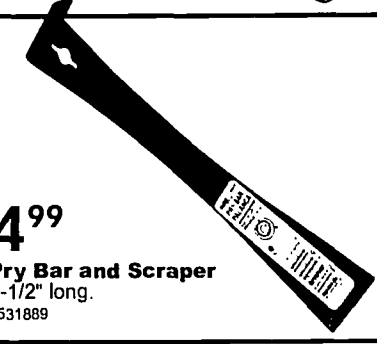

4⁹⁹

ProEdger
Edge closer to ceiling and baseboards. Attaches to all standard poles. 783458

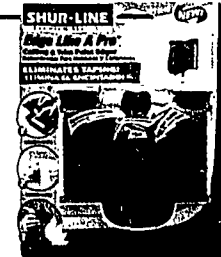

3 Pk. Premium Roller Covers
3/8" nap. 772373



One Coat 4 piece tray set



Your Choice!
5⁹⁹

4 Pk. Premium Metal Tray & Roller Set
Includes tray, 5-wire roller frame, One Coat semi-smooth 9" cover, and a 2" foam trim brush. 789944



enviro Earth Friendly Products

SYLVANIA

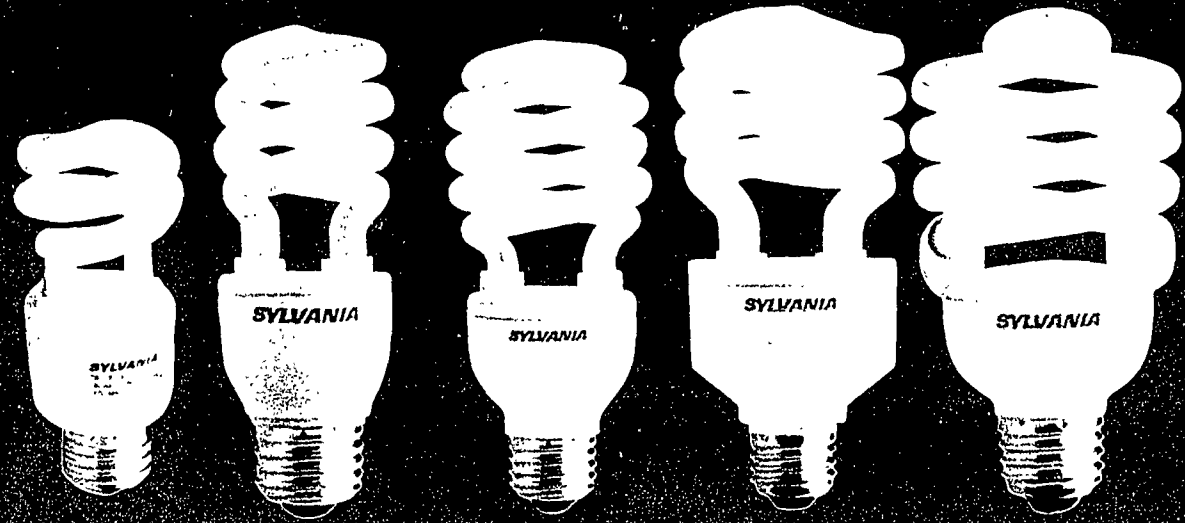

SIZE	7W	11W	13W	20W	23W	30W	3-WAY
EQUIVALENT	25	40	60	75	100	100+	30/70/100
SALE PRICE	\$2.97	\$2.97	\$1.50	\$3.97	\$3.97	\$4.97	\$9.99

5⁹⁹
16W Indoor Flood Lamp
Compare to 65 Watt
5207907

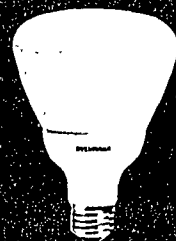

9⁹⁹
Dimmable Indoor Flood
Compare to 65 Watt
5207910



7⁹⁹
23W Outdoor Flood Lamp
Compare to 75 Watt
5207909

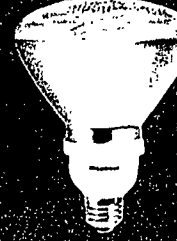

4⁹⁹
9W Globe
Compare to 40 Watt
5207912



9⁹⁹
2 Pk 9W Fan Light Bulb
Compare to 40 Watt
5207914



9⁹⁹
2 Pk 9W Decor Combo Base
Candelabra or Medium base
5207920



\$1.50 OFF **ComEd** smart ideas

All CFL Light Bulbs!

\$1.50 Per Package Paid By Instant Rebate.

Limit 12 Light Bulb Packages Per Customer.

Customer Must Fill Out One Coupon Per Package.



3⁴⁹
Great Stuff Gaps & Cracks
Minimal expanding. Forms an airtight, waterproof seal.
12 oz. 266170

4⁴⁹
Great Stuff Window & Door Sealant
Low-Pressure Formula. 267601

3⁹⁷
Mortite Weatherstrip and Caulking Cord
Caulk putty seals windows and more. Pliable, peel and press into place. Will not crack or harden. Gray. 45' L. 288551
90' Grey or Brown.....5.74

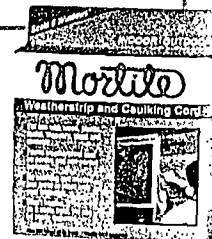

5⁹⁷
10 Ft. x 2 Ft. Coverall Plastic Sheeting
3 mil thick clear or black
5100211/32
15' x 25' 4 mil ... 14.97 5100239
20' x 25' 4 mil ... 19.97 5100246



Energy Saving Products Save \$\$\$



15⁸⁸
6 x 15 Kraft Faced R-19
48.96 sq. ft. roll
INSK66



9⁷⁸
3 1/2 x 15 Kraft Faced R-13
40 sq. ft. roll
INSK95

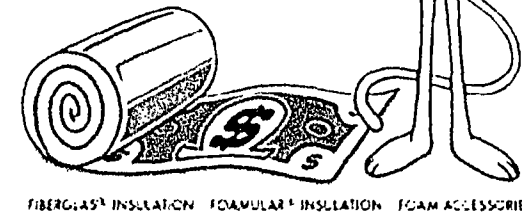

FIBERGLASS INSULATION FOAMULAR INSULATION FOAM ACCESSORIES



15⁸⁸
9 1/2 x 15 Unfaced R-30
31.25 sq. ft. roll
INSE22

Honeywell Programmable Thermostats

19⁹⁷
Basic Programmable Thermostat
For use with central gas, oil, electric furnaces, and central air. For single stage heating and cooling or millivolt systems. 5600819

29⁹⁷
5/2-Day Programmable Thermostat
For use with central gas, oil, electric furnaces, and central air. For single stage heating and cooling or millivolt systems. 427365

59⁹⁷
5-1-1-Day Programmable Thermostat
Compatible with gas, oil, electric, heat pump, and millivolt heating and cooling systems. Displays room temp and thermostat setpoint. 438002

1⁹⁷
Indoor Window Insulation Kit
Includes one shrink film sheet 42" x 62", and tape. Fits windows up to 3' x 5'. Stops drafts and helps prevent frosty windows. 263028



1⁹⁷
PVC Closed Cell Vinyl Foam Tape
Air tight, self-adhesive. 1/8" T. x 1/4" W. x 17' L. Gray. 266900



99¢
Air Deflector
Adjusts from 10" to 14". For floor & sidewall registers. 6208829

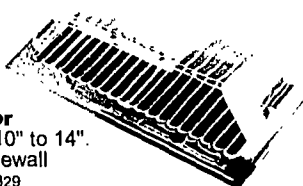

3⁹⁷
Seal 'N Peel Removable Weatherstrip Caulk
Temporary seal for doors and windows. Clear. 10.1 oz. 268801



Series 1200 Replacement Double Hung

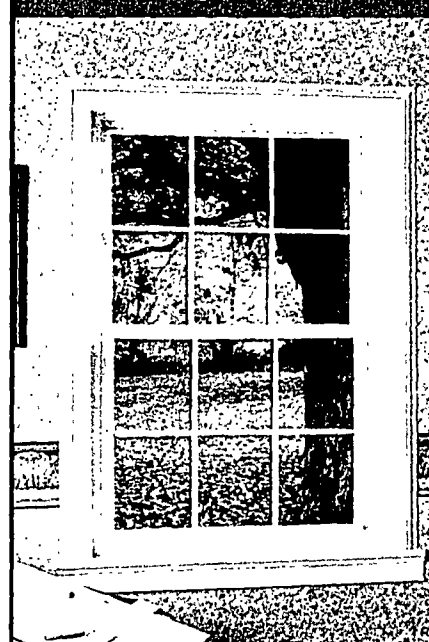

- Cost Effective**
- Fusion-welded construction creates a strong, durable weather-tight window
 - Maintenance free vinyl will not peel, flake or corrode, therefore never needs painting
 - 5/8" insulated glass provides comfort and energy savings
 - Top and bottom sashes tilt in for easy cleaning from inside the home
 - Limited Lifetime Warranty

Anniversary Special: FREE Lowe Upgrade!



Can be ordered to meet or exceed the requirements for the ENERGY STAR Program.

SilverLine WINDOWS • DOORS
an Andersen Company



When it comes to your home, Hurd gives you precisely what you want. Our windows and doors come in distinctive styles with the upscale performance you demand and all the options you're looking for - specialized glazing, designer hardware finishes and beautiful, alternative wood species. After all, we're trying to achieve the same thing as you: Perfection.

3⁹⁷

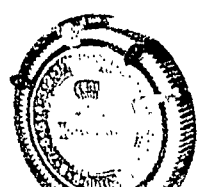

Plug-In Lamp and Appliance Timer
Two On/Off settings. Plugs into any wall outlet. 647580

1⁹⁷



18" Multiple Outlet Strip
Turns 1 grounded outlet into 4 grounded outlets. 14/3 SJT cord. UL listed. 523160

7⁹⁷

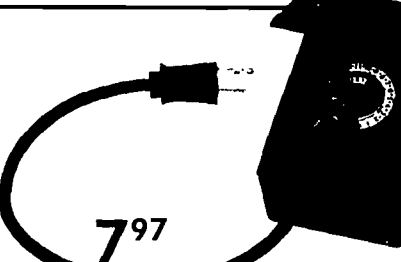

All-Weather Timer
10A. Manual override On/Off switch. 24 hour outdoor timer. 15" heavy-duty 14-gauge cord. 552208

9⁹⁷

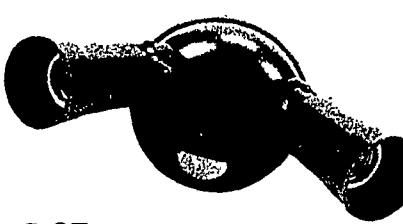

Twin Floodlight Motion Fixture
Adjustable sensitivity settings. (Bulbs not included). Bronze or white. 537764 537756

Special Purchase Special Value

Your Choice!

9⁹⁷

2 Pk. 1-Light Ceiling Fixtures
11" diameter. Brushed Nickel. 515017

2 Pk. 1-Light Ceiling Fixtures
11" diameter. Oil-rubbed Bronze. 515008

1-Light Lantern
Uses energy saving compact fluorescent. Dusk to dawn. Polished Brass or Sienna Finish. 5203535/42

2-Light Ceiling Fixture
13" diameter. Cosumel Gold Finish. 5203500

Heating, Humidifying and Lighting Products

16⁹⁷



Milkhouse Utility Heater
Large commercial grade design. Safety tip over switch and overheat fuse. Two settings: 750W or 1500W 5600550

34⁹⁷



The Heat Cube New Nano
Ceramic honeycomb technology. 5600671

49⁹⁷

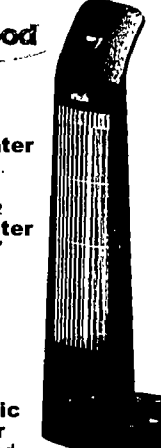

30" Tower Heater
Dual heat settings. Quiet carbon fiber technology. 5600692

19" Tower Heater
5600685. 29.97

34⁹⁷



Oil Filled Electric Radiator Heater
Permanently oil filled. No maintenance, No odor. 3 heat settings: 600/900/1500 watts. Adjustable thermostat. 5600601

19⁹⁷

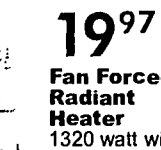

Fan Forced Radiant Heater
1320 watt with thermostat. 5600636

44⁹⁷



3-Speed Humidifier
3 gallon evaporative room size humidifier. Humidifies 700 sq. ft. Humidistat automatically controls humidity level. 520411

79⁹⁷



Tower Multi-Room Evaporative Humidifier
Digital control panel. Four speeds, quiet nighttime setting, refill light, automatic shut-off. 520373

27⁹⁷

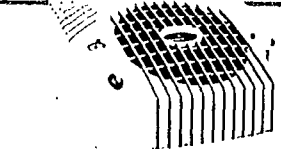
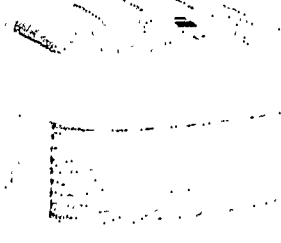

Table Top Humidifier
Built-in hydrometer measures room humidity. Water level window with nitelight for easy convenient read. 2 gallon reservoir replaceable ESSICK super wick filter. Top flow grill, easy to clean & fill. 504122

99⁹⁷



Whole-House Evaporative Humidifier
Digital control panel. Easy top fill pour-in and option to add 2-stage air care filter. Variable speed with quiet nighttime setting. Refill light and automatic shut-off. 502715

69⁹⁹



16" Electric Chain Saw
3.0 HP motor and 16" bar come fully assembled. Manual oiling with easy push squeeze bulb. Wrap around front hand guard for maximum safety. 767316

2⁵⁹



Bar and Chain Oil
For use in -20° to 40° temperatures. Quart. 725722

5⁹⁹



21" Do It Best Bow Saw
723907

12⁹⁹



By-Pass Lopping Shear
Non-stick coated blade. 29-1/2" long. Lifetime warranty. 742021

11⁹⁹



Super Winterguard Fertilizer
Apply as the last feeding in fall for a quick spring green-up. 5,000 sq. ft. bag. 707139. Not available in all areas. Check for availability. 15,000 Sq. Ft. 741111. \$31.44

8⁹⁹



Super Winterguard Plus
Controls weeds. Quicker green-up in spring. 5,000 sq. ft. bag. 24-3-12. SEA305

15⁹⁹



Scotts Classic

7⁴⁴



Fall Grass Seed Mix
Build a thicker lawn next spring. Contains ryegrass, Kentucky blue grass and fescue. Covers 1500 sq. ft. SEA230

Is your lawn ready for fall?

7⁴⁴



Home Insect Control
Ready-to-use. Gallon. 727945

2⁹⁹



6 Pk. MouseMax Mouse Killer
Kills in one feeding. 735803

5⁹⁹



Wild Bird Food
20 lb. 740668

2¹⁷



Yard Waste Bags
5 bags per pack. 100% recyclable. 706809

5⁹⁷



Steel Tine Lawn Rake
22" tine steel lawn rake. Handle is 49". Ideal for gathering wet leaves, grass and plant trimmings, and thatching. 751494

4⁹⁷



E-Z Fill Suet Cake Holder
Holds 1 standard suet cake. 737674

5⁴⁴



3 Pk. Indoor Fogger
Each can of fogger treats up to 6,000 cu. ft. Three 6 oz. cans. 727914

99^c



4 Pack Glue Traps
For Roaches & Mice. Non-Toxic, Disposable. Ready-to-use. 5701407

Make sure to change
your filters on time!

16x20x1, 16x25x1,
20x20x1, 20x25x1

7⁹⁷

Micro Allergen Air Filters

Captures microscopic dust,
pollen, smoke, mold spores,
and pet dander.

448073 448082 448091 448108



49⁹⁷

Electric Super Blower/Vacuum

12A motor. Produces 230 mph air velocity.
A blower, vacuum, and shredder all in one.
Converts easily to a vacuum with no tools
required. Cleans sticks, debris, and leaves.

768936



**Lowest
Price
of the
Season!**

Big Fall Savings!

Your
Choice!

1⁹⁹

50 Mini Light Set

Multi-color or clear bulbs.
Approximately 13' long.

900583 900664

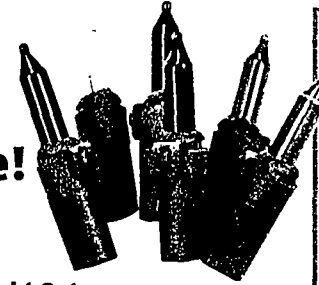

5⁹⁷

Energizer Multi-Pack Batteries

Choose from 4 pk. "D" or "C"
8 pk. "AA" or "AAA", or 2 pk. 9 Volt.

801186 801658 809365 802409 803871

1⁴⁹

**Windshield
Washer Fluid**

-20° formula.
Gallon. 574248



3⁹⁹ Bundle

Hardwood Firewood

.65 cu. ft. ready to burn

SEA380

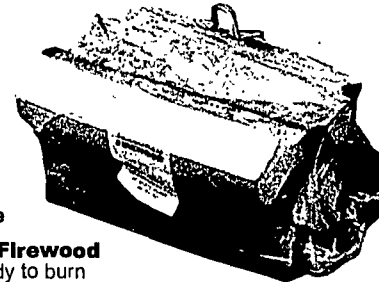

Carhartt

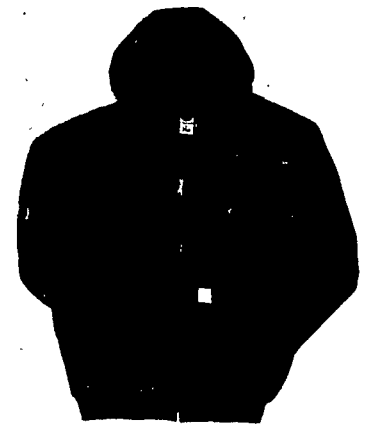

44⁹⁷

**Thermal Lined Hooded
Zip Front Sweatshirt J149**

20% OFF

**all other Carhartt Products
Stocked at Skokie & Montrose**



Crafty Beaver Home Centers

74th Year A HOME CENTER...PLUS A COMPLETE LUMBER YARD!

VISIT OUR NEW E-SHOWROOM

A COMPLETE PRODUCT GUIDE AND VIRTUAL SHOWROOM AT: craftybeaver.com

<p>Skokie 4810 W. Oakton Phone: 847-673-3000</p> <p>OPEN DAILY 6:30 A.M. - 8 P.M. SATURDAY 8 A.M. - 5 P.M. SUNDAY 9 A.M. - 5 P.M.</p>	<p>Chicago 1522 W. Lawrence Phone: 773-271-2288</p> <p>OPEN DAILY 6:30 A.M. - 7 P.M. SATURDAY 8 A.M. - 5 P.M. SUNDAY 9 A.M. - 5 P.M.</p>	<p>Chicago 3850 W. Montrose Phone: 773-478-5510</p> <p>OPEN DAILY 6:30 A.M. - 8 P.M. SATURDAY 8 A.M. - 5 P.M. SUNDAY 9 A.M. - 5 P.M.</p>	<p>Chicago 4306 N. Central Ave. Phone: 773-725-4432</p> <p>OPEN DAILY 6:30 A.M. - 8 P.M. SATURDAY 8 A.M. - 5 P.M. SUNDAY 9 A.M. - 5 P.M.</p>
--	---	---	---

OPEN 7 DAYS A WEEK...SATURDAY AND SUNDAY TIL 5 P.M.

All items subject to prior sale. Some items not in stock at all locations. We reserve the right to limit quantities and correct printing errors. Merchandise may vary from illustration.

Prices are pick-up and save. DELIVERY AVAILABLE AT NOMINAL COST.

D-6471-01

Sale Prices Expire November 20th



Do it Best® stores are committed to truthful and accurate advertising. While every effort has been made to ensure the accuracy of this advertisement, descriptive, typographic and photographic errors are subject to corrections and Do it Best stores shall have no liability of any kind for such errors. The prices in this advertisement are suggested by Do it Best Corp., Ft. Wayne, IN. These advertised prices do not include taxes and may vary at independent Do it Best retailers. Some prices may be higher, some may be lower, some may be special reduced prices, others may be regular everyday low prices. If an item is out of stock, Do it Best retailers can offer a suitable replacement, or a "rain check" for the advertised item. Colors shown may vary and assembly may be required on some items.



**FREE Reusable
Shopping Bag With
\$10 Purchase**

Coupon good thru 12/31/08



Save money.

Get GEICO.

Visit your local office today.

GEICO
Local Office[®]

630-671-0600

670 S. Roselle Road | Schaumburg

Mon-Fri: 9:00AM-9:00PM

Sat: 9:00AM-2:00PM

You could save \$500 by switching to GEICO.

The folks at your local GEICO office can tell you more.

WITH A LOCAL GEICO OFFICE, IT'S EASY TO SAVE.

People say to me, I don't have time to look for car insurance. And I say to them, have you ever made \$500 in 15 minutes? Call or visit your local office. Answer some quick questions and get an accurate rate quote. You could save \$500.

VALUE. IT'S SAVINGS AND SERVICE.

People know they could save \$500. But what about GEICO's service? I tell people, GEICO isn't just about saving hundreds. There's also the 24/7 service with real live people. They're on the phones at all hours answering your questions. GEICO is about value. And that means savings and service.

DEPENDABILITY. IT'S THE GEICO WAY.

I get asked, how dependable is GEICO? For more than 70 years, GEICO has provided customers with comprehensive policy service and fast, fair claim handling at a great price. That sounds dependable to me.

PROTECT LOTS OF THINGS WITH GEICO.

Sure, GEICO does cars. Everyone knows that. But, you could also save big when GEICO insures your motorcycle or ATV. Homeowner's and renter's insurance? GEICO can help you with those, and boats and PWCs, too.

LOOK, IT ALL MAKES A LOT OF SENSE.

It's easy to switch, so go to GEICO and you could save \$500. You'll get the GEICO value and service all my mates love.

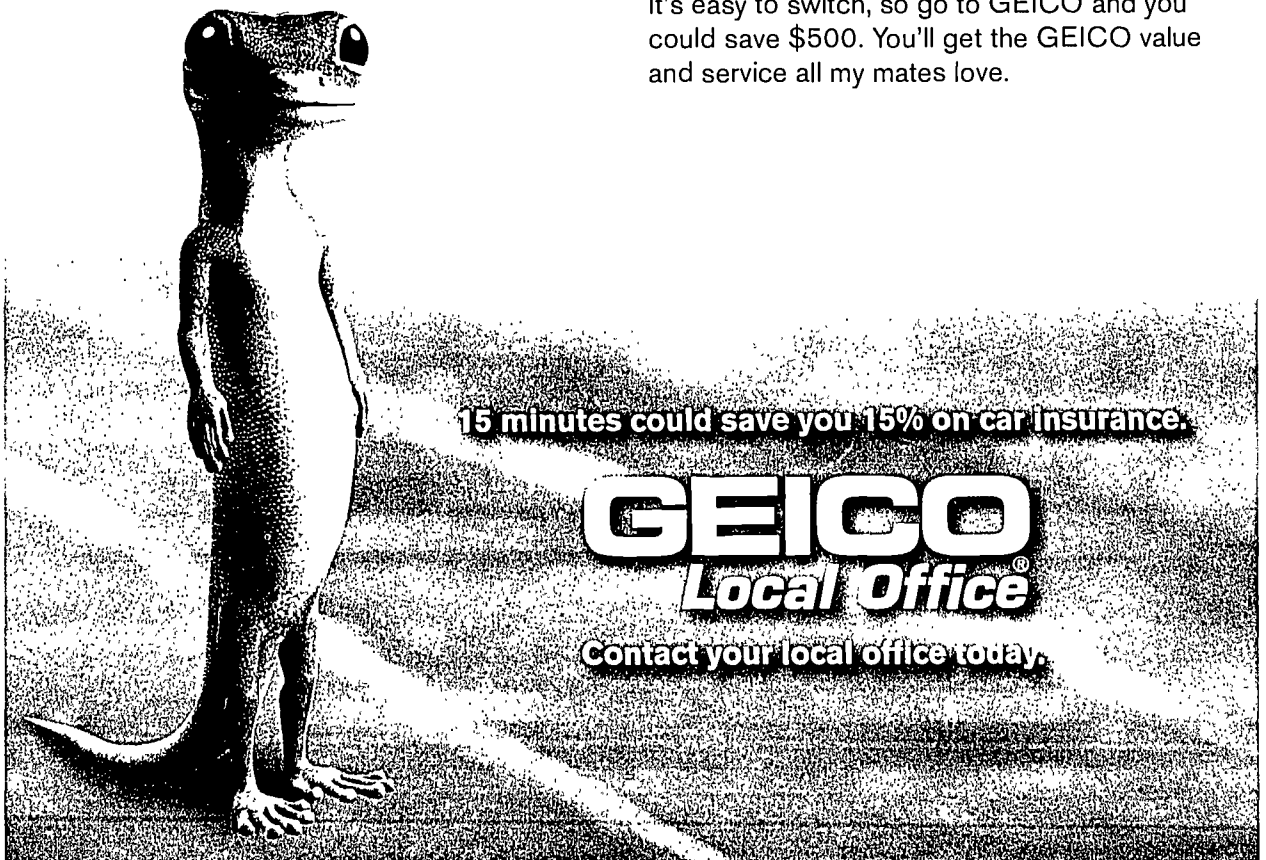

15 minutes could save you 15% on car insurance.

GEICO

Local Office®

Contact your local office today.

Customer satisfaction based on an independent study conducted by Alan Newman Research, 2000. Average savings based on national GEICO New Policyholder Survey Data through February 2000. Some discounts, coverages, payment plans, and features are not available in all states or in all GEICO companies. GEICO auto insurance is not available in Mass. Government Employees Insurance Co. • GEICO General Insurance Co. • GEICO Indemnity Co. • GEICO Casualty Co. These companies are subsidiaries of Berkshire Hathaway Inc. The GEICO gecko image © 1999-2000. GEICO: Washington, DC 20076. © 2000 GEICO

SEARCHCHICAGO autos

SearchChicago.com/autos

THURSDAY

INSIDE 

At large in the Pilot

All-new SUV from Honda
challenges petite drivers



THE EXCHANGE

A Division of Semersky Enterprises, Inc.



2008
Premier
Porsche Dealer

2300 Skokie Valley Rd. • Highland Park, IL

(847) 266-7000

www.4porsche.com



Magna
Society

2490 Skokie Valley Rd. • Highland Park, IL

(847) 432-5020

www.audiexchange.com



Mark of
Excellence
Award

1 Sherwood Terrace, Lake Bluff, IL

(847) 615-1111

www.saabexchange.com



autoREVIEW

Honda's 2009 Pilot delivers decent mileage



by JILL CIMINILLO
SearchChicago-Autos Editor
jcciminillo@suntimes.com

There are few occasions when I actually look forward to a large SUV landing in my parking space for the week. Luckily, the week I had the 2009 Honda Pilot was one of those rare occasions: Chicago Marathon week.

My family was visiting — with all of their large luggage — and it was nice to be able to cart everything and their stuff in a single vehicle.

The Pilot is another all-new vehicle from Honda for 2009, and it is 2.9 inches longer, 1 inch wider and 1 inch taller than the previous model. Total cargo volume behind the first row is 87 cubic-feet, which is down 0.6 cubic-feet from 2008, but there are cargo volume gains behind the second and third rows with measurements ringing in at 47.7 and 20.8 cubic-feet respectively.

The 2009 Pilot is a large vehicle: It felt large, and it drove large too. I'm not a fan of giant SUVs, and even though it was nice to have some

extra passenger space during the test period, I would have preferred something of the crossover variety that provides similar space and cargo volume but doesn't create such a huge foot print.

It took me a couple days to get used to the sheer size of the Pilot, and initially I was timid about changing lanes in highway traffic. I was constantly watching the large side mirrors to see if I had enough space, and more often than not I felt like it was more of a guess than a certainty. I found it difficult to maneuver through parking garages and my small condo parking lot.

The test vehicle really could have used the optional running boards (\$619 to \$784) or side steps (\$445 to \$663) because getting into the Pilot was a bit of a challenge for those who are petite, older or had just run a marathon.

In addition to the big step-in height, there are other reasons this car isn't quite right for someone who's petite in stature. I was able to adjust the seat and steering wheel to get good visibility out of the front and side windows, but comfort went completely out the door. Because of my far-forward, height-adjusted position, I sat too close to the underbelly of the dash. I found that my legs were virtually pinned between the seat and the dash, with little room to move my right leg from gas pedal to brake. Coincidentally, this is

also a problem I noticed in the smaller Honda CR-V.

Another size-related issue I had was with the steering wheel. It was incredibly meaty, which made it hard for me to keep a comfortable grip on the wheel during turns and tight maneuvers.

The test vehicle, with a base price of \$40,630, was a top-of-the-line four-wheel-drive Touring model with a DVD rear entertainment system. Because it came equipped with navigation, leather seats, heated front seats, XM satellite radio, a 115-volt power outlet, Bluetooth connectivity, an auxiliary input jack and most of the other luxury items you could want in a nonluxury SUV, there weren't any options added to the test vehicle. Surprisingly, there are a plethora of small accessories that can be added — like running boards, kayak attachments or a towing kit — to customize the vehicle to your tastes and lifestyle.

The Pilot starts as a LX two-wheel-drive model with a base price of \$28,230 and travels upward in both 2WD and 4WD variations of the LX, EX, EX-L and Touring models.

The Pilot was introduced in 2003 and got a styling refresh in 2006, but 2009 introduces the second generation of the eight-passenger SUV. Along with a complete redesign, the Pilot adds several completely new features. Some are necessary evolutions like the standard tilt/telescoping steering wheel, auxiliary input jack and center stack mounted shifter. Others, like the hill start assist, tailgate with lift-up glass hatch and humidity control as a part of the standard air conditioning, are items you wouldn't necessarily expect on a Honda.

One my favorite all-new features, however, is Honda's variable cylinder management. This enables the 3.5-liter V-6 engine to use all cylinders when power is needed, but it operates on three or four cylinders when decelerating or traveling at a constant speed — like when you engage cruise control while traveling at 65 mph on the highway.

What this means is that Honda can add 6

horsepower and 13 pound-feet of torque to the new Pilot, yet the fuel economy ratings increase at least 1 mpg in both city and highway driving. The 2WD model has city/highway fuel estimates of 17/23 mpg, and the 4WD model rings in at 16/22 mpg. Considering that the Pilot is a 4,590-pounder that seats eight, those fuel estimates are actually encouraging. During the test week, I averaged around 18 mpg in the 4WD model during combined driving.

I thought the 250 horsepower and 244 pound-feet of torque being delivered by the V-6 engine was fine for a vehicle of this size. It didn't feel sluggish, but there wasn't the smooth, seamless power that I've experienced in other large SUVs equipped with a V-8.

Overall, the Pilot is not my kind of vehicle. But if you're in the market for a large SUV, the variable cylinder system alone is a reason to consider this as an option. Another reason is the base price less than \$30,000.

AUTOSPECS

2009 HONDA PILOT

- ENGINE:** 250-horsepower 3.5-liter i-VTEC V-6 with variable cylinder management
- TRANSMISSION:** five-speed automatic
- DRIVETRAIN:** 2WD, 4WD (available)
- FUEL ECONOMY:** 17/23 (2WD); 16/22 (4WD)
- BASE PRICE:** \$28,230
- AS TESTED:** \$40,630
- WEB SITE:** www.honda.com

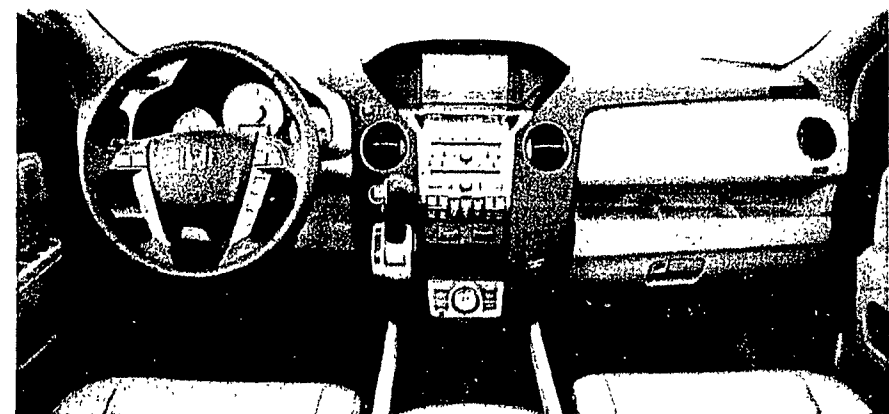

GOLF MILL Ford

#1 FORD DEALER IN ILLINOIS & THE ENTIRE MIDWEST

YOU'RE GONNA SAVE MUCH MUCH MORE AT GOLF MILL FORD!

VISIT US 24/7 AT WWW.GOLFMILLFORD.COM

BRAND NEW 2008 FORD EDGE
\$21,791 \$369
0% APR X 72 MONTHS!

BRAND NEW 2008 FORD F-150
\$10,391 \$179
#91352, FULLY FACTORY EQUIPPED!

BRAND NEW 2008 FORD FOCUS
\$10,991 \$189
#92011, ALL NEW BODY STYLE!

2009 FORD MUSTANG
\$16,491 \$279
#30038, POWER LOCKS & WINDOWS, CD, ALLOY WHEELS, LOADED!

BRAND NEW 2008 FORD F-150 SUPERCAB
\$16,498 \$278
#82359, V6, AUTOMATIC TRANSMISSION, REAR SLIDING WINDOW, PRIVACY GLASS, AC, ALLOYS

2009 FORD FUSION S
\$13,321 \$229
#90415, TOTALLY NEW FORD DESIGN!

BRAND NEW 2008 FORD ESCAPE
\$15,389 \$259
#90407, ALL NEW BODY STYLE! FULLY FACTORY EQUIPPED! NAV SYSTEM!

BRAND NEW 2008 FORD E-150 CARGO VAN
\$18,444 \$309
#92445, POWER LOCKS & WINDOWS, TILT, CRUISE, AC, KEYLESS ENTRY

NOVEMBER SPECIAL!

- TAURUS
- FUSION
- ESCAPE
- MUSTANG INCLUDING GT MODELS
- F-150
- EXPLORER
- EXPEDITION

0% X 60 MOS

0% APR X 60 MONTHS ON 2008 FORD EXPEDITION! LIMITED TIME ONLY!

BRAND NEW 2008 FORD EXPLORER XLT
\$19,999 \$339
#92412

BRAND NEW 2008 FORD TAURUS AWD SEL
\$20,988 \$359
#82222, LEATHER, MOONROOF!

BRAND NEW 2008 FORD FLEX V6
\$23,871 \$399
#90151, ALLOYS, SUNSCREEN GLASS, POWER WINDOWS, TILT, CRUISE, CD, LOADED!

59 AVAILABLE AT VARYING PRICES!

21 AVAILABLE AT VARYING PRICES!

48 AVAILABLE AT VARYING PRICES!

127 AVAILABLE AT VARYING PRICES!

37 AVAILABLE AT VARYING PRICES!

127 AVAILABLE AT VARYING PRICES!

97 AVAILABLE AT VARYING PRICES!

48 AVAILABLE AT VARYING PRICES!

ONLY \$500 DOWN DELIVERS!

1.9% SPECIAL FINANCING AVAILABLE

ON PRE-OWNED VEHICLES ONLY AT GOLF MILL FORD!

ALL PAYMENTS INCLUDE TAX, TITLE, LICENSE & DOC FEE!

6 YEAR/100,000 MILE WARRANTY ON ALL CERTIFIED PRE-OWNED VEHICLES

YOUR CHOICE! ALL 4 SPECIALS FOR ONLY \$129/MONTH!

SPECIALS

<p>01 HONDA CIVIC LX SEDAN \$8,989 or \$189</p> <p>02 CHRYSLER SEBRING LXI CONVERTIBLE \$8,989 or \$189</p> <p>03 CHRYSLER PT CRUISER LTD \$8,989 or \$189</p> <p>04 CHEVY IMPALA LS SEDAN \$10,989 or \$239</p> <p>05 CHEVY MALIBU LT SEDAN \$10,989 or \$239</p> <p>06 CHEVY COBLALT LT COUPE \$11,989 or \$259</p> <p>03 SAAB 9-3 \$12,989 or \$279</p>	<p>05 FORD F-150 \$9,989 or \$219</p> <p>05 CHEVY SILVERADO EXT 4X4 \$15,989 or \$349</p> <p>06 CHEVY AVALANCHE 2-71 OFFROAD PKG \$16,989 or \$369</p> <p>02 FORD COUNTRY VAN \$7,989 or \$169</p> <p>03 MAZDA MPV LX \$13,989 or \$299</p> <p>07 CHRYSLER TOWN & COUNTRY TOURING \$13,989 or \$299</p>	<p>05 DODGE DAKOTA QUAD CAB 4X4 \$12,989 or \$279</p> <p>05 DODGE RAM QUAD CAB 4X4 HEMI \$15,989 or \$349</p> <p>03 FORD F-450 DIESEL CREW CAB 4X4 DUMP TRUCK \$22,989 or \$499</p> <p>05 CHRYSLER TOWN & COUNTRY \$8,989 or \$189</p> <p>04 FORD FREESTAR SES \$10,989 or \$239</p> <p>08 FORD E-250 CARGO VAN \$15,989 or \$349</p> <p>08 FORD E-350 CARGO VAN \$15,989 or \$349</p>	<p>04 FORD ESCAPE XLT \$9,989 or \$219</p> <p>04 CADILLAC SRX \$14,989 or \$329</p> <p>05 GMC ENVOY EXT 4X4 SLT \$14,989 or \$329</p> <p>07 FORD EXPLORER XLT \$15,989 or \$349</p> <p>08 JEEP COMMANDER 4X4 \$17,989 or \$339</p> <p>08 SUZUKI GRAND VITARA 4X4 LTD EX \$17,989 or \$339</p>	<p>05 CHEVY EQUINOX LT AWD \$12,989 or \$279</p> <p>08 CHRYSLER PACIFICA TOURING \$14,989 or \$329</p> <p>06 PONTIAC TORRENT LT \$14,989 or \$329</p> <p>08 KIA SPORTAGE LX 4X4 \$16,989 or \$369</p> <p>05 NISSAN MURANO SL AWD \$17,989 or \$339</p> <p>08 SUZUKI GRAND VITARA 4X4 LTD EX \$17,989 or \$339</p>	<p>05 CHRYSLER TOWN & COUNTRY LTD \$13,989 or \$299</p> <p>05 MERCEDES C230 KOMPRESSOR \$18,989 or \$359</p> <p>08 HONDA ELEMENT EX 4X4 \$18,989 or \$359</p> <p>05 AUDI A4 3.0 QUATTRO \$19,989 or \$379</p> <p>08 MAZDA CX-7 \$21,989 or \$419</p> <p>04 CHEVY TAHOE LTZ 4X4 \$33,989 or \$659</p>	<p>05 MAZDA 6 \$17,989 or \$339</p> <p>08 CADILLAC CTS \$18,989 or \$359</p> <p>05 CADILLAC STS \$19,989 or \$379</p> <p>08 FORD EXPLORER EDGIE BAUER \$20,989 or \$399</p> <p>08 BMW 330i \$24,989 or \$479</p> <p>08 FORD MUSTANG GT 800 \$42,989 or \$809</p>
---	---	---	---	---	--	--

SALES HOURS: MON-FRI 9AM-9PM, SAT 9AM-7PM • SERVICE & PARTS HOURS: MON-THURS 7AM-10PM, FRI 7AM-6PM, SAT 8 AM-5PM

STOP BY, WE SPEAK YOUR LANGUAGE: SPANISH • POLISH • RUSSIAN • GREEK • GERMAN • ENGLISH • FILIPINO • ASYRIAN

9401 N. MILWAUKEE AVE. NILES JUST SOUTH OF GOLF ROAD

1-800-500-CARS

(2277)

294 COMING FROM THE NORTH EXIT ONLY ON EAST TO MILWAUKEE GOV'T

294 COMING FROM THE SOUTH EXIT BEMPTER EAST TO MILWAUKEE NORTH

94 FROM THE NORTH OR SOUTH EXIT BEMPTER WEST TO MILWAUKEE NORTH

2008 FORD ESCAPE IS 0% APR FOR 36 MONTHS. 2009 FORD ESCAPE IS 0% APR FOR 36 MONTHS. 2008 FORD FOCUS IS 3.9% APR FOR 36 MONTHS. 2009 FORD FOCUS IS 3.9% APR FOR 36 MONTHS. 2008 FORD EXPLORER IS 3.9% APR FOR 36 MONTHS. 2009 FORD EXPLORER IS 3.9% APR FOR 36 MONTHS. 2008 FORD MUSTANG IS 3.9% APR FOR 36 MONTHS. 2009 FORD MUSTANG IS 3.9% APR FOR 36 MONTHS. 2008 FORD TAURUS IS 3.9% APR FOR 36 MONTHS. 2009 FORD TAURUS IS 3.9% APR FOR 36 MONTHS. 2008 FORD FLEX IS 3.9% APR FOR 36 MONTHS. 2009 FORD FLEX IS 3.9% APR FOR 36 MONTHS. 2008 FORD EXPLORER XLT IS 3.9% APR FOR 36 MONTHS. 2009 FORD EXPLORER XLT IS 3.9% APR FOR 36 MONTHS. 2008 FORD TAURUS AWD SEL IS 3.9% APR FOR 36 MONTHS. 2009 FORD TAURUS AWD SEL IS 3.9% APR FOR 36 MONTHS. 2008 FORD FLEX V6 IS 3.9% APR FOR 36 MONTHS. 2009 FORD FLEX V6 IS 3.9% APR FOR 36 MONTHS. 2008 FORD EXPLORER XLT SEL IS 3.9% APR FOR 36 MONTHS. 2009 FORD EXPLORER XLT SEL IS 3.9% APR FOR 36 MONTHS. 2008 FORD TAURUS AWD SEL LEATHER IS 3.9% APR FOR 36 MONTHS. 2009 FORD TAURUS AWD SEL LEATHER IS 3.9% APR FOR 36 MONTHS. 2008 FORD FLEX V6 LEATHER IS 3.9% APR FOR 36 MONTHS. 2009 FORD FLEX V6 LEATHER IS 3.9% APR FOR 36 MONTHS. 2008 FORD EXPLORER XLT SEL LEATHER IS 3.9% APR FOR 36 MONTHS. 2009 FORD EXPLORER XLT SEL LEATHER IS 3.9% APR FOR 36 MONTHS. 2008 FORD TAURUS AWD SEL LEATHER EXPLORER IS 3.9% APR FOR 36 MONTHS. 2009 FORD TAURUS AWD SEL LEATHER EXPLORER IS 3.9% APR FOR 36 MONTHS. 2008 FORD FLEX V6 LEATHER EXPEDITION IS 3.9% APR FOR 36 MONTHS. 2009 FORD FLEX V6 LEATHER EXPEDITION IS 3.9% APR FOR 36 MONTHS. 2008 FORD EXPLORER XLT SEL LEATHER EXPEDITION IS 3.9% APR FOR 36 MONTHS. 2009 FORD EXPLORER XLT SEL LEATHER EXPEDITION IS 3.9% APR FOR 36 MONTHS. 2008 FORD TAURUS AWD SEL LEATHER EXPEDITION IS 3.9% APR FOR 36 MONTHS. 2009 FORD TAURUS AWD SEL LEATHER EXPEDITION IS 3.9% APR FOR 36 MONTHS. 2008 FORD FLEX V6 LEATHER EXPEDITION IS 3.9% APR FOR 36 MONTHS. 2009 FORD FLEX V6 LEATHER EXPEDITION IS 3.9% APR FOR 36 MONTHS. 2008 FORD EXPLORER XLT SEL LEATHER EXPEDITION IS 3.9% APR FOR 36 MONTHS. 2009 FORD EXPLORER XLT SEL LEATHER EXPEDITION IS 3.9% APR FOR 36 MONTHS. 2008 FORD TAURUS AWD SEL LEATHER EXPEDITION IS 3.9% APR FOR 36 MONTHS. 2009 FORD TAURUS AWD SEL LEATHER EXPEDITION IS 3.9% APR FOR 36 MONTHS. 2008 FORD FLEX V6 LEATHER EXPEDITION IS 3.9% APR FOR 36 MONTHS. 2009 FORD FLEX V6 LEATHER EXPEDITION IS 3.9% APR FOR 36 MONTHS. 2008 FORD EXPLORER XLT SEL LEATHER EXPEDITION IS 3.9% APR FOR 36 MONTHS. 2009 FORD EXPLORER XLT SEL LEATHER EXPEDITION IS 3.9% APR FOR 36 MONTHS. 2008 FORD TAURUS AWD SEL LEATHER EXPEDITION IS 3.9% APR FOR 36 MONTHS. 2009 FORD TAURUS AWD SEL LEATHER EXPEDITION IS 3.9% APR FOR 36 MONTHS. 2008 FORD FLEX V6 LEATHER EXPEDITION IS 3.9% APR FOR 36 MONTHS. 2009 FORD FLEX V6 LEATHER EXPEDITION IS 3.9% APR FOR 36 MONTHS. 2008 FORD EXPLORER XLT SEL LEATHER EXPEDITION IS 3.9% APR FOR 36 MONTHS. 2009 FORD EXPLORER XLT SEL LEATHER EXPEDITION IS 3.9% APR FOR 36 MONTHS. 2008 FORD TAURUS AWD SEL LEATHER EXPEDITION IS 3.9% APR FOR 36 MONTHS. 2009 FORD TAURUS AWD SEL LEATHER EXPEDITION IS 3.9% APR FOR 36 MONTHS. 2008 FORD FLEX V6 LEATHER EXPEDITION IS 3.9% APR FOR 36 MONTHS. 2009 FORD FLEX V6 LEATHER EXPEDITION IS 3.9% APR FOR 36 MONTHS. 2008 FORD EXPLORER XLT SEL LEATHER EXPEDITION IS 3.9% APR FOR 36 MONTHS. 2009 FORD EXPLORER XLT SEL LEATHER EXPEDITION IS 3.9% APR FOR 36 MONTHS. 2008 FORD TAURUS AWD SEL LEATHER EXPEDITION IS 3.9% APR FOR 36 MONTHS. 2009 FORD TAURUS AWD SEL LEATHER EXPEDITION IS 3.9% APR FOR 36 MONTHS. 2008 FORD FLEX V6 LEATHER EXPEDITION IS 3.9% APR FOR 36 MONTHS. 2009 FORD FLEX V6 LEATHER EXPEDITION IS 3.9% APR FOR 36 MONTHS. 2008 FORD EXPLORER XLT SEL LEATHER EXPEDITION IS 3.9% APR FOR 36 MONTHS. 2009 FORD EXPLORER XLT SEL LEATHER EXPEDITION IS 3.9% APR FOR 36 MONTHS. 2008 FORD TAURUS AWD SEL LEATHER EXPEDITION IS 3.9% APR FOR 36 MONTHS. 2009 FORD TAURUS AWD SEL LEATHER EXPEDITION IS 3.9% APR FOR 36 MONTHS. 2008 FORD FLEX V6 LEATHER EXPEDITION IS 3.9% APR FOR 36 MONTHS. 2009 FORD FLEX V6 LEATHER EXPEDITION IS 3.9% APR FOR 36 MONTHS. 2008 FORD EXPLORER XLT SEL LEATHER EXPEDITION IS 3.9% APR FOR 36 MONTHS. 2009 FORD EXPLORER XLT SEL LEATHER EXPEDITION IS 3.9% APR FOR 36 MONTHS. 2008 FORD TAURUS AWD SEL LEATHER EXPEDITION IS 3.9% APR FOR 36 MONTHS. 2009 FORD TAURUS AWD SEL LEATHER EXPEDITION IS 3.9% APR FOR 36 MONTHS. 2008 FORD FLEX V6 LEATHER EXPEDITION IS 3.9% APR FOR 36 MONTHS. 2009 FORD FLEX V6 LEATHER EXPEDITION IS 3.9% APR FOR 36 MONTHS. 2008 FORD EXPLORER XLT SEL LEATHER EXPEDITION IS 3.9% APR FOR 36 MONTHS. 2009 FORD EXPLORER XLT SEL LEATHER EXPEDITION IS 3.9% APR FOR 36 MONTHS. 2008 FORD TAURUS AWD SEL LEATHER EXPEDITION IS 3.9% APR FOR 36 MONTHS. 2009 FORD TAURUS AWD SEL LEATHER EXPEDITION IS 3.9% APR FOR 36 MONTHS. 2008 FORD FLEX V6 LEATHER EXPEDITION IS 3.9% APR FOR 36 MONTHS. 2009 FORD FLEX V6 LEATHER EXPEDITION IS 3.9% APR FOR 36 MONTHS. 2008 FORD EXPLORER XLT SEL LEATHER EXPEDITION IS 3.9% APR FOR 36 MONTHS. 2009 FORD EXPLORER XLT SEL LEATHER EXPEDITION IS 3.9% APR FOR 36 MONTHS. 2008 FORD TAURUS AWD SEL LEATHER EXPEDITION IS 3.9% APR FOR 36 MONTHS. 2009 FORD TAURUS AWD SEL LEATHER EXPEDITION IS 3.9% APR FOR 36 MONTHS. 2008 FORD FLEX V6 LEATHER EXPEDITION IS 3.9% APR FOR 36 MONTHS. 2009 FORD FLEX V6 LEATHER EXPEDITION IS 3.9% APR FOR 36 MONTHS. 2008 FORD EXPLORER XLT SEL LEATHER EXPEDITION IS 3.9% APR FOR 36 MONTHS. 2009 FORD EXPLORER XLT SEL LEATHER EXPEDITION IS 3.9% APR FOR 36 MONTHS. 2008 FORD TAURUS AWD SEL LEATHER EXPEDITION IS 3.9% APR FOR 36 MONTHS. 2009 FORD TAURUS AWD SEL LEATHER EXPEDITION IS 3.9% APR FOR 36 MONTHS. 2008 FORD FLEX V6 LEATHER EXPEDITION IS 3.9% APR FOR 36 MONTHS. 2009 FORD FLEX V6 LEATHER EXPEDITION IS 3.9% APR FOR 36 MONTHS. 2008 FORD EXPLORER XLT SEL LEATHER EXPEDITION IS 3.9% APR FOR 36 MONTHS. 2009 FORD EXPLORER XLT SEL LEATHER EXPEDITION IS 3.9% APR FOR 36 MONTHS. 2008 FORD TAURUS AWD SEL LEATHER EXPEDITION IS 3.9% APR FOR 36 MONTHS. 2009 FORD TAURUS AWD SEL LEATHER EXPEDITION IS 3.9% APR FOR 36 MONTHS. 2008 FORD FLEX V6 LEATHER EXPEDITION IS 3.9% APR FOR 36 MONTHS. 2009 FORD FLEX V6 LEATHER EXPEDITION IS 3.9% APR FOR 36 MONTHS. 2008 FORD EXPLORER XLT SEL LEATHER EXPEDITION IS 3.9% APR FOR 36 MONTHS. 2009 FORD EXPLORER XLT SEL LEATHER EXPEDITION IS 3.9% APR FOR 36 MONTHS. 2008 FORD TAURUS AWD SEL LEATHER EXPEDITION IS 3.9% APR FOR 36 MONTHS. 2009 FORD TAURUS AWD SEL LEATHER EXPEDITION IS 3.9% APR FOR 36 MONTHS. 2008 FORD FLEX V6 LEATHER EXPEDITION IS 3.9% APR FOR 36 MONTHS. 2009 FORD FLEX V6 LEATHER EXPEDITION IS 3.9% APR FOR 36 MONTHS. 2008 FORD EXPLORER XLT SEL LEATHER EXPEDITION IS 3.9% APR FOR 36 MONTHS. 2009 FORD EXPLORER XLT SEL LEATHER EXPEDITION IS 3.9% APR FOR 36 MONTHS. 2008 FORD TAURUS AWD SEL LEATHER EXPEDITION IS 3.9% APR FOR 36 MONTHS. 2009 FORD TAURUS AWD SEL LEATHER EXPEDITION IS 3.9% APR FOR 36 MONTHS. 2008 FORD FLEX V6 LEATHER EXPEDITION IS 3.9% APR FOR 36 MONTHS. 2009 FORD FLEX V6 LEATHER EXPEDITION IS 3.9% APR FOR 36 MONTHS. 2008 FORD EXPLORER XLT SEL LEATHER EXPEDITION IS 3.9% APR FOR 36 MONTHS. 2009 FORD EXPLORER XLT SEL LEATHER EXPEDITION IS 3.9% APR FOR 36 MONTHS. 2008 FORD TAURUS AWD SEL LEATHER EXPEDITION IS 3.9% APR FOR 36 MONTHS. 2009 FORD TAURUS AWD SEL LEATHER EXPEDITION IS 3.9% APR FOR 36 MONTHS. 2008 FORD FLEX V6 LEATHER EXPEDITION IS 3.9% APR FOR 36 MONTHS. 2009 FORD FLEX V6 LEATHER EXPEDITION IS 3.9% APR FOR 36 MONTHS. 2008 FORD EXPLORER XLT SEL LEATHER EXPEDITION IS 3.9% APR FOR 36 MONTHS. 2009 FORD EXPLORER XLT SEL LEATHER EXPEDITION IS 3.9% APR FOR 36 MONTHS. 2008 FORD TAURUS AWD SEL LEATHER EXPEDITION IS 3.9% APR FOR 36 MONTHS. 2009 FORD TAURUS AWD SEL LEATHER EXPEDITION IS 3.9% APR FOR 36 MONTHS. 2008 FORD FLEX V6 LEATHER EXPEDITION IS 3.9% APR FOR 36 MONTHS. 2009 FORD FLEX V6 LEATHER EXPEDITION IS 3.9% APR FOR 36 MONTHS. 2008 FORD EXPLORER XLT SEL LEATHER EXPEDITION IS 3.9% APR FOR 36 MONTHS. 2009 FORD EXPLORER XLT SEL LEATHER EXPEDITION IS 3.9% APR FOR 36 MONTHS. 2008 FORD TAURUS AWD SEL LEATHER EXPEDITION IS 3.9% APR FOR 36 MONTHS. 2009 FORD TAURUS AWD SEL LEATHER EXPEDITION IS 3.9% APR FOR 36 MONTHS. 2008 FORD FLEX V6 LEATHER EXPEDITION IS 3.9% APR FOR 36 MONTHS. 2009 FORD FLEX V6 LEATHER EXPEDITION IS 3.9% APR FOR 36 MONTHS. 2008 FORD EXPLORER XLT SEL LEATHER EXPEDITION IS 3.9% APR FOR 36 MONTHS. 2009 FORD EXPLORER XLT SEL LEATHER EXPEDITION IS 3.9% APR FOR 36 MONTHS. 2008 FORD TAURUS AWD SEL LEATHER EXPEDITION IS 3.9% APR FOR 36 MONTHS. 2009 FORD TAURUS AWD SEL LEATHER EXPEDITION IS 3.9% APR FOR 36 MONTHS. 2008 FORD FLEX V6 LEATHER EXPEDITION IS 3.9% APR FOR 36 MONTHS. 2009 FORD FLEX V6 LEATHER EXPEDITION IS 3.9% APR FOR 36 MONTHS. 2008 FORD EXPLORER XLT SEL LEATHER EXPEDITION IS 3.9% APR FOR 36 MONTHS. 2009 FORD EXPLORER XLT SEL LEATHER EXPEDITION IS 3.9% APR FOR 36 MONTHS. 2008 FORD TAURUS AWD SEL LEATHER EXPEDITION IS 3.9% APR FOR 36 MONTHS. 2009 FORD TAURUS AWD SEL LEATHER EXPEDITION IS 3.9% APR FOR 36 MONTHS. 2008 FORD FLEX V6 LEATHER EXPEDITION IS 3.9% APR FOR 36 MONTHS. 2009 FORD FLEX V6 LEATHER EXPEDITION IS 3.9% APR FOR 36 MONTHS. 2008 FORD EXPLORER XLT SEL LEATHER EXPEDITION IS 3.9% APR FOR 36 MONTHS. 2009 FORD EXPLORER XLT SEL LEATHER EXPEDITION IS 3.9% APR FOR 36 MONTHS. 2008 FORD TAURUS AWD SEL LEATHER EXPEDITION IS 3.9% APR FOR 36 MONTHS. 2009 FORD TAURUS AWD SEL LEATHER EXPEDITION IS 3.9% APR FOR 36 MONTHS. 2008 FORD FLEX V6 LEATHER EXPEDITION IS 3.9% APR FOR 36 MONTHS. 2009 FORD FLEX V6 LEATHER EXPEDITION IS 3.9% APR FOR 36 MONTHS. 2008 FORD EXPLORER XLT SEL LEATHER EXPEDITION IS 3.9% APR FOR 36 MONTHS. 2009 FORD EXPLORER XLT SEL LEATHER EXPEDITION IS 3.9% APR FOR 36 MONTHS. 2008 FORD TAURUS AWD SEL LEATHER EXPEDITION IS 3.9% APR FOR 36 MONTHS. 2009 FORD TAURUS AWD SEL LEATHER EXPEDITION IS 3.9% APR FOR 36 MONTHS. 2008 FORD FLEX V6 LEATHER EXPEDITION IS 3.9% APR FOR 36 MONTHS. 2009 FORD FLEX V6 LEATHER EXPEDITION IS 3.9% APR FOR 36 MONTHS. 2008 FORD EXPLORER XLT SEL LEATHER EXPEDITION IS 3.9% APR FOR 36 MONTHS. 2009 FORD EXPLORER XLT SEL LEATHER EXPEDITION IS 3.9% APR FOR 36 MONTHS. 2008 FORD TAURUS AWD SEL LEATHER EXPEDITION IS 3.9% APR FOR 36 MONTHS. 2009 FORD TAURUS AWD SEL LEATHER EXPEDITION IS 3.9% APR FOR 36 MONTHS. 2008 FORD FLEX V6 LEATHER EXPEDITION IS 3.9% APR FOR 36 MONTHS. 2009 FORD FLEX V6 LEATHER EXPEDITION IS 3.9% APR FOR 36 MONTHS. 2008 FORD EXPLORER XLT SEL LEATHER EXPEDITION IS 3.9% APR FOR 36 MONTHS. 2009 FORD EXPLORER XLT SEL LEATHER EXPEDITION IS 3.9% APR FOR 36 MONTHS. 2008 FORD TAURUS AWD SEL LEATHER EXPEDITION IS 3.9% APR FOR 36 MONTHS. 2009 FORD TAURUS AWD SEL LEATHER EXPEDITION IS 3.9% APR FOR 36 MONTHS. 2008 FORD FLEX V6 LEATHER EXPEDITION IS 3.9% APR FOR 36 MONTHS. 2009 FORD FLEX V6 LEATHER EXPEDITION IS 3.9% APR FOR 36 MONTHS. 2008 FORD EXPLORER XLT SEL LEATHER EXPEDITION IS 3.9% APR FOR 36 MONTHS. 2009 FORD EXPLORER XLT SEL LEATHER EXPEDITION IS 3.9% APR FOR 36 MONTHS. 2008 FORD TAURUS AWD SEL LEATHER EXPEDITION IS 3.9% APR FOR 36 MONTHS. 2009 FORD TAURUS AWD SEL LEATHER EXPEDITION IS 3.9% APR FOR 36 MONTHS. 2008 FORD FLEX V6 LEATHER EXPEDITION IS 3.9% APR FOR 36 MONTHS. 2009 FORD FLEX V6 LEATHER EXPEDITION IS 3.9% APR FOR 36 MONTHS. 2008 FORD EXPLORER XLT SEL LEATHER EXPEDITION IS 3.9% APR FOR 36 MONTHS. 2009 FORD EXPLORER XLT SEL LEATHER EXPEDITION IS 3.9% APR FOR 36 MONTHS. 2008 FORD TAURUS AWD SEL LEATHER EXPEDITION IS 3.9% APR FOR 36 MONTHS. 2009 FORD TAURUS AWD SEL LEATHER EXPEDITION IS 3.9% APR FOR 36 MONTHS. 2008 FORD FLEX V6 LEATHER EXPEDITION IS 3.9% APR FOR 36 MONTHS. 2009 FORD FLEX V6 LEATHER EXPEDITION IS 3.9% APR FOR 36 MONTHS. 2008 FORD EXPLORER XLT SEL LEATHER EXPEDITION IS 3.9% APR FOR 36 MONTHS. 2009 FORD EXPLORER XLT SEL LEATHER EXPEDITION IS 3.9% APR FOR 36 MONTHS. 2008 FORD TAURUS AWD SEL LEATHER EXPEDITION IS 3.9% APR FOR 36 MONTHS. 2009 FORD TAURUS AWD SEL LEATHER EXPEDITION IS 3.9% APR FOR 36 MONTHS. 2008 FORD FLEX V6 LEATHER EXPEDITION IS 3.9% APR FOR 36 MONTHS. 2009 FORD FLEX V6 LEATHER EXPEDITION IS 3.9% APR FOR 36 MONTHS. 2008 FORD EXPLORER XLT SEL LEATHER EXPEDITION IS 3.9% APR FOR 36 MONTHS. 2009 FORD EXPLORER XLT SEL LEATHER EXPEDITION IS 3.9% APR FOR 36 MONTHS. 2008 FORD TAURUS AWD SEL LEATHER EXPEDITION IS 3.9% APR FOR 36 MONTHS. 2009 FORD TAURUS AWD SEL LEATHER EXPEDITION IS 3.9% APR FOR 36 MONTHS. 2008 FORD FLEX V6 LEATHER EXPEDITION IS 3.9% APR FOR 36 MONTHS. 2009 FORD FLEX V6 LEATHER EXPEDITION IS 3.9% APR FOR 36 MONTHS. 2008 FORD EXPLORER XLT SEL LEATHER EXPEDITION IS 3.9% APR FOR 36 MONTHS. 2009 FORD EXPLORER XLT SEL LEATHER EXPEDITION IS 3.9% APR FOR 36 MONTHS. 2008 FORD TAURUS AWD SEL LEATHER EXPEDITION IS 3.9% APR FOR 36 MONTHS. 2009 FORD TAURUS AWD SEL LEATHER EXPEDITION IS 3.9% APR FOR 36 MONTHS. 2008 FORD FLEX V6 LEATHER EXPEDITION IS 3.9% APR FOR 36 MONTHS. 2009 FORD FLEX V6 LEATHER EXPEDITION IS 3.9% APR FOR 36 MONTHS. 2008 FORD EXPLORER XLT SEL LEATHER EXPEDITION IS 3.9% APR FOR 36 MONTHS. 2009 FORD EXPLORER XLT SEL LEATHER EXPEDITION IS 3.9% APR FOR 36 MONTHS. 2008 FORD TAURUS AWD SEL LEATHER EXPEDITION IS 3.9% APR FOR 36 MONTHS. 2009 FORD TAURUS AWD SEL LEATHER EXPEDITION IS 3.9% APR FOR 36 MONTHS. 2008 FORD FLEX V6 LEATHER EXPEDITION IS 3.9% APR FOR 36 MONTHS. 2009 FORD FLEX V6 LEATHER EXPEDITION IS 3.9% APR FOR 36 MONTHS. 2008 FORD EXPLORER XLT SEL LEATHER EXPEDITION IS 3.9% APR FOR 36 MONTHS. 2009 FORD EXPLORER XLT SEL LEATHER EXPEDITION IS 3.9% APR FOR 36 MONTHS. 2008 FORD TAURUS AWD SEL LEATHER EXPEDITION IS 3.9% APR FOR 36 MONTHS. 2009 FORD TAURUS AWD SEL LEATHER EXPEDITION IS 3.9% APR FOR 36 MONTHS. 2008 FORD FLEX V6 LEATHER EXPEDITION IS 3.9% APR FOR 36 MONTHS. 2009 FORD FLEX V6 LEATHER EXPEDITION IS 3.9% APR FOR 36 MONTHS. 2008 FORD EXPLORER XLT SEL LEATHER EXPEDITION IS 3.9% APR FOR 36 MONTHS. 2009 FORD EXPLORER XLT SEL LEATHER EXPEDITION IS 3.9% APR FOR 36 MONTHS. 2008 FORD TAURUS AWD SEL LEATHER

LINCOLNWOOD VOLVO

FRANCHISE TERMINATION

Come in now for your chance to get **BELOW DEALER COST* PRICING ON OVER 150 VOLVOS** before the factory takes possession and transports these vehicles back to the factory. **THE SELL-OFF MUST BEGIN IMMEDIATELY!**

NEW 2008 VOLVO S60

3 AT SIMILAR SAVINGS!
\$19,995 OFF MSRP

NEW 2008 VOLVO C30

FINAL ONE!
\$22,995 OFF MSRP

NEW 2008 VOLVO V70

3 AT SIMILAR SAVINGS!
\$24,995 OFF MSRP

SAVE THOUSANDS OFF ON NEW VOLVOS!

EVERY VOLVO MUST GO IMMEDIATELY!

NEW 2008 VOLVO XC70

4 AT SIMILAR SAVINGS!
\$11,000 OFF MSRP

NEW 2008 VOLVO C70

2 AT SIMILAR SAVINGS!
\$10,435 OFF MSRP

NEW 2008 VOLVO S80

3 AT SIMILAR SAVINGS!
\$31,995 OFF MSRP

NEW 2008 VOLVO XC90

2 AT SIMILAR SAVINGS!
\$12,705 OFF MSRP

OVER 125 LUXURY DOMESTIC AND IMPORT VEHICLES, ALL DRASTICALLY REDUCED!

'00 Honda Accord T90670A	\$4,995*	'04 Lexus ES330 VU1290	\$15,995*
'00 Jeep Wrangler T82229B	\$4,995*	'04 Toyota 4Runner LTD V80205A	\$16,995*
'00 Toyota Echo Y8900A	\$4,995*	'05 Infiniti G35X NAVIGATION SYSTEM VU1401	\$16,995*
'05 Dodge Grand Caravan VU1359A	\$6,995*	'05 Volvo XC90 VU1374	\$16,995*
'04 Volvo S40 VU1397	\$8,995*	'06 Ford Mustang GT VU1286	\$16,995*
'00 Lexus GS300 VU1399A	\$9,995*	'08 Toyota RAV-4 4x4 VU1388	\$17,995*
'04 Toyota Corolla LE V80097A	\$9,995*	'08 Toyota Solara SPORT VU1354A	\$18,995*
'05 Lincoln LS VU1383	\$12,995*	'05 Volkswagen Phaeton VU1358	\$21,995*
'04 Volvo C70 CONVERTIBLE 7K MILES! VU1398	\$13,995*	'06 Infiniti M35 VU1304	\$21,995*
'05 Cadillac CTS NAVIGATION SYSTEM VU1220A	\$14,995*	'03 Lexus LX470 LOADED! VU1357A	\$25,995*

PLUS A HUGE SELECTION OF VOLVO CERTIFIED PRE-OWNED, ALL AT STORE CLOSING PRICES!

1.9% APR CERTIFIED PRE-OWNED FINANCING AVAILABLE

EVERYTHING MUST GO!

LINCOLNWOOD VOLVO

6747 N. LINCOLN AVE • LINCOLNWOOD • 60712

WWW.GROSSINGERVOLVO.COM

866-238-4771

CALL TOLL FREE

Offers to qualified buyers. *Excludes tax, title, lic. & doc. fee. †MSRP may not be the actual selling price within trading area. ††.9% APR for 24 months on 2000-2004 Certified Pre-Owned Volvos †††2.49 per \$1,000 financed to qualified buyers, offered through Volvo Car Finance North America. ††††Dealer cost does not reflect amount paid over invoice. Dealer will not honor pricing errors in this ad. Photos for illustration purposes only. Offers end 3 days from publication.

grossingertoyotanorth.com

FINAL DAY FOR OUR BEST OFFER EVER!

TOYOTA

NEW '09 TOYOTA YARIS 3DR

35 MPG
35 AVAILABLE

\$13,595*

STK #91102, Auto

0

SAVED BY %

HEAD OVER

TOYOTA FINANCING ON VIRTUALLY EVERY NEW TOYOTA

0

PAYMENTS FOR 90 DAYS

0

MONEY DOWN

NEW '08 TOYOTA RAV-4 4X4

27 MPG
35 AVAILABLE

\$20,995* \$189

STK #91074, Auto, 4 Dr, 4.0L, 2000 down plus 1st mo. payment, tax, title, lic. & doc. fee (\$150), see dep. included. In qualified buyers thru 11/02. 12,000 miles/yr. 25mpg rate over. Residual \$13,845

NEW '09 TOYOTA COROLLA

35 MPG
47 AVAILABLE

\$14,995* \$169

STK #91074, Auto, 4 Dr, 2.0L, 2000 down plus 1st mo. payment, tax, title, lic. & doc. fee (\$150), see dep. included. In qualified buyers thru 11/02. 12,000 miles/yr. 25mpg rate over. Residual \$13,845

NEW '09 TOYOTA SIENNA CE

23 MPG
70 AVAILABLE

\$21,995* \$279

STK #91074, Auto, 3 Dr, 3.5L, 2000 down plus 1st mo. payment, tax, title, lic. & doc. fee (\$150), see dep. included. In qualified buyers thru 11/02. 12,000 miles/yr. 25mpg rate over. Residual \$13,845

NEW '09 TOYOTA CAMRY LE

31 MPG
95 AVAILABLE

\$19,995* \$249

STK #91074, Auto, 4 Dr, 2.5L, 2000 down plus 1st mo. payment, tax, title, lic. & doc. fee (\$150), see dep. included. In qualified buyers thru 11/02. 12,000 miles/yr. 25mpg rate over. Residual \$13,845

NEW '08 TOYOTA HIGHLANDER

24 MPG
35 AVAILABLE

\$23,495* \$379

STK #91074, Auto, 3 Dr, 3.5L, 2000 down plus 1st mo. payment, tax, title, lic. & doc. fee (\$150), see dep. included. In qualified buyers thru 11/02. 12,000 miles/yr. 25mpg rate over. Residual \$13,845

NEW '09 TOYOTA MATRIX

29 MPG
38 AVAILABLE

\$15,395* \$149

STK #91074, Manual, 4 Dr, 2.0L, 2000 down plus 1st mo. payment, tax, title, lic. & doc. fee (\$150), see dep. included. In qualified buyers thru 11/02. 12,000 miles/yr. 25mpg rate over. Residual \$13,845

NEW '08 TOYOTA 4RUNNER SR5 4X4

21 MPG
40 AVAILABLE

\$24,995* \$369

STK #91074, Auto, 3 Dr, 4.0L, 2000 down plus 1st mo. payment, tax, title, lic. & doc. fee (\$150), see dep. included. In qualified buyers thru 11/02. 12,000 miles/yr. 25mpg rate over. Residual \$13,845

OVER 300 QUALITY USED VEHICLES TO CHOOSE FROM!

09 FORD EXPLORER	\$2,995	07 PONTIAC G6	\$11,995
00 NISSAN XTRERRA	\$4,995	04 NISSAN MAXIMA 3.5SL	\$11,995
05 DODGE GRAND CARAVAN	\$5,995	05 FORD ESCAPE	\$12,995
02 JEEP GRAND CHEROKEE	\$5,995	07 NISSAN VERSA S	\$12,995
00 TOYOTA SOLARA CHRYSLER	\$6,995	03 TOYOTA CAMRY LE	\$12,995
04 CHEVY MONTE CARLO	\$6,995	08 TOYOTA MATRIX XR	\$12,995
00 MERCEDES ML320	\$6,995	08 SCION TC	\$13,995
08 TOYOTA AVALON	\$7,995	04 CHEVY SUBURBAN Z71	\$15,995
06 KIA OPTIMA	\$8,995	07 HYUNDAI AZERA	\$15,995
08 MITSUBISHI LANCER	\$8,995	07 VW JETTA	\$15,995
03 INFINITI G35	\$8,995	07 HONDA ACCORD EX	\$16,995
02 VW JETTA GTI TURBO	\$9,995	02 FORD THUNDERBOLT CONV	\$16,995
05 SCION XB	\$10,995	08 HONDA ELEMENT	\$16,995
07 NISSAN SENTRA S	\$10,995	08 TOYOTA PRIUS	\$23,995

ECONOMY CORNER SPECIALS BUY ONE GET ONE FREE!

99 DODGE CARAVAN	\$1,995	00 TOYOTA ECHO	\$3,995
01 HYUNDAI ELANTRA	\$2,995	98 TOYOTA RAV-4	\$4,995
00 GMC ENVY	\$3,995	04 PONTIAC GRAND AM	\$5,995

Ya Gotta Go To...

Grossinger

FAMILY OWNED & OPERATED FOR OVER 80 YEARS

TOYOTA SCION NORTH

866-610-2505

7225 N. CIGERO AVE., LINCOLNWOOD, IL • 60712

www.grossingertoyotanorth.com

NEED CREDIT? WE CAN HELP!
GET A CAR & WE'LL HELP YOU CLEAN UP YOUR CREDIT!
CALL 24 HOURS A DAY! 866-612-1870

The Midwest's #1 Volume Ford Truck Dealer!

FORD of FRANKFORT

0% APR x 60 Months Available!

VOTED ONE OF THE TOP 100 FORD DEALERS IN THE COUNTRY 4 YEARS IN A ROW!

NEW 2008 FORD FOCUS \$10,495*	NEW 2008 FORD FUSION \$13,197*	NEW 2008 FORD TAURUS \$18,788*	NEW 2008 FORD ESCAPE \$14,142*	NEW 2008 FORD EDGE \$20,877*	NEW 2007 FORD MUSTANG GT CONVERTIBLE V8, LOADED! \$23,250*
---	--	--	--	--	--

WE'LL BEAT ANY DEAL ON ANY NEW FORD VEHICLE!

NEW 2008 FORD RANGER \$10,970*	NEW 2008 FORD F-150 \$10,191*	NEW 2008 FORD F-150 Super Cab \$15,795*	NEW 2008 FORD F-250 Super Duty \$16,681*	NEW 2008 FORD EXPLORER XLT \$18,995*	NEW 2008 FORD EXPEDITION XLT \$23,981*
--	---	---	--	--	--

OVER 600 PRE-DRIVEN VEHICLES AVAILABLE!

2.9% APR Financing Available on Certified Pre-Owned Vehicles!

UNDER \$8,000	TRUCKS, VANS & SUVs	CARS
2002 FORD TAURUS SE \$4,895*	2002 DODGE GRAND CARAVAN SE \$8,650*	2003 MERCURY GRAND MARQUIS GS \$9,950*
2000 DODGE DAKOTA RT \$5,950*	2002 FORD E250 HIGH TOP CONVERSION VAN \$8,750*	2003 TOYOTA MATRIX XR \$9,350*
2001 PONTIAC GRAND AM GT \$5,950*	2002 MAZDA TRIBUTE LX \$9,695*	2005 DODGE NEON SXT \$9,395*
2001 FORD ESCAPE XLT \$5,950*	2002 CHEVROLET TRAILBLAZER LT 4WD \$9,850*	2001 TOYOTA CAMRY LE \$9,650*
2005 DODGE NEON SXT \$6,550*	2004 JEEP GRAND CHEROKEE LAREDO 4WD \$9,850*	2004 VOLKSWAGEN NEW BEETLE GLS \$9,850*
2001 DODGE CARAVAN SPORT \$6,850*	2004 HYUNDAI SANTA FE GLS \$10,250*	2002 BMW 530i \$10,250*
2002 FORD ESCAPE XLT 4WD \$7,250*	2005 DODGE CARAVAN \$10,495*	2004 FORD CROWN VICTORIA LX \$10,495*
2003 FORD WINDSTAR SEL \$7,250*	2005 SUZUKI GRAND VITARA EX 4WD \$12,650*	2004 CHRYSLER 300M \$10,750*
2001 FORD TAURUS SES \$7,250*	2001 GMC SIERRA 1500 SLE EXTENDED CAB 4WD \$13,695*	2005 MITSUBISHI GALANT LS \$12,250*
2004 MITSUBISHI OUTLANDER LS \$7,350*	2005 FORD EXPEDITION EDDIE BAUER 4WD \$13,750*	2004 HONDA ACCORD EX \$13,450*
2002 MERCURY GRAND MARQUIS GS \$7,850*	2005 HONDA PILOT LX 4WD \$13,850*	2007 DODGE CALIBER SXT \$13,850*
2004 NISSAN SENTRA 1.8S \$7,950*	2004 CADILLAC SRX \$13,950*	2006 SCION TC \$13,950*
2002 SUZUKI XL-7 TOURING AWD \$7,950*	2004 FORD F150 LARIAT CREW CAB \$14,650*	2005 FORD MUSTANG PREMIUM \$14,550*
	2005 FORD FREESTAR LIMITED \$14,850*	2006 MERCURY MILAN PREMIER \$15,450*
	2005 MERCURY MOUNTAINEER AWD \$14,950*	2008 PONTIAC GRAND PRIX GP \$15,750*
	2004 NISSAN PATHFINDER SE AWD \$14,950*	2005 LEXUS ES330 \$16,925*
	2008 KIA SPORTAGE LX 4WD \$15,375*	2006 VOLKSWAGEN GTI \$16,950*
	2005 BUICK RAINIER 4X4 CXL \$15,450*	2008 FORD CROWN VICTORIA LX \$17,350*
	2007 CHRYSLER TOWN & COUNTRY TOURING \$15,650*	2007 MAZDA 5 GRAND TOURING \$17,450*
	2008 CHEVROLET TRAILBLAZER LT 4WD \$17,750*	2008 VOLKSWAGEN NEW BEETLE S \$18,450*
	2005 FORD EXPEDITION SPORT TRAC ADRENALINE 4WD \$17,950*	2006 PONTIAC SOLSTICE CONVERTIBLE \$18,450*
	2007 FORD EXPEDITION XLT \$19,950*	2006 FORD MUSTANG GT PREMIUM \$20,650*
	2006 LINCOLN AVIATOR ELITE AWD \$20,550*	2007 TOYOTA CAMRY SE \$20,950*
	2006 MERCURY MOUNTAINEER PREMIER AWD \$21,993*	2006 BMW 325i \$20,950*
	2006 INFINITI QX56 4WD \$22,520*	2007 CADILLAC CTS \$21,750*
	2009 NISSAN MURANO S AWD \$25,795*	2006 DODGE CHARGER RT \$22,295*
	2006 VOLKSWAGEN PASSAT V6 LUXURY \$26,650*	2008 NISSAN MAXIMA 3.5 SE \$24,495*
	2006 VOLVO XC90 2.5T AWD \$26,650*	2008 FORD MUSTANG GT \$25,450*
	2008 INFINITI G35X AWD \$28,950*	2005 CHEVROLET CORVETTE \$36,550*

MADE MISTAKES? GET FORGIVEN AND DRIVE HOME TODAY!

Currie Motors
NICE PEOPLE TO DO BUSINESS WITH

Sales & Service Open until 10pm!
9423 W. LINCOLN HIGHWAY
FRANKFORT, IL 60423

866-YES-FORD

www.fordoffrankfort.com

25 Miles South of I-30 on Route 40 Lincoln Hwy

Just 1 Block East of LaGrange Road on Hwy 30
25 minutes from Naperville!

*Plus tax, title, license & doc fee. Includes factory rebates when applicable in lieu of financing offers. **To qualified buyers with approved credit. Photos for illustration purposes only & may not reflect the actual vehicle. Dealer not responsible for pricing errors in this advertisement. Prices and offers expire 2 days from publication date. ***Based on Executive Information System Dealer Ranking for Ford Division 41. All Retail Truck sales for 2007. †Must be an identical equipped vehicle in stock. Dealer reserves the right to verify deal. All offers apply only to new retail deliveries taken from dealer stock within the applicable advertised time period. Offers do not apply to fleet, wholesale or prior sales. ††Based on MSRP. You must qualify, see dealer for details. †††Based on MSRP. Must qualify and finance through Ford to receive rebate. Subject to insurability and credit, rate dependent upon credit, some may not qualify. ††††.9% APR financing for 60 months on 2008 Fusion V6, Mustang, Taurus, Edge, Escape, Sport Trac, Explorer, Ranger, F-150 (excluding Harley) in lieu of rebates to qualified buyers. 60 months at \$16.67 per month per \$1,000 financed at 0% (0% tier 1) with \$0 down on select models only. Expires 11/18/2008. †††††Based on MSRP. Must currently own or lease a 1995 or newer Ford Explorer Sport Trac, Ford Explorer or Mercury Mountaineer, and purchase a new 2008/2009 model Ford Escape (excl Hybrid), Edge, or 2009 Model Flex to be eligible for the Retail Owner Loyalty Incentive. Not competitive with Red Carpet Lease. Customer does not have to be the original owner to be eligible for the Incentive. Must take new retail delivery from dealer stock by 1/1/08. See dealer for complete details.



Life. LIBERTY. AND THE PURSUIT.

STEVE FOLEY

Cadillac of Northbrook

100,000 MILE WARRANTY

2008 models. Whichever comes first. See dealer for limited warranty details.

JUST ANNOUNCED!

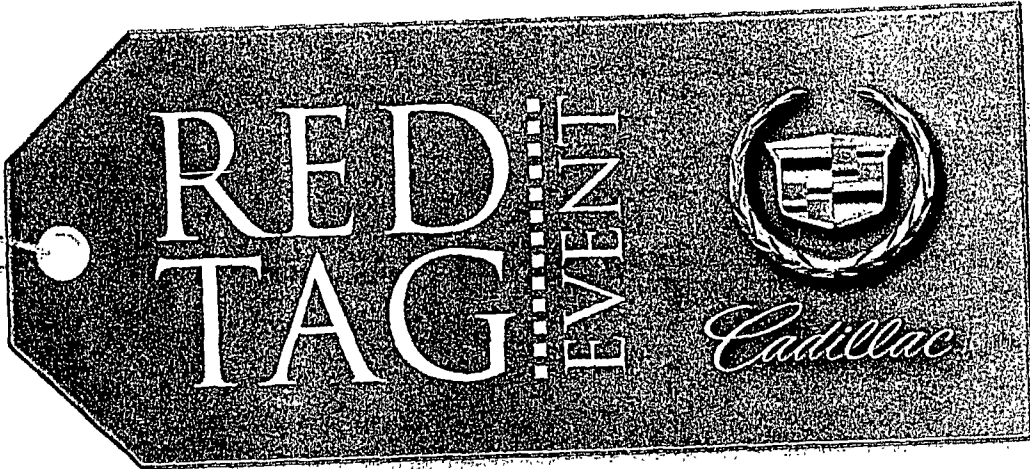

The Price on the Tag is the Price You Pay!
No Hassles, No Haggles, **JUST 1 LOW PRICE!**

You Get the Low Red Tag Price,
PLUS \$1000-\$6750 Rebates!

New 2008 Cadillac Escalade

MSRP \$65,920
RED TAG PRICE \$61,254
REBATE -\$3,000
LEASE TO BUY REBATE -\$2,000

SALE PRICE \$52,504

New 2008 Cadillac DTS

MSRP \$44,045
RED TAG PRICE \$41,591
REBATE -\$3,000
LEASE TO BUY REBATE -\$2,000

SALE PRICE \$33,891

New 2008 Cadillac STS

MSRP \$53,790
RED TAG PRICE \$41,591
REBATE -\$3,000
LEASE TO BUY REBATE -\$2,000

SALE PRICE \$42,022

Pre-Owned Cadillac RED TAG SELL-OFF!

9114A 2009 CADILLAC SRX AWD V6 \$37,995	P9197 2008 CADILLAC DTS II \$26,995	B355A 2006 CADILLAC ESCALADE PLAT \$25,995	P9146 2006 CADILLAC CTS 3.6 \$24,995
P9133 2008 CADILLAC SRX AWD V6 \$35,995	P9189 2008 CADILLAC CTS AWD 3.6 \$40,995	P9170 2006 CADILLAC XLR \$44,995	B165A 2005 CADILLAC ESCALADE ESV \$24,995
P9200 2008 CADILLAC ESCALADE AWD \$46,995	P9204 2008 CADILLAC CTS AWD 3.6 \$39,995	P9211 2006 CADILLAC XLR \$44,995	B617B 2005 CADILLAC STS V8 \$24,995
P9212 2008 CADILLAC ESCALADE AWD \$51,995	P9205 2008 CADILLAC CTS 3.6 \$32,995	B218A 2006 CADILLAC STS V8 \$24,995	B577A 2005 CADILLAC STS V8 \$20,995
P9161 2008 CADILLAC XLR PLATINUM \$62,995	P9182 2008 CADILLAC CTS \$30,995	P9098 2006 CADILLAC STS V6 \$24,995	P9076 2005 CADILLAC STS AWD V8 \$27,995
P9093 2008 CADILLAC STS-V \$53,995	P9183 2008 CADILLAC CTS \$29,995	P9155 2006 CADILLAC STS V6 \$23,995	P9065 2005 CADILLAC DEVILLE \$17,995
P9202 2008 CADILLAC STS V8 \$31,995	P9220 2007 CADILLAC SRX AWD V6 \$29,995	P9196 2006 CADILLAC STS AWD V8 \$30,995	P9100 2005 CADILLAC CTS 3.6 \$22,995
P9198 2008 CADILLAC STS V6 \$36,995	B303A 2007 CADILLAC ESCALADE AWD \$33,995	P9113 2006 CADILLAC SRX AWD V8 \$31,995	P9104 2005 CADILLAC CTS 3.6 \$22,995
P9143 2008 CADILLAC STS AWD V8 \$46,995	P9142 2007 CADILLAC STS AWD V8 \$38,995	P9214 2006 CADILLAC ESCALADE ESV \$27,995	B024C 2005 BMW 645 CIC \$39,995
P9199 2008 CADILLAC STS AWD V8 \$39,995	P9144 2007 CADILLAC STS AWD V8 \$38,995	P9193 2006 CADILLAC DTS \$28,995	P9001A 2004 CADILLAC SEVILLE SLS \$13,995
P9143 2008 CADILLAC DTS III \$31,995	P9215 2007 CADILLAC ESCALADE AWD \$41,995	P9217 2006 CADILLAC DTS \$29,995	B428B 2004 CADILLAC DEVILLE \$11,995
P9178 2008 CADILLAC DTS III \$32,995	P8959 2007 CADILLAC DTS \$32,995	9139A 2006 CADILLAC DTS II \$20,995	P9132A 2004 CADILLAC CTS-V \$22,995
P9135 2008 CADILLAC DTS II \$26,995	P8923 2007 CADILLAC DTS II \$24,995	P9221 2006 CADILLAC DTS II \$25,995	P9082 2004 CADILLAC CTS 3.6 \$16,995
P9153 2008 CADILLAC DTS II \$25,995	P9208 2007 CADILLAC CTS 3.6 NAV \$26,995	P8919A 2003 CADILLAC DEVILLE \$10,995	B891A 2003 CADILLAC DEVILLE \$10,995
P9167 2008 CADILLAC DTS II \$27,995	P9099 2006 CADILLAC SRX AWD V8 \$27,995	B084A 2006 CADILLAC CTS 3.6 \$21,995	B091B 2003 CADILLAC CTS \$12,995

100 Skokie Blvd.
NORTHBROOK, IL 60062
one block west of the Edens between
Lake Cook & Dundee roads
800.295.3576

Your First Choice for Cadillac
STEVE FOLEY
Cadillac of Northbrook

visit us at:
stevefoley.com
SALES HOURS
Monday-Thursday 9am-9pm
Friday and Saturday 9am-6pm
SERVICE HOURS
Monday-Friday 7:30am-6pm

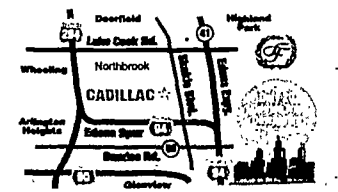

*Please add tax, title, license and \$150 doc fee. Sales price includes all applicable rebates and in lieu of financing. Price not available with special GMAC financing or lease offers. 2) Any GMAC lessee with a lease ending before 6/30/09 or competitor lessee with a lease contract ending before 2/2/09 is eligible, proof of lease required at purchase. No trade-in required. Financing subject to credit approval and insurability and in lieu of rebates. Finance rate varies based on credit worthiness of customer as determined by GMAC. Some customers will not qualify. Offer not available on prior purchases & subject to change without notice. See dealer for details. Offer expires 11/13/08.

NISSANCHICAGO.COM

0% APR FOR 72 MONTHS!

DELIVERS

NEW 2009 NISSAN VERSA

Advertising vehicle. Model 52269. 4 available at this price.

0% APR or buy this vehicle for only...
\$11,795*

NEW 2009 NISSAN ALTIMA

Advertising vehicle. Model 05619. 4 available at this price.

0% APR or buy this vehicle for only...
\$16,995*

DURING THESE TOUGH TIMES BERMAN'S WANTS TO DO ALL WE CAN TO GET YOU THE NISSAN YOU WANT!

NEW 2008 NISSAN SENTRA

Advertising vehicle. Model 42868. SIK # 8981, 8917

0% APR or buy this vehicle for only...
\$12,495*

NEW 2008 NISSAN ROGUE

Advertising vehicle. Model 77218. SIK # N1961, 8357

0% APR or buy this vehicle for only...
\$16,995*

THIS WEEK'S USED CAR SPECIALS:

2007 NISSAN QUEST LOW MILES #112788A \$15,995*	2007 NISSAN PATHFINDER 4X4 SILVER #SF922 \$16,995*	2008 NISSAN MAXIMA 4DR #112788A \$17,995*	2009 NISSAN MURANO AWD LOW MILES LOADED \$21,995*
---	---	--	--

STAR NISSAN USED CAR OUTLET

'03 Nissan Sentra \$7,995*	'05 Nissan Murano \$15,995*	'99 Dodge Neon \$3,995*	'03 Toyota Corolla \$9,995*
'02 Honda Accord \$9,995*	'07 Toyota Highlander \$17,995*	'04 Chevy Monte Carlo \$7,750*	'06 Nissan Altima \$11,995*
'05 VW Jetta \$11,995*	'07 Nissan Maxima \$17,995*	'01 Nissan Quest \$6,995*	'05 VW Jetta \$12,995*
'04 Nissan Quest \$12,995*	'08 Nissan Quest \$17,995*	'02 Ford Escape \$7,995*	'05 Nissan Murano \$12,995*
'04 Honda Accord \$12,995*	'04 VW Touareg \$18,995*	'04 Honda Civic \$8,995*	'05 Nissan Pathfinder \$14,995*
'05 Nissan Altima \$12,995*	'05 Lexus ES330 \$19,995*	'05 Scion xA \$9,895*	'06 Nissan Maxima \$14,995*
'05 Toyota Sienna \$13,995*	'06 Lexus RX330 \$22,995*	'01 VW Passat \$9,995*	'06 Nissan Pathfinder \$15,995*
'07 Nissan Versa \$14,995*	'05 Infiniti FX35 \$24,995*	'03 Nissan Altima \$9,995*	'05 Infiniti G35x \$16,995*

MID CITY NISSAN USED CAR OUTLET

STAR NISSAN
5757 W. TOUHY AVENUE • NILES
starnissan.com 888-598-7491

MID CITY NISSAN
4444 W. IRVING PARK • CHICAGO
888-590-8666 midcitynissan.com

SUBARUCHICAGO.COM

SUBARU SAVINGS EVENT

NEW 2008 SUBARU IMPREZA 2.5i
\$16,051 OR **\$217** PER MO. **0% APR**
THIS IS NOT A LEASE!

NEW 2009 SUBARU LEGACY 2.5i SPECIAL EDITION
\$20,106 OR **\$279** PER MO. **0% APR**
THIS IS NOT A LEASE!

NEW 2008 SUBARU OUTBACK
\$2000 CASH BACK! **0% APR**

NEW 2009 SUBARU FORESTER 2.5X Model 9FA
\$19,178 OR **\$259** PER MO. **0% APR**
MOTORTREND SUV. OF THE YEAR!

NEW 2008 SUBARU TRIBECA 5 PASSENGER
\$23,911 OR **\$349** PER MO. **0% APR**
THIS IS NOT A LEASE!

THIS WEEK'S USED SPECIALS:

- '04 SUBARU LEGACY OUTBACK AWD 56K Mil Auto. CD, full power, heated seats! #F6129 **\$13,878***
- '06 SUBARU FORESTER AWD 19K Mil Auto. full power, extra clean! #SU2211A **\$13,950***
- '05 SUBARU LEGACY GT LTD 44K Mil Auto! Every option! Hurry!!! #SU2233A **\$16,490***
- '06 SUBARU B9 TRIBECA LTD AWD Low Mil Auto, full power, moonroof, CD! #SU2335A **\$18,390***
- '08 SUBARU LEGACY AWD 6K Mil Auto. full power, CD, moonroof! Like new! #SU2024 **\$18,870***

SUBARU
MID CITY SUBARU
4330 W. IRVING PARK • CHICAGO
888-598-7467
SUBARUCHICAGO.COM

DRIVE HOME TODAY

SALE • SALE • SALE • SALE • SALE

500 TOP-QUALITY SUBURBAN TRADES

2 Great Mancari Locations

NO REASONABLE OFFER REFUSED

MINIVAN SPECIALS

1996 CHRYSLER TOWN & COUNTRY
Fully loaded, leather interior, power seats, 7 passenger, power windows, power locks, keyless entry. ONLY... \$4,995

2005 CHRYSLER TOWN & COUNTRY
Loaded, automatic, air conditioning, power windows, power locks, AM/FM/CD, tilt, cruise. ONLY... \$7,995

2005 CHRYSLER TOWN & COUNTRY
Absolutely loaded, DVD, navigation, moonroof, chrome wheels, power windows, power locks, AM/FM/CD. ONLY... \$10,995

2006 CHRYSLER TOWN & COUNTRY
Loaded, 7 passenger, automatic, air conditioning, power windows, power locks, 12k Certified Miles, Keyless entry. ONLY... \$10,995

2005 DODGE GRAND CARAVAN SXT
Absolutely loaded, DVD, rear heat & air, power seat automatic, power windows, power locks, AM/FM/CD ONLY... \$11,995

2007 DODGE GRAND CARAVAN SXT
Fully loaded, Chrysler Certified, leather interior, heated power seats, full power, AM/FM/CD. ONLY... \$13,995

2007 CHRYSLER TOWN & COUNTRY
Fully loaded, Chrysler Certified, leather interior, power seats, rear heat & air, keyless entry, AM/FM/CD. ONLY... \$18,995

1995 CHEVY CAMARO
Loaded, automatic, air conditioning, power windows, power locks, AM/FM/CD, tilt, cruise. ONLY... \$5,995

2003 PONTIAC GRAND AM
Loaded, moonroof, automatic, air conditioning, power windows, power locks, chrome wheels, AM/FM/CD. ONLY... \$7,995

2006 CHRYSLER PT CRUISER
Loaded, automatic, air conditioning, power windows, power locks, AM/FM/CD, low miles. ONLY... \$8,995

2002 TOYOTA AVALON
Loaded, automatic, air conditioning, power windows, power locks, tilt, cruise, AM/FM/CD. ONLY... \$10,995

2006 CHRYSLER PACIFICA
Loaded, automatic, air conditioning, power windows, power locks, keyless entry, AM/FM/CD, tilt, cruise. ONLY... \$11,995

2006 CHEVY TRAILBLAZER
Loaded, 4.2L V6, auto, air conditioning, full power, AM/FM/CD, tilt, cruise, 26K certified miles. ONLY... \$12,995

2005 CHEVY MALIBU
Loaded, 3.5L V6 automatic, air conditioning, power windows, power locks, Low miles! ONLY... \$12,995

2006 PONTIAC G6
Fully loaded, leather interior, power sealed seats, power windows, power locks, keyless entry, chrome wheels. ONLY... \$12,995

2002 JEEP GRAND CHEROKEE
Loaded, automatic, air conditioning, power windows, power locks, AM/FM/CD. ONLY... \$7,995

2004 CHEVY MONTE CARLO
Loaded, automatic, air conditioning, power windows, power locks, AM/FM/CD, tilt, cruise. ONLY... \$7,995

2005 DODGE STRATUS
Loaded, 3.0L V6 automatic, power windows, power locks, air conditioning, AM/FM/CD. ONLY... \$9,995

2005 CHEVY EQUINOX LT
Loaded, automatic, air conditioning, power windows, power locks, AM/FM/CD, tilt, cruise. ONLY... \$10,995

2008 CHRYSLER PT CRUISER
Loaded, Chrysler Certified, automatic, air conditioning, power windows, power locks, AM/FM/CD. ONLY... \$11,995

2005 MERCURY MOUNTAINEER
Fully loaded, leather interior, moonroof, power windows, power locks, keyless entry, AM/FM/CD. ONLY... \$12,995

2005 DODGE DURANGO
Loaded, automatic, air conditioning, power windows, power locks, AM/FM/CD. ONLY... \$12,995

2006 PONTIAC GRAND PRIX
Loaded, 3.8L supercharged V6 automatic, leather interior, moonroof, power windows, power locks, AM/FM/CD. ONLY... \$12,995

BIG PRICE REDUCTIONS 500

BRAND NEW 2008 CHRYSLERS & JEEPS ON DISPLAY FOR IMMEDIATE DELIVERY

CHRYSLER 300s

JEEP GRAND CHEROKEES 4X4

CHRYSLER TOWN & COUNTRY

JEEP COMMANDERS

CHRYSLER SEBRING SEDANS & CONVERTIBLES

JEEP LIBERTYS, COMPASS, WRANGLERS 2DR & 4DR

ECONOMY CARS

2003 SATURN ION 3 ADR
Loaded, 2.2L, full power, tilt, cruise, temperature & compass gauges. Great On Gas! Stk# 10-01136-8 ONLY... \$5,995

2001 PONTIAC GRAND PRIX GT
Fully loaded, 3.8L V6, leather interior, moonroof, power windows, power locks, am/fm/CD. Stk#9-01104-8 ONLY... \$5,995

2004 SATURN L 300 SEDAN
Loaded, 2.2L, auto, air, conditioning, full power, ABS, side air bags, tilt, cruise, AM/FM/CD. Stk# 9-01004-8 ONLY... \$8,995

2005 CHEVY MALIBU MAXX LS
Loaded, 3.5L V6, auto, air conditioning, power seat, full power, am/fm/CD, keyless entry, great on gas! Stk#9-01023-8 ONLY... \$9,995

2005 CHEVY EQUINOX LT AWD
Loaded, 3.4L V6, leather interior, sunroof, power windows, power locks, am/fm/CD, aluminum wheels. Stk# 9-01070-8 ONLY... \$9,995

2007 CHEVY HHR LS
Loaded, automatic, air conditioning, power windows, power locks, keyless entry, am/fm/CD, extra clean. Stk# 8-01015-8 ONLY... \$10,995

2006 CHRYSLER PT CRUISER TOURING
Loaded, automatic, air conditioning, power windows, power locks, am/fm/CD, Chrysler Certified. Stk# 8-0975-8 ONLY... \$10,995

2007 DODGE CHARGER SXT
Fully loaded, 3.5L V6, 5 speed automatic, ABS, full power, keyless entry, Boston Acoustics CD/satellite radio w/26 watt amp. Stk# 8-0951-8 ONLY... \$13,995

MINIVANS & SUVs

2002 FORD EXPLORER XLT 4X4
Loaded, 7 passenger, 4.0L V6, auto, front/rear air & heat, ABS, full power, AM/FM/CD/cassette, running boards. Stk# 9-01109-8 ONLY... \$7,995

2002 DODGE CARAVAN SPORT
Loaded, 3.3L FlexFuel V6, auto, air, ABS, integrated child seats, overhead console, trip computer 6 disc CD. Stk# 98-01060-8 ONLY... \$7,995

2000 LINCOLN NAVIGATOR 4X4
3rd row seating, 5.4L V8, leather heated power seats, climate control, full power 6-disc CD/cassette, low pkg., running boards. Stk# 8-0967-8 ONLY... \$7,995

2005 JEEP GRAND CHEROKEE
Loaded, 3.7L V6, auto, air conditioning, ABS, power seat, AM/FM/CD, roof crossbars, OHL tires, alloy wheels. Stk# 9-01099-8 ONLY... \$10,995

2003 JEEP WRANGLER SAHARA 4X4
4.0L V6, auto, air, side steps, soft top, 30" OHL tires, high pressure gas charged shocks, aluminum wheels. Mechanic's Special. Stk# 9-01057-8 ONLY... \$10,995

2004 BUICK RAINIER CXL AWD
Fully loaded, 5.3L V8, leather interior, OnStar, power seats, full power, keyless entry, am/fm/CD, aluminum wheels. Stk#9-01038-8 ONLY... \$11,995

2006 CHEVY TRAILBLAZER LT 4X4
Loaded, 4.2L V6, moonroof, auto, air conditioning, full power, alarm, am/fm/CD, one owner. Stk# 8-01029-8 ONLY... \$11,995

2005 DODGE DAKOTA SLT
Loaded, 4.7L V8, automatic, air conditioning, full power, AM/FM/CD, great work truck. Stk# 7-0870P-8 ONLY... \$12,995

IMPORTS & LUXURY CARS

2002 KIA SPORTAGE
Loaded, automatic, air conditioning, power windows, power locks, am/fm/CD. Great on Gas! Stk# 9-01077-8 ONLY... \$5,995

2003 KIA SORENTO
Absolutely loaded, 3.5L V6, leather, moonroof, ABS, keyless entry, roof rack, AM/FM/CD. Stk# 10-01163-8 ONLY... \$7,995

2004 NISSAN PATHFINDER 4X4
Loaded, auto, air conditioning, luggage rack, running boards, tow hooks, heated mirrors, security alarm, full power. Stk# 10-01165-8 ONLY... \$10,995

1999 MERCEDES BENZ S 420 SEDAN
Absolutely loaded, 4.2L V8, moonroof, leather, heated power memory seats, premium sound, garage door opener, aluminum wheels. Stk# 7-0902P-8 ONLY... \$10,995

2004 SUZUKI XL-7
Fully loaded, 2.7L V6, 7 passenger, auto, air conditioning, full power, AM/FM/CD. Stk# 9-01099-8 ONLY... \$11,995

2002 HONDA CR-V EX 4X4
Fully loaded, moonroof, 2.4L AFS, 6-disc CD, full power, keyless entry, aluminum wheels. Stk# 9-01072-8 ONLY... \$11,995

2007 NISSAN VERSA 4DR
Loaded, 1.8L, full power, side air bags, power windows, tilt, cruise, AM/FM/CD, anti-theft system, bumper-to-bumper factory warranty. Stk# 7-0900P-8 ONLY... \$12,995

2005 NISSAN ALTIMA 4DR
Loaded, 2.5L, moonroof, auto, air, power seat, full power, AM/FM/CD, aluminum wheels, Stk# 7-0909P-8 ONLY... \$14,995

18 or OLDER NO CO-SIGNER

EVERYBODY DRIVES REGARDLESS OF CREDIT

• 1ST TIME BUYERS • NO CREDIT • SENIOR CITIZEN • SINGLE • WIDOWED • DIVORCED • MARRIED
• NEW TO THIS COUNTRY • NO PROOF OF INCOME • SELF-EMPLOYED • A USED CAR FOR EVERY BUDGET

EVERYBODY DRIVES REGARDLESS OF CREDIT

2005 JEEP LIBERTY 4X4
Loaded, 3.7L V6 automatic, air conditioning, power windows, power locks, tilt, cruise, AM/FM/CD. ONLY... \$13,995

2008 DODGE AVENGER
Loaded, certified, automatic, air conditioning, power windows, power locks, AM/FM/CD, keyless entry. ONLY... \$13,995

2005 JEEP GRAND CHEROKEE LIMITED 4X4
Loaded, leather interior, automatic, air conditioning, full power, keyless entry, AM/FM/CD. ONLY... \$14,995

2007 FORD FUSION
Loaded, one owner, automatic, air conditioning, power windows, power locks, power seat, keyless entry. ONLY... \$14,995

2008 CHRYSLER 300
Loaded, automatic, air conditioning, power windows, power locks, AM/FM/CD, tilt, cruise. ONLY... \$14,995

2007 DODGE CHARGER
Loaded, Certified, power windows, power locks, automatic, air conditioning, AM/FM/CD. ONLY... \$15,995

2008 DODGE CHARGER
Loaded, Chrysler Certified, automatic, air conditioning, power windows, power locks, keyless entry. ONLY... \$17,995

2008 BUICK LUCERNE
Fully loaded, leather interior, moonroof, automatic, air, power windows, power locks, AM/FM/CD. ONLY... \$19,995

2007 PONTIAC GRAND PRIX
Fully loaded, leather interior, automatic, air conditioning, OnStar, power windows, power locks, AM/FM/CD. ONLY... \$13,995

2008 DODGE MAGNUM
Loaded, automatic, air conditioning, power windows, power locks, keyless entry, AM/FM/CD. ONLY... \$13,995

2006 JEEP COMMANDER
Loaded, Chrysler Certified, 4.7L V8 automatic, air conditioning, full power, keyless entry, AM/FM/CD. ONLY... \$14,995

2007 NISSAN ALTIMA
Loaded, automatic, air conditioning, power windows, power locks, AM/FM/CD, keyless entry. ONLY... \$14,995

2005 JEEP GRAND CHEROKEE 4X4
Loaded, Chrysler Certified, automatic, air conditioning, power windows, power locks, keyless entry. ONLY... \$15,995

2007 CHRYSLER 300
Loaded, Chrysler Certified, automatic, air conditioning, power windows, power locks, AM/FM/CD, keyless entry. ONLY... \$15,995

2005 AUDI A4
Loaded, leather interior, moonroof, automatic, air, power windows, power locks, AM/FM/CD. ONLY... \$18,995

2006 INFINITI G35
Loaded, leather interior, moonroof, automatic, air, conditioning, full power, keyless entry, AM/FM/CD. ONLY... \$21,995

2007 CHRYSLER PACIFICA
Loaded, automatic, air conditioning, power windows, power locks, AM/FM/CD, tilt, cruise. ONLY... \$13,995

2005 JEEP GRAND CHEROKEE 4X4
Loaded, automatic, air conditioning, power windows, power locks, AM/FM/CD, keyless entry. ONLY... \$14,995

2006 PONTIAC TORRENT
Loaded, automatic, air conditioning, power windows, power locks, AM/FM/CD. ONLY... \$14,995

2008 DODGE CALIBER
Loaded, Certified, automatic, air conditioning, power windows, power locks, AM/FM/CD. ONLY... \$14,995

2006 CHEVY TAHOE
Loaded, automatic, air conditioning, keyless entry, power windows, power locks, AM/FM/CD. ONLY... \$15,995

2006 MAZDA 6 AWD
Loaded, automatic, air conditioning, power windows, power locks, AM/FM/CD. ONLY... \$16,995

2008 DODGE DURANGO
Loaded, Full Factory Warranty, automatic, air conditioning, full power, AM/FM/CD. ONLY... \$18,995

2007 CHRYSLER 300 SRT-8
Fully loaded, 6.1L HEMI automatic, leather interior, moonroof, full power, heated power seats, navigation, MUST SEE! ONLY... \$26,995

2005 CHRYSLER 300 LIMITED
Fully loaded, 3.5L V6, moonroof, leather interior, power heated seats, full power, alarm, keyless entry, am/fm/CD. Stk# 4-0480P-8 ONLY... \$13,995

2008 DODGE AVENGER SXT
2.4L, automatic, air conditioning, power seat, full power, keyless entry, tire pressure monitoring, side airbags, AM/FM/CD, tilt, cruise. Stk# 10-01111P-8 ONLY... \$14,995

2007 CHRYSLER SEBRING TOURING
Loaded, automatic, air conditioning, full power, keyless entry, am/fm/CD, Great on Gas! Stk# 9-01086P-8 ONLY... \$14,995

2006 PONTIAC G6 V6 GT
Absolutely loaded, moonroof, leather, chrome wheels, heated seats, AM/FM/CD, low miles, factory warranty. ONLY... \$14,995

2006 CHEVY IMPALA SS
Absolutely loaded, moonroof, leather, OnStar, power seat, ABS, keyless entry, rear spoiler, aluminum wheels. Stk# 8-0957P-8 ONLY... \$15,995

2006 CHRYSLER PACIFICA LIMITED AWD
7-passenger, moonroof, leather heated seats, 3.3L V6, ABS, climate control, rear park assist, DVD entertainment. Stk# 8-0988P-8 ONLY... \$16,995

2008 JEEP LIBERTY SPORT 4X4
Fully loaded, 3.7L V6, auto, air, all speed traction control, ABS, tire pressure monitoring, ABS, keyless entry, side airbags, AM/FM/CD. Stk# 10-0124P-8 ONLY... \$17,995

2008 DODGE NITRO SXT 4X4
Fully loaded, 3.7L V6, auto, air, ABS, traction control, keyless entry, full power, side airbags, tire pressure monitoring, AM/FM/CD. Stk# 10-01138P-8 ONLY... \$17,995

2006 JEEP GRAND CHEROKEE 4X4
Fully loaded, 3.7L V6, auto, air, ABS, electronic stability, power seat, AM/FM/CD, info center, garage door opener. Stk# 4-0480P-8 ONLY... \$12,995

2006 CHRYSLER TOWN & COUNTRY LIMITED
Loaded, 3.8L V6, Stow 'n Go, heated power memory seats, climate control, rear park assist, DVD entertainment. Stk# 9-01054P-8 ONLY... \$13,995

2007 JEEP LIBERTY SPORT 4X4
Loaded, 3.7L V6, command trac, full power, tilt, cruise, AM/FM/CD, 16" aluminum wheels. Stk# 7-899P-8 ONLY... \$14,995

2007 DODGE CALIBER R/T ALL WHEEL DRIVE
Fully loaded, 2.4L, CVT, air conditioning, ABS, side airbags, keyless entry, full power, 18" aluminum wheels, Chrysler Certified. Stk# 9-01030-8 ONLY... \$14,995

2006 DODGE GRAND CARAVAN SXT
Loaded, 3.8L V6, Stow 'n Go, great seats, keyless entry, ABS, power sliding doors, full power, CD/cassette. Stk# 8-0957P-8 ONLY... \$14,995

2006 JEEP COMMANDER 4X4
7-passenger, 3rd row seat, ABS, side airbags, power seats, full power, rear park assist, full power, keyless entry, AM/FM/CD, tilt, cruise. Stk# 8-0988P-8 ONLY... \$15,995

2005 JEEP WRANGLER SPORT 4X4
4.0L 8 Cyl., hard & soft tops, full doors, air conditioning, AM/FM/CD, w/usb/woofer & tweeters, OHL tires. Stk# 8-01001P-8 ONLY... \$16,995

2007 CHEVY TAHOE LTZ 4X4
Fully loaded, leather heated navigation, sunroof, heated power seats, 3rd row seating, custom chrome wheels, OnStar, bumper-to-bumper warranty, am/fm/CD. Stk# 6-01059-8 ONLY... \$35,995

2001 MERCEDES BENZ E320 4MATIC
Absolutely loaded, 3.2L V6, navigation, leather, moonroof, heated power memory seats, ABS, chrome wheels. Stk# 9-01081-8 ONLY... \$14,995

2004 MERCEDES BENZ C240
Absolutely loaded, moonroof, leather interior, 2.6L FlexFuel V6, woodgrain trim, full power, Stk#10-01159-8 ONLY... \$15,995

2005 CHRYSLER 300 C
Fully loaded, 5.7L HEMI V8, leather interior, heated power seats, keyless entry, power sunroof, am/fm/CD. Stk#7-0820P-8 ONLY... \$16,995

2005 INFINITI G35 X AWD
Absolutely loaded, 3.5L V6, moonroof, leather heated memory seats, ABS, full power, AM/FM/CD, bumper to bumper factory warranty. Stk# 6-01011P-8 ONLY... \$21,995

2007 CHRYSLER 300 C
Fully loaded, 5.7L HEMI, leather interior, heated power seats, power windows, power locks, alarm, keyless entry, Chrysler Certified, am/fm/CD. Stk# 6-01011P-8 ONLY... \$21,995

2006 INFINITI G35 COUPE
Fully loaded, 3.5L V6, leather interior, auto, air, full power, AM/FM/CD, Low Miles. Stk# 10-01208-8 ONLY... \$22,995

2006 DODGE CHARGER SRT-8
Back Beauty! Absolutely loaded, 6.1L HEMI V8, navigation, moonroof, leather, full power, rear spoiler, AM/FM/CD, Chrysler Certified. ONLY... \$27,995

2007 LEXUS LS 460 L
Absolutely loaded, 4.8L V8, custom leather interior, moonroof, touch screen cruise, navigation, U-Connect, power memory seats, rear parking assist, factory warranty. Stk# 6-01059-8 ONLY... \$59,995

MANCARI.com 8 YEAR 80,000 MILE WARRANTY ON ALL CERTIFIED PRE-OWNED VEHICLES

MANCARI'S CHRYSLER • JEEP® **OAK LAWN**

4630 W. 95th St. (708) 423-0910

1 Block East of Cicero Avenue

MANCARI'S CHRYSLER • JEEP® **OF ORLAND**

8821 W. 159th St. (708) 460-8400

Between Harlem Ave. & LaGrange Rd.

Prices are plus tax, title, license and \$150 doc fee. Manufacturer offers subject to change without notice. All offers in fact are and expire 3 working days from publication date. Dealer will not honor errors in this advertisement.

DON'T MISS LIBERTYVILLE TOYOTA'S

GIANT BAIL OUT EVENT

WE ARE BAILING YOU OUT OF HIGH PRICES! THERE HAS NEVER BEEN A BETTER TIME TO BUY!

Just Announced! Manufacturer Programs Have Been Extended!

SAVE \$500-\$10,000 OFF MSRP

OVER 100 TOYOTAS AVAILABLE

0%

LOWER YOUR PAYMENT TODAY!

MAXIMUM VALUE GUARANTEED FOR YOUR TRADE!

APR FINANCING AVAILABLE ON ALMOST EVERY NEW TOYOTA!

2009 COROLLA

0% APR FINANCING

UP TO 35 MPG HWY

4-SPEED AUTOMATIC, DEMO #9J031533

\$189 ZERO DOWN

LEASE PER MONTH FOR 36 MONTHS*

36 month lease based on \$89 total due at lease signing includes 1st mo. payment, \$0 Down, Security Deposit waived.

OR **\$14,499**

2009 CAMRY

0% APR FINANCING

UP TO 31 MPG HWY

5-SPEED AUTOMATIC, DEMO #9R065518

\$199 ZERO DOWN

LEASE PER MONTH FOR 36 MONTHS*

36 month lease based on \$199 total due at lease signing includes 1st mo. payment, \$0 Down, Security Deposit waived.

OR **\$17,995**

NEW 2009 SIENNA LE

0% APR FINANCING

UP TO 23 MPG HWY

7 PASSENGER, STANDARD, AUTOMATIC #9S233000

\$349 ZERO DOWN

LEASE PER MONTH FOR 36 MONTHS*

36 month lease based on \$349 total due at lease signing includes 1st mo. payment, \$0 Down, Security Deposit waived.

OR **\$22,591**

EASY CREDIT TERMS... DRIVE TODAY • REGARDLESS OF YOUR PAST CREDIT HISTORY! CALL OUR CAR CREDIT HOTLINE TODAY AT 866-308-3813

LAKE COUNTY'S LARGEST SELECTION OF PRISTINE USED VEHICLES UNDER 10,994!

1990 HONDA ACCORD EX BLACK #A158174	2002 MAZDA PROTEGE SILVER #K105670	2000 PLYMOUTH GRAND VOYAGER SE WHITE #M55775	2003 HYUNDAI SANTA FE RED #D4014
1992 TOYOTA PREVIA DELUXE BURGUNDY #N1024157	2003 MITSUBISHI GALANT BLACK #E128472	2000 VOLKSWAGEN BEETLE GLS BLACK #M46775	1994 TOYOTA LAND CRUISER BLUE #P49198
1998 MERCURY MYSTIQUE LS BLACK #H040465	1999 TOYOTA AVALON XLS SILVER #K122961	1999 NISSAN ALTIMA SE SILVER #K122961	2000 CHEVROLET TAHOE SILVER #T10107
1993 OLDSMOBILE SILHOUETTE RED #T131022	1997 FORD ESCORT LX RED #W176459	2001 DODGE RAM 1500 TRUCK SILVER #M56109	2006 CHEVROLET COBALT LS SILVER #K122961
2000 FORD WINDSTAR LX SILVER #H987230	1998 TOYOTA 4RUNNER SR5 GRAY #M102359	2002 AUDI A4 1.8T QUATTRO SILVER #L14237	2007 FORD FOCUS SE SILVER #K122961
1993 HONDA CIVIC EX RED #L04201	1999 TOYOTA CAMRY LE GRAY #M46775	2001 CHEVROLET IMPALA BLUE #K122961	2003 SUBARU FORESTER X SILVER #K122961
2001 HYUNDAI TIBURON BLACK #H225190	2003 DODGE CARAVAN SPORT BURGUNDY #K144719	2005 NISSAN SENTRA S RED #L14237	2004 TOYOTA HIGHLANDER SPORT DARK BLUE #K122961
1999 PONTIAC GRAND AM GT RED #M10172	1999 CHEVROLET EXPRESS VAN 1500 WHITE #K102152	2003 SATURN VUE SILVER #K122961	2005 TOYOTA CELICA GT SILVER #K122961

MAKE NO PAYMENTS FOR 90 DAYS!

JUST ANNOUNCED! LOW 3.9% APR*

Need an Oil Change? LibertyvilleToyota.com 24/7 At Libertyville Toyota we speak...
 Govorin Po Russku 866-314-3798 Mowimy Po Polsku 877-862-7147 Se habla Español 866-242-2704 Nagsasalita po tayo ng Pilipino 877-476-6652 877-862-7151

Libertyville Toyota/Scion 1180 S. MILWAUKEE AVENUE LIBERTYVILLE (866) 259-8144
 STORE HOURS: Monday thru Friday 9am to 9pm Saturday 9am to 7pm SERVICE HOURS: Monday thru Friday 6:30am to 11pm Saturday 8am to 4pm
 LIBERTYVILLETOYOTA.COM

www.rockenbach.com

23 ACRES OF INVENTORY!

Rockenbach MEGASTORE

SEE A LOT! SAVE A LOT!

Taking it all off!

23 ACRES OF NEW & USED VEHICLES

2008'S!

FRIDAY, SATURDAY, & MONDAY OPEN 'TIL MIDNIGHT!

3 DAYS ONLY!

\$10,000 OFF! ALL NEW '08 SILVERADO CHEVROLET

\$7,000 OFF! ALL NEW '08 IMPALA CHEVROLET

\$15,000 OFF! ALL NEW '08 CORVETTE CHEVROLET

\$6,000 OFF! ALL NEW '08 CORVETTE CHEVROLET

THIS IS WHY WE SELL MORE CHEVYS SELECTION! SELECTION! SELECTION!

20 FINANCE INSTITUTIONS READY TO LEND!

Certified USED VEHICLES GET 0% X 60' FINANCING ON PRE-OWNED VEHICLES

02 FORD F150 REG CAB V8 2X BEDLINER AC STEREO CD #470072B	2,995
05 CADILLAC DEVILLE CONCOURSE LOADED W/SLIP BENCH W/THR #10402B	3,995
07 CHEVY 8-PASS VAN LS PW, PL, REAR AC, CRUISE, ALLOYS, #10463A	4,790
08 DODGE DURANGO SRT 4X4 PW, PL, CD, #28064A	5,350
07 JAGUAR XJ6 4 DR, AT, SUNROOF, PW, PL, LTR BUCKETS, WOOD TRIM, #281197C	5,950
08 CHEVY 12-PASS VAN S300 PW, PL, CRUISE, ABS, #10547B	6,595
02 FORD RANGER EDGE 4X4 YELLOW/STEPSIDE, V8, AT, STEREO CD, #180591A	6,950
02 CHEVY 8-PASS VAN LS PW, PL, REAR AC, CRUISE, ALLOYS, #281212A	6,995
01 MERCURY SABLE LS PREMIUM V8, 6 CD CHANGER, 1 OWNER, PW LTHR SEAT, #10432B	7,450
00 MERCURY CARGO VAN ABS, AC, AT, AM/FM STEREO, ANTI-THEFT SYSTEM, #10300A	7,995
00 MERCURY MARQUIS GRAND GS PW, PL, PWR SEAT, CD, #190390B	7,995
07 SUZUKI FORENZA 4 CYL, FWD, PW, PL, BUCKETS, CD, #10437A	9,950
03 FORD EXPLORER XLT 4X4 V8, PW, PL, PW LTHR BUCKETS, #281317A	9,975
05 CHEVY UPLANDER FWD, COMMERCIAL, ABS, PW, PL, PWR BUCKETS, FT PARTITION, #10546A	9,995
03 SATURN ION 4 CYL, FWD, SUNROOF, PW, PL, PWR BUCKETS, ALLOYS, #10504A	10,500
07 CHEVY COBALT LS 2 DR, YELLOW, 5 SPD, 4 CYL, STEREO CD, 1 OWNER, #18019A	11,295
05 SATURN RELAY V6, PW, PL, PWR BUCKETS, REAR AC, DVD, TOW PKG, ALLOYS, #10452A	12,430
06 CHEVY UPLANDER LS V8, MP3, PW, PL, SRD SPLIT BENCH SEAT, #180848A	12,550
03 CADILLAC DEVILLE 4.8 L, LOADED W/FRULL PWR 4 LTR THRU OUT, ALLOYS, #281073A	12,650
06 CHEVY AVEO LS 4 DR, AT, 4 CYL, AC, 4 CYL, STEREO CD, CERT, #10584A	13,450
04 FORD CROWN VICTORIA LX PW, PL, PW SEAT, ALLOYS, CD, #10471A	13,485
07 FORD FOCUS SE 4 CYL, AT, FWD, AC, PW, PL, BUCKETS, CD, #10573A	13,485
06 CHEVY AVEO LS 4 DR, AT, AC, 4 CYL, STEREO CD, CERT, #100116A	13,790
04 CADILLAC SRX LOADED W/HEATED LTHR, TV/DVD, SHRF, NAV, #10540A	13,950
06 HONDA S2000 CONVERTIBLE, RED, 4 CYL, 6 SPD, PW, PL, LTR BUCKETS, #190160B	13,950
04 NISSAN MAXIMA SE SUNROOF, PW, PL, PWR LTHR BUCKETS, ALLOYS, #180397A	13,995
07 CHEVY HHR PANEL, 4 CYL, PW, PL, PWR BUCKETS, REAR AC, CD, #290118A	13,999
05 FORD LTD V8, SUNROOF, PW, PL, PWR LTHR SEATS, ALLOYS, #10511A	14,500
05 FORD ESCAPE XLT AWD, PW, PL, PWR LTHR BUCKETS, TOW PKG, #10574A	14,850
06 CHEVY UPLANDER 6 CYL, FLEXFUEL, XM, ONSTAR, SRD SEAT, PW, PL, #10443A	14,950
01 FORD MUSTANG CONVERTIBLE YELLOW, 5 SPD, PW LTHR HEATED BUCKETS, ALLOYS, #280547B	14,995
06 MAZDA 5-SPORT 4 CYL, AT, SHRF, SRD SEAT, PW, PL, AC, CD, #190235A	14,995
05 FORD F150 STX 4X4 EXT CAB, BEDLINER, AC, ABS, ALLOYS, #271279A	15,050
04 FORD F150 F4 OFF-ROAD 4X4 SUNROOF, ANTI-ROLL BAR, LTR, EXT CAB, #280779A	15,950
03 CHEVY SILVERADO LS EXT CAB 4X4 ABS, PW, PL, PWR SEATS, PWR MIRRORS, #171039C	15,950
06 FORD FOCUS SE 4 CYL, 4 DR, PW, PL, ALLOYS, BUCKETS, #10577A	16,450
06 PONTIAC GRAND PRIX V6, PW, PL, PW BUCKET, ALLOYS, CD, CERTIFIED, #10590A	16,995
06 CHEVY CARGO VAN ABS, AC, BUCKETS, #10599A	16,995
07 PONTIAC G6 V6, PW, PL, PW BUCKETS, ALLOYS, CD, CERTIFIED, #10568A	16,999
06 PONTIAC GRAND PRIX V6, PW, PL, PW BUCKET, ALLOYS, CD, CERTIFIED, #10559A	17,295
07 FORD EDGE SE V8, FWD, ABS, TOW PKG, STEREO CD, #280072A	17,450
06 NISSAN FRONTIER SE 4X4 4 DR, V8, 6 SPD, ABS BEDLINER, PW, PL, #280493B	17,595
07 CHRYSLER 300 TOURING V6, SATELLITE RADIO, LTR BUCKETS, #10588A	17,950
04 CHEVY SUBURBAN Z71 SUNROOF, TV/DVD, LOADED W/HTD LTR BUCKETS, #270163A	17,995
04 CADILLAC SRX V8, LOADED, AWD, SRD SEAT, LTHR, FULL PWR THRUOUT, #10462A	18,695
06 CHEVY IMPALA SS SUNROOF, LOADED W/HTD LTHR BUCKETS, #270388A	18,750
02 FORD QUALITY 4 DR, DIESEL, P/L, LOADED W/ LTHR THRU-OUT, #480008A	18,895
06 TOYOTA HIGHLANDER V8, AWD, SUNROOF, TV, NAV, LTR BUCKETS, #10537C	18,950
05 CHEVY AVALANCHE Z71 4X4 PW, PL, BUCKETS, ALLOYS, TOW PKG, CERT, #271670A	18,950
06 NISSAN ALTIMA 2.5 S 4 CYL, PW, PL, AT, BUCKETS, #10476A	19,650
07 SATURN ION HYBRID, 4 CYL, FWD, PW, PL, PW BUCKETS, ALLOYS, CD, #10546B	19,650
07 BUICK LUCERNE CXL V6, PW, PL, PWR LTHR HTD BUCKETS, ALLOYS, #10562A	19,950
07 TOYOTA HIGHLANDER V8, AWD, SUNROOF, PW, PL, STEREO CD, #10477A	19,975
07 CHEVY TAHOE LS 4X4 PW, PL, PW BUCKETS, REAR AC, SRD SEAT, TOW PKG, #280103A	21,750
06 HONDA PILOT 3.5, PWR, PWR LTHR BUCKETS, REAR AC, CD, #180899A	22,950
04 BMW 330C CONVERTIBLE, RED, AT, ALLOYS, LOADED W/HTD LTR, #280444A	26,995
06 CHEVY SUBURBAN LT 4X4 SHRF, REAR AC, PW LTHR BUCKETS, TOW PKG, #10555A	27,950
06 PONTIAC G6 GT SUNROOF, ABS, ONSTAR, XM, LOADED W/HTD LTR, #281252A	28,950
06 CHEVY CONVERSION VAN H-TOP, LOADED W/THR, TV/DVD/VIDEO, REAR AC, #380191A	33,750
06 FORD SHELBY GT 6 SPD, ABS, AC, PWR LTHR BUCKETS, ALLOYS W/LOCKS, #180406A	43,995
06 CHEVY CORVETTE Z-06 6 SPD, ABS, XM, BOSE, NAV, TRICEN CNTRL, #180737A	58,790

NO CREDIT SCORE TOO LOW! Our 10 Credit Experts Can Get Any Credit Approved! CALL MR. GREEN 847-276-8018

We Speak Spanish, Polish & Russian!
 Rockenbach 888-FUN-CHEVY
 STORE HOURS: MON-FRI 9AM-9PM, SAT 9AM-8PM
 SERVICE HOURS: MON-FRI 7AM-7PM, SAT 8AM-2PM
 LOCATED ON RTE 120 JUST WEST OF THE TRI-STATE IN GRAYSLAKE



*Plus tax, title, license and doc fee. Plus tax, title, license and doc fee. MSRP may not be price at which vehicle is sold in trade area. With approved credit. Dealer is a dealer sponsored buydown rate and may affect the final selling price. Max balance of \$10,000 financed with \$0 down. Not available with advertised prices. May require up-front payments. Dealer will not honor any pricing errors in this advertisement. Prices are good 2 days from date of publication. Pictures are for illustration purposes only. See dealer for details.

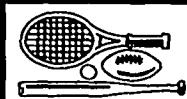

RECREATION

S-5 AIRPLANES
S-10 BOATS POWER
S-11 BOATS SAIL
S-12 BOATS SUPPLIES
S-20 SEASONAL SPORTS
S-22 RECREATIONAL VEHICLES
S-25 MOTORCYCLES SCOOTERS

S-25 MOTORCYCLES SCOOTERS

MOTORCYCLES WANTED CASH PAID!

Will Pick-Up! Call 630-660-0571



AUTOMOTIVE

T-5 FOR SALE IMPORTS

T-6 CUSTOM MODIFIED
T-7 SERVICE
T-9 ANTIQUE CARS
T-10 VANS
T-11 SUV
T-12 TRUCKS
T-13 TRAILERS
T-14 RENT
T-15 LEASE
T-16 FINDERS SERVICE
T-17 SERVICE REPAIR
T-18 TOWING
T-19 PARTS AND ACCESS
T-21 LOANS
T-22 INSURANCE
T-23 AUTOS WANTED
T-25 FOR SALE DOMESTIC
T-26 LIMOUSINES

T-5 FOR SALE IMPORTS

ACURA '04 TL Black, 76K, Fully Id, \$34,200 obo. 773-977-9526
ACURA '93 VIGOR GS. Wht. 4 Dr. Lthr. Snr. All Pwr. Alloys. Great. \$11,000. 773-725-8434

MADE MISTAKES?

GET FORGIVEN AND DRIVE HOME TODAY! APPLY ONLINE AT... www.Ford Of Frankfort.com or Call 800-260-0500 24 Hour Credit Hotline

FORD of FRANKFORT

9423 W. LINCOLN HIGHWAY • FRANKFORT, IL 60423 or call the dealership at 888-770-9975

Currie Motors NICE PEOPLE TO DO BUSINESS WITH

FORD of FRANKFORT 9423 W. LINCOLN HIGHWAY • FRANKFORT, IL 60423 or call the dealership at 888-770-9975

HYUNDAI '03 ACEENT GT. 2 Dr. Auto, 4 Cyl, Gas Saver, Runs, Looks Exc. \$2,500. 847-307-9109

'01 Hyundai Elantra #1906781A \$11,995 OLAR 1-866-610-8607

INFINITI '96 Q45 V8 4 dr, silver, w/hk inter., am/fm, CD changer, load ed, alloys, \$2,500 obo. 773-931-8186

JAGUAR '06 XJ6 auto, 32K mi, blu w/wht. Inter. Has warrt \$25,000 OBD 773-768-1828

'06 Kia Optima #Y8342A \$8,995 OLAR 1-866-610-8607

KIA '00 SEPIA 50K miles, auto, red, 4 dr., full pwr., alloys, 1 owner, \$11,000. 773-907-2276

'98 Kia Sportage \$2300

'94 Nissan Sentra \$1600

'91 Subaru Legacy \$950

3377 N. Milwaukee 773-282-1098 visit samsautochicago.com

'04 Lexus ES330 #VU1290 \$15,995 Grossinger Volvo 866-595-0620

'00 Lexus GS300 #VU1399A \$6,995 Grossinger Volvo 866-595-0620

'05 Lincoln LS #VU1383 \$12,995 Grossinger Volvo 866-595-0620

Mazda 1994 323 HB Runs Good \$1195 Ask for Jerry 773-847-1515 4030 S. Archer Ave., Chicago

'98 Mercedes C280 oldroyd drivon, runs great \$2850 773-240-3077

Mercedes '95 S420 Luxury Edt. all opt., 104K mi., runs like new, xtra cin extor., 20" chrm runs w/ orig. tires, \$7,500, 773-665-1254

MERCEDES '93 S400 SEL smoko silver, big body, lthr, snr, lks & runs excl., A.C., H.C., \$3,000, 773-526-9690

MITSUBISHI '08 Galant ES #14309 \$13,995 or \$2599/MO CALL NOW! 888-695-7313

MITSUBISHI '01 GALANT ES auto, blk, 4dr, snr, cold A/C, full pwr, runs outstanding, like new, \$3,100, 773-725-9639

MITSUBISHI '97 DIAMANTE LS-4dr, w/ht, lthr., snr., full pwr., alloys, CD, like new, \$3,400, 773-907-2276

Mitsubishi '97 Galant ES auto., 4 dr., 4cyl, pwr., exc. hi. lged., runs & lks exc., \$2,000. 708-574-4901

MITSUBISHI 95 ECLIPSE RS Gm, Alloys, Really Fancy, Gorgeous, Must See! \$1,900, 773-907-2276

Daewoo '01 Leganza auto, blk, 4dr, lthr, full pwr, runs exc., \$1,700, 773-725-9639

HONDA '99 ACCORD EX CPE. Runs Great! \$4,100 obo. Call 773-977-9526

HONDA '96 ACCORD LX. Blk. 4 Dr. Full Pwr. CD/Cass. Alloys, Runs Outstanding. \$2,100, 773-713-7245

HONDAS FOR \$500! Police Impounds! For Listings 800-473-7523 x3436

HONDA '92 ACCORD 4 DR. 5 Spd. Good Gas Mi. \$750. Call 708-698-3150

HONDA '93 VIGOR GS. Wht. 4 Dr. Lthr. Snr. All Pwr. Alloys. Great. \$11,000. 773-725-8434

'07 Nissan Sentra S 1.8S \$10,995 DLAR 1-866-610-8607

'04 Nissan Maxima 3.5SL #18223013 \$11,995 OLAR 1-866-610-8607

Nissan '01 Maxima #3815148 \$6,995 Call 888-679-2244 GlendaleNissan.com

'01 Nissan Maxima 4DR Auto, Air, Extra Clean, SR Alloys Sharp \$4895 Midway Motor 708-656-5756

'00 Nissan Altima #90003A \$6,995 or \$1299/MO CALL NOW! 888-695-7313

Nissan '98 Sentra #381502A \$3,995 Call 888-679-2244 GlendaleNissan.com

NISSAN '96 ALTIMA #VU1399A \$11,995 Call 773-444-8001

NISSAN '94 ALTIMA Very Dependable, AC/Heat, Good Dn Gas, \$900, Call 773-526-9690

\$500! Police Impounds! Cars from \$500! For Listings 1-800-473-7523 XC436

Subaru '08 Outback #207481A \$18,995 or \$3599/MO CALL NOW! 888-695-7313

Suzuki '06 Grand Vitara XL-7 #P132728A \$13,895 or \$2599/MO CALL NOW! 888-695-7313

Toyota '09 Solara LE #P14489 \$16,995 or \$3199/MO CALL NOW! 888-695-7313

'08 Toyota Prius #Y8996 \$23,995 DLAR 1-866-610-8607

'06 Toyota Corolla LE #190602A \$12,995 OLAR 1-866-610-8607

TOYOTA '06 SCION XB - SILVER 5DR, AUTO, AC, PBL, PS, PW, TILT, CD, 34K, MAG WHEELS, 90 MILES, 28 MPG. \$11,500 Call 773-792-2771

'06 Toyota Sienna LE \$13,995 OLAR 1-866-610-8607

TOYOTA '03 CAMRY 4cyl, 34K, lmm, cond., 1 owner, new tires, \$10,900 obo. 708-983-9848

TOYOTA '00 COROLLA LE 60K miles, runs & lks perfect. 1 owner, gas saver, \$4,600, 773-742-7791

Toyota '00 Solara SEL #67218 \$6,995 or \$1299/MO CALL NOW! 888-695-7313

JAGUAR '72 XKE COUPE V12, 48K, Wires, 77k opt. Mile! \$16,600 obo. 630-357-4235

TOYOTA '94 AVALON XL- AUTO, GRAY, 4 DRS., FANCY RIMS, COLD AC, MUST SEE, \$2,700, 773-907-2276

TOYOTA '94 CAMRY V6 LE, Blk. 2 DR. Lthr. Snr. Full Pwr. Alloys, Must See! \$1,700, 773-717-7246

TOYOTA '93 CAMRY 4dr, 4 cyl, 129K mi., 1 owner, very nice cond., \$2,950 obo. 847-791-5819

'05 Volkswagen Phaeton #VU1304 Grossinger Volvo 866-595-0620

'02 Chovy w/astro Conversion Van #96 Astro Conversion Van, exc. cond., runs grt., all pwr., \$1,450 obo. 708-692-8697

CHEVY '94 LUMINA APV LS Blue, Alloys, Fabulous Minivan. Gas Saver, Must See! \$1,200, 773-271-4029

'05 Dodge Caravan #VU1359A \$6,995 Grossinger Volvo 866-595-0620

Dodge '03 Caravan SXT #8368A \$7,995 or \$1439/MO CALL NOW! 888-695-7313

Dodge '02 Caravan Sport 7 pass. silver, full pwr, cold A/C, alloys, gorgeous, \$2,900, 773-271-7246

Dodge '99 RAM 2500 Conversion, Tan Int, Lthr, Must See! \$2,500 630-273-5057

DODGE '96 CARAVAN SPORT Full pwr., exc. cond., in and out, runs like new, \$2,300, 630-201-8018

Plymouth '97 Grand Voyager SE 7pass, gold, old A/C, gas sav, Must See! \$1,100, 773-725-8434

Plymouth '96 Grand Voyager SE 7 Pass, Auto, runs grt, lks, grt., \$1,750 obo. 773-430-6777

Plymouth '97 Grand Voyager SE 7pass, gold, old A/C, gas sav, Must See! \$1,100, 773-725-8434

Plymouth '96 Grand Voyager SE 7 Pass, Auto, runs grt, lks, grt., \$1,750 obo. 773-430-6777

Plymouth '97 Grand Voyager SE 7pass, gold, old A/C, gas sav, Must See! \$1,100, 773-725-8434

Plymouth '96 Grand Voyager SE 7 Pass, Auto, runs grt, lks, grt., \$1,750 obo. 773-430-6777

Plymouth '97 Grand Voyager SE 7pass, gold, old A/C, gas sav, Must See! \$1,100, 773-725-8434

Plymouth '96 Grand Voyager SE 7 Pass, Auto, runs grt, lks, grt., \$1,750 obo. 773-430-6777

Plymouth '97 Grand Voyager SE 7pass, gold, old A/C, gas sav, Must See! \$1,100, 773-725-8434

Plymouth '96 Grand Voyager SE 7 Pass, Auto, runs grt, lks, grt., \$1,750 obo. 773-430-6777

Plymouth '97 Grand Voyager SE 7pass, gold, old A/C, gas sav, Must See! \$1,100, 773-725-8434

Plymouth '96 Grand Voyager SE 7 Pass, Auto, runs grt, lks, grt., \$1,750 obo. 773-430-6777

Plymouth '97 Grand Voyager SE 7pass, gold, old A/C, gas sav, Must See! \$1,100, 773-725-8434

Plymouth '96 Grand Voyager SE 7 Pass, Auto, runs grt, lks, grt., \$1,750 obo. 773-430-6777

Plymouth '97 Grand Voyager SE 7pass, gold, old A/C, gas sav, Must See! \$1,100, 773-725-8434

Plymouth '96 Grand Voyager SE 7 Pass, Auto, runs grt, lks, grt., \$1,750 obo. 773-430-6777

Plymouth '97 Grand Voyager SE 7pass, gold, old A/C, gas sav, Must See! \$1,100, 773-725-8434

Plymouth '96 Grand Voyager SE 7 Pass, Auto, runs grt, lks, grt., \$1,750 obo. 773-430-6777

Plymouth '97 Grand Voyager SE 7pass, gold, old A/C, gas sav, Must See! \$1,100, 773-725-8434

Plymouth '96 Grand Voyager SE 7 Pass, Auto, runs grt, lks, grt., \$1,750 obo. 773-430-6777

Plymouth '97 Grand Voyager SE 7pass, gold, old A/C, gas sav, Must See! \$1,100, 773-725-8434

Plymouth '96 Grand Voyager SE 7 Pass, Auto, runs grt, lks, grt., \$1,750 obo. 773-430-6777

Plymouth '97 Grand Voyager SE 7pass, gold, old A/C, gas sav, Must See! \$1,100, 773-725-8434

Plymouth '96 Grand Voyager SE 7 Pass, Auto, runs grt, lks, grt., \$1,750 obo. 773-430-6777

'07 NISSAN SENTRA S 1.8S \$10,995 DLAR 1-866-610-8607

'04 Nissan Maxima 3.5SL #18223013 \$11,995 OLAR 1-866-610-8607

Nissan '01 Maxima #3815148 \$6,995 Call 888-679-2244 GlendaleNissan.com

'01 Nissan Maxima 4DR Auto, Air, Extra Clean, SR Alloys Sharp \$4895 Midway Motor 708-656-5756

'00 Nissan Altima #90003A \$6,995 or \$1299/MO CALL NOW! 888-695-7313

Nissan '98 Sentra #381502A \$3,995 Call 888-679-2244 GlendaleNissan.com

NISSAN '96 ALTIMA #VU1399A \$11,995 Call 773-444-8001

NISSAN '94 ALTIMA Very Dependable, AC/Heat, Good Dn Gas, \$900, Call 773-526-9690

\$500! Police Impounds! Cars from \$500! For Listings 1-800-473-7523 XC436

Subaru '08 Outback #207481A \$18,995 or \$3599/MO CALL NOW! 888-695-7313

Suzuki '06 Grand Vitara XL-7 #P132728A \$13,895 or \$2599/MO CALL NOW! 888-695-7313

Toyota '09 Solara LE #P14489 \$16,995 or \$3199/MO CALL NOW! 888-695-7313

'08 Toyota Prius #Y8996 \$23,995 DLAR 1-866-610-8607

'06 Toyota Corolla LE #190602A \$12,995 OLAR 1-866-610-8607

TOYOTA '06 SCION XB - SILVER 5DR, AUTO, AC, PBL, PS, PW, TILT, CD, 34K, MAG WHEELS, 90 MILES, 28 MPG. \$11,500 Call 773-792-2771

'06 Toyota Sienna LE \$13,995 OLAR 1-866-610-8607

TOYOTA '03 CAMRY 4cyl, 34K, lmm, cond., 1 owner, new tires, \$10,900 obo. 708-983-9848

TOYOTA '00 COROLLA LE 60K miles, runs & lks perfect. 1 owner, gas saver, \$4,600, 773-742-7791

Toyota '00 Solara SEL #67218 \$6,995 or \$1299/MO CALL NOW! 888-695-7313

JAGUAR '72 XKE COUPE V12, 48K, Wires, 77k opt. Mile! \$16,600 obo. 630-357-4235

TOYOTA '94 AVALON XL- AUTO, GRAY, 4 DRS., FANCY RIMS, COLD AC, MUST SEE, \$2,700, 773-907-2276

TOYOTA '94 CAMRY V6 LE, Blk. 2 DR. Lthr. Snr. Full Pwr. Alloys, Must See! \$1,700, 773-717-7246

TOYOTA '93 CAMRY 4dr, 4 cyl, 129K mi., 1 owner, very nice cond., \$2,950 obo. 847-791-5819

'05 Volkswagen Phaeton #VU1304 Grossinger Volvo 866-595-0620

'02 Chovy w/astro Conversion Van #96 Astro Conversion Van, exc. cond., runs grt., all pwr., \$1,450 obo. 708-692-8697

CHEVY '94 LUMINA APV LS Blue, Alloys, Fabulous Minivan. Gas Saver, Must See! \$1,200, 773-271-4029

'05 Dodge Caravan #VU1359A \$6,995 Grossinger Volvo 866-595-0620

Dodge '03 Caravan SXT #8368A \$7,995 or \$1439/MO CALL NOW! 888-695-7313

Dodge '02 Caravan Sport 7 pass. silver, full pwr, cold A/C, alloys, gorgeous, \$2,900, 773-271-7246

Dodge '99 RAM 2500 Conversion, Tan Int, Lthr, Must See! \$2,500 630-273-5057

DODGE '96 CARAVAN SPORT Full pwr., exc. cond., in and out, runs like new, \$2,300, 630-201-8018

Plymouth '97 Grand Voyager SE 7pass, gold, old A/C, gas sav, Must See! \$1,100, 773-725-8434

Plymouth '96 Grand Voyager SE 7 Pass, Auto, runs grt, lks, grt., \$1,750 obo. 773-430-6777

Plymouth '97 Grand Voyager SE 7pass, gold, old A/C, gas sav, Must See! \$1,100, 773-725-8434

Plymouth '96 Grand Voyager SE 7 Pass, Auto, runs grt, lks, grt., \$1,750 obo. 773-430-6777

Plymouth '97 Grand Voyager SE 7pass, gold, old A/C, gas sav, Must See! \$1,100, 773-725-8434

Plymouth '96 Grand Voyager SE 7 Pass, Auto, runs grt, lks, grt., \$1,750 obo. 773-430-6777

Plymouth '97 Grand Voyager SE 7pass, gold, old A/C, gas sav, Must See! \$1,100, 773-725-8434

Plymouth '96 Grand Voyager SE 7 Pass, Auto, runs grt, lks, grt., \$1,750 obo. 773-430-6777

Plymouth '97 Grand Voyager SE 7pass, gold, old A/C, gas sav, Must See! \$1,100, 773-725-8434

Plymouth '96 Grand Voyager SE 7 Pass, Auto, runs grt, lks, grt., \$1,750 obo. 773-430-6777

Plymouth '97 Grand Voyager SE 7pass, gold, old A/C, gas sav, Must See! \$1,100, 773-725-8434

FORD '03 WINDSTAR LTD Exc. Van, 2 tone, lthr inter, w/ quade captain chairs w/ park trunk bck up sensors, ht seats, pwr, sliding drs, rear a/c & ht, CD, full enter, center, and many many more opt. mint swrnm cond. Must See to appreciate. Vacation use, always gorged dealer mainl. looks & drives postively like new, \$7900 obo. 847-973-9911

'03 Lincoln Mark 5 runs great. 55k miles, some rust \$900 or offer 773-240-3077

CORVETTE WANTED 1953-1972. Any Condition, Competitive Buyer, 1-800-650-3556 corvettebuyer.com

FORD '70 MUSTANG Conv., V8, stck, \$4,000obo. Call 773-430-9274

CORVETTE WANTED No Dealers Please. 618-278-4403

Ford '02 E250 Cargo Van #74644A \$6,995 or \$1299/MO CALL NOW! 888-695-7313

Dodge '01 Ram 1500 #381431A \$6,995 Call 888-679-2244 GlendaleNissan.com

Dodge '98 Durango #831392 \$3,995 Call 888-679-2244 GlendaleNissan.com

DODGE '99 DURANGO 4DR, Full Pwr. Alloys, 3rd Row Seat, Special Lthr. Lights, \$2,200, 773-725-9639

OOOGE '99 DURANGO SLT Exc. Cond. Best Motor \$1,800 Call NOW! 888-695-7313

Ford '02 Windstar #P14448 \$5,995 or \$1099/MO CALL NOW! 888-695-7313

Ford '02 Windstar #P14448 \$5,995 or \$1099/MO CALL NOW! 888-695-7313

Ford '03 Explorer XLT Auto, Air, Pwr. Tilt, \$7,495 866-532-5660

Ford '03 Explorer XLT Auto, Air, Pwr. Tilt, \$7,495 866-532-5660

Ford '03 Explorer XLT Auto, Air, Pwr. Tilt, \$7,495 866-532-5660

Ford '03 Explorer XLT Auto, Air, Pwr. Tilt, \$7,495 866-532-5660

Ford '03 Explorer XLT Auto, Air, Pwr. Tilt, \$7,495 866-532-5660

Ford '03 Explorer XLT Auto, Air, Pwr. Tilt, \$7,495 866-532-5660

Ford '03 Explorer XLT Auto, Air, Pwr. Tilt, \$7,495 866-532-5660

Model Year-End SAVINGS EVENT!

TOP

DOLLAR PAID FOR ALL TRADE-INS

FINANCING AVAILABLE AT HONDA CITY!



NEW 2008 HONDA ACCORD LX
NOT A LEASE! **\$223** / 84 MO.
31 MPG HWY
21 MPG CITY



NEW 2008 HONDA CR-V LX 2WD
NOT A LEASE! **\$236** / 84 MO.
27 MPG HWY
20 MPG CITY

HOME OF THE 2-YEAR 100,000 MILE WARRANTY ON PRE-OWNED VEHICLES!

- 2003 HONDA ODYSSEY LX Auto, Silver, 79K, #C1731B \$8,985
- 2006 HYUNDAI ACCENT GLS Auto, Blue, Clean, #P429 \$9,985
- 2007 HYUNDAI SONATA GLS Auto, White, 35K, #P432 \$12,485
- 2007 PONTIAC G6 GT Auto, White, #P463 \$12,985
- 2008 FORD FOCUS SE Auto, Red, 25K, #P464 \$13,485
- 2008 CHEVY IMPALA LS Auto, White, 24K, Clean, #P425 \$13,485

ALL CREDIT APPLICATIONS ACCEPTED!

- 2005 HONDA ACCORD LX SE CPE Auto, Silver, Clean, #C2437A \$14,985
- 2007 HONDA CIVIC EX Auto, NAV, 9K, #C2399A \$18,985
- 2008 HONDA ACCORD LX SDN Auto, Silver, 5K, #C2122A \$18,985
- 2008 HONDA CR-V LX 4WD Auto, Blue, 5K, #C2301A \$19,985
- 2005 MERCEDES-BENZ C240 Auto, Silver, 19K, #P472 \$19,985
- 2007 HONDA CR-V EX-L Auto, Beige Metallic, 7K, #DC2402A \$22,985

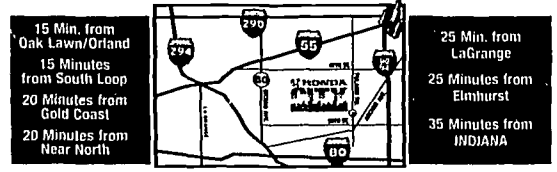

4950 South Pulaski, Chicago (ARCHER & PULASKI - 2 MILES SOUTH OF I-55)

888-528-8532

SE HABLA ESPAÑOL • MOWIMY PO POLSKU • FALAMOS PORTUGUES • WE SPEAK SERBIAN & MACEDONIAN • 我們講中文

Prices/payments plus tax, title, lic. acq and doc fee. All rebates and incentives applied. *0% APR financing is a buy down rate available to qualified buyers with approved credit. Buy down rate may affect final sale price, see dealer for details. \$5000 down, payments based on 6.99% APR financing x 84 mos., must qualify. #Based on 2008 EPA mileage estimates, reflecting new EPA fuel economy methods beginning with 2008 models. Use for comparison purposes only. Do not compare to models before 2008. Your actual mileage will vary depending on how you drive and maintain your vehicle. +Limited powertrain warranty, 2-years or 100K miles, whichever occurs first. Available on qualified vehicles only. Work must be performed at Honda City, see dealer for details. Photos are for illustration purposes only and may not reflect actual vehicles. Vehicle availability based on press time and all vehicles subject to prior sale. Dealership not liable for price misprints or typographical errors. Manufacturer incentives subject to change without notice and may affect dealer's selling price.

HONDACITYCHICAGO.COM

New Car Buyers Guide

Authorized Dealers

Acura
JOE RIZZA ACURA 8150 W. 159th Street
Orland Park 888-261-8642 rizzacars.com

Audi
AUDI OF TINLEY PARK 8021 W. 159th St.
866-379-5929 audi@tinleypark.com

LAUREL AUDI OF WESTMONT 276 E. Ogden Ave.
866-383-3044 www.laurelaudi.com

BMW
BILL JACOBS BMW 1564 W. Ogden Ave.,
Naperville, IL 1-866-516-8015 www.billjacobsbmw.com

BMW OF ORLAND PARK 8470 159th St.
Orland Park, 888-500-2369 bmwop.com

ELMHURST BMW 466 W. Lake St., Elmhurst 888-287-6555 www.elmhurstbmw.com

LAUREL BMW OF WESTMONT 430 E. Ogden Ave. 866-385-9527 bmwofwestmont.com

PATRICK BMW 700 E. Golf Road, Schaumburg
877-749-9921 www.patrickbmw.com

Buick
Grossinger Buick 6900 N. McCormick
Lincolnwood 866-670-2599 www.grossingerbuick.com

RIZZA BUICK 8425 West 159th St.,
Tinley Park, IL 866-360-4575 www.rizzacars.com

Cadillac
Bill Jacobs Cadillac 2001 W. Jefferson St., Joliet
800-540-0731 www.BillJacobsAuto.com

Cadillac of Naperville 1507 W. Ogden Ave.,
Naperville, 630-355-2700 www.napervillecadillac.com

GROSSINGER CADILLAC 6900 N. McCormick
Lincolnwood 866-670-2599 www.grossingercadillac.com

GROSSINGER CITY CADILLAC 1241 N. Wells
Chicago 800-783-9315 www.grossingercitycadillac.com

HERITAGE CADILLAC 303 W. Roosevelt rd.,
Lombard 630-629-3300 www.heritagecadillac.com

PATRICK CADILLAC 526 Mall Dr., Schaumburg
877-749-9921 www.patrickcadillac.com

RIZZA CADILLAC 8425 W. 159th St., Tinley Park,
866-360-4574 www.rizzacars.com

STEVE FOLEY CADILLAC 100 N. Skokie Blvd.
Northbrook 866-372-3654 www.stevefoley.com

Chevrolet
ADVANTAGE CHEVROLET I-55 & Route 53,
Bolingbrook 888-655-5359 www.advantagechev.com

ADVANTAGE CHEVROLET LaGrange & Joliet
Roads, Countryside Auto Mall 800-961-7609
www.advantagechev.com

Bill Jacobs Chevrolet 2001 W. Jefferson St.,
Joliet 800-507-6841 www.BillJacobsAuto.com

BILL KAY CHEVROLET 601 Ogden & I-355
Downers Gv/Lisle 630-968-2900 billkaychevrolet.com

BREDEMANN CHEVROLET 1401 W. Dempster
St. Park Ridge 847-698-1234 Next to Lutheran General
Hospital www.bredemann.com

Currie Motors Chevy Forest Park 7901
W. Roosevelt Rd., 888-294-3409 www.curriechevy.com

GROSSINGER CHEVROLET 151 E. Lake Cook
Rd. Palatine 877-359-2438 www.grossingerchevy.com

HOSKINS CHEVROLET 175 N. Arlington Hts Rd., Elk Grove Village
847-439-0900 www.hoskinschevrolet.com

JACK PHELAN CHEVROLET "You Gotta See Jack"
4000 S. Harlem, Lyons 877-206-1111 jackphelan.com

Chevrolet (cont'd)
LARRY ROESCH CHEVY 866-235-0505
333 W. Grand Ave., Bensenville www.larryroesch.com

PHILLIPS CHEVROLET Rtes. 30 & 45,
Frankfort 866-281-0769 www.phillipschevy.com

RIZZA CHEVROLET 8200 S. Harlem,
Bridgeview, (888) 560-7799 www.rizzachevy.com

SUNRISE CHEVROLET 147th & Cicero
SunriseDeals.com (866) 892-0836

WEBB CHEVROLET 888-545-0275
9440 S. Cicero Ave., Oak Lawn www.webbchevy.com

Chrysler
Bill Kay Downers Grove Chrysler 2100
Ogden Ave. www.billkaychrysler.info 866-514-5555

GREGORY CHRYSLER-JEEP
130 Cedar Ave., Lake Villa 800-770-6582

Mancari Chrysler-Jeep in Oaklawn
4630 W. 95th St. 1-708-423-0910

ZEIGLER CHRYSLER /DODGE /JEEP
208 W. Golf, Schaumburg 847-882-8400 zdodge.com

New Car Buyers Guide

Authorized Dealers

Dodge
ADVANTAGE CHRYSLER JEEP DODGE
77 Rand Rd., Des Plaines 888-504-5037
www.advantagecd.com

DODGE OF NAPERVILLE 1565 W. Ogden
Ave. (630) 355-3410 www.napervilledodge.com

SHERMAN DODGE 7601 N. Cicero Ave., Skokie
(888) 738-9744, #1 Dodge Dealer in IL

Ford
ANDERSON FORD 6539 W. Ogden, Berwyn, IL
708-795-7900 www.AndersonBrosFord.com

ARLINGTON HTS. FORD www.ahford.com
801 W. Dundee Rd, Arlington Heights (847) 346-3042

AUTONATION/WOODFIELD FORD
815 E. Golf Road Schaumburg 877-211-1935

BILL KAY FORD MIDLOTHIAN 800-804-3558
14633 S. Cicero Ave. www.billkayford.com

CURRIE MOTORS FORD-FRANKFORT #1 In
Midwest Rt.30&45 fordoffrankfort.com 866-YESFORD

JOE RIZZA FORD OF NORTH RIVERSIDE
2100 S. Harlem, 1-888-400-1222 rizzacars.com

JOE RIZZA FORD OF ORLAND PARK
8100 W. 159th St., 866-933-7850 rizzacars.com

MCCARTHY FORD, INC 11400 S. Pulaski,
Chicago 773-239-7900 www.mccarthyfordinc.net

Webb Ford on 95th 2601 W. 95th Evergreen
Pk IL 708-423-3500 www.webbford95th.com

Jeep
ADVANTAGE CHRYSLER JEEP DODGE
77 Rand Rd., Des Plaines 888-504-5043
www.advantagecd.com

GREGORY CHRYSLER-JEEP 18850 W
Grand Ave Lake Villa(Gumee) IL 800-770-6582

NAPERVILLE JEEP DODGE 3300 W. Ogden
Ave. Lisle (630) 505-8282 www.napervillejeep.com

GMC Truck
GROSSINGER GMC 6900 N. McCormick
Lincolnwood 866-670-2599 www.grossingergmc.com

Honda
CARR'S HONDA 6600 N. WESTERN AVE.
CHICAGO 773-274-7777 www.carrshonda.com

CASTLE HONDA 6900 W. Dempster, Morton
Grove (847) 965-7070 www.castlehonday.com

ED NAPLETON HONDA South Side's #1 Hon-
da Dealer - 6701 W. 95th St., Oak Lawn 866-430-0044

HONDA CITY 4950 S. Pulaski, Chicago
773-582-5000 www.hondacitychicago.com

McGRATH CITY HONDA 6750 W. Grand Ave.,
Chicago 888-614-4422 www.mcgrathcityhonda.com

O'HARE HONDA - River Rd & Oakton, Des
Plaines. For The Lowest Prices. Call 888-247-0425

PLANET HONDA 157 & Rt. 30, MATTESON AUTO
MALL www.planethondaonline.com 800-780-4139

RIVER OAKS HONDA 17220 Torrence Ave,
Lansing IL 800-928-5630 www.riveroakshonda.com

SCHAUMBURG HONDA - Automobiles "A Bob
Rohman Dealership" 750 E. Golf Rd. 847-88-HONDA

THE HONDA SUPERSTORE OF JOLIET
Route 30 & I-55 815-439-2222 www.hondaofjoliyet.com

VALLEY HONDA in Naperville/Aurora 4173
Ogden Ave. (Rt. 34) 630-851-5700 valleyhonda.com

Land Rover
Bill Jacobs Land Rover Hinsdale 300 E Ogden
Hinsdale, IL 60521 866-516-8045 landrovers.com

Bill Jacobs Land Rover Hoff Est. 1051 W.
Higgins Rd. 60169 866-516-8035 landrovers.com

LAND ROVER CHICAGO AT HOWARD ORLOFF
KENNEDY EXP AT ARMITAGE 888-820-3229

LAUREL LAND ROVER Tinley Park 1-800-509-7439
Now Open! 8031 W. 159th St. laurelandrover.com

PATRICK LAND ROVER 1559 W. Ogden Ave. Naperville
630-300-5000 www.landroverofnaperville.com

Lexus
BREDEMANN LEXUS IN GLENVIEW 2000
N. Waukegan Rd. 847-729-6000 www.bredemann.com

LEXUS OF ORLAND
8300 W. 159th 708-342-6475 www.lexusoforland.com

McGRATH LEXUS OF CHICAGO Kennedy at
Division 877-866-3887 www.mcgrathlexus.com

Hyundai
FAMILY HYUNDAI 8101 W. 159th St. Tinley
Park, IL 60477 800-406-9591 www.familyhyundai.com

GREGORY HYUNDAI 490 Skokie Valley Rd.
Highland Park 800-770-6578

LOREN HYUNDAI 1610 Waukegan Road
Glenview 847-729-0300 www.lorenAutoGroup.com

McGRATH CITY HYUNDAI 6750 W. Grand
Ave., 888-613-6611 www.mcgrathcityhyundai.com

NAPLETON HYUNDAI 1985 River Oaks Drive,
Calumet City, IL www.napleton.com 708-868-6500

O'HARE HYUNDAI River Rd & Oakton, Des Plaines.
For The Lowest Prices Call Direct 888-419-9567

PATRICK HYUNDAI 1020 E. Golf Rd.
Schaumburg www.patrickcars.com 866-314-4539

Hyundai (con't)
WILKINS HYUNDAI 750 N. York Rd., Elmhurst
630-279-3000 www.wilkinscars.com

Hummer
RIZZA HUMMER 8425 West 159th
St., Tinley Park, IL 866-360-4576 www.rizzacars.com

Jaguar
HOWARD ORLOFF JAGUAR www.orloff.com
KENNEDY EXP AT ARMITAGE 888-820-3229

JAGUAR ELMHURST 490 W. Lake St.,
Elmhurst www.jaguarelmhurst.com 888-287-6211

LAUREL JAGUAR OF TINLEY PARK
8031 W. 159th St. 866-451-0812 laureljaguar.com

PATRICK JAGUAR OF NAPERVILLE 1559 W.
Ogden Ave. (877) 749-9921 www.patrickjaguar.com

Kia
Bill Jacobs Kia 2525 W. Jefferson St.,
Joliet 800-630-7607 www.BillJacobsAuto.com

EVERGREEN KIA 9205 S. Western Ave., Chicago
(866) EVERKIA, www.evergreenkia.com

GERALD KIA OF NAPERVILLE 1210 E. Ogden
Ave., Naperville 630-355-3900 www.GeraldKia.com

JOE RIZZA KIA 159th & 80th Ave.
Orland Park, 708-403-0300 rizzacars.com

Pontiac
ARNIE BAUER PONTIAC/BUICK/GMC
Matteson Auto Ma ll Rt 30 & I-57 1-708-720-1900

Bill Kay Buick Pontiac GMC 2300 Ogden,
Downers Grove 630-969-0022 billkaypontiac.com

Grossinger Pontiac 6900 N. McCormick
Lincolnwood 866-670-2599 www.grossingerpontiac.com

Porsche
JOE RIZZA PORSCHE 8130 W. 159th Street,
Orland Park 708-364-2400 rizzacars.com

Loeber Motors Porsche 7101 N Lincoln So. of
Touhy, Lincolnwood 800-952-6831 www.loebermotors.com

Scion
BREDEMANN SCION 1301 W. Dempster,
Park Ridge (847) 698-3700 www.bredemann.com

MIDTOWN SCION 2700 N. Cicero, Chicago, IL
60639 773-622-6300

NORTHBROOK SCION 1530 Frontage Rd
800-734-3205 www.northbrookscion.com

Lincoln-Mercury
BERMAN'S MID CITY LINCOLN MERCU -
RY 4330 W. Irving Park Rd. Chicago 800-509-0391

JOE RIZZA LINCOLN/MERCURY 2055 West
Ogden, Naperville, IL 888-753-4262 rizzacars.com

Mazda
AUTOBARN MAZDA Countryside 6060 S.
LaGrange Rd. 708-354-2700 www.mazdaguys.com
Evanston 1015 Chicago Ave. 847-866-9666
www.mazdaofchicagoand.com

Wilkins Mazda 225 W. Roosevelt Rd
Villa Park 630-495-0800 www.wilkinscars.com

Mercedes-Benz
AUTOHAUS ON EDENS 1600 Frontage Rd
Northbrook 800-716-6517 autohausonedens.com

Loeber Motors * 4255 W. Touhy Ave. Lincolnwood
60712 800-952-5988 www.loebermotors.com

Mercedes-Benz Naperville 1569 W. Ogden Ave
888-769-5484 - mbofnaperville.com

MERCEDES-BENZ OF ORLAND PK 8430 W.
159th St., 866-259-6000 www.mercedesoforland.com

Mercedes-Benz of Westmont 200 E. Ogden
Ave. 866-368-1522 mbofwestmont.com

Mini
BILL JACOBS Mini 1564 W. Ogden Ave.,
Naperville, IL 1-866-516-8015 www.billjacobsmini.com

Mitsubishi
GRAND MITSUBISHI 303 W. Grand Ave.
Bensenville 630-860-3100 GrandMistu.com

MAX MADSEN MITSUBISHI
He's Mad, He's Bad, He's at 3 SALE locations in
Countryside 708-469-5050, Downers Gv 630-960-5040
Aurora 630-898-6000 www.MaxMadsen.com

SOUTH HOLLAND MITSUBISHI 150 W.
159th St. 708-680-5100 www.southhollandmitsubishi.com

Nissan
AUTOBARN NISSAN OF EVANSTON 1034
Chicago Ave. 847-475-8200 www.theautobarn.com

BERMAN'S MID CITY NISSAN 4444 W.
Irving Pk. Rd. Chgo. 888-590-8669 midcitynissan.com

BERMAN'S STAR NISSAN 5757 W. Touhy,
Niles (888) 601-2789 www.starnissan.com

GERALD NISSAN 1575 W. Ogden Naperville 630-
355-3337, 189 & Orchard Rd., N. Aurora 630-907-0800
www.GeraldNissan.com

KELLY NISSAN 4300 W. 95th St.
Oak Lawn 708-499-1000 www.kellynissan.com

MARTIN NISSAN 5240 Golf Road, Skokie
866-838-2300 www.martinnissan.com

Subaru (cont'd)
EVANSTON SUBARU #1 Subaru Dir in Illinois,
715 Chicago Ave., Evanston 60602 1-888-473-1603

GERALD SUBARU 1210 E Ogden, Naperville
630-355-3900 188 & Orchard Rd, N. Aurora
630-907-0800 www.GeraldSubaru.com

Grand Subaru York Rd. & Grand Ave., Elmhurst,
Bensenville www.GrandSubaru.com 630-595-0250

Suzuki
Grossinger Suzuki 6900 N. McCormick
Lincolnwood 866-670-2599 www.grossingersuz.com

JACK PHELAN SUZUKI You Gotta See Jack
7050 W. Ogden, Berwyn 888-400-1847

Suzuki of Elmhurst 334 W. Grand Ave.,
Elmhurst 630-532-5600 www.suzukiofelmhurst.com

Toyota
BREDEMANN TOYOTA 1301 W. Dempster,
Park Ridge 847-698-3700 www.bredemann.com

CHICAGO NORTHSIDE TOYOTA
5625 N. Broadway 773-728-6000 chicagotoyota.com

ELMHURST TOYOTA "The Low Price Leader"
888-205-8340. http://www.elmhursttoyota.com

FOX LAKE TOYOTA 75 S. Rte 12 /Rand Rd
Fox Lake 847-497-9875 www.foxlaketoyota.com

GROSSINGER CITY TOYOTA 1233 N. Wells
Chicago 800-783-9315 www.grossingercitytoyota.com

GROSSINGER TOYOTA NORTH
7225 N. Cicero Ave., Lincolnwood 866-610-8608
Grossingertoyotanorth.com

Libertyville Toyota Scion 1180 S. Milwaukee
Av, Libertyville 877-311-3817 www.libertyvilletoyota.com

NORTHBROOK TOYOTA 1530 Frontage Rd.
800-734-3205 www.northbrooktoyota.com

OAK LAWN TOYOTA 4320 W 95th St. 800-NEW
TOYOTA 800-639-8696 www.oaklawntoyota.com

Orland Toyota/Scion 8505 W. 159th St.
Tinley Park, IL 708-342-6429 www.OrlandToyota.com
www.OrlandScion.com

PAULY TOYOTA 1035 S. Rt. 31, One Mile South of
Rt. 14, Crystal Lake 815-459-7100 847-658-9050

PLANET TOYOTA I-57 & Rt 30, Matteson Auto
Mall, 800-625-7012 www.planettoyotaonline.com

TOYOTA SCION ON WESTERN
6941 S. Western Ave. Chicago
773-884-7200 www.toyotaonwestern.com

Volkswagen
Autobarn Volkswagen Countryside
6191 Joliet Rd. 708-354-8600 (Only 15 minutes from
Downtown Chicago) www.vwofchicagoand.com
Evanston 1033 Chicago Ave. 847-866-7600
Mt. Prospect 333 W. Rand Rd. 847-392-6300
www.theautobarn.com

BILL JACOBS VOLKSWAGEN 2211 Aurora
Ave. Naperville, IL 1-866-516-8025 www.billjacobsvw.com

CITY VOLKSWAGEN 5330 W. Irving Park Rd.,
Chicago 866-717-6611 www.cityvwchicago.com

NORTH SHORE VW 1350 Park Ave W Highland
Park 847-433-7900 www.northshorecars.com

VW OF ORLAND PARK 8920 W. 159th St.
877-444-9167 vwofland.com Sat Service 82

Smart
Smart Center Lincolnwood 4255 W. Touhy
Lincolnwood 800-952-4539 www.loebermotors.com

Subaru
AUTOBARN SUBARU 6070 S. LaGrange Rd.,
Countryside (15 minutes from Downtown Chicago)
708-497-3999 www.theautobarn.com

BERMAN'S MID CITY SUBARU 4300 W.
Irving Pk. Chgo 888-598-7467 subaruchicago.com

Volvo
GROSSINGER VOLVO 6747 N. Lincoln Ave.,
Lincolnwood, IL 866-238-4771

HOWARD ORLOFF VOLVO www.orloff.com
KENNEDY EXP. AT ARMITAGE 888-820-3229

LAUREL VOLVO OF TINLEY PARK
8031 W. 159th St. 866-339-4583 St. laurelvolvo.com

PATRICK VOLVO 1600 E. Higgins Rd.,
Schaumburg 877-749-9921 www.patrickvolvo.com



MULLER HONDA

Highland Park



IT'S MULLER SAVINGS TIME!
1.9%
 APR Financing Available

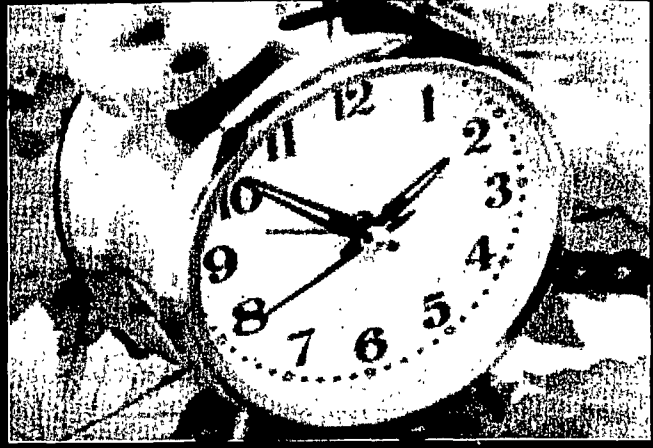

2009 Honda Civic LX
 Sedan
 Automatic Model # FA1859EW, 584R21810
BUY FOR
\$17,499
TIME TO SAVE



2009 Honda Accord LX
 Sedan
 Automatic Model # CP2639EW, 584R21904
LEASE FOR
\$169
 Per Month For 24 Months
TIME TO SAVE



2009 Honda Pilot EX
 4WD
 Automatic Model # BFY449EW, 584R21150
LEASE FOR
\$299
 Per Month For 36 Months
TIME TO SAVE



2009 Honda Odyssey EX
 Model # RL2649EW, 584R21795
LEASE FOR
\$299
 Per Month For 36 Months
TIME TO SAVE



2.9% APR Financing Available On Select Models!	20 TO CHOOSE 2004-07 Accords From \$15,997 To \$27,999	18 TO CHOOSE 2004-07 Civics From \$12,997 To \$19,997	Certified Used Cars	10 TO CHOOSE 2004-07 Odysseys From \$19,997 To \$28,997	12 TO CHOOSE 2004-07 Pilots From \$19,997 To \$31,997	10 TO CHOOSE 2004-07 CR-Vs From \$17,997 To \$28,977
--	--	---	----------------------------	---	---	--

*Prices plus tax, license and dealer fees and destination charge. **Qualified buyers with approved credit through Muller Honda Credit. Special financing for 24 months only. Example 1.9% APR financing for 24 months - \$28.62 per month per \$1000 financed. Dealer reserves financing. See dealer for details. Honda Financial Services and third party credit services apply. Based on a 24-month lease. To qualify buyers with approved credit. \$1,000 down plus tax per year. For the next additional mile. All lease contracts require tax, title license & \$150 (for the above signing). CR-Vs: Residual \$17,659. 09 Odyssey: Residual \$19,500. Additional options extra. Lessee is responsible for excess mileage, wear and tear, insurance, theft, and early termination penalties. Valid from 11/6/08 to 11/30/08. Dealer not responsible for this advertisement. Not available with any previous offers.



MULLER HONDA

Highland Park

Shop On-Line At www.muller-honda.com • 847-831-4200
550 Skokie Valley Road

Today's New Homes

NORTH EDITION NOVEMBER 5-7, 2008

WILLOW FALLS, CREST HILL

Independent senior living

Condominiums make up community's final phase

The Willow Falls condominiums, a new four-story, elevator-equipped building in Crest Hill, offer more than just a maintenance-free lifestyle for active seniors. Whether purchasing or renting a spacious condominium, all residents (at least 55 years of age) become members of a private club that has access to an indoor swimming pool, hot tub, heavily landscaped walking paths, community rooms and more.

This senior living community offers five different studio or one-bedroom floor plans that are carefully placed throughout the secure 78-unit building. With fully equipped kitchens and bathrooms designed to accommodate people with physical disabilities, Willow Falls sets the stage for those looking for an independent senior lifestyle and facilities that provide opportunities for socializing. Bus trips to points of interest are routinely scheduled too.

Situated on 33 picturesque acres, residents can walk along beautifully landscaped paths bordered by flower gardens and trees. Tranquil ponds filled with fish and peaceful gazebos are placed throughout the community too. A 5,000-square-foot recreational center equipped with a television, fireplace, numerous chairs/tables and fully equipped kitchen make this room perfect for parties, special events or family gatherings. Wii bowling tournaments, Tai Chi exercise classes, card games and other activities are hosted here as well.

The lower level of the rec center features a heated swimming pool and an oversized hot tub that can soothe sore muscles. The heated pool is also used for low impact, exercise classes and certified

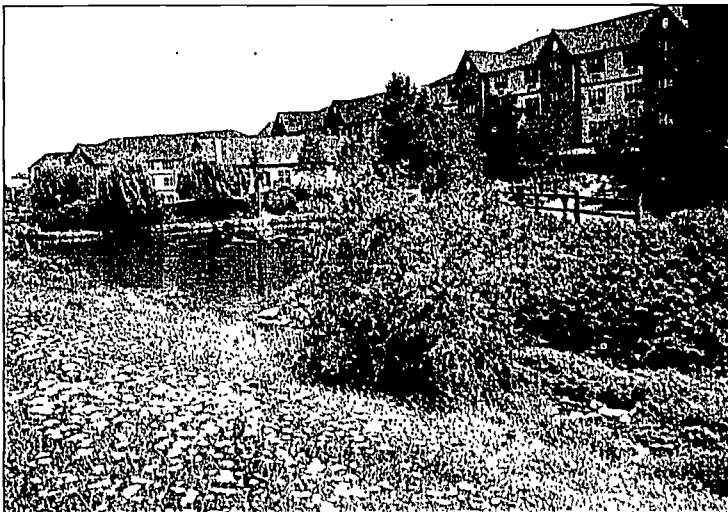

Willow Falls offers seniors an active lifestyle along with high quality studio and one-bedroom condominiums. These maintenance-free homes in an elevator-equipped building can be purchased or rented. The most affordable studio home can be purchased for \$102,895 or rented for \$1,585 per month. Additional spacious one-bedroom condominiums are available for up to \$140,485 or \$2,145 per month.

Arthritis Foundation exercises as well. This self-contained community also boasts an old time general store, bank, hair salon, soda fountain and a dining room. A charming library is accessible to families who wish to surf the Internet, access e-

mail, or pick out a free movie to take back to their private condominium.

For maximum financial flexibility, these studio

Turn to WILLOW FALLS, 8

inside

A boat load of family fun

At Vacation Village, young and old can enjoy high-quality amenities.

Page 3

Have cash for a down payment, job security, a good credit score? Experts believe this home-buying market might be the best since World War II.



Read **Don DeBat**, Page 3

Whether lakes, riverwalks, streams or ponds, there's something soothing about living along the water.

Page 6

online

Market news, expert advice, neighborhood profiles and more. Visit:



searchchicago.com/homes

Find out more online today by visiting www.willowfalls.com

KILDEER ESTATES

MODEL GRAND OPENING SALE



Model Grand Opening Sale
Exquisite customizable homes in a luxurious landscape
From \$599,900-\$1,000,000
Up to \$75,000 in Savings!!!

Kildeer Estates is a magnificent community that combines convenience, quality, the beauties of nature together with the highly acclaimed Stevenson High School. Located on the northeast corner of Quentin Rd and Route 22, Kildeer Estates is just steps away from premier restaurants and shopping at the nearby Deer Park Mall. For a limited time, Dartmoor is offering fully customizable homes from \$599,000. These Model Grand Opening Prices are only for a limited time so hurry in for this special and receive an incentive of up to \$75,000 in savings. Offer expires November 30, 2008.

(Other Dartmoor Communities)

Timber Trails of Western Springs

Custom Homes from \$749,000-\$1,099,000
Maintenance-free Townhomes from \$529,000-\$699,000
1017 White Pine Lane
Western Springs, IL 60558
(708) 783-1600

Pre-Construction Pricing

Devonshire Woods of Hoffman Estates
Custom Homes from \$639,000-\$749,000
1684 Heron Way
Hoffman Estates, IL 60192
(847) 289-0022

Close-out Special Weatherstone of Inverness

Maintenance-free Townhomes from \$639,000-\$799,000
(847) 842-0400 or
(847) 230-7060

Stevenson High School Coventry Creek of Lake Zurich

Custom Homes From \$719,000-\$779,000
1432 Conrad Lane
Lake Zurich, IL 60047
(847) 726-3600



OFFER EXPIRES NOVEMBER 30, 2008

Sales near 85 percent mark at park-like senior haven at Belle Plaine Commons

Seniors searching for an affordable condominium in a park-like setting are invited to tour Belle Plaine Commons at 2335 W. Belle Plaine Avenue near Irving Park and Western avenues in the North Center neighborhood.

A groundbreaking ceremony was held recently for a park on the campus that houses several senior living facilities, including Belle Plaine Commons, a five-story, 92-unit new-construction condominium development.

Sales are nearing the 85-percent mark at Belle Plaine Commons, which anchors the north side of the five-acre North Center Senior Campus, bounded by Irving Park Road, Western Avenue, Belle Plaine Avenue and Oakley Avenue.

"There is still a wide selection of one-bedroom, one-bedroom-plus-den and two-bedroom residences available at Belle Plaine Commons," said Judy Westerberg, sales manager for Garrison Partners Consulting, the exclusive sales and marketing agent for North Center Associates, the developer. "But at these prices, this is a rare opportunity that won't last."

Prices at Belle Plaine Commons range from \$194,990 to \$212,990 for one-bedroom condominiums with 848 to 900 square feet of living space; \$204,990 to \$249,990 for one-bedroom plus den condominiums with 944 to 1,011 square feet of living space; and \$245,990 to \$298,990 for two-bedroom condominiums with 1,134 to 1,288 square feet of living space.

All prices include one outdoor parking space. Heated garage parking is available for an additional \$15,900.

Current average prices for one-bedroom condominiums elsewhere in the North Center neighborhood are about \$237,000, and two-bedroom condominiums go for about \$392,000, making Belle Plaine Commons a rare and attractive choice for discerning adults.

City officials, members of the North Center neighborhood (including senior renters and condo owners from the senior campus and surrounding neighborhoods), recently attended a groundbreaking ceremony for a new half-acre park, which is planned for completion this fall, Westerberg said.

The parcel of land is the second and largest of two parks on the block-long senior housing campus that encompasses Belle Plaine Commons, the 104-unit Martha Washington rental apartments, and the 86-unit St. Vincent DePaul Residence. The new park is at the hub of the three senior housing buildings, while the first and smaller park is nearing completion at Oakley and Belle Plaine, Westerberg said.



To visit this community

The Belle Plaine Commons sales center, at 2335 W. Belle Plaine Avenue, is open Saturday through Wednesday from 10 a.m. to 5 p.m. The sales center is closed Thursday and Friday. View floor plans and amenities at www.belleplainecommons.com. For more information or a personal appointment, call Judy Westerberg at (773) 442-6995.

Workers have now begun efforts to transform the larger park from soft mounds of dirt into a floral den of sorts replete with flowers and foliage, benches, Romanesque colonnades and a fountain.

"Each park will have a fountain that is being imported from England, no less," Westerberg said.

"We wanted to create a model that really did not exist anywhere in America," Ald. Schuller said, addressing the small crowd that gathered for the park's ground breaking, which included a delegation of city officials and others who wielded golden shovels to "break" ground for the park's construction start.

Others on hand for the event Father Robert Beaven, St. Benedict Parish; Ralph Brown, president, Technical Assistance for Corporate Housing (TACH) Development; Nelson Cheung and Dinal Wayne, Department of Planning & Development; Bill Povalla, assistant commissioner for senior housing, Department of Housing; Tom O'Donnell, president, Ravenswood Community Council; Kevin Clark, landscape engineer and project manager, Lakota Group.

Belle Plaine Commons is especially appealing to empty-nester singles and couples who have owned homes, two-flat or three-flat buildings in the neighborhood and have seen a strong rise in property values and real estate taxes.

"With the mayor's support, we were able to open on July 1 our senior satellite facility here that provides the opportunity of living computer usage and a luncheon program Monday through Friday," Ald. Schuller said.

Ralph Brown, president of TACH Development, one of the developers of the senior housing campus, chronicled the effort to bring both the senior housing and the green spaces to fruition. He said developing the parks has been an eight-year process so far, cross-pollinating the efforts of several developers and the city and several funding sources.

The developers of the three senior buildings formed Central Green Corporation, a nonprofit, to develop the parks.

Though privately developed, the parks ultimately will be open to the public upon completion, Brown said.

"When the construction is finished, we're going to turn them over to the city," Brown said. "So these will be city parks."

The Lakota Group designed the parks. "I think it's going to be tranquil," said Kevin Clark, a landscape engineer with The La-

Kota Group. "That's the one word. Hopefully, it'll be a nice respite from the busy street."

The fountain will be the focal point of the central park, Clark said. He described the design as being like "an open lawn with a nice path."

Architectural remnants from the razed building where the larger park will stand will be part of the design, Clark said.

"They salvaged some columns and the pediments that go along the top of them," Clark said. "The four columns are going to be at the corner of Belle Plaine and Oakley as the entrance to the park, from the corner. It's going to be a pretty cool thing. That are going to be the entrance to the parks."

A decorated model is available for viewing at Belle Plaine Commons, said Rena Appel of North Center Associates.

"The majority of the buyers at Belle Plaine Commons are people who have resided in or near the North Center neighborhood for decades and who are looking forward to maintenance-free condominium living," Appel said.

"We also are attracting buyers from the suburbs, other city neighborhoods and people from out of state who are moving back to North Center to be near their grown children who own homes or condominiums in the neighborhood," Appel said.

"It's a condo that is comfortable to live in, yet designed for a buyer who is downsizing from a larger home, townhome or condominium," Westerberg said.

"Many of these long-time neighborhood residents are tired of the financial and physical burdens of maintaining their aging

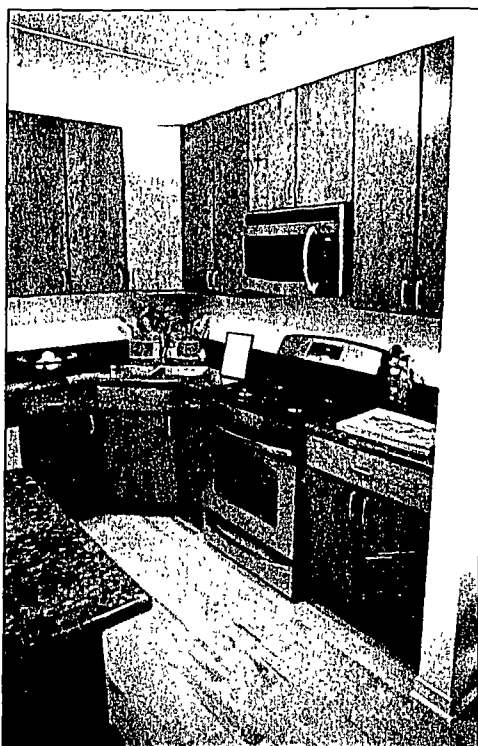

All residences at Belle Plaine Commons feature 9-foot ceilings; ceramic-tile flooring in the foyer, kitchen and bathrooms; carpeting in the living room, dining room and bedrooms; individually controlled HVAC; and high-speed Internet capability.

properties," Appel noted. One member of the household has to be 55 years of age or better, but the other member may be as young as 48 years, he said.

Upscale building amenities include a furnished lobby, community room, fitness center and a library.

The lower level of the building contains the 58, leased parking spaces and individual resident storage lockers. The 43 outdoor parking spaces and 11 guest parking spaces are located in a parking lot contiguous to the building.

Most residences have balconies, Juliet balconies or patios. Kitchens are equipped with G.E. appliances, including refrigerator with icemaker, gas oven and range, dishwasher, disposal, and built-in microwave oven and designer cabinetry.

Most baths include ceramic tile, oversized mirrors, linen closets and designer cabinetry. Residents of Belle Plaine Commons will have access to the Advocate Health Center, also part of the Senior Campus.

Ald. Schuller has long said it was his long-range goal to build a senior campus to enable longtime residents to remain in the community.

"Many seniors who have to move out of their homes for a variety of reasons including financial, health and mobility issues now have the opportunity to remain in their neighborhood," Ald. Schuller said.

"In partnership with Ald. Schuller and the City of Chicago, Advocate Health Care was pleased to be able to donate five acres of land to make affordable housing a reality for senior citi-

zens in the 47th Ward," said Jim Skogsborg, Advocate's president and chief executive officer.

Belle Plaine Commons is located in the heart of the North Center neighborhood, on the northern edge of Lake View and near the upscale housing enclaves of St. Ben's, Ravenswood and Lincoln Square.

New restaurants and shops have made this area one of the fastest growing and most popular in Chicago.

The Belle Plaine Commons sales center, at 2335 W. Belle Plaine Avenue, is open Saturday through Wednesday from 10 a.m. to 5 p.m. The sales center is closed Thursday and Friday. View floor plans and amenities at www.belleplainecommons.com. For more information or a personal appointment, call Judy Westerberg at (773) 442-6995.

Lincolshire Place
ON THE VILLAGE GREEN

62 New construction luxury, full amenity condominiums by Weiss Development in downtown Lincolshire.

Stop looking. Start Living.

Call Today 847.276.2670

www.lincolshireplace.com

To grandmother's vacation house we go

Vacation Village living gets better and better, any time of year

Life at Vacation Village condominium development, a lakefront summer and winter vacation spot located at 6800 State Park Rd. in Fox Lake is just about to get even better.

Long-time Chicago-area developers and partners of Vacation Village Venture LLC added an additional 114 units to enhance the existing condo buildings built in 1970. A picturesque gated community, Vacation Village is situated on Dunn's Lake with easy access to the Chain of Lakes. Grandma and Grandpa, make way for the kids; this new plan provides more spacious condominium

units to accommodate visits from the whole fun-loving family.

Jeff Nelson, sales manager for the group, said approximately 300 people showed up on Saturday, Aug. 30, for a Labor Day kick-off party at the site. Completion of the first condo units is estimated before the end of the year. Vacation Village Venture LLC is offering incentives for early buyers, including full payment of association dues for the first year.

On any given summer day, a visit to Vacation Village will find the place teeming with adults and kids of all ages... splashing in the large, inviting pool, swinging on the playground or grilling and laughing it up with family on patios that overlook the calm, boat-studded lake. All this in an otherwise quiet, mostly adult population of condo owners ranging from week-end warriors making the one-hour

trek from Chicago and snow birds who flock here for the summer to first-time buyers looking for a great value and lush surroundings.

Fortunately for today's buyers, the fun at Vacation Village is not wasted on the young. According to Nelson, it's all about amenities, amenities, amenities, and the developers are proud to offer a long list of high quality products as standard features rather than as upgrade options. He believes condo units with this list of standard amenities would usually sell for a much greater price.

All of this fits the developer's mantra of giving the buyer the best product for the money; buyers get the advantage of high quality amenities without being optioned to death.

New units at Vacation Village—two-bedroom or two-bedroom plus a den—are priced from \$219,000 to \$259,000.

Sizes range from 1250 to 1475 square feet. All units have multiple balconies and most units have water views.

Standard features include maple cabinets; solid surface counter tops; GE or Whirlpool appliances; washer and dryer; central AC; six-panel colonist door; oversized trim; ceramic tile; double hung windows with Low-E glass; upgraded carpet; fire alarm and sprinkler system.

Upgrade options include raised panel cabinets; granite counter tops; hardwood floors; pine or oak doors and trim; appliance upgrade; Whirlpool bathtub; shower stall in lieu of bathtub, and fireplace.

Vacation Village, a waterfront property surrounded by 100 acres of forest, nature trails and walking paths, is a nearby vacation destination for the entire family. Recreational amenities include access to the Chain of Lakes; private beach for residents; private boat slips; pool; club house

and tennis courts. Winter attractions include cross-country skiing, snowmobiles and a toboggan slide will keep kids coming back for more.

The developers believe Vacation Village offers exactly what many purchasers desire most in this market and are proud to offer the highest quality for the best dollar value. Buyers will enjoy the larger units to keep the family vacationing together (new condo units are twice the size of the original Vacation Village units) and a vacation destination that's less than a gas tank away from Chicago. Throw in an easy commute to the city (the Metro station is a five minute drive from Vacation Village) and you're looking at a boat-load of quality and fun in these financially difficult times.

For sales and general information about Vacation Village, contact Nelson at (847) 951-9895.

Now may be best home-buying market since World War II

Amid what some experts believe may be the best home-buying market since the end of World War II, Chicago-area house hunters who are bold enough to sign a residential sales contract are beginning to reap hefty financial rewards, often saving tens of thousands of dollars, analysts say.



Don DeBat ON THE HOME FRONT

If you are thinking about purchasing a home or condominium this fall, have down payment cash, job security, a good credit score, and can qualify for a mortgage, "now may be the perfect time to buy," advises Nicholas S. Gouletas, chairman and CEO of American Invivo.

"The current downturn is not a real estate crisis in the United States. It is a financial crisis," noted Gouletas, a condo-conversion specialist who has developed, marketed and managed over 45,000 units in more than 100 buildings in 40 markets nationwide since 1969.

"It's still very much a buyer's market," Gouletas said.

Although it may take "up to three years" for the Chicago-area housing market to fully rebound, Gouletas expects it to come roaring back.

Resale home sales numbers improved in September as people took advantage of the buyers-market conditions with low interest rates, ample supply, and negotiating room on price, according to Illinois Association of Realtors.

The Chicago-area existing home market is down, but far from dead, reported the latest IAR home sales survey for the Chicago area. Single-family

home and condominium sales totaled 6,371 units. While the sales number is 6.2 percent less than the 6,794 home sales in September of 2007, the total is impressive, considering the shape of the economy.

The median home sale price for the Chicago area was \$224,000 in September 2008, down 13 percent from \$257,500 in September 2007, so there are bargains to be had in the Chicago area. The IAR survey includes Cook, DeKalb, DuPage, Grundy, Kane, Kendall, Lake, McHenry and Will counties.

"Some downward pressure on prices is expected as we move through the inventory of homes and some would-be buyers and sellers simply wait out uncertainty in the financial markets and economy," observed Pat Callan, president of the IAR.

Another positive exists for first-time purchasers, who between now and June 30, 2009,

are eligible for a new \$7,500 tax credit and increased loan limits on FHA-insured mortgages.

"The economy has reached proportions that have many analysts suggesting that it is by far the worst since the Second World War," noted Dr. Geoffrey J.D. Hewings, director of the Regional Economics Applications Laboratory (REAL) of the University of Illinois.

"With the passage of the bailout plan and the international collaborative efforts to address the systemic problems of ailing economies, there is some basis for optimism that a turnaround may be possible in 2009," said Hewings.

The Home Front, Don DeBat's weekly real estate column syndicated by DeBat Media Services, unravels the complexities of home buying, mortgage shopping, homeownership, renting, building, renovation and re-

modeling. For more home-buying information, visit his Web site at www.dondebat.net.

Today's New Homes

NORTH EDITION is produced by Fox Valley Publications, 495 North Commons Drive, Suite 200, Aurora, Illinois.

Vol. 1, No. 22

Editorial Tammy Matthews, PIONEER PRESS (847) 486-7312; tmh@pioneerlocal.com

Advertising Mike Sperling, BUILDER ADVERTISING SENIOR DIRECTOR (312) 321-2176; msperling@suntimes.com

Rita Walker, BUILDER ADVERTISING SALES MANAGER (708) 633-4924; rwalker@mwpml.com

Jessica Santillo (847) 599-2132; jsantillo@pioneerlocal.com

Dick Walters (708) 524-4428; dwalters@pioneerlocal.com

"You're Moment Has Arrived... Model Grand Opening"

THE ADDRESS YOU WANT...THE LIFESTYLE YOU DESERVE.

Seven minutes to 294...five minutes to 94...and...steps to Whole Foods, Starbucks and more. Onsite sales center located at the corner of Techny Rd. and Founders Drive. Just west of Waukegan Rd. **Sales hours: M,W-F: 11:00-6:00. Tuesday by appt. Sat. & Sun.: 12:00-5:00.**

FROM \$495K

Call or Email today (847) 559-0500 www.MeadowRidgeNorthbrook.com

KZF development. Kogen-Zivin-Friedman

Sales by: **GIBSON & JAMES** Properties Inc.

MEADOW RIDGE

MORTGAGE GUIDE

Check rates daily at <http://suntimes.interest.com>

Bankrate.com

Program	Rate	Points	Fee	% Down	APR
GREAT NORTHERN FINANCIAL CORP. 630-653-4700 http://www.gnfc.com					
30 yr fixed	Call for Rates				
15 yr fixed	Call for Rates				
5/1 jumbo ARM	Call for Rates				
7/1 jumbo ARM	Call for Rates				
FHA allows purchase with 3% down and cash out refi to 95% (A) 2850 Golf Rd., Ste. 403, Rolling Meadows, IL 60008					
PRESTIGE MORTGAGE CORPORATION 708-579-3333 http://www.prestigemortgage.com					
30 yr fixed	6.250	0.000	\$575	5%	6.283
15 yr fixed	5.750	0.000	\$575	5%	5.804
5/1 jumbo ARM	5.375	0.000	\$575	20%	4.620
7/1 jumbo ARM	5.625	0.000	\$575	20%	4.891
Celebrating 14 years. A select member of the BBB. (B) 130 N. LaGrange Rd., Ste. 110, LaGrange, IL 60525 MB0004300					
ABI MORTGAGE 847-585-1995 http://www.abimortgage.com					
30 yr fixed	6.125	1.000	\$1300	20%	6.295
30 yr FHA	6.000	1.000	\$1300	5%	6.177
5/1 ARM	5.250	1.000	\$1300	20%	5.362
5/1 jumbo ARM	5.375	1.000	\$1300	20%	5.365
CASHOUT REFINANCE UP TO 95% via FHA! (B) 1901 N. Roselle Rd., Suite 320, Schaumburg, IL 60195					
AMERICAN DREAM MORTGAGE CORPORATION II 866-407-0920 www.AmericanDream2.com					
CALL THE EXPERTS FOR RATES! FHA, VA, Reverse & Rehab Loans					
Now is A Great Time to Buy A Home! 1st time HomeBuyer Tax Credit					
Up To \$7500! Buy a HUD home for \$100 down and get a 203k Rehab Loan to do Repairs! Refinance up to 95% LTV, Pay off Credit Cards					
(B) 2829 W. 87th Street, Evergreen Park, IL 60805 MB.6759334					
AT HOME MORTGAGE GROUP 847-971-9674 http://www.AllHomeMortgage.com					
30 yr fixed	6.250	0.000	\$889	20%	6.369
15 yr fixed	5.875	0.000	\$714	20%	6.067
5/1 ARM	5.375	0.000	\$945	20%	5.856
5/1 jumbo ARM	5.375	0.000	\$945	20%	5.782
(C) 10410 S. Route 31, Suite 2, Algonquin, IL 60102 MB.6760504					
MORTGAGE RATES & INFO AVAILABLE 24 HRS A DAY, 7 DAYS A WEEK ON THE INTERNET @ http://suntimes.interest.com					
Loan Program	Rate	Monthly Payment			
1 yr ARM	6.09%	\$998.83			
5 yr ARM	6.67%	\$1,061.43			
15 yr fixed	6.46%	\$1,433.70			
30 yr fixed	6.77%	\$1,072.38			
Source: Bankrate.com. For more information visit www.bankrate.com . Bankrate national average based on 100 largest institutions in the top 10 markets in the United States.					

LENDERS, TO PARTICIPATE IN THIS FEATURE CALL BANKRATE.COM SALES DEPARTMENT @ 800-509-4636

TODAY'S NEW HOMES

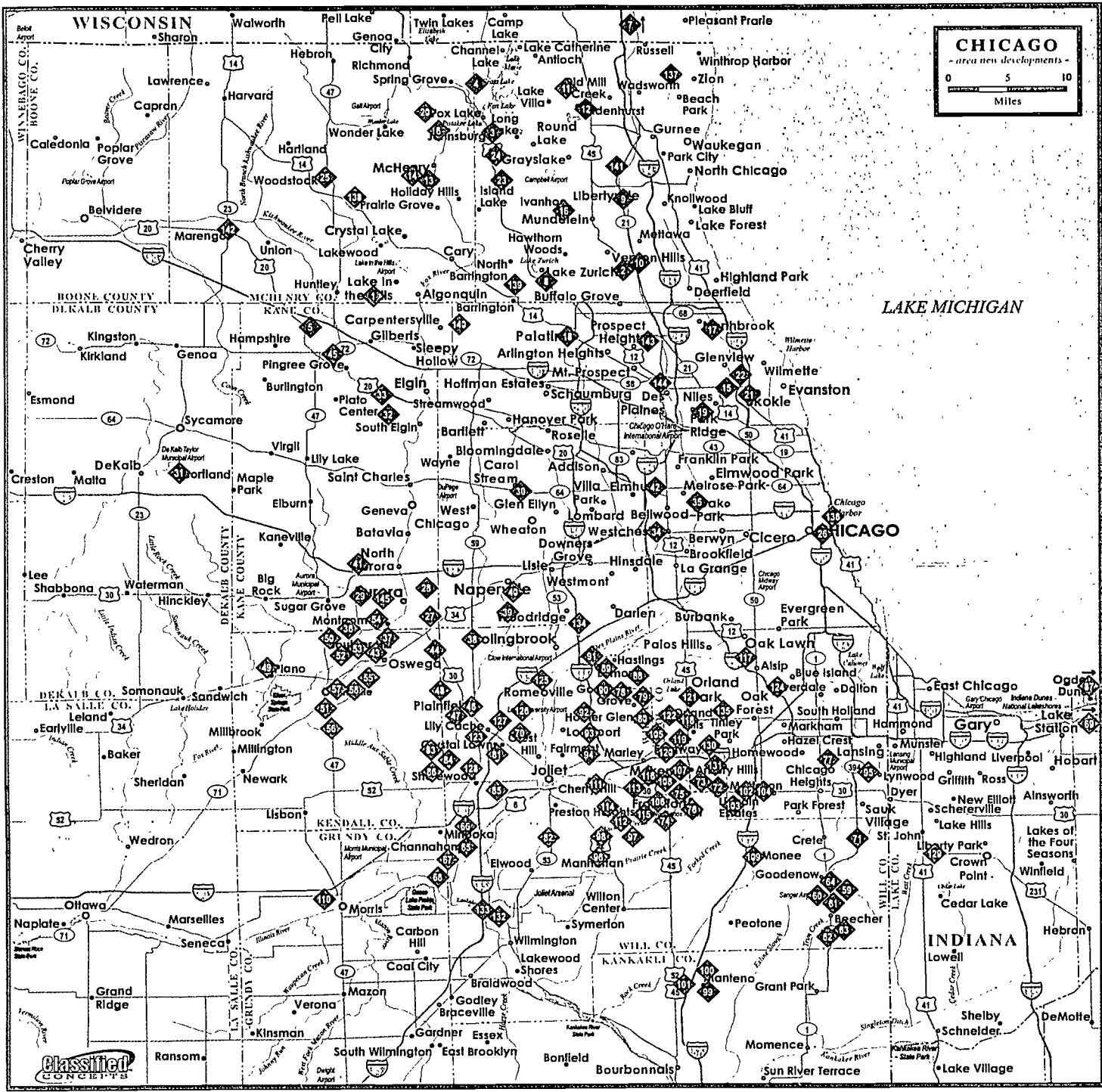

FALL SHOWCASE DIRECTORY

- Looking for a new home?**
Use our interactive new homes map
- YORKVILLE** 9 listings
OSWEGO 2 listings
- searchchicago.com/buildermap
Browse new homes by location, visiting builders' websites, get turn-by-turn directions and more.
- Today's New Homes**
- CHANNAHAN**
66 Channahon Town Center
Platinum Properties
ppthomes.com
\$239,000 (SF)
815-521-4601
- 65 Channahon Town Center**
Platinum Properties
ppthomes.com
\$379,000 (TH)
815-521-4601
- 67 Hunter's Crossing**
Sharp Builders
sharphomesusa.com
\$189,900 to \$270,000 (SF)
815-467-4699
- 68 Deer Ridge**
Scaggs Construction
scaggsconstruction.net
\$240,000 (SF)
815-521-4610
- CHESTERTON, Ind.**
69 Village Green at Coffee Creek
Phillippe Builders
phillipebuilders.com
\$197,900 (TH)
219-921-1200
- CREST HILL**
70 Renaissance Crossing
Zausa Homes
zausahomes.com
\$166,000 (CN)(SF)
708-745-5461
- 71 Prairie Trails**
Phillippe Builders
phillipebuilders.com
\$221,900 (CN)
630-243-6162
- FRANKFORT**
72 White Oak
Blackwater Development
blackwaterconstruction.com
\$395,000 (SF)
815-464-9400
- 73 Lighthouse Pointe**
Circle II
\$339,900 (TH)
815-464-1201
- 74 Misty Falls**
Flaherty Homes
flahertyhomes.com
\$166,999 (SF)
815-464-2213
- 75 Abbey Woods**
Flaherty Homes
flahertyhomes.com
\$449,900 (TH)
815-806-1521
- 76 Lighthouse Pointe**
Kirly Construction Co.
\$429,900 (RN)
815-485-6202
- GLENWOOD**
77 Villas Of Glenwood
Lincoln-Way Builders
lincoln-wayhomes.com
\$243,000 (RN)(DU)
708-758-2436
- 78 Erin Hills**
Finnegan Construction
finneganconstruction.com
\$650,000 to \$699,000 (SF)
630-257-3408
- 79 Goodings Grove**
Gallagher & Henry
gallagherandhenry.com
\$269,300 (CN)
708-301-9790
- 80 Kingston Hills**
Gallagher & Henry
gallagherandhenry.com
\$279,325 (TH)
708-301-7203
- 81 Timbers Edge Villas**
Epcor Communities
epcorcommunities.com
\$219,557 to \$241,915 (RN)
815-609-0150
- 82 Estates at Cedar Creek**
Pasquini Homes
pasquinihomes.com
\$193,990 to \$298,790 (SF)
815-726-8700
- 83 Theodore's Ridge**
Pasquini Homes
pasquinihomes.com
\$196,990 to \$273,990 (SF)
815-254-1313
- 84 Whisper Glen**
Phoenix
\$199,900 (SF)
708-946-0100
- PHOENIX DEVELOPERS**
85 Silver Leaf
Phoenix
phoenixdevelopers.com
\$150,000 to \$159,900 (TH)
815-730-0008
- 86 Hunter's Ridge**
Sharp Builders
sharphomesusa.com
\$180,000 to \$284,000 (SF)(TH)
815-521-9609
- LAPORTE, Ind.**
87 Outlook Cove
Outlook Cove LLC
gmt1.com
\$219,900 (CN)
219-362-7722
- 88 Glens at Connemara**
Castletown
castletownhomes.com
\$520,000 (SF)
630-257-2600
- 89 Woodglen**
Downen
downenhomes.com
\$459,900 (TH)
630-243-1818
- 90 Ashbury Woods 2**
Downen
downenhomes.com
\$389,900 (TH)
630-243-1110
- 91 Lemont Lofts**
Marquette Management
lemontlofts.com
\$221,900 (CN)
630-243-6162
- LOCKPORT**
92 Creekside Estates South
Beechen & Dill Homes
beechendill.com
\$384,900 to \$600,000 (SF)
815-838-4357
- 93 Oak Creek**
MC/BWC
oakcreeklockport.com
\$350,000 to \$359,999 (SF)(TH)
815-838-5506
- 94 Vintage Of Willow Walk**
Zausa Homes
zausahomes.com
\$201,990 to \$219,990 (TH)
815-407-1150
- LYNWOOD**
95 Creekside Pointe
J&T Homes
jandthomes.com
\$195,000 (TH)
708-474-4025
- MANHATTAN**
96 Autumn Creek
Leighlin/Briggs
leightlinbriggs.com
\$264,900 (SF)
815-462-4035
- 112 Taylor Glen**
Camelot Homes
camelot-homes.com
\$300,000 (SF)
815-485-1100
- MANHATTAN**
96 Manor Lakes at Leighlin/Briggs
Hartz
hartzhomes.com
\$285,900 (SF)
815-463-0945
- 115 Water Chase**
Hearthside
hearthsidehomebuilders.com
\$450,000 (SF)
815-485-2400
- 116 Horizon Meadows**
Hearthside
hearthsidehomebuilders.com
\$369,000 (SF)
815-485-2400
- 131 Brookside Glen**
Blackwater Development
blackwaterconstruction.com
\$249,900 (CO)
815-464-9400
- OAK FOREST**
135 Heritage Ridge Condos
Heritage Ridge North & South, Inc.
heritageridgecondos.com
\$184,625 (CO)
708-687-4200
- OAK LAWN**
117 Foxwoods
Dremco
DremcoHomes.com
\$220,000 to \$250,000 (CO)
708-396-8676
- ORLAND PARK**
118 Colette Highlands
Cachey Homes
cacheybuilders.com
\$304,900 (TH)
708-349-8586
- 103 Maplebrook Homes**
MC/Sales
maplebrook.net
- OSWEGO**
43 Mill Street Station
Stevco Builders
stevcobuilders.com
\$230,000 (TH)
630-363-5955
- 44 Prescott Mill**
Pulte Homes
pulte.com
\$160,000 (TH)
630-551-2490
- 64 Hunter's Chase**
Phillippe Builders
phillipebuilders.com
\$199,900 (SF)
708-946-0100
- PINGREE GROVE**
45 Cambridge Lakes
Cambridge Homes
\$150,000 to \$169,900 (CO)(SF)
630-898-2778
- 28 Sheffer Woods**
E&A Construction
eaconst.com
\$270,000 to \$300,500 (SF)
630-554-3997
- 29 Tanglewood Oaks**
Tanglewood Homes
tanglewood-homes.com
\$300,000 (SF)(RN)
630-897-2026
- CAROL STREAM**
30 Easton Park
Lakewood Homes, Inc.
lakewoodhomes.com
\$300,000 (CO)(SF)
630-665-0531
- CORTLAND**
31 Richland Trails
Cambridge Homes
mycambridgehome.com
\$142,000 to \$178,000 (SF)
847-984-4994
- ELGIN**
32 Edgewater
Del Webb
delwebbchicagoand.com
\$190,000 (SF)
847-697-8200
- 33 Providence**
Town & Country Homes
townandcountryhomes.com
\$179,995 to \$449,995 (CO)(SF)(TH)
866-902-6341
- HILLSIDE**
34 Westbrook Condominiums
Westbrook Development LLC
wbcondo.com
\$99,000 (CO)
888-830-3837
- MAYWOOD**
35 221 North First Avenue
KLY Development
221northfirstavenue.com
\$246,177 (CO)
708-410-2664
- MONTGOMERY**
36 Foxmoor
Cambridge Homes
mycambridgehome.com
\$242,500 to \$321,000 (SF)
847-984-4580
- 37 Boulder Hill Condos**
SW Boulder Ventures, LLC
boulderhillcondos.com
\$75,900 to \$113,900 (CO)
630-844-8500
- 145 Balmorea**
Santoga Homes
mysantogahome.com
\$159,000 (SF)(TH)
866-481-5144
- NAPERVILLE**
38 Carillon Club
Cambridge Homes
mycambridgehome.com
\$186,000 to \$388,000
847-984-4857
- 39 The Ponds of Naperville**
Marquette Management
pondsofnaperville.com
\$130,000 (CO)
630-848-0488
- 40 R/K Design Group**
\$1,579,500 (SF)
630-527-9466
- NORTH AURORA**
41 Lake Run Estates
Toll Brothers
tollbrothers.com
\$412,975 (SF)
630-208-0600
- NORTH LAKE**
42 Wolf Ridge
Neri Companies
nericons.com
\$232,900 (CO)
- OSWEGO**
43 Mill Street Station
Stevco Builders
stevcobuilders.com
\$230,000 (TH)
630-363-5955
- 44 Prescott Mill**
Pulte Homes
pulte.com
\$160,000 (TH)
630-551-2490
- 64 Hunter's Chase**
Phillippe Builders
phillipebuilders.com
\$199,900 (SF)
708-946-0100
- PLAINFIELD**
46 Patriot Square
Cambridge Homes
mycambridgehome.com
\$193,000 to \$226,000 (TH)
847-984-4949
- 47 Liberty Grove**
Cambridge Homes
mycambridgehome.com
\$250,000 to \$339,000 (SF)
847-984-4550
- 48 Grande Park**
MPI
grandpark.com
\$200's to \$800's (SF)(TH)(DU)
866-244-7275
- PLANO**
49 Wood Wind
Sharp Homes
sharphomesusa.com
\$185,000 to \$279,000 (SF)(DU)
630-552-0780
- YORKVILLE**
50 Bristol Bay
Centex
centexhomes.com
\$132,995 (SF)(TH)(CO)
866-668-6422
- 51 Whittail Ridge**
Dev. Matt Blocker
\$152,500 to \$350,000 (SF)
630-554-1705
- 52 Mill Crossing at Grand Reserve**
Pasquini Homes
pasquinihomes.com/chicago/
millcrossing.aspx
\$145,990 to \$212,990 (TH)
630-896-5368
- 53 Pioneer Place at Grande Reserve N.**
Pasquini Homes
pasquinihomes.com
\$171,990 to \$253,990 (TH)
630-553-9185
- 54 Colonies at Grand Reserve**
Pasquini Homes
pasquinihomes.com
\$181,900 to \$283,990
630-553-1518
- 55 Traditions at Grand Reserve**
Pasquini Homes
pasquinihomes.com
630-553-3952
- 56 Commons at Grand Reserve**
Pasquini Homes
pasquinihomes.com
\$143,990 to \$203,990 (TH)
630-896-5179
- 57 Autumn Creek**
Pulte Homes
pultechnicagoland.com
\$130,000 (TH)
630-553-4300
- 58 Autumn Creek**
Pulte Homes
pultechnicagoland.com
\$230,000 (SF)
630-553-4300
- 61 Prairie Park**
Castletown
castletownhomes.com
\$170,000 (DU)
708-946-9620
- 62 Preserve at Cardinal Creek**
MGM
mgm-homes.com
\$249,990 (SF)
708-946-1560
- 63 Preserve at Cardinal Creek**
MGM
mgm-homes.com
\$145,000 to \$250,000 (TH)
708-946-1560
- 64 Hunter's Chase**
Phillippe Builders
phillipebuilders.com
\$199,900 (SF)
708-946-0100
- mycambridgehome.com**
\$135,000 to \$411,000 (SF)(MFRD)
847-984-4881
- WOODSTOCK**
25 Woodstock Station
Brownstones
Hummel Group, Ltd.
thehummelgroup.com
\$250,000 to \$388,000
847-984-4857
- 138 Ponds of Bull Valley**
Deerpointhomes.com
deerpointhomes.com
\$243,000 (SF)
815-337-1410
- 39 The Ponds of Naperville**
Marquette Management
pondsofnaperville.com
\$130,000 (CO)
630-848-0488
- 40 R/K Design Group**
\$1,579,500 (SF)
630-527-9466
- NORTH AURORA**
41 Lake Run Estates
Toll Brothers
tollbrothers.com
\$412,975 (SF)
630-208-0600
- NORTH LAKE**
42 Wolf Ridge
Neri Companies
nericons.com
\$232,900 (CO)
- OSWEGO**
43 Mill Street Station
Stevco Builders
stevcobuilders.com
\$230,000 (TH)
630-363-5955
- 44 Prescott Mill**
Pulte Homes
pulte.com
\$160,000 (TH)
630-551-2490
- 64 Hunter's Chase**
Phillippe Builders
phillipebuilders.com
\$199,900 (SF)
708-946-0100
- ALGONQUIN**
1 Terrace Lakes
Wynwood Builders
villasofchesnutridge.com
\$400,000 (CO)(SF)
847-658-8608
- BARRINGTON**
139 Woodland Shores
Harris Builders
harriscustombuilders.com
\$2,590,000 (SF)
847-382-2210
- 140 Hidden Valley**
Harris Builders
harriscustombuilders.com
\$3,790,000 (SF)
847-382-2210
- BUFFALO GROVE**
2 Villas of Chestnut Ridge
Kevin Charles Homes
villasofchesnutridge.com
\$587,900 (SF)
847-295-8400
- DES PLAINES**
144 Lexington Park
Lexington Homes
lexingtonchicago.com
\$380,000 (TH)
847-299-0500
- FOX LAKE**
3 Duck Lake Crossing
Reserve One Homes
reserveonehomes.com
\$15,759-0808
- 4 Vern's Landing**
Reserve One Homes
reserveonehomes.com
\$15,759-0808
- HAMPSHIRE**
5 Lakewood Crossing
Lakewood Homes, Inc.
lakewoodhomes.com
\$160,000 to \$220,000 (CO)(SF)
847-683-3379
- JOHNSBURG**
6 Running Brook Farm
Reserve One Homes
reserveonehomes.com
\$15,759-0808
- 140 Hidden Valley**
Harris Builders
harriscustombuilders.com
\$3,790,000 (SF)
847-382-2210
- KENOSHA, Wisc.**
7 Kilbourn Woods
Cambridge Homes
mycambridgehome.com
\$200,000 to \$245,000 (SF)
847-984-4855
- LAKE ZURICH**
8 Meadow Wood
Pulte Homes
pulte.com
\$260,000 (TH)
847-550-8025
- LIBERTYVILLE**
9 School Street District
Brownstones
The Hummel Group, Ltd.
thehummelgroup.com
\$800,000 (TH)
224-513-5500
- 141 The Enclave at the Reserve at the Merit Club**
Merit Homes
merithomes.net
\$800,000 (SF)
847-680-0090
- LINCOLNSHIRE**
10 Lincolnshire Place
Weiss Development
lincolnshirereplace.com
\$419,900 to \$939,900 (CO)
847-276-2570
- LINDENHURST**
11 Grant's Grove
Pulte Homes
pulte.com
\$340,000 (SF)
847-265-5378
- 12 Heritage Park**
Pulte Homes
pultechnicagoland.com
\$270,000 (TH)
847-245-7374
- MARENGO**
142 Deeppass Meadows
Leonard W. Besinger & Associates
doerpass.net
\$266,000 (TH)
815-568-0011
- MCHENRY**
13 The Greens of Irish Prairie
Cnat Inc.
greensofirishprairie.com
\$97,900 to \$139,900 (CO)
815-363-0322
- 14 The Townhomes of Prairie Lakes**
Cnat Inc.
cnaul.com
\$179,900 (TH)
815-385-9999
- MORTON GROVE**
15 Crossings at Morton Grove
Toll Brothers
tollbrothers.com
\$384,995 (Flowhome)
847-581-0888
- MUNDELEIN**
16 Grand Dominion
Del Webb
delwebbchicagoand.com
\$270,000 (SF)
847-949-0033
- NORTHBROOK**
17 Meadow Ridge
KZF Development
meadowridgenorthbrook.com
\$495,000 to \$895,000 (DU)(TH)
847-559-0500
- MARENGO**
142 Deeppass Meadows
Leonard W. Besinger & Associates
doerpass.net
\$266,000 (TH)
815-568-0011
- MCHENRY**
13 The Greens of Irish Prairie
Cnat Inc.
greensofirishprairie.com
\$97,900 to \$139,900 (CO)
815-363-0322
- PALATINE**
18 The Heritage of Palatine
R. Franczak & Associates
rfranczak.com
\$246,900 (CO)
847-705-6238
- PARK RIDGE**
19 Gateway Estates
Neri Companies
gatewayrowhouses.com
\$149,995 (TH)
866-902-6338
- WHEELING**
143 Willow Place
Lexington Homes
lexingtonchicago.com
\$329,900 (TH)
847-618-0800
- AURORA**
27 HomeTown Aurora
Bigelow Homes
bigelowhomes.com
\$159,000 (SF)(TH)
866-481-5144
- WOODSTOCK**
25 Woodstock Station
Brownstones
Hummel Group, Ltd.
thehummelgroup.com
\$250,000 to \$388,000
847-984-4857
- 138 Ponds of Bull Valley**
Deerpointhomes.com
deerpointhomes.com
\$243,000 (SF)
815-337-1410
- 39 The Ponds of Naperville**
Marquette Management
pondsofnaperville.com
\$130,000 (CO)
630-848-0488
- 40 R/K Design Group**
\$1,579,500 (SF)
630-527-9466
- NORTH AURORA**
41 Lake Run Estates
Toll Brothers
tollbrothers.com
\$412,975 (SF)
630-208-0600
- NORTH LAKE**
42 Wolf Ridge
Neri Companies
nericons.com
\$232,900 (CO)
- OSWEGO**
43 Mill Street Station
Stevco Builders
stevcobuilders.com
\$230,000 (TH)
630-363-5955
- 44 Prescott Mill**
Pulte Homes
pulte.com
\$160,000 (TH)
630-551-2490
- 64 Hunter's Chase**
Phillippe Builders
phillipebuilders.com
\$199,900 (SF)
708-946-0100
- ALGONQUIN**
1 Terrace Lakes
Wynwood Builders
villasofchesnutridge.com
\$400,000 (CO)(SF)
847-658-8608
- BARRINGTON**
139 Woodland Shores
Harris Builders
harriscustombuilders.com
\$2,590,000 (SF)
847-382-2210
- 140 Hidden Valley**
Harris Builders
harriscustombuilders.com
\$3,790,000 (SF)
847-382-2210
- BUFFALO GROVE**
2 Villas of Chestnut Ridge
Kevin Charles Homes
villasofchesnutridge.com
\$587,900 (SF)
847-295-8400
- DES PLAINES**
144 Lexington Park
Lexington Homes
lexingtonchicago.com
\$380,000 (TH)
847-299-0500
- FOX LAKE**
3 Duck Lake Crossing
Reserve One Homes
reserveonehomes.com
\$15,759-0808
- 4 Vern's Landing**
Reserve One Homes
reserveonehomes.com
\$15,759-0808
- HAMPSHIRE**
5 Lakewood Crossing
Lakewood Homes, Inc.
lakewoodhomes.com
\$160,000 to \$220,000 (CO)(SF)
847-683-3379
- JOHNSBURG**
6 Running Brook Farm
Reserve One Homes
reserveonehomes.com
\$15,759-0808
- 140 Hidden Valley**
Harris Builders
harriscustombuilders.com
\$3,790,000 (SF)
847-382-2210
- KENOSHA, Wisc.**
7 Kilbourn Woods
Cambridge Homes
mycambridgehome.com
\$200,000 to \$245,000 (SF)
847-984-4855
- LAKE ZURICH**
8 Meadow Wood
Pulte Homes
pulte.com
\$260,000 (TH)
847-550-8025
- LIBERTYVILLE**
9 School Street District
Brownstones
The Hummel Group, Ltd.
thehummelgroup.com
\$800,000 (TH)
224-513-5500
- 141 The Enclave at the Reserve at the Merit Club**
Merit Homes
merithomes.net
\$800,000 (SF)
847-680-0090
- LINCOLNSHIRE**
10 Lincolnshire Place
Weiss Development
lincolnshirereplace.com
\$419,900 to \$939,900 (CO)
847-276-2570
- LINDENHURST**
11 Grant's Grove
Pulte Homes
pulte.com
\$340,000 (SF)
847-265-5378
- 12 Heritage Park**
Pulte Homes
pultechnicagoland.com
\$270,000 (TH)
847-245-7374
- MARENGO**
142 Deeppass Meadows
Leonard W. Besinger & Associates
doerpass.net
\$266,000 (TH)
815-568-0011
- MCHENRY**
13 The Greens of Irish Prairie
Cnat Inc.
greensofirishprairie.com
\$97,900 to \$139,900 (CO)
815-363-0322
- PALATINE**
18 The Heritage of Palatine
R. Franczak & Associates
rfranczak.com
\$246,900 (CO)
847-705-6238
- PARK RIDGE**
19 Gateway Estates
Neri Companies
gatewayrowhouses.com
\$149,995 (TH)
866-902-6338
- WHEELING**
143 Willow Place
Lexington Homes
lexingtonchicago.com
\$329,900 (TH)
847-618-0800
- AURORA**
27 HomeTown Aurora
Bigelow Homes
bigelowhomes.com
\$159,000 (SF)(TH)
866-481-5144
- WOODSTOCK**
25 Woodstock Station
Brownstones
Hummel Group, Ltd.
thehummelgroup.com
\$250,000 to \$388,000
847-984-4857
- 138 Ponds of Bull Valley**
Deerpointhomes.com
deerpointhomes.com
\$243,000 (SF)
815-337-1410
- 39 The Ponds of Naperville**
Marquette Management
pondsofnaperville.com
\$130,000 (CO)
630-848-0488
- 40 R/K Design Group**
\$1,579,500 (SF)
630-527-9466
- NORTH AURORA**
41 Lake Run Estates
Toll Brothers
tollbrothers.com
\$412,975 (SF)
630-208-0600
- NORTH LAKE**
42 Wolf Ridge
Neri Companies
nericons.com
\$232,900 (CO)
- OSWEGO**
43 Mill Street Station
Stevco Builders
stevcobuilders.com
\$230,000 (TH)
630-363-5955
- 44 Prescott Mill**
Pulte Homes
pulte.com
\$160,000 (TH)
630-551-2490
- 64 Hunter's Chase**
Phillippe Builders
phillipebuilders.com
\$199,900 (SF)
708-946-0100
- ALGONQUIN**
1 Terrace Lakes
Wynwood Builders
villasofchesnutridge.com
\$400,000 (CO)(SF)
847-658-8608
- BARRINGTON**
139 Woodland Shores
Harris Builders
harriscustombuilders.com
\$2,590,000 (SF)
847-382-2210
- 140 Hidden Valley**
Harris Builders
harriscustombuilders.com
\$3,790,000 (SF)
847-382-2210
- BUFFALO GROVE**
2 Villas of Chestnut Ridge
Kevin Charles Homes
villasofchesnutridge.com
\$587,900 (SF)
847-295-8400
- DES PLAINES**
144 Lexington Park
Lexington Homes
lexingtonchicago.com
\$380,000 (TH)
847-299-0500
- FOX LAKE**
3 Duck Lake Crossing
Reserve One Homes
reserveonehomes.com
\$15,759-0808
- 4 Vern's Landing**
Reserve One Homes
reserveonehomes.com
\$15,759-0808
- HAMPSHIRE**
5 Lakewood Crossing
Lakewood Homes, Inc.
lakewoodhomes.com
\$160,000 to \$220,000 (CO)(SF)
847-683-3379
- JOHNSBURG**
6 Running Brook Farm
Reserve One Homes
reserveonehomes.com
\$15,759-0808
- 140 Hidden Valley**
Harris Builders
harriscustombuilders.com
\$3,790,000 (SF)
847-382-2210
- KENOSHA, Wisc.**
7 Kilbourn Woods
Cambridge Homes
mycambridgehome.com
\$200,000 to \$245,000 (SF)
847-984-4855
- LAKE ZURICH**
8 Meadow Wood
Pulte Homes
pulte.com
\$260,000 (TH)
847-550-8025
- LIBERTYVILLE**
9 School Street District
Brownstones
The Hummel Group, Ltd.
thehummelgroup.com
\$800,000 (TH)
224-513-5500
- 141 The Enclave at the Reserve at the Merit Club**
Merit Homes
merithomes.net
\$800,000 (SF)
847-680-0090
- LINCOLNSHIRE**
10 Lincolnshire Place
Weiss Development
lincolnshirereplace.com
\$419,900 to \$939,900 (CO)
847-276-2570
- LINDENHURST**
11 Grant's Grove
Pulte Homes
pulte.com
\$340,000 (SF)
847-265-5378
- 12 Heritage Park**
Pulte Homes
pultechnicagoland.com
\$270,000 (TH)
847-245-7374
- MARENGO**
142 Deeppass Meadows
Leonard W. Besinger & Associates
doerpass.net
\$266,000 (TH)
815-568-0011
- MCHENRY**
13 The Greens of Irish Prairie
Cnat Inc.
greensofirishprairie.com
\$97,900 to \$139,900 (CO)
815-363-0322
- PALATINE**
18 The Heritage of Palatine
R. Franczak & Associates
rfranczak.com
\$246,900 (CO)
847-705-6238
- PARK RIDGE**
19 Gateway Estates
Neri Companies
gatewayrowhouses.com
\$149,995 (TH)
866-902-6338
- WHEELING**
143 Willow Place
Lexington Homes
lexingtonchicago.com
\$329,900 (TH)
847-618-0800
- AURORA**
27 HomeTown Aurora
Bigelow Homes
bigelowhomes.com
\$159,000 (SF)(TH)
866-481-5144
- WOODSTOCK**
25 Woodstock Station
Brownstones
Hummel Group, Ltd.
thehummelgroup.com
\$250,000 to \$388,000
847-984-4857
- 138 Ponds of Bull Valley**
Deerpointhomes.com
deerpointhomes.com
\$243,000 (SF)
815-337-1410
- 39 The Ponds of Naperville**
Marquette Management
pondsofnaperville.com
\$130,000 (CO)
630-848-0488
- 40 R/K Design Group**
\$1,579,500 (SF)
630-527-9466
- NORTH AURORA**
41 Lake Run Estates
Toll Brothers
tollbrothers.com
\$412,975 (SF)
630-208-0600
- NORTH LAKE**
42 Wolf Ridge
Neri Companies
nericons.com
\$232,900 (CO)
- OSWEGO**
43 Mill Street Station
Stevco Builders
stevcobuilders.com
\$230,000 (TH)
630-363-5955
- 44 Prescott Mill**
Pulte Homes
pulte.com
\$160,000 (TH)
630-551-2490
- 64 Hunter's Chase**
Phillippe Builders
phillipebuilders.com
\$199,900 (SF)
708-946-0100
- ALGONQUIN**
1 Terrace Lakes
Wynwood Builders
villasofchesnutridge.com
\$400,000 (CO)(SF)
847-658-8608
- BARRINGTON**
139 Woodland Shores
Harris Builders
harriscustombuilders.com
\$2,590,000 (SF)
847-382-2210
- 140 Hidden Valley**
Harris Builders
harriscustombuilders.com
\$3,790,000 (SF)
847-382-2210
- BUFFALO GROVE**
2 Villas of Chestnut Ridge
Kevin Charles Homes
villasofchesnutridge

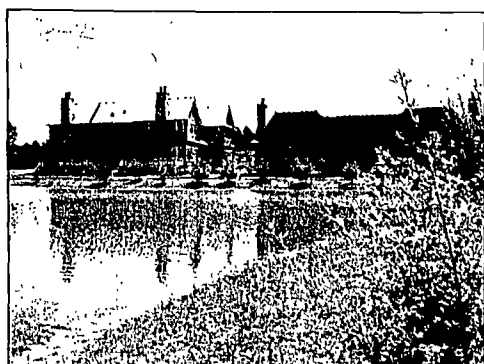

Willow Lake, an upscale 52-unit development in Lake Forest on Chicago's North Shore, features two lakes and takes its cues from the site's natural elements and spectacular setting.

Splash of relaxation

Water-oriented communities lure homebuyers with tranquility

There's something tranquil about living in a residential community developed on a lake, on a river walk, a stream or even a quiet rural pond. Quite simply, the quiet splash of water and open green space is a magnet for prospective homebuyers, housing experts say.

Willow Lake, an upscale 52-unit development in Lake Forest on Chicago's North Shore, features two lakes and takes its cues from the site's natural elements and spectacular setting next to Willow Lake, noted developer John McLinden, principal of Centrum Properties.

Willow Lake is being developed on the former Fitzmorris Estate, a beautiful 21.6-acre former private enclave located at Illinois 60 and Field Court in the western portion of the upscale suburb, McLinden said.

The villas — attached single-family homes — will feature 3,885 to 3,995 square feet of living space in addition to a finished basement. Select units will showcase lookout basements. Base prices for the villa homes start at \$999,000.

Another new water-oriented residential development is Meadow Ridge, a gated, 164-unit townhome and duplex community on 40 acres at Waukegan and Founders roads in north suburban Northbrook.

Meadow Ridge is a private, gated community targeted to empty-nester buyers moving from large single-family homes on the North Shore, according to KZF Development, the developer. Among Meadow Ridge's unique features is the lavish landscaping, overlooking waterfalls, waterways and two man-made lakes.

Condominium buyers at Everleigh, 144-unit development on the northwest corner of River Street and Des Plaines River Road near downtown Des

Plaines, can enjoy a quiet stroll along a river walk that overlooks a scenic creek.

Here are details on the three water-oriented communities:

Willow Lake

A swank villa homes model — professionally decorated and furnished by the architectural firm of Darcy Bonner and Associates — has grand opening at Willow Lake.

"Darcy Bonner and Associates LLC, the celebrated Chicago-based architecture and interior design firm, has thoughtfully created an elegant design concept for the interior of the Sheridan model at Willow Lake," McLinden said. "A second furnished model, the Deerpath, also is on display."

"Sophisticated North Shore buyers who love French antique furnishings should enjoy touring the furnished model designed by Darcy Bonner," said McLinden. Centrum Properties sent the designer to Paris to buy gallery antiques and flea market furnishings to decorate the model with stylish flair. "The design goal was to fill the entire place with Parisian artwork and antiques and items from European antique shops," McLinden said.

Centrum designed the luxury villa homes for a mix of buyers from young professionals moving to the North Shore to empty-nester couples seeking to move down from a large single-family home, McLinden said.

"We've meticulously designed multiple floor plans, elevations and color options to maintain a diverse neighborhood," McLinden said. "This is achieved by first having two different footprints and further diversified by having different elevations for each footprint, making for a wide variety of choices."

The homes will showcase gourmet kitchens equipped with

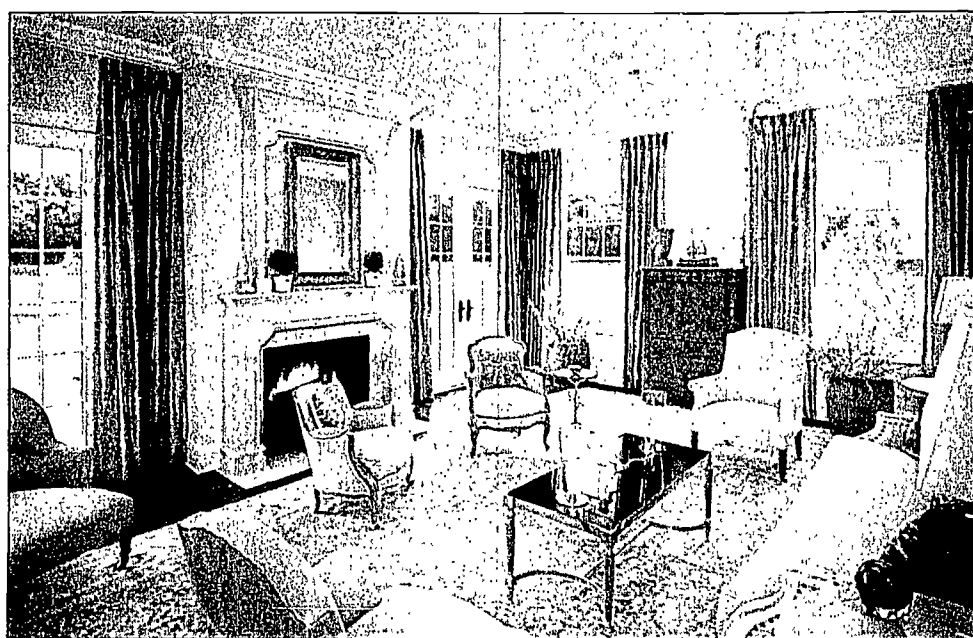

Sophisticated North Shore buyers who love French antique furnishings should enjoy touring the furnished model designed by Darcy Bonner.

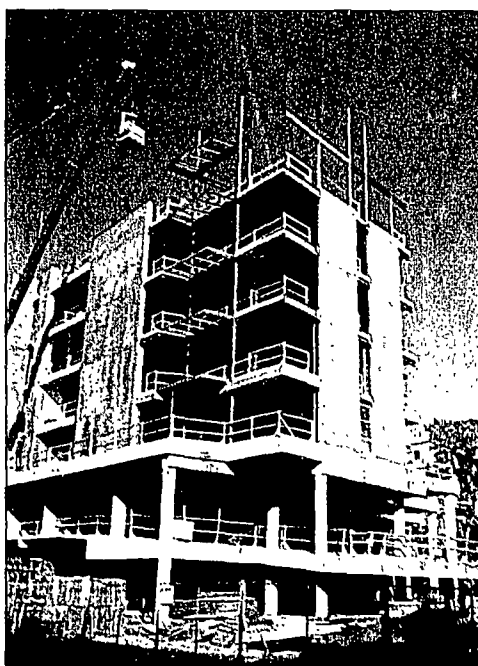

The nine-story contemporary-style new-construction condominium development overlooks a wooded area along scenic Weller Creek, a tributary of the Des Plaines River.

stainless-steel appliances, 42-inch Brookhaven by Woodinod cabinets, 1 1/4-inch-thick granite countertops, work islands and white-oak flooring.

Each villa at Willow Lake will have a two-car-plus garage with room for guest parking in driveways. In addition, all residences will have a passenger elevator. The other floor plan has first floor master bedroom.

The home exteriors at Willow Lake will showcase English-Country style architecture highlighted by diverse natural colors and textures, said Jaclyn Krashin, project manager for Centrum Properties. Rooflines will be ac-

cented with natural cedar shingles. Upper exterior walls of the homes will be highlighted with stained clapboard siding with an option for cedar shingles or stained stucco. The solid base of the exteriors will be formed with heavier materials, brick and lantern stone.

The model and on-site sales center at Willow Lake is open at the intersection Kennedy Road (Route 60) and Field Court in Lake Forest. Take Interstate-294 to Route 60 and exit east to Field Court. Turn left (north) to the models.

The center is open Monday through Wednesday from 10



Meadow Ridge is a private, gated community targeted to empty-nester buyers moving from large single-family homes on the North Shore.

a.m. to 5 p.m. and Saturdays and Sundays from 10 a.m. to 5 p.m. and by appointment. For more information, call (847) 735-1400, or visit the Web site at: www.centrum.com.

Meadow Ridge

Construction is well underway on both townhomes and duplexes at Meadow Ridge. KZF Development said a model is scheduled for grand opening on the weekend of October 25 and 26 and the development is scheduled for completion in March of 2011.

The two-bedroom and three-bedroom, 2 1/2-bath all brick residences are extremely spacious, with 2,243 to 3,174 square feet of living area. The residences will be built in two-unit duplex and four-unit townhome buildings in the upscale community, which features a guardhouse and private streets.

Unit E, the two-bedroom, 2 1/2-bath townhome model, has 2,243 square feet of living space plus a 285-square-foot unfinished bonus space (attic). Other highlights include a first-floor study, a great room and two-car attached garage. Unit E is base-priced from \$495,000.

KZF Development reports that more than 100 luxury townhomes already have been sold at Meadow Ridge, noted Shannon Gibson-Giampa, sales manager. Base prices range from \$495,000 to \$895,000.

The demand for homes at Meadow Ridge is a result of the developments water-oriented design, the maintenance-free lifestyle and property's premiere East Northbrook location.

"Public schools that are among the top in the nation, the North Shore's low crime rate and the site's proximity to transportation, shopping and employment concentrations all make this such a desirable location," said Gibson-Giampa.

"Meadow Ridge is designed for a maintenance-free lifestyle for empty-nester couples that are seeking the security of a gated community and like to winter in Arizona and Florida," she said.

Meadow Ridge has something for everyone, even younger urban purchasers. Buyers may choose from a selection of all brick duplex homes and townhomes, all with water views. The duplexes are built side-by-side in two-unit buildings. The townhomes are built in clusters of four units per building.

The two-story duplexes are available with three bedrooms, 2 1/2 baths and 2,364 to 2,640 square feet of living space. The duplex homes, which come with an unfinished bonus room, feature a private entry, soaring ceilings and a two-car attached garage.

KZF Development reports that more than 100 luxury townhomes already have been sold at Meadow Ridge, noted Shannon Gibson-Giampa, sales manager. Base prices range from \$495,000 to \$895,000.

Turn to SPLASH, 8

Stunning Forester ranch open for touring in Libertyville

Established community with breathtaking grounds welcomes visitors

Come for a visit

Savvy mature home buyers searching for an innovative ranch house located in an established neighborhood with nearby recreational facilities and a natural landscape should look no further than The Enclave at The Reserve at the Merit Club in Libertyville.

Here beautiful rock gardens, sparkling ponds and colorful wildflowers spread a blanket of beauty and serenity throughout the community.

Buyers are delighted to assume the advantages of purchasing a new home in an established neighborhood. First and foremost, they don't have to deal with the dust and debris so prevalent when a new neighborhood is under construction. Secondly, they can see how the community looks and will not encounter any surprises.

Empty-nesters can choose from five luxurious ranch plans or two two-story designs with first-floor master bedrooms. Featuring 1,800 to 3,000 square feet, homes have two to four bedrooms and up to three-and-a-half baths. They are priced from \$655,000 to \$799,000.

Almost complete and open for guided tours is the three-bedroom, 2 1/2-bath Forester ranch plan. A huge great room with vaulted ceiling and fireplace has floor-to-ceiling windows. With its convenient center island and eating nook, the gourmet kitchen

en has a large breakfast room.

There's a spacious master bedroom suite with a walk-in closet and deluxe master bath. On the other side of the home, there are two bedrooms providing privacy for the owners and their guests: A multi-purpose media room can convert into a study, living room or fourth bedroom.

The 17-home Enclave is part of a gated community called the Reserve at the Merit Club, which is comprised of 102 semi-custom homes on 100 acres of rolling land. Honored with the Best Overall Community award from the Home Builders Association, the community was recognized for excellence in design and construction.

What makes this neighborhood unusual are the picturesque views of the Merit Club, an 18-hole private golf course that is ranked as one of the top 100 courses in the world by Golf and Travel Magazines. Several years ago, The Merit Club hosted the U.S. Women's Open.

Five ranch plans cater to mostly empty-nesters and young professionals who want the convenience of single-level living, mainly because it eliminates having to walk up and down stairs. Even though comfort and relaxed living is their first priority, these homebuyers also want spare bedrooms for when their kids are home from college. Grandparents are interested in a home large enough to accommodate their grandkids frequent visits.

In addition to the benefits of

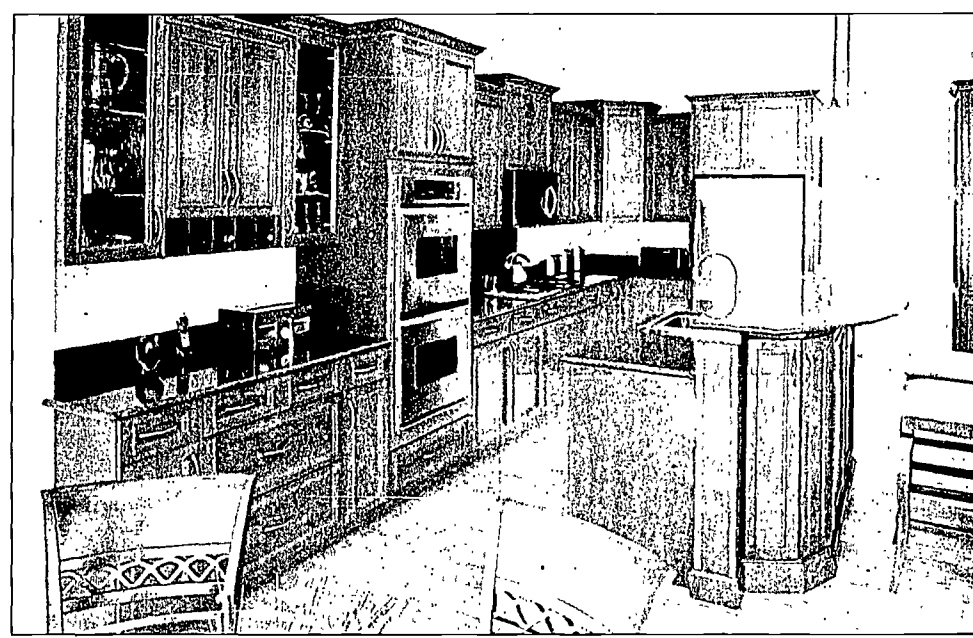

At The Enclave, kitchens include oak flooring, maple cabinets, granite countertops and large breakfast rooms with access to the back yard.

one-level living, buyers are attracted to the architectural design of the ranch plans. High ceilings throughout the home and open

floor plans establish a feeling of spaciousness. Kitchens, family rooms and living rooms flow into each other making entertaining

convenient, while separate bedroom areas provide privacy and

Turn to FORESTER, 8

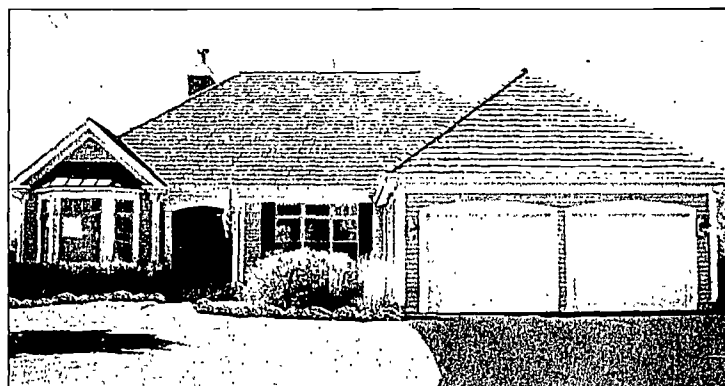

The Forester is one of five ranch plans at The Enclave, where 17 homes are now available in an established community in Libertyville.

Luxury Living at its Finest in Libertyville

MERIT CLUB HOMES

In a scenic setting filled with landscaped ponds, beautiful rock gardens and wild flowers, and surrounded by the famous Merit Club golf course, come home to your very special ranch home. Enjoy a completely appointed residence in our award-winning, well established Libertyville community.

Sneak preview ranch home • From mid \$600s

(847) 680-0090
merithomes.net

THE ENCLAVE
AT THE RESERVE
AT THE MERIT CLUB

194 to Rt. 137, west to Rt. 21 (Milwaukee Ave) north 1 1/2 miles to entrance. Follow signs to Sales Center open daily 10-5, closed Tuesday & Wednesday.

MAINTENANCE FREE LIVING...YOU DESERVE IT!

INDOOR HEATED PARKING WITH STORAGE, IN-UNIT LAUNDRY ROOMS, PRIVATE BALCONIES, UPSCALE AMENITIES, FULLY APPLIANCED KITCHENS, CLOSE TO TRAINS AND EXPRESSWAYS!

<p>Wolf Ridge</p> <p>Model Grand Opening! \$5K to \$15K Homestead Discount Starting from \$232,900 in Northlake www.wolfcondos.com 708.492.1010</p>	<p>TRAFALGAR SQUARE</p> <p>Only 10 Condos left with great incentives! Walk to Morton Grove Metra Stop! www.trafalgarcondos.com 847.965.9444</p>	<p>GATEWAY ESTATES PARK RIDGE</p> <p>Ground Breaking Soon! Beautiful Row Homes in Park Ridge! Blocks to downtown and Metra! www.gatewayrowhomes.com 847.692.3800</p>
--	--	---

NERI COMPANIES

TCN REAL ESTATE AUCTION NOVEMBER 22

DEVELOPER DIRECTS CLOSEOUT SALE

3 Maintenance Free Single Family Homes, Walking Distance To Independence Grove, Libertyville, IL

AUCTION:
Sat., Nov. 22, 2008 at 12:00 Noon
Sheraton Gateway Suites Hotel, Rosemont, IL

ONE HOME TO BE SOLD WITHOUT RESERVE REGARDLESS OF PRICE

For Brochure, Terms of Sale & Bid Packet
CHARTWELL GROUP, LLC / Call: 877-430-9558
Burton Blinick, Illinois R.E. Broker & Auctioneer

optima

Amazing architecture, value and views

Experience downtown living...at the North Shore.

Final floor plan shown in this view. Actual floor plan may vary.

Optima Old Orchard Woods Condominiums

847.583.4700 www.optimaweb.com

Willow Falls

FROM PAGE 1

or one-bedroom condominiums can be purchased or rented. The most affordable studio home can be purchased for \$102,895 or rented for \$1,585 per month. More spacious one-bedroom condominiums are available for up to \$140,485 or \$2,145 per month. Association fees to keep the landscaping, ponds and common areas in top condition, and parking lots and sidewalks plowed, salted and shoveled in the winter time range from \$146 to \$229/month.

Within each of these spacious condominiums, filled with an abundance of natural light from the oversized windows, potential residents will find oak trim, individually controlled heating/air conditioning, Moen faucets, ceramic floored bathtubs, 17-inch-high toilets and hookups for washer/dryer. For the ultimate in independent living, these homes feature kitchens furnished with a full-size GE refrigerator/freezer, GE electric range with oven and a GE dishwasher.

Privacy and security are of the utmost importance to prospective Willow Falls condominium owners, and the builder has addressed these issues in spades. To ensure sound doesn't transmit from home to home, all ceilings and floors are constructed of concrete and

“We take care of our residents like they are family members.”

Renee Wolf, manager,
Willow Falls Condominiums



walls are built with sound suppression materials. For safety, the secured building is constructed of fire resistant materials, has interconnected fire alarms, and a sprinkler system installed throughout the building and each unit.

Residents looking for a little help now and then with meals or housekeeping, the Willow Falls community offers a supportive care package. If a person purchases a condominium, they can purchase this package for \$525/month (\$450/month for a second person) and it includes: one full course meal seven days a week, 24 hour emergency call button response, and twice a month housekeeping service. For families choosing to rent a Willow Falls condominium, the supportive care package is included in the monthly rent for the first person and a second person can be added for an additional \$450/month. For renters, this package also includes a free clothes washer & dryer, and association

fees as well.

Constructed and managed by the husband-and-wife team of Greg and Renee Wolf, Willow Falls Condominiums represents the third and final phase of the Willow Falls senior living community. The townhome portion of the community is sold out, the assisted living portion of the community is usually full and the new condominiums are available immediately.

“We are very much aware of the importance of communicating and talking with our residents and resolving issues in a timely manner,” emphasized Renee. “Unlike some senior lifestyle communities that are owned by big corporations, we take care of our residents like they are family members. This is easy for us to do because my own mother lives here, and anytime we make changes or implement new programs we always think about how she will react.”

For more information about the condominiums and active lifestyle offered at Willow Falls, call (815) 725-5868 or visit www.willowfalls.com. Decorated models are open Mondays to Fridays from 10 a.m. to 5 p.m., Saturdays from 10 a.m. to 2 p.m., or by appointment. To reach this community from I-55, exit Weber south, 6.5 miles to Knapp Drive and turn left to Willow Circle Drive. From I-80 exit Larkin Avenue north, and drive 2.5 miles to Knapp Drive, then turn right onto Willow Circle Drive.

Splash

FROM PAGE 6

The two-story townhomes have three bedrooms including a first-floor master suite, 2½ baths and 2,243 to 2,600 square feet of living space. Townhomes feature grand two-story living rooms, nine-foot-high first floor ceilings and an attached two-car garage.

All of the duplex and townhome floor plans come with high-end standard kitchen finishes including granite kitchen counter tops, 42-inch maple or oak cabinetry, stainless-steel GE appliance package and a choice of ceramic floor tile or oak plank flooring. Each unit includes an interior sprinkler system for fire protection.

Other standard features include: nine-foot-high first-floor ceilings and first-floor laundry room with washer/dryer hookups. The master bath includes a five-foot soaker tub, separate shower with glass door, double vanity and a choice of ceramic tile or oak plank flooring.

The residences also come with fully sodded yards with irrigation system, landscaping (per plan), drywall finished garages, concrete sidewalks (per plan), asphalt driveway and heat and air-conditioning systems and pre-wire security system lines.

The Meadow Ridge sales center at Waukegan and Founders roads in Northbrook is open weekdays from 11 a.m. to 6 p.m. and Saturday and Sunday from 1000 to 5 p.m. The center is closed on Tuesdays. For more information, call (847) 559-0500, or visit www.MeadowRidgeNorthbrook.com.

Everleigh

The nine-story contemporary-style new-construction condominium development overlooks a wooded area along scenic Weller Creek, a tributary of the Des Plaines River. Miles of walking trails and bicycle paths are nearby, along with peaceful picnic areas and flourishing woodlands.

“If you wander just beyond your backyard at Everleigh, you’ll be instantly in touch with nature,” said Michael Glazier, principal of Seritus Capital Partners, LLC. “You don’t even have to leave your home to enjoy the wooded view.”

“The attraction of northwest sub-

urban Des Plaines includes pastoral outdoor spaces, quiet environs, nearby shopping and dining, and easy access to downtown Chicago, not to mention O’Hare International Airport,” Glazier said.

Condominiums at the \$50-million Everleigh development have handsome, open-plan living spaces that boast floor-to-ceiling windows which extend the home into the peaceful lush neighboring forest preserve,” Glazier said.

The development features a wonderfully broad selection of one-bedroom, one-bedroom-plus-den, two-bedroom, two-bedroom-plus-den and three-bedroom condominiums with one to 2½ baths and 891 to 2,529 square feet of living area. Base prices range from \$217,900 and \$583,900.

“For buyers seeking true luxury living at affordable prices, these contemporary-styled residences have rich wood flooring, stainless-steel appliances, granite kitchens, spacious private balconies or terraces, and private indoor heated and secured parking,” said Glazier.

Creatively designed by A. Epstein and Sons International, Inc., Everleigh also overlooks Metropolitan Square, a 114,000-square-foot retail and commercial center located off Miner Street between River Road and Lee Street.

Everleigh also is conveniently close to the Metra station, where the Metra/North Central line express trains take riders to the Loop in 28 minutes.

Construction at Everleigh is nearing the top-out stage and slated for completion in late 2008. The concrete and masonry mid-rise building features a distinctive glass and masonry facade. The building is rising past the seventh floor, windows are being installed and a model condominium on the third floor is underway.

Sales are off to a strong start with more than 30 percent of the units on seven residential floors already under contract, according to Tina Rago, sales manager.

The Everleigh Downtown Des Plaines sales center is located off-site at 520 S. River Road in downtown Des Plaines. Hours are 11 a.m. to 6 p.m. daily. For more information or to reserve a residence at Everleigh Downtown Des Plaines, call (847) 827-4900 or visit the Web site and take a virtual tour at www.everleighcondos.com.

Forester

FROM PAGE 7

personal space.

Large basements are perfect for creating a spacious recreational room for teenagers, or they can be transformed into in-law quarters with a full bath. “When out-of-town guests remain for an extended stay, you can still maintain your privacy,” said Jeri Szatko, Director of Sales and Marketing. “Ranches are also more suitable homes when in-laws need a temporary or permanent residence.”

Szatko gives her homebuyers every opportunity to customize their homes. Buyers start with a plan and they can change the footprint of the house and eliminate or add rooms. There’s a lot of flexibility and they can select from the same finish level as the custom homebuyer. Upgraded luxury features come standard at The Enclave. Homes include

oak flooring, Kohler fixtures, maple cabinets, granite countertops, full masonry fireplace, extensive trim details, wood windows, cedar shake roofs, zoned temperature control, fire suppression systems, and patios.

Also, Merit Homes guarantees its buyers that the natural setting will remain a conservation area forever. Homebuyers understand that there will be no future development because the site is protected by a conservation easement.

Enhancing the quality of life is a variety of cultural and educational opportunities. Within walking distance, homeowners can visit Independence Grove, a 325-acre recreational facility featuring a large lake and seven miles of trails for biking, jogging or roller blading. Millennium Plaza has an amphitheater for special events and concerts, a native plant garden with a waterfall, trees and benches. Beach facilities with locker rooms feature swimming, volleyball, a picnic area and playground. Canoeing, kayaking, fishing and paddle boating are offered at the marina.

The David Adler Cultural Center is an important educational, historic, cultural and economic resource in Lake County offering art and music classes, folk and ethnic concerts, art exhibitions, special events, tours and programs for adults and children. Within close proximity are the Cuneo Museum and Gardens, Ravinia Festival and the Marriott Lincolnshire Resort.

Conveniently located off Milwaukee Avenue in Libertyville, residents may catch commuter trains in either Graylake or Libertyville with a 50-minute commute to Chicago. Only one mile away, there is easy access to I-94.

To visit the community, take I-94 to Route 137, go west to Route 21 (Milwaukee Avenue), then north 1½ miles to entrance. Follow signs to the Sales Center, open daily from 10 a.m. to 5 p.m., closed Tuesday and Wednesday. Call (847) 680-0090 or visit merithomes.net.

Which would your parents prefer, your place or ours?

They can have ours for only \$1,564 a month.*

Your parents love time spent with the grandkids, but living with them is a different story. And right now Belle Plaine Commons has an amazing offer for empty nesters 55 and better. For only \$1,564* a month, they can enjoy maintenance free condominium living. Amenities include furnished lobby and library, community room, fitness center, beautifully landscaped grounds and more. Comfortable, carefree and affordable. Visit Belle Plaine Commons today to see if they qualify for this amazing value.



BellePlaineCommons.com
2335 West Belle Plaine
773.442.6995
Sales Center Open Sat-Wed 10am-5pm
Just east of Western
1 block north of Irving



*Based on a one bedroom unit priced at \$184,000 and 20% down payment of \$36,800, the loan amount of \$147,200 and a 30-year fixed rate mortgage at 6.22% with an APR of 6.44%. The monthly principal and interest payment is \$1,000. Monthly price also includes a 2% property tax of \$324.84 and monthly assessments of \$239.16. Total monthly payment of \$1,564.21. Terms and conditions herein are subject to change without notice. Program limitations. For qualified buyers only.

The most effective advertising in print

CLASSIFIED

FOR YOUR INFORMATION: Plans and related documents are available at the Village's Community Development Department, Planning Division, (847) 933-8447, from 8:30 AM to 5:00 PM.

SPECIAL AID Available upon request for the disabled call (847) 933-8447 or TDD (847) 933-8445.

Interested parties are invited to attend this meeting. This notice is for informational purposes only. Published in the Skokie Review on November 6, 2008.

Paul Luko, Chairman
Published in Pioneer Press 11/6/08 (164380) C

PUBLIC HEARING

NOTICE IS HEREBY GIVEN that a public hearing will be held before the Planning and Zoning Commission on Monday, November 24, 2008, at 7:30 p.m. in the City Council Chamber of Park Ridge City Hall, 505 Butler Place, Park Ridge, Illinois, with the following matter will be considered:

Zoning Code Number 00-403

Application for a special use to allow a 2000 sq. ft. St. Luke's Lutheran Church, the R-2 Single Family Residential District, and consideration for any exceptions that may be requested as part of the project, in accordance with the requirements of Section 4.6 of the Zoning Ordinance of the City of Park Ridge of the following property:

Lot 16 in Block 4 in Park Ridge, sold Park Ridge before a subdivision of parts of Blocks 1, 2, 3, 4, and 5 of Block 1, a subdivision of parts of the Southeast quarter of Section 26, Township 41 North, Range 12 East of the Third Principal Meridian, in Cook County, Illinois.

Lot 12 (except the South 74 feet thereof) and all of Lot 13 in Block 3 in the Resubdivision of parts of Blocks 1, 2, 3, 4 and 5 in Plan and Meachom's Subdivision of the Southeast quarter of Section 26, Township 41 North, Range 12 East of the Third Principal Meridian, in Cook County, Illinois.

The South 23 feet of Lot 14 and the North 57 feet of Lot 15 in Block 4 in Brickton being Penny and Meachom's Subdivision of the Southeast quarter of Section 26, Township 41 North, Range 12 East of the Third Principal Meridian, in Cook County, Illinois.

The property commonly known as: 202 North Prospect Avenue, Park Ridge, IL 60064

All persons interested in the above described matter are invited to attend and will be heard.

The case file for this matter is available for review in the Department of Community Preservation and Development in City Hall.

Alfredo Marr, Chairman
Planning and Zoning Commission
Published in Pioneer Press 11/6/08 (164380) C

Buying or Selling, Pioneer Classified is the place for you!

(847) 998-3400

& online

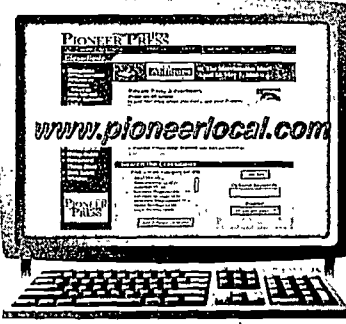

PIONEER PRESS YOUR LOCAL SOURCE

1060- Plan Commission & Zoning Hearings

LEGAL NOTICE OF PUBLIC HEARING

Skokie Plan Commission, Thursday, December 4, 2008. Village of Skokie, 5127 Oakton Street, Skokie, Illinois 60077, at 7:30 P.M., to consider the following:

Case No. 2008 P 064200
Special Use Permit, 8500 Gross Point Road, G.P.D. LLC requests a special use permit for a limited service restaurant at 8500 Gross Point Road in a 12 Commercial district and any other relief that may be requested as determined by Village Staff during the review of this case.

2008 310 - Special Use Permit, 8500 Gross Point Road, G.P.D. LLC requests a special use permit for outdoor dining at 8500 Gross Point Road in a 12 Commercial district and any other relief that may be requested as determined by Village Staff during the review of this case.

FOR YOUR INFORMATION

Plans and related documents are available at the Village's Community Development Department, Planning Division, (847) 933-8447, from 8:30 AM to 5:00 PM.

SPECIAL AID Available upon request for the disabled call (847) 933-8447 or TDD (847) 933-8445.

Interested parties are invited to attend this meeting. This notice is for informational purposes only. Published in the Skokie Review on November 6, 2008.

Paul Luko, Chairman
Published in Pioneer Press 11/6/08 (164380) C

ESTATE OF BETTY FUMBANKS

IN THE MATTER OF THE ESTATE OF BETTY FUMBANKS, Deceased.

Case No. 2008 P 4584
AFFIDAVIT OF NON-RESIDENCE

CARY A. LIND, on oath states for purposes of governing the First and Last Act of 578-4. Any interested person termination Independent administration or any time by mailing or delivering a petition to terminate to the clerk of the court or before April 27, 2009, which date is the date of the first publication of this notice and any claim not filed within that period is barred. Claims against the estate may be filed in the office of the clerk on or before April 27, 2009, which date is the date of the first publication of this notice and any claim not filed within that period is barred.

Published in Pioneer Press 11/6/08 (164380) C

STATE OF ILLINOIS

IN THE MATTER OF THE ESTATE OF BETTY FUMBANKS, Deceased.

Case No. 2008 P 4584
AFFIDAVIT OF NON-RESIDENCE

CARY A. LIND, on oath states for purposes of governing the First and Last Act of 578-4. Any interested person termination Independent administration or any time by mailing or delivering a petition to terminate to the clerk of the court or before April 27, 2009, which date is the date of the first publication of this notice and any claim not filed within that period is barred.

Published in Pioneer Press 11/6/08 (164380) C

STATE OF ILLINOIS

IN THE MATTER OF THE ESTATE OF BETTY FUMBANKS, Deceased.

Case No. 2008 P 4584
AFFIDAVIT OF NON-RESIDENCE

CARY A. LIND, on oath states for purposes of governing the First and Last Act of 578-4. Any interested person termination Independent administration or any time by mailing or delivering a petition to terminate to the clerk of the court or before April 27, 2009, which date is the date of the first publication of this notice and any claim not filed within that period is barred.

Published in Pioneer Press 11/6/08 (164380) C

STATE OF ILLINOIS

IN THE MATTER OF THE ESTATE OF BETTY FUMBANKS, Deceased.

Case No. 2008 P 4584
AFFIDAVIT OF NON-RESIDENCE

CARY A. LIND, on oath states for purposes of governing the First and Last Act of 578-4. Any interested person termination Independent administration or any time by mailing or delivering a petition to terminate to the clerk of the court or before April 27, 2009, which date is the date of the first publication of this notice and any claim not filed within that period is barred.

Published in Pioneer Press 11/6/08 (164380) C

STATE OF ILLINOIS

IN THE MATTER OF THE ESTATE OF BETTY FUMBANKS, Deceased.

Case No. 2008 P 4584
AFFIDAVIT OF NON-RESIDENCE

CARY A. LIND, on oath states for purposes of governing the First and Last Act of 578-4. Any interested person termination Independent administration or any time by mailing or delivering a petition to terminate to the clerk of the court or before April 27, 2009, which date is the date of the first publication of this notice and any claim not filed within that period is barred.

Published in Pioneer Press 11/6/08 (164380) C

STATE OF ILLINOIS

IN THE MATTER OF THE ESTATE OF BETTY FUMBANKS, Deceased.

Case No. 2008 P 4584
AFFIDAVIT OF NON-RESIDENCE

CARY A. LIND, on oath states for purposes of governing the First and Last Act of 578-4. Any interested person termination Independent administration or any time by mailing or delivering a petition to terminate to the clerk of the court or before April 27, 2009, which date is the date of the first publication of this notice and any claim not filed within that period is barred.

Published in Pioneer Press 11/6/08 (164380) C

STATE OF ILLINOIS

IN THE MATTER OF THE ESTATE OF BETTY FUMBANKS, Deceased.

Case No. 2008 P 4584
AFFIDAVIT OF NON-RESIDENCE

CARY A. LIND, on oath states for purposes of governing the First and Last Act of 578-4. Any interested person termination Independent administration or any time by mailing or delivering a petition to terminate to the clerk of the court or before April 27, 2009, which date is the date of the first publication of this notice and any claim not filed within that period is barred.

Published in Pioneer Press 11/6/08 (164380) C

1062- Probate

COO- COUNTY PROBATE

STATE OF ILLINOIS IN THE CIRCUIT COURT OF COOK COUNTY, PROBATE DIVISION

In the matter of the estate of JANUSZ SZYBOWSKI

Case No. 2008 P 4431
PUBLICATION NOTICE

Notice is given of the death of DAPHNE BENOS of Cook County, Illinois. Letters of office were issued on October 17, 2008, to CRYA LIND, Attorney for the estate, whose attorney is EDWIN R. ARMSTRONG, 1110 N. Ashland Ave., Chicago, IL 60622, 773 276-1227.

Notice is given to unknown heirs who are the heirs or assigns in the above entitled proceeding. Claims against the estate may be filed in the office of the clerk of the court or before April 23, 2009, which date is the date of the first publication of this notice and any claim not filed within that period is barred. Copies of any claim filed with the clerk of the court or before April 23, 2009, which date is the date of the first publication of this notice and any claim not filed within that period is barred.

Published in Pioneer Press 11/6/08 (164380) C

STATE OF ILLINOIS

IN THE MATTER OF THE ESTATE OF JANUSZ SZYBOWSKI

Case No. 2008 P 4431
PUBLICATION NOTICE

Notice is given of the death of DAPHNE BENOS of Cook County, Illinois. Letters of office were issued on October 17, 2008, to CRYA LIND, Attorney for the estate, whose attorney is EDWIN R. ARMSTRONG, 1110 N. Ashland Ave., Chicago, IL 60622, 773 276-1227.

Notice is given to unknown heirs who are the heirs or assigns in the above entitled proceeding. Claims against the estate may be filed in the office of the clerk of the court or before April 23, 2009, which date is the date of the first publication of this notice and any claim not filed within that period is barred.

Published in Pioneer Press 11/6/08 (164380) C

STATE OF ILLINOIS

IN THE MATTER OF THE ESTATE OF JANUSZ SZYBOWSKI

Case No. 2008 P 4431
PUBLICATION NOTICE

Notice is given of the death of DAPHNE BENOS of Cook County, Illinois. Letters of office were issued on October 17, 2008, to CRYA LIND, Attorney for the estate, whose attorney is EDWIN R. ARMSTRONG, 1110 N. Ashland Ave., Chicago, IL 60622, 773 276-1227.

Notice is given to unknown heirs who are the heirs or assigns in the above entitled proceeding. Claims against the estate may be filed in the office of the clerk of the court or before April 23, 2009, which date is the date of the first publication of this notice and any claim not filed within that period is barred.

Published in Pioneer Press 11/6/08 (164380) C

STATE OF ILLINOIS

IN THE MATTER OF THE ESTATE OF JANUSZ SZYBOWSKI

Case No. 2008 P 4431
PUBLICATION NOTICE

Notice is given of the death of DAPHNE BENOS of Cook County, Illinois. Letters of office were issued on October 17, 2008, to CRYA LIND, Attorney for the estate, whose attorney is EDWIN R. ARMSTRONG, 1110 N. Ashland Ave., Chicago, IL 60622, 773 276-1227.

Notice is given to unknown heirs who are the heirs or assigns in the above entitled proceeding. Claims against the estate may be filed in the office of the clerk of the court or before April 23, 2009, which date is the date of the first publication of this notice and any claim not filed within that period is barred.

Published in Pioneer Press 11/6/08 (164380) C

STATE OF ILLINOIS

IN THE MATTER OF THE ESTATE OF JANUSZ SZYBOWSKI

Case No. 2008 P 4431
PUBLICATION NOTICE

Notice is given of the death of DAPHNE BENOS of Cook County, Illinois. Letters of office were issued on October 17, 2008, to CRYA LIND, Attorney for the estate, whose attorney is EDWIN R. ARMSTRONG, 1110 N. Ashland Ave., Chicago, IL 60622, 773 276-1227.

Notice is given to unknown heirs who are the heirs or assigns in the above entitled proceeding. Claims against the estate may be filed in the office of the clerk of the court or before April 23, 2009, which date is the date of the first publication of this notice and any claim not filed within that period is barred.

Published in Pioneer Press 11/6/08 (164380) C

STATE OF ILLINOIS

IN THE MATTER OF THE ESTATE OF JANUSZ SZYBOWSKI

Case No. 2008 P 4431
PUBLICATION NOTICE

Notice is given of the death of DAPHNE BENOS of Cook County, Illinois. Letters of office were issued on October 17, 2008, to CRYA LIND, Attorney for the estate, whose attorney is EDWIN R. ARMSTRONG, 1110 N. Ashland Ave., Chicago, IL 60622, 773 276-1227.

Notice is given to unknown heirs who are the heirs or assigns in the above entitled proceeding. Claims against the estate may be filed in the office of the clerk of the court or before April 23, 2009, which date is the date of the first publication of this notice and any claim not filed within that period is barred.

Published in Pioneer Press 11/6/08 (164380) C

STATE OF ILLINOIS

IN THE MATTER OF THE ESTATE OF JANUSZ SZYBOWSKI

Case No. 2008 P 4431
PUBLICATION NOTICE

Notice is given of the death of DAPHNE BENOS of Cook County, Illinois. Letters of office were issued on October 17, 2008, to CRYA LIND, Attorney for the estate, whose attorney is EDWIN R. ARMSTRONG, 1110 N. Ashland Ave., Chicago, IL 60622, 773 276-1227.

Notice is given to unknown heirs who are the heirs or assigns in the above entitled proceeding. Claims against the estate may be filed in the office of the clerk of the court or before April 23, 2009, which date is the date of the first publication of this notice and any claim not filed within that period is barred.

Published in Pioneer Press 11/6/08 (164380) C

STATE OF ILLINOIS

IN THE MATTER OF THE ESTATE OF JANUSZ SZYBOWSKI

Case No. 2008 P 4431
PUBLICATION NOTICE

Notice is given of the death of DAPHNE BENOS of Cook County, Illinois. Letters of office were issued on October 17, 2008, to CRYA LIND, Attorney for the estate, whose attorney is EDWIN R. ARMSTRONG, 1110 N. Ashland Ave., Chicago, IL 60622, 773 276-1227.

Notice is given to unknown heirs who are the heirs or assigns in the above entitled proceeding. Claims against the estate may be filed in the office of the clerk of the court or before April 23, 2009, which date is the date of the first publication of this notice and any claim not filed within that period is barred.

Published in Pioneer Press 11/6/08 (164380) C

STATE OF ILLINOIS

IN THE MATTER OF THE ESTATE OF JANUSZ SZYBOWSKI

Case No. 2008 P 4431
PUBLICATION NOTICE

Notice is given of the death of DAPHNE BENOS of Cook County, Illinois. Letters of office were issued on October 17, 2008, to CRYA LIND, Attorney for the estate, whose attorney is EDWIN R. ARMSTRONG, 1110 N. Ashland Ave., Chicago, IL 60622, 773 276-1227.

Notice is given to unknown heirs who are the heirs or assigns in the above entitled proceeding. Claims against the estate may be filed in the office of the clerk of the court or before April 23, 2009, which date is the date of the first publication of this notice and any claim not filed within that period is barred.

Published in Pioneer Press 11/6/08 (164380) C

1062- Probate

STATE OF ILLINOIS

IN THE MATTER OF THE ESTATE OF JANUSZ SZYBOWSKI

Case No. 2008 P 4431
PUBLICATION NOTICE

Notice is given of the death of DAPHNE BENOS of Cook County, Illinois. Letters of office were issued on October 17, 2008, to CRYA LIND, Attorney for the estate, whose attorney is EDWIN R. ARMSTRONG, 1110 N. Ashland Ave., Chicago, IL 60622, 773 276-1227.

Notice is given to unknown heirs who are the heirs or assigns in the above entitled proceeding. Claims against the estate may be filed in the office of the clerk of the court or before April 23, 2009, which date is the date of the first publication of this notice and any claim not filed within that period is barred.

Published in Pioneer Press 11/6/08 (164380) C

STATE OF ILLINOIS

IN THE MATTER OF THE ESTATE OF JANUSZ SZYBOWSKI

Case No. 2008 P 4431
PUBLICATION NOTICE

Notice is given of the death of DAPHNE BENOS of Cook County, Illinois. Letters of office were issued on October 17, 2008, to CRYA LIND, Attorney for the estate, whose attorney is EDWIN R. ARMSTRONG, 1110 N. Ashland Ave., Chicago, IL 60622, 773 276-1227.

Notice is given to unknown heirs who are the heirs or assigns in the above entitled proceeding. Claims against the estate may be filed in the office of the clerk of the court or before April 23, 2009, which date is the date of the first publication of this notice and any claim not filed within that period is barred.

Published in Pioneer Press 11/6/08 (164380) C

STATE OF ILLINOIS

IN THE MATTER OF THE ESTATE OF JANUSZ SZYBOWSKI

Case No. 2008 P 4431
PUBLICATION NOTICE

Notice is given of the death of DAPHNE BENOS of Cook County, Illinois. Letters of office were issued on October 17, 2008, to CRYA LIND, Attorney for the estate, whose attorney is EDWIN R. ARMSTRONG, 1110 N. Ashland Ave., Chicago, IL 60622, 773 276-1227.

Notice is given to unknown heirs who are the heirs or assigns in the above entitled proceeding. Claims against the estate may be filed in the office of the clerk of the court or before April 23, 2009, which date is the date of the first publication of this notice and any claim not filed within that period is barred.

Published in Pioneer Press 11/6/08 (164380) C

STATE OF ILLINOIS

IN THE MATTER OF THE ESTATE OF JANUSZ SZYBOWSKI

Case No. 2008 P 4431
PUBLICATION NOTICE

Notice is given of the death of DAPHNE BENOS of Cook County, Illinois. Letters of office were issued on October 17, 2008, to CRYA LIND, Attorney for the estate, whose attorney is EDWIN R. ARMSTRONG, 1110 N. Ashland Ave., Chicago, IL 60622, 773 276-1227.

Notice is given to unknown heirs who are the heirs or assigns in the above entitled proceeding. Claims against the estate may be filed in the office of the clerk of the court or before April 23, 2009, which date is the date of the first publication of this notice and any claim not filed within that period is barred.

Published in Pioneer Press 11/6/08 (164380) C

STATE OF ILLINOIS

IN THE MATTER OF THE ESTATE OF JANUSZ SZYBOWSKI

Case No. 2008 P 4431
PUBLICATION NOTICE

Notice is given of the death of DAPHNE BENOS of Cook County, Illinois. Letters of office were issued on October 17, 2008, to CRYA LIND, Attorney for the estate, whose attorney is EDWIN R. ARMSTRONG, 1110 N. Ashland Ave., Chicago, IL 60622, 773 276-1227.

Notice is given to unknown heirs who are the heirs or assigns in the above entitled proceeding. Claims against the estate may be filed in the office of the clerk of the court or before April 23, 2009, which date is the date of the first publication of this notice and any claim not filed within that period is barred.

Published in Pioneer Press 11/6/08 (164380) C

STATE OF ILLINOIS

IN THE MATTER OF THE ESTATE OF JANUSZ SZYBOWSKI

Case No. 2008 P 4431
PUBLICATION NOTICE

Notice is given of the death of DAPHNE BENOS of Cook County, Illinois. Letters of office were issued on October 17, 2008, to CRYA LIND, Attorney for the estate, whose attorney is EDWIN R. ARMSTRONG, 1110 N. Ashland Ave., Chicago, IL 60622, 773 276-1227.

Notice is given to unknown heirs who are the heirs or assigns in the above entitled proceeding. Claims against the estate may be filed in the office of the clerk of the court or before April 23, 2009, which date is the date of the first publication of this notice and any claim not filed within that period is barred.

Published in Pioneer Press 11/6/08 (164380) C

STATE OF ILLINOIS

IN THE MATTER OF THE ESTATE OF JANUSZ SZYBOWSKI

Case No. 2008 P 4431
PUBLICATION NOTICE

Notice is given of the death of DAPHNE BENOS of Cook County, Illinois. Letters of office were issued on October 17, 2008, to CRYA LIND, Attorney for the estate, whose attorney is EDWIN R. ARMSTRONG, 1110 N. Ashland Ave., Chicago, IL 60622, 773 276-1227.

Notice is given to unknown heirs who are the heirs or assigns in the above entitled proceeding. Claims against the estate may be filed in the office of the clerk of the court or before April 23, 2009, which date is the date of the first publication of this notice and any claim not filed within that period is barred.

Published in Pioneer Press 11/6/08 (164380) C

STATE OF ILLINOIS

IN THE MATTER OF THE ESTATE OF JANUSZ SZYBOWSKI

Case No. 2008 P 4431
PUBLICATION NOTICE

Notice is given of the death of DAPHNE BENOS of Cook County, Illinois. Letters of office were issued on October 17, 2008, to CRYA LIND, Attorney for the estate, whose attorney is EDWIN R. ARMSTRONG, 1110 N. Ashland Ave., Chicago, IL 60622, 773 276-1227.

Notice is given to unknown heirs who are the heirs or assigns in the above entitled proceeding. Claims against the estate may be filed in the office of the clerk of the court or before April 23, 2009, which date is the date of the first publication of this notice and any claim not filed within that period is barred.

Published in Pioneer Press 11/6/08 (164380) C

STATE OF ILLINOIS

IN THE MATTER OF THE ESTATE OF JANUSZ SZYBOWSKI

Case No. 2008 P 4431
PUBLICATION NOTICE

Notice is given of the death of DAPHNE BENOS of Cook County, Illinois. Letters of office were issued on October 17, 2008, to CRYA LIND, Attorney for the estate, whose attorney is EDWIN R. ARMSTRONG, 1110 N. Ashland Ave., Chicago, IL 60622, 773 276-1227.

Notice is given to unknown heirs who are the heirs or assigns in the above entitled proceeding. Claims against the estate may be filed in the office of the clerk of the court or before April 23, 2009, which date is the date of the first publication of this notice and any claim not filed within that period is barred.

Published in Pioneer Press 11/6/08 (164380) C

1066- Public Notices

PUBLIC NOTICE

BOARD OF EDUCATION SKOKIE SCHOOL DISTRICT 734 COOK COUNTY, ILLINOIS

Notice of Time and Place for Filing Nominating Petitions

Notice is hereby given that on Tuesday, the 7th day of April 2009, an election will be held in Skokie School District 734, Cook County, Illinois, for the purpose of electing four (4) members to the Board of Education.

To be eligible to serve on a Board of Education Member, candidates must be 18 years of age, a U.S. citizen, a District 734 resident for at least one year, and a registered voter. In addition, candidates must submit a nominating petition, which will be submitted to the Board of Education on or before April 21, 2009.

Prospective applicants interested in serving on the Board of Education must come to the Superintendent's Office, 8000 East Prairie Road, Skokie, Illinois, to file their names, a letter of intent to serve, and a nominating petition, on or before Tuesday, October 28, 2008. The first day for the submission of nominating petitions for candidates will be on or before Tuesday, October 28, 2008. The last day for the submission of nominating petitions for candidates will be on or before Tuesday, October 28, 2008. The first day for candidates to be accepted for the Superintendent's Office will be on or before Tuesday, October 28, 2008. The last day for candidates to be accepted for the Superintendent's Office will be on or before Tuesday, October 28, 2008.

Further information may be obtained by contacting Laurie Kattos, in the Superintendent's Office at (847) 674-8237.

Andrea Reson
Secretary
Skokie School District 734
Board of Education

Published in Pioneer Press 11/6/08 (164380) C

PUBLIC NOTICE

THE HOUSING AUTHORITY OF THE COUNTY OF COOK

Public Notice is hereby given that the Housing Authority of the County of Cook (HAC) will hold three Public Hearings on the Public Housing Program, which is required by HUD under Section 515 of the Housing Act of 1954, and the Quality Housing and Work Responsibility Act (QHWRA) of 2002. The first Public Hearing will be held on Tuesday, November 11, 2008, at 8:00 a.m. at the County Administration Center, 1110 N. Ashland Ave., Chicago, IL 60622. The second Public Hearing will be held on Thursday, November 13, 2008, at 8:00 a.m. at the County Administration Center, 1110 N. Ashland Ave., Chicago, IL 60622. The third Public Hearing will be held on Friday, November 14, 2008, at 8:00 a.m. at the County Administration Center, 1110 N. Ashland Ave., Chicago, IL 60622. A draft copy of the Plan is available for review and in accordance with the public notice of the Housing Authority of the County of Cook, Central Administrative Office, 175 W. Jackson Blvd., Suite 350, Chicago, IL 60604.

A draft copy of the Plan is available for review and in accordance with the public notice of the Housing Authority of the County of Cook, Central Administrative Office, 175 W. Jackson Blvd., Suite 350, Chicago, IL 60604.

Section 8 recipients, public housing residents, resident council, organizations, and interested parties are invited to attend and submit suggestions, recommendations, comments and ideas on the Draft 2009 Agency Plan. Persons requiring special accommodations to attend or participate in the hearing should contact the Central Administrative Office at (312) 441-4111 at least one (1) week prior to the hearing.

Larry Newton
Executive Director

Published in Pioneer Press 11/6/08 (164380) C

PUBLIC NOTICE

THE HOUSING AUTHORITY OF THE COUNTY OF COOK

Public Notice is hereby given that the Housing Authority of the County of Cook (HAC) will hold three Public Hearings on the Public Housing Program, which is required by HUD under Section 515 of the Housing Act of 1954, and the Quality Housing and Work Responsibility Act (QHWRA) of 2002. The first Public Hearing will be held on Tuesday, November 11, 2008, at 8:00 a.m. at the County Administration Center, 1110 N. Ashland Ave., Chicago, IL 60622. The second Public Hearing will be held on Thursday, November 13, 2008, at 8:00 a.m. at the County Administration Center, 1110 N. Ashland Ave., Chicago, IL 60622. The third Public Hearing will be held on Friday, November 14, 2008, at 8:00 a.m. at the County Administration Center, 1110 N. Ashland Ave., Chicago, IL 60622. A draft copy of the Plan is available for review and in accordance with the public notice of the Housing Authority of the County of Cook, Central Administrative Office, 175 W. Jackson Blvd., Suite 350, Chicago, IL 60604.

A draft copy of the Plan is available for review and in accordance with the public notice of the Housing Authority of the County of Cook, Central Administrative Office, 175 W. Jackson Blvd., Suite 350, Chicago, IL 60604.

Section 8 recipients, public housing residents, resident council, organizations, and interested parties are invited to attend and submit suggestions, recommendations, comments and ideas on the Draft 2009 Agency Plan. Persons requiring special accommodations to attend or participate in the hearing should contact the Central Administrative Office at (312) 441-4111 at least one (1) week prior to the hearing.

Larry Newton
Executive Director

Published in Pioneer Press 11/6/08 (164380) C

PUBLIC NOTICE

THE HOUSING AUTHORITY OF THE COUNTY OF COOK

Public Notice is hereby given that the Housing Authority of the County of Cook (HAC) will hold three Public Hearings on the Public Housing Program, which is required by HUD under Section 515 of the Housing Act of 1954, and the Quality Housing and Work Responsibility Act (QHWRA) of 2002. The first Public Hearing will be held on Tuesday, November 11, 2008, at 8:00 a.m. at the County Administration Center, 1110 N. Ashland Ave., Chicago, IL 60622. The second Public Hearing will be held on Thursday, November 13, 2008, at 8:00 a.m. at the County Administration Center, 1110 N. Ashland Ave., Chicago, IL 60622. The third Public Hearing will be held on Friday, November 14, 2008, at 8:00 a.m. at the County Administration Center, 1110 N. Ashland Ave., Chicago, IL 60622. A draft copy of the Plan is available for review and in accordance with the public notice of the Housing Authority of the County of Cook, Central Administrative Office, 175 W. Jackson Blvd., Suite 350, Chicago, IL 60604.

A draft copy of the Plan is available for review and in accordance with the public notice of the Housing Authority of the County of Cook, Central Administrative Office, 175 W. Jackson Blvd., Suite 350, Chicago, IL 60604.

Section 8 recipients, public housing residents, resident council, organizations, and interested parties are invited to attend and submit suggestions, recommendations, comments and ideas on the Draft 2009 Agency Plan. Persons requiring special accommodations to attend or participate in the hearing should contact the Central Administrative Office at (312) 441-4111 at least one (1) week prior to the hearing.

Larry Newton
Executive Director

Published in Pioneer Press 11/6/08 (164380) C

PUBLIC NOTICE

THE HOUSING AUTHORITY OF THE COUNTY OF COOK

Public Notice is hereby given that the Housing Authority of the County of Cook (HAC) will hold three Public Hearings on the Public Housing Program, which is required by HUD under Section 515 of the Housing Act of 1954, and the Quality Housing and Work Responsibility Act (QHWRA) of 2002. The first Public Hearing will be held on Tuesday, November 11, 2008, at 8:00 a.m. at the County Administration Center, 1110 N. Ashland Ave., Chicago, IL 60622. The second Public Hearing will be held on Thursday, November 13, 2008, at 8:00 a.m. at the County Administration Center, 1110 N. Ashland Ave., Chicago, IL 60622. The third Public Hearing will be held on Friday, November 14, 2008, at 8:00 a.m. at the County Administration Center, 1110 N. Ashland Ave., Chicago, IL 60622. A draft copy of the Plan is available for review and in accordance with the public notice of the Housing Authority of the County of Cook, Central Administrative Office, 175 W. Jackson Blvd., Suite 350, Chicago, IL 60604.

A draft copy of the Plan is available for review and in accordance with the public notice of the Housing Authority

Pioneer Press Classified Auto Dealer Directory

JEEP

DUPAGE DODGE CHRYSLER JEEP
800 EAST ROCKFORD
(ONLY 3 MILES WEST OF 355)
(866) 388-0387
DUPAGEJITP.COM

FIELDS CHRYSLER JEEP DODGE
670 FRONTAGE ROAD, NORTHFIELD
(866) 419-3387
FIELDSAUTO.COM

GREGORY CHRYSLER JEEP
18836 WEST GRAND AVE.
GURNEE
(800) 370-6582
GREGORYAUTOGROUP.COM

WALTON JEEP
5050 DEWITT STREET, SKOKIE
(847) 673-6700
WALTONCHRYSLERJEEP.COM

LEXUS

BREDEMANN LEXUS
2000 N. WALKER RD., GLENVIEW
(847) 729-6000
BREDEMANN.COM

MC GRATH LEXUS OF CHICAGO
1250 W. DUNDEE
(800) NEW-LEXUS
WWW.MCGRATHLEXUS.COM

MC GRATH LEXUS OF WESTMONT
470 E. OGDEN AVE.
(800) NEW-LEXUS
WWW.MCGRATHLEXUS.COM

LEXUS OF HIGHLAND PARK
3040 SKOKIE VALLEY ROAD,
HIGHLAND PARK
(847) 432-1900
LEXUSAUTO.COM

LEXUS OF ORLAND
8300 W. 159TH ST.
(708) 342-5475
WWW.LEXUSOFORLAND.COM

BOB ROHRMAN'S ARLINGTON LEXUS IN PALATINE
1285 W. DUNDEE ROAD, PALATINE
(LAST WEST OF IIT, 53 ON DUNDEE)
(847)-991-0444

LANDROVER

FIELDS LAND ROVER - WINNETKA
80 GRIFFIN ROAD, WINNETKA
(847) 446-6665
FIELDSAUTO.COM

LANDROVER OF CHICAGO AT HOWARD ORLOFF
KIMBLEY EXP. AT ARMBRIDGE
(888)510-0669
ORLOFF.COM

LANDROVER OF HINDSDALE
300 E. OGDEN AVE.
(866)516-8045
HINDSDALELANDROVER.COM

LANDROVER HOFFMAN ESTATES
1051 W. HIGGINS ROAD,
HOFFMAN ESTATES
(866) 516-8035
LANDROVERHOFFMAN.COM

LANDROVER LAKE BLUFF KNAUZ AUTO PARK
ROUTE 41 @ RT. 176, LAKE BLUFF
(847) 604-8100
KNAUZ.COM

PATRICK LANDROVER OF NAPERVILLE
1559 WEST OGDEN AVE.
NAPERVILLE
(630)300-5000
LANDROVERPATRICK.COM

LINCOLN

KNIAUZ LINCOLN MERCURY
1333 PARK AVE. WEST
HIGHLAND PARK
(847) 831-5880
KNAUZ.COM

JOE RIZZA LINCOLN/MERCURY
2055 WEST OGDEN AVENUE,
NAPERVILLE
(630) 352-8140
RIZZACARS.COM

NAPLETON LINCOLN/MERCURY
826 TOLBY AVE., PARK RIDGE
(800) 931-6583
DARRIN@LINCOLNMERCURY.COM

Napleton
Lincoln Mercury/Park Ridge

828 Touhy Ave., Park Ridge, IL
800-794-8046
www.napleton.com

All New 2009 Lincoln MKS

18" Alcantara
Adaptive
Control
Blind Spot
Warning
Head
Seats
and More!

We Welcome All Lincoln Mercury & Ford Owners To Our State-Of-The-Art Facility. Open 6 Days A Week.

Lease For **\$464** per mo. 39 mos.

Buy For **\$36,118.40**

39 month closed end lease with qualified credit. Security deposit waived with approved credit. Lessee may be responsible for excess wear, tear and/or mileage over 10,000 miles per year. Offer expires 10/31/08. Excludes tax, title, license, and doc fee.

MAZDA

THE AUTOBARN MAZDA OF COUNTRYSIDE/LA GRANGE
5700 LA GRANGE RD.
(708) 354-2700
MAZDAUSA.COM

BIGGERS MAZDA
1320 E. OGDEN ST., ELGIN
(866) 9-MACHINE

MULLER MAZDA
150 SKOKIE VALLEY ROAD,
HIGHLAND PARK, IL
(847) 831-4100
MULLERMAZDA.COM

MERCEDES

AUTOHAUS ON EDENS MERCEDES BENZ
1600 FRONTAGE RD, NORTHBROOK
(800) 716-6495
AUTOHAUSONEDENS.COM

KNAUZ MERCEDES BENZ KNAUZ ALTO PARK
ROUTE 41 @ RT. 176,
LAKE BLUFF
(847) 234-1700
KNAUZ.COM

MINI

BILL JACOBS MINI
1564 W. OGDEN AVE.
(866) 516-8015
BILLJACOBSMINI.COM

KNIAUZ MINI
KNIAUZ AUTO PARK
ROUTE 41 @ RT. 176, LAKE BLUFF
(847) 604-5050
KNAUZ.COM

PATRICK MINI
700 WEST OGDEN RD.
SOVIAMURKING, IL 60173
(866) 370-6567
PATRICKMINI.COM

MITSUBISHI

LIBERTYVILLE MITSUBISHI
1119 S. MILWAUKEE AVE., LIBERTYVILLE
LIBERTYVILLEMITSUBISHI.COM

NISSAN

THE AUTOBARN NISSAN OF EVANSTON
1001 DUNDEE AVE.,
EVANSTON
(847) 475-8200
THEAUTOBARN.COM

BOB ROHRMAN'S ARLINGTON NISSAN
"WE SPEAK YOUR LANGUAGE"
915 WEST DUNDEE ROAD
BURLEIGH GLEN
(847) 590-6100
ROHRMAN.COM

LIBERTY NISSAN
3905 MILWAUKEE AVE., LIBERTYVILLE
(866) 329-2296
LIBERTYVAULTONAZA.COM

MARTIN NISSAN
5240 GOLF ROAD, SKOKIE
(866) 799-0300
MARTINNISSAN.COM

NAPLETON MITSUBISHI
826 TOLBY AVE., PARK RIDGE
(800) 931-6583
NAPLETON.COM

PONTIAC

GROSSINGER PONTIAC
6900 N. MCCORMICK BLVD.,
LINCOLNWOOD
(866) 670-1654
GROSSINGERPONTIAC.COM

LOREN PONTIAC/BUICK
1610 WALKER RD., GLENVIEW
(847) 729-8900
LORENNAUTOGROUP.COM

MULLER PONTIAC
150 SKOKIE VALLEY ROAD,
HIGHLAND PARK, IL
(847) 831-4100
MULLERMAZDA.COM

SULLIVAN PONTIAC
777 W. DUNDEE ROAD,
ARLINGTON HEIGHTS, IL
(847) 332-6660
BILLSULLIVAN.COM

PORSCHE

LOEBER MOTORS PORSCHE
7101 N. LINCOLN AVE.-SOUTH OF
TOLBY, LAKE BLUFF
(847) 675-1000
LOEBERMOTORS.COM

JOE RIZZA PORSCHE
8130 W. 159TH STREET,
ORLAND PARK
(847) 266-2400
RIZZACARS.COM

PORSCHE EXCHANGE PORSCHE PREMIER DEALER
2300 SKOKIE VALLEY RD.,
HIGHLAND PARK
(847) 266-7000
PORSCHE.COM

MOTOR WORKS
BARRINGTON & DUNDEE RD.,
BARRINGTON
(866) 289-6275
MOTORWORKS.COM

ROLLS-ROY

STEVE FOLEY ROLLS-ROYCE
100 SKOKIE BLVD, NORTHBROOK
(847) 564-4090
STEVESROLLSROYCE.COM

SAAB

SAAB EXCHANGE
715 OGDEN AVE., EVANSTON
(866) 924-1111
SAABEXCHANGE.COM

PATRICK SAAB
526 MAIN ST., MOUNTAIN VIEW
(888) 350-1599
PATRICKSAAB.COM

SCION

BREDEMANN SCION
1301 W. DEWITT ST., PARK RIDGE
(847) 698-3700
WWW.BREDEMANN.COM

CLASSIC SCION
425 N. GRIFFIN RD., WALKER
(888) 300-0958
CLASSICSCION.COM

CONTINENTAL SCION

9960 JOLIET ROAD, COUNTRYSIDE
(708) 354-5800
CONTINENTALMOTORS.COM

FOX LAKE SCION
75 S. Rte. 12, FOX LAKE
(847) 497-9147
FOXLAKESCION.COM

NORTHBROOK SCION
1530 FRONTAGE ROAD,
NORTHBROOK
(708) 364-2400
WWW.NORTHBROOKSCION.COM

SMART

SMART Center LAKE BLUFF
KNAUZ AUTO PARK
ROUTE 41 & ROUTE 176
LAKE BLUFF
(847) 234-2800
KNAUZ.COM

SUBARU

AUTOBARN SUBARU OF COUNTRYSIDE/LA GRANGE
100 SKOKIE BLVD, NORTHBROOK
(847) 564-4090
STEVESROLLSROYCE.COM

EVANSTON SUBARU
715 OGDEN AVE., EVANSTON
(888) 473-1605
EVANSTONSUBARU.COM

SUZUKI

GROSSINGER SUZUKI
6900 N. MCCORMICK BLVD.,
LINCOLNWOOD
(866) 670-1654
GROSSINGERSUZUKI.COM

TOYOTA

BREDEMANN TOYOTA
1301 W. DEWITT ST., PARK RIDGE
(847) 698-3700
BREDEMANN.COM

CLASSIC TOYOTA
425 N. GRIFFIN RD., WALKER
(888) 300-0958
CLASSICSCION.COM

GROSSINGER TOYOTA NORTH

1725 N. CICHGO, LINCOLNWOOD
(847)675-7100
GROSSINGER.COM

GROSSINGER CITY TOYOTA

1233 N. WELLS ST., CHICAGO
(312)707-9500
GROSSINGER.COM

LIBERTYVILLE TOYOTA

1180 SOUTH MILWAUKEE AVE.,
LIBERTYVILLE
(847) 362-1500
LIBERTYVILLETOYOTA.COM

PAULY TOYOTA

1035 S. Rte. 31,
ONE MILE SOUTH OF RT. 14
(815) 459-7100 (847) 658-9050

NORTHBROOK TOYOTA

1530 FRONTAGE ROAD,
NORTHBROOK, IL 60062
(800) 743-9594
WWW.NORTHBROOKTOYOTA.COM

OAKBROOK TOYOTA/SCION IN WESTMONT

550 E. OGDEN AVENUE,
(630) 789-9600
OAKBROOKTOYOTA.COM

ORLAND TOYOTA/SCION

8505 W. 159TH ST., TOLBY PARK
(708) 429-3900
ORLANDSCION.COM

VOLKSWAGEN

AUTOBARN VOLKSWAGEN OF COUNTRYSIDE/LA GRANGE
619 JOLIET RD.
ONLY 15 MINUTES FROM DOWNTOWN CHICAGO
(708) 354-6600
THEAUTOBARN.COM

BILL JACOBS VOLKSWAGEN

221 ALPHEA AVE., NAPERVILLE
(866) 516-8025
BILLJACOBSVOLKSWAGEN.COM

JENNINGS VOLKSWAGEN

201 WALKER RD., GLENVIEW
(866) 729-9505
JENNINGSVOLKSWAGEN.COM

NORTHSHORE VOLKSWAGEN

RT. 41 & PARK AVE. WEST,
HIGHLAND PARK
(847) 433-7900
WWW.NORTHSHOREVOLKSWAGEN.COM

BARRINGTON VOLVO

300 N. HOUER (RT. 59), BARRINGTON
(847) 381-9400

FIELDS VOLVO HIGHLAND PARK

250 SKOKIE VALLEY ROAD,
HIGHLAND PARK
(847) 831-2100

FIELDS VOLVO

1121 S. MILWAUKEE AVE.,
LIBERTYVILLE
(847) 362-9200
FIELDSAUTO.COM

GROSSINGER VOLVO

6747 N. LINCOLN AVENUE,
LINCOLNWOOD
(800)783-3497
GROSSINGERVOLVO.COM

HOWARD ORLOFF VOLVO

KIMBLEY EXP. AT ARMBRIDGE
(888)510-0669
ORLOFF.COM

PATRICK VOLVO

1600 E. HIGGINS RD.,
SOVIAMURKING, IL
(847) 605-4005
PATRICKVOLVO.COM

VOLVO OF LISLE

Market's Largest Volvo Superstore
RTE. 53 1/2 MI. S. OF I-55
(E/W TOLLWAY)
(630) 852-6000
WWW.VOLVOOF LISLE.COM

WHY pay TO ANSWER YOUR PHONE?

Get Free Incoming Calls, Texts and Pix only from U.S. Cellular.

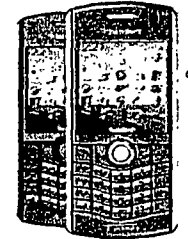

BLACKBERRY PEARL™ 8130 SMARTPHONE
features media player for music and videos.
-Take Facebook™ on the go.

\$79.95

After \$70 mail-in rebate that comes as a Visa™ Debit Card. Requires new 2-yr. agmt. plus \$39.95 voice plan and Smartphone Plan purchases \$30 act. fee may apply. Available in Red and Amethyst.



LG UX830
features touch screen and GPS with voice turn-by-turn directions.

\$99.95

After \$50 mail-in rebate that comes as a Visa Debit Card. New 2-yr. agmt. plus 3-yr. unlimited anytime™ plan required. \$30 act. fee may apply.

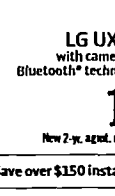

LG UX300
with camera and Bluetooth™ technology.

1¢

New 2-yr. agmt. required.
Save over \$150 instantly.



U.S. Cellular
believe in something better™

Discover the Difference: Put our network, products and customer service to the test for 30 days - Change your calling plan at any time during your service agreement without signing a new contract - Renew your contract and take advantage of new phone pricing before your current contract ends

Let us help you find a location: visit uscellular.com or call 1-888-BUY-USCC

Things we want you to know: Offer valid on plans of \$39.95 per month or higher. New two year agreement (subject to early termination fee), credit approval and a \$30 activation fee required. 96¢ Regulatory Cost Recovery Fee applies, this is not a tax or government required charge. Additional fees, taxes, terms, conditions and coverage areas apply and vary by plan, service and phone. Use of service constitutes acceptance of the terms of our Customer Service Agreement. See store for details or visit uscellular.com. 30-Day Guarantee: Customer is responsible for any usage charges incurred prior to return. Phone must be returned undamaged in the original packaging. Contract Renewals: Customers who have completed at least 18 months of a two year agreement are eligible for promotional equipment pricing. See store for eligibility. Promotional Phone subject to change. U.S. Cellular Visa Debit Card issued by MetaBank pursuant to a license from Visa U.S.A. Inc. Allow 10-12 weeks for processing. Card does not have cash access and can be used at any merchant location that accepts Visa Debit Cards. Card valid for 120 days after issued. \$9.95 unlimited anytime access plan applies. Limited time offer. Trademarks and trade names are the property of their respective owners. ©2008 U.S. Cellular



Count Dracula (Christopher Zavacki) has more than just his eye on Lucy Westenra (Laura Behnke) in the Resurrection High School Drama Department's production of "Dracula."



Dracula (Christopher Zavacki) has a taste for Lucy Westenra (Megan Armstrong).



Exploring the chaotic mind of the mental patient, Renfield (Allison Coppin), Dr. Seward (Michael Kratochvil), and Professor Van Helsing (MaryRose Moss) seek information to track down the mysterious Count Dracula.

'Dracula' gives bite to drama at Resurrection

By WYNN KOEBEL FOSTER
wfooster@pioneerlocal.com

Just in time for Halloween last month, the Drama Department at Resurrection High School, 7500 W. Fullert Ave., Chicago, premiered "Dracula," written by John Mather and directed by Kathie Poszew. The show is a theatrical adaptation of the classic story of Count Dracula, with comic overtones. The cast included young women from Resurrection and young men from other local high schools.

Count Dracula (St. Patrick senior Christopher Zavacki) lives next door to an insane asylum run by the naïve Dr. Peter Seward (St. Patrick junior Michael Kratochvil). Pro-

fessor Van Helsing (sophomore MaryRose Moss) tries to convince the doctor that Count Dracula is a vampire and the hospital staff, including Dr. Seward's aide (sophomore Angela Christides), are busy running the asylum and dealing with bug-eating inmate Renfield (senior Allison Coppin).

Dracula has his blood-thirsty eye on young beauty Lucy Westenra (seniors Megia Armstrong and Laura Behnke) and an Lucy's friend, Mina Murray (seniors Ashley Berneck and Rachel Norak). Lucy is engaged to Jonathan Harker (Loyola Academy junior Kristofer VanAhnen), while Mina is engaged to Arthur Hallowood (Loyola Academy junior Greg Selinger). The cast was

rounded out by Lucy's mother, Martha Westenra (senior Samantha Santos), Aunt Henrietta (senior Kathryn Kuffin), the Westens' maid, Charlotte (senior Margaret Mann) and servant (senior Molly Carriety).

Adding to the terror, the cast also included a group of lovely vampires (seniors Claire Compell and Melissa Ganzel; sophomores Michelle Klokhnawski, Andrea Melwege, Gina Orlandi, Britney Rzany and Maria Tyrrell; and freshmen Ashley Bowers, Cassandra Jordan and Amanda Willner).

Performances were Oct. 29, Oct. 30, Nov. 1 and Nov. 2.

Comment: pioneerlocal.com

Torn up over defective T-shirts



STEPHANIE ZIMMERMANN
THE FIXER - Chicago Sun-Times

Dear Fixer: Monarchy Collection is a high-end clothing company that specializes in men's T-shirts. I've been a big fan of their clothes for a long time and have spent more than \$1,000 to \$2,000 on their clothing line. Their T-shirts are generally close to \$100 each.

I had an issue with two shirts a few months ago. One came up at the stitching running along the side after just one wash and the other had a bad sew line along the neck. I contacted them, and Mariah from their quality control called me and asked if I could send her the shirts. I told her I had thrown the ripped one away, but I overnighted her the shirt that had a bad neckline sew.

I never heard back from her, so I contacted them again and she said they were going to send me another shirt and a free shirt for the troubles. I received another T-shirt. I've been a big fan of their clothes for a long time and have spent more than \$1,000 to \$2,000 on their clothing line. Their T-shirts are generally close to \$100 each.

I tried contacting Mariah again and she said she would look into it and make sure I get my shirt, but I never heard back.

So I'm out two shirts, and they have the one I sent them and won't even send that back, even if I wanted it.

I have the e-mails from them if needed. I really love their brand, but when you spend a premium for premium clothing, you expect the clothes to survive at least one wash.

Dear Iman: The Fixer prefers \$10 T-shirts, but after seeing Monarchy's cool A-list designs, we can see why you were smitten. And at \$100 a pop, we can see why you expect a high-quality item. The good news is, once we got your problem to the folks at Matt Marx, parent of Monarchy, this was fixed immediately. Everyone from the CEO on down wanted you to know they were on top of it. They offered their apologies, and overnighted you a package containing a pair of jeans, a hooded sweatshirt and three different shirts.

And now -- we'll consider this fixed.

Dear Readers: Thanks to everyone who's put a tip in The Fixer's Tip Jar at www.suntimes.com. The Tip Jar is your place to either give a tip to fellow readers or take a tip on saving money, avoiding a scam or fixing a problem.

Here are two recent tips we found in the jar: From tag: "This is about a gift card seam. Last Christmas, I received an American Express gift card from my dad. I had checked the balance a couple of months before I tried to use it. I had about \$17 left. When I gave it to the cashier, I told her to apply this card to my balance and let me know the new total. I also told her I didn't remember how much was left on it. She supposedly swiped it and told me there was a zero balance on it. I was confused and thought maybe I made a purchase of \$17 and just forgot about it. I said 'OK, then I'll just write you a

Keep tips coming

check for the total amount." She then said, "Do you want me to just throw away the card?" Something told me to get the card back and call again about my balance. "I did that when I came home and found I really did have \$17 left on the card. I wonder how many others tell them to just throw it away there at the store, and the cashier just keeps the cards."

And from Marianne, who wrote about her granddaughter using a gift card in a store and being told (by a dishonest cashier) that it was all out of money: "The store manager sided with the cashier. My granddaughter made the mistake of not getting back the card. The next time it happened, at the same store, her mom was with her and had the receipt and got the card back this time. I think teenagers are more likely to be the victims, since they might not ask for the card back.

local families in the community at Thanksgiving for some time, this year it is a community effort. Since the need is greater, several Niles banks will be collection sites for food donations. Due to the economy, loss of jobs, homes, recent flooding in the area and soaring utility and food prices, the need for assistance in our community has escalated. Your help is needed. Through combined efforts as a community we can help brighten the holidays for families in our own area.

Meals and food will be donated to community area families as well as to area food pantries. Non-perishable food items, including: tuna, canned meats, pasta, chili, oatmeal, pasta, pasta sauces (no glass items jars), etc. are needed. Your support can help make a positive difference in the lives of people coping with financial hardship. Every donation you make will go to help families with children in

need in the community. Donations will be accepted from Oct. 13 through Nov. 21 at the following locations: Niles Fire Department, 8360 Dempster; Niles Family Fitness Center, 987 Civic Center Drive; Citibank, 8400 W. Dempster St.; First American Bank, 7747 N. Waukegan Road; First Bank, 8720 W. Dempster St.; Fifth Third Bank, 7100 W. Oakton St. and 5950 W. Touhy Ave.; MB Financial, 7757 W. Oakton St.; and PNA Bank, 7840 N. Milwaukee Ave. If you have any questions, contact Bernadette Knapik-Fish of the Niles Fire Department at (847) 588-6800.

Help chase away the blues for sick children by attending "Changing the World Together," an estate tour of the ultimate green home located at 6N558 Kim Lane in St. Charles, the proceeds of which will benefit Advent Lutheran

Comment: pioneerlocal.com

PEEK AT THE WEEK

DEADLINES

Submissions for Community Calendar are required 10 days preceding the date of publication. Send to: Niles Managing Editor, Pioneer Press, 3701 W. Lake Ave., Glenview IL 60026. Information may be fixed to (847) 486-7495 or e-mailed to mbettari@pioneerlocal.com.

AUCTION

The Chicago Rush will be holding auctions for the 2009 Adrenaline Rush Dancers Nov. 30 at the Stephens Convention Center in Rosemont. Registration begins at 8 a.m., and auctions start at 9 a.m. Arrive early and expect to spend the entire day auctioning. Semi-finalists will continue with mandatory training camp sessions from 7 p.m. to 10 p.m. Dec. 2 and 4 in preparation for the final round to be held Dec. 6 in front of a panel of

judges and special invited guests. Dancers participate in all home games, attend community events, take part in media interviews and promotional opportunities and attend photo shoots throughout the year. Dancers wishing to audition must submit a \$25 non-refundable registration fee, be able to commit to the squad for one year and be age 18 by Nov. 30. For more information and to pre-register, visit www.chicgorush.com or call (773) 243-3434.

BAKE SALES

Our Lady of Ransom Catholic Women's Club, Queen of Peace Guild, will hold its 36th annual Holiday Craft and Bake Sale the weekend of Nov. 15 to 16, in the newly renovated, elevator-accessible Phloeh Hall, 8300 Greenwood Ave., Niles, between the hours of 8 a.m. to 6 p.m. Saturday and 8 a.m. to 2 p.m. Sunday. Stop by and see a variety of hand-made crafts, ornaments, wreaths, quilts, baby knit quilts, dolls, home decorations, jewelry and more. There will also be a grand raffle, bake sale, a turkey booth and Christmas stocking tree for added chances at beautiful gifts and items. Home-baked bread will also be for sale. Proceeds benefit the parish. For more information, call the Ministry Center (847) 823-2550.

BENEFITS

Sport Clips' stores in Niles and Chicago are working with Children's Memorial Hospital to help raise funds for the Brown Family Life Center. From Nov. 1 to Nov. 30, Sport Clips "Clips for a Good Cause" program will donate \$2 per every MVP haircut sold to Children's Memorial Hospital. Sport Clips is open everyday with no appointment necessary, and features TV's playing sports for clients who get their hair cut by "guy-smart" stylists. The participating stores are 5944 W. Touhy Ave., in Niles (next to Al's Beef and Fifth Third Bank) and 1223 W. Fullerton Ave., in Racine Avenue, in Chicago. If you would like to nominate your favorite charity or organization for Sport Clips' "Clips for a Good Cause" program, contact Ashley Felts at (312) 923-1010.

Niles Fire Department has been donating food to

need in the community. Donations will be accepted from Oct. 13 through Nov. 21 at the following locations: Niles Fire Department, 8360 Dempster; Niles Family Fitness Center, 987 Civic Center Drive; Citibank, 8400 W. Dempster St.; First American Bank, 7747 N. Waukegan Road; First Bank, 8720 W. Dempster St.; Fifth Third Bank, 7100 W. Oakton St. and 5950 W. Touhy Ave.; MB Financial, 7757 W. Oakton St.; and PNA Bank, 7840 N. Milwaukee Ave. If you have any questions, contact Bernadette Knapik-Fish of the Niles Fire Department at (847) 588-6800.

Help chase away the blues for sick children by attending "Changing the World Together," an estate tour of the ultimate green home located at 6N558 Kim Lane in St. Charles, the proceeds of which will benefit Advent Lutheran

Comment: pioneerlocal.com

Digital

Continued from PAGE 23

a regional College Bowl tournament in December.

College Bowl is an inter-collegiate academic quiz competition that challenges participants in their knowledge of current events, history, math, geography, sports and literature.

For more information contact Gary Newhouse, (847) 635-1640, garyn@oakton.edu, or Ann Marie Barry, (847) 635-1699, annmarie@oakton.edu.

Enroll in single-session continuing-education courses offered by the Alliance for Lifelong Learning at Oakton.

Step up to the New Technologies (DAT E05-01) provides information on how to make use of iPods, MP3 players, digital scrapbooking and the wireless Internet. The session will meet 6:30-8:30 p.m. Nov. 18 at the Des Plaines campus, 1600 E. Golf Road. The fee is \$19.

Impressionism: The Hand and Glove of Debussy and Monet (MUS S42-01) explores the influence of

Impressionistic art on Claude Debussy. The course will meet 7:30-9 p.m. Nov. 18 at Glenbrook South High School, 4000 W. Lake Ave., Glenview. The fee is \$20.

Avoiding Winter Accidents (MED 106-01) offers safety tips on how to protect against frostbite, hypothermia and other outdoor injuries. The course meets 7-8:30 p.m. Nov. 19 at Maine West High School, 1755 S. Wolf Road, Des Plaines. The fee is \$5.

Instant Piano for Hopelessly Busy People (MUS S01-01) demonstrates how

those with little or no musical experience can learn to play the piano in just three hours. The course meets 6:30-9 p.m. Nov. 20 at the Des Plaines campus. The fee is \$30. (Anyone interested in this workshop may request a free pamphlet by sending a self-addressed, stamped envelope to: Innovative Keyboard Instruction, 1019 N. Plymouth Court, Gilbert AZ 85234.)

Other courses include Floral Design Workshop (ART D33-02), Carpal Tunnel and Work Station Ergonomics (MED 104-01) and Memory Assessment (MED 108-01).

For a complete Alliance for Lifelong Learning class schedule go to www.oakton.edu/all, or call (847) 982-9888, and press 3.

The Chicago Writers Series at Oakton Community College will welcome National Book Critics Circle Award finalist Aleksandar Hemon at 2 p.m. Nov. 12 at the Des Plaines campus, 1600 E. Golf Road.

Hemon, a native of Sarajevo, the largest urban center in Bosnia and Herzegovina, will showcase his current novel, *The Lazarus Project*, which centers on

the murder of a young Jewish immigrant. Hemon is the winner of the 2008 Chicago Tribune Heartland Award in fiction, and recipient of a 2004 MacArthur "Genius" Grant and a 2003 Guggenheim Fellowship.

This event is free and open to the public. Refreshments will be served.

This program is funded by Oakton Student Activities and the Oakton Educational Foundation.

For more information about the Chicago Writers Series, contact Lynn Woodbury, (847) 635-1953, woodbury@oakton.edu.

Campus

Continued from PAGE 22

English from Monmouth College.

Elizabeth Fallucco, Kathryn Fallucco and Emily Nuffer, all of Niles, made the dean's list at Drake University during the spring term.

Kristen M. Greif, of Niles, received recognition on the dean's list for the spring semester at Bradley University.

Nicole L. Vanacora, of Niles, made the dean's list for the spring term at the University of Wisconsin-Whitewater.

Andrew Bishop, of Niles, placed on the dean's list at

Clarke College for the spring term.

Excelsior College

Rebecca S. Choi, a Niles resident, has earned a Bachelor of Science from Excelsior College.

Excelsior College (www.excelsior.edu) is a private, nonprofit institution of higher learning.

Founded in 1971 and located in Albany, N.Y., Excelsior is one of the nation's oldest distance learning and online colleges. It is accredited by the Commission on Higher Education of the Middle States Association of Colleges and Schools.

National-Louis University

Dorothy Gawn, of Niles,

earned a Master of Education degree in reading from National-Louis University's National College of Education in Chicago. Graduation was in March 2008.

National-Louis University, founded in 1886, has grown from being the National College of Education to a university that includes fields of study in the

College of Arts and Sciences and the College of Management and Business. The university offers 60 degree programs targeted at both traditional-aged students and working adults. National-Louis serves more than 13,000 undergraduate and graduate students annually on eight campuses across the United States and a site in Poland.



NorthSide Community Bank
The Very Best in Banking

Safe. Secure.

These are challenging times. There is turmoil and uncertainty about our nation's economy. And in challenging times, consumers need to stick with the tried and true and the institutions that have served them well.

NorthSide Community Bank is safe and secure. We are focused on doing what is best for our customers and communities.

Your Community Bank. Safe and Secure.

CERTIFICATE OF DEPOSITS

6-9 MONTHS **3.42% APY***
12-15 MONTHS **4.15% APY***

Proud member of 

Gurnee 5103 Washington Street, 847-244-5100
Riverwoods 1155 Milwaukee Avenue, 847-279-1155
Mundelein 800 North Route 83, 847-837-8883
Niles 8040 Oakton Street, 847-692-7500
Chicago 205 West Wacker, 312-781-0670

www.nscmbank.com

*\$5,000 MINIMUM DEPOSIT

The world must remember. We must never forget.

Kristallnacht

November 9 to 10, 1938

Night of Broken Glass

70 years ago, throughout Germany and Austria, the Nazis unleashed a wave of terror against the people of the Jewish faith.

Thousands of Jewish homes, businesses and places of worship were burned and destroyed.

30,000 Jewish people were forced into concentration camps, countless others were beaten or killed.

This remembrance is made possible by a gift from the Al Gruen Philanthropic Fund at the Jewish United Fund / Jewish Federation of Metropolitan Chicago



24 Months
NO DOWN PAYMENT INTEREST*

TREADMILLS

SEATED ELLIPTICALS

VIBRATION

HOME GYMS

ELLIPTICALS

BIKES

monday-friday 10-9		saturday 10-5	sunday 12-5
Addison	630.438.5166	Naperville	630.369.9705
Algonquin	847.854.5390	Northbrook	847.205.4388
Bolingbrook	630.771.1866	Orland Park	708.226.1364
Crystal Lake	815.455.7137	Plainfield Center	630.922.3041
Downers Grove	630.953.8490	Rockford	815.633.7630
Geneva	630.262.3673	Schaumburg	847.995.0737
Glenview	847.904.7140	Skokie	847.673.2071
Kenosha, WI	262.697.6001	South Elgin	847.214.8570
Lake Zurich	847.550.1020	Tinley Park	708.444.4270
Lincoln Park	773.477.7216	Vernon Hills	847.549.7306
Merrillville, IN	219.736.9465	Westmont	630.789.0691
Mishawaka, IN	574.277.2086	Wheeling	847.808.6031
Mokena	708.478.6593		

TRADES ALWAYS WELCOME • WE BUY GENTLY USED GEAR















www.2ndwind.net

*With agreement credit check in store only. See store for details.

Peek

Continued from PAGE 67

General's Midwest Children's Brain Tumor Center and other special pediatric programs in Park Ridge. Scheduled for Nov. 8 from noon to 7 p.m., the estate tour will include several highlights for attendees including an appearance by Dan Hampton between noon and 2:30 p.m. and an "ultimate green" expo hosted by builder Robert Lord

and his team of environmental vendors, set for 2:30 to 5 p.m. Lord will highlight features of his one-of-a-kind, eco-friendly residence, which is designed to yield astounding energy savings as well as pamper occupants with lavish appointments and high-end amenities. Additionally, the hospital's engineering team will discuss its new "green" patient tower — the first of its kind in Illinois. An organic wine tasting is slated for 5 to 7 p.m.; attendees can

sample a variety of organic wines, learn the fundamentals of wine-tasting and hear from experts what makes a wine organic. A silent auction of valuable items will be conducted between noon and 6:30 p.m. Admission is \$15 in advance or \$20 at the door. To register and purchase tickets, visit www.RobertLord-Builders.com.

Maine South Mothers' Scholarship Club will sponsor its fall benefit, "... And the Winner Is ... Scholar-

ships," from 7-10 p.m. Nov. 6 at Park Ridge Country Club. The event will include an appetizer and dessert buffet, and raffle prizes. Tickets are \$25, and are available by calling Nadine Sir, (847) 696-2645. This is the first of two yearly fundraisers. In 2007-08 the club awarded \$34,000 in scholarships to Maine South High School seniors.

HOPE Fair Housing Center is celebrating its 40th anniversary with a benefit dinner Nov. 6 at Hyatt Lisle

Hotel in Lisle. The fair-housing center promotes equal housing, lending and home insurance opportunities. The featured speaker will be Shanna L. Smith, president and chief executive officer of the National Fair Housing Alliance. Tickets are \$60. To order tickets contact HOPE, (630) 690-6500, ext. 3.

Entertainment Books are available from the Knights of Columbus Council 4338. The 2009 edition costs \$20 and contains many

coupons. For more information, or to reserve a book, call Bob Galassi, (847) 965-0920. Proceeds go to area charities.

St. John Brebeuf's Inaugural Ball 2008 will be at 6 p.m. Nov. 8 in the St. John Brebeuf Parish Ministry Center, 8305 N. Harlem Ave. The committee is looking for donations of goods and services from businesses and community members, and takers of ads for

Peek, PAGE 74

Food **HUNGRY FOR MORE?** Find more recipes on the Web www.pioneerlocal.com.

MANAGING EDITOR: Sara Burrows
sburrows@pioneerlocal.com | (847) 486-7387

FOR GOOD HEALTH, PUT HEART IN YOUR COOKING

BY CHRISTINE A. VERSTRAETE
Contributor

Too often, people think that developing heart disease dooms them to a life of boring, tasteless food. North Shore cardiologists Dr. Micah Elmer and Dr. Irwin Silverman challenge that notion by teaming up again with Chef Dawn Dlugosz of "A New Dawn Cooking School" which meets in Whole Foods Market, North-

brook, for a heart healthy cooking class in the grocery store's classroom. "Cardiologists are real good at dispensing medications, but when we tell someone to eat better, to eat healthier, no one knows what that means," said Elmer, of Cardiovascular Associates of Glenbrook and Evanston (CAGE). "We thought this would be a really good way to show what we mean." The "Cooking with CAGE: A Healthy Thanks-



Bonnie Kastin, nutritionist, and Dr. Micah J. Elmer confer as Chef Dawn Dlugosz, right, adds a bit of sage to the top of her grilled sweet potato salad.

giving" class will be held at Nov. 13 at the Whole Lifestyle Center in Northbrook's Whole Foods Market. Up first on the 1 1/2 hour class menu is tour around the store with one of the doctors.

Healthy differences

"For example, we'll step by the olive oil and talk about the benefits of extra virgin versus regular olive oil," said Elmer. "There's a big difference. Extra virgin olive oil, which is the first pressing of the olives, has more antioxidants and has more beneficial effects on cholesterol." And lest you think healthy food means boring, the next experts up will change your mind. Along with diet tips by nutritionist Bonnie Kastin, the class includes cooking tips and demonstrations by Chef Dlugosz, along

with samples of the featured recipes accompanied by a glass of wine. "The class is an informal, fun way to help heart patients and anyone interested in better health learn about choosing and making healthy food they'll want to eat. In Dlugosz's hands, even the traditional turkey dinner comes out flavorful, tasteful, but a whole lot healthier. The trade-off for better health means using other ingredients that capitalize on flavor.

Getting fresh

"We'll be using a lot of olive oil instead of butter, and introducing a lot more whole grains and fiber," said Dlugosz. "It's a better idea to use fresh ingredients and whole products instead of food being prepared with a lot of preservatives." Suggestions include using heart-friendly olive oil instead of butter in the potatoes. "Garlic adds the flavor," she said. Sweet potatoes can get healthier, too, enhanced with a light salad vinaigrette instead

Cooking for health

- "Cooking with CAGE: A Healthy Thanksgiving" takes place at 6:30 p.m., Nov. 13 at the Whole Lifestyle Center, Whole Foods Market, 840 Willow Road, Northbrook. Cost is \$30 per person. To register, call Jill Bass at Cardiovascular Associates of Glenbrook and Evanston, (847) 901-5240.
- A New Dawn Cooking School in Whole Foods Market, Northbrook offers two other classes on healthful eating. "Superfoods to the Rescue!" noon to 1:30 p.m. Nov. 17, features ways to use foods that contain powerful nutrients that may improve physical and mental health. The class includes demonstrations and tasting. Cost is \$30, registration required. "Lighten Up: Thanksgiving Favorites," 7 p.m. on Nov. 19 will present tips and tricks for fighting the battle of the holiday bulge and creating a healthful holiday meal. The evening includes demonstrations and a full meal. Cost is \$35, registration required. For more information, call (847) 205-5853.

of being buried in marshmallows or brown sugar. A lighter, tastier way to toast a turkey breast is to tuck a sautéed apple-sage mixture under the skin for extra flavor. "You get the flavor to go all the way through the breast," Dlugosz said. "If you add a lot of fresh, flavorful ingredients you don't need all that fat and can take the skin off." **Comment:** pioneerlocal.com

Safe. Secure. Stable.

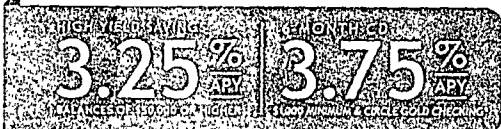

Since our founding in 1871, we've always believed in conservative, careful business practices. After all, we know that it isn't just our money that's at stake, it's yours. But you don't have to take our word for it. Your deposits are insured by the Federal Deposit Insurance Corporation an additional \$150,000 per depositor - to at least \$250,000 - until December 31, 2009. And our bank ratings are some of the strongest among financial institutions. Now more than ever, you need a bank you can count on and we're here to help. If you have any questions about your money, please stop by a branch, call 1-877-TOP-RATE or visit charterone.com

OUR CREDIT RATINGS
S&P A+
MOODY'S Aa3
FITCH DEPOSIT RATING AA



MEMBER FDIC

Member FDIC. All accounts subject to individual approval. See a banker for details and deposit insurance limitations. Offers valid in IL only. CD, Annual Percentage Yield (APY) is accurate as of this publication date. 3.75% APY applies to the 6-month term. Limited-time offer may be withdrawn at any time. This offer cannot be combined with any other CD offer. Circle K Gold Checking account with \$100 minimum opening deposit is required. Other rates and terms available. Minimum opening term deposit \$1,000. Penalty for early withdrawal: 10% APY. Account cannot be accessed using an ATM or Debit Card, \$10,000 minimum opening deposit is required. Personal accounts only. \$5,000,000 maximum deposit per customer. Minimum transaction amount of \$10,000 for withdrawals. Non-qualifying transaction fee of \$25 each for any withdrawal under \$10,000 in a statement period. High Yield Savings account, 3.75% APY based on collected balances for new personal accounts. 3.25% APY for balances of \$50,000 or greater. 2.75% APY for balances of \$10,000 to \$49,999. 1.00% APY for balances up to \$9,999. Fees may reduce earnings. APYs accurate as of this publication date and may change before or after account opening. Charter One is a division of BGS Gilzean, N.A.

Quality, Value & Service In Any Language

Produce World
INTERNATIONAL MARKET • DELI • BAKERY • MEATS • SEAFOOD

Produce			
Florida Grapefruit 49¢ LB.	Stem Tomatoes \$1.29 LB.	Sweet Cantalopes 3 lbs. for \$1	
RED SEEDLESS GRAPES 88¢ LB.	TEXAS LOOSE BEETS 29¢ LB.	"A" SIZE RED POTATOES 33¢ LB.	
MEAT			
Grade "A" Fresh Whole Chicken 99¢ LB.	Lean & Tender Boneless Pork Chops \$2.49 LB.	U.S.D.A. Choice Boneless Pot Roast \$2.49 LB.	U.S.D.A. Choice Veal Roast \$3.49 LB.
Deli			
Boar's Head Oven Roasted Turkey \$4.99 LB.	Kretschmar Smoked Ham \$2.99 LB.	Domestic Swiss Cheese \$3.99 LB.	Eckrich Hard Salami \$3.49 LB.
DAIRY			
DEAN'S SKIM MILK \$2.39 Ex. Gal.	DEAN'S COTTAGE CHEESE 2 for \$4 Ex. 24 Oz.	DEAN'S HALF & HALF 89¢ Ex. Pint	
GROCERIES			
Ceresota All Purpose Flour \$2.99 5 LB.	Sunny Hill Honey \$2.99 1 LB.	Motts Apple Sauce \$1.89 25 Oz.	Liguria Assorted Tomatoes \$1.09 28 Oz.
Gray Poupon Dizon Or Country Mustard \$2.59 8 Oz.	Assorted Polar Sardines 79¢ 4.5 Oz.	Knossoas Extra Virgin Olive Oil \$21.99 3 Lt.	

8800 WAUKEGAN RD. MORTON GROVE, IL.
CORNER OF WAUKEGAN & DEMPSTER HOURS: MON-FRI 8-9 SAT 8-8 SUN 8-7
847-581-1029
SALE DATES: NOVEMBER 6TH - NOVEMBER 12TH

Grilled Sweet Potato Salad with Honey-Balsamic Vinaigrette

4 large sweet potatoes
2 T olive oil
1/8 tsp. kosher salt
Pepper to taste

Honey-Balsamic Vinaigrette
1/4 C balsamic vinegar
1 T Giovanni (soft Cream of Balsamic) (a flavored, thick balsamic reduction.)
1 T honey
1/2 C olive oil
2 tsp. Dijon mustard
1/8 tsp. kosher salt
Pepper to taste

Place potatoes in a large pot and cover with cold water. Bring to a boil and cook until tender but still firm, about 15 minutes. Let cool and cut into 1/2-inch slices.

Heat a cast iron grill pan or outdoor grill over high heat until very hot.

Drizzle sliced potatoes with olive oil and sprinkle with salt and pepper. Grill the potatoes until browned, about 2-3 minutes per side.

Whisk together all vinaigrette ingredients except olive oil. While continuously whisking, slowly stream in the olive oil until combined.

Loss: grilled sweet potatoes with vinaigrette will be full warm. Serve salad warm or at room temperature. Makes 8 servings.

Weekly Worship

CHICAGO

Edison Park United Methodist Church
6740 North Clifton Avenue
Chicago IL 60631
Phone: (773) 792-3030
Fax: (773) 792-3031
www.edisonparkume.com
Email: pastor@edisonparkume.com
Worship Days & Hours
Sundays, 10:30 a.m., Polka, 11:30 a.m.
Sunday School for Preschoolers & Nursery Age
Bible Study, Thursdays, 10:30 a.m. & Fridays, 7:00 p.m.
Youth (High School) Bible Study, Sunday 1:00 p.m.
Young Adults Bible Study, Sunday, 12:00 p.m.
Choir Practice: Sundays, 9:30 a.m.
Susannah Wesley Club (Women's Group)
Meets once a month on 4th Tuesday of the month
Youth Worship Sunday, 3rd Sunday of every month
Pastor, Rev. Jerry Miller
Organist, Dana Samaya
Musical/Youth Director, Natalyn Baraja
Senior Exercise Class, Tuesdays & Thursdays 9:00 a.m.
Fellowship Hall
James Downing Theater Performances
Edison Park United Methodist Church is a church with Open Hearts.
Open Minds, Open Doors.
Choir List Available
Parking in Rear
The Edgemoor Church
6155 W. Touhy Avenue, (773) 631-1155
http://edgemoorchurch.org
Sunday Worship 10:30 am
Ensemble Practice, Wednesday 6:30 pm
Praise, Prayer & Bible Study Wednesday 7:30 pm
Pastor Phil Oswald
Bethel Community Church
7601 W. Foster Ave.
(773) 775-2355
www.bethelcommunity.org
Sunday Worship 8:30 & 11:00 am
Encounter Gathering, Sunday 6:00 pm
Sunday School & Adult Bible Study - 9:45 am

CHICAGO

Senior Pastor - Pastor Paul Jordan
Associate Pastor - Pastor Bob Rinkowski
Student Ministries - Pastor Shawn Clarke
Music & Worship - Pastor Andy Clifton
Childcare available for all services.
Seniors & Women's Bible Studies - September thru May - call for information or see the website.
Norwood Park Lutheran Church - ELCA
5917 N. Nina Avenue (at Nickerson) (773) 631-2860
Sunday Services - 10:00 am
Holy Communion celebrated 1st, 3rd & 5th Sundays
Service of the Word on 2nd & 4th Sundays
Sunday Church School - 9:00 am (with Confirmation Ministry)
Unstaffed Nursery available Sunday from 9:45 - 11:00 am
Rev. Robert C. Johnson, Pastor
Joyce M. Kissenger, Director of Music
Children's Sermons 2nd Sunday of the Month
"Celebrating God's grace and mercy for over 86 years in old Norwood Park"
Our Lady Mother of the Church
8701 W. Lawrence Avenue (773) 625-3369
www.oneladymotherchurch.com
ohm@motherchurch.org
Mass Schedule
Wechsels Monday through Friday 8:30 am
Saturday 5:00 pm
Sunday 8:00, 9:30 & 11 am
Sunday 11:00 am Young People's Liturgy of the Word - Holy Days 8:30 am & 7:00 pm
Tuesday 9:00 am Perpetual Help Novena
Eucharistic Adoration
First Fridays 9:00 am - 3:00 pm
Saturday Confession 4:00 - 4:30 pm
Baptism 2nd & 4th Sundays of the Month
Rev. Richard J. Klajbor, Pastor
Our Savior Lutheran Church - Norwood Park LCMS
6099 N. Northhall Ave.
at Nickerson & Hood Avenues
(773) 631-1100 & (773) 631-1606
www.oslc3sbeglobal.net
Sunday Worship 9:00 am
Sunday School and Adult Bible

CHICAGO

Study 10:30 am
Wednesday Worship Chapel Service at Norwood Crossing at 2:00 pm
6016 N. Nina Avenue, Chicago, IL 60631
Advent & Lenten Worship Services - Wednesday at 7:00 pm
Rev. Velce Berg
St. Eugene Catholic Church
7958 W. Foster Ave. • (773) 775-6659
www.st-eugene.org
Daily Masses: Mon thru Fri 6:30 & 9:00 am
Weekend Masses: Sat - 8:30 am & 5:30 pm
Sun - 7:00, 9:30, 11:30 am & 4:30 pm
Confessions: 4:00 - 5:00 pm Sat
Baptism: 1:00 pm 1st & 3rd Sunday of the month
Rev. George Koerner, Pastor
Rev. Jerome Twarog, Associate Pastor
Rev. Philip Grb, SJ, Resident
St. James Lutheran Church
7400 W. Foster Avenue,
(773) 631-7666
www.stjamespastor.org
Sunday Morning Worship - 10:00 am
Call Church for Dates & Times for the Following Activities:
Jazzercise, Weight Watchers, Climb
Lane Dancing, A. A. Meetings,
Girl Scouts
Pastor Susan Schmitzer
St. Mary of the Woods Catholic Church
7033 N. Moselle, (773) 763-0206
www.smonw.org
Saturday Vigil Mass 4:30 pm
Sunday Masses: 7:30, 9:00, 10:30 am and noon
Weekday Masses Mon - Fri 6:30 and 8:00 am
Confession Saturday 3:30 - 4:15 pm Holy Days Vigil 7:30 pm
Holy Days 6:30, 8:00, 9:00 am and 7:30 pm
Rev. Gregory Sackowicz, Pastor
We have a Preschool (3 yrs. Old) through 8th Grade School and offer wonderful programs of Religious Education for children and adults.
St. Monica Catholic Church
5136 N. Nottingham, (773) 763-1661
www.stmonicachicago.com
Daily Mass: Mon - Fri 8:00 am
Weekend Masses: Saturday - 4:00 pm

CHICAGO

Sunday - 7:30, 9:00, 10:30 am, and 12:00 pm
Polish Liturgy Mass: Sunday - 1:30 pm
Confessions: Saturday - 3:00 to 3:45 pm
Baptism: 1st Saturday and 3rd Sunday of the Month
Rev. Ted Sehmil, Pastor
Rev. Andrew Ezyk, Associate Pastor
Fr. James O'Brien, In Residence
Fr. William Holbrook, In Residence
contact@parish@stmonica-chicago.com
www.st-monica.org
St. Paul Lutheran Church
5650 N. Canfield, 60631
708-867-5044
www.stpaulmchicago.org
Street Level, Air Conditioned
Sunday Worship 8:15 & 10:45 am
Sunday School & Adult Bible 9:30 am
Saturday Worship 6:00 pm
St. Paul Lutheran Christian Day School
Pre-K - Grade 8
SHARING GOD, TOUCHING LIVES, EVERYWHERE
Victory Worship Center
3750 N. New, (773) 205-3787
www.victoryworshiponline.com
Sunday Morning Worship 11:00 am
Wednesday Bible Study 7:00 pm
Friday Worship 7:30 pm
Youth Service Friday 7:30 pm
Christopher Lewis, Pastor
Rev. Ramona Dorsey
Windy City Community Church
6131 N. Newark Avenue,
(773) 631-WCCC (9222)
www.windycitycommunitychurch.org
Sunday 10:00 am Worship Service
Adult Sunday School 9:00 am
Children's Sunday School 10:00 am
Many Ministry Groups for all Ages
Senior Pastor Steve Story
Church Email - wccc@ameritech.net

DES PLAINES

Holy Day Masses: 7:00 & 9:00 am, 7:00 pm
Confessions: Saturday 4:00 - 4:30 pm
Rev. Gerald Rogala, Pastor
Rev. Flavio Gonzalez, Associate Pastor
Trinity Lutheran Church
Announcing in Christ Congregation of the Evangelical Lutheran Church in America
675 E. Algonquin Road (At Wolf Road)
847-827-6656
www.trinitydesplaines.org
Email: trinityldp@ameritech.net
"In response to the love of Christ, all are welcome here."
Saturday Contemporary Worship 5:30 pm
Sunday worship 8:00 and 10:30 am
Children provided during Sunday worship.
Sunday Adult Education 9:15 am
Sunday School 10:30 am
Wednesday Trinity Activity Night offers Education, chats and fellowship for all ages.
(phone call for more information)
George M. Scheller, Senior Pastor
Leslie Williams, Associate Pastor
Danglas S. Williams, Minister of Music
Cathy Williams, Sunday School Director

MORTON GROVE

St. Luke's Christian Community Church
9233 Sherman Rd. 1847 966-9233
Sunday Worship - 10:00 am
Sunday School 11:00 am
Sunday Teen Praise Band Rehearsal 11:00 am
Choir Rehearsal Wednesday 7:30 pm
Youth Group Friday 8:00 pm
Praise Service Last Sunday of each month
Featuring our Praise Band
Pastor Gordon Smith

To List your congregation please call Andrea Shumate at 847-486-7252. Changes can be faxed to her at 847-486-7456 or ashumate@pioneerlocal.com.

DES PLAINES

St. Stephen Protomartyr Church
1280 Prospect (847) 824-2026
Hispanic Number (847) 824-7526
www.ststephen-desplaines.org
Daily Mass - 8:00 am
Saturday Masses: 9:00 am & 5:00 pm
Sunday Masses: 8:30 & 10:30 am, 6:00 pm Spanish Mass

Weekly Worship

NILES

Lutheran Church of the Resurrection
8450 N. Sherman Rd.
Niles IL 60714
(847) 965-8210
Sunday (Sept.-June) 10:30 (June-Sept) 9:30 a.m.
1st Sunday of Month, 7:30 p.m. - Jazz Vespers Service (Sept.-June)
Rev. Dr. Bruce T. Anderson - Pastor
Carolyn N. Sanderson - Minister of Music
A member congregation of the Evangelical Lutheran Church in America
St. Michael's Orthodox Church
7313 N. Waukegan Road, (847) 647-8398
www.stmichaelsniles.org
Sunday Worship 10:00 am
Discover the ancient faith and rich traditions of the Orthodox Church - the first Christian Church - founded by the Lord Jesus Christ and described in the pages of The New Testament. Today her Apostolic doctrine, worship, and structure remain intact.
First Baptist Church of Park Ridge
1266 N. Northwest Highway
(Corner Poller Rd. and Northwest Hwy)
(847) 692-6101
http://fbch-park-ridge.il.us
Sunday Worship 11:00 am
(Childcare provided)
Sunday School 9:45 am
Wednesday Night Prayer Meeting & Bible Study 7:00 pm
Rev. Matthew K. Weber
First Church of Christ, Scientist
330 Touhy Ave. (847) 823-3329
Sunday Service 10:30 am
Wednesday Testimonial Meeting 7:30 pm
Sunday School 10:30 pm
Christian Science Reading Room,
13 N. Prospect Ave. in Park Ridge
Hours: Tues - Fri 10:00 am - 4:00 pm.
Sat 10:00 am - 1:00 pm
St. Andrew's Lutheran Church & School
260 N. Northwest Highway
(847) 823-6656
www.slandreosparkridge.org
Sunday Worship: September through May 8:30 & 11:00 am, June - August 9:00 am
Contemporary Worship: Saturday 5:00 pm
Vespers: Monday 7:30 pm
Sunday School & Adult 9:45 am
(September thru May)
Christian Day School - Pre-Kindergarten thru 8th Grade

PARK RIDGE

St. Luke's Lutheran Church (ELCA)
A Reconciling in Christ Congregation
205 N. Prospect Ave. (847) 825-6659
www.stlukespr.org
Email: office@stlukespr.org
Sunday Worship: 8:30 & 11:00 am
(School Year), 8:30 & 10:00 am (Summer)
Thursday Worship (Summer) 7:00 pm
Sunday - Christian Education for all ages
9:45 am (School Year) Child Care Provided
Rev. Dr. Stephen M. Larson, Lead Pastor
Rev. Kristina C. Weber, Associate Pastor
Rev. Dr. Malcolm Minnick, Jr., Pastor
Emeritus, Anne Krenzli Organ, Director of Music Ministries
Melinda Ramseth Holand, Director of Children's Chorus, Nancy Olson, Member Care Coordinator
St. Mary's Episcopal Church
306 S. Prospect Ave. (847) 823-4126
www.stmaryspr.org
Sunday Services: 8:00 & 10:00 am
Wednesday Service: 9:00 am
Sunday School & Nursery during worship.
Youth Fellowship
The Rev. Sarah D. Oddersted, Rector
The Rev. Amy Carrubba, Curate
WHERE ALL ARE WELCOME!
Check website for all activities.
Handicap Accessible
Park Ridge Presbyterian Church
1300 W. Crescent Ave., (847) 823-4135
www.parkridgepres.org
Sunday Worship 10:30 am
Nursery care during service
Children's Programming for Ages 3 - High School
Adult Education 9:15 am
Rev. James P. McCracken

ROSEMONT

Our Lady of Hope
9711 W. Drown Avenue, (847) 825-HOPE (4673)
www.ourladyofhopechurch.com
Rev. John Clemons, Pastor
Saturday Mass 5:00 pm
Sunday Masses 8:00, 9:30, 11:00 am
Weekday Mass 8:30 am
Eucharistic Services M-F 12:10 pm
Confession Saturday 4-4:40 pm
Holy Days 8am, 12:10 and 7:00 pm
Little People's Church ages 3-5.
First three Sundays pm, 10:45 am-noon
Religious Education Programs grades 1-8.
Sacramental Programs also offered
SKOKIE
Carter-Wrastminster
United Presbyterian Church
4950 W. Pratt, (847) 673-4441
www.cwpc.org
Sunday Morning Worship Schedule:
9:00 Contemporary Service
10:00 Sunday School (for all ages)
11:00 Traditional Service
12:00 Fellowship Hour
Michael Scott Porter, Senior Pastor
Alex Wickell, Director of Youth Ministries
Office Hours: Mon., Tues. & Thurs. 8:30 am to 4:30 pm
Temple Beth Israel
3601 W. Dempster St.
847-675-0951
www.tbiskokie.org
Liturgy Shabbat/Kabbalat Shabbat,
first Friday of each month, 5:30 p.m.
Light Nosh - 6:15 pm, Kabbalat Shabbat service
Shabbat Service Fridays 8:15 p.m.
Shabbat Service Saturdays 10:30 a.m.
Shabbat Katan, third Saturday of each month, 10:00 a.m.
for families with children under the age of five.
Morning Minyan Monday - Friday 7:30 a.m.
Religious School Pre-K - 7th Grade Sundays 9:00 a.m. - 11:00 a.m.
Hebrew School Grades 3-7 Sundays 11:10 a.m. - 12:10 p.m.
and Wednesdays 4:15 p.m. - 6:00 p.m.
Youth Groups Adult Education
Koleynu - Volunteer Choir
High Holiday Services
Rabbi Michael A. Wenberg Cantor Parel Royzman
Lan B. Sagan Director of Congregational Learning
St. Paul Lutheran Church
5201 Galitz Street, (847) 673-5030
web.nar.com/slpaulskokie
Sunday Morning Worship 10:00 am
Saturday Evening Worship 5:00 pm
Fellowship Hour, Sundays 8:45 - 9:45 am

SKOKIE

Sunday School & Bible Study Class,
Sundays 9:00 - 9:45 am
Rev. Peter A. Zdenek, Jr. Vacancy Pastor
John Selman, Minister of Music
Dale Luksha, PK - 8 Academy Principal
The Church is Handicap Accessible &
Variety of Worship Formats, Small Group Ministry
Adult Choir & Handbell Choir
St. Peter's United Church of Christ
Oakton Street & Laramie Avenue,
(847) 673-8166
www.stpetersskokie.org
Sunday Worship 10:00 am Sunday School 9:00 am (September thru May)
Rev. Richard Lanford Childcare provided.
Air Conditioned Sanctuary
Congregation Bene Shalom
4435 Oakton, (847) 677-3330
www.beneshalom.org
Fridays 7:30 pm: Kabbalat Shabbat 6:30 pm
on 3rd Friday of the month
Kabbalistic Prayer/Meditation Service 10:30 am
On 2nd Saturday of the month
Special Kabbalistic Meditation Service Sunday,
August 31st, 10:00 pm
Esther Knapp Religious School
Sundays 9:00 am - 12:00 pm
Hebrew School Sunday 12:00 - 1:00 pm
Thursday 4:00 - 5:00 pm
Rabbi Dr. Douglas Goldhamer
Asst. Rabbi Shari Chen
Cantorial Soloist Chaelece Brooks
Choir Director Nona Balk
Interfaith Families Welcome
All services sign language
Check our website for Adult Education classes
And High Holiday Schedule
Handicap Accessible
Devar Emet Messianic Synagogue
7800 Niles Avenue, (847) 674-9146
www.devaremet.org
Saturday 10:00 am Shabbat Morning Services
Wednesday 7:00 pm Mikvah Religious Studies for Adults and Youth
Wednesday 6:30 pm Club Macabee
Children's Devotional
For K-5th Graders at Our Oakton School in Skokie
Rabbi Kirk Gilbre
Devar Emet Messianic Synagogue is a community of Jews who believe and teach that Yeshua (Jesus) is the Promised Jewish Messiah.

SKOKIE

Temple Judra Mizpah
8610 Niles Center Road,
(847) 676-1566
www.templejm.org
Friday 8:00 pm
Second Friday of the Month 7:00 pm
Family Shabbat
Religious School Grades K-7
Sunday 9:30 am - 12:00 pm
Hebrew School Grades 3 - 7
Tuesday 4:15 - 5:15 pm
Religious School Grades 8 - 12
Sunday 11:45 am - 1:15 pm
Religious School PreK
Two Sundays a month 10:15 am
Rabbi Amy L. Memis-Foler
Cantorial Intern Beryl Bellows
Sally Gold - Education Director
Terry J. Kane - Executive Director
Adult Education Multi-faith
Families Welcome
Community Theater
High Holiday & Festival
St. Timothy Lutheran Church
9000 N. Kildare, (847) 676-3300
www.sttimothyskokie.com
Sunday Worship 10:30 am
Choir Practice, Thursday 7:30 pm
Bible Study, Monday 10:00 am
Youth Christian Education 3rd Sunday at 10:30 am
Rev. Erik Weber
Birthday Sunday 3rd Sunday of each month
Accessible Building

To List your congregation please call Andrea Shumate at 847-486-7252. Changes can be faxed to her at 847-486-7456 or Email: ashumate@pioneerlocal.com.

Peek

Continued from PAGE 75

free chamber music concert at 7:30 p.m. Nov. 10 at the Noble-Seymour-Crippen House, 5624 N. Newark Ave., Chicago. Young Spanish violinist Joan Plana, joined by the stellar duo of Canadian cellist Anna Sampson and Chicago harpsichordist Jason Moy, will present "Stylus I'm-tasticus: The Fantastical Style in 17th Century Italy." Join them as they explore, on period instruments, rarely performed 17th-century Italian masterpieces by Castello, Cina, Bertali, Uccellini, and their contemporaries. All are welcome. For more information, contact Gwen Ihnat, Gwen@norwoodparkhistoricalsociety.org, visit the Norwood Park Historical Society, or call (773) 631-4633.

CRAFTS

Resurrection High School will host its annual

Full Arts & Craft Fair from 10 a.m. to 4 p.m. Nov. 8 at 7500 W. Talcott Ave., Chicago. More than 200 booths will feature a wide variety of handcrafted items. For more information, call (773) 775-6616 Ext. 129, or visit www.reshs.org.

The St. Juliana Mothers' Club is looking for crafters for its 2007 Holiday Craft Fair. The fair will be 9 a.m. to 4 p.m. Nov. 22 in the St. Juliana's Ahearn Center, across from the church, at 7201 N. Oketo Ave. The fee for each table is \$55. Electricity is available for an additional fee, but is limited. For more information or an application form, vendors should contact Patti McDonough, (773) 792-3931, or the St. Juliana parish business office, (773) 631-4127.

The Parents Club of Guerin College Preparatory High School seeks crafters for its annual craft show from 10 a.m. to 3 p.m. Nov. 29, featuring only handcrafted items across the first floor of the school,

8001 W. Belmont Ave., River Grove. Admission is \$2; children younger than 12 are free (strollers are not permitted). Refreshments will be available for purchase. For more information about the show, or to receive an application form, call (708) 453-6233. Crafters may also download an application at www.guerinprep.org.

St. Raymond de Penafort Church of Mount Prospect is looking for artists to participate in its annual Old St. Nicholas Holiday Boutique from 8 a.m. to 1 p.m. Dec. 7. Applications are available at www.st-raymond.org. All items must be handcrafted.

FITNESS CENTER

Niles Family Fitness Center, 987 Civic Center Drive, (847) 588-8400, www.nilesfitness.com.

The Fitness Center has scheduled some Fantastical programs for children to correspond with its popular aerobic classes. Instructors

will even escort the children to and from the Clubhouse. A half-hour in the ClubHouse is included in all Fantastical class fees. Classes are held Mondays through Fridays: sports, fitness, art, science, cooking and more. Stop by or call; ask for Jenny or Joy at (847) 588-8400.

Friday Night Fun for ages 5 to 12 offers an evening filled with swimming, gym, crafts, snack and more from 6 to 9 p.m. Fridays, Nov. 14 and Dec. 19. Fees are \$10, members; \$15, nonmembers.

The following is the Group Fitness schedule. Daily drop-in fees are \$8 for residents; \$9, nonresidents.

A.I.S. Stretch: Isolated stretching to increase flexibility; 8-8:50 a.m. Tuesdays.

Aerobic Medley and Tone: Low-impact aerobics, kickboxing with some toning exercises for beginner and advanced participants, working at their own pace; 5:15-6:15 p.m. Wednesdays.

Body Flex: Increase lean

muscle mass and boost resting metabolic rate with this strength-training class 6:20-7:20 p.m. Mondays and Wednesdays; 10:05-11:05 a.m. Tuesdays and Thursdays; 9:05-10:05 a.m. Saturdays; and 9:30-10:30 a.m. Sundays.

Cardio Dance: Instructor will teach a variety of moves; intermediate to advanced level; 8:45-9:30 a.m. Sundays.

Cardio Interval: Try this cardiovascular workout with muscle shaping. Participants will interval Step, HI/Lo, Kickboxing or BOSU combinations with weight training. Intermediate to Advanced levels; 9:20-10:20 a.m. Wednesdays.

Cardio Kickbox: This 60-minute workout combines high-intensity aerobics, boxing, kickboxing and conditioning exercises. Handwraps are required and are available at the Membership Service Desk for \$5; 7:30-8:30 p.m. Mondays.

Cardio Step: This step

class includes a warmup, high-intensity step aerobics, abdominal exercise and a cool-down stretch; 6:10-7:10 p.m. Tuesdays.

Core Challenge: Challenging core stability with cardiovascular and strength drills on the BOSU balance trainer; 9:10-10:05 a.m. Mondays.

Easy Does It: Offers mature adults the opportunity to exercise under the close supervision of a certified instructor to achieve individual desired level of fitness. The class consists of low-impact aerobics, step or walking, resistance work, floor work and stretching; 10:10-11:05 a.m. Mondays and 10-11 a.m. Fridays.

Dance Aerobics: Includes a mix of dance and aerobics, followed by an abdominal workout for intermediate to advanced levels; 6:10-7:10 p.m. Mondays.

Step, Drills and Strength: This class will offer variety from week to week for intermediate to

advanced levels; 6:10-7:05 p.m. Thursdays.

Total BodyToning: Participants will develop muscle tone using higher repetitions of lighter weights; for beginner to advanced levels, 5:15-6:05 p.m. Tuesdays.

Yoga: Stretch and soothe your mind from 8-9 a.m. or 5:20-6:20 p.m. Mondays, 7-8:05 p.m. Tuesdays, 8:15-9:15 p.m. Wednesdays, 6:50-8 p.m. Thursdays, and 10:10-11:20 a.m. Fridays.

Spinning Is Indoor cycling to motivating music. Everyone rides at their own pace in a team atmosphere. Reservations are required at the Service Desk before each class. Bring a towel, heart-rate monitor and a water bottle to class. Classes are 45 minutes. Class times vary. Daily drop-in fees are \$6 for members; \$9, nonmembers.

Spinning-Yoga Blend class will flow from Spinning right into yoga. Express Yoga will focus on stretching, and include core strengthening. Express Spin is from 6 a.m. to 6:35 a.m., and Express Yoga from 6:40 a.m. to 7:15 a.m. Wednesdays.

Niles Family Fitness Center, 987 Civic Center Drive, offers Fall Fantastical Children's Programs. The goal of the programs is to provide a stimulating environment that will encourage learning and fun. Beginning classes are for parents and children to explore and create together. For class schedule go to www.nilesfitness.com, or call (847) 588-8400.

Lil Pilgrim, 1 to 5 years. Parents and children are invited to join in a special Thanksgiving celebration with crafts, games stories and more. **Holly Day Party, 1 to 5 years.** Holly Day games, crafts, stories and more will fill a child's morning. **Friday Night Fun 5 to 11 years.** Join the enthusiastic staff for an evening filled with swimming, gym, crafts, snack and more. **Girls Spa Night, 5 to 11 years.** Girls get ready to be

pampered during adult hair, nails, lotions, jewelry-making and anything else "girly." **Aqua Antics, 1 to 5 years.** Play group in the pool! Non-instructional swim class is designed to help children become comfortable in the water. Splash around while participating in active songs and circle fun. Water toys will be available. **Parent/child. Mini Picasso's, 18 months to 3-years:** toddler to explore their creative side with painting, play dough and bubbles. Class may be messy, so dress accordingly. **Parent/child. Romp, Stomp & Roll, 10- to 20-months.** This class is a social experience for both parent and child. Mats, balls, tunnels and age appropriate toys will be offered in this active free play class. Your toddler can climb, jump and roll around in our carpeted multi-purpose room. **Parent/child. Tiny tot Playtime, 1 to 2 years.** Meet other parents and interact with your child during movement, activities, free play and a simple craft. Music and circle time will add to the FUN. **Parent/child. Me Two 2 years.** Stories, music and art to ease fears and encourage independence in a semi-structured environment. Child only **Mini sportsters, 2 to 4 years.** An introductory sports class for your active toddler. Try out a different sport each week. Have fun while getting fit. **Parent/child. Tumble bees, 2 to 4 years.** Introduction to basic tumbling skills by participating in activities that teach gross motor skills and organized movement. Basic introduction to the balance beam, floor and horizontal bar. **Parent/child. Just For Me, 3 to 4 years.** Designed for children who missed the Sept. 1 cut-off for preschool, but are ready to be on their own in a social environment. Letters, numbers and colors will be taught through active play. Daily gym time and snacks are provided. This class will be offered with a continuing curriculum through spring 2009. **Body Flex Kids, 3 to 6 years and 5 to 9 years.**

Scheduled during adult Body Flex, this high energy exercise class will get your child moving and grooving. Class ends with kid's yoga. Instructor escorts children to and from the Clubhouse. **Fantastic Fridays, 3 to 6 years.** Children play games, make crafts, swim and make new friends. Must be toilet trained. **Playtime Picasso's 3 to 6 years.** Arts and crafts, painting play dough along with age appropriate play. Messy class. **Recipe for fun, 3 to 6 years.** Make simple recipes. Measuring, mixing, pouring and stirring. Each chef will get to eat or take home their own creations. **Silly science 3 to 6 years.** Hands on science class is designed to combine learning and fun. Using everyday household items, kids become a silly scientists with simple experiments. **Sports Kids 4-6 years.** We introduce your child to a variety of sports: Football, basketball, bowling, and more. Class is designed to improve listening skills, instill a sense of teamwork and encourage physical development.

The Niles Fitness Center, 987 Civic Center Drive, is taking registration for fitness classes, including: **Aqua-Arthritis,** an opportunity for people with arthritis and post-rehab conditions to help improve flexibility, coordination and muscle strength (a doctor's note is required); **Big Event Boot Camp,** which is designed to help participants lose weight and tone up for a special event, combines cardio with resistance training and ends with a stretch; **Core Strength,** which offers total-body-strength exercises using weight and the BOSU and includes abdominal and low back exercises (all ability levels are welcome); **Lighter Yoga,** a technique that uses simple laughter exercises, interspersed with gentle breathing, stretching exercises and rhythmic clapping; **Senior Strength,** designed to improve the strength, agility, balance and flexibility of older adults, using light weights,

flexible tubing, and small resistance balls; **Zumba,** a Latin-dance-inspired fitness class featuring aerobic/fitness interval training with a combination of fast and slow rhythms that tone and sculpt. Call (847) 588-8400 for days, times and fees, or go to www.nilesfitness.com.

Niles Family Fitness Center offers the following Pilates classes: a nine-week program of MAT Pilates, using a series of controlled exercises that engages the mind and body to develop

strong flexible muscles without building bulk. Each movement begins with the abdomen, focusing on controlling core muscles. Routines alternate stretching with strengthening, Pilates for Golf is designed to improve balance, coordination and flowing movement. This class will help with spine and shoulder stabilization and core strength. Bring an iron to class. The Fitness Center offers classes Monday, Wednesday, Thursday and Saturday.

Call for times and details. For those experienced in Mat Pilates private and semi private training sessions are available in the Pilates Reformer Training Room. All sessions are 50 minutes, and members and non-members may purchase 1-, 5-, or 10-session packages. Call Danielle Desherow, (847) 588-8410, for times and pricing options.

FUND-RAISERS

Sport Clips stores in Peek, PAGE 78



www.pioneerlocal.com
Your local source 24 hours a day.

Sweetie Pies
Bakery Cakery Café

Place your holiday order NOW!

home baked goodness pastries, cookies, and more...

Award Winning Pies

Cakes Weddings Birthdays & Special Occasions

7931 Lincoln Ave. Skokie, IL Downtown Skokie 847-213-0900 www.sweetiepiesbakery.com

PHOTO STORE

Out of the paper and into your hands.

Order prints of your favorite Pioneer Press photos in a variety of sizes and on a wide range of media, from traditional photo paper to t-shirts, mugs and computer mouse pads.

www.pioneerlocal.com

Wrap up the season with an ad in our **HOLIDAY GIFT Guides**

Publishing: Nov. 19/20 & Dec. 4/5

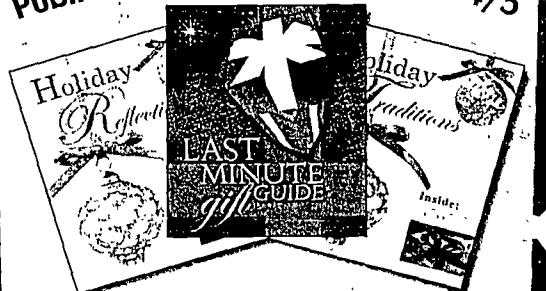

for print and online opportunities
Call (847) 486-7300
to advertise your business today!

PIONEER PRESS YOUR LOCAL SOURCE
NEWS-SUN LAKE COUNTY
The Brights

Peek

Continued from PAGE 77

Chicago and Niles are working with Children's Memorial Hospital to help raise funds for the Brown Family Life Center. Through Nov. 30, Sport Clips "Clips for a Good Cause" program will donate \$2 per every MVP haircut sold to Children's Memorial Hospital. Sport Clips is open every day with no appointment necessary, and

features TVs showing sports while getting your haircut by "guy-smart" stylists. The local participating store is at 5944 W. Touhy Ave. in Niles. Each one of Sport Clips' 38 Chicago stores will participate in other "Clips for a Good Cause" programs this year. If you would like to nominate your favorite charity or organization for Sport Clips "Clips for a Good Cause" program, contact Ashley Felts at (312) 923-1010. The chain is the off-

cial haircutter of many professional sports teams, as well as the Veterans of Foreign Wars, and offers preferential pricing to all veterans. For more information, please visit www.sport-clips.com.

Cheeseburger in Paradise, well-known for its long-standing musical heritage, is calling all music lovers to help the VII Save the Music Foundation fund instrumental music programs in public schools, with the chance to win a

Jimmy Buffett autographed guitar along the way. Specially designed Cheeseburger in Paradise VII Save the Music T-shirts will be available for purchase through Nov. 15 at all Cheeseburger in Paradise locations. The local Cheeseburger in Paradise is located in Metropolitan Square in Des Plaines. All profits from T-shirt sales will help fund a teaching salary and musical instruments. Children's shirts cost \$10 each. Adult sizes are available for \$12 each. Enter online at www.CheeseburgerinParadise.com to win the acoustic guitar with a personalized signature from Jimmy Buffett. The winner of the signed guitar will be announced in late November.

The Men's and Women's Association of Advocate Lutheran General Hospital will sponsor an Avon products fund-raiser sale from 9 a.m. to 5 p.m. Nov. 7 in the Grainger Atrium of the hospital. The sale will feature bubble bath, skin softener, face creams, shower gels and other products including Skin-So-Soft, Bug Guard, Foot Works and Moisture Therapy. For more information about the Avon sale, call (847) 723-6105.

Honor Flight Chicago will host a fund-raiser from 6 to 9 p.m. Nov. 13 at Cheeseburger in Paradise, 1472 Market St., Metropolitan Square, Des Plaines. Proceeds will allow World War II veterans to see their memorial in Washington, D.C., free of charge. Tickets are \$20 and include food and live entertainment. For more information, contact Steven Schaefer at (847) 452-6991.

The dressbarn store in Niles, has joined in support of Breast Cancer Awareness Month. The retail store will contribute profits from the sale of Chloe, a plush dog, to the American Cancer Society's local and national initiatives. Chloe sells for \$5; dressbarn will donate a minimum of \$2.50 from the sale of each dog to

the American Cancer Society, targeting breast-cancer research. Chloe will be sold through Dec. 15, or while supplies last. For more information call (847) 688-3100.

Our Lady of Ransom Parish in Niles is selling Entertainment 2009 Books for \$20. Discounts cover a variety of areas, including travel, restaurants, car rentals, movie theaters and hotel discounts. The sale benefits the parish. To get a book contact Josephine Bax, (847) 823-2550.

HEALTH

Advocate Lutheran General Hospital is taking appointments for its annual flu shot program through its Flu Shot Hotline, 1-800-995-4267. Locally, Senior Advocate is hosting clinics on Nov. 7, 10 and 12, between the hours of 10 a.m. and 3 p.m. There is no cost to those who have Medicare Part B; otherwise, the charge is \$30. Flu shots are offered to those over the age of 18. Call the Flu Shot Hotline for locations and registration.

Advocate Lutheran General Hospital and the American Red Cross offer an Infant/Child CPR Course. This five-hour course teaches participants how to recognize and care for breathing and cardiac emergencies in infants and children. It also includes information on how to prevent injuries to infants and children at home and in play areas. The next course will be held from 8 a.m. to 1 p.m. Nov. 8 at Advocate Lutheran General Hospital, 1775 Dempster St., Park Ridge. An upcoming session will be held Nov. 22. Fee for the course is \$50. Call 1-800-323-8622 or visit www.advocatehealth.com to register. The code for this class is 8C16.

Advocate Lutheran General Hospital will host a seminar and book-signing featuring Rosalie Devonshire, author of *Taking Charge of Fibromyalgia* and therapist at Advocate Medical Group's Counseling

Center. The event will be held from 9 a.m. to 2 p.m. Nov. 8 in the Olson Auditorium at Lutheran General, 1775 W. Dempster St., Park Ridge. Attendees will learn about the diagnosis, symptoms and treatment of fibromyalgia and will be provided with coping tips, pain management techniques and resources. Signed copies of Devonshire's book will be available for purchase at \$15, cash only. Additional speakers include Soozie Cotter-Schaufele, music therapy/guided imagery, as well as other health professionals. Exhibits will be open from 8:30 to 11 a.m. and a light lunch will be provided. There is no charge to attend, however, registration is required. To register, call Health Advisor at 1-800-323-8622 and ask for Code: 8C87. Free parking is available in the Lutheran General Center for Advanced Care garage, which is located at the southwest corner of Dempster Street and Luther Lane.

The American Cancer Society, Chicago office is seeking partnerships with faith-based organizations to outreach in various Chicago communities to provide resources involving cancer issues. In organizations where no health ministry exists, ACS will help the organization begin a ministry, or will provide health related information. Through this program, Churches Against Cancer (CAC), ACS will provide a comprehensive health awareness campaign within the organization to help build capacity, provide culturally appropriate resource materials and technical assistance to member churches. To participate, faith-based organizations must approve joining CAC. For more information about CAC, contact Desmond Kondu at (312) 270-7278, desmond.kondu@cancer.org

LIBRARY

Niles Public Library, 6960 Oakton St. (847) 683-1234; www.nileslibrary.org

www.nileslibrary.org. Registration is required for programs.

The Go Club for ages 6 to 12 usually meets the first and third Saturdays of each month on a drop-in basis.

"Benjamin Franklin, in Search of a Better World," an exhibit, will be displayed up to Dec. 6 at Niles Public Library, with special programs and events for both children and adults. The exhibit is sponsored by the National Endowment for the Humanities and the American Library Association.

MAINE TOWNSHIP

Maine Township will host two days of flu shots from 10 a.m. to 4 p.m. Nov. 7 and 10 at Maine Town Hall, 1700 Ballard Road, Park Ridge. Advocate Healthcare will be on hand administering the shots. There will be no charge for those who display a Medicare B card, but those without can receive a shot for \$30, payable by cash or check. Those interested must schedule an appointment and can do so by calling 1-800-995-4267. For more information visit www.maintownship.com.

Maine Township's FISH (Friends Indeed Serve and Help) is in need of volunteer drivers to provide residents free transportation to medical facilities in and near Maine Township. Volunteers may choose how much time they wish to devote. Requirements include a current drivers license and proof of auto insurance. The program requires residents in need be mobile, or be able to use a cane or walker. FISH also asks that appointments be set three or more days in advance. To become a volunteer driver call Ed Oken, (847) 696-0761. To schedule a ride or for information call FISH coordinator Gloria Slepcek, (847) 297-2510, ext. 283.

PARKS

Niles Park District is offering Indoor Micro Soccer

for girls and boys, kindergarten through sixth grade. This fun, fast-paced program is played with smaller teams to insure more touches of the ball and greater skill development. Soccer clinic is Nov. 15. Season play runs Dec. 6 to Feb. 7. Team T-shirts are provided with the fee of: residents, \$70; nonresidents, \$87. Registration deadline is Nov. 14. Registration is being accepted at the Howard Leisure Center, 6676 W. Howard St. For more information, call (847) 967-6633.

Niles Park District's IceLand Arena is taking registrations for Fall Classes. IceLand offers Tot, Learn-to-Skate, and Freestyle Classes, ages 4 years and older. The Rangers Hockey Instructional program includes \$10 Intro to Rookie Rangers and Rookie Rangers for beginner skaters, ages 4 to 13. All required equipment is provided for free for these two hockey classes. Season begins Nov. 11. There is a variety of class days and times available. Call (847) 297-8010, for information or register at IceLand Arena, 8435 Ballard Road.

Adult Dodgeball for ages 18 and older is offered in compliance with the Amateur Dodgeball Association. The focus is fun, safe, competitive and exciting recreation. Team jerseys are supplied. Sign up as an individual or a team of eight. Games are played at Golf View Recreation Center from 6:30 to 9 p.m. Tuesdays, Nov. 18 to Feb. 3. Fee per individual is residents, \$44; nonresidents, \$55. Call (847) 967-6623 with any questions.

Come to Pioneer Park for Family Fun Nights at 5 p.m. every Friday night. The \$5-per-person fee includes a round of miniature golf, a batting-cage token, a hot dog and a small drink for each family member. Pioneer Park is at 7135 N. Harlem Ave. Call (847) 683-2746 for more information.

Niles Park District is still taking registration for fall

dance classes. Classes include pre-ballet for ages 3 to 5, ballet and tap for ages 4 to 9, jazz for ages 6 to 12, and Hip Hop for ages 6 to 11. Classes for adults are also available. For more information on the Dance Program, call (847) 967-6633.

Niles Park District helps plan children's birthday parties. Party packages include: Tie-Dye, Crafty Creations, Rumble Jumble, Princess Party and Dora & Diego. Parties are 6:30 p.m. to 8 p.m. Fridays, and 10:30 a.m. to noon or 1 p.m. to 2:30 p.m. Saturdays. Call the Howard Leisure Center, (847) 967-6633, for more information.

Resident and non-resident registration for Niles Park District Bright Beginnings Preschool for 2008-09 is being taken. Spaces are available in the mornings and afternoons for 3- and 4-year-old classes. Registration will be accepted at the Howard Leisure Center, 6676 W. Howard St., until classes are filled. For more information stop in the Howard Leisure Center, or call (847) 967-6633.

Relive old memories at the Park District's annual Classic Cruisers Car Shows which will take place every Thursday night, weather permitting from 7 to 9 p.m. at Pioneer Park, 7135 N. Harlem Ave.

Pioneer Park, 7135 N. Harlem Ave., has an 18-hole miniature-golf course, seven batting cages and a concession stand. Parties and fund-raisers are also available. Call (847) 583-2746 for more information.

Golf Maine

Golf Maine Park District is taking registrations for:

Preschool. Sign up now for the fall 2008 semester. Early registration is urged. A five-day morning program and four-day afternoon program are offered for children turning 4 years old by Sept. 1.

For more information visit one of the Park District offices, Feldman

Recreation Center, 8800 Kathy Lane (one block south of Golf Road on Western Avenue), Niles; or Dee Park, at the corner of Dee and Emerson Roads, Des Plaines; or call (847) 297-3000.

Park Ridge Park District

The Park Ridge Community Center's amenities include: new fitness equipment; indoor pools; running track; racquetball & basketball courts; sauna & whirlpool; child care services; fitness and spinning classes; private adult lockers; party rentals; personal trainers. Call (847) 692-5129 or visit www.priparks.org.

RELIGION

Registrations for the St. John Brebeuf "Joy in Jesus" Sunday preschool program are now being taken. The program is open to children ages 3 1/2 through kindergarten-age. Classes are during the 10:45 a.m. Mass each Sunday. The registration fee is \$40 and covers all materials for the year. Special emphasis is given to the development of self-awareness in children and their place in the Christian community. The goal of the program is to provide a foundation for a future understanding of faith. To register, or for more information, call Charlotte Lindquist, (847) 470-1434.

Mary Seat of Wisdom, at Cumberland and Granville avenues in Park Ridge, offers a once-a-month Mass for young adults at 4:30 p.m. the third Sunday of each month. A priest who works specifically with young adults and a choir that incorporates both voice and instruments to provide upbeat music for liturgies will be featured. Liturgies will be prepared and presented by young adults. All young adults, ages 22 to 40-plus, married or single, with or without children, are invited. For more information call Peg Barry, (847) 720-7914, or e-mail pegbarry@bjpartners.com.

Peek, PAGE 80



FOR SPECIAL OCCASIONS
Be it a Bar/Bat Mitzvah, Birthday, Shower or Corporate celebration, the complete planner, helpful features, creative ideas and shopping suggestions can help assure it will be a success.

FOR WEDDINGS
Digest-sized guide includes expert's advice, newest fashions, the area's best shopping locations and a handy personal planner. Inside your copy are 4 FREE tickets to the area's hottest bridal shows -

The Complete Wedding Expo.

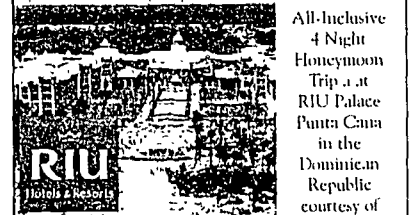

APPLE VACATIONS.com
Full contest rules are available on the website or upon request from Contest Rules, Chicago Wedding Resource, 3453 Commercial Ave., Northbrook, IL 60062

Please send my FREE copy of the Chicago Wedding Resource & Guide for Special Occasions to the address below or order by email at www.chicagoweddingsresource.com

Name _____
Address _____
City _____
State _____ Zip _____
Daytime Phone (____) _____
E-Mail Address _____
Date of Wedding or Event _____
Type of Event _____

Mail this form to: Chicago Wedding Resource, 3453 Commercial Ave., Northbrook, IL 60062
Copies also available at northbrook court Guest Services

Wrap up the season with an ad in our **HOLIDAY GIFT Guides** IN PRINT AND ONLINE
Now playing online at <http://adfare09.afa.com/ads/pioneerlocal/page.htm>
Call (847) 486-7300 to advertise your business today!
PIONEER PRESS NEWS-SUN THE BRINGS YOUR LOCAL VOICE

Peek

Continued from PAGE 79

Ezra-Habonim, the Niles Township Jewish Congregation, 4500 Dempster St., Skokie, offers Introduction to Judaism and beginning adult Hebrew classes on Sundays and monthly Yiddish. Members and non-members are welcome. For more information call (847) 675-4141, or go to www.chnt.org.

Registration is open for the 2008 fall programs at Gan Yeladim, the early-childhood program of Ezra Habonim, the Niles Township Jewish Congregation, 4500 Dempster St., Skokie. The program, which serves children ages 2 to 5 and their families, is open from 7:30 a.m. to 6 p.m. Monday through Friday. Half- and full-day programs, as well as early-morning drop-off, a lunch program and afternoon enrichment classes, are offered. It integrates Ju-

daica, literacy, math, science, art, music and drama into its developmental, play-based curriculum with a low teacher-child ratio. Interested families are invited to visit, talk with the director and view the facility. Visiting hours are from 10 a.m. to 11:30 a.m., but first call (847) 675-4152. Go to www.ganskokie.org.

MAINE SENIORS

Advocate Healthcare will offer flu shots at Maine Town Hall from 10 a.m. to 4 p.m. Nov. 7 and Nov. 10. There is no charge for those who present a Medicare B card; otherwise the charge is \$30, payable by cash or check. To schedule a flu shot call the Advocate hotline, 1-800-995-4267.

A trip from 9 a.m. to 5:30 p.m. Nov. 6 is offered to see "Forever Plaid: Plaid Tidings" at the newest Mid-west venue, the Armory, where World War II soldiers trained for combat.

The drill hall is now the Drill Hall Theatre. Enjoy a three-course meal and then hear the boys in a Christmas show. The cost is \$82 for members; \$87, guests. All day trips depart from Golf Mill Shopping Center in Niles.

SENIOR CENTER

Grandparents Circle, is a free outreach program to provide education and support for Jewish grandparents with interfaith grandchildren. The first session will be held at 7:30 p.m. Nov. 11, with five other free classes to follow through February. The course will be held at 4500 Dempster St., in Skokie. The program offers grandparents skills and techniques to nurture, and in some cases help establish, their interfaith grandchildren's Jewish identities. It also provides participants with a supportive and open-minded environment to share their achievements, express their frustrations, and acknowl-

edge their challenges. Cosponsored by Ezra-Habonim, the Niles Township Jewish Congregation, in partnership with Jewish Community Center of Chicago. For more information, contact Judy Fleischer at (708) 799-7050 or jfletcher@gjcc.org.

SINGLES

Young at Heart Singles Club (ballroom dancers of all ages) will feature a dance at 8:30 p.m. Nov. 8 at the VFW Hall, 16th Street and Harlem Avenue, Berwyn, with the music of the Variety Pak. Members pay \$7 for each dance; guests, \$9. Attire is semi-dressy/dressy. Call the hotline at (630) 415-3499 for more information, or for directions, call (847) 678-7068.

Thunderbird Singles will host a giant super mixer at 8 p.m. Nov. 7 at the Doubletree Oakbrook Hotel, 1909 Spring Road, Oakbrook. Admission is \$8. For more

information, call (847) 604-3446.

North Shore Singles will feature a dance at 6 p.m. Nov. 9 at 94th Aero Squadron Restaurant, 1070 S. Milwaukee Ave., Wheeling. Admission is \$8. Call (847) 604-3446 for more information.

SUPPORT

The next National Alliance on Mental Illness Cook County North Suburban free education program open to the public titled "How the Criminal Justice System is Changing to Deal with Mentally Ill" will be held from 7 to 8:30 p.m. Nov. 10 at the Kenton-Knox Conference Center, 9701 N. Knox Ave., Skokie. For more information, call the NAMI-CCNS office at (847) 716-2252.

Advocate Lutheran General Hospital is offering a free program that teaches beauty techniques to women who are actively undergoing cancer treat-

ment to help them combat the appearance-related side effects of radiation and chemotherapy. The next class will be offered from 10:30 a.m. to 12:30 p.m. Nov. 10 at the hospital's Center for Advanced Care, 1700 Luther Lane in Park Ridge. For more information and to register call HealthAdvisor at 1-800-323-8622 or visit www.advocatehealth.com. The code for this class is 8C24.

Catholic Charities of the Archdiocese of Chicago invites anyone who has experienced the loss of a loved one to suicide to participate in its Loving Outreach to Survivors of Suicide Program. Meetings will be from 7 p.m. to 9 p.m. Sundays, Nov. 9 and Dec. 14, at Catholic Charities' Northwest Office, 1717 Rand Road, Des Plaines. To learn more about Des Plaines-based Catholic Charities North/Northwest Suburban Services and how they can help, call (847) 376-2118.

Pioneer Press Mortgage Guide
Check rates daily at <http://pioneerlocal.interest.com> Bankrate.com

Program	Rate	Points	Fees	% Down	APR	Program	Rate	Points	Fees	% Down	APR																														
THE GLEN FINANCIAL, INC. 847-901-0808 http://www.TheGlenFinancial.com						ALLSTAR HOME MORTGAGE, INC. 847-441-5050 Bob@Allstarhomemortgage.com																																			
30 yr fixed	6.250	0.000	\$800	20%	6.296	30 yr fixed	6.375	0.000	\$1490	20%	6.462																														
20 yr fixed	6.250	0.000	\$550	20%	6.292	5/1 ARM	5.375	0.000	\$1490	20%	5.848																														
15 yr fixed	5.875	0.000	\$800	20%	5.951	5/1 Jumbo ARM	5.375	0.000	\$1490	20%	5.797																														
10 yr fixed	5.750	0.000	\$800	20%	5.857	7/1 ARM	5.625	0.000	\$1490	20%	5.899																														
(B) 2550 Compass Rd., Ste. D., Glenview, IL 60026 MB 6759906						(B) 1780 Maple St., Suite 22, Northfield, IL 60093 MB0006457																																			
THIRD COAST MORTGAGE LLC 847-849-8800						GLENVIEW STATE BANK 847-729-1900 http://www.gsb.com																																			
30 yr fixed	6.375	0.000	\$850	20%	6.424	30 yr fixed	7.000	0.000	\$1035	20%	7.062																														
5/1 jumbo ARM	5.375	0.000	\$850	20%	4.626	5/1 ARM	6.000	0.000	\$1035	20%	5.027																														
5/1 jumbo ARM (interest only)	5.625	0.000	\$850	20%	5.726	7/1 ARM	6.500	0.000	\$1035	20%	5.520																														
7/1 jumbo ARM	5.750	0.000	\$850	20%	4.961	15 yr fixed	6.750	0.000	\$1035	20%	6.851																														
Contact Stuart L. Cohen, Mortgage Expert, at 847-772-1818						Restrictions apply, please inquire.																																			
(B) 1161 Lake Cook Rd., Suite 1, Deerfield, IL 60015 60777						(C) 800 Waukegan Rd., Glenview, IL 60025																																			
UNITED HOME LOANS 708-531-8317 http://www.UHLloans.com						GREAT NORTHERN FINANCIAL CORP. 630-653-4700 http://www.gnlcorp.com																																			
30 yr fixed	Call for Rates					30 yr fixed	6.375	0.000	\$850	20%	6.424																														
5/1 jumbo ARM	5.625	0.000	\$1195	20%	6.285	15 yr fixed	6.000	0.000	\$850	20%	6.081																														
7/1 jumbo ARM	5.875	0.000	\$1195	20%	6.288	5/1 jumbo ARM	5.500	0.000	\$850	20%	5.860																														
10/1 jumbo ARM	Call for Rates					7/1 jumbo ARM	5.875	0.000	\$850	20%	5.742																														
Living and Lending in Your Neighborhood						FHA allows purchase with 3% down and cash out refi to 95%																																			
(B) 3 Westbrook Corp. Center, Westchester, IL 60154 MB.0006479						(A) 2850 Golf Rd., Ste. 403, Rolling Meadows, IL 60008																																			
<table border="1"> <thead> <tr> <th>Loan Program</th> <th>Rate</th> <th>Monthly Payment</th> </tr> </thead> <tbody> <tr> <td>1 yr ARM</td> <td>6.00%</td> <td>\$998.83</td> </tr> <tr> <td>5/1 ARM</td> <td>6.67%</td> <td>\$1,061.43</td> </tr> <tr> <td>15 yr fixed</td> <td>6.48%</td> <td>\$1,433.70</td> </tr> <tr> <td>30 yr fixed</td> <td>6.77%</td> <td>\$1,072.38</td> </tr> </tbody> </table>						Loan Program	Rate	Monthly Payment	1 yr ARM	6.00%	\$998.83	5/1 ARM	6.67%	\$1,061.43	15 yr fixed	6.48%	\$1,433.70	30 yr fixed	6.77%	\$1,072.38	<table border="1"> <thead> <tr> <th>30 yr fixed</th> <th>15 yr fixed</th> <th>5 yr ARM</th> </tr> </thead> <tbody> <tr> <td>This week</td> <td>6.77</td> <td>6.46</td> <td>6.67</td> </tr> <tr> <td>Last week</td> <td>6.32</td> <td>5.93</td> <td>6.49</td> </tr> <tr> <td>Last year</td> <td>6.29</td> <td>5.99</td> <td>6.22</td> </tr> </tbody> </table>						30 yr fixed	15 yr fixed	5 yr ARM	This week	6.77	6.46	6.67	Last week	6.32	5.93	6.49	Last year	6.29	5.99	6.22
Loan Program	Rate	Monthly Payment																																							
1 yr ARM	6.00%	\$998.83																																							
5/1 ARM	6.67%	\$1,061.43																																							
15 yr fixed	6.48%	\$1,433.70																																							
30 yr fixed	6.77%	\$1,072.38																																							
30 yr fixed	15 yr fixed	5 yr ARM																																							
This week	6.77	6.46	6.67																																						
Last week	6.32	5.93	6.49																																						
Last year	6.29	5.99	6.22																																						
<p>Here's what the monthly loan payment would be on a \$100,000 mortgage loan using the following programs at prevailing interest rates</p>						<p>Source: Bankrate.com. For more information visit www.bankrate.com. Bankrate national averages are based on 100 largest institutions in the top 10 markets in the United States.</p>																																			

Introducing SUPREME COURT
HIGH SCHOOL BASKETBALL PREVIEW SECTIONS
Your favorite teams - Our best local coverage

Our **Mid Suburban League Edition** is publishing on **November 26 and 27**

Planned editorial includes: Game previews, schedules, team rosters, player profiles and coaching profiles for both boys and girls basketball.

SCORE big with an ad

For the **Mid Suburban League Edition** of Supreme Court, Contact **Tony Ralenkotter** 847.797.5125 | tralenkotter@pioneerlocal.com

For the **Central Suburban League North Edition** of Supreme Court, Contact **Mike Shalin** 847.486.7326 | mshalin@pioneerlocal.com

To advertise in the **West Edition** of Supreme Court, Contact **Chuck Agresti** 708.524.4460 | cagresti@pioneerlocal.com

Your Community.
Your Interests.
Your Local Source.

Every week Pioneer Press delivers coverage of local news like no one else can.

Call (847) 486-9300 to subscribe or visit www.pioneerlocal.com

PIONEER PRESS
YOUR LOCAL SOURCE

MEMORIAL LUNCHEONS

- Banquet Room Available
- Groups of 10-200

Edtweiss
German American Cuisine

708-452-6040

7650 W. Irving Park Road
Northridge, Illinois 60706
www.edtweissdining.com

TOP Newspapers

Reasons to Advertise

REASON #9

CONVENIENT
Newspapers are portable and convenient

PIONEER PRESS
CALL 847-486-7300

MORTGAGE UPDATE

Mortgage matches highest rate of the year By Holden Lewis • Bankrate.com

The roller-coaster ride continues with mortgage rates. This week, they climbed to the highest level in three months, matching the highest level of the year.

The benchmark 30-year fixed-rate mortgage rose 45 basis points, to 6.77 percent, according to the Bankrate.com national survey of large lenders. A basis point is one-hundredth of 1 percentage point. The mortgages in this week's survey had an average total of 0.39 discount and origination points. One year ago, the mortgage index was 6.29 percent; four weeks ago, it was 6.41 percent.

The benchmark 15-year fixed-rate mortgage rose 53 basis points, to 6.46 percent. The benchmark 5/1 adjustable-rate mortgage rose 18 basis points, to 6.67 percent.

The 30-year fixed reached 6.77 percent in Bankrate's July 23 survey. That's the highest it has been all year. The last time the 30-year rate was higher was in Bankrate's survey of July 18, 2007, when it fell 21 basis points, then rose 54 basis points the next week, then fell 42 basis points the week after that, followed by this week's rise of 45 basis points. Mortgage rates seldom move in such wide swings. It's frustrating to borrowers who want to snag the best rate.

"It makes it difficult, particularly when you have clients who are preapproved, out looking for homes," says Dan Dowling, president of United Mortgage Capital in Altamonte Springs, Fla. "There's so much (housing) inventory, it's tough for them to decide which one. Then combine that with extreme volatility of interest rates."

He counsels home buyers to get a good deal on a house -- that's not difficult with Florida real estate -- and to grab a good interest rate when an acceptable one passes by.

Lately, a mortgage rate is "like the weather in Seattle," he says. "If you are disappointed with it, wait a while and it will change."

With mortgage rates this volatile, it's difficult to pin down the cause for the twists and turns. Dick Lepre, senior loan consultant for Residential Pacific Mortgage, in San Francisco, traces it to a surge in the issuance of commercial paper -- short-term debt that companies issue.

The Federal Reserve has started to buy commercial paper, breaking the ice in an important part of the frozen credit markets. Now that corporations are more able to borrow, their prospects look brighter -- and that development led to Tuesday's 889-point rise in the Dow Jones Industrial Average.

Lepre believes that investors sold mortgage-backed securities (among other investments) to buy stocks -- and that sell-off led to the rise in mortgage rates.

Swinging rates frustrate This month, the benchmark rate on the 30-year fixed was in Bankrate's survey of July 18, 2007, when it fell 21 basis points, then rose 54 basis points the

MORTGAGE RATES & INFORMATION AVAILABLE 24/7 ON THE INTERNET @ <http://pioneerlocal.interest.com>

Remember your loved one

with a Pioneer Press "In Memoriam" ad

(847) 486-7479

deathnotices@pioneerlocal.com

PIONEER PRESS YOUR LOCAL SOURCE

Local Death Notices

Death Notices

Campbell, Judith E. "Judy" Judy Campbell, nee Julek, age 68, of Glenview, Illinois, passed peacefully in her sleep at home on Thursday, October 30, 2008 after a long struggle with Alzheimer's Disease. She was the cherished wife of Dr. Walter D. Campbell, the loving mother of Scott and Christopher, and the beloved grandmother of eight. Born in Bad Axe, MI. Judy earned educational degrees from Central Michigan University and National Louis University. She taught junior high school subjects in District 34 prior to her retirement. She also sang with Northwestern University Chorus and Glenview Community Church Choir for several years prior to her illness. Visitation was held Sunday, November 2, at HABEN Funeral Home & Crematory, 8057 Niles Center Rd., Skokie, Illinois. Interment was Monday, November 3, in Fairview Cemetery in Homer, Michigan. A Memorial Service will be held Saturday, November 8, at 10 a.m. at Glenview Community Church, 1000 Elm St., Glenview, IL. In lieu of flowers, memorial contributions may be made to The Alzheimer's Disease Association, 8430 Bryn Mawr Ave., Suite 800, Chicago, Illinois 60631. Funeral Info 847.673.6111. Sign Guestbook at legacy.pioneerlocal.com

You may send a death notice to deathnotices@pioneerlocal.com or call for more information (847) 486-7479

Death Notices

Feth Jr., Edward L. Edward L. Feth, Jr., age 81. 50 year resident of Park Ridge: passed away October 31, 2008. Beloved husband of June, nee Johnson, for 53 years; dear father of Susan, Jim, Cheryl (William) McCall and Nancy; loving grandfather of Kevin and Karlin; Graveside services were held Monday, Nov. 3, 2008 at Town of Maine Cemetery, Park Ridge. Memorials may be made to St. Luke's Lutheran Church, 205 N. Prospect, Park Ridge, IL 60068 operated. Arrangements conducted by Nelson Funeral Home, Park Ridge. 847-823-5122 or www.nelsonfunerals.com. Sign Guestbook at legacy.pioneerlocal.com

You may send a death notice to deathnotices@pioneerlocal.com or call for more information (847) 486-7479

PIONEER PRESS YOUR LOCAL SOURCE

Death Notices

Huff, Mildred B. Mildred B. "Mar-Mor" Huff, nee Anderson, formerly of Park Ridge and Glenview, Illinois, died peacefully at her home November 1, 2008. In Naples, Florida with her family at her bedside. Mildred, born January 25, 1917, was a loving mother, grandmother, and great-grandmother as well as one of the early learning disabilities teachers in America. She earned her masters degree of Northwestern University in Evanston, Illinois. She went on to help hundreds of children reach their full potential. She is survived by her son, Steven Huff, and his wife Marlene; her daughter Catherine (Kate) and her husband Richard (Dick) Gottfried; her grandchildren Michael Huff and wife Kristine, Kimberly Huff, Brad Gottfried, Lindsey Gottfried, Halton and husband Joshua, Pamela Gottfried MacPherson and husband Matthew; great-grandchildren Stephanie, Tommy, Decker, Drew, Allie; and her long time caregiver and friend Nadine Gayle. A memorial service will be held on Friday, December 5th, at the Glenview Community Church at 7 PM. Visitation begins at 6 PM. In honor of her dedication to helping children read, charitable donations may be made to the Mildred Huff Reading Fund at Leap Learning Systems. leaplearningsystems.org. Sign Guestbook at legacy.pioneerlocal.com

You may send a death notice to deathnotices@pioneerlocal.com or call for more information (847) 486-7479

Death Notices

Peterson, Marjorie Marjorie Peterson nee Johnston, 84, of Covenant Village, Northbrook former resident of Park Ridge for over 40 years. October 29, 2008. Beloved wife of Warren. Loving mother of Lindo (Norman) DeGraff, Scott (Judy Desenis) Peterson, and Ellen (Peter) Clark. Cherished grandmother of 9. Proud Great grandmother of 4. Dear sister of Donald (Dolores) Johnson. Memorial Service Sunday, November 23, 2008 at 1:30pm at Northbrook Covenant Church, 2737 Techny Rd. (at Pfinsten Rd.), Northbrook. In lieu of flowers memorials may be made to the Benevolent Fund of Covenant Village, 2625 Techny Rd., Northbrook, IL 60062 or Midwest Palliative & Hospice CareCenter, 2050 Claire Ct., Glenview, IL 60025. Funeral Info 847-998-1020. Sign Guestbook at legacy.pioneerlocal.com

Szewczyk, Michael Michael "Mike" Szewczyk, 60 of Park Ridge; passed away Oct. 27, 2008 after a long struggle with brain cancer. He was employed of Motorola as a customer service rep. for nine years. Beloved husband of Ursula for 37 years; dear father of Andrea (Joseph) DiLeonardi; loving brother of James (Lynda) Shoemaker and Thomas (Margie); fond uncle of Brian and Mark. Visitation was Wednesday Oct. 29, at Nelson Funeral Home, 820 Talcott Road (at Cumberland) Park Ridge. Funeral was Thursday from the funeral home to Mary, Seat of Wisdom Church for Mass 10. Committal service Acacia Park Cemetery. Info 847-823-5122 or www.nelsonfunerals.com. Sign Guestbook at legacy.pioneerlocal.com

Funeral Directors and Associated Services

You may send a death notice to deathnotices@pioneerlocal.com or call for more information (847) 486-7479

You may send a death notice to deathnotices@pioneerlocal.com or call (847) 486-7479

RYAN-PARKE Funeral Home 120 South Northwest Highway Park Ridge Suburban (847) 823-1171 • Chicago (773) 792-1811 www.ryan-parke.com

FAMILY OWNED & OPERATED SINCE 1922 PRE ARRANGED & PREPAID FUNERALS AVAILABLE

Cooney Funeral Home FUNERAL DIRECTORS To Be Worthy of Your Confidence 3918 W. Irving Pk. Rd. CHICAGO, IL 60618 Phone (773) 588-5850 Fax (773) 279-9802 625 Busse Hwy. PARK RIDGE, IL 60068 Phone (847) 685-1002 Fax (847) 685-1005

It's included.

Our package prices are designed to combine our popular caskets with our uncompromised services. And, we include all of those things that usually add up to make a funeral expensive—just one of the many ways you'll be pleasantly surprised.

Complete Burial Service • Visitation • Funeral Service • Quality Steel or Hardwood Casket • Professional Services • Concrete Vault \$7,495

Olson Burke/Sullivan Funeral & CREMATION CENTER 6467-73 N Northwest Hwy • Chicago, IL 60631-1451 • (773) 774-3333

Please send me more information on the services you offer. Name Address City State/Zip Phone There is no cost or commitment

If you're eligible for Medicare or know someone who is

Are you getting all the health care benefits you deserve?

Compare for yourself and see:	Humana ChoicePPO®	Your plan
• Affordable monthly plan premium	✓	—
• Prescription drug coverage	✓	—
• Preventive coverage	✓	—
• Gym membership at no additional cost	✓	—
• Quit smoking program	✓	—
• 24 hour nurse hotline	✓	—
• Emergency coverage at home or when you travel	✓	—
• Humana Active Outlook® wellness program	✓	—
• And more!	✓	—

All from a company that has been serving people with Medicare for over 20 years.
Call today to learn about HumanaChoicePPO® or to find an informational seminar near you.
1-800-372-7216 • TTY 1-877-833-4486
 8 a.m. - 8 p.m., seven days a week

HUMANA Medicare
Group Health
Individual health
Dental, Life, Vision
Guidance when you need it most

A Medicare-approved PPO available to anyone enrolled in both Part A and Part B of Medicare through age or disability. Enrollment period restrictions apply; call Humana for details. Plans may be renewed annually. Copayment, service area, and benefit limitations may apply. You must continue to pay your Medicare applicable premiums if not otherwise paid for under Medicaid or by another third party. M0006_GHA_02VYRR IL 11/08

Dr. Memmel not only
she's walked in
in their shoes.



Heidi Memmel, M.D.
Breast Surgeon
Advocate Lutheran General Hospital

As a breast cancer survivor and a breast cancer surgeon, Dr. Memmel knows what it's like to be a patient and brings this rare perspective and experience to the women she treats. All of our physicians - including nine surgeons - at Lutheran General Hospital's Caldwell Breast Center work together with other breast health professionals as a team to provide the best medical care. And by utilizing the latest diagnostic technologies and treatment options, the center is leading the way in comprehensive, specialized breast health care.

To learn more about the Caldwell Breast Center's expert team and to read more about Dr. Memmel's background and qualifications, visit www.advocatehealth.com/caldwell.

Advocate Lutheran General Hospital
Caldwell Breast Center
 1700 Luther Lane • Park Ridge

FOOTBALL PLAYOFFS

Notre Dame nearly upsets Bartlett

Dons give impressive effort in 10-7 loss

By JIM EDISON
jedison@pioneerlocal.com

For the third year in a row, Notre Dame's football team had to face a top-seeded team in the first round of the state playoffs. And for the second time in those three games, the Dons threw a huge scare into an undefeated opponent. This time, it was Bartlett Friday night at Streamwood High School.

The Hawks (9-0) were one of only four unbeaten

teams in the Class 8A bracket.

The Notre Dame defensive unit didn't let Bartlett's record bother it, however, as the Dons turned in a stellar effort. And while Bartlett did manage to carve out a 10-7 triumph, it had to earn it every inch of the way.

"We came to play tonight," longtime head coach Mike Hennessey said moments after the 2008 season came to a halt. "Our defense was outstanding. We caused, and recovered, some turnovers and stopped their offense for the most part.

"Our problem was that we couldn't establish our own offense. We were

never able to get any favorable field position."

The ND defensive squad did indeed play an inspired game. **Jack Thompson, Kyle English, Billy Hughes, Sean O'Hara and Pat Lazzara** all displayed a high level of intensity. Bartlett quarterback Josh Hasenberg was under pressure from the opening series.

The Hawks did break the scoreless deadlock with 3 minutes, 33 seconds left in the first quarter when they capped a 65-yard drive with a 27-yard field goal by Dnn Knrys. Bartlett's defense, which sacked ND quarterback **Eric Hennessey** picked up a crucial fourth-and-one at midfield and

Bartlett failed to add to its narrow lead until midway through the final quarter. The Hawks finished off a 58-yard drive with a 1-yard TD plunge by Fabian Liberi. Karys' PAT kick made it 10-0.

Amazingly, at that point, ND's offense came to life. Hennessey (14 completions for 137 yards), who had left the game with a bruised ankle, returned to the field and orchestrated a 70-yard drive that culminated with a 24-yard touchdown pass to Lazzara. **John Jennings** kick made it 10-7 with 4:48 left.

With time running down, however, Bartlett picked up a crucial fourth-and-one at midfield and

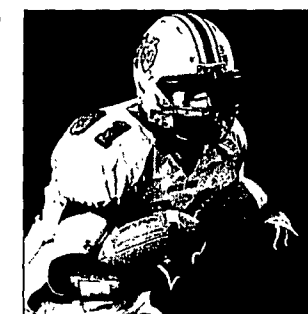

JEFF KRAGE/FOR PIONEER PRESS

Notre Dame's Pat Lazzara returns a kickoff during Friday's first-round playoff game against Bartlett at Streamwood High School.

ran out the clock.

"I thought we gave it a valiant effort," Hennessey said. "Even though we were 5-4, we know the quality of our schedule (in the East Suburban Catholic Conference) makes us better.

"This was a good senior class. We have made the playoffs three straight years now and that is always the main goal."

Comment: pioneerlocal.com

HOCKEY

Notre Dame notches its 20th victory of season

Continuing their winning ways after an upset victory over Fenwick last week, the Notre Dame Ice Dons improved their record to 20-2 with victories over Libertyville 4-1, St. Viator 5-1 and CCM of Crystal Lake 10-5.

On Oct. 28, the Ice Dons defeated Libertyville 4-1. Goals were scored by **Kyle Gronset, Mike Coca** and **Kevin Orchard** with a pair. Assists were credited to **Orehard, Anthony Fabris** and **Johnny Blas** (3). **Ryan Malze** was in net for the victory.

On Thursday, Notre Dame defeated St. Viator 5-1 in a Catholic League game. Goals were scored by **Tim VanDermeir, Anthony Lupo, Fabris, Blas** and **Orchard**. Assists were credited to **Coca, Micah Orchard, Blas** (2) and **Lupo** (2). **Jeremy Krautstrunk** was in the nets for the win.

On Saturday the Dons notched their 20th victory of the season over the CCM Tigers of Crystal Lake 10-5. Goals were scored by **Jeff Levar, Ryan Zanon, VanDermeir, Blas,**

Dominick Von Aulock, Matt Dunne, Kevin Orehard (2) and **Alex Murphy** (2). Assists were credited to **Coca, Murphy, Micah Orchard, Dunne, Blas, Levar, Sean Corcoran** and **Gronset** (3).

The Dons' next home game is at 8:15 p.m. Nov. 19 at the Niles Ice Rink against Providence.

JUNIOR VARSITY

The JV Ice Dons had a successful week, defeating Cary-Grove 5-2, CCM Tigers 7-0 and Libertyville 5-3 and improved their

Metro Central record to 6-1 with their victories.

On Oct. 29, the JV Dons traveled to Crystal Lake and defeated Cary-Grove 5-2. Goals were scored by **Nico Lazzaroni, Vince Pergande, Joseph Santelli** and a pair by **David Fabris**. Assists were credited to **Peter Prestia, Tyler Zanon, Stephen Kavanaugh, Chet Polonitzka, Dino Loverde, Kevin Saneira** and **Brian Gronset** each had two assists.

On Saturday, Notre Dame defeated the CCM Tigers 7-0. **Kevin Frost**

recreated his first shutout of the season, making 17 saves in the victory.

Scoring for Notre Dame were **Loverde, Saneira, Zanon** and **Fabris** (4), while assists were credited to **Lazzaroni, Gronset, Zanon, Kavanaugh** and **Brandon Taylor**. **Dziadosz** and **Loverde** each had three assists.

On Sunday, the Ice Dons defeated Libertyville 5-3 on goals by **Lazzaroni, Fabris** and a hat trick by **Loverde**. Assists were credited to **Saneira, Fabris** and **Taylor** with **Dzi-**

dosz getting 3 assists.

The JV's next home game is at 8:20 p.m. Tuesday against Prairie Ridge at the Niles Ice Rink.

The Notre Dame High School open house is scheduled from 5:30-8:30 p.m. today.

The Ice Dons encourage all 6th-, 7th- and 8th-graders attending the open house to stop by the hockey table and meet some of the players and coaches and get a free pass to an upcoming home game.

Comment: pioneerlocal.com

NOTRE DAME CROSS COUNTRY

Belpedio, Curley end seasons at sectional meet

By JIM EDISON
jedison@pioneerlocal.com

Notre Dame cross country coach Mike Jankowski knew the road was going to get a lot tougher for his two run-

ners when they competed at the Niles West Sectional.

Both **Tony Belpedio** and **Tim Curley** had qualified for Saturday's huge gathering in Skokie as individual contestants out of the

Loyola Regional a week earlier. The two Don runners gave it all they had in the highly competitive three-mile race, but it was not enough to advance to this year's state meet.

"I thought they ran

pretty well for the most part," Jankowski said. "They may have gone out a little too fast early, but this was their first sectional."

Belpedio ended the

race with a time of 16 minutes, 51 seconds, which was good enough for 80th place overall. Curley entered the chute with a time of 17:15 (120th place).

"Tony is a junior and

"Tim is a sophomore," Jankowski said. "So both of them will be back next year and this was great experience for them."

Comment: pioneerlocal.com

Sports

BOYS SOCCER

Demons fall after upsetting Loyola

By JIM EDISON
jedison@pioneerlocal.com

While it's impossible to predict the future, it would be a good guess that Maine East's boys soccer success will have a lasting effect.

The Demons (17-5-3) had a phenomenal 2008 season. And while they fell short of their ultimate goal — in advance to the state finals — it was clearly a year to remember.

East's players had the curtain drop on their magical season Saturday afternoon when it fell to No. 1-ranked New Trier 4-0 in the championship game of the Niles North Sectional. But before they howed out of the

postseason, coach Vic DiPrizio's athletes pulled off a major upset in the

shut to give his team the lead with 14 seconds left before intermission. As it

"We were not intimidated coming in here and played hard."

Coach Vic DiPrizio

semifinals.

Playing second-seeded Loyola on Oct. 29, the Demons squeaked out a grueling 1-0 victory.

After controlling most of the action in the first half, East was awarded a free kick at about the 20-yard line. All-State midfielder **James Kelly** took the shot, which bounced off the crossbar. Luckily for East, **Josh Swoboda** was positioned perfectly and buried the rebound

turned out, that would be the only goal of the night.

"Everyone was expecting it to be a Loyola-New Trier final here (at Niles North)," DiPrizio said. "But our kids came to play. We had a good scouting report and prepared ourselves. I think they (Loyola) were ranked eighth in the state."

On Saturday, the Demons returned to Skokie for their champi-

onship battle with the nationally ranked Trevians. New Trier entered the contest with an impressive record of 18-1-1. Amazingly, it was the Demons who had the first real opportunity to score. Kelly stole a ball in New Trier territory and moved in on goalkeeper John Secaras. His shot was just wide.

Late in the half, New Trier increased the pressure and Matt Weaver drilled a shot past East goalkeeper **Milan Tijanic**. The Trevians were awarded a penalty kick just four minutes into the second half and Kyle McCrudden made it 2-0. New Trier later had goals from Chris Ritter and Benjamin Beaver.



BUZZ ORR/STAFF PHOTOGRAPHER
Maine East's Cesar Castanon (right) battles Von Steuben's Chukwueneke Nwabara, during their Oct. 24 match at Maine South High School.

"You can't make mistakes with a team of this caliber," DiPrizio said. "And we had a couple. But I was so proud of our

team. We were not intimidated coming in here and played hard."

Comment: pioneerlocal.com

MANAGING EDITOR: Rick Hibbert
rhibbert@pioneerlocal.com | (708) 524-4440

MAINE EAST ROUNDUP

Road to Peoria ends at Niles West Sectional meet

By JIM EDISON
jedison@pioneerlocal.com

The road to Peoria and the state cross country meet ran through Skokie and the Niles West Sectional Saturday.

And while no Maine East runner, on either the boys or girls teams advanced, the Demons were well-represented at the huge gathering.

On the boys side, coach Chris Peters had three individual competitors in the three-mile race. **Blazej Szymoniak**, **Gatthoon Garmos** and **Steven Grounsnick** all earned tickets to the sectional out of the Loyola Regional one week earlier.

Szymoniak finished the race in 92nd place with a time of 16 minutes, 30 seconds. Garmos (194th, 17:10) was next and Grounsnick (147th, 17:39) completed East's showing.

"Overall, it was a great experience for the guys," Peters said. "They got to run in a very fast race against a lot of quality runners."

"And it was so nice to see Blazej run his best time of the season. I think the season went well. We had a lot of new kids and many of them are already talking about participating in track this spring."

On the girls side, the Demons had their full team at Niles West. East

finished 19th out of 20 in the team standings with 566 points.

Leading the way for the Demons, as she has all season, was junior **Michelle Zdobylak**, who ended the day in 90th place with a time of 20:03. **Zaklina Thell** (98th, 20:18) was next into the chute, followed by **Angela Jones** (125th, 21:35), **Marian Lopez** (126th, 21:39) and **Zenya Yap** (127th, 21:46).

GIRLS SWIMMING

With the Central Suburban League North meet slated for Saturday at Glenbrook North, the Demons have one major goal — get healthy. Coach Scott Guilfoil's

signal has been hit with a barrage of ailments in recent days. The longtime skipper is hoping his athletes will be ready for GBN and then the Stevenson Sectional on Nov. 15.

"We have just had so many different things affecting the team," Guilfoil said. "Some kids are sick and some have injuries. We've had ear infections, colds and other things. And two of our best girls are included in that. **Natalia (Bialecka)** has a sore back and **Jelena (Krstic)** is dealing with a shoulder problem. So we really need to get everyone healthy as we move into the crucial part of the season."

With people in and out of the lineup, sustaining a solid attack has been difficult. The Demons dropped their last two meets, falling to Highland Park 80-46 on Oct. 24 and then to Maine West 103-62 Oct. 30.

In the meet with HP, East's only two individual victories were garnered by Bialecka. The talented junior won the 100-yard backstroke with a time of 1 minute, 6.54 seconds and the 50 freestyle in 25.95. East also captured the 200 freestyle relay as Bialecka, Krstic, **Jackie Lam** and **Alyssa Jenrick** combined for a time of 2:01.26.

Against Maine West,

the Demons collected wins from Bialecka in the 100 freestyle (56.54), Krstic in the 100 breaststroke (1:10.53) and Bialecka, Krstic, **Agnes Dadej** and **Natasha French** in the 200 medley relay (2:13.52).

GIRLS VOLLEYBALL

The 2008 season came to an abrupt halt for East's girls volleyball squad Oct. 30.

Competing at the Eymston Regional, one-of-four regionals in the Highland Park Sectional, the Demons were defeated by Von Steuben 25-21, 23-25, 24-18 in the opening round.

Comment: pioneerlocal.com

RMS Liquors

1714 E. Kensington Rd
Mt. Prospect, IL 60056
(847) 298-7960

We carry a large variety of
♦ Domestic & Imports
♦ Spirits & Wine

With the lowest prices in
Mount Prospect and the vicinity.

We also carry a large variety of
Domestic import Beers
which include:

- Polish ♦ Netherlands
- German ♦ Jamaican
- Mexican ♦ Czech

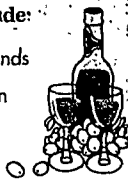

FANTASY FOOTBALL MONTHLY

WINNER GETS \$100!

ENTRIES MUST BE POSTMARKED BY 11/30/08 FOR DECEMBER CONTEST

- PICK 2 QUARTERBACKS & A WRITE-IN (NOT LISTED)
First Quarterback (choose 1)
— Peyton Manning
— Carson Palmer
— Jay Cutler
— Tony Romo
- Second Quarterback (choose 1)
— Donovan McNabb
— Drew Brees
— Aaron Rodgers
— Philip Rivers

- PICK 2 RUNNING BACKS & A WRITE-IN (NOT LISTED)
First Running Back (choose 1)
— Brian Westbrook
— Adrian Peterson
— Joseph Addai
— LaDarius Tomlinson
— Steven Jackson
- Second Running Back (choose 1)
— Frank Gore
— Marion Barber
— Clinton Portis
— Marshawn Lynch

- PICK 2 WIDE RECEIVERS & A WRITE-IN (NOT LISTED)
First Wide Receiver (choose 1)
— Randy Moss
— Reggie Wayne
— Brandon Marshall
— Tottell Owens
- Second Wide Receiver (choose 1)
— Lairy Fitzgerald
— Greg Jennings
— Marques Colston
— Blayton Edwards

NO PURCHASE NECESSARY. A PURCHASE WILL NOT INCREASE YOUR CHANCES OF WINNING. Open to legal residents of Illinois, Indiana, Wisconsin and Iowa 18 and older. Void where prohibited. One \$100 cash prize will be awarded to the entrant who has the most points for the month (see rules for tie). All touchdowns run, caught or thrown count. Only touchdowns in that month count. Write-in can't be already listed and will be used to break ties only. Only one entry per person per month. Subject to official rules available at <http://www.pioneerlocal.com> <http://www.pioneerlocal.com/>. Sponsors: Pioneer Press, 3701 W. Lake Avenue, Glenview IL 60026.

Name _____ Mail Entries To:
Address _____ Pioneer Press Fantasy
Town, Zip _____ Football Contest
Phone _____ Age _____ c/o Second Floor
3701 W. Lake Ave
Glenview, IL 60026

LET US CATER YOUR NEXT Holiday PARTY

Stub's
Cyrus Ribon Chicken Hamburgers

We Deliver
3727 West Dempster, Skokie

For Fast Carry-Out Service Call
(847) 673-9409 or 677-7695 • FAX: (847) 677-7701
Hours Mon. - Thurs. 11am - 11pm • Fri. & Sat. 11am - 12 Midnight • Sunday 11am - 10pm

Patio Open - Weather Permitting
www.hubs-restaurant.com

Just a Family Business Where Quality Still Counts Since 1976

Cardinal WAREHOUSE WINE & LIQUORS

7780 N. MILWAUKEE

GREY GOOSE
2188
LIMIT 1 CASE
EXPIRES 11-09

CONCHAYORO
5.88
LIMIT 1 CASE

Heineken
10.88
LIMIT 5 CASES

JACK DANIEL'S
29.88
LIMIT 1 CASE

Prestige Wine & Spirits Des Plaines

Grand Opening!
14711 e. St. Des Plaines
TEL: 630-963-9233
Fax: 630-963-9222

Other Location
Westmont
TEL: 630-963-9233
Fax: 630-963-9222

Full-Service Beverage Center

FEATURING
Great Selection and Value
Wines
Blends
Spirits
Cigars

PARTY SPECIAL
We Match Any Current Local Ad
Buy Your Liquor on Commitment
Pay for what you open
Delivery Available

5% off \$1 off 1/2 off

Excludes Sale Items - Limit 1 per Customer
Any 15 Liter Size
Excludes Wine & Spirits
Des Plaines - (630) 963-9233
Westmont - (630) 963-9233
In the event of a tie, the number of cases will determine the winner.
Offer good on purchases of 12 or more cases.
Offer expires 12/31/08
0% points 12/2/08

FROZEN ROPES Baseball and Softball TRAINING CENTERS

6000 W. Touhy, Chicago, IL 60646 773-631-4300
www.frozenropes.com

FROZEN ROPES ROOKIE CLUB
Tuesday or Thursday 4pm-6:50
Exciting New Drills Ages 5 and 6
Rookie Club prepares you for Little League for a successful upcoming season. A fun, non-competitive and upbeat class format led by professional Frozen Ropes instructors focuses on the Big Three keys to success: "Hitting" "Throwing" "Fielding"

AFTER SCHOOL ACADEMY
Monday or Wednesday 4pm-6:50
Classes consist of hands on group instruction, continuous station change to promote speed of play and controlled scrimmages. The Academy is open to players ages 7-9.

All sessions begin in October for additional classes and events visit us www.frozenropes.com/chicago

Score Big!

DOMINIC'S KITCHEN
STUKE

8 S. Northwest Hwy., Park Ridge
Next to the Pickwick Restaurant
847-698-1255
www.JustCHEFit.com

Invite Big Green Egg To Your Tailgate Party

verizon wireless

Add lines for \$9.99

monthly access per line after the first 2 lines for \$99.99 monthly access

Save more when everyone is on one plan.

Everyone on the plan gets
Unlimited
Text, Pix, IM & Flix
to anyone on any network in the U.S.

With a new 1- or 2-yr. Agmt. per line on a Nationwide Select Family SharePlan* \$99.99 monthly access or higher. (Activation fees, taxes & other charges apply.) * Messaging not everywhere in Nationwide Area.

Plus, talk all you want to any
Verizon Wireless customer.

(When calling from the Nationwide Area.)



MOTO™ W755
Hot music phone with expandable memory
\$69.99

\$119.99 2-yr. price - \$50 mail-in rebate debit card. With new 2-yr. activation.



Nokia 6205
Sleek music phone with external controls
Verizon Wireless Exclusive
\$49.99

\$99.99 2-yr. price - \$50 mail-in rebate debit card. With new 2-yr. activation.



Family bonus!
Buy any phone \$29.99 or higher and get up to
3 FREE

MOTO™ VU204 camera phones
\$79.99 2-yr. price - \$50 mail-in rebate debit card. With new 2-yr. activation per phone.

Switch to America's Most Reliable Wireless Network®

Call 1.877.2BUY.VZW

Click verizonwireless.com

Visit any store

VERIZON WIRELESS COMMUNICATIONS STORES

All listed locations are open on Sunday (except where indicated). Call for store hours.

ADDISON
open 1801 W. Lake St.
ARLINGTON HEIGHTS 138 E. Rand Rd. 847-253 0329 *
AURORA 740 N. Rte. 59 630 851-2254 *
BATAVIA 350 Randall Rd. 630 761-2160 *
BELVIDERE 1912 Gateway Center Dr. 815 547-9493
BLOOMINGDALE Shafter Square Mall 630 582-4707
136 W. Army Trail Rd. 630 980-4322 *
BOLINGBROOK 224 Weber Rd. 630 226-4660
691 L. Boughton Rd. 630 783 8966 *
BOURBONNAIS Northfield Square Mall 815-936 7605
BRADLEY 940 Kinzie Ave. 815 379 0293
CALUMET CITY 1245 Torrence Ave. 708 862 0500
CHICAGO NORTH 6451 W. Diversey 773 836-4401 *
1652 N. Milwaukee Ave. 773-489 6200 *
3670 W. Irving Park Rd. 773-463-5364 *
- 4265 N. Harlem Ave. 708-452-1312 *
810 W. North Ave. 312-397-5800 *
CHICAGO SOUTH 120 W. 87th St. 773 994-9100
3435 W. 26th St. 773-522-9300 *
CHICAGO CITY 500 W. Madison 312 831-0127**
500 N. Michigan Ave. 312-464-1300 *
209 S. LaSalle St. 312 658 3900**
3103 S. State St. 312-291 0499 *
open 36 State St. 312-726 8277
CHICAGO RIDGE Chicago Ridge Mall 708 346 9557 *
CRESTWOOD 13441 S. Cicero Ave. 708 396 9822 *
CRYSTAL LAKE 1125 South Route 31 815 444 6080
DOWNERS GROVE 1404 Butterfield Rd. 630 953 8052
GURNEE 6543 Grand Ave. 847 855 6019 *
HILLSIDE 2201 S. Wolf Rd. 708 947 2500 *
HODGKINS 9402 Lakes Rd. 708-387 0554 *
HOFFMAN ESTATES 7734 N. Sutton Rd. 847 645 0190 *
JOLIET 3330 Mall Loop Dr. 815-439 5100
LAKE IN THE HILLS 290 N. Randall Rd. 847-458 2866

In Collaboration with

Alcatel-Lucent



Visit the Verizon Wireless Store locator one of the smartest things you can do.

BUSINESS CUSTOMERS
1-800-809-3249

HABLAMOS ESPAÑOL

AUTHORIZED RETAILERS Equipment prices, models & return policy vary by location. Authorized Retailers may impose additional equipment related charges, including cancellation fees.

ALGONQUIN
The Wireless Network 847 658 0808
ARLINGTON HTS.
The Cellular Connection 847-255-2222
BARTLETT
Wireless Millennium Communications 630-483 5050
ELMHURST
The Cellular Connection 630 834-2716
HANOVER PARK
Wireless Millennium Communications 630 213 6060
JOLIET
The Wireless Network 815 838-2900
LAKE ZURICH
Corporate Cellular 847-540-4440
OAK LAWN
The Cellular Connection 708-499-4088
ROUND LAKE BEACH
The Wireless Network 219-917-9900
VERNON HILLS
Star Wireless 847-247 0361
WAUCONDA
Wauconda Cellular 847-487 0400
WEST BUNDEE
The Wireless Network 847-426-9933
WILMETTE
Linear Communications 847 853-3500



*Our ServiceCharges (incl. Fed. Util. Sur. of 11.4% of interstate & int'l telecom charges) varies quarterly. 7% Regulatory & E&C Administrative/line/mon., & others by area) are not taxes (details: 1-888-684-1888); gov't taxes & our service charges could add 9% - 33% to your bill. Activation fee/line: \$35 (\$25 for secondary Family SharePlan lines w/ 2-yr. Agmt.).

IMPORTANT CONSUMER INFORMATION: Subject to Customer Agent, Calling Plan, rebate form & credit approval. Up to \$175 early termination fee/line & other charges. Offers and coverage, varying by service, not available everywhere. Device capabilities: Add'l charges & conditions apply. Rebate debit card takes up to 6 weeks & expires in 12 months. Max 5 lines on same account. Limited time offers. While supplies last. Network details and coverage maps at verizonwireless.com. © 2008 Verizon Wireless. AUDIO

CORRECTION

PREVIOUS DOCUMENT REPHOTOGRAPHED
TO ASSURE LEGIBILITY

 Microsystems, Inc.

DIRECT FROM THE HEART OF BROADWAY! THE STAR & SHOW YOU'VE HEARD ABOUT!

Sold Out in New York, Philadelphia & W. Palm Beach— Now Coming to Skokie!

"Funny! Dazzling! Beautiful! Like Billy Crystal's 700 Sundays!"
The New York Times

"Lots of Laughs, But Also Very Serious. This Hit Show Has Taken New York By Storm!"
FOX TV



jake ehrenreich's
A JEW GROWS IN BROOKLYN

a rock 'n roll true story, holocaust family, borscht belt... **COMEDY MUSICAL?!**

One Week Only - Nov. 5-9, 2008

Wed 2 & 7:30pm, Thurs 7:30pm, Fri 8pm, Sat 2 & 8pm, Sun 1 & 5pm
NORTH SHORE CENTER FOR THE PERFORMING ARTS
9501 Skokie Blvd., Skokie, IL 60077
Box Office: 847-673-6300 • Group Sales: 312-423-6612
www.AJewGrowsInBrooklyn.com

go.

Continued from **PAGE B20**

#2001 Autumn Gala dinner dance and showcase, 5-11:30 p.m. Nov. 8 at the Sheraton Chicago Northwest Hotel, 3400 W. Euclid Ave., Arlington Heights. Featuring performances by U.S. Standard Champions Igor Mikushov and Anna Dmedova and U.S. Senior II Standard Champions Lonny and Susie Tsang. Black tie optional. Tickets: \$65 for members; \$70 nonmembers. Registration deadline is Oct. 31. For tickets, visit www.usadancechicago.org or call Susie Johnson, (847) 541-1585.

FAIRS & FESTIVALS

Holly and Ivy Bazaar and Holiday

Bake Sale, presented by the Ladies Philoptochos Society, 9 a.m.-9 p.m. Nov. 21 and 9 a.m.-5 p.m. Nov. 22 at St. Haralambos Greek Orthodox Church, 7373 N. Caldwell Ave., Niles. Lunch will be served on both days from 11:30 a.m.-2:30 p.m. and dinner will be served on Friday only, from 5:30-9 p.m. (847) 647-8880.

FILM

Des Plaines Public Library, 1501 Elinwood St. (847) 376-2787. www.dpl.org. Advance registration required for activities unless noted otherwise. Nov. 16, 2 p.m.: Screening and discussion of "Persepolis." Morton Grove Public Library, 6140 Lincoln Ave. (847) 965-4220. Nov. 10, 2 p.m.: "Das Boot: Director's Cut." In German with English subtitles. Nov. 11, 11:30

a.m.: "Flags of Our Fathers," rated R. Nov. 13, 2 p.m.: "The Breakfast Club," rated R. Reel Conversation to follow the film. Nov. 18, 11:30 a.m.: "Turtles Can Fly," rated PG-13. In Kurdish with English subtitles. Nov. 19, 7 p.m.: "Do the Right Thing," rated R. Nov. 20, 2 and 7 p.m.: "Iron Man," rated PG-13. Nov. 21, 2 p.m.: "Pretty in Pink," rated PG-13. Reel Conversation to follow the film. Nov. 22, 2 p.m.: "Bella," rated PG-13. Reel Conversation to follow the film. Park Ridge Public Library, 20 S. Prospect Ave., Park Ridge. (847) 825-3123. www.parkridgelibrary.org. Films @ the Library - No registration needed. Doors open for seating one-half hour before show time. Nov. 11, 2 and 7 p.m.: "Forgetting Sarah Marshall," rat-

go., PAGE B24

Wrap up the season with an ad in our

HOLIDAY GIFT Guides

Publishing: Nov. 19/20 & Dec. 4/5

for print and online opportunities
Call (847) 486-7300
to advertise your business today!

PIONEER PRESS LAKE COUNTY NEWS-SUN The Hoopings
YOUR LOCAL SOURCE

A VALUE every CHICAGO FAMILY CAN SUPPORT.

Families talk all they want with anyone they want on the Unlimited National Family Plan from U.S. Cellular.

Our Unlimited National Family Plan gives you:

- Unlimited calling with anyone on any wireless network or landline in the nation
- Free Incoming Texts and Pix
- Get the first line for \$99.99 and the second line for \$49.99
- Add up to three more lines for just \$49.99 each

Get up to five LG UX300s for 1¢ each when you get a line for yourself and up to four other lines for family members.

LG UX300
Camera and Bluetooth® Technology

UP TO FIVE 1¢ EACH
New 2-yr. agmts. required. \$30 act. fees may apply.

Save over \$150 each instantly.
Available in Blue or Silver.

U.S. Cellular
believe in something better

Exclusive wireless provider of the Chicago Bears.

Discover the Difference: Put our network, products and customer service to the test for 30 days • Change your calling plan at any time during your service agreement without signing a new contract • Renew your contract and take advantage of new phone pricing before your current contract ends

Let us help you find a location: visit uscellular.com or call **1-888-BUY-USCC**

Things we want you to know: Offer valid on plans of \$39.95 per month or higher. New two-year agreement (subject to early termination fee), credit approval and a \$30 activation fee required. 96¢ Regulatory Cost Recovery Fee applies; this is not a tax or government-required charge. Additional fees, taxes, terms, conditions and coverage areas apply and vary by plan, service and phone. Use of service constitutes acceptance of the terms of our Customer Service Agreement. See store for details or visit uscellular.com. Unlimited National Plan: Customers must have a billing address within U.S. Cellular's Wide Calling Area to be eligible. U.S. Cellular reserves the right to terminate your service if less than 50% of your overall minutes in each of three consecutive billing cycles is used in U.S. Cellular's Wide Calling Area. The Unlimited National Plan may not be used for conference calling. Call Forwarding, monitoring services, transmission of data, broadcasts or recorded material, or other connections that do not consist of uninterrupted live dialogue between two persons. The Unlimited National Family Plan requires a minimum of two lines at \$149.98 per month. Maximum of five lines per account. 30-Day Guarantee: Customer is responsible for any usage charges incurred prior to return. Phone must be returned undamaged in the original packaging. Contract Renewals: Customers who have completed at least 18 months of a two-year agreement are eligible for promotional equipment pricing. See store for eligibility. Promotional Phone subject to change. U.S. Cellular Visa Debit Card issued by MetaBank pursuant to a license from Visa U.S.A. Inc. Allow 10-12 weeks for processing. Card does not have cash access and can be used at any merchant location that accepts Visa Debit Cards. Card valid for 120 days after issued. \$9.95 unlimited easyedge access plan applies. Limited-time offer. Trademarks and trade names are the property of their respective owners. ©2008 U.S. Cellular.

10% OFF FRI-SUN **15% OFF TUES-THURS**
With This Coupon. Dine in Only. (Not Valid w/ Lunch Specials, Holidays.)

Thanksgiving Greetings
Restaurant/Banquets/Dancing

Glass of wine: Chardonnay • Merlot • Cabernet • White Zinfandel
Choice of Soups: Cream of Pumpkin • Sage & Smoked Ham
• Chicken Noodle Soup
Appetizer: Smoked Salmon & Jumbo Shrimp
Salad: Baby Spinach, Cranberries, Walnuts, Gorgonzola cheese, Raspberry & Balsamic Reduction Vinaigrette
Choice of Entrees served w/ sweet potatoes, veggies, & risotto rice:
Roasted Turkey stuffing & cranberry sauce • Turkey Orloff • Dijon & Peppercorn crusted N.Y. Steak • Lamb Shanks Provencal, Brunoise of Vegetables & fresh Herbs • Salmon Filet • Lake Superior White Fish • Almond Crusted Tilapia Filet • Caesar Salad w/ Roasted Turkey
Dessert choice Coffee or Tea Included: Apple Pie Ala Mode • Pumpkin Pie • Carrot Cake • Ice Cream or Sorbet \$28.95 + Tax & Gratuity • Kids Menu Available

9925 GROSS POINT RD • SKOKIE (847) 982-1400
(Formerly the Tower Garden)

ARE YOU A VETERAN?

Join your fellow Vets in Chicago!

Over 25 posts in your area are accepting members now!

AMVETS offers open membership to all military men and women with an honorable discharge.

Call (800) 638-8387 for more information, or visit us at www.amvets.org.

AMVETS is one of the most respected volunteer-led organizations in the country. Please join our organization of Veterans Serving Veterans.



go.

Continued from PAGE B22

ed R. Nov. 25, 7 p.m.: "Pieces of April" rated PG-13.
Skokie Theatre, 7924 N. Lincoln Ave., Skokie. (847) 677-7761. www.skokiethatre.com. Tickets: \$13 for feature films, \$11 students and seniors; \$10 for documentaries, \$8 students and seniors.
Nov. 21-23: Polish Film Festival in America. Friday: "Katyn" at 6:30 p.m.; "Chronicle of the Ghetto Uprising According to Marek Edelman" at 8:30 p.m. Saturday: "Death to Zygelmajm" at 6 p.m.; "The Purim Miracle" at 7 p.m.; "Deborah" at 8:30 p.m. Sunday: "The Sender's List" at 3 p.m.; "Phoamateur" at 4 p.m.; "Far from a Window" at 5 p.m.; and "Austeria" at 7 p.m.

WORKSHOPS & CLASSES

Alliance for Lifelong Learning at Oakton Community College offers a variety of single-session continuing education courses that meet evenings at various locations. To register, visit www.oakton.edu/all or call (847) 982-9888 and press 3. Nov. 18, 7:30-9 p.m.: "Impressionism: The Hand and Glove of Debussy and Monet" (MUS 542-01) explores the influence of Impressionistic art on Claude Debussy. Course meets at Glenbrook South High School, 4000 W. Lake Ave., Glenview. Fee is \$20.

ET CETERA

The Art of Beadwork, the Bead Society of Greater Chicago's sale of members' work, noon-5 p.m. Nov. 16 at the Skokie Banquet and Conference Center at the Holiday Inn North Shore, 5300 W. Touhy Ave., Skokie. \$4 admission. www.bsgc.org.
Fall Bead Bazaar presented by Aylas Wonderful World of Beads from 10 a.m.-5 p.m. Nov. 9 at the Hilton Garden Inn, 1818 Maple Ave., Evanston. Admission \$2. \$2 with card that can be picked up at Aylas Bead Store, 1511 Sherman Ave., Evanston. Call (847) 328-4040 for information.
Park Ridge Public Library, 20 S. Prospect Ave., Park Ridge. (847) 825-3123. www.parkridgelibrary.org. Nov. 18, 2 p.m.: "Thankful Tales" Professional storyteller Elyne Handler will entertain with tales from Japan, Alaska, Cuba and Europe that uniquely illustrate thankfulness.
Skokie Theatre, 7924 Lincoln Ave., Skokie. (847) 677-7761. www.skokiethatre.com. Nov. 8-9, 2 p.m. and 8 p.m.: "A Conversation with Teddy Roosevelt." \$15/\$20.

LIABILITY

ICMA Retirement Trust 55,048; AFLAC 6,613; The United Way Of Skokie 3,328; National Guardian Life Ins Co 1,171; Byerly & Company 3,592; Blue Cross Blue Shield 91,954; Delta Dental Of Illinois 6,894; Vision Service Plan 2,042; Total 170,304

EXPENDITURE SUMMARY:

Chicago Party Rental 22,341; 2XL Corporation 5,819; R16 Productions 4,299; Able Services & Supply 58,959; Ace Hardware 18,207; Action Sports Holding 60,000; Acme Electrical Supply 4,400; Joe Alas 2,506; All American Music & Sound Inc. 10,000; All American Trophy King 4,470; All Star Security, Inc. 25,568; Atman Bus Service 97,959; Amateur Hockey Association Of 3,763; Aronbek Company 5,221; American Awning & Window 14,793; American Carpet & Linoleum 3,800; American English 5,000; American Express 150,035; American Messaging 3,687; Ameritech/AT&T 24,830; Anderson Lock 7,389; Aquatic Ecosystems Management 4,634; Archival Designs, Inc. 17,405; Arena Development Enterprises, 6,602; Arthur Gless, Inc. 15,758; AT&T Mobility Circular 6,999; Matt Baldwin 7,600; Bank Chemical Solutions, LLC 17,991; Beacon Athletics 3,485; Bell Foods, Inc. 89,325; Best Quality Charming, Inc. 19,914; Blue Cross Blue Shield 375,462; Bob Higgins, Inc. 27,059; Brian M. Peterson, d.b.a. 5,715; Broadway in Chicago Group 3,685; Broadway Management 4,345; Best Times 2,522; Chicago Land Paving Contractors 111,250; Circular Wireless 2,599; Cantan 18,005; City Wedding Sales 6,376; Classic Bowl 5,570; Classic Design Awards, Inc. 3,422; Classic Graphic Industries 9,000; Climate Service, Inc. 49,278; Coca-Cola Enterprises, 2,925; CorvRad 2,735; Commonwealth Edison 56,025; Courtyard/Edison 3,862; Concentra Medical Centers 3,548; Concept II Inc. d.b.a. 13,145; Conary FIS 6,732; Contry Beaver Home Center 10,005; Creative Sounds 6,252; Crown Chem & Co 16,544; Crown Trophy of Skokie 3,018; Cyber International, Inc. 13,451; Cystary 3,271; Jerry DeRose 6,150; Datas Fiber & Web Co 13,501; Darco Tech, Inc. 9,190; David Group Inc. 9,016; DayStar Flooring 4,234; Delta Dental of Illinois 29,221; Direct Fillets Solutions 44,485; Discount School Supply 4,184; Dog Obedience Group, LLC 9,387; Drop Zone 19,499; Stephen Duman dba 52,086; E Proteas Solutions 29,716; Earth Way, LLC 4,000; Easy Picker Golf Products 10,922; Edge Marketing & Management 4,218; Ercor Services Midwest 53,674; Employee Resource Systems, Inc 2,540; Enterprise Fleet Svcs 5,578; Enterprise Rent-A-Car 8,358; Esco Lip/Imp, Inc. 5,572; Everston Part 3,761; Exclusively Extra 3,715; Federal Express Corp 3,733; Fenceworks 6,591; Jim Finnerty dba Fiber Tech 3,150; Mark Findlay 5,475; Julie Pinkwater 4,344; Fotogram Printing 2,800; Fox & Security Systems, Inc. 8,069; First Impressions, Inc. 36,635; First United Methodist Church 7,068; Fourth July Parade Committee 12,000; Funk Socks Tennis Camps, Inc. 81,151; Fun Crap 4,329; GANK Enterprises 5,065; G Hydro Irrigation Svcs 8,408; Green Up Landscaping Inc. 51,003; Greer Wedding Company 4,882; Hing Nurseries 4,495; Hi-Liter Graphics 74,145; Hi-Tech Auto Body of Skokie 8,560; High Psi, LTD 4,005; Holiday Inn North Shore 7,150; Home Carpet One 33,675; Home Depot 6,075; House of Rental 15,359; Emily Hughes 5,000; Identity Sports 48,346; I.E. Park & Recreation Assoc. 10,658; Illinois Association of Park 6,182; Illinois Hockey Officials Assoc 5,672; Inhois Pumps, Inc. 11,872; Inhois Shotokan Karate Club 14,313; Inhois State Police Bureau 9,609; International Handwriting 71,771; J.P. Morgan Chase Bank 109,678; Jennifer Becker Design, Inc. 7,800; Jerry's Pro Shop 11,736; John Steere Co 24,805; Joseph Mahoney Distributors 2,708; J-Wing Football 4,485; Kathy Huber dba Kathy's 3,133; Kallen Muncher-Peckman LLP 20,000; Kate Co. 2,542; Kinrossville, LTD 7,650; Klester Music Four States 2,500; Kohler Rental Power 17,640; Lardmark Ford-Springfield 31,318; Lantaseeker 4,252; Laska Brothers Inc. 15,319; Lee Auto Parts 8,914; Leo's 3,133; Lesco 10,789; Lifeguards Store 8,701; Loyola Academy Bowling Assoc. 3,250; Lurvey Landscaping 11,687; Evan Lysarak 5,218; M & A Cement Work, Inc 9,210; Mares Niles Association of 457,358; Mario's Plumbing 14,664; Mark 1 Restoration Company 507,915; Mayberry Tunn 3,992; Mironov Pyrotechnics, Inc. 25,000; MetLife 29,058; Midwestern Energy 611,152; Midwest Corporation 5,170; Miller Cooper & Co., LTD. 29,751; Moody's Investment Service 5,800; Morton Grove Supply Co. 2,722; Mr. K Garden Center 5,195; Multitool Software 11,050; MWM Contracting Group, Inc. 5,000; National Recreation & Park 2,760; National School Towels 5,808; National Seed Mkt 5,854; National Taxpayer De Academy 3,734; Nels J. Johnson Tree Experts 17,010; Nel Connection 21,000; Neuman Pools, Inc. 4,512; Richard Neuman 3,259; Nick & Ernie's 3,221; Nicor 9,936; Niles Township Property Tax 6,693; Nordson 41,312; North American Sill Company 5,359; North Shore Bath/Detail Camps 5,012; North Shore Electrical Supply 5,470; North Shore Uniforms 3,125; Northern Illinois District 9,865; Nulays Lelaia Products 50,065; Oriental Trading Co., Inc 4,851; Ots Elevator Company 10,073; Tom Panocha 5,660; Passaic Autos, Inc. 3,750; Park District Park Management 200,623; Pease Scherer 8,197; Peak Body Systems dba B, 225; Percy Turndales 4,345; Pest Enders, Inc. 4,228; Fay Andrews dba 2,953; Pitt Rock 3,634; Pioneer Press 19,432; Pritco Bows Inc. 3,086; Poney Bowes Reserve Accounts 20,220; Poobible 4,367; Nancy Portillo 3,035; Professional Fitness Concepts 53,605; Prosource 3,950; Public Storage 2,979; Pulse Advantage 7,610; Quality Catering Inc. 25,541; Quality Milk Products, LLC 3,419; R&H Theatricals 2,736; R&R Societies 3,005; Range Automation Systems LLC 34,476; Richard Associates 55,280; Resident 6,781; Resolute Fire Equipment 4,321; Resolute Mail Svc. 22,314; RMC, Inc. 47,412; Todd Ruth 2,996; Rowing Republic Center, Inc. 5,200; Scott Hunko 4,519; Russco Ace Hardware 19,605; Alex Saigado 43,298; Sama Club 15,252; Emanuel Scharf 3,000; Scharin Carpet 40,370; SCD Golf Co. Pavers-Hotrock 9,651; Sheffield Press 5,215; Shiban Nussleis 25,778; Shavin Williams 5,747; Sikes Auto Body 2,894; Sigma Mow 9,962; Skokie Indian Lake League 23,130; Skokie Rotary Club 15,452; Skokie Youth 71,525; Sleepless in the City 3,880; Scott Smith 5,000; Specialty Floors, Inc. 3,966; Sports Supply Group/ESN 3,965; Surftek Aquatics Institute 3,883; Sunco Electric 4,098; Technique Eng., Inc. 2,716; Temple Display 3,685; Teeling Service Corporation 2,760; Three Oaks Grounds Care 15,900; Total Optimal Performance Inc 3,954; Tru-Link Fence 3,489; Tru-Pro Chem-Dry 12,801; Tuff Professionals Equipment 1,277; U.S. Postal Service 57,917; US Toys Company 3,553; Umass Greenhouse Inc 15,417; US Fiber 21,085; US Food Service 10,082; USA Hockey 3,070; Crystal VanHyning 3,116; VanHage 4,534; Veolia Environmental Svcs 14,703; Vermeer Systems 16,520; Village of Skokie 123,655; Village Profile 5,990; Vision Service Plan 12,647; W&W Granger 23,873; Walchouse Direct 22,795; Waupesa Sand 5,034; WebDocNet LLC 10,750; Wells Fargo Bank Minnesota, NA 4,498,672; Windy City Heavy Equipment 2,537; Winco, Inc. 8,974; Winco Golf Supply Co. 2,642; Wincom Audio, Inc. 3,234; World Data Products, Inc. 4,559; Xerox Corporation 64,197; Zenon Co. 5,665; Expense Disbursements Under 2,500 db 482,745; total 11,316,589

November 23 at 4:30 p.m. • November 24 at 7:30 p.m.

Passion & Power

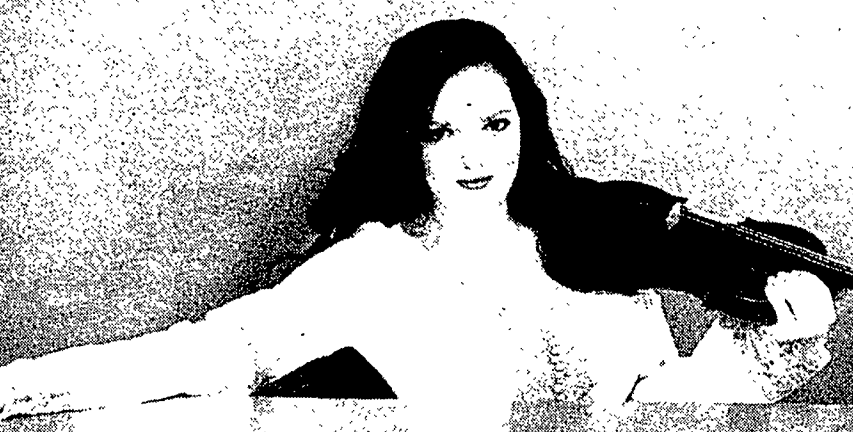

Rachel Barton Pine

BIZET Carmen Suite No. 1
SAINT-SAËNS Introduction and Rondo Capriccioso
Rachel Barton Pine, violin
SARASATE Carmen Fantasy
Rachel Barton Pine, violin
BRAHMS Symphony No. 4

ArsViva!
Symphony Orchestra
Alan Heatherington, Music Director

847 673-6300 www.arsviva.org
North Shore Center for the Performing Arts in Skokie
9501 Skokie Blvd. Ample free parking

PIONEER PRESS
YOUR LOCAL SOURCE

ORGANIZATIONS

Des Plaines Art Guild meets at 7 p.m. on the second Tuesday of the month at the Prairie Lakes Community Center, 515 Thacker St., Des Plaines. New members are welcome. For information, call Margaret Newman, (847) 824-8952, or visit www.dpag.org. Nov. 16 Dianne Kovack from the Clayground Art Studio in Mount Prospect will show techniques in hand-building clay forms.
Des Plaines Camera Club meets at 7 p.m. on the second and fourth Mondays of the month, September through June, in the Prairie Lakes Community Center, 515 E. Thacker St., Des Plaines. Call (847) 384-9487 or visit www.desplainscameraclub.com.

Your passion is our passion.

Read reviews each week in Diversions of dance performances coming soon to suburban stages - in addition to shows, musicals, concerts, and special recitals.



PIONEER PRESS
YOUR LOCAL SOURCE

Diversions

Call (847) 486-9300 to subscribe.

SUMMARY STATEMENT OF CONDITION

(Except from Comparative Report)

	GENERAL	SPECIAL REVENUE	DEBT SERVICE	CAPITAL PROJECT	ENTERPRISE	FIDUCIARY
Revenues	3,588,858	11,619,153	4,657,316	31,447	0	0
Expenditures	2,627,563	10,955,641	4,667,954	1,494,470	0	0
Excess of Revenues Over (Under) Expenditures	941,293	633,512	(10,638)	(1,463,023)	0	0
Transfers In	0	112,600	0	1,000,000	0	0
Transfer Out	1,112,600	0	0	0	0	0
Bond Proceeds	0	0	46,502	2,064,273	0	0
Other	0	0	0	0	0	0
Net Increase (Decrease) in Fund Balance	(171,307)	746,112	35,864	1,601,250	0	0
Previous Year Fund Balance	3,136,908	2,592,029	408,499	71,661	0	0
Other	0	(211,814)	0	0	0	0
Current Year Ending Fund Balance	2,965,601	3,124,527	444,363	1,673,111	0	0
TOTAL DEBT	OUTSTANDING BEGINNING OF YEAR	ISSUED CURRENT FISCAL YEAR	RETIRED CURRENT FISCAL YEAR	OUTSTANDING END OF YEAR		
	44,275,362	7,736,791	7,902,700	44,109,453		

Subscribed and sworn to Andrew Buffa this day of October 24, 2008.

Published in Pioneer Press 11/6/08 (1643396) 31

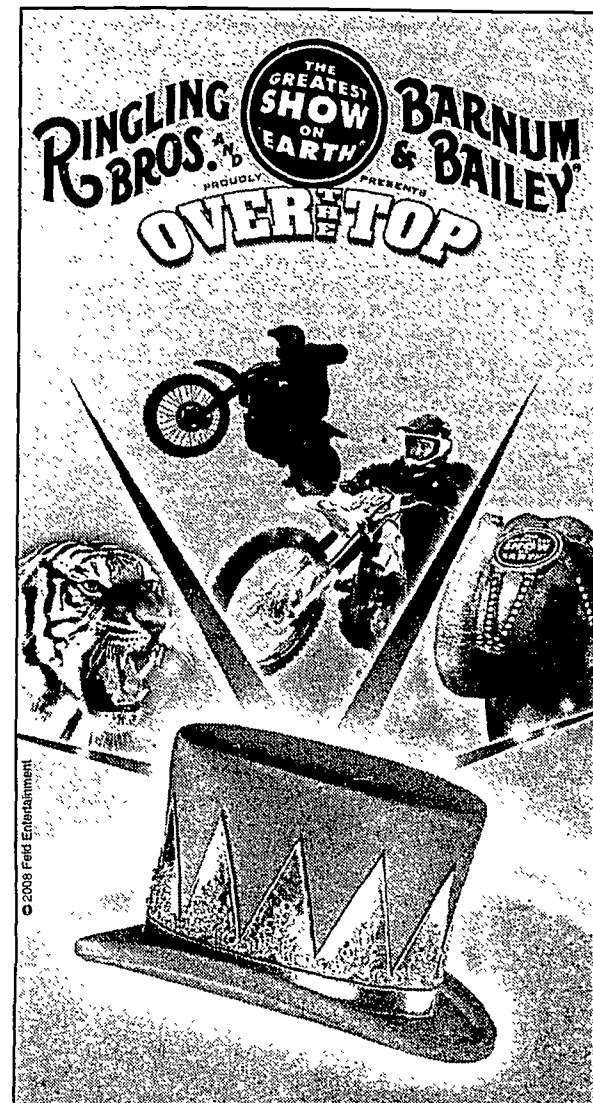

Unbelievable Unforgettable Affordable

OPENS TONIGHT ★ TICKETS \$11!*

Thu. NOV. 6 7:00 PM*	Fri. NOV. 7 7:00 PM*	Sat. NOV. 8 11:30 AM 3:30 PM 7:30 PM	Sun. NOV. 9 1:00 PM 5:00 PM
Wed. NOV. 12 7:00 PM*	Thu. NOV. 13 7:00 PM*	Fri. NOV. 14 7:00 PM	Sat. NOV. 15 11:30 AM 3:30 PM 7:30 PM
Sun. NOV. 16 1:00 PM 5:00 PM			

NOV. 18 - 30 UNITED CENTER

Tue. NOV. 18 * 7:00 PM	Wed. NOV. 19	Thu. NOV. 20	Fri. NOV. 21	Sat. NOV. 22	Sun. NOV. 23
7:00 PM*	7:00 PM*	7:00 PM*	7:00 PM*	11:30 AM 3:30 PM 7:30 PM	1:00 PM 5:00 PM
NOV. 24 NO SHOWS	NOV. 25 7:00 PM*	NOV. 26 7:00 PM*	NOV. 27 NO SHOWS	NOV. 28 11:30 AM 3:30 PM 7:30 PM	NOV. 29 11:30 AM 3:30 PM 7:30 PM
					NOV. 30 1:00 PM 5:00 PM

Buy tickets online, at ticketmaster.com Retail Locations, Arena Box Offices or call (312) 559-1212

For information call (847) 635-6601 Rosemont or (312) 455-4500 Chicago Groups (847) 891-8916 Rosemont or (312) 455-7469 Chicago

TICKET PRICES: \$13 - \$19 - \$24

Come one hour early to meet our animals and performers at the All Access Pre-show - FREE with your ticket!

Stay Connected At The All-New Ringling.com

- | | | | | | |
|--|-------------------------------------|--|-------------------------------------|--|-------------------------------------|
| ACROSS | 52 Yesterday's thresher | 87 Pianist Jorge Lillian or Dorothy | 3 Stiffened a shirt | 44 With 47 Down, Italian export | 82 Swash-buckling novelist |
| 1 TV host John | 53 Lillian or Dorothy | 88 "Old Cow Hand" ("36 song) | 4 Contains | 45 Produce pies | 83 '48 Hitchcock film |
| 5 Full of oneself | 54 Ivy Leaguer | 89 Objective | 5 Expand | 46 Actress Long | 84 Texas town |
| 9 Amontillado container | 55 Fancy dessert | 90 Counter change | 6 Free-for-all | 47 See 44 Down | 86 "I Love Lucy" surname |
| 13 Beseeched | 56 First dog in space | 91 Botanist Gray | 7 City on the Danube | 48 Manipulate | 87 Tour-de-France vehicle |
| 17 Nile feature | 57 Where cats congregate | 92 Age | 8 Day- — | 49 Diffident | 88 Adjectival suffix |
| 18 In good health | 58 Pie — mode | 95 End of remark | 9 Finger food | 50 Drum din | 90 Aptitude |
| 19 " — Without Love" ('68 hit) | 59 Lofty peak | 104 Road to enlightenment | 10 Stun | 51 Nick of "Q&A" | 91 Say please |
| 20 Sanctuary | 60 Distribute the donuts | 105 Generally | 11 Less loopy | 52 Gets on | 92 Pound of poetry |
| 22 Hood's handle | 61 Keats composition | 106 — choy | 12 TV's " — Landing" | 55 Perkins role | 93 Extend |
| 23 Admiral Zumwalt | 62 Middle of remark | 107 Rocker Billy | 13 Symbol of immortality | 56 "Frederica" composer | 94 Wrestling giant |
| 24 Tiny part of a second | 70 Born | 108 Tracking tool | 14 Drink like a Doberman | 57 Mature | 96 Twangy |
| 25 Wagner work | 71 '87 Peace Prize winner | 110 Manuscript enc. | 15 Happening | 60 Descendant | 97 Commerce city |
| 26 Annealing oven | 72 Solidly | 111 "Surely you —" | 16 Writer Walcott | 61 Ready to reduce | 98 Classical nonet |
| 27 Flagon filler | 73 " — Shook Up" ('57 smash) | 113 Lowliest cadet | 17 Tyne of "Cagney & Lacey" | 63 Silverware city | 99 "Hedda Gabler" playwright |
| 28 Newspaper | 74 Corny goddess? | 114 Caustic | 21 West. | 64 Infirmary item | 100 Club creed |
| 30 Take-home | 77 Colossal commotion | 115 Yemeni port | 27 Coldest cont. | 65 Went wrong | 101 What i.e. stands for |
| 31 Start of a remark | 78 Malicious to the max | 116 "New Jack City" actor | 28 Audacity | 66 Snowy bird | 102 "Ora pro —" |
| 35 Ring slat | 80 Where rams romp | 117 Beast of Borden | 29 Teyve's portrayer | 67 "Big Three" site | 103 Painter Paul |
| 36 Thwack | 81 Bus starter? | 118 Long lunch? | 32 Sneeze and wheeze | 68 New York city | 109 Word on a pump |
| 37 Compact cotton | 82 Thirteen, to a baker | 119 For fear that | 33 Superior to | 69 — Bator | 111 Bowie or Bakker |
| 38 "Great Expectations" character | 83 Soprano Fleming | 120 Non-stereo | 34 Chip's chum | 74 — au vin | 112 Author Umberto |
| 40 Cad | 84 — impasse | 121 Little ones | 39 Infant oinker | 75 Aussie walker | 113 Cosset a corgi |
| 42 Mythical being | 85 Dachshund or donkey | | 40 "Greetings!" | 76 Cell stuff | |
| 44 Hatelul | | | 41 Early computer | 77 Dandy | |
| 50 Give a little | | | 42 Buccaneers' head-quarters | 78 Hailing from | |
| 51 Green | | | 43 Spare part? | 79 In accord | |

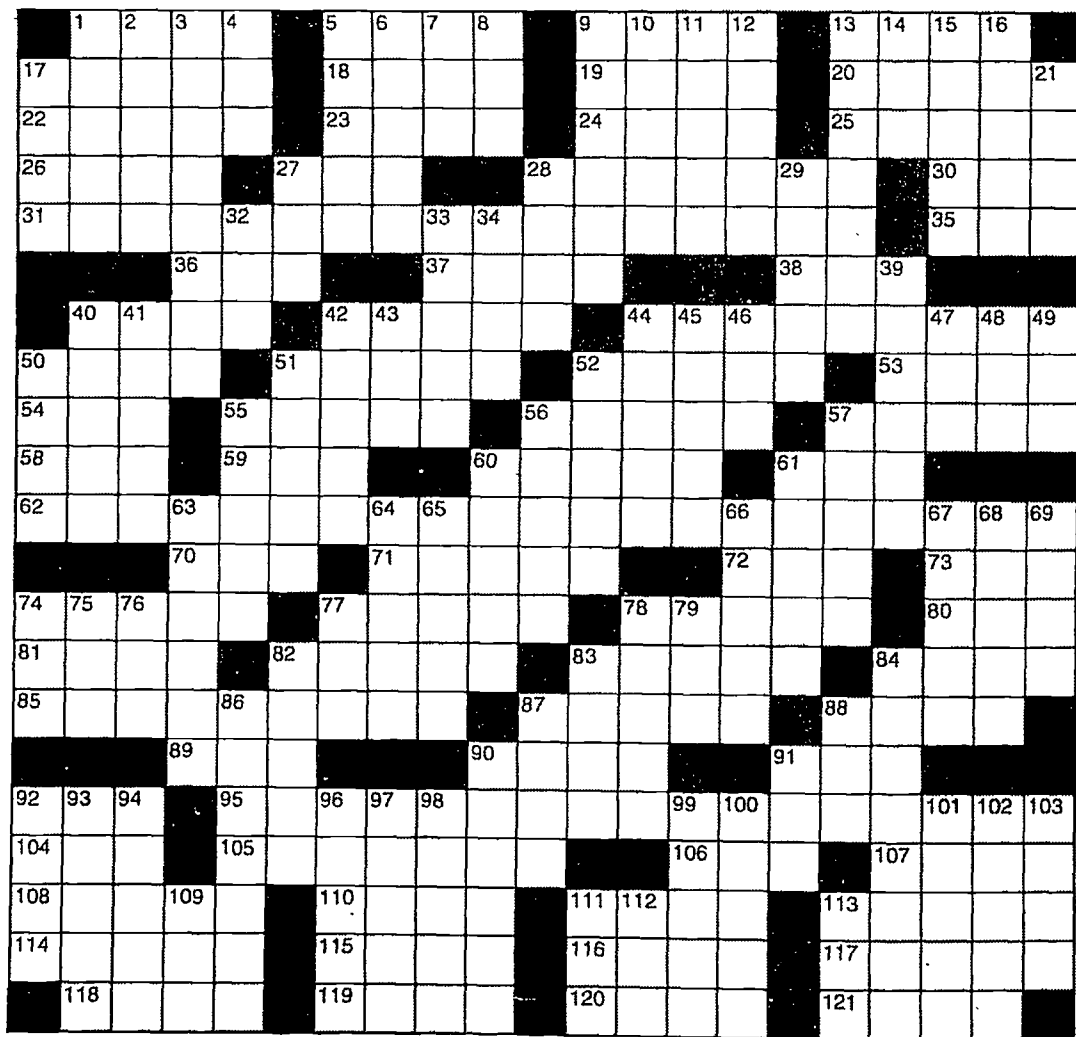

Answers: inside today's classified section
See the Web for the horoscope, www.pioneerlocal.com

THREE DAYS ONLY! Wed-Thurs-Fri Nov 12th, 13th, 14th

IMMEDIATE PAYMENT FOR

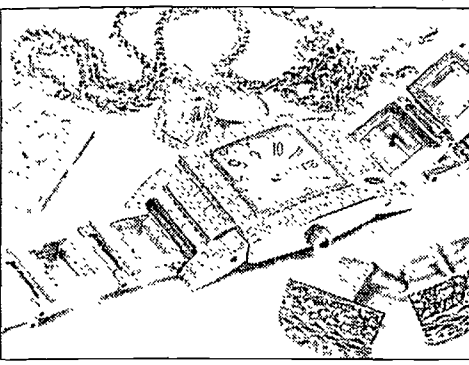

Old Gold and Platinum
WE ARE PAYING THE HIGHEST PRICES EVER! We buy all old & unwanted gold and platinum in any condition. Solid Gold Chains, Bracelets, Rings, Earrings, Charms, Pendants, Pins, Brooches, Clips, Gold Nuggets, Dental Gold (white and yellow), Broken Bits and Pieces of Gold. COME AND SEE US TO GET OUR BEST OFFER!



Estate Jewelry
Quit insuring it, dusting it, hiding it or worrying if your children will fight over or dispose of it. You know, CASH in the bank is better than unused items sitting in your jewelry, safety deposit box or dresser drawer. If you haven't worn it in 3 years, chances are you won't wear it again. Bring your items in for a free evaluation and receive cash for your jewelry.

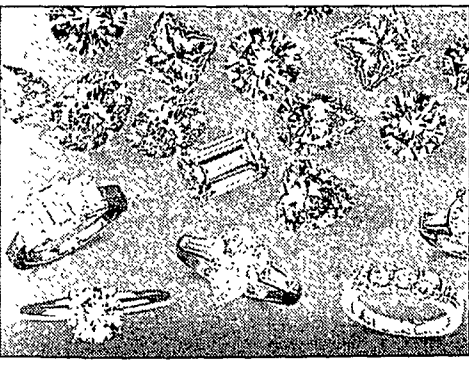

Diamonds-All sizes from 1 carat and up
We buy diamonds with or without certificates. Loose or Mounted Diamonds. All Shapes and Sizes. All Diamond Rings. Diamond Bracelets. Diamond Earrings. Diamond Pins. Diamond Necklaces. Diamond Pendants. All Platinum and Diamond Jewelry. ALL JEWELRY SET WITH DIAMONDS.

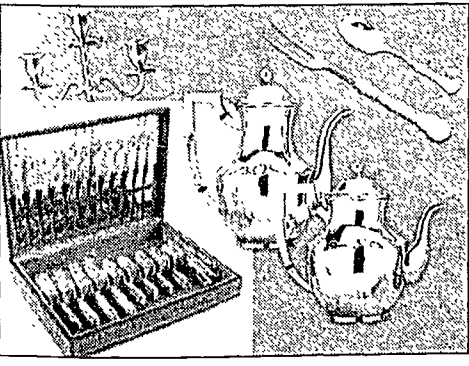

Sterling Silver
All sterling silver flatware and hollowware by any maker, foreign or domestic: Sterling silver tea sets - Full or partial flatware sets - Sterling pitchers, bowls & trays - Sterling candelabrum - Sterling dresser sets, figurines & novelty items - Sterling silver spoons and any item in sterling silver. ITEM MUST SAY STERLING SILVER. No silver-plated items please. Not sure? Bring it in.

U.S. Coins & Paper Money
PAYING HIGHEST PRICES
SILVER COINS & SILVER DOLLARS
Silver Dollars (PRE-1936 \$10.00 TO \$20,000.00)
10C, 25C, 50C (PRE-1965 UP TO \$THOUSANDS\$)
COMPLETE AND PARTIAL SETS AND ACCUMULATIONS.
ALL GOLD COIN JEWELRY.
PAPER MONEY.
PROFESSIONAL NUMISMATIST ON PREMISES.
BUYING OLD RUSSIAN COINS - Especially Need Russian Gold Coins.
RUSSIAN COIN EXPERT ON PREMISES.



Wristwatches
all ROLEX (especially, EXPLORER, DAYTONA, GMT, MILGAUS, SUBMARINER) all PATEK PHILIPPE, CARTIER, AUDEMARS PIGUET, VACHERON CONSTANTIN all Chronographs - BREITLING, HEUER, OMEGA, LECOULTRE, LONGINES, MOVADO all Alarm, Moon Calendars, Diamond Dials, Military, Platinum and Gold Cased Watches all Ladies Watches with Platinum and Diamond Cases
Watches need not be running

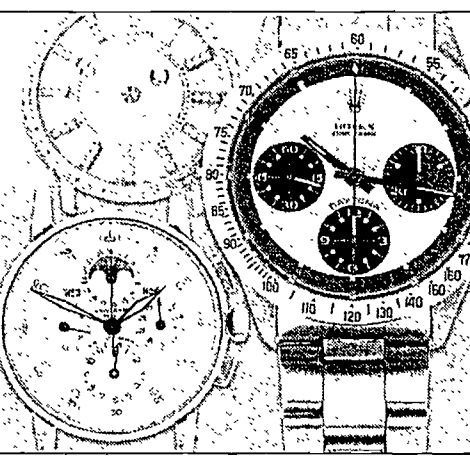

Pocketwatches
all Railroad (BALL, ELGIN, HAMILTON, HOWARD, ILLINOIS, WALTHAM) all PATEK PHILIPPE, CARTIER, AUDEMARS PIGUET, VACHERON CONSTANTIN all Chiming Watches, Military, Fancy Dials & Cases (Enamel-Multi-Color, Diamonds)
CLOCKS - We also buy ATMOS, CARTIER, CARRIAGE, CHELSEA, LECOULTRE
Watches need not be running

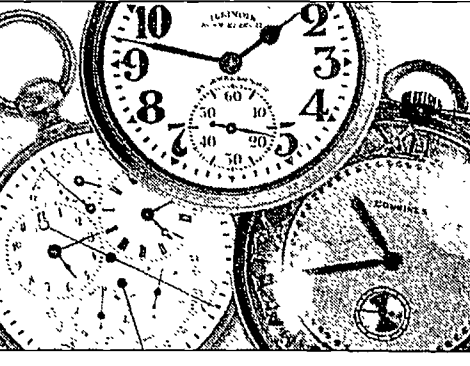

L & B
LONDON BRIDGE ESTATE BUYERS
(847) 323-8530

Wednesday, Nov 12th 10am-5pm
Thursday, Nov 13th 10am-7pm
Friday, Nov 14th 10am-5pm
Hampton Inn & Suites - Skokie
5201 Old Orchard Road
(West of Edens on Old Orchard Road)

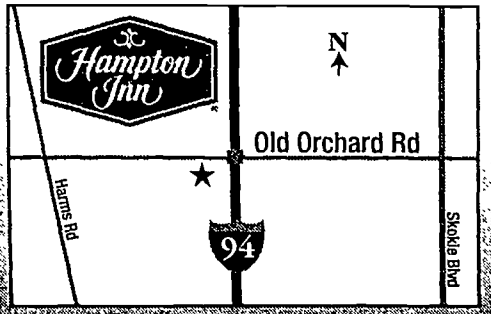

Make us a part of your family.

Call (847) 486-9300 today to subscribe to your local paper.

PIONEER PRESS
YOUR LOCAL SOURCE
www.pioneerlocal.com

WILDCAT FANS WEAR PURPLE!

**NOVEMBER 22 - RYAN FIELD
WILDCATS VS. ILLINOIS**

TICKETS START AS LOW AS \$35!
U.S. CELLULAR DAY - THE FIRST 12,500 FANS INTO THE STADIUM WILL RECEIVE A WILDCAT STOCKING CAP.

YOUTH FOOTBALL DAY
Members of area youth football teams and their families can purchase one zone ticket to the game at half price. That's only \$18 per ticket! Plus, all youth football participants can take part in exclusive activities throughout the day.

WILDCAT BASKETBALL SEASON IS ALMOST HERE!

WILDCAT MEN'S BASKETBALL HOME SEASON OPENER TAKE A KID TO THE GAME DAY

Sunday November 16 at 1 p.m. - Welsh-Ryan Arena
One adult ticket gets two kids (8th grade and under) in FREE. (Valid on the day of the game only) Plus: Face painting, Wild at Crafts, Balloon Animals and a POSTGAME AUTOGRAPH SESSION with the team!

NUsports.com
WILDCATMARKETING@NORTHWESTERN.EDU
847.491.CATS

THE CENTER FOR PERFORMING ARTS

Smokey Joe's Cafe
National Touring Production

Inspired by Mary Pope Osborne's Best-Selling Book Series

MAGIC TREE HOUSE THE MUSICAL
Tickets start at just \$22!

3 Shows Only!
Brand New Show!

"A rock star in the children's literary world."
-The Times-Picayune

Saturday, November 22 at 11am & 3pm
Sunday, November 23 at 2pm

Order your tickets today! tickets: 708-235-2222 | centertickets.net
The Center is located minutes off I-57 at the Sauk Trail exit. Free Parking Available.

CLASSIFIED

IMPORTANT INFO

Hours/Locations
Call-In Hours: 8:30 am - 5:00 pm, Mon - Fri
Walk-In Hours: 9:30 am - 4:30 pm, Mon - Fri
Address: - 3701 W. Lake Ave., Glenview

Payment - We accept American Express, Diners Club, Discover, Mastercard and VISA.

Deadlines
Private Party Ads: West & Doings - 3:00 pm Tues
All Other Zones - 4:30 pm Tues

Legal Ads: 5:00 pm Monday
Classified Display Ads: 5:00 pm Mon
Logos or Artwork: 5:00 pm Mon
Commercial Ads: May vary - consult your rep

Terms
Please check your ad: The publisher will not be responsible for more than one incorrect insertion. Pioneer Press Classified must be notified before the second insertion.

Acceptability: The newspaper reserves the right to edit or reject any advertisement.

Cancellations: No classified ad can be cancelled after deadline. Display ads and ads containing artwork may incur a charge if cancelled prior to first insertion.

YOUR LOCAL ZONE

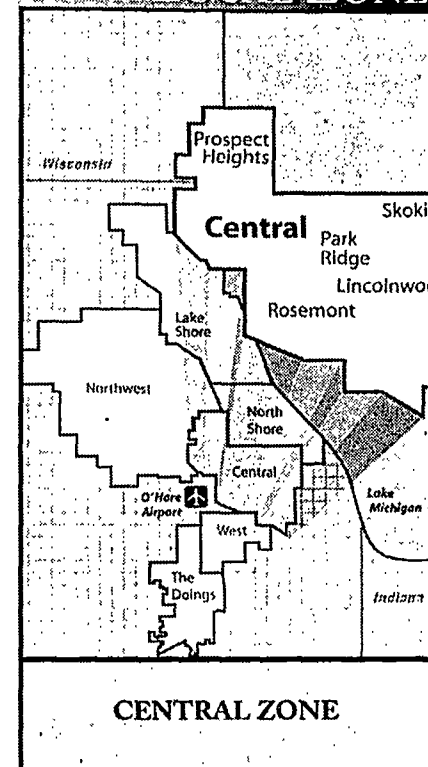

ADVERTISE WITH US

Classified Ads....847 998-3400

Help Wanted
Hotline ..847 998-3404

Real Estate
to place ads call
North Shore, Lake Shore847 486-7254
Northwest, Central847 486-7252
West, The Doings847 486-7252

Home Services
to place ads call
847 486-7239

INDEX

- Announcements100s
 - Business Directory200s
 - Homes Services300s
 - Employment400s
 - Rentals500s
 - Real Estate For Sale600s
 - Marketplace700s
 - Sporting Mart800s
 - Automobiles900s
 - Legal Notices1000s
- Private Party Self-Service Classifieds 24/7**
- Go to pioneerlocal.com, click the Classified link, and follow a few simple steps for placing your classified ad!
- www.pioneerlocal.com

Call: 847 998-3400 Email: classified@pioneerlocal.com Fax: 847 486-7456

The Meeting Place

TO PLACE AN AD FOR FREE, CALL
1-888-228-9060

TO LISTEN AND RESPOND, CALL
1-900-226-1096
Calls cost \$2.19/min. Must be 18+.

TO RESPOND USING YOUR CREDIT CARD, CALL
1-888-491-5625

WOMEN SEEKING MEN

ARE YOU THE ONE?
SWF, 29, mother, looking for a gentleman, 28-40, for friendship progressing into a relationship. **2297246**

TOTAL LOSER!
I have no looks, no interests, no talent, no IQ, no friends, no job, and haven't dated since 1982! In truth, I am a SWF, 47, 5'8", blonde, shapely, bright (advanced degree), fun, caring, passionate, and one of the nicest people you will ever meet. Among other things, I love great conversations, a great sense of humor, integrity, and great kissing. Seeking compatible male, late 40s to mid 60s, for permanent best friend/lover. **2749453**

ATTRACTIVE
Successful SWF, 32, seeks gorgeous, successful, mature male, 30-36, independent and spontaneous, not into games. Face open. **2294303**

MEET SOMEONE YOU CLICK WITH AT: WWW.PIONEERMEETINGPLACE.COM

Free Ads: Free ads placed in this section are not guaranteed to run every week. Be sure to renew your ad frequently to keep it fresh. Guidelines: Persons are for adults 18 or over seeking monogamous relationships. To ensure your safety, carefully screen all responses and have first meetings occur in a public place. This publication reserves the right to edit, revise, or reject any advertisement at any time at its sole discretion and assumes no responsibility for the content of or replies to any ad. Not all ads have corresponding voice messages. To review our complete guidelines, call (617) 425-2636

DOWN-TO-EARTH
BF, 32, looking for SM, 27-45, to hang out and spend time with. If you're out there, give me a ring. **2259962**

SOMEONE SPECIAL
Sweet, down-to-earth SWF, 32, in search of mature, older man who enjoys dining, movies, and quiet evenings at home. **2280146**

ARE YOU THE ONE?
SBF, 31, 5'9", enjoys bowling, bingo, shopping, dining out, quiet times at home. Seeking SBM, 35-40, for possible relationship. **2297696**

DOWN-TO-EARTH
SWF, 59, 5'4", good-looking, HW proportional, wants to meet a SWM, 55-75, for friendship first. Call, let's talk! **2296684**

RETIRED SWF...
75, attractive, 5'2", blonde/blue, ISO honest, special man, 60-70s, for dining, travel, movies, theater, downtown. **2289976**

SPECIAL PERSON
Attractive senior, WBF, author and motivational speaker, sexy. I love the lord, love dancing, theater, great SOH. Looking for sincere male, 61-75, with same qualities. **2297468**

OLDER GENTLEMAN
WNAF, 5'11", 110lbs, college grad, attractive, active, 70s, caring, friendly, enjoys walks, movies, music, theater. Seeking intelligent man, 77-82, to share pleasant times together. **2224625**

PRETTY ITALIAN GAL
SF, 40, nice figure, would like to meet a gentleman, who enjoys dining out, quiet evenings, and fun times. Looking for a companion call now. **2249258**

LATINA LADY
Pretty SWF, 50s, 5'2", 120lbs, seeks honest, kind SWM, 55-63, tall, slim, good-looking, respectful, nice personality, for friendship first maybe more. **2293158**

MEN SEEKING WOMEN

I'M YOUR MAN
SWM, 51, 5'9", brown/blue, fit, very good job, laid-back, N/S, likes bowling, live theater, painting, travel, cooking. ISO nice lady, 25-45, to spend time with. **2266644**

TAKE A CHANCE
SWM, 34, looks younger, 5'6", 135lbs, brown/green, likes all kinds of music, fishing, camping, hiking, sports. Looking for a lady, 21-40, for casual dating first. **2298262**

HOMEBOODY
Tall BM, 6'2", would like to meet a good woman, 34-42, ND, N/S, who likes spending time at home. **2298279**

GIVE ME A CALL!
SBM, 25, 5'7", medium build, light complexion, handsome, looking for SF, 18-30, N/S, for possible relationship. **2296376**

ARE WE A MATCH?
SWM, 33, 5'11", 185lbs, goatee and glasses, likes karaoke, music, video games, just chilling out. Seeking SF, 21-50, who is loyal, faithful, sweet, caring. **2296409**

CALL ME!
SBM, 32, 5'9", looking for a good woman, 25-35, for fun friendship, maybe more. I love sports, bowling, beaches. **2296527**

ARE WE A MATCH?
SAM, 27, 190lbs, black hair, dark brown eyes, wants to meet a sexy, fun SF, 18-38, for friendship first, maybe more. **2296308**

INTERESTED
Affectionate WM, 57, 6', 185lbs, looking for an average woman, who is kissable, huggable, HWP. I'm looking for an LTR who likes to travel. **2290315**

OLD COUNTRY BOY
SWM, 60, 6'4", 260lbs, enjoys dining in/out, flea markets, outdoor activities, casinos, c&w music, seeking nice SWF, 50-60, Waukegan area. **2281889**

A CATCH FOR YOU?
WM, 57', 140lbs, financially secure, very healthy, active, optimistic, independent, well-traveled, graduate-degreed, affectionate, considerate, enjoys dining in or out, walks, dancing, movies, theater, concerts, travel, classic music, etc. Seeks secure lady for LTR, possible marriage. **2290528**

Self Service Classifieds

TWENTY FOUR SEVEN

www.pioneerlocal.com

PIONEER PRESS
YOUR LOCAL SOURCE
The Doings

Log on to our website at www.pioneerlocal.com then click "Place an Ad" and follow a few simple steps for placing your classified ad!

FOR PRIVATE PARTY ADVERTISERS ONLY.

Answers to Super Crossword

Answers to Super Crossword grid with words like TESH, SMUG, CASK, PLED, DELTA, WELL, AMAN, HAVEN, ALIAS, ELMO, NANO, OPERA, LEHR, ALE, GAZETTE, NET, YOU, CAN, LEAD, A PERSON, TKO, HIT, BALE, PIP, HEEL, TROLL, OBNOXIOUS, BEND, NAIVE, FLAIL, GISH, ELI, BOMBE, LAIKA, ALLEY, ALA, ALP, SERVE, ODE, TOCOT, TAGE, CHEESE, BUTY, YOU, NEE, ARIAS, GEL, ALL, CERES, FUROR, WORST, LEA, OMNI, DOZEN, RENEE, ATAN, QUADRUPED, BOLET, IMAN, AIM, TIPS, ASA, ERA, CANT, MAKE, H, SHRINK, ZEN, ASAR, RULE, BOK, IDOL, RADAR, SASE, JEST, PLEBE, ACRID, ADEN, ICET, ELSIE, HERO, LEST, MONO, TOTS

108- Personals
Glory be to the Father, Son & Holy Spirit. Thank you, Mary & Joseph St. Jude The Entire Heavenly Body For: -Everyday -Helmeted & unseen -Joys of the heart -Comfort/Hope -Being there (here) Offered by one who 'KNOWS' JUST BELIEVE IT'S MAGIC! Then say 'Thanks'

110- Adoptions Wanted
Adopt a Beach house full of LOVE, joy, fun & day parties, prof'l dad, FT mom wait for baby. Expenses pd + Brian & Cindy 800-989-6766

SERVICE GUIDE For Business and Home

Business Services

Accounting Services/ Income tax...204 Art Work...205 Beauty Services...207 Bridal Services...207 Business Services...212 Camps...216 Catering, Party Svcs...218 Computer, Electronic Svcs...222 Dressmaking, Alterations...226 Entertainment...226 Equipment Rental...228 Financial Services...230 Florists, Greenhouses...232 Fortune Telling, Astrology, Advisors, Psychics...234 Health Services...238 Internet Services...238 Investors Wanted...238 Legal Services...242 Limousine Services...244 Loans & Investments...245 Musical Instruction...250 Personal Services...254 Personal Services...255 Photographers...258 Piano, Organ Tuning...260 Printing Services...266 Schools & Instructions...280 Video Taping...284 Travel & Travel Services Agencies...285 Amusement Parks...286 Bed & Breakfasts...287 Campgrounds...288 Festivals...289 Resorts...290 Senior Discounts...291 Time Shares...292 Tour Companies...293 Vacation Rentals...294

Classified Avenue

\$3,000 to \$7,000 weekly. Full Training and Support 247. NO Selling. NO Products. NO MLM. 866-391-3048 www.livericheasy.com
Classified Avenue provides Pioneer Press with advertising of a national appeal. To advertise in this category, please call Classified Avenue directly at (888) 486-2466. Pioneer Press recommends advertising when responding. Please refer questions and comments directly to Classified Avenue.

Classified Avenue

Advertise your product or service nationwide or by region in up to 14 million households in North America's best suburbs! Place your classified ad over 1000 suburban newspapers just like this one. Call the Classified Avenue at 888-486-2466 www.classifiedavenue.net
ALL CASH CANDY ROUTE Do you earn \$800 in a day? Your own local candy route. Includes 30 Machines and Candy. All for \$9,995. 800-875-1185 VOID IN SD

Classified Avenue

DONATE YOUR CAR-SPECIAL KIDS FUND! Help Disabled Children with Camp and Education. Non-Runners OK! Quick! Free Towing. Free Cruise/Hotel Voucher. Tax Deductible. Call 1-866-448-3254.
GET A NEW COMPUTER Brand Name Laptops & desktops. Bad or NO Credit. NO Problem. Smallest weekly payments avail. Its yours NOW. Call 1-800-618-3765
HIGH SCHOOL DIPLOMA! Fast Affordable & Accredited FREE By Home Call NOW! 1-888-593-2655 www.confinedacademy.com
HOTTEST Energy Drink Route Avail. \$46K-\$60K Profit Potential Yearly! Turn Key Established National Franchise. Call 247-1-888-428-5392 Code2 Minimum Investment Required!

Buying or Selling, Pioneer Classified is the place for you! (847) 998-3400

Announcements

100s Announcements...101 Birth Announcements...102 Car Pool & Rides...104 Disclaimers of Debt...104 Greetings...105 In Memoriam...106 Lost & Found...107 Personals...108 Adoption Wanted...110 Adoption Services...111 Just a Friend...112 Single Scene...113

101- Announcements

ROLL ENDS Available at our production facility located at 275 Northfield Road in Northfield. The cost is \$3.00 per inch based on the depth of the paper on the roll. For more information, please contact Bertha Jones 847-501-2196 or Marty Kroschel 847-501-4197.
PIONEER PRESS YOUR LOCAL SOURCE
Buying or Selling, Pioneer Classified is the place for you!

107- Lost & Found

8 ponds brown cat w/black stripes and a hint of orange and white chin. Last seen September 12th behind Acorn Ct in Round Lake beach. Reward upon return. Please leave your return address, phone number, Bob & Paulette: 847-265-6163 or Paulette: 847-356-3254
LOST CAT. He is a grey Siberian Forest Cat who answers to 'Popi' and who weighs about 11 pounds. He seems to have left our home Tuesday October 21, 2008 and we'd love to get him back. If found, please call 847-864-7174.
Buying or Selling, Pioneer Classified is the place for you!

Collector's Corner
CHICAGOLAND'S PREMIER ANTIQUE SHOW
NOVEMBER 29 & 30 Saturday 10-8 • Sunday 10-4
DU PAGE EXPO ACROSS FROM PHEASANT RUN RESORT ST. CHARLES, IL (Rt. 64)
2-DAY ADMISSION: \$6 (\$1.00 off w/ad) ZURKO • 715-526-9769

100's of OLD Stained Glass Windows
Funderburg Antiques
815-547-8186 www.FunAntiques.com
4650 Newburg Rd. Belvidere, IL

Quality Antiques and Estates Wanted!
Why not sell some of your antiques, jewelry or collectibles? FOR UPCOMING AUCTIONS...
Antiq. Furniture, Oriental Rugs, Paintings, Pottery, Figurines, Lighting, Bronzes & Jewelry
Antique & Collectible Auctions Every 2 Weeks!
Quality Consignments Accepted. One Piece or Entire Estate!
We buy Antiques & Estates!
Visit our Website for Photos & Results, Upcoming Auction Dates, & Current Listing
Direct Auction Galleries
2232 N. Western Ave., Chgo., IL (773) 465-3300 www.directauction.com

GRAYSLAKE • NEW LOCATION
★ ZURKO ★ ANTIQUE COLLECTIBLES • MARKET
SUNDAY, NOV. 9th • 8am-3pm/\$5 EARLY BUYERS: SUN. 8am-9am/\$25
LAKE COUNTY FAIRGROUNDS GRAYSLAKE (Rt. 83/Peterson Rd.)
ANTIQUÉ • FLEA MARKET
SUN., Nov. 16th • 8am-3pm/\$5 EARLY BUYERS 6am-8am/\$10
DuPage County Fairgrounds WHEATON, IL • 715-526-9769 www.zurko.com
ANTIQUE SHOW • NOV. 29th & 30th DuPage Expo — ST. CHARLES, IL

Is Your Silver Tarnished and Collecting Dust?
Flatware • Tea Sets • Trays • Bowls • Candlesticks Jewelry Other Sterling Silver
We buy sterling silver with careful evaluation for maximal payment
Contact: Zach Douglas 847-251-3225 KENILWORTH



SERVICE GUIDE For Business and Home

Classified Avenue

SELURENT YOUR TIMESHARE NOW!!! Maintenance fees too high? Need Cash? Sell your unused timeshare today. No commissions or Broker Fees. Free Consultation. www.sellmytimeshare.com 1-866-786-6699

Computers, Electronic Services - 220 -

Computer/Roe Consulting: Technology installations, repairs & tutoring for home & sm bus. \$39/hr. Special Senior Citizen rates! 20 yrs exp. Call 312-238-9992 www.computerroe.com
Fortune Telling, Astrology, Advisors, Psychics - 234 -

PSYCHIC READINGS BY JESSICA PATE TELLS PAST, PRESENT & FUTURE WITH PINPOINT ACCURACY. SPECIALIZING IN REUNITING LOVED ONES. SOLVES ALL LIFE'S PROBLEMS. STRICTLY PRIVATE & CONFIDENTIAL. 773-853-0669

Legal Services - 242 -

FLAT FEE LEGAL SERVICES-A Debt Relief Agency, Collections, Traffic & DUI, Eviction, Criminal Bankruptcy & Foreclosure Def., Divorce \$200 and up 312-592-1271 www.illiantleesol.com

Caulking - 314 -

Tubs, Stalls, Windows, Tile Repair, Grout, Shower Doors Visa/MC. Dan 847-520-5301

Clock Repair - 315 -

CLOCK REPAIR-Grandfather-Walk-Mantel 847-253-2423

Cleaning Services - 316 -

1-847-548-7625 GRACE CLEANING Hard Working Polish Crew

ARE YOU TIRED OF? Switching Services To Get Results...A cleaning service that starts great then slips...Point Cleanin' is the answer!

Point Cleanin' is the answer! English Speaking Floors done by hand www.pointcleanin.com 847-361-8540

EUROPEAN MAIDS EXCELLENT SERVICE Reliable cleaners, Affordable prices. \$10 an hour. First visit (halina's) 847-674-5401

Halina's Maids, Inc. Team of 4 847-692-6754

Home Services

300s Abatement...302 Audio, Video Services...302 Air Conditioning, Heating...304 Air Duct Cleaning...304 Appliance Service, Repair...306 Basement...307 Back Door...309 Blacktopping, Paving, Sealcoat...309 Builders, Contractors...310 Carpentry, Cabinet Work...310 Carpets & Rugs...313 Caulking...315 Clock Repair...315 Cleaning Services...316 Cleaning-Min. Bldg...317 Closet Design...319 Concrete, Brick Work...319 Countertops...319 Decks...321 Draperies, Slipcovers...322 Drywall...322 Drycleaning & Laundry Svcs...324 Excavating, Grading...325 Exterminating, Pest Control...328 Fencing & Chaining...330 Firewood...335 Flood Water Damage...336 Floors...337 Foundation Repair...338 Home Maintenance...338 Furniture Repair, Refinishing...340 Garage, Garage Doors...341 Glass, Glass Block, Mirrors...342 Gutters & Downspouts...343 Handyman...344 Home Improvement...345 Interior Decorating...346 Insulation...347 Kitchens & Bathrooms...348 Landscaping, Nurseries, Gardens...349 Lawnmower Services...351 Lawn Sprinkler Systems...351 Light Fixtures...352 Locksmith, Security Devices...353 Masonry...355 Movers (Licensed), Storage...356 Pest Control...357 Painting, Papering...358 Pet Services...359 Plumbing (Licensed)...361 Porcelain Resurfacing...363 Power Washing...364 Roofing...364 Siding...368 Siding...367 Show Removal...367 Screens & Awnings...371 Shuco...372 Shutter Installation...372 Signage...373 Telephone Installation...374 Tile...375 Trenching & Carp...375 Tuckpointing...380 Upholstery...385 Water Conditioners, Treat...386 Waterproofing...390 Windows...393 Windows & Doors...394 Wood Restoration...395

Concrete, Brick Work - 319 -

CARRENO CONCRETE Sidewalks, Patios, Driveways & Steps • Full Ins/Free Est. 847-288-9251 847-738-9718

Decks - 321 -

UNIQUE DECKS Cedar, Trex & Screen Rooms Showroom 172 Skokie Valley uniquedeck.com 847-831-1388

Drywall - 323 -

CANTIERI INC. Drywall • Taping • Plaster Comm. Res. • Bonded & Ins. Free Est. Mike: 708-456-7171
JAKE THE WALL DOCTOR Repairs • Skim Coating Drywall • Plaster Free Estimate 773-398-7430

Electrical Services - 325 -

AN EXP'D. ELECTRICIAN Looking for side work. No job too big or small. FREE EST! 847-224-1884
ELECTRICIAN Local/Remodeling Free Est. 773-314-3940

Fencing - 331 -

A-1 FENCE INC. New & Repair-All Types 708-452-1210

Floors - 337 -

A Floors By Tom Sanding • Staining • Install 847-255-6500 www.hardwoodfloorbytom.com

AR & K Hardwood Flooring Sanding, Installation, Repairs 708-650-0079

DANIEL'S FLOORING Co Sanding • Repairs • Finishing Installation • Good references Insured • Free Estimates 708-667-0101

Excellent Flooring Inc. Hard Floors, Installation, Repairs, Refinishing, Dustless Sanding 847.934.1061

ARE YOU TIRED OF? Switching Services To Get Results...A cleaning service that starts great then slips...Point Cleanin' is the answer!

Point Cleanin' is the answer! English Speaking Floors done by hand www.pointcleanin.com 847-361-8540

EUROPEAN MAIDS EXCELLENT SERVICE Reliable cleaners, Affordable prices. \$10 an hour. First visit (halina's) 847-674-5401

Halina's Maids, Inc. Team of 4 847-692-6754

Cleaning Services - 316 -

HOME DELIGHT, INC. Cleaning Service, Detail-Oriented, Affordable, 15 Yrs. Exp. Ins./Bonded Exc. Refs. 312-971-0089 • 773-625-2676

Concrete, Brick Work - 319 -

CARRENO CONCRETE Sidewalks, Patios, Driveways & Steps • Full Ins/Free Est. 847-288-9251 847-738-9718

Decks - 321 -

UNIQUE DECKS Cedar, Trex & Screen Rooms Showroom 172 Skokie Valley uniquedeck.com 847-831-1388

Drywall - 323 -

CANTIERI INC. Drywall • Taping • Plaster Comm. Res. • Bonded & Ins. Free Est. Mike: 708-456-7171
JAKE THE WALL DOCTOR Repairs • Skim Coating Drywall • Plaster Free Estimate 773-398-7430

Electrical Services - 325 -

AN EXP'D. ELECTRICIAN Looking for side work. No job too big or small. FREE EST! 847-224-1884
ELECTRICIAN Local/Remodeling Free Est. 773-314-3940

Fencing - 331 -

A-1 FENCE INC. New & Repair-All Types 708-452-1210

Floors - 337 -

A Floors By Tom Sanding • Staining • Install 847-255-6500 www.hardwoodfloorbytom.com

AR & K Hardwood Flooring Sanding, Installation, Repairs 708-650-0079

DANIEL'S FLOORING Co Sanding • Repairs • Finishing Installation • Good references Insured • Free Estimates 708-667-0101

Excellent Flooring Inc. Hard Floors, Installation, Repairs, Refinishing, Dustless Sanding 847.934.1061

ARE YOU TIRED OF? Switching Services To Get Results...A cleaning service that starts great then slips...Point Cleanin' is the answer!

Point Cleanin' is the answer! English Speaking Floors done by hand www.pointcleanin.com 847-361-8540

EUROPEAN MAIDS EXCELLENT SERVICE Reliable cleaners, Affordable prices. \$10 an hour. First visit (halina's) 847-674-5401

Halina's Maids, Inc. Team of 4 847-692-6754

Gutters & Downspouts - 343 -

COX & SONS GUTTERS INSTALLED & REPAIRED 25 yr Family Bus. CLEANED & SCREENED 1-847-253-1622

JOHN'S GUTTER SERVICE Cleaning, Mount & Repairs 888-647-3353 or 847-873-5353

Handyman - 344 -

1-847-520-5301 A to Z SERVICES INC. Call Dan for Quality Repairs & Remodeling, 30 Yrs Exp. Ins. Visa/MC

Handyman - 344 -

1-847-945-8114 ELEC. PAINTING, Carpentry, Painting & All Other Repairs

A HANDYMAN Mr. FIXER ALL REPAIRS Elec. Faucets & Water Htr. Closets. JAY 847-967-6442

Andy OnCall Handyman Services NOT Handy? Call Andy! Bonded & Insured 847-328-3100

For the Lowest Price! Free Est. 30 Yrs. Exp. STEVE THE HANDYMAN Call 773-474-6522

PETER THE HANDYMAN Remodeling - Plumbing Electrical - Painting Carpentry 847-722-1677

Snow Blower Repair. Handyman Services. Paul's Repairs 847-724-2070

Plastering - 360 -

JAKE THE WALL DOCTOR Repairs • Skim Coating Drywall • Plaster Free Estimate 773-398-7430

Plastering - 360 -

JAKE THE WALL DOCTOR Repairs • Skim Coating Drywall • Plaster Free Estimate 773-398-7430

Plastering - 360 -

JAKE THE WALL DOCTOR Repairs • Skim Coating Drywall • Plaster Free Estimate 773-398-7430

Plastering - 360 -

JAKE THE WALL DOCTOR Repairs • Skim Coating Drywall • Plaster Free Estimate 773-398-7430

Plumbing (Licensed) - 361 -

AFFORDABLE REPAIRS By Retired Plumber Fully Insured Lic. #055-020762 Call 708-914-6755 • 847-674-7584

J.P.G. PLUMBING ALL PLUMBING REPAIRS BIG or small - Reasonable Free Est. 847-518-0390

MY SMALL-LAD SAVES YOU MONEY! Pay For Results Bob Peterson Inc. #088-106741 20% off w/this ad. 847-332-1234 www.meet-bob-peterson.com

RED'S HAULING SERVICE Removal of Unwanted Items From Basement Garage, Attic, Business Construction Debris Dump/Infill 773-616-0390

KITCHENS, BATHS FLOORS, etc. Free Est., Ins. Bonded. Peter 847-477-3451

Movers - 356 -

Illinois law requires movers to be licensed by the Illinois Commerce Commission. The ICC number and respective business license must appear in the advertisement in this category. Movers must have insurance on file. For more information, contact the Illinois Commerce Commission

Handyman - 344 -

1-847-520-5301 A to Z SERVICES INC. Call Dan for Quality Repairs & Remodeling, 30 Yrs Exp. Ins. Visa/MC

Handyman - 344 -

1-847-945-8114 ELEC. PAINTING, Carpentry, Painting & All Other Repairs

A HANDYMAN Mr. FIXER ALL REPAIRS Elec. Faucets & Water Htr. Closets. JAY 847-967-6442

Andy OnCall Handyman Services NOT Handy? Call Andy! Bonded & Insured 847-328-3100

For the Lowest Price! Free Est. 30 Yrs. Exp. STEVE THE HANDYMAN Call 773-474-6522

PETER THE HANDYMAN Remodeling - Plumbing Electrical - Painting Carpentry 847-722-1677

Snow Blower Repair. Handyman Services. Paul's Repairs 847-724-2070

Plastering - 360 -

JAKE THE WALL DOCTOR Repairs • Skim Coating Drywall • Plaster Free Estimate 773-398-7430

Plastering - 360 -

JAKE THE WALL DOCTOR Repairs • Skim Coating Drywall • Plaster Free Estimate 773-398-7430

Plastering - 360 -

JAKE THE WALL DOCTOR Repairs • Skim Coating Drywall • Plaster Free Estimate 773-398-7430

Plastering - 360 -

JAKE THE WALL DOCTOR Repairs • Skim Coating Drywall • Plaster Free Estimate 773-398-7430

Plumbing (Licensed) - 361 -

AFFORDABLE REPAIRS By Retired Plumber Fully Insured Lic. #055-020762 Call 708-914-6755 • 847-674-7584

J.P.G. PLUMBING ALL PLUMBING REPAIRS BIG or small - Reasonable Free Est. 847-518-0390

MY SMALL-LAD SAVES YOU MONEY! Pay For Results Bob Peterson Inc. #088-106741 20% off w/this ad. 847-332-1234 www.meet-bob-peterson.com

RED'S HAULING SERVICE Removal of Unwanted Items From Basement Garage, Attic, Business Construction Debris Dump/Infill 773-616-0390

KITCHENS, BATHS FLOORS, etc. Free Est., Ins. Bonded. Peter 847-477-3451

Remodeling - 364 -

KITCHENS, BATHS FLOORS, etc. Free Est., Ins. Bonded. Peter 847-477-3451

Roofing - 365 -

1-847-714-9200 AVONDALE Roofing • Siding Gutters • Windows www.avondalerofing.com

Handyman - 344 -

1-847-520-5301 A to Z SERVICES INC. Call Dan for Quality Repairs & Remodeling, 30 Yrs Exp. Ins. Visa/MC

Handyman - 344 -

1-847-945-8114 ELEC. PAINTING, Carpentry, Painting & All Other Repairs

A HANDYMAN Mr. FIXER ALL REPAIRS Elec. Faucets & Water Htr. Closets. JAY 847-967-6442

Andy OnCall Handyman Services NOT Handy? Call Andy! Bonded & Insured 847-328-3100

For the Lowest Price! Free Est. 30 Yrs. Exp. STEVE THE HANDYMAN Call 773-474-6522

PETER THE HANDYMAN Remodeling - Plumbing Electrical - Painting Carpentry 847-722-1677

Snow Blower Repair. Handyman Services. Paul's Repairs 847-724-2070

Plastering - 360 -

JAKE THE WALL DOCTOR Repairs • Skim Coating Drywall • Plaster Free Estimate 773-398-7430

Plastering - 360 -

JAKE THE WALL DOCTOR Repairs • Skim Coating Drywall • Plaster Free Estimate 773-398-7430

Plastering - 360 -

JAKE THE WALL DOCTOR Repairs • Skim Coating Drywall • Plaster Free Estimate 773-398-7430

Plastering - 360 -

JAKE THE WALL DOCTOR Repairs • Skim Coating Drywall • Plaster Free Estimate 773-398-7430

Plumbing (Licensed) - 361 -

AFFORDABLE REPAIRS By Retired Plumber Fully Insured Lic. #055-020762 Call 708-914-6755 • 847-674-7584

J.P.G. PLUMBING ALL PLUMBING REPAIRS BIG or small - Reasonable Free Est. 847-518-0390

1008- Assumed Name

ASSUMED NAME
Notice is hereby given, pursuant to an Act in relation to the use of an Assumed Business Name...

ASSUMED NAME
Notice is hereby given, pursuant to an Act in relation to the use of an Assumed Business Name...

ASSUMED NAME
Notice is hereby given, pursuant to an Act in relation to the use of an Assumed Business Name...

ASSUMED NAME
Notice is hereby given, pursuant to an Act in relation to the use of an Assumed Business Name...

ASSUMED NAME
Notice is hereby given, pursuant to an Act in relation to the use of an Assumed Business Name...

ASSUMED NAME
Notice is hereby given, pursuant to an Act in relation to the use of an Assumed Business Name...

1008- Assumed Name

ASSUMED NAME
Notice is hereby given, pursuant to an Act in relation to the use of an Assumed Business Name...

ASSUMED NAME
Notice is hereby given, pursuant to an Act in relation to the use of an Assumed Business Name...

ASSUMED NAME
Notice is hereby given, pursuant to an Act in relation to the use of an Assumed Business Name...

ASSUMED NAME
Notice is hereby given, pursuant to an Act in relation to the use of an Assumed Business Name...

ASSUMED NAME
Notice is hereby given, pursuant to an Act in relation to the use of an Assumed Business Name...

ASSUMED NAME
Notice is hereby given, pursuant to an Act in relation to the use of an Assumed Business Name...

1008- Assumed Name

ASSUMED NAME
Notice is hereby given, pursuant to an Act in relation to the use of an Assumed Business Name...

ASSUMED NAME
Notice is hereby given, pursuant to an Act in relation to the use of an Assumed Business Name...

ASSUMED NAME
Notice is hereby given, pursuant to an Act in relation to the use of an Assumed Business Name...

ASSUMED NAME
Notice is hereby given, pursuant to an Act in relation to the use of an Assumed Business Name...

ASSUMED NAME
Notice is hereby given, pursuant to an Act in relation to the use of an Assumed Business Name...

ASSUMED NAME
Notice is hereby given, pursuant to an Act in relation to the use of an Assumed Business Name...

1008- Assumed Name

ASSUMED NAME
Notice is hereby given, pursuant to an Act in relation to the use of an Assumed Business Name...

ASSUMED NAME
Notice is hereby given, pursuant to an Act in relation to the use of an Assumed Business Name...

ASSUMED NAME
Notice is hereby given, pursuant to an Act in relation to the use of an Assumed Business Name...

ASSUMED NAME
Notice is hereby given, pursuant to an Act in relation to the use of an Assumed Business Name...

ASSUMED NAME
Notice is hereby given, pursuant to an Act in relation to the use of an Assumed Business Name...

ASSUMED NAME
Notice is hereby given, pursuant to an Act in relation to the use of an Assumed Business Name...

1010- Auctions

Notice of Sale or Disposition of Property
Pursuant to Illinois State Law...

Notice of Sale or Disposition of Property
Pursuant to Illinois State Law...

Notice of Sale or Disposition of Property
Pursuant to Illinois State Law...

Notice of Sale or Disposition of Property
Pursuant to Illinois State Law...

Notice of Sale or Disposition of Property
Pursuant to Illinois State Law...

Notice of Sale or Disposition of Property
Pursuant to Illinois State Law...

1010- Auctions

Notice of Sale or Disposition of Property
Pursuant to Illinois State Law...

Notice of Sale or Disposition of Property
Pursuant to Illinois State Law...

Notice of Sale or Disposition of Property
Pursuant to Illinois State Law...

Notice of Sale or Disposition of Property
Pursuant to Illinois State Law...

Notice of Sale or Disposition of Property
Pursuant to Illinois State Law...

Notice of Sale or Disposition of Property
Pursuant to Illinois State Law...

1010- Auctions

NOTICE OF PUBLIC SALE OF PERSONAL PROPERTY
Notice is hereby given that pursuant to Section 4 of the Self-Service Storage Facility Act...

NOTICE OF PUBLIC SALE OF PERSONAL PROPERTY
Notice is hereby given that pursuant to Section 4 of the Self-Service Storage Facility Act...

NOTICE OF PUBLIC SALE OF PERSONAL PROPERTY
Notice is hereby given that pursuant to Section 4 of the Self-Service Storage Facility Act...

NOTICE OF PUBLIC SALE OF PERSONAL PROPERTY
Notice is hereby given that pursuant to Section 4 of the Self-Service Storage Facility Act...

NOTICE OF PUBLIC SALE OF PERSONAL PROPERTY
Notice is hereby given that pursuant to Section 4 of the Self-Service Storage Facility Act...

NOTICE OF PUBLIC SALE OF PERSONAL PROPERTY
Notice is hereby given that pursuant to Section 4 of the Self-Service Storage Facility Act...

1010- Auctions

NOTICE OF PUBLIC SALE OF PERSONAL PROPERTY
Notice is hereby given that pursuant to Section 4 of the Self-Service Storage Facility Act...

NOTICE OF PUBLIC SALE OF PERSONAL PROPERTY
Notice is hereby given that pursuant to Section 4 of the Self-Service Storage Facility Act...

NOTICE OF PUBLIC SALE OF PERSONAL PROPERTY
Notice is hereby given that pursuant to Section 4 of the Self-Service Storage Facility Act...

NOTICE OF PUBLIC SALE OF PERSONAL PROPERTY
Notice is hereby given that pursuant to Section 4 of the Self-Service Storage Facility Act...

NOTICE OF PUBLIC SALE OF PERSONAL PROPERTY
Notice is hereby given that pursuant to Section 4 of the Self-Service Storage Facility Act...

NOTICE OF PUBLIC SALE OF PERSONAL PROPERTY
Notice is hereby given that pursuant to Section 4 of the Self-Service Storage Facility Act...

LEGAL DEADLINES FOR TAX LEVY, TREASURER'S REPORT, and ANNUAL STATEMENT OF AFFAIRS
The deadline for these notices is THURSDAY at 12:00 NOON ONE WEEK BEFORE PUBLICATION DATE.

Buying or Selling, Pioneer Classified is the place for you!
(847) 998-3400

Buying or Selling, Pioneer Classified is the place for you!
(847) 998-3400

Buying or Selling, Pioneer Classified is the place for you!
(847) 998-3400

Buying or Selling, Pioneer Classified is the place for you!
(847) 998-3400

1010- Auctions

NOTICE OF PUBLIC SALE TO BE HELD AT: The Lock Up Storage Centers 1930 N. Cicero Ave. Chicago, IL 60641 773-755-1906

DATE: November 14, 2008 AT: 10:00 A.M. CONDITIONS: All units will be sold to the highest bidder. Bids taken only for each unit in its entirety. Payments by public auction, the following storage units. The goods to be sold are generally described as household goods. The terms of the sale will be cash only. U-Haul Co. North Shore Chicago/Kenosha, WI. reserves the right to refuse any and all bids. The sales will be at the following location: 4301 N. Cicero Avenue, Chicago, IL 60641 and will be at or after 8:00 a.m. and continue day by day until all units are sold.

- Unit # 4506 Eric Coburn Box Springs, Mattress, Bike, Painting & Boxes
Unit # 2002 Brian Johnson Cash Register, Trash can, Lamp, Grill, Boxes
Unit # 2409 Alyse Evtan Tables, Rugs, Shelving
Unit # 542 Dennis Mayatt Recreational Equipment, Video Tapes, Shelving, Amplifiers
Unit # 2213 Deanne Benas Boxes, Luggage, Chair, Desk
Unit # 721 Deane Vanes Assorted Boxes, Assorted Bags
Unit # 1226 Richard Reizen Love seat, Dresser, Chair, Christmas Items
Unit # 2442 Alyse Evtan Chairs, Sofa, Table
Unit # 2022 Deane & Linda Mayatt Luggage, Stereo, Book Shelves

1010- Auctions

NOTICE OF SALE UNDER THE SELF STORAGE FACILITY ACT, ILLINOIS REVISE STATUTES, CHAPTER 114, PARAGRAPH 301, ET. SEQ.

Notice is hereby given that on November 11, 2008, U-Haul Auctioneer, Executive Administrator, Storage Clerk for U-Haul Co. North Shore Chicago/Kenosha, WI. will be offering for sale under the Judicial Lien process, by public auction, the following storage units. The goods to be sold are generally described as household goods. The terms of the sale will be cash only. U-Haul Co. North Shore Chicago/Kenosha, WI. reserves the right to refuse any and all bids. The sales will be at the following location: 4301 N. Cicero Avenue, Chicago, IL 60641 and will be at or after 8:00 a.m. and continue day by day until all units are sold.

- Eric Bolden - 4041 5th Ave., Chicago, IL 60624
Luz Ramon - 4018 W. Palmer St., Chicago, IL 60639
Ossa McCullough - 1637 S. Lawndale, Chicago, IL 60623
John Doe - 4301 N. Cicero, Chicago, IL 60641
Ronny David - 5017 W. Grand, Chicago, IL 60639
John Doe - 4301 N. Cicero, Chicago, IL 60641
Jenniffer Uyeda - 5656 N. Cambridge, Chicago, IL 60641
William Reed - 3757 N. Kedzie Ave., Chicago, IL 60618

1010- Auctions

Unit #A13 - Clothes, books, misc. furniture

Thomas Garner - 6145 S. Rockwell, 2nd Fl., Chicago, IL 60637
Published in Pioneer Press 10/30, 11/08 (1642026) C

- Eric Bolden - 4041 5th Ave., Chicago, IL 60624
Luz Ramon - 4018 W. Palmer St., Chicago, IL 60639
Ossa McCullough - 1637 S. Lawndale, Chicago, IL 60623
John Doe - 4301 N. Cicero, Chicago, IL 60641
Ronny David - 5017 W. Grand, Chicago, IL 60639
John Doe - 4301 N. Cicero, Chicago, IL 60641
Jenniffer Uyeda - 5656 N. Cambridge, Chicago, IL 60641
William Reed - 3757 N. Kedzie Ave., Chicago, IL 60618

1010- Auctions

Notice of Sale or Disposition of Property

Pursuant to Illinois State Law, a sale or disposition of property stored in the renter's space to satisfy the owner's debt will be held on November 20, 2008 at or after 10:00 AM and continue until complete.

- Unit 317 - Margaret Williams Dresser, Bed, Table, Printer, Keyboard, Box
Unit 570 - Wexmand Smith Boxes, 2 Copiers, Sale
Unit 829 - Chris Cole Office Furniture, Picture, Boxes
Unit 837 - Sylvio Robinson Chair, Bed, Air Conditioner, Microwave, Lavaset, Boas, Stereo
Unit 968 - Matthew Lee 2 Fax Machines, Shredder, Box
Unit 986 - Matthew Lee Boxes, 3 Briefcases, Table
Unit 995 - Faith Cornelius Couch, Lavaset, Bed, Mirror, Boxes, Pictures
Unit 1011 - Lynell Dohy Bed, Toys, Chair, Boxes, Tables
Unit 1032 - Kim Berry Exercise Equipment, 6 Boxes
Unit 1059 - Neil Thomas

1010- Auctions

6 Boxes

Unit 1235 - Wordall McClain Suitcase, File cabinet, Boxes
Unit 1249 - Alton Potts Stereo, Printer, Sofa, Bed, 2 Tables, 3 Chairs, Boxes
Unit 1519 - Raymond Thomas Boas

- Unit 1235 - Wordall McClain Suitcase, File cabinet, Boxes
Unit 1249 - Alton Potts Stereo, Printer, Sofa, Bed, 2 Tables, 3 Chairs, Boxes
Unit 1519 - Raymond Thomas Boas
Unit 1037 - Mary Abbott: Clothes, household, crores
Unit 1054 - Caroline Nute: Boxes, 6 boxes, 2 boxes, 1 box
Unit 1159 - Howard J. Kramer: 2 Jukeboxes, boxes
Unit 1202 - John Taylor: Tire, Dalley
Unit 2197 - Mary Abbott: Household items
Unit 2001 - Tyrone Gibbs: Clothes, boxes
Unit 4100 - Gregorio Martinez: Boxes, Bikes
Unit 5009 - Pro-Forme Plumbing
Georgianna French - 745 N. Lombard - Chicago, IL 60642
Lolayna Scoggins - 5612 W. Ohio St Apt 2A - Chicago, IL 60644
Tatibita Castillo - 5147 W. Fullerton - Chicago, IL 60641
Jose Miranda - 8242 W. Barry - Chicago, IL 60618
Stephen Vauter - 339 N. La Grange - Chicago, IL 60641
Chante Selby - 140 N. Menard - Chicago, IL 60644
Joy Sanders - 3435 W. Oak Park Ave - Chicago, IL 60634
Sergio Taulgas - 2428 N. Linder - Chicago, IL 60639
Ricardo Rivera - 1617 N. Richmond - Chicago, IL 60642
Loranda Jones - Pa box 1475 - Chicago, IL 60624
Elton Gales - 168 N. LaGrange - Chicago, IL 60644
R. T. Setzler - 4952 W. Thomas st, apt 304 - Chicago, IL 60651
Vanessa de la Garza - 388 N. Hamilton - Chicago, IL 60624
Latoya Owens - 4545 W. Monteno - Chicago, IL 60639
Fredie Diaz - 61st Avenue, Cicero IL 60694
Rene Flores - 2449 N. Tripp - Chicago, IL 60639
Sofia Rodriguez - 3268 W. Fullerton - Chicago IL 60639
Gladys Morales - 2036 N. Albany - Chicago, IL 60622
Jessica Carrasquill - 2036 N. Albany - Chicago, IL 60622

1034- Foundation Notices

PRIVATE FOUNDATION The Annual Report (Form 990) of the David Husman Foundation, a private foundation, for the year ending September 30, 2008, is available at its principal office, 1220 N. Ashland Ave., Chicago, IL 60644. Copies are available for any citizen who requests it within 30 days from the date of this notice. The Foundation's Principal Manager is David Husman.

1046- Liens

That on 12/28/2008, a sale will be held at 3:00 p.m. at: Grand Auto & Truck Center, 2427 W. 117th Avenue, Chicago, IL 60642. All bids will be in writing, to sell the following articles of personal property existing under the laws of the State of Illinois against such articles for labor, services, skills or material expended upon or storage furnished for such articles of the request of the following designated persons), unless such articles are redeemed within thirty (30) days of the publication of this notice.

NAME OF PERSON(S) Frank Norman Sharon Perry Americredit Financial Services DESCRIPTION OF ARTICLE 2008 Dodge Durango 1D4HB48276F188997 AMOUNT: \$12,255.92 Published in Pioneer Press 10/30, 11/7/08 (1640975)C

1010- Auctions

Notice of Sale Under THE SELF STORAGE FACILITY ACT, ILLINOIS REVISE STATUTES, CHAPTER 114, PARAGRAPH 301, ET. SEQ.

Notice is hereby given that on November 11, 2008, U-Haul Auctioneer, Executive Administrator, Storage Clerk for U-Haul Co. North Shore Chicago/Kenosha, WI. will be offering for sale under the Judicial Lien process, by public auction, the following storage units. The goods to be sold are generally described as household goods. The terms of the sale will be cash only. U-Haul Co. North Shore Chicago/Kenosha, WI. reserves the rights to refuse any and all bids. The sales will be at the following location: 4301 N. Cicero Avenue, Chicago, IL 60641 and will be at or after 8:00 a.m. and continue day by day until all units are sold.

- Latoya Fields - 4423 W Fullerton - Chicago, IL 60624
Rm#3229 - Couch, mattress, table
Dollie Arco - 2122 N Laramie - Chicago, IL 60639
Yanika Johnson - 4913 W Bloomingdale - Chicago, IL 60624
Sharon Murry - 4409 W 1202 John Taylor - Tire, Dalley
Gregory Ivankhik - 151 W N Michigan - Chicago, IL 60606
Georgianna French - 745 N Lombard - Chicago, IL 60642
Lolayna Scoggins - 5612 W Ohio St Apt 2A - Chicago, IL 60644
Tatibita Castillo - 5147 W Fullerton - Chicago, IL 60641
Jose Miranda - 8242 W Barry - Chicago, IL 60618
Stephen Vauter - 339 N La Grange - Chicago, IL 60641
Chante Selby - 140 N Menard - Chicago, IL 60644
Joy Sanders - 3435 W Oak Park Ave - Chicago, IL 60634
Sergio Taulgas - 2428 N Linder - Chicago, IL 60639
Ricardo Rivera - 1617 N Richmond - Chicago, IL 60642
Loranda Jones - Pa box 1475 - Chicago, IL 60624
Elton Gales - 168 N LaGrange - Chicago, IL 60644
R. T. Setzler - 4952 W Thomas st, apt 304 - Chicago, IL 60651
Vanessa de la Garza - 388 N Hamilton - Chicago, IL 60624
Latoya Owens - 4545 W Monteno - Chicago, IL 60639
Fredie Diaz - 61st Avenue, Cicero IL 60694
Rene Flores - 2449 N Tripp - Chicago, IL 60639
Sofia Rodriguez - 3268 W Fullerton - Chicago IL 60639
Gladys Morales - 2036 N Albany - Chicago, IL 60622
Jessica Carrasquill - 2036 N Albany - Chicago, IL 60622

1010- Auctions

Notice of Sale Under THE SELF STORAGE FACILITY ACT, ILLINOIS REVISE STATUTES, CHAPTER 114, PARAGRAPH 301, ET. SEQ.

Notice is hereby given that on November 11, 2008, U-Haul Auctioneer, Executive Administrator, Storage Clerk for U-Haul Co. North Shore Chicago/Kenosha, WI. will be offering for sale under the Judicial Lien process, by public auction, the following storage units. The goods to be sold are generally described as household goods. The terms of the sale will be cash only. U-Haul Co. North Shore Chicago/Kenosha, WI. reserves the rights to refuse any and all bids. The sales will be at the following location: 4301 N. Cicero Avenue, Chicago, IL 60641 and will be at or after 8:00 a.m. and continue day by day until all units are sold.

- Latoya Fields - 4423 W Fullerton - Chicago, IL 60624
Rm#3229 - Couch, mattress, table
Dollie Arco - 2122 N Laramie - Chicago, IL 60639
Yanika Johnson - 4913 W Bloomingdale - Chicago, IL 60624
Sharon Murry - 4409 W 1202 John Taylor - Tire, Dalley
Gregory Ivankhik - 151 W N Michigan - Chicago, IL 60606
Georgianna French - 745 N Lombard - Chicago, IL 60642
Lolayna Scoggins - 5612 W Ohio St Apt 2A - Chicago, IL 60644
Tatibita Castillo - 5147 W Fullerton - Chicago, IL 60641
Jose Miranda - 8242 W Barry - Chicago, IL 60618
Stephen Vauter - 339 N La Grange - Chicago, IL 60641
Chante Selby - 140 N Menard - Chicago, IL 60644
Joy Sanders - 3435 W Oak Park Ave - Chicago, IL 60634
Sergio Taulgas - 2428 N Linder - Chicago, IL 60639
Ricardo Rivera - 1617 N Richmond - Chicago, IL 60642
Loranda Jones - Pa box 1475 - Chicago, IL 60624
Elton Gales - 168 N LaGrange - Chicago, IL 60644
R. T. Setzler - 4952 W Thomas st, apt 304 - Chicago, IL 60651
Vanessa de la Garza - 388 N Hamilton - Chicago, IL 60624
Latoya Owens - 4545 W Monteno - Chicago, IL 60639
Fredie Diaz - 61st Avenue, Cicero IL 60694
Rene Flores - 2449 N Tripp - Chicago, IL 60639
Sofia Rodriguez - 3268 W Fullerton - Chicago IL 60639
Gladys Morales - 2036 N Albany - Chicago, IL 60622
Jessica Carrasquill - 2036 N Albany - Chicago, IL 60622

1010- Auctions

Notice of Sale Under THE SELF STORAGE FACILITY ACT, ILLINOIS REVISE STATUTES, CHAPTER 114, PARAGRAPH 301, ET. SEQ.

Notice is hereby given that on November 11, 2008, U-Haul Auctioneer, Executive Administrator, Storage Clerk for U-Haul Co. North Shore Chicago/Kenosha, WI. will be offering for sale under the Judicial Lien process, by public auction, the following storage units. The goods to be sold are generally described as household goods. The terms of the sale will be cash only. U-Haul Co. North Shore Chicago/Kenosha, WI. reserves the rights to refuse any and all bids. The sales will be at the following location: 4301 N. Cicero Avenue, Chicago, IL 60641 and will be at or after 8:00 a.m. and continue day by day until all units are sold.

- Latoya Fields - 4423 W Fullerton - Chicago, IL 60624
Rm#3229 - Couch, mattress, table
Dollie Arco - 2122 N Laramie - Chicago, IL 60639
Yanika Johnson - 4913 W Bloomingdale - Chicago, IL 60624
Sharon Murry - 4409 W 1202 John Taylor - Tire, Dalley
Gregory Ivankhik - 151 W N Michigan - Chicago, IL 60606
Georgianna French - 745 N Lombard - Chicago, IL 60642
Lolayna Scoggins - 5612 W Ohio St Apt 2A - Chicago, IL 60644
Tatibita Castillo - 5147 W Fullerton - Chicago, IL 60641
Jose Miranda - 8242 W Barry - Chicago, IL 60618
Stephen Vauter - 339 N La Grange - Chicago, IL 60641
Chante Selby - 140 N Menard - Chicago, IL 60644
Joy Sanders - 3435 W Oak Park Ave - Chicago, IL 60634
Sergio Taulgas - 2428 N Linder - Chicago, IL 60639
Ricardo Rivera - 1617 N Richmond - Chicago, IL 60642
Loranda Jones - Pa box 1475 - Chicago, IL 60624
Elton Gales - 168 N LaGrange - Chicago, IL 60644
R. T. Setzler - 4952 W Thomas st, apt 304 - Chicago, IL 60651
Vanessa de la Garza - 388 N Hamilton - Chicago, IL 60624
Latoya Owens - 4545 W Monteno - Chicago, IL 60639
Fredie Diaz - 61st Avenue, Cicero IL 60694
Rene Flores - 2449 N Tripp - Chicago, IL 60639
Sofia Rodriguez - 3268 W Fullerton - Chicago IL 60639
Gladys Morales - 2036 N Albany - Chicago, IL 60622
Jessica Carrasquill - 2036 N Albany - Chicago, IL 60622

1010- Auctions

Notice of Sale Under THE SELF STORAGE FACILITY ACT, ILLINOIS REVISE STATUTES, CHAPTER 114, PARAGRAPH 301, ET. SEQ.

Notice is hereby given that on November 11, 2008, U-Haul Auctioneer, Executive Administrator, Storage Clerk for U-Haul Co. North Shore Chicago/Kenosha, WI. will be offering for sale under the Judicial Lien process, by public auction, the following storage units. The goods to be sold are generally described as household goods. The terms of the sale will be cash only. U-Haul Co. North Shore Chicago/Kenosha, WI. reserves the rights to refuse any and all bids. The sales will be at the following location: 4301 N. Cicero Avenue, Chicago, IL 60641 and will be at or after 8:00 a.m. and continue day by day until all units are sold.

- Latoya Fields - 4423 W Fullerton - Chicago, IL 60624
Rm#3229 - Couch, mattress, table
Dollie Arco - 2122 N Laramie - Chicago, IL 60639
Yanika Johnson - 4913 W Bloomingdale - Chicago, IL 60624
Sharon Murry - 4409 W 1202 John Taylor - Tire, Dalley
Gregory Ivankhik - 151 W N Michigan - Chicago, IL 60606
Georgianna French - 745 N Lombard - Chicago, IL 60642
Lolayna Scoggins - 5612 W Ohio St Apt 2A - Chicago, IL 60644
Tatibita Castillo - 5147 W Fullerton - Chicago, IL 60641
Jose Miranda - 8242 W Barry - Chicago, IL 60618
Stephen Vauter - 339 N La Grange - Chicago, IL 60641
Chante Selby - 140 N Menard - Chicago, IL 60644
Joy Sanders - 3435 W Oak Park Ave - Chicago, IL 60634
Sergio Taulgas - 2428 N Linder - Chicago, IL 60639
Ricardo Rivera - 1617 N Richmond - Chicago, IL 60642
Loranda Jones - Pa box 1475 - Chicago, IL 60624
Elton Gales - 168 N LaGrange - Chicago, IL 60644
R. T. Setzler - 4952 W Thomas st, apt 304 - Chicago, IL 60651
Vanessa de la Garza - 388 N Hamilton - Chicago, IL 60624
Latoya Owens - 4545 W Monteno - Chicago, IL 60639
Fredie Diaz - 61st Avenue, Cicero IL 60694
Rene Flores - 2449 N Tripp - Chicago, IL 60639
Sofia Rodriguez - 3268 W Fullerton - Chicago IL 60639
Gladys Morales - 2036 N Albany - Chicago, IL 60622
Jessica Carrasquill - 2036 N Albany - Chicago, IL 60622

1010- Auctions

Notice of Sale Under THE SELF STORAGE FACILITY ACT, ILLINOIS REVISE STATUTES, CHAPTER 114, PARAGRAPH 301, ET. SEQ.

Notice is hereby given that on November 11, 2008, U-Haul Auctioneer, Executive Administrator, Storage Clerk for U-Haul Co. North Shore Chicago/Kenosha, WI. will be offering for sale under the Judicial Lien process, by public auction, the following storage units. The goods to be sold are generally described as household goods. The terms of the sale will be cash only. U-Haul Co. North Shore Chicago/Kenosha, WI. reserves the rights to refuse any and all bids. The sales will be at the following location: 4301 N. Cicero Avenue, Chicago, IL 60641 and will be at or after 8:00 a.m. and continue day by day until all units are sold.

- Latoya Fields - 4423 W Fullerton - Chicago, IL 60624
Rm#3229 - Couch, mattress, table
Dollie Arco - 2122 N Laramie - Chicago, IL 60639
Yanika Johnson - 4913 W Bloomingdale - Chicago, IL 60624
Sharon Murry - 4409 W 1202 John Taylor - Tire, Dalley
Gregory Ivankhik - 151 W N Michigan - Chicago, IL 60606
Georgianna French - 745 N Lombard - Chicago, IL 60642
Lolayna Scoggins - 5612 W Ohio St Apt 2A - Chicago, IL 60644
Tatibita Castillo - 5147 W Fullerton - Chicago, IL 60641
Jose Miranda - 8242 W Barry - Chicago, IL 60618
Stephen Vauter - 339 N La Grange - Chicago, IL 60641
Chante Selby - 140 N Menard - Chicago, IL 60644
Joy Sanders - 3435 W Oak Park Ave - Chicago, IL 60634
Sergio Taulgas - 2428 N Linder - Chicago, IL 60639
Ricardo Rivera - 1617 N Richmond - Chicago, IL 60642
Loranda Jones - Pa box 1475 - Chicago, IL 60624
Elton Gales - 168 N LaGrange - Chicago, IL 60644
R. T. Setzler - 4952 W Thomas st, apt 304 - Chicago, IL 60651
Vanessa de la Garza - 388 N Hamilton - Chicago, IL 60624
Latoya Owens - 4545 W Monteno - Chicago, IL 60639
Fredie Diaz - 61st Avenue, Cicero IL 60694
Rene Flores - 2449 N Tripp - Chicago, IL 60639
Sofia Rodriguez - 3268 W Fullerton - Chicago IL 60639
Gladys Morales - 2036 N Albany - Chicago, IL 60622
Jessica Carrasquill - 2036 N Albany - Chicago, IL 60622

1010- Auctions

Notice of Sale Under THE SELF STORAGE FACILITY ACT, ILLINOIS REVISE STATUTES, CHAPTER 114, PARAGRAPH 301, ET. SEQ.

Notice is hereby given that on November 11, 2008, U-Haul Auctioneer, Executive Administrator, Storage Clerk for U-Haul Co. North Shore Chicago/Kenosha, WI. will be offering for sale under the Judicial Lien process, by public auction, the following storage units. The goods to be sold are generally described as household goods. The terms of the sale will be cash only. U-Haul Co. North Shore Chicago/Kenosha, WI. reserves the rights to refuse any and all bids. The sales will be at the following location: 4301 N. Cicero Avenue, Chicago, IL 60641 and will be at or after 8:00 a.m. and continue day by day until all units are sold.

- Latoya Fields - 4423 W Fullerton - Chicago, IL 60624
Rm#3229 - Couch, mattress, table
Dollie Arco - 2122 N Laramie - Chicago, IL 60639
Yanika Johnson - 4913 W Bloomingdale - Chicago, IL 60624
Sharon Murry - 4409 W 1202 John Taylor - Tire, Dalley
Gregory Ivankhik - 151 W N Michigan - Chicago, IL 60606
Georgianna French - 745 N Lombard - Chicago, IL 60642
Lolayna Scoggins - 5612 W Ohio St Apt 2A - Chicago, IL 60644
Tatibita Castillo - 5147 W Fullerton - Chicago, IL 60641
Jose Miranda - 8242 W Barry - Chicago, IL 60618
Stephen Vauter - 339 N La Grange - Chicago, IL 60641
Chante Selby - 140 N Menard - Chicago, IL 60644
Joy Sanders - 3435 W Oak Park Ave - Chicago, IL 60634
Sergio Taulgas - 2428 N Linder - Chicago, IL 60639
Ricardo Rivera - 1617 N Richmond - Chicago, IL 60642
Loranda Jones - Pa box 1475 - Chicago, IL 60624
Elton Gales - 168 N LaGrange - Chicago, IL 60644
R. T. Setzler - 4952 W Thomas st, apt 304 - Chicago, IL 60651
Vanessa de la Garza - 388 N Hamilton - Chicago, IL 60624
Latoya Owens - 4545 W Monteno - Chicago, IL 60639
Fredie Diaz - 61st Avenue, Cicero IL 60694
Rene Flores - 2449 N Tripp - Chicago, IL 60639
Sofia Rodriguez - 3268 W Fullerton - Chicago IL 60639
Gladys Morales - 2036 N Albany - Chicago, IL 60622
Jessica Carrasquill - 2036 N Albany - Chicago, IL 60622

1010- Auctions

Notice of Sale Under THE SELF STORAGE FACILITY ACT, ILLINOIS REVISE STATUTES, CHAPTER 114, PARAGRAPH 301, ET. SEQ.

Notice is hereby given that on November 11, 2008, U-Haul Auctioneer, Executive Administrator, Storage Clerk for U-Haul Co. North Shore Chicago/Kenosha, WI. will be offering for sale under the Judicial Lien process, by public auction, the following storage units. The goods to be sold are generally described as household goods. The terms of the sale will be cash only. U-Haul Co. North Shore Chicago/Kenosha, WI. reserves the rights to refuse any and all bids. The sales will be at the following location: 4301 N. Cicero Avenue, Chicago, IL 60641 and will be at or after 8:00 a.m. and continue day by day until all units are sold.

- Latoya Fields - 4423 W Fullerton - Chicago, IL 60624
Rm#3229 - Couch, mattress, table
Dollie Arco - 2122 N Laramie - Chicago, IL 60639
Yanika Johnson - 4913 W Bloomingdale - Chicago, IL 60624
Sharon Murry - 4409 W 1202 John Taylor - Tire, Dalley
Gregory Ivankhik - 151 W N Michigan - Chicago, IL 60606
Georgianna French - 745 N Lombard - Chicago, IL 60642
Lolayna Scoggins - 5612 W Ohio St Apt 2A - Chicago, IL 60644
Tatibita Castillo - 5147 W Fullerton - Chicago, IL 60641
Jose Miranda - 8242 W Barry - Chicago, IL 60618
Stephen Vauter - 339 N La Grange - Chicago, IL 60641
Chante Selby - 140 N Menard - Chicago, IL 60644
Joy Sanders - 3435 W Oak Park Ave - Chicago, IL 60634
Sergio Taulgas - 2428 N Linder - Chicago, IL 60639
Ricardo Rivera - 1617 N Richmond - Chicago, IL 60642
Loranda Jones - Pa box 1475 - Chicago, IL 60624
Elton Gales - 168 N LaGrange - Chicago, IL 60644
R. T. Setzler - 4952 W Thomas st, apt 304 - Chicago, IL 60651
Vanessa de la Garza - 388 N Hamilton - Chicago, IL 60624
Latoya Owens - 4545 W Monteno - Chicago, IL 60639
Fredie Diaz - 61st Avenue, Cicero IL 60694
Rene Flores - 2449 N Tripp - Chicago, IL 60639
Sofia Rodriguez - 3268 W Fullerton - Chicago IL 60639
Gladys Morales - 2036 N Albany - Chicago, IL 60622
Jessica Carrasquill - 2036 N Albany - Chicago, IL 60622

1010- Auctions

Notice of Sale Under THE SELF STORAGE FACILITY ACT, ILLINOIS REVISE STATUTES, CHAPTER 114, PARAGRAPH 301, ET. SEQ.

Notice is hereby given that on November 11, 2008, U-Haul Auctioneer, Executive Administrator, Storage Clerk for U-Haul Co. North Shore Chicago/Kenosha, WI. will be offering for sale under the Judicial Lien process, by public auction, the following storage units. The goods to be sold are generally described as household goods. The terms of the sale will be cash only. U-Haul Co. North Shore Chicago/Kenosha, WI. reserves the rights to refuse any and all bids. The sales will be at the following location: 4301 N. Cicero Avenue, Chicago, IL 60641 and will be at or after 8:00 a.m. and continue day by day until all units are sold.

- Latoya Fields - 4423 W Fullerton - Chicago, IL 60624
Rm#3229 - Couch, mattress, table
Dollie Arco - 2122 N Laramie - Chicago, IL 60639
Yanika Johnson - 4913 W Bloomingdale - Chicago, IL 60624
Sharon Murry - 4409 W 1202 John Taylor - Tire, Dalley
Gregory Ivankhik - 151 W N Michigan - Chicago, IL 60606
Georgianna French - 745 N Lombard - Chicago, IL 60642
Lolayna Scoggins - 5612 W Ohio St Apt 2A - Chicago, IL 60644
Tatibita Castillo - 5147 W Fullerton - Chicago, IL 60641
Jose Miranda - 8242 W Barry - Chicago, IL 60618
Stephen Vauter - 339 N La Grange - Chicago, IL 60641
Chante Selby - 140 N Menard - Chicago, IL 60644
Joy Sanders - 3435 W Oak Park Ave - Chicago, IL 60634
Sergio Taulgas - 2428 N Linder - Chicago, IL 60639
Ricardo Rivera - 1617 N Richmond - Chicago, IL 60642
Loranda Jones - Pa box 1475 - Chicago, IL 60624
Elton Gales - 168 N LaGrange - Chicago, IL 60644
R. T. Setzler - 4952 W Thomas st, apt 304 - Chicago, IL 60651
Vanessa de la Garza - 388 N Hamilton - Chicago, IL 60624
Latoya Owens - 4545 W Monteno - Chicago, IL 60639
Fredie Diaz - 61st Avenue, Cicero IL 60694
Rene Flores - 2449 N Tripp - Chicago, IL 60639
Sofia Rodriguez - 3268 W Fullerton - Chicago IL 60639
Gladys Morales - 2036 N Albany - Chicago, IL 60622
Jessica Carrasquill - 2036 N Albany - Chicago, IL 60622

1010- Auctions

Notice of Sale Under THE SELF STORAGE FACILITY ACT, ILLINOIS REVISE STATUTES, CHAPTER 114, PARAGRAPH 301, ET. SEQ.

Notice is hereby given that on November 11, 2008, U-Haul Auctioneer, Executive Administrator, Storage Clerk for U-Haul Co. North Shore Chicago/Kenosha, WI. will be offering for sale under the Judicial Lien process, by public auction, the following storage units. The goods to be sold are generally described as household goods. The terms of the sale will be cash only. U-Haul Co. North Shore Chicago/Kenosha, WI. reserves the rights to refuse any and all bids. The sales will be at the following location: 4301 N. Cicero Avenue, Chicago, IL 60641 and will be at or after 8:00 a.m. and continue day by day until all units are sold.

- Latoya Fields - 4423 W Fullerton - Chicago, IL 60624
Rm#3229 - Couch, mattress, table
Dollie Arco - 2122 N Laramie - Chicago, IL 60639
Yanika Johnson - 4913 W Bloomingdale - Chicago, IL 60624
Sharon Murry - 4409 W 1202 John Taylor - Tire, Dalley
Gregory Ivankhik - 151 W N Michigan - Chicago, IL 60606
Georgianna French - 745 N Lombard - Chicago, IL 60642
Lolayna Scoggins - 5612 W Ohio St Apt 2A - Chicago, IL 60644
Tatibita Castillo - 5147 W Fullerton - Chicago, IL 60641
Jose Miranda - 8242 W Barry - Chicago, IL 60618
Stephen Vauter - 339 N La Grange - Chicago, IL 60641
Chante Selby - 140 N Menard - Chicago, IL 60644
Joy Sanders - 3435 W Oak Park Ave - Chicago, IL 60634
Sergio Taulgas - 2428 N Linder - Chicago, IL 60639
Ricardo Rivera - 1617 N Richmond - Chicago, IL 60642
Loranda Jones - Pa box 1475 - Chicago, IL 60624
Elton Gales - 168 N LaGrange - Chicago, IL 60644
R. T. Setzler - 4952 W Thomas st, apt 304 - Chicago, IL 60651
Vanessa de la Garza - 388 N Hamilton - Chicago, IL 60624
Latoya Owens - 4545 W Monteno - Chicago, IL 60639
Fredie Diaz - 61st Avenue, Cicero IL 60694
Rene Flores - 2449 N Tripp - Chicago, IL 60639
Sofia Rodriguez - 3268 W Fullerton - Chicago IL 60639
Gladys Morales - 2036 N Albany - Chicago, IL 60622
Jessica Carrasquill - 2036 N Albany - Chicago, IL 60622

1010- Auctions

Notice of Sale Under THE SELF STORAGE FACILITY ACT, ILLINOIS REVISE STATUTES, CHAPTER 114, PARAGRAPH 301, ET. SEQ.

Notice is hereby given that on November 11, 2008, U-Haul Auctioneer, Executive Administrator, Storage Clerk for U-Haul Co. North Shore Chicago/Kenosha, WI. will be offering for sale under the Judicial Lien process, by public auction, the following storage units. The goods to be sold are generally described as household goods. The terms of the sale will be cash only. U-Haul Co. North Shore Chicago/Kenosha, WI. reserves the rights to refuse any and all bids. The sales will be at the following location: 4301 N. Cicero Avenue, Chicago, IL 60641 and will be at or after 8:00 a.m. and continue day by day until all units are sold.

- Latoya Fields - 4423 W Fullerton - Chicago, IL 60624
Rm#3229 - Couch, mattress, table
Dollie Arco - 21

The most effective advertising in print

WHAT ARE YOU LOOKING FOR?

chicagajobs.com

per together.

CLASSIFIED

Real Estate, Employment, Services, and more.

& online

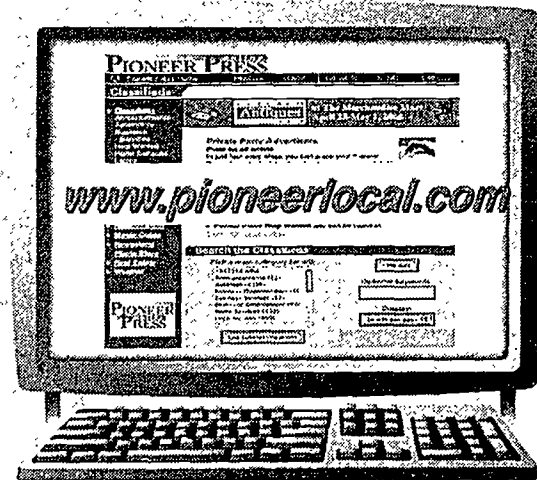

PIONEER PRESS
YOUR LOCAL SOURCE

1060- Plan Commission & Zoning Hearings

LEGAL NOTICE OF PUBLIC HEARING
Skokie Plan Commission, Thursday, October 4, 2008, Village of Skokie, 5127 Oakton Street, Skokie, Illinois 60077, at 7:30 P.M., to consider the following:

NEW
2008-30P - Special Use Permit: 8800 Gross Point Road GPO, LLC requests a special use permit for a limited service restaurant at 8800 Gross Point Road in a 1st Commercial district and any other relief that may be required as determined by Village Staff during the review of this case.

2008-31P - Special Use Permit: 8800 Gross Point Road GPO, LLC requests a special use permit for outdoor dining at 8800 Gross Point Road in a 2nd Commercial district and any other relief that may be required as determined by Village Staff during the review of this case.

FOR YOUR INFORMATION: Plans and related documents are available at the Village's Community Development Department, Planning Division, (847) 933-8447, through Friday, from 8:30 AM to 5:00 PM.

SPECIAL AID: Available upon request for the disabled. Call (847) 933-9500 or TOD (847) 933-8455.

Interested parties are invited to attend this meeting. This notice is for information purposes only. Published in the Skokie Review on November 6, 2008.

Paul Luke, Chairman
Published in Pioneer Press 11/6/08 (164480) C

PUBLIC HEARING

NOTICE IS HEREBY GIVEN that a public hearing will be held before the Planning and Zoning Commission on Monday, November 24, 2008, at 7:30 p.m. in the City Council Chambers of Park Ridge City Hall, 505 Butler Place, Park Ridge, Illinois, when the following matter will be considered:

Zoning Case Number 08-03
Application for a special use to allow an addition to St. Luke's Lutheran Church, the R-2 Single Family Residential District, and consideration for any exceptions that may be requested as part of the project, in accordance with the requirements of Section 4.6 of the Zoning Ordinance of the City of Park Ridge at the following property:

Lot 16 in Block 4 in Park Ridge, sold Park Ridge being a Re-subdivision of parts of Blocks 1, 3, 4, and 5 of Brickton, a Subdivision of parts of the Southeast quarter of Section 26, Township 41 North, Range 12 East of the Third Principal Meridian, in Cook County, Illinois.

Lot 12 (except the South 74 feet thereof) and all of Lot 13 in Block 4 in Brickton being a Re-subdivision of parts of Blocks 1, 3, 4, and 5 in Penny and Meacham's Subdivision of the Southeast quarter of Section 26, Township 41 North, Range 12 East of the Third Principal Meridian, in Cook County, Illinois.

The South 23 feet of Lot 16 and the North 27 feet of Lot 17 in Block 4 in Brickton being a Re-subdivision of parts of Blocks 1, 3, 4, and 5 in Penny and Meacham's Subdivision of the Southeast quarter of Section 26, Township 41 North, Range 12 East of the Third Principal Meridian, in Cook County, Illinois.

The property commonly known as: 205 North Prospect Avenue, Park Ridge, IL 60068

All persons interested in the above described matter are invited to attend and will be heard.

The case file for this matter is available for review in the Department of Community Preservation and Zoning Commission

Alfredo Marr, Chairman
Planning and Zoning Commission
Published in Pioneer Press 11/6/08 (164390) C

Buying or Selling,
Pioneer Classified
is the place for you!

1062- Probate

COOK COUNTY PROBATE CLERK'S OFFICE
STATE OF ILLINOIS IN THE CIRCUIT COURT OF COOK COUNTY, ILLINOIS PROBATE DIVISION

In the matter of the estate of JANUSZ SZYBOWSKI Deceased.

Case No. 2008 P 006200
PUBLICATION NOTICE
Notice is hereby given of the death of JANUSZ SZYBOWSKI of Park Ridge, Illinois. Letters of office were issued on October 7, 2008 to Anna Szybowska, 401 Ascot Dr., Park Ridge, IL 60068, whose attorney is PRO SE.

Claims against the estate may be filed in the office of the Clerk of the Circuit Court in Room 1202, Richard J. Daley Center, Chicago, Illinois 60602 or with the representative and whose name or address is set forth below, on or before April 23, 2009 which date is not less than 6 months from the date of the first publication of this notice and any claim filed with the Clerk of the Circuit Court or with the representative and to the attorney within 10 days after it is filed.

Within 42 days after the effective date of the original order of admission or from the date of the first publication of this notice, you may file a petition with the court to require proof of the will by testimony of the witness to the will in open court or other evidence, as provided in 5/6-21 of the Probate Act of 1975 (ILCS 1992.755, 5/6-21).

You also have the right under 5/6-1 of the Probate Act (ILCS 1992.755, 5/6-1) to contest the validity of the will by filing a petition with the court within six (6) months after admission of the will to probate.

The estate will be administered without court supervision, unless under 5/6-4 of the Probate Act (ILCS 1992.755, 5/6-4). Any interested person terminates independent administration at any time by mailing or delivering a petition to terminate to the Clerk.

Claims against the estate may be filed in the office of the Clerk of the Circuit Court on or before April 27, 2009, which date is not less than six (6) months from the date of the first publication of this notice and any claim not filed within that period is barred.

Any questions or petitions should be directed to Edwin R. Niemira, as attorney for the estate of Oaephne Benos (Deceased) Case No. 2008 P 4431.

Published in Pioneer Press 10/23, 10/30, 11/6/08 (163886) C

IN THE CIRCUIT COURT OF COOK COUNTY, ILLINOIS COUNTY DEPARTMENT PROBATE DIVISION

ESTATE OF BETTY L. FUMBANKS CHAMBERLAIN, Deceased

Case No. 2008 P 4506
AFFIDAVIT OF NON-RESIDENCE
CARY A. LIND, an oath taker for purposes of administering the First and Final Account of the Supervised Administrator of this Estate and for closing of the Estate, as to UNKNOWN HEIRS OF NATHANIEL CHAMBERLAIN

1. UNKNOWN HEIRS OF NATHANIEL CHAMBERLAIN, on due 11/6/08, I have found no one who I believe to be a claimant of the estate of UNKNOWN HEIRS OF NATHANIEL CHAMBERLAIN upon diligent inquiry.

The place of residence of UNKNOWN HEIRS OF NATHANIEL CHAMBERLAIN upon diligent inquiry should be ascertained and their last known place of residence is unknown.

/s/ Cary A. Lind
Subscribed and sworn to before me September 15, 2008

/s/ Jan Ballatore
Notary Public

CARY A. LIND
Attorney for Representative
121 S. Wilke Road-Suite 407
Arlington Heights, IL 60005
(847) 577-0030
Attorney No. 23703

Published in Pioneer Press 10/30, 11/6, 11/13/08 (164148) C

Published in Pioneer Press 11/6, 11/13, 11/20/08 (164293) C

Published in Pioneer Press 11/6, 11/13, 11/20/08 (164293) C

Published in Pioneer Press 11/6, 11/13, 11/20/08 (164293) C

Published in Pioneer Press 11/6, 11/13, 11/20/08 (164293) C

Published in Pioneer Press 11/6, 11/13, 11/20/08 (164293) C

Published in Pioneer Press 11/6, 11/13, 11/20/08 (164293) C

Published in Pioneer Press 11/6, 11/13, 11/20/08 (164293) C

Published in Pioneer Press 11/6, 11/13, 11/20/08 (164293) C

Published in Pioneer Press 11/6, 11/13, 11/20/08 (164293) C

1062- Probate

STATE OF ILLINOIS IN THE CIRCUIT COURT OF COOK COUNTY, ILLINOIS PROBATE DIVISION

In the matter of the estate of OAPHNE BENOS, Deceased.

Case No. 2008 P 4431
PUBLICATION NOTICE
Notice is given of the death of OAPHNE BENOS of Chicago, Illinois. Letters of office were issued on October 17, 2008, to KIM PAULSEN, whose attorney is EOWIN R. NIEMIRA, 1110 N. Ashland Ave., Chicago, IL 60622, 773-276-1322.

Notice is given to the heirs who are the heirs or legatees in the above entitled estate to appear in court to proceed to create a will and whose name or address is set forth below, on or before April 23, 2009 which date is not less than 6 months from the date of the first publication of this notice and any claim filed with the Clerk of the Circuit Court or with the representative and to the attorney within 10 days after it is filed.

Within 42 days after the effective date of the original order of admission or from the date of the first publication of this notice, you may file a petition with the court to require proof of the will by testimony of the witness to the will in open court or other evidence, as provided in 5/6-21 of the Probate Act of 1975 (ILCS 1992.755, 5/6-21).

You also have the right under 5/6-1 of the Probate Act (ILCS 1992.755, 5/6-1) to contest the validity of the will by filing a petition with the court within six (6) months after admission of the will to probate.

The estate will be administered without court supervision, unless under 5/6-4 of the Probate Act (ILCS 1992.755, 5/6-4). Any interested person terminates independent administration at any time by mailing or delivering a petition to terminate to the Clerk.

Claims against the estate may be filed in the office of the Clerk of the Circuit Court on or before April 27, 2009, which date is not less than six (6) months from the date of the first publication of this notice and any claim not filed within that period is barred.

Any questions or petitions should be directed to Edwin R. Niemira, as attorney for the estate of Oaephne Benos (Deceased) Case No. 2008 P 4431.

Published in Pioneer Press 10/23, 10/30, 11/6/08 (163886) C

Published in Pioneer Press 10/23, 10/30, 11/6/08 (163927) C

Published in Pioneer Press 10/23, 10/30, 11/6/08 (163927) C

Published in Pioneer Press 10/23, 10/30, 11/6/08 (163927) C

Published in Pioneer Press 10/23, 10/30, 11/6/08 (163927) C

Published in Pioneer Press 10/23, 10/30, 11/6/08 (163927) C

Published in Pioneer Press 10/23, 10/30, 11/6/08 (163927) C

Published in Pioneer Press 10/23, 10/30, 11/6/08 (163927) C

Published in Pioneer Press 10/23, 10/30, 11/6/08 (163927) C

Published in Pioneer Press 10/23, 10/30, 11/6/08 (163927) C

Published in Pioneer Press 10/23, 10/30, 11/6/08 (163927) C

Published in Pioneer Press 10/23, 10/30, 11/6/08 (163927) C

Published in Pioneer Press 10/23, 10/30, 11/6/08 (163927) C

Published in Pioneer Press 10/23, 10/30, 11/6/08 (163927) C

Published in Pioneer Press 10/23, 10/30, 11/6/08 (163927) C

Published in Pioneer Press 10/23, 10/30, 11/6/08 (163927) C

Published in Pioneer Press 10/23, 10/30, 11/6/08 (163927) C

Published in Pioneer Press 10/23, 10/30, 11/6/08 (163927) C

Published in Pioneer Press 10/23, 10/30, 11/6/08 (163927) C

Published in Pioneer Press 10/23, 10/30, 11/6/08 (163927) C

1066- Public Notices

PUBLIC NOTICE
BOARD OF EDUCATION
SKOKIE SCHOOL DISTRICT
73 1/2
COOK COUNTY, ILLINOIS

Notice of Time and Place for Filing Nominating Petitions

Notice is hereby given that on Tuesday, the 7th day of April 2009, an election will be held in Skokie School District 73 1/2, Cook County, Illinois, for the purpose of electing four (4) members to the Board of Education.

To be eligible to serve as a Board of Education Member, candidates must be 18 years of age or older, a U.S. citizen, a District 73 1/2 resident for at least one year, and a registered voter. In addition, completed paperwork must be submitted. Candidates elected will serve four-year terms expiring in April 2013.

Prospective applicants interested in serving on the Board of Education may come to the Superintendent's Office, 8000 East Prairie Road, Skokie, Illinois, to submit their names, a letter of interest, and pick up forms and information.

Materials may be picked up on any business day beginning October 28, 2008, between 8:00 a.m. and 4:00 p.m. Tuesday, October 28, 2008, is the first day that prospective candidates may circulate nominating petitions for the April 7, 2009, school board election.

The first day for candidates to file nominating papers is Tuesday, October 28, 2008, beginning at 8:00 a.m. The last day for filing is Monday, January 26, 2009, beginning at 8:00 a.m. and ending at 5:00 p.m. Candidate's names will appear on the election ballot in the order in which their nominating papers are received.

Further information may be obtained by contacting Laurie Schauburg, Superintendent's Office at 847.676.8237.

Andrea Rosen
Secretary
Skokie School District 73 1/2
Board of Education

Published in Pioneer Press 11/6, 11/13, 11/20/08 (164347) C

Published in Pioneer Press 11/6, 11/13, 11/20/08 (164347) C

Published in Pioneer Press 11/6, 11/13, 11/20/08 (164347) C

Published in Pioneer Press 11/6, 11/13, 11/20/08 (164347) C

Published in Pioneer Press 11/6, 11/13, 11/20/08 (164347) C

Published in Pioneer Press 11/6, 11/13, 11/20/08 (164347) C

Published in Pioneer Press 11/6, 11/13, 11/20/08 (164347) C

Published in Pioneer Press 11/6, 11/13, 11/20/08 (164347) C

Published in Pioneer Press 11/6, 11/13, 11/20/08 (164347) C

Published in Pioneer Press 11/6, 11/13, 11/20/08 (164347) C

Published in Pioneer Press 11/6, 11/13, 11/20/08 (164347) C

Published in Pioneer Press 11/6, 11/13, 11/20/08 (164347) C

Published in Pioneer Press 11/6, 11/13, 11/20/08 (164347) C

Published in Pioneer Press 11/6, 11/13, 11/20/08 (164347) C

Published in Pioneer Press 11/6, 11/13, 11/20/08 (164347) C

Published in Pioneer Press 11/6, 11/13, 11/20/08 (164347) C

Published in Pioneer Press 11/6, 11/13, 11/20/08 (164347) C

Published in Pioneer Press 11/6, 11/13, 11/20/08 (164347) C

Published in Pioneer Press 11/6, 11/13, 11/20/08 (164347) C

Published in Pioneer Press 11/6, 11/13, 11/20/08 (164347) C

Pioneer Press Classified Auto Dealer Directory

ACURA
BOB ROHRMAN'S
ARLINGTON ACURA
IN PALATINE
1275 W. DUNDEE RD, PALATINE
JUST WEST OF RT. 53 ON OUNDEE
(847) 991-9000

JOE RIZZA ACURA
2055 WEST 159TH STREET,
ORLANDO PARK
708-403-7770
RIZZACARS.COM

MULLERS WOODFIELD ACURA
1099 WEST HIGGINS ROAD
HOFFMAN ESTATES, IL
847-519-9550
MULLERCARS.COM

PAULY ACURA
2699 SKOKIE VALLEY ROAD
HIGHLAND PARK, IL
847-433-8200
PAULYACURA.COM

AUDI
THE AUDI EXCHANGE
2480 SKOKIE VALLEY RD,
HIGHLAND PARK
(847) 432-5020
AUDIEXCHANGE.COM

SCHAUMBURG AUDI
320 W. GOLF ROAD
SCHAUMBURG
(866) 503-8153
SCHAUMBURGAUDI.COM

BENTLEY
STEVE FOLEY BENTLEY
100 SKOKIE BLVD., NORTHBROOK
(847) 564-4090
KNAUZLARGESTBENTLEYDEALER

BMW
BILL JACOBS BMW
1564 W. OGDEN AVE., NAPERVILLE
(866) 516-8015
BILLJACOBSSBMW.COM

ELMHURST BMW
6425 WEST LAKE STREET, ELMHURST
(888) 287-6555
ELMHURSTBMW.COM

FIELDS BMW NORTHFIELD
700 FRONTAGE ROAD,
NORTHFIELD
(847) 441-5300
FIELDSAUTO.COM

KNAUZ BMW KNAUZ AUTOPARK
ROUTE 41 @ RT. 176,
LAKE BLUFF
(847) 604-5000
KNAUZ.COM

PATRICK BMW
700 EAST GOLF RD.
SCHAUMBURG, IL 60173
(866) 652-6124
PATRICKBMW.COM

BUICK
ETTLESON
CADILLAC-BUICK-PONTIAC-GMC
6150 S. LAGRANGE RD.
HODKINS
(708) 614-2277
PATRICKCADILLAC.COM

GROSSINGER BUICK
6900 N. MCCORMICK BLVD.
LINCOLNWOOD
(866) 670-1654
GROSSINGERBUICK.COM

KNAUZ BUICK KNAUZ AUTOPARK
ROUTE 41 @ RT. 176, LAKE BLUFF
(847) 234-2800
KNAUZ.COM

LOREN BUICK/PONTIAC
1610 WAUKEGAN ROAD,
GLENVIEW
(847) 729-8900
LORENAUTOGROUP.COM

RIZZA BUICK
8425 WEST 159TH STREET,
TINLEY PARK
(708) 429-6000
RIZZACARS.COM

ELMHURST BMW
6425 WEST LAKE STREET, ELMHURST
(888) 287-6555
ELMHURSTBMW.COM

FIELDS BMW NORTHFIELD
700 FRONTAGE ROAD,
NORTHFIELD
(847) 441-5300
FIELDSAUTO.COM

KNAUZ BUICK KNAUZ AUTOPARK
ROUTE 41 @ RT. 176,
LAKE BLUFF
(847) 604-5000
KNAUZ.COM

PATRICK BUICK
526 MALL DRIVE
SCHAUMBURG, IL 60173
(866) 614-2277
PATRICKCADILLAC.COM

GROSSINGER CADILLAC
6900 N. MCCORMICK BLVD.
LINCOLNWOOD
(866) 670-1654
GROSSINGERCADILLAC.COM

HERITAGE CADILLAC
303 WEST ROOSEVELT RD.
LOMBARD
(630) 629-3300
HERITAGECADILLAC.COM

PATRICK CADILLAC
526 MALL DRIVE
SCHAUMBURG, IL 60173
(866) 614-2277
PATRICKCADILLAC.COM

RIZZA CADILLAC
8425 WEST 159TH STREET,
TINLEY PARK
(708) 429-6000
RIZZACARS.COM

SHEPARD CHEVROLET AND MEDIUM DUTY TRUCK CENTER
RTE 43 AT RTE 176, LAKE BLUFF
(847) 234-7900

GURNEE DODGE
7255 GRANO AVE
(1 mile west of Gurnee Mills)
(847) 623-3000
GURNEEDODGE.COM

PAULY HONDA
1111 SOUTH MILWAUKEE AVE
LIBERTYVILLE
(866) 861-9716
WWW.PAULYHONDA.COM

PATRICK JAGUAR
1559 OXDEN AVE
NAPERVILLE, IL 60540
(866) 861-9716
PATRICKJAGUAR.COM

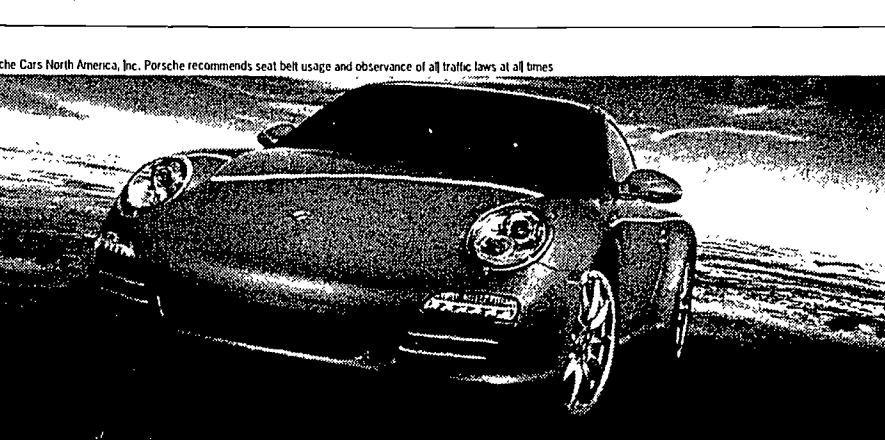

It gives. You take. It's the perfect relationship.

The new 911. Experience the reengineered legend.

Premier
Porsche Dealer
THE EXCHANGE
(847) 266-7000
2300 Skokie Valley Rd.
Highland Park, IL 60035
www.4porsche.com
Hours M - Th 9AM - 8PM, Fri 9AM - 6PM, Sa 9AM - 5PM

CHEVROLET
BILL STASEK CHEVROLET
700 W. DUNDEE RD, WHEELING
CORNER OF DUNDEE RD. AND RT. 63
(847) 537-7000
STASEKCHEVROLET.COM



Exploring the chaotic mind of the mental patient, Renfield (Allison Coppin), Dr. Seward (Michael Kratochvil), and Professor Van Helsing (MaryRose Moss) seek information to track down the mysterious Count Dracula.

'Dracula' gives bite to drama at Resurrection

Count Dracula (Christopher Zavacki) has more than just his eye on Lucy Westenra (Laura Behnke) in the Resurrection High School Drama Department's production of "Dracula."



Dracula (Christopher Zavacki) has a taste for Lucy Westenra (Megan Armstrong).

By WYNN KOEBEL FOSTER
wfooster@pioneerlocal.com

Just in time for Halloween last month, the Drama Department at Resurrection High School, 7500 W. Talcott Ave., Chicago, premiered "Dracula," written by John Mathera and directed by Kathie Foszcz. The show is a theatrical adaptation of the classic story of Count Dracula, with comic overtones. The cast included young women from Resurrection and young men from other local high schools.

Count Dracula (St. Patrick senior Christopher Zavacki) lives next door to an insane asylum run by the naive Dr. Peter Seward (St. Patrick junior Michael Kratochvil). Pro-

fessor Van Helsing (sophomore MaryRose Moss) tries to convince the doctor that Count Dracula is a vampire and the hospital staff, including Dr. Seward's aide (sophomore Angela Christides), are busy running the asylum and dealing with bug-eating lunatic Renfield (senior Allison Coppin).

Dracula has his blood-thirsty eye on young beauty Lucy Westenra (senior's Megan Armstrong and Laura Behnke) and on Lucy's friend, Mina Murray (senior's Ashley Beranek and Rachel Novak). Lucy is engaged to Jonathan Harker (Loyola Academy junior Kristofer VonAhnen), while Mina is engaged to Arthur Hallowood (Loyola Academy junior Greg Schamberger). The cast was

rounded out by Lucy's mother, Martha Westenra (senior Samantha Santos), Aunt Henrietta (senior Kathryn Karlin), the Westenras' maid, Charlotte (senior Margaret Morun) and servant Molly Garrity).

Adding to the terror, the cast also included a group of lovely vampires (seniors Claire Compall and Melissa Gonzalez; sophomores Michelle Klobukowski, Andrea Melvage, Gina Orlandi, Britney Rzyany and Maria Tyrell; and freshmen Ashley Bowers, Cassandra Jordan and Amanda Willner).

Performances were Oct. 29, Oct. 30, Nov. 1 and Nov. 2.

Comment: pioneerlocal.com



Torn up over defective T-shirts



STEPHANIE ZIMMERMANN

THE FIXER - Chicago Sun-Times

Dear Fixer: Monarchy Collection is a high-end clothing company that specializes in men's T-shirts. I've been a big fan of their clothes for a long time and have spent more than \$1,000 to \$2,000 on their clothing line. Their T-shirts are generally close to \$100 each.

I had an issue with two shirts a few months ago. One came apart at the stitching running along the side after just one wash and the other had a bad sew line along the neck. I contacted them, and Marian from their qual-

ity control called me and asked if I could send her the shirts. I told her I had thrown the ripped one away, but I overnighted her the shirt that had a bad neckline sew.

I never heard back from her, so I contacted them again and she said they were going to send me another shirt and a free shirt for the troubles. I received another e-mail from someone else in the company and they asked my size. I replied back the same day and never heard back again.

I tried contacting Marian again and she said she would look into it and make sure I get my shirt, but I never heard back.

So I'm out two shirts, and they have the one I sent them and won't even send that back, even if I wanted it.

I have the e-mails

from them if needed.

I really love their brand, but when you spend a premium for premium clothing, you expect the clothes to survive at least one wash.

Iman Jalali

Dear Iman: The Fixer prefers \$10 T-shirts, but after seeing Monarchy's cool A-list designs, we can see why you were smitten.

And at \$100 a pop, we can see why you expect a high-quality item.

The good news is, once we got your problem to the folks at Hart Marx, parent of Monarchy, this was fixed immediately. Everyone from the CEO on down wanted you to know they were on top of it. They offered their apologies, and overnighted you a package containing a pair of jeans, a hooded sweatshirt and three different shirts.

And now — we'll consider this fixed.

PEEK AT THE WEEK

DEADLINES

Submissions for Community Calendar are required 10 days preceding the date of publication. Send to: Niles Managing Editor, Pioneer Press, 3701 W. Lake Ave., Glenview IL 60026. Information may be faxed to (847) 486-7495 or e-mailed to mbottari@pioneerlocal.com.

AUDITION

The Chicago Rush will be holding auditions for the 2009 Adrenaline Rush Dancers Nov. 30 at the Stephens Convention Center in Rosemont. Registration begins at 8 a.m., and auditions start at 9 a.m. Arrive early and expect to spend the entire day auditioning. Semi-finalists will continue with mandatory training camp sessions from 7 p.m. to 10 p.m. Dec. 2 and 4 in preparation for the final round to be held Dec. 6 in front of a panel of

judges and special invited guests. Dancers participate in all home games, attend community events, take part in media interviews and promotional opportunities and attend photo shoots throughout the year. Dancers wishing to audition must submit a \$25 non-refundable registration fee, be able to commit to the squad for one year and be age 18 by Nov. 30. For more information and to pre-register, visit www.chicagorush.com or call (773) 243-3434.

BAKE SALES

Our Lady of Ransom Catholic Women's Club, Queen of Peace Guild, will hold its 36th annual Holiday Craft and Bake Sale the weekend of Nov. 15 to 16, in the newly renovated, elevator-accessible Paluch Hall, 8300 Greenwood Ave., Niles, between the hours of 8 a.m. to 6 p.m. Saturday and 8 a.m. to 2 p.m. Sunday. Stop by and see a vari-

ety of hand-made crafts, ornaments, wreaths, afghans, baby knit quilts, dolls, home decorations, jewelry and more. There will also be a grand raffle, bake sale, a turkey booth and Christmas stocking tree for added chances at beautiful gifts and items. Home-baked bread will also be for sale. Proceeds benefit the parish. For more information, call the Ministry Center (847) 823-2550.

BAZAAR

St. Haralambos Ladies Philoptochos Society will hold a Holly and Ivy Bazaar and Bake Sale from 9 a.m. to 9 p.m. Nov. 21 and 9 a.m. to 5 p.m. Nov. 22 at St. Haralambos Greek Orthodox Church, 7373 N. Caldwell Ave. Niles. Holiday bazaar, crafts, gifts, Greek pastries and coffee shop. Lunch served both days, dinner only on Friday. Visit with Santa from 10 a.m. to 5 p.m. Saturday. Call Sandy at (847) 647-8880.

Keep tips coming

Dear Readers: Thanks to everyone who's put a tip in The Fixer's Tip Jar at www.suntimes.com. The Tip Jar is your place to either give a tip to fellow readers or take a tip on saving money, avoiding a scam or fixing a problem.

Here are two recent tips we found in the jar:

From tag: "This is about a gift card scam. Last Christmas, I received an American Express gift card from my dad. I had checked the balance a couple of months before I tried to use it. I had about \$17 left. When I gave it to the cashier, I told her to apply this card to my balance and let me know the new total. I also told her I didn't remember how much was left on it.

"She supposedly swiped it and told me there was a zero balance on it. I was confused and thought maybe I made a purchase of \$17 and just forgot about it. I said 'OK, then I'll just write you a

check for the total amount.' She then said, 'Do you want me to just throw away the card?' Something told me to get the card back and call again about my balance.

"I did that when I came home and found I really did have \$17 left on the card. I wonder how many others tell them to just throw it away there at the store, and the cashier just keeps the cards."

And from Marianrose, who wrote about her granddaughter using a gift card in a store and being told (by a dishonest cashier) that it was all out of money: "The store manager sided with the cashier. My granddaughter made the mistake of not getting back the card. The next time it happened, at the same store, her mom was with her and had the receipt and got the card back this time. I think teenagers are more likely to be the victims, since they might not ask for the card back.

Now, whenever I buy a gift card for someone, I also give them the receipt."

Do you have a tip? Add it to the Tip Jar at www.suntimes.com. Click on "columns" and "The Fixer" and look for the Tip Jar.

Fixer live Web chat

So far, we haven't had any live, on-air melt-downs, but you never know! Join The Fixer at noon on Monday at www.suntimes.com for our weekly chat about consumer rip-offs and how to save money.

Getting the runaround about a consumer problem?

Tell it to The Fixer at www.pioneerlocal.com, where you'll find a simple form to fill out. If you don't have a computer, you can mail a brief description of your problem, your name, address and telephone number, to: The Fixer, 3701 W. Lake Ave., Glenview IL 60026. Letters are edited for length and clarity.

Comment: pioneerlocal.com

local families in the community at Thanksgiving for some time, this year it is a community effort. Since the need is greater, several Niles banks will be collection sites for food donations. Due to the economy, loss of jobs, homes, recent flooding in the area and soaring utility and food prices, the need for assistance in our community has escalated. Your help is needed. Through combined efforts as a community we can help brighten the holidays for families in our own area.

Meals and food will be donated to community area families as well as to area food pantries. Non-perishable food items, including: tuna, canned meats, stews, chili, oatmeal, pasta, pasta sauces (no glass items jars), etc. are needed. Your support can help make a positive difference in the lives of people coping with financial hardship. Every donation you make will go to help families with children in

need in the community.

Donations will be accepted from Oct. 13 through Nov. 21 at the following locations: Niles Fire Department, 8360 Dempster; Niles Family Fitness Center, 987 Civic Center Drive; Citibank, 8400 W. Dempster St.; First American Bank, 7747 N. Waukegan Road; First Bank, 8720 W. Dempster St.; Fifth Third Bank, 7100 W. Oakton St. and 5950 W. Touhy Ave.; MB Financial, 7757 W. Oakton St.; and PNA Bank, 7840 N. Milwaukee Ave. If you have any questions, contact Bernadette Knapik-Fish of the Niles Fire Department at (847) 588-6800.

Help chase away the blues for sick children by attending "Changing the World Together," an estate tour of the ultimate green home located at 6N558 Kim Lane in St. Charles, the proceeds of which will benefit Advocate Lutheran

Peek, PAGE 70

Digital

Continued from PAGE 23

a regional College Bowl tournament in December.

College Bowl is an inter-collegiate academic quiz competition that challenges participants in their knowledge of current events, history, math, geography, sports and literature.

For more information contact Gary Newhouse, (847) 635-1640, garyn@oakton.edu, or Ann Marie Barry, (847) 635-1699, annmarie@oakton.edu.



Enroll in single-session continuing-education courses offered by the Alliance for Lifelong Learning at Oakton.

Step up to the New Technologies (DAT E05-01) provides information on how to make use of iPods, MP3 players, digital scrapbooking and the wireless Internet. The session will meet 6:30-8:30 p.m. Nov. 18 at the Des Plaines campus, 1600 E. Golf Road. The fee is \$19.

Impressionism: The Hand and Glove of Debussy and Monet (MUS S42-01) explores the influence of

Impressionistic art on Claude Debussy. The course will meet 7:30-9 p.m. Nov. 18 at Glenbrook South High School, 4000 W. Lake Ave., Glenview. The fee is \$20.

Avoiding Winter Accidents (MED I06-01) offers safety tips on how to protect against frostbite, hypothermia and other outdoor injuries. The course meets 7-8:30 p.m. Nov. 19 at Maine West High School, 1755 S. Wolf Road, Des Plaines. The fee is \$5.

Instant Piano for Hopelessly Busy People (MUS S01-01) demonstrates how

those with little or no musical experience can learn to play the piano in just three hours. The course meets 6:30-9 p.m. Nov. 20 at the Des Plaines campus. The fee is \$30. (Anyone interested in this workshop may request a free pamphlet by sending a self-addressed, stamped envelope to: Innovative Keyboard Instruction, 1019 N. Plymouth Court, Gilbert AZ 85234.)

Other courses include Floral Design Workshop (ART D33-02), Carpal Tunnel and Work Station Ergonomics (MED I04-01) and Memory Assessment (MED I08-01).

For a complete Alliance for Lifelong Learning class schedule go to www.oakton.edu/all, or call (847) 982-9888, and press 3.

The Chicago Writers Series at Oakton Community College will welcome National Book Critics Circle Award finalist Aleksandar Hemon at 2 p.m. Nov. 12 at the Des Plaines campus, 1600 E. Golf Road.

Hemon, a native of Sarajevo, the largest urban center in Bosnia and Herzegovina, will showcase his current novel, *The Lazarus Project*, which centers on

the murder of a young Jewish immigrant. Hemon is the winner of the 2008 Chicago Tribune Heartland Award in fiction, and recipient of a 2004 MacArthur "Genius" Grant and a 2008 Guggenheim Fellowship.

This event is free and open to the public. Refreshments will be served.

This program is funded by Oakton Student Activities and the Oakton Educational Foundation.

For more information about the Chicago Writers Series, contact Lynn Woodbury, (847) 635-1953, woodbury@oakton.edu.

Campus

Continued from PAGE 22

English from Monmouth College.

Elizabeth Fallucco, Kathryn Fallucco and Emily Nufer, all of Niles, made the dean's list at Drake University during the spring term.

Kristen M. Grelf, of Niles, received recognition on the dean's list for the spring semester at Bradley University.

Nicole L. Vanacora, of Niles, made the dean's list for the spring term at the University of Wisconsin-Whitewater.

Andrew Bishop, of Niles, placed on the dean's list at

Clarke College for the spring term.

Excelsior College

Rebecca S. Choi, a Niles resident, has earned a Bachelor of Science from Excelsior College.

Excelsior College (www.excelsior.edu) is a private, nonprofit institution of higher learning.

Founded in 1971 and located in Albany, N.Y., Excelsior is one of the nation's oldest distance learning and online colleges. It is accredited by the Commission on Higher Education of the Middle States Association of Colleges and Schools.

National-Louis University

Dorothy Gawne, of Niles,

earned a Master of Education degree in reading from National-Louis University's National College of Education, in Chicago. Graduation was in March 2008.

National-Louis University, founded in 1886, has grown from being the National College of Education to a university that includes fields of study in the

College of Arts and Sciences and the College of Management and Business. The university offers 60 degree programs targeted at both traditional-aged students and working adults. National-Louis serves more than 13,000 undergraduate and graduate students annually on eight campuses across the United States and a site in Poland.

NorthSide Community Bank
The Very Best in Banking

Safe. Secure.

NorthSide Community Bank is safe and secure. We are focused on doing what is best for our customers and communities.

Your Community Bank. Safe and Secure.

These are challenging times. There is turmoil and uncertainty about our nation's economy. And in challenging times, consumers need to stick with the tried and true and the institutions that have served them well.

CERTIFICATE OF DEPOSITS

6-9 MONTHS **3.42% APY***

12-15 MONTHS **4.15% APY***

Proud member of

\$5,000 MINIMUM DEPOSIT

Gurnee
5103 Washington Street
847-244-5100

Riverwoods
1155 Milwaukee Avenue
847-279-1155

Mundelein
800 North Route 93
847-837-8883

Niles
3060 Oakton Street
847-692-7500

Chicago
205 West Madison
312-781-0670

www.nscombank.com

*Interest on the certificate is compounded on a monthly basis. The advertised APY is accurate as of 11/4/08. The minimum annual percentage yield (APY) assumes that interest will remain on deposit. Free or low-drawals will reduce earnings. A substantial penalty for early withdrawal for your certificate may apply. Minimum deposit of \$5,000. Rates subject to change without notice.

The world must remember. We must never forget.

Kristallnacht

November 9 to 10, 1938
Night of Broken Glass

70 years ago, throughout Germany and Austria, the Nazis unleashed a wave of terror against the people of the Jewish faith.

Thousands of Jewish homes, businesses and places of worship were burned and destroyed.

30,000 Jewish people were forced into concentration camps, countless others were beaten or killed.

This remembrance is made possible by a gift from the Al Gruen Philanthropic Fund at the Jewish United Fund / Jewish Federation of Metropolitan Chicago

THINGS TO DO

FEEL GOOD, LOOK GREAT LIVE LONGER!

24 Months

NO DOWN PAYMENT INTEREST*

TREADMILLS

SEATED ELLIPTICALS

VIBRATION

HOME GYMS

ELLIPTICALS

BIKES

	monday-friday 10-9	saturday 10-5	sunday 12-5
Addison	630.438.5166	Naperville	630.369.9705
Algonquin	847.854.5390	Northbrook	847.205.4388
Bolingbrook	630.771.1866	Orland Park	708.226.1364
Crystal Lake	815.455.7137	Plainfield Center	630.922.3041
Downers Grove	630.953.8490	Rockford	815.633.7630
Geneva	630.262.3673	Schaumburg	847.995.0737
Glenview	847.904.7140	Skokie	847.673.2071
Kenosha, WI	262.697.6001	South Elgin	847.214.8570
Lake Zurich	847.550.1020	Tinley Park	708.444.4270
Lincoln Park	773.477.7216	Vernon Hills	847.549.7306
Merrillville, IN	219.736.9465	Westmont	630.789.0691
Mishawaka, IN	574.277.2086	Wheeling	847.808.6031
Mokena	708.478.6593		

TRADES ALWAYS WELCOME • WE BUY GENTLY USED GEAR

www.2ndwind.net

*With approved credit, some restrictions apply. See store for details.

Peek

Continued from PAGE 67

General's Midwest Children's Brain Tumor Center and other special pediatric programs in Park Ridge. Scheduled for Nov. 8 from noon to 7 p.m., the estate tour will include several highlights for attendees including an appearance by Dan Hampton between noon and 2:30 p.m. and an "ultimate green" expo hosted by builder Robert Lord

and his team of environmental vendors, set for 2:30 to 5 p.m. Lord will highlight features of his one-of-a-kind, eco-friendly residence, which is designed to yield astounding energy savings as well as pamper occupants with lavish appointments and high-end amenities. Additionally, the hospital's engineering team will discuss its new "green" patient tower — the first of its kind in Illinois. An organic wine tasting is slated for 5 to 7 p.m.; attendees can

sample a variety of organic wines, learn the fundamentals of wine-tasting and hear from experts that makes a wine organic. A silent auction of valuable items will be conducted between noon and 6:30 p.m. Admission is \$15 in advance or \$20 at the door. To register and purchase tickets, visit www.RobertLord-Builders.com.

Maine South Mothers' Scholarship Club will sponsor its fall benefit, "... And the Winner Is ... Scholar-

ships," from 7-10 p.m. Nov. 6 at Park Ridge Country Club. The event will include an appetizer and dessert buffet, and raffle prizes. Tickets are \$25, and are available by calling Nadine Sir, (847) 696-2645. This is the first of two yearly fundraisers. In 2007-08 the club awarded \$34,000 in scholarships to Maine South High School seniors.

HOPE Fair Housing Center is celebrating its 40th anniversary with a benefit dinner Nov. 6 at Hyatt Lisle

Hotel in Lisle. The fair-housing center promotes equal housing, lending and home insurance opportunities. The featured speaker will be Shanna L. Smith, president and chief executive officer of the National Fair Housing Alliance. Tickets are \$60. To order tickets contact HOPE, (630) 690-6500, ext. 3.

Entertainment Books are available from the Knights of Columbus Council 4338. The 2009 edition costs \$20 and contains many

coupons. For more information, or to reserve a book, call Bob Galassi, (847) 965-0920. Proceeds go to area charities.

St. John Brebeuf's Inaugural Ball 2008 will be at 6 p.m. Nov. 8 in the St. John Brebeuf Parish Ministry Center, 8305 N. Harlem Ave. The committee is looking for donations of goods and services from businesses and community members, and takers of ads for

Peek, PAGE 74

Safe.
Secure.
Stable.

HIGH-YIELD SAVINGS 3.25% APY
6-MONTH CD 3.75% APY

Since our founding in 1871, we've always believed in conservative, careful business practices. After all, we know that it isn't just our money that's at stake, it's yours. But you don't have to take our word for it. Your deposits are insured by the Federal Deposit Insurance Corporation an additional \$150,000 per depositor - to at least \$250,000 - until December 31, 2009. And our bank ratings are some of the strongest among financial institutions. Now more than ever, you need a bank you can count on and we're here to help. If you have any questions about your money, please stop by a branch, call 1-877-TOP-RATE or visit charterone.com

OUR CREDIT RATINGS
S&P A+
MOODY'S Aa3
FITCH DEPOSIT RATING AA

Charter One

Member FDIC. All accounts subject to individual approval. See a banker for details and deposit insurance limitations. Offers valid in IL only. CD Annual Percentage Yield (APY) is accurate as of this publication date. 3.75% APY applies to the 6-month term. Limited-time offer may be withdrawn at any time. This offer cannot be combined with any other CD offer. Circle Gold Checking account with \$100 minimum opening deposit is required. Other rates and terms available. Minimum opening term deposit \$1,000. Penalty for early withdrawal: HVIS: Account cannot be accessed using an ATM or Debit Card. \$10,000 minimum opening deposit is required. Personal accounts only. \$5,000,000 maximum deposit per customer. Minimum transaction amount of \$10,000 for withdrawals. Nonqualifying transaction fee of \$25 each for any withdrawal under \$10,000 in a statement period. High Yield Savings account APY based on collected balances for new personal accounts: 3.25% APY for balances of \$50,000 or greater, 2.75% APY for balances of \$10,000 to \$49,999, 1.00% APY for balances up to \$9,999. Fees may reduce earnings. APYs accurate as of this publication date and may change before or after account opening. Charter One is a division of FBS Citizens, N.A.

Quality, Value & Service In Any Language

Produce World

INTERNATIONAL MARKET • DELI • BAKERY • MEATS • SEAFOOD

Produce			
Florida Grapefruit 49¢ LB.	Stem Tomatoes \$1.29 LB.	Sweet Cantalopes 3 LBS. for \$1	
RED SEEDLESS GRAPES 88¢ LB.	TEXAS LOOSE BEETS 29¢ LB.	"A" SIZE RED POTATOES 33¢ LB.	
MEAT			
Grade "A" Fresh Whole Chicken 99¢ LB.	Lean & Tender Boneless Pork Chops \$2.49 LB.	U.S.D.A. Choice Boneless Pot Roast \$2.49 LB.	U.S.D.A. Choice Veal Roast \$3.49 LB.
Deli			
Boar's Head Oven Roasted Turkey \$4.99 LB.	Kretschmar Smoked Ham \$2.99 LB.	Domestic Swiss Cheese \$3.99 LB.	Eckrich Hard Salami \$3.49 LB.
DAIRY			
DEAN'S SKIM MILK \$2.39 Ea. Gal.	DEAN'S COTTAGE CHEESE 2 for \$4 Ea. 24 Oz.	DEAN'S HALF & HALF 89¢ Ea. Pint	
GROCERIES			
Ceresota All Purpose Flour \$2.99 Ea. 5 Lb.	Sunny Hill Honey \$2.99 Ea. 1 Lb.	Motts Apple Sauce \$1.89 Ea. 25 Oz.	Liguria Assorted Tomatoes \$1.09 Ea. 28 Oz.
Grey Poupon Dizon Or Country Mustard \$2.59 Ea. 8 Oz.	Assorted Polar Sardines 79¢ Ea. 4.5 Oz.	Knossos Extra Virgin Olive Oil \$21.99 Ea. 3 Lt.	

8800 WAUKEGAN RD. MORTON GROVE, IL.
CORNER OF WAUKEGAN & DEMPSTER HOURS: MON-FRI 8-9 SAT 8-8 SUN 8-7
847-581-1029
SALE DATES: NOVEMBER 6TH - NOVEMBER 12TH

Food

HUNGRY FOR MORE? Find more recipes on the Web www.pioneerlocal.com.

FOR GOOD HEALTH,
♥ PUT
HEART IN
YOUR COOKING

BY CHRISTINE A. VERSTRAETE
Contributor

Too often, people think that developing heart disease dooms them to a life of boring, tasteless food.

North Shore cardiologists Dr. Micah Eimer and Dr. Irwin Silverman challenge that notion by teaming up again with Chef Dawn Dlugosz of "A New Dawn Cooking School" which meets in Whole Foods Market, North-

brook, for a heart healthy cooking class in the grocery store's classroom.

"Cardiologists are real good at dispensing medications, but when we tell someone to eat better, to eat healthier, no one knows what that means," said Eimer, of Cardiovascular Associates of Glenbrook and Evanston (CAGE). "We thought this would be a really good way to show what we mean."

The "Cooking with CAGE: A Healthy Thanks-



Bonnie Kastin, nutritionist, and Dr. Micah J. Eimer confer as Chef Dawn Dlugosz, right, adds a bit of sage to the top of her grilled sweet potato salad.

giving" class will be held at Nov. 13 at the Whole Lifestyle Center in Northbrook's Whole Foods Market. Up first on the 1 1/2-hour class menu is tour around the store with one of the doctors.

The prescription? Making better food choices.

Healthy differences

"For example, we'll stop by the olive oil and talk about the benefits of extra virgin versus regular olive oil," said Eimer.

Getting fresh

"We'll be using a lot of olive oil instead of butter, and introducing a lot more whole grains and fiber," said Dlugosz. "It's a better idea to use fresh ingredients and whole products instead of food being prepared with a lot of preservatives."

Suggestions include using heart-friendly olive oil instead of butter in the potatoes. "Garlic adds the flavor," she said. Sweet potatoes can get healthier, too, enhanced with a light salad vinaigrette instead

Cooking for health

• "Cooking with CAGE: A Healthy Thanksgiving" takes place at 6:30 p.m., Nov. 13 at the Whole Lifestyle Center, Whole Foods Market, 840 Willow Road, Northbrook. Cost is \$30 per person. To register, call Jill Bass at Cardiovascular Associates of Glenbrook and Evanston, (847) 901-5240.

• A New Dawn Cooking School in Whole Foods Market, Northbrook offers two other classes on healthful eating. "Superfoods to the Rescue!" noon to 1:30 p.m. Nov. 17, features ways to use foods that contain powerful nutrients that may improve physical and mental health. The class includes demonstrations and tasting. Cost is \$30, registration required. "Lighten Up: Thanksgiving Favorites," 7 p.m. on Nov. 19 will present tips and tricks for fighting the battle of the holiday bulge and creating a healthful holiday meal. The evening includes demonstrations and a full meal. Cost is \$35, registration required. For more information, call (847) 205-5353.

of being buried in marshmallows or brown sugar. A lighter, tastier way to roast a turkey breast is to tuck a sautéed apple-sage mixture under the skin for extra flavor. "You get the flavor to go all the way through the breast," Dlugosz said. "If you add a lot of fresh, flavorful ingredients you don't need all that fat and can take the skin off."

Comment: pioneerlocal.com

Grilled Sweet Potato Salad with Honey-Balsamic Vinaigrette

4 large sweet potatoes
2 T olive oil
1/8 tsp. kosher salt
Pepper to taste.

Honey-Balsamic Vinaigrette

1/4 C balsamic vinegar
1 T Giovanni Isola Cream of Balsamic (a flavored, thick balsamic reduction.)
1 T honey
1/2 C olive oil
2 tsp. Dijon mustard
1/8 tsp. kosher salt
Pepper to taste.

Place potatoes in a large pot and cover with cold water. Bring to a boil and cook until tender but still firm, about 15 minutes. Let cool and cut into 1/2-inch slices.

Heat a cast iron grill pan or outdoor grill over high heat until very hot.

Drizzle sliced potatoes with olive oil and sprinkle with salt and pepper. Grill the potatoes until browned, about 2-3 minutes per side.

Whisk together all vinaigrette ingredients except olive oil. While continuously whisking, slowly stream in the olive oil until combined.

Toss grilled sweet potatoes with vinaigrette while still warm. Serve salad warm or at room temperature. Makes 8 servings.



Weekly Worship

CHICAGO

Edison Park United Methodist Church
6740 North Oliphant Avenue
Chicago IL, 60631
Phone: (773) 792-3030
Fax: (773) 792-3031
www.edisonparkumc.com
Email: pastor@edisonparkumc.com
Worship Days & Hours
Sundays, 10:30 a.m. Potluck, 11:30 a.m.
Sunday School for Preschoolers & Nursery Age
Bible Study, Thursdays, 10:30 a.m. & Fridays, 7:00 p.m.
Youth (High School) Bible Study, Sunday 1:00 p.m.
Young Adults Bible Study, Sunday, 12:00 p.m.
Choir Practice: Sundays, 9:30 a.m.
Susannah Wesley Club (Women's Group)
Meets once a month on 4th Tuesday of the month
Youth Worship Sunday, 3rd Sunday of every month
Pastor, Rev. Jerry Miller
Organist, Dana Samson
Musical/Youth Director, Noralyn Baroja
Senior Exercise Class, Tuesdays & Thursdays 8:30 a.m.
Fellowship Hall
James Downing Theatre Performances
Edison Park United Methodist Church is a church with Open Hearts, Open Minds, Open Doors.
Chair Lift Available
Parking in Rear
The Edgebrook Church
6155 W. Touhy Avenue, (773) 631-1155
http://edgebrookchurch.org
Sunday Worship 10:30 am
Ensemble Practice, Wednesday 6:30 pm
Praise, Prayer & Bible Study Wednesday 7:30 pm
Pastor Phil Ostwald
Bethel Community Church
7601 W. Foster Ave.
(773) 775-2355
www.bethelcommunity.org
Sunday Worship 8:30 & 11:00 am
Encounter Gathering, Sunday 6:00 pm
Sunday School & Adult Bible Study - 9:45 am

CHICAGO

Senior Pastor - Pastor Paul Jordan
Associate Pastor - Pastor Rob Bukowski
Student Ministries - Pastor Shawna Clarke
Music & Worship - Pastor Andy Clifton
Childcare available for all services.
Seniors & Women's Bible
Studies - September thru May - call for information or see the website.
Norwood Park Lutheran Church - ELCA
5917 N. Nina Avenue (at Nickerson)
(773) 631-2860
Sunday Services - 10:00 am
Holy Communion celebrated 1st, 3rd & 5th Sundays
Service of the Word on 2nd & 4th Sundays
Sunday Church School - 9:00 am (with Confirmation Ministry)
Unstaffed Nursery available Sunday from 9:45 - 11:00 am
Rev. Robert C. Johnson, Pastor
Joyce M. Kissenger, Director of Music
Children's Sermons 2nd Sunday of the Month
"Celebrating God's grace and mercy for over 86 years in old Norwood Park"
Our Lady Mother of the Church
8701 W. Lawrence Avenue, (773) 625-3369
www.ourladymotherchurch.com
olmotherchurch@aol.com
Mass Schedule:
Weekdays Monday through Friday 8:30 am
Saturday 5:00 pm
Sunday 8:00, 9:30 & 11 am
Sunday 11:00 am Young People's Liturgy of the Word - Holy Days 8:30 am & 7:00 pm
Tuesday 9:00 am Perpetual Help Novena
Eucharistic Adoration
First Fridays 9:00 am - 3:00 pm
Saturday Confession 4:00 - 4:30 pm
Baptism 2nd & 4th Sundays of the Month
Rev. Richard J. Klajbor, Pastor
Our Savior Lutheran Church - Norwood Park LCMS
6099 N. Northcott Ave.
at Nickerson & Hood Avenues
(773) 631-1100 & (773) 631-1606
www.oslc3@sbcglobal.net
Sunday Worship 9:00 am
Sunday School and Adult Bible

CHICAGO

Study 10:30 am
Wednesday Worship Chapel Service at Norwood Crossing at 2:00 pm
6016 N. Nina Avenue, Chicago, IL 60631
Advent & Lenten Worship
Services - Wednesday at 7:00 pm
Rev. Peter Berg
St. Eugene Catholic Church
7958 W. Foster Ave. • (773) 775-6659
www.st-eugene.org
Daily Masses: Mon thru Fri - 6:30 & 9:00 am
Weekend Masses: Sat - 8:30 am & 5:30 pm, Sun - 7:00, 9:30, 11:30 am & 4:30 pm
Confession: 4:00 - 5:00 pm Sat
Baptism: 1:00 pm 1st & 3rd Sunday of the month
Rev. George Koenne, Pastor;
Rev. Jerome Twarog, Associate Pastor;
Rev. Philip Grib, SJ, Resident
St. James Lutheran Church
7400 W. Foster Avenue,
(773) 631-7666
www.stjamesonfoster.org
Sunday Morning Worship - 10:00 am
Call Church for Dates & Times for the Following Activities:
Jazzercise, Weight Watchers, Choir
Line Dancing, A. A. Meetings,
Girl Scouts
Pastor Susan Schneider
St. Mary of the Woods Catholic Church
7033 N. Moselle, (773) 763-0206
www.smow.org
Saturday Vigil Mass 4:30 pm
Sunday Masses: 7:30, 9:00, 10:30 am and noon
Weekday Masses Mon - Fri 6:30 and 8:00 am,
Confession Saturday 3:30 - 4:15 pm Holy Days Vigil 7:30 pm
Holy Days 6:30, 8:00, 9:00 am and 7:30 pm
Rev. Gregory Sackowicz, Pastor
We have a Preschool (3 yrs. Old) through 8th Grade School And offer wonderful programs of Religious Education for Children and adults.
St. Monica Catholic Church
5136 N. Nothingham, (773) 763-1661
www.stmonica-chicago.com
Daily Mass: Mon - Fri 8:00 am
Weekend Masses: Saturday - 4:00 pm

CHICAGO

Sunday - 7:30, 9:00, 10:30 am, and 12:00 pm
Polish Liturgy Mass: Sunday - 1:30 pm
Confessions: Saturday - 3:00 to 3:45 pm
Baptism: 1st Saturday and 3rd Sunday of the Month
Rev. Ted Schmitt, Pastor
Rev. Andrew Izak, Associate Pastor
Fr. James O'Brien, In Residence
Fr. William Holbrook, In Residence
contactparish@stmonica-chicago.com
St. Paul Lutheran Church
5650 N. Canfield, 60631
708-867-5044
Rev. Walt Schoenfeldts
www.stpaulcanfield.org
Street Level, Air Conditioned
Sunday Worship 8:15 & 10:45 am
Sunday School & Adult Bible 9:30 am
Saturday Worship 6:00 pm
St. Paul Lutheran Christian Day School
Pre-K - Grade 8
SHARING GOD, TOUCHING LIVES, EVERYWHERE
Victory Worship Center
3750 N. Neva, (773) 205-3787
www.victoryworshiponline.com
Sunday Morning Worship 11:00 am
Wednesday Bible Study 7:00 pm
Friday Worship 7:30 pm
Youth Service Friday 7:30 pm
Christopher Lewis, Pastor
Rev. Ramona Dorsey
Windy City Community Church
6131 N. Newark Avenue,
(773) 631-WCCC (9222)
www.windycitycommunitychurch.org
Sunday 10:00 am Worship Service
Adult Sunday School 9:00 am
Children's Sunday School 10:00 am
Many Ministry Groups for all Ages
Senior Pastor Steve Story
Church Email - wcccchgo@ameritech.net

DES PLAINES

Holy Day Masses: 7:00 & 9:00 am, 7:00 pm
Confessions: Saturday 4:00 - 4:30 pm
Rev. Gerald Rogala, Pastor
Rev. Flavio Gonzalez, Associate Pastor
Trinity Lutheran Church
A Reconciling in Christ Congregation Of the Evangelical Lutheran Church in America
675 E. Algonquin Road (At Wolf Road)
847-827-6656
www.trinitydesplaines.org
Email: trinityldp@ameritech.net
"In response to the love of Christ, all are welcome here."
Saturday Contemporary Worship 5:30 pm
Sunday worship 8:00 and 10:30 am
Childcare provided during Sunday worship.
Sunday Adult Education 9:15 am
Sunday School 10:30 am
Wednesday Trinity Activity Night offers Education, choirs and fellowship for all ages.
(please call for more information)
George M. Schelter, Senior Pastor
Leslie Williamson, Associate Pastor
Douglas S. Williams, Minister of Music
Cathy Williams, Sunday School Director

MORTON GROVE

St. Luke's Christian Community Church
9233 Shermer Rd. (847) 966-9233
Sunday Worship - 10:00 am
Sunday School 11:00 am
Sunday Teen Praise Band Rehearsal 11:00 am
Choir Rehearsal Wednesday 7:30 pm
Youth Group Friday 8:00 pm
Praise Service Last Sunday of each month
Featuring our Praise Band
Pastor Gordon Smith
DES PLAINES
St. Stephen Protomartyr Church
1280 Prospect (847) 824-2026
Hispanic Number (847) 824-7526
www.ststephen-desplaines.org
Daily Mass - 8:00 am
Saturday Masses: 9:00 am & 5:00 pm
Sunday Masses: 8:30 & 10:30 am, 6:00 pm Spanish Mass

To List your congregation please call Andrea Shumate at 847-486-7252. Changes can be faxed to her at 847-486-7456 or ashumate@pioneerlocal.com.

Weekly Worship

NILES

Lutheran Church of the Resurrection
8450 N. Shermer Rd.
Niles IL, 60714
(847) 965-8210
Sunday (Sept.-June) 10:30 (June-Sept) 9:30 a.m.
1st Sunday of Month: 7:30 p.m. - Jazz Vesper Service (Sept.-June)
Rev. Dr. Bruce T. Anderson - Pastor
Carolyn N. Sanderson - Minister of Music
A member congregation of the Evangelical Lutheran Church in America
St. Michael's Orthodox Church
7313 N. Waukegan Road, (847) 647-8398
www.stmichaelsniles.org
Sunday Worship 10:00 am
Discover the ancient faith and rich traditions of the Orthodox Church - the first Christian Church - founded By the Lord Jesus Christ and described in the pages of The New Testament. Today her Apostolic doctrine, worship, and structure remain intact.
PARK RIDGE
First Baptist Church of Park Ridge
1266 N. Northwest Highway
(Corner Potter Rd. and Northwest Hwy)
(847) 692-6101
http://fbcc.park-ridge.il.us/
Sunday Worship 11:00 am
(Childcare provided)
Sunday School 9:45 am
Wednesday Night Prayer Meeting & Bible Study 7:00 pm
Rev. Matthew K. Weber
First Church of Christ, Scientist
330 Touhy Ave. (847) 823-3329
Sunday Service 10:30 am
Wednesday Testimonial Meeting 7:30 pm
Sunday School 10:30 pm
Christian Science Reading Room, 13 N. Prospect Ave. in Park Ridge
Hours: Tues - Fri 10:00 am - 4:00 pm, Sat 10:00 am - 1:00 pm
St. Andrew's Lutheran Church & School
260 N. Northwest Highway
(847) 823-6656
www.standrewsparkridge.org
Sunday Worship: September through May 8:30 & 11:00 am, June - August 9:00 am
Contemporary Worship: Saturday 5:00 pm
Vespers: Monday 7:30 pm
Sunday School & Adult 9:45 am (September thru May)
Christian Day School - Pre-Kindergarten thru 8th Grade

PARK RIDGE

St. Luke's Lutheran Church (ELCA)
A Reconciling in Christ Congregation
205 N. Prospect Ave. (847) 825-6659
www.stlukespr.org
Email: office@stlukespr.org
Sunday Worship: 8:30 & 11:00 am (School Year), 8:30 & 10:00 am (Summer)
Thursday Worship (Summer) 7:00 pm
Sunday - Christian Education for all ages 9:45 am (School Year) Child Care Provided
Rev. Dr. Stephen M. Larson, Lead Pastor
Rev. Kristina C. Weber, Associate Pastor
Rev. Dr. Malcolm Minnick, Jr., Pastor Emeritus, Anne Krentz Organ, Director of Music Ministries Melinda Ramseth Holland, Director of Children's Choirs, Nancy Olson, Member Care Coordinator
St. Mary's Episcopal Church
306 S. Prospect Ave. (847) 823-4126
www.stmaryspr.org
Sunday Services: 8:00 & 10:00 am
Wednesday Service: 9:00 am
Sunday School & Nursery during worship, Youth Fellowship
The Rev. Sarah D. Odderston, Rector
The Rev. Amity Carruba, Curate
WHERE ALL ARE WELCOME!
Check website for all activities.
Handicap Accessible
Park Ridge Presbyterian Church
1300 W. Crescent Ave., (847) 823-4135
www.parkridgepresby.org
Sunday Worship 10:30 am
Nursery care during service
Children's Programming for Ages 3 - High School
Adult Education 9:15 am
Rev. James P. McCracken

ROSEMONT

Our Lady of Hope
9711 W. Devon Avenue, (847) 825-HOPE (4673)
www.ourladyofhopechurch.com
Rev. John Clemens, Pastor
Saturday Mass 5:00 pm
Sunday Masses 8:00, 9:30, 11:00 am
Weekday Mass 8:30 am
Eucharistic Services M-F 12:10 pm
Confession Saturday 4-4:40 pm
Holy Days 8 am, 12:10 and 7:00 pm
Little People's Church ages 3-5,
First three Sundays/mo. 10:45 am-noon
Sacramental Programs also offered
SKOKIE
Carter-Westminster United Presbyterian Church
4950 W. Pratt, (847) 673-4441
www.cwupc.net
Sunday Morning Worship Schedule:
9:00 Contemporary Service
10:00 Sunday School (for all ages)
11:00 Traditional Service
12:00 Fellowship Hour
Michael Scott Porter, Senior Pastor
Alex Wickell, Director of Youth Ministries
Office Hours: Mon., Tues. & Thurs. 8:30 am to 4:30 pm
Temple Beth Israel
3601 W. Dempster St.
847-675-0951
www.tbiskokie.org
Likrat Shabbat/Kabbalat Shabbat, first Friday of each month, 5:30 p.m.
Light Nosh - 6:15 pm. Kabbalat Shabbat service Shabbat Service Fridays 8:15 p.m.
Shabbat Service Saturdays 10:30 a.m.
Shabbat Katan, third Saturday of each month, 10:00 a.m. for families with children under the age of five.
Morning Minyan Monday - Friday 7:30 a.m.
Religious School Pre-K - 7th Grade Sundays 9:00 a.m. - 11:00 a.m.
Hebrew School Grades 3-7 Sundays 11:30 a.m. - 12:10 p.m. and Wednesdays 4:15 p.m. - 6:00 p.m.
Youth Groups Adult Education
Koleynu - Volunteer Choir
High Holiday Services
Rabbi Michael A. Weinberg Cantor Pavel Roytman
Lori B. Sagarin Director of Congregational Learning
St. Paul Lutheran Church
5201 Galitz Street, (847) 673-5030
web.nac.com/stpaulskokie
Sunday Morning Worship 10:00 am
Saturday Evening Worship 5:00 pm
Fellowship Hour, Sundays 8:45 - 9:45 am

SKOKIE

Sunday School & Bible Study Class, Sundays 9:00 - 9:45 am
Rev. Peter A. Zadeik, Jr. Vacancy Pastor
John Schman, Minister of Music
Dale Luksha, PK - 8 Academy Principal
The Church is Handicap Accessible
Variety of Worship Formats, Small Group Ministry
Adult Choir & Handbell Choir
St. Peter's United Church of Christ
Oakton Street & Laramie Avenue,
(847) 673-8166
www.stpeterusskokie.org
Sunday Worship 10:00 am Sunday School 9:00 am (September thru May)
Rev. Richard Lanford Childcare provided.
Air Conditioned Sanctuary
Congregation Bene Shalom
4435 Oakton, (847) 677-3330
www.beneshalom.org
Fridays 7:30 pm; Kabbalat Shabbat 6:30 pm on 3rd Friday of the month
Kabbalistic Prayer/Meditation Service 10:30 am On 2nd Saturday of the month
Special Kabbalistic Meditation Service Sunday, August 31st, 10:00 pm
Esther Knapp Religious School
Sundays 9:00 am - 12:00 pm
Hebrew School Sunday 12:00 - 1:00 pm
Thursday 4:00 - 5:00 pm
Rabbi Dr. Douglas Goldhamer
Asst. Rabbi Shari Chen
Cantorial Soloist Charlene Brooks
Choir Director Nona Balk
Interfaith Families Welcome
All services sign language
Check our website for Adult Education classes
And High Holiday Schedule
Handicap Accessible
Devar Emet Messianic Synagogue
7800 Niles Avenue, (847) 674-9146
www.devaremet.org
Saturday 10:00 am Shabbat Morning Services
Wednesday 7:00 pm Midweek Religious Studies for Adults and Youth
Wednesday 6:30 pm Club Maccabee
Children's Club
For K-5th Graders at Devonshire School in Skokie
Rabbi Kirk Gliebe
Devar Emet Messianic Synagogue is a community of Jesus who believe and teach that Yeshua (Jesus) is the Promised Jewish Messiah.

SKOKIE

Temple Judea Mizpah
8610 Niles Center Road,
(847) 676-1566
www.templejm.org
Friday 8:00 pm
Second Friday of the Month 7:00 pm
Family Shabbat
Religious School Grades K-7
Sunday 9:30 am - 12:00 pm
Hebrew School Grades 3 - 7
Tuesday 4:15 - 5:15 pm
Religious School Grades 8 - 12
Sunday 11:45 am - 1:15 pm
Religious School PreK
Two Sundays a month 10:15 am
Rabbi Amy L. Memis-Foler
Cantorial Intern Beryl Bellows
Sally Gold - Education Director
Terry J. Kane - Executive Director
Adult Education Multi-faith
Families Welcome
Community Theater
High Holiday & Festival
St. Timothy Lutheran Church
9000 N. Kildare, (847) 676-1300
www.sttimothyskokie.com
Sunday Worship 10:30 am
Choir Practice, Thursday 7:30 pm
Bible Study, Monday 10:00 am
Youth Christian Education 3rd Sunday at 10:30 am
Rev. Erik Weber
Birthdays Sunday 3rd Sunday of each month
Accessible Building

To List your congregation please call Andrea Shumate at 847-486-7252. Changes can be faxed to her at 847-486-7456 or Email: ashumate@pioneerlocal.com.

Peek

Continued from PAGE 70

its Gala Ad and Sponsor Book. Anyone interested in donating items is asked to call Michael Moore, (847) 967-1306; anyone interested in placing an ad is asked to call Jerry Cichon, (847) 366-5449. Proceeds will benefit St. John Brebeuf School.

CENTER OF CONCERN

The Center of Concern, 1580 N. Northwest Highway, Suite 310, Park Ridge, (847) 823-0453. Calendar of events includes:

(The center will be closed Nov. 27, 28, and 29 for Thanksgiving.)

Every Tuesday, Wednesday and Thursday - Employment counseling, by appointment.

Monday, Nov. 10 - Alzheimer's caregivers support group, 10 a.m.

Tuesday, Nov. 11 - Illinois Circuit Breaker assistance, by appointment.

Tuesday, Nov. 18 - Medicare and tax counseling, by appointment.

Wednesday, Nov. 19 - Grief and loss support group (call first).

Saturdays, Nov. 8 and 22 - Legal counseling, by appointment.

Saturday, Nov. 22 - Blood pressure and blood sugar testing, 10 a.m. to noon (no appointment needed).

Center tax counselors are available to help eligible residents apply for Illinois Circuit Breaker property-tax relief grants and license-plate discounts, Illinois Cares Rx (prescription-drug assistance), the senior citizen real estate tax deferral, and the senior citizen tax-assessment freeze.

Employment counseling and preparation of simple wills and durable powers of

attorney for health care and property also are available by appointment.

Support groups for Alzheimer's caregivers, those suffering from grief and loss, and seniors seeking to improve their nutrition are available at the Center of Concern in Park Ridge. The center also offers affordable personal counseling to adults of all ages. For more information call center social worker Myrna Fogarty, (847) 823-0453. The center is at 1580 N. Northwest Highway, Suite 310, Park Ridge. The center also offers housing counseling for seniors and others seeking affordable housing, programs designed to prevent homelessness, in-home health care referrals, friendly visitors for the homebound and volunteer opportunities in the office and in the field.

CHAMBER

The Niles Chamber of Commerce is currently accepting applications for the

Board of Directors positions for the upcoming year. Board member terms are three years. Interested members should contact Katie DiMaria, Executive Director (847) 268-8180, for more information.

CLASSES

TLC: Total Learning Community in Partnership with Oakton Community College is offering free Family Literacy Classes Saturday mornings. Free child care is also provided. Participants will learn: about the United States school system; how to report a child's absent from school; understand report cards; prepare for parent-teacher conferences; how to complete school required forms; help with homework; and participate during the parent-child activity. Register now. Classes runs from 9 a.m. to noon at Stevenson School, 9000 Capitol Drive, Des Plaines. Classes will start at Stevenson and continue there until Gemini Jr. High reopens. Note: Child

care is available for children who are out of diapers only. If you have any further questions, call Pamela Surber, TLC director, at (847) 827-4137.

Adelia's Closet, a bead store at 9227 Waukegan Road, Morton Grove, hosts free beginning jewelry-making classes at 9 a.m. weekdays. For more information call (847) 966-2323.

CLUBS

The Alumnae Club of Park Ridge will meet at 1 p.m. Nov. 12 in the South Park Fieldhouse, Talcott Road and Cumberland Avenue in Park Ridge. Norm Stranczek will present a slide show of the people of Maasai, where he and his sister built three classrooms, a library, a women's center and a small clinic. In January, they will complete a dormitory for teachers and bring water to the village of Sanya Juu, Tanzania. Hostesses for the meeting will be the Elk's Club Bridge group. Guests are

always welcome. Residency is not required for membership.

The Park Ridge Catholic Woman's Club will attend 11 a.m. Mass Nov. 11 for its deceased members at Holy Family Chapel in St. Paul of the Cross Church, 320 S. Washington St., Park Ridge. After Mass, they will meet at 12:15 p.m. in the South Park Recreation Center, 833 W. Talcott Road, Park Ridge. The Rev. John Clemens will speak followed by a mini-lunch. Any woman residing in Park Ridge or a surrounding community is welcome to become a member.

Chicago Northwest Suburban Alumnae Chapter of Delta Delta Delta will host a Founder's Day Dinner at 7 p.m. Nov. 11 at Oregon's Corner Cafe in Hawthorne Woods. All area Tri Deltas are invited. Call (847) 438-0192 for information, directions and to make a reservation.

Professionals in Learning Disabilities and Special Ed-

ucation will hold its Fall Seminar from 8:15 a.m. to 1 p.m. Nov. 22 at McCracken Middle School, 8000 E. Prairie Road, Skokie. "Warm Them Up to Writing: Working with Reluctant Writers" will be presented by Dr. Therese Hogan, director of Graduate Programs in Special Education at Dominican University. Three hours CPDU credit for the seminar. Limited space. Registration is \$40 for members, \$45, non-members and \$30, students. Lunch included. Register and send check by Nov. 17. For more information call G. Lemme at (847) 432-2061.

Northwest Suburban Council of Genealogists meets at 7:30 p.m. on the third Tuesday of the month at Forest View Educational Center, Room 100, 2121 S. Goebbert Road, Arlington Heights. Guests are welcome. Visit www.nwscg.com or call (847) 818-9159.

LeTip International, a business networking organization, recently opened a new local chapter. Area professionals seeking new leads, networking opportunities and valuable business tips are invited to join the group, which meets every Thursday at 7:01 a.m. at Omega, 9100 W. Golf Road in Niles. At each meeting, members exchange qualified business referrals, build professional relationships, create alliances, develop public speaking skills and take turns promoting their products and services. Fellow members serve as your sales force, providing access to clients you would not otherwise be able to contact. Also, in every LeTip chapter, each business category is represented by one member to prevent conflicts of interest (once you join, your competition cannot). To learn more about the Des Plaines/Mount Prospect/Niles chapter of LeTip, contact Janet Hansen at (815) 728-1488 or at jvhansen@letip.com. For more information on LeTip, visit www.LeTip.com.

Join the Catholic Women's Bowling League for Ladies Night Out at Classic Bowl, 8530 Waukegan Road, Morton Grove. Fee is \$15 per week. All skill levels welcome. Call Deanne Drozd at (224) 628-4009 or d.drozd@comcast.net.

The Knights of Columbus provides ways for members to help others in the community while trying to improve their family and spiritual lives. During the next few weeks the North American Martyrs Council, Niles, will offer several opportunities to have a Catholic man or woman learn about membership in the organization. For more information contact Bob Galassi, (847) 965-0920.

The American Jewish Artists Club is accepting new members. The group, founded in the early 1920s, focuses on the broad aspects of artistic performance and serves to enrich the cultural fiber of the Jewish community. For more information call Lorre Slaw, (847) 272-0744, or e-mail lslaw@oakton.edu.

Audubon Society of Park Ridge meets at 7:30 p.m. the fourth Thursday of the month in the Maine Park Leisure Center, Forestview and Sylvanwood. Guests of all ages are welcome. Call Roger Ginger, (847) 825-2982, for more information.

The Jerseyne Cruisers Motorcycle Touring Club meets at 7:45 p.m. the fourth Tuesday of each month in the Des Plaines Elks Club, lower level, 495 Lee St. (two blocks north of Route 14), Des Plaines. Jerseyne Cruisers' Sunday Breakfast Rides leave at 9 a.m. from McDonald's Restaurant at Oakton and Lee streets in Des Plaines. Rides are usually 25 to 85 miles. Call Betty, (708) 366-3822; or Joe, (847) 217-5876, for more information. Visit www.jerseynecruisers.org.

Niles Chapter Toastmasters meets at 7:15 p.m. the second and fourth Wednesdays of the month at the Morton Grove, 6140 Lin-

coln Ave. Members learn how to feel comfortable and have self-confidence talking to an audience. Call (847) 583-9928.

COMMUNITY

The Real Estate Investment Association will hold a breakfast meeting, "The Economic Effects of the November Presidential and Congressional Elections" Nov. 13 at Maggiano's Little Italy, 111 W. Grand Ave., Chicago. The keynote speaker will be Ambassador J.D. Bindenagel, vice president, community governmental and international affairs, DePaul University and former U.S. Ambassador. Louis P. Vitullo will moderate a panel of experts. Breakfast at 7:45 a.m. with program at 8:15 a.m. Cost is \$40, members and \$60, nonmembers. Call (847) 676-0222 or go to www.reia.org.

The U.S. Census Bureau is conducting Employment Testing. Thousands of part-time, well-paid jobs are available with the US Census Bureau. All positions require successfully passing a qualifying exam which will be given from 1 to 4 p.m. Nov. 18 at the Niles Fitness Center, 987 Civic Center Drive. For more information, call 1-866-861-2010.

Grandparents Circle is a free outreach program to provide education and support for Jewish grandparents with interfaith grandchildren. The first session will be at 7:30 p.m. Nov. 11, with five subsequent sessions (also at no charge) to follow through February. The sessions will be held at 4500 Dempster St., in Skokie. This event is cosponsored by Ezra-Habonim, the Niles Township Jewish Congregation, in partnership with Jewish Community Center of Chicago. For more information, contact Judy Fleischer at (708) 799-7650 or jfleischer@gjcc.org.

The Norwood Park Historical Society will offer a

Reasons to Advertise
5
Newspapers
REASON #3
INTELLIGENT
People with higher education are more likely to read newspapers.
PIONEER PRESS
CALL 847-486-7300

Chicago Sweet Connection Bakery
10% off on purchase of \$25 and up. Bring this Coupon. Expires Nov. 30.
5569 N. Northwest Highway, Chicago, IL 60630
Phone: (773) 283-4430
Fax: (773) 283-9375
Toll Free: (800) 865-6199
November Specials
• Cakes: Tiramisu Cake or Coconut Custard Cake \$19.95
• Cheesecakes: Cherry Cheese Cake \$20.95
• Pies: Cherry pie or Pumpkin Pie \$6.95 11" pies
FRESH DAILY • GOOD PRICES • EXCELLENT QUALITY
Monday through Saturday 6 a.m. to 8 p.m. • Sunday 8 a.m. to 5 p.m.

\$50 GIFT CARD
to **BEST BUY**
or your choice of gift card from 12 participating retailers including
macy's BARNES & NOBLE BOOKSELLERS www.bn.com CVS/pharmacy
Here's how!
1. Receive a \$25 Gift Card when you open a Free Checking Account with On-line Banking.
2. Add Direct Deposit and receive an additional \$25 Gift Card of your choice.
Pick your term!
18 or 24 months
4.25%
CD SPECIAL PLUS
\$5,000 Minimum
when you open a checking account with direct deposit
Plaza Bank. Be part of our family.
7460 W. Irving Park Rd., Norridge 6500 W. Irving Park Rd., Chicago 4660 N. Harlem Ave., Harwood Heights.
1198 N. Harlem Ave., Norridge 6000 W. Montrose Ave., Chicago 7201 N. Harlem Ave., Niles
5601 W. Belmont Ave., Chicago 379 S. River Rd., Des Plaines
3555 N. Harlem Ave., Chicago 7429 W. Grand Ave., Elmwood Park
(708) 456-3440 • (773) 625-4100 plazabankillinois.com
*New money only. Must open a Free Checking Account with On-line Banking and a minimum deposit of \$100 by 12/11/08 to receive the \$25 Gift Card and must set up a recurring direct deposit of \$100 or more by 1/31/09 to receive additional \$25 Gift Card. Social Security Number or ITIN is required for account opening. Offer subject to change without notice. Gift Card may be substituted with item of equal or greater value. Not to be combined with any other offer. Limit one per customer. Limit one per household. Limited time offer. Offer valid until 12/31/08 or while supplies last. We reserve the right to cancel promotion at any time. The listed merchants are in no way affiliated with Plaza Bank nor are the listed merchants considered sponsors or co-sponsors of this program. Use of merchant names and/or logos are by permission of each respective merchant and all trademarks are the property of their respective owners. Terms and conditions are applied to gift cards/certificates. Please see the merchant gift card certificate for additional terms and conditions, which are subject to change at merchant's sole discretion. Merchants are not liable for any actual or alleged claims related to this offer. All logos are registered trademarks. All rights reserved. Must be 18 years or older to participate. A U.S. address is required for delivery. Other restrictions may apply. The listed merchants are in no way affiliated with Plaza Bank nor are the listed merchants considered sponsors or co-sponsors of this program. Use of merchant names and/or logos are by permission of each respective merchant and all trademarks are the property of their respective owners. Terms and conditions are applied to gift cards/certificates. Please see the merchant gift card certificate for additional terms and conditions, which are subject to change at merchant's sole discretion. Merchants are not liable for any actual or alleged claims related to this offer. All logos are registered trademarks. All rights reserved. Must be 18 years or older to participate. A U.S. address is required for delivery. Other restrictions may apply. BEST BUY and the BEST BUY logo are trademarks of BEST BUY Enterprise Services, Inc. *New money only. Terms lengths available for 18 and 24 months. \$5,000 minimum deposit. CD earns compounded interest paid quarterly. Must open a Checking Account with minimum deposit of \$100 and recurring direct deposit for the entire term of the CD to receive Annual Percentage Yield. Promotional CDs may receive into a different term. Limited time offer. Rate is effective 11/2/08 and is subject to change. Penalty will be applied for early withdrawal. Withdrawal may reduce earnings. Fees may reduce earnings.

LET US HELP YOU
Celebrate!
Announce Your Special Family Events:
Engagements Birth Announcements Weddings Birthdays Anniversaries Graduations Bar & Bat Mitzvahs Special Retirements
Each 3.1" x 5.9" Announcement with photo \$50
Each 3.1" x 2.8" Announcement with/without photo \$35
Each Additional Paper \$10
SAMPLE AD
It's a girl!
Gabrielle Maria Brichta
October 7, 2008
5 pounds, 3 ounces • 17 inches
Gabby was welcomed to the world with love and excitement by her parents Mike and Tressie Brichta of Chicago. She is the first grandchild for both sets of proud grandparents: Rand and Marla Brichta of Northbrook and Liz and Ed Stefan of Minooka, IL. Gabby will be loved and adored by great grandparents: Sid Brichta of Northbrook, Otto and Teresa Stefan of River Forest, Desmond and Marta du Mont of Chicago, and Shirley Alper of Chesterfield, MO.
Congratulations to her loving parents
Mike and Tressie Brichta
Any orders of two or more towns will receive a **FREE** print suitable for framing!
For more information, contact:
Liz Maier at (847) 486-7230 or celebrate@pioneerlocal.com
Submit your ads online at: www.pioneerlocal.com— "Send Us Your News"
PIONEER PRESS YOUR LOCAL SOURCE
The Doings

Peek

Continued from PAGE 75

free chamber music concert at 7:30 p.m. Nov. 10 at the Noble-Seymour-Crippen House, 5624 N. Newark Ave., Chicago. Young Spanish violinist Joan Plana, joined by the stellar duo of Canadian cellist Anna Sampson and Chicago harpsichordist Jason Moy, will present "Stylus Phantasticus: The Fantastical Style in 17th Century Italy." Join them as they explore, on period instruments, rarely performed 17th-century Italian masterpieces by Castello, Cima, Bertali, Uccellini, and their contemporaries. All are welcome. For more information, contact Gwen Ihnat, Gwen@norwoodparkhistoricalsociety.org, visit the Norwood Park Historical Society, or call (773) 631-4633.

CRAFTS

Resurrection High School will host its annual

Fall Arts & Craft Fair from 10 a.m. to 4 p.m. Nov. 8 at 7500 W. Talcott Ave., Chicago. More than 200 booths will feature a wide variety of handcrafted items. For more information, call (773) 775-6616 Ext. 129, or visit www.reshs.org.

The St. Juliana Mothers' Club is looking for crafters for its 2007 Holiday Craft Fair. The fair will be 9 a.m. to 4 p.m. Nov. 22 in the St. Juliana's Ahearn Center, across from the church, at 7201 N. Oketo Ave. The fee for each table is \$55. Electricity is available for an additional fee, but is limited. For more information or an application form, vendors should contact Patti McDonagh, (773) 792-3931, or the St. Juliana parish business office, (773) 631-4127.

The Parents Club of Guerin College Preparatory High School seeks crafters for its annual craft show from 10 a.m. to 3 p.m. Nov. 29, featuring only handcrafted items across the first floor of the school,

8001 W. Belmont Ave., River Grove. Admission is \$2; children younger than 12 are free (strollers are not permitted). Refreshments will be available for purchase. For more information about the show, or to receive an application form, call (708) 453-6233. Crafters may also download an application at www.guerinprep.org.

St. Raymond de Penefort Church of Mount Prospect is looking for artists to participate in its annual Old St. Nicholas Holiday Boutique from 8 a.m. to 1 p.m. Dec. 7. Applications are available at www.st-raymond.org/. All items must be handcrafted.

FITNESS CENTER

Niles Family Fitness Center, 987 Civic Center Drive, (847) 588-8400, www.nilesfitness.com.

The Fitness Center has scheduled some Funtastic programs for children to correspond with its popular aerobic classes. Instructors

will even escort the children to and from the Clubhouse. A half-hour in the ClubHouse is included in all Funtastic class fees. Classes are held Mondays through Fridays: sports, fitness, art, science, cooking and more. Stop by or call; ask for Jenny or Joy at (847) 588-8400.

Friday Night Fun for ages 5 to 12 offers an evening filled with swimming, gym, crafts, snack and more from 6 to 9 p.m. Fridays, Nov. 14 and Dec. 19. Fees are \$10, members; \$15, nonmembers.

The following is the Group Fitness schedule. Daily drop-in fees are \$8 for residents; \$9, nonresidents.

A.I.S. Stretch: Isolated stretching to increase flexibility; 8:30-9 a.m. Tuesdays.

Aerobic Medley and Tone: Low-impact aerobics, kickboxing with some toning exercises for beginner and advanced participants, working at their own pace; 5:15-6:15 p.m. Wednesdays.

Body Flex: Increase lean

muscle mass and boost resting metabolic rate with this strength-training class 6:20-7:20 p.m. Mondays and Wednesdays; 10:05-11:05 a.m. Tuesdays and Thursdays; 9:05-10:05 a.m. Saturdays; and 9:30-10:30 a.m. Sundays.

Cardio Dance: Instructor will teach a variety of moves; intermediate to advanced level; 8:45-9:30 a.m. Sundays.

Cardio Interval: Try this cardiovascular workout with muscle shaping. Participants will interval Step, Hi/Lo, Kickboxing or BOSU combinations with weight training. Intermediate to Advanced levels; 9:20-10:20 a.m. Wednesdays.

Cardio Kickbox: This 60-minute workout combines high-intensity aerobics, boxing, kickboxing and conditioning exercises. Handwraps are required and are available at the Membership Service Desk for \$5; 7:30-8:30 p.m. Mondays.

Cardio Step: This step

class includes a warmup, high-intensity step aerobics, abdominal exercise and a cool-down stretch; 6:10-7:10 p.m. Tuesdays.

Core Challenge: Challenging core stability with cardiovascular and strength drills on the BOSU balance trainer; 9:10-10:05 a.m. Mondays.

Easy Does It: Offers mature adults the opportunity to exercise under the close supervision of a certified instructor to achieve individual desired level of fitness. The class consists of low-impact aerobics, step or walking, resistance work, floor work and stretching; 10:10-11:05 a.m. Mondays and 10-11 a.m. Fridays.

Dance Aerobics: Includes a mix of dance and aerobics, followed by an abdominal workout for intermediate to advanced levels; 6:10-7:10 p.m. Mondays.

Step, Drills and Strength: This class will offer variety from week to week for intermediate to

A Pioneer Press Publication

A Pioneer Press Publication

advanced levels; 6:10-7:05 p.m. Thursdays.

Total BodyToning: Participants will develop muscle tone using higher repetitions of lighter weights; for beginner to advanced levels, 5:15-6:05 p.m. Tuesdays.

Yoga: Stretch and soothe your mind from 8-9 a.m. or 5:20-6:20 p.m. Mondays, 7-8:05 p.m. Tuesdays, 8:15-9:15 p.m. Wednesdays, 6:50-8 p.m. Thursdays, and 10:10-11:20 a.m. Fridays.

Spinning is indoor cycling to motivating music. Everyone rides at their own pace in a team atmosphere. Reservations are required at the Service Desk before each class. Bring a towel, heart-rate monitor and a water bottle to class. Classes are 45 minutes. Class times vary. Daily drop-in fees are \$6 for members; \$9, nonmembers.

Spinning-Yoga Blend class will flow from Spinning right into yoga. Express Yoga will focus on stretching and include core strengthening. Express Spin is from 6 a.m. to 6:35 a.m., and Express Yoga from 6:40 a.m. to 7:15 a.m., Wednesdays.

Niles Family Fitness Center, 987 Civic Center Drive, offers Fall Funtastic Children's Programs. The goal of the programs is to provide a stimulating environment that will encourage learning and fun. Beginning classes are for parents and children to explore and create together. For class schedule go to www.nilesfitness.com, or call (847) 588-8400.

Lil Pilgrim, 1 to 5 years. Parents and children are invited to join in a special Thanksgiving celebration with crafts, games stories and more. **Holly Day Party, 1 to 5 years.** Holly Day games, crafts, stories and more will fill a child's morning. **Friday Night Fun 5 to 11 years.** Join the enthusiastic staff for an evening filled with swimming, gym, crafts, snack and more. **Girls Spa Night, 5 to 11 years.** Girls get ready to be

pampered in an evening of hair, nails, lotions, jewelry-making and anything else "girly." **Aqua Antics, 1 to 5 years.** Play group in the pool! non-instructional swim class is designed to help children become comfortable in the water. Splash around while participating in active songs and circle fun. Water toys will be available. Parent/child. **Mini Picasso's, 18 months to 3 years:** toddler to explore their creative side with painting, play dough and bubbles. Class may be messy, so dress accordingly. Parent/child. **Romp, Stomp & Roll, 10- to 20-months.** This class is a social experience for both parent and child. Mats, balls, tunnels and age appropriate toys will be offered in this active free play class. Your toddler can climb, jump and roll around in our carpeted multi-purpose room. Parent/child. **Tiny tot Playtime, 1 to 2 years.** Meet other parents and interact with your child during movement, activities, free play and a simple craft. Music and circle time will add to the FUN. Parent/child. **Me Two 2 years.** Stories, music and art to ease fears and encourage independence in a semi-structured environment. Child only. **Mini sportsters, 2 to 4 years.** An introductory sports class for your active toddler. Try out a different sport each week. Have fun while getting fit. Parent/child. **Tumble bees, 2 to 4 years.** Introduction to basic tumbling skills by participating in activities that teach gross motor skills and organized movement. Basic introduction to the balance beam, floor and horizontal bar. Parent/child. **Just For Me, 3 to 4 years.** Designed for children who missed the Sept. 1 cut-off for preschool, but are ready to be on their own in a social environment. Letters, numbers and colors will be taught through active play. Daily gym time and snacks are provided. This class will be offered with a continuing curriculum through spring 2009. **Body Flex Kids, 3 to 6 years and 5 to 9 years.**

Scheduled during adult Body Flex, this high energy exercise class will get your child moving and grooving. Class ends with kid's yoga. Instructor escorts children to and from the Clubhouse. **Funtastic Fridays, 3 to 6 years.** Children play games, make crafts, swim and make new friends. Must be toilet trained. **Playtime Picasso's 3 to 6 years.** Arts and crafts, painting, play dough along with age appropriate play. Messy class. **Recipe for fun, 3 to 6 years.** Make simple recipes. Measuring, mixing, pouring and stirring. Each chef will get to eat or take home their own creations. **Silly science 3 to 6 years.** Hands on science class is designed to combine learning and fun. Using everyday household items, kids become a silly scientists with simple experiments. **Sports Kids 4-6 years.** We introduce your child to a variety of sports: T-ball, basketball, bowling and more. Class is designed to improve listening skills, instill a sense of teamwork and encourage physical development.

The Niles Fitness Center, 987 Civic Center Drive, is taking registration for fitness classes, including: **Aqua-Arthritis**, an opportunity for people with arthritis and post-rehab conditions to help improve flexibility, coordination and muscle strength (a doctor's note is required); **Big Event Boot Camp**, which is designed to help participants lose weight and tone up for a special event, combines cardio with resistance training and ends with a stretch; **Core Strength**, which offers total-body-strength exercises using weight and the BOSU and includes abdominal and low back exercises (all ability levels are welcome); **Laughter Yoga**, a technique that uses simple laughter exercises, interspersed with gentle breathing stretching exercises and rhythmic clapping; **Senior Strength**, designed to improve the strength, agility, balance and flexibility of older adults, using light weights,

Call for times and details. For those experienced in Mat Pilates private and semi private training sessions are available in the Pilates Reformer Training Room. All sessions are 50 minutes, and members and non-members may purchase 1-, 5-, or 10-session packages. Call Danielle Desherow, (847) 588-8410, for times and pricing options.

FUND-RAISERS

Sport Clips stores in Peek, PAGE 78



www.pioneerlocal.com
Your local source 24 hours a day.

Sweetie Pies Bakery Cakery Café

Place your holiday order NOW!

home baked goodness pastries, cookies, and more...

Award Winning Pies

Cakes Weddings Birthdays & Special Occasions

7931 Lincoln Ave. Skokie, IL Downtown Skokie 847-213-0900 www.sweetypiesbakery.com

PHOTO STORE

Out of the paper and into your hands.

Order reprints of your favorite Pioneer Press photos in a variety of sizes and on a wide range of media, from traditional photo paper to t-shirts, mugs and computer mouse pads.

www.pioneerlocal.com

Wrap up the season with an ad in our

HOLIDAY GIFT Guides

Publishing: Nov. 19/20 & Dec. 4/5

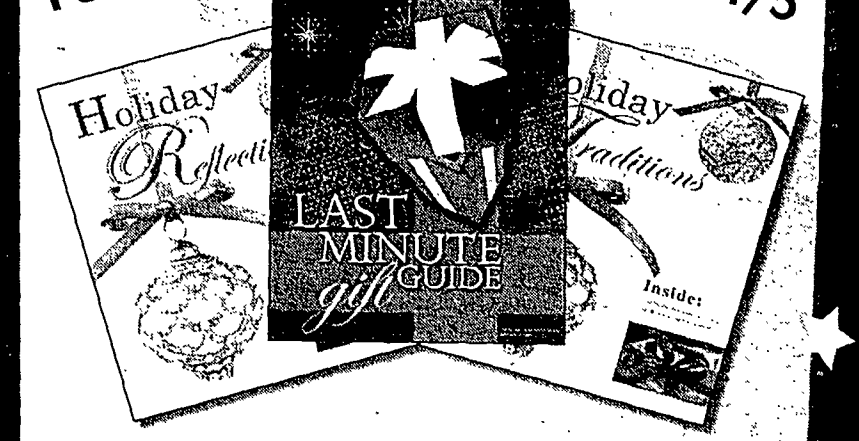

for print and online opportunities
Call (847) 486-7300
to advertise your business today!

PIONEER PRESS NEWS-SUN The Boring
YOUR LOCAL SOURCE

Peek

Continued from PAGE 77

Chicago and Niles are working with Children's Memorial Hospital to help raise funds for the Brown Family Life Center. Through Nov. 30, Sport Clips' "Clips for a Good Cause" program will donate \$2 per every MVP haircut sold to Children's Memorial Hospital. Sport Clips is open every day with no appointment necessary, and

features TVs showing sports while getting your haircut by "guy-smart" stylists. The local participating store is at 5944 W. Touhy Ave. in Niles. Each one of Sport Clips' 38 Chicago stores will participate in other "Clips for a Good Cause" programs this year. If you would like to nominate your favorite charity or organization for Sport Clips' "Clips for a Good Cause" program, contact Ashley Felts at (312) 923-1010. The chain is the offi-

cial haircutter of many professional sports teams, as well as the Veterans of Foreign Wars, and offers preferential pricing to all veterans. For more information, please visit www.sport-clips.com.

Cheeseburger in Paradise, well-known for its long-standing musical heritage, is calling all music lovers to help the VHI Save the Music Foundation fund instrumental music programs in public schools, with the chance to win a

Jimmy Buffett autographed guitar along the way. Specially designed Cheeseburger in Paradise VHI Save the Music T-shirts will be available for purchase through Nov. 15 at all Cheeseburger in Paradise locations. The local Cheeseburger in Paradise is located in Metropolitan Square in Des Plaines. All profits from T-shirt sales will help fund a teaching salary and musical instruments. Children's shirts cost \$10 each. Adult sizes are available for \$12 each. Enter online at www.CheeseburgerinParadise.com to win the acoustic guitar with a personalized signature from Jimmy Buffett. The winner of the signed guitar will be announced in late November.

The Men's and Women's Association of Advocate Lutheran General Hospital will sponsor an Avon products fund-raiser sale from 9 a.m. to 5 p.m. Nov. 7 in the Grainger Atrium of the hospital. The sale will feature bubble bath, skin softener, face creams, shower gels and other products including Skin-So-Soft, Bug Guard, Foot Works and Moisture Therapy. For more information about the Avon sale, call (847) 723-6105.

Honor Flight Chicago will host a fund-raiser from 6 to 9 p.m. Nov. 13 at Cheeseburger in Paradise, 1472 Market St., Metropolitan Square, Des Plaines. Proceeds will allow World War II veterans to see their memorial in Washington, D.C., free of charge. Tickets are \$20 and include food and live entertainment. For more information, contact Steven Schaefer at (847) 452-6991.

The dressbarn store in Niles, has joined in support of Breast Cancer Awareness Month. The retail store will contribute profits from the sale of Chloe, a plush dog, to the American Cancer Society's local and national initiatives. Chloe sells for \$5; dressbarn will donate a minimum of \$2.50 from the sale of each dog to

the American Cancer Society, targeting breast-cancer research. Chloe will be sold through Dec. 15, or while supplies last. For more information call (847) 588-3100.

Our Lady of Ransom Parish in Niles is selling Entertainment 2009 Books for \$20. Discounts cover a variety of areas, including travel, restaurants, car rentals, movie theaters and hotel discounts. The sale benefits the parish. To get a book contact Josephine Bax, (847) 823-2550.

HEALTH

Advocate Lutheran General Hospital is taking appointments for its annual flu shot program through its Flu Shot Hotline, 1-800-995-4267. Locally, Senior Advocate is hosting clinics on Nov. 7, 10 and 12, between the hours of 10 a.m. and 3 p.m. There is no cost to those who have Medicare Part B; otherwise, the charge is \$30. Flu shots are offered to those over the age of 18. Call the Flu Shot Hotline for locations and registration.

Advocate Lutheran General Hospital and the American Red Cross offer an Infant/Child CPR Course. This five-hour course teaches participants how to recognize and care for breathing and cardiac emergencies in infants and children. It also includes information on how to prevent injuries to infants and children at home and in play areas. The next course will be held from 8 a.m. to 1 p.m. Nov. 8 at Advocate Lutheran General Hospital, 1775 Dempster St., Park Ridge. An upcoming session will be held Nov. 22. Fee for the course is \$50. Call 1-800-323-8622 or visit www.advocatehealth.com to register. The code for this class is 8C16.

Advocate Lutheran General Hospital will host a seminar and book-signing featuring Rosalie Devonshire, author of *Taking Charge of Fibromyalgia* and therapist at Advocate Medical Group's Counseling

Center. The event will be held from 9 a.m. to 2 p.m. Nov. 8 in the Olson Auditorium at Lutheran General, 1775 W. Dempster St., Park Ridge. Attendees will learn about the diagnosis, symptoms and treatment of fibromyalgia and will be provided with coping tips, pain management techniques and resources. Signed copies of Devonshire's book will be available for purchase at \$15, cash only. Additional speakers include Soozie Cotter-Schaufele, music therapy/guided imagery, as well as other health professionals. Exhibits will be open from 8:30 to 11 a.m. and a light lunch will be provided. There is no charge to attend, however, registration is required. To register, call Health Advisor at 1-800-323-8622 and ask for Code: 8G37. Free parking is available in the Lutheran General Center for Advanced Care garage, which is located at the southwest corner of Dempster Street and Luther Lane.

The American Cancer Society, Chicago office is seeking partnerships with faith-based organizations to outreach in various Chicago communities to provide resources involving cancer issues. In organizations where no health ministry exists, ACS will help the organization begin a ministry, or will provide health related information. Through this program, Churches Against Cancer (CAC), ACS will provide a comprehensive health awareness campaign within the organization to help build capacity, provide culturally appropriate resource materials and technical assistance to member churches. To participate, faith-based organizations must approve joining CAC. For more information about CAC, contact Desmond Konadu at (312) 279-7278 desmond.konadu@cancer.org

LIBRARY

Niles Public Library, 6960 Oakton St., (847) 663-1234

www.nileslibrary.org. Registration is required for programs.

The Go Club for ages 6 to 12 usually meets the first and third Saturdays of each month on a drop-in basis.

"Benjamin Franklin, in Search of a Better World," an exhibit, will be displayed up to Dec. 5 at Niles Public Library, with special programs and events for both children and adults. The exhibit is sponsored by the National Endowment for the Humanities and the American Library Association.

MAINE TOWNSHIP

Maine Township will host two days of flu shots from 10 a.m. to 4 p.m. Nov. 7 and 10 at Maine Town Hall, 1700 Ballard Road, Park Ridge. Advocate Healthcare will be on hand administering the shots. There will be no charge for those who display a Medicare B card, but those without can receive a shot for \$30, payable by cash or check. Those interested must schedule an appointment and can do so by calling 1-800-995-4267. For more information visit www.maintownship.com.

Maine Township's FISH (Friends Indeed Serve and Help) is in need of volunteer drivers to provide residents free transportation to medical facilities in and near Maine Township. Volunteers may choose how much time they wish to devote. Requirements include a current drivers license and proof of auto insurance. The program requires residents in need be mobile, or be able to use a cane or walker. FISH also asks that appointments be set three or more days in advance. To become a volunteer driver call Ed Oken, (847) 696-0761. To schedule a ride or for information call FISH coordinator Gloria Stepek, (847) 297-2510, ext. 283.

PARKS

Niles

Niles Park District is offering Indoor Micro Soccer

for girls and boys, kindergarten through sixth grade. This fun, fast-paced program is played with smaller teams to insure more touches of the ball and greater skill development. Soccer clinic is Nov. 15. Season play runs Dec. 6 to Feb. 7. Team T-shirts are provided with the fee of: residents, \$70; nonresidents, \$87. Registration deadline is Nov. 14. Registration is being accepted at the Howard Leisure Center, 6676 W. Howard St. For more information, call (847) 967-1529.

Niles Park District's IceLand Arena is taking registrations for Fall Classes. IceLand offers Tot, Learn-to-Skate, and Freestyle Classes, ages 4 years and older. The Rangers Hockey Instructional program includes \$10 Intro to Rookie Rangers and Rookie Rangers for beginner skaters, ages 4 to 13. All required equipment is provided for free for these two hockey classes. Season begins Nov. 11. There is a variety of class days and times available. Call (847) 297-8010, for information or register at IceLand Arena, 8435 Ballard Road.

Adult Dodgeball for ages 18 and older is offered in compliance with the Amateur Dodgeball Association. The focus is fun, safe, competitive and exciting recreation. Team jerseys are supplied. Sign up as an individual or a team of eight. Games are played at Golf View Recreation Center from 6:30 to 9 p.m. Tuesdays, Nov. 18 to Feb. 3. Fee per individual is residents, \$44; nonresidents, \$55. Call (847) 967-1529 with any questions.

Come to Pioneer Park for Family Fun Nights at 5 p.m. every Friday night. The \$5-per-person fee includes a round of miniature golf, a batting-cage token, a hot dog and a small drink for each family member. Pioneer Park is at 7135 N. Harlem Ave. Call (847) 583-2746 for more information.

Niles Park District is still taking registration for fall

dance classes. Classes include pre-ballet for ages 3 to 5, ballet and tap for ages 4 to 9, jazz for ages 6 to 12, and Hip Hop for ages 6 to 11. Classes for adults are also available. For more information on the Dance Program, call (847) 967-6633.

Niles Park District helps plan children's birthday parties. Party packages include: Tie-Dye, Crafty Creations, Rumble Jumble, Princess Party and Dora & Diego. Parties are 6:30 p.m. to 8 p.m. Fridays, and 10:30 a.m. to noon or 1 p.m. to 2:30 p.m. Saturdays. Call the Howard Leisure Center, (847) 967-6633, for more information.

Resident and non-resident registration for Niles Park District Bright Beginnings Preschool for 2008-09 is being taken. Spaces are available in the mornings and afternoons for 3- and 4-year-old classes. Registration will be accepted at the Howard Leisure Center, 6676 W. Howard St., until classes are filled. For more information stop in the Howard Leisure Center, or call (847) 967-6633.

Relive old memories at the Park District's annual Classic Cruisers Car Shows which will take place every Thursday night, weather permitting from 7 to 9 p.m. at Pioneer Park, 7135 N. Harlem Ave.

Pioneer Park, 7135 N. Harlem Ave., has an 18-hole miniature-golf course, seven batting cages and a concession stand. Parties and fund-raisers are also available. Call (847) 583-2746 for more information.

Golf Maine

Golf Maine Park District is taking registrations for:

Preschool. Sign up now for the fall 2008 semester. Early registration is urged. A five-day morning program and four-day afternoon program are offered for children turning 4 years old by Sept. 1.

For more information visit one of the Park District offices, Feldman

Recreation Center, 8800 Kathy Lane (one block south of Golf Road on Western Avenue), Niles; or **Dee Park, at the corner of Dee and Emerson Roads, Des Plaines**; or call (847) 297-3000.

Park Ridge Park District

The Park Ridge Community Center's amenities include: new fitness equipment; indoor pools; running track; racquetball & basketball courts; sauna & whirlpool; child care services; fitness and spinning classes; private adult lockers; party rentals; personal trainers. Call (847) 692-5129 or visit www.parkridge.org.

RELIGION

Registrations for the St. John Brebeuf "Joy in Jesus" Sunday preschool program are now being taken. The program is open to children ages 3 1/2 through kindergarten-age. Classes are during the 10:45 a.m. Mass each Sunday. The registration fee is \$40 and covers all materials for the year. Special emphasis is given to the development of self-awareness in children and their place in the Christian community. The goal of the program is to provide a foundation for a future understanding of faith. To register, or for more information, call Charlotte Linquist, (847) 470-1434.

Mary Seat of Wisdom, at Cumberland and Granville avenues in Park Ridge, offers a once-a-month Mass for young adults at 4:30 p.m. the third Sunday of each month. A priest who works specifically with young adults and a choir that incorporates both voice and instruments to provide upbeat music for liturgies will be featured. Liturgies will be prepared and presented by young adults. All young adults, ages 22 to 40-plus, married or single, with or without children, are invited. For more information call Peg Barry, (847) 720-7914, or e-mail pegbarry@bjbpartners.com.

Peek, PAGE 80



FOR SPECIAL OCCASIONS
Be it a Bar/Bat Mitzvah, Birthday, Shower or Corporate celebration, the complete planner, helpful features, creative ideas and shopping suggestions can help assure it will be a success.

FOR WEDDINGS
Digest-sized guide includes expert's advice, newest fashions, the area's best shopping locations and a handy personal planner. Inside your copy are 4 FREE tickets to the area's hottest bridal shows -

The Complete Wedding Expo.



All-Inclusive 4 Night Honeymoon Trip at RIU Palace Punta Cana in the Dominican Republic courtesy of

APPLE VACATIONS.com

Full contest rules are available on the website or upon request from: Contest Rules, Chicago Wedding Resource 3453 Commercial Ave., Northbrook, IL 60062

Please send my FREE copy of the **Chicago Wedding Resource & Guide for Special Occasions** to the address below or order by email at www.chicagoweddingresource.com

Name _____
Address _____
City _____
State _____ Zip _____
Daytime Phone (_____) _____
E-Mail Address _____
Date of Wedding or Event _____
Type of Event _____

Mail this form to: Chicago Wedding Resource, 3453 Commercial Ave., Northbrook, IL 60062

Copies also available at: **northbrook court** Guest Services

Wrap up the season with an ad in our **HOLIDAY GIFT Guides** IN PRINT AND ONLINE

Now playing online at <http://adfare09.afare.com/ads/pioneerlocal/page.htm>

NEW ONLINE VIDEO ADS!

Call (847) 486-7300 to advertise your business today!

PIONEER PRESS NEWS-SUN The Boring

Peek

Continued from PAGE 79

Ezra-Habonim, the Niles Township Jewish Congregation, 4500 Dempster St., Skokie, offers Introduction to Judaism and beginning adult Hebrew classes on Sundays and monthly Yiddish. Members and non-members are welcome. For more information call (847) 675-4141, or go to www.ehnt.org.

Registration is open for the 2008 fall programs at Gan Yeladim, the early-childhood program of Ezra Habonim, the Niles Township Jewish Congregation, 4500 Dempster St., Skokie. The program, which serves children ages 2 to 5 and their families, is open from 7:30 a.m. to 6 p.m. Monday through Friday. Half- and full-day programs, as well as early-morning drop-off, a lunch program and afternoon enrichment classes, are offered. It integrates Ju-

daica, literacy, math, science, art, music and drama into its developmental, play-based curriculum with a low teacher-child ratio. Interested families are invited to visit, talk with the director and view the facility. Visiting hours are from 10 a.m. to 11:30 a.m., but first call (847) 675-4152. Go to www.ganskokie.org.

MAINE SENIORS

Advocate Healthcare will offer flu shots at Maine Town Hall from 10 a.m. to 4 p.m. Nov. 7 and Nov. 10. There is no charge for those who present a Medicare B card; otherwise the charge is \$30, payable by cash or check. To schedule a flu shot call the Advocate hotline, 1-800-995-4267.

A trip from 9 a.m. to 5:30 p.m. Nov. 6 is offered to see "Forever Plaid: Plaid Tidings" at the newest Midwest venue, the Armory, where World War II soldiers trained for combat.

The drill hall is now the Drill Hall Theatre. Enjoy a three-course meal and then hear the boys in a Christmas show. The cost is \$82 for members; \$87, guests. All day trips depart from Golf Mill Shopping Center in Niles.

SENIOR CENTER

Grandparents Circle, is a free outreach program to provide education and support for Jewish grandparents with interfaith grandchildren. The first session will be held at 7:30 p.m. Nov. 11, with five other free classes to follow through February. The course will be held at 4500 Dempster St., in Skokie. The program offers grandparents skills and techniques to nurture, and in some cases help establish, their interfaith grandchildren's Jewish identities. It also provides participants with a supportive and open-minded environment to share their achievements, express their frustrations, and acknowl-

edge their challenges. Cosponsored by Ezra-Habonim, the Niles Township Jewish Congregation, in partnership with Jewish Community Center of Chicago. For more information, contact Judy Fleischer at (708) 799-7650 or jfleischer@ojccc.org.

SINGLES

Young at Heart Singles Club (ballroom dancers of all ages) will feature a dance at 8:30 p.m. Nov. 8 at the VFW Hall, 16th Street and Harlem Avenue, Berwyn, with the music of the Variety Pak. Members pay \$7 for each dance; guests, \$9. Attire is semi-dressy/dressy. Call the hotline at (630) 415-3499 for more information, or for directions, call (847) 678-7068.

Thunderbird Singles will host a giant super mixer at 8 p.m. Nov. 7 at the Doubletree Oakbrook Hotel, 1909 Spring Road, Oakbrook. Admission is \$8. For more

information, call (847) 604-3446. North Shore Singles will feature a dance at 6 p.m. Nov. 9 at 94th Aero Squadron Restaurant, 1070 S. Milwaukee Ave., Wheeling. Admission is \$8. Call (847) 604-3446 for more information.

SUPPORT

The next National Alliance on Mental Illness Cook County North Suburban free education program open to the public titled "How the Criminal Justice System is Changing to Deal with Mentally Ill" will be held from 7 to 8:30 p.m. Nov. 10 at the Kenton-Knox Conference Center, 9701 N. Knox Ave., Skokie. For more information, call the NAMI-CCNS office at (847) 716-2252.

Advocate Lutheran General Hospital is offering a free program that teaches beauty techniques to women who are actively undergoing cancer treat-

ment to help them combat the appearance-related side effects of radiation and chemotherapy. The next class will be offered from 10:30 a.m. to 12:30 p.m. Nov. 10 at the hospital's Center for Advanced Care, 1700 Luther Lane in Park Ridge. For more information and to register call HealthAdvisor at 1-800-323-8622 or visit www.advocatehealth.com. The code for this class is 8C24.

Catholic Charities of the Archdiocese of Chicago invites anyone who has experienced the loss of a loved one to suicide to participate in its Loving Outreach to Survivors of Suicide Program. Meetings will be from 7 p.m. to 9 p.m. Sundays, Nov. 9 and Dec. 14, at Catholic Charities' Northwest Office, 1717 Rand Road, Des Plaines. To learn more about Des Plaines-based Catholic Charities North/Northwest Suburban Services and how they can help, call (847) 376-2118.

Pioneer Press Mortgage Guide

Check rates daily at http://pioneerlocal.interest.com

Bankrate.com

Table with mortgage rates from various lenders including The Glen Financial, Inc., Allstar Home Mortgage, Inc., Mortgage Square, Inc., Third Coast Mortgage LLC, Glenview State Bank, United Home Loans, Great Northern Financial Corp., and Revere Mortgage Ltd. Includes a 'Mortgage Update' section with a bar chart showing rates for 30 yr fixed, 15 yr fixed, and 5 yr ARM loans.

Mortgage Update: Mortgage matches highest rate of the year By Holden Lewis • Bankrate.com. The roller-coaster ride continues with mortgage rates. This week, they climbed to the highest level in three months, matching the highest level of the year.

The benchmark 30-year fixed-rate mortgage rose 45 basis points, to 6.77 percent, according to the Bankrate.com national survey of large lenders. A basis point is one-hundredth of 1 percentage point. The mortgages in this week's survey had an average total of 0.39 discount and origination points. One year ago, the mortgage index was 6.29 percent; four weeks ago, it was 6.41 percent. The benchmark 15-year fixed-rate mortgage rose 53 basis points, to 6.46 percent. The benchmark 5/1 adjustable-rate mortgage rose 18 basis points, to 6.67 percent. The 30-year fixed reached 6.77 percent in Bankrate's July 23 survey. That's the highest it has been all year. The last time the 30-year rate was higher was in Bankrate's survey of July 18, 2007, when it fell 21 basis points, then rose 54 basis points the next week, then fell 42 basis points the week after that, followed by this week's rise of 45 basis points. Mortgage rates seldom move in such wide swings. It's frustrating to borrowers who want to snag the best rate. "It makes it difficult, particularly when you have clients who are preapproved, out looking for homes," says Dan Dowling, president of United Mortgage Capital in Altamonte Springs, Fla. "There's so much (housing) inventory, it's tough for them to decide which one. Then combine that with extreme volatility of interest rates." He counsels home buyers to get a good deal on a house -- that's not difficult with Florida real estate -- and to grab a good interest rate when an acceptable one passes by. Lately, a mortgage rate is "like the weather in Seattle," he says. "If you are disappointed with it, wait a while and it will change."

MORTGAGE RATES & INFORMATION AVAILABLE 24/7 ON THE INTERNET @ http://pioneerlocal.interest.com

Rate effective as of 10/30/08. © 2008 Bankrate, Inc. http://www.bankrate.com. 1.FIGURED: (A) Mortgage Banker, (B) Mortgage Broker, (C) Bank, (D) S & L, (E) Credit Union. "Call for Rates" means actual rates were not available at press time. Illinois Mortgage Licensure: Conventional loans are based on loan amounts of \$165,000. Jumbo loans are based on loan amounts of \$435,000. Points quoted include discount and/or origination. Lock Days: 30-60. Annual percentage rates (APR) are based on fully indexed rates for adjustable rate mortgages (ARMs). The APR on your specific loan may differ from the sample used. Fees refer to the APR. If your down payment is less than 20% of the home's value, you will be subject to private mortgage insurance, or PMI. Bankrate, Inc. does not guarantee the accuracy of the information appearing above or the availability of rates and fees in this table. All rates, fees and other information are subject to change without notice. Bankrate, Inc. does not open any financial institutions. Some or all of the companies appearing in this table pay a fee to appear in this table. If you are seeking a mortgage in excess of \$417,000, recent legislation may enable lenders in certain locations to provide rates that are different from those shown above. We recommend that you contact your lender directly to determine what rates may be available to you. To appear in this table, call 800-509-4636. To report any inaccuracies, call 888-509-4636. http://pioneerlocal.interest.com

Introducing SUPREME COURT HIGH SCHOOL BASKETBALL PREVIEW SECTIONS Your favorite teams - Our best local coverage. Our Mid Suburban League Edition is publishing on November 26 and 27. Planned editorial includes: Game previews, schedules, team rosters, player profiles and coaching profiles for both boys and girls basketball. SCORE big with an ad. For the Mid Suburban League Edition of Supreme Court, Contact Tony Ralenkotter 847.797.5125 | tralenkotter@pioneerlocal.com. For the Central Suburban League North Edition of Supreme Court, Contact Mike Shalin 847.486.7326 | mshalin@pioneerlocal.com. To advertise in the West Edition of Supreme Court, Contact Chuck Agresti 708.524.4460 | cagresti@pioneerlocal.com.

Your Community. Your Interests. Your Local Source. Every week Pioneer Press delivers coverage of local news like no one else can. Call (847) 486-9300 to subscribe or visit www.pioneerlocal.com. PIONEER PRESS YOUR LOCAL SOURCE

MEMORIAL LUNCHEONS • Banquet Room Available • Groups of 10-200. Edelweiss German American Cuisine. 708-452-6040. 7650 W. Irving Park Road Norridge, Illinois 60706 www.edelweissdining.com

TOP 10 Newspapers REASON #9 CONVENIENT Newspapers are portable and convenient. PIONEER PRESS CALL 847-486-7300

Remember your loved one

with a Pioneer Press "In Memoriam" ad

(847) 486-7479

deathnotices@pioneerlocal.com

PIONEER PRESS
YOUR LOCAL SOURCE

Local Death Notices

Death Notices

Campbell, Judith E. "Judy"
Judy Campbell, nee Jelinek, age 68, of Glenview, Illinois, passed peacefully in her sleep at home on Thursday, October 30, 2008 after a long struggle with Alzheimer's Disease. She was the cherished wife of Dr. Walter D. Campbell, the loving mother of Scott and Christopher, and the beloved grandmother of eight. Born in Bad Axe, MI, Judy earned educational degrees from Central Michigan University and National Louis University. She taught junior high school subjects in District 34 prior to her retirement. She also sang with Northwestern University Chorus and Glenview Community Church Choir for several years prior to her illness. Visitation was held Sunday, November 2, at HABEN Funeral Home & Crematory, 8057 Niles Center Rd., Skokie, Illinois. Interment was Monday, November 3, in Fairview Cemetery in Homer, Michigan. A Memorial Service will be held Saturday, November 8, at 10 a.m. at Glenview Community Church, 1000 Elm St., Glenview, IL. In lieu of flowers, memorial contributions may be made to The Alzheimer's Disease Association, 8430 Bryn Mawr Ave., Suite 800, Chicago, Illinois, 60631. Funeral Info 847.673.6111.
Sign Guestbook at legacy.pioneerlocal.com

Death Notices

Feth Jr., Edward L.
Edward L. Feth, Jr., age 81, 50 year resident of Park Ridge; passed away October 31, 2008. Beloved husband of June, nee Johnson, for 53 years; dear father of Susan, Jim, Cheryl (William) McCall and Nancy; loving grandfather of Kevin and Karin; Graveside services were held Monday, Nov. 3, 2008 at Town of Maine Cemetery, Park Ridge. Memorials may be made to St. Luke's Lutheran Church, 205 N. Prospect, Park Ridge, IL 60068 appreciated. Arrangements conducted by Nelson Funeral Home, Park Ridge. 847-823-5122 or www.nelsonfunerals.com.
Sign Guestbook at legacy.pioneerlocal.com

Death Notices

Huff, Mildred B.
Mildred B. "Mor-Mor" Huff, nee Andersen, formerly of Park Ridge and Glenview, Illinois, died peacefully at her home November 1, 2008, in Naples, Florida with her family at her bedside. Mildred, born January 25, 1917, was a loving mother, grandmother, and great-grandmother as well as one of the early learning disabilities teachers in America. She earned her masters degree at Northwestern University in Evanston, Illinois. She went on to help hundreds of children reach their full potential. She is survived by her son, Steven Huff, and his wife Marlene; her daughter Catherine (Kate) and her husband Richard (Dick) Gottfred; her grandchildren Michael Huff and wife Kristine, Kimberly Huff, Brad Gottfred, Lindsey Gottfred Holton and husband Joshua, Pamela Gottfred MacPherson and husband Matthew; great-grandchildren Stephanie, Tommy, Decker, Drew, Allie; and her long time caregiver and friend Nadine Gayle. A memorial service will be held on Friday, December 5th, at the Glenview Community Church at 7 PM. Visitation begins at 6 PM. In honor of her dedication to helping children read, charitable donations may be made to the Mildred Huff Reading Fund at Leap Learning Systems, leaplearningsystems.org.
Sign Guestbook at legacy.pioneerlocal.com

Death Notices

Peterson, Marjorie
Marjorie Peterson nee Johnston, 84, of Covenant Village, Northbrook former resident of Park Ridge for over 40 years, October 29, 2008. Beloved wife of Warren. Loving mother of Linda (Norman) DeGraff, Scott (Judy Desenis) Peterson, and Ellen (Peter) Clark. Cherished grandmother of 9. Proud Great grandmother of 6. Dear sister of Donald (Delores) Johnston. Memorial Service Sunday, November 23, 2008 at 1:30pm at Northbrook Covenant Church, 2737 Techny Rd. (at Pfinsten Rd.), Northbrook. In lieu of flowers memorials may be made to the Benevolent Fund of Covenant Village, 2625 Techny Rd., Northbrook, IL 60062 or Midwest Palliative & Hospice CareCenter, 2050 Claire Ct., Glenview, IL 60025. Funeral Info 847-998-1020.
Sign Guestbook at legacy.pioneerlocal.com

You may send

a death notice to

deathnotices

@pioneerlocal.com

or call

for more information

(847) 486-7479

PIONEER PRESS
YOUR LOCAL SOURCE

You may send a death notice to
deathnotices@pioneerlocal.com
or call for more information
(847) 486-7479

You may send a death notice to
deathnotices@pioneerlocal.com
or call for more information
(847) 486-7479

Funeral Directors and Associated Services

You may send a death notice to
deathnotices@pioneerlocal.com

or call for more information
(847) 486-7479

You may send a death notice to
deathnotices@pioneerlocal.com
or call (847) 486-7479

RYAN-PARKE

Funeral Home
120 South Northwest Highway Park Ridge
Suburban (847) 823-1171 • Chicago (773) 792-1811

www.ryan-parke.com

FAMILY OWNED & OPERATED SINCE 1922 PRE ARRANGED & PREPAID FUNERALS AVAILABLE

Cooney Funeral Home

FUNERAL DIRECTORS

To Be Worthy of Your Confidence

3918 W. Irving Pk. Rd. CHICAGO, IL 60618
Phone (773) 588-5850 Fax (773) 279-9802
625 Busse Hwy. PARK RIDGE, IL 60068
Phone (847) 685-1002 Fax (847) 685-1005

It's included.

Our package prices are designed to combine our popular caskets with our uncompromised services. And, we include all of those things that usually add up to make a funeral expensive—just one of the many ways you'll be pleasantly surprised.

Complete Burial Service

- Visitation
 - Funeral Service
 - Quality Steel or Hardwood Casket
 - Professional Services
 - Concrete Vault
- \$7,495**

Olson Burke/Sullivan Funeral & CREMATION CENTER

6467-73 N Northwest Hwy • Chicago, IL 60631-1451 • (773) 774-3333

Please send me more information on the services you offer.

Name _____
Address _____
City _____ State/Zip _____
Phone _____

There is no cost or commitment

If you're eligible for Medicare or know someone who is
Are you getting all the health care benefits you deserve?

Compare for yourself and see:

- Affordable monthly plan premium
- Prescription drug coverage
- Preventive coverage
- Gym membership at no additional cost
- Quit smoking program
- 24 hour nurse hotline
- Emergency coverage at home or when you travel
- Humana Active Outlook® wellness program
- And more!

Humana ChoicePPO®

Your plan

✓	_____
✓	_____
✓	_____
✓	_____
✓	_____
✓	_____
✓	_____
✓	_____
✓	_____
✓	_____
✓	_____

All from a company that has been serving people with Medicare for over 20 years.
 Call today to learn about HumanaChoicePPO® or to find an informational seminar near you.

1-800-372-7216 • TTY 1-877-833-4486

8 a.m. - 8 p.m., seven days a week

HUMANA. -Medicare
 -Group Health
 -Individual health
 -Dental, Life, Vision
Guidance when you need it most

A Medicare-approved PPO available to anyone enrolled in both Part A and Part B of Medicare through age or disability. Enrollment period restrictions apply, call Humana for details. Plans may be renewed annually. Copayment, service area, and benefit limitations may apply. You must continue to pay your Medicare applicable premiums if not otherwise paid for under Medicaid or by another third-party.
 M0006_GHA_02VYRR IL 11/08

Dr. Memmel not only

she's walked 3 miles
 in their shoes.

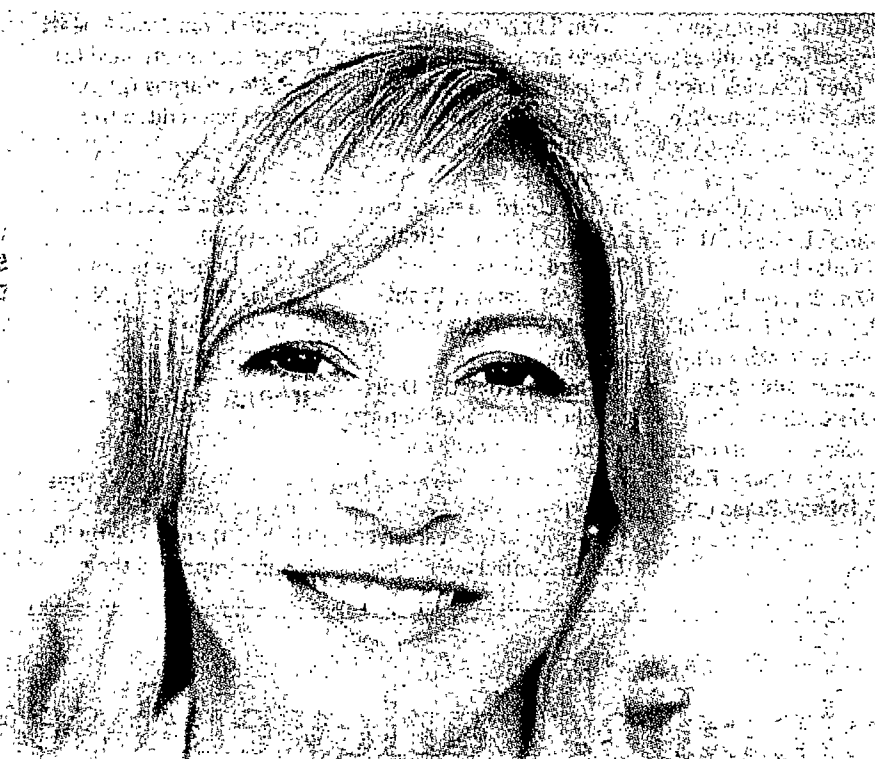

Heidi Memmel, M.D.
 Breast Surgeon
 Advocate Lutheran General Hospital

As a breast cancer survivor and a breast cancer surgeon, Dr. Memmel knows what it's like to be a patient and brings this rare perspective and experience to the women she treats. All of our physicians - including nine surgeons - at Lutheran General Hospital's Caldwell Breast Center work together with other breast health professionals as a team to provide the best medical care. And by utilizing the latest diagnostic technologies and treatment options, the center is leading the way in comprehensive, specialized breast health care.

To learn more about the Caldwell Breast Center's expert team and to read more about Dr. Memmel's background and qualifications, visit www.advocatehealth.com/caldwell.

Advocate Lutheran General Hospital
 Caldwell Breast Center
 1700 Luther Lane • Park Ridge

FOOTBALL PLAYOFFS

Notre Dame nearly upsets Bartlett

Dons give impressive effort in 10-7 loss

By JIM EDISON
 jedison@pioneerlocal.com

For the third year in a row, Notre Dame's football team had to face a top-seeded team in the first round of the state playoffs. And for the second time in those three games, the Dons threw a huge scare into an undefeated opponent. This time, it was Bartlett Friday night at Streamwood High School.

The Hawks (9-0) were one of only four unbeaten

teams in the Class 8A bracket.

The Notre Dame defensive unit didn't let Bartlett's record bother it, however, as the Dons turned in a stellar effort. And while Bartlett did manage to carve out a 10-7 triumph, it had to earn it every inch of the way.

"We came to play tonight," longtime head coach Mike Hennessey said moments after the 2008 season came to a halt. "Our defense was outstanding. We caused, and recovered, some turnovers and stopped their offense for the most part."

"Our problem was that we couldn't establish our own offense. We were

never able to get any favorable field position."

The ND defensive squad did indeed play an inspired game. **Jack Thompson, Kyle English, Billy Hughes, Sean O'Hara** and **Pat Lazzara** all displayed a high level of intensity. Bartlett quarterback Josh Hasenberg was under pressure from the opening series.

The Hawks did break the scoreless deadlock with 3 minutes, 33 seconds left in the first quarter when they capped a 65-yard drive with a 27-yard field goal by Dan Karys. Bartlett's defense, which sacked ND quarterback **Eric Hennessey** seven times, also did a tremendous job.

Bartlett failed to add to its narrow lead until midway through the final quarter. The Hawks finished off a 58-yard drive with a 1-yard TD plunge by Fabian Liberi. Karys' PAT kick made it 10-0.

Amazingly, at that point, ND's offense came to life. Hennessey (14 completions for 137 yards), who had left the game with a bruised ankle, returned to the field and orchestrated a 70-yard drive that culminated with a 24-yard touchdown pass to Lazzara. **John Jennings** kick made it 10-7 with 4:48 left.

With time running down, however, Bartlett picked up a crucial fourth-and-one at midfield and

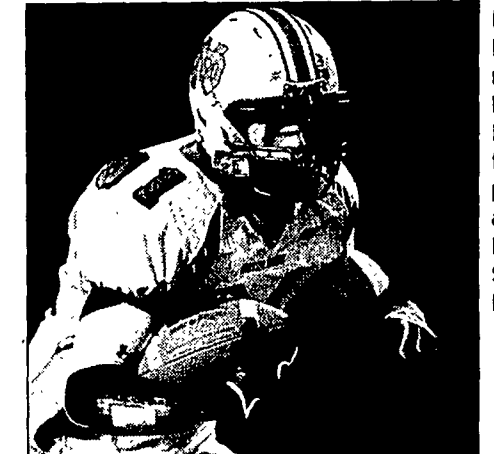

JEFF KRAGE/FOR PIONEER PRESS

Notre Dame's Pat Lazzara returns a kickoff during Friday's first-round playoff game against Bartlett at Streamwood High School.

ran out the clock.

"I thought we gave it a valiant effort," Hennessey said. "Even though we were 5-4, we know the quality of our schedule (in the East Suburban Catholic Conference)

makes us better.

"This was a good senior class. We have made the playoffs three straight years now and that is always the main goal."

Comment: pioneerlocal.com

HOCKEY

Notre Dame notches its 20th victory of season

Continuing their winning ways after an upset victory over Fenwick last week, the Notre Dame Ice Dons improved their record to 20-2 with victories over Libertyville 4-1, St. Viator 5-1 and CCM of Crystal Lake 10-5.

On Oct. 28, the Ice Dons defeated Libertyville 4-1. Goals were scored by **Kyle Gronset, Mike Coca** and **Kevin Orchard** with a pair. Assists were credited to Orchard, **Anthony Fabris** and **Johnny Blas** (3). **Ryan Malze** was in net for the victory.

On Thursday, Notre Dame defeated St. Viator 5-1 in a Catholic League game. Goals were scored by **Tim VanDermeir, Anthony Lupo**, Fabris, Blas and Orchard. Assists were credited to Coca, **Micah Orchard**, Blas (2) and Lupo (2). **Jeremy Krautstrunk** was in the nets for the win.

On Saturday the Dons notched their 20th victory of the season over the CCM Tigers of Crystal Lake 10-5. Goals were scored by **Jeff Levar, Ryan Zanon**, VanDermeir, Blas,

Dominick Von Aulock, Matt Dunne, Kevin Orchard (2) and **Alex Murphy (2)**. Assists were credited to Coca, Murphy, Micah Orchard, Dunne, Blas, Levar, **Sean Corcoran** and Gronset (3).

The Dons' next home game is at 8:15 p.m. Nov. 13 at the Niles Ice Rink against Providence.

JUNIOR VARSITY

The JV Ice Dons had a successful week, defeating Cary-Grove 5-2, CCM Tigers 7-0 and Libertyville 5-3 and improved their

Metro Central record to 6-1 with their victories.

On Oct. 29, the JV Dons traveled to Crystal Lake and defeated Cary-Grove 5-2. Goals were scored by **Nico Lazzaroni, Vince Pergande, Joseph Santelli** and a pair by **David Fabris**. Assists were credited to **Peter Prestia, Tyler Zanon, Stephen Kavanaugh, Chet Polonitza, Dino Loverde, Kevin Sanetra** and **Brian Gronset** each had two assists.

On Saturday, Notre Dame defeated the CCM Tigers 7-0. **Keryn Frost**

recorded his first shutout of the season, making 17 saves in the victory.

Scoring for Notre Dame were Loverde, Sanetra, Zanon and Fabris (4), while assists were credited to Lazzaroni, Gronset, Zanon, Kavanaugh and **Brandon Taylor**. Dziadosz and Loverde each had three assists.

On Sunday, the Ice Dons defeated Libertyville 5-3 on goals by Lazzaroni, Fabris and a hat trick by Loverde. Assists were credited to Sanetra, Fabris and Taylor with Dzia-

dosz getting 3 assists.

The JV's next home game is at 8:20 p.m. Tuesday against Prairie Ridge at the Niles Ice Rink.

The Notre Dame High School open house is scheduled from 5:30-8:30 p.m. today.

The Ice Dons encourage all 6th-, 7th- and 8th-graders attending the open house to stop by the hockey table and meet some of the players and coaches and get a free pass to an upcoming home game.

Comment: pioneerlocal.com

NOTRE DAME CROSS COUNTRY

Belpedio, Curley end seasons at sectional meet

By JIM EDISON
 jedison@pioneerlocal.com

Notre Dame cross country coach Mike Jankowski knew the road was going to get a lot tougher for his two run-

ners when they competed at the Niles West Sectional.

Both **Tony Belpedio** and **Tim Curley** had qualified for Saturday's huge gathering in Skokie as individual contestants out of the

Loyola Regional a week earlier. The two Don runners gave it all they had in the highly competitive three-mile race, but it was not enough to advance to this year's state meet.

"I thought they ran

pretty well for the most part," Jankowski said.

"They may have gone out a little too fast early, but this was their first sectional."

Belpedio ended the

race with a time of 16 minutes, 51 seconds, which was good enough for 80th place overall. Curley entered the chute with a time of 17:15 (120th place).

"Tony is a junior and

Tim is a sophomore," Jankowski said. "So both of them will be back next year and this was great experience for them."

Comment: pioneerlocal.com

Sports

BOYS SOCCER

Demons fall after upsetting Loyola

By JIM EDISON
jedison@pioneerlocal.com

While it's impossible to predict the future, it would be a good guess that Maine East's boys soccer success will have a lasting effect.

The Demons (17-5-3) had a phenomenal 2008 season. And while they fell short of their ultimate goal — to advance to the state finals — it was clearly a year to remember.

East's players had the curtain drop on their magical season Saturday afternoon when it fell to No. 1-ranked New Trier 4-0 in the championship game of the Niles North Sectional. But before they bowed out of the

postseason, coach Vic DiPrizio's athletes pulled off a major upset in the

"We were not intimidated coming in here and played hard."

Coach Vic DiPrizio

semifinals.

Playing second-seeded Loyola on Oct. 29, the Demons squeaked out a grueling 1-0 victory.

After controlling most of the action in the first half, East was awarded a free kick at about the 20-yard line. All-State midfielder **James Kelly** took the shot, which bounced off the crossbar. Luckily for East, **Josh Swoboda** was positioned perfectly and buried the rebound

shot to give his team the lead with 14 seconds left before intermission. As it

turned out, that would be the only goal of the night.

"Everyone was expecting it to be a Loyola-New Trier final here (at Niles North)," DiPrizio said. "But our kids came to play. We had a good scouting report and prepared ourselves. I think they (Loyola) were ranked eighth in the state."

On Saturday, the Demons returned to Skokie for their champi-

onship battle with the nationally ranked Trevians. New Trier entered the contest with an impressive record of 18-1-1.

Amazingly, it was the Demons who had the first real opportunity to score. Kelly stole a ball in New Trier territory and moved in on goalkeeper John Secaras. His shot was just wide.

Late in the half, New Trier increased the pressure and Matt Weaver drilled a shot past East goalkeeper **Milan Tjanic**. The Trevians were awarded a penalty kick just four minutes into the second half and Kyle McCrudden made it 2-0. New Trier later had goals from Chris Ritter and Benjamin Beaver.



BUZZ ORR/STAFF PHOTOGRAPHER
Maine East's Cesar Castanon (right) battles Von Steuben's Chukwueneka Nwagbara, during their Oct. 24 match at Maine South High School.

"You can't make mistakes with a team of this caliber," DiPrizio said. "And we had a couple. But I was so proud of our

team. We were not intimidated coming in here and played hard."

Comment: pioneerlocal.com

MAINE EAST ROUNDUP

Road to Peoria ends at Niles West Sectional meet

By JIM EDISON
jedison@pioneerlocal.com

The road to Peoria and the state cross country meet ran through Skokie and the Niles West Sectional Saturday.

And while no Maine East runner, on either the boys or girls teams advanced, the Demons were well-represented at the huge gathering.

On the boys side, coach Chris Peters had three individual competitors in the three-mile race. **Blazej Szymoniak**, **Gathoon Garmos** and **Steven Grousnick** all earned tickets to the sectional out of the Loyola Regional one week earlier.

Szymoniak finished the race in 92nd place with a time of 16 minutes, 30 seconds. Garmos (134th, 17:10) was next and Grousnick (147th, 17:39) completed East's showing.

"Overall, it was a great experience for the guys," Peters said. "They got to run in a very fast race against a lot of quality runners."

"And it was so nice to see Blazej run his best time of the season. I think the season went well. We had a lot of new kids and many of them are already talking about participating in track this spring."

On the girls side, the Demons had their full team at Niles West. East

finished 19th out of 20 in the team standings with 566 points.

Leading the way for the Demons, as she has all season, was junior **Michelle Zdobylak**, who ended the day in 90th place with a time of 20:03. **Zaklina Theil** (98th, 20:18) was next into the chute, followed by **Angela Jones** (125th, 21:35), **Marian Lopez** (126th, 21:39) and **Neyza Yap** (127th, 21:46).

GIRLS SWIMMING

With the Central Suburban League North meet slated for Saturday at Glenbrook North, the Demons have one major goal — get healthy.

Coach Scott Guilfoil's

squad has been hit with a barrage of ailments in recent days. The longtime skipper is hoping his athletes will be ready for GBN and then the Stevenson Sectional on Nov. 15.

"We have just had so many different things affecting the team," Guilfoil said. "Some kids are sick and some have injuries. We've had ear infections, colds and other things."

"And two of our best girls are included in that. **Natalia (Bialecka)** has a sore back and **Jelena (Krstic)** is dealing with a shoulder problem. So we really need to get everyone healthy as we move into the crucial part of the season."

With people in and out of the lineup, sustaining a solid attack has been difficult. The Demons dropped their last two meets, falling to Highland Park 89-66 on Oct. 24 and then to Maine West 103-62 Oct. 30.

In the meet with HP, East's only two individual victories were garnered by Bialecka. The talented junior won the 100-yard backstroke with a time of 1 minute, 6.54 seconds and the 50 freestyle in 25.95. East also captured the 200 freestyle relay as Bialecka, Krstic, **Jackie Lam** and **Alyssa Jenrick** combined for a time of 2:01.26.

Against Maine West,

the Demons collected wins from Bialecka in the 100 freestyle (56.54), Krstic in the 100 breaststroke (1:19.53) and Bialecka, Krstic, **Agnes Dadej** and **Natasha French** in the 200 medley relay (2:13.52).

GIRLS VOLLEYBALL

The 2008 season came to an abrupt halt for East's girls volleyball squad Oct. 30.

Competing at the Evanston Regional, one-of-four regionals in the Highland Park Sectional, the Demons were defeated by Von Steuben 25-21, 23-25, 25-16 in the opening round.

Comment: pioneerlocal.com

RMS Liquors

1714 E. Kensington Rd
Mt. Prospect, IL 60056
(847) 298-7960

We carry a large Variety of
♦ Domestic & Imports
♦ Spirits & Wine

With the lowest prices in
Mount Prospect and the vicinity.

We also carry a large variety of
Domestic import Beers
which include:

- Polish ♦ Netherlands
- German ♦ Jamaican
- Mexican ♦ Czech

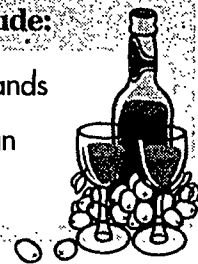

FANTASY FOOTBALL MONTHLY

WINNER GETS \$100!

ENTRIES MUST BE POSTMARKED BY
11/30/08 FOR DECEMBER CONTEST

- PICK 2 QUARTERBACKS & A WRITE-IN (NOT LISTED)
- | | |
|-------------------------------------|--------------------------------------|
| First Quarterback (choose 1) | Second Quarterback (choose 1) |
| — Peyton Manning | — Donovan McNabb |
| — Carson Palmer | — Drew Brees |
| — Jay Cutler | — Aaron Rodgers |
| — Tony Romo | — Phillip Rivers |

- PICK 2 RUNNING BACKS & A WRITE-IN (NOT LISTED)
- | | |
|--------------------------------------|---------------------------------------|
| First Running Back (choose 1) | Second Running Back (choose 1) |
| — Brian Westbrook | — Frank Gore |
| — Adrian Peterson | — Marion Barber |
| — Joseph Addai | — Clinton Portis |
| — LaDarian Tomlinson | — Marshawn Lynch |
| — Steven Jackson | |

- PICK 2 WIDE RECEIVERS & A WRITE-IN (NOT LISTED)
- | | |
|---------------------------------------|--|
| First Wide Receiver (choose 1) | Second Wide Receiver (choose 1) |
| — Randy Moss | — Larry Fitzgerald |
| — Reggie Wayne | — Greg Jennings |
| — Brandon Marshall | — Marques Colston |
| — Terrell Owens | — Braylon Edwards |

NO PURCHASE NECESSARY. A PURCHASE WILL NOT INCREASE YOUR CHANCES OF WINNING. Open to legal residents of Illinois, Indiana, Wisconsin and Iowa 18 and older. Void where prohibited. One \$100 cash prize will be awarded to the entrant who has the most points for the month (see rules for ties). All touchdowns run, caught or thrown count. Only touchdowns in that month count. Write-ins can't be already listed and will be used to break ties only. Only one entry per person per month. Subject to official rules available at <http://www.pioneerlocal.com> <http://www.pioneerlocal.com>. Sponsor: Pioneer Press, 3701 W. Lake Avenue, Glenview IL 60026.

Name: _____ Mail Entries To: _____
 Address: _____ Pioneer Press Fantasy
 Town, Zip: _____ Football Contest
 Phone: _____ Age: _____ c/o Second Floor
 3701 W. Lake Ave.
 Glenview, IL 60026

LET US CATER YOUR NEXT Holiday PARTY

Stub's
Gyros
Ribs
Chicken
Hamburgers

We Deliver
3727 West Dempster, Skokie
For Fast Carry-Out Service Call
(847) 673-9409 or 677-7695 • FAX: (847) 677-7701
Hours: Mon.-Thurs. 11am - 11pm • Fri. & Sat. 11am - 12 Midnight • Sunday 11am - 10pm

Patio Open - Weather Permitting
www.hubs-restaurant.com
Just a Family Business Where Quality Still Counts Since 1976

Cardinal WAREHOUSE WINE & LIQUORS

7780 N. MILWAUKEE

5⁸⁸ 1.5LTR
LIMIT 1 CASE

10⁸⁸ 12-PACK
LIMIT 5 CASES

21⁸⁸ 750ML
LIMIT 1 CASE
EXPIRES 12/09

29⁸⁸ 1.75L
LIMIT 1 CASE

Prestige Wine & Spirits Des Plaines

Grand Opening!
1471 Lee St., Des Plaines
PH: 630-963-0900
Fax: 630-963-3850

Other Location
Westmont
PH: 630-963-9733
Fax: 630-963-9722

Full-Service Beverage Center

FEATURING
Great Selection and Value!
-Wines -Spirits
-Beers -Cigars

PARTY SPECIAL
We Match Any Current Local Ad
Buy Your Liquor on Consignment
Play for what you open
Delivery Available

5% off Any 1.75 Liter Spirit Excludes Sale Items - Limit 5 Bottles Prestige Wine & Spirits Des Plaines - (847) 924-9900 Westmont - (630) 963-9733 With this coupon. Not valid with other offers or prior purchases. Offer expires 12/2/08	\$1 off Case of beer Excludes Sale Items - Limit 5 cases Prestige Wine & Spirits Des Plaines - (847) 924-9900 Westmont - (630) 963-9733 With this coupon. Not valid with other offers or prior purchases. Offer expires 12/2/08	1/2 off 750 ml Bottle of Wine Buy one (1) bottle of wine at regular price. Get the second bottle at 50% off. Excludes Sale Items. Prestige Wine & Spirits Des Plaines - (847) 924-9900 Westmont - (630) 963-9733 With this coupon. Not valid with other offers or prior purchases. Offer expires 12/2/08
---	---	---

FROZEN ROPES Baseball and Softball TRAINING CENTERS

6000 W. Touhy, Chicago, IL 60646 773-631-4300
www.frozenropes.com

FROZEN ROPES ROOKIE CLUB
Tuesday or Thursday 4pm-4:50
Exciting New Drills Ages 5 and 6
Rookie Club prepares your Little Leaguer for a successful upcoming season. A fun, non-competitive and upbeat class format led by professional Frozen Ropes instructors focuses on the Big Three keys to success: •Hitting •Throwing •Fielding

AFTER SCHOOL ACADEMY
Monday or Wednesday 4pm-4:50
Classes consist of hands on group instruction, continuous station change to promote speed of play and controlled scrimmages. The Academy is open to players ages 7-9.

All sessions begin in October for additional classes and events visit us www.frozenropes.com/chicago

Score Big!

DOMINIC'S KITCHEN STORE

8 S. Northwest Hwy., Park Ridge
Next to the Pickwick Restaurant
847-698-1255
www.JustCHEFit.com

Invite Big Green Egg To Your Tailgate Party

verizonwireless

Add lines for \$999

Save more when everyone is on one plan.

monthly access per line after the first 2 lines for \$99.99 monthly access

Everyone on the plan gets
Unlimited
Text, Pix, IM & Flix
to anyone on any network in the U.S.

With a new 1- or 2-yr. Agmt per line on a Nationwide Select Family SharePlan* \$99.99 monthly access or higher. (Activation fees, taxes & other charges apply.) *Messaging not everywhere in Nationwide Area.

Plus, talk all you want to any
Verizon Wireless customer.

(When calling from the Nationwide Area.)



MOTO™ W755
Hot music phone with
expandable memory
\$69.99

\$119.99 2-yr. price - \$50 mail-in rebate
debit card. With new 2-yr. activation.



Nokia 6205
Sleek music phone
with external controls
Verizon Wireless Exclusive
\$49.99

\$99.99 2-yr. price - \$50 mail-in rebate
debit card. With new 2-yr. activation.



Family bonus!
Buy any phone \$29.99
or higher and get up to
3 FREE

MOTO™ VU204 camera phones
\$79.99 2-yr. price - \$50 mail-in rebate debit card.
With new 2-yr. activation per phone.

Switch to America's Most Reliable Wireless Network.®

Call 1.877.2BUY.VZW

Click verizonwireless.com

Visit any store

VERIZON WIRELESS COMMUNICATIONS STORES

All listed locations are open on Sunday (except where indicated). Call for store hours

ADDISON

OPEN SOON 1801 W. Lake St.

ARLINGTON HEIGHTS 138 E. Rand Rd. 847-253-0329 ★

AURORA 740 N. Rte. 59 630-851-2254 ★

BATAVIA 350 Randall Rd. 630-761-2160 ★

BELVIDERE 1912 Gateway Center Dr. 815-547-9493

BLOOMINGDALE Stratford Square Mall 630-582-4707

336 W. Army Trail Rd. 630-980-4322 ★

BOLINGBROOK 224 Weber Rd. 630-226-4660

697 E. Boughton Rd. 630-783-8966 ★

BOURBONNAIS Northfield Square Mall 815-936-7605

BRADLEY 840 Kinzie Ave. 815-929-0693

CALUMET CITY 1245 Torrence Ave. 708-862-0500

CHICAGO NORTH 6451 W. Diversey 773-836-4401 ★

1652 N. Milwaukee Ave. 773-489-6200 ★

3620 W. Irving Park Rd. 773-463-5364 ★

4265 N. Harlem Ave. 708-457-1377 ★

810 W. North Ave. 312-397-5800 ★

CHICAGO SOUTH 120 W. 87th St. 773-994-9100

3435 W. 26th St. 773-522-9300 ★

CHICAGO CITY 500 W. Madison 312-831-0127**

500 N. Michigan Ave. 312-464-1390 ★

209 S. LaSalle St. 312-658-3900**

1103 S. State St. 312-291-0499 ★

OPEN SOON 36 State St. 312-726-8277

CHICAGO RIDGE Chicago Ridge Mall 708-346-9557 ★

CRESTWOOD 13447 S. Cicero Ave. 708-396-9822 ★

CRYSTAL LAKE 1125 South Route 31 815-444-6080

DOWNERS GROVE 1404 Butterfield Rd. 630-953-8052

GURNEE 6543 Grand Ave. 847-855-6019 ★

HILLSIDE 2201 S. Wolf Rd. 708-947-2500 ★

HODGKINS 9402 Joliet Rd. 708-387-0554 ★

HOFFMAN ESTATES 2734 N. Sutton Rd. 847-645-0190 ★

JOLIET 3330 Mall Loop Dr. 815-439-5100

LAKE IN THE HILLS 290 N. Randall Rd. 847-458-2866

In Collaboration with

Alcatel-Lucent

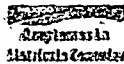

Visit the Verizon Wireless
Store inside one of the area's
Great City locations

BUSINESS CUSTOMERS
1-800-809-0289

HABLAMOS
ESPAÑOL

AUTHORIZED RETAILERS Equipment prices, models & return policy vary by location. Authorized Retailers may impose additional equipment related charges, including cancellation fees.

ALGONQUIN

The Wireless Network 847-658-0808

ARLINGTON HTS.

The Cellular Connection 847-255-2222

BARTLETT

Wireless Millennium Communications 630-483-5050

ELMHURST

The Cellular Connection 630-834-2776

HANOVER PARK

Wireless Millennium Communications 630-213-6060

JOLIET

The Wireless Network 815-838-2900

LAKE ZURICH

Corporate Cellular 847-540-4440

OAK LAWN

The Cellular Connection 708-499-4088

ROUND LAKE BEACH

The Wireless Network 219-947-9900

VERNON HILLS

Star Wireless 847-247-0361

WAUCONDA

Wauconda Cellular 847-487-0400

WEST DUNDEE

The Wireless Network 847-426-9933

WILMETTE

Linear Communications 847-853-3500



*Our Surcharges (incl. Fed. Univ. Svc. of 11.4% of interstate & int'l telecom charges (varies quarterly), 7% Regulatory & 85¢ Administrative/line/mo., & others by area) are not taxes (details: 1-888-684-1888); gov't taxes & our surcharges could add 9%-33% to your bill. Activation fee/line: \$35 (\$25 for secondary Family SharePlan lines w/ 2-yr. Agmts).

IMPORTANT CONSUMER INFORMATION: Subject to Customer Agmt, Calling Plan, rebate form & credit approval. Up to \$175 early termination fee/line & other charges. Offers and coverage, varying by service, not available everywhere. Device capabilities: Add'l charges & conditions apply. Rebate debit card takes up to 6 weeks & expires in 12 months. Max 5 lines on same account. Limited-time offers. While supplies last. Network details and coverage maps at verizonwireless.com. © 2008 Verizon Wireless. AALNB