

The background of the cover is a deep blue space filled with stars. A large, dark, textured planet, likely Earth, is visible in the lower half. A complex space station or orbital structure is shown in the center, with a prominent horizontal beam and various smaller components. A bright red sun or star is positioned behind the main title, creating a lens flare effect.

The PRAETORIAN STARSHIP

The Untold Story of the Combat Titan

Jerry L. Thigpen
Colonel, USAF, Retired



The Praetorian STARShip
The Untold Story of the Combat Talon

JERRY L. THIGPEN
Colonel, USAF, Retired

Air University Press
Maxwell Air Force Base, Alabama

December 2001

Air University Library Cataloging Data

Thigpen, Jerry L., 1946–

The Praetorian STARShip : the untold story of the Combat Talon / Jerry L. Thigpen.

p. cm.

Includes bibliographical references and index.

ISBN 1-58566-103-1

1. Hercules (Turboprop transports)—History. 4. Search and rescue operations—United States—History.

5. Airdrop—History. I. Title.

358.41'35'0973—dc21

Disclaimer

Opinions, conclusions, and recommendations expressed or implied within are solely those of the author and do not necessarily represent the views of Air University, the United States Air Force, the Department of Defense, or any other US government agency. Cleared for public release: distribution unlimited.

*This book is dedicated to all
Special Operators,
both living and dead.*

*All men dream: but not equally. Those who
Dream by night in the dusty recesses of their minds
Wake in the day to find that it was vanity; but the
Dreamers of the day are dangerous men, for they
May act their dream with open eyes, to make it
Possible. This I did.*

—T. E. Lawrence,
The Seven Pillars of Wisdom

THIS PAGE INTENTIONALLY LEFT BLANK

Definitions

Praetor: A high elected magistrate of the Roman Republic, ranking below the consulate and functioning for one year as a high judge and for the next year as the chief administrator of a province.

Praetorian Guard: The elite guard of the Roman emperors, usually numbering about 5,000 men. Originally the bodyguard of a praetor under the Roman Republic.

STARS: Acronym for the surface-to-air recovery system (or Fulton Recovery System).

The Praetorian STARShip: A unique unconventional warfare aircraft designed to infiltrate, resupply, and exfiltrate elite US Army Special Forces, US Navy SEALs, and US Air Force Air Commando personnel into denied areas utilizing both clandestine and covert operational procedures—more commonly known as **Combat Talon**.

Note: At the request of the author, some first names are omitted after chapter 7.

THIS PAGE INTENTIONALLY LEFT BLANK

Contents

<i>Chapter</i>		<i>Page</i>
	DISCLAIMER	<i>ii</i>
	DEDICATION	<i>iii</i>
	DEFINITIONS	<i>v</i>
	FOREWORD	<i>xv</i>
	ABOUT THE AUTHOR	<i>xvii</i>
	PREFACE	<i>xix</i>
	A WORD FROM THE COMMANDER	<i>xxiii</i>
	ACKNOWLEDGMENTS	<i>xxv</i>
	INTRODUCTION	<i>xxix</i>
1	Establishment of Combat Talon	1
	Notes	17
2	The Combat Talon Weapons System	19
	Notes	57
3	Combat Knife (The Pope Air Force Base Years: 1965–74)	59
	Notes	74
4	Combat Spear (The Vietnam War Years: 1966–74)	77
	Notes	120
5	Combat Arrow (Europe: 1968–74)	123
	Notes	136
6	The Son Tay Prisoner of War Raid (1970)	139
	Notes	157
7	Between the Wars (1975–79)	159
	Notes	177
8	The Iranian Rescue Mission (1979–80)	179
	Notes	233
9	Project Honey Badger and Credible Sport (1980–81)	235
	Notes	250
10	From Desert One to Point Salines (1981–83)	251
	Notes	287
11	Road to Combat Talon II (1984–89)	291
	Notes	315
12	Operation Just Cause (1989–90)	317
	Notes	335

<i>Chapter</i>		<i>Page</i>
13	Desert Shield/Desert Storm (1990–91)	337
	Notes	366
14	Mount Pinatubo to Operation Joint Endeavor (1991–95)	369
	Notes	416
15	Operation Assured Response to the New Millennium (1996–2000)	419
	Notes	458
	EPILOGUE	461

Appendices

A	Live Fulton STARS Made by Combat Talon Aircraft	467
B	Partial Summary of Upgrades, MOD-90 Combat Talon I	473
	GLOSSARY	477
	INDEX	485

Illustrations

Figure

1	Servicing Diagram for C-130E(I), circa 1967	20
2	C-130A/B Fulton Skyhook Installation (External View)	31
3	C-130A/B Fulton Skyhook Installation (Internal View)	32
4	Miscellaneous Recovery Equipment for STARS-Equipped C-130E	34
5	Typical Recovery Sequence	
	a. Aircraft Approaches Lift Line	35
	b. Aircraft Engages Lift Line	35
	c. Lift Line Engaged by Parahook	35
	d. Snatch Block Attached to Lift Line	35
	e. Anchor Clamp Attached to Lift Line	35
	f. Snatch Block and Parahook Removed from Lift Line	36
	g. Lift Line Released from Sky Anchor	36
	h. Lift Line Attached to Primary Winch	37
	j. Package Retrieved and Stopped at Davit Pulley	37
	k. Package Brought Aboard Aircraft	37
6	Monopulse Resolution Improvement Technique	40
7	Antenna Scan Patterns	41
8	Zero Command Line	41
9	Template Shift Due to Gross Weight Changes	42
10	Template Shift Due to an Increase in Flight Vector	42
11	Template Shift Due to an Increase in Negative Flight Vector	42
12	Template Shift Due to an Increase in Tailwind	42

<i>Figure</i>		<i>Page</i>
13	Template Shift Due to a Change in Set Clearance	43
14	Radar Blanking Zone	43
15	Obstacle Warning Template	43
16	Terrain-Avoidance Mode	44
17	Terrain-Following Mode	45
18	Cross-Scan Mode	47
19	Fail Light Maintenance Panel	48
20	Components of the Sling Ejection System	50
21	SEDS Plan View	51
22	Forward Fuselage—Upper Structure with UARRSI Opening	53
23	UARRSI Installed on Combat Talon	53
24	Typical Point-Parallel Procedure	55
25	First Resupply Mission into North Vietnam, 17 January 1967	85
26	Route of Flight, Crew S-01, 28/29 December 1967	95
27	Map of North Vietnam with Son Tay POW Prison	140
28	Aircraft Participating in Son Tay POW Raid	152
29	Route of Flight into North Vietnam, Son Tay POW Raid	153
30	The First Plan Developed by SOD, 16 November 1979	186
31	C-130 Formation Plan and Actual Formation Flown	220
32	Desert One, Fixed-Wing Arrival	224
33	Desert One, Rotary-Wing Arrival	226
34	Desert One, Bluebeard 3 Collides with Republic 4	227
35	Grenada and the Caribbean	272
36	Map of Grenada Area	283
37	Map of Grenada with Urgent Fury Objectives	285
38	Map of Panama	318
39	H-Hour Deployments, Operation Just Cause	324
40	Schematic of Rio Hato AB, Panama	329
41	Map of Panama with Operation Just Cause Objectives	334
42	Map of the Philippine Islands	338
43	Map of Southwest Asia	342

<i>Figure</i>	<i>Page</i>
44 AFSOC Deployed Locations during Desert Shield/Desert Storm	348
45 Batman Depicted in Eastern Turkey, North of Turkish/Iranian Border	359
46 BLU-82B Drop Locations	365
47 Map of Bangladesh	370
48 Map of the Philippines Depicting Mount Pinatubo and Clark AB	371
49 7th SOS Operating Locations in the Balkans	415
50 Operation Assured Response Objective Areas	421
51 Map of Palau, Located in the South Pacific	428
52 Route of Whisk 05, 1997 MacKay Trophy Winner	437
53 Route of Flight, Operation High Flight	439
54 Route of Flight, 7th SOS Crew Shark 01, 1998 Tunner Award	442
55 Map of Mongolia	444

Photographs

Carpetbagger B-24, circa 1945	3
581st ARCW B-29 over North Korea	7
ARS C-119 in French Markings	8
Heavy Hook C-123 with Outboard Jets	13
C-130E(I) Aircraft 64-0523	16
Robert Fulton's Stinson Aircraft with V Fork	27
Intermountain Aviation B-17 Modified with Skyhook	29
US Army C-7 Caribou Equipped with Fulton Recovery System	30
SEDS Sling Assembly, Ramp Up	51
SEDS Sling Assembly, Ramp Down	52
HSLADS Ramp Air Deflectors Installed on Combat Talon	52
Aircraft 65-0566, Pope AFB, N.C., circa 1966	59
First Two-Man STAR by an Operational Talon Crew, 24 August 1966	60
Official Patch, 318th SOS	71
Combat Talon at Hurlburt Field, Fla., circa 1973	72

	<i>Page</i>
Col Don Britton, First Commander of Stray Goose	77
SSgt Gerald R. Paulsen, Nha Trang AB, Vietnam, 1966	77
Official Patch, MACVSOG	78
The Anh Hoa Hotel, Nha Trang City, Vietnam, 1969	78
Enlisted Quarters, Nha Trang AB, Vietnam	78
Aircraft 64-0561 with Left Main Landing Gear Hanging	79
Aircraft 64-0561 Unloads Supplies at Hue-Phu Bai, Vietnam	80
Combat Spear at Ban Me Thuot AB, Vietnam	80
Sample Leaflets Dropped by Combat Spear	81
Aircraft 64-0561 Off-loading Ammunition, Hue-Phu Bai, 1967	82
SG-5 Crew	86
Transload of SOG Team, Nakhom Phanom, Thailand, 1966	87
Aircraft 64-0563, Nha Trang AB, Vietnam, 25 November 1967	89
Damage to US Facilities, 1968 Tet Offensive, Nha Trang City, Vietnam	103
Combat Spear Ramp with Revetments, Nha Trang AB, Vietnam	103
Enlisted Flight Crew Quarters, Nha Trang AB, Vietnam	105
Len Butler Fends First Pickup of Don James, 6 February 1971	112
SG-21 Crew on the Beach, May 1971	113
Original “Hole-in-the-Wall” Gang	113
Combat Spear Rigged for Leaflet Drop, Tempo Surge	115
Aircraft 64-0551 at Ramstein AB, Germany, circa 1968	123
7th SOS Aircraft 64-0572 HALO Drop	128
Presentation Ceremony, 7th SOS and Greek Hellenic Raiding Forces	128
7th SOS Crew Plans Flintlock III Mission	129
7th SOS Son Tay Rescue Crew	129
7th SOS Receives CINCUSAFE Most Outstanding Support Squadron Trophy, 25 June 1971	131

	<i>Page</i>
Combat Talon and HH-3/HH-53s Prepare for Son Tay POW Raid	146
Combat Talon Leading US Army UH-1 and Two HH-53s	146
Combat Talon Leading A-1 Skyraiders	146
Irl L. Franklin and John Gargus, Son Tay Reunion, November 1997	154
IR Landing Light Modification	188
Fuel Blivet Rigged on Combat Talon	188
Fuel Blivets on K-Loader Ready to be Rigged	188
Overhead Photo of Twin Otter Landing Area	208
Hangar at Wadi Kena, Egypt	213
Tent City at Masirah Island	213
Mission Aircraft Deployed to Masirah Island	214
Dragon 1 Crew	217
Dragon 2 Crew	217
Republic 4 Crew	218
Republic 5 Crew	218
Republic 6 Crew	219
Night Two Lead Crew	229
Motto “The Guts to Try”	230
Benson Fuel Tank System	237
Front View, Credible Sport Aircraft	242
Mark 56 Rocket Motor Installation	242
Shrike Rocket Mounting Pylon	243
ASROC Mounting Pylon, Aft Beavertail	243
Horsal and Dorsal Fin Modification	243
Double-Slotted Flap Configuration	244
Modified Tailhook Installed on Credible Sport	244
Aircraft 74-1683 Rocket-Assisted Takeoff, 29 October 1980	245
Aircraft 74-1683 Begins Rocket-Assisted Landing Sequence	245
Lower ASROC Rockets Are Fired Manually from the Cockpit	245

	<i>Page</i>
Aircraft 74-1683 Crashes onto Runway	245
Aircraft 74-1683 Wreckage on Runway	245
Aircraft 74-1686 during Credible Sport II Testing	257
Combat Talon 63-7785 Mired in Sand	270
Rear View of Aircraft 63-7785	270
Foxtrot 33 Crew	278
Foxtrot 34 Crew	278
Foxtrot 35 Crew	279
Foxtrot 40 Crew	279
Foxtrot 41 Crew	280
November 10 Crew	286
Combat Talon 63-7785 after Hit by Small-Arms Fire, 22 May 1985	298
Combat Talon II on the Ramp	300
Aircraft 64-0551 Nose Section Modified for Project 46	305
Aircraft 64-0551 APU Modification	305
Aircraft 64-0551 Hydraulic Control Panel	305
Project 46 Nose Strain Static Test	306
Aircraft 64-0551 Intercepts Six-Man Lift Line	313
Failed Radome after 1,500-Pound Pickup	314
Author with Maj Skip Davenport, Edwards AFB, Calif.	314
Project 46 Test Team	315
Rio Hato AB, Panama	323
Crew 1, Operation Just Cause	325
Crew 2, Operation Just Cause	325
Crew 3, Operation Just Cause	326
Tent City, KFIA, Saudi Arabia	346
Construction of Underground Bunker	348
Life at Arar AB	348
Crew 1, Desert Shield/Desert Storm	350
Crew 2, Desert Shield/Desert Storm	350
Crew 3, Desert Shield/Desert Storm	351

	<i>Page</i>
Crew 4, Desert Shield/Desert Storm	351
Crew 5, Desert Shield/Desert Storm	352
Crew 6, Desert Shield/Desert Storm	352
Crew 7, Desert Shield/Desert Storm	353
Crew 8, Desert Shield/Desert Storm	353
Crew 9, Desert Shield/Desert Storm	354
Crew 10, Desert Shield/Desert Storm	354
BLU-82B Rigged for Airdrop	363
BLU-82B Detonation	363
Pilot and Copilot Display, Combat Talon II	382
Nav/EWO Panel, Combat Talon II	382
Combat Talon 64-0565—First MOD-90 Modification	385
Ramp at Guantanamo Bay, Cuba, during Operation Uphold Democracy	401
Aircraft 64-0561 at Pap, Haiti	401
MC-130Es and HC-130P/Ns at Guantanamo Bay, Cuba	401
Gen Wayne Downing Visits Troops Deployed to Guantanamo Bay	402
MH-53J at US Embassy, Monrovia, Liberia	422
Combat Talon II Departs Dakar, Senegal	423
Evacuees Transload to Combat Talon II	423
Skyanchor Removal from Nose Section	424
15th SOS Multiple-Ship Formation	454
Combat Talon II En Route to Balkan Operations	456
Tech Sergeant Beck Prepares for High-Altitude Leaflet Drop	456
Leaflet Drop during Operation Allied Force	456
14 April 1999 Leaflet Mission	457
1 June 1999 Leaflet Mission	457
1 June 1999 Leaflet Mission	457
3 June 1999 Leaflet Mission	458
4 June 1999 Leaflet Mission	458

Foreword

As a young lieutenant flying tactical C-130s at Langley Air Force Base (AFB), Virginia, in the spring of 1967, I heard one Friday night in the Officers' Club that Tactical Air Command (our parent command) was looking for four C-130 copilots to transfer to Pope AFB, North Carolina, for training in a Top Secret C-130 squadron designated Combat Knife. That had to be more exciting than hauling trash, I thought. The following Monday I volunteered, and within a few months I was on my way to Pope AFB. This led to an exciting Air Force career flying the most versatile C-130 ever produced—the Combat Talon.

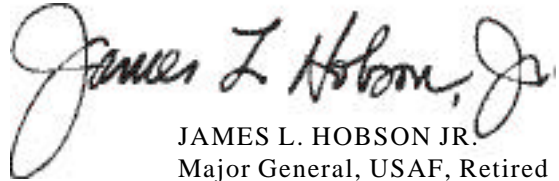
Jerry Thigpen's study on the history of the Combat Talon is the first effort to tell the story of this wonderfully capable machine. This weapons system has performed virtually every imaginable tactical event in the spectrum of conflict and by any measure is the most versatile C-130 derivative ever produced. First modified and sent to Southeast Asia (SEA) in 1966 to replace theater unconventional warfare (UW) assets that were limited in both lift capability and speed, the Talon I quickly adapted to theater UW tasking, including infiltration and resupply and psychological warfare operations into North Vietnam. After spending four years in SEA and maturing into a highly respected UW weapons system, the Joint Chief of Staff (JCS) chose the Combat Talon to lead the night, low-level raid on the North Vietnamese prison camp at Son Tay. Despite the outcome of the operation, the Talon I cemented its reputation as the weapons system of choice for long-range, clandestine operations.

In the period following the Vietnam War, United States Air Force (USAF) special operations gradually lost its political and financial support, which was graphically demonstrated in the failed Desert One mission into Iran. Thanks to congressional supporters like Earl Hutto of Florida and Dan Daniel of Virginia, funds for aircraft upgrades and military construction projects materialized to meet the ever-increasing threat to our nation. Under the leadership of such committed, hard-driven officers as Brenci, Uttaro, Ferkes, Meller, and Thigpen, the crew force became the most disciplined in our Air Force. It was capable of penetrating hostile airspace at night, in a low-level mountainous environment, covertly to execute any number of unconventional warfare missions.

The highly trained, disciplined Talon I crews led the invasions of Grenada in October 1983 and Panama in December 1989. The long-range "pathfinder" capability of the Talon Is made them the indispensable choice for these classic airfield seizure operations. In Desert Storm the Talon Is reverted to their Vietnam psychological warfare role by dropping millions of leaflets over Iraq and Kuwait. Additionally, they dropped eleven 15,000-pound BLU-82B bombs. Today the Talon I largely fulfills the penetrating tanker role, which includes the low-level penetration of hostile airspace and electronic countermeasures (ECM) protection for combat search and rescue rotary-wing forces.

The Talon I has earned its place in history as the forerunner of modern Air Force Special Operations. Today both the Talon I and Talon II continue to infiltrate, exfiltrate, and resupply friendly forces around the world. The Talon I has recovered packages and people with the Fulton Recovery System in virtually every theater, and both aircraft have dropped every conceivable object off their

ramps, from motorcycles to 15,000-pound bombs. Because of the capabilities of the versatile MC-130, and the extraordinary men and women who unselfishly support its mission of vital national importance, the future of Air Force Special Operations is secure.

A handwritten signature in black ink that reads "James L. Hobson, Jr." in a cursive style. The signature is positioned to the left of the printed name and title.

JAMES L. HOBSON JR.
Major General, USAF, Retired

About the Author



USAF Photo

Col Jerry L. Thigpen, USAF, retired, was commissioned in 1969 and served more than 30 years on active duty, the last 21 of which were in special operations units. He fought in Southeast Asia during the Vietnam War and logged more than 1,000 hours of combat time over northern Laos. During preparation for the rescue of American hostages from Iran in 1980, Colonel Thigpen was a member of the team that pioneered fixed-wing night-vision goggle (NVG) airland operations. He was a member of the crew selected to lead the rescue force into Manzariyeh, Iran, during the Night Two exfiltration mission. He was the air mission commander and Combat Talon formation leader of a five-ship formation that landed under fire at Rio Hato Air Base, Panama, in 1989 during Operation Just Cause.

During his distinguished Air Force career, Colonel Thigpen held a variety of operational and staff positions to include the J3-Air and chief of the Africa Region for Special Operations Command Europe (SOCEUR), commander of the 8th Special Operations Squadron, deputy commander of the 1st Special Operations Group, commander of the 353d Special Operations Group, director of safety for Air Force Special Operations Command, deputy commander of Special Operations Command-Korea (SOC-K), and director of research and analysis for Air Force Special Operations Command. He is a command pilot, certified instructor, and flight evaluator with more than 5,500 flying hours, 4,000 of which are in the MC-130E Combat Talon I.

Colonel Thigpen received his Bachelor of Arts degree in mathematics from North Texas State University in 1969 and later earned his master's degree in liberal arts from Texas Christian University. He completed the National Defense University (National Security Management) course by correspondence and the Air War College by seminar. In 1991 he graduated from the US Army War College resident program at Carlisle Barracks, Pennsylvania. His publications include *AFSOC: The Air Force's Newest Command*, published by the US Army War College. He also served as the publisher of *FOCUS, The AFSOC Commando Safety Journal*, from 1995 to 1997, during which time he authored numerous articles for the quarterly major command publication. He currently resides with his family in Shalimar, Florida.

THIS PAGE INTENTIONALLY LEFT BLANK

Preface

In the spring of 1997, while assigned to Headquarters Air Force Special Operations Command, an idea materialized that would ultimately dominate my life for the next three years. As I reflected over 19 years in special operations, I realized just how little I actually knew about the Combat Talon aircraft in which I had spent most of my active duty career. I could cite line and page number from complex technical orders, and I had been qualified as a flight examiner and instructor pilot, but I did not have a clue about the origins of Combat Talon, what operations the aircraft were involved in, or the people who flew and maintained them. Life in a special operations squadron was secretive, where only those with an official “need to know” were read into limited access programs. With the compartmentalization of information within the squadron, personnel working side by side were often not aware of what other members of the unit were doing. I was convinced that it was the right time to document the untold story of the Combat Talon.

The commander of Air Force Special Operations Command was Maj Gen Jim Hobson at the time. As a young lieutenant, he had been assigned to the 15th SOS at Nha Trang Air Base, Vietnam. I felt that if the project were explained to General Hobson, I stood a good chance of getting his approval. In March of 1997 I prepared a staff summary package outlining the Combat Talon Project and forwarded it to Herb Mason, the Headquarters AFSOC command historian. I provided four reasons the Combat Talon Project should be approved. First, I noted that much of the documented history of the weapons system was fragmented and could only be found in the files of private contractors, including Lockheed Air Service (LAS) Ontario and the Robert Fulton Company. LAS Ontario was no longer involved in the Combat Talon program and was scheduled to cease operation in the spring of 1998. The remaining LAS Ontario projects were scheduled to move to Palmdale, California, and join the highly classified Skunk Works program. The company did not plan to move most of its Combat Talon files, preferring to destroy them in place rather than store them at its new location. With the pending decision to terminate the Fulton recovery system for the Combat Talon I, the Robert Fulton Company no longer would provide equipment to the Air Force. Fulton was 88 years young, and his keen mind held a vast treasure of information about early development of the system. His comprehensive files also contained documentation on the Fulton system that was not available anywhere else. These key resources would not be available to future historians.

The second factor that I cited centered around recent Air Force reorganizations. Many commands either were combined or redesignated (e.g., Air Force Logistics Command [AFLC] had become the Air Force Materiel Command [AFMC], and whole divisions had been eliminated in the process). At Wright-Patterson AFB, Ohio, the home of AFMC, the old Air Force Logistics Command Directorate, which managed the Combat Talon program for the Air Force, had disbanded. Most of its records either had been destroyed or placed in long-term storage. The Air Force reorganization was across the board, and a tremendous amount of classified files was being eliminated. Prompt approval of the project would allow access to some of the remaining files, and copies could be made for future research.

The third factor driving approval of the project was the age of Vietnam-era veterans. Many who flew the Combat Talon during the 1960s were in their sixties, and some had already reached their seventies. Because of sketchy written documentation created by compartmentalization, it was imperative that these senior special operators be contacted and oral history interviews be conducted before it was too late. The last point made in the staff summary package was closely related to the previous one. Much of the operational history of the aircraft, including photographs and documentation of specific events, could only be found in the personal files of former Combat Talon operators. It was absolutely imperative that these files be sourced while they were still available.

With the staff summary package in hand, Mason took the ball and set out to gain approval. During 1997 the USAF celebrated its 50th anniversary as a separate service. Herb Mason proposed that the Combat Talon project be included as part of the yearlong event. Discussing the project with him and with his deputy, Clay T. McKutchen, the consensus was that the project would take at least two years to complete. AFSOC would celebrate its 10th anniversary as a separate Air Force command during calendar year 2000, and we agreed that the book would make an excellent commemorative of the important year. Thanks to the diligence of Mason, the Combat Talon project received approval by General Hobson on 31 March 1997.

The project consisted of three parts. The first was the publication of an unclassified monograph, titled "The Praetorian STARShip: The Untold Story of the Combat Talon." A companion book, not available to the general public and containing both classified and unclassified information, would be provided to AFSOC/HO. The third part of the project included the creation of a Combat Talon archive containing source material used in compiling the book. Included in the archive were unit histories, extracts of key documents important to Combat Talon history, oral history interviews, videotapes of the Combat Talon in operation, technical manuals, and so forth. The Combat Talon archive would be delivered to AFSOC/HO at the completion of the project and then maintained either at Hurlburt Field or at the Historical Research Agency at Maxwell AFB, Alabama.

Research for the Combat Talon Project was set to begin in June of 1997, but due to operational requirements, it was delayed until August. In the interim General Hobson relinquished command of AFSOC to Maj Gen Charles R. Holland. A project briefing was conducted in late August, at which time General Holland endorsed the project. Over the next two years, I worked continuously on the project, except during periods when operational necessity required that I fill critical manning requirements elsewhere. By the fall of 1999, I had been able to complete only 19 months of the 24-month project, having been tasked to fill operational commitments away from Hurlburt Field for over five months during the two-year period. With the limited time remaining before my retirement, I could not finish the project. Again, Mason stepped in and campaigned to have me to continue the project under civilian contract. Lt Gen Clay Bailey assumed command of AFSOC when General Holland left for duty in Europe in the summer of 1999. He reviewed the status of the Combat Talon Project and supported Mason's initiative to have the book completed under contract.

After retiring from the Air Force on 1 December 1999, I returned to my desk at the USAF Special Operations School in early January under contract with Madison Research Corporation. The project continued through early summer, at which time I delivered a smooth draft to Dr. Richard Bailey, my editor at Air University

Press. Although frustrating at times, the satisfaction of bringing the project to a successful conclusion is the crowning achievement of my professional career. After over four years and the review of literally thousands of documents, the product you are about to read still only scratches the surface of the Combat Talon story. My hope is that this book will provide a framework from which others far superior to me will be able to piece together the rest of the story. Until then, I must put down my pen and find peace in that I gave it my best shot. I pray that you will find I have done an acceptable job.

THIS PAGE INTENTIONALLY LEFT BLANK

A Word from the Commander

We in Air Force Special Operations Command (AFSOC) are blessed with a rich heritage that can be traced back to World War II and the Air Commandos of the China-Burma-India theater in the Far East. Because the special operations mission has been historically one of low visibility and little publicity, many times significant contributions to our nation's defense go unrecorded for general public release. Most often operational missions are classified and compartmented to protect the tactics used, assistance provided by friendly nations, and the special operators themselves.

I have tasked AFSOC's command historian with the responsibility to review past accomplishments systematically and to recommend subject areas, which warrant possible release to the public. The declassification process is a long and deliberate one and is coordinated through Air Staff, but our past efforts have been successful in getting information released that would not harm our national security. Over the past five years, AFSOC has commissioned several major works and has made them available for your reading. The first publication in the series was a study by SSgt Randy Bergeron, titled *AFSOC in the Gulf War*. The next effort was a book by USAF Col Michael E. Haas, retired, titled *Air Commando! 1950–1975: Twenty-five Years at the Tip of the Spear*. We followed up this second effort with a more in-depth work, also by Mike Haas, titled *Apollo's Warriors: US Air Force Special Operations during the Cold War*. In 1999 AFSOC commissioned Maj Forest L. Marion to document the impact of the eruption of Mount Pinatubo on our special operations forces stationed at Clark Air Base, Philippines. *Ash Warriors: The Relocation of the 353d Special Operations Wing, June–December 1991* provides unique insight into both the human and physical tragedy caused by the event.

The latest AFSOC effort, commissioned in 1997 and titled *The Praetorian STARShip: The Untold Story of the Combat Talon*, documents the exploits of the Combat Talon weapons system from original manufacture through the present day and tells the story of the men and women who support them. This is the most comprehensive and complete work to date and will be mandatory reading for all special operators. A future work will be a monograph of USAF special operations rotary-wing aircraft beginning with the Air Commandos of World War II and ending with the retirement of the last MH-53J/M. We also plan to publish a comprehensive work that documents the history of USAF Special Tactics. Additionally, plans are being developed to commission an AC-130H/U gunship monograph that covers the period from 1972 to the present.

As you can see AFSOC's publication program is an ambitious one, with the ultimate goal of publishing a book on each of our major weapons systems similar to *The Praetorian STARShip*. I am confident that you will enjoy this latest book by Col Jerry Thigpen, USAF, retired. We will continue to provide you with comprehensive histories that tell the USAF special operations story.



MAXWELL C. BAILEY
Lieutenant General, USAF

THIS PAGE INTENTIONALLY LEFT BLANK

Acknowledgments

I have saved this section until last, and I must tell you that it is by far the hardest to write. To express my gratitude to all of you who have contributed so much to this project, both directly and indirectly, somehow doesn't seem enough. But, with the full knowledge that I will inadvertently overlook someone, I will try.

For over 20 years, I have had the privilege to work in special operations and fly the amazing MC-130E Combat Talon. Throughout the entire time, I was blessed with great commanders, a challenging mission, and the total support of my wife, Mary, and my two children, Robert Allen and Stacy Diane. It was not all a bed of roses, however. The intensity and constant stress that those in the special operations community faced over the years took its toll. Fine marriages and great friendships had to take a back seat to the special operations mission. Although the devastating loss of those at Desert One proved to be the salvation of special operations, I miss those who died still today. We all owe a great debt to their personal sacrifice.

Over the years, several individuals have had a profound affect on my life. I would like to thank Col Gordy Ettenson for his friendship and counsel that saw me through many trying times. I would also like to thank Col Dave Schantz, retired, who is the hardest working and most dedicated officer I have ever known—you should have been a general officer. To Lee Hess, thanks for your passion and enthusiasm for Combat Talon. Your Stray Goose International organization is remarkable. To Col Bernie Moore, thank you for your help and friendship. I know that I have written the book you always wanted to write. To Lt Col Bob Meller, retired, a personal friend and mentor, you are the best Combat Talon pilot that I have ever had the privilege to fly with. To Col Bob Brenci, retired, you are the finest combat commander under which I have ever served. Thanks for seeing something in me and saving me in my time of need. Without your help, I would have left the Air Force in 1981. Thanks to all of you and to many others whose names have paled with the passing of time.

My years in Europe assigned to the 7th SOS and to Special Operations Command Europe (SOCEUR) taught me the importance of the special operations mission. My assignment to SOCEUR introduced me to my all-time personal hero, US Army Col John P. Gritz, retired, affectionately known as the “old gray-haired, pot-bellied ranger.” You always had faith in me, and you provided superior leadership during four hard years fighting terrorists across Europe, North Africa, and the Middle East. I will forever be in your debt. When I completed my SOCEUR tour, Maj Gen Robert B. Patterson, retired, reached out and selected me to be the commander of the 8th SOS. Thank you for giving me the opportunity to give something back to the special operations community. Thanks to the leadership of Brig Gen George W. Gray, retired, 1st SOW/CC, I thoroughly enjoyed my time at Hurlburt Field in squadron command. Thank you for believing in me.

My experiences while attending the US Army War College in 1991 established the foundation upon which I would rely to write *The Praetorian STARShip*. There is simply no way that you can stand on the rain-swept battlefields of Gettysburg on a chilly November day and not be moved by the awesome finality of history. I had always been a casual student of history, but from that day at Gettysburg, I

was changed forever. The US Army War College gave me the opportunity to make my first sojourn into recording history. I was pleased with my Military Studies Program publication, entitled *AFSOC: Air Force's Newest Command*. Although it does not compare in scope to *The Praetorian STARShip*, it represents my first major writing effort.

My thanks to Lt Gen Bruce L. Fister, retired, who gave me the opportunity to command the 353d Special Operations Group at Kadena Air Base, Japan. The 26 months spent in group command was by far the most demanding assignment of my career, and it was the most rewarding. To have the opportunity to be the senior Air Force Special Operations commander in WestPac was a thrill I will never forget. To the men and women of the 353d SOG, I must say that you earned your superior reputation every day that I had the privilege to command. I will never forget the experience. While assigned to Headquarters AFSOC as the director of safety, my staff was professional and supportive, and taught me the importance of doing the right thing the first time. What I thought would be a dull and tedious assignment turned out to be challenging and rewarding. The safety awards that AFSOC earned during my tenure in safety was indicative of the fine work of everyone in the command. As my time as the director of safety (and, indeed, my Air Force career) neared its end, my long-held desire to write the Combat Talon story surfaced as my top priority. I approached Herb Mason, Headquarters AFSOC/HO, with an outline of the project, and he was interested in presenting it to the command staff. I will forever be grateful to him and to Maj Gen James L. Hobson, retired, for approving the effort.

Although I had little experience in undertaking such a colossal project, Clay T. McCutchan, Headquarters AFSOC staff historian, soon introduced me to Joseph D. Caver and Essie G. Roberts of the Air Force Historical Research Agency (AFHRA) at Maxwell Air Force Base, Alabama. Over the next three years, I fear that I wore my welcome thin, but Joe and Essie did everything humanly possible to provide what I needed to complete my research. Other members of the AFHRA staff who were helpful included Archangelo DiFante and Dr. Forest Marion. I could not have written the book without their patience and help. The documents housed in AFHRA are truly a national treasure that would not be available without the dedication of the professionals working there.

When the project was still in its infancy, I received a telephone call from John Gargus, a Combat Talon operator from the 1960s and 1970s era. His help in guiding me through the early years of Combat Talon was critical in telling that portion of the Talon story. As the months passed, others came forward to help. When I needed illustrations and photographs to include in the book, I was introduced to John R. Lewis, now retired from Lockheed Air Service. His continual help over the course of the project has been of untold value. His contributions have helped make the book come alive with images from the past. I had the privilege of spending a week with Robert E. Fulton Jr. and his lovely wife, Ann. Thank you both so very much for your help with the project.

As my administrative requirements grew, the USAF Special Operations School provided essential support to keep the project on track. From computers to paper clips, the school provided everything that I needed. Col Brian Maher, retired, was extremely supportive of my effort, and Joyce A. Weber never failed me when I needed supplies to keep the project moving. When Herb Mason sent out a call for help on the project to the historians assigned to AFSOC, MSgt Daniel Wheaton of the 353d SOG immediately responded with a copy of all 1st SOS unit histories.

His quick reaction helped to jump start the project and saved me countless additional days TDY to AFHRA. The 16th SOW History Office, under the leadership of Dr. John Dabrowski, was also extremely helpful in providing information on wing-assigned Talon units.

I have enjoyed the support of successive AFSOC commanders, including Lt Gen Charles C. Holland and Lt Gen Maxwell C. Bailey. Their support allowed me to see the project through to completion. As the project comes to fruition, I look back on my life and realize just how fortunate I have been to spend almost my entire career in special operations. As Gen Jimmy Doolittle once said, "I could never be so lucky again." To the men and women of Air Force Special Operations Command, to those of the US Army Special Forces, and to those of the US Navy SEALs, I stand in awe of your accomplishments. Without a doubt, your sacrifice and devotion to duty is no less than that of the Praetorian Guard of ancient Rome. To associate with the best and brightest of today's military has made me a better man. Thank you all for the experience.

THIS PAGE INTENTIONALLY LEFT BLANK

Introduction

Welcome to the world of Combat Talon! The book you are about to read represents more than four years of research and writing dedicated almost exclusively to the Combat Talon project. It traces the colorful history of the Combat Talon weapons system from its predecessors of World War II and Korea up through the present day.

The first chapter establishes the historical foundation that leads to the requirement for Combat Talon in the mid-1960s. During late 1943 and early 1944, the US Army Air Force (USAAF) established two units to support forces assigned to the Office of Strategic Intelligence (OSS) operating in central Europe. Flying out of England and North Africa, B-17 and B-24 aircraft executed long-range, low-level penetration missions into central France to infiltrate, resupply, and exfiltrate friendly forces. From a humble beginning of three B-17s assigned to OSS/Algiers in 1943, USAAF-committed forces increased to 76 B-24s, four C-47s, and three B-17s by the summer of 1944. During daring operations over France, 13 B-24s were lost in combat by the Carpetbaggers, and another three aircraft were destroyed in noncombat accidents. Immediately after the end of World War II, the OSS was disbanded, and the special operations units that had supported it were decommissioned. The long-range, low-level mission into hostile territory first employed by these early pioneers formed the basis for Combat Talon.

Five years after the end of World War II, at the outbreak of the Korean War, the USAF had no unconventional warfare (UW) assets trained and equipped to support emerging UW requirements. The Central Intelligence Agency, a civilian organization with quasi-military responsibilities, was created in 1947. By 1950 there had not been a clear differentiation of duties and responsibilities between it and the three military services. Gen Douglas MacArthur, the commander of the Far East Command, was responsible for the defense of South Korea. He quickly sought to create an organization that would centralize control of all UW activities and develop a UW plan to employ against Soviet- and Chinese-backed invaders. The new organization was known as the Covert, Clandestine, and Related Activities-Korea (CCRACK), and it was partially staffed with former OSS officers familiar with the low-level, clandestine mission. To facilitate air support for CCRACK, the USAF established Unit 4, 21st Troop Carrier Squadron, in late July 1950 at Taegu Air Base (AB), Korea. Two months later Unit 4-assigned C-47s were flying the first low-level missions behind enemy lines. On 1 April 1952 B Flight of the 6167th Operations Squadron was established at Seoul City AB. It was assigned a combination of B-26 medium bombers and C-46/C-47 transport aircraft. Both B Flight and Unit 4 aircraft supported CCRACK low-level UW operations through 1953.

When the USAF was established in 1947, the greatest threat to our nation's survival came from the Soviet Union and its growing nuclear arsenal. Early USAF development was greatly influenced by this threat, which eventually became known as the cold war. One of the programs developed by the Air Staff to counter Soviet aggression was in the area of psychological operations. In 1948 the Air Staff established the Psychological Warfare (PW) Division. By 1950 the Air Resupply and Communications Service (ARCS) had been established, and under the new service, three Air Resupply and Communications Wings (ARCW) were

stood up, two of which were operational by 1952. There would eventually be three ARCWs—one based at Mountain Home AFB, Idaho, a second based at Clark AB, Philippines, and a third based at Wheelus AFB, Libya—supporting worldwide PSYWAR tasking. The Clark AB unit flew long-range leaflet missions into northern Korea in black-painted B-29 aircraft heavily modified for the PSYWAR mission. Also, during this period ARCW-assigned C-119 transports operating out of Clark AB supported the French in Southeast Asia (SEA). The SEA mission continued the tradition established in World War II of Air Force assets supporting non-Department of Defense agencies in covert resupply operations. After the Korean Armistice was signed in 1953, the ARCS continued to operate around the world and continued to fly the traditional long-range, low-level mission. By the mid-1950s, however, the Air Force had redirected its priorities away from psychological operations, opting instead to invest heavily in strategic bombers, nuclear missiles, and tactical fighters. As a result the last ARC unit was deactivated on 25 October 1956. Again, as had been the case after World War II, the Air Force was without any UW capability. The low-level penetration mission, however, would be revived a few years later in SEA.

The French, even with extensive air support from the United States, were defeated at Dien Ben Phu in May 1954, and from that time forward, USAF requirements to support American objectives in SEA steadily increased. In February 1962 the Military Assistance Command, Vietnam (MACV), was established in Saigon to manage the large increase in US personnel arriving in South Vietnam. Over the next three years, MACV grew in size and importance as the American commitment to SEA increased. President John F. Kennedy made a commitment to build a special operations force to support UW requirements around the world, and in the coming years, US Army Special Forces and US Air Force Air Commandos were trained and deployed to SEA and to Europe. The United States did not have a joint organization established to manage the diverse UW mission, so an organization was created to pull together Army, Navy, Air Force, and non-Department of Defense assets under an umbrella organization tasked with the UW mission. On 24 January 1964 MACV stood up a new UW organization similar to the earlier CCRACK unit in Korea and identified it as the Studies and Observations Group (SOG). USAF support for the new organization consisted of six specially modified C-123 aircraft equipped with electronic countermeasure (ECM) equipment, radar detection, and enhanced navigation. The unit, named Heavy Hook, was stationed at Nha Trang AB, Vietnam. The unit received the first C-123 aircraft on 25 June 1964, and it flew its first low-level combat mission into North Vietnam on 16 December. With its air requirements rapidly escalating, SOG requested additional air support. During the same period the USAF was developing the Fulton surface-to-air recovery system (STARS), which was designed to recover downed crew members from deep inside North Vietnam. As a result of the two requirements, Air Staff directed that 14 HC-130 aircraft (on the assembly line at Lockheed-Georgia) be modified into the UW configuration. The aircraft were identified as the C-130E(I) (later redesignated the MC-130E) and named the Combat Talon. Early aircraft were camouflaged with a combination of black and dark green paint, and they were commonly referred to as “Blackbirds.”

The second chapter is provided to familiarize the reader with the basic C-130 aircraft and to describe major UW modifications made to the 14 HC-130 aircraft. The Fulton STARS is discussed in-depth, with emphasis placed on early system development. To allow the new aircraft to fly its low-level mission and avoid enemy threats, terrain-following/terrain-avoidance radar was developed. Chapter 2 describes the theory and operation of the special radar. The chapter concludes with a description of the other major modifications to the weapons system, including ECM and the high-speed low-level aerial delivery system. After review of the basic weapons

system, the following three chapters cover the first 10 years of Combat Talon, from 1965 to 1974. During this period the Combat Talon community grew into three distinct units—Combat Knife in the continental United States, Combat Spear in the Pacific, and Combat Arrow in Europe. Chapter 3 tells the story of the Combat Talon unit (Combat Knife) established at Pope AFB, North Carolina. The Combat Knife unit was attached to the 779th Troop Carrier Squadron and was tasked with the initial organization and training of aircrews to man the complex weapons system. The Combat Knife unit later became the 318th Special Operations Squadron, and it moved to Hurlburt Field, Florida, in 1974 as the 8th SOS.

Chapter 4 documents the early years of Combat Spear. In the fall of 1966, four aircraft and six crews deployed from Pope AFB to SEA as Combat Spear and were assigned to the 314th Troop Carrier Wing at Ching Chang Kuang (CCK) AB, Taiwan. The final beddown location of the Combat Spear unit was Nha Trang AB, Vietnam, where it was colocated with its sister squadron, Heavy Hook. By the end of the year, Combat Spear aircraft were flying SOG-tasked missions into North Vietnam. Low-level infiltration and resupply drops, along with high-altitude leaflet drops, made up the majority of the combat missions flown. The legacy of the World War II Carpetbaggers and the ARCWs of the early 1950s was revived. During 1967 Combat Spear lost two of its assigned aircraft, one over North Vietnam and a second on the ground during a mortar attack. In 1968 the unit's name changed to the 15th Special Operations Squadron, and it continued to support SOG requirements until 1972 when it relocated to Kadena AB, Okinawa, as the 90th SOS. Six months later the squadron's name again changed to the 1st SOS.

The third Combat Talon unit, also made up of four aircraft and six crews and identified as Combat Arrow, deployed to Ramstein AB, Germany, in 1968 and became part of the 7th SOS. Chapter 5 traces the early years of the 7th SOS as it transitioned from C-123, C-47, and UH-1 helicopters to the new Combat Arrow. September 1968 marked the beginning of a long and successful exercise series in Europe when the 7th SOS participated in Flintlock I. The exercise series continued over the next 22 years during some of the most tense periods of the cold war. In March 1973 the 7th SOS moved from Ramstein AB to Rhein Main AB, Germany, where it remained for the next 19 years.

Chapter 6 presents a detailed account of the Son Tay prisoner-of-war (POW) raid as told through the eyes of the Combat Talon crews that participated in the heroic event. Mission preparation and rehearsal in the Florida Panhandle before deployment to SEA is covered in detail. Because of limited numbers of Combat Talon aircraft and crews worldwide, one crew and aircraft were sourced from the 318th SOS, one crew from the 7th SOS, and one aircraft from the 15th SOS. By spreading the tasking throughout the Talon community, no one unit was adversely affected, and the Top Secret operation could be better protected from compromise. The mission was a team effort from the start, with Combat Talon providing lead pathfinder duties for both rotary-wing and fixed-wing formations. Although the POWs were moved from Son Tay Prison before the raid, the planning and execution of the mission were almost flawless. Had the POWs been there, the rescue force would have undoubtedly been successful.

By the mid-1970s the United States had departed Vietnam, and a period of military drawdown and consolidation had begun. Chapter 7 covers the period from 1974 to 1979. During this period USAF conventional and unconventional warfare forces were reduced significantly. For Combat Talon the 14-aircraft fleet was maintained, but funding for spare parts and base infrastructure to support them was

greatly reduced. By the end of 1975, the entire Air Force SOF capability had been cut to one undermanned wing (the 1st SOW) at Hurlburt Field, Florida, with three squadrons assigned (the 8th, 16th, and 20th SOSs), and two Talon squadrons stationed overseas (the 1st and 7th SOSs). Barely 3,000 personnel remained in SOF during the late 1970s.

The watershed event for modern special operations—the Iranian rescue mission—occurred in 1980 and is covered in detail in chapter 8. After a brief discussion of the events leading up to the taking of the US Embassy in Tehran, the author traces the development of special tactics and unique equipment to allow the Combat Talon to do its tasked mission. In a manner similar to chapter 6, this chapter emphasizes Air Force preparations and rehearsals leading up to the actual mission. When the mission failed at Desert One, the Combat Talon community only paused briefly before it resumed preparations to return to Iran. The next chapter, chapter 9, documents post-Desert One developments under the Honey Badger program. Advancements in equipment and technology are discussed. By late summer 1980 a companion program, separate from Honey Badger, was begun. Known as Credible Sport the objective of the developmental program was to create a C-130 aircraft capable of landing and taking off in a 100-yard distance. From the beginning of planning for the rescue of the hostages, the most difficult task (from an Air Force standpoint) was getting rotary-wing aircraft into and out of the embassy area safely. Across the street from the American embassy was a soccer stadium. If the United States could develop a C-130 aircraft that could land, onload its precious cargo, and then take off in the distance of the soccer field, the entire rotary-wing problem could be eliminated. Early requirements for the Credible Sport aircraft included the capability to land on an aircraft carrier with the aid of an arresting hook. The carrier-landing requirement originated from the need to quickly move potentially critically wounded personnel to a trauma center for medical care. From concept to partial modification of the first aircraft, Credible Sport was flying three weeks after the program began. Within 60 days a fully modified aircraft had been delivered to the test crews. During a test mission on 29 October 1980, the aircraft crashed and was destroyed during a maximum effort short-field landing test. Shortly afterwards a new president was elected, and talks with the Iranians accelerated. The crisis was resolved in January 1981 when the hostages were released immediately after President Ronald Reagan was sworn into office. The hostage release brought to an end the initial Credible Sport program, but Honey Badger continued on into 1981. The tactics and equipment developed under Honey Badger formed the foundation for modern-day SOF. Fallout from Desert One resulted in the relocation of the 1st SOS from Okinawa to Clark AB, Philippines, in early 1981.

After the Desert One mission, the Holloway Commission was formed by the Department of Defense to investigate why the mission failed. The commission found that the mission was well planned and that it would have probably succeeded except for circumstances beyond the control of the participants. It made several recommendations, many of which were incorporated into the Department of Defense structure. Chapter 10 discusses the period after the release of the hostages, including the initial requirement for the Combat Talon II weapons system. The Combat Talon II program first utilized the remaining Credible Sport aircraft, and the effort was identified as Credible Sport II. The Credible Sport II program validated many of the advancements incorporated into the Combat Talon II, but the extensive dorsal, dorsal, and retro-rocket modifications developed for the unique Credible Sport mission were not included in the production aircraft. In 1983 all Air Force special operations aircraft were transferred from Tactical Air Command to the Military Airlift Command (MAC), including the two overseas Combat Talon squadrons. The

move was partially driven by the Air Staff's desire to consolidate all special operations assets under one command and thus eliminate redundancy and standardize the fleet. Only a few months after moving to MAC, Combat Talon was tasked to support US operations in Grenada. The chapter ends with an in-depth look at Combat Talon support for Operation Urgent Fury. During the air assault on Point Salines, Grenada, Lt Col Jim Hobson earned the MacKay Trophy for the most prestigious flight of 1983.

By 1984 Congress had grown impatient with the three services regarding the slow improvement of SOF and expressed its dissatisfaction over the next two years. Chapter 11 follows the changes in SOF organization through 1989. At the heart of Congress's concern was the Combat Talon II. Since 1982 Congress had included funding for the new weapons system in the annual budget, but each year the Air Force redirected the funds to other, more important conventional priorities. In 1984 the Air Force developed its own plan to fix special operations, which included divesting itself of all rotary-wing SOF assets. Known as Initiative 17, the agreement between the chiefs of staff of the US Air Force and US Army called for transfer of the SOF rotary-wing mission to the US Army. The agreement infuriated many members of Congress, who looked upon the initiative as a first step by the Air Force to rid itself of the entire special operations mission. Two years later Congress passed the Goldwater–Nichols Department of Defense Reorganization Act of 1986, which was the landmark legislation that established modern-day SOF. The act created the US Special Operations Command (USSOCOM) and, for the first time ever, Congress earmarked a major force program to fund SOF requirements. Thus, USSOCOM was given the responsibility to manage SOF appropriations separate from service funding. The Combat Talon program was included in the new organization. In 1988 the Combat Talon II faced a major program crisis due to cost overruns and delivery delays linked to the poor performance of the radar, forcing the restructuring of the entire program to save it from cancellation. Chapter 11 ends in 1989 on the eve of Operation Just Cause—the US invasion of Panama.

The following two chapters discuss Combat Talon participation in contingency operations in both Panama and Southwest Asia. Chapter 12 begins in December 1989 when the 8th SOS was alerted to deploy to Panama for Operation Just Cause. Crews of the 8th SOS landed at Rio Hato AB, Panama, only minutes after the initiation of hostilities, delivering vital equipment and personnel. In the following days Combat Talon crews supported special operations throughout the country, and on 3 January 1990, an 8th SOS Combat Talon exfiltrated Manuel Noriega from Panama to the United States. Chapter 13 describes Combat Talon operations in Southwest Asia during 1990 and 1991. Seven months after Just Cause, the 8th SOS deployed four aircraft and six crews to Saudi Arabia within days of the start of Operation Desert Shield. The deployment continued for the next eight months, with most of the squadron's energy directed towards that theater. During Desert Storm the 8th SOS dropped millions of leaflets in a highly successful psychological warfare campaign and delivered 11 BLU-82B 15,000-pound bombs in support of coalition objectives. The 7th SOS also deployed two Combat Talons to Turkey in mid-January 1991 to support the joint search-and-rescue mission. Chapter 13 ends with both units returning to their home stations.

The catastrophic explosion of Mount Pinatubo near Clark AB, Philippines, forms the backdrop for the beginning of Chapter 14. Many heroic actions were performed by members of the 353d SOW and the 1st SOS as the Pacific Talons were forced from their Pacific island base. For the next year the squadron remained in limbo, with the decision delayed until 1992 to base all Pacific SOF fixed-wing assets at

Kadena AB and all rotary-wing assets at Osan AB, Korea. Also, during 1992 the 15th SOS was activated at Hurlburt Field and became the first operational squadron assigned the Combat Talon II. Later in the year the 7th SOS moved to Royal Air Force Alconbury, United Kingdom, and converted to the Combat Talon II weapons system. At year's end the 1st and 8th SOSs operated the Combat Talon I aircraft, with the 7th and 15th SOSs assigned the new Combat Talon II. At Kirtland AFB, New Mexico, three Combat Talon II aircraft were assigned to the 1550th Combat Crew Training Wing, and all formal Talon II training was shifted from Hurlburt Field to that location over the following year. During 1995, as a result of Commando Vision, the 1st SOS converted to Combat Talon II, and their Combat Talon I aircraft were subsequently transferred to the 711th SOS at Duke Field, Florida. By the end of 1995, the 8th SOS was the only active duty squadron flying the older Combat Talon I, with the 1st, 7th, 15th, and 550th SOSs flying the new Combat Talon II. The 711th SOS at Duke Field, assigned to the Air Force Reserve Component (AFRC), operated the remainder of the older Combat Talon Is. Chapter 14 closes with a description of the 7th SOS's participation in Operation Joint Endeavor.

The final chapter covers Combat Talon operations from 1996 to 2000. Contingency operations in Africa and the Balkans, along with the extended commitment to Southwest Asia, characterized the period. During the late 1990s the Combat Talon II weapons system was brought to maturity, and the sophisticated weapons system trainer became operational at Kirtland AFB. In 1997 a 7th SOS crew won the MacKay Trophy for its heroic actions during contingency operations in Africa. It was the second time that the award was won while operating a Combat Talon aircraft. In 1998 the 8th SOS flew the remains of one of its fallen comrades, 1st Lt Michael Blassie, from Arlington National Cemetery to his home in St. Louis, Missouri. Lieutenant Blassie had been shot down in Vietnam in 1972, and his remains had been honored in the Tomb of the Unknowns since 1984. The 7th SOS was heavily involved in Operation Assured Response during the spring of 1999. The European Talon II squadron dropped millions of leaflets as it contributed to the most concentrated air operation since World War II. The highly successful psychological operations campaign contributed significantly to the early cessation of hostilities by warring Serb forces. As the year 2000 began, the 8th SOS moved to Duke Field and collocated with the 711th SOS, becoming the first Air Force active associate squadron. Under the new arrangement all 14 Combat Talon I aircraft were transferred to AFRC, with both active duty and Reserve component crews operating them.

The future of Combat Talon is discussed in the epilogue, with a look at the impact of the new CV-22 tilt-rotor aircraft on Talon force structure. The Combat Talon of the future is also presented with a discussion of the MCX concept aircraft, which is a stealthy special operations delivery aircraft still on the drawing board. The future of Combat Talon is bright. As long as there is a need for a long-range, low-level aircraft capable of penetrating hostile airspace to deliver men, materiel, or leaflets anywhere in the world, the Combat Talon will remain the centerpiece of contemporary SOF.

* * * * *

I hope that you find this story as interesting and exciting to read as it was for me to put down on paper. In the end, however, history isn't always interesting or exciting. *The Praetorian STARShip* was written as a smorgasbord of facts and events that covers over 50 years of Combat Talon history. Partake of the feast as much as you like, then saddle up and take a ride with Combat Talon.

Chapter 1

Establishment of Combat Talon

And so, my fellow Americans, ask not what your country can do for you, ask what you can do for your country.

—John F. Kennedy

It was November 1979 on a return flight from Pope Air Force Base (AFB), North Carolina, when Lt Col Bob Brenci first mentioned the possible involvement of our unit, the Eighth Special Operations Squadron, in an attempt to rescue American hostages in Iran. As the sun dipped below the horizon, I thought of what this might mean in the forthcoming months. Our idle speculation soon turned into reality a few days later as tasking flowed from the Joint Chiefs of Staff (JCS). The effort expended over the following 12 months by the special operations community would ultimately set a course that would result in the rebirth and resurrection of special operations. For those of us intimately involved in special operations at the time, we could not see how our nation could allow such a unique capability to fade away. Yet, since Vietnam special operation forces (SOF) assets had steadily declined. Perhaps a successful rescue could save our cherished mission.

I had checked out in the MC-130E Combat Talon weapons system in November 1978 and had been upgraded to instructor pilot the following fall. I had little knowledge of the heritage and traditions of the former Combat Talon units. Indeed, the whole talon program had been cloaked in secrecy, with little more than barroom war stories ever told of early exploits. I had gone to Southeast Asia (SEA) as a second lieutenant in 1971 to fly the EC-130E and had gazed with envy at the Combat Spear and Heavy Chain aircraft that would occasionally transit the Air America ramp at Udorn Royal Thai AFB, Udorn Thani, Thailand. I vowed to be a part of this exciting special operations program one day. As the purple sky grew dark over Georgia, I had little concept of what Colonel Brenci's words would mean to me personally, but I was soon to feel the pain, as did the whole SOF community, of the greatest adventure of my life.

But the story of Combat Talon didn't begin here, nor did it begin in SEA. Rather, it began some 40-odd years before, over the skies of occupied France. Nazi Germany had extended its iron fist over the continent of Europe, and all that remained

of French resistance was small bands of partisans operating throughout their occupied nation.

To support and build a viable partisan force, Allied planners developed the concept of low-level infiltration, resupply, and, in some cases, exfiltration of Allied forces sent to help the partisan bands. Although aircraft have changed dramatically since the early beginnings, the mission has remained virtually the same. To understand how the modern MC-130E/H Combat Talon weapons systems have evolved into what they are today, we must make a brief sojourn back into history.

World War II: The Office of Strategic Services and the US Army Air Force

The modern-day Combat Talon mission can be traced to World War (WW) II and the French campaign in Central Europe from 1944 to 1945. The long-range, low-level mission was also employed by the 1st Air Commando Group in the China-Burma-India theater in the Far East. When Nazi Germany overran France early in the war, the venue was set for the long-range, low-level penetration mission to infiltrate, resupply, and exfiltrate friendly forces operating behind enemy lines. Throughout France, partisan bands organized to resist the brutal occupation of their homeland by Nazi Germany. The key to partisan success lay in their ability to receive Allied support, thus providing them the capability to continue their struggle. The Office of Strategic Services (OSS) headed by William J. "Wild Bill" Donovan was tasked to support these behind-the-lines operations. Although some operations could be done by way of land or sea infiltration, the vast majority of OSS requirements relied on air for support. Royal Air Force (RAF) special duties squadrons supported their own special operations forces, but they did not possess air assets in sufficient quantities to service OSS needs. General Donovan organized his European OSS operations to best support the French area of operations. He established two primary operating locations—one just outside London, known as OSS/London, and one in North Africa, known as OSS/Algiers. The

OSS had no dedicated aircraft to support its air requirements, but instead it relied on theater operational commanders for support. Because of the high demand placed on the United States Army Air Force (USAAF) in Europe at the time, and because of the specialized nature of the mission, support was not forthcoming. In the fall of 1942, General Donovan set about to acquire a commitment from the JCS for dedicated air support of his operations in France.

In December 1942 the OSS presented a detailed operations plan (OPLAN), JCS OPLAN 170/1, to the Joint Chiefs of Staff for their approval. The document outlined requirements for OSS clandestine activities in the western Mediterranean, including the requirement for three bomber-type aircraft for each moonlit night of the month. Sourcing of these aircraft was left to the discretion of the theater commander. The plan was endorsed by the JCS on 18 December 1942 and forwarded to Gen Dwight D. Eisenhower in Algiers for his approval. On 7 February 1943 General Eisenhower gave his approval in principle to the OSS plan. Aircraft assigned to the region belonged to the Northwest African Air Forces (NAAF) under the leadership of Lt Gen Carl A. "Tooney" Spaatz. Citing higher priorities for conventional air operations, General Spaatz deferred NAAF support for the OSS plan.

Without dedicated air assets, the OSS had to compete with conventional forces for support. The heavy requirements generated by high-altitude daylight bombing of Germany did not leave any heavy bomber assets available to support OSS operations. The OSS considered the situation intolerable. In Washington, General Donovan submitted a letter to the JCS on 13 June 1943 outlining the need for dedicated special air units for his overseas OSS bases. He requested that JCS approve six bomber-type aircraft for OSS/Algiers and one squadron of 12 aircraft for OSS/London. The JCS disapproved Donovan's request, again deferring sourcing of air assets to the overseas combat theater commanders. JCS reasoned that if the mission was important to theater commanders, then they should be willing to provide air assets out of hide. In August 1943 General Spaatz finally approved assignment of three NAAF B-17s to OSS/Algiers.¹

The assignment of the three B-17s to OSS/Algiers gave the OSS a meager air capability in North Africa for the first time. The aircraft and crews were sourced from the 2d, 99th, and 301st Bomb Groups. On 26 September 1943 three

aircraft and three crews were officially assigned to the new Special Flight Section of OSS/Algiers. The Special Flight Section set up operations at Massicault Airfield, Tunisia, where the 2d Bombardment Group was also located. Being an ad hoc organization with no maintenance of its own, OSS/Algiers aircraft were maintained by 2d Group personnel.²

The B-17 training program began with daylight, low-level, cross-country flights across Tunisia and Algeria. Aircraft flew as low as 400 feet above the ground, and aircrews soon transitioned to night low-level training flights as navigational skills improved. Unlike their modern-day C-130 Talon cousins, the B-17s were extremely limited when it came to night low-level operations, having to rely on visual cues for both terrain avoidance and navigation. The first operational mission flown by an assigned OSS/Algiers B-17 occurred on 20 October 1943. A lone B-17F of the Special Flight Section departed Blida Airfield near Algiers and headed north towards the southern coastline of France. After low-altitude penetration into southern France, the aircraft continued low level to its drop zone (DZ) near the Swiss border and air-dropped 10 containers of weapons, ammunition, and other supplies to a group of French Maquisards under the supervision of a British agent. During the return leg of the mission, the aircraft was hit and badly damaged by enemy anti-aircraft fire, forcing shutdown of two of the aircraft's four engines. The crew nursed the aircraft back to Algeria, where it made an emergency landing. Although suffering combat damage to the aircraft, the first OSS/Algiers resupply mission was an operational success.³

With success came additional support in late October 1943. Three B-25 medium bombers, followed a short time later by an additional three, were assigned to OSS/Algiers by Twelfth Air Force (AF) to be used for personnel infiltration missions. Employment of the B-25s proved unsatisfactory for OSS operations into France—they were deemed too fast for personnel drops, and they had neither the range nor the payload to reach France from North Africa. With six aircraft assigned, the Special Flight Section was reorganized into two units—the 122d Liaison Squadron and the 68th Reconnaissance Group. In late December 1943 the 122d and the 68th redeployed to Manduria, Italy, where the B-25s could be better utilized. The B-17s were left in North Africa and moved to Blida Air Base (AB), Algeria, which was located some 20 miles from OSS/Algiers headquarters and was

colocated with the British RAF's Halifax-equipped Special Duties Flight.⁴

As OSS/Algiers acquired its meager allotment of B-17s and B-25s, OSS/London continued to refine its requirements and seek USAAF support. On 6 February 1943 OSS/London dispatched a message to OSS/Washington, establishing its requirement for "at least 12 specially modified B-24 Liberators." In Washington, as he had done since the previous fall, General Donovan continued to work, albeit unsuccessfully, to convince the JCS to dedicate aircraft for OSS/London (and also increase aircraft allocations for OSS/Algiers).⁵

Not until the fall of 1943 did the OSS break the logjam, and only then by a quirk of fate. The War Department and the Navy Department agreed that the Navy would be the sole service responsible for airborne antisubmarine warfare. The 9 July 1943 agreement released the USAAF from the antisubmarine mission, which was being performed in Europe by Eighth Air Force's 479th Antisubmarine Group with four squadrons of B-24 Liberators. Navy aircraft were scheduled to arrive in Europe to replace the 479th in October 1943. The USAAF antisubmarine B-24s had been heavily modified for their naval warfare role and were unusable as conventional bombers. In addition, 479th aircrews were not trained in high-altitude precision bombing.⁶

Maj Gen Ira C. Eaker, the Eighth AF commander, quickly worked out a plan to employ the 479th B-24s and their crews for OSS support. With JCS approval of OSS/London's operational plan arriving on 17 September 1943, General Eaker directed Eighth AF to implement the air portion of the OSS plan. The initiative was designated the Carpetbagger Project. In November two new special operations squadrons were activated as the 36th and 406th Bombardment Squadrons (Special) and were stationed at Royal Air Force (RAF) Alconbury.⁷

Through the remainder of the year, aircrews from the disbanded 479th Group were trained for their new low-level mission by RAF special duty crews. Thirty-two B-24s were concurrently modified at Eighth AF maintenance depots, and by the first of January 1944, initial aircrews and aircraft were certified combat ready.⁸

Modifications to the aircraft included measures to improve their night-flying capabilities and modifications to allow personnel to parachute from the aircraft. Engine exhaust flame dampers, muzzle flash suppressers for defensive guns, and blackout curtains throughout the aircraft were all

designed to reduce the possibility of visual detection by the enemy. For personnel airdrops, the ball turret and its supporting structure were removed from the floor of the aircraft, thus leaving a large circular hole through which agent drops could be made by parachute. Many other minor modifications were also made: OSS/Algiers B-17 and B-25 aircraft were painted black under the wings and under the fuselage, while the Carpetbagger B-24s were painted solid black.⁹

The first Carpetbagger mission was flown into France on 4 January 1944, followed by 16 other missions throughout the month. In February and again in March, the Carpetbaggers moved locations, finally settling at their permanent location of Harrington Airdrome. The Carpetbaggers flew 56 missions in February and 69 in March. By the end of March, all 32 B-24s were modified and combat ready, resulting in 99 missions being flown in April. In May the number of missions jumped to 200.¹⁰

As missions increased and OSS/London's air operations matured into a first-rate force, OSS/Algiers continued its operations with its three original B-17s and six B-25s assigned during the previous fall. While the B-25s supported operations in Italy and the Balkans, the B-17s made up the higher priority OSS/Algiers commitment to France. From October 1943 through January 1944, however, the three B-17s had flown 26 missions, with only 11 resulting in successful airdrops.¹¹

General Eaker was promoted to lieutenant general in January 1944 and was transferred to the Mediterranean as commander, Mediterranean Allied Air Forces (MAAF). His success with the Carpetbagger B-24s motivated him to seek similar capabilities for OSS/Algiers. For the next



USAF Photo

Carpetbagger B-24, circa 1945.

three months, Eaker lobbied Washington for support. On 9 March 1944 the War Department authorized Eaker to designate one squadron to be organized for OSS operations. The 122d Liaison Squadron was inactivated, and men and equipment throughout MAAF were redirected to form the new unit.¹²

General Eaker used the three-plane B-17 element at Blida to form the nucleus of the new squadron. Fifteenth Air Force was directed to detach 12 B-24 Liberators from its bomber force to be utilized by the special operations unit. The aircraft were sent to a maintenance depot in Tunis for modifications and painting during March and April, and aircrews were trained in low-level operations. In February the unit flew five missions; in March and April, 35 were flown. In May, well before all crews were trained and aircraft modified, 88 missions were completed. On 10 April 1944 the new unit was officially activated as the 122d Bombardment Squadron (Heavy), and on 15 June 1944, it was redesignated the 885th Bombardment Squadron (Heavy) (Special), with three B-17s and 12 B-24s assigned.¹³

On 2 May 1944 General Eisenhower directed General Spaatz to provide an additional 25 aircraft for the Carpetbagger Project. On 10 May the 788th and 850th Bombardment Squadrons were assigned to the Carpetbaggers, thus bringing the total aircraft strength to 64 Liberators assigned to the 801st Bomb Group.¹⁴

Throughout the spring, OSS/London and OSS/Algiers accelerated combat operations into France in preparation for Operation Overlord, the invasion of France by way of Normandy, and Operation Anvil, the invasion of southern France. Before D day, special operations missions concentrated on the delivery of weapons and ammunition to resistance groups operating in occupied France.¹⁵ To a lesser degree, agents and agent teams were infiltrated to assist in organizing French resistance forces. After the Normandy and southern France invasions, the air effort shifted to personnel airdrops, as hundreds of Allied teams were inserted into the French interior. As ammunition and supplies were expended, resupply drops were flown to keep those forces operationally sound.¹⁶ Special Operations B-17s and B-24s flew their low-level missions at 1,000 feet above the ground, at approximately 150 knots indicated air speed (KIAS). Once near the drop zone, the aircraft descended to 800 feet for personnel drops or to 400 feet for resupply drops, then slowed to 120 KIAS. Resupply DZs were usually

marked by flashlights or small fires placed there by the reception team. For personnel infiltrations, many teams were dropped into unmanned and unmarked drop zones.¹⁷ From January 1944 until the end of the Normandy campaign nine months later, OSS-tasked B-17s and B-24s flew into France on virtually every moonlit night to execute covert operations. OSS/Algiers aircraft also flew a few missions into Italy and the Balkans, and OSS/London Carpetbaggers flew occasionally into Denmark and Norway. The primary objective, however, was always France.¹⁸

Support for OSS covert operations did not come without a price. At its peak in the summer of 1944, the USAAF committed 83 aircraft to the covert low-level infiltration, resupply, and exfiltration of OSS-sponsored agents (three B-17s, 76 B-24s, and four C-47s). Of these, the Carpetbaggers lost 13 B-24s and 219 personnel over France, while the 122d/885th did not lose a plane operating out of North Africa. One 122d B-17 and two Carpetbagger B-24s were also lost in noncombat accidents. By September 1944 German presence in France had all but ceased. Only small pockets of German resistance in fortified enclaves could be found. On 12 September the 885th Bomb Squadron flew its last sorties into France, and on 17 September the Carpetbaggers ceased operations there.¹⁹

After a successful French campaign, the Carpetbaggers continued operations into Norway, Denmark, and over Germany itself. Operating from southern Italy, the 885th flew missions into northern Italy, the Balkans, and Eastern Europe. The units continued to provide critical support to the Allied war effort throughout the remainder of the war. Like many other units at war's end, special operations units completely disappeared from the USAAF, and the OSS itself ceased to exist. It would take another war, which occurred halfway around the globe in a place called Korea, before special operations aircraft would fly again the low-level mission around which Combat Talon was designed.

Post–World War II—The Cold War, Korea, and the Road to Vietnam

World War II ended in the Pacific in August 1945, and a nation weary of a half-decade of war eagerly transitioned to the role of an emerging superpower. Europe and Japan lay devastated from the war, yet America was virtually untouched. The huge demands of rebuilding the world's economy placed the United States at the forefront of this massive undertaking and thrust it into an economic boom unparalleled in history.

Two days before the surrender of the Japanese in the Pacific, the Soviet Union declared war on Japan and marched into Manchuria and northern Korea. The Soviet Union took the United States by surprise with its swift action; therefore, the United States hastily proposed that Soviet forces accept surrender of the Japanese north of the 38th parallel, saying that the United States would accept surrender south of that point. US leaders reasoned that elections would be held in the near future to determine the makeup of post-World War II Asia, including Korea. The Soviets readily accepted the proposal, but free elections never were held, thus setting the stage for a future conflict on the Korean peninsula.

Throughout the remainder of 1945 and into 1946, the United States demobilized its air, land, and naval forces that had fought and won World War II. The United States had not historically maintained a large standing military during peacetime. With demands placed on the United States to rebuild Europe and Japan, US demobilization seemed the right course of action. The one miscalculation made by the United States was the Soviet Union's dogged determination to expand communism through world dominance. The resultant cold war was not recognized in its early stages for what it actually was—a war. Not until the summer of 1950, when the North Korean Peoples Army (NKPA)—trained and equipped by the Soviet Union and communist China—invaded South Korea, did this miscalculation come to light.

With the disbanding of the OSS in 1945, the National Security Council (NSC) was tasked with covert and clandestine operations and established infrastructure and organizational responsibility for carrying out those operations. The National Security Act of 1947 established the National Security Council and the Central Intelligence Agency (CIA) as independent agencies responsible for collecting intelligence affecting the national security of the United States. During peacetime the CIA was designated the primary agency for conducting covert and clandestine actions. In times of war, the Department of Defense (DOD) had primary responsibility, but there was a great deal of undefined areas, which would inevitably cause conflict between the two civilian and military organizations. From 1947 to 1954, NSC directives outlined when either DOD or the CIA was responsible for these actions.²⁰

When the NKPA invaded Korea on 25 June 1950, DOD and CIA relationships were still in

their infancy. As a result, military, CIA, and South Korean unconventional warfare (UW) efforts in Korea were uncoordinated and disjointed from the outset. The initial organization set up to manage UW efforts in Korea was known as the Far East Command (FECOM) "Liaison Group," or FEC/LG. This staff organization was FECOM's link to intelligence and partisan organizations controlled by DOD and CIA case officers. The CIA was an independent civilian organization and, as such, guarded its independence from the military establishment. The reluctance to cooperate between these two organizations doomed FEC/LG. By late fall the FECOM commander, Gen Douglas MacArthur, sought to create an organization tasked to centralize control of all UW activities and to develop a UW-coordinated plan. The classified title for the new organization was Covert, Clandestine, and Related Activities—Korea (CCRACK) and was located in downtown Seoul. Its unclassified title was the "Combined Command for Reconnaissance Activities—Korea." CCRAK (pronounced see crack) was a joint organization made up of both military and CIA personnel. The CIA division of CCRAK was entitled the "Joint Activities Commission, Korea (JACK)." The director of CCRAK was a military officer who was appointed by FECOM; the deputy director was a civilian CIA officer who was also the director of JACK. As was the case for FEC/LG, cooperation between the military and CIA civilians was voluntary within the organization. The CIA would not relinquish its independence to a military boss. As the war progressed, this ad hoc organizational structure would impact CCRAK's ability to accomplish its mission in an effective and efficient manner.²¹

FEC/LG, and later CCRAK, required air support to infiltrate its agents behind the lines just as the OSS had required during World War II. To facilitate airborne infiltration of these agents, Unit 4 of the 21st Troop Carrier Squadron (TCS) was established at Taegu Airfield (K-2) in southern Korea in late July 1950. On 26 September 1950 two C-47s from Unit 4 accomplished the first of many infiltration missions by air-dropping nine agents behind the retreating NKPA. All landed safely and were later exfiltrated by foot to report NKPA movements.²² After the United Nation (UN) breakout from the Pusan perimeter and the landing of General MacArthur's forces at Inchon, Unit 4 moved forward to Kimp'o Airfield (K-14), located just outside Seoul. For the next three months, CCRAK missions were flown deep into northern Korea from K-14. Chinese forces invaded Korea

across the Yalu River in November 1950 and steadily pushed UN forces back toward Seoul. Pressure from the invading Chinese forced Unit 4 to redeploy to K-2 by February 1951.²³

As Unit 4 reconstituted itself at K-2, it received orders from its parent wing, the 374th Troop Carrier Wing (TCW), to establish a Special Air Missions detachment. Subsequently, on 20 February 1951 Unit 4 was deactivated, and the Special Air Missions detachment stood up to provide VIP air support in addition to its CCRAK commitment. The Special Air Missions detachment was tasked to provide additional air support to the US ambassador to Korea, president of the Republic of South Korea, commander in chief (CINC) FECOM (now Gen Matthew Ridgway), and to 8th US Army (USA) staff. The Special Air Missions detachment was also tasked to fly psychological warfare (PSYWAR) missions as requested by 8th Army. This new tasking placed a tremendous burden on the small Special Air Missions unit. By day attached Fifth AF crews flew VIP missions throughout the theater in a converted VB-17 bomber and a VC-47 transport. By night 8th Army PSYWAR missions were flown by Special Air Missions aircrews in two C-47 speaker-equipped aircraft, and covert CCRAK infiltrations were made by three additional C-47s formerly owned by Unit 4. Although modifications to the latter aircraft were requested by CCRAK, the only modification made was the addition of the SCR-300 radio.²⁴ Throughout 1951 Special Air Missions C-47s executed CCRAK low-level infiltration missions into northern Korea.

Special Air Missions aircrews were literally flying around the clock to support all mission taskings. CCRAK requirements soon exceeded the Special Air Missions detachment's capabilities. As a result, on 1 April 1952 B Flight, 6167th Operations Squadron, was activated at Seoul City AB (K-16) to increase FECOM's special operations capabilities. B Flight was equipped with B-26 medium bombers and C-46/C-47 transports. The B-26 aircraft were modified to accommodate up to six jumpers who would parachute from the aircraft through the open bomb bay. All B Flight aircraft were painted black to reduce detection during nighttime operations.²⁵

The primary mission of B Flight was the infiltration and resupply of agents or teams operating behind enemy lines whose purpose was to gather intelligence and to perform other covert activities,

including the rescue of downed aircrew. B Flight also had a psychological operations (PSYOPS) mission that included leaflet drops and speaker broadcast. More conventional in nature, B Flight crews were also trained in night flare operations. Other operations included personnel snatch utilizing transport-type aircraft.^{*26}

On 29 December 1952 a Fifth AF letter outlined a new capability for retrieving downed aircrew or agents from enemy-held territory. The system was known as the Personnel Pickup Ground Station and was more commonly referred to by aircrew as "the snatch system." The system was similar to banner-towing aircraft pickups whereby a wire was suspended between two poles, with a second wire attached to the object (or person) to be picked up. An aircraft equipped with a tailhook (usually a C-47 transport) would fly low just above the horizontal wire and hook the line with the tailhook. The aircraft would then perform a rapid climb to altitude while the package was retrieved into the pickup aircraft.^{**27}

On two occasions during 1953, B Flight was tasked to perform a snatch mission. The first attempt ended unsuccessfully when the downed airman was captured before the aircraft arrived in the pickup area. The second attempt had to be aborted after the pickup aircraft received heavy fire and severe damage during its run-in for pickup.²⁸ Like the Special Air Missions detachment, B Flight continued to operate and fly CCRAK missions until the signing of the Korean War Armistice in 1953.

Air Resupply and Communications Service

By 1948 it became apparent to US leadership that the Soviet Union under Joseph Stalin could not be appeased, persuaded, or otherwise convinced to respect the territorial rights of its neighbor nations. The US Air Force (USAF) and the CIA had been created by the National Security Act of 1947 and activated a short time later. Visionaries in the Pentagon reasoned that the next war would be fought and won (or lost) in the minds of those fighting it. Subsequently, the Psychological Warfare Division was established at the Air Staff in February 1948. By definition psychological warfare in 1948 was synonymous with special operations as defined during World War II. The new PSYWAR (also known as PW) division

*Vietnam-era C-130E(I) Combat Talons would execute virtually identical missions for Military Assistance Command Vietnam, Special Operations Group (MACVSOG).

**The Fulton Surface-to-Air Recovery System (STARS) was developed by Robert Edison Fulton Jr. during the 1960s and was a vast improvement over the older "snatch" system. STARS was installed on the 14 C-130E(I) Combat Talons and was deployed to SEA in the mid-1960s.

immediately set about to develop plans to fight this “new” type of warfare, which came to be known as psychological warfare, or PSYWAR for short.²⁹

In 1950 Air Staff/PW created two special operations wings devoted to the PSYWAR mission and scheduled them to be activated in 1952. The plan called for three additional wings to be activated in 1953, with future growth programmed to seven wings. On 5 January 1951 the Military Air Transport Service (MATS) was tasked to organize, train, and equip these new wings. For security purposes, the special operations wings were designated “air resupply and communications wings.” A new service was established to provide oversight for this new capability and was designated the Air Resupply and Communications Service (ARCS).³⁰

Activated on 23 February 1951 at Andrews AFB, Maryland, the ARCS represented the most ambitious commitment to special operations since World War II and was responsible for oversight of the PSYWAR mission of the US Air Force. The catalyst for this new capability was the requirement by the CIA for long-range air transport of guerrilla warfare agents and supplies into Soviet-occupied Europe and Northwest Asia. ARCS was responsible for USAF unconventional warfare (guerrilla warfare), direct action (commando-type raids), strategic reconnaissance (intelligence gathering), and PSYWAR operations.³¹

The 580th Air Resupply and Communications Wing (ARCW) was activated at Mountain Home AFB, Idaho, in April 1951, with a second wing, the 581st ARCW, following in July. A third wing, designated the 582d ARCW, was activated in 1952. The three wings were organized and equipped in a similar manner, with the exception that the 581st ARCW was the only wing having rotary-wing aircraft. First-year activities for the 580th and 581st were devoted to training aircrew and support personnel in their new PSYWAR mission and in rebuilding Mountain Home AFB, which had fallen into disrepair since the end of World War II. In early 1952 the 581st received orders to forward deploy to Clark AB, Philippines, and to be assigned to Thirteenth AF. The first to deploy overseas, the composite wing arrived at Clark AB in July 1952 with six squadrons specifically tailored to perform the PSYWAR mission.³²

Of the six squadrons assigned to the wing, the 581st Air Resupply Squadron (ARS) was the lone squadron devoted to flying operations. Assigned to the 581st ARS were 12 specially modified B-29

heavy bombers, four C-119 heavy transports, four SA-16 amphibians, and four H-19A helicopters. (The 580th/582d ARS were equipped with the same number of fixed-wing aircraft.) All aircraft were new, except for the B-29s, which had been pulled from USAF storage at Warner Robins AFB, Georgia. The mission of the 581st ARS was the infiltration, resupply, and exfiltration of guerrilla-type personnel, and the aerial delivery of PSYWAR materiel (leaflets and other similar materiels). The other five squadrons supported the 581st ARS by providing maintenance, cargo airdrop rigging, long-range communications, and PSYWAR/leaflet production. One unique squadron was devoted to preparing guerrilla-type personnel for insertion into enemy-occupied territory.³³

The 581st ARCW proved to be a very flexible wing, and its initial theater deployment plan, outlined in FECOM Operations Plan (OPLAN) 3-52, capitalized on this flexibility. The OPLAN established a concept of operations for theater forward deployment of assigned 581st ARCW assets. Four B-29s and associated support personnel were placed on a 60-day rotation schedule to Yokota AB, Japan, to be collocated with the 91st Strategic Reconnaissance Squadron, which also flew the B-29. The four C-119 and support personnel were placed on a 90-day rotation schedule, with the commander, 315th Air Division (AD), to determine where the aircraft would be deployed. Two SA-16s were sent to K-16 in Korea to augment B Flight of the 6167th Air Base Group. The four H-19A helicopters were also forward deployed to K-16 in support of the 2157th Air Rescue Squadron (in fact, they were collocated with the 2157th but actually supported B Flight, as did the two SA-16s).³⁴ CCRAK maintained Operational Control (OPCON) of these forces and employed them into northern Korea along with B Flight and Special Air Missions detachment aircraft.

Extensive modifications were required for the B-29 Superfortress to enable it to perform the special



Photo courtesy of Apollo's Warriors

B-29s from the 581st ARCW supported long-range psychological leaflet operations into northern Korea.

operations mission. All turrets, except the tail turret, were removed from the aircraft, leaving the aircraft unarmed and incapable of self-defense. A parachutist's exit was made where the belly gun turret was originally located. Resupply bundles were mounted on bomb racks inside the bomb bay, thus allowing the bundles to be dropped like bombs over the drop zone. Aircraft were painted black, and a crude HTR-13 obstruction-warning radar was installed to warn the crew of approaching terrain. Later Combat Talon aircraft would be equipped with a highly sophisticated radar allowing low-level, adverse weather terrain-following operations. The major flaw in the B-29 employed in the special operations role, however, was that it had been designed for high-altitude precision bombing, not low-level airdrop. Over the drop zone at drop airspeed, the aircraft was near its stall speed and was difficult to maneuver.³⁵

A B-29 assigned to the 580th ARCW conducted trials at Eglin AFB, Florida, during the summer of 1951 to determine if the aircraft could be used to extract personnel utilizing the prototype Personnel Pickup Ground Station extraction system. The test aircraft was modified with a 48-inch diameter opening in place of the aft-belly turret and with an elongated tailhook at the rear of the aircraft. The system was similar to the one adopted in 1952 by Fifth AF for the C-47s of the Special Air Missions detachment in Korea. The tests proved technically feasible, but the project was dropped for the B-29 aircraft due to aircraft size and safety considerations of flying it so close to the ground.³⁶

The solid black B-29s flew long-range leaflet-drop missions over northern Korea. PSYWAR "leaflet bombs" were loaded with various forms of PSYWAR materiel and then airdropped from high altitude. An altitude-sensitive fuse opened the container at a predetermined set altitude, dependent on premission forecast winds and desired dispersal patterns. On 15 January 1953 a 581st ARS B-29, with the wing commander on board, was shot

down 12 miles south of the Yalu River in far northern Korea on a leaflet-drop mission. Radar-controlled searchlights illuminated the unarmed Superfortress, and "day only" MiG-15s shot the aircraft down. Surviving crew members were imprisoned by Chinese communist forces and were put on trial in October 1954. Not until 4 August 1955, two years after the Korean War Armistice, were the surviving crew members released from Chinese prison.³⁷

At the direction of the 315th Air Division commander, the 581st ARS C-119s provided limited airlift support to FECOM's Korean operations throughout 1952. Beginning in 1953, however, the C-119s were employed in Southeast Asia in support of French operations in Indochina. Supplies, including ammunition, vehicles, and barbed wire, were delivered to Haiphong Airfield in ever-increasing quantities. When US presence in Indochina could not be publicly escalated, plans were developed to utilize 581st personnel in a discrete support role. Refurbished C-119s, under French markings, were flown into Indochina by 581st crews, and French C-119s were flown out for depot repair at Clark AB. Instructors from the 581st were also tasked to train CIA-employed Civil Air Transport (CAT) civilian aircrews in the C-119. American support for the French only prolonged the inevitable fall of the former colonial power. In May 1954, the French were defeated at Dien Bien Phu, thus ending 100 years of French colonial rule in Indochina.³⁸

In October 1954, after being downsized to a group in September 1953, the 581st was relocated from Clark AB, Philippines, to Kadana AB, Japan, where it continued reduced operations out of that location for the next two years. In September 1956, the group was officially deactivated, thus closing a chapter in special operations history in the Pacific.³⁹

* * * * *

In July and September 1952 the 580th ARCW, which had been stationed at Mountain Home AFB since its activation, embarked its support personnel by way of ship to North Africa for its initial deployment overseas. Assigned B-29s flew out of Westover AFB, Massachusetts, with a planned refueling and overnight crew rest stop in the Azores en route to Wheelus AB, Libya. The C-119s and SA-16s, with a much shorter range than the B-29s, took a northern route through Iceland, England, and Italy before arriving in Libya.⁴⁰



Photo courtesy of Apollo's Warriors

Picture depicts ARS C-119 in French markings. Squadron supported US interest in SEA during the early 1950s.

Life at Wheelus AB for the 580th was Spartan, at best, for the first six months of operations. Personnel lived and worked in tents enduring the sweltering summer heat of North Africa. Low-level training was emphasized for the aircrews. The B-29s and C-119s flew low over the Mediterranean Sea, and flew 500 feet above the Libyan desert. In January 1954 a B-29 was lost during a low-level training mission when it failed to clear a ridgeline.⁴¹

A primary customer for the 580th was the 10th Special Forces Group (Airborne) [(10th SFG) (A)], which was garrisoned at Bad Tölz, Germany, in the Bavarian Alps. Tenth Group personnel would deploy to Libya for parachute and desert survival training. Dropping at 1,000 feet above the ground, B-29 navigators utilized the Nordon bombsight developed during World War II to determine the release point. The bombsight proved to be equally as accurate at 1,000 feet as it had been dropping bombs at high altitude during WWII.⁴²

Assigned SA-16s were tasked to fly classified courier missions throughout the Mediterranean, Middle East, and southern Europe. The amphibian aircraft proved to be versatile and on several occasions was tasked to fly extremely sensitive missions, including ones into the Balkans behind the so-called iron curtain and into southern Russia. Operating out of Tehran, Iran, in March 1956, an SA-16 penetrated Soviet airspace at low-level altitude en route to a night amphibious exfiltration from the Caspian Sea. The mission went as planned, resulting in the successful exfiltration of a man, woman, and two children. The family was flown directly to a water rendezvous in the Mediterranean Sea and from there transferred to an awaiting ship.⁴³

During the summer of 1952, while the 580th was deploying to Wheelus AB, the Air Staff announced its decision to reduce the number of ARC wings from seven to four. Only three wings were eventually activated, however (the 580th, 581st, and 582d).⁴⁴ The primary reason for this reduction was funding. The Air Force was essentially operating a national-level special operations program for an agency outside the DOD (the CIA) with dollars needed for higher priority strategic forces. With the rapid buildup of the Strategic Air Command to counter Soviet cold war aggression and the resulting funding requirements, the lesser priority PSYWAR mission was curtailed. In April 1953 the Air Staff directed ARCS to limit operations to Air Force-only projects, thus ending support for such outside agencies as the CIA. Nine months later Department of the Air Force Letter 322 and Military Air

Transport Service General Order 174 deactivated ARCS, effective 1 January 1954.⁴⁵

In September 1953, after the Korean Armistice was signed that ended active conflict on the Korean peninsula and three months before deactivation of the ARCS, the three active wings were reduced to air resupply groups. The downsized groups were approximately one-half the size of the former wings and consisted of two squadrons—one flying squadron and one support squadron—as compared to six squadrons in each wing before the reorganization.⁴⁶

* * * * *

The third and last ARC wing, the 582d, was activated at Mountain Home AFB on 24 September 1952, to coincide with the deployment of the 580th to Libya. As the previous two wings had done, the 582d spent its first year at Mountain Home AFB training and preparing assigned personnel for its PSYWAR mission. Having been newly redesignated the 582d Air Resupply Group, it deployed from Mountain Home AFB to RAF Molesworth, United Kingdom (UK), and set up operations in Europe in February 1954.⁴⁷

The 582d was assigned to Third Air Force and provided the bulk of its air support to the 10th SFG (A), which had been transferred in total from Fort Bragg, North Carolina, to Bad Tölz, Germany, by this time. For the next two and one-half years, the 582d worked closely with the 10th Group providing airdrop, resupply, and airland support with its assigned B-29 and C-119 aircraft. The versatile SA-16 was utilized for amphibious missions, including night water-infiltration/exfiltration operations.⁴⁸

By 1956 USAF interest in the unconventional warfare mission had run its course. General Order 37, Headquarters Seventeenth Air Force, dated 12 October 1956, deactivated the 580th ARG in place in Libya. Third Air Force General Order 86, dated 18 October 1956, deactivated the 582d ARS, effective 25 October 1956. With the deactivation of the 581st at Kadena AB in September 1956, the USAF closed the book on the long-range unconventional warfare mission around which the ARCS and its associated wings were based.⁴⁹ The book would open again eight years later when the United States found itself in a hot war in SEA.

Early American Assistance to Vietnam

As the tide of battle changed in favor of the Allies near the end of WWII, agents of the United

States began working with resistance groups opposed to the Japanese occupation of Indochina. The OSS played the predominant role in these early operations. Ho Chi Minh guerrillas were actively resisting Japanese occupation, and as a result, OSS agents were approved by President Franklin D. Roosevelt in early 1945 to train the Viet Minh and help lead them in their efforts against the Japanese. The war in Europe was reaching its climax, and France had been liberated from Nazi occupation. The OSS had the capacity to redirect much of its attention to the war in the Pacific. During this early period of US involvement in Indochina, Ho Chi Minh had not declared himself a communist. What has come to be an ironic twist of fate, the first American aid to SEA was to the Viet Minh guerrillas fighting against Japanese occupation. These guerrillas would become America's enemy during the Second Indochina War.⁵⁰

The United States opposed the return of the French to Indochina after Japan's defeat in 1945, but with the death of President Roosevelt in April, there was little formal opposition. In the view of President Harry S. Truman the United States had more important commitments elsewhere in the postwar world than in Indochina. The United States also needed French support in Europe against the Soviet Union and consequently backed off from its opposition of the French claiming their colonies in SEA. Thus, a near-total withdrawal of US aid was coupled with a concurrent French buildup in their former colony. Ho Chi Minh did not favor the return of the French; rather, he viewed their return as an extension of the century-old occupation of Indochina by foreigners. Ho Chi Minh moved to the countryside and continued his resistance to foreign occupation that he had begun against the Japanese. With no Western aid available, he turned to the Chinese communists for support. With the defeat of the Nationalist Chinese by Communist forces in 1949, the United States reevaluated how it looked at the French-Viet Minh conflict. With the onset of the cold war and the resultant containment policy of the United States, America began to associate the Indochina conflict as an East versus West one—communism versus the Free World. North Korea, with the support of both Chinese and Stalinist communists, invaded South Korea on 24 June 1950. The United States established the Military Assistance and Advisory Group (MAAG) in Saigon in August 1950. From that time until the defeat of the French at Dien Bien

Phu in May 1954, America provided 80 percent of the logistical costs of French activities in Indochina.⁵¹

During the 1954–55 period, the United States was negotiating in Paris and in Saigon to gain permission to train the South Vietnamese Army. On 10 May 1955 (one year after Dien Bien Phu), the White House announced that the United States had undertaken responsibility for the training of Vietnamese armed forces upon the request of the government of Vietnam and with the agreement of the government of France. Ten days later, French military forces evacuated Saigon, thus ending their government's official participation in the affairs of its former colony.⁵²

From the very onset of US training of Vietnamese forces, America suffered from the so-called Korean syndrome; that is, America concentrated on building a conventional army to fight a conventional enemy that would attack the South over the demilitarized zone (DMZ) separating the two countries. A strong conventional army was viewed as the key to stopping communist aggression. There were some individuals in Washington, however, who did not view the Vietnamese conflict solely in conventional terms. As a result, the most knowledgeable unconventional warfare expert in the US military was sent to Saigon to establish an unconventional warfare capability—Col Edward F. Lansdale of the US Air Force.⁵³

Colonel Lansdale had gained recognition for his work in the Philippines during the Communist Hukbalahap's (Philippine People's Anti-Japanese Army) Huck rebellion of the late 1940s. With Lansdale's assistance, Philippine president Ramón Magsaysay had executed an unconventional warfare campaign that proved to be the most successful campaign of its kind up to that time. Some in Washington saw similarities in Vietnam that existed during the early years of the Huck rebellion, and they felt that experience gained there could be applied by Colonel Lansdale to the Vietnamese conflict.

In June 1954 Colonel Lansdale arrived in Saigon to become the chief of the Saigon Military Mission (SMM). His charter included the establishment of an organization for clandestine and covert actions against North Vietnam (NVN). These actions were to discredit "an active and intelligent enemy who made full use of legal rights to screen his activities in establishing his stay-behind organization south of the 17th parallel."⁵⁴ Two months after Lansdale's arrival, NSC issued Directive 5412, which defined covert operations

conducted by the United States. Several previous directives addressing covert operations were also rescinded at the same time. A follow-on NSC Directive, 5412/2, provided the national authority for UW operations as conducted in SEA, namely, propaganda, political action-economic warfare, preventive direct action, including sabotage, anti-sabotage, and demolition; escape, evasion, and evacuation measures; subversion against hostile states or groups, including resistance movements and guerrilla or refugee liberation groups; support of indigenous and anticommunist elements in threatened countries of the Free World; and deception plans and operations.⁵⁵ NSC 5412/2 further stated that such operations did not include armed conflict by recognized military forces, espionage, and counterespionage, nor cover and deception for military operations.⁵⁶ The most significant outcome of Directive 5412/2 was the establishment of Special Group (5412), which was the highest national authority to grant approval and disapproval of covert operations.⁵⁷

By August 1954 Colonel Lansdale's SMM was adequately staffed, and armed with the just issued NSC Directive 5412, he commenced operations against the North. Paramilitary teams were established in Hanoi, Haiphong, and south of the 17th parallel. Initial efforts centered on propaganda campaigns utilizing leaflets distributed by these teams designed to cast doubt on individual ownership of property under the communists, on money reform, and on individual freedoms. Sabotage of key war-fighting materiel, such as contamination of oil stocks, was an example of direct-action-type missions these teams performed. Perhaps the most important mission assigned to the paramilitary teams by SMM was the recruiting and training of stay-behind indigenous forces to be employed after the two countries were divided. Another important mission was the caching of supplies for use by these stay-behind forces. By 1955 Ho Chi Minh had assumed complete control of the North, and an unofficial report reviewed the accomplishments of the SMM up to that time: "It had taken a tremendous amount of hard work to beat the Geneva deadline—to locate, select, exfiltrate, and equip the men of these (indigenous) teams and have them in place, ready for actions required against the enemy."⁵⁸

In 1955 the US government put its support behind Ngo Dinh Diem, a member of the Christian minority in a predominately Buddhist South Vietnam. Diem's early successes to consolidate power in the South was perceived in a positive light in

Washington and more aid was provided to his government. The truth behind his early success was, in fact, that Communist forces were concentrating on consolidating power in the North and had not yet begun large-scale, organized efforts in the South. Just as SMM had equipped and trained indigenous stay-behind forces in the North, Viet Minh guerrillas (later known by Americans as Vietcong) were organized and equipped in the South to challenge the South Vietnamese government. Beginning in 1957 the Viet Minh began escalating armed attacks against Diem's forces because of actions taken by Diem that affected Vietcong objectives in the South. These actions included Diem's cancellation of elections prescribed by the Geneva Accord in 1956, his intensified campaign to eliminate the Viet Minh in South Vietnam by military force, and his close economic, military, and political ties with America. Throughout the remainder of the 1950s and through 1961, the communist insurgency intensified and expanded throughout South Vietnam. In September 1960 the US ambassador to Saigon advised President John F. Kennedy that "it may become necessary for the US government to begin consideration of alternative courses of action and leaders."⁵⁹

US-Soviet relations in early 1961 strengthened America's resolve to defend freedom in Southeast Asia. In his now-famous speech of January 1961, Nikita S. Khrushchev announced Moscow's intention to back "wars of national liberation" around the world. In April of 1961 President Kennedy suffered the humiliation of the Bay of Pigs fiasco, which set off alarms in Washington that would quickly be heard in Vietnam. On 20 April 1961, the day after the attempted Bay of Pigs invasion of Cuba, President Kennedy asked the secretary of defense to apprise him of the Vietnam situation and to recommend a course of action that would prevent communist victory in Indochina. The resultant plan submitted to President Kennedy articulated a greater emphasis on covert and paramilitary operations as well as deployment of additional military and CIA personnel to South Vietnam. With the president's approval and endorsement by the secretary of state and the secretary of defense, the plan marked the beginning of a commitment to SEA that would continue throughout the 1960s and ultimately cost more than 50,000 American lives and nearly fracture the very foundation of American society.⁶⁰

The plan approved by President Kennedy advanced the following authorities:

authority to expand positive and counter intelligence operations against communist forces in South Vietnam and the use of civilian aircrews of Americans and other nationalities, as appropriate, in addition to Vietnamese in operations against North Vietnam. The US would assist the RVNAF [Republic of Vietnam Air Force] to increase border patrol and insurgency suppression capabilities by establishing an effective border intelligence system, by instituting regular aerial surveillance over the entire frontier area, and by applying modern technological area-denial techniques to close the roads and trails along the border.⁶¹

Almost immediately after the plan was approved, in May 1961, the first US Special Forces teams arrived in South Vietnam.

In June 1961 President Kennedy clarified his support of unconventional warfare operations and his faith in the military's ability to conduct covert and paramilitary operations when National Security Action Memorandums (NSAM) 55, 56, and 57 were published.

NSAM 55 stated that the advice of the JCS, in cold war as well as declared war, was to come to the President unfiltered and direct. NSAM 56 expressed the President's interest in using unconventional warfare operations to meet future requirements, and requested DOD and CIA inventory all paramilitary assets in the US Armed Forces and consider where indigenous paramilitary forces could be employed. NSAM 57 provided the basis for assignment of covert and paramilitary operations against North Vietnam. It also defined paramilitary operations (PM) as "those operations in which tactics, requirements in military-type personnel, equipment and training approximate those in conventional military operations."⁶²

Before publication of NSAMs 55, 56, and 57, the secretary of defense had restructured the DOD to streamline how to plan, coordinate, and conduct covert and clandestine activities. In February 1961 Brigadier General Lansdale (formerly stationed in Saigon as the SMM chief) was appointed the assistant to the secretary of defense (ASTD) to handle functions related to (1) Special Group (5412)/303 Committee matters, (2) special defense activities as approved by the secretary of defense, and (3) CIA-DOD relationships of special interest to the secretary of defense.⁶³ Also in February the deputy secretary of defense requested that a small, secure staff element be established on the Joint Staff to serve as a point of contact between General Lansdale and the JCS. The purpose of the new office was to facilitate coordination between the Office of the Secretary of Defense and various agencies on the Joint Staff and overseas commands. This staff element, designated the

Special Operations Division (SOD), had responsibilities to ASTD for (1) special logistical support, such as military equipment, airlift, and realty facilities, and (2) planning in connection with support requirements for special operations of an interdepartmental nature.⁶⁴

The SOD arrangement remained unchanged throughout 1961, but in early 1962 it was transferred from under the director of plans and policy to directly under the director of the Joint Staff. SOD was also redesignated as the Office of the Special Assistant for Counterinsurgency and Special Activities (OSACSA).⁶⁵

The reorganization of OSACSA followed closely on the heels of the establishment of the Special Group (Counterinsurgency [CI]), a top echelon decision-making body with authority similar to that of the Special Group (5412); however, its purview covered overt and declared military actions. Through the NSAM of 18 January 1962, which activated the Special Group (CI), came two lines of authority for prosecuting the war in Southeast Asia from Washington: Special Group (5412)/303 Committee monitored covert actions and Special Group (CI) monitored conventional (counterinsurgency) operations.⁶⁶

As the conflict in Vietnam began to accelerate in 1961, US personnel assigned to the theater began to increase dramatically. In a letter from President Diem to President Kennedy released on 15 December 1961, Diem states, "For, if we lose this war, our people will be swallowed by the Communist Block, all our proud heritage will be blotted out by the 'Socialist Society' and Vietnam will leave the pages of history. We will lose our national soul." President Kennedy responded to this plea with, "We (the United States) shall promptly increase our assistance to your defense effort."⁶⁷

To manage the large increase in personnel, the MAAG was replaced by the Military Assistance Command, Vietnam in February 1962.⁶⁸ Throughout 1962 both conventional and unconventional warfare throughout Vietnam grew. By 1963 it was apparent that America's efforts had not diminished the threat from North Vietnam. In fact, the position of the South Vietnamese was even less tenable than in previous years. Various meetings throughout 1963 resulted in the conclusion that counterinsurgency efforts and unconventional warfare actions should be escalated. From these meetings emerged OPLAN 34A.⁶⁹

*NSAM 57 envisioned the establishment of the Strategic Resources Group as the decision-making body for determination of responsibility for operations; however, the Special Group (5412) retained its status. Special Group (5412) was renamed later as the 303 Committee.

Precursor to OPLAN 34A

The American program of covert and clandestine operations in Laos and North Vietnam began in late 1960 and early 1961. The earlier CIA/SMM effort to establish a viable stay-behind organization in North Vietnam after the Geneva Agreements of 1954 had been largely unsuccessful.⁷⁰ By the time Lansdale and the SMM began the program to recruit and train indigenous forces in the North in the summer of 1954, the Viet Minh had already established considerable power over the people there. Although a courageous effort, the program by Lansdale and the SMM was an example of too little, too late.

Their program centered on establishing an indigenous force in North Vietnam and Laos to provide intelligence concerning North Vietnam military movements towards the South. From 1961 to 1964 the program underwent several disruptive changes that impacted upon its effectiveness. From an initial mission of intelligence collection, the principle mission migrated to sabotage and harassment operations, with intelligence collection becoming a secondary task. These mission changes, plus the Geneva Accord addressing the neutrality of Laos in 1962, severely undermined US unconventional warfare efforts.⁷¹

The two primary means of CIA/SMM infiltration were by air and by sea. Twenty-three of 33 agent team infiltrations were accomplished by way of air-drop. Acquisition of five C-123 aircraft, specially configured with electronic countermeasure (ECM) equipment and manned by non-US crews, considerably enhanced the delivery capability of agent teams into North Vietnam. Operations in Laos and North Vietnam required minimal USAF support; however, the Air Force provided logistics, weather forecasting, and aerial reconnaissance support for the C-123 crews.⁷²

OPLAN 34A—The Combined Task Force

Throughout 1963 there emerged a more active role for the DOD in conducting special operations in SEA. By the end of the year, the US administration had made the decision to expand the covert and clandestine program against North Vietnam. During November meetings were held by various divisions within the US government, and OPLAN 34A emerged as the combined US plan. The OPLAN specified five types of operations: intelligence collection, psychological operations, political

pressure, resistance operations, and physical destruction (hit-and-run and aerial attacks).⁷³

In December 1963 the plan was presented to President Lyndon B. Johnson, who established a committee to select from the plan those missions offering the greatest return with minimal risk. Maj Gen Victor H. Krulak, the chief of OSACSA, chaired the committee. (The ASTD, formerly headed by Lansdale, had been disbanded earlier in the year and was replaced by OSACSA.) The committee was less than enthusiastic, but it considered the advantages of proposed operations to outweigh the risks. A joint MACV task force was to implement OPLAN 34A. Operational control rested with commander, US Military Assistance Command, Vietnam (COMUSMACV); overall political control rested with the US ambassador to Vietnam. On 24 January 1964 the task force stood up as the Military Assistance Command, Vietnam Special Operations Group, but was soon changed to MACV Studies and Observations Group for security purposes.⁷⁴ The organization came to be known by its shortened acronym—SOG. Just as OSS/London, OSS/Algiers, and CCRACK had done during previous conflicts, SOG was tasked to execute special operations missions assigned by the theater commander.

In preparation for execution of the plan, the secretary of defense had deployed equipment and personnel to Saigon to begin initial operations. The principal requirement levied on the Air Force called for six specially modified C-123 aircraft equipped with ECM, radar detection, and enhanced navigation equipment. The aircraft were modified under the Duck Hook program during the first half of 1964 and were delivered to the USAF at Nha Trang AB, Vietnam, during the third quarter.⁷⁵ The now well-defined low-level



Photo courtesy of John R. Lewis

The Heavy Hook C-123 was modified for the low-level penetration mission. Note the outboard jets added in the late 1960s to improve the aircraft's performance.

infiltration, resupply, and exfiltration mission refined over the previous 20 years was the primary mission of the new C-123 outfit.

The formation of SOG marked the beginning of a graduated US campaign of covert and clandestine activities against North Vietnam. The objective of the campaign was to convince North Vietnamese leaders to cease waging war against South Vietnam. This goal was not achieved during the one-year charter of the organization. SOG continued to conduct covert and clandestine missions in Southeast Asia until it ceased operations in 1972. The establishment of SOG under the operational control of COMUSMACV on 24 January 1964 did not effect a complete transfer of all UW activities to MACV. Within SOG itself, non-DOD personnel continued to handle some functions, including supervision of air operations through previously established channels.⁷⁶

On 14 October 1964 the DOD assumed all responsibility, including non-DOD operations, for obtaining appropriate clearances for the conduct of air operations over North Vietnam. The process began with a monthly operations schedule, submitted by COMUSMACV approximately 10 days before the period began. This schedule, incorporating commander in chief's, Pacific Command (CINCPAC) comments, went to the JCS. OSACSA, the action agency for such matters, obtained approval through coordination with the deputy secretary of defense [a member of the Special Group (5412)/303 Committee], and the deputy secretary of state. Approval of the operations schedule represented final Washington authority for executing scheduled missions. Twenty-four hours before execution of each mission, however, COMUSMACV obtained political clearance from the US ambassador in Vietnam. Concurrently, a notice of intent was sent to JCS, who in turn informed the secretary of defense and the secretary of state. The 24-hour requirement was later reduced to 12 hours, and the National Military Command Center (NMCC) was charged with the responsibility for electronically transmitting notices of intent to the appropriate offices. Once the mission was launched, MACV continued to submit launch, recovery, abort, and spot reports, usually by force-level-alerting-system precedence. After completion of a mission, a post-mission report provided aircrew debriefing comments.⁷⁷

The above procedures pertained to missions with an already approved mission concept. In early 1966 the JCS delegated to CINCPAC the authority to approve and execute specific OPLAN

34A air missions whose mission concepts had already been approved by Washington. For a mission that fell outside an already approved concept, Washington retained the authority to approve it prior to execution. Once a precedent was firmly established, however, CINCPAC received approval authority for that type of mission. Tight Washington control hampered the conduct of operations, especially impeding timeliness. There was also a need for a more integrated organization in Washington since SOG conducted operations near other US forces.⁷⁸

Oversight at the highest levels of government placed a heavy burden on the rapidly expanding SOG operations. From an initial contingent of six officers and two enlisted men to over 400 by 1969, SOG was beset with some problems, especially in the early stages of buildup. The chief of SOG Air Operations alluded to the shortcomings of his new personnel, observing that the "initial selection (of personnel) was based on availability of people with retainability in the theater and with the proper rank—a major problem was the total ignorance of everyone concerned in this type of operation."⁷⁹

As personnel increased, SOG organizational structure proliferated. By the end of 1964, there were five major branches under the commander (an Army colonel) and the deputy commander, including administration, intelligence, operations, logistics, and communications. Additionally, four command elements came under the operational control of the SOG commander: SOG Flight Detachment at Nha Trang, Psychological Operations Group, Long Thanh Training Detachment, and Maritime Operations Group. In 1965 the deputy commander was redesignated the special assistant to the commander, and the 1st Flight Detachment at Nha Trang was renamed the Air Operations Group.⁸⁰

Programs and Operations

Under the charter of OPLAN 34A, SOG initiated four types of UW operations against North Vietnam under the Footboy program: Maritime Operations (Parboil), Psychological Warfare Operations (Humidor), Airborne Operations (Timberwork), and Air Operations (Midriff).⁸¹ There were requirements for air support for all four types of UW operations; however, some operations required greater air support than others. Air support for Maritime Operations was negligible; nonetheless, USAF assets provided high- and medium-level sea surveillance and occasionally

were on call to assist in case of an emergency at sea.⁸² Psychological Warfare Operations was the most successful program against North Vietnam. One of the primary means of delivery of propaganda, including the delivery of leaflets, gift kits, and portable radios, was accomplished through air assets. The rapid expansion of the Humidor program was reflected by statistics showing the number of leaflets dispersed over North Vietnam: 67 million leaflets were dropped in 1965, 142 million during 1966, and 171 million during 1967.⁸³ The Humidor program was integrated with Air Operations, since aerial delivery was the principal means for delivering leaflets.⁸⁴

The Timberwork program encountered immense difficulties under SOG direction. Evaluations of these operations revealed that they were largely ineffective and were, in fact, the least successful of the Footboy subprograms.⁸⁵ In 1964 SOG inserted one team and conducted 13 reinforcement/resupply missions.⁸⁶ In 1965 SOG infiltrated two more teams and successfully completed 22 reinforcement and resupply missions. Teams continued to conduct harassment, destruction, and temporary interdiction missions; however, greater emphasis was placed on intelligence collection and development once overt bombing of North Vietnam by the United States was initiated. Additionally, the need to determine how much aid North Vietnam was receiving from China and from the Soviet Union reduced the requirement for direct-action missions.⁸⁷

The Heavy Hook Project

In 1963 the secretary of defense directed that six C-123 aircraft be modified with special navigational and ECM equipment for use in an unconventional warfare role against North Vietnam. The project name was originally Duck Hook, but was later changed to Heavy Hook.⁸⁸ The aircraft were located at Nha Trang AB, South Vietnam, under the organizational title of 1st Flight Detachment. The detachment was originally dedicated to an earlier program, but with the implementation of OPLAN 34A, it was placed under the operational control of the chief, SOG, who assumed responsibility for the supervision of Heavy Hook in 1964. The first Heavy Hook aircraft arrived on 25 June 1964, and the detachment flew its first mission on 16 December.⁸⁹ First-year activities concentrated on negotiating contracts, organizing the unit, and developing operating procedures.⁹⁰

From the onset of activities, 1st Flight Detachment suffered from a lack of specific guidelines and directives covering its formation and its operations. In the haste to organize to meet OPLAN 34A requirements, individual service components were not tasked to support SOG; hence, SOG experienced difficulty in acquiring qualified personnel, spare parts, and equipment necessary to sustain a flying organization. The situation was similar to the one faced by OSS/Algiers with its three B-17 and the ad hoc support organization cobbled together by a reluctant USAAF leadership to support them. OPLAN 34A did not address air operations in detail; rather, it stated only broad requirements for training aircrews in mine laying and for installing special equipment on the six C-123 aircraft. The plan did not specify flying hours nor sortie requirements or related matters, which would prove critical during subsequent attempts to validate a six-aircraft requirement.⁹¹

Compounding the organizational problems of 1st Flight was SOG's lack of personnel experienced in UW operations initially assigned to its air operations branch. An Air Force officer related the problem, remarking that "none of the original Air Force personnel assigned to MACSOG had any previous background in UW operations. This was despite the fact that at Hurlburt Field the Air Force had a group of personnel trained and experienced in such operations. The result: MACSOG merely continued to do what had been previously done (prior to its formation) without any real change in direction, scope, or effort of the program itself."⁹²

As previously noted, service components were not tasked to support SOG air activities. From the very beginning of air operations at Nha Trang, maintenance support for 1st Flight aircraft became a controversial issue. An agreement was finally reached in November 1964 whereby rear echelon maintenance would be conducted in Taiwan, and USAF maintainers would support flight-line maintenance at Nha Trang.⁹³

Even before 1st Flight stood up with its Heavy Hook C-123 aircraft, SOG questioned its suitability for the mission. Although the aircraft possessed equipment enabling it to perform low-level, long-range combat missions over hostile and mountainous territory, SOG requested a replacement aircraft, presumably the C-130, by the close of 1964. SOG's 1964 command history related dissatisfaction with the C-123, "The C-123 load capacity, operating range, and inability to fly in adverse weather greatly hampered airborne operations."⁹⁴ A letter

from SOG's airborne operations section, dated 30 December 1964, further alluded to navigational and delivery limitations of the C-123. The letter stated that "reports from in-place teams indicate that resupply bundles are landing too far from drop zones. Distances involved range from 1,000 to 3,000 meters. Teams spend anywhere from two to seven days locating bundles because of the rugged terrain and dense vegetation surrounding the drop zones."⁹⁵

One explanation behind SOG's displeasure with the C-123's performance during its first year of operation could be contributed to the proficiency of the non-USAF aircrews. When first assigned to 1st Flight, the aircrews were not experienced in the C-123. The aircraft did not begin arriving until June 1964, with the mission crews arriving the following October. The first mission was flown in December, only two months later. Aircrew proficiency rose dramatically during 1965 and subsequent years; however, mission effectiveness was impacted early on in the program. Another explanation of SOG's insistence on the C-130 aircraft was that the C-130 was the latest, most modern transport aircraft available to the US military. Lessons learned in Europe during WWII with converted B-24s and those of the 1950s operating B-29s at low level, drove the development of a UW-specific aircraft—a modified C-130. Regardless of the underlying reasons, SOG was determined to acquire C-130s for its air operations, and the C-130E(I) Combat Talon was the weapons system designed from the ground up to perform this unique mission.

During this period, OPLAN 34A missions could not be flown by USAF aircrews. As a result third country nationals were trained in the demanding low-level mission. Normally, four crews were on station at Nha Trang, and two crews were on rotation at Hsin-Chu AB, Taiwan. In October 1965 1st Flight received its first full US aircrew complement.⁹⁶ To maintain a qualified crew force, SOG drafted a plan to train six Vietnamese Air Force (VNAF) crews in the Heavy Hook mission. Initial results of the VNAF training program were somewhat successful, but "the Vietnamese were difficult to control. They were very independent, and seemed to feel that they were doing us (the United States) a favor when they flew a mission. They did not see the mission from a nationalistic point of view."⁹⁷

The problem with the VNAF aircrews may have been as much political in nature as it was

psychological. The VNAF officers selected for C-123 training were former A-1 pilots belonging to Air Comdr Nguyen Cao Ky's exclusive squadron. The requirement to remain proficient in the A-1 aircraft complicated matters. They irked some of their American counterparts by requests for special compensation for their services to 1st Flight. Despite these problems, three VNAF C-123 aircrews completed training in 1965. Success was short-lived: one crew was lost operationally (hit a mountain outside Da Nang), another was considered "politically unstable" and withdrawn from the program, and a third was ineffective because of a copilot vacancy.⁹⁸

By 1966 the problems with the VNAF training program had become such a hardship that the SOG deputy chief of the operations branch disqualified the one remaining aircrew and canceled plans for sending additional VNAF crews to the United States for training. Stopping the program had minimal impact on operations since the third country national aircrews had attained a high degree of proficiency by that time.⁹⁹

The Combat Talon Aircraft

In 1965 the Air Force directed that 14 C-130E aircraft be modified on the production line to an UW configuration. These aircraft were assigned to the Special Operations Forces element under the project name Stray Goose, which was later renamed Combat Talon.*¹⁰⁰



USAF Photo

C-130E(I) aircraft 64-0523 was delivered to the Air Force on 4 August 1965 and received the STARS modification beginning 3 December 1965. The aircraft was painted black and green camouflage in August 1966.

*In 1966 four of these aircraft were deployed to the Pacific Command (PACOM) area of responsibility (AOR); the code name of this component was Combat Spear.

SOG had asked for more suitable aircraft to replace the C-123 as early as 1964, and it reemphasized its requirement after the loss of two Heavy Hook aircraft in late 1964 (one on 1 November and one on 10 December). At that time JCS deferred decision on the SOG request for several reasons: (1) modified C-130 aircraft would not be available before mid-1965; (2) only US crews were considered capable of operating the sophisticated C-130, and US aircrews flying OPLAN 34A missions were not a viable concept under the existing UW program; and (3) higher authorities imposed restrictions on employment of the C-130 in a UW role at that time.¹⁰¹

In March 1965, with the 14 C-130E(I) aircraft already under construction, CINCPAC reopened the subject by requesting MACV to furnish additional justification for acquisition of the UW-modified aircraft. Again, the JCS rejected the MACV proposal. Later during the year, however, CINCPAC, providing additional justification, supported a MACV proposal to use C-130 aircraft for OPLAN 34A operations as outlined in the "C-130E Sky Hook Study" completed 27 September 1965. The JCS concurred, and on 31

March 1966, it notified CINCPAC of approval of the request and directed the Air Force to deploy four UW-modified C-130 aircraft to PACOM.¹⁰²

* * * * *

The Combat Talon had finally come of age. After 20 years, from North Africa, Central Europe, and Northeast Asia to Vietnam, lessons learned flying B-17s, B-24s, B-29s, C-47s, and a host of other aircraft were finally incorporated into a special purpose platform designed specifically for the highly specialized low-level mission. The aircraft was officially designated the C-130E(I) and was later redesignated the MC-130E. Twenty-five years later, a vastly updated version of the Combat Talon was fielded under the designation MC-130H. The C-130E(I) aircraft was deployed to the European theater under the project name Combat Arrow and to the Pacific theater under Combat Spear. US-based aircraft would operate under the project name Combat Knife, having both a worldwide operational commitment and responsibility for all stateside Combat Talon formal training. The adventure had begun.

Notes

1. Bernard V. Moore II, *The Secret Air War Over France: USAAF Special Operations Units in the French Campaign of 1944* (Maxwell AFB, Ala.: Air University Press, 1993), 10–11.
2. *Ibid.*, 12.
3. *Ibid.*, 12–13.
4. *Ibid.*, 13–14.
5. *Ibid.*, 14–15.
6. *Ibid.*, 15–16.
7. *Ibid.*, 16.
8. *Ibid.*
9. *Ibid.*, 29.
10. *Ibid.*, 16–17.
11. *Ibid.*, 17.
12. *Ibid.*, 22.
13. *Ibid.*
14. *Ibid.*, 23.
15. *Ibid.*
16. *Ibid.*, 25.
17. *Ibid.*, 29.
18. *Ibid.*, 31.
19. *Ibid.*, 35.
20. Project CHECO Report, *The Role of the USAF in Support of Special Activities in SEA*, 1 July 1976, prepared by Tom G. Abbey, Maxwell AFB, Ala.: USAF Historical Research Agency (HRA), 4.
21. Michael E. Haas, *Apollo's Warriors: US Air Force Special Operations during the Cold War* (Maxwell AFB, Ala.: Air University Press, 1997), 17–18.
22. *Ibid.*, 22–23.
23. *Ibid.*, 33.
24. *Ibid.*, 34–35.
25. *Ibid.*, 40.
26. *Ibid.*, 42.
27. *Ibid.*, 50.
28. *Ibid.*
29. *Ibid.*, 78.
30. *Ibid.*
31. *Ibid.*, 96–98.
32. *Ibid.*, 79.
33. *Ibid.*
34. *Ibid.*, 80–81.
35. *Ibid.*, 100, 117.
36. *Ibid.*, 36.
37. *Ibid.*, 83.
38. *Ibid.*, 90–92.
39. *Ibid.*, 92–93.
40. *Ibid.*, 115.
41. *Ibid.*, 117.
42. *Ibid.*, 119.
43. *Ibid.*, 119–22.
44. *Ibid.*, 107.
45. *Ibid.*, 108.
46. *Ibid.*, 124.
47. *Ibid.*, 125.
48. *Ibid.*
49. *Ibid.*, 124–25.
50. Project CHECO Report, 5–6.
51. *Ibid.*, 6.
52. *Ibid.*, 8.
53. *Ibid.*, 9.
54. *Ibid.*
55. *Ibid.*, 4–5.
56. *Ibid.*, 5.
57. *Ibid.*

PRAETORIAN STARSHIP

58. Moore, 10.
59. Project CHECO Report, 11–12.
60. Ibid., 12–13.
61. Ibid., 13.
62. Ibid., 14.
63. Ibid., 15.
64. Ibid.
65. Ibid., 15–16.
66. Ibid., 16.
67. Ibid.
68. Ibid., 16–17.
69. Ibid., 17.
70. Ibid.
71. Ibid., 18.
72. Ibid., 18–19.
73. Ibid., 20–21.
74. Ibid., 23.
75. Ibid.
76. Ibid., 25–27.
77. Ibid., 119–20.
78. Ibid., 120.
79. Ibid., 27.
80. Ibid., 28.
81. Ibid.
82. Ibid., 30.
83. Moore, 30–31.
84. Project CHECO Report, 31.
85. Ibid., 32.
86. Ibid.
87. Ibid.
88. Ibid., 54.
89. Ibid.
90. Ibid.
91. Ibid., 55.
92. Ibid., 55–56.
93. Ibid., 56–57.
94. Ibid.
95. Ibid., 57.
96. Ibid., 61.
97. Ibid.
98. Ibid., 61–62.
99. Ibid., 62.
100. Ibid., 68.
101. Ibid.
102. Ibid., 69.

Chapter 2

The Combat Talon Weapons System

Speak softly and carry a big stick; you will go far.

—Theodore Roosevelt

From Duck Hook to Stray Goose

The requirement for Combat Talon was deeply rooted in SEA, but actually resulted from the failed Bay of Pigs invasion of 1961. After the failure, NSAM 57 was issued in June of that year. In accordance with NSAM 57, the DOD was charged with the responsibility for conducting both overt and covert paramilitary operations that required significant numbers of military trained personnel and/or large numbers of military-type equipment. President Kennedy directed a worldwide review of ongoing covert operations in 1962 to determine if any of them fit into the category defined in NSAM 57. The American program, begun in 1955 and directed towards North Vietnam under the supervision of then-Col Edward Landsdale, fit into the NSAM guidelines for transfer to the DOD. When SOG was established in January 1964, responsibility for air operations in support of the program was officially assigned to the new organization, although it lacked any organic air capability of its own.¹ As discussed in chapter 1, to support SOG's fixed-wing requirements, six C-123B aircraft were modified by Lockheed Air Service (LAS) Ontario under the program titled Project Duck Hook. The first aircraft began modification in February 1964, one month after the formation of SOG. The last aircraft was delivered to the USAF in June of that year. The project included the installation of special receivers, ECM transmitters, a Doppler Navigation System, and a special seven-color camouflage paint scheme.² Its mission was code named Heavy Hook. On 14

October 1964 SOG assumed full responsibility for unconventional air operations into North Vietnam, with the six C-123B aircraft as its primary air asset.³

In addition to Duck Hook, LAS Ontario was tasked in September 1964, under the USAF Big Safari program, to conduct a study to determine what capabilities were needed to support other non-DOD classified operations. From the study a new program emerged and was identified as Thin Slice. This program resulted in a contract to modify two C-130Es (aircraft 64-0506 and 64-0507) that would eventually become Combat Talons 62-1843 and 63-7785.* Modifications to the two Thin Slice aircraft included the addition of a terrain-following radar (the SPR-3—later upgraded to the AN/APQ-115), a surveillance capability (the AN/APR 25/26), and an electronic warfare (EW) suite for self-protection.⁴ As part of the original modifications, the two aircraft were sanitized of all identifying markings, including original aircraft serial numbers. As the aircraft were further modified to support unique mission requirements, they were redesignated Rivet Yard I in August 1966, and the Thin Slice project was officially terminated.⁵

In 1965 the US Army Special Forces (SF) established the requirement for a long-range aircraft capable of supporting its worldwide low-level infiltration/exfiltration mission. Many early SF officers had served during WWII in the OSS, and a few had served in special operations units in Korea in the 1950s. The legacy of units like the Carpetbaggers served as the basis for their requirement.

*Aircraft 64-0506 and 64-0507 were produced by Lockheed in September 1964, and three months later, in December 1964, they were removed from any published inventory. The author could find no further record of these two aircraft. Through interviews with both LAS Ontario and former Combat Talon personnel, confidential conversations revealed that aircraft 64-0506 and 64-0507 were those originally modified under the Thin Slice program, which later became Project Heavy Chain. Because of the sensitive (and still classified) nature of Heavy Chain operations, the two aircraft were sanitized, and all serial numbers were removed from the aircraft. While operating in the Heavy Chain program, they remained "ghost ships" without numbers that could connect them to their controlling organization. In 1972, when the Heavy Chain program was terminated, the two aircraft were renumbered and brought back into the USAF inventory as Combat Talons 62-1843 and 63-7785. These two aircraft had actually been destroyed during the Vietnam War, and official records were altered to show that they had been repaired and placed back into service as Combat Talons. According to the US Navy Center for Naval Analysis, which published an official report on aircraft losses and damage in SEA beginning in 1962, aircraft 62-1863 was destroyed near Tuy Hoa AB, Vietnam, on 20 December 1965. The crew was on temporary duty from Dyess AFB, Texas, en route to a permanent change of station to CCK AB, Taiwan, and were operating out of Naha AB, Okinawa. The actual mission was generated from Nha Trang AB, Vietnam, and the crash occurred when the aircraft overflew the runway at Tuy Hoa and impacted a hillside well past the airfield. Aircraft 63-7785 was a US Navy aircraft that was lost on 17 June 1966 in the South China Sea. The aircraft departed Cam Ranh Bay, Vietnam, en route to Kadena AB, Okinawa, on an operational airlift support mission. About 30 minutes into the flight, with the aircraft 43 miles northeast of Nha Trang AB, the crew of a naval gunboat cruising off the coast of South Vietnam observed the aircraft explode and crash into the South China Sea. No hostile fire was observed, and the exact cause of the crash could not be determined, although sabotage was suspected. Information on the loss of aircraft 62-1843 and 63-7785 was provided by Bob Daley of Dallas, Texas.

During 1965 Heavy Hook C-123B aircraft in Vietnam were again validating the unique low-level mission required to support unconventional warfare operations. SOG was, however, not totally pleased with the C-123B airframe and was building a case in the joint arena for acquisition of the C-130E. Shortly after their arrival in SEA in late 1964, two of the six Heavy Hook aircraft were lost, thus putting into question whether the C-123 was the right aircraft for the mission. In response to the newly established USA Special Forces's validated requirement and supported by SOG's needs in SEA, 14 USAF C-130E aircraft were modified beginning in 1965 for the long-range infiltration, resupply, and exfiltration mission. The original program was named Stray Goose, and the aircraft were assigned the identification C-130E(I).

When the aircraft were delivered to the USAF beginning in the late summer of 1965, they were production model HC-130s with no specialized equipment. The Fulton Aerial Recovery System* was added at the Lockheed-Marietta Georgia facility beginning in December 1965. In March 1966 the first four STARS-equipped C-130E(I)s were flown to the LAS Ontario facility in California to receive the Rivet Clamp modification. Four additional aircraft were modified beginning in July

1966, with the final four beginning modification in January 1967 (fig. 1).⁶

In August 1966 the Thin Slice program was terminated when aircraft 64-0506 and 64-0507 (later renumbered 62-1843 and 63-7785) received the Rivet Yard I modification. Concurrently, the classified Thin Slice program was renamed Heavy Chain, and the program's requirements were increased from two to four aircraft. C-130E(I) aircraft (64-0564 and 64-0565—both with Fulton STARS installed) were pulled from the Stray Goose program and modified under project Rivet Yard II in September 1966 and assigned to the Heavy Chain program. The four Rivet Yard aircraft flew missions under the code name Combat Sam until the program closed in late 1972.⁷ Throughout its existence, Heavy Chain aircraft served as the test bed for modifications that would eventually appear on the Combat Talon fleet. These modifications included, in part, the forward looking infrared radar (FLIR) system, the high-speed low-level aerial delivery system (HSLADS), and numerous EW modifications.

The 12 remaining Stray Goose aircraft received the Rivet Clamp modification at LAS Ontario beginning in March 1966. With the Fulton STARS installed, the aircraft had a unique appearance,

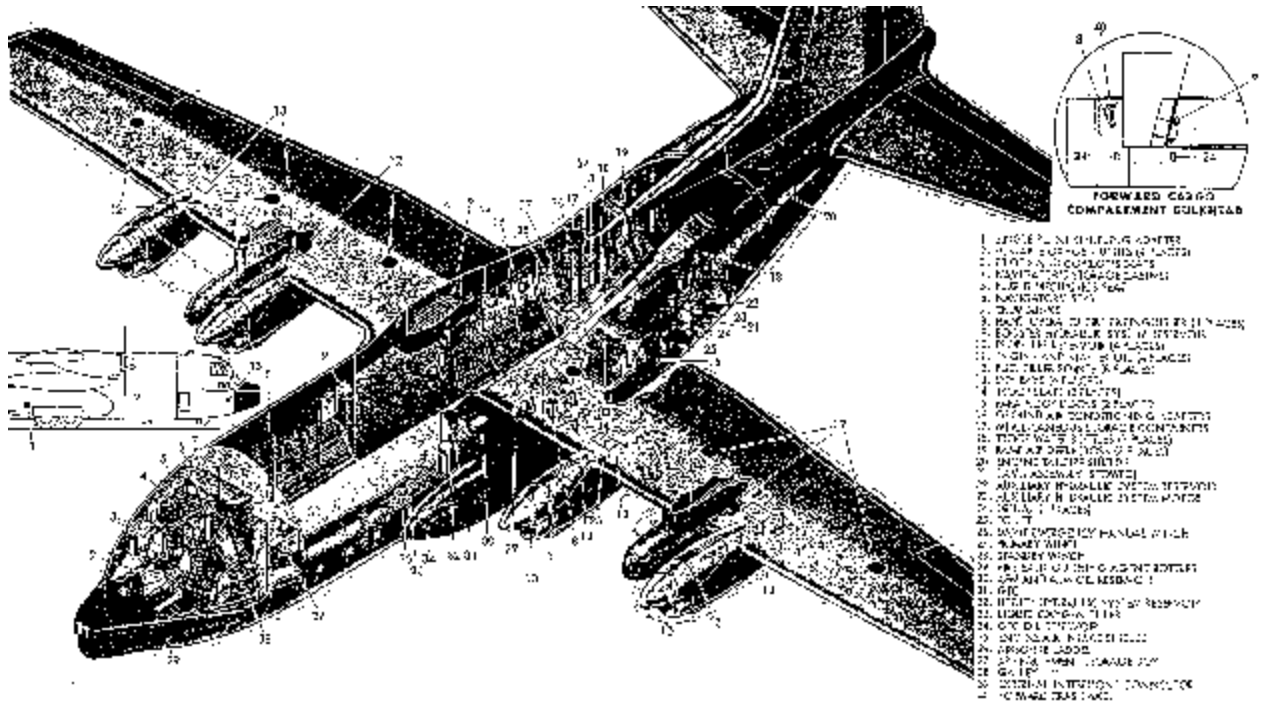


Figure 1. Servicing Diagram for C-130E(I), circa 1967 (Source: T.O. 1C-130(I)-1, 25 March 1967, provided by James W. Thomas.)

*The Aerial Recovery System was renamed the Fulton Surface-to-Air Recovery System (STARS) in the mid-1980s. For clarity throughout the text, the author calls the system the Fulton STARS when referring to the system designed by Robert E. Fulton Jr. and installed on USAF-designated aircraft.

although the early Fulton modification was identical to the rescue HC-130s of the period. What made the Stray Goose aircraft unique was the installation of a multimode terrain-following/terrain-avoidance (TF/TA) radar and a defensive EW suite. In the fall of 1967, two of the original 12 Combat Talons (64-0547 and 64-0563) were lost in Vietnam, thus leaving a fleet of 10 operational aircraft. To compensate for the loss, the USAF pulled two additional C-130E aircraft from operational units (aircraft 64-0571 and 64-0572) in March 1968, and contracted with LAS Ontario to modify them to the Rivet Clamp configuration. These two aircraft were identical to the original 12 Rivet Clamp Combat Talons with the exception that they did not have the Fulton STARS installed.⁸ Thus, by late 1968 the 12 Combat Talons were identified as “Clamp” aircraft, with 10 (64-0523, 64-0551, 64-0555, 64-0558, 64-0559, 64-0561, 64-0562, 64-0566, 64-0567, and 64-0568) having the Fulton capability and two (64-0571 and 64-0572) not having it. The four Heavy Chain aircraft (62-1843, 63-7785, 64-0564, and 64-0565) were identified as “Yard” aircraft.*

The production C-130E aircraft was the foundation upon which Combat Talon was built. Major modifications to the E model aircraft included installation of the Fulton Skyhook recovery system, AN/APQ-115 TF/TA radar system, and defensive countermeasure equipment. A review of the production E model and these major modifications provide a basic understanding of the Combat Talon.

The Basic C-130E Aircraft

The C-130 Hercules was first flown on 28 August 1954, with the first production model designated the C-130A. There were 233 A models produced before the next generation C-130B was put into service. During the B model production run, there were 230 B models built, with the last aircraft delivered in 1962. From 1962 to 1975, 491 C-130E models were produced.⁹ Eighteen E models eventually became Combat Talons—the 14 Stray Goose aircraft modified in 1965, the two replacement aircraft brought into the program in 1968, and the two original Thin Slice/Heavy Chain-modified aircraft.

*In 1972, when Heavy Chain deactivated, the four aircraft assigned to that program were transferred to Combat Talon, modified specifically for PACAF employment, and designated “Yank” aircraft. At that time aircraft 64-0571 and 64-0572 were declared excess to the Combat Talon program and were transferred out of special operations. All of their ECM equipment and the TF/TA portion of their radars were removed. They were assigned to Kirtland AFB, New Mexico, and Hill AFB, Utah, respectively, within Air Force Systems Command, and were designated as “Swap” aircraft. When 64-0558 was lost in late 1972, 64-0572 was returned to the Combat Talon fleet as a “Clamp” aircraft. When aircraft 64-0564 was lost in 1981, aircraft 64-0571 was returned and modified as a “Yank” aircraft assigned to the Pacific.

General Description

The Lockheed C-130E aircraft was an all-metal, high-wing, long-range, land-based monoplane designed to provide transportation for cargo and personnel. The aircraft was multipurpose and could be used in various roles including airdrop, airland, and air ambulance, along with many other applications. Designed with a short-field capability, it could operate from minimally improved airfields in forward areas. With the Fulton STARS installed, the overall length was increased from 97 feet 9 inches to 98 feet 9 inches. A modified radome and recovery yokes accounted for the additional length. With the yokes extended, the overall length of the aircraft increased to 106 feet 4 inches. Other principal dimensions included the following:

Wing Span	132 feet 7 inches
Height	38 feet 6 inches
Stabilizer Span	52 feet 8 inches
Cargo Compartment	
Length	41 feet
Width (Minimum)	10 feet 3 inches
Height (Minimum)	9 feet
Maximum Gross Weight	175,000 pounds

Engines and Propellers

The aircraft was powered by four Allison T-56-A-7 engines. The static standard-day, sea level, take-off rating of each engine at 100 percent rotations per minute (RPM) (13,820) was 3,755 propeller shaft horsepower (SHP). The maximum allowable torque-meter-indicated power was 19,600 inch-pounds. This was equivalent to 4,200 SHP in addition to 100 SHP allowance for gearbox and accessory losses, or a total of 4,300 SHP.¹⁰ Each engine was equipped with a Hamilton Standard, four-blade, electrohydromatic, full-feathering, reversible-pitch propeller. The propeller operated as a controllable-pitch propeller for throttle settings below flight idle and as a constant-speed propeller for throttle settings of flight idle or above.¹¹

Assisted Takeoff

Provisions were made for the external mounting of eight solid fuel-assisted take-off (ATO) units of 1,000 pounds thrust each, which supplied

additional thrust when it was desired to shorten takeoff distance. The system was electrically controlled and operated from the ATO control panel mounted on the flight control pedestal. The units were fired simultaneously and gave thrust until the propellant was exhausted. After firing, the expended ATO units could be jettisoned to reduce airplane weight and drag.¹² The system was similar to the space shuttle auxiliary boosters that powered the space shuttle into orbit. It is important to note that once the system was ignited, there were no means to turn it off—the boosters would burn until the propellant was consumed.

The Fuel System

The fuel system was a modified manifold flow-type, incorporating a fuel cross-feed system, a single-point refueling and defueling system, and a fuel dump system. The system provided fuel supply for the four engines and the gas turbine compressor. Each engine could be supplied fuel either directly from its respective main fuel tank or through the cross-feed manifold system from any tank. Wing and external tanks could be refueled or defueled from a single-point ground refueling and defueling receptacle located in the right aft landing gear fairing. Fuel was routed from the single-point receptacle through the refueling manifold. As an alternate method of refueling the aircraft, tanks could be fueled separately through a filler opening in the top of each tank.¹³

The Electrical System

All internal electrical power for the aircraft came from five alternating current (AC) generators or from the battery. Each engine supplied power to operate its own 40-kilovolt ampere (KVA) AC generator, and the air turbine motor operated an additional 20-KVA AC generator. These AC generators provided electrical power for airplane use: 28-volt direct current (DC); 200/115-volt, 400-cycle, three-phase primary AC; and 115-volt, 400-cycle, single-phase, secondary and primary AC. The four engine-driven AC generators were connected through a series of relays to four AC buses; left-hand AC bus, essential AC bus, main AC bus, and right-hand AC bus. The relay system operated so that any combination of two or more of the engine-driven AC generators would power all four of the buses. With one generator operating, the generator would power only the essential AC bus and the main AC bus. The air turbine motor-driven

AC generator powered only the essential AC bus at any time.¹⁴

Both DC and AC external power receptacles were located on the left side of the fuselage, just aft of the battery compartment. DC power from the external source was supplied through two current limiters to the main DC bus. Any electrically operated equipment on the airplane, except equipment connected to the battery bus, could be supplied from an external DC source. When an external AC power source was connected to the airplane, it supplied power to all AC buses, to the DC buses through transformer-rectifier units, and to the battery bus to charge the battery when the DC power switch was in the battery position.¹⁵

The Hydraulic System

A booster hydraulic system, utility hydraulic system, and auxiliary hydraulic system made up the power supply sources for all hydraulic components on the aircraft. The booster system provided hydraulic power to a portion of the surface control boost system only. The utility system normally operated the landing gear, wing flaps, brakes, nose wheel steering, and a portion of the surface control boost system. The auxiliary system normally operated the ramp system and provided emergency pressure for brake operation. It also provided pressure for emergency extension of the nose landing gear.¹⁶

The Flight Control System

The flight control system included the aileron, rudder and elevator systems, and a tab control system. The main surfaces were controlled by mechanical systems, consisting of cables, pushrods, bellcranks, and torque tubes. Hydraulically driven booster units provided most of the force required to move the surfaces. The booster units were driven by hydraulic pressure supplied simultaneously by the booster and the utility hydraulic systems, each of which served to power one portion of the booster units. System operation was such that failure or malfunction of any component of either system in any booster unit would allow normal function of the other system powering the same unit. A loss of hydraulic pressure in either hydraulic system resulted in a corresponding loss in the booster unit, and a proportionate loss of power to operate the unit. The airplane could be controlled with complete loss of booster unit power through trim tabs and engine power, along with coordinated increased efforts by the pilot and copilot. The

trim tabs were controlled electrically and operated independently of the hydraulic system.¹⁷

The Flap System

The airplane was equipped with four flaps, consisting of an inboard and an outboard flap on each wing. The flaps were of the Lockheed-Fowler, high-lift type in which the flap motion was a combination of an aft movement to increase wing area and a downward tilting movement to alter the airfoil section to increase lift and drag. The time required for full extension or retraction of the flaps was between 10 and 13 seconds. When 100 percent extended, the flaps formed an angle of approximately 35 degrees with the wings. The flaps were operated by a reversible hydraulic motor, cam-actuated microswitch follow-up mechanism, torque tubes, gearbox, and drive screw assemblies. The hydraulic motor operated the torque shaft section extending outboard to the gearbox, which rotated ball bearing drive screws for actuation of the flaps. Utility hydraulic system pressure operated the flap system. The flaps could also be operated manually with a handcrank.¹⁸

The Main Landing Gear

The main landing gear system consisted of four wheels, two mounted in tandem on each side of the fuselage. Each wheel had a separate strut. The landing gear actuation system was normally supplied hydraulic fluid under pressure by the utility system. Fluid from the utility system flowed through a landing gear control valve to each of the two main landing gear motors. Each pair of struts was raised and lowered in vertical tracks by screw jacks driven by torque shafts powered by a hydraulic motor through a gearbox. A flow control regulator in the down line controlled the raising time of the gear by regulating the flow of return fluid. A controllable restrictor valve was located in the up line between the flow regulator and the hydraulic motor. It was mechanically actuated at a point approximately one inch from the fully retracted position by a bracket located in the top of the front strut of each main landing gear. The gearbox contained a main landing gear spring-loaded brake assembly, which held the gear in the up position until released by hydraulic pressure or by mechanical means. With the main gear down and the airplane on the ground, friction washers on the screw jack assemblies served as down locks. Mechanical linkage between the aft main landing gear struts and the doors caused

the doors to open and close as the main landing gear was extended or retracted. Six pressure-sealed doors, three on each wheel well bulkhead, were provided to permit access to malfunctioning main landing gear components while in flight. Glass panels, two on each wheel well bulkhead, permitted visual inspection of the main landing gear.¹⁹

The Nose Landing Gear

The nose landing gear was a swinging-type gear. Extending down and aft, it was actuated by a hydraulic cylinder and secured in the up and down positions by locks. The gear was normally supplied with hydraulic fluid under pressure by the utility supply system; however, during an emergency, the nose gear could be extended with the auxiliary hydraulic system. Hydraulic fluid either from the up or down side of the landing gear control valve flowed to the nose landing gear uplocks and downlocks and to the nose landing gear actuating cylinder. A manual release handle at the flight station provided a mechanical means of unlocking the nose gear uplock should normal extension of the nose gear become impossible. A manual hand pump could be used to unlock the nose gear uplock; it was also used to pump the gear into the down-and-locked position. The nose gear could be visually checked through a nose gear inspection window on the aft bulkhead of the nose wheel well under the flight deck.²⁰

The Brake System

A hydraulically operated, disk-type multiple puck brake was installed on each of the four main landing gear wheels. The nose gear wheels did not have brakes. The brakes normally operated from utility hydraulic system pressure with an alternate supply available through the auxiliary hydraulic system. If electrical power were unavailable, both systems supplied pressure to operate the brakes. If both utility and auxiliary hydraulic pressure were not available, hydraulic pressure could be supplied by the auxiliary system hand pump to provide one continuous brake application to stop the aircraft.²¹

The Navigational System

The aircraft was fully instrumented and was all-weather capable. Two individual C-12 compass systems were installed in the aircraft and provided an accurate heading reference to aid in navigation, regardless of the latitude position of

the aircraft. In addition to providing a visual heading reference, each C-12 compass furnished heading information to other aircraft navigational systems. Operating controls for the number 1 and number 2 compass systems were located on the digital controller for each system. The digital controllers were located on the navigator's instrument panel. Each system was capable of operating in one or two modes. In the magnetic heading mode, used in latitudes where no distortion of earth's magnetic field was encountered, the directional gyro in the system was slaved to earth's magnetic field and the indicators displayed magnetic heading of the aircraft. In the directional gyro mode, used in latitudes where the magnetic meridian was distorted or weak, the system gyro acted as a directional gyro and maintained the position manually selected by the navigator. The indicators displayed the manually established heading.²²

Instrumentation on the pilot and copilot instrument panels included an attitude direction indicator (ADI), horizontal situation indicator (HSI), bearing-distance-heading indicator (BDHI), and radio magnetic indicator (RMI). The aircraft was also equipped with both a pressure altimeter and a radar altimeter. Radios included two ultrahigh frequency (UHF), one very high frequency (HF), two high frequency, and two automatic direction finding sets.²³ The system was considered the state of the art when it was introduced in 1962.

There were many additional systems that made up the complex C-130E Lockheed Hercules aircraft. The company continued to improve the airplane through follow-on models, but most of the basic C-130 systems found on the early E aircraft continued in production over the next three decades.

The C-130E(I) Combat Talon Aircraft

On 22 July 1965 the USAF took delivery of the first two C-130E aircraft that were slated to be modified into Combat Talons. Aircraft 64-0551 and 64-0555 were assigned to the 464th Troop Carrier Wing at Pope AFB, North Carolina. The remaining 12 aircraft were delivered to the USAF during the following five months, with the last aircraft (64-0568) being temporarily assigned to the 4442d Combat Crew Training Wing on 17 December 1965. Earlier in the month, on 3 December, aircraft 64-0523 became the first aircraft to enter STARS modification at the Lockheed-Georgia facility.²⁴ The Fulton

STARS was the most visible of the Combat Talon modifications, and the capability would become the centerpiece for most of the Combat Talon community for the next 30 years.

The Fulton Surface-to-Air Recovery System

During the 1920s, a mail pickup system was invented by Lytle S. Brown and was employed to retrieve outgoing mail in remote areas where overland pickup was impractical. Using Brown's invention, All American Aviation developed a modified pickup system in the 1930s that consisted of two steel poles, set 54 feet apart, with a transfer line swung between them. A pickup aircraft would approach the cable at 90 miles per hour, with a 50-foot steel pickup cable trailing behind. Just before impact with the transfer cable, the pickup pilot would pull the nose of the aircraft up and engage the transfer cable with a four-pronged grapple anchored to the end of the pickup cable. A flight mechanic stationed in the fuselage of the aircraft then used a winch to reel the package on board.²⁵ The system was operational by 1941 at the outbreak of World War II.

The All American System— Forerunner to STARS

As the war progressed and the Allies prepared for the eventual invasion of Europe, it became apparent that a capability was needed to extract personnel who had previously parachuted behind enemy lines. Literally thousands of paratroopers were dropped by Carpetbagger B-24 and B-17 aircraft, along with RAF Halifaxes, in the months before and immediately after the Normandy invasion. The primary option for their recovery was a risky overland trek through enemy-held territory followed by an equally risky linkup with Allied forces in the field. Hoping to find their exfiltration solution in the All American Aviation system, the British began testing the capability early in the war.²⁶

In July 1943 the USAAF validated the need for the extraction of downed airmen from behind enemy lines and began an operational test of the All American Aviation system. Initial test produced unsatisfactory results for personnel pickups, with instrumentation recording more than 17 g's (acceleration of gravity) at initial contact with the pickup line. Modifications were made in the parachute harness and the transfer line, thus reducing the initial force on the pick-up package to 7 g's. On 5 September 1943, the first volunteer paratrooper,

Lt Alex Doster, was picked up by a Stinson aircraft utilizing the All American Aviation system.²⁷

The USAAF continued to improve the capability, and by early 1944 it had developed an airdrop kit containing telescoping poles, a transfer line, and a parachute harness to be worn by the person being extracted. In February 1944 the first operational use of the system came when a C-47 extracted a glider from a remote location in Burma and returned it to a base in India. For the remainder of the war, the USAAF refrained from using the All American Aviation system for extraction of personnel, but records indicate that the British did use it for that purpose.²⁸

After the war further development of the retrieval system was discontinued. Not until the Korean War was interest revived. In the summer of 1951 a B-29 of the 580th ARCW conducted trials at Eglin AFB, Florida, to determine if a large aircraft could be used for pickups. Although proven technically feasible, safety considerations of flying such a large aircraft close to the ground resulted in the program being dropped for the B-29.²⁹

In early 1952 the CIA renewed its interest in the All American Aviation system. The agency was attempting to establish a resistance network in Manchuria with its proprietary airline CAT dropping agents and supplies into Kirin Province by way of C-47 transports. The rugged terrain found in Manchuria favored an extraction system such as the All American Aviation system over airland exfiltration by way of an unprepared runway. By the fall of 1952, CAT C-47 pilots were making static pickups in Japan and successfully retrieved aircraft mechanic Ronald E. Lewis during a training pickup. With the system tested and operationally ready, a CAT C-47 aircraft equipped with the All American Aviation system departed Seoul City Airport (K-16) on the evening of 29 November 1952 for a scheduled pickup of team members previously inserted into Manchuria. Along with two pilots there were two CIA officers on board—John T. Downey and Richard G. Fecteau. A double agent had compromised the team, and Chinese gunners were waiting to ambush the CIA crew. On initial approach in preparation for extraction of the team, the C-47 was shot down, resulting in the death of the two pilots and capture of the two CIA officers by the Chinese. After two decades of imprisonment, the two officers were eventually released from Chinese prison—Fecteau in December 1971 and Downey in March 1973.³⁰

The All American Aviation system was adapted by the USAF for C-47 use late in 1952. Building

on knowledge gained from the B-29 test the previous year, B Flight, 6167th Operations Squadron, operating out of K-16 near Seoul, Korea, was assigned the extraction mission by Fifth AF. On two occasions in 1953, B Flight attempted to perform extractions utilizing the system. The first attempt was aborted when the downed airman was captured before the aircraft arrived in the pickup area. The second attempt resulted in heavy damage to the C-47 aircraft during the run-in for pickup. The mission had to be canceled, and the aircraft limped back to its home station without the survivor.³¹

The system proved to be an operational failure for pickup of downed airmen in a hostile environment. All American Aviation did develop a successful engagement system, however, in the late 1960s. The follow-on system enabled C-130-equipped aircraft to snag satellite packages in midair as they parachuted to earth from orbit.

Robert Edison Fulton Jr.

During a demonstration of the All American Aviation system in London after World War II, a young inventor named Robert Edison Fulton Jr. observed the process and undoubtedly thought that he could develop a better system. During the war Fulton had developed a first-generation flight simulator, but was unsuccessful in marketing the device to the US military. There was little interest in flight simulators at the time, with the consensus that aviators could only gain necessary flying skills in an actual airplane. Not to be dissuaded by initial rejection, Fulton converted his flight simulator to an aerial gunnery trainer, which he called the Aerostructure. The device used film to simulate aerial combat and provided instant feedback when the operator successfully hit the target. Fulton demonstrated the device in May 1942 to Comdr Luis de Florez, who was in the process of establishing a special training division for the US Navy. With de Florez' support, Fulton was provided developmental funds, and the Navy eventually ordered 500 trainers at a cost of \$6 million. In addition to the trainer, Fulton developed a complete training system that he would later acknowledge as his greatest contribution to the war effort. The US Navy documented a quantum improvement in air-to-air gunnery performance by its new pilots as the Aerostructure became the primary gunnery simulator for the Navy utilizing Fulton's training system.³²

With the success of the gunnery trainer, Fulton was recognized within the US Navy as a man who could identify a need and apply his unique

analytical skills in developing a solution. His early childhood and growth into a young adult prepared him for this “out-of-the-box” thinking. Fulton was a product of an affluent early twentieth-century America. A distant relative of Robert Fulton, the steamship and submarine inventor, and having a middle name the same as another famous inventor (although the name itself was an old family one), he was destined to become a world-class inventor himself. With his father the president of Mack Truck Company, Fulton was blessed with enough wealth and privilege to be given the opportunity to develop and grow into whatever his abilities allowed. His mother encouraged him to become an architect, so he enrolled in the University of Vienna’s prestigious school of architecture, renowned as one of the preeminent architectural schools of the day. As he neared graduation in 1932, Fulton received a letter from his father encouraging him to return to New York by way of the Orient so that he could experience the variety of architectural forms and life styles found throughout the East. Of course, his father envisioned a conventional mode of transportation (rail or ship) for the journey. As it turned out, young Fulton made a deal with an English motorcycle company to ride around the world on one of its motorcycles and document the event through photography.

In July 1932 Fulton set out on his Douglas twin-cylinder motorcycle from England and headed east. Over the next year and a half, his adventure resulted in experiences that would affect and shape the rest of his life. On 24 December 1933, Fulton drove into the courtyard of his parents’ home in New York City, having traveled over 40,000 miles during his 18-month odyssey.

After his around-the-world trip, Fulton’s passion for photography guided him through the next phase of his life. He worked for Pan American Airlines (PanAm) as a photographer tasked to document the airline’s expansion around the world. Throughout the late 1930s, PanAm built runways, hangars, terminals, and other facilities required to support its worldwide operations. Particularly challenging was PanAm’s Pacific island locations that had to be built from the ground up. Fulton was there to photograph PanAm’s progress. In 1939 Fulton left PanAm to develop the flight simulator that he later converted to the aerial gunnery trainer purchased by the Navy during World War II.

As Fulton first observed the All American Aviation system in 1946, he was also heavily involved

in developing an aircraft capable of being converted to an automobile for ground transportation. Fulton had traveled extensively in his Stinson airplane during the war to support his gunnery trainer contract and was constantly confronted with the problem of ground transportation after he arrived at each destination. The Airphibian was his solution. Fulton purchased 15 acres adjacent to the Danbury Municipal Airport and set up his production facilities. He built and tested eight versions of the aircraft at Danbury. Because the aircraft was also an automobile, the long process of certification was nearly doubled to meet both ground and air specifications. Also, the Airphibian was the first of its type, and federal regulators were unsure of what requirements needed to be met. After a lengthy four-year process, with his personal funds nearly exhausted, Fulton was forced to sell the controlling interest in his company to outsiders to raise enough cash to finish the certification process. Just as the aircraft design was finally being certified, the new owners decided that producing the aircraft would not be profitable, and they canceled production and went in a different direction with the company. Fulton was heartbroken. He had managed to get the only convertible airplane-automobile in history certified by the Federal Aviation Administration, yet it would not be produced for sale to the public. What he had worked on so hard for nearly five years was now gone.

Through disappointment sometimes comes opportunity. While flying over isolated areas of the globe, Fulton wondered how he would be rescued if he had the misfortune to crash land. He remembered the All American Aviation demonstration he had observed in London back in 1946. He decided to begin work on an improved system that was designed specifically to extract downed airmen.

Early Skyhook Development

Fulton began his experiments in 1950 using a weather balloon, nylon lift line, and weights of 10 to 15 pounds each. His concept was a simple one. Instead of poles supporting a transfer cable as the All American Aviation system had done, Fulton wanted to raise the lift line into the air by way of a helium-filled balloon. Instead of a grapple hook attached to the end of a pickup cable, he designed a fork, or V, which was mounted on the nose of the aircraft. Early experimental designs placed the fork on the left wing of the aircraft, with knots tied in the lift line at intervals near the lift balloon. When the lift line was engaged by the forks

as the aircraft struck the line, the lift line would pass through the fork until a knot was encountered. This process took only a fraction of a second because of the speed of the aircraft. A long pole was used to snag the lift line behind the fork, and the line was then pulled into the fuselage of the pickup aircraft by an auxiliary crew member. After retrieval the end of the lift line was attached to a winch, and the weighted package was retrieved into the aircraft.

Using his own Stinson aircraft, Fulton made numerous pickups, testing his ideas and developing reliable recovery procedures. After experiencing some degree of success and convinced the idea was sound, Fulton had his son film the entire process. Fulton then took the film to then-Adm Luis de Florez, who had supported him 10 years earlier when Fulton brought the aerial gunnery trainer to the Navy during World War II. Admiral de Florez had become the director of technical research at the CIA. Believing the idea had merit, de Florez put Fulton in touch with the Office of Naval Research (ONR) with the belief that the system could be better developed by the military. Because of de Florez' support, Fulton was awarded a developmental contract from ONR to refine his recovery system and to produce a working prototype.³³ Fulton named his pickup system Skyhook.

Throughout the 1950s Fulton continued to develop both ground and air equipment necessary to support the Skyhook system. ONR provided a US Navy P2V Neptune aircraft for Fulton's research. Operating out of El Centro, California, Fulton gradually increased the weight of the pickup package until his original line began to break. He solved this problem by developing a braided nylon line with a test strength of 4,000 pounds. The most difficult piece of equipment to perfect was the locking anchor, called the sky anchor, which was placed in the apex of the fork. Fulton found that knots in the lift line significantly decreased its strength. Additionally, once engaged, the knots could not be easily disengaged from the fork for subsequent pickups. The sky anchor solved the problem by wrapping the lift line around a spool, thus locking the line over itself when the sky anchor was actuated upon contact with the lift line. After the line was secured in the aft of the aircraft, the sky anchor could then be unwound by the pickup crew and the lift line pulled through to clear it for another pickup. By 1958 all major components of the retrieval system had taken final shape.³⁴ Along with the sky anchor, Fulton created an upgraded winch system for the back of

the aircraft, and he modified the original weather balloon to a more stable dirigible shape.

The P2V was modified with a tubular steel V protruding from the nose of the aircraft, 30-feet long, and spreading at a 70-degree angle. The lift line was 500-feet long and was made of high-strength, braided nylon. The aircraft flew at 425 feet above ground level (AGL) and impacted the line near a Mylar marker placed there to provide the pilot with a discernible aim point. As the aircraft hit the line, the balloon was released by way of a quick disconnect mechanism, and the sky anchor secured the line to the nose of the aircraft. As the line streamed back under the aircraft, the pickup crew snagged the line with a hook, attached it to the winch, and retrieved the pickup package into the rear of the aircraft. Fulton used instrumented dummies to measure g-forces during the pickup. He also used a pig and a monkey to validate their survivability when picked up by the system. The first human recovery took place on 12 August 1958, when SSgt Levi W. Woods, US Marine Corps, was successfully extracted by the P2V. The entire recovery sequence took approximately six minutes.³⁵

The next major milestone in Skyhook development occurred in August 1960, when a Skyhook-equipped P2V flew to Point Barrow, Alaska, and picked up mail and an assortment of items from the Floating Ice Island T-3. The mission also involved retrieving prehistoric artifacts from an archeological party and geological samples from Peters Lake Camp. The climax of the mission came when the P2V dropped a recovery kit near the icebreaker USS *Burton Island*. The recovery package was retrieved by one of the ship's boats, and a recovery



Photo courtesy of Robert E. Fulton

Robert Fulton modified his Stinson aircraft with a V fork on the left wing to test the feasibility of his aerial recovery idea.

was made from the ship's deck. The Alaskan trials were the last step in certifying the system for operational use.³⁶

Operation Coldfeet— The First Operational Use of Skyhook

After the 1960 Alaskan trials, the US Navy continued to refine the Fulton Skyhook system. Although contracted to provide lift lines and balloons to the Navy, Fulton's developmental contract had ended. In May 1961 what would become the first operational use of the Skyhook system began as Operation Coldfeet. The Soviet Union, along with the United States, operated a series of drift stations deep in the Arctic for research purposes. As nuclear-powered submarines made transit of the North Pole feasible, both super powers turned their efforts to detecting them as they traveled beneath the polar region. A naval aircraft flying an aeromagnetic survey over the Arctic Ocean reported sighting an abandoned Soviet drift station. Soon afterwards, the Soviets announced that they had abandoned Station NP 9 because of a crack in the ice runway that supported its operations. ONR, with its recently developed Skyhook recovery system, was interested in seeing what secrets the station might possess. The station was too far north and out of conventional helicopter range. The Skyhook system provided a means to reach the ice station and retrieve equipment or documents the Soviets might have left behind.³⁷

After preliminary approval by the chief of naval operations, the mission was tentatively set for September 1961, when the weather would be favorable and the station would be within 600 miles of Thule AB, Greenland. ONR selected two highly qualified individuals to parachute into the ice station and investigate its secrets. USAF Maj James Smith was an experienced jumper and Russian linguist who had served on two US drift stations. Lt Leonard A. LeSchack, US Navy Reserve, was a geophysicist who had been involved with the setup of surveillance equipment on drift station T-3 in 1960. During the summer of 1961, in preparation for the mission scheduled for September, the two men trained on the Fulton Skyhook system at the Naval Air Test Center, Patuxent River, Maryland. Although not previously jump-qualified, LeSchack soon became proficient in required parachuting skills.³⁸

As training continued, top Navy brass became increasingly skeptical over the whole operation. Some experts felt that the operation was risky

and that loss of life was inevitable. Regardless, the mission received final approval in late September 1961. Other delays were experienced when specialized equipment designed for the mission failed cold-weather testing at Eglin AFB's climatic hangar in Florida. By the time the equipment was certified and everything was ready to go, winter had set in and the weather had deteriorated to a point that mission success was highly doubtful. The mission was subsequently postponed until the next spring. In March 1962, with the mission still on hold, naval intelligence learned that a second ice station, designated NP 8, had been abandoned in haste by the Soviets because of another ice breakup near the unit. Being a much newer facility than NP 9, attention was shifted to the new target. The US government received permission from Canada to operate out of the Royal Canadian AFB at Resolute Bay, which was located 600 miles from the abandoned ice station NP 8.³⁹

The Skyhook-equipped P2V, accompanied by a C-130 support aircraft, departed Patuxent River in mid-April en route to Resolute Bay. The hunt for NP 8 began in clear weather with unrestricted visibility. The C-130 flew to the station's last-known coordinates and began a 10-mile box search pattern. After hours of searching and with fuel running low, the aircraft was forced to return to base. The next day, the C-130 decreased its box pattern to five-mile intervals but was still unable to locate the elusive ice station. With allocated flight hours exhausted after four additional days of searching, the mission commander reluctantly canceled the mission.⁴⁰

Not long after the expedition returned to Patuxent River, a US reconnaissance flight spotted NP 8 well to the east of the position searched by the C-130. ONR was out of funds, and the modified P2V had been deployed to Antarctica, so ONR turned to the intelligence community for support. Fulton was working with the CIA to develop a Skyhook capability for the agency when the ONR contacted him regarding the NP 8 mission. In October 1961 Intermountain Aviation, a CIA proprietary airline specializing in aerial delivery techniques, had equipped a B-17 with the Fulton Skyhook system. For nearly six months, CIA-contract pilots Connie W. Seigris and Douglas Price had practiced the mission and had perfected equipment needed to extract agents from the field. Fulton approached Intermountain Aviation with ONR's request. The Defense Intelligence Agency made available \$30,000 for the project, and the proprietary agreed to fly the

mission with the Fulton-equipped B-17 and a support C-46 cargo aircraft.⁴¹ An additional \$30,000 was eventually provided to Intermountain Aviation to offset the expense of the mission.

On 26 May 1962 Intermountain Aviation launched the two aircraft to Point Barrow, Alaska, to begin the next phase of Operation Coldfeet. On 27 May Seigris and Price launched north from Point Barrow to the last-known position of NP 8, but after 13 hours of flying, they were unable to find the elusive ice station. Weather was poor with decreased visibility. The next day, with the assistance of a more sophisticated P2V out of Kodiak Island, the crew located its target. Smith and LeSchack parachuted out of the “Joe hole” in the belly of the B-17 just as OSS operatives had done during World War II. After dropping supplies to the two men on the ice and completing a radio check, the crew departed for Point Barrow.⁴²

While the two investigators probed the abandoned ice station, Intermountain Aviation mechanics installed the tubular steel pickup boom on the nose of the B-17 at Point Barrow. A test flight was conducted on 30 May, and all equipment was determined ready for the following day’s mission. By 31 May, 72 hours had elapsed since the B-17 had dropped the two men on to the ice station. They had completed their investigative mission and were ready for extraction. The B-17 pickup aircraft launched with Robert Fulton aboard, along with a full complement of flight and pickup crew members. Weather had deteriorated since the initial drop, and the aircraft was unable to locate the station. A dense fog had formed due to heating of the ice. The crew reluctantly returned to Point Barrow for an attempt the following day. After another unsuccessful search on 1 June, the mission commander again called in the P2V for assistance in locating the target. On 2 June the P2V took off two and one-half hours before the B-17 to give it time to find the ice station. The P2V quickly located NP 8 with its more sophisticated navigational equipment.⁴³

When the B-17 arrived over NP 8, the weather was marginal at best for a pickup. The surface wind was blowing at 30 knots, and the horizon was barely discernible to the flight crew. The first pickup was made by Seigris and consisted of a 150-pound bundle of exposed film, documents, and sensitive equipment. After the package was successfully brought on board, Price moved to the left seat for the next pickup. LeSchack was the next package scheduled to be retrieved. The wind had increased in intensity, and when the balloon

began to rise after the two men had inflated it, LeSchack tore loose from the grasp of Smith and was dragged some 300 feet across the ice. He finally managed to stop sliding when his body hit an ice block. At almost the same time that he hit the ice block, Price hit the lift line and LeSchack disappeared from Smith’s view through the fog. Price and Seigris changed seats again, and the crew set up for the last recovery. Back on the ice, Smith held on to a tractor as he inflated the helium balloon. As had LeSchack a few minutes before, he was unable to remain stationary when the balloon rose to altitude, and he began to slide across the ice. He managed to find a surface crack in the ice, and he planted the heels of his boots firmly in it. As Smith lay on his back on the ice with his heels wedged in the crack, Seigris hit the lift line. Minutes later, Smith was aboard the B-17 and on his way back to Point Barrow with his fellow investigator.⁴⁴

Operation Coldfeet was an operational success. The intelligence value gained from the material extracted from NP 8 showed that Soviet research in polar meteorology and oceanography was superior to that of the United States. Additionally, it was learned that the ice station was configured to allow extended periods of low-noise operation, confirming the importance the Soviets placed on acoustical work. But beyond the intelligence value of the mission, Coldfeet had validated the operational use of the Fulton recovery system.⁴⁵ With winds outside the designed operational capability of the system, the flight crew still had managed to make three successful recoveries. The system was ready for expanded application in both the US Army and the US Air Force.



Photo courtesy of Robert E. Fulton

Intermountain Aviation modified a B-17 with the Fulton Skyhook system (later identified as STARS). Aircraft was used during Operation Coldfeet.

Expansion of the Skyhook System

With the success of Operation Coldfeet, interest in Fulton's invention gained momentum throughout the US military. US Army Special Forces needed a reliable exfiltration method for its expanding Green Beret program. The Green Beret's mission often took them deep behind enemy lines and often involved parachute operations into the objective area. Just as OSS troops of World War II had needed a means to return to friendly territory when the mission was complete, so did the special forces. In 1962 the US Army operated a growing fleet of fixed-wing C-7 Caribou aircraft. The Fulton Skyhook system was adapted for this aircraft. Installation on the Caribou was similar to that of the Navy P2V and Intermountain Aviation's B-17. A large tubular steel V was mounted on the nose of the aircraft, and the sky anchor was installed at its apex. The winch system was modified and installed in the cargo compartment of the aircraft. An operational test and evaluation was flown in the Caribou during the fall, culminating in the Army's first live pickup of Capt James Skinner on 15 October 1962. Six additional live pickups were successfully completed in the C-7 during October and November training flights.⁴⁶

The US Navy was also interested in expanding its Skyhook capability. On 3 April 1963 a US Navy S2F Tracker performed a live recovery of US Marine Corps sergeant Paul Mayer at its Patuxent River facility. Navy S2Fs and Army C-7s continued to perform live pickups during training throughout 1963 and 1964 to refine their respective programs. The US Air Force performed its first live Skyhook recovery on 27 November 1964, when Capt Nelson



Photo courtesy of Robert E. Fulton

US Army C-7 Caribou equipped with the Fulton recovery system, early 1960s.

Gough was picked up by a modified C-123H aircraft at Eglin AFB, Florida. During 1965 another 22 live pickups were accomplished on Army C-7 and Navy S2F aircraft. Of the first recorded 98 Skyhook pickups, 52 were performed by Army C-7 Caribous, 32 by Navy S2F Trackers, 11 by Navy P2V Neptunes, two by Intermountain Aviation's B-17 during Operation Coldfeet, and one by USAF's C-123H.⁴⁷

All but one of the 98 live pickups was successful. In April 1963, during an S2F Tracker recovery, the pickup volunteer experienced vertigo and disorientation as he was brought into the aircraft. An inexperienced recovery crew inadvertently disconnected the lift line before fastening a safety line to the individual. With no restraining line attached, the individual stumbled and fell through the open hatch of the aircraft to his death. No other fatality was attributed to the system for the next two decades.⁴⁸

The USAF C-130A/B Skyhook Modification

With minimum change, the proven Fulton Skyhook system was adapted by Lockheed engineers to the C-130A and C-130B aircraft. The basic difference between the P2V and the C-130 installation was found in the retrieval procedures. On the P2V the pickup package was brought on board the aircraft through a hatch in the lower fuselage. On the C-130 the package came aboard through the rear cargo ramp and door.⁴⁹

The V yoke and supporting truss was mounted on the nose of the C-130 and designed in such a way as to allow installation or removal in approximately two hours. The yoke forks had a spread of 24 feet from tip to tip, thus allowing ample tolerance when maneuvering the aircraft for engagement of the lift line. The fixed-position yoke guided the lift line into the sky anchor, which automatically secured the line to the nose of the aircraft. A propeller guard cable was connected from the yoke ends to the left and right wing tip of the aircraft. The purpose of the guard cable was to deflect the pickup line away from the propellers in the event the pilot missed the line with the yoke. A retrieving line deflector cable, attached to the right yoke tip and to the left yoke base, prevented the lift line from hanging up on the nose radome (fig. 2).⁵⁰

Recovery equipment mounted on a pallet in the cargo compartment included a hydraulic winch, hoist with operator controls, safety fence mounted on the ramp, cable-retrieving hook, and snatch-pole. A pallet was secured to the ramp floor by

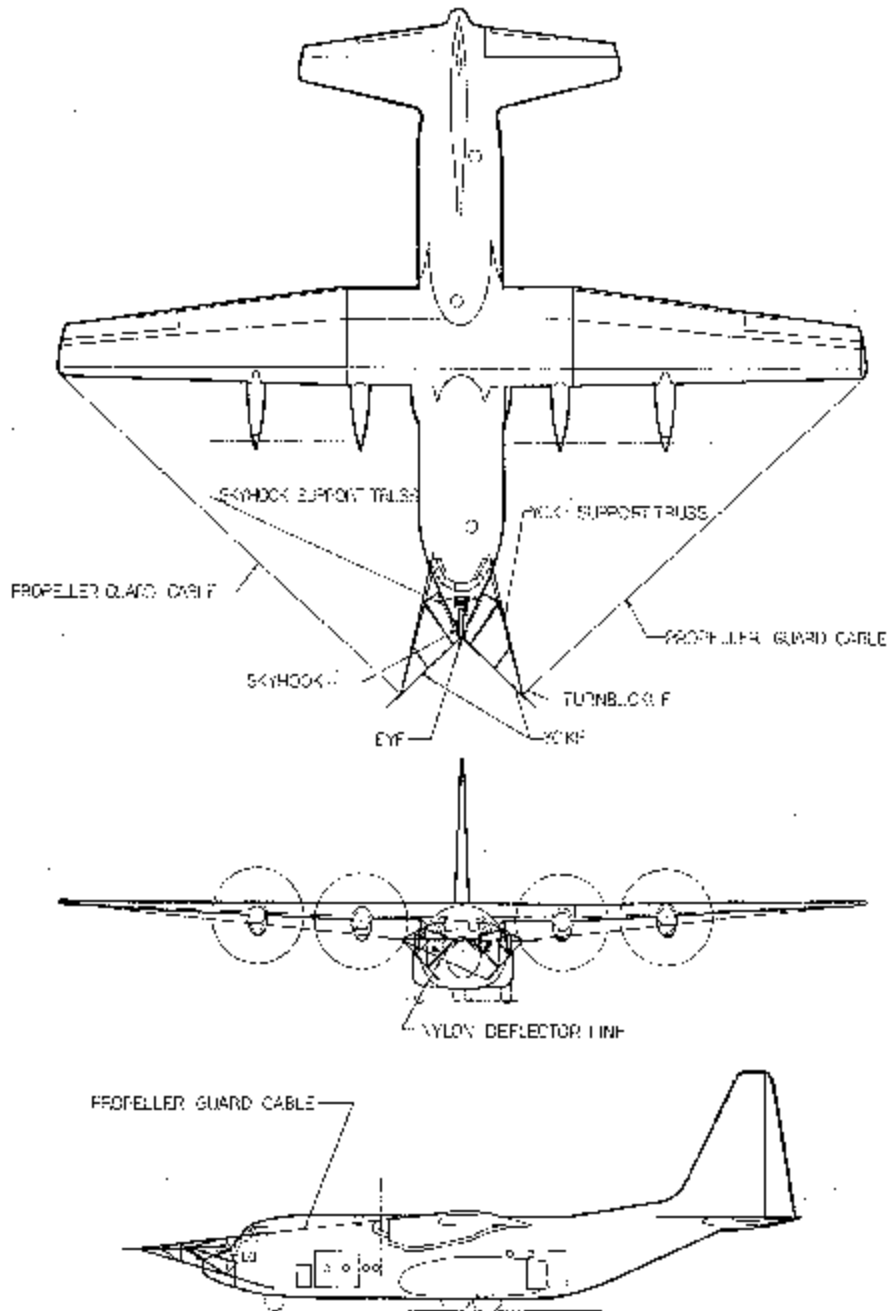


Figure 2. C-130A/B Fulton Skyhook Installation (External View) (Source: Lockheed Aircraft Corporation, ER-4112, 8 February 1960.)

standard tie-down rings located in the recesses of the floor. The winch consisted of two cantilever-suspended drums mounted to the winch gearbox and powered by a hydraulic motor. An emergency manually operated level-wind roller was also provided in the event of primary winch failure (fig. 3).⁵¹

The Skyhook components, comprising the pickup equipment on the nose of the aircraft and the retrieval equipment on the cargo ramp, were designed as a package unit capable of being stored as a kit. The Skyhook system could be installed on

aircraft tasked to fly a recovery mission with the following minor structural and system adaptations completed:

1. Minor beef-up of the upper windowsill longeron where the nose pickup truss attached to the aircraft.
2. Hydraulic system pressure and return lines adapted to allow for pallet power source tie-in by installation of tubing fittings, quick-disconnect fittings, and dust covers.
3. Electrical system adapted for the Skyhook power source tie-in by the installation of an AC quick disconnect plug-in type junction box.

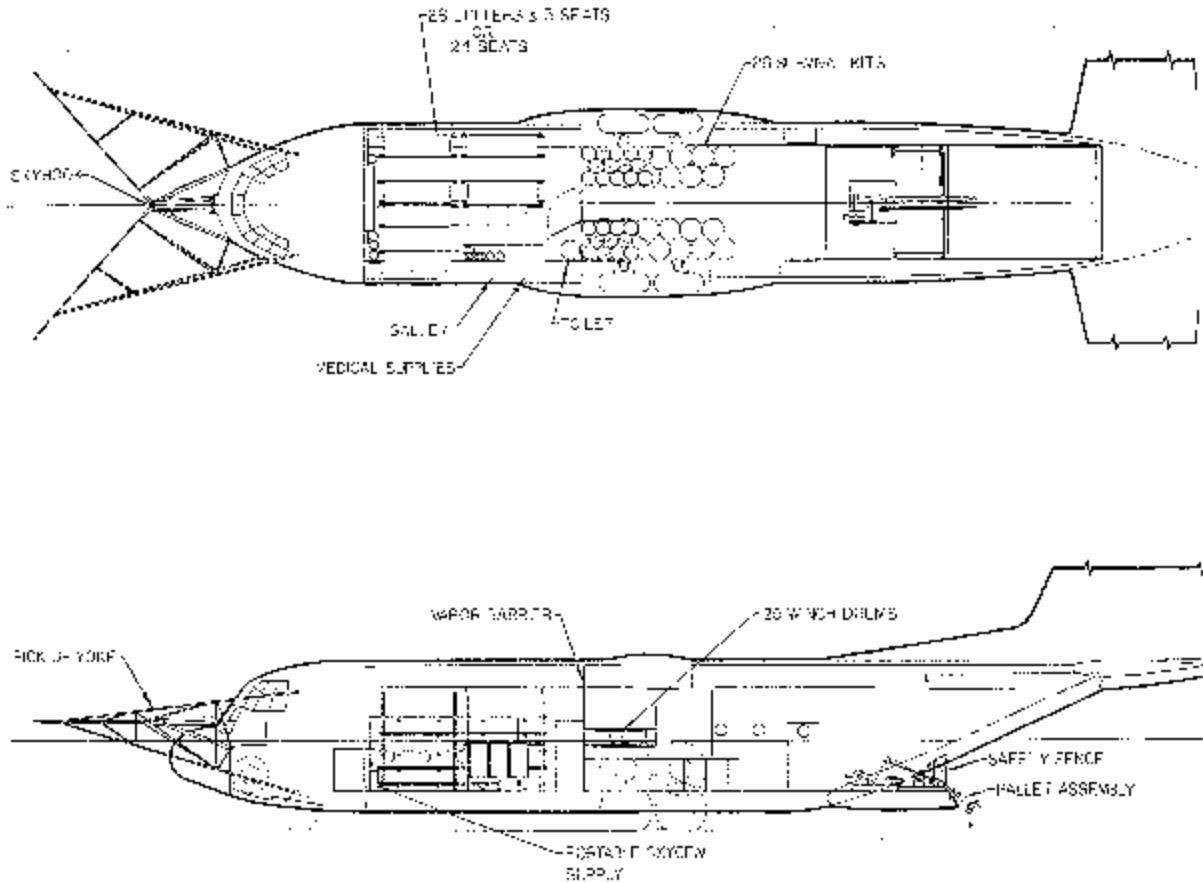


Figure 3. C-130A/B Fulton Skyhook Installation (Internal View) (Source: Lockheed Aircraft Corporation, ER-4112, 8 February 1960.)

4. Communication system control panel added in the cargo compartment near the pallet operator's workstation.⁵²

USAF was interested in the Fulton recovery capability and conducted a formal operational test and evaluation of the system mounted on the C-130 during 1962 and 1963. No recorded live pickups were made during the test phase. In 1964 USAF made the decision to install a permanent Skyhook system on specially modified C-130E aircraft in response to the growing requirement to rescue airmen shot down in Vietnam.

Skyhook and Combat Talon

The C-130E was the newest model aircraft in the C-130 series and marked a significant increase in capability over the earlier C-130A and C-130B. The removable tubular V yoke tested on the earlier model aircraft was redesigned by Lockheed engineers and transformed into a fully retractable, hydraulically operated unit mounted permanently on the nose of the aircraft. The configuration required redesign of the nose radome,

resulting in the characteristic nose found on early Combat Talons. Fulton equipment located in the cargo compartment was removable and installed on the aircraft dependent on mission tasking. More than 75 USAF C-130 aircraft, including the 14 original E model Combat Talons, were eventually modified with the Fulton system.

The Combat Talon Fulton system consisted of a yoke assembly, sky anchor, davit assembly, manual davit winch, two hydraulically operated winches, ramp air deflectors, ramp guards, parahooks, miscellaneous recovery equipment, recovery kits, control panels, and fending lines. The yoke assembly was designed to fold back along the fuselage of the aircraft when not required for Fulton operations. The sky anchor, located at the apex of the yoke, was mounted internally in the upper nose section of the aircraft. This configuration helped protect it from the harsh environment experienced by units previously mounted in an exposed configuration. The internal mount of the sky anchor also resulted in a more aerodynamically clean nose, thus decreasing drag when the aircraft was in flight.⁵³

The davit assembly was a V-shaped boom mounted on the cargo ramp floor; it provided a means of raising the retrieved package over the aft end of the ramp and lowering it to the ramp. Two hydraulically operated winches were included in the Talon configuration, an improvement over the earlier winch that had two spools but only one set of gears. The winches were mounted, one above the other, on the cargo compartment floor just forward of the ramp hinge and were designed to retrieve the lift line after the sky anchor secured it to the nose of the aircraft. The top winch was the primary winch, and the bottom winch was the standby. To decrease windblast around the ramp area during recovery operations with the ramp lowered, a buffer board was mounted on each side of the cargo ramp. The fence system designed for the earlier C-130A/B configuration was eliminated. Three protective guards were attached to the aft end of the ramp to provide protection for the lift line during recovery. The yoke was controlled from the yoke panel at the pilot's station. The sky anchor was controlled from the sky anchor control box just forward of the left paratroop door. The winches were operated by control handles on the winch platform (fig. 4).⁵⁴

To retrieve the line, a torpedo-shaped parahook was provided. The parahook, which closely resembled a conventional iron bomb, had a hook on each side and was used to hook and retrieve the lift line. The parahook was attached to a recovery line, which passed through a portable pulley assembly mounted above the ramp in the cargo compartment of the aircraft. After passing through the pulley assembly, the recovery line was attached to the standby winch. The parahook and recovery line were deployed to retrieve the lift-line trajectory beneath the airplane and had to be maneuvered until the lift line was hooked. Airspeed of the aircraft directly affected the trajectory of the parahook, with higher airspeeds and heavier packages requiring a heavier parahook. One 30-pound and one 75-pound parahook were provided for lift-line recovery. When not in use, the parahooks were stowed in the retrieval equipment stowage box located on the aircraft.⁵⁵

Miscellaneous recovery equipment included in the Fulton recovery kit consisted of a cleat bar, portable pulley assembly, snatch blocks, pilot's hooks, anchor clamp, and personnel restraint harnesses. All the miscellaneous recovery equipment was stowed in the retrieval equipment storage box in the forward cargo compartment. One pilot's

hook was stowed on brackets on the flight-station aft bulkhead. The cleat bar, which mounted on the aft right side of the ramp floor, contained two cleats. The cleats were used to secure the lift line when removing the snatch block from the line. The portable pulley hooked into the overhead structure above the aft center of the ramp. The pulley was used to raise the davit assembly when the recovery package reached the ramp. The snatch block was used to pull enough slack in the lift line to enable the lift line to be secured to the cleat bar. The pilot's hook was used in the cockpit to pull the lift line into the airplane, where the line could be cut to release the balloon connector end. Personnel restraint harnesses were used by personnel working on the ramp during recovery when the ramp was lowered.⁵⁶

Building on the lessons learned from Operation Coldfeet, a ground anchor kit was provided for use both on land and on ice. The anchor kit consisted of ground anchor stakes, anchor tie-lines, shovels, sledgehammers, and operating instructions for the use of the ground anchor equipment. Two types of ground anchor stakes were provided in the kit: one, with movable spades, was used for normal, compacted soil; the other, a shorter stake with a sharp spike, was used for ice and frozen ground. The ground anchor components were placed in the drop kit when forecast surface winds were more than approximately 20 knots and were air-dropped with the recovery kit to personnel on the ground.⁵⁷

Two propeller guard cables, known as fending lines, were provided to protect the lift line from striking the propellers head-on in the event the pilot missed the line with the yoke. The fending lines also protected the pickup package from movement in the event of a miss. Early fending lines did not have cutter knives installed; rather, they relied on the aircraft's propeller to cut the line in case of a miss. These early fending lines placed the lift line in an optimum position so that it could be properly cut by the propeller without danger of having the line ingested into the engine. A later modification installed cutter knives on the fending line to cut the pickup line automatically if missed by the yoke. The fending lines were attached to the outboard end of each wing tip and to a point just aft of the sky anchor and were stowed in the cargo compartment when the airplane was not configured for recovery operations.⁵⁸

An aerial sight was provided for the pilot to align the airplane with the lift line during lift-line

recovery equipment-typical

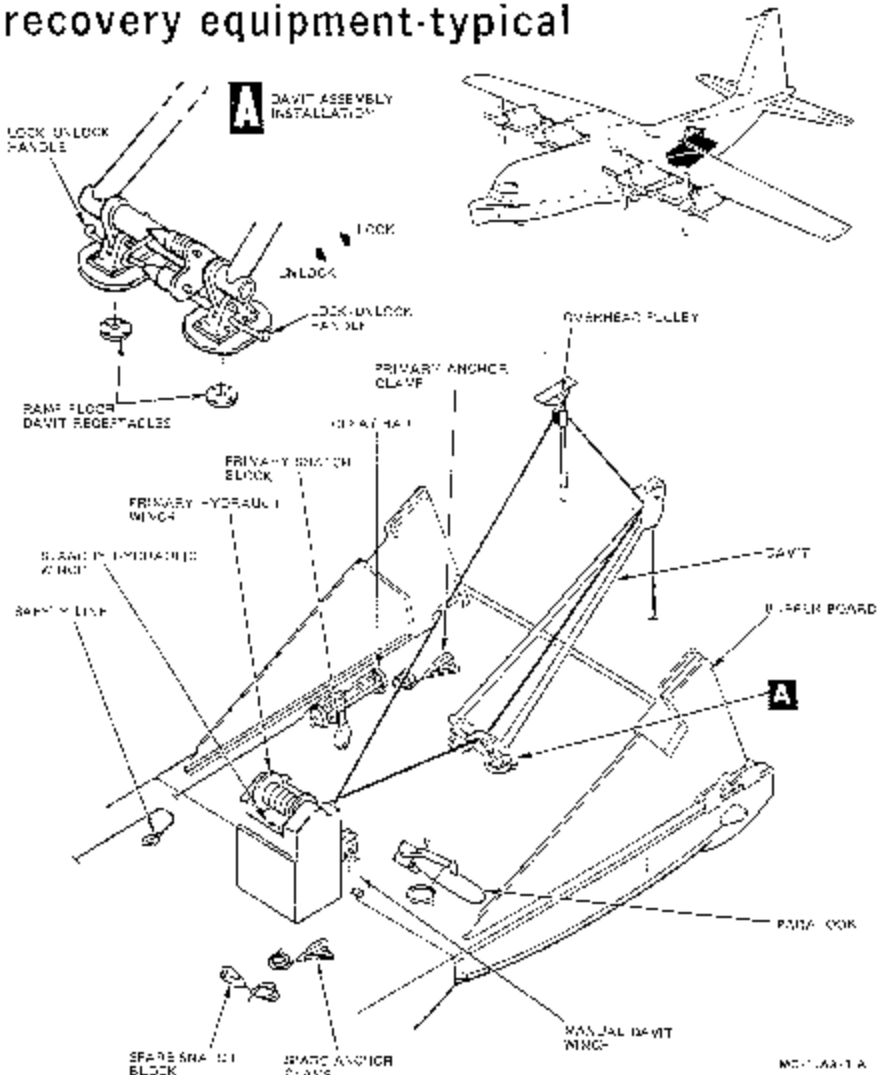


Figure 4. Miscellaneous Recovery Equipment for STARS-Equipped C-130E (Source: Lockheed Technical Manual (LTM) 1MC-130E-1, 1 October 1981, Combat Talon Archive, HQ AFSOC/HO, Hurlburt Field, Fla.)

engagement. The intercept sight was a portable optical instrument that attached to a mount located over the pilot's forward windshield. The sight contained a two-position toggle switch and a rheostat that controlled the brilliance of the reticle projected on the reflector plate. When the sight was not in use, it was stowed behind the pilot's seat.⁵⁹

Normal System Operation

The recovery operation began with the airdrop of the recovery kit. The kit was configured either for water or for land use and was delivered at 130 KIAS. Following recovery kit deployment, the ramp crew installed the necessary recovery equipment (such as the overhead pulley, snatch

block, and anchor clamp), set the sky anchor to its ready position, turned on the hydraulic pressure switch to the two winches, donned safety harnesses, and prepared to lower the parachute. The forward escape hatch was removed, and the pilot's hook was removed from its stowed position. The aircraft was slowed to recovery airspeed, the yoke extended, the ramp and door opened, and the aircraft was flown upwind into the lift line between the upper and lower markers (fig. 5a).⁶⁰

Upon contact with the yoke, the lift line was guided into the sky anchor, where it was locked to the airplane. At that time the balloon broke free, the upper part of the lift line flowed aft over the upper fuselage, and the lower part trailed in an arc under the fuselage (fig. 5b). The ramp crew

the anchor clamp and tie-down line assumed the lift-line load. When enough slack in the lift line was available, the lift line was tied to the cleat bar. The parahook, overhead pulley, primary winch drum, and the snatch block were removed and carried forward past the ramp hinge to clear the working area on the ramp. An empty drum was then installed on the primary winch (fig. 5f). With the lift line positively locked to the aircraft by the cleat bar and the anchor clamp, the sky anchor was released.⁶¹ When the sky anchor had been released, the lift line was pulled through the sky anchor from the ramp (fig. 5g). Once the loose end of the lift line was retrieved by the ramp crew, a knot was tied in the end of the lift line, and it was inserted into the detent on the primary winch drum. The slack lift line was then fed on to the drum. Just before the primary winch assumed the load, the lift line was untied from the cleat bar. The primary winch continued to reel in until the anchor clamp could be removed from the lift line (fig. 5h).

After the anchor clamp had been removed, the lift line was reeled in at maximum speed until the davit was ready to be installed, at which time the reel in was stopped. The davit was moved under the lift line, and the pip pin was installed over the line. The davit was locked to the ramp floor, and the lift line was forced under the forward davit roller.⁶²

After the davit was installed and the lift line was forced under the roller, the primary winch was reengaged and operated at maximum speed until the package approached the ramp. Concurrently, the davit rotation line was attached to the standby winch. As the package neared the ramp, the primary winch was slowed gradually and was stopped when the package harness reached the davit roller (fig. 5j).

The standby winch was then reeled in to rotate the davit, and the ramp crew stabilized the package and attached the retention line to the D ring on the package harness. The primary winch was then reeled out, allowing the package to descend to the ramp with excess slack in the lift line. The package was then moved forward of the ramp hinge line where it could be safely detached from the lift line and retention line (fig. 5k).

After retrieval, if no other recoveries were planned, the davit was removed, the cargo ramp and door were closed, all recovery equipment was stowed, and hydraulic pressure was shut off to the winches.⁶³ For multiple recoveries, the sky anchor was reset to the ready position, an

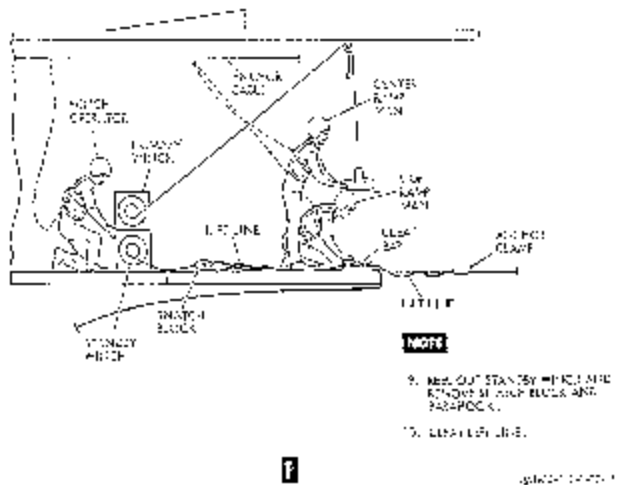


Figure 5f. Snatch Block and Parahook Removed from Lift Line (Source: LTM 1MC-130E-1, 1 October 1981, Combat Talon Archive, HQ AFSOC/HO, Hurlburt Field, Fla.)

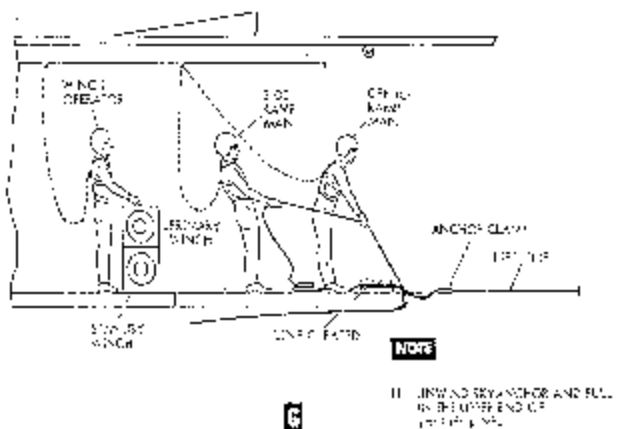


Figure 5g. Lift Line Released from Sky Anchor (Source: LTM 1MC-130E-1, 1 October 1981, Combat Talon Archive, HQ AFSOC/HO, Hurlburt Field, Fla.)

empty spool was installed on the primary winch, and the aircraft was left in the recovery configuration with the yoke extended and the ramp and door open. If additional recoveries were scheduled later in the mission, the yoke was retracted, the ramp and door were closed to enable the aircraft to accelerate to en route airspeed, and the Fulton gear was left in place on the ramp. The entire recovery operation took approximately six minutes, depending on factors including ramp crew proficiency, turbulence, day or night operations, and normal operation of all equipment. Detailed emergency procedures were available in the event any component of the system failed to operate properly.

Skyhook/STARS Live Recoveries

A measure of confidence in the Fulton recovery system was found in the willingness of the command controlling the Combat Talon to perform live pickups. A live pickup was defined as a recovery that involved a human being, whether in training or during a contingency operation. When the USAF made the first live recovery in the C-130 aircraft on 3 May 1966, there had already been 98 live attempts, with only one of those being unsuccessful. The system was a proven one, yet confidence in its capability could only be maintained by continued live pickups. (A view held by some, but not all, in the Special Operations community.)

There were two major schools of thought concerning live pickups. The first school encompassed commanders who felt that since the system was man-rated by the USAF, live personnel pickups were no more risky than any other capability designed into the aircraft. As an example, the aircraft was designed to fly low-level terrain following with its AN/APN-115 radar. The system was a day-night, adverse-weather one. It was undoubtedly more risky to fly at night in the weather than in day visual-flight rules, yet the aircraft was operated in all modes, up to designed system limitations. Why not the Fulton recovery system, too? This school of thought assessed that if the system were not regularly used for live pickups during exercises and training, it would not be considered a viable option when a combat or contingency tasking was received. The US military trained the way it fought; so, if the system was unsafe for training, it was unsafe for actual operations.

The second school of thought held that live pickups presented an unacceptable risk to the individual and that training value received from an actual live pickup could be gained through a pickup utilizing a training dummy. This school theorized, for example, that since the US military did not engage in actual combat during training, with the resultant loss of life and limb, it was unnecessary to perform actual live pickups that put an individual's life in danger for the sake of training.

Throughout the history of USAF's involvement with the Fulton system, the two schools clashed over the live versus dummy issue. During the early years of Fulton employment on the Combat Talon, the live school dominated the Combat Talon community in the Pacific. Six live recoveries were performed between May and August

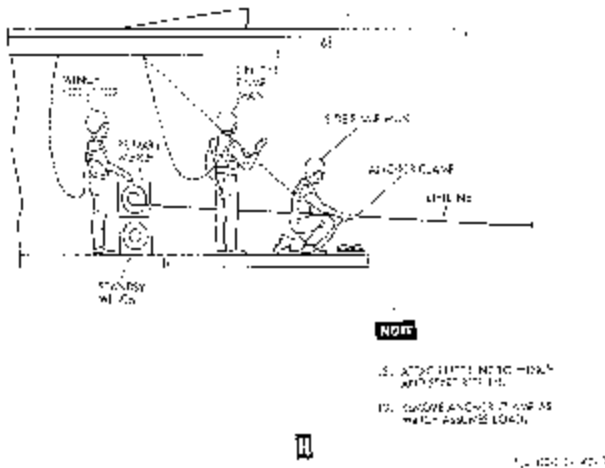


Figure 5h. Lift Line Attached to Primary Winch (Source: LTM 1MC-130E-1, 1 October 1981, Combat Talon Archive, HQ AFSOC/HO, Hurlburt Field, Fla.)

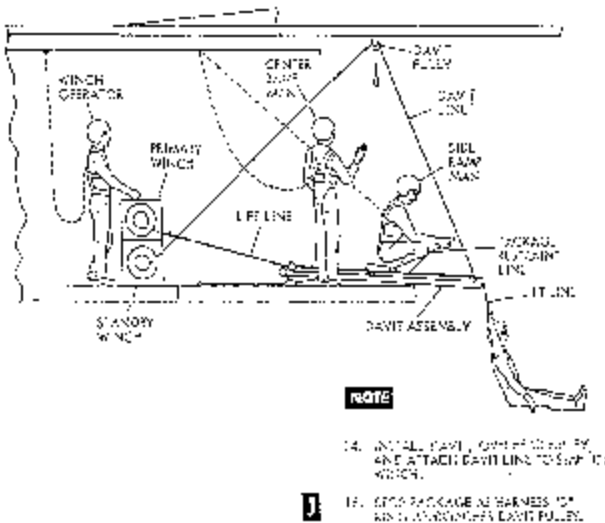


Figure 5j. Package Retrieved and Stopped at Davit Pulley (Source: LTM 1MC-130E-1, 1 October 1981, Combat Talon Archive, HQ AFSOC/HO, Hurlburt Field, Fla.)

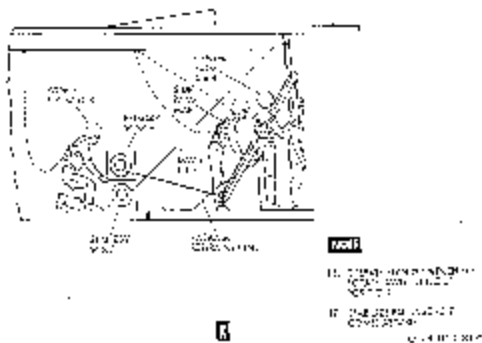


Figure 5k. Package Brought Aboard Aircraft (Source: LTM 1MC-130E-1, 1 October 1981, Combat Talon Archive, HQ AFSOC/HO, Hurlburt Field, Fla.)

1966 when the system was new and being certified for operational use. As the Combat Spear contingent deployed to SEA, Combat Talon live recoveries continued there during 1967 and 1968. By 30 September 1968 Combat Spear crews had performed 29 additional live recoveries, and the unit continued live pickups until 30 August 1971.⁶⁴ No malfunctions were recorded that resulted in injury or loss of life. After August 1971 Combat Spear did not make any more recorded live pickups. In 1973 Combat Spear converted to non-Fulton-capable “Yank” aircraft and closed the book forever on the recovery capability in the Pacific.

After Combat Spear deployed to SEA in 1966, the Combat Knife unit at Pope AFB was tasked with training additional crews for the Combat Arrow unit in Europe and training replacement crews for the 1968 SEA rotation. Available records indicate that after the initial six live recoveries were made in 1966, no other live pickups were performed by the stateside-based Combat Knife unit. The school of “no live recoveries for training” was firmly in control at Tactical Air Command (TAC) headquarters. Similarly, the European Combat Arrow unit did not perform live recoveries after its 1968 deployment to Ramstein AB, Federal Republic of Germany (FRG). Ironically, it would be the European unit that championed the utility of the Fulton system and displayed it as a primary capability for long-range extraction of friendly forces from behind enemy lines. It did not, however, record any live pickups during training until the late 1970s, when the system again was utilized for live training recoveries.

In 1978 US Army colonel William H. Tyler, commander, Special Operations Task Force, Europe, initiated a request to US Air Force, Europe (USAFE) for resumption of limited live pickups for training. Capt John Harbison and TSgt Buff Underwood, both assigned to the 7th Special Operations Squadron (SOS) at that time, put together a presentation for the USAFE/deputy commander of operations, Maj Gen Robert W. Clements, and briefed him on the system. At the conclusion of the briefing, Colonel Tyler asked for approval to do a live surface-to-air recovery and was promptly told “no.” Not being one to take no for an answer, Colonel Tyler postponed any further requests and vowed privately to do a live surface-to-air recovery during the next Flintlock exercise, when he would have operational control of the 7th SOS. True to his word, Colonel Tyler authorized the 7th SOS to perform a live surface-

to-air recovery, and on 23 April 1979 he became the first person extracted by the 7th SOS utilizing the Fulton recovery system. A few days later, Capt Skip Davenport made a second live pickup, extracting Air Force Capt Bruce Weigel during Subexercise Schwarzes-Pferd in southern Germany. For the next three years, live surface-to-air recoveries were accomplished during the annual Flintlock exercise by 7th and 8th SOS personnel. The last live surface-to-air recovery attempt occurred on 26 April 1982 at Canadian forces base, Lahr, in southern Germany. A system malfunction resulted in the release of the person being picked up, and he did not survive his injuries.

Combat Talon crews assigned to the 7th and 8th SOS continued to maintain proficiency in the system after a thorough refurbishment was conducted in the 1985 period. The “no live recoveries for training” idea persisted, however, and no live surface-to-air recoveries were ever again accomplished. In November 1998 the Fulton STARS was removed from the remaining Combat Talon Clamp aircraft, and the capability was no longer available. The STARS had been an integral part of the weapons system since its inception in 1965. (See appendix A for a list of persons picked up by the Fulton STARS.)

The Terrain-Following/ Terrain-Avoidance Radar System

Although not as visually overt as the Fulton STARS modification, the ability of Combat Talon to fly low level in the TF/TA mode was at the heart of its unique capability. By 1965 Texas Instruments (TI) had produced an operational TF/TA radar for the RF-4 Phantom, which it identified as the AN/APQ-99. When Project Heavy Chain aircraft were modified beginning in late 1964, the AN/APQ-99 was adapted for the C-130E as the SPR-3 and installed in the two assigned aircraft. When Project Stray Goose kicked off in the spring of 1966, the SPR-3 was further modified by TI to the AN/APQ-115 configuration and installed by LAS Ontario on the 14 Combat Talon aircraft. The original C-130E production radar (the AN/APN-59B) was removed from the aircraft at that time.

The AN/APQ-115 remained the primary radar system on the Combat Talon throughout the 1960s, but it suffered from a low mean-time-between-failure (MTBF) rate. A low MTBF rate equated to increased downtime for the radar, with additional maintenance and parts required to keep the system operationally ready. The more often a piece of

equipment malfunctioned, the more time, dollars, and manpower were required to repair it. Many times during the early years of Combat Talon, aircraft were flown on missions with an inoperative radar because the radar could not be kept in commission. Along with the MTBF problem, the AN/APQ-115 suffered from inaccurate references (poor stabilization and Doppler inputs) that degraded its performance. In 1968 LAS Ontario began a study into a possible replacement radar that would be more reliable and require less maintenance between flights. The USAF was in the procurement stage for a new radar to improve its adverse-weather air-dropping capability. The new radar system was designated the Adverse Weather Aerial Delivery System (AWADS). The AWADS radar was further identified as the AN/APQ-122(V)1, and it had the basic characteristics required for the Combat Talon mission, except that it did not have a TF/TA capability. TI engineers, in conjunction with LAS Ontario, developed the AN/APQ-122(V)8 radar for the Combat Talon and incorporated the TF/TA function into its operation. To help eliminate the reference problems found in the AN/APQ-115, the new radar was coupled with the Litton LN-15J inertial navigation system (INS) that was tied to the Doppler and the Loran C. The new INS provided track, heading, and stabilization information that was far superior to anything available earlier.*

After extensive testing, the USAF initially procured the AN/APQ-122(V)8 for the four Heavy Chain aircraft, and from 1970 to 1972, the radar was also procured and installed in the 12 Combat Talons. The AN/APQ-122 radar was part of a sweeping modernization initiative for Combat Talon that was identified as the MOD-70 program. Many other system improvements were part of this upgrade, including the dual navigator's station on the flight deck and an upgraded electronic warfare/radio operator console in the cargo compartment. To accommodate the dual-radar antenna and the Fulton sky anchor, a new radome was developed that had an elongated chin in the lower front portion of the unit. The new radome made the 12 Clamp Combat Talons unique and physically different from all other C-130 aircraft. The standard round nose found on the basic C-130 remained on the Heavy Chain non-Fulton aircraft and on aircraft 64-0571 and 64-0572, which did not have Fulton STARS installed. The distinctive

nose radome adopted for the new radar during the MOD-70 program remained on the Clamp surface-to-air recovery aircraft from that time forward.

Through the 1970s and 1980s, the AN/APQ-122(V)8 radar remained virtually unchanged. Minor system improvements were incorporated into the radar, but no major modifications were made. By the late 1980s the radar had aged nearly 20 years, and many of its subsystems were on the verge of becoming nonsupportable. In the most extensive follow-on upgrade to the Combat Talon since 1970, the MOD-90 program was developed, and an extensive radar upgrade was incorporated into it. Beginning in the late 1980s, aircraft 64-0567 was dedicated to the MOD-90 program and was designated the first Special Operations Forces-Improved (SOF-I) aircraft. The SOF-I designation was the interim identification for Combat Talons having undergone the first phase of the MOD-90 conversion. SOF-I Phase I focused on upgrading the navigational suite, but it also included installation of the WJ-1840 (APR-46A) panoramic ECM receiver. The aircraft went through perhaps the most extensive test program ever developed for an already operational system going through modification. For more than two years, the 8th SOS provided flight crews and support personnel dedicated to the test effort. By the time Operation Just Cause commenced in December 1989, aircraft 64-0567 had completed its SOF-I operational test and evaluation (OT&E), and the squadron commander chose it to lead the airland assault into Rio Hato AB, Panama. The long and often frustrating test program had paid off. The next phase of the SOF-I program focused on ECM upgrades, including the ALQ-172, ALQ-196, and AAR-44. Aircraft 64-0565 was the first full-up MOD-90 aircraft. So thorough was the testing on 64-0567 that the first production aircraft had few setbacks and was brought up to operational status in minimal time.

* * * * *

Back in 1965 TF/TA theory was little understood by technicians outside the TI community. Having received the contract to modify the four Heavy Chain aircraft with the SPR-3 radar, LAS Ontario set about building its own TF/TA expertise. By 1966, when the company began modifying Combat Talons with the AN/APQ-115 radar, their technicians had advanced to a point that rivaled

*Harry Pannill, Mike Connaughton, Rethel Jones, and John Gargus, along with eight Heavy Chain pilots and navigators, were the first crew members to be trained on the new INS by Litton Industries at Menlow Park, California. The capabilities found in the LN-15J were "pure magic" to the crew members and represented the most significant operational improvement for the Combat Talon since its creation in 1965.

any other in the world on TF/TA operations. Educating USAF operators and maintainers on the new system proved more challenging. The basic problem with USAF personnel was that the radar was classified and that operational information about it was not readily accessible. Flight crews and maintainers could not easily refer to the technical orders, thus hindering their ability to attain vital systems knowledge. In the flying squadrons, electronic warfare officers kept radar manuals in their EW safe and signed them out to pilots and navigators when requested. Because they were all classified, the manuals could not be removed from the squadron building, thus preventing self-study during off-duty periods. An unclassified article, published by the McDonnell-Douglas Aircraft Corporation in 1965, discussed the AN/APQ-99 TF/TA radar installed in the RF-4 aircraft. The article was reproduced and distributed to pilots and navigators while they were attending initial Talon training at Pope AFB. As late as 1968, when the 7th SOS received its four Combat Talons, the RF-4 article was still considered the best unclassified document available on the TF/TA system.

Efforts to declassify the radar and to provide better information to the Combat Talon community was realized in 1971, when the annual Combat Talon Management Review Conference adopted the first unclassified Lockheed Technical Manual (LTM) that contained detailed information describing the TF/TA radar system. The description of radar operations contained in the first LTM was improved over the years and included in subsequent LTMs produced for the Combat Talon.

Terrain-Following Radar System Theory*

To appreciate the low-level adverse-weather capability of the Combat Talon weapons system, one must understand the basic operation of the TF/TA radar. Conventional airborne search radar provided range and azimuth data of sufficient accuracy for normal high-level aircraft navigation. The beams generated by these radar, however, did not possess the vertical angular resolution necessary to provide the precision required for terrain-following and terrain-avoidance flight.

Terrain-avoidance radar required good horizontal antenna stabilization and a radar-beam pattern that, besides detecting targets in range

and azimuth, could distinguish between obstacles located at or above the true horizontal plane of the aircraft and those located below it. In addition terrain-following radar (TFR) required a good horizontal reference for its antenna. Its beam had to accurately measure the angular aircraft-to-obstacle relationship in the vertical plane and feed this information to a computer, which, in turn, could furnish necessary climb and dive commands for maintaining desired vertical-terrain clearances.

The TFR employed either the aircraft's Doppler system or its inertial navigation system for its antenna's primary vertical and horizontal reference. For the AN/APQ-122(V)B radar, the stabilization reference could be manually or automatically switched to the MD-1 gyros if the LN-15J became unreliable or inoperative. If the Doppler failed while utilizing the AN/APQ-115, however, the radar would display a fail indication, and TF operation normally would be discontinued. The required radar beam angular resolution and precision for terrain following and terrain avoidance was attained by the monopulse resolution improvement (MRI) technique (fig. 6).

The AN/APQ-115 radar had a single contoured, spoiled parabola face antenna for its operation. On the AN/APQ-122, a special flat-face antenna and a separate X band receiver were used to generate the MRI video. During the transmit cycle the radio frequency energy was first split into two parts that had an equal amplitude and phase relationship. Then, the radio frequency energy was radiated through a grid circular polarizer screen from the

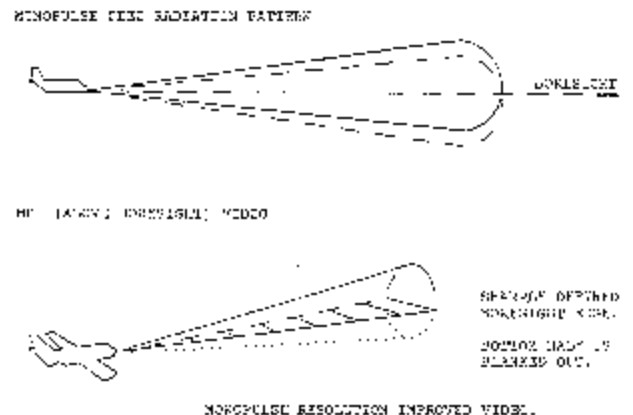


Figure 6. Monopulse Resolution Improvement Technique (Source: 1st SOW, CTF *Student Study Guide*, Hurlburt Field, Fla., 23 June 1991.)

*The following description was extracted from the USAF Combat Talon Formal School publication, *AN/APQ-122(V)8 Terrain-Following Radar Handout*, 1 January 1979. Information in this handout was later updated and included in the 1st SOW-Central Training Flight (CTF) Combat Talon Formal School publication, *Student Study Guide*, Hurlburt Field, Fla., 23 June 1991. Information regarding the AN/APQ-99 and the AN/APQ-115 was extracted from the publication titled *McDonnell Aircraft Field Support Digest*, Fourth Quarter, 1965.

top and bottom halves of the antenna. This radiation produced two overlapping, equal strength pencil beams that were circularly polarized to improve weather penetration. During the receive cycle the patterns of both were vectorally added and subtracted to produce sum and difference patterns. Through this process, a phase difference between above and below boresight targets was generated. The return echoes of both patterns were further phase shifted and fed into a phase detector, which identified echoes that were above antenna boresight. Output of the detector went to the video processor, which produced the MRI above boresight video.

The MRI video had a distinct, sharply defined vertical boresight edge. Consequently, when the antenna was properly referenced to the aircraft's true horizon, the sharp (video) edge could trace the aircraft's true horizontal plane during its lateral (TA) sweep and measure the angular aircraft-to-obstacle relationship during its vertical (TF) sweep (fig. 7).

The TA mode was the simpler of the two. Given a reliable horizontal reference, the MRI video would display those targets that were at the aircraft's true horizontal plane or above it. With TA targets displayed on the radarscope, the pilot could fly the aircraft around obstacles maintaining either constant altitude or a climb. A dive or a descent could result in impact with the ground, since the radar could only detect terrain at the boresight of the aircraft or above it. To ensure safe flight, the antenna also had to be oriented to the aircraft's projected track instead of its true heading. For this reason, the radar was interfaced with the aircraft's primary drift reference so the antenna was provided with the proper azimuth stabilization. For the AN/APQ-115 the primary drift reference was the Doppler, and for the AN/APQ-122, it was the INS.

Terrain-following flight was more complicated than terrain-avoidance flight. Horizontal and drift references were required as in TA; however, the MRI beam scanned along a vertical plane down the projected aircraft's track. The scan pattern was a narrow rectangle that, when traced by the beam, outlined a rectangular search cone 7.5 degrees wide—spanning from +8 degrees above to -17 degrees below the aircraft's boresight for the AN/APQ-122—and 5.0 degrees, +7 degrees, and -18 degrees, respectively, for the AN/APQ-115. Targets inside the cone were processed and analyzed by the computer and then displayed on the pilot's indicator. The computer compared reflected echoes against a variable template (gate) that was the radar's reference line for climb and dive commands.

The command template and the effective radar scan search cone could be likened to a sightless man's cane. A walking man using his cane would trace a definite pattern in front of him. This was comparable to the TF scan pattern. The length of his cane was the front and bottom side of the template, which was displayed as a 0-degree command line on the pilot's radar indicator. As the sightless man hastened his steps, he found it necessary to scan farther out and stretch out his arm. As the aircraft's ground speed increased, the front face of the template also moved out farther ahead of the aircraft, thus paralleling its original slope (fig. 8).

An elderly man, or one carrying a load on his back, would concern himself with the incline of the terrain ahead. The heavier his load, the gentler the slope he would seek by tracing his cane closer to the ground. In the case of the aircraft, its climb performance varied with its gross weight; therefore, the reference template steepened for lighter and shallowed for heavier gross weights (fig. 9).

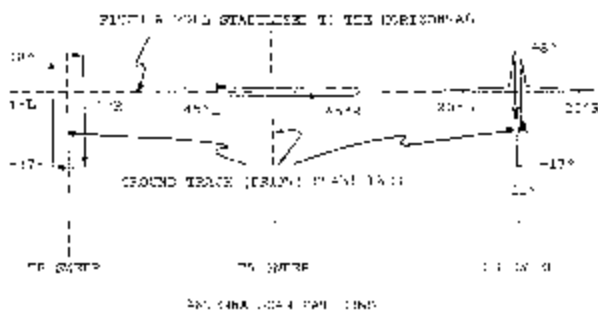


Figure 7. Antenna Scan Patterns (Source: 1st SOW, CTF Student Study Guide, Hurlburt Field, Fla., 23 June 1991.)

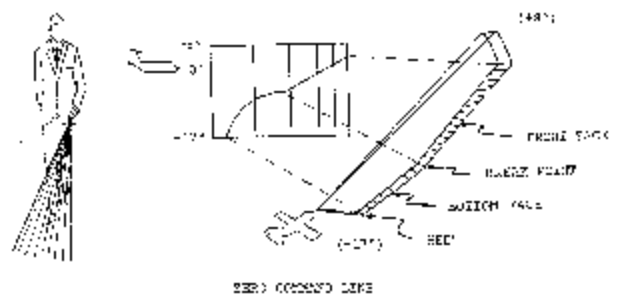


Figure 8. Zero Command Line (Source: 1st SOW, CTF Student Study Guide, Hurlburt Field, Fla., 23 June 1991.)

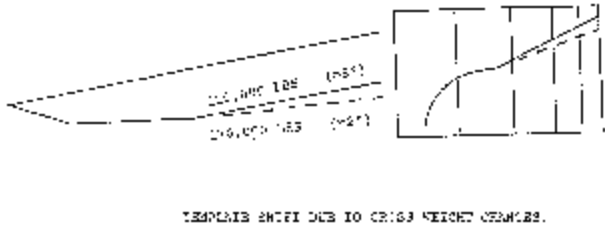


Figure 9. Template Shift Due to Gross Weight Changes (Source: 1st SOW, CTF *Student Study Guide*, Hurlburt Field, Fla., 23 June 1991.)

When a sightless man walked up an incline, he slowed down some, and his scan pattern altered. He searched more carefully farther out and also closer in, actually touching the surface of the terrain or obstacle. If an incline became too steep or an obstacle too great, he would seek another path. Keeping in mind that the template was his cane, that his cane touched, not penetrated, the ground and that this touch caused an alteration in his cane motion, it could be deduced that the template accomplished the same result. The template could not be penetrated by a target (obstacle) as long as the aircraft responded properly to the pitch bar command issued to it by the computer. As the aircraft's pitch increased, the front face of the template would shift closer to the aircraft as if the obstacle was pushing on it. It would continue its parallel shifting with each increase in the aircraft's pitch until the proper flight vector was attained (the antenna scan pattern would remain unchanged and boresighted to the horizon).

Parallel shifting of the front face would be accomplished by a proportional angular shifting (up tilting) of the bottom face. For each degree of flight vector increase, the bottom face would tilt up .7 degrees. This flight-vector template shift would be quite noticeable on the pilot's indicator (fig. 10).

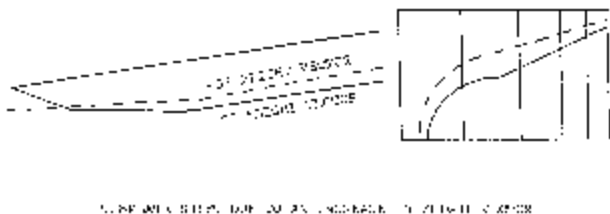


Figure 10. Template Shift Due to an Increase in Flight Vector (Source: 1st SOW, CTF *Student Study Guide*, Hurlburt Field, Fla., 23 June 1991.)

The reverse would be true when the aircraft was descending, and the flight vector was negative. The front face would parallel shift away from the aircraft, and the bottom face would down tilt 1.1 degrees for every one degree of flight vector (fig. 11).

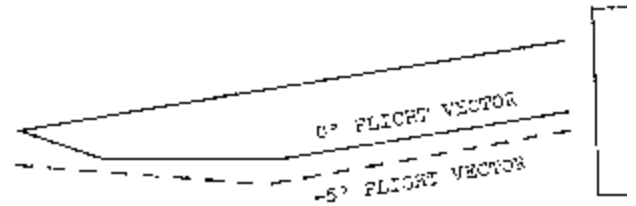


Figure 11. Template Shift Due to an Increase in Negative Flight Vector (Source: 1st SOW, CTF *Student Study Guide*, Hurlburt Field, Fla., 23 June 1991.)

The aircraft's climb performance was related to its true airspeed. An aircraft heading toward a hill at 240 knots ground speed and 200 knots true airspeed would approach the hill at the same rate as one flying at 240 knots true airspeed with 0 knots tailwind. The latter aircraft would negotiate the climb with greater ease, however, because of its greater momentum (kinetic energy) through the air mass. Therefore, the front-face template of the aircraft had to be lowered when an aircraft experienced a tailwind condition. This action caused the aircraft to begin its climb a greater distance from the obstacle and thus compensate for its relatively slower airspeed. The front-face template was automatically adjusted for up to 40 knots of tailwind at a calibrated rate of approximately .2 degree per 10 knots (fig. 12).

Finally, the TF template could be altered manually by selecting different desired terrain clearances. Set clearance altitude was the vertical distance in feet from the radar to a point directly under it. The template's bottom face, even though

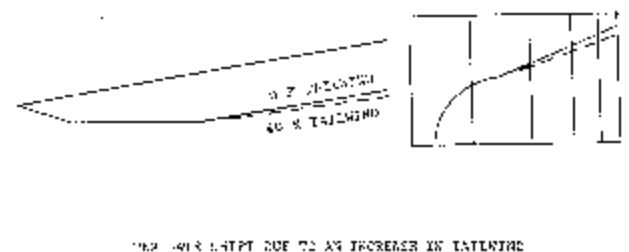


Figure 12. Template Shift Due to an Increase in Tailwind (Source: 1st SOW, CTF *Student Study Guide*, Hurlburt Field, Fla., 23 June 1991.)

it did not extend all the way to it, pivoted around that point. The AN/APQ-115 had provisions for three set clearances—250, 500, and 1,000 feet. Its computer allowed any altitude to be selected between the preset clearances by rotating the clearance select knob. For the AN/APQ-122 radar, four set clearances were available—250, 500, 750, and 1,000 feet. On the APQ-122 radar, clearances other than the four preset ones were not available to the flight crew (fig. 13).

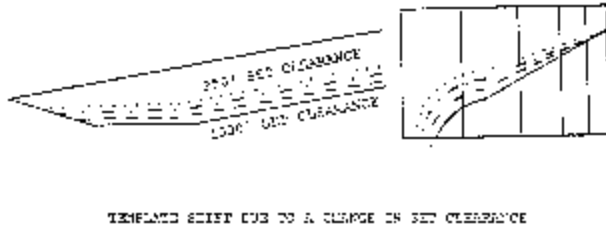


Figure 13. Template Shift Due to A Change in Set Clearance (Source: 1st SOW, CTF Student Study Guide, Hurlburt Field, Fla., 23 June 1991.)

Two additional zones were incorporated into the TF template and played a significant role during TF operations. A blanking zone, which extended in front of the aircraft 750 feet to 1,000 feet, had a two-fold purpose. First, it gave the radar the necessary recovery time between transmissions; and second, it cut out close-in side lobe targets, which could cause erroneous climb commands. A second zone, the obstacle-warning zone, was an area within the template that, when penetrated by an obstacle, triggered a visual and an audible obstacle warning (figs. 14 and 15).

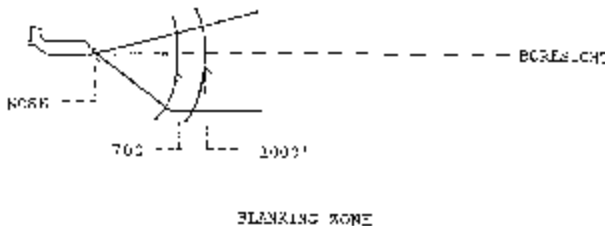


Figure 14. Radar Blanking Zone (Source: 1st SOW, CTF Student Study Guide, Hurlburt Field, Fla., 23 June 1991.)

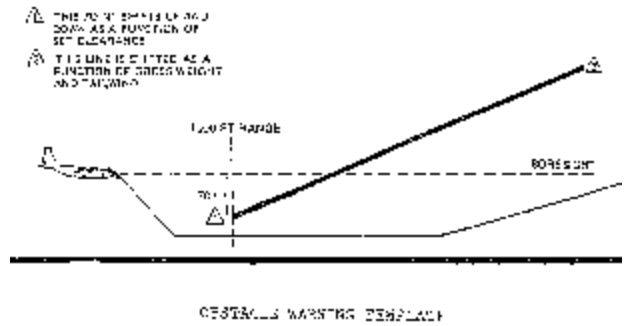


Figure 15. Obstacle Warning Template (Source: 1st SOW, CTF Student Study Guide, Hurlburt Field, Fla., 23 June 1991.)

Terrain-Following Radar Operation

The pilot was the primary controller of the terrain-following radar. He was the only one who could select the terrain-following or terrain-avoidance modes, thus overriding selections made by the right navigator. With the pilot’s selector switch in the MAP mode, the right navigator controlled operating modes on all three indicators. By moving his selector switch from MAP to TA, TF, or cross scan (CS), the pilot routed X band radio frequency energy to the TF antenna and, on pre-MOD-90 aircraft, controlled the modes of his and the left navigator’s indicators, with only one exception. The E squared presentation of the TF mode was not available to the left navigator. Therefore, whenever the pilot was in this mode, the left navigator’s indicator displayed the KA band precision ground mapping (PGM) mode, provided that the mode was selected by the right navigator. The right navigator could not display TF, TA, and CS modes on his indicator and was limited to the KA band’s PGM as long as the X band was being controlled by the pilot. As part of the MOD-90 upgrade in the late 1980s, both the left and right navigators were given increased capability to view the selected TFR presentation concurrently with the pilot. During TF flights both frequency bands could be employed, each transmitting from a different antenna. The pilot would normally monitor the E squared presentation* on his indicator, the left navigator would monitor TA presentation, and the right navigator would provide navigational information from the precision ground mapping display (fig. 16).

*In radar terminology, the E scan represents the vertical sweep of the antenna (up and down), and the left and right sweep is the range. For Combat Talon application, the range was originally “exponential,” thus the E squared designation. Later modifications to the radar included digital scanner converter (DSC) TF display, which was actually an E scan, but the range was logarithmic.

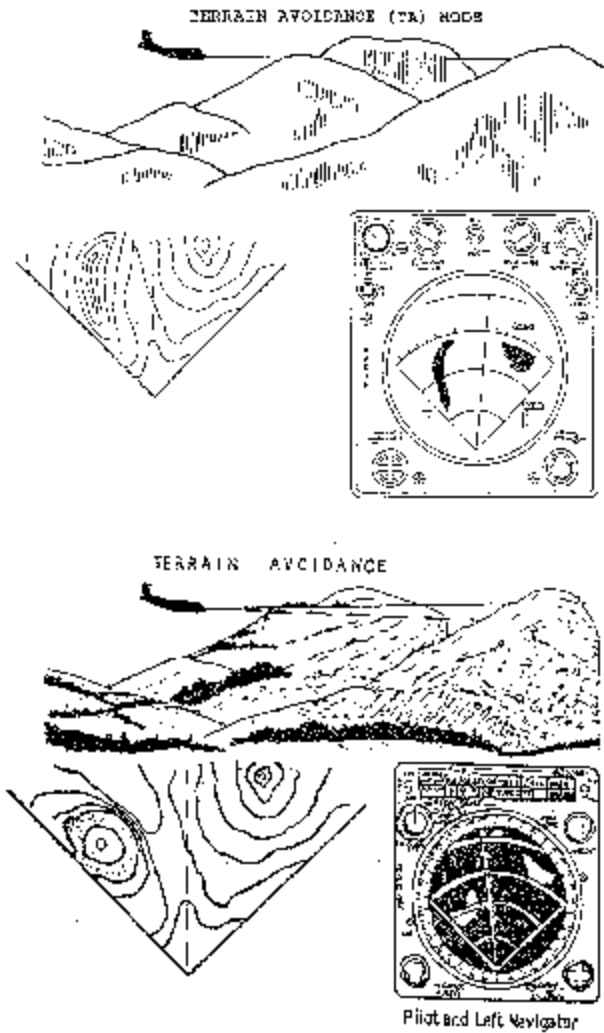


Figure 16. Terrain-Avoidance Mode (Source: 1st SOW, CTF Student Study Guide, Hurlburt Field, Fla., 23 June 1991.)

The TA mode was selected when the crew desired to minimize aircraft exposure to enemy threats by flying around mountain peaks and ridgelines instead of flying over them. The mode had inherent limitations and had to be employed with a great degree of caution and skill. The TA mode did not generate climb or dive commands and did not display terrain that was below the aircraft's true horizon. Therefore, this mode could not be relied upon during descents, especially when flying over unfamiliar terrain. TA operation was very carefully planned, and the navigators kept close track of the aircraft's geographical position by continuously monitoring terrain elevation, pressure altitude, and terrain clearances measured by the radio and radar altimeters. The TA mode could also be utilized quite effectively during weather penetrations even though the X

band weather mode was designed specifically for that purpose. By occasionally switching to the TA mode, the pilot and the left navigator could positively identify terrain that was at or above the aircraft's flight level.

In the TA mode the antenna sweep was 45 degrees left and right, and the indicators normally displayed a 90-degree offset sector sweep with the aircraft's track at the top of the scope. A variable-range control was available for expanding or compressing the radar display. A fixed, dotted range marker at 17 nautical miles (NM) served as the TA video test pulse on the AN/APQ-122 radar. On the AN/APQ-115, a test pulse dot was visible in the upper right-hand corner of the radar screen. In the TA mode both radar operated as forward-looking radar; therefore, it was essential that their antenna scans were drift oriented. Mechanical mounting permitted the antenna to compensate for only plus or minus 10 degrees of drift (+ or -25 degrees in CS). If these limits were exceeded, the TF ANT-FAIL light would illuminate on the radar control panel, and the top of the screen displayed the aircraft's true heading (fig. 17).

The TF mode of operation could be used for manual or automatic low-level flights at altitudes ranging from 250 to 1,000 feet, dependent upon whether using the AN/APQ-115 or the AN/APQ-122. In the TF mode the antenna scanned a very narrow vertical, rectangular box pattern. This scan pattern was drift oriented so that it covered only the terrain along the aircraft's projected track. Radar target data obtained from the scan was processed with various aircraft performance outputs in the TF computer, thus generating appropriate pitch bar climb or dive commands necessary to maintain desired AGL altitudes. In addition to the pitch bar commands, the radar produced E squared video depicting a vertical cross section of terrain and programmed command line parameters. Scope depiction on the AN/APQ-115 differed from that of the AN/APQ-122. On the AN/APQ-115 scope, one mile was halfway from the left edge to the right edge (halfway across the scope), and two miles was halfway from one mile to the right edge or three-fourths of the way across the display. Three miles was halfway from two miles to the right edge. The net effect was to squeeze the range presentation down past three miles out to the limit of the radar. For the AN/APQ-122, almost 13 miles of range was displayed on an exponential scale with vertical range markers at one, two, three, and four miles. The

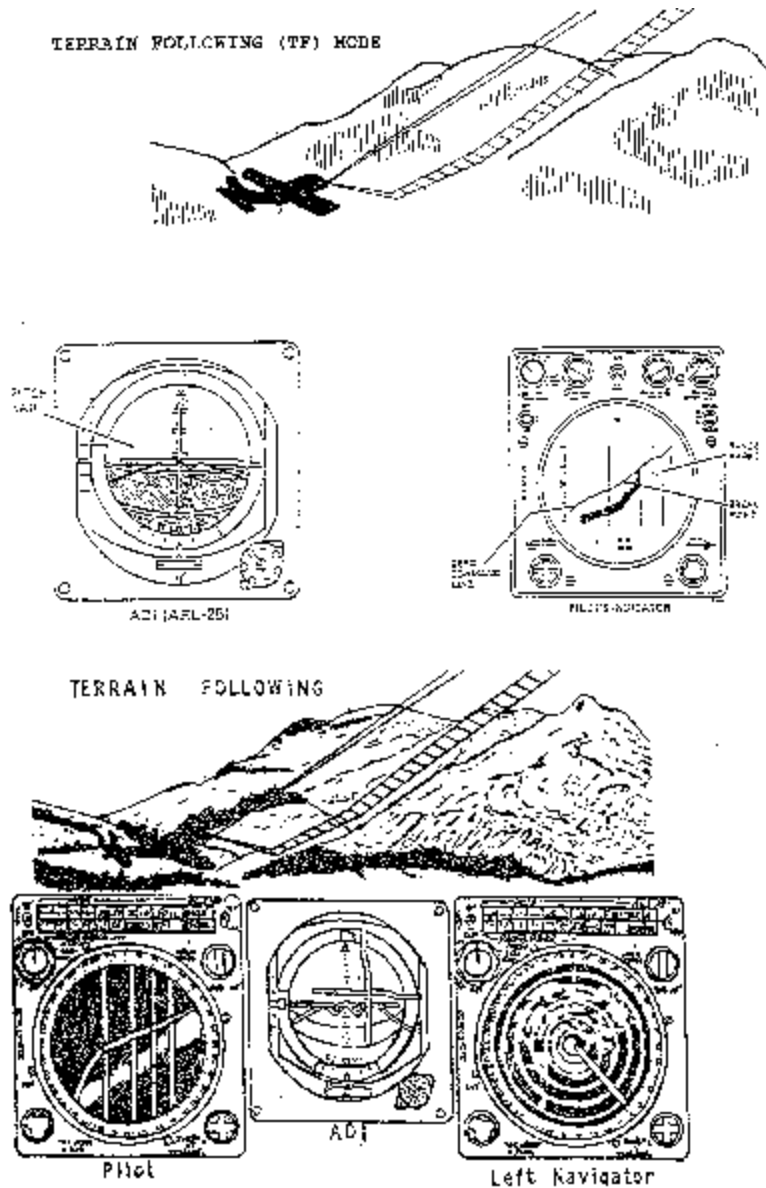


Figure 17. Terrain-Following Mode (Source: 1st SOW, CTF *Student Study Guide*, Hurlburt Field, Fla., 23 June 1991.)

vertical range markers were displayed across the face of the scope, and the distance between each was exponential and resembled the older AN/APQ-115 display. The zero command line (or TF template) was nearly identical for both radars, varying its shape with different in-flight conditions. A thorough understanding of the zero command line and its relationship to the video display was essential for the pilot to analyze TFR performance.

Over level terrain, video—commonly called grass—would hug the bottom face of the command line up to the break point. On hill climbs the front face of the template would make the

initial engagement with the obstacle. As the pilot responded to the resultant climb command, the zero command line would appear to resist video penetration and, as a soft flexible spaghetti, would push back in the direction of the aircraft and bulge up and round out toward the upper left-hand corner of the E squared display. The bulging and shifting would continue with pitch increases until the aircraft attained the necessary flight vector for clearing the obstacle at the desired set clearance. Optimum climb flight vectors were related to aircraft gross weights. For this reason, a different front-face command line sloping was programmed for each gross-weight setting. Since the front face

of the command line receded and the bottom face increased its slope angle (bulges on the E square), the optimum flight vector could be exceeded without causing target penetration of the command line. Thus, a heavy aircraft, one weighing 135,000 pounds and whose optimum flight vector was 3.8 degrees, would receive, if necessary, a pitch command that could double the optimum flight vector.

In a dive the command line would react in the opposite direction. The front-face bulge would literally drop out and down toward the bottom of the E squared as if it were eager to meet new video. Because the display was exponentially scaled, the grass accelerated as it slid along the zero command line toward the aircraft.

A satisfactory TFR would maintain terrain clearances within + or - (10 percent of set clearance + 50 feet) over level terrain and at or above 70 percent of set clearance over hilly terrain. Clearances were checked by radar altimeters, and substandard performance could normally be identified visually on the E squared presentation. Over level terrain the grass would hug the bottom face of the command line. Grass penetration of the command line normally occurred during lower-than-desired terrain clearances, whereas grass/command line separation was indicative of higher-than-programmed altitudes. The most common cause of terrain clearance problems was found in antenna stabilization. For this reason a "dual-angle indicator" mounted on the navigator's panel was frequently monitored during level portions of flight to determine the most reliable pitch angle input.

Occasionally, the aircraft might encounter an obstacle that it could not clear safely. For that reason a distinct obstacle warning (OW) zone was built into the TF template. Any obstacle that penetrated its parameters would trigger a full fly up and sound a beeping warning horn. This would rarely occur on a well-planned route with the aircraft flying a constant heading. The pilot, who was monitoring his E squared presentation, could see the obstacle penetrating the zero command line prior to its reaching the OW zone. Most frequent OW alarms were sounded by other aircraft flying through the OW portion of the TF scan or by hilly terrain that entered the OW area sideways during turning maneuvers or on-course corrections. Whenever an unplanned OW occurred, an immediate climb command was displayed on the ADI, and an immediate corrective evasive action was initiated. Evasive

action included application of maximum climb power, initiation of a climb, and a turn in the direction of lower terrain or in the direction provided by the navigator.

On occasions, TF flight was conducted over water, snow, sand, and other surfaces that did not reflect radio frequency energy, including very smooth and level terrain. Under these conditions radar echoes were of insufficient strength to produce video and generate necessary climb commands. To avoid a disastrous dive command into earth's surface, the system was programmed to switch to radar altimeter operation whenever the TFR commanded a dive below desired clearance altitude, and there was no visible grass in the two well-defined altimeter override inhibit zones located within the template. While operating on altimeter override, the system's performance tolerances were the same as for level terrain.

The cross-scan mode of operation combined the features of TA and TF and was the mode most frequently employed during terrain-following flights. In this mode the antenna alternated between horizontal and vertical scans, providing either TF or TA video to the pilot's indicator and TA video to the left navigator's indicator. Because of alternating scans, there was a pause in the TF display during the TA antenna sweep and visa versa. This video pause did not affect continuous command input to the pitch bar. To keep the time interval between successive TF sweeps at a minimum, the horizontal-scan azimuth was reduced to + or -20 degrees. Even though this TA azimuth reduced the coverage of the normal TA mode by more than one-half, the compromise gave the left navigator sufficient sector scan to monitor above flight-level obstacles during terrain-following operations. TA monitoring was also available to the pilot who could select either E squared or TA video by flipping a toggle switch (fig. 18).

During all TF turns, the scan pattern provided climb and dive commands based on terrain that passed laterally across the aircraft's nose. Those commands could change rapidly, with changing terrain profile, from climb to dive and back again until the aircraft was firmly established on its new course. For this reason descending turns were never made during terrain following. A turn was made either level or climbing, provided the pitch bar commanded a climb. A dive command on the pitch bar would be ignored even when flying over water on altimeter

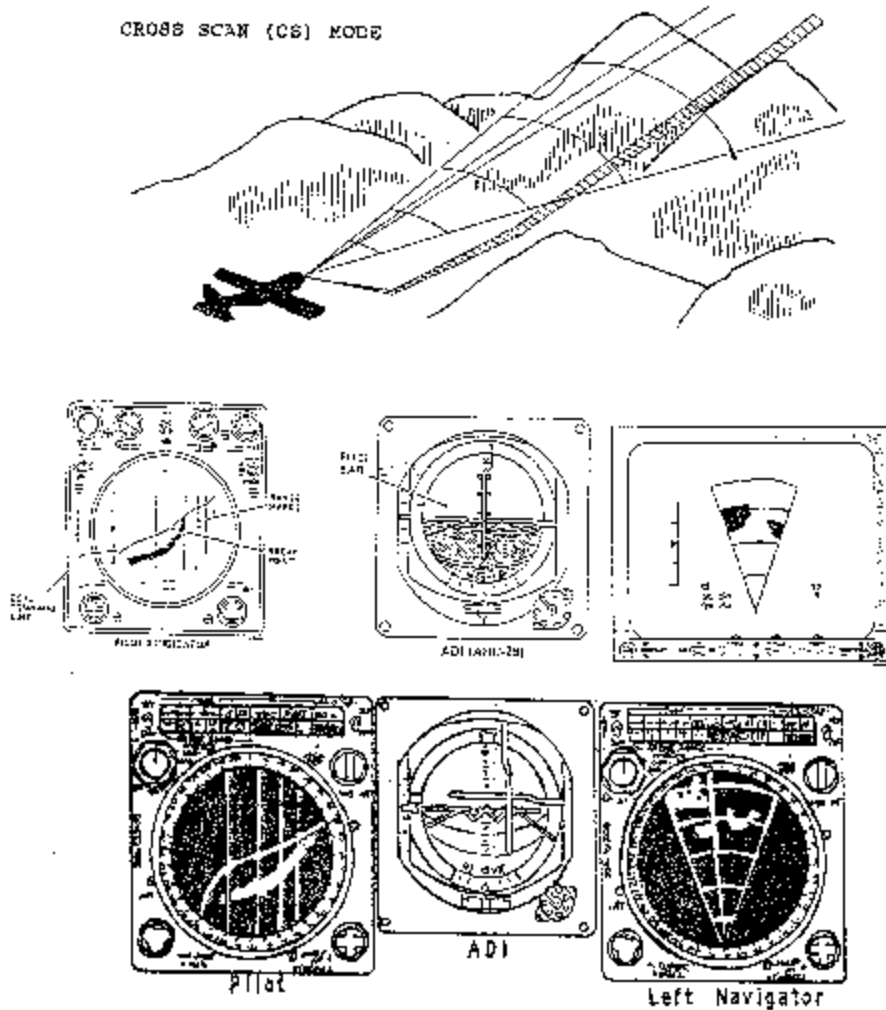


Figure 18. Cross-Scan Mode (Source: 1st SOW, CTF *Student Study Guide*, Hurlburt Field, Fla., 23 June 1991.)

override. During maximum bank angle turns, radar altimeters were likely to indicate greater-than-actual altitudes and command a dive.

The AN/APQ-122 had a sophisticated fail-safe circuitry that monitored the system's performance and warned its operators when dangerous (safety of flight) or substandard operating conditions developed. The logic of the fail system was such that fail signals were displayed in front of the operator who was most concerned. Thus, most fail indicators were presented on the pilot's indicator. Somewhat fewer fails were indicated on the left navigator's indicator and none on the right navigator's indicator. The right navigator, however, could monitor the fail displays of the KA band, X band, and antenna controls. All fail monitoring lights were duplicated on the maintenance panel, which was monitored by the left navigator (fig. 19).

Throughout Combat Talon's existence, the TFR performed well. It provided a capability that enabled the crew to accomplish its low-level mission during adverse weather conditions and allowed the aircraft to fly beneath the lethal range of most known threats. Two aircraft losses—one in 1967 and one in 1981—were partially attributed to either TFR design or to operator error. In both instances, however, all flight deck crew members perished in the resultant crash, thus leaving it to accident investigators to determine the cause. The 1967 crash occurred in North Vietnam during the SEA war and was never investigated to determine its exact cause. The 1981 crash was over open water and limited aircraft wreckage was recovered. Investigators suspected that a malfunction occurred in the radar altimeter override system. Operators continue to rely on the TFR for their worldwide low-level mission and express confidence in the system's reliability.

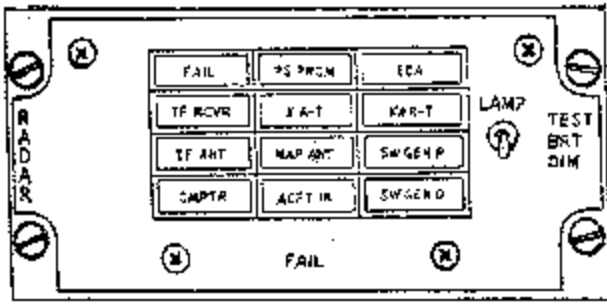


Figure 19. Fail Light Maintenance Panel (Source: 1st SOW, CTF Student Study Guide, Hurlburt Field, Fla., 23 June 1991.)

The Electronic Countermeasure Suite

The primary defensive tactic for Combat Talon was to fly beneath radar coverage and under the lethal range of enemy threat. The original Combat Talon was equipped with the AN/APQ-115 TF/TA radar, which allowed the aircraft to fly as low as 250 feet above the ground. At this altitude enemy systems faced in the 1960s and 1970s did not pose a great threat to the aircraft. But the aircraft could not always operate at 250 feet. Although the system was designed to operate in adverse weather conditions, the radar was limited to the amount of precipitation it could penetrate before commanding a fly up on the pitch bar. Once a fly up was displayed, the pilot had no choice but to climb to an altitude that would ensure terrain clearance, thus putting the aircraft into a higher threat envelope. Also, the TF/TA radar dampened out climbs and dives and thus varied the actual altitude above the ground. The system would fly a set clearance over level terrain, but in mountains the radar would command a climb prior to reaching an obstacle and would maintain an altitude above set clearance from that point until clearing the mountain or ridgeline. Similarly, in descents the aircraft would descend at a rate slightly less than that of the terrain, thus resulting in an altitude higher than the detent selected.

Various airdrops also required altitudes above the minimum set clearance for TF flight. For example, static line personnel drops required an altitude ranging from 800 to 1,500 feet above the ground, depending on the type of parachute used by the jumpers. High-altitude low-opening (HALO) and PSYOP/leaflet drops were conducted up to 25,000 feet and higher. The Fulton STARS was typically conducted at 425 feet altitude. Thus, to perform the air-drop mission, the aircraft often

exceeded its minimum TF altitude when it was threatened by enemy missiles, antiaircraft artillery (AAA), and airborne interceptor aircraft.

To combat the threat, ECM equipment was installed on the Combat Talon to enable the crew to detect the threat and to take appropriate action to evade it. ECM equipment was operated by a specially trained navigator designated as the electronic warfare officer (EWO). In addition to the capacity to detect a threat to the aircraft, the EWO had a limited capacity to confuse, decoy, or otherwise neutralize whatever threat his warning receivers identified.

Early Combat Talons were equipped with first-generation equipment that was marginally effective in detecting and neutralizing enemy threats. When aircraft 62-1843 and 63-7785 were modified under the Thin Slice program (beginning in September 1964), ECM equipment was included in the basic modification. The AN/APR-25/26 provided radar warning to the crew, and the Buster-41 and Buster-61 systems provided repeater/jammer capability. The ALE-27 chaff dispenser was installed to provide the EWO the ability to decoy certain enemy threats.⁶⁵ When Project Stray Goose began in 1965, the ECM suite designed for the Thin Slice aircraft was improved and installed on the 14 new aircraft.

For Combat Talon, the Buster-41 repeater/jammer was improved and redesignated the System 50, while the Buster-61 was also improved and redesignated the System 60. Both the APR-25/26 radar-warning receiver and the ALE-27 chaff-dispenser system were also installed on Combat Talon. The EWO, sitting beside the radio operator (RO), employed the EW systems from a workstation located in the cargo compartment of the aircraft. When the aircraft were modified under the MOD-70 program, the EWO/RO crew station was expanded into a full console that remained a part of the aircraft from that time forward. With the addition of the ECM suite on Combat Talon, the overall classification of the aircraft was raised to Secret. So closely held was the EW capability on early Talons that the EWO was not listed as a separate crew position. Rather, the EWO was referred to as the third navigator on the crew.

The MOD-70 update provided some increased ECM capability for the early Combat Talons. Systems 50/60 were replaced by the TRIM 7 and TRIM 9 systems, which were modified for Combat Talon from existing aircraft programs. The TRIM 7 and TRIM 9 were redesignated System 55 and System 65, respectively, and were installed on the

Yank aircraft operating in the Pacific. For the remaining 10 Clamp aircraft, System 65 and System 66 were installed. Later modifications added the System 66 to the four Yank aircraft along with the System 56 self-protection system.* The ALE-27 chaff dispenser was retained for the Combat Talon fleet. Pacific Combat Spear aircraft faced a different array of threats from those in Europe, thus requiring a different ECM suite. US-based aircraft assigned to TAC, although tasked to support both theaters, were generally configured the same as the European Combat Talons. Thus, over time, two distinct aircraft developed—four Combat Spear aircraft configured for the Pacific and the remaining 10 Combat Arrow/Combat Knife aircraft primarily configured for Europe. In 1978 the four European Combat Arrow Talons were further modified with the European EW configuration, effectively creating three distinct sets of aircraft (four Pacific Yanks, six US-based Clamps, and four European E-modified Clamps). The differences in US- and overseas-modified aircraft complicated the training of new EWOs, since the Combat Talon School flew aircraft different from the ones found in the two overseas units.

Throughout the 1970s and 1980s, improvements were made in the basic EW systems, but no major advancements were seen until 1978, when the four European Clamp-configured aircraft received the E modification. For this update the older System 65 was replaced with the ALQ-117, and a panoramic receiver (the WJ-1840) was added. An additional system that greatly increased the aircraft's stand-off jammer capability was provided with the installation of the ALQ-155. The added jamming equipment came at a considerable cost to the overall performance of the aircraft, adding more than 5,000 pounds to an already heavy aircraft and limiting the aircraft's ability to operate on unimproved runways due to the large bathtub installed in the belly of the aircraft to protect the system's transmit/receive antennas.** When USAF procured the Compass Call weapons system in the late 1980s, the stand-off jamming capability provided by the Combat Arrow aircraft equipped with the ALQ-155 system was no longer required. MOD-90 removed the

equipment and standardized the Combat Talon fleet.

In the late 1980s Combat Talons began another modification program that was identified as MOD-90. Phase I of the MOD-90 program concentrated on improved navigation and radar performance and was known as SOF-I. Later phases of MOD-90 saw extensive upgrades to the EW suite. Because of MOD-90, the following standardized EW suite was installed on all 14 Combat Talon aircraft, thus bringing the weapons system to the age of modern electronic warfare. The following is a list of MOD-90 electronic warfare equipment:

APR-46A	WJ-1840 Panoramic Receiver (to allow EWO to monitor the threat environment)
QRC-84-05	Radar Warning Receiver
ALR-69	Radar Warning Receiver
ALQ-172	Repeater/Jammer
ALQ-196	Repeater/Jammer
QRC 84-02A	IRCM (infrared countermeasures) Pods
ALE-40	Flare and Chaff dispensers, 30 rounds each
AAR-44	Infrared Missile Alert Warning System ⁶⁶

The Combat Talon of the 1990s proved to be an extremely capable weapons system with the addition of the sophisticated MOD-90 ECM suite. The best defense employed by the Combat Talon, however, remained the same as in early days—avoid the threat by planning around it, but if the mission required the aircraft to fly through the threat, fly low and use terrain-avoidance/terrain-masking techniques to defeat the threat. The crew relied on the EWO and the EW system for protection if detected by an enemy threat. The EWO remained the primary crew member around which the EW system was built and was the key crew position responsible for the aircraft's defense.

Major Follow-On Modifications to Combat Talon

The Combat Talon weapons system, from its initial concept to the present day, was a system in transition. As a new capability was fielded, other, more sophisticated systems were being developed to improve the overall capability of the aircraft. Three major modifications were made to

*The System 56 was a multimode ECM system that was geographically oriented towards Pacific threats. It covered lobe-on-receiver-only (LORO), conical-rotating-threat-antenna (CONSCAN), and track-while-scan (TWS) radar, with a low-frequency band for known AAA threats. System 66 was added to all Combat Talons to cover threats with swept-tracking frequencies, such as the US-made Hawk surface-to-air missile. (The Hawk had been sold to Iran and to other overseas customers.)

**The E requirement for the European Combat Talon was established by USAFE and was procured in lieu of the universal aerial refueling receptacle/slipway installation (UARRSI) in-flight refueling (IFR) modification, which was installed on both PACAF and TAC Combat Talons. The inability to refuel the European Talons, coupled with their increased weight and decreased short-field landing capabilities, resulted in the 7th SOS (that operated the aircraft in Europe) being eliminated from the 1980 Iranian rescue mission.

the original Combat Talon aircraft that significantly increased its capability—high-speed low-level aerial delivery system for airdrops up to 250 knots indicated airspeed, the universal aerial refueling receptacle/slipway installation that allowed the aircraft to be refueled while airborne, and the helicopter aerial refueling installation that gave the Combat Talon the capability to refuel helicopters while airborne.

High-Speed Low-Level Aerial Delivery System

From the days of the Carpetbaggers of World War II, unconventional warfare forces identified a need to deliver supplies to friendly forces without the requirement to decrease speed for the airdrop. Low-level routes in the C-130 were normally flown between 230 to 240 knots ground speed, with their ramp and door opening limited to 150 knots. Thus, for those missions requiring opening of the ramp or main cargo door, a slowdown was required to get below the 150-knot limit. In sophisticated radar environments employed after WWII, the slowdown maneuver could be detected, thus compromising the drop zone and perhaps the team on the ground. By the late 1960s a high-speed drop system for the C-130 had been developed that allowed ramp and door opening at airspeeds up to 250 knots.

The new system was designated the HSSLADS. Structural modifications to the C-130 aft-area fuselage, cargo door, and ramp were required to prevent twisting of the empennage section and to protect the aft door during its operation. In addition, a second cargo door hydraulic actuating cylinder and uplock were added along with electrical circuitry modifications to the door and ramp systems. The electrical change allowed the ramp to open approximately 19 inches before any movement of the door. The ramp thus deflected airflow away from the cargo door as its locks were released, thus allowing the door to smoothly transition to the up and locked position. Ramp air deflectors, or buffer boards, which were developed for the Fulton STARS, were installed on the ramp to reduce air turbulence in the aft ramp area.⁶⁷

HSSLADS was first flight-tested in 1967 by the Air Force Flight Test Center (AFFTC) under project directive no. 67-116. During the test, five parachute systems were evaluated utilizing parachute-extracted loads varying from 250 to 2,200 pounds and at airspeeds up to 250 knots. Satisfactory results

were obtained; however, further testing was recommended to develop an ejection system that would provide a consistent load trajectory and eliminate the need for an extraction parachute. The parachute-extraction method of load delivery resulted in somewhat erratic drop scores due to varying load exit times. In conjunction with the initial testing of the system, a gravity-stabilized optical-sighting device was also developed to determine the timing distance for visual releases.⁶⁸

The four Heavy Chain aircraft (62-1843, 63-7785, 64-0564, and 64-0565), flown by the 1198th Operational Evaluation and Training Squadron, were the first aircraft to be modified with HSSLADS (May–December 1968). To eliminate the inconsistency experienced by the AFFTC utilizing parachute extracted drops, the squadron developed the sling ejection system (SEDS) (fig. 20). The SEDS was a load-ejection system designed to rapidly and consistently release loads up to a maximum weight of 2,200 pounds.⁶⁹

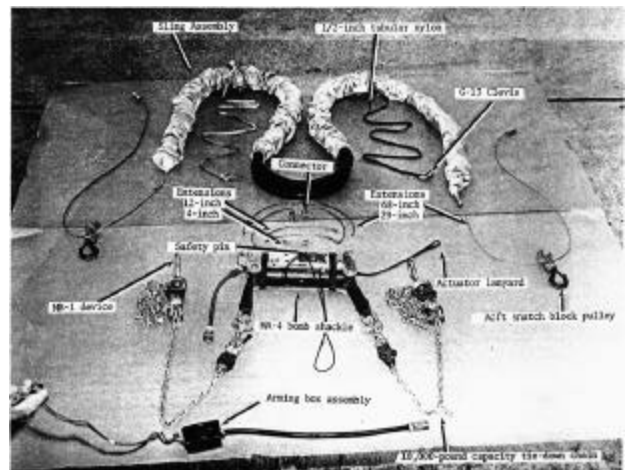


Figure 20. Components of the Sling Ejection System (Source: Operational Test and Evaluation Final Report, March 1974.)

The SEDS was composed of a bungee sling attached to the airframe and an MA-4A bomb-release mechanism wired through the aircraft aerial delivery system (fig. 21). The sighting device developed during the test center's initial test was equipped with a recticle that was set at a fixed depression angle of 18.45 degrees. This allowed the absolute altitude in feet to be expressed directly as a timing distance in yards from the point of impact. The sight was stabilized by a weight and ball joint and was mounted in the copilot or pilot's C-4 light mount.⁷⁰

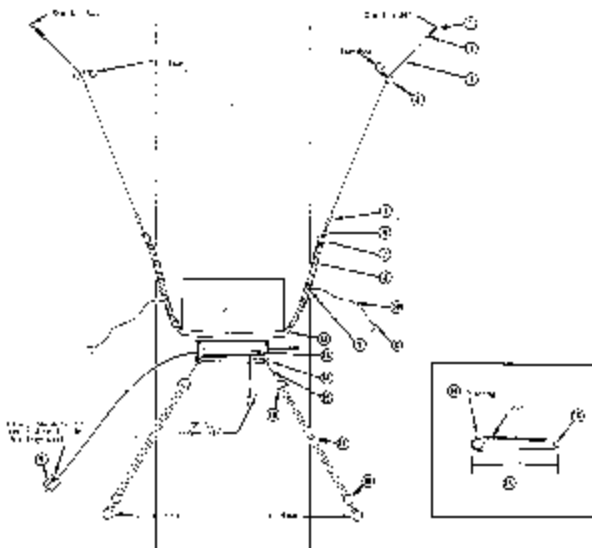


Figure 21. SEDS Plan View (Source: TAC Project 73A-079T, March 1974.)

The 1198th experienced excellent results with the SEDS and successfully employed the system operationally until the unit was disbanded in 1972. When plans were finalized for the Combat Talon MOD-70 program, HSSLADS was incorporated into the modification. From 1970 to 1972 the 12 C-130E(I) Combat Talons underwent MOD-70 upgrade, which included HSSLADS, as they cycled through LAS Ontario for their scheduled programmed depot maintenance (PDM). The HSSLADS, utilizing parachute extracted loads, was employed by Combat Talon units through 1973. Because the SEDS was never formally tested, USAF/XOOSO, in a 15 June 1973 letter to Tactical Air Command (TAC), directed a second OT&E be conducted on the HSSLADS utilizing the SEDS ejection system. The second OT&E was conducted by the USAF Tactical Air Warfare Center (TAWC) at Eglin AFB, Florida, under TAC Project Order 73A-079T. The project manager was Lt Col Irl L. Franklin, who was assigned to TAWC/TEL. The inclusive dates of the test were from 10 August to 25 October 1973.⁷¹

The new test expanded the earlier OT&E conducted by the AFFTC. The stated purpose of the second test was to determine the operational suitability and capability of the HSSLADS to satisfy Combat Talon unconventional warfare requirements. The TAC project included the evaluation of standard parachutes, containers, and the gravity-stabilized optical sight. The HSSLADS was evaluated on the Combat Talon at airspeeds up to 250 knots with the ramp and door open and with load

weights from 250 to 2,200 pounds utilizing the SEDS. During the course of the OT&E, 217 bundles were air-dropped. The parachutes evaluated were the T-10, G-14, G-12D, 15-foot ring slot, 22-foot ring slot, 28-foot ring slot, and 68-inch pilot parachutes. The containers evaluated included the A-7A, A-21, and A-22.⁷²

The HSSLADS demonstrated satisfactory operational suitability to air-drop two A-22 (1,000 pounds each) or six A-21 (250 pounds each) containers and single containers weighing from 250 to 2,200 pounds each at 250 knots indicated air-speed. Unacceptable damage occurred to the T-10, G-14, and 68-inch pilot parachutes and to the A-7A container. Consequently, these items were deemed unacceptable for HSSLADS use. Each load weight was air-dropped at various altitudes, and a minimum effective altitude was established for each: 250- and 500-pound loads at 250 feet; 1,000- and 1,500-pound loads at 500 feet; and 2,000- and 2,200-pound loads at 750 feet. During the course of the test, aircrew and rigging procedures were developed, and existing procedures were refined for the HSSLADS. The gravity stabilized optical sight was found to be an acceptable backup air-droppable method for HSSLADS, provided visual contact with the drop zone was maintained. The 15-foot ring slot, 22-foot ring slot, 28-foot ring slot, and G-12D parachute used with the A-21 and A-22 containers were recommended for use with HSSLADS.⁷³

The second OT&E validated the use of the SEDS with HSSLADS for Combat Talon and provided recommendations to improve the system further. During the course of the OT&E, a short-fall in measuring the tension of the bungee, and

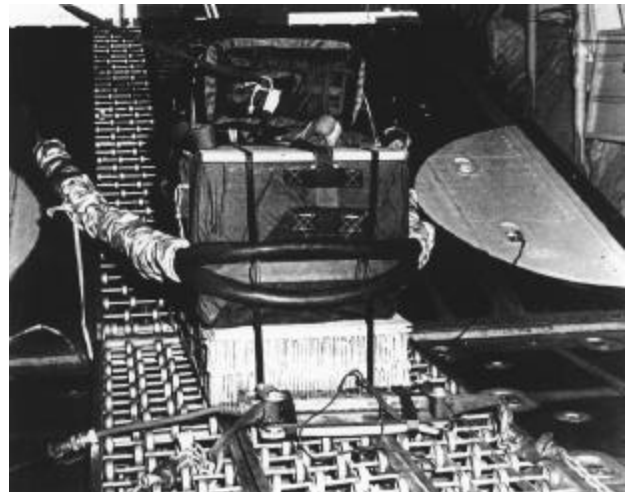


Photo courtesy of TAC Project

SEDS sling assembly, ramp up. SEDS sling assembly rigged on Combat Talon aircraft.

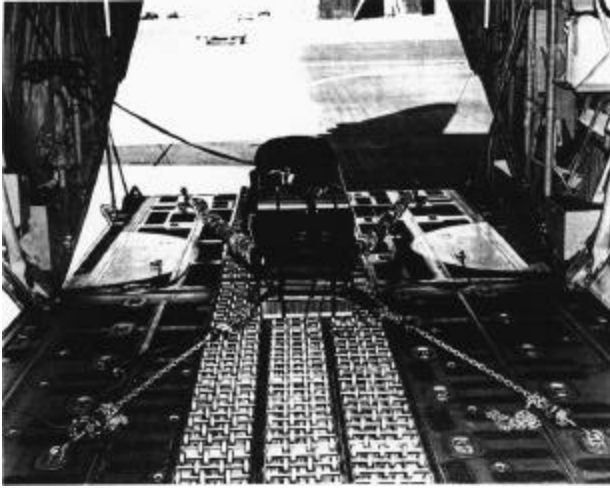


Photo courtesy of TAC Project

SEDS sling assembly, ramp down. With ramp in open position, SEDS sling assembly is armed with tension on the bungee cord.



Photo courtesy of John R. Lewis

Air deflectors were installed on the ramp to reduce turbulent airflow during HSSLADS operations.

subsequently adjusting the tension to a predetermined setting, was identified. As a result the formal test report recommended that provisions be made to correct the shortfall. Also, the final report recommended that an aerodynamically stable container and a stronger parachute be developed to improve the system. As a result of the test, the SEDS-augmented HSSLADS was formally adopted for Combat Talon, and the procedures and parachute ballistics developed during the test were incorporated into Combat Talon manuals.⁷⁴ The system proved so successful that when Combat Talon II began development in the early 1980s, HSSLADS was a baseline system requirement for the new aircraft.

The Universal Aerial Refueling Receptacle/Slipway Installation

Low-visibility, long-range operations were the centerpiece capability for Combat Talon from its inception. By the mid-1970s, with the rise of terrorism throughout the world, operations requiring an intermediate stop for fuel became increasingly more difficult. The reluctance of world governments to directly assist the United States during a covert or low-visibility mission increased as states supporting international terrorism gained the capability to strike at those governments assisting the United States. The C-130 aircraft carried enough fuel for approximately 10 hours of continuous flight. For a mission requiring ingress to and egress from an objective area, this range equated to approximately 1,250 miles each way. Many potential trouble spots around the world were outside the 1,250-mile range of US territory, thus requiring either in-flight refueling or an intermediate refueling stop in another country to reach them. For operational missions, even friendly nations were sometimes reluctant to provide direct assistance for fear of reprisals. Additionally, the Combat Spear unit, operating out of Kadena AB, Okinawa, had long sought the aerial refueling capability due to the distances involved in operating in the Pacific. As a result, Pacific Air Forces (PACAF) took the lead in establishing the requirement for in-flight refueling capability for its four assigned Combat Talon aircraft. TAC was also interested in the capability since its stateside Combat Knife unit, the 8th SOS, had augmentation responsibilities for the Pacific Combat Spear unit and had a growing role in combating world terrorism. Since 1973 all four Combat Spear-assigned aircraft had previously been in the Heavy Chain program and had the more powerful Allison T-56-A-15 engines installed. The 8th SOS aircraft, however, along with those of the 7th SOS in Europe, were fitted with the standard C-130E T-56-A-7 engine. The cost to convert the four PACAF aircraft already equipped with the Dash-15 engines was considerably less than those requiring upgrade from the less powerful Dash-7s.

On 4 August 1976 the US Air Force placed LAS Ontario on contract to develop an in-flight refueling capability for the Combat Talon. The project required the design and installation of a covert (as viewed during ground operations) refueling capability that was compatible with the KC-135 boom refueling system.⁷⁵ LAS Ontario engineers designed the universal aerial refueling receptacle/slipway installation and first installed it on Combat Talon aircraft 64-0564 in late 1976 (fig. 22).

refueling. The third flight evaluated the Combat Talon during engine-out operations and tested the pilot's ability to remain in the contact position without the KC-135 flying on autopilot. During the fourth flight, heavy KC-135 and Combat Talon operations were evaluated along with toboggan procedures. (Toboggan was a maneuver whereby the KC-135 established a shallow descent while the Combat Talon refueled. The maneuver provided the Combat Talon the ability to remain in the contact position unloading fuel up to its maximum gross weight.) The fifth flight concentrated on night refueling procedures and the sixth on 60,000-pound top-off capability. For the fourth, fifth, and sixth flights, PACAF and Air Force Logistics Command (AFLC) crew members assigned to Ontario, California, received training on in-flight refueling procedures.⁷⁸

The UARRSI system performed exceptionally well throughout the evaluation. Primary crew members submitted comment worksheets to the test director after each flight. The pilot noted excellent visibility during all portions of the rendezvous and aerial refueling operation. Aerial refueling director lights were in full view day or night. For the approach to precontact, precontact to contact, and the contact position, flying qualities of the C-130E(I) were good. Power response was noted as adequate, but aircraft separation was immediate when power was reduced. The breakaway maneuver was excellent in that the aircraft stayed behind and below the tanker, and the copilot or flight engineer could remain in visible contact with the tanker through the upper windows. No abnormal noise levels were noted in the cockpit. The position of the pilot's aerial refueling status lights was noted as satisfactory, but the original lighting scheme (black lenses with transparent letters) was deemed unsatisfactory because the pilot was required to move his head to see the lights. This practice could cause disorientation during night or marginal weather refueling operations. Lenses were replaced with transparent ones that were more easily seen by the pilot. Some pilots believed that the autopilot/aerial-refueling disconnect switch located on the yoke was too short, and they occasionally fumbled to find the switch. A section of the guard closest to the pilot was recommended to be removed to expose more of the switch. The overall pilot evaluation concluded that the Combat Talon had satisfactory flying

qualities as a receiver during aerial refueling operations with the KC-135. The pilot workload was judged to be less than that of a B-52, C-5, or receiver C-135 aircraft.⁷⁹

During the tests the flight engineer concluded that the aerial-refueling control panel functioned well throughout all phases of operation. Labeling and switchology were excellent. The controls allowed for operation of the aerial-refueling system for refueling, fuel transfer (using the dump-pump switches located on the overhead panel), and manifold drain operation. The controls provided the capability for using main-tank dump pumps to supply fuel for engine operation in the event of a main-tank pump failure.⁸⁰

Navigator comments centered mainly around rendezvous procedures developed to enable the tanker and receiver aircraft to join up for the refueling operation. The maneuver was identified as a point parallel rendezvous with the tanker at an altitude from 12,000 to 14,000 feet and the Combat Talon 1,000 feet below the tanker. The two aircraft approached each other head on, with the tanker maintaining an air-speed of 255 KIAS, and the receiver maintaining 250 KIAS with 1,000-foot altitude separation. The tanker would fly an offset of 4.5 NMs and would begin the turn 12 NMs from the receiver. Using the point-parallel procedure, the tanker would roll out approximately three miles in front of the receiver, 1,000 feet above the receiver's altitude, and at an airspeed of 210 KIAS (fig. 24). The Combat Talon would then depart its assigned altitude and overtake the tanker, stabilizing at the precontact position.⁸¹ With the system validated, all that remained was to fly an operational mission utilizing the in-flight refueling capability.

What came to be known as the Special Operations Aerial Refueling and Sea, Air, Land (SEAL) support mission launched from Edwards AFB for Clark AB, Philippines, with three refuelings scheduled and an airdrop of 17 SEAL personnel on Luzon prior to mission termination. The mission took 27.8 hours, which at the time was by far the longest C-130 flight yet recorded. The first two refuelings provided full main tanks in the Combat Talon before the KC-135 pumps shut off; however, the external tanks would only fill to within 1,500 pounds of capacity. The totalizer for all tanks together indicated slightly above 56,000 pounds. Only after slowing to 160 KIAS could the flight engineer transfer

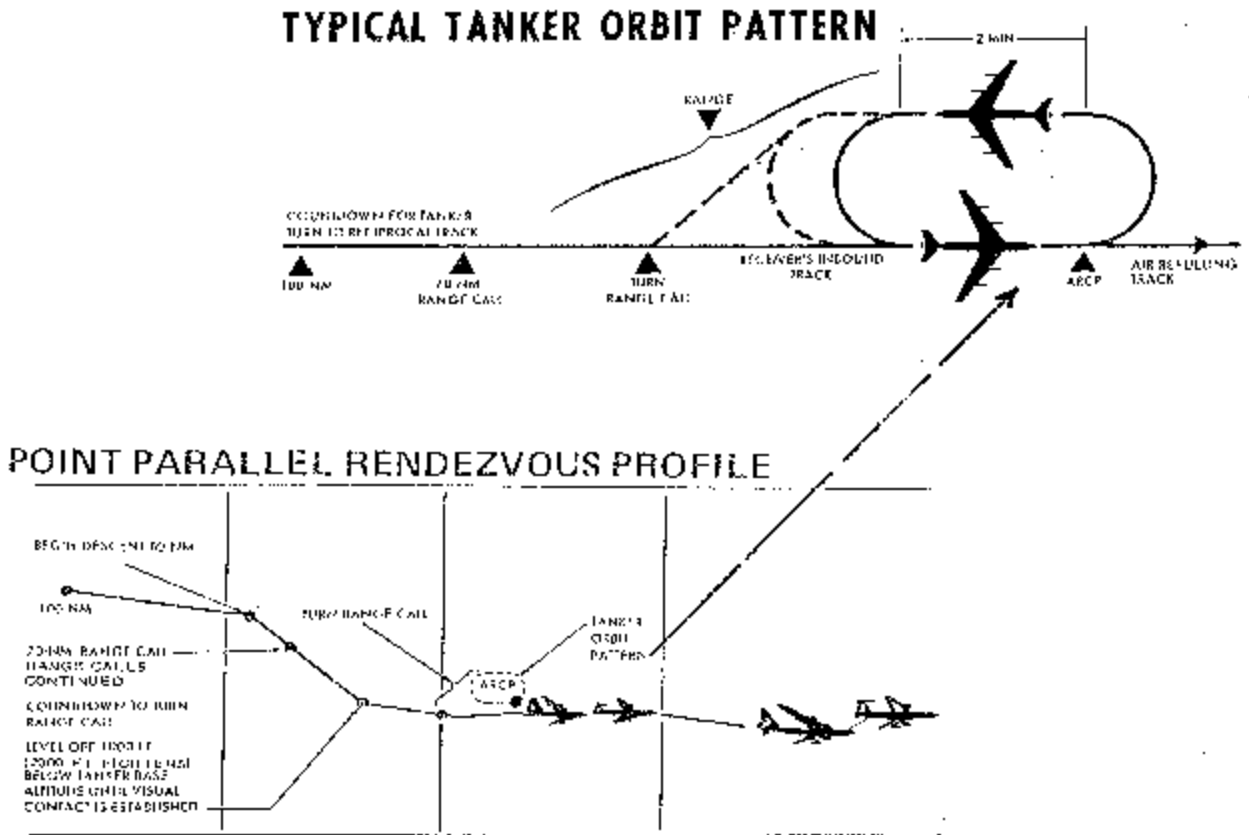


Figure 24. Typical Point-Parallel Procedure (Source: TO 1-1C-1-29, "Flight Crew Air Refueling Procedures with KC-135 and KC-10," 1 February 1977.)

fuel from the main tanks into the externals to get a full external tank indication. Because of the inability to fuel the external tanks fully while connected to the tanker, operators were advised to plan for a total fuel quantity of 56,000 pounds after refueling. The point-parallel rendezvous procedure was used during two rejoins using the briefed 12 NM turn range and approximately 4.5 NM offset. The procedure worked perfectly, and it was recommended for use throughout the Combat Talon community. The 1st SOS crew that flew the long-range mission included Steve Gardella, AC/SQ CC; Bob Meller, FP; Jerry Nichols, FP; Jack Holbein, NAV; Joe McBride, NAV; Paul Whetzel, NAV; Rueben Cole, FE; "Rat" Moretz, FE; Chuck Javens, RO; John Mink, RO; Ray Doyle, LM; and John Stumpf, LM.

To fly anywhere in the world without relying on ground-based aerial refueling was a reality. No longer did the United States have to rely on other nations to provide refueling support facilities that were subject to political pressures. The modern-day Combat Talon weapons system was nearly complete.

The Helicopter Aerial-Refueling Modification

By the mid-1980s the number of military helicopters with in-flight refueling capability had increased significantly over the previous decade. The medium-lift special operations helicopter, the MH-53 Pave Low, formed the backbone of the USAF SOF rotary-wing capability. A smaller, light-lift helicopter, the MH-60G Pave Hawk, also provided specialized SOF rotary-wing support. With Congress's passing of the Goldwater-Nichols Department of Defense Reorganization Act of 1986, renewed emphasis was placed on America's SOF forces. As part of the SOF aviation modernization program that was developed after the act, both USAF and USA aircraft were provided increased capabilities, including aerial refueling for USA Chinook helicopters dedicated to SOF support. Just as planners a decade before had recognized the need to install in-flight aerial refueling receiver capability on the Combat Talon, SOF rotary-wing assets were modified, or designed from the ground up, with the capability to receive fuel while airborne. The

increase in aerial refuelable helicopters created the need for additional SOF tanker aircraft, especially those that could penetrate hostile territory and refuel over denied areas.

The Combat Talon was designed as a long-range, low-level penetrator aircraft. With the addition of helicopter refueling pods under its wings, it could provide fuel to helicopters anywhere the helicopter could fly. Helicopter refueling technology already had been developed, and wing pods had been installed on USAF HC-130N/P rescue aircraft and on US Marine Corp (USMC) KC-130s. The modification allowed helicopters to refuel from the tanker aircraft. The first six Talons modified with the helicopter refueling pod system were the Clamp aircraft assigned to Hurlburt Field. The modification was accomplished concurrently with SOF-I Phase I. The remainder of the Combat Talon fleet received the wing pod refueling as part of the MOD-90 program. By the late 1980s, funds had been allocated to modify all Clamp-configured Combat Talons. By 1995 all 14 Combat Talons had been modified with the helicopter aerial-refueling system.

The aerial refueling system provided the Combat Talon with the capability to transfer fuel through the modified fuel-dump manifold. Two aerial-refuelable-equipped helicopters, either individually or simultaneously, could refuel through refueling hoses trailed from pods located beneath the outer wing area. An auxiliary control panel was located overhead at the flight engineer's station. When installed, the components formed an integral part of the fuel system. For refueling operations, a drogue and hose trailed behind the pod for engagement with the receiver helicopter. A self-seal reception coupling prevented flow of fuel until the hose was engaged. A fuel range of 56 to 76 feet was marked on the forward end of the refueling hose with two five-foot white bands. In addition to the fueling range bands, the hoses were marked with one-foot wide white bands 10 feet apart. The hose reel responded automatically to receiver engagement and movements of the receiver airplane by reeling in or out to take up slack or extend as necessary. The reel operated on hydraulic pressure, but in the event of utility hydraulic system failure, the hose could be mechanically released and trailed behind the pod. The hose could then be cut loose by a guillotine device located in the pod.⁸²

The two aerial refueling pods contained a hydraulic system for reel operation, associated plumbing, and three status indicator lights. The status lights were located on the aft end of the pod, were visible to the receiver, and indicated tanker ready (yellow light), fuel flowing (green light), and hydraulic pressure off (red light). The hydraulic system provided power for extension, retraction, and locking of the air refueling hose. Controls for the air refueling system were located on the auxiliary fuel control panel and the main fuel control panel.

The aerial refueling capability on the Combat Talon provided a quantum increase in SOF capability. When Combat Talon II was designed, helicopter aerial refueling was not included in the baseline aircraft. Throughout the 1990s requirements continued to expand for penetrating tankers. A palletized centerline aerial refueling system was tested in the mid-1990s for Combat Talon II but did not perform to expectations. Funds were allocated in 1998 for the modification of the Combat Talon II with a permanently mounted improved aerial refueling system similar to the one on the Combat Talon I. The modification was programmed for installation in the 2001–5 period. Combat Talon had matured to the point that it could receive fuel while airborne and deliver it to helicopters in denied areas. No other aircraft possessed similar versatility.

Summary of Combat Talon Modifications

In addition to the major modifications made to the basic C-130E aircraft covered in the previous pages, literally hundreds of other upgrades and improvements have been made to the Combat Talon over the past three decades. The modern-day Combat Talon I has changed so dramatically that it barely resembles the original aircraft that came off the Lockheed assembly line in 1965. Not an upgrade per se, but perhaps the most structurally sound improvement to the aircraft was the installation of new wings in the early 1990s. Since the majority of Combat Talon flying hours historically are flown at low-level altitudes, the aircraft aged at approximately five times the rate of standard C-130s. For this reason, critical aircraft components, including the center-wing box and outer-wing sections, have been changed to ensure the structural integrity of the airframe. (See appendix B for a partial listing of Combat Talon modifications.)

Notes

1. Project CHECO Report, *The Role of the USAF in Support of Special Activities in SEA*, 1 July 1976, prepared by Tom G. Abbey, Maxwell AFB, Ala.: USAF HRA, 23.
2. Pamphlet, 12 October 1990, provided to the author by John R. Lewis from his personal files, Combat Talon Archive, Headquarters Air Force Special Operations Command historian (hereafter cited as HQ AFSOC/HO), Hurlburt Field, Fla., 5.
3. Project CHECO Report, 25.
4. *Big Safari Reunion*, 6, on file, Combat Talon Archive, HQ AFSOC/HO, Hurlburt Field, Fla., 12 October 1990.
5. Ibid.
6. Ibid., 8.
7. Ibid., 7.
8. Ibid., 7-8.
9. Lars Olausson, *Lockheed Hercules Production List, 1954-1995*, 12th ed., privately published by author, February 1994, 90-92.
10. Flight Manual (FM), *USAF Series C-130E*, Technical Order (TO) 1C-130E-1, 15 March 1966, Combat Talon Archive, HQ AFSOC/HO, Hurlburt Field, Fla., 1-4.
11. Ibid., 1-26.
12. Ibid., 1-31.
13. Ibid., 1-37.
14. Ibid., 1-50.
15. Ibid.
16. Ibid., 1-71.
17. Ibid., 1-78.
18. Ibid., 1-84.
19. Ibid., 1-87.
20. Ibid., 1-91.
21. Ibid.
22. Ibid., 4-103.
23. Ibid., 1-98.
24. AFTO Form 95s, aircraft 64-0523, 64-0551, 64-0555, and 64-0568 records, Combat Talon Archive, HQ AFSOC/HO, Hurlburt Field, Fla.
25. William M. Leary, *Robert Fulton's Skyhook and Operation Coldfeet*; on-line, Internet, n.d. available from <http://www.terrorism.net/Pubs/csi/Lea/html>.
26. Ibid.
27. Ibid.
28. Ibid.
29. Michael E. Haas, *Apollo's Warriors: US Air Force Special Operations during the Cold War* (Maxwell AFB, Ala.: Air University Press, 1997), 103.
30. Leary.
31. Haas, 50.
32. Leary.
33. Ibid.
34. Ibid.
35. Ibid.
36. Ibid.
37. Ibid.
38. Ibid.
39. Ibid.
40. Ibid.
41. Ibid.
42. Ibid.
43. Ibid.
44. Ibid.
45. Ibid.
46. Official Report, *List of Persons Picked Up by the Fulton Skyhook Aerial Recovery System*, Robert E. Fulton Jr., 6 January 1964, Combat Talon Archive, HQ AFSOC/HO, Hurlburt Field, Fla.
47. Ibid.
48. Ibid.
49. Official Report, *ER-4112, C-130 Fulton Skyhook Aerial Recovery System*, Lockheed Aircraft Corp., 8 February 1960, Combat Talon Archive, HQ AFSOC/HO, Hurlburt Field, Fla., 1.
50. Ibid., 3.
51. Ibid., 3-4.
52. Ibid., 4-5.
53. FM, *Partial Flight Manual, C-130E Skyhook*, TO 1C-130E(I)-1, 23 March 1967, Combat Talon Archive, HQ AFSOC/HO, Hurlburt Field, Fla., 4-18-4-19.
54. Ibid., 4-18.
55. Ibid., 4-25.
56. Ibid.
57. Ibid.
58. Ibid.
59. Ibid.
60. Ibid., 2-26.
61. Ibid., 4-26.
62. Ibid.
63. Ibid.
64. History, 15th Special Operations Squadron, 1 July-30 September 1968, USAF HRA, Maxwell AFB, Ala., K-SQ-A-CMDO-15-HI, 10-11.
65. *Big Safari Reunion*, 6-7.
66. 19th Special Operations Squadron (SOS), MC-130E Combat Talon Pilot *Student Study Guide*, Hurlburt Field, Fla., 30 December 1998.
67. FM, *USAF Series MC-130E*, TO LTM 1MC-130E-1, 1 October 1981, Combat Talon Archive, HQ AFSOC/HO, Hurlburt Field, Fla., 4-315.
68. Technical Report, *High Speed Low Level Aerial Delivery System (HSLADS), OT&E Final Report*, March 1974, prepared by Irl L. Franklin, Combat Talon Archive, HQ AFSOC/HO, Hurlburt Field, Fla., 1.
69. Ibid.
70. Ibid., 1-2.
71. Ibid., iii.
72. Ibid., v.
73. Ibid., v-vi.
74. Ibid., vi.
75. *Big Safari Reunion*, 22.
76. Maj Robert L. Berry, ed., *1st SOW Pilot/Navigator Textbook*, n.d., Combat Talon Archive, HQ AFSOC/HO, Hurlburt Field, Fla., 4-2.
77. Ibid.
78. Capt Raymond L. Harris, USAF, and Edward I. Seto, *C-130 Aerial Refueling Evaluation, April 1977, Final Report*, Combat Talon Archive, HQ AFSOC/HO, Hurlburt Field, Fla., 38.
79. Ibid., 23.
80. Ibid., 25.
81. Ibid., 17.
82. FM, *USAF Series MC-130E*, 4-359.

THIS PAGE INTENTIONALLY LEFT BLANK

Chapter 3

Combat Knife (The Pope Air Force Base Years: 1965–74)

On the three types of individuals who play the game: “First, there are those who are winners and know they are winners. Then there are the losers who know they are losers. Then there are those who are not winners but don’t know it. They’re the ones for me. They never quit trying. They’re the soul of our game.”

—Paul “Bear” Bryant

In the Beginning There Was Pope

Fourteen C-130E aircraft that would later become known as Combat Talons came off the Lockheed-Marietta assembly line and were accepted by the USAF beginning in July 1965. They were production aircraft and were not equipped with the Fulton STARS modification, the AN/APQ-115 TF/TA radar, or any ECM equipment. The 464th Troop Carrier Wing, Pope AFB, North Carolina, was designated the stateside unit to receive the first Combat Talon aircraft. Ramp space at Pope was extremely limited in the summer of 1965 due to the massive buildup for the war in Vietnam. As a result, the new C-130E aircraft were temporarily stored at Sewart AFB, Tennessee, until adequate facilities became available and maintenance personnel were trained at Pope AFB. Personnel from Pope AFB traveled on temporary duty to Sewart AFB to gain experience in the aircraft. While awaiting the initial STARS modification, aircrews ferried the aircraft to Greenville, South Carolina, where Ling-Tempco-Vaught Electrosystems painted them in the low-radar reflective black and green paint scheme from which they would come to be called Blackbirds. A heavy, porous paint, it added 370 pounds to the aircraft’s basic weight. Starting in December 1965, three aircraft each month were sent to Lockheed-Georgia, where the Fulton STARS modification was completed. Aircraft 64-0565 and 64-0568 were temporarily assigned to the 4442d Combat Crew Training Wing while awaiting modifications. By May 1966 all 14 Combat Talon aircraft had been modified with the Fulton STARS. As each aircraft completed the Fulton modification, it was sent to LAS Ontario for installation of the AN/APQ-115 TF/TA radar and the ECM suite.

The 779th Troop Carrier Squadron, commanded by Lt Col Rodney H. Newbold, 464th Troop Carrier Wing, was identified as the squadron to operate the new C-130E(I) aircraft under the code name Project Skyhook. In March 1966

the 779th sent a C-130 instructor crew to Edwards AFB, California, for initial checkout in the Fulton system. The checkout took a month to complete, with each pilot accomplishing 15 recoveries. Enlisted crew members returned to Pope AFB on 14 April 1966 and organized the Skyhook ground school. Officer crew members received additional instruction on the AN/APQ-115 radar and returned to Pope AFB on 30 April. The initial instructor crew formed the nucleus of the Skyhook program for Tactical Air Command.¹

Between 1 May and 30 June, six additional crews were qualified by 779th instructors in the Skyhook system and were identified to deploy to SEA under the code name Project Stray Goose. Initial training stressed operations utilizing the AN/APQ-115 TF/TA radar and the Fulton STARS. Low-level training was conducted at 1,000 feet AGL at night and 500 feet during the day. The ground-school portion of training included radar and Fulton mock-ups to familiarize students with those unique capabilities before beginning the flying phase. Lt Col Donald J. Britton, formerly assigned to the operations plans branch of the 464th TCW, was designated the Stray Goose detachment commander (see chap. 4).²



Photo courtesy of Richard H. Sell

Aircraft 64-0566 on the ramp at Pope AFB, North Carolina, spring of 1966.

Once the Stray Goose detachment completed training, 779th instructors concentrated on the checkout of additional crews to fill their own training requirements. The 779th continued its primary mission of tactical airlift, with Project Skyhook personnel forming up F Flight within the squadron.

The basic Combat Talon crew consisted of 11 personnel—three pilots, two navigators, one electronic warfare officer, two flight engineers (originally designated as flight mechanics), one radio operator, and two loadmasters. In contrast, a slick C-130 had a crew of six personnel—two pilots, one navigator, one flight engineer, and two loadmasters. The third pilot on the Combat Talon performed safety duties during Fulton recovery operations and assisted in map reading while flying low level. The second navigator was responsible for map reading and terrain avoidance during low-level maneuvers. The EWO was a trained navigator who had additional training in operating the sophisticated ECM equipment installed on the Combat Talon. It was his job to detect enemy threats and to defend the aircraft electronically until the crew could maneuver to safety. The second flight engineer operated the Fulton winch during recovery operations and assisted the primary flight engineer during systems operations. The radio operator was responsible for external communications between the aircraft and the agency controlling the mission. In addition to their normal C-130 loadmaster duties, Combat Talon loadmasters were responsible for completing the Fulton recovery from the ramp of the aircraft once the lift line had been intercepted by the pilot. Because of the large crew and varied duties of each assigned crew member, the aircraft commander was often challenged to the maximum of his abilities to manage the crew safely and efficiently. To increase crew proficiency, and thus its survivability in combat, most Combat Talon crews flew as hard crews (i.e., the same crew members flew together to maximize mission success). The 779th instructors, however, could not fly as hard crews when instructing students in the aircraft.

Although the Fulton STARS had been utilized for live pickups since August 1958, no recorded live pickups had been made by USAF C-130 aircraft by the spring of 1966. On 3 May 1966 the first live Fulton recovery in a USAF C-130 aircraft was made at Edwards AFB, California. Test pilot Carl A. Hughes piloted the aircraft, picking up Capt Gerald E. Lyvere in a single live pickup. Later in the day a two-man pickup was



USAF Photo

Capt Straun L. Paddon and SSgt Frederick L. Thrower, 24 August 1966—the first two-man surface-to-air recovery by an operational Talon crew.

also performed by Hughes. Col Allison C. Brooks and A/3dC Ronald L. Doll were successfully retrieved utilizing the two-man system.³ By August of 1966 the 779th TCS had refined its Fulton STARS capability and was approved to perform a live recovery by Headquarters TAC. Maj George G. Hellier and his Combat Talon crew performed both a one-man and a two-man live surface-to-air recovery at Pope AFB on 24 August 1966. TSgt Jacob C. Legrand was the first to be recovered, followed by Capt Straun L. Paddon and SSgt Frederick L. Thrower. The three personnel were all active duty Air Force members. The two successful recoveries marked the first live surface-to-air recoveries made by an operational Air Force crew and ushered in an era of live pickups that would last for the next 16 years.⁴

The Project Stray Goose contingent departed for SEA on 8 September 1966. The initial deployment consisted of four Combat Talon aircraft (64-0547, 64-0561, 64-0562, and 64-0563), six Combat Talon qualified aircrews (66 personnel), and 190 maintenance and support personnel. Upon arrival

at Ching Chang Kuang AB, Taiwan, the unit was organized as Detachment 1, 314th Troop Carrier Wing, and was assigned permanently to PACAF.⁵ The successful training of Project Stray Goose crew members marked a significant achievement for the 779th Skyhook unit. By year's end the 779th was well along in training its own contingent of aircrew and maintenance personnel. Considering the challenges the unit faced bringing the new weapons system on line during its first full year of operations, unit accomplishments were nothing short of outstanding. The next year would prove to be equally challenging. The six Stray Goose crews deployed to SEA would have to be replaced at the end of their 12-month tours, and the 779th would have to mature its own instructor cadre.

1967: Combat Talon Expands

Operations continued at a hectic pace at Pope AFB throughout January and February 1967. Along with its Combat Talon-unique skills, Combat Knife (the Skyhook unit at Pope AFB was later renamed Combat Knife) crews of the 779th maintained other skills found in tactical C-130 units. On 16 January 1967 aircraft 64-0567 was damaged during a ramp personnel airdrop at Pope AFB. The MC-1 strap used to retrieve parachute static lines broke and caused rips and tears to the underside of the aft section of the horizontal stabilizer. During March aircraft 64-0551 suffered damage to its HF antenna during Fulton recovery operations. Experience over the years in STARS would show that HF antennas and pilot windcreens were often casualties during Fulton recoveries, with the windcreens being especially vulnerable at night. (Night lift lines had lights woven into them, and if the light hit the front windscreen, breakage of the glass windscreen was sometimes the result.) Eventually, most of these problems were minimized by relocating the HF antennae and by improving the design of the Fulton night lift line.

In the spring of 1967, the Air Force went through a major reorganization. As a result, units at Pope AFB received new designations. The 464th TCW became the 464th Tactical Airlift Wing (TAW), and the 779th TCS became the 779th Tactical Airlift Squadron (TAS). Other units throughout tactical airlift were similarly renamed.⁶ In May the second big push began to train the next contingent of Stray Goose crews bound for SEA. The Taiwan-based Combat Spear unit had moved to Nha Trang, Vietnam, late in

1966 and had been renamed Detachment 1, 314th TAW, effective 1 August 1967. Six crews were trained throughout the summer, along with maintenance personnel, to replace personnel who had deployed the previous year.

On 26 July 1967, during a low-level training mission out of Pope AFB, aircraft 64-0551 experienced the loss of the right fending line, which resulted in damage to the number three and number four propellers. The line was chopped to bits upon contact, and pieces of the line punctured a hole in the number three propeller cowling, scratching and denting both number three and number four propellers. The propellers were replaced after an uneventful landing at Pope AFB with approximately 20 feet of fending line trailing from the nose of the aircraft.⁷

Lt Col Dow A. Rogers Jr., the commander designate of Detachment 1, 314th TAW, led the second contingent to SEA along with his operations officer, Lt Col Thomas F. Hines. Combat Knife instructors in the 779th did an outstanding job preparing the new crews, who finished training in pairs and departed by way of military air from July through September. The staggered reporting dates were designed to lessen the impact of the 100 percent turnover of personnel for a unit that was engaged in combat over North Vietnam daily. The 779th spent the remainder of 1967 preparing crews to deploy to the 7th Air Commando Squadron (ACS) in Germany, which was scheduled for conversion to Combat Talons in the spring of 1968. As was the case for the Combat Spear unit in the Pacific, the European Combat Arrow squadron had six crews and four Combat Talon aircraft assigned along with maintenance and support personnel (see chap. 5).

On 25 November 1967 Nha Trang AB, Vietnam, came under mortar attack, and aircraft 64-0563 was destroyed. This was the first aircraft of the original 14 to be lost, and USAF quickly moved to replace it with another aircraft. On 6 December 1967 aircraft 64-0571 was assigned to the 779th as a slick C-130E. It was used for tactical airlift until it was sent to LAS Ontario on 11 April 1968. It received Combat Talon radar and ECM modifications but not the Fulton recovery system. The Air Staff determined that the remaining Combat Talons equipped with Fulton STARS were adequate to meet projected tasking. On 30 August 1968 aircraft 64-0571 returned to Pope AFB as the first Talon without the Fulton recovery system installed.⁸

1968: The Establishment of Detachment 2, 1st Special Operations Wing

On 29 December 1967 the SEA Combat Spear unit lost Crew S-01 and Combat Talon 64-0547 over North Vietnam. This was the second of the original 14 aircraft to be lost. As a result the heavy student load already placed on the 779th to train Combat Arrow aircrews for Europe was increased so that a replacement crew for the Pacific could be trained. Schedules were adjusted with student crews destined for SEA accelerated by two months to enable the unit to reconstitute its sixth crew as soon as possible. The 779th did an outstanding job meeting this challenge. To maintain a 14-aircraft fleet of Combat Talons, aircraft 64-0572 was designated by Air Staff to replace aircraft 64-0547.

Along with the training provided to the Combat Spear replacement crew, early 1968 was marked by final preparation to deploy Combat Arrow trained crews and maintenance personnel to the 7th Air Commando Squadron. (Note: After August 1968 all squadrons previously designated Air Commando Squadrons became Special Operations Squadrons.) The first Combat Talon and crew deployed to Ramstein AB, Federal Republic of Germany, on 24 February 1968. An additional crew and aircraft arrived in Germany on 3 March, with the third aircraft and crew arriving on the 28th of June 1968 (see chap. 5).

For more than two years, the 779th had provided trained personnel to fill Combat Talon requirements, first in the Pacific and then later in Europe. By the spring of 1968, the Air Force was consolidating its US-assigned special operations units in the Florida Panhandle at Eglin AFB Auxiliary Field No. 9, which was also known as Hurlburt Field. On 7 April 1968 the Combat Talon training mission performed by the 779th within TAC was transferred, along with its personnel and equipment, to Detachment 3, 319th Air Commando Squadron, Tactical Airlift. On 1 May 1968 the name of the new organization became Detachment 2, 1st Special Operations Wing (SOW), which was located at Hurlburt Field.⁹ The new detachment remained at Pope AFB as a tenant unit but reported to the 1st SOW in Florida.

With Combat Talon assets deployed worldwide, Combat Knife concentrated on developing its operational mission. To this time almost all unit resources were dedicated to the training mission. In addition to operating the Combat Talon

schoolhouse, Detachment 2 was assigned the operational mission of supporting unconventional warfare plans of commander in chief, European Command (CINCEUR); CINCPAC; commander in chief, Southern Command (CINCSO); and commander in chief, Strike Command (CINC-STRIKE) for both limited and general war. Specific tasks in support of this primary mission included delivery of personnel and cargo by airdrop or airland methods to designated points in enemy territory; resupply of clandestine operations conducted by US Army Special Forces and other US government agencies; exfiltration of personnel, equipment, cargo, and intelligence data from the ground or water; dissemination of psychological warfare materiel; pickup of escapee or evadee personnel from designated safe areas within enemy territory; and training of both aircrew and maintenance personnel to support worldwide Combat Talon requirements.¹⁰

On 8 July 1968 Lt Col Pierce M. Meyers Jr. became the new commander of Detachment 2. Under Myers's leadership the unit stabilized with an authorized strength of 42 officers and 161 airmen.¹¹ There was another big push in the summer of 1968 to replace Combat Spear personnel rotating from SEA. As had been the case the previous year, many personnel returned to Pope AFB after their Vietnam tour, or they elected to PCS to the 7th SOS in Germany. Combat Talon had become somewhat of a closed system and was composed of experienced personnel who rotated among the three squadrons. Detachment 2 benefited as experienced personnel brought valuable combat skills back to the unit.

In the haste to field the original Combat Talon weapons system in 1966, which was driven by SEA operational requirements, special Stray Goose equipment installed on the aircraft had never been through an OT&E to determine system effectiveness. In May of 1968, during a Detachment 2 Combat Talon capabilities briefing to the Special Air Warfare Center staff at Eglin AFB, Florida, and to the staff of the 1st SOW, Maj Cecil Clark identified the need for a formal OT&E. In September Lt Col Howard Hartley, the Combat Knife project officer for SOF on the TAC staff, requested Maj George Hellier and Major Clark brief him on Combat Knife capabilities and limitations. Upon completion of the briefing and armed with the knowledge of the need for a formal OT&E, Colonel Hartley took the briefers with him to the Air Staff to brief the shortfall and to obtain support.

During meetings with Air Staff personnel, Colonel Black (AFXSME) discovered that there was no fiscal 1970 funding for Combat Talon. Discussions further revealed that the TAC-assigned Combat Knife unit lacked specific mission responsibility, which prevented identification of future funding. Without specific mission responsibility, neither future modifications nor additional equipment could be justified. Because of the meeting a plan of action was developed to bring the Combat Talon program into line to qualify the weapons system for future funding. The plan included the following recommendations: develop a concept of employment; brief the SOF commander on Combat Knife capabilities and limitations; brief the TAC/DO and TAC/DPL on Combat Knife capabilities and limitations; brief commander in chief, Atlantic Command (CINCLANT) and CINCSRIKE on Combat Knife with the objective of including the weapons system in their respective war plans; and request TAC support a worldwide Combat Talon conference to identify equipment and modification requirements.¹²

In October Gen Robert Gardenas, the commander of TAC, was briefed and the following recommendations were approved: (1) give a similar briefing to CINCLANT and CINCSRIKE; (2) send a request to Air Staff (AFXOSO) to convene a worldwide Combat Talon conference; and (3) request Air Staff authorize a formal OT&E be conducted on the Combat Talon weapons system. On 3 December 1968 Major Hellier and Major Clark briefed CINCLANT and CINCSRIKE planners at Langley AFB, Virginia, and obtained tentative agreement from both commands to review their respective war plans for possible inclusion of Combat Talon.¹³

Six months had passed since Major Clark had first briefed the OT&E shortfall, but the effort paid off. The Air Staff approved a formal OT&E for the Combat Talon weapons system. Additionally, Air Staff began organizing the first Combat Talon Management Review (CTMR) conference and tentatively set a conference date for mid-March 1968. And finally, staff actions were begun between TAC and the Air Staff to determine the extent Combat Knife could support CINCLANT and CINCSRIKE.¹⁴ The initial OT&E shortfall identified by Major Clark in May 1968 had ultimately saved the entire Combat Talon program.

While the briefing process was going on during the fall, Detachment 2 was able to get sufficiently ahead of schoolhouse requirements to begin participating in joint exercises. During November

Detachment 2 participated in two joint exercises—one with the USA 7th Special Forces Group and another with the 3d Special Forces Group. Successful personnel and Fulton kit drops were accomplished during these exercises, along with Fulton STARS intercepts utilizing a training dummy. During the last half of the year, along with its limited exercise participation, Detachment 2 accomplished 200 day STARS, 80 night STARS, 86 day equipment drops, 86 night equipment drops, 40 personnel drops, 11 Fulton kit drops, 42 short-look maneuvers, and 510 airborne intercepts with fighter aircraft and flew 38 hours engaged with RBS ground radar sites conducting EWO training.¹⁵ Although 1968 had been a busy year, unit personnel looked forward to 1969 and upcoming opportunities flying the Combat Talon.

1969: First Combat Talon Management Review and the Development of Operational and Training Manuals

Detachment 2 personnel had enjoyed a quiet holiday season and were ready to fly when January arrived. On 16 January 1969 all was normal as Maj James H. Browning and his crew prepared a night training mission to be flown from Pope AFB round-robin through the mountains of western North Carolina. As aircraft 64-0558 approached Brown Mountain, just east of Asheville, for an unknown reason, the aircraft clipped a ridgeline while in a shallow right turn. The aircraft impacted trees with its right wing and severely damaged the number four propeller, thus causing the crew to shut down the engine immediately. Tree debris also penetrated the right wing fuel tank and the underbelly of the aircraft just forward of the main landing gear. Thanks to outstanding crew coordination and flying skills, the crew maintained aircraft control with multiple-engine shutdowns and made an emergency landing at the Hickory Municipal Airport, Hickory, North Carolina.¹⁶ No one was injured in the accident, but the aircraft required major repair. Initial fieldwork was done at Hickory to enable the aircraft to be flown back to depot for permanent repair.

Postflight investigation could not determine the cause of the accident, although 779th personnel were convinced that the AN/APQ-115 radar had somehow malfunctioned and allowed the aircraft to descend to a point where it impacted the

ridgeline. John R. Lewis, a technical representative from Texas Instruments (the prime contractor for the AN/APQ-115) was called in as part of a depot-level technical team to examine the radar. The team conducted preliminary interviews of flight-crew personnel and performed an operational evaluation of the integrated system while the aircraft remained at Hickory. The main components of the AN/APQ-115 were then removed from the aircraft and returned to Pope AFB for evaluation by Air Force technicians. The investigation concluded that the radar was working within parameters when it was checked after the accident.¹⁷ Why the aircraft struck the trees would remain a mystery. The aircraft was repaired and returned to Detachment 2 on 24 June 1969. Its near brush with destruction would forebode its future. After participating as one of two Combat Talons in the Son Tay POW Raid in 1970, the aircraft was destroyed in a midair collision with an F-102 interceptor on 5 December 1972, with the loss of everyone aboard.

The CTMR conference, which had been proposed the previous fall, was hosted by AFLC/LO at LAS Ontario from 11 to 13 March 1969. This was the first of the yearly conferences that brought together US and overseas Combat Talon units, representatives from their respective commands, and contractor personnel from industry to discuss the Combat Talon weapons system and its future development. The objectives for the first conference were ambitious and reflected the importance of future meetings of this type. Conference objectives included the following:

1. Review and validate the basic concept of operations in light of combat experience gained since initial employment.
2. Validate established mobility criteria upon which applicable tables of allowance were based.
3. Review the published aircrew training syllabus for comprehensiveness and applicability in terms of tactics and procedures used in weapons system employment.
4. Review the published weapons system security guide.
5. Review the proposed FY-70 modification program.
6. Identify operational requirements, which formed the basis for future system modifications.
7. Discuss Combat Talon logistics procedures established for peculiar equipment.
8. Review the Air Force Logistics Command (AFLC) IRAN schedule and work package.
9. Resolve or initiate action on any problems associated with personnel, materiel and operational requirements.¹⁸

The conference was chaired by Maj Benjamin N. Kraljev, Air Staff AFXOSO. In addition to the

published agenda, conference attendees agreed to discuss the Lockheed Technical Manual, which had been designed to provide aircrew and maintenance personnel with the appropriate procedures for those peculiar systems not covered by standard Air Force publications. The existing LTM was classified Secret because of sections dealing with ECM equipment installed on the aircraft. Certain other parts of the document described the AN/APQ-115 terrain-following radar and was classified Confidential. The majority of the document, however, contained unclassified information. With an overall classification of Secret, proper utilization of the technical order was difficult for both maintenance and operations personnel alike. Conference attendees agreed to delete operational procedures and tactics from the LTM and to include them in an appropriate 55-series procedures manual. Also, those portions of the LTM describing the AN/APQ-115 radar (except its operational limitations) would be declassified. The ECM portion of the LTM would be published as a classified appendix to the basic LTM, thus leaving the majority of the document as a stand-alone unclassified tech manual that could be more easily used in daily operations.¹⁹

Lt Col P. M. Meyers, Headquarters TAC, submitted a draft concept of employment for the Combat Talon that contained detailed information required to properly plan a Combat Talon mission. After review by conference attendees, the document was adopted for use by all three Combat Talon squadrons. Other discussions revolved around the Fulton STARS and perceived operational shortfalls. Long-range exfiltration of a US Army A-Team could not be accomplished without airlanding a Combat Talon. Airlanding in enemy territory made the option risky. USAFE/7th SOS concluded that a STARS capable of extracting up to 4,000 pounds should be explored and agreed to review the requirement further. If additional study warranted, USAFE agreed to submit a required operational capability to Air Staff. Attendees also confirmed the requirement for a high-speed (250 knots) air-drop capability that would eliminate drop zone compromise during the slow-down maneuver. The high-speed modification was in the prototype phase of development and had already proven its feasibility in the Heavy Chain program. Air Staff (AFXOSO) agreed to include the capability in future Combat Talon modernization proposals.²⁰

A whole host of additional topics was discussed and actions agreed upon. At the conclusion of the

conference, attendees felt that the format and content of the conference was about right and they were very enthusiastic about attending future annual meetings. The conference adjourned at 1500 on 13 March 1969 after having addressed critical Combat Talon issues that had not been consolidated or reviewed during the previous four years.²¹ The CTMR conference would remain an annual meeting until the Combat Talon program was transferred from LAS Ontario to Warner Robins, Georgia, in 1995.

Effective 19 May 1969, Lt Col Robert W. Folts assumed command of Detachment 2. His initial assessment of his unit's effectiveness contained in official Air Force documents reflected his concern over the impact of operational requirements on the detachment. While maintaining fully qualified combat crews, Detachment 2 also fulfilled the combat crew training function by training six 11-man crews annually for SEA and replacement crews for itself and the 7th SOS in Europe. The 7th SOS had been organized the year prior, with most of its personnel on three-year overseas tours. To meet experience levels for Combat Spear, Detachment 2 instructors (both maintenance and aircrew alike) were assigned to SEA duty, resulting in a 70 percent annual turnover rate. New personnel assigned to Detachment 2 remained just long enough to gain the required experience to qualify for overseas duty. Colonel Folts campaigned hard for a three-year stabilized tour for his assigned instructors.²² Not until Nha Trang AB closed in 1972, however, and Combat Spear moved to Kadena AB, Japan, did Detachment 2 get much relief from the constant turnover.

Because of TAC and Air Staff initiatives from the previous year, a Combat Knife mission statement was developed and published by TAC for the first time in the fall of 1969. The mission of Combat Knife was articulated

to provide a global unconventional warfare C-130 force (Combat Talon) to support unconventional warfare plans of CINCEUR, CINCPAC and CINCLANT for both limited and general war; secondary mission is the pickup of escapee and evadee personnel from designated 'safe areas' within enemy territory; correlative mission is the initial qualification training of replacement aircrew personnel and the initial training of certain select aircraft maintenance personnel assigned to all Combat Talon units.²³

Specific tasks were developed within TAC to support the successful execution of the above mission by Combat Knife assets. Detachment 2 was tasked to maintain trained crews and combat-

ready aircraft equipped to penetrate enemy airspace for long distances, accomplish an airdrop, surface-to-air recovery, or airlanding; and then safely return to friendly territory. Combat Knife also had to be prepared to resupply US Army Special Forces and other US government agency personnel engaged in clandestine operations. Exfiltration capabilities included extraction from both land and water. Another task specifically assigned to Combat Knife was the dissemination of psychological warfare materiel.²⁴

On 12 November 1969, Lt Col Peyton E. Cook assumed command of Detachment 2. Lt Col Albert P. "Friday" Blosch was appointed his operations officer.²⁵ In October Blosch attended a TAC-directed AFM 51-130, *Flying Training, C-130 Aircrew Training Manual*, conference at Hurlburt Field, Florida. The purpose of the conference was to revise AFM 51-130. Detachment 2 was tasked to write chapter 6, which for the first time included the Combat Talon weapons system. Colonel Hellier was the recognized expert for Combat Talon training, and his input to Blosch was the key to creating a meaningful document that could be used in the field.²⁶ Since the creation of Combat Talon in 1966, little had been published for use in the Pope AFB schoolhouse due to concern over security classifications. Maj John Gargus authored the main text for the AFM 51-130 update, while Blosch concentrated on tactical checklists. The combined effort of the three officers resulted in a superior Combat Talon training document.

The long anticipated OT&E for the Stray Goose modifications to the aircraft was begun in August 1969 with TAC as the office of primary responsibility. TAC Test Plan 69-416, dated August 1969, was the test directive under which the OT&E was flown. In accordance with the directive, TAWC and SOF were designated joint test agencies. The program was divided into four phases, with aircraft and personnel from Detachment 2 supporting all four phases. From October to December 1969, Phase I and all but one flight of Phase II were completed.²⁷

1970: Combat Knife Participates in the Son Tay Raid

Combat Knife continued to improve and strive for excellence. As a geographically separated unit from its parent wing at Hurlburt Field, Florida, it faced unique challenges at Pope AFB. In February 1970 the 464th TAW selected Detachment 2 as the best large support squadron. Considering

that it was a tenant unit of the host wing, the selection marked a milestone in its maturity.²⁸ In April Col Robert W. Gates (1st SOW/CC) presented Detachment 2 with the TAC Unit Achievement Award for the period 17 January 1969–16 January 1970. The unit had gained recognition as one of the best organizations in TAC.²⁹

The second CTMR conference was held at LAS Ontario from 27 to 30 January 1970. Its major goal was to finalize LTM changes recommended the previous year and to coordinate a draft of the new Multi-Command Manual (MCM) 55-130, *Aircrew Operations Manual*. Other major items discussed included the Combat Talon training program for 1971 and the fiscal year 1971 aircraft modification program. As had been the case the previous year, representatives from each major command and each unit operating the Combat Talon aircraft attended the conference.³⁰ As a follow-up to the CTMR conference, Major Gargus traveled to Headquarters TAC (DOSOS) on 16 March to coordinate MCM 55-130 changes agreed to at the CTMR conference. A follow-up tasking for Detachment 2 personnel was a comprehensive review of all tactical checklists. The checklists were then included in the final MCM 55-130.³¹

From 24 March to 1 April, Detachment 2 participated with two aircraft in a joint capabilities demonstration for foreign dignitaries, senior service personnel, and selected groups. The demonstrations were held on the Fort Bragg ranges and consisted of personnel drops and Fulton STARS operations. Twelve sorties were flown, with 72 personnel air-dropped and six recoveries performed utilizing a training dummy. The objective of the demonstrations was to educate personnel in key US and allied government positions about the capabilities of the Combat Talon and other US weapons systems.³²

In early summer (9–14 June) Detachment 2 participated in joint Exercise Gobbler Woods. Six US Army Special Forces A Teams were infiltrated into the objective area and were resupplied five days later. Primary drop zones were lighted, and all events were successfully accomplished on these lighted drop zones.³³ The exercise again demonstrated the ability of Detachment 2 to support its Special Forces customers while concurrently operating the schoolhouse and training replacement aircrews for worldwide Combat Talon assignment.

A Syllabi and Phase Training Conference was also held in June 1970. The purpose of the conference was to evaluate existing syllabi and manuals and to institute changes to promote better and

more efficient training goals and procedures. The result of this conference was the ratification of the new 75-flying-hour Combat Talon Syllabus. The previous syllabus had required 90 flying hours. Additionally, correction of all phase manuals was accomplished with emphasis on mission sequence, time changes, applicability of subject material, format, and administrative cleanup.³⁴ While overseas Talon units concentrated on operational commitments to their theater commanders, Detachment 2 was methodically upgrading and improving the Combat Talon training system so that personnel could be trained more efficiently and a more proficient graduate be produced by the formal school.

July was highlighted by participation in another joint exercise named Gobi Springs I. Detachment 2 participated along with A Company, 6th Special Forces Group, and operated out of Pope AFB. The exercise proved to be the most realistic of the year, with 111 personnel and more than 5,000 pounds of cargo air-dropped. A scheduled Fulton STARS was canceled the day before the event by the participating Special Forces commander. Other than this one cancellation, other events were flown as planned. The scenario allowed schoolhouse students bound for SEA the opportunity to fly some of the exercise missions and thus gain valuable experience training in a realistic operational environment.³⁵

In August 1970 Detachment 2 was tasked to provide an aircraft and crew to begin preparation for Operation Ivory Coast, which was the attempt to free American prisoners of war from Son Tay Prison in North Vietnam. Colonel Blosch and his crew, flying aircraft 64-0558, departed Pope AFB for Eglin AFB, Florida, and began a three-month training period that culminated in the November 1970 raid deep into North Vietnam (see chap. 6). This was the first combat mission flown by Detachment 2, although many of the unit's personnel had served in SEA before being assigned to Combat Knife. Blosch was a member of the original Stray Goose contingent that deployed to SEA in 1966 and was the operations officer of Detachment 2 in the summer of 1970. The 7th SOS also provided a crew for the raid, and the 15th SOS provided a second Combat Talon—aircraft 64-0523.

The year ended on a positive note. Detachment 2 won the 1st SOW Best Squadron Management Award for 1970 because the unit demonstrated outstanding management of assigned resources. The hard work by dedicated squadron personnel had resulted in many administrative

and operational achievements throughout the year. With the unit separated from its parent wing, recognition such as this was even more noteworthy.³⁶

1971: MOD-70 Combat Talon and the Activation of the 318th SOS

In February 1971 two significant events took place. The third annual CTMR conference at LAS Ontario was conducted from 16 to 19 February, and the TAC inspector general gave the unit an operational readiness inspection (ORI) from 18 to 20 February. The CTMR conference was very productive, with attendance similar to previous years. Detachment 2 earned a satisfactory rating for the ORI. The unit also made progress in the facilities area. Building 718 at Pope AFB was tentatively committed to Detachment 2 with projected occupancy scheduled for 1 May 1971.³⁷

From March through June 1971, Detachment 2 graduated three student classes. Class 71-4 began training on 1 March and graduated on 16 April. It consisted of six pilots, three navigators, two EWOs, one flight engineer, and one loadmaster. Class 71-5 began on 19 April and graduated on 4 June. It consisted of six pilots, four navigators, two EWOs, one flight engineer, and two loadmasters. These crew members were replacements for the 90th SOS at Nha Trang AB. (The 15th SOS had been redesignated as the 90th SOS on 1 November 1970.) Class 71-6 started training on 7 June and graduated on 24 July.³⁸

Effective 1 August 1971 Colonel Hellier assumed command of Detachment 2.³⁹ One of Colonel Hellier's greatest challenges was preparing his unit for the new MOD-70 Combat Talon aircraft. Since its introduction into the USAF inventory in 1965, the C-130E(I) Combat Talon aircraft had experienced certain equipment performance limitations, the most serious of which was the low MTBF of the AN/APQ-115 terrain-following radar. The AN/APQ-115 was a modified Texas Instruments AN/APQ-99 radar designed for the F-4 Phantom. Even after numerous improvements, the MTBF remained at approximately 19 hours. In 1968 LAS Ontario began design studies to correct the deficiencies in the radar. USAF approved LAS Ontario's proposals in the fall of 1969 and obligated \$35 million for the improved radar system. Heavy Chain aircraft 64-0564 and 64-0565 were first to receive the new upgrade in 1970. The first Combat Talon to receive the new radar (64-0562) entered the modification phase in March 1971. The updated aircraft was designated

MOD-70, with aircraft 64-0562 being the first to be modified. It arrived at Pope AFB on 29 September 1971 for Category III testing.⁴⁰

The MOD-70 upgrade was extensive and marked the first time major modifications were done since introduction of the Talons in 1965. The heart of the modification centered on the terrain-following radar and an upgraded inertial navigation system. The new radar was designated the AN/APQ-122(V)8 and carried the promise of a much longer MTBF with much more potential than the older AN/APQ-115. Other systems included in the MOD-70 program were the installation of the Litton LN-15J inertial navigation system, the addition of an autopilot pitch monitor, an improved Doppler, an improved Loran C, and modification of the fuselage of the aircraft for HSLPADS. The latter modification allowed the ramp and door to open at a maximum airspeed of 250 KIAS, thus eliminating the need for slowdown when air-dropping supplies. The package of improvements greatly increased the operational capability of the weapons system.⁴¹

The new radar provided day and night low-level capability in the 250, 500, 750, and 1,000-foot modes. In addition, the system had the capability to penetrate light-to-medium rain if encountered along the low-level route. The radar could also be operated in the beacon, weather, precision ground mapping, and automatic navigation updating modes. The theoretical MTBF of the radar was 350 hours, but AF technicians felt that around 190 hours was more realistic, a figure, that was still 10 times better than the older AN/APQ-115.⁴²

The LN-15J inertial navigation system provided a considerable increase in accuracy over the Doppler system installed in the original Talon. It provided a much improved pitch and roll stabilization input for the radar and supplied fully automatic steering from takeoff to landing with 20 preset way points. Accuracy was maintained within one-half NM per hour. The system also included an automatic computed aerial release point (CARP) function that could steer the aircraft to a drop point 50 yards wide by 50 yards long and as low as 250 feet above the ground. The auto CARP function could be employed at airspeeds ranging from 125 to 250 KIAS.⁴³

Another improvement provided by MOD-70 was the autopilot pitch monitor, which was designed as a safety measure while flying low-level

terrain following utilizing the autopilot. Experience in SEA and in Europe established the requirement to fly long and physically demanding missions at low altitude. The ability to engage the autopilot while in the terrain-following mode was designed to give the pilot a break from the continuous demands of manual low-level flight. The autopilot pitch monitor disengaged the autopilot when it sensed a rapid climb or dive command with the autopilot engaged. The system was designed to prevent an autopilot-induced hard-over driving the aircraft into the ground due to autopilot or other system failures.⁴⁴

To eliminate the slowdown requirement for resupply drops, the HSSLADS was installed on the MOD-70 aircraft. This modification consisted of strengthening the fuselage of the aircraft and installing a second hydraulic cylinder to augment the opening and closing of the rear aircraft door.⁴⁵ Since the days of the Carpetbaggers in World War II, special operators had looked for a way to perform airdrops without the slowdown maneuver. If the aircraft was being tracked by radar or by other electronic means, a slowdown could compromise the drop zone and thus reveal to the enemy the location of the airdrop. Early tactics developed to confuse the enemy included making multiple slowdowns to mask the actual drop zone. Although somewhat effective, multiple slowdowns put the aircraft at a slow airspeed close to the ground in enemy territory, thus increasing its vulnerability and the likelihood of the aircraft being hit by enemy fire. Multiple slowdowns also complicated navigational timing because a constant ground speed could not be maintained, thus making it more difficult to make exact times as flight planned on subsequent legs of the route. The HSSLADS was designed for resupply drops since physical limitations of the human body would not permit personnel drops outside the established airspeeds of 125–150 KIAS.

Aircraft 64-0566 departed Detachment 2 for the 7th SOS on 5 September, thus beginning a two-year period of exchanging aircraft among the three Combat Talon units to accommodate the MOD-70 output schedule. As the schoolhouse for the Combat Spear and Combat Arrow units, Combat Knife was tasked to train aircrews in both the pre-MOD-70 aircraft and in the new system. As MOD-70 aircraft were assigned to the overseas units, training on the older system was discontinued, and only MOD-70 training was provided for new crew members.

Detachment 2, 1st SOW Becomes the 318th SOS

Special Order G-267, dated 3 November 1971, activated the 318th Special Operations Squadron, effective 15 November 1971, and assigned the new squadron to the 1st SOW at Hurlburt Field, Florida. In conjunction with its activation, Detachment 2, 1st SOW, was inactivated. All personnel and equipment formally assigned to Detachment 2 was reassigned to the 318th SOS.⁴⁶ Colonel Hellier remained as the squadron commander until 1 December, when Lt Col Valentino Bagnani Jr. assumed command.⁴⁷

The 318th SOS had a long history in special operations. Originally activated on 1 May 1944 as the 318th Troop Carrier Squadron (Commando), the 318th was assigned to the 3d Air Commando Group and operated in the Pacific theater flying C-47s. Originally located at Camp MacCall, North Carolina, the unit deployed to Nadzab, New Guinea, on 26 October 1944. It distinguished itself during the campaigns of the Western Pacific, Leyte Gulf, and Luzon. It was deactivated on 25 March 1946 after the end of the war.⁴⁸ Its proud heritage was displayed in the pride shown by Detachment 2 personnel toward the new designation.

When Combat Talon 64-0562 arrived from LAS Ontario in late September after completion of MOD-70, unit personnel had been identified to fly the Category III flight tests. Majors John M. Connaughton and Harry L. Pannill had been selected as the two pilots, and Majors John Gargus and Rethel H. Jones were the two navigators. Gargus was the primary instructor for the AN/APQ-122(V)8 multimode radar, and Jones taught the LN-15J inertial navigation system. All four flyers had spent much of the previous summer on temporary duty to LAS Ontario learning the systems. The first unit terrain-following flight on aircraft 64-0562 occurred on 8 November and was followed by numerous additional flights that tested all phases of the new system. On 18 November the first night terrain-following flight was flown. On 22 December the second MOD-70 aircraft (64-0561) was delivered to the 318th.⁴⁹ By late December, three 318th crews had been trained on the MOD-70 system.⁵⁰

When the original 14 C-130E aircraft were modified to the Combat Talon configuration in 1965, the designation given to the new unconventional warfare aircraft had been the C-130E(I), which identified the aircraft as being Fulton-intercept capable. When the aircraft were modified

under the MOD-70 program, the designation was changed to C-130E(CT) to signify that they had been modified to the Clamp configuration, which was the name assigned to the suite of modifications done on the Fulton STARS aircraft. Aircraft 64-0571 and 64-0572 did not have the Fulton system installed because they were replacement aircraft for Vietnam combat losses during 1967. The decision was made at the time that 12 Fulton-capable Combat Talons were sufficient to satisfy worldwide requirements. Other than the Fulton STARS, these two aircraft were Clamp configured just as the other 12 Combat Talons and were also given the new C-130E(CT) designation. Combat Talons 64-0564 and 64-0565 had been transferred to the Heavy Chain program in 1966 and received their modifications under the Rivet Yard program. Those two aircraft would be modified in 1970 under the MOD-70 program, but would remain Yard configured along with 62-1843 and 63-7785. The four Heavy Chain aircraft would be modified in 1973 under the Combat Talon program and be designated C-130E(Y), which signified that they were equipped with the Yank ECM suite of modifications. Yank aircraft would be assigned exclusively to the Pacific area of responsibility and operated by the Combat Spear unit there.

By the end of February 1972, MOD-70 instructors and students had flown more than 450 hours in aircraft 64-0561 and 64-0562. The new radar performed well during the test period, especially considering the availability of spare parts and the experience of maintenance personnel. The Texas Instruments technical representative, Niel Staub, along with dedicated Air Force maintenance technicians assigned to Detachment 4, were responsible for much of this early success. Through the entire test period, the radar did not once perform below designed system tolerances while in the terrain-following mode. Pilots liked the new radar, although numerous fail indications frequently interrupted low-level radar operations. In most cases the left-seat pilot switched the mode-selector control rapidly between selected outputs (called mode toggling) and usually cleared the malfunction indication. Another aircrew concern was that the ground-mapping mode was severely degraded during operations in poor weather. The effective range of the KA band radar was reduced to three to five miles when flying in visible precipitation. The most severe problem experienced by the aircrew was illumination of the radar air-fail light during high-level operations. When climbing to altitude, radar cooling was insufficient above

16,000 feet, thus rendering the radar inoperative above that point. High-altitude low-opening drops were routinely made up to 25,000 feet. This deficiency was noted as unacceptable by the test crew.⁵¹

Throughout the test phase the LN-15J inertial navigation system was the primary navigational mode used by the crew. The aircraft seldom strayed more than one-half NM off track. When the Loran C and Doppler were used as the primary navigational modes, their performances were closely monitored by the navigators to ensure accurate system operation. Early flights determined that the position of the aircraft remained within one-fourth NM of the flight-plan track when integrated navigation modes were utilized.⁵²

The MOD-70 aircraft proved to be a major advancement in the capabilities of Combat Talon. Beginning in the fall of 1971, as aircraft were modified by LAS Ontario, deficiencies found by the 318th test crew and squadron permanent-party instructors were corrected by the contractor and incorporated into the MOD-70 design. The second MOD-70 aircraft, 64-0561, was delivered to the 318th on 22 December 1971. At the close of the year, the 318th had three permanent-party crews trained in the MOD-70 weapons system and possessed three aircraft—MOD-70 aircraft 64-0561, 64-0562, and nonmodified aircraft 64-0571—with aircraft 64-0558 in MOD-70 upgrade at LAS Ontario.⁵³ In summary, 1971 had been a watershed year for Combat Knife. The unit that had begun as a flight of the 779th TCS had grown to Detachment 2 of the 1st SOW, thence to a fully manned special operations squadron—the 318th SOS.

1972: Combat Talon 64-0558 Is Lost Over South Carolina

As 1972 began MOD-70 testing was in full swing. The squadron was awarded the TAC Unit Achievement Award for accident-free operations during the period 17 January 1971–16 January 1972. The squadron also participated in Exercise Gallant Hand 72 with one aircraft and crew. The mission aircraft launched out of Pope AFB for a Special Forces A-Team airborne infiltration into the Fort Hood, Texas, area. The air-dropped team conducted reconnaissance operations and prepared a landing site for a subsequent air-mobile assault. The crew recovered at Canon AFB, New Mexico, after the drop and flew a second mission the next day. After departing Canon AFB the aircrew flew a diversionary penetration into the Fort Hood area with F-4C fighter interceptors scheduled

to intercept the aircraft. The fighters were a no-show, but all other facets of the sortie were executed as planned. Other than not having sufficient time for mission planning, the exercise was deemed a success with the aircrew getting realistic training while supporting US Army Special Forces.⁵⁴

The TAC ORI team visited the 318th from 3 to 6 April and administered an ORI to the squadron. The rating given to the squadron by the ORI team was an overall satisfactory. Col Daniel J. Gibson, the ORI team chief, however, stated that the 318th SOS had performed in an excellent manner and that the ORI was one of the best he had seen.⁵⁵

As MOD-70 aircraft continued to come off the line at LAS Ontario, aircraft were shuffled between the three operational squadrons. By the end of June 1972, the 318th SOS had four aircraft assigned and three possessed—64-0558, 64-0559, 64-0568, and 64-0572 (at LAS Ontario for modifications).⁵⁶ Throughout the period, the squadron continued a heavy training load that included Fulton STARS intercepts. During the first three months of 1972 alone, the 318th performed 103 day and 126 night surface-to-air recoveries.⁵⁷ With the large number of intercepts accomplished, squadron personnel maintained a high degree of proficiency in the system. Fulton intercepts, utilizing a training dummy or a canvas sandbag, were routinely included in exercises in which the squadron participated. TAC leadership did not feel that the risks associated with a live surface-to-air recovery were justified during training. The system was, however, fully man-certified and capable of performing a live pickup at any time. On 24 July the 318th demonstrated the Fulton system to members of the 10th Special Forces Group at Fort Devens, Massachusetts, during the closing day of Exercise Rocky Rival. During the period 21–22 August, four Fulton STARS were flown in support of Exercise Cabot Sound VI at Union, South Carolina. Between 30 August and 5 September, the squadron performed five surface-to-air recoveries at the Canadian International Air Show, Toronto, Canada. From 19 to 22 September, the 318th made two additional STARS intercepts at the Eglin AFB Open House in Florida.⁵⁸ The purpose of these demonstrations was to familiarize

potential customers with the Fulton capability and to publicize special operations. (Funding was tenuous for special operations as the Vietnam War wound down, and public relations events were deemed essential by TAC to spread the word about SOF.)

During the month of October, the 318th deployed one aircraft and crew plus a support package to RAF Sculthorpe, United Kingdom, and participated in field training exercise (FTX) Flintlock V. Flying in Europe was a new experience for most of the aircrew as they received some of the most realistic training of the year. November found squadron personnel deployed to Elmendorf AFB, Alaska, to brief the staff of the Alaskan Command on capabilities of the Combat Talon. A Fulton STARS demonstration was made during the visit. There were three other exercises that the squadron participated in during the fall, including Brave Shield III, Gobi Springs VIII, and Brass Key I.⁵⁹ The fall period was extremely busy with the squadron committed to numerous JCS exercises after a spring and summer that required much of the unit's effort be expended on training replacement crews for SEA.

As the year ended tragedy struck the squadron. On 5 December 1972, while on a continuation training mission near Conway, South Carolina, Combat Talon 64-0558 collided with an F-102 aircraft assigned to the South Carolina Air National Guard during airborne intercept training maneuvers. The F-102 impacted the Talon in the area of the right external fuel tank, resulting in the loss of both aircraft and all souls on board.*⁶⁰

The crash of Combat Talon 64-0558 marked the loss of the third aircraft of the original 14 modified in 1965. The year 1973, however, would prove to be the largest growth period for Combat Talon since its inception even though aircraft 64-0558 was not replaced by another production aircraft. Project Heavy Chain ceased operations in 1973, and the four aircraft assigned to that program were transferred to Combat Talon. Aircraft assigned to Heavy Chain and subsequently transferred to Combat Talon included 62-1843 (originally 64-0506), 63-7785 (originally 64-0507), and two of the original 14 Combat Talons that had been transferred

*The 318th SOS Combat Talon crew lost in the accident included Capt Douglas S. Peterson, pilot; Lt Col Donald E. Martin, instructor pilot; 2d Lt Douglas L. Thierer, cadet pilot; Capt John R. Cole, navigator; Maj Keith L. Van Note, navigator; Capt Marshall J. Dickerson, EWO; Capt Louis R. Sert, instructor EWO; SSgt Billy M. Warr, flight engineer; TSgt Claude L. Abbott, flight engineer; TSgt Robert E. Doyle, instructor flight engineer; SSgt Gilmore A. Mikley Jr., radio operator; and A1C Gerald K. Faust, loadmaster.

to Heavy Chain in 1966—64-0564 and 64-0565.*⁶¹ At the close of 1972, however, the 318th SOS possessed only two Combat Talons—64-0559 and 64-0568.⁶²

1973: HSSLADS Capability Comes to Combat Talon

The New Year was a tough one for the 318th. The loss of aircraft 64-0558 and its crew was a severe blow to squadron morale. But there was little time to reflect on the loss as taskings mounted during the first three months of the year. The squadron was assigned aircraft 64-0562 to replace 64-0558 and had three possessed by the end of the quarter—64-0559, 64-0562, and 64-0568.⁶³ In addition to a heavy Air Force training load, the schoolhouse produced four pilots and two navigators for the 1115th Marine Air Support Squadron, US Marine Corps. The Marine crew was trained in all phases of Combat Talon operations, except the Fulton STARS capability. (The Air Force was the sole military service operating the Fulton system.) On 8 February one C-130E(CT) Combat Talon flew an employment training mission in support of the US Navy SEAL special operations forces. The mission consisted of the airdrop of eight SEALs into a designated water drop zone on Chesapeake Bay and marked the first such support for the squadron. The event opened a new chapter in joint-service operations between the 318th and US Navy SEALs that would become a permanent mission for Talon crews worldwide.⁶⁴

Also in February 1973, the 318th adopted a new squadron emblem in a ceremony at Pope AFB. The new emblem was unveiled by the squadron commander, Colonel Bagnani and the squadron operations officer, Colonel Hellier. The emblem was symbolic of the unit and the Air Force, with ultramarine blue and golden yellow used in the design. The primary feature of the new emblem was a stylized bird prominently positioned in the center of the patch. The upper two-thirds portion of the bird was black and the lower one-third was white, signifying the proportion of the flying mission spent during darkness and daylight. The lower white portion of the emblem depicted the general shape of a hook and represented the unit's unique Skyhook aerial recovery capability.⁶⁵ The new emblem was an immediate

success and served the 318th until it moved to Hurlburt Field, the following year. When the 8th SOS was established at Hurlburt Field and absorbed the 318th's aircraft, personnel, and equipment, the emblem was incorrectly adopted by the newly designated squadron. The emblem remained unchanged until the mid-1990s, when the CSAF directed a review of all unit emblems. As a result of the review, the 8th SOS (the second oldest continuously active squadron in the Air Force) was authorized to adopt a new emblem. The effort resulted in an official patch that resembled the original 318th Blackbird emblem.



USAF Photo

After squadron members submitted designs during a contest to create a new unit patch, the winning entry was unveiled during a squadron ceremony in February 1973.

The operation's tempo remained very high through the spring of 1973. In June the 318th was given its annual ORI, which was accompanied by a management effectiveness inspection. From 6 to 9 June all facets of operational readiness were evaluated by the TAC inspector general and his team. At the completion of the combined inspection, the squadron was awarded an overall satisfactory rating.⁶⁶

The most significant event for the 318th SOS for 1973 was the OT&E of the HSSLADS. The test began on 10 August 1973 and continued for the next two months, ending on 25 October. Lt Col Irl L. Franklin, who had recently returned from duty with the 7th SOS in Germany and

*Before MOD-70 aircraft 64-0564 and 64-0565 had the Skyhook radome removed and a standard C-130E round nose installed. Aircraft 64-0564 was lost in the Philippines in 1981, and hydraulic plumbing and electrical wiring for the Fulton recovery system were removed from aircraft 64-0565 during MOD-90.

assigned to the USAF Tactical Air Warfare Center at Eglin AFB, Florida, was the project director. The 318th project officer was Maj J. J. Clary. Project loadmasters assigned to validate rigging and air-drop procedures for the new system were CMSgt Jesse R. Goddard and TSgt Charles E. Glentz, both assigned to the TAWC at Eglin AFB along with Franklin. The HSSLADS test was conducted under TAC Project Order 73A-079T. The remainder of the aircrew and the test aircraft was sourced from the 318th SOS (see chap. 2 for test results).⁶⁷

As the HSSLADS test continued at Eglin AFB, the 318th continued its heavy exercise and formal school schedule. From 10 to 23 August, the squadron deployed one aircraft and support personnel to Alaska to participate in Exercise Ember Dawn V/Punch Bowl XIX. Squadron participation in the exercise was a follow-on to the briefings and demonstrations given by unit personnel the previous November at Elmendorf AFB. The primary objective of the deployment was to provide initial orientation and training for the Alaskan Command in the employment of the Combat Talon weapons system. Before this exercise the Alaskan Command had no experience with Combat Talon and had no knowledge of the proper employment of the weapons system during a contingency. The aircraft actually supported aggressor forces during the exercise, but its tactical application in a combat scenario was highlighted to the Alaskan Command staff. The deployment was the first in an annual series to Alaska.⁶⁸ One systemic problem identified during the Alaskan deployment was the need for a ground-based radio station to support aircraft operations. The Combat Talon had an extensive radio package on board and a highly trained airborne radio operator; yet, there was no way to communicate back to the controlling agency responsible for the mission. The aircraft could communicate with air traffic control facilities and to personnel on the drop zone but not back to its higher headquarters. In SEA Combat Spear maintained a small ground-based radio station at Nha Trang AB, but SOG was responsible for providing communications links during operational missions. Combat Spear aircraft usually operated from its home base; therefore, deployable communications equipment was rarely required. The 7th SOS, on the other hand, spent a large amount of its time deployed and was the pioneer in developing a deployable aircraft war reserve spares kit (WRSK) and a communications package for support while on the road. Because of

the Alaskan deployment, the 318th recommended that TAC commission a study to determine the feasibility of adding ground radio equipment to the mobility package for the squadron.⁶⁹

From 25 August to 23 September, the 318th deployed an aircrew to Flintlock VI and flew with the 7th SOS during the course of the exercise. As in the previous year, personnel were challenged with realistic mission scenarios that included the special operations mission planning process and a realistic near-wartime footing of participants.⁷⁰ To help offset the many flying requirements placed on the unit, on 27 August the 318th was assigned Combat Talon 64-0566 as a nonoperational training asset. The aircraft had been stationed in the Pacific Combat Spear unit after a brief stay with the 7th SOS in Europe. The assignment of aircraft 64-0566 increased the number of 318th Combat Talons to four, with one committed to the TAWC HSSLADS test through October.⁷¹

On 1 December 1973 Colonel Bagnani relinquished command of the 318th to Lt Col Peter K. Nikonovich.⁷² Colonel Nikonovich would have his hands full during 1974 with the move of his squadron from Pope AFB to Hurlburt Field, Florida. The HSSLADS test had been completed in October, and actions were under way to source materials needed to assemble the SEDS and associated HSSLADS equipment. The squadron was back to having four aircraft assigned, closing out the year with Combat Talons 64-0559, 64-0562, 64-0566, and 64-0568. The year 1973 had been a good one for the Pope-based Combat Knife unit after the loss of aircraft 64-0558 the previous year.



USAF Photo

Combat Talon aircraft on the Hurlburt Field ramp, circa 1973. Note the black and green camouflage paint that masks the aircraft identification numbers.

1974: The 8th SOS Is Established in Florida

January saw a continuation of 318th support to the SEALs, which had begun the previous year. FTX Snatch Block 74 was scheduled from 15 January to 15 February and consisted of three missions flown out of Pope AFB. The mission profile included on loading SEAL team platoons out of Langley AFB, Virginia, and air-dropping them into the Atlantic Ocean south of Moorehead City, North Carolina. The missions were plagued with delays due to severe weather and high seas off the eastern coast, and only one of the three scheduled missions went as planned. The one successful mission marked the first time a Combat Knife crew air-dropped a SEAL team into the open ocean followed by a team linkup with a US Navy support ship.⁷³ The exercise was similar to one accomplished by the 7th SOS off the coast of Greece the previous year.

The 318th participated in a second Alaskan Command exercise from 14 to 27 February named Ace Card VII/ Punch Card XX. One Combat Talon and crew, along with 24 support personnel, departed Pope AFB on 14 February and flew to McChord AFB, Washington, by way of Dyess AFB, Texas. After a minimum crew rest period at McChord AFB, the aircraft continued on to Eielson AFB, Alaska, where it remained for the exercise. Ace Card exercises were conducted during the coldest part of the winter to test participants' ability to operate in severe cold weather. Twenty-one Air Force units, three Army units, and one SEAL team participated along with Canadian and Norwegian forces. The Combat Talon flew resupply, Fulton STARS, and infiltration/exfiltration missions. The temperature was cold, with the average temperature during the deployment at -30 degrees Fahrenheit and with lows often dipping to -65 degrees. After flying 14 employment sorties, including two Fulton recoveries, personnel returned to Pope AFB on 27 February. The crew made a refueling stop at K. I. Sawyer AFB, Michigan, during the return trip.⁷⁴ In the after action report to TAC, Nikonovich again reiterated the need for a ground-based radio station. He envisioned an HF secure net that was compatible with other systems deployed worldwide. Nikonovich noted that Combat Spear in the Pacific and Combat Arrow in Europe already had the capability.⁷⁵

As mentioned earlier, the personnel and equipment of the 318th SOS relocated to Hurlburt

Field during the first half of 1974 and were assigned to the 8th SOS. As part of the relocation process, the squadron was renamed the 8th SOS. Nikonovich and his staff worked tirelessly to make the move a smooth one. On 1 March 1974 the 8th SOS (which was in a caretaker status) was officially reassigned from Thirteenth Air Force, Clark AB, Philippines, to the 1st SOW at Hurlburt Field, Florida, by Headquarters TAC Special Order GA-2, dated 22 January 1974 and amended by TAC Special Order GA-6, dated 8 March 1974. The unit was moved without equipment or personnel in accordance with PACAF Movement Order 2, dated 15 February 1974.⁷⁶

While preparing for its move, the 318th accomplished another first when it deployed a crew (sans aircraft) to the Pacific on 8 March to participate in Foal Eagle 74 in Korea. From 14 to 24 March the 318th crew flew six exercise missions and logged 17.9 hours in Combat Spear aircraft. A significant achievement for the 318th crew was its checkout in the Combat Spear aircraft, which was equipped with the more powerful Dash-15 engines.⁷⁷ All four Combat Spear aircraft, equipped with the larger engines and having no Fulton STARS capability, had been transferred from Project Heavy Chain to the 1st SOS the previous fall. Through the transfer, the 318th received aircraft 64-0567. The squadron was manned and equipped for only four operational aircraft, with Combat Talon 64-0566 remaining assigned to the 318th as a nonoperational fifth asset.

As April arrived preparations accelerated for the pending move to Florida. On 15 April an advance party from the 318th moved from Pope AFB to Hurlburt Field. The advance party was tasked with making preparations for the unit's move, which was to be completed by the end of June. On 8 May the first 318th load of nonmobility cargo was moved to Hurlburt Field, followed by a second load on 15 May. On 20 May one-half of the assigned squadron personnel moved to Hurlburt Field. From 22 to 29 May two additional loads of nonmobility cargo were moved. On 31 May, three of the 318th's Combat Talons were loaded at Pope AFB for an early morning departure to Florida the next day. On 1 June 1974 the three 318th aircraft flew to Hurlburt Field, where the squadron was officially inactivated. The aircraft and personnel became part of the 8th SOS on that date. On 3 June the two remaining Combat Talons still at Pope AFB flew five loads to Hurlburt Field,

making multiple sorties to accomplish the task in one day. On 4 and 5 June three TAC C-130 aircraft moved multiple loads from Pope AFB to Hurlburt Field, and on 6 June the last load was moved by a unit-assigned Combat Talon. The unit move was officially complete with the 318th SOS deactivated and the 8th SOS operational as part of the 1st SOW.⁷⁸ The five aircraft transferred and assigned to the 8th SOS in June of 1974 were 64-0559, 64-0562, 64-0566, 64-0567, and 64-0568.

The squadron would operate its Combat Talons out of Hurlburt Field for the next 25 years. In addition to fulfilling its operational commitments in the Pacific, Europe, and South America, the 8th SOS would staff the formal Combat Talon School as had its predecessor at Pope. Many victories, and some failures, would be realized by the squadron. In the summer of 1974, however, as everyone settled into assigned facilities at Hurlburt Field, life was good in the Florida Panhandle.

Notes

1. History, 464th TAC, 1 January–30 June 1966, USAF HRA, Maxwell AFB, Ala., 24–25.
2. *Ibid.*, 25.
3. Technical Report, *List of Persons Picked Up by the Fulton Skyhook Aerial Recovery System*, Robert Fulton personal file number 11AA, Newtown, Conn.
4. History, 464th TAC, 1 July–31 December 1966, 26.
5. *Ibid.*, 22.
6. History, 464th TAC, 1 January–30 June 1967, document 11.
7. History, 464th TAC, 1 July–31 December 1967, attach. C.
8. AFTO Form 95, aircraft 64-0571 record, Combat Talon Archive, HQ AFSOC/HO, Hurlburt Field, Fla.
9. History, 1st Special Operations Wing (TAC), 1 July–31 December 1968, USAF HRA, Maxwell AFB, Ala., vol. 1, supporting document 14.
10. *Ibid.*, 1.
11. *Ibid.*, 2–3.
12. *Ibid.*, 10–11.
13. *Ibid.*, 11.
14. *Ibid.*
15. *Ibid.*, 6.
16. “Plane Makes Emergency Landing Here,” *Hickory Daily Record*, 17 January 1969, Combat Talon Archive, HQ AFSOC/HO, Hurlburt Field, Fla.
17. John R. Lewis to Walt Sonksen, letter, subject: Trip Report to Pope AFB, N.C., 5 February 1969, Combat Talon Archive, HQ AFSOC/HO, Hurlburt Field, Fla.
18. History, Detachment 2, 1st Special Operations Wing (TAC), 1 January–30 June 1969, 16th Special Operations Wing historian files, Hurlburt Field, Fla., 9.
19. *Ibid.*, document 1, 1–2.
20. *Ibid.*, 2–3.
21. *Ibid.*, 11.
22. *Ibid.*, 2.
23. History, Detachment 2, 1st Special Operations Wing (TAC), 1 July–31 December 1969, 3.
24. *Ibid.*
25. *Ibid.*, 4.
26. *Ibid.*, 18.
27. *Ibid.*
28. History, 1st Special Operations Wing (TAC), 1 January–31 March 1970, 63.
29. History, 1st Special Operations Wing (TAC), 1 April–30 June 1970, 67.
30. History, 1st Special Operations Wing (TAC), 1 January–31 March 1970, 65.
31. *Ibid.*, 66.
32. History, 1st Special Operations Wing (TAC), 1 April–30 June 1970, pt. 2, chap. 5, 5.
33. *Ibid.*, pt. 2, chap. 4, 5.
34. *Ibid.*, pt. 2, chap. 6, 8.
35. History, 1st Special Operations Wing (TAC), 1 July–30 September 1970, 58.
36. History, 1st Special Operations Wing (TAC), 1 October–31 December 1970, 42.
37. History, 1st Special Operations Wing (TAC), 1 January–31 March 1971, vol. 2, 7.
38. History, 1st Special Operations Wing (TAC), 1 April–30 June 1971, vol. 1, 42.
39. History, 1st Special Operations Wing (TAC), 1 July–30 September 1971, vol. 1, 38.
40. *Ibid.*, vol. 2, attach. 2, 1.
41. *Ibid.*
42. *Ibid.*
43. *Ibid.*, 2.
44. *Ibid.*
45. *Ibid.*
46. History, 1st Special Operations Wing (TAC), 1 October–31 December 1971, vol. 2, supporting document 17.
47. *Ibid.*, supporting document 16, 7.
48. History, 1st Special Operations Wing (TAC), 1 January–31 March 1972, vol. 1, 63.
49. History, 1st Special Operations Wing (TAC), 1 October–31 December 1971, vol. 2, supporting document 16, 7.
50. John Gargus, “Summary of 318th SOS’s Experiences with the MOD-70 Aircraft,” Combat Talon Archive, HQ AFSOC/HO, Hurlburt Field, Fla.
51. *Ibid.*
52. *Ibid.*
53. History, 1st Special Operations Wing (TAC), 1 October–31 December 1971, vol. 2, supporting document 16, 3, 7.
54. History, 1st Special Operations Wing (TAC), 1 January–31 March 1972, vol. 1.
55. History, 1st Special Operations Wing (TAC), 1 April–30 June 1972, vol. 1, 65.
56. *Ibid.*, vol. 2, supporting document 17, 3.
57. History, 1st Special Operations Wing (TAC), 1 January–31 March 1972, vol. 1, 66.
58. History, 1st Special Operations Wing (TAC), 1 July–30 September 1972, vol. 1, supporting document 48, xviii–xx.
59. History, 1st Special Operations Wing (TAC), 1 October–31 December 1972, vol. 2, supporting document 47, 7.
60. *Ibid.*, vol. 1, 30.
61. John R. Lewis, “Program Family Tree,” Combat Talon Archive, HQ AFSOC/HO, Hurlburt Field, Fla.
62. History, 1st Special Operations Wing (TAC), 1 October–31 December 1972, vol. 2, supporting document 47, 3.
63. History, 1st Special Operations Wing (TAC), 1 January–31 March 1973, vol. 2, attach. 1, 2.

64. *Ibid.*, vol. 1, 29.
65. History, 1st Special Operations Wing (TAC), 1 April–30 June 1973, vol. 1, 42.
66. *Ibid.*, vol. 2, supporting document 48.
67. Technical Report, High-Speed Low-Level Aerial Delivery System (HSSLADS) OT&E Final Report, March 1974, prepared by Irl L. Franklin, Combat Talon Archive, HQ AFSOC/HO, Hurlburt Field, Fla., iii.
68. History, 1st Special Operations Wing (TAC), 1 July–30 September 1973, vol. 1, 46.
69. History, 1st Special Operations Wing (TAC), 1 July–30 September 1973, vol. 2, supporting document 16, 2.
70. History, 1st Special Operations Wing (TAC), 1 July–30 September 1973, vol. 1, xvi.
71. *Ibid.*, 45.
72. History, 1st Special Operations Wing (TAC), 1 October–31 December 1973, vol. 1, 40.
73. History, 1st Special Operations Wing (TAC), 1 January–31 March 1974, supporting document 18, 1.
74. *Ibid.*, 25–26.
75. *Ibid.*, supporting document 14.
76. *Ibid.*, 8.
77. *Ibid.*, 27.
78. History, 1st Special Operations Wing (TAC), 1 April–30 June 1974, supporting document 35, 16.

THIS PAGE INTENTIONALLY LEFT BLANK

Chapter 4

Combat Spear (The Vietnam War Years: 1966–74)

*Cannon to right of them,
Cannon to left of them,
Cannon behind them
Volleyed and thundered;
Stormed at with shot and shell,
While horse and hero fell,
They that had fought so well
Came through the jaws of Death,
Back from the mouth of Hell,
All that was left of them,
Left of six hundred.*

—Alfred Lord Tennyson
The Charge of the Light Brigade

Stray Goose Deploys to Vietnam

By the summer of 1966, four aircraft and six aircrews, along with associated maintenance and support personnel, were ready for deployment to SEA under the code name Combat Spear (Pacific-based, PACOM-assigned). Remaining Combat Talons were designated Combat Arrow (European-based European command [EUCOM]-assigned) and Combat Knife (US-based, TAC-assigned). Special Order G-225, dated 22 July 1966, established Detachment 1, Headquarters 314th Troop Carrier Wing, at Ching Chang Kuang AB, Taiwan, effective 1 September 1966. Aircraft and crews arrived at CCK on 12 September 1966 and began operations.¹

The final beddown location of Detachment 1 was Nha Trang AB, Republic of Vietnam, but due

to nonavailability of facilities there in September 1966, further forward deployment of the unit was delayed. The 14th Air Commando Wing (later the 14th Special Operations Wing) was located at Nha Trang AB and served as the host wing for the deployed Combat Talon aircraft. The wing had neither ramp space for the aircraft nor billeting space for personnel due to other programs tentatively scheduled for the base. The original deployment schedule called for two aircraft and associated support personnel to be in place at Nha Trang AB by 15 September; however, only a small number of personnel were at Nha Trang AB by that date.² Throughout the fall of 1966, Seventh



Photo courtesy of Gerald R. Paulsen

Col Don Britton, first commander of Stray Goose Detachment 1, 314th TCW, in the cockpit of a Combat Spear aircraft.



Photo courtesy of Gerald R. Paulsen

When Combat Spear deployed to Nha Trang AB in the fall of 1966, there were no aircraft revetments on the ramp to protect the aircraft. A year later, one aircraft would be lost and another seriously damaged during a mortar attack on the base. SSgt Gerald R. Paulsen is in front of a Combat Talon, Nha Trang AB, 1966.

AF, the numbered air force designated to provide support to the Combat Spear unit, prioritized basing options at Nha Trang AB, and by the end of the year, Detachment 1, 314th TCW was settled and in full operation.

The chain of command was not explained to squadron members until after they arrived in-theater. In fact, command lines were never formally laid out for all squadron members, but senior leadership in the unit was briefed. Operational control of the unit was exercised by Military Assistance Command, Vietnam, Studies and Observation Group (MACVSOG, or more commonly shortened to SOG), located in Saigon. Administrative command (ADCOM) was originally exercised through the 314th TCW to Seventh AF, but by 1967 it had been transferred from the 314th to the 14th Air Commando Wing (ACW). PACAF was the Major Command (MAJCOM) to which Seventh AF reported,

and PACOM was the Unified Command responsible for the Pacific theater. OPCON of the Combat Talons meant that Studies and Observation Group (a joint headquarters commanded by a US Army colonel) had mission-tasking authority over the unit, but all support requirements were the responsibility of Seventh AF. From the beginning distrust and misunderstandings arose between Seventh AF and SOG over who “owned” the Talons. The flying unit was often at odds with both headquarters. The basic concern of Seventh AF was the proper utilization (as defined by Seventh AF) of critical Air Force assets. It was not until the summer of 1969 that the issue came to the forefront. From 1966 until the stand-down of SOG in 1972, however, the Combat Talons operated under less-than-ideal conditions due to this misunderstood chain of command.

When the unit moved to Nha Trang AB from CCK in the fall of 1966, commanding officers were allowed to live downtown in government-funded



USAF Photo

From the time of its initial deployment to SEA in 1966 until it relocated to Kadena AB, Okinawa, in 1972, Combat Spear operated under operational control of SOG. Combat Talon and Heavy Hook provided fixed-wing support, while the 20th SOS provided rotary-wing lift. Pictured is the official patch of MACVSOG.



Photo courtesy of Harold E. Tuttle

The Anh Hoa Hotel was leased by Stray Goose-assigned officers in downtown Nha Trang City and served as the unit’s bachelor officers quarters (BOQ) until September 1969.



Photo courtesy of George Powell

Exterior view of the enlisted quarters on Nha Trang AB.

quarters and were provided their own transportation. Colonel Britton was authorized a 1958 Chevrolet four-door sedan. Stray Goose officers were also allowed to live downtown at their own expense and were provided an open-air World War II-era command pickup, which became the responsibility of the copilot of crew SG-01. The Anh Hoa Hotel, located in downtown Nha Trang City, was leased by the Stray Goose officers and became an unofficial bachelor officer's quarters. With heavy maintenance done at CCK, personnel were frequently given the opportunity to travel back and forth and acquire items in short supply in Vietnam, including soap, fans, bicycles, motorcycles, and water heaters. Additional duties were assigned at the Anh Hoa Hotel to keep it running smoothly—mess officer, club manager, and hotel manager were key duties that required many hours of additional commitment. Within six months the facility was the envy of everyone and was the only one of its type in SEA. Enlisted personnel were required to live in the barracks on Nha Trang AB, but they too set about improving their quarters, as did the officers.³

With its own transportation assigned, Detachment 1 personnel handled their transportation needs internally both on and off base. As a result, the unit was able to isolate itself from the rest of the base population, which was important due to the sensitive nature of its SOG mission. Although the host wing performed some maintenance functions, heavy maintenance was done in Taiwan. Approximately every six weeks, an aircrew would take a Talon to CCK and remain there for three to four days while the scheduled maintenance was being accomplished.⁴

Two major problems associated with Detachment 1 during this period were training deficiencies for the aircrews and lack of test equipment and spare parts for unique electronic gear on the aircraft. Accelerated training was performed during November and December in Taiwan and in the Philippines to correct training deficiencies. (It took most of September and all of October for the unit to set up routes and begin quality low-level training.) Electronic equipment repair continued to be a problem during the early Talon deployment to SEA because of the long lead time from the supplier to the field and because of limited spares.⁵

During a pilot proficiency sortie flown out of CCK on 24 September 1966, aircraft 64-0561 experienced a potentially catastrophic main landing-gear malfunction. Maj Albert P. Blosch was giving



USAF Photo

Aircraft 64-0561 with left main landing gear hanging from the aircraft. The aircraft was flown from CCK AB, Taiwan, to Kadena AB, Japan, where Lt Col Albert P. Blosch made a perfect landing on the foamed runway.

Capt Samuel R. Rose an instructor upgrade ride when the malfunction occurred. The crew had completed 36 touch-and-go landings when the control tower called advising them that the left main landing gear was hanging below the aircraft. A similar malfunction on a slick C-130 had resulted in aircraft destruction and loss of the crew while landing at Ton Son Nut AB in Vietnam. Recognizing the severity of the situation, Blosch requested foam be laid down on the runway. Due to a previous C-130 crash at Ton Son Nut, the aircraft was diverted to Kadena AB, Japan, where foam was available, and the political repercussions of an aircraft crash was less than in Taiwan. It was 1600 local time when the malfunction occurred at CCK; therefore, a night landing at Kadena AB was required. Blosch was a highly experienced C-130 aircraft commander, having logged more than 2,000 flying hours in the C-130 aircraft and 1,500 hours in civilian crop-duster/sprayer-type airplanes. He had also completed a previous combat tour in Vietnam before being assigned to Combat Talon. He was the right man to have at the controls of the Combat Talon during the emergency.

Blosch requested 5,000 feet of foam be laid on the diagonal runway at Kadena AB. The flying safety officer at Kadena AB demanded that for security reasons all airfield lights be extinguished until after the emergency. There were thunderstorms moving into the Kadena AB area, thus allowing time for only 4,500 feet of foam to be laid. With the airfield in total darkness, the Combat Talon crew had to locate the approach end of the runway by utilizing the lights of a "follow-me" jeep that was positioned with its headlights at the beginning of the runway. Blosch shot the approach so that the predominant crosswind came

from the aircraft's right, thus requiring a right-wing low approach. With the right-wing low approach compensating for the crosswind, the left main gear was held off the runway until the last moment as the airspeed decreased. Once on the runway, Blosch used inboard differential power and nose-wheel steering to maintain aircraft control, and he directed shutdown of the outboard engines as the aircraft slowed to prevent contact of the number one propeller with the runway if the aircraft settled on its left side. As the aircraft slowed, the left main gear seated itself under the fuselage of the aircraft, and the aircraft came to a stop in a wings-level position. The landing used every foot of available foam, with the nose gear ending up on the runway and the main gear resting in the foam. The aircraft suffered only minor damage requiring minimal costs to repair. After a wash job and on-scene repairs, the Talon was flown back to CCK. Due to security considerations, Colonel Britton determined that he could not submit the crew for any formal recognition, and the landing itself was recorded as a normal landing. Maintenance did determine the cause of the malfunction, and action was taken to rectify the problem fleetwide.⁶

As Detachment 1 refined its war-fighting skills in Taiwan and in the Philippines, SOG air operations continued to expand. First Flight Detachment, also located at Nha Trang AB with its C-123 Heavy Hook aircraft, flew infiltration and resupply missions into North Vietnam. With combat missions over North Vietnam being flown by 1st Flight, the immediate concern of SOG planners when Combat Talon arrived in country was the tremendous logistics backlog of SOG equipment throughout Vietnam. The greater load carrying capability of the C-130 aircraft made it the aircraft of choice over the C-123 to reduce this backlog. An SOG officer related the situation in the following interview:

There was a tremendous backlog of logistic supplies to be moved. Most of the cargo could be airlifted by 7AF outfits. However, because of the classification of some of the cargo, it was very difficult to have the [logistics] people at that point in time to make a complete switch into the 7AF system. As a result, MACSOG hauled tremendous tonnage with MACSOG available aircraft. . . . (After) the C-130s arrived and helped reduce the backlog, we were able to identify cargo that was to be handled strictly by 7AF. However, all special cargo continued to be handled with C-123 and C-130 SOG aircraft (and a civilian C-45 and C-47 on contract).⁷

The first logistics support mission was flown in support of Shining Brass by Combat Talon aircraft



Photo courtesy of Richard H. Sell

Combat Spear and Heavy Hook aircraft moved SOG supplies throughout South Vietnam supporting joint requirements. Here, aircraft 64-0561 unloads supplies at Hue-Phu Bai.



Photo courtesy of Obie Hill

Combat Spear aircraft delivering supplies destined for the Central Highlands, Ban Me Thuot AB, Vietnam.

of Detachment 1 on 20 October 1966; the first PSYOPS leaflet-drop mission was flown on 3 November; and the first OPLAN 34A resupply and agent delivery mission was flown on Christmas Day 1966.⁸ (Project Shining Brass was the forerunner of Project Fire, which involved the infiltration and resupply of a specially recruited force of Nungs into Laos.) The UW-modified C-123 aircraft of 1st Flight was the primary workhorse for SOG air operations during 1966, although Combat Talon and high-performance aircraft, such as the F-4 and the A-1, were used to support both airborne and psychological operations. Heavy Hook aircraft, along with the contract C-45 and C-47, transported 4,891,228 pounds of cargo and 13,893 passengers during the year.⁹

Because of the security classification of each mission, Talon aircrews knew little information outside the mission itself. A typical in-country mission was flown in support of SOG moving

Hãy đòi hỏi ĐẢNG
một đời sống cơm no áo ấm
trước khi đi bỏ phiếu .



Yêu cầu đồng bào phổ biến truyền đơn này trên toàn cõi Việt-Nam.

THÔNG CÁO CỦA CHÍNH PHỦ



Để kịp thời phá tan những âm mưu của bọn phản cách mạng đang lan rộng trong nước, Hồ Chủ Tịch đã kêu gọi toàn quân, toàn dân đề cao cảnh giác, qua bài nói của Người tại Đại hội thi đua của Lực lượng công an nhân dân.

Bọn phản cách mạng này tự xưng là Phong trào Gươm Thiếng Ái Quốc đang ra sức kích động tinh thần chống đối Đảng và Chính phủ để làm cho nhân dân nản lòng trong công cuộc sản xuất và xây dựng xã hội chủ nghĩa của ta. Chúng thường đem những lời đường mật để khuyến khích đồng bào lấy lương

thực và dụng cụ của hợp tác xã, xui giục một số cán bộ rời bỏ hàng ngũ Đảng và hứa hẹn hảo huyền một đời sống hoà bình và thịnh vượng. Ngoài ra chúng còn tiếp tay cho những toán phá hoại ngấm ngầm các cơ sở Đảng. Hàng ngày chúng dùng đài phát thanh lưu động, gọi là Đài Gươm Thiếng Ái Quốc để tung ra những tin tức xuyên tạc và lời tố cáo bịa đặt chống lại Đảng và Chính phủ. Giờ phát thanh của chúng thường vào lúc 2g trưa, trên sóng điện 7216 ki-lô xích, tức là 41th57 và 9430 ki-lô xích tức là 31th81. Chúng còn tung ra rất nhiều đài, hy vọng rằng nhân dân ta sẽ nghe theo lời bịp bợm của chúng mà tạo nên phong trào đấu tranh phản cách mạng khắp mọi nơi.

Vậy để ngăn chặn và trừng trị kịp thời những hành động nguy hiểm của chúng, tất cả các cấp ủy Đảng, các cấp chính quyền, công an nhân dân địa phương từ nay phải tăng cường quản lý nắm tình hình, đề cao cảnh giác nhân dân và tuyệt đối cấm không ai được phép nghe những buổi phát thanh của bọn phản cách mạng Gươm Thiếng Ái Quốc.

Leaflets courtesy of M. O. Bechel

Leaflets were produced by US Army PSYOPS personnel and were provided to Combat Spear crews for delivery into North Vietnam. These leaflets were dropped during the 1966-67 period.

cargo and personnel from one location to another. Cargo was manifested by code word, and crew members did not always know what they were airlifting. Emphasis was placed on proper cargo manifesting, including weights and cubes. Most Special Forces camps that Combat Talon supported were serviced by austere dirt strips, thus demanding a high degree of proficiency by the aircrew for short-field landings.¹⁰

The 11-man Combat Talon crew formed the baseline for crew manning for tasked missions. Crew members would be added or deleted, depending on the mission being flown. For in-country logistics support missions, usually two pilots and one navigator would fly, along with one flight engineer, the radio operator, and two loadmasters, for a total of seven. For PSYOPS/leaflet-drop combat missions, additional Army or Air Force personnel would sometimes fly as kickers (in WWII they were called dispatchers) and would assist in deploying leaflets from the ramp of the aircraft. A crew could expect to fly just over 400 hours during a 12-month tour in SEA.¹¹

All cross-border missions flown in Laos, North Vietnam, or the southwestern portion of South Vietnam were flown radio silent except for HF radio. The crew monitored a pre-established HF signal and would abort the mission at the direction of the controlling agency. The crew also would transmit short preplanned Morse code messages at critical phases of flight (i.e., penetration of hostile airspace, completion of airdrop, mission abort, in-flight emergency, etc.).¹²

A typical PSYOPS combat mission entailed dropping leaflets from an altitude of 18,000 to 30,000 feet. A Combat Talon aircraft would penetrate North Vietnam by way of low-altitude, terrain-following flight, at approximately 1,000 feet AGL. At a precomputed point on the low-level route, the aircrew would accelerate to maximum indicated airspeed with throttles at full power. The pilot would then raise the nose of the aircraft and perform a maximum effort climb to drop altitude. The aircraft would climb to the computed drop altitude or until the predeparture, computed wind vector was reached, whichever came first. The computed wind vector was sometimes found at an altitude below that planned for the drop. Wind vector was more important to a successful leaflet drop than the altitude from which the leaflet left the aircraft because drift of the leaflet determined where it would reach the ground. Once the drop was complete, the aircraft descended swiftly back into low-level



Photo courtesy of Richard H. Sell

Combat Spear C-130s were ideally suited for hauling large, heavy loads. A huge load of ammunition is offloaded from aircraft 64-0561 at Hue-Phu Bai in 1967.

terrain-following flight to minimize exposure to enemy threats. If a threat were encountered during the pop-up maneuver that had the potential to destroy the aircraft, the aircrew would execute an escape maneuver. The escape maneuver was performed by reducing power to flight idle on all four engines, retracting the flaps, closing the ramp and door if open, lowering the nose, and banking up to 60 degrees left or right. Maximum descent would occur at approximately 320 KIAS when descending from 20,000 feet. The critical part of the maximum effort descent was keeping the aircraft's relative position established with the ground. The navigator determined where the aircraft was positioned in relation to the terrain beneath the aircraft, and the pilot flying the aircraft would maneuver left and right up to the 60 degree limit of bank to break radar lock during the descent. The aircraft would descend to emergency safe altitude and, once cleared by the navigator, would descend further to minimum safe altitude (MSA), where the aircraft would then pick up its low-level route and descend to 1,000-foot terrain-following altitude on the preplanned escape route.¹³

Combat Spear versus Heavy Hook Capabilities

The C-123 was a proven combat veteran by 1965, whereas the C-130E was the newest transport aircraft in the Air Force inventory. There had never been a comparison of the two aircraft with emphasis on their UW capabilities. In 1965 MACV commissioned a comparative analysis of the two weapons systems in a study titled the "C-130E Sky Hook Study."

The study cited the following advantages of the Combat Talon C-130 over the Heavy Hook C-123:

1. Of the two aircraft, only the C-130 aircraft had the growth potential to meet future payload requirements. Using the 463L aerial delivery system (ADS), it could deliver three 12-foot platforms of 8,000 pounds each as opposed to approximately one for the C-123.
2. The C-130's higher altitude envelope considerably increased the psyop delivery capability. The longer periods of drift of psyops material permitted drop points in relatively undefended areas for targets in heavily defended areas, which were inaccessible to C-123 aircraft.
3. The C-130 was capable of significantly higher speed, decreasing the exposure time in hostile territory.
4. The C-130's radar and terrain avoidance equipment enabled a contour low-level profile rather than merely a low altitude mission capability. It could be operated in valleys out of line of sight of early warning (EW) radar and fire control systems. The C-130 had the capacity for expansion of ECM equipment to cope with the improving air defenses in North Vietnam. The C-123 had exhausted its stretch-out capability due to limited payload capacity.¹⁴

The Combat Talon's improved load capacity also enhanced combat missions over North Vietnam by eliminating the need to stage or refuel at Thai bases, as was the case for the C-123. Furthermore, several PSYOPS leaflet drops could be accomplished on one C-130 sortie, thus eliminating the need for multiple aircraft sorties to service the same target area. The Combat Talon could dispense approximately five million leaflets on one mission, whereas Heavy Hook could dispense only one-half that amount.¹⁵

Although a distinction of capabilities was made to justify acquisition of the C-130, the difference of capabilities between the C-123 and the C-130 was not normally a primary consideration in the selection of an aircraft to support a particular mission. An equitable allocation of flying hours to both the Combat Spear and Heavy Hook units by SOG, along with user preference, was more common criteria that determined aircraft selection. After the development of HALO insertion methods in 1967, however, the higher-altitude capabilities of the Combat Talon became a valid consideration in the selection of an aircraft to support a HALO mission.¹⁶

Heavy Hook and Combat Talon aircraft performed three principal types of missions: insertion and resupply/reinforcement of agent teams, delivery of PSYOPS material, and logistics airlift. To a lesser degree, these aircraft were also flown in support of aircrew proficiency and reconnaissance team training.¹⁷

Air Operations—1966

As 1966 came to a close, Combat Talon had settled into its Nha Trang AB facilities. The concentrated training program continued throughout the fall, and coupled with experience gained in tactical airlift of SOG assets, the new crews seasoned quickly. There were three team insertions and 28 reinforcement and resupply missions flown by the two weapons systems. Helicopters, high-performance aircraft, and the Combat Talon enhanced SOG's resupply capability, but an evaluation of the success of aerial delivery at the end of 1966 resulted in the development of new airborne concepts.¹⁸

As the air war over North Vietnam and SEA escalated throughout 1966, increasing numbers of Americans were falling into the hands of enemy forces or were being listed as missing in action (MIA). To assist in the recovery of these personnel, MACVJ-5, in coordination with Thirteenth AF, was tasked to establish an organization dedicated to the recovery of these downed personnel. Subsequently, on 17 September 1966, commander, US Military Assistance Command Vietnam (COMUSMACV) officially activated the Joint Personnel Recovery Center (JPRC) under the command of Col Harry "Heinie" Aderholt. The JPRC was also known as the recovery studies element and was placed within the SOG organizational structure.¹⁹

With the Fulton STARS modification, the Combat Talon became the most capable aircraft in SEA designed specifically for the JPRC mission. Although STARS saw limited operational employment during 1966 and subsequent years, it allowed Talon crews to become proficient in recovery operations. The capability allowed SOG to penetrate deep into North Vietnam well beyond the range of helicopters and to extract downed crew members. To maintain crew proficiency in this highly specialized capability, demonstration recoveries were made throughout South Vietnam, the Philippines, and Thailand. Although actual combat recoveries were planned, available records indicate that the system never was used in actual combat.²⁰

1967: Year of Living Dangerously

As 1967 began, Combat Talon had matured to a point whereby its aircrew could perform the full array of demanding missions tasked by SOG. Growing pains had been intense at Nha Trang AB, but with excellent billeting and good aircraft facilities, little stood in the way of a successful

year. By the close of 1967, however, Detachment 1 would have lost two of its four assigned Combat Talons, and 11 crew members would disappear over North Vietnam, not to be heard from for the next 25 years.

The First Combat Talon Resupply Mission into North Vietnam*

The first resupply mission flown in a C-130 aircraft over North Vietnam was tasked to Detachment 1, 314th TCW, for the night of 16 January 1967. Using the established unit rotation schedule for combat missions, crew SG-5, under the command of Maj Howard Reeve, was tasked to plan and fly the mission. An SOG OPLAN 34A road watch team had been inserted into North Vietnam four months earlier, and the team was running low on food and supplies. The team had been monitoring North Vietnamese forces moving down the Ho Chi Minh Trail towards South Vietnam.

After receiving its initial mission briefing, the crew began its mission planning by plotting all-known enemy threats along its ingress route. The low-level route was planned at 500 feet above the ground, with the drop itself set for 1,200 feet. The crew utilized the Doppler radar to provide course and ground speed and the Loran C for navigation. There was only one Loran C station in SEA in early 1967, and there were no means to get a cross-fix to determine the aircraft's exact location. Consequently, the crew relied heavily on map reading to maintain orientation with known landmarks on the ground.

To identify prominent terrain features, the crew was limited to a minimum of 50 percent moon illumination and 10 to 15 miles flight visibility. The weather forecast predicted marginal visibility for the primary mission night. Being the dry season, farmers across SEA were burning their fields, and the smoke remained suspended in the atmosphere without sufficient air currents to dissipate it. Other than the marginal en route visibility, everything else looked good for the mission. Knowing that they would have to rely almost exclusively on the Doppler radar to maintain course, the crew made the decision to fly the mission as planned on 16 January due to the need to resupply the team on the ground.

The drop zone was located 90 miles southwest of Hanoi, surrounded by dense jungles and situated behind a low ridgeline. The crew was given a time over target (TOT) of 0100 local, with a drop signal consisting of five lighted flare pots arranged in a cross. The drop zone would be lighted 30 seconds either side of the TOT.

For the mission the crew planned to depart Nha Trang AB (fig. 25) and climb to its en route altitude. The aircraft would fly north along the coast to Da Nang AB, then turn due west and fly over Laos until reaching Udorn Royal Thai Air Force Base (RTAFB), Thailand. At Udorn RTAFB the aircraft would fly an instrument approach to the airfield and then enter low level after executing a low approach. The Combat Talon would proceed north into Laos and continue low level until reaching the drop zone. The return leg basically retraced the route of flight back to Nha Trang AB.

On the night of 16 January, the crew launched in aircraft 64-0563 and flew the first half of the inbound route as planned. Visibility was marginal at best (just as forecasters had predicted), thus requiring the crew to rely on its Doppler radar as the primary means to maintain course. About halfway through the first half of the mission, the Doppler radar failed. Without a means to maintain course, the crew had no choice but to abort the mission. A disappointed crew reversed course and returned to Nha Trang AB. SOG subsequently slipped the mission 24 hours, and the crew entered crew rest for the mission the following night.

The night of 17 January 1967 was clear, with 15 miles of visibility and a bright moon. A weak cool front had moved through the area during the day and had cleared the smoke from the air. All systems on Combat Talon 64-0563 were working perfectly as the crew entered low level at Udorn RTAFB. As the crew flew across the Plain of Jars in northern Laos at 500-foot altitude, there were numerous AAA bursts above their altitude. Enemy forces on the ground were firing at the sound of the Combat Talon as the aircraft passed near their positions, but the gunners could not see the blacked-out aircraft in time to get an accurate shot. Two minutes before the drop, the crew slowed to 115 knots, opened the rear cargo ramp and door, and prepared the five-bundle load for airdrop.**

*The following account was extracted from an unpublished article titled "STRAY GOOSE: Memoirs of a C-130 Special Operations Pilot," dated 22 April 1999. The author of the article, Richard H. Sell, was one of the pilots assigned to crew SG-5. He also flew onboard the Combat Talon for the mission.

**A slowdown below 150 knots was required since the HSSLADS had not been developed at that time. Enemy response to the airdrop indicated that Hanoi could track the aircraft when it climbed to 1,200 feet and slowed to drop speed. Had the HSSLADS been available, the Combat Talon could have remained at 500 feet and dropped its resupply load at 250 knots, thus eliminating the dangerous exposure of the aircraft and crew to enemy fire.

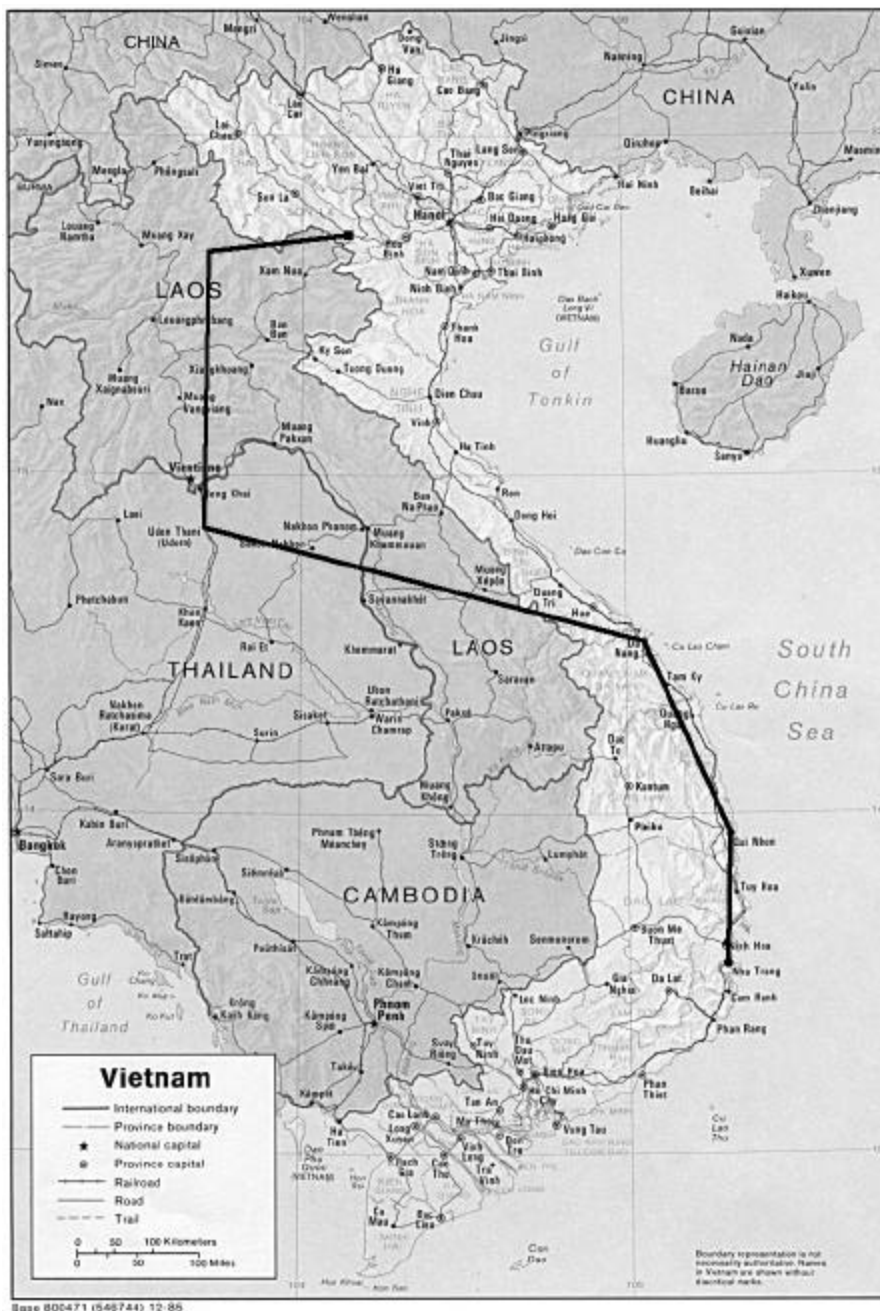


Figure 25. First Resupply Mission into North Vietnam, 17 January 1967 (Source: Map provided by Richard H. Sell, Miami, Fla.)

One minute out, the aircraft climbed to 1,200-foot altitude and stabilized on its preplanned run-in heading. At about 30 seconds from their TOT, the front-end crew acquired the lighted cross, and Major Reeve maneuvered the aircraft to properly align it with the marking. At green light, the load exited the aircraft and impacted the drop zone within 15 seconds of the planned TOT.

With the load clear, the left navigator called red light, and the aircraft began a left descending turn to reverse course and to escape the area. While

still descending and closing the ramp and door, the sky lit up with tracers and AAA bursts from 23 and 37 mm shells. After several seconds of chinking and dodging, the aircraft was safely egressing the area at 500 feet above the ground and headed to Nha Trang AB. After landing, the aircraft was inspected and no damage was found. The post-mission report from the team on the ground indicated that four of the five bundles landed in the middle of the drop zone, with the fifth bundle landing 100 meters to the left of centerline.



Photo courtesy of Richard H. Sell

Crew SG-5 that flew the 16 January 1967 resupply mission into North Vietnam. Back row, left to right: Capt Richard H. Sell, Capt M. O. Becnel, Capt Paul Lukavic, Maj Howard Reeve, SSgt Weldon Cameron, and SSgt Glenn Patton. First row, left to right: A1C Melvin Gibson, SSgt Harold Ferguson, Capt Dean Leverenz, and SSgt Gerald Paulsen. Not pictured is Capt James L. C. Smith.

Several days after the mission, the crew received a personal letter of congratulations from Gen William Westmoreland, COMUSMACV, commending them for their outstanding accomplishment. For the mission, the entire crew (six officers and five enlisted) of Stray Goose-5 was awarded the Distinguished Flying Cross by Special Order G-1467, dated 21 September 1967. The crew that flew the first Combat Talon resupply drop into North Vietnam on 17 January 1967 included Maj Howard Reeve, Capt Marion O. Becnel, Capt Dean A. Leverenz, Capt Paul Lukavic, Capt Richard H. Sell, Capt James L. C. Smith, SSgt Weldon G. Cameron, SSgt Harold W. Ferguson, SSgt Glenn L. Patton, SSgt Gerald R. Paulsen, and A1C Melvin B. D. Gibson.

Into the Tiger's Mouth

As new crews came into the unit in 1967, an organized checkout program was established to ensure thorough theater orientation. In-country checkout included an actual combat mission over North Vietnam. The pilot and navigator of a new crew would fly as auxiliary crew members on a combat mission. Their job was to look, listen, and ask questions during the post-mission briefing. The new crew flew as a hard crew, with substitutions made only for duty not including flying (DNIF) or when a crew member was unavailable due to rest and relaxation or previous commitments (aircraft delivery for inspect and repair as necessary [IRAN] in Taiwan,

for example). It was essential to fly as a hard crew in combat because the large Talon crew of 11 required their continual working together to reach its maximum capability.²¹

In the early months after deployment to Nha Trang AB, tasking flowed directly to Detachment 1 from SOG. Later organizational changes created the deputy commander for special operations within the 14th SOW, and this position served as the intermediate staff agent between SOG and the operational unit. Once a mission tasking (known as a fragmentary, or frag, order) was received at Nha Trang AB, the unit commander and his staff would break out the frag and assign a mission number and crew. Throughout 1967 and 1968, Talon crews would average one combat mission every five to seven days. Aircrews would be assigned against the mission on a rotational basis. When tasking for a new mission arrived, the next crew in line would be alerted, and the planning process would begin. An entire 11-man crew would fly the mission, unless someone was DNIF or otherwise not available. A minimum of 24 hours was required to plan a combat mission. If all vital information was not available at the beginning of the process, SOG would forward what was initially available and would then send additional data when received. The final flight plan was sent to SOG for approval once all planning was complete. All missions were approved by SOG and PACOM and by the National Command Authority by exception (dependent upon type of mission).²²

In addition to logistics missions within South Vietnam, Combat Talon flew in support of Army Special Forces teams scheduled for insertion into Laos. On these missions, the aircraft would pick up a team at Da Nang AB or Long Bien, then transport the team to Nakhon Phanom (NKP) RTAFB, Thailand. Once at NKP, the team would be covertly off-loaded into covered vehicles and taken to the Special Forces' compound nearby. The compound was run by Special Forces personnel—two officers and 13 enlisted personnel—on a permanently assigned basis. The teams were known as road watch teams and consisted of two Americans and from six to 10 indigenous personnel.²³ The special isolation facility provided the teams with support requirements until inserted by way of rotary-wing aircraft into Laos. On many occasions, Combat Talon would pick up a team that had been exfiltrated and was being moved back to South Vietnam. On these occasions, the aircrew was provided a rest area in the compound so that

proper crew rest could be maintained while awaiting arrival of the team from the field.²⁴

Combat Talon also flew in-country infiltration missions, where cargo and/or personnel would be air-dropped after flying a low-level route to the drop zone. Strict security was always maintained, with only the loadmasters actually seeing airlifted personnel. The procedure was used to protect both the team and the crew in case of shutdown and capture by the enemy.

When a crew was alerted for a combat mission, the unit navigator began the planning process by scheduling the next crew in line for a mission briefing. The navigator and the intelligence officer were the primary mission briefers. A typical combat mission included low- and high-level flight operations. The key to mission success was to avoid known enemy threats and to react appropriately to mobile or unplanned threats during the course of the mission. The aircraft was restricted to 1,000 feet AGL for night terrain following because of radar limitations but could fly as low as 250 feet AGL if the enemy threat warranted the lower altitude. Terrain masking at low level, avoiding known enemy threats, and flying during periods of darkness were the best defenses for the Talon. Navigation during low-level flight was accomplished by a combination of pilot/navigator map reading and by radar ground-mapping techniques. Each complemented the other and relied heavily on first identifying prominent terrain features, then locating the feature on available maps. The initial point (IP) was usually a prominent terrain feature (river bend, mountaintop, etc.) from which final coordinates could be verified and then updated in the drop computer. The IP to drop zone run-in was the most critical phase of the airdrop, since mission success depended on airdrop accuracy.²⁵

Before mission execution, a no-go point was established in the event of loss of navigation or communication capability. During the course of the mission, a communication link was maintained by way of HF radio with a site near Clark AB, Philippines. If a crew could not establish communication with Clark AB, or if they experienced navigational equipment failure before the no-go point, the mission would be aborted.²⁶

The same aircrew that planned the mission would fly it, with the exception of the unit staff navigator. In some instances, if a mission was postponed, a different crew could fly the mission, but this was rarely the case. Only the crew flying the mission, the operations officer, and the commander,

along with the staff navigator and intel officer responsible for planning assistance to the crew, knew the details of a particular mission. All missions over North Vietnam were classified Top Secret (TS), limited distribution (LIMDIS), with special category (SPECAT) access required to protect both the Talon crew and the personnel being infiltrated or resupplied.²⁷

The TS-LIMDIS-SPECAT classification created unique problems for mission deconfliction through friendly airspace. Many times, lower-echelon operators were not informed when a Talon transitioned through their airspace, resulting in inadvertent tracking by friendly radar. Deconfliction was especially difficult with naval assets off the coast of North Vietnam. Invariably, on those missions requiring coastal penetration into North Vietnam, the Talon was detected by friendly ships in the Gulf of Tonkin. Radar operators on board these ships routinely were not notified of Talon operations in their area. There never was a recorded incident where a Talon was fired upon by friendly forces, but many nights were spent by the aircrew worrying about the possibility of fratricide.²⁸

In May 1967, under the code name Daniel Boone, limited ground reconnaissance operations in Cambodia were approved by JCS, with the use of rotary-wing aircraft for emergency extractions only. Later revised operating procedures allowed for rotary-wing insertion and exfiltration and the use of forward air control (FAC) aircraft to visually recon an insertion/extraction area. The program was renamed Salem House in 1969.²⁹ (By 1970 Combat Talon was flying Salem House resupply missions into Cambodia in support of the Special Forces teams employed there.)

May also marked the first actual combat recovery attempt using the Fulton STARS. The mission



Photo courtesy of Gerald. R. Paulsen

Combat Spear transloading an SOG team to a waiting Air America C-7 Caribou, Nakhom Phanom, Thailand, 1966.

involved the recovery of two downed crew members located deep inside North Vietnam. Operation Gambler, the code name for the recovery operation, began on 21 May 1967, when F-4 aircraft dropped recovery kits near the two downed airmen. Unfortunately, the recovery kits landed some distance from the survivors and North Vietnamese security elements recovered the packages, thus forcing the Combat Talon aircraft to abort its pick-up mission. Because of this attempt, SOG expressed the following limitations of the Fulton system.

The Fulton Recovery System [STARS] has proven to be of doubtful use in the recovery of aircrews downed in hostile environments. If SAR forces are unable to recover downed airmen due to the presence of hostile troops, automatic weapons, anti-aircraft artillery, etc., it is extremely unlikely that the use of the Fulton system will succeed where others failed. The drop of a Fulton kit to a downed aircrew may give away their position, and the amount of time required to retrieve and activate the kit gives hostile forces ample time to locate and capture the aircrew, or prepare an ambush for the Combat Talon C-130 making the pickup.³⁰

The Combat Spear unit continued to maintain its high level of proficiency in the STARS, but without support from SOG, there was little chance that the system would be used operationally.

On 1 August 1967 Detachment 1, 314th Troop Carrier Wing, changed to Detachment 1, 314th Tactical Airlift Wing, when its parent wing changed designation. The detachment's relationship with the 14th ACW did not change at that time. The 14th ACW continued to function as the host wing for Detachment 1, a tenant unit, and SOG continued to exercise OPCON of assigned Combat Spear assets.

Throughout 1967 Combat Spear and Heavy Hook aircraft flew PSYOPS/leaflet drops over North Vietnam in support of the Fact Sheet program. An average of 60 million leaflets each month was delivered to North Vietnam targets. In addition to Talon and Heavy Hook aircraft, F-4s also dropped leaflets over the North. Only 10 percent of all leaflets reached the Red River delta, however, an area that was considered by PSYOPS planners as the key target for a successful PSYOPS campaign. An expanded PSYOPS program, code-named Frantic Goat, was proposed to Lt Gen William M. Momyer, Seventh AF/CC, by his director of operations. The goal of the Frantic Goat program was to increase leaflet delivery to 100 million leaflets each month, with 60 million reaching targets in the Red River delta area. The new program permitted Combat Talon to operate

in North Vietnam to 20 degrees north latitude. Entry into North Vietnam was by way of the western border, and aircraft were restricted to no closer than 20 NM from the eastern coast. General Momyer expressed concern over Talon operations so close to the coast due to the threat located there, and in his 10 November 1967 approval of the program, he directed his staff to "feel our way into this area."³¹

The issue of command and control of AF assets committed to SOG operations continued to fester, and by late 1967 relations between SOG and Seventh AF were near the breaking point. Since 1965 the level of both special and conventional operations had risen dramatically throughout SEA. Increasing numbers and types of USAF aircraft supported SOG operations. Intense competition among different activities for a limited number of air assets became evident. The lack of defined coordination channels and responsibilities between Seventh AF and SOG led to distrust and a strained relationship between the two organizations.³² SOG was a joint unit, and its commander was a US Army Special Forces 06 (Col Richard Singlaub at the time Combat Spear deployed to SEA) who was extremely security conscious and objected to having to explain and justify to Seventh AF each individual aircraft support request. On the other hand, Seventh AF suspected that Combat Talon and 1st Flight aircraft assigned to support SOG were being misused and that proper Air Force supervision was not being provided for critical flight operations, including tactics, flying safety, and crew protection.³³

The rapid escalation of operations and competition for air resources was only part of the reasons for the Seventh AF-SOG rift. The extreme sensitivity of SOG activities added another complication. SOG's requests for air support to Seventh AF encountered difficulties because few Seventh AF personnel were SOG-briefed. From the Seventh AF standpoint, compartmentalization and secrecy created concern for the proper and efficient use of AF assets under the OPCON of SOG.³⁴

Although specific command and control procedures before 1968 were not documented in official correspondence, various interviews and official evaluations indicated where responsibilities rested and problems existed. A senior Marine officer assigned to SOG in 1966 and 1967 made the following statement:

Early in MACSOG's operations, the execution of air missions was controlled almost exclusively by MAC-SOG. Later we learned that our messages concerning air operations were not being disseminated to the

proper people. Moreover, some of our maritime operations were being interfered with by friendly aircraft. Finally, Seventh AF insisted on coordinating all flying activities, including those of MACSOG. This improved coordination and control of missions.³⁵

An AF officer assigned to SOG during the same period further related difficulties in command and control and specifically cited problems in the relationship between SOG and Seventh AF:

We had communications difficulties from our facility in Saigon in handling air operations, which originated from bases removed from the Saigon complex. Because of security requirements and the lack of hot line facilities, in many cases our hands were tied in coordinating air operations plans. This resulted in our recommendation to have an air operations command post, which would have hot line communications direct to air facilities and the base camps from which forces would launch. From an AF standpoint, command relations were rather tenuous for a while. [Complex] missions were laid on with very short notice. This caused us a great deal of anxiety in attempting to get support from Seventh AF. On many occasions, the Seventh AF frag for the next day's combat operations was already cut. Seventh AF would have to divert air assets from laid-on strikes. . . . As might be expected, Seventh AF was constantly badgering us for better advanced planning.³⁶

To rectify this unsatisfactory situation, a series of meetings were held between SOG and Seventh AF, and a memorandum of understanding (MOU) was signed on 26 October 1967. The MOU was signed by the chief of staff, Air Force (CSAF), Seventh AF, and the chief, SOG, and established the Office of Deputy Commander for Special Operations (DCSO) under the commander, 14th SOW. In SOG terminology, the DCSO was designated the commander, Air Studies Group (later changed to Air Operations Group). Nha Trang-based C-130E(I) Combat Talons and 1st Flight UWC-123 Heavy Hook aircraft were OPCON to the DCSO. In addition, the 20th SOS UH-1 gunships were under tactical control (TACON) to the DCSO for SOG special operations missions.³⁷ The underlying concept of this structure was to bring the unique operations performed by the three units under one authority.

As a result of this MOU, OPCON of Combat Talon and Heavy Hook flowed from SOG through the DCSO directly to the units themselves, effectively placing an intermediate organization between SOG and the unit commanders. Through the 14th SOW, the DCSO was also responsible for all administration and supervision of assigned personnel, including (1) flying safety, (2) adherence to AF regulations, directives, and policy, and (3) performance of such other functions normally associated with service responsibility. The DCSO

had two 04s (special operations staff officers) and one airman (administrative supervisor) to assist him in performing assigned duties, and he was rated by the 14th SOW commander. A letter of performance was provided by the SOG commanding officer for inclusion in the DCSO's evaluation report.³⁸ The first DCSO was Col David C. Collins, who was previously stationed at Headquarters Tactical Air Command, Langley AFB, Virginia.³⁹

25 November 1967—Loss of Aircraft 64-0563

In November 1967 the first loss of a Combat Talon aircraft occurred. Lt Col Thomas F. Hines was the squadron operations officer and had a policy of flying with all assigned crews at least on one combat mission over North Vietnam. On 25 November he was scheduled to fly a combat mission with one of his crews on aircraft 64-0563. He and the crew had arrived at the aircraft and had begun the preflight when he was notified by operations that the mission had been canceled. By this time the crew had completed the outside portion of the preflight and was preparing to start the cockpit checklist. Hines picked up his helmet and flight gear and departed the flight line in the vehicle that had brought the mission cancellation orders. He wanted to confirm that SOG had canceled the mission and tried to determine why. The remaining crew members, along with maintenance personnel, buttoned-up the aircraft and departed the flight-line area. Since this was the only mission scheduled that night, the flight line was deserted in just a few minutes. As Hines entered the operations center of 1st Flight Detachment



USAF Photo

Wreckage of aircraft 64-0563 after the mortar attack on Nha Trang AB, 25 November 1967. Note the absence of revetments in the parking area.

about a mile from where 64-0563 was parked, he heard an explosion and turned to see the glow of fire on the flight line from where he had just come. He hastily made his way back to discover that 64-0563 had taken a direct hit from an enemy mortar shell and was totally engulfed in flames. Had the mission gone as planned, the entire crew would have been in their seats with engines running. In addition, maintenance and launch personnel would have been around the aircraft in preparation for taxi. There was no doubt in Hine's mind that many lives would have been lost had the mission not been canceled.⁴⁰

Fire trucks had responded and were pouring foam on to the burning remains of the aircraft. There were three Talons parked nearby and all sustained damage, one seriously, from the exploding mortar shell. The most seriously damaged aircraft required a month to complete temporary repairs before being flown back to the United States for further work. In the haste to move another Talon parked beside 64-0563, personnel entered the aircraft and started all four engines without resetting the engine oil circuit breakers. The procedure for maintenance at the time was to pull the engine oil circuit breakers after post-flight inspections were complete. The circuit breakers were not reset before engine start, resulting in all four engines being destroyed by lack of oil during taxi.⁴¹ The heroic effort to move the aircraft, however, undoubtedly saved them from destruction.*

The potential loss of all four Combat Talons stationed at Nha Trang AB was a sobering thought. Future ramp improvements included revetments for the aircraft, but little could be done to guard against a direct hit. When the Tet offensive kicked off the following January, Combat Talon operations were temporarily moved to Taiwan, thus taking the aircraft out of harm's way. The loss of aircraft 64-0563 would prove to be the only combat loss due to ground fire in the history of the program.

29 December 1967—Loss of Aircraft 64-0547 and Crew S-01

Maj John Gargus was a navigator planner in Detachment 1 during the fall of 1967. In this capacity he was responsible for briefing aircrews and providing assistance to them during the mission planning process. On 25 December he was notified that a combination PSYOPS/resupply

combat mission had been tasked by SOG for launch on 28 December and was returning to Nha Trang AB early on the 29th. The mission was planned and launched without incident, and the first portion was flown as planned. After an operations normal HF-radio call at 0430L on 29 December 1967, not a trace was seen or heard of the aircraft or aircrew. The aircraft did not return to Nha Trang AB as scheduled. The loss of the aircraft would remain a mystery for the next 25 years. The following account of the alert, planning, and execution of the mission by Combat Talon Crew S-01, flying aircraft 64-0547, was provided by Col John Gargus, retired, USAF.

* * * * *

This is the story of Combat Talon C-130E(I), tail number 64-0547, which was lost with its 11 crew members on December 29, 1967, while conducting a SOG mission over North Vietnam. After many years of silence, Maj John Plaster authored a book, SOG—The Secret Wars of America's Commandos in Vietnam, in which he described exploits of commandos who lost their lives on missions that had not been brought to public attention for numerous security reasons. The loss of this aircraft fits into that mold. It was, according to Major Plaster, our largest single aircraft loss over North Vietnam. I hope that this story will honor the eleven lost crew members and acknowledge the role of all men who served in the Combat Talon unit, which was first named as Detachment 1 of the 314th Tactical Airlift Wing, then the 15th Air Commando Squadron/Special Operations Squadron and finally the 90th Special Operations Squadron.

At the time of this incident, Detachment 1, 314th TAW was based at Nha Trang Air Base, Republic of Vietnam, with six–eleven member crews and four MC-130E Combat Talon I aircraft. These aircraft were equipped with terrain-following radar, the Fulton Recovery System, and an array of passive electronic countermeasures. They were painted with special dark green paint, which significantly reduced their reflected radar energy, and because of their overall appearance, they were affectionately called the "Blackbirds." They provided Military Advisory Command Vietnam-Studies and Observations Group (MACVSOG, or more commonly abbreviated to SOG) with dedicated airlift during daytime and conducted highly classified, clandestine missions at night. These night missions were called "combat missions" even though

*A later modification prevented engine start if the engine's oil circuit breakers were out.

we never intended to engage in what would certainly be a one-sided battle with the enemy. The only arms we carried were our survival .38 caliber pistols. We relied on our low-level terrain-following capability, the element of surprise, and experienced airmanship to fly wherever tasked over North Vietnam.

Our "combat missions" were generated at SOG headquarters in Saigon. They ranged from quite ordinary to some bizarre air-drop operations. Thus, we would drop teams of infiltrators behind enemy lines and then resupply them periodically. At times we would drop specially rigged personnel parachutes without infiltrators and imaginatively assembled resupply loads to convince the enemy that we had teams operating in this or that area. Sometimes our air-dropped loads were rigged to fall apart in the air or be booby trapped for the NVA soldiers on the ground. There were also psychological operations consisting of high-altitude leaflet drops and low-altitude drops of pretuned radios or gift packages to fishermen in the Gulf of Tonkin. This was interesting and rewarding work. It made us feel that we were making a very significant contribution to the overall war effort by creating considerable confusion inside the enemy's own territory.

To be effective in our clandestine air operations, we had to maintain a very low profile and avoid shoptalk with airmen of other units. Our geographical separation from SOG headquarters in Saigon helped us in not being visibly tied to their operations. Only a few of us (key command officials and mission planners) were permitted to visit SOG headquarters. We were told only operational data for which we had a need to know. We understood the need for this arrangement and loyally carried out our role as dedicated airlifters for this important player in the war.

As we acquired more experience in performing our assigned tasks, we became aware that there were problems with some of the teams we supported in the North. We had to make some peculiar drops with very specific instructions and, at times, execute them under the supervision of tight-lipped SOG jumpmasters who were assigned to fly with us on some missions. This led us to believe that we were dealing with probable double agents and some questionable characters. As mission planners we did not share these concerns with our crews, but some details had to be disclosed when astonished loadmasters reported to the cockpit that our SOG jumpmasters halted the paradrop after the first man went out and that they made

the rest of the team sit down without offering any explanation. Then after landing, just as the aircraft came to a halt in its parking area, a van would appear, and the remaining jumpers would smartly pile into it without any comments to the crew. Events like that and cargo loads that were purposely rigged to foul up or break up upon hitting the air stream had to be explained to the crew involved.

Because the success of our missions depended on secrecy, we were naturally apprehensive about dealing with complete strangers who would not speak to us. In time, we learned that some of the teams were compromised and feared that our aircraft could become an easy target over a drop zone. In mission planning, we dreaded the possibility that one day we could be directed to recover a questionable agent or a package from North Vietnam using our Fulton Recovery System. We were known to the enemy for delivering booby-trapped resupply bundles. A recovery of an agent or a package would be an opportune time to return the favor and bring down a Blackbird.

There was also considerable internal secrecy in our work. Crews were not allowed to discuss their combat missions with other crews. Locations of drop zones and types of delivery payloads could not be shared with others. One could not be exposed to too many details of our clandestine operations. There was always a possibility of being forced down and captured behind enemy lines. For this reason, Major Thompson, a C-130 navigator, who was not a Combat-Talon-qualified crew member, was assigned to our unit as a mission planner. As such, he knew about the locations of infiltrated teams and about the type of airdrops we were conducting. He did not have a crew position and was not allowed to fly "combat missions." This arrangement lasted only for the duration of his one-year tour. It also gave me, Major John Gargus, navigator, and 1st Lt John Lewis, electronic warfare officer (EWO), both from the S-05 crew, the opportunity to succeed him when he rotated to his next duty station. By that time it didn't matter any more that two crew members from the same crew would become his replacements and continue flying combat missions. We began our on-the-job training by helping him to plan this fateful mission. Roy Thompson, who retired as a colonel, agreed to collaborate on putting this story together. Unfortunately his contribution was lost forever. He passed away on 25 July 1997 before he could join me and John Lewis in sharing his memories of almost 30 years ago.

The frag order for this fateful mission came from SOG on Christmas Day. Our whole detachment celebrated Christmas in the courtyard of Nha Trang's Roman Catholic Cathedral with Christian Boy and Girl Scouts and their parents. When we returned to our hotel after the festivities, Roy Thompson, the dedicated mission planner for the unit, came by to tell me that 1st Flight Detachment operations section had a classified message tasking us with our next combat mission. He wanted to know if I was interested in going with him to review it. I was eager to see what it was all about, so we hopped into our jeep and drove to the Vietnamese side of the base where we shared our secure mission planning and communications facilities with our sister unit. First Flight was another SOG air asset flying C-123s with some very interesting crew members. Their cargo specialists assembled all our air-drop packages, rigged all our parachutes, and even loaded the cargo for our combat missions. We were to trust their methods and procedures no matter how weird or foreign the resulting drop configurations looked to our loadmasters.

The frag order called for an unusual combat mission. It directed us to execute two airdrops deep inside North Vietnam. The first one was to be a high-altitude leaflet drop on an NNE heading just west of the Red River and the second one a low-level resupply drop on a southerly heading just west of the Black River. We positioned ourselves in front of a large-scale classified wall chart with numerous circles of various diameters and colors that depicted locations of known enemy defenses. We traced a probable inbound and outbound route with our fingers and concluded that the mission was a feasible one. The only possible threat to our aircraft would come during the leaflet drop when the Blackbird would be in proximity to the Yen Bai Air Base and its MiG interceptors or from any other Hanoi area base that had MiGs on night alert. Otherwise, everything else looked good. We would be able to lay out a flight path that would be clear of lethal ranges of all known surface-to-air missiles (SAM) and antiaircraft artillery (AAA).

With this accomplished, we returned to the Anh Hoa Hotel to brief our detachment commander, Lt Col Dow Rogers, and our operations officer, Lt Col Tom Hines, on the forthcoming combat mission. The mission was scheduled for the night of the 28th and early morning of the 29th of December.

At the Anh Hoa Hotel, things were in a festive mood. Maj Charlie Claxton, who had performed the role of Santa Claus, was now busy in the kitchen making sure that everything was on schedule for our big evening meal. We were hosting the American officers of 1st Flight and borrowed their gourmet cook to assist our own very capable Chinese kitchen staff. Capt Gerald Van Buren, our officers' open mess steward, had already done his job. He made sure that all needed kitchen supplies either were procured in the Saigon commissary or that they were obtained from his various contacts at special forces operating locations. We would trade with the special forces outposts on almost every visit to their remote sites. San Miguel beer, obtained on our visits to Taiwan or to the Philippines, was traded for crates of fresh vegetables grown in their neighboring montagnard villages. Charlie Claxton was aspiring to replace Gerald Van Buren as the mess steward when Gerald completed his one-year tour in Vietnam.

That evening we had what must have been the best feast of our Vietnam tour. We all complimented our kitchen staff, Charlie Claxton and Gerald Van Buren for their superb performance. Our rooftop bar activity that night was somewhat subdued. Most of us retreated to our rooms early to make audiotapes for our families. We all owed special thanks to our wives for making our Vietnamese Christmas as good as it could have been. All the sweets, toys, and clothing for the cathedral party and gift dispensing visits to several local orphanages were sent to us by our well-organized wives. They enlisted support of their local chambers of commerce for donations of clothing, candy, and gifts and arranged with the USAF for shipments of assembled goods by opportune C-130 airlift. We were proud of them for their contributions to this civic action effort. Sorting of donated clothing became a major undertaking, which took us several days to complete. We sized and sorted the clothing in the hot, unventilated upstairs storage rooms of our operations building. Sgt Jim Williams spent countless hours helping me in my capacity as the unit's civic action officer. He took charge in keeping the effort going when some other volunteers gave up because of uncomfortable heat and troublesome clothing lint and dust in our improvised Santa's workshop. Sergeant Williams recruited SSgt Ed Darcy to help until the clothing was finally sorted, boxed, and labeled for distribution. During the festivities in the cathedral courtyard, both of these young men displayed great enthusiasm in playing games with the scouts. We all had a great time.

Christmas spirit and joy overcame all language and age barriers.

Early the next morning Roy Thompson, John Lewis, and I settled down in our secure planning room where we drew out the route and prepared master charts for the crew that was going to fly the mission. Our master charts would be used the next day by the mission crew members who would study them and customize them for their personal use.

The entire flight would take about eight hours. It would follow our often-repeated, high-level route from Nha Trang AB to the skyline beacon in Laos. There the Blackbird would descend to a terrain-following altitude and fly a short, zigzagging route toward the first leaflet drop area. Then, after a "short look" (rapid climb to high altitude, quick drop, and rapid descent), the aircraft would resume terrain following through the low-level resupply drop and return to the skyline beacon. From that point the aircraft would continue back home at normal cruising altitude.

In planning our terrain-following routes, we always tried to stay away from populated areas, selecting prominent radar return targets for turning points and navigational instrument updates. A unique feature of our terrain-following flights was that we flew at controlled ground speeds rather than constant airspeeds. Our aircraft was equipped with the APN-115 terrain-following radar, which used the aircraft's speed over the ground in its computations for maintaining desired altitude above the ground. Typically, we flew at 500 feet above the ground during daytime and at 1,000 feet at night. Flights over uneven terrain required continuous throttle adjustments to maintain our standard 230-knot ground speed (265 miles per hour). The pilots had a Doppler ground speed indicator, which they monitored continuously. The pilot (left seat) had an APN-115 screen, which in one display mode traced the terrain directly ahead of the aircraft and in another (cross-scan mode) painted the terrain 20 degrees left and right of the projected ground track. The radar navigator had a third-mode option for map reading. This one gave him a 45 degree left and right view of the aircraft's projected track, but when the radar was in this mode, the terrain-following input used by the pilot was disabled. Flying in the pilot's left seat was very strenuous. For all practical purposes it was like flying a sustained instrument landing system (ILS) approach for hours at a time. Blackbird pilots had to fly the altitude director indicator's (ADI) pitch bar, which received commands based on radar

terrain returns and Doppler ground speed. They had to monitor their radar scope for visual terrain signals and manipulate engine throttles to maintain the desired ground speed. During daytime, well-placed cockpit windows allowed the pilot to verify approaching terrain, but on a dark night, this was impossible. One could not fix his eyes to the outside through the ever-present glare of the cockpit's amber lights and not lose focus on the instruments by which he had to fly. For that reason it became our standard practice to have the first pilot fly in the left seat and have the aircraft commander sit in the right. This was the only way he could command his 11-member crew. He could not take time away from the instruments to focus on even a routine in-flight problem.

Terrain following, combined with special navigational and flying techniques, would get us to where we needed to go, but our ultimate survivability over North Vietnam depended on the skills of our EWO. At that time, North Vietnam had the most formidable air defense system in the history of air warfare. It is true that their radars were not the state of the art, but they were effectively used by operators who had gained considerable skills with them. The same could be said about the AAA and SAM crews. Their tours of duty were not limited to one year like ours. They were at home defending their country against a sophisticated allied war machine for as long as their war lasted. So these Soviet-made radars, which were first introduced in Eastern Europe, were now being combat tested.

Our knowledge of the locations of these radars, combined with our low-level tactics, would get us into most target areas without detection. Once detected, however, it became the EWO's job to analyze the threats these radars posed. If all radars were in the locations we plotted on our charts, we would be able to fly through their scanning ranges and stay away from the effective ranges of missiles or artillery they controlled. During mission planning, the EWO would prepare a scenario that would tell him at which point of flight and from which direction each radar's scan would illuminate our aircraft. If he detected radar not plotted on his chart and the received signal strength was stronger, indicating a closer proximity to our flight track, he would have to direct the pilots to change course. By monitoring his state-of-the-art instruments, he could tell whether the enemy radars were in routine mode or were focused on his aircraft. In a concentrated radar signal area, such as our aircraft would enter upon its climb-to-drop altitude, the EWO would

receive welcomed assistance from the crew radio operator who shared his instrument console and sat on his left. All our radio operators became adept EWO assistants.

Blackbird EWOs also had the capability to detect and disrupt an attack by a MiG interceptor. Using passive electronic techniques, they could confuse a MiG long enough to enable their aircraft to escape into hilly terrain where the interceptor's radar was ineffective and the pursuing pilot risked flying into the ground.

In addition, Blackbird EWOs could dispense highly reflective chaff, which would instantly paint a brighter and larger target than the aircraft. With all that equipment and our special training, we had what we needed to conduct challenging, but safe, operations in the hostile skies of North Vietnam. No one expected a large, slow, and unarmed transport aircraft to operate in the same North Vietnamese air space that was so challenging to the most advanced high-performance aircraft in the US inventory.

Our success rate over the enemy territory was commendable. Many of our low-level missions through North Vietnamese air space went undetected. Some were tracked during portions of their flight, but always succeeded in avoiding AAA fire. A few had to abort their high-altitude leaflet drops when a missile-control radar locked onto them. They always managed to break their radar lock on during a rapid roller-coaster dive down to the minimum safe altitude. Fewer still experienced a MiG chase with an airborne radar lock on. Our EWOs always saved the night for us. Consequently, it didn't take long for a Blackbird crew to develop a due respect for the skills of its EWO.

Two months before, in mid-October, our S-05 crew's EWO, John Lewis, defeated three passes of an interceptor that jumped us just off the coast of NVN near the Haiphong harbor. We were dropping pretuned radios to the local fishermen. Pursued, we flew as low and as fast as we could, shaking and bouncing on the air currents our aircraft stirred off the otherwise calm sea. When John called "break left," we had to pop up a few feet to avoid dipping the left wing into the water. Our operations officer, Lt Col Tom Hines, flew with us that night. It was daylight when we landed at Nha Trang AB. The wings and the fuselage of our Blackbird were white with salt. John Lewis may still hold the Combat Talon record for besting a pursuing fighter pilot three times on a single "combat mission."

Our first problem on the 29 December mission would be the early warning radar at Na San. We had to stay as low and as far south of its range as possible to avoid detection while crossing into North Vietnam. Once inside North Vietnam, we had to get to the east side of the central mountains and stay out of range of well-placed AAA and SAM sites along the Red River valley. We tried to avoid getting picked up and tracked by the multitude of radar associated with those antiaircraft weapons. These radars by themselves could not hurt us but would alert AAA and SAM crews for possible action if we came within range of their weapons. Our best scenario was to have no radar track us until we began our rapid climb to 30,000+ feet for the leaflet drop. We knew that once our aircraft got to 9,000–10,000 feet, all available radar would come up and keep our EWO extremely busy. If the enemy did not respond with a launch of interceptors, the leaflet drop would be completed, and the aircraft would resume low-level terrain following and proceed westward just south of the China border along the 22d parallel until reaching the Black River valley. There a southbound turn would be made. Staying in the mountains along the west side of the river, the second airdrop would be executed NW of the Na San early warning radar (fig. 26).

Our avoidance of the Na San radar was not our concern at this point in the flight. By this time a warning would have been issued from the Hanoi side of the mountains that a leaflet dropping intruder was moving westward toward Dien Bien Phu. Consequently, this early warning radar would be scanning in a NW direction, expecting the emergence of our Blackbird. Na San's detection of our flight at this time could actually assist in the accomplishment of the second portion of our mission. Our resupply drop was what we called a "notional" drop, or a diversionary drop. There was no friendly team to receive the two resupply bundles. These bundles were carefully planned by imaginative minds at SOG to confuse the enemy and to have him expend considerable resources searching for infiltrators who did not exist. So the resupply bundles were meant to be captured by the enemy. Na San's detection of our aircraft's slowdown could assist the enemy in locating the bogus cargo.

By the time we finished with our planning, we learned that an augmented S-01 crew would fly the mission. It was S-01's turn to take the next mission, but there were some questions about the possibility of having this crew skip its turn. Maj Dick Day, S-01's aircraft commander, and one of the crew's loadmasters, were on duty not including flying. His

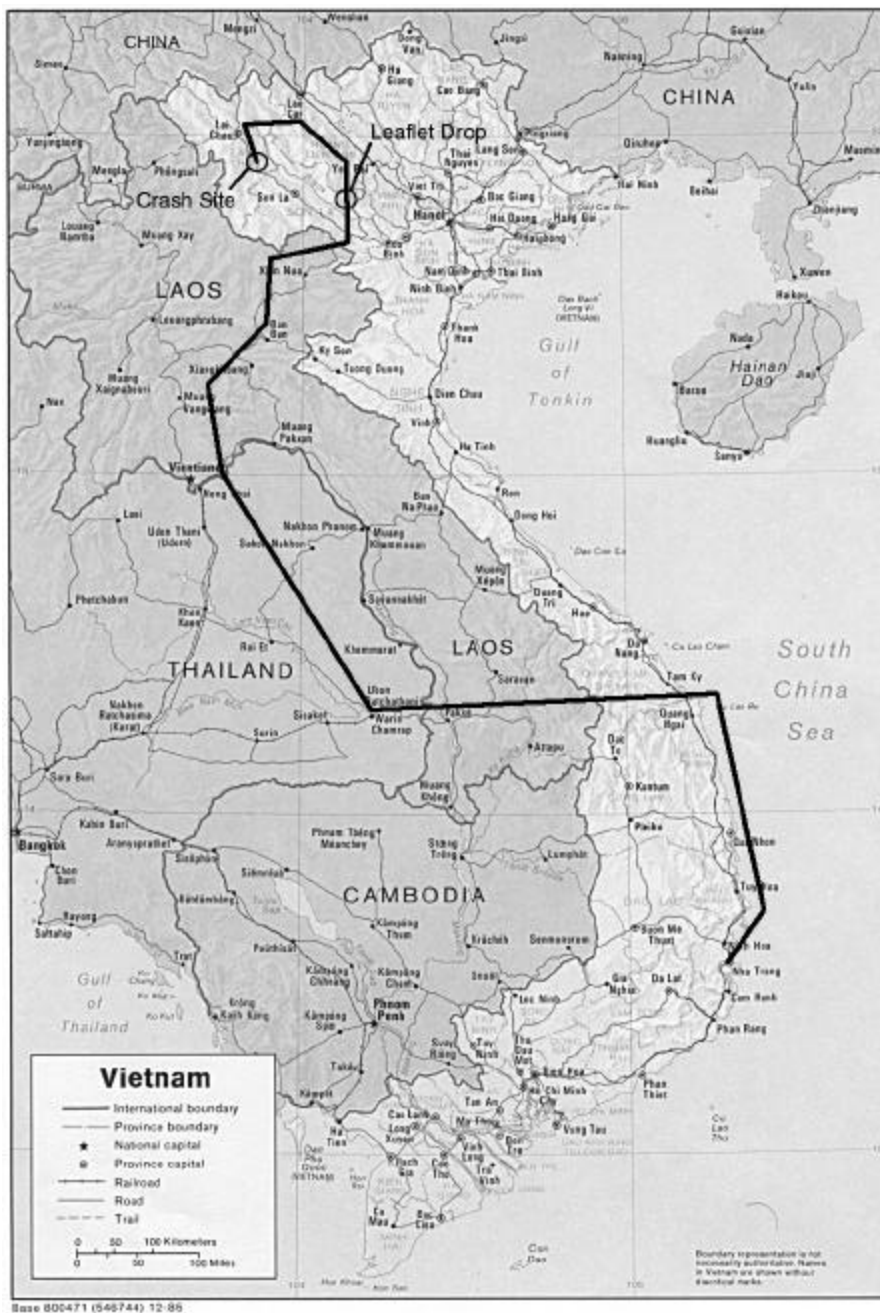


Figure 26. Route of Flight, Crew S-01, 28/29 December 1967 (Source: Provided by John Gargus.)

senior navigator, Lt Col Don Fisher, was not yet back from his R&R (rest and recreation) in Hawaii. His earliest expected return was on that day, 26th December. Earlier on this day, the other crew loadmaster departed with S-03 crew on that crew's flight to our parent 314th Wing in Taiwan. He had made arrangements with SSgt Ed Darcy from S-03 crew to switch places. Ed Darcy, a quiet, conscientious young man, planned to save some money by staying in Nha Trang

City. He did not want to spend his money on a three to five day stay in Taiwan while the ferried Blackbird went through its scheduled IRAN in a maintenance facility that was equipped to handle C-130 aircraft. The crews looked forward to their turn to ferry a Blackbird for an IRAN in Taiwan. It was a most welcomed vacation break from the wartime conditions in Vietnam. So Darcy became a volunteer replacement for one S-01 loadmaster. Sgt James Williams agreed

to take the place of the other loadmaster, who was also DNIF.

This mission provided an opportunity for Capt Edwin Osborne to take command of the S-01 crew and for Captain Van Buren to move up to the first pilot's position. The second pilot's slot was filled by Major Claxton from my S-05 crew. He had missed an earlier combat mission when he was DNIF, so this would become a makeup mission for him. I made up my mind that I would take Colonel Fisher's place if he did not return in time from Hawaii. I would have been the logical replacement in any case because I already knew the route and mission details and could be used to step in to replace him up to the last minute.

Later on that evening I heard that Don Fisher was back. I went to see him and found him in a most jovial mood. He had just returned from a memorable R&R in Hawaii with his whole family. He had just had the greatest of Christmases and repeated to me and to others that he was "in love with the whole world." He was ready to fly combat.

Edwin Osborne was also ready to fly as an aircraft commander of a combat mission. All our first pilots were highly experienced as C-130 airlift aircraft commanders before being qualified in the Combat Talon Blackbird. Many felt that to become a highly qualified copilot in the Combat Talon program was somewhat of a career regression even though they understood the need for such demanding pilot qualifications. As experienced pilots, they were simply outranked by others with more impressive pilot credentials who became Combat Talon aircraft commanders. Osborne was clearly a pilot who should not be taking a back seat to anyone. He was an excellent pilot qualified as an instructor in the Blackbird.

The next day, 27 December, John Lewis and I rode with the S-01 officer crew to the mission planning room. Van Buren drove the crew van. He normally drove whenever his crew went to fly. I was told that as our commissary officer he even drove through Saigon on his crew's periodic commissary runs when his crew's Blackbird got extra ground time at Tan Son Nhut to accommodate his grocery shopping. Since Claxton was destined to inherit that duty from him, it meant that my S-05 crew would get the long ground time on some future transits through Saigon.

On the way to our secure mission planning room, I sat across from Capt Frank Parker, a tall blond young man who was the crew's EWO. He was telling several of us how fortunate we were in having missions where we could sneak in and

sneak out without stirring up a hornet's nest. He had recently returned from Thailand where he ran into several of his EWO classmates who were flying the RB-66. Their mission was to deliberately challenge the enemy's electronic detection systems and deadly retaliation in their efforts to pinpoint locations of enemy radar. He used the term we sometimes applied to those situations when one would prefer to be on the ground rather than in the air. He said that his friends were "eating their livers" on their RB-66 missions.

Thompson had everything ready for us when we arrived. All the charts we prepared the day before either were posted on easels or laid out on worktables. Fresh, unmarked charts, flight plan logs, and other necessary mission forms were placed on tables where the crew members could use them. Thompson gave a brief overview of what the mission entailed. About the only unusual thing that he noted was that TOTs were not prescribed because neither drop zone had a reception team. The PSYOPS (leaflet) drop had a fixed-drop leg at an altitude of 30,000 feet or more, depending on the wind velocity and direction. Weaker winds would require a higher altitude. The heart of Hanoi would be from 65 to 70 miles away, and it was hoped that some of the leaflets would make it that far before sunrise. Lack of TOTs also explained to them why their flight plan was not completed with time of arrival at turning points. They were to calculate these by themselves, planning on a 260–265 true air speed at high altitudes and a standard 230 knots ground speed at terrain-following levels.

Once Thompson was finished with his mission introduction, I joined Fisher and Gordie Wenaas, the two crew navigators, to work on the flight planned route. Lewis and Parker got together to work on the enemy's defenses. Thompson joined the three pilots. Our enlisted crew members—two flight engineers, two loadmasters, and one radio operator—normally did not participate in this phase of mission planning.

Wenaas thought the mission would be a "piece of cake." He quickly noted that there were practically no threat circles anywhere near our track. Then he started crunching out flight plan times between turning points. Fisher and I went over each low-level turning point, examining the terrain in its vicinity. Practically all were river bends or rivers that would show up well on radar. Some turning points had been used on previous missions and were reported to be good ones. The selected drop zone for the second drop was a location

with good radar targets. Fisher was satisfied with everything and began to prepare his own navigational chart. In this task, Wenaas was way ahead of him.

Wenaas was a man who undertook every single task meticulously. I remember his going around our hotel taking care of chores whenever his S-01 crew was scheduled to be the hotel's duty crew. Each crew was regularly scheduled for hotel crew duty by operations scheduling as if it were a flight assignment. These duties consisted of servicing our two electrical generators, bringing in fresh potable water from the air base, taking care of mail, stocking the rooftop bar, and performing whatever maintenance chores were needed at the hotel. Wenaas was conspicuous by keeping himself occupied with these chores. He showed me how to start up and switch our two noisy generators.

I was then drawn into a conversation with the pilots. Osborne liked the route and had only one concern. It was the interval between the end of the first drop and the start of the second one. Would his two loadmasters have enough time to move the cargo to the ramp for this drop? How many bundles would there be? How much would they weigh? And, of course, What is this notional stuff? The answer to this question could only be provided by our cargo rigger, a warrant officer from 1st Flight. Van Buren was dispatched to go next door to get him. Van Buren returned alone, but he had the information we needed. He also succeeded in making arrangements for the loadmasters and the flight engineers to be at the aircraft the next morning to witness cargo loading. He commented that the warrant officer reminded him that no one was to mess with the cargo and question its rigging. Everything would be set up by the 1st Flight loadmaster just the way it should be dropped. Anything nonstandard or out of place should be ignored. Our job was to fly it there and drop it just as it was configured.

Osborne showed much interest in the terrain-following portion of flight. So the pilots gathered around Fisher who had already drawn his chart. He walked through every leg of flight and explained each turning point. Claxton had the weight of the aircraft calculated at the point of acceleration and climb to high altitude. There were questions about how much of the area west of Hanoi the crew would be able to see. The aircraft's track was over the eastern slopes of the central highlands. Numerous peaks with elevations of up to 9,000 feet were immediately to the left and the sprawling Red River valley with level terrain west

of Hanoi to the right. It was to be a dark night with a new moon beginning on 30 December. There would be total darkness. Some lights would no doubt be burning towards Hanoi. Our prior flights noted that North Vietnam did not have a complete blackout. The night would be perfect for the two map readers—Wenaas on the right and Claxton on the left—to use the somewhat cumbersome starlight scope to monitor the terrain below. The scope was of little use at terrain-following levels because it had excessive tunnel vision. This made the terrain fly by so fast that it caused the images to blur. But at drop altitude, where the Blackbird would seem to be at a standstill in relation to the ground below, the scope would give its user a fascinating view of terrain otherwise hidden in total darkness. Very little cloud coverage was predicted for that night.

We pointed out the location of Yen Bai Air Base that would be at the aircraft's 1 to 2 o'clock position during the drop. If there were any MiGs on night alert, Yen Bai AB would pose the greatest threat. This would also be Parker's greatest challenge that night. He would have to defend against possible interceptors.

Osborne examined the terrain into which the aircraft would have to descend after the leaflet drop. He was concerned about the rapidly approaching ground during their maximum rate of descent when radar stabilization was habitually temporarily lost, and the Doppler computer would revert to "memory" because its limits were also exceeded. I pointed out that a rapid descent should not be executed unless the aircraft was in jeopardy due to SAM or interceptor attack. All crews seemed to have the same training mindset, which they acquired at Pope AFB. During our training there, each short look was followed by a maximum rate descent, a maneuver that put a lot of stress on the aircraft. This was practiced at every opportunity. In real life, however, if a threat to our aircraft did not materialize, there was no need to put it through such a stressful maneuver where the crew experienced weightlessness and everything not tied down floated about. Then, at the point of leveling off, the tremendous G-load would force the standing crew members down to their knees. On this mission there would be additional cargo just behind the EWO and the radio operator compartment. We did not want any of it to break loose during such a stressful maneuver.

Osborne was concerned with the time remaining before the second drop. His loadmasters and the second flight engineer would have to move the

cargo to the back of the aircraft and get it set for the drop. Normally, the cargo would be all set from the point of takeoff. But not this time. The back of the aircraft would have to be cleared of any remaining restraining straps from the leaflet drop. Then the resupply bundles would have to be moved into place. Normally this would not be that difficult because the palletized bundles were on rollers. Being on rollers in straight and level flight is one thing, however, but being on rollers during aggressive terrain-following flight is quite another. Great care was needed to avoid injury or have the cargo slip off the rollers at an angle where the pallet would jam. This would no doubt be a new experience for these loadmasters. Osborne noted with some satisfaction that the terrain-following leg going westbound along the 22d parallel was relatively level because we were taking advantage of the break between 10,000-foot high peaks on the right and 9,000-foot ones on the left.

At a prominent turning point over the Black River, the mission would turn south. The Blackbird would fly almost due south hiding behind the high terrain west of the river. This would keep it west of the valley's populated areas. Ahead at the aircraft's 10-to-11-o'clock position would be the Na San early warning radar. This radar would be looking for the reappearance of the intruder, which was sure to excite the radar on the Hanoi side of the mountains in the Red River valley. This radar was not capable of directing MiG interceptors, and none were expected to come west out of the Red River valley.

Our drop zone was in an isolated area in the vicinity of Highway 6. It was a logical place for a drop zone. This would no doubt add to the credibility of the nonexistent team's presence. The deceptive nature of this drop was explained by Thompson. There would be no ground markings or signals. The drop would occur on Fisher's green light command when his Doppler distance to go read zero. After the drop the crew would continue terrain following into Laos where the high-altitude route home would resume at the skyline beacon.

At some point during this low-level route review we were joined by Parker and Lewis, who had concluded their study of the enemy's electronic air order of battle. They pointed out correctly that once the aircraft crossed into the Black River region, the enemy defenses were such that a return home at any altitude would be safe. That was a good thought in case of any in-flight problems, such as navigational, mechanical, or outside visibility degradation due to weather.

The whole group then gathered around Parker's chart. His chart differed from those of Fisher and the map readers, Claxton and Wenaas. Theirs had smaller threat circles along the flight-planned track. They represented lethal ranges of SAMs and AAA. Parker's chart had the mission flying through much larger circles, which outlined scan ranges of various radar. His chart showed that the aircraft would be exposed to many radars throughout the northbound portion of the flight along the Red River. He estimated that even before the aircraft would reach its drop altitude of 30,000+ feet, all available radars would be alerted to their presence and that he would be saturated with a tremendous amount of visual and aural signals from his sensors. He acknowledged that he would have to rely on some able assistance from Gean Clapper, the crew radio operator, who would be sharing his console behind the cargo compartment curtain.

Clapper was a true professional in his field. He had many years of experience as a HAM radio operator. As such he had contacts with colleagues throughout the world. On flights over international waters, where it was permissible, he would raise his contacts and relay personal greetings and messages to families back home. He was also very good at electronic warfare. He could positively recognize the chirping of various radars. This would be a great asset on a flight such as this one where many audible returns from threat radars would keep Parker extremely busy.

Parker concluded that with Clapper's help he should be able to detect anything out of the ordinary and call for evasive action before any harm could come to the Blackbird. It would be Fisher's task to find a safe evasive flight path through the mountains on the left.

After the final mission review, each crew member went on his own, putting finishing touches on all paperwork he had produced. We three mission planners assisted them with anything they needed and ensured that all mission documents they produced were properly stamped Top Secret. None of the documents could leave with the crew. They were collected by us and locked in 1st Flight's safe. They would not be released to the crew until the next night before the predeparture mission briefing.

The next day's mission briefing (28 December) was a whole crew affair attended by our commander, Lt Col Dow Rogers, and our operations officer, Lt Col Tom Hines. This would be the first time the enlisted crew members learned about the target area. All five, the two flight engineers, the

two loadmasters, and the radio operator, were present when 1st Flight's cargo handlers loaded the aircraft. Flight engineer TSgt Jack McCrary gave us a thumbs up on the condition of the aircraft. He was a very meticulous crew member, well regarded, not just by Osborne, but also by his flight engineer peers. I wondered how much sleep he had gotten during the day. His eyes looked red as if he had not slept at all. But we all knew that his nickname was "Red Eye." He had an eye condition that made his eyes look red and bloodshot all the time. His second, SSgt Wayne Eckley, was an engineer of lesser experience, but not short on enthusiasm. His nickname was "Bones." The jungle fatigue uniforms (designed as one size fits all) exaggerated his lean and bony body.

The mission briefing started with Thompson who stood in front of several chart-filled easels placed in the front of the briefing room. He briefed the weather. It was going to be favorable for this flight with few clouds on the east side of the mountains in North Vietnam and strong favorable WNW winds at drop altitude. Low-level pressure was moving southeast from China, bringing some cloudiness into the target area in the Black River valley late in the morning.

Next, the mission briefing was turned over to Fisher who briefed the route and the drop sequences. He was followed by Parker, who covered the enemy order of battle. He presented the latest SOG intelligence, which included known types and numbers of different MiG interceptors available to North Vietnamese defenses. As always, he mentioned the standard radio silence precautions. Minimum chatter on the intercom! He was going to run every one of his sophisticated tape recorders, which registered all electronic signals, generated by enemy radar and which also captured the crew's intercom transmissions. This was going to be a special night for him to gather electronic intelligence signals for our future use. We would end up with a sizable amount of signals from all types of radar. These tapes would then be used by other crew EWOs interested in sharpening their listening and signal interpretation skills.

Parker's briefing was followed by the aircraft commander, Osborne. He briefed the crew assignments that had been previously reviewed by Colonel Hines. Osborne would fly the entire mission in the right seat. Van Buren would be in the left seat from the takeoff through the low-level, terrain-following part of the flight. Claxton would map read from behind Van Buren during terrain following and then take the left seat at high altitude on the way

home. Fisher would ride the radar navigator's seat with the curtain drawn during terrain following and the leaflet drop. Wenaas would stand behind Osborne's right seat and map read from there. McCrary would fly the engineer's seat during terrain following. Eckley would spend his time in the back playing the safety observer role and provide assistance to the loadmasters. Parker and Clapper were to man their consoles behind the bulkhead curtain, and the two substitute loadmasters, Williams and Darcy, were to make sure they kept their restraining harnesses on during the drops. All crew members were to go on demand regulator oxygen upon entering North Vietnam and then on 100 percent oxygen during the leaflet drop.

There were a few standard questions from Colonels Rogers and Hines about everyone's fitness and emphasis on safety. Finally, the crew was wished good luck. After this the crew was sanitized. All personal effects, identifications, family photographs, and even jewelry were placed into plastic bags and saved for the crew's return. Each crew member had only his dog tags and Geneva Convention card as identifying documents. That was the standard procedure for all combat missions.

Because the mission planners had to secure all the classified mission documents and the crew's personal effects, the crew members were already in their assigned positions running their pre-departure checklists when we rejoined them at the aircraft. We witnessed an orderly engine start and watched the Blackbird taxi out to the end of the runway. From our vantage point we saw them take off and disappear into the darkness over the South China Sea.

About three hours later, I returned with Thompson to our operations office to monitor the North Vietnamese portion of the mission. We had one of our radio operators monitor a special HF radio frequency over which Clapper transmitted coded mission progress reports every 30 to 40 minutes—when the aircraft reached a significant in-flight turning point. A radio station in an unknown location would broadcast continuous one-letter Morse Code at regular intervals. Our airborne operator would monitor the same frequency and at proper moments would insert a two-letter Morse Code signal that would let us know which point of the route was reached and gave us the status of the mission's progress. This was such a short burst of transmitted energy that our enemy, who was sure to monitor the same frequency, would not have enough time to zero in his direction finders to locate the position of our aircraft. These transmissions were the only

breaks in radio silence allowed during our combat missions.

Upon checking with our radio operator, we learned that the flight was already over North Vietnam and right on time. We did not have any mission documents with us other than the radio operator's log with numbered points and corresponding estimated times of arrival over them, but we had a good mental picture of what must have been happening in the cockpit. As we sat there, sipping on some strong coffee that the radio operator prepared, we made occasional comments on what the crew must have been going through.

For the leaflet drop, all the cockpit lights were at their dimmest and the radar navigator and EWO/radio operator compartment curtains were drawn to prevent any outside light to affect the night vision of the rest of the crew. All were on oxygen and their intercom voices were muffled by the oxygen-mask microphones that registered and exaggerated the sound of every breath they took. The aircraft began its acceleration prior to the rapid climb. Maximum aircraft acceleration to 932-degree turbine inlet temperature was attained in relatively short-level flight with the aircraft shaking as if its four turbojets were ready to tear loose and leave the bulky aircraft carcass behind.

Then as the aircraft began its rapid climb, Parker's console surely began to light up. At first he would pick up a number of AAA and SAM radars, which would routinely scan their assigned areas. As they detected the Blackbird, they would focus their scan on their just-discovered target and activate their height finders to establish the aircraft's altitude. They would pass their acquired target data through their established notification channels. This would cause even more radar to come up and focus on this rapidly rising, but now slow moving, target. The crew would hear Parker reporting the inevitable. Two or three AAA radars were tracking them, but from a safe distance. Of greater concern would be the SAM radars. These had longer reach, but were expected to be out of range. He would certainly be calling these to Osborne's attention. Then the level off and the start of the drop. Each man could tell when each cardboard box exited the aircraft. There was a whoosh sound to each exit as the departing load created an added vacuum in the rare atmosphere of the cargo compartment. The aircraft would seem to stand still, just hanging in the thin air, being as high as it could climb on the thin cushion of available air. And as Parker watched for the emergence of a GCI radar and its tracking pattern to determine if

there was an intent to launch a MiG, Wenaas must have struggled with the night-vision scope looking for Yen Bai AB some 30 miles away. This was the place from which the nearest MiGs would come. His night-vision scope would certainly pick up the heat of an interceptor at takeoff. He would have to be pointed in the right direction. Others in the cockpit were getting the answer to whether they could see the lights of distant Hanoi now at their three o'clock position. Fisher must have had his face buried in the hood of his radar as he carefully traced every mile of ground covered by the aircraft. He had to know exactly where he was in case Parker reported a radar or interceptor lock on that would demand an immediate descent to a safe terrain between the mountain peaks on the left.

We did not hear any interruptions to the monotonous V sound on the radio, so we assumed that all was okay. All the leaflets were delivered. The aircraft was on its way down and proceeding westward to its turning point over the Black River. The next report came just as expected. All was still okay. The aircraft was now southbound running its checklist for the bundle drop near Highway 6.

Thompson and I planned to return to the hotel right after the next report and get a couple of hours of sleep before coming back to greet the returning crew. But as we waited, nothing happened. There were no further reports from the aircraft. Our first assumption was that something went wrong with Clapper's radio. We would surely hear something once the aircraft emerged from its radio silence over the skyline beacon. That is when the aircraft would report a small problem like that to our radar sites in Thailand. Once again, there was nothing. With that we returned to the hotel and reported our concerns to Dow Rogers and Tom Hines.

There were anxious moments as the aircraft's return time approached. Calls were made to find out if any landings were made in Thailand or at Da Nang AB. Then the command at SOG was notified. The SOG took over all search and rescue efforts. Several F-4 Phantoms were launched to survey the area south of the last known reported position. The weather turned bad. The front moved in as expected, and the F-4s could not see a thing on the ground. They monitored radios for signals from the aircraft's crash position indicator and from any crew member survival radios. They heard nothing. After several attempts, the search

was given up. The crew of 11 was declared as missing in action (MIA) on 29 January 1968.

There were many guesses and opinions as to what might have happened. A loss to enemy action was discounted. The aircraft was proceeding normally on its assigned mission after the leaflet drop, which was the most hazardous part of the flight. Enemy attack on the aircraft would have been reported. The enemy had a chance to detect our aircraft by Na San radar, which must have been alerted about our aircraft's escape toward Dien Bien Phu. Had this happened, there might have been some forces in the vicinity of the drop zone capable of bringing down a low-flying aircraft with small-arms fire. But such an act would have been heralded as a great victory by North Vietnam. The enemy should have learned of our aircraft's fate almost immediately. Even with our low profile, the failure of our aircraft to return to Nha Trang AB could not be concealed for long. The enemy would have concluded that it was the aircraft that had dropped several million leaflets west of Hanoi. They did not take credit for its disappearance during this mission. But some thought of a more sinister scenario. The enemy had the aircraft and perhaps some members of the crew, and they would use them for propaganda purposes. However, as time went on, this probability dissipated. It became clearer and clearer that our aircraft must have impacted a mountain in an isolated area sometime after making its last position report. The return of our POWs in 1973 confirmed that the names of the crew members were not known by any of the returning POWs.

The location of Blackbird 64-0547 continued to be a mystery for 25 years. In 1991, when the villagers of Phu Nung heard that the United States was searching for remains of American airmen, various individuals reported that they knew of a crash site in their vicinity. In November 1992 a joint US-Vietnam team was led to a very isolated location at coordinates 21-39-80N 103-31-20E (grid 48QUJ 4744596161) where they found few remaining parts of an aircraft that turned out to be our Blackbird.

The crash site is located in a rugged mountainous terrain of Lai Chau province, some 32 miles northeast of Dien Bien Phu. It lies just a few miles east of the route that many of our crews flew in the opposite direction toward the same prominent bend in the river over which the last aircraft position report was made. This river bend had a very distinct radar return, and we used it on those missions that required our undetected entry into areas

between Hanoi and the China border. Since I was unable to retrieve the flight plan for this mission, I do not have the exact location of the initial point for the drop or for the drop zone. I must rely only on my memory and conclude that the aircraft either was on its planned route to the initial point or making a course correction to it. Distance wise, the crash occurred seven and a half minutes from the reporting point at the river bend. Description of the aircraft's impact point reveals that it was heading directly toward the Na San radar site, which was about 45 NM away.

The US recovery team pinpointed the crash location on the best available 1:50,000 scale chart. This chart shows it to be at 4,780 feet on a steep 60-degree slope of a NNW facing crescent shaped mountain. The crest of this mountain goes only up to 4,870 feet. The main peak of this karst-studded mountain, known as Nam Bo, rises to 5,174 feet, and it is one mile due west of the crash site. The crash site is small. Its measurements established by the recovery team are given as 105 feet by 72 feet. This is a small area for an aircraft as large as a C-130. Since all the crew remains were recovered from this small location, it can be safely concluded that the aircraft did not bounce and break up along its track before coming to a stop. Its crash heading must have been perpendicular to the face of the mountain. With that, the destruction of the aircraft was instantaneous.

At the time of the crash, the crew was getting ready for the second drop. Eckley, Darcy, and Williams were in the cargo compartment making sure that the load was properly positioned for the drop. They were moving about and did not yet have their restraining harnesses hooked up. Claxton and Wenaas were the other two crew members who were not fastened to any seats. Their map reading duties called for them to stand behind the pilots and peer outside through the side windows.

The first person on the scene of the crash was a 12-year-old boy. He reported that the aircraft was in many pieces and that it was still burning. He did not find any survivors.

The recovery team found little at the crash site. The villagers had pilfered the site within days after the crash and over the years carted away all aircraft parts they could use. In 1991, when they learned about the US search for remains of airmen, they returned to the site and removed all human remains they could locate. They turned them over to the proper authorities. When the team returned to the site in 1993, they found only a few fragments of human remains, and the team leader

recommended that any further attempts at recovery should be abandoned. All recovered remains were sent to Hawaii for proper identification.

Why did the site go so long without being reported? The team's investigation revealed that the crash site was reported to the village authorities immediately. It may be that the village leaders were so isolated from the governmental authorities that they didn't know what to do. Or, on the other hand, they were astute enough to realize what kind of fate would descend upon them for pilfering the crash site and keeping the crew weapons, as well as those that must have been packaged in the air-drop cargo. Consequently, keeping the news of the crash a village secret had some benefits for the isolated indigenous population. Once the American rewards for locating aircraft crash sites became known and profitable, the village secret was revealed.

Our own information channels were also flawed. Personnel associated with Combat Talon were never officially informed about the crash site discovery. In mid-1997 plans were put in motion at Hurlburt Field to erect a memorial for the 11 lost crew members whose status had been changed from MIA to KIA in 1978. As an individual who was closely tied to this unfortunate mission, I agreed to write this story so that the families of the lost airmen would learn about the work their loved ones did in Vietnam and so that those who flew the Blackbirds in that war would recall and share their mission recollections with others. I finished the first draft of this story in July 1997, hoping that John Lewis's and my recollections of the route and events of 30 years ago would help someone to locate the missing aircraft. The title of this first draft was "Missing Combat Talon C-130E." The word of my writing went out, and in August I received a surprise phone call from a man who had been looking for information about his friend who flew on that mission. It was Gene Kremin, a radio operator buddy of Clapper. He informed me that the aircraft had been located almost five years before and that his information about the crash site came from the Library of Congress in Washington, D.C.

Air Operations—1967

With the expansion of Shining Brass and the commencement of Daniel Boone operations, logistics airlift increased rapidly during 1967. As a result, by the end of the year, most combat resupply missions into North Vietnam were moved to high-performance aircraft, thus freeing up larger

transport aircraft to move sensitive cargo. During 1967 Heavy Hook, Combat Talon, and contract aircraft moved 10,738,580 pounds of cargo and 25,016 passengers. SOG was allocated 75 hours each month, or 900 hours each year, for each Combat Talon aircraft assigned, and actually employed the aircraft for an average of 938 hours each during 1967. One unique requirement levied on SOG air operations during the year was to develop a free-fall aerial delivery method to drop rice to Cambodian troops. From an altitude of 1,000 feet, the aircraft dropped triple-bagged rice, of which fully 97 percent was recoverable.⁴²

During 1967 Combat Talons accomplished 12 out of 30 scheduled resupply missions, while Heavy Hook flew eight of 32. The number of PSYOPS missions during the year grew substantially. Detachment 1 accomplished 44 out of 67 scheduled PSYOPS/leaflet drop missions.⁴³

1968: Year of Transition and Rebuilding

After the loss of two of the four assigned Combat Talons in the closing months of 1967, the New Year brought a heavy dose of reality for Combat Spear personnel. Missions over NVN had proven to be extremely dangerous. Even life at Nha Trang AB had changed after the November attack on the airfield. As January passed, aircraft tasked to search for crew S-01 were diverted to other priority missions. There was no trace of the lost crew. Weather across western NVN had remained overcast with low ceilings throughout the month. On 29 January the search was terminated, and the crew was officially listed as MIA.

At 12:35 A.M. on Tuesday, 30 January, the Tet offensive of 1968 kicked off in South Vietnam on the outskirts of Nha Trang City. The initial attack was on the Vietnamese Naval Training Center, but due to confusion by the attackers, an all-out push to capture the city did not occur until four hours later. Fourteen hours of fighting ensued, during which time Combat Spear personnel manned firing positions on top of the Anh Hoa Hotel. Within 28 hours of the initial attack, Vietcong enemy forces had been beaten, and the city was declared clear by South Vietnamese security forces. The attempt to capture Nha Trang was a costly one for the Vietcong. According to official South Vietnamese records, of an initial force of 800 soldiers attacking the city, 377 were killed, 77 were captured, and one surrendered. Eighty-eight South Vietnamese troops were killed, and 220 were wounded in action, 32 civilians were

killed, and 187 were wounded with 600 homes destroyed.⁴⁴ Other than a few bullet holes, the Anh Hoa Hotel escaped unscathed, as did the air base. Combat Talon aircraft parked there were unharmed. The Tet offensive of 1968 would prove to be the watershed event defining the course by which the United States would pursue the Vietnam War. There was little immediate impact on the Talon mission, but the resultant bombing halt nine months later would eliminate all combat operations into NVN.

On 15 March 1968 Detachment 1, 314th TAW was redesignated the 15th ACS and was assigned to the 14th SOW by PACAF Special Order G-43, dated 23 February 1968. Existing OPCON arrangements continued in effect, with the transfer of four aircraft, 39 officers, and 122 airmen to the 14th ACW. Colonel Rogers, a P-47 combat veteran of 38 missions during WW II and the incumbent Detachment 1, 314th TAW commander, was designated the first commander of the 15th ACS.⁴⁵ The following mission statement of the squadron reflected the unit's unconventional warfare nature.

The mission of the 15th ACS is to conduct tactical airlift operations in support of selected US and South Vietnamese counterinsurgency forces in Southeast Asia; to conduct rescue and recovery operations as directed by the Joint Personnel Recovery Center, using the Fulton Recovery System; and to carry out a program of unconventional warfare operations assigned under 7AF OPORD 460-68, "Combat Spear," classified Top Secret.⁴⁶

On 29 April 1968 Rogers passed command of the 15th ACS to his operations officer, Colonel Hines. Hines continued in command until 4 September, when he returned to the United States after passing command to Lt Col Russell A. Bunn.

During the spring and summer of 1968, the 15th ACS experienced a near 100 percent turnover of assigned aircrew and support personnel. Crew S-01, which was lost the previous December, was replaced by crew S-07 in March; Crew S-02 rotated to the United States in May and its replacement, S-08, was certified crew ready in June. Crews S-03 through S-06 rotated in July/August and were replaced by Crews S-09 through S-11, respectively. The net result of these rotations was a reduction of six to five crews, for a manning ratio of 1.33 crews per assigned aircraft. A sixth crew, crew S-12, was formed of mixed crew members and was combat qualified during the summer transition period. Crew S-12 lacked two pilots; therefore, the squadron commander and the operations officer, along with pilots from other formed crews, augmented these two positions.⁴⁷



Photo courtesy of Robert Zura

Some US facilities located in Nha Trang City were heavily damaged during intense fighting on 30/31 January 1968 at the onset of the Tet offensive. Pictured is the MAC Civil Operations District Office (CORDS). The Anh Hoa Hotel and Nha Trang AB escaped attack, thanks to the effort of both US and South Vietnamese personnel.

Manning was actually based on 1.5 aircrew per assigned aircraft for six crews. With crew S-12, the squadron effectively maintained six crews, even though S-12 was out of hide. By October additional crew members were assigned, and the unit stabilized again with six assigned crews. Consolidation of the squadron under 14th SOW also resulted in 68 maintenance personnel being transferred to the 14th Field Maintenance Squadron, thus leaving 39 officers and 54 enlisted personnel in the unit.⁴⁸ The shortage of aircrew and the transfer of maintenance personnel had little impact on the unit's ability to perform its tasked SOG mission. Of four C-130E(I) Combat Talons assigned, the unit possessed an average of three throughout



Photo courtesy of George Powell

After the 1968 Tet offensive, revetments were added to the Combat Spear ramp.

1968, with the fourth at LAS Ontario undergoing modifications and phase inspections.⁴⁹

The most difficult challenge for the Combat Spear unit was in the continuation training area. To meet the requirement to replace all assigned crews in such a short period, Detachment 2 at Pope AFB had to accelerate by two months those aircrews scheduled for SEA duty. The resultant Combat Knife output ensured that the Vietnam-based Combat Spear Talons would continue to be manned by fully qualified crews on a timely basis.⁵⁰ After initial checkout at Pope AFB, aircrews arriving in South Vietnam had to continually practice their special qualifications to maintain proficiency. The Fulton STARS capability required a heavy continuation training commitment. A STARS training site established at Cam Ranh Bay in June 1967 was put to near-continual use during the summer of 1968. In July the squadron activated an extensive STARS demonstration program whereby a Combat Talon aircraft would perform recoveries at bases throughout SEA, including Thailand and the Philippines. This demonstration program ensured that the unit would have continuous training opportunities, while at the same time introducing the capability to potential customers from all services.⁵¹ An added benefit to the demonstrations was to further validate the system and refine its components to improve the capability. One such improvement was identified for the recovery-kit parachute. With ground winds over 15 knots, the kit was dragged a considerable distance before it could be retrieved by ground-party personnel. Through US sourcing, this problem was eliminated with the development of the ring-slot parachute.⁵² Use of this parachute was later adopted by the other two Combat Talon squadrons.

Training in low-level terrain following was conducted in the Philippines and Thailand. Combat Talon aircraft conducted airborne interceptor training, code-named Black Baron, with the 405th Fighter Interceptor Wing and with ground-control intercept controllers at Clark AB, Philippines. A similar program was conducted in Thailand with interceptor aircraft based at Udorn RTAFB and other air bases throughout Thailand under the same Black Baron program.⁵³

August brought about another organizational change in the 15th ACS. On 1 August the 15th ACS was redesignated the 15th Special Operations Squadron by Special Order G-147, Headquarters PACAF, dated 11 July 1968. The squadron remained under the 14th SOW, with no

changes in organizational structure. The only major change was found in the unit detail listing, dated 31 July 1968. The personnel assigned to 1st Flight Detachment were added to the 15th SOS. Since the two units were not colocated at the time, this change created problems in the administrative and training areas. Additionally, the 15th SOS commander had no direct control over 1st Flight since both unit commanders reported directly to the 14th SOW DCSO.⁵⁴ Later facility upgrades and command agreements brought the two units both physically and administratively together, thus minimizing personnel accountability problems.

From 1 July to 30 September, the 15th SOS performed nine live Fulton STARS recoveries utilizing personnel from units where the system was being demonstrated. On 2 August the 15th SOS commander, Colonel Hines, was recovered utilizing the system at Nha Trang AB. By 30 September the unit had performed 29 live recovery demonstrations since its deployment to SEA in 1966. In conjunction with these demonstrations, unit personnel would sometimes prepare high-speed delivery kits for F-4 fighter airdrop. The overall package was quite impressive and succeeded in publicizing the capability while providing the opportunity for Combat Spear aircrews to practice the event. The unit maintained the capability to conduct Fulton combat recovery operations in accordance with MACV OPLAN 37F-67.⁵⁵

On 12 October 1968 President Lyndon B. Johnson proclaimed a bombing halt and restricted flight operations into North Vietnam. SOG operations in NVN were directed to cease, and the remainder of the month was spent recovering agent teams. By the first of November, all agent teams either had been exfiltrated or abandoned if they were identified as being double agents. The cessation of operations into North Vietnam had a demoralizing affect on the 15th SOS. Virtually all combat missions assigned to the squadron were eliminated. The taskings most affected were those supporting UW operations and the potential tactical use of the Fulton STARS.⁵⁶ There was little likelihood of utilizing the recovery system in South Vietnam, since in-country-based, rotary-wing assets were tasked to perform the rescue mission.

Three additional surface-to-air recovery demonstrations were conducted in October and November by Talon crews, two of which were two-man pickups. The second dual pickup was conducted at Cubi Point Naval Air Station (NAS) and was complicated by an uncontrollable spinning of the two

volunteers shortly after they became airborne. The spinning lasted approximately four minutes. After the spinning stopped, the recovery continued uneventfully. Because of the incident, two-man demonstration recoveries were suspended, and a hazard report was submitted to Seventh AF.⁵⁷ (No additional two-man live surface-to-air recoveries were attempted until a 7th SOS crew, commanded by Capt J. W. Bates, extracted two personnel from the waters off the coast of RAF Macrihanish, UK, on 2 December 1981.)

With no combat missions being flown into North Vietnam in November and December, SOG tasked the squadron to fly combat support missions throughout the area of responsibility. Unilateral training sorties were also flown, and personnel focused on improving facilities at Nha Trang AB when not in the air. With already one of the best enlisted quarters in SEA, personnel continued to improve their barracks during their off-duty time. Each enlisted six-man aircrew shared an air-conditioned room on the top floor of the barracks. Each room was well insulated and removed from the normal distractions of a crowded barracks. By housing each crew in its own room, crew integrity and proper crew rest were maintained. Nonaircrew squadron personnel were billeted on the ground floor, which was also divided into a reading/game room and a room for recreational activities. Squadron personnel were responsible for the design, fabrication, painting, and continued cleanliness of the barracks facility.⁵⁸ The 15th SOS won the 14th SOW/CC Outstanding Unit Trophy in November 1968. During the period officers and assigned civilian contractors continued to reside downtown in the Anh Hoa Hotel.

Command and Control

Throughout 1968 relations between SOG and Seventh AF were strained, even after the signing of the MOU in the fall of 1967. The basic problem with the MOU was that it was general in nature and did not specifically address command relationships. The MOU had created, however, the 14th SOW DCSO position, and the first incumbent to fill that position arrived at Nha Trang AB on 2 March 1968. In his end of tour report the following year, he documented the state of affairs at that time (as he perceived them).

Both Seventh AF and MACSOG were delighted with the results after the DCSO office was activated. Problems that previously had been hashed and rehashed in conferences were bucked to me for solution. Being located



Photo courtesy of Obie Hill

Six-man enlisted flight crew quarters located on Nha Trang AB. Note TV monitor in center of rear wall and air conditioner in right rear corner of room. Special operations crews were authorized air conditioning because they flew at night and slept during the day.

a considerable distance from Saigon [Nha Trang], I had no personality problems with either 7AF or MACSOG. Consequently, each problem could be examined in light of facts and mission requirements. Fortunately, most problems were relatively minor in nature and when isolated from an atmosphere of mutual hostility, the solution was fairly obvious. MACSOG was well satisfied with the air support they received, and all mission requirements were fulfilled. Seventh Air Force was delighted because minor problems that had previously consumed an enormous number of man-hours were now being handled by my office, and they gradually withdrew from close supervision of MACSOG activities.⁵⁹

Thus, according to the first DCSO, the new arrangement proved to be satisfactory. Subsequent appraisal by Seventh AF headquarters, however, indicated that it was still not highly satisfied with the working relationship between itself and MACSOG. A Seventh AF staff study conducted in July 1968 pointed out several problem areas. The study specifically criticized the 1967 MOU insofar as it addressed only administrative matters and not the broad spectrum of Seventh AF support of MACSOG activities. It further noted that Seventh AF/MACSOG problems frequently could not be resolved in the absence of mutually agreed upon directives. As a result of the continued friction between the two headquarters, MACV was asked to arbitrate. MACV consequently directed that Seventh AF, in conjunction with MACSOG, prepare an MOU to formalize new procedures and to assure systematic and effective support of SOG missions.⁶⁰ The resultant document was identified as OPOD 460-68, and it greatly expanded and clarified the earlier MOU.

Air Operations—1968

Figures on aircraft utilization in 1968 reflected reduced combat operations over North Vietnam compared to those of 1967. Combat Talon aircraft successfully executed five of 21 resupply missions. On the other hand, the percentage of flight time committed to logistical airlift increased from 65 to 85 percent of total hours flown. Combined cargo tonnage of Heavy Hook and Combat Spear operations totaled over 8 million pounds, and more than 34,000 personnel were transported by the two units.⁶¹

1969: Tasking Outside North Vietnam

Colonel Bunn succeeded Colonel Hines as the second commander of the 15th SOS on 4 September 1968. He remained in command until 27 March 1969, when Lt Col John R. Kummer replaced him. At that time Bunn became the 14th SOW/DCSO after the incumbent DCSO was killed in an aircraft accident.⁶² The problems experienced during the last half of 1968 in personnel accountability for 1st Flight Detachment was solved when both 1st Flight and the 15th SOS moved into their joint operations building during the week of 13 January 1969. The colocated facility brought the two units into a closer relationship than was possible with separate facilities.⁶³

Relationships between Seventh AF and SOG did not improve, even after OPOD 460-68 was finalized. By the first of February 1969, in an apparent effort to exert its authority over SOG-dedicated assets, Seventh AF made the decision to task 15th SOS aircraft to fly missions when not otherwise employed by SOG. From 3 through 11 February, Seventh AF tasked the 15th SOS to fly seven flare-illumination missions, although the aircrew had neither flare training nor any flare dispersal equipment aboard the Combat Talon. In 1973, Lt Col Marlon Banks, then retired, recalled his crew checkout to drop flares and his first flare mission.

We went out one afternoon and got an hour of training from an EOD [explosive ordnance disposal] type on how to set your time delay and everything, and launch a flare and hook it up so it would pop the string and light. We put some 200 odd flares on board. Our mission that night was strictly a delaying tactic. We were to illuminate a [road] intersection for eight hours. . . . We didn't have any FACs with us normally if we saw anything to call strikes on. We were briefed on the [AAA] threat—how high the 37 mm and 57 mm could go. Well, it [the threat] ran me up to 14,000 feet. You couldn't work without oxygen. . . . That was probably one of the worst missions I've ever been on. I've never seen so much

firepower. It was all there, AAA, and I'm sure none of it was radar controlled or we wouldn't be here today. . . . We would vary our altitude every pass two to three thousand feet.

It [AAA] would go up above us, sometimes below us. . . . I would say they had 6 to 9 installations—batteries—and they would sometimes all fire at the same time, sometimes three or four at the same time. We used up a lot of their ammo that night for them. After six hours, we were out of flares, thank goodness, and left.⁶⁴

The continued debate over who had OPCON of the 15th SOS Talons was temporarily resolved when Seventh AF discontinued tasking the Combat Talon for flare missions after the 11 February mission. SOG adopted the tactic of tasking the 15th SOS, with its higher-mission priority, every time Seventh AF tasked the unit. After 11 February the situation was not resolved, but rather an uneasy truce went into effect. OPOD 460-68 had proven to be inadequate because it still did not specifically address command relationships between SOG and Seventh AF.

As was the case in 1968, meetings were again held throughout 1969 to further resolve command relationships. On 1 November 1969 an updated OPOD 460-70 was signed. The stated purpose of this OPOD was to establish procedures for command, control, and support of forces designated to support COMUSMACV Footboy air operations.⁶⁵ It tasked Headquarters Seventh AF, 14th SOW, 314th TAW (CCK, Taiwan), and the 15th SOS at Nha Trang AB. Mission capabilities of the 15th SOS were allocated in support of SOG operations. It placed the 15th SOS under the operational control of the commander, Seventh AF, administered through DCSO, 14th SOW.⁶⁶ The OPOD established Seventh AF/Director of Operations as the action agency responsible for monitoring the SOG Mission Fragmentary Order. As such, Seventh AF/DO was tasked to keep abreast of all Combat Spear activities and to maintain timely coordination with SOG 32 (Air Studies Branch) on all matters.

The OPOD went on to delineate specific responsibilities of the 14th SOW/DCSO. The DCSO was tasked to exercise operational control of the 15th SOS for the commander, Seventh AF, during all missions operating within Seventh AF's area of responsibility. The DCSO was also responsible for Seventh AF Frag Orders and for direct tasking by SOG for USAF assets under his control. He continually informed Seventh AF/DOCO, 314th TAW, and SOG of technical and scheduling details in support of Footboy air operations and SOG combat airlift requirements. Mission details

were provided to SOG by the DCSO, with Seventh AF an information addressee on all message traffic.⁶⁷

The OPORD also outlined the following responsibilities of SOG.

1. Establish mission priorities for air support furnished by USAF assets.
2. Provide direct tasking to the 14th SOW/DCSO for air support furnished by 15th SOS.
3. Provide adequate, secure office space for Combat Spear operations at Nha Trang.
4. Designate MACSOG 32 as the agency responsible for the execution and flight monitoring of scheduled Combat Spear missions. This responsibility included:
 - a. Reviewing the scheduled mission profile, weather, route, and times as a basis for rendering the go/no go decision.
 - b. Passing mission execution or cancellation decisions to the 15th SOS.
 - c. Monitoring mission launch times, flight following of missions, and mission down times.
 - d. Keeping abreast of all Seventh AF/MACSOG activities and maintaining timely coordination with Seventh AF/DOCO on all matters concerning the fragging and preplanned changes to Combat Spear missions and with Seventh AF TACC/DOCC on the execution of these missions.⁶⁸

The general instructions of the OPORD stated that the 15th SOS would not be used to support operations other than unconventional warfare missions without the specific approval of the commander in chief, Pacific Air Forces. The commander, Seventh AF, was given ultimate command of the 15th SOS Combat Talon assets while they were operating in his area of responsibility.⁶⁹ The OPORD also identified force requirements needed to support the Combat Talon mission. The unit equipment for the 15th SOS was listed as four C-130E(I) aircraft. All aircraft were to be Combat Spear configured. Monthly flying time allocated for each aircraft was 75 hours, and the aircraft were manned with a crew ratio of 1.5 to 1.⁷⁰ OPORD 460-70 finally satisfied Seventh AF by detailing command and control relationships between its headquarters and SOG.

With the bombing halt of the previous October still in effect, Combat Talon unconventional warfare activities outside of South Vietnam remained limited during 1969.⁷¹ Two additional live surface-to-air recovery demonstrations were flown on 20 January and 26 February at Cubi Point NAS, Philippines. SOG canceled one other demonstration because of a conflict with a higher-priority mission.⁷² For February, as in each month of 1969, SOG was allocated 300 hours of flying time for the four-assigned 15th SOS Combat Talons. Due

to heavy combat support mission requirements, the squadron overflowed this allocation by 138.5 hours during the month. At the same time experienced 14th SOW maintenance personnel were rotating back to the United States and being replaced by three-level technicians. Aircraft parts also became more difficult to source and transport to Nha Trang AB. Available maintenance personnel were required to work 70 hours per week during this period. As a result of all these factors, the operational-ready rates plummeted during the month of March.⁷³

By May the summer rotation schedule was in full swing. Three of the six assigned crews rotated back to the United States by 1 July. For a brief period the unit dropped below authorized manning in certain crew positions; however, the reduced manning did not prevent the 15th SOS from completing its assigned mission.⁷⁴ On 21 July the 15th SOS commander was picked up at Nha Trang AB utilizing the Fulton STARS by Lt Col John F. Newell, the squadron operations officer.⁷⁵

In June planning was begun for the reintegration of field maintenance specialists back into the 15th SOS. This planning was necessitated by the decision to move the 14th SOW from Nha Trang AB to Phan Rang AB, South Vietnam. With President Richard M. Nixon's Vietnamization policy coming to fruition, the majority of Nha Trang AB was scheduled to be turned over to the South Vietnamese Air Force. The 15th SOS and its sister unit, 1st Flight Detachment, remained at Nha Trang AB as the only two operational USAF units there.⁷⁶

On 5 August Colonel Newell assumed command of the 15th SOS from Colonel Kummer. Later in the month one Combat Talon aircraft was returned to the United States for modifications that would take approximately five months to complete. Three aircraft remained at Nha Trang AB throughout the fall. On 8 September the 15th SOS performed a live surface-to-air recovery at Koke Kathiem, Thailand, for the king and queen of Thailand.⁷⁷

Fourth quarter 1969 was marked by the move of the 14th SOW from Nha Trang AB to Phan Rang AB. Although major portions of Nha Trang AB were turned over to the Vietnamese Air Force, barracks were retained for remaining US personnel stationed there, along with the base officers' club. All AF personnel living off base were directed to move to base quarters. Until 20 September 15th SOS officers and civilian technical representatives continued to live downtown in the Anh

Hoa Hotel. The move from the Anh Hoa Hotel to on-base quarters began on 12 September and was completed on the 20th. Several more days were required to move government equipment from the hotel to storage facilities on base. Each officer was provided a one-man room that was supplied with a refrigerator and an air-conditioner. Although not as desirable as living downtown, base quarters were considered very adequate.⁷⁸

The turmoil associated with the 14th SOW's departure from Nha Trang AB threw the 15th SOS supply section into a tailspin. Several factors contributed to decreased efficiency of the supply unit. In August the supply section experienced a 100 percent turnover in personnel. In September the move from the Anh Hoa Hotel created a large requirement to account for and store government assets located there. All excess equipment was turned in, with the remainder either being stored or installed in the Nha Trang Officers' Club. The biggest impact on 15th SOS supply, however, was the transfer of the base supply function to the 12th Tactical Fighter Wing (TFW) at Cam Ranh Bay.⁷⁹ Being separated from its primary support unit, the 15th SOS would soon feel the strain of a system geographically detached and unresponsive to its operational needs.

As 1969 came to a close, squadron members looked back on the year with mixed emotions. No aircraft had been lost to the enemy, yet the bombing halt remained in effect, thus preventing Talons from executing their primary UW mission into North Vietnam. The Anh Hoa Hotel had been returned to its Vietnamese owners, and most of Nha Trang AB had been turned over to the Vietnamese Air Force. Officers and civilian technical representatives were living on base in quarters formerly occupied by 14th SOW personnel. Several popular leisure activities that were located at the Anh Hoa Hotel were moved to the officers' club, including the shuffleboard and nightly movies. The unit looked forward to 1970 and, hopefully, an increase in combat tasking.

Air Operations—1969

During 1969 the 15th SOS continued its aircrew proficiency training program. Training missions, however, were only a small percentage of the overall flying effort, as logistics support requirements placed great demands on the unit. A breakdown of Combat Talon flight time, for example, revealed that 79 percent of the total flying hours were devoted to logistics support, 10 percent to

combat support missions, and 4 percent to maintenance flights.⁸⁰

Mission figures for 1969 showed that Combat Talon aircraft flew 12 combat missions. They transported 7,681,460 pounds of cargo and 42,590 passengers. Combat Spear crews conducted 18 Black Baron training sessions, but the number of Red Baron missions could not be determined, since the crews conducted this training in conjunction with routine logistics missions. Combat Talon aircrews practiced low-level terrain-following flight and demonstrated the Fulton recovery system on six occasions throughout the year. Several factors adversely affected aircraft utilization. Aircraft availability rates for the C-130E(I) decreased because of modification programs as the aircraft began rotating back to the United States in August.⁸¹

1970: Redeployment Efforts

Beginning in 1970 and extending into 1971, the Air Force began a series of initiatives, outlined by two memorandums from the chief of staff, Air Force to JCS in May and September of 1970, to withdraw the Combat Talon from South Vietnam. The thrust of the Air Force position was that Combat Talon aircraft were not being used sufficiently in a combat role to justify their retention in South Vietnam and that most SOG logistics requirements could be satisfied by the Common User Airlift System. MACV, however, with CINCPAC's backing, insisted that these assets remain in South Vietnam. Countering the Air Force rationale, MACV cited the "maintain in readiness" doctrine postulated by the JCS after the bombing halt in 1968 and contended that security considerations precluded the use of Common User Airlift System to transport SOG's sensitive cargo and passengers.⁸²

Although no formal proposals to relocate the unit actually surfaced until 1970, Air Force planners had expressed concern over the utilization of the Combat Spear aircraft as early as the summer of 1969. A commander in chief, PACAF (CINCPACAF) message, dated 12 August 1969, revealed that the use of Combat Talon aircraft had come under close examination from October 1968 to July 1969. PACAF analysis showed that 81 percent of 15th SOS flying time was devoted to combat support (logistics) missions, whereas only 7 percent was committed to combat missions and about 8 percent to training missions.⁸³

The 1970 SOG history stated that Seventh AF proposed relocation of the Combat Spear unit as

early as January 1970. The earliest firsthand documentation, however, was a 17 April 1970 letter from the commander, Seventh AF to COMUSMACV, which made the following statement.

Examination of this unit (15th SOS), in terms of its essentiality as an element of MACV strength, leads to the conclusion that, in the present and likely future context of limitations on US force structure in SEA, it is marginally productive:

- a. It is special mission, contingency-oriented as opposed to the multipurpose, firepower orientation of tactical units subject to withdrawal now and in the future.
- b. It requires space and supporting personnel and facilities at Nha Trang which will impede expansion of the VNAF under the I&M (Improvement and Modernization) program.
- c. Relocation in-country (i.e., to Cam Ranh Bay) requires extraordinary preparation and investment.
- d. For the last eight months, the hours flown were less than one *[sic]* percent combat, 20 percent mission peculiar (sensitive combat support), with the remainder being routine logistic support, which can be accomplished by the MACV in-country airlift system or dedicated off-shore support.

In my view, there is insufficient justification to maintain this unit at Nha Trang or to move it elsewhere in SEA. I question the essentiality of its contingency mission in competition with other units in an austere force structure; however, retention and relocation offshore (Taiwan) may be warranted.⁸⁴

The commander, Seventh AF, concluded the discussion with the recommendation that COMUSMACV concur on one of two proposals. The first proposal was, as a minimum, to relocate the 15th SOS to an offshore location. The second proposal called for the deactivation of the unit if further joint examination warranted. COMUSMACV did not agree to either proposal.⁸⁵

With COMUSMACV's nonconcurrency to the commander, Seventh AF proposals merely shifted discussions to higher echelons of command. CINCPACAF dispatched a message on 15 May 1970 stating that the time might be right for the CSAF to intercede with the JCS on this matter. On 21 May 1970 a CSAF memo was presented to the JCS. It contained a brief historical sketch of the Combat Talon aircraft and presented statistics similar to those contained in the earlier PACAF analysis.⁸⁶ The CSAF memo went on to recommend that Combat Talon support to SOG be provided on a temporary basis from an offshore location. This would provide SOG with the unique capabilities of the Combat Talon aircraft when mission requirements dictated and would provide CINCPACAF with greater flexibility in satisfying CINCPAC theater-wide special operations requirements. Specific

benefits of an offshore-based unit were noted in the memo that follows:

- a. Protecting the weapons system for future employment in its primary UW mission.
- b. Permitting tactical training to sustain proficiency for deep penetration into hostile environments.
- c. Providing CINCPAC flexibility by being able to operate from any forward base in PACOM.
- d. Providing CINCPAC a responsive force to conduct on-going *[sic]* Psyops throughout PACOM.
- e. Affording a substantial saving by basing the C-130s with like aircraft while permitting rapid deployment to forward operating bases.
- f. In keeping with present national policy of withdrawing forces from the RVN [Republic of Vietnam].⁸⁷

Because of the joint/combined service implications of the CSAF proposal, the JCS solicited CINCPAC and MACV for comment. CINCPAC responses on 12 June and 4 July, supported by a COMUSMACV message on 1 July, strongly opposed the CSAF position. CINCPAC, in addition to advancing the same argument that COMUSMACV used against the Seventh AF proposal, stated that deployment of the Combat Talon unit to an offshore location would include an additional cost and that the split operation would degrade SOG's capabilities to support emerging mission requirements throughout SEA. CINCPAC further noted that the Vietnamese Air Force was incapable of furnishing the necessary air support and directly contested statistics pertaining to Combat Talon flying time provided by Seventh AF. He also stated that the aircraft were being "fully used in combat or sensitive combat support missions." The JCS agreed with CINCPAC and denied the CSAF request.⁸⁸

Despite unfavorable consideration by the JCS on the first CSAF memorandum, a CSAF trip report on a July visit to SEA indicated that staff action should continue to relocate the Combat Talon unit. Preliminary Air Force actions centered on attempts to acquire more management information on all aspects of air support to SOG. These unilateral efforts to obtain more definitive operational statistics were, by themselves, to no avail; for in the final analysis, the Air Force had to convince the Joint Staff. After some headway was made, the CSAF again asserted his desire to relocate the 15th SOS. The proposal appeared to have been ill timed. A "personal for" message (correspondence that receives special handling by the message center to ensure that only the person to whom it is addressed receives and reads the message), dated 12 October 1970 from CINCPAC to the chairman, JCS, requested an abrupt stop to any attempts to change the location of the 15th

SOS.⁸⁹ The message effectively stopped all pending relocation actions for Combat Spear.

The Combat Talon unit remained at Nha Trang AB until 1972, closing out its operation shortly before the deactivation of SOG. Although earlier attempts by the Air Force to withdraw the unit from South Vietnam were unsuccessful, these attempts did focus high-level attention on the unit and thus enabled the Air Force to acquire more comprehensive management information on the unit's activities.⁹⁰

Business as Usual at Nha Trang Air Base

Colonel Newell continued in command of the 15th SOS until 23 February 1970, when he relinquished command to Lt Col Leo W. Tubay. Training requirements continued to be a high-emphasis item for the squadron. Three additional surface-to-air recovery demonstrations were performed—two on 25 February (one at Lop Buri, Thailand, and a second at Nha Trang AB) and one on 14 March at Clark AB, Philippines. The Nha Trang AB demonstration was for Maj Gen Wilburn Dolvin, chief of staff, MACV. The Lop Buri pickup was for approximately 50 delegates to the Southeast Asia Treaty Organization. The pickup at Clark was in support of the Pacific Jungle Survival School.⁹¹

The year 1970 started with a record few combat missions being flown. Aircrews and support personnel were kept busy, however, performing logistical and training missions. President Nixon's Vietnamization policy continued to reduce US forces stationed in SEA. The bombing halt continued in effect, thus eliminating any combat operations into North Vietnam. The Fulton system, designed to extract downed crew members from deep behind enemy lines, was not the system of choice for recoveries where rotary-wing aircraft could be employed. Therefore, the Fulton recovery mission was virtually eliminated as an option for tactical employment. Relocation options for the squadron would be a major point of discussion until October 1970, when CINCPAC successfully killed all relocation initiatives.⁹²

During the spring quarter, the 15th SOS sustained moderate battle damage from ground fire on aircraft 64-0568. One loadmaster crew member (John C. Stumpf) suffered a bullet wound to his left arm. The aircraft was flown to CCK, Taiwan, for repairs that could not be accomplished at Nha Trang AB.⁹³ Another live surface-to-air recovery demonstration was performed for the Pacific Jungle Survival School on 23 May.⁹⁴

When the 14th SOW moved from Nha Trang AB to Phan Rang AB in mid-1969, responsibility for managing maintenance personnel assignments shifted to the 483d Tactical Support Group at Cam Ranh Bay. Resultant manning support proved to be unacceptable for the 15th SOS due to a large decline in skill levels and in shortages of assigned personnel. To correct this situation, effective 1 January 1970, Seventh AF/DP began managing all personnel assignments for the 15th SOS. Resultant improvements in maintenance personnel manning were considerable. This policy was changed, however, effective in September 1970, when the 483d again assumed manning responsibility for the 15th SOS. After this time the Seventh AF retained manning responsibility for enlisted aircrew manning, including AFSC's A293X2E, A431X1A, A435X0A, and A607X0.⁹⁵

On 10 September another live surface-to-air recovery was performed at Clark AB. The demonstration was delayed for an approaching typhoon and later for aircraft maintenance. As in previous demonstrations for the survival school, students and faculty alike were appreciative of the support.⁹⁶

Late summer brought about a reapportionment of billets previously occupied by 15th SOS officers at Nha Trang AB. USA personnel had been assigned to the base when the 14th SOW relocated to Phan Rang AB the previous fall. A new agreement between the USAF and USA assigned 50 percent of available air-conditioned rooms to Army personnel. Room assignments were made based upon crew duty status and on date of rank. The two 15th SOS technical representatives also lived in the air-conditioned quarters shared by USAF and USA officers. Officer morale remained high, with movies and shuffleboard in the officers' club, and tennis courts, the library, and a stereo tape-recording center all within one block of their assigned quarters. A close social relationship sprang up between Air Force and Army officers sharing the barracks' facilities. Enlisted personnel spent many man-hours participating in self-help projects designed to improve the quality of their quarters. These projects included remodeling the hallway on the lower floor, laying tile in all rooms and in the hallway, and converting the lounge area into a small movie theater.⁹⁷

As was the case during the previous two summers, there was a near 100 percent turnover of assigned squadron personnel during the summer of 1970. July witnessed the heaviest turnover. With many replacement crew members not arriving until August, a serious degradation of combat-ready

resources resulted. Available combat-ready crews dropped from six to three during this period. By September the number of combat crews had again reached five and continued to increase to six throughout the fall.⁹⁸

The future of the 15th SOS continued to be tenuous, with rumors reaching the squadron of attempts either to disband the unit or to relocate it to an offshore location. There was strong pressure from Seventh AF and PACAF to move the squadron and just as much pressure to maintain the unit at Nha Trang AB from SOG. As October arrived a new initiative was revealed—the 15th SOS was to be renamed the 90th SOS.⁹⁹

Department of the Air Force Movement Order Number 27, dated 23 October 1970, directed the commander, Seventh AF, to take necessary action to move the 90th Attack Squadron from Bien Hoa AB, South Vietnam, to Nha Trang AB, without personnel and equipment.¹⁰⁰ Once at Nha Trang AB, the 90th was assigned to the 14th SOW and renamed the 90th SOS. Personnel and equipment of the 15th SOS were transferred in place to the 90th SOS, and the 15th SOS designation was retired from active service. Colonel Tubay became the first commander of the 90th SOS, effective 1 November 1970. Air Force leadership made the decision to retain the 90th designation on active duty due to its long and colorful heritage dating back to World War I. Nonetheless, there was some reluctance to give up the old 15th SOS designation.¹⁰¹ It would be nearly 25 years before the 15th SOS flag would be raised again at Hurlburt Field, Florida, with the unit operating the MC-130H Combat Talon II.

Live surface-to-air recovery demonstrations continued during the last three months of 1970. Three demonstrations were performed at Clark AB (10 October, 14 November, and 5 December), one at Udorn RTAFB, Thailand, on 30 October, and one at Ubon RTAFB, Thailand, on 31 October. Live demonstrations continued as a point of pride within the squadron and helped to build confidence in the system by prospective customers. As in previous years, however, the Fulton recovery system was not employed operationally for an actual combat recovery.¹⁰²

By year's end an effort to consolidate 90th SOS officers into the two-building complex of building 1538 and building 1532 was realized. The year 1970 had been marked by numerous changes, including the renaming of the squadron. As the war in SEA continued to wind down for American forces stationed there, the 90th SOS looked toward

1971 with expectations of increased employment into Cambodia.¹⁰³

Air Operations—1970

In 1970 the number of combat support missions flown by the 15th SOS increased significantly. Combat Talon aircraft executed 18 of 21 scheduled combat missions within SEA. No missions were flown into North Vietnam. Logistic airlift also increased because of higher "in-commission" and availability of aircraft rates. Combat Talon carried 4,874,600 pounds of cargo and 23,515 passengers.¹⁰⁴

Existing logistics airlift commitments and a lack of interceptor aircraft participation limited aircrew proficiency training during the year. The 15th SOS accomplished nine Black Baron events. Combat Talon crews accomplished Red Baron training during in-country airlift missions. In addition to ECM training, crews practiced low-level, terrain-following flights in the Philippines about every three months. Fulton recovery pickups (both live and utilizing sandbags) continued to constitute a part of Combat Talon training throughout the year.¹⁰⁵

1971: Cambodia and the PSYOPS Campaign

The long-awaited increase in combat mission tasking came to fruition during the first three months of 1971. SOG tasked the squadron to conduct strategic PSYOPS leaflet drops on to Cambodia. Five combat missions were flown each week, in addition to continuing combat support missions. The increased workload was readily accepted by the squadron, and morale soared to heights not seen since the bombing halt of 1968.¹⁰⁶ Lt Col Ernest L. Howell assumed command of the 90th SOS on 1 February 1971 from Colonel Tubay. Two live surface-to-air recoveries were made at Clark AB on 24 January and 6 February in support of the squadron's commitment to the Pacific Jungle Survival School.¹⁰⁷ During the second quarter of 1971, three more live surface-to-air recoveries were made for the school—two on 15 May and one on 14 June.¹⁰⁸

The self-help program for the enlisted barracks was recognized during an inspector general (IG) inspection of Nha Trang AB. The team recognized the 90th SOS enlisted barracks as the best it had seen in South Vietnam. The team chief went on to speculate that the barracks were probably the best in all of SEA.¹⁰⁹

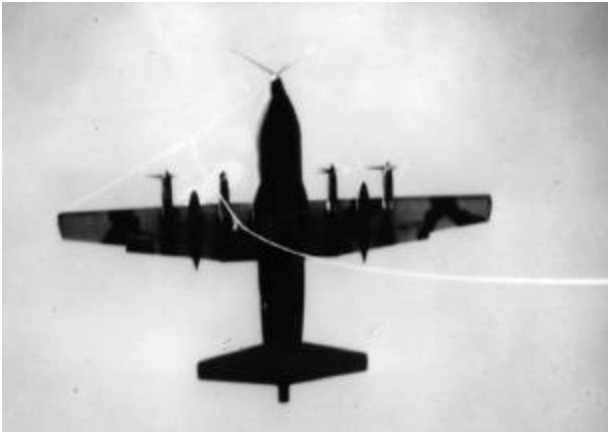


Photo courtesy of Len Butler

On 6 February 1971, Capt Len Butler successfully extracted Maj Don James utilizing the Fulton STARS. Picture shows the first unsuccessful attempt. Butler “fended” the line on the first try due to severe crosswinds and balloon layover of 35°. On the second try, everything worked as advertised. Butler did not miss again throughout his long career in Combat Talon.

Since the move of the 14th SOW from Nha Trang AB, aircraft parts for the Combat Talon had become increasingly more difficult to source. The 90th SOS supply section was a satellite of the 483d TAW located at Cam Ranh Bay, and being a SOF unit assigned to the 14th SOW, it did not have a high priority when aircraft parts were needed. To fix the parts-sourcing problem, a C-130 war readiness spares kit was approved by PACAF for the 90th SOS in May 1971. The kit was located at Nha Trang AB and greatly simplified sourcing of parts for the Combat Talon. Up to that time, supply personnel at Nha Trang AB were dependent upon a forward supply point stocked from Cam Ranh Bay. Due to many factors, the forward supply point had never operated satisfactorily. The WRSK proved to be a vital source of spare parts for the squadron.¹¹⁰

As SEA continued to draw down for US forces stationed there, facilities previously maintained and supported by the 14th SOW were reduced at Nha Trang AB. When the 14th relocated to Phan Rang AB, the 327th Combat Support Group was formed at Nha Trang AB to coordinate base support requirements with Cam Ranh Bay. As part of the Vietnamization process, the 327th was later deactivated, and Nha Trang AB was transferred to Vietnamese control. As the major USAF unit remaining at Nha Trang AB after the transfer, the 90th fell heir to the remaining base functions still needed to support the troops stationed there. (A medical aid station, the security police force, and remaining supply

personnel were attached to the squadron.) The deactivation of the 327th had a huge impact on the quality of life for remaining personnel, but the 90th stepped up and did its best to maintain services at an acceptable level.¹¹¹

There were other closures on Nha Trang AB due to the base transfer. The combined officer/NCO club was transferred to the Vietnamese Air Force and was unavailable to US personnel. Other base services that closed included the base exchange, snack bar, library, tape center, and dining hall. Personnel were no longer able to obtain meals on Nha Trang AB. The 90th SOS set up bus transportation to the nearest dining facility, which was located three miles away at the US Army’s Camp McDermott.¹¹² The beach area continued to be a place where personnel could go and relax when off duty.

The 90th SOS joined with other units remaining at Nha Trang AB to form a community reactions committee with the sole purpose of identifying problems in the support area and then formulating possible solutions to those common problems. Such subjects as linen exchange, supplies for BOQ, trash removal, and Civil Engineering support were addressed. Several working subcommittees were established to address specific areas of concern. The community reactions committee became the single representative body that instituted plans and policies that affected all units, thus eliminating inconsistencies and annoyances and improving maintenance and appearance of the base.¹¹³

To offset the closure of the combined club, both officers and noncommissioned officers constructed their own separate club facilities. By year’s end the new clubs were operating as the social centers of the base. The new officers’ club facility was burglarized, and the sound system, movie projector, and bar stock were stolen. Vietnamese Air Force authorities denied the squadron’s request to hire a security guard, so other measures were taken to improve physical security. The noncommissioned officers set about building bunkers around their club from discarded sandbags found around the base, while officers relied on better locks to protect their assets.¹¹⁴

The squadron had operated throughout the year with four Combat Talon aircraft. On 1 July aircraft 64-0568 left Nha Trang AB for CCK, and on 10 July it was transferred to TAC and returned to the United States. For the remainder of the year, the 90th SOS possessed three aircraft—64-0523, 64-0555, and 64-0567.¹¹⁵ Two additional

live surface-to-air pickups were made during the summer for the Pacific Jungle Survival School. One was made on 12 July and a second on 30 August. On 25 August one Combat Talon received minor battle damage from ground fire while flying a support mission in South Vietnam. The aircraft was repaired and returned to operational status the same day.¹¹⁶

September marked another milestone. On 1 September the 90th SOS and 1st Flight Detachment were transferred from the 14th SOW at Phan Rang AB to the 483d TAW at Cam Ranh Bay due to the pending closure of the 14th SOW. On 10 September a formal deactivation ceremony was held at Phan Rang AB for the 14th SOW, and the wing was officially deactivated on 30 September 1971.¹¹⁷ In October Lt Col Robert N. Pinard arrived at Nha Trang AB as the squadron commander-designate. Having just completed Combat Talon training at Pope AFB, he had observed two incidents of sky anchor failure during STARS training, a condition that resulted in the pickup package being dropped by the aircraft. He surmised that if the sandbag had been an actual live pickup, the individual could have died. He advised Howell of the sky anchor failures, and after weighing the pros and cons of continued live pickups during training, Howell decided to suspend temporarily live recoveries during training missions. He continued to support recoveries for actual operational missions. On 5 November Pinard assumed command from Howell and made the “no live recoveries for training” policy permanent.¹¹⁸ The US-based Combat Knife unit at Pope AFB and the Combat Arrow unit in Europe were not performing live recoveries when the policy went into effect. With the Combat Spear unit no longer performing live recoveries, none were made for the next eight years.

As 1971 came to a close, 90th SOS personnel were authorized to wear the bush hat with their utility uniform. The colorful bush hat’s origins could be traced to World War II, the China-Burma-India theater, and the 1st Air Commando Group. Although the hat was quite popular among squadron personnel, leadership in the 483d TAW did not appreciate its origins and promptly banned wearing the hat at Cam Ranh Bay. Wearing the bush hat was tenuous at best, but 90th SOS personnel wore it at Nha Trang AB while performing official duties in their field uniforms.¹¹⁹

Air Operations—1971

In 1971 the 90th SOS increased its unit flying time, primarily as a result of expanded PSYOPS missions into Cambodia. On 25 January the 90th



Photo courtesy of Len Butler

The beach area was a popular meeting place for the 90th SOS. Pictured in May 1971 is crew SG-21. Standing, left to right: John Murphy, Len Butler, Ray Doyle, Tim Terrell, Dave Haynes, Cliff Steger, and unknown. Kneeling: Bill Laughlin, Charlie Jones, and Bob Cepeck.

assumed responsibility for the aerial delivery of leaflets under the program names of Frantic Goat, Fountain Pen, and Brown Stallion. In all, the 90th SOS successfully completed 226 combat missions (including PSYOPS missions) of 282 scheduled. Mission figures for 1971 included an increase in the number of infiltration and resupply missions. Overall logistics airlift during the year reflected a decrease in tonnage, due primarily to greater reliance on 834th Air Division assets. Training statistics for 1971 were documented using total flying hours rather than numbers of missions; therefore, a comparison to previous years was not possible.¹²⁰

1972: Relocation from SEA

With the deactivation of the 14th SOW and the transfer of Nha Trang AB to Vietnamese Air



Photo courtesy of Len Butler

The original “Hole-in-the-Wall” gang. Note “Big Red” on the back wall. Pictured left to right: Don James, Denzel Greene, Len Butler, and Wayne Mathias.

Force control the previous fall, it was apparent that the 90th SOS's days in SEA were numbered. The driving force keeping the unit in South Vietnam was SOG, and SOG was in its last four months of existence. Air Force leadership was still convinced that the mission could be performed from an offshore location. Throughout South Vietnam, the US military was withdrawing and turning over facilities to its Vietnamese counterparts.

On 3 January 1972, with three of four authorized aircraft possessed, the 90th SOS sent aircraft 64-0567 for IRAN at CCK and subsequently on to the 7th SOS in Germany. In exchange the 90th received aircraft 64-0551. From January to March 1972, the 90th flew 164 MACSOG-tasked missions, the majority being PSYOPS leaflet drops into Cambodia.¹²¹

At the squadron level, rumors continued to abound regarding the relocation of the squadron. During the latter part of the quarter, the squadron was notified that it would move to Kadena AB, Okinawa, by mid-April. Colonel Pinard and his staff set about planning the details of the move. It soon became apparent that there was insufficient airlift to move the squadron expeditiously, so squadron loadmasters developed load plans to move everything by way of organic airlift. Concurrently, all SOG missions were supported during the April move. By the end of April, all 90th SOS personnel and equipment had been relocated to Kadena AB. Although the unit continued to support SEA operations for another two years, relocation outside South Vietnam closed a colorful chapter in Combat Talon history. On 15 May 1972 SOG was deactivated and was redesignated the Strategic Technical Directorate Assistance Team.¹²²

Six years of Combat Talon support to SOG achieved mixed results, primarily due to various obstacles endemic to SEA operations. The following factors were the major limitations to overall mission success.

1. North Vietnam, under a strong totalitarian regime, was a closed society with efficient ant subversion machinery.
2. High echelon control and mission approval/disapproval procedures impeded the planning and execution of operations.
3. Diplomatic restrictions, such as the initial limitation on overflights of Laotian territory and on the use of Thai facilities, restricted flexible planning of missions.
4. Terrain features and climatic conditions imposed severe difficulties in achieving accurate aerial delivery of personnel and supplies.
5. The North Vietnamese and Viet Cong apparently had a good intelligence collection system near Long Thanh training facility and possibly had secured information sources in the South Vietnamese Strategic Technical Directorate.
6. There was not full cooperation between the American Embassy, Vientiane, and MACSOG.
7. The air defense system of North Vietnam prevented operations in the vicinity of population centers for both the C-123 Heavy Hook and the C-130 Combat Talon.
8. A shortage of air assets limited the number of combat operations and training exercises.
9. Navigational aids on SOG fixed-wing aircraft did not enable pinpoint delivery accuracy in aerial drops over obscured drop zones.
10. Heavy cloud cover and other missions of higher priority sometimes denied SOG the necessary aerial photography for mission planning.¹²³

The full extent of USAF's contribution to the SOG UW program cannot be measured. Statistics relate only part of the story and do not capture the color of the SOG mission and the people who executed it. USAF members participating in SOG operations were highly dedicated, well trained, and operated sophisticated aircraft to support unusual missions. The organization itself was unusual. It was flexible and divorced from standard command and control channels. Stringent security procedures wrapped it in a mantle of secrecy.¹²⁴ Combat Talon crews continued to support US operations in SEA operating from Kadena AB and from its forward operating location (FOL) in Thailand.

Redesignation as the 1st SOS

With transfer of the 90th SOS to Kadena AB, Okinawa, in March 1972, the squadron's chain of command also changed. The unit consisted of 38 officers and 44 enlisted men and was assigned to the 18th Tactical Fighter Wing at Kadena AB. The 18th TFW reported to the 313th Air Division, also located at Kadena AB, and the 313th AD reported to Fifth AF at Yakota AB, Japan. Above Fifth AF was PACAF at Hickham AFB, Hawaii, and Headquarters United States Air Force, at the Pentagon.¹²⁵ When the unit deployed to its FOL location in Thailand, OPCON was exercised by Thirteenth AF, which was the numbered air force responsible for all Air Force operations originating from that country. With the reorganization of SOG and the end of US combat forces stationed in Vietnam, both SOG and Seventh AF were no longer in the 90th SOS's chain of command.

During the months following relocation, Colonel Pinard and his staff stayed busy with bed-down requirements at Kadena AB. Building 3433

served as the squadron's administrative and operations headquarters, while building 874 housed the loadmaster section and stored the Fulton STARS equipment. Squadron life support was located in one-third of building 3432 along with individual aircrew lockers used to store aircrew flight gear. The fourth facility assigned to the 90th SOS was a quonset hut (building T-829), which provided storage for infrequently used equipment items.¹²⁶ Unaccompanied billeting was a problem from the beginning at Kadena AB, with enlisted members being housed in Barracks 713, which was a substandard, nonair-conditioned facility.

Although the unit's days at Nha Trang AB had ended, the squadron continued to fulfill an operational commitment to SEA. The squadron established an FOL at Nakom Phanom RTAFB, Thailand, and maintained one aircraft and one crew there, with a small support staff and a maintenance package, to fly leaflet missions targeted primarily at North Vietnam. On 10 November 1972 the squadron was notified that its four Clamp-modified Talons would be replaced with four Yank aircraft equipped with more powerful Allison T56-A-15 engines (see chap. 2).^{*127}

On 20 November the squadron was alerted for deployment of a second aircraft and crew to NKP in preparation for an expanded PSYOPS campaign designed to coincide with the peace talks taking place in Paris. The operation was designated Tempo Surge, and Pinard put two aircrews on 24-hour alert status. On 10 December, with peace talks at a critical phase, the 90th SOS sent a second aircraft and two crews to NKP. Pinard deployed forward to supervise arrangements associated with the expanded operation. For the first week, the 90th SOS, supported by 18th TFW maintenance personnel, flew multiple sorties daily while living in hot, open-bay barracks. Because of the overcrowding at NKP, Pinard and his staff began to look for a better base of operations, one capable of accommodating the expanded tasking.¹²⁸

Before deploying for Tempo Surge, word arrived at Kadena AB that the squadron would be redesignated the 1st SOS. PACAF Movement Order



Photo courtesy of Steve Cromer

Combat Spear rigged for leaflet drop during Tempo Surge. Note the flare pistol held by the loadmaster, Steve Cromer. It gave new meaning to the old phrase "unarmed and unafraid."

Number 15, dated 5 December 1972, directed the commanders, Thirteenth Air Force and Fifth Air Force, to take whatever actions necessary to relocate the 1st SOS and the 90th SOS, without personnel and equipment, from NKP, Thailand, and Kadena AB, Okinawa, to Kadena AB and Clark AB, respectively, effective 15 December 1972. Upon arrival of the 1st SOS flag at Kadena AB, the squadron was reassigned to the 18th TFW and assumed the assets of the 90th SOS. In turn the 90th SOS moved to Clark AB and was assigned to the 405th Fighter Wing awaiting personnel and equipment.^{**129}

On 13 December the first Yank aircraft, tail number 63-7785, arrived at Kadena AB. The first training flight in the new aircraft was conducted on 14 December, and by the end of the month, most personnel had been trained. With Tempo Surge operations in full swing, fully one-half of the newly designated 1st SOS was deployed to its FOL in Thailand. On 15 December aircraft 64-0561 was sent to Ramstein AB, Germany, as part of the aircraft redistribution program, and was permanently assigned to the 7th SOS.¹³⁰ A second Yank aircraft (62-1843) arrived at Kadena from LAS Ontario on 6 February 1973.

*The four aircraft—62-1843, 63-7785, 64-0564, and 64-0565—had formerly been Yard-configured and were assigned to the Heavy Chain program. When Heavy Chain was terminated earlier in the year, the four aircraft were modified into the Yank configuration and were assigned to Combat Spear in the Pacific. The more powerful engines allowed higher operating altitudes critical to the high-altitude delivery of PSYOPS material.

**The 1st SOS had been stationed at NKP RTAFB, Thailand, flying A-1E Skyraiders from December 1967 to November 1972. The squadron flew its last mission in the A-1 Skyraider on 7 November 1972. Unit aircraft and equipment were transferred to the Vietnamese Air Force and other friendly countries in the region, and its personnel were reassigned to units throughout the Air Force. The 90th SOS had been a fighter squadron when its flag was transferred to Nha Trang AB without personnel or equipment, to absorb the deactivated 15th SOS. The 90th was retained on active duty, and the 15th SOS flag was retired at that time. With the move of the 90th's flag to Clark AB, Philippines, it became once again a fighter squadron flying the F-4 Phantom.

Tempo Surge was having its affect on the enemy. Radio Hanoi and other communist-oriented radio stations in SEA devoted hours of broadcast time trying to negate the effects of the campaign. Instructions were broadcast directing the populace to immediately destroy individual leaflets before reading them, and campaigns were begun to collect large quantities of leaflets for ceremonial burning. The leaflets covered a myriad of subjects, including Henry Kissinger's secret peace talks in Paris, messages from President Nixon and other US officials, and conditions of North Vietnamese troops on the battlefield.¹³¹

One special mission tasked to the 1st SOS during Tempo Surge was the dropping of packages containing small transistor radios with batteries. The radios were pretuned to stations that broadcast information and music prepared by the Asian version of Radio Free Europe. The mission was effective in reaching North Vietnamese farmers, soldiers, and peasants who could not read.¹³²

Concurrent with increased temporary duty assignments to SEA, training requirements continued at an accelerated pace. Two crews deployed to Clark AB, Philippines, for week-long, low-level training in the rugged mountains there. Each deployment accomplished more than 20 training sorties, with low-level operations being emphasized. Because Kadena AB was located on the island of Okinawa, only minimal training could be accomplished at home station. Limited airdrop, surface-to-air recovery, and assault landing operations could be completed at the training area at Ie Shima. With the arrival of the two Yank aircraft, which were not Fulton-equipped, recovery training requirements were reduced to two STARS-qualified aircrews.¹³³ The 1st SOS maintained the STARS capability until August 1973, when the last Fulton-equipped aircraft (64-0566) was transferred to the 318th SOS at Pope AFB.

1973: Cease-Fire in Vietnam

As the New Year began, the 1st SOS continued to support Tempo Surge. During the first 28 days of January, the squadron flew 46 PSYOPS/leaflet missions, often changing targets and/or routings just before takeoff to accommodate the rapidly changing battlefield environment in Vietnam. The tactical situation was changing each hour due in part to the volatile political situation leading up to the cease-fire agreement. At 0000Z on 28 January 1973, the cease-fire agreement was signed, thus bringing to a close direct American military involvement in Vietnam. The 1st SOS's role in

Tempo Surge was brought to an end with the signing of the cease-fire.¹³⁴

The PSYOPS campaign had its affect on the cease-fire process. The North Vietnamese became so enraged at some of the leaflets that they began naming individual leaflets delivered by the 1st SOS in their retaliatory propaganda broadcasts. Several messages were received from higher headquarters congratulating the squadron on its superior performance, the most notable of which came from Kissinger himself. In a 7 February 1973 letter, Kissinger stated:

The President greatly appreciated the very effective manner in which the Department of Defense supported the [US] Government's psychological warfare campaign against North Vietnam. Among the many tasks undertaken with great dedication and professionalism, that of creating a variety of specialized leaflets and dropping them in the hundreds of millions, was a noteworthy accomplishment. These efforts contributed markedly to the success of the program designed to help bring an end to hostilities.¹³⁵

When the cease-fire was established for Vietnam, 1st SOS tasking was shifted to Cambodia. Although the intensity of activities lessened, the squadron continued to fly daily sorties into Cambodian airspace with one aircraft and crew assigned to its FOL. On 17 February the 1st SOS moved its FOL from NKP to Takhli RTAFB, Thailand, where better facilities were available with less crowding. Unit aircraft were utilized to move assets from NKP to Takhli RTAFB. During the move, the squadron continued to fly tasked missions into Cambodia, not canceling a single sortie.¹³⁶

While high-level combat operations were being flown out of the FOL in Thailand, low-level training requirements continued to challenge squadron members back at Kadena AB. In its 14 March 1973 message, Thirteenth AF notified the 1st SOS that all low-level flights were canceled over the Philippine island of Luzon. The message cited political reasons for the termination of low-level operations.¹³⁷ As a result of the loss of training, on 22 March the squadron began flying low-level route surveys in South Korea. Up to that time, the squadron depended almost exclusively on the Philippines for low-level proficiency training. The mountainous terrain found in South Korea proved to be even more challenging than the routes flown in the Philippines.¹³⁸ Required agreements were finalized during April, and the routes were operational in May. The 1st SOS was authorized to conduct low-level operations at night, three times a week, by the 314th AD (located at Osan AB, Republic of Korea) and by the

Korean government.¹³⁹ To ensure that the squadron would not be caught again with a sole source for low-level training, the 1st SOS began preparing additional training routes in Taiwan.¹⁴⁰

Throughout the spring of 1973, the 1st SOS was assigned five aircraft—three Yank and two Clamp (62-1843, 63-7785, 64-0564, 64-0566, and 64-0567). Yank aircraft 64-0564 arrived in April, with Clamp aircraft 64-0567 being retained by the unit until 10 August. During the summer the PSYOPS campaign continued to target Cambodia. North Vietnam had invaded that country, and the US government attempted to turn the tide of battle in favor of the provisional Cambodian army. Captured North Vietnamese soldiers indicated that PSYOPS leaflets dropped by 1st SOS aircraft were definitely having an effect on both soldiers and civilians on the ground. A North Vietnamese company commander surrendered to a South Vietnamese unit and indicated that he had personally seen the effects of leaflets, radios, and counterfeit bank notes during the past year. He further stated that all were quite effective and were a deciding factor in influencing him to surrender.¹⁴¹

In March the squadron received the SA-1800CC-AN/UNH airborne speaker system, project code-named Big Mouth, to augment its PSYOPS capabilities. On 9 May the system was tested over the Ie Shima training range, and optimum operational altitudes were established. By 25 June the results of the tests had been tabulated, and aircrew checklists were sent to PACAF for approval and incorporation into MCM 55-130, volume 2. The speaker system provided either a microphone or tape input capability that was amplified and then transmitted outside the aircraft through the left paratroop door. Although not immediately employed in SEA, the new system promised to improve PSYOPS capabilities for the squadron.¹⁴²

On 23 August 1973 the 1st SOS ferried aircraft 64-0566 to the 318th SOS at Pope AFB. With its departure the Fulton STARS capability was no longer deployed to the Pacific region. Remaining Fulton equipment was sent back to Pope AFB. Unit personnel remained current in the capability until the end of the year, although no additional recoveries were made from August onward. The system had proved to be a unique capability, but the cost associated with maintaining proficiency and keeping the system operational by maintenance personnel proved to be an expensive undertaking. The 318th SOS maintained a STARS commitment to PACAF, and it could be tasked to

forward deploy if the capability was needed in theater.¹⁴³

With its requirement to fly low-level training missions in South Korea, the 1st SOS sought to become more involved in Korean exercises. The squadron was not earmarked for Korean employment in time of war, and unless it participated in the joint/combined exercise program there, its approval to train in country would eventually be rescinded by the Korean government. Exercise Foal Eagle was sponsored by the JCS and included participation by US Army, US Navy, US Air Force, and Republic of Korea forces. The 1st SOS was successful in getting itself force listed for Foal Eagle 74, which was scheduled for the February–March 1974 period. In preparation for its participation, the squadron began expanding its low-level route structure during the fall of 1973. Also in preparation for the exercise, 1st SOS crews began dropping US Navy SEALs into water drop zones off the coast of South Korea. The water drops marked the first time the squadron had dropped SEALs into open water drop zones. As its Korean commitment expanded, the FOL at Takhli RTAFB continued in operation with one aircraft stationed there on a continuous basis. Daily combat missions were flown over Cambodia in support of the PSYOPS campaign.

On 29 October 1973 the 1st SOS received its fourth Yank aircraft (64-0565) from LAS Ontario. This aircraft was the first Talon equipped with the S3-A FLIR system and the new System 56 ECM suite. A basic requirement of the installation of the equipment was that it had to be covert and could not be identified from outside the aircraft while on the ground. To accommodate this requirement, the FLIR ball was mounted in a retractable turret located behind the nose landing gear. Inside the FLIR ball was an infrared lens that differentiated between objects by determining their relative temperatures. A display screen, resembling a television screen, was mounted at the navigation console on the flight deck. The remainder of the FLIR system was mounted in the cargo compartment. FLIR allowed the navigator to view unmarked and unlit drop zones, and it also provided the capability to display terrain during low-level operations. Such major areas as airfields, rivers, and lakes could be seen on the screen, which displayed a picture similar to a black and white television. In operation the navigator could zoom in on a particular target by way of the FLIR's telephoto system, thus providing the navigator with an expanded close-up view of the target. The system was developed by Texas Instruments and was designed

to complement the other sophisticated navigation equipment found on the Combat Talon.¹⁴⁴

Also in October PACAF tasked the 1st SOS to evaluate the Combat Talon's capability to accurately airdrop supplies utilizing the container delivery system (CDS) from altitudes up to 11,000 feet. Aircrews were not current in the CDS and required training in the basic procedure before moving on to high-altitude airdrops. The 1st SOS project officer, Lt Col Joseph J. Neff, contacted the 374th TAW at CCK, Taiwan, for assistance. The 374th TAW sent standardization/evaluation personnel to Kadena AB to supervise the 1st SOS checkout. The evaluation consisted of 10 airdrops and commenced on 17 October. For the drops, 1st SOS crews recorded a circular error average of 17 yards from the desired point of impact from 11,000 feet above the ground. After two days of multiple airdrops, all 1st SOS crews were qualified, and the 374th TAW personnel returned to Taiwan. To facilitate safe CDS operations by the Combat Talon, system improvements were developed. A new forward restraint assembly was designed by TSgt John C. Stumpf to accommodate the expected larger loads associated with CDS drops. MSgt Jimmie O. Riggs and TSgt Ray C. Doyle undertook the project of researching and writing the checklists for the new-type drop. The draft checklists were forwarded to Headquarters PACAF for inclusion in MCM 55-130, volume 2.¹⁴⁵ Within the next four months, the newly acquired capability was employed in SEA operations.

The worldwide fuel shortage brought on by the Organization of Petroleum Exporting Countries' oil embargo had a severe impact on military operations around the world in the late fall of 1973. The 1st SOS was the only unit assigned to the 18th TFW/Fifth AF to have a combat mission in SEA. As a result the decision was made to reduce the Cambodian operation from 150 flying hours each month to 130 hours. At home station the unit was reduced from 150 flying hours each month to 37 hours, thus resulting in a total reduction of 167 hours each month for the squadron. The reduction in flying hours effectively decreased unit training sorties by 79 percent. Although flying time available to the unit was temporarily reduced, additional training opportunities were realized in November when the Philippine government approved resumption of low-level flying. The low-level routes were surveyed in November, and the squadron flew its first training flight in December.¹⁴⁶

Tasking for the 1st SOS at Takhli RTAFB, although reduced by 20 hours each month flying time,

continued with daily sorties into Cambodia. To save valuable flight time, PSYOPS materials were condensed into loads that maximized the aircraft's cargo compartment during each mission. Mission profiles were also altered to maximize fuel efficiency. Squadron support vehicles, including trucks, forklifts, and other general purpose vehicles, either were parked or turned over to the base motor pool. Conservation efforts resulted in significant reductions in total MO-GAS and JP-4 consumption.¹⁴⁷

The Psychological Operations Campaign in SEA ended in December 1973. The final campaign had begun in January 1971, when the 90th SOS was still stationed at Nha Trang AB, Vietnam. During the four months prior to the January 1973 Vietnam cease-fire, when the sortie rate was increased from three each day to six, the 1st SOS flew 145 sorties and dropped more than 1.5 billion leaflets. For the entire campaign, the 1st SOS dropped more than 9.5 billion leaflets with many different themes and psychological messages directed at North Vietnam and Cambodia.¹⁴⁸ With the end of the PYSOPS campaign, the FOL at Takhli RTAFB was shut down, and the aircraft, equipment, and personnel were redeployed to Kadena AB. The success of the overall campaign could be directly attributed to the hard work and dedication of the men and women of the 1st SOS and its predecessor, the 90th SOS.

1974: High-Altitude Airdrops into Cambodia and the End of Hostilities

It was not long before combat operations in SEA were once again the focal point of the 1st SOS. As a result of its newly acquired CDS capability, the squadron was tasked on 23 February 1974 to deploy within 24 hours to U-Tapao RTAFB, Thailand, for high-altitude CDS drops into Cambodia. During the period 24–27 February, one aircraft and crew flew seven combat sorties and delivered 70 tons of needed ammunition to ground combat forces under enemy fire in Cambodia. All 16 loads were dropped on target from an altitude of 11,000 feet. The combination of a highly accurate navigation system and an upgraded System 56 ECM suite made the Combat Talon ideal for the high-altitude CDS mission.¹⁴⁹

During March 1974 the squadron participated in its first Foal Eagle exercise in Korea. The low-level routes that had been surveyed the previous fall were utilized. Just as the Flintlock exercise series in Europe became the centerpiece special operations exercise for the 7th SOS, Foal Eagle 74

marked the beginning of a continuous commitment by the 1st SOS to Foal Eagle through the remainder of the century. The 1st SOS established an Air Force operating base at Taegu AB, Republic of Korea, and deployed additional staff personnel to the exercise headquarters located near Seoul, Korea. The 1st SOS was responsible for the air support of Army and Navy forces participating in the exercise, scheduling and supervising US C-130 and HH-3 operations, and coordinating Republic of Korea Air Force (ROKAF) C-46 operations. Airdrops included land and water drop zones.¹⁵⁰ The exercise proved to be extremely valuable in providing a challenging training environment that increased aircrew proficiency in hard-to-maintain, low-level flying skills. It also firmly connected the 1st SOS with South Korea and ensured its access to challenging Korean training routes.

Not long after its return from Foal Eagle 74, the squadron was tasked to deploy two aircraft and four crews again to U-Tapao RTAFB. A few days later, an additional aircraft and crew were also deployed. The 374th TAW had been flying the high-altitude CDS mission into Cambodia, but because of long supply lines and an unusually high-breakage rate of its AWADS equipment, the wing was unable to maintain the sortie rate needed to resupply the Cambodians. During the period 3–23 April 1974, 1st SOS crews flew 64 single-ship sorties, dropping 531 tons of much needed rice and ammunition to beleaguered Cambodian ground forces. Because the troops were under constant ground fire from the invading Vietnamese army, many drop times had to be changed because of air strikes in the drop area, or they had to be adjusted to allow the ground forces to take cover from incoming artillery fire. In addition to the single-ship sorties flown by the 1st SOS, the squadron flew 47 sorties as the lead aircraft for the 374th TAW C-130 aircraft. With the 1st SOS Combat Talon aircraft in the lead, the 374th dropped 648 tons of supplies. As the 374th TAW maintenance status improved toward the end of April, the 1st SOS was withdrawn and redeployed to Kadena AB.¹⁵¹

Since its relocation to Kadena AB from Nha Trang AB in 1973, squadron enlisted personnel had been billeted in Barracks 713. The facility was substandard due to its overall poor condition, including plumbing and outdated electrical wiring. Because of the wiring, air conditioning was prohibited. Squadron flight personnel were constantly having their crew rest interrupted by various work shifts,

alerts, and recalls of wing personnel living in the barracks. With its commitment to SEA combat operations, 1st SOS personnel needed adequate quarters to relax and rest when they were at home station. The rigors of combat took its toll on the overall health and welfare of the squadron. Although he had been unsuccessful in getting adequate quarters for his personnel in the past, Colonel Pinard seized the opportunity to plead once again his case with his 18th TFW host. This time his efforts were successful. He was able to obtain air-conditioned quarters in the security police complex, and his men volunteered to paint and refurbish the quarters. Although these quarters were a step up from those in Barracks 713, Colonel Pinard pushed for an entire wing of air-conditioned rooms equipped with adequate furniture and carpet for his personnel. CMSgt Joe K. Jackson, the squadron senior airman advisor, coordinated with several groups on base and obtained a full wing of 12 air-conditioned rooms with washer and dryer facilities, privacy, and a low-noise level, which was important for proper crew rest.¹⁵² Personnel continued to improve their assigned areas and eventually received best-on-base recognition by the 313th Air Division commander.¹⁵³ With barracks' life improved at home station, the squadron was able to better support the SEA war.

In June the 1st SOS was called upon again to augment 374th TAW CDS operations in Cambodia. From 2 to 17 June 1974, flying out of U-Tapao RTAFB the squadron flew 36 sorties and dropped an additional 350 tons of rice and ammunition. To offset the additional hours expended in combat operations, Fifth AF allocated additional flying hours so that the unit could complete its training, upgrade, and theater indoctrination requirements.¹⁵⁴ A fourth deployment to U-Tapao RTAFB was accomplished from 24 July to 12 August 1974. Outposts on the ground in Cambodia were constantly under fire, and many times loads dropped only a few meters from friendly troops could not be recovered. During the deployment the 1st SOS dropped 115 tons of ammunition and food to the Cambodians.¹⁵⁵

The high-altitude CDS drops in Cambodia during the spring and summer of 1974 marked the end to the 1st SOS's participation in combat operations in SEA. The Cambodian operation had resulted in more than 425 flight hours and 158 sorties, with 1,600 tons of cargo dropped either single ship or in formation with the 374th TAW. From the fall of 1966 until August of 1974, the

unit, along with its predecessors—the 15th SOS and the 90th SOS—performed its wartime duties in an exemplary manner. After 10 years of fighting in SEA, America was tired of the war and wanted to put Vietnam in its past. Little did the public realize (or for that matter, did the military)

that the next war was soon to begin—the war of international terrorism. The 1st SOS, along with its sister squadrons in the United States and in Europe, was destined to play a pivotal role in this new kind of war.

Notes

1. History, 314th Troop Carrier Wing (PACAF), 1 July–31 December 1966, USAF HRA, Maxwell AFB, Ala., vol.1, 11.
2. History, 14th Air Commando Wing (PACAF), 1 July–30 September 1966, USAF HRA, Maxwell AFB, Ala., vol.1, 10.
3. Personal notes of Lt Col Albert P. Blosch, Retired, provided to the author, 3 November 1998, Combat Talon Archive, Headquarters AFSOC/HO, Hurlburt Field, Fla.
4. Lt Col Marlon Banks, USAF, Retired, interview by Lt Col V. H. Gallacher and Maj Lyr R. Officer, 6 February 1973, USAF HRA, Maxwell AFB, Ala., 12.
5. History, 314th Troop Carrier Wing (PACAF), 1 July–31 December 1966, vol.1, 14.
6. Personal notes of Lt Col Albert P. Blosch.
7. Project CHECO Report, *The Role of the USAF In Support of Special Activities In SEA (U)*, USAF HRA, Maxwell AFB, Ala., 1 July 1976, 70.
8. *Ibid.*, 69.
9. *Ibid.*
10. Banks interview, 4.
11. *Ibid.*, 9.
12. *Ibid.*, 18.
13. *Ibid.*, 18–19.
14. Project CHECO Report, 70.
15. *Ibid.*
16. *Ibid.*, 71.
17. *Ibid.*, 74.
18. *Ibid.*, 33.
19. *Ibid.*, 47–48.
20. *Ibid.*, 49.
21. Banks interview, 10.
22. *Ibid.*, 22.
23. Col Daniel J. Gibson, Air National Guard, interview by Cindi L. Noel, 9–10 May 1989, USAF HRA, Maxwell AFB, Ala., 3 April 1974, 24–25.
24. Banks interview, 5.
25. *Ibid.*, 5–6.
26. *Ibid.*, 7.
27. *Ibid.*, 8.
28. *Ibid.*, 9.
29. Project CHECO Report, 44–46.
30. *Ibid.*, 49–50.
31. Staff Summary Sheet, Seventh AF/DOOT, Lt Gen William W. Momyer, subject: Frantic Goat Psyop Program, 4 November 1967, USAF HRA, Maxwell AFB, Ala., vol. 3, 1–2.
32. Project CHECO Report, 122.
33. End of Tour Report, Col David C. Collins, USAF, deputy commander, Special Operations, 14th SOW, n.d., USAF HRA, Maxwell AFB, Ala., 1.
34. Project CHECO Report, 123.
35. *Ibid.*
36. *Ibid.*
37. Collins, 1.
38. *Ibid.*
39. History, 14th Air Commando Wing (PACAF), 1 January 1968–31 March 1968, vol. 1, 7.
40. Col Thomas F. Hines, Retired, interview by author, College Station, Tex., 13 June 1998. Recorded on 8 mm videotape, not transcribed, Combat Talon Archive, HQ AFSOC/HO, Hurlburt Field, Fla.
41. *Ibid.*
42. Project CHECO Report, 175.
43. *Ibid.*, 35, 75.
44. Don Oberdorfer, *Tet!*, published by Don Oberdorfer, 1971, 124–25.
45. History, 14th Air Commando Wing (PACAF), 1 January–31 March 1968, vol. 1, 6.
46. History, 14th Air Commando Wing (PACAF), 1 April–30 June 1968, vol. 2, 1.
47. History, 14th Air Commando Wing (PACAF), 1 July–30 September 1968, vol. 1, 6.
48. History, 14th Air Commando Wing (PACAF), 1 April–30 June 1968, vol. 2, 9.
49. History, 14th Air Commando Wing (PACAF), 1 October–31 December 1968, vol. 1, 35.
50. History, 14th Air Commando Wing (PACAF), 1 July–30 September 1968, vol. 1, 3.
51. History, 14th Air Commando Wing (PACAF), 1 April–30 June 1968, vol. 2, 7–8.
52. History, 14th Air Commando Wing (PACAF), 1 July–30 September 1968, vol. 1, 11.
53. *Ibid.*, 9.
54. *Ibid.*, 1–2.
55. *Ibid.*, 10–11.
56. History, 14th Special Operations Wing, 1 October–31 December 1968, vol. 1, 6.
57. *Ibid.*, 9.
58. *Ibid.*, 11.
59. Project CHECO Report, 125.
60. *Ibid.*, 125–26.
61. *Ibid.*, 75.
62. History, 14th Special Operations Wing, 1 January–31 March 1969, 51.
63. *Ibid.*
64. Banks interview, 23–26.
65. Official AF Order, Operations Order no. 460-70, Seventh Air Force, subject: Combat Spear, 1 November 1969, USAF HRA, Maxwell AFB, Ala., vol. 12, cover.
66. *Ibid.*, 1.
67. *Ibid.*, 3.
68. *Ibid.*, 4.
69. *Ibid.*, 5.
70. *Ibid.*, A-1.
71. History, 14th Special Operations Wing, 1 January–31 March 1969, 53.
72. *Ibid.*, 54.
73. *Ibid.*, 55.
74. History, 14th Special Operations Wing, 1 April 1969–30 June 1969, 3.
75. History, 14th Special Operations Wing, 1 July–30 September 1969, 8.

76. History, 14th Special Operations Wing, 1 April–30 June 1969, 10.
77. History, 14th Special Operations Wing, 1 July–30 September 1969, 3, 7, 25.
78. *Ibid.*, 12.
79. *Ibid.*, 9.
80. Project CHECO Report, 77.
81. *Ibid.*, 77–78.
82. *Ibid.*, 81.
83. *Ibid.*
84. *Ibid.*, 81–82.
85. *Ibid.*
86. *Ibid.*, 83.
87. *Ibid.*, 83–84.
88. *Ibid.*, 84.
89. *Ibid.*, 84–85.
90. *Ibid.*, 85.
91. History, 14th Special Operations Wing, 1 January–31 March 1970, 6.
92. *Ibid.*, 13.
93. History, 14th Special Operations Wing, 1 April–30 June 1970, 4.
94. *Ibid.*, 6–8.
95. History, 14th Special Operations Wing, 1 July–30 September 1970, 2.
96. *Ibid.*, 7.
97. *Ibid.*, 11–12.
98. *Ibid.*, 14.
99. *Ibid.*, 14–15.
100. *Ibid.*
101. History, 14th Special Operations Wing, 1 October–31 December 1970.
102. *Ibid.*
103. *Ibid.*
104. Project CHECO Report, 78.
105. *Ibid.*, 78–79.
106. History, 14th Special Operations Wing, 1 January–31 March 1971, 18.
107. *Ibid.*, 7.
108. History, 14th Special Operations Wing, 1 April–30 June 1971, 5.
109. History, 14th Special Operations Wing, 1 January–31 March 1971, 11.
110. History, 14th Special Operations Wing, 1 April–30 June 1971, 8.
111. *Ibid.*, 10.
112. *Ibid.*
113. *Ibid.*
114. History, 90th Special Operations Squadron, 1 October 1971–31 December 1971, Combat Talon Archive, HQ AFSOC/HO, Hurlburt Field, Fla.
115. History, 483d Tactical Airlift Wing/90th Special Operations Squadron, 1 July 1971–30 September 1971, USAF HRA, Maxwell AFB, Ala., vol. 2, 5.
116. History, 90th Special Operations Squadron, 1 July–31 August 1971, 4.
117. History, 14th Special Operations Wing, 1 July–30 September 1971, 13.
118. Lt Col Robert N. Pinard, Retired, interview by author, Hurlburt Field, Fla., 7 July 1998. Recorded on 8 mm videotape, not transcribed, Combat Talon Archive, HQ AFSOC/HO, Hurlburt Field, Fla.
119. History, 90th Special Operations Squadron, 1 October–31 December 1971.
120. Project CHECO Report, 79–80.
121. History, 90th Special Operations Squadron, 1 January–31 March 1972.
122. Project CHECO Report, 41.
123. *Ibid.*, 35.
124. *Ibid.*, 53.
125. History, 1st Special Operations Squadron, 1 October–31 December 1972, Combat Talon Archive, HQ AFSOC/HO, Hurlburt Field, Fla., 4.
126. *Ibid.*, appendix, 4.
127. *Ibid.*, iv.
128. *Ibid.*, 7.
129. *Ibid.*, appendix, 7.
130. *Ibid.*, iv.
131. *Ibid.*, 8.
132. *Ibid.*
133. *Ibid.*, 10.
134. History, 1st Special Operations Squadron, 1 January–31 March 1973, 7.
135. History, 1st Special Operations Squadron, 1 April–30 June 1973, appendix. 1.
136. History, 1st Special Operations Squadron, 1 January–31 March 1973, 8.
137. *Ibid.*, 10.
138. *Ibid.*, 8.
139. History, 1st Special Operations Squadron, 1 April–30 June 1973, 14.
140. *Ibid.*, 15.
141. *Ibid.*, 10–11.
142. *Ibid.*, 11.
143. History, 1st Special Operations Squadron, 1 July–30 September 1973, 8.
144. History, 1st Special Operations Squadron, 1 October–31 December 1973, 14.
145. *Ibid.*, 15–16.
146. *Ibid.*, 16–17.
147. *Ibid.*, 17.
148. History, 1st Special Operations Squadron, 1 January–31 March 1974, 12–13.
149. *Ibid.*, 10.
150. *Ibid.*, 14.
151. History, 1st Special Operations Squadron, 1 April–30 June 1974, 9.
152. *Ibid.*, A-6.
153. History, 1st Special Operations Squadron, 1 July–30 September 1974, A-5.
154. History, 1st Special Operations Squadron, 1 April–30 June 1974, 9.
155. History, 1st Special Operations Squadron, 1 July–30 September 1974, 10–11.

THIS PAGE INTENTIONALLY LEFT BLANK

Combat Arrow (Europe: 1968–74)

Associate yourself with men of good quality if you esteem your reputation, for 'tis better to be alone than in bad company.

—George Washington

Project Skyhook

The initial Stray Goose deployment to SEA was completed in the early fall of 1966. By January 1967 Detachment 1, 314th TCW, was flying SOG-tasked missions out of Nha Trang AB deep into North Vietnam. Deployment to Europe was the next major milestone for the new weapons system. In March 1964 Detachment 4, 1st SOW, had deployed from Hurlburt Field, Florida, to Sembach AB, FRG, on temporary duty to US Air Force, Europe (USAFE). On 1 July 1964 Detachment 4 was stood up as the 7th Air Commando Squadron (Composite) (USAFE). Authorized with 265 personnel, the new squadron was equipped with four C-123s, six C-47s, and two U-10 aircraft. The unit was the only special operations squadron assigned to USAFE.¹ In February 1967 the 7th ACS was designated the unit to receive the C-130E(I) Combat Talon.

The 603d Air Base Wing (ABW), the host wing for the 7th ACS at Sembach AB, published Programming Plan 507-67, *Skyhook*, dated 25 February 1967, outlining the reception and support of four C-130E(I) aircraft to be assigned to the 7th ACS. These aircraft were to replace the four C-123s that were assigned to the unit. Code name for the deployment was Project Skyhook. Initial preparations were made by the 603d ABW, but in April 1967 Seventeenth AF, the numbered air force responsible for the 603d ABW, sent a message to the wing stating that the C-130s had been deleted from USAFE programming documents and further directed the wing to discontinue preparation for Project Skyhook pending additional guidance.² As late as June 1967, no further action was taken in preparation for the deployment.

USAFE was notified in late June that Project Skyhook was reactivated and that the code name for the deployment had been changed to Combat Arrow. Headquarters USAFE made the decision to base the Combat Arrow aircraft at Ramstein AB, FRG, with tentative arrival date set as 15 March 1968. Two C-47 aircraft and the main body of the 7th ACS would move to Ramstein AB from Sembach AB on 1 July 1968. The C-123s would return to Hurlburt Field, and the four additional C-47s,

along with the two U-10s, would move to Otis AFB, Massachusetts, and form Detachment 1, 7th ACS.³ Throughout the summer and fall of 1967, preparations were made at Sembach AB and at Ramstein AB for the arrival of the Combat Talon aircraft.

1968: Establishment of Combat Talon in Europe

The first C-130E(I) Combat Talon aircraft, tail number 64-0551, arrived at Ramstein AB on 24 February 1968, with the next two aircraft (64-0559 and 64-0561) arriving on 3 March and 28 June, respectively. On 30 April the first C-123B aircraft was returned to the 4410th Combat Crew Training Wing at Hurlburt Field, Florida.⁴ The composite squadron, with its mix of Combat Talon and C-47 aircraft, was authorized 62 officers and 203 enlisted personnel and was commanded by Col William A. McLaughlin.⁵ The Combat Arrow aircraft were configured the same as Combat Spear and Combat Knife—the AN/APQ-115 TF/TA radar, the Fulton STARS, and an ECM suite designed to enhance aircraft survivability.⁶ From February to June the new aircraft flew 202.6 hours, almost all of which were dedicated to unit training and theater familiarization.⁷

USAFE Movement Order 4, dated 25 March 1968, directed the movement of the 7th ACS from



USAF Photo

Combat Arrow aircraft 64-0551 on the ramp at Ramstein AB, Germany, circa 1968. This was the first C-130E(I) assigned to the 7th SOS.

Sembach AB to Ramstein AB, effective 15 July 1968. USAFE Special Order G-62, dated 2 July 1968, redesignated the 7th ACS as the 7th Special Operations Squadron, which was also effective on 15 July.⁸ During the period from 5 to 18 July, the four C-47s, the remaining C-123s, and the two U-10s were returned to the United States. Colonel McLaughlin, the commander of the 7th ACS and commander-designate for the new 7th SOS, was the ideal choice to head the newly designated squadron. A combat veteran from World War II, he had flown the B-17 for more than 300 combat hours over central Europe from July 1944 until the end of the war in Europe. During the Korean War, he flew C-124s based at McChord AFB, Washington, thus gaining valuable airlift experience throughout the Pacific. In the summer of 1965, after assignments to USAFE and to the Military Air Transport Service, he completed C-123 training at Hurlburt Field and was assigned as the commander of the 310th Air Commando Squadron at Nha Trang AB. Upon returning from SEA in September 1966, Colonel McLaughlin transferred to Europe and was assigned as the commander of the 7th ACS at Sembach AB.⁹

During and immediately after the move to Ramstein AB, the redesignated 7th SOS was faced with a host of problems, most of which were attributed to the move itself and to the massive turnover of personnel caused by the reconfiguration of unit-assigned aircraft. USAFE made the decision to move the squadron from Sembach AB to Ramstein AB because European bases were consolidating under the Crested Cap program, and Sembach AB operations were being reduced. At Ramstein AB, however, there was not adequate administrative space, nor was there adequate ramp space for assigned aircraft. After the arrival of 64-0551 in February, the squadron had split operations between the two bases for the next six months. By the end of the year, however, most of these problems had been resolved or acceptable work-arounds had been established. Unit personnel concentrated on training in the new weapons system (both aircrew and maintenance) and on meeting the continuing commitments of the squadron.¹⁰

As the 7th SOS settled into its quarters at Ramstein AB, squadron aircrew personnel continued to train throughout the theater. Aircraft 64-0559 deployed to the United States on 14 July 1968 for further modifications, thus leaving 64-0551 and 64-0561 available in-theater. From 13 to

26 July one Combat Talon deployed to Zaragoza AB, Spain, for HALO training with the 10th Special Forces Group. The deployment marked the beginning of a long series of training initiatives in Spain. Three hundred and eighteen personnel were dropped from an altitude of 25,000 feet during 29 sorties and 36.2 hours of flying.¹¹

September 1968 marked the beginning of a long and successful Flintlock exercise series. Joint/combined Exercise Flintlock I was conducted in the fall of 1968 and consisted of four subexercises—Grune Krupfalz in Germany, Zeus 68 in Greece, El Sarrío III in Spain, and Sallow in Denmark.¹² In support of Subexercise Zeus 68, one Combat Talon aircraft deployed to Souda Bay, Crete, in September and flew infiltration and resupply missions. Another Combat Talon deployed to Moron AB, Spain, for El Sarrío III. Long-range, low-level exercise missions in Spain were subsequently cancelled by the Spanish government, thus making the deployment of marginal benefit to the squadron. Being based in central Europe, Combat Talon aircrews could not accomplish all of their training requirements without deploying to other locations. The Flintlock exercise series became the key to introducing the squadron to new training areas and opening the door to many of these countries. It would prove to be a valuable means to introduce Combat Talon to unconventional warfare units throughout Europe.

An area in which the 7th SOS pioneered was the deployment of maintenance and spare parts to support Combat Talon while away from home station. US-based Talons and those in SEA operated from their home bases. Early on, the 7th SOS had to deploy maintenance technicians, test equipment, and spare parts to keep its Talons operating while away from home station for extended periods of time. In a period before WRSKs were created for SOF units, the squadron had great success operating the extremely complex Combat Talon system while on the road.¹³

When Combat Talon deployed to Europe, aircraft ECM equipment could not be operated for training purposes due to host nation constraints and due to US restrictions on US peacetime operation. In October 1968 permission was received to operate the electronic countermeasures equipment on board Combat Talon in certain restricted training modes. All 7th SOS electronic warfare officers had gone noncurrent for airborne intercepts and for ground radar events during the previous eight months, so a concerted effort was put forth to get them current and proficient. The first

ECM mission was flown in Spain on 2 October 1968 with the 496th Fighter Interceptor Squadron under the code name Creek Picador. Six sorties of two hours each were flown at low level, with 146 air-to-air intercepts accomplished. Another Creek Picador mission was flown the third week of October with the 32d Fighter Interceptor Squadron (FIS) and a third with the 526th Fighter Interceptor Squadron FIS during the first week of December with similar success. At the completion of this training series in Spain, all assigned EWOs were proficient in airborne intercepts. As a result of this training, and under USAFE sponsorship, a formal airborne intercept training program, code-named Creek Baron, was established in Germany. Creek Baron provided continuous opportunities for the 7th SOS to train with Allied fighter aircraft.¹⁴ It was similar to the Black Baron program flown by the Combat Spear unit in SEA. Ground radar training, which required access to a radar bomb scoring (RBS) site, was not included in the agreement. Permission to use the additional Talon ECM equipment outside the United States was required before RBS training could be approved.

By the end of 1968, Combat Arrow had logged 1,362.4 hours of both unit and joint/combined training.¹⁵ Four aircrews acquired training and proficiency in unique Combat Talon skills. The coming year would expand training opportunities and result in six combat trained crews operating throughout the European AOR.

1969: Expansion of Training Opportunities

The period of the late sixties was one of modernization and change throughout the North Atlantic Treaty Organization (NATO). The cold war conflict between the East and West focused on Central Europe, as America fought a hot war on the battlefields of SEA. The C-130 was the aircraft of choice for tactical airlift in Europe, but by 1969 only a few European countries had purchased it and had crews trained and tactics developed to maximize its effectiveness. Great Britain, Norway, Denmark, Belgium, France, Spain, Germany, Greece, and Turkey would eventually have the aircraft in their air forces, but they would need US assistance to develop their own capabilities. The C-130E(I) Combat Talon was a relatively new aircraft in 1969, and it was heavily modified for the unconventional warfare/special operations role. Combat Spear aircraft operating in SEA had gained almost a mystical reputation with their

work with MACVSOG over North Vietnam. It was an excellent opportunity for the 7th SOS to capitalize on this reputation and to expand its own training throughout Europe. The unit did so by supporting the US Army Special Forces unit assigned to Europe—the 10th Special Forces Group (Airborne) [(10th SFG(A))—and the special operations forces of NATO countries.

The year 1969 began with a no-notice ORI administered by the USAFE inspector general. The squadron received its evaluation from the 6th to the 11th of January during the worst weather of the year. Both Combat Talon and C-47 aircrews and maintenance personnel performed well. The aggressive training schedule of the previous fall paid off in an overall grade of satisfactory.¹⁶ The Creek Baron program continued to expand throughout 1969. During the month of January alone, the 7th SOS scheduled 22 Creek Baron missions in the FRG and 20 in Spain. Of those, eight were flown in Germany and five were flown in Spain. The no-notice ORI caused the cancellation of 16 sorties, with the remainder canceled either for weather or by the participating fighter organization.¹⁷ Airborne intercept training was the focus of the Creek Baron program, although access to RBS sites were also required to train 7th SOS EWOs.

To gain access to high-quality, low-level training routes, the squadron provided continuous training opportunities for Allied special warfare units, including the Danish Jaegerkorpsset, Greek Hellenic Raiding Forces, British Special Air Service (SAS), and the Norwegian Parachute School. The primary US participant was the 10th SFG(A)'s Special Forces Detachment (A) Europe, located at Bad Tölz, FRG.¹⁸

As a follow-on to the highly successful Zeus 68 exercise, unit planners developed an in-depth training plan in Greece that combined the needs of the Greek Hellenic Raiding Forces, the 10th SFG(A), and the 7th SOS. Beginning in 1969 and continuing throughout the 1970s, the squadron kept a Combat Talon deployed almost continuously to Greece. The February 1969 deployment was typical of the monthly trainers. From 22 February to 18 March, a Combat Talon, along with aircrew and maintenance personnel, supported the Hellenic Forces Parachute School, Phase III HALO training, with 10th SFG(A) providing HALO instructors. A Combat Talon was based at Athenae International Airport (IAP) and staged out of Elefsis AB, Greece. Drops were conducted daily from 5,800 feet to 25,000 feet, with the

Combat Talon departing Athenae IAP early each morning, landing at Elefsis AB to onload jumpers, and then taking off and climbing to altitude for multiple jumps. Most drops utilized a high-altitude release point (HARP), which was computed by the flightcrew. HARP-computed drops averaged 550-meters circular error, while jumpmaster-spotted drops averaged 650 meters. A total of 528 paratroopers were dropped during the deployment. At the completion of each day's drop events, the crew flew a low-level route through the mountainous northern region of Greece, then returned to the Athens area for mission termination. During the month-long deployment, the Combat Talon flew 66 sorties and 87.6 hours.¹⁹ A follow-on HALO trainer to Greece in July dropped 1,044 paratroopers while completing 96 sorties. The 7th SOS became the primary jump platform for the jump school at a time when the Greek air force had no aircraft capable of performing HALO operations.²⁰

On 3 April 1969 the squadron experienced the loss of one of its two C-47 aircraft and its crew. Maj Paul C. Jones was the instructor pilot, Capt Randolph S. Crammer was the copilot, and SSgt Donald J. Bissell was the flight engineer. The aircraft was on an instrument training flight and had departed Sembach AB for Ramstein AB when the accident occurred. From eyewitness accounts, the plane entered a steep nose low spin at approximately 1,700 feet and impacted the ground. Post-crash investigation revealed that the vertical stabilizer on the C-47 had collapsed, thus putting the aircraft into a condition from which the crew could not recover. Combat Talon aircraft also experienced five incidents during this period, which resulted in minor damage to the aircraft—four damaged HF antennas and one cracked windscreen—all of which were attributed to contact with the Fulton STARS lift line during recovery operations.²¹

In June 1969 the 7th SOS participated in Exercise Market Garden, celebrating the 25th anniversary of the invasion of Holland by British and American forces. The exercise was a reenactment of the 1944 Allied invasion and received worldwide coverage.²² Throughout the spring and early summer, the 7th SOS plans section prepared for Flintlock II. The flying portion of the exercise was flown from 1 to 23 September, but exercise

personnel began deploying on 12 August to prepare each operating location. Two subexercises in Germany were supported out of Ramstein AB and staged through RAF Upper Heyford, UK, where jumpers were unloaded for airdrop back into the exercise area. Exercise Rote Erde was conducted in north-central Germany in the Dusseldorf area and involved US Army Special Forces and German Armed Forces District Command (WBK III) personnel. Fifteen sorties and 29.5 hours were flown during infiltration, resupply, and exfiltration missions. Walhalla was conducted in south-east Germany in the Schwandorf area and involved British SAS, German Border Guard Forces, and US Army Special Forces. Eight sorties, staged out of Ramstein AB through RAF Upper Heyford, were flown utilizing 28.4 hours. A Combat Talon also supported a long-range personnel infiltration mission from RAF Upper Heyford to the exercise area in the Middle East. The aircraft flew a total of 17.5 hours in support of the subexercise, with the long-range infiltration mission lasting more than nine hours.²³ The 7th Special Operations Flight, located at Otis AFB, Massachusetts, also forward deployed its four C-47s in support of the exercise. This marked the first time the 7th SOS was reconstituted since its split the previous year. Flintlock II proved to be a challenging exercise, with unit personnel gaining a high state of proficiency.

After return from Flintlock II, Talon crews spent the first two weeks of October flying local training missions and reconstituting after an aggressive month of flying. On 12 October the squadron flew its first Berlin corridor mission in one of its C-47 aircraft. USAFE made the decision not to fly the highly classified Combat Talon on these missions. As a result Talon crews were not qualified to fly into Berlin.²⁴ Unit C-130E(I)s were in great demand throughout the theater, however, so the denial of the corridor mission had little impact on Talon tasking.

With a year of successful training in Greece completed, Colonel McLaughlin and three of his plans officers deployed to Athens during the second week of December to attend a Special Operations Task Force Europe (SOTFE)-sponsored conference with the objective of establishing a formal training plan for calendar year (CY) 70.*

*When SOCEUR was originally formed, its title was Special Operations Center Europe. During OPLAN 4102 activation, it formed Special Operations Task Force Europe, or SOTFE. For day-to-day peacetime operations, the small headquarters staff, located at Patch Barracks, Stuttgart, Germany, was referred to as SOTFE. In 1983 the term *SOTFE* was retired, and the center became a subunified command of US European Command (EUCOM), thus becoming the Special Operations Command Europe, or SOCEUR. (From 1983 onward, SOCEUR has been the recognized acronym for Special Operations Command Europe, whether referring to the unit during peacetime or in war.)

On 10 December a meeting was held at Joint United States Military Assistance Group (JUSMAG) Greece with the Embassy Army Section, the Greek Hellenic Raiding Forces, SOTFE, Special Forces Detachment-Europe, the US air attaché to Greece, and Colonel McLaughlin and his staff. A comprehensive training plan was developed that outlined 12 deployments to Greece during CY 70. Some months had two deployments scheduled, while the fall Flintlock period had none. Mission profiles approved included support for the Hellenic Parachute School and day/night visual flight rule (VFR) low-level operations utilizing the Combat Talon. Low-level approval was not contingent upon Greek air-drop support but rather was approved for both combined and unilateral training. Selected Greek airfields were made available, day or night, to service the Combat Talon aircraft. Agreement was also reached to allow the 7th SOS to perform Fulton STARS operations, as well as short-field landings, day or night. In short, Greece became the primary training location for the squadron, and the 7th SOS became the principal air-drop platform for the Greek Hellenic Raiding Forces.²⁵

1970: The 7th SOS and the Son Tay Raid

With training access to Greece assured, the 7th SOS looked north for additional training opportunities. With SOTFE sponsorship, the squadron signed an agreement with the Danish Jaegerkorpset entitled the *Tactical Air Command Denmark Operation Instruction No. 18*, which outlined combined air-drop training between the two units. In a similar agreement to the one in Greece, the 7th SOS committed its C-47 and C-130 aircraft to air-borne support for the Jaegerkorpset in return for low-level operations in Denmark. Missions were normally staged out of Aalborg Royal Danish Air Force Station and consisted of infiltration and exfiltration operations. Because of the restricted size of the country, however, and the often poor weather associated with its geographical location, benefits to the 7th SOS did not compare with those of Greece.²⁶ From 24 to 27 January the 7th SOS participated in a planning conference with MAAG-Norway, SOTFE, and Norwegian military representatives to negotiate a training plan there. The finalized plan supported Norwegian military requirements and established low-level routes in Norway for 7th SOS training. The rugged mountains found in Norway were the most challenging of all low-level routes in the theater.²⁷

On 30 January the squadron flew its second C-47 Berlin corridor flight and qualified a second instructor pilot to fly the mission.²⁸ The 13th and 27th of February marked the third and fourth corridor missions, thus qualifying four 7th SOS aircraft commanders in the Berlin Corridor mission.²⁹ Beginning on 16 February the USAFE IG kicked off its second no-notice ORI of the 7th SOS with a unit alert and recall. The 17th and 18th were devoted to operational tasks associated with the squadron mission statement. These tasks included low-level navigation, personnel and equipment airdrops, airland assault operations, reconnaissance and loudspeaker operations, an ECM exercise, and a Fulton STARS. Aircraft and special operations-qualified crews from the 322d and the 513th Tactical Airlift Wings were integrated into 7th SOS operations and were tasked as part of the squadron. Tenth SFG(A) personnel from Bad Tölz, FRG, also participated in the ORI. Extremely poor weather, with snow, low ceilings, and reduced visibility, required some missions to be rescheduled and flown later in the exercise. As in the previous year's ORI, the unit earned a satisfactory grade from the inspector general.³⁰

From 2 through 6 March, the squadron participated in an evaluation of its psychological operations capabilities. In SEA the primary mission of the 15th SOS had become the delivery of leaflets and other PSYWAR material. In Europe, however, the 7th SOS had not developed this capability. Four leaflet drops were scheduled for the evaluation, but only two were flown due to poor weather in the mission area. Participating in the evaluation was the USA 5th Psychological Operations Battalion. The results of the two successful missions were excellent, but the evaluation was put on hold indefinitely until weather improved, and the evaluation was never completed. European SOF never developed a leaflet-drop capability near that of the one employed in SEA. PSYOPS remained a secondary mission for the 7th SOS and was rarely exercised.³¹

In April an agreement was reached with the Belgium ministry of defense for the 7th SOS to train with Belgium army paratroopers. A joint/combined HALO training mission was subsequently flown in Belgium in June, utilizing 42.7 flying hours and 24 sorties. Maintenance problems and adverse weather in Belgium caused the cancellation of six sorties, but overall the effort was a resounding success. Belgium paratroopers and USA SF personnel were dropped from an altitude of 20,000 feet.³²

June also saw the most complex mission yet flown in Greece. The 7th SOS deployed on 15 June with one aircraft and made an operations stop at Neubiberg AB to onload 22 US Army SF personnel and their equipment. Late receipt of country clearance from the Greek government forced the flight to airland at Athenae IAP and off-load its personnel rather than completing its long-range infiltration mission into the drop zone. After arrival the 7th SOS spent the next two days planning with Greek Hellenic Raiding Forces personnel. Many drop zone changes were made by Greek participants, but by 18 June all problems were resolved, and scheduled missions were flown. On 20 June eight resupply drops were scheduled on one sortie for teams operating in the field. During the mission the aircraft's Doppler equipment was completely inoperative, and the TF/TA radar indicated an REC/COM FAIL for approximately 75 percent of the flight. The mission was continued utilizing the E² presentation. Numerous thunderstorms were encountered en route, requiring deviation from the planned route. Northern Greece was completely covered with clouds, which resulted in the completion of six drops and the air abort of the last two. The crew picked up an instrument clearance and returned to Athenae IAP. On 21 June seven additional resupply drops were flown, with all aircraft equipment working perfectly. Six drops were successful, with the seventh drop being canceled for lack of a team on the drop zone. (The 7th SOS maintenance section had worked throughout the night of 20 June to get the Doppler and the terrain-following radar operational.) On 23 June, 85 personnel were air-dropped during two early morning sorties. On the 24th the aircrew redeployed back to home station with an airdrop of US Army Special Forces

personnel on to Karen drop zone in Germany and mission termination at Ramstein AB.³³ Some of the low-level missions into northern Greece had been seven hours long. The amount of training and the experience gained by the crew on challenging missions of this duration could not be duplicated anywhere else in the European area. Future deployments to Greece included two aircraft, when possible, to capitalize on the excellent training environment found there.³⁴

The next month, July, marked another milestone in the expansion of 7th SOS training opportunities with the deployment to Pau, France, in support of the French army's 11th Airborne Division. The deployment marked the first time a US military organization had been asked to participate in combined training since the French had withdrawn military support for NATO in the mid-1960s. The deployment consisted of familiarizing members of the French 11th Airborne Division and associated French units with US parachute operations, US equipment, and C-130 aircraft operations. Between 26 July and 1 August, 231 French paratroopers were given familiarization flights and were air-dropped on Wright drop zone near Pau. The deployment was so successful that the commander, 11th Airborne Division, French Parachute School, requested that the 7th SOS return to Pau for additional combined training with his division.³⁵

Combat Talons assigned to the 7th SOS, along with those in the United States and in the Pacific, continued to receive upgrades as they cycled through PDM. Aircraft 64-0551 returned from PDM on 15 July, and aircraft 64-0572 departed



USAF Photo

7th SOS HALO drop from aircraft 64-0572.



USAF Photo

At the conclusion of the Greek trainer, Colonel McLaughlin presented a 7th SOS memento to Maj Gen Lambros Sirmos, commanding general, Greek Hellenic Raiding Forces.

for LAS Ontario two days later. Col Richard C. Reeder assumed command of the squadron on 7 August, when Colonel McLaughlin returned to the United States.³⁶ On 8 August aircraft 64-0561 was heavily damaged by fire while completing a taxi check in accordance with Time Compliance Technical Order 1C-130-778. The entire left wheel-well area was destroyed. The fire was attributed to a brake failure in the left main landing gear, with brake fluid being ignited by hot brakes. Over 3,350 man-hours were required to repair the aircraft, which took the next nine months to complete. A team from Warner Robins Air Material Area (WRAMA) deployed to Ramstein AB and performed the necessary repairs. With aircraft 64-0572 already in PDM in the United States, the loss of aircraft 64-0561 left only two operational aircraft for European employment—64-0551 and 64-0559.³⁷

Between 10 August and 2 October 1970, the 7th SOS participated in Flintlock III. The FTX was expanded over the previous year and consisted of five subexercises located in the UK, Norway, the FRG, Italy, and Greece. Unlike the previous year Flintlock III required almost the entire squadron to deploy from Ramstein AB to RAF Greenham Commons, UK, and set up its operation there. Within 36 hours of notification, the squadron had deployed its forces and was in place ready for tasking. Unit aircraft and C-130s from the 513th Tactical Airlift Wing based at RAF Mildenhall, UK, transported squadron personnel and equipment to the deployed location. During the course of the exercise, the 7th SOS flew 137 sorties and 364 hours throughout the theater. The 10th SFG(A) had 256 personnel air-dropped from 7th SOS aircraft, and 235 foreign troops were also air-dropped during subexercises in their countries. Some 776 personnel and 50 tons of cargo were airlanded.³⁸ As in Flintlock II, C-47 aircraft and personnel deployed from Otis AFB to participate in the exercise.

While deployed to RAF Greenham Commons, UK, for FTX Flintlock III, Colonel Reeder received a message from SOTFE that contained a request for a combat-ready crew to deploy back to CONUS for mobility training. The message was a by-name request for individual crew members, but compliance would require breaking up several of his formed crews. After informal coordination with SOTFE, Colonel Reeder agreed to provide the requested aircraft commander, Maj Irl L. Franklin, and one of his six 7th SOS-formed combat crews.³⁹



USAF Photo

A 7th SOS crew plans a Flintlock III mission. From left to right: Unknown, J. K. Taylor, Bob Metsker, Bill Bush, Darrel Grapes, Bill Hawkins, and Bruce Ehly.

Major Franklin's crew departed Europe the next day and arrived at Eglin AFB, Florida, on 28 August. Brig Gen Leroy Manor, the air component commander for the operation, informed the crew of its selection for a very dangerous mission that only volunteers would be allowed to fly. The general also indicated that no additional information regarding the purpose of the mission would be provided until those with a strict need to know were briefed. All 7th SOS crew members volunteered for the mission without actually knowing what they were volunteering for. In time the crew was briefed that its mission was to rescue American



USAF Photo

7th SOS crew that flew the Son Tay Raid. Pictured, standing left to right: Robert Renner, William Kennedy, James Shepard, Leslie Tolman, Kenneth Lightle, and Earl Parks. Kneeling, left to right: Thomas Mosley, James McKenzie, Thomas Stiles, Thomas Eckart, William Guenon, Randal Custard, and Irl Franklin.

prisoners of war held captive at Son Tay Prison, North Vietnam.⁴⁰ Major Franklin's crew flew Combat Talon 64-0523 (assigned to the 15th SOS at the time) during preparation and execution of the raid.

During the month of September, the 7th SOS crew, along with a crew from Detachment 1, 1st SOW, developed procedures to fly dissimilar formation with both helicopters and with A-1 fixed-wing aircraft. Procedures and techniques for air-dropping ordnance never before carried by a C-130 aircraft were developed. Near the end of September, a complete mission profile was flown with the entire raiding force to validate the plan. One Combat Talon led the helicopter assault force, and the second Combat Talon led the A-1 strike force. On 10 November the force began deploying to SEA, arriving at Takhli RTAFB, Thailand, on 15 November. During the final preparation phase at Takhli RTAFB, Major Franklin and his crew learned that they would lead the assault force of helicopters during the raid. On the night of 20 November, the force launched from several bases in Thailand en route to Son Tay. Although no prisoners were found there, the Combat Talon portion of the operation went off without a hitch. All mission aircraft and personnel returned safely to Thailand for mission debriefing.⁴¹ The 7th SOS crew flew aircraft 64-0523 back to Norton AFB, California, and turned it over to LAS Ontario technicians. The crew returned to Ramstein AB, while Franklin flew to Eglin AFB to participate in the after action review. The crew had been on temporary duty for more than three months and returned to its squadron as combat warriors. (Chapter 6 provides a detailed account of the Son Tay POW raid.)

1971: The Commander in Chief's Trophy

As 1970 ended squadron morale was at an all-time high. Participation in the Son Tay POW raid by one of the squadron's crews brought great satisfaction. For 1971 the squadron continued with a full plate of exercises and unilateral training events designed to maintain its high state of readiness. In each of the first six months of 1971, 7th SOS Combat Talons deployed to Greece and flew low-level training missions in conjunction with air-drop support to the Greek Hellenic Raiding Forces. The USAFE IG administered its third ORI to the squadron in March. Weather was improved over the previous two years, with Combat Talons flying six sorties and 17.9 hours. IG

tasking included low-level navigation, personnel and equipment airdrops, infiltration and exfiltration of personnel, assault landings, photoreconnaissance, airborne speaker operations, electronic countermeasures (RBS and airborne intercepts), and an airborne rescue demonstration using the Fulton STARS.⁴² The overall rating was again satisfactory.

The WRAMA team continued to work on repairs to aircraft 64-0561. The original estimated time in commission (ETIC) date was 15 March, but unforeseen delays required extension of the ETIC to 5 April. The aircraft was finally turned over to flight-line maintenance on 15 April. Four days later the aircraft was put into phase inspection after numerous minor write-ups were cleared by maintenance personnel. On 2 May the aircraft successfully completed its functional check flight (FCF) and was certified airworthy.⁴³ On 19 May the aircraft was flown back to the United States for PDM and for other major modifications at LAS Ontario.⁴⁴ While at LAS Ontario the aircraft received the MOD-70 upgrade, which included the new AN/APQ-122(V)8 multimode radar.

Since its formation in 1964, the 7th SOS had been a composite squadron made up of different aircraft with a variety of capabilities. On 10 May 1971 the squadron added two UH-1N helicopters to complement the two C-47 and four C-130E(I) aircraft already assigned. Two additional UH-1N helicopters were received in October while the unit was deployed to Flintlock IV. They were assembled after personnel returned from the exercise, and they flew their initial FCFs in November. One major problem the squadron faced with the new aircraft was the lack of qualified maintenance personnel. Even by the end of the year, assigned maintenance personnel could support only a two-aircraft operation.⁴⁵

As one of the busiest units in USAFE, the 7th SOS was engaged in activities from Norway to North Africa and from Turkey to Spain. With the Son Tay POW raid the previous fall, the unit had also contributed directly to America's effort in the Vietnam War. On 22 May 1972, in a ceremony conducted by Maj Gen Dale S. Sweat, commander, Seventeenth AF, members of Major Franklin's crew were awarded the Silver Star for their actions during the Son Tay raid. On 25 June Gen Joseph R. Holzapple, CINCUSAFE, presented the commander in chief's trophy to the 7th SOS for being the most outstanding support squadron in USAFE for 1970.⁴⁶ The squadron had excelled and continually improved as it expanded



USAF Photo

On 25 June 1971, Gen Joseph R. Holzapple, CINCUSAFE, presented Colonel Reeder (7th SOS commander) with the CINCUSAFE trophy for the Most Outstanding Support Squadron in the command. Note the bush hat and fatigues worn by Colonel Reeder (the standard uniform for the 7th SOS).

its operations in Europe. For the Combat Talon, mission tasking had been accomplished with only two aircraft on-station for half of 1970 and most of 1971. Through all this the squadron had risen to the top of its class.

There was little time during the summer of 1971 to reflect on the squadron's accomplishments of the previous year. During the month of July, the squadron concentrated on local training in Germany in preparation for Flintlock IV, which had expanded from the previous year with a total involvement of 14,000 personnel in five different countries. For Flintlock IV there were five subexercises supported by special operations forces from Germany, Greece, Norway, Turkey, UK, Canada, and France. On 10 August the squadron deployed to three exercise operating locations—the Combat Talons to RAF Greenham Commons, UK; the C-47s to the Athenae IAP, Greece; and the UH-1Ns to Sembach AB, Germany.⁴⁷

The most significant mission for Combat Talon during Flintlock IV occurred on 25 August during a long-range infiltration into Subexercise Zeus 71. The 7th SOS never had dropped personnel into a water drop zone for subsequent linkup with a surface vessel and an over-the-shore infiltration into the objective area. The 25 August mission involved onloading an eight-man SEAL team at RAF Greenham Commons and flying a high-altitudes low profile to a point off the coast of Greece, where the team was dropped in proximity to an awaiting friendly ship. Rendezvous tech-

niques were coordinated with the US Navy and included the display of a vertical light pattern on the ship and authentication utilizing the ground airborne radar beacon. The aircraft flew over the ship at 1,000-foot altitude and dropped the SEAL team 150 meters to starboard. The team rendezvoused with the ship, then accomplished a maritime beach landing and executed a preplanned direct action mission. The mission was so successful that EUCOM later requested additional training be conducted with the objective of incorporating the technique into appropriate service tactical manuals. Another highly demanding mission included in Flintlock IV was a long-range infiltration into an objective area in the Middle East. Two US Army Special Forces A Teams were on-loaded at RAF Greenham Commons and were flown nonstop to the drop zones. The flight took more than nine hours to complete with both drops on the drop zone and within seconds of the planned time over target.⁴⁸

Throughout the Flintlock exercise, Combat Talon aircraft experienced continual problems with the AN/APQ-115 radar. All missions were flown, however, to successful completion although many crews did not have an operational radar for the low-level portion of the route. Because of unusually good weather, VFR tactics were employed, and the aircrews dropped utilizing visual procedures. Within the next year the AN/APQ-115 radar would be replaced by the AN/APQ-122(V)8 during the MOD-70 upgrade, and many problems associated with the older radar would be resolved. The squadron's other two types of aircraft, the C-47 and the UH-1N, experienced a much higher operational ready rate than did the Talons. As in the three previous Flintlocks, the best training of the year was accomplished during the exercise.⁴⁹ Nowhere else in the Talon community was such complex training accomplished. Distances flown and types of missions completed reflected those found in OPLAN 4102 wartime tasking.

The squadron returned to Ramstein AB after the 60-day exercise and soon commenced further development of tactics and procedures first tried during Flintlock IV. One Combat Talon deployed to Souda Bay, Greece, in October to refine air/sea rendezvous procedures with US Navy SEALs. Six sorties were flown (8.9 hours) to refine procedures for both radar and nonradar-equipped aircraft. Onboard radar, Doppler, and FM radio homing were found to be the most valuable aids in completing the drops successfully.⁵⁰ The plans section also remained busy evaluating exercise results

and presenting briefings to USAFE and to EU-COM. Unit OPLAN and operations orders were updated with the most current information.⁵¹

Twelve aircrews completed Combat Mission Planning, which was conducted by the squadron intelligence (IN) section throughout the year. IN utilized actual orders of battle found in the OPLAN 4102 tasking. Many of the crews trained were not assigned to the 7th SOS but were apportioned to the squadron in time of conflict. For most it was their first exposure to planning missions into enemy territory while avoiding known enemy threats.⁵² As a testimony to how good the IN section had become, TSgt James M. Burns was selected as the 17AF Non-Commissioned Officer of the Year for 1971. Sergeant Burns distinguished himself through outstanding performance as Non-Commissioned Officer in Charge of the IN section and contributed immensely to the Combat Mission Planning effort.⁵³ The section was also recognized as the most outstanding IN section in the Seventeenth AF.

In September, while deployed to Flintlock IV, the 7th SOS received aircraft 64-0566 from Detachment 2, 1st SOW, Pope AFB, North Carolina. The aircraft was part of a restructuring of Combat Talon aircraft worldwide. On 18 September 1971, aircraft 64-0566 flew its first mission as a 7th SOS aircraft.⁵⁴ In exchange for the aircraft, the 7th SOS sent aircraft 64-0551 to the 90th SOS at Nha Trang AB. A 7th SOS crew departed Ramstein AB the day after Christmas en route to SEA and arrived at Nha Trang AB on 1 January 1972, logging 55.8 hours during the deployment.⁵⁵ As 1972 began, the 7th SOS had three C-130E(I) aircraft assigned—64-0561 (which was at LAS Ontario for PDM), 64-0566, and 64-0572.

1972: The MOD-70 Combat Talon Comes to Europe

When the 7th SOS was stood up at Ramstein AB in the summer of 1968, Seventeenth AF was designated as the squadron's higher headquarters. From this initial period until March of 1972, the squadron remained directly under Seventeenth AF. Special Order GB-23, dated 16 March 1972, relieved the squadron from assignment to Seventeenth AF and placed it under the 26th Tactical Reconnaissance Wing (TRW), also located at Ramstein AB, effective on 17 March. The new arrangement integrated the squadron's standardization/evaluation section and its maintenance section into the 26th TRW. Operational control was retained by Headquarters USAFE.⁵⁶ Under OPLAN

4102 activation during times of increased hostilities, the 7th SOS transferred from USAFE to SOTFE and received its wartime tasking from that joint headquarters. In peacetime, however, the 7th SOS received its daily tasking and support from USAFE through Seventeenth AF and the 26th TRW. During the annual Flintlock exercise, OPLAN 4102 command and control arrangements were exercised, which included the exercise of operational control by SOTFE.

On 28 April 1972 the 7th SOS was assigned its fourth Combat Talon (64-0555), which was the replacement for aircraft 64-0551 sent to SEA in January 1972. The squadron sent a crew to Nha Trang AB to pick up the aircraft and fly it back to Ramstein AB. The aircraft flew its first local training sortie in the 7th SOS on 8 May and departed off-station on the 10th.⁵⁷ Affectionately known as Triple Nickel, the aircraft would become a mainstay of 7th SOS operations and one of the most dependable Talons in its fleet.

Access to low-level training routes continued to be a major problem for 7th SOS aircrews, even after agreements were finalized with Greece. The 7th SOS had routes in Norway and in Denmark, as well as Germany, but training manuals required 18 hours of terrain following per crew for each six-month period. The hours could only be logged in minimum one-hour uninterrupted blocks and were extremely difficult for crews to complete. By 1972 the squadron had six combat crews requiring low-level continuation training and had additional crew members who were required to maintain their tactical qualifications (the squadron commander, operations officer, and staff). To augment existing training routes, the squadron had long sought a low-level training area in Spain. The country had the required combination of airspace, terrain, and good weather to provide a fertile training environment. After months of concentrated negotiation between the 7th SOS plans section and the JUSMAG Spain, limited low-level operations were approved by the Spanish government. On 12 June 1972 one Combat Talon aircraft deployed to Madrid for the first low-level training mission to that country. Torrejon AB, near Madrid, was selected as the staging base for this training due to availability of C-130 support and because it offered adequate on-base quarters. For the initial deployment, four low-level missions were authorized by the Spanish air ministry. Low-level routes were planned from Madrid to the San Javier area of southern Spain. At San Javier the aircrew supported the Spanish

Parachute Brigade's air-drop requirements. HALO drops were accomplished up to 25,000 feet, with static line drops at 1,000 feet. Four low-level routes were successfully flown with excellent training received by all crew members.⁵⁸ This combined exercise established the precedent for future deployments to Spain that included low-level operations. The 7th SOS was the only C-130 unit in Europe regularly permitted to fly low level in Spain, but this unique status proved to be a tenuous one over the years.

From August to October the 7th SOS participated in Flintlock V and deployed to RAF Sculthorpe, to support subexercises in Greece, Germany, Norway, Denmark, and Italy. Aircraft from Hurlburt Field, including four C-123Ks and two UH-1Ns, along with three Air National Guard C-119s from other US locations, deployed to England to augment the 7th SOS. Upon closure of assigned forces at RAF Sculthorpe, the 7th SOS expanded to 25 aircraft and 537 personnel. The commander of the 7th SOS served as the exercise air component commander for USAF-committed forces. The squadron flew 432 sorties in direct support of the exercise with no maintenance cancellations. Throughout the exercise, the squadron maintained a 93 percent mission accomplishment rate.⁵⁹ Flintlock V proved to be a challenging and diverse exercise that demanded the utmost from both aircrew and support personnel alike.

During the month of September, while deployed for Flintlock V, the 7th SOS was notified by USAFE that it would leave Ramstein AB the following March and move to Rhein Main AB near Frankfurt, Germany. At Rhein Main AB, the squadron would be assigned to the 322d TAW and would have four Combat Talon aircraft and associated personnel assigned. The C-47s and UH-1s would remain at Ramstein AB and form a detachment of the 7th SOS until June of 1973, when they would transfer back to the United States. The target date for having the squadron moved and operationally ready was 15 March 1973.⁶⁰

The first MOD-70 aircraft was received in August 1972, just as the squadron was deploying to Flintlock V. Personnel from the 318th SOS (formerly Detachment 1, 1st SOW), Pope AFB, North Carolina, delivered the aircraft to Ramstein AB. Maj John Gargus, an instructor navigator and Son Tay raider who had been instrumental in the operational test and evaluation of the MOD-70 aircraft while assigned to the 318th SOS, arrived at the 7th SOS in June 1972. He was given the task of overseeing the checkout program for 7th

SOS aircrews along with Maj William A. Guernon Jr., an instructor pilot who had also flown on the Son Tay raid with Major Gargus. Throughout the summer and fall, 7th SOS crew members attended MOD-70 ground school conducted by the two instructors. In November a second MOD-70 aircraft was delivered to the squadron. Most of November and December were spent deployed to Greece and Spain for MOD-70 upgrade training. Aircraft 64-0551 and 64-0571 were the first two MOD-70 assigned to Europe. On 8 November aircraft 64-0571—with Gargus, Guernon, and two crews—deployed to Greece for a week-long MOD-70 unilateral training exercise. After a normal departure from Ramstein AB, the aircraft had to return for maintenance support. After some delay the mission departed without incident and landed at Athenae IAP after a 7.4-hour flight. The 9 November flight was a combination minimum-safe altitude and terrain-following mission for 5.7 hours. All systems performed well enough for a successful mission. Some problems were noted with inertial navigation steering, but most were attributed to aircrew unfamiliarity with the new system. During the 10 November flight of 6.3 hours, the navigators utilized the relative CARP solution for the first time during a terrain-following day mission. As the week progressed, the crew became increasingly familiar with the AN/APQ-122(V)8 radar and the operation of the new inertial navigation system. When the aircraft redeployed to home station on 14 November, the first two crews had been certified in the MOD-70 aircraft. A similar deployment of aircraft 64-0551 to Greece on 5 December resulted in the checkout of two additional crews. Ten hours were expended supporting the Hellenic Raiders Parachute School, with the remaining time spent on conversion training for the MOD-70. Majors Gargus and Guernon flew every day while deployed, with each crew flying every other day. The pace was demanding, but the excellent training environment made the effort worthwhile. Both day and night TF missions were successfully completed, with the crews becoming proficient on the MOD-70 aircraft by the end of the deployment. On 15 December the aircraft redeployed to Torrejon AB, Spain, for additional low-level training.⁶¹ On 3 and 28 December, respectively, aircraft 64-0566 and 64-0572 were reassigned to the 318th SOS, and on Christmas Eve 1972 aircraft 64-0561 returned as a full-up MOD-70. By the spring of 1973, all assigned aircrews had been trained on the new system.⁶²

1973: Combat Talon Moves to Rhein Main Air Base

The first three months of 1973 were extremely busy, with the squadron meeting all commitments while preparing for the move to Rhein Main AB. Hard work by the plans section the previous fall paid off with the deployment to Spain in January in support of Spanish airborne forces. During the deployment of the 31 sorties flown in Spain, 17 were flown low level for a total of 43.3 hours. The excellent weather in January and the challenging terrain provided valuable TF training on the MOD-70 aircraft. The deployment was based out of Torrejon AB, from where 235 Spanish and American paratroopers were dropped.⁶³

Effective 31 January 1973, the 7th SOS was reassigned to the 86th TFW until the squadron relocated to Rhein Main AB on 15 March. At that time, the squadron was reassigned to the 322d Tactical Airlift Wing. One Combat Talon deployed to Greece during February and flew 16 sorties and 34.7 hours supporting the Greek Hellenic Raiding Forces. Also during the Greek deployment, all remaining crew members completed MOD-70 conversion training.⁶⁴

Movement Order 23, dated 5 December 1972, directed that the 7th SOS move to Rhein Main AB and to be in place there no later than 15 March. On 12 and 13 March the squadron moved its equipment and personnel, and by 15 March it was operationally ready at its new location.⁶⁵ On 20 March Colonel Reeder relinquished command to the acting commander, Lt Col Lincoln A. Perry, who remained as the acting commander until Col Ralph W. Haymaker arrived in May.⁶⁶ The 7th SOS closed out a significant part of its history with its move to Rhein Main AB. Both the C-47 and UH-1N flights remained at Ramstein AB and were assigned to the squadron as a flight detachment. By the summer of 1973, however, only the Combat Talons (64-0523, 64-0551, 64-0555, and 64-0566) stationed at Rhein Main AB remained in Europe. All other SOF assets had been either decommissioned or returned to the United States.

Rhein Main Air Base and the 322d TAW

With the reassignment of the C-47 and UH-1N flights and their associated administrative support, the squadron that moved to Rhein Main AB was far different from the one that had operated out of Ramstein AB. Although the squadron continued to maintain its operational status in the Combat Talon, the unit faced the immediate challenge of

an ORI from the USAFE/IG. The 322d TAW was due an ORI in the April–May time frame. Due to the turmoil associated with the move and the major reorganization of the squadron, Colonel Perry wasted no time in documenting the unit's shortfalls and requesting postponement of the ORI until the July period. In his 11 April letter to the 322d TAW/commander, Colonel Perry noted that unit plans and regulations had to be rewritten to align them with the 322d TAW. He also noted that the unit was committed to Alpine Friendship in southern Germany and would have to be restructured internally immediately after the exercise. He pointed out that the combat control team and the loadmaster, flight engineer, and rigging and life support sections were still in the process of moving to Rhein Main AB. More than 45 families still lived at Ramstein AB, and squadron personnel returned there during weekends, thus making regular off-duty time normally used for ORI preparation unavailable to squadron leadership. Colonel Perry proposed an alternate date of 15 July, which would allow the squadron time to settle into its new location and give the new commander time to get his feet on the ground after his June arrival. The USAFE/IG approved Colonel Perry's request on 18 April, and the new date was set for sometime after 15 July.⁶⁷ With the ORI postponed by USAFE, the 322d TAW set about to "fix" the squadron's shortfalls outlined in Colonel Perry's letter.

The first "help" that the squadron received was a combined 322d TAW operations/safety inspection, which was conducted from 15 to 18 May. Without the proper time and opportunity to organize and prepare for the inspection, the final result was just as Colonel Perry predicted. Training and standardization/evaluation were rated unsatisfactory. Virtually every area of the squadron that was inspected either received an unsatisfactory or a marginal rating.⁶⁸ Effective 1 June 1973, Colonel Haymaker assumed command of the squadron and vowed to correct the documented deficiencies. As Colonel Haymaker's operations officer, Colonel Perry was quite familiar with squadron operations, so the two formed a team and went immediately to work. In the next 45 days, the squadron was reorganized, and deficiencies identified in the May visit were corrected. By mid-July the squadron was somewhat ready for the pending ORI.

On 16 July the USAFE/IG hit the base, with the 322d TAW, from the commander on down, predicting another disaster for the special operations

squadron. To the amazement of the wing, and perhaps the 7th SOS itself, the 7th SOS passed the ORI successfully. It was the best performance in 7th SOS history. There were no functional pass/fail areas rated less than satisfactory, and the only two items that received a marginal rating were wing/base support functions. With the successful completion of the ORI, the move to Rhein Main AB was officially termed a success.⁶⁹ The reorganization of the squadron under Colonels Haymaker and Perry's guidance had successfully molded the varied functions of the most diverse squadron in USAFE into an operationally sound unit. The squadron was almost self-sufficient, having been assigned its own flight surgeon and medical team, photography section, life-support section, combat control team, communications section, intelligence, avionics, plans, safety, standardization/evaluation, and other operational and support functions.⁷⁰ The squadron had earned respect from the wing and from USAFE.

As had been the case in previous years, the 7th SOS participated in the annual Flintlock exercise. Deployment to RAF Sculthorpe went without a hitch, and four subexercises were supported in the August time frame. On 1 September the squadron deployed two Combat Talons and 58 personnel to a location in Southwest Asia, and two days later two USAFE C-130s deployed additional 7th SOS maintenance and support personnel. The squadron established an Air Force Special Operations Facility and flew unconventional warfare missions for the duration of the exercise. In total, 16 sorties and 46 hours were flown, which included one-hour, low-level routes that terminated in airborne infiltrations, resupplies, and a Fulton STARS.⁷¹ Suitable tactical landing zones were not available within the exercise area, thus eliminating any airland exfiltration sorties. Although the exercise was a success for a first-time-ever event, tasking was not sufficient for the two Combat Talons. Host nation C-130s also supported the exercise, and several missions originally planned for the 7th SOS were actually flown by them. By the end of September, the squadron had redeployed to Rhein Main AB, where the process of supporting 322d TAW activities continued to be a high priority.

Brig Gen Thomas M. Sadler, the 322d TAW commander, requested permission from the USAFE vice commander, Lt Gen Samuel V. Wilson, to organize the 7th SOS under the 322d TAW director of operations. With the reorganization, General Sadler proposed that the squadron commander be

reduced in grade from a full colonel to a lieutenant colonel, which was in-line with other squadron commanders assigned to his wing. Colonel Haymaker, citing Air Force Manual 26-2, *Organization, Policy, and Guidance*, agreed with General Sadler and noted that the reorganization would streamline the span of control of the wing commander. The requirement to have a colonel as commander of the 7th SOS stemmed from the unit's wartime tasking. EUCOM OPLAN 4102 and SOTFE's Supporting Plan 4304 tasked the 7th SOS to form a Special Operations Wing, designated the 7575th SOW and to assume command of an Air Force Joint Unconventional Warfare Task Force. The wartime tasking required a full colonel, yet normal peacetime duties could be performed by a lieutenant colonel. During exercises and contingencies, the colonel position was required to fulfill the commander's role. General Wilson felt that General Sadler's proposal had merit, but the sourcing of the wartime commander for the 7575th SOW was a contentious issue. General Sadler believed that his assistant director of operations could fulfill this role, but the requirement to have special operations experience could not be guaranteed under that arrangement.⁷² The reorganization was ultimately tabled, and operations continued with the squadron assigned under the wing commander with a full colonel squadron commander authorized. Colonel Haymaker remained the squadron commander until 12 February 1974, when he relinquished command to Colonel Perry and moved up to be the 322d TAW vice wing commander. Although the 7th SOS commander had been reduced to an O5 because of this move, the colonel authorization remained valid and was later filled by a full colonel when Colonel Perry left the squadron in 1975.⁷³

1974: Low-Level Training in Spain Canceled

To maintain proficiency in the Combat Talon, the squadron continued to deploy to Allied countries throughout Europe, including Denmark, UK, Italy, Greece, and Spain. Since the introduction of the weapons system in 1968, however, there was not a flight simulator available for 7th SOS use. As a result the simulator requirement for pilots and navigators had been waived for the European-assigned squadron. Tactical Air Command required 12 hours each year in the simulator, and allied nations, including the UK, required up to 48 hours for its pilots. As the pilot force entering the Combat Talon became younger and less

experienced with the Vietnam War ending, the need for access to a simulator for USAFE-assigned C-130E(I) pilots became even more acute. The only C-130 simulators in Europe belonged to the RAF, and after initial contact with them, tentative agreement was reached whereby some simulator time would be provided to 7th SOS crew members. The fuel crisis of 1973 brought a reduction in available hours for the UK simulator, and the initial agreement was scrapped. Additional coordination was accomplished, with the 7th SOS requesting 12 hours each month in the simulator. The RAF responded that it could only support four hours each quarter, with the possibility of four hours every six weeks. A compromise was reached whereby the RAF would provide two, four-hour training blocks on consecutive days each quarter. The arrangement would allow the 7th SOS to accomplish critically needed upgrade and emergency procedures training. On 1 April 1974 the 7th SOS sent its first crew to RAF Lyneham, UK, for the first two-day simulator session. During the two days emergency procedures, engine runs, aborted takeoffs, and engine-out landings were practiced.⁷⁴ The arrangement was good for the squadron because it provided access to a simulator on a regular basis.

As the simulator program got under way, the 7th SOS faced another challenge with the loss of its low-level routes in Spain. Although the squadron supported the Spanish Parachute Brigade on a regular basis and was well received by the Spanish military, the general populace objected to low-level aircraft flights due to the noise that it created. As a result, the Spanish government established a policy that no low-level training would be made available to any foreign forces after 31 December 1974. To compensate for the lost training, the squadron proposed to shift its training to Portugal since the terrain there was rugged, and rural areas were sparsely populated.⁷⁵ Although

sporadic approval to fly in Portugal was eventually given in conjunction with the Flintlock exercise series, there were many restrictions imposed by the Portuguese that effectively eliminated the area as a training site. During Flintlock 74, which operated out of Rhein Main AB and consisted of two subexercises, low-level training was accomplished in Norway and in southern Germany. Thus, the impact of the loss of routes in Spain at year's end was minimized.⁷⁶

By the fall of 1974, the 7th SOS had operated the Combat Talon in Europe for more than six years. During that period the unit had decreased in size to four assigned Combat Talon aircraft, and it had moved from Ramstein AB to Rhein Main AB. The afterglow of the Son Tay raid had long since faded in the minds of the squadron's USAFE bosses. The squadron was different from fighter squadrons of the command, and USAFE leadership was unsure of how to manage the specialized SOF asset. The cold war was the central focus in Europe, with tensions remaining high between East and West. With training areas dwindling, the future looked bleak for European SOF. The secret to success for any organization, however, lay in its ability to adapt to the changing environment. For the 7th SOS to survive, it had to bring to the table a capability needed by its USAFE war-fighter boss. The requirement for a standoff jammer platform to provide an operational capability until the EF-111 was fielded in the early 1980s was the capability that would keep the squadron viable in the minds of USAFE leadership. The decision in the mid-1970s to equip 7th SOS aircraft with an upgraded ECM capability in lieu of the IFR modification would ensure the unit remained an integral part of USAFE's war plan, but it eliminated the 7th SOS from participation in the 1980 Iranian rescue mission.

Notes

1. History, 603d Air Base Wing (USAFE), 25 September–31 December 1966, USAF HRA, Maxwell AFB, Ala., A-3-18.

2. History, 603d Air Base Wing (USAFE), 1 January–30 June 1967, A-1-5.

3. History, 603d Air Base Wing (USAFE), 1 July–31 December 1967, C-I-15-16.

4. History, 7th Air Commando Squadron (Composite), 1 January–30 June 1968, USAF HRA, Maxwell AFB, Ala., iv-vi.

5. *Ibid.*, vii-viii.

6. *Ibid.*, 1.

7. *Ibid.*, 9.

8. History, 7th Special Operations Squadron, 1 July–31 December 1968, USAF HRA, Maxwell AFB, Ala., 2.

9. History, 7th Air Commando Squadron (Composite), 1 January–30 June 1968, 13-14.

10. History, 7th Special Operations Squadron, 1 July–31 December 1968, 3.

11. *Ibid.*, encl. 9, 1.

12. *Ibid.*, 4.

13. *Ibid.*, 8.

14. *Ibid.*, 7.

15. *Ibid.*, 9.

16. History, 7th Operations Squadron, 1 January–30 June 1969, 3.

17. *Ibid.*, encl. 3, 2.
18. *Ibid.*, 3.
19. *Ibid.*, encl. 5, 1.
20. History, 7th Operations Squadron, 1 July–30 September 1969, 3.
21. History, 7th Operations Squadron, 1 January–30 June 1969, 7.
22. History, 7th Operations Squadron, 1 July–30 September 1969, 4.
23. *Ibid.*, Flintlock II AAR, 4–9.
24. History, 7th Operations Squadron, 1 October–31 December 1969, 4.
25. *Ibid.*, document 4.
26. History, 7th Operations Squadron, 1 January–31 March 1970, 4.
27. *Ibid.*, 1.
28. *Ibid.*
29. *Ibid.*
30. *Ibid.*, 5.
31. *Ibid.*, 6.
32. History, 7th Operations Squadron, 1 April–30 June 1970.
33. *Ibid.*, 1–2.
34. *Ibid.*, 4.
35. History, 7th Operations Squadron, 1 July–30 September 1970, 2–3.
36. *Ibid.*, 14.
37. *Ibid.*, 3.
38. *Ibid.*, 3–4.
39. History, 7th Operations Squadron, 1 October–31 December 1970, 1.
40. *Ibid.*, 2.
41. *Ibid.*, 2–3.
42. History, 7th Operations Squadron, 1 January–31 March 1971, 3.
43. History, 7th Operations Squadron, 1 April–30 June 1971, 4.
44. *Ibid.*, 3.
45. History, 7th Operations Squadron, 1 October–31 December 1971, 9.
46. History, 7th Operations Squadron, 1 April–30 June 1971, 1–2.
47. History, 7th Operations Squadron, 1 July–30 September 1971, 4.
48. *Ibid.*, 5.
49. *Ibid.*, 12.
50. History, 7th Operations Squadron, 1 October–31 December 1971, 4.
51. *Ibid.*, 7.
52. *Ibid.*
53. *Ibid.*
54. *Ibid.*, 6.
55. *Ibid.*, 7.
56. History, 7th Operations Squadron, 1 January–31 March 1972, 8.
57. History, 7th Operations Squadron, 1 April–30 June 1972, 7.
58. *Ibid.*, 11.
59. History, 7th Operations Squadron, 1 July–31 December 1972, 8.
60. *Ibid.*, 9.
61. Col John Gargus, Retired, interview by author, College Station, Tex., 13 June 1998. Recorded on 8 mm videotape, not transcribed, Combat Talon Archive, HQ AFSOC/HO, Hurlburt Field, Fla.
62. History, 7th Special Operations Squadron, 1 July–31 December 1972, 2.
63. History, 7th Operations Squadron, 1 January–31 March 1973, 4.
64. *Ibid.*, 5–8.
65. *Ibid.*, 1.
66. *Ibid.*, 4.
67. History, 322d Tactical Airlift Wing, 1 April–30 September 1973, USAF HRA, Maxwell AFB, Ala., 17–18.
68. *Ibid.*, 18–19.
69. *Ibid.*, 20–22.
70. *Ibid.*, 41.
71. *Ibid.*, 46.
72. History, 322d Tactical Airlift Wing, 1 October–31 December 1973, 13–14.
73. History, 322d Tactical Airlift Wing, 1 January–30 June 1974, vol. 2, 3.
74. *Ibid.*, vol. 1, 16–17.
75. History, 322d Tactical Airlift Wing, 1 July–30 September 1974, vol. 1, 7.
76. *Ibid.*, 8.

THIS PAGE INTENTIONALLY LEFT BLANK

The Son Tay Prisoner of War Raid (1970)

Duty, honor, country: Those three hallowed words reverently dictate what you ought to be, what you can be, what you will be.

—Douglas MacArthur

Operation Polar Circle

By 1970 America's war in SEA had dragged on for nearly a decade. Even before the Tet offensive of January 1968, the American public and many US politicians had distanced themselves from the war. Throughout 1969 and into 1970, demonstrations and antiwar protests increased. President Richard M. Nixon made the decision to expand the war into Cambodia in the spring of 1970, and the nation exploded into violence. During the first week of May 1970, four students were shot and killed by National Guardsmen at Kent State University. With a campaign promise to bring American soldiers home from Vietnam and to end the war, the president appeared to be expanding the war rather than ending it. US intelligence revealed that American POWs, some of them held for more than six years in the worst of conditions, were in bad shape and were dying from years of captivity and torture. Their state of health was no longer simply declining but was, rather, in a process of rapid deterioration.¹ America's POWs were the one issue upon which all agreed—something had to be done.

Combat Talon had matured into a highly respected special purpose weapons system after four years in SEA and its deployment to Europe. Four aircraft were assigned to Detachment 2, 1st SOW, Pope AFB, North Carolina, and supported initial aircrew training. The 15th SOS had four Talons assigned and continued to fly SOG-tasked missions out of Nha Trang AB, Vietnam. The 7th SOS, also with four aircraft assigned, was supporting European special operations out of Ramstein AB, Germany. The Combat Talon fleet, consisting of 12 total aircraft, was undergoing various modifications at LAS Ontario, California, thus leaving the operational units with an average of three aircraft on the ramp at each location.

The US intelligence community had as one of its top priorities the identification of POW camps in SEA. On 9 May 1970 two personnel from the USAF 1127th Special Activities Squadron (SAS) (Headquarters Command), Fort Belvoir, Virginia, identified a possible POW prison compound 23

miles west of Hanoi in a small township called Son Tay (fig. 27). Col George J. Iles and Col Rudolph C. Koller, both assigned to the 1127th SAS, took the information to USAF General James R. Allen, director of plans and policy, Headquarters USAF. General Allen validated the 1127th SAS discovery, and on 25 May 1970, he briefed US Army brigadier general Donald D. Blackburn, the special assistant for counterinsurgency and special activities (SACSA) on the Joint Staff.² General Blackburn was intimately familiar with the plight of American POWs. He had served in Laos under the White Star program in 1961 and had been the first commander of SOG from 1965 to 1966. After receiving the initial briefing from General Allen, General Blackburn wasted no time. He immediately contacted the chairman of the Joint Chiefs of Staff, Gen Earle G. Wheeler, and arranged to brief him on the newly discovered information. General Wheeler gave approval for SACSA to develop a recommendation on how to proceed. On 26 May 1970 SACSA transmitted a message calling for a select group of personnel, sourced from all services, to deploy to the Pentagon to form a special study group under SACSA. The small group of 12 personnel convened on the first Monday of June 1970 to begin planning Operation Polar Circle.³

Working virtually around the clock, the small study group developed options to rescue the American POWs thought to be held at Son Tay. The study group also looked at a second site, identified as Ap Lo, but soon determined that Son Tay was the compound most likely to contain American prisoners. On 5 June 1970 General Blackburn and US Army colonel E. E. Mayer, chief, Special Operations Division, SACSA, briefed the special study group's findings to the Joint Chiefs of Staff in the tank, and recommended that an in-depth feasibility study be conducted. The JCS agreed with the preliminary recommendations of the special study group, and on 10 June SACSA convened an expanded 15-man feasibility study group. For the remainder of the month and into July, the feasibility study group, chaired by USAF colonel Norman H. Frisbie, Air Force Plans and

Policy Directorate, the Pentagon, looked at options on how to proceed.⁴

The objective of the feasibility study group was to develop an outline of a workable plan to rescue the hostages. Various options were developed. One option included a HALO drop some distance from Son Tay, with the HALO team moving to the prison by way of the Song Con River that ran close to its outside walls. At a predetermined time, the HALO team would blow an opening in the prison wall and additional troops arriving by way of helo or static line drop would assault the prison through the opening. The static-line-drop option was quickly eliminated due to the necessity of having to rapidly assemble and apply maximum firepower during the assault. (Troop marshaling after an airdrop historically required several minutes, and the jumpers usually suffered injuries.) Another option considered was to land helicopters some distance from the prison, travel overland by way of jeeps equipped with battering rams, and penetrate the prison gates in a coordinated assault. This option also considered landing a C-130

aircraft on one of the many crushed limestone roads leading into Son Tay, abandoning the aircraft after the assault and exfiltrating by way of helicopter.⁵

As the feasibility study group explored options, it became clear that any successful rescue attempt would have to commence from inside the prison walls and expand outward from that point. The prison walls could serve to the raiders' advantage if they were on the inside of the prison at the onset of the assault. By the third day of planning, the feasibility study group knew that the only way to get inside the compound quickly was through helicopter insertion. The area inside the compound was not large enough to make a conventional helicopter landing, so consideration was made to rapidly land a helicopter inside the compound, with the assumption that damage would render the aircraft nonflyable. The disabled helicopter would then be destroyed using an explosive charge as the raiders and the rescued prisoners departed the area.⁶



Figure 27. Map of North Vietnam with Son Tay POW Prison (Source: Air University Library, Maps and Charts Division, Maxwell AFB, Ala.)

Once the basic idea of crash landing a helicopter inside the compound was accepted, a whole set of additional challenges faced the study group. Where could additional helicopters be landed outside the walls to assist the assault force inside? How would the helicopters find the prison and land nearby simultaneously? Being only 21 miles from Hanoi, what kind of response should the raiders expect from the enemy? Within five miles of Son Tay prison, there were 12,000 North Vietnamese troops stationed in various locations. There were two major SAM installations nearby. How would these enemy forces react to the raiders?⁷

General Blackburn was familiar with Combat Talon capabilities. As chief of SOG in the mid-1960s, he had employed both Combat Talon and Heavy Hook aircraft on long-range, low-level missions into North Vietnam. Although the helicopter held the key to penetrating the walls of Son Tay and successfully delivering the assault force there, it would take the Combat Talon to provide precise low-level navigation to get the force to the prison. With the threat in the immediate area, Combat Talon would also play an important role in deceiving enemy defenders while the assault force executed the rescue. The Combat Talon aircraft was capable of single-ship, low-level flight in the weather, but aircrews had not flown formation with helicopters using the terrain-following system. Although IFR capable, Combat Talon aircrews preferred VFR conditions along its route to update and ensure accuracy of its electronic navigation equipment. Many hours would be spent during the training phase on dissimilar fixed- and rotary-wing formation techniques and procedures.

Moon illumination and favorable weather were essential considerations for a successful raid. If a force consisting of several helicopters and attack aircraft were to assault the prison simultaneously, formation procedures would have to be utilized. In addition, to attain precise navigation, prominent features on the ground had to be identified by aircrews that were otherwise dependent on outdated charts and limited equipment. The feasibility study group determined that a quarter moon would be the most desirable, with 15–45 degrees above the horizon as ideal. With the large concentration of enemy forces in and around Son Tay, the group determined that the raid should commence between midnight and dawn at 10 minutes past the hour, to take advantage of the enemy's sleep and shift-change cycles. Favorable weather periods were also researched,

and a determination was made that September, October, and November were the most favorable months for low-level flying. Since it was already June, the month of September was ruled out because a force could not be organized and trained by that time. Ideal moon illumination and azimuth positioning would occur between 18 and 25 October and again during the same period the following month. The feasibility study group, therefore, recommended the October dates as the primary mission window, with November as the backup.⁸

Using all-source intelligence, the Defense Intelligence Agency (DIA) determined that 61 prisoners were being held at Son Tay. On 10 July 1970 General Blackburn, Colonel Mayer, and Colonel Frisbie briefed the Joint Chiefs of Staff on the feasibility study group's findings. The group determined that Son Tay could be successfully assaulted and Americans being held there could be rescued and returned to friendly territory with minimum loss. A joint task force consisting of helicopters, C-130E(I) Combat Talons, and A-1 attack aircraft would launch from bases in Thailand, fly low-level across Laos into North Vietnam, assault Son Tay Prison utilizing a coordinated attack plan, rescue the prisoners, and then retrace their route back through Laos to recover at bases in Thailand. The JCS approved the concept and directed that more detailed planning be conducted and an update briefing be given in early August. Dependent on the August briefing, a determination would be made whether to form a joint contingency task group (JCTG) or to cease planning the operation and shelve the whole idea.⁹ The August briefing would include a detailed operations plan and a training plan. If the mission still seemed feasible, then the secretary of defense would be briefed on the concept before the formation of the joint task force.¹⁰

Detailed Planning and Selection of Commanders

The feasibility study group recommended to the JCS that the overall JCTG commander be an Air Force brigadier general because of the complexities of sourcing and coordinating aircraft and support requirements across several commands. Tactical Air Command owned all US-based A-1s and Combat Talons; Military Airlift Command owned both the helicopters needed for the assault and the strategic airlift assets required to move the task force to its theater forward operating location; Strategic Air Command owned the SR-71

and other reconnaissance assets; PACAF owned additional fixed- and rotary-wing assets needed (including Talons, A-1s, and helicopters) for the operation; and USAFE owned a contingent of Combat Talons and crews from which to draw additional support.¹¹

With a green light from the JCS, the already hectic planning tempo accelerated. The next major milestone was the selection of a mission commander. On 10 July USAF brigadier general Leroy Manor received a telephone call from the Pentagon shortly after SACSA briefed the mission to the JCS. He was told that he had been selected to command a special mission for the Joint Chiefs of Staff. He was instructed to fly to Washington the next day and to make an operation's stop at Pope AFB, North Carolina, to pick up a US Army colonel named Arthur D. Simons. General Manor was, at the time, the commander, USAF SOF, located at Eglin AFB, Florida, and was responsible for training Air Force Special Operations Forces supporting worldwide tasking, including Combat Talon operations in SEA and in Europe. He was a highly respected Air Force general officer and combat veteran, having flown 345 missions in World War II and in Vietnam. He was the former wing commander of the 37th Tactical Fighter Wing stationed at Phu Cat, South Vietnam.¹² General Manor thought it strange that he was directed to stop and pick up an Army colonel at Pope AFB. Although they had never met, General Manor would soon come to appreciate the abilities of Colonel Simons, who, as it turned out, had been designated the ground force commander. Colonel Simons's nickname was "Bull," and he had earned his reputation through three decades of soldiering. He had entered the Army in 1941 as a second lieutenant fresh out of Reserve Officer Training Corps. After his light artillery unit was disbanded while in New Guinea, his unit was absorbed into the Sixth Rangers. He commanded B Company of the Sixth Rangers during the invasion of the Philippines. In the early 1960s he worked with General Blackburn preparing Special Forces's soldiers for White Star team operations in Laos. His mission there was to help establish a Laotian army and to instruct it in basic military skills. Bull Simons joined SOG when General Blackburn was its commander in 1965; he enjoyed General Blackburn's complete trust.¹³

General Manor and Colonel Simons reviewed the operational plan that General Blackburn and his staff had briefed to the JCS. Both concurred with the feasibility study group that the mission

was, indeed, possible. Meetings were held with DIA, CIA, and National Security Agency representatives where the two men were pledged complete support from each agency. With a window of 18–25 October only three months away, much work needed to be done to establish the JCTG and bring it up to mission-ready status. A rough timetable was worked out to ensure the raiding force was trained and ready. The two commanders would return to their respective locations and immediately begin selection of the nucleus of their force. On 8 August they would return to Washington with their deputies for a five-day detailed planning session. A training site would be selected during the planning session, and a detailed training plan would be prepared and ready by 20 August. The OPLAN would be completed by 28 August, with actual training commencing by 9 September. Support missions, including SR-71 and unmanned drone reconnaissance flights over North Vietnam, would be laid on during this period. Cover stories would be developed by a special security section in SACSA, and measures to prevent information leaks would be put into place. The raiding force would be fully trained and ready to deploy by 10 October to meet the first mission window.¹⁴

General Manor and Colonel Simons used separate approaches to find and recruit volunteers for the mission. At Fort Bragg Colonel Simons selected his key deputies and then discreetly put out the word that he was looking for volunteers for a "moderately hazardous" mission, instructing all who were interested to form up in the base theater at an appointed time. Through an extensive process whereby Colonel Simons personally interviewed every volunteer, just over 100 men were selected from the 500 who answered the call. This group would be reduced later to a raiding force of 56 men.¹⁵

General Manor used a different approach. He called in men whom he was sure would volunteer and told them only that he had a highly classified mission and asked if they would like to participate with him. He explained that there were some risks and that it was a good project, but he did not disclose the actual objective of the mission. He offered to excuse anyone who did not want to participate.¹⁶

The Air Force contingent consisted of aircrews and support personnel for two Combat Talons, five A-1E Skyraiders, one HH-3, and five HH-53 helicopters.¹⁷ One Combat Talon crew was sourced from Detachment 2, 1st SOW, Pope AFB and was commanded by Colonel Blosch. The second Talon

crew was sourced from the 7th SOS, Ramstein AB and was commanded by Major Franklin. The two Talon crews, along with spare personnel, remained with the task group throughout the training phase, deployed to Takhli RTAFB, Thailand, for the mission, and then redeployed to the United States and to Europe after mission completion.¹⁸ The two augmented Combat Talon crews that were selected in August 1970 for the Son Tay Prison raid were as follows:¹⁹

Cherry 1
(Talon 64-0523)
(7th SOS)

Maj Irl L. Franklin
Maj Thomas L. Mosley
Capt Randal D. Custard
Capt Thomas K. Eckhart
Capt William A. Guenon Jr.
Capt James F. McKenzie Jr.
Capt Thomas L. Stiles
MSgt Leslie G. Tolman
TSgt William A. Kennedy
TSgt Kenneth C. Lightle
TSgt James M. Shepard
SSgt Earl D. Parks
SSgt Robert L. Renner

Cherry 2
(Talon 64-0558)
(Detachment 2, 1st SOW)

Lt Col Albert P. Blosch
*Lt Col Cecil M. Clark
Maj John Gargus
Maj Harry L. Pannill
Capt John M. Connaughton
*Capt Ronald L. Jones
Capt David M. Kender
Capt Norman C. Mazurek
Capt William D. Stripling
TSgt Billy J. Elliston
*TSgt Failus Potts
TSgt Jimmie O. Riggs
TSgt Paul E. Stierwalt
*SSgt William T. Brown
TSgt Dallas R. Criner
SSgt Melvin B. D. Gibson

*Alternate crew members who did not fly on the mission.

Operation Ivory Coast

On 8 August 1970, after the update briefing by General Manor and Colonel Simons, Adm Thomas H. Moorer, the new JCS chairman sent a message to all unified and specified commands announcing the formation of the JCTG under General Manor and Colonel Simons's command. The operation was identified as Ivory Coast, but no details were given concerning the purpose of the new organization. The new designation replaced the name Operation Polar Circle that had been used during the initial planning phase. The following Monday, 10 August, an expanded group of 27 personnel, designated the Ivory Coast Planning Group, convened in the Pentagon to refine the feasibility study group's plan.²⁰

As the Ivory Coast Planning Group met, one of the first items on its agenda was to identify a training area. A small advanced party was dispatched to Eglin AFB, Florida, and soon identified Eglin Auxiliary Field No. 3 (Duke Field) as the

ideal location to house the raiding force. Air assets would remain nearby at Eglin AFB and at Eglin Auxiliary Field No. 9 (Hurlburt Field), where many were permanently stationed. Planners reasoned that less notice would be made if the aircraft remained at their home stations rather than deploying a few miles north to Duke Field.²¹

As aircrew and support personnel were brought on board, they were briefed that the mission of the new force was to develop the capability to free American hostages from anywhere in the world, but not specifically Son Tay. Selected crew members and planners from each weapons system were briefed on the actual Son Tay mission to facilitate mission planning. Combat Talon personnel initially briefed by General Manor and his staff at Eglin AFB included Thomas L. Stiles, John Gargus, Cecil M. Clark, Albert P. Blosch, and Irl L. Franklin. They were sworn to secrecy and did not divulge details of the mission until the mass briefings held in Thailand just before mission execution. In the interim, real-world events provided plenty of fodder for speculation. There was considerable turmoil throughout the world at the time and particularly in the Middle East, where two airliners had been hijacked and the mainly American passengers removed to an undisclosed location. American diplomats had been kidnapped and held hostage. Cuba was also on everyone's mind, and many volunteers felt sure that Castro was the target. All this deflected attention from the group's real objective in SEA.²²

As he had done for his other helicopter and fixed-wing assets, General Manor sourced his Combat Talons from different units to reduce the possibility of compromise. Being fully committed to the SOG mission in SEA, the 15th SOS was not tasked to provide any personnel, but one of its aircraft (64-0523) was diverted from LAS Ontario to General Manor's JCTG. It had just completed modifications at the California facility. The other Combat Talon (64-0558) was sourced from Detachment 2, 1st SOW.

General Manor planned for redundancy in each weapons system. For the Combat Talon, he needed one aircraft to provide low-level navigation escort for the helicopter force, but he needed a spare in case the first Talon had to abort anytime during the mission. The number 2 Talon was tasked to provide escort for the A-1s, and a spare was to be ready to escort the helos if number 1 dropped out. With 12 Combat Talons in existence and nine available, a two-aircraft package over a prolonged period was a significant commitment of

the force. By sourcing one aircraft from PACAF, one aircraft from TAC, and one aircrew each from TAC and USAFE, no single unit was overtaxed. Ongoing programs were not negatively affected.²³

As detailed planning continued during the second week of August, several capabilities not found on the Combat Talon were identified as being essential for mission success. One such requirement was the FLIR. There was no FLIR capability on the Combat Talon at the time, but an FLIR system was in use on similar Heavy Chain C-130E aircraft. Arrangements were made to borrow two FL-2B FLIR systems from Heavy Chain and to mount them on the two Combat Talons with a temporary external pod configuration. The two aircraft were modified during the late August period and returned to Eglin AFB in time to participate in the September training phase. FLIR was considered essential to the helicopter escort mission because most of the turn points during the low-level route were river crossings or lakes, and the early generation FLIR did a good job of identifying the contrast between land and water.²⁴ Another innovation to assist the Combat Talon in acquiring the helicopter after inadvertent formation breakup was the installation of the ground acquisition responder/interrogator (GAR/I) beacon on the helicopter. The GAR/I was designed to identify a signal transmitted from a drop zone to the aircraft to help assist the navigator during blacked-out airdrops. For the raid, a GAR/I beacon was installed on each helicopter, and the Combat Talon successfully read their positions when interrogated.²⁵

An additional requirement for Combat Talon was the capability to drop napalm to create a ground marker for the A-1 attack aircraft. Planners needed a ground marker that would burn for an extended period, thus providing the A-1s a point of reference from which to orbit in proximity to the ground attack. In the event the ground force commander needed assistance, the A-1s could respond in minimal time from their holding locations. Conventional delivery of the BLU-27/B napalm canister by fighter aircraft resulted in a large area of flame that burned for only a short period. For Son Tay the BLU-27/B was modified to function as a visual ground marker that required special rigging and palletizing for C-130 delivery. A developmental and test program was conducted on the Eglin AFB ranges that produced all procedures and checklists necessary for handling, loading, and delivering the munitions. Drag chutes from old B-47 drop tanks were available through

supply channels, and these chutes were acquired and attached to the BLU-27/B napalm canisters. The palletized canisters were then dropped on the Eglin AFB range. Napalm delivered in this vertical manner tended to pool in a concentrated area and burned for nearly an hour. Duration of the assault was planned for 30 minutes. With General Manor's 100 percent redundancy requirement, the extended burn time was certified as acceptable.²⁶

Another requirement identified by the Ivory Coast planners was the dropping of firefight simulators to confuse any enemy troops in the area and to delay their response to the prison assault. The simulators were actually firecrackers encased in a plastic sleeve that were dropped utilizing a pallet system from the Combat Talon and, once on the ground, sounded as if an actual firefight was under way.²⁷ Flares were also needed to illuminate the Son Tay Prison compound. The conventional flare utilized in SEA was the Mark 24, but it was a high-altitude flare that could not be dropped at low level. The maximum altitude over Son Tay was 1,500 feet, based upon the SAM and AAA threat in the immediate area. The Mark 24 was unacceptable even at this altitude. The Mark 6, or MK-6 log flare, was similar to a railroad flare and could be delivered manually at low altitude from the rear of the aircraft. (There was no aircraft delivery system designed for this type flare.) A supply of MK-6s was procured for Combat Talon use and was tested over the Eglin AFB range. Testing proved quite successful. The long-burning flare created acceptable light and had the added advantage of creating confusion on the ground when it started small fires amongst enemy forces.²⁸

With modifications under way and personnel selected to participate in the raid, flight training commenced on 20 August 1970. The next 60 days would prove to be demanding yet rewarding for the entire force.

Training in Northwest Florida

In August of 1970 Colonel Blosch and Major Franklin were recognized as two of the most experienced Combat Talon aircraft commanders then flying the sophisticated weapons system. Colonel Blosch had been one of two pilots in the Air Force who was qualified to fly the slot position on a four-ship C-130 demonstration team known as the Hercules Horseman while stationed in PACAF's 315th Air Division.²⁹ Both men were part of the initial cadre Stray Goose deployment to Nha

Trang AB, Vietnam, in 1966. Ten of the 29 crew members chosen for the Son Tay mission were part of the initial SEA deployment. While in Vietnam, Colonel Blosch commanded crew SG-04, and Major Franklin commanded SG-06. They had completed their tours and had continued in the Talon program—Colonel Blosch at the schoolhouse at Pope AFB and Major Franklin at Ramstein AB.³⁰ Lt Col Benjamin N. Kraljev, a member of the Ivory Coast Planning Group assigned to the Air Staff, was familiar with Combat Talon from his days assigned to Pope AFB. With General Manor's approval Colonel Kraljev contacted Colonel Blosch, who was the operations officer and acting squadron commander of Detachment 2, 1st SOW, and arranged for a demonstration flight for a select group of Pentagon staffers. Colonel Blosch flew a Talon to Andrews AFB that same evening and provided the requested demonstration. He was told of his selection for the mission the next morning.³¹

Early in August Major Franklin had deployed to RAF Greenham Commons, as part of the 7th SOS contingent for Flintlock III. He received a message from Headquarters USAFE through his squadron commander directing him and his crew to report to Eglin AFB and to await further instructions. Major Franklin had upgraded to squadron standardization and evaluation officer while assigned to Pope AFB, and when he moved to Ramstein AFB with Combat Arrow, he was assigned to the squadron's standardization/evaluation section without a crew. The message from USAFE requested each crew member by name, but the requested crew members were dispersed throughout the six assigned crews. To prevent affecting several crews in the midst of a major exercise, the squadron commander negotiated with USAFE to provide his most capable hard crew and to provide Major Franklin as its aircraft commander. Crew members were not told anything about the mission until their arrival at Eglin AFB on 28 August. Both Colonel Blosch and Major Franklin were highly qualified in the long-range, low-level, single-ship Talon mission. Son Tay, however, would require dissimilar formation skills not resident anywhere in the Air Force, and the two aircraft commanders would quickly be immersed in developing these skills.

The primary mission of the Combat Talon for the Son Tay raid was to escort the helicopter assault force and to provide it with precision navigation across Laos and into North Vietnam. Talons were not capable of helicopter air refueling, so a

third C-130—an HC-130P—was tasked to refuel the helicopters over Laos, then hand off the formation to the Combat Talon for the ingress portion of the mission. The HC-130P did not have adequate navigational or ECM equipment required to penetrate North Vietnamese air defenses and to reach Son Tay.

Formation flying with rotary-wing aircraft was a new experience for Talon crews. Both Colonel Blosch and Major Franklin quickly realized just how difficult it would be to lead a dissimilar formation into combat. Planners had chosen a smaller aircraft (either the HH-3 or the UH-1) to land inside the prison compound. A major problem arose over the maximum cruise airspeed of the two aircraft. Their maximum cruise airspeed was less than the minimum computed en route airspeed for the Combat Talon.

Stall speed for the Combat Talon in the clean configuration was approximately 12 knots above the maximum cruise speed for the HH-3/UH-1. Simply put, the Talon could not fly as slow as the maximum capable speed of the two smaller helicopters. Through testing and experimentation, however, aircrews found that the slower helicopters could draft in a position eight to 13 feet behind and above the left wing of the Combat Talon and increase their maximum cruise speed to 105 KIAS, which was an increase of 18 knots. At 105 KIAS and with 70 percent flaps extended, the Combat Talon was five knots above its power-on stall speed in straight and level flight and was well within the flight envelope of the larger HH-53s. The two aircraft commanders also found that by using the two inboard engines at high-power settings with the outboards at reduced power, the Combat Talon could fly at a lower airspeed than the computed stall speed. As long as symmetrical power was maintained, the two commanders were confident that planned airspeeds of 105 KIAS were safe and posed little threat of the aircraft stalling. Throttle technique was the key to slow-speed flight, which was a skill the pilots developed during the training phase. As fuel was burned during the mission, the weight and stall speed of the Talon would decrease, resulting in an even greater margin of safety between the aircraft's stall speed and its en route airspeed. Mountain ranges in eastern Laos and western North Vietnam would require continuous turns and changes in altitude and would present a challenging obstacle for the slow-moving helicopter formation.³²

Aircrews were ready to start initial training by late August 1970. Mission aircraft 64-0523 and

64-0558 were sent to LAS Ontario for installation of the FL-2B FLIR. A slick C-130 was furnished by TAC for initial formation training while the Talons were at LAS Ontario. Initial flights were over the Gulf of Mexico in the Eglin AFB water ranges at 1,000 feet AGL, an altitude that would allow successful recovery if the C-130 approached a stall. Because none existed at the time, Talon aircrews were faced with the challenge of developing unorthodox formation procedures compatible with the C-130, HH-53, HH-3, UH-1, and A-1. The two Combat Talon crews swapped out helicopter and A-1 lead responsibilities on alternate nights during training. This enabled the two crews to become proficient in both missions. Formation procedures for the Combat Talon and the A-1 were not extremely difficult to resolve due to more compatible en route airspeeds—the A-1 cruised at 140 KIAS, which was well within the Talon's flight-performance envelope. At 105 KIAS, however, the Combat Talon was limited in its ability to maneuver with the helicopters in tow. In the event of engine loss, the Combat Talon's only option was to accelerate by increasing power on the remaining good engines, pushing the nose over and descending while accelerating to its engine-out controllable airspeed. The altitude from which the recovery was initiated would determine the success of the maneuver. At Takhli, RTAFB the day before mission execution on 19 November, helicopter lead would be assigned to Major Franklin's crew and A-1 lead to Colonel Blosch.³³

Once the aircrew felt proficient in daylight dissimilar formation procedures, training shifted to night overland routes. Procedures were developed for inadvertent weather penetration, loss of visual contact with lead, and formation rejoin if the slower helicopter fell out of its draft position. Mission duration increased from two to four hours and external lighting was systematically reduced to near blacked-out levels. Night after night the raiding force honed its low-level formation skills over the rugged terrain of northern Alabama and the mountains of Tennessee. Cockpit lighting was dimmed to the lowest settings possible to allow aircrews to see critical instruments, and external navigational lighting was turned off. Low-light binoculars were tested by the aircrew, but even low instrument light settings did not allow vision past the windscreen. Night-vision goggles (NVG) had not been perfected in 1970, so aircrews had to rely upon their own vision using ambient light to see in the dark. Radio-out procedures were also utilized during



USAF Photo

Combat Talon in formation with an HH-3 and two HH-53s during training for the Son Tay mission. Note the HH-3 in "draft" position behind the Combat Talon. Photo taken over north end of runway 18 at Hurlburt Field, Fla.



USAF Photo

Combat Talon leading a US Army UH-1 and two HH-53s. Planners were unsure if an operational HH-3 would be available in SEA, so a backup plan utilizing the UH-1 was rehearsed.



USAF Photo

Combat Talon leading A-1 Skyraider formation during workup for the Son Tay POW raid.

all phases of flight, including formation rejoins after an inadvertent weather penetration. During the training phase, mission aircraft logged 1,017 hours during 368 sorties without a single flying-related incident. By the second week of September, scarcely three weeks after beginning training, aircrews were ready to begin joint training with the ground component force.³⁴

Because of the need for redundancy, both crews had to be proficient in each other's flight profile, including helicopter formation flying and napalm/flare drop operations. The A-1 formation flew a higher airspeed than did the helicopters. Therefore, the faster formation's route of flight was planned to coincide roughly with that of the slower one, but with timing dog legs built into the low-level route to compensate for the slower helicopters. If helo lead had to abort the mission after launch, the two Combat Talons would conduct a rotate maneuver. Helo lead would transmit "rotate, rotate" followed by either "can do" or "cannot do." If helo lead transmitted "can do," A-1 lead would take over as helo lead, and helo lead would assume A-1 lead. If helo lead transmitted "cannot do," he would transfer the helicopter formation to A-1 lead and return to home base. In the latter case, the A-1s would be on their own to navigate to Son Tay without a lead Combat Talon aircraft.³⁵

Flight plan timing for the low-level portion of the flight and the arrival in the objective area had to be carefully planned for several reasons. First of all, the inbound routes of the two formations had to be planned close to each other with numerous crossing points to permit an expeditious lead change should it become necessary. Consequently, once the helicopter formation (lead call sign Cherry 1) was formed after refueling with the tanker aircraft, all timing to the target area became relative to the rotary-wing formation. At the completion of its refueling operation, the fixed-wing formation (lead call sign Cherry 2) planned to be 10 minutes behind the helicopters. To ensure that the strike formation knew how the progress of the assault formation was going, Cherry 1 had to make timing calls at points 4, 7, and 10 along the route, giving only its estimated "ahead" or "behind" times in minutes for upcoming points 7, 10, and the IP, respectively. The time separation between the two formations at the IP was to decrease to not less than two minutes. The two-minute separation at the IP was also critical because it was needed to assure sufficient

time, altitude, and track separation between various aircraft, which were also maneuvering in the Son Tay area. Cherry 1 and Cherry 2 were to drop flares, markers, and battle simulators on nearly head-on tracks. After dropping its four illuminating flares over Son Tay Prison, Cherry 1 had to make a right-hand teardrop turn to the south, dropping markers and battle simulators for the next three minutes before exiting the area to the west. As Cherry 1 completed its drops, the helicopters remained at low level and landed, discharged their troops, and moved back to their pre-designated holding area. Cherry 2, arriving at the IP two minutes after Cherry 1, was to split from its five A-1s. The A-1s then had to climb to their attack altitudes and establish their orbit patterns based on the napalm ground markers dropped by the Talons for their reference points. The plan assumed that the A-1s would not be needed until after the ground forces had engaged the enemy. An early arrival of the A-1s could interfere with the helicopters and the departing Cherry 1. After formation breakup, Cherry 2 had to climb to its drop altitude, slow to 130 KIAS, and drop its assortment of napalm and flare markers with battle simulators on a track that turned to the south four miles short of Son Tay. After its drops Cherry 2 reversed course and headed west to its holding area.*

For the raid to be successful, the raiding force would have to penetrate North Vietnam's formidable air defenses. General Manor zeroed in on the enemy's SAM, AAA, and MiG aircraft that could threaten the force. There were eight SAM sites located northeast, east, and southeast of the POW camp. Another SAM site, located only three and one-half kilometers from Son Tay, was being utilized as a SAM training facility but could possibly respond in case of an attack. Intelligence revealed that AAA posed no threat to the raiding force, except near the SAM sites, and that all SAM sites could be avoided, except the one near Son Tay itself. This site had an 85 mm AAA battery associated with it that had an effective range above 3,000 feet. To minimize the effect of this battery, the raiding force would limit its maximum altitude to 3,000 feet, thus flying under the effective range of the AAA.³⁶ There were MiG aircraft at Phuc Yen AB, which was 10 miles north of Hanoi, but the MiGs were primarily daylight-only fighters that needed a ground control intercept (GCI) controller to direct their air-to-air intercepts. General Manor reasoned that a diversion

*Expansion of timing procedures provided by John Gargus.

launched from US Navy aircraft carriers over the Gulf of Tonkin would hold their attention. He also had a backup capability aboard the Talons that would seriously degrade the GCI controllers if any MiGs launched. For the mission to be a total success, however, surprise was essential for both the ground force and for its supporting aircraft.

Range C-2 and Barbara

By the time Colonel Simons arrived at Duke Field on 3 September 1970, Colonel Blosch and Major Franklin were well on their way to having their dissimilar formation procedures refined and ready for the joint phase of training. There was a lot going on at Duke Field at the time, so the addition of the raiding party and the coming and going of mission aircraft went virtually unnoticed. Other special forces personnel and air commandos from Hurlburt Field were transiting Duke Field and were working with soldiers from the nearby US Army ranger camp. To the casual observer, the raiding party was just another group exercising on the vast Eglin AFB range. Weeks of preparation already had been expended getting the force selected and ready for the training phase. For Colonel Simons and his men, it was time to get down to business.³⁷

Early in the planning process, General Blackburn's feasibility study group had recommended construction of a full-scale mock-up of the Son Tay Prison compound. The mock-up would be used by Colonel Simons's assault force during rehearsals and would replicate terrain features found in the North Vietnamese prison camp. Colonel Simons wanted a realistic replica built, but counterintelligence personnel cautioned against such construction. A detailed structure inadvertently could reveal the actual objective to members of the raider force, or a casual observer could possibly draw the correct conclusion and figure out what was going on. A remote site on the Eglin AFB range, site C-2, was chosen as the ground force training area. Controlled access to the site eliminated the casual observer threat, but overhead Soviet satellite imagery could not be eliminated. A Soviet satellite passed over C-2 twice each day, and often there were two such satellites in orbit. A permanent, detailed mock-up could not be constructed, yet Colonel Simons could not rehearse his assault plan without one.³⁸

Mission planners and Colonel Simons agreed to construct a mock-up that could be dismantled when the Soviet satellites were overhead. Target

cloth and 2-by-4 studs were used to replicate walls of buildings. Doors, windows, and gates either were painted on or cut into the cloth. The 2-by-4s were mounted into holes in the ground, and when the structure was removed and rolled up, covers were placed over the holes to eliminate the outline of the structure. Large trees were dug up and replanted to conform exactly to those found at Son Tay. Thus, when the helicopters flew into the mock-up, the pilots' view was the same as it would be for the actual operation. When set up, the mock-up replicated the prison itself, right down to the foliage pattern found there.³⁹

To provide even greater detail for the assault force, a model of Son Tay Prison, code-named Barbara, was constructed by the CIA. Barbara was built to exact scale based on reconnaissance photographs taken by US satellites and SR-71 aircraft. It was tabletop size and replicated the terrain, fauna, flora, and the prison itself. An optical platform device was used to view any part of the model. The device could be placed anywhere in the model and, through a series of mirrors, would reflect a horizontal view as though the viewer was actually standing on the ground inside the compound itself. Barbara provided an early version of what later would be called virtual reality. Ground forces spent countless hours on the model and were able to memorize every detail of the prison, including locations of the prison cells, North Vietnamese Army officers' quarters, and the main gate (in daylight or darkness).⁴⁰ A second model of the bridge and surrounding terrain near Son Tay Prison was also built that had similar characteristics as Barbara.

On 9 September Colonel Simons and his men began their training on the mock-up. By 17 September night training was in full swing, including operations with the assault force helicopters. On Monday, 28 September, full-scale joint training began, using all parts of the mission previously practiced separately—low-speed, low-level helicopter/Combat Talon formation, FLIR operations, napalm and flare drop, and ground force assault on the mock-up. Three objective area rehearsals were made each day, followed by three more each night. On Tuesday, 6 October, a full-scale dress rehearsal was held at C-2. The rehearsal included a 687-mile low-level flight over the southeastern United States, which mirrored the route to be flown in SEA. Exact times were flown, and the assault force employed live munitions on the Eglin AFB range. General Blackburn and Colonel Mayer flew down from

the Pentagon and viewed the full-dress rehearsal as Manor and Simons's assault force performed flawlessly. In six short weeks, the raiding force had come from concept to mission-ready status. All that remained was in-theater coordination and mission-execution approval.⁴¹

The Mission Approval Process

Approval to plan and execute the mission was received incrementally throughout the seven-month planning cycle. When SACSA first contacted chairman, Joint Chiefs of Staff (CJCS) on 25 May, SACSA was given the tentative go-ahead to develop a recommendation on how to proceed. SACSA formed a special study group, which recommended to the JCS on 5 June that an in-depth feasibility study should be conducted. The JCS concurred and the special study group was expanded into a larger feasibility study group. On 10 July the feasibility study group briefed the JCS that Son Tay could be successfully assaulted and that Americans held there could be rescued with minimum US casualties. The JCS approved further detailed planning and directed that an update briefing be given on 8 August. The update briefing was given on that date, resulting in a CJCS message to all unified and specified commands worldwide, which announced the establishment of a Joint Chiefs Task Group under the command of General Manor and Colonel Simons.⁴²

When the JCTG was officially formed, the JCS had approved only detailed planning and training for the Son Tay mission. General Manor was instructed to report to the JCS when he felt the concept was tested, proven feasible, and training was nearly complete. From General Manor's report, the JCS would determine whether to seek approval from higher civilian authority.⁴³ Training progressed rapidly at Eglin AFB once the main force was selected and deployed there. By mid-September the two commanders were ready to report to the JCS.

On 16 September they briefed the JCS that the concept had been tested and proven feasible and that the JCTG would be ready to deploy to SEA on 10 October. The two commanders also recommended that in-theater coordination and deployment be accomplished in time to facilitate mission execution between 20 and 25 October, with 21 October designated as the primary mission execution date. The JCS again concurred, and on 24 September General Manor and Colonel Simons briefed the secretary of defense, Melvin L. Laird,

and the director of the CIA, Richard M. Helms, recommending approval of the mission and the October dates.⁴⁴

Secretary Laird deferred approval pending coordination with higher authority but authorized General Manor to brief CINCPAC, Adm John McCain, who was in Washington at the time on other business. Admiral McCain was briefed the following day, 25 September. General Manor had been concerned that Admiral McCain, whose son was a POW being held in North Vietnam but not at Son Tay, might be less supportive since there was a possibility that prisoners left behind would face even harsher treatment. As it turned out, however, Admiral McCain was supportive and offered any assistance the JCTG needed.⁴⁵

It was 8 October before General Manor and Colonel Simons could get on the White House briefing schedule. At this briefing Dr. Henry Kissinger and Gen Alexander M. Haig were present, but President Nixon did not attend. Dr. Kissinger liked the plan and saw no reason it would not work. General Haig had little to say during the meeting. At the conclusion of the briefing, Dr. Kissinger asked when approval of the mission was needed to make the October dates. General Manor replied that he needed approval by the next day, to which Dr. Kissinger expressed grave doubts that a decision could be reached by that time. President Nixon was out of town, and he would need to be briefed to determine the merits of the proposal. Dr. Kissinger directed that the JCTG continue training but to plan on the November dates.⁴⁶ A new date for the operation was then set as 21 November 1970.

On 27 October CJCS Admiral Moorer approved deployment of the JCTG in-theater coordination staff, starting on 1 November, and deployment of the main body beginning on 10 November. On 1 November General Blackburn, General Manor, and Colonel Simons departed by commercial air for Southeast Asia by way of Hawaii. Once in Hawaii the team updated Admiral McCain on the status of the rescue attempt. From Hawaii to Saigon, Admiral McCain provided his command aircraft for the briefing team's use. Admiral Moorer sent a message to Gen Creighton General Abrams, COMUSMACV, announcing the arrival of the briefing team and asked him to listen to their briefing. In addition to COMUSMACV, the Seventh AF commander also attended.⁴⁷ At the conclusion of the briefing, General Abrams had only one question—Who did the JCTG work for? When told that the task group would be working directly

for the CJCS through CINCPAC, General Abrams pledged his support with all the resources under his command, including those of Seventh AF.⁴⁸

The next key player to be briefed was the commander of Carrier Task Force 77.0, Adm Frederic A. Bradshar. His carrier task force would be responsible for providing the diversionary air attack over Haiphong Harbor and the Gulf of Tonkin. General Blackburn, General Manor, and Colonel Simons flew out to the flagship and briefed Admiral Bradshar on the operation. Admiral Bradshar agreed to mount a diversionary attack on mission night and offered his forces for any objective area assistance needed by the JCTG. General Manor thanked him for his offer but explained that the JCTG had finalized its plans for the objective area assault. The night of 21 November was still the primary launch date.⁴⁹

Starting on 5 November, JCTG staff officers visited each wing, squadron, or facility commander supporting the operation. A letter of instruction was delivered that contained necessary information each commander would need to support the operation. Senior officers at Seventh AF established the *bona fides* for the JCTG staff officers before their arrival, and all commanders enthusiastically endorsed the operation and pledged their support.⁵⁰

On 10 November Colonel Blosch and Major Franklin, with their aircrew and support personnel, departed Eglin AFB in Combat Talons 64-0523 and 64-0558, respectively, en route to SEA. The two aircraft deployed through Norton AFB, California, to Hickham AFB, Hawaii, then through Wake Island to Kadena AB, Okinawa. From Kadena AB the two crews flew on to Takhli RTAFB, Thailand. The deployment used Project Heavy Chain as a cover, with message traffic to CINCPACAF and US Defense Attaché Office, Bangkok, requesting routine aircraft servicing and personnel billeting during en route stops. Diplomatic clearance into Thailand was also requested at the same time. The call signs for the two deploying Combat Talons were Daw 43 and Thumb 66.⁵¹ Between the 11th and 14th of November, four C-141s departed the United States loaded with the raiding force, their equipment, and the US Army UH-1 helicopter.* On 14 November the two Talons arrived at Takhli RTAFB, and by 17 November the remaining raiding force had also closed there.⁵² At Takhli RTAFB General Manor received final execution authority for

Operation Kingpin (the code name given to the execution phase of the mission) by way of Red Rocket message from the JCS on 18 November. From that date forward, he was delegated the authority by CJCS to make whatever decisions necessary to successfully complete the mission and was given OPCON of forces supporting the operation.⁵³

From initial approval to develop a recommendation on 25 May to final execution authority on 18 November, nearly six months had elapsed. During that time, a raiding force had been selected and trained, a detailed plan had been created and refined, and complex weapons systems had been modified to suit mission needs. New capabilities had been acquired for mission aircraft, and combat tactics had been developed. The force was in place in Thailand, and all that was needed was decent weather and a bit of good luck.

Operation Kingpin

After all forces had arrived at Takhli RTAFB on 17 November, mission personnel assembled in the base theater for a joint mission briefing for Operation Kingpin. General Manor covered the air plan and Colonel Simons the ground attack plan. For security purposes objective area names and geographical locations were omitted from the briefing. When the mission briefing concluded, Air Force crews continued to work on mission charts and flimsies. Colonel Blosch and Major Franklin had been at Takhli RTAFB since 14 November, and most of their work was complete. The mission briefing had provided additional altitude, communication, and en route procedures. On 19 November another briefing was held that covered command and control, intelligence, search and rescue, and evasion and escape (E&E).⁵⁴ All looked good, except for the weather forecast.

About once every 10 years, SEA experienced a major typhoon. On 18 November Typhoon Patsy hit the Philippines and headed west toward Hanoi. At the same time, a large weather system, consisting of a cold front with associated poor weather, began slowly moving southeast out of southern China. Weather forecasters determined the two systems would meet somewhere near Son Tay on the night of 21 November, which was Day for the raid.⁵⁵

General Manor had two excellent weather forecasters from the 1st Weather Wing, and he arranged a T-39 shuttle from Saigon to Takhli

*Although the decision had been made to use the HH-3, General Manor wanted to deploy with the UH-1 in the event an operational HH-3 was not available in-theater. The HH-3 was in the process of being withdrawn from SEA and was being replaced by the larger HH-53.

RTAFB for them to obtain the latest weather information. (Takhli RTAFB was in the process of closing, and its weather gear had been previously removed.) Although weather in the objective area was a major concern for General Manor, en route weather for the two Talon formations and high seas and reduced visibility in the Gulf of Tonkin for Task Force 77.0 could also severely affect mission success. The two weather forecasters were very knowledgeable in SEA weather patterns. They had previously observed phenomena whereby clear weather preceded an advancing cold front. Conditions were right, they concluded, for clear weather to occur in the objective area 24 hours before the cold front arrived. General Manor was faced with a difficult decision—should he launch 24 hours early into marginal en route weather with a chance of clear weather over the objective area, or should he stick to the plan and almost certainly have to postpone the operation for at least a week or more.⁵⁶ With the forecast eye of Typhoon Patsy less than 100 miles off the North Vietnamese coast by the night of 21 November, Task Force 77.0 would be unable to launch its diversionary strike. Winds at Da Nang would be marginal, with crosswinds gusting to 30 knots. Extensive clouds, poor visibility, and high winds would cover North Vietnam. The cold front would converge with the typhoon in the Red River valley region and would continue widespread poor weather for another week. The night of 20 November was the only night that offered even marginally acceptable weather.⁵⁷

A moon illumination of 25 percent to 75 percent, 15 degrees to 45 degrees above the eastern horizon, was desired for precise navigation to the objective area. Aircraft could launch under instrument flight conditions, but good visibility clear of clouds was required during and after formation join-up. Only light turbulence could be tolerated during blacked-out aerial-refueling operations. In the Red River valley, there could be no more than scattered low and middle clouds to permit adequate moon illumination. The A-1s needed no more than scattered clouds below 3,500 feet for optimum employment.⁵⁸

On the afternoon of 20 November, General Manor tasked an RF-4 aircraft from Seventh AF, with a weather observer on board, to fly a weather reconnaissance mission across Laos to the North Vietnamese western border. The aircraft landed back at Takhli RTAFB, and the observer verified that weather conditions ahead of the cold front were dry and clearing. The RF-4

mission also confirmed that en route weather across Laos consisted of scattered to broken clouds, with bases at 5,000 feet and tops at 8,000 feet, and broken to overcast clouds over the mountains of North Vietnam. Weather in the Son Tay objective area was expected to be good with excellent visibility. With these factors taken into consideration, General Manor made the decision to move the mission up 24 hours and launch late on 20 November, with H hour early on the 21st.⁵⁹ A precise H hour was not identified; rather, the operation was based on timing from the moment Major Franklin's Combat Talon dropped its illumination flares over Son Tay Prison.

At noon on 20 November, while the RF-4 was flying its weather reconnaissance mission over Laos, General Manor had not yet announced that he had received the Red Rocket message authorizing mission launch nor that he was considering moving the mission forward by 24 hours. Ground force personnel were issued sleeping pills and ordered by Colonel Simons to sleep from 1200 to 1700 hours. During the rest period, with information back from the RF-4 flight, General Manor issued the launch order at 1556 in the afternoon. Following the evening meal, the force was assembled in the Takhli RTAFB base theater for a route briefing, which included the target, its geographical location, and its proximity to Hanoi.⁶⁰ Maj Frederic M. Donahue, aircraft commander of the gunship-configured HH-53, recalled General Manor's words: "This evening at 2300, you will take off and fly into the most heavily defended valley in history. You will deliver the Green Beret troops to the Son Tay Prison Camp, and they will free all of the American POWs held there. Then you will return the POWs and the Special Forces to friendly hands. Son Tay is located 21 miles from downtown Hanoi." General Manor paused, and the silent and stunned men broke into spontaneous applause that lasted for a full five minutes. The pent-up feelings and emotions of the past few months were released, and the air was electrified. Only the United States could develop a capacity to fly to the outskirts of Hanoi and then free its prisoners.⁶¹

With the launch order issued, 116 aircraft, operating from seven bases and three aircraft carriers, had to be prepared for combat. Royal Thai Air Force bases at Takhli, Udorn, and Nakhon Phanom served as forward operating bases for primary mission aircraft (see fig. 28).⁶² At Udorn RTAFB HH-53s and HH-3s were permanently assigned to the rescue unit there, along with HC-130P tanker aircraft.

At NKP, A-1 Sandy attack aircraft were permanently assigned. At U-Tapao RTAFB Seventh AF had positioned three C-130s and placed them on alert for JCTG use. One of the C-130s moved aircrew and support personnel from Takhli RTAFB to Udorn and Nakhon Phanom RTAFBs to rendezvous with their respective aircraft. Fear of not having an HH-3 mission-capable aircraft in-theater did not materialize. A Udorn RTAFB HH-3, along with a spare aircraft, was mission ready. Once the aircrews were in position, mission aircraft were pre-

flighted and prepared for a late-night launch. A second Seventh AF C-130 from U-Tapao RTAFB moved the assault ground force from Takhli RTAFB to Udorn RTAFB and transloaded them to the waiting helicopters.

As the plan swung into motion, Major Franklin had problems with Combat Talon 64-0523 at Takhli RTAFB. He could not get the number 3 engine started. General Manor and his command staff had deployed to COMUSMACV's command post at Monkey Mountain near Saigon, where he had

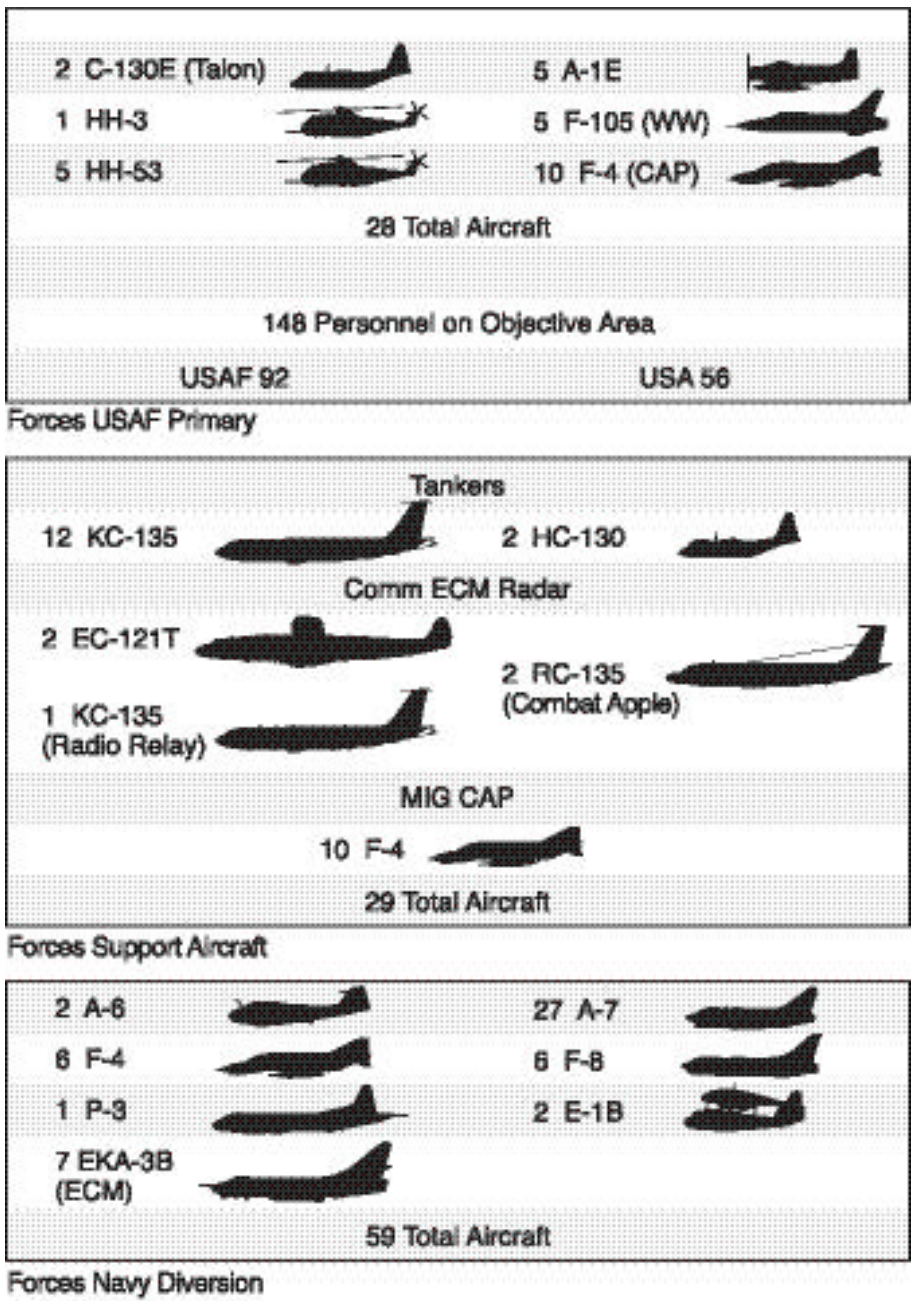


Figure 28. Aircraft Participating in Son Tay POW Raid (Source: Official Report, *The Son Tay Prisoner of War Rescue*, pt. 1, 18 December 1970, USAF HRA, Maxwell AFB, Ala.)

secure communications with his airborne mission commander, Colonel Frisbie, as well as with General Blackburn and the National Command Authority back in Washington. When Major Franklin's launch time of 1555Z passed, General Manor queried his launch element in Thailand for an explanation. When informed that Major Franklin could not start one of his engines, General Manor immediately turned to Colonel Kraljev, his Combat Talon staff expert, for options. Quick calculations determined that the Talon could operate on three engines but would have to perform the rotate maneuver and exchange helicopter formation lead with Colonel Blosch. If Major Franklin lost the number 4 engine after takeoff, however, he would have serious problems remaining airborne. General Manor thought the mission warranted the risk. As his staff prepared to transmit approval for a three-engine takeoff, word came from Thailand that Major Franklin was airborne at 1618Z and was on his way to rendezvous with the helicopter formation over Laos after completion of their planned aerial refueling. He was 23 minutes late, but he would make up the time without any mission impact.⁶³ Major Franklin had called for maintenance to check out the number 3 engine. They determined that the engine-bleed air valve was stuck closed and could not be opened by standard operating procedures. Remembering an emergency demonstration in the simulator the previous year, Major Franklin had maintenance button up number 3, and he performed a simultaneous start on number 3 and number 4 engines. It worked, and both engines came on-speed at the same time.

At 1618Z, just as Major Franklin broke ground at Takhli RTAFB, the HH-53s and HH-3, along with the HC-130Ps, launched from Udorn RTAFB. All aircraft taxied, took off, and maintained strict radio silence. Takeoff clearance was given by the control tower by way of a green light. If the aircrew had not received a green light by 30 seconds after scheduled takeoff, the crew was instructed to takeoff without clearance. After single-ship departure, the aircraft joined in formation with the HC-130Ps for the first leg of their journey to the refueling track in central Laos.⁶⁴ Shortly after helicopter launch, the A-1s launched from NKP and orbited in the area to join up with Colonel Blosch's number 2 Combat Talon. Colonel Blosch had launched without incident at 1528Z from Takhli RTAFB but was unable to locate the A-1s over NKP. The A-1s proceeded toward Vientiane, Laos, and turned north after passing that location. Colonel Blosch

overtook the A-1 flight and joined en route prior to the helicopter refueling track.⁶⁵

Out of Udorn RTAFB the helicopter formation, lead by Maj William J. Kornitzer Jr. in an HC-130P, flew north into Laos. En route to the refueling track, the formation encountered clouds at 2,000 feet. The formation climbed to 7,000 feet and maintained VFR on top conditions until after refueling with the HC-130Ps. The tankers remained in orbit over central Laos as Major Franklin's Combat Talon assumed formation lead and headed northeast toward North Vietnam direct to the rendezvous point. Major Franklin had regained the lost 23 minutes by flying higher-than-planned airspeeds direct to the rendezvous point. As Major Franklin proceeded down track with his helicopter formation, Colonel Blosch had his A-1 formation in tow and shadowed Major Franklin's route (fig. 29). The only visible external lighting from the Talons was three blue formation lights on top of each wing. The two formations were initially in the clear but entered a cloud layer while still in eastern Laos. After approximately 10 minutes in the clouds, the two formations broke out and had clear sailing until reaching the North Vietnamese border. Not long after penetrating North Vietnamese airspace, however, broken clouds were again encountered in the mountains near the western border. The formations remained

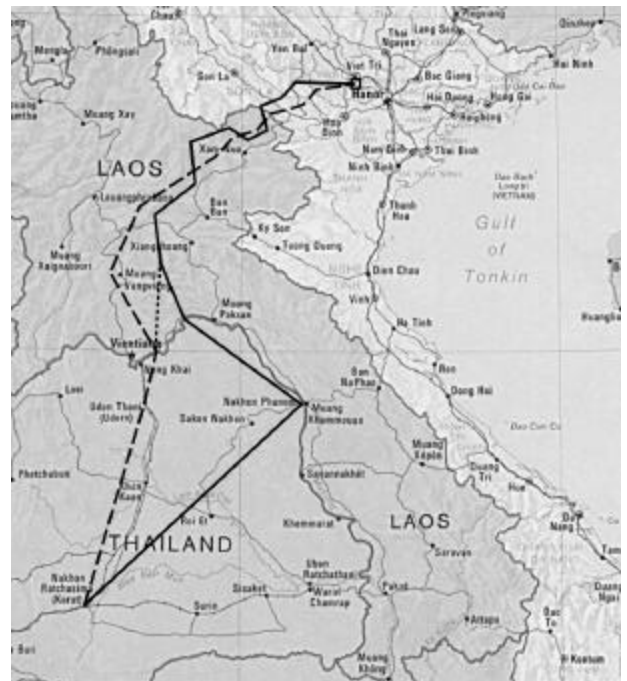


Figure 29. Route of Flight into North Vietnam, Son Tay POW Raid (Source: Route constructed by author from official Air Force records; map provided by Air University Library, Maps and Charts Division, Maxwell AFB, Ala.)



Photo courtesy of Col Jerry Thigpen

Irl L. Franklin (left), aircraft commander of Cherry 1, and John Gargus, lead navigator of Cherry 2, at Son Tay Raider Reunion, Dallas, Texas, November 1997.

intact, with each aircraft spreading out and maintaining course. The same maneuver had been practiced many times across the southern United States while in training, so it came as no surprise that each aircraft was exactly where it was supposed to be when the formations broke out of the clouds.⁶⁶ As the formations cleared the ridgeline to the southwest of Son Tay at 500-foot AGL, the Red River valley opened before them. Hanoi was plainly visible on the horizon, and the objective area was clear.⁶⁷

As the two formations penetrated North Vietnamese airspace from the west, Carrier Task Force 77.0 began its diversionary attack east of Haiphong with a force of 59 aircraft (mainly A-6s and A-7s). The Navy diversionary aircraft were not armed with bombs but rather with flares and electronic devices to simulate an actual attack. Air-to-air configured F-4s, however, were armed and ready to neutralize any MiGs that might launch against the force. The diversion provided a twofold benefit. The most obvious was that it focused North Vietnamese defenses to the east away from the raiders' ingress. Mission planners calculated that North Vietnamese defense systems would detect the low-flying formations 11 minutes before they reached Son Tay. With the Navy diversion, those defenses were turned eastward, and the raiding force flew undetected to the objective area.⁶⁸ A second benefit of the diversionary strike was that it saturated the Chinese/North Vietnamese Crosstell System, thus making

a coordinated response to the attack nearly impossible.⁶⁹

Major Franklin's helicopter formation arrived at the IP, which was a small lake just west of the Black River, two minutes ahead of Colonel Blosch's A-1 formation and 12 minutes from Son Tay Prison. The helicopter formation was one minute behind the flight-plan true airspeed time at the IP.⁷⁰ Major Franklin's formation consisted of his Combat Talon and six helicopters—five HH-53s and one HH-3. Two HH-53s were spread out above one wing, three were spread out above the other wing, and the HH-3 was tucked up close above the left wingtip, drafting on the Talon to maintain the en route airspeed of 105 KIAS. At the IP Major Franklin passed to his formation the heading of 072 degrees to Son Tay and began a climb to 1,500 feet. Numbers 4 and 5 HH-53 (call signs Apple 4 and Apple 5) followed Major Franklin's Talon in the climb. Apple 4 was the backup aircraft for the flare drop over Son Tay Prison in the event the Talon could not drop its flares. The HH-3 (call sign Banana 1) and the three remaining HH-53s descended to 200 feet. Number 3 HH-53 (call sign Apple 3) accelerated ahead of the other three helos to set up a gun pass on the prison guard towers. At precisely 1,500 feet over Son Tay, Major Franklin's Talon (call sign Cherry 1) dropped four flares that immediately illuminated the prison area, and Apple 3 began its gun pass to neutralize the guard towers. Cherry 1 then made an immediate descending right turn to 500 feet and dropped two battlefield simulators southeast and south of the city of Son Tay, both on target. At the release point for the first BLU-27/B napalm ground marker, the weapon armed but did not exit the aircraft. A second BLU-27/B was dropped on its planned target. The first firebomb was subsequently jettisoned over a lake west of the objective area, and Cherry 1 departed the area heading for its planned orbit point in Laos.⁷¹ After Apple 3 successfully completed its gun pass using side firing miniguns, the aircraft departed to the west to await further instructions from the ground force commander. Banana 1, now inbound with Apple 1 and Apple 2 slightly behind, maneuvered over the courtyard of the prison and executed a controlled crash landing, as planned, inside the prison walls. The raiding force on Banana 1 immediately engaged the enemy at point blank range.⁷²

During the run-in Apple 1, with Colonel Simons on board, strayed slightly right of course and mistakenly landed 400 meters short of the

objective area at a compound previously identified as a secondary school. Unaware that he had landed short of Son Tay, Colonel Simons and his raiding force deplaned and immediately engaged enemy forces. Apple 2, realizing that Apple 1 was at the wrong location, corrected back to course and executed an alternate attack plan that eliminated Apple 1 from the assault. Colonel Simons, in the meantime, realized that he was not at Son Tay and quickly called Apple 1 back for extraction. Nine minutes elapsed before Colonel Simons could disengage the enemy and get his force to Son Tay Prison aboard Apple 1.⁷³

Colonel Blosch's Talon, call sign Cherry 2, arrived at the IP at almost the desired time separation from Cherry 1, disengaged from its flight formation, climbed, slowed down, and dropped two BLU-27/B napalm ground markers. Cherry 2 then dropped its pallets of battle simulators and MK-6 log flares as planned. After its airdrops Colonel Blosch entered a holding pattern 15 NM west of Son Tay. With Major Franklin's mission a success, Colonel Blosch was now tasked to remain in orbit on call to provide any assistance Colonel Simons needed during the course of the attack. At approximately H+ 13 minutes, Cherry 2 detected unexpected AAA activity near its holding pattern. Evasive action was taken, and the aircraft sought protection in the hills northwest of Mount Ba Vi (a prominent peak in the immediate area) and established its preplanned alternate holding orbit. The remainder of Colonel Blosch's orbit time was spent below 1,000-foot AGL, with almost continuous SAM radar activity being received by his EWO.⁷⁴ Numerous SAMs were sighted by the crew over the Son Tay area. As many as eight impacted into the hills west of the Red River where Cherry 2 was orbiting. None were directed at the Combat Talon. They were missiles that missed their high-altitude F-4 and F-105 targets and exploded in the darkened hills as they fell back to earth. Colonel Blosch was scheduled to be the last aircraft out of the objective area. In the event anyone else was shot down, he would direct SAR forces during any ensuing rescue operation.⁷⁵ He also had three Fulton recovery kits on board, and the aircraft had been configured for recovery operations in the event a surface-to-air recovery extraction was required. He had two other alternate missions—jamming enemy communications and providing an HF secure communication link between General Manor at Monkey Mountain and Colonel Simons at Son Tay. While in orbit,

Colonel Blosch's crew performed the two alternate missions.⁷⁶

When Cherry 1 completed its airdrops, Major Franklin accelerated and headed west out of North Vietnam. En route to its holding point, Cherry 1 detected prelaunch emissions from a SAM site and descended to 1,000-foot AGL. The signal disappeared, and the aircraft climbed back to its flight-plan altitude. At this time a missile launch was detected, and the aircraft descended back to 1,000-foot AGL. The crew observed a missile exploding several miles east of the aircraft.⁷⁷ Once in Laos Major Franklin activated a homing beacon on his Combat Talon to assist the remaining forces as they departed the objective area, and Cherry 1 orbited for 49 minutes at the planned holding point. Back at Son Tay, the operation was going like clockwork. Apples 4 and 5 logged on an island in a finger lake some seven miles west of the prison. Their mission was to extract the American prisoners once Colonel Simons called them into Son Tay.⁷⁸ Apple 3, the gunship aircraft, logged about 1,000 yards west of Son Tay with Apple 1 and Apple 2. The three aircraft were set to extract the raiding force and provide additional firepower if Colonel Simons called.

As the operation was unfolding, Carrier Task Force 77.0 continued its diversionary attack to the east of Hanoi. High overhead the prison, F-4 Phantoms and F-105G Wild Weasels prowled the skies in search of enemy MiGs and SAMs. The Wild Weasels had their hands full with SA-2s. Sixteen SAMs were fired at the F-105s, and they retaliated with eight Shrike antiradiation missiles. During the fight two F-105s were hit by enemy SAMs, with one aircraft sustaining significant damage. As the two aircraft turned towards the west and the relative safety of Laos, the pilot of the more severely damaged aircraft detected a rapid loss of fuel. The SAM had punctured one of the aircraft's fuel cells. Although a standby KC-135 tanker aircraft rushed toward the disabled fighter, the aircraft ran out of fuel before it could make contact. The two-man crew ejected safely over Laos while the other F-105 returned to its base in Thailand and landed without incident.⁷⁹ MiG activity was absent. There were only two night interceptors at Phuc Yen on alert that night. They were reported by subsequent intelligence to have been ready to launch at the end of the runway but never took off. Their inability to launch might have been due to the effectiveness of the jamming packages aboard Cherry 2 and the US Navy aircraft. While holding west of Son Tay,

Cherry 2's EWO actively jammed North Vietnamese GCI controller frequencies as did the Navy A-6s over Haiphong. Consequently, MiG pilots could not receive instructions from their controllers to complete their air-to-air intercepts.⁸⁰

At H+ 10 minutes the assault force commander advised "negative items [POWs] at this time." Immediately after this call, Colonel Simons advised his force to "prepare to withdraw for LZ extraction." There were no prisoners at Son Tay. Apple 1 was called in from its logger location at H+ 14 minutes, and Apple 2 at H+ 22 minutes. As Apple 2 arrived, Colonel Simons directed demolition of the disabled HH-3 (Banana 1). At H+ 27 minutes Apple 2 departed Son Tay with all remaining forces on board.⁸¹

As the assault force headed west, single-ship Cherry 2 remained in orbit near Mount Ba Vi jamming GCI controller frequencies. Apples 3, 4, and 5 departed to the west, followed by the A-1s and the overhead F-4s and remaining F-105s. As the force cleared the objective area, Cherry 2 departed westward following them. Over the Plain of Jars in northeastern Laos, two survival beacons were picked up from the downed F-105 crew. Colonel Blosch proceeded to the area at 8,500 feet and established an orbit while running his Fulton STARS checklist. He reasoned that there was a possibility that the two crew members might need immediate extraction, so he was prepared to get them. Concurrently, Apple 4 and Apple 5 refueled from the HC-130P over Laos and established an orbit over the downed crew members. At first light, with Colonel Blosch's Talon orbiting near the downed crew members, Apple 4 picked up the front-seat pilot, and Apple 5 picked up the back-seat EWO. The two HH-53s, along with Colonel Blosch's Combat Talon, then returned to Udorn RTAFB and landed without further incident.⁸²

At Udorn RTAFB Major Franklin and the entire raiding force had landed by the time Colonel Blosch and the two HH-53s arrived. General Manor had flown by way of T-39 from Da Nang AB to meet Colonel Simons and his troops when they landed. Although everyone was exhausted, a formal mission debriefing was held, and a detailed "summary of operations" message was prepared by General Manor and Colonel Simons for transmission back to the Pentagon. The message was transmitted at 0915Z, but for unexplained reasons it was never received by JCS. The two commanders were ordered to fly back to Washington immediately, and by late morning they were on their way. At 1500Z on 23 November, they

landed at Andrews AFB, Maryland, aboard an Air Force KC-135 Looking Glass aircraft.⁸³ As it turned out, their immediate return had been directed by President Nixon, who wanted to personally decorate the two in a special White House ceremony.

After the hot wash at Udorn RTAFB, the Talon crews returned to Takhli RTAFB for much needed rest. Redeployment to the United States retraced their deployment route earlier in the month with departure from Takhli RTAFB on 22 November and arrival at Norton AFB on 25 November. At Norton AFB the two Talons were turned over to LAS Ontario on 26 November for removal of the FLIR. Aircrew and en route support items were returned to Pope AFB by way of TAC C-130 on 26 November.⁸⁴ Colonel Blosch and Major Franklin flew on to Eglin AFB to assist in writing the after action report. Over 90 days had passed since they had reported to Eglin AFB for training the previous summer.

Aftermath

After the rescue attempt at Son Tay, the North Vietnamese consolidated the American prisoners in the Hanoi area and closely held secret their exact locations. Although there was some planning for a follow-on operation, consolidation of the prisoners in Hanoi effectively eliminated another rescue attempt. The consolidation, however, had a positive effect on the overall condition of the prisoners. Before the raid many prisoners had been held in remote rural areas, under primitive conditions. Most had been kept in solitary confinement for years, with no contact with others. Immediately before the raid, several had died after years of torture and captivity. Bringing them all to the Hanoi area caused an overcrowding of existing facilities. To house all the prisoners, North Vietnamese authorities had no choice but to put them in common cells. The American prisoners were finally able to talk openly with each other, and they met friends from their old units. Those in bad shape were nursed back to health by their fellow prisoners. Morale soared as word trickled in that the United States had attempted to rescue some of them from Son Tay.⁸⁵ US fears that the remaining prisoners would suffer because of the raid did not materialize. Rather, their overall condition improved dramatically over time.

There was much speculation by the media regarding why the prisoners were not at Son Tay. The failure was blamed by most media reports on poor intelligence and, perhaps, even a breach of

security. General Manor vehemently denied both. He pointed out that every US intelligence agency had contributed to the mission, including the CIA and DIA. Although some reports indicated the CIA had not been consulted (and the CIA did little to refute this claim), the CIA had been supportive of the operation from the start. The American prisoners were probably moved because of summer flooding of the Black River that ran just outside the walls of Son Tay Prison. Brig Gen John P. Flynn, Retired, a former POW released by North Vietnam in 1973, contends that the prisoners had been moved from Son Tay because North Vietnam had begun to upgrade the prison—it had not originally been built as a prison and had serious security shortfalls. The Soviet Union and China had provided grant money, and some of this money had been used to repair and modify POW facilities. During the upgrade at Son Tay, prisoners were moved to an alternate location. Activity detected by US spy satellites was actually the construction crew working on the compound. Since American prisoners and the construction workers dressed the same in black pajama-like clothing, the fact that the prisoners had been moved went undetected.⁸⁶ As to the notion that the raid had been compromised by a breach of security, General Manor pointed out that the operation was a complete surprise to North Vietnam. Had they known the raid was coming, General Manor surmised, they would have ambushed the raiders and used the failure for propaganda purposes.

John Gargus, lead navigator on Cherry 2, recalled that when the raiders landed back at Udorn RTAFB after the raid, they were disappointed in not having rescued the Americans but felt good about the raid and were satisfied with the effort they had made. Out of the entire operation, one US Army soldier was grazed by a bullet on the inside of his thigh, and a USAF helicopter crew chief suffered a broken ankle during the controlled crash of Banana 1. Every aspect of the raid had been executed as planned.⁸⁷ The plan had worked perfectly. The raiders had penetrated

North Vietnamese defenses, landed, and deployed troops, and the troops had secured the area and searched every building. Everyone was recovered, and the area was safely egressed. There was no loss of American life, but no Americans were freed.⁸⁸ As the weeks passed after the raid, however, the US press labeled the entire operation a failure and accused the raiders of bringing additional hardship on the prisoners. For many raiders, years of self-incrimination and doubt ensued. It was not until the 25th anniversary of the return of the American prisoners of war in 1998 did Major Gargus finally accept the raid as the single-most positive event of the POWs' long captivity and that, indeed, it was a success.⁸⁹

Thanks to the pioneering work of Colonel Blosch and Major Franklin, and their crews, the Talon community made great strides because of the raid, both in equipment and in combat tactics. Before the raid the Talon fleet was scheduled for extensive modification and upgrades, which were later designated as MOD-70. The FLIR system that was temporarily installed on the Talons was the most notable addition. It had proven to be effective in assisting the aircrew during low-level precision navigation. Jamming of GCI controller frequencies was also proven quite effective. Although MOD-70 did not include a standoff jamming capability, European-assigned Talons did receive this capability in the late 1970s.⁹⁰

For the Combat Talon community, Son Tay was a resounding success. Lessons learned would be applied for years to come. The prestige of the entire Combat Talon community was enhanced by being part of such a noble endeavor. Ten years later, at a place called Desert One in Iran, America would once again question its ability and commitment to execute another rescue mission—the rescue of Americans held hostage in Tehran. As it was at Son Tay, Combat Talon would be an integral part of the Iranian operation. In failure, however, Desert One would prove to be the salvation of Combat Talon and would provide the catalyst for the rebirth of modern special operations.

Notes

1. USAF oral history interview with Lt Col Keith R. Grimes, 10 September 1992, USAF HRA, Maxwell AFB, Ala., 2.

2. W. J. McQuillen, USAFSOF historian, "Son Tay POW Rescue Attempt Operation," monograph, Eglin AFB, Fla., 25 February 1971, USAF HRA, Maxwell AFB, Ala., 1.

3. Grimes, 2.

4. McQuillen, 2.

5. Grimes, 4–5.

6. *Ibid.*, 6–7.

7. *Ibid.*

8. *Ibid.*, 15–16.

9. *Ibid.*, 14–16.

10. *Ibid.*, 24.

11. *Ibid.*, 32.

12. Benjamin F. Schemmer, *The Raid* (New York: Harper & Row, 1976), 67–68.

13. *Ibid.*, 64–66.
14. *Ibid.*, 69.
15. *Ibid.*, 73–74.
16. Grimes, 35.
17. McQuillen, 3.
18. *Ibid.*, 5.
19. Official Report, *The Son Tay Prisoner of War Rescue Operation*, pt. 1, 18 December 1970, USAF HRA, Maxwell AFB, Ala., vol. 1, attach. 4, A-5-A-6.
20. Schemmer, 74–75.
21. *Ibid.*, 75.
22. Hugh N. Ahman, Lt Col David Mets, Julie Massoni, and Donald D. Little, transcript of oral history interview with Lt Gen Leroy J. Manor, Eglin AFB, Fla., 26–27 January and 9 May 1988, USAF HRA, Maxwell AFB, Ala., 106–7.
23. *Ibid.*, 110–11.
24. *Ibid.*, 118.
25. *The Son Tay Prisoner of War Rescue Operation*, pt. 2, E-50.
26. Ahman, Mets, Massoni, and Little interview, 119.
27. *Ibid.*, 119–20.
28. Brig Gen Leroy J. Manor, “Transcript of Oral Account, Son Tay Search and Rescue Mission,” presented to HQ USAF-SOF, Eglin AFB, Fla., 31 December 1970, USAF HRA, Maxwell AFB, Ala., 7.
29. Personal notes of Lt Col Albert P. Blosch, Retired, 3 November 1998, Combat Talon Archive, HQ AFSOC/HO, Hurlburt Field, Fla.
30. Scrapbook, History of Stray Goose International (SGI), maintained by Col Leon E. Hess, Retired, Shalimar, Fla., for the SGI organization.
31. Blosch personal notes.
32. Grimes, 40.
33. Col John Gargus, Retired, interview by author, College Station, Tex., 13 June 1998. Recorded on 8 mm videotape, not transcribed, Combat Talon Archive, HQ AFSOC/HO, Hurlburt Field, Fla.
34. Schemmer, 89–90.
35. Grimes, 43–44.
36. Manor, 3.
37. Grimes, 37–38.
38. Schemmer, 75–76.
39. *Ibid.*, 75–77.
40. Lt Col Judd Katz, transcript of oral history interview with CMSgt Wayne L. Fisk, 31 August 1988, Gunter AF Station, Ala., USAF HRA, Maxwell AFB, Ala., 94–95.
41. Schemmer, 91–93.
42. *Ibid.*, 74.
43. McQuillen, 12.
44. *Ibid.*
45. Ahman, Mets, Massoni, and Little interview, 128.
46. *Ibid.*, 127–28.
47. *Ibid.*, 129–30.
48. *Ibid.*, 130.
49. *Ibid.*, 132.
50. McQuillen, 14.
51. Draft messages, 1198th Operational, Evaluation, and Training (OE&T) Squadron to Hickham AFB, Hawaii, and US Defense Attaché Office (DAO) Bangkok from personal records, Col Irl L. Franklin, Retired, Combat Talon Archive, HQ AF-SOC/HO, Hurlburt Field, Fla.
52. Manor, 10.
53. *Ibid.*, 5.
54. McQuillen, 18–19.
55. Grimes, 135.
56. Manor, 11.
57. McQuillen, 20.
58. *Ibid.*, 19–20.
59. *Ibid.*, 22–23.
60. *Ibid.*, 19, 23.
61. Col Frederic M. Donohue, “Mission of Mercy,” Air War College no. 4560, USAF HRA, Maxwell AFB, Ala.
62. McQuillen, vi.
63. *Ibid.*, 25.
64. Grimes, 95.
65. Schemmer, 160–61.
66. Donohue.
67. Grimes, 97.
68. Ahman, Mets, Massoni, and Little interview, 138.
69. Grimes, 198.
70. *Ibid.*, 99.
71. *The Son Tay Prisoner of War Rescue Operation*, pt. 1, 65.
72. Grimes, 100.
73. *Ibid.*, 100–102.
74. *The Son Tay Prisoner of War Rescue Operation*, pt. 1, 66.
75. Ahman, Mets, Massoni, and Little interview, 144.
76. Blosch personal notes.
77. *The Son Tay Prisoner of War Rescue Operation*, pt. 1, 73.
78. McQuillen, 25.
79. Manor, 14.
80. Gargus interview.
81. McQuillen, 33.
82. Gargus interview.
83. Schemmer, 183–84.
84. Franklin messages.
85. Lt Col Arthur W. McCants Jr. and Dr. James C. Hasdorff, transcript of oral history interview with Gen John W. Vogt, Annapolis, Md., 8–9 August 1978, Combat Talon Archive, HQ AFSOC/HO, Hurlburt Field, Fla., 205–6.
86. Lecture, Brig Gen John P. Flynn, Air Command and Staff College, 24 June 1974, Maxwell AFB, Ala., 35.
87. Gargus interview.
88. Donohue.
89. Gargus interview.
90. *Ibid.*

Chapter 7

Between the Wars (1975–79)

Eternal vigilance is the price of liberty.

—Thomas Jefferson

For more than 10 years, the United States had overtly supported its allies in SEA. The long struggle against communist aggression had sapped the will of the American people to continue the war. By the fall of 1974, only a short time remained before all American combat forces, which were primarily those of the US Air Force by that time, would be withdrawn from the theater.

Combat Talon Fights for Survival

High-altitude CDS airdrops into Cambodia by the 1st SOS during the summer of 1974 were the last Combat Talon activity there. Unconventional warfare and special operations were tied to the SEA theater of operations, so it was predictable that the USAF looked hard at SOF when force reductions were considered.

1st and 7th SOS Narrowly Escape Deactivation

In the Office of the Chief of Staff, Air Force, message dated 030023Z December 1974, the 1st SOS was identified for inactivation during the fourth quarter of 1975. Subsequent message traffic changed the deactivation date to the first quarter of 1976 and included the 7th SOS, which was still located at Rhein Main AB, FRG. The Air Staff plan consisted of the transfer of the eight Combat Talons assigned to the two overseas units to the 8th SOS at Hurlburt Field, Florida, thus forming a TAC-assigned 12 aircraft Combat Talon unit. Because of NATO's European troop commitments, the 8th SOS would be required to maintain a four-aircraft detachment in Europe until force level questions could be resolved.¹ There would be no Combat Talons left in the Pacific under the reorganization plan. Air Staff gave PACAF and USAFE the opportunity to respond to the planned action.

In its 270650Z December 1974 response, Fifth AF (the numbered Air Force unit to which the 1st SOS was assigned) expressed its concern to PACAF over the loss of the unique Combat Talon capability in the Pacific. It pointed out that the 1st SOS

was the only unconventional warfare asset in PACAF and that its inactivation would reduce UW assets to zero. Familiarity with potential operating locations throughout the Pacific theater gained by theater presence would be lost. It noted that response time for contingencies would be greatly increased, and the ability to support deployed forces would be reduced due to the lack of available parts in-theater. Perhaps the greatest argument for retention of the weapons system in PACAF was the emerging Republic of Korea requirement for the maritime surveillance of its coastal waters.

Initial sea surveillance tests were conducted by the 1st SOS in August of 1974 at Subic Bay, Philippines, at 10,000 feet altitude using the FLIR as a television monitor.² On 13 September 1974, the 314th AD, located at Osan AB, ROK, working in concert with the Republic of Korea Air Force, identified the need for night surveillance of the ROK's offshore islands to inhibit North Korean infiltration operations. At the direction of CINCPACAF, the 314th AD provided a concept of operation (CONOP) for utilizing the Combat Talon in the infiltration detection mission. Upon review of the 314th AD's proposed concept, Headquarters PACAF pronounced it sound on 25 October and forwarded it to the CSAF.³

A second series of tests were run on 6 and 7 December at 1,000 feet altitude using professional photographers. During this test, one photograph was taken of the FLIR picture and a second of the actual target. Analysis of the two pictures confirmed that the FLIR presentation was accurate and that recognition of the target could be easily made from the photograph. The FLIR had the capability to be tied directly to a video recorder, thus enabling the operator to acquire the target, analyze and evaluate it, and record the image on videotape or photograph it from the FLIR scope without additional assistance.⁴

Although the CONOP for the sea surveillance mission was still being developed, Fifth AF felt it was too soon to scrap the promising capability by deactivating the squadron. Also citing the

squadron's role as formation lead for station-keeping equipment (SKE) equipped C-130s, which it demonstrated in Cambodia, Fifth AF argued that the 1st SOS would be the only unit in PACAF capable of performing the AWADS mission once the 374th TAW was transferred from CCK. In summary, Fifth AF felt that the loss of the 1st SOS would have a far-ranging impact by eliminating many unique capabilities available in-theater and thus degrading the CINC's war-fighting and contingency response options.⁵

USAFE was not as convinced as PACAF of the need to continue the forward stationing of Combat Talons in Europe because it faced a different challenge than did PACAF. With Talons available at Hurlburt Field, the weapons system could be forward deployed to Europe within 36 hours of notification, a response time that included a 15-hour flight across the Atlantic. (The earliest that Talons could arrive in the Western Pacific was 72 hours after notification, based on flight time and unit mobilization requirements.) US-based forces routinely focused on the European theater and spent a portion of their training time participating in exercises based around a European war scenario. With PACAF/Fifth AF strongly supporting retention of the 1st SOS in the Pacific, however, USAFE/Seventeenth AF came onboard supporting the continued presence of the 7th SOS in Europe.

As the Air Staff proposal to deactivate the two squadrons was being staffed, Colonel Pinard, the 1st SOS squadron commander, developed a plan to reduce the authorized unit detail listing (UDL) by 12 aircrew positions for the squadron, thus decreasing its operating costs. The UDL decrease was made possible by the squadron's loss of the Fulton STARS capability the previous year. The C-130E (Clamp) Fulton-equipped Combat Talon required an 11-man crew, including two flight engineers and three pilots, whereas the C-130E (Yank) required only nine. Pinard's proposal eliminated the second flight engineer and the third pilot on each of the six assigned crews. Annual savings under the proposal were more than \$190,000.⁶ Although not a large decrease in assigned personnel, the reduction was viewed by Air Staff as a good-faith effort to minimize the costs of keeping the squadron on active duty and deployed to the Pacific. Eventually, the initiative to deactivate the overseas Talon squadrons was canceled.

The 1st SOS Is Reduced to Three Flying Squadrons

The 8th SOS had been established at Hurlburt Field under the 1st SOS in the late spring of 1974 with personnel and equipment of the deactivated 318th SOS. As the squadron settled into life at Hurlburt Field, the 1st SOS was being systematically dismantled. Just as the 1st SOS had been committed to SEA, so had US-based SOF. Four units of the 1st SOS were deactivated during the April to June 1974 period alone, and on 1 July the 1st SOS was redesignated the 834th TCW, a move that was seen as an attempt by the US Air Force to distance itself from special operations and its Vietnam legacy. The wing would be further reduced to three flying squadrons in the coming year—the 8th SOS flying the Combat Talon, the 16th SOS flying the AC-130H gunship, and the 20th SOS operating all remaining special operations rotary-wing aircraft. Although the wing was concerned about Combat Talon force restructuring, it was faced with the very real prospect of not surviving the post-Vietnam drawdown.

1975: Turmoil and Change

As the New Year began in the Pacific, the 314th AD CONOP for sea surveillance of the coastal waters of the ROK began to develop rapidly. A major challenge for the defense of the ROK was North Korean high-speed boats that staged from uninhabited islands off the coast of South Korea and infiltrated special agents at night into the south. During daylight hours the boats would hide under camouflaged netting to escape detection from the air. The large number of islands made surface search a hit-and-miss proposition and required a large commitment of manpower not available to the ROK at that time.⁷

Sea Surveillance Mission Emerges for the 1st SOS

Headquarters PACAF reviewed the 314th AD requirement and concluded that the RF-4 was not the ideal choice for the emerging mission. PACAF determined that the Kadena-based 1st SOS, flying the FLIR-equipped Combat Talon C-130E(Y) aircraft, was the most capable asset for conducting the mission.⁸ The PACAF staff also sketched a concept of employment for the Combat Talon in the counterinfiltration role envisioned by the 314th AD. After arriving at Osan AB, ROK, the crew would be briefed for surveillance missions by the 314th AD staff per the concept of employment.

Tentatively, the primary area for the surveillance was the islands and ocean between 36 degrees 00 minutes north and 37 degrees 00 minutes north latitudes and between 125 degrees 00 minutes east and 126 degrees 00 minutes east longitudes. Search emphasis would be placed on the uninhabited islands identified by ROK Air Force intelligence. (This area was later altered for a number of policy reasons.)⁹

After takeoff from Osan, the Talon would be monitored by the Korean Tactical Air Control System while flying at an altitude that would provide continuous ultrahigh frequency radio contact and positive radar monitoring. The 1st SOS mission was planned to be flown during hours of darkness because most previous detections of sea infiltrations had occurred during those times and because of the AAA threat posed by the North Korean high-speed boats. CINCPACAF further noted that the normal nighttime activities and signature previously established by the Combat Talon in Korea would further cloak evidence of US involvement in counterinfiltration operations. When the PACAF plan was presented to US Forces, Korea (USFK), the operational area was moved south of 35 degrees north latitude, and flights were restricted to the territorial limits of the ROK. USFK briefed the American embassy in Seoul on the proposed operation and received no objections to the operation as long as the restrictions imposed by USFK were followed.¹⁰

Headquarters PACAF proposed that a series of test missions be flown to validate the CONOP including seven missions during two flying periods. Subsequently, three night missions of three sorties each were planned during the first week of February 1975 in an area bounded by 34 degrees north and 35 degrees north latitudes and 125 degrees east and 127 degrees east longitudes. The search altitude was to vary from 1,000 feet to 12,000 feet above the ground, with the aircraft remaining under GCI control, to determine the parameters to be used in actual operations. When below 4,000 feet, the Combat Talon had to maintain a minimum of one NM slant range from all watercraft. The primary effort would be to locate and identify small craft (identified in counterintelligence operations as "skunk" boats) by means of the FLIR. Videotape recordings would be made of all sightings, with scope photography as a backup. Additional restrictions during the test included a minimum number of passes to identify a craft, and the crew could not drop any objects (including flares) from the aircraft.¹¹

The three-part Combat Talon test program actually began on 8 March 1975 in accordance with the newly published 314th AD OPOD 75-27, with the mission lasting 4.9 hours. The second and third sorties were flown on 10 and 11 March, which completed the first phase of the test program. Although problems were encountered in communicating with the HF and UHF radios on the first two missions, the problems were overcome by the third sortie. Numerous watercraft were sighted and were identified with the FLIR. The crews began to adjust quickly to evaluating the numerous targets and determining whether they were friend or foe. Individual island searches also produced numerous IR returns. The third sortie, flown on 11 March 1975, detected a possible infiltration craft at 0310 hours, local time. The boat appeared to be the size of previously captured skunk boats (40 feet) and was under way at a higher rate of speed than other sightings. The high speed of the boat was further evidenced by the large wake created as it sped through the water. IR returns indicated a larger-than-normal engine, and IR emissions were detected from the front of the boat that had not been seen before. The boat was also without lights and was not reflected on the KA band radar of the Talon. The sighting was recorded on videotape, and photographs were made from the video playback. Since the surveillance aircraft was prohibited by 314th AD OPOD 75-27 from taking tracking action, the destination of the suspected infiltration craft could not be determined within the short period of time the boat was observed on the FLIR.¹²

In response to the 11 March sighting, Headquarters PACAF instructed 314th AD on 31 March to amend OPOD 75-27 to allow Combat Talon aircraft to track suspected infiltration craft for the purpose of acquiring additional information. PACAF requested that 314th AD define procedures that would protect the Combat Talon from direct involvement if ROK forces decided to intercept and capture the skunk boat with the information provided by 314th AD. The 314th AD was cautioned to ensure that the Combat Talon aircraft remained passive in its surveillance and tracking and that the classified systems on the aircraft were protected from unauthorized disclosure.¹³

The second phase of the test, consisting of four additional sorties, were flown by the 1st SOS in early April, with the last sortie of the second phase flown on 21 April 1975. The results were similar to the first phase sorties flown in March, with a general improvement in communications

equipment aboard the aircraft. Numerous boats were sighted, and crews practiced and improved methods for identifying them. The second-phase testing was followed by an interim analysis of the counterinfiltration operation by the 314th AD, since the division felt that it had enough data to complete the Combat Talon test. Three more test flights were conducted in May 1975, but the later flights did not change the findings of the interim 314th AD analysis.¹⁴

On 24 April the 314th AD reported to Fifth AF that the test program, identified as Commando Talon, was successfully completed on 12 April and forwarded its conclusion that permanent operations should be established. The summary, prepared by USAF Korea's headquarters, included comments on limitations discovered during the test as well as recommendations for making future operations more effective. The flight tests revealed that the FLIR system provided high-resolution imagery "approaching visual photography," which was capable of providing not only real-time identification of vessels detected during open water surveillance but was also capable of permitting island survey operations for detecting agent staging bases. The practical consequences of the testing confirmed the validity of surveillance techniques and provided the means for making observations, which would reveal the nature of North Korean operations.¹⁵

On the assumption that Commando Talon operations would continue, the 314th AD expanded its earlier concept of operations around which employment plans were drawn. Inbound infiltration boats would continue to be reported to the 314th AD command advisory function, tracked to their destinations if possible, tied to specific locations, and passed to the ROK for appropriate action. If an outbound boat was detected, the 314th AD believed that the C-130E(Y) Combat Talon should follow it out to sea (as far as possible without violating sensitive area rules) to determine the operational methodology of North Korean employment.¹⁶

Two operating limitations were identified during the test program. First, the system's operator found that weather conditions seriously degraded the FLIR imagery. Clouds, moisture, or dust rendered the FLIR imagery virtually unusable. Second, the narrow field of view of the FLIR system placed restrictions on the method of searching a large area. Although a large area could be searched in a three-hour period (the test missions covered 1,800 square miles), one aircraft could not

scrutinize an area 60 miles in length and 30 miles in breadth in a short time. As a result, an infiltration craft could penetrate ROK territorial waters in one portion of a search area while the Combat Talon examined another. This limitation could be overcome by using more than one aircraft in a search area with appropriate altitude or sector separation.¹⁷ The 314th AD provided a number of recommendations for improving subsequent operations:

1. Commando Talon surveillance missions should not become a part of the peacetime aerial reconnaissance program.
2. The current 314th AD OPORD 75-27 should be used for continued operations until a new one could be written and coordinated.
3. The PACAF daily mission summary, required of all sorties, should be simplified. For routine sightings of surface craft, the mission summary should be brief, while those for suspicious sightings should be reported as currently required.
4. The surveillance mission should be fringed to operate in the area south of 37 degrees north latitude within the territorial seas of the Republic of Korea. When operating below 35 degrees north latitude, the sea boundaries should be expanded to the Korean air defense identification zone (ADIZ), as a minimum.
5. The utility of using two C-130E(Y) aircraft simultaneously should be considered.
6. Since an analysis of the multiple videotape coverage of islands could not be accomplished by the 314th AD for the survey and mapping objectives outlined for the second phase of the test, the 18th TFW should be tasked to obtain aerial photography of the islands covered and to make a comparison of the photo and FLIR coverage.
7. The limited capability of the 314th AD to perform a preliminary analysis of videotapes should be recognized and accepted, at least for the short term, because of the restrictions imposed upon the procurement of video equipment.
8. The development of close coordination between US and Republic of Korea Navy, Air Force, and other interested elements for utilizing the Commando Talon FLIR capability should be studied.

If the operations were to be continued, the 314th AD recommended that at least five missions

be undertaken in May, beginning on 5 May 1975. While adding observations of its own, Fifth AF concurred with all eight 314th AD recommendations and supported the conclusion that Commando Talon be made permanent in its 2 May 1975 message to CINCPACAF. Because of CINCPAC guidance and JCS policy, however, Fifth AF considered it unlikely that Commando Talon operations could be conducted between 35 and 37 degrees north latitude.¹⁸

On 3 May 1975 CINCPACAF authorized three more test flights to be flown by Combat Talon aircraft in its 032128Z May 1975 message to Fifth AF/DO. Headquarters PACAF reasoned that since commander, US Forces, Korea's (COMUSFK) position on the establishment of a permanent Commando Talon operation had not been received, it would be appropriate to call the 5–10 May sorties, proposed by both 314th AD and Fifth AF, additional test missions for acquiring more data. Of the original 10 missions authorized during phase 1 and phase 2, three had been canceled due to weather. The May missions would make up for the ones lost the month before. The PACAF staff again emphasized to its subordinate headquarters the need for developing procedures to prevent the Combat Talon from becoming involved in the reaction of the ROK to identified infiltration boats. Three additional flights were flown on the nights of 6/7 May, 7/8 May, and 10 May 1975. They were flown in the same area off the coast of the ROK as in the previous missions, using Taegu AB as the primary staging base in Korea. Although fishing boats, freighters, and other small boats were identified, no suspected infiltration craft were sighted.¹⁹

With its summer rotation of personnel, USFK did not respond to the test results until August. In its 221019Z August 1975 message to CINCPAC/J3, USFK provided its appraisal of Commando Talon operations conducted the previous spring. USFK concurred with both the 314th AD and Fifth AF recommendations provided to PACAF on 2 May. Since seaborne infiltrations by North Korean agents had been a long-standing concern of the ROK, COMUSFK strongly recommended that Commando Talon operations be established in certain key areas to contend with the peninsula-wide threat. The USFK staff recommended that the Commando Talon program be established for six months "to determine the feasibility of upgrading gathered intelligence from passive to active" collection. For

the operator in Korea, real-time information conveyed quickly to an operational unit "would meet the criteria of timely intelligence." The passive collection methodology, outlined in earlier 314th AD message traffic and advocated by USAF planners, was clearly not acceptable to COMUSFK.²⁰

The issue of active versus passive collection procedures and the transfer of data to the ROK were staffed throughout the fall of 1975. The PACAF staff did not consider the 314th AD OPORD 75-27 adequate for coastal surveillance operations by the C-130E(Y) aircraft in an active collection mode or for operations north of 35 degrees. It instructed Fifth AF to review and update its CONOP for gathering intelligence data and to prepare the details of how the evaluation was to be performed and how gathered intelligence was to be routed into ROK channels. In effect, PACAF requested Fifth AF to be prepared to revise OPORD 75-27 as well as to compile an appropriate set of rules of engagement.²¹

In a message from 314th AD on 15 September 1975, the 1st SOS was asked to begin Commando Talon operations as an interim capability until ROK Air Force FLIR-equipped AC-123 aircraft were modified and made available to perform the mission. Operations below 35 degrees north latitude were authorized, with operations approved on both the east and west coast of the Republic of Korea.²² Not comfortable that the capability was ready to employ operationally, Fifth AF restricted the 314th AD request to radar tracking and radar hand-off involving US forces only for the initial missions.²³ The PACAF staff recommended, in the meantime, that two additional Commando Talon test missions be flown to develop workable secure communications between friendly forces and to improve ground-based radar vector procedures to an intercepted agent boat. The additional test missions were flown on 28 October and 28 November 1975 but did not appreciably alter the earlier evaluations of the Combat Talon's capability to detect and identify infiltration boats in Korean waters.²⁴ It would be 1976 before Commando Talon missions would be flown operationally.

The Commando Talon program effectively tied the 1st SOS to the Korean peninsula and ensured that the squadron would not be deactivated. In addition to the Korean sea surveillance mission, the squadron continued to exercise and train throughout the theater during 1975. Foal Eagle 75 was flown out of Taegu AB in the spring of 1975, further tying the squadron to the Korean area of operations. Since its relocation from Nha

Trang AB in 1972, Lt Col Bob Pinard had commanded the squadron. On 1 July 1975 Lt Col Stephen G. Gardella Jr. assumed command of the squadron, with Maj Don James becoming the squadron operations officer and Capt Leon E. Hess assuming the assistant operations officer position.²⁵ Having commanded the 90th SOS/1st SOS longer than any previous commander and having successfully moved the squadron from SEA to Kadena AB, Colonel Pinard believed his lasting legacy was his successful campaign to keep the unit from being deactivated and continue as the only SOF unit in PACAF.

To further enhance its ECM training, the squadron participated in a fighter intercept program code-named Commando Lark. Beginning on 21 January 1975 and continuing monthly throughout the year, 1st SOS C-130E(Y) Combat Talons flew fighter intercept training missions with the Chinese Air Force (CAF) based out of Taiwan. The mission profile included launch of the Combat Talon from Kadena AB and penetration of the Taiwan ADIZ to test Taiwan's ability to respond to an intruder. With the Combat Talon playing the aggressor role, Taiwanese GCI radar would vector fighter aircraft into its ADIZ to intercept the penetrating Talon. The objective of the exercise was to evaluate the GCI radar operator's ability to maneuver his fighter into a position to allow the pilot to shoot down the penetrating aircraft. The exercise proved to be extremely realistic and provided outstanding training for both the CAF and Combat Talon crews.²⁶

A sign of permanency for the 1st SOS in PACAF was seen when the squadron moved into the former 345th TAS operations building on 11 and 12 September 1975. The new building effectively consolidated the squadron into one facility instead of the four buildings it previously occupied. The new facility was located along the flight line next to the squadron's aircraft. Without disrupting its flying schedule, the entire move was accomplished by using only 1st SOS personnel.²⁷ By the end of the year, the 1st SOS was stabilized at Kadena AB in its new facilities, with future deactivation plans for the squadron put on indefinite hold.

Reorganization in Europe Impacts 7th SOS

As the situation in the Pacific began to stabilize, European SOF was entering a period of turmoil and change. Effective 31 December 1974 the 7th SOS's low-level routes in Spain were canceled by the Spanish government. The squadron suffered another blow in early 1975 when Greece

temporarily denied the squadron use of its low-level routes. The long association between the squadron and the Hellenic Raiding Force was brought to an end due to rising political tension between the Greek government and the United States. In March 1975 the 7th SOS deployed an aircraft to Aviano AB, Italy, to conduct low-level route surveys and accomplish Fulton STARS training. Unseasonably poor weather allowed only one day of surface-to-air recovery operations at Aviano AB, but the facilities available there, along with the rugged terrain found in Italy, made the area an ideal training site. The squadron began to focus its efforts on Italy to solve its dwindling training opportunities across Europe.²⁸ As had been the case in other countries, Flintlock would provide the avenue for approval of low-level operations in Italy.

To help offset the effects of lost training and to provide a training venue that complemented the early fall Flintlock exercise, the squadron participated annually in a joint exercise in Germany known as Alpine Friendship. From 21 April to 16 May 1975, the 7th SOS deployed three Combat Talons to southern Germany and flew missions in support of the US Army Special Forces stationed at Bad Töelz. Missions flown included nine paradrop infiltrations, nine resupply airdrops, one STARS mission, and five airland exfiltrations. In addition to its main operating location, the unit deployed a communications team to Bad Töelz. The 7th SOS Combat Control Team also was infiltrated by way of airland and set up beacons on three drop zones in preparation for resupply airdrops. In total, the squadron flew 134.1 hours and 62 sorties in which 112 personnel and 2,500 pounds of cargo were air-dropped. In addition, 60 personnel and 4,300 pounds of cargo were airlanded through the course of the exercise. The major problem encountered was the lack of proper DZ markings, which resulted in several resupply drops being canceled and later rescheduled. Nonadherence to established procedures outlined in the *Joint Unconventional Warfare Standard Operating Procedures* publication was identified as the cause.²⁹

The summer of 1975 brought about another change in the 7th SOS's command relationship with USAFE. On 1 July the 322d TAW was inactivated at Rhein Main AB, and the 7th SOS was reassigned to Seventeenth AF at Sembach AB, Germany, by Special Order GB-20, dated 27 June 1975. Rhein Main AB was also reassigned to the Military Airlift Command, and the 435th TAW

was established as the base host wing. On 22 August Colonel Perry relinquished command of the squadron to Col Jerry A. Crist and retired from the Air Force. The unit's assignment to Seventeenth AF was short-lived. On 16 October the squadron was again reassigned by Special Order GB-6, dated 6 October 1975, to the 601st TCW located at Wiesbaden AB, Germany.³⁰ For the next two years, the 7th SOS's chain of command passed through the 601st TCW to Seventeenth AF at Sembach and thence on to USAFE. Throughout the turmoil created by these many changes, the squadron continued to focus on its wartime mission and the training required to successfully accomplish it.

The 8th SOS Becomes Interim Gunship Squadron

At Hurlburt Field the year 1975 also brought about many changes for the 8th SOS. On 7 March Lt Col Donald W. Burger assumed command of the squadron, replacing Col Peter K. Nikonovich. As the year progressed, the 834th TCW (formerly the 1st SOW) continued to decrease in size. On 30 June 1975 the 415th Special Operations Training Squadron (SOTS), with two assigned AC-130H gunships, was deactivated, and its personnel and equipment were assigned to the 8th SOS, effective 1 July. The 8th SOS had continued to operate the formal Combat Talon School, which provided trained crews to the two overseas squadrons. With the absorption of the 415th SOTS into the 8th SOS, the Combat Talon squadron also became responsible for all gunship training for the active Air Force.³¹

The long-range gunship plan was to relocate the SEA-based 16th SOS from Korat RTAFB, Thailand, to Hurlburt Field and to then transfer all former 415th SOTS assets to the gunship squadron. The plan was executed on 12 December 1975 when the eight Thailand-based AC-130H gunships were reassigned to Hurlburt Field. Because of the move, Hurlburt Field gained the only operational active duty gunship squadron in the Air Force, and the 8th SOS lost its gunship mission when the two AC-130H aircraft were transferred to the 16th SOS.³²

To increase the efficiency of Fulton STARS training, a ground-training platform was built by 8th SOS loadmasters for use in both the formal school and to fulfill continuation-training requirements of the squadron. An initiative proposed to TAC by the 834th TCW to save money was the elimination of Fulton STARS training in

the formal school. Since its creation in 1966, the Combat Knife unit had provided surface-to-air recovery training for all crew members during initial qualification. The wing's proposal noted that only a small number of crews actually maintained currency in the system once assigned to their operational squadrons and that by training all new crew members, valuable training time and scarce dollars were wasted. The elimination of the recovery training would result in savings of \$27,105 for each crew and would cut five days off the length of the course.³³ Crew members that needed qualification training in the Fulton system would be trained in their own units. TAC subsequently approved the proposal, and Class 76-03 became the first class without Fulton training.³⁴ In the post-Vietnam Air Force, dollars were extremely scarce, and budget cuts were the norm of the day. As 1975 ended for the 8th SOS, however, the permanency of the overseas squadrons ensured that its primary role as the formal Combat Talon schoolhouse was secure.

1976: Combat Talon Testing Receives Priority

The operations tempo in the Pacific remained steady, yet manageable, throughout 1976. The flurry of activity seen the previous fall over the Korean sea-surveillance mission had subsided. For the first half of the year, USFK, PACAF, PACOM, and the Joint Staff weighed the pros and cons of utilizing the Combat Talon in that mission. From 11 March to 4 April, the 1st SOS participated in Foal Eagle 76, committing two of its aircraft and 50 personnel to the exercise. The squadron flew 41 sorties and 134.6 hours during the three-week exercise, air-dropping 580 personnel and 8,400 pounds of cargo. The Commando Lark missions into Taiwan continued on a monthly basis, with outstanding airborne intercept training received by both the 1st SOS and the CAF.³⁵

Commando Talon Operations Begin for 1st SOS

Weeklong trainers to Clark AB, Philippines, were flown almost monthly by 1st SOS crews. Previous restrictions stemming from political disagreements between the US government and the Philippine government had been resolved. Occasional weeklong trainers were flown out of Korea, but it was in the Philippines that the squadron accomplished most of its quality low level. By the

fall of 1976, unit aircrews were being qualified on the HSSLADS airdrop capability. The system had been tested and certified in 1973, but budget reductions throughout SOF and the additional requirement for US Army certification had prevented earlier employment of the system throughout the Talon community.³⁶

The long-anticipated tasking for Commando Talon operations came in October, and the squadron deployed to Osan AB during three weeklong periods beginning on 16 October 1975. The 1st SOS flew successful missions nightly from 16 to 22 October, 16 to 23 November, and 10 to 17 December.³⁷ By year's end the 1st SOS had become an active participant in the defense of the ROK.

The squadron also participated in Specwarx 1-77 from 4 to 14 November in the Philippines. During the exercise several small-unit counter-terrorism field problems were executed, with the climax of the exercise designed around a hostage rescue mission on 12 November. For this mission participants included USA Special Forces soldiers, USAF Combat Control Team (CCT) members, and an aggressor force made up of US Navy SEALs. The 1st SOS began the exercise by unloading 11 Special Forces, seven CCT personnel, and one jeep with a driver and a gunner, and then departing the airfield for a two-hour low-level infiltration route. The scenario called for airdrop of the paratroopers, who were tasked with freeing the hostages and securing the landing/extraction zone. Within 10 minutes of the drop, CCT had marked the landing zone, and the Special Forces team had moved into position to free the hostages. The Combat Talon landed and off-loaded the gun jeep, which was used to assist in the hostage rescue operation. After 11 minutes on the ground, 35 "hostages" were successfully freed from their captors, and the aircraft departed the airfield with everyone on board. The total elapsed time from airdrop to final departure was 20 minutes. The operation was considered a success, but additional procedures were needed to decrease ground time for the aircraft.³⁸ Although this rescue operation was rudimentary compared to later exercises, it marked the first time that a hostage rescue scenario was included in an SOF exercise with Combat Talon participation. With the coming storm of international terrorism, it certainly would not be the last.

The 8th SOS Becomes a Talon Test Squadron

At the 8th SOS 1976 marked an upsurge in Combat Talon system testing by the squadron. Early in the year, from 18 to 19 February, an HSSLADS orientation conference was held at Hurlburt Field that was hosted by the TAWC and attended by Aeronautical System Division (ASD) representatives and members of the joint community that would employ the system. The conference was to standardize rigging and loading procedures and to resolve any questions potential users might have of ASD. At the conclusion of the conference, a forward restraint system was identified as a system deficiency, and TAWC agreed to provide preliminary engineering studies to ASD for action. The conference was a success, resulting in an improved HSSLADS capability.³⁹

On 28 February one aircraft and crew deployed to Nellis AFB, Nevada, to participate in TAC Project 75T-902, code-named Seabear. The test project was to evaluate the Combat Talon terrain-following and mapping radar systems in a simulated combat environment. Sorties were flown on 2, 3, and 4 March, with redeployment to Hurlburt Field on 5 March 1976. During the test, a problem with the AN/APQ-122(V)8 radar was noted. The 4 March flight was planned to fly over a sand dune ridge located in the Nellis AFB range. The area had been identified by F-111 pilots as hazardous because their radar did not "paint" the dunes and provide a command to fly over them. When the Talon passed over the dunes, its TF/TA radar did not provide a climb command either, thus bringing the crew to the conclusion that the system might not detect some terrain in arid, sandy environments.⁴⁰ A warning was later placed in the Lockheed Technical Manual to alert operators to the hazard of flying in the TF mode over deep sand or snow.

The primary purpose of the Seabear test was to determine if certain enemy ECM equipment affected the Talon radar. Also, chaff and radar decoys were tested against the radar to determine if there was any interference. The test determined that the chaff had little effect on the KA band mapping radar, but it did create interference when operating in the terrain-following mode. The radar decoys had no effect on the Talon's radar. Two enemy jamming systems were also tested against the AN/APQ-122(V)8, with mixed results. In general there was some degradation of the Talon radar, but the system continued to function while in the low-level mode.⁴¹

From 28 March to 1 April, another Combat Talon aircraft deployed to Nellis AFB for TAC Project 74T-902T, which was part of an ongoing effort to determine the effectiveness of the Rivet Clamp ECM modification installed on the aircraft during the MOD-70 update. The first test flight in the series had been flown on 2 September 1974. The series of tests were designed to develop optimum defensive tactics for the Combat Talon when faced with certain Soviet threats. Rivet Clamp equipment tested included the AN/ALR-46(V) radar warning receiver, the TRIM 7 and TRIM 9 deception repeater jammers, and internal fuselage AN/ALE-27 chaff dispensers. Four Soviet radar threat systems were evaluated. The test determined that the Soviet-made systems posed a threat to the Combat Talon, even with all defensive systems operating within design parameters. Tactics developed included an escape maneuver whereby the aircraft would turn away from the threat and descend while jinking. At the same time the TRIM 7/9 would be operated in its maximum jamming mode. The test also determined that chaff should not be used during the escape maneuver because it had little effect other than to draw attention to the aircraft.⁴²

TAC Project 76A-022T was conducted by the 8th SOS in waters near Hurlburt Field from 13 to 22 April. The test objective was to develop a means to air-drop one or two inflatable boats to be used as raiding craft by US Navy SEAL teams. The British Royal Air Force had previously developed an air-drop system for its inflatable boats, and this test evaluated the British system as modified for US Air Force aircraft. The boat used in the test was 16 feet long and was dropped by way of a parachute from the Combat Talon. A 40 horsepower outboard motor, fuel tank, and various supplies were packed inside the boat. The unit was mounted on a plywood platform that had sandbags attached to it that would sink the platform after the boat landed in the water. Under operational conditions, the boat was dropped from 1,250 feet altitude, with the SEAL team exiting the aircraft two to four seconds after the boat.⁴³

During the course of the test, a problem was discovered with the deployment of the boat's main parachute. On drops 1, 3, and 7, the vacuum created above the free-falling platform caused a delay in the opening of the pilot chute. In the first drop, the package fell from 1,250 feet to 700 feet above the water before the main chute opened. On the third drop, also from 1,250 feet, the main chute did not open until the platform

was between 300 and 400 feet above the water. On the seventh drop, a slight delay in the main chute opening was experienced. The SEAL jumpmaster used the opening of the main parachute as the cue for the team to exit the aircraft. With delayed opening of the main chute, the jumpers landed too far from the boat to link up with it successfully. A solution was found by using pilot chute openings as the cue for the jumpers to exit the aircraft. This procedure proved satisfactory, though under contingency operations, a slight possibility existed that the main chute would malfunction, thus causing the boat to be destroyed when it impacted the water.⁴⁴ The test resulted in the development of drop procedures for the combat-rubber-raiding-craft (CRRC), which were later employed throughout the Combat Talon community.

The 8th SOS also participated in a test of the AAQ-8 infrared ECM system, which was conducted from 2 to 11 June. One aircraft departed Hurlburt Field on 2 June en route to LAS Ontario. Once there, two AAQ-8 pods were temporarily installed on the aircraft. (The AAQ-8 system had not been part of the MOD-70 program but was a follow-on modernization effort that had not been thoroughly evaluated.) On 5 June the aircraft departed LAS Ontario, with test personnel and equipment bound for McConnell AFB, Kansas, where the actual test was to be conducted. On the 7th and 8th of June, engine-running ground tests of the pods were conducted. On the 9th and 10th, the flight phase of the test was conducted. After completion of the test, the aircraft returned to LAS Ontario for removal of the pods from the aircraft.⁴⁵

A new camera mount for the Combat Talon was also tested during the spring of 1976. CMSgt Clarence E. Sibley and SSgt Francisco C. Sablan had developed the mount locally at Hurlburt Field. It was used successfully for the first time on 14 April during Exercise Solid Shield 76. A modification was made to the mount on 26 April to prevent the camera from being damaged when the aircraft ramp was opened or closed. On 30 April the camera mount was approved as a Class 1B modification, thus allowing the 1st SOW to meet one of its assigned tasks—that of limited aerial photography. The two inventors of the camera mount received the Air Force Invention Award for 1976 for their effort.⁴⁶

On 12 December 1976 aircraft 64-0523 deployed to LAS Ontario for a flight test of the System 66 ECM suite. At LAS Ontario the aircraft

was modified with test equipment on 13 and 14 December. On 15 December the aircraft departed LAS Ontario and flew a test mission in the China Lake restricted area. The mission profile included multiple passes at 10,000 feet and 3,000 feet above the ground and two passes at 250 feet. All test objectives were met, and the mission was terminated by midafternoon. The aircraft returned to LAS, where test equipment was removed, and the aircraft returned to Hurlburt Field on 17 December, just in time for the Christmas holidays.⁴⁷ For the 8th SOS, 1976 had been filled with schoolhouse and test-oriented missions.

1977: Combat Talon Redesignated as the MC-130E

Early in 1977 the most significant event in recent Talon history occurred when aircraft 64-0564 deployed from the United States to the western Pacific utilizing two in-flight refuelings and flying 27.8 nonstop hours. The aircraft had been the first to be modified with the UARRSI. Crew members from the 1st SOS were among the first to be trained on the new system during the last week of January 1977. The mission profile began with the onload of US Navy SEAL personnel at Coronado Naval Air Station, California, on 10 February. With the 17-man SEAL team onboard, the Combat Talon was refueled twice during its transit of the Pacific en route to the Philippines. The first air refueling was completed over Hawaii and the second near Guam. After the second refueling the Combat Talon proceeded on to the Philippines, where it dropped the SEAL team at Subic Bay.⁴⁸ To deploy over long distances and air-drop special operations personnel anywhere in the world dramatically improved the capability of the Combat Talon (see chap. 2).

Another significant event in Combat Talon history occurred during early 1977. The Combat Talon was redesignated by Headquarters USAF as the MC-130E to reflect its multirole status. Combat Talon had been originally given the designation C-130E(I), which denoted its special status as a Fulton STARS-equipped, or intercept-capable, aircraft. After MOD-70 the Combat Talon carried three designations—C-130E(C), or Clamp configuration for STARS-equipped aircraft; C-130E(Y), or Yank configuration for Pacific non-Fulton aircraft; and C-130E(S), or Swap configuration for the two non-Fulton-equipped aircraft (64-0571/64-0572) that were occasionally loaned to other organizations outside of SOF. The MC-130E became the one designation for all

Combat Talons in early 1977, regardless of equipment installed on the aircraft.⁴⁹

1st SOS Excels during ORI

The spring of 1977 was a busy time for the 1st SOS. The annual Foal Eagle exercise was combined with Exercise Team Spirit 77 during March and April. During the exercise the first of three limited operational readiness inspections (LORI) were held. The next month, during Cope Thunder in the Philippines, units of the 18th TFW flew a second LORI. These two LORIs, along with one flown earlier in the year, composed the wing's ORI. The 1st SOS scored an excellent overall rating and was the highest rated squadron in the 18th TFW.⁵⁰ Along with the LORIs, the 1st SOS flew three additional Commando Talon missions. On 17 June 1977 Lt Col Richard E. Clinton assumed command of the squadron from Lieutenant Colonel Gardella. A formal change of command ceremony, presided over by Brig Gen Walter H. Baxter III, the 18th TFW commander, was held on 20 June.⁵¹

Deployments to the Philippines and to Korea were conducted throughout the summer and fall of 1977. To expand the unique capabilities of the weapons system, a 1st SOS MC-130E aircraft, en route to programmed depot maintenance at LAS Ontario, participated in Project Mauna Loa in Hawaii. The mission consisted of evaluating the ability of the aircraft's FLIR system to detect lava tubes of the volcano Mauna Loa. The idea was to use FLIR information to help track lava flow. Results of the mission were highly encouraging, and data collected was provided to Headquarters PACAF.⁵²

The 7th SOS Identified to Receive European ECM MOD

In Europe the summer of 1977 brought about another major change in the 7th SOS's chain of command. USAFE Special Order GB-19, dated 14 June 1977, formally activated the 7575th Operations Group (OG) at Rhein Main AB, FRG, effective 1 July, and assigned the new OG directly under Seventeenth AF. Along with the 7th SOS, the 7405th Operations Squadron, also located at Rhein Main AB and known informally as the "Berlin for Lunch Bunch," was placed under the 7575th. The changes were designed to give Seventeenth AF a better span of control over its highly specialized C-130 units.⁵³

The 7575th OG exercised OPCON of the 7th SOS and directed all local and training flights. Operational flying missions continued to be tasked by SOTFE, which continued to operate from Patch Barracks, Germany. Liaison with Seventeenth AF was maintained by Seventeenth AF/DOSO and with USAFE through USAFE/DOUO. The 7th SOS maintained its Operating Location Alpha at Bad Tölz, Germany, which was responsible for coordinating all air support requirements for elements of the 10th Special Forces Group (Airborne) located there. Maintenance support for the 7th SOS was provided by the 435th TAW, the Military Airlift Wing responsible for Rhein Main AB. The squadron remained a USAFE-assigned tenant unit on the Military Airlift Command base. With the creation of the 7575th OG, however, greater emphasis was placed on support of 7th SOS aircraft, including daily maintenance activities and spare parts.⁵⁴

The annual Combat Talon Management Review Conference was held from 12 to 14 July 1977, and the newly established 7575th OG sent its commander, Col L. D. Chetelat, to the meeting, along with representatives from the 7th SOS and USAFE. Colonel Chetelat stressed to conference attendees USAFE's assessment that the Clamp Combat Talon was not capable of operating in some areas required by existing war plans. The 7th SOS representatives further expanded on shortfalls of the ECM equipment installed on their aircraft. New wartime targets had been assigned to the squadron that had previously been considered as denied. To improve the ECM systems installed on the aircraft, the squadron had submitted a required operational capability (ROC) to USAFE. The ROC identified the requirement for improved ECM equipment to enable the Combat Talon to reach the new areas. In addition to equipment requirements identified by the 7th SOS, USAFE also identified a requirement to equip Combat Arrow aircraft with an interim standoff jamming capability because the EF-111 initial operational capability had slipped. USAFE wanted its Combat Talons to have a standoff jamming capability until the EF-111s were operational in Europe.⁵⁵ To satisfy both requirements identified by USAF at the CTMR, a highly sophisticated and much more capable ECM suite was developed for European Talons and was installed on them beginning in 1978. Combat Talon 64-0561 was the first of the European ECM-modified aircraft, with 64-0523, 64-0555, and 64-0566 eventually receiving the updated ECM equipment. While 64-0561 was

undergoing initial modification and testing, aircraft 64-0567 was loaned to the 7th SOS so that four aircraft could be maintained in Europe.

Throughout 1977 maintenance for Combat Talons assigned to Rhein Main AB was particularly challenging. The decision had been made to permanently assign the 37th TAS to Rhein Main, and throughout the year, actions necessary to stand up the new squadron were completed. Before the 37th TAS's permanent assignment to Germany, temporary duty personnel from state-side C-130 units deployed to Europe to fulfill C-130 requirements. The deployed maintainers serviced the Combat Talons along with their own assigned aircraft. With the permanent change of station of the 37th TAS, C-130 maintenance became a permanent part of the 435th TAW. Maintenance experience level was low for those initially assigned to the wing to support the 37th TAS, and there was a shortage of personnel in critical maintenance career fields for some time. Maintenance for the 7th SOS suffered from the low-experience level. Once newly assigned personnel arrived in sufficient quantities and attained proficiency, Combat Talon maintenance reliability improved significantly.⁵⁶

Continuation Training Keeps 8th SOS Occupied

While the 7th SOS was undergoing organizational changes in Europe, the 8th SOS continued to train newly assigned Combat Talon crew members and continued testing various Combat Talon subsystems. The US Army required that all new air-drop capabilities be tested and certified using Army equipment. The HSSLADS test conducted in 1973 had not included US Army participation, thus resulting in an approved system for the US Air Force but one that could not be used for US Army airdrops. Consequently, TAC published Project 77F-062T for the dual purpose of gaining certification of HSSLADS by the Army and for certifying multiple container drops for the Combat Talon. One MC-130E (64-0567) deployed to Pope AFB on 20 July and conducted tests on 21–22 July. During the test the Combat Talon flew four sorties and dropped 20 500-pound bundles at a speed of 250 knots and an altitude of 250 feet. High-speed cameras in the aircraft and on the ground recorded the results. After film analysis, an additional 10 drops were added to the test to determine the cause of a recurring parachute malfunction. Aircraft maintenance problems forced the cancellation of the remaining drops,

and on 23 July the aircraft redeployed to Hurlburt Field. The test was resumed the following month when aircraft 64-0568 deployed to the Yuma Proving Grounds in Arizona. From 22 August to 2 September, 51.8 hours were flown during 36 scheduled sorties. Ninety airdrops were completed, of which 78 were successful. Although experiencing some inconsistency, the test determined that either the 22- or the 28-foot ring-slot parachute should be used with the HSSLADS. The mission commander, Maj John M. Logan, recommended that the test be extended and that approximately 25 additional drops be accomplished using only new parachutes.⁵⁷ A third deployment was accomplished from 8 to 17 November to Pope AFB, and the project was successfully completed, resulting in US Army certification of the HSSLADS. The certification cleared the way for Combat Talon units worldwide to use the system when supporting US Army parachute operations. The squadron finished out the year under the command of Lt Col Hugh L. Hunter.

1978: Combat Arrow Wins the USAFE Commander in Chief Trophy

One of the challenges for the Combat Talon community was to remain engaged throughout its area of operations so that, when tasked to execute a mission on short notice, the unit could deploy without undue attention. Nowhere was it more difficult to maintain theater familiarity than in the Pacific. Huge distances created a challenge that was not easily overcome. The 1st SOS was stationed on the island of Okinawa and regularly exercised in Korea and in the Philippines. The squadron had little experience in other countries of the area.

1st SOS Begins the Pacific Area Trainer Program

In January 1978 the 1st SOS began a program known as the Pacific Area Trainer (PAT); it was designed to expose the Combat Talon to areas that might be needed during a deployment for a crisis. The first PAT was flown from 23 to 27 January 1978. The main objectives of the PAT were to operate the MC-130E aircraft outside the normal operations/training areas and to build a presence for future PACOM-tasked operations; to build aircrew experience and familiarization of PACOM areas that could be used for possible future deployments; to gather data on facilities and locations for possible future use; to accomplish

MCM 51-130 flying training requirements; to collect electronic intelligence along the route of flight within the capabilities of Combat Talon equipment; and to analyze the 1st SOS HF command and control radio network.⁵⁸

A second PAT was flown from 20 to 30 May; it transited Agana NAS, Guam; Whenuapai Royal New Zealand AFB, New Zealand; Ohakea Royal New Zealand AFB, New Zealand; Brisbane International Airport, Australia; Port Moresby International Airport, Papua, New Guinea; and Cubi Point NAS, Philippines. During the 48.3-hour deployment, the crew executed a long-range in-flight refueling leg utilizing its in-flight refueling capability and a USAF KC-135 tanker. It was the second time that a 1st SOS crew had performed a long-range refueling mission.⁵⁹

In conjunction with the PAT 002 deployment, 1st SOS personnel attended the preliminary planning conference for Exercise Gonfalon. Designed as a joint/combined unconventional warfare exercise, Gonfalon was hosted by the Royal New Zealand Special Air Services (RNZSAS) and was scheduled for the following September. Participants included the RNZSAS, the Australian Special Air Service, the British Special Air Service, the Royal Marine Small Boat Squadron, US Army Special Forces, US Navy SEALs, and the 1st SOS.

From 18 September to 21 October, one Combat Talon deployed to New Zealand in support of Gonfalon. The first aircraft departed Kadena AB on 13 September, with a second one departing on 27 September. The exercise was the first attempt by members of the Australia, New Zealand, and US Treaty to exercise their special operations forces in an exercise designed around an unconventional warfare scenario. The general consensus expressed by participating commanders at the conclusion of the exercise was that it was too long and too rigid in its training cycles, which resulted in groups being locked into one phase of training and not being able to participate or observe others. Recommendations resulting from the exercise included holding the exercise every other year, with a symposium in the off year to discuss techniques and advancements in each country's special operations program. The 1st SOS was welcomed by all participants and received quality training throughout the exercise. Weather was a factor, however, and resulted in the cancellation of the scheduled HALO school and the CRRC airdrops. Including deployment and redeployment, 166.2 hours were flown during 59 sorties over the 33-day exercise.⁶⁰

The last half of the year saw two additional PATs flown by 1st SOS crews. PAT 003 departed Kadena on 25 July en route to Misawa AB, Japan, where the crew remained for two days of airborne intercept training with Japanese Defense Force interceptors. The mission continued north on 29 July, with a refueling stop at Shemya AFB, Alaska, with a final destination of Elmendorf AFB. During the following five days of operations out of Elmendorf AFB, airborne intercept training, low-level terrain following, and a coastal penetration were accomplished. Some of the best training of the year was completed during PAT 003. On 2 August the aircraft departed Alaska and returned to Kadena AB by way of a refueling and overnight stop at Adak NAS, Alaska. During the final leg to home station, the aircraft was air refueled by a Kadena-based KC-135 tanker. All objectives of the PAT were accomplished, including familiarization with northern Japan and Alaska, tactical and proficiency training, long-range fuel planning and navigation, and aerial-refueling operations.⁶¹

The final PAT of the year was flown between 26 November and 5 December; it was scheduled to support Exercise Midlink, a combined Iran-Pakistan exercise with US, British, and host-nation naval forces participating. The 1st SOS flew to Clark AB, Philippines, on 26 November, and unloaded SEAL Team One the following day at Cubi Point NAS. En route stops during the deployment included Seletar Airfield, Singapore, and Diego Garcia. Sri Lanka was originally scheduled in lieu of Diego Garcia, but a fuel shortage there required that the flight be rescheduled. The 1st SOS also transited Halim P. International Airport, Indonesia, en route back to Cubi Point to off-load the SEAL team after the completion of the exercise. During the course of the employment, the 1st SOS contingent was based at Drigh Road AB, Karachi, Pakistan. Due to miscommunications between PACAF and USAFE (Pakistan was assigned to USAFE at the time), the host government would not approve 1st SOS tactical operations scheduled for the exercise, including a CRRC airdrop in the Bay of Bengal. After several frustrating days in Pakistan, the crew departed as scheduled for its return to Kadena AB. Although Midlink objectives were not met, PAT 004 was productive. Information and experience gained by transiting international and territorial airspace, load limitations, and other planning factors were beneficial to the squadron's future deployments throughout the Pacific. Discussions with US Embassy officials clarified transit procedures for the

countries visited and allowed discussions with them on political considerations that could affect future operational missions. PAT 004 provided the 1st SOS with a solid database for planning future missions into the Indian Ocean area.⁶²

The 7th SOS Returns to Iran for JCS Exercise Aresh 78

In an ongoing program similar to PACAF's PATs, the 7th SOS continued to deploy throughout its area of responsibility. During 1975 Greece and the United States were at odds over the Turkey situation, and the 7th SOS suffered by being restricted from flying in Greece. By 1976, however, the squadron began limited operations, primarily supporting the Hellenic Raider's HALO School and occasionally being approved for low-level operations. Agreement was reached in 1978 between USAFE and the Hellenic Air Force to allow the 7th SOS to provide continual low-level orientation flights to Hellenic Air Force pilots and navigators in exchange for unilateral low-level operations. A typical profile for a Greek trainer in 1978 was to base out of Hellenikon AB, fly to Elefsis AB (located near Athens) to onload Greek observers from the Royal Hellenic Air Force's 356th Tactical Airlift Squadron, and then fly a four-hour low-level route up the length of the country. A stop was made to off-load the observers at Elefsis at the completion of the low-level portion of the mission, and the aircraft would then return to Hellenikon.⁶³

In addition to the Greek trainers, the 7th SOS renewed its airborne intercept-training program, beginning in November 1977, with the 401st Tactical Fighter Wing's F-4s stationed at Torrejon AB, Spain. The squadron also supported the Spanish HALO School during its deployments. Although still conservative when approving low-level requests, the Spanish government slowly eased its restrictions and occasionally approved low-level operations for the 7th SOS. All operations, however, had to be in direct support of the Spanish military to get approval to fly in Spain.⁶⁴

On 30 March 1978 Lt Col (select) Thomas P. Bradley assumed command of the squadron from Lt Col Charles A. Caven, who had been the commander since 13 July 1976. Colonel Bradley brought a wealth of experience to his new job. He had served a combat tour in Vietnam as an instructor pilot in the C-130 and had completed an exchange officer assignment to the Royal Australian Air Force. He had also served as the course director, Military Science Division, at the Air

Force Academy, and had over 5,800 flying hours when he assumed command of the squadron.⁶⁵

In the April-to-May period, the entire squadron deployed to RAF Sculthorpe, UK, and participated in its annual major exercise—Flintlock 78. The 7575th OG/7th SOS, augmented by MAC maintenance and USAFE support personnel, formed the 7575th SOW and established an Air Force Special Operations base to provide command and control of air assets dedicated to the exercise. The 7575th OG commander, Col Robert L. Biggs, became the 7575th SOW commander for the exercise and was the overall Air Force unconventional warfare forces commander. Elements of the 7th SOS, 8th SOS, 435th TAW, and 71st Aviation Squadron participated in various subexercises. Missions flown included infiltration, exfiltration, resupply, STARS operations, and logistics support. A 7th SOS communications team deployed to Karup, Denmark, and formed the nucleus of the forward operating base located there. One aircraft and associated personnel were sent to Mehrabad International Airport, Tehran, Iran, to participate in Aresh 78. Another aircraft and associated personnel were deployed to Bizerte Airport, Tunisia, for Subexercise Sahel 78.⁶⁶

Aresh 78 was the second time a Flintlock subexercise had been held in Iran. The purpose of the exercise was to demonstrate and improve the readiness posture of participating special operations forces that could be called upon to form a combined force for military action. Operational missions included in the exercise centered on land and sea infiltrations of combined US/Iranian direct-action teams. Sahel 78 centered around a scenario that included a simulated aggressor force invading Tunisia from the west and the southeast. After establishing a base of operations at Bizerte, US forces supported the Tunisian military to defeat the notional aggressor force.⁶⁷

For the 60-day Flintlock 78 exercise, 387.3 hours were flown during 141 sorties, and 471 personnel were air-dropped along with 4,700 pounds of cargo. Support to the exercise also included the airlanding of 167,100 pounds of additional cargo. Flintlock 78 was by far the largest in the exercise series to date and provided some of the best training of the year for both 7th SOS and 8th SOS aircrew and support personnel.⁶⁸ The exposure to other countries that the Flintlock series provided to the 7th and 8th SOS was invaluable in preparing the squadrons for future contingency operations. No other special operations-oriented exercise could rival Flintlock in scope or in complexity.

On 25 August 1978 Gen John W. Pauly, commander in chief, USAFE, presented the USAFE commander in chief's trophy to the 7th SOS for the most outstanding flying support squadron in USAFE for the year 1977. The award marked another significant accomplishment for the squadron. The citation noted that the squadron was the only unconventional warfare unit in USAFE and, as such, was charged with the support of US Army Special Forces, US Navy SEALs, and all allied special operations forces located in the theater. While executing an aggressive exercise program, the squadron had flown 2,200 accident-free flying hours during 1977, most of which were flown at low level in a tactical environment.⁶⁹ With its selection for the award, the 7th SOS had firmly placed itself at the forefront of the Combat Talon community.

It's Sleepy Hollow at Hurlburt Field

The 8th SOS had a quiet year during 1978. It continued to participate in both joint and combined exercises, but TAC seemed to grow tired of the UW mission and showed little desire to maintain the capabilities found at Hurlburt Field. Rumors flourished that the 16th SOS would be deactivated after fiscal year 1979 and that the only mission keeping the 8th SOS active was the formal school requirements that were driven by the overseas Combat Talon units. Above the wing only one staff position existed at Ninth AF, which was the numbered Air Force responsible for the special operations mission in TAC. There were no positions specifically identified as SOF on the TAC staff. On the Joint Staff there was a small contingent responsible for Air Force support for US Army Special Forces and US Navy SEALs. At Hurlburt Field long-time Combat Talon operators were passed over for promotion at a much higher rate than across the regular Air Force, and a veil of gloom permeated the wing. When personnel from the 1st SOS and 7th SOS finished their tours, the Air Force Military Personnel Center did not recognize TAC as their losing command, thus resulting in many experienced Combat Talon personnel being assigned to slick C-130 units outside of special operations. By December 1978 the comment around the 8th SOS was for "the last one out to turn out the lights."

Individual 8th SOS squadron members continued to develop tactics that would improve the Combat Talon weapons system. A very low-altitude (VLA) tactic was developed by squadron members to enhance the survivability of the aircraft. Twice

during 1978 the squadron deployed an aircraft to Selfridge Air National Guard Base, Michigan, and qualified selected crew members in the VLA procedure. The northern Michigan peninsula had the only approved VLA route published for US military aircraft in the United States. The VLA maneuver consisted of an altitude step-down from 1,000 feet to 250 feet on the terrain-following radar, then flying at 100-foot altitude utilizing outside visual references to maintain altitude. Radar altimeters were set at 90 feet as designated crew members monitored them and advised pilots if their altitude decreased below that setting. The maneuver was primarily designed to be used for coastal penetration but could be used if a mission were delayed over hostile territory, and the aircraft had to egress during daylight hours.

By December 1978 many of the highly experienced pilots assigned to the 8th SOS had left the Air Force for more lucrative careers with civilian airlines or had been passed over for promotion. Events of 1980 and the aftermath of the failed rescue mission in Iran would provide unprecedented opportunities for replacement pilots who entered Combat Talon in the 1978 period. In two back-to-back classes in June and August, six pilots received their initial training in Combat Talon. Five of the six eventually would be promoted to full colonel and would spend their careers in special operations. As 1979 began, however, there was little optimism at the 8th SOS that any improvement would come for Combat Talon during the New Year.

1979: The Year Before the Fall

By 1979 the C-130E aircraft was getting old, and many of its systems needed to be upgraded or replaced with new equipment. On 11 December 1978 all USAF C-130s were grounded for inspection and repair of engine throttle-control cables. The grounding included the Combat Talon fleet.

It was early 1979 before all Talons were repaired and recertified as combat ready. The grounding of the fleet had the immediate impact of lost training for its aircrews, and since it came at the end of the training year, many crew members did not complete their required annual training events and thus required waivers to continue flying.

1st SOS Expands Its PAT Program

At Kadena AB the 1st SOS experienced severe problems with its terrain-following radar system. The squadron had seen a large turnover of both

maintenance and aircrew personnel. To identify and fix the radar problems, LAS Ontario sent its top expert on the AN/APQ-122(V)8 radar system, John R. Lewis, to Kadena AB from 7 to 28 March 1979. Lewis provided his expertise to maintenance personnel and to functional check flight aircrews alike. When not working on the flight line instructing maintenance personnel on the repair of the radar, he conducted seminars with 1st SOS pilots and navigators to discuss TF theory and the radar's interface with the aircraft's navigational systems. His contribution to the 1st SOS was invaluable in getting the squadron's Combat Talons back to mission-ready status.⁷⁰

From 23 to 27 April the 1st SOS received an ORI from the PACAF/IG. The squadron deployed three aircraft and four mission-ready crews, along with 18th TFW-assigned maintenance personnel, to Clark AB, Philippines. Nine night-combat profile missions were flown; they included electronic warfare, air refueling, airdrops, and short-field operations. Seven of the nine takeoffs were within one minute of the scheduled takeoff time. The maximum course deviation on low-level routes was one-half mile, and seven of eight TOTs were within 15 seconds of the briefed times. ECM maneuvers employed against F-4 aircraft, GCI sites, and the Crow Valley range complex provided effective countermeasures to these realistic threats. An additional graded event was an exfiltration mission designed around a rescue scenario. The mission briefing was highly professional, reflected thorough planning, and provided an in-depth intelligence analysis of present and anticipated threats. The 1st SOS's overall rating for the ORI was excellent, a grade that reflected the professionalism and dedication of all 1st SOS personnel.⁷¹

A fifth PAT was flown from 9 to 19 October and again focused on Indian Ocean operations. One Combat Talon launched from Kadena AB on 9 October and stopped at Clark AB en route to Diego Garcia. The original routing took the aircraft as far west as Djibouti, but political unrest in the region forced the mission to stop short at Diego Garcia. While at Diego Garcia, the 1st SOS mission briefing was given to the commander of Naval Support Activities there, and many questions concerning support for the Combat Talon were addressed. Other locations visited during PAT 005 included Tengah Airfield, Singapore, and Penang International Airport, Malaysia. PAT 005 provided excellent orientation for the crew and provided experience operating in the Indian Ocean area.⁷² It also created a presence in the

region that would soon be needed when the squadron deployed in support of the 1980 Iranian rescue mission.

On 19 October 1979 Lt Col Raymond Turczynski Jr. assumed command of the 1st SOS from Lt Col Darryl Grapes. A formal change of command ceremony was held at the 18th TFW headquarters with Brig Gen James Brown officiating.⁷³ (Colonel Turczynski would command the squadron during the Iranian rescue train up and execution period and would fly to Desert One as the senior 1st SOS member participating in the mission.)

Two months after Colonel Turczynski assumed command, PAT 006 was flown, again to the Indian Ocean region, but this time the mission went all the way to Africa. After departure from Kadena AB on 9 December, the aircraft spent an overnight at Clark AB and then continued on to Don Muang AB, Thailand. On 12 December the aircraft departed Thailand and proceeded to Diego Garcia for another overnight's stay. On the 13th of December, the aircraft arrived at Eastleigh AB, Kenya. After a two-day stay in Kenya and briefing the US Embassy staff there, the crew departed Eastleigh AB bound again for Diego Garcia. PAT 006 terminated on 18 December after another stop at Clark AB.⁷⁴ Throughout the deployment, at every stop, embassy personnel questioned the crew about its ability to support a rescue operation should their facility come under siege. Embassy officials were no doubt reacting to the 4 November 1979 takeover of the US Embassy in Iran.

Live STARS Operations Resumed by 7th SOS

In Europe the 7th SOS deployed to RAF Lyneham, UK, and participated in the first-ever Exercise Stalwart Friend from 2 to 12 February 1979. The exercise was designed as an exchange program between the 7th SOS and the 47th Squadron/RAF. There were five training objectives established for the exercise, including low-level terrain-following flight; infiltration, resupply, and exfiltration operations; and fighter interceptor/radar bomb site (RBS) training. Squadron crews utilized the day/night low-fly areas in Wales and Scotland and observed map reading of the 200-foot Doppler low-level routes flown by the 47th Squadron. Additionally, members of the UK SAS and the 7th SOS CCT were infiltrated into the tactical training area utilizing static line and HALO air-drop procedures. Further 7th SOS support to the exercise included HSSLADS and equipment resupply

sorties. Assault landing operations on marked landing strips (both paved and unpaved) were conducted during exfiltration operations. Day and night low-level intercept training was scheduled with 11th Group/RAF F-4 Phantoms. RBS activity with the Spadeadam EW range was also an integral part of the exercise. Aircraft 64-0555 and 64-0561 participated in the exercise along with three aircrews, CCT, and maintenance personnel. For three days the two aircraft further deployed to RAF Leuchars, UK, as part of the exercise.⁷⁵

For the 10-day deployment, the 7th SOS flew a total of 47.0 hours and accomplished a vast array of tactical events, including 19 HSSLADS, 13 combat profiles, 38 night-assault takeoffs and landings, nine day-assault takeoffs and landings, and 33 airborne intercepts. Exercise Stalwart Friend proved invaluable in providing hard-to-find aircrew training and in establishing a meaningful exchange of information on doctrine and flying techniques between US and UK SOF. All training objectives were met and exceeded, and bonds of goodwill and friendship were firmly established.⁷⁶

Post-exercise analysis confirmed that the low-fly system in the UK, coupled with the availability of drop zones and landing zones, presented the most cost-effective training found anywhere in Europe. The entire spectrum of Combat Talon operations could be practiced, with weather and aircraft maintenance being the limiting factors. UK low-level routes were suitable for greatly expanded night operations, and the introduction of low-level evasive tactics greatly improved aircrew proficiency. An additional spin-off of the exercise was the introduction of low-level RBS training at Spadeadam. All 7th SOS training requirements could be accomplished in the UK, and future efforts to develop quality training scenarios would focus there.⁷⁷ Stalwart Friend would become a continuing exchange between the 7th SOS and the 47th Squadron/RAF. It would prove to be one of the lasting and most successful programs of the squadron.

The annual Flintlock exercise was held from 27 March to 31 May, with the majority of the 7th SOS committed to the exercise. Due to exercise funding limitations, central European missions were flown out of Rhein Main AB, with aircrews flying to the United Kingdom to onload personnel, then returning to the southern Germany exercise area to drop on small, unmarked drop zones. Additional subexercises were again flown in Tunisia and Norway, and the exercise was expanded into

Italy for the first time. The long-awaited approval for low-level operations in Italian airspace became a reality during Flintlock 79.⁷⁸ Throughout the exercise, the 7th and 8th SOS employed an MC-130E crossfly concept that was new to EUCOM. The concept permitted the aircrews from each squadron to fly the other unit's aircraft. The capability proved to be successful by increasing scheduling flexibility and by demonstrating a significant degree of interoperability.⁷⁹

A real-world intelligence scenario was used for the first time during Flintlock 79. The scenario was based on a notional NATO-Warsaw Pact order of battle and provided realism that had been absent from previous Flintlocks. The 8th SOS aircraft that deployed to the exercise from Hurlburt Field was capable of in-flight refueling, but no tankers were scheduled since the 7th SOS did not utilize that capability. Long-range deployment from the United States, similar to the missions flown earlier by the 1st SOS in the Pacific, was scheduled for future Flintlock exercises.⁸⁰

On 23 April in conjunction with Subexercise Schwarzes-Pferd in Southern Germany, Capt Terrance Janke and his Combat Talon crew successfully completed the first live Fulton STARS since 30 August 1971. The commander of SOTFE, Col Bill Tyler, USA, had volunteered and was picked up after he had personally campaigned to have live surface-to-air recoveries resumed. Colonel Tyler felt that it was important to do live surface-to-air recoveries during training so that confidence in the system could be restored. (Few personnel on active duty had ever seen a live pickup by this time.) These 7th SOS personnel made up the crew that accomplished the first live recoveries in Europe: Lt Col Tom Bradley, mission commander; Captain Janke, aircraft commander; Maj Bob Tyndall, first pilot; Capt Dennis Paul, mission navigator; Capt Wayne Owens, mission navigator; Capt Steve Bacon, EWO; 1st Lt Dave Stone, safety pilot; TSgt Buff Underwood, winch operator; TSgt Don Folley, flight engineer; SSgt Jim Kowalik, radio operator; SSgt Mike Martinez, loadmaster; and SSgt Bill Fowler, loadmaster.⁸¹

Capt Skip Davenport and his Crew 2 accomplished a second live recovery later in the exercise. Capt Bruce Weigle, assigned to the 7th SOS CCT, was the volunteer extracted from the southern Germany exercise area. The two live recoveries marked the beginning of a three-year period highlighted by a dozen live recoveries. Colonels

Tyler and Bradley had successfully implemented the "live STARS for training" policy in Europe.

The summer of 1979 saw the 7th SOS focused on the Mediterranean for continuation training activities. During the months of June and July, three weeklong Greek trainers supporting the Hellenic Raiding Forces HALO School were flown. In July and August two Italian tactical training deployments were accomplished out of Aviano AB, Italy. Both deployments were weeklong trainers that included low-level and air-drop sorties.⁸²

From 1 to 10 November the 7th SOS deployed to Spain for Crisex 79, which was a joint/combined exercise that included both US and Spanish forces. Along with the 7th SOS, personnel from the 10th Special Forces Group, the Spanish Brigada Paracaidista, US Navy SEALs, Spanish air force F-1s and F-4s, elements of the Spanish navy, US Navy surface combatants from CTF-60 (including the USS *Nimitz*, the USS *Texas*, and the USS *California*), and F-4s from the 401st TFW participated in the exercise. Airborne intercepts with both carrier-based US Navy F-14s and USAF/Spanish F-4s were accomplished during the exercise. ECM training with CTF-60 surface combatants was also a high point. Combined US/Spanish HALO, static line, and resupply drops were also part of the exercise. One of the most visible events of the exercise was a live Fulton STARS performed by Capt Mark Tuck and his Crew 1. In a demonstration for King Juan Carlos of Spain, Crew 1 successfully extracted the SOTFE/J3, Lt Col Ray Oujano, USA, during a capabilities demonstration attended by a large crowd of dignitaries.⁸³ The recovery was the third live one conducted during the year. The 7th SOS flew 144.5 hours, successfully air-dropping 84 personnel and 3,545 pounds of equipment. Thirty-two percent of the squadron's semiannual training requirements were completed during Crisex 79. Particularly hard-to-get events, including airborne intercepts and ECM training against surface combatants, were the most significant accomplishments during the exercise. In conjunction with support for the Spanish Paracaidista, the squadron was allowed to fly low level in Spain, thus fulfilling one of its long-term training goals.⁸⁴

An Era Comes to an End for the 8th SOS

The 8th SOS remained busy throughout the first half of 1979, participating in three major exercises, including Jack Frost 79 in Alaska, Flintlock 79 in Europe, and Solid Shield 79 in the eastern United States. The first major exercise of the

year was Jack Frost 79, which was held in Alaska from 10 January to 15 February. There were five phases of the exercise, with the 8th SOS participating in phases II, III, and IV. One Combat Talon deployed on 17 January from Hurlburt Field en route to Elmendorf AFB, Alaska. During the exercise both infiltration and resupply missions were flown in support of US Army Special Forces and US Navy SEAL exercise participants. One CRRC drop was accomplished for a SEAL direct-action mission. A scheduled recovery mission and two coastal ADIZ penetration missions were canceled due to severe weather. In total the 8th SOS flew 23 sorties and 61.9 hours during the exercise. Redeployment began on 5 February when the Combat Talon departed Elmendorf AFB for its return flight to Hurlburt Field. Although the exercise was not specifically dedicated to unconventional warfare, the squadron received valuable training in cold weather operations.⁸⁵

Flintlock 79 was conducted from 22 March to 1 June, with an 8th SOS Combat Talon deployed to Rhein Main AB, FRG, from 11 April to 8 May. Unlike Jack Frost, the Flintlock exercise series revolved around a UW scenario, with conventional forces such as USAF FB-111 bombers participating as part of the overall scenario. The 8th SOS crew flew 21 sorties and 59.7 hours during the employment phase of the exercise. In total the 8th SOS logged 96.9 hours during the three-week deployment.⁸⁶

Solid Shield 79 began as a command post exercise on 12 February and continued through May when forces deployed during the field-training exercise phase. The 8th SOS, along with additional wing assets, deployed to Pope AFB and was operational beginning 4 May. During the unconventional warfare phase of the exercise, which was conducted just before the major conventional ground-assault exercise, 8th SOS crews infiltrated US Army and US Navy SEAL personnel into the exercise area to carry out sabotage, gather intelligence, and attack the opposition force's offensive and defensive capabilities. The final phase of the exercise was flown in support of SOF units that had been tasked to support conventional ground forces.⁸⁷ The Combat Talon flew 18 sorties and 42.7 hours during the exercise. The after action exercise review revealed that there was a lack of planning by higher headquarters regarding SOF play. The shortfall could be directly attributed to the lack of SOF-experienced personnel assigned to the headquarter's staff.⁸⁸ Virtually all SOF experience was resident at Hurlburt Field and in the overseas

Talon units, and many times decisions were made at planning conferences where there were no planners present with SOF expertise. The results were predictable.

For the last half of 1979, the 8th SOS was scheduled to participate in three additional major exercises—Bold Eagle 79, Red Flag 80-1, and Foal Eagle 79. After a tremendous amount of planning and pre-exercise preparation, 8th SOS activity was canceled for Red Flag, and Exercise Foal Eagle 79 was canceled due to civil unrest in the ROK. Bold Eagle, conducted during October 1979, was a JCS-coordinated, US Readiness Command-sponsored exercise that centered on the Eglin AFB range in the Florida Panhandle.⁸⁹ Exercise-dedicated forces were located at Eglin AFB, Hurlburt Field, Tyndall AFB, and MacDill AFB, Florida. Committed forces included a joint task force formed from the 82d Airborne Division, the equivalent of five tactical fighter squadrons, unconventional warfare forces of the 1st SOW (including the 8th SOS), and combat support and combat service support forces. Opposition forces consisted of the 197th Infantry Brigade, the equivalent of four tactical fighter squadrons, and combat and combat service support units.⁹⁰

In total Bold Eagle 80 involved approximately 20,000 US Army, US Navy, and US Air Force personnel. The Air Force alone provided more than 100 aircraft and more than 4,600 personnel. In addition to the 1st SOW's MC-130E, AC-130H, CH-3E, and UH-1N aircraft, other aircraft types involved in the exercise included the F-15, F-4, F-111, A-7, A-10, C-130, EC-130, F-105, F-106, EB-57, A-37, O-2, C-123, C-7, and C-141.⁹¹ The Bold Eagle Air Force Special Operations base was operational at Hurlburt Field on 12 October with two MC-130E Combat Talons and their crews committed to the exercise, along with other 1st SOW rotary- and fixed-wing assets. During the exercise the Combat Talons conducted electronic warfare training against Integrated Air Defense System (IADS) sites. In addition to its IADS activities, the 8th SOS accomplished all of its exercise objectives, including employment of the HSSLADS for resupply missions, dropping four CRRCs, successfully accomplishing three Fulton STARS utilizing a training dummy, executing fuel-bladder airdrops, and performing night short-field exfiltration operations. Good weather throughout the exercise precluded the need to airdrop utilizing instrument procedures.⁹²

One of the three recoveries was a first for the 8th SOS. After parachuting into a water DZ, a 1st

SOW CCT member linked up with the USS *McCard*, a US Navy destroyer, and set up Fulton equipment on its deck. The Combat Talon made a successful recovery from the destroyer, extracting a simulated package of sensitive equipment. The 8th SOS also conducted an actual psychological operations leaflet drop and a tactical deception drop of dummy paratroopers. One HALO infiltration, considered highly successful, dropped a Special Forces team into a small drop zone under simulated combat conditions. The fuel-bladder drop consisted of a 3,000-pound fuel bladder dropped to provide a forward-area refueling point for helicopter refueling. The capability greatly expanded the employment flexibility of rotary-wing assets.⁹³ For the exercise the two Combat Talons flew 36 sorties and logged 69.6 hours in direct support of Bold Eagle 80.⁹⁴

* * * * *

As Bold Eagle came to a close, the final chapter of the first two decades of Combat Talon was also ending. On 4 November 1979 student radicals stormed the walls of the US Embassy in Tehran, Iran. No one knew at the time, and especially not the personnel assigned to Combat Talon, that SOF changed forever on that day. Beginning in November and culminating with the release of the hostages in January 1981, Sleepy Hollow, as Hurlburt Field had affectionately come to be known, would awaken to find itself in the full glare of the international media. It would take another decade of modernization and improvements to the Combat Talon to make it truly survivable on the modern-day battlefield. In the decade of the 1980s, the Combat Talon fleet would increase from 14 aircraft to 38 with the introduction of Combat Talon II, a highly sophisticated version of the venerable Vietnam-era MC-130E. The next great adventure for Combat Talon was about to begin.

Notes

1. History, 1st Special Operations Squadron, 1 October–31 December 1974, Combat Talon Archive, HQ AFSOC/HO, Hurlburt Field, Fla., A-7.
2. *Ibid.*, 9.
3. History, Pacific Air Forces, 1 July–31 December 1975, USAF HRA, Maxwell AFB, Ala., vol. 1, 748.
4. History, 1st Special Operations Squadron, 1 October–31 December 1974, 9.
5. *Ibid.*, append., 8.
6. *Ibid.*, 5.
7. History, Pacific Air Forces, 1 July–31 December 1975, vol. 1, 749.
8. *Ibid.*
9. *Ibid.*, 450.
10. *Ibid.*, 750–53.
11. *Ibid.*, 753–57.
12. *Ibid.*, 757–58.
13. *Ibid.*, 759.
14. *Ibid.*, 759–60.
15. *Ibid.*, 760.
16. *Ibid.*, 761.
17. *Ibid.*
18. *Ibid.*, 762–64.
19. *Ibid.*, 764–65.
20. *Ibid.*, 767.
21. *Ibid.*, 768–69.
22. History, 1st Special Operations Squadron, 1 July–30 September 1975, 12.
23. History, 1st Special Operations Squadron, 1 October–31 December 1975, 12.
24. History, Pacific Air Forces, 1 July–31 December 1975, vol. 1, 772.
25. History, 1st Special Operations Squadron, 1 April–31 June 1975, 6.
26. History, 1st Special Operations Squadron, 1 January–31 March 1975, 8.
27. History, 1st Special Operations Squadron, 1 July–30 September 1975, 7–8.
28. History, 322d Tactical Airlift Wing, 1 January–31 March 1975, USAF HRA, Maxwell AFB, Ala., vol. 1, 9.
29. History, 322d Tactical Airlift Wing, 1 April–30 June 1975, vol. 1, 7–8.
30. History, 7th Special Operations Squadron, 1 July–16 October 1975, Combat Talon Archive, HQ AFSOC/HO, Hurlburt Field, Fla., 23.
31. History, 1st Special Operations Wing (formerly 834th Tactical Composite Wing), 1 July–30 September 1975, 16th Special Operations Wing historian files, Hurlburt Field, Fla., 3.
32. *Ibid.*, 9–11.
33. *Ibid.*, 11.
34. History, 1st Special Operations Wing (formerly 834th Tactical Composite Wing), 1 October–31 December 1975, 35.
35. History, 1st Special Operations Squadron, 1 January–31 March 1976, 12.
36. History, 1st Special Operations Squadron, 1 July–30 September 1976, 10.
37. History, 1st Special Operations Squadron, 1 October–31 December 1976, iv.
38. *Ibid.*, A-4.
39. History, 1st Special Operations Wing, 1 January–31 March 1976, 36.
40. *Ibid.*, 39.
41. *Ibid.*, 39–40.
42. History, 1st Special Operations Wing, 1 October–31 December 1976, 9.
43. *Ibid.*, 10.
44. *Ibid.*, 11.
45. *Ibid.*, 12.
46. *Ibid.*, 13.
47. *Ibid.*, supporting document 11, 13.
48. History, 1st Special Operations Squadron, 1 January–31 March 1977, 10.

PRAETORIAN STARSHIP

49. History, 313th Air Division and 18th Tactical Fighter Wing, 1 April–30 June 1977, USAF HRA, Maxwell AFB, Ala., vol. 1, 25.
50. *Ibid.*, 26.
51. History, 1st Special Operations Squadron, 1 April–30 June 1977, 6.
52. History, 1st Special Operations Squadron, 1 October–31 December 1977, 10.
53. History, 7th Special Operations Squadron, 1 April–30 June 1977, 9.
54. History, 7th Special Operations Squadron, 1 July–30 September 1977, 3.
55. *Ibid.*, 5.
56. History, 7th Special Operations Squadron, 1 October–31 December 1977, 13.
57. History, 1st Special Operations Wing, 1 July–30 September 1977, 14–16.
58. History, 1st Special Operations Squadron, 1 January–31 March 1978, 10.
59. *Ibid.*, 11.
60. History, 1st Special Operations Squadron, 1 October–31 December 1978, supporting document D 6.
61. History, 1st Special Operations Squadron, 1 July–30 September 1978, supporting document 8, 2–7.
62. History, 1st Special Operations Squadron, 1 October–31 December 1978, document 8.
63. History, 7th Special Operations Squadron, 1 January–31 March 1978, 8.
64. *Ibid.*, 8–9.
65. *Ibid.*, 14.
66. History, 7th Special Operations Squadron, 1 April–30 June 1978, supporting document 9.
67. *Ibid.*
68. *Ibid.*
69. History, 7th Special Operations Squadron, 1 July–30 September 1978, 11.
70. History, 1st Special Operations Squadron, 1 January–31 March 1979, 12.
71. History, 1st Special Operations Squadron, 1 April–30 June 1979, 10.
72. History, 313th Air Division and 18th Tactical Fighter Wing, 1 October–31 December 1979, vol. 1, 71.
73. *Ibid.*, supporting document 2.
74. *Ibid.*, 72–73.
75. History, 7th Special Operations Squadron, 1 January–31 March 1979, 7.
76. *Ibid.*, 8.
77. *Ibid.*
78. History, 7th Special Operations Squadron, 1 April–30 September 1979, 6.
79. History, 1st Special Operations Wing, 1 January–30 June 1979, vol. 1, 28.
80. *Ibid.*, 30–32.
81. Capt Robert A. Gualtieri, “7th SOS Performs ‘Live’ Exercise with Army,” *Gateway*, Rhein Main AB newspaper, 18 May 1979, Combat Talon Archive, HQ AFSOC/HO, Hurlburt Field, Fla.
82. History, 7th Special Operations Squadron, 1 April–30 September 1979, vi.
83. History, 7th Special Operations Squadron, 1 October–31 December 1979, 8.
84. *Ibid.*
85. History, 1st Special Operations Wing, 1 January–30 June 1979, vol. 1, 17–22.
86. *Ibid.*, 24–29.
87. *Ibid.*, 33–35.
88. *Ibid.*, 37–38.
89. History, 1st Special Operations Wing, 1 July–31 December 1979, vol. 1, 16.
90. *Ibid.*, 18.
91. *Ibid.*, 21–22.
92. *Ibid.*, 24–25.
93. *Ibid.*, 26.
94. *Ibid.*, 28.

Chapter 8

The Iranian Rescue Mission (1979–80)

*The credit belongs to the man who is
Actually in the arena; whose face is marred
By dust and sweat and blood; who strives
Valiantly; who errs and comes short again
And again; who knows the great enthusiasms,
The great devotions, and spends himself in a
Worthy cause; who at the best knows in the end the triumph of
High achievement; and
Who at the worst, if he fails, at least fails while
Daring greatly.*

—Theodore Roosevelt

When aircraft 64-0551 landed in the early evening of 20 November 1979 on a return flight from Pope AFB, North Carolina, the question of a rescue mission to Iran hung heavily in the air of the crowded cockpit. Colonel Brenci's comment that the 8th Special Operations Squadron could become involved in a rescue attempt was tantalizing, but no one knew (except perhaps Brenci himself) what effort it would take to make the mission a success. The 8th SOS had historically been the Combat Talon training squadron that provided aircrews for the two overseas squadrons. The 1st SOS, stationed at Kadena AB, Japan, had a long and colorful heritage centered on SEA and the exploits of the early Stray Goose operators. In recent years, however, the 7th SOS had enjoyed the bulk of funding and modernization initiatives as the cold war in Europe continued, and by late 1979 many considered it as the premier Combat Talon unit. Throughout the 1970s, the 8th SOS had been relegated to augmenting these two "operational" units. As crew members finished their paperwork after the flight and headed home to their families, a quick check of the weekly schedule showed no local flights at Hurlburt Field over the upcoming Thanksgiving holiday. It would prove to be the last real break for the 8th SOS over the next 12-month period.

The next day was Wednesday, 21 November 1979, and Brenci was in the squadron early, as were several crew members from the previous night's mission. Brenci was the chief pilot and assistant operations officer and was filling in for Lt Col Less Smith, who had been called away to Washington, D.C., a few days earlier. Captain Thigpen, who had flown with Brenci as an instructor pilot on the flight the evening before, was also in the squadron. He was working behind the opera-

tions desk finalizing the following week's schedule when Brenci called him into his office and closed the door. Brenci had received a call from Smith in Washington directing him to begin preparations for conducting blacked-out NVG landings in the Combat Talon. The only unit in the 1st SOW that possessed the relatively rare NVG equipment was the 20th Special Operations Squadron, which was the rotary-wing unit assigned to the wing. Brenci sent Thigpen to the 20th SOS to sign out 10 PVS-5 NVGs so that the squadron could become familiar with their operation.

Within the hour Thigpen had signed out the goggles and was back in the squadron. Two things impressed him regarding the transaction—first, his hand receipt totaled over \$200,000 for the NVGs, a sizable sum for a captain to be responsible for, and second, the insistence by 20th SOS pilots who had said that fixed-wing aircraft could not be safely landed on NVGs due to the lack of depth perception and a limited field of view. Several crew members, including Brenci and Thigpen, spent the afternoon familiarizing themselves with proper goggle operation. By utilizing a darkened room, basic functions of the NVGs, such as turning them on and off and focusing them both near and far, were reviewed. A night sortie was scheduled for the following Monday on TAB-6, a local auxiliary airfield located just north of Hurlburt Field on the Eglin AFB range. Since the following week's range schedule already had been finalized, Thigpen had to spend several "green stamps" with the Eglin AFB range schedulers to get the landing zone. He was successful, and, with everything set for the NVG operation on Monday night, the NVGs were secured in the squadron, and everyone went home for Thanksgiving.

On Monday, 26 November 1979, the first NVG mission was flown by the 8th SOS. Combat Talon 64-0567 flew 4.6 hours, with Brenci, Major Meller, Major Uttaro, and Thigpen sharing pilot duties. Meller was a highly experienced Combat Talon flight evaluator assigned to the 1st SOW, and Uttaro was the squadron standardization-evaluation pilot. Since Thigpen was an instructor pilot and had set up the mission on short notice the prior week, he had included himself on the initial mission. Because there were no procedures written for airland NVG operations, the crew started its NVG work utilizing established airborne radar approach (ARA) procedures. Each ARA was flown utilizing heading and altitude calls provided by the left navigator. Meller and Brenci took turns in the left seat, and Uttaro and Thigpen swapped right-seat duties. Partially because of the rotary-wing pilots' insistence that fixed-wing aircraft could not land on NVGs, the first several approaches were flown on "eyeballs" by the left-seat pilot. During the approach the right-seat pilot turned out all of his cockpit lights and focused his goggles on his instrument panel as the left-seat navigator called out headings and altitudes. The idea was to darken the cockpit enough to allow the left-seat pilot, the standing third (or safety) pilot, and the flight engineer to see outside the aircraft and not be blinded by the glare of lights coming from within the cockpit.

As the right-seat pilot flew the approach, the left-seat pilot and the safety pilot, utilizing their NVGs, assisted the navigators during alignment for each approach. In addition, the third pilot, standing behind the left pilot's seat, also backed up the flight engineer in such critical areas as landing gear and flap configuration. The right-seat pilot flew the aircraft down to ARA minimums, 300 feet above the ground. When the left-seat pilot had the runway environment within view and the runway was confirmed by both the third pilot and the flight engineer, he took control of the aircraft from the right-seat pilot and landed the aircraft. Without any lights on the runway or on the aircraft, landing the Combat Talon proved to be quite challenging. As soon as the aircraft touched down, the right-seat pilot focused his goggles outside the aircraft and assisted the left-seat pilot as the aircraft slowed to taxi speed. After several "bone-crushing" touchdowns, it was apparent that the left-seat pilot needed more help than his own eyes could give him. Depth-perception

problems or not, the left-seat pilot actually had to land while wearing NVGs. From this first effort, the squadron made great strides in perfecting blacked-out NVG airland procedures. Within the next three weeks, NVG airland procedures were developed and refined, and those procedures formed the basis for a capability that would radically change Combat Talon airland tactics forever. When the first Combat Talon NVG landing was made, it had been 23 days since the 4 November 1979 takeover of the US Embassy in Tehran.

Prelude to 4 November 1979

The United States had enjoyed a long association with Iran and with its ruler, the shah, Mohammed Reza Pahlavi. Military-to-military cooperation, by both conventional and unconventional forces, had developed to a point by the late 1970s that frequent exercises and exchanges were commonplace. The 7th SOS had exercised in Iran, first during Flintlock V in 1972 (Subexercise Aresh 72) and later in the decade during Aresh 78. For Aresh 72, two Combat Talons deployed to Shiraz, Iran, supported US and Royal Iranian Special Forces, and worked with the Royal Iranian Air Force. Although somewhat restricted to the local exercise area, the two-ship deployment did accomplish most of its exercise goals. No airland operations outside Shiraz were scheduled or flown, however. During Aresh 78, the 7th SOS operated from Mehrabad International Airport, Tehran, and flew similar missions as those accomplished during the 1972 exercise. During the 1978 exercise, long-range missions were flown into the province of Baluchistan, located in the extreme southeastern corner of Iran adjacent to Pakistan. ECM training was also conducted on the Anarak range 300 miles southeast of Tehran. The 7th SOS Talons landed on the 3,000-foot dirt strip associated with the range.*¹

Although military-to-military relations continued to be strong, by 1978 political turmoil inside Iran created a near-breaking point between the governments of Iran and the United States. During that year an internal fundamentalist revolution engineered by the Ayatollah Ruhollah Khomeini against the shah threatened the stability of the entire Middle East. Either through oversight or miscalculation, the Carter administration did not assess the severity of the shah's situation. The

*An isolated landing location to refuel the helicopters during the rescue attempt in 1980 would become one of the greatest challenges for mission planners.

shah had embarked on a program to modernize and to westernize Iran earlier in the decade, and the resultant “trappings” of the West, from women’s attire to US weaponry, were identified by Khomeini and his followers as the source of evil that was at the root cause of the nation’s problems.

With political control of Iran diminished due to the near-disintegration of his military, the shah fled Iran on 16 January 1979, and two weeks later, on 1 February, Khomeini returned from exile in France to a throng of cheering supporters. Khomeini and his followers portrayed the United States as the Great Satan. When the Ayatollah returned to Iran, Americans stationed and living there were advised to leave immediately. In the coming weeks 45,000 Americans, most of whom were employees of American firms doing business in the country, were evacuated. With mobs roaming the streets of Tehran chanting “death to Americans,” the US government still believed that Tehran would eventually stabilize and establish normal diplomatic relations. In anticipation of future normalization of relations with the Khomeini government, 75 foreign-service personnel were retained by the US government at their embassy posts while the remainder were returned to the United States.²

As Iran slipped into anarchy, rumors spread that the United States was harboring SAVAK officers (Iranian secret police loyal to the shah) inside the US Embassy, and on 14 February 1979 a large band of revolutionaries overpowered embassy guards and took some 70 US personnel hostage. Two US Marines were wounded, and one Iranian citizen was killed during the rioting. The group demanded that the United States return the shah to Iran to face Islamic justice and punishment for his crimes against the people. The Khomeini government, under Prime Minister Shahpour Bakhtiar, quickly persuaded the revolutionaries to release the Americans and to leave the embassy. Over the next two months, Khomeini continued to focus his anger on the United States and to demand that the shah be returned to Iran for trial. In April 1979 Khomeini accused the United States of meddling in Iranian internal affairs by setting into motion satanic plans to overthrow the newly created Islamic Republic. In May 1979 more than 150,000 people marched on the US Embassy shouting “death to Carter.” Again, the US government underestimated the seriousness of the situation but did urge some 2,000 Americans still living in Iran to leave the country.³

All but approximately 200 took the advice. For the remainder of 1979, tensions remained high, as Khomeini continued to focus on the United States and its relationship with the shah. The United States maintained a skeletal workforce at its embassy in Tehran with fewer than 70 personnel assigned.

As the year progressed, unknown to the United States, the shah’s medical condition steadily declined. He was suffering from lymphatic cancer and had only a short time to live. Disregarding predictions from the US Embassy in Tehran that anti-US violence would erupt across the country if the shah entered the United States, President Carter allowed the shah to come to the United States on 20 October 1979 to seek medical treatment at the Cornell (University) Medical Center in New York. No other country would allow the shah entry due to the tense political situation in Iran. The US government had been assured by high-ranking Iranian officials that US interest in Iran would be protected while the shah underwent medical treatment. While at Cornell, the shah had a gall bladder operation and had his cancer treated with radiation therapy.⁴

By the time the shah came to the United States in October 1979, the US Embassy staff in Tehran had been reduced substantially, yet basic embassy functions continued. President Carter felt that by leaving the embassy open, the action would help shore up Bakhtiar’s government and would eventually promote better US-Iran relations. Embassy security had been increased to a point that the State Department felt the US Marine guards stationed there could hold out for several hours against an attack, and by that time the Iranian military would respond and quell any disturbance. As had been the case throughout the demise of the shah and the rise of the Ayatollah, the United States underestimated the deep anti-US sentiment prevalent in the Islamic fundamentalist-inspired revolution.⁵ On 4 November 1979 a mob of rabid anti-American rioters scaled the wall of the US Embassy in Tehran, and thus began the 444-day hostage crisis that resulted in the fall of an American president and the death of eight American special operators at Desert One.

Operation Rice Bowl

From the outset of the crisis, few argued against a military option, except Secretary of State Cyrus Vance. Vance felt that Khomeini was using the hostages to consolidate his power over the Iranian people and that to harm them would

negatively impact that plan. Also, Vance felt that military action would result in casualties and the death of some of the hostages, some of the Iranian guards, and perhaps some number of US military personnel carrying out the rescue. A military operation against Iran would also result, he argued, in a backlash against the United States by other Islamic countries, with the United States being the big loser on the international stage. As the administration pondered what course of action to take, the American public was being bombarded with street scenes of thousands of Iranians demanding the return of the shah while expounding anti-US rhetoric. With pressure mounting to do something to free the hostages, events began to move forward. On 6 November 1979 Dr. Zbigniew Brzezinski, President Carter's national security advisor, contacted Defense Secretary Harold Brown on behalf of the president and instructed him to develop a plan to rescue the American hostages.⁶

Secretary Brown summoned the chairman of the Joint Chiefs of Staff, Gen David C. Jones, USAF, and tasked him to develop the plan. There was not a counterterrorism division on the Joint Staff, so almost by default, General Jones turned to his J-3 SOD and tasked SOD to organize and plan the rescue effort.* Since its Vietnam days, SOD had been the focal point for unconventional warfare and special operations activities on the Joint Staff. At the outset of the planning effort, SOD was commanded by US Army colonel King, a Vietnam veteran and former Special Forces battalion commander who also wore the prestigious US Army ranger tab. He was well versed in joint special operations activities and was well suited for the challenge at hand. On his staff was USAF Lt Bob Horton, who was SOD's expert on C-130 operations. Another key member of Colonel King's staff was USAF Maj Lee Hess, who was assigned to USAF/XOOS and detailed to SOG for the rescue operation. Hess had come to the Pentagon after tours with PACAF in Hawaii and with the 1st SOS at Kadena AB, Japan, flying Combat Talons. Hess was well known in the Pacific, and he was a personal friend of Lt Col Ray Turczynski, the commander of the 1st SOS at Kadena AB. On 7 November, in anticipation of the Combat Talon being selected for the rescue mission, Hess called Turczynski and asked him to begin practicing no-light landings in the Combat Talon. That night,

Turczynski had six pilots landing without using their aircraft landing or taxi lights at NAS Cubi Point, Philippines, with the runway lights on. For the next month, the 1st SOS crews practiced landing without the use of overt aircraft lights.⁷

If a rescue mission proved to be impossible, Jones needed other options to direct against the Iranians to cause them to release the hostages. To develop these other options, Jones established an ad hoc planning group and selected Major General Taylor, who was assigned to the Air Staff as the USAF/XOO. Taylor chaired the ad hoc group known as the Operations Planning Group (OPG) and began looking at military options that might be used against Iran to resolve the crisis.⁸

As planning got under way, one of the initial requirements for SOD was to name an air mission commander. One name immediately came to mind—Col James H. Kyle, who had a long history in special operations, having flown AC-130 gunships during the Vietnam War. Almost as important as his special operations background was his relationship with General Taylor. Kyle, along with Hess, had worked for Taylor when they had both been on the PACAF staff. Kyle was well respected by Taylor for his keen mind and his analytical approach to problem solving. On 11 November Hess was directed to contact Kyle, who had recently been assigned to Kirtland AFB, New Mexico.⁹ Within 24 hours, Kyle was at the Pentagon being briefed on the status of initial planning. As Kyle was en route to Washington, the overall joint task force (JTF) commander, Maj Gen James B. Vaught, and the elite Delta Force counterterrorism unit commander, Col Charles A. Beckwith, were also inbound to assume their JTF duties. Thus, by 12 November 1979, the nucleus of JTF had been formed.

Initial briefings were given by SOD on 12 November to the US Army chief of staff, Gen Edward C. Meyer, and to Vaught. The initial recommendation from SOD was a direct assault on the embassy to be conducted by Delta Force, the US Army counterterrorist unit created specifically for just such a crisis. The initial plan also envisioned US Army CH-47 Chinook helicopters staging from a base in eastern Turkey and transporting Delta Force to Tehran. Even using Turkey as a staging base, however, a refueling stop was still required somewhere inside Iran. No refueling site was identified at this early stage of planning. There

*Through internal reorganization of the Joint Staff during the 1970s, the organization formerly known as the Special Assistant for Counterinsurgency and Special Activities was renamed the Special Operations Division and was placed under the Operations Directorate (J-3). Just as SACSA had been responsible for oversight of the Son Tay POW rescue, J-3 SOD was assigned the responsibility for planning Operation Rice Bowl.

were other courses of action briefed to General Meyer that included operations from Kuwait, Bahrain, or Saudi Arabia, but all of these options, including Turkey, were ruled out for both security and political reasons. As other options were proposed during the ensuing days, Egypt and Diego Garcia emerged as the only two staging bases acceptable to Jones and the Joint Staff. These two staging bases were 5,000–7,000 miles from Tehran and required a 24-hour round-trip flight by way of C-130 aircraft with two to three air refuelings en route. To get Delta Force to an undetected position near the embassy, and then to extract the force with the hostages in tow, required rotary-wing aircraft. The process of identifying the proper helicopter for the operation would prove to be challenging for mission planners. One concession that Jones offered to planners was the utilization of Saudi Arabian airspace during either ingress or egress, thus reducing flight time from Egypt to Tehran to approximately 12 hours. For planning purposes, Turkish airspace was also approved for egress after the hostages had been rescued. To avoid transiting Saudi airspace twice on successive nights, which could compromise the mission, the long 24-hour flight around the kingdom was still facing planners for the ingress route. With these restrictions foremost in mind, SOD set about to identify forces that were capable of accomplishing the mission. To get Delta Force into Iran over such vast distances was clearly in the USAF's area of responsibility.

* * * * *

It was surprising that the United States had not developed a joint counterterrorist capability by late 1979. Three years before the embassy takeover in Iran, on 3 and 4 July 1976, Israeli commandos had conducted a raid on Entebbe International Airport in Kampala, Uganda, to rescue 105 Israelis taken when an Air France jetliner was hijacked. The terrorists were sympathetic to the Palestine Liberation Organization and had threatened to kill the hostages if Israel failed to meet their demands. Operation Jonathan, the code name for the rescue, relied upon a highly specialized commando force supported by Israeli air force C-130 aircrews. During the operation, six terrorists were killed while the Israelis lost two commandos and four civilian hostages. The following year, on 18 October 1977, West German GSG-9 counterterrorist forces killed four Arab terrorists when they stormed a hijacked Lufthansa airliner at the airport at Mogadishu,

Somalia.¹⁰ Each rescue was considered a tactical success.

As international terrorism increased, visionaries in the US Army realized that it was only a matter of time before the United States would become a terrorist target. Accordingly, on 19 November 1977, with chief of staff of the Army (CSA) Gen Bernard W. Rogers's support, Delta Force was activated at Fort Bragg, North Carolina. The activation order described the unit's mission, its basic structure, and its high priority for obtaining equipment and personnel to bring it to mission-ready status. The man chosen to head the new unit was Colonel Beckwith, a seasoned Vietnam veteran who had also completed an exchange tour with the British Special Air Service.¹¹ From the time of activation and throughout its first two years of operation, Beckwith and Delta Force fought an uphill battle for funds and personnel, even though the activation order clearly provided US Army priority in both areas. By the summer of 1978, Delta Force was still only partially mission capable. At the direction of General Meyer, the US Army deputy chief of staff for operations at the time, and with the support of General Rogers, an initial evaluation and validation of the unit was conducted. Although Beckwith and his men passed the limited evaluation, those closely associated with Delta Force at that time felt that many areas of the evaluation were unfair and did not adequately measure Delta Force's capabilities.

Throughout the remainder of 1978, Delta Force continued to field special equipment and recruit top personnel for the unit. By 1979 the unit began to do some advanced training activities outside the United States. A typical European training mission would include deploying a Delta Force member to West Germany, who would be met by a member of the 10th Special Forces Group and then briefed on a notional mission involving a terrorist attack on a US citizen. The Delta Force operator would have a strict timetable to complete his mission, which usually involved in-depth target research and reconnaissance of the notional target and development of a course of action to free the hostage. Once the mission was complete, the operator returned to Fort Bragg, where he was debriefed and evaluated regarding the mission.

In addition to these overseas deployments for training, Delta Force began an exchange program in 1979 with the British Special Air Service. Representatives from the Special Air Service visited Delta Force at Fort Bragg and provided training in

such special military skills as constructing booby traps. Other international counterterrorism units also visited Delta Force, including the German GSG-9, the French Groupe d'Intervention de la Gendarmerie Nationale, and the Israelis. By late 1979 Delta Force had become a viable, albeit untested, member of the international counterterrorist community.¹²

With over two years dedicated to establishing and then commanding Delta Force, Beckwith was told by General Meyer, the new CSA after Rogers's departure in June of 1979, that he would leave Delta Force sometime in late October or early November to command Special Operations TAOK Force, Europe (SOTFE). General Rogers had departed the CSA job to become the Supreme Allied commander, Europe and had requested that Beckwith take over the special operations unit located at Patch Barracks, Germany, to bring his counterterrorist skills to the European theater. Before departing Delta Force, Beckwith was tasked by Meyer for a second evaluation to validate newly established tasks, conditions, and standards for the elite unit.¹³ It had been a year since Delta Force's last evaluation. For its second evaluation, Delta Force received high marks from the exercise director on down, with all involved agreeing that the second evaluation was much more effective in measuring the actual capability of Delta Force. One criticism from a participating British Special Air Service observer was that many key players (the president, the secretary of state, etc.) had not participated, as would have been the case in his own country. All agreed, however, that Delta Force was ready and was fully mission capable (FMC). As Beckwith and his Delta Force returned to their quarters after debriefing the exercise, they were ready for some much needed rest. Beckwith had shipped his household goods to Germany the previous week, and he was ready to leave with his family for his new assignment to Europe. The date was 4 November 1979.¹⁴

* * * * *

Since Vietnam, as service budgets were cut, USAF Special Operations Forces had steadily declined from nearly 10,000 personnel and 550 aircraft in the 1960s to a skeletal force by the late 1970s. By November 1979 there were scarcely 3,000 personnel assigned to the 1st SOW at Hurlburt Field, Florida, operating 10 AC-130H Spectre gunships, six MC-130E (Clamp) Combat Talons, and a mixture of HH-3 and UH-1 helicopters.¹⁵ In the Pacific the 1st SOS, with 100

personnel assigned, operated four MC-130E (Yank) Combat Talons, and in Europe, the 7th SOS was similarly equipped with four European Clamp Combat Talons and 150 personnel. Of the 14 Combat Talons available to planners, seven had received the in-flight refueling modification—the four PACAF-assigned aircraft (62-1863, 63-7785, 64-0564, and 64-0565) and three of six 8th SOS Talons (64-0562, 64-0567, and 64-0572). The four Talons in Europe (64-0523, 64-0555, 64-0561, and 64-0566) had undergone extensive ECM upgrades in lieu of the IFR modification and weighed some 5,000 pounds more than the other 10 aircraft. As SOD planners began to refine their fixed-wing requirements for the rescue attempt, the IFR capability was identified as essential for the 24-hour flight. Thus, from the start of planning, the 7th SOS and its nonair-refuelable Combat Talons were deemed unacceptable for the mission. Likewise, USAF and USMC HC-130 tanker aircraft capable of refueling helicopters in flight were discounted because they, too, did not have the IFR capability.

With Kyle in place as the air mission commander on 12 November, USAF participation in the planning process accelerated. SOD continued to look at options and began to refine its force structure to meet known mission requirements. Meanwhile, General Taylor and his OPG were developing alternate plans in case the primary rescue plan developed by SOD was not activated. On 13 November, under the cover of increased Far Eastern tension, the 1st SOW deployed four AC-130H gunships from Hurlburt Field to Guam with a total force of 185 personnel. The OPG had developed a retaliatory option against Iran and centered it around the AC-130H gunship. The four aircraft departed Hurlburt Field within two minutes of each other at an approximate gross weight of 165,000 pounds and flew the 7,219 NM trip utilizing four aerial refuelings from KC-135 tankers. The deployment was flown at 10,000 feet because the gunship could not be pressurized. The mission was the longest nonstop flight ever by a C-130 aircraft, surpassing the 1st SOS's flight the previous year by more than two hours. The average sortie length was 29.5 hours, with the longest being 29.7 and the shortest 29.3. Personnel who did not deploy on the gunships, along with 6.5 tons of support equipment, were moved to Guam between 13 and 16 November by way of C-141 cargo aircraft. The gunship move to Guam was the first operational commitment of USAF combat aircraft dedicated to the Iranian crisis.

The 1st SOW maintained the four gunship detachment on Guam for the next four months, re-deploying to Hurlburt Field on 3 March 1980.¹⁶

The gunship mission envisioned by OPG involved a punitive strike against a coastal target in Iran. After deploying from Guam to Diego Garcia, the gunship force would fly a 21-hour round-trip mission from there to its target along Iran's coast. Navy carrier-based fighter aircraft and SAC KC-135 tankers would support the strike. Retaliatory strikes were planned by OPG in the event that Khomeini's terrorists in the embassy began killing the hostages, a threat that had been made early in the crisis. Two other OPG scenarios included the blockade of the Strait of Hormuz at the entrance to the Persian Gulf and the seizure of Iran's Kharg Island oil refinery complex. If retaliatory strikes were executed, SOD's rescue option would no longer be viable.¹⁷

Combat Talon Is Selected for the Rescue Mission

The distances from Diego Garcia and Egypt were enormous. Kyle and his small SOD staff looked at possible weapons systems that could do the job. There was only one aircraft capable of in-flight refueling, covert penetration of hostile airspace, and precision navigation to some point in the heart of Iran, and that aircraft was the MC-130E Combat Talon. Kyle briefed Vaught on his Talon requirements, and on 14 November Vaught approved Kyle's request to bring three planners familiar with the weapons system to Washington. The next stop for Kyle was Lee Hess, who recommended Lt Col Les Smith (the operations officer of the 8th SOS), Maj Doug Ulery (a highly experienced Combat Talon navigator and mission planner), and Maj Paul Gorsky (a highly experienced navigator assigned to TAC headquarters). Hess reasoned that Smith could return to Hurlburt Field to put the Combat Talon package together after initial planning and would transition to be the JTF's point of contact for the squadron. Ulery was well known by both Kyle and Hess, all three having worked together on Korean issues while they were assigned to the Pacific. Gorsky had been previously assigned to the Heavy Chain program (1198th OT&E Squadron) and participated in the initial flight tests and verification of the MOD-70 upgrade. He would act as the JTF liaison officer to TAC as the preparation for the mission progressed.¹⁸ Hess also connected Kyle

with Turczynski. During a 15 November secure telephone call, Kyle asked Turczynski to continue the no-light landings that the squadron had begun on 7 November.* Kyle also authorized Turczynski to brief the 18th TFW/DO on the mission and gave him Col Bob Pinard's name as the 1st SOW point of contact at Hurlburt Field.

The three Combat Talon planners arrived in Washington on 16 November. Kyle and Hess immediately briefed them, and they began looking at possible ingress and egress routes. The SOD plan had evolved into a two-night operation that included both USAF Combat Talons and US Navy RH-53D helicopters. Night One would utilize an isolated airfield in southern Egypt, known as Wadi Kena (also identified as location Alpha), from which Combat Talons and KC-135 tankers would launch. From Wadi Kena, the force would fly down the Red Sea clear of Saudi Arabian airspace and refuel over international waters abeam South Yemen. The force would continue eastward along the coast of Saudi Arabia and turn north near Masirah Island over the Gulf of Oman. The Combat Talons would cross the Gulf of Oman and fly east of the Strait of Hormuz at low level, penetrating Iranian airspace at a point where intelligence indicated a gap in radar coverage. Once over land, options to either drop fuel or airland were still to be worked out. Planners were instructed to build their low-level route to a point 300–400 NM from Tehran. Further refinement of the overland portion of the mission would be done after helicopter rendezvous and refueling options were finalized.¹⁹ A different egress route would be flown after refueling the helicopters, with all Combat Talons landing back at Wadi Kena after a second air refueling (fig. 30).

Utilizing Saudi Arabian airspace, Night Two would depart Wadi Kena and cross Saudi Arabia north of Riyadh, where an aerial refueling would take place with KC-135 tankers. After refueling, the Combat Talons would continue on to the Persian Gulf, enter low level, and penetrate Iranian airspace east of Kuwait. Available intelligence had not pinpointed any gaps in Iranian coastal defenses in the northern Persian Gulf area, so from the penetration point onward, the route was initially left unplanned. In the event Egypt denied use of Wadi Kena, an alternate plan was developed that called for launch and recovery from Diego Garcia in the Indian Ocean, then low-level penetration of the Iranian coast near the same point as planned from Egypt.²⁰

*Kyle and Turczynski both served on the PACAF staff and trusted each other's judgment.

By November of 1979 there were seven Combat Talon aircraft modified for in-flight refueling. Four of those seven were assigned to the 1st SOS at Kadena AB. Accordingly, Kyle instructed the three planners to develop a deployment route for the 1st SOS aircraft across the western Pacific and the Indian Ocean to Diego Garcia. The 8th SOS Combat Talons would deploy to Wadi Kena by way of the Atlantic, thus reducing the signature of so many specialized aircraft converging on the objective area from the same direction. By including the 1st SOS in the operation, however, Kyle had created a colossal training challenge, with forces literally located half a globe apart. He had no choice because the seven IFR-modified Combat Talons were the only aircraft capable of accomplishing the mission as envisioned during initial planning, and Kyle needed them all to succeed.²¹

Smith and his Combat Talon planners had a formidable task, yet they knew that the mission was possible after initial distances, loads, and fuel

requirements were computed. Although helicopter refueling options were far from complete, Smith was anxious to start developing what he knew would be the most difficult scenario at the objective area—performing blacked-out landings on an unimproved airstrip to refuel the helicopters from the ground. As planning developed Smith received permission to contact Brenci at Hurlburt Field and task him to begin developing a blacked-out landing capability. Six days later, after borrowing NVGs from the 20th SOS, Brenci and his crew, in aircraft 64-0567, were at TAB-6 developing those procedures.

Training Begins for Combat Talon

Smith initially tasked Brenci to train two crews in the blacked-out landing procedure. After training began on 26 November, additional crews were handpicked by Brenci and Smith to develop procedures and to become proficient in NVG landings. The initial two crews that began training in late November were as follows:²²

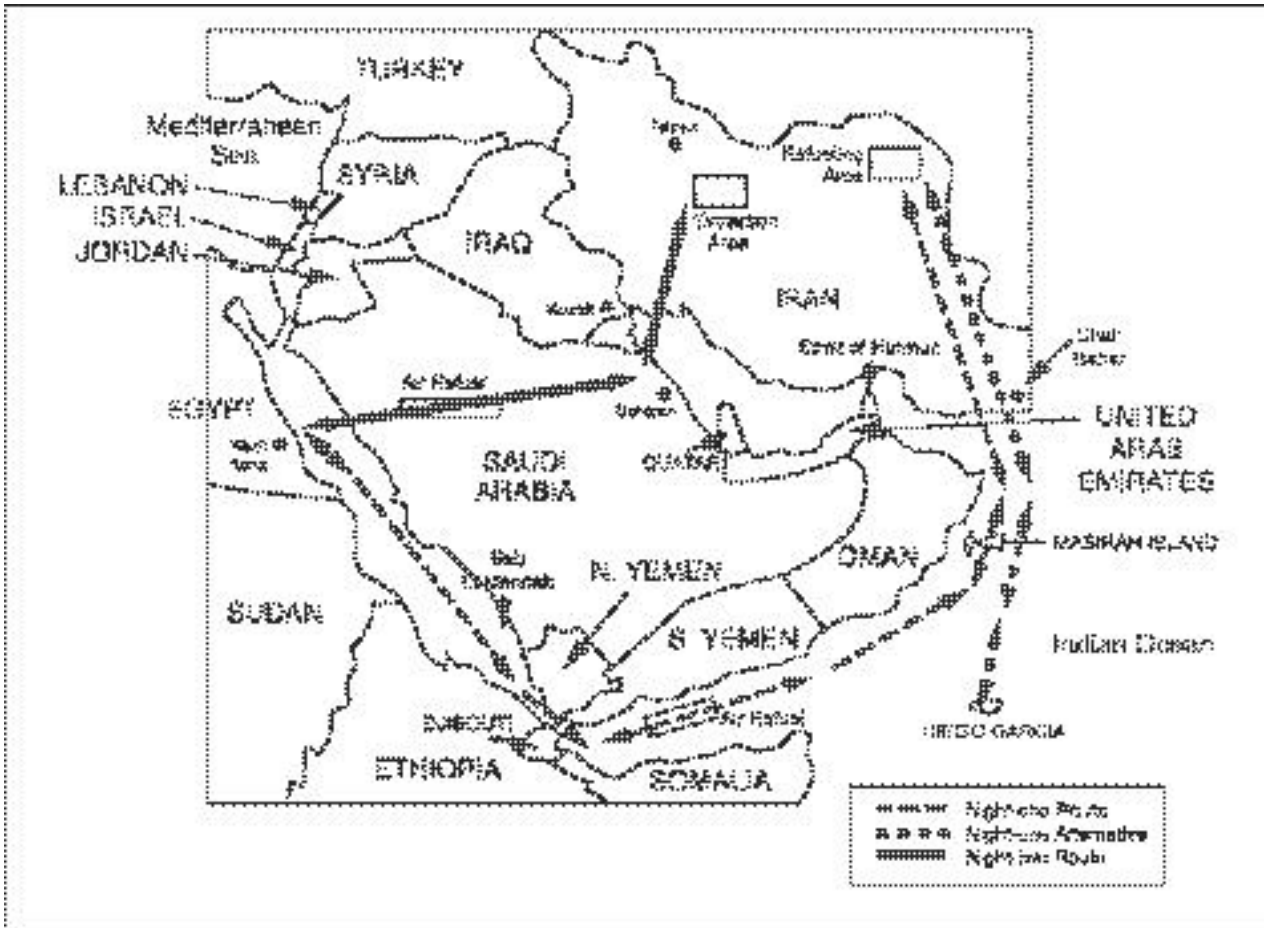


Figure 30. The First Plan Developed by SOD, 16 November 1979 (Source: Created by Daniel Armstrong, Air University Press, Maxwell AFB, Ala.)

Crew 1	Crew 2
Brenci	Uttaro
Meller	Diggins
Thigpen	Lewis
Chapman	Galloway
Holbein	Bakke
Almanzar	Newberry
Chitwood	Gingerich
Sanchez	Doyle
McClain	Thomas
Wiley	Chesser

Initial training determined that the C-130 could be landed utilizing NVGs, but first-generation PVS-5s required ambient light to allow its image intensifiers to operate properly. On nights with little or no moon, the pilot landing the aircraft needed illumination from an outside source to see the runway and to determine such critical flight parameters as sink rate and runway alignment. Taxi lights were used for safety purposes on the darkest of nights, but the overt taxi light could be seen by the naked eye. Any illumination from the aircraft was unacceptable since hostile forces could see the aircraft and shoot it down during landing. The lighting requirement was transmitted back to Smith and the mission planners in Washington. Kyle and Hess swung into action.

Since the creation of Combat Talon in 1965, LAS Ontario had been heavily involved in the modification and upkeep of the specialized Combat Talon fleet. Each year, at the CTMR conference, issues were addressed that affected the health and modernization of the fleet. At the 1979 CTMR Hess had met the new commander of USAF's Detachment 4, 2762d Logistics Squadron (Special), Lt Col Kenneth D. Oliver. Detachment 4 served as the liaison between the USAF and LAS Ontario. On 27 November 1979 Hess placed a call to Oliver and introduced him to Kyle. The heart of the conversation was centered around two requirements. First, Kyle asked Oliver if he could help put the aging Combat Talon fleet into tip-top shape. Second, he relayed to Oliver that he might need some help developing new capabilities for the aircraft. Within two hours, Oliver had secured approval from his boss at Air Force Systems Command (AFSC) to provide any assistance Kyle needed, with systems command to work out funding details later.²³ A quick call from Oliver to Kyle placed into motion perhaps the most important and far-reaching developmental program in Combat Talon history.

With Brenci and his crews requiring external covert illumination for safe blacked-out landings, it didn't take Kyle long to contact Oliver again with a request for IR filters that were compatible with the PVS-5 NVGs. Oliver and his staff were asked to develop IR landing and taxi lights, as well as an upper-rotating beacon mounted on the top of the vertical fin of the aircraft. The rotating-beacon modification was to be used during low-level formation to help identify each aircraft. With virtually no experience with NVGs, Detachment 4 searched for a solution to Kyle's problem. Oliver borrowed a set of goggles from the 1st SOW and began researching possible sources for an IR filter. He located a supply of IR paper that was manufactured by Polaroid and bought up the last three rolls that the company had in its inventory. Because of the scarcity of NVGs, the 8th SOS needed every pair it could get its hands on. So Oliver put in an emergency request for two new sets and had them delivered from the manufacturer to Detachment 4 within four days. He then returned the borrowed set to the 1st SOW.²⁴

Oliver was on a roll. He selected CMSgt Buie E. Kindle as his deputy and put together a small developmental team of Detachment 4 personnel to address the following concerns:

1. What was the best IR material available?
2. What optical characteristics must it possess?
3. How fast could the material be fielded?
4. How could the filters be attached to the aircraft?
5. Once these questions were answered, validate the IR filter under actual blacked-out conditions.

Working through Polaroid, the team obtained the basic characteristics of the IR filter paper. The team found a US company that manufactured IR glass and ordered several test pieces to determine which glass worked best with the PVS-5. Both IR illumination and visibility to the naked eye were evaluated, and the RG-850 filter glass was determined to be the best glass for the PVS-5 application. With funding assured by AFSC, Oliver placed a large order for landing-light lenses, taxi-light lenses, and a separate filter for the rotating beacon. At \$250/\$450 each for the taxi/landing light filters, the large order did not come cheap.²⁵

With the IR glass ordered, Oliver's developmental team began designing a way to attach the



USAF Photo

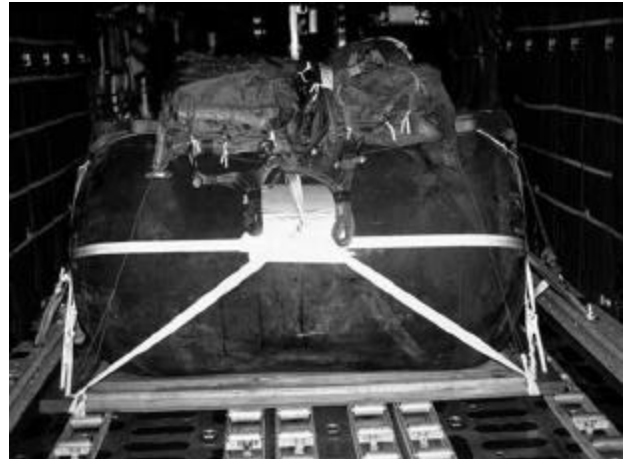
IR landing light modification. The double retaining ring is on the right, and the IR lens is on the left.

lenses to the aircraft. The IR paper purchased by Oliver could not be attached to the existing aircraft lighting system. The team designed a doubling attachment that consisted of fastening two retaining rings together, one normally used to mount the aircraft-landing light itself and the second one to hold the IR filter. The IR lens, which mounted inside the outer ring, consisted of two pieces of tempered glass with the IR filter paper sandwiched between them. A spacer was installed between the lens and the light to keep the glass from touching the hot surface. The lens, along with its spacer, was the same size as the permanent IR glass that Oliver had ordered, thus allowing for a one-for-one substitution when the permanent IR lenses became available from the manufacturer. (The whole design process for the IR-lens assembly had taken only two weeks to develop and produce, and it was later permanently adopted for the entire Talon I and Talon II fleet.)²⁶ By mid-December, when Oliver's effort came to fruition, Brenci and his Talon crews desperately needed the IR-lighting capability.

For the rescue mission to be a success, the Kadena-based 1st SOS had to attain proficiency in the same blacked-out landing skills as the crews from Hurlburt Field. Turczynski's job was infinitely more difficult than was Brenci's at Hurlburt Field. The 1st SOS was assigned to the 18th TFW and relied on the wing for support. The primary mission of the 18th was to provide fighter aircraft in support of a war in Korea. It had no special operations experience outside the personnel assigned to the 1st SOS and had little "need to know" about the rescue mission. Turczynski found himself many times at odds with the wing and

was constrained by not being able to explain why he needed certain support. The sheer magnitude of preparing his squadron for the mission and the exceptional manner in which he conducted the squadron's preparation attests to his outstanding abilities. Interestingly, the crews from the two squadrons developed NVG procedures half a globe apart, with the resulting procedures having major differences. (It would take another year before the procedures were standardized and incorporated into the appropriate training manuals.) By late December 1979, however, two NVG blacked-out airland procedures had been developed and became a reality. Each squadron would use its own procedures for the rescue mission.

From Hurlburt Field Brenci deployed with his crew to Pope AFB in late November to test a fuel-bladder air-drop procedure in the Combat Talon. The bladder, commonly referred to as a fuel blivet, weighed 5,000 pounds and resembled a



USAF Photo

Up to five 5,000-pound fuel blivets could be dropped at one time.



USAF Photo

Blivets on K-loader in preparation for rigging for airdrop.

large rubber doughnut mounted on a 463L pallet. All associated hoses, pumps, and related equipment were dropped along with the blivet by utilizing CDS procedures. One option being developed by JTF planners called for the simultaneous air-drop of five fuel blivets, which was the maximum number of blivets that could be carried by the Combat Talon. The concept was to drop the blivets so that they landed near each other and then parachute a small US Army ranger team into the DZ. The ranger team would then prepare the blivets for follow-on helicopter refueling. Due to equipment availability, only one blivet was dropped at Pope AFB during the initial test. Brenci's airdrop marked the first time a Combat Talon utilizing CDS procedures dropped the 5,000-pound blivet.²⁷

The ability to air-drop fuel to the helicopters was only half of the fuel challenge for Talon planners. The other requirement was to develop blacked-out, communications-out procedures for night in-flight refueling operations between the Combat Talon and the KC-135 tanker. Beginning in December 1979 a KC-135 was deployed almost continuously to either Hurlburt Field or Eglin AFB and was dedicated to training with Combat Talon and gunship aircraft. Before this time, routine tanker support for the 1st SOW was extremely limited, with only a few pilots and navigators being checked out at any given time. The standard IFR procedure, known as the point-parallel rendezvous, was modified so that all radio calls were eliminated. The procedures were developed during the AC-130H gunship deployment to Guam. Also, all lights were turned off on the Combat Talon (except slip-way lights), and most tanker lights were reduced significantly. The communications-out rendezvous came to be known as the overtaking rejoin, a maneuver that consisted of the tanker flying over the Combat Talon 1,000 feet above it and then stabilizing approximately three miles in front of the receiver at 210 knots indicated air-speed. The Talon would accelerate to 250 KIAS and climb the 1,000 feet as it closed on the tanker. Utilizing position lights on the belly of the tanker, the Talon would be cleared into position for the unloading of fuel. Formation (cell) procedures were also established for refueling from multiple tankers with multiple receivers. To provide training for the 1st SOS crews and the AC-130H gunship crews deployed to Guam, special KC-135 operating locations were established at Guam, Diego Garcia, and Wadi Kena.

The 1st SOS sent pilots and navigators on temporary duty to Guam to fly with gunship crews, since they were the most experienced in this type of refueling operation.²⁸

As each JTF component worked on its own part of the rescue plan, General Vaught moved to bring the various air and ground elements together for a joint training exercise based on the Night One air-drop scenario. For this first event, two Talons and one gunship were used for a limited run-through of the plan. Six US Navy RH-53Ds were used for the rotary-wing portion of the exercise. Beckwith and his Delta Force were deployed from their Camp Smokey training facility in North Carolina and relocated to specially prepared facilities at the US Army's Yuma Proving Grounds in Arizona. Objectives for the Yuma exercise included an assessment of helicopter training, set up of a drop zone, airborne delivery of fuel blivets near the helicopters already in place near the drop zone, refueling the helicopters from the fuel blivets, and demonstrating the accuracy of the gunship to participants.²⁹

On 3 December Brenci and Uttaro deployed with their crews on Combat Talons 64-0562 and 64-0567, respectively, from Hurlburt Field to Davis-Monthan AFB, Arizona. The cover story for the deployment was that the Air Force special operations aircraft were participating in a US Army evaluation, a regularly scheduled event that the 8th SOS had been involved with in the past. Nothing was out of the ordinary for the crews and maintenance personnel as they prepared for their nightly missions. Instead of a single blivet drop like the one at Pope AFB a few days earlier, however, tasking for the Yuma exercise included air-drop of five fuel blivets by each aircraft.³⁰

Talon crews had never dropped five fuel blivets in the past, nor were they proficient in CDS procedures. What the Talon community did have was a group of highly experienced loadmasters who had grown up in special operations and had a "nose" for what was right and what was wrong regarding air-drop procedures. Duke Wiley, Ray Doyle, Taco Sanchez, Dave Chesser, Jim McClain, and Ron Thomas were six of the best loadmasters in the entire C-130 community. When the blivets were delivered to the MC-130s at Davis-Monthan AFB, the loadmasters put their heads together to make sense of the rigging instructions provided by US Army personnel accompanying the loads. It didn't pass their "smell" test. Their concern was that, once the load began to exit the aircraft, the blivets would accelerate

and fall on top of each other, thus causing failure of the parachute system and the destruction of the blivets. Some of the loadmasters had been in Talons since the Vietnam era and were familiar with MACVSOG's "no questions asked" policy for their loads. After many debates, and some reservations, the blivets were accepted by the loadmasters and were rigged according to US Army specifications, then readied for the nighttime mission.³¹

The night was clear and crisp, with nearly 100 percent moon illumination, when Brenci and Uttaro departed Davis-Monthan AFB. A route was planned that mirrored the one to be flown into Iran to give the crew experience in low-level operations flying one minute in trail with another Combat Talon. The Talon had been designed as a single-ship penetrator aircraft, so low-level formation in the terrain-following mode was not a normal procedure. The 8th SOS crews flew many sorties to develop procedures and skills to perform this maneuver. As the Talons traveled low over the desert floor, their shadows on the ground from the bright moon were clearly visible to the crew. Everyone on board was aware of the importance of the drop but was a bit apprehensive about the heavy 25,000-pound load and its unproven rigging procedures. About six minutes out from the drop, pilots from Brenci's crew wearing NVGs spotted light patterns on the ground resembling the Yuma DZ. After quickly determining the position of the aircraft, the left navigator assured the crew that the aircraft was still a significant distance from the DZ, so the crew continued to press on. Later debriefing by the crew determined that the lights were probably small campfires not visible to the naked eye, yet easily seen by the NVGs. The crew was thankful that they had not convinced themselves that the lights were on the DZ and dropped the load on unsuspecting campers.

As the two aircraft lined up for the drop, the combat controller on the DZ called to confirm the run-in heading—a strange call since the whole operation was scheduled to be conducted radio-out. There had apparently been a question concerning the orientation of the helicopters in relation to the Talon's inbound drop heading. With the question answered, the formation continued towards the DZ. Brenci was in the lead with Uttaro one minute in trail, and everything looked good for a successful drop. As the left navigator called "green light," the blivets began to move. From the cockpit the shadows of the blivets were easily visible on the ground as they exited the aircraft.

So, too, were the RH-53D helicopters lined up on the right side of the DZ. As the last blivet left the aircraft, the loadmaster called the load clear but relayed that a malfunction had occurred. Just as the Talon loadmasters had predicted, all five blivets accelerated out the aft end of the aircraft and literally fell on top of each other. As they left the aircraft, the force exerted on the aft anchor cable assembly caused it to fail and tear loose from the aft bulkhead. The cable shot forward and nearly beheaded Brenci's radio operator, MSgt Andy Chitwood, who was untouched but shaken by the near miss. The incident reinforced the need for everyone in the cargo compartment to wear a helmet when air-dropping loads with static lines attached to the anchor cables.

With the cable torn loose, the five blivets from Brenci's aircraft streamed into the DZ, destroying them when they hit the ground. Uttaro was one minute behind Brenci and was not notified to abort his drop before two of his five blivets had pancaked onto the DZ. His aircraft experienced less damage than had Brenci's, but seven of the 10 blivets dropped were destroyed on the DZ. The short flight back to Davis-Monthan AFB was sobering to all, especially for Chitwood.

Inspection of the anchor cables revealed that the damage could be repaired, and by the next afternoon, the two aircraft were again mission ready for another attempt at the multiple CDS airdrop. The Combat Talon loadmasters devised a gate system whereby each blivet, as it moved towards the ramp of the aircraft by means of gravity, would cut the restraining cord for the following blivet. Thus, all five blivets would exit the aircraft with adequate spacing to allow each parachute to open without interfering with the one behind it. The two aircraft took off and flew their low-level routes as they had done the previous night. The airdrop went flawlessly, with all 10 blivets safely landing on the DZ. By utilizing the gate system, however, the dispersion pattern on the ground was not as concentrated as was hoped, and efforts to move the blivets into position on the ground to refuel the helicopters took more time than was planned.

Beckwith and his Delta Force had moved by way of the RH-53D helicopters to the DZ and had witnessed both nights' operations along with Vaught and Kyle and the JTF planning staff. With the failure of the blivet drop on the first night, and the dispersion pattern of the second night's drop, the consensus was that a better way had to be found to get fuel to the

helicopters. The exercise did validate that the JTF had a viable in-extremist means to get fuel to the helicopters. After the airdrop, the AC-130H gunship put on a dazzling show for the JTF that demonstrated the aircraft's ability to provide sustained and accurate fire in support of the ground force commander. From that time forward, the gunship became an integral part of the force package that Beckwith would require to ensure protection during the embassy takedown.³²

The afternoon after the second airdrop, unknown and unplanned by Kyle, a C-141 landed at Davis-Monthan AFB and unloaded a Vietnam-era fuel bladder designed to be carried by the C-130 aircraft. The 3,000-gallon bladder could hold 20,000 pounds of fuel, but it was not capable of being air-dropped. It resembled a huge rubber water bed that was strapped inside the fuselage of the aircraft and covered almost the entire cargo floor. Kyle soon learned that J-3 SOD had sent the bladder out to be evaluated by the JTF. The 8th SOS loadmasters were again consulted by Kyle, and in short order the bladder system was loaded on to an aircraft, and a fuel truck was called. After several refueling pauses to tighten fittings that had worked loose over the years, the bladder was filled, and a short flight was conducted to test its airworthiness. The flight was uneventful, with the aircraft landing back at Davis-Monthan AFB. Since the bladder could not be air-dropped, an airlanding somewhere in Iran would be required if the system were to be used, and hoses and pumps were needed to connect the bladder to the helicopters. As the Combat Talons deployed back to their home station on 9 December, there seemed to be more questions about Night One than there were before the exercise. Beckwith was convinced that air-dropping blivets posed too many variables that could delay or prevent helicopter refueling. One thing was for sure—to utilize the bladder system, a site would have to be found in Iran that allowed the heavy C-130 to land and refuel the helicopters.³³

By the second week in December, JTF planning for the rescue attempt was moving at a frantic pace. Six RH-53D Sea Stallion helicopters had been slipped aboard the USS *Kitty Hawk* as it steamed past Diego Garcia in the Indian Ocean. (The aircraft were later transferred to the USS *Nimitz*.) The plan had not been finalized, but everyone agreed that whatever operation was undertaken to free the hostages would include helicopters.³⁴ At Hurlburt Field the arrangement between Brenci and Smith was becoming

unworkable. As a primary crew member on the Talon rescue force, Brenci was flying at night and in crew rest during the day and at times was on temporary duty away from Hurlburt Field. Critical coordination had to take place during periods when Brenci was not available. An awkward situation also had developed in the 8th SOS since Brenci had been selected to be the squadron point of contact—Lt Col Roland Guidry, the squadron commander of the 8th SOS, had not been read into the operation! Thus, as the two Combat Talon crews developed NVG blacked-out procedures and began CDS delivery of the fuel blivets, Guidry did not have a “need to know” about the operation and was “officially” unaware of his squadron's training initiatives.

Guidry was new to the Combat Talon in November 1979, having taken command of the squadron the previous summer. He had not flown operationally for the previous eight years and was required to complete the formal Combat Talon School before being certified in the aircraft. He was not entirely new to special operations, however. His assignment before coming to the 8th SOS had been to the Tactical Air Warfare Center at Eglin AFB. There he was responsible, among his other duties, for the test and evaluation of the CRRC, a project that the 8th SOS had completed in 1978. As the test director, Guidry had worked with 8th SOS and 1st SOW personnel and had a working knowledge of the wing. When Ninth AF looked for a new commander AS the incumbent (Colonel Hunter) neared the end of his time in command, Guidry was chosen to lead the squadron. In late November 1979 Guidry was still in Combat Talon School and was not certified in the MC-130E. For these reasons, Les Smith went to Brenci as his point of contact for the squadron. As chief pilot, Brenci was in a position to assess his pilots' abilities as he selected crews for the mission.

By 9 December, with the Yuma blivet drops completed, it was apparent that the number of personnel at Hurlburt Field read into the plan had to be increased. Kyle was aware of the situation with Guidry and elected to meet with him personally and brief him on the mission. After talking with Guidry and assessing his ability to successfully coordinate mission preparations at Hurlburt Field, Kyle put him in charge of the Hurlburt MC-130E operation.³⁵ Guidry proved to be a highly skilled technician who meticulously prepared the squadron for every event leading up

to the actual mission. As a manager and coordinator, skills that he developed as a flight-test program manager were brought to bear on the challenge before the squadron. Guidry proved to be the right person to perform this vital function, and his inclusion in the operation freed Brenci to concentrate on aircrew and operational issues.

Another key player responsible for getting Hurlburt Field's aircraft ready for the mission was Col Bob Pinard, who had been the squadron commander of the 1st SOS at Kadena AB, Japan, in the early 1970s. A pilot by trade, Pinard had also commanded the 90th SOS when it was stationed at Nha Trang AB, Vietnam, and had moved the squadron to Kadena AB in 1972. When the 90th SOS was redesignated as the 1st SOS, Pinard remained in command of the unit and continued in that position until 1975. In all, he commanded the Pacific Combat Talon squadron for more than four years, the longest tenure of any squadron commander in the unit's history. He knew what special operations was all about. In the fall of 1979, Pinard was the deputy commander for maintenance for the 1st SOW and was responsible for aircraft maintenance and support. Like Guidry, Pinard was the right person to contribute his unique skills in preparing 1st SOW aircraft for the rescue mission. As the mission grew more complex, Pinard was called on by Kyle to provide increased support. On the south side of Eason Hangar at Hurlburt Field, high above the hangar floor, Pinard provided office space and secure work areas for wing planners and JTF personnel deployed to Hurlburt Field.³⁶ Communications were established so that Kyle could keep in touch with Vaught by way of secure telephone and radio. The work area was so isolated that few even knew that it existed. As maintenance crews worked busily on aircraft inside the hangar, Kyle, Guidry, and a small staff (mainly radio operators) settled in to what would become a four-month marathon focused on preparing the force for the rescue mission.

It was apparent that the JTF needed more Combat Talon crews to fly the complicated mission. Kyle authorized Brenci to increase the aircrew pool from two to three crews, and by mid-December the new crew alignment was firmed. This was done primarily by moving highly skilled crew members from the two existing crews to form the nucleus of the third crew. (Guidry was qualified as an NVG safety pilot and rotated between the crews, usually flying on Meller's crew. Also, some crew members moved among the

crews during different training missions. Most safety pilots were also qualified as right-seat NVG first pilots and rotated into that position to maintain their proficiency.) The three crews created by Brenci in mid-December 1979 included the following personnel:

Crew 1	Crew 2	Crew 3
Brenci	Uttaro	Meller
Tharp	Diggins	Thigpen
Ferkes	Lewis	McIntosh
Holbein	Bakke	McBride
Galloway	Chapman	Smith
Gamble	Yagher	Robb
Almanzar	Newberry	Daigenault
Chitwood	Gingerich	Mink
Wiley	Doyle	Chesser
Sanchez	McClain	Thomas

The early December Yuma exercise had been a limited run-through of the first night's scenario utilizing the option of air-dropping fuel blivets to refuel the helicopters. With so many questions arising from the exercise, JTF planners temporarily put the Night One operation aside and concentrated on the Night Two scenario. Vaught reasoned that they had an in extremis plan (dropping the blivets) if a mission execute order was issued in the short term. Work continued on the fuel-bladder/airland option.

During the third week of December, the crews of Uttaro, Meller, and Brenci, (the latter commanded by Major Diggins) deployed to Savannah, Georgia, and commenced training with the USA ranger battalion stationed there. Colonel Williford commanded the ranger battalion, and his troops were tasked to seize and hold Manzarriyeh, an airfield located southwest of Tehran selected by JTF planners for the Night Two extraction of the hostages, Delta Force, and the RH-53D helicopter crews. Most of the initial airfield seizure training was conducted at Wright Field, Georgia, where the three Combat Talons deployed to rehearse with the rangers. The seizure and follow-on extraction proved to be a complicated undertaking.³⁷

An airfield seizure had to proceed like clockwork to be successful. After landing blacked out on NVGs, the first aircraft to land would roll out to the end of the runway. A ranger force would exit the aircraft in a machine-gun mounted jeep. Immediately after the jeep, four off-road motorcycles would exit the Talon and rapidly close on preassigned targets in the landing area (usually buildings, guard outposts, communications areas,

or barracks). Also on board the lead Talon were some 50 rangers who were responsible for aircraft defense and for any required mopping-up action. The second and third Talons also carried similar numbers of soldiers and vehicles that were assigned to neutralize remote areas of the airfield. The number two Talon would land and turn off midway down the runway and taxi back to the approach end for download. The number three aircraft would stop midway down the runway and offload its assault package. With minimum spacing between aircraft, a three-ship package could be on the ground within one minute of the landing of the first aircraft. With practice, the rangers reduced their exit time to 10 seconds, a feat that was somewhat remarkable considering the fact that the entire operation was conducted without lights.³⁸ Also complicating the operation was that not all participants had access to NVGs. The three pilots and the flight engineer, along with the two loadmasters, each had a set of the PVS-5s. The rangers were limited to providing NVGs to the jeep drivers, motorcycle drivers, and about one in 10 of the foot soldiers. There simply were not enough NVGs for everyone to have a pair. For the aircrews, the problem of external IR lighting for NVG blacked-out landings had still not been solved, resulting in several hard landings during training operations.

The fuel bladder that had been test-flown at Davis-Monthan AFB in early December had been transported back to Hurlburt Field, and 8th SOS loadmasters and flight engineers had worked to develop a system that could be used to refuel the helicopters. The problem with the bladder was that it lacked pumps and hoses to connect it to the helicopters at a safe distance from the C-130 aircraft. To partially eliminate this problem, the bladder system was rigged through the aircraft refueling system, and by utilizing the aircraft's fuel pumps, fuel could be transferred through a hose to the helicopter. With this Rube Goldberg setup, the bladder proved that it could do the job.³⁹

During a midmonth visit to Hurlburt Field to see how the Combat Talon crews were progressing in their training, Vaught viewed a demonstration of the bladder system that the 8th SOS had been working on. A Talon successfully pumped fuel to a 20th SOS helicopter, and Vaught was somewhat pleased with the results. He authorized a full-blown effort to locate and manufacture the correct pumps, hoses, and fittings necessary for the system to work at its optimum. Effort was

also initiated to find fuel-trained airmen to operate the system. Vaught also ordered another joint exercise to be conducted at Yuma. New helicopter crews had been selected after the blivet drops earlier in the month, and Vaught wanted to see them in action.⁴⁰

On 15 December the 8th SOS deployed its three NVG crews to Norton AFB, California, in preparation for the upcoming Yuma exercise. Kyle had a new observer for the exercise—Turczynski from the 1st SOS. Blacked-out NVG landings were still sometimes rough, with the external IR illumination problem not fixed. During the first night's operation from Norton AFB, the Combat Talons flew to NAS Fallon to practice blacked-out landings. The moon was partially full, and the landings went well. With Kyle observing the operation from the control tower, one of Vaught's special assignment guys delivered to him a roll of black IR paper that Vaught had sourced from CIA stocks. It turned out to be the same IR paper that Oliver had purchased from Polaroid a few days earlier. Kyle wasted no time in contacting Detachment 4 and was pleasantly surprised to learn that Oliver was nearly finished with the landing lighting modification.⁴¹

At Yuma Vaught wanted another blivet drop to further validate the capability. For this event, five blivets were dropped, along with a tractor (called a mule), which was used to move the blivets to their refueling location near the helicopters. The drop went perfectly, with Beckwith and his men helping to round up the blivets in the dark. The whole operation was still time-consuming and tedious work, and Beckwith did not like it.⁴²

When the Talon arrived back at Norton AFB, Kyle called Detachment 4, and Oliver and Kindle deployed in short order. It wasn't long before the dual-ring attachment mechanism that Oliver's team had been working on was attached to the aircraft along with a sandwiched piece of IR paper. The following evening, the new lenses were tested with NVGs, and they worked perfectly. Kyle found, however, that the IR paper was susceptible to heat from the landing light, burning through the thin paper in about a minute. The glass was also prone to break. Tempered glass would eventually be used to eliminate the glass-breakage problem. The IR-modified aircraft departed Norton AFB and headed for Yuma for blacked-out landing practice. When the landing lights were turned on, it was like landing in daylight on the NVGs. Yet, the light could not be seen by the naked eye. As soon as the aircraft touched

down and began slowing to taxi speed, the lights were turned off to prevent burn through. On that night, 17 December 1979, safe blacked-out landings on NVGs became a reality for fixed-wing aircraft. The IR paper first located by Oliver and then by Vaught's JTF staff, and the lenses developed by Oliver's team at Detachment 4, revolutionized Combat Talon airland capabilities.⁴³

The First Night One/Night Two Combined Exercise Is Flown

On the nights of 18 and 19 December, the first two-night joint exercise was flown in the deserts of southern California and western Arizona. Vaught had seen pieces of the two-night operation, but he wanted to put them together for a run through to see where additional work was needed. Air Force objectives for the exercise were threefold: to refine NVG blacked-out landing tactics (utilizing the newly acquired IR paper lenses), to test helicopter refueling procedures from the 3,000-gallon bladder system installed on one of the Combat Talons, and to evaluate the AC-130H's ability to covertly illuminate the MC-130E landing zone. Night One refueling operations would take place at Twenty-Nine Palms Marine Corps Expeditionary Airfield, California, while the Night Two exfiltration would utilize Holtsville Airport, California. Norton AFB and Laguna Army Airfield (AAF) at Yuma, Arizona, were used as staging and onload locations.⁴⁴

While the 8th SOS was refining its NVG procedures, Turczynski and his 1st SOS crews had continued their no-light practice landings. From 19 to 23 December, Turczynski was scheduled to attend the PACAF Commander's Conference in Hawaii. Soon after his arrival in Hawaii, Kyle contacted Turczynski and told him to proceed to Norton AFB and link up with Brenci. Turczynski flew as an extra crew member on Brenci's aircraft during the combined exercise, took notes, and observed blacked-out NVG approaches and landings.

For the Night One operation, Brenci's Combat Talon onloaded the ranger security force at Laguna AAF and departed low level en route to Twenty-Nine Palms. Concurrently, six Navy RH-53Ds lifted off from Laguna AAF with Beckwith and his Delta Force onboard. At Norton AFB the number two Talon, commanded by Uttaro, was loaded with the 3,000-gallon fuel bladder, while the number three aircraft, commanded by Meller, simulated carrying a bladder the same as the number two aircraft (there was only one fuel bladder system available at the time). The launch of

the number two and number three Talons from Norton AFB was timed to allow the two aircraft to fall in behind Brenci's aircraft as the three made their approach to Twenty-Nine Palms. After a two-hour low-level route, Brenci lined up on the totally blacked-out airfield for his approach and landing. On short final he extended the IR-covered landing lights and made a textbook touchdown on the aluminum-clad runway. It was a moonless night, and those viewing the landing with the naked eye could not see the aircraft as it rolled out to its preplanned off-load location.⁴⁵

As Brenci's aircraft came to a stop, Williford's rangers exploded from the back of the aircraft and dispersed across the airfield. Part of Brenci's assault force, which was made up of CCT personnel from Hurlburt Field, raced to mark the runway in a newly developed light pattern known as the "box four and one." The lights were covered with the same IR paper used for the Talons landing lights and provided additional landing cues for the follow-on aircraft. Just as Brenci had done, Uttaro and Meller made flawless landings utilizing the IR-covered landing lights. The two Talon tankers moved to their preplanned positions, and Uttaro's crew set up hoses to refuel the soon-to-arrive helicopters. After some delay four of the original six helicopters landed at Twenty-Nine Palms and were marshaled by the CCT to Uttaro's location. (Two of the helicopters had aborted en route, thus leaving only four aircraft to participate in the refueling operation.)⁴⁶

Helicopter refueling from Uttaro's Talon was an awkward operation. The hoses were not long enough to permit safe operations, and the loadmaster's intercom cord was too short, thus requiring hand signals between the loadmaster and the refueling crew while wearing NVGs. Uttaro had to back his aircraft into position dangerously close to the helicopters for the hose to reach. Marshaling helicopters and the Talon was extremely difficult with no illumination whatsoever and with everyone on NVGs. The refueling operation was a limited success, but it was apparent to Vaught and to Kyle that more work was required to make ground operations on NVGs safe. After receiving their fuel, the four helicopters departed Twenty-Nine Palms with Delta Force on board, and the three Combat Talons departed with the rangers. After an operation's stop at Laguna AAF to off-load rangers, Brenci and the other two Talons returned to Norton AFB for crew rest in anticipation of Night Two.⁴⁷

Since the Talons began training with the rangers at Wright AAF, the rangers' ability to rapidly exit the aircraft without any lighting had been a problem. The standard configuration for a C-130 carrying a maximum load of troops included center-isle seats and sidewall seats, all of which could be folded to allow the troops to exit the aircraft. The center-isle/sidewall seat configuration, however, made it difficult for the rangers to rapidly exit the aircraft while maintaining unit integrity. For the Night Two operation at Holtsville Airport, the center-isle/sidewall seats were removed and, for the first time, sponge-rubber mattresses were laid on the floor of the aircraft, thus allowing the rangers to lay on the mattresses during the long low-level flight. On landing the rangers could then stand and exit the aircraft in organized units. The configuration came to be known as the "Sealy configuration" for obvious reasons and was adopted for the operation.⁴⁸ Future development of restraining devices that snapped into the floor of the aircraft made the Sealy configuration a standardized means of carrying large numbers of troops that required rapid off-load at the objective area.

The three Combat Talons departed Norton AFB and headed for Laguna AAF during the early evening hours of 19 December. After onload, the Talons flew a low-level route to the Holtsville Airport, timing their landings to coincide with Delta Force's takedown of a simulated embassy hostage site. Within 15 minutes of landing, the rangers had secured the airfield, and the force was ready for the arrival of Delta Force and the helicopters. Again, the transfer operation was rough, with accountability problems between the rangers and Delta Force. Vaught had made it crystal clear that no one would be left in Iran, so elaborate accounting procedures were developed to ensure that everyone was accounted for and loaded aboard waiting fixed-wing aircraft.⁴⁹ It was again apparent that the procedures had to be refined if Vaught's directions were to be realized. After departure and with another operation's stop at Laguna AAF to discharge the rangers and Delta Force, the Talons continued on to Hurlburt Field for a much needed rest.

At the exercise debrief attended by Kyle and selected exercise participants, Vaught observed that the helicopter piece of the operation was not up to standards, and he directed that the bladder-refueling system be improved with the longer hoses and correct fittings to make it work properly. He also stated that the blivet drop was the

primary means of getting fuel to the helicopters until the bladder-refueling system was perfected. In Vaught's closing remarks at the hot wash, he released all participants to their respective commanders and directed that the JTF stand-down for the Christmas holiday. Training would resume on 2 January 1980 after the Christmas break.⁵⁰ At Hurlburt Field the Christmas stand-down was greeted with mixed feelings. Everyone was grateful for the break and the opportunity to spend the holidays with friends and family, but the sudden halt in training cast doubt in many minds of whether the rescue mission was being seriously considered in Washington. How could the mission be so important yet the entire JTF could stand-down for two weeks? Even with the lingering doubts, all went home to their families for the holidays.

Turczynski departed California and headed back to Hawaii on 22 December, linking up with Capt Nichols, who was the PACAF SOF liaison officer at Hickham AFB. Nichols borrowed 25 sets of PVS-5 NVGs from the 25th Infantry Division and signed them over to Turczynski on a hand receipt. PACAF provided a KC-135 for the return flight of its commanders to WestPac, so Turczynski was able to hand carry the NVGs with him. He arrived at Kadena AB on 24 December 1980 armed with his newly acquired NVGs and a book full of notes on NVG procedures. While Hurlburt Field enjoyed the holidays, Turczynski began a squadron recall on Christmas Eve.

Rice Bowl Expands Throughout the Combat Talon Community

As the stateside-based operational units relaxed over the Christmas holidays, the JTF was not completely idle. The Combat Talon, with its distinctive Fulton nose and black-paint scheme, was visibly different from standard C-130s. Planners feared that the Talon's presence at Wadi Kena, Egypt, would create suspicion among the local military members stationed there and perhaps even the Russians, whose satellites flew over the area daily. Also, Egyptian Air Traffic Control (ATC) was responsible for aircraft movement in and out of Egypt in a manner similar to the United States. A large influx of aircraft converging on Wadi Kena at the same time would undoubtedly raise questions. The 7th SOS was stationed at Rhein Main AB and operated the Combat Talon Clamp-configured MC-130E, which to the casual observer was identical to the 8th SOS aircraft. The European Talons were not

equipped with in-flight refueling, and their updated ECM equipment made them heavier and less capable of landing on unimproved airstrips. For these reasons the 7th SOS was ruled out for participation in the mission itself, but planners reasoned that their aircraft could be used to establish a signature at Wadi Kena.

On 1 January Col Tom Bradley, the commander of the 7th SOS, was alerted through his intelligence flight of a pending tasking to begin operations from Rhein Main AB to Wadi Kena, Egypt. Beginning on 2 January 1980, 7th SOS aircraft commenced flight operations into the remote base. Bradley received permission to brief his operations officer, Maj Ron Jones, and his aircraft commanders that the purpose of the new mission was to support a possible rescue attempt of the hostages in Iran. Not even Bradley, however, was briefed on details of the emerging rescue mission. Operating under a MAC call sign, 7th SOS Combat Talons departed Rhein Main AB and flew under normal ATC procedures to Sigonella AB, Italy, where the aircraft landed and refueled. Bradley deployed a liaison officer, Capt Dave Blum, to Sigonella AB to coordinate operations from there onward to Egypt. From Sigonella AB the Combat Talon crews filed a classified flight plan or flew "due regard" along the flight boundary between Greece, Libya, and Egypt, remaining in international airspace until turning south toward Cairo. Bradley deployed Capt Art Rohling to Cairo to serve as the ATC liaison with the Egyptian ATC facility there. From the time the Talons penetrated Egyptian airspace until arrival at Wadi Kena, the Talons received special handling by Egyptian ATC. The cover for the entire operation was that of a combined US-Egyptian exercise.⁵¹

Once at Wadi Kena, 7th SOS personnel established liaison with local Egyptian air force personnel. An exercise program was initiated with the Egyptian air force that included airborne intercept training between the Combat Talon and Egyptian air force MiG-21 aircraft. Missions were also flown against Egyptian surface-to-air missile batteries. Additional flights were conducted over the Red Sea along with low-level training sorties over the southern desert area of Egypt. As the Combat Talons flew from central Europe to Wadi Kena, cargo and equipment to be used by the rescue force were also moved. Sensitive cargo, including ammunition for the AC-130H gunship, was discreetly moved to Wadi Kena and stored there.⁵²

On the first of April, Bradley was alerted for a surface-to-air recovery mission, and he quickly re-deployed his two Talons from Wadi Kena to Rhein Main AB to reconfigure them for the mission. On 2 April the two Combat Talons, along with associated Fulton recovery equipment, were in place back at Wadi Kena. On 3 April a CIA twin Otter, carrying two pilots and Maj John Carney (a USAF combat controller), flew its mission deep into Iran to install the covert landing lights that were later used to guide Brenci and his rescue force of Talons and EC-130E aircraft to Desert One. In the event that the Otter could not depart its landing site or had to set down somewhere else in Iran, Bradley's Combat Talon was tasked to extract the three men by way of the STARS. Bradley deployed one of his two Talons from Wadi Kena to Oman International Airport, with Major Janke as the aircraft commander. Bradley was the first pilot, and Jones was the third pilot. Landing after dark the Talon parked on the military side of the airfield among other C-130s and shut down while awaiting a call if Carney's mission ran into trouble. The twin Otter performed flawlessly and flew the round-trip mission without a hitch. Before daylight Bradley and his crew departed Oman and returned to Wadi Kena without having to perform the recovery.⁵³

The 7th SOS remained at Wadi Kena through the 8th of April, re-deploying just in time to participate in Flintlock 80. The 7th SOS's participation in the annual joint/combined exercise continued as planned so that there would be no suspicion of anything else going on with the squadron. When 8th SOS aircraft deployed to Wadi Kena through Rhein Main AB, the JCS exercise continued to provide cover for the rescue mission. During the Wadi Kena operation, the 7th SOS deployed two aircraft and over 100 support personnel for 93 days. Approximately 95 percent of the squadron deployed there at one time or another, with 60 percent of the squadron physically on temporary duty to Egypt at any given time. As for Bradley, he spent 89 days out of the 93 deployed to Egypt.⁵⁴ By establishing a signature early in the year, the 7th SOS enabled the rescue force to deploy to Wadi Kena virtually undetected. No one outside the operation was even remotely aware of the true nature of the Talon mission.

From the beginnings of Operation Rice Bowl, the 1st SOS was an integral part of the rescue mission. All four of its aircraft previously had received the in-flight refueling modification, a capability that the JTF planners felt essential to

executing the mission. Kyle had just come from PACAF headquarters in Hawaii and was familiar with the 1st SOS and its unique aircraft. When Turczynski initiated his selected squadron recall on Christmas Eve, his crews had been landing without aircraft lights for more than a month but had not used NVGs for blacked-out operations. He briefed his crews on the new NVG requirement but did not divulge the reason behind it. Squadron personnel assumed that it was a new capability that had resulted from the commander's conference that Turczynski had just attended. Four crews began training in the new blacked-out procedure. Unit schedulers managed to coordinate a short-notice deployment to Yachon, Korea, on 26 December. Yachon was located approximately 50 miles northwest of Taegu AB and offered an isolated 10,000-foot-long runway that was ideal for NVG operations. Mitchell, the 314th AD SOF liaison officer at Osan AB, Korea, coordinated with the Republic of Korea Air Force to have the runway lights turned off. The Combat Talon flew a tactical aid to navigation (TACAN) approach to a full-stop landing using normal instrument procedures and runway lights. Once on the runway the crew transmitted a code word to the tower, and all airfield lighting was turned off. For the next three hours, the Combat Talon flew multiple blacked-out approaches and landings. When Turczynski called for departure clearance back to Kadena AB, the Yachon tower turned the airfield lights back on. The whole operation went exactly as planned. As with the 8th SOS, NVG blacked-out landings were new to the 1st SOS, and the crews had to develop their own procedures as they became proficient with the goggles. Turczynski decided that the capability could not be limited to four crews, so early on all crew members in the squadron began training with the devices. As the rest of the JTF rested over Christmas, the 1st SOS developed its new skills. By the first of the year, the squadron had advanced to a point whereby the crews felt confident landing with NVGs.⁵⁵

In early January Turczynski was tasked to deploy one Combat Talon and crew to Hurlburt Field for the next joint rehearsal. He reviewed the progress that his flyers had made over the previous

weeks, and selected two NVG crews.* The two crews included the following personnel:⁵⁶

Crew 1	Crew 2
Jubelt	Osborne
Nimmo	Fleming
Turczynski	Schwall
Sumida	Peppers
Beres	Townsend
Prator	Novy
Tafoya	Felton
Diehl	Devine
Frederickson	Hickman
Joy	Huff

Jubelt's crew was the first to deploy to the United States. The JTF had decided that it was time to mesh the 1st SOS with the combined training program being conducted by its sister squadron. There was little time to adjust to the training schedule. The JTF was again in a maximum-effort mode preparing for the next full-blown two-night rehearsal.

The New Year Brings New Challenges

As training progressed, additional requirements were identified as essential to the mission. Oliver and his developmental team at Detachment 4 were kept busy fulfilling those requirements. Before 1980 the Talon's terrain-following radar's maximum gross weight setting was 135,000 pounds. With the heavy fuel and equipment loads required for the mission, an increase of 30,000 pounds to this maximum gross weight was required. The increased weight capability would enable the TF computer to properly compute climb and dive commands and keep the aircraft at its proper set clearance. Oliver contacted John R. Lewis, the Lockheed radar specialist for the APQ-122(V)8 radar. Lewis, in coordination with LAS Ontario engineers, developed a "plus 30,000-pound weight chip" for the TF computer, which allowed the aircraft to terrain follow at a maximum gross weight of 165,000 pounds. The heavy-weight chip fixed the problem, and Oliver coordinated its installation in the Hurlburt Field Combat Talons. The next major challenge was to improve the communications capability of the aircraft.

*Thom Beres would move to the 8th SOS in March 1981, and Les Smith would move from the 8th SOS to the 1st SOS as the operations officer. Beres and Smith would exchange crew positions in their respective squadrons. Osborne would later take leave with his family to Taiwan and be temporarily replaced by Steve Fleming as aircraft commander. Paul Rumble was added to the crew as the safety pilot. Two days after Osborne went on leave, the crew deployed back to the United States for another round of exercises. Osborne did not return to the crew after his leave due to the accelerated pace of training. Art Schwall moved up to first-pilot duties, and Rumble assumed permanent duties as the safety pilot.

Vaught had been frustrated with the lack of dependable communications between the JTF and the rescue force and had tasked his communications experts to develop a way to improve overall secure communications. Satellite communications (SATCOM) proved to be a reliable means of long-range secure-voice communications. There was no provision, however, to mount the SATCOM antenna on the C-130. Oliver was given the task to develop a way to quickly mount an antenna. The mounting had to be portable, since there were not enough SATCOM sets to put on every aircraft. The antenna to be mounted was a Dorn Margollin dish-type unit that was about 18 inches in diameter and mounted on a center pedestal. The developmental team selected the forward escape hatch on the top of the C-130 as the best location for the antenna. Oliver had a unit flown to Ontario from the manufacturer, and he used his top-priority status to acquire a forward overhead escape hatch from the assembly line at Lockheed-Martin, Marietta, Georgia. After two quick days of design and assembly, the antenna was flight-tested on an MC-130E that was at LAS Ontario for periodic maintenance. Two days later the antenna was shipped to Kyle and the JTF. Almost immediately another request came to Oliver for a similar mounting for a C-141, and within another four-day period, he had the C-141 antenna completed.⁵⁷

The next problem area for Oliver was the Combat Talon FLIR system. The FLIR was nearly 10 years old by 1980 and had been adapted from the US Navy P-3 program for use during the Son Tay rescue mission. The original specification required that the FLIR be covert and not visible from the exterior of the aircraft. This requirement placed the set behind the nose landing gear, with the FLIR door covered by the aft nose landing gear door when the aircraft was on the ground. The installation required a pressure box to isolate the FLIR from the pressurized fuselage, a worm gear extension and retraction system, and a relatively sophisticated door to close up the whole system when not in use. The primary function of the FLIR was to provide an aid to navigation during terrain following. Before lowering the aircraft landing gear, the FLIR had to be retracted and was thus unusable to the crew for landing. Over the years, as funding for SOF decreased after the end of the Vietnam War, available FLIR assets were transferred to the 1st SOS and were employed for the Korean sea surveillance mission. None of the 7th or 8th SOS aircraft

had the FLIR installed, and their crews were not proficient in FLIR operations.

As the airland option for both Night One and Night Two developed, the need for a “gear-down, FLIR down” capability emerged. Oliver was tasked to find a solution. He removed an aft nose landing-gear door from a C-130 at LAS Ontario and had a semicircular opening cut in the door to allow the FLIR turret to be extended through it with the nose gear down. LAS engineers also designed a cover for the opening that could be installed when the capability was not required. There were also wiring changes needed to allow the FLIR to be down with the gear extended. With the modified door in the back of a Combat Talon, Oliver deployed to Hurlburt Field to test it on an 8th SOS aircraft.⁵⁸

Oliver arranged for an acoustical engineer to meet him at Hurlburt Field and to install sensors on the test bird to determine noise and vibration levels inside the aircraft. With the nose gear door installed, Meller’s crew flew a test mission out of Hurlburt Field to determine if Oliver’s brainchild provided a workable solution. With the cutout just below the flight deck, the noise and vibration proved totally unacceptable. The fix that Oliver’s team came up with proved to be one of its few failures.⁵⁹ Tactics used for the rescue mission were subsequently modified to allow for a gear-up “FLIR pass” by a Combat Talon down the runway to determine if the runway was clear of obstacles. The FLIR bird would then maneuver to land at the end of the aircraft flow. (When the Combat Talon II and the AC-130U gunship were developed and fielded in the late 1980s, the FLIR problem was finally solved by installing the FLIR ball in front of the nose gear. This arrangement allowed FLIR operation with the landing gear down. The requirement for a covert installation was no longer a factor, since many aircraft were equipped with FLIR by that time.)

* * * * *

January 1980 would prove to be the most demanding month during the preparation for the mission. Kyle had continued to work with his planners and had settled on a plan that required six Combat Talons for Night One—Brenci’s lead aircraft would carry the ranger airfield security force, Jubelt’s and Osborne’s aircraft would carry Delta Force, and Uttaro and Meller’s aircraft would be configured as bladder birds to refuel the helicopters. Four Combat Talons originally had been planned for the mission, but with the

addition of two more aircraft, the number of crews also had to be increased. With three 8th SOS crews and two 1st SOS crews trained in NVG operations by the first of January, an additional crew would be needed when three bladder systems became available.

It was during this period that Kyle thought about the EC-130E airborne battlefield command, control, and communications (ABCCC) aircraft that were stationed at Keesler AFB, Mississippi. The aircraft were equipped with the in-flight refueling modification and had been modified to accommodate a large capsule that could be removed during aircraft maintenance. With the capsule removed the ABCCC aircraft, with their Dash 15 engines and relatively lightweight, seemed ideal to Kyle for the bladder-bird mission. Unlike the Combat Talon, the ABCCC aircraft did not have a permanent console mounted in the cargo compartment and could accommodate two of the 3,000-pound fuel bladders as compared to one for the Combat Talon. Intelligence indicated that en route altitudes to the objective area significantly above Combat Talon terrain-following clearances were adequate for the Night One mission. Utilizing the ABCCC aircraft as bladder birds, 10 helicopters could be refueled by three aircraft, with associated hoses, pumps, and filters carried on the cargo ramp. The number of helicopters required for the mission was still up in the air in early January, so Kyle delayed sourcing the ABCCC aircraft for security reasons. He theorized that he could always get the Keesler AFB aircraft if he needed them. In the meantime Vaught was pushing for another combined exercise that included the 1st SOS.⁶⁰

From 3 to 5 January, Meller's crew deployed to Pope AFB for fuel-cell testing. Brenci's crew also deployed to Pope AFB from 8 to 10 January for testing of chemical lights (chem-light sticks) for runway marking. Meller and Uttaro joined Brenci for fuel-blivet drops at Pope AFB from 9 to 10 January. Thirty fuel blivets were air-dropped from the three Talons without a single failure. The dispersion pattern on the ground proved to be acceptable. Both at Hurlburt Field and at Pope AFB, almost every night saw some form of mission-related training being conducted. By midmonth Jubelt's crew had arrived from Kadena AB, and Turczynski was busy getting himself and his crew up to speed for the next combined exercise.⁶¹ During the deployment from Kadena AB, Kyle had directed that Jubelt stop at LAS Ontario. On a Sunday afternoon the 1st SOS crew landed and was met by

Oliver and his team. The aircraft remained overnight as Lockheed technicians proofed the newly developed "+ 30,000-pound" chip for the TF radar. The following morning Beres flew with Oliver and the Detachment 4 crew to flight check the installation. Aircraft 64-0565 passed successfully and became the first heavyweight-modified Combat Talon. Later in the day Jubelt and the remainder of the crew took off and headed towards Hurlburt Field. Also aboard the aircraft was the prototype Benson tank system that Oliver had been developing for the refueling operation. As the aircraft leveled off at altitude, fuel fumes began venting from the tank, forcing the crew to return to Ontario for repairs. The problem was solved that evening, and the crew made an uneventful flight to Florida the following morning.

The mid-January exercise was planned to replicate the complete 48-hour, two-day mission cycle. Four Combat Talons staged out of Hurlburt Field and unloaded both Delta Force and the rangers at TAB-6 in the Eglin AFB range complex. Night one was planned for Desert Rock, a small auxiliary airfield located in the Nellis AFB range complex, and night two was planned for Indian Springs Airfield, Nevada. Brenci, in Combat Talon 64-0562, had his "Rat Patrol" ranger assault force on board and was the first aircraft scheduled to land at Desert Rock. Talon 64-0572 with Meller's crew was the number two aircraft and Talon 64-0565 with Jubelt's crew was the number three aircraft. These aircraft featured the Sealy configuration and had Delta Force on board. Uttaro's aircraft (64-0567) was the number four Combat Talon that was configured as a bladder bird. (There was still only one operational bladder system.) Uttaro's aircraft configuration was designated Exxon to denote the aircraft's fuel tanker status. Jubelt was also scheduled to make an initial FLIR pass down the Desert Rock runway to determine if the runway was clear of obstacles and suitable for Brenci's initial landing.⁶²

All four aircraft departed TAB-6 with their scheduled loads and proceeded high level to their refueling track over north Texas. Unknown to the task force, one of the KC-135 tankers scheduled to refuel the Talons had aborted for a landing gear malfunction, and its wingman also had "sympathetically" aborted, thus leaving no tanker support for the Night One mission. By the time Kyle learned of the situation, it was too late to scramble a backup tanker. As the extended four-ship formation approached the Dallas, Texas, area, ATC

was asked to coordinate a 180-degree course reversal back to northwest Florida. Several minutes of pandemonium with ATC resulted, but the formation managed to reverse itself and proceed back to TAB-6 to return the rescue force to their isolation facility. Night One had been a bust.⁶³ It was the one and only time that a rehearsal had to abort for lack of tanker support. By the time Vaught and Kyle finished rearranging SAC's priorities, everyone was on the same sheet of music.

Night Two operations were more successful. The rangers were unloaded at TAB-6 in a blinding rainstorm, and the four-ship formation, all rigged in the Sealy configuration, departed for Indian Springs with an air refueling again scheduled over north Texas. The refueling operation went smoothly, and the formation proceeded to its objective area. Clouds over the mountains obscured the terrain during the ARA, but all aircraft made it safely down for their NVG landing. Jubelt's aircraft was the first across the airfield, confirming that the runway was clear with his FLIR. Brenci was one minute behind him for landing. On short final, while relying on the pressure altimeter for height reference, Brenci's crew came dangerously close to the desert floor short of the runway and had to execute a go-around. Procedures developed over the previous six weeks had relied on the pressure altimeter as the primary altitude reference during the approach to landing. The pressure altimeter required an accurate local altimeter setting to give correct information. With a weather system moving through the area, barometric pressure had changed, and without a source for the correct setting, Brenci's altimeter read higher than the aircraft's actual altitude. Because of the incident, procedures were modified so that from that time forward crews used the radar altimeter for primary height reference during NVG approaches to uncontrolled airfields.⁶⁴

With Brenci executing a go-around, the following three aircraft landed in sequence without a security force on the airfield. Brenci landed last. Another valuable lesson was learned—if the landing sequence were disrupted for any reason, plans had to include options for the follow-on aircraft flow so that the proper element was on the ground in proper order (a lesson that was forgotten in Grenada three years later). Once on the ground, aircraft movement was again confused with aircrews and rangers not communicating with each other, partially because of nonstandard hand signals. Because of

the confusion, USAF CCT personnel later were assigned the sole responsibility for marshaling aircraft while on the ground.⁶⁵

After the airfield seizure operation, all aircraft departed Indian Springs en route back to TAB-6 and Hurlburt Field. A second IFR was accomplished without incident between Tucumcari, New Mexico, and Childress, Texas. The entire flight logged an average of 14.6 hours for each aircraft and a total of 79.9 hours. Although long and exhausting, the routes and times closely replicated the ones required to ingress and egress Iran. Kyle was somewhat pleased with the exercise, but the lessons learned about the pressure altimeter and the aircraft ground-marshaling plan had to be quickly incorporated into standard operating procedures. There was no time to waste—another practice was scheduled from 28 January to 4 February.

Four Combat Talon crews had participated in the midmonth Indian Springs exercise. Kyle's vision was to use six Combat Talons for the Night One mission or to use a combination of Combat Talons and ABCCC aircraft. It was time to increase the number of crews from four to five for the next exercise. Jubelt and his crew had performed well during their first exercise; a testimony to the preparation that Turczynski had made in getting his squadron ready. Kyle called on the 1st SOS for the fifth crew, and in short order Capt Bill Osborne and his crew was headed east in Combat Talon 64-0564 from Kadena AB to Hurlburt Field, with an en route stop in Hawaii for fuel and crew rest. East of Guam, Osborne rendezvoused with a KC-135 tanker and spent the next hour dodging thunderstorms and combating turbulence as he unloaded 30,000 pounds of fuel. With a full fuel load, the aircraft proceeded towards Hawaii. About an hour later the engine fire warning light illuminated for the number four engine, indicating an engine fire. After shutting the engine down, the firelight remained illuminated, and one of two fire bottles was discharged. The fire indication went out, and the flight engineer, along with the loadmasters, scanned the engine for any further sign of fire. All was well with the crew adjusting its altitude and en route airspeed for three-engine operations. To the surprise of Osborne and his crew, Col Dick Dunwoody came up on the flight deck during the emergency. As the commander of the 1st SOW, he had been deployed to Guam with the four gunships. He had hitched a ride on the Talon, but the crew did not know his identity until the emergency. Osborne continued on to Hawaii,

where he landed without further incident. It took another two days to repair the aircraft and once again get moving towards Hurlburt Field. Dunwoody arranged a commercial flight out of Hawaii and continued to Hurlburt Field immediately after Osborne landed.⁶⁶

Before departing from Hawaii, Osborne called back to the squadron at Kadena AB and was instructed to make an operation's stop at LAS Ontario en route to Hurlburt Field. To make the scheduled landing time at Hurlburt Field, Osborne had to land at LAS Ontario at 0200 Pacific standard time. The crew thought it strange that LAS Ontario would be open at that hour of the night, but pressed on to California anyway. On landing, the aircraft taxied to the controlled ramp at LAS Ontario just as Jubelt had done earlier in the month, and the security gate opened to allow the aircraft to enter. On shutdown Oliver appeared on the flight deck, along with Buie Kindle and their maintenance crew. The aircraft had been diverted to LAS Ontario for installation of the 30,000-pound heavyweight chip for the TF radar. Within two hours Oliver and his team had Osborne airborne and on its way for the final leg to Hurlburt Field. Just as planned the 1st SOS crew landed at Hurlburt Field and was met by Turczynski, Captain Lewis, and Captain Bakke. For the next two hours, Osborne's crew was in-briefed by Turczynski's team, and the details of the upcoming exercise were laid out for the crew to digest. Turczynski's second crew was now in the thick of the operation.⁶⁷

The last 10 days of January 1980 was an extremely busy period. Each day marked another milestone that would enhance the Talon crews' ability to accomplish their mission. Formation in-flight refueling utilizing the new communications-out procedure was practiced during the nights of 23 and 24 January. Jubelt's crew also worked on its FLIR procedures, while Osborne's crew flew in the Eglin AFB range to familiarize itself with multiship operations.⁶⁸

On 28 January Jubelt and Osborne deployed to Pope AFB to preposition their aircraft for the next exercise. Turczynski was the element commander responsible for getting the aircraft and crews settled down for the overnight stay at Pope AFB. He also coordinated aircraft servicing and the launch schedule for the following day. The weather forecast was not good, but with a little luck, all would go well for the exercise scheduled to begin on 29 January. The two Talons were parked on the Yellow Ramp away from the main C-130 operating

area, and the crews were billeted in Eisenhower Hall at Fort Bragg, the US Army base adjacent to Pope AFB. When the crews awoke the next morning, there were easily six inches of snow covering the ground. Turczynski was in crew rest with the two crews, and when he arrived at Pope AFB in the early afternoon, he was confronted with his maintainer's request for support. Pope AFB was in the midst of a heavy local-training day air-dropping the 18th Airborne Corps and would not send fuel trucks or aircraft deicing equipment to the remote area where the Talons were parked. Faced with mission delay or possible cancellation, Turczynski swung into action. For the remainder of the afternoon, he did everything humanly possible to get the Pope AFB wing to support his early evening launch but to no avail. He even visited the wing commander and asked for his support but was shackled by security restrictions that prevented him from divulging the nature of his mission. He found that a mere lieutenant colonel with two special operations MC-130s had absolutely no priority at Pope AFB. Turczynski reluctantly found a secure telephone at the base command post and called Kyle. The East Coast snowstorm had also delayed other aircraft participating in the rehearsal along with the two Talons. There was nothing left for Vaught to do but to cancel the night's rehearsal and reschedule it for the following evening, 30 January.⁶⁹

The entire rehearsal was postponed for 24 hours. The next day, when Turczynski and his crews arrived at the Yellow Ramp, it was literally alive with support personnel. From the wing commander on down, every colonel on Pope AFB who had even a remote responsibility for supporting an aircraft launch was present. Fuel trucks, deicing trucks, and trucks to refuel the deicing trucks were all standing by. Kyle had made a couple of telephone calls, and Pope AFB's priorities were rearranged.⁷⁰ There would be no delays ever again at Pope AFB due to nonsupport of the operation.

For this rehearsal Desert Rock, Nevada, was again used for Night One operations, and Indian Springs was used for Night Two. Jubelt and Osborne carried Delta Force, and Brenci carried the rangers, with all three aircraft rigged in the Sealy configuration. Uttaro and Meller were both Exxon configured, with a complete fuel-bladder system installed on both aircraft for the first time. Jubelt, in aircraft 64-0565, was the first aircraft to take off from Pope AFB, followed five minutes later by Osborne in aircraft 64-0564. Brenci departed Hurlburt Field 25 minutes later

and headed west in aircraft 64-0562. Forty-five minutes after Brenci's takeoff, Uttaro and Meller departed Hurlburt Field with five-minute spacing. Again, a refueling track was established over north Texas, and Jubelt, Brenci, and Osborne successfully unloaded 25,000 pounds of fuel each during a communications-out cell refueling. During the refueling operation an air traffic controller questioned why so many C-130s were heading west at the same time. He openly speculated that it must be a practice for a possible rescue attempt of the hostages in Iran. Although he had no knowledge of the actual mission, he had guessed exactly what was going on. Later procedures that did not rely on verbal transmissions to air traffic control were developed that reduced the possibility of a lucky guess. One hour after the first two aircraft had finished refueling, Uttaro and Meller hit the track and also unloaded 25,000 pounds of fuel. When the second element departed the tanker track, Jubelt was still three hours out of Desert Rock.⁷¹

Jubelt's FLIR approach to Desert Rock went flawlessly, and he made a planned go-around to maneuver for landing behind Uttaro. Brenci was the first to land, touching down on the blacked-out runway exactly one minute after Jubelt's FLIR pass. Williford's rangers departed Brenci's aircraft and set about securing the airfield. By this time, the rangers had acquired enough NVGs for every soldier to be issued a set. The gun jeep and the CCT motorcycles also had IR paper lenses installed over their headlights. The seizure went like clockwork. Twenty minutes after Brenci's landing, Osborne was on the ground with Delta Force, and five minutes later Jubelt was down with the rest of Beckwith's men. With their personnel downloaded, Jubelt, Brenci, and Osborne departed the airfield to make room for the two Exxon aircraft and the RH-53Ds. Ten minutes after Brenci departed, Uttaro and Meller landed in five-minute trail formation. The two aircraft taxied into their planned refueling positions and waited for the RH-53Ds to arrive. When the helicopters landed later than planned, the two Combat Talons backed up using reverse propeller thrust to reach the static helicopters (planners had determined that it was safer to back up the Talon than to taxi the large helicopters near the C-130 and risk contact with the main rotors). Some problems were encountered during the refueling operation that were attributed to determining the exact distance from the helicopters to the Combat Talon aircraft. Delta Force loaded on to the RH-53Ds

after the refueling operation was completed, and the rangers collapsed their perimeter defenses and departed the airfield onboard the two Talons. In-flight refueling went flawlessly during the return leg, and all aircraft landed back at Hurlburt Field, logging an average of 14.5 hours each.⁷²

Ten hours after Meller's Talon landed at Hurlburt Field, the five crews were assembled for the mission brief for Night Two. All five Combat Talons were Sealy configured, with a landing sequence of Meller, Brenci, Uttaro, Osborne, and Jubelt. As was the case during Night One, Jubelt's crew would make an initial FLIR pass over Indian Springs to determine if the runway was clear. Meller would be the first to land on the blacked-out runway. Jubelt was the first to depart Hurlburt Field, followed three minutes later by Meller, and then the rest of the formation five minutes in trail. The in-bound refueling operation with the KC-135 went as planned. Seven and one-half hours after takeoff, Jubelt was making his FLIR pass over Indian Springs. One minute later Meller was on the ground, with Brenci landing one minute after him. Five minutes after Brenci's landing, Uttaro landed, followed two minutes later by Osborne, then Jubelt.

Prior to the arrival of the Talons at Indian Springs, Delta Force assaulted a simulated embassy compound that was 30 miles from the airfield. The helicopter formation that was to extract Delta Force from the embassy compound was late arriving, thus causing a delay in transporting Delta Force to its exfiltration point at Indian Springs. The helicopters showed up over two hours late at Indian Springs, and Delta Force, along with the role-playing hostages, boarded the Talons and departed the airfield.⁷³ For both nights' rehearsals, the fixed-wing portion of the plan had gone almost flawlessly. The late arrival of the helicopters on both nights, however, created some doubt in the minds of the Talon crews of the helicopter crews' ability to execute the actual mission on the planned time line.

As the simulated embassy takedown and exfiltration operation was taking place, an AC-130H gunship orbited over Indian Springs to provide on-call fire support. The entire two-night rehearsal was considered a huge success by senior leadership. For the first time since training began in November, the JTF could savor the satisfaction of having a workable plan on the shelf. There were a lot of moving parts, and they all had to mesh. Weather also had to cooperate to ensure mission success. A feeling of accomplishment permeated

the rescue force (except perhaps the helicopters). Vaught quickly relayed the news to the CJCS and the Joint Staff that the JTF had a workable plan. He had a private meeting with the chairman and came away from it a bit deflated—the administration was getting cold feet regarding a military option. The political climate in Iran seemed to be swaying back towards a release of the hostages. The roller-coaster ride that the JTF had been on for three months had just taken a nosedive.⁷⁴

At Hurlburt Field the Talon crews were ecstatic. Two solid months of intense training had paid off. Throughout the history of special operations, those who operated Combat Talon prized individualism and personal abilities. The nature of a lone Combat Talon penetrating hostile airspace at low level for hours on end bred a sense of independence and individualism in those who flew them. But the successful rehearsal brought out new feelings among the special operations participants—the feeling of teamwork and the realization that the sum of the parts for mission success was greater than the effort of a single crew. The rehearsal had been a success because of teamwork and because every individual involved did his best. Everyone was exhausted after the two-day practice, and an early beer at the club was a welcomed relief. The mission was doable, and the Combat Talon community was going to put the JTF on its back and make it happen.

* * * * *

With Washington again in a wait-and-see mode, the intensity of JTF operations ratcheted down several notches during the early days of February. Part of the more relaxed climate was a direct result of the successful rehearsal conducted at Desert Rock and at Indian Springs. Turczynski took his two aircraft and crews back to Kadena AB, and the 8th SOS caught its breath as it concentrated on continuation-training requirements for the squadron. The general feeling at Hurlburt Field was that Washington had decided to pursue a political solution to the hostage crisis and that the mission was no longer high on President Carter's list of options. Les Smith departed the 8th SOS and headed for Kadena AB as Turczynski's new operations officer, and Brenci moved up to become the operations officer of the 8th SOS under Guidry.

At J3-SOD Hess continued to coordinate actions of the JTF with Taylor's OPG. Although much had been done by the JTF to develop the rescue option, the OPG had continued to look at other possibilities designed to punish Tehran if the hostages were harmed. The punitive-strike option by the four gunships stationed at Guam continued to be one such possibility. At the 8th SOS a fifth Combat Talon crew was formed in early January under the command of Capt John Arnold. His crew flew initial missions from 9 to 24 January 1980 testing the feasibility of new technology that was designed to seriously degrade Tehran's ability to produce and transport electrical power through its grid network. The program was code-named Project Elbow Rub and continued throughout 1980 in anticipation of employment against Iran. In early April Arnold and his primary loadmaster, Rudy Blazek, deployed to the Pacific with the capability, and two 1st SOS Combat Talons (aircraft 62-1843 and 63-7785) were modified to deliver it. A third 1st SOS crew, commanded by John Pearson, was trained for the Elbow Rub mission. Turczynski was selected by PACOM as the mission commander should the mission be employed. When Turczynski deployed to Diego Garcia in mid-April, Arnold and Blazek moved the Elbow Rub equipment by way of C-141 to Diego Garcia to provide Turczynski the capability to use it should the situation dictate. Although neither the gunship strike nor the capability developed by Arnold and his crew was ever used against Iran, the OPG had both options ready in case they were needed.*

February 1980: The Relentless Pursuit of Excellence

Although the hectic pace had subsided a bit at Hurlburt Field, the February lull provided Brenci and his 8th SOS crews time to refine and perfect their newly acquired NVG, air-drop, and communications skills. Both Kyle and Hess went on much needed leaves after finishing postexercise requirements. The antenna that Oliver's development team had manufactured was installed on a Combat Talon, and on 15 and 16 February, the SATCOM system was tested for its suitability to the MC-130E. The test validated the installation, giving commanders, from the president on down, the ability to communicate with the aircraft—in flight or on the ground—nearly anywhere in the

*Project Elbow Rub remained highly classified throughout the 1990s. The exact nature of the capability developed during 1980 remained on the cutting edge of military technology. John Arnold continued to be associated with Special Operations and became known for his intellect and keen ability to grasp difficult concepts and then apply them to unique military requirements.

world. Before acquiring the SATCOM Combat Talon had relied on the HF radio for long-range communications, with scrambling and decoding devices required if communications were kept secure.⁷⁵

From 20 to 24 February, refurbished FLIR systems were installed and tested on the three 8th SOS aircraft. Most Hurlburt Field aircrews had never seen an FLIR since they had not been installed in TAC MC-130s over most of the previous 10 years. Only the 1st SOS had maintained the FLIR capability throughout the 1970s for its sea surveillance mission. Hurlburt Field crews soon mastered the system and incorporated the FLIR into their low-level mission profile. It was none too soon—Vaught was getting nervous about the relaxed pace of the JTF. He was also uneasy about the helicopters—they had yet to show that they could accurately navigate to the rendezvous site on time. He and his JTF staff wanted another full-scale rehearsal, but the CJCS denied his request. A political solution was being vigorously pursued by the Carter administration, and Jones did not want to risk affecting that process. Towards the end of February, Jones reluctantly approved a limited joint training exercise for a portion of the JTF. It so happened that both Kyle and Hess were still on leave when the planning began for the late February rehearsal. Through oversight of the JTF planners, Turczynski was not notified in time to bring his two crews back from Kadena AB to participate in the rehearsal. The 8th SOS crews interpreted their absence as another indication that President Carter was not seriously considering a military option.

On 25 February Uttaro prepositioned his Combat Talon (aircraft 64-0572) to Pope AFB in preparation for a 26 February launch. The limited rehearsal was scheduled to use Twenty-Nine Palms for Night One and Laguna AAF for Night Two, with both scenarios compressed into the same night. Only three Combat Talons were available for this practice, with Brenci flying 64-0562 and Meller flying 64-0567. One nonair-refuelable AC-130H, commanded by Dunwoody, also participated in the exercise. (Dunwoody would land at Davis-Monthan AFB to refuel.) Uttaro's and Brenci's aircraft were both in the Sealy configuration, with Uttaro carrying Delta Force and Brenci carrying a reduced ranger airfield seizure package. Meller's aircraft was in the Exxon configuration and for the first time had internal pallet-mounted twin Benson tanks installed instead of the rubber fuel bladder. (Oliver's team had come through again with a

prototype twin-tank, roll-on, roll-off assembly.) The now-standard sequence of events began on 26 February, when Uttaro departed Pope AFB with his Delta Force on board. Brenci was next, taking off from Hurlburt Field one hour after Uttaro left Pope AFB. One hour after Brenci, Meller was airborne from Hurlburt Field. Uttaro and Brenci joined up en route and refueled in cell formation with a KC-135 tanker and then proceeded towards Twenty-Nine Palms. Meller followed the other two aircraft with a single-ship refueling and continued on his flight-planned route.⁷⁶

Uttaro flew the FLIR clearing pass over Twenty-Nine Palms with the newly installed FLIR system, and Brenci landed on the blacked-out runway one minute later with his ranger airfield-seizure package. Fifteen minutes after Brenci's landing, Uttaro was down with Delta Force. A short time later, Brenci was airborne, with Uttaro following him 15 minutes later. Meller was the last to land at Twenty-Nine Palms, and he taxied into position and began to set up for the scheduled helicopter refueling. Weather in the high-desert country of southern California had been marginal during the operation, but all three Talons were able to make their scheduled landings as planned. The helicopters, however, could not make it through the mountain passes to the airfield and had to return to Laguna AAF. With the helicopters canceled due to weather, Meller's crew loaded up the rangers and departed Twenty-Nine Palms. With the three Talons airborne, Vaught decided to rehearse the ground helicopter refueling operation at Laguna AAF. The short one-hour flight was uneventful, and Meller was the first to land at Laguna AAF, followed by Brenci and Uttaro. After another hour on the ground waiting for the helicopters, the three Talons departed for a short flight to Davis-Monthan AFB, where they went into crew rest for their return flight to Florida the following day. Late in the evening on 28 February, the three aircraft arrived back at Hurlburt Field.⁷⁷

The limited rehearsal had not gone as well as Vaught and Kyle had expected, primarily due to bad weather and its impact on the helicopters. The Combat Talon portion of the exercise was perfect, with even Vaught commenting to Kyle on how well he thought the Talon crews performed. The weather had been a problem for the helicopters but not for the fixed-wing aircraft.

By March 1980 only about 11 hours of darkness were available for the rescue force to complete its Night One operation. The helicopters

* * * * *

required eight and one-half hours of darkness to penetrate into the center of Iran, refuel, and fly on to their hide site before first light. If all went according to plan, the helicopters had an hour and a half to spare. The last Combat Talon had to be clear of Iranian airspace no later than nine hours after darkness. Figuring a 30-minute pad for the Talons and one hour for the helicopters, 1 May was the last night with nine and one-half hours of darkness. The mission had to go on or before that date.⁷⁸

Life at Kadena AB had settled down a bit after Jubelt and Osborne returned from the early February exercise. The squadron had continued to refine its blacked-out NVG procedures and had increased its formed crews from two to three. Heavy equipment drops, including the 5,000-pound blivet, were not practiced because of the lack of equipment and rigging support in the Pacific. Communications-out IFR and low-level formation procedures were practiced. The month of February passed quickly as the Pacific Combat Talon crews maintained their flight proficiency, and March began with no indication of increased JTF activity. Osborne reluctantly went on a long leave with his family to Taiwan. Two days after his departure, Turczynski got a call to deploy two aircraft and two crews back to the United States. With Osborne off the island, Fleming moved up to aircraft commander, and Ruple was added to the second crew as the safety pilot. Turczynski's three crews included the following personnel:*

Crew 1	Crew 2	Crew 3
Jubelt	Fleming	Pearson
Nimmo	Schwall	Osborne
Turczynski	Ruple	Wilson
Sumida	Peppers	Ozlin
Smith	Townsend	Ross
Prater	Novy	Perkumas
Tafoya	Felton	Banks
Diehl	Devine	Farrell
Frederickson	Hickman	Kirby
Joy	Huff	Baker
--	--	Hamilton

Deployment to Hurlburt Field went smoothly for Jubelt and Fleming. They arrived back in Florida to find the 8th SOS preparing for another full-blown dress rehearsal. The next exercise was scheduled for 25–27 March.

From the early stages of Operation Rice Bowl, JTF planners had selected Manzariyeh as the Night Two exfiltration location. Night One had remained up in the air as various options were considered. The first option developed by the JTF was to air-drop fuel blivets in an isolated location in the interior of Iran, and then refuel the helicopters from these blivets. Beckwith did not like this option because there were too many variables in the plan. What if the blivets landed in a ravine and couldn't be moved? Or, what if the helicopters could not find the blivets after they were air-dropped? What if the parachute-delivery system failed? Beckwith's unanswered list of questions was a long one. The second option, and the one most exercised during the training phase leading up to the March rehearsal, was airlanding the fixed-wing aircraft on a small, disused airfield somewhere in central Iran and seizing it for follow-on refueling operations. This option left the ranger security force on the airfield for 24 hours while Delta Force, aboard the helicopters, moved to the Tehran area for the rescue. The rangers would be exfiltrated the following night at the same time that Delta Force and the hostages were being extracted. Planners felt this option was somewhat "iffy" because of the extended time required on the ground in Iran. The third option considered by JTF planners called for a landing at a remote desert-landing site and refueling the helicopters from the C-130s. After completion of the refueling operation, the C-130s would depart Iran before first light, and the helicopters would proceed to a laager site to await Night Two.

The challenge for the third option was finding a suitable landing site that could support heavy C-130 aircraft. By February the JTF intelligence section had located a site that promised to fulfill the Night One airland requirement. The location was a large, flat area of compacted sand located approximately 530 miles from the southwest coast of Iran and about 220 miles from the desert hide site selected for the overnight layover of the helicopters. Using those distances, the helicopters could reach the location from their carrier launch point, refuel, fly to the hide site, and still have enough fuel to make it to Tehran to pick up the hostages and then fly on to Manzariyeh. There was one drawback to the location—a dirt road ran down the center of the area being considered for the

*Crew 3 was the primary Elbow Rub crew and the spare crew for the rescue mission. Had Elbow Rub launched, Pearson's crew would have been augmented by Arnold, Blazek, and Turczynski, the mission commander.

landing zone. The road appeared to be similar to rural dirt roads in America and connected the two small towns of Yazd and Tabas. How much traffic traveled the road at night was a question that could not yet be answered.⁷⁹ By March the desert landing location had been identified as Desert One, with the helicopter overnight hide site called Desert Two. Kyle was adamant about one thing before landing a C-130 in the desert—there had to be a site survey done to determine if the subsurface could support the heavyweight aircraft.

From aerial photos Desert One appeared to offer a suitable landing area. With the dirt road on one side, there were approximately 4,000 feet of hard sand that could be used for a runway. North of the road also appeared to be usable. Tracks of vehicles cutting across the area indicated that the sand there was also compacted and could at least support heavy trucks. For the site to accommodate six C-130s and eight helicopters, an area 800 feet wide was needed near the end of each runway. To ensure that the site could handle C-130 aircraft and to put into place some means for the C-130 crews to determine the beginning of the landing zone, a survey mission had to be flown to the site before commencement of the operation.⁸⁰

With the sourcing of a second bladder system, it was time to expand the 8th SOS crew pool from three to four. The prototype Benson tank used by Meller’s crew during the previous dress rehearsal was still under development, and it would take Detachment 4 and LAS Ontario some time to field the production version. The JTF decided to proceed with the rubber fuel bladders since they were on the shelf and available. Brenci realigned his existing three crews and created a fourth crew commanded by Capt Hal Lewis. Some new personnel were brought on board, with the four formed 8th SOS crews consisting of the following personnel:

Crew 1	Crew 2	Crew 3	Crew 4
Brenci	Uttaro	Meller	Lewis
Tharp	Diggins	Thigpen	McIntosh
Ferkes	Bagby	Williamson	Harrison
Chapman	Beres	Lauder	Bakke
Galloway	Weaver	McBride	McMillan
Gamble	Yagher	Robb	Drohan
Almanzar	Newberry	Daigenault	Mayo
Chitwood	Gingerich	Mink	Beyers
Wiley	Doyle	Chesser	McClain
Sanchez	Metherell	Thomas	Bancroft

Hurlburt Field had been scheduled for major runway resurfacing and repair during fiscal year 80, and the contractor had been continually postponed in starting the work. Since Hurlburt Field had only one runway, the repair would close the airfield for an extended period. Therefore, on 14 March all Combat Talons were moved to Eglin AFB, and the gunships were relocated to Duke Field. Future operations would stage out of Eglin AFB, with aircrews and maintenance personnel being shuttled from Hurlburt Field for each flight. The 1st SOS aircraft also staged out of Eglin AFB when they returned for the next exercise.

By March Kyle was ready to source one EC-130E (ABCCC) aircraft from Keesler AFB, Mississippi. His security concerns had been minimized when Pinard’s maintenance deputy, Colonel Robertson, was transferred from Hurlburt Field to Keesler AFB to become the chief of maintenance for the ABCCC outfit. Darden and a basic Combat Talon crew picked up ABCCC aircraft 62-1857 in mid-March, and training began to develop low-level formation procedures with the Combat Talon. The EC-130E did not have the sophisticated radar and navigational equipment found on the Combat Talon. For the next two weeks, formation flights were conducted to allow crews to become proficient in the ABCCC aircraft. With the large communications capsule removed, there was a full cargo compartment that could handle two of the rubber fuel bladders. With the in-flight refueling modification already installed on the aircraft, it was nearly ideal for the bladder-refueling mission.

Preparation for the 25 to 27 March rehearsals intensified as the JTF fixed-wing aircraft operated out of Eglin AFB. Still uneasy about refueling the helicopters on the ground, Kyle had asked Guidry to look at the possibility of refueling the helicopters in flight using the Combat Talon. Without refueling pods installed, Guidry looked at the possibility of extending a refueling hose out the ramp of the Talon to allow the helicopter to refuel immediately behind the aircraft. A test mission was flown on 18 March with a 20th SOS helicopter, and Guidry determined that turbulence immediately behind the Talon was too great to allow safe operation of a centerline hose system. Guidry reported back to Kyle that the only way to refuel the helicopters was to have the wing refueling pods installed on the Talons. Oliver was working a solution at LAS Ontario, but the lead time was too long for the capability to be in place for the rescue attempt.⁸¹

The prototype Benson tank was operating well in aircraft 64-0572, but it could only be used for ground refueling of the helicopters or to replenish the aircraft's own fuel supply.

The next dress rehearsal began on 24 March when Jubelt, in aircraft 64-0565, and Fleming, in aircraft 64-0568 (nonair-refuelable), departed Eglin AFB for Pope AFB.* With their now-standard Sealy configuration, they would transport Delta Force the following night to Twenty-Nine Palms for the Night One transload to the helicopters. Indian Springs would serve as the night two rehearsal site. On 25 March Jubelt was the first to take off out of Pope AFB, with Brenci in aircraft 64-0551 (nonair-refuelable) and his ranger force the next to get airborne at Eglin AFB. At Pope AFB Fleming was the third aircraft in the flow to take off, followed by Uttaro (64-0572), Lewis (64-0567), and Meller (64-0562) in two-minute trail formation out of Eglin AFB. Lewis and Meller were both delayed slightly but made up the lost time en route to the tanker track. Uttaro's aircraft had the Benson tank installed, with Lewis and Meller in the standard Exxon configuration with a rubber fuel bladder in each aircraft. Jubelt refueled over Abilene, Texas, as Brenci and Fleming pressed on to their low-level entry points. Uttaro, Lewis, and Meller also refueled from a KC-135 tanker.⁸²

At Twenty-Nine Palms the airfield assault went like clockwork, with each Talon executing its approach and landing exactly as planned. Lewis's crew, participating as a formed crew in a joint exercise for the first time, performed like old hands. Even the helicopters arrived as planned and were refueled without incident. After departure from Twenty-Nine Palms, both Brenci and Fleming stopped for fuel before returning to Eglin AFB. The other four aircraft refueled over Texas during their return leg.⁸³

For the Night Two rehearsal, four Combat Talons and one C-141 were used. Meller had trained a C-141 crew in NVG operations at Hurlburt Field back in February, and the crew had been working on its own aircraft-specific procedures since that time. As Beckwith's Delta Force team expanded to 120 personnel to execute the complex hostage-rescue plan, JTF planners turned to the larger and faster C-141 aircraft to accommodate the increased load. The C-141 could also deliver any wounded personnel to a medical facility

almost twice as fast as could the C-130. Like the ABCCC aircraft, however, it had limited low-level navigational capability, and it required additional navigational aids on the airfield to make a successful approach and landing.⁸⁴

Four Combat Talons, one C-141, and one AC-130H gunship were used for the Night Two rehearsal. All aircraft, except the C-141, originated from Eglin AFB, with Gallagher in the AC-130H being the first to depart. The four Combat Talons were in the Sealy configuration with rangers on board and were commanded by Jubelt, Meller, Uttaro, and Lewis. All four Talon aircraft refueled in cell with two KC-135 tankers three hours after takeoff. After an extended low-level route, Jubelt again made a FLIR pass at Indian Springs, with Meller landing one minute later. Uttaro followed Meller 60 seconds later, with Lewis two minutes behind Uttaro. Jubelt landed last, two minutes after Lewis touched down.⁸⁵

As the aircraft were landing at Indian Springs, Gallagher's AC-130 was orbiting some 20 miles from the airfield. Beckwith transmitted the code word Ornament over secure radio, signaling that Delta Force was going over the embassy wall to rescue the hostages. The call came just before Jubelt's FLIR pass. Indian Springs was secure within 20 minutes of Meller's landing, and the C-141 was cleared for its approach. The CCT had installed a portable TACAN near the approach end of the runway and portable landing lights down the runway to help the larger aircraft to land. As the C-141 crew approached the airfield, the pilot initiated a go around and made a low approach. The aircraft flew a second approach with the same results. After several tries, and with the helicopters landing, Vaught called time out and had the regular airfield runway lights turned on for safety purposes. With the C-141 finally down, the transload operation was completed. The remainder of the rehearsal went smoothly. One of the helicopters had gotten lost en route to the embassy objective area and had impacted Beckwith's timing. The helicopters were again late to arrive at the airfield for transload of personnel to the C-141 and to the Combat Talons.⁸⁶

All aircraft departed Indian Springs as planned, with the four Combat Talons and the gunship refueling for a second time en route back to Eglin AFB. The C-141 returned Delta

*Turczynski did not participate in the 24-25 March dress rehearsal. He was tasked to remain at Kadena AB and be prepared to launch the Elbow Rub mission if that option was selected. Kyle was not read into the Elbow Rub mission and was quite perturbed when he found out that Turczynski could not return to the United States for the final rehearsal. The next time Turczynski would join the JTF would be at Masirah Island, Oman, during the execution phase of the rescue mission.

Force and the JTF staff to Pope AFB. With the exception of the C-141 low approaches and the late helicopters, the rehearsal had been another success. Postexercise review determined that the C-141 problem could be eliminated for the actual mission into Manzariyeh by turning on the runway lights after the assault force had secured the airfield. The element of surprise would no longer be needed since, by that time, Beckwith would have already freed the hostages from the embassy compound.⁸⁷ As it turned out the March rehearsal was the last full-scale exercise before the April mission.

The Pieces of the Puzzle Fall into Place

The JTF intelligence folks had continued to study the Desert One landing site identified back in February, and by the end of March, they were convinced that the site was the answer to the landing problem. By 1 April Kyle had considered the desert landing site almost a dead issue since little additional information had been passed to him during the workup for the March full-dress rehearsal. Kyle's insistence on a landing-zone survey of Desert One, however, paid off. Unknown to Kyle in a 22 March 1980 meeting at Camp David, President Carter approved a reconnaissance mission to the proposed Desert One landing location. The president had received his first full-mission briefing from Jones at that time and thought enough of the plan to approve the flight.⁸⁸

Maj John Carney, a USAF CCT member attached to the JTF, was selected to fly with two CIA pilots in a Twin Otter aircraft across Iran to the landing site. The mission was set for 3 April 1980. Tom Bradley was alerted at Wadi Kena, and he quickly redeployed his two 7th SOS Combat Talons from Egypt to Germany for installation of Fulton STARS equipment. Bradley then returned to Wadi Kena with the two aircraft in time to provide an emergency means of extracting the three Americans from Iran in the event the CIA aircraft experienced a mechanical problem and was unable to depart the country.

The survey mission went as planned, with no aircraft mechanical problems. Bradley's STARS backup capability was not needed. After landing at Desert One, Carney unloaded a small motorcycle and headed north to survey the area. The plan had been to land to the south of the dirt road that ran through the landing zone. Carney soon realized that the aircraft had actually landed north of the dirt road, so he backtracked to his starting location and set off to the south on the motorcycle.

He tested the consistency of the hard-packed sand and determined that it would support the heavy C-130 aircraft. It took Carney about an hour to finish the survey and to bury the landing lights that had been developed by the CIA specifically for the rescue mission. While Carney was burying the lights, four vehicles passed him on the dirt road.⁸⁹ When Carney's survey was finished, the three men took off from Desert One and retraced their ingress route out of Iran. For several days the intelligence community closely monitored all available sources to determine if the flight had been detected. When there was no reaction from the Iranians, it was clear that the mission had gone without their knowledge. Another piece of the puzzle had fallen into place.

With the knowledge that Desert One was C-130 capable, Kyle shifted training emphasis at Hurlburt Field to short-field operations into a dirt strip. (Before their departure back to Kadena AB, the 1st SOS crews had trained on a seldom-used dirt strip in the Eglin AFB range complex named landing zone (LZ) East. By the time Carney's mission was completed on 3 April, Turczynski and his two crews were already back at Kadena AB.) LZ East was located in the eastern part of the Eglin AFB range, just a few air miles northeast of Duke Field. The LZ consisted of hard-packed red clay and was 3,500-foot long and 60-foot wide. Approach to the dirt strip was restricted to landing to the southwest to avoid Duke Field's landing pattern. The approach put the aircraft just north of Defuniak Springs, Florida, as the crew maneuvered for its

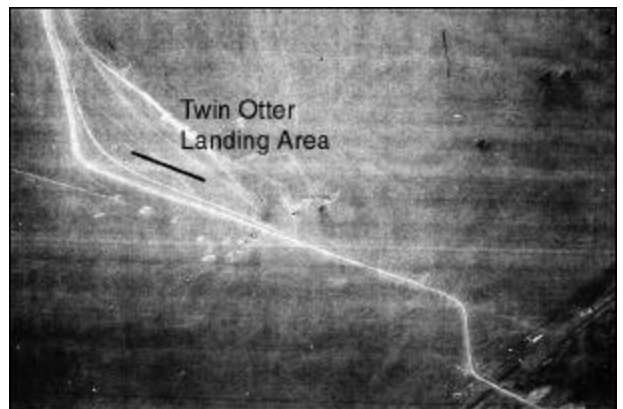


Photo courtesy of Roland Guidry

The Twin Otter planned to land to the south of the dirt road. When John Carney deplaned and headed north to find the road, he realized that he was, in fact, on the north side. He retraced his route and crossed the road near the bend in the road. He buried the landing lights in the desert floor to help guide the lead Combat Talon to a successful landing.

NVG landings. Because of the short runway, covert IR lights were set up in the box-four-and-one pattern, which was the same light pattern that Carney had buried at Desert One. Large pine trees surrounded LZ East, further making it a challenging landing for the Talon crews. A dirt road ran down the south side of the strip and had to be closed when operations were conducted. In short order the 8th SOS mission crews honed their skills on the LZ and refined their proficiency in dirt short-field landings.

* * * * *

The two-night plan developed over the past three months had conformed to Chairman Jones's direction that no location other than Egypt or Diego Garcia be used for the operation. Both nights were planned to originate from Wadi Kena, Egypt. Night one was by far the longest mission, with mission aircraft flying down the Red Sea, around Saudi Arabia, refueling south of Yemen, and then penetrating Iranian airspace low level to the landing location. After takeoff from Desert One, the aircraft would retrace their route of flight, refueling again on the return leg, and landing back at Wadi Kena. The 18-hour mission was executable, but a closer launch location would improve the probability of mission success. At about the same time that Carney's CIA aircraft was penetrating Iranian airspace, Vaught received word that Masirah Island, just off the southwest coast of Oman, had been approved for staging the Night One mission. British pilots and support personnel were stationed at the airfield and supported the sultan of Oman's air force. The approval for a suitable staging location was another critical piece of the complicated puzzle. With approval to use Masirah Island, Doug Ulery was redeployed from Hurlburt Field to Washington, D.C., to plan the flight from there to Desert One. The roller-coaster ride had peaked again—in a short week's time since the March rehearsal, it appeared that Carter was headed toward a military option for solving the hostage crisis.⁹⁰ With concentrated dirt-landing training under way at Hurlburt Field, Vaught decided that one more limited rehearsal was needed to validate the desert refueling operation. Vaught's final limited rehearsal would utilize one Combat Talon, one EC-130E, and four RH-53D helicopters and was scheduled from 10 to 16 April.

The Last Rehearsal

Brenci's crews had been busy at Hurlburt Field and on the Eglin AFB range. In the previous five months, Brenci had formed four crews that were proficient in NVG landings, in-flight refueling, blivet drops, bladder-bird operations, and low-level formation procedures. The two-night plan that was finalized during the first few days of April called for five mission crews from the 8th SOS and three crews from the 1st SOS (one of the 1st SOS crews was to serve as a spare). Brenci again used many personnel who had been involved in the previous dress rehearsals and created a fifth and final crew. Brenci's five crews that would execute the two-night Iranian rescue mission included the following personnel:

Crew 1	Crew 2	Crew 3
Brenci	Uttaro	*Meller
Ferkes	Diggins	Thigpen
Guidry	Bagby	Williamson
Chapman	Beres	Launder
Galloway	Weaver	McBride
Gamble	**Yagher	Robb
Almanzar	Newberry	Diagenault
Chitwood	Gingerich	Mink
Wiley	Doyle	Chesser
Sanchez	Metherell	Thomas
— —	***Cole	Chamness
Crew 4	Crew 5	
Lewis	Tharp	
McIntosh	Darden	
Harrison	Burke	
Bakke	Logan	
McMillan	Poole	
**Drohan	Garrett	
Mayo	Latona	
Beyers	Messer	
McClain	Thomas	
Bancroft	Chesser	
***Witherspoon	— —	

Turczynski's contingent remained intact at Kadena AB, with Jubelt and Fleming being designated primary mission crews and Pearson's crew serving as the primary Elbow Rub crew and a spare mission crew. There was not enough time to bring the 1st SOS crews back from Kadena AB

*Meller's crew did not fly on the Night One mission to Desert One. His crew was designated the lead crew into Manzariyeh for Night Two.

**Yagher and Drohan did not fly on the Night One mission. The EC-130Es that Uttaro and Lewis flew to Desert One did not have ECM equipment that required an EWO.

***The following personnel were designated spare crew members in case of DNIF: Rhode, Ulery, Mosley, Cole (flew with Uttaro's crew to Desert One), Javens, Presson, and Witherspoon (flew with Lewis's crew to Desert One).

to participate in the mid-April final rehearsal. Carter had decided on the night of 24 April as the execute date for Night One. Turczynski's three 1st SOS crews included the following personnel:

Crew 1	Crew 2	Crew 3
Jubelt	Fleming	Pearson
Nimmo	Schwall	Osborne
Turczynski	Rumple	Wilson
Sumida	Peppers	Ozlines
Smith	Townsend	Ross
Prator	Novy	Perkumas
Tafoya	Felton	Banks
Diehl	Devine	Farrell
Frederickson	Hickman	Kirby
Joy	Huff	Baker
--	--	Hamilton

From 10 to 16 April, two aircraft deployed from Hurlburt Field to the desert southwest, and 21 training sorties were flown in direct support of Operation Rice Bowl. Desert airdrops of Delta Force were accomplished, along with desert landings in both the MC-130E and the EC-130E. The training culminated with a mission rehearsal during the night of 14 April. Meller's crew (in Combat Talon 64-0562) and Tharp's crew (EC-130E aircraft 62-1857) participated in an NVG airland operation on the dry lake bed at Edwards AFB, California. The plan was for Meller to land first in his Combat Talon, followed by Tharp in the bladder-configured EC-130E. Fifteen minutes after Tharp landed, four RH-53D helicopters would arrive and refuel from Tharp's aircraft. Kyle and the JTF planners felt that this limited rehearsal would test everything they needed to validate refueling the helicopters from a desert location. Most of the operation already had been rehearsed in previous exercises.⁹¹

Exactly on cue Meller touched down on the covertly lighted desert LZ, but Tharp, who was following Meller in trail, executed a go-around. Tharp then maneuvered the less-capable EC-130E for another approach and landing. Five minutes after Meller's landing, Tharp touched down and was marshaled to his ground-refueling location. Tharp's crew set up the hoses and pumps and was ready to refuel the helicopters when the four helicopters arrived 15 minutes later. Within 30 minutes, the helicopters had been refueled and were on their way to the simulated hide site.⁹² After the helicopters departed the area, Meller and Tharp rolled up their operation and departed the desert LZ.

Some problems were encountered during the limited rehearsal that had to be resolved before mission execution. Tharp's aircraft had been parked on a slight downhill slope on the dry lake bed, with the nose slightly lower than the tail. As a result, some 2,000 pounds of fuel could not be pumped from the bladder. There also were some minor problems with marshaling the helicopters, but the operation went smoothly. During the low-level route with the MC-130E leading the EC-130E, no major problems were encountered. Utilizing NVGs the covertly lighted Combat Talon was easily seen by Tharp's crew up to five miles in trail. Because there was no moon illumination, however, Tharp was required to fly 1,000 feet above Meller's altitude to ensure terrain clearance. With two fuel bladders installed, the EC-130E was much heavier than the Combat Talon, which resulted in a higher final-approach speed that caused spacing problems when the Talon slowed down to lower its gear. Tharp's closure on lead was the reason he executed the go-around after Meller executed his landing. A recommendation resulting from the limited rehearsal was that the EC-130E and the MC-130E practice low-level formation procedures, with emphasis on the slowdown for landing maneuver.⁹³ (At Hurlburt Field the formation slowdown maneuver was practiced on 16 and 17 April, and all crews gained proficiency.) Vaught was convinced—of the three options being considered for getting fuel to the helicopters (blivet airdrop, seizure of a disused airfield, or a desert landing)—the desert-landing and refueling option provided the best possibility for mission success.

The Plan

With the use of Masirah Island a reality, the two-night plan was rapidly finalized. Doug Ulery plotted the low-level route from Masirah Island to Desert One, and the electronic order of battle was plotted to ensure that the aircraft could not be detected. The Night Two route was finalized, with Manzariyeh planned as the transload location. Three mission aircraft of the 8th SOS, along with three ABCCC EC-130Es crewed by 8th SOS personnel, would depart the Florida Panhandle and proceed to Wadi Kena, Egypt. The three 1st SOS MC-130Es would deploy from Kadena AB, Japan, to Diego Garcia in the Indian Ocean. From Diego Garcia, Turczynski's aircraft would fly to Masirah Island, Oman, and establish a forward-operating base two days before arrival of the rest of the force. Once established at Masirah Island,

the 1st SOS crews would fly sea surveillance missions over the Gulf of Oman to provide a cover for the actual mission. From Wadi Kena one MC-130E and the three EC-130E aircraft would further deploy to Masirah Island. Thus, there would be four MC-130Es and three EC-130Es at Masirah Island, with one of the 1st SOS Talons serving as a spare for the mission.

On Night One, three MC-130Es would depart Masirah Island loaded with Delta Force and a ranger roadblock team tasked to secure the dirt road that ran through the landing zone. The Talons would carry Farsi-speaking translators, a special assault team to take down the ministry of foreign affairs where Bruce Langen and three others were being held, and a team of combat controllers. In all there would be 139 personnel on the three aircraft. Just before sunset the first MC-130E would launch from Masirah Island, followed one hour later by the two Talons and the three EC-130Es. The Talons would lead two separate formations with the EC-130Es and would be responsible for navigating to Desert One.⁹⁴

Concurrently, with the launch of the fixed-wing aircraft from Masirah Island, eight RH-53D helicopters would depart the USS *Nimitz*, which would be in a position approximately 50 miles off the coast of Iran in the Gulf of Oman. The timing was such that the first MC-130E would arrive at Desert One well ahead of the rest of the force and would survey the area utilizing the aircraft's FLIR equipment. The lights that Carney had buried in the desert would be remotely activated by the first Combat Talon, and the aircraft would then land. Once on the ground, the roadblock team would secure strategic approaches to the site, and the CCT would set up a second LZ across the dirt road and parallel to the original runway. The CCT also would set up a portable TACAN that would aid the RH-53Ds in finding the landing area. An hour after the first Talon touched down, the numbers two and three Talons would land with the remainder of Delta Force.⁹⁵

After the third Talon was on the ground, two EC-130Es would land three and six minutes later, respectively, and the first two Talons would then take off and return to Masirah Island. After the first two Talons departed Desert One, the third EC-130E would land, thus leaving four aircraft on the ground—two EC-130Es on the north side of the dirt road and one MC-130E and the third EC-130E on the south side.

The remaining MC-130E was loaded with three 500-gallon fuel blivets in the event one of the EC-130Es had problems either getting to Desert One or pumping fuel once there. With the fourth aircraft on the ground, the eight helicopters would arrive 15 minutes after the last fixed-wing aircraft landed and refuel from the three EC-130Es. As the refueling operation was taking place, Delta Force would board the helicopters in preparation for the two-hour flight to the hide site. The three EC-130Es could carry 18,000 gallons of fuel and could refuel 10 helicopters. With the MC-130E fuel blivets in reserve, there would be plenty of fuel for the eight mission helicopters.⁹⁶

The ground helicopter-refueling operation was scheduled to take 40 minutes. Once complete the helicopters would depart Desert One and proceed to a point some 50 miles southeast of Tehran. There Dick Meadows and his reception committee would meet Delta Force and isolate them until time for the Night Two embassy assault. Meanwhile, the MC-130E and the three EC-130Es at Desert One would depart the area and exit Iran by way of a route different from the one they flew during their ingress. At a location 120 miles south of the Iranian coastline in the Gulf of Oman, KC-135 tankers would refuel the four aircraft, and they would return to Masirah Island.⁹⁷

At Masirah Island, after the Desert One mission was complete, three MC-130E crews would board a C-130 support aircraft and fly as passengers back to Wadi Kena, Egypt, sleeping en route with the aide of flight-surgeon-administered sleeping pills. The flight from Masirah Island to Wadi Kena was approximately eight hours long, which put the three crews in Egypt just in time to brief and launch for the Night Two mission. For Night Two, four MC-130Es would launch from Wadi Kena with a 100-man ranger airfield seizure force on board. Inbound to Iran and over Saudi Arabia, the four Talons would refuel from KC-135 tankers. Shortly after the Talons departed Wadi Kena, four AC-130H gunships would also depart and refuel after the four Combat Talons. One gunship was tasked to support Beckwith's embassy assault, with a second tasked to suppress fighter activity at Mehrabad Airport. The third gunship supported the airfield seizure operation at Manzariyeh and the fourth aircraft served as an airborne spare.⁹⁸

Two C-141s would be prepositioned at Dhahran, Saudi Arabia, and would depart there to land at Manzariyeh 10 minutes after the airfield was secured. One of the C-141s was configured as a flying hospital and was tasked to receive any wounded personnel and administer to their medical needs while returning to Europe from the Middle East. The second C-141 was configured with airline-type seats and was tasked to carry Delta Force, the helicopter crews, and the uninjured hostages. From the time Beckwith went over the embassy wall, it would take up to 45 minutes to free all of the hostages. Once freed, Delta Force would move the hostages across the main street in front of the embassy and into a nearby soccer stadium. At the soccer stadium, the helicopters would land and extract Delta Force and the hostages. The helicopters would then fly to Manzariyeh, where the hostages and rescue personnel would board the two C-141s and depart Iran. The helicopters would be disabled and left at Manzariyeh, and the four Combat Talons would unload all remaining personnel and depart the airfield for Wadi Kena. Once the force had been recovered in Egypt, the JTF would move out of the Middle East over the next several days.⁹⁹ The plan was well thought out and rehearsed but had many moving parts. To have the force in place for Night One, the plan required 10 days lead time to get everyone in position. Practice was over—it was time to lock and load.

Operation Eagle Claw Swings into Action

The plan had been finalized, but much remained to be done to position the mission aircraft for the 24–25 April mission. KC-135 tankers, C-141 cargo aircraft, and the whole JTF contingent had to be picked up and moved from the United States to the Middle East undetected. Kyle called Turczynski during the early morning hours of 13 April and told him that the rescue mission had been approved for 24 April. Turczynski was to deploy three Combat Talons to Diego Garcia with as much support equipment as they could carry, including avionics spares, tents, rations for two weeks, and a full water buffalo. Kyle cleared Turczynski to proceed only as far as Diego Garcia, where he was to wait until cleared onward to Masirah Island. To ensure that everything was ready for Night One, forces began to move on 14 April. As Meller and Tharp were validating desert helicopter-refueling tactics at Edwards AFB, Turczynski's crews began processing for the 18th TFW ORI at Kadena AB, which had begun on 14

April. The ORI was used as the cover for the 1st SOS aircraft. On Tuesday night, 15 April, three Kadena-based Combat Talons (62-1843, 63-7785, and 64-0564) took off in one-hour increments bound for the Indian Ocean. Their flight plans showed them landing at Clark AB, Philippines, but they overflew the airfield as they headed for their tanker track southwest of Thailand. Colonel Miller, the 18th TFW/DO, quietly removed the three Combat Talons from the command post tracking board at Kadena AB. The Combat Talons were lost in the fighter wing's huge deployment. As Jubelt, Fleming, and Pearson closed in on Diego Garcia after a second air refueling and 16 hours of flying, 15 MAC C-141s departed Charleston AFB, South Carolina, en route to Wadi Kena.¹⁰⁰ The execution phase of Operation Rice Bowl, code-named Operation Eagle Claw, was under way.

On 17 April the RH-53D helicopter crews were moved from Andrews AFB, Maryland, by way of C-141 westward toward the Indian Ocean. With an operations stop in Hawaii to brief CINCPAC, the aircraft continued on to the west, refueling at Guam, the Philippines, Diego Garcia, and finally arriving in Oman. From Oman the helicopter crews, along with a JTF liaison package, was shuttled aboard the USS *Nimitz* by Navy helicopters. The crews spent the next several days preparing the eight mission helicopters that had been placed aboard the aircraft carrier four months prior.¹⁰¹

At Diego Garcia Turczynski's crews flew sea surveillance missions for two days to reinforce their cover story. Kyle had instructed Turczynski not to reveal to his crews the actual destination of Masirah Island until cleared to proceed from Diego Garcia. On 18 April Turczynski received a secure call from the Pentagon directing him to proceed on to Masirah Island. He put his crews in crew rest for the seven-hour flight, which he scheduled for the following day—19 April.¹⁰²

At Hurlburt Field the maintenance package for the Talons, gunships, and the EC-130Es departed for Wadi Kena. In all some 124 support personnel and their equipment moved to Egypt by way of five C-141s and were in place ready to receive the C-130s by midnight on 18 April. Along with maintenance and support personnel, spare parts and aircraft generation equipment needed to launch the JTF force for mission night also were delivered.¹⁰³ The activity at Wadi Kena over the past several months made the arrival

of the C-141s appear to be just another US-Egyptian exercise.

When the 1st SOS returned to Kadena AB after the March rehearsal, aircraft 64-0565, with its operational FLIR, was retained by the JTF at Hurlburt Field. Along with the 1st SOS Talon, the three in-flight refuelable 8th SOS mission Talons (64-0562, 64-0567, and 64-0572) needed to be flown to Wadi Kena. On 14 April the second and third EC-130Es (62-1809 and 62-1818) were picked up from Keesler AFB and flown to Eglin AFB. All total there were seven mission aircraft at Hurlburt Field and Eglin AFB requiring crews to fly them to Egypt (four Talons and three EC-130Es), but Brenci had only five mission crews. Using spare crew members and third pilots from the five crews, Brenci formed a sixth crew commanded by Capt George Ferkes. The members of crew six were Ferkes, Diggins, Weaver, Cole, Beyers, and Thomas.

Kyle dipped into his bag of tricks to provide the seventh crew. Since the beginning of the operation, Ken Oliver and his team from Detachment 4 at LAS Ontario had supported every request from the JTF. Kyle picked up the telephone and asked Oliver if he could provide a basic crew for a few days training at Hurlburt Field. Within 24-hours Oliver was on his way to northwest Florida. By 18 April Brenci had seven crews to fly the four Combat Talons and three EC-130Es to Wadi Kena.

When Oliver received the call from Kyle, all Kyle told him was that he needed a Talon crew for a few days to support the ongoing operation.



Photo courtesy of J. V. O. Weaver

To provide maximum security and isolation from the rest of the base, mission crew members were housed in hangars at Wadi Kena. Cots were set up for sleeping, and the crews were bussed to an "exercise chow hall" where hot meals were served. For those who wanted it, two cold beers a day were provided.

Detachment 4 was scheduled to deliver a Talon to Hurlburt Field on 17 April, so Oliver quickly picked his crew. For his copilot he chose Wes Werling, a highly experienced instructor who had been the program engineer for the in-flight refueling modification on the Combat Talon. Oliver chose Dennis Ray, a quiet but highly experienced flight engineer who had been in the Combat Talon community for years, as his flight engineer. For the loadmaster position, Oliver chose Kindle, who had been on Oliver's developmental team from the beginning of Operation Rice Bowl. For avionics support Oliver selected John Gerkey, who would prove to be a key individual at Masirah Island when aircraft 64-0565 returned damaged from Desert One. Oliver arrived at Hurlburt Field late on 17 April, and his crew was put into crew rest for the following day's launch. It wasn't until the 1600 briefing on 18 April that Oliver learned that he would be taking a Talon to Egypt.¹⁰⁴ For a small organization that had given everything it had in support of the rescue mission for the past four and one-half months, selection to fly an operational mission was an honor for the crew. Augmented by 8th SOS personnel, members of Crew 7 included Oliver, Werling, Guidry, Launder, Ulery, Ray, Kindle, Latona, Gerkey, and Messer.

All the pieces of the complex deployment puzzle were now in place. After the 1600 briefing on 18 April, the 8th SOS aircraft began to move toward Wadi Kena. Ferkes was the first to depart in aircraft 64-0567 at 2030 local time on 18 April. Using the call sign of Imber 71, his route of flight took him over the Atlantic, with in-flight refueling en route, to Rhein Main AB, Germany. Tharp and Lewis were the next two



Photo courtesy of J. V. O. Weaver

A small tent city was constructed at Masirah Island as mission crews and support personnel arrived.

to depart in EC-130E aircraft 62-1857 and 62-1809. Their formation flights (call signs Imber 38/39) refueled just east of Bermuda and continued on to Lajes Field, Azores. Uttaro and Brenci (call signs Imber 52/53) departed Hurlburt Field in EC-130E aircraft 62-1818 and Combat Talon 64-0565, respectively, and headed for the Bermuda refueling track en route to Lajes Field.

Oliver's crew was assigned Combat Talon 64-0562 and departed Hurlburt Field the next evening at 2100 local time. Using call sign Quaff 45, Oliver refueled just east of Newfoundland and proceeded on to Rhein Main AB, where Ferkes had landed earlier the previous day. Twenty-four hours after Oliver departed Hurlburt Field, the last crew to depart northwest Florida was Meller's crew, flying Combat Talon 64-0572 under the call sign Mossy 17. Meller was bound for Rhein Main AB on the same routing as Ferkes and Oliver. Aboard Meller's aircraft was Pinard. Thus, three Combat Talons transited Germany, while the three EC-130Es and one Combat Talon passed through the Azores.¹⁰⁵ The objective was to converge on Wadi Kena and Masirah Island from diverse locations to avoid arousing suspicion.

Mid-April marked the kickoff of the annual Flintlock special operations exercise held in Europe. Bradley and his two 7th SOS Combat Talons had redeployed from Wadi Kena on 8 April and were scheduled to participate in the Flintlock exercise. When the three 8th SOS Talons passed through Rhein Main AB, Bradley's squadron was already deploying to the United Kingdom, so the additional aircraft did not raise any questions. Ron Jones, the 7th SOS director

of operations and a participant in the Son Tay POW raid, met each plane as it arrived and took care of billeting and aircraft servicing. Observant 7th SOS flight-line personnel did notice that more Combat Talons were on the ramp than were assigned to the squadron, but they knew from experience not to speculate or openly comment to others.

With Turczynski having the green light to proceed from Diego Garcia to Masirah Island, on 19 April Jubelt's crew departed the base for the seven-hour flight. Upon landing at Masirah Island the aircraft was directed by the control tower to an isolated location adjacent to a dirt strip on the east side of the airfield. A JTF liaison officer had arrived the day prior and had made the necessary arrangements to beddown the aircraft. After shutdown Turczynski found two large wooden crates filled with cots for his men. Turczynski's men set about constructing the first portion of the tent city that the rescue force would use for the next several days. The wooden tent stakes could not be driven into the rock-hard ground, so the JTF liaison officer procured steel stakes from the base. With much effort and hard work, the dark green canvas was raised on the tent poles. The tents had been designed for the moist, cool climate of central Europe. In the hot, arid climate of Masirah Island, the temperature inside the tents soared. The following day, 20 April, the other two 1st SOS aircraft, commanded by Fleming and Pearson, flew from Diego Garcia to Masirah Island. Also on 20 May Turczynski launched Jubelt's crew on a diversionary sea surveillance mission just as he had done at Diego Garcia. A daily routine of flying sea surveillance missions was established that continued for the next three days leading up to mission launch.¹⁰⁶

From both Lajes Field and Rhein Main AB, 8th SOS mission aircraft flew nonstop to Sigonella AB, Italy, where each crew was met by Blum (the liaison officer provided by the 7th SOS to brief mission crews and to arrange servicing for their aircraft). From Sigonella AB the seven aircraft flew the identical routes that Bradley's 7th SOS aircraft had been flying for the past three months. To an observer the aircraft were part of the ongoing exercise that had been taking place in southern Egypt. Tharp and Lewis were in the first mission aircraft to land at Wadi Kena on 20 April, with Uttaro and Brenci following one hour behind them. Vaught, Kyle, and the rest of the JTF also arrived at Wadi Kena on 20 April. To reduce radio



Photo courtesy of J. V. O. Weaver

Mission aircraft deployed to Masirah Island. Combat Talon 64-0565 is in the foreground, with the three EC-130s and the three additional MC-130s parked in line.

transmissions, no calls were made after the aircraft passed Cairo and were handed off to military controllers. The ATC liaison in Cairo worked his magic with the Egyptians. Even the landings at Wadi Kena were cleared by way of light signals from the tower instead of using the radio. Ferkes was the fifth aircraft to arrive four hours after Brenci, with Oliver's crew 24 hours behind him on 21 April. On 22 April Meller's Combat Talon was the last to land at Wadi Kena.¹⁰⁷

On 21 April the four AC-130H gunships launched from Hurlburt Field and flew nonstop to Wadi Kena, utilizing four in-flight refuelings. Because the gunship was so distinct, with its guns protruding from the left side of the aircraft, Kyle feared that they would draw unwanted attention if they landed anywhere en route. Also on the 21st, three C-141s carrying Beckwith and his Delta Force departed Pope AFB and headed to Rhein Main AB en route to Wadi Kena. They arrived in Egypt on 22 April and immediately went into isolation at the airfield.¹⁰⁸

By 22 April Brenci had been at Wadi Kena for 36 hours, and it was time for him to move forward to Masirah Island. The crews that had ferried the seven mission aircraft from Hurlburt Field to Egypt were reconstituted into the five hard crews for the mission. Brenci, flying the 1st SOS-assigned Combat Talon 64-0565, followed by Tharp, Lewis, and Uttaro in the three EC-130Es, departed Wadi Kena on 22 April. Meller's crew, which arrived at Wadi Kena three hours after Brenci's departure, remained in Egypt to continue refining the Night Two plan. Kyle determined that the expertise found in Oliver's men might be essential in launching the aircraft on mission night, so he authorized them to move on to Masirah Island with the mission crews. On board Brenci's Talon were additional tents and bare-base gear to make their stay tolerable for the short period of time they would be there. On board each EC-130E were two fuel bladders with a total of 6,000 gallons of fuel. Fully loaded, the Talon weighed just over 175,000 pounds, and the EC-130Es grossed over 185,000 pounds.¹⁰⁹ Take-offs at that heavy gross weight and at high-ambient temperatures challenged the aircraft and their crews.

After nine hours flying time, the four aircraft arrived at Masirah Island. Brenci and the three EC-130Es had flown down the Red Sea and over the Gulf of Aden just off the coast of Saudi Arabia in radio silence. Upon landing, all aircraft scheduled to participate in the Night One desert

landing operation were in place, with a spare Talon in case one aborted for mechanical reasons (the 1st SOS Talon would spare the other Talons and the EC-130E bladder bird, if required). To anyone who wondered, the aircraft were joining the 1st SOS already at Masirah Island for the sea-surveillance exercise.¹¹⁰ It was 22 April 1980, and the stage was nearly set for Desert One.

By 23 April, in addition to the seven C-130s positioned at Masirah Island, six KC-135s were at Diego Garcia ready to refuel them. At Wadi Kena 19 mission aircraft were cocked and ready, including KC-135 tankers, C-141 cargo aircraft, AC-130H gunships, and the Combat Talons.¹¹¹ Early in the morning of 23 April, Thigpen, Daigenault, and Robb went to the already scorching flight line and began installing the IR landing-light lenses and the IR covers for the upper-rotating beacons on the Combat Talons. The IR lenses and covers had not been installed before that time so that the aircraft could use its normal lights during the long deployment from the states. At Masirah Island McIntosh, along with Oliver, spearheaded the IR lens installation on the mission aircraft there. Ferkes had been put in charge of the NVGs for the 8th SOS, and he had distributed them to each crew before departing from Hurlburt Field. Also at Masirah Island crews used black paint to cover the belly and the yellow-highlighted emergency exits on the exterior skin of the EC-130Es. Their propellers were also painted black to reduce the probability of detection while on the ground at Desert One. By late afternoon on 23 April, all mission aircraft were operationally ready and cocked for the 24 April launch.

Kyle had moved forward to Masirah Island with Brenci and the three EC-130Es. By 1000 on 24 April, he had organized a crew of maintenance personnel and had begun erecting tentage for Delta Force, set to arrive at Masirah Island by mid-afternoon. At 1400 Vaught received the final aircraft status report at his headquarters at Wadi Kena—the seven C-130s at Masirah Island and the eight helicopters aboard the USS *Nimitz* were operationally ready and prepared for launch. At 1445 the first of two C-141s carrying General Gast and part of Delta Force arrived at Masirah Island and moved to the newly erected tentage by way of covered truck. A second C-141 arrived at 1530 with Beckwith and the rest of Delta Force. With the arrival of Delta Force, there were now 132 assault-force members at

Masirah Island—120 Delta Force and 12 ranger roadblock personnel.¹¹²

Throughout the afternoon the three Talons were loaded with equipment needed for the mission. On Brenci's aircraft (64-0565) a gun-jeep for the roadblock team and five motorcycles were put on board. Three of the motorcycles were to be used by the rangers to provide mobility for the roadblock force and two by Carney's CCT to mark the second parallel runway. A portable TACAN was also put on board the aircraft to be used to help the helicopters find Desert One. Two large sheets of aluminum planking also were carried in case the aircraft became mired in the desert sand. Jubelt's and Fleming's aircraft were loaded with camouflage nets for the hide site, support systems, and Red Eye heat-seeking missiles that would be transferred to the helicopters at Desert One. Fleming's aircraft also carried three 500-gallon fuel blivets to be used by the helicopters if they had any problems getting all the fuel they needed from the EC-130Es.¹¹³

At 1630 mission crews received their final mission briefing. Weather for the next 48 hours was forecast to be ideal, and there was no change in the Iranian radar status. Intelligence confirmed that there were no Russian trawlers under the aircraft's ingress flight path. After the formal briefing, the crews reviewed the low-level route and went over terrain features and any threats the aircraft might face. Everything looked good, and by 1700 all crews had been briefed. All that remained was the launch decision that would come from Vaught back at Wadi Kena. Gast and Kyle went to the communications tent and waited for the launch order while the crews prepared their aircraft.¹¹⁴ They did not have long to wait.

At Wadi Kena General Vaught received his final weather briefing at 1700. The weather was as good as it would ever be, according to an Iranian advisor to Vaught who had spent 20 years flying in Iran. After reviewing the satellite photos and the weather charts one last time, Vaught announced that the mission was a "go." At 1720 local time the execute order was transmitted to Gast and Kyle at Masirah Island.¹¹⁵ Five and one-half months of backbreaking effort had come down to this moment—the JTF rescue force was cleared to launch into Iran to free the American hostages after 173 days of captivity.

Six mission crews and a spare Combat Talon crew had been briefed, and their aircraft were readied for launch from Masirah Island. The six primary crews, their aircraft tail numbers, and their call signs included the following:

Dragon 1 (Talon 64-0565)	Dragon 2 (Talon 64-0564)	Dragon 3 (Talon 63-7785)	
Brenci	Jubelt	Fleming	
Ferkes	Nimmo	Schwall	
Guidry	Turczynski	Rumple	
Chapman	Sumida	Peppers	
Galloway	Smith	Townsend	
Gamble	Prator	Novy	
Almanzar	Tafoya	Felton	
Chitwood	Diehl	Devine	
Wiley	Frederickson	Hickman	
Sanchez	Joy	Huff	
*Wicker	--	--	
**Kyle	--	--	

Republic 4 (EC 62-1809)	Republic 5 (EC 62-1857)	Republic 6 (EC 62-1818)	Spare Crew (Talon 62-1843)
***Lewis	Tharp	Uttaro	Pearson
***McIntosh	Darden	Diggins	Osborne
Harrison	Burke	Bagby	Wilson
***Bakke	Logan	Beres	Ozlines
***McMillan	Poole	Weaver	Ross
--	--	--	Perkumas
***Mayo	Garrett	Newberry	Banks
Beyers	Latona	Gingerich	Farrell
McClain	Messer	Doyle	Kirby
Bancroft	Thomas	Metherell	Baker
Witherspoon	Chesser	Cole	Hamilton
Dryer	Moore	Neckar	--
Tuttle	Benstra	DeLong	--
Marine	Jerome	Franks	
Walton	Rowe	Houghton	

With less than one hour left before scheduled takeoff, Beckwith boarded Brenci's aircraft with 56 of his soldiers. In addition to Delta Force, two Iranian general-officer advisors, 12 ranger roadblock soldiers, six Iranian truck drivers, and seven Farsi-speaking American driver monitors also boarded the aircraft. Carney and his CCT, along with Wicker and Kyle, finished out the load. Literally every square inch of the cargo compartment was taken by either personnel or equipment. At 1750 Brenci began his taxi to the north runway, followed by Pearson in the engine-running spare Talon. The plan included rapid movement from Brenci's aircraft to Pearson's if the

*1st SOW mission commander

**JTF air mission commander

***Indicates crew members killed at Desert One when an RH-53D Sea Stallion helicopter crashed into their aircraft after refueling. EC-130E aircraft 62-1809 was destroyed in the resultant fire.



Photo courtesy of J. V. O. Weaver

Dragon 1 Crew. Standing left to right: Galloway, Chapman, Gamble, Ferkes, Almanzar, Sanchez, Brenci, Wiley, Guidry, and Chitwood.



Photo courtesy of J. V. O. Weaver

Dragon 2 Crew. Standing left to right: Frederickson, Turczynski, Prator, Tafoya, Sumida, Diehl, Nimmo, Smith, Joy, and Jubelt.

Author's note: Photo not available for Dragon 3 crew. Rick Bakke took the picture, and the film was in his camera when the accident occurred at Desert One.



Photo courtesy of J. V. O. Weaver

Republic 4 Crew. Standing left to right: Bakke, Bancroft, Mayo, McIntosh, Lewis, McMillan, Beyers, Harrison. Kneeling left to right: Dryer, McClain, Witherspoon, Tuttle, Marine, and Walton.



Photo courtesy of J. V. O. Weaver

Republic 5 Crew. Standing left to right: Moore, Garrett, Burke, Tharp, Poole, Thomas, Darden. Kneeling left to right: Messer, Benstra, Jerome, Chesser, Rowe, Latona, and Logan.



Photo courtesy of Rick Bakke

Republic 6 Crew. Standing left to right: Beres, Bagby, Diggins, Uttaro, Weaver, Cole. Kneeling left to right: Unknown, Gingerich, Neckar, DeLong, Franks, Doyle, Newberry, Metherell, and Houghton.

primary aircraft aborted for any reason. Kyle estimated that a transfer could be made in 15 minutes, a time that could be made up en route. At precisely 1805 local Masirah Island time, Brenci (Dragon 1) lifted off the 8,200-foot runway and headed out over the Gulf of Oman for Desert One.¹¹⁶

Along with the cargo already loaded on Jubelt's aircraft, an additional 50 Delta Force soldiers came on board just before engine start. Fleming had the remaining 32 Delta Force soldiers on his aircraft, and he carried three Marine fuels personnel to operate the fuel blivets if the helicopters needed additional fuel. On Lewis's, Tharp's, and Uttaro's EC-130E tankers, four fuels personnel who were responsible for operating the rubber fuel-bladder system were also loaded onto each aircraft.¹¹⁷

By 1830 Brenci was far out over the Gulf of Oman at 500 feet above the water. On the USS *Nimitz*, the eight RH-53D helicopters began their engine runs to check out their systems, and 35 minutes later they lifted off and headed for the southern Iranian coastline. About 100 miles northeast of Masirah Island, Brenci passed over several large ships steaming towards the Strait of Hormuz. With Brenci's early launch time from Masirah Island, it was still daylight, and the Combat Talon was clearly visible. At Kyle's direction Brenci climbed to

3,000 feet altitude to reduce the possibility of detection. At 140 miles northeast of Masirah Island and clear of shipping, Brenci began his descent to 250 feet above the water for his coastal penetration.¹¹⁸

On the ground at Masirah Island, Jubelt (Dragon 2) taxied his Talon into position on the runway and prepared for takeoff. There were no radio transmissions authorized from any of the aircraft, and it was nearly dark on the blacked-out airfield. Tharp (Republic 5) mistakenly began his taxi ahead of Lewis (Republic 4), which placed Lewis out of position to take off behind Jubelt. Because of the restricted taxi area, Lewis could not get ahead of Tharp. To reach the takeoff position, all aircraft had to taxi down the active runway to the hammerhead at the approach end of the runway. With a takeoff time scheduled for 1910 and no way readily available to unsnarl the two formations, Jubelt elected to take off and sort out his formation. After Jubelt departed the next takeoff was Fleming (Dragon 3) in his Combat Talon. When Fleming departed, Uttaro thought it was Tharp's aircraft, and he began his back taxi down the active runway to the hammerhead position. With his exterior lights illuminated, Uttaro met Lewis head-on on the runway as Lewis was on his takeoff roll. To avoid a collision Uttaro departed the runway on to the hard-packed sand,

and Lewis stopped his aircraft on the runway. After the flight engineers quickly inspected the two aircraft, both Uttaro and Lewis taxied back to the approach end of the runway. Tharp was the next to take off, with Lewis and Uttaro following him without further incident.*

After Fleming departed Masirah Island, the three EC-130Es followed him in trail. All aircraft were extremely heavy, and it quickly became apparent that Lewis could not accelerate to the speed required to join up with Jubelt. His only choice was to remain with Fleming’s formation as a fourth aircraft. Uttaro was the last to take off from Masirah Island and was also having difficulty joining up with Fleming. Sensing that he would be left behind and unable to find Desert One, Uttaro made a brief radio call to Fleming to advise him of his situation. Fleming continued across the Gulf of Oman at a reduced airspeed so that Uttaro and the other two ABCCC aircraft could join up with him. The modified formation that Fleming would lead to the heart of Iran thus became a four-ship diamond, with Tharp on his right wing, Lewis on his left wing, and Uttaro in trail. The four aircraft were behind schedule, but they were all together. After determining that Lewis could not join up

with his aircraft, Jubelt accelerated to his en route speed and pressed on into the darkness of the Gulf of Oman. Jubelt continued on to Desert One single ship while Fleming led the four-ship tanker force (fig. 31).¹¹⁹

At 1925 Brenci penetrated Iranian airspace at 250 feet above the ground and perpendicular to the southern coastline. He continued at 250 feet until reaching the first plateau, which rose 4,000 feet above sea level. At that point Brenci climbed to 6,000 feet. From then until reaching Desert One, he would fly at altitudes between 1,000 feet and 3,000 feet above the ground. Pre-mission planning had determined that the higher altitudes would keep the aircraft clear of known Iranian threats. The higher altitudes also conserved fuel and reduced the possibility of being detected by ground-based outposts.¹²⁰ The helicopter formation apparently did not receive the same intelligence briefing on the USS *Nimitz* that the fixed-wing aircraft had received at Masirah Island—the helicopters elected to fly as low as possible to ensure that they were not detected by enemy radar. Their decision to fly low level across Iran impacted significantly their ability to find Desert One and to keep their aircraft operational.

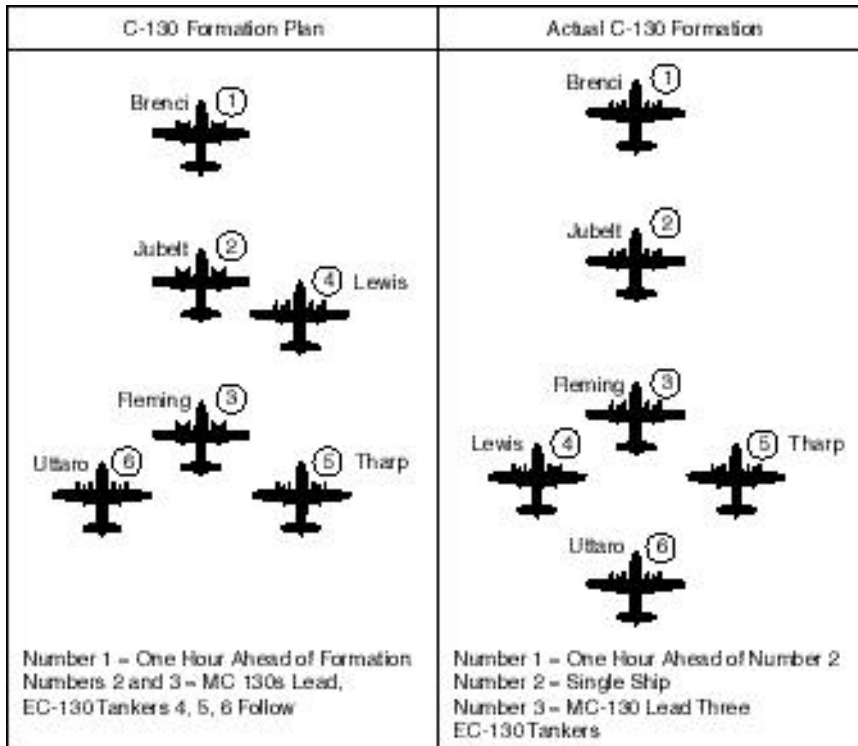


Figure 31. C-130 Formation Plan and Actual Formation Flown (Source: USAF Special Operations School, Hurlburt Field, Fla.)

*Narrative of the takeoff events at Masirah Island provided by Uttaro.

Fleming had slowly climbed to 10,000 feet as he led his formation across the gulf. At 100 miles south of the Iranian coastline, Fleming began his descent to 1,000 feet above the water. Novy, Fleming's EWO, called an "all clear" from his EW indicators. Because the coastal-penetration point had been planned into a gap between radars, no early warning signals were received. After 40 minutes and a further descent to 250 feet, the coastline appeared on Townsend's radarscope. As Townsend updated his position with the radar cursor, he determined that the INS had drifted only about a half mile since takeoff. With everything considered, the system was performing well within tolerances. The navigation system corrected to the preplanned route, and Fleming corrected his formation back to course.¹²¹

As Fleming's formation penetrated the Iranian coastline, Brenci was already 210 miles ahead, and the eight-ship helicopter formation was 90 miles inland. Once over land Fleming flew between 500- and 1,000-foot altitude until reaching the 4,000-foot plateau. From that point he flew roughly the same altitudes and headings as Brenci in Dragon 1.¹²² Brenci had run into a problem ahead of Fleming's formation. Guidry was standing on the flight deck of the Talon and was scanning outside with his NVGs when the aircraft entered a thin haze layer that blocked out most of the moon's illumination. After conferring with Kyle, the crew determined that the condition was not severe enough to break radio silence and pass back to Fleming's formation or to the helicopters. In a few minutes Brenci popped out of the haze into clear air again and continued on course. At about 320 miles inland, Brenci's aircraft again entered a haze layer, this time much thicker, with flight visibility reduced to an estimated one mile. Kyle was worried. He asked Wicker to work up a message and transmit it back to the other aircraft to advise them of the weather. His intent was to give them a heads up of what was coming. Carney came up on the flight deck and quickly informed the crew that the restriction to visibility was called a "haboob," a weather condition that he and the CIA pilots had been briefed on for the earlier reconnaissance flight to Desert One. The condition was caused by distant thunderstorms that stirred up fine sand from the desert floor and propelled it up into the air. The uplifting effect of air currents associated with thunderstorms could carry the dust to an altitude of 10,000 feet, and the dust could remain suspended in the air for hours after the storm had dissipated. There had been no mention of

a haboob by the JTF weatherman, and its existence came as a total surprise to Kyle and the crew.¹²³

Kyle estimated that the second, thicker haboob was about 100 miles across. When Brenci broke out of the dust, he was 30 minutes from Desert One, and the air was crystal clear. Wicker came back up on the flight deck shortly after Brenci cleared the second haboob and informed Kyle that he had been unable to encrypt a message to send to the other aircraft. Although the SATCOM radio provided secure communications, Kyle had been instructed to encrypt everything that went out over it just in case the Russians were able to intercept and decipher the message. In the blacked-out cargo compartment, Wicker had been unable to construct the message from the codebook that the SATCOM radio operator provided. As a result the helicopters were already in the dust, along with Fleming and his four-ship formation. Kyle silently prayed that the helicopters had missed the dust since their route of flight was 30 miles to the east.¹²⁴ His prayer was not to be answered.

When Fleming hit the haboob, he slowed down and began a slight climb so that his three wingmen could stay in position. He hoped that he could climb above the dust, but he soon realized that he was not able to do so. Meanwhile, Townsend was having trouble updating his INS—there were no radar targets, and the dust had obscured any hope of visual updates. The flight plan showed an Iranian VHF omnidirectional radio (VOR) located 10 miles east of an Iranian airfield, so Townsend asked Nimmo to turn on the VOR and dial in the frequency. The idea was to fly over the VOR (a known point) and update the navigation system. As the formation proceeded toward the VOR, the dust thinned slightly, and the crew observed an airfield's runway and taxiways clearly visible below them. The airfield was located in a different position from what the charts had indicated! There was no possibility to avoid the airfield, so Fleming pressed on over it. Townsend got his update over the VOR moments later as the formation broke out of the dust. This was the first haboob that Brenci had encountered, but it had intensified over Fleming's route. About an hour later the formation entered another haboob, but it was not as severe as the first one.¹²⁵ Just as Brenci had done, Fleming broke out of the second haboob about 30 minutes before Desert One.

With skies clear and visibility unrestricted, Brenci was bearing down on Desert One. Brenci was in the left seat on NVGs, Ferkes was in the right, Guidry was standing behind Brenci in the

safety pilot's position on NVGs, and Carney (also on NVGs) was behind Ferkes to assist in acquiring the runway environment. Almanzar was in the flight engineer's seat on NVGs also scanning for the runway. Kyle was on the flight deck along with Wicker and Mitch Bryan, one of Carney's CCT members who was tasked to send the signal to remotely activate the landing lights that Carney had buried there on 3 April. At five miles out, Bryan sent the activation signal as everyone peered out into the darkness. Galloway and Chapman were scanning the area with the FLIR. Carney was the first to see the lights, which were off to the right of the aircraft. With a 30-degree course correction and a descent to 1,000 feet, Brenci brought the aircraft down the "box four and one" lighted runway for a planned low approach. As the aircraft passed over the landing area, Galloway spotted a truck moving down the road with the FLIR and immediately called for a turn to the north. The aircraft passed well behind the truck, and Brenci maneuvered back to the landing zone in a wide circle.¹²⁶

During the second pass Carney noticed that the lights at the approach end of the runway were too close to the shoulder of the dirt road. He advised Brenci to land to the right of the lights and aim for the light at the far end of the LZ. The second pass determined that the road and LZ were clear, and Brenci went around and began his traffic pattern to align the aircraft for landing. Flying a box pattern to final approach, Brenci rolled out on short final but was too close for a safe landing. He went around for a third time. On the fourth approach, Brenci lined up on final and continued the approach as the navigator called out airspeeds and altitudes. The landing proved to be extremely difficult—on short final, with the aircraft weighing nearly 150,000 pounds, the aircraft's sink rate increased to a point that Brenci did not have enough airspeed to break his descent before touchdown. As the aircraft impacted the desert LZ, it bounced back into the air before landing a second time. In the cargo compartment, Beckwith and his men were pitched about, but no one was injured. It was 2245 as Brenci slowed to taxi speed and proceeded to his off-load location.¹²⁷

Twenty minutes out of Desert One, Fleming's crew began configuring for landing. Lewis, Tharp, and Uttaro took spacing, with the second and third aircraft scheduled to land in three-minute increments behind Fleming. Ten minutes out from landing, Townsend saw the landing environment on radar—he had studied the area around the LZ

and knew every contour within 10 NM of Desert One. Fleming did not have any problem finding the LZ—there was a huge fire burning where he had to land!¹²⁸ His first thought was that Brenci had crashed, yet he had heard the landing call from Brenci's radio operator, and he could see Jubelt ahead of him in Talon 64-0564. But there it was, like a beacon showing him the way to his objective.

As Brenci stopped at his off-load location, Beckwith's Delta Force, the roadblock team, and the remaining personnel in the cargo compartment departed the rear of the aircraft. As Kyle walked down the ramp, to his right he saw a bus traveling down the dirt road just north of the aircraft. The vehicle was quickly stopped, and the passengers were removed to a location clear of the operation. A few minutes later, a large explosion occurred west of the runway area, and a large fireball lit up the night. The roadblock team had encountered a gasoline truck and, after it would not halt, fired an antitank round into its cab. The round went through the cab and penetrated the fuel tank and ignited the gasoline. The driver managed to escape the truck and fled the scene in a small pickup that was following the tanker. In less than 10 minutes, two significant deviations from the ground plan had occurred. Kyle discussed the situation with Beckwith and determined that the fuel truck was probably driven by bandits since an escort vehicle had accompanied it. The pickup gave the truck driver the opportunity to escape in the event that local police stopped the vehicle. The two theorized that the escaped driver would not contact local police to report the incident. Beckwith also suggested that the bus be run into the burning tanker to make it appear that the two had collided head-on. The passengers would be flown out of Iran on Brenci's Talon and deposited back at Manzariyen on Night Two. Both the air and ground mission commanders concluded that the mission had not been compromised and that the operation was still on track.¹²⁹

As things settled down on the ground at Desert One, Jubelt maneuvered his number two Combat Talon for landing. The fuel truck was burning furiously, and the resulting illumination rendered the crew's NVGs practically useless. On Jubelt's first approach, he did not pick up the runway lights in time to correct his inbound course and land. The fire had washed out his NVGs. Jubelt went around and maneuvered his aircraft for a second approach. In less than 10 minutes, Jubelt

had landed on his second approach and had off-loaded his passengers.¹³⁰

Three minutes after Jubelt landed on the north runway, Fleming landed on the south side. (Carney's CCT had set up a second runway on the north side of the dirt road and had repositioned the remote landing lights on the south runway after arriving aboard Brenzi's aircraft.) Fleming's touchdown was also firm but resulted in no damage to the aircraft. As Fleming landed on the south runway, Lewis (in Republic 4) touched down on the north runway and taxied to his helicopter refueling location.¹³¹ Tharp, in Republic 5, was the next to land on the south runway and was marshaled to his refueling location. Meanwhile, the blivet refueling system aboard Fleming's Combat Talon was rolled off his aircraft, and an alternate helicopter-refueling location was established. There were now five aircraft on the ground at Desert One, with the helicopters inbound and due to land shortly. Kyle needed to launch Brenzi and Jubelt to make room for Uttaro's tanker and the inbound helicopters. It was time to move the bus passengers to Brenzi's aircraft for transport out of Iran. Kyle learned at that time that one of the Iranian generals had lost a loaded pistol perhaps while aboard Brenzi's aircraft. After a prolonged search of the cargo compartment, the weapon could not be found. Kyle made the decision to move the passengers to Fleming's number three Talon to make sure that the pistol did not fall into the hands of one of the Iranian prisoners.¹³²

Carney's CCT marshaled Brenzi into position on the south runway for takeoff, and he departed Desert One for Masirah Island as soon as the dust settled from Tharp's landing. Jubelt was then cleared for takeoff, and he departed the north runway behind Brenzi. There were now three aircraft on the ground at Desert One, with Uttaro (Republic 6) orbiting near the LZ. With Brenzi and Jubelt airborne, Uttaro was cleared to land on the north runway. The fuel truck was still burning as Uttaro passed over it on his approach, and he was forced to make a go around. After a second attempt to land that resulted in a second go around, Republic 6 touched down uneventfully on its third approach and was marshaled to its refueling position next to Lewis's tanker on the north runway. The four aircraft at Desert One were aligned with Lewis and Uttaro on the northeast end of the north runway and Tharp and Fleming roughly at the same position on the south runway. Fleming's aircraft was

turned 180 degrees from the other three, facing down the runway to the southwest (fig. 32). It was 2315 at Desert One, and the helicopters were not in sight.¹³³

The helicopter formation (call signs Bluebeard 1 through 8) was having a terrible time making it to Desert One. Their departure from the USS *Nimitz* and the initial leg of their low-level route went as planned. Shortly after takeoff, however, Bluebeard 5 experienced TACAN radio failure and began to experience some yaw problems brought on by a malfunctioning automatic flight-control system. Although not 100 percent capable, the aircraft was still flyable and able to complete its mission.¹³⁴ About 140 miles inland, the next helicopter maintenance problem occurred. Bluebeard 6 experienced a blade inspection method (BIM) warning light on his RH-53D, a condition that indicated possible loss of the main rotor blade's internal-nitrogen pressure due to a crack in the blade. The aircraft commander landed his aircraft and shut down his engines to inspect the BIM visually. Meanwhile, Bluebeard 8 landed to assist the downed aircraft. The crew of Bluebeard 6 determined that the aircraft was not airworthy and elected to abandon their aircraft and board Bluebeard 8. There were now seven RH-53D helicopters en route to Desert One.¹³⁵ The helicopters were operating radio silent, and the lead helicopter did not know the status of Bluebeard 6 or Bluebeard 8. With both crews on board, Bluebeard 8 was 15 minutes behind the other six helicopters.

The helicopter formation was flying at 200 feet above the ground when it entered the first haboob. What had been only a mild nuisance to Brenzi and the fixed-wing aircraft was nearly catastrophic for the helicopters. Barely able to see the ground, Bluebeard 1 pressed on, hoping to pop out on the other side. Visibility decreased from a mile to a quarter of a mile, but the formation managed to stay together. Visibility improved as the formation departed the first haboob. After a few minutes in the clear, the formation entered the second, denser haboob, and had extreme difficulty seeing each other in the thick dust. When Bluebeard 1 could no longer see the ground and could only occasionally see Bluebeard 2, he elected to turn his formation around and attempt to exit the dust storm on a reverse heading. Upon exiting the haboob, Bluebeard 1 landed in the desert with Bluebeard 2 in trail. The remainder of the formation did not see Bluebeard 1 make the U-turn and had continued on

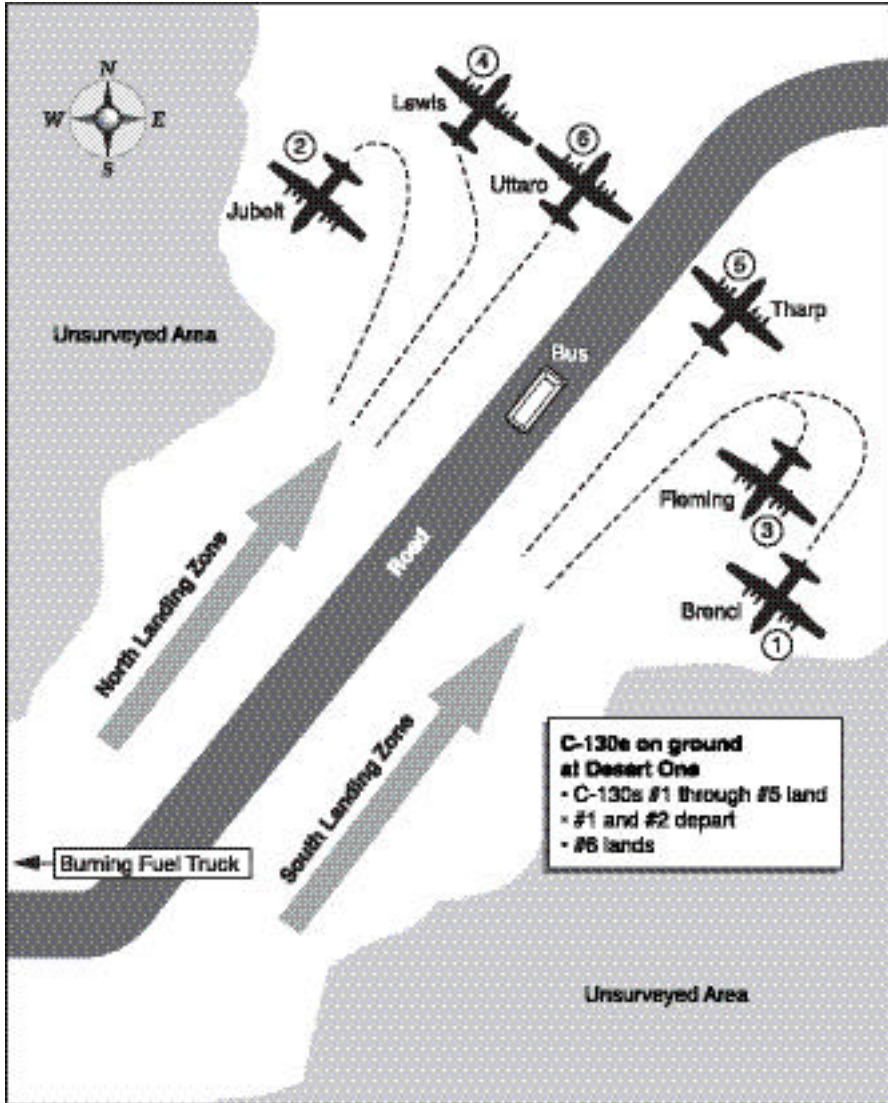


Figure 32. Desert One, Fixed-Wing Arrival (Source: Jim Kyle, *The Guts to Try*, New York: Orion Books, 1990.)

its original heading. After approximately 20 minutes on the ground, Bluebeard 1 determined that the rest of his formation was still on its way to Desert One. He decided to proceed on towards Desert One in formation with Bluebeard 2 at a reduced airspeed and at an altitude between 500 and 1,000 feet above the ground. He was hoping that the dust would subside and allow his formation to make it to its destination.¹³⁶

At 2250 local time the helicopter formation was well into the second haboob. Bluebeard 3 was now lead, with Bluebeards 4, 5, and 7 in tow. Bluebeard 8, with the crew of Bluebeard 6 on board, was 15 minutes behind the formation, and Bluebeards 1 and 2 were 20 minutes behind Bluebeard 8. As Bluebeards 1 and 2 entered the second haboob, Bluebeard 2 lost its second-stage

hydraulics, which powered the number one automatic flight-control system and a portion of the primary flight controls. Other than in wartime, the condition warranted immediate landing and shutdown. The crew decided to continue in formation with Bluebeard 1 to Desert One in the hope that the aircraft could somehow be fixed once it arrived there. Meanwhile, Bluebeard 5 was experiencing additional instrument problems. As the dust got thicker, visibility was reduced to zero, and when Bluebeard 5 could no longer see either the ground or his lead aircraft, he elected to turn away from lead and descend to 50 feet above the ground to ensure spacing. The aircraft's primary flight instruments had failed, and the secondary system was sticking in turns. Without those instruments, it was nearly impossible to fly the aircraft without

outside references. Facing a 9,800-foot mountain range and unsure that he could make it back to the USS *Nimitz* before running out of fuel, Bluebeard 5 elected to abort his mission and try to make it back to the Gulf of Oman where the carrier's rescue force could pick up the crew from the water. The crew had come to within 145 miles of Desert One when it elected to turn back. There were now six helicopters inbound to Desert One—Bluebeard 3 in the lead, followed by Bluebeard 4 and Bluebeard 7; 10 minutes behind was Bluebeard 8, and Bluebeards 1 and 2 were 35 minutes behind the leader. Bluebeard 2, however, was nursing a sick aircraft that was suffering from severe hydraulic system problems.¹³⁷

* * * * *

Kyle and the four fixed-wing aircraft were waiting for the helicopters at Desert One. Nearly an hour and a half had passed since Uttaro had landed and set up his refueling point. Fuel for the C-130s was becoming a problem. Lee Hess was at Wadi Kena with Ulery and the JTF planning staff. A quick calculation of fuel required to make it to the tanker track off the coast of Iran showed that the Desert One aircraft had to be airborne within the hour. Hess knew that, with the helicopters still en route to Desert One, there was no way that the refueling operation would be completed within that time. After a second reminder to King, Hess was able to convince King to launch the standby tankers. At 0020 local two KC-135s were scrambled at Wadi Kena, launched into the night, and headed southeast towards the Iranian coastline.¹³⁸ At the same time Bluebeards 3 and 4 landed at Desert One.

Following the marshaling plan for eight helicopters (Kyle did not know how many helicopters were still inbound to his location), CCT marshaled the first two aircraft to Hal Lewis's tanker. Because of the loose sand on the LZ, the helicopters could not ground taxi but rather used a leapfrog tactic, or held the nose gear off the ground while moving forward on the main landing gear. Both maneuvers kicked up a large amount of dust. When Bluebeard 7 arrived at 0035, he was marshaled to Republic 5's location for refueling. (Bluebeard 7 had turned around when he lost sight of Bluebeard 5. When he could not find his wingman in the haboob, Bluebeard 7 assumed that Bluebeard 5 had crashed in the desert. He did not know that Bluebeard 5 was en route back to the carrier. Bluebeard 7 turned around once again and proceeded to Desert One and was 15

minutes behind the first two helicopters.) When Bluebeard 8 arrived with the crew of Bluebeard 6 onboard, CCT marshaled it to Republic 4. By 0100 Bluebeards 1 and 2 had landed, with Bluebeard 1 marshaled to Republic 6 (Uttaro) and Bluebeard 2 marshaled to Republic 5 (Tharp). There were now six helicopters at Desert One, which was the minimum number required for the mission to continue as planned. Time was still critical. With another hour needed to refuel all six helicopters and a two-hour flight to Delta Force's drop-off site, the helicopters could make it to their laager site 45 minutes before sunrise (fig. 33).¹³⁹

As Kyle and Beckwith went between the helicopters to determine their exact status, Bluebeard 2 shutdown behind Tharp's tanker. The problem with the second-stage hydraulic system could not be fixed, and the aircraft was grounded on the spot. With only five flyable helicopters now available at Desert One, the mission fell into an abort status. Kyle went to Beckwith to see if Delta Force could be reduced, but he was told that it could not be done. With only five helicopters left, Kyle had no other choice but to abort the mission. Beckwith headed for the other helicopters to get his men off and back on to the fixed-wing aircraft. Kyle headed for the SATCOM radio to inform General Vaught of his abort recommendation.¹⁴⁰

With Kyle's recommendation sent to Vaught at Wadi Kena, cleanup action at Desert One got under way. In about 20 minutes Vaught radioed back approving the abort recommendation and directed that the number two helicopter be destroyed in place. The bus passengers were to be released, and the five flyable helicopters would be returned to the USS *Nimitz*. Vaught could have ordered Bluebeard 2 to continue the mission, but he respected the crew's decision and the recommendation from Kyle.¹⁴¹

By the time the abort decision had been finalized, the fixed-wing aircraft had been on the ground two and one-half hours. The additional ground time had cut into their fuel reserves. When Kyle knew for sure that only six helicopters were going to make it to Desert One, he authorized the C-130s to pump 1,000 gallons of fuel from their bladders to their main fuel tanks. Lewis already had refueled three helicopters, and his fuel bladder was empty. Thus, he needed to depart Desert One as soon as possible, or he would not make it out of Iran before running out of fuel. Bluebeards 3 and 4 were parked behind Lewis's aircraft and had to be moved before Lewis could taxi for take-off. Otherwise, the dust kicked up by

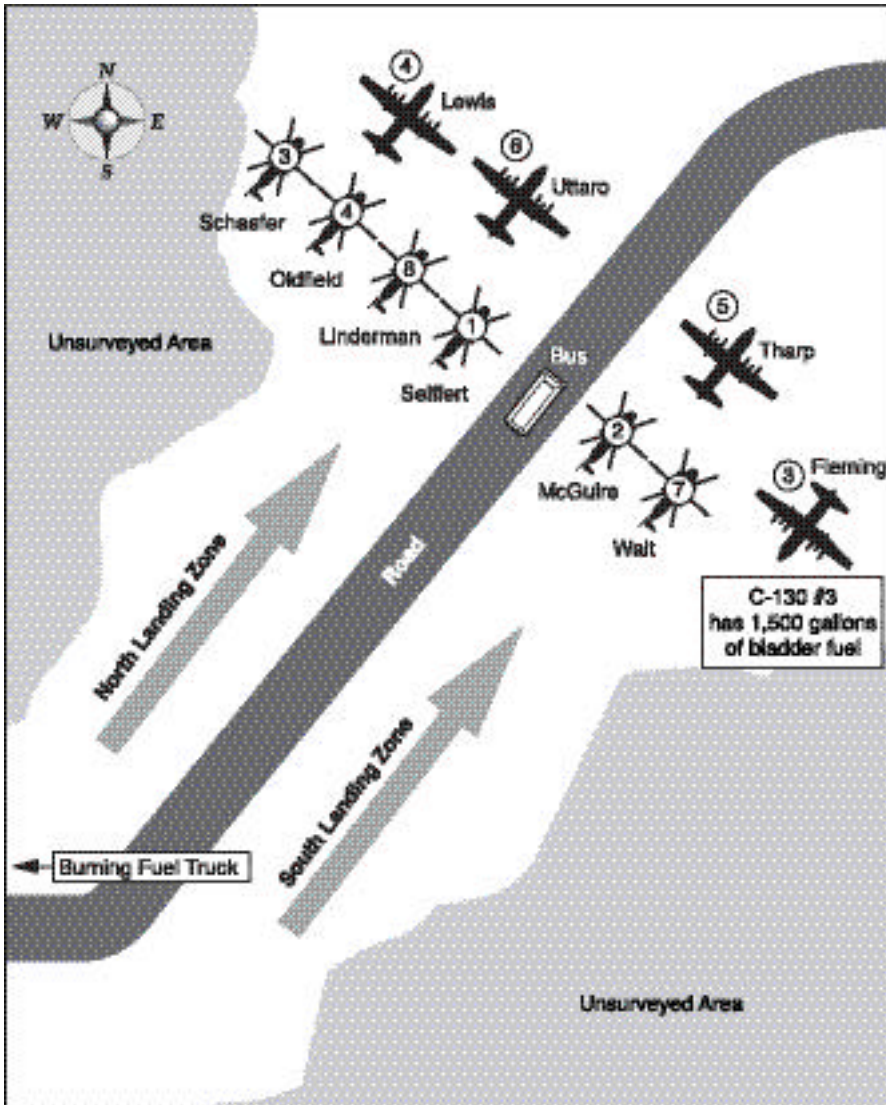


Figure 33. Desert One, Rotary-Wing Arrival (Source: Jim Kyle, *The Guts to Try*, New York: Orion Books, 1990.)

the turning C-130 propellers would destroy the helicopters. Bluebeard 4 also needed more fuel before it departed Desert One, so Kyle coordinated additional fuel to be provided by Republic 5 after Lewis was airborne. Bluebeard 3 had a nose landing gear problem, having deflated the nose-gear tire upon his initial landing. To move the aircraft the helicopter had to be air-taxed to a position north of Lewis’s aircraft. With a CCT marshaller monitoring the operation, Bluebeard 3 lifted off in a heavy cloud of dust at 0248 hours and proceeded to the north and to the left of the parked tanker. Once airborne the pilot became disoriented and allowed the aircraft to drift back to the right. With insufficient altitude to clear the vertical stabilizer of Republic 4, the main rotor blades slammed into the EC-130E, exploding as it plummeted on top of

the parked tanker. The RH-53D impacted the EC-130E along the wing route and slid forward on top of the fuselage, coming to rest just above the C-130 cockpit with its nose facing forward in the same direction as the tanker. Fire erupted immediately, and the two aircraft were engulfed in flames. Aboard Republic 4 were 14 crew members (including fuels personnel) and a portion of Delta Force that already had boarded the aircraft and were lying on the empty fuel bladders. The bladders had become time bombs waiting to explode when the flames got to them (fig. 34).¹⁴²

As the two aircraft burned, Witherspoon, one of Lewis’s loadmasters, managed to get the right paratroop door open, and Delta Force personnel began bailing out the door and rolling in the sand to extinguish their flaming clothing. McClain

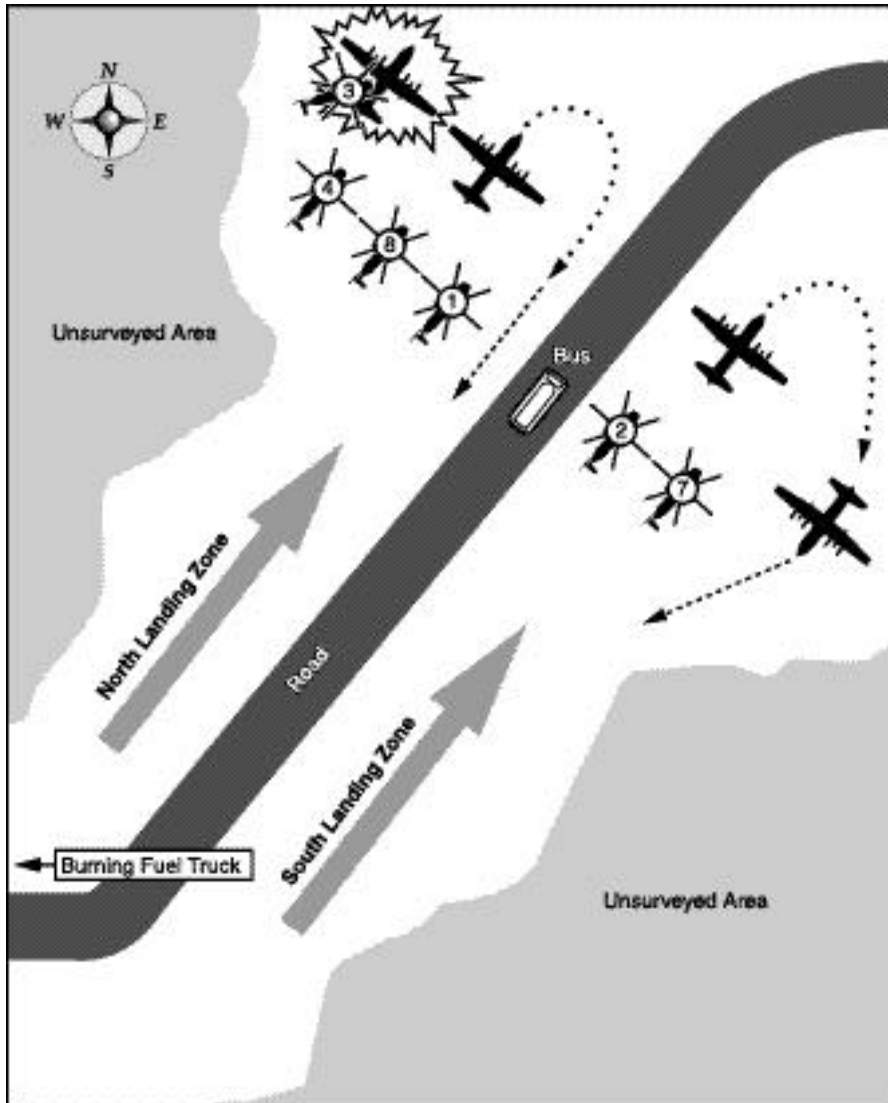


Figure 34. Desert One, Bluebeard 3 Collides with Republic 4 (Source: Jim Kyle, *The Guts to Try*, New York: Orion Books, 1990.)

partially opened the left paratroop door, but quickly closed it when flames shot through the opening. Bancroft, the third loadmaster on Republic 4, tried to keep the soldiers from bunching up at the door opening. On the flight deck Harrison escaped past the galley and raced to the paratroop door with only minor injuries. Byers, the radio operator of Republic 4, was also on the flight deck and was engulfed in flames. Suffering severe burns to his hands and arms, Beyers could not make it through the burning aircraft. Two Delta Force team members raced back into the burning inferno and pulled Beyers to safety.¹⁴³ Beyers had suffered severe burns on his hands and arms, but he had made it out of the aircraft alive.

Uttaro, in aircraft 62-1818, was parked next to the now burning and exploding wreckage that

only moments before had been aircraft 62-1809 and Bluebeard 3. With missiles, bullets, and grenades exploding around him, Uttaro powered up his engines and began taxiing away from the burning wreckage, dragging the still-connected fuel hoses behind his aircraft. Gingerich, Uttaro's radio operator aboard Republic 6, deplaned and moved to the front of Lewis's aircraft. There he found the pilot and copilot of Bluebeard 3 trying to escape the wreckage. Gingerich had seen the pilots exit the burning helicopter and slide down the nose of the C-130. He helped the two to safety, avoiding the still-turning propellers of the tanker. Three additional helicopter crew members did not escape from the rear of the helicopter and remained in the wreckage. In the EC-130E Lewis, McIntosh, Bakke, McMillan, and Mayo were also

trapped in the inferno. In a matter of seconds, the organized withdrawal from Desert One had turned to tragedy. The three helicopters near the accident were abandoned by their crews and were ripped apart by the exploding ordnance. With Bluebeard 2 already grounded behind Tharp's Republic 5, only Bluebeard 7 remained flyable on the south runway. Kyle passed the word that nobody would leave until he could sort out the casualty situation and organize the withdrawal.¹⁴⁴ He made the decision that all helicopters would be left at Desert One.

Kyle directed that a thorough search of the area be made to ensure that everyone was aboard one of the three remaining C-130s. Carney and his CCT were Kyle's primary means for ensuring that no one was left. Three roadblock team members came out of the darkness and were loaded on to one of the C-130s. The CCT picked up the remotely activated landing lights and replaced them with chem-lite sticks (a decision that would nearly cause the loss of two airplanes on takeoff). The bus passengers that had been loaded on Fleming's aircraft were moved back to their bus and released. Tharp, in Republic 5, was the first aircraft to be cleared to depart Desert One. As Tharp's aircraft accelerated down the dirt runway and neared the 3,000-foot point, the aircraft hit the berm of the dirt road and catapulted over it on to the other side. There was a large cloud of dirt kicked up by the impact, but the aircraft continued to accelerate. Tharp managed to get the aircraft airborne, and he struggled for altitude. With the aircraft slowly accelerating, Tharp had made it. The second to take off was Steve Fleming in Dragon 3, also on the south runway. Just as Tharp had done, Fleming ploughed through the dirt berm and continued his takeoff. Dragon 3 struggled for altitude, became airborne, and then slowly climbed into the night sky en route back to Masirah Island. When the CCT removed the runway lights and replaced them with chem-lites, they did not realize that the pilots could not see the dimmer chemlites that outlined the runway. After Tharp successfully departed, Fleming lined up on the tire ruts made by Tharp's aircraft and followed them down the runway.¹⁴⁵ A catastrophe was avoided thanks to the durability of the tough C-130 aircraft and the superior flying skills of their crews.

Kyle and Carney were the last to board Uttaro's aircraft for departure from Desert One. Uttaro made a perfect takeoff from the north runway, and in minutes the aircraft was flying smoothly over

the dark Iranian desert miles from Desert One. Over four hours had passed since Brenci had first landed in the Iranian Desert. Tharp had shut down an engine after takeoff due to loss of engine oil pressure and was proceeding to Masirah Island on three engines. Uttaro soon passed him, with Kyle electing to continue on to Masirah Island and monitor Tharp's progress by way of SATCOM radio. (Uttaro's aircraft had burn victims on board, and Kyle wanted to get them to Masirah Island so that their medical needs could be better attended.) By 0500 Uttaro had cleared Iranian airspace and was one hour out of Masirah Island.¹⁴⁶ None of the aircraft returning from Desert One needed fuel from the KC-135 tankers scrambled by Hess from Wadi Kena. The additional fuel taken from the fuel bladders allowed the two EC-130Es to complete the return leg without refueling. Fleming's aircraft showed less than 4,000 pounds of fuel remaining when he touched down at Masirah Island.

Tharp was the last to land back at Masirah Island. The burn victims from Uttaro's aircraft were transferred to a waiting C-141, and Delta Force boarded a second C-141 for the five-hour flight back to Wadi Kena. General Gast organized a head count of all Air Force personnel to determine exactly who did not return from Desert One. The count verified that Hal Lewis and four of his crew members aboard Republic 4 had been killed in the accident (along with three Marine crew members). The full impact of what had happened only hours before began to sink in. A noble effort to free American hostages in Iran had ended in tragedy. The Combat Talon force, however, flying both MC-130Es and EC-130Es, had performed exceptionally well and had adjusted their plan when operational requirements changed. Operation Eagle Claw had come to an unfortunate end.

* * * * *

At Wadi Kena Pinard brought the news of the Desert One disaster to Meller's crew. Pinard had been up throughout the night and had monitored the mission at Vaught's JTF headquarters. Meller's crew had been in crew rest for the Night Two portion of the operation after being extremely busy since its arrival at Wadi Kena. On 24 April Thigpen and Williamson had configured the Night Two mission aircraft (64-0562, 64-0567, and 64-0572) with IR lenses and rotating-beacon covers, a challenging feat without an operational "cherry picker" to reach the tip of the

vertical stabilizer. Daigenault, Meller's flight engineer, had stayed busy preflighting the aircraft and coordinating with maintenance actions required for the Night Two launch. McBride and Launder, the two crew navigators, had fine-tuned the low-level route to Manzariyeh and had created mission folders for each crew. Drohan, Yagher, and Robb (EW officers from Lewis's, Uttaro's, and Meller's crews, respectively) had analyzed each route segment and had "shadowed" each one with known enemy threats so that the crews could easily determine when the aircraft would be detected by Iranian radar. They also coordinated with Meller's two navigators to adjust the low-level route if there was any time that the aircraft entered a lethal-threat ring. Mink, Meller's radio operator, spent his time working with the JTF communications element refining the execution checklist and checking out the aircraft's radios. Chesser and Thomas, the two primary loadmasters on Meller's crew, had flown with Tharp on Republic 5 to Desert One and were not at Wadi Kena. The third loadmaster on Meller's crew, Chamness, was new to Combat Talon, but he was already highly respected for his knowledge. He inspected

each aircraft and ensured that their cargo compartments were properly configured for the Night Two mission.

Meller coordinated his crew's effort. He knew that there would be little time for Brenci, Uttaro, and Lewis to prepare for the Manzariyeh mission, so he and Thigpen prepared an in-depth briefing that covered all phases of the flight. His plan was to brief the Night One crews on the Night Two mission immediately after their arrival back at Wadi Kena and provide them the mission folders containing essential mission details. There was just enough time to answer questions before take-off. Daigenault and Chamness had the aircraft preflighted and ready to go. The pilots reviewed every bit of data for the Night Two mission—from weight and balance forms to the EWO's threat assessment to the navigator's low-level route. By the time Pinard arrived with the news of the Desert One disaster, Meller and his crew had the Night Two mission finalized and were ready to brief the mission.

With Delta Force and the injured soldiers and airmen gone from Masirah Island, General Gast, Kyle, the communications crew, the CCT, and the five Combat Talon crews were all that remained.



Photo courtesy of J. V. O. Weaver

Night Two Lead Crew. Left to right: Mink, *Chesser, Thigpen, Launder, Daigenault, Meller, *Thomas, McBride, Williamson, and Robb. Not pictured: Chamness.

*Also flew during 24 April Desert One mission.

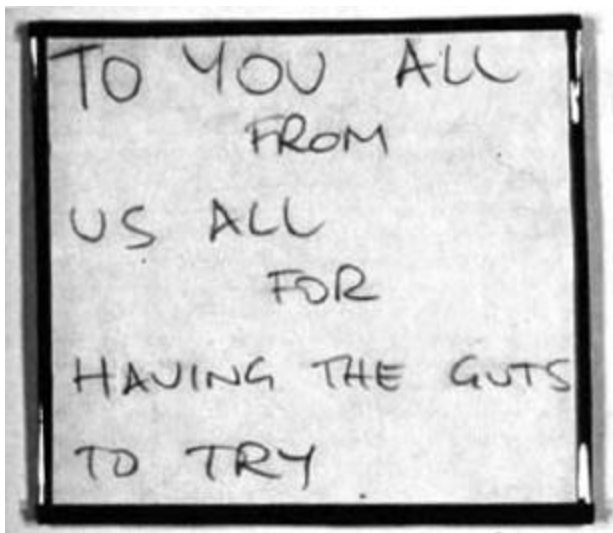


Photo courtesy of Roland Guidry

The inscription on the cardboard beer case was later adopted by the 8th SOS as its squadron's motto—The Guts to Try. The box top hangs on the wall of the 8th SOS at Duke Field.

Everyone was mentally and physically drained. Two British personnel assigned to the sultan of Oman's air force pulled up in a jeep and deposited two cases of beer. Written on the cardboard case was the phrase that has since become the motto of the 8th SOS: "To you all, from us all, for having the guts to try." The beer was a welcomed respite from the previous night's tragedy. As everyone settled down for a much needed rest, maintenance crews were busy inspecting the aircraft.

Combat Talon 64-0565 was in bad shape. Brenci had turned the aircraft over to maintenance, and Oliver swung into action. Kyle asked Oliver to inspect the aircraft to determine if it was safe to fly. The large radome on the belly of the aircraft, which housed ECM equipment, had the front half torn off, and the rear of the radome was filled with Iranian sand. There were skin cracks in areas identified as "secondary structure," including the wing-fairing skin. Buie Kindle inspected the landing gear, expecting to find damage there due to the forces exerted during the impact with the desert floor. Visual inspection revealed no damage, but Oliver ordered a nondestructive inspection (NDI) performed to determine if there was damage not detectable to the naked eye. On 26 April an NDI technician arrived by way of a support C-130, and he set about inspecting the aircraft. To Oliver's surprise the landing gear checked out fine. The NDI also showed minor cracks in the wing areas, but Oliver determined

that the aircraft was safe to fly with a reduced fuel load.¹⁴⁷

On 28 April Oliver and his Detachment 4 crew departed Masirah Island in 64-0565 for Wadi Kena with the NDI technician and Kyle on board. Kyle was subsequently ordered back to Washington, D.C., and departed Wadi Kena by way of a C-141 bound for Europe and the United States. After an overnight stay in Egypt, Oliver flew on to Rhein Main AB by way of a refueling stop at Sigonella AB. He requested an Air Force structural engineer meet the aircraft in Germany. After another day of inspections by the engineer, the aircraft was certified as airworthy, and Oliver departed Germany for Keflavik, Iceland. With stops in Greenland and Goose Bay, Labrador, Oliver flew on to Wright-Patterson AFB, Ohio, where he stopped to brief the Air Force Logistics Command vice commander on his participation in Eagle Claw. The last leg of the flight terminated at LAS Ontario. Aircraft 64-0565 had made it home. Later inspections revealed that the leading- and trailing-edge wing spars were severely cracked, and the "rainbow" fittings, which provided the means to attach the wings to the fuselage of the aircraft, were also cracked. In short the aircraft was in terrible shape.¹⁴⁸ The Talon would be dismantled and rebuilt from the ground up. After only nine months at LAS Ontario, Combat Talon 64-0565 was returned to the fleet and resumed its distinguished service. Ironically, Turczynski was the aircraft commander who accepted the aircraft in February 1981. Lockheed technicians at LAS Ontario had corrected every discrepancy in the aircraft's forms. The aircraft was on an "initial" with no delayed discrepancies in the form K. It was the only time in his career that Turczynski flew a Talon with no write-ups.

The Holloway Commission Report

Over the next 10 days, the Talon crews made their way back to their home bases. Turczynski departed Masirah Island on 28 April and was the last to leave. He retraced his route of flight through Diego Garcia, where his crews again spent the night. The next day his aircraft refueled twice en route nonstop to Kadena AB. The Hurlburt Field crews retraced their deployment routes back through either Rhein Main AB or Lajes Field. Uttaro and other designated crew members stayed in Germany and provided an escort for the remains of Lewis and his fallen airmen after their release by the Iranians. Meller's crew also stayed in Germany for several days awaiting

a decision whether his Combat Talon would be used for the return of the aircrew remains to the United States. Meller was eventually released, and on 2 May 1980 his crew arrived back at Hurlburt Field, Florida, in Combat Talon 64-0572, the last to return home from the mission.

The month of May revolved around honoring the fallen airmen and marines, with memorial services held at Hurlburt Field and in Washington, D.C., and funeral services conducted at the Air Force Academy and in Valdosta, Georgia. On 9 May 1980 President Carter presided over a memorial service at Arlington National Cemetery for the eight men lost at Desert One. As the special operations community buried its dead, the inevitable investigations began to determine what happened at Desert One and who was to blame for the failure.

The Senate Armed Services Committee convened on 7 May 1980 to investigate the failed mission. Chaired by Sen. John Stennis, the committee was limited to asking questions regarding the rescue mission from the time of its inception up to its failure at Desert One. There was to be no speculation on any planning for a follow-up attempt. Vaught, Gast, Kyle, Beckwith, and the Marine helicopter formation commander, Lt Col Ed Seiffert, testified before the senators. The hearing opened with Stennis reading a statement that everyone on the committee had pride in their military and that the purpose of the hearing was to learn the facts behind the failed mission. Sen. Barry Goldwater, who had supported the president in his decision to execute the mission, insisted that no person be admonished or demoted because of the failure. Sen. Strom Thurmond expressed concern over command and control issues. As the hearing progressed, Sen. Sam Nunn cut to the heart of the matter when he asked two important questions: What had we learned from the failure? and What could be done to make the system better for the future?¹⁴⁹ Both questions needed answering, and Beckwith provided an answer to the second one—establish a permanent task force responsible for the counterterrorism mission. The seeds were planted during the hearings that would eventually grow into the establishment of the US Special Operations Command a few years later. (Senators Nunn and Cohen later coauthored the text of the Defense Appropriations Act of 1986 that established the new US Special Operations Command.)

The House Armed Services Committee conducted hearings during May, and the principle

commanders were again called to testify. Guidry also testified before the House committee. House representatives seemed fixed on determining why the RH-53D helicopter was selected for the mission over perhaps other, more capable aircraft (the USAF MH-53 Pave Low, for example). After two weeks of testimony on Capitol Hill, Congress decided to drop its investigation and turn the task over to the Joint Chiefs of Staff. Congress apparently decided that the Joint Chiefs could better investigate itself to determine what went wrong. Towards the end of May 1980, the Department of Defense established the Special Operations Review Group, which came to be known as the Holloway Commission and was chaired by Adm James L. Holloway III, former chief of naval operations. The commission was chartered to conduct a forward-looking, no-holds-barred assessment of the attempted rescue mission. The purpose of the commission was to provide an independent appraisal of the rescue attempt so the commission could recommend improvements in planning, organizing, coordinating, directing, and controlling any similar operation in the future.¹⁵⁰

The commission was made up of six flag and general officers representing all four services. In addition to its chairman (Admiral Holloway), members of the commission included Lt Gen Samuel V. Wilson, Retired, USA; Lt Gen Leroy J. Manor, Retired, USAF; Maj Gen James C. Smith, USA; Maj Gen John L. Piotrowski, USAF; and Maj Gen Alfred M. Gray, USMC.¹⁵¹ The group reviewed all pertinent written documentation, including planning documents, training reports, mission debriefs, congressional testimony, media clips, press releases, technical analyses, and the after action report. All principals involved in the operation were also interviewed. The commission traveled to Fort Bragg and to Hurlburt Field and received detailed briefings on each participating unit's capabilities. At Hurlburt Field an airfield seizure demonstration was conducted with Brenci's and Meller's crews performing blacked-out landings at Holley Field, a small airfield located in the Florida Panhandle. The short runways and confined taxiways challenged the participants, but the demonstration went off without a hitch. Two HH-53 Pave Low helicopters from the 20th SOS and one AC-130H gunship from the 16th SOS also participated in the demonstration. In addition to viewing actual demonstrations and receiving mission briefings, the commission also conducted roundtable discussions with mission personnel of

all grades, from commanders to airmen, to determine individual skill levels, motivations, and levels of proficiency to perform the special operations mission. Because the commission was chartered by the JCS, most of the commission's discussions were with military personnel and their organizations within the National Military Command System. The majority of the commission's findings and recommendations, therefore, dealt with matters internal to the Department of Defense.¹⁵²

By August 1980 the Holloway Commission had completed its investigation and had presented its findings to the JCS. The commission identified 23 issues, which it felt deserved full analyses but provided a note of caution. The commission unanimously concluded that no one action or lack of action caused the rescue attempt to fail and that no one alternative or all alternatives could have guaranteed its success. The mission was high risk and involved the possibility of failure. From the 23 issues the commission drew the following 10 specific conclusions:

1. The concept of a small clandestine operation was valid and consistent with national policy objectives.
2. The operation was feasible and probably represented the plan with the best chance of success at the time the mission was launched.
3. The rescue mission was a high-risk operation.
4. The first realistic capability to successfully accomplish the rescue of the hostages was reached at the end of March.
5. OPSEC was an overriding requirement for a successful operation.
6. Command and control was excellent at the upper echelons but became more tenuous and fragile at the intermediate levels.
7. External resources adequately supported the JTF and were not a limiting factor.
8. Planning was adequate, except for the number of backup helicopters and the provisions for weather contingencies.
9. Two factors combined to directly cause the mission abort: unexpected helicopter failure rate and low-visibility flight conditions en route to Desert One.
10. The citing of Desert One near a road probably represented a higher risk than indicated by the JTF assessment.¹⁵³

In addition to the 10 specific conclusions, the commission also identified two general conclusions that emerged as fundamental concerns that were related to most of the 23 major issues. The two general conclusions were as follows:

1. The ad hoc nature of the organization and planning was related to most of the major issues and im-

pacted the commission's conclusions. By not having an existing JTF organization, the JCS had to start from the beginning to establish a JTF, find a commander, create an organization, provide a staff, develop a plan, select the units, and train the forces before attaining even the most rudimentary degree of mission readiness.

2. Operations security impacted on the JTF's ability to do many actions that would have enhanced mission success. A carefully structured JTF organization would have inherently provided an OPSEC environment within which a selective process could have allowed a wider initial disclosure policy based on selective disclosure rather than minimum disclosure.¹⁵⁴

At the conclusion of the three-month investigation, the Holloway Commission made two recommendations to the JCS. It recommended that a Counterterrorist Joint Task Force be established as a field agency of the Joint Chiefs of Staff with permanently assigned staff personnel and certain assigned forces. It also recommended that the Joint Chiefs of Staff give careful consideration to the establishment of a Special Operations Advisory Panel, composed of a group of carefully selected high-ranking officers (active and/or retired) who had career backgrounds in special operations or who had served at the CINC or JCS levels and who had maintained a current interest in special operations or defense policy matters.¹⁵⁵ With the conclusion of the commission's investigation, the final chapter closed on Operation Eagle Claw.

* * * * *

May had been a time of mourning and reconstitution for special operators at Hurlburt Field and at Kadena AB. With the House and Senate Armed Services Committees finished with Operation Eagle Claw and the Holloway Commission investigation under way, Talon aircrews were convinced that any opportunity to free the hostages had passed. As June arrived, however, another plan was being formulated in Washington, D.C., that centered on Combat Talon. There had been many innovations and new tactics developed over the previous months that had brought the Combat Talon weapons system light years ahead of where it had been in late 1979. As the National Command Authorities pondered the next move, Brenci and Turczynski wasted no time. They were going back to Iran.

Notes

1. Col Thomas P. Bradley, Retired, former commander, 7th Special Operations Squadron, interview by author, 12 May 1999, Hurlburt Field, Fla. Cassette tape on file, Combat Talon Archive, HQ AFSOC/HO, Hurlburt Field, Fla.
2. Paul B. Ryan, *The Iranian Rescue Mission* (Annapolis, Md.: Naval Institute Press, 1985), 7.
3. Ibid.
4. Ibid., 8.
5. Ibid., 8–9.
6. Ibid., 11–12.
7. James H. Kyle, *The Guts to Try* (New York: Orion Books, 1990), 16–17.
8. Ibid.
9. Ryan, 12.
10. Ibid., 42.
11. Charles A. Beckwith, *Delta Force* (New York: Harcourt–Brace–Jovanovich, 1983), 118.
12. Ibid., 171.
13. Ibid., 180.
14. Ibid., 186.
15. Ryan, 20.
16. History, 1st Special Operations Wing, 1 July–31 December 1979, on file 16th SOW historian file, Hurlburt Field, Fla., vol. 1, 48–49.
17. Ryan, 65–66.
18. Ibid., 43.
19. Ibid., 50.
20. Ibid., 50–51.
21. Ibid., 52.
22. Aircrew names were taken from original scheduling documents created at the time by the 8th SOS scheduling section. The author harvested the documents from destruction in 1982 when the 1980 files were being purged from the section. Some names may have changed, or have been omitted by the respective section scheduler, before an actual flight took place. By providing the names of the aircrews, the author communicates to the reader the dynamics of the evolution of the crews as training matured in preparation for the rescue attempt. The author expresses regret if the crew lists provided are not 100 percent accurate. See History, Daily, Weekly, and Monthly Schedule, 8th SOS, 1 December 1979–30 May 1980, Combat Talon Archive, HQ AFSOC/HO, Hurlburt Field, Fla.
23. Kenneth D. Oliver, “They Called It Peanut Field,” 1996, extract on file, Combat Talon Archive, HQ AFSOC/HO, Hurlburt Field, Fla., 195.
24. Ibid., 196.
25. Ibid., 197.
26. Ibid., 197–98.
27. Kyle, 77.
28. Ibid., 78–79.
29. Ibid., 86–87.
30. Ibid., 93.
31. Ibid., 94.
32. Ibid., 96–97.
33. Ibid., 98–99.
34. Ibid., 80.
35. Ibid., 99.
36. Ibid.
37. Ibid., 101.
38. Ibid., 100–101.
39. Ibid., 102.
40. Ibid., 103.
41. Ibid., 107.
42. Ibid., 108.
43. Ibid., 108–9.
44. Personal notes, Col Roland D. Guidry, Retired, former commander, 8th Special Operations Squadron, extract on file, Combat Talon Archive, HQ AFSOC/HO, Hurlburt Field, Fla.
45. Kyle, 113–14.
46. Ibid., 114.
47. Ibid., 114–15.
48. Ibid., 116.
49. Ibid.
50. Ibid., 117–18.
51. Bradley interview.
52. Ibid.
53. Ibid.
54. Ibid.
55. John Townsend, “A View from Behind the Curtain,” 28 December 1997, memoir, Combat Talon Archive, HQ AF-SOC/HO, Hurlburt Field, Fla., 6.
56. Bradley interview, 14.
57. Oliver, 198–99.
58. Ibid., 200–201.
59. Ibid., 201.
60. Kyle, 131–32.
61. Guidry personal notes.
62. Ibid.
63. Kyle, 132.
64. Ibid.
65. Ibid., 132–33.
66. Townsend, 7–8.
67. Ibid., 8–9.
68. Guidry personal notes.
69. Townsend, 10–11.
70. Ibid., 11.
71. Guidry personal notes.
72. Ibid.
73. Ibid.
74. Kyle, 136.
75. Guidry personal notes.
76. Ibid.
77. Ibid.
78. Kyle, 139.
79. Ibid., 134.
80. Ibid., 144.
81. Ibid., 158.
82. Guidry personal notes.
83. Ibid.
84. Ibid.
85. Ibid.
86. Kyle, 164.
87. Ibid.
88. Ibid., 167.
89. Ibid., 173.
90. Ibid., 172.
91. Ibid., 189.
92. Ibid., 190.
93. Guidry personal notes.
94. Kyle, 178.
95. Ibid., 178–79.
96. Ibid., 179–80.
97. Ibid., 181.
98. Ibid.
99. Ibid., 183–84.
100. Ibid., 205–6.
101. Ibid., 206–7.
102. Ibid., 207.

PRAETORIAN STARSHIP

103. Ibid., 208.
104. Oliver, 202–3.
105. Guidry personal notes.
106. Townsend, 17.
107. Guidry personal notes.
108. Kyle, 210–11.
109. Ibid., 211.
110. Ibid., 212.
111. Ibid., 213.
112. Ibid., 226–28.
113. Ibid., 229.
114. Ibid., 231.
115. Ibid., 234.
116. Ibid., 236–37.
117. Ibid., 236.
118. Ibid., 238–39.
119. Townsend, 19.
120. Kyle, 242–43.
121. Townsend, 19–20.
122. Kyle, 244–45.
123. Ibid., 248–49.
124. Ibid., 250–51.
125. Townsend, 20.
126. Kyle, 257.
127. Ibid., 258.
128. Townsend, 20.
129. Kyle, 261–63.
130. Ibid., 272–73.
131. Ibid., 273.
132. Ibid., 274–75.
133. Ibid., 275.
134. Ibid., 243.
135. Ibid., 249–50.
136. Ibid., 253–55.
137. Ibid., 267–69.
138. Ibid., 278.
139. Ibid., 285.
140. Ibid., 288–89.
141. Ibid., 292–93.
142. Ibid., 295–96.
143. Ibid., 296–97.
144. Ibid., 299.
145. Ibid., 304–5.
146. Ibid., 306.
147. Oliver, 211.
148. Ibid., 211–12.
149. Kyle, 318–19.
150. J. L. Holloway III, “Holloway Rescue Mission Report,” August 1980, Combat Talon Archive, HQ AFSOC/HO, Hurlburt Field, Fla., 1.
151. Ibid., 1–2.
152. Ibid., 2–4.
153. Ibid., 57–60.
154. Ibid., 60.
155. Ibid., 61.

Project Honey Badger and Credible Sport (1980–81)

All the king's horses and all the king's men, couldn't put Humpty together again.

It had been nearly six months since planning for the Iranian rescue mission kicked off in the fall of 1979. For the Combat Talon community, the period would come to be recognized as the greatest period of Combat Talon system advancement in its history. The tragedy at Desert One relegated the rescue attempt to one of failure, but the tactics developed and hardware procured during preparation for the mission formed the foundation of Combat Talon capabilities for the next two decades.

NVG Blacked-Out Landing

The greatest development during the period was blacked-out landing operations. Before Desert One Combat Talon crews were trained in short-field landing operations to austere landing zones, but they required overt lights to mark the runway during hours of darkness. Several portable lighting systems were used, including smoke pots filled with kerosene and battery-powered “bean bag” lights that provided marginal overt illumination of the runway. The major drawback of these lights was twofold: first, they were hard to see by the pilot flying the approach, and second, unfriendly forces on the ground could see them. General Vaught had tasked Kyle early in the planning phase to develop a capability to land the Combat Talon without any external overt lighting, including lights on the aircraft or lights on the runway. To fulfill this tasking, NVGs were acquired and employed for the first time by fixed-wing crews.

When the 8th SOS first began to develop its NVG procedures, the copilot (or right-seat pilot) wore NVGs that were focused on infinity, and he searched outside the aircraft for the runway environment. A five-light pattern was developed to provide the pilots a visual reference for the runway. In the early stages of NVG airland development, these five lights were overt and could be seen by the naked eye. As the capability matured IR filters were developed so that the lights could be seen only by NVGs. One pair of lights was placed on each shoulder of the

runway 500 feet down from the approach end, and a second pair was placed 1,000 feet from the first set of lights. At the far end of the runway, a single light was placed on the left side of the runway. The visual effect was similar to sighting a hunting rifle with manual sights—the distant light was centered between the four closer lights, resulting in the aircraft being lined up properly down the runway.

Approach guidance was provided to the pilot by the left navigator, who constructed a standard 2.5-degree airborne radar-approach glide slope for the aircraft's landing. As the left navigator called out headings and altitudes, the left-seat pilot, who initially was not on NVGs, flew the approach according to the navigator's instructions. When the right-seat pilot acquired the landing light pattern or the runway environment on NVGs, he notified the left-seat pilot and started flying the ailerons to assist in aligning the aircraft with the runway. When the left-seat pilot acquired the runway with his naked eyes, he took control of the aircraft and landed using a controlled sink rate and visual references to the portable lights. Both the aircraft's landing and taxi lights remained off during the approach and landing. Although the procedure proved to be reliable, several hard landings occurred when the left-seat pilot misjudged the aircraft's actual sink rate.

After 17 December 1979 when IR filter paper was attached to the landing and taxi lights to provide covert illumination during blacked-out landings, procedures were changed so that the left-seat pilot landed the aircraft while using NVGs. The IR filter paper was sandwiched between two pieces of tempered glass and attached to both the landing and taxi lights by using modified brackets developed by Oliver and his developmental team. During the approach to landing, the landing lights were extended, but not turned on, until one to two miles out on final. At that time the left-seat pilot called for lights, and the flight engineer turned them on to illuminate the approach end of the runway. The later NVG procedure required

that everyone in front of the navigator's curtain use NVGs. The right-seat pilot flew the approach with panel lights turned out, while the flight engineer monitored the engine instruments and the right-seat pilot's approach. Both the right-seat pilot and the flight engineer focused their NVGs inside the cockpit. To prevent any light bleeding forward from the navigators' station, heavy black-out curtains were installed in place of the thin dividing curtain used on standard C-130 aircraft. All lights forward of the curtain were either turned off or taped to prevent illuminating the interior of the cockpit. Throughout the approach the left-seat pilot and the third pilot (safety pilot) focused their NVGs outside the aircraft and scanned for the runway environment. At one to four miles out from landing, the left-seat pilot acquired the landing lights, the safety pilot confirmed them, and the left-seat pilot began flying the aircraft. Airspeed, absolute altitude, and vertical-velocity information were read to the left-seat pilot by the right-seat pilot and the left navigator until the aircraft touched down on the runway. If no lights were on the runway, the left-seat pilot usually acquired the runway within a mile of the approach end, depending on moon illumination and the brightness of the runway striping. As the aircraft decelerated through 40 knots after landing, the landing lights were turned off, and the aircraft rolled out to its predetermined off-load location. Covert taxi lights were used sparingly and usually only during turns or in congested areas.¹

For NVG takeoffs the left-seat pilot maintained runway alignment with visual reference to the runway centerline while still using NVGs. The right-seat pilot read off the airspeeds as the aircraft accelerated. On rotation the right-seat pilot provided the left-seat pilot with the number of degrees nose-up attitude and the aircraft's airspeed on climb out. With the introduction of the IR filters for the aircraft lights and for the portable runway lights, Vaught's requirement for total blacked-out landings (to the naked eye) was achieved.²

Fuel-Cell (Blivet) Airdrop

The 8th SOS had initially identified the need to air-drop fuel to helicopters during the October 1979 Red Flag exercise held at Nellis AFB, Nevada. When the requirement to refuel helicopters arose in late November, JTF planners turned to the air-drop method as their first solution to the refueling problem. The initial blivet drop was

conducted using rigging similar to the CRRC, with two G-12D parachutes to support a rigged weight of 3,500 pounds (500 gallons of fuel). As the number of helicopters were expanded to six, then later to eight, the number of blivets to be dropped by each C-130 increased to five. Between December 1979 and February 1980, the blivet drop was refined to include all equipment required to position the blivets and then to pump fuel to the waiting helicopters. Thus, the standard five-blivet airdrop included two petroleum, oil, and lubricant pumps (A-22s) and a small tractor, called a mule, to move the blivets into position. The total weight of the load was approximately 20,000 pounds.³

Testing was done on the five blivet loads at Fort Bragg and at Yuma, Arizona, in December and in early 1980. Testing confirmed that CDS procedures provided were the most accurate and effective means to deliver the heavy load. The following modifications were made to the Combat Talon to allow for successful CDS air-drops:

1. Additional intermediate rails were installed.
2. A dual CDS gate (strap with cutter blade) was developed.
3. Retractable VanZelm ratchets were installed.
4. Individual gates were used for each blivet.

Although the fuel blivet air-drop procedure was not used for the actual mission, the air-drop option remained the JTF's first choice until shortly before mission execution. A secondary airland method of delivering the blivets also was developed. Called the blivet combat off-load, it included modification of the ground-loading ramps with skate wheels to allow the aircraft to taxi with the loading ramps deployed. After the aircraft had landed and taxied to its off-load location, each blivet would be released from its restraints one at a time as the aircraft taxied forward. After the first blivet was downloaded, the aircraft would stop, the loadmaster would cut the second blivet loose, and the aircraft would resume taxi while the blivet exited the rear of the aircraft. The procedure was repeated until all blivets were unloaded. At Desert One Fleming's crew downloaded three fuel blivets using the combat off-load procedure.⁴

Fuel-Bladder Refueling System

Although airdrop of the fuel blivets proved to be a viable delivery technique, the Delta Force commander, Col Charlie Beckwith, did not like the idea of having to depend on air-dropped

blivets to fuel the helicopters. He reasoned that too many things could go wrong—drop malfunctions, unlevel ground that could prevent movement of the blivets to the helicopters, inability of the helicopters to find the refueling site—for him to have confidence in the capability. A rubber fuel-bladder system was developed to allow ground refueling of the helicopters from the C-130 aircraft, thus eliminating the need to air-drop the blivets. Two bladder configurations were developed, one for the Combat Talon and the other for the EC-130E aircraft. The Combat Talon configuration utilized a single 3,000-gallon rubber-bladder system with associated hoses, filters, and pumps. Only 2,700 gallons of this fuel could be downloaded from the bladder due to fuel trapped in the filters, pumps, and hoses and because of residual fuel in the bottom of the rubber bladder.⁵

As the number of helicopters increased to eight, the amount of fuel required to refuel them also increased. The MC-130E had an electronic warfare console in the cargo compartment of the aircraft, thus leaving 27 feet of available cargo space. A standard C-130 had a full cargo compartment measuring 41 feet and could accommodate two fuel bladders. The EC-130E was selected for the bladder mission because it had a full cargo compartment (with the ABCCC capsule removed) that would accommodate two fuel bladders and because it was capable of in-flight refueling. In the dual-bladder configuration, 6,000 gallons of fuel could be loaded aboard the aircraft, 5,400 gallons of which was usable fuel. Each bladder was fitted with two pumps, four hoses, and two filter assemblies. With two fuel bladders installed, takeoff gross weight for the EC-130Es flown to Desert One ranged between 185,000 to 187,000 pounds with 60,000 pounds of internal aircraft fuel and 6,000 gallons in the fuel bladders.

To employ the system, ground helicopter refueling procedures had to be developed. One early concern of the aircrews was how to determine the distance between the C-130 and the H-53 helicopter. The solution found was to extend the standard 50-foot long loadmaster's communications cord to 200 feet, which was the same length as the refueling hoses. Whether the ground-taxi plan required the C-130 to back up to the static helicopters or the helicopters to taxi to the C-130, the distance between the two aircraft always could be determined by the loadmaster with his communications cord. CCT personnel would marshal the aircraft into the refueling

position, and the refueling specialists would engage the hoses and the ground wire. A loadmaster then would either transfer the fuel utilizing the aircraft's fuel control panel, or he would supervise the fuel specialists as they operated the pumps associated with the fuel bladder. The entire operation was safe and efficient, and it provided the helicopters a means of refueling from a remote airfield.⁶

Oliver and his team, along with LAS Ontario engineers, developed a removable, dual-tank, 3,600-gallon fuel system (commonly referred to as a Benson tank) that could be used in lieu of the bladder system. The Benson tank could be connected to the aircraft's fuel system, and fuel could be pumped to the helicopters utilizing the aircraft's dump pumps through the single-point refueling panel. No additional pumps or filters were required. The bladder system took approximately 40 minutes to pump 1,500 gallons of fuel, whereas the Benson tank, with its higher-manifold pressure, took about 20 minutes to transfer the same amount. The Benson tank had many advantages over the bladder system, including the elimination of leaks and fumes normally found with the bladders, increased fuel capacity (two tanks with 1,800 pounds in each tank, for a total of 3,600 pounds), and the use of fuel from the Benson tank while airborne. The major drawback to the system was that it required a dual-rail system installed in each aircraft, which the EC-130Es did not have. Procurement lead time also was such that only one system could be manufactured before the execution of Desert One.



USAF Photo

The Benson fuel tank system pictured was developed by Ken Oliver's team and LAS Ontario engineers. The configuration allowed the tanks to be removed when not required for a mission.

Additional Modifications to Combat Talon

Other modifications were made to Combat Talon to enable the weapons system to execute the Desert One mission. Those modifications included the following:

1. Modified the terrain-following computer to accommodate 165,000 pounds maximum aircraft gross weight (previous limit was 135,000 pounds).
2. Modified the right side 463L rail locking mechanism.
3. Modified the rollers to accommodate the blivet drop system.
4. Modified the forward escape hatch to accommodate the PSC-1 SATCOM antenna.
5. Modified the top rotating beacon with a filter for an IR flasher.
6. Installed heavy-duty blackout curtains between the pilots' and navigators' crew stations.
7. Modified an Army IR tank searchlight for use as an illuminator.
8. Installed over-the-counter "fuzz busters" to detect certain types of radar threats.⁷

To utilize the new capabilities, tactics and procedures were developed and refined by Combat Talon crew members. The point-parallel IFR procedure, which required radio communications to coordinate both tanker and receiver aircraft, was modified to a communications-out, overtaking rendezvous procedure. In addition, both the tanker and the receiver lights were reduced to a minimum level to decrease the visual signature of the aircraft. The FLIR was installed on 8th SOS aircraft for the first time in nearly 10 years, and the aircrews were trained in its operation. The tactic of flying a Combat Talon down the runway with the FLIR extended to determine the runway's status was refined. Rapid onload and off-load procedures for jeeps, bikes, and personnel were also developed. Prior to Desert One, the Combat Talon did not fly in formation; rather, it used single-ship employment tactics during operational missions. Low-level formation procedures with both the EC-130E and other Combat Talons were developed utilizing the terrain-following radar. To fly low-level formation, a whole new set of procedures had to be developed since the radar system was designed for single-ship operation, and limitations such as wing-tip clearances and aircraft climb rates had to be determined. Procedures were also developed for station keeping between a string of MC-130Es using existing equipment (radar, the SST-181 beacon, and air-to-air TACAN).⁸

By May 1980 a second plan to rescue the hostages was well under way. At no time in history was the Combat Talons force more capable and better prepared to do its job. With the Holloway Commission still investigating the Desert One

mission, it was time to put the new hardware, tactics, and procedures together and develop a new plan to free the hostages.

Project Honey Badger

Within two weeks of the failed Desert One mission, a second hostage rescue planning effort was moving forward in the Pentagon. JCS-J3/SOD continued to provide the cover and physical working space for the JTF, but another organization, named the Joint Test Directorate (JTD), was established to assist the JTF planners. The mission of JTD was to coordinate the development of new capabilities and strengths that the JTF could draw upon when developing its plans.⁹ As JTF planners developed various options to resolve the hostage situation, the JTD analyzed them and developed capabilities to make the options viable. When the April rescue mission failed, the Iranians dispersed the hostages to various locations outside Tehran, thus making any follow-on effort extremely difficult and more complex. There were also emerging requirements, many of which were still unknown, that faced JTF planners. It was the JTD's responsibility to catalogue and retain new capabilities so that JTF planners could source them when mission requirements were identified. Thus, no capability was "lost" as the planners developed their various options. The JTD effort was code-named Honey Badger, with the training and testing costs funded from US Army and US Air Force sources.¹⁰

The Honey Badger program developed capabilities without regard to a specific rescue scenario. The JTD then compiled a robust list of Honey Badger-tested and -validated capabilities from which the JTF planners could develop options. Actual mission responsibilities remained the same as the original rescue attempt: Delta Force focused on the embassy and other high-value targets, the rangers were responsible for airfield seizure operations, and the 1st SOW provided aviation planning. A new US Army aviation organization was also in the process of being formed and was given aviation planning responsibilities along with the 1st SOW. On 3 June 1980 General Vaught briefed the JCS on the status of JTF planning and outlined force requirements that had been identified. For the Air Force, a new nine-aircraft, HH-53 Pave Low, squadron was established at Hurlburt Field, with the aircraft being assigned to the 20th SOS. The HH-53 had been developed after Vietnam by the Military Airlift Command for night rescue operations and had a terrain-following

radar system similar to the Combat Talon. With the aircraft scheduled to become operational in July 1980 and assigned to McClellan AFB, California, the Air Staff took action to redirect the weapon system to Hurlburt Field and to assign them to TAC. The unsatisfactory performance of the US Navy RH-53Ds at Desert One had convinced planners that an improved rotary-wing capability was needed if the mission was to be a success. Along with the nine Air Force aircraft, Vaught identified the need for 30 US Army UH-60 Blackhawks and more than a dozen CH-47 Chinooks.¹¹ For the Combat Talon, Honey Badger improvements centered on tactics development rather than hardware improvements. One MC-130E undergoing IFR modification at LAS Ontario, however, was accelerated and completed ahead of schedule, thus increasing the number of IFR-capable Combat Talon aircraft assigned to Hurlburt Field from three to four.

As the JTD developed capabilities under the Honey Badger program, the relatively small force that was tasked during the Desert One rescue attempt was expanded to include many new players. By the summer of 1980, the JTD had trained a wide spectrum of forces dedicated to executing the various options developed by JTF planners. The forces numbered 2,377 personnel and 136 aircraft, and most of them were employed during July in the first large-scale exercise since Desert One.¹² The Combat Talon was still a critical part of the rescue plan, but its role was much smaller compared to the overall aviation force dedicated to the new effort.

The Summer of 1980

Kyle and Guidry had spent much of May either preparing for or testifying before Congress, as had the other primary commanders in the failed raid. As Operation Eagle Claw slipped farther into history, however, the reality of the present took hold. The hostages were still prisoners in Tehran, and the prospects of getting them back to the United States were slim. After the failed rescue, the hostages were dispersed throughout Tehran, with some being moved out of the city to remote areas. The problem of locating them and rescuing them unharmed was much more difficult than had been the case in April. In any case President Carter needed an

executable rescue plan should the Iranians begin to carry out their threat to kill the Americans. A second attempt would undoubtedly suffer more casualties, but the president needed a military option just in case it was required.

The Holloway Commission visited Hurlburt Field during the second week of June, and an airfield seizure demonstration was flown during the night of 10 June. The purpose of the demonstration was to show commission members the new capabilities that the Air Force had developed for Desert One. Brenci, flying aircraft 64-0562, flew the lead aircraft into a small airfield just to the west of Hurlburt Field known as Holley Field. At 2230 local time he made a blind airdrop of 20 US Army ranger personnel on to the airfield and then departed the area on a short low-level route. Thirty minutes later Meller was inbound to the field and made a blacked-out landing on the 3,600-foot landing strip. Meller had additional airfield security personnel and CCT aboard and downloaded them at the departure end of the runway. Brenci landed three minutes later at 2303 with the remainder of the security force. At 2320 two HH-53 Pave Low helicopters from the 20th SOS landed and were marshaled behind the two Talons to transfer their passengers to the fixed-wing aircraft. At 2340 the two Talons departed two minutes in trail and flew a terrain-following leg back to Hurlburt Field. Commission members boarded the two HH-53s and flew back to Hurlburt Field, where the mission was debriefed and commission members' questions answered.¹³

During the course of the airfield seizure, an AC-130H orbited overhead and provided notional cover for the raiding force. Commission members were quite complimentary of the operation, having seen firsthand what a coordinated airfield seizure effort looked like. The exercise marked the first time the 20th SOS had participated in an airfield seizure operation.*

Oro Grande Marine Corps Station and Exercise Rusty Badger

After the completion of the Holloway Commission's visit, Hurlburt Field turned its full attention towards the next major exercise code-named Rusty Badger. The JTD had been busy developing capabilities to support JTF rescue options and

*After the Desert One failure, the Air Staff transferred nine HH-53 Pave Low helicopters from the Military Airlift Command's Air Rescue Service to the 1st SOW. As had the Combat Talon squadrons, USAF rotary-wing special operations capabilities had been allowed to decay to a point that only a few obsolete HH-3s and UH-1Ns remained in the special operations inventory by 1979. Along with the nine HH-53H Pave Lows, the 1st SOW also received two HH-53Bs and three HH-53Cs, for a total of 14 aircraft.

was ready to rehearse and validate them. The March rehearsal for Desert One had been the last time that both Hurlburt Field and the Kadena-based Combat Talon crews had flown together. Turczynski had spent the time expanding his crew force and training additional crew members in NVG blacked-out operations. For Rusty Badger, he brought back to the United States three aircraft—62-1843, 63-7785, and 64-0564—and three crews under the command of Fleming, Pearson, and Rumble. Brenci had to replace Hal Lewis's crew and at the same time expand his crew force as Combat Talon requirements continued to increase. Ferkes and Thigpen were identified to become aircraft commanders of their own crews, both having been involved in the preparation for the Desert One mission from its early days. For the July exercise the 8th SOS provided four aircraft—64-0562, 64-0567, 64-0568, and 64-0572—along with four Combat Talon crews commanded by Brenci, Uttaro, Tharp, and Meller. On 29 June pre-exercise training began, with one C-130 transporting 25 passengers and their equipment from Pope AFB, North Carolina, to Condron Army Airfield near White Sands, New Mexico.¹⁴

Six days later the entire 1st SOS/8th SOS contingent was settled into Oro Grande, a small US Marine Corps facility near Condron AAF. Personnel were transported between Condron AAF and Oro Grande when their duties required them to be at the aircraft. A central chow hall provided messing for all personnel, and open-bay barracks provided sleeping accommodations. From 6 to 8 July, squadron loadmasters worked with Army rangers performing static onload and off-load training during the day, while the remainder of the crew flew night low-level missions to short-field dirt landings in the area. On 9 July the air-drop of a 25,000-pound bulldozer was accomplished along with a combat off-load of a fuel blivet by two Combat Talons. The bulldozer drop was one of the new capabilities developed by the JTD to satisfy JTF planner requirements to clear a runway rapidly should it be blocked during an airfield seizure operation.¹⁵

During the night of 10/11 July, three iterations of the same exercise were flown between 2115 and 0600 the following morning. Each iteration consisted of a bulldozer drop followed by ranger and CCT static-line drops to a blacked-out runway/drop zone. Forty minutes after the dozer drop, three MC-130s landed with the remainder of the airfield clearing team. After completion of each iteration,

CCT and ranger personnel were extracted to White Sands, and another iteration would begin with a different ranger battalion. In all, three ranger companies were trained in the airfield seizure operation, and all seven Combat Talon crews gained experience in delivering the airfield seizure package.¹⁶

During the night of 13 July, General Vaught visited Condron AAF and Oro Grande and observed an AC-130H live-fire demonstration and an airfield seizure operation. At the completion of the Condron AAF seizure, Vaught and most of his party flew on to Michaels AAF, Utah, on an MC-130E. After departing Michaels AAF on its return leg to White Sands, the Combat Talon performed a blacked-out, communications-out air refueling with a KC-135 before its final landing. With the training period complete, the deployed force was now ready for a full-scale rehearsal. During the night of 15 July, forces originating from Condron AAF hit two objective areas simultaneously. Fleming and Brenci, flying aircraft 64-0564 and 64-0572, departed Condron AAF en route to Tonapah, a small airfield in the Nellis AFB range complex. Fleming flew a FLIR runway clearing pass, and Brenci landed one minute later. On Brenci's aircraft were two jeeps and 50 rangers who were tasked to secure the southern portion of the airfield. Five minutes after Brenci landed, Fleming landed with one jeep, two motorcycles, 50 rangers, and CCT personnel. The rangers' objective was to secure the northwest portion of the airfield, and the CCT's objective was to mark the runway for follow-on aircraft.¹⁷

While the first two Combat Talons were assaulting Tonapah, the other four aircraft were committed to a similar operation at Fallon NAS, California. After all four aircraft refueled en route, Paul Rumble, flying aircraft 62-1843, began the airfield seizure operation when he dropped a bulldozer and seven jumpers on to the runway. Five minutes later Tharp, in Combat Talon 64-0567, dropped 17 additional jumpers. Uttaro, in aircraft 64-0562, was the first to land at Fallon NAS some 45 minutes after the bulldozer drop. Pearson, Tharp, and Rumble landed behind Uttaro in three-minute increments. After approximately 30 minutes on the ground, the airfield had been secured, and the four aircraft were cleared to depart back to Condron AAF. Both the Tonapah and Fallon NAS exercises went off without a hitch, with all exercise objectives being either met or exceeded.¹⁸

The final major event during the July deployment was a Trainex conducted on 20 July that flew into Reese AFB, Texas. All seven Talon crews flew during the exercise, with Thigpen commanding Meller's crew for the first time. A new tactic, employing dual-runway procedures, was validated. This tactic included flying in formation to the objective area, then simultaneously landing on parallel runways to seize the airfield. Tharp and Uttaro flew EC-130E aircraft 62-1818 and 62-1825, and each carried a small helicopter known as a light observation and command helicopter (LOACH). After the two EC-130s landed and parked in their designated locations, the small helicopters were rapidly off-loaded, and their rotor blades were attached. In a matter of minutes, the LOACHs were launched on their assigned mission.¹⁹ As had been the case for the earlier exercises, the Trainex validated important capabilities (including dual-runway operations, bulldozer airdrops, and helicopter delivery by way of C-130 aircraft), which the JTD retained in its "bag of tricks" until the JTF planners needed them. By the end of July, Brenci's Talon crews were redeployed to northwest Florida and the relative tranquility of everyday home-station operations. Turczynski and his personnel returned to Kadena AB by way of commercial air. The three 1st SOS Combat Talons remained at Hurlburt Field. July had been a busy month for the two Talon squadrons. The tempo would not slack up for another four months. The 1st SOS crews returned to Hurlburt Field in August and remained there supporting Honey Badger operations until they were released in October.

Credible Sport

As the Talon crews worked to perfect their airfield seizure packages and to develop a capability to rapidly off-load and assemble the LOACH aircraft from the EC-130E, the JTD was working on an even more radical capability. The requirement to extract Delta Force and the hostages from the embassy area in Tehran had always driven planners towards such large, heavy-lift helicopters as the HH-53. The helicopter had proven to be the weak link in the Desert One mission and had, in the end, caused its failure. Planners desired to eliminate the helicopter requirement but to do so required the development of a large, fixed-wing aircraft capable of landing in a small area. Across the street from the American embassy in Tehran was the Amjaden soccer stadium, which had a standard soccer playing field that was surrounded

by bleachers. The stadium had been designated as the rallying point for Delta Force, the freed hostages, and the RH-53Ds after the planned April embassy takedown. If a C-130 could be modified to land within the confines of the soccer stadium, unload the rescue force and the freed hostages, and be able to take off in a distance of approximately 100 yards, the logistics of getting the helicopters to Tehran would be eliminated. As a result of this ultrashort-field requirement, USAF asked Lockheed-Martin in early July to conduct a feasibility study and to develop a technical concept.²⁰ Although the C-130 was designed to take off and land on short, unimproved airfields, crews rarely landed on runways less than 3,000 feet in length. The developmental program that the USAF and Lockheed undertook was named Credible Sport.

JTF planners envisioned a mission that would originate from the United States and fly nonstop to Tehran, performing five IFRs en route and then flying low level across Iran to avoid the country's air defense system. After departing the soccer stadium with Delta Force and the hostages, the aircraft would exit Iranian airspace overwater and land on a US Navy aircraft carrier to download its personnel. Planners estimated that there could be up to 50 wounded Americans aboard the aircraft, and the carrier landing was necessary to get them medical help in the shortest time. To be capable of performing the mission, a C-130 would have to be extensively modified to take off and land in the 100-yard distance, and it would have to be capable of landing on an aircraft carrier utilizing the ship's arresting cable system.

The Air Force Systems Command put together a team of specialists to investigate the possibility of modifying an aircraft to perform the mission. The team consisted of civilian experts from Lockheed-Marietta and LAS Ontario, along with rocket propulsion experts from the US Navy. USAF special operations crews and avionics system engineers also worked with the combined team, and within three weeks the effort had developed a technical concept, a production approach, an integration scheme, and a test program. The capability required the installation of rockets on the aircraft to assist during the takeoff phase, to decelerate during the landing phase, and to stabilize the aircraft during transition-to-flight periods. A package was approved by USAF and a contract was signed on 19 August 1980 authorizing production of two Credible Sport-modified aircraft. In all there were some 20 US Navy, 50 US Air Force, and over 1,000 civilians committed to the project.²¹

Three Combat Talon crews were formed to fly the Credible Sport aircraft—one each from the 1st SOS, 7th SOS, and 8th SOS. Uttaro and Fleming had their own crews and were heavily involved in the Honey Badger program. Having just returned from the Oro Grande deployment in July, Brenci called both of the aircraft commanders into his office at Hurlburt Field and told them that they had been selected for a special assignment and to report to the Pentagon in two days. Hess had the details of the program and was responsible for briefing the two pilots. Neither officer wanted to give up his crew and a second chance to return to Iran, but each had no choice in his selection for the special assignment. After two days of briefings in Washington, Uttaro and Fleming returned to Hurlburt Field, and each requested by name additional flyers to fill out their crews. Uttaro worked through Brenci, and Fleming through his squadron commander, Turczynski. The 7th SOS crew was selected in a similar manner, with Jones designated as the third aircraft commander for the project. The three Combat Talon crews selected in early August 1983 for the Credible Sport project were made up of the following individuals:²²

1st SOS	7th SOS	8th SOS
Fleming	Jones	Uttaro
Schott	Tuck	Hermanson
Ozlines	Roberts	Galloway
Armstrong	Saier	Poole
Tafoya	Moody	Almanzar
Hickman	--	Doyle
Fredrickson	--	Bancroft

Three C-130H aircraft were sourced from the 463d Tactical Airlift Wing—tail numbers 74-1683, 74-1686, and 74-2065. The aircraft were identified as the XFC-130H Super STOL (short-field takeoff and landing), and modifications were begun in late August. The contract called for two aircraft to be fully modified to the Credible Sport configuration within 90 days or fewer. The third aircraft (74-2065) was designated as a test bed and was used to test various combinations of rockets and control modifications as the two primary aircraft were being modified. Five sets of rocket motors were required to create the super-STOL capability. Thirty rockets were mounted on the airframe, including eight antisubmarine rocket (ASROC) motors mounted on the fuselage and pointed forward to stop the aircraft during landing and eight AGM-45 Shrike rocket motors mounted above the wheel

wells and pointed downward to break the aircraft's descent rate. In addition, for takeoff, eight Mark-56 rocket motors were mounted on the aft rear-fuselage area on pylons and were pointed toward the rear of the aircraft and downward at approximately a 45-degree angle. To stabilize the aircraft during transition from takeoff, two sets of Shrike rocket motors were mounted on each wing pylon. To prevent overrotation during the takeoff phase, two additional ASROC rocket motors were mounted on pylons in the rear fuselage area in front of the beavertail. An onboard computer that had a manual backup should the computer fail controlled the rockets.²³

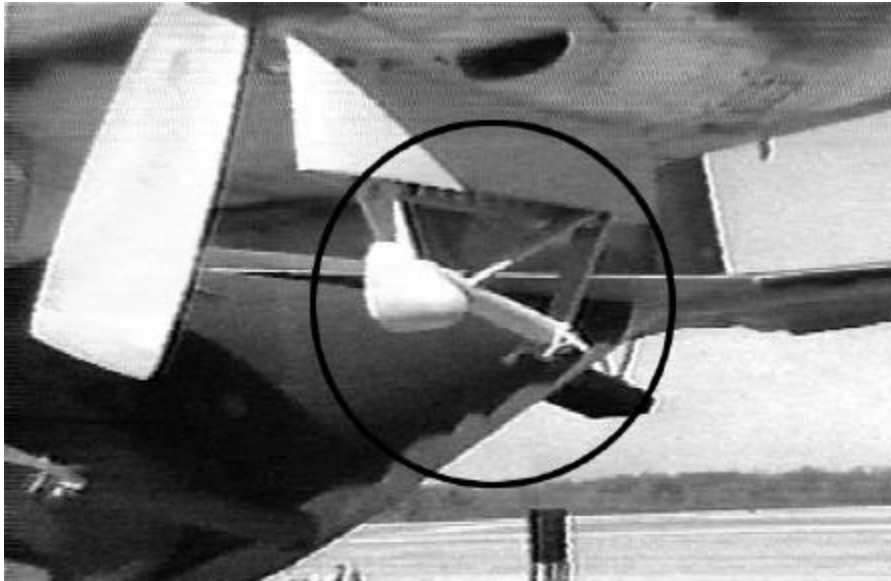
Other external modifications included installation of horsal fins forward of the horizontal stabilizer and a dorsal fin running from near the base of the vertical stabilizer forward on the upper spine of the aircraft. The flaps were modified into a double-slotted configuration, and the ailerons were extended to improve their effectiveness during low-speed flight. To provide a means to stop the



USAF Photo
Front view of Credible Sport aircraft with eight ASROC rockets extended.



USAF Photo
Eight Mark 56 rocket motors (four on each side) were mounted on the aft rear fuselage area and were pointed rearward at a 45-degree angle.



USAF Photo

Two sets of Shrike rockets were mounted on an external pylon to stabilize the aircraft during takeoff.

aircraft on the aircraft carrier, a modified tailhook was installed forward of the ramp hinge on the underbelly of the aircraft. To eliminate the nose landing gear/FLIR problem found on the MC-130E engineers mounted a DC-130 radome on the front of the aircraft and installed a FLIR turret forward of the nose-wheel assembly. The FLIR's laser-range system was integrated into the onboard computer and provided inputs to fire the forward-facing ASROC engines when the aircraft was 20 feet above the ground during the landing phase. To provide in-flight refueling capability, an externally mounted refueling system was installed on the top of the fuselage, similar to the system found on the C-141B aircraft. A Texas Instruments TF/TA radar was installed to enable the aircraft to fly low level,

and a Canadian Marconi Doppler, along with a Global Positioning System (GPS), was tied into the aircraft's dual inertial navigation system to improve overall system accuracy. To protect the aircraft from electronic threats, a basic ECM suite was installed on the aircraft.²⁴

Aircraft 74-2065 was partially modified and was ready to begin flight-tests three weeks after the program began. The three Credible Sport aircraft were transferred to Lockheed as government-furnished equipment for the project, and on 18 September a Lockheed flight-test crew flew the first flight on the test-bed aircraft. Two days later the aircraft began a series of trials that tested the forward-mounted ASROC rockets in incremental tests that lasted for the next three weeks. The flight-tests determined that the aircraft had to be physically on the ground prior to firing the lower set of rockets, but the upper set could be fired



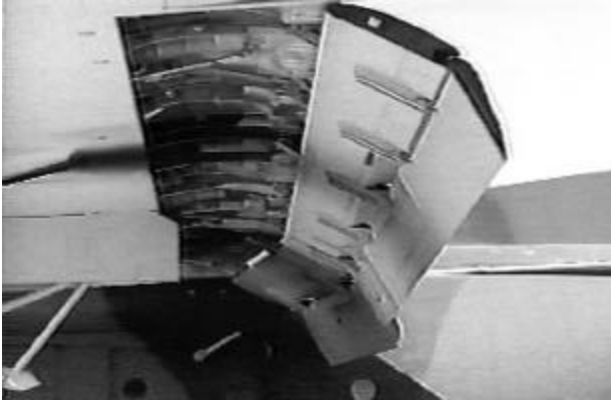
USAF Photo

Two ASROC rockets were mounted near the aft beaver-tail and prevented over rotation during takeoff.

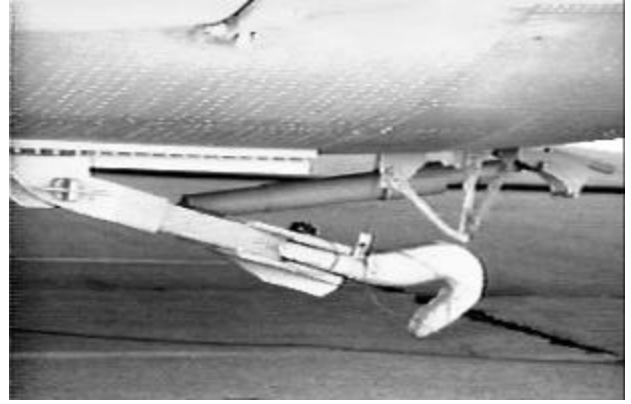


Photo courtesy of John R. Lewis

Horsal and dorsal fins were installed on Credible Sport to improve stability during low-speed flight.



USAFPhoto

Double-slotted flap configuration used on Credible Sport.

USAFPhoto

Modified tailhook installed on Credible Sport.

while the aircraft was still in the air. While the initial flight-test was being conducted by the Lockheed crew, the three USAF flight crews cycled through a specially designed engineering simulator located at Lockheed-Marietta that exposed them to the critical landing phase of the operation. The aircrews flew more than 400 hours in the simulator-like device, gaining valuable experience in the operation of the advanced FLIR, the updated avionics system, and the onboard computer that controlled the rocket-firing sequence. The training device was primarily an engineering tool and did not have motion simulation, as would normally have been the case for a flight simulator. It was used to replicate the landing phase of flight from one-half mile out on final to touchdown.

The first fully modified XFC-130H Super STOL Credible Sport aircraft (74-1683) was delivered on 17 October. During its first flight, it experienced aileron flutter problems attributed to the increased size of the ailerons. Within two days a fix was made to the system, and the aircraft was flown to TAB 1, a disused airfield located in the Eglin AFB range complex in the Florida Panhandle.²⁵

From the time aircraft 74-1683 arrived at TAB 1, it was subjected to rigorous flight-testing of the experimental systems on board the aircraft. The first test profile included firing only two of the Mark 56 booster rockets. Subsequent test flights evaluated the wing-mounted yaw-correcting Shrike rockets. During the 10 days between 19 and 29 October, multiple sorties were flown by the Lockheed test crew and by the Combat Talon crews dedicated to the program. The crews found that the new flap system, along with the horsal and dorsal fins, allowed the aircraft to be flown at an airspeed of

85 KIAS on final, with an eight-degree glide slope. Everything worked flawlessly during the initial tests, and on 29 October a complete test profile, which included firing all rockets for both the takeoff and landing phases, was scheduled to be conducted by the Lockheed flight-test crew. Before the flight, test engineers determined that the aircraft's onboard computer needed additional calibration to fully integrate the landing rocket-firing sequence during the landing phase. The Lockheed flight crew elected to fly the mission using manual inputs to fire the ASROC rocket motors, relying on the experience gained from the engineering simulator and from their previous flights. During the 29 October test, aircraft 74-1683 set several STOL records. The nose gear lifted six feet off the ground after 10 feet of takeoff roll with all eight Mark 56s employed, and the aircraft was airborne within 150 feet of brake release. Within the length of a soccer field, it had reached an altitude of 30 feet and an airspeed of 115 knots.²⁶

Everything continued to go as planned after takeoff, and the aircraft turned on to final for its rocket-assisted short-field landing. When the upper deceleration rockets fired at approximately 12-foot altitude, the aircraft slowed rapidly. The flight engineer, blinded by the forward rocket blast in front of the cockpit, thought the aircraft was on the runway and manually fired the remaining lower rockets. The resultant drop in altitude caused the right wing to break off on impact with the runway, and a fire ignited as the wing trailed behind the aircraft during rollout. Within eight seconds of the aircraft coming to a stop, emergency crews had the fire extinguished, and the flight crew successfully exited the wreckage. No one was injured in the crash, but aircraft 74-1683 was destroyed. Most of the



USAF Photo
Credible Sport aircraft 74-1683 performs a rocket-assisted short-field takeoff on 29 October 1980. From brake release to liftoff, the aircraft traveled 150 feet.



USAF Photo
With all eight ASROC rockets fired, the aircraft's forward flight vector was reduced to near zero, resulting in rapid descent to the runway. The right wing broke between the number three and number four engines. The aircraft is traveling down the runway just after impact.



USAF Photo
Aircraft 74-1683 begins its rocket-assisted maximum-effort landing. The top four reverse-mounted ASROC rockets have fired to slow the aircraft's forward flight vector.



USAF Photo
The Credible Sport aircraft comes to a stop still on the runway. Within eight seconds, crash response teams were on the scene to extinguish the fire. Most of the program-unique systems were salvaged from the aircraft prior to its complete destruction.



USAF Photo
The lower four ASROC rockets have been fired manually from the cockpit. Note the altitude of the aircraft above the runway.

unique Credible Sport equipment was salvaged from the aircraft.*²⁷

The second Credible Sport aircraft (74-1686) was nearing completion of its modifications when the 29 October accident occurred. Events in Iran and the results of the November presidential elections spelled the end of the program. On 31 October Tehran announced an Algerian-brokered plan to release the hostages. On 2 November the Iranian Parliament endorsed the plan but stipulated that certain conditions had to be met before the release of the hostages. With the election of Ronald Reagan and the pending release of the

*For security reasons, the hulk was demolished by US Navy SEALs, and the remains were buried on the Eglin AFB range complex so that the existence of the unique capability would not be revealed to anyone outside the tightly controlled Credible Sport program.

hostages, the Credible Sport program was terminated.²⁸ The capability to land in a soccer field across the street from the American embassy in Tehran would not become a reality.*

Preparations Continue for a Return to Iran

As the Credible Sport program got under way in late July, the 1st and 8th SOS were completing their Oro Grande deployments. On 23 August 1980, the Holloway Commission released its findings and recommendations on the Desert One mission. Within 30 days of the release, the secretary of defense began action to have the chairman of the JCS task the three military services to fund, equip, and man a standing counterterrorism task force. The new organization was to be based at Fort Bragg, North Carolina. The new command's charter included assuming responsibility for all mission planning and operational matters that were currently assigned to Vaught's JTF 1-79. As the new command was being established at Fort Bragg, Vaught's JTF/JTD team continued to explore rescue options and test capabilities that might be needed for another rescue attempt.

The next major training exercise involving Combat Talon was scheduled for 13 September at Moody AFB, Georgia. Turczynski and three of his crews (commanded by Jubelt, Pearson, and Wilson) returned from Kadena AB to Hurlburt Field to participate in the Trainex. Brenci now had five crews fully qualified in blacked-out NVG operations (Brenci, Ferkes, Meller, Tharp, and Thigpen). Uttaro had been drafted into the Credible Sport program and was no longer involved with Honey Badger. The Moody Trainex included a dual-runway airfield seizure operation, with Meller and Thigpen landing on parallel runways simultaneously at 2200 local time. Pearson and Jubelt landed 30 seconds later, thus resulting in four aircraft being on the ground within the first minute of the operation. Brenci landed two minutes behind Jubelt, followed by Wilson six minutes later. Ferkes and Tharp flew the last two aircraft scheduled to land, both EC-130E aircraft. During the departure phase of the exercise, as Jubelt pulled out on the runway in aircraft 64-0551, the nose gear collapsed, and the aircraft came to a halt with its nose resting on the runway. The exercise

was terminated and, upon inspection, maintenance determined that damage was minimal and consisted mainly of a crushed nose-gear door. Once temporary repairs were made, the aircraft was returned to Hurlburt Field.

Events in Iran were still driving preparations for a second rescue mission. On 22 September Iraq invaded Iran to seize the strategically important Shat al Arab waterway at the confluence of the Tigris and Euphrates Rivers. Charging that the United States was behind the invasion, Iran suspended all talks on the release of the hostages. At the same time, news came to the JTF that the hostages were being moved back into Tehran for their safety, with some reports indicating that all were back in the American embassy.²⁹ On 1 October 1980, Roland Guidry departed the 8th SOS for assignment to Fort Bragg, and Bob Brenci moved up to be the squadron commander. Lt Col James L. Hobson, who had arrived in the squadron the previous April, took Brenci's place as the operations officer.

The situation in Iran seemed to be driving a second rescue attempt. From 9 to 16 October, another combined exercise was held that included Delta Force, the rangers, USAF CCT, and both rotary- and fixed-wing assets. What proved to be the final JTF exercise, code-named Storm Cloud, was conducted during the last week in November 1980. The majority of the JTF forces were involved in this large and complex operation. The exercise was executed during the night of 23–24 November without deviation from the operational plan and without any injuries or aircraft incidents. With the exercise hotwash conducted the next day at the Pentagon, Vaught was about ready to turn over his responsibilities to the newly created joint command.³⁰ The election of Ronald Reagan and the subsequent softening of Iran's position towards the hostages indicated that another rescue mission would not be required.

Beginning in November General Vaught directed that all JTF/JTD capabilities developed during the previous 12 months be compiled into a document that would be available to all services for future reference. His motivation was to ensure that the lessons learned and the capabilities developed during workup for Desert One and Honey Badger would not be lost but instead would be passed on to those in the special operations community. The resultant document, titled *JTF Force*

*The second Credible Sport aircraft (74-1686) would later become the test bed for Combat Talon II. Many of the STOL features of Credible Sport were considered for Combat Talon II, but in the end funding limitations eliminated the modifications from the final CT II aircraft. Credible Sport aircraft 74-1686 eventually would be donated to the Warner Robins Aircraft Museum and would never return to operational status. The third aircraft (74-2065) would be converted back to its original airlift configuration and returned to the USAF C-130H tactical transport fleet. No additional flights were conducted utilizing the rocket system after the 29 October 1980 accident.

Capabilities Review, was published on 11 May 1981 and contained pertinent information on more than 200 initiatives resulting from the Honey Badger program.³¹

At the 1st SOW, the wing established an organization known as the Special Operations Mission Planning Division under the director of operations (1st SOW/DOS). The new division was established as the "sole coordinating and planning agency for the wing's special tasking." Headquarters TAC provided 11 manpower authorizations for the division, and personnel already assigned to the wing, including Combat Talon planners who had participated in the Desert One mission, filled them. The Mission Planning Division served as the wing focal point and communications channel for interface with the new command at Fort Bragg and for coordinating with other Air Force, Army, and Navy special operations units. The division provided personnel for concept planning, exercise training, and contingency operations. The division also provided the nucleus of an organization to manage "intense levels of activity when directed by the 1st SOW Wing Commander." When operating in that capacity, the chief, special mission planning staff, became the 1st SOW chief of staff for special operations.³² The division matured into a highly effective organization that provided excellent support for the wing's special tasking, and it continued as an integral part of the wing from that point forward.

The new joint command assumed mission responsibility from JTF 1-79 on 22 December 1980, and on that date Vaught's JTF was officially deactivated. For the next 45 days, select elements of JTF 1-79 remained in the Pentagon and served as liaisons during the critical transition of the new administration. At 12:03 P.M. on 20 January 1981, as President Ronald Reagan was being administered his presidential oath, two Algerian transports carrying the American hostages were cleared for takeoff from Tehran. A few minutes later they were airborne and headed out of the country to freedom.³³ After 444 days of captivity, the hostages were finally free. There would not be a second rescue attempt.

Fallout in the Pacific over Desert One

The 1st SOS had moved from Nha Trang AB, Vietnam, to Kadena AB, Okinawa, in the spring of 1972. The island location did not offer adequate training facilities for Combat Talon crews. Being a relatively small island, insufficient space was available for aircrews to train in their challenging low-level terrain-following mission. The unit was

placed at Kadena AB because the facilities there were among the best in the Pacific and because the location offered a central point in WestPac from which the squadron could support contingency operations. Training initiatives to gain permission for the squadron to fly low level in Korea, Taiwan, and the Philippines were begun when the squadron arrived at Kadena AB. All three countries were located within two to three hours from Okinawa and offered the potential for outstanding training. The unit had flown in the Philippines when it was located in Vietnam. After relocation to Kadena AB in 1972, at least one of these three areas was maintained for low-level training, thus enabling assigned aircrews to maintain proficiency. A fourth major training area available to the squadron was Alaska, but it was eight hours to the north and required either a tanker or a fuel stop along the way. Although regular Alaskan deployments were accomplished, each required a significant commitment by the squadron in both time away from home station (usually a minimum of a week for each deployment) and in personnel to support the aircraft. Squadron leadership had long determined that the relatively unrestricted training environment found in the Philippines was ideal for squadron training.

The Japanese government, and particularly the Okinawans, were never keen on basing a special operations unit on their soil but had little inclination to block the move in 1972. By 1980, however, opposition to basing large numbers of American troops on Okinawa had grown to a point that there were occasional demonstrations and protests demanding the removal of at least some of the US forces. When the Iranian rescue mission failed, little publicity regarding the extent of 1st SOS participation surfaced, but it was generally thought by the Japanese that the squadron had played a role. The Okinawans who opposed American basing there seized upon the rescue and labeled it an act of aggression toward another sovereign nation initiated from Japanese soil. By the summer of 1980, it was clear to military leaders that moving the squadron was in the best interest of both the unit and the Okinawans. Consequently, on 12 August 1980, the Air Staff directed that the 1st SOS initiate action to relocate its aircraft, personnel, and associated equipment from Kadena AB, Japan, to Clark AB, Philippines, with the transfer to be completed during the second quarter of FY 81. All actions necessary to effect the move were published in Program Action Directive 80-8, with the move to be completed by 15 January 1981. Turczynski and his aircrews continued to be heavily committed to

Project Honey Badger throughout the fall, so actual movement of unit assets did not begin until close to the first of the year. The squadron was authorized to stand down from training missions during the preparation and move period, but all Honey Badger requirements had to be met. As part of the movement plan, the unit was required to resume normal training activities no later than seven days after the move was complete.³⁴

Throughout the late fall, 1st SOS aircraft deployed from Kadena AB to Clark AB for unit training, and each carried a full load of unit equipment from home station. Critical items that were one of a kind, or those critical to the Combat Talon, were moved beginning on 8 January. From 8 to 15 January 1981, shuttles were flown between the two locations, and the remainder of the squadron's equipment and personnel were relocated to Clark AB. On 15 January Brig Gen James R. Brown, 18th Tactical Fighter Wing commander, conducted a departure ceremony on the Kadena AB flight line, and Turczynski boarded the last Combat Talon and led a three-ship Talon formation to Clark AB. Upon arrival he was met by the commander of the 3d TFW, Col Thomas G. McNerny, who welcomed the squadron to the Philippines. With the arrival of the three Combat Talons, the squadron completed its unit move to Clark AB, and it resumed local training the following day.³⁵

Special Warfare Exercise 81 and the Loss of Aircraft 64-0564

Since the mid-1970s the 1st SOS had participated in an annual joint and combined exercise in the Philippines known as Special Warfare Exercise (Specwarex). The exercise was hosted by US Navy SEALs and had gradually expanded to include forces from the Philippine Navy Special Warfare Brigade and the Australian and New Zealand Special Air Services. Shortly after arriving at Clark AB, the squadron deployed aircraft 62-1843 and 64-0564, along with 55 personnel, to Cubi Point NAS, Philippines, for Specwarex 81. From 9 to 27 February, two aircrews, one commanded by Fleming and the other by Jim Kirk, flew a full array of missions supporting the exercise. The objectives were (1) to test and evaluate joint/combined planning, coordination, and command and control of special warfare operations; (2) to conduct special warfare training while exchanging operational techniques and expertise; (3) to conduct combined and unilateral operations; and (4) to promote common defense efforts through the mutual exchange of operational concepts. To meet these objectives,

the exercise was designed around two phases. The first phase was dedicated to unit cross training and the exchange of operational techniques. The second phase was a series of continuous field training exercises that were supported by the two Combat Talons and by helicopters, surface ships, submarines, and other designated craft. The 1st SOS established an Air Force Special Operations Base (AFSOB) at Cubi Point NAS and was responsible for all fixed-wing aircraft support for the exercise. Low-level terrain-following routes were flown that terminated in CRRC airdrops, high-speed low-level aerial delivery system airdrops, static line drops, and psychological warfare operations. Short-field takeoffs and landings were also accomplished in conjunction with infiltration and exfiltration missions.³⁶

During the three-week period, the crews flew a combination of daytime and nighttime missions but gradually transitioned to night-only operations toward the end of the exercise. During the 16-day period from 10 to 26 February, Kirk's crew was scheduled to fly 12 missions. Each mission was scheduled for a duration of five hours, with a total of 60 hours scheduled for each crew. Throughout the exercise the missions went as planned, with only minor deviations due to aircraft maintenance and weather in the objective area. On 25 February Kirk's crew was tasked to fly to Clark AB to pick up an engine for aircraft 62-1843 after completing its tactical mission in support of Specwarex. The administrative airlift mission landed back at Cubi Point NAS at noon after a 12-hour crew day that had begun the previous midnight. The crew was scheduled for their last mission of the exercise early the following morning. Due to their extended crew day on the 25th, their scheduled takeoff time on the 26th of February was slipped from 0105 to 0430 local. The length of the mission was also shortened, with the landing and mission termination changed to 0546.³⁷

The aircrew departed their quarters at 0200 on 26 February and arrived at the AFSOB at 0205. The crew was familiar with the low-level route, having flown it several times during the exercise. The mission profile included a nontactical departure followed by a tactical landing at Cubi Point NAS 30 minutes later. Upon landing exercise personnel would rapidly onload the aircraft, and the aircraft would then make a tactical departure with the nine-man crew and 15 additional exercise personnel on board. After reviewing the mission profile, the crew briefed and filed their flight plan by 0235. The aircraft departed Cubi Point NAS at

0428 local, made its tactical landing at Cubi Point NAS at 0506, unloaded its personnel, and departed at 0508. The AFSOB ground radio station received an operational normal call at 0514 local. The last transmission received from the aircraft was at 0521 and did not indicate that the crew was having any problems. At 0523, 15 minutes after the second takeoff, local fishermen near Capones Island, located northwest of Cubi Point NAS, observed the aircraft impact the water and explode. After approximately 10 minutes, the wreckage sank in 240 feet of water. Twenty-three people were killed on impact, with Lieutenant Blohm, the electronic warfare officer and lone survivor, being thrown from the aircraft and rescued by local fishermen.³⁸

Postaccident investigation could not determine the exact cause of the crash, but the most probable explanation was thought to be fatigue brought on by the stress of the previous year's activities. The operation's tempo during preparations for the Iranian rescue mission coupled with the recent move to Clark AB had taken its toll on the squadron. The administrative flight on the 25th of February also had interrupted the crew's circadian rhythm cycle, thus resulting in degraded crew rest before the mission. A second possible cause of the accident was a malfunctioning terrain-following radar system. The system was designed to convert to a "radar override" condition when the aircraft was over water, and there were no returns from the water's surface. Engineers theorized that if the system did not enter the override mode, the radar could fly the aircraft into the water without any radar reference available to determine the aircraft's altitude.* One of several modifications made to the Combat Talon stemming from the accident provided a warning light that told the crew when the aircraft was in radar override. Personnel from the 1st SOS killed in the 26 February 1981 crash of aircraft 64-0564 were Maj James M. Kirk, Capt Norman L. Martel, Capt Thomas D. Patterson, Capt Gregory S. Peppers, TSgt Stephen A. Blyler, TSgt Barry R. Chumbley, TSgt Gary W. Logan, and SSgt John T. Felton.^{39**}

Post-Desert One Advancements for Combat Talon

Since the failed Desert One rescue attempt, the special operations community had made huge advancements in both hardware procurement and tactics development. During Honey Badger both USAF and US Army rotary-wing capabilities

received the most attention, thus resulting in a much superior helicopter capability than the US military had in November 1979. For Combat Talon the advancements made before Desert One continued during Honey Badger, and important tactics were developed and refined to allow the weapons system to better accomplish the difficult counterterrorism mission.

The tactic of determining if a runway were clear using the Combat Talon FLIR was perfected early in the Desert One training period, but the ability to clear the runway if something heavy were blocking it still needed to be solved. A solution was found by developing drop procedures to deliver either a 15,000-pound or 25,000-pound bulldozer to be used to remove any runway obstruction. If the FLIR pass determined that the runway were blocked, a Combat Talon could air-drop the bulldozer and a combined team of US Army rangers and USAF CCT personnel. The rangers would use the bulldozer to clear runway obstructions. Once the runway was clear, the CCT would provide air traffic control for follow-on aircraft to land.⁴⁰

Another challenge for planners was to airland as many aircraft as quickly as possible on an airfield so that the maximum number of soldiers could be inserted in the shortest time. A tactic known as dual-runway operations was developed that fulfilled this requirement.⁴¹ Flying in formation the Combat Talon lined up on the primary runway in pairs and, at a preplanned point, would spread apart so that the wingman was aligned with the parallel runway. Both aircraft would touch down on each runway at the same time. Follow-on aircraft would employ the same tactic, with a 30-second spacing between landings on the same runway. Thus, within a 60-second span as many as six aircraft could land on two parallel runways. To arrive in formation at the prescribed time and with the proper spacing, procedures were refined that allowed the aircraft to use its air-to-air TACAN and the SST-181 beacon to maintain spacing, whether in weather or in the clear. Complex procedures were also developed to allow for lead change and formation breakup/rejoin should the situation arise.

A unique tactic that was also developed during Honey Badger was the transport of a small helicopter that was off-loaded from the Combat Talon, assembled, and flown away to support the ground force tactical plan. Six OH-58s were originally modified with short struts to allow rotor-head

*The theory was confirmed two years later when an LAS Ontario test crew observed a continual fly-down command by the TF radar while flying over water. The test was terminated when the aircraft descended to 100 feet.

**Peppers and Felton flew to Desert One on 24 April 1980.

clearance inside the C-130. The OH-6 later replaced the OH-58. Both helicopters required removal of their main rotor blades before loading on to the aircraft. After landing and removal of the helicopter from the Combat Talon, the rotor blades were again attached, and the helicopter was flown away. The whole operation took only a few minutes from the time the helicopter was rolled off the C-130 until it was airborne.

Another shortfall identified during preparation for Desert One was the number of in-flight refuelable Combat Talons. Only seven of 14 Talons were IFR capable in November 1979. The four aircraft assigned to the 1st SOS and three of the six aircraft assigned to the 8th SOS had been modified. None of the four aircraft assigned to the 7th SOS had IFR capability. During the spring of 1980, a fourth 8th SOS Talon was modified for IFR and became available to the JTF by late summer. The remainder of the Combat Talon fleet also was scheduled to receive the IFR modification, including those in USAFE, as a result of the identified shortfall.

The Combat Talon underwent upgrades to its ECM suite. The ALE-40 chaff and flare dispenser and the ALR-69 threat receiver were adapted for the Combat Talon. Many other ECM modifications were fielded in the years following Desert One.

The threats faced in the 1980s were much more sophisticated than those of the Vietnam era, thus requiring more capable systems to protect the aircraft. Honey Badger and its follow-on programs brought the Combat Talon's ECM equipment decades ahead of its pre-Desert One configuration.

* * * * *

The period from November 1979 to early 1981 was a unique time in Combat Talon history. Hardware procured and tactics developed during that period changed Combat Talon forever. For the personnel in special operations, the days of neglect and decay were coming to an end, although it would take a number of years before the community actually saw any increase in aircraft to support the mission. Credible Sport laid the foundation for the next generation Talon—the MC-130H Combat Talon II. In 1982 Credible Sport would fly again as the test bed for the new aircraft. Procurement for Combat Talon II would begin in 1984 and continue throughout the 1980s. It would be the early 1990s before (more than 10 years after Desert One) Talon II would be declared operationally ready. In the interim, it would be the old warhorse, the MC-130E, that would carry the fight to the adversary's doorstep.

Notes

1. Personal Notes, Col Roland D. Guidry, Retired, former commander, 8th Special Operations Squadron, extract on file, Combat Talon Archive, HQ AFSOC/HO, Hurlburt Field, Fla.
2. Ibid.
3. Ibid.
4. Ibid.
5. Ibid.
6. Ibid.
7. Ibid.
8. Ibid.
9. Col Rod Lenahan, Retired, *Crippled Eagle* (Charleston, S.C.: Narwhal Press, 1998), 157.
10. Ibid., 160.
11. Ibid., 161.
12. Ibid., 167.
13. Guidry personal notes.
14. Ibid.
15. Ibid.
16. Ibid.
17. Ibid.
18. Ibid.
19. Ibid.
20. Lenahan, 180.
21. Ibid., 181.

22. Personal notes, Col Jerry Uttaro, Retired, answers to questions submitted by author, hard copy on file, Combat Talon Archive, HQ AFSOC/HO, Hurlburt Field, Fla.
23. Lenahan, 181.
24. Ibid.
25. Ibid., 182.
26. Ibid.
27. Ibid.
28. Ibid., 182–83.
29. Ibid., 173–74.
30. Ibid., 183.
31. Ibid., 195.
32. History, 1st Special Operations Wing, 1 October–31 December 1980, 16th SOW historian file, Hurlburt Field, Fla., vol. 10, 28–29.
33. Lenahan, 188.
34. History, 1st Special Operations Wing, 1 October–31 December 1980, 10.
35. Ibid., 10–11.
36. Ibid., 11–12.
37. Ibid., 12.
38. Ibid.
39. Ibid.
40. Guidry personal notes.
41. Ibid.

Chapter 10

From Desert One to Point Salines (1981–83)

History does not teach fatalism. These are the moments when the will of a handful of free men breaks through determinism and opens up new roads. People get the history they deserve.

—Charles de Gaulle

Tom Bradley and his 7th SOS aircraft had departed Wadi Kena only a few days before the arrival of the force that went to Desert One. The 7th SOS's role in the rescue attempt had been one of support—to establish a signature at Wadi Kena for the Combat Talon aircraft so that undue attention would not be aroused when the mission aircraft deployed from there for the rescue mission. A secondary role for the squadron was to provide cover for the Combat Talon deployment through Rhein Main AB, Germany, as the 7th SOS deployed for Flintlock 80. The squadron's efforts were flawless, with the rescue force deploying all the way to Masirah Island without detection.

The personnel of the 7th SOS were disappointed at not being able to participate in the actual mission, but their contributions were, nevertheless, significant. Part of the continued deception was to execute Flintlock 80 as if nothing else was happening in the European theater. As the 8th SOS crews transited Rhein Main AB en route to Egypt, 7th SOS aircraft were deploying to the United Kingdom. Special Operations Task Force Europe established its headquarters at RAF West Raynham, UK, and the 7575th Special Operations Wing (made up primarily of the 7th SOS) was established at RAF Weathersfield, UK. Along with the four 7th SOS Combat Talons, the 8th SOS deployed one aircraft and crew commanded by Capt Tom Hermanson. Other forces supported the large unconventional warfare exercise, including USAFE F-111s, Military Airlift Command C-130s and C-141s, Strategic Air Command B-52s, and British RAF C-130s. Ground forces included US Army Special Forces and US Navy SEALs, along with troops from six different countries.¹ For the Combat Talons, the highlight of the exercise was two live STARS recoveries, one accomplished by the 7th SOS and another by Hermanson's crew from the 8th SOS. The live recovery for the 8th SOS was accomplished during Subexercise Schwarzes-Pferd in southern Germany on 5 May 1980. It was the first such

event for the squadron since the mid-1960s, when the unit was stationed at Pope AFB as the 779th Troop Carrier Squadron.

Throughout the months of April and May 1980, virtually the entire 7th SOS remained deployed for the large unconventional warfare exercise. By the time June arrived, most personnel were back at Rhein Main AB, and the 8th SOS Talon had returned to Hurlburt Field. A second live recovery for the year was conducted on 5 June 1980 by Crew 1, commanded by Maj Mark Tuck in aircraft 64-0555. The recovery was made at Algero, Italy, in support of SOTFE requirements. On 6 June, by USAFE Special Order G-3, Lt Col Walter K. Schmidt assumed command of the 7th SOS from Tom Bradley.² The previous six months had been grueling on the squadron, with an operations tempo that brought the squadron to near exhaustion. June provided a brief break in the hectic pace, and squadron personnel used the time to become reacquainted with their families. July began another busy cycle, with deployments to the United Kingdom, Italy, Denmark, and Greece. Beginning in August the last subexercise of the 1980 Flintlock series—Zeus 80—was flown from 30 August to 17 September.³ The squadron deployed two aircraft and three crews, along with associated maintenance and support personnel, to Hellenikon AB, Greece. As had been the case in Zeus 78, the staging base was excellent, and the flying was outstanding. The major critique of the exercise was its lack of sufficient mission tasking for the Combat Talons, which resulted in the return of one aircraft to Rhein Main AB earlier than originally planned. With the US Navy SEALs and US Army Special Forces dispersed to different locations throughout Greece, communications between them and the 7th SOS at Hellenikon AB were difficult. The lack of reliable communications was partly to blame for the low-utilization rate of the deployed Combat Talons.⁴

The remainder of the year saw portions of the squadron deployed to the United Kingdom, Norway, Greece, and Italy. The biggest problem that

the 7th SOS faced during this period was a shortfall of qualified aircrews. The unit possessed all four of its authorized aircraft but only four of its six authorized crews. The aircrew shortfall was due in part to the loss of Lewis's crew the previous April and the domino effect that the loss caused throughout the Talon community. Several crew members, who were scheduled to move from the 8th SOS to Rhein Main AB, were extended at Hurlburt Field and were unavailable to the USAFE unit. Although new personnel were selected and brought into the pipeline, it was not until mid-1981 that the Combat Talon school at Hurlburt Field trained enough personnel to make up for the loss.*⁵

At the 8th SOS Honey Badger initiatives continued to be the focus, even as the possibility of a second rescue attempt dimmed. On 10 October 1980 8th SOS personnel and one Combat Talon aircraft deployed to Yuma, Arizona, to test the feasibility of high-speed personnel and cargo parachute airdrops. The deployment was the first of a three-phase test to determine if personnel could survive an airdrop at airspeeds up to 250 knots. The existing speed for personnel airdrops was 125 knots, with 150 knots the maximum acceptable. Cargo drops were normally made at 130 knots. With an en route airspeed of 250 knots maximum, the Combat Talon had to decrease its speed for personnel and cargo drops. This slowdown could be detected by enemy radar, and it placed the aircraft in a vulnerable situation close to the ground for an extended time. The HSSLADS had been perfected in the early 1970s and provided the capability to drop at airspeeds up to 250 knots, but the system was not designed to drop personnel, nor could it drop cargo that exceeded certain size and weight limitations. Both the USAF and USA wanted a system that would eliminate the need for a slowdown. A high-speed sled was developed for personnel drops, which included special rigging and cushioning to reduce the shock of parachute opening and the resultant impact of the load with the ground. Specially instrumented dummies were used to measure the forces exerted on the load during the drop sequence. From 8 to 15 December, the second phase of the test was conducted.⁶ After experiencing system failures, which would have resulted in fatal injuries to personnel and the destruction of the

cargo, testing was suspended indefinitely, awaiting additional engineering.

1981: Combat Talon II Testing Begins

The operations tempo for the 7th SOS continued at a high rate as 1981 began. The squadron trained for its wartime mission of unconventional warfare operations as outlined in commander in chief, US Air Forces Europe, Operations Plan 4102 and COMSOTFE Operations Plan 4304. To fulfill its tasking under the two war plans, the squadron was given specific responsibilities. It maintained liaison with United States Army Europe (USAREUR) Special Forces units and conducted joint training in unconventional warfare operations. The squadron was prepared to deploy all or part of the unit to a forward-operating base and provide support as required by SOTFE. The 7th SOS was also tasked to train other special operations supporting units, including MAC special operations low-level (SOLL) crews. Once deployed, the 7th SOS provided the bulk of the command element for the 7575th SOW and provided mission control of assigned air resources. To fulfill its responsibilities, the squadron maintained a Special Operations Combat Control Team (SOCCT) and a ground communications flight equipped with radios and communications gear capable of communicating with the Combat Talon aircraft during mission execution. Each crew was required to plan and brief a real-world mission annually using actual wartime targets and threats. The squadron maintained an intelligence section that was assigned responsibility (along with contingency response) for the mission planning exercises. Deployments throughout the year were designed to provide training opportunities so that the squadron could maintain proficiency in its various wartime skills.⁷

The annual Combat Talon Management Review Conference was held at LAS Ontario from 10 to 13 February 1981. Headquarters personnel from PACAF, USAFE, and TAC attended the conference along with representatives from each Combat Talon squadron. The conference addressed personnel, equipment, and other operational and maintenance issues facing the Combat

*When Kirk's crew was lost in February 1981, a similar situation arose in the 1st SOS. Two unprogrammed crew losses within a year severely strained the schoolhouse at Hurlburt Field. An additional problem faced by the 1st SOS was the lack of available aircraft. With 64-0564 lost and 64-0565 at LAS Ontario, only two aircraft were available to the 1st SOS, and one of those two departed for PDM in the spring of 1981. In July 1981 Clamp aircraft 64-0572 was transferred from the 8th SOS to the Pacific until 64-0571 could be recalled from Air Force Systems Command and modified as a Yank aircraft.

Talon community.⁸ The IFR modification for the Combat Talon fleet was discussed, along with the upcoming Talon II test program. A schedule was developed that allowed aircraft upgrades to be made by LAS Ontario without creating an undue hardship on any one squadron.

The annual Flintlock exercise in Europe was the best opportunity for the 7th and 8th SOS to train with other special operations forces and practice their wartime mission. From 16 April to 23 May 1981, the 7th SOS again deployed to RAF Weathersfield and established an Air Force Special Operations Base for Flintlock 81. Subexercises were conducted in Jordan, Tunisia, Italy, Germany, Kenya, Norway, and the Netherlands. Two live STARS were accomplished during the German Subexercise Schwarzes-Pferd, the first on 4 May 1981 by Major Tuck from the 7th SOS and the second on 8 May by Maj Bob Meller from the 8th SOS. During the exercise a 7th SOS aircraft deployed to Kenya for Subexercise Black Rock 81 under the command of Major Muggenborg. When the aircraft landed on an unimproved dirt runway for its first mission, the Combat Talon broke through the runway's outer crust and became mired in mud up to its belly. All subsequent Black Rock missions were canceled, as maintenance and aircrew personnel spent the next several days recovering the aircraft. Unnecessary equipment was removed, and ramps were built to allow the main gear tires to slowly rise out of the mud as the aircraft was pulled forward by a large tractor. A basic crew eventually flew the aircraft to Nairobi, where minimal repairs were made to several antennas on the aircraft's underbelly.⁹

* * * * *

The 8th SOS deployed one Combat Talon to Flintlock 81, with Meller as the aircraft commander of 64-0567. Meller proceeded to RAF Weathersfield, UK, and two 20th SOS HH-53H Pave Low helicopters were deployed to Pisa AB, Italy, by way of C-5 aircraft. The original exercise requirement called for two Combat Talons from the 8th SOS, but higher headquarters tasking and maintenance problems at Hurlburt Field precluded deploying the second aircraft. The original deployment included a nonstop flight from Hurlburt Field to RAF Weathersfield, with two IFRs across the Atlantic. Bad weather on the first tanker track forced the cancellation of the refueling, and Meller was forced to divert to Lajes Field,

Azores. As the crew was preparing to depart Lajes Field on 25 April, they discovered a fuel leak, which grounded the aircraft. Fuel-cell repair was not available at Lajes Field, thus forcing Meller to request assistance from home station. Most of the Talon crew was sent ahead to the UK on a C-141 while Meller, with a basic crew, remained at Lajes Field until maintenance support could reach them. On 28 April a fuel-cell technician arrived and began working the fuel leak. Repairs were made, and the aircraft departed Lajes Field and arrived at RAF Weathersfield on 2 May. Between 4 and 18 May, Meller and his crew flew five exercise missions but had three others canceled by the Army after the crew had planned them and was ready for launch. On 8 May Meller successfully completed a live Fulton STARS when he exfiltrated a US Army Special Forces officer from the Schwarzes-Pferd subexercise area. The live recovery was the first for Meller and was the second one completed by an 8th SOS crew. Due to higher priorities, Meller was recalled from the exercise early and returned nonstop to Hurlburt Field on 19 May. After a 21-hour crew day and one IFR, the aircraft arrived back at its home station in Florida.¹⁰

* * * * *

When the Iranian rescue mission kicked off for the 1st SOS in December 1979, the squadron had recently begun its PAT program, which was designed to expose squadron members to seldom traveled areas of the Pacific. Contacts made and information gathered on airfield operations proved essential during the long deployment to Oman through the Indian Ocean. The program laid dormant throughout 1980 due to higher priority Honey Badger tasking, but in June of 1981, Turczynski resurrected the program, and his planners coordinated an eight-day, one-aircraft deployment (PAT 007) to Thailand from 21 to 29 June. During the deployment a FLIR and NVG demonstration was given to RTAF officials, and a briefing was given to the Joint US Military Advisory Group, Thailand (JUSMAGTHAI) outlining the capabilities of the Combat Talon weapons system. In addition to the demonstration and the briefing, the squadron reintroduced the MC-130E to Thailand and, in the process, exposed the country to the Combat Talon and its unique characteristics. A secondary purpose of the deployment was to reintroduce joint special operations forces to Thailand. A contingent of US Army Special

⁸A Combat Talon basic crew consists of two pilots, one navigator, one flight engineer, one radio operator, and one loadmaster.

Forces, US Navy SEALs, and USAF CCT members accompanied the aircraft. During the deployment Turczynski's crew operated out of Don Muang AB, Thailand, which was located near the capital city of Bangkok. Airborne operations were conducted at Koke-Kathiem AB in central Thailand. Airfields formerly used by USAF aircraft during the Vietnam War were also visited for the first time since the end of the war. During the weeklong deployment, the Talon flew approaches into and landed at Udorn, Ubon, and Korat RTAFBs. The squadron determined that all three airfields were much as the United States had left them in 1975. The 1st SOS assessed the three airfields as operational and capable of supporting US aircraft during contingency operations. Although an approach was flown to Nakhon Phanom RTAFB, a low approach was executed due to the deteriorated runway and uncontrolled status of the airfield. It was considered not usable for US aircraft. On 29 June the aircraft redeployed to Kadena AB, having accomplished all of its predeparture objectives.¹¹ The new era of PAT programs for the 1st SOS had begun with a highly successful deployment to SEA.

The loss of aircraft 64-0564 had been a severe blow to the 1st SOS. The exact cause of the crash could not be determined, but investigators theorized that the AN/APQ-122(V)8 radar could have malfunctioned and could have given an erroneous fly-down command to the crew. As a result a conference was held at LAS Ontario between 4 and 5 June 1981 to discuss the radar and possible malfunctions that might have caused the accident. Technicians determined that there was a possibility for the radar altimeter override logic to command an erroneous fly down without the crew readily detecting the condition. A safety supplement was subsequently issued to the field that modified crew procedures to compensate for the possible TF radar deficiency.¹² Engineers at LAS Ontario began development of a permanent fix to the altimeter override problem. Part of the fix included the installation of an altimeter override light on the top of the pilot's instrument panel. The light was designed to illuminate whenever the radar was operating in the altimeter override mode. During the next two years, the modification was flight tested and installed on all Combat Talons.

Throughout the spring and early summer, the 1st SOS had operated with only two aircraft after the loss of aircraft 64-0564 and the extended PDM of 63-7785. At times there was only one aircraft

on the ramp, with the second aircraft undergoing some phase of maintenance repair. On 6 July Combat Talon 64-0572 was officially transferred from the 8th SOS to the 1st SOS. On 26 September aircraft 63-7785 returned to Clark AB, thus giving the squadron its first full complement of aircraft since the February accident. Aircraft 63-7785 was the first Pacific MC-130E to bear the new European One paint scheme.¹³ The previous velvet black camouflage paint that had been on the Combat Talons since their creation in 1965 had been phased out after the 3M Company discontinued its production.

July also saw a change of command for the 1st SOS. On the 15th, Lt Col John S. Prater assumed command from Ray Turczynski by Thirteenth AF Special Order G-19. Wilson moved up as the interim operations officer for the squadron. The 3d Tactical Fighter Wing commander presided over the ceremony held in front of base operations with two Combat Talons parked behind the troop formation. The change of command marked the end of the most demanding period of 1st SOS history with Ray Turczynski at the helm.¹⁴

Colonel Prater continued the PAT program, and from 21 to 29 September, PAT 009 deployed to Jakarta, Indonesia, and to Takhli, Thailand. The PAT's primary objective was to introduce the Combat Talon to Indonesia and to follow up on PAT 007 initiatives in Thailand. The squadron deployed one aircraft and crew, a basic maintenance capability, and a command representative to coordinate in-country activities. A secret-level briefing covering the Combat Talon weapons system was given to US Embassy personnel in Jakarta, and an unclassified version of the same briefing was later presented to Indonesian air force officials in conjunction with a static display. In Thailand a joint US-Thai air-drop operation was conducted at Takhli RTAFB, followed by a second friendship drop near the town of Phetchabun, Thailand. PAT 009 was a resounding success, with overall US-Indonesian and US-Thai military-to-military relations benefiting from the deployment.¹⁵ Just as the 7th SOS deployed throughout Europe during the Flintlock exercise series to open new areas for training, the PAT program in the Pacific accomplished the same objective for the 1st SOS.

As life settled down for the new commander, the PACAF inspector general conducted an ORI of the 3d TFW from 2 to 14 October. The 1st SOS had received a grade of excellent during the previous August's standardization and evaluation visit,

and it repeated the feat during the ORI. The life-support program and the intelligence section were specifically noted for their improved performance.¹⁶ The ORI served as a warm-up for Foal Eagle 81, which was held the following month in Korea. From 4 to 6 November, the 1st SOS deployed three Combat Talons and four crews to Teagu AB, Korea, and established a Combined Air Force Special Operations Base (CAFSOB). For the first time, all air assets were consolidated under the control of the CAFSOB, including three C-130Es and six crews from the 374th TAW and six ROKAF C-123s based at Seoul City AB, Korea. The CAFSOB also provided air liaison officers to the Hardened Tactical Air Control Center at Osan AB and to the Special Warfare Center at Songnam. Throughout the 10-day exercise, air assets achieved a 79 percent mission success rate, which exceeded the exercise goal. As a direct result of bringing the ROKAF C-123s and MAC SOLL assets together in the CAFSOB, it was possible to conduct several airfield assault operations. These were multi-aircraft events involving elements from each CAFSOB component. Face-to-face planning for these events was done at the CAFSOB and included the ROKAF for the first time. The biggest problem faced by the unit planners was the size of the exercise. With limited overhead staff the CAFSOB managed 305 separate events supporting US Army, US Navy, and ROK Army Special Operations Forces. Although the pace of the exercise taxed everyone involved, the combined operations marked another first for unconventional warfare training in Korea.¹⁷

Just after the conclusion of Foal Eagle 81, the 1st SOS deployed one MC-130E and an augmented crew to Auckland, New Zealand, for Exercise Gonfalon 81. As had been the case in previous years, the New Zealand SAS hosted the exercise. The 1st SOS established an AFSOB and, along with a 374th TAW C-130, supported the two-phased unconventional warfare exercise. Phase I consisted of cross-training among the participants, and Phase II was a UW field-training exercise. Of the 133 events scheduled during Phase I, the AFSOB successfully completed 86 of them, with the remaining events canceled due to bad weather. During the Phase II FTX, all events were successfully completed.¹⁸ The FTX began on 3 December, continued until 14 December, and included 15 separate direct-action missions, 12 of which required AFSOB support. In total 23 sorties were scheduled to meet exercise requirements. Missions included low-level terrain-following, high-altitude high-opening

(HAHO)/HALO personnel drops, static line and CRRC infiltration airdrops, and minimally lighted short-field landing operations. The final event of the exercise was a free-play hostage snatch and clandestine airfield assault, which was planned and executed by the exercise Combined Special Operations Task Group (CSOTG). The AFSOB did not have personnel assigned to the CSOTG (its higher headquarters for the exercise), so the final planning and coordination of the event was extremely difficult. Regardless, the mission was a success, with the two-aircraft assault package delivering its direct-action package as planned.¹⁹ A highlight for the 1st SOS was the maintenance reliability of its Combat Talon aircraft, which deployed from home station with minimal parts and maintenance personnel yet met all exercise tasking.

In-flight Refueling for the 7th SOS

Throughout 1981 7th SOS aircraft were modified for IFR at LAS Ontario. Aircraft 64-0555 and 64-0523 were modified during the year, and 64-0561 was sent to LAS Ontario in December.²⁰ Along with the IFR capability, the squadron also began training in NVG blacked-out landing operations but did not send an aircraft or crew to any of the stateside quarterly exercises until 1982. From 21 to 31 October, the squadron deployed one aircraft with support equipment to Wadi Kena, Egypt, for low-level and fighter-interceptor training with the Egyptian air force. While deployed to Egypt, intelligence reports indicated that Libyan president Muammar Qadhafi had sent agents to the area armed with shoulder-fired SAMs. The agents were to attack the E-3A airborne warning and control system (AWACS) aircraft that had been operating out of Wadi Kena since the assassination of Egyptian president Anwar Sadat. CINC-USAFA directed the 7th SOS to fly SAM search missions before each AWACS takeoff and landing. The Combat Talon used its ECM equipment to electronically detect (in theory) any missile launch. Sweeps were made off the approach and departure ends of the runway out to 15 miles at an altitude of 500–1,000 feet above the ground. Observers wearing restraining harnesses scanned out the open ramp and door for visual detection of any SAM launches. During the employment period no threats were detected, and the AWACS continued to operate without incident.²¹ The threat never materialized into any known action on the part of the Libyans.

From 4 to 14 November, the squadron was placed on alert to support the forced recovery, if required, of the first space shuttle and crew in the event of a malfunction during its return from space. With the growing terrorism threat, there was concern that the shuttle could fall into the hands of some unfriendly nation should it be forced to land outside the United States during its reentry. Talon crews were selected, and plans were made for rapid deployment of a Combat Talon aircraft anywhere in the European Command area of responsibility. No sorties were flown as the shuttle safely returned to its recovery base at Edwards AFB, California.²²

The highlight of 1981 for the 7th SOS came on 2 December, when the unit's first two-man live STAR was accomplished off the coast of Scotland near RAF Machrihanish, UK. SSgt Gus Rhinehart, USAF, and Cmdr Rich Kuhn, USN, were safely recovered by Capt Jim Bates and his crew. During the recovery the crew experienced mechanical difficulties with the sky anchor but were able to safely complete the recovery mission.²³ Bate's ramp crew was awarded an Air Force Commendation Medal for its professionalism during the difficult retrieval of the two-person package. The previous two-man recovery had been accomplished on 22 November 1968 by the 15th SOS at Cubi Point NAS, Philippines.*

* * * * *

Representatives from the 8th SOS attended a Headquarters USAF-hosted Combat Talon II planning meeting held at the Pentagon on 15 May 1981. The meeting was to present preliminary concepts for Combat Talon II. Lieutenant Colonel Hilten, the Air Staff Big Safari project officer, chaired the meeting. Maj Dave Pearson, Air Force Logistics Command (AFLC/ AZ), presented a first-cut-concept briefing for Combat Talon II. Most equipment being considered, except for the ECM suite and the radar, was scheduled for testing the following summer by Air Force Systems Command, Special Projects Office (AFSC/DRA). The Combat Talon II briefing presented three possible equipment configurations, but none of them included a radio operator crew member. Because of 8th SOS's objections to the elimination of the radio operator crew position, the requirement was left open and was scheduled to be evaluated in the initial testing of the system's equipment.²⁴

Also in May the 8th SOS deployed to Fort Campbell, Kentucky, for Exercise Caliber Excellence. For the initial portion of the exercise, from 12 to 22 May, one MC-130E conducted daily company-size missions from Fort Campbell and from Fort Benning, Georgia. During the night of 27 May, a battalion-size rehearsal was flown, followed by a joint command evaluation exercise on 28 May. The entire Eglin AFB range was utilized during the two-night event, with two MC-130E Combat Talons, two AC-130H gunships, and two HH-53H Pave Lows participating. With the successful completion of the exercise, ground forces committed to the new joint command increased from one to two battalions, and they were fully qualified in unique mission-specific special operations tasks.²⁵

Since Desert One there had been increased pride in the squadron and in the facilities that it occupied at Hurlburt Field. The 8th SOS squadron operations facility had been built in the early sixties during the Vietnam War buildup. Over the years the building had deteriorated, and the squadron had acquired new requirements (such as secure storage for NVG goggles) that needed additional space. To improve the 8th SOS facility, an extensive self-help program was initiated early in 1981 to upgrade both the exterior and the interior of the building. TAC had no money budgeted for new facilities at Hurlburt Field but was supportive of providing funds out of its operations and maintenance account if the squadron furnished the labor. Captain Poole and Senior Master Sergeant Messer headed a squadron self-help team that provided the necessary volunteer labor: the front lawn was leveled, and grass was planted; shrubbery was removed, and more attractive plants were planted; wooden borders were built around the main lawn area, and gravel was placed between the sidewalks and the building's external walls; a new squadron logo was painted on the front of the building; and the front entryway was upgraded. Inside the building, a nonoperational six-stall concrete shower was demolished, and a new current operations section was created in its place. The entire operations section was paneled, and the publications library was upgraded within the operations section. The squadron briefing room was upgraded with audiovisual equipment, and the windows were enclosed to increase the room's security. The aggressive self-help program reflected the commitment that 8th SOS personnel had for their

*Live STARs had been performed on a routine basis during the early years of Combat Talon, but they were discontinued in the early 1970s.

squadron and to the improvement of their assigned facilities.²⁶

Credible Sport II

During the summer of 1981, the Combat Talon II program began to pick up momentum. To save funds and to capitalize on work done in the Credible Sport program the previous year, the remaining Credible Sport aircraft was considered an option to serve as the test bed for Combat Talon II. Credible Sport had been conducted from August to November 1980 and resulted in the modification of two C-130H aircraft into a super STOL configuration (chap. 9). A third aircraft had been partly modified and had served as the Credible Sport test-bed aircraft while the other two were undergoing modifications at Lockheed-Marietta. Credible Sport aircraft 74-1683 crashed during testing on 29 October 1980 and was destroyed, and the partly modified test-bed aircraft (74-2065) was later demodified and returned to the Air Force inventory. The third aircraft (74-1686) remained at Warner Robins AFB, Georgia, with the rocket motors removed but with other STOL modifications operational. The initial requirement for Combat Talon II included the STOL capability—without augmenting rockets to assist during the takeoff and landing phase of flight. After review of various options, Headquarters TAC made the decision to use aircraft 74-1686 as the test bed for the new Combat Talon, and it designated the 8th SOS as its representative for the Credible Sport/Combat Talon II developmental program. The effort was designated Credible Sport II, and an initial planning conference was conducted from 21 to 26 July 1981 at the Credible Sport Program Office in Atlanta, Georgia.²⁷



Photo courtesy of John R. Lewis

Aircraft 74-1686 during Credible Sport II testing. The aircraft served as the test bed for Combat Talon II.

The Credible Sport II program had two phases: Phase I incorporated minor modifications to improve aerodynamics and safety of flight, while Phase II incorporated modifications to enhance mission capability and to align more closely the Credible Sport experimental vehicle configuration with Combat Talon II configuration requirements. Major Uttaro, who had participated in the Desert One rescue mission and the original Credible Sport program in 1980, was designated by TAC as the deputy, Combined Test Force for the Credible Sport Operational Utility Evaluation (OUE), which the program was officially called. The Combined Test Force included personnel from Air Force Systems Command, Test and Engineering Division, Edwards AFB, California; Lockheed-Marietta contractor personnel; and 8th SOS crew members who together were designated as the OUE Team. The 8th SOS crew was made up of two pilots, two navigator/electronic warfare officers, and one flight engineer. At the conclusion of the conference, a Test and Evaluation Master Plan (TEMP) was drafted, and the test location was narrowed to either Duke Field or Hurlburt Field, both located in the Florida Panhandle.²⁸

The 8th SOS Earns the Joseph B. Duckworth Award

The 8th SOS was recognized in August for its contributions to instrument flight by earning the 1980 USAF Joseph B. Duckworth instrument award. The Duckworth award was presented annually to the unit or individual considered to have made the most significant contribution to the art or science of instrument flight. The squadron was selected because of its innovative precision airborne radar approach (PARA) procedure that required only airborne equipment already installed in the aircraft for approach and landing during daylight or darkness and in all weather conditions. The PARA combined the efforts of the three pilots, the two navigators, and the flight engineer into a highly cohesive system. The squadron was also recognized for introducing NVGs to the PARA procedure, which allowed the crew to fly the PARA in a darkened cockpit and land the aircraft without overt aircraft or runway lights. The new PARA had been developed to a point that it was taught to the crews from USAFE and PACAF Combat Talon sister squadrons and to MAC SOLL C-130, C-141, and C-5 units.²⁹

As the summer of 1981 progressed, the 8th SOS continued to participate in JCS and quarterly special operations exercises. In August the

squadron flew two MC-130Es in support of JCS Exercise Ocean Venture 81. One Combat Talon on-loaded a CRRC and a US Navy SEAL team at Norfolk, Virginia, and a second aircraft did the same at Pope AFB, North Carolina. After the two aircraft completed their IFRs en route to the exercise area in the Caribbean, they successfully air-dropped their loads near Vieques Island on Salinas water DZ. The two aircraft then air-landed additional personnel and equipment at Roosevelt Roads AB, Puerto Rico. The successful SEAL-infiltration mission was flown during the night of 6 August and turned out to be the only Combat Talon mission of the exercise. The remainder of Ocean Venture was canceled due to an approaching hurricane.³⁰

Since the fall of 1980, joint requirements for the 1st SOW and for Combat Talon had continued to grow. A large-scale special operations exercise, named Marvel Exodus, was planned from 13 to 26 September 1981, with aircraft and personnel deployed to Fort Lewis, Washington, for the initial phase of the exercise. The 1st SOW deployed three MC-130Es, two AC-130Hs, six HH-53Hs, and 271 aircrew and support personnel. The advanced party of the 1st SOW, with 1st SOW/DOS personnel forming its nucleus, arrived at Fort Lewis on 9 September and spent the next four days preparing for the arrival of the main body. The three Combat Talons arrived on schedule on 13 September, and the crews began their mission-planning process. From 14 to 17 September, 1st SOW assets participated in Phase I training events, with one MC-130E scheduled to air-drop fuel blivets and heavy equipment, while the other two aircraft practiced airfield seizure events with US Army ranger personnel. The blivet and heavy equipment drops had to be canceled on the 14th because of a lack of rigging material, but the drops were rescheduled and successfully accomplished on the 16th. The airfield seizure training events went according to plan. Also scheduled during Phase I were IFR operations between a KC-135 tanker and the Combat Talons, HALO airdrops, static-line personnel airdrops, and NVG airland operations. On the 17th of September, scheduled forward area refueling point (FARP) operations between an MC-130E and the HH-53Hs were canceled due to bad weather in the Fort Lewis area. The following day 1st SOW assets moved from Fort Lewis to Fairchild AFB, Washington, and planning was begun for Phase II. The FARP training that was canceled on the

17th was completed at Fairchild AFB without incident.

The next major event of Marvel Exodus was a full-scale airfield seizure operation at Indian Springs, Nevada. Along with Hurlburt Field forces, additional aircraft and personnel deployed to Fairchild AFB from across the United States, including forces from Fort Bragg and Pope AFB, North Carolina; Dyess AFB, Texas; Charleston AFB, South Carolina; Grissom AFB, Indiana; Plattsburg AFB, New York; McClellan AFB, California; and Eglin AFB, Florida. Phase II had two major airfield seizure events, with the first scheduled for 20 September and the second for the 24th. The MC-130E Combat Talons and MAC SOLL C-130s were to airland at Indian Springs in a complex scenario that included HH-53H FARP operations with the Combat Talons and transload of personnel to a C-141 for rapid exfiltration from the exercise area. The Combat Talons and the MAC SOLL C-130s carried mixed loads, with the Combat Talons carrying both an airfield assault package and FARP equipment. Just as he had done at Desert One, Brenci flew the lead Combat Talon into Indian Springs, followed by the other two Combat Talons and three SOLL C-130s. Thigpen commanded one of the other two Talons, which was configured with Benson tanks and FARP personnel. Brenci landed first as planned, but the number two SOLL C-130 went around. The number three SOLL C-130 landed as planned, followed by the number four Combat Talon commanded by Thigpen. The number five aircraft, a SOLL C-130 aircraft from Dyess AFB, scheduled to land after Thigpen, had taxied off the runway en route to his FARP location. During the approach the SOLL aircraft entered a high sink rate on short final, which resulted in the aircraft impacting the ground short of the runway. The impact severely damaged the aircraft, and a fire broke out as it came to a stop in the airfield overrun. It was almost midnight at Indian Springs when the accident occurred. The aircrew managed to escape the burning wreckage, but seven personnel in the cargo compartment were killed. The exercise was immediately stopped, and forces already on the ground were redirected to respond to the accident. Medical personnel aboard Thigpen's Combat Talon deplaned and assisted the base crash response team in tending to the survivors. Brenci moved to Thigpen's Talon and coordinated exercise aircraft movements along with the Indian Springs tower. Once initial crash response actions were completed,

exercise aircraft on the ground were released to return to home station, except for Thigpen's aircraft. It was well past 6:00 A.M. when Thigpen and his crew took off with Brenci on board and proceeded back to Fairchild AFB.* The remainder of the exercise was subsequently canceled, and assets returned to their home stations between 22 and 23 September. The loss of the SOLL C-130 was the first fixed-wing accident since Desert One the previous year. As for the 1st SOW, it flew 79 sorties and 353.2 hours during Marvel Exodus, with the three Combat Talons flying 20 sorties and 103.4 hours of that total.³¹

With forces redeployed to Hurlburt Field, the 1st SOW prepared for US Readiness Command (USREDCOM) Exercise Bold Eagle 82, which was flown out of home station beginning on 13 October and lasting throughout the month. Due to heavy tasking for quarterly training exercises the previous year, Bold Eagle 82 was the first opportunity in over 18 months for the 1st SOW to concentrate a significant portion of its assets on joint training with USREDCOM forces.³² Wing assets included the 8th SOS Combat Talons, 16th SOS AC-130H gunships, and 20th SOS HH-53H Pave Lows. The first Combat Talon sorties were long-range infiltrations of SEAL platoons from Norfolk NAS, Virginia, which included CRRC drops, IFR, and low-level TF. Other missions were flown from Pope AFB and from Hunter AAF, Georgia, to both land and water DZs throughout the Eglin AFB range complex. All airdrops were made to blind DZs without any markings on the ground. The Combat Talons also performed three resupply missions utilizing door bundles when the users could not prepare them for HSSLADS delivery. One HSSLADS airdrop was later accomplished on 23 October. Two Fulton STARS (utilizing training sandbags) and two blacked-out NVG landings also were successfully completed.³³ Because of a shortage of exercise airlift, the 8th SOS was tasked to fly logistics support missions from Pope and MacDill AFBs. Throughout the exercise the 8th SOS dedicated two aircraft and flew 71.3 hours during 29 sorties.³⁴

The wing had hardly caught its breath from Bold Eagle participation when the next major joint exercise, named Certain Tribute 82, began at four locations in the eastern United States. The exercise was held from 6 to 16 November at Campbell AAF, Kentucky; Redstone AAF, Alabama; and Volk AAF and Fort McCoy, Wisconsin. The thrust of

the exercise was to train US Army rangers in airfield seizure and hostage rescue techniques. Initial training was devoted to company-size events from 6 to 12 November with load training at Campbell AAF and airfield seizure practice at Redstone AAF. A battalion-size operation launched from Campbell AAF on the night of 14 November en route to Volk AAF, with a rescue and live fire scheduled at Fort McCoy. At Volk AAF blacked-out landings utilizing NVGs were employed in the now-standard airfield seizure operation. For Certain Tribute 82, a first-ever formal joint search and rescue (SAR) plan was developed. For the exercise two 8th SOS MC-130E aircraft participated, flying 11 sorties and 44.2 hours.³⁵

Credible Sport II, Phase I

After the initial planning conference held in July, Uttaro and his Credible Sport OUE team began its test activities on 24 August and continued through the fall until 11 November. The OUE test team was composed of the following 8th SOS crew members: Uttaro, Schwartz, Galloway, Armstrong, and Almanzar.³⁶

The purpose of Credible Sport II, Phase I, was to satisfy prototype test requirements for Combat Talon II and to identify margins of safety for the STOL configuration and associated avionics. During the initial tests, 25 sorties and 60.5 flight hours were flown. Volumes of test data were collected concerning STOL performance, handling qualities, margins of safety, and avionics capabilities. The Phase I program also identified major design deficiencies in the airframe and in its avionics suite, and the test established the fact that the Credible Sport I aircraft had been designed for a specific, limited mission and did not possess the normal margins of safety required for peacetime operations. A major effort that would prove to be expensive and time consuming was identified to bring the aircraft up to production standards.³⁷

During Phase I testing issues surfaced that had to be resolved before proceeding to Phase II. These issues included the configuration of improved flight controls, the preparation of flight director/autopilot control laws, the installation of a stall warning system, improved stability augmentation, and proof testing of the STOL flaps. Lockheed-Marietta, as the prime contractor supporting the test, was required to expand the center of gravity envelope and provide improved roll

*Description of events at Indian Springs is provided from the author's recollections. Exact landing sequence and timing of events may not be totally accurate since no notes were taken at the time.

control, rudder installation, and yaw stability to satisfy the issues raised by the OUE team. The radar system installed on the Credible Sport aircraft was also deemed inadequate, and the team felt that it could affect the avionics evaluation scheduled for Phase II. Cockpit configuration needed improvement, and with the emphasis on terminal approach avionics during Phase I, the air-drop mode of operation was not evaluated. The many problems and issues identified during Phase I required resolution before the program could move to Phase II.³⁸

* * * * *

As the 8th SOS wound down operations in Certain Tribute, preparations were being finalized for the squadron's participation in Bright Star 82 scheduled to be held in Sudan from 22 November to 12 December. On 30 November two MC-130Es departed Hurlburt Field en route to the exercise. One aircraft, commanded by Brenci, with Hobson as his first pilot, flew a nonstop, long-range infiltration mission into Wadi Seidna, Sudan, utilizing three IFRs and 27 hours flying time. The second Talon proceeded to Lajes Field, Azores, with one IFR and then flew on to Sudan the following day.³⁹ Local training and exercise sorties were flown by exercise participants beginning on 30 November. Bright Star 82 provided excellent desert training in low-level terrain following and very low altitude operations along with NVG blacked-out landings.⁴⁰ During the first MC-130E flight after arriving in Sudan, one of the Talons experienced a flap-brake failure. After attempts to install a locally procured flap brake from a different manufacturer failed, maintenance was able to source the correct part from Cairo West and finally solved the problem. The second Talon required a propeller change during the initial phase of the exercise, but it was replaced without the loss of any exercise missions.⁴¹ Both MC-130Es redeployed from Wadi Seidna on 10 December and stopped at Rhein Main AB and Lajes Field during their return trip. The last leg of the redeployment included IFR over Bermuda, with the aircraft arriving back in Florida on 14 December after logging 54 sorties and 201 total hours during the 15-day deployment.⁴²

1982: Joint Tasking Challenges the 1st SOW

On 1 January 1982, Colonel Hess assumed the position of operations officer of the 1st SOS from

Wilson. Hess used the first three months of 1982 to concentrate on unit training in the Philippines. Since relocating to Clark AB the prior year, the squadron had developed extensive low-level routes throughout Luzon and had benefited from the rich training environment found there. From 8 to 26 February, the squadron supported Specwarex 82 from Clark AB, setting up an AF-SOB there and dedicating two aircraft and three crews to the US Navy SEAL exercise. The exercise provided excellent training for the squadron, including hard-to-get rapid onload and off-load events.⁴³ By mid-March the squadron was back in Korea for Team Spirit 82. From 16 March to 5 April, two 1st SOS MC-130Es, four ROKAF C-123s, and two 374th TAW C-130E SOLL aircraft formed the CAFSOB at Kimhae AB, Korea, and supported the exercise. Unlike Foal Eagle, Team Spirit was a conventional exercise with unconventional warfare units serving as opposition forces for large-scale maneuvers around which the exercise was centered. The CAFSOB was tasked to support both "blue" and "orange" forces, thus creating confusion within the special operations headquarters. The exercise was unrealistic for CAFSOB participants, but some excellent training events were accomplished.⁴⁴

At Hurlburt Field the New Year promised to be a busy one for the 8th SOS. Since Desert One squadron tasking had steadily increased, with new joint requirements added to the squadron's traditional exercise schedule. Throughout 1981 the operations tempo had been so intense that the squadron could not support all requests. The Special Mission Plans Division (DOS) continued to plan and coordinate 1st SOW support for special tasking. The 1st SOW, and in particular the 8th SOS, worked with the US Army's Task Force 160 (TF-160) of the 101st Aviation Group and the 75th Ranger Regiment. The wing also supported US Navy SEALs and worked with specifically identified SAC, MAC, and Aerospace Rescue and Recovery Service (ARRS) units that were qualified in certain special operations capabilities. From 8 to 17 January, one MC-130E deployed to Gray AAF, Fort Lewis, Washington, for Exercise Gossamer Wings. Both low-level operations and HALO drops were accomplished during the exercise. The primary thrust of the deployment was to obtain load training for the Combat Talon crews and for the ranger battalion stationed at Fort Lewis. The exercise identified US Army loading procedures that were not compatible with those of the USAF. Because of the exercise,

standard operating procedures for combat loading were drafted for later review and approval by standardization personnel.⁴⁵

The new joint command at Fort Bragg conducted a no-notice exercise named Vagabond Warrior from 30 January to 7 February 1982. The 1st SOW deployed 49 officers and 117 enlisted personnel, along with two Combat Talons, two AC-130H gunships, and two HH-53H Pave Low helicopters to Barking Sands, Hawaii. The exercise alert order arrived at the 1st SOW on the morning of 28 January, and the deployment order arrived shortly before midnight. The two Combat Talons departed Hurlburt Field on 30 January and completed two IFRs during their 17-hour flight, landing at Barking Sands on the 31st. The employment phase of the exercise was scheduled to begin on 2 February with a mission rehearsal, but it had to be postponed for 24 hours due to severe weather in the objective area. The rehearsal went as planned on 3 February on the island of Oahu near Barber's Point NAS. As Combat Talon 64-0551 returned to Barking Sands, it experienced a right main-gear problem that grounded the aircraft upon landing. High winds precluded jacking the aircraft at Barking Sands, so a one-time waiver to fly the aircraft to Hickam AFB was approved. Hangar space was available at Hickam AFB, but the part to fix the aircraft could not be located, thus necessitating a waiver to fly the aircraft back to the West Coast for repairs. The night-two scenario of Vagabond Warrior was completed without the grounded Combat Talon, and all exercise objectives were met. On 6 February, while preparing to redeploy to the continental United States, the second Combat Talon, aircraft 64-0568, developed a propeller problem that required a propeller change. After transiting through McClellan AFB, California, the last Talon arrived back at Hurlburt Field on 12 February. During the exercise the two MC-130E aircraft flew 12 sorties and 76.2 hours. The exercise demonstrated the ability of the 1st SOW to deploy quickly on short notice and move long distances in support of JCS tasking. The 1st SOW and the 8th SOS considered Vagabond Warrior a success.⁴⁶

Exercise Kindle Liberty 82 in Panama was supported by the 1st SOW during the January to February time frame. On 9 February an 8th SOS MC-130E flew a long-range infiltration mission into the Canal Zone and landed at Howard AFB to off-load additional cargo and personnel. After

spending the night at Howard AFB, the aircraft returned to Hurlburt Field on 11 February. An unplanned logistics flight was flown from Hurlburt Field to Howard AFB on 14 February to deliver parts for the gunships deployed for the exercise. In total the 8th SOS flew 26.6 hours in support of Kindle Liberty 82.⁴⁷

Live STARS Suspended

The spring once again found the 1st SOW and the 8th SOS in Europe for the annual Flintlock exercise. Flintlock 82 covered the period from 11 April to 21 May, with the first Combat Talon aircraft departing Hurlburt Field for Pisa AB, Italy, on 14 April. The aircraft deployed through Lajes Field, logging 16.5 hours during the two-day deployment. Upon landing at Pisa AB, maintenance found a main fuel tank leak, which required a one-time flight to Rhein Main AB for repair. On 24 April the 8th SOS crew proceeded on to RAF Weathersfield, UK, and joined the main body of the exercise. Ferkes's crew deployed from Hurlburt Field to RAF Weathersfield from 22 to 24 April and arrived in the UK at the same time as the first aircraft. During the exercise 7th SOS and 8th SOS crews flew each other's aircraft to maximize both aircraft and aircrew utilization. Thirty-seven hours were flown by 7th SOS crews on 1st SOW Combat Talons, and the two 8th SOS crews flew 23.6 hours on 7th SOS aircraft. During the course of the exercise, the 8th SOS flew 156.4 hours and 29 sorties. No Fulton STARS operations were accomplished by 8th SOS personnel during the exercise.*⁴⁸

A two-man land STARS had been successfully completed by Davenport and 7th SOS Crew 2 at Monrovia, Liberia, early in the exercise. A second one-man STARS was scheduled for 26 April at Canadian Forces AB, Lahr, in southern Germany. The recovery was in conjunction with Subexercise Schwarzes-Pferd. The 7th SOS Crew 1, with Bates commanding and flying Combat Talon 64-0523, departed RAF Weathersfield early on Saturday morning, 26 April, and proceeded to the exercise area. The aircraft lined up for the recovery and engaged the lift line normally. The sky anchor did not secure the lift line properly, however, thus resulting in the line slipping through the mechanism a few seconds after engagement. SFC Cliff Strickland, a US Army Special Forces soldier, was being picked up at the time, and he fell back to the ground just outside the runway

*TAC had previously restricted the squadron from performing live recoveries, and the STARS events scheduled for Flintlock 82 all involved live pickups.

area. He suffered a punctured lung and a broken hip. En route to the hospital aboard a medical evacuation helicopter, US Army medics performed an unsuccessful tracheotomy that resulted in the death of SFC Strickland. His death was eventually classified as an Army accident, with the USAF identified as a contributing factor.⁴⁹ Because of the fatality, all live Fulton STARS were suspended, and the system was restricted to the recovery of training bundles and equipment only. (There were no additional live pickups performed after the Flintlock 82 accident. In 1997 the last Fulton training mission was flown, and the system was retired from operational use.)

While the 7th and 8th SOS were deployed to Flintlock 82, the 1st SOS was participating in Team Spirit 82. After return from the exercise, the squadron spent the remainder of the spring maintaining aircrew proficiency and improving the unit's facilities at Clark AB. In April and again in June, the squadron participated in a local operational readiness exercise conducted by the 3d TFW. During June and July, the squadron deployed to SEA twice for exchange training in Thailand. The rich training environment found in Thailand had become a valued addition to the unit's local training program. Ulchi Focus Lens and Foal Eagle 82, both held in Korea during the late summer and fall, finished out a busy year for the squadron. For Foal Eagle the 1st SOW deployed one MC-130E from the 8th SOS and two Pave Low helicopters from the 20th SOS. The 1st SOW deployment to Korea was the first since Desert One and marked the wing's return to Northeast Asia.⁵⁰ The 8th SOS Combat Talon island-hopped across the Pacific, making stops in Hawaii, Kwajalein Island, and Guam en route to Korea. All missions were designed around an unconventional warfare scenario and involved low-level flight operations, infiltrations, exfiltrations, personnel and resupply airdrops, and in-flight refueling operations with KC-135 tankers. During exfiltration missions NVGs were used to land on blacked-out and minimally lighted runways.⁵¹

In the Caribbean, Exercise Ocean Venture 82 was held from 26 April to 17 May and included one 8th SOS Combat Talon operating out of Hurlburt Field under the operational control of the Air Force Forces Joint Unconventional Warfare Task Force Atlantic (AFFORJUWTF). Twelve sorties out of 13 scheduled were flown, including infiltrations, resupplies, exfiltrations, and one photoreconnaissance mission. In all 32.9 hours were dedicated to the exercise.⁵² The Ocean

Venture exercise was deemed highly successful by Colonel Drohan, the commander of AFFORJUWTF, since most exercise objectives were met while his staff gained excellent training in managing the joint operation.⁵³

* * * * *

By 1982 the new joint command at Fort Bragg had matured into an efficient organization dedicated to combating the growing terrorist threat. Tactics and capabilities developed during the preparation for Desert One and during Honey Badger were maintained by the new command. The quarterly exercises were dedicated to maintaining these unique capabilities. From 4 to 23 June, a 7th SOS Combat Talon, along with an augmented crew, deployed from Rhein Main AB to Hunter AAF, Georgia, to participate for the first time in a quarterly exercise (Castle Tower). Utilizing IFR for a long-range, nonstop deployment from Europe, the 7th SOS arrived in Georgia on schedule. Once at Hunter AAF, the crew flew low-level missions and practiced communications-out refueling procedures. Precision airborne radar approaches and heavy-equipment drops not available in Germany were also accomplished. During the three-week deployment, the crew flew 63.8 hours, dropped 60 personnel, and airdropped 314 others. The squadron also dropped 1,000 pounds of cargo and airdropped another 154,000 pounds.⁵⁴ The exercise was beneficial to the 7th SOS and enabled the squadron to increase its proficiency in new capabilities that had been developed by the other two Combat Talon units since Desert One.

On 8 July 1982, Lt Col William E. Hudspeth assumed command of the 7th SOS from Walt Schmidt. The following month the squadron deployed two aircraft, three crews, and a support element to Hellenikon AB, Greece, for Zeus 82, which was the Greek subexercise of Flintlock 82. An Air Force Special Operations Facility (AF-SOF) was activated at Hellenikon AB, and a 7th SOS communications team established connectivity between the AFSOF and SOTFE's Unconventional Warfare Task Force located at Rendina, Greece. From 27 August to 17 September, missions were flown in support of US Army Special Forces and US Navy SEALs. A few days into the exercise, all USAF C-130E aircraft were placed on flight restrictions for weight and stress due to cracks found in the wings of some aircraft. For Combat Talon, the restrictions eliminated low-level operations for the exercise. The Combat Talon worldwide fleet remained on restrictions

until after the first of the year. For Zeus 82 all missions were supported by the two deployed aircraft, but they flew from Hellenikon AB to the exercise area at altitudes ranging from 4,000 to 6,000 feet.⁵⁵ The remainder of the year was spent operating with the restrictions while supporting 7th SOS customers throughout the theater.

On 26 July 1982, Lt Col James L. Hobson assumed command of the 8th SOS from Brenci. Hobson had been the operations officer since 1 May 1980, and Colonel Sims was selected to move up to Hobson's old position. When the USAF directed the inspection of all 1964 and earlier C-130s for suspected structural deficiencies in September, terrain-following operations were suspended for all three Combat Talon squadrons, and limitations were imposed on aircraft speed, maneuvering, and fuel/cargo combinations. At Hurlburt Field Combat Talon 64-0568 was initially grounded for wing cracks after being inspected but was subsequently cleared for a one-time flight to Warner Robins for repair. Aircraft 64-0551, 64-0559, and 64-0562 passed the Level I inspection, but they remained restricted from low-level flight and certain maneuvers until a more in-depth follow-on inspection for wing cracks could be completed. Combat Talon School low-level training was canceled, thus severely impacting the school's ability to graduate its students.⁵⁶ Hobson had his hands full keeping his crews proficient and the school in operation.

* * * * *

After a low-visibility recall and departure from Rhein Main AB, the 7th SOS deployed one MC-130E and 24 personnel to the United States from 25 October to 17 November to participate in the next quarterly exercise—Roughen Turf. As had been the case in June, the initial portion of the deployment concentrated on airdrop and unilateral training. Operating out of Pope AFB, the crew dropped fuel blivets and heavy equipment provided by the US Army Airborne Board. The next several days were spent on precision airborne radar approaches and NVG blacked-out landings. On 29 October the crew practiced rapid onload and off-load procedures with US Army rangers at North Field, South Carolina, and on 30 October the crew deployed on to Hurlburt Field. From 1 to 8 November additional airdrops and unilateral training were accomplished. During the night of 9 November, a full dress rehearsal utilizing the Roughen Turf scenario was conducted, including NVG blacked-out

landings, rapid onload and off-load, and an airfield seizure operation. The actual Roughen Turf mission was flown during the night of 10 November. Exercise participants included two 8th SOS Combat Talons from Hurlburt Field, Delta Force from Fort Bragg, North Carolina; and US Army rangers from Hunter AAF, Georgia. Three Combat Talons—two 8th SOS and one 7th SOS—launched from Hurlburt Field to the Nellis AFB range area with an IFR en route. Indian Springs, Nevada, was the primary airland location, with other portions of the exercise being conducted at Pahute Air Field, Nevada, and at other sites in the Nellis AFB test range. The 7th SOS crew performed a blacked-out NVG landing at Indian Springs and later departed there for Nellis AFB, where all three Talon crews entered crew rest for the night. On 11 November maintenance determined that the 7th SOS aircraft needed an engine change, thus requiring the crew to remain at Nellis AFB for the next two days while the aircraft was being repaired. After returning to Hurlburt Field on 15 November, the crew departed for Lajes Field the following day. The aircraft arrived back at Rhein Main AB on 17 November after flying 95 hours during the deployment. Over 100 takeoffs and landings and 45 precision airborne radar approaches to NVG blacked-out landings also were completed.⁵⁷ Nowhere in Europe could this type training be found.

Credible Sport II, Phase II

A Credible Sport II, Phase II, plan was developed by Major Uttaro and his OUE team during the first quarter of 1982. The plan detailed the Phase II test program and was presented to the Credible Sport II program manager. The OUE plan was enthusiastically received, and a Phase II flight-test start date of 15 June 1982 was established. During the interim period, aircraft 74-1686 received additional modifications to correct deficiencies identified during Phase I testing.⁵⁸

The Credible Sport OUE continued through the fall of 1982. Jerry Uttaro, after four years in the 8th SOS, was reassigned to the Pentagon, Washington, D.C., and Maj Norty Schwartz took over as the director of the OUE test team. In November the team published the final OUE test report after it had determined that all "prototype" objectives and requirements of the Credible Sport II, Phase II program had been met. The final report determined that the Credible Sport II aircraft design, in its final configuration, was

ready for production as the new Combat Talon II aircraft. During Phase II testing, significant changes made by Lockheed-Marietta after Phase I had resulted in significant improvements in the areas of avionics, equipment, and aircraft design. From 4 to 6 November the OUE team attended the Combat Talon II configuration conference. The conference centered on Credible Sport II OUE findings and the application of those findings to Combat Talon II.⁵⁹

With Phase II completed and the final report published, action was required to determine the final disposition of the Credible Sport aircraft (74-1686). Uttaro had pursued assignment of the aircraft to the 1st SOW earlier in the year, but in a June 1982 message to Air Staff, TAC declined to support the initiative. Subsequently, Air Staff made the decision to return the aircraft to MAC when Credible Sport II, Phase II, testing was completed. With the announcement in the fall of 1982 that MAC would absorb all USAF special operations assets the following spring, action was renewed within the 1st SOW to have aircraft 74-1686 assigned to Hurlburt Field. In November Schwartz submitted a staff package to MAC through the 1st SOW wing commander, Col Hugh L. Cox III, with rationale and justification for retaining the aircraft in the wing. Combat Talon II designated aircraft were just beginning their initial construction phase at Lockheed and would not be modified into Combat Talon IIs for another three years. The 1st SOW felt that the Credible Sport aircraft could provide an interim capability until the new aircraft became available.⁶⁰ The proposal also outlined an initiative to exchange one of the new C-130H aircraft earmarked for the Combat Talon II program for the Credible Sport aircraft. In the end, however, MAC agreed with TAC and did not support assignment of aircraft 74-1686 to the 1st SOW. The aircraft was destined to remain at Warner Robins and never fly again as an airlifter—the cost to demodify the aircraft to its original configuration exceeded its value to the Air Force. The aircraft would eventually be transferred to the Warner Robins Aircraft Museum, where it remained from that time forward. Special operations was denied a valuable asset that would have undoubtedly improved its airland infiltration/exfiltration capability.

TAC and MAC Strike a Deal

Since the failed rescue attempt in 1980, special operations had been scrutinized at all levels to determine how available resources could be better

organized and trained. During 1982 the Air Force inspector general conducted a functional management inspection (FMI) of Air Force special operations forces and determined that SOF should be consolidated under one command to enhance available resources. The 1982 Defense Guidance and the Air Force 2000 study identified the lower end of the conflict spectrum as the most likely area of involvement of US forces over the next 20 years. The net result was an increase in SOF requirements. To address those requirements, Air Force/XO hosted an SOF working group from 13 to 22 July 1982, which reviewed existing capabilities and presented a series of recommendations to the Air Force Council on 31 August.⁶¹

Because of these actions, TAC and MAC convened a study group in the fall of 1982 to respond to the SOF study group recommendations and to the IG's FMI report. The study group developed a proposal that consolidated special operations and combat rescue under MAC. The group recommended that the consolidation take effect on 1 April 1983, with minimal disruption in basing and force distribution. Special operations forces and combat rescue would retain their unique identities, with the overseas CINCs having operational control over the forces stationed in their respective theaters. On 7 December 1982, the Air Force formally announced the decision to consolidate SOF under MAC. For the first time, the Combat Talon community would reside under one command, which would eventually result in standardization of equipment and an increase in assignment opportunities for SOF personnel.⁶² In December 1982, however, there was little enthusiasm for the consolidation plan in the three Combat Talon units.

1983: Combat Talon Moves to MAC

The New Year saw the 1st SOS as busy as ever. On 1 March 1983 MAC assumed command of all USAF special operations forces, including the 1st SOS in the Pacific. At Clark AB the 1st SOS became a tenant unit to the 3d TFW along with the 374th TAW, which was also a MAC unit located at Clark. The 374th was assigned maintenance responsibility for the 1st SOS Combat Talons, since both were MAC units. Operational control of the 1st SOS was retained by Headquarters PACAF, while command of the unit passed to the newly created MAC-assigned 2d Air Division at Hurlburt Field. The first commander of the 2d AD was Col Hugh Cox, who was the former commander of the 1st SOW. The 2d AD was assigned

to MAC's newly formed Twenty-Third Air Force, which was responsible for all special operations and SAR forces. The Twenty-Third Air Force was located at Scott AFB, Illinois, and was made up primarily of rescue personnel that had been assigned to the deactivated Air Rescue Service.* The immediate result of the reorganization for the 1st SOS was felt in the maintenance area. Since coming to Clark AB as part of the 3d TFW, the squadron had developed an excellent and dedicated maintenance capability for Combat Talon unique systems. When the squadron was transferred to MAC, the 3d TFW retained many of the squadron's specialized maintenance personnel in its wing, with the remainder transferred to the 374th TAW. The 374th TAW then assigned the specialists throughout its maintenance shops, thus resulting in a huge decrease in maintenance capability for the 1st SOS.⁶³ The decreased maintenance capability would affect the squadron for the remainder of the year.

A few days after the reorganization, the 1st SOS deployed two aircraft and a CAFSOB support package to Korea for Team Spirit 83 and operated out of Kimhae AB from 5 to 22 March. Some of the former 3d TFW dedicated maintenance personnel already had been committed to the exercise before the conversion to MAC, resulting in smooth maintenance operations during the exercise. Aircraft and personnel from the 374th TAW and the 317th TAW (located at Pope AFB) also deployed for the exercise, each with a "MAC mission commander" designated to command its respective element. The resulting confusion had an impact on the exercise, with CAFSOB planners from the 1st SOS questioned by other MAC-committed units as to command and control arrangements. During the exercise 66 missions were successfully completed out of a tasked 95, with weather being responsible for 16 cancellations. Overall, the exercise was a success due to the commitment of all exercise participants.⁶⁴

Concerned with decreasing maintenance indicators since the transfer to MAC, Colonel Cox visited Clark AB and the 1st SOS from 18 to 20 April. What Cox saw so concerned him that he sent an immediate message to the commander of Twenty-Third Air Force, relaying the problems

faced by the squadron. Since consolidation under MAC, 1st SOS aircraft had deteriorated to a point that the specialized subsystems installed on the aircraft were marginally operational. One assigned aircraft had 67 delayed discrepancies, and the aircraft suffered from low-maintenance priority within the 374th TAW. Documents revealed that the host wing did not work the Combat Talons until they appeared on the flying schedule—and only then were systems critical for flight repaired. The sophisticated radar and ECM equipment were rarely in fully mission-capable status. With the reorganization the 374th TAW had not maintained the capability to repair the radar, the inertial navigation system, the electronic countermeasures system, or the aerial refueling system installed on the Combat Talon. After returning to Hurlburt Field, Cox sent a report to Twenty-Third Air Force outlining the problems he found at Clark AB.⁶⁵ Some improvements were seen locally for the squadron after Cox's visit, but little increase in maintenance capability was seen until after the end of the calendar year.

* * * * *

The year of 1982 had been extremely busy for the 8th SOS, and 1983 promised to be the same, with traditional exercises scheduled along with quarterly joint events. In addition, weekly training was scheduled to keep joint components ready to respond to the growing worldwide terrorist threat to the United States.

Throughout the latter part of January, 1st SOW forces participated in the Alaskan Exercise Brim Frost 83, with the 8th SOS deploying one aircraft and crew. Hobson was designated the AFSOB commander for the exercise. The Combat Talon flew two air defense exercises on 24 and 25 January as a slow-moving airborne penetrator. On 31 January the 8th SOS flew an infiltration mission and, on 1 February, exfiltrated two Special Forces teams from Fort Wainwright. The Combat Talon flew nine sorties and 50.5 hours during the exercise.⁶⁶

Beginning on 1 February, the 1st SOW was alerted for a no-notice quarterly exercise named Prairie Runner. For the next 48 hours, the wing mobilized and prepared to launch forces to Patrick AFB, Florida. On 4 February one Combat

*When Air Rescue Service was deactivated, the facilities that it occupied at Scott AFB, along with most of its personnel, were transferred to the newly established Twenty-Third Air Force. The primary emphasis of the headquarters (as perceived by Combat Talon operators) heavily leaned towards improving combat rescue capabilities rather than those of special operations. Over succeeding years resentment grew between the two factions, with career special operations personnel being forced into assignments at Scott AFB when volunteers were not available. Promotions suffered for SOF personnel assigned to the headquarters, as MAC and Twenty-Third Air Force looked out for their career officers who had grown up in the MAC system, or at least that was the perception within the Combat Talon community.

Talon—along with two AC-130Hs, three HH-53Hs, and four C-141s filled with personnel and equipment—were deployed. Twenty-four hours later a second Talon from the 8th SOS and one from the 7th SOS also arrived at Patrick AFB. For the next two weeks, deployed forces planned, rehearsed, and executed a series of complex operations originating from northeast Florida and terminating in the exercise area in east Texas. Airfield seizure rehearsal operations were conducted, and during the night of 11 February, the centerpiece airfield seizure event was successfully completed at Orange County Airport north of the Houston metroplex. Overcoming severe weather over the Gulf of Mexico en route to the objective area, all aircraft successfully landed as planned at Orange County. In total, 52 hours were flown by 8th SOS Talons during Prairie Runner.⁶⁷

During the months of April and May, Flintlock 83 was held, and it resembled recent exercises in the series. The 7th SOS deployed to RAF Sculthorpe and established the AFSOB. From the UK unconventional warfare subexercises were conducted in core NATO countries, with additional subexercises flown in Tunisia, Morocco, and Jordan. Just before the deployment for Flintlock 83, command of the 7th SOS was transferred to MAC as had been the case for the other two Combat Talon squadrons. The 7th SOS was no longer assigned to USAFE. This reorganization created some changes for the squadron at Rhein Main AB, but had little impact on Flintlock 83. The 7th SOS was transferred from USAFE's 7575th OG and was assigned to the 2d AD at Hurlburt Field. It remained stationed at Rhein Main AB. The 2d AD exercised command of the 7th SOS and controlled all local and training operations. USAFE retained operational control of the squadron, while SOTFE assumed OPCON from USAFE under certain wartime conditions.⁶⁸ One immediate change seen by the squadron was that efficiency reports went to the 2d AD instead of to USAFE. In addition, when personnel rotated back to the United States after completion of their tours of duty, they returned to MAC, which was their designated losing command.*

The squadron remained a tenant organization at Rhein Main AB, with the 435th TAW providing maintenance support similar to the arrangement at Clark AB. Both units were assigned to MAC, but the 7th SOS remained separate from the host wing. To provide specialized avionics

and electronic countermeasures maintenance for the squadron, an avionics maintenance shop was created and attached to the 7th SOS.⁶⁹

At the 8th SOS the transition from TAC to MAC was completed effective 1 March 1983. The change in major commands had some impact on the squadron's daily operations. The training section was tasked to write a new training manual, which was designated as MAC Regulation 51-130. The projected implementation date was set for 1 January 1984, and it replaced MACR 51-1 and TAC Manual 51-60. The new manual encompassed all training requirements and was the single training regulation for MAC-assigned units. With the change to MAC, there was also a greater emphasis on ground-training events, including systems refresher, security, and buffer zone orientation. Some pilots and navigators were given the opportunity to attend the Combat Aircrew Training School at Nellis AFB which was a three-week school designed to familiarize crew members with tactics developed for employment in a hostile environment.⁷⁰

As special operations transitioned to MAC, 8th SOS Combat Talon tasking reached a critical stage during April and May of 1983. Both JCS Exercise Flintlock 83 and Exercise Solid Shield 83 were scheduled during this period, with each exercise tasking the 8th SOS for two Combat Talon aircraft. During the same period, special mission requirements continued for two Combat Talons. The Combat Talon School also required one aircraft for its training program. There were only three aircraft available to fill requirements for seven aircraft, with aircraft 64-0572 loaned to the 1st SOS and aircraft 64-0567 at LAS Ontario for scheduled maintenance.

Beginning in the fall of 1982, the 1st SOW had asked for relief from some of its Combat Talon tasking scheduled for the following spring. None was forthcoming, so on 17 January Col Hugh L. Hunter, the new commander of the 1st SOW, formally requested that the two Combat Talons be eliminated from Exercise Solid Shield 83 and that the Combat Talon requirement for Flintlock 83 be reduced to one aircraft. An agreement was eventually reached to support Solid Shield with one Combat Talon operating from Hurlburt Field, with no more than eight sorties dedicated to the exercise. For Flintlock, the tasking was reduced to one Combat Talon, with MAC agreeing to provide an additional MAC SOLL C-130 in the place of the

*Before the consolidation personnel had no losing command, since TAC did not claim USAFE and PACAF SOW returnees.

second Talon.⁷¹ With the limited number of aircraft available during the period, the reduction in Combat Talon commitments was still not enough to allow remaining requirements to be met. The brunt of the shortfall was absorbed by the Combat Talon School and by the virtual elimination of local training sorties. All other requirements were met. The level of tasking for Combat Talon during this period was somewhat typical of the operations tempo that the squadron had maintained since Desert One.

For its Flintlock 83 participation, the 8th SOS's Combat Talon witnessed the implementation of a new tactic. Early infiltration of committed special operations forces always had been a key objective for European planners, but the number of Combat Talons available in Europe limited employment of this tactic. The tactic of flying a combination deployment/employment mission, which originated from the United States and culminated with the infiltration of a special forces team directly into the combat area, could help eliminate the shortfall. On 22 April an 8th SOS Combat Talon departed Hurlburt Field en route to Westover AFB, Massachusetts, to link up with a US Army Special Forces team. After face-to-face briefings with the team and crew rest for the crew, the mission launched on 24 April with a successful IFR being accomplished near Iceland from a KC-135. The Combat Talon made a low approach at RAF Sculthorpe without making a landing. Upon departing the traffic pattern and contacting departure control, the crew requested clearance onward to southern Germany and the Schwarzes-Pferd subexercise area. A new flight plan had been filed by exercise planners at RAF Sculthorpe with a new call sign and the route of flight. The crew proceeded on to Germany and entered low level near Frankfurt. The seven-man team was dropped on a blacked-out DZ exactly on time and on target. The aircraft proceeded back to the UK after climbing to altitude and obtaining an instrument clearance from ATC. Upon landing at RAF Sculthorpe, the mission terminated with 18.4 hours being logged.⁷² The aircraft remained in the UK and supported subexercises in Belgium, Luxembourg, and Germany. The exercise had expanded again from the previous year, with the operations tempo greatly increased for the Combat Talons. Approximately twice as many missions were flown during the 1983 exercise than were flown in 1982, with MC-130E sortie generation exceeding the projected wartime utilization rate.⁷³ For the 8th SOS, however, its crew flew six employment missions,

including the initial United States to Germany infiltration, and logged 48.6 hours. An additional 15 hours were logged during the redeployment to Hurlburt Field in mid-May. The two Combat Talon squadrons again flew each other's aircraft, which created a problem with the electronic warfare officer, as had been the case the year prior. The exercise highlighted the potential problems that could arise if the three Combat Talon squadrons were ever employed together during the same contingency—all three squadrons had different ECM systems installed on their aircraft that precluded the universal exchange of crew members.⁷⁴ Because of the problems surfaced during the Flintlock interfly program, MAC's initiative to standardize the Combat Talon fleet gained momentum.

Between 21 April and 6 May, an 8th SOS MC-130E participated in Exercise Solid Shield 83. No major problems arose during the execution of the exercise. The Combat Talon operated out of Hurlburt Field and flew 42.7 hours while successfully completing six tasked missions. Standard infiltration, exfiltration, and resupply missions were flown.⁷⁵ As May passed, and the two large JCS exercises came to an end, the 8th SOS prepared for June and another period of heavy tasking. Exercise Universal Trek 83, utilizing the Caribbean region as the exercise area, was flown between 2 and 6 June and began with a long-range infiltration. In addition to the initial long-range infiltration mission, 8th SOS Talons flew three employment sorties from Roosevelt Roads AB, Puerto Rico, and a long-range exfiltration from Puerto Rico to Pope AFB at the end of the exercise.⁷⁶

A few days later the squadron provided one Combat Talon for Exercise Casino Dancer, which was held from 11 to 23 June. Hobson deployed as the 1st SOW mission commander to Harrisburg IAP, Pennsylvania, and commanded wing-committed forces for the duration of the exercise. Infiltration and exfiltration operations with committed ground forces kept the Combat Talon busy. Perhaps due to the operations tempo during the previous two months, the aircraft was grounded for maintenance problems for a good portion of the exercise.⁷⁷ The remainder of June and most of July was spent catching up on local training and flying Combat Talon School sorties. From 26 July to 4 August, another quarterly exercise (Night Venture) was conducted with one MC-130E. Mountain low-level terrain following and US Army Special Forces personnel airdrops were

accomplished by a Combat Talon crew. As it turned out, Night Venture was the last joint special operations exercise involving the Combat Talon before Operation Urgent Fury the following October in Grenada.

April and May had been dedicated to Flintlock 83 for the 7th SOS, but the pace did not decrease after the unit returned to Rhein Main AB. Local proficiency sorties were flown in June, with emphasis on flying staff personnel who had worked in the AFSOB and could not fly during the two-month-long exercise. From 7 to 15 July, the squadron participated in Black Baron I, which was a US-based exercise involving one MC-130E and an augmented crew. The aircraft departed Rhein Main AB with a US Army Special Forces A Team (SFODA) and flew nonstop to the Fort Bragg range area. The crew refueled over the Atlantic twice and terminated the tactical portion of its mission with an airdrop of the SFODA on Saint Mere DZ near Pope AFB. The crew then landed at Pope, logging 16.3 hours of flying time during the nonstop mission. Heavy equipment and blivet drops were successfully executed during the following week along with airborne intercept training with the New Jersey Air National Guard's F-106s.⁷⁸

In the Pacific one 1st SOS MC-130E aircraft deployed to Utapao Royal Thai Naval Base from 19 to 31 July for JCS Exercise Cobra Gold 83. The exercise had been greatly expanded over previous years, with the 1st SOS programmed to fly 58.2 hours. The squadron was scheduled to participate in a variety of events, including personnel drops, CRRC drops, HSSLADS resupply drops to Special Forces teams deployed in the field, and airland exfiltrations of combined SEAL platoons.⁷⁹ Flying activities were severely curtailed due to recurring maintenance problems associated with the Combat Talon. During the first three days of the employment phase of the exercise, all missions were air aborted due to a master fire warning light indication, which required the shutdown of the number 2 engine. The problem was finally resolved on 24 July when a broken wire was found in the fire detection system. On 26 July, while flying a unilateral night short-field landing sortie at Utapao, the left outboard elevator trim tab flex-drive assembly failed, resulting in the loss of the elevator trim tab motor. The aircraft landed without further incident. Replacement parts arrived late on 29 July, and the aircraft was cleared to fly the following afternoon. The maintenance downtime caused the loss of four personnel drops, two

CRRC drops, two HSSLADS drops, and one airland exfiltration of two combined SEAL platoons from Hat Yai Airfield in southern Thailand. Only 29.9 hours were actually flown during the exercise.⁸⁰ The 1st SOS element redeployed to Clark AB on 31 July without accomplishing its pre-exercise goals.

At Hurlburt Field the early part of August was spent finalizing preparations for Bright Star 83, which had one 8th SOS and one 7th SOS Combat Talon committed. The 8th SOS MC-130E departed Hurlburt Field on 9 August en route to Cairo West, Egypt. After arriving on 11 August, the crew began planning employment missions, which were scheduled to commence two days later. Exercise participants were housed in a tent city at Cairo West, with field latrines used for sanitation. Many personnel became ill from unsanitary living conditions and the proximity of the field latrine. The 8th SOS Combat Talon flew eight infiltration missions, three resupply missions, and one low-level airborne intercept mission.⁸¹

On 10 August, one day before the arrival of the 8th SOS, one 7th SOS MC-130E and 36 personnel arrived at Cairo West. The squadron flew missions in Egypt and in three subexercises during the following two weeks. A 12-man SFODA was infiltrated into the Somalia subexercise on 15 August. After departure from Cairo West, the crew flew a high-level profile over the Red Sea and refueled from a KC-10 tanker. The refueling was the first for the squadron from the new jumbo tanker. After completion of the refueling operation, the aircraft entered low level and flew a two-hour route to its DZ. During the low-level portion of the mission, the number 3 engine was shut down for fluctuating gearbox oil pressure, but the crew elected to continue the mission. Operating under emergency conditions, the aircraft was positioned over the DZ within 10 seconds of its TOT when the ground party called a no-drop for excessive ground winds. The Combat Talon proceeded to Mogadishu, Somalia, where the team was airlanded. Total mission time was 9.8 hours. On 20 August the 7th SOS MC-130E departed Cairo West on a combined infiltration and resupply mission destined for Sudan. A nighttime IFR from a KC-10 was accomplished, and the crew continued on for another three hours to successfully drop the SFODA and to resupply another team that was already in the field.⁸² Bright Star 83 demonstrated that the 7th SOS had come a long way since Desert One in developing its IFR, airdrop,

and NVG skills. The unit could deploy and perform along side its sister squadrons with equal capabilities.

Problems were encountered with Egyptian Air Traffic Control when exercise planners could not provide 72-hour notice for all flights. In addition, at a preplanning conference that squadron representatives had not been allowed to attend, MAC had agreed to daylight only airlift operations. Special operations was not an airlift-specific mission, but it was included with other MAC support.⁸³ Night operations for special operations were essential. The situation was somewhat rectified during the exercise after many long sessions with Egyptian exercise support personnel. After nearly a month in Egypt, the 8th SOS Talon arrived back at Hurlburt Field on 7 September while the 7th SOS returned to Rhein Main AB.

A second low-visibility mission, code-named Black Baron II, was flown by the 7th SOS between 13 and 21 August. One 7th SOS-augmented crew deployed to Zaragosa, Spain, after picking up a US Navy SEAL platoon at RAF Machrihanish, UK. A second Combat Talon also deployed to Zaragosa as a spare for the primary mission aircraft. On mission night the primary aircraft departed Zaragosa AB en route to a point off the coast of Lebanon. After refueling from a KC-135 tanker, the Combat Talon air-dropped the SEAL platoon and a CRRC approximately 50 miles off the Lebanese coast near Beirut. The entire operation was executed at night, with the Combat Talon returning to Rhein Main AB nonstop after a second IFR. The spare Combat Talon remained at Zaragosa and returned to Rhein Main AB on 21 August.⁸⁴

During Reforger 83 the 7th SOS participated in Subexercise Carson Woods, flying out of Rhein Main AB and successfully completing 12 missions. Infiltration and exfiltration missions were accomplished in support of both European-based active duty and US-based reserve US Army Special Forces units. Missions were flown into southern Germany and into Belgium. Squadron-assigned SOCCT personnel were also infiltrated along with the special forces teams to assist in locating and surveying DZs and helicopter landing zones. Once in the field, SOCCT personnel also instructed special forces teams on the Fulton STARS, with emphasis on equipment setup and operation in preparation for a Fulton recovery.⁸⁵

The 1st SOS's performance during Cobra Gold 83 had been disappointing, but squadron leadership was committed to improving the unit's overall maintenance status. On 1 August 1983, Hess assumed command of the squadron from Prater, and Major Jahnke was appointed as his new operations officer. From 9 September to 12 October, the squadron deployed two Combat Talons to Port Hedland, Western Australia, for the triennial Exercise Westwind/Kangaroo 83. With 33 personnel and two aircraft deployed, the 1st SOS made up 50 percent of the USAF commitment for the exercise. The squadron set up a CAFSOB at Port Hedland and operated under field conditions. Tactical events coordinated by the CAFSOB included a full range of special operations capabilities. During the month-long exercise, tactical events accomplished by dedicated USAF aircraft included short-field day/night takeoffs and landings with infiltration or exfiltration of long-range patrol vehicles and personnel, coastal penetration missions working against picket ship radar and airborne interceptors, day and night HALO and HAHO infiltrations, and CRRC drops.

During one of the short-field landings, Combat Talon 63-7785 became mired in sand after the main landing gear broke through the dirt runway surface. After downloading fuel and removing everything possible from the aircraft, a combined US/Australian recovery team freed the aircraft with only minor damage. The aircraft and crew returned to the exercise with minimal impact to planned operations. CAFSOB assets also completed resupply airdrops to teams in the field, including blacked-out and IR night landing-zone operations, and participated in desert aircrew survival training. The 1st SOS flew 15 sorties while air-dropping 86 personnel and airlanding 106.

Although improved over Cobra Gold, maintenance support for the 1st SOS aircraft still did not meet the squadron's needs. Most of the unit's problems revolved around the lack of spare parts and aircraft support equipment. No exercise funds were made available to deploy spare parts or aerospace ground equipment. All equipment and supplies needed to support the month-long bare-base deployment, including personnel, ground equipment, and supplies, were deployed on the 1st SOS Talons. Critically needed parts could not be deployed because of supply shortfalls at Clark AB and a lack of additional air transportation to Australia. As a work around, exercise

* * * * *

aircraft made resupply flights to Royal Australian Air Force (RAAF) Pearce and to RAAF Darwin and coordinated short-notice diplomatic clearances for unprogrammed resupply flights from home station. The RAAF C-130 base at Richmond, Australia, was also utilized for aircraft parts but was 2,000 miles from Port Hedland. The situation caused extended down times for the Talons and severely affected the exercise.⁸⁶ (Colonel Cox again visited the 1st SOS from 29 November to 1 December to evaluate how the squadron was progressing under MAC support. Cox's visit was followed by General Ryan, commander in chief, MAC, on 5 December. General Ryan was accompanied by General Brown (MAC/DO) and General Watts (MAC/XP). The high-level interest was generated in part by Cox's previous correspondence to the Twenty-Third Air Force commander earlier in the year and the continued poor maintenance status of the squadron.)⁸⁷

The Australian deployment terminated on 12 October with the return of the two Combat Talons to Clark AB. Two weeks later the 1st SOS was deployed again to Foal Eagle 83. The Korean exercise was similar to those of previous years, with the CAFSOB established at Kimhae AB. The squadron deployed two aircraft as part of a USAF eight C-130 aircraft commitment to the exercise. The ROKAF committed six C-123 aircraft and formed an exercise-dedicated detachment at K-16. External events negatively affected the exercise by degrading the squadron's ability to successfully execute planned missions. Real-world events, including the Soviet shutdown of Korean Airline's flight 007 and the attempted assassination of the president of Burma, eliminated 26 ROK Army teams from the exercise, when those teams were needed for national security duty. Coupled with those two events, the North Koreans stepped up their number of attempted border infiltrations into South Korea. President Reagan visited South Korea in November, and the exercise was shortened so that some participants could conduct their real-world security duties. Also in October 1983, the United States executed Operation Urgent Fury in Grenada, and 2d AD forces committed to the exercise, including 8th SOS Combat Talons, were canceled just before the exercise. In total, 50 percent of the projected MC-130E missions were lost.⁸⁸

* * * * *

During the months of September and October, 7th SOS aircraft deployed to Aviano AB, Italy; Kenitra AB, Morocco; and Hellenikon AB, Greece; in support of US Army Special Forces and US Navy SEALs. On 22 October the US Marine barracks in Beirut, Lebanon, were blown up by terrorists, and EUCOM forces were put on increased alert. The 7th SOS had a week-long Greek trainer scheduled to deploy the following day. Additional preparations were made to protect the aircraft and personnel should the terrorist assault spill over to Greece. Almost unnoticed by 7th SOS personnel were recent events on the tiny Caribbean island of Grenada. With the tragedy unfolding in the Middle East, little thought was given to the developing crisis across the Atlantic.

Thigpen and his crew reported to the 7th SOS squadron operations building at 0500 on Sunday, 23 October, to prepare for the deployment to Hellenikon AB. Preflight planning was proceeding normally, and the mission briefing was completed by 0615 local. Just before Thigpen departed for base operations to file the flight



Photo courtesy of Sam Garrett

Combat Talon 63-7785 mired in sand.



Photo courtesy of Sam Garrett

Rear view of aircraft 63-7785.

plan, Colonel Hudspeth arrived in the squadron and pulled Thigpen aside. Hudspeth was en route to the Rhein Main AB Command Post, where he had a secure telephone call waiting for him. Both officers assumed the call was related to the Beirut disaster. Hudspeth directed Thigpen to continue on to base operations and file his flight plan but to delay departure until released by him personally. With the flight plan filed, the pilots and navigators proceeded to aircraft 64-0561 and began their preflight duties. The crew was waiting in their seats ready for engine start when Hudspeth returned in his staff car. The secure telephone call had been from Twenty-Third Air Force, and Hudspeth directed that the crew return to the squadron and prepare for an alternate mission. In short order, crew members were released to return to their quarters and pack for a 30-day deployment. No other details were given. On returning to the squadron, the crew was instructed to plan a flight from Rhein Main AB to Hurlburt Field, Florida. Hudspeth explained that there would be no tanker support, thus requiring the crew to stop at Keflavic, Iceland, and Goose Bay, Labrador, for fuel and servicing. Thigpen was instructed to contact Colonel Dutton, the Twenty-Third Air Force director of operations, en route for additional guidance. Just after 1000 local on 23 October, the aircraft departed Rhein Main AB en route to Keflavic.⁸⁹ Hudspeth had given Thigpen a sealed envelope to be opened only after takeoff, and when cockpit duties settled down, Thigpen opened the letter and read aloud the commander's remarks. Hudspeth emphasized the importance of the mission and assured the crew that it was for real but did not elaborate on its purpose. He closed by wishing the crew the best of luck and Godspeed. The crew still had no idea that the deployment was in support of Operation Urgent Fury.

The first leg of the flight was uneventful, and, as the day turned into night, the aircraft was bearing down on Goose Bay, Labrador, after refueling in Iceland. Nearing its 16-hour crew day, the radio operator contacted the MAC command post at Scott AFB, Illinois, by way of phone patch, and Thigpen talked with Dutton. The crew's duty day was extended by two hours, and Thigpen was instructed to press on toward Hurlburt Field until told to do otherwise. Every two hours the crew contacted Dutton, and the answer was always

the same—continue on to Hurlburt Field. Ground time at Goose Bay was minimal, and the aircraft was back in the air within two hours of landing. All aircraft systems were operating normally as the crew flew down the East Coast of the United States. Twenty-six hours into crew day, the aircraft overflew Hunter AAF, Georgia, en route to Florida. Little did the crew know that Operation Urgent Fury preparations were already under way beneath them.

The aircraft touched down at Hurlburt Field just before dawn on 24 October, and the crew was met by 1st SOW/DOS personnel. The mission had taken 18.2 hours to complete over a 27.5-hour crew day. It was perhaps the only time a C-130 aircraft had transited the Atlantic without tanker support during one continuous crew day. Although exhausted, the crew was ready to quickly reconstitute to whatever mission might be forthcoming. The Hurlburt Field reception party shed little light on the reason for the short-notice deployment, but the crew already had guessed that it must be connected to Grenada. By 0600 local the 7th SOS crew had settled into billeting at Hurlburt Field and entered crew rest. Meanwhile, the 1st SOW was alerted, and the wing began final preparations for Operation Urgent Fury. Later that day the 7th SOS Combat Talon (64-0561) was flown to Hunter AAF by an 8th SOS crew and served as a spare for the operation. That night, with the 7th SOS crew still at Hurlburt Field, the operation kicked off. The 7th SOS crew had missed participating in the operation by 24 hours.*

Operation Urgent Fury: A Rescue Mission in Grenada

With a population of approximately 100,000 people, the island nation of Grenada has a long history of colonial rule. In 1763, by the Treaty of Paris, the island was ceded by France to Great Britain and remained under British colonial rule from 1833 until 1967, when it attained home-rule status. In 1974 Grenada became fully independent but remained a member of Great Britain's Commonwealth of Nations. Five years later the fledgling nation faced economic hardships, and its people had grown disenchanted with the government of Prime Minister Sir Eric Gairy. In a bloodless coup in 1979, led by Marxist Maurice Bishop, a communist government, friendly to

*The above narrative was provided from the memory of the author. Although events described occurred as indicated, exact takeoff and landing times, along with the names of other 7th SOS crew members, have faded with time. The story was included to illustrate how the 7th SOS contributed to Operation Urgent Fury.

Cuba and the Soviet Union, assumed total power. From 1979 to 1983, the Marxist's regime replaced democratic institutions with communist ones and placed severe limitations on the British governor-general, Sir Paul Scoon (fig. 35).⁹⁰

The centerpiece project of Bishop's regime was a 9,000-foot runway located at Point Salines. Bishop claimed the runway was essential to the island's tourism industry and to economic growth. Leaders in the United States did not believe the new airport was designed for tourism, noting that one large commercial airliner could hold more than 300 people and that there were fewer than 300 hotel rooms on the entire island.⁹¹ Military analysts believed that the runway was actually designed for military aircraft, with Cuba, the Soviet Union, and communist Eastern bloc countries its most likely customers. Fidel Castro provided 600 men to assist the Grenadians in constructing the facility. Once complete the airfield could support Cuban MiG-23s, which would extend their operating range throughout the Caribbean basin. Cuba also was heavily involved in Angola with more than 50,000 men, and Grenada was 1,600 miles closer to Africa. Additionally, the facility could provide a transition point for Libya and Soviet bloc nations bent on intrigue in Central and South America.⁹² But perhaps the area of most concern for the United States was the proximity of Grenada to vital sea lanes that carried a large portion of the oil used by the United States. A base of operations for the Cubans and for the Soviet Union that could threaten that oil

supply was a daunting thought for strategic planners.

Bishop had maintained an anti-US position since seizing power and had developed strong ties with Cuba. By 1983, however, Fidel Castro was encouraging Bishop to tone down his rhetoric against the United States. In an unofficial visit to Washington, Bishop met with low-level government officials and indicated that he sought to reconcile differences between the two countries. Bishop's brand of communism allowed 60 percent of the country's economy to remain in private hands. Hardliners serving on the party's Central Committee did not like this soft approach to communism and looked past Bishop for another leader who would accelerate rather than slow down the nation's conversion to a total Marxist state. Serving in Bishop's cabinet was Deputy Prime Minister Bernard Coard, who, along with others in the regime, did not believe that Bishop's actions were in the best interest of their Marxist revolution. Unaware of his tenuous position, Bishop left the country in late September for an official visit to Czechoslovakia and Romania. In his absence the Central Committee instituted a collective leadership scheme that called for shared power between Bishop and Coard. When Bishop returned from his western European trip and learned of his new status as coleader, he confronted his former deputy. Coard denied that any change had been made in the government and resigned his position.⁹³



Figure 35. Grenada and the Caribbean (Source: AU Library, Maps and Charts Division, Maxwell AFB, Ala.)

At midnight on 12 October 1983, with the assistance of Gen Hudson Austin, commander in chief of the Grenada armed forces, Coard placed Bishop under house arrest. During the ensuing week, followers of the popular Bishop staged rallies in St. George's, the capital city of the island nation, and demanded that he be released and reinstated to his former position. The crowds continued to grow, reaching an estimated 25,000 loyalists by 19 October. In a move designed to free Bishop, several thousand supporters surrounded his residence and demanded that the guards release him and his education minister, Jacqueline Creft, who was living in the same residence with Bishop. After ignoring verbal warnings and gunshots fired over their heads by military guards, the large crowd stormed the gates and freed both Bishop and Creft. Carrying Bishop on their shoulders, the crowd proceeded to the center of St. George's, where an impromptu rally was held. From there, Bishop led the crowd to Fort Rupert, a Grenadian army compound near the city harbor.⁹⁴

Once at the fort, Bishop pleaded with the guards to put down their weapons and to join him. The soldiers initially complied, and Bishop, accompanied by some of the crowd, entered the courtyard of the fort. Bishop ordered that the cantina be opened and that cold drinks be served to his followers. A Soviet-built armored personnel carrier (APC) appeared in the courtyard, armed with a machine gun mounted on its gun turret. The APC opened fire on the crowd as some of Bishop's followers tried to flee over the fort's walls. Although exact figures were not available, about 140 people were killed in the massacre. Bishop was out of the line of fire and was not hit by the APC during the initial assault. He was, however, subsequently arrested along with Creft (who with Bishop had a four-year-old son), two other cabinet members, and two union leaders loyal to Bishop. The six were taken further into Fort Rupert and were executed on the spot with single pistol shots to the head.⁹⁵ Before she was murdered, Creft was severely beaten by her captors.

After the massacre General Austin went on Radio Free Grenada to announce that he now led a 16-member Revolutionary Military Council (RMC) that was in charge of running the government. In his broadcast Austin announced a four-day, around-the-clock curfew that would be enforced by the military, with violators being shot on sight. The exact status of Coard was unknown, with speculation that he was either still running the government from behind the scenes or that he

had left the island, leaving Austin in total command.⁹⁶ Along with the curfew, Austin closed the Pearls Airport, effectively prohibiting anyone wishing to leave the island from doing so. The restrictions caused special hardships on 600 students attending St. George's School of Medicine. To obtain food and water, the students were forced to violate the curfew.⁹⁷ Keeping a close eye on events in Grenada, the Reagan administration could not afford to allow the situation to deteriorate into a hostage crisis similar to the one faced by Carter three years earlier. Within 24 hours of the massacre of Bishop and his followers, the United States took the first steps toward intervention in the crisis. Of prime concern were the medical students who could be singled out by Austin and the RMC as a way to hold the United States hostage to their demands.⁹⁸ Along with concern for the students, the construction of the airfield at Point Salines also worried the administration. The control of the airfield by Marxist radicals posed the threat of future communist expansion throughout the Caribbean.

Subsequently, a Joint Chiefs of Staff warning order was sent to US commander in chief, Atlantic Command, Adm Wesley L. McDonald. The order called for courses of action for a three- to five-day noncombatant evacuation operation of American citizens and others wishing to leave the island. The warning order designated US commander in chief, Readiness Command, and US commander in chief, Military Airlift Command, as supporting commanders. Preparations were set in motion for the 25 October US incursion into Grenada, code-named Operation Urgent Fury, to rescue Americans living there.⁹⁹

The United States Responds

When Bishop was placed under house arrest on 12 October, there was increased concern in Washington for the safety of Americans living on the island. On 14 October Alphonso Sapia-Bosch, the Latin American desk officer on the National Security Council, contacted the Joint Operations Division, Operations Directorate (J3, JOD), and asked about forces available in the Caribbean that could be used on short notice to evacuate Americans from Grenada. Lt Gen Richard L. Prillaman, USA, the director of operations (J3), was told of the query, upon which he activated a response cell in the National Military Command Center to assess the crisis and to formulate possible responses. The unified command responsible for operations in the Caribbean was the US Atlantic

Command (USLANTCOM), and on the afternoon of 14 October, the JCS response cell contacted the USLANTCOM operations center. The JCS response cell asked for a list of options that ranged from a show of force to noncombatant evacuation operations. As the next several days passed and tensions increased in Grenada, informants there warned of the growing danger to the US medical students. Because of these reports, a meeting was held on 17 October, when the State Department asked the JCS to begin contingency planning for military operations to rescue the students. On 18 October the JCS consulted Admiral McDonald on options for evacuating the medical students. Options ranged from permissive or peaceful operations to armed resistance by Austin's military.¹⁰⁰ One unknown element was the 600 Cubans who were on the island and who were working on the airfield at Point Salines. On 19 October, after the murder of Bishop and his followers at Fort Rupert, the JCS warning order was issued.

When the JCS warning order arrived at USLANTCOM, CINCLANT's staff reviewed contingency plans for the Caribbean, including non-combatant evacuation operation (NEO) and show-of-force options. Along with naval forces, the plans required forces from the US Army's 18th Airborne Corps, located at Fort Bragg, North Carolina, and forces from the Tactical Air Command located at bases throughout the United States.¹⁰¹ Without adequate intelligence data, the USLANTCOM staff developed several courses of action that included both permissive (friendly) and hostile operations. (As had been the case three years earlier in Iran, the United States did not have an adequate human intelligence network established at the onset of the crisis. The lack of this capability again demonstrated the importance of maintaining a somewhat robust capability in peacetime to respond on short notice to a crisis or contingency.) For a permissive NEO, the staff recommended that the State Department negotiate with the government of Grenada for approval of commercial aircraft to land at Pearls Airport and evacuate US citizens. In the event of a nonpermissive or hostile NEO, the staff recommended that a forced entry into Grenada be made by the Marine Amphibious Ready Group (MARG) 1-84, which was currently en route from Morehead City, North Carolina, to Lebanon. To support the MARG during the operation, the USS *Independence* Carrier Battle Group (CBG), which was in transit from Hampton

Roads, Virginia, to the Mediterranean, could also participate in the operation. One or more airborne battalions from USREDCOM would be needed to secure a second evacuation location. Coordination for the NEO would be handled by a team from US Forces, Caribbean, located in Key West, Florida.¹⁰²

The JCS received the USCINCLANT plan early on 20 October, and the chairman of the JCS, Gen John W. Vessey Jr., USA, directed the J3, J5, and CIA to assess the impact of the proposed courses of action. Before noon that same day, Vessey gave the assessment to the Crisis Pre-Planning Group (CPPG) of the National Security Council. Upon review of the assessment, the CPPG agreed that the JCS should continue planning for a possible military operation. The CPPG also recommended that the Special Situation Group (SSG), which was the highest crisis management committee of the NSC, convene immediately to review USCINCLANT's plan and the JCS's assessment. The SSG was made up of the vice president as its chairman, and its chief members included the secretary of state, secretary of defense, director of Central Intelligence, counselor to the president, chief of staff to the president, deputy chief of staff to the president, assistant to the president for national security affairs, and chairman of the Joint Chiefs of Staff. Since there had been no decision made for a military operation, the crisis was still a diplomatic one, with the State Department responsible for its management. In an afternoon session of the SSG, Secretary George P. Schultz briefed the committee on the advantages and disadvantages of amphibious and airborne military operations to support an NEO. Schultz supported disarmament of the Grenadian military as part of any evacuation.¹⁰³

After Schultz finished his presentation, General Vessey briefed the SSG on the possibilities of a third country intervening militarily on behalf of Grenada if the United States took action. Although the Grenadian People's Revolutionary Army (PRA) would resist, the Defense Intelligence Agency felt that neither Cuba nor the Soviet Union were likely to intervene militarily. Cuba's navy was too weak to be of any consequence, and the Soviet Union was incapable of mounting any resistance in the Caribbean. Further discussions centered around the impact of a military operation in Grenada on US forces based in Europe and in the Middle East. With the diversion of the USS *Independence* CBG and

MARG 1-84 to Grenada, MARG 2-83 and the CBG currently located in either the Mediterranean Sea or in the Indian Ocean would have to be extended on station until the operation terminated. The annual JCS exercise in Spain, Crisex 83, also would have to be severely curtailed or canceled without naval support, thus creating unknown repercussions with the Spanish government.¹⁰⁴

Memory of the Iranian hostage situation still was fresh in everyone's mind. Given the fact that danger to the US medical students likely would continue to increase, the SSG decided that the president probably would order intervention sometime in the near future. With the probability of armed resistance almost certain, the SSG supported continued contingency planning by the JCS and began drafting a National Security Decision Directive that expanded the original mission to include neutralization of enemy forces and the political reconstruction of Grenada. The USS *Independence* CBG had just departed the East Coast of the United States en route to Lebanon along with a force of some 1,900 Marines in MARG 1-84. To provide adequate forces for the expanded operation, the JCS directed the diversion of MARG 1-84 to a location east of Puerto Rico and the USS *Independence* CBG to the vicinity of Dominica. Both positions were within striking distance of Grenada. Late in the evening of 20 October, both units altered course to move to their contingency response positions.¹⁰⁵

The following day General Vessey called Admiral McDonald to advise him that the NEO operation had been expanded to include the neutralization of Grenadian and Cuban military forces located on the island. Vessey also told McDonald that military forces to be considered should include both battalions of the US Army rangers and a follow-on peacekeeping force made up of the 82d Airborne Division.¹⁰⁶ With the inclusion of special operations forces in the possible assault, the Joint Special Operations Command (JSOC) became the third supporting command. At 1700 on 21 October, the CPPG met again to review intelligence reports of possible armed Cuban soldiers arriving in Grenada. Earlier in the month, on 6 October, the Cuban naval vessel *Vietnam Heroica* had arrived in St. George's and might have carried as many as 240 Cuban combat troops. Other intelligence reports indicated that there were some 50 Soviet citizens living in Grenada. The possible involvement of Cuban troops increased the probability that a military operation would be needed to protect the medical students during the NEO

and to disarm hostile forces located elsewhere on the island.¹⁰⁷

Immediately after the CPPG adjourned, Vessey sent a message with new guidance to USLANTCOM, MAC, USREDCOM, and JSOC. The JCS directed that USCINCLANT plan for the most demanding contingency, which included rescue of the medical students under fire and/or the mounting of a small invasion with the purpose of disarming the Grenadian and Cuban forces. To position forces for either eventuality, USCINCLANT was to move the USS *Independence* CBG and MARG 1-84 closer to Grenada, while CINCMAC looked at ways to reduce the airlift time required to deliver special operations forces to the objective area. To execute the follow-on neutralization mission, two or more battalions of the 82d Airborne Division would require airlift to the island. Intelligence estimates placed 1,000–1,200 soldiers in the PRA, 2,000–5,000 in the militia, and about 250 armed Cubans on the island. As events unfolded on 25 October, these figures would prove to be much lower than the actual number of forces on the island.¹⁰⁸

Acting on Vessey's message, special operations planners arrived at USLANTCOM headquarters in Norfolk, Virginia, on 21 October to begin the planning phase of the operation. Liaison personnel from the 82d Airborne Division arrived the next day. USLANTCOM planners, along with liaison officers from MAC, sat down with the Army planners to develop a preliminary concept of operation. As the planning session got under way, political events began to accelerate in the Caribbean. Members of the Organization of Eastern Caribbean States (OECS) voted to ask Barbados, Jamaica, and the United States to join them in sending a multinational peacekeeping force to Grenada. Early on 22 October the British governor-general of Grenada, Sir Paul Scoon, asked the OECS to free his country from the radical RMC that was led by Austin. At 0430 on the morning of 22 October, the SSG contacted Secretary Schultz and advised him of the two requests for intervention. Schultz contacted the president, and a teleconference with members of the SSG was set for 0900. With the addition of the president, the SSG became the National Security Planning Group (NSPG), which stood at the highest level in the NSC system.¹⁰⁹

With two requests for intervention a reality, the NSPG discarded the permissive NEO option and tasked the JCS to plan a military operation with the objective of seizing control of the island

from local military forces. Having anticipated such a tasking, the JCS had developed two force packages, one consisting of two ranger battalions augmented with JSOC elements and a second made up of a Marine battalion landing team with SEALs totaling about 1,800 men. New intelligence was received on 22 October that revealed that the Grenadian army was mobilizing about 2,000 reservists to augment the estimated 1,500-man regular army. There were also approximately 600 Cubans located on the island, most of whom were thought to be construction workers at Point Salines. Facing a force of over 4,000 troops, the JCS concluded that neither force package alone was enough to ensure mission success. As a result, the NSPG directed the JCS to send an execute order to CINCLANT authorizing him to employ a joint force composed of JSOC, rangers, marines, and airborne troops into Grenada, commencing on 25 October 1983.¹¹⁰

As the execute order was being sent by the JCS, DIA provided a revised estimate of Grenadian army capabilities. With a 1,500-man regular army and 3,000 reservists, DIA assessed that Grenadian forces would put up a sustained resistance should the United States mount a military operation against the country. Equipment possessed by the Grenadian army included six Soviet APCs (BTR 60s) and four Soviet 23 mm anti-aircraft guns (ZSU-23s), most of which were cited around the airfield at Point Salines. There were also 50 Cuban military advisors and 600 construction workers at Point Salines, but DIA assessed a low probability that they would put up any resistance.¹¹¹ This assumption would prove to be invalid when the Combat Talon force appeared above Point Salines.

On 23 October the US State Department continued its negotiations for the evacuation of Americans and other foreign nationals. Austin and his RMC vehemently denied that there was any reason for an evacuation and further stated that anyone desiring to leave the island could do so by commercial air. However, all commercial air service had been suspended after the massacre on 19 October, and the Pearls Airport remained closed with the strict curfew still in effect. The no-evacuation position enforced by Austin effectively prohibited any foreign nationals from leaving the country.¹¹² As the rescue plan came together, little hope remained for a peaceful resolution of the crisis.

The 8th SOS Gets the Call

Hobson and the 8th SOS had participated in the quarterly joint exercises and had maintained a rigorous exercise schedule throughout the fall of 1983. The quarterly exercises had been challenging, with a complex airfield seizure operation the climax of each exercise. The squadron flew in Exercise Night Venture from 26 July to 4 August but without another opportunity to work with large numbers of joint forces since that time. Bright Star 83 had consumed the remainder of August, and September was spent completing the squadron's quarterly training requirements. The concept of operations that the special operations planners worked out at USLANTCOM headquarters (beginning on 21 October) called for five MC-130E Combat Talons to airland a combination of USA rangers and other special operations forces at Point Salines during the early morning darkness of 25 October. In the event the runway was blocked, an alternate plan was developed to air-drop the force. Historically, such complex contingency operations as Son Tay and Desert One took six months to plan and to rehearse before execution. When Hobson received the call on 22 October to be prepared to launch into Grenada, he had less than 72 hours to select his crews, plan the operation from an Air Force perspective, get his Talons mission ready and his crews rested, position his force at the onload location, and then execute the mission. He had no time to waste.

Since Desert One the Combat Talon force had been in a state of rebuilding. The loss of two crews within a 10-month period had taxed the community's ability to train and season new replacements. At the same time, personnel who had been in special operations and who were highly experienced were in demand throughout the Air Force. At MAC headquarters, staff positions were created along with positions at Twenty-Third Air Force. At the Pentagon special operations-experienced personnel were also highly prized. Many Combat Talon "old timers" had filled these career-enhancing assignments by late 1983. With MAC charged with the responsibility for Air Force special operations and with the overseas Talon units also part of MAC, returning personnel remained in special operations and were not lost to the community. Former crew members from the 1st SOS and the 7th SOS had rotated back to the 8th SOS and formed the highly experienced core from which Hobson chose his crews. To support JSOC tasking

for five Combat Talons, Hobson and his staff formed the following five mission crews, plus one additional spare crew.*¹¹³

Crew 1 (Talon 64-0562) Foxtrot 33	Crew 2 (Talon 64-0572) Foxtrot 34	Crew 3 (Talon 64-0568) Foxtrot 35	Crew 4 (Talon 64-0567) Foxtrot 40
Tindall	Bach	Hobson	Miles
Marshall	Baker	Helm	Thompson
McMath	Stephenson	Hale	McManus
DeMocko	Owens	Sharkany	Hill
McBride	Honaker	James	Schwartz
Smith	Mosley	Dredla	Gentry
Hess	Thommen	Garrett	Newberry
Plitt	Gingerich	Davis	Rinehart
Beattie	Fowler	Doyle	Blazek
Painter	Metherell	McClain	Strollo
	Crew 5 (Talon 64-0551) Foxtrot 41	Spare Crew (Talon 64-0561)	
	Davenport	Dill	
	Warr	Moon	
	Barragy	Sammons	
	Dykes	Weiler	
	Kelly	Rohling	
	Fiel	Nolan	
	Folley	Sanchez	
	Latona		
	Duffie		
	Holloman		
	Stephenson		
	Katz		

With Hobson finalizing the selection of his mission crews, 1st SOW/DOS deployed planners to Fort Bragg to refine the contingency plan. Details of the operation had to be worked out between 1st SOW planners, rangers, and other special operations forces. It quickly became apparent to the 1st SOW/DOS planners that there were many more questions than answers. The most pressing question regarded the defenses at Point Salines. Current and accurate intelligence available on the airfield was extremely sketchy and was totally inadequate to plan a combat mission. Working on an assumption that the Cubans were actually construction workers and that the Grenadian army had little capability to mount an air defense at the airfield, planning proceeded at a torrid pace.

The Plan

By 23 October Admiral McDonald's staff had revised USLANTCOM's concept of operations and had expanded it to satisfy CJCS Vessey's guidance. McDonald flew to Washington to brief the JCS on the new concept, titled "Evacuation of US Citizens from Grenada." The operational concept had four phases. Phase I was titled "Transit," and in this phase the USS *Independence* CBG would close to a position 55 miles northwest of Grenada, while MARG 1-84 closed to a position 40 miles due north of the island. At H minus six hours, five Combat Talons would launch from Hunter AAF, Georgia, loaded with rangers and, concurrently, seven SOLL C-130s would launch from Pope AFB, North Carolina, with JSOC and 82d Airborne soldiers. One hour later 10 additional C-130 aircraft would launch from Pope AFB loaded with additional 82d Airborne soldiers.¹¹⁴

Phase II of the plan was titled "Insertion" and began with helicopter and seaborne infiltration of special operations forces several hours before the main force arrived over the island. The objective of the early infiltration missions was to collect intelligence at Point Salines and Pearls airfields and to conduct direct-action missions aimed at the Grenadian police and other military installations in St. George's. An additional mission assigned to the initial infiltration teams was to move to Governor-General Scoon's residence and protect him from harm. At H hour (scheduled for 0400 local time on 25 October), the five MC-130E Combat Talons and seven SOLL C-130s would begin airlanding rangers at Point Salines, with an airdrop planned as a backup if the runway was blocked. At precisely the same time, Marines from MARG 1-84 would assault and secure Pearls airfields. AC-130H gunships would be in position over the two airfields to provide on-call fire support. If the assault force encountered resistance from the Grenadian army or from the Cubans, it was to take whatever action necessary to neutralize them and secure the island. As a reserve force, the 82d Airborne Division at Fort Bragg would go on full alert at H minus three hours and would be available to reinforce the initial assault, if tasked.¹¹⁵

After the initial assault had secured the two airfields and other key military and government installations, Phase III, titled "Stabilization/

*Only five 8th SOS Combat Talons were available for the operation. Aircraft 64-0561 was flown from Rhein Main AB to Hurlburt Field for the operation, arriving at 0500 on the morning of 24 October. To provide a spare aircraft for the mission, the 7th SOS Talon was flown to Hunter AAF a few hours later by an 8th SOS crew. The aircraft was not required for the operation and was subsequently returned to the 7th SOS crew waiting at Hurlburt Field. A few days after the commencement of Operation Urgent Fury, the 7th SOS crew flew the Talon back to Europe.



USAF Photo

Foxtrot 33 Crew. Standing left to right: Tindall, Beattie, Plitt, Hess, Smith, McBride, DeMocko. Kneeling left to right: Painter, Marshall, and McMath.



USAF Photo

Foxtrot 34 Crew. Left to right: Gingerich, Thommen, Stephenson, Metherell, Bach, Mosley, Baker, Fowler, and Owens. Not pictured: Honaker.



USAF Photo

Foxtrot 35 Crew. Standing left to right: Garrett, Doyle, Dredla, Hobson, and Helm. Kneeling left to right: McClain, Hale, Sharkany, Davis, and James.



USAF Photo

Foxtrot 40 Crew. Left to right: Newberry, Rinehart, Blazek, Gentry, Miles, Hill, Thompson, and McManus. Not pictured: Schwartz and Strollo.



USAF Photo

Foxtrot 41 Crew. Standing left to right: Stephenson (flight surgeon), Holloman, Folley, Dykes, Davenport, Warr, and Kelly. Kneeling left to right: Katz, Latona, Duffie, Barragy, and Fiel.

Evacuation,” would begin. In Phase III military forces would locate and protect US citizens, foreigners (including those from the Soviet Union and Eastern bloc communist countries), and Governor-General Scoon. Phase IV would begin with the evacuation of civilians from the island, including the 600 American medical students. The final phase would continue until an interim government was established in Grenada and the country was back on the road to political and economic recovery.¹¹⁶

To execute the plan, Admiral McDonald proposed to establish a combined joint task force (CJTF), which he identified as CJTF-120. He chose Adm Joseph Metcalf III, USN, who was the standing commander of the US Second Fleet, to command the CJTF. The CJTF would be made up of four separate task forces identified as TF-121, TF-123, TF-124, and TF-126. TF-121 represented the major conventional force for the operation and was composed of the 2d and 3d Battalions of the 82d Airborne Division along with supporting 82d Airborne units. TF-123 was the special operations task force and was made up of JSOC-assigned forces, US Army rangers, US Air Force Combat Talons and SOLL C-130s, and US Navy SEALs. TF-124 consisted of the USS *Independence* CBG

and MARG 1-84. TF-126 included Air Force E-3s, F-15 fighters from the 33d Tactical Fighter Wing at Eglin AFB, Florida; and airborne command, control, and communications EC-130Es from Keesler AFB, Mississippi. Metcalf would command the CJTF from his flagship, the USS *Guam*, off the coast of Grenada. Additional SAC and MAC forces supporting the operation would remain under the command of their parent organizations and would not come under Metcalf's CJTF.¹¹⁷

The JCS did not agree with portions of the command arrangement proposed by McDonald, but after several adjustments that included inserting US Army general H. Norman Schwarzkopf as an advisor assigned to Metcalf, the plan was approved. With the approval McDonald formally activated CJTF-120 with a CINCLANT operations order on 23 October. The OPOD summarized the revised concept of operations and added significant intelligence information regarding enemy defenses on the island.¹¹⁸ The command and control arrangement was also delineated.

The Operation Begins

Since planning for the operation had begun on 19 October, intelligence information regarding the

defenses at Point Salines and Pearls airfields had been virtually nonexistent. To provide the information necessary to plan the initial assault, JCS ordered TF-123 to insert reconnaissance teams into the objective area before H hour. Consequently, 24 hours before commencement of Operation Urgent Fury—before dawn on 24 October—two TF-123 C-130 SOLL aircraft each dropped a four-man SEAL element and a Boston Whaler boat off the coast of Grenada near Point Salines and Pearls. Along with the two airfields, the SEALs were tasked to reconnoiter the beaches that landing forces planned to use during the assault. The Pearls element determined that beach conditions did not favor the amphibious assault planned for the Marine battalion landing team and recommended instead a helicopter airborne assault on the airfield. The second SEAL element was to rendezvous with the USS *Clifton Sprague* near Point Salines after it reconnoitered the area, but it did not make the rendezvous. The four SEALs, along with their support boat, had vanished in unusually rough seas without reporting to their headquarters.¹¹⁹

A few hours later Admiral McDonald conducted a preinvasion commander's conference at his headquarters in Norfolk, Virginia, attended by his TF commanders, including Gen Richard A. Scholtes, USA, who was the commander of TF-123. Scholtes relayed to McDonald and the other TF commanders the loss of the four-man SEAL element off Point Salines earlier that morning. Without adequate intelligence of the defenses at the airfield, the TF commanders considered postponing the operation by 24 hours to insert another element to get the required information. Representatives from the State Department attending the conference were opposed to any delay in the invasion plans, noting that the fragile Caribbean Peacekeeping Force, made up of regional island nations, might become nervous and cause the peacekeeping force to dissolve, thus leaving the United States in a vulnerable diplomatic position. Admiral McDonald also was opposed to any delay in the D-day schedule, but he did agree to postpone H hour from 0400 to 0500 hours to allow TF-123 forces time to attempt a second look at Point Salines. Moving H hour back an hour, meant the assault force would attack Point Salines at dawn instead of in the dark as originally planned.¹²⁰ The change would put the Combat Talons and the SOLL C-130s in a vulnerable position the following morning.

The 1st SOW Is Alerted and the 8th SOS Moves Out

At 0900 on the morning of 24 October, 1st SOW/DOS alerted Hobson and the 8th SOS Combat Talons to move forward to Hunter AAF, Georgia, for the positioning phase of Operation Urgent Fury. Hobson's crews had been in crew rest since the previous night in anticipation of the upcoming 24-hour operation. The five 8th SOS Combat Talons and the single 7th SOS Talon spare departed Hurlburt Field at noon en route to Hunter AAF. Once there, the remainder of the afternoon and evening was spent coordinating final plans with the seven C-130 SOLL aircraft from the 317th TAW and loading the aircraft before launch. Still without adequate intelligence regarding the threat at Point Salines, planners turned to the three AC-130H gunships to provide cover for the assault force.¹²¹

The assault at Point Salines was planned for three waves of MC-130Es and SOLL C-130s, along with other C-130 tactical aircraft. The first wave, first element, was made up of two MC-130E Combat Talons (64-0562 and 64-0572) commanded by Tindall and Bach, respectively. The primary means of delivery was to airland the rangers directly on to the airfield, with an airdrop scheduled as a backup should the runway be unusable. The appropriate option would be selected based upon reports received from a TF-123 CCT that was scheduled to be inserted into the waters off Point Salines just before the operation commenced. (The CCT unit was required after the original four-man SEAL element was lost on 24 October.) If the CCT was unable to report the runway status, an AC-130H gunship orbiting above the airfield would provide the information. The first wave, second element, was to be led by Jim Hobson in MC-130E aircraft 64-0568. Along with Hobson in the second element were four SOLL C-130s. The five-aircraft package was to airland its headquarters and communications element 30 minutes after Tindall and Bach completed their initial infiltration. A second wave consisting of two MC-130Es (64-0567 and 64-0551), commanded by Miles and Davenport, and three SOLL C-130s, would airland additional rangers seven minutes after Hobson's arrival. A third wave of 10 C-130s with elements of the 82d Airborne Division would airland approximately three hours after the initial assault, depending upon the tactical situation on the airfield when they arrived in the Point Salines objective area.¹²²

The planned run-in heading was 090 degrees, which was oriented down the center of the 9,000-foot-long runway. If the airland option was not feasible, an airdrop would be made. The standard drop altitude of 1,000 feet above the ground was planned, with an altitude as low as 500 feet possible, dependent on the threat. Planners felt that the major hazard facing the paratroopers in the event of an airdrop was the water on either side of the runway. Each crew was briefed to be over the airfield before releasing jumpers. A drop into the rough seas off either side of the runway would be fatal to the heavily armed rangers. H-hour assault operations had been slipped from 0400 to 0500 so that the CCT would have time to reconnoiter the airfield. The new time coincided with the Marine assault on Pearls.¹²³

Six hours before the scheduled landings at Grenada, Tindall departed Hunter AAF with Bach close behind. The two Combat Talons (call signs Foxtrot 33 and Foxtrot 34) made up the first wave, first element, and were to proceed to their initial point west of Grenada. Bach would close to 30 seconds in trail behind Tindall. Thirty minutes after the first two Combat Talons were airborne, Hobson (Foxtrot 35) departed Hunter AAF with four SOLL C-130s. The five-ship formation made up the first wave, second element, and was to proceed to a holding point 70 miles to the west of Grenada. Seven minutes after Hobson's departure, Dave Miles (Foxtrot 40) was airborne, with Skip Davenport (Foxtrot 41) and three additional SOLL C-130s making up the third wave.¹²⁴ With the assault force airborne and unknown to the flight crews, the US State Department contacted Havana and advised Cuba that a strike was imminent, assuring Castro that it was not aimed at his Cuban workers in Grenada. The tip-off invariably gave the defenders at Point Salines knowledge of the assault and allowed them time to prepare their defenses to repel the force.¹²⁵

As the formations neared the objective area, weather in the southern Caribbean steadily deteriorated. Due to extreme sea states, the CCT was unable to get ashore at Point Salines to determine the runway status. At 0400 an AC-130H gunship was directed by the air mission commander aboard the ABCCC EC-130 to make a reconnaissance flight over Point Salines. The gunship determined that the runway was blocked by heavy construction equipment and barricades but could not determine if any antiaircraft defenses were in place around the airfield. Thirty minutes before his scheduled TOT, Tindall was notified to scrub

his airland option and plan for an airdrop of his rangers. Loadmasters on the Combat Talons and the SOLL II aircraft reconfigured for an airdrop, while the rangers hastily rigged their parachutes and prepared for the jump. Having to dodge thunderstorms and work their way through rain showers, Tindall's two-ship formation was on time as it approached the IP. Twenty miles west of Grenada, at 500 feet above the water and in the clouds, Tindall's LN-15J inertial navigation system malfunctioned along with his AN/APQ-122(V)8 radar. In total darkness and in the weather, Tindall had no choice but to abort his run in. The air mission commander notified Tindall to hold in place and directed Bach to join behind Hobson's aircraft 30 seconds in trail. With Hobson 30 minutes behind Tindall, the new TOT was slipped to 0530.¹²⁶ With MARG 1-84's assault on Pearls still set for 0500, there would be no possibility of a surprise attack by the special operations force.

Bach successfully maneuvered his aircraft and joined Hobson's formation as directed. The new landing sequence had Hobson as the lead aircraft, Bach 30 seconds in trail behind him, and four SOLL C-130s behind Bach. The original landing sequence had combat troops aboard the first two Combat Talons. Hobson's load consisted of the ranger command and control element, but he had no assault troops. With weather still threatening and dawn approaching, there was not sufficient time to resequence the formation. Bach was 30 seconds behind Hobson, and his assault troops would be on the ground only seconds after the command element. The ground mission commander made the decision to continue the approach in the new sequence. With the antiaircraft threat unknown and with the threat of ground fire to his troops, Lt Col Wesley B. Taylor, USA—commanding the 1st Ranger Battalion and onboard Hobson's aircraft—decided to jump at 500 feet above the ground instead of the standard 1,000 feet. The lower altitude would protect the aircraft better from AAA, and the rangers would reduce their time of descent and their vulnerability to ground fire. The Talon crews wore NVGs to assist them during the drop. Approximately six miles out from Point Salines, Hobson's crew picked up the outline of the airfield, but shortly afterwards a bright spotlight illuminated the aircraft and washed out the crew's NVGs. As the aircraft passed the coastline, it slowed to 125 KIAS and opened the ramp and door. At green light time (0536 local),

as the rangers began exiting the aircraft, Hobson's loadmasters spotted AAA tracers coming toward the aircraft from positions around the airfield. The fire was so intense that Hobson relayed to the rest of his formation to break off the approach. Bach was only 30 seconds behind Hobson's aircraft and immediately began to turn away from the airfield. His aircraft took three hits from small-arms ground fire as he maneuvered to escape the trap.¹²⁷ When the last jumper cleared Hobson's aircraft, he put the Combat Talon in a dive and executed a maximum performance turn away from the AAA and towards the water. His aircraft was not hit, and later he would be recognized for saving the aircraft and crew with

his immediate action. As soon as the rangers landed on the runway, they were engaged by hostile forces. With Bach forced to abort his drop, the command element on the ground was now vulnerable and exposed. The success of the assault at Point Salines hung in the balance (fig. 36).¹²⁸

With the ranger command and control element pinned down by small-arms fire, AC-130H gunship 69-6573 (call sign Lima 58), commanded by Major Twiford, went to work. Twiford's gunship was on station above Point Salines airfield when Hobson made his airdrop, and the gunship crew observed the orange tracers tracking the Combat Talon. Experience told the gunship crew that the tracers were from 23 mm AAA, and the gunship

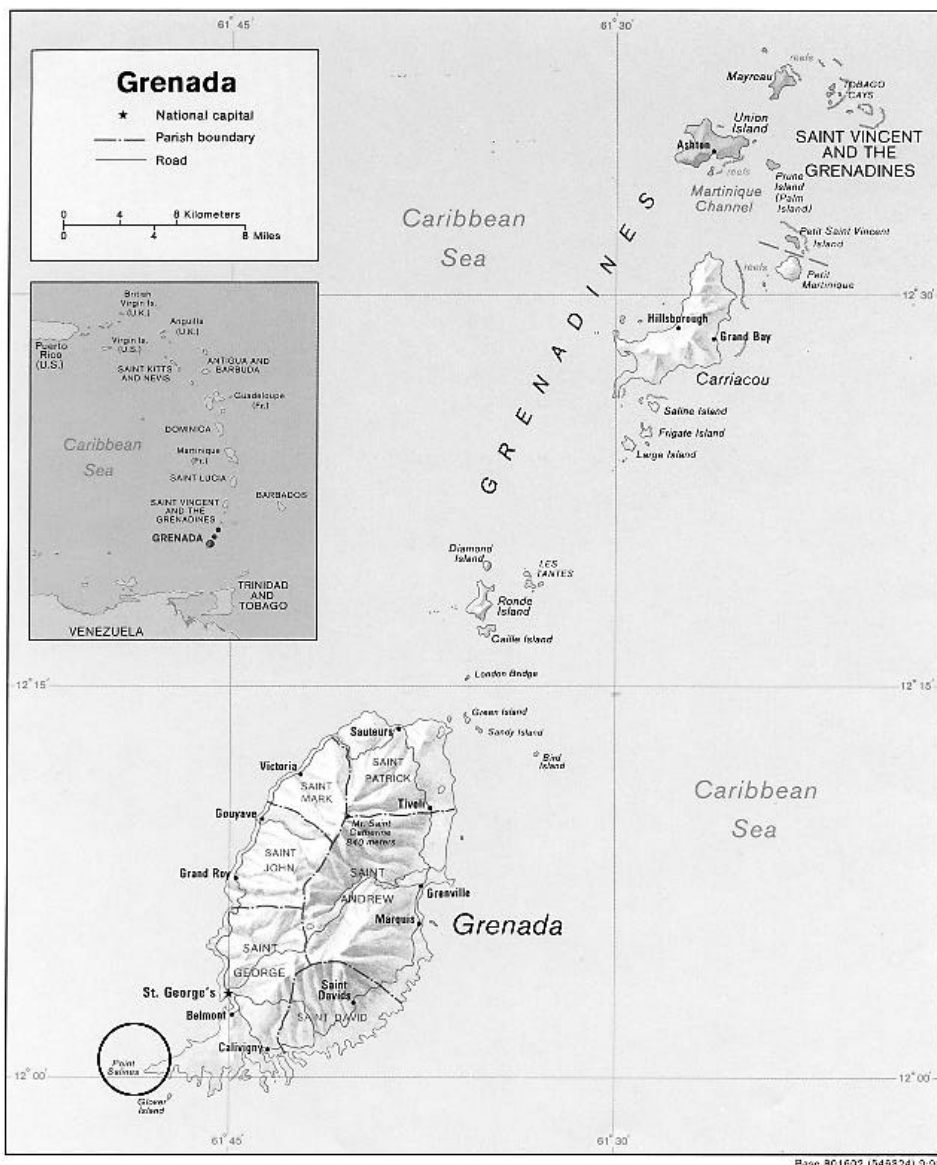


Figure 36. Map of Grenada Area (Source: AU Library, Maps and Charts Division, Maxwell AFB, Ala.)

engaged the positions as soon as Hobson's aircraft cleared the immediate area. As the gunship fired on the AAA locations, the rangers already on the ground tried to get a fix on the small-arms locations that had them pinned down. Twiford experienced minor gun problems and pulled off the target temporarily to work them. A second AC-130H (Lima 56), commanded by Maj Michael J. Couvillon, rolled in on the target and continued to attack both AAA and small-arms positions. With the AAA silenced, Bach and the SOLL C-130s were called back in by the air mission commander to air-drop their assault troops and relieve the command and control element on the ground.¹²⁹

The five C-130s were in holding to the west when they were given the green light to continue their airdrops. By this time it was bright daylight at the airfield. Bach made his approach and dropped his troops at 500-foot altitude, followed by the other C-130s. As the formation was making its drops, Lt Col Dave Sims (commander of the 16th SOS and the former operations officer of the 8th SOS) moved into position over the airfield in gunship 69-6574 (call sign Lima 57) and continued to engage enemy positions. With the airdrops from the first wave complete, Miles and Davenport, along with their three SOLL II C-130s, were cleared into Point Salines and completed their airdrops. On the ground, a company of rangers assembled on each end of the airfield. Hot wiring a bulldozer and using it to clear obstacles from the runway, the rangers simultaneously attacked the Cuban and Grenadian army defenders. Once the rangers had cleared the runway and neutralized the small-arms threat, CCT personnel who had jumped with the rangers began clearing the remaining aircraft for landing. Both Miles and Davenport had additional equipment aboard their aircraft that was needed on the ground, so they were subsequently cleared to land and off-load. Tindall had been in holding to the west of the airfield and was cleared to land. With improved weather and daylight conditions, he was able to find the airfield and safely deliver his load of rangers.¹³⁰

Within two hours of the initial assault, the rangers had surrounded and captured 250 Cubans at Point Salines. At 0900 hours they rescued 138 American medical students from one of the university's campuses located adjacent to the airfield. The resistance encountered at Point Salines was in sharp contrast to the marine assault on Pearls. With virtually no resistance, the marines secured the Pearls area within two hours of their

initial infiltration. The Cuban construction workers at Point Salines had turned out to be Cuban soldiers, many of whom were veterans who had fought in Ethiopia and Angola.¹³¹ The two ZSU-23s that had been reported by intelligence had also multiplied into nearly a dozen.

As the rangers faced heavy resistance at Point Salines, McDonald asked for reinforcements from Vessey. In response to the request, Vessey authorized the launch of the 82d Airborne strategic reserve force, which consisted of 1,500 soldiers at Fort Bragg. The division had been on full alert, and by 1000 hours they were loaded and were headed south to join the fight. Meanwhile, the rangers began to move north from the Point Salines area to mount an assault on military emplacements at St. George's, which included the residence of Governor-General Scoon. From the beaches north of St. George's, a Navy SEAL platoon was also making its way to the Scoon's residence. The rangers continued to encounter stiff resistance from Grenadian army soldiers equipped with APCs, and their progress north was slow. The SEALs, however, reached Scoon's residence and were able to overpower the guards and rescue the governor-general. Again, Grenadian APCs engaged the SEALs with heavy fire and threatened to overrun their position. Lacking antitank weapons the SEALs fought a delaying action with hand grenades and automatic weapons and waited for the rangers. Vice Admiral Metcalf, from his flagship USS *Guam*, ordered Navy and Marine Cobra helicopters to fly support missions over the residence. Heavy anti-aircraft fire from Fort Frederick and Fort Rupert in St. George's downed two of the Cobras and prevented others from reaching the governor-general's residence. Consequently, US Navy A-7 Corsairs from the CBG attacked the AAA positions (fig. 37).¹³²

While the battle progressed across the island on the 25th, it became apparent that most defenses were concentrated in the southern part of the island, between Point Salines and St. George's. A second medical school campus was also found at Grand Anse. At noon Metcalf and Schwarzkopf met to reassess the ground tactical plan. The marines at Pearls had completed their operation, prompting Schwarzkopf to recommend to Metcalf that they move around the island and land at Grand Mal Bay just north of St. George's. The maneuver would open a second front behind the defending Grenadian army that had the rangers and SEALs engaged with their APCs. Metcalf

The unexpected heavy resistance throughout 25 and 26 October at Point Salines, Grand Mal, Grand Anse, and Fort Frederick had taken its toll on the assault force. Consequently, late on 26 October, McDonald asked for two more battalions from the 82d Airborne Division. By 2117 local the battalions and a brigade headquarters had been moved from Pope AFB to Point Salines. The total airborne troops on the island thus increased from 2,000 to about 5,000. With fresh reserves in place, TF-121 methodically advanced on Lance aux Epines on the 27th and 28th. On 28 October it secured another 202 medical students at the Lance aux Epines campus. These were the last students to be rescued. The number of American medical students rescued during the operation totaled 564. With the students freed, the next several days were devoted to cleanup operations and re-establishment of a viable civilian government. By 29 October US forces had rescued 599 US citizens and 121 foreigners and had defeated the Cuban and Grenadian army forces defending the island.¹³⁵

After the initial assault at Point Salines on 25 October, the five Combat Talons recovered to Roosevelt Roads AB, Puerto Rico, where the aircraft were inspected for battle damage. Bach's aircraft (Talon 64-0572) had taken three small-arms

rounds, but the remainder of the Combat Talons escaped without a scratch. The crews entered crew rest as maintenance personnel continued to inspect the aircraft. The Point Salines assault was the only major action that the Combat Talons faced during Operation Urgent Fury. One additional mission was flown by Bach's crew on 31 October. Under the call sign November 10, Bach dropped leaflets in support of Operation Duke, which was the last offensive action of the Grenada operation. Before the commencement of Operation Duke, the crew dropped leaflets over Carriacou, where a suspected Cuban guerrilla-training base was located. At 0530 on 1 November, a Marine assault force landed unopposed and within three hours had occupied all objectives. No Cubans were found, although the marines did capture 17 Grenadian army soldiers and a cache of military equipment including rifles, radios, explosives, ammunition, jeeps, a truck, and other assorted items. The crew that flew the leaflet-drop mission included Crew 7 (Talon 64-0572) members Bach, Spicer, Lary, Armstrong, Dowd, Moore, Long, Elder, Caldwell, and Winnie.¹³⁶ With the safe return of Bach's crew from the 31 October mission, Combat Talon participation in Operation Urgent Fury ended. Combat operations on the island officially ended on 2 November after Phase I



USAF Photo

November 10 Crew. Left to right: Bach, Lary, Dowd, Spicer, Winnie, Caldwell, and Moore. Not pictured: Armstrong, Long, and Elder.

through Phase III objectives had been met. Phase IV, which included the establishment of a civilian government in Grenada, would continue throughout the remainder of the year.

Lessons Learned

Operation Urgent Fury was a success, having attained its military objectives during the period from 25 October to 2 November. For special operations and the entire military community, however, weaknesses in command and control were highlighted. CJTF-120 was made up of four separate task forces, and these task forces were not colocated and could not readily communicate among each other nor with CJTF-120. Airlift and tanker forces were not OPCON to the CJTF but rather responded to tasking through JCS. Each TF had aircraft committed to it, but no single air manager was designated. The CJTF arrangement resulted in piecemeal control of forces and uncertainties as to specific areas of responsibility. From an Air Force perspective, the constant flux in force composition caused significant difficulties for air planners in determining requirements and assessing employment capabilities and options. Operation Urgent Fury also did not use an existing plan as the basis of the operation. If it had used an existing plan, it might have avoided some of the confusion. A contingency plan was in existence, which covered the type of operation faced in Grenada, and it had been practiced in joint exercises before Operation Urgent Fury. The decision was made not to use the plan, which effectively meant that the operation started from a no-plan status. Command difficulties also were experienced on the ground, with General Schwarzkopf acting in an advisory role during the first two days of the operation. He eventually was designated as Vice Admiral Metcalf's deputy com-

mander, which cleared up some confusion in the chain of command.

The short notice of the operation did not allow Combat Talon sufficient time to plan and "what if" the plan before execution. Because of the need to react quickly and decisively to the threat, a rehearsal of the airfield seizure operation was not possible. Had a rehearsal been conducted, weaknesses in the plan (i.e., an abort en route or systems failure that precluded planned drop sequencing) could have been more thoroughly addressed and provisions made for rapid adjustments. There were also not enough Combat Talons to perform the mission. Only five aircraft were available at Hurlburt Field from the 8th SOS, and all five were committed to the Point Salines airfield assault. A sixth Combat Talon was hastily deployed from Europe to serve as a spare for the mission. Additional SOLL II C-130s were used in combination with the Talons so that adequate numbers of special operations forces could be infiltrated on to the airfield. In all, five Combat Talons and seven SOLL II C-130s transported rangers into Point Salines. Had there been sufficient numbers of Talons to support the mission, there would not have been a requirement for SOLL II augmentation. As had been the case three years earlier at Desert One, the weather played a major part in the success of the assault. Postmission analysis pointed to the fact that the ability to forecast accurate weather information was critical to mission success.

The weaknesses in executing a joint operation did not go unnoticed by Congress. Within three years, in the Goldwater-Nichols Defense Reorganization Act of 1986, Congress created the US Special Operations Command (USSOCOM), which was tasked to organize and train a special operations force made up of soldiers, airmen, and sailors from the three services. USSOCOM would trace its roots back to the OSS of World War II, and Combat Talon would become a key player in the new command.

Notes

1. History, 7th Special Operations Squadron, 1 April–30 June 1980, USAF HRA, Maxwell AFB, Ala., supporting document 11, 5.
2. *Ibid.*, 3.
3. *Ibid.*, iv.
4. *Ibid.*, 8.
5. History, 7th Special Operations Squadron, 1 October–31 December 1980, 18.
6. History, 8th Special Operations Squadron, 1 October–31 December 1980, 16th Special Operations Wing historian file, Hurlburt Field, Fla.
7. History, 7th Special Operations Squadron, 1 April–30 June 1981, 1–2.

8. History, 8th Special Operations Squadron, 1 January–31 March 1981.
9. History, 7th Special Operations Squadron, 1 April–30 June 1981, 13, 21.
10. History, 1st Special Operations Wing, 1 April–30 June 1981, 16th Special Operations Wing historian file, Hurlburt Field, Fla., vol. 1, II-37 to II-39.
11. History, 1st Special Operations Squadron, 1 April–30 June 1981, Combat Talon Archive, HQ AFSOC/HO, Hurlburt Field, Fla., supporting document 4, D4-3 to D4-5.
12. *Ibid.*, 11.
13. History, 1st Special Operations Squadron, 1 July–30 September 1981, 11.

14. *Ibid.*, supporting document D1, D1-1.
15. *Ibid.*, 11.
16. History, 1st Special Operations Squadron, 1 October–31 December 1981, 7.
17. *Ibid.*, 11.
18. *Ibid.*, 11–12.
19. History, 1st Special Operations Squadron, 1 January–31 March 1982, supporting document D2, 3.
20. History, 7th Special Operations Squadron, 1 October–31 December 1981, USAF HRA, Maxwell AFB, Ala., 4.
21. *Ibid.*, 9.
22. *Ibid.*, 10.
23. *Ibid.*
24. History, 8th Special Operations Squadron, 1 April–30 June 1981.
25. History, 1st Special Operations Wing, 1 April–30 June 1981, vol. 3, 700–701.
26. History, 8th Special Operations Squadron, 1 January–31 March 1981.
27. History, 1st Special Operations Wing, 1 July–30 September 1981, vol. 3, 444.
28. *Ibid.*
29. *Ibid.*, 447.
30. *Ibid.*, vol. 1, II-37.
31. *Ibid.*, 51–52.
32. History, 1st Special Operations Wing, 1 October–31 December 1981, vol. 1, II-43.
33. *Ibid.*, II-29.
34. *Ibid.*, II-38.
35. *Ibid.*, II-57, II-58, II-60.
36. History, 1st Special Operations Wing, 1 July–30 September 1981, vol. 3, 638.
37. *Ibid.*, vol. 1, II-66 to II-67.
38. *Ibid.*, II-67.
39. History, 1st Special Operations Wing, 1 October–31 December 1981, vol. 1, II-48.
40. *Ibid.*, II-49.
41. *Ibid.*, II-51.
42. *Ibid.*, II-55.
43. History, 1st Special Operations Squadron, 1 April–30 June 1982, supporting document D1.
44. *Ibid.*, supporting document D2.
45. History, 1st Special Operations Wing, 1 January–31 March 1982, vol. 1, II-54 to II-55.
46. *Ibid.*, II-59 to II-63.
47. *Ibid.*, II-37.
48. History, 1st Special Operations Wing, 1 April–30 June 1982, II-40 to II-43.
49. History, 7th Special Operations Squadron, 1 April–30 June 1982, 10.
50. History, 1st Special Operations Squadron, 1 October–31 December 1982, supporting document D2, 2.
51. History, 1st Special Operations Wing, 1 October 1982–28 February 1983, II-39 to II-40.
52. History, 1st Special Operations Wing, 1 April–30 June 1982, II-51.
53. *Ibid.*, II-49.
54. History, 7th Special Operations Squadron, 1 April–30 June 1982, 9.
55. *Ibid.*, 2, 6, 9.
56. History, 1st Special Operations Wing, 1 April–30 June 1982, vol. 3, 880.
57. History, 7th Special Operations Squadron, 1 October–31 December 1982, supporting document 8.
58. History, 1st Special Operations Wing, 1 January–31 March 1982, vol. 3, 476.
59. History, 1st Special Operations Wing, 1 October 1982–28 February 1983, 747.
60. *Ibid.*, 773.
61. History, 7th Special Operations Squadron, 1 October–31 December 1982, 11.
62. *Ibid.*
63. History, 2d Air Division, 1 March–30 June 1983, USAF HRA, Maxwell AFB, Ala., vol. 2, II-140 to II-141.
64. History, 1st Special Operations Squadron, 1 March–30 June 1982, supporting document D1, D1-2.
65. History, 2d Air Division, 1 March–30 June 1983, II-143–44.
66. History, 1st Special Operations Wing, 1 October 1982–28 February 1983, vol. 3, II-44 to II-45.
67. *Ibid.*, II-82 to II-84.
68. History, 2d Air Division, 1 March–30 June 1983, vol. 3, 2.
69. *Ibid.*, 3.
70. History, 1st Special Operations Wing, 1 March–30 June 1983, vol. 3, 1963.
71. History, 2d Air Division, 1 July–31 December 1983, vol. 1, III-214.
72. *Ibid.*, III-234.
73. *Ibid.*, III-241.
74. *Ibid.*, III-262.
75. *Ibid.*, III-221 to III-222.
76. *Ibid.*, III-270.
77. “Grenada: Special Report,” *Airman Magazine*, February 1984, USAF HRA, Maxwell AFB, Ala., 1964.
78. History, 2d Air Division, 1 July–31 December 1983, vol. 2, 9.
79. History, 1st Special Operations Squadron, 1 July–31 December 1983, 10.
80. *Ibid.*, supporting document D1.
81. “Now To Make It Work,” *Time*, 14 November 1983, USAF HRA, Maxwell AFB, Ala., II-36.
82. History, 2d Air Division, 1 July–31 December 1983, vol. 2, 9–10.
83. “Now To Make It Work.”
84. History, 2d Air Division, 1 July–31 December 1983, vol. 2, 9.
85. *Ibid.*
86. History, 1st Special Operations Squadron, 1 July–31 December 1983, supporting document D2.
87. *Ibid.*, iv.
88. *Ibid.*, supporting document D3, 1–4.
89. History, 2d Air Division, 1 July–31 December 1983, vol. 2, 7.
90. Ronald H. Cole, *Operation Urgent Fury: The Planning and Execution of Joint Operations in Grenada, 12 October–2 November, 1983* (Washington, D.C.: Office of the Chairman of the Joint Chiefs of Staff, 1997), copy located in Combat Talon Archive, HQ AFSOC/HO, Hurlburt Field, Fla., 9.
91. “A Strange Peace After A Strange War,” *U.S. News and World Report*, 28 November 1983, USAF HRA, Maxwell AFB, Ala., 35.
92. Cole, 10.
93. “A Crisis in the Caribbean,” *Newsweek*, 31 October 1983, 21.
94. *Ibid.*
95. “Now To Make It Work,” 21.
96. “A Crisis in the Caribbean,” 21.
97. Cole, 11.
98. “Spice Island Power Play,” *Time*, 31 October 1983, 78.
99. Cole, 14.
100. *Ibid.*, 12–13.

101. *Ibid.*, 14.
102. *Ibid.*, 16.
103. *Ibid.*, 16–17.
104. *Ibid.*, 17–18.
105. *Ibid.*, 18.
106. *Ibid.*, 19.
107. *Ibid.*
108. *Ibid.*, 20–21.
109. *Ibid.*, 22.
110. *Ibid.*, 23, 26.
111. *Ibid.*, 27.
112. Briefing, subject: Operation Urgent Fury, Combat Talon Archive, HQ AFSOC/HO, Hurlburt Field, Fla.
113. Official Document, query, subject: Grenada, Operation Urgent Fury, 8 April 1985, HQ AFSOC/HO, Hurlburt Field, Fla.
114. Cole, 28–29.
115. *Ibid.*, 29.
116. *Ibid.*
117. *Ibid.*, 30.
118. *Ibid.*, 32.
119. *Ibid.*, 34–35.
120. *Ibid.*, 35.
121. Briefing, Operation Urgent Fury.
122. *Ibid.*
123. *Ibid.*
124. *Ibid.*
125. “Now To Make It Work,” 23.
126. Briefing, Operation Urgent Fury.
127. *Ibid.*
128. “Grenada: Special Report,” 37.
129. Briefing, Operation Urgent Fury.
130. *Ibid.*
131. Cole, 42–43.
132. *Ibid.*, 44.
133. *Ibid.*, 45.
134. *Ibid.*, 49.
135. *Ibid.*, 57, 60.
136. Query, Grenada, Operation Urgent Fury.

THIS PAGE INTENTIONALLY LEFT BLANK

Road to Combat Talon II (1984–89)

I will prepare and some day my chance will come.

—Abraham Lincoln

By 1984 nearly four years had passed since the failed Iranian rescue mission, yet in that time, the Combat Talon force had actually decreased from 14 to 13 aircraft. Talon 64-0571 had been returned to Hurlburt Field from the 4950th Test Wing, Wright-Patterson AFB, Ohio, on 27 October 1981 after the loss of aircraft 64-0564 the previous February. The aircraft had been designated as a Swap aircraft since the early 1970s when Heavy Chain closed, and the four aircraft assigned to that program were transferred to Combat Talon. It had been partially demodified, with the KA-band portion of its radar and its ECM equipment removed. The aircraft had not undergone modifications that had been made to the rest of the Combat Talon fleet, including in-flight refueling and Honey Badger upgrades. Additionally, the ECM equipment removed in 1973 had been consumed by the Talon fleet over the years and was no longer available to reinstall in the aircraft. The out-of-production equipment was not available in 1982, thus requiring it to be manufactured under special contract with Lockheed. The aircraft was delivered to LAS Ontario on 28 September 1982, after having served almost a year in the 1st SOW as a basic “pilot-proficiency” aircraft not capable of performing the complex Combat Talon mission. Aircraft 64-0571 remained at LAS Ontario undergoing modification to the Combat Talon Yank configuration until being delivered to the 1st SOS at Clark AB, Philippines, on 14 April 1984.¹

As Combat Talon growth remained static, efforts to procure the new Combat Talon II took shape after Desert One. The initial purchase of new Combat Talon IIs was set at 12 aircraft by Air Staff, although documented requirements of the war-fighting CINCs reflected a need for more than 100 airframes. Beginning in 1982 the 12 Combat Talon II aircraft program competed in the yearly budget cycle, but it had not made the funding cut by 1984. Simply stated Combat Talon did not compete with other Air Force programs because the conventional Air Force was not interested in funding special operations. Historically, SOF had experienced a roller-coaster ride throughout its existence, with funding for vital SOF airlift

programs reduced to near zero after World War II and Vietnam. After each buildup SOF was decimated and receded into the background (or ceased to exist altogether) while national security concerns focused on deterring major conventional or nuclear war.²

After Desert One the Holloway Commission Report was published and contained two recommendations to improve SOF throughout the Department of Defense. The first recommendation was to establish a counterterrorist joint task force (CTJTF) as a field agency of the Joint Chiefs of Staff with permanently assigned staff personnel and certain assigned forces. The second recommendation focused on the establishment of a Special Operations Advisory Panel composed of a group of carefully selected high-ranking officers (both active duty and retired) who were either experienced in special operations activities or who had served at the CINC level. Both recommendations were approved and implemented by DOD. The Joint Special Operations Command was established as the CTJTF and became operational in December of 1980. The Special Operations Advisory Panel also was created in the fall of 1980, and it eventually became the Special Operations Policy Advisory Group (SOPAG). There was little pressure from Congress in 1980 to reorganize special operations, but events over the next five years would convince key members of Congress that SOF was broken and needed a major overhaul.³ Much of the dissatisfaction centered on the procurement of the Combat Talon II (or, to be more precise, the lack of procurement of the new weapons system).

1984: The Air Force Develops a Plan to Fix Special Operations

When MAC gained control of special operations on 1 March 1983, the command concentrated on short-term fixes to the Combat Talon airlift shortfall. To satisfy the growing requirements of the Joint Special Operations Command MAC developed the Special Operations Low Level II capability. SOLL II crews were trained to land with NVGs on covertly lighted runways utilizing the

five-light system developed for Desert One. The aircraft were standard AWADS C-130E aircraft modified with NVG-compatible cockpit lighting. They were not capable of terrain following, nor did they have the sophisticated ECM equipment that was found on the Talons. MAC maintained six C-130E aircraft and nine SOLL II crews at Pope AFB for the specialized airland mission. In addition to the Pope-based SOLL II capability, MAC developed a similar program for the C-141 and the C-5, all of which supported the counterterrorism mission. With most of the near-term modernization initiatives being expended for upgrade of other MAC aircraft, the MC-130E Combat Talons received little attention. When Operation Urgent Fury kicked off in October 1983, there were only five 8th SOS Combat Talon aircraft available to participate in the assault on Point Salines. Twelve Talons were needed for the contingency operation. Consequently, seven less-capable SOLL II C-130Es from Pope AFB augmented the five Talons for the operation.

Long before Urgent Fury the Air Force looked at itself to determine what direction it should take to improve its special operations capability. In 1981 the Air Force inspector general and the deputy chief of staff for operations, plans, and readiness (XO) directed a full-scale review of USAF SOF. The review, known as a functional management inspection, was conducted from November 1981 to July 1982. The FMI team gathered data, identified problems, and made recommendations to improve SOF's ability to meet national security objectives. The team identified three critical areas: (1) a lack of essential mission elements (SOF roles and missions, operational doctrine, and tactics); (2) an inadequate force structure; and (3) force readiness. The team determined that "the Air Force is not currently capable of fully supporting JCS/unified command special operations." Because of the FMI, the USAF chief of staff decided in December 1982 to transfer SOF forces (which included the worldwide Combat Talon fleet) from TAC to MAC. The Twenty-Third Air Force was created under MAC to manage SOF. Of the nearly 10,500 personnel initially assigned to the Twenty-Third AF, SOF forces totaled 3,500. The mission of the Twenty-Third AF included combat rescue, peacetime search and rescue, weather reconnaissance, high-altitude atmospheric sampling, missile site support, aeromedical evacuation, operational support airlift (VIP transport), and SOF.⁴ To manage special operations forces assigned to the Twenty-Third AF, the 2d

AD was established at Hurlburt Field. From the onset many felt that SOF was relegated to a secondary mission within the new numbered AF.

Career SOF personnel looked upon the consolidation under MAC as a hostile takeover by a much larger bureaucracy that had little concern for SOF revitalization but rather was focused on gaining control of SOF assets to upgrade its rescue forces. With the Twenty-Third AF headquarters made up almost entirely of rescue personnel, resentment quickly grew over the fact that SOF was commanded by a headquarters with virtually no SOF experience. MAC's effort to assign experienced Special operations personnel to the Twenty-Third AF staff met with great resistance from the SOF community because the assignment was looked upon as a career-ending move. When several SOF officers were forcibly assigned to the headquarters, they did not fare well during future promotion cycles. The consolidation under MAC was not all negative, however, for Combat Talon personnel. Before the consolidation, three separate commands (TAC, PACAF, and USAFE) had Combat Talon personnel assigned. All three commands were fighter oriented, with key higher-headquarters assignments and early promotions going to the fighter community. When Combat Talon officers left TAC for assignment to one of the two overseas commands, they were "lost" to the stateside Talon community. TAC did not consider them as a TAC resource upon returning to the United States after completion of their tours. Personnel returning from the 1st and 7th SOS many times would be assigned to non-SOF conventional duty in lieu of special operations positions at Hurlburt Field. The flow between commands resulted in a lower promotion rate than that experienced by non-SOF officers. With MAC gaining responsibility for all SOF units, assignments were controlled by Headquarters MAC, and placement outside SOF was made only after requirements were met within the SOF community.⁵ By 1985 promotion rates had improved for SOF, with the opportunity for advancement within the MAC system being realized.

In October of 1983 Deputy Secretary of Defense Paul Thayer authored a memorandum that reiterated National Command Authorities emphasis on the US military's special operations capability. The 3 October memorandum was sent to the service secretaries and other high-ranking Department of Defense personnel and addressed special operations forces. The memorandum observed that "US national security requires the

maintenance of special operations forces capable of conducting the full range of special operations on a worldwide basis, and the revitalization of those forces must be pursued as a matter of national urgency.”⁶

Secretary Thayer directed that force structure expansion be implemented quickly and completed by the end of fiscal year 1990, including improvements in command and control, personnel, training, and equipment. The memo further stated that “each Service [*sic*] will assign SOF and related activities sufficient resource allocation priority and will establish appropriate intensive management mechanisms to ensure that these objectives are met.” In addition to the above guidance, Secretary Thayer directed that once resources had been committed to SOF and revitalization decisions had been made, they would not be changed unless coordinated with the principle deputy assistant secretary of defense for International Security Affairs and with the OSD comptroller, and then approved by the secretary of defense. By 1 March 1984 Secretary Thayer wanted a time-phased master plan for reaching the goals in his memorandum.⁷

In response to Secretary Thayer’s memorandum, Air Force Chief of Staff general Charles A. Gabriel and Secretary of the Air Force Verne Orr directed that an Air Force master plan be developed for SOF. The master plan would respond to the memorandum and provide a time-phased schedule for the improvement of Air Force SOF. Existing joint guidance and service agreements charged the Air Force with the mission of supporting joint special operations with rapid response and quick employment of long-range, low-level aircraft capable of penetrating hostile airspace and operating in austere locations with minimal support. Special operations was essentially an offensive capability carried out by both rotary- and fixed-wing aircraft. With all Air Force SOF under the command of CINCMAC, the responsibility for developing the SOF Master Plan was assigned to MAC. The plan identified the 14 MC-130E Combat Talons, along with the AC-130H gunships and the HH-53H Pave Low helicopters, as core SOF assets.⁸ It also established the requirement for 19 primary aircraft assigned (PAA) and two backup aircraft inventory (BAI) MC-130H Combat Talon IIs, which were to be procured beginning in FY 83. The standard production C-130H aircraft would be modified into the Combat Talon II configuration after delivery to the Air Force, with the first modified aircraft available in FY 87. The Combat Talon

II would have similar capabilities as the older MC-130Es, including a highly accurate navigation system, a self-contained precision instrument approach system, defensive ECM/IRCM (infrared countermeasures), IFR, HSELLADS, and NVG-compatible internal and external lighting. The initial operational capability (IOC) was set for the third quarter of FY 87, with all aircraft delivered by 1991.⁹

MAC also established the requirement for the procurement of 24 HH-60D Nighthawk helicopters for its combat SAR mission and tied the new Combat Talon’s avionics suite to the development of the HH-60 to reduce overall acquisition costs.¹⁰ For the MC-130E Combat Talon (now redesignated as the Combat Talon I), improvements included the installation of the helicopter aerial refueling system to allow the aircraft to operate as a long-range penetrating tanker. The Talons assigned to the 8th SOS at Hurlburt Field would get the helicopter aerial-refueling modification by FY 4/85.¹¹

To improve the SOF airlift capability in the short term while awaiting the delivery of the Combat Talon II, MAC proposed to increase US-assigned SOLL II crews from nine to 11 and to upgrade the overseas SOLL I crews to SOLL II status by the second quarter of FY 85. Pacific Command and European Command would each have six SOLL II crews available for employment in their respective areas of operation.¹² The SOLL II capability would be in addition to the unit’s primary conventional airlift mission.

General Gabriel signed the SOF Master Plan on 19 March 1984, and Secretary Orr followed on 4 April. Contained in the plan were provisions for an annual review by the Air Staff Board before its consideration of the yearly program objective memorandum (POM). In addition, to ensure that it was kept current and reflected the latest developments, the SOF Master Plan was to be revised every two years. MAJCOM supporting plans were required to be submitted to Headquarters AF/XOXP by 1 October 1984. When the master plan was forwarded to Secretary Thayer, both General Gabriel and Secretary Orr advised him that money and research and development lead times would prevent the Air Force from achieving completion of improvements outlined in the plan by FY 90 (as required by Secretary Thayer’s original memo).¹³

Following close on the heels of the SOF Master Plan was an agreement between the US Army and the US Air Force addressing the improvement of

the total force and its war-fighting capabilities. With increased emphasis on joint operations at all levels, General Gabriel and the chief of staff of the Army, Gen John A. Wickham, signed a memorandum of agreement (MOA) on 22 May 1984. Attached to the MOA were 31 initiatives that articulated concerns of both services. Initiative 17 addressed special operations and would have a far-reaching impact on the Air Force's ability to improve its SOF capability. Initiative 17, Rotary Wing Lift Support for Special Operations Forces, stated that "the Air Force will transfer the responsibility for providing rotary-wing lift support for SOF to the Army. A detailed implementation plan will be jointly developed."¹⁴

With the stroke of a pen, General Gabriel had given away the rotary-wing SOF mission to the USA and by so doing had put the entire SOF revitalization program, as outlined in the SOF Master Plan, in jeopardy. Without the rotary-wing SOF mission, funding for MAC's 24 HH-60D Nighthawks and the avionics development program that was shared with Combat Talon II was tenuous. CINCMAC strongly disagreed with the initiative, but at the Corona Fall 84 conference held from 3 to 6 October 1984, all attending 0-10 general officers voted against retaining the vertical-lift mission. Not only did Initiative 17 impact the Talon II program, but it also had implications for the emerging tilt-rotor joint vertical lift airlift (JVX) mission. An argument could be made that the JVX should transfer to the Army along with other Air Force rotary-wing assets, although the initiative did not specifically address the tilt-rotor mission.¹⁵ Initiative 17 had opened a veritable Pandora's box for the Air Force that affected much more than its relatively small SOF mission area.

* * * * *

The first C-130H aircraft (83-1212) was delivered to the Air Force on 8 June 1984 and was the first aircraft delivered of the original 12 MC-130H Combat Talon II (CT II) purchase. The aircraft was a production H model Hercules and did not have the specialized equipment necessary to accomplish the difficult Combat Talon mission. The original concept of buying off-the-shelf equipment for the new Talon had not materialized, especially for the sophisticated radar. With the Air Force's decision not to buy the Talon I APQ-122(V)8 for CT II, there was no other radar in existence that could provide the features required to accomplish the mission. Consequently, the first aircraft was put into short-term storage

until decisions could be made regarding the radar and ECM suite to be installed. On 19 November 1984 the aircraft was flown to LAS Ontario to have the HSLADS installed. The following May the aircraft was delivered to E-Systems in Greenville, Texas, to begin the extensive CT II modification without a final decision being made on the radar/ECM suite. Aircraft 84-1212 was the first to be modified under the CT II program.¹⁶

In some ways the CT II was designed with less capability than the older MC-130E Talon I. It did not get the Fulton STARS nor helicopter aerial-refueling pods, but it did get an updated ECM suite that was superior to the CT I. The specifications for the new CT II radar were somewhat vague but required that it "meet or exceed" the capabilities found in the CT I AN/APQ-122(V)8 radar. The development of the new radar would result in years of delay and would cause the cost of the aircraft to skyrocket by the time it was ready for operational use. The glass cockpit envisioned for the HH-60D Nighthawk helicopter was reduced in scope and was installed on the Talon II. Although not a total glass cockpit, the effort resulted in most of the complicated navigation, radar, and FLIR displays being presented on the aircraft's cockpit screens. The analogue dials for the four engines were reduced in size and installed in a similar configuration as the Talon I. Another advantage found in the CT II was that it had the entire cargo compartment available, whereas in the CT I a console for the radio operator and the electronic warfare officer took up an entire pallet position. The crew for the Talon II was also smaller than the CT I, having only one navigator and no radio operator authorized. The CT II also required only two pilots for the NVG airland mission. (The CT I required a third pilot to act as a safety during the demanding blacked-out landing procedure.) As the CT II developed during the next eight years, it would become a highly capable asset on which special operators would rely for the long-range, low-level mission. But in 1984 aircraft 84-1212 did not resemble what it would eventually become.

Congress Reacts to the Air Force Plan

Congress had been concerned about SOF since the failed Iranian rescue attempt in 1980. The cycle of neglect for special operations by the conventional Air Force was apparent when looking at funding levels before Desert One. Air Force special operations AC-130H gunships were scheduled

for deactivation or transfer from the active to the Reserve force in the late 1970s and were not funded in the Air Force budget after 1979. The MC-130E Combat Talon was old and had not been significantly improved since the MOD-70 upgrade in the early 1970s. SOF rotary-wing capabilities had decreased to a point of near extinction by 1980. After Desert One Air Staff transferred the HH-53H Pave Low helicopter to SOF, although it was developed as a combat SAR asset by MAC. The HH-53 was the only rotary-wing developmental program for the Air Force throughout the 1970s. Congress had authorized the purchase of 12 Combat Talon II aircraft in 1981, and it was the funding of these 12 aircraft that became especially frustrating. From 1981 to 1984 Congress authorized funding for the new aircraft, and each year Air Force programmers redirected those funds to other higher-priority conventional programs. With the creation of the Special Operations Panel under the House Armed Services Committee in 1983, congressional interest in SOF and low-intensity conflict (LIC) intensified. Speaking on the Senate floor, Sen. Sam Nunn (D-Ga.) expressed his frustration with the Air Force, saying:

For about three years, we have been waiting on the five-year defense plan to reflect the needs of the special operations forces. . . . We had the Iranian hostage rescue mission and a woeful inadequacy of transportation for the forces at that stage. Senator Goldwater and I had written letters, done everything we could to try to focus on the need for transportation for special operations forces. The regular forces were not interested. . . . So we mandated that they include transportation for special operations forces in the five-year defense plan. In addition, we held up certain aircraft programs until they did. Guess what happened? They finally decided they needed the aircraft so they . . . put the special operations forces in the plan. What happened then? They came back and now they have taken those special operations aircraft out of the plan. This is a sad commentary.¹⁷

When the Air Force signed the MOA with the Army that included Initiative 17, the action apparently took Congress by surprise. Rep. Dan Daniel of Virginia, chairman of the House Subcommittee on Readiness, and Rep. Earl Hutto of Florida, chairman of the Readiness Committee's Special Operations Panel, got involved. Hurlburt Field was in Representative Hutto's congressional district, and he and his staff made numerous visits to the base to determine the impact of the initiative on Air Force SOF. Representative Daniel also visited Hurlburt Field and, along with Representative Hutto, voiced serious reservations about the initiative. Deputy Secretary of Defense William

Taft IV also was publicly not pleased with the helicopter transfer to the Army.¹⁸

Secretary Taft was briefed on the initiative on 26 November and was reported to have remarked that the services needed a better case for Initiative 17 before he would approve it. After the briefing Taft wrote to Chairman Daniel on 29 November stating that no final decision had been made and suggested a meeting with Generals Gabriel and Wickham. Secretary Taft added a hand-written note to the letter to Chairman Daniel stating that if the chairman still did not agree with the initiative after discussing it with the two generals, Secretary Taft would not pursue the transfer over Chairman Daniel's objections. On 3 December Congressmen Daniel and Hutto and the two chiefs had breakfast, followed by a briefing in the afternoon by a combined Army/Air Force team. The briefing failed to convince the two congressmen. After the briefing Congressman Hutto sent a strongly worded letter to Gabriel in which he expressed his concern that Initiative 17 was the beginning of a plan by the Air Force to divest itself of the special operations mission.¹⁹ During the next week Taft's staff worked tirelessly to determine the best course of action, relying heavily on the SOF community for input as to the overall impact the initiative would have on USAF special operations. The initiative was not an isolated, disconnected decision that affected only Air Force rotary-wing assets, but rather it influenced the entire SOF community, especially the development of the new Combat Talon II. On 13 December 1984 Secretary Taft wrote to the chairman of the Joint Chiefs of Staff advising that he had decided to "defer" implementation of the Army/Air Force rotary-wing plan.²⁰

After Secretary Taft's deferment of Initiative 17, Congressmen Daniel and Hutto continued to voice their concerns that the transfer of the SOF rotary-wing mission to the Army was "hastily conceived and inadequately staffed." Indeed, special operations personnel on the Air Staff had not participated in the drafting of the initiative and were not asked for comments before the final Air Force decision. The process had been flawed from the start, the congressmen maintained, and the results were predictably invalid. In April 1985 Secretary Thomas E. Cooper, USAF assistant secretary for research, development, and acquisition, announced that Initiative 17 was dead. There would be no transfer of rotary-wing SOF from the Air Force to the Army. With strong congressional

interest the conventional Air Force had backed away from the controversial issue.²¹

The year of 1984 had been a pivotal one for Air Force SOF. From a position of high-level AF/SOF support (the SOF Master Plan) to an attempt to divest itself of rotary-wing SOF (Initiative 17), the Air Force had emerged in 1985 committed to rebuilding its SOF capability. Support at the congressional level undoubtedly turned the tide in favor of special operations, but the roller-coaster ride that had occurred during 1984 convinced many in Congress (both in the House and Senate) that special operations throughout the three services was broken. Visionaries in Congress worked over the next two years to fix the problem. For Combat Talon II, the first aircraft was delivered during 1984 without an operational radar, and five more aircraft were scheduled to be delivered during 1985. The coming year would be a frustrating one for the Twenty-Third AF and for the Combat Talon community.

New MAC-Sponsored SOF Modernization Programs

Throughout 1984 MAC had been listening and reacting to developments in Washington. The command had strongly opposed Initiative 17, with CINCMAC the only dissenting four-star at the Corona fall commanders conference. Working on the assumption that Initiative 17 would be eventually turned around by Congress, the Headquarters MAC staff, working in concert with the Twenty-Third AF, developed its five-year POM for fiscal years 1986–90 that recommended funding of seven new SOF programs. Upon review the Air Staff later added three additional programs based on the SOF Master Plan. The 10 SOF programs and the fiscal year proposed for funding them included the following:

1. Night Vision Goggles: Procure 1,015 AN/AVS-6 Night Vision Goggles (FYs 87–90)
2. AC-130H Sensor Improvement: Provide improvements needed to maintain gunship capability to support JCS tasking, including ECM, moving-target indicator, and low-light level TV (FYs 87–90)
3. AC/MC-130 Defensive System: Provide ECM upgrade to the MC-130E, and ECM and navigation equipment upgrade on the AC-130A (FYs 87–90)
4. Probe Refueling: Procure high-speed drogues and “snap-top” probes for modifying SOF fixed-wing aircraft (FYs 87–90)
5. HH-53 Conversion: Transfer and modify aircraft from the 6594th Test Group to the AF/SOF (FYs 87–90)
6. Pacific Build-up: Place six HH-53s and two HC-130 tankers from the 6594th in the Pacific (FYs 87–90)
7. CAMPS Maintenance: Fund hardware and maintenance for four computer-aided mission planning systems (CAMPS) (FYs 87–90)
8. Flying Hour Increase: Increase flying hours available for JCS taskings (FYs 86–90)
9. Manpower: Provide manning at Pope and Charleston AFBs to support MAC SOLL activities (FYs 87–90)
10. Combat Control Team Manpower: Fund 22 additional CCT personnel in direct support of the Joint Special Operations Command (JSOC) (FYs 87–90)²²

The Combat Talon II requirement had been increased from the original 12 aircraft to 19 PAA/2 BAI (total of 21 aircraft) based on the SOF Master Plan. A deputy secretary of defense memorandum of 23 August 1984 included one additional Combat Talon II aircraft in fiscal years 1988, 1989, and 1990 (for a total of 24 aircraft), and the Budget Estimate Submission for 1985 included the additional three aircraft. The Air Force Council also approved a 90-aircraft HH-60A program to replace obsolete AF rescue helicopters but did not support funding of the 24 combat rescue HH-60Ds.²³ Without the HH-60D program, the sophisticated glass cockpit and integrated avionics systems earmarked for Combat Talon II would not be developed. The decision would result in a delay in the fielding of the new Talons at a much higher cost per aircraft.

Along with the new programs, Headquarters MAC also supported an aggressive Special Operations Forces-Improvements program designed to enhance existing SOF weapons systems. The SOF-I program included \$103.7 million in the fiscal years 1984–88 period and included improvements in the MC-130E and AC-130H fleets. The SOF-I program included the following:

1. A highly accurate inertial navigation system, an infrared warning receiver (AAR-44), radar detection (WJ-1840), and digital burst message communications.
2. A radar jammer (the ALQ-117 Pave Mint) for six of the 14 MC-130Es.
3. Additional AAQ-10 FLIR sensors for the Combat Talon.
4. Gunport covers for the AC-130H to allow aircraft pressurization at high altitude.
5. An improved fire control system for the AC-130H.

The SOF-I program also funded 23 AAQ-4 IR jammers for the HH-53B/C/H helicopters.²⁴

The Air Force POM included additional improvements not included in the proposed MAC SOF-I program. Combat Talons would get radar jammers for the remaining eight MC-130Es and

also would get improved chaff and flare dispensers along with improved radar warning receivers (RWR).²⁵ The MAC SOF-I package, as augmented by Air Staff, represented the most sweeping advancement in the Combat Talon weapons system since MOD-70 15 years earlier. The new system would ensure that the MC-130E would remain a viable combat asset for the remainder of the twentieth century.

The State of Affairs in the Talon Squadrons

At Clark AB Lee Hess had his hands full trying to get his MC-130Es mission ready. The 374th TAW continued to be responsible for Talon maintenance, but the wing could not maintain the sophisticated equipment installed on the aircraft. Both the 374th TAW and the 1st SOS were assigned to MAC, but the 1st SOS was a tenant unit at Clark AB reporting to the 2d AD at Hurlburt Field. In June of 1984 Hess reported to 2d AD that he had not had a fully mission-capable (FMC) aircraft available to fly in more than a year. The major problem continued to be the radar, INS, and ECM equipment.²⁶

At Rhein Main AB the 7th SOS was in the same status as the 1st SOS at Clark AB—it was a tenant unit of the 435th TAW and also assigned to the 2d AD at Hurlburt Field. The major difference for the 7th SOS was that it possessed an aircraft maintenance section (AMS) that was made up of maintenance specialists trained to maintain Combat Talon-unique avionics systems. Because it had its own specialized maintenance, the 7th SOS enjoyed a better FMC rate than did the 1st SOS at Clark, but parts availability kept the European Talon FMC rate below MAC standards. The 2d AD worked through the Twenty-Third AF to solve the problems of the overseas units. Despite its best efforts, it took another year for the 2d AD to obtain approval for specialized maintenance for the Pacific Talons. For FY 86 more than 100 maintenance personnel were programmed to join the 1st SOS to enable the unit to establish its own organic maintenance capability.²⁷

On 26 June 1984 Colonel Bortner succeeded Hudspeth as the squadron commander of the 7th SOS. At Hurlburt Field the following month, Colonel Miles assumed command of the 8th SOS from Hobson when Hobson moved on to the Pentagon to work special operations programs and resources. Talons from the three squadrons continued to participate in JCS exercises as they had done in previous years, including Team Spirit and

Foal Eagle in the Pacific and Flintlock in Europe. The Joint Special Operations Command also tasked the Talon units to participate in its quarterly joint readiness training (JRT) exercises. As MAC moved to improve its SOF capabilities during 1984, tragedy struck the 20th SOS with the loss of a UH-1N and two HH-53H Pave Lows. The UH-1N went down on 9 January 1984 while participating in Operation Bat, a counterdrug operation in the Caribbean. The first Pave Low crashed during Exercise Cope Thunder in the Philippines on 17 October 1984, and the second was lost on 14 November while on a training mission in the United States.²⁸

Hobson, who had commanded the lead Combat Talon (64-0568) over Point Salines, Grenada, during Operation Urgent Fury, was awarded the prestigious Mackay Trophy for the most meritorious flight of 1983. The defenders at Point Salines obviously knew that the rescue force was coming as Hobson's Talon approached the airfield for its personnel drop. On Hobson's inbound leg, his aircraft was illuminated by a searchlight located on the airfield. As the Talon was dropping at 500 feet and with only half of Hobson's rangers clear of the aircraft, enemy AAA opened fire on the Talon. Holding his course steady until all jumpers were clear, Hobson then banked hard to his right, descending at the same time towards the surface of the ocean. Maj Gen William J. Mall, commander of the Twenty-Third AF, was aboard Hobson's Talon and credited him with saving the aircraft. In a ceremony held in November 1984 at Hurlburt Field, additional Talon personnel who had participated in Operation Urgent Fury were also decorated. They were recognized for their contribution to the success of the overall operation.²⁹

1985: Life in the Trenches

The three Combat Talon squadrons faced heavy tasking throughout 1985. As Air Force and Congress continued their dialogue on the future of SOF, life in the trenches was brutal. The Combat Talon operations tempo had never been higher, with more work for the squadrons than could possibly be done with the limited number of aircraft available. From three to six aircraft were at LAS Ontario throughout the year for major maintenance, thus leaving the squadrons with only two-thirds of their assigned aircraft. Although the year would be challenging, there would be no major contingency operations.

On 13 February 1985 the 1st SOS narrowly escaped disaster while participating in a joint special

operations exercise in the Pacific. The squadron had deployed two Combat Talons to Andersen AFB, Guam, and had worked with USA Special Forces and US Navy SEALs during the course of the exercise. The 8th SOS also had deployed two Combat Talons from Hurlburt Field. An airfield seizure operation was scheduled for the night of 13 February on Tinian Island and involved both Air Force and Army aircraft. Captain Sharpe was in command of Combat Talon 63-7785 and was on final approach for landing at Tinian Island. With Gilbert flying the aircraft, Sharpe was scanning outside on NVGs looking for the runway environment. As the Talon approached the LZ at approximately 30 feet above the ground, Sharpe suddenly saw a blacked-out helicopter's rotor blades in his NVGs. Sharpe immediately took control of the Combat Talon, pulled back hard on the yoke and applied maximum power to break his descent. The rotor blades of the Army UH-60 helicopter sliced through the main landing gear tires of Sharpe's aircraft as the Talon passed over the helicopter. The force of the impact destroyed the helicopter's main rotor blades and caused the Blackhawk to crash on the runway, seriously injuring those on board but resulting in no fatalities. Sharpe managed to keep his aircraft airborne after touching down momentarily on the runway. Nimmo's crew (in another 1st SOS Talon) checked out Sharpe's aircraft, and the damaged Talon proceeded back to Andersen AFB for an emergency landing. After two hours in holding and successfully dumping excess fuel, Sharpe made a perfect no-flap landing. Post-flight inspection revealed that one-half of the right wing flap had been torn off by a piece of the helicopter's rotor blades. There was no other significant damage to the aircraft other than the slashed main landing gear tires and minimal damage to radio antennas on the belly of the aircraft. For his quick decisions and his expert airmanship, Sharpe was awarded the Air Medal in a ceremony later in the year.³⁰ Other members of Sharpe's crew were Gilbert (pilot), Washer (pilot), Calvert (navigator), Slepetz (EWO), Frederickson (loadmaster), and Whorles (flight engineer).*

A second incident involving Combat Talon 63-7785 occurred on 22 May 1985 when Fleming and his crew were flying a training mission over northern Luzon in the Philippines. The aircraft

was struck by small-arms ground fire from a rebel faction known as the New Peoples' Army. The rounds ignited a fire and caused damage to the number 4 engine, thus requiring it to be shut down. With three operating engines, the crew battled the in-flight fire for more than 20 minutes while returning to Clark AB. The fire was contained in the single-point refueling manifold area, and no crew members were injured. Along with Fleming the entire crew was awarded the Air Medal for its actions. Other members of Fleming's crew were Master Sergeant Fleming, Captain Hockley, First Lieutenant Knight, Staff Sergeant Monroe, Captain Payne, Master Sergeant Rode, Staff Sergeant Tappan, Captain Washer, and First Lieutenant Wernette.³¹ A repair team was later dispatched to Clark AB to repair the aircraft.

Having had nearly two years at the helm, Hess relinquished command of the 1st SOS to Colonel Jahnke on 31 May 1985. Jahnke had been Hess's operations officer before assuming command of the squadron. It was not until 10 August that his new operations officer—Col T. J. Doherty—arrived to help him run the diverse squadron operations section.³² The maintenance problems that had plagued Hess continued with little improvement for the remainder of the year.

At the 8th SOS Miles spent much of his time supporting joint special operations requirements.



Photo courtesy of John R. Lewis

Damage to aircraft 63-7785 after the aircraft was hit by small-arms fire on 22 May 1985. Area pictured is just aft of the right main landing gear. The resultant in-flight fire caused most of the damage.

*Details of the mission were provided by Sharpe during a telephone interview conducted on 23 August 1999. The timing for Sharpe's arrival at Tinian Island had been moved up 10 minutes by the air mission commander on board an EC-130E ABCCC aircraft. The UH-60 pilot had acknowledged the change. Probably due to task saturation at the time, the Blackhawk crew did not clear the approach end of the runway in time for Sharpe to land. With the helicopter being totally blacked out, the Talon crew could not see the Blackhawk in time to avoid the collision.

After the February exercise in Guam, two 8th SOS aircraft deployed to Hunter AAF, Georgia, and participated in sustainment training in support of the USA rangers stationed there. From 17 March to 4 April, one MC-130E deployed to Amman, Jordan, for a JCS-directed exercise. During the two-week deployment, the crew planned and flew mission profiles designed to help the Jordanian military evaluate its air defense network, while at the same time providing hard-to-get threat training for the Talon crew. Additional ECM training was accomplished when airborne intercept missions were successfully flown against Royal Jordanian Air Force fighter aircraft.³³ From 27 July to 25 August, the squadron participated in Bright Star 85, flying exercise missions into Jordan, Oman, and Somalia while basing out of Cairo West, Egypt. In September Miles took two of his Talons to Gowen AAF, Boise, Idaho, for the 1st SOW's ORI. The ORI, named Casino Gambit, tasked the Talon crews to fly missions that included night mountain terrain following, personnel airdrop of USA Special Forces, in-flight refueling, helicopter air refueling, and ECM training. Casino Gambit was designed to prepare the squadron and the wing for their upcoming ORI.³⁴

From 2 to 10 December the squadron deployed to Biggs AAF, Texas, for the 1st SOW's ORI, which was named Purple Duck. Four MC-130Es, six crews, and a Combat Talon planning staff participated in the evaluation along with other wing assets. Included in the employment phase were HALO personnel drops of CCT and leaflet drops supporting the psychological warfare scenario of the exercise.³⁵ Throughout the evaluation disconnects and misunderstandings occurred between the MAC evaluators and the special operations participants, primarily because of unclear grading criteria. Although the Talon crews performed satisfactorily, the ORI was halted on 10 December, and the wing was redeployed to Hurlburt Field. In the coming year, much effort would be expended to develop criteria that applied to SOF employment so that a fair and impartial ORI could be administered.

* * * * *

As the three Talon squadrons struggled to satisfy the increasing demands on their scarce resources, terrorist acts against the United States accelerated around the world during 1985. In April a bomb exploded in a restaurant frequented by American service members near Torrejon AB, Spain. Eighteen Spaniards were killed, and 82

others were injured, including 15 Americans. In June 1985 TWA Flight 847 was hijacked over the Mediterranean, thus beginning a two-week hostage drama that saw the murder of one American as the aircraft flew to different Arab countries around the region. Non-American hostages were released at various times during the ordeal. The remaining 39 mostly American passengers were eventually released in Damascus, Syria, after being held in Beirut, Lebanon. In El Salvador (also in June) four US marines and two American businessmen were killed along with 13 others during a machine-gun attack on a street-side cafe in the capital city of San Salvador. In August a large car bomb exploded at Rhein Main AB, Germany, near the 435th TAW headquarters and one block from the 7th SOS operations building, killing two airmen and injuring 20 others. The following day German police found the body of a US soldier, who was apparently murdered for his identification (ID) card. The stolen ID had been used by the terrorists to gain access to the air base.

In October 1985 four Palestinian terrorists hijacked the Italian cruise ship *Achille Lauro* along with 400 passengers and crew off the coast of Egypt. The terrorists killed a disabled American tourist, 69-year-old Leon Klinghoffer, and threw his body and his wheelchair overboard. The terrorists demanded the release of 50 Palestinian prisoners being held in Israeli jails. After a two-day drama, the terrorists surrendered in exchange for safe passage back to the Middle East. An Egyptian airliner attempted to fly the terrorists to freedom, but US Navy F-14 fighters intercepted the airliner and forced it to land in Sicily. Italian authorities took the terrorists into custody as US Navy SEAL Team Six and US Army Delta Force soldiers prepared to assault the Egyptian aircraft. The following month another Egyptian airliner was hijacked by terrorists, and one American on board was murdered. In a scenario similar to the TWA hijacking the previous June, the hijackers made demands as the aircraft was flown to airports around the Mediterranean. The episode ended in a bloodbath with the loss of 60 lives, when Egyptian commandos stormed the aircraft while it was on the ground in Malta. The volatile year ended in December with Arab suicide bombers simultaneously striking US and Italian check-in counters at the Rome and Vienna airports. In the two attacks, 20 people were killed, including four terrorists who carried out the acts.

The ability of the United States to respond to terrorist attacks had improved since 1980, but

forces in being in 1985 were not adequate to cope with the worldwide threat to US citizens. Congress looked for ways to improve the capability of America's counterterrorism. In August of 1985 Representative Daniel, still not convinced that the three services (Army, Navy, and Air Force) were serious about building a robust special operations capability to fight the terrorist threat, published an article in *Armed Forces Journal* advocating the creation of a sixth service dedicated to special operations and low-intensity conflict. Many felt at the time that the true objective of Daniel's article was to stimulate controversy within the services and in Congress so that action would be taken to improve SOF. Daniel was convinced that service SOF initiatives up to that time had treated the symptoms of the disease rather than the causes. He felt that although SOF was organizationally part of the three services, SOF had never been truly institutionally part of those services. He argued that SOF did not "fit" into the conventional military and concluded that the system didn't work because the individual services held SOF to be peripheral to the interests, missions, goals, and traditions that the services viewed essential. Listing seven key reasons a sixth service was needed, Daniel believed that anything less would result in continued poor performance by SOF because the services ultimately would determine the health of SOF by controlling forces and dollars committed to it.³⁶

In October 1985 a two-year Senate Armed Services Committee staff study, "Defense Organization: The Need for Change," was published. The staff study was headed by James Locher and included a detailed look at the Department of Defense and the national command structure. Locher and his staff looked at a number of special operations as part of their research, including those in Vietnam, Iran, and Grenada, and concluded that America did not have a good record of accomplishments in successfully completing unconventional operations. Historical analysis dating back to the American Revolution provided the basis of a series of recommendations contained in the study. His staff report concluded that a new command structure was essentially needed when it proposed a "strong . . . multifunctional, organizational focus for low-intensity warfare and special operations." Many in Congress took Locher's staff study seriously and throughout 1986 worked to see that the recommendations were implemented. The October 1985 staff study formed the foundation for the Goldwater-Nichols Defense Reorganization

Act of 1986, which revolutionized SOF and the Combat Talon force.³⁷

In the Air Force the fiasco of 1984's Initiative 17 had faded into the past, but the service's commitment to SOF still was questioned by many. Five additional C-130H aircraft (84-0475, 84-0476, 85-0011, 85-0012, and 86-1699) were delivered to the Air Force during calendar year 1985 as part of the CT II program, but the radar problem had not been solved. Because the radar had been envisioned as an off-the-shelf acquisition, Air Force program managers had made the decision not to remanufacture the older CT I radar because of its cost—it was estimated that the APQ-122(V)8 would cost between \$8 and 10 million each, and the conventional Air Force wanted a cheaper radar for the CT II. All five aircraft received the HSSLADS modification at LAS Ontario before being delivered to E-Systems in 1986. Air Force contracted with IBM to develop a new TF/TA-capable radar for the CT II, but the company subcontracted the effort to Emerson Electronics. The resultant poor performance of the Emerson radar nearly resulted in the cancellation of the entire CT II program. Congressional interest in CT II development had continued, thus leaving the Air Force little choice but to continue to work with the contractor to bring the radar up to operational status. In the end the AN/APQ-170 radar emerged as the radar for the new Talon at a cost of nearly \$20 million each, and the delivery of the first operational aircraft to the 8th SOS was delayed until 1991.³⁸

In September 1985 Maj Gen Robert B. Patterson assumed command of the Twenty-Third AF and quickly set about to develop a road map for future SOF expansion within the Air Force. Looking



USAF Photo

The new Combat Talon II has an extended radome and chin-mounted FLIR turret. The large radome is required to accommodate both the FLIR and the AN/APQ-170 radar.

at current and anticipated growth, Patterson's staff projected an increase of 120 aircraft and 3,000 personnel by 1999 (based on the SOF Master Plan) but conceded that the existing organizational structure could not support even 1985 requirements. With the C-130H CT II aircraft already being delivered, a detailed plan had to be developed. On 31 October 1985 Patterson was ready with his vision of the future when his Twenty-Third AF staff presented his Forward Look briefing to the MAC staff. The Twenty-Third AF briefing cited examples of programs that had been directed from top down rather than being initiated by the Twenty-Third AF or MAC, including the acquisition of the MC-130H Combat Talon II. The briefing also noted the less-than-adequate support for the MAC-generated SOF Master Plan. Even after the Master Plan was approved by the Air Force chief of staff and the secretary of the Air Force, the plan received low priority and low-level attention. Earlier in 1985 the Air Force also had canceled the HH-60D combat SAR helicopter with apparently little concern of its impact on the Combat Talon II program. The Forward Look briefing also addressed perceptions held by Congress and the majority of the conventional Air Force regarding SOF capabilities.

The Twenty-Third AF proposed taking actions that demonstrated both philosophical and organizational changes. The major change involved focusing on capabilities rather than on the mission (i.e., Twenty-Third AF personnel would not be trained just for combat rescue or for special operations, but would instead be trained so that they could employ whatever mission was tasked). The complex system of squadrons and detachments dedicated to peacetime search and rescue in the United States and abroad was recommended either to be consolidated and converted to SOF units, or to be disbanded altogether. Most peacetime SAR units had obsolete equipment and suffered from years of neglect by the conventional Air Force. Outside the United States, host nations or local governments were fulfilling rescue requirements. No longer was there a need for many of the rescue units. A second objective of the reorganization was to streamline command and control to provide more responsive theater forces. The basic concept of Forward Look was the establishment of four special air warfare (SAW) wings

under the Twenty-Third AF that would include both special operations and rescue forces. In the view of the Twenty-Third AF, the wings could develop multimission capabilities that included special air operations, counterterrorism, combat rescue, and some reconnaissance capability under the blanket title of special air warfare. The four wings would be designated as SAW wings to better represent their combined capabilities.³⁹

The four wings identified in the Forward Look concept consisted of one wing each in the Pacific and in Europe and one wing each on the West Coast and East Coast of the United States. The overseas wings would include the 1st and 7th SOS, and the East Coast wing, located at Hurlburt Field, would include the 8th SOS. The West Coast wing would be built around the 41st Rescue and Weather Reconnaissance Wing at McClellan AFB, California, and the 1st SOW would form the nucleus of the East Coast wing at Hurlburt Field.*⁴⁰

The Twenty-Third AF viewed the long-range future of the East Coast wing (1st SOW) as one of significant growth. The 1st SOW, in line with the overall reorganization, would be redesignated a SAW wing. The proposed wing buildup included an eight-aircraft tanker squadron that resulted from the consolidation of the 41st and 55th Aerospace Rescue and Recovery Squadrons. The existing 20th SOS would grow to 12 MH-53Hs and two MH-53B/C aircraft, while the 8th SOS would convert to Combat Talon IIs and grow to an 11-aircraft MC-130H squadron. The 1st and 7th SOSs would absorb most of the 8th's MC-130Es. To support operations at Fort Bragg, a 15 CV-22 tilt-rotor aircraft squadron would be stationed at Pope AFB as part of the East Coast wing. These actions would be completed by 1999. The reorganization included the deactivation of the 2d AD in 1987.⁴¹

On 30 December 1985 CINCMAC approved the reorganization of special operations and combat rescue forces largely in line with General Patterson's Forward Look proposal. Throughout the coming year, Forward Look was staffed at the highest levels of the USAF as Congress moved to create its own vision of SOF.

*In 1989 MAC made the decision to revitalize the Air Rescue Service and to divest the Twenty-Third AF of both peacetime and combat SAR responsibilities. The West Coast wing, located at McClellan AFB, California, was assigned to the new ARS. Hurlburt Field would continue as the only active duty SOF base in the United States. In the early 1990s, Kirtland AFB, New Mexico, would become the training center, under Air Education Training Command (AETC), for all SOF rotary-wing and Combat Talon II training. The formal Combat Talon I School remained at Hurlburt Field as part of the 1st SOW.

1986: The Goldwater–Nichols Defense Reorganization Act

Representative Daniel's article had accomplished its primary goal—it created dialogue within Congress and the Department of Defense on ways to improve special operations. In January 1986 Sen. William Cohen, in an article published in *Armed Forces Journal International*, "A Defense Special Operations Agency: Fix for a SOF Capability That Is Most Assuredly Broken," called for a national special operations agency. He outlined an organization that he named the Defense Special Operations Agency (DSOA), which would be made up of two major components—an agency staff and a subordinate joint command. The DSOA mission would be to prepare and conduct joint special operations. He envisioned the DSOA reporting directly to the secretary of defense. Command and control would be exercised through the subordinate joint command.⁴²

Under Cohen's vision, all Army, Navy, and Air Force SOF assets would be assigned to the new joint command, which would maintain liaison elements within each of the unified commands. During periods of conflict the joint command would forward deploy to the wartime theater and serve as that CINC's special operations command. On the civilian side an assistant secretary of defense for special operations would provide the civilian control necessary to conduct politically sensitive special operations.⁴³ As Senator Cohen and Representative Daniel developed their proposals during the first half of 1986, Patterson's Forward Look proposal had worked its way through the Air Staff.

Gen Duane H. Cassidy, CINCMAC, approved most of Patterson's Forward Look concept on 30 December 1985. Planning had proceeded at MAC headquarters during early 1986 on the reorganization of the Twenty-Third AF, and on 13 March General Cassidy wrote to the Air Force vice chief of staff providing details of Forward Look. In his executive summary, CINCMAC reviewed the organizational history of the Twenty-Third AF. He noted that when the new numbered air force was activated, the ARRS was assigned to it to oversee all rescue assets, and 2d AD was established as a parallel umbrella organization over Air Force special operations forces. On 1 October 1983, however, ARRS flying squadrons began reporting directly to the Twenty-Third AF, thus leaving only the Air Force Rescue Coordination Center reporting to ARRS. This change eliminated the need, in the opinion of MAC and the Twenty-Third AF, for

an intermediate level of command between SOF and the Twenty-Third AF. General Cassidy concluded that the time had come to deactivate 2d AD and merge the capabilities of both combat rescue and SOF into one cohesive command.⁴⁴

In an attachment to CINCMAC's letter, a proposal was made to integrate special operations and combat rescue forces to provide a force multiplier and an organizational structure for SOF paralleling that of the CINCs they supported. Four CINCs had formed special operations subunified commands—Special Operations Commands Europe, Pacific, Central, and Atlantic (SOCEUR, SOCPAC, SOCCENT, and SOCLANT)—while Southern Command (SOUTHCOM) had established a Joint Special Operations Task Force (JSOTF) until it could establish a subunified command. General Cassidy supported having the 1st SOW tasked against SOCCENT, SOCLANT, SOUTHCOM's JSOTF, and the commander, JSOC requirements. The overseas wings would support SOCPAC and SOCEUR. In his letter General Cassidy also deleted the SAW designation for the four-wing Forward Look plan, preferring to retain the traditional SOW designation.⁴⁵

Although the details of Forward Look were becoming known in the SOF community, the official position taken by MAC was to keep the plan closemouthed and to brief only selected commanders and their staffs. On 17 June 1986 the Twenty-Third AF advised 2d AD, the 1st SOW, and the 39th Aerospace Rescue and Recovery Wing (the European-designated SOF wing) that Headquarters MAC had agreed to allow the Twenty-Third AF to brief selected personnel in their commands on Forward Look. Only senior 2d AD personnel and wing staff officers, along with squadron commanders and their operations officers, would be briefed. The briefing was given to Hurlburt Field units on 19 June and to the 39th ARRW the next day. The Forward Look briefing went into considerable detail on the reorganization, its goals, aircraft reassignments, and organizational changes. It emphasized combat capability based on integrated missions by multimission aircraft, responsive theater structures, organization that could accommodate future growth, and the Twenty-Third AF mission. By the fourth quarter of 1988, the Twenty-Third AF hoped to have the new organization up and operating.⁴⁶

Concurrent with the 39th ARRW briefing at Eglin AFB on 20 June, Headquarters MAC advised the Twenty-Third AF that the Air Force Council had concurred with the reorganization

proposal. The details of the reorganization plan were not officially released until August 1986. At that time General Patterson signed out a letter with an attachment titled, "The Basis of Forward Look, Reorganizing the Twenty-Third AF." Although Patterson's letter served as the official announcement, it did not provide details of the timetable for implementation.⁴⁷ For the three Combat Talon squadrons, the reorganization provided the possibility of greater support (especially in the overseas units), with emphasis on command and control and the maintenance area.

While MAC and the Twenty-Third AF developed Forward Look, Congress continued to debate the reorganization of SOF. By May 1986 Senator Cohen, with cosponsorship by Sen. Sam Nunn, introduced Senate bill S. 2453, and the following month Daniel introduced House bill H. R. 5109. Many of the key provisions of those two bills later would form the basis for the defense authorization bill that was signed into law on 14 October 1986. The final bill passed in October directed the formation of a unified command for SOF (the US Special Operations Command), created the Office of the Assistant Secretary of Defense for Special Operations and Low-Intensity Conflict, and established a coordinating board for low-intensity conflict within the National Security Council.⁴⁸

Perhaps the most far-reaching provision of the October legislation was the creation of Major Force Program (MFP) 11. Before this legislation, there were only 10 MFPs, and SOF funding was provided by the services from those funds. All three services had a poor record of accomplishment for funding SOF. The acquisition of the Combat Talon II was an example of how the Air Force ignored an SOF program that was desired by Congress while funding conventional core requirements instead. Representative Daniel had made his case for separate SOF funding in his article the previous August proposing a sixth service. In defense of the services, SOF programs were funded throughout each service's POM, and the relatively small expenditures for SOF had often been lumped with larger programs within each service. It was extremely difficult for the services to manage SOF funding with this disjointed (for SOF) system in place. Consolidation under MFP 11 made funds visible to both Congress and to the services, and it provided a measure of protection against spending SOF dollars for non-SOF items. With the passage of the defense authorization bill, Congress passed into law the requirement to reorganize SOF. It would take another two years,

however, before the new US Special Operations Command would be established and operational at MacDill AFB, Florida.⁴⁹

With congressional action directing SOF reorganization signed into law, MAC's Forward Look initiative put the command on track to fulfill Congress's mandate within the Air Force. A Headquarters MAC/XPP point paper, dated 31 December 1986, reviewed the reorganization and listed the reasons MAC supported the initiative. Forward Look would reduce command layers below the Twenty-Third AF by inactivating the 2d AD at Hurlburt Field, and it would establish in-theater wings in Europe and in the Pacific. It would also align combat units by location rather than by mission and by region where they were expected to be employed. The paper concluded that Forward Look created a command structure that could absorb future growth, including the Combat Talon II. In early January 1987 final Air Staff approval of Forward Look was received, and a public announcement was made shortly afterwards. On 20 January 1987 Special Order GA-49 was published, thus putting Forward Look into motion. The 2d AD was inactivated, the USAF Special Operations School was reassigned from 2d AD to the Twenty-Third AF, the 1st SOS was reassigned from 2d AD to the Twenty-Third AF, the 7th SOS was reassigned from 2d AD to the 39th ARRW at Eglin AFB, and the 1st SOW (including the 8th SOS) was reassigned from 2d AD to the Twenty-Third AF; all effective on 1 February 1987.⁵⁰

Included in the January announcement were plans to move the Headquarters Twenty-Third AF, from Scott AFB, Illinois, to Hurlburt Field and to collocate with the 1st SOW. The headquarters would transfer 177 military and 29 civilian positions. On 1 April 1987 USSOCOM was activated at MacDill AFB, Florida, with General Lindsay, USA, commander in chief. On 30 July 1987 General Patterson issued a statement concerning his understanding of the new relationships among MAC, USSOCOM, the other unified commands, and Headquarters, Twenty-Third AF. In the statement Patterson unofficially designated the Twenty-Third AF as the Air Force Special Operations Command and recognized its status as the air component of USSOCOM. On 1 August 1987 the Twenty-Third AF officially moved to Hurlburt Field, and a flag-raising ceremony was held marking the establishment of the new organization in the heart of USAF special operations.⁵¹

* * * * *

With rumors swirling throughout 1985 of possible reorganization options and how those options would affect the Combat Talon force, the three Combat Talon squadrons found it difficult to focus on their primary mission. World events, however, continued to underscore the importance of their role in providing SOF airlift. The 7th SOS had deployed Talons during 1985 in response to the hijacking of TWA Flight 847 and in response to the *Achille Lauro* crisis. In March 1986 a terrorist bomb exploded in a West Berlin disco that was frequented by US service members. Two people were killed, and more than 200 were injured. German and US investigators uncovered a connection between the bombing and the Libyan leader, Muammar Qadhafi. Libya had previously declared the Gulf of Sidra, off its northern coast, as a no-fly zone and had drawn a line across its mouth that it labeled the line of death for any intruders. US Navy fighters routinely had penetrated the illegally imposed no-fly zone and had clashed with Libyan jets. In April 1986 the 7th SOS had deployed for the annual Flintlock exercise when President Reagan responded to the Berlin bombing. Although the 7th SOS Talons did not take part in Operation Eldorado Canyon, more than 100 other aircraft did, with USAFE FB-111 fighter-bombers striking key locations around the Libyan capital of Tripoli. The strike successfully reduced the level of Libyan sponsorship of international terrorism, but the perceived threat to Americans abroad increased after the skirmish.

As part of the ongoing modernization of the Combat Talon fleet, three of the 7th SOS aircraft (64-0523, 64-0555, and 64-0561) received the "+30" or "heavyweight" chip modification during the spring of 1986, thus allowing the aircraft to terrain follow with gross weights up to 165,000 pounds. The capability had been developed during preparation for the Iranian rescue mission in 1980, with the Combat Talons from the 1st SOS and 8th SOS being modified at that time. The fourth 7th SOS Talon, aircraft 64-0566, received its heavyweight modification while at LAS Ontario undergoing its scheduled PDM.⁵² The five-year delay in getting the modification funded and installed on the four European Talons was another indicator to career SOF personnel that the Air Force had not been serious in its effort to modernize the existing Combat Talon fleet. On 18 September 1986 Colonel Casteel assumed command of the 7th SOS from Bortner, who had commanded the squadron since 26 June 1984. Colonel Ferkes filled the position of operations

officer under Casteel, having come to the squadron from the Joint Special Operations Command at Fort Bragg.⁵³

Project 46

At the 8th SOS long-standing limitations of the Fulton STARS were addressed early in 1986 with commencement of the testing of a new and improved recovery system. Since the fatality in April 1982, the STARS had undergone intense scrutiny, and many maintenance procedures either were modified or created so that system reliability could be maintained. By 1985 a refurbishment program for the Talon's sky anchor had been finalized, and the recovery yokes located on the nose of the aircraft had been scheduled for upgrade. Live Fulton recoveries had not been reinstated, however, although the system was cleared for operational use in the event of a real-world contingency requirement. The system had been originally designed to pick up as many as two persons or 500 pounds but was not capable of handling larger loads. Both USA Special Forces and US Navy SEAL teams operated under a team concept in units composed as many as 12 people. Most employment missions involved the insertion of a four- or six-man team into enemy territory for performing either direct action or strategic reconnaissance missions. When the mission was complete, and the team was ready for exfiltration, the two-man recovery system on the Combat Talon was not capable of rapidly extracting the entire team with one pickup. Development began in 1985 to determine if it was feasible to extract four to six personnel at the same time (up to 1,500 pounds total weight) with the Fulton recovery system. With the increased capability, one aircraft could extract up to a six-man team on one pass, thus decreasing the exposure time for the Combat Talon crew and subsequently providing a greater probability of a successful recovery of the team. The four-to-six-man requirement came to be known as Project 46. Warner Robins Air Logistics Center was designated as the STARS item manager for Project 46, with LAS Ontario serving as the prime and sole-source contractor tasked to engineer and modify a test-bed aircraft. The Robert Fulton Company, builder of the original Fulton recovery system, was a subcontractor through Warner Robins and LAS Ontario.⁵⁴

Project 46 consisted of three phases, with Phase I concentrating on the design of a new STARS kit and the production of a prototype.

Project 46 STARS equipment had to be much heavier to enable the successful recovery of 1,500-pound loads and required the redesign of the entire kit. The new kit consisted of larger and heavier fending lines, a larger recovery balloon to lift the heavy pickup line, pickup suits, goggles, new davit assembly, new heavy-duty sky anchor, heavy-duty recovery winch, and a large parabomb to retrieve the lift line. Phase II called for the manufacture of the STARS kits, modification of a test aircraft, and flight tests to validate the new system. During Phase III the system would be certified for live pickups, a process that required the successful pickup of a full array of package weights and personnel combinations.

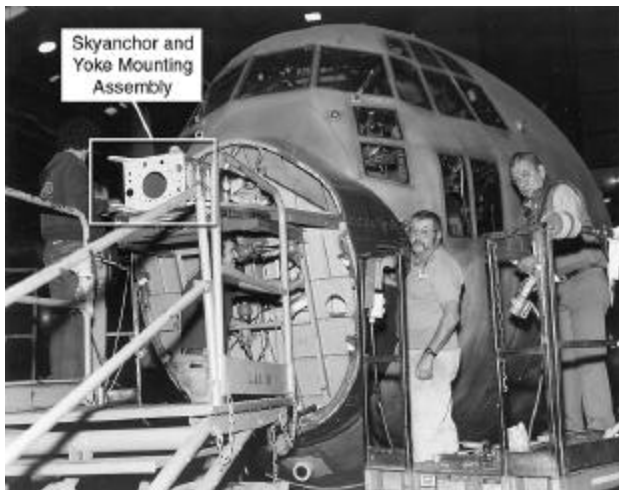


Photo courtesy of John R. Lewis

The nose section of Combat Talon 64-0551 was reinforced by unidentified LAS Ontario workers to accommodate up to 34,000 pounds of stress.



Photo courtesy of John R. Lewis

The C-130H APU replaced the standard GTC on aircraft 64-0551. The modification was required to provide sufficient electrical capacity for Project 46 equipment.

Phase I began in 1985 and continued into 1986. The initial design phase was plagued with unforeseen problems and malfunctions of the new equipment, but by the summer of 1986, the 8th SOS was ready to begin limited flight tests. From February to May 1986, Combat Talon 64-0551 was modified to accommodate the Project 46 system with a much larger hydraulic system and with the installation of an auxiliary power unit to provide power to operate the winch and davit assembly. Maj David L. "Skip" Davenport was selected to command the 8th SOS Talon crew for Project 46. The crew deployed to LAS Ontario and flew its test missions over the dry lake beds at Edwards AFB. Phase II flight-testing began in August of 1986.

A fending line test consisting of two one-man, three two-man, three four-man, and one six-man recoveries was flown on 6 August. The one-, two-, and four-man recoveries went well. The six-man test was accomplished by using a 50-foot section of the heavy six-man line woven on to a two-man pickup line. Instead of cutting the pickup line with the aircraft's fending line, the number 4 propeller cut it. A modification was made in the knives embedded in the fending lines, and on 9

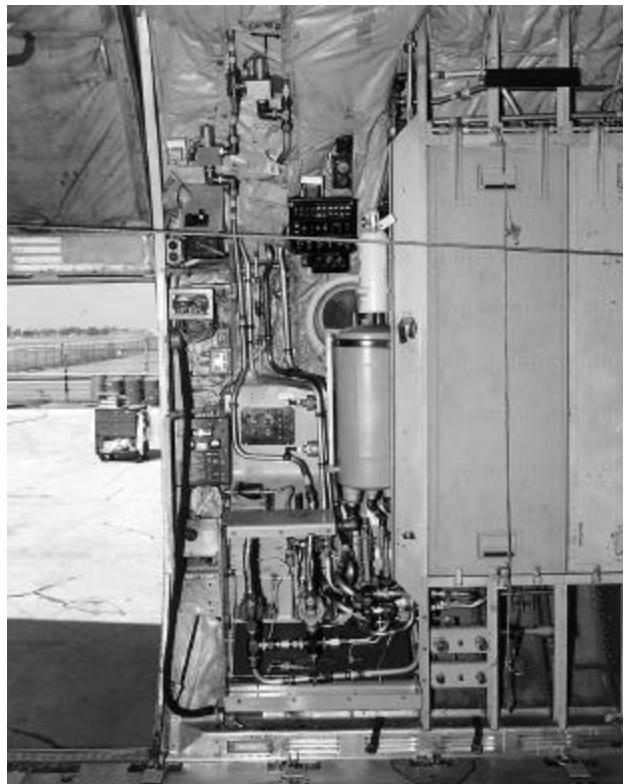


Photo courtesy of John R. Lewis

A 30-gallons-per-minute hydraulic control panel was installed on aircraft 64-0551 just forward of the left parachute door.



Photo courtesy of John R. Lewis

Project 46 nose strain static test for a 15,000-pound static load.

August four successful fendes were completed using the new six-man line and the larger P-46 balloons. On the four test runs, the knives on the aircraft's fending lines cut the pickup line on a single run, but the propellers made a second cut that caused minor sheet-metal damage to the left helicopter refueling pod. Additional test missions were flown during the remainder of August. During September tow tests of two-, four-, and six-man packages were successfully completed. The packages were stable, the lift line could be reached to engage the parabomb, and bringing the packages into the aircraft posed no problems.⁵⁵

With the fending line and tow test complete, the test engineers were ready for actual lift-line engagements by the sky anchor. During the week of 28 September to 4 October, three Project 46 sorties were completed. During the first sortie the attempt to retrieve a six-man package failed due to the inability of the sky-anchor cup to rotate enough turns to lock in the lift line. On the second sortie a standard two-man line could not be picked up by the Project 46 sky anchor. Before the third sortie, the sky anchor was replaced, and the new sky anchor successfully retrieved a standard two-man package. When a heavier load was engaged, however, the sky anchor failed again. A Fulton Company engineer determined that the spring tension in the sky anchor was not sufficient to overcome the force exerted on the lift line at engagement and subsequently decided to increase the spring tension by 80 percent with a new spring. The new spring was designated the 2X.⁵⁶

With the new spring manufactured and installed in the sky anchor, three more Project 46 sorties were flown in November on the 15th, 22d, and 23d. The 15 November sortie was terminated early due to a nacelle overheat indication on one engine. Heavy rains made the normally dry, hard lake bed at Edwards AFB wet and soft, thus causing a week's delay before operations could resume. During the last two sorties, 15 intercepts were attempted, with one being fended after the pilot missed the line with the Fulton yokes. Of the remaining 14 pickups, 11 were successful and three were failures. The Fulton Company representative determined from the test that, although the 2X spring handled most sky-anchor engagements, a heavier 4X spring was needed to ensure consistently successful results. The 2X spring turned only once in the first one-half second after engagement, whereas the system required one and one-half turns in that time. The 4X spring was ordered, and a January 1987 delivery date was established to continue the tests. During the course of the fall test, periodic meetings were held at Wright-Patterson AFB, Ohio, and at Detachment 4, LAS Ontario, to keep track of progress made in the Project 46 tests. As 1986 came to a close, the test team felt that the effort was on track and looked forward to completing the tests in early 1987.⁵⁷

* * * * *

Jahnke had moved mountains to keep his Combat Talons operational in the Pacific. As had been the case for the other two Talon squadrons, his operations tempo had been extremely high, having participated in annual SOF training events and exercises in Korea, Thailand, the Philippines, and throughout the Pacific area. To correct the long-standing maintenance deficiencies experienced since relocating to Clark AB, the squadron was assigned an in-house maintenance organization by midyear. Some of the personnel transferred from the 374th Operational Maintenance Squadron located at Clark AB, but the majority came to the squadron from stateside locations. By 27 June personnel had arrived to form the nucleus of the squadron's dedicated maintenance flight, and by year's end 140 maintenance specialists had been assigned to the special operations squadron.⁵⁸

During most of 1986 the 1st SOS was plagued with a lack of airframes, especially during the third quarter of the year. Aircraft 62-1843 and 63-7785 were both in PDM at LAS Ontario, and

aircraft 64-0571 was transferred back to the 8th SOS at Hurlburt Field to await a scheduled wing modification, having been restricted from low-level flight due to wing cracks. To compensate for the loss of the three aircraft, the 8th SOS loaned aircraft 64-0572 to the 1st SOS. Along with assigned aircraft 64-0565, the squadron struggled to fulfill all its commitments and at the same time keep its crews current in the many Combat Talon events. By year's end, however, 62-1843 and 63-7785 were back at Clark AB, and the aircraft shortage crisis temporarily eased.⁵⁹

1987: Forward Look Becomes a Reality

With the public announcement by the Twenty-Third AF of the implementation of Forward Look in January 1987, the New Year promised to be one of transition for the three Combat Talon squadrons. By year's end the Twenty-Third AF would consist of six wings with 14,500 personnel and 320 aircraft assigned worldwide. At the 1st SOS the squadron expanded by 70 maintenance personnel as it stood up its specialized maintenance capability. It would be another two years before the Pacific wing, which was designated as the 353d SOW, would become operational, and in the interim period, the Twenty-Third AF was determined to make things better for the often isolated squadron. Jahnke began to see improvements in his maintenance reliability, but his aircraft availability remained a problem. Since Desert One and the renewed emphasis on upgrading the Combat Talon, the squadron had operated with two to three aircraft, with its remaining assets either in PDM or in some phase of modification at LAS Ontario. The first half of the year once again saw the squadron in SEA, participating in exercises in Thailand and in Malaysia. The annual JCS exercises in Korea (Team Spirit and Foal Eagle) were also supported with all available squadron assets.

On 5 June Colonel Doherty, who had been the squadron operations officer, assumed command of the unit from Jahnke. General Hargrove, vice commander of the Twenty-Third AF, officiated at the ceremony. Col Terry Silvester became Doherty's new operations officer. Under the new leadership, the operations tempo continued high throughout the year, with the squadron deploying nine times to Thailand and eight times to Korea.⁶⁰

* * * * *

When 2d AD deactivated on 1 February 1987, the 7th SOS at Rhein Main AB, Germany, was reassigned to the 39th ARRW at Eglin AFB. Colonel Hobson, a former commander of the 8th SOS, was the incumbent 39th commander.⁶¹ Later in the year the 39th ARRW was redesignated the 39th SOW in line with Patterson's Forward Look plan. In Europe Casteel led the 7th SOS in deployments to Morocco, Spain, Denmark, and the United Kingdom. The squadron also deployed to Toulouse, France, for a joint/combined exchange training (JCET) event. The deployment to France marked the first time in several years that the squadron had exercised in that country with host-nation forces. Training accomplishments included low-level operations, HALO and static-line personnel airdrops, ECM training, pilot proficiency sorties, and the interfly of a 7th SOS pilot in a French C-160 aircraft. The squadron also deployed one aircraft and crew to the Central African nation of Zaire for another JCET event. During the seven-day deployment, 615 personnel were either static-line or HALO air-dropped from the Combat Talon.⁶² Professional relationships developed with France during the earlier Toulouse deployment helped the Talon crew satisfy exercise requirements in Zaire.

During its theater deployments, aircraft maintenance requirements continued to challenge the squadron. Unlike its sister squadron in the Pacific, the 7th SOS had maintained an Avionics Flight that was responsible for keeping the specialized ECM equipment operational. It had fared better than the 1st SOS, but the squadron still relied on the 435th TAW for other maintenance support, and its aircraft were assigned to the host wing. On 25 May 1987 the squadron began to assume more control of its maintenance when one of its aircraft and the aircraft's crew chief were transferred from the 435th TAW to the 7th SOS. Over the next two weeks, the squadron took control of the two remaining Talons and their crew chiefs. The squadron's fourth Combat Talon was in PDM at LAS Ontario and was transferred to the 7th SOS when it returned to Rhein Main AB later in the year. On 15 June the squadron began receiving personnel from various specialist shops (instruments, hydraulics, engines, etc.), and by 1 July it was responsible for all aircraft maintenance functions except sheet-metal repair, isochronal inspections, aircraft refurbishment, fuel-cell and shop-level maintenance, all of which remained the responsibility of the 435th TAW.⁶³ The squadron was basically responsible for

all on-aircraft maintenance, and the personnel required to perform that function was assigned to it.

Aircraft improvements continued to be a high-emphasis item. Aircraft 64-0566 received the heavyweight chip during its PDM at LAS Ontario and returned to Rhein Main AB in the spring. With its arrival in Europe all Combat Talons in the fleet could fly up to 165,000 pounds utilizing TF radar. Combat Talon 64-0523 became the first Talon to be modified with the improved Fulton two-man STARS, thus making it the first aircraft to be certified for live pickups since the 1982 fatality.⁶⁴ In the following three years, the remaining eight Fulton Clamp aircraft would be modified, but no live Fulton recoveries would be performed during the remaining life of the system.

At the 8th SOS aircraft 64-0567 was delivered to LAS Ontario on 12 November 1986 for its scheduled PDM and was subsequently designated as the first Combat Talon aircraft to receive the SOF-I modification. Throughout 1987 the aircraft remained at LAS Ontario, thus reducing the number of aircraft available at Hurlburt Field. In 1987 and for the next several years, almost half of the Combat Talon fleet remained at LAS Ontario undergoing either PDM or other system upgrades. Twenty-year-old systems on the Combat Talon were replaced with technology designed to protect the aircraft for the remainder of the century. The short-term result of the aggressive upgrade program was that few Combat Talons were available for operational use.⁶⁵ The 8th SOS struggled to fulfill its operational requirements with a maximum of four aircraft available, one of which was dedicated to the formal Combat Talon School. (The overseas units averaged two aircraft on the ramp during the late 1980s and early 1990s.)

During 1987 the 8th SOS stayed busy supporting the many JCS exercises and deploying in support of joint special operations taskings. The squadron deployed to Honduras, Jordan, and Egypt and also supported JCS exercises Flintlock in Europe and Foal Eagle in Korea. As had been the case in previous years, some exercises overlapped each other and prevented the squadron from supporting all taskings with the limited number of aircraft possessed. One Combat Talon deployed to Jordan for an exercise in the March–April period and then joined the Flintlock exercise at Moron AB, Spain, after leaving the Middle East. Immediately following Flintlock, one Talon participated in Solid Shield, operating out of home station and flying missions into Central America.

The Talon flew four Solid Shield missions, one of which was a long-range HSSLADS resupply into Honduras.⁶⁶

From 24 June to 11 July, the squadron deployed one MC-130E to Nellis AFB, Nevada, and participated in Red Flag 87-04. The challenging exercise concentrated on electronic warfare operations and pitted the Combat Talon crew against both ground-based threats and interceptor aircraft. The major limitation of the exercise was that it was daylight only, which put the Talon crew at a distinct disadvantage against the threats. The after action report included a request for a nighttime Red Flag exercise dedicated to SOF. In July the squadron deployed one MC-130E to Cairo, Egypt, for Bright Star 87. The long exercise was plagued by problems identified during previous exercises, including inadequate billeting and messing facilities. The Hurlburt Field contingent did not return to home station until early September.⁶⁷

Beginning in March 1987 the 8th SOS deployed in support of USA ranger sustainment training in seven- to 10-day blocks spaced throughout the year. Additional tasking included participation in a joint capabilities exercise (Capex) at Pope AFB in September, and a large-scale readiness exercise named Casino Gambit, which lasted three weeks in October and November at Little Rock AFB, Arkansas. Bilateral training with other joint forces was conducted for one-week periods in November and December.⁶⁸ The varied events and level of tasking during these training periods could not be found anywhere else in the SOF community. By regularly exercising with joint special operations forces, the squadron maintained the high level of proficiency required to execute the challenging joint mission.

Along with its other taskings, the 8th SOS was preparing for the arrival of the Combat Talon II. During 1987 five more C-130H aircraft (87-0023, 87-0024, 87-0125, 87-0126, and 87-0127) were accepted by the Air Force and sent to LAS Ontario for HSSLADS and IFR modifications.⁶⁹ The first operational CT II aircraft was scheduled to arrive at Hurlburt Field in August 1988 after its modification by E-Systems and flight testing at Edwards AFB. As 1987 passed, however, continuing delays with the CT II radar threatened the new aircraft's delivery schedule.

Patterson's Forward Look initiative moved ahead during 1987 with many existing Air Force rescue units being either deactivated or converted to special operations squadrons. USSOCOM had

been activated on 1 June at MacDill AFB, Florida, followed by the move of the Twenty-Third AF to Hurlburt Field, effective 1 August. On the surface it appeared that the previous year's legislation directing the reorganization of special operations forces was on track. The issue of establishing the Office of the Assistant Secretary of Defense for Special Operations and Low-Intensity Conflict (ASD/SOLIC) was another issue altogether. The Defense Department interpreted the 1986 legislation directing the establishment of ASD/SOLIC as authorization for another ASD, while Congress meant for the new position to come from within resources already authorized. After much debate Congress agreed to authorize the additional civilian billet. Even with the new billet, DOD was not eager to fill the position. Many SOF programs (including Army, Navy, and Air Force) were being managed by existing ASDs, and there was a great reluctance by them to give up highly visible SOF responsibilities. As the year passed, little progress was made in identifying a candidate for the ASD/SOLIC position that was acceptable to both the Department of Defense and to Congress.⁷⁰ Convinced that DOD was not yet serious about SOF reorganization, Congress enacted another piece of binding legislation on 4 December 1987. Section 1211, P. L. 100-180, was a piece of "follow-up" legislation designed to clarify Congress's intent regarding its desire for DOD SOF reorganization. The new law designated the ASD/SOLIC as the principal civilian adviser to the secretary of defense on special operations and low-intensity conflict matters. It directed the secretary of defense to publish a charter for the ASD/SOLIC. It also designated the secretary of the Army as the acting ASD/SOLIC until the office was formally filled for the first time. Finally, the law gave USCINCSOC head of agency authority to facilitate the development and procurement of special operations peculiar hardware.⁷¹

1988: The Combat Talon II Program Crisis

Despite the passage of the binding legislation in 1986 and 1987 that was designed to force the three services to properly fund and modernize SOF, programming and budgeting problems continued throughout 1988. To clarify segments of the two previous laws, Congress passed a third piece of legislation on 29 September 1988. The 1988 legislation (P. L. 100-456) required that CINCSOC prepare and submit a POM that included all SOF program recommendations and budget proposals. CINCSOC was to exercise authority, direction,

and control over expenditures of funds for all forces under his command, including those forces assigned to its air component (the Twenty-Third AF) that were designated SOF. The authority also included forces assigned to theater-unified commands (SOCEUR and SOCPAC for Combat Talon I).⁷² With the three pieces of legislation enacted, Congress had completed its quest to direct the services to fix SOF. Over the coming years, programs begun by MAC and managed by the Twenty-Third AF would result in a far superior Combat Talon force than the one that MAC inherited in 1983. A huge price would be paid, however, as the Talon Is went through extended periods in modification, and the Combat Talon II initial operational capability slipped into the 1990s.

* * * * *

In the Pacific the 1st SOS established its own dedicated maintenance section during 1987. To validate the new capability, the Headquarters MAC IG team administered a maintenance evaluation (MSET) to the squadron from 24 February to 1 March 1988. The squadron received an overall excellent rating, and during the out briefing, the 1st SOS maintenance section was lauded for having the "best small maintenance Job Control [that the team had] ever seen." The MSET team also recognized the squadron for having the "cleanest, best looking C-130s in the Pacific." The esprit de corps of the Combat Talon unit was apparent. Doherty had finally turned around the 1st SOS's most severe problem, thanks to the assignment of his own maintenance capability.⁷³

Before the MSET the squadron deployed one aircraft and two crews to Lawson AAF, Georgia, to participate in a quarterly joint training exercise. From 4 January to 3 February, the squadron worked closely with exercise participants, refining their NVG skills and introducing its crews to the difficult counterterrorist mission. The deployment marked the first time in several years that the squadron was able to participate in a US-based exercise due to aircraft availability and the level of tasking in the Pacific. During the deployment the squadron flew 95 hours, which included both the deployment and redeployment flying time from Clark AB to the United States.⁷⁴

After the MSET the squadron deployed one Combat Talon to Wewak International Airport, Papua, New Guinea, and flew joint training missions with USA Special Forces soldiers. The deployment provided valuable experience flying in the austere environment of the island nation.

During the following months, the 1st SOS deployed to Thailand, Malaysia, and Korea for both bilateral and JCS exercise tasking.⁷⁵ From 16 to 21 August, two aircraft and three crews deployed to Guam for Exercise Vector Hawk. The no-notice exercise was based out of Andersen AFB and provided the squadron the opportunity to work with some of the same units that it had participated with in the quarterly exercise the preceding January.⁷⁶

During Foal Eagle 88 the 1st SOS was administered an ORI by the MAC IG. From 23 October to 17 November, the squadron deployed to Korea and flew its traditional low-level infiltration, resupply, and exfiltration missions. The 1st SOS received grades of excellent or outstanding on all graded events and received an overall excellent for its composite grade. After returning to Clark AB, the IG administered a unit evaluation inspection (UEI) to measure the administrative abilities of the squadron. Having been deployed to Korea for an entire month before the evaluation, the UEI proved to be taxing on squadron personnel. Numerous administrative functions were lauded by the IG during the out briefing, including the squadron ECM shop, maintenance job control, and the squadron Crisis Action Team. For the UEI the squadron received an overall satisfactory rating. The two evaluations, along with the MSET earlier in the year, validated the unit's ability to perform both its peacetime and wartime missions.⁷⁷

In Europe the 7th SOS continued to support an expanded SOCEUR JCET program. Early in 1988 the squadron deployed to Kenitra AB, Morocco, and air-dropped Moroccan paratroopers based at Rabat. More than 275 personnel were air-dropped using static-line and HALO procedures. In-flight refueling, night mountain terrain following in the rugged Atlas mountains, cargo drops, and NVG airland operations also were completed. In addition to Morocco, the squadron deployed to Norway, Italy, and the United Kingdom for JCETs and completed valuable training events not available in Central Europe.⁷⁸ During April and May the entire squadron deployed to RAF Sculthorpe, UK, for Flintlock 88. For the first time one MC-130E and 70 personnel deployed to Zaire for a 20-day subexercise named Mbote. While in the Central African nation, the Talon crew flew 25 missions, including 20 infiltrations, four exfiltrations, and one resupply. The large scope and level of activity during the Flintlock exercise challenged the squadron and provided the best training of the year.⁷⁹

After the squadron returned to Germany from Flintlock, a 7th SOS crew (flying aircraft 64-0523) experienced a collapsed nose gear during a pilot proficiency sortie at Niederstetten German Air Force Base (GAFB), Germany. The accident resulted in extensive damage to the aircraft. A USAF aircraft recovery team successfully removed the aircraft from the runway, and a repair team from Warner Robins AFB, Georgia, was dispatched to make needed repairs. For the next four months, the Talon underwent repair of the underbelly and replacement of the failed nose gear assembly. The aircraft was returned to the squadron in late fall of 1988.⁸⁰

On 1 August 1988 Col George Ferkes assumed command of the squadron from Casteel. Ferkes had participated in the 1980 Iranian rescue mission, flying with Brenci in the first Talon to land at Desert One. Colonel Dickenson served as Ferkes's operations officer until the arrival of Norm McCaslin later in the year.⁸¹

At the 8th SOS the major challenge for 1988 revolved around aircraft availability. Along with its formal Combat Talon School commitment, the squadron supported test programs that were essential to Talon modernization. Talon 64-0567 had been modified into the Phase I, SOF-I configuration and was dedicated to the SOF-I test program. As such it was not available to the squadron for extended periods. When the test profile did allow occasional operational use, only the few personnel qualified in the new SOF-I system were authorized to fly the aircraft. Combat Talon 64-0551 had been modified for the Project 46 test program and was involved in periodic testing of that new system. From 23 May to 22 June, Davenport and the Project 46 crew deployed to LAS Ontario for continued Phase III testing. Another ongoing program that required a dedicated aircraft and crew was Volant Knight, which focused on ECM improvements for the Combat Talon. On 6 July 1988 Colonel Thigpen assumed command from Colonel Harbison, who had been the commander since 1986. Like Ferkes at the 7th SOS, Thigpen had come to the squadron after completing a joint tour (at SOCEUR) and being certified as a joint service officer (JSO). With the emphasis on jointness brought on by congressional legislation over the previous three years, JSO status for potential SOF commanders had become extremely important.

Just before the 8th SOS change of command, Air Staff announced that the Combat Talon II projected initial operational capability had been

slipped indefinitely due to continuing unsatisfactory progress of the aircraft's radar. The USAF conducted a thorough program review during the latter half of 1988, which resulted in the program being restructured and having a more realistic IOC date established. During 1988 five more C-130H aircraft were delivered—88-0191, 88-0192, 88-0193, 88-0194, and 88-0264—thus bringing the number of CT II identified airframes delivered to the USAF to 16 aircraft. The five aircraft were cycled through LAS Ontario's Chino facility for initial modifications then put in long-term storage at Lockheed-Georgia, and at Rickenbacker AFB, Ohio, awaiting further modification at E-Systems. Flight testing at Edwards AFB and CT II modifications at Greenville continued on the first 11 aircraft. For the 8th SOS the full impact of the slip of the Combat Talon II IOC date began to unfold during the fall of 1988.

After assuming command and settling into the job, Thigpen focused on the number of aircraft available to the squadron for operational use. The Talon I test programs, along with PDM and modification schedules, steadily reduced the number of available aircraft to the 8th SOS throughout the fall of 1988, with an all-time low of one Talon I aircraft projected to be available in the spring of 1989. Without the Combat Talon II aircraft to offset the loss of the Talon Is, the squadron could not fulfill its commitments. With responsibility for the formal Combat Talon School and facing an ORI in January, the situation had to change. At the annual Combat Talon Management Review conference held at LAS Ontario in the fall of 1988, the problem was surfaced, and possible solutions were discussed. During follow-up actions spearheaded by the Twenty-Third AF, the modification schedule was adjusted by slipping several input dates. Agreements also were reached with SOCPAC and SOCEUR that essentially assured that the 8th SOS would not fall below four aircraft being assigned at any time. Four aircraft available at Hurlburt Field were the minimum required to keep the Combat Talon School functioning, keep assigned crews proficient, and support joint requirements with a two-aircraft package. The agreement would leave the 1st and 7th SOS with only two Combat Talons much of the time, but each squadron was augmented with an assigned slick C-130E to provide additional pilot- and navigator-proficient sorties. The 8th SOS also was assigned a C-130E for basic-proficiency flying.

With a plan developed to ensure Talon I availability, the 8th SOS prepared for its upcoming ORI scheduled for January 1989. The 1st SOW had not been given an ORI since the December 1985 Purple Duck evaluation at Biggs AAF. Since that time MAC had completely rewritten ORI criteria by which the wing would be evaluated. Using a building-block approach, the wing conducted limited recall and mobilization exercises and then put the parts together during a local ORE. By December a second ORE had been completed, and wing leadership felt that they were ready for the following month's evaluation.

1989: Project 46 Is Terminated

Although Forward Look was still in the implementation phase in January 1989, the ORI of the 1st SOW would be the first test of the Twenty-Third AF's reorganization. With only one SOF wing in the numbered air force, the 1st SOW represented the majority of USAF's SOF capability. The 1st SOW ORI, named Jaguar Bite, was conducted from 9 January to 17 February 1989. The US Special Operations Command sponsored the exercise. It was the first JCS-coordinated, USSO-COM-sponsored exercise and had the largest participation of Air Force SOF assets in the history of Air Force SOF. Along with four Combat Talons from the 8th SOS, the 1st SOW deployed MH-53H Pave Low helicopters and AC-130H gunships to Fort Campbell, Kentucky, when alerted by the MAC IG team. Weather was a significant factor during the exercise, with wind-chill factors recorded at minus 70 degrees Fahrenheit in the Montana exercise area and minus 50 degrees in Michigan.⁸² Elements of the USA's 1st Special Operations Command provided most of the ground forces for the ORI. The 39th SOW at Eglin AFB also participated with its assigned HC-130 and MH-60 aircraft, but they were not part of the 1st SOW's evaluation.

The exercise was unprecedented in scope and duration, taking place over a 40-day period and encompassing operations based out of Hurlburt Field, Pope AFB, and Fort Campbell. Rotary-wing operations were conducted as far north as the upper peninsula of Michigan. The western exercise area centered on Helena, Montana, and primarily involved the 8th SOS Combat Talons. Despite the weather and the extreme distances flown, the most grueling evaluation in SOF history resulted in an overall rating of excellent by the MAC IG. Some problems surfaced in command and control and in joint coordination, but

the ORI overwhelmingly endorsed Forward Look initiatives.⁸³ The 8th SOS was evaluated on every Combat Talon operational capability that it possessed, including a Fulton STARS recovery completed during a driving rainstorm towards the end of the evaluation.

As USSOCOM matured General Lindsay, commander in chief, Special Operations Command (CINCSOC), determined that the effort being expended by the small Twenty-Third AF staff on non-SOF related matters was unacceptable. He requested Headquarters USAF (over the objections of General Patterson) to divest his air component of all non-SOF units. The Air Staff officially took General Lindsay's request under consideration. Partially in response to General Lindsay's request and with the ORI complete, CINCMAC announced on 25 February 1989 his decision to redesignate the ARRS the Air Rescue Service and to reorganize, rebuild, and reassign rescue-oriented units from the Twenty-Third AF to the newly created ARS. CINCMAC established a target date of 1 August 1989 for the transfer of rescue forces.⁸⁴

The Pacific-based special operations wing was designated the 353d SOW under Forward Look and was activated at Clark AB, Philippines, on 6 April 1989. Plans to move the 39th SOW from Eglin AFB to Rhein Main AB, Germany, were also finalized. On 8 May 1989 the 39th SOW raised its flag in Germany, thus putting into place the two overseas wings envisioned in Forward Look. As announced earlier in the year, on 1 August 1989 Headquarters ARRS was redesignated Headquarters ARS and was formally established at McClellan AFB, California. Remaining rescue-oriented units were transferred from the Twenty-Third AF to the new ARS. Thus, the vision of an all-SOF command formulated in December 1985 by General Patterson finally became a reality. On 7 September 1989 General Eggers succeeded Patterson as the commander of the Twenty-Third AF.⁸⁵

At Clark AB January 1989 brought about a change of command for the 1st SOS. On 27 January Col Terry Silvester assumed command of the squadron from Doherty. Silvester's immediate task was to prepare a suitable beddown for the new Pacific wing, the 353d SOW. Effective 6 April 1989, the 1st SOS was assigned to the 353d SOW, which was established at Clark AB that same day. Throughout the year, the new wing grew and expanded its capabilities as personnel arrived. Traditional wing functions that had been assigned

to the 1st SOS were transferred to the 353d SOW, including the squadron's maintenance section, its life-support section, and the squadron's communications element.⁸⁶

With the new wing gradually absorbing the administrative workload of the squadron, Silvester was able to concentrate on his heavy exercise and bilateral training program. During 1989 the 1st SOS deployed five times to Thailand (one week each), three times to Korea (Team Spirit, Ulchi Focus Lens, and Foal Eagle), twice to Australia, and once to Malaysia.⁸⁷ From 20 to 24 August the squadron also deployed to Andersen AFB, Guam, for a no-notice contingency exercise. Skills developed during the previous quarterly training exercise in the United States were put to the test, and the squadron did exceptionally well. The exercise validated the squadron's ability to operate in the demanding joint arena.⁸⁸ With Foal Eagle in Korea during the fall, the 1st SOS completed an ambitious year filled with challenges and successes.

At Rhein Main AB the 7th SOS experienced a marked improvement in its launch reliability and in-commission rate, which was primarily due to the maturing of its maintenance section. It had assumed control of its assigned aircraft from the 435th TAW the previous year and had developed an outstanding relationship between assigned operations and maintenance personnel. For most of the year, the 7th SOS possessed three Combat Talon aircraft and one slick C-130E. Along with its traditional training locations, the squadron deployed for the first time to Cameroon, Africa, during the spring of 1989. As had been the case in the Pacific, some assigned squadron functions were transferred to the 39th SOW when the wing raised its flag at Rhein Main AB on 8 May, but the transition was a seamless one. The squadron had been assigned to the 39th SOW during the previous year and was familiar with the command arrangement. Modernization initiatives continued to become reality as the European Talons received an NVG-compatible cockpit lighting panel and a cargo compartment NVG lighting kit. The modifications enhanced the aircrew's ability to operate without any overt lighting while utilizing NVGs.⁸⁹

Since 1967 the 7th SOS had participated in the annual JCS-directed Flintlock exercise series during the April and May period. For 1989 the exercise was restructured and divided into three phases. Phase I was combined with a major NATO command post exercise known as Wintex/Cimex. During Phase I the 7th SOS deployed personnel to various exercise locations for the 14-day exercise.

Phase II consisted of three subexercises (Moscos, Muflone, and Mbote) that resembled the traditional Flintlock FTX. Moscos was a 13-day exercise conducted out of Rhein Main AB, with employment missions flown into Norway. Muflone in Italy and Mbote in Central Africa were both three weeks in duration and consisted of deployments of 7th SOS aircraft and personnel.⁹⁰ Phase III of Flintlock 89 was a no-notice, contingency-response exercise conducted from 1 to 7 September. The 7th SOS, operating under the OPCON of SOCEUR, conducted infiltrations that supported a follow-on mass airdrop of paratroopers. The scenario included the transload of personnel from an MH-53H Pave Low helicopter to a 7th SOS Combat Talon during the exfiltration portion of the exercise. The entire no-notice exercise was flown without any late takeoffs or delays. All training objectives were met, as the European SOF unit again validated its ability to perform the demanding joint mission.⁹¹

In preparation for Flintlock Phase III, the 7th SOS deployed one Combat Talon and an augmented crew to the United States to participate in JRT 89-3 from 16 July to 3 August 1989. Working with other joint forces, the squadron flew low-level terrain-following, NVG airland, IFR, and combat onload/off-load training events. The quality and amount of training received during the two-week exercise far exceeded that which could be found in Central Europe. By participating in the quarterly joint exercise program, the 7th SOS was able to maintain the skills required to support contingency operations. Later in the year, from 6 through 18 December, the squadron also participated in JRT 90-1.⁹² As the aircraft was redeploying to Rhein Main AB on 18 December, events in Panama escalated, and on the following day, Operation Just Cause kicked off. As had been the case six years earlier during Operation Urgent Fury, the 7th SOS crew just missed participating in the contingency.⁹³

Daily operations settled down a bit at the 8th SOS after Jaguar Bite. The grueling ORI had taken its toll on the entire wing. With four aircraft committed to the exercise, the 8th SOS flew 325 hours during late January and early February 1989.⁹⁴ The long missions and harsh weather completely drained both aircrew and support personnel. After a short rest at home station, the daily grind resumed without another pause for the remainder of the year. The SOF-I Phase I test on aircraft 64-0567 was completed during the first half of the year, with the system upgrades being

certified for the entire Combat Talon I fleet. The major improvement that Phase I SOF-I gave to the Combat Talon was a much improved navigation capability. The CMA-880 Doppler computer and the old LN-15J inertial navigation system were replaced by two inertial navigation systems that were tied together by two mission computers using a 23-stage Kalman filter. The resulting accuracy and system reliability vastly improved the Combat Talon's ability to execute its long-range, low-level mission in remote areas of the world.⁹⁵ The 8th SOS Combat Talons were the first scheduled for the SOF-I modification, with all squadron aircraft to be modified by early 1990.

For the third consecutive year, the squadron deployed to Jordan for a JCS-coordinated exercise. On 1 June Combat Talon 64-0572 departed Hurlburt Field for a nonstop flight to the Middle East. In-flight refuelings were successfully completed near Newfoundland, off the coast of Spain, east of Italy, and just south of Greek-controlled airspace. Entering low level near Al Aqabah, Jordan, the crew flew a one-hour route to an airdrop on Gahtos DZ near Azrak, Jordan. The crew then landed at Azrak and joined the exercise in progress. In all, the long-range infiltration mission took 24.6 hours to complete and was the longest Combat Talon flight since the early 1980s. During the course of the exercise, two multiship highway landings were conducted, with transload of personnel being accomplished between the Combat Talon and Jordanian rotary-wing aircraft. A desert landing also was made in the valley of Wadi Rum, where exercise ground



Photo courtesy of John R. Lewis

Aircraft 64-0551 intercepts a six-man lift line during Project 46 system testing.



Photo courtesy of John R. Lewis



Photo courtesy of author

The radome on aircraft 64-0551 failed after a 1,500-pound pickup. The program was suspended for a year while a new, stronger radome was developed.

forces participating in a cross-training exercise were resupplied.⁹⁶

Aircraft 64-0551 was deployed to LAS Ontario for a Project 46 Phase III test from 8 August to 15 September. Over the previous two years, the test effort had faced several delays, including one after the failure of the aircraft's nose radome during a heavyweight recovery. The radome was redesigned, strengthened, and installed on aircraft 64-0551 for the 1989 test. The objective of Phase III was to man-rate the Project 46 recovery system, thus allowing live pickups under operational conditions. Skip Davenport continued as the Project 46 aircraft commander and successfully picked up a variety of packages over the course of the test. With two-thirds of the test successfully completed, a 1,500-pound heavyweight recovery was attempted. During the initial stage of the recovery, the sky anchor engaged the heavy lift line, and the package came off the ground normally. Moments later the sky anchor failed, and the weight of the package stripped the line back through the sky anchor. The package fell to the hard surface of the Edwards AFB dry lake bed. Investigation revealed that the sky anchor had

failed internally, thus allowing the mechanism to release the lift line. After the sky anchor failure, the program was suspended, and no additional Project 46 recoveries were attempted. The crew returned to Hurlburt Field while the program's status was determined.

A thorough review of the Project 46 program was conducted by Twenty-Third AF, USSOCOM, and LAS Ontario test engineers during the fall of 1989. With an improved MH-53H Pave Low helicopter capability and the programmed fielding of the tilt-rotor JVX, USSOCOM decided to cancel Project 46. Aircraft 64-0551 was eventually demodified from the Project 46 configuration during a scheduled PDM at LAS Ontario, and the capability to extract four to six men, or up to 1,500 pounds of equipment, passed into history. Project 46 marked the last major effort by the Air Force to develop an improved Fulton recovery capability.⁹⁷

Combat Talon II-designated aircraft 88-0195 and 88-1803 also were delivered to the Air Force during 1989, thus bringing the number of delivered C-130H aircraft to 18. As 1989 closed the



Photo courtesy of John R. Lewis

The test team that brought Project 46 to the threshold of success in 1989. Standing left to right: Witherspoon, James Avant, Larry Beattie, Mike Duffie, Bill Fowler, Gene Koppe, Dave Payne, Tony Walton, Ann Fulton, John Plasko, Russ Tharp, Dave Tarpley, Frank Sharkany, and Bob Almanzar. Kneeling left to right: Jim Hobbs, John R. Lewis, Tim Kerns, Bob Neal, Don Nicholson, Denis Freizvee, Robert Fulton, Dee Newberry, Larry Edwards, and George Adams.

new aircraft were in various states of modification, flight testing, or long-term storage.⁹⁸ The available CT I fleet would be tested in late December when Manuel Noriega created a crisis in Panama that required US intervention to protect

American lives. For the third time during the decade of the 1980s, the Combat Talon would be called upon to deliver special operations forces into combat to defend vital US interests abroad.

Notes

1. Aircraft Records, AFTO Form 95, aircraft 64-0571, Combat Talon Archive, HQ AFSOC/HO, Hurlburt Field, Fla.
2. Official Paper, "AFSOC: The Air Force's Newest Command," Lt Col Jerry L. Thigpen, USAF, US Army War College Military Studies Program (Carlisle Barracks, Pa.: Army War College, 1991), 37.
3. Col William G. Boykin, USA, "The Origins of the United States Special Operations Command," n.d., originally published as a US Army War College Military Studies Program paper, "Special Operations and Low-Intensity Conflict Legislation: Why It Passed and Have the Voids Been Filled?" (Carlisle Barracks, Pa.: Army War College, 1991), 2.
4. "AFSOC: The Air Force's Newest Command," 38-39.
5. Ibid., 40.
6. History, 2d Air Division, 1 January-31 December 1984, 16th Special Operations Wing historian file, Hurlburt Field, Fla., vol. 1, I-32 to I-33.
7. Ibid., I-32.
8. Ibid., I-33 to I-34.
9. Ibid., I-57.
10. Ibid., I-46.
11. Ibid., I-50.
12. Ibid., I-49.
13. Ibid., I-33.
14. Ibid., I-85.
15. Ibid., I-86 to I-88.
16. Aircraft Records, AFTO Form 95, aircraft 83-1212.
17. Boykin, 8.
18. History, 2d Air Division, 1 January-31 December 1984, vol. 1, I-93.
19. Ibid., I-93 to I-94.
20. Ibid., I-95.
21. Ibid.
22. Ibid., I-66 to I-67.
23. Ibid.
24. Ibid., I-67 to I-68.
25. Ibid., I-68.
26. Ibid., I-14.
27. History, 2d Air Division, 1 January-31 December 1985, vol. 1, 1225.

PRAETORIAN STARSHIP

28. History, 2d Air Division, 1 January–31 December 1984, vol. 1, II-189, II-211, II-291.
29. *Ibid.*, II-305.
30. History, 2d Air Division, 1 January–31 December 1985, vol. 2, II-149.
31. *Ibid.*, vol. 8, 1217.
32. History, 2d Air Division, 1 January–31 December 1988, 1212.
33. History, 2d Air Division, 1 January–31 December 1985, vol. 2, II-185.
34. *Ibid.*, II-188.
35. *Ibid.*, II-189.
36. “AFSOC: The Air Force’s Newest Command,” 43–44.
37. Boykin, 5.
38. Aircraft Records, AFTO Form 95, aircraft 84-0475, 84-0476, 85-0011, 85-0012, and 86-1699.
39. History, 2d Air Division, 1 January–31 December 1986, vol. 1, I-6 to I-7.
40. *Ibid.*, I-7.
41. *Ibid.*
42. “AFSOC: The Air Force’s Newest Command,” 44.
43. *Ibid.*
44. History, 2d Air Division, 1 January–31 December 1986, vol. 1, I-9.
45. *Ibid.*, I-9 to I-10.
46. *Ibid.*, I-10.
47. *Ibid.*, I-17 to I-18.
48. “AFSOC: The Air Force’s Newest Command,” 45.
49. *Ibid.*
50. History, 2d Air Division, 1 January–31 December 1986, vol. 1, I-19 to I-20.
51. “AFSOC: The Air Force’s Newest Command,” 45–46.
52. History, 2d Air Division, 1 January–31 December 1986, vol. 8, 267.
53. *Ibid.*, 2.
54. History, 2d Air Division, 1 January–31 December 1986, vol. 1, I-37 to I-38.
55. *Ibid.*, I-42 to I-43.
56. *Ibid.*, I-43.
57. *Ibid.*, I-43 to I-44.
58. History, 2d Air Division, 1 January–31 December 1986, vol. 8, 814.
59. *Ibid.*
60. History, 1st Special Operations Squadron, 1 January–30 June 1987, Combat Talon Archive, HQ AFSOC/HO, Hurlburt Field, Fla., 8.
61. History, 39th Aerospace Rescue and Recovery Wing, 1 January–30 June 1987, Combat Talon Archive, HQ AFSOC/HO, Hurlburt Field, Fla., 2.
62. History, 7th Special Operations Squadron, 1 July–31 December 1987, Combat Talon Archive, HQ AFSOC/HO, Hurlburt Field, Fla., 13–14.
63. *Ibid.*, 3.
64. *Ibid.*, 8.
65. Aircraft Records, AFTO Form 95, aircraft 64-0567.
66. History, 1st Special Operations Wing, 1 January–31 December 1987, 16th Special Operations Wing historian file, Hurlburt Field, Fla., vol. 8, 677–79.
67. *Ibid.*, 679.
68. *Ibid.*
69. Aircraft Records, AFTO Form 95, aircraft 87-0023, 87-0024, 87-0125, 87-0126, and 87-0127.
70. Boykin, 16–17.
71. Col Rod Lenahan, Retired, *Crippled Eagle* (Charleston: Narwahl Press, 1998), 212–13.
72. *Ibid.*, 213.
73. History, 1st Special Operations Squadron, 1 January–30 June 1988, 4.
74. *Ibid.*, 7.
75. *Ibid.*
76. History, 1st Special Operations Squadron, 1 July–31 December 1988, 18.
77. *Ibid.*, 4.
78. History, 7th Special Operations Squadron, 1 January–30 June 1988, 11.
79. *Ibid.*, 13.
80. *Ibid.*, 7.
81. History, 7th Special Operations Squadron, 1 January–30 June 1989, 2.
82. History, 1st Special Operations Wing, 1 January–30 June 1989, vol. 1, II-73.
83. “AFSOC: The Air Force’s Newest Command,” 54.
84. *Ibid.*, 54–55.
85. *Ibid.*, 55.
86. History, 1st Special Operations Squadron, 1 January–30 June 1989, 9.
87. *Ibid.*, 1 July–31 December 1989, 9.
88. *Ibid.*
89. History, 7th Special Operations Squadron, 1 July–31 December 1989, 8.
90. History, 7th Special Operations Squadron, 1 January–30 June 1989, 12.
91. History, 7th Special Operations Squadron, 1 July–31 December 1989, 15.
92. *Ibid.*
93. *Ibid.*
94. History, 1st Special Operations Wing, 1 January–30 June 1989, vol. 1, II-75.
95. *Ibid.*, 1 January–30 June 1989, vol. 7, 368.
96. *Ibid.*, 1 January–30 June 1989, vol. 1, II-77 to II-78.
97. *Ibid.*, 1 January–30 June 1989, vol. 8, 261.
98. Aircraft Records, AFTO Form 95, aircraft 88-0195 and 88-1803.

Operation Just Cause (1989–90)

I firmly believe that any man's finest hour—his greatest fulfillment to all he holds dear—is that moment when he has worked his heart out in a good cause and lies exhausted on the field of battle—victorious.

—Vince Lombardi

On 17 December 1989 the 8th SOS learned that an operation in Panama was imminent. The squadron had just completed a series of demanding training exercises that culminated in an airfield seizure operation conducted at Choctaw Auxiliary Airfield just west of the Eglin AFB range complex. It was Sunday evening, and most assigned personnel and their spouses were attending the annual 8th SOS Squadron Christmas party being held at Liollo's restaurant in downtown Fort Walton Beach. Honored guests had begun to arrive, with about 150 people already at the restaurant, when the 1st SOW commander, Col George Gray, came in. An easygoing and likable professional, Gray showed no outward sign that something was brewing. After greeting several members of the squadron, Gray found an opportune time to speak privately with the 8th SOS squadron commander, Colonel Thigpen, and confide in him the developing situation. Tensions had increased in Panama over the past several days, and Manuel Noriega, the strongman who had controlled the country since the early 1980s, had declared war on the United States. Gray directed Thigpen to put together four crews and to place them in crew rest in anticipation of a noon Monday launch from Hurlburt Field.

Not to arouse suspicion, Colonel Gray remained at the Christmas party through the dinner meal, but during the break at 2030, Thigpen made an announcement to the group. The squadron had just completed JRT 90-1 the previous Friday, and Thigpen relayed to the guests that another iteration of the exercise had been scheduled for the following week. All 8th SOS assigned personnel were told to continue to enjoy the social event but to stop consuming alcohol by 2100. The party resumed, although somewhat subdued, with entertainment and other scheduled activities. Although nothing further was said about the unplanned tasking, spouses and squadron members alike (many of whom had been in special operations for most of their professional lives) sensed that something more than an exercise was imminent. Earlier in the evening, Thigpen had talked with Colonel

O'Reilly, his operations officer, and had directed him to quietly leave the party after dinner, proceed to the squadron, and put together four Combat Talon augmented crews. O'Reilly was to use the same crews that had participated in the recent JRT, where possible. Some crew members, however, had departed on Saturday, 16 December, for Christmas leave and were not available. (The old adage that you never, never go on leave while assigned to a special operations unit rang true again!) Thigpen remained at the party until 2230, when it began to break up, and the attendees left for home. He went straight to the squadron operations center at Hurlburt Field, where O'Reilly had assembled a cadre of schedulers and aircrew personnel. With only minor adjustments, Thigpen approved the four crews and directed O'Reilly to put them in crew rest for a Monday morning (18 December) launch. With notifications made, everyone left for a brief night's sleep. Before noon the next day, the largest air operation since the Vietnam War was under way, and the 8th SOS Combat Talons were in the thick of it.

Events Leading Up to Operation Just Cause

Panama had a long history of association with the United States going back to the turn of the century. In 1903 a revolutionary junta, under the protection of the United States, carried out a successful rebellion against Columbia. As a result Columbia granted the United States the territory for a canal under the Isthmian Canal Convention (the Hay-Bunau-Varilla Treaty of 1903) and ceded to the revolutionary junta the territory that became the independent country of Panama. From 1903 through the Second World War, political power in Panama was concentrated in the hands of a few upper-class families. They built an oligarchy that traced its roots to the early Spaniards. After World War II, the situation continued to change. Since 1904 the National Police Force had been Panama's only official armed service. By 1947 Jose Antonio Remon had risen through the

ranks to become commandant of the police. Remon began to convert the national police to a national guard that was trained in military skills. As Remon became more powerful, so did his police force. By 1952 he had been elected president of the country and had nearly completed the conversion of the National Police Force to the National Guard. Remon's presidency was notorious for graft and corruption, and in 1955 he was assassinated. The old oligarchy returned to power and ruled the country for the following 13 years. During that period the National Guard that Remon had created grew in power and influence, until it was in a position to again directly influence the conduct of the government (fig. 38).¹

A political crisis developed in 1968 that resulted in the election of Arnulfo Arias as the country's new president. Assuming office he immediately announced sweeping changes in the leadership of the National Guard. Having become extremely powerful over the past decade, the National Guard promptly removed Arias from office, established a provisional military junta, and disbanded the National Assembly along with all political parties. Throughout the following year, members of the military junta maneuvered to gain control of the country. Omar Torrijos, who was the commander of the National Guard at the time, was able to consolidate his power and gain control of the government after he defeated a coup in 1969. Once in control Torrijos expanded his political base by continuing to increase the size of the National Guard and by preventing the formation of politi-

cal parties. He replaced the country's National Assembly in 1972 with a National Assembly of Community Representatives, whose members were selected by the Torrijos-controlled government and not by popular vote.²

Under the guise of reforming the 1972 constitution, political parties were legalized in 1978, and Torrijos gave up his position as president. The perceived softening of Torrijos toward a civilian government was actually a result of ongoing negotiations with the Carter administration over the return of the Panama Canal to the country of Panama. Torrijos knew that the US Congress would not ratify a treaty with a Panamanian government that was not at least outwardly democratic. The National Assembly elected Aristides Royo as president, but political power remained in the hands of Torrijos. Presidential elections were set for 1984, and Torrijos established his own political party—the Democratic Revolutionary Party (PDR)—to prepare for them.³

Torrijos was killed in an airplane crash on 31 July 1981, and Panama was plunged into a series of crises over the next two years. Most of the turmoil came from within the National Guard, with the recently formed political parties too weak to exert much influence. Out of the internal National Guard power struggle, Manuel Noriega emerged as dictator of Panama. Noriega had been a longtime protégé of Torrijos and relied upon corruption, repression, and the National Guard to remain in power. Noriega continued to expand the National Guard, and he created the Panamanian Defense Force (PDF), a combination of National



Figure 38. Map of Panama (Source: AU Library, Maps and Charts Division, Maxwell AFB, Ala.)

Guard, Panamanian air force, Panamanian navy, Canal Defense Force, local police force, Traffic Department, Department of Investigation, and Immigration Department. By 1987 the PDF had expanded to nearly 15,000 personnel. To control the PDF Noriega placed it within a network of his most trusted and loyal followers.⁴

By the 1984 presidential elections, it was apparent that Noriega and the PDF were firmly in control of the government. The PDF presidential candidate, Nicolas Ardito Barletta, easily defeated three-time president Arnulfo Arias in an election fraught with blatant irregularities. Less than a year later, Noriega had Barletta removed from office, and he installed Vice President Eric Arturo Delvalle as the new president of Panama. To maintain control Noriega and the PDF became even more repressive during the following four years. Special elements within the PDF were used to squash public opposition to Noriega's iron-fisted rule. Noriega also created local militias, known as dignity battalions, to frighten and harass political opposition.⁵

Throughout 1987 allegations continued to arise over the illegal activities of Noriega. Col Roberto Diaz Herrera, a former PDF chief of staff who Noriega forced out of the National Guard in 1984, charged that Noriega was heavily involved in narcotics trafficking and money laundering for Columbian-based drug cartels. Herrera also claimed that Noriega had rigged the 1984 presidential election and that he had ordered the brutal murder of an outspoken critic of the regime, Dr. Hugo Spadafora. In February 1988 two US federal grand juries indicted Noriega on drug trafficking charges, thus formally pitting the Reagan administration against the Panamanian dictator. On 25 February 1988, under pressure from the US government, President Delvalle attempted to fire Noriega as commander of the PDF. Noriega reacted by removing Delvalle from office, thus initiating a period of anti-US demonstrations and increased harassment of US military forces assigned to Panama. Relationships continued to worsen between the United States and Noriega throughout 1988, with the United States putting increased economic pressure on the government of Panama.⁶

The next major confrontation between Noriega and the United States resulted from the national elections held on 7 May 1989. The Civil Democratic Opposition Alliance of Guillermo Endara, Ricardo Arias Calderon, and Guillermo Ford were in the lead when Noriega abruptly stepped in and annulled the election with the help of the PDF.

During the ensuing demonstrations, the PDF brutally crushed the opposition.⁷ Former US President Jimmy Carter, in Panama to monitor the elections, declared the Opposition Alliance victors by a three-to-one margin and denounced the military dictatorship of Noriega and his actions to take the election by fraud. When the Opposition Alliance candidates led a protest march through the streets of Panama City, they were attacked by thugs of the dignity battalions. Beaten and cowed into submission, the opposition retreated from any further direct confrontation with Noriega.⁸ The United States reacted by imposing additional economic sanctions, a move that placed considerable strain on Panama's already depressed economy.

As 1989 passed Noriega's position steadily weakened due to international condemnation of his actions and due to US economic sanctions. On 3 October 1989 a respected Panamanian officer, Maj Moises Giroldi Vega, attempted to overthrow Noriega. Giroldi was the chief of security at Noriega's headquarters, the La Comandancia, which was located in downtown Panama City, and was one of only a few who were allowed to be armed in the presence of Noriega. On the morning of 3 October, Giroldi and a small number of soldiers took control of La Comandancia and captured Noriega. Noriega refused to resign and leave the country, so Giroldi contacted US officials to arrange a hand-over of Noriega to US military forces stationed in Panama. Noriega was the godfather to Giroldi's children, and he did not want Noriega to be taken out of Panama for trial in the United States. While Giroldi negotiated with the United States, dozens of heavily armed Battalion 2000 soldiers loyal to Noriega assaulted Giroldi's positions and recaptured the La Comandancia.⁹

Giroldi was captured by the Battalion 2000 assault force, and Noriega was subsequently released. During the night of 3 October, Giroldi was murdered after being tortured by several of Noriega's leading officers. In the following days, Noriega had over 70 soldiers shot, with another 600 arrested and put in prison. The events of 3 October had so shaken Noriega that he began moving from place to place, never sleeping in the same place twice. The 1988 US indictments made his departure from Panama impossible, and his long-term survival in the country was doubtful.¹⁰

Tensions continued to increase between the United States and Panama throughout the remainder of October. On 3 November US marines on Galeta Island exchanged fire with unidentified attackers. Throughout November Noriega

continued to verbally attack the United States and to poison relations between the two countries. His verbal attacks reached a climax on 15 December, when he “declared war” on the United States. On 16 December a US Marine officer was killed by Panamanian troops, and another officer was beaten by PDF soldiers at a checkpoint in Panama City. With no diplomatic solution feasible and with rising attacks against Americans in Panama, President George Bush decided to execute Operation Just Cause on 17 December 1989. The following day the Just Cause execute order was issued, with H hour established as 0100 on 20 December (D day).¹¹

Development of the Blue Spoon Operations Order

The planning process for possible US intervention in Panama officially began with the issuance of a JCS planning order on 28 February 1988—after Noriega was indicted by a US grand jury for drug trafficking. From that time until the December 1989 invasion, a series of plans were developed under the umbrella title of Operation Elaborate Maze. During the 22-month process, the name was changed to Operation Prayer Book. Under the contingency plans, two separate categories of operations emerged—one focused on military force and the other on post-Noriega restoration. The military force option was titled Operation Blue Spoon and would later emerge as Operation Just Cause. The post-Noriega plans had three successive names—Operations Krystal Ball, Blind Logic, and Promote Liberty. Throughout most of 1988 the post-Noriega plans received the most attention, but by 1989, with rising hostilities towards the US military stationed in Panama, the military force option came to the forefront.¹²

In August of 1989, Gen Maxwell R. Thurman was designated the new USCINCSO, Quarry Heights, Panama, and he focused most of his energy on Blue Spoon. The plan had been under intense revision since June 1989. Thurman later would state that he did not spend five minutes on the post-Noriega option. He was intent on developing the campaign plan for what would become Operation Just Cause.¹³ The original Blue Spoon OPORD did not address the capture of Noriega but only the neutralization of the PDF as an institution. This would change as Noriega stepped up his anti-US attacks. Over the summer of 1989, changes were made in the strategic objectives of the plan. The planners made the basic

assumption that the simultaneous elimination of all PDF areas by “overwhelming force” would be required to ensure a successful operation and to keep casualties at an absolute minimum. The overwhelming force requirement resulted in the addition of a brigade task force under the command of Lt Gen Carl Stiner, USA, who was the commander of the 18th Airborne Corps located at Fort Bragg, North Carolina. The plan called for the brigade task force to be introduced into Panama by way of airborne assault at Torrijos/Tocumen International Airport. General Stiner was designated commander, JTF-South, and his headquarters was assigned the responsibility to execute the Blue Spoon OPORD.¹⁴ All special operations forces, including the 8th SOS Combat Talons, were assigned to a JSOTF under the command of Maj Gen Wayne Downing, USA. The JSOTF was a subordinate command of JTF-South, and General Downing reported directly to General Stiner. After the plan was finalized in early October, it was briefed to the JCS and was approved for execution at the direction of the president of the United States.

With Operation Blue Spoon finalized and approved by JCS, a detailed rehearsal schedule was developed to validate the plan. The conventional airborne forces of JTF-South rehearsed their assigned portion of the OPORD on 6 December, and the JSOTF-assigned special operations forces did the same during a quarterly joint exercise (JRT 90-1) from 6 to 18 December. During the night of 14 December, a full-scale airfield seizure and target engagement dress rehearsal was executed, thus validating the special operations portion of the plan. While the JSOTF forces were redeploying back to their home stations on 15 December (the 8th SOS had participated in the JRT from Hurlburt Field), the Panamanian National Assembly, which was appointed by Noriega and controlled by the PDF, declared Noriega head of the Panamanian state. Noriega promptly delivered his “state of war” message. Events rapidly escalated over the next 48 hours, culminating in the issuance of the Operation Just Cause execute order on 18 December.¹⁵

The Plan

The JCS-approved Blue Spoon OPORD called for simultaneous attacks by conventional and special operations forces on critical command and control nodes and key transportation nodes, and simultaneous defensive operations to protect US citizens and the Panama Canal infrastructure.

The mission was, in short, to neutralize the PDF while minimizing loss of life on both sides. The campaign objectives included the removal of Noriega, restructure of Panamanian security forces, and realignment of Panama's civil-military relations that had become convoluted over the years with dictatorial rule. General Stiner served as the overall war-fighting commander, with the 7th Infantry Division, one brigade of the 82d Airborne Division, one mechanized battalion from the 5th Mechanized Division, a battalion-size task force of Marines, and assets of the in-place 193d Light Infantry Brigade (located at Howard AB) committed to his task force. Air transportation for the conventional forces included C-141s and C-130s from MAC and assets of the 24th Composite Wing stationed at Howard AB. JSOTF forces included the 75th Ranger Regiment, SEAL elements from the Naval Special Warfare Group, 3d and 7th Special Forces Groups, and the 1st SOW. In all, including support- and combat-support-designated forces, more than 27,000 soldiers, sailors, airmen, and marines were assigned to the operation.¹⁶

To accomplish the objectives of the operation, assigned forces were organized into various task forces and committed to specific targets within Panama. Organized as Task Force Bayonet, the 193d Brigade was to seize and secure the Curundu-Ancon Hill-Balboa areas by ground attack and was to conduct an air assault against the PDF's 5th Company, which was garrisoned at Fort Amador. As a part of Task Force Bayonet, Task Force Gator was task organized around the 4th of the 6th Infantry (Mechanized) and was committed to attacking Torrijos/Tocumen International Airport at H hour. Included in Task Force Bayonet's tasking was the isolation and reduction of Noriega's headquarters, La Comandancia, located in downtown Panama City. Task Force Red Tango, consisting of one battalion of the 75th Ranger Regiment, simultaneously would conduct an air assault on the international airport as Task Force Gator attacked from the ground. (H hour had been selected early in the planning process as 0100 hours based primarily on the density of traffic flow into Torrijos/Tocumen International Airport.) The Marine battalion, reinforced with one engineer battalion, formed Task Force Semper Fi, and it was tasked to block the western approaches to Panama City and to secure the strategic Bridge of the Americas. Task Force Atlantic, made up of the 4th of the 17th Infantry (Light) and the 3d of the 504th Infantry (Assault), was to

isolate the city of Colon on the Atlantic seaboard, neutralize the PDF's 8th Company and its naval company stationed there, protect Madden Dam, and free a number of political prisoners at the Renacer Prison located at Gamboa, midway across the Isthmus of Panama.¹⁷

The remaining two battalions of the 75th Ranger Regiment made up Task Force Red Romeo and was committed to a parachute assault on Rio Hato AB located to the west of Panama City. The parachute assault would commence at H hour, with a five-ship airlanding 35 minutes later to infiltrate additional personnel and equipment. (The five-ship airland formation was made up of three MC-130E Combat Talons of the 8th SOS and two SOLL II C-130Es of the 317th TAW.) At Rio Hato AB, the PDF 6th and 7th Infantry Companies were garrisoned in a barracks complex to the southwest of the airfield. The base also was located near Noriega's coastal vacation villa, a location that many US intelligence sources considered Noriega's preferred hiding place. Other JSOTF units, organized as Task Force Black, Task Force White, and Task Force Blue, were tasked to attack other key targets at H hour. JSOTF targets included a PDF patrol craft in Balboa Harbor, a TV tower at Cerro Azul, and neutralization of Paitilla Airfield, where Noriega maintained a Lear Jet capable of taking him to safety outside of Panama. An additional on-call mission for the JSOTF was to mount operations to capture Noriega or to rescue American hostages, as required.¹⁸

Forty-five minutes after Task Force Red Tango's drop on Torrijos/Tocumen International Airport, a brigade task force from the 82d Airborne Division, organized as Task Force Pacific, would parachute on to the airfield. From there the brigade would conduct helicopter air-assault operations to neutralize Noriega's Battalion 2000, which was garrisoned at Fort Cimarron, attack the 1st Heavy Weapons Infantry Company at Tinajitas, and engage the calvary squadron and special forces elements located at Panama Viejo. Follow-on operations called for occupation of Panama City to restore law and order, then movement to the interior of Panama to neutralize PDF elements located there.¹⁹

Thus, when the hatred that was directed against the United States by Noriega boiled over on the 16th of December, a comprehensive plan was on the shelf, and rehearsals had been conducted to validate it. Unlike Operation Urgent Fury in 1983, there had been sufficient time to complete the deliberate planning

process. Events beginning just after midnight on 20 December 1989 would provide the proof that US special operations forces, working closely with a large conventional force, had matured significantly since Desert One. The Blue Spoon OPORD was renamed Operation Just Cause for the execution phase of the plan.

The 8th SOS Deploys to Lawson AAF, Georgia

The 1st SOW was a blur of activity by Monday morning, 18 December, when the 8th SOS crews were alerted and reported to the squadron. By 0900 there were five crews ready to brief in the 8th SOS squadron briefing room. (During the previous night, the requirement for a fifth crew materialized, and it was put in crew rest for the Monday morning show.) The 20th SOS, along with US Army MH-47s, was in the process of deploying to Panama. The 9th SOS at Eglin AFB was tasked to refuel the helicopters and to provide SAR support over the Gulf of Mexico during the helicopter deployment. The 8th SOS was tasked to provide backup tanker support if the 9th SOS experienced an aircraft abort. Two 8th SOS Talons were placed on alert for the backup helicopter refueling mission. Two other MC-130Es, along with the three Just Cause mission crews, departed for Lawson AAF, Georgia, at 1100 local. The 9th SOS successfully completed the helicopter refueling mission, and the two alert Combat Talons were subsequently released to join the first two Combat Talons in Georgia. They departed Hurlburt Field and arrived at Lawson AAF during the late afternoon on 18 December. At 1500, a mass aircrew briefing was held at Fort Benning, Georgia, which was adjacent to Lawson AAF and the home of the 75th Ranger Regiment. The crews were given as much information as was available on the objective area and on possible threats to the aircraft. At the briefing the 8th SOS crews learned that their objective was Rio Hato Airfield and that their mission was to airlift elements of Task Force Red Romeo utilizing NVG airlift procedures. With information in hand, the planners and crews sat down to put together the assault package plan. An intelligence update and an in-progress review were scheduled for 2100 that evening, leaving no time to spare.²⁰

Most of the crew members from the 8th SOS had participated in the recently completed JRT 90-1 and were familiar with the task. Throughout the evening additional SOLL I and SOLL II C-130 crews arrived from Pope, Dyess, and Little Rock

AFBs. Most of them also had participated in the JRT. At the 2100 briefing, there were 20 SOLL crews and five Combat Talon crews in attendance. A mission planner began the briefing by announcing that the US president had signed the executive order for Operation Just Cause, which signified to all attendees that the mission was a go. The Rio Hato air assault force was divided into two packages—a 15-ship C-130 air-drop package that was scheduled to drop at H hour and a five-ship NVG airlift package that was made up of the three 8th SOS Combat Talons and two Pope-assigned C-130 SOLL II aircraft. The airlifting was scheduled 35 minutes after the parachute assault. After the 2100 briefing, planners and crew members assigned to the two packages continued to refine their mission plans. The five-ship airlift package was ready to brief back its mission by 0200 on 19 December. With some questions still not answered by planners during the brief back, the crews went into crew rest at 0300.²¹

Four MC-130Es and five Combat Talon crews deployed to Lawson AAF for Operation Just Cause. After final mission planning, only three Combat Talons (plus a spare aircraft) and three augmented crews were required. Thigpen and O'Reilly had the difficult task of deciding the final makeup of the three mission crews. Because of the anticipated extended crew duty day for the mission (more than 24 hours), additional crew members were moved from Ted Korver's crew to the three mission crews. The following 8th SOS augmented crews were finalized during the mission planning phase on 18 December. (Crews 1, 2, and 3 flew the Rio Hato AB assault mission on 19/20 December 1989. Ted Korver deployed to Howard

Crew 1 (Talon 64-0567)	Crew 2 (Talon 64-0562)	Crew 3 (Talon 64-0572)	Spare Crew
Thigpen	Davenport	Gallagher	Korver
Gregor	O'Reilly	Batts	English
Abbott	Prior	Harstad	--
Ross	Cochran	Strang	--
Weiler	Franco	Reynolds	Kersh
Ammons	McCabe	Inkel	Aldridge
Bouressa	Crisafi	Tagert	Pearson
Alaniz	Bonn	Vonsik	DeBoe
Gorczynski	Long	Tremblay	Fleming
Pies	Dunn	Gillian	--
Bonck	Boulware	Balok	--
Harris	Ballerstadt	Foster	--
Wilcox	Crayne	Joy	Corlew
Brackett	Hickman	Clark	Bohannon
Doyle	--	--	Gallo
Fox	--	Linder	Gobbi
Cribbs	Sobell	--	--



USAF Photo

Rio Hato AB, Panama, looking north from the Pacific Ocean. The 8th SOS Combat Talons landed to the south just past the Pan American Highway, which bisected the runway at its midpoint. The FARRP location is identified at right center of picture.

AB on 23 December to participate in follow-on operations in Panama. Additional 8th SOS crews flew in country until 4 January 1990, when all hostilities ceased with the capture of Manuel Noriega and his delivery to the United States aboard Skip Davenport's Combat Talon.)

While the 8th SOS crews were in crew rest, a cold front swept through Georgia and onward to the East Coast, bringing with it low clouds, rain, and near-freezing temperatures. At Pope AFB, where the 18th Airborne Corps was scheduled to depart for its insertion into Panama, a severe ice storm threatened to cancel the launch. Weather, which had played a pivotal role in both Desert One and in Operation Urgent Fury, was again giving the invasion force fits. At Lawson AAF the biggest problems faced by the force were the low clouds and generally miserable weather associated with the light, cold rain. The Combat Talon crews arrived at their aircraft at 1500 on the afternoon of 19 December. Through a scheduling snafu between Air Force and Army planners, the ranger force had arrived hours earlier and was huddled behind the mission aircraft waiting for the aircrews. The troops were dressed for the hot, tropical environment of Panama and were chilled to the bone. The crew chiefs quickly opened the locked aircraft and started the gas turbine com-

pressors so that the aircraft heaters could be operated. With the soldiers on board, the three aircraft were warmed up as maintenance and aircrew personnel initiated their preflight duties. By 1700 personnel and cargo were loaded, and all was ready for launch.²²

The three Combat Talons were heavy. The first two aircraft had nearly identical loads, which consisted of two US Army gun-jeps and one USAF Special Tactics Squadron (STS) all-terrain vehicle (basically, a four-wheel-drive combat ambulance). In addition, there were two motorcycles, 4,000 pounds of Class A explosives, a forward-area-refueling-and-rearming-point (FARRP) system with two USAF fuels technicians, and 45 rangers, plus the aircrew. T. J. Gallagher's aircraft did not carry a special tactics vehicle, Class A explosives, or FARRP equipment, but was loaded to capacity with additional rangers. Each aircraft carried 58,000 pounds of fuel, with the first two Talons grossing out at approximately 180,000 pounds. The number three Combat Talon weighed slightly less.²³

There were approximately 25 C-130s at Lawson AAF—15 primary C-130s for the air assault, three MC-130E Combat Talons, and two SOLL II C-130s for the NVG airland, and an assortment of spare aircraft should any primary aircraft abort during

launch. By 1730 the entire flight line was on the move. The proverbial walk of the elephants was under way, with the C-130s loaded and maneuvering to their takeoff positions. The Combat Talon crews had an excellent view of the spectacle, being parked on a side taxiway just 100 yards from where the larger formation would begin its takeoff roll. At precisely 1802, Eastern Standard Time, the first C-130 began its takeoff roll, followed every 15 seconds by another aircraft. The weather had remained marginal throughout the afternoon, and the ceiling was 300 feet overcast with one-mile visibility as the C-130s lifted off into the near darkness of the approaching night. One by one the aircraft disappeared into the overcast. Not one aircraft failed to make its scheduled departure time. By 1807 local the C-130 formation had departed, leaving behind the engine-running spare aircraft and the five-ship airland formation. There were only a few minutes left for the Talon crews to reflect on the night's events before it was time for them to make their own departure (fig. 39).²⁴

Assault on Rio Hato, Panama

After a short taxi to the runway, Thigpen lined up the lead aircraft (64-0567) for its takeoff roll. At 1844 local, the lead Combat Talon began to roll, with the other two Talons following at two-minute intervals at 1846 and 1848. The two SOLL II aircraft, which were not capable of in-flight refueling,

and were lighter and faster than the Talons, followed the last Talon 15 minutes later at 1903. As the heavy Combat Talons lifted into the now darkened night, they entered a solid overcast as they passed the departure end of the runway. The cold temperature helped create badly needed thrust for the turboprop engines, but the aircraft could climb only at about 300 feet per minute to a cruise ceiling of 14,000 feet. Eventually, as the aircraft burned off fuel, the formation continued its climb to 18,000 feet. After the two SOLL II aircraft departed Lawson AAF, one experienced a maintenance problem and had to return to the airfield for repairs. Thanks to a superior maintenance effort, the problem was fixed, and the aircraft was able to launch and to make its landing time at Rio Hato.²⁵

As the three Combat Talons flew south towards Panama, the early portion of the mission went according to plan. After passing the Yucatan Peninsula of Mexico, the three Talons were scheduled for an IFR from two KC-135 at 10,000-foot altitude. At the air refueling control point, there were no tankers in sight. High overhead the Talon crews could see an armada of aircraft heading south on the same track as their formation, but none were slowing to refuel the MC-130Es. Eventually, one KC-135 rendezvoused with the Talon formation, and Davenport was first to receive his on load of fuel. With only one tanker, the three Talons could not take their preplanned fuel load. The crew navigators quickly calculated the minimum

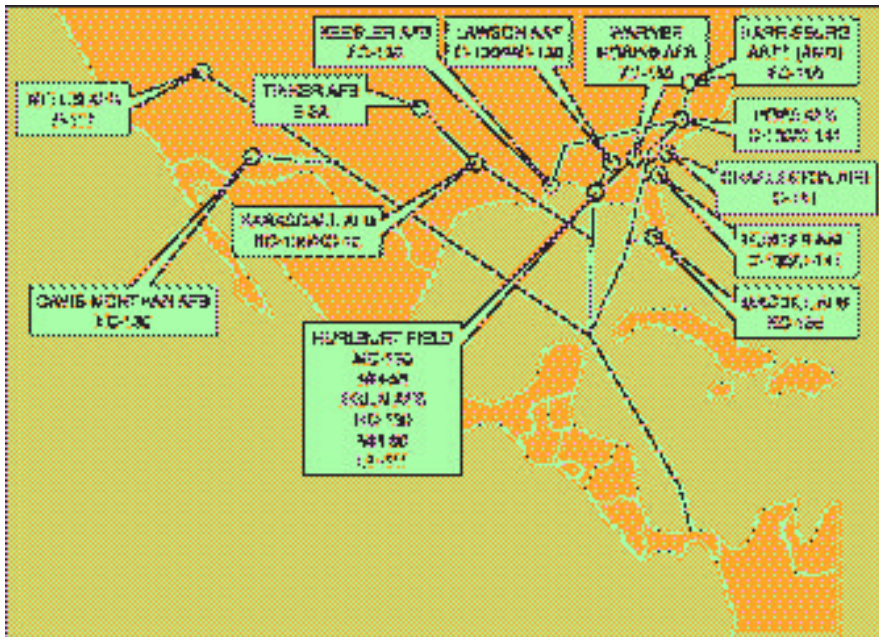


Figure 39. H-Hour Deployments, Operation Just Cause



USAF Photo

Crew 1, Operation Just Cause. Standing left to right: Alaniz, Ross, Weiler, Gregor, Thigpen, Ammons, Wilcox, and Gorczynski. Kneeling left to right: Bouressa, Harris, Bonck, Abbott, and Brackett. Not pictured: Pies, Doyle, Fox, and Cribbs.



USAF Photo

Crew 2, Operation Just Cause. Standing left to right: Long, Ballerstadt, Franco, O'Reilly, Davenport, Prior, Cochran, McCabe, and Crisafi. Kneeling left to right: Crayne, Boulware, and Dunn. Not pictured: Bonn, Hickman, and Sobell.



USAF Photo

Crew 3, Operation Just Cause. Standing left to right: Vonsik, Reynolds, Gallagher, Balok, Linder, Foster, and Joy. Kneeling left to right: Inkel, Tremblay, Harstad, and Clark. Not pictured: Batts, Strang, Tagert, and Gillian.

amount of fuel each Talon had to take to complete its primary airland mission, depart Rio Hato, and either land at Howard AB for additional fuel or refuel with another tanker en route back to Hurlburt Field. Gallagher was second on the boom, and he received his computed minimum fuel. Thigpen was the last to hook up to the single tanker. He knew that his secondary mission, after airlanding his rangers and STS personnel, was to set up a ground FARRP at Rio Hato to service helicopter gunships supporting the ranger assault. Consequently, he elected to onload all remaining fuel available from the tanker, which was about 5,000 pounds more than his planned on load. Thus, number two and number three Talons received slightly less than their planned on load while number one unloaded 5,000 pounds more fuel than was originally planned. If all went according to the premission timetable, and Thigpen landed at his scheduled time, he would have to dump the excess fuel before landing to stop in the available runway. During the recent Blue Spoon JRT, however, the ranger air-assault operation had taken more time than planned, and the follow-on airland mission was delayed until the runway was cleared. There was a good chance, Thigpen reasoned, that the formation would have to hold and wait for the runway clear call. The extra fuel would allow the lead Talon to

hold for an additional hour and then still be able to deliver the planned fuel to the helicopter gunships. The IFR operation was extremely challenging for the three Combat Talon crews, being in and out of the weather throughout the entire operation. Visual contact was lost several times between the formation aircraft, but the operation was successfully completed. Departing the tanker refueling track, the three Talons began their climb back to 18,000 feet and continued south. The two SOLL II C-130s had closed slightly on the three Talons during the refueling operation. The number five aircraft, which had to return to Lawson AAF for repair, was still behind schedule but was catching up to the rest of the formation as it flew south.²⁶

As the formation neared the northern coast of Panama, the three Talons began their descent to 500 feet above the water in the terrain-following mode. The two SOLL II C-130s descended to approximately 1,000 feet above the water and flew modified contours once over land. Coastal penetration was near Point Mauseto, Panama, with three low-level legs planned before the initial point for Rio Hato. From the time the formation descended to its low-level altitude, it was in and out of the weather until landing. When the lead Talon passed the Panamanian coastline, for some unknown reason, the ALE-40 flare system activated,

and three defensive flares were launched from the aircraft. Any possibility of aircrew complacency was quickly forgotten, as the crew scrambled to determine the source of the flare activation. The crew could not determine why the three flares were expended, but there was little time to worry about it. The second turn point was rapidly approaching.²⁷

As the three Talons approached the second turn point at 500 feet, a C-141 formation passed overhead on a northerly heading out of Panama. They had air dropped Task Force Red Tango at Torrijos/Tocumen International Airport at H hour. The large, blacked-out jets passed about 500 feet above the three blacked-out Combat Talons. The next critical decision point for the Rio Hato formation was a runway clear call expected at 0130, as the lead aircraft approached the initial point for landing. No call was received, so the three Talons entered holding at that point. The lead Combat Talon held at 500 feet, number two climbed to 1,000 feet, and number three climbed to 1,500 feet. The two SOLL II C-130s held at the preinitial point at approximately 2,000 feet. Holding was flown in a fan pattern, with each aircraft passing over the holding point each time it made a complete circuit. The formation avoided flying the same ground track to minimize the possibility of drawing fire from hostile forces. The three Talons were in the clouds for most of the holding pattern, which increased the risk to the formation of a midair collision or impact with the ground. They utilized their terrain-following radar to remain clear of the terrain and altitude separation to remain clear of each other. Each time one of the aircraft passed through the radar signals of one of the other two aircraft, the system would sound an alarm and direct an immediate fly up. With coordinated crew effort, the fly ups were systematically analyzed to make sure that there was not a clearance problem with the ground and were then overridden by the navigator. As the minutes passed, it became apparent that the lead Talon would need the additional fuel it had taken from the tanker a few hours earlier.²⁸

While the formation held short of Rio Hato, the crews monitored the progress of the action on the airfield by way of the aircraft's radios. At H hour two F-117A aircraft had each dropped a 2,000-pound bomb near the PDF barracks southwest of the airfield. As the bombs fell, the C-130 formation that had departed Lawson AAF just before the Talons began its airdrop. Fifteen aircraft

dropped personnel and equipment of Task Force Red Romeo and then escaped to the north upon completion of the airdrop. The PDF defenders were waiting for the formation, having been alerted 15 minutes earlier when the initial attack kicked off in Panama City. Several aircraft suffered battle damage during the drop and had to recover at Howard AB for combat repairs. Along with the rangers, USAF special tactics personnel also parachuted into Rio Hato. Bernie Oder, the senior special tactics team member on the airfield, had become separated from his six-man team and from the ranger ground force commander during the airdrop. The PDF continued to put up a determined defense on the airfield as Oder made his way down the runway to the designated rendezvous point with the ranger command element. Oder observed that the runway was blocked by two large trucks that had their tires deflated to make them more difficult to move. Once linked up with the ground force commander, Oder monitored the unfolding situation as the rangers moved to secure the airfield. Because of the stubborn resistance by the PDF, it took the assault force approximately 90 minutes to clear the runway of obstructions. Overhead two AC-130 gunships from the 1st SOW were pounding PDF strongholds around the airfield. From Howard AB a contingent of US Army OH-6 gunship helicopters deployed in direct support of the rangers. As the battle raged, the helicopters began to run low on both fuel and ammunition. The FARRP equipment dropped by one of the C-130s could not be made operational, thus leaving the helicopters with no means of refueling. The FARRP equipment aboard the two Combat Talons became critical to the helicopter gunship operation. By 0215 the helicopters had begun to land on the beaches to the east of Rio Hato to await fuel and ammunition. By 0230 the rangers had pushed the PDF off the main airfield and had removed the two vehicles from the runway. The airfield was ready for the five-ship airland formation. Using the ABCCC aircraft as a relay, the radio operator on board the lead Combat Talon received Oder's call clearing the formation to land. With clearance received, the lead Talon's navigator quickly computed the aircraft's landing time and passed it to the other four aircraft in the formation. Thigpen's landing time was established as 0253 local, with Davenport landing at 0256, and Gallagher at 0259. The remaining two SOLL II C-130s would land 10 minutes after the last Combat Talon, with five minutes

spacing between the aircraft. With the battle still raging around the perimeter of the airfield, Thigpen departed holding inbound to Rio Hato.²⁹

Aircraft 64-0567 was the only SOF-I-modified aircraft of the 14 Combat Talons. Its navigational equipment was far superior to that found on the less-capable MOD-70 Talon. Thigpen had chosen the aircraft to lead the formation specifically because of its improved accuracy and reliability. The extended holding period had degraded the MOD-70 navigation system on Davenport's aircraft, but Thigpen's system was "tight" and was performing at peak efficiency. As the aircraft neared the four-mile point on final, tracers from the approach end of the runway were seen by the crew as they arched up into the dark sky. Knowing that he had the gun-jeeps and the critical FARRP system on board, Thigpen decided to continue the approach. Meanwhile, Davenport, in the number two Talon, was having problems with his MOD-70 navigation system and was approaching the airfield well to the west of his planned track. Gallagher, in Talon 64-0572, was still in holding and was maneuvering to begin his approach.³⁰

When the number one Talon touched down on the 4,300-foot runway, it weighed 145,000 pounds, which was exactly its premission computed weight. The SOF-I system had brought the aircraft down the middle of the runway perfectly aligned for landing. As the aircraft slowed to taxi speed, Thigpen made a 180-degree turn on the runway and taxied back to the perpendicular taxiway located 2,000 feet down from the approach end. As the first Talon cleared the active, Davenport was maneuvering for his landing. The MOD-70 system had taken the aircraft to the west of Rio Hato. Scanning outside the aircraft with NVGs, the crew had realized the system error and had made a hard left turn, followed by a right turn to final for landing. With the number one Talon clear of the runway, Davenport landed and rolled out as planned. Meanwhile, Thigpen had down loaded his gun-jeeps, the STS vehicle, and the ranger force on the parallel taxiway, and had begun to back the aircraft 300 yards down the parallel taxiway to a point abeam the approach end of the runway. As Thigpen began his reverse-taxi maneuver, Davenport cleared the active runway on the perpendicular taxiway. The number one aircraft had to stop his back-taxi maneuver on a call from his loadmaster, Brackett. There was a tree growing too close to the taxiway, blocking the aircraft's path. Thigpen authorized Brackett to deplane and cut down the tree with the aircraft's crash ax. Meanwhile, being

unable to taxi to his planned offload position because of the position of the number one aircraft, Davenport's loadmasters briefed their ranger personnel of their new position, and downloaded them on the perpendicular taxiway. As Davenport completed his download, Brackett had the tree cut down, and Thigpen continued his reverse taxi down the parallel. A second call to stop reverse taxiing came from Wilcox, and Thigpen again cleared Brackett out for a second time to chop down another tree. With the removal of the second tree, Thigpen was able to continue reverse taxiing to his preplanned FARRP location (fig. 40).³¹

While the first two aircraft were maneuvering to their final positions on the parallel taxiway, Gallagher landed at 0259, made a 180-degree turn on the runway, and taxied back to the approach end to download his assault force. Within five minutes of touchdown, Gallagher was again airborne in aircraft 64-0572 and headed back to Hurlburt Field. Ten minutes after Gallagher departed, the number four SOLL II C-130E landed, made a 180-degree turn, and taxied back to the approach end of the runway. Once in position on the northern perpendicular taxiway, the number four aircraft offloaded its personnel and cargo. The number five SOLL II aircraft was on short final when tracers appeared from west of the airfield. The crew initiated a low approach and took the aircraft around. Once number five was clear of the runway, number four taxied into position and departed the airfield to the south. Approximately 10 minutes later, number five landed without further incident and taxied to the northern perpendicular taxiway. Once its personnel and cargo were offloaded, the number five C-130 reconfigured internally to a medevac configuration and remained in position ready to extract wounded personnel from the airfield.³²

At the southern end of the airfield, Davenport had reverse taxied down the parallel taxiway and had stopped in front of Thigpen's Talon. He had an identical FARRP system onboard his aircraft and was prepared to carry out the FARRP tasking in the event Thigpen's Talon was not able to do so. The lead Talon already had deployed a fuel hose and had set up a fuel pumping system that was connected to the aircraft's single-point refueling manifold. All available crew members were cleared off headsets to assist the two ranger munitions specialists in transporting the 180-pound rocket containers approximately 100 yards to the helicopter refueling and rearming point. As soon as the FARRP was operational (approximately 15

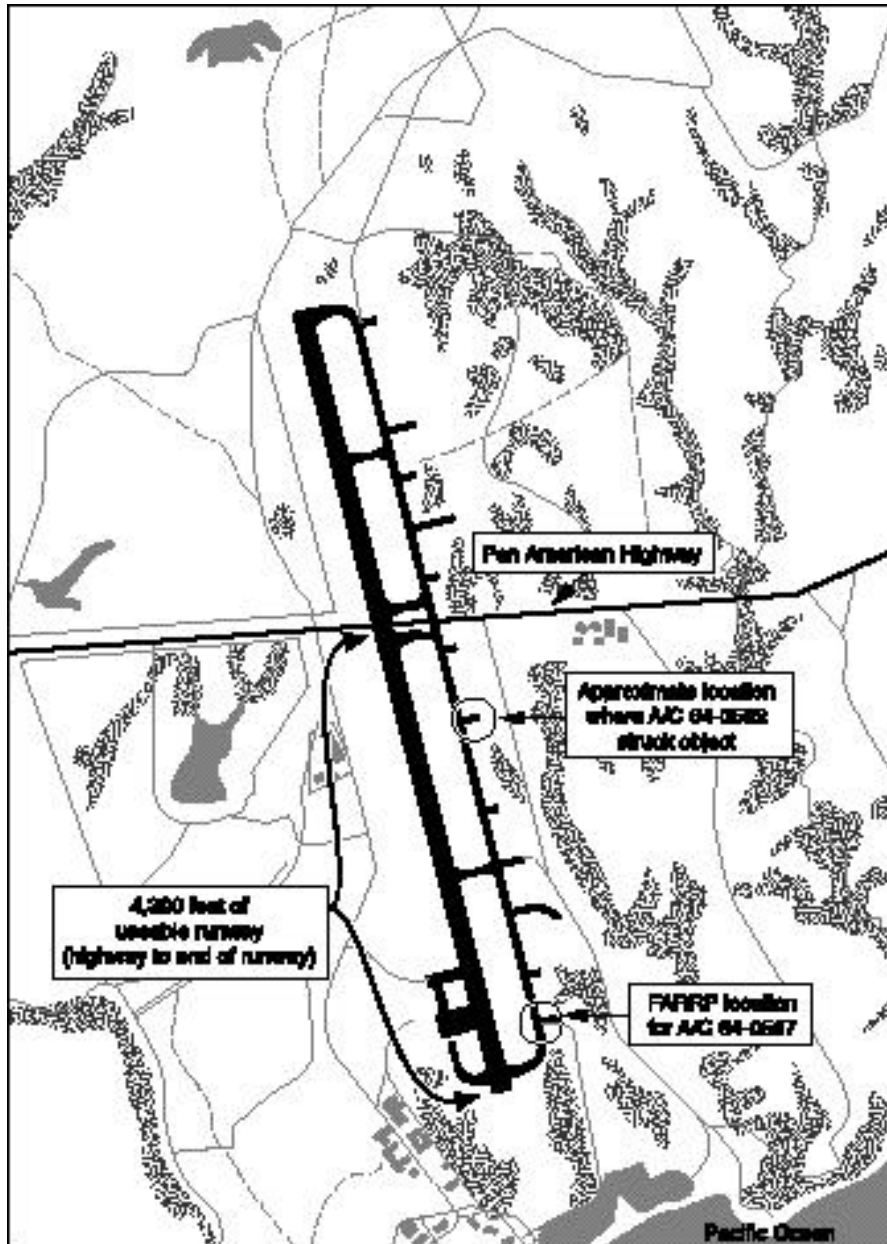


Figure 40. Schematic of Rio Hato AB, Panama (Source: USAF Special Operations School, Hurlburt Field, Fla.)

minutes), OH-6 helicopter gunships began arriving for fuel and ammo servicing. For the next two hours, aircraft 64-0567 remained in its position and serviced the OH-6 gunship helicopters.³³

As the two Talons sat on the parallel taxiway, the battle between the rangers and the PDF raged about them. While ground forces engaged the PDF, the two AC-130 gunships hammered away at the enemy's defensive positions. Tracers filled the night sky, as friendly forces moved to the west and to the south, where most of the heavy concentration of PDF were located. At the

north end of the airfield was the Pan American Highway, and just to the north of it, sporadic fire-fights erupted. After approximately one hour on the ground, Davenport reached "bingo" fuel status and prepared to maneuver for departure. (He had not been able to take on as much fuel as the number one Talon because only one of two scheduled tankers had made it to the refueling track.)³⁴

During premission planning, Talon crews had studied the airfield environment, including the taxiways to the east of the single runway. Available photographs did not show the full extent of the

vegetation growing on the airfield. The photographs indicated that the taxiways were 60 feet wide, with cleared areas on each side well past the wingtips of the C-130 aircraft. In actuality, vegetation had grown past the edges of the taxiways, leaving only about 35 feet of clear asphalt down the center. On either side of the taxiways, "elephant grass" grew to a height of approximately eight feet, which totally obscured any obstacles that might be lying within the wingtips of the C-130. Because of the airdrop earlier in the evening, the tall grass was covered with parachute canopies, further obscuring the area below the top of the grass. With the PDF still waging stiff resistance to the west of the runway, Davenport called for clearance to taxi up the eastern parallel taxiway en route to the northern end of the runway. From premission study, the Talon should have had no problem with this taxi route. Davenport was cleared to taxi, and he began to move north on the parallel. Approximately 2,000 feet up the parallel, the right side of the aircraft suddenly began vibrating violently as the aircraft taxied between what was once an interior fence line. The number three engine was shut down as the Talon came to a stop, but the vibration persisted. The number four engine was then shut down, and the vibration stopped. Davenport continued his taxi utilizing the number one and number two engines until he reached the northern perpendicular taxiway. Here, he deplaned a flight engineer and his loadmasters to look for possible damage to the number four propeller. Upon examination, one propeller blade was found to be bent, probably due to striking a hard object on the ground. The engine could not be restarted with the bent propeller tip. After consulting with his crew and conferring with the JSOTF air component commander (Colonel Gray) at Howard AB, Davenport was cleared to restart number three engine and make a three-engine NVG takeoff. All but essential crew members were downloaded on the northern taxiway to reduce the number of personnel on the aircraft during the risky takeoff. The crew members who deplaned from Davenport's aircraft moved south down the east taxiway and boarded Thigpen's Talon, which was still conducting FARRP operations on the southern end of the airfield. Davenport was cleared on to the active runway, and he back-taxied north across the Pan American Highway so that he could have as much available runway as possible for the three-engine takeoff. (The Pan American Highway crossed the Rio Hato runway approximately at its

halfway point. A fence, including its fence posts, had been removed by the ranger assault force as it moved north in pursuit of PDF defenders. Of the original 8,000-foot-long runway, Davenport was able to use approximately 6,000 feet after his back-taxi maneuver. Davenport was later awarded the Distinguished Flying Cross for his heroism.) Davenport, along with John O'Reilly as first pilot, Vinny Franco as navigator, Harvey Long as flight engineer, and Gary Crayne as loadmaster, successfully made the first-ever three-engine NVG takeoff under combat conditions in Talon history. With only minor deviations, the aircraft performed as predicted, and the crew was airborne on its way to Howard AB. As the aircraft cleared the runway and struggled for altitude, tracers from PDF emplacements to the west of the runway were fired in its general direction. No rounds hit the aircraft, however, as the crew safely departed the area.³⁵

At the FARRP location, business was booming. The helicopters came and went, as they needed fuel or ammo. They quickly expended their ordnance and returned to reload. About every third trip into the FARRP site, the helicopters topped off with fuel. As time passed, with all four engines running, the Combat Talon approached its bingo fuel level. For the aircraft to depart the airfield and make it to the tanker track north of Panama, the navigators had computed required fuel at 14,000 pounds. To go directly from Rio Hato to Howard AB would take 8,000 pounds of fuel. The other determining factor for departure was the approaching daylight. The entire airland operation had been completed in total blacked-out conditions. With daylight approaching the Combat Talon would be a sitting duck for PDF mortars that could be directed at it once the aircraft could be seen by the naked eye. With the helicopters needing fuel and rearming every few minutes, however, it was imperative that the FARRP be maintained as long as possible. As the Talon's fuel decreased below 14,000 pounds, the navigators recomputed the fuel reserves and determined that 12,000 pounds out of Rio Hato would allow one try at the tanker then a divert back to Howard AB if fuel was not received. From the tanker track to Howard AB required 8,000 pounds of fuel to land with 4,000 pounds of fuel remaining. (In the C-130E aircraft, fuel gauges are not considered reliable with less than 1,000 pounds of fuel remaining in each of the four main fuel tanks. When the fuel gauges showed 4,000 pounds of fuel remaining, the crew had to assume that the tanks

were empty. Therefore, all missions were planned to land with a minimum of 4,000 pounds of fuel remaining, plus the required fuel reserves.) With 13,000 pounds remaining and within 30 minutes of daylight, the FARRP operation was discontinued reluctantly, and the aircraft was readied for takeoff. The heavy fuel hose was disconnected from the SPR manifold and left at the FARRP site along with additional ammo from Davenport's Talon. With takeoff clearance received, Thigpen taxied north on the active runway and made a 180-degree turn at the Pan American Highway intersection. The number five SOLL II C-130E had unloaded casualties earlier and already had departed the airfield. As Thigpen's Talon lifted off approximately 2,000 feet down the runway, enemy tracers were seen off the nose of the aircraft. The crew transitioned immediately to the 250-foot terrain-following mode to minimize exposure to the small-arms threat. Within seconds, the Talon was out over the dark Pacific and away from enemy fire. The aircraft made a slow right turn to the north en route to the northern coastline and to the "white" tanker track. There were 11,000 pounds of fuel remaining at that time.³⁶

Before departing Rio Hato, Thigpen's radio operator (Bonck) had coordinated IFR requirements with the ABCCC aircraft controlling the operations at Rio Hato. Thigpen was to refuel at 13,000 feet and onload 35,000 pounds of fuel, which was enough to fly nonstop to Hurlburt Field. As the Talon approached the white tanker track, at least 10 fighter aircraft were on the same refueling frequency and also on guard channel, and all were looking for a tanker. The radio chatter was similar to the Vietnam War years when there were continual tanker anchors established over Laos and out over the Gulf of Tonkin. Ross had replaced Thigpen in the left seat of the Combat Talon, and Abbott was in the right seat. As the Talon continued north, the fuel gauges showed 10,000 pounds remaining. There was no tanker in sight, and soon the aircraft would have to divert to Howard AB for fuel. Scanning outside the aircraft, the crew visually acquired a tanker below and slightly to the left of its track. The tanker was at approximately the same airspeed as the Combat Talon but at about 6,000-foot altitude. The navigator made several calls on guard channel after the tanker did not answer on the designated refueling frequency. Descending in an S turn, Ross maneuvered the Combat Talon to join with the tanker. As the Talon approached the KC-135 from the aft quadrant, it was visually apparent

that the tanker was prepared to deliver fuel at 200 KIAS. In precontact another call was made on guard, but the tanker still did not answer. Perhaps due to radio failure on the tanker aircraft, the two crews could not communicate with each other. The boom operator gave Ross a forward light, indicating that he was ready to refuel. Ross smoothly moved into the contact position and unloaded 35,000 pounds of fuel before disconnecting. Without any verbal contact with the tanker, the Talon crew had gotten its gas and was on its way back to Hurlburt Field. The remainder of the flight home was uneventful, although everyone on board was exhausted from the previous night's operation.³⁷

Upon landing at Hurlburt Field, Maj Gen Tomas Eggers and Brig Gen Jim Hobson met the aircraft as it parked in front of the 8th SOS operations building. It was 1000 local on 20 December 1989. Gallagher and his crew had landed hours before and had already departed the area for a much needed rest. Davenport and a portion of his crew were at Howard AB in crew rest with the aircraft undergoing a number four propeller change. The squadron had performed well during the operation and would be called upon again in the following days to support JSOTF operations in Panama.³⁸

H-Hour Operations across Panama

As the Combat Talon formation was bearing down on the Panamanian coastline, combat operations in Panama already were under way. Sporadic firing started near Albrook Air Station well before the established H hour. To preserve tactical surprise, CINCSO (General Thurman) ordered the JTF-South commander (General Stiner) to move H hour up to 0045 for those forces stationed in Panama. Just before the new H hour, the legally elected Panamanian president (Guillermo Endara) and his two vice presidents (Arias Calderon and Billy Ford) were sworn into office. Initial combat operations in Just Cause were begun by forces assigned to the JSOTF under General Downing. Task Force Black fast-roped into Cerro Azul and removed a critical component of Panamanian TV Channel 2's transmission facility, thus disabling the pro-Noriega station. Task Force Black was also tasked with surveillance of the Pacora River Bridge and interdicting movement across it. The bridge was situated between the Torrijos/Tocumen International Airport and Fort Cimarron, where the Panamanian Battalion 2000 force was located. As

Task Force Black forces moved into their blocking positions near the bridge, they spotted a PDF convoy approaching from Fort Cimarron. With help from USAF AC-130 gunships and attached special tactics personnel, Task Force Black held its position with minimal casualties, while the PDF suffered the loss of six of their vehicles in the battle. With the Pacora River Bridge blocked, PDF reinforcements could not reach the Torrijos/Tocumen International Airport.³⁹

Before the commencement of Just Cause, four Sheridan tanks had been covertly infiltrated into Panama under the cover of darkness. Before H hour on 19 December, the tanks deployed with their armored vehicle support element and assumed a position on Ancon Hill. The tanks were part of JTF-South's Task Force Gator, which had the primary objective of isolating Noriega's headquarters in downtown Panama City. At 0045 two AC-130H gunships of the 1st SOW moved into position over Noriega's headquarters (La Comandancia) and began a relentless attack with their heavy 105 mm canons. At the same time, Task Force Gator moved on the ground through Barrio Chorillo en route to the PDF headquarters building. One of the task force's lead armored personnel carriers was hit by a rocket-propelled grenade, resulting in the track commander being killed by PDF small-arms fire during the resulting firefight. The PDF set fire to Barrio Chorillo to obscure La Comandancia from the air and to slow down the advancing ground force. Task Force Gator was able to penetrate the dense smoke and establish its blocking positions around the headquarters building. As the task force fought the PDF on the ground, the AC-130H gunships continued to pulverize the concrete headquarters from the air.⁴⁰

Task Force Bayonet, a brigade-sized element, was tasked with securing portions of the old Canal Zone. Attacking out of Fort Clayton and across Albrook Airfield, Task Force Bayonet initially secured the US housing areas at Curundu and Curundu Heights. With a large portion of Task Force Bayonet (including Task Force Gator) engaged at La Comandancia and the Curundu-Ancon areas, remaining elements conducted an air assault on Fort Amador, which was home to a PDF infantry battalion and housed a large number of US military families. After notifying family members of the pending operation, the attacking force hit the PDF barracks buildings and commenced a room-by-room clearing operation. After stiff resistance the PDF barracks area was neutralized. Task Force Bayonet also was tasked to establish military

control throughout the Balboa area, which was where the Panama Canal's Pacific terminal was located. With the objective of limiting collateral damage and undue civilian casualties, the task force faced tough resistance as it completed its mission.⁴¹

Task Force Semper Fi, which had been in place on the west bank of the Panama Canal for the past 18 months, quickly moved to block the western approaches to Panama City. It was Task Force Semper Fi's job to block both ends of the Bridge of the Americas and to provide "outside the wire" security for Howard AB. During the previous October's coupe, PDF forces stationed at Rio Hato had responded to the crisis and had passed through the western positions now assigned to Task Force Semper Fi. Any PDF forces escaping Task Force Red Romeo's attack on Rio Hato would face the marines before entering Panama City.⁴²

On the eastern side of Panama City, an AC-130 gunship opened fire at H hour on the PDF compound located on Torrijos/Tocumen International Airport. Three minutes later four companies of rangers, who made up Task Force Red Tango, parachuted from 500 feet on to the tarmac. Once on the ground, the soldiers assembled quickly and assumed their assigned positions to defend the airfield in the event that the mechanized Battalion 2000 force was able to break through Task Force Black's position at the Pacora River Bridge. Task Force Red Tango also was tasked with securing the airfield for the scheduled airdrop of Task Force Pacific 45 minutes later. The assault on Torrijos/Tocumen was a success, with Task Force Red Tango narrowly missing capturing Noriega himself during the operation. Noriega had spent the night with a call girl at the Ceremi PDF recreation center, located near the entrance to the military side of the airport. Noriega was forced to flee Ceremi, leaving behind his briefcase, wallet, and uniform.⁴³

US Navy SEALs, under command of the JSOTF, made up Task Force White and were assigned the mission of neutralizing Paitilla Airfield in downtown Panama City. Paitilla Airfield was situated on the coast and was most easily accessible from the water. At approximately H hour minus two (2300 local time on 19 December), three platoons of SEAL Team Four embarked in patrol boats of Special Boat Unit 26 of the Panamanian navy. The patrol boats transported the SEALs out into the open Pacific Ocean where they transferred to CRRCs for the return assault

on Paitilla Airfield. The objective of the operation was to quietly slip on to the airfield and block the runway with a disabled aircraft or vehicle. Noriega kept a jet aircraft at Paitilla Airfield that planners felt could be his primary means of escaping the country. While the CRRCs were inbound to their objective area, General Thurmond moved up H hour to 0045. The SEAL team could not reach Paitilla Airfield before its original time of 0100 due to the distance left to travel across the water. When the SEALs reached the airfield, the enemy force there was already alerted by Task Force Bayonet's assault on Fort Amador and on La Comandancia 15 minutes earlier. The enemy engaged the SEALs as they moved down the runway, resulting in the loss of four team members. Task Force White fought on across Paitilla Airfield and was able to complete its mission when it disabled Noriega's jet aircraft and blocked the runway. A second mission assigned to Task Force White was the disabling of PDF patrol boats anchored in Balboa Harbor. Two demolition teams of two men each conducted an underwater scuba assault on two patrol boats and placed limpet mines on their drive shafts. At precisely 0100 the mines detonated and rendered both boats inoperable.⁴⁴

As operations got under way on the Pacific side of Panama, Task Force Atlantic swung into operation in the northern Colon area. The task force was charged with three missions: (1) securing the vital Gatun Locks on the Atlantic end of the Panama Canal, (2) isolating the Colon area and neutralizing a 100-man naval infantry company at Coco Solo, and (3) securing the Madden Dam. In addition to its primary mission, Task Force Atlantic was given the task of rescuing political prisoners being held in Renacer Prison. Within hours of beginning its operations, Task Force Atlantic had accomplished its objectives, including liberating 64 persons from Renacer Prison.⁴⁵

At Rio Hato the attack began at H hour with two F-117s from Nellis AFB, Nevada, each delivering two 2,000-pound bombs near the PDF barracks located southwest of the main airfield. Three minutes later, Task Force Red Romeo, made up of rangers and USAF CCT personnel, began exiting their C-130 aircraft over Rio Hato. The defending PDF soldiers had been alerted and were waiting on the airfield for the airborne assault to begin. The rangers began taking on small-arms fire even before they exited the aircraft. At least one ranger was severely injured while standing in the door of one of the aircraft, and several C-130s sustained battle damage when small-arms fire

ripped through their fuselages. The C-130 formation held a steady course despite AAA tracers coming up to meet them. Once on the ground, the rangers attacked the PDF garrison area. Other ranger elements established an airhead and moved to the southeast to seize the beach house often used by Noriega. There were two large trucks disabled on the single runway, and it took 90 minutes to drive the PDF defenders off the immediate area and remove the trucks so that the follow-on Combat Talon SOLL II formation could land. At approximately 0230 local time, the special tactics units cleared the five-ship formation to land at Rio Hato. Ground combat operations continued as the MC-130Es and the SOLL II aircraft landed and downloaded their assault troops and motorized vehicles. Supporting the ranger assault were OH-6 helicopter gunships, which were refueled and rearmed by the lead Combat Talon by way of a FARRP on the east taxiway. Hostilities continued in and around Rio Hato until well after daylight, at which time the PDF defenders were finally routed from their positions.⁴⁶

Task Force Pacific, made up of the 82d Airborne Division from Fort Bragg, North Carolina, was scheduled to air-drop into Torrijos/Tocumen at 0145 local after Task Force Red Tango had prepared the airfield for its arrival. The cold front that had swept through central Georgia early on 19 December had created havoc when it turned into a severe ice storm across North Carolina. It was the most severe ice storm seen in the area in years, and the deicing equipment at Pope AFB was inadequate to service the C-141 aircraft scheduled to conduct the airdrop. CINCMAC mobilized his entire CONUS force to move deicing equipment and trained technicians to Pope AFB from as far away as McChord AFB in Washington State. Reservists living in the Pope AFB area reported for duty without being officially activated. With a Herculean effort by everyone involved, lead elements of Task Force Pacific dropped on schedule in Panama. By 0400 local Panama time, the entire force had arrived. Once on the ground, the brigade prepared to conduct air assault operations to neutralize PDF forces at Fort Cimarron, Tinajitas, and Panama Viejo. Throughout the morning hours of 20 December, Task Force Pacific moved to occupy key positions on the eastern side of Panama City to restore order in the heavily populated area.⁴⁷

JTF-South forces, including those of the JSOTF, continued mopping up actions across Panama after the initial H-hour objectives were met. The one objective that was not accomplished during the initial assault was the capture of Manuel Noriega. Over the next two weeks, Noriega sought the protection of the Vatican Embassy, but in the end he would be taken into custody and returned to the United States to stand trial for his illegal drug-trafficking activities.

Follow-On Combat Talon Operations

In the days immediately following the H-hour assault on Rio Hato, 8th SOS Combat Talons and their crews continued to support Operation Just Cause. Davenport had departed Rio Hato with his number four engine shutdown and had proceeded on to Howard AB for repairs. The C-130 formation that had dropped Task Force Red Romeo also had recovered at Howard AB. Many of the C-130s had sustained battle damage during their airdrop and required repair. After arranging for a propeller change, Davenport and his crew went into crew rest in preparation for their return flight to Hurlburt Field. During the evening of 20 December, Davenport departed Howard AB and recovered at Hurlburt Field without incident. All 8th SOS Combat Talons were back at home station at that time (fig. 41).

On 23 December the squadron was alerted to deploy two Combat Talons to Howard AB in support of follow-on JSOTF operations. Korver and

Ross commanded their respective crews and were in Panama in position and on alert status by Christmas Eve. The following morning, Christmas Day, Ross's crew was alerted for an in-country mission to David AB, Panama, to exfiltrate Panamanian colonel DelCid, who had been captured by JSOTF forces in the western sector of Panama. Within 30 minutes of notification, the crew had their engines running and were ready for takeoff. On board the Combat Talon was the JSOTF commander, General Downing, and flying in the left seat of the aircraft was Colonel Gray. Flying low-level across Panama and avoiding suspected enemy positions, the mission went according to plan. As the aircraft approached David AB, the special tactics units controlling the airfield advised the Talon crew that the runway was damaged and that only 3,000 feet was available for landing. With Colonel Gray at the controls, the crew made a flawless approach followed by an assault landing, avoiding the large craters as the aircraft rolled out on the runway. Colonel DelCid, along with a special forces security team, was quickly unloaded with engines running. A short-field takeoff was accomplished, and the aircraft headed back to Howard AB. At Howard AB the Talon crew downloaded DelCid to a waiting C-130 aircraft for return to the United States to face drug-trafficking charges. For the remainder of Christmas Day, Ross's crew moved cargo and supplies between Howard AB, Torrijos/Tocumen International Airport, Rio Hato AB, and David AB. The final sortie of the day moved Panamanian POWs from David AB to

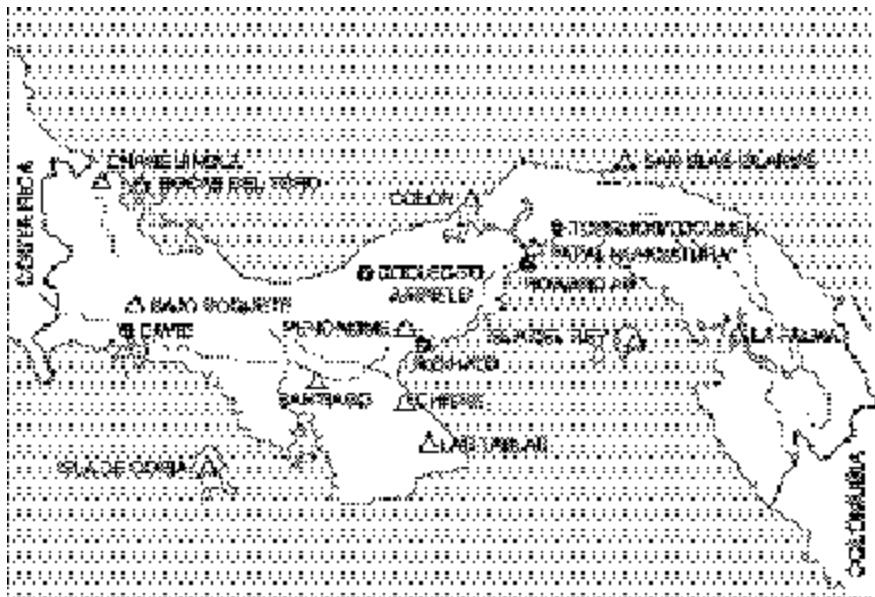


Figure 41. Map of Panama with Operation Just Cause Objectives (Source: USAF Special Operations School, Hurlburt Field, Fla.)

Howard AB. Although the crew flew a long and demanding day, some of the cargo delivered on Christmas Day included turkey dinners for troops holding the various objective areas. The crew went back into alert status on 26 December after completing crew-rest requirements. The crew that flew the 25 December David AB exfiltration mission included Ross, Gray, Gregor, Harstad, Ammons, Knight, Mellinger, Alaniz, Long, Fabbro, Ballerstadt, Boulware, Clark, Wilcox, and Thigpen.⁴⁸

The squadron continued to maintain two aircraft in alert status at Howard AB for the remainder of December and shuttled fresh crews from Hurlburt Field. Noriega took refuge in the Nunciatura (the Vatican Embassy) on 24 December, and US forces established a constant vigil at the compound. On 3 January 1990, Noriega walked out of the Nunciatura and was immediately arrested by US marshals. As Noriega was being unloaded to an awaiting helicopter, Davenport and his Combat Talon crew were alerted to transport Noriega from Panama to the United States. In less than 12 minutes, the crew was at the aircraft and had engines running. When Noriega arrived at the aircraft, he was escorted by an entourage of US marshals, Drug Enforcement Agency personnel, photographers, and doctors. Using minimum lighting on the Combat Talon, the aircraft departed Howard AB with the party on board. En route to Homestead AFB, Florida, the crew flew VFR with minimum radio communications outside the aircraft. Several lines of thunderstorms were avoided to remain clear of the clouds. At approximately 150 miles west of its destination and approaching the US Air Defense Identification Zone, the crew picked up an instrument clearance and proceeded IFR to Homestead AFB. Upon landing Noriega was quickly off-loaded along with the rest of the party.

The crew departed Homestead AFB for Hurlburt Field and the completion of the last Combat Talon operational mission of Operation Just Cause. The crew that flew the Noriega exfiltration mission included Davenport, Stone, Cochran, Bell, Franco, Schwab, Bonn, Gorzynski, Minton, Mitchell, Thorpe, and Fox.⁴⁹

After Davenport's 3 January mission, 8th SOS assets were released by the JSOTF to redeploy to home station. On 4 January Prior and Phillips commanded their Combat Talon crews and departed Panama for Hurlburt Field. English's crew deployed from Hurlburt Field to Howard AB on 5 January to onload additional Talon equipment and personnel still in Panama. On 6 January English's crew returned to Hurlburt Field with all remaining Combat Talon assets, and the 8th SOS's participation in Operation Just Cause officially ended.

* * * * *

Special operations had made tremendous advancements in the 10 years since Desert One. From a position of near extinction, the MC-130E Combat Talon force had rebounded with new upgrades that had increased its capabilities beyond any other C-130 aircraft. The MC-130H Combat Talon II was still in its test phase at Edwards AFB, California, when the decade ended. The 1990s would prove to be even more challenging than the previous 10 years, with brushfire wars and peacekeeping requirements tasking the Combat Talon community to the maximum. As the 8th SOS slowed down in early January 1990 and its personnel celebrated a delayed Christmas season with their families, seven months remained before the next major test—Operation Desert Shield/Desert Storm.

Notes

1. Dr. Richard H. Shultz Jr., *The Aftermath of War: US Support for Reconstruction and Nation-Building in Panama Following Just Cause* (Maxwell AFB, Ala.: Air University Press, 1993), 5–6.

2. *Ibid.*, 7.

3. *Ibid.*, 8.

4. *Ibid.*, 9.

5. *Ibid.*, 10.

6. *Ibid.*, 15.

7. *Ibid.*

8. Official paper, Dr. Edward Mark, "JUST CAUSE, The United States Air Force in Panama," Washington, D.C., Center for Air Force History, 1993, 10.

9. Shultz, 11–12.

10. Mark, 13.

11. Case Study, "Operation JUST CAUSE," Department of Military Strategy, Planning and Operations, Course 3, Carlisle Barracks, Pa., Army War College, November 1990, 10.

12. Shultz, 16.

13. *Ibid.*

14. Case Study, 43.

15. *Ibid.*, 44.

16. *Ibid.*, 45.

17. Shultz, 45.

18. Case Study, 45–46.

19. *Ibid.*, 46.

20. Lt Col Jerry L. Thigpen, commander, 8th Special Operations Squadron, interview by Don Little, 8 February 1990, Hurlburt Field, Fla., draft manuscript on file, Combat Talon Archive, HQ AFSOC/HO, Hurlburt Field, Fla.

- 21. Ibid.
- 22. Ibid.
- 23. Ibid.
- 24. Ibid.
- 25. Ibid.
- 26. Ibid.
- 27. Ibid.
- 28. Ibid.
- 29. Ibid.
- 30. Ibid.
- 31. Ibid.
- 32. Ibid.
- 33. Ibid.
- 34. Ibid.
- 35. Ibid.
- 36. Ibid.

- 37. Ibid.
- 38. Ibid.
- 39. Case Study, 46.
- 40. Ibid., 47.
- 41. Ibid., 48.
- 42. Ibid.
- 43. Ibid.
- 44. Ibid., 49.
- 45. Ibid., 49–50.
- 46. Ibid., 50.
- 47. Ibid., 51–52.
- 48. Official Document, award submission for the crew of Maj David L. Davenport, Air Force Commendation Medal, n.d., on file, Combat Talon Archive, HQ AFSOC/HO, Hurlburt Field, Fla.
- 49. Ibid.

Desert Shield/Desert Storm (1990–91)

We, and all others who believe in freedom as deeply as we do, would rather die on our feet than live on our knees.

—Franklin D. Roosevelt

The decade of the 1980s began with Combat Talon crews attempting to rescue American hostages from Iran. Because the attempt failed, Congress forced the services to revitalize SOF and to build a capability that would deter the rising terrorist threat to US citizens around the world. In 1983, in response to threats to US medical students in Grenada, Combat Talons led the initial assault on Point Salines. In 1989 Combat Talons lead the airland assault on Rio Hato AB during Operation Just Cause. During most of the decade, the new Combat Talon II was under development and was within a year of initial delivery by 1990. As the 1990s began to unfold, USSOCOM moved to formally establish Twenty-Third AF as the Air Force Special Operations Command (AFSOC), and on 22 May 1990, AFSOC was officially established. The new command would serve as the air component for USSOCOM and would be designated as a major command within the USAF. It would no longer be a part of MAC, but rather it would be a separate stand-alone command. The 1980s had been one of revitalization for SOF and one spent fighting terrorism around the globe. The 1990s would be characterized as a period of SOF employment in “operations other than war.” But, in the summer of 1990, a conventional conflict in the Middle East would test the mettle of the new AFSOC and see Combat Talon once again at war in service to its country.

The Calm before the Storm

Operation Just Cause validated the many improvements made by SOF during the 1980s. For Combat Talon and the entire special operations community, capabilities had been developed that brought the services from a Vietnam War-era posture to a viable SOF presence for the 1990s. The 8th SOS had been heavily involved in Operation Just Cause, and the lessons learned and tactics employed by the squadron were incorporated into all three Talon squadrons. At Clark AB, as the 8th SOS prepared for Just Cause, Silvester led the 1st SOS through a transition period as the 353d SOW matured and gained its full complement of assigned

personnel. After Foal Eagle was completed in November 1989, the squadron returned to Clark AB to prepare for the coming year. During the first six months of 1990, the 1st SOS deployed to Thailand and Singapore for JCS exercises and for joint/combined exchange training events. To ensure that the squadron maintained the perishable skills required for the demanding joint mission, the squadron deployed one Combat Talon to Southeast Asia in February for a one-week, no-notice JCS/PACOM contingency exercise known as Fringe Keeper 90. The exercise was unique in that the crew was alerted and deployed to its forward operating location and was then isolated with other participating SOF forces during mission preparation. The execution phase of the exercise went without a hitch, again demonstrating the unit’s ability to perform at a high level of proficiency in the most difficult mission assigned to Combat Talon.¹

From 15 to 23 April, the Headquarters MAC Aircrew Standardization/Evaluation Team (ASET) inspected the 1st SOS during local training operations in the Philippines. The 353d SOW received an overall outstanding rating for the evaluation, while the 1st SOS was graded a perfect Q-1 on 34 flight evaluations. The aircrew written portion of the evaluation was equally impressive for the squadron, with all 66 exams receiving a passing score. The grades reflected the high standards and quality personnel found in the Pacific Talon unit.²

To improve working conditions for assigned personnel, construction on a new squadron operations building began in 1989. In May 1990 building 7288 was completed, and the squadron began moving into the facility the following month. Problems surfaced with telephone lines and fire-detection systems and delayed the full occupation of the building until September.³ Regardless, the facility was the best squadron operations building on the base and reflected the level of commitment to SOF from MAC and PACAF.

On 11 July 1990, Lieutenant Colonel Douglas assumed command of the 1st SOS from Silvester. Colonel Nance, commander of the 353d SOW, officiated at the ceremony held at Clark AB in the

Cope Thunder Wind Tunnel. As Douglas settled in as the new commander, the strongest earthquake to hit the Philippines in 14 years shook the island of Luzon on 16 July. It measured 7.7 on the Richter scale and was classified as a major earthquake. The town of Cabanatuan, located 47 miles northeast of Clark AB, was at the earthquake's epicenter. Lasting only two minutes, the quake's severity proved disastrous to most areas within 80 miles. The death toll was in the thousands, with Baguio City being one of the hardest hit. Landslides blocked the roads leading to Baguio, and poor visibility and damage to the city's Loakan Airport initially closed the runway to all air traffic (fig. 42).⁴

At the 1st SOS five crews were immediately put into crew rest, and two Combat Talons were prepared to respond to the disaster. All five crews were ready for employment by 0700 local on 17 July. The initial tasking for the squadron included a massive airlift of relief supplies into the hardest hit areas. Since Loakan Airport was still closed, all supplies had to be flown into San Fernando Airport located at Wallace Air Station. From Wallace Air Station, helicopters shuttled the cargo 15 minutes to Camp John Hay. The first Talon airlifted medical technicians, cots, rations,

meals ready to eat (MRE), blankets, and rain gear. On the return leg, 55 people were evacuated to Clark AB.⁵

As relief supplies were moved into the disaster area, a fuel crisis developed that threatened to shut down relief efforts. Consequently, the 1st SOS was tasked to establish a FARP in support of the operation. On Wednesday, 18 July, an MC-130E established the FARP operation at San Fernando Airport. Talon crews pumped more than 23,900 pounds of fuel to relief aircraft during the first day of operation. The ramp at the small and usually quiet San Fernando Airport was a virtual beehive of activity throughout the early days of the disaster, with two Combat Talons, one HC-130, multiple HH-3 helicopters, and scores of Philippine air force fixed- and rotary-wing aircraft transiting the ramp. At its peak the small ramp had five C-130s and 25 other fixed- and rotary-wing aircraft on the ground at one time. Throughout the first week of operations, the 1st SOS MC-130Es and the 17th SOS HC-130P/Ns (which were stationed at Kadena AB, Okinawa) continued to shuttle fuel to San Fernando and to pump it to both US Marine and Philippine air force helicopters. In a single day, 111,450 pounds of fuel were delivered.⁶



Figure 42. Map of the Philippine Islands (Source: AU Library, Maps and Charts Division, Maxwell AFB, Ala.)

For a two-week period (from 16 July to 3 August), the squadron focused on the FARP operation at San Fernando Airport. The final mission of the 1st SOS came on 7 August when it air-dropped supplies to US personnel stranded on Mount Kabuyao. After two drops the crew proceeded to Loakan Airport, which had reopened to air traffic, and airlifted to Clark AB the remains of two US citizens killed in the earthquake. The effort put forth by the squadron and the entire 353d SOW showed great determination and a willingness to help others during a time of need. During the entire operation, the combined 1st and 17th SOS effort resulted in 377,000 pounds of fuel being pumped through multiple FARPs. In addition, aircrews dropped 1,500 pounds of cargo to earthquake victims throughout the region.⁷

As the Baguio City earthquake relief wound down, the squadron prepared for the arrival of the new SOF-I-modified aircraft. All of the 8th SOS-assigned Combat Talons had received the SOF-I modification, and the 1st SOS was scheduled to begin receiving its assigned aircraft in July 1990. In preparation for the first SOF-I aircraft, the squadron sent an augmented crew to LAS Ontario for training in the new system. The schedule called for the first SOF-I aircraft to be flown to Clark AB by the 1st SOS crew at the end of July, but the date was slipped when the aircraft did not complete its flight tests as scheduled. During the first week of August, Iraq invaded Kuwait, and Operation Desert Shield began a few days later. Due to Desert Shield priorities, the 1st SOS aircraft was delayed indefinitely at LAS Ontario, and the crew returned to Clark AB by way of commercial air. The coming months would see a heavy burden placed on the squadron when the Combat Talon formal school closed due to a lack of aircraft at home station. Three pilots and two navigators were sent directly to Clark AB unqualified, which resulted in the commitment of limited 1st SOS resources to train its new crew members.⁸ The protracted conflict in the gulf would have other, far reaching impacts on the Pacific-based Talons.

In Europe, after the 7th SOS crew returned from JRT 90-1 in December and just as Operation Just Cause kicked off, the squadron relaxed in Germany over the snowy Christmas holidays. Early January saw a Combat Talon deployed to RAF Woodbridge, UK, for FARP training with 21st SOS MH-53 helicopters. The five-day deployment also included low-level operations in the Scottish Highlands, IFR, and NVG blacked-out

landings. One Combat Talon deployed to RAF Machrehanish, Scotland, for a recovery training mission supporting the US Navy SEAL team stationed there. Additional deployments were completed to Gardemoen, Norway; Moron AB, Spain; and Royal Danish Air Force, Aalborg, Denmark, as the squadron prepared for the annual Flintlock exercise in the April and May time frame.⁹

Joint Combined Readiness Exercise (JCRX) Flintlock 90 was conducted concurrently with the 39th SOW's ORI. It was the first time that the European SOF wing had been evaluated, although it had deployed HC-130s and MH-60 helicopters to the 1st SOW's ORI while still stationed at Eglin AFB, Florida. The 39th SOW, including the 7th SOS, deployed under the operational control of SOCEUR and conducted infiltration, resupply, and exfiltration missions. Flintlock 90 was similar to previous exercises in the series, with the MAC IG evaluating the wing's participation on a noninterference basis. Although most of the missions had been preplanned and coordinated by "trusted agent" mission planners before the start of the exercise, unit participants were not briefed on their missions until each was tasked by SOCEUR during the course of the exercise. The 7th SOS flew 53 sorties in eight countries, completing 18 infiltration, 19 resupply, and 16 exfiltration missions. Aircraft generation and initial deployment were graded outstanding, with the 39th SOW receiving an overall excellent for the ORI.¹⁰ With the squadron redeployed to Rhein Main AB after the ORI, the squadron once again took a short breather before resuming its vigorous exercise and training schedule. Later in the summer, on 1 August 1990, Lt Col Norm McCaslin assumed command of the 7th SOS from Ferkes. With successful completion of the 39th SOW's ORI in Europe and the outstanding Aircrew Standardization/Evaluation Team rating for the 353d SOW in the Pacific, General Patterson's Forward Look vision was nearly complete.

At the 8th SOS, the 4 January 1990 mission bringing Manuel Noriega to the United States to stand trial on drug-trafficking charges marked the climax of the unit's participation in Operation Just Cause. The following day, 5 January 1990, the squadron completed its first-ever air refueling of USA MH-47 helicopters, as the 8th SOS led three other fixed-wing tankers and seven helicopters (five MH-53s and two MH-47s) from Panama to the United States. Later in the month, the squadron deployed Combat Talons to Nellis AFB, Nevada, for Black Flag, which was

the first night that Red Flag dedicated training to SOF aircraft. The deployment resulted in excellent training for participating aircrews.¹¹

Throughout the spring of 1990, the squadron maintained a heavy exercise schedule, participating in JRT 90-2 Phase I and Phase II in March and April, JCS Exercise Ocean Venture from 23 April to 6 May, and JCRX Flintlock 90 from 29 April to 20 May. For the fourth consecutive year, the squadron deployed one Combat Talon and two crews to the Middle East from 22 May to 20 June for JCS Exercise Eastern Desert 90. The remainder of June was filled with bilateral training events, including one deployment to Panama. On 2 July 1990, Lt Col Tom Beres assumed command of the squadron from Colonel Thigpen, who departed Hurlburt Field for the US Army War College at Carlisle Barracks, Pennsylvania. Two weeks later the squadron deployed to Hill AFB, Utah, for mountain training and while there, dropped the BLU-82B 15,000-pound bomb during a training mission.*¹²

As August began the squadron was operating smoothly as it prepared for its fall exercise schedule and for the arrival of the first Combat Talon II aircraft. Before dawn on 2 August 1990, Saddam Hussein's Iraqi army invaded Kuwait and quickly occupied the small, oil-rich country. Beres and the men and women of the 8th SOS would soon be faced with the grim reality of war.

Prelude to 2 August 1990

Modern-day Iraq was created out of the ancient region known as Mesopotamia, after centuries of conflict between Sunni and Shia Muslims and between ancient nations that would eventually become the twentieth-century countries of Iran, Saudi Arabia, Syria, and Turkey. The bitter conflict between the Sunnis and Shias could be traced to the Battle of Karbala, which took place in 680 A.D. The Shias were defeated in the otherwise insignificant battle, but it set the stage for perpetual conflict between the two factions. In 1258, after disastrous floods throughout the country, the Mongols captured Baghdad, burning the city and butchering its citizens. The caliph was also executed, and the country's economy was ruined for the next several centuries. By 1405 Turkish tribes from Anatolia controlled

the region. In 1534 Iraq was conquered by the Ottoman Empire, and the resultant peace brought prosperity to the otherwise volatile region. Except during brief periods of Shia rule by Persia (modern-day Iran), Iraq remained a part of the Ottoman Empire until World War I.¹³

In 1914 the British invaded southern Iraq as part of the Allied plan to defeat the Axis powers aligned with the Ottoman Empire. After a prolonged campaign that included most of the Middle East, Baghdad was captured by the British in 1917. On 23 August 1921 Prince Faisal of Hijaz (modern-day southwestern Saudi Arabia) won a popular vote, taking 96 percent of the electorate, and was declared king of Iraq. As King Faisal began his rule, unrest in the region escalated when the Kurds in the north and the Shias in the south fought for their independence. Other regional powers, including Saudi Arabia and Turkey, also worked to destabilize Iraq. British forces remained in Iraq at the request of King Faisal. On 10 October 1922 the new king signed an alliance with Great Britain, thus tying the fledgling nation to the British Empire. In 1923 the borders between Iraq and Kuwait were drawn, and a neutral zone between Kuwait and Saudi Arabia was established.¹⁴ In a 1930 treaty between the two nations, Great Britain agreed to give Iraq its independence but retained control over Kuwait. On 3 October 1932 Iraq was declared an independent nation and was admitted to the League of Nations. A year later, in 1933, King Faisal died of natural causes, and his son, Ghazi, succeeded him and reigned as king for the next six years. With King Ghazi on the throne, oil was discovered in 1938. In 1939 King Ghazi died, thus throwing the nation into turmoil on the eve of World War II. As had been the case during World War I, Iraq aligned itself with the Axis powers. In 1941, after four weeks of war with Great Britain, Iraq was again occupied, and a pro-British government was formed. A puppet state of Great Britain, Iraq formally declared war on Adolf Hitler's Germany in 1943. For the remainder of the war, Iraq remained aligned with Great Britain and the Allies. Immediately after the war, Kurdish unrest in northern Iraq, which many thought was instigated by the Soviet Union, brought on another crisis. A parliamentary election was conducted in 1953, and King Faisal II,

* At Hill AFB the Air Force maintained two BLU-82B bombs, which had a shelf life of one year each and were ready for employment. The 8th SOS dropped one of these two bombs every six months to maintain proficiency. When the Gulf War broke out and General Schwarzkopf looked for a weapon to neutralize Iraqi minefields, Beres developed a proposal to employ the weapon. Along with PSYOPS leaflet drops, the employment of the BLU-82B was the major 8th SOS contribution to the Gulf War. The proficiency maintained by 8th SOS crews enabled them to employ the large bomb when called upon in early 1991.

who was three years old when his father died in 1933, was elected to the throne. The new government was somewhat independent of Great Britain, but King Faisal II remained allied with the British Empire to ensure stability within the country. On 14 July 1958 a military coup, led by Gen Karim Kassem, overthrew the elected government, and King Faisal, his son (the crown prince), and the prime minister were assassinated.¹⁵

On 19 June 1961 British protection of Kuwait was terminated, and Kuwait entered the Arab League as an independent nation under the strong objections of Iraq. Two years later, on 8 February 1963, Kassem was overthrown by a group of Iraqi officers who were aligned with the Ba'ath political party. Abdul Salam Arif became the new president, and 10 months later, he agreed to give up Iraq's claim to Kuwait. President Arif died three years later of natural causes and was succeeded by his brother, Abdul Rahman Arif. During the Arab-Israeli Six-Day War of 1967, Iraq aligned itself against Israel and further distanced itself from the West. On 17 July 1968 President Arif was overthrown, and Ahmed Hassan al-Bakr became the new president. Under Bakr Iraq aligned itself with the Soviet Union and made concessions to the Kurds in the northern part of the country to bring about stability. Following 10 years of Kurdish unrest, President Bakr agreed to establish an autonomous Kurdish region in 1970 and to let the Kurds have representation in the Iraqi cabinet. Over the next several years, however, the relationship between the Iraqi government and the Kurds did not improve, primarily because the Kurds accepted aid from Iran, the archenemy of Baghdad. Iran and Iraq did not agree to a common border until 1975, when a formal agreement was signed. Iran agreed to stop supporting the Kurds in northern Iraq for certain concessions regarding the common border. After the agreement was put into effect, the Iraqi army quickly defeated the Kurds.¹⁶

Bakr continued as president of Iraq until June 1979, when he was removed from power and placed under house arrest by Saddam Hussein. Appointing himself as president, Hussein moved to consolidate his power by ruthlessly eliminating those who opposed his authority. In August 1979 he had 400 members of the ruling Ba'ath Party executed and established his rule based on fear and intimidation. The Islamic Revolution experienced in Iran during 1979 formed the catalyst for renewed fighting by the Kurds in northern Iraq.

On 17 September 1980 Hussein declared the Iraqi/Iranian border agreement of 1975 null and void, and he laid claim to the entire oil-rich and strategically important Shatt el-Arab region. On 22 September 1980 Iraq invaded Iran and quickly gained control over a large piece of Iranian territory. Two years later, after much suffering and loss of life, Iran mounted a counteroffensive and drove Iraq out of most of its occupied territory. Fighting continued for the next six years, until the two countries agreed to a cease-fire on 20 August 1988. With the cease-fire in effect, Hussein again unleashed his military on the Kurds. Using poison gas, the Iraqi army killed thousands as it attempted to wipe out the Kurdish insurrection. Once the Kurdish situation stabilized, Saddam Hussein turned his attention south towards Kuwait and the long-held position that Kuwait was a province of Iraq.¹⁷ On 17 July 1990 Hussein accused Kuwait of overproduction and theft of oil from the Rumailia oil field located astride the Iraqi/Kuwaiti border. One week later, on 25 July, the US ambassador to Iraq, April Glaspie, told Hussein that the Iraqi/Kuwaiti dispute was an Arab matter and one that did not concern the United States. One week later Saddam Hussein made his move.

With 100,000 troops attacking across the border on 2 August 1990, Iraq invaded Kuwait and quickly overran the small country's meager defenses. The emir of Kuwait fled to the United States as Iraqi troops entered Kuwait City. On 8 August Iraq officially annexed Kuwait under the condemnation of the Arab League and the United Nations.¹⁸ The stage was thus set for Operation Desert Shield, which culminated five months later with Operation Desert Storm (fig. 43).

United States Reacts to the Invasion

Immediately after the invasion President Bush froze Iraqi and Kuwaiti bank accounts in the United States. The United Nations condemned the invasion and called for an immediate withdrawal. On 6 August economic sanctions were imposed, and on the following day, Secretary of Defense Dick Cheney visited Saudi Arabia. With a formal request for assistance from the Saudi government in hand, Secretary Cheney authorized the initial deployment of the 82d Airborne Division and several fighter squadrons. At Hurlburt Field, Headquarters AFSOC was alerted by USSOCOM to be prepared to provide forces as required to support Special Operations Command Central, the subunified special operations headquarters assigned to US Central Command.

Within days of notification, the 1st SOW was on the move to Southwest Asia.

* * * * *

It was Thursday, 7 August 1990, when Colonel Weaver, 1st SOW/Directorate of Operational Plans, received a secure telephone call from Colonel Gray, the 1st SOW commander. Weaver's peacetime job was to manage the wing's exercise program and, as the chief, Current Operations Division, he had frequently deployed around the world for both contingencies and exercises. He had flown with Uttaro and Beres on the number six EC-130E into Desert One a decade earlier and was considered an "old head" in the close-knit Combat Talon community. Before coming to work that day, he had reflected on the possibility of the 1st

SOW becoming involved in the unfolding crisis in Southwest Asia. The conflict was shaping up as a conventional one, he reasoned, and he concluded that there was little possibility that special operations forces would be involved. With Colonel Gray on the other end of the telephone, however, Weaver was surprised when Gray told him to pack his bags and get to MacDill AFB to link up with SOCCENT personnel preparing to depart for Southwest Asia. Weaver had four hours to hurry home, pack his bags, and get on a flight to Tampa. Along with Weaver two logistics specialists from Headquarters AFSOC, a CCT member, and a para-rescueman (PJ) made up the initial five-person advanced cadre (ADVON) team.¹⁹

At MacDill Weaver and his team joined with a 40-man SOCCENT ADVON party and departed

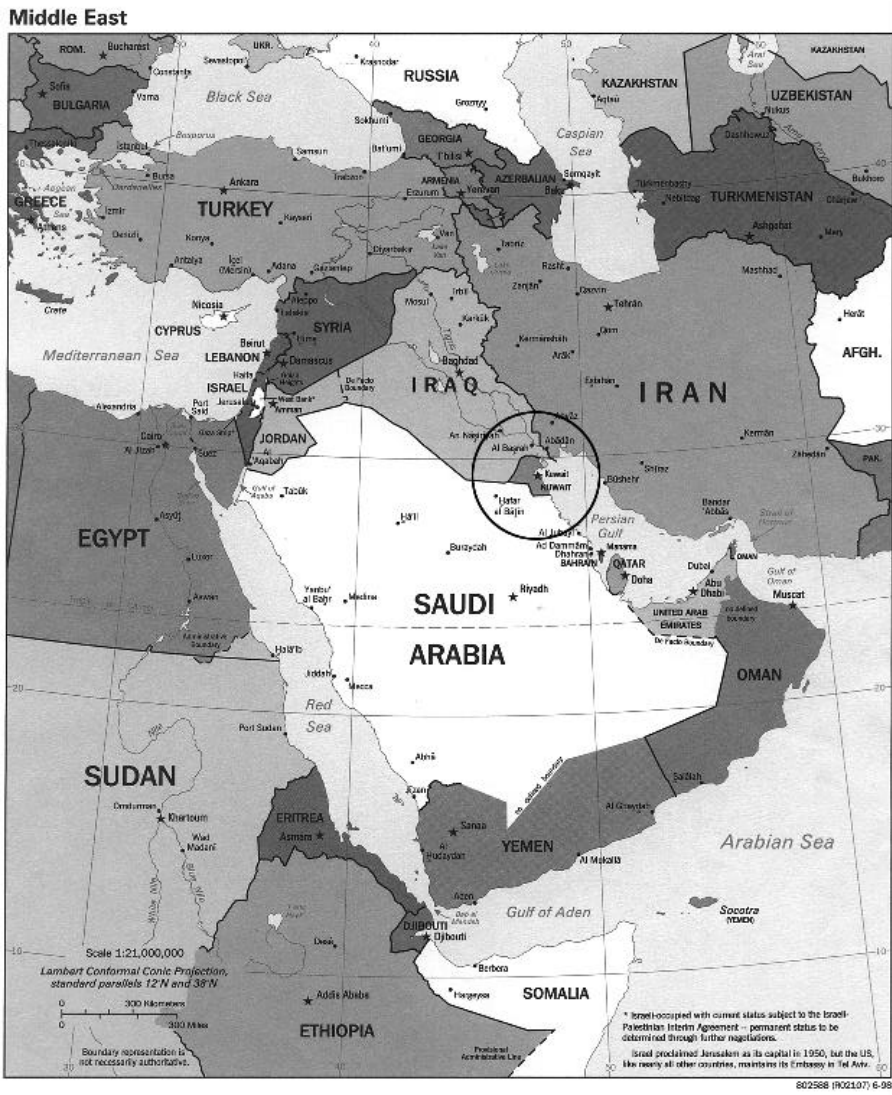


Figure 43. Map of Southwest Asia (Source: AU Library, Maps and Charts Division, Maxwell AFB, Ala.)

the next day (8 August) for Riyadh, Saudi Arabia. While the ADVON team was en route, Saddam Hussein announced that Iraq had annexed Kuwait. The AFSOC ADVON team's mission was to find a suitable airfield that would accommodate SOF aircraft and then determine what was needed to support SOF operations. On the ground at Riyadh, Weaver went to US Central Command (CENTCOM) headquarters and contacted the US Air Forces, Central Command (CENTAF) representative responsible for airfield allocations. Weaver ran into Maj Gen Tom Olson, who was the vice commander of CENTAF. Both officers had been assigned to CINCPAC in Hawaii a few years earlier, and Weaver had served under General Olson while stationed there. During the course of the conversation, General Olson mentioned that there was a base under construction near Dhahran and recommended that Weaver take a look to see if it was close enough to completion to serve SOF needs. The general also asked Weaver to look at the possibility of placing an A-10 wing at the same airfield. Procuring two cars for their use, Weaver and his five-man team departed Riyadh for Dhahran. Once in Dhahran the team linked up with US Embassy personnel, who coordinated permission to visit the new airport. Northwest of Dhahran was King Fahd International Airport (KFIA), and from the first time that the ADVON team laid eyes on the facility, they knew that it was the place to beddown SOF. It had dual runways that could accommodate both A-10 and SOF rotary- and fixed-wing aircraft. A couple of days before the ADVON team's arrival at KFIA, the last concrete slabs had been poured for the runways, but the runway lights had not yet been installed. KFIA had partially constructed terminals for passengers and their king and an unfinished control tower, runways, and parking ramps. About 5,000 construction workers were employed across the sprawling complex. As the ADVON party entered the airport area, about 1,000 construction workers were walking out the front gate and making their way to Dhahran for departure from the country.*²⁰

The ADVON team met with the manager of Bectal Corporation (the general contractor responsible for the airport's construction) and discussed beddown requirements. A tour was hastily arranged, and the team was shown around the facility. The first area visited was the control tower,

which was not finished but had running water, electricity, and ample room in the building at its base. The control tower itself did not have any equipment installed and was completely gutted, but the CCT representative felt that it could be made operational within hours by installing portable radios for communications. The next stop on the tour was the MABCO compound, which consisted of 16 trailers that had been occupied by some of the departing construction workers. There were air-conditioned bed spaces for approximately 400 personnel and ample room for additional tentage adjacent to the trailers. The Bectal general manager was cooperative and offered all of his facilities at KFIA if approved by the Saudi government. Satisfied that KFIA was the place to be, the team drove back to Riyadh to confer with General Olson and with the SOCCENT commander, Colonel Johnson. Olson gave tentative approval for the use of KFIA, with the USAF A-10s using the east ramp and SOF aircraft using the west ramp. Conferring with Colonel Johnson, Weaver recommended that SOCCENT collocate with AFSOC forces at KFIA, and plans were made for the joint headquarters to begin moving forward the following day.²¹ Almost as an afterthought, General Olson mentioned that the 1st SOW initial echelon had arrived in-theater and were, he thought, already in Dhahran. Saying a quick good-bye, the ADVON team hit the road again for the five-hour drive to Dhahran to link up with the 1st SOW element.

At Hurlburt Field Gray had been extremely busy since his telephone call to Weaver. The wing had mobilized and had processed its initial elements for deployment to Southwest Asia. In the first several days after alert, there was much confusion as CENTCOM prioritized forces needed to defeat an invasion of Saudi Arabia by Iraq. General Schwarzkopf, commander in chief, Central Command, anticipated a fierce fight with considerable US combat air losses. Consequently, he included SOF elements in the initial deployment to serve in the combat search and rescue role. The MH-53H Pave Low, MC-130E Combat Talon, and HC-130P/N were, thus, part of the initial SOF cadre. Thom Beres and the 8th SOS were alerted, and four Combat Talon aircraft and five crews were prepared for departure. The MC/HC-130 package would self-deploy from the United States to Southwest Asia by way of Europe, while the Pave Low helicopters would be shipped by way of C-5 aircraft. With initial actions completed, 1st

*The Iraqi army was poised a few hundred miles to the north and was threatening to invade Saudi Arabia at any time.

SOW forces leaned forward to await a deployment order.*

On 11 August Colonel Hassell (1st SOW/assistant director of operations) was notified that he was to deploy that evening with the advanced cadre Pave Low package. With approximately 30 personnel and eight pallets of equipment and supplies, he departed Hurlburt Field on the first of two C-141B aircraft bound for Riyadh. The C-141s were followed by a C-5 aircraft with two Pave Low helicopters onboard. The route of flight went through Goose Bay, Labrador, and on to Rhein Main AB, Germany, where Hassell met with Col Byron R. Hooten, the 39th SOW commander. With just over two hours on the ground at Rhein Main AB, Hassell briefed Hooten and his director of operations on the situation and the anticipated level of involvement of the 1st SOW. After the C-141 was refueled and serviced, Hassell and his team departed for the final leg to Riyadh. At 0400 local time on 13 August, the first C-141 touched down at Riyadh and taxied into parking. With aircraft arriving and departing continuously from Riyadh, it was important to unload as fast as possible to make room on the ramp for the next aircraft. Quickly unloading, Hassell found a vacant corner in a nearby aircraft hangar and had his team begin unpacking and setting up their SATCOM radios. He found a telephone and called back to the 1st SOW to talk with Colonel Gray. Hassell learned from Gray that the plan had changed en route and that he was to proceed on to Dhahran. As Hassell headed back to the hangar to stop the unpacking process, the C-141 that had brought him to Riyadh took off, thus leaving part of the 1st SOW element without air transportation. Although exhausted from the long flight, everyone quickly began to pack up and prepare to move. On the ramp the second C-141 was on the ground and was beginning the unloading process. As Hassell moved to the C-141, he saw the C-5 taxiing in loaded with the two Pave Low helicopters and additional support personnel. Coordinating with the MAC air lift control element (ALCE) team, he quickly told the

C-5 crew to stand by and await further instructions. Moving to the C-141, he told them to stop unloading. A meeting was held behind the C-141 with the two aircraft commanders, the ALCE chief, and Colonel Hassell. They agreed to load as much of the cargo from the hangar as possible and fly on to Dhahran. In short order all but three pallets were loaded on to the C-5 and the C-141, and they were off again for their next destination. At 0900 local time the two aircraft taxied into parking at Dhahran.²²

Al Hassell had three priorities: first, to get the Pave Low helicopters downloaded and to get them assembled; second, to get his personnel off the hot tarmac and into an adequate facility so they could get some rest and be prepared to fly; and third, to contact either SOCCENT or CENTAF for further instructions. As the helicopters were being unloaded, the temperature on the flight line already exceeded 112 degrees Fahrenheit, so Hassell moved his troops not involved in the download operation to a nearby empty C-12 hangar to get them out of the direct heat. With no fans or any circulation inside the hangar, the heat was stifling. Attached to the hangar was a set of offices that supported US Embassy operations at Dhahran. The facility was air-conditioned, so Hassell moved his troops into the hallways for some air-conditioned rest. It was at this time that Weaver and his ADVON team arrived from Riyadh. Weaver discussed with Hassell the facilities at KFIA, and the two agreed that initial operations should be established at Dhahran until King Fahd was ready for flight operations. It was critical that the two Pave Low helicopters be assembled, flight-checked, and put on alert with crew-rested flight crews as soon as possible if the planned Iraqi invasion materialized.²³

Down the hallway where Hassell's troops were resting was the ADVON party of the 1st Fighter Wing (FW) out of Langley AFB, Virginia. They had arrived as part of the first wave of forces three days earlier. Both the 1st FW commander and the Langley base commander

*In 1989 CINCMAC had reestablished Air Rescue Service at McClellan AFB, California, and had assigned all rescue-designated forces from Twenty-Third AF to ARS. When AFSOC was formally established as the air component of USSOCOM on 22 May 1990, a secondary mission of SOF was to be prepared to conduct "combat rescue" operations, as required. ARS was in the initial stages of upgrading its assigned forces with HH-60 Blackhawk helicopters, but did not possess an adequate force structure to execute the demanding combat search and rescue (CSAR) mission by 1990. When CINCCENT looked for a standing CSAR force that could immediately deploy to Southwest Asia, his only choice was SOF. Throughout the entire Desert Shield buildup and preparation phase, AFSOC's assigned mission was to support CSAR operations. In Vietnam CSAR missions were flown into North Vietnam and Laos and consisted of both helicopter and fixed-wing (Sandy) support aircraft. The A-10s stationed at KFIA would prove to be the modern-day equivalent to the A-1 Skyraider of the Vietnam War era. Much work was needed, however, to develop a viable force of fixed- and rotary-wing aircraft capable of penetrating Iraqi defenses and rescuing downed crew members. As Desert Storm drew near, however, the 8th SOS Combat Talons assumed additional roles as a leaflet (PSYOPS) platform and as the delivery system for the HLU-82B 15,000-pound bomb.

were there. Col David L. Peebles (the Langley base commander) had been designated the mayor of Dhahran AB by CENTAF, and he agreed to provide any support that he could for Hassell and his troops.* Weaver relayed to Hassell that SOCCENT was not yet operational and recommended that he operate autonomously until the SOF higher headquarters was ready. Later in the afternoon, Peebles learned there was an air-conditioned school on Dhahran airport that might be available to US forces. The school was not in session for the summer and was vacant. Peebles took Hassell to the school and quickly arranged with the school custodian for the 1st SOW contingent to move in. The custodian was glad to provide the school to the Americans. Thus, Hassell became the “slum lord” of the school, and over the next week, the number of personnel housed in the facility swelled to over 750 (175 SOF- and 600 CENTAF-assigned personnel). Col Ben Orrell (1st SOW/DO) arrived at Riyadh on 14 August with additional SOF staff personnel, and he proceeded to SOCCENT headquarters at KFIA to assume duties as the senior AFSOC officer in-theater. This was to be the last SOF flow for the next two weeks—CINCCENT had decided that the probability of an Iraqi attack on Saudi Arabia had lessened, and the need for SOF/CSAR forces early in the deployment flow was no longer a high priority. Hassell was forced to operate his small contingent with the equipment brought in on the two C-141s and the two C-5s. Meanwhile, the break in the flow allowed Orrell and Weaver to get a breather at KFIA.²⁴

As the initial 1st SOW ADVON was deploying from Hurlburt Field on 11 August, Thom Beres and the 8th SOS Combat Talon contingent departed the United States en route to Southwest Asia. With four aircraft (64-0559, 64-0562, 64-0567, and 64-0568) and six crews, the squadron was cleared to forward deploy to RAF Woodbridge, UK, and to remain there awaiting additional instructions. Arriving in the UK on 13 August, Beres learned of the new CENTCOM priorities and was directed to remain at RAF Woodbridge for the next nine days awaiting onward-movement authorization. Personnel from the 8th SOS, who made up the initial deployment package to Southwest Asia, consisted of 38 officers and 22 enlisted personnel including the following:

Pilots	Navs	EWOs	Fit Eng	ROs
Phillips	Calvert	Anderson	Gorczynski	Minton
Close	Saier	Smith	Garvey	Dent
Davenport	Bell	Lawler	Fleming	Foster
Cochran	Thomas	Pearson	Dunn	Bonck
Harstad	Lorenz	Burnett		
Palmer	Tagert	**DeBoe		
Henry	Pulmano	**Bynum		
Biermacher	**Crisafi			
Prior	Bouressa		Loads	Others
O'Reilly	Richard		Crayne	Beres
Hinck	**Tardiff		Bohannon	Meller
Boitano	**Cooper		Corlew	Schommer
**Linder	Eskind		Pearson	Livesay
**Mohylski	Franco		Gobbi	Baylor
**Stephenson			Roberson	Phillips
			Kelly	
			Carroll	
			Gallo	
			**Sausedo	

At KFIA Weaver had staked out his claim to a portion of the airfield, and SOCCENT had moved from Riyadh to colocate with the AFSOC element in the tower building. Other units were beginning to arrive and settle into KFIA, including the USA's 101st Airborne Division and its aviation battalions. The 101st Airborne Division wanted the tower facility and the MABCO compound for its operations, and demanded much of the ramp space that Weaver had portioned for SOF aircraft. With the help of General Olson and Colonel Johnson, Orrell and Weaver were able to retain most of the real estate that they needed. The ADVON team posted an armed guard at the MABCO compound and claimed the tower area for combined AFSOC/SOCCENT use. To prepare the airfield for flight operations, the airfields large fuel tanks were cleaned, and a source for JP-4 fuel was found. Fuel trucks to refuel the aircraft were brought in by CENTAF planners. In a short period, the airfield was brought up to minimal operational standards, but it would take another two months before it was fully operational.²⁵

At Dhahran Hassell had apportioned the three wings of the school to the 20th SOS, 8th SOS, and 9th SOS. The latter two squadrons were waiting to be called forward from RAF Woodbridge, UK, and Hassell was pressured into opening up the school to other CENTAF personnel. With an imprest fund of \$100,000 and a contracting officer to obligate it, Hassell had procured hundreds of mattresses from the local economy by the second day in the school. By the fifth day life at the school

*Peebles had been the 435th TAW deputy wing commander at Rhein Main AB, Germany, and was familiar with SOF and the 7th SOS.

**Denotes personnel assigned to other units and attached to the 8th SOS for flying.

was “not bad.” On the flight line buildup of the first two MH-53s had begun shortly after their arrival. On 15 August the second two helicopters were delivered aboard a C-5 aircraft. The limiting factor for Hassell was the lack of maintenance personnel (only 26 maintainers were included in the original deployment package) and war readiness spares kit parts to assemble and operate the sophisticated machines.²⁶ Borrowing tools and miscellaneous equipment from British contractors and a crane from the 82d Airborne Division, the maintainers were able to assemble the four helicopters by 17 August. There were not enough spare parts to keep all four helicopters operational, so Hassell made the decision to use the fourth aircraft as a cannibalization bird to keep the other three helicopters flying. With functional check flights complete, AFSOC finally had an operational presence in-theater.²⁷

Although Hassell had four helicopters and 175 personnel, he had no guns or ammunition to arm the helicopters. If tasked to fly a CSAR mission, the slow-moving helicopters would have no means of self-defense. Lt Col Rich Comer, the commander of the 20th SOS, had deployed to Dhahran on the first C-5. He and Hassell kept pressure on the 1st SOW back at Hurlburt Field for help in resolving the shortfall. Because of their efforts, the first shipment of guns and ammunition arrived on 20 August by way of the 1st SOW’s HC-130 aircraft that had been delayed at RAF Woodbridge. Headquarters AFSOC coordinated with the 39th SOW to transfer the equipment to the 20th SOS until the 1st SOW’s own equipment resumed its flow into Saudi Arabia. The HC-130s also brought additional spare parts to keep the helicopters operational. A regular shuttle was established between RAF Woodbridge and Dhahran every four days until the SOF flow resumed. The last four MH-53s did not arrive in Southwest Asia until 4 September, and the WRSK did not reach 100 percent fill until 20 September.²⁸

With airfield conditions improving at KFIA, Orrell decided to move the Dhahran helicopter operation forward to its final beddown location. From 20 August to 3 September, personnel and equipment moved from Dhahran to KFIA. With SOF personnel gone from the school, Hassell turned over the administrative responsibilities to CENTAF and graciously bowed out of his far-reaching commitments at Dhahran. He returned to Hurlburt Field and remained there throughout the



USAF Photo

Tent City, KFIA, Saudi Arabia. Maintenance and support crews stayed just ahead of arriving AFSOC forces at King Fahd International Airport.

remainder of the conflict, running the operations directorate in the absence of Ben Orrell. At RAF Woodbridge Beres received orders to proceed onward to KFIA. On 22 August 1990 the four Combat Talons arrived in Saudi Arabia, thus beginning a Combat Talon commitment that would last for the next eight months. On 28 August two EC-130E aircraft of the 193d SOG Air National Guard arrived, and three days later Colonel Gray moved forward from Hurlburt Field to assume command of Air Force Special Operations Command Central (AFSOCCENT). Thus, within three weeks of notification, AFSOCCENT was established and operational in the desert of Saudi Arabia. By 8 September four AC-130H gunships had closed at KFIA, and four days later the fifth and final gunship arrived.²⁹ With SOCCENT also colocated at KFIA, Weaver’s vision of a consolidated SOF presence in Southwest Asia became a reality.

Training in the Desert

Along with the other squadron commanders, Beres had his hands full during the initial month after arriving at KFIA. The MABCO compound was overflowing with personnel, and air-conditioned “temper tents” were erected as the population of the airfield grew. AFSOCCENT was able to keep just ahead of the buildup with everyone pitching in. Officers and enlisted personnel alike constructed tents. One of the 8th SOS aircrews got so proficient that they could put up a temper tent in 20 minutes—from the start of breaking down its packing box to having it completely erected. By 1 September there were almost 20,000 troops living

at KFIA. The 354th TFW from Myrtle Beach, North Carolina, was designated by CENTAF as the host wing for KFIA, having approximately 3,000 personnel and 48 A-10 aircraft assigned. The 23d TFW from England AFB, Louisiana, also had a contingent of A-10 aircraft and associated personnel assigned to the base. Under the arrangement, AFSOCCENT had to coordinate its requirements through the host 374th TFW base commander, a situation that became strained as AFSOCCENT requirements expanded and went unfilled. Equipment and supplies specifically earmarked for AFSOC were redirected by the host wing to fill its own requirements. The USA's 101st Airborne Division, with 600 helicopters assigned, was also a large presence at the airfield and further taxed the host wing's ability to support its tenants. Gray had to fall back on the informal relationship, established by Weaver and Orrell, with General Olson at CENTAF headquarters to finally get the situation resolved. After much turmoil and hard feelings between major tenant units and the host wing, the operation began to smooth out in mid-October.³⁰

With SOF crews deployed to Saudi Arabia, continuation training requirements became a priority. All AFSOC crews were fully trained and mission ready when they arrived in country, but unique SOF skills were perishable and needed to be practiced on a regular basis to maintain proficiency. Training flights in the traffic pattern at KFIA and resupply sorties for SOCCENT-assigned forces stationed up and down the northern border of Saudi Arabia were flown, but no real tactical training missions occurred until early October. The Royal Saudi Air Force controlled all airspace, and it was restrictive when giving permission for US aircraft to fly low level either during the day or night. Eventually, as Saudi Arabia came to the realization that Saddam Hussein was not going to give up Kuwait and stop threatening Riyadh, airspace approval was granted, and SOF aircraft were allowed to train for their wartime mission. On 9 October an MC-130E Combat Talon flew its first low-level training mission that included helicopter aerial refueling and reception light committee (RLC) landings at KFIA. The crew was also able to fly NVG approaches to blacked-out landings after RLC training was completed. Two days later a similar Combat Talon training mission was flown, with rapid off-loads at KFIA added to the profile. In the following weeks Combat Talons performed IFR operations with KC-135 tankers, executed ground FARP operations, and completed HSLLD and bundle

airdrops. On 6 November an MC-130E participated in a full-scale CSAR exercise (CSAREX), refueling both MH-60 and MH-53 helicopters and receiving fuel from a KC-135. The CSAREX incorporated A-10 fighters as "Sandy" support aircraft in a rescue scenario that included recovery of a downed pilot from hostile territory.³¹ Unlike the primary mission of long-range, low-level infiltration and exfiltration of personnel and equipment from denied areas, the CSAR mission had not been rehearsed by SOF aircrews and conventional fighter forces since Vietnam. Tactics and procedures had to be developed to ensure that the mission could be safely conducted in a combat environment.

As the fall months passed, negotiations with Saddam Hussein reached an impasse. In anticipation of the commencement of hostilities, AFSOCCENT deployed from KFIA on 2–3 October 1990 an ADVON team headed by Weaver. The team was tasked to look for possible locations where helicopters and tankers could maintain ground CSAR alert closer to the southern Iraqi border. The team included doctors, logisticians, CCT, and PJs who were authorized to make commitments for AFSOCCENT. The search resulted in identifying Arar and Rafhá Airfields, which were located near the Iraqi border, as forward staging bases for rotary-wing alert. The two airfields were too close to the border for sustained operations, so the team continued to look for a forward operating location that would support the two smaller airfields. On 28 November Weaver's team identified Al Jouf AB as an ideal FOL. Al Jouf was far enough from the border that both rotary- and fixed-wing aircraft could stage from there, and Arar and Rafhá Airfields were close to the border and made ideal forward ground alert locations. Flight time from the latter two airfields into Iraq was approximately 15 minutes (fig. 44).³²

Earlier in the month, on 8 November, President Bush had authorized the additional deployment of US forces to Southwest Asia to give CENTCOM an "offensive capability," a move that effectively doubled the number of US forces in the region. For AFSOCCENT forces deployed to Southwest Asia, the buildup signified a long-term commitment to the region. Beginning in mid-November, many of the original SOF personnel, who had deployed to Saudi Arabia in August and September, were replaced by new personnel from Hurlburt Field. Colonel Gray made the decision to swap-out personnel so that the impact of a prolonged deployment (already over 90 days for



Figure 44. AFSOC Deployed Locations during Desert Shield/Desert Storm (Source: USAF Special Operations School, Hurlburt Field, Fla.)

many) could be spread among more special operators. On 29 November the UN Security Council authorized the use of force if Iraq did not withdraw from Kuwait by midnight, Eastern Standard Time, on 15 January 1991. With the main base at KFIA operating smoothly and its forward bases secured, AFSOCENT was ready for the onset of war.

By December of 1990 SOCCENT's Coalition warfare mission had progressed to a point that an exercise to validate the capability was finalized. Exercise Desert Alliance was conducted from 18 to 23 December, with AFSOCENT aircraft flying 20

sorties supporting SOCCENT's Coalition units, including Kuwaiti, French, Egyptian, Saudi, British, and American forces. The exercise placed demands on both aircrew and maintenance personnel by increasing the operations tempo to wartime levels.



USAFPhoto

Photo details construction of underground bunker used during Desert Storm.



Photo courtesy of Mike Lavengood

Life at Arar AB was basic at best. Mike Lavengood pictured on the steps of an underground command bunker. Note the two MH-60s on strip alert in the background.

Three Combat Talons flew night low-level, NVG landings, IFR, and rapid exfiltration of exercise forces. All AFSOCCENT aircrews, including those of the MC-130E, MH-53H, MH-60G, HC-130P/N, and AC-130H, performed in an exemplary manner.³³ The week of 9–12 January 1991 was the last week of training before the beginning of the air war over Iraq. Combat Talons flew training sorties every night during that final week. In total Combat Talon aircraft flew 49 training sorties during Desert Shield. When Desert

Storm began on 16 January 1991, the squadron was ready.

From the initial buildup in August, and continuing on well past the end of the ground war in February, the 8th SOS deployed 13 crews. Some personnel moved from one crew to another and remained in Saudi Arabia when the November rotation was completed. The 13 crews from the 8th SOS that supported Operation Desert Shield/Desert Storm are listed below:*

Crew 1	Crew 2	Crew 3	Crew 4	Crew 5	Crew 6	Crew 7	Crew 8
Phillips	Davenport	Henry	Collins	O'Reilly	Barragy	Abbott	Black
Close	Cochran	Close	Zack	Hinck	Linder	McCoy	Barragy
Stone	Palmer	English	Meller	Harstad	Boitano	Batts	Gabreski
Reynolds	Beres	Bell	Pulmano	Crisafi	Tagert	Inkel	Booz
Chapman	Saier	Thomas	Kersh	Franco	Weiler	Clites	Traudt
Anderson	Smith	Filer	Pearson	Bonn	Shin	Henderson	Clayton
Pies	Gorczynski	Tremblay	Fleming	Dunn	Rother	Fabbro	Singletary
Burton	Bonck	Ballerstadt	Dent	Boulware	Westby	Westby	Harris
Mulcahy	Crayne	Corlew	Gobbi	Kelly	Kelly	Scott	Hartke
Baker	Lutman	Pearson	Roberson	Tavarez	Carroll	Martin	Klink
Manley	Martin	Restifo	Prior	Carroll	Fleming	Lutman	Scott
	Bohannon	Santiago	Lorenz	Clark		Kersh	Clites
	Calvert	Biermacher	Linder	Burnett		Packard	
	Packard	Chapman	Boitano	Vonsik		Klink	
	Boulware	Lawler	Mitchell	Foster			
	Ballerstadt	Garvey	Cox				
	Long	Minton					
Crew 9	Crew 10	Crew 11	Crew 12	Crew 14			
Murdock	Cox	Michenfelder	Gabreski	Cochran			
English	Boitano	Rowe	Larson	Settergren			
Weiler	Cody	Reynolds	Howell	Reynolds			
Gantert	Franco	Lindhorst	Acosta	Hilliard			
Alaniz	Bonn	Messer	Knight	Vanderley			
Long	Ferguson	Sager	Packard	Lowery			
Sanders	Kyle	Everett	Boulware	Keelan			
Rodriguez	Livingston	Durbin	Rodriguez	Burton			
Mitchell	Pickering	Rodriguez	Tavarez	Grover			
Santiago	Kenney	Fillen		Ward			
Makela	Harris	Shin					
Massey		Hinck					
Turner							
Beres							

*Crews 1, 4, and 5 returned to Hurlburt Field during the November 1990 swap out. Some crew members from these three crews augmented the six formed crews remaining at KFIA and awaiting the start of the war. Crews 2, 3, 6, 7, 8, and 9 flew leaflet and BLU-82B missions during the January/February Desert Storm period. Crews 10, 11, 12, and 14 deployed to Saudi Arabia after the termination of the ground war in late February. Some members of the latter four crews had flown during Desert Storm and remained in place at KFIA after cessation of the ground war. No crew photos are available for crews 11, 12, and 14, and no crew was designated Crew 13. Crew members flew on different crews during the prolonged deployment to Southwest Asia. Not all crew members were available for each crew picture.



USAF Photo

Crew 1, Desert Shield/Desert Storm. Standing left to right: Manley, Anderson, Stone, Burton, Reynolds, Close, Phillips, and Chapman. Kneeling left to right: Mulcahy, Baker, and Pies.



USAF Photo

Crew 2, Desert Shield/Desert Storm. Standing left to right: Davenport, Bohannon, Gorczyński, Saier, Calvert, Ballerstadt, and Boulware. Kneeling left to right: Crayne, Cochran, Smith, Long, and Palmer. Not pictured: Beres, Bonck, Lutman, Martin, and Packard.



USAFPhoto

Crew 3, Desert Shield/Desert Storm. Standing left to right: Thomas, Biermacher, Henry, Close, Ballerstadt, and Tremblay. Kneeling left to right: Bell, Lawler, Corlew, and Restifo. Not pictured: English, Filer, Pearson, Santiago, Chatman, Garvey, and Minton.



USAFPhoto

Crew 4, Desert Shield/Desert Storm. Left to right: Dent, Lorenz, Boitano, Linder, Fleming, Mitchell, Prior, Cox, Kersh, and Gobbi. Not pictured: Collins, Zack, Meller, Pulmono, Pearson, and Roberson.



USAF Photo

Crew 5, Desert Shield/Desert Storm. Standing left to right: O'Reilly, Franco, Hinck, Carroll, Crisafi, and Dunn. Kneeling left to right: Kelly, Harstad, and Tavarez. Not pictured: Bonn, Boulware, Clark, Burnett, Vonsik, and Foster.



USAF Photo

Crew 6, Desert Shield/Desert Storm. Standing left to right: Weiler, Boitano, Westby, Linder, Barragy, and Rother. Kneeling left to right: Kelly, Tagert, Fleming, and Shin. Not pictured: Carroll.



USAF Photo

Crew 7, Desert Shield/Desert Storm. Standing left to right: Martin, Packard, Batts, Westby, McCoy, Kersh, Abbott, and Inkel. Kneeling left to right: Klink, Lutman, Scott, Fabbro, and Henderson. Not pictured: Clites.



USAF Photo

Crew 8, Desert Shield/Desert Storm. Standing left to right: Black, Barragy, Singletary, Clayton, Traudt, Hartke, and Scott. Kneeling left to right: Clites, Fleming, Klink, Booz, Gabreski, and Harris.



USAF Photo

Crew 9, Desert Shield/Desert Storm. Standing left to right: Alaniz, Murdock, Massey, Rodriguez, Makela, Sanders, and Mitchell. Kneeling left to right: Beres (squadron commander), Weiler, Gantert, and English. Not pictured: Long, Santiago, and Turner.



USAF Photo

Crew 10, Desert Shield/Desert Storm. Left to right: Livingston, Ferguson, Kenney, Cox, Boitano, Bonn, and Pickering. Not pictured: Cody, Franco, Kyle, and Harris.

Combat Talon Wartime Tasking Expand

The deployment to Southwest Asia had taken the US military and the 1st SOW by surprise. Before deployment to the desert, the wing had participated in a heavy exercise schedule. Within each exercise specific scenarios were rehearsed so that participating units could practice operations that they were not normally exposed to during local unilateral training. One capability employed during selected JCS exercises was the delivery of airborne leaflets in support of an exercise PSYOPS campaign plan. With environmental considerations taken into account, however, leaflet missions were usually limited to one or two for each exercise, with a minimum number of leaflets actually dropped. From the time of initial deployment to Desert Shield, the primary tasking for AFSOCCENT was CSAR, and most of the training during the fall of 1990 revolved around developing that capability. The Combat Talon was the only "penetrating tanker" available to SOCCENT (i.e., it was the only weapons system that had a sophisticated defensive ECM suite that allowed the aircraft to refuel helicopters at low altitude in denied territory). The HC-130P/N had the primary mission of helicopter refueling, but it did not have the ECM suite found on the Combat Talon. As the New Year approached, however, a theater-wide PSYOPS campaign began to materialize that consisted of a combination of airborne radio and television broadcasts and the airborne delivery of PSYOPS material. On 22 November 1990 the 193d SOG from the Pennsylvania Air National Guard (attached to AFSOCCENT at KFIA) began airborne broadcasts of *Voice of America* programs to Iraqi troops. Around 1 January 1991, the USA's 4th PSYOPS Group liaison officer, who was stationed at KFIA with the 193d SOG, contacted the 8th SOS and inquired about the squadron supporting leaflet dissemination missions. With a long history of PSYOPS leaflet support dating back to the Vietnam War and with its sophisticated ECM suite, the 8th SOS was the obvious choice for the mission. The squadron had sufficient assets in country (four Combat Talons and six crews) to support the emerging PSYOPS mission and still maintain CSAR alert. Within days tasking began to flow from Riyadh to the 8th SOS for leaflet support.*

A second capability maintained by the 8th SOS was the delivery of the BLU-82B bomb. At 15,000 pounds total weight, the BLU-82B was the largest conventional bomb in the USAF inventory. It had been used in Vietnam to clear helicopter LZs in dense tropical jungle. There were no jungles in Southwest Asia, but the BLU-82B would prove to be a valuable addition to CENTCOM's capability when its forces faced the entrenched Iraqi divisions occupying Kuwait and southern Iraq.

Development of the BLU-82B

On 20 November 1967 MACV requested assistance from the Southeast Asia mobile explosive ordnance disposal team at Tan Son Nhut AB, Republic of Vietnam, to design a method to clear helicopter LZs in dense areas. The EOD team first looked at an M118 3,000-pound bomb, and on 9 December 1967, it transported a specially rigged M118 to Dak To for test detonation. The bomb cleared an area 150-feet wide and detonated all booby traps installed for the test. Because of the test, MACV tasked Seventh Air Force to develop a capability to deliver specialized ordnance employed in a jungle clearing operation. As Seventh AF began its test program in Vietnam after the first of the year, the Armament Development and Test Center at Eglin AFB conducted a series of tests from 29 April to 31 July 1968. Eglin AFB's test centered on a 1,000-pound BLU-1B/B fire-bomb casing filled with either DBL-22L explosives or Astrolite A-1-5. Eglin AFB's test confirmed that the 1,000-pound bomb filled with either of the two explosives failed to clear a forest area suitable for helicopter landings. It became obvious that if an instant helicopter LZ was to be created, a far heavier munitions would have to be developed.³⁴

At Fort Benning, Georgia, the USA began tests of the M121 10,000-pound bomb, a device that had been developed in the 1940s for employment by the B-36 strategic bomber. The large bomb had been in storage and out of production since the B-36 was decommissioned in the 1950s, and only a limited number was available. For the LZ clearing operation, the M121 was modified and redesigned with two independent fuzing systems, one forward and one aft, as well as a stabilization parachute. By the end of the year, airborne rigging and delivery techniques had been developed for the C-130 aircraft, and the munitions were

*In combination with the airborne television broadcast, the PSYOPS leaflet program became one of the most successful operations of Desert Storm.

ready for testing in Southeast Asia. From 12 to 20 December 1968, the 834th Air Division, headquartered at Tan Son Nhut AB, conducted a 10-weapon operational test of the M121 in South Vietnam under the code name *Commando Trap* (which was later changed to *Commando Vault*).³⁵ The average miss distance from the desired point of impact during the test was 103 meters, although the greatest miss distances were recorded on the first four drops. The M121 test was a technical success, but the bomb did not satisfy the MACV requirement to clear a helicopter zone capable of landing five helicopters at one time.³⁶

Between November 1968 and February 1969, discussions were conducted to determine if the M121 should be brought back into production, or if an entirely new, super heavy (up to 35,000 pounds) munitions should be developed. The chief of staff of the Air Force favored resumption of the production of the M121, since the existing inventory was extremely low. As a result, early efforts by the Air Force turned to adapting the M121 to the new jungle clearing role. After considerable testing and analysis, the Air Force Weapons Laboratory's Special Applications Branch, located at Kirtland AFB, New Mexico, concluded that it would be advantageous to try a new explosive, designated DBA-22M, and load it into a larger bomb casing. The Air Force subsequently requested Sandia Laboratory, through the Albuquerque Operations Office of the Atomic Energy Commission, to design and develop a possible follow-on bomb to the M121, weighing 15,000 pounds and filled with the gelled slurry explosive DBA-22M.*³⁷

Comparing the two bombs gained a perspective of each one's destructive power. The M121 was approximately 9½ feet long, nearly 4 feet in diameter, and weighed 10,800 pounds. The explosive agent Tritonal accounted for 8,050 of the 10,800 pounds. The BLU-82B measured 1½ feet in length (without a fuze extender) and 4½ feet in width. Its filled weight was 15,000 pounds, with the explosive agent being 12,600 pounds of ammonium nitrate powdered aluminum (DBA-22M) slurry. Tritonal was composed of 80 percent TNT and 20 percent powdered aluminum and was loaded into the bomb casing by the manufacturer. DBA-22M was a powerful explosive made up, in part, of particulate aluminum, ammonium nitrate, water, thickeners, and stabilizers. The

two main components of the slurry, which were inert before being combined, were designed to be shipped separately and mixed in the field. This capability made the BLU-82B potentially easier and safer to handle during shipment.³⁸

The first live, full-scale test drop of the BLU-82B took place on 1 April 1969 at the Tonopah test range in Nevada. The rigged bomb was loaded on to a C-130 aircraft at Hill AFB, Utah, and was flown to the Nellis range in Nevada, where it was dropped. The large bomb impacted one of the dry lake-bed targets at the Tonopah range. The design and development program lasted throughout most of 1969 and culminated in the initial fabrication of 225-prototype 15,000-pound BLU-82B bomb casings. Management of the program was then transferred from Kirtland AFB to the Armament Development and Test Center at Eglin AFB.³⁹

As part of the test and development program, a number of experimental BLU-82s (identified as CD-1s) was shipped to SEA for operational evaluation. On 11 May 1969 two CD-1s and two M121s were dropped so that their effectiveness could be compared. Although the CD-1 did not clear a five-helicopter landing zone, it did clear an area approximately two and one-half times greater than the smaller M121. After reviewing results of the operational test, the commander, Seventh AF, recommended that the Air Force concentrate on development of the CD-1/BLU-82B in lieu of resuming production of the M121. An added advantage in deciding on the BLU-82B was that it could be available in SEA by early 1970, whereas the long lead time to resume production of the M121 delayed its availability by nearly one year.⁴⁰

Although the explosive force of the BLU-82B did not fulfill MACV requirements, several benefits were confirmed during the operational tests. Employed over proper terrain, the bomb provided at least a one-ship (and almost always a two-ship) landing zone. Flash from the explosion burned tree foliage and brush out to about double the radius of the useable zone itself. The shock wave from the blast incapacitated enemy troops out to 600 meters from ground zero, leaving them shocked and dazed for up to 18 hours. Helicopters landing on the cleared zones were assured of two vital conditions: first, the area immediately in or around the zone would be completely cleared of

* USAF interest in DBA-22M originated in Sandia Laboratory's need for a conventional high explosive that could be used as a test device capable of producing a simulated nuclear cloud for the exercise of RB-57 sampler aircraft under Project Cloudmaker. The simulated nuclear test device was to weigh 45,000 pounds (for comparison, the largest World War II conventional bomb weighed 23,000 pounds). The sampler program was scrapped before the large test device was operational, but the DBA-22M slurry developed for it was later used in the BLU-82B bomb.

booby traps; and second, there would normally be no effective enemy forces within half a kilometer of the drop zone, blast pressure having incapacitated or killed them. Assault forces would usually be unopposed as they secured the LZ area.⁴¹

With these results, Air Staff concurred with the production of the BLU-82B, and the first operational bombs began arriving in Vietnam in February 1970. The first drop of the production model took place on 23 March 1970. Both the BLU-82B and the remaining inventory of the M121s were dropped at a rate of approximately 20 per month throughout 1970. By October 1970, 323 bombs had been used to clear helicopter LZs or to create clearings for fire bases (a total of 216 M121s and 107 BLU-82Bs). The last M121 was dropped on 8 August 1970, thus exhausting the inventory of those munitions.⁴² For the remainder of US involvement in SEA, the BLU-82B was employed in support of US troops in the field. When the war ended, residual BLU-82B casings were put into storage at Hill AFB, Utah, awaiting future requirements, and filled bombs were stored in the Philippines and in depots in the United States.

One limitation of the DBA-22M slurry, and one that was apparently forgotten after the Vietnam War, was that it became unstable after a time. Approximately 12 months after mixing the slurry and loading it into a BLU-82B bomb casing, the slurry became unstable, and after an extended time, the mixture could spontaneously detonate. On 7 September 1978 10 Vietnam War-era BLU-82Bs, stored at the Sierra Army Ammunition Depot, spontaneously detonated (one probably set off the other nine). Post-accident investigation revealed that the unfuzed bombs had been loaded almost seven years earlier—during the Vietnam War era. Remaining bombs stored in bomb dumps around the world were inspected, and their slurry analyses confirmed that they were also unstable.⁴³ The existing inventory of premixed bombs was destroyed, with the residual inventory of bomb casings remaining in storage at Hill AFB.

After the 1978 accident two BLU-82B bombs were kept loaded and in storage for a short-notice contingency requirement. The two bombs were loaded in six-month intervals, thus requiring destruction of one bomb every 180 days. The destruction process was originally carried out by bomb disposal technicians, but beginning in the mid-1980s, the 8th SOS began dropping the BLU-82Bs scheduled to be destroyed. Thus, every six months an 8th SOS Combat Talon would deploy

to Hill AFB and drop a BLU-82B on nearby ranges. The arrangement allowed 8th SOS crew members to maintain proficiency in BLU-82B operations, while at the same time disposing of the six-month-old bomb before it became unstable. When the squadron deployed to KFIA in August 1990, one of its crews had dropped a BLU-82B during the previous month. Knowing that the two bombs were filled and ready for employment, Beres prepared a concept for the employment of the BLU-82B in Southwest Asia.

The 7th SOS Deploys in Support of CTF Proven Force

When Iraq invaded Kuwait in August 1990, the UN response was quick and decisive, with thousands of US troops deploying to Saudi Arabia and other Persian Gulf countries over the following weeks. To the north, Iraq shared its border with Turkey, a NATO country with strong ties to the United States. Iraq and Turkey were trading partners before the invasion, with a large oil pipeline passing from Iraq through Turkey to oil terminals in the Mediterranean. When the United States approached the Turkish government for approval to station combat forces in Turkey for use against Iraq, the Turks were reluctant to provide facilities for fear of economic and political repercussions. Consequently, UN forces were denied basing privileges through the fall of 1990. The 39th SOW at Rhein Main AB was alerted to deploy to Turkey several times from September to December, but each time the deployment was canceled at the last minute.⁴⁴

As the UN deadline for Iraqi withdrawal from Kuwait approached, the 39th SOW was alerted on 10 January 1991 for deployment to Incirlik AB, Turkey. The wing was to support CTF Proven Force, the US Central Command task force established in Turkey for Operation Desert Storm. The wing was to function as the SOF air component of the JSOTF, which consisted of all SOF stationed in Turkey and committed to the northern portion of Iraq. SOCEUR, as the SOF component of CTF Proven Force, established the JSOTF (identified as JSOTF Elusive Concept) under the command of Brig Gen Richard K. Potter. On 13 January two MC-130E Combat Talons of the 7th SOS deployed to Incirlick AB and were followed the next day by four HC-130s of the 67th SOS. The wing's Pave Low helicopters were prepared for shipment by way of C-5 but were delayed in the United Kingdom awaiting available airlift. They did not arrive in Turkey until 17 January, the day after the

start of the air war. The 7th SOS remained at Incirlick AB for the duration of the war, but the rotary-wing aircraft deployed forward to Batman, a small airfield in eastern Turkey. At Batman the MH-53s maintained SAR alert for missions into northern Iraq (fig. 45).⁴⁵

As was the case for 1st SOW forces at KFIA, the 39th SOW was assigned the CSAR mission, but because of sensitivities to the word *combat* by the Turkish government, the mission title was changed to joint search and rescue (JSAR).⁴⁶ When Col Ben Josey and his MH-53 ADVON party arrived at Batman to begin preparations for the arrival of the main-body helicopter force, they found conditions at the airfield austere. Batman was located just 72 miles from the Iraqi border in the mountains of eastern Turkey. In freezing rain the ADVON party found itself in mud up to its calves and with no Gortex rain gear for protection from the miserably cold and wet weather. There were two Turkish military munitions storage areas at Batman, one of which was filled with bombs. The second above-ground facility was empty, and the local Turkish military provided it to the ADVON team for its use. In 22-degree weather and with freezing rain falling outside, the ADVON team moved into the bomb storage facility and began preparations for the arrival of its aircraft. Living on MREs and bottled water, the ADVON team worked around the clock.⁴⁷ On 20 January 1991 the four helicopters arrived at Batman and assumed alert duties for JSAR four days after the war began. By 24 January there were more than 200 personnel living at Batman. The two 7th SOS Combat Talons stood alert at Incirlick AB in support of the Batman JSAR mission.⁴⁸

Final Preparations for Operation Desert Storm

It had been five months since the 1st SOW was alerted and had deployed to Southwest Asia. As 1991 arrived AFSOCCENT had its aircraft on alert and its crews trained and ready for the CSAR mission. The 20th SOS also had worked with USA Apache helicopter crews during the previous three months and had perfected a first-strike attack against Iraqi radar positions in preparation for the start of the air war. A full-scale rehearsal had been conducted in early January, with everything going exactly as planned. For the 8th SOS, tasking for prewar PSYOPS leaflet operations began to flow in early January. Just as their Stray Goose predecessors of the Vietnam War had done, the squadron would fly night leaflet

missions targeted at key enemy positions. A typical leaflet mission profile included takeoff from KFIA and then flying on an easterly heading until reaching the Persian Gulf coastline. At the coast the Combat Talon would turn north until just south of the Kuwaiti/Saudi border. At that point the aircraft would turn west while staying within Saudi airspace. Dependent upon the target location and the prevailing winds, the aircraft would climb to its drop altitude and release its leaflets over a predetermined point. Prewar leaflet drops targeted both Kuwait City and Iraqi troop concentrations within the southeastern corner of Kuwait. After 16 January Combat Talons occasionally entered Iraqi airspace to deliver leaflets targeted at specific Republican Guard units occupying positions in northern and western Kuwait. Leaflet missions usually departed KFIA after midnight, when the evening bombing raids had concluded. Each mission was timed so that the leaflets would reach their intended targets between two and five o'clock in the morning.⁴⁹

Leaflet delivery was not a precise science but rather an art based on both known and unknown factors. The weight of the leaflet paper and how it was folded had a great impact on the accuracy of the drop. Ideally, a properly constructed leaflet would rotate about its longitudinal axis and would fall at a constant rate based on gravity. Thus, in a no-wind condition, Combat Talon navigators could determine exactly where a leaflet would impact the ground—a leaflet dropped at 20,000 feet, for example, would travel 20,000 feet horizontally from its release point before reaching the ground. Cardboard boxes of leaflets were loaded on board the aircraft in reverse order from their scheduled delivery. The containers were designed to break apart when they hit the aircraft's slipstream during the drop. The static line was rigged in such a way as to jerk the bottom out of the cardboard box and, thus, release the leaflets. The key to successful leaflet delivery was in the application of variables (primarily wind velocity) to the leaflet's constant rate of fall.⁵⁰ During premission planning weather forecasters would provide their best guesses as to wind speed and direction, and from the forecast Combat Talon navigators would compute the premission release point. Once airborne the navigators would compare the actual flight winds with the forecast winds as the aircraft climbed to drop altitude. The release point was then adjusted, as required, before releasing the leaflets, ensuring that they



Figure 45. Batman Depicted in Eastern Turkey, North of Turkish/Iranian Border (Source: AU Library, Maps and Charts Division, Maxwell AFB, Ala.)

had the best opportunity of reaching their assigned target.

Before the start of the air war on 16 January, Coalition aircraft were prohibited from flying near the Kuwaiti border. The 8th SOS Combat Talons were exempted from that policy for the delivery of PSYOPS material. The first officially acknowledged leaflet mission of the war was flown by the 8th SOS during the night of 11/12 January. Iraqi troops occupying the Kuwait City area were the specific target. A secondary objective of the mission was to reassure the Kuwaiti resistance fighters, who were active in the Kuwait City area, that Coalition forces would soon liberate their country. Dropping from 20,000 feet and with favorable winds, the leaflets scored a direct hit on Kuwait City, which was 60 miles from the border.⁵¹

On the morning of 12 January, Kuwaiti resistance fighters relayed to Coalition forces in Saudi Arabia that the leaflets had found their targets. Portions of the city were saturated with leaflets. During the next two nights, Combat Talons continued to deliver leaflets targeted at Kuwait City and its suburbs. On the eve of the air war (the night of 15/16 January), the 8th SOS flew its last prewar leaflet mission, which was targeted at frontline Iraqi troops within southeastern Kuwait.⁵² Thus, when the air war began on 16 January, the 8th SOS already had flown four PSYOPS leaflet missions with superb results.

As the 8th SOS made its initial leaflet drop on 12 January, AFSOCCENT received orders from SOCCENT to move forward to its FOLs and to man its wartime battle stations. Four days earlier

Orrell had deployed forward to Al Jouf with an ADVON team to make final preparations for the anticipated move. From 12 to 14 January, both rotary- and fixed-wing aircraft prepared to depart KFIA and move forward. On 14 January eight MH-53s and four MH-60s, along with two HC-130s, made the six-hour flight to Al Jouf and closed at the FOL. The four Combat Talons remained at KFIA, flew PSYOPS leaflet missions, and pulled ground alert for CSAR. Just before the start of the air war, Combat Talons not tasked to fly leaflet missions were dispersed to Thumrait AB, Oman, to reduce their vulnerability to attack by Iraqi missiles at KFIA. AFSOC-assigned units dropped more than 18 million leaflets during the course of the campaign.

Initial AFSOCENT CSAR Tasking

At 0800 on 16 January 1991, the UN deadline for the withdrawal of Iraqi troops from Kuwait passed without any movement by Saddam Hussein's forces. Colonel Gray, the AFSOCENT commander, received word shortly afterwards that H hour had been established by General Schwarzkopf as 0300 on 17 January. At 1400 Gray called Al Jouf to speak to Orrell, who was the FOL commander there. The H-hour time was relayed, and Orrell was advised to prepare his forces for the initial mission of the war. During the 1930 local changeover briefing at KFIA, Gray gave the order for all personnel to begin taking their P pills (medication designed to lessen the effects of chemical agents) should the base come under chemical attack by the Iraqis.⁵³

At Al Jouf, Orrell and Comer established a mission briefing time of 2230 local and a takeoff time of 0100 local to meet a TOT of 0238. The TOT was established 22 minutes before H hour so that the assigned radar targets could be destroyed before the launch of the initial wave of Coalition aircraft into Iraq. Four MH-53H Pave Lows of the 20th SOS were to lead a formation of eight USA Apache helicopters into Iraq to destroy Soviet-built early warning radars that could detect the approach of Coalition aircraft. The radar systems included the Spoon Rest mobile early warning radar, the Flat Face early warning and target acquisition radar, and the Squat Eye search and target acquisition radar.⁵⁴

At the 2130 briefing the combined Pave Low/Apache team reviewed the mission and the sequence of events for each aircraft. The formation was identified as Task Force Normandy and was charged with creating a break in radar coverage

along the southern Iraqi border. At 0212 local Task Force Normandy crossed the border into Iraq after an on-time takeoff. There were two primary targets, each consisting of early warning radar vans and communications equipment, which tied the sites into the overall Iraqi defense network. Two Pave Lows led each formation through southern Iraq, flying at a maximum altitude of 50 feet and maneuvering around numerous Bedouin camps to avoid detection. At precisely 0238 the Apaches struck the two targets, destroying them with their AGM-114 Hellfire laser-guided missiles and Hydra 70 rockets. Minutes later hundreds of Coalition aircraft penetrated Iraqi airspace undetected through the gap created by the attack and dropped thousands of bombs on Baghdad before the Iraqis could react.⁵⁵

Two of the Pave Low helicopters returned to Arar and maintained CSAR alert during the remainder of the first night's air strikes. Although planners estimated a 2 percent loss rate, only one British aircraft was lost during the first 24 hours of the war. The other two helicopters refueled from HC-130 tankers of the 9th SOS and returned to Al Jouf. As the Coalition aircraft recovered to their launch bases, the 8th SOS flew its first leaflet mission of Desert Storm, dropping two million leaflets on Iraqi troops positioned in southern Kuwait. The leaflets became known as the original surrender card, encouraging the Iraqis to put down their arms and surrender to Coalition forces. Many of those leaflets were found on Iraqi soldiers when they surrendered a month later at the end of the ground war.

In the weeks that followed, AFSOCENT continued to provide a CSAR alert force forward deployed to Al Jouf, with helicopters shuttled to Arar and Rafhá each night to sit ground alert. On 19 January AFSOCENT responded to its first CSAR call by launching two MH-53H Pave Lows out of Rafhá into an area just west of Talil Airfield in central Iraq. After 30 minutes of searching, the F-16 pilot could not be located, and the CSAR force had to return to Rafhá empty-handed. On the following day, a second daylight CSAR was attempted that included an A-10 escort package and F-15 fighter coverage. Upon arrival at the downed pilot's location, no radio contact could be established. After 30 minutes of searching in the area, the two Pave Lows returned to Al Jouf.⁵⁶

Although extremely disappointing to the AFSOCENT crews, the initial two unsuccessful recoveries did not dampen the enthusiasm for the CSAR mission. On 21 January the first successful

recovery was completed. The AFSOCENT Rescue Coordination Center at KFIA received word from Riyadh that two good parachutes were spotted after a US Navy F-14 Tomcat was shot down 130 miles inside Iraq. An A-10 pilot was in radio contact with the downed crew. AFSOCENT quickly contacted Jerry Garlington (FOL commander) at Arar, where a Pave Low helicopter was still on alert from the previous night. Captain Trask, an MH-53 aircraft commander, was alerted, and his crew launched at 0805 into a dense fog. With two F-15s providing cover, the helicopter proceeded north in broad daylight to a position 50 miles north of Mudaysis Airfield and 60 miles northwest of Baghdad. Reaching the coordinates given by the A-10 pilot, Trask and his formation searched the area for the next 25 minutes, but there was no trace of a survivor. With fuel running low, AFSOCENT ordered Trask's formation to return to Arar. After landing at Arar and beginning the refueling process, Trask received word that one of the A-10s had made visual contact with one of the survivors. After refueling, the two MH-53s launched at 1220 and headed back north into Iraq. At 1340 Trask was relayed the probable location of the survivor, but to reach the position the Pave Lows had to cross a major four-lane highway clogged with Iraqi military vehicles. Finding a gap in the traffic, Trask's formation was able to cross the highway at a 90-degree angle and at approximately 10-foot altitude. Fifteen minutes later Slate 46, the call sign of the downed pilot, called on his survival radio after spotting the two Pave Lows. The pilot was in a position 25 miles to the north of where Trask thought he would be. As the Pave Lows turned north, Trask's crew observed a truck making a beeline toward Slate 46's position. The truck obviously had picked up the downed airman's radio signal and had homed in on the survival radio. An escort A-10 quickly destroyed the truck, and Trask flew directly toward the burning hulk. Not 150 yards away US Navy lieutenant Devon Jones popped up out of his foxhole and signaled to the helicopters. Landing on the sandy desert, CCT and PJ personnel on board Trask's Pave Low quickly retrieved Jones, and the aircraft departed the area with the first AFSOCENT save of the war.⁵⁷

The first CSAR attempt by the 39th SOW also began on 21 January, just one day after the 21st SOS arrived at Batman. The mission was delayed 24 hours when permission to launch the rescue force was delayed by the Turkish government.* As a result of the delay, the mission was postponed until 22 January when permission was finally received from Turkey, and a large strike package was launched into northern Iraq. The JSAR force consisted of two HC-130P/Ns of the 67th SOS, one MC-130E of the 7th SOS, and two MH-53Hs from the 21st SOS. Fighter support was provided by a combined F-15 and F-16 escort package. After launch the two helicopters refueled from the HC-130P/Ns while still over Turkish territory and then proceeded into Iraq with the Combat Talon serving as the command and control aircraft for the recovery operation. The downed airmen's last-known positions were located in a high-threat area near Baghdad. To provide a diversion designed to deflect Iraqi attention away from the downed flyers, the fighter escort aircraft initiated a diversionary air strike against the Iraqi defenders. When the two Pave Lows went in, they attempted to contact the downed pilots (call sign Corvette 03) by way of radio and immediately began taking AAA fire. It was apparent that the Americans had been captured and that there was a trap set for the rescuers.⁵⁸ The JSAR force departed the Baghdad area and returned to Turkey without rescuing either of the two American flyers.

AFSOCENT forces, augmented by JSOTF Elusive Concept forces in Turkey, continued to pull CSAR alert duties for the remainder of the war. The Corvette 03 rescue attempt was the only mission flown by the 7th SOS out of Turkey. For the 8th SOS their PSYOPS leaflet mission was soon to expand with the addition of BLU-82B tasking.

8th SOS PSYOPS/Leaflet Missions during Desert Storm

When the air war began on 16 January, the 8th SOS already had completed four prewar PSYOPS leaflet missions. Those missions had been directed toward Iraqi troops occupying Kuwait City and the extreme southeastern portion of Kuwait. After

*Although the Turkish government was sympathetic to US requirements, the issue of trade and lost revenues with the shutdown of the Iraqi oil pipeline made overt assistance by Turkey against Iraq especially perilous. Turkey also shared with Iraq the common problem of the Kurds. Just as the Kurds had demanded autonomy in Iraq, they had also conducted years of guerrilla warfare against Turkey to gain independence of the eastern portion of the country. Flight approval and host-nation restrictions had not been thoroughly delineated since the 39th SOW had deployed to Batman only one day before the 21 January mission. As the war progressed, and the 39th SOW's presence solidified at both Incirlick AB and at Batman, more streamlined procedures were developed that eased some of the friction between US forces stationed there and the Turkish military.

16 January the PSYOPS campaign shifted to a coordinated effort that included B-52 air strikes, BLU-82B delivery, EC-130E Volant Solo airborne radio and television broadcasts, and leaflets delivered by various means (including artillery shells and balloons). During the course of Operation Desert Storm, more than 29 million leaflets were delivered, with the 8th and 9th SOS dropping 16.5 million of that total. The 8th SOS completed 13 leaflet missions, and the 9th SOS completed two.⁵⁹

Each leaflet mission consisted of several phases and oftentimes required multiple sorties. A typical profile began with an early morning (between 0200 and 0500) airdrop of leaflets by an 8th SOS Combat Talon on a specific target. The leaflets would promise that B-52s would soon bombard the position and would graphically depict injury to the Iraqi soldier. Just before dawn an EC-103E Volant Solo aircraft would begin radio broadcasting the same message that was printed on the leaflets. The Volant Solo transmitted the message of a pending B-52 air strike over known Iraqi military and civilian frequencies. Early the following evening, a B-52 air strike of three or more aircraft would service the target, thus fulfilling the warning contained in the leaflets and in the radio broadcasts. In the early hours following the air strike, the 8th SOS would drop a second set of leaflets that warned of another B-52 strike and encouraged the Iraqis to lay down their arms and surrender to Coalition forces. An EC-130E Volant Solo would then arrive in the area and broadcast the same message. A second B-52 air strike would then be flown early in the day to complete the cycle. Once this leaflet-broadcast-strike-leaflet-broadcast-strike profile was completed, the PSYOPS package would move on to another target.⁶⁰

The profile was modified for BLU-82B missions. The 8th SOS dropped the bomb from an altitude of 16,000 to 21,000 feet, which was within the SAM and heavy AAA kill zone of the Iraqi defenders. Beres felt that the first leaflet mission (announcing that a BLU-82B was on its way) would put the bomb delivery crew in danger—the Iraqis could set a trap and shoot down the relatively low-flying Combat Talon. Therefore, the BLU-82B mission profile began with the dropping of two bombs followed by the EC-130E Volant Solo radio broadcasts. The next night another set of leaflets were dropped, promising another BLU-82B strike in the general area. Instead of dropping the second set of bombs on the same target, the next set of bombs would be

dropped just to the east of the previous drop but well within ear and eyesight of the troops in the vicinity of the previous drop. During the course of the war, the 8th SOS worked from west to east along the Saudi-Iraqi and Saudi-Kuwaiti borders dropping the bombs. When the ground war began, virtually every Iraqi soldier along the front lines had seen a BLU-82B drop and had read one or more of the leaflets delivered by the squadron.⁶¹

The fifth leaflet mission for the 8th SOS (and the first after commencement of the air war) was flown during the night of 16/17 January 1991. More than two million leaflets were dropped on Iraqi troops positioned in southern Kuwait. The mission delivered the original surrender card, which encouraged Iraqi troops to lay down their arms and surrender to Coalition forces. The subsequent mission (flown on 19/20 January) targeted the Iraqi 16th Infantry Division and contained the Geneva Convention card leaflet, a leaflet that reassured the Iraqi soldier that he would be treated humanely if he surrendered. All subsequent leaflet missions contained both the surrender card and the Geneva Convention card in addition to leaflets targeted at specific combat units.⁶²

The seventh leaflet mission was flown over a two-night period during the nights of 20/21 and 21/22 January, and it again targeted the Iraqi 16th Infantry Division. The leaflet-broadcast-bomb-leaflet-broadcast-bomb cycle was utilized on frontline troops, with B-52 strikes and Volant Solo broadcasts being employed. Mission number eight was flown during the nights of 27/28 and 30/31 January and employed the standard PSYOPS cycle. The target for this mission was general frontline troop concentrations in the south central region of Kuwait. Mission number nine, flown on 9/10 February, again targeted general troop concentrations in south central Kuwait. Mission number 10 included 8th SOS BLU-82B drops, with four sorties being flown between the nights of 6/7 and 16/17 February. Because of the Iraqi threat, the initial leaflet drop promising delivery of the bomb was not flown, but the postbomb leaflet drop was made. A massive three BLU-82B drop targeted at Faylaka Island on 18 February was not supported by any leaflet drops.⁶³

Mission number 11 was flown on 14/15 February and targeted frontline troops in the westernmost portion of the triborder region. As a prelude to the coming ground war, mission number 12 delivered leaflets with comprehensive surrender instructions for individual Iraqi soldiers. The leaflets also offered medical care and safety to anyone

who surrendered. The last leaflet mission for the 8th SOS was mission number 15, which was flown on 26/27 February. (Leaflet mission numbers 13 and 14 were flown by the 9th SOS during the nights of 17/18 and 21/22 February. Mission number 13 serviced the Iraqi 7th Infantry Division with a follow-up B-52 leaflet. Mission number 14 serviced the Iraqi 28th Infantry Division after a B-52 strike and was the last leaflet mission before commencement of the ground war. The 9th SOS flew the two missions when the 8th SOS Combat Talons were tasked to drop the three BLU-82B bombs on Faylaka Island.) Leaflet mission number 15 was the last leaflet drop of the war. The target area was the northernmost regions of Kuwait and was directed at selected airfields and elite Republican Guard units.⁶⁴

BLU-82B Operations

Not long after he arrived at KFIA, Beres had approached Gray and had proposed using the BLU-82B bomb against Iraqi targets. Colonel Gray had floated the proposal up the chain of command, but USCENTCOM declined to approve its use at that time. When President Bush approved the doubling of US troops committed to Desert Shield in November 1990, Beres again raised the question of BLU-82B employment. This time there was more interest in the bomb, but the decision to use it against Iraq was postponed to a later date. As the air war progressed after 16 January, intelligence estimates identified massive troop concentrations, all of which were defended by elaborate minefields. US planners feared that combat losses would be high, as Coalition forces attacked across the Iraqi border into Kuwait and southern Iraq.

On 20 January 1991 Beres again proposed using the BLU-82B but this time as a psychological-warfare weapon against Iraqi troops. The proposal

was staffed through the AFSOCENT and SOC-CENT headquarters, and on 28 January Colonel Gray briefed the proposal to General Schwarzkopf himself. The CINC was familiar with the weapon from his days in Vietnam, and he saw its application in clearing minefields ahead of attacking ground troops. The BLU-82B had never been used or tested against minefields, and its effectiveness was unknown. Because of the 28 January briefing, however, General Schwarzkopf approved the dropping of the first two BLU-82Bs on minefields and on troop concentrations located in southern Kuwait.⁶⁵

On 3 February the two preloaded BLU-82Bs arrived at KFIA from Hill AFB. In the days that followed, 16 additional bombs were delivered to KFIA (18 total bombs) by MAC airlift and were stored in the nearby bomb dump. The standard tactic for dropping the large bomb was to release it at an altitude of 6,000 feet above the ground, but that altitude put the Combat Talon in the threat envelope of Iraqi AAA and SAMs. To reduce the threat to the aircraft, squadron planners increased the drop altitude to a range between 16,000 and 21,000 feet. To increase the psychological effects of the weapon and to take advantage of tactical surprise, AFSOCENT elected to drop multiple bombs on each mission. To protect the aircraft during their bombing runs, USAF EF-111 Ravens, F-4 Wild Weasels, and EC-130 Compass Calls were tasked to support the drops. During the night of 6/7 February, the first BLU-82B mission was flown. Davenport's crew was assigned the mission of dropping the first bomb on a minefield in the southwestern corner of Kuwait, while Henry's crew simultaneously dropped on a troop concentration in the same area. Davenport's BLU-82B blasted a large gap in the Iraqi minefield across the border from US Marine positions in



Photo courtesy of Gary Crayne

A BLU-82B rigged for airdrop. The extended nose fuse has not been installed.



USAF Photo

The BLU-82B dropped by the 8th SOS in conjunction with leaflets proved to be the ultimate psychological warfare tool. Note the mushroom cloud and shock wave created by the explosion.

Saudi Arabia. Henry's bomb, which was targeted at an Iraqi battalion headquarters, resulted in the battalion commander and several of his officers defecting across the border and surrendering to US forces. They cited the effects of the BLU-82B as the deciding factor in this surrender.⁶⁶

In addition to the destruction caused by the two blasts, there was also a secondary effect. The explosion looked like an atomic bomb when it detonated, and the shock wave and sound from the detonation traveled for miles across the flat desert floor. The blast caused so much confusion that many Iraqis interpreted it as the beginning of the ground war. As a result they activated many of their radars that had not been turned on before that time. US intelligence was able to pinpoint some of the radars by tracking their transmissions, and the next night Coalition aircraft attacked the newly identified radars.⁶⁷ With the success of the first two missions, CENTCOM approved continued use of the weapon.

The second BLU-82B mission was flown in the triborder area of southern Kuwait on 14 February. Two BLU-82Bs were dropped on troop concentrations across the Saudi border, resulting in significant casualties. With the success of the first four bombs, both USA and US Marine Corps commanders were convinced that the BLU-82B was the weapon of choice to support their upcoming ground assault. As G day approached (the start of the ground war), both Army and Marine commanders submitted requests for BLU-82B employment. The Marines wanted a BLU-82B dropped in front of each division's ingress route to Kuwait, but many of their nominated targets could not be serviced due to the high threat to the Combat Talon.⁶⁸

The third BLU-82B mission flown consisted of three bombs and was targeted at Faylaka Island in the Persian Gulf. Throughout the air war, Coalition forces had indicated to the Iraqis that the invasion of Kuwait would come from the Persian Gulf. The Faylaka Island mission was designed to neutralize Iraqi forces occupying the island and to reinforce the Gulf invasion scenario. MARCENT (the US Marine component of USCENTCOM) put in a request to have three BLU-82Bs dropped on the western two square miles of Faylaka Island. On 16 February CENTCOM tasked SOCCENT for the mission. Faylaka Island was a 10-square-mile area located in the Persian Gulf 10 NM northeast of Kuwait City. The mission was planned to have the three bombs impact on the western edge of the island. The desired result of the mission was to upset the morale of the Iraqi troops on the island by causing heavy

casualties and destroying their will to fight. Iraqi ground troops, guarding the beaches of Kuwait 10 miles away, also would see and hear the effects of the large bombs, thus encouraging them to lay down their arms and surrender. Another objective of the drop was to destroy any obstacles that the Marines might face when they assaulted the island from the western beaches.⁶⁹

To increase the psychological effect of the BLU-82B, the battleship USS *Wisconsin* would begin shelling the island with 2,000-pound projectiles throughout the day and night before the drop. One hour before the 8th SOS's TOT, the USS *Wisconsin* would stop its shelling, thus giving the Iraqi troops the false sense that the barrage had ended. After delivery of the three bombs, the USS *Wisconsin* would then resume shelling for the remainder of the night. The entire operation would have a tremendous affect on the Iraqi troops on Faylaka Island and on those stationed on the nearby Kuwaiti shoreline.⁷⁰ (Fewer than 48 hours after the dropping of the three BLU-82B bombs, two Iraqi divisions were moved to the Kuwait beach area in anticipation of a seaborne invasion by Coalition forces.)

To plan the Faylaka Island mission, Davenport's, Henry's, and Barragy's crews were alerted at 1900 on 16 February and briefed on the operation. Over the next five hours, detailed mission planning was conducted, and by 2330 the plan was complete. Support requirements for the mission included US Navy E-2C Hawkeyes and EA-6B Prowlers that would provide electronic protection during the drop. Combat Talon systems identified as critical to mission success included the aircraft's ground-mapping radar and the inertial navigation system. The two systems were required to ensure a pinpoint drop. To reduce aircraft signature in the target area, all three aircraft used the same preinitial point, then altered course so that each arrived over its release point simultaneously. The drop was planned at 17,000-foot mean-sea-level, which kept the Combat Talons above Iraqi light and medium AAA emplacements located on the island. With planning complete late on 16 February, all was set for the 17/18 February mission.⁷¹

On 17 February, beginning at 1700 local, the three mission aircraft were towed to the hot-cargo loading area at KFIA. Each aircraft was loaded with a BLU-82B bomb, fuzed, and then rigged for airdrop. After the joint air-drop inspection was complete, the aircraft were towed again to clear the hot-cargo area. At 2000 local the three Talon crews reported for their weather, intelligence, and final mission briefings. The crews arrived at

their aircraft at 2330 local and made final preparations for the mission. The lead Combat Talon, manned by Davenport's crew (call sign Mamba 31), departed KFIA at 0059 local on 18 February. In 30-second intervals, Henry (Mamba 32) and Barragy (Mamba 33) followed the lead Talon. The TOT for the multiship drop was 0213 local, with a planned 0425 recovery at KFIA. At 0203 the formation split at the preinitial point, slowed to 190 KIAS and turned toward the target area. Davenport flew a northwesterly heading, while Henry and Barragy headed due north.⁷²

At 10 NM out from the drop, the aircraft slowed to 140 knots, and the navigators updated the inertial navigation system with their precision ground-mapping radar. At one minute from the drop, the loadmasters spotted AAA coming from the target area, but because of the slow airspeed and the high altitude, the aircraft could not maneuver. The AAA proved to be inaccurate, and no parts of the aircraft were hit. At approximately 1 NM from the target, the navigator called green light, and the three BLU-82Bs exited the Combat Talons almost simultaneously. All three bombs impacted within 200 meters of their intended targets and detonated within four seconds of each other. At red light, two Talons escaped to the southeast and the third to the northeast. Davenport and Barragy rejoined in formation and proceeded back to KFIA for an uneventful landing. Henry's Talon suffered minor damage to its aft anchor cable when the BLU-82B exited the aircraft. The crew proceeded back to KFIA at a

slower airspeed and made an uneventful landing. The highest visibility mission for Combat Talon had been completed exactly as planned.⁷³

The fourth BLU-82B mission was directed against two Iraqi logistics points and was flown on 20 February. The two-bomb package was dropped from 21,000 feet due to thunderstorms over the target area. Both Combat Talons penetrated violent thunderstorms to complete the mission. One of the BLU-82Bs was dropped on a mine-strewn Wadi inside Kuwait. Due to the severe weather, post-mission battle damage assessment was not available, but when British troops reached the target area a few days later, many Iraqi troops were found dead, still in their foxholes.⁷⁴

The fifth BLU-82B drop was scheduled for 22 February, the day before G day. The two-bomb mission targeted Marine objectives in southern Kuwait. To make the mission appear more like a leaflet drop (and, thus, less threatening to the Iraqis), the bombs were dropped two hours apart. During the first drop, the Combat Talon came under radar threat, but the Iraqis did not launch any AAA or SAMs at the aircraft. Both bombs were on target and proved to be the last BLU-82B drops of the war (fig. 46). When Coalition forces moved into southern Iraq and southeastern Kuwait, the battlefield remained dynamic, making it difficult to pinpoint friendly forces. The 8th SOS received four requests for BLU-82B drops within 24 hours after the ground war began, but each time the tasking was canceled prior to launch due to a dynamic battlefield. Upon cessation of hostilities, EOD

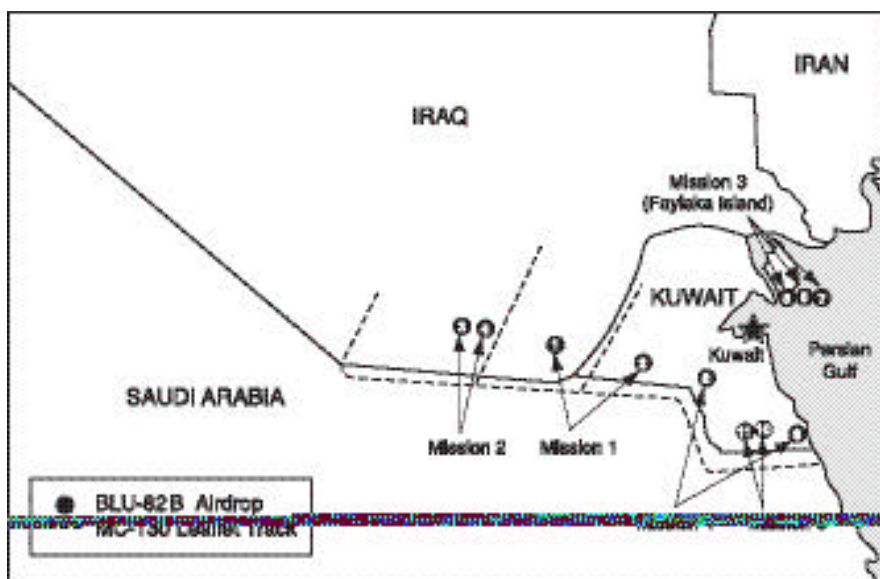


Figure 46. BLU-82B Drop Locations (Source: USAF Special Operations School, Hurlburt Field, Fla.)

experts destroyed the seven remaining BLU-82Bs that were in storage at KFIA.⁷⁵ The 8th SOS support for the BLU-82B mission had come to a close.

The Ground War

As the air war continued through February, political discussions between UN representatives and Iraqi officials were unproductive, and a final Iraqi withdrawal date from Kuwait was unilaterally established by the UN as 23 February 1991. When Iraq did not comply with the UN mandate, President Bush authorized the ground war to begin. On 23 February Coalition ground troops pushed forward into southern Iraq and southeastern Kuwait in a coupe-de-main designed to quickly defeat the Iraqi defenders. During the first day of the ground war, a record 1,200 sorties were flown by Coalition aircraft against Iraqi emplacements in Kuwait. More than a dozen of those sorties were flown by AFSOCCENT aircraft, including USAF MH-53s and USA CH-47s/UH-60s flying infiltration/exfiltration missions and three USAF AC-130Hs flying air base ground-defense sorties. Two additional HC-130P/N air-refueling missions and two AC-130H gunship missions were flown on 24 February. On 26 February five more missions were flown (AC-130H, HC-130P/N, and HH-3 MEDEVAC). The final day of the ground war saw 13 AFSOCCENT missions completed, including the final 8th SOS leaflet mission into northern Kuwait.⁷⁶

By the evening of 27 February, Iraq agreed to Coalition terms for a cease-fire, and President Bush stopped the ground war. Exactly 100 hours had passed since the ground war had begun on 23 February. Thousands of Iraqi troops surrendered

without a fight, or with only token resistance. The PSYOPS campaign, which included both leaflet and BLU-82B drops by the 8th SOS, was credited with heavily influencing Iraqi soldiers to lay down their arms and to surrender. The PSYOPS campaign was one of the most successful achievements of the Gulf War.

Return to Home Station

During Desert Storm the 8th SOS flew 134.9 combat hours and 49 combat sorties. For AFSOCCENT Operation Desert Storm resulted in nearly 3,500 combat hours being logged on 1,300 combat sorties. In combination with Operation Desert Shield, AFSOCCENT flew a total of 10,000 hours and more than 5,000 sorties. Once Iraq agreed to the cease-fire on 27 February, AFSOCCENT personnel began to redeploy from KFIA to their stateside locations.⁷⁷ The US effort had been tremendous, and the special operations forces committed to the war effort had made a huge impact on its outcome. The last of the 39th SOW's deployed forces, including those of the 7th SOS, returned to their home stations by 18 March 1991. However, the European SOF wing would be only three weeks from the termination of Operation Proven Force when it would be back in Turkey for Operation Provide Comfort. Saddam Hussein unleashed his army on the Kurds of northern Iraq, and the 7th SOS was tasked to drop food and supplies to them for their survival. Meanwhile, Beres and the men and women of the 8th SOS returned to Hurlburt Field as heroes, and the venerable MC-130E Combat Talon I was hailed as one of the workhorses of the Gulf War. For the remainder of the decade, SOF commitment to Southwest Asia would prove to be a long and costly one.

Notes

1. History, 1st Special Operations Squadron, 1 January–30 June 1990, Combat Talon Archive, HQ AFSOC/HO, Hurlburt Field, Fla., 9.

2. Ibid.

3. Ibid., 5.

4. History, 1st Special Operations Squadron, 1 July–31 December 1990.

5. Ibid.

6. Ibid.

7. Ibid.

8. Ibid.

9. History, 7th Special Operations Squadron, 1 January–30 June 1990, Combat Talon Archive, HQ AFSOC/HO, Hurlburt Field, Fla., 13.

10. Ibid., 14.

11. History, 1st Special Operations Wing, 1 January–30 June 1990, III-58.

12. History, 1st Special Operations Wing, 1 January–31 December 1990, supporting document 89, 386–88.

13. Tore Kjeilen, *Encyclopedia of the Orient*, on-line, Internet, 1996, available from http://i-cias.com/e.o/iraq_5.htm.

14. Kjeilen, *Encyclopedia of the Orient*, on-line, Internet, 1996, available from http://i-cias.com/e.o/kuwait_5.htm.

15. Kjeilen, *Encyclopedia of the Orient*, on-line, Internet, 1996, available from http://i-cias.com/e.o/iraq_5.htm.

16. Ibid.

17. Ibid.

18. Kjeilen, *Encyclopedia of the Orient*, on-line, Internet, 1996, available from http://i-cias.com/e.o/kuwait_5.htm.

19. History, 1st Special Operations Wing, 1 January–31 December 1991, 16th SOW historian files, Hurlburt Field, Fla., vol. 3, supporting document 52.

20. Ibid.

21. Ibid.

22. *Ibid.*, supporting document 53.
23. *Ibid.*
24. *Ibid.*
25. *Ibid.*, supporting document 52.
26. TSgt Randy G. Bergeron, USAF, HQ AFSOC/HO, "Desert Shield/Desert Storm—Air Force Special Operations Command in the Gulf War," January 1997, 13.
27. *Ibid.*, 15.
28. *Ibid.*, 16.
29. *Ibid.*, 29–31.
30. History, 1st Special Operations Wing, 1 January–31 December 1991, vol. 3, supporting document 52.
31. *Gulf War Air Power Survey*, "A Statistical Compendium and Chronology" (Washington, D.C.: Government Printing Office, 1993), vol. 5, table 62, 201–16.
32. History, 1st Special Operations Wing, 1 January–31 December 1991, vol. 3, supporting document 52, 16–17.
33. Bergeron, 50.
34. Project CHECO Southeast Asia Report, *Commando Vault*, 12 October 1970, USAF HRA, Maxwell AFB, Ala., 1–2.
35. *Ibid.*, 3.
36. *Ibid.*, 6.
37. *Ibid.*, 4–5.
38. *Ibid.*, 12.
39. *Ibid.*, 4–5.
40. *Ibid.*, 7–8.
41. *Ibid.*, 16.
42. *Ibid.*, 8.
43. Newsletter, *Loader Jam!*, April 1999, HQ AFSOC/DOXT, vol. 99-2.
44. Bergeron, 35.
45. History, 39th Special Operations Wing, 1 July 1990–31 December 1991, extract on file, Combat Talon Archive, HQ AFSOC/HO, Hurlburt Field, Fla., 23–24.
46. *Ibid.*, 24.
47. Bergeron, 37.
48. *Ibid.*, 40.
49. Richard D. Johnson, *Seeds of Victory* (Atglen, Pa.: Schiffer Publishing Ltd.), November 1997, 138.
50. *Ibid.*, 139.
51. *Ibid.*, 140–41.
52. *Ibid.*, 141.
53. Bergeron, 78.
54. *Ibid.*, 84–86.
55. *Ibid.*, 88–90.
56. *Ibid.*, 91–92.
57. *Ibid.*, 96–98.
58. *Ibid.*, 93.
59. Johnson, 138.
60. *Ibid.*, 145–46.
61. *Ibid.*, 146.
62. *Ibid.*, 159.
63. *Ibid.*, 159–60.
64. *Ibid.*, 160.
65. Bergeron, 101.
66. *Ibid.*, 101–2.
67. *Ibid.*, 102.
68. *Ibid.*
69. Briefing, subject: 8th SOS Faylaka Island BLU-82B Briefing, n.d., text on file, Combat Talon Archive, HQ AFSOC/HO, Hurlburt Field, Fla.
70. *Ibid.*
71. *Ibid.*
72. *Ibid.*
73. *Ibid.*
74. Bergeron, 103.
75. *Ibid.*, 104.
76. *Ibid.*, 113–14.
77. *Ibid.*, 115.

THIS PAGE INTENTIONALLY LEFT BLANK

Mount Pinatubo to Operation Joint Endeavor (1991–95)

Neither a wise man nor a brave man lies down on the tracks of history to wait for the train of the future to run over him.

—Dwight D. Eisenhower

1991: Mount Pinatubo Explodes into the Pacific

Early January 1991 found the bulk of the Combat Talon force deployed to Southwest Asia and preparing for the rapidly approaching UN deadline for Saddam Hussein to withdraw from Kuwait. In the Pacific the 353d SOW had not been tasked to provide Talon crews for Operation Desert Storm due to the threat posed by the North Koreans in Northeast Asia. The wing had been alerted several times to be prepared to augment AFSOC forces in Saudi Arabia, but each time the tasking was postponed.

1st SOS: Operation Sea Angel

On 8 February 1991, as the air war raged over Iraq, Colonel Mallon assumed command of the 1st SOS from Colonel Douglas. Mallon had been the operations officer for the squadron and was highly experienced in the MC-130E Combat Talon.¹

His immediate challenge was to support the heavy exercise and JCET tasking scheduled throughout the spring. Deployments to Thailand and to Korea, along with exercises in the Philippines, taxed the squadron's resources. In addition to the heavy exercise schedule, the squadron soon became involved in a large-scale disaster relief operation. During the early morning hours of 30 April 1991, a super typhoon with 225-knot winds slammed into the southeastern coast of Bangladesh. The associated tidal surge and heavy rains resulted in heavy loss of life and property. Tens of thousands were killed, and literally hundreds of thousands were left homeless. International relief organizations were overwhelmed, thus prompting a request by the US ambassador to Bangladesh for US aid. The 353d SOW was subsequently tasked by SOCPAC to support the US relief effort, which was identified as Operation Sea Angel. On 11 May the 1st SOS deployed its C-130 slick aircraft, and the 17th SOS sent two of its HC-130s to provide disaster relief. The three aircraft transported international relief organizations' material

and supplies to Chittagong, Bangladesh, where the supplies was transloaded to USA helicopters and moved further inland (fig. 47).² For the next week the two special operations squadrons flew missions in support of Operation Sea Angel. On 15 May the 1st SOS redeployed to Clark AB, while the 17th SOS remained in country for several more days flying personnel and supplies to hard hit areas. By early June 1991 all 353d SOW assets were back at home station at either Clark or Kadena ABs.

The 353d SOW had celebrated its second anniversary in April, and the outlook was bright for its continued presence at Clark AB. Base negotiations continued, and it appeared that both Clark AB and Subic Bay would remain US bases for at least another seven years. One of the more important points of the base negotiations was a proposal for the "joint use" of Clark AB by the US and Philippine Air Forces. Fighter aircraft of the 3d TFW were to relocate from the base by October 1991, and studies were under way to determine the best use of the existing facilities. The 17th SOS was still located at Kadena AB, Okinawa, but was scheduled to move to Clark AB later in the year.³ Colonel Hess, the 353d SOW commander, had his wing operating at peak efficiency. Events triggered by the eruption of Mount Pinatubo, beginning on 9 June 1991, would forever change the posture of SOF in the Pacific.

Mount Pinatubo and the Loss of Clark AB

On 2 April 1991 local Filipinos awoke to see a 1.5 kilometer-long line of vents high on the slopes of Mount Pinatubo after a series of small explosions during the previous night. The explosions formed a line of new craters, destroyed vegetation in the immediate area, deposited soil debris around the vents, and dusted villages to the southwest with a fine volcanic powder. By the next day the line of craters had extended to the southwest of the summit. Evacuations began for about 5,000 people living in the immediate area. Although Clark AB was 8.2 miles to the east of

Mount Pinatubo, it was not immediately affected by the initial evacuation order (fig. 48). Volcanologists from the Philippine Institute of Volcanology and Seismology (PHILVOLCS) teamed with colleagues from the US Geological Survey to install several portable seismographs near the northwest foot of the volcano and began recording earthquake data. The joint team set up operations on Clark AB and established the Pinatubo Volcano Observatory (PVO). A network of high-speed personal computers was set up at the PVO to analyze data as it arrived from the volcano monitoring locations.⁴

For the remainder of April and May, the PVO monitored the volcano. On 1 June, as 353d SOW aircraft conducted local training operations, a

second cluster of earthquakes began to develop approximately one kilometer to the northwest of the volcano's summit. A small explosion early on 3 June signaled the beginning of increased activity near the summit that included minor ash emissions and increased seismicity beneath the vents. In response to the increased activity, PHILVOLCS issued an alert level 3 announcement on 5 June warning of a major pyroclastic eruption within the next two weeks.⁵

On Thursday morning, 6 June, the 353d SOW leadership called all 1st SOS personnel and dependents to gather in the squadron briefing room. Colonel Stankovich, the 353d SOW vice wing commander, began the briefing by describing volcanic characteristics. He described Mount

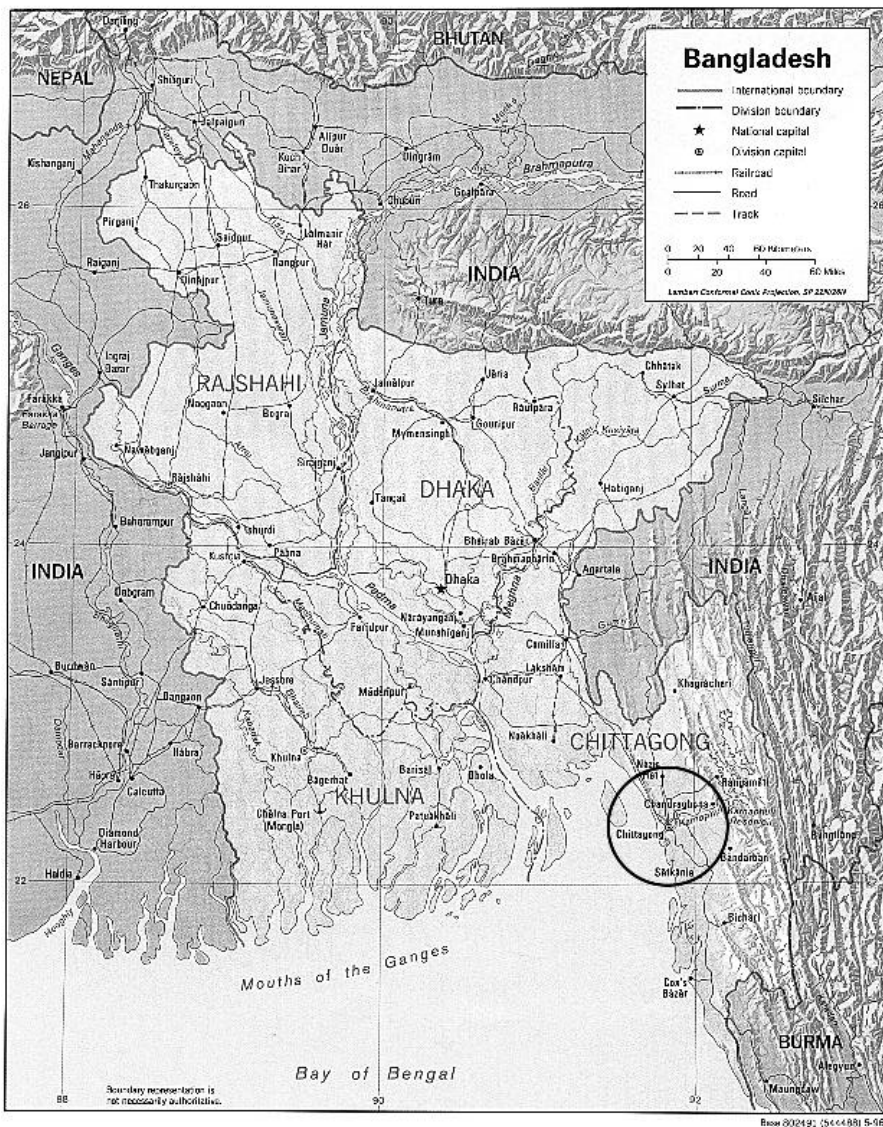


Figure 47. Map of Bangladesh (Source: AU Library, Maps and Charts Division, Maxwell AFB, Ala.)



Figure 48. Map of the Philippines Depicting Mount Pinatubo and Clark AB (Source: AU Library, Maps and Charts Division, Maxwell AFB, Ala.)

Pinatubo as an explosive-type volcano similar to Mount Saint Helens in California, as opposed to the lava-flow-type volcano found in Hawaii. When Mount Saint Helens erupted, it had created a pyroclastic flow of 3,000-degree ash that rapidly traveled down the mountainside and destroyed everything in its path. Mallon followed Stankovich and reviewed the base volcano evacuation plan, including levels of alert. Dependents' off-base addresses were confirmed, and everyone was released to make final preparations in the event the situation worsened.⁶

As the 353d SOW ran its emergency checklists, an electronic tiltmeter installed by PHILVOLCS on Mount Pinatubo began to show a gradually increasing outward tilt on 6 June. The outward tilt, along with the volcano's seismicity, continued to increase over the next 24 hours, culminating in an explosion that generated a column of steam and ash seven to eight kilometers high. Because of the event PHILVOLCS announced an increase to alert level 4—eruption possible within 24 hours. The next five-day period was marked by continued weak ash emission and episodic harmonic tremor. On 9 June PHILVOLCS increased the alert level to 5—eruption in progress. The radius of evacuation was increased to 20 kilometers, and an additional 25,000 personnel were ordered to evacuate.⁷

By midafternoon on 9 June, Mallon knew that it was time to assemble squadron aircrews and to brief them on what he perceived as an inevitable evacuation order. Later that afternoon General Studer, the 3d Tactical Fighter Wing commander, and Colonel Hess (353d SOW/CC) decided to evacuate all base aircraft from Clark AB. The 353d SOW assets included two MC-130Es, one C-130E slick, and four MH-53J helicopters. NAS Cubi Point was identified as the evacuation location. One MH-53J had been torn down for inspection and had to be reassembled before flight. There was also an airlift C-130H aircraft from Elmendorf AFB, Alaska, which was undergoing major isochronal inspection in the 353d SOW's hangar facility. It had to be put back together before it could be flown to safety. On 10 June these last two aircraft were flown to Cubi Point, and the crews then returned to Clark AB to evacuate their own families.⁸

Also on 10 June General Studer initiated the Clark AB mandatory evacuation plan, and 15,000 US military personnel and their dependents departed the base in a mass motorcade bound for Subic Bay Naval Base. The bumper-to-bumper procession averaged six hours en route, a distance that normally took little more than an hour. Upon reaching Subic Bay, the evacuees met another colossal traffic jam trying to get through the main

gate. Processing and assignment to quarters was a long and tedious ordeal that rivaled the trip from Clark AB.* Of Clark AB's total base population, about 1,500 military personnel remained behind to provide security and basic infrastructure maintenance. A 14-member 353d SOW stay-behind team, headed by Stankovich, also remained at Clark AB to look after wing assets. Hess moved to Subic Bay to provide senior leadership for 353d SOW personnel located there. The PVO team of volcanologists remained at Clark AB and continued to monitor the volcano around the clock.⁹

The first major explosive eruption began at 0851 local on 12 June, generating a column of ash and steam that rapidly rose to 60,000 feet. At Cubi Point Mallon was preparing to conduct an officer's call at the Cubi Point Bachelor Officer's Quarters. He wanted to pass on the latest information to his personnel and to determine how many crews he could put together in the event his aircraft had to be evacuated from Cubi Point. As the officer's call began, a huge mushroom cloud could be seen rising to the north. There was no doubt in anyone's mind that Mount Pinatubo had finally exploded. Sensing that evacuation of the aircraft from Cubi Point was imminent, Mallon dispersed his aviators to their quarters so that they could get their flight gear—no small task for many who lived up to 45 minutes away in Barrio Barreta and with little transportation available. When the 1st SOS aircrews returned to the flight line, activity was at a feverish pace. The initial plan was to start engines as soon as a minimum crew complement arrived and then to wait for further instructions. As Mallon moved amongst his Combat Talons, he could feel the awesome power of the eruption and could see the ash cloud rising high into the clear sky. There was no rush of air, no sound, or even any ash fall from his location.¹⁰ At Clark AB, 600 of the remaining 1,500 military personnel were ordered to evacuate the base, and the mandatory evacuation area was increased to 39 kilometers from Mount Pinatubo. The action increased the number of evacuees to at least 58,000. Stankovich and his team remained at Clark AB.

With Mount Pinatubo erupting Hess ordered the wing's fixed- and rotary-wing aircraft dispersed from Cubi Point. Within one hour and 17 minutes of the 12 June eruption, all four 353d SOW C-130s (including the C-130H from Elmendorf AFB)

were airborne and headed towards Villamor AB, a Philippine air force base collocated with Ninoy Aquino International Airport in Manila. Colonel Miles, the 353d SOW deputy commander for Operations and former commander of the 8th SOS, led the evacuation of the aircraft. By 1500 local that afternoon, little ash had fallen at NAS Cubi Point, and the prevailing winds held steady carrying the ash out to sea. With conditions at Cubi Point unaffected by the latest explosion, Hess elected to recall all wing assets to Cubi Point, and within the next hour they had completed the short return flight.¹¹

At 2252 that evening (12 June), Mount Pinatubo exploded for a second time, and personnel from the 353d SOW again scrambled to get their aircraft airborne and away from the ash fallout. The flight line was again a beehive of activity, but this time it was dark as maintenance crews hurried through preflights, removing dust covers from engine intakes and pulling safety pins. Mallon pulled aside a pilot and a navigator and tasked them to build a mass holding pattern near Cubi Point that wing aircraft could hold in until it could be determined where the ash would fall. Both C-130s and MH-53s were to use the same holding pattern, and they used altitude separation to deconflict their flight paths. As crew members arrived, engines were started, and the aircraft were readied for departure even before a minimum crew complement could be found. Mallon issued an order that no aircraft was to depart until a minimum crew complement (two pilots, one navigator, one flight engineer, and one loadmaster) could be formed. He had to rescind the order for one aircrew when a flight engineer and a loadmaster were not available (a crew chief served as the flight engineer). One hour and 11 minutes after initial notification, all 353d SOW aircraft were airborne and headed for the holding pattern.¹²

There was a large thunderstorm over the planned holding pattern area, forcing the crews to move to the east of Clark AB to stay clear of the weather. The Elmendorf AFB C-130H aircraft developed a propeller malfunction at 0200 local that required an engine shutdown. The 1st SOS crew flew the aircraft back to Cubi Point and landed without incident at 0230 on 13 June. The prevailing wind continued to push the ash fallout away from Cubi Point, and the remainder of the aircraft returned from the holding pattern during the early morning darkness. At 0841 on 13 June, a third

*The evacuees were told to pack for three to four days' stay and that they would return to Clark AB after the immediate threat subsided. Most never saw their homes or their personal belongings again.

major eruption occurred. Seismographs on the mountain were now recording approximately 300 tremors each day, which indicated a growing instability inside the mountain. Hess brought his staff together and reviewed possible options. Wing leadership had the difficult decision of separating military members from their families if the aircraft were evacuated. The 353d SOW was unique in that most of its personnel were on accompanied tours, and its military members had their families with them (most other military personnel in the Philippines were on 12-to-24 month unaccompanied tours). After the third eruption on the morning of 13 June, it appeared almost certain that the 353d SOW aircraft would have to be evacuated further from the volcano. Aircrews had flown throughout the previous night and were not in shape for another launch at that time. Hess decided to put all of his fixed-wing crews in crew rest, and he arranged to have the MH-53J helicopters hangared at Cubi Point.¹³

In the early morning hours of 14 June, a brief period of clear weather offered a good look at the mountain. Although long-period earthquakes had intensified throughout the preceding 24 hours, there was little visible ash and plume being emitted from the summit at that time. During the afternoon of 14 June, after 28 hours without a major eruption, activity picked up and continued to accelerate throughout the evening hours and on into the early hours of 15 June. With an additional threat posed by Typhoon Yunda, Hess ordered the evacuation of the two MC-130E Combat Talons, the C-130E slick, and the C-130H aircraft to Kadena AB. By late evening on 14 June, all fixed-wing aircraft had departed the Philippines, with the MH-53s remaining hangared at Cubi Point. Mount Pinatubo continued to increase its activity, and evidence mounted that there were eruption clouds venting from two different locations on the mountain.*¹⁴

At dawn on 15 June, PVO volcanologists were able to observe a huge ash cloud as Mount Pinatubo exploded for the fourth time at 0555 local. Unlike the tall narrow columns of ash formed during the 12 and 13 June eruptions, the 15 June eruption produced a relatively low ash cloud that spread out laterally rather than vertically from the volcano. This development raised concern that the volcano's summit could collapse, thus causing lateral blast and pyroclastic flow during future eruptions. The lateral blast could be directed toward

Clark AB. Consequently, most remaining personnel at Clark AB were directed to evacuate and seek safety further to the east.¹⁵

Until 15 June Cubi Point had escaped any serious affects from the volcano due to favorable winds carrying ash to the west over the South China Sea. Luck was about to change, however, as Typhoon Yunda continued to build off the eastern coast of Luzon. The storm moved relentlessly to the west, and by 0930 local on 15 June, its eye was directly over Subic Bay. Typhoon Yunda was producing 40 to 50 kilometer winds and heavy rains. The most devastating effect of the typhoon, however, was its northwest winds that carried ash from Mount Pinatubo toward Subic Bay and Cubi Point and then on towards Clark AB, by 1000 local the sky was completely dark. Mallon described the darkness as that found in a "sealed closet," with exploding electrical transformers the only light in the blackness. The continuous earthquakes struck fear into everyone, compelling some to seek safety outside in the event of building collapse. But outside, blizzard-like ash and a surreal electrical storm created by the exploding transformers were more frightening than the danger of collapsing buildings.¹⁶

Throughout the remainder of the morning and into the early afternoon, volcanic activity continued to increase. By 1430 all but one of the PVO seismometers were inoperative, which was probably due to pyroclastic flow. Ash, with large pumice fragments, was falling on Clark AB. In all probability the climatic eruption was under way by this time, but the volcano could not be observed visually due to total obscuration of the mountain, nor could it be monitored electronically due to the loss of the seismometers. At that time all remaining personnel evacuated Clark AB, including Stankovich's team, and moved to Pampana Agricultural College—about 38 kilometers east of Mount Pinatubo.¹⁷

The events of 15 June were a living hell for anyone caught in the maelstrom created by the typhoon and the exploding volcano. Many of the 1st SOS dependents left behind after the 14 June aircraft evacuation were housed in the Marmont Hotel off base, and by 2100 three nearby buildings had collapsed. Throughout the area more than 200 buildings collapsed during the night due to the tremendous weight of the rain-soaked ash. Sergeant Kay, the 1st SOS first sergeant, and

*PVO geologists north of the volcano saw two or more ash sources during increased activity on the afternoon of 14 June. At Clark AB a thermal-infrared scanner recorded possible multiple vents during a 2320 eruption on 14 June.

others from the squadron established a field hospital in the lobby of the Marmont Hotel. Some squadron members gathered children together and tried to soothe their fears, while many wives teetered on the edge of hysteria, having had virtually no rest during the previous 48 hours. Work crews were organized to shovel accumulated ash from the roof to keep the building from collapsing. Despite their best efforts, the fourth floor collapsed in the early hours of 16 June. Kay and several others risked their lives going door to door in dark hallways to get everyone out.* Once free of the hotel structure, the dependents walked down ash-filled streets toward the nearby Sea Breeze Hotel, becoming drenched in wet, gritty ash in the process. As morning approached there were 200 353d SOW dependents stranded at the Sea Breeze Hotel. They had spent most of the night in the hotel lobby or outside in the ash and rain. Dawn brought sunlight again, and everyone's spirits rose with the feeling that the worst was over. Eventually, several buses made their way through the heavy ash, picked up the dependents, and transported them to base shelters. Most of the 1st SOS dependents were moved to the jet engine shop and were issued cots and MREs. Although living conditions were austere, life there improved over the next several days.¹⁸

By 16 June the total evacuation of Clark AB had been completed without a single loss of any 353d SOW personnel. The challenge of finding sufficient food and water for those evacuated to Subic Bay Naval Base became top priority. There was neither water nor electricity, no telephones, and only a limited stock of food. The only solution to the developing crisis was a mass evacuation from the Philippines. Over the next several days, the ordeal of processing dependents for return to the United States was undertaken.¹⁹ The evacuation began with more than 3,000 Air Force and Navy dependents boarding the aircraft carriers USS *Abraham Lincoln* and USS *Midway*. The carrier support ships were also filled with evacuees. Their destination was a temporary airhead established at Mactan AB, which was located 360 miles south of Subic Bay. From Mactan AB the dependents boarded MAC aircraft for their trip to Guam and then on to the West Coast of the United States. By 18 June almost all 353d SOW dependents and nonessential personnel had departed Subic Bay.²⁰ Some 800 353d SOW military personnel remained behind in the Philippines for clean-up operations.

On 17 June Stankovich's stay-behind team returned to Clark AB to establish command and control and to make an initial assessment of damage to 353d SOW facilities. Mount Pinatubo erupted throughout the day, but PVO had re-established seismological monitoring devices on the mountain and had determined that the major eruption on 15 June was, indeed, the big one. There was little danger of renewed pyroclastic flow, so the team remained at Clark AB during the eruptions.²¹

On 21 June Hess led a team back to Clark AB to make a more in-depth assessment of 353d SOW facilities. Mallon was part of Hess's team, and he focused on the 1st SOS squadron operations building to salvage important records and unit heraldry. The facility had been completed only nine months earlier, but it was almost totally destroyed. Thousands of gallons of water had leaked through the roof, and the interior of the building was flooded. New computers were water-soaked, and complete libraries of technical publications were ruined. Clark AB was a barren wasteland covered under layers of volcanic ash.²²

Between 22 and 24 June, water and electricity were periodically restored to some areas of Clark AB, and food service was established at one of the base chow halls. Back at Subic Bay an assault strip 5,000-feet long was cleared by Navy Seabees to accommodate C-130 aircraft. Hess forward deployed Stankovich to Kadena AB as the senior 353d SOW officer. At Kadena AB a temporary beddown location for the wing was established, thanks to the hard work of Colonel Stankovich and Colonel Maher, the 17th SOS commander. Both had worked closely with the 313th Air Division commander, General Hurd, to make the beddown happen. The Combat Talons and the HC-130s were collocated on the west ramp of the sprawling military complex. The four MH-53J helicopters were still hangared at Subic Bay, but Hess began coordination to have them moved to Okinawa. By the end of June, three of the four Pave Lows had arrived in Okinawa by way of the USS *Midway*. The fourth helicopter was flown there on 2 July by way of C-5 aircraft. Space was not readily available at Kadena AB for the large helicopters, but Stankovich was able to negotiate temporary beddown of the helicopters at Futenma Marine Corps Air Station (MCAS), which was located five miles from Kadena AB.²³

Conditions at Clark AB continued to improve as long-distance telephone service and limited mail service were re-established. Although austere,

*Sergeant Kay was awarded the Airmen's Medal for his heroic actions.

life at Clark AB was slowly returning to normal. Throughout June and early July, 353d SOW personnel worked on the assumption that the wing would return to Clark AB when the base infrastructure was rebuilt. A decision that rocked the wing occurred in mid-July when the Philippine government refused to renew the US lease. The decision put the 353d SOW in limbo and resulted in a period of more than six months of uncertainty for its assigned personnel and their families. Early efforts to find an alternate beddown location for the wing focused on Andersen AFB, Guam, for the wing's fixed-wing assets and an FOL at NAS Cubi Point for the helicopters. As the year progressed, however, other locations were considered, including Korea, Thailand, Hawaii, Alaska, and the West Coast of the United States. For various reasons, all of those locations were unsuitable. The "unknown" status of the 353d SOW became the greatest concern for senior leadership because no new personnel could be assigned until an official beddown location was established.²⁴ As personnel departed the wing during the fall of 1991, manning soon became critical.

As efforts continued to find a beddown location for the 353d SOW, the 1st SOS settled into its temporary facilities at Kadena AB. The temporary squadron operations building consisted of an 800-square-foot building located on the east side of the runways near the MAC terminal. The small building (two small offices and one large room) functioned as the operations center, life support, administration, and aircrew briefing facility, and it housed up to 80 personnel. The unit was cramped, with people literally tripping over each other. Regardless of the cramped quarters, the squadron continued to fly operational missions from Kadena AB and continued to fulfill its exercise commitments.²⁵

A major effort was expended by the wing to recover 353d SOW equipment left at Clark AB. The 1st SOS flew two to three shuttles a week to NAS Cubi Point to onload salvaged equipment. While the aircraft were being loaded at Cubi Point, additional squadron personnel would travel to Clark AB to check on their household goods. Personal belongings were packed for storage until a beddown location was announced. The 1st SOS also focused on salvaging squadron records from its flooded building. The water-soaked acoustical ceiling tile had disintegrated into a gooey, wet mass of pulp, which coated desks, computers, furniture, and papers. Anything not stored inside

desks or file cabinets was basically rendered useless. Thousands of dollars of mobility gear, computers, copy machines, wooden office furniture, and memorabilia were damaged beyond repair.²⁶

During August and September, Mallon led an effort to retrieve all classified materials that had been locked in the squadron's vault, destroy non-critical documents, and prepare the remainder for air shipment to Kadena AB. He and his team spent weeks sorting through the wet, mildewed mess to account for all classified material. By the end of October, all of the squadron's supplies, furniture, and equipment worth keeping had been loaded into SeaLand containers and transported to Subic Bay, where they awaited a decision on the beddown of the wing.²⁷

Personnel began departing the squadron by way of permanent change of station (PCS) between July and October, with no replacements assigned to the 1st SOS or to the wing. The squadron was officially on temporary duty from Clark AB to Kadena AB, and PCS assignments to Kadena AB were not possible. By the November/December time frame, outbound assignments increased dramatically as squadron members elected to return to the United States and join their families who had evacuated from Clark AB the previous June. The continued uncertainty as to where the 353d SOW and the 1st SOS would be permanently located had a negative effect on assigned personnel. By the end of November, the squadron was manned at only 50 percent. To offset the loss of personnel, both 7th and 8th SOS personnel augmented the squadron beginning in September. With two aircraft possessed (64-0571 and 64-0572), the 1st SOS maintained two crews, and its sister squadrons maintained a third crew so previous commitments could be kept. For a brief period in December, there were four crews available to the 1st SOS, including its two crews, one crew from the 7th SOS, and one crew from the 8th SOS.²⁸

On 3 September 1991 Hess flew his final flight as the 353d SOW commander in a 1st SOS Combat Talon (64-0571). The following day Hess relinquished command of the 353d SOW to Stankovich. Colonel Jahnke, a former commander of the 1st SOS, replaced Stankovich as the new vice wing commander. The 1st SOS continued to fly shuttle missions to Cubi Point, and by the end of the year, had logged 44 sorties and 287.2 hours bringing critical equipment and supplies to Kadena AB.²⁹ On 26 November 1991 the 353d SOW flag was lowered at Clark AB by Stankovich and his

senior enlisted advisor, Chief Master Sergeant Showalter, in a solemn ceremony attended by General Studer. The small ceremony marked an end to the 10-year SOF adventure in the Philippines that had begun after Desert One in 1980. At year's end the nightmare of Mount Pinatubo was six months in the past, but it would be another year before the 1st SOS and the 353d SOW would attain a permanent beddown location.³⁰

The 7th SOS and Operation Provide Comfort

In Europe the 7th SOS had redeployed from Operation Proven Force on 18 March 1991 after the end of Desert Storm. At 0200Z on 6 April, scarcely three weeks later, the squadron received an execute order from SOCEUR to return to Turkey for Operation Provide Comfort. The new operation was in support of the Iraqi Kurds who had supported Coalition forces against Saddam Hussein during the Gulf War. With the majority of American forces back at their home stations in the United States and in Europe, Hussein moved to increase pressure on the Kurds, with the objective of eliminating them from Iraq once and for all.³¹

The first crew from the 7th SOS, led by Major Evans, took off from Rhein Main AB at 1842Z on 6 April, only 16.5 hours after the wing received the execute order. Colonel Hooten, the 39th SOW commander, flew on the first Talon. The next two MC-130Es, piloted by Captain Henneberry and Major Weart, departed at 2102Z. These two aircraft carried eight containers of relief supplies. Two HC-130s from the 67th SOS also departed for Turkey during the first day's deployment.³²

Evans's Combat Talon arrived at Incirlick AB at 0145Z on 7 April, followed by Henneberry and Weart at 0345Z. In total the 7th SOS deployed three MC-130E Combat Talons and 51 personnel for the operation. Eight hours after arrival in Turkey, the crews received an updated intelligence briefing and coordinated their mission with fighter pilots tasked to escort them into and out of Iraqi airspace. With their aircraft loaded and mission planning complete, two MC-130Es departed Incirlick AB at 0919Z on 7 April and headed for their DZ in northern Iraq. At their preplanned TOT of 1100Z, the Combat Talons dropped their eight-ton load utilizing the container release system. After a total of two hours and 45 minutes, the two aircraft arrived back at Incirlick AB after the successful resupply mission.³³

During the following weeks 7th SOS Combat Talons employed their unique systems in a vari-

ety of roles in support of the relief effort, including flying additional resupply missions. The communications package installed on the aircraft made it capable of acting as an airborne radio relay platform, thus providing a communications link between ground parties, airlift forces, and E-3 Sentry aircraft. The FLIR provided the means to look for groups of refugees moving towards Turkey and also provided the capability to videotape the size and location of refugee camps. Refugee movement information was important to relief providers because they tailored their efforts based on where the refugees were located. The 39th SOW Intelligence Section also acquired a tactical information broadcast system (TIBS) suite that was installed on the Combat Talon. The TIBS allowed the crews to collect signal intelligence as they flew over the northern Iraqi mission area.³⁴

As Operation Provide Comfort continued, resupply efforts shifted to ground transportation, and the need for the 7th SOS's unique capabilities was not as acute. Rescue teams on the ground established temporary refugee camps and organized a system to supply them over land. With decreased need for the Combat Talon, SOCEUR released the 7th SOS Talons from the operation, and they returned to Rhein Main AB on 14 May 1991. The Talons had dropped a total of 785,000 pounds of relief supplies during the deployment, flying 93 sorties and 413 hours.³⁵ By 10 June 1991 the remainder of the 39th SOW forces had been released and was back at home station.

On 23 July the 39th SOW was again alerted and deployed four MH-53s and two HC-130s to Incirlick AB for SAR support for what became known as Operation Provide Comfort II. The deployment package did not include the 7th SOS Combat Talons.³⁶ The new tasking would continue throughout the remainder of 1991 and on into 1992. For the 7th SOS its major tasking for the last half of 1991 was in support of the 39th SOW's JCET program. It was the only flying unit in the wing not tasked to support Provide Comfort II, and the lion's share of all remaining wing exercises fell to the squadron. Countries that the 7th SOS deployed to included Denmark, France, Italy, Norway, Spain, and the United Kingdom. By year's end the wing was stressed with its continued commitment to Turkey, but the 7th SOS was able to pick up the load for tasking outside Operation Provide Comfort II. During the third quarter of FY 91, the squadron was notified that it would move to RAF Alconbury, along with the rest of the 39th SOW, a move that would have the squadron

relocated out of Germany for the first time since its establishment in the mid-1960s. The 7th SOS would also convert to the Combat Talon II during 1992, thus ending the era of MC-130Es in Europe. As 1991 came to a close, the 7th SOS had four Combat Talon Is assigned—64-0523, 64-0555, 64-0561, and 64-0566—and one slick C-130E, 63-7814. The year 1992 would see the most changes for the squadron in its history.

The 8th SOS Prepares for Combat Talon II

At Hurlburt Field the spring of 1991 found the Combat Talons of the 8th SOS still in Southwest Asia. During Operation Desert Storm, the squadron had conducted both psychological warfare and helicopter air refueling operations. On 17 March two of its Combat Talons redeployed from KFIA to Hurlburt Field, thus leaving two aircraft and four crews in-place in Saudi Arabia. The two aircraft Combat Talon package remained at KFIA until 22 May, when one aircraft was released and returned to Hurlburt Field.³⁷ By early summer all 8th SOS Combat Talons and most of its personnel were back at home station.

When Beres took command of the squadron in the summer of 1990, one of his major challenges was to prepare the squadron for the arrival of the new Combat Talon II. The events in Southwest Asia had focused the majority of his attention on Iraq, but he had detailed other personnel not deployed to work CT II beddown issues. The CT II had been scheduled for delivery to the 8th SOS several times during the late 1980s, but it had been delayed when the radar could not successfully complete its test profile. In mid-1988 Headquarters AFSOC decided to delay delivery of the CT II until its radar and supporting subsystems met design specifications. As a result of this decision, the 1988 delivery date to the 8th SOS was slipped to 1990, and this date was subsequently slipped further to 1991. As the weapons system went through its test cycle, personnel to maintain and fly them were also being identified and trained. For aircrew personnel the Air Force Personnel Center manned the 8th SOS with additional flight crews beginning in 1990. With a manning authorization of 79 officers and 82 enlisted personnel, the squadron grew to 93 officers assigned (plus 19 attached) and 96 enlisted assigned personnel (plus 17 attached) by June 1991.³⁸

Combat Talon formal training and beddown of the CT II continued to be contentious issues through 1991. Since the creation of the Combat Talon in 1966, all formal training had been accomplished by the US-based operational Talon squadron (the 779th TCS or the 318th/8th SOS). With only 14 aircraft in the fleet, the community could not afford to man four squadrons, with one dedicated solely to formal training. Historically, during periods of heavy operational commitments, including Desert One and Just Cause, the school-house function took a back seat. The same aircraft and instructor crew members that manned the formal school also had operational commitments to fulfill. During Operations Desert Shield/Desert Storm, formal training at Hurlburt Field was suspended, and the school ceased operations for almost a year because 8th SOS crews and aircraft were deployed to Southwest Asia. During the period the 1st and 7th SOS had to accept unqualified crew members and train them with their scarce theater-committed aircraft.

Air Mobility Command (AMC) provided formal training for its conventional airlift forces, and with 24 CT II aircraft available, a formal training squadron could be maintained. The earlier decision to establish a four-aircraft squadron at Kirtland AFB, New Mexico (beginning in July 1991) was reaffirmed by Air Staff, and a new delivery date was established as March 1992. Along with the CT II decision, Air Staff also announced the transfer of CT I formal training from the 8th SOS to Kirtland AFB by 1 January 1994. Both weapons systems would be assigned to the 542d Crew Training Wing (CTW). The first CT II classes would be conducted by initial cadre instructors assigned to both the 8th SOS and to the 542d CTW during 1991 and 1992.

The 17th SOS in the Pacific and the 7th SOS in Europe were scheduled to convert to the CT II during the summer and fall of 1992. The 7th SOS CT I aircraft would be transferred to the 542d CTW at Kirtland AFB. The 1st and 8th SOS would remain the only two active duty operational squadrons flying the older CT I aircraft. Along with the 7th SOS, a new operational squadron, designated as the 15th SOS and assigned to Hurlburt Field, would operate the CT II. As 1991 and 1992 passed, the basing plan would change to accommodate support equipment and spares availability, but by mid-1991 the game plan for CT II had been established and a formal shift of CT I training to Kirtland AFB finalized.

Combat Talon II Is Delivered to Hurlburt Field

Throughout the spring of 1991, test crews assigned to Edwards AFB, California, continued the long and tedious process of certifying the Combat Talon II radar for operational use. In February 1991, while the air war was in full swing in Southwest Asia, the advanced systems of the CT II were field tested during a deployment to Alaska. Low-level operations, down to 250 feet in the rugged Alaskan mountains, were accomplished with F-15 fighter aircraft attempting to intercept the Combat Talon II. The ECM suite designed to evade the fighter aircraft's weapons systems and the terrain-following radar worked as designed. Along with the flight-test profile, another objective of the Alaskan deployment was to test the aircraft's systems in cold weather. With only minor deficiencies, the aircraft passed with excellence. In March 1991 test crews deployed to Eglin AFB and conducted additional tests on the AN/APQ-170 radar. Following that series of tests, a CT II deployed to Clark AB, for its tropical evaluation. The steaming heat and moisture of Southeast Asia provided a challenge to both aircraft and maintenance crews alike, but again the aircraft passed with only minor deficiencies.³⁹ Although testing would continue at Edwards AFB over the next several years, the weapons system had performed at an acceptable level and was ready for delivery to the 8th SOS.

The first operational MC-130H CT II (87-0024) was delivered to the 8th SOS on 29 June 1991, with three additional aircraft (87-0023, 85-0012, and 84-0476) being delivered over the next four months. On 17 October 1991 an AFSOC acceptance ceremony was held at Hurlburt Field, and the initial cadre of MC-130H CT IIs were officially placed in the USAF inventory. Although the mission of the CT II was similar to its older cousin, it lacked two major capabilities found on the CT I—it was not capable of air refueling helicopters, and it did not have the Fulton STARS modification. Requirements for these two capabilities had not been established for CT II and were not included in the basic design of the new weapons system. The CT II did have, however, a greater cargo capacity than the CT I, since the radio operator/electronic warfare officer console (located in the cargo compartment of the CT I) was not required for the CT II. The console was not required because the radio operator and the second navigator crew positions were eliminated for the CT II, thus reducing the crew to two pilots,

one navigator, one EW officer, one flight engineer, and two loadmasters (total of seven for the CT II as opposed to nine for the CT I). The EW officer crew position was moved to the flight deck where the second navigator position was located on the CT I. With a clean cargo compartment, the CT II could carry six pallets of cargo as compared to five for CT I.⁴⁰ By 31 December 1991 the 8th SOS was assigned a combination of six CT Is and six CT IIs. CT Is possessed by the squadron included aircraft 64-0551, 64-0559, 64-0562, 64-0567, 64-0568, and 64-0565. Squadron CT II aircraft tail numbers included 84-0476, 85-0011, 85-0012, 86-1699, 87-0023, and 87-0024. In addition to the 12 Combat Talons, the squadron was also assigned one slick C-130E, thus making the Hurlburt Field unit the largest Talon squadron in AFSOC.⁴¹

During the following year CT II aircraft were delivered to operational units in AFSOC and in ATC. The 542d Combat Training Wing (ATC) at Kirtland AFB, New Mexico, received its first CT II (87-0126) in March 1992, followed in June by aircraft 87-0125. Kirtland AFB's third CT II (85-0012) was transferred from the 1st SOW in July 1992, and aircraft 88-0191 was delivered in October 1992. The 7th SOS received its first aircraft (86-1699) from the 1st SOW in September 1992, followed by aircraft 85-0012, which was transferred from Kirtland AFB in November 1992. The 7th SOS's third aircraft (84-0476) was delivered to the squadron in December 1992.⁴² The 17th SOS was also scheduled to receive its initial CT IIs during the fourth quarter CY 92, but the CT II program manager at Warner Robins determined that a fourth operating location was not supportable at that time due to the availability of test equipment and spares. As a result the conversion of the 17th SOS to the CT II was postponed for two years, until the summer of 1995.

The Air Force Objective Wing

As the 8th SOS began accepting the new CT II aircraft during the fall of 1991, the CSAF, Gen Merrill McPeak, outlined his vision of a restructured Air Force during a speech titled "Organize, Train, and Equip" made at the Air Force Association annual meeting in September 1991. The primary focus of his presentation was the reorganization of the Air Force to make it more efficient in a period of decreased funding and reduced manpower. Earlier in the year McPeak had initiated actions to reform the Air Staff, and he had eliminated air divisions while severely reducing the size and functions of numbered Air Force

headquarters. For AFSOC McPeak's vision would directly impact the organization of the 1st SOW by restructuring it into an objective wing, and for the overseas wings, it would mark the systematic dismantling of their wing structure and result in their downgrade from wings to groups.⁴³ For the three Combat Talon squadrons, the restructuring would result in the transfer of on-aircraft maintenance to each operational squadron. With implementation of the objective wing concept, the Combat Talon squadrons would more than double in size.

In response to an August 1991 CSAF tasking message and a letter from Headquarters AFSOC, Colonel Johnson, vice wing commander of the 1st SOW, presented four options on 17 September for possible reorganization of the wing into the objective wing structure. Johnson's proposal was based around the establishment of two groups within the wing—an operations group and a logistics group. Since AFSOC did not own Hurlburt Field, the 1st SOW would not have a support group as part of its structure.* Likewise the Hurlburt Field clinic was a satellite facility belonging to Eglin AFB, thus eliminating the requirement for a medical group within the wing.⁴⁴

With inputs from across the Air Force, the CSAF convened an objective wing conference on 27 September 1991. Major command representatives were briefed by Air Staff deputy chiefs of staff (DCS) and directors on where each wing function should be located. A Headquarters USAF vice chief of staff message, dated 3 October 1991, summarized the results of the conference and was transmitted to the field. Although the conference was a first-step effort towards attaining an objective wing structure across the Air Force, major commands generally had more questions than answers. As 1991 neared its end, both AFSOC and the 1st SOW worked long, hard hours to develop an operational structure that was both acceptable to CSAF and that would provide a logical and efficient means to reorganize SOW. To meet the implementation schedule, the Headquarters AFSOC staff developed a study that outlined the establishment of the objective wing in AFSOC, and the study was briefed at the

November 1991 AFSOC Commander's Conference. With AFSOC commander inputs a comprehensive briefing schedule was finalized. USSOCOM was scheduled to be briefed in December and Headquarters USAF briefed after the first of the year.⁴⁵ USAF reorganization into the objective wing structure would become the focus of AFSOC and the 1st SOW throughout 1992.

1992: The 15th SOS Is Activated and Assigned Combat Talon II

As 1992 began AFSOC was working hard to refine its objective wing structure. A Headquarters USAF Air Staff briefing was scheduled for 18 February 1992. The February briefing outlined the "two group" option for the 1st SOW and proposed retaining the overseas wings. It also provided an outline for combining the operations squadrons with on-aircraft maintenance. An implementation date of 1 October 1992 was proposed.

The Objective Wing Is Implemented within AFSOC

Because of feedback from the Air Staff at the February briefing, AFSOC amended its presentation before briefing General McPeak to include a recommendation to downgrade the two overseas wings (the 39th SOW and the 353d SOW) to special operations groups. The one base, one wing, one boss guidance from CSAF was the primary reason behind Air Staff nonconcurrence of AFSOC's desire to retain the two overseas wings. The downsized SOGs would consist of one rotary-wing and two fixed-wing squadrons, and a special tactics, maintenance, and operational support squadron along with a reduced headquarters staff. The briefing proposed retaining the 1st SOW designation, changing the 39th SOW in Europe to the 352d SOG to claim the historical lineage of the 2d Air Commando Group, and redesignating the 353d SOW in the Pacific as the 353d SOG to retain the lineage of the 3d Air Commando Group.⁴⁶ The 1st SOS would be assigned to the 353d SOG and the 7th SOS to the 352d SOG.

*Hurlburt Field remained a Military Airlift Command base after the formation of AFSOC in 1990. To manage the base and to provide support functions to the 1st SOW, MAC established the 834th Air Base Wing. When Johnson was tasked to develop an objective wing structure for the 1st SOW, the "one wing, one base, one boss" guidance from McPeak could not be followed. Headquarters AFSOC did not own any bases; therefore, before assuming base support responsibilities, it had to create a base management function on its headquarters staff. When the 1st SOW stood up as an objective wing on 1 October 1992, USAF recognized it as a Phase I stand-up and that the base would transfer to AFSOC as soon as command oversight could be established. Over the next two years, the base would be transferred to AFSOC along with the Hurlburt Field Clinic. With the completion of those two actions, the 1st SOW stood up its support group and its medical group, thus becoming a true four-group objective wing as envisioned by CSAF in 1991.

The 8th SOS would continue to be assigned to the 1st SOW.

On 3 April 1992 Headquarters AFSOC sent a message to PACAF and USAFE announcing that the CSAF and CINCSOC had approved AFSOC's objective wing structure in principle. In the message General Fister, the commander of AFSOC, stated, "Our theater CINCs can expect and will receive the same high level of support as in the past. While all AFSOC units will reorganize, they will remain independent, tenant units at bases around the world." General Fister also announced the new designations for the overseas groups and established effective dates of 1 October 1992 for the 1st SOW and 1 December 1992 for the overseas groups.⁴⁷

With the basic structure of the AFSOC objective wing approved, the difficult task of determining the implementing details fell to the 1st SOW. On 8 May Johnson convened the first of a series of steering group meetings, and he appointed Colonel Clark (a former 7th SOS MC-130E pilot and plans officer) to head the effort. Johnson stressed to the steering group the need for the full support by all involved and directed that a phased approach be followed during the conversion. He called for early agreement on wing staff manning, for early stand-up of the operations and logistics group structures, and a step-by-step move of the on-aircraft maintenance function into the operational squadrons. The 20th SOS was designated the first squadron to transition to the new structure, with the fixed-wing squadrons following soon afterwards. Over the next four months, the steering group would establish milestones and meet regularly to review the wing's progress towards attaining the objective wing structure. On 15 July the 20th SOS assumed control of its maintenance function, followed by the 16th SOS on 15 August. On 9 September Headquarters USAF advised Headquarters AFSOC by letter that its 17 April reorganization plan was approved and cleared the 1st SOW to fully implement its objective wing structure effective 1 October 1992. Five days later the 8th SOS assumed its on-aircraft maintenance responsibilities.⁴⁸

Actions identified by Clark AB's steering committee continued to take place during September, and by the 22d of the month, the wing was functioning as an objective wing. On 1 October a formal low-key ceremony was conducted, with Headquarters AFSOC publishing Special Order GA-014, effective on that date. The special order identified the actions taken as a first stage objective wing. The 1st

SOG and the 1st Special Operations Logistics Group (SOLG) were activated and assigned to the 1st SOW.⁴⁹ Colonel Schwartz (formerly assigned to the 8th SOS and the incumbent director of operations under the old organizational structure) became the 1st SOG commander, while Colonel Gross (the incumbent director of maintenance) became the commander of the SOLG.

The 8th SOS Establishes CT I and CT II Flights

As the 1st SOW worked through the development of its objective wing structure, Beres and his 8th SOS staff were busy training aircrews for CT II and preparing the squadron for the assignment of maintenance personnel. With 13 aircraft assigned, the squadron had doubled in size from the summer of 1991 to the summer of 1992. On 29 May 1992 Colonel Murdock was appointed the new squadron commander to succeed Beres, who departed the squadron to attend the National War College in Washington, D.C. Murdock had served as the squadron operations officer under Beres during Operation Desert Storm and had been a flight examiner and instructor pilot in the squadron during the mid-1980s. The difficult task of completing the squadron reorganization process and supporting the stand-up of the new CT II unit would fall on Murdock's shoulders.⁵⁰ In June the 8th SOS celebrated its 75th birthday and was recognized as the second oldest continuously active duty squadron in the Air Force.

After the end of the ground war in Southwest Asia, the 8th SOS had returned to Hurlburt Field to prepare for the arrival of the CT II. During 1992 the squadron remained at home station, supporting local training missions and participating in JRT events at Hunter and Lawson Army Air Fields in Georgia. The squadron also deployed to Pope AFB for a large-scale Capex and provided one aircraft and crew for JCS Exercise Ocean Venture 92.⁵¹ The workload associated with dividing the squadron into independent CT I and CT II units, while at the same time developing a maintenance capability for both squadrons, took up most of the squadron leadership's time. Assisting Murdock in this undertaking were two exceptional officers (Colonels Poole and Saier) who served as Murdock's CT I and CT II operations officers. When the 8th SOS was assigned its own maintainers on 15 September, the transition went relatively smooth with few problems. Two weeks later the 15th SOS was officially activated with its own maintainers assigned. The two events marked the

culmination of years of hard work by programmers, planners, operators, and maintainers.

Activation of the 15th SOS

On 13 April 1992 a Headquarters USAF/MO letter to AFSOC/CC formally announced the activation of the 15th SOS, effective on or about 16 October 1992, with its assignment to AFSOC. The letter noted that the squadron had been previously inactivated on 31 October 1970, and it directed AFSOC to issue a G-series order in accordance with applicable Air Force regulations. Headquarters AFSOC subsequently issued Special Order GA-011 on 1 June 1992, which activated the 15th SOS, effective 1 October 1992, and further assigned the squadron to the 1st SOW. With the G-series orders issued, Saier (the CT II operations officer of the 8th SOS and commander-designate of the new squadron) had a target date to get his personnel and equipment ready. His focus was on CT II preparations, while his counterpart in the 8th SOS, Poole, concentrated on the CT I and the issue of absorbing maintenance into the CT I squadron. By September all was ready to divide personnel and equipment assigned to the 8th SOS and to stand up the new CT II unit. Special Order GB-014, issued by Headquarters AFSOC and dated 1 October 1992, formally designated Saier as the new commander of the 15th SOS.⁵²

On 1 October, in a formal ceremony held on the Hurlburt Field flight line, Saier assumed command of the 15th SOS with Colonel Schwartz officiating. The squadron's history dated back to 5 February 1942 when it was initially activated as the 18th Observation Squadron. Nine months later it was redesignated the 15th Antisubmarine Squadron (Heavy) (H) and was assigned to the 26th Antisubmarine Wing, Miami, Florida. The unit flew the B-24 Liberator until 1944, when it converted to the B-29 and was redesignated the 15th Bomb Squadron (BS) (Very Heavy) (VH). It soon deployed to the Pacific theater and participated in the Allied offensive against mainland Japan. During the Japanese surrender ceremony on-board the USS *Missouri* in Tokyo Bay, 15th BS (VH) aircraft provided a formation fly-over to honor Allied lives lost during the defeat of Japan. The unit was inactivated after WWII, but was formed again as the 15th Air Commando Squadron at Nha Trang AB, Vietnam, on 15 March 1968.* Five months after activation (on 1 August

1968) the unit was renamed the 15th Special Operations Squadron.⁵³

For the next two years, the 15th SOS distinguished itself in Southeast Asia as the primary air component of MACVSOG, flying the MC-130E Combat Talon on both psychological operations and personnel infiltration/resupply missions into North Vietnam and Laos. On 31 October 1970 the 15th SOS was inactivated, and the squadron was redesignated the 90th SOS. From 31 October 1970 until 1 October 1992, the 15th SOS remained in an inactive status. Thus, when Saier took the flag from Schwartz during the formal activation and assumption of command ceremony, one of the most decorated Combat Talon squadrons from the past was again active. With the assignment of the CT II weapons system, the 15th SOS was once again an operational Combat Talon squadron molded in the proud tradition of its Vietnam-era Stray Goose ancestors.⁵⁴

Although the new MC-130H CT II performed the same mission as the MC-130E CT I, it incorporated a highly automated control and display system that was designed to reduce cockpit workload while providing on-line information to the flight crew. The entire cockpit and cargo compartment were compatible with NVGs, thus eliminating the need to reduce light levels or to tape critical warning lights that were required in the CT I. The cockpit configuration was designed around the pilot and copilot displays on the cockpit instrument panel, and the navigator/EWO displays, which were mounted in a two-position console located in the right rear area of the cockpit. Although not a complete "glass" cockpit, each crew station had two video displays and a data-entry keyboard. One of the two EWO video displays was dedicated to electronic warfare data, while the two navigator videos displayed navigational information. Integral to each video display was a switch that contained 21 variable-function, software-controlled switches. Key legends were shown on the video display next to each switch to indicate the current switch function. The five switches in the top row were used for the primary display mode selection, while the eight switches on each side provided controls appropriate to the selected primary display mode.⁵⁵

The primary pilot and copilot display formats included basic flight instrumentation and situational data. There were several varieties of vertical display formats for control of the aircraft and

*Personnel and aircraft making up the 15th Air Commando Squadron had deployed to Southeast Asia in 1966 as the original Stray Goose detachment from Pope AFB, North Carolina.



USAF Photo

Pilot and copilot display, Combat Talon.



USAF Photo

Nav/EWO panel on right side of Combat Talon II flight deck.

presentation of flight guidance information. Horizontal display formats presented tactical information and radio navigation information. The display formats were available with symbology alone or symbology overlaid with sensor video. The navigator used ground map displays, forward-looking infrared displays, tabular mission management displays, and equipment status presentation. The EWO displays were used for EW data display and to supplement the navigator in certain critical phases of flight. With the two pilots, navigator, EWO, and flight engineer crew stations all located on the flight deck, only the two loadmaster crew stations were located in the cargo compartment. The configuration promoted crew

coordination and efficiency during the difficult and often demanding low-level phases of flight.⁵⁶

By the fourth quarter of CY 92, both the 15th SOS at Hurlburt Field and the 542d CTW at Kirtland AFB were operational with the CT II. On 1 December 1992 the 7th SOS officially converted to the CT II, and their CT I aircraft were transferred back to the United States. The issue of relocating CT I training to Kirtland AFB was readdressed in December 1992 by the 1st SOG/CC, Colonel Schwartz. In his 14 December 1992 letter to the AFSOC/DO, Colonel Schwartz expressed his concern over the January 1994 target date to move the formal CT I school to Albuquerque. Although he supported the move, he cited several issues, including aircraft availability and lack of a flight simulator and other facilities at Kirtland AFB to accommodate CT I as issues needing to be resolved before moving training from Hurlburt Field. Of the three CT Is scheduled for Kirtland AFB (64-0523, 64-0555, and 64-0561), only 64-0523 would be available in January 1994, with the two other aircraft still at LAS Ontario undergoing MOD-90 upgrade. With only three fully modified MOD-90 aircraft scheduled to be on the ramp at Hurlburt Field in January 1994, Colonel Schwartz felt it unrealistic to expect the 1st SOG to loan a MOD-90 CT I to Kirtland AFB due to projected operational commitments.⁵⁷

Also cited in Colonel Schwartz's letter was the lack of facilities at Kirtland AFB. The establishment of the CT II schoolhouse had placed classroom and office space at a premium. If construction projects under way at Kirtland AFB were delayed for any reason, sufficient space to conduct classes alongside existing fixed- and rotary-wing classes would not exist. Colonel Schwartz ended his letter with the observation that the distinct possibility existed that, due to shortages of aircraft and facilities at Kirtland AFB, problems faced at Hurlburt Field would only be shifted and exacerbated if CT I training was shifted. He felt that the timing of the move was ill advised and that the 1st SOG could be forced to continue the formal CT I training after scarce manpower and training resources had been transferred to Kirtland AFB. He requested that the 1 January 1994 target date be delayed until resources were in place and more CT Is were available for the training squadron.*⁵⁸

*Colonel Schwartz's concerns were considered by AFSOC, and the January 1994 target date was eventually postponed to FY 96 by Air Staff. Kirtland AFB experienced unprogrammed challenges as it matured the CT II and the MH-53J Pave Low formal schools. (AETC had assumed all formal training requirements for AFSOC along with the CT II.) After years of delays, the Air Staff decided to retain the CT I formal school at Hurlburt Field and to stand up a training squadron (the 19th SOS) dedicated to its operation.

At the end of 1992 the 8th SOS possessed three MOD-90 aircraft with a new communications system, improved electronic warfare systems, and the ALQ-172 SPJ. In addition, the CT Is had been fitted with an integrated GPS, improved IR capability, and the ALE-40 system for decoying IR guided missiles. For STARS missions the 8th SOS was the only squadron that maintained airframes capable of performing Fulton recoveries. Plans called for a reduction from nine to three STARS-capable CT Is to reduce the cost of maintaining the expensive system.⁵⁹ Except for the Pacific Talons, all CT Is either were at Hurlburt Field assigned to the 8th SOS or at LAS Ontario undergoing MOD-90 upgrade.

Kirtland AFB Receives the Combat Talon II

Kirtland AFB had been preparing to receive the Combat Talon II since the late 1980s. When AFSOC was formed as a separate command in May 1990, the decision to base SOF training at Albuquerque was reviewed. Senior leadership felt that AFSOC was too small a command to be able to absorb its own training program, while at the same time supporting real-world contingency tasking. The decision to base Combat Talon II training at Kirtland AFB was validated, however, and preparations for the arrival of the weapons system continued at the New Mexico base. With its first CT II scheduled for delivery in July 1991, the first class was tentatively scheduled for the following November. In anticipation of these events, work on the Talon II pilot and navigator courseware was completed in January 1991. Work on the CT II flight engineer and loadmaster courseware was completed in May. Plans to validate the CT II courseware before the first students arrived at Kirtland AFB was also finalized. An interim schoolhouse was planned at Hurlburt Field beginning in March 1991, lasting for two to three months and utilizing both Kirtland AFB instructors and those from the 8th SOS. The interim schoolhouse would allow the courseware to be tested and validated before the first students arrived at Kirtland AFB.⁶⁰

Design work was finished for an MC-130H Combat Talon II flight simulator building in May 1990, followed closely by the design of a new avionics maintenance facility. The wing included the two projects in its FY 90 military construction program, and on 22 October a contract for the construction of the simulator building was awarded. The wing held a groundbreaking ceremony on 12

November, and construction began on 20 November. The projected cost to build the new facility was \$5 million, and the contractor expected to have it finished by December 1991. A contract to build the avionics maintenance facility was awarded on 30 November 1990 for \$3.6 million, and the formal ground breaking ceremony was held on 28 December. The two projects represented two of the more costly construction projects required to beddown the Combat Talon II.⁶¹ As 1990 came to a close, Kirtland AFB was on track to receive its initial Combat Talon II weapons system.

The Combat Talon II radar continued to delay the delivery of the new aircraft, and the 1 July 1991 delivery of the first aircraft to Kirtland AFB was slipped to the following spring. Kirtland AFB received its first Combat Talon II in March 1992 but had the official roll out ceremony in June. Three more Combat Talon IIs were delivered between 15 September and 10 November 1992. In October 1991 the wing sent its initial cadre of Combat Talon II instructors to Hurlburt Field to help the 8th SOS teach the first two MC-130H formal classes. The first class started on 21 October 1991 and finished on 7 February 1992; the second class began on 20 January 1992 and finished on 24 April. The Kirtland AFB instructors returned to their home bases and taught the first class there beginning on 7 July 1992. Kirtland AFB and Hurlburt Field jointly taught formal classes during the following six months. All formal CT II classes after 11 December 1992, however, were taught only at Kirtland AFB. The new formal school planned to train approximately 16 Combat Talon II crews the first year and 12 crews annually thereafter.⁶²

As the new Combat Talons began arriving at Kirtland AFB in the spring and summer of 1992, the 1550th Combat Crew Training Wing (CCTW) (the host wing for Combat Talon) was going through a tumultuous period in its own history. On 19 February 1976 the 1550th Aircrew Training and Test Wing (ATTW) moved from Hill AFB, Utah, to Kirtland AFB. On 1 October 1983 the 1550th ATTW joined Twenty-Third AF as a MAC unit assigned to Scott AFB, Illinois. On 15 May 1984 it was redesignated the 1550th CCTW and continued to train HC-130P/N and USAF rotary-wing crew members.⁶³ To provide base support for the 1550th CCTW, the 1606th Air Base Wing (ABW) was established as a second MAC wing located at Kirtland AFB, and it served as the host wing for all base-assigned units. On 1 October

1991 the 1550th CCTW merged with the 1606th ABW to form the 542d CTW. General Higham assumed command of the 542d CTW, and a former Combat Talon I operator, Colonel Vycital (previously the commander of the 1550th CCTW), was appointed vice commander of the 542d. Manpower and resources were transferred to the 542d CTW, and all former unit designations of the 1606th were inactivated.⁶⁴

The merging of the two wings was only temporary. At the Corona Fall 92 commander's conference, plans were unveiled by CSAF (General McPeak) to transfer Kirtland AFB from MAC (now Air Mobility Command) to Air Force Materiel Command (AFMC) because the latter held the preponderance of forces assigned to the base. The transfer of the base became effective on 1 January 1993. The impact of the base transfer resulted in the establishment of a new AFMC host base wing using support units from the 542d CTW. In late December 1992 approval from Air Staff was received to activate the 377th ABW as Kirtland AFB's new host base wing.⁶⁵

The 542d CTW remained a separate crew training wing assigned to AMC and a tenant unit at Kirtland AFB throughout its operational life. It was solely responsible for the aircrew training mission. The pattern of constant change continued through 1993, when on 1 July, the 542d CTW was transferred to AETC located at Randolph AFB, Texas. The move to AETC was brought on by CSAF initiatives associated with USAF reorganization and alignment. The constant change and turmoil had their impact on the new Combat Talon II training program, but thanks to dedicated individuals committed to making the effort a success, the schedule was not impacted to a point where student training was impeded.⁶⁶

Decision Made to Base Pacific Units at Kadena AB

The year 1992 found the 353d SOW still in limbo after Mount Pinatubo, with forces located at Kadena AB and Futenma MCAS on Okinawa. Since evacuating Clark AB on 11 June 1991, and with the subsequent denial of the government of the Philippines to continue the lease there, Headquarters AFSOC had continued to look for a suitable beddown location. As the months passed and personnel returned to the United States, much of the wing's functions were performed by temporary duty augmentees provided by the 1st SOW at Hurlburt Field. As the wing approached its 180-day temporary duty limit, AFSOC was forced to

redesignate the wing so that it could continue to operate in the Pacific. On 31 December 1991 the 353d SOW was redesignated the Special Operations Wing Provisional, 353d. Operating under provisional status allowed the wing to continue its mission until a basing decision was made. From 31 December 1991 to 5 February 1992, the wing functioned with a handful of people permanently assigned, while most other personnel were attached to the provisional wing in TDY status under a program known as Scimitar Sweep. During this period AFSOC kept the provisional wing manned at approximately 55 percent—297 personnel, excluding 177 assigned to the 17th SOS already at Kadena AB (total of 474).⁶⁷ On 17 January 1992 the American embassy in Tokyo informed the government of Japan of the proposed interim relocation of the 353d SOW to Kadena AB. General Hurd, who had taken over as the 18th Wing commander, softened the impact on Okinawa by privately informing Governor Ota before the public announcement. Headquarters AFSOC publicly announced the decision on 11 February. Surprisingly, there was no public outcry, and Headquarters PACAF quietly issued orders officially moving the 353d SOW from Clark AB to Kadena AB, effective 5 February 1992.⁶⁸

Following the beddown decision, agreements between Air Force and base level personnel managers allowed a steady increase in the wing's manning by about 75 personnel each month as new permanent party members began arriving and Scimitar Sweep augmentees departed. By the end of September 1992, all TDY manning for the 353d SOW had ended, while the 31st SOS (which had moved to Osan AB, ROK, from Futenma MCAS) maintained a few TDY personnel through December. With the 353d SOW reconstituted, Headquarters AFSOC deactivated the Special Operations Wing Provisional, 353d, on 28 February 1993.⁶⁹

No formal public announcement was made on the decision to relocate the 31st SOS from Futenma MCAS to Osan AB, ROK, and the decision was kept classified until 1 April 1993. Even after declassification, no public announcement was made at the request of the Republic of Korea. South Korea was in peace negotiations with North Korea and did not want the new special operations unit to become entangled in that process. Although the beddown decision had been made, one stipulation in the wording of the decision continued to affect the permanent status of the 353d SOW and its assigned squadrons—the decision to locate the wing in Okinawa and in

Korea was identified as an interim decision, which implied that the decision would be reviewed sometime in the future. This caveat made the basing issue more acceptable to both Japan and South Korea, but it made facilities improvements and new construction extremely difficult for the wing.⁷⁰

On 23 February 1992 Colonel Reinholz assumed command of the 1st SOS from Mallon, who was reassigned to the Joint US Military Group in Manila, Republic of the Philippines. With the announcement of the beddown of the wing at Kadena AB and at Osan AB, agreements had to be made between the 353d SOW and the 18th Wing, which was the host unit at Kadena AB, and with the 51st Wing at Osan AB. On 14 May Stankovich signed a facilities agreement with General Hurd at Kadena AB, and on 4 June he signed an MOU with the 51st Wing at Osan AB. These two agreements were followed in September with the awarding of a contract for \$4.5 million for refurbishment of facilities at Kadena AB, and a \$1.5 million contract for Osan AB.⁷¹

During the summer of 1992, the 1st SOS received its first two MOD-90 MC-130E Combat Talons (63-7785 and 64-0565). The third MOD-90 aircraft (62-1843) arrived in January 1993. Additional

modifications to replace the center wing and to add helicopter refueling capability to the Pacific Talons were scheduled for 1993. In addition to the two MC-130Es, the 1st SOS continued to possess one C-130E slick, which it had used extensively to move 353d SOW equipment from Clark AB to Kadena AB. The C-130E slick also provided a pilot proficiency platform that enabled the squadron to train and season new crew members as they were assigned to the squadron.⁷²

To minimize the impact of the unplanned relocation of the squadron from Clark AB, Reinholz and the 1st SOS maintained an aggressive exercise schedule. Many of the training areas frequented by the squadron had taken years to develop, and the island location of Kadena AB made those training areas even more important. The squadron kept its assigned aircraft on the road supporting both JCS exercise commitments and smaller, yet equally important, JCET events. Deployments included those to Australia, Korea, mainland Japan, Malaysia, Singapore, and the Philippines. The squadron also supported JCS Exercise Tandem Thrust in the western United States and unilateral training in Hawaii. Although the schedule was sometimes hectic and challenged the squadron to execute as planned,



Photo courtesy of John R. Lewis

Combat Talon 64-0565 was the first aircraft to receive the complete MOD-90 modification. Pictured is part of the MOD-90 production team. Note the rising Phoenix and the motto "The Guts to Try" nose art. The aircraft had been heavily damaged at Desert One. First row left to right: Rich Ryan, Mike Rosenbaum, Frank Sharkany, and Guy Washburn. Second row left to right: Darwin Nicely, Don Henderson, Tom Jozwiak, Tom Willis, Jim Schaeffer, Bob Lewis, John Waddington, and Jeff Hurst.

all commitments were fulfilled, and the 1st SOS maintained its training areas throughout the transition period.

During 1992 the Air Force went through the most sweeping reorganization in its history. For the 353d SOW it was reorganized and redesignated the 353d SOG, effective 1 December 1992.⁷³ The reorganization impacted the 1st SOS Talon squadron by placing on-aircraft maintenance in the squadron, thus resulting in the doubling of the number of 1st SOS-assigned personnel. Both the 352d SOG (formerly the 39th SOW) and the 353d retained their wing-like status, with duties and responsibilities normally found in a wing (public affairs, finance, manpower, historian, etc.). As the newly designated 353d SOG closed out 1992, a feeling of permanence had grown in the special operations group. The New Year would prove as challenging as the old, with the group facing its first ORI in the fall of 1993 during Foal Eagle.

The 7th SOS Moves to RAF Alconbury with CT II

As 1992 began for the European Talons, the 39th SOW was completing final preparations for its relocation to RAF Alconbury, UK. On 15 January the 39th SOW headquarters began the move. The 7th SOS remained at Rhein Main AB at that time, but it was scheduled to move later in the year. At the squadron level most of the coming year revolved around preparations for Combat Talon II, preparing for the move, and in supporting contingency operations tasked by SOCEUR. From 3 to 7 February, the first Combat Talon II site activation task force (SATAF) was conducted at RAF Alconbury, and 7th SOS personnel played a key role in the process.⁷⁴ A schedule to send crews to Kirtland AFB for conversion training was finalized, and a schedule for the return of the Combat Talon I to the US was completed.

During the first three months of 1992, the 7th SOS conversion to Combat Talon II had not yet begun, thus enabling the squadron to send an argumentation crew to the 1st SOS. The Pacific squadron was struggling to meet its theater commitments after Mount Pinatubo, and the augmentation helped the 1st SOS until additional permanent party personnel arrived in late spring. By April, however, McCaslin (7th SOS/CC) wrote a request for US-based Combat Talon crew augmentation for

the 7th SOS during the period from August to October 1992. He based his request on two major factors: (1) no CT I inbounders were being assigned to the squadron because of the conversion to CT II; and (2) some of his current CT I crews were scheduled to attend CT II conversion training and would not be available to the squadron.*⁷⁵

The spring exercise schedule began with a wing deployment to Teamwork 92, which was held in Norway from 5 to 22 March. A total of 170 wing personnel participated in the exercise, and the 7th SOS deployed one MC-130E Combat Talon between 13 and 22 March to support exercise tasking. Missions flown during the exercise included personnel and resupply air drops, infiltration of personnel and equipment by way of sea and land, and assault landings in the exercise area that stretched from Evenes, Norway, to north of Bardufoss. Severe arctic weather challenged the deployed force throughout the exercise, but 7th SOS crews managed to fly 27.5 hours supporting the operation.⁷⁶

Not long after returning from Teamwork 92, wing assets were tasked to support a contingency operation in Sierra Leone. SOCEUR issued a warning order on 29 April 1992 tasking the 39th SOW for two MC-130Es from the 7th SOS and two HC-130P/Ns from the 67th SOS for Operation Silver Anvil. The following day SOCEUR published the Silver Anvil Operations order and transmitted it to the tasked units. The OPOD listed a five-phase plan for the evacuation of approximately 80 US Army medical team members from the city of Freetown, Sierra Leone. Phase I consisted of the deployment of the 7th and 67th SOS aircraft, two of which were tasked to fly to Stuttgart, Germany, and onload 71 USA Special Forces personnel. Phases II through V included deployment of maintenance and support personnel along with a contingent of 21st SOS MH-53Js and crews. On 30 April the four fixed-wing aircraft launched, then refueled at NAS Rota, Spain, as they continued on to Dakar, Senegal, where the 39th SOW established its base of operation.⁷⁷

Two days after their arrival in Senegal, the JCS issued an execute order for the extraction of the medical team, but also included an NEO for American citizens, third country nationals wishing to leave the country, and any local nationals as directed by the US ambassador in Sierra Leone. Also on 2 May a 7th SOS Combat Talon

*As a result of McCaslin's request, the 8th SOS began augmenting the 7th SOS in September so there would be a continuous combat capability in Europe during the conversion to CT II.

flew a SOCEUR assessment team into Freetown. The NEO actually began on 3 May when the 7th SOS flew four missions and evacuated 129 personnel, while the 67th SOS flew an additional four missions and extracted 84 personnel. The 7th SOS also inserted a 64-man security team into Freetown upon its initial landing. On 4 May one of the 7th SOS crews extracted the security team while a second crew evacuated an additional 40 people. The 4 May flights marked the last two sorties for the 7th SOS Combat Talons during Operation Silver Anvil.⁷⁸

The two fixed-wing squadrons remained in Senegal two additional days awaiting further tasking from SOCEUR. When none was received, they were released and departed Senegal for their home stations on 6 May. For the 39th SOW, assigned assets remained on alert at home station through 15 May, at which time SOCEUR terminated the operation.⁷⁹

From 7 to 10 May the second Combat Talon II SATAF was held at RAF Alconbury. Progress was being made for the beddown of the new weapons system, but the issue of combat capability in Europe was still unresolved. The first Combat Talon II was scheduled to arrive in-theater in September, with the second one due in November. The remaining Combat Talon Is were scheduled for transfer to the United States in October. Colonel Ronsick, the 39th SOW commander, proposed that the CT I transfer be delayed for three months until the CT IIs were operational in sufficient numbers to assure Talon commitments were met. On 30 July 1992 USSOCOM approved Ronsick's request, and the MC-130Es were retained at Rhein Main AB for an additional three months. McCaslin's request for aircrew augmentation was also approved, and the 8th SOS sent crew members to Germany in the early fall. With agreements finalized, the 7th SOS was able to maintain a Combat Talon capability throughout the transition period.⁸⁰

On 2 September Combat Talon 64-0566 was transferred to the 8th SOS, becoming the first 7th SOS CT I to permanently leave the squadron. Seven days later, on 9 September 1992, the first Combat Talon II was accepted by the 7th SOS at RAF Alconbury.* The following day, the wing was notified that it would be reorganized in accordance with Air Force directives under the objective wing concept. Because of the reorganization, the 39th

SOW stood up two provisional groups identified as the operations group and the logistics group, effective on 1 October 1992. As part of this reorganization, on-aircraft maintenance transferred from the wing to the operational squadrons. The 7th SOS assumed control of its own Combat Talon maintainers effective 1 October.⁸¹

Just as the new organization was coming together, Air Staff made another reorganization decision. On 5 October Air Force Special Operations Command announced that the 39th SOW would be deactivated effective 1 December 1992 and would be replaced by the 352d SOG. The Pacific wing was also redesignated as a group. The 352d SOG would basically mirror its sister group in the Pacific, with a downsized headquarters responsible for administrative and command matters, three flying squadrons, a special tactics squadron, a special operations support squadron, and a maintenance squadron responsible for off-aircraft maintenance.⁸²

Unrest in western Africa again impacted the 7th SOS when, on 21 October, SOCEUR alerted the 39th SOW for Operation Silver Compass. Warring factors in Monrovia, Liberia, posed a serious threat to the safety of US citizens living there. The 7th SOS was recalled and prepared to support Operation Silver Compass. After several days of planning and preparation, the crisis subsided, and SOCEUR released the wing from further tasking before any actual deployment could take place. On 1 November the 7th SOS was alerted for another African contingency, which was identified as Operation Silver Gauntlet. The contingency tasking included deployment to Luanda, Angola, with a US Navy SEAL team, with follow-on operations as directed by SOCEUR. As had been the case the previous month, SOCEUR canceled the pending tasking on 4 November before deployment of forces after the crisis in Angola diminished.⁸³

Starting on 5 November elements of the 7th SOS began the move from Rhein Main AB to RAF Alconbury. The date marked the official move of the squadron, but remaining CT I crews and maintenance personnel continued to operate out of Germany. Detachment 7, 39th SOW, was established at Rhein Main AB, effective 5 November, to provide oversight for the CT I element. The next day, on 6 November 1992, Colonel Lauderdale assumed

*The 7th SOS was still physically located at Rhein Main AB, Germany, when the first CT II was delivered to the 39th SOW at RAF Alconbury. As CT II aircrew and maintenance personnel completed training in the United States, they reported to RAF Alconbury for their duty assignment vice to Rhein Main AB. No CT II aircraft or personnel were assigned to the unit at Rhein Main AB. When the 7th SOS moved to RAF Alconbury in November 1992, a CT I contingent was established as Detachment 7, 39th SOW, at Rhein Main AB and continued to operate the CT Is there until they departed the theater.

command of the squadron from McCaslin, thus ushering in a new Combat Talon II era in Europe. Three weeks later the 39th SOW was officially inactivated, and the 352d SOG was activated in its place at RAF Alconbury. The year 1992 had been one of change and reorganization. As European SOF approached the New Year, the 7th SOS was operational with the Combat Talon II, with the older CT Is being transferred back to the United States. During the entire process there was never a lapse in theater combat capability.

1993: Year of Change throughout AFSOC

A Combat Talon II SATAF visited Kadena AB in January to evaluate the suitability of Kadena AB for CT II beddown during 1993, and it rated the site unsatisfactory. The SATAF determined that the support equipment and spares requirements for the new aircraft could not be met in the Pacific theater, thus making maintenance of the new aircraft impossible. A shortage of spare parts for the CT II at the already established CT II locations would only be made worse by the long supply chain from the United States to Okinawa.⁸⁴ Also, the lack of a second C-130-capable hangar was identified as a shortfall that had to be rectified before arrival of the new aircraft.

As a result of the SATAF findings, Headquarters AFSOC completed an internal study and determined that the programmed delivery of the Pacific CT IIs had to be changed. A working group convened at Hurlburt Field in March and proposed several possible courses of action. From these, Headquarters AFSOC agreed to change the beddown of the five Kadena-bound CT IIs as follows—15th SOS (three PAA and one BAI) and the 550th FTS (Kirtland AFB) (one PAT); extend the five PAA/one BAI HC-130s at Kadena AB through FY 4-95; and continue growth of the 1st SOS to four PAA/one BAI MC-130Es but maximize beddown of helo-refuelable Talons at the 8th SOS to accommodate US-based aerial refueling requirements. Headquarters AFSOC recommended delaying fielding of the CT II in the Pacific until 1995 and forwarded a program change request to USCINCSOC in June. The new schedule had the 353d SOG receiving a total of four CT II aircraft by the end of 1995, with the 17th SOS receiving its new CT IIs during FY 4-95.⁸⁵

Pacific-Based Talons Rebuild

As the CT II beddown issue was being debated, the 353d SOG and the 1st SOS concentrated on their rebuilding program in the wake of the decision to beddown the group at Kadena AB. In addition to the beddown initiatives, the thrust of the group's activities focused on improving readiness in preparation for its first ORI, which was scheduled for the following November. For most of February and March, the group deployed aircraft to Thailand in support of Exercise Balance Torch. The 1st SOS Combat Talons, and aircraft from its sister squadrons in the group, participated in the unconventional warfare exercise. In the midst of executing the exercise, AFSOC was hit with an 18.5 percent reduction in flying hours (and associated funding), and Headquarters AFSOC subsequently reduced the 353d SOG's allocation proportionately. From Kadena AB, Stankovich quickly notified the squadrons of the situation, halted all purchases from supply, and canceled all nonessential TDYs. For Balance Torch all flying not directly in support of exercise-tasked missions was canceled. The 17th SOS suspended flying for 10 days due to the crisis. Combat Talon missions that had been planned for five to six hours were cut to two hours, which was just enough time to deliver the troops to their exercise areas and then return to base. On 2 March AFSOC was able to give the group an additional 75 hours to complete Balance Torch. By the end of March the USSOCOM had reinstated funding for AFSOC, and the previously lost flying hours were restored to the 353d SOG.⁸⁶

In another step towards stability, Headquarters PACAF issued orders on 29 March permanently assigning the 31st SOS to Osan AB, Korea. For the remainder of the group, Kadena AB continued as its interim beddown location.⁸⁷ In May Admiral Larson, CINCPAC, issued his commander's intent statement for FY 94. He reiterated the PACOM strategy of cooperative engagement and emphasized his goals of cementing US military ties with Northeast Asian nations and furthering relationships with Australia, Thailand, and the Philippines. Japan and Korea continued to be the two most important alliances in the Pacific region. For the 1st SOS the squadron actively supported the CINC's cooperative engagement strategy through its participation in the SOCPAC JCET program. Reinholz's diligence the previous year in supporting all JCET and JCS exercise commitments did not go unnoticed throughout the region.⁸⁸

Early in the spring of 1993, all three flying squadrons had their unit mission statements updated to reflect their new operational capabilities. Changes made included adding helicopter refueling for the 1st SOS and deleting its sea surveillance mission. The addition of the helicopter refueling mission was required after the 1st SOS received its first Combat Talon aircraft modified with aerial refueling pods. With the 1st SOS acquiring the helicopter refueling modification, the 17th SOS was scheduled to receive the new Combat Talon II aircraft and return its assigned HC-130s to other units in the United States. The 1st SOS had maintained the capability to perform sea surveillance since the early 1970s, but it had not been tasked to perform the mission for the past several years.⁸⁹ Training required to maintain the sea surveillance capability was eliminated.

The first six months of 1993 also saw an acute manning shortfall for the 1st SOS. The squadron experienced a shortage of navigators and loadmasters. It also suffered from a lack of aircrew experience as it rebuilt following the complete turnover of personnel in 1992. The squadron was often assigned crew members fresh from initial flight training or crew members from bomber, fighter, or transport units. The rapid growth of the Combat Talon II crew force in the United States and in Europe had drained the experienced CT I aircrew and maintenance pool.⁹⁰ Inexperienced crew members required additional training sorties, but they were enthusiastic about the Combat Talon mission and worked hard to gain experience in the shortest amount of time.

On 25 June 1993 Stankovich relinquished command of the 353d SOG to Colonel Thigpen, who had been the deputy commander, 1st SOG, before coming to Kadena AB. The ceremony was officiated by General Fister and was attended by General Rokosz, the commander of SOCPAC. Stankovich had made great strides in acquiring facilities for the emergency beddown of the group at both Kadena and Osan ABs. It would fall to Thigpen to continue the aggressive facilities renovation/construction program already under way and to prepare the group for its ORI that was scheduled during Exercise Foal Eagle in the fall.⁹¹

When Thigpen assumed command in June, the 353d SOG had 21 facilities projects in the construction phase at Kadena AB and three more in

the design stage. At Osan AB 19 projects were in the works for the 31st SOS. Some of the Kadena AB projects called for major renovations to buildings, thus requiring relocation of the group's squadrons during the construction phase. For the 1st SOS the squadron had to move to two rooms in building 3524 during the renovation of its operations facility, a building that had been formerly occupied by an SR-71 squadron. The group was scattered across the sprawling Kadena AB complex in 12 different buildings, sharing some facilities with 18th Wing units. Although the facilities met minimum requirements, they did not meet planned future growth requirements or address organizational changes under the new objective force restructuring directed by General McPeak. Additionally, the wide dispersal of 353d SOG buildings was not conducive to unity of command. As a result of these shortcomings, Colonel Thigpen called for a "comprehensive review of facilities requirements" in late June. He established a facilities working group to assess the group's long-term needs.⁹²

Over the course of the summer, the working group reassessed the 353d SOG's building requirements with an eye towards future growth and consolidation. The working group developed a list of objectives that included group consolidation, adequate (as opposed to minimum) space for its assigned units, maintaining unit integrity, and providing a quality environment in which to work. The recent CT II SATAF had identified the need for a second hangar for the group, and the working group developed further justification for the facility. In addition to the CT II requirement, maintenance needed an additional hangar to minimize aircraft downtime, perform corrosion control, and to operate a fuel cell facility.* Sufficient storage space for the group's Readiness Spares Package, its Benson tanks, and its aircraft maintenance supplies generated additional facility requirements. A strategic facilities plan was developed by the working group that identified each group requirement and how it could be met. The plan was finalized in September 1993.⁹³

The decision to permanently beddown the 353d SOG at Kadena AB came on 24 September 1993 when US Forces Japan (USFJ) released an official statement announcing the group's new status. It had been nearly two and one-half years since

*Aircraft assigned to the 1st and 17th SOS routinely waited days to get into the 18th Wing fuel cell facility due to higher priority for Kadena-assigned F-15 aircraft. The group was given fuel cell priority from 1800 on Friday until 0800 on Monday. Both the MC-130E and the HC-130P/N were older aircraft that required fuel cell repair on a more frequent basis than the newer C-130H model. The situation was unfair to group maintenance personnel because it compelled them to work weekends to repair their aircraft after the aircraft sat during the week. The addition of a second-group-assigned hangar where fuel cell repair could be accomplished became a high priority for the facilities' working group.

leaving the Philippines just before the catastrophic explosion of Mount Pinatubo. The USFJ announcement coincided with the removal of seven C-12 aircraft from Kadena AB and the inactivation of the 39th Rescue Squadron at Misawa AB, Japan. The announcement spurred a brief period of protest from the Okinawan public, mostly over the issue of noise pollution, night operations, and airdrop accidents. By year's end, however, Okinawan protest aimed at the 353d SOG had subsided and had taken on a tone of overall antibase sentiments with the objective of closing Kadena AB and removing all US military forces from the island.⁹⁴

With the interim status removed and with a detailed strategic facilities plan in hand, the 353d SOG commander wasted no time in contacting key leadership in the 18th Wing. Thigpen's two major goals were to secure a second hangar for the CT II and to secure a facility large enough to consolidate both the support squadron and group headquarters. In informal discussions with Colonel Bingham, the 18th Operations Group commander, agreement was struck to exchange four soon-to-be-renovated 353d SOG buildings for a much larger facility (building 3524), which was occupied by the 18th Operations Support Squadron.* The four buildings were located in the heart of Bingham's Operations Group on the eastside of the runway. His support squadron was located on the west side of Kadena AB in a large, 36,000-square-foot facility that had been originally built for the Strategic Air Command in 1967. The building was across the street from the 1st SOS, adjacent to the 320th STS building, and in proximity to the 353d maintenance complex.

The two colonels informally agreed to swap buildings 3381, 872, 874, and 876 for building 3524. The only stipulation was that the 18th Wing would retain the use of the central command post facility in the event an alternate location was required during exercises or natural disasters. In October the 18th Wing's Space Review and Allocation Panel met and approved the facilities swap that had been worked out by the two group commanders.⁹⁵

The 353d SOG then focused on the issue of a second hangar. Across from building 3524 was a large and seldom-used hangar (building 3559) referred to as the Hush House. It had been designed and built as a noise abatement facility by

the government of Japan for the KC-135 aircraft. The original engines on the KC-135 were extremely noisy, and the Hush House had internal baffles and thick insulation installed to smother the sound during maximum-power engine runs. Newer fan jets had been installed on the KC-135s in the early 1990s, and they were much quieter than the older jet engines. The baffles in the Hush House would not connect to the newer fan jets, thus making the facility unusable for engine runs. The hangar was used during typhoon evacuations when a KC-135 could not be flown off the island and when an aircraft required jacking for maintenance action. Installed in the Hush House was an elaborate fire suppression system in the event an aircraft caught fire while performing an engine run. The fire suppression system would allow fuel cell work to be done inside the hangar. The facility was near perfect for the 353d SOG. By the end of the year, the 353d SOG had made agreements with the 18th Wing that effectively assigned the hangar to the group (effective in January 1994), thus fulfilling the two-hangar requirement identified by the CT II SA-TAF in January 1993.

With beddown issues coming together in the fall of 1993, the next major challenge for 353d SOG leadership was the pending ORI. The group had been scheduled for its first ORI during Fowl Eagle 91, but the evacuation from Clark AB had postponed the inspection indefinitely. Beginning on 19 October with the AFSOC/IG initial warning order, the group began its first-ever comprehensive evaluation of its combat capability. The AFSOC/IG evaluated the group in five major areas: initial response, overall unit employment, combat support, deployed mission support, and augmenting mission support. The IG team rated the group's initial response as outstanding, noting that the 353d SOG's performance was "indicative of a well-thought-out, clearly defined, sufficiently practiced, and operationally flexible deployment machine." The team judged the overall unit employment phase as excellent, citing numerous examples of superior performance. Aircraft maintenance earned an outstanding for its support during the employment phase. In the area of combat support, the group was rated as excellent. Deployed mission support received an overall excellent, while the augmenting mission support area was rated as outstanding. All three flying

*When the 353d SOW relocated from Clark AB, the only buildings available for its headquarters and support squadron had been previously condemned and were awaiting destruction. Clark AB relocation funds were used to bring the four buildings up to acceptable standards, but their combined 18,000 square footage and their location on the east side of Kadena AB, separated from most of the group's squadrons, made the complex barely acceptable.

squadrons earned excellent evaluations, as did the 320th STS. In all the IG team identified 27 people as professional performers.

An overall rating of excellent was awarded to the group, a rating that validated the combat status of the entire organization. The ORI was significant to not only the group, but also to Headquarters AFSOC and to PACOM. The inspection had validated finally that the group was operationally sound after Mount Pinatubo and was a viable combat asset in the Pacific. By the close of 1993, the 353d SOG was operating near the level of proficiency it had under Hess before the Mount Pinatubo eruption. The coming year would see further maturity in the group and increased SOF capability in the Pacific.

The First Operational Commitment for Combat Talon II

Elements of the newly designated 352d SOG were still in the process of moving to RAF Alconbury when the New Year arrived. On 15 December 1992 the last two MC-130E Combat Talon Is had departed Rhein Main AB for the United States. Detachment 7, 352d SOG, continued to operate until 27 January. The detachment was officially inactivated on 30 April 1994.⁹⁶ Lauderdale and the rest of the 7th SOS had settled into life at RAF Alconbury with the first two MC-130H Combat Talon IIs and throughout January and early February concentrated on training events designed to increase the proficiency of aircrew and maintenance personnel. Conversion training was still under way for some of the 7th SOS-assigned crews, and the 15th SOS provided an augmenting crew to assist the 7th SOS from December 1992 through the early part of February. As the Talon Is departed the theater, the new Talon IIs were prepared to take over the mission.⁹⁷

On 22 February 1993 General Kellogg, commander of SOCEUR, alerted the 352d SOG of a pending deployment for Operation Provide Promise II, a humanitarian relief effort in the Balkans. The group was in the process of deploying to Norway for Exercise Battle Griffin 93 and its scheduled ORI. Personnel quickly regrouped and redirected assigned forces for the real-world deployment. The ORI was subsequently postponed. SOCEUR's warning order, issued on 23 February, stated that the group's personnel would work in conjunction with USA Special Forces and US Navy SEAL teams to provide SAR and personnel recovery (PR) coverage for the forces conducting air drops to besieged pockets of personnel in Bosnia-Herzegovina. For

the 7th SOS it deployed one MC-130H to Rhein Main AB after the initial notification by SOCEUR on 22 February. The deployment marked the first operational commitment for the Combat Talon II.⁹⁸

Once the crew arrived it commenced planning for leaflet and resupply drops as tasked, but political sensitivities prevented employment of the 7th SOS crew. A second 7th SOS Talon arrived at Rhein Main AB on 25 February, followed the next day by a third aircraft. The last aircraft to deploy had just arrived at RAF Alconbury from the United States, and maintenance had completed the acceptance inspection and launched the aircraft within 17 hours of its arrival in the United Kingdom. Planners feared that a wrong signal could be sent to the population of Bosnia-Herzegovina if the Combat Talons executed low-level flights over the country, so they opted for the midlevel delivery of relief supplies by conventional C-130 aircraft.⁹⁹ The Combat Talon IIs, therefore, were not tasked to fly any operational missions.

The majority of the 352d SOG deployed to Brindisi, Italy, where the main SOF operating base was established for Operation Provide Promise II. Group-assigned MH-53Js and HC-130s, along with members of the 320th STS, established an SAR/PR alert. At Rhein Main AB the 7th SOS contingent received several mission taskings, but each time the tasking was canceled by the JTF headquarters before execution. Loadmasters from the squadron flew on other NATO aircraft during resupply missions and observed their airdrop procedures. A major problem surfaced during the resupply effort that affected the safety of refugee personnel on the ground. If a resupply bundle landed on someone, the impact could kill or seriously injure that person. Four personnel from the 352d SOG set about to develop a delivery system that would not pose such a threat. Captain Ash (7th SOS), Senior Master Sergeant Regi (352d SOG), and Master Sergeants Duffie (7th SOS) and Heflin (352d Special Operations Support Squadron) created a system that came to be known as the triwall aerial delivery system (TRIADS). The basic concept was based on the Halverson (the Berlin airlift candy bomber) delivery method whereby a large load could be dropped in individual units with the resultant impact on the ground (or on personnel) minimized.¹⁰⁰

The primary food being delivered to Bosnia-Herzegovina was US-government-supplied MREs. The four-person team theorized that if allowed to

fall separately from the aircraft, the MREs would flutter to the ground, much like Halverson's candy during the Berlin relief operation. Delivery of individual MREs had two advantages—a wider distribution of food and increased safety for civilians on the ground. The four-man team altered procedures already used for leaflet airdrops by substituting a slightly larger box filled with individual MREs. Thus, the delivery was virtually the same for the aircrews as leaflet drops, with minimal additional aircrew training required. The team cut cardboard boxes, taped and strapped them back together, and placed individual MREs in them. On 7 March 1993 members of the 7th SOS completed a test of the system and determined that it worked as planned. The following day, Colonel Scott, the 7th SOS Operations officer, traveled to Ramstein AB to brief the Joint Force Air Component commander for Operation Provide Promise II on the new system.¹⁰¹

Seven days later the first TRIADS drop was completed in Bosnia-Herzegovina by tasked C-130 crews out of Rhein Main AB, and it was a resounding success. More drops were requested, and personnel from the 352d SOG were tasked to train 37th TAS personnel on the rigging and delivery of the TRIADS. The 7th SOS stood ready to employ the new system, but the mid-level drop by conventional C-130s proved to be the method of choice for JTF planners. The TRIADS was effective and became the primary delivery method in Bosnia-Herzegovina. With no tasking received for the 7th SOS, the three Combat Talon IIs were redeployed to RAF Alconbury on 22 March 1993, thus ending their initial support to Operation Provide Promise II.¹⁰² The SAR/PR mission at Brindisi continued throughout the remainder of the year.

The 7th SOS and the 352d SOG JCET Program

With the majority of the 352d SOG committed to Operation Provide Promise II in Italy and Provide Comfort II in Turkey, most other group commitments fell to the 7th SOS. Along with supporting these commitments, the squadron became heavily involved in planning for another unit move after USAFE made the decision to close RAF Alconbury. From 13 to 19 March, the first project task force (PROTAF) was conducted at RAF Mildenhall to consider requirements to relocate the 352d SOG to that location. On 7 May 1993 Headquarters USAFE announced that the

352d SOG would move to RAF Mildenhall during FY 94, a move necessitated by the USAFE decision to close RAF Alconbury. For an organization almost totally committed to contingency operations, a second move was almost more than the group could bear.¹⁰³

May marked the first major exercise for the 352d SOG since the New Year. From 10 to 20 May the group participated in Exercise Carthage Express. Crews of the 7th SOS carried their own support personnel and deployed one aircraft to Brindisi, Italy, with an operations stop in Stuttgart to onload additional personnel from SOCEUR. The Italian base was used as the forward staging base for the exercise. The scenario for Carthage Express centered on the recovery of three American citizens held captive by a notional terrorist organization on the Tunisian island of Zembra. The operational portion of the exercise began on 16 May when the 7th SOS Combat Talon II inserted a SEAL team by way of a CRRC water drop 20 miles from the island. The SEALs navigated to shore and maneuvered overland to the notional terrorist's location. Three MH-53Js, supported by two HC-130s, departed Brindisi during the night of 18 May and inserted a direct action team to conduct the recovery operation. After successfully engaging the notional terrorists, the rescue force, along with the three American hostages, were exfiltrated by the MH-53Js and transported to Sidi Ahmed Airfield, Tunisia, where they were transloaded on to the waiting MC-130H CT II. The 7th SOS crew then flew back to Brindisi, where the exercise terminated. Although coordination problems detracted from the realism of the operation, the exercise was a success, with 352d SOG forces receiving overall excellent training.¹⁰⁴

On 24 May Colonel Orrell (the 352d SOG commander) sent a request to Headquarters AFSOC for help in meeting the ongoing tasking for his group. As a result of this initiative, Headquarters AFSOC relieved the 352d SOG of its commitments to Provide Comfort II in Turkey, effective 13 July 1993. Elements of the 20th SOS, the 55th SOS, and the 9th SOS, all assigned to the 16th SOW at Hurlburt Field, assumed responsibility for the Turkish mission.^{*105} With the reduced commitment the 352d SOG was able to continue plans for the upcoming move to RAF Mildenhall and support the heavy commitment to Operation Provide Promise II at Brindisi. Early August found the 7th SOS in Africa supporting Exercise Roaring Lion. The scenario for the exercise centered on

*The 1st SOW had been redesignated the 16th SOW in conjunction with CSAF reorganization directives.

the evacuation of British civilians from former British colonies in Africa.¹⁰⁶ Additional countries that the 7th SOS exercised with during the late summer and fall of 1993 included France, Denmark, Norway, Italy, and Morocco. From 16 August to 3 September, a 7th SOS crew also deployed to Biggs AAF, Texas, and participated in a JRT exercise.¹⁰⁷

Perhaps the most interesting mission for the 7th SOS during the late fall of 1993 was its support of the European Survey and Assessment Team (ESAT). With the fall of the Soviet Union, newly independent states called on the US government to establish embassies in their countries so that there could be closer relationships with America. The establishment of these new embassies created an influx of Americans. SOCEUR was tasked with providing an ESAT that would survey each embassy area and then develop an NEO plan in event an evacuation was needed. The 7th SOS was tasked by SOCEUR to provide transportation for the team, and the 352d SOG provided personnel to assist in the evaluation of airfields and potential evacuation locations.¹⁰⁸

A 7th SOS Combat Talon II supported the ESAT from 4 to 18 November. The capital cities of four countries were visited, including Ashkhabad, Turkmenistan; Tashkent, Uzbekistan; Dushanbe, Tajikistan; and Bishkek, Krygyzstan. Each stop included a briefing to the US ambassador and his staff followed by two days of site surveys in the region to determine the best NEO locations. Maintenance personnel serviced the aircraft at night and kept the Combat Talon operational throughout the deployment.¹⁰⁹ The squadron finished out the year by transporting medical supplies and clothing to Ravino, Ukraine, as part of Operation Silver Hope. The year had been a grueling one for the 7th SOS and for the 352d SOG.

* * * * *

Since the end of the Desert Storm ground war in February 1991, special operations forces had remained in Saudi Arabia supporting CSAR requirements of USCENTCOM. The 8th SOS Combat Talons had all returned to Hurlburt Field by June 1991, but the 20th SOS, with its MH-53J Pave Low III helicopters and the 9th SOS with its HC-130P/N Combat Shadow tankers, had continued to pull CSAR alert. The 55th SOS also stood alert duties during much of the period. On 5 February 1993 all remaining 1st SOW forces departed Southwest Asia and turned over the CSAR alert commitment to HH-60s assigned to the Air Com-

bat Command. In an 18 February message, the AFSOC commander, General Fister, expressed his thanks to the men and women who had supported the US effort to contain Iraqi aggression. He noted that AFSOC aircraft were among the first to deploy to the region and had established a CSAR alert effective 19 August 1990. For the next two and one-half years, AFSOC forces maintained a CSAR alert, making it the longest continuously serving force in the area. General Fister noted the difficult conditions under which the deployed forces operated in the desert. Those conditions included extreme heat, lack of moon illumination due to poor visibility, blinding dust stirred up by wind and helicopter rotor blades, and moving sand dunes, which were encountered unexpectedly. The congratulatory message concluded with the general's observation that "I am proud of the contributions you made to our nation's commitments in Southwest Asia the past two and one-half years. I appreciate the sacrifices of you and your families. This was a job well done."¹¹⁰ The 8th SOS, 9th SOS, 20th SOS, and 55th SOS had all performed the CSAR alert mission in an outstanding manner.

The Objective Wing Matures at Hurlburt Field

The objective wing reorganization initiatives began in AFSOC the previous year continued in 1993. The two-group structure of the 1st SOW had matured and was working reasonably well, with base support functions still being provided by MAC's 834th ABW. Headquarters AFSOC had established its base management oversight capability by early February 1993 in anticipation of having Hurlburt Field transferred from MAC to AFSOC. Consequently, on 25 February AFSOC announced that the 1st SOW would absorb base support functions and would have assigned to it a third group identified as the 1st Special Operations Support Group (SOSPTG). The 1st SOSPTG received the newly activated civil engineering, mission support, security police and services, and morale, welfare, and recreation squadrons. Transportation, supply, and contracting squadrons were assigned to the 1st SOW Logistics Group. The actions were to be effective on 1 March 1993, but this date was later slipped to 24 March. At that time the 834th ABW was deactivated, and Hurlburt Field became the only base assigned to AFSOC. For the 8th SOS daily operations did not change significantly except that deployment processing

was greatly simplified with the 1st SOW having the mobility function assigned to it.

During the first half of 1993, the 8th SOS and 15th SOS participated in local exercises and proficiency training events. Both squadrons concentrated on fine-tuning their organizations after the many changes of the previous fall. The 15th SOS CT IIs maintained a mission capable (MC) rate of less than 50 percent for its assigned aircraft, while the 8th SOS CT Is averaged more than 80 percent. The low MC rate for the CT II was attributed to the fielding of the new weapons system and the problems associated with getting the aircraft's subsystems fully up to speed. Events in Mogadishu, Somalia, required the 1st SOW to deploy a large four-ship gunship package to Djibouti on 7 June, but there was no requirement for the Combat Talon. While the gunships supported UN actions against Gen Mohamed Farrah Aideed and his followers, the Talons remained at Hurlburt Field.¹¹¹ The 15th SOS off-station tasking was held to a minimum throughout 1993 so that the aircraft's support infrastructure could mature, and the squadron's aircrews could season in the highly sophisticated aircraft. Late summer and fall saw the 8th SOS deployed to JCS exercises in Honduras, Egypt, and South Korea.

On 1 October 1993 the 1st SOW's designation was changed to the 16th SOW at Air Staff direction, a move that infuriated Air Commando veterans of World War II and Vietnam. The change was directed after an extensive review of the heritage and honors of all active duty Air Force wings. As part of the new Air Force structure created by General McPeak, no two wings could have the same numerical designation. The 1st Fighter Wing at Langley AFB, Virginia, was assigned the 1st designation, while the "1st" SOW was changed to the 16th SOW. The wing did, however, retain all the lineage and honors of the 1st Air Commando Group of World War II and the 1st Air Commando Wing/Special Operations Wing of the Vietnam War. Although the change was a highly emotional one, the newly designated 16th SOW, commanded by Gen Maxwell C. Bailey, continued to perform its highly demanding special operations mission without any loss of combat capability.¹¹²

The MC-130H Weapons System Trainer

By 1993 all Combat Talon II formal training was being taught at Kirtland AFB. The 550th Flight Training Squadron (FTS) was responsible for fixed-wing training, including the HC-130P/N

and the MC-130H Combat Talon II. From 2 to 13 February 1993, the 550th FTS participated in a bilateral exercise named Onset Thunder, which was the first exercise in which the squadron's MC-130H Combat Talon II aircraft were employed. The crews flew six missions that involved US Army rangers from Fort Lewis, Washington. The squadron employed NVG blacked-out airdrop and airland operations to deliver more than 120,000 pounds of cargo and personnel. The squadron also participated in the locally generated Exercise Chile Flag from 8 to 12 March 1993. Missions flown in the Combat Talon II included IFR, airdrops, and airland operations. The Chile Flag exercise series had begun four years earlier, but the March iteration was the first to include the Combat Talon II. The regularly scheduled exercise was coordinated through USSOCOM and usually had one special operations unit either from the Army or the Navy as its primary customer. During the course of the exercise, both permanent party instructors and formal school students received invaluable training, while the joint customer benefited from the use of the aircraft to complete their required training events.¹¹³

In FY 90 USSOCOM funded four projects at Kirtland AFB valued at \$13.7 million with MFP 11 resources. During 1992 three of the projects were completed, including the Combat Talon II simulator building. The building was originally designed and funded to house the MC-130H Combat Talon II and the MC-130E Combat Talon I weapons system trainer (WST), but when both WST delivery dates slipped, the facility was occupied by an MH-53J, TH-53A, and MH-60G WST. The delivery of the MC-130H/E WSTs was slipped until FY 94 and FY 96, respectively. The annual simulator requirement for permanently assigned Talon II crew members was satisfied by sending them to Dyess AFB, Texas, where a conventional C-130H simulator was located.¹¹⁴

On 1 July 1993 the 542d CTW was transferred to AETC, Randolph AFB, Texas, including the four Combat Talon II aircraft flown by the 550th FTS. The wing reported directly to Nineteenth Air Force, which was also located at Randolph AFB. Throughout the remainder of the year, the wing prepared to receive the MC-130E Combat Talon I weapons system. Four CT I aircraft were scheduled to transfer to Kirtland AFB on 1 January 1994. As previously noted, Colonel Schwartz, the 1st Special Operations Group commander at Hurlburt Field, had sent a letter to Headquarters AFSOC requesting to delay the transfer due to

limited aircraft availability. AFSOC and Air Staff concurred with the request, and slipped the Talon I move to the first quarter of 1996.¹¹⁵ With the Talon I move postponed two years, the 542d CTW could concentrate on the Combat Talon II and resolve the WST facility issue.

On 18 October 1993 Headquarters AETC notified the 542d CTW commander, Colonel Jeffreys, of yet another name change under direction of the CSAF organizational review. On 1 April 1994 the 542d CTW would be inactivated, and the 58th SOW would be stood up in its place. The 550th and 551st FTSs were also to be redesignated special operations squadrons, and several other realignments and inactivations throughout the wing were announced.¹¹⁶ As 1993 came to a close, Kirtland AFB was poised to become only the second base to host a special operations wing in the continental United States.

1994: Contingency Operations and Reorganization

The year was rocked by the announcement that Commando Vision would be implemented throughout AFSOC, thus bringing the command in further compliance with CSAF directives. A crisis would develop in the Caribbean and bring the United States to the brink of conflict during Operation Uphold Democracy. At Kirtland AFB the 542d would become the 58th SOW. As tension escalated in the Balkans and in Africa, Combat Talon would continue to execute its mission around the world.

The Last Talon IIs Are Delivered

During 1994 the last four CT II aircraft (89-0282, 89-0283, 90-0161, and 90-0162) were scheduled for delivery to AFSOC. In February the CT II development systems manager, Colonel Craw, responded to a letter from General Bailey expressing the 16th SOW's concern over the lack of critical line replaceable units (LRU) for the last four aircraft. Colonel Craw noted that in 1985, when production began on the new Combat Talons, 24 sets of the LRUs were purchased.

After production began, several of those LRUs were used to fill other critical fielding requirements (bench test sets, spares, etc.), with the assurance from the field that they would be replaced later. With the pending delivery of the last four CT IIs, Colonel Craw could not deliver fully operational aircraft with the LRUs still being utilized in the field. Aircraft 89-0282 did not have an

AN/APQ-170 radar X band receiver/transmitter or the servo power supply to operate it, nor was there a SATCOM receiver available to install in the aircraft. All SATCOM receiver assets had been previously issued to AFSOC, thus leaving the CT II program short three sets. In addition to the LRU shortages, Colonel Craw projected delivery of aircraft 89-0283 and 90-0161 missing its infrared detection system (IDS) receivers. The IDS shortfall resulted because the CT II Field Support Team shipped all IDS receivers to AFSOC earlier in the production cycle, and there were no additional units procured. Colonel Craw assured General Bailey that his Field Support Team would advise the 16th SOW if the final production CT II aircraft (90-0162) would be delivered with a full-up set of LRUs.¹¹⁷ As AFSOC worked to replace the LRUs for the last production aircraft, the 7th SOS and the 15th SOS continued to mature their new CT IIs. Because of its operational commitments to SOCEUR, the 7th SOS received priority on scarce spare parts, including any repaired LRUs, with the 15th SOS being forced to cannibalize parts from its larger aircraft fleet.

Both commanders of the Hurlburt-based Combat Talon squadrons changed during the first half of 1994. Colonel Poole, who had formerly served as the 8th SOS CT I operations officer, assumed command of the squadron from Murdock on 18 April. Poole had been in Combat Talons since the late 1970s and had been assigned to the Talon squadron several times before assuming command. Saier relinquished command of the 15th SOS to Colonel Lovett on 30 June when he departed Hurlburt Field for senior service school. Like Poole, Lovett had been in special operations for most of his career, having served in the AC-130H gunship before completing a tour on the Air Staff.¹¹⁸

Commando Vision

In the late 1980s General Patterson developed his Forward Look strategy that resulted in the establishment of the 39th SOW (later redesignated the 352d SOG) in Europe and the 353d SOW (later the 353d SOG) in the Pacific. General McPeak's Air Force reorganization resulted in the downgrade of the two overseas wings to special operations groups in the early 1990s. The change in status was perceived by theater CINCs as a reduction in SOF commitment to their theater war plans. Beginning in 1991 the long-awaited arrival of CT II became a reality, and by the close

of 1994, all 24 aircraft had been delivered to AFSOC. Late in 1994 the first AC-130U gunship was delivered to the 16th SOW, with the remaining 12 aircraft scheduled for delivery over the next 24 months. As the new aircraft were delivered to Hurlburt Field, the need for a second US base intensified. While AFSOC experienced significant growth as a command, gunship and Combat Talon support to the war-fighting CINCs actually declined during the same period. This decline was due, in part, to the heavy modification schedule for the MC-130E CT I and due to the loss of two AC-130H gunships. From 1985 to 1994 from four to six CT Is were at LAS Ontario undergoing extensive modifications (SOF-I, MOD-90, center-wing replacement, etc.) at any given time. With an average of eight aircraft available, the 1st and 7th SOS averaged two aircraft each on-station, while the 8th SOS averaged four CT Is to fulfill its operational and formal school training commitments.

With only eight gunships available for the latter part of the period, 16th SOS aircrew and maintenance personnel were tasked at an extremely high rate to fill contingency requirements in overseas locations including Panama, Southwest Asia, Somalia, and Bosnia. The original basing plan for the AC-130U had the older AC-130H aircraft transferring to the Air Force Reserves at Duke Field (an airfield located in the Eglin AFB range complex) and the aging AC-130A gunships being retired. With continuing commitments to Southwest Asia across the Air Force, the number of days that Air Force personnel were away from home station on temporary duty became a major concern. Consequently, Air Staff established the standard for maximum annual TDY as 120 days, a number that was not attainable in the gunship community. To help reduce the active duty gunship TDY rate, AFSOC readdressed the decision to put the AC-130H in the Air Force Reserve.*

General Fister had tasked his plans division in 1993 to develop the Commando Vision strategy. Throughout early 1994 the plan was refined, and by early summer it was ready to be briefed to the SOF community. General Hobson assumed command of AFSOC on 22 July 1994, and it fell to him the difficult task of gaining theater support for the plan. On 25 August 1994 senior leadership in the 16th SOW was briefed on Commando Vi-

sion. For the remainder of the fall, the AFSOC staff briefed senior leaders both in the United States and abroad on the proposal.

In the formal briefing Commando Vision was identified as a plan for the future to efficiently posture the active forces and to make the best use of assets assigned to the Air Force Reserve and Air National Guard. Demands for SOF had continued to increase over the years, and future projections confirmed that the trend would continue. To better support the theater CINCs, Commando Vision would first require a reduction in the overseas units and a repositioning of some of the US force. The war-fighting CINCs would all benefit from Commando Vision through enhanced gunship availability, by a more potent mix of assets overseas, and from enhanced flexibility in projecting power. Commando Vision would also posture Air Force SOF for future growth. Although the concept had been staffed by Headquarters AFSOC, critical issues such as the location of a second SOF wing in the United States and improvements required at Duke Field to support the CT I were not known by the close of the year. Commando Vision promised better support to theater CINCs, but AFSOC faced a difficult challenge convincing them to embrace the plan and to gain their approval.¹¹⁹

At Hurlburt Field the rapid expansion of SOF in the early 1990s quickly outstripped the existing base infrastructure, thus requiring a massive military construction program that ran into the hundreds of millions of dollars. Even with the new construction, space to expand was limited due to wetlands surrounding the main base. The need for a second operating base in the United States was apparent. When Forward Look was finalized in the late 1980s, it included a West Coast wing located at McClellan AFB, California. When CINCMAC made the decision to divest AFSOC of rescue forces, the California base was assigned to the newly created Air Rescue Service. Commando Vision called for the establishment of a SOF West Coast wing that would be oriented towards the Pacific but would also support SOUTHCOM and JSOC. The existing East Coast wing (the 16th SOW) would continue to be oriented towards the remaining theater CINCs and would also support the national JSOC mission.

*The decision was ultimately made to keep both the AC-130H and the AC-130U weapons systems on active duty, and to transfer eight MC-130E Combat Talon I aircraft and five HC-130P/N Shadows to the 919th SOW at Duke Field. Thus, establishment of a second US-based SOF wing, active duty/Reserve force structure changes, and war-fighting CINC support were all addressed in 1994 when Headquarters AFSOC unveiled its plan for the future—Commando Vision.

A key element of Commando Vision was the conversion of the 919th SOW, located at Duke Field, Florida, from nine AC-130A gunships to four HC-130P/Ns and eight MC-130Es. The Combat Talons would be assigned to the 711th SOS, which had operated the AC-130A since the Vietnam era. The AC-130H gunships of the 16th SOS, which had been scheduled by Air Staff to be transferred to the reserve unit at Duke Field, would be retained on active duty and would remain at Hurlburt Field. The new AC-130U, which began arriving at Hurlburt Field in the fall of 1994, would be assigned to the new West Coast wing (location to be determined) along with a cadre of CT IIs and MH-53J Pave Low IIIs. The plan effectively doubled the number of gunships on active duty and transferred more than half of the CT Is to the reserves. The 24 new CTs would all be assigned to active duty squadrons (including the 1st SOS in the Pacific), thus reducing the critical CT shortfall identified in theater war plans.¹²⁰

To establish the West Coast wing, the two overseas SOGs would have to be significantly reduced and their manpower authorizations reallocated. The Pacific SOG would change to an FOL of approximately 19 personnel, with aircraft and maintenance rotating from the West Coast wing. The FOL would maintain the capability to conduct deliberate planning and to provide an initial response to OPLAN tasking. It would also maintain the capability to respond to contingency plan (CONPLAN) tasking and would support JCET planning. Units that would be inactivated under Commando Vision included the 7th SOS, 67th SOS, 352d Maintenance Squadron, and the 31st SOS. Units relocating and forming the West Coast wing under the plan included the 353d SOW (formerly the 353d SOG) from Kadena AB, the 4th SOS (AC-130U gunships) from Hurlburt Field, and the 21st SOS from RAF Mildenhall. Numerous unit realignments were also planned, including the 352d SOG moving to Hurlburt Field and becoming part of the 16th SOW. The FOL at Kadena AB would be assigned to the West Coast wing and would be designated the 53d OG. On a rotational basis the 53d OG would possess six MH-53J Pave Low III helicopters and a mixture of MC-130H CT IIs and HC-130P/N Shadows. The FOL would expand during periods of increased hostilities with augmentation of aircraft and personnel from the West Coast wing.¹²¹

In Europe the end of the cold war marked a massive reduction in the number of troops committed to the region. When Commando Vision was briefed to senior leadership there, concurrence was received

for the plan, with the understanding that theater war plans would be supported from Hurlburt Field. The deployment time from the East Coast to Central Europe was about 15 hours, thus ensuring that Hurlburt-based forces would arrive in-theater within 24 hours of tasking. In the Pacific, however, it was an entirely different situation. Deployment time from the West Coast to Kadena AB was approximately 24 hours, with onward deployment to Diego Garcia in the Indian Ocean taking another 15 hours. The 353d SOG maintained an aggressive JCET program under USPACOM's cooperative engagement strategy and was continuously deployed to locations throughout the Pacific. In Northeast Asia commitments to US Forces Korea were significant. As North Korea increased its threat to the Republic of Korea during the mid-1990s, US leadership in the region came to refer to a potential conflict there as a come-as-you-are war. That is, if open hostilities began, there would be little advanced warning, and those forces based in the region, including those at Kadena AB, would have to repel the initial invasion. A two-day deployment timetable from the United States to Northeast Asia would not meet the theater CINC's requirements. From the fall of 1994 through 1995, USPACOM/SOCPAC postponed a decision on Commando Vision and never agreed to the reorganization plan. In the spring of 1995, the US ambassador to Japan advised the State Department that Commando Vision should be put on hold until 1998, thus removing US political support for the initiative. In the end USPACOM simply could not take the risk of a conflict in Northeast Asia without SOF in-place in WestPac, nor could it agree to an inevitable decrease in JCET support across the Pacific.

After two years of planning, the US-based two-wing reorganization that was the centerpiece of Commando Vision was deleted from the plan. For Combat Talon, however, portions of Commando Vision did come to fruition. The plan to transfer eight MC-130E CT I aircraft to the Air Force Reserve's 919th SOW at Duke Field became a reality, and both the AC-130H and the AC-130U gunships were retained on active duty at Hurlburt Field. Throughout the entire process Headquarters AFSOC concentrated on ways to better support the theater CINCs, and in so doing helped reestablish Air Force SOF as an indispensable component ready to execute its portion of the CINC's war plans.

Operation Uphold Democracy

The fall of 1994 saw a crisis develop in the Caribbean nation of Haiti. The United States had a long history of involvement in that country, having exercised military control over the island from 1915 until 1935. From 1935 until 1957 a succession of weak governments ruled the country, with each ending in a military coup. In 1957 Francois "Papa Doc" Duvalier won a convincing election. Papa Doc remained in power until his death in 1971, at which time he was succeeded by his son, Jean-Claude "Baby Doc" Duvalier. Baby Doc ruled the island nation for the next 15 years. Corruption was rampant during the dictatorship of the two Duvaliers, and by the mid-1980s, a military junta had had enough. Baby Doc was forced into exile in France, and a five-year period began that was characterized by weak leadership and corruption. From 1985 to 1990 a succession of five different governments ruled. On 16 December 1990, with 67 percent of the popular vote, Jean-Bertrand Aristide was democratically elected as the new president of Haiti, and he took office on 7 February 1991. It was hoped that the election would mark the beginning of an era of democratic, social, and economic progress. Seven months later, however, President Aristide was overthrown in a coup d'état and forced into exile by Gen Raoul Cedras, who had been chief of the nation's armed forces.¹²²

The violent and unlawful actions of the Haitian military during and immediately following the coup were quickly condemned by the international community. Within hours of the coup d'état, the permanent council of the Organization of American States (OAS) condemned the action. The council further demanded adherence to the Haitian constitution, the physical safety of the elected president, and the rights of the Haitian people. Meeting on 2 October 1991, the OAS ministers of foreign affairs drafted a resolution demanding the immediate reinstatement of President Aristide and released the resolution the following day. The ministers recommended the diplomatic, economic, and financial isolation of the de facto authorities and the suspension of any aid except that provided for humanitarian purposes. On 3 October President Aristide addressed the UN Security Council, after which time the president of the council issued a statement condemning the coup and calling for the return of Aristide to his presidency. On 11 October the UN General Assembly adopted by consensus Resolution 46/7, which condemned the illegal

replacement of the president of Haiti, the use of violence and military coercion, and the violation of human rights in Haiti. The resolution also affirmed as unacceptable any entity resulting from the overthrow and demanded the immediate restoration of the legitimate government of President Aristide.¹²³

For nearly eight months following the October resolution, little progress was made towards getting President Aristide reinstated as the legal head of Haiti. Finally, on 21 June 1993, General Cedras responded to the UN special envoy's invitation to travel to New York and meet with Aristide to resolve the crisis. After almost a week of talks, on 3 July 1993, President Aristide and General Cedras signed an agreement on Governor's Island, New York, that paved the way for a satisfactory solution to the crisis. The agreement specifically requested the presence of UN personnel in Haiti to assist in modernizing the armed forces and establishing a new police force.¹²⁴

To implement the Governor's Island agreement, the UN passed Resolution 862, which created an advanced team that would prepare Haiti for the follow-on deployment of a UN peacekeeping force. In accordance with the resolution, an advanced team of military and police personnel deployed to Port-au-Prince during September and October 1993. On 23 September 1993 UN Resolution 867 was passed authorizing the establishment and immediate deployment of a peacekeeping force. The peacekeeping force embarked on the US Navy ship *Harlan County* and arrived off Port-au-Prince on 11 October 1993. Armed civilians in the seaport area created disturbances and prevented the ship from docking. Journalists and diplomats who were to meet the UN force were also threatened, and the ship departed Haiti without successfully off-loading.¹²⁵ In the following days the UN advanced party left Haiti, and the UN Security Council issued statements deploring the 11 October incident.

Over the next year General Cedras continued to defy the United Nations and refused to implement the Governor's Island agreement. By the summer of 1994, it was apparent that Cedras and his corrupt cronies had no intention of returning the nation to its democratically elected president. In July the 193d SOG, assigned to the Pennsylvania Air National Guard and a component unit of AFSOC, deployed to the Caribbean and began radio broadcasts directed at Haiti. A psychological warfare campaign plan was developed by the US Army's 4th PSYOPS Group that was similar to

the one used during Desert Storm. From July to September daily radio broadcasts from the 193d SOG Commando Solo aircraft were conducted to unsettle Cedras and his followers and to cause them to peacefully transfer control of the government back to President Aristide. In early September the Combat Talons of the 8th SOS were tasked to begin leaflet drops over the island.

Poole had been the commander of the 8th SOS since the spring of 1994, and his Talon crews were highly experienced in delivering leaflets after their combat experiences in Desert Storm. The squadron's first leaflet drop was targeted at the capital city of Port-au-Prince during the night of 9/10 September 1994. Departing Hurlburt Field the crew first flew to Pope AFB, where the leaflets were unloaded along with mission support personnel from the 4th PSYOPS Group. The leaflets were to be dropped from an altitude of 5,000 feet, making drop ballistics critical in ensuring that the leaflets fell on the target area as planned. Poole was one of the two crew navigators responsible for determining the CARP, and he queried the Army PSYOPS personnel regarding the weight and fold of the leaflets. He was told that the leaflets were printed on 50-pound paper stock and were folded for autorotation during descent. Using this information the 8th SOS crew computed the release point and finalized mission details before departing Pope AFB en route to its first KC-135 IFR. After receiving its programmed fuel, the Talon proceeded on to the objective area and maneuvered to its planned CARP location over Port-au-Prince. After dropping the leaflets the crew accomplished a second IFR and recovered back at Hurlburt Field. Post-drop assessment revealed that most of the leaflets had missed the target and had landed in the water near the city. To determine why the leaflets missed, the crew reviewed the entire drop sequence and the calculations used to determine the release point. During this process planners discovered two contributing causes for the missed drop—the leaflets were not configured in the autorotating mode as told to the crew prior to departing Pope AFB, and secondly, the crew discovered that there was a continuous wind shear near the surface that blew the leaflets wide of their mark. The low-level wind shear was characteristic of the objective area and was unknown to the crew before the drop. The fold of the leaflets and the wind shear combined to degrade drop accuracy.¹²⁶

First Contingency Employment of Combat Talon II

On 13 September the 15th SOS was tasked for its first leaflet drop into Haiti, which was the first combat mission flown by the squadron since its missions into North Vietnam during the late 1960s. It was also the first contingency tasking for the CT II weapons system. Lovett* chose Crew 1, commanded by Major White, to plan and fly the mission. Members of Crew 1 were Major White, Colonel Lovett, Captain Kellogg, Major Gantert, Captain VanDerHoven, Captain Fallert, Sergeant Clevenger, Sergeant Sloan, Chief Master Sergeant Sanchez, Sergeant Fredricksen, Sergeant Fine, and Sergeant Ochoa.¹²⁷

White's crew planned the mission on 14 September for execution the following night. With knowledge of the previous 5,000-foot leaflet drop by the 8th SOS crew, the 15th SOS looked at the possibility of a nonstandard low-altitude leaflet drop. Review of the threat (including AAA and small-arms fire) convinced the crew that a drop from 500 feet above the ground was feasible. To ensure accurate wind data and to minimize warning to the Haitian defenses, the ingress was planned over the Gulf of Gonave at an altitude that varied from 50 to 200 feet above the water. Two passes over Port-au-Prince were planned at 500 feet. The first pass would begin with a coastal penetration just east of the Haitian naval base located on the southwest edge of the city. After coast-in, the aircraft would make a sweeping turn to the northeast, dispensing leaflets over the eastern and southern portions of the city. The second pass would begin after completing a wide turn to a westerly heading in the valley northeast of the city.¹²⁸

With the mission planned White's crew entered crew rest for the next evening's mission. On 15 September, at 2121Z, the CT II departed Hurlburt Field en route to Pope AFB to onload the leaflets and 4th PSYOPS Group personnel. The profile was similar to the previous 8th SOS mission, with two KC-135 tankers required to refuel the Talon II. Just before takeoff from Hurlburt Field, White learned that a 40 mm AAA gun had been moved to a ridgeline overlooking Port-au-Prince. The planned coastal penetration point was in range of the AAA. Quickly figuring the depressed angle of the gun barrels, the crew's EWO (Fallert) determined that the gun could not accurately fire on the aircraft until it was out of

*Lovett was the 15th SOS/CC and was also designated as the airborne mission commander for the mission.

range. The crew determined that the mission was still executable as planned.¹²⁹

At Pope AFB the leaflets and Army PSYOPS personnel were unloaded, and the aircraft departed at 0107Z on 16 September. The route of flight was by way of airways to an IFR point north of Cuba. After the refueling the crew canceled IFR south of Great Inagua before flying the standard Guantanamo Bay approach. White flew the approach down to 100 feet, which was below Cuban radar coverage, and then turned easterly toward Haiti. South of Gonave Island the CT II descended to 50 feet above the water, with the navigator recording the winds so that the drop release point could be refined. As the CT II flew low over the water, Lovett called for an immediate climb, having seen a large three-masted schooner directly in the path of the aircraft. Once past the schooner the Talon descended back to its preplanned altitude and continued its terrain-following profile. As the aircraft flew over the coastline at 500 feet, the first set of leaflets were released over the Haitian naval base. Late information given to the crew had changed the first target area to the naval base because intelligence sources thought that Cedras might be spending the night at the base. PSYOPS planners felt that a direct hit where Cedras was staying would be effective in convincing him that the UN was serious about demanding he leave the country. After the first drop the planned profile was flown, with the aircraft dispensing leaflets over designated areas of the city. When the second pass was complete, the aircraft exited the objective area on a westerly heading. The TOT was slightly less than 10 minutes, although to the crew it seemed like an hour. No hostile fire was taken, and no evasive action was required. After the second refueling, the crew recovered back at Hurlburt Field at 1026Z on the morning of 16 September after an 11.4-hour flight. Post-drop analysis revealed that the drop was successful, with the leaflets saturating the target area.¹³⁰

As the 15th SOS completed its mission, the 8th SOS was preparing for the third (and final) leaflet drop over Haiti. The squadron was tasked to fly a similar profile as the one flown by the 15th SOS. The 8th SOS drop was accomplished during the night of 16/17 September and also utilized low-level drop procedures. It was the first low-level leaflet drop completed by the squadron. As had been the case for the 15th SOS, the leaflets were right on target.¹³¹

With the PSYOPS campaign ongoing, D day was established as Sunday, 17 September, with SOF forces prepositioned in the southern United States and in the western Caribbean before H hour. AFSOC deployed significant forces from the 16th SOW in support of the operation, including 14 MH-53J Pave Low IIIs, five HC-130P/N Combat Shadows, four AC-130H gunships, and three MC-130E Combat Talon Is. An additional five AC-130A gunships were deployed from the 919th SOW at Duke Field, and a contingent of AFSOC MH-60G Pave Hawks from the 55th SOS were deployed along with USA helicopters for the operation.¹³² The EC-130E Commando Solo aircraft continued to fly missions out of Key West, Florida, and out of Puerto Rico. The 15th SOS remained on alert at Hurlburt Field for follow-on tasking.

By the evening of 17 September, additional AFSOC forces were in place and prepared to execute their portion of the operation. President Clinton, in a final effort to resolve the crisis, sent a peace delegation to Haiti that was headed by former president Jimmy Carter. Other members of Carter's delegation included the former chairman of the Joint Chiefs of Staff, Gen Colin Powell, and Sen. Sam Nunn, chairman of the Senate Armed Services Committee. On Sunday, 17 September, the delegation met with Cedras and his top officials. Little apparent progress was made, and by Sunday evening the invasion force was poised to strike. At MacDill AFB 28 C-130 aircraft loaded with Army rangers and their equipment departed the air base en route to Port-au-Prince. At approximately the same time, Carter's delegation announced from Haiti that an agreement had been reached. Thirty minutes after takeoff the C-130s were recalled, and they returned to MacDill AFB to await further instructions.¹³³

At Guantanamo Bay the 8th SOS Combat Talons were on alert to refuel the 20th SOS helicopters, which were on call for emerging mission tasking. With the operation put on hold, no additional combat missions were tasked to the squadron. In the coming weeks the AFSOC commitment solidified into one of providing SAR alert. For the next two months, the three 8th SOS CT Is remained at Guantanamo Bay on SAR alert. As airlift requirements mushroomed after 17 September, the squadron volunteered to shuttle personnel and supplies into Haiti. Numerous sorties were flown in support of the peacekeeping operation. Just before Christmas 1994 the 8th

SOS contingent was released and redeployed back to Hurlburt Field, thus bringing to a close its support for Operation Uphold Democracy.¹³⁴ For the 15th SOS the squadron deployed two CT IIs to Shaw AFB and was prepared to execute post-invasion operations in Haiti. With the operation canceled the squadron's CT IIs were not needed for the ensuing peacekeeping operation, and the aircraft were subsequently redeployed back to home station without flying any additional sorties into Haiti.

As part of the agreement brokered by former president Carter's peace commission, Cedras and his key leaders were allowed to depart Haiti in exile, and President Aristide returned to claim once again the office to which he was democratically elected. A great amount of effort had been expended to return him to Haiti, and additional bloodshed had been avoided by the peace agreement. For AFSOC, Operation Uphold Democracy once again demonstrated the unique capabilities of SOF and the impact its forces could have when employed in a coordinated theater campaign plan. For the CT II the operation marked the first actual contingency employment for the new weapons system.

The 1st SOS Identified to Receive Combat Talon II

By January 1994 Commando Vision had been briefed in the Pacific, and the permanent status of the 353d SOG was once again an uncertainty. Vision had two phases, the first of which centered on aircraft force structure. Under Commando Vision the MC-130E CT Is of the 1st SOS would transfer to the 919th SOW (USAFR) at Duke Field, Florida, and the squadron would be assigned the CT II. The 17th SOS, which had been previously identified to receive the CT II, would retain its HC-130s. Phase II of Commando Vision called for the relocation of the 353d SOG to the United States, deactivation of the 31st SOS at Osan AB, Korea, and the re-establishment of the 353d SOW at a West Coast location. Throughout the year Commando Vision was debated by senior leadership both in the Pacific and in the United States. The 353d SOG, in the meantime, retained its permanent status and continued to posture for a long-term stay at Kadena AB.¹³⁵

One of the shortfalls of basing at Kadena AB was the lack of EW ranges for the 1st SOS. While at Clark AB the squadron had direct access to the sophisticated Crow Valley ECM range, but the only available facility near Kadena AB was the



Photo courtesy of Robert Jingst

Combat Talons 64-0561, 64-0555, and 64-0562 on the ramp at Guantanamo Bay during Operation Uphold Democracy. HC-130s from the 9th SOS are also seen in the background.



Photo courtesy of Robert Jingst

Aircraft 64-0561 on the ramp at Pap, Haiti.



Photo courtesy of Robert Jingst

Ramp at Guantanamo Bay. On the left are MC-130Es from the 8th SOS and HC-130P/Ns from the 9th SOS. On the right are AC-130As from Duke Airfield.



Photo courtesy of Robert Jings

Gen Wayne Downing (CINCSOC) visited the troops while they were deployed to Guantanamo Bay. General Downing is pictured fourth from the left.

Pilsung range in Korea. Pilsung range was an obsolete facility that did not have the threat array required to challenge the Combat Talon, and it was a joint-use facility shared with the Korean air force. It was also open only one night a week, and with the 1st SOS flying almost exclusively at night, there was not enough opportunity to schedule the range to keep assigned crews proficient. To improve access to ECM ranges, the 1st SOS turned to Australia and to Alaska. Building on previous JCET events in Australia, the 353d SOG participated in several combined exercises with Australia's Special Air Service and US Army Special Forces. In conjunction with the combined exercises, airborne intercept training with Royal Australian Air Force F/A-18s was conducted. At Darwin, Australia, an ECM range was available for Royal Australian Air Force use, and the 353d's long-term goal was to gain permission for the 1st SOS to fly on the range. In Alaska 1st SOS crews participated in several joint and unilateral exercises that emphasized air intercept and ECM training. Australian and Alaskan deployments gave the 1st SOS access to vast and unrestricted flying areas and effectively filled the critical ECM training shortfall.¹³⁶

From 18 to 29 April the group passed another milestone when it received an ASET visit from Headquarters AFSOC. The team evaluated flight operations and training by conducting flight checks, aircrew testing, and inspections of documentation to measure compliance with directives. The ASET administered 92 aircrew check rides, 88 of which

were graded as fully qualified (Q-1), three were conditionally qualified (Q-2), and only one was categorized as unqualified (Q-3). The team also conducted 166 written evaluations. An overall rating of excellent was earned by the group, with a score of 95.2 percent being awarded by the team. The ASET was another indicator of how far the group had come since relocating to Kadena AB.¹³⁷

To assess Kadena AB's ability to support the CT II, another SATAF was held from 6 to 8 June 1994. As had been the case the previous year, the SATAF pronounced Kadena AB as unsatisfactory based on its assessment of spare parts availability, including AN/APQ-170 radar spares and C-130 common parts. The SATAF also determined that facilities planning, although vastly improved from the previous year, was still marginal. The facilities rating was a result of the close time line for modifying building 3306 as a radar maintenance shop. Lack of mobility storage space, joint use of the base fuel cell and corrosion control facilities, and the high-risk work for building 3306 were all reasons for the overall unsatisfactory rating.¹³⁸

The new CT II beddown schedule had the 1st SOS receiving its first CT II aircraft during July 1995. Another four aircraft would arrive from August through December 1995. The 1st SOS would lose one MC-130E in December 1994 and then lose one each month during August through November 1995. The graduated phase-in of the CT II was designed to minimize the impact of losing the CT I in-theater and was critically important

to the success of the new Combat Talon in the Pacific.¹³⁹

On 20 June 1994 Colonel Williamson assumed command of the 1st SOS from Reinholz, who departed Kadena AB for the National War College. Williamson had arrived at Kadena AB the previous January and had served as the squadron's operations officer until assuming command. Colonel Barwick became the new squadron operations officer.¹⁴⁰ Williamson would have to focus much of his time over the next year on personnel issues generated by the conversion of the squadron to Talon IIs. Barwick would concentrate on training his Talon I crews on the new helicopter aerial refueling system and on maintaining CT I combat capability during the transition.

The decision to convert the 1st SOS to the CT II prompted several concerns for the squadron. Chief among those concerns were personnel issues stemming from the lack of career opportunities for CT I personnel. By transferring most of the CT I fleet to the Air Force Reserve, little opportunity was left for active duty CT I crew members to remain in the weapons system. The decision also placed some 1st SOS crew members at risk of having to cross train into a third weapons system within three years. To cope with the anticipated personnel turbulence, the 1st SOS identified aircrew members wishing to convert to the CT II and sought to find those wanting to remain at Kadena AB positions either within the 353d OSS or in the 17th SOS.*¹⁴¹

On 8 July 1994 attention focused on North Korea when Kim Il Sung died at the age of 82. He had maintained his dictatorial position as the Great Leader of the Hermit Kingdom since the late 1940s. Possible instability resulting from his death resulted in US forces in the Northeast Asian region increasing their level of vigilance. South Korean military forces went on alert in anticipation of a possible attack from North Korea. At the 353d SOG appropriate plans were reviewed, and each squadron's tasking under the plans was assessed. Tension on the Korean peninsula had remained high between the United States and North Korea over the north's refusal to halt development of its nuclear capability. Only after former president Jimmy Carter brokered a deal in June 1994 did the tension slightly subside. The death of Sung put the agreement at risk. Af-

ter additional negotiations, however, a new agreement was signed in November even though a successor to the late communist leader had not been publicly announced.¹⁴²

Through the fall of 1994, the 353d SOG continued to make progress on improving its facilities at both Kadena AB and at Osan AB. Two K-Span hangars were completed at Osan AB, and a contract for renovating building 3524 was finalized at Kadena AB. Headquarters AFSOC went to the Air Staff and secured \$1.3 million for the extensive renovation project. In late September the 18th Wing finalized a renovation contract for \$800,000, which was the low bid for the project. The remainder of the Air Staff designated funds was used for other 18th Wing projects.¹⁴³

Exercise Foal Eagle absorbed most of the group's resources during November, with a majority of the group's assets deployed to Korea for the exercise. By the close of 1994, the group had many accomplishments to its credit. Perhaps the most gratifying award came when the group was recognized as having the Outstanding Safety Program of the Year for AFSOC. The group had also made great strides in implementing quality air force initiatives, having completed a Unit Self Assessment over a grueling two-month period in August and September. For 1995 the group was ready for the scheduled Quality Air Force Assessment (QAFA) and was zeroing in on final preparations for CT II.

The 7th SOS Deploys for Operation Support Hope

After the previous hectic year for the 7th SOS, 1994 promised to be a bit more normal, with the squadron concentrating on training in the Combat Talon II and supporting the 352d SOG exercise program. During a touch-and-go landing at RAF Macrihanish, Scotland, on 23 February, the crew experienced complete radar failure on its AN/APQ-170 radar. The crew returned to the base to determine if the radar could be repaired and the mission continued. Upon inspection maintenance found a two-foot by four-foot by 10-inch deep impression in the nose radome that had caused severe damage to both radar antennas and to other associated radar equipment. A bird strike was discounted, and later investigation revealed that the

*Late in 1994 Air Force Personnel Center and Headquarters AFSOC dispatched a combined personnel team to Kadena AB to recruit aircrew personnel for the new AC-130U model gunship and to assist crew members in attaining assignments of their choice. The personnel team arranged assignments for 80 1st SOS personnel, including 17 who would retrain into CT II, 14 who would remain with the MC-130E CT I and later transfer to the 8th SOS at Hurlburt Field, five to transfer to the HC-130P/N, and the remaining personnel either transferring to the AC-130U gunship or remaining at Kadena AB in a nonflying staff position.

radome had experienced structural failure. Inspection of the Combat Talon II fleet identified several other radomes with cracks and soft spots that severely impacted the operational readiness of the weapons system.¹⁴⁴

The following month one 7th SOS Combat Talon deployed to Norway for Exercise Arctic Express. The squadron provided almost all of the personnel for the exercise since most of the 352d SOG was still heavily committed in Brindisi, Italy. Colonel Scott served as the Joint Special Operations Air Component Command (JSOACC) commander and established his base of operations at Bardufoss, Norway. In addition to the 7th SOS Combat Talon II, the 160th Special Operations Aviation Regiment from Fort Campbell, Kentucky, deployed a contingent of CH-47D aircraft for the duration of the exercise. The exercise consisted of insertion, extraction, and resupply of special forces ground units. While on the ground the units executed special reconnaissance of strategic points (beach heads, fjord inlets, airports, and transportation routes), and direct action missions and were prepared to execute personnel recovery missions as required. Although the Combat Talon was hampered by the loss of a transformer rectifier early in the exercise, most exercise objectives were accomplished by the squadron.¹⁴⁵

The 352d had not received an ORI for several years, and one was scheduled in the spring of 1994. Continued tasking for Operation Provide Promise II/Deny Flight had prevented an earlier inspection. To allow the group the opportunity to complete its ORI, Headquarters AFSOC agreed to assume the Brindisi commitment with other assigned forces and temporarily to release the 352d SOG. Elements from the 16th SOW, including two 8th SOS Combat Talon Is, assumed the SAR alert duty on 1 March. The last of the 352d SOGs personnel departed Brindisi on 4 April. The 16th SOW remained at Brindisi until 17 June, when the 352d returned to assume the alert duties.¹⁴⁶

During March and April the group conducted two operational readiness exercises (ORE) to help prepare for the ORI scheduled for May. The AFSOC IG team originally wanted the group to deploy to Italy for the inspection, but when Italian officials denied permission due to the saturated airspace caused by the Balkan operation, they had to look elsewhere. Locations in Spain, Germany, and the United Kingdom were considered, but in the end the only viable location turned out to be home station. The scenario for the exercise included a terrorist event in a Middle Eastern

country controlled by religious fundamentalists. For the 7th SOS the unit committed all three of its Combat Talon IIs to the ORE. Five days after completion of the second ORE, SOCEUR issued an exercise warning order to the group, which put into motion Phase I of the ORI. On 27 April a SOCEUR exercise execute order was issued, and the initial deployment phase of the inspection began. After marshaling cargo and generating all participating aircraft, the deployment phase was complete after 36 hours. On 4 May Phase I employment operations began and continued until 11 May. During Phase I of the ORI, crews completed 100 percent of tasked missions, flying 44 sorties and 145.4 hours. After completion of the first phase, the group stood down for 48 hours to reconstitute before Phase II. Between 18 and 24 May, group assets deployed to RAF Macrihanish and executed a complex exercise scenario, with two 7th SOS Combat Talon IIs participating. At the completion of Phase II, the deployed assets returned to RAF Alconbury for ORI termination. Overall, the group received a grade of excellent, having received an outstanding for initial response, a satisfactory for unit employment, and an excellent for combat support. The manner in which the group and the 7th SOS performed validated its combat capability.¹⁴⁷

With the ORI successfully behind them, group personnel redeployed to Brindisi to assume once again SAR alert duties in support of Operation Provide Promise/Deny Flight. By midmonth elements of the 21st SOS, 67th SOS, and the 321st STS were in position at Brindisi. For the 7th SOS preparations were under way for a change of command for the squadron. On 1 July 1994 Colonel Scott assumed command of the squadron from Lauderdale. Scott had been the operations officer before taking command, and he continued to emphasize training and support of the group's exercise and JCET program.

Throughout the spring and summer, a civil war had raged in the Central African country of Rwanda. By July the situation had deteriorated to such a degree that the US government publicly committed itself to providing humanitarian relief to the besieged people living there. As a result of this commitment, SOCEUR was tasked by USEUCOM to provide air and ground support, and on 22 July it issued a warning order for the 352d SOG to be prepared to deploy all available 7th SOS Combat Talon IIs in support of Operation Support Hope. Four hours later the group

received a verbal execute order to commence relief operations in Rwanda by 24 July.¹⁴⁸

Scott immediately swung into action. He recalled one MC-130H that was deployed for a training exercise and his staff began working logistics and mission planning requirements. Throughout the day preparations continued. At 1630 local, just 10 hours after initial notification, three 7th SOS crews entered crew rest, and one hour later the recalled Talon landed at RAF Alconbury. Its crew entered crew rest as maintenance prepared the three Combat Talons for the long flight to Central Africa.¹⁴⁹

At 0630 local on 23 July, less than 24 hours after receiving the initial call, the first 7th SOS crew (call sign Perm 45) departed the United Kingdom for Stuttgart, Germany, to onload the SOCEUR command element that would make up JSOTF3. A half-hour later the second and third Talons departed with elements of the 321st STS, 352d OSS, 352d MS, and Headquarters 352d SOG. The three aircraft were to rendezvous off the coast of Sicily for the first of two IFRs, but loading delays in Stuttgart prevented the first Combat Talon from joining the other two until over Egypt. The three Combat Talons refueled from KC-135 tankers over the Red Sea and proceeded on to Entebbe, Uganda, which served as the task force operating base. While still en route the Talon crews received coordinates from SOCEUR for the first airdrops scheduled for the following day. Navigators aboard the three Talons began planning the next day's mission as the formation closed on Entebbe. At 0015 local on 24 July, after a 4,300 mile, 16-hour flight, the Talons landed in Uganda.¹⁵⁰

With postflight duties complete, the crews traveled the treacherous 30-minute route to their quarters in Kampala. By 0300 local the crews had settled into their quarters as maintenance and support personnel continued to prepare the aircraft for the afternoon mission. At 1000 local the duty crew, additional maintainers, and the JSOTF3 staff arrived at the airport to complete aircraft preparations and mission coordination. A C-5 transport was parked in the same area as the Combat Talon IIs, thus creating an extremely congested parking area. The Talons had to be taxied one at a time to the refueling area, then loaded one pallet at a time by an all-terrain forklift. The process was slow and time consuming. Mission planners had little to work with, but did their best to plan a route to the DZ. The TOT was established at 1730 local, based on the anticipated launch time from Entebbe. The new TOT was one

hour later than requested by the relief workers on the DZ and was caused by difficulties experienced in loading and servicing the aircraft. For unknown reasons the UN leaders at the drop location denied the later drop time, and at 1500 local, JSOTF3 notified the 7th SOS that it had to make the original TOT of 1630 local.¹⁵¹

The crews were prepared to drop the relief supplies by way of CDS airdrop procedures, but suggested that TRIADS be utilized. The UN leaders rejected TRIADS in lieu of a conventional CDS drop. In addition the UN demanded that the airdrop be made in formation, a tactic that the squadron had not practiced and was not proficient in. When it became apparent that the UN representatives were not going to adjust their tasking, Colonel Helms, the mission commander, elected to fly the mission as requested. Through extraordinary effort, the three crews managed to make an early takeoff and proceeded to the objective area in three-ship trail formation. As the crews approached the DZ, they observed thunderstorms three to four miles southwest of the area and adjusted their escape heading to avoid them. At four miles out the crews obtained the DZ visually through a broken overcast, and at three miles confirmed the DZ with orange marker panels displayed. Although the crew could hear the combat controller on the ground, the controller could not copy the aircraft's transmissions. With positive identification of the DZ, a marked point of impact for the load, and no cancellation call from the combat controller, the lead Combat Talon dropped its CDS bundles at 1624 local. The second and third aircraft followed with their bundles, and all loads landed on the DZ. The crews estimated that the loads landed 150 to 200 yards at the one to two o'clock position. The formation executed a hard right turn to avoid the thunderstorm and returned to Entebbe for landing.¹⁵²

The initial 7th SOS mission proved to be the squadron's only airdrop of the operation, with UN ground personnel opting for a much slower overland resupply method to get food to the starving natives. The squadron did fly, however, other support missions for the JSOTF3 commander. On 26 July one crew flew an ALCE assessment team and a State Department official to Kigali, Rwanda. The aircraft and crew remained in Kigali for the next four days, at which time it departed with the same personnel it had brought earlier. On 29 July another Combat Talon flew an airland mission into Goma, Zaire, with two water bladders and associated equipment, and seven members of the

international news media. Two days later, on 31 July, two additional missions were flown. The first consisted of transporting the US secretary of defense, the supreme allied commander Europe, the JTF commander, a US congressman, and 36 other dignitaries from Kigali to view refugee camps from the air. The original 7th SOS resupply DZ was also overflown. The second mission on 31 July consisted of transporting a vehicle, water, food, 10 ALCE personnel, and three members of the Organization of African States. The final two missions were flown on 1 and 2 August, with the Combat Talon IIs transporting vehicles, food supplies, and personnel to Kigali and to Goma. On 3 August, after conventional C-130 units arrived to take over the mission, USEUCOM relieved the squadron from further tasking. On 4 August the three Combat Talons and other 352d SOG personnel returned to RAF Alconbury.¹⁵³

Operation Support Hope proved to be the last contingency operation for the 7th SOS during the year. From 28 September to 17 October, one Combat Talon II deployed to the United States and participated in Red Flag 95-1, period 1.154 The remainder of the fall was spent on preparations for the unit move to RAF Mildenhall. Members of the squadron also concentrated on training initiatives designed to season the young 7th SOS crew. Additional deployments from Norway to Africa, and to former Warsaw Pact countries, provided the unit with unique challenges through the New Year.

The 542d CTW Becomes the 58th SOW

On 1 April 1994 the Air Force moved the 56th FW, the USAF's fifth most prestigious wing (as determined by General McPeak) from MacDill AFB, Florida, to Luke AFB, Arizona. The 56th replaced the 58th FW (ranked 22d under the same system) at Luke AFB. The Air Force then reassigned the 58th FW to Kirtland AFB, effective 1 April, and redesignated it the 58th SOW. The 58th SOW replaced the 542d CTW, which was inactivated. The move to Kirtland AFB meant major organizational changes for the new special operations wing. The 550th FTS and 551st FTS were redesignated the 550th SOS and 551st SOS, respectively. Other squadrons in the wing were renamed similarly.¹⁵⁵

Even though the 58th SOW moved to Kirtland AFB without personnel or equipment, it brought a long and distinguished history with it that dated back to 15 January 1941. The wing traced its lineage to the 58th Pursuit Group at Selfridge Field,

Michigan, which trained fighter pilots destined to fight in World War II. The pursuit group went on to serve in the Pacific theater during the latter part of the war. The wing then served in the Korean War flying combat missions in the F-84 Thunder Jet, after which time it was inactivated. In 1969 the wing was reactivated at Luke AFB to train fighter pilots once again. Its decorations included two Distinguished Unit Citations, the Philippine Presidential Unit Citation, the Republic of Korea Presidential Unit Citation, and six Air Force Outstanding Unit Awards.¹⁵⁶

Special Order G-37, dated 30 March 1994, redesignated the 550th FTS as the 550th SOS and assigned it to the 58th SOW, effective the following day. The squadron continued to fly the HC-130P/N and the MC-130H Combat Talon II aircraft. Along with its heavy student load, the squadron participated in the quarterly Chile Flag exercises. From 11 to 22 July, the 550th SOS supported US Navy SEALs from North Island NAS, California, in Chile Flag 94-04. Aircrews conducted training in night low level and airdrop/recovery of SEAL team personnel. The exercise again provided a venue whereby both permanent party and student crews could participate in a demanding joint exercise.¹⁵⁷ In a Headquarters AETC message dated 192047Z May 94 to the 58th SOW, AETC/XOT proposed that the wing periodically participate in AFSOC joint exercises. The message stipulated that only permanent party personnel could participate in the program and that a 58th SOW aircraft could occasionally deploy. The initiative ensured that the instructors at the schoolhouse would be kept abreast of current tactics and procedures employed by the operational units.¹⁵⁸

In June 1994 the Air Staff made the decision to cancel the move of the MC-130E Combat Talon I and the CT I WST to Kirtland AFB as originally planned. Headquarters AFSOC wanted to consolidate CT I and CT II training at the New Mexico base, but initiatives driven by Commando Vision necessitated the change. Under Commando Vision the CT Is programmed for Kirtland AFB would be transferred instead to Duke Field and be assigned to the 919th SOW, USAF Reserve Component. The CT I WST would be located at Hurlburt Field and would be centrally located for use by the two remaining CT I squadrons. The decision did not affect the planned installation of the CT II WST, which was scheduled for October 1995.¹⁵⁹ As 1994 ended operations in the 58th SOW had finally

settled down, and the Combat Talon II formal school was operating smoothly.

1995: War in the Balkans Expands

Although portions of Commando Vision were tabled, Combat Talon I transfer to the USAF Reserve went on as planned. In the Pacific, the 1st SOS received its initial Combat Talon IIs, and Kirkland AFB survived a closure scare from the Base Realignment and Closure (BRAC) Commission. The 7th SOS moved to RAF Mildenhall as the 352d SOG struggled to fulfill its tasking in the Balkans.

The Objective Wing Is Refined in AFSOC

As Haiti and Operation Uphold Democracy faded into the past for AFSOC, General Hobson initiated a request to Air Staff for a variance from the objective wing structure. Hobson felt that the operational flying squadrons had grown too large for their squadron commanders to effectively supervise the complex operations and maintenance functions.

The two Hurlburt-based Combat Talon squadrons had tripled in size since absorbing their maintenance function, while the 1st SOS at Kadena AB had doubled. The 8th SOS had grown to 381 personnel assigned, while the 15th SOS had topped out at 414 assigned by late December 1994.¹⁶⁰ As a general rule the flying squadron commanders had little maintenance experience and had to rely on relatively junior officers to advise them on maintenance issues. There were times when flying requirements took precedence over maintenance actions, thus having the long-term effect of decreased capability as maintenance actions were regularly postponed. Hobson felt that on-aircraft maintenance should be supervised by maintenance professionals and not by rated operational commanders. The variance that he requested would create separate maintenance squadrons and leave the operations squadrons to concentrate on their flying activities. On 11 August 1995 Hobson's requested variance was approved by Air Staff. Both fixed- and rotary-wing maintenance squadrons were subsequently established, and they were activated effective 2 October 1995. The action resulted in the 8th SOS decreasing in size to 142 assigned personnel and the 15th SOS to 132.¹⁶¹ The two overseas Talon squadrons (the 1st SOS and the 7th SOS) were not affected by the change at Hurlburt Field at that time. Maintenance remained assigned to those two squadrons for another year.

The 8th SOS Supports Operation Joint Endeavor

In December 1994 the 8th SOS was tasked to deploy two MC-130Es to Italy in support of the ongoing Bosnian operation. Later, in the spring of 1995, the 8th SOS aircraft returned to Hurlburt Field when the 9th SOS relieved them. On 14 August 1995 the 8th SOS received a no-notice tasking to redeploy to San Vito in support of Operation Deliberate Force/Joint Endeavor. Dodging two Atlantic hurricanes en route, the aircraft were in-place at San Vito 14 hours before the JCS deadline. The deployment was in support of NATO operations in Bosnia-Herzegovina and involved providing CSAR alert to refuel helicopters if the need materialized. On 30 August Serbian gunners shot down a French Mirage fighter (call sign Ebro 33) near the town of Pale with two crew members onboard. During the following days, intense mission planning was conducted to determine if the French officers could be rescued. On 6 September a flight of US Navy SH-60 helicopters from the USS *Roosevelt* attempted a recovery but was turned back due to bad weather and intense small-arms fire. On 7 September the JSOTF at Brindisi, launched a second rescue attempt. The 8th SOS MC-130Es were part of the Ebro 33 task force and was tasked to refuel the helicopters performing the rescue. The SAR force was unable to locate the crew members, and it was learned that they had been captured. The French pilots were later released unharmed in December as part of the Paris peace agreement. In all the 8th SOS participated in three CSAR missions during Operation Deliberate Force before the peace agreement took effect.¹⁶²

Less than 24 hours after the signing of the peace agreement in Paris, AFSOC crews, including those of the 8th SOS, were carrying US Army Special Forces teams into Sarajevo in support of Operation Joint Endeavor. The MC-130Es of the 8th SOS were tasked to support special forces troop movements into both Sarajevo and Tuzla, which were the two main hubs for air operations. With dense fog blanketing the city, an 8th SOS Combat Talon was the first aircraft to land in Sarajevo after the agreement was signed. Throughout the early stages of Joint Endeavor, the weather played havoc with aircraft movements in both Bosnia and in Italy. The Combat Talon was the only fixed-wing aircraft that could consistently fly a precision airborne radar approach to a successful landing in the fog and drizzle of central

Bosnia. In Italy maintenance personnel battled the continuous rain and cold to produce mission-ready aircraft, even though working conditions on the flight line were miserable. After the initial peacekeeping force was delivered to its assigned areas, the 8th SOS mission reverted to CSAR alert. At year's end Poole and his Combat Talons were still deployed to Italy in support of Operation Joint Endeavor.¹⁶³

Back at Hurlburt Field the 8th SOS participated in the third annual Operation Christmas Wish by delivering more than \$40,000 in medical supplies, food, books, bicycles, and toys to the needy orphans and poor children of Honduras. In 1992 the squadron had unofficially adopted the La Cieba orphanage, located just outside the Golosan Honduran AB. Since that time the squadron had provided the 235 children there with toys and other essentials donated by the local Fort Walton Beach community during the Christmas season. The amount delivered in 1995 was characteristic of the generosity of concerned citizens for the welfare of the children of Honduras. The year 1995 had been a busy and rewarding one. At year's end the squadron had 142 personnel assigned and possessed five MC-130E aircraft, including 64-0551, 64-0559, 64-0562, 64-0566, and 64-0568.¹⁶⁴

The 15th SOS Completes Its First Full Year of Tasking

For the 15th SOS, 1995 marked the first full year that the squadron was subjected to both exercise and contingency taskings. The squadron had used 1993 and most of 1994 to season its young crew force and to mature its maintenance capability. With Operation Uphold Democracy in the fall of 1994, the squadron validated its mission capable status and soon increased its participation in the JCS exercise program. In the last half of 1995, the 15th SOS participated in an average of seven exercises each month. These events included joint readiness exercises (JRX), joint readiness training center activities, multiple bilateral training exercise, and higher headquarters tasked static displays and crew proficiency training. Along with participation in the rigorous exercise program, the unit also upgraded the MC-130H terrain-following radar system, integrated the GPS into the onboard navigation system, and incorporated mission computer high-altitude release point calculations into the system.¹⁶⁵

From 29 November to 15 December, the squadron was a key player in JRX 95-5 (Javelin Steel).

The exercise called for six MC-130H Combat Talons to fly in night low-level formation to a personnel drop. Three of the Talons then proceeded inbound to a nearby airfield and executed blacked-out landings to infiltrate the remaining personnel and equipment. As soon as the assault force was off-loaded, the CT IIs departed the airfield and established a holding pattern until called back to extract the ground force. After receiving the call to return to the airfield, the three Combat Talons again made blacked-out landings and successfully extracted all exercise personnel. Throughout the exercise the 15th SOS made all of its TOTs with split second accuracy and with all paratroopers landing on the DZ. At the close of 1995, the squadron had 132 personnel assigned along with 10 CT II aircraft, 83-1212, 84-0475, 85-0012, 87-0024, 89-0280, 89-0281, 89-0282, 89-0283, 90-0161, and 90-0162. Aircraft 85-0011 was loaned to Kirtland AFB on 12 October 1995.¹⁶⁶

Combat Talon I Moves to the Air Force Reserves at Duke Field

Efforts by Headquarters AFSOC to gain approval of Commando Vision during the last half of 1994 and the first half of 1995 had not been met with total success. Opposition to the drastic reduction in the size of the overseas special operations groups, especially the 353d SOG in the Pacific, had proved too great a challenge. By mid-1995 the concept of a West Coast wing had been shelved and was all but abandoned. The effort to retain the AC-130H gunship on active duty, however, had continued. The 711th SOS, a USAF Reserve unit located at Duke Field, Florida, and assigned to the 919th SOW, had flown the AC-130A since the Vietnam War era. The pre-Commando Vision plan was to transfer the AC-130H to the 711th SOS when the squadron's A-model gunships were retired from service. Commando Vision retained the AC-130H on active duty at Hurlburt Field and transferred eight Combat Talon Is to the 711th SOS. Throughout 1995 the 711th SOS prepared for the Combat Talon I, and on 28 September the squadron's gunship mission was officially terminated. On 6 October Combat Talons 64-0571 and 64-0572 arrived at Duke Field from the 1st SOS at Kadena AB, and the era of Combat Talons in the 711th SOS began. On 8 November Combat Talon 63-7785 was transferred from Hurlburt Field and became the third aircraft to be assigned to the unit.¹⁶⁷

Aircrews trained for months in preparation for the arrival of the first aircraft. By year's end two

fully mission ready crews were nearing certification, with additional crews following soon afterwards. Major Norris was the first mission ready Talon pilot assigned to the squadron. The new Talon I squadron was commanded by Colonel Hanson, who had assumed command of the 711th SOS on 5 December 1994. Much of the early success of the squadron could be attributed to his effort to bring the weapons system smoothly online. The conversion did not come without a price, however. Growing pains with the Combat Talon I at Duke Field and unseasonably poor weather reduced the sortie completion rate, resulting in the standard 22-week training schedule having to be extended to 32 weeks. Several lessons were learned from the initial cadre that were implemented for future classes. Phase A (ground training) was separated from Phase B (flying training), thus allowing a better match to traditional reservist availability. Training was also later transferred to Duke Field and was accomplished on unit-assigned aircraft rather than the operationally committed aircraft of the 8th SOS.¹⁶⁸ By the end of 1995, the 711th was well positioned to complete its transition to Combat Talon I during the following year.

Combat Talon II Delivered to the 1st SOS

The New Year began for the 353d SOG with the Headquarters AFSOC IG-administered QAFA. The group had prepared for the inspection the previous fall when it completed an in-depth unit self assessment. Although the whole quality process was still new to the group, the IG assessment was designed to gauge the group's progress in applying quality principles to improve mission accomplishment. The assessment focused on three areas: direct mission accomplishment, strategic plan support, and compliance with Air Force special interest items. Inspectors used Headquarters AFSOC's quality criteria on a curved rating scale designed to implement a 60 percent grading scale for the 1995 QAFA, an 80 percent scale for the next QAFA in 1997, and a 100 percent scale for 1999 and each out-year after that time. Inspectors found the group in compliance with the two special interest items and recognized the group's safety program as outstanding. The operations and security and intelligence oversight programs received an excellent rating. QAFA inspectors also lauded senior leadership for successfully incorporating quality principles into most areas of 353d SOG operations. The QAFA reinforced the concept that quality was a

journey and that AFSOC units had only begun their journey in achieving a quality oriented organization.¹⁶⁹

Also in early January Colonel Stevens visited the 353d SOG to get inputs from group leadership regarding theater reservations about Commando Vision. Armed with briefing papers and data provided by the group staff, Stevens returned to Hurlburt Field and briefed Headquarters AFSOC. From 3 to 7 March 1995, Headquarters AFSOC convened the Commando Vision Conference, and General Hobson tasked the attendees to "put the meat on the bones" of Commando Vision, with a promise that AFSOC would take the finalized plan to the overseas CINCs to gain their approval. A great amount of work already had been accomplished and the conference built upon that previous work. Colonel Dredla, commander of the 353d OSS and a Combat Talon EWO, led a five-person 353d SOG team to the conference. AFSOC created a multidisciplinary tiger team to focus on issues surfaced during the conference with the goal of better defining Commando Vision.¹⁷⁰

Dredla presented a group white paper summarizing the unit's proposed concept of operations in the Pacific under Commando Vision. The primary purpose of the paper was threefold: (a) to provide an AFSOF capability that the group believed would be acceptable to COMSOPAC, (b) to provide AFSOC functional managers a baseline of mission needs against which they could project resources, and (c) to give AFSOC programmers a baseline of requirements against which Commando Vision could be constructed. The main theme put forth by Colonel Dredla highlighted the capability that had to be available both during and after Commando Vision. After discussing several assumptions made by Commando Vision planners, Dredla closed his presentation by pointing out two key flaws in the Commando Vision concept that made it untenable—the West Coast wing structure was not sufficiently robust to supply rotational personnel to the Pacific while at the same time supporting the national mission and SOUTHCOM requirements, and Commando Vision failed to take into account the qualitative capability brought to USPACOM by having permanently based forces assigned to the theater.¹⁷¹ PACOM had become comfortable with its SOF-assigned forces and was not readily willing to give up its in-place capability for an unproven Commando Vision.

Soon after the conference AFSOC sent a wrap-up message to its field units declaring that Commando Vision “is our best course of action to develop experience and maintain readiness.” When Walter Mondale, the US ambassador to Japan, informed Washington later in the spring that it would be wise to halt Commando Vision implementation until 1998, Commando Vision was subsequently put on indefinite hold, and Phase II was never implemented.¹⁷²

From 27 February to 2 March, the 353d SOG hosted another CT II SATAF. It was the fifth SATAF since the 353d SOG was programmed to receive the new aircraft. The SATAF executive committee assessed the 353d SOG site activation again as unsatisfactory, based on a shortage of AN/APQ-170 radar spares, aircraft nose radomes, and AP-102 spares needed for the CT II. The group expected to receive those spares by November 1995. The committee deemed the group’s facility planning as marginal due to the ongoing modifications to building 3306, a facility designed to house the CT II radar test station.* Plans continued to assign the group’s first CT IIs to the 1st SOS in the summer of 1995.¹⁷³

May marked the first deployment of the CT II to the Pacific theater during JCS Exercise Cobra Gold in Thailand. From 1 to 28 May, two MC-130H CT IIs from the 15th SOS flew missions in support of the exercise. Talon II aircrew and maintenance personnel interfaced with 1st SOS personnel during the exercise, providing hands-on experience for Pacific-assigned personnel. Following Cobra Gold the two CT IIs returned to Kadena AB and remained there through August. Newly trained 1st SOS crews and maintenance personnel were able to fly and maintain the aircraft during this transition period. The first-ever deployment to Thailand for the CT II did highlight to 353d planners the need for additional support equipment before the group operated the CT IIs extensively. The hot, humid conditions of Kadena AB and Southeast Asia required that the large air-conditioning units designed for the aircraft’s electronic equipment had to be in place for the CT II to operate properly.¹⁷⁴

On 11 July 1995 the first CT II (88-0195) was delivered to the 1st SOS. Over the next three months, the remaining four aircraft arrived at Kadena AB and were accepted by the squadron. From 24 to 26 July, the sixth and final CT II

SATAF was held at Kadena AB. The previous SATAF in February had rated Kadena AB as unsatisfactory, but this rating was upgraded to marginal during the final meeting. Major areas of improvement included facilities planning, which was assessed as fully capable after completion of the radar facility in June 1995. Maintenance training remained at fully capable, as did manpower and personnel issues. The issues that drove the marginal rating were those over which the 353d had no control—the continued shortage of AN/APQ-170 radar and aircraft nose radome spares. The SATAF assessed that the 1st SOS should have no problem meeting its future milestones in bringing the weapons system on-line.¹⁷⁵

August saw a change of command for the 353d SOG. On 8 August Colonel Thigpen relinquished command to Colonel Beres, who became the fifth commander of the 353d SOG since it was activated as the 353d SOW on 6 April 1989. General Hobson officiated at the ceremony, which was held in the newly acquired Commando West hangar (formerly the Hush House). Beres was a highly experienced Combat Talon commander who had participated in both Desert One and in Desert Shield/Desert Storm. He had followed Thigpen as the commander of the 8th SOS in 1990 and had spent a tour assigned to the Joint Staff, J-3 Directorate, the Pentagon, before coming to the 353d.¹⁷⁶

With the death of Kim Il Sung, Beres’s immediate concern focused on the Korean peninsula and on improving the group’s ability to support special operations there if open hostilities resumed. During Thigpen’s time as group commander, much of the organization’s energy had been spent on acquiring facilities and modifying them to meet the group’s needs, but for Beres, Korea would be his central issue. CINCPAC’s Cooperative Engagement strategy was also viewed by Beres as a key operational commitment. For the group to continue to succeed, Beres had to continue to support Cooperative Engagement, but he also had to increase the group’s commitment to Korea. During the latter half of 1995, Beres sought to establish Taegu AB, Korea, as a periodic SOF training base for US Army Special Forces and for assigned group assets. The plan included deploying one to two aircraft, with associated support personnel, for two to three days a week. The 1st Battalion, 1st Special Forces Group, based at Tori Station, Okinawa, was the primary Army unit included in the

*The renovations to building 3306 were completed on 24 June 1995, and the building was available before the arrival of the first permanently assigned CT II. A huge amount of work was required by both Headquarters AFSOC/CE and the PACAF/CE staff to quickly get the building on-line. Without the facility the CT II radar could not have been bench tested, and the sophisticated aircraft could not have been maintained in a mission ready status.

concept. The group planned to begin exercising at Taegu AB under the JCET program, with deployments to Korea identified as Gryphon Knife in early 1996.¹⁷⁷

For the first time since World War II, the USAF participated in a military-to-military exercise with the Indian Air Force in India under the JCET program. Teak Iroquois 95-4, a stand-alone JCET conducted at Agra Air Station, India, was not related to any other exercise that the 353d SOG had previously flown. Teak Iroquois 95-4 included 40 members of the 353d SOG and one aircraft from the 17th SOS (the 1st SOS was in transition to the new CT II and could not participate). The first-time event was another example of how the 353d SOG supported the CINC's Cooperative Engagement strategy with expanded deployments in the Pacific region.¹⁷⁸

After the arrival of the first CT II in July, the 1st SOS received its additional aircraft in the August to October time frame. On 16 August aircraft 88-0264 was delivered, followed by aircraft 88-1803 on 25 September. The last CT IIs were delivered on 11 October (88-0191) and 15 October (88-0192). As the new aircraft came on-line, the remaining CT Is were returned to the United States. Aircraft 64-1843 had been previously reassigned from the 1st SOS in December 1994, and on 1 August 1995, aircraft 64-0565 was transferred to Duke Field. The last two CT Is (64-0571 and 64-0572) departed Kadena AB on 2 October 1995 in conjunction with the 1st SOS change of command ceremony. Aircraft 63-7785 was at LAS Ontario undergoing modification and was transferred directly to the 919th SOW when its PDM was completed.¹⁷⁹

Colonel Barwick assumed command of the 1st SOS from Williamson on 2 October. At the conclusion of the ceremony, Williamson boarded an awaiting CT I and led the two-ship formation back to the United States. The last two CT Is were subsequently transferred to the 919th SOW at Duke Field. Williamson returned to Kadena AB as the 353d SOG assistant deputy commander.¹⁸⁰

In November the group deployed to Korea for the annual Foal Eagle exercise. For the 1st SOS it marked the first major deployment of its new CT II aircraft. Throughout the 30-day exercise, the group maintained a 99 percent mission effectiveness rate, the best ever for any Foal Eagle. The Combat Talon IIs performed near flawlessly, accomplishing every mission tasked to them.¹⁸¹ By year's end the entire group was back at Kadena

AB, and the 1st SOS was settling in with its new weapons system.

The 7th SOS Moves to RAF Mildenhall

In Europe the 7th SOS was the first 352d SOG unit to move from RAF Alconbury to RAF Mildenhall. On 12 January 1995 squadron members ran the unit's guideon overland to the new beddown location. The Combat Talon IIs were flown over later that day by aircrew personnel. Five days later the 352d SOG Headquarters' staff moved, and by 1 April the entire group had relocated to RAF Mildenhall. To help facilitate the 67th SOS move, the 8th SOS deployed from Hurlburt Field to Brindisi from 15 February to 15 April with its Combat Talon I aircraft, thus releasing the tanker unit to return to home station and complete its move. The whole process proved to be easier than the one two years earlier. Colonel Connelly, who had taken command of the group from Orrell, immediately set about to integrate group activities into those of the 100th Air Refueling Wing (ARW), which was the host wing at RAF Mildenhall. In a short period Connelly had made great strides in achieving his goal. The biggest impact on morale for 352d SOG personnel was the lack of housing. There was not enough military family housing on base or economy housing off-base to satisfy group needs. Many families remained at RAF Alconbury, and the military members commuted the hour each way to RAF Mildenhall. Another problem that delayed some of the unit's relocation was the lack of facilities. The 21st SOS was especially affected when a new hangar was not completed in time for its move. Most of the other problems were associated with normal growing pains as the group settled into life at RAF Mildenhall.¹⁸²

The first major deployment for the 7th SOS during 1995 was to the Middle East for Exercise Noble Rose. Two 7th SOS MC-130H Combat Talon IIs and two HC-130P/N Combat Shadows from the 67th SOS supported US Army Special Forces and US Navy SEAL forces from 15 March to 4 April. The objective of the exercise was to recover personnel and equipment that had notionally fallen into the hands of forces unfriendly to the United States. Training rehearsals were conducted during the first portion of Noble Rose. For the exercise itself 7th SOS crews flew special forces personnel to a forward staging base (FSB), where they were transloaded to US Army MH-47Es and then transported on to the target area. While the helicopters were en route to the target

area, the SEALs were infiltrated over land by US Army MH-60s that were refueled by the Combat Shadow tandems. Simultaneous attacks on the target area resulted in the successful recovery of exercise personnel and the equipment they carried. The special forces soldiers and the freed hostages were exfiltrated by way of the MH-47Es and flown back to the FSB, while the SEALs conducted an egress by sea. At the FSB all personnel were transloaded on to the waiting Combat Talons for movement to the intermediate staging base. The operation went smoothly, with all exercise objectives met. The 352d SOG assets redeployed to RAF Mildenhall at exercise termination, and the other forces returned to the United States.¹⁸³

After returning to the United Kingdom, the majority of the 7th SOS was once again at home station. For the next month local training sorties were emphasized. On 31 May 1995 two MC-130Hs, along with a large contingent of 352d SOG assets from the 21st SOS, the 67th SOS, and the 321st STS, deployed to Thessalonica AB, Greece, for Exercise Alpine Festung. Pre-exercise operations included low-level route surveys and airdrops in support of US Army and Greek Army requirements. As the exercise progressed, sorties included aerial refueling, HALO paradrops, resupply drops, CRRC drops, infiltrations, extractions, and transload operations. The excellent low-level routes provided outstanding training, and the many additional events proved to be invaluable in improving aircrew proficiency. On 12 June the majority of 352d SOG forces redeployed to home station after two weeks of challenging training in the mountains of Greece.¹⁸⁴

On 1 July 1995 Colonel Helm assumed command of the 7th SOS from Scott. For the remainder of the summer until early fall, the squadron supported the group's JCET program and continued to fly local training sorties in the Scottish Highlands low-level area. Members of the squadron also participated in training conferences, attended academic and flight upgrade courses, and hosted instructors from the 550th SOS. The 550th visit allowed its Combat Talon II instructors to fly with operational crews of the 7th SOS and to gain valuable European theater experience that they could use to better train new crew members.¹⁸⁵

From 13 to 25 September, two 7th SOS Combat Talon IIs deployed to Hunter AAF in Savannah, Georgia, for Exercise Knotted Whip. This marked a continuing commitment by the squadron to participate in the large quarterly stateside exercises. During the deployment crews flew assault

landings, airdrops, resupply drops, infiltration, exfiltration, SAR, and casualty evacuation missions. The aircrews also practiced forward area rearming and refueling operations and low-level terrain-following flights. The training was outstanding, and the deployed personnel were able to refine skills that could not be practiced in the more restrictive European environment.¹⁸⁶ This deployment marked the last major commitment for the 7th SOS before the situation in the Balkan's required 7th SOS support.

Base Realignment and Closure Commission Recommends Realignment of Kirtland AFB

On 28 February 1995 members of the 58th SOW were surprised by the announcement of the proposed realignment of Kirtland AFB. The Defense Department's BRAC commission made the recommendation, which included moving the 58th SOW to Holloman AFB, New Mexico. If approved the realignment would close most facilities at Kirtland AFB except for the Sandia and Phillips Laboratories, the Department of Energy facilities, and a munitions squadron. The Air Force projected the cost of realignment to be \$277.5 million, with a savings of \$464.5 million over a 20-year period.¹⁸⁷

Shortly after the BRAC commission's announcement, the 58th SOW began compiling the moving costs, facilities, and requirements needed to set up operations at Holloman AFB. From 13 to 17 March 1995, a team of 16 members from AETC visited the 58th SOW to conduct a site survey of the wing's space requirements. On 20 March an 11-member 58th SOW team visited Holloman AFB to make a quick assessment of the base's facilities. From 3 to 7 April the wing sent a six-person survey team to Holloman AFB to analyze the facilities available as opposed to the established 58th SOW requirements. The objective was to calculate the costs to bring Holloman AFB up to a level that could adequately support the special operations wing. From the site visit, team members estimated that construction costs alone could run as high as \$226 million. There were also huge hidden costs for environmental assessments for new low-level routes, helicopter and C-130 DZs, and pararescue training areas. The survey team estimated the total cost of moving to Holloman AFB to be about \$231 million.¹⁸⁸

It became increasingly clear to the 58th SOW that huge construction costs at Holloman AFB were making it a nonsupportable option. Air Staff had already notified the wing to keep construction

costs at Holloman AFB under \$110 million or to select an alternate site at Beale AFB, California. By 4 May plans were being made by AETC to conduct a site survey at both Beale and Hill AFBs. Site surveys were conducted at the two bases by teams from AETC, Air Combat Command, AFSOC, and the 58th SOW from 7 through 13 May. The 58th SOW team estimated the cost of moving to Beale or Hill AFBs to be about \$149.8 million and \$114.43 million, respectively. After reviewing both bases the wing considered Beale AFB its first choice for relocation because its facilities were centrally located on the flight line and were designed for operational and maintenance functions. They were built in the 1960s, making them much newer than Hill AFB's World War II-vintage buildings.¹⁸⁹

On 9 June 1995 Defense Secretary William Perry, in a letter to the BRAC commission chairman, stated that the realignment of Kirtland AFB no longer represented a financially or operationally sound scenario. Secretary of the Air Force Sheila Widnall and other top Air Force officials testified at the BRAC commission hearing on 14 June 1995 that they no longer supported the Kirtland AFB realignment because it would not be cost-effective. On 22 June the commission voted unanimously to drop Kirtland AFB from its list of bases. The decision came as a relief to the 58th SOW. The special operations wing wanted to remain at Kirtland AFB, and the decision was met with approval by its senior leadership.¹⁹⁰

Throughout the entire BRAC commission process, Combat Talon II operations at Kirtland AFB continued unabated. Along with training new CT II crews, the 550th SOS supported other operational requirements. An MC-130H Combat Talon II from the 550th SOS participated in experimental airdrops at Yuma Proving Grounds at Yuma, Arizona, from 13 to 17 March 1995. The 10-member crew tested two experimental air-drop systems for the Department of the Army—the Early Entry and Lethality Battle Laboratories—and on behalf of the USAF Air Mobility Warfare Center. The test resulted in two world records being set—one for the heaviest payload suspended by a parafoil (27,000 pounds) and a second for the largest parafoil dropped (7,200 square feet). The USAF Air Mobility Warfare Center requested the 58th SOW perform the tests due to the wing's highly experienced MC-130H instructor force and the need to guarantee mission success.¹⁹¹

With the BRAC commission's decision to drop Kirtland AFB from its realignment list, the 58th

SOW continued with its facilities program to support the CT II. The original simulator building constructed in 1992 was being used by existing flight simulators assigned to the wing, and there was no room for the CT II WST. In August 1995 construction began on a new simulator facility and an academic training facility, at a cost of \$9.6 million. When finished the simulator facility would house the CT II WST, the C-130 Air Refueling Part Task Trainer, the HC-130 WST, the HH-60G Operational Flight Trainer, the MH-53J Part Task Trainer, and the UH-1N Operational Flight Trainer.¹⁹² Loral Defense Systems was scheduled to ship the CT II WST to Kirtland AFB in late October 1995, but without a suitable facility to house the complex system, the date had to be slipped. Loral was also having problems during its final phase of testing the WST. Consequently, the delivery date of the WST was slipped to 1996. The WST problems experienced by Loral were primarily related to the contractor's effort to integrate off-the-shelf systems to keep the costs within budget. More specifically, technicians were having trouble resolving software glitches that prevented subsystems from working together. To compensate for the late arrival of the WST, Headquarters AFSOC agreed to keep four fully operational CT II aircraft at Kirtland AFB at all times, with the fourth aircraft being employed as a CT II Part Task Trainer.¹⁹³ As 1995 ended, the long-awaited arrival of the CT II WST was still months away.

The 7th SOS and Operation Joint Endeavor

In early 1993 allied leaders decided to send aid to the people of Bosnia-Herzegovina because of the suffering of the civilian population brought on by the continuing civil war. The first unit to deploy from the 352d SOG was the 7th SOS, which established an operating location at Rhein Main AB, Germany. Political concerns prevented the squadron from flying low-level resupply missions into Bosnia-Herzegovina, and the squadron eventually redeployed to RAF Alconbury a few weeks later. Members of the 352d SOG and the 7th SOS did make, however, a significant contribution to the operation when they developed the TRIADS for the delivery of MREs to the starving civilians. The TRIADS became the primary delivery method for the allied resupply effort and was considered a resounding success. When the 7th SOS deployed to Germany, additional 352d SOG assets deployed to Brindisi, and they remained there

supporting Bosnia-Herzegovina relief efforts and providing a SAR capability.¹⁹⁴

Throughout 1994 and 1995 the 7th SOS supported the group's JCET program and rarely deployed to Brindisi. On 21 November 1995 a peace agreement was signed by the warring factors at Wright-Patterson AFB, Ohio, that was known as the Dayton Peace Accords. Following announcement of the agreement, on 2 December 1995, the JCS issued an execute order which committed SOF and conventional forces to Operation Joint Endeavor.¹⁹⁵ The 352d SOG was tasked to support the Special Operations Command Implementation Forces (SOCIFOR), which was made up primarily of members from SOCEUR, the group's theater SOC headquarters.

With the commencement of Operation Joint Endeavor, the mission of the 352d SOG expanded significantly over Operation Provide Promise. From a mission primarily centered on SAR alert, the group transitioned to providing the primary source of air support for SOCIFOR movements into Bosnia-Herzegovina. The severe flying weather in the Balkans during the winter months made the Combat Talon weapons system the ideal choice by planners to support the expanded SOCIFOR mission.¹⁹⁶

On 4 December 1995, after receiving a deployment order from SOCEUR, two 7th SOS Combat Talon IIs departed RAF Mildenhall for Stuttgart, Germany, to onload the SOCEUR ADVON party and to proceed forward to Brindisi. The SOCEUR ADVON was the initial element that would form SOCIFOR. After downloading personnel and equipment, including a small 7th SOS ADVON party, the two aircraft returned to RAF Mildenhall. On 5 December the next CT II mission was flown utilizing the same mission profile as the one on 2 December. Three days later, two more CT II missions were flown that moved the remainder of SOCEUR's equipment and personnel to Italy. On 9 December the last deployment supporting SOCEUR requirements was flown.¹⁹⁷

After a down day on 10 December, the squadron deployed two MC-130H aircraft to Brindisi on 11 December. A third Combat Talon was positioned there on 12 December. A local orientation flight was completed on 13 December by one MC-130H, with crew members from each of the deploying hard crews receiving valuable exposure to local operating procedures. On 14 December two MC-130H Combat Talon IIs assumed alert duties and were prepared to launch as required in support of SOCIFOR tasking. Flying into Bosnia-

Herzegovina during the winter was extremely hazardous, with ground navigational equipment marginally operational due to the prolonged civil war. The mountainous terrain posed a huge threat to the safe operation of the aircraft. Unique systems aboard the Combat Talon allowed its crews to complete missions that could not be done by any other asset. The ability to fly self-contained instrument approaches to near zero-to-zero conditions was utilized by the crews to safely find the runway and land. To fly under such extreme conditions required exceptional crew coordination, and hard crews were deployed from home station to ensure that the coordination process was optimized. The 7th SOS had five hard crews that deployed to Brindisi for the operation. The five crews that supported SOCIFOR mission tasking during Operation Joint Endeavor were:¹⁹⁸

Crew 1 (Dawg Pound)	Crew 2 (Night Rider)	Crew 3 (Dominator)	Crew 4 (Merlin's Magic)	Crew 5 (Hacker Baby)
Walker	Corallo	Lockhart	Joss	Willard
Powell	Scoggins	White	Saunders	Pannell
Chinlund	Wessberg	Nielsen	Freeman	McMullen
Partain	Koury	Ramsey	Snippen	Butter
Brown	Tremblay	Soja	Linnevers	Biggs
Filer	Gray	Grimes	Lewis	Smith
Garret	Carson	Casey	Jones	Higgins
Jones			Overman	
Metheny			Simmons	
Colpitts			Welch	
Cunningham			Moon	
			Thorpe	

Notes: Floaters not assigned to a crew included Helm, Kisner, Michenfelder, Burford, Blackington, Horton, and Baker.

Every crew member assigned to the 7th SOS flew missions in support of Operation Joint Endeavor, thus gaining valuable contingency experience in Bosnia-Herzegovina.

The first Combat Talon mission supporting Operation Joint Endeavor was flown from Brindisi to Sarajevo by an 8th SOS crew in a Combat Talon I aircraft on 15 December 1995 (fig. 49). Later in the day, two 7th SOS MC-130H Combat Talon IIs delivered SOCIFOR personnel to the same location. The next day two additional missions were tasked to the 7th SOS, with the first one including pickup of personnel at Aviano AB, Italy, and delivering them to Sarajevo. The second mission included two sorties from Aviano AB to Sarajevo. The first sortie of the second mission went as planned, but the second sortie was unable to land due to zero visibility from fog and blowing snow at Sarajevo. Severe weather conditions that even the Combat Talons could not overcome continued to plague the operation on 17 December, with one



Figure 49. 7th SOS Operating Locations in the Balkans (Source: AU Library, Maps and Charts Division, Maxwell AFB, Ala.)

sortie scheduled for Tuzla diverting to Sarajevo. A second mission on 17 December, which was also scheduled for Tuzla, diverted to Zagreb. By the next day (18 December 1995), weather had improved enough to allow three Combat Talon IIs to complete two sorties into Sarajevo and two into Tuzla. On 19 December the squadron again launched all three of its deployed aircraft, with two flying sorties into Sarajevo and one into Tuzla. The next two days were a repeat of the 19 December missions, with three aircraft flying missions into both Sarajevo and Tuzla. On 21 December the last SOCIFOR infiltration missions were completed into Bosnia-Herzegovina. On 22 December the last SOCIFOR resupply mission flown by the 7th SOS was completed, and the unit prepared to redeploy to RAF Mildenhall.¹⁹⁹

By late 23 December, all three Combat Talon IIs had returned to home station, but the squadron continued to maintain a two-aircraft alert in the event that SOCIFOR required additional support. During December, the 7th SOS flew 215.8

hours and 77 sorties supporting Operation Joint Endeavor. No aircraft losses or damages were incurred during the month-long operation, yet the threat from freedom fighters on the ground, and the severe weather restricting flight visibility, had posed a real threat to the safety of the crews.²⁰⁰ The training that the crews had received since converting to the CT II had paid off. As 1995 ended the 7th SOS members were again home with their families for the holiday season.

* * * * *

The first half of the decade of the nineties proved to be one of change and reorganization. By the close of 1995, the 1st SOW had been reorganized and redesignated as the 16th SOW, and the 39th and 353d SOWs had been redesignated as wing-like groups. The 39th SOW had also been renamed the 352d SOG. Two operational Talon units had converted to the Combat Talon II (1st SOS and 7th SOS), and the 15th SOS had been activated for the first time since the Vietnam

War. A training squadron had been established at Kirtland AFB (550th SOS) that was responsible for the formal Combat Talon II School. The 711th had converted to Combat Talon Is at Duke Field, and eight Combat Talon Is had been assigned to the AF Reserve unit. As 1996 approached AFSOC had completed the major reorganization and bas-

ing challenge brought on by the eruption of Mount Pinatubo, objective wing directives, and relocation actions required in Europe after the end of the cold war. The latter half of the decade of the 1990s promised more stability as Air Force SOF prepared for the Commando Vision-22 and the twenty-first century.

Notes

1. History, 353d Special Operations Wing, 1 January–30 June 1991, vol. 1, 353d SOG historian file, Kadena AB, Japan, vi.
2. *Ibid.*, 5-3.1.
3. *Ibid.*, iv.
4. Edward W. Wolfe, *REPORT: The 1991 Eruptions of Mount Pinatubo, Philippines*; on-line, Internet, n.d., available: http://vulcan.wr.usgs.gov/Volcanoes/Pinatubo/Publications/Wolfe/wolfe_report.html, 1–2.
5. *Ibid.*, 3.
6. *Ibid.*, 2.
7. *Ibid.*, 4.
8. Terry Mallon, “If They Sacrificed Pigs, This Might Not Have Happened . . .,” Combat Talon Archive, HQ AFSOC/HO, Hurlburt Field, Fla., 3.
9. *Ibid.*
10. *Ibid.*, 3–4.
11. *Ibid.*, 4.
12. *Ibid.*, 5.
13. *Ibid.*
14. Wolfe, 4–5.
15. *Ibid.*, 5.
16. Mallon, 6.
17. Wolfe, 5.
18. Mallon, 6–7.
19. *Ibid.*, 7.
20. Maj Forrest L. Marion, “Ash Warriors: The Relocation of the 353d Special Operations Wing, June–December 1991,” HQ AFSOC/HO, Hurlburt Field, Fla.
21. *Ibid.*
22. Mallon, 9.
23. Marion.
24. *Ibid.*
25. History, 353d Special Operations Wing, 1 July–31 December 1991, vol. 1, 1st SOS History.
26. *Ibid.*
27. *Ibid.*
28. *Ibid.*
29. *Ibid.*
30. History, 353d Special Operations Group, 1 January–31 December 1992, vol. 1.
31. History, 39th Special Operations Wing, 1 July–31 December 1991, HQ AFSOC/HO, Hurlburt Field, Fla., vol. 1, xiii.
32. *Ibid.*, 27.
33. *Ibid.*, 40.
34. *Ibid.*, 40–41.
35. *Ibid.*, 41.
36. *Ibid.*, 43.
37. History, 1st Special Operations Wing, 1 January–31 December 1991, 16th Special Operations Wing historian file, Hurlburt Field, Fla., vol. 1, 63.
38. *Ibid.*
39. *Ibid.*, 77.
40. *Ibid.*, 76.
41. *Ibid.*, 62.
42. History, 1st Special Operations Wing, 1 January–31 December 1992, vol. 4, supporting document 79.
43. History, 1st Special Operations Wing, 1 January–31 December 1992, vol. 1, 9.
44. *Ibid.*, 14.
45. *Ibid.*, 14–19.
46. *Ibid.*, 19–21.
47. *Ibid.*, 21.
48. *Ibid.*, 24–29.
49. *Ibid.*, 33.
50. *Ibid.*, 3.
51. *Ibid.*, 173.
52. History, 1st Special Operations Wing, 1 January–31 December 1992, vol. 2, supporting document 7.
53. *Ibid.*, supporting document 8.
54. *Ibid.*
55. *Ibid.*
56. *Ibid.*
57. History, 1st Special Operations Wing, 1 January–31 December 1992, vol. 4, supporting document 78.
58. *Ibid.*
59. History, 1st Special Operations Wing, 1 January–31 December 1992, vol. 1, 195.
60. History, 1550th Combat Crew Training Wing, 1 January–30 June 1990, USAF HRA, Maxwell AFB, Ala., vol. 1, 21.
61. History, 1550th Combat Crew Training Wing, 1 July–31 December 1990, USAF HRA, Maxwell AFB, Ala., 1 July–31 December 1990, vol. 1, 50.
62. History, 1550th Combat Crew Training Wing, 1 July–30 September 1991; and 542d Crew Training Wing, 1 October 1991–31 December 1992, USAF HRA, Maxwell AFB, Ala., vol. 1, 30.
63. History, 1550th Combat Crew Training Wing, 1 July–30 September 1991, vol. 2, 4–5.
64. *Ibid.*, xx.
65. *Ibid.*
66. *Ibid.*, xx–xxi.
67. History, 353d Special Operations Group, 1 January–31 December 1992, vol. 1, 19.
68. *Ibid.*, 30.
69. *Ibid.*, 19.
70. *Ibid.*, 30.
71. *Ibid.*, xii.
72. *Ibid.*, 41.
73. *Ibid.*, xiii.
74. History, 39th Special Operations Wing, 1 January–31 December 1992, vol. 1, xi.
75. *Ibid.*, 26.
76. *Ibid.*, 75–76.
77. *Ibid.*, 69–70.
78. *Ibid.*, 70–71.
79. *Ibid.*, 72.
80. *Ibid.*, 90–91.

81. *Ibid.*, xiv–xv.
82. *Ibid.*, xv.
83. *Ibid.*, 72–74.
84. History, 353d Special Operations Group, 1 January–30 June 1993, vol. 1, 68.
85. *Ibid.*, 69.
86. *Ibid.*, 60–61.
87. *Ibid.*, viii–x.
88. *Ibid.*, 7.
89. *Ibid.*, 9.
90. *Ibid.*, 56.
91. *Ibid.*, 4.
92. *Ibid.*, 64.
93. History, 353d Special Operations Group, 1 July–31 December 1993, vol. 1, 46.
94. *Ibid.*, 15–16.
95. *Ibid.*, 47–48.
96. History, 352d Special Operations Group, 1 December 1992–31 December 1993, vol. 1, xv, xviii.
97. *Ibid.*, 26.
98. *Ibid.*, 54.
99. *Ibid.*, 57.
100. *Ibid.*, 70–71.
101. *Ibid.*, 71.
102. *Ibid.*
103. *Ibid.*, xviii.
104. *Ibid.*, 97.
105. *Ibid.*, xix.
106. *Ibid.*, 101.
107. *Ibid.*, 112.
108. *Ibid.*, 101.
109. *Ibid.*, 101–2.
110. History, 1st Special Operations Wing, 1 January–30 June 1993, vol. 1, 14–15.
111. *Ibid.*, xvii–xviii.
112. History, 16th Special Operations Wing, 1 July–31 December 1993, 16th Special Operations Wing historian file, Hurlburt Field, Fla., vol. 1, 99.
113. History, 542d Crew Training Wing, 1 January–30 June 1993, vol. 1, 26–27.
114. *Ibid.*, 22–23.
115. *Ibid.*, 5.
116. History, 542d Crew Training Wing, 1 January–31 March 1994, vol. 1, 1–2.
117. History, 16th Special Operations Wing, 1 January–30 June 1994, vol. 1, 88–89.
118. *Ibid.*, xiii–xiv.
119. *Ibid.*, 1 July–31 December 1994, vol. 1, 37–38.
120. *Ibid.*, 40.
121. *Ibid.*, 1 January–31 December 1994, vol. 4, supporting document I-185.
122. *The United Nations and the Situation In Haiti (30 November 1994)*, on-line, Internet, n.d. available: <http://www.hartford-hwp.com/archives/43a/131.html>, 1.
123. *Ibid.*, 1–2.
124. *Ibid.*, 6–7.
125. *Ibid.*, 9.
126. Col Ken Poole, interview by author, 4 November 1999, no transcript available.
127. David G. White, “Mission to Haiti,” n.d., Combat Talon Archive, HQ AFSOC/HO, Hurlburt Field, Fla.
128. *Ibid.*
129. *Ibid.*
130. *Ibid.*
131. *Ibid.*
132. History, 16th Special Operations Wing, 1 July–31 December 1994, vol. 3, supporting document II-35.
133. Paul De La Garza, “United States Special Operations Command Public Affairs After Action Report, News Clippings Supplement, UPHOLD DEMOCRACY,” and “28 Cargo Planes, Crews Stand-by at MacDill AFB,” *St. Petersburg Times*, 20 September 1994, HQ AFSOC/HO, Hurlburt Field, Fla.
134. Poole interview.
135. History, 353d Special Operations Group, 1 January–3 June 1994, vol. 3, 11–12.
136. *Ibid.*, 22.
137. *Ibid.*, 32.
138. *Ibid.*, 59.
139. *Ibid.*, 60.
140. *Ibid.*, 2.
141. History, 353d Special Operations Group, 1 January–3 June 1994, vol. 1, Japan, 22.
142. *Ibid.*, x.
143. *Ibid.*, xiii.
144. *Ibid.*, 1 January–30 June 1994, HQ AFSOC/HO, Hurlburt Field, Fla., vol. 1, 89–90.
145. *Ibid.*, 75.
146. *Ibid.*, 28.
147. *Ibid.*, 66–69.
148. *Ibid.*, 1 July–31 December 1994, HQ AFSOC/HO, Hurlburt Field, Fla., vol. 1, 27–28.
149. *Ibid.*, 28.
150. *Ibid.*, 29.
151. *Ibid.*, 30–31.
152. *Ibid.*, 31–32.
153. *Ibid.*, 33–34.
154. *Ibid.*, 36.
155. History, 58th Special Operations Wing, 1 April–31 December 1994, USAF HRA, Maxwell AFB, Ala., vol. 1, 1.
156. *Ibid.*, 1–2.
157. *Ibid.*, 22.
158. *Ibid.*, vol. 2, supporting document 20.
159. *Ibid.*, vol. 2, 28–29.
160. *Ibid.*, 1 July–31 December 1994, vol. 1, 134.
161. *Ibid.*, 1 July–31 December 1995, vol. 1, xv–xvii.
162. *Ibid.*, 83–84.
163. *Ibid.*, 84.
164. *Ibid.*, 84–85.
165. *Ibid.*, 97.
166. *Ibid.*, 98.
167. History, 919th Special Operations Wing, 1 January–31 December 1995, HQ AFSOC/HO, Hurlburt Field, Fla., vol. 1, 20.
168. *Ibid.*, 21–22.
169. History, 353d Special Operations Group, 1 January–30 June 1995, vol. 1, 16–19.
170. *Ibid.*, 1 July–31 December 1994, vol. 1, 11–12.
171. *Ibid.*, 1 January–30 June 1995, vol. 1, 11–14.
172. *Ibid.*, 14.
173. *Ibid.*, 57–58.
174. *Ibid.*, 38.
175. History, 353d Special Operations Group, 1 July–31 December 1995, vol. 1, 67.
176. *Ibid.*, 21–22.
177. *Ibid.*, 51.
178. *Ibid.*, 37.
179. *Ibid.*, 70.
180. *Ibid.*, 23.
181. *Ibid.*, 44.
182. History, 352d Special Operations Group, 1 January–31 December 1995, vol. 1, 201.

PRAETORIAN STARSHIP

183. Ibid., 37–38.
184. Ibid., 39–40.
185. Ibid., 47.
186. Ibid., 44.
187. History, 58th Special Operations Wing, 1 January–30 June 1995, vol. 1, 1.
188. Ibid., 2–4.
189. Ibid., 4–5.
190. Ibid., 5.
191. Ibid., 25.
192. Ibid., 1 July–31 December 1995, vol. 1, 9.
193. Ibid., 22.
194. History, 352d Special Operations Group, 1 January–31 December 1995, vol. 1, 73.
195. Ibid., 75.
196. Ibid.
197. Briefing, subject: Joint Endeavor/Decisive Edge—7th SOS Operations in Support of SOCIFOR, 27 December 1995, Combat Talon Archive, HQ AFSOC/HO, Hurlburt Field, Fla.
198. Ibid.
199. Ibid.
200. Ibid.

Operation Assured Response to the New Millennium (1996–2000)

Wars may be fought with weapons, but they are won by men. It is the spirit of the men who follow and of the man who leads that gains the victory.

—George S. Patton

1996: Operations Other Than War

The operations tempo experienced in 1995 continued unabated throughout 1996. Beginning on 14 December 1995, Operation Joint Endeavor in Bosnia-Herzegovina consumed much of AFSOC's time. Special Operations Command Europe had been tasked by USEUCOM in February 1993 to establish a Joint Special Operations Task Force (identified as JSOTF2) at San Vito AS, Brindisi, Italy, and to provide CSAR, fire support, and air-drop capabilities for employment in the area formerly known as Yugoslavia. From the time of its establishment, AFSOC provided SOF air assets to support SOCEUR's mission. Throughout 1996 AFSOC personnel and aircraft from the 4th SOS (AC-130U), 8th SOS (MC-130E), 7th SOS and 15th SOS (MC-130H), 16th SOS (AC-130H), 20th SOS and 21st SOS (MH-53J), and associated maintenance squadrons continually deployed to San Vito AS and executed a variety of missions, from CSAR alert to air-drop/airland missions in Bosnia. Operation Joint Endeavor officially ended on 20 December 1996, with the Combat Talons of AFSOC playing a significant role during its execution.¹

The 7th SOS—Balkan Tasking and the JCET Program

Although the 7th SOS had returned to RAF Mildenhall and was no longer deployed to Brindisi, the squadron was tasked occasionally to support the Bosnia-Herzegovina operation. Tasking for the 7th SOS usually resulted from SOF-unique airlift requirements that could only be fulfilled by the MC-130H. On 8 January 1996, while two MC-130H Combat Talons were flying an approach into Sarajevo, numerous fires on the ground activated the Combat Talon IIs infrared detection system, thus automatically causing the ejection of flares from the aircraft. Once parked on the ramp, crew members could see tracers off the approach end of the runway. After unloading their supplies both aircraft departed, with one returning to Brindisi and the second flying on to Stuttgart,

Germany. During the through-flight inspection at Stuttgart, crew members discovered a one-inch hole in the right horizontal stabilizer that had been made by a 7.62 mm round. The aircraft had most likely received the hit during its approach to Sarajevo. No additional damage was found.²

The following month, on 20 February, SOCEUR alerted the 7th SOS of a possible deployment of one MC-130H to the Republic of Macedonia for a JCET from 13 to 14 March. The actual deployment occurred on 12/13 March and included members of the US Army's 10th SFG(A) and Macedonian army parachutists. The deployment was significant because it was the first JCET conducted in Macedonia, and it gave the 7th SOS crew a unique opportunity to gain experience in the area.³

Later in the month the squadron deployed one Combat Talon II to Norway for a long-range infiltration training mission into Greenland. Two Norwegian marine Jagers were infiltrated by parachute into Greenland on 29 March and began their attempt to break the world record for the fastest trans-Greenland crossing time without the aid of animals or motorized vehicles. Before the infiltration mission began, the deployed Talon crew flew low-level training flights in Norway and completed self-contained instrument approaches at their deployed location. To reduce the flight time to the air-drop location in Greenland, the Danish government allowed the crew to land at Narssarsuaq, Greenland, to clear customs. The crew returned to RAF Mildenhall after completion of the mission, and the Jagers achieved their world record goal on 22 June 1996.⁴ Meanwhile, in western Africa tension was building between rival factors, and as April began the largest commitment for Combat Talon in recent history began to unfold.

Operation Assured Response

Tension in the West African nation of Liberia reached the boiling point in April 1996. Factions there had been maneuvering for power for several years, and the crisis was brought on by the actions

of Charles Taylor, a representative on the six-member ruling council. On 3 April Taylor moved to have a fellow councilman and rival faction leader, Roosevelt Johnson, arrested and jailed. The action immediately plunged the country into civil war. Rival gangs roaming the streets of Monrovia threatened anyone caught outside, and the situation intensified during the first week of April. On 8 April the US ambassador to Liberia requested an emergency assessment team be sent to Monrovia to determine the threat to US personnel living there. The 352d SOG, which included the 7th SOS, received a deployment order from SOCEUR that same day. Within hours of the ambassador's request, USEUCOM forces and those assigned to the 16th SOW at Hurlburt Field were placed on alert.⁵

The 7th SOS initial tasking was vague, but it included a water insertion of an 18-man SEAL team off the coast of Liberia and the forward deployment of additional assets to Freetown, Sierra Leone. The SEAL team was to move over water to the US Embassy, which was located on the coast, and then join up with embassy security personnel to defend the embassy should it come under attack. Additional forces were to deploy to the area and stand by for a possible NEO. AFSOC forces identified by CJCS for the operation included five MH-53J helicopters from the 21st SOS, two MC-130Ps* from the 67th SOS, four MC-130Hs from the 7th SOS, two MC-130Es from the 8th SOS, and two AC-130Hs from the 16th SOS. Including non-SOF assets, the number of aircraft committed to the operation was 31. Planners quickly realized that the selected intermediate staging base of Freetown, could not support such a large contingency. Consequently, agreement was made with Senegal to base all fixed-wing aircraft at Dakar, with all rotary-wing aircraft being based at Freetown.⁶

Even before the deployment order was issued, MC-130Hs from the 7th SOS were positioning in anticipation of the start of the operation. Captain Willard's augmented crew was deployed to Brindisi, in support of recovery operations for Secretary of Commerce Ron Brown and his party.** The crew had flown a 30-hour crew day just prior to completing its tasking in Dubrovnik. On 7 April Willard was tasked by General Canavan, commander, SOCEUR, to move his staff from Dubrovnik to Stuttgart, Germany. Willard's in-

structions were to land at Stuttgart, off-load the SOCEUR commander and his staff, and then stand by for further instructions. After landing, as the Combat Talon taxied to parking, the crew observed a second Talon in the process of loading while parked in the ramp area. The second aircraft was commanded by Captain Walker, and it had arrived from RAF Mildenhall to onload the SEAL team for the initial insertion into Liberia. The airborne mission commander and squadron commander of the 7th SOS, Colonel Helms, was one of the crew members on Walker's Talon. Helms directed Willard to put his crew in crew rest and be prepared for additional tasking. Emerging SOCEUR transportation requirements, however, created the need for a second Talon to proceed on to Liberia, so Willard's crew quick turned its aircraft and prepared to move forward with Walker's Talon. After filing flight plans and loading personnel and equipment, the two Talon IIs departed Germany at 2206Z and 2236Z, respectively, on 7 April. Operation Assured Response was under way.⁷ Willard and his crew faced another 30-hour duty day.

The route of flight took the two aircraft out over the Atlantic to a point off the coast of Portugal, where the first of two IFRs was completed. A second refueling was accomplished near the Canary Islands. During the long flight Captain Walker, in the lead Talon, received a cancellation order for the SEAL insertion and was directed to airland the team instead at Freetown. The decision to cancel the drop came after the situation in Monrovia somewhat stabilized. Political leaders in the United States also became concerned over the perception that the drop might create in the minds of the American public. The cancellation of the drop allowed the second aircraft, commanded by Captain Willard, to land first in Freetown. Willard landed at 1018Z, followed at 1026Z by Walker and his Combat Talon crew (fig. 50).⁸

Fifteen hours after official notification of tasking, the first USAF C-5 Galaxy, with two MH-53Js on board, was airborne and headed for Freetown. On 9 April the 7th SOS deployed a third Combat Talon II from RAF Mildenhall to Dakar under the command of Captain Corallo, and he refueled en route from a KC-135 tanker flown by the 100th ARW. On 10 April the CJCS issued its execution order for Operation Assured Response, which included associated military operations in

*AFSOC HC-130P/N aircraft were redesignated MC-130P to denote their special operations as rescue status.

**Secretary Ron Brown and his official party were killed, along with the Air Force crew, when his airplane crashed while on approach to Dubrovnik.

support of a noncombatant evacuation operation. A fourth 7th SOS aircraft landed at Dakar two days later. Two 8th SOS MC-130Es arrived at Dakar on 13 April and prepared to support helicopter refueling operations in conjunction with the MC-130Ps of the 67th SOS.⁹

After their arrival at Freetown, the first two 7th SOS Talon II crews entered crew rest in anticipation of follow-on tasking. On 8 April Captain Walker's crew was tasked to fly to Dakar and onload a special tactics team and return it to Freetown. The team was then tasked to look for possible FARP sites that the helicopters could use after they completed their transload operation. The US Embassy in Monrovia had estimated that as many as 15,000 personnel could require NEO support, and the FARP location would be critical in rapidly refueling and turning the helicopters after landing. The second Talon, commanded by Willard, departed Freetown and conducted an aerial reconnaissance of a site near the Sierra Leone/Liberian border and then proceeded to Roberts Airfield, which was located south of Monrovia. Willard's mission was to identify possible alternate NEO locations in the event the embassy location became overwhelmed with refugees. For the flyover at Roberts Airfield, the crew lowered the cargo ramp, and a combat controller positioned himself on one side and one of the crew loadmasters positioned himself on the other. As the aircraft flew down the runway, the two took pictures of the runway and taxiway areas. Willard was concerned with possible SA-7

missiles that had been reported in the area, but as the crew made the low pass, they observed people coming out of buildings on to the airfield and waving in a friendly manner. The crew completed the mission and returned to Freetown after 2.3 hours of flight time. When Willard landed at Freetown, the first MH-53J was completing its FCF and SOCEUR personnel were preparing for the first NEO flight into the embassy compound.¹⁰

After completing the MH-53J FCF, Major Webb and his crew from the 21st SOS unloaded the SEAL team, additional US Army Special Forces personnel, and USAF combat controllers for transport to Monrovia. The hot and heavy conditions resulted in a sluggish performance by the MH-53J, but Webb lifted off without incident and flew a direct route to the embassy landing area. The aircraft approached the capital city over water approximately 10 miles off the coast. The helicopter then turned towards the embassy and descended to 50 feet above the water. The reception party on the LZ, made up of US Marines assigned to the embassy, popped green smoke as the helicopter approached the landing area. The LZ was approximately 50 feet above the water, thus the helicopter's approach was shielded by buildings and trees along the shore. Webb landed in the LZ, but quickly determined that it was too restricted for safe operations. As the SEALs departed the aircraft, he asked them to coordinate removal of several light poles, tall trees, and large flower baskets located near the touchdown point. With those obstacles removed, Webb felt that the

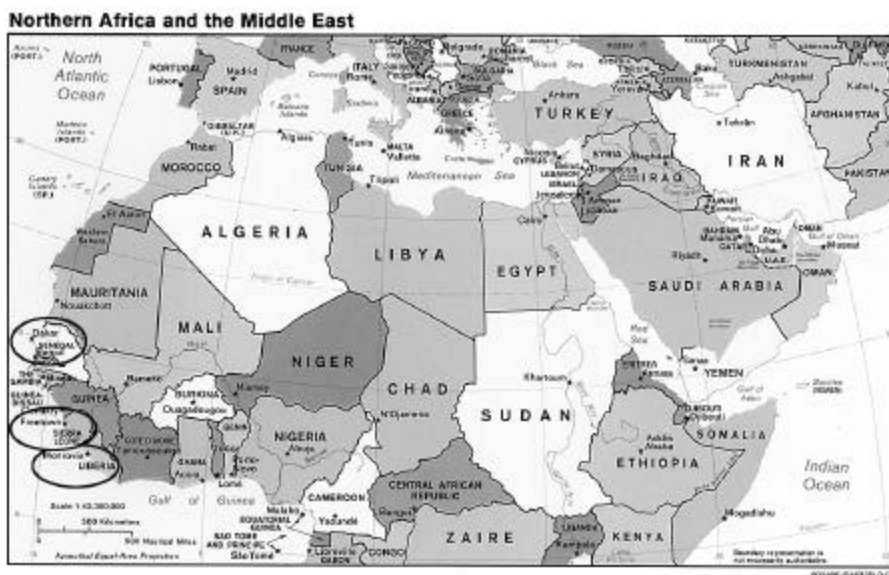


Figure 50. Operation Assured Response Objective Areas (Source: AU Library, Maps and Charts Division, Maxwell AFB, Ala.)

LZ was suitable for continued operations. As soon as all personnel off-loaded, the first contingent of evacuees was led to the aircraft and loaded aboard. In less than 10 minutes, Webb was back in the air and headed north to Freetown with the first of what would be a large NEO. At Freetown Webb landed, and the evacuees departed the helicopter with engines running. Webb taxied to the FARP site, refueled, and then unloaded General Canavan and additional personnel for a return flight to Monrovia. Willard unloaded the first evacuees on to his Talon and took off for Dakar, where the evacuees were met by other personnel responsible for their safety. Willard returned to Freetown and unloaded the second set of evacuees flown out of Monrovia on the second MH-53J flight.¹¹

The NEO continued through 11 April, with aircrews operating on extended 18-hour crew days to maximize available assets. During one approach to the embassy LZ, Colonel Dryer's MH-53J crew observed two splashes in the water near his aircraft. The splashes were later confirmed as RPGs that had been aimed at Dryer's Pave Low. General Canavan subsequently suspended the NEO to allow the fighting around the embassy to subside. The incident led Colonel Connelly, the JSOAC commander and commander of the 352d SOG, to request a mission to flush out the party responsible for the attack. By this time four MH-53Js were operational at Freetown after two 20th SOS helicopters arrived from Hurlburt Field, Florida. With General Canavan's approval, a four-ship MH-53J package launched and proceeded to Monrovia. Flying 15 minutes in trail, the aircraft flew a circular pattern around the embassy, but encountered no resistance. With fuel running low, the aircraft returned to Freetown. After an additional delay of

several hours, General Canavan made the decision to resume the NEO.¹² He reasoned that the RPG firing was an isolated incident and not part of a campaign to prevent his forces from completing the operation.

Evacuation flights increased at a rapid rate. Over the next two days (12–13 April), crews evacuated 1,070 men, women, and children from Monrovia and flew 276 hours. As the 8th SOS and 67th SOS arrived and began operations, a helicopter air-refueling anchor was established off the coast of Liberia that gave the MH-53Js the capability of refueling in flight and foregoing the ground refueling operation. Thus, the aircraft's turn-around ground time at Freetown was greatly reduced. Crews from the 7th SOS and other conventional Air Force units continued to transload evacuees and transport them from Freetown to Dakar for onward movement.¹³ By the evening of 13 April, personnel desiring evacuation stabilized at a greatly reduced rate, and General Canavan directed that the US effort shift from one of evacuation to sustainment. Special forces and SEAL personnel were replaced by conventional soldiers, who assumed the security role for the embassy. Support flights continued through 17 April, when there were virtually no personnel remaining in Monrovia desiring evacuation.¹⁴

On 17 April USEUCOM released the four MH-53Js and the US Army Special Forces and US Navy SEAL team personnel. A Marine Expeditionary Unit was tasked by USEUCOM to take over the operation and was scheduled to arrive in the area by 20 April. The Combat Talons, AC-130H gunships, and KC-135 tankers remained committed to Operation Assured Response until the Marine Expeditionary Unit was in place and operational. The four 7th SOS Combat Talon IIs were released on 21 April and returned to RAF Mildenhall over the next two days. The two Combat Talon Is of the 8th SOS were released on 22 April and began their return trip to Hurlburt Field. The 7th SOS CT IIs flew 173.3 hours, while the 8th SOS Talon Is flew 67.4. During the course of the eight-day evacuation operation, 2,122 personnel were airlifted out of Monrovia, including 436 American citizens. Fifty-five rotary-wing evacuation sorties were flown from Monrovia to Freetown, with 35 fixed-wing sorties flown from Freetown to Dakar. By 2 May 1996 the last support aircraft had departed Sierra Leone, and Operation Assured Response was terminated. Combat Talons participating in the operation included 8th SOS MC-130E aircraft 64-0551 and 64-0568



USAF Photo

Evacuees prepare to board an MH-53J flown by a 21st SOS crew at the US Embassy in Monrovia, Liberia. Note the downed trees to the left of the landing zone.



USAF Photo

A 7th Special Operations Squadron crew departs Dakar, Senegal, for another transload operation at Freetown, Sierra Leone.

and 7th SOS MC-130H aircraft 84-0476, 87-0023, 88-0193, and 88-0194.¹⁵ The operation once again demonstrated the flexibility of SOFs to react to a developing crisis, deploy halfway around the world, and then accomplish the tasked mission within a short period. Operation Assured Response was a resounding success.

As the 7th SOS settled back into the local routine at RAF Mildenhall, the 352d SOG JCET program again took center stage. Throughout the summer and fall of 1996, the squadron deployed to France, Greece, Italy, Norway, and Tunisia while completing nine JCETs. Scenarios ranged from unilateral infiltration missions to complex, multiple events that included low-level operations, airborne intercepts, and airland events. Squadron members used the deployments to gain valuable experience in operating away from home station, working with foreign forces, and observing different cultures throughout Europe and Africa. Another benefit of the JCET program was that it allowed the squadron to deploy to southern locations where more nighttime hours were available in the summer and fall than were available in Central Europe and points north. Flight restrictions and limitations on night operations were generally less restrictive than in the United Kingdom.¹⁶

In early September JSOTF2 at Brindisi received an initial notification of pending tasking to support a presidential delegation (PRESDEL) into Bosnia-Herzegovina during the upcoming national elections in that country. On 8 September SOCEUR issued an operations order to JSOTF2 that included tasking for two 7th SOS Combat Talon II aircraft. Planning began both at RAF Mildenhall and at Brindisi, and by 9 September forces were identified, and a rehearsal



USAF Photo

Evacuees of many nationalities await loading on an MC-130H at Freetown, Sierra Leone, before their movement on to Dakar, Senegal.

plan was developed. MH-53J crews flew site surveys throughout the Sarajevo area, and on 11 September they were joined by the two 7th SOS aircraft. Emphasis was placed on flying actual routes to the various locations that the PRESDEL needed to visit, then flying the published approaches to landings. Crews made multiple instrument and self-contained approaches to become thoroughly familiar with each location. All PRESDEL support aircraft stood down on 13 September in preparation for the actual mission the following day. On 14 September the MH-53Js and the two MC-130Hs flew to Sarajevo and on-loaded members of the PRESDEL. The 7th SOS crews took members of the delegation to Banja Luka and to Mostar, while the 21st SOS helicopters traveled to Tuzla with their passengers. After the Combat Talon off-loaded its PRESDEL at Banja Luka, it flew on to Mostar and joined up with the other CT II aircraft to await the extraction call. Once the PRESDEL personnel completed their mission, the Talons and the MH-53Js transported them back to Sarajevo. During the course of the workup and execution of the mission, crews flew 46 sorties and logged 95.5 hours of flying time. On 15 September, the day after completion of the mission, the two Combat

Talons returned to home station, and the MH-53Js resumed their SAR alert at Brindisi.¹⁷

From 3 to 15 November, elements of all three 352d SOG-assigned squadrons deployed to San Javier AB, Spain, for Exercise Popex 96. This marked the first time that all three squadrons had deployed together since Exercise Noble Rose in 1994. The exercise consisted of supporting Spanish special forces utilizing a variety of insertion methods for personnel, cargo, and equipment, and both day and night tactical scenarios. At the peak of the exercise, 128 members from the group deployed to Spain, and assets included three 7th SOS CT IIs, one 67th SOS MC-130P, and two 21st SOS MH-53Js. A major glitch occurred when deploying airlift was redirected to support a real-world contingency operation. This caused the loss of a number of exercise events because of the lack of spare parts and equipment to repair the deployed aircraft. High winds and marginal weather also impacted several days of training. Overall, however, the exercise was a success, with deployed crews, maintenance personnel, and support personnel alike gaining valuable experience working together as a team.¹⁸

In November the situation in Central Africa, which resulted from the 1994 Hutu and Tutsi civil war, again intensified. On 5 November, while Exercise Popex was getting under way in Spain, news of a mass exodus of refugees from Zaire to Rwanda reached USEUCOM. Planning began for a humanitarian aid mission, named Operation Guardian Assistance, that would help deliver food and supplies to the affected refugees. It was not until 13 November, after the employment of a USEUCOM survey team, that a statement of requirement emerged. Initial requirements included 352d SOG MH-53Js, MC-130Ps, and two 16th SOW-assigned AC-130Hs. The 7th SOS was not included in the initial tasking. On 29 November one AC-130U gunship deployed to Entebbe, Uganda, to provide reconnaissance support for the operation. Because of limited billeting, rations, and support at Entebbe, the 7th SOS received tasking to airlift needed supplies there. On 29 November the squadron deployed one MC-130H from RAF Mildenhall. After an overnight stop at Brindisi, the Talon II continued on to Entebbe on 30 November. The crew delivered a full load of supplies and remained at Entebbe until 2 December, when it was released and returned to Brindisi.¹⁹

The AC-130U flew reconnaissance missions during the early part of December and collected

enough data to convince EUCOM and national leaders that the majority of the refugees had returned to Rwanda of their own free will. The number of refugees proved to be much lower than initially projected. Consequently, international relief agencies determined that Rwanda had the capacity, and the will, to take care of the refugees. On 11 December EUCOM issued a redeployment order, and on 14 December the AC-130U returned to Brindisi. Remaining units of the 352d SOG were relieved of tasking, and Operation Guardian Assistance was terminated.²⁰ The mission to Central Africa marked the last significant event for the 7th SOS for 1996.

Fulton STARS Operations Terminated

The year 1996 began at Hurlburt Field with a change-of-command ceremony for the 8th SOS. Colonel Moore assumed command of the squadron from Poole on 5 January 1996. Four months later on 24 May 1996, Colonel Glausier assumed command of the 15th SOS from Ron Lovett.²¹ Both new commanders had grown up in Combat Talons, having served previous tours with the



USAF Photo

The Skyanchor is removed from the nose section as the STARS is officially retired from the Air Force.

7th SOS in Europe and with the 8th SOS at Hurlburt Field.

The 16th SOW received an operational readiness inspection from 15 April to 29 May 1996. For the inspection three 8th SOS MC-130Es and four 15th SOS MC-130Hs deployed to Cecil Field, Florida, along with other wing assets. The 45-day evaluation was extremely demanding on all participants, but in the end the 16th SOW received an overall excellent rating, as did the 8th SOS. The 15th SOS was given a satisfactory rating, which validated for the first time its combat capability in the still-new CT II weapons system.²² The CT II had come a long way since the program was nearly canceled in the late 1980s.

The 8th SOS continued periodically to rotate aircraft and crews to Brindisi, Italy, and the unit maintained a vigorous exercise schedule from home station. In September 1996 Saddam Hussein once again caused tensions in the Middle East to escalate when he refused to allow the UN special commission inspection team access to key facilities thought to house weapons of mass destruction. In response to the crisis, the commanding general of Special Operations Command, Central (COMSOCCENT) requested additional forces be deployed to the region to augment the existing CSAR force. The 8th SOS was tasked to provide two MC-130Es, and on 10 October they departed Hurlburt Field bound for the Middle East. With four IFRs en route, the deployment was planned as a nonstop flight to Prince Sultan AB, Saudi Arabia. Within 36 hours of tasking, the 8th SOS Combat Talons had arrived at their beddown location.²³

Although the region did not erupt into an all-out shooting war, the expanded Southern Watch operation resulted in the approval for UN fighter aircraft to strike back at Iraqi military targets when those targets challenged the enforcement of the no-fly zone. For the remainder of the year, the 8th SOS maintained two Combat Talons in Saudi Arabia, with at least one aircraft on continuous CSAR alert in the event of a friendly aircraft shoot down by the Iraqis.

As the 8th SOS deployed to the Middle East in September, another significant event occurred for the squadron. Since its inception in 1965, the Fulton surface-to-air recovery system had been an integral part of the MC-130E weapons system. Although several combat missions were planned during the Vietnam War era, no actual combat recoveries were made with the system. By the 1990s SOF rotary-wing aircraft had been modified

with IFR capability that allowed them to refuel from C-130 tanker aircraft. This capability extended the range of the helicopter, thus eliminating most of the need for STARS. The acquisition of the CV-22 tilt-rotor aircraft, with its extended range and ability to land and pick up survivors, finally eliminated the requirement for STARS altogether. Headquarters AFSOC determined that STARS was too expensive to continue to maintain and moved to cancel the program when it sent a request to USSOCOM asking relief from the requirement. Sporadic training continued on the system for the next 12 months.²⁴ In its 031722Z September 1997 message, Headquarters AFSOC announced that USCINCSOC had finally approved the termination of the Fulton mission. The message directed both the 16th SOW at Hurlburt Field (the 8th SOS) and the 919th SOW at Duke Field (the 711th SOS) to terminate all training, maintenance, and equipment acquisition associated with STARS.²⁵ Subsequent to the 3 September message, the last STARS training mission was flown out of Hurlburt Field, with several long-time Talon crew members on the flight for the historic event. With the retirement of the Fulton system, a long and colorful chapter in Combat Talon history ended.

The 15th SOS supported numerous exercises and training events out of Hurlburt Field for the remainder of 1996. With 10 aircraft assigned, it was by far the largest of the Combat Talon units, and its personnel had gained valuable experience flying the complex aircraft over the past three years.

The 711th SOS Employs the Combat Talon I

At Duke Field 1996 was a year of training and growth for the 711th SOS. As the New Year began, the squadron had three Combat Talon I aircraft assigned and was in the process of certifying its second combat crew. On 13 February the fourth Combat Talon (62-1843) was assigned to the 919th SOW, followed by 64-0561 on 6 March and 64-0565 on 8 March. For most of the remainder of the year, the squadron operated with seven aircraft, with the eighth aircraft (64-0551) being assigned on 6 December 1996.²⁶ The squadron was tasked to establish a minimal Talon I combat capability by the end of CY 96, and it focused its efforts on attaining that goal. As the squadron established its Talon I crew, it drew on a combination of former squadron members from the AC-130A gunship and from Talon I personnel separating

from the active Air Force. Its new aircrew was made up of 64 percent former gunship personnel, 16 percent highly experienced Talon I crew members fresh off active duty, and 20 percent from other weapons systems. The mixture of seasoned and inexperienced crew members was able to make great strides throughout the year.²⁷

The Combat Talon II Weapons System Trainer Is Delivered to Kirtland AFB

The long-planned MC-130H Combat Talon II WST was delivered to Kirtland AFB on 1 April 1996, and Loral Defense Systems contractors set about to install and bring the complex system online. The Combat Talon II WST was designated as a six-degree freedom-of-motion-based flight simulator. It provided a platform for MC-130H special operations training and mission rehearsal. The WST crew positions included a pilot, copilot, flight engineer, navigator, and EWO. The WST fully duplicated all MC-130H aircraft functions to allow training in cockpit procedures, instrument flight, and integrated sensor operations, including the multimode radar, the infrared detection system, and the integrated inertial navigation system/global positioning system navigation suite.²⁸ For the remainder of the year, technicians worked to get the simulator operational.

At the 550th SOS the first half of the year was spent training many students for the CT II. By summer the squadron was able to participate in the next Chile Flag exercise. From 10 June to 2 August, 58th SOW assets participated in Chile Flag 96-05. The primary joint customer for the exercise was SEAL Team 5 from North Island NAS, California. On 23 July a 550th SOS crew flew to North Island NAS, picked up a 12-man SEAL team and their equipment, and then transported them back to Kirtland AFB. During the following two-week exercise, 58th SOW assets, including the MC-130H CT II, supported the SEAL team with personnel airdrops, alternate insertion extraction, and live fire range support. The scenario was designed to test participating crews' ability to insert and recover personnel from a high-threat environment. On 2 August a 550th SOS CT II flew the SEALs back to California, thus ending a highly successful Chile Flag.²⁹ The 550th SOS participated in two additional Chile Flag exercises during the fall—97-01 in September and 97-02 in October. The scenario for the follow-on exercises was similar to the July event, with all participants benefiting from the close association of the joint units.

The new simulator building was completed on 19 October 1996, with the academic training facility also completed the same day. The two projects (costing \$7.52 million) were the last two major projects required for the beddown of the Combat Talon II at Kirtland AFB. Along with the MC-130H WST, the simulator housed other weapons systems part-task trainers and the HC-130P WST.³⁰

JCET Tasking Dominates Pacific SOF

In early January 1996, 71 members of the 353d SOG deployed to the Philippines for JCET Balance Piston 96-1. After the successful deployment the previous November to Foal Eagle, Barwick felt it was time to put the new Combat Talon II weapons system on the road. Balance Piston 96-1 was held 6–22 January at Subic Bay and Clark AB and had as its primary objective the furthering of bilateral relations between the 353d SOG and the Armed Forces of the Philippines. The 1st SOS contingent included two MC-130H CT II aircraft that provided airlift and exercise support for both US Army and Philippine participating forces. During the exercise the 1st SOS accomplished an assortment of training events, including NVG low-level, personnel and resupply airdrops, assault landings, and tactical infiltrations and exfiltrations. Members of the Philippine air force flew on the Combat Talons and observed their capabilities. For the exercise the 1st SOS flew 75 hours and completed 15 of 16 scheduled sorties.³¹

Beres's initiative to use Taegu AB as a SOF training area came to fruition in early 1996 when the 353d SOG made its first JCET deployment there 13–15 February. The primary objective of the deployment was to validate the group's Gryphon Knife checklist. Fifteen members of the 17th SOS and one MC-130P supported the deployment. At the completion of the event, Beres relayed to SOCPAC and AFSOC that his Korean training initiative was on track. He planned to increase future use of Taegu AB by incorporating all three of the group's flying squadrons.³²

One 1st SOS Combat Talon II deployed to Abdul Rachman AB in Malang, Indonesia, for JCET Balance Iron 96-3 from 4 to 12 April 1996. The new Combat Talon performed well, although the Indonesian military made several changes that negatively impacted the training value of the exercise. Major problems centered on the country's national air show that was scheduled for the same period. The squadron was forced to relocate from its original base, only to find that there was no

fuel available at the new location because it had been diverted for the air show. The aircrew had to fly 30 minutes to another airfield to obtain fuel and then fly two more hours to onload the US Army Special Forces team and host-nation exercise participants. The squadron did not receive the expected training value, although aircrew and maintainers alike learned more about operating the sophisticated MC-130H in an austere environment.³³

Also in April the 353d SOG underwent another major reorganization when the on-aircraft maintenance function was moved from the fixed-wing squadrons (the 1st SOS and 17th SOS) to the 353d Maintenance Squadron. The move reduced each flying squadron by 50 personnel and eliminated the first sergeant position in both squadrons. The action created turmoil once again in the 353d SOG, a state that had become almost normal since Mount Pinatubo. Beres vehemently objected to the reorganization, communicating back to General Hobson that his unit organization was not broken and that the reorganization would create undue stress and turmoil in his group. He particularly objected to the loss of the two first sergeant positions. Over the next several months, he continued to work with AFSOC manpower and eventually received one authorization for a first sergeant. The position was assigned to the group headquarters with responsibility for the welfare of enlisted personnel in both the 1st SOS and 17th SOS.³⁴

From 12 April to 6 May, the 1st SOS participated in JCET Vector Flash Action 96-2 with two MC-130H aircraft and more than 100 group personnel. Along with the 353d SOG-assigned units, US Navy SEALs and the Australian Special Air Service Regiment participated in the largest JCET in recent history. Exercise participants were based out of Swanborne, Keanie College, Royal Australian Air Force, Pearce AB (Perth) and Bidoon, Western Australia. The 1st SOS's primary training objectives centered on low-level flight operations, including NVG low-level and airborne intercept training with the Royal Australian Air Force. The exercise proved to be the best yet for the 1st SOS, with all pre-exercise objectives being met. The CT II again performed near flawlessly.³⁵

In May the 1st SOS participated in JCS Exercise Cobra Gold in Thailand. The squadron flew 59.1 hours and completed eight tasked missions during the exercise. Throughout the first six months of 1996, the CT II continued to perform in

an excellent manner. The only problem with the new aircraft was a continued shortage of radar spares that regularly impacted its operational status. Aircraft 88-1803 also experienced a "pulling to the left" during taxi operations, but after a depot maintenance team inspected the aircraft at Kadena AB, no defective part could be found. The team recommended switching the number 1 and number 4 propellers, which maintenance did, and the problem was eliminated. The other four aircraft had no major problems. The transition of the 1st SOS to the CT II had been a smooth one, and the squadron was operating the aircraft throughout the Western Pacific.³⁶

The 1st SOS deployed two Combat Talons to the Philippines from 16 July to 4 August for the second Balance Piston (93-3) JCET of the year. This exercise staged out of Subic International Airport, Clark International Airport, and Mactan AB (Cebu).^{*} Although the exercise was planned to accommodate both US and Philippine military objectives, misunderstandings on low-level approval and unseasonably severe weather reduced the training value for the event. During the course of the exercise, more than 35 inches of rain was dumped on the exercise area by two typhoons. Eight missions were canceled due to the bad weather. The CT II aircraft did, however, perform well, given the bad weather experienced throughout the exercise.³⁷

Colonel Garlington led a Headquarters AFSOC ASET visit to the 353d SOG from 22 July to 2 August. As had been the case the previous year, the group did well on the evaluation. Garlington lauded the group and its squadrons for making significant progress in all deficient areas identified in the February 1995 visit. Tech Sergeant Eubanks of the 1st SOS was recognized for his widely acclaimed MC-130H flight engineer newsletter, which provided vital information on the new weapons system to crew members in the squadron.³⁸

On 25 September the Koror Babelthaup Bridge in the Palau Islands (located southeast of the Philippines and just north of New Guinea) collapsed. The 257-yard long two-lane concrete structure linked vital utilities and the local airport, located on the main island of Babelthaup, to the population and business center of Koror. Two people were killed, and the water lifeline for 10,000 residents was severed. Five days later the 353d SOG was tasked by COMSOPAC to provide airlift support to deliver water purification equipment and

^{*}NAS Cubi Point had been renamed Subic International Airport, and Clark AB had been renamed Clark International Airport earlier in the year.

supplies from Andersen AFB, Guam, to the island republic. Two aircrews and two MC-130H CT IIs of the 1st SOS responded on 1 October with more than 70,000 pounds of relief supplies and desalination equipment. The squadron transported five reverse-osmosis water-purification units, three high-pressure pumps, six water bladders, and seven Air Force and two Navy personnel to operate the equipment. The quick response helped Palau recover from the disaster by providing fresh water for many of its residents (fig. 51).³⁹

In November the group deployed 428 personnel to Korea for Foal Eagle 96 and received its second ORI during the course of the exercise. For the 1st SOS it deployed four MC-130H CT II aircraft. Harsh Korean weather caused the cancellation of 11 group-tasks missions, which resulted in an overall mission effectiveness rate of 94 percent. The 1st SOS Combat Talon crews flew 46 sorties and logged 95.2 hours as they successfully completed infiltration, exfiltration, and resupply missions. During the deployment phase of the evaluation, all three group-assigned flying squadrons received a grade of excellent. After a difficult and challenging month of flying, the group was awarded an overall satisfactory rating by the AFSOC IG.⁴⁰

After the squadron returned to Kadena AB in December, the 1st SOS deployed one MC-130H CT II to Guam in support of the US Navy SEALs stationed there. During the course of the exercise, on 8 December, the crew was asked to join in the

search for a missing family (husband, wife, and son) who had not returned from a boating trip. After the initial search proved fruitless by civilian authorities, the Combat Talon crew joined the effort. Five hours into the flight, Captain Bauernfeind's crew spotted the family on an atoll about 600 miles southeast of Guam. The crew loadmasters (Staff Sergeant Corlew, Staff Sergeant Schwinghamer, and Tech Sergeant Faulkner) rigged an air-drop package, consisting of a life raft and radio, for the family. The drop was significant because the crew was not trained for the SAR mission and did not have life rafts rigged for airdrop. On the second pass the loadmasters tossed in-flight meals and a first-aid kit to the survivors. The family advised the crew through the survival radio that they were extremely dehydrated and needed water. A third pass was quickly made, and water was dropped to them. As a result of the actions of the CT II crew, the lives of the three individuals were saved.⁴¹ The year closed with the crew back at Kadena AB with the rest of the 1st SOS.

1997: African and Asian Operations Dominate Combat Talon

The 1996 ORI had validated the combat capability of the 1st SOS Combat Talon IIs. With the inspection complete the squadron could look forward to expanding the capability throughout the Pacific. In January 1997 alone the squadron deployed aircraft to Australia, Guam, and Thailand



Figure 51. Map of Palau Located in the South Pacific (Source: AU Library, Maps and Charts Division, Maxwell AFB, Ala.)

for JCET events. In February one MC-130H and 32 personnel deployed to Hussein Sastranegara AB in Bandung, Indonesia, for JCET Balance Iron 97-2. Along with the 1st SOS, elements of the Indonesian army, USAF Special Tactics personnel, and US Army Special Forces from the 3d Battalion, 1st Special Forces Group, participated in the two-week-long exercise. The primary objective of the JCET was to promote interoperability and cooperation between the United States and Indonesian armed forces and to improve bilateral relationships in support of USCINCPAC's Cooperative Engagement strategy. The 1st SOS had several specific objectives for the deployment: conducting resupply and personnel airdrops in support of US and Indonesian JCET participants, executing low-level and NVG operations, and providing specialized airlift support for US Army participants.⁴²

During the course of the event, 37.2 hours were flown in the process of accomplishing exercise objectives. Personnel drops included both static-line and HALO infiltration events. From 24 January to 8 February, the deployed crews flew eight days and accomplished all of their pre-exercise objectives. An important lesson learned from the deployment was that future events in Indonesia should be planned during the dry season. The period from December through April was the monsoon season, and several missions were canceled because of torrential rains. The squadron also deployed a qualified Indonesian linguist whose presence greatly enhanced the effectiveness of the exercise. When the contingent redeployed on 8 February, military-to-military relationships had been greatly improved.⁴³

The end of February saw a 1st SOS-assigned Combat Talon II deployed to Takhli RTAFB, Thailand, for Teak Torch 97-5. The primary thrust of the JCET was to conduct airborne intercept training with Thai F-16 aircraft and to fly training missions against Thai coastal defense batteries to test the crew's ability to avoid the threats. The 121st Air Refueling Wing, Ohio National Guard, deployed a KC-135 tanker for the exercise, and both Thai F-16s and 1st SOS Combat Talons received valuable in-flight refueling training. Low-level terrain-following operations and NVG landings were also completed. The 1st SOS crews flew 42.5 hours between 23 February and 3 March and accomplished all of their objectives.⁴⁴

The squadron deployed one Combat Talon to McChord AFB, Washington, from 11 to 28 March to participate in Gryphon Mariner. While there the crews were able to accomplish events not

available in the Pacific. Also in March one Combat Talon deployed to Guam and supported the US Navy SEAL detachment located there. The two-week JCET, named Gryphon Globe, concentrated on CRRC drops and on NVG night-landing operations.⁴⁵

Progress continued throughout the year to establish a regular deployment to Taegu AB, Korea. During the first half of 1997, aircraft from the 1st SOS and 17th SOS deployed weekly for one- to two-day events. Typically, the aircraft would shuttle US Army Special Forces personnel and USAF STS team members from Kadena AB to Korea, then support them during each short exercise. Beres focused his group on the North Korean threat and had the group maintain a high state of preparedness in the event the volatile situation intensified into open conflict. Along with the regularly scheduled overnight missions, almost daily out-and-backs were flown from Kadena AB. A typical out-and-back profile began with a high-altitude leg, then a descent into low-level after crossing the South Korean coastline. A lowlevel profile would then be flown, terminating in an airdrop near Taegu AB. If a tanker was available, the crew would climb to altitude, accomplish an IFR, and then proceed back to Kadena AB for mission termination. If a tanker was not available, the crew would land at Kunsan AB, Korea, and refuel. After refueling the crew would then return to Kadena AB for mission termination. The entire flight was usually seven-to-nine hours in duration. Although demanding the profile offered the best training opportunity available from home station.

On 3 June 1997 Colonel Herrera assumed command of the 1st SOS from Barwick, who had been either the operations officer or commander of the squadron for the past five years. Barwick returned to Hurlburt Field to become the deputy commandant of the USAF Special Operations School. Herrera had been in Talons for most of his flying career, having served a tour in the 7th SOS in Europe before coming to the Pacific.⁴⁶

Operation Bevel Edge

In the summer of 1997 tensions increased in the Cambodian capital of Phnom Penh after factions loyal to the country's two rival leaders, First Prime Minister Prince Norodom Ranariddh and Second Prime Minister Hun Sen, clashed in the streets of the city. The two leaders had been partners in a coalition government following the UN-monitored elections in 1993 but had grappled for power throughout 1996 and 1997. Bloody skirmishes

had occurred frequently, with the resultant deaths of both civilian and military personnel. On 5 July 1997, as Hun Sen forces gained control of Phnom Penh, his troops sacked the city, looting and plundering everything that they could get their hands on. During the battle for the capital, government officials estimated that more than 150 personnel either were killed or wounded. As Hun Sen consolidated his power, fighting spread to northwestern Cambodia, and Ranariddh and his followers fled the country for asylum in France. On 10 July the US government ordered all but 20 of its diplomats out of Cambodia and advised the more than 1,000 Americans living in the country to leave.⁴⁷

With the government in limbo and the country disintegrating into anarchy, COMSOPAC issued an alert/deployment order on 8 July, and 12 hours later the first Combat Talon from the 1st SOS was airborne and headed to Thailand.⁴⁸ The 353d SOG was tasked to support a USPACOM JTF under the command of Brig Gen Norton A. Schwartz. Group-assigned deploying forces included three MC-130H Combat Talon II aircraft, three MC-130Ps, three MH-53Js, and 340 personnel. The JTF, identified as JTF Bevel Edge, was tasked to assess the Cambodian situation and be prepared to execute a noncombatant evacuation order if required. The deployment from Kadena AB to Utapao, Thailand, was supported by C-5, C-17, C-141, and KC-135 aircraft.⁴⁹

The situation stabilized in Phnom Penh over the next several days, and the new government allowed non-Cambodian citizens to depart the country by way of commercial air if they chose to do so. JTF Bevel Edge remained in place until 22 July, at which time forces redeployed to home station. Although an NEO was not required, the group learned valuable lessons about short-notice deployments and demonstrated its ability to react rapidly to a real-world crisis. The 1st SOS deployed aircraft 88-0195, 88-0191, and 88-1803 and flew 72 hours supporting JTF Bevel Edge.⁵⁰

The following three months saw the 1st SOS continue to support both JCS-sponsored exercises and theater JCET events. As the JTF Bevel Edge tasking ended, the 1st SOS deployed two Combat Talons to Udorn RTAFB for JCET Balance Torch 97-4. More than 100 personnel deployed for the training event. Because of other commitments a KC-135 previously committed to Balance Torch was withdrawn, and the resultant loss of IFR training for the RTAF severely impacted the remainder of the exercise. The RTAF canceled

scheduled airborne intercept training and was generally uncooperative. As a result the training value of the deployment was greatly reduced. In August elements of the 1st SOS deployed along with other members of the 353d SOG to Korea for JCS-directed Exercise Valid Response. Two Combat Talons, one Combat Shadow, and three Pave Low III helicopters took part in the exercise. During the last part of August, the group participated in the annual JCS Exercise Ulchi Focus Lens 97, which was sponsored by the United States and the Republic of Korea. By the first of September the majority of group personnel was back at Kadena AB.⁵¹

On 2 September 1997 Colonel Folkerts assumed command of the 353d SOG from Beres in a ceremony conducted in the group's Commando West hangar. The ceremony was presided over by Maj Gen Charles R. Holland, who had recently become the AFSOC commander. Like Beres, Folkerts's number one goal was to enhance the group's combat readiness. His second priority, and closely linked to the first, was to continue 353d SOG efforts to refine Korean War plans that included group assets in its force structure.⁵² For the operational squadrons there was little impact as the new commander smoothly transitioned into his role as the senior Air Force SOF commander in WestPac.

A second Indonesian JCET was conducted by 1st SOS personnel from 5 to 22 September and was named Teak Iron 97-4. The JCET again operated out of Bandung, Indonesia, and only USAF and IAF personnel participated. This was the first time that an Air Force-only JCET event had been conducted in that country. Previous events revolved around a ground scenario driven by the Indonesian army. The primary thrust of Teak Iron 97-4 was HALO operations from both US and IAF aircraft. A problem developed when it was discovered that IAF oxygen procedures were significantly different from those of the United States. As a result USAF STS personnel jumping from IAF aircraft were restricted to a maximum altitude of 10,000 feet. The 1st SOS aircraft dropped from altitudes up to 25,000 feet. Constantly changing winds on the DZ and in the surrounding mountains restricted the number of actual drops, but an adequate number of HALO events was completed to make the training a success.⁵³

The annual Foal Eagle exercise kicked off in October and continued into November. The 353d SOG deployed more than 300 personnel, all four MC-130H Combat Talons, three MC-130P (previously

HC-130P) Combat Shadows, and three MH-53J Pave Low III helicopters to Taegu AB and flew missions in support of the combined unconventional warfare task force. The group established a combined Air Force Special Operations Component (CAFSOC) and provided the command and control structure to manage the large special operations contingent. During the exercise 747 hours were flown during 223 tasked missions, and an additional 1,000 hours were flown during unilateral training not specifically tasked by the exercise. Colonel Folkerts served as the CAFSOC commander and employed additional forces from the 1st SOW and US Army aviation during the course of the exercise. Foal Eagle 97 continued to provide the best training of any exercise for the group.⁵⁴

By 6 November Foal Eagle had come to a successful close, and all forces had redeployed to their home stations. The 1st SOS later deployed a Combat Talon to Guam during the last half of the month to support the SEALs stationed there. On 17 November the crew was again requested to fly a SAR mission out of Guam. The US Coast Guard, Marianas Section, requested the crew search for a missing 18-foot skiff with four persons on board. The vessel (named *Chico*) had been missing for three days. The crew launched early the next morning with the daunting task of finding a small boat in a 2,500-square-mile search area. The crew was commanded by Captain Roller, with additional maintenance personnel on board to help scan for possible survivors. It was almost an impossible task, but within one hour of commencing the search, the boat was spotted. The crew radioed back to the Coast Guard the location of the *Chico* and was informed that the location could not be reached until the following day. The aircrew devised a means to drop supplies to the four survivors, with the two loadmasters using flotation devices, duct tape, and garbage bags to create packages containing bottled water and food. The crew also dropped a survival radio and then headed for Truk Islands to refuel. The Coast Guard was able to coordinate with a Micronesian ship operating in the area to pick up the *Chico* crew. The Combat Talon returned from Truk Islands to assist the Micronesian vessel in finding the small craft. The aircraft orbited overhead and guided the ship to the survivors; all four personnel were rescued and returned home safely.⁵⁵ The crew that flew the mission was Captain Roller, Captain Hastert, Captain Ziener, Captain Scudder, Tech Sergeant Dampier, Tech Sergeant Demchenko, and

Tech Sergeant Paul. The dramatic rescue was the last major action for the 1st SOS during 1997.

An 8th SOS Crew Helps Locate Downed Pilot in Utah

An 8th SOS MC-130E and crew deployed to Hill AFB, Utah, in early February as part of the squadron's mountain training program. On 4 February 1997, while the aircraft was flying a mountain terrain-following mission, Hill AFB called and requested its assistance in locating a downed F-16 crew. The F-16D was assigned to the 419th Fighter Wing, which was also located at Hill AFB. Proceeding to the aircraft's last known position, the Combat Talon maneuvered through the rugged mountains utilizing its terrain-following radar system and was able to locate the crash site on the side of a steep mountain range. The crew recorded the position of the wreckage with its sophisticated navigation system and relayed the coordinates to a US Army HH-60 Blackhawk helicopter that was assisting in the search. As the HH-60 neared the wreckage site, the Combat Talon crew dropped flares over the area to help guide the helicopter. The Blackhawk crew was able to locate the downed crew members and extract them from the snow-covered terrain. The downed airmen were transported back to Hill AFB for medical checkups and later released from the base hospital. For both the Combat Talon crew and the Blackhawk crew, it was a job well done.⁵⁶

Throughout 1997 the 8th SOS continued to fill both contingency and exercise taskings. From April to July the unit once again deployed to Southwest Asia in support of Operation Southern Watch. Aircrew, intelligence, and support personnel from the 8th SOS, the 711th SOS, and maintenance personnel from the 16th Logistics Group deployed to Prince Sultan AB, Al Kharj, Saudi Arabia. Two crews and support personnel from the 8th SOS and one crew from the 711th SOS flew two MC-130E Combat Talon Is on a 26.4-hour nonstop flight, arriving in Saudi Arabia on the evening of 11 April. The Combat Talon crews assumed alert duty, beginning on 15 April, after a brief transition period with the HC-130 crews from the 71st Rescue Squadron out of Patrick AFB, Florida. On 17 July, following their 90-day tour at Prince Sultan AB, members of the 8th SOS returned to Hurlburt Field, thus completing the squadron's second deployment to Southwest Asia in support of Operation Southern Watch since the fall of 1996.⁵⁷

The squadron also maintained a vigorous JCET deployment schedule to Southern Command. On four separate occasions the unit deployed one MC-130E to countries in Central and South America, including Panama, Ecuador, and Venezuela.⁵⁸ Excellent training was accomplished by the Talon crews as they worked with host-nation and US Army Special Forces personnel. On 18 July 1997 Colonel Alderfer assumed command of the 8th SOS from Moore. Alderfer had been previously assigned to the 15th SOS and was the first Combat Talon II experienced officer to command a Talon I squadron.⁵⁹

A 15th SOS Crew Is Awarded Venezuela's Highest Medal of Gallantry

The 15th SOS also maintained a rigorous schedule throughout the year. On 15 February 1997 the squadron received a deployment order for one MC-130H and crew to deploy to South America to conduct combined aviation training with elements of the US Army's 7th and 20th Special Forces Groups and with soldiers from the host nation visited. The training included high-speed, low-level aerial delivery system airdrops, low-level terrain following, and personnel airborne operations. The aircraft and crew performed in an exceptional manner and successfully completed all exercise objectives. On 27 February the 15th SOS crew returned to Hurlburt Field after a successful deployment.⁶⁰

Perhaps the most significant event for the 15th SOS during 1997 occurred while deployed to Venezuela during a JCET event. On 10 July Venezuela experienced a 6.9-magnitude earthquake, and the squadron subsequently was tasked to support relief operations. During the ensuing effort the 15th SOS provided relief to more than 15,000 earthquake victims by delivering 175,000 pounds of supplies during the presidential-directed relief operation. The aircrew was recognized for its support by receiving Venezuela's highest medal of gallantry, the Order of Jose Antonio Anzoategui. The squadron also deployed an MC-130H aircraft and a crew three additional times throughout the year for JCET events in South America. It closed out the year deployed to Cherry Point (MCAS), North Carolina, for JRX 98-1.⁶¹

The 711th SOS Deploys to Operation Southern Watch

At Duke Field the 711th SOS was ready to move on to greater challenges as a Combat Talon I

operational squadron. On 1 March 1997 the squadron became operational, and by so doing, became available for worldwide tasking through Headquarters AFSOC.⁶² The squadron's first operational deployment was to Operation Southern Watch. From 10 April to 15 May 1997, 711th SOS crew members augmented the 8th SOS at Prince Sultan AB, Al Kharj, Saudi Arabia. The deployment provided much needed relief for the 71st Rescue Squadron, which had been heavily tasked to support the operation. The 8th SOS provided two of its assigned MC-130Es, and the two squadrons pooled their crew resources to make up three crews. Once in Saudi Arabia personnel were billeted in a tent city that had most of the amenities of home station. The work schedule consisted of a two-day CSAR alert followed by a training flight, then two days as the duty crew, followed by another training flight. The six-day cycle would then be repeated.⁶³ Throughout the 35-day deployment, 711th SOS personnel worked seamlessly with their active duty counterparts.

During March and April the squadron participated in air-drop operations out of Biggs AAF, El Paso, Texas, and deployed to Green Flag 97-3 supporting the 3d and 7th Special Forces Groups.⁶⁴ On 3 August the 711th was involved in a dramatic sea rescue while supporting a joint exercise out of home station. A 711th SOS Talon I had completed the first portion of an infiltration/exfiltration mission for a US Army ranger company and had departed the DZ, flying south over the Gulf of Mexico. A crew member on board the Talon spotted a debris field about 10 miles off the coast. The debris included a cooler, a gray fiberglass panel, and possibly a ship's mast. There was no sign of life, but the crew contacted the US Coast Guard to report the sighting. There were no missing vessels reported in the area, but the Coast Guard responded in case there had been a sinking. Later in the mission, after landing and refueling, the 711th crew returned to the last known position of the debris field but could not find any trace of survivors even with the use of NVGs and the aircraft's FLIR system. The Coast Guard later found a man and his son floating in a life raft near the position that the crew had relayed. The alert action of the crew undoubtedly saved the lives of the two individuals.⁶⁵

On 1 October 1997 the flying training portion of the formal Combat Talon I School was moved to Duke Field. At that time the 711th SOS took on the added responsibility of flight training all USAF active and reserve crew members in the Talon I

aircraft. The 19th SOS at Hurlburt Field retained overall responsibility for the formal school and continued to conduct Phase I ground training, including instruction in the Talon I simulator. Under the new concept students reported to the 711th SOS at Duke Field for the flying phase.⁶⁶ The 711th SOS created nine instructor positions to conduct the training and a chief of training position to supervise the program. The new positions were all air reserve technicians, and they had a dual chain of command. When flying in support of the formal school, the instructors reported directly to the 19th SOS at Hurlburt Field. When not flying schoolhouse lines, the instructors reported to the 711th commander, and they were responsible for all ground training, flight training, and scheduling for the 711th SOS. The dual reporting organization allowed the 919th SOW to meet its goal of providing effective, efficient flight training while producing mission-qualified active duty and reserve aircrew members for AFSOC and the Air Force Reserve Component (AFRC).⁶⁷ The arrangement further cemented the close relationship between the active and reserve Talon I force. As the year ended the 711th SOS had attained its place as an operational Talon I squadron.

The 550th SOS Expands Its Participation in Bilateral Exercises

The Headquarters AETC initiative to include the 58th SOW in AFSOC joint exercises came to fruition in early 1997. During March and April the 550th SOS participated in five bilateral exercises. The first exercise kicked off on 4 March and lasted through 13 March. The exercise began with the 550th SOS deploying to Patrick AFB, Florida, to conduct continuation training events, which included personnel and resupply airdrops. During the deployment the squadron flew 30 hours in support of joint exercise participants. On 13 March the crew returned to Kirtland AFB after completion of a successful exercise.⁶⁸

On 8 March a second CT II deployed to Fort Campbell AAF, Kentucky, to participate in the second bilateral exercise of the month. The Talon II crew unloaded 160th SOAR and US Army ranger personnel and then continued on to Biggs AAF, Texas, which was the site of the exercise. Although maintenance problems forced the rescheduling of several sorties, the Kirtland AFB crew managed to support the exercise and get excellent training themselves. On 11 March the Talon II returned the 160th SOAR team to Kentucky and later returned to Kirtland AFB.⁶⁹

The next bilateral exercise took place on 27 and 28 March. On 27 March the squadron deployed one CT II to Gila Bend, Arizona, to onload 14 passengers and two Humvee tactical vehicles and then transported them to Libby AAF. A second sortie was flown back to Gila Bend to pick up five additional passengers, one Humvee, and a trailer. Once the exercise participants were in place at Libby AAF, the CT II crew began the air-drop portion of the exercise. The 550th air-dropped 26 troops and one A-21 bundle during the two-day exercise. On 28 March the aircraft returned to Kirtland AFB, thus completing the third bilateral exercise during March.⁷⁰

Another bilateral exercise was conducted from 7 to 11 April and included one Combat Talon II and elements of the 22d Special Tactics Squadron, the 15th SOS, the 1st Special Forces Group, and the 446th Air Evacuation Squadron. On 7 April the 550th SOS flew a deployment sortie from Kirtland AFB to McChord AFB, Washington. During the following five days, the crew flew 16.8 hours and completed personnel airdrops, additional unilateral tactical training, and Rapid on/off-load events. The 550th SOS crew, along with one from the 15th SOS, completed 80 percent of its planned training events for the five-day exercise. During the return flight to home station on 11 April, the 550th crew conducted one additional personnel airdrop during the 5.1-hour sortie. A second bilateral exercise was conducted from 12 to 19 April and staged out of Portland, Oregon. A 550th SOS MC-130P participated in this exercise, thus giving the squadron's Combat Talon IIs a break from their rigorous deployment schedule.⁷¹

By the end of June 1997, the Combat Talon II WST had been integrated into the intersimulator network with other local and/or off-site simulators. Although technical problems still plagued the completion of the pilot, navigator, and flight engineer regular and refresher simulator courses, the WST offered the EWO simulator refresher course and the loadmaster refresher course. More than 100 crew members completed the latter two simulator courses during the first half of 1997.⁷²

The 550th SOS continued to train Combat Talon II crew members throughout 1997. From 1 July to 31 December 1997, students attended 11 Combat Talon II specific courses. The course of instruction was extremely demanding for the students. By the end of September, 83 MC-130H students had graduated either as new or upgraded Combat Talon II crew members. The high graduation rate could

be directly attributed to the dedicated, professional instructors of the 550th SOS.⁷³

The squadron's bilateral exercise schedule continued to challenge the unit through the fall and winter of 1997. Bilateral training events were conducted from 11 to 16 September, 20 to 30 October, and 16 to 19 December. The September exercise focused on airborne intercept training. On 11 September one 550th SOS Combat Talon deployed to Hanscom Field, Massachusetts. During the deployment leg the MC-130H crew completed airborne intercept training with four F-15 fighters assigned to the 131st FW. Once settled at Hanscom Field, the crew members flew daily sorties that tested their ability to conduct low-level operations while evading an airborne threat. During each sortie the crew was challenged by two F-16 aircraft assigned to the 158th Fighter Group.⁷⁴

After completing their airborne intercept work out of Hanscom Field, the crew members successfully completed assault landings at Pope AFB and proceeded on to Shaw AFB, South Carolina. After completing pilot proficiency training sorties out of Shaw, the crew returned to Kirtland AFB on 16 September. During the redeployment to home station, the crew flew against the Poinsett EW range and logged a midlevel ground radar event. The crew also completed two instructor qualification check rides, additional continuation training events, and multiple training events for the electronic warfare officer.⁷⁵

On 20 October the 550th deployed one MC-130H to Peterson AFB, Colorado, and picked up soldiers assigned to the 2d Battalion, 10th Special Forces Group, and one pallet of their equipment. The aircraft proceeded on to Burris DZ and completed a static-line drop. For the next six days, the crew conducted HALO and static-line drops in support of the Special Forces team. On 30 October the Combat Talon II redeployed to Colorado and made one last combination HALO and static-line drop, then airlanded the remaining personnel and supplies at Peterson Field. The crew continued on to Kirtland AFB, logging 36 hours during the 10-day exercise.⁷⁶

The last bilateral exercise of the year was flown out of Mountain Home AFB, Idaho, from 16 to 19 December. The thrust of this exercise was again airborne intercept training. For three days the 550th crew conducted airborne intercept training with the 389th Fighter Squadron's assigned F-15 and F-16 aircraft. In addition to flying against the fighters, the crew also completed low-level training events and flew multiple self-contained

approaches. Only one intercept event had to be canceled on the first day of training due to poor weather. The last training mission was flown on 19 December after the crew completed six sorties and logged 13.2 flying hours. The mission commander, Captain Bauernfeind, commented, "The trip to Mountain Home provided some of the best airborne intercept training that the 550th SOS had ever received. It is highly recommended that the 550th SOS continues to return to Mountain Home for this hard to find training."⁷⁷ The Idaho deployment was the last off-station event of the squadron for 1997.

The 1997 MacKay Trophy Is Awarded to a 7th SOS Crew

Elements of the 7th SOS had redeployed from Central Africa to home station in mid-December 1996 and had spent the holiday season with their families. As 1997 began, other units of the 352d SOG were heavily committed to operations in the Balkans. Operation Joint Endeavor had changed to Operation Joint Guard on 20 December 1996, but the group's tasking for CSAR alert, which included MH-53Js and MC-130Ps, remained in place. The 7th SOS continued to execute group tasking under the USEUCOM JCET program.⁷⁸ The group was scheduled for a Headquarters AF-SOC/IG-administered operational readiness inspection in October, and the 7th SOS would facilitate the group's preparation for it during JCET events throughout the year.

The first deployment of the year for the 352d SOG was to Evenes AB, Norway, from 7 to 16 January and included one MC-130H, two MC-130Ps, and 60 aircrew and support personnel. Participating personnel were processed for the JCET through the RAF Mildenhall mobility processing system, with cargo being marshaled and inspected, aircraft loaded, and then launched utilizing ORI criteria. Once at Evenes AB the deployed force was faced with severe cold and extreme weather conditions that affected airborne operations. Airborne intercept events scheduled for the 7th SOS were canceled, but squadron personnel accomplished most of the other objectives for the exercise. One benefit derived from the deployment was that unit personnel were able to evaluate facilities at Evenes AB in the event the location were used for the actual ORI in October.⁷⁹ The JCET was an excellent first step towards getting the group up to speed for the fall evaluation.

February marked the first time that the 7th SOS deployed to Hungary. From 19 to 27 February, one

MC-130H aircraft, crew, and support personnel executed missions that primarily revolved around an airborne threat scenario during the USEUCOM-sponsored JCET event. Hungarian Air Force MiG aircraft, along with surface-to-air-missile systems, challenged the 7th SOS crew as it flew tactical profiles. The training was realistic, with both sides gaining valuable experience flying against each military's weapons systems. The JCET was highly successful and helped to promote a positive military-to-military relationship between Hungary and the United States.⁸⁰

The second ORI rehearsal was conducted from 1 to 12 March during Exercise Adventure Express. The 352d SOG deployed one 7th SOS MC-130H Combat Talon II and a robust A staff to replicate the one to be used during the ORI. An AFSOD was established at the deployed location, and it reported to JTF Norway during the course of the exercise. To challenge the staff and to provide valuable tracking experience, the AFSOD not only reported the daily status of the MC-130H but also reported on the remainder of group aircraft located back at home station. The flying portion of the exercise was challenging, with high winds associated with fronts passing through the exercise area canceling several sorties. The high winds created moderate to severe turbulence in the mountains and impacted the parachutists' ability to safely land on the DZ. The two-week exercise was an excellent second step in the group's preparation for the fall inspection.⁸¹

During the next three months, the 7th SOS operated primarily out of home station flying training lines and supporting short-duration tasking. Unrest in Central Africa caused SOCEUR to put elements of the 352d SOG on alert during the March time frame, including the four MC-130H Combat Talons of the 7th SOS. Tasking was eventually eliminated for the 7th SOS aircraft, but on 24 March the 352d SOG deployed a package consisting of MC-130Ps and MH-53Js to support Operation Guardian Retrieval. After completion of tasking, all group assets returned to RAF Mildenhall on 10 April.⁸² Tensions remained high in Central and Western Africa, and by May the group was again on alert. After several days of intense planning, USEUCOM deleted the 352d SOG from its deployment alert status.⁸³

On Saturday, 7 June 1997, the 352d SOG received verbal tasking for Operation Firm Response, a possible NEO in the Central African country of the Republic of the Congo. The 7th SOS placed two aircrews in crew rest for possible deployment in

response to the deteriorating situation. Stability continued to decrease in the capital city of Brazzaville, and on 8 June the two 7th SOS MC-130H Combat Talon IIs launched and headed to Stuttgart, Germany, to link up with SOCEUR personnel at Patch Barracks. The first Talon arrived at Stuttgart at 0245Z on Monday, 9 June, and the crew immediately entered crew rest for possible onward movement to Central Africa. The second Talon experienced a short maintenance delay before departure from RAF Mildenhall and did not arrive in Stuttgart until 0601Z on 9 June. The second crew also went into crew rest for the pending mission. Members of Crew One (call sign Whisk 05, Talon 86-1699) included Captain Foster, Captain Baker, Captain Walker, Captain Ramsey, Staff Sergeant Hoyt, Master Sergeant Scott, Tech Sergeant Baker, and Colonel Kisner. Members of Crew Two (call sign Whisk 21, 87-0023) were Captain Corallo, Captain Garstka, Captain Toth, Captain Burford, Tech Sergeant Colpitts, Tech Sergeant Riddell, and Staff Sergeant Grimes. Upon arrival at Stuttgart the mission commander, Colonel Kisner, was met by Captain Simmons (also of the 7th SOS) and taken to SOCEUR Headquarters for an updated mission briefing.⁸⁴

The SOCEUR planning staff had developed various courses of action (COA) for the operation. The COAs ranged from the insertion of a robust security force into the American embassy compound in Brazzaville to the insertion of a 12-man ESAT. The ESAT was composed primarily of US Army and Navy special operators equipped with a communications package that gave CINCEUR an eyes-on-target assessment of the situation in and around the embassy. With the ESAT recommendations in-hand, SOCEUR and EUCOM planners could then tailor any additional response, as needed. The larger security team was designed to augment the US Marine security force at the embassy and provide additional firepower should the embassy come under direct attack.⁸⁵

Throughout the day planning continued, but the situation seemed to stabilize somewhat as embassy reports filtered into SOCEUR Headquarters. Reports were so favorable that SOCEUR released its planning staff for a much needed rest at 1830Z on 9 June. However, sporadic reports from the embassy indicated that the situation was worsening, and by 1930Z EUCOM made the decision to launch both Combat Talons with a robust ESAT composed of both the assessment team and a beefed-up security element. Both crews were alerted, and they departed Panzer Kassern for

Stuttgart AAF at 2045Z. When the crews arrived at the airfield, they learned that the plan had changed once again. Instead of the two-ship package, the force had been trimmed back to fit into one Combat Talon. The 12-man ESAT was equipped with two Humvees to provide it mobility on the ground in Brazzaville. The Combat Talon contingent consisted of the seven-man Whisk 05 crew, and a special tactics team led by Captain Collins. Other USAF personnel making up the deployment package included Staff Sergeant McAlister, dedicated crew chief; Senior Airman Zdancewicz, turbo prop specialist; Airman First Class Burghardt, security police (force protection); Airman First Class Evans, security police (force protection); and Captain Jones, 352d SOG logistics planner.⁸⁶

The combined package included 30 personnel, their gear, and the two Humvees. Each Humvee was loaded with additional water, ammunition, and rations needed for an extended operation. In total more than 22,000 pounds of equipment was loaded on board the one Combat Talon. For the mission the crew had to use the emergency war planning weight of 175,000 pounds. Three IFRs were scheduled to allow the Combat Talon to make the long flight nonstop. On Tuesday, 10 June 1997, at 0100Z, aircraft 86-1699, call sign Whisk 05, departed Stuttgart and headed south towards the Mediterranean and into Algerian airspace. The second Combat Talon crew, in aircraft 87-0023, went back into crew rest and was placed in alert status at Stuttgart for follow-on tasking.⁸⁷

Whisk 05 rendezvoused with two KC-135 tankers over Algeria four hours and 45 minutes after takeoff and began the first of three IFRs. Although Algerian overflight had been approved to reduce the deployment time, the lack of suitable alternate airfields over the vast Sahara Desert required the crew to refuel up to 175,000 pounds during each refueling. Because of the high outside temperature and the aircraft's heavy gross weight, the last 10,000 pounds of fuel had to be unloaded during a descent (or toboggan) maneuver. Rising terrain and extended time on the boom taxed the Talon crew, but after two hours and 30 minutes of taking fuel during the three refuelings, the Talon departed the southern end of the refueling track and headed into Niger. Brazzaville was still six hours away, and the Combat Talon had to fly over Niger, Nigeria, and Cameroon to get to its destination (fig. 52). At approximately four hours out from

landing, Whisk 05 was informed by way of secure satellite radio to expect evacuees when they arrived. Two hours out from landing, crew loadmasters handed out flak jackets and prepared their weapons, and maintenance personnel assisted in positioning Kevlar mats to be used to protect the evacuees during departure.⁸⁸

At approximately 15 miles north of Brazzaville, the EUCOM Command Center informed the crew that a firefight was occurring near the control tower. The crew was directed to hold north of the airfield and was asked how long could it hold before having to divert. With only 20 minutes of fuel reserve remaining, Whisk 05 requested permission from EUCOM to land if the French forces controlling the airfield cleared the aircraft for landing. EUCOM responded with permission to continue but stated that the crew assumed the risk associated with its action. The Talon was subsequently cleared for the approach by a French controller in the tower, and the crew flew a self-contained approach to runway 06. The crew made a textbook approach, turning tightly around mountains north of the airfield and avoiding built-up areas to the west. In broad daylight and with the firefight barely contained, the Talon crew touched down at 1521Z after a 14.4-hour flight from Stuttgart. The aircraft was instructed to remain on the runway and to taxi to the departure end. Once there the loadmasters began a rapid off-load of the ESAT and its two Humvees. The Kevlar bulletproof mats were installed on the aircraft floor, and within five minutes of the initial landing, the aircraft was fully prepared to accept its passengers.⁸⁹

A cordon of French forces established a perimeter around the tall grass on either side of the Combat Talon, and additional French soldiers escorted the evacuees from the aero club hangar to the awaiting aircraft. In total 56 scared, confused, and shell-shocked noncombatants were rapidly loaded on to the Combat Talon. The ESAT team came under fire as it waited for the aircraft to finish the loading process. At 1544Z, just 23 minutes after landing, Whisk 05 was again airborne and headed for its next destination of Libreville, Gabon. After another 2.4 hours of flying time, the aircraft landed with 30 Americans and 26 nationals from 11 different countries and 9,000 pounds of fuel remaining. In total the crew logged 16.8 hours and flew a grueling 21-hour crew duty day.⁹⁰

⁸⁶The 7th SOS crew was awarded the 1997 MacKay Trophy for the "most meritorious flight for the year by either an Air Force military member or an aircrew." The award also recognized the crew for "gallantry, intrepidity, unusual initiative, resourcefulness, and achievement of outstanding results." Personnel receiving the prestigious award were Lieutenant Colonel Kisner, Major (Dr.) Michaelson, Captain Baker, Captain Foster, Captain Ramsey, Captain Toth, Master Sergeant Scott, Tech Sergeant Baker, Staff Sergeant Hensdill, and Staff Sergeant Hoyt.⁹¹

At Brazzaville the ESAT proceeded to the American embassy overland and commenced its assessment of the situation. Over the next eight days, Whisk 05 remained on alert at Libreville in the event it became necessary to extract the US ambassador, his staff, and the ESAT. At Stuttgart Whisk 21 was released from alert on 14 June and proceeded back to RAF Mildenhall, arriving back at home station at 1042Z. On 17 June a cease-fire between the warring factions went into place, and a charter aircraft was arranged for the following day for the US ambassador. Whisk 05 was tasked to exfiltrate the ESAT after the departure of the ambassador and his staff. On 18 June Whisk 05 departed Libreville at 0558Z and landed at Brazzaville at 0801Z. The aircraft was on the ground 25 minutes and departed at 0826Z with the ESAT

and one passenger. Two hours later the Combat Talon landed at Libreville, off-loaded the passenger, and then onloaded the STS and maintenance personnel for a five-hour flight to Ascension Island in the South Atlantic. Once there the crew waited for the arrival of a liquid oxygen (LOX) converter for the aircraft. On 22 June a new LOX converter was installed, and the aircraft departed Ascension Island en route to Dakar, Senegal, where it refueled and proceeded on to Rota AB, Spain. At Rota AB the crew spent the night and rested after a long day of flying. On 23 June the crew made an operations stop at Stuttgart to deliver the ESAT, then proceeded on to RAF Mildenhall. For the entire mission the crew logged 47.4 hours.⁹² The two-week mission in support of Operation Firm Response had been a resounding success.

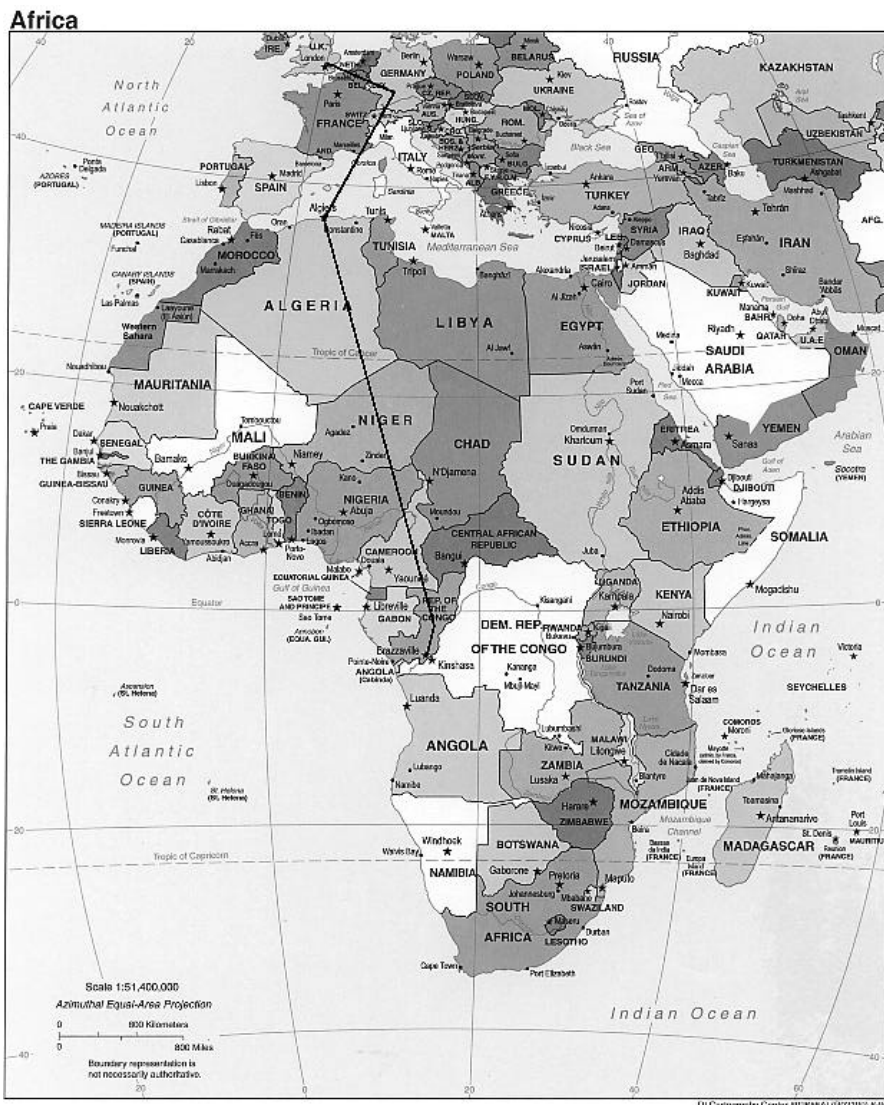


Figure 52. Route of Whisk 05, 1997 MacKay Trophy Winner (Source: AU Library, Maps and Charts Division, Maxwell AFB, Ala.)

With the Central African crisis behind it, the 7th SOS concentrated on preparations for the upcoming ORI. The squadron deployed one MC-130H CT II to Aalborg, Denmark, for a JCET event with the Danish Jaggerkorpset during the first week of July. From 8 to 14 August, a large 352d SOG contingent deployed to RAF Macrihanish, Scotland, for ORE Hadrian's Wall. Unlike the previous small-scale JCET events, Hadrian's Wall included all three flying squadrons, along with a robust headquarters staff, maintenance, and support personnel. A full range of special operations missions was conducted, with the 7th SOS crews performing in an excellent manner. Many lessons were learned, and the experience gained by the staff and the flying squadrons left the group well prepared as it entered the final 60-day countdown to its ORI in October.⁹³

With the ORE behind it, the 7th SOS concentrated on correcting deficiencies identified during the exercise and soon was on the road again supporting the group's JCET program. Single-ship deployments were made to Norway and Morocco during September, and the group was tasked for a no-notice contingency-oriented exercise named Elipse Bravo in Italy. Scheduled operations were soon overcome by another real-world event off the coast of Namibia in Southern Africa.

Operation High Flight

On 14 September a USAF C-141B Starlifter departed Windhoek, Namibia, bound for Ascension Island in the South Atlantic. At 0900Z on 15 September, Headquarters Air Mobility Command relayed to US Atlantic Command and to USEUCOM that the aircraft was overdue and was missing. At the same time a German Luftwaffe TU-154 that was on a training flight in the area was also reported missing. At approximately 1200Z Colonel Planert, the 352d SOG commander, received a call from the commander, Special Operations Command Europe, General Lambert, who queried him on the availability of crews and aircraft for possible support of a SAR mission. By late afternoon Planert had been tasked to put together a SAR package available for deployment in the event EUCOM directed SOCEUR to do so. Both 7th SOS and 67th SOS personnel were put in crew-rest status, and maintenance personnel prepared unit aircraft for the long flight to Namibia. Group assets tasked to support the SAR, which was named Operation High Flight, included one MC-130H Combat Talon II and one MC-130P Combat Shadow as

primary aircraft, and three MH-53J Pave Low III helicopters on standby alert. With a USEUCOM execute order in hand, 352d SOG forces quickly began to move out. At 0755Z the first aircraft, a 67th SOS MC-130P, departed RAF Mildenhall with a special tactics team, zodiac inflatable boat, and Colonel Barnett on board as the mission commander. Two hours later the MC-130H departed at 0954Z with Colonel Arnold as the aircraft commander. Each crew also transported elements of an A staff, security forces, direct-support operators, contractor, and medical personnel. The package totaled 77 airmen, including crew members flying the two aircraft.⁹⁴

The route of flight took them over Algeria, Niger, Nigeria, Cameroon, Gabon, Congo, Zaire, and finally Namibia (fig. 53). The first IFR was completed in Algerian airspace, followed by a second one over Gabon. As the two aircraft were transiting south, the search operation got under way off the coast of Namibia with a South African air force C-130 and Boeing 707. A German Dassault Atlantique antisubmarine aircraft was also part of the search team. Two South African helicopters would join the search in short order. After nearly 18 hours in the air, the MC-130P landed at Windhoek at 0143Z on 16 September, and the 7th SOS MC-130H landed at 0416Z. The crews immediately entered crew rest so that they could commence the search operation as soon as possible. The A staff set up communications gear, and Barnett contacted his coalition counterparts to begin integrating his operation into the search.⁹⁵

The first SAR mission for the 7th SOS was conducted during the night of 16 September. The Talon II departed Windhoek at 2043Z and employed its sophisticated radar and FLIR systems. The radar had the capability to detect wreckage on the surface of the ocean, and the FLIR could detect any heat sources (survivors). On board the Combat Talon were one special tactics combat controller and two pararescuemen equipped with a zodiac boat and an MA-1 sea rescue package (two seven-man rafts and supplies) that was rigged for airdrop should survivors be found. The crew flew at 1,000 feet above the water at 180 KIAS. On the first mission nothing was found, and the crew returned to Windhoek. Before landing the crew experienced problems with the number 2 engine and shut it down. The aircraft required an engine change, and it was not until 18 September that a new one could be shipped and installed.⁹⁶

Over the next week both aircraft flew daily sorties, but only a small amount of wreckage and

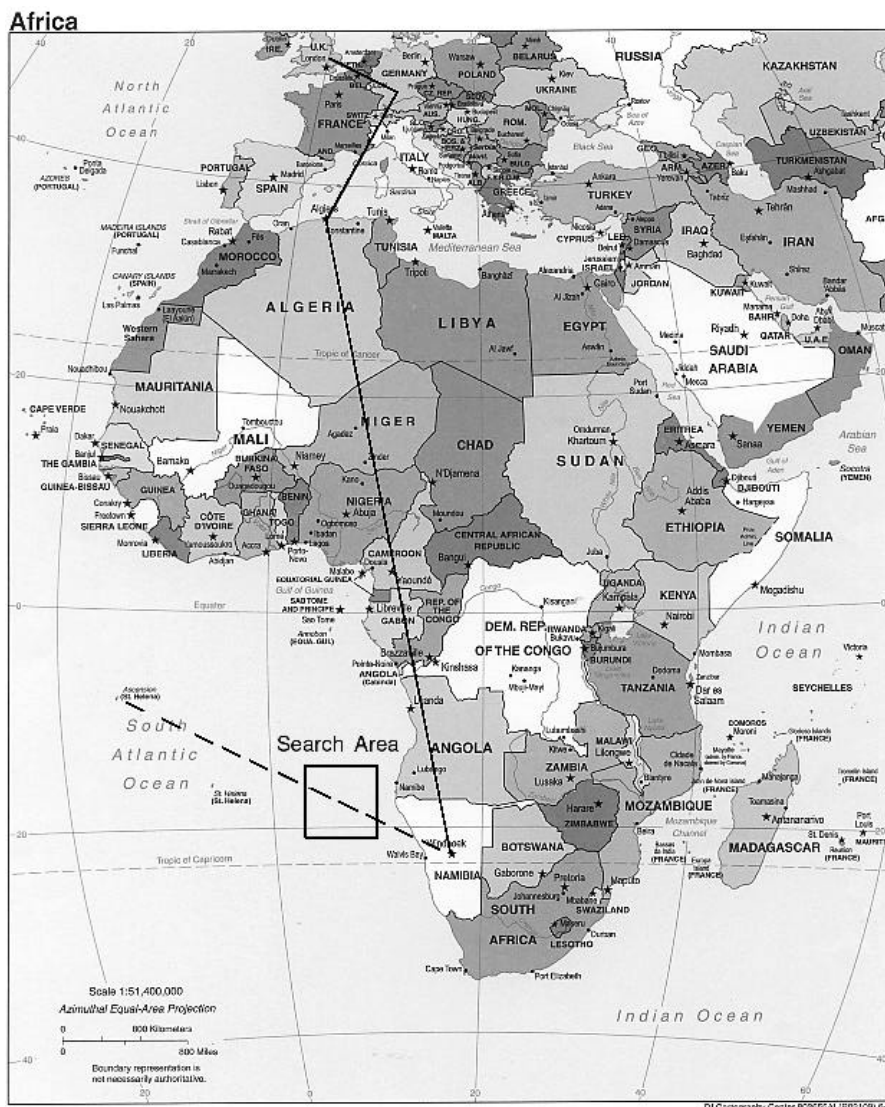


Figure 53. Route of Flight, Operation High Flight (Source: AU Library, Maps and Charts Division, Maxwell AFB, Ala.)

an oil slick was located. Enough wreckage was found to determine that the C-141 and the TU-154 had collided over the South Atlantic. On 25 September the recovery operation shifted unofficially from SAR to search and salvage after it was determined that there was no possibility of finding survivors. The last SAR mission flown by the 7th SOS was on 26 September, after which time the effort was officially classified as a search and salvage.⁹⁷ The Combat Talon departed Namibia on 27 September, followed by the MC-130P the next day. Both aircraft stayed overnight at Rota AB, Spain, and by 29 September the 352d SOG contingent had recovered at RAF Mildenhall. Although no survivors were found, General Lambert and USEUCOM praised the professionalism of everyone participating in the operation.⁹⁸

The long anticipated ORI kicked off in October and was named Operation Nordic Retrieval. The first organic aircraft to deploy was a 7th SOS MC-130H on 9 October carrying the group's advanced team to Andoya AS, Norway. Personnel arrived at 2115 local and immediately commenced preparations for the arrival of the remaining aircraft and personnel. Over the next five days, personnel, equipment, and aircraft continued to arrive at Andoya AS and formed the AFSOC. The deployed AFSOC included three MH-53Js, four MC-130H Combat Talon IIs, and two MC-130Ps. On 14 October all 352d SOG forces had closed on Andoya AS, and SOCEUR tasked the group to form a Combined Joint Special Operations Task Force (CJSOTF), with Colonel Planert as the Task Force commander. Low-level route surveys, LZ surveys,

and initial leaflet drops in support of the exercise scenario were accomplished during the next two days. Throughout the following week a full array of missions was flown, and the CJSOTF was given the opportunity to demonstrate its ability to survive and operate during a chemical warfare attack on its main operating base. By 24 October the exercise scenario had provided the Headquarters AFSOC/IG with enough opportunities to complete its evaluation. Beginning on 24 October assets began redeploying to RAF Mildenhall. Overall the 352d SOG earned an excellent rating for the ORI, with the 7th SOS receiving an outstanding rating during the critical "employment phase" of the inspection. The months of preparation, coupled with real-world deployments, had prepared the group for the challenging exercise.⁹⁹

For the final two months of the year, the 7th SOS continued to fly local training sorties and deployed for a JCET in Italy just after Thanksgiving. As 1997 ended the squadron had time to reflect on its many accomplishments throughout the year. From the cold of Andoya AS to the steaming heat of Namibia, the crews and aircraft of the squadron had performed admirably. Everyone looked forward with anticipation to 1998.

1998: First Lieutenant Blassie of the 8th SOS Comes Home

The year 1998 was marked by expanded employment of Combat Talon II to remote areas of the world and to previously denied areas of Eastern Europe. For the 8th SOS the remains of a lost pilot from the Vietnam War were identified and laid to rest. The 7th SOS continued its history of excellence by winning the 1998 Tunner Award. For the Combat Talon community, the year would be another memorable one.

The 7th SOS Returns to Africa

Both the JCET and JCS exercise programs continued to be the primary emphasis of the 7th SOS during the first half of 1998. Two MC-130H aircraft and crews participated in Red Flag 98-2 from 26 January to 6 February at Nellis AFB, Nevada. The 7th SOS contingent joined special operations crews from the 1st SOS and the 8th SOS during the two-week exercise.

For the 7th SOS, deployment began on 21 January when a two-aircraft Talon II package departed RAF Mildenhall bound for Halifax, Nova Scotia. After spending the night at Halifax, the two crews flew on to Peterson AFB, Colorado,

where they remained for the next two days. The crews arrived at Nellis AFB on 24 January and settled into their working areas, and the Combat Talons were prepared for the scheduled missions. On 26 January both crews conducted familiarization flights to orientate themselves with the local area. The primary mission for the 7th SOS during Red Flag included flying in an intensive EW environment while conducting airdrops and participating in infiltration and exfiltration scenarios.¹⁰⁰

Beginning 27 January the first 7th SOS mission was flown into the Nellis range and consisted of a container airdrop followed by NVG landings at a remote assault strip. For the duration of the exercise, the two crews alternated flying every other day, gaining valuable experience working with crews from the other two Talon squadrons. Inclement weather caused the cancellation of several sorties, but the crews were successful in attaining most of their exercise goals.¹⁰¹

The squadron experienced another first in February when it deployed one MC-130H aircraft and two crews to Riga, Latvia, for a JCET working with the Latvian Special Forces and Naval Special Warfare Unit Two. Although the initial deployment could be characterized as somewhat uncoordinated, the Latvians were eager to work with US forces and were excellent hosts. The two major disconnects during the JCET were misunderstandings over the requirement for DZ surveys and outside commitments that tended to distract the crews from their flying mission. For future deployments the mission commander recommended that a field grade officer deploy to take care of the official functions not associated with the actual JCET. Also recommended was that CCT personnel accomplish DZ surveys during predeployment planning. Overall the experience was a positive one for US participants, and members of both militaries departed with a better understanding of each other's capabilities and limitations.¹⁰²

Members of the 352d SOG deployed to Hungary for a second JCET, this time from 17 to 27 March. Both the 7th SOS and 67th SOS deployed an aircraft and augmented crew, plus support personnel. Besides dropping Hungarian paratroopers the crews flew air-intercept training sorties against MiG-21s and MiG-29s of the Hungarian air force and flew EW training sorties against SAM sites. The training was rated by the crews as the best ever accomplished. The training was enhanced because the Hungarian system operators were highly trained in their particular weapons system, thus providing realistic and challenging threats to

the Combat Talon II crews. The Hungarians were cooperative in answering all questions posed and provided visits to their air defense sites. Some training could have been improved, however. The 7th SOS desired more night sorties utilizing NVGs, and the Hungarians wanted more air intercept sorties and more parachute operations. Future planning would incorporate those recommendations into the training plan.¹⁰³

For the next three months, the 7th SOS deployed on a JCET each month, including JCETs in Gibraltar, Souda Bay, Crete, and Kenitra, Morocco. By early summer the squadron had completed six JCETs and two exercises that reached from North Africa to Norway and from the continental United States to Eastern Europe. The training schedule was interrupted on 9 June 1998 when another crisis developed in western Africa. Within hours of tasking, the 7th SOS was en route for another NEO identified as Operation Shepherd Venture.

The president of Guinea-Bissau, a small country in western Africa, fired his chief of staff for smuggling weapons in late 1977 and governed without a replacement throughout the first half of 1998. Tension continued to mount within the government, with the fired chief of staff threatening to retaliate if the president did not reinstate him. On 7 June 1998 the president appointed a replacement, and the former chief of staff immediately launched a coup. Intense fighting broke out in the capital city of Bissau, located on the coast. The fighting resulted in many third-country nationals seeking refuge in the US Embassy. Security for these people and US citizens living in the country became a concern of the US ambassador. As time passed the fighting increased and further threatened the embassy compound. On 9 June the US ambassador to Guinea-Bissau formally requested an NEO.¹⁰⁴

At the 352d SOG verbal tasking flowed from SOCEUR, and crews from both the 7th SOS and 67th SOS were put into crew rest for possible launch later in the day. The following morning two MC-130Ps launched from RAF Mildenhall and proceeded to Stuttgart to onload a security team and its associated equipment. By late afternoon they were ready to depart. USEUCOM selected Dakar, Senegal, as the intermediate staging base, and at 1809 local the two MC-130Ps departed Stuttgart. Thirty minutes later one MC-130H from the 7th SOS departed RAF Mildenhall with maintenance and support equipment aboard. At 0323Z on 11 June, the two MC-130Ps landed at Dakar, and 36

minutes later the Combat Talon arrived. Communications personnel went to work setting up their equipment, support personnel occupied facilities and began to set up their work areas, and maintainers began preparing the aircraft for future missions. Later in the day a second CT II arrived after relocating from a JCET in Morocco. After only two hours on the ground, the second Combat Talon was directed by SOCEUR to return to Stuttgart and to stand by for additional tasking. US Navy captain Schoultz, SOCEUR chief of staff, was designated as the deployed JTF Commander for Operation Shepherd Venture. Upon his arrival he immediately entered into talks with the US ambassador to Senegal and with French and Portuguese authorities on the status of the Guinea-Bissau situation.¹⁰⁵

As planning continued through 11 June for a possible NEO, a Portuguese bulk freighter docked in Bissau, and the decision was made to use the ship for the NEO instead of relying on an airborne operation. Approximately 1,000 French, 70 Portuguese, and 50 Americans subsequently boarded the ship to escape the fighting. By 13 June all remaining personnel desiring to leave Guinea-Bissau had departed by other means, and the need for an NEO was eliminated. The 7th SOS maintained an alert crew through 14 June, at which time it was released from its commitment. On 15 June the 7th SOS Talon II departed Dakar for home station. Although an NEO was not accomplished, the 352d SOG once again demonstrated its ability to respond to real-world tasking in minimal time.¹⁰⁶

A 7th SOS Combat Talon II Crew Wins the 1998 Tunner Award

At 1600Z on 19 September, the 7th SOS was alerted and began planning for another mission to western Africa. Tensions had again increased in Liberia, and USCINCEUR was considering options to insert an ESAT team into the US Embassy. The crisis was brought on earlier when two embassy personnel were wounded during a fire-fight between Liberian security forces and supporters of faction leader Roosevelt Johnson. The ESAT would provide intelligence information for USCINCEUR, and it would provide increased manning for the small embassy security force.¹⁰⁷

An augmented 7th SOS crew was placed on minimum crew rest status, while additional crews preflighted and sealed Combat Talon 87-0023. Contingency planners from 7th SOS/DOX developed a route of flight and coordinated in-flight and ground refueling requirements. Group intelligence

officers and NCOs assembled navigational charts and imagery, while the mobility staff secured weapons, MREs, bottled water, and protective equipment for the operational crew. The result was a total group and squadron effort.¹⁰⁸

At 0030Z on 20 September, the crew was alerted for an immediate launch and delivery of the ESAT to Freetown, Sierra Leone. Immediate launch was required because the situation in Liberia had worsened over night. The small security force at the embassy was in danger of being overwhelmed by rogue warriors loyal to President Taylor. The rogue warriors were roaming the streets and challenging personnel loyal to Roosevelt Johnson. At 0355Z on 20 September, just three hours and 25 minutes after notification, Shark 01 departed RAF Mildenhall en route to

Stuttgart AAF for the first leg of Operation Shadow Express.¹⁰⁹

At 0545Z on 20 September, MC-130H aircraft 87-0023 touched down at Stuttgart AAF and quickly uploaded the 14-man ESAT. Along with the team members, equipment included weapons, ammunition, and provisions required to sustain the team for the next several weeks. Crew members finalized arrival procedures at Freetown with the ESAT chief. At 0708Z, one hour and 23 minutes after landing, the crew and ESAT personnel launched from Stuttgart. A KC-135 from the 100th Air Refueling Wing rendezvoused with Shark 01 over water, and a successful IFR was completed (fig. 54).¹¹⁰

There were no US-approved instrument precision approaches into Dakar, Senegal. Consequently, the

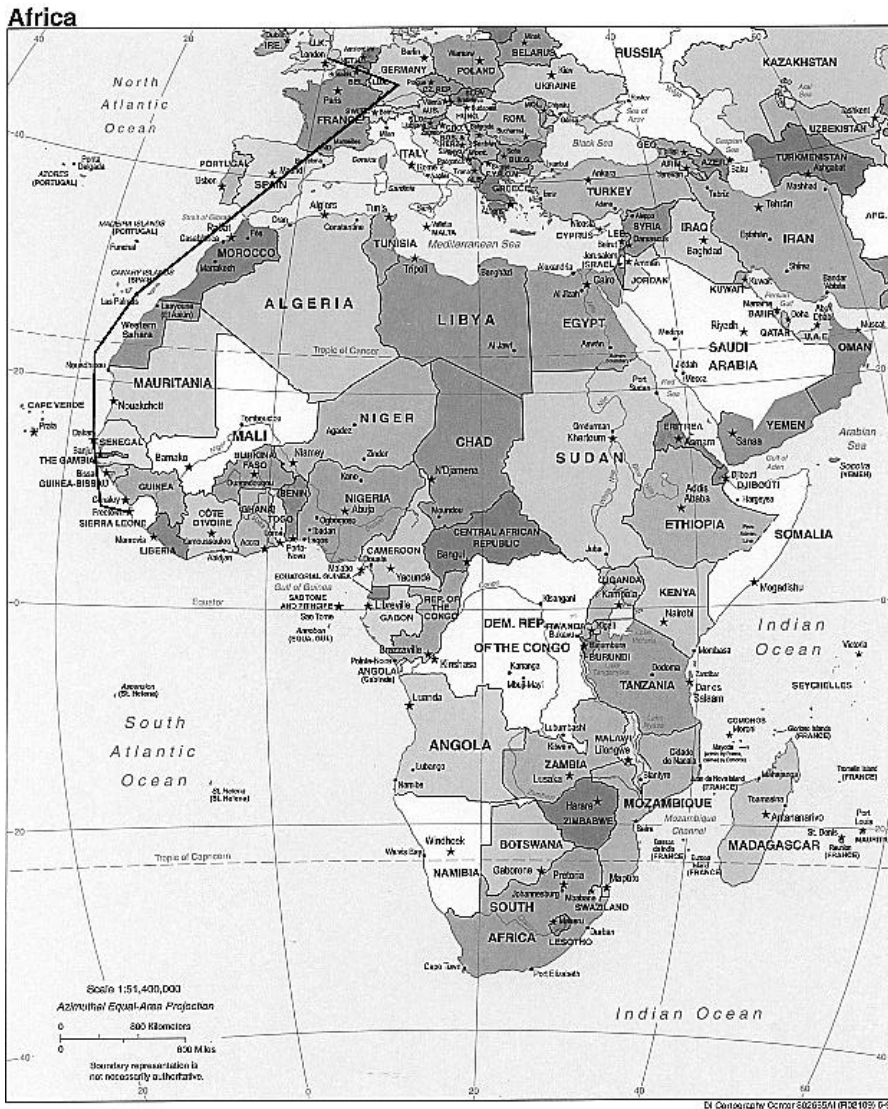


Figure 54. Route of Flight, 7th SOS Crew Shark 01, 1998 Tunner Award (Source: AU Library, Maps and Charts Division, Maxwell AFB, Ala.)

crew navigator used information from imagery provided prior to the mission and the aircraft's onboard computers to generate a fully self-contained, dual INS/GPS straight-in approach for landing. At 1720Z, 10 hours and two minutes after departing Germany, Shark 01 landed at Dakar and completed a second ground refueling. The crew was now into a 17-hour crew day as it awaited clearance from Stuttgart to continue the mission. After assessing the crew's condition for safe flight, and with the situation continuing to deteriorate in Monrovia, clearance was given to continue the mission. At 1926Z the crew departed Dakar inbound to the designated transload location at Sierra Leone. Weather conditions deteriorated as the crew approached its destination, causing the aircraft to divert 50 miles to the west of its desired inbound route of flight to circumnavigate buildups and thunderstorms. At 2130Z on 20 September, the Talon II landed at Freetown well ahead of the scheduled transload and forward movement of the team to Monrovia. As the aircraft landed, Roosevelt Johnson and 23 of his supporters sought refuge inside the US Embassy as President Taylor's forces closed in on them.¹¹¹

With the ESAT delivered, the 7th SOS crew returned to Senegal and awaited further tasking. At 2149Z Shark 01 departed Freetown for Dakar in anticipation of tasking for an NEO. The weather experienced on the inbound leg had worsened, and the crew was forced to dodge large thunderstorms off the coast of western Africa. While on final approach to Dakar, and nearly 22 hours into its crew day, the crew noticed the number 4 engine becoming erratic and had to shut it down. The procedure went smoothly, and the aircraft landed without further incident.¹¹²

For the next 20 days, Shark 01 maintained a 24-hour alert posture in the event that an NEO was required. An additional mission that the crew was prepared to execute if tasked was to deliver MREs and water to the embassy compound. During the period additional forces joined the 7th SOS crew at Dakar in anticipation of further action. Negotiations for the safe departure of Johnson and his supporters were finally concluded, and on 9 October 1998, President Taylor approved the negotiated settlement, and Roosevelt Johnson departed Liberia for asylum in another West African country. Shark 01 flew 14.1 hours to redeploy the ESAT and Naval Special Warfare Unit forces to Stuttgart after refueling stops in Dakar and Rota AB. The crew returned to RAF Mildenhall on 10 October 1998

and reconstituted for future contingency response. The crew was awarded the 1998 Tunner Award for the most outstanding strategic airlift mission of the year.

The 1st SOS Deploys to Mongolia for Balance Magic 98-1

The 1st SOS had returned to Kadena AB in late November 1998 after completing a challenging Foal Eagle 97 exercise. Although providing the best training of any exercise that the squadron regularly participated in, Foal Eagle did not include an active EW scenario. Missions were planned and flown against notional threats, but the crews did not get the opportunity to react to threat indications displayed on the aircraft's defensive systems during flight. In late January the 1st SOS deployed two MC-130H Combat Talons to Nellis AFB to participate in Red Flag 98-1 (RF 98-01). The RF exercise showcased a robust threat scenario that challenged the crew during the course of each mission. Both the 7th SOS and 8th SOS deployed aircraft and crews for the exercise. During the two-week period, the 1st SOS flew 131.6 hours, with the majority of the time logged during the deployment and redeployment flights from the western Pacific. RF 98-1 proved to be an excellent training environment for all three Talon squadrons. It provided the opportunity for the 1st SOS crews to perform air-drop and airland missions in a high-threat environment. While successfully completing their airdrops and airlands, the crews experienced intensive ECM and air intercept training. On 10 February the two 1st SOS Talons departed Nellis AFB and arrived back at Kadena AB the following day. The entire RF experience had been a good one, and the crews gained valuable hands-on experience when faced with active real-world threat scenarios.¹¹³

The next major JCET for the squadron was Vector Flash Action 98-1 (VFA 98-1) in Australia from 25 February to 28 March. SOCPAC special operations units and the Australian Special Air Service Regiment conducted train-up exercises prior to the arrival of the 353d SOG contingent. The group deployed one MC-130H Combat Talon II and one MC-130P on 11 March to Royal Australian Air Force Base, Pearce, which was located on the outskirts of Perth, Australia. Mission profiles flown included NVG infiltrations and exfiltrations, static-line personnel airdrops, HALO personnel airdrops, and CRRC water insertions. Prior to joining other exercise participants, the two aircraft flew training missions that included low-level

route surveys and airland operations into austere landing strips.¹¹⁴

The actual FTX began on 21 March and was based on a full-scale joint/combined mission profile. Events rehearsed during the work-up phase were employed in a tactical scenario during the FTX. VFA 98-1 was an excellent JCET for the 353d SOG and for the Australian and US special operations participants. The opportunity to execute multiple mission essential tasks with potential customers provided outstanding preparation for possible future contingencies. The 1st SOS Combat Talon (88-0195) flew 57.8 hours during the JCET and flew 12 out of the 20 days deployed. The crew arrived back at Kadena AB on 30 March.¹¹⁵

The squadron returned to Thailand during the March–April time period for Exercise Balance Torch 98-2. The JCET was based out of Phitsanulok RTAB, Thailand, and was conducted from 19 March to 9 April. The 1st SOS deployed two MC-130H Combat Talons nonstop from Kadena AB, with the first aircraft arriving on 16 March with members of 1st Battalion, 1st Special Forces Group, which was also stationed on Okinawa. The second Combat Talon deployed on 20 March. The primary objective of the JCET was to support a military free fall level-one certification course for the Thai army, but additional drops and air intercept training

were also accomplished during the course of the exercise. During the military free fall certification course, 550 personnel were dropped from the Combat Talons. Aircraft 88-0192 flew the bulk of the missions because aircraft 88-1803 needed an engine. The exercise was an excellent training opportunity for all participants.¹¹⁶

Perhaps the most interesting JCET of the year was conducted in Ulaanbaatar, Mongolia, from 25 March through 17 April and was named Balance Magic 98-1 (BM 98-1). US special operations personnel participated with 30 members of the Mongolian Civil Defense Force in training events that focused on enhancing Mongolian foreign internal defense and the country's disaster relief capabilities. For the 1st SOS JCET support was broken down into two periods, the first coming at the start of the exercise and the second during a one-week period at exercise conclusion. The first Combat Talon deployed to Ulaanbaatar on 25 March, and the crew participated in opening ceremonies the following day. On 27 March the aircraft returned to Kadena AB. A second Combat Talon deployed on 10 April and remained in Mongolia flying exercise sorties until 18 April. BM 98-1 marked the first deployment of 353d SOG assets to Mongolia, and the Combat Talon was well received by host-nation participants. Although some disconnects were inevitable, the JCET was an overall success (fig. 55).¹¹⁷



Figure 55. Map of Mongolia (Source: AU Library, Maps and Charts Division, Maxwell AFB, Ala.)

Early summer found the 1st SOS deployed to Korea for JCET Teak Knife 98-04 (TK 98-04) with three Combat Talon II aircraft. From 5 to 17 June, the aircraft operated from Osan AB and focused on combined training with the 255th SOS (ROKAF) and with ROK Army Special Warfare Center Special Forces. The original concept included operating out of Taegu AB, but when it became unavailable, the JCET was moved to Osan AB. Both ROKAF and 353d SOG forces performed personnel and equipment airdrops, HALO airdrops, and engine running off-loads and on-loads. The large 353d contingent included the MC-130H Combat Talons, two MC-130P Combat Shadows, and three MH-53J Pave Lows. The JCET served as a workup for the group's ORI scheduled later in the year during JCS Exercise Foal Eagle 98. In total the group deployed 178 personnel to Korea for TK 98-04. The JCET was a rewarding and challenging exercise that enhanced the ability of the 353d SOG and ROK Special Warfare Center to operate together in a complex joint/combined scenario.¹¹⁸

The following month much of the group's assets were deployed for a no-notice contingency response exercise named Bantam Runner. Following alert and deployment orders from SOCPAC, the 353d SOG deployed two MC-130H Combat Talons, two MC-130P Combat Shadows, and three MH-53J Pave Lows to Kaneohe Bay MCAS, Hawaii, from 6 to 19 July. The exercise was designed to test the SOCPAC commander's ability to respond and resolve a crisis. More than 240 personnel from the 353d SOG participated in the exercise along with 300 US Army, Navy, and Marine Corps soldiers and sailors. Exercise objectives included a personnel recovery operation, a CSAR event, coordination with the Department of Justice, operations from a barebase, and integration of sister-service reconnaissance capabilities (US Navy submarine and P-3 aircraft) into the operation. For the 353d SOG Bantam Runner was an extremely successful test of the group's ability to deploy on short notice in support of contingency operations. Group aircraft flew 260.4 hours while supporting the joint operation and demonstrated their ability to operate from a barebase thousands of miles from home station.¹¹⁹

From 21 July to 10 August, the 1st SOS deployed two Combat Talon II aircraft to Perth, Australia, for Exercise Tourniquet Mile. The JCET was similar to the one flown earlier in the year, except that US-based special operations forces made up the bulk of US-committed forces.

The 1st SOS also supported a second JCET to Thailand, Balance Torch 98-3, with one Combat Talon II from 24 July to 7 August. As had been the case earlier in the year, HALO training was the primary focus of the Thailand JCET. In early fall, from 15 September to 5 October, two Combat Talons were deployed to Elmendorf AFB, Alaska, for JCET Gryphon Ale 98-1. After landing at Elmendorf AFB, deployed maintenance was directed by home station to perform a one-time inspection for corrosion, and they found extensive corrosion under the numbers 2 and 3 engine heat shields on Talon 88-0191. The corrosion grounded the aircraft for the duration of the exercise. The second Talon (88-0192) had to take up the slack, and thanks to outstanding maintenance, was able to support pre-exercise scheduled sorties. Aircraft 88-0191 was repaired and flown back to Kadena AB at the completion of the event.¹²⁰

The annual JCS Exercise Foal Eagle 98 provided the venue for the 353d SOG's ORI, which was flown from 13 October to 2 November 1998. The exercise involved nearly 35,000 US and 500,000 ROK troops, thus making it the largest joint/combined exercise in the world. From 13 to 22 October, Headquarters AFSOC/IG examined the group's initial response and mission support activities at both Kadena and Osan ABs. During initial response the 353d SOG was evaluated on its ability to shift from a peacetime posture to a wartime posture. The group was also evaluated on how well it mobilized and interfaced with the 18th Fighter Wing at Kadena AB and the 51st Fighter Wing at Osan AB. During the initial phase of the ORI, Typhoon Zeb threatened Okinawa, forcing the aircraft to be evacuated to Guam from 15 to 18 October. After returning from Guam all fixed-wing aircraft were generated and ready for ORI tasking within 23 hours of their arrival.¹²¹

On 21 October the 353d SOG deployed 476 personnel and 165 short tons of equipment to Taegu AB and commenced the employment phase of the ORI. The 1st SOS performed in a superb manner throughout all phases of the evaluation but did exceptionally well during the employment phase. Typical mission profiles included terrain-following radar operations, threat avoidance, infiltration, exfiltration, and resupply. The 1st SOS crews also performed PSYOPS, IFR, FARP operations, and NVG low-level navigation missions during the exercise. The squadron flew 13 graded tactical sorties totaling 34 hours of flight time. Foal Eagle 98 was a highly successful exercise, with the 353d SOG receiving an overall grade of excellent for

the ORI. The group once again demonstrated its ability to contribute to the defense of the Republic of Korea.¹²²

During the remainder of the year, the 1st SOS deployed to Australia and Korea for JCETs Foreconex 99-1 and Teak Knife 99-02, respectively. The final JCET of the year was Teak Piston, which was flown out of Mactan AB, Philippines, from 1 to 13 December. One MC-130H and a small maintenance support package supported US Navy SEALs and Philippine Naval Special Warfare Unit Five while working closely with the Philippine Air Force (PAF) during the drop phase of the exercise. The PAF had recently obtained two B-model C-130s from the United States and was interested in developing an air-drop capability to assist in disaster relief operations within the Republic of the Philippines. The JCET was a success, with relationships developed during the course of the exercise promising to open the door for future operations between the 353d SOG and the PAF.¹²³ The year had been a good one for the 1st SOS, with unit proficiency reaching a new level as the squadron executed JCET and exercise events from Hawaii to Mongolia. The coming year would be more of the same.

The 8th SOS Returns to Southwest Asia

Early in 1998 the 8th SOS deployed to Southwest Asia for another contingency operation. Alderfer, the squadron commander, led 31 squadron personnel on a two-ship deployment to Kuwait. Combat Talon Is 64-0559 and 64-0566, three crews, and a small planning staff made up the 8th SOS contingent. While deployed two Talon I crews flew to Qatar in support of JCS Exercise Eastern Viper. The exercise deployment helped to reinforce military-to-military relationships between host-nation forces and the US military. Events completed during the exercise included both static-line and HALO personnel airdrops. After completion of Eastern Viper, the aircraft and crews returned to Kuwait.¹²⁴

The squadron continued to excel throughout the remainder of the year, supporting contingency operations and a robust exercise program. Two members of the squadron were recognized by Headquarters AFSOC for their superior performances. For 1998 Captain Wormley was awarded the AFSOC Electronic Warfare Officer of the Year, and Captain Anderson was recognized as the AFSOC Navigator of the Year. Captain Anderson was also awarded the 1998 AFSOC Aircrew Member of the Year. The high

caliber of people assigned to the squadron made the 8th SOS one of the premier special operations squadrons in the command.¹²⁵

First Lieutenant Blassie, the Tomb of the Unknown Soldier, and the 8th SOS

On 11 May 1972 Lieutenant Blassie's A-37 Dragonfly, assigned to the 8th SOS and stationed in South Vietnam, was shot down near An Loc. His body was not recovered at the time. Later that same year remains were found in wreckage near his last known position, but positive identification could not be made, and the remains were classified as unknown. On Memorial Day, 1984, the unknown remains were entombed in Arlington National Cemetery's Tomb of the Unknowns, where for the next 14 years, the remains were honored. After a recommendation by the Department of Defense working group charged with identifying remains of the Vietnam unknowns, the tomb was opened, and the remains were removed in May 1998 to undergo DNA testing.¹²⁶

On 30 June 1998 Secretary Cohen announced that the remains had been identified with "99.9 percent degree of certainty" as those of Blassie. The confirmation set into motion efforts to return Blassie's remains to his family and home near St. Louis. When Alderfer discovered that Blassie was a former member of the 8th SOS, he offered to conduct a flyover at Blassie's memorial service. During the course of gaining Air Force approval for the flyover, the squadron was asked to transport Blassie's remains from Washington, D.C., to his home. On 9 July 1998 Combat Talon 64-0566 departed Hurlburt Field en route to Dover AFB, Delaware, where the crew picked up Blassie's remains and transported them to Scott AFB, Illinois. On 10 July the Combat Talon took off for St. Louis, using call sign Hawk 02, which was Blassie's call sign when he was shot down in 1972. The crew of Combat Talon 64-0566 attended the memorial service on 11 July and was personally thanked by the acting secretary of the Air Force, F. Whitten Peters, for its part in bringing Blassie's remains home.¹²⁷ After the memorial service, the crew returned to Hurlburt Field.

The 15th SOS in Europe and Southwest Asia

The 15th SOS continued to support a robust JCET program in 1998. One crew deployed to Barcelona, Venezuela, from 29 April to 11 May 1998, in support of JCET 8339. The crew's mission was

to conduct airborne training with elements of the US Army's 7th Special Forces Group. Six missions were flown, which included static-line personnel drops and low-level terrain following. From 17 to 27 May, elements of the 15th SOS deployed to Ecuador for another JCET. While there the crew flew three humanitarian relief sorties for flood victims ravaged by unseasonably heavy monsoon rains. Supplies delivered included more than 25 tons of water, water-purification equipment, rice, bananas, and medicine. For the exercise the Talon flew 20 sorties in support of one of the largest JCETs to ever take place in SOUTHCOM. In all, more than 1,000 personnel were committed to the exercise. Both airland and air-drop missions were completed, and 240 Ecuadorian paratroopers earned their US parachutist badges by jumping from the Talon II.¹²⁸

From 29 May to 18 June, the squadron deployed two aircraft and crews to Jordan for JCS Exercise Early Victor. The aircraft operated out of Markka International Airport, Amman, Jordan. Personnel airdrops of host-nation forces were completed, and infiltration and exfiltration missions involving US Army Special Forces and US Navy SEALs were flown in southern Jordan. Airland missions were flown to a highway landing strip near Qatranah, Jordan, with the crew utilizing its on-board precision navigation system to fly the approach. Additional airdrops over the water south of Aquaba were completed in support of the SEALs. Psychological operations in the form of leaflet drops were conducted over the Jordanian desert, and airborne intercept training with Royal Jordanian Air Force fighters was also completed.¹²⁹

During the return trip to the United States from Early Victor, the two crews stopped at RAF Mildenhall for intersquadron training with the 7th SOS. The 15th SOS crews flew several training sorties, including low-level flights in the Scottish Highlands. A two-ship close interval formation flight was also flown with one crew and aircraft from each squadron. The formation flight gave both squadrons an opportunity for the valuable exchange of tactics and techniques.¹³⁰

On 17 July 1998 Colonel Wert assumed command of the 15th SOS from Colonel Glausier in a ceremony on the Hurlburt Field flight line. Wert had been the operations officer of the squadron before assuming command. Additional JCETs were flown by the squadron in South America during the second half of the year. Deployments into SOUTHCOM's area of responsibility included

those to Puerto Rico, Bolivia, and Ecuador. Experience gained by the crews and by maintenance personnel was invaluable in seasoning the 15th SOS CT II weapons system.¹³¹

Kirtland AFB Operations Are Refined

At Kirtland AFB the MC-130H WST was operational throughout 1998, with earlier problems of software compatibility resolved. With full-motion and graphical video feedback, the WST came close to replicating the actual aircraft throughout all flight scenarios. The WST provided a virtual-reality presentation that challenged both students and permanent party instructors alike. One hundred students completed the MC-130H simulator course during the first six months of the year. The Combat Talon II program saw 38 pilots, two navigators, 20 flight engineers, and 40 loadmasters complete their training in the WST.¹³² During the last half of the year, 56 students received training, with 15 of those graduating by year's end. The remainder were carried over to the following year, as they continued their formal training program. For the second straight year, no students were eliminated from the Combat Talon II program.¹³³

The 58th SOW's bilateral exercise program continued to expand throughout the first half of 1998. The first two bilaterals scheduled for the 550th SOS in January and February, however, were canceled at the last minute due either to aircraft availability or lack of DZ surveys. The third bilateral exercise that a 550th SOS's MC-130H was scheduled to participate in was from 11 to 13 February. On 11 February one MC-130H departed Kirtland AFB for Isleta DZ. The crew performed dry passes and then flew a low-level route in the Utah Test and Training Range, receiving ECM training during the low-level event. The crew then proceeded to Michael AAF, Utah, for self-contained practice approaches and then flew a midlevel route to Monterey, California, where it remained overnight. On 12 February the crew gave the students of the Naval Postgraduate School an orientation flight, followed by a static display. On the last day of the deployment, the crew flew a low-level route in the Utah Test and Training Range for another ECM training event. The low-level route terminated at Michael AAF, where the crew again flew multiple self-contained approaches. The crew returned to Kirtland AFB by way of a low-level route through Utah, terminating at home station with two simulated HSSLADS and two simulated CRS drops on Isleta DZ. For the three-day trip, the

crew logged 15.3 flying hours and accomplished multiple continuation training events.¹³⁴

From 27 February to 1 March, the 550th SOS deployed one MC-130H to Peterson AFB. The crew supported soldiers from the 10th SFG(A) with static-line and HALO drops planned in conjunction with practice self-contained approaches for aircrew proficiency. The first exercise mission was flown on 28 February and included a low-level route, ECM training for the EWO, and multiple self-contained approaches. Bad weather set in the following day, with heavy snow and high winds canceling the scheduled personnel drops. On 28 February the crew departed Peterson AFB and flew multiple personnel drops on Walker DZ, then returned to its staging base. The crew completed an engine running onload of 2d Battalion jumpers, then headed back to Walker DZ. The final sortie of the day saw the crew land at Camp Guernsey and offload equipment before returning to Peterson AFB for mission termination. On Sunday, 1 March, the crew flew a 5.2-hour sortie, successfully completing nine personnel static-line airdrops and three HALO drops on Walker DZ. An additional sortie was flown from Peterson AFB, with a final landing at Camp Guernsey, to deliver the day's air items. After finishing their exercise work, the crew members returned to Peterson AFB, onloaded its crew chiefs and maintenance equipment, and returned to Kirtland AFB for mission termination.¹³⁵

The 550th SOS continued to support the 58th SOW's bilateral exercise program throughout the remainder of the spring. One aircraft deployed from 23 April to 11 May to Fort Campbell, Kentucky, to work with the 1st Battalion, 5th Special Forces Group. From 30 April to 3 May, one MC-130H deployed to Hurlburt Field and flew airborne intercept missions with the Texas Air National Guard. On 4 and 5 May, one Talon II supported the 4th Reconnaissance Battalion, USMC, out of Camp Pendleton, California. Two additional bilaterals were completed in May, including deployments to Kelly AFB, Texas, and Fort Collins, Colorado.¹³⁶ Six more bilaterals were completed from June to December. The aggressive bilateral program helped to mature the young 550th SOS instructor force and provided excellent training for the formal Combat Talon II student crew members.

The last Chile Flag exercise of the year (99-01) was conducted out of Kirtland AFB from 26 October to 6 November, and the 550th SOS participated in it along with other assets assigned to the

58th SOW. Although bad weather and coordination problems plagued the exercise, the event provided good training for wing participants and for US Army Special Forces soldiers. As 1998 ended the 550th SOS was highly proficient in all aspects of the CT II mission.¹³⁷ As a testament to how far the 550th SOS had come since initially receiving the CT II, squadron members were recognized by AETC for their superior abilities. The Nineteenth Air Force Special Operations Instructor Pilot of the Year was awarded to Captain Bauernfeind of the 550th SOS, and Captain Lum, also assigned to the 550th SOS, was recognized as the Nineteenth Air Force Electronic Warfare Officer Instructor of the Year.¹³⁸

MC-130H Full Operational Capability

On 30 June 1993 the 15th SOS-assigned MC-130H Combat Talon II weapons system reached initial operational capability. At that time full operational capability (FOC) was projected to occur when the entire fleet of 24 aircraft had been delivered. After initial operational capability three deficiencies were identified that would affect FOC status. Those deficiencies included (1) reliability of the AN/APQ-170(V)1 radar, (2) performance of the nose radome anti-icing system, and (3) the structural reliability of the nose radome.¹³⁹

The AN/APQ-170(V)1-432 radar never reached its specified 191-hour mean-time-between-failure (MTBF) rate. Studies showed that while improvements were possible, the 191-hour specification was an unrealistic threshold. Consequently, the threshold was changed to a 75-hour MTBF figure. Engineers determined that this threshold could be achieved with the completion of the -425 radar upgrade.¹⁴⁰

During the initial qualification testing of the radome anti-icing system, it was determined that the system did not provide adequate warm air to keep the nose radome free of ice. The prime contractor had been working on a solution to this problem for the past five years. It appeared that the contractor was finally approaching an acceptable solution that would keep ice off critical portions of the radome. Implementation of repair to the anti-icing system uncovered a structural problem with many of the existing radomes. This problem significantly impacted on spares availability. Until a final solution was found and implemented, AFSOC remained concerned about the number of operational radomes available.¹⁴¹

Headquarters AFSOC established the following conditions for declaring FOC: (1) completion of

the -425 upgrade to the AN/APQ-170(V)1 radar, including required spares, (2) completion of the radome anti-icing upgrade, and (3) sufficient numbers of operationally suitable radomes to support contingency and peacetime training requirements. AFSOC estimated that all requirements for FOC would not be met until October 2000, at which time FOC would be declared.¹⁴²

The 711th SOS Deploys to Brindisi

On 7 February 1998, Colonel Wilson replaced Colonel Hanson as the commander of the 711th SOS. Hanson became the 919th SOW vice commander on 4 April when the incumbent moved to another position outside the wing. Later in the spring Headquarters AFSOC and Headquarters AFRC announced plans for a new Reverse Associate Program Concept that the Air Force projected for the 919th SOW. Under the concept all 14 Combat Talon I aircraft would be transferred to the AFRC under the 919th SOW at Duke Field. The 8th SOS, which was the only remaining active duty Combat Talon I squadron, would relocate to Duke Field and continue to fly the reserve-assigned Talon Is. The concept was unique because, for the first time, an active duty flying unit would be associated with a Reserve unit and would fly reserve-assigned aircraft, instead of the traditional active duty-assigned aircraft being flown by Reserve crews. A site survey was conducted at Duke Field from 3 to 5 August to lay the foundation for actions required to make the Reverse Associate Program Concept a reality. The projected implementation date was established as 1 January 2000.¹⁴³

Members of the 919th SOW began deploying to Brindisi, Italy, in support of the ongoing Balkan operation in mid-August 1998. From August to mid-October, more than 150 personnel deployed to Italy in five different rotations, with 711th SOS's CT Is covering the first four and the 5th SOS picking up the last and final rotation. Squadron crews flew missions into Sarajevo and Tuzla in the Republic of Bosnia and refueled special operations helicopters committed to the operation. Deployed maintenance personnel spent long days and many additional hours keeping the aging Combat Talons mission ready. When unit personnel returned to Duke Field in the fall, they had made a significant contribution to the allied effort in the Balkan region.¹⁴⁴ As 1998 came to an end, the New Year promised to see the Reverse Associate Program Concept become a reality.

1999: Operation Allied Force Brings Peace to the Balkans

The last year of the decade saw the Combat Talon force deployed around the globe. In the Balkans the 7th SOS went to war as part of the largest air campaign since World War II. Preparations were finalized to transfer 14 CT Is to USAFRC, and the 8th SOS prepared to move to Duke Field. By year's end the Combat Talon would have written another colorful chapter in its long and distinguished history.

The 1st SOS Returns to Mongolia

The 1st SOS began the New Year by deploying two MC-130H Combat Talons to Nellis AFB for Red Flag 99-2 (RF 99-2), Period 1. Forty-nine personnel from the 1st SOS and 353d Maintenance Squadron deployed on 6 January 1999 to participate in the intensive exercise from 10 to 22 January. This was the second consecutive participation in the RF series by the 1st SOS.

On 17 January the 17th SOS deployed one MC-130P for the second period of the exercise. Both squadrons used NVG/terrain-following systems, air-drop/airland resupply procedures, and low-level profiles to support Blue forces participating in the exercise. As the scenario progressed to a high-threat environment, the two special operations squadrons transitioned to CSAR support.¹⁴⁵

Red Flag 99-2 provided an excellent training environment for the MC-130H aircrews. The mission commander, Colonel Buterbaugh, characterized the exercise as "the most intensive tactical combat training the squadron received" to date. It gave the 1st SOS an opportunity to use special tactics while integrating into diverse mission packages and operating in a medium-to-high threat environment. Few training exercises offered profiles with such extensive ECMs as those encountered on the Nellis range. While participating in RF 99-2, the two squadrons flew 38 sorties and 125.1 flying hours.¹⁴⁶

The following month the squadron participated in JCET BM 99-1 and for the second time deployed a Combat Talon to Mongolia in support of host-nation and US Army Special Forces personnel. The initial planning conference for BM 99-1 had been conducted the previous November in Ulaanbaatar, Mongolia, after completion of the initial JCET to that country. During the conference the US ambassador to Mongolia, the Hon. Alphonse F. La Porta, expressed his support for training between US SOF and Mongolian defense

forces. Five mission essential training events were prioritized by the ambassador for the 1999 JCET event: cold weather survival techniques, a medical civic-action project, search and rescue operations, personnel air-drop operations, and aerial resupply operations. The ambassador emphasized the need to demystify US military involvement in Mongolia and suggested the Foreign Affairs Office inform the Russian and Chinese defense attachés about BM 99-1 and to invite them to observe operations. Brig Gen Jack R. Holbein Jr., the SOCPAC commander, approved the request for a foreign military observation flight.¹⁴⁷

Due to political sensitivities, the ambassador outlined other general guidelines for the JCET event. He asked that participating aircraft stay clear of international borders. The deputy director general of Civil Aviation Authority (CAA) directed that MC-130H aircrews participating in the JCET have an English/Mongolian speaker on board and remain in contact with air traffic control for all missions. Representatives from the 353d SOG agreed to establish a 50-kilometer buffer zone from all international borders to prevent any incidents. In addition the 353d SOG agreed to provide the crew flight logs and low-level charts to the CAA for coordination purposes.¹⁴⁸

On 19 February 1999 the 1st SOS airlifted members of 2d Battalion, 1st SFG(A), to Dzuunbayan, Mongolia, to prepare for the medical capabilities exercise, survival training, SAR training, and aerial resupply operations. The following day the 1st SOS Talon II supported friendship parachute jumps involving both Mongolian and US special forces personnel. The aircrew also demonstrated the aerial resupply capability of the Combat Talon at a Soviet-built airfield five kilometers from the training site at Dzuunbayan. When the day's activities ended, the crew planned to fly a low-level route survey on its return flight to Ulaanbaatar. Mongolian CAA officials, however, denied approval, thus compelling the crew to fly back at 3,000 feet altitude. The Talon returned to Kadena AB on 21 February as Phase I of BM 99-1 concluded.¹⁴⁹

The 1st SOS deployed a second Talon II on 5 March for Phase II of BM 99-1. Due to extremely cold temperatures at Ulaanbaatar International Airport, the aircraft diverted to Osan AB. On 6 March the Combat Talon (88-1803) continued its deployment flight and touched down at Ulaanbaatar and began preparations to support JCET operations at Dzuunbayan. In addition to supporting JCET airborne events, the 1st SOS

planned to conduct unilateral training events to include SAR, low-level navigation, short-field landings, and NVG operations. Due to the extreme cold, aircraft 88-1803 experienced several maintenance problems that grounded the aircraft and prevented it from flying preplanned missions 7–12 March. The 1st SOS deployed a second Combat Talon II to Ulaanbaatar with repair parts, and the second aircraft attempted to support scheduled JCET activities. Resupply of food and water to the Dzuunbayan exercise area was denied by CAA, and the transport of USSF personnel from there back to Ulaanbaatar was also denied. The problem arose because of poor communication and misunderstandings between the CAA and other divisions within the Mongolian government. Although the Mongolian CAA had agreed to low-level and night operations at the November planning conference, it repeatedly denied permission during the exercise. Some training objectives were not met by the 1st SOS, but the challenge of operating in Mongolia made the JCET beneficial to the squadron and to the group. Aircraft 88-1803 was repaired and departed Mongolia on 17 March 1999, thus ending 1st SOS participation in Balance Magic 99-1.¹⁵⁰

Also in February the 1st SOS returned to Australia for Vector Balance Action 99-1 (VBA 99-1). One MC-130H Combat Talon II (88-0264) participated in the 1999 Australian International Air Show at Avalon Airfield in Geelong, Australia, from 19 to 21 February. The aircraft then repositioned to RAAF Pearce on 22 February to participate in VBA 99-1. On 28 February the squadron deployed a second aircraft (88-0191) to the same location, and it joined the exercise in progress. The primary 1st SOS customer for the JCET was the Australian Special Air Services Regiment 2d Squadron, whose personnel conducted HALO and HAHO airdrops, infiltration/exfiltration training, and CRRC water drops. In addition aircraft 88-0264 staged out of RAAF Tindal (near Darwin) during four days of ECM and air intercept training with F/A-18s assigned to the RAAF 75th Squadron. Throughout the exercise the two MC-130H Talons flew 54 sorties and logged over 96 hours supporting exercise participants. VBA 99-1 was an excellent training exercise.¹⁵¹

The 1st SOS continued to execute a vigorous exercise and JCET schedule throughout the spring. On 18 March, with the 1st SOS under the command of Colonel Prior, the 353d SOG deployed 121 personnel, one MC-130H Combat Talon II, and two MC-130P Combat Shadows to

Guam for JCS Exercise Tandem Thrust 99. In addition the group deployed 98 personnel and two MH-53J helicopters from the 31st SOS based at Osan AB, Korea. During the exercise 353d SOG aircrews employed NVG/terrain-following systems, performed air-drop and airland missions, and accomplished low-level profiles during the course of the exercise. Combined, the Combat Talon and Combat Shadow aircraft flew 47 sorties and logged 83.5 flying hours. Also in March the 1st SOS deployed to Ubon RTAFB, Thailand, for JCET Balance Torch 99-4. The 15th SOS also deployed one MC-130H from Hurlburt Field to participate in the two-week long event. En route maintenance problems delayed the arrival of the Hurlburt Field Talon by eight days, putting a strain on the 1st SOS crew to accomplish scheduled exercise sorties. The JCET was a success due to the exceptional work by deployed maintenance specialists. Even with the delay of the 15th SOS Talon, the JCET enjoyed a 100 percent launch rate and a 93 percent mission effectiveness rate.¹⁵²

The squadron returned to Korea in May for Teak Knife 99-6 with two CT IIs. Emphasis was placed on working with the ROKAF 255th SOS and its C-130H aircraft. Mission rehearsals were executed from 12 to 18 May, and the exercise culminated on 19 May with a full-blown tactical event. The JCET was the sixth of the year in Korea for the 353d SOG. In July the squadron deployed one Combat Talon II to Singapore for Merlynx 99-1, which was a JCET designed around a naval scenario with US Navy SEALs and a royal Singapore naval diving unit as the primary customers. Airborne intercept training was also accomplished between the 1st SOS Combat Talon and F-15 fighters from the 497th Fighter Squadron, which was also based in Singapore. The JCET staged out of Paya Lebar AB, and short-field landings were completed at Sudong Island airstrip. The Singapore 122d Fighter Squadron also participated in airborne intercept training during the exercise.¹⁵³

The squadron accomplished another first in July when it deployed one MC-130H to Antananarivo International Airport in Madagascar to participate in Balance Mist 99-1. On 22 July the 1st SOS transported 12 members of the 2d Battalion, 1st SFG(A), to Madagascar, and remained in country until returning to Kadena AB on 25 July. Although no tactical sorties were flown in the host country, the crew received valuable experience as it transited locations in the Indian Ocean. The crew stopped at Diego Garcia, Kuala Lumpur, and

Hong Kong before landing back at Kadena AB. The landing in Hong Kong was significant because it was the first time a US military aircraft had been allowed to land there since the accidental bombing of the Chinese embassy in Belgrade, Yugoslavia, by NATO forces on 7 May 1999. On 26 August, as Balance Mist drew to a close, a 17th SOS Combat Shadow retraced the Talon's route of flight, and picked up the US team and returned it to Kadena AB on 3 September.¹⁵⁴

The fall period was spent supporting Korean exercises, including Ulchi Focus Lens and Foal Eagle 99. In November the 1st SOS had the opportunity to participate in a humanitarian relief operation in Vietnam. As a result of damage caused by severe flooding in six provinces and in the provincial capital of Hue, the US ambassador there determined that the situation was of such magnitude that the US government should step in and assist the Vietnamese government. One MC-130H and one MC-130P launched from Kadena AB and proceeded to Andersen AFB, Guam, where the two aircraft unloaded 10 pallets of general relief supplies from the Office of Foreign Disaster Relief storage warehouse located there. On 11 November the two aircraft flew from Guam to Hue, and delivered 22,000 pounds of plastic sheeting, 3,600 blankets, and 5,000 water containers. The aircraft shutdown near the control tower after taxiing past farmers using the taxiways to dry their yellow rice. With no K-loaders or specialized equipment to off-load the aircraft, volunteers stepped in to unload the supplies by hand. Working side by side 353d SOG personnel, members of the Vietnamese military, and civilian laborers swiftly removed the supplies from the aircraft. The two aircraft departed the same day and returned to Kadena AB. Although the effort was a small one, it demonstrated to the people of central Vietnam that the US government was ready to help in time of need.¹⁵⁵

The year 1999 ended as it had begun with the 1st SOS deployed throughout the Pacific. The Combat Talon II was a mature weapons system that had demonstrated its ability to go anywhere in the theater and accomplish its mission.

The 8th SOS to Become First Active Associate Squadron

Operations at Hurlburt Field continued at a high pace during 1999 for the two Talon squadrons stationed there. For the 8th SOS the New Year began with a deployment to Red Flag 99-2. The squadron deployed two MC-130E Combat

Talon Is from 10 to 23 January, with both crews and maintenance personnel consolidating with the 1st SOS and 7th SOS. Although the 8th SOS was the only Talon I unit in the exercise, the older Talon shared similar tactics and procedures with the newer Talon II. The squadron deployed two additional Combat Talon Is to Desert Fox beginning in the January period.¹⁵⁶

On 5 March 1999 the Air Force officially announced changes in force structure that would have a direct impact on the 8th SOS. The changes were made to prepare Hurlburt Field for the introduction of the CV-22 Osprey in the early twenty-first century. For the Talon I squadron, the force structure that had been under review since the spring of 1998 was finalized. The Reverse Associate Program Concept was to become a reality, with the 8th SOS moving to Duke Field and becoming an active associate squadron. All 14 Talon I aircraft would be transferred to the USAF Reserve Component (USAFRC), with the 8th SOS itself remaining as a USAF active duty unit. Squadron crews would fly the USAFRC-assigned aircraft. The implementation date was confirmed as 1 January 2000, with the final move of the squadron to be completed no later than 1 April 2000.¹⁵⁷

Once at Duke Field the 8th SOS would colocate with the 711th SOS, its USAFRC sister squadron, and would share the same support facilities. Of the 14 Talon I aircraft, 10 would remain primary-assigned aircraft, two would be designated as trainers, and two would be backup inventory aircraft. Thus, the Talon I force would be manned with a combination of 15 active duty and Reserve crews, with two additional instructor crews authorized for the formal Combat Talon I School.¹⁵⁸

* * * * *

Early in 1999 General Toney, COMSOCCENT, requested the 8th SOS by name to provide fixed-wing support to the Joint Special Operations Task Force-Southwest Asia (JSOTF-SWA). The squadron deployed immediately, sending two aircraft, three aircrews, and additional support personnel to augment a JSOAC staff located in Kuwait. JSOTF-SWA provided a unique capability to Joint Task Force-Southwest Asia (JTF-SWA), which was tasked with enforcing the UN sanctions that established the no-fly zone over southern Iraq. The 8th SOS joined elements of the 720th Special Tactics Group, the 2d Battalion of the 160th Special Operations Aviation Regiment, and the 5th Special Forces Group (Airborne), plus support elements of the 16th SOW, to form JSOTF-SWA.

Within 72 hours of arrival in Kuwait, the 8th SOS was tasked to support a no-notice, NCA-directed mission. The squadron, under the command of Colonel Chapman, launched both aircraft within two hours of notification and met their time on target over the Persian Gulf.¹⁵⁹

Later in the year personnel of the 8th SOS were called upon to support the US European Command Stabilization Forces (SFOR) in Bosnia-Herzegovina with staff augmentation from June to August 1999. Major Higgins served as special operations advisor to Gen Wesley Clark, supreme allied commander, Europe, coordinating all USAF and NATO special operations air missions. Captain Stallings led a forward-deployed staff of air planners to Sarajevo that coordinated all air missions in support of NATO SFOR in Bosnia, Croatia, and Serbia. Captain Stallings's team planned and executed the movement of eight heads of state, including President Bill Clinton to and from the Stability Pact Summit in Sarajevo.¹⁶⁰

In late July 1999 and in response to USCINC-SOUTH mission tasking, the 16th SOW directed the deployment of a two-ship 8th SOS CT I force package to Bogota, Colombia. The deployment was tasked with supporting personnel recovery operations following the crash of a US Army RC-7 aircraft in the rugged Andes Mountains. From 29 July to 10 August, the two Combat Talon Is flew 18 sorties totaling 76.1 flying hours. During these sorties the Talon airlifted 27 recovery personnel, 28 tons of recovery equipment, and 44 tons of aviation fuel to Tres Esquinas AB, Colombia, where recovery operations had been established. The air base had no navigational aids and only 4,200 feet of usable runway due to recent damage by heavy rains. To overcome the limitations found at Tres Esquinas, the aircrew employed instrument meteorological condition self-contained radar approach procedures. The crews utilized onboard infrared sensors, terrain-following radar, precision ground mapping radar, and highly accurate navigational computers to fly numerous airland sorties into the air base despite low visibility, low ceilings, and no base instrumentation. An additional challenge for the crews was the elevation of the airfield at Bogota, which sat at 8,361 feet above sea level. The high elevation limited the Combat Talons to a maximum gross takeoff weight of 147,000 pounds. This restriction represented a 15 percent reduction in normal cargo capacity, thus increasing the number of sorties required to move equipment forward.¹⁶¹

In addition to moving personnel and cargo to Tres Esquinas AB, the 8th SOS crews established a FARP at the Colombian air base and conducted multiple hot refuelings for helicopters assigned to the operation. The high operations tempo required to complete the mission in the time allotted by the Colombian government was sustained thanks to the efforts of the 8th SOS. The Combat Talon Is also airlifted human remains and vital equipment, including the mishap aircraft's flight data recorder, out of the recovery area. When a mission MH-60 helicopter was grounded for lack of parts, a Talon brought the needed parts directly to the forward operating base. By the conclusion of the operation, the Colombian JTF had accomplished all of its objectives with the help of the 8th SOS Combat Talon Is. A tired but successful 8th SOS contingent redeployed to Hurlburt Field at the completion of the operation.¹⁶²

The squadron remained active in the SOUTHCOM JCET program during 1999. Crews deployed to both Bolivia and Uruguay during the year, logging more than 250 flying hours in support of CINCSOUTH objectives in these two countries. The primary objective of the South American JCETs was to conduct basic jump schools to develop a static-line personnel infiltration capability for the host nations. While deployed to Bolivia the squadron was called upon to assist the Bolivian government to map out-of-control forest fires that were devastating the countryside. With guidance from the US Embassy, the deployed crews flew fire reconnaissance missions in near-zero visibility caused by the dense smoke in the objective area. The FLIR system and the GPS were invaluable in accurately plotting the locations of more than 60 fires burning in a 1,400-square-mile area. The information provided by the Combat Talon I crew was vital to Bolivia's effort to fight the fires that threatened vast forest areas and the town of Ascension de Guarayos.¹⁶³

Since Desert Storm the squadron had maintained proficiency in dropping the 15,000-pound BLU-82B conventional bomb. During October 1999 the squadron deployed one Combat Talon I and 55 personnel to Hill AFB, Utah, to drop one of the bombs on the nearby range complex. The weapon was dropped from an altitude of 6,000 feet above the ground, and it impacted 27 yards from its intended target. The accuracy demonstrated by the crew in delivering the largest conventional area weapon in the USAF inventory showed, in fact, such delivery could be a precise operation.¹⁶⁴

For the seventh consecutive year, the squadron sponsored Operation Christmas Wish, which was a volunteer effort to support the SOS orphanage in La Ceiba, Honduras. Squadron members collected bicycles, toys, clothing, medical supplies, and necessities, and then delivered them to the orphanage. Captain Piel, the 8th SOS project officer, worked with representatives of the Air Commando Association and the Threshold Foundation of Fort Walton Beach to collect 15,000 pounds of donations. He coordinated with SOUTHCOM, SOCSOUTH, and the Department of State to accomplish the mission. In addition to providing toys for the children, the 1999 effort also raised enough funds to purchase two washers and two dryers for the orphanage, eliminating washing by hand. The project provided members of the 8th SOS, along with other members of the 16th SOW and the local community, the opportunity to help needy children in an economically depressed Central American country.¹⁶⁵ By the time Operation Christmas Wish ended in mid-December, the squadron was making final preparations for its move to Duke Field and colocating with its sister unit. The year 1999 had been a good one and would be the last year that the squadron would be assigned to Hurlburt Field.

The 15th SOS Supports SOUTHCOM Tasking

The 15th SOS remained busy supporting both JCET events, major exercises, and real-world contingency operations throughout the first half of 1999. From 11 to 19 January, the squadron deployed two MC-130H Combat Talons to Elmendorf AFB, Alaska, for Gryphon Ale 99-01. During the JCET the crews participated in mountainous terrain-following training as well as conducting air-intercept sorties against F-15C and F-15E aircraft from the 3d Fighter Wing. The crews also flew against realistic AAA and surface-to-air simulators located in the ECM range near the city of Fairbanks. After the completion of the JCET, the two Talons redeployed to McChord AFB, Washington, from 20 to 25 January and supported the US Army's 2d Battalion, 75th Ranger Regiment, stationed at Fort Lewis, Washington.¹⁶⁶

The following month, from 5 to 28 February, two MC-130H aircraft deployed to Santa Cruz, Bolivia, to provide air-drop support to the US Army's 7th Special Forces Group. During the deployment phase, the crews delivered critical medical supplies to the capital city of La Paz. Operations were based out of Viru International Airport,



USAF Photo

Support for large-scale personnel airdrops required the 15th SOS to develop multiple-ship formation tactics. Pictured are three Combat Talon IIs joining on lead.

and flights were flown daily in support of the Bolivian Airborne School and for unilateral training. Personnel airdrops were conducted near Cochabamba in the Bolivian interior. With the 15th SOS's help the 7th SFG(A) was able to requalify more than 400 Bolivian airborne troopers and jumpmasters.¹⁶⁷

The Andes mountains provided a unique venue for the crews' training. While deployed one crew flew the US ambassador to Bolivia, the Hon. Donna Jean Hrinak, on an orientation flight so that she could observe firsthand the quality of training received by both militaries. The two Talon crews had the opportunity to fly into La Paz, where the runway was 13,300 feet above sea level. The approach required the Talon crew to be on oxygen throughout the maneuver.¹⁶⁸

From the heart of South America, the 15th SOS next deployed to SEA for JCET Balance Torch 99-4 from 12 March to 14 April. Based out of Ubon RTAFB, Thailand, one aircraft and two crews supported Royal Thai armed forces and US military personnel in a full array of training events. Once in Thailand the 15th SOS contingent came under the operational control of the 353d SOG and accomplished training events to include IFR, HALO and HAHO airdrops, personnel static-line airdrops, equipment drops, and night mountain-TF events. During the month-long deployment, the lone Combat Talon flew 44 sorties and logged 78.5 hours.¹⁶⁹

With the Thailand deployment still under way, the 15th SOS deployed five aircraft to Alexandria, Louisiana, and participated in Joint Readiness Exercise 2-99. The crews, along with staff and support personnel, operated out of the Joint Readiness Training Center compound. Although the event was extremely complex and challenged maintenance and aircrews alike, the squadron enjoyed a 100 percent mission accomplishment rate throughout the intense exercise. The joint scenario included infiltrations, exfiltrations, hot refuelings, and air-drop operations. In addition to the JRX, the squadron continued to participate in bilateral exercises at Lawson and Hunter AAFs, Georgia; Harrisburg IAP, Pennsylvania; and Tonopah Test Range in Nevada. The 15th SOS's primary customer was the 75th Ranger Regiment, but it also supported other special operations units assigned to USSOCOM.¹⁷⁰

The squadron kicked off the second half of 1999 by supporting the 75th Ranger Regiment at Fort Benning, Georgia. Unit aircraft and personnel conducted a regimental airdrop of more than 1,500 soldiers during the event. Colonel Wert, the 15th SOS squadron commander, was the air mission commander for the large airdrop. In August the squadron deployed one aircraft to Andrews AFB, Maryland, to provide a familiarization ride for the new secretary of the Air Force. During the orientation ride to Pope AFB, the secretary made a tandem HALO jump into the sprawling Fort Bragg range. The mission went off flawlessly,

with the secretary appreciative of the skill of the Combat Talon II crew.¹⁷¹

Towards the latter part of August, the squadron deployed six crews to Boise, Idaho, for an airfield seizure exercise with 75th Ranger Regiment personnel stationed at Fort Lewis, Washington. While deployed to the Northwest, the crews flew ECM sorties in the Sailor Creek range. Two months later two crews deployed to the Middle East to participate in JCS Exercises Eastern Viper and Inherent Fury. Based out of Ali Al Salem AB, Kuwait, the two crews flew nine of 11 days and successfully executed exercise missions in Qatar and Bahrain. Many of the missions included the airdrop of host-nation personnel. During the deployment the squadron flew sorties into Oman, which was the first into that country in a number of years. The squadron finished out the year with a JRX out of Cape Canaveral, Florida. The four crews executed tasked missions in an exceptional manner. As the year came to a close, most of the 15th SOS was back at Hurlburt Field.¹⁷²

The 550th SOS Wins the 1999 AETC Maintenance Effectiveness Award

At Kirtland AFB the 550th SOS continued to train new CT II crew members in the formal school, with the WST operational. Air refueling missions with both KC-135 and KC-10 aircraft were completed in conjunction with the formal school and for continuation training. The Chile Flag exercise series continued to provide squadron exposure to the demanding joint arena, with tactical airdrops accomplished for both US Army Special Forces and US Navy SEALs. During the 58th SOW's ORI, the 550th SOS was the only squadron to receive an outstanding rating by the Headquarters AETC/IG. The squadron also excelled during a Nineteenth Air Force Standardization and Evaluation Visit, again receiving the highest rating of the entire wing.

While conducting an off-station night training mission, a Combat Talon II crew responded to an aircraft crash in its operating area. After locating the crash site, the aircraft landed on a nearby runway, and three crew members deplaned to assess the situation and to determine if the pilot had survived the crash. The crew members found that the pilot was still alive but was trapped in the mangled wreckage. While two crew members provided fire protection with aircraft fire extinguishers, Tech Sergeant Belsches crawled into the crushed inverted wreckage and managed to

free the trapped pilot. For his heroism Belsches was awarded the USAF Airman's Medal.

The squadron finished out the year by being awarded the prestigious 1999 AETC Maintenance Effectiveness Award for the best medium-aircraft category squadron in the command. The squadron was poised to enter the new millennium as one of the top units in AETC.

The 7th SOS Goes to War in the Balkans: Operation Allied Force

On 3 January 1999 the holiday season came to an abrupt end when three 7th SOS Combat Talon II aircraft and crews were tasked to fly a mission in support of Operation Joint Forge in Bosnia-Herzegovina. Within two hours of initial notification, the three Combat Talons were airborne and headed for Stuttgart, Germany, to pick up key staff personnel and then to move them forward to the Balkans. Weather in the target area had dropped to minimums, and it was questionable as to whether even the Combat Talon, with its sophisticated navigation and instrumentation systems, could complete the mission. The aircrew flew self-contained approaches down to minimums and was able to see the runway environment and land at Tuzla AB. No other weapons system could have landed in such foggy conditions.¹⁷³

On 24 March 1999 NATO launched Operation Allied Force, a US-led air operation directed against Serbia and its leader, Slobodan Milosevic. The conflict was caused when Milosevic refused to accept a diplomatic settlement to the Kosovo crisis that involved withdrawing Serbian troops from Kosovo, accepting a force of international peacekeepers, and agreeing to a plan for Kosovo autonomy. On 19 March 1999, a week before the actual beginning of air strikes, a planning order was issued by the CJCS to USCINCEUR outlining possible forces to be used in support of NATO operations in Kosovo.¹⁷⁴

The planning order requested that USCINCEUR identify both strategic and tactical targets that, if eliminated, would impede the movement of the Yugoslav army and police forces into and out of Kosovo. Also on 19 March Secretary of Defense William Cohen issued a deployment order for support of Operation Noble Anvil, the phased air operation portion of Allied Force. Portions of the 16th SOW (including AC-130 gunships and MH-53s) and the entire 352d SOG were tasked to support the operation. Forces were alerted at both locations, and each tasked



Photo courtesy of David Sammons

Combat Talon II en route to a high-altitude leaflet drop over the Republic of Yugoslavia.



Photo courtesy of David Sammons

High-altitude leaflet drops required supplemental oxygen for aircrew personnel. Pictured is Tech Sergeant Beck during a PSYOPS mission.



Photo courtesy of David Sammons

Leaflets departing a 7th SOS Combat Talon II during Operation Allied Force.

unit made preparations to deploy to Brindisi, Italy, where JSOTF-Noble Anvil was established as the headquarters for SOF.¹⁷⁵

On 23 March the 7th SOS deployed four Combat Talon IIs to Brindisi to deliver key staff personnel and equipment to San Vito AS in preparation for the NATO air war. These prepositioned forces served as the nucleus for all special operations activities in-theater, including combat search and rescue and AC-130 gunship employment. For the 7th SOS Combat Talons, tasking revolved primarily around leaflet missions flown in support of the Joint Psychological Operations Task Force.

The PSYOPS leaflet campaign was the largest since World War II. Because of the low-altitude AAA and SAM threats, Combat Talon crews flew at 30,000-foot altitude, unpressurized, and during daylight hours to accomplish their mission. On 3 April 1999 the first of 52 combat mission sorties was flown by a 7th SOS Combat Talon. For the next 79 days, the CT II squadron maintained a 24-hour cycle of planning, executing, and recovering missions flown over the Republic of Yugoslavia.¹⁷⁶

The 7th SOS dropped more than 101.7 million leaflets on 81 separate targets.¹⁷⁷ Drop accuracy was confirmed daily as international news media broadcast the arrival of each leaflet type as it landed on its intended targets. The phenomenal success enjoyed by NATO forces throughout the campaign could be partially attributed to the excellent work done by the deployed Combat Talon crews. Milosevic was forced to accept the desires of the people of Kosovo and to agree to the terms demanded by NATO to protect its welfare. Combat operations were terminated for the squadron on 8 June 1999 after the last leaflet mission was completed.

Throughout the remainder of the year, the 7th SOS pulled alert duties at RAF Mildenhall in anticipation of follow-on tasking in the Balkans and actually launched on several occasions. The penetration capabilities of the aircraft were far superior to anything else in the theater. In addition to supporting combat operations in Bosnia-Herzegovina, the 7th SOS participated in five of the 352d SOG's JCETs, two JCS exercises, and 15 SOF training deployments. The squadron deployed to Romania for the first time ever and participated with Romanian forces in NATO's Partnership for Peace initiative. A CT II crew flew night terrain-following missions in marginal weather through the Romanian mountains



Photo courtesy of David Sammons

Crew that flew the 14 April 1999 leaflet Operation Allied Force mission. Standing left to right: Moran, Kremer, Garstka, Bruckner, Gray, McDaniel, Arnold, McJunkins, Sanchez, and Mischke. Kneeling left to right: Montalvo, Hammer, and Sammons.

and flew airborne intercept training missions against MiG-21s and MiG-29s. The aircraft also flew against SA-2, SA-3, and SA-6 SAM systems, using its ECM equipment to identify the threats. The training value of the JCET was exponentially increased due to the experience of the former Warsaw Pact-trained soldiers and the variety of equipment employed against the Combat Talon.¹⁷⁸ The squadron finished out 1999 with highly experienced combat crews that were prepared for the new century.

* * * * *

Operation Allied Force was the last major contingency tasked to Combat Talon during the



Photo courtesy of David Sammons

Crew that flew the 1 June 1999 Operation Allied Force leaflet mission. Standing left to right: Kisner, Moran, Hubberd, Ballard, Courtney, Kremer, Garstka, McJunkins, and Hegedusich. Kneeling left to right: McDaniel, Mischke, Sanchez, Lacharite, and Humphrey.

twentieth century. From 1965 to 2000 the weapons system was involved in virtually every major conflict or contingency, including the Vietnam War and Operation Desert Storm. By 2000 the early 1960s-era Combat Talon I airframe was nearing its service life limitations, and most of the newer Combat Talon IIs were already 15 years old. If the capability were to remain viable, major upgrade and modernization programs had to be undertaken. The first 10 years of the new millennium would determine the fate of the Praetorian STARShip.



Photo courtesy of David Sammons

Crew that flew the 1 June 1999 Operation Allied Force mission. Back row, left to right: Montalvo, Grover, Bruckner, Stucki, Feltner, and Lucus. Front row: Lockhart, Sammons, Rife, Diehl, Bohannon, Melton, and Gard.



Photo courtesy of David Sammons

Crew that flew the 3 June 1999 Operation Allied Force mission. Standing, left to right: Thurber, Bourque, Weiss, Ballard, Spencer, Arnold, Stucki, Bruckner, Montalvo, and Humphrey. Kneeling, left to right: Keyes, Lightner, and Grover.



Photo courtesy of David Sammons

Crew that flew the 4 June 1999 Operation Allied Force mission. Left to right: Foster, Hammer, Gard, Gray, Wendel, Diehl, Boguslawski, Kasten, Beck, and Wright.

Notes

1. History, 16th Special Operations Wing, 1 January–31 December 1996, vol. 1, 16th Special Operations Wing historian file, Hurlburt Field, Fla., 79.

2. History, 352d Special Operations Group, 1 January–30 June 1996, vol. 1, HQ AFSOC/HO historian file, Hurlburt Field, Fla., 68.

3. Ibid., 39–40.

4. Ibid., 40.

5. History, 16th Special Operations Wing, 1 January–31 December 1996, 107.

6. History, 352d Special Operations Group, 1 January–30 June 1996, vol. 1, 138–39.

7. Ibid., 144–45.

8. Ibid.

9. History, 16th Special Operations Wing, 1 January–31 December 1996, 107.

10. History, 352d Special Operations Group, 1 January–30 June 1996, 149–50.
11. *Ibid.*, 151–52.
12. *Ibid.*, 155.
13. *Ibid.*
14. *Ibid.*, 156–57.
15. History, 16th Special Operations Wing, 1 January–31 December 1996, 111–12.
16. History, 352d Special Operations Group, 1 July–31 December 1996, 38.
17. *Ibid.*, 65–67.
18. *Ibid.*, 28–29.
19. *Ibid.*, 25.
20. *Ibid.*, 26.
21. History, 16th Special Operations Wing, 1 January–31 December 1996, 20.
22. *Ibid.*, 157–58.
23. *Ibid.*, vol. 8, Supporting Document I-309.
24. *Ibid.*, vol. 1, 16th Special Operations Wing historian file, 59.
25. History, 16th Special Operations Wing, 1 January–31 December 1997, vol. 4, Supporting Document SD-153.
26. History, 919th Special Operations Wing, 1 January–30 September 1996, vol. 1, HQ AFSOC/HO historian file, Hurlburt Field, Fla., 53.
27. *Ibid.*, 4–5.
28. History, 58th Special Operations Wing, 1 January–30 June 1996, vol. 1, USAF HRA, Maxwell AFB, Ala., 26–27.
29. History, 58th Special Operations Wing, 1 July 1996–30 June 1997, 28–29.
30. History, 58th Special Operations Wing, 1 January–30 June 1996, 26.
31. History, 353d Special Operations Group, 1 January–30 June 1996, vol. 1, 353d SOG historian file, Kadena AB, Japan, 30–31.
32. *Ibid.*, 63–64.
33. *Ibid.*, 42–45.
34. *Ibid.*, 15.
35. *Ibid.*, 45–47.
36. *Ibid.*, 82.
37. History, 353d Special Operations Group, 1 July–31 December 1996, 10–11.
38. *Ibid.*, 59–62.
39. *Ibid.*, 44–45.
40. *Ibid.*, 32.
41. *Ibid.*, 47–48.
42. History, 353d Special Operations Group, 1 January–30 June 1998, vol. 1, 8.
43. *Ibid.*, 9–10.
44. *Ibid.*, 11–12.
45. *Ibid.*, 122.
46. *Ibid.*, 4.
47. History, 353d Special Operations Group, 1 July–31 December 1998, 30.
48. *Ibid.*, 32.
49. *Ibid.*, 31.
50. *Ibid.*, 33.
51. *Ibid.*, 16–17.
52. *Ibid.*, 9–11.
53. *Ibid.*, 19–22.
54. *Ibid.*, 22–24.
55. *Ibid.*, 37–38.
56. History, 16th Special Operations Wing, 1 January–31 December 1997, 27.
57. *Ibid.*, 41–42.
58. *Ibid.*, 31.
59. *Ibid.*, vi.
60. *Ibid.*, 32.
61. *Ibid.*, 32–33.
62. History, 919th Special Operations Wing, 1 October 1996–30 September 1997, vol. 1, 2.
63. *Ibid.*, 13–14.
64. *Ibid.*, 14.
65. *Ibid.*, 18.
66. History, 919th Special Operations Wing, 1 October 1997–30 September 1998, 18.
67. *Ibid.*, 10–11.
68. History, 58th Special Operations Wing, 1 July 1996–30 June 1997, vol. 1, 35.
69. *Ibid.*, 36–37.
70. *Ibid.*, 37–38.
71. *Ibid.*, 38–39.
72. *Ibid.*, 25.
73. History, 58th Special Operations Wing, 1 July–31 December 1997, 29.
74. *Ibid.*, 48.
75. *Ibid.*, 49.
76. *Ibid.*, 51–52.
77. *Ibid.*, 53–54.
78. History, 352d Special Operations Group, 1 July–31 December 1996, vol. 1, 50.
79. History, 352d Special Operations Group, 1 January–30 June 1997, 32.
80. *Ibid.*, 34.
81. *Ibid.*, 20.
82. *Ibid.*, 95.
83. *Ibid.*, 104.
84. Lt Col Frank Kisner, 7th SOS/CC, memorandum to SOCEUR/J3, subject: Narrative of 7th SOS Response to Non-combatant Evacuation of Brazzaville, Republic of Congo, 10 June 1997, 12 April 1998, Combat Talon Archive, HQ AFSOC/HO, Hurlburt Field, Fla.
85. *Ibid.*
86. *Ibid.*
87. *Ibid.*
88. *Ibid.*
89. *Ibid.*
90. *Ibid.*
91. Message, DTG 070800ZMay98, HQ AFSOC/CC to 352d SOG/CC, subject: 1997 Air Force MacKay Trophy Winner, Combat Talon Archive, HQ AFSOC/HO, Hurlburt Field, Fla.
92. Kisner memorandum.
93. History, 352d Special Operations Group, 1 July–31 December 1997, 56.
94. *Ibid.*, 23–24.
95. *Ibid.*, 25.
96. *Ibid.*, 29–30.
97. *Ibid.*, 32.
98. *Ibid.*, 34.
99. *Ibid.*, 66–78.
100. History, 352d Special Operations Group, 1 January–30 June 1998, 38–39.
101. *Ibid.*, 39.
102. *Ibid.*, 70.
103. *Ibid.*, 46–47.
104. *Ibid.*, 28.
105. *Ibid.*, 30–31.
106. *Ibid.*, 33.
107. Narrative of 1998 Tunner Award submission to USAF, n.d., Combat Talon Archive, HQ AFSOC/HO, Hurlburt Field, Fla.
108. *Ibid.*

PRAETORIAN STARSHIP

109. Ibid.
110. Ibid.
111. Ibid.
112. Ibid.
113. History, 353d Special Operations Group, 1 January–30 June 1998, vol. 1, 21–23.
114. Ibid., 24–25.
115. Ibid., 26–27.
116. Ibid., 28–29.
117. Ibid., 30–33.
118. Ibid., 38–41.
119. History, 353d Special Operations Group, 1 July–31 December 1998, 22–23.
120. Ibid., 34–35.
121. Ibid., 36.
122. Ibid., 37–38.
123. Ibid., 50–51.
124. History, 16th Special Operations Wing, 1 January–30 June 1998, 26.
125. Eighth Special Operations Squadron, nomination package, “1999 AFSOC Squadron of the Year Award Nomination Package,” n.d., to 16th SOW, Combat Talon Archive, Hurlburt Field, Fla.
126. History, 16th Special Operations Wing, 1 July–31 December 1998, vol. 1, 18.
127. Ibid., 18–19.
128. History, 16th Special Operations Wing, 1 January–30 June 1998, 28.
129. Ibid., 28–29.
130. Ibid., 29.
131. Ibid.
132. History, 58th Special Operations Wing, 1 January–30 June 1998, 41.
133. Ibid., vol. 4, 59.
134. Ibid., vol. 1, 47–48.
135. Ibid., 50–51.
136. Ibid., 62.
137. History, 58th Special Operations Wing, 1 July–31 December 1998, vol. 1, 85.
138. History, 58th Special Operations Wing, 1 January–30 June 1998, vol. 4, Supporting Document 103.
139. History, 16th Special Operations Wing, 1 July–31 December 1998, 22–23.
140. Ibid., 23.
141. Ibid.
142. Ibid., 23–24.
143. History, 919th Special Operations Wing, 1 October 1997–30 September 1998, vol. 1, 3.
144. Ibid., 23.
145. History, 353d Special Operations Group, draft, 1 January–30 June 1999.
146. Ibid.
147. Ibid.
148. Ibid.
149. Ibid.
150. Ibid.
151. Ibid.
152. Ibid.
153. Ibid.
154. Ibid.
155. Ibid.
156. History, 16th Special Operations Wing, 1 January–30 June 1999, vol. 1, 73.
157. Ibid., 5.
158. Ibid.
159. Eighth Special Operations Squadron, nomination package.
160. Ibid.
161. Ibid.
162. Ibid.
163. Ibid.
164. Ibid.
165. Ibid.
166. History, 16th Special Operations Wing, 1 January–30 June 1999, vol. 1, 13.
167. Ibid., 14.
168. Ibid.
169. Ibid., 15.
170. Memorandum, subject: 15th SOS Semi-Annual History Update, to 16th SOW/HO, 27 July 1999, Combat Talon Archive, Hurlburt Field, Fla.
171. Ibid., 19 January 2000, Combat Talon Archive, Hurlburt Field, Fla.
172. Ibid.
173. Seventh Special Operations Squadron, nomination package, “AFSOC Outstanding Special Operations Squadron of the Year, 1999,” n.d., to 352d SOG, Combat Talon Archive, Hurlburt Field, Fla.
174. History, 16th Special Operations Wing, 1 January–30 June 1999, vol. 1, 25.
175. Ibid.
176. Seventh Special Operations Squadron, nomination package.
177. Ibid.
178. Ibid.

Epilogue

2000 and Beyond: A Combat Talon Journey

As the new millennium dawned, Combat Talon maintained its position as a key element in AFSOC's arsenal. The move of the 8th SOS went as planned, with the squadron flag being carried by unit runners from Hurlburt Field to Duke Field on 5 February 2000. The last Combat Talon I was flown to Duke on 9 February, thus completing the transfer of all Combat Talon I aircraft to the USAFR. For the first time since 1974, there were no Combat Talon Is stationed at Hurlburt Field. All Combat Talon Is were transferred to the 711th SOS, with the 8th SOS flying the Reserve aircraft as an Active Associate Unit. Both Talon I squadrons supported the national special operations mission and were prepared to support theater tasking worldwide. The 14 Combat Talons assigned to the 711th SOS were as follows:

62-1843	64-0562
63-7785	64-0565
64-0523	64-0566
64-0551	64-0567
64-0555	64-0568
64-0559	64-0571
64-0561	64-0572

The Combat Talon II continued to support theater tasking in the Pacific and in Europe. The two stateside-based units were responsible for the national special operations mission, support to Central and South America, and all formal Talon II training. The 15th SOS was also tasked to augment the two overseas squadrons if required. The aircraft had proven itself in combat and contingency operations around the world during the last decade of the twentieth century, and the lion's share of Talon tasking in the new century would fall to it. The 24 Combat Talon IIs were assigned to the following units:

1st SOS	7th SOS	15th SOS	58th SOW
88-0191	84-0476	83-1212	87-0125
88-0192	86-1699	84-0475	87-0126
88-0195	87-0023	85-0011	87-0127
88-0264	88-0193	85-0012	
88-1803	88-0194	87-0024	
		89-0280	
		89-0281	
		89-0282	
		89-0283	
		90-0161	
		90-0162	

Future Direction*

For Combat Talon to remain a viable weapons system, upgrades will be required in the near term. For Combat Talon I a Directed Infrared Countermeasures System has been developed and will be installed on all 14 aircraft by 2003. The system will improve the aircraft's defensive capability so that it can continue to survive in the ever-increasing twenty-first century threat environment. To improve the aircraft's communications capability, an improved SATCOM has been developed, and a new HF long-range radio will be installed to round out the Talon I's communications suite. The Combat Talon II will also receive the Directed Infrared Countermeasures System. NVG compatible lighting will be

*The following narrative was extracted from the "AFSOC Mission Area Plans, Final Report," dated December 1999, presented by Lt Col John Geis, Headquarters AFSOC/XPPX, during the AFSOF 2027 Symposium, Hurlburt Field, Florida.

installed in the Talon II's cargo compartment, and the aircraft's communication and navigation systems will be upgraded.

The most significant improvement scheduled for Combat Talon II is the installation of an aerial refueling system capable of refueling both helicopter and tilt-rotor aircraft. The refueling system installed on the Combat Talon I utilizes a refueling pod designed in the late 1950s that requires aircraft electrical power, hydraulics, and aircraft fuel pumps for proper operation. Although maintenance on the older pods is not complex, meantime between failures is low, thus requiring excessive maintenance actions to keep the pods operational. Fuel output rate is also dependent on fuel pressure generated by the aircraft's dump pumps. To overcome the shortfalls of the Talon I pods, AFSOC began testing the MK 32B-902E pod on a Hurlburt-based Talon II aircraft in 1999. The new pod has a "ram air turbine" that powers an internal fuel pump, thus eliminating the need to use the aircraft's dump pumps. Also, the pod has a DC motor that operates the hose-reel assembly. The hose is retrieved by use of a hose-reel tensator spring, thus eliminating the need for aircraft hydraulic pressure. The new pod will be capable of supporting all refueling operations from 105 knots to over 180 knots without having to land and change drogues. Because of its augmenting fuel pump, the pod will be capable of simultaneously passing over 150 gallons per minute of fuel to two receivers. The increased off-load rate will significantly reduce the time a receiver aircraft has to spend "on the hose" refueling. The programmed completion date for the modification is 2007 for the Talon II fleet.

At its current utilization rate, the Combat Talon I will require a service life extension program (SLEP) to be initiated by 2007. At the present time, SLEP is not funded for Combat Talon I, which will mean that the older Talons will reach the end of their service life by 2015. With the SLEP, the aircraft will remain serviceable through 2025.

The CV-22

To augment the current Talon fleet, AFSOC has developed two initiatives that will provide flexibility and improved delivery capability. The first initiative is the CV-22. It is currently undergoing testing by a joint AFSOC/Marine Corps team, with the first four CV-22s scheduled for delivery to Kirtland AFB, New Mexico, in 2003. The revolutionary tilt-rotor aircraft will provide fixed-wing en route speed with the landing capability of a rotary-wing aircraft. It fulfills a long-standing USSOCOM requirement to be able to accomplish a long-range infiltration/exfiltration mission during one period of darkness. The extended range of the CV-22 (as compared to conventional rotary-wing aircraft) reduces its dependency on penetrating tankers. Its design also improves its survivability and reduces maintenance downtime. An added benefit is that the aircraft is self-deployable—it will fly to the fight instead of relying on scarce airlift for transport as does the current rotary-wing fleet.

The CV-22 has a terrain-following/terrain-avoidance radar capability similar to the Combat Talon. It also has an ECM suite that will protect it from enemy threats in hostile areas. Approximately 90 percent of the CV-22's airframe and equipment is common to the Marine Corps's MV-22, thus reducing the costs of future maintenance and improving the availability of parts. The CV-22's performance is similar to the Combat Talon, with en route speeds of 230 knots and a service ceiling of 25,000 feet. It can carry 25,000 pounds of cargo, compared to 51,000 for the Combat Talon, with an unrefueled combat radius of 500 miles compared to the Combat Talon's 1,000 miles. Current planning does not have the CV-22 replacing any Talons, but rather it replaces the current AFSOC rotary-wing fleet (the MH-53 Pave Low and the MH-60 Pave Hawk). A total of 50 tilt-rotor aircraft have been funded, with the last four being delivered in 2009.

The MC-X

The twenty-first century provides many challenges for special operations aircraft, foremost among them is the growing threat by hostile forces. By 2015 most of the world's

surface will be covered by layers of threats that cannot be defeated by today's technology. To survive in this nonpermissive environment, AFSOC's second major initiative focuses on the development of a reduced signature aircraft identified as the MC-X. With the service life expiring on many of its current C-130 aircraft (including the Combat Talon I), AFSOC is developing a mixed fleet of delivery vehicles that are not all based on the C-130 airframe. This mix will give SOF planners more flexibility to meet mission tasking.

The MC-X, although still in the conceptual stage, will be smaller than the C-130, with three pallet positions available for cargo and personnel. It will be made of low-observable materials and will utilize stealth technology to mask it from enemy threats. The aircraft will be jet powered to increase its en route speed and reduce its visibility, and it will have longer range and greater maneuverability than current aircraft. The estimated cost of each new MC-X is \$250 million, with 50 to 75 aircraft being fielded by 2025. The Air Force has identified \$7 billion for MC-X development and fielding through 2019, with additional funds provided in the out years as AFSOC ramps up the new MC-X fleet.

Future Outlook for Combat Talon

The crown jewel that represents the very essence of Combat Talon capability is the people who fly, maintain, and support the weapons system. Unlike their predecessors of World War II, Korea, and Vietnam, today's special operators are not faced with wholesale elimination of their special operations mission. Instead, special operators are highly respected throughout the Air Force and sought after by the defense establishment. They are highly motivated, thoroughly trained, and adequately equipped to carry out their mission. Senior leadership has recognized the continued need for special operations forces in a volatile, unpredictable new world. With USSOCOM charged with nurturing this national asset, the future looks bright.

The long-range mission to infiltrate, resupply, and exfiltrate friendly forces into denied areas of the world will undoubtedly continue as long as there is conflict. The question remains as to what airframe will conduct the mission. The Combat Talon I fleet will move out of the Air Force inventory by 2015 if the aircraft do not receive the SLEP, and the Combat Talon II will be 25–30 years old at that time. The CV-22 will absorb a portion of the Talon mission, but its reduced payload and range will limit its ability to perform all current Talon tasking. The 50-aircraft CV-22 fleet will require penetrating tankers to increase its range, a mission currently performed by Talon I and scheduled for Talon II by 2007.

Future battlefields will be increasingly hostile, so much so that both the C-130 and the CV-22 may not be able to survive. To ensure that AFSOC assets remain viable in a high-threat environment, the MC-X will be fielded. Although it is extremely difficult to predict what the future will bring, it is safe to say that there will be a continual need for two kinds of forces—those designed for low-end conflict (the MC-130E/H and CV-22) and those designed for the high-end spectrum of war (the MC-X). Actions taken during the first 10 years of the twenty-first century will determine if AFSOC can continue to execute the vital Combat Talon mission.

THIS PAGE INTENTIONALLY LEFT BLANK

Appendix A

THIS PAGE INTENTIONALLY LEFT BLANK

Live Fulton STARS Made by Combat Talon Aircraft

The following list may not be all-inclusive; rather, it represents all live Fulton STARS operations documented by the author. No records were available for recoveries made between 25 August 1966 to 1 July 1968.

Person Recovered	Date	Location	Recovery Pilot Unit	Remarks
1. Jacob C. Legrand (USAF)	24 Aug 1966	Pope AFB, NC	George G. Hellier	First operational one-man STAR (Training)
2. Straun L. Paddon and	24 Aug 1966	Pope AFB, NC	George G. Hellier 779th TCS	First operational two-man STAR (Training)
3. Frederick L. Thrower				
4 through 23—No Records Available				
24. R. W. Thornbury	2 Jul 1968	Korat RTAFB, Thailand	Walter Pine 15th ACS	Demonstration (Training)
25. D. E. Hornbeck	6 Jul 1968	Ubon RTAFB, Thailand	P. Lansier 15th ACS	Demonstration (Training)
26. G. G. Davis Jr.	11 Jul 1968	Udon RTAFB, Thailand	R. Bunn 15th ACS	Demonstration (Training)
27. R. R. Pratt Jr. (USN)	15 Jul 1968	Cubi Point, Philippines	G. Smith 15th ACS	Demonstration (Training)
28. A. E. Williams	24 Jul 1968	NKP RTAFB, Thailand	R. Jones 15th ACS	Demonstration (Training)
29. S. Michaels	20 Jul 1968	Takhli RTAFB, Thailand	H. Kempe 15th ACS	Demonstration (Training)
30. Tom Hines (USAF)	2 Aug 1968	Nha Trang, Vietnam	R. Bunn 15th SOS	Demonstration (Training) Pickup of Sq/CC
31. R. Roberts	4 Sep 1968	Bien Hoa AB, Vietnam	R. Franzen 15th SOS	Demonstration (Training)
32. D. McNabb	11 Sep 1968	Cam Ranh Bay, Vietnam	J. Kummer 15th SOS	Demonstration (Training)
33. D. Nunnally Jr. (USAF)	4 Oct 1968	Phan Rang AB, Vietnam	J. Kummer 15th SOS	Demonstration (Training)
34. D. Prentice (USN) and	29 Oct 1968	Cubi Point, Philippines	K. Hilchey 15th SOS	Demonstration (Training) 2-man STAR
35. R. Henry (USMC)				
36. W. Haley (USN) and	22 Nov 1968	Cubi Point, Philippines	D. Martin 15th SOS	Demonstration (Training) Uncontrollable spinning during pickup. 2-man STAR suspended
37. J. Mitchell (USAF)				
38. J. W. Hall (USN)	20 Jan 1969	Cubi Point, Philippines	M. Banks 15th SOS	Demonstration (Training)
39. J. T. Distad (USN)	26 Feb 1969	Cubi Point, Philippines	G. Smith 15th SOS	Demonstration (Training)
40. D. E. S. Horne (USA)	23 May 1969	Koke Kathiem, Thailand	K. Hilchey 15th SOS	Demonstration (Training)
41. J. R. Kummer (USAF)	21 Jul 1969	Nha Trang AB, Vietnam	J. Newell Jr. 15th SOS	Demonstration (Training) Pickup of Sq/CC
42. R. G. Lundy (USA)	8 Sep 1969	Koke Kathiem, Thailand	F. Rast 15th SOS	Demonstration (Training) for king and queen of Thailand

Person Recovered	Date	Location	Recovery Pilot Unit	Remarks
43. H. H. Stevens (USA)	3 Dec 1969	Lop Buri, Thailand	B. Jefferies 15th SOS	Demonstration (Training)
44. G. Booth (USMC)	25 Feb 1970	Nha Trang AB, Vietnam	R. Popejoy 15th SOS	Demonstration (Training) Viewed by MACV chief of staff Maj Gen Wilburn Dolvin
45. Unknown	25 Feb 1970	Lop Buri, Thailand	J. Reynolds 15th SOS	Demonstration (Training) Viewed by members of Southeast Asia Treaty Organization
46. C. W. Arnold (USAF)	14 Mar 1970	Clark AB, Philippines	K. Henderson 15th SOS	Demonstration (Training) Pacific Jungle Survival School
47. R. Earle (USN)	23 May 1970	Clark AB, Philippines	G. Dentz 15th SOS	Demonstration (Training) Pacific Jungle Survival School
48. F. Hopewell (USAF)	10 Sep 1970	Clark AB, Philippines	J. Nelson 15th SOS	Demonstration (Training) Pacific Jungle Survival School
49. F. Hopewell (USAF)	10 Oct 1970	Clark AB, Philippines	R. Hite Jr. 15th SOS	Demonstration (Training) Pacific Jungle Survival School
50. R. Hite Jr. (USAF)	30 Oct 1970	Udon RTAFB, Thailand	R. Clinton 15th SOS	Demonstration (Training)
51. R. L. Hughes (USAF)	31 Oct 1970	Udon RTAFB, Thailand	R. Clinton 15th SOS	Demonstration (Training)
52. C. J. Kraft (USA)	14 Nov 1970	Clark AB, Philippines	D. Green 90th SOS	Demonstration (Training) Pacific Jungle Survival School
53. J. E. Evermann (USAF)	5 Dec 1970	Clark AB, Philippines	C. McClellan 90th SOS	Demonstration (Training) Pacific Jungle Survival School
54. T. H. Terrell (USAF)	24 Jan 1971	Clark AB, Philippines	C. Buntgens 90th SOS	Demonstration (Training) Pacific Jungle Survival School
55. D. James (USAF)	6 Feb 1971	Clark AB, Philippines	L. Butler 90th SOS	Demonstration (Training) Pacific Jungle Survival School
56. L. Butler (USAF)	15 May 1971	Clark AB, Philippines	B. McGough 90th SOS	Demonstration (Training) Pacific Jungle Survival School
57. Baucknight	15 May 1971	Clark AB, Philippines	B. McGough 90th SOS	Demonstration (Training) Pacific Jungle Survival School
58. R. Uteguard	14 Jun 1971	Clark AB, Philippines	A. Rowe 90th SOS	Demonstration (Training) Pacific Jungle Survival School
59. Unknown	12 Jul 1971	Clark AB, Philippines	A. Rowe 90th SOS	Demonstration (Training) Pacific Jungle Survival School
60. Unknown	30 Aug 1971	Clark AB, Philippines	W. Kornemann II 90th SOS	Demonstration (Training) Pacific Jungle Survival School

The 90th SOS/CC suspended live STAR operations for training in November 1971. No additional live STARS were flown until April 1979.

61. W. Tyler COMSOTFE	23 Apr 1979	Germany	T. Jahnke 7th SOS	One-man land in conjunction with (ICW) Flintlock 79 (first live STAR since 1971 Subexercise Schwarzes-Pferd)
62. Taylor (USA)	Apr 1979	Germany	D. Davenport 7th SOS	One-man land ICW Flintlock 79 Subexercise Schwarzes-Pferd
63. Quijano (USA)	Nov 1979	Almeria, Spain	W. Tuck 7th SOS	One-man land ICW Crisex 79 Viewed by King Juan Carlos
64. B. Weigel (USAF)	5 May 1980	Germany	T. Hermanson 8th SOS	One-man land ICW Flintlock 80 8th SOS crew attached to 7th SOS
65. Unknown	5 June 1980	Germany	W. Tuck 7th SOS	One-man land ICW Flintlock 80 Subexercise Schwarzes-Pferd

Person Recovered	Date	Location	Recovery Pilot Unit	Remarks
66. Unknown	4 May 1981	Germany	W. Tuck 7th SOS	One-man land ICW Flintlock 81 Subexercise Schwarzes-Pferd
67. T. Powell	8 May 1981	Oberkessack, Germany	R. Meller 8th SOS	One-man land ICW Flintlock 81 8th SOS crew attached to 7th SOS Subexercise Schwarzes-Pferd
68. Unknown	Apr 1981	Germany	D. Davenport 7th SOS	One-man land ICW Flintlock 81
69. R. Kuhn (USN) and	2 Dec 1981	Macrihanish, UK	J. Bates 7th SOS	Two-man water for training. Sky anchor failure procedures required. Ramp crew awarded AF Achievement Medal.
70. L. Rhinehart (USAF)				First two-man live recovery since November 1968.
71. Unknown (USA) and	Apr 1982	Monrovia, Liberia	D. Davenport 7th SOS	Two-man land ICW Flintlock 82 Subexercise Palm 82
72. C. Ebling (USAF)				
73. C. Strickland	26 Apr 1982	CFB Lahr, Germany	J. Bates 7th SOS	One-man land ICW Flintlock 82 Fatality—last attempted live STAR

THIS PAGE INTENTIONALLY LEFT BLANK

Appendix B

THIS PAGE INTENTIONALLY LEFT BLANK

Partial Summary of Upgrades, MOD-90 Combat Talon I

1. Wings: New outer wings were installed on Combat Talon aircraft in the late 1980s. New center-wing boxes and vertical beams (for the landing gear) were installed in the 1990s.
2. Dash-15 Engines: Provides increased power for in-flight refueling operations.
3. Battery Compartment: Contains an additional aircraft battery to provide backup power for inertial navigation units and mission computers.
4. Radome: Houses two antennas assemblies and associated radar components. Fulton aircraft have the distinctive drooped nose, while non-Fulton have the standard C-130E configuration.
5. Fulton Yokes: Guides the lift line to the Sky anchor. (Note: The Fulton yokes were removed and placed in storage in 1998.)
6. Sky anchor: Secures the lift line to the aircraft. (Note: The Sky anchor was removed and placed in storage in 1998.)
7. Fending Lines: Guides the lift line away from the props and cuts the line to prevent inadvertent package pickup in the event the pilot misses the lift line with the yoke. (Note: Fending lines have been removed and placed in storage along with other Fulton STARS equipment.)
8. Free Air Temp Bulbs: Interfaced with the mission computers.
9. Rosemount Probe: Provides outside air temperature data to the air-data computer.
10. Angle of Attack Probe: On leading edge of vertical stabilizer. (Note: The first production Stray Goose aircraft had the probe mounted on the wing tip.)
11. SST-181X Antenna: Aerial refueling beacon transmitter.
12. Antennas: Various antennas located around the aircraft that provide input to the Doppler, radar altimeters, communications equipment, and ECM transmitters/receivers.
13. FLIR System: AAQ-18 located behind the nose landing gear in a retractable pressure box. (Note: The FLIR was installed in this location because original specifications required that the modification be covert and not identifiable from outside the aircraft while on the ground. The original FLIR was identified as the S3-A and was later replaced by the AAQ-10. The current FLIR is the AAQ-18. The FLIR is not usable with the landing gear in the down position.)
14. Universal Aerial-Refueling Receptacle/Slipway Installation: Located on top of the fuselage at flight station 162, it provides ability to refuel from any boom-equipped tanker aircraft.
15. Beaver Tail: Provides protection for ECM antennas oriented to the rear quadrant of the aircraft.
16. High-Speed Ramp: Structural modification of the empennage to allow operation of the cargo ramp and door at speeds up to 250 KIAS. Support has been added along the lower-aft section of the fuselage.
17. Paint: Two-tone low-gloss gray.
18. Infrared Defensive Pods: QRC-84-02A is mounted under the external fuel tanks.
19. Chaff/Flare Dispensers: ALE-40 system consisting of 20 dispensers with 30 rounds each.

20. Horizontal Stabilizer Strengthening: An extra layer of skin was added to the leading edge of the horizontal stabilizer of the empennage for extra strength to prevent damage from ALE-27 chaff-bundle strikes. (Note: Probably not necessary for the current ALE-40s.)
21. Exterior Lighting Changes:
 - Covert taxi and landing lights.
 - Covert rotating beacon on vertical stabilizer.
 - Relocated overt upper rotating beacon or strobe.
 - Lower rotating beacon or strobe lights.
 - Aerial refueling fuselage, area and slipway lights.
 - Helo aerial refueling pod and hose illumination and formation lights.
 - Additional formation lights: Electroluminescent lights aft of each paratroop door and aft end of each wing tip forward of the dump mast.
22. Helo Aerial Refueling Pods: Mounted under outside wing area outboard of the external fuel tanks.
23. Underbelly Protection System: Protects lower ECM antenna from damage when operating on unimproved runways.
24. Inside the Nose Wheel-Well Area:
 - Radome Anti-Ice System.
 - Electronic Control Amplifier.
 - Inertial Navigation Unit (INU) Battery Access Panel.
 - KA Band Receiver/Transmitter: On Fulton-modified aircraft.
 - X Band Receiver/Transmitter: On non-Fulton-modified aircraft.

Non-Fulton Aircraft Exterior Differences

1. No Fulton Yokes or Fending Lines.
2. Standard C-130E Radome.
3. KA Band Receiver/Transmitter: Located in aircraft nose section.
4. X Band Receiver/Transmitter: Located in aircraft nose section.

Interior Differences

1. Flight Deck:
 - Bunks removed and equipment rack installed.
 - Dual navigator station installed on right side of flight deck. Provide work area for two navigators. Displays radar, INS, and other associated navigation systems.
 - Pilot and copilot flight instruments rearranged to add radar and additional equipment panels. Added NVG-compatible lighting panels, additional radio control panels, and Fulton yoke control panel. Relocated flap position indicator and landing/taxi light control panel.
 - Overhead control panel has aux landing lights, in-flight refueling control panel, air refueling control panel, dump mast valve switches, ALE-40 flare/chaff release switch, generator disconnect switches, and generator bearing failure lights.
 - Modified dual navigation station with computer-aided navigation system.
 - Improved flight deck air conditioning by addition of H-Plus Pack air-conditioning unit.
2. Cargo Compartment:
 - Safe: For storage of classified documents.
 - FLIR Sensor Turret Installation.
 - Freon Pressurization System: Provides pressure for the KA band radar.

- X Band Receiver/Transmitter: On Fulton aircraft.
 - EWO/RO Console: Located in the cargo compartment and provides location for communications and EW equipment.
 - Electronic Equipment Racks: Located in the cargo compartment and supports NAV, ECM, and communication equipment.
 - Added Lighting above EWO/RO Console: Provides additional lighting for maintenance and preflight duties.
 - NVG Compatible Cargo Lighting: Reostat controlled overhead lighting that can be used with NVGs.
 - Remote Aerial Delivery System (ADS) Control Box.
 - Secondary ADS Arming Box Assembly: Located on the right side of the aircraft on the right anchor cable.
 - Modified Dual Rails: Accommodates palletized cargo in five pallet positions. Rails allow for the EWO/RO console installation.
 - Nitrogen Pressurization: Pressurizes ECM wave guides.
 - ALE-40 Switches: Red guarded switches located aft of the left wheel area.
 - Cargo Door and Ramp: Modified for HSLPADS with two cargo door uplocks, two cargo door actuators, 19-inch sequencing microswitch, buffer boards, and ADS arms.
 - Fulton STARS Connections: Located in the left rear area of the cargo compartment aft of the left main landing gear.
 - Hydraulic Reservoirs: Capacity increased for utility system to 7.0 gallons, auxiliary system to 6.22 gallons.
 - Troop Doors: Large rectangular window installed for helicopter aerial refueling.
 - Flare/Chaff Launcher Switches and Remote Releases for the ALE-40 System: Located by each paratroop door.
 - Cargo Capability:
 - Pax 47 (61 with wheel-well seats)
 - Paratroopers 38
 - Litters 30
 - Pallets 5
 - Benson Tanks: Provisions are made for palletized internal fuel tanks providing 22,780 pounds of additional fuel.
3. Aircraft Gross Weight: Basic weight increased up to 96,000 pounds, with lightest aircraft weighing 92,000 pounds. (There is a 4,000-pound difference in basic weight, dependent on aircraft.)

Emergency Equipment

1. Oxygen System:
 - Six portable oxygen bottles.
 - Thirteen oxygen regulators.
 - Smoke masks and quick-don masks.
 - Four oxygen-filler hoses.
2. Five Halon Fire Extinguishers.
3. Twelve First Aid Kits.
4. Four Emergency Escape Breathing Devices.
5. Master Fire Warning Light: Added to copilot's instrument panel.
6. Paratroop Retrieval Bar and Towed Paratroop Retrieval System: Used for troop door parachutists retrieval.
7. Chopping Locations: Marked above each paratroop door.

Electronic Warfare Equipment (see chap. 2)

Personnel Protective Armor: Separate personnel protective seat armor is provided for all crew positions. There is also floor armor available for all crew positions except the loadmaster and flight engineer. The lower side windows on the flight deck have acrylic shields, and the liquid oxygen bottle is armored.

Blackout Curtains: Blackout curtains are provided to isolate the EWO/RO console from the cargo compartment. Blackout covers are provided for all cargo compartment windows. Blackout curtains are provided to isolate the light from the navigator station from the pilot and flight engineer stations.

Glossary

AAA	antiaircraft artillery
AAF	Army Airfield
ABCCC	airborne battlefield command, control, and communications
ABW	Air Base Wing
ACS	Air Commando Squadron
AD	Air Division
ADCOM	administrative command
ADI	altitude direction indicator
ADIZ	air defense identification zone
ADS	aerial delivery system
ADVON	advanced party
AETC	Air Education and Training Command
AFFORJUWTF	Air Force Forces Joint Unconventional Warfare Task Force Atlantic
AFFTC	Air Force Flight Test Center
AFLC	Air Force Logistics Command
AFMC	Air Force Materiel Command
AFP	Armed Forces of the Philippines
AFRC	Air Force Reserve Component
AFSC	Air Force Systems Command
AFSOB	Air Force Special Operations Base
AFSOC	Air Force Special Operations Command
AFSOCCENT	Air Force Special Operations Command Central
AFSOF	Air Force Special Operations Forces
AGL	above ground level
AIE	alternate insertion extraction
ALCE	airlift control element
AMC	Air Mobility Command
AMS	Aircraft Maintenance Section
AOR	area of responsibility
APC	armored personnel carrier
ARA	airborne radar approach
ARCS	Air Resupply and Communications Service
ARCW	Air Resupply and Communications Wing
ARRS	Aerospace Rescue and Recovery Squadrons
ARS	Aerial Recovery System Air Rescue Service Air Resupply Squadron
ARW	Air Refueling Wing
ASD	Aeronautical System Division
ASD/SOLIC	Assistant Secretary of Defense for Special Operations and Low-Intensity Conflict and Special Activities
ASET	Aircrew Standardization and Evaluation Team
ASROC	antisubmarine rocket
ASTD	assistant to the secretary of defense
ATC	Air Traffic Control Air Training Command
ATO	assisted takeoff
ATTW	Aircrew Training and Test Wing
AWACS	airborne warning and control system

AWADS	adverse weather aerial delivery system
BAI	backup aircraft inventory
BDHI	bearing-distance-heading indicator
BH	Bosnia-Herzegovina
BIM	blade inspection method
BRAC	Base Realignment and Closure
BS	Bomb Squadron
CAA	Civil Aviation Authority
CAF	Chinese Air Force
CAFSOB	combined AFSO base
CAFSOC	Combined Air Force Special Operations Component
CAMPS	computer-aided mission planning systems
CARP	computed aerial release point
CAT	Civil Air Transport
CCRAK	Covert, Clandestine, and Related Activities—Korea
CCT	Combat Control Team
CCTW	Combat Crew Training Wing
CDS	container delivering system
CENTAF	US Air Forces, Central Command
CENTCOM	US Central Command
CI	counterinsurgency
CINC	commander in chief
CINCEUR	commander in chief, European Command
CINCLANT	commander in chief, Atlantic Command
CINCMAC	commander in chief, Military Airlift Command
CINCPAC	commander in chief, Pacific Command
CINCPACAF	commander in chief, Pacific Air Force
CINCISO	commander in chief, Southern Command
CINCISOC	commander in chief, Special Operations Command
CINCSTRIKE	commander in chief, Strike Command
CJCS	chairman, Joint Chiefs of Staff
CJSOTF	combined Joint Special Operations Task Force
CJTF	Combined Joint Task Force
COA	courses of action
COMSOCCENT	commanding general of Special Operations Command, Central
COMSOTFE	commander, Support Operations Task Force, Europe
COMUSFK	commander, US Forces, Korea
COMUSMACV	commander, US Military Assistance Command, Vietnam
CONOP	concept of operation
CONSCAN	conical-rotating threat antenna
CPPG	Crisis Pre-Planning Group
CRB	Carrier Battle Group
CRRC	combat-rubber-raiding craft
CS	cross scan
CSA	chief of staff, Army
CSAF	chief of staff, Air Force
CSAR	combat search and rescue
CSAREX	CSAR exercise
CSTOG	combined Special Operations Task Group
CT II	Combat Talon II
CTF	Carrier Task Force Central Training Force

CTJTF	Counterterrorist Joint Task Force
CTMR	Combat Talon Management Review
CTW	Crew Training Wing
CV	Commando Vision
DCS	deputy chief of staff
DCSO	deputy commander for Special Operations
DIA	Defense Intelligence Agency
DMZ	demilitarized zone
DNIF	duty not including flying
DSOA	Defense Special Operations Agency
DZ	drop zone
ECM	electronic countermeasure
ESAT	European Survey and Assessment Team
ETIC	estimated time in commission
EUCOM	European Command
EW	electronic warfare
EWO	electronic warfare officer
FAC	forward air control
FARP	forward-area-refueling point
FARRP	forward-area-refueling-and-rearming point
FCF	functional check flight
FECOM	Far East Command
FIS	Fighter Interceptor Squadron
FLIR	forward looking infrared radar
FMC	fully mission capable
FMI	functional management inspection
FOC	full operational capability
FOL	forward operating location
FSB	forward staging base
FTS	Flight Training Squadron
FTX	field training exercise
FW	Fighter Wing
GAR/I	ground acquisition responder/interrogator
GCI	ground controlled intercept
GPS	Global Positioning System
H	heavy
HAHO	high-altitude high-opening
HALO	high-altitude low-opening
HARP	high-altitude release point
HF	high frequency
HSI	horizontal situation indicator
HSSLADS	high-speed low-level aerial delivery system
IADS	Integrated Air Defense System
IAF	Indonesian Air Force
IAP	international airport
IDS	Infrared Detection System
IFR	in-flight refueling
IG	inspector general

IN	intelligence
INS	inertial navigation system
IOC	initial operational capability
IP	initial point
IR	infrared
IRAN	inspect and repair as necessary
IRCM	infrared countermeasures
J3, JOD	Joint Operations Division, Operations Directorate
JACK	Joint Activities Commission, Korea
JCET	joint/combined exchange training
JCRX	joint combined readiness exercise
JCS	Joint Chiefs of Staff
JCTG	joint contingency task group
JPRC	Joint Personnel Recovery Center
JRT	joint readiness training
JRX	joint readiness exercises
JSAR	joint search and rescue
JSO	joint service officer
JSOAC	Joint Special Operations Air Component
JSOC	Joint Special Operations Command
JSOTF	Joint Special Operations Task Force
JSOTF-SWA	Joint Special Operations Task Force-Southwest Asia
JTD	Joint Test Directorate
JTF	Joint Task Force
JUSMAG	Joint US Military Assistance Group
JUSMAGTHI	Joint US Military Assistance Group, Thailand
JVX	joint visual lift airlift
K-2	Taegu Airfield
K-14	Kimpo Airfield
K-16	Seoul City Airport
KFIA	King Fahd International Airport
KIAS	knots indicated airspeed
KVA	kilovolt ampere
LAS	Lockheed Air Service
LIC	low-intensity conflict
LOACH	light observation and command helicopter
LORI	limited operational readiness inspections
LORO	lobe-on-receiver only
LOX	liquid oxygen
LRU	line replaceable units
LTM	Lockheed Technical Manual
MAAF	Mediterranean Allied Air Forces
MAAG	Military Assistance and Advisory Group
MAC	Military Airlift Command
MACSOG	Military Airlift Command Special Operations Group
MACV	Military Assistance Command, Vietnam
MACVSOG	Military Assistance Command, Vietnam Special Operations Group
MAJCOM	major command
MARCENT	US Marine Corp Component of USCENTCOM
MARG	Marine Amphibious Ready Group

MATS	Military Air Transport Service
MC	mission capable
MCAS	Marine Corps Air Station
MCM	Multicommand Manual
MEU	Marine Expeditionary Unit
MFF	military free fall
MFP	Major Force Program
MIA	missing in action
MOA	memorandum of agreement
MOU	memorandum of understanding
MRE	meals ready to eat
MRI	monopulse resolution improvement
MSA	minimum safe altitude
MSET	maintenance evaluation
MTBF	mean-time-between failure
NAAF	Northwest African Air Forces
NATO	North Atlantic Treaty Organization
NDI	nondestructive inspection
NEO	noncombatant evacuation operation
NKP	Nakhon Phanom
NKPA	North Korean Peoples Army
NSAM	National Security Action Memorandum
NSC	National Security Council
NSPG	National Security Planning Group
NVA	North Vietnamese Army
NVG	night-vision goggle
NVN	North Vietnam
OAS	Organization of American States
OECS	Organization of Eastern Caribbean States
OG	Operations Group
ONR	Office of Naval Research
OPCON	operational control
OPG	Operations Planning Group
OPLAN	Operations Plan
OPORD	Operations Order
ORE	operational readiness exercises
ORI	operational readiness inspection
OSACSA	Office of the Special Assistant for Counterinsurgency and Special Activities
OSD	Office of the Secretary of Defense
OSS	Office of Strategic Services
OT&E	operational test and evaluation
OUE	operational utility evaluation
OW	obstacle warning
PAA	primary aircraft assigned
PACAF	Pacific Air Forces
PACOM	Pacific Command
PAF	Philippine Air Force
PARA	precision air radar approach
PAT	Pacific Area Trainer
PCS	permanent change of station

PDF	Panamanian Defense Force
PDM	programmed depot maintenance
PDR	Democratic Revolutionary Party
PGM	precision ground mapping
PHILVOLCS	Philippine Institute of Volcanology and Seismology
PJ	pararescuemen
POM	program objective memorandum
PR	personnel recovery
PRA	People's Revolutionary Army
PRESDEL	presidential delegation
PROTAF	project task force
PSYOPS	psychological operations
PSYWAR	psychological warfare
PVO	Pinatubo Volcano Observatory
PW	PSYWAR
QAFA	Quality Air Force Assessment
RAAF	Royal Australian Air Force
RAF	Royal Air Force
RBS	radar bomb scoring
RLC	reception light committee
RMC	revolutionary military control
RMI	radio magnetic indicator
RNZSAS	Royal New Zealand Special Air Services
RO	radio operator
ROC	required operational capability
ROK	Republic of Korea
ROKAF	Republic of Korea Air Force
RTAF	Royal Thailand Air Force
RTAFB	Royal Thailand Air Force Base
RWR	radar warning receiver
SACEUR	Supreme Allied Commander, Europe
SACSA	special assistant for counterinsurgency and special activities
SAM	Special Air Missions
	surface-to-air missile
SAR	search and rescue
SAS	search and salvage
	Special Air Service
SASR	Special Air Services Regiment
SATAF	Site Activation Task Force
SATCOM	satellite communications
SAVAK	Iranian secret police loyal to the shah
SAW	Special Air Warfare
SEA	Southeast Asia
SEAL	sea-air-land
SEDS	slingshot ejection system
SF	Special Forces
SFG	Special Forces Group
SFODA	US Army Special Forces A Team
SFOR	Stabilization Forces
SGI	Stray Goose International
SHP	shaft horsepower

SKE	station-keeping equipment
SLOG	Special Operations Logistics Group
SMM	Saigon Military Mission
SOAR	Special Operations Aerial Refueling
SOCCENT	Special Operations Command Central
SOCCT	Special Operations Combat Control Team
SOCEUR	Special Operations Command Europe
SOCIFOR	Special Operations Command Implementation Forces
SOCLANT	Special Operations Command Atlantic
SOCPAC	Special Operations Command Pacific
SOD	Special Operations Division
SOF	Special Operations Forces
SOF-I	Special Operations Forces-Improved
SOG	Special Operations Group
	Studies and Observations Group
SOLL	special operations low level
SOPAG	Special Operations Policy Advisory Group
SOS	Special Operations Squadron
SOSPTG	Special Operations Support Group
SOTFE	Special Operations Task Force Europe
SOTS	Special Operations Training Squadron
SOUTHCOM	Southern Command
SOW	Special Operations Wing
SPR	single-point refueling
SSG	Special Situation Group
STAR	surface-to-air recovery
STARS	Surface-to-Air Recovery System
STOL	short-field takeoff and landing
TA	terrain avoidance
TAC	Tactical Air Command
TACAN	tactical aid to navigation
TAS	Tactical Airlift Squadron
TAW	Tactical Airlift Wing
TAWC	Tactical Air Warfare Center
TCS	Troop Carrier Squadron
TCW	Troop Carrier Wing
TDY	temporary duty
TEMP	Test and Evaluation Master Plan
TF	terrain following
TF/TA	terrain-following/terrain-avoidance
TFR	terrain-following radar
TFW	Tactical Fighter Wing
TI	Texas Instruments
TIBS	Tactical Information Broadcast System
TO	technical order
TOT	time over target
TRIADS	Tri-wall Aerial Delivery System
TRW	Tactical Reconnaissance Wing
TWS	track while scan
UARRSI	universal aerial refueling receptacle/slipway installation
UDL	unit detail listing
UEI	unit evaluation inspection

UHF	ultrahigh frequency
USAAF	US Army Air Forces
USAF	US Air Force
USAFE	US Air Force Europe
USAFRC	USAF Reserve Component
USECOM	US European Command
USFJ	US Forces Japan
USFK	US Forces, Korea
USGS	US Geological Survey
USLANTCOM	US Atlantic Command
USREDCOM	US Readiness Command
USSOCOM	US Southern Command
UTTR	Utah Test and Training Range
UW	unconventional warfare
UWO	unconventional warfare officer
VFR	visual flight miles
VH	very heavy
VLA	very low altitude
VNAF	Vietnamese Air Force
VOR	VHF omnidirectional radio
WBKII	German Armed Forces District Command
WRAMA	Warner Robins Air Materiel Area
WRSK	war readiness spares kit
WST	weapons system trainer

Index

Aircraft

- B-17: 2–4, 15, 17, 24, 28–30, 124
B-17F: 2
B-24: 3–4, 17, 24, 381
B-25: 2–3
B-26: 6
B-29: 7–9, 16–17, 25, 381
B-36: 355
B-47: 144
B-52: 54, 251, 362–63
C-5: 54, 257, 292, 343–46, 357, 374, 405, 420, 430
C-7: 30, 176
C-12: 23–24, 344, 390
C-17: 430
C-45: 80
C-46: 6, 29
C-47: 4–6, 8, 17, 25, 68, 80, 123, 125–27, 129–31, 133–34
C-119: 7–9, 133
C-123: 13–17, 20, 80, 82–83, 123–24, 176, 255, 270
C-123B: 19–20, 123
C-123H: 30
C-124: 124
C-130: 2, 15–17, 21, 24–25, 28, 30, 32, 37, 39, 50, 52–54, 56, 59–61, 65, 74, 79–80, 83–84, 88, 101, 123, 125, 127–30, 132–33, 135, 140, 144, 146, 152, 156, 160, 168–69, 171–72, 182–84, 187, 189, 191, 193, 195–96, 198, 201–2, 205–8, 211–12, 215, 226–28, 230, 236–37, 240–41, 250–51, 255, 257–58, 263, 266, 270–71, 277, 280–82, 284, 287, 309, 321–24, 326–28, 330, 333–35, 338, 355–56, 369, 372, 374, 385, 388, 391–92, 400, 402, 406, 412–13, 425, 438, 446
C-130A: 21, 30, 32–33
C-130B: 21, 30, 32–33
C-130E: 6, 16–17, 19–21, 24, 32, 38, 51–52, 54, 56, 59, 61, 67–69, 71, 82, 123, 125–26, 130, 132, 141, 144, 160, 162–64, 168, 255, 260, 262, 292, 311, 321, 328, 331, 371, 373, 377–78, 385
C-130H: 242, 246, 257, 264, 293–94, 300–301, 308, 311, 314, 371–73, 389, 394, 451
C-135: 54
C-141: 150, 176, 184, 191, 198, 203, 207–8, 212–13, 215, 228, 230, 251, 253, 257–58, 266, 292, 321, 327, 333, 344–45, 430, 439
C-141B: 243, 344, 438
C-160: 307
EC-130E: 298, 400
HC-130: 20–21, 296, 311, 338–39, 343, 346, 357, 360, 374, 376, 388–89, 391–92, 431
HC-130P: 145, 151, 153, 156, 426, 431
HC-130P/N: 338, 343, 349, 355, 361, 366, 383, 386, 389, 393–94, 396–97, 400, 403, 406
HH-3: 154
HH-53: 156
K-16: 270
KC-10: 268, 455
KC-130: 56
KC-135: 52–54, 155–56, 170–71, 184–85, 189, 195, 199–200, 202, 204, 207, 211–12, 215, 225, 228, 258, 262, 267, 269, 324, 331, 347, 390, 399, 405, 420, 422, 429, 430, 436, 442, 455
MC-130: 189, 201, 204, 240, 296
MC-130E: 1, 17, 168–70, 175–77, 184–85, 191, 194–95, 198, 203, 210–11, 228, 237–39, 240, 243, 250, 253–56, 258–63, 267–68, 270, 276–77, 281, 292–97, 299, 301, 308, 310, 321–24, 333, 335, 338, 343, 347, 349, 357, 361, 366, 369, 371, 373, 376–77, 380–81, 385–89, 391, 394, 396–97, 400–403, 406–8, 419–22, 425, 431–32, 451
MC-130H: 1, 17, 250, 293–94, 301, 335, 378, 381, 383, 391–92, 394, 405–6, 408, 410–14, 419–20, 423–30, 432–35, 438–45, 447–51, 453
MC-130P: 420–21, 424, 426, 430, 433–35, 438–39, 441, 443, 445, 449–51
MH-53: 55, 231
MH-53H: 349
MH-53J: 419–20, 422–24, 430–31, 434–35, 439, 451
MH-60: 311, 431, 453
MH-60G: 55, 349
RB-57: 356
U-10: 123
VB-17: 6
VC-47: 6
Air Force Flight Test Center (AFFTC): 50–51, 53
Air Force Special Operations Command (AFSOC): 296–97, 302–3, 337
Air Force Special Operations Command Central (AFSOC-CENT): 341, 346
Air Force Special Operations Forces (SOF): 1, 71, 125, 131, 142, 170, 172, 253, 264, 267, 275–77, 287, 342
Air Staff: 6, 7, 9, 61–64, 145, 159–60, 182, 239, 247, 256, 264, 291, 293, 295–97, 302–3, 310, 312, 357, 377–79, 382, 384, 387, 394–97, 403, 406–7, 412
Aristide, Jean-Bertrand: 398–99, 401
Bay of Pigs: 11, 19
Brown, Harold: 182
Brzezinski, Zbigniew: 182
Bush, George: 341, 347, 363, 366
Carpetbagger: 3–4, 19, 24, 50, 68
Carter, Jimmy: 180–82, 203–4, 208–9, 231, 239, 318–19, 400–401, 403
Civil Air Transport (CAT): 8, 25
Central Intelligence Agency (CIA): 5–9, 11–13, 25, 27–28, 142, 148–49, 157, 193, 196, 208–9, 221, 274
Cheney, Richard “Dick”: 341
Clinton, William “Bill”: 400, 452
Combat Arrow: 17, 38, 49, 61–62, 68, 73, 77, 123, 125, 145, 169–70
Combat Knife: 17, 38, 49, 52, 61–63, 65–66, 68–69, 72–73, 77, 123, 165
Combat Shadow: 393, 400, 411–12, 430–31, 438, 445, 450–51
Combat Spear: 1, 17, 38, 49, 52, 61–62, 65, 68–69, 72–73, 77–78, 82–83, 88, 123, 125
Combat Talon (CT): 1–2, 6, 8, 16–17, 19–21, 24, 32–33, 37–40, 43, 47–56, 59–74, 77–80, 82–84, 86–88, 90, 123–28, 130–36, 139, 141–48, 150–52, 154–57, 159–70, 172–77,

179–80, 182, 184–200, 202–16, 219, 221–23, 228–32,
 235–42, 244, 246–47, 249–62, 264–71, 276–77, 280–83,
 286–87, 291–300, 303–5, 307–13, 315, 317, 320–24,
 326–31, 333–35, 337–40, 342–47, 349, 355, 357–65, 369,
 372–79, 381, 383, 385–89, 391, 393–97, 399–400, 402–10,
 414–15, 419–20, 422–32, 434–41, 444–46, 449–57
 Combat Talon (CT) I: 56, 188, 293–94, 300–301, 309, 313,
 315, 366, 377–78, 380–84, 386–89, 394–97, 400, 406–9,
 411, 414, 416, 422, 425–26, 432–33, 449, 452–53, 457
 Combat Talon (CT) II: 52, 56, 177, 188, 246, 250, 252, 256–
 57, 259, 264, 291, 293–96, 300–301, 303, 308–11, 314,
 335, 337, 340, 377–79, 380–84, 386–95, 399–416, 419–20,
 423, 425–30, 432–33, 435, 438, 440–41, 443, 445, 447–48,
 450–52, 455–57
 Commando Talon: 162–63, 165–66
 Commando Trap: 356
 Commando Vault: 356
 Credible Sport: 235, 241–46, 250, 257, 259–60, 263–64
 Credible Sport I: 259
 Credible Sport II: 257, 259, 263–64

 Defense Intelligence Agency (DIA): 28, 141–42, 157, 274, 276
 Delta Force: 182–84, 189–90, 192, 194–95, 198–99, 201–2,
 204–5, 207, 211–12, 215–16, 219, 222, 225–29, 236, 238,
 241, 246, 263, 299
 demilitarized zone (DMZ): 10
 Department of Defense (DOD): 5, 9, 12–14, 19, 291–92, 300,
 302, 309, 446
 Department of Defense Reorganization Act of 1986: 55
 Desert One: 157, 181, 196, 206, 208–9, 211, 215–16, 219–26,
 228–29, 231–32, 235, 237–40, 246–47, 249–51, 256–60,
 262, 267–68, 276, 291–92, 294–95, 307, 310, 322–23, 335,
 342, 376–77, 410
 Desert Shield: 337, 339, 341, 344, 349, 355, 363, 366, 377, 410
 Desert Storm: 335, 337, 341, 349, 355, 357–58, 360–62, 366,
 369, 376–77, 380, 393, 399, 410, 453, 457
 Desert Two: 206
 Diem, Ngo Dinh: 11
 Dien Bien Phu: 8, 10, 94, 101
 Donovan, William J.: 1–2
 Duck Hook: 13, 15, 19
 Duvalier, Jean-Claude “Baby Doc”: 398

 Eaker, Ira L.: 3–4
 Eisenhower, Dwight D.: 2, 4
 Entebbe: 424
 Exercises
 Ace Card: 73
 Adventure Express: 435
 Arctic Express: 404
 Balance Torch: 388
 Bantam Runner: 445
 Battle Griffin 93: 391
 Black Flag: 339
 Bold Eagle: 176–77, 259
 Bold Eagle 82: 259
 Bright Star 85: 299
 Bright Star 87: 308
 Brim Frost: 265
 Caliber Excellence: 256
 Carthage Express: 392
 Casino Dancer: 267
 Castle Tower: 262
 Certain Tribute: 260
 Certain Tribute 82: 259
 Chile Flag: 394, 426, 455
 Cobra Gold: 268, 410, 427
 Cope Thunder: 297
 Desert Alliance: 348
 Early Victor: 447
 Eastern Desert 90: 340
 Eastern Viper: 446, 455
 Ember Dawn V: 72
 Flintlock: 38, 70, 124, 126–27, 129, 131–33, 135–36, 145,
 164, 172, 175–76, 196, 214, 251, 253–54, 261–62, 266–
 68, 297, 304, 308, 310, 312–13, 339
 Flintlock 88: 310
 Flintlock 90: 339–40
 Flintlock II: 126
 Flintlock IV: 130–32
 Flintlock V: 133
 Foal Eagle: 73, 163, 165, 176, 255, 260, 262, 270, 297,
 307–8, 312, 337, 386, 389, 403, 411, 426, 430–31, 443
 Foal Eagle 88: 310
 Foal Eagle 91: 390
 Foal Eagle 96: 428
 Foal Eagle 97: 443
 Foal Eagle 98: 445
 Foal Eagle 99: 451
 Fringe Keeper 90: 337
 Gallant Hand: 69
 Gonfalon: 170, 255
 Gossamer Wings: 260
 Honey Badger: 235, 238–39, 241–42, 246–50, 252–53,
 262, 291
 Inherent Fury: 455
 Jack Frost: 176
 Jack Frost 79: 176
 Javelin Steel: 408
 Kindle Liberty 82: 261
 Market Garden: 126
 Marvel Exodus: 258–59
 Night Venture: 276
 Noble Rose: 411, 424
 Ocean Venture: 262, 340
 Ocean Venture 92: 380
 Onset Thunder: 394
 Popex 96: 424
 Prairie Runner: 265–66
 Punch Bowl: 72
 Punch Card: 73
 Red Flag: 176, 236, 308, 340, 440, 449
 Red Flag 95-1: 406
 Red Flag 98-1: 443
 Red Flag 98-2: 440
 Red Flag 99-2: 451
 Roaring Lion: 392
 Roughen Turf: 263
 Rusty Badger: 239–40
 Solid Shield: 266–67
 Solid Shield 76: 167
 Solid Shield 79: 175–76
 Stalwart Friend: 174
 Storm Cloud: 246
 Tandem Thrust: 385, 451
 Team Spirit 77: 168
 Tourniquet Mile: 445
 Ulchi Focus Lens: 97, 262, 312, 430, 451
 Universal Trek: 267
 Vagabond Warrior: 261
 Valid Response: 430
 Vector Hawk: 310

Far East Command (FECOM): 5–8
 Fulton Company: 304
 Fulton, Jr., Robert Edison: 25
 Fulton STARS: 294, 304, 308, 314, 378

Gabriel, Charles A.: 293–95
 Geneva Accord: 11, 13
 Goldwater–Nichols Defense Reorganization Act of 1986: 287
 Gulf War: 340, 366, 376

Heavy Chain: 1, 19–21, 38–39, 50, 52, 64, 67, 69–71, 73, 144, 150, 185, 291
 Heavy Hook: 15–17, 19, 20, 80, 82–83, 88, 141
 Ho Chi Minh Trail: 84
 Holloway Commission: 230–32, 238–39, 246, 291
 Huck rebellion: 10
 Hussein, Saddam: 341, 347, 360, 366, 369, 376, 425

Indochina: 8, 10–11
 Islamic Revolution: 341

Johnson, Lyndon B.: 13
 Johnson, Roosevelt: 442–43
 Joint Chiefs of Staff (JCS): 1–2, 142, 231–32, 246, 273–74, 291, 295, 400
 Joint Combat Talon II: 296
 Joint Special Operations Command (JSOC): 291
JTF Force Capabilities Review: 247

Kennedy, John F.: 11–12, 19
 Khrushchev, Nikita S.: 11
 Korean War: 6, 8, 124, 406

MacArthur, Douglas: 5
 Mediterranean Allied Air Forces (MAAF): 3–4
 Military Air Transport Service (MATs): 7, 9, 124
 Military Assistance and Advisory Group (MAAG): 10
 Minh, Ho Chi: 10–11
 Missiles

- SA-2: 155, 457
- SA-3: 457
- SA-6: 457
- SA-7: 421
- SA-16: 7–9

 MOD-70: 39, 48, 51, 67–71, 130–34, 157, 167–68, 185, 295, 297, 328
 MOD-90: 39, 43, 49, 56, 71, 382–83, 385, 396

National Security Act of 1947: 5–6
 National Security Council (NSC): 5, 10–11, 273–74, 303
 Nixon, Richard M.: 139, 149, 156
 Noriega, Manuel: 315, 317–21, 323, 332–35, 339
 North Atlantic Treaty Organization (NATO): 125
 North Korean Peoples Army (NKPA): 5
 Northwest African Air Forces (NAAF): 2

Office of Strategic Services (OSS): 1–5, 10, 13, 15, 19, 29–30, 287, 403, 405, 409
 Operations

- Allied Force: 455, 457
- Anvil: 4
- Assured Response: 419–20, 422–23
- Balance Torch: 388
- Bat: 297
- Bevel Edge: 429
- Blind Logic: 320
- Blue Spoon: 320
- Chile Flag: 406
- Chile Flag 94-04: 406
- Christmas Wish: 408, 453
- Coldfeet: 28–30, 33
- Deliberate Force: 407
- Deny Flight: 404
- Duke: 286
- Eagle Claw: 212, 228, 230, 232, 239
- Elaborate Maze: 320
- Eldorado Canyon: 304
- Firm Response: 435, 437
- Gambler: 88
- Guardian Assistance: 424
- Guardian Retrieval: 435
- High Flight: 438
- Ivory Coast: 66, 143
- Joint Endeavor: 407–8, 413–15, 419, 434
- Joint Forge: 455
- Joint Guard: 434
- Jonathan: 183
- Just Cause: 39, 313, 317, 320, 322, 334–35, 337, 339
- Kingpin: 150
- Krystal Ball: 320
- Noble Anvil: 455
- Nordic Retrieval: 439
- Overlord: 4
- Polar Circle: 139, 143
- Prayer Book: 320
- Promote Liberty: 320
- Proven Force: 366, 376
- Provide Comfort: 366, 376
- Provide Comfort II: 376
- Provide Promise: 404, 414
- Provide Promise II: 391–92, 404
- Rice Bowl: 181–82, 196, 205, 210, 212–13
- Sea Angel: 369
- Shadow Express: 442
- Shepherd Venture: 441
- Silver Anvil: 386–87
- Silver Compass: 387
- Silver Gauntlet: 387
- Silver Hope: 393
- Southern Watch: 431–32
- Support Hope: 403–4, 406
- Uphold Democracy: 395, 398, 401, 407–8
- Urgent Fury: 268, 270–71, 273, 277, 281, 286–87, 292, 297, 313, 321, 323

operations plan (OPLAN): 2, 12–17, 84, 126, 131–32, 135, 141–42, 397
 OPLAN 34A: 80
 operational readiness inspection (ORI): 67, 70–71, 125, 127, 134–35, 168, 173, 212, 254–55, 299, 310–13, 339, 386, 388–91, 404, 425, 428, 434–35, 438–40, 445, 455
 Orr, Verne: 293

Palestine Liberation Organization (PLO): 183
 Panamanian Defense Force (PDF): 318–21, 327, 329–30, 332–33
 Powell, Colin: 400
 Project 46: 304–6, 310–11, 314
 psychological operations: 82–83, 88
 psychological warfare (PSYWAR): 6–9, 62, 65, 248, 299

Reagan, Ronald: 245–46, 270, 273, 304, 319

Republican Guard: 358
 Roosevelt, Franklin D.: 10

Schwarzkopf, H. Norman: 280, 284, 340, 343, 360, 363

Ships
 Abraham Lincoln: 374
 California: 175
 Clifton Sprague: 281
 Guam: 280, 285
 Independence: 274–75, 277, 280
 Kitty Hawk: 191
 Midway: 374
 Missouri: 381
 Nimitz: 175, 215, 211–12, 219–20, 223, 225
 Roosevelt: 407
 Texas: 175
 Wisconsin: 364

Six-Day War: 341

Skyhook: 21, 26–28, 30–32, 37, 59–61, 71, 123

Son Tay Prison Raid: 64–65, 127, 136, 143, 145, 198

Southeast Asia (SEA): 1, 6, 10–11, 13, 19–20, 38, 47, 59–62, 65–66, 68, 70, 72, 77, 79, 82–84, 88, 123–25, 127, 130, 132, 139, 142–45, 148–51, 159–60, 164–65, 254, 262, 307, 356–57, 454

Soviet Union: 5–6, 10, 15, 28, 157, 272, 274, 280, 340–41, 393

Spaatz, Carl A.: 2, 4

Special Operations: 309

Stalin, Joseph: 6

Strategic Air Command (SAC): 9, 251

Stray Goose: 16, 19–21, 38, 48, 59–62, 65–66, 77, 79, 86, 123, 144, 358, 381

Sung, Kim Il: 403, 410

Surface-to-Air Recovery System (STARS): 6, 20–21, 24, 38–39, 48, 50, 59–61, 63–64, 83, 87–88, 123, 130, 196, 259, 262, 304, 312

Team Spirit: 265, 297, 307, 312

Thayer, Paul: 292–93

Thigpen, Jerry: 179–80, 187, 192, 209, 228–29, 240, 246, 258–59, 270–71, 310–11, 317, 322, 324, 326–28, 330–31, 340, 389–90, 410

Timberwork: 15

Truman, Harry S.: 10

United States Army Air Force (USAAF): 2, 4, 15, 24–25

US Army Special Forces: 125–26, 128, 131, 164, 170, 172, 176, 251, 253–54, 261–62, 267–68, 270

Vance, Cyrus: 181

Viet Minh: 10–11, 13

Vietnam War: 70, 130, 136, 182, 198, 254, 256, 317, 337, 344, 355, 357–58, 394, 408, 416, 440

Vietnamese Air Force (VNAF): 16

Vietnamese Army: 10

World War I: 340

World War (WW) II: 1, 4–7, 9, 16, 24–27, 29–30, 50, 68, 79, 82, 124, 142, 287, 291, 317, 340, 356, 381, 394, 406, 411, 413, 449